



Preliminary Drainage Report

Overlook at Homestead Subdivision El Paso County, Colorado

Prepared for:

PT Overlook LLC
1864 Woodmoor Drive, Suite 100
Monument, CO 80132

Prepared by:

Kimley-Horn and Associates, Inc.
2 North Nevada Avenue, Suite 900
Colorado Springs, Colorado 80903
(719) 453-0180
Contact: Kevin Kofford, P.E.

Project #: 196239003

PCD Filing No.: SP238

Prepared: December 4, 2023

Kimley»»Horn



CERTIFICATION

DESIGN ENGINEER'S STATEMENT

The attached drainage plan and report were prepared under my direction and supervision and are correct to the best of my knowledge and belief. Said drainage report has been prepared according to the criteria established by the County for drainage reports and said report is in conformity with the master plan of the drainage basin. I accept responsibility for any liability caused by any negligent acts, errors or omissions on my part in preparation of this report.

SIGNATURE (Affix Seal): _____
Kevin Kofford, P.E. Date

OWNER/DEVELOPER'S STATEMENT

I, the developer, have read and will comply with all of the requirements specified in this Drainage Report and Plan.

PT Overlook LLC
Name of Developer

Authorized Signature Date

Joe DesJardin
Printed Name

Director of Entitlements
Title

1864 Woodmoor Drive Suite 100, Monument, CO 80132
Address

EL PASO COUNTY

Filed in accordance with the requirements of the Drainage Criteria Manual, Volumes 1 and 2, El Paso County Engineering Criteria Manual and Land Development Code as amended.

Joshua Palmer, P.E. Date
County Engineer/ ECM Administrator

Conditions:

TABLE OF CONTENTS

CERTIFICATION1
DESIGN ENGINEER'S STATEMENT1
OWNER/DEVELOPER'S STATEMENT1
EL PASO COUNTY1

TABLE OF CONTENTS2

INTRODUCTION3
PURPOSE AND SCOPE OF STUDY3
LOCATION3
DESCRIPTION OF PROPERTY3

FLOODPLAIN STATEMENT3

DRAINAGE BASINS4
MAJOR BASIN DESCRIPTIONS4
COMPLIANCE WITH PREVIOUS FINAL DRAINAGE REPORT4
EXISTING SUB-BASIN DESCRIPTIONS4
PROPOSED SUB-BASIN DESCRIPTIONS7

DRAINAGE DESIGN CRITERIA.....13
DEVELOPMENT CRITERIA REFERENCE13
HYDROLOGIC CRITERIA13
HYDRAULIC CRITERIA13
DETENTION.....13
CULVERT, CHANNEL, & SWALE SIZING14
CHANNEL STABILIZATION14

THE FOUR STEP PROCESS15

DRAINAGE FEES16
FEES16

SUMMARY16

REFERENCES17

APPENDIX
APPENDIX A: VICINITY MAP
APPENDIX B: FEMA MAP & SOILS REPORT
APPENDIX C: HYDROLOGY
APPENDIX D: HYDRUALICS
APPENDIX E: EL PASO COUNTY DRAINAGE BASIN MAP
APPENDIX F: APEX RANCH DRAINAGE REPORT
APPENDIX G: DRAINAGE MAPS

INTRODUCTION

PURPOSE AND SCOPE OF STUDY

The purpose of this Preliminary Drainage Report (PDR) is to provide the hydrologic and to document the drainage design methodology in support of the proposed Overlook at Homestead Subdivision (“the Project”) for PT Overlook LLC. The finalized hydraulic design and associated calculations will be provided with the Final Drainage Report. The Project is located within the jurisdictional limits of El Paso County (“the County”). Therefore, the hydrologic and hydraulic design is based on the County’s criteria which is described in further detail within the report.

LOCATION

The Project Site located east of Elbert Road within El Paso County, Colorado including parcels 4122000005, 4100000255, 4100000256. More specifically, the site is a Portion of Section 22 and a Portion of Section 27, Township 11 South, Range 64 West of the 6th PM, County of El Paso, State of Colorado. North of the project site is agricultural and rural residential land, to the east is Homestead Ranch Park owned and maintained by El Paso County, and to the south and west is Homestead Ranch subdivisions. A vicinity map has been provided in the **Appendix** of this report.

The Site is currently owned by PT Overlook LLC and will be developed by PT Overlook LLC.

DESCRIPTION OF PROPERTY

The Site is approximately 350.8 acres consisting of mostly vacant, undeveloped land with native vegetation and a rural single-family residential home situated within the north of the Project Site and is classified as Agricultural Grazing Land. Vegetation within the site is characterized primarily by prairie grasses along with some area of scrub brush and trees. The Site does not currently provide water quality or detention for the Project area.

The existing topography consists of slopes ranging from 1% to 33% with an existing butte covering much of the northern portion of the Site. Flows in the existing conditions run off site into one of four major drainage basins. Detailed descriptions of the existing major drainage basins can be found later in the report.

According to NRCS soil mapping data, USCS Type B soils are the primary soil type within the site. Type B soils having a moderate infiltration rate when thoroughly wet. These consist chiefly of moderately deep or deep, moderately well drained, or well drained soils that have moderately fine texture to moderately coarse texture. These soils have a moderate rate of water transmission. Soils mapping information has been provided in the **Appendix**.

The full development of this site will consist of 62, five (5) acre residential lots with roadway improvements, roadway grading, six full spectrum detention ponds, roadside ditches, culverts, and drainage swales. The property is planned to be developed as two separate filings.

FLOODPLAIN STATEMENT

The Site is located outside the 100-year floodplain and within Zone X (an area of minimal flood hazard) as noted on the FEMA FIRM Map No. 08041C0350G revised on December 7, 2018 (See **Appendix**).

DRAINAGE BASINS

MAJOR BASIN DESCRIPTIONS

The Project Site is tributary to four major drainage basins in the El Paso County Drainage Basin Map. Bijou Creek, East Kiowa Creek, Upper Black Squirrel, and La Vega Ranch Drainage Basins. These drainage basins are located in the north central portion of El Paso County. The northeast portion of the site is tributary to Bijou Creek Drainage Basin, the northwest portion of the site is tributary to East Kiowa Creek Drainage Basin, the southwest portion of the site is tributary to Upper Black Squirrel Drainage Basin, and the southeast portion of the site is tributary to La Vega Ranch Drainage Basin. In an effort to simplify basin nomenclature, the following naming conventions have been used for both existing and proposed drainage sub-basins labeling. Proposed Basins have been designed in effort to keep runoff within the same existing basins, as to not transfer runoff between basins.

- A - Upper Black Squirrel Drainage Basin (CHBS2000)
- B - La Vega Ranch Drainage Basin (CHBR0400)
- C - East Kiowa Creek Drainage Basin (KIKI0400)
- D - Bijou Creek Drainage Basin (BIBI0200)

El Paso County Drainage Basin map has been provided in the **Appendix**. A summary of flows in existing and proposed conditions has been added to the **Appendix**.

COMPLIANCE WITH PREVIOUS FINAL DRAINAGE REPORT

A portion of the proposed Project Site falls within the existing approved “Final Drainage Report for Apex Ranch Estates” by Terra Nova Engineering, Inc. approval date September 3, 2008. The basins OS-1, OS-2, and OS-3 as outlined in the report are part of sub-basins C1, C2, and C3 in the proposed drainage study Area. Flows from sub basins C2 and C3, as described in detail later in this report, are to be captured and treated by a proposed private full spectrum extended detention basin. Flows from these basins will be at or below history values. In the proposed conditions sub-basin C3 (which includes a portion of existing sub-basin OS-1) is to flow directly into the existing Apex Ranch subdivision. There are no proposed public improvements within this sub-basin, but single-family homes will be constructed and excluded the large lot exclusion I.7.1.B.5. These flows are not included in the calculation for the existing detention facility. Excerpts from the previously approved FDR have been provided in the **Appendix**.

EXISTING SUB-BASIN DESCRIPTIONS

Historically the runoff from the Site drains into one of four major drainage basins as described above. Slopes vary from 2-33% throughout the site with various natural features. The Site has been divided into 13 onsite basins A1-A2, B1-B5, C1-C5, D1, and 5 offsite basins OS-A1 to OS-A2, and OS-C1 to OS-C3. The offsite basins are located west of the Site and generally flow west towards to existing stormwater infrastructure. Descriptions of each individual sub-basin can be found below.

Sub-Basin A1

This on-site sub-basin consists of an area of 19.92 acres, located in the southwest corner of the Site. Drainage flows overland from the northeast to the southwest where it is captured by an existing culvert at DP 1 and outfalls west of Elbert Rd. The weighted imperviousness for this sub-basin is 8%. Runoff during the 5-year and 100-year events are 8.43 cfs and 38.41 cfs respectively. Refer to the **Appendix** for the Existing Conditions Drainage Map.

Sub-Basin A2

This on-site sub-basin consists of an area of 61.50 acres, located in the southwest corner of the Site. Drainage flows overland from the northeast to the southwest where it flows offsite at DP 2 into Reata subdivision south of the Site. The weighted imperviousness for this sub-basin is 1%. Runoff during the 5-year and 100-year events are 13.00 cfs and 87.58 cfs respectively. Refer to the **Appendix** for the Existing Conditions Drainage Map.

Sub-Basin B1

This on-site sub-basin consists of an area of 45.75 acres, located in the south-central portion of the Site. Drainage flows overland from the north to the south where it flows offsite at DP 3 into Reata subdivision south of the Site. The weighted imperviousness for this sub-basin is 0%. Runoff during the 5-year and 100-year events are 9.87 cfs and 72.48 cfs respectively. Refer to the **Appendix** for the Existing Conditions Drainage Map.

Sub-Basin B2

This on-site sub-basin consists of an area of 42.42 acres, located in the south-central portion of the Site. Drainage flows overland from the north to the south where it flows offsite at DP 4 into Reata subdivision south of the Site. The weighted imperviousness for this sub-basin is 0%. Runoff during the 5-year and 100-year events are 9.41 cfs and 69.09 cfs respectively. Refer to the **Appendix** for the Existing Conditions Drainage Map.

Sub-Basin B3

This on-site sub-basin consists of an area of 25.42 acres, located in the southeast portion of the Site. Drainage flows overland from the north to the south where it flows offsite at DP 5 into Reata subdivision south of the Site. The weighted imperviousness for this sub-basin is 0%. Runoff during the 5-year and 100-year events are 5.91 cfs and 43.40 cfs respectively. Refer to the **Appendix** for the Existing Conditions Drainage Map.

Sub-Basin B3A

This on-site sub-basin consists of an area of 24.23 acres, located in the southeast corner of the Site. Drainage flows overland from the north to the south where it flows offsite at DP 5A into Reata subdivision south of the Site. The weighted imperviousness for this sub-basin is 0%. Runoff during the 5-year and 100-year events are 5.99 cfs and 43.98 cfs respectively. Refer to the **Appendix** for the Existing Conditions Drainage Map.

Sub-Basin B4

This on-site sub-basin consists of an area of 8.59 acres, located in the eastern portion of the Site. Drainage flows overland from west to east where it flows offsite at DP 6 into Homestead Ranch Park east of the Site. The weighted imperviousness for this sub-basin is 0%. Runoff during the 5-year and 100-year events are 2.54 cfs and 18.64 cfs respectively. Refer to the **Appendix** for the Existing Conditions Drainage Map.

Sub-Basin B5

This on-site sub-basin consists of an area of 8.95 acres, located in the eastern portion of the Site. Drainage flows overland from west to east where it flows offsite at DP 7 into Homestead Ranch Park east of the Site. The weighted imperviousness for this sub-basin is 0%. Runoff during the 5-

year and 100-year events are 2.67 cfs and 19.63 cfs respectively. Refer to the **Appendix** for the Existing Conditions Drainage Map.

Sub-Basin C1

This on-site sub-basin consists of an area of 53.41 acres, located in the central portion of the Site. Drainage flows overland from east to west where it flows offsite at DP 8 into offsite basin OS-C1 where flows travel overland into an existing roadside ditch and ultimately into an existing stormwater detention pond. The existing extended detention basin was not sized to detain this flow, but the flows will by-pass as they do in the existing condition. The weighted imperviousness for this sub-basin is 0%. Runoff during the 5-year and 100-year events are 13.04 cfs and 95.74 cfs respectively. Refer to the **Appendix** for the Existing Conditions Drainage Map.

Sub-Basin C2

This on-site sub-basin consists of an area of 8.47 acres, located in the central portion of the Site. Drainage flows overland from northeast to southwest where it flows offsite at DP 9 into offsite basin OS-C2 where flows travel overland into an existing roadside ditch and ultimately into an existing stormwater detention pond. The weighted imperviousness for this sub-basin is 0%. Runoff during the 5-year and 100-year events are 2.28 cfs and 16.77 cfs respectively. Refer to the **Appendix** for the Existing Conditions Drainage Map.

Sub-Basin C3

This on-site sub-basin consists of an area of 5.55 acres, located in the central portion of the Site. Drainage flows overland from east to west where it flows offsite at DP 10 into offsite basin OS-C3 where flows travel overland into an existing roadside ditch and then north along Fletcherville Lane. The weighted imperviousness for this sub-basin is 0%. Runoff during the 5-year and 100-year events are 1.62 cfs and 11.89 cfs respectively. Refer to the **Appendix** for the Existing Conditions Drainage Map.

Sub-Basin C4

This on-site sub-basin consists of an area of 6.40 acres, located in the northern central portion of the Site. Drainage flows overland from south to north where it flows offsite at DP 11 into the agricultural grazing land to the north. The weighted imperviousness for this sub-basin is 0%. Runoff during the 5-year and 100-year events are 1.89 cfs and 13.87 cfs respectively. Refer to the **Appendix** for the Existing Conditions Drainage Map.

Sub-Basin C5

This on-site sub-basin consists of an area of 10.50 acres, located in the northern central portion of the Site. Drainage flows overland from south to north where it flows offsite at DP 12 into the agricultural grazing land to the north. The weighted imperviousness for this sub-basin is 0%. Runoff during the 5-year and 100-year events are 2.96 cfs and 21.72 cfs respectively. Refer to the **Appendix** for the Existing Conditions Drainage Map.

Sub-Basin D1

This on-site sub-basin consists of an area of 29.73 acres, located in the northeast portion of the Site. Drainage flows overland from southwest to northeast where it flows offsite at DP 13 Homestead Ranch Park east of the Site. The weighted imperviousness for this sub-basin is 0%. Runoff during the 5-year and 100-year events are 7.71 cfs and 56.62 cfs respectively. Refer to the **Appendix** for the Existing Conditions Drainage Map.

Sub-Basin OS-A1

The off-site sub-basin consists of an area of 4.06 acres, located in the western central portion of the drainage study area. Drainage flows overland from the northeast to southwest where it is captured by an existing drainage culvert at DP 14 and directed west of Elbert Road. The weighted imperviousness for this sub-basin is 19%. Runoff during the 5-year and 100-year events are 3.76 cfs and 12.49 cfs respectively. Refer to the **Appendix** for the Existing Conditions Drainage Map.

Sub-Basin OS-A2

The off-site sub-basin consists of an area of 4.45 acres, located in the central portion of the drainage study area. Drainage flows overland from the north to south where it enters sub-basin A2 at DP 15 and follows the patterns described in sub-basin A2. The weighted imperviousness for this sub-basin is 19%. Runoff during the 5-year and 100-year events are 3.76 cfs and 12.49 cfs respectively. Refer to the **Appendix** for the Existing Conditions Drainage Map.

Sub-Basin OS-C1

The off-site sub-basin consists of an area of 27.49 acres, located in the central portion of the drainage study area. Drainage flows overland from east to west where it enters the existing roadside ditch at Apex Ranch Road at DP 16 and is ultimately conveyed through an existing culvert to the existing detention pond just west of Fletcherville Road. The weighted imperviousness for this sub-basin is 9%. Runoff during the 5-year and 100-year events are 12.21 cfs and 59.93 cfs respectively. Refer to the **Appendix** for the Existing Conditions Drainage Map.

Sub-Basin OS-C2

The off-site sub-basin consists of an area of 6.15 acres, located in the central portion of the drainage study area. Drainage flows overland from the east to west where it enters the existing roadside ditch at Apex Ranch Road at DP 17 and is ultimately conveyed through an existing culvert to the existing detention pond just west of Fletcherville Road. The weighted imperviousness for this sub-basin is 17%. Runoff during the 5-year and 100-year events are 4.26 cfs and 15.78 cfs respectively. Refer to the **Appendix** for the Existing Conditions Drainage Map.

Sub-Basin OS-C3

The off-site sub-basin consists of an area of 21.89 acres, located in the northwest portion of the drainage study area. Drainage flows overland from the west to east where it enters the existing roadside ditch at Fletcherville Road and flows north at DP 18. The weighted imperviousness for this sub-basin is 11%. Runoff during the 5-year and 100-year events are 11.63 cfs and 51.77 cfs respectively. Refer to the **Appendix** for the Existing Conditions Drainage Map.

PROPOSED SUB-BASIN DESCRIPTIONS

For the proposed condition, stormwater will generally maintain historic flow patterns. The proposed roadways will alter some of the existing flow paths. The roadway ditches will capture runoff from the roadways and direct flows via proposed culverts back to the existing flow paths, which will ultimately follow historic patterns or be captured by one of the six (6) proposed storm water ponds. The proposed Site has been divided into 17 onsite basins A1-A2, B1-B6, C1-C6, D1, and 5 offsite basins OS-A1 to OS-A2, and OS-C1 to OS-C3. The offsite basins are located west of the Site and generally flow west towards to an existing detention pond, and existing grass lined swales. Descriptions of each individual sub-basin can be found below. The off-site basins are fully developed and no changes to the upstream basins are anticipated. Per Final Drainage Report for Apex Ranch Estates by Terra Nova Engineering, dated September 3, 2008, the existing extended detention basin, on the northwest corner of Apex Ranch Road and Fletcherville Lane was designed and sized to provide water quality for the entire basins A-J of the Apex Ranch Estates Final Drainage Report. This area includes all the proposed roadway extensions through

the ROW preservation within the Apex Ranch Estates Subdivision. The six proposed full spectrum extended detention basins will be designed to release flows less than or equal to historic rates for this project before passing the property line. This project does not rely on the water quality or detention volumes provided by the existing detention basin within Apex Ranch Estates. More detail regarding the proposed full spectrum extended detention basins can be found in the detention basin of this report as well as the **Appendix**.

Sub-Basin A1

This on-site sub-basin consists of an area of 19.55 acres, located in the southwest corner of the Site. Drainage flows overland from the northeast to the southwest where it is captured by an existing culvert at DP 1 and outfalls west of Elbert Rd. There are no proposed improvements in sub-basin A1. The weighted imperviousness for this sub-basin is 15%. Runoff during the 5-year and 100-year events are 10.41 cfs and 41.24 cfs respectively. Due to the slight increase in sub-basin imperviousness, the 100-yr runoff increases from 38.41 to 41.24 cfs. The additional runoff will be accepted and mitigated through the nearly 1500 ft long, 50 ft wide existing drainage channel located within the sub-basin. Flows from this basin will be collected in roadside ditches along Elbert Rd and routed under Elbert Road. The runoff from this basin will not impact the Reata subdivision south of the Site. The minor increase in flows is not anticipated to impact the capacity of the existing culvert, which will be analyzed as part of the final drainage report. Refer to the **Appendix** for the Proposed Conditions Drainage Map.

Sub-Basin A2

This on-site sub-basin consists of an area of 58.27 acres, located in the southwest corner of the Site. Improvements within this sub-basin include proposed roads, roadside ditches, culverts, and proposed private full spectrum detention basin A2. Drainage flows overland from the northeast to the southwest where it flows into proposed roadside ditches, is conveyed through proposed stormwater culverts, and is ultimately captured by propose private full spectrum detention basin A2 at DP 2. The weighted imperviousness for this sub-basin is 12%. Runoff during the 5-year and 100-year events are 20.99 cfs and 92.96 cfs respectively. Due to the increase in sub-basin imperviousness, the 100-yr runoff for DP 2 is anticipated to increases from 87.58 cfs to 92.96 cfs. The additional runoff will be collected and released at less than historic rates via a proposed private full spectrum detention basin. Flows from this basin will exit into the Reata subdivision south of the Site via existing, vegetated natural drainage channels and outfall to an existing stock pond within the adjacent property south of the Site. The minor increase in flows will be mitigated by the proposed full spectrum detention basin A2 and released a less than historic rates. Refer to the **Appendix** for the Proposed Conditions Drainage Map.

Sub-Basin B1

This on-site sub-basin consists of an area of 40.74 acres, located in the south-central portion of the Site. Improvements within this sub-basin include proposed roads, roadside ditches, culverts, and proposed private full spectrum detention basin B1. Drainage flows overland from the north to the south where it flows into proposed roadside ditches, is conveyed through proposed stormwater culverts, and is ultimately captured by propose private full spectrum detention basin B1 at DP 3. The weighted imperviousness for this sub-basin is 10%. Runoff during the 5-year and 100-year events are 16.77 cfs and 80.40 cfs respectively. Due to the increase in sub-basin imperviousness, the 100-yr runoff for DP 3 is anticipated to increases from 72.48 cfs to 80.40 cfs. The additional runoff will be collected and released at less than historic rates via a proposed private full spectrum detention basin. Flows from this basin will exit into the Reata subdivision south of the Site via existing, vegetated natural drainage channels and outfall to an existing stock pond within the adjacent property south of the Site. The minor increase in flows will be mitigated

by the proposed full spectrum detention basin B1 and released a less than historic rates. Refer to the **Appendix** for the Proposed Conditions Drainage Map.

Sub-Basin B2

This on-site sub-basin consists of an area of 16.00 acres, located in the south-central portion of the Site. Drainage flows overland from the north to the south where it flows offsite at DP 4. Improvements within this sub-basin include proposed public roads. This sub-basin includes an approx. 14,351 sq ft improved area of roadway that will not be receiving water quality treatment. A detailed discussion regarding water quality treatment has been included in Step-2 of the Four Step Process. The weighted imperviousness for this sub-basin is 9%. Runoff during the 5-year and 100-year events are 7.82 cfs and 38.64 cfs respectively. It is anticipated in a 100-yr storm event the total runoff for DP 4 will reduce from 69.09 cfs to 38.64 cfs, as the proposed roadway will cut off much of the upstream portion of the existing drainage basin and route those flows to a proposed full spectrum detention basin. As such there are no anticipated downstream impacts. Refer to the **Appendix** for the Proposed Conditions Drainage Map.

Sub-Basin B3

This on-site sub-basin consists of an area of 19.11 acres, located in the southeastern portion of the Site. Drainage flows overland from the northwest to southeast where it flows off site at DP 5. There are no proposed public improvements within this sub-basin, but single-family homes will be constructed and excluded the large lot exclusion I.7.1.B.5 and discussed in step 2 of the four-step process. The weighted imperviousness for this sub-basin is 7%. Runoff during the 5-year and 100-year events are 7.83 cfs and 42.71 cfs respectively. In the proposed conditions, it is anticipated in a 100-yr storm event the total runoff for DP 5A (DP 5 in proposed conditions) will reduce from 43.98 to 42.71, as such there are no anticipated downstream impacts. Refer to the **Appendix** for the Proposed Conditions Drainage Map.

Sub-Basin B4

This on-site sub-basin consists of an area of 8.50 acres, located in the eastern portion of the Site. Drainage flows overland from west to east where it flows offsite at DP 6. There are no proposed public improvements within this sub-basin, but single-family homes will be constructed and excluded the large lot exclusion I.7.1.B.5 and discussed in step 2 of the four-step process. The weighted imperviousness for this sub-basin is 7%. Runoff during the 5-year and 100-year events are 3.77 cfs and 20.58 cfs respectively. Due to the slight increase in sub-basin imperviousness in proposed conditions, the 100-yr runoff for DP 6 increases from 18.64 to 20.58 cfs. The additional runoff will sheet flow east across an 800 ft heavily vegetated and established natural area. Any additional flows from this sub-basin will be negligible and is not anticipated to have any downstream impacts. Refer to the **Appendix** for the proposed Conditions Drainage Map.

Sub-Basin B5

This on-site sub-basin consists of an area of 8.95 acres, located in the eastern portion of the Site. Drainage flows overland from west to east where it flows offsite at DP 7. The weighted imperviousness for this sub-basin is 7%. There are no proposed public improvements within this sub-basin, but single-family homes will be constructed and excluded the large lot exclusion I.7.1.B.5 and discussed in step 2 of the four-step process. Runoff during the 5-year and 100-year events are 4.01 cfs and 21.85 cfs respectively. Due to the slight increase in sub-basin imperviousness in proposed conditions, the 100-yr runoff for DP 7 increases from 19.63 to 21.85 cfs. The additional runoff will sheet flow east across a nearly 1400 ft heavily vegetated and established natural area. Any additional flows from this sub-basin will be negligible and is not anticipated to have any downstream impacts. Refer to the **Appendix** for the Proposed Conditions Drainage Map.

Sub-Basin B6

This on-site sub-basin consists of an area of 53.31 acres, located in the central portion of the Site. Improvements within this sub-basin include proposed roads, roadside ditches, and culverts. Drainage flows overland from the northeast to the southwest where it flows into proposed roadside ditches, is conveyed through a proposed stormwater culvert at DP 8, and into sub-basin B8. From there, flows will follow path as described in sub-basin B8 where it will ultimately be captured in proposed full spectrum detention basin B8. The weighted imperviousness for this sub-basin is 10%. Runoff during the 5-year and 100-year events are 22.55 cfs and 106.95 cfs respectively. Refer to the **Appendix** for the Proposed Conditions Drainage Map.

Sub-Basin B7

This on-site sub-basin consists of an area of 2.46 acres, located in the southern portion of the Site. Drainage flows overland from the north to south where it flows off site at DP 9. There are no proposed improvements within this sub-basin. The weighted imperviousness for this sub-basin is 7%. Runoff during the 5-year and 100-year events are 1.13 cfs and 6.17 cfs respectively. Refer to the **Appendix** for the Proposed Conditions Drainage Map.

Sub-Basin B8

This on-site sub-basin consists of an area of 9.52 acres, located in the southern portion of the Site. Drainage flows overland from the north to south where it is captured by proposed private full spectrum extended detention basin B8 at DP 10. It should be noted that sub-basin B8 accepts flows from sub-basin B6 at DP 8. Refer to sub-basin B6 for information regarding the proposed flows from sub-basin B6. Aside from the proposed extended detention basin there are no proposed improvements within this sub-basin. The weighted imperviousness for this sub-basin is 7%. Runoff during the 5-year and 100-year events are 4.22 cfs and 23.05 cfs respectively. In addition to the increase of imperviousness, sub-basin B8 is also accepting flows from sub-basin B6 to the north. The combination of these factors results in a proposed increase of flows at DP 10 (DP 5 in existing conditions) from 43.40 cfs to 130.00 cfs. The additional runoff will be collected and released at less than historic rates via a proposed private full spectrum detention basin. Flows from this basin will exit into the Reata subdivision south of the Site via existing, vegetated natural drainage channel and outfall to an existing established vegetated area within the adjacent property south of the Site. The minor increase in flows will be mitigated by the proposed full spectrum detention basin B8 and released a less than historic rates. Refer to the **Appendix** for the Proposed Conditions Drainage Map.

Sub-Basin C1

This on-site sub-basin consists of an area of 25.91 acres, located in the central portion of the Site. Drainage flows overland from east to west where it flows offsite at DP 11 into offsite basin OS-C1 where flows travel overland into an existing roadside ditch and ultimately into an existing stormwater detention pond. The existing extended detention basin was not sized to detain this flow, but the flows will by-pass as they do in the existing condition. This sub-basin includes an approx. 22,316 sq ft improved area of roadway that will not be receiving water quality treatment. A detailed discussion regarding water quality treatment has been included in Step-2 of the Four Step Process. The weighted imperviousness for this sub-basin is 9%. Runoff during the 5-year and 100-year events are 11.18 cfs and 55.47 cfs respectively. In the proposed conditions, it is anticipated in a 100-yr storm event the total runoff for DP 11 (DP 8 in existing conditions) will reduce from 95.74 cfs to 42.71 cfs, as the proposed roadway will cut off much of the upstream portion of the existing drainage basin and route those flows to a proposed full spectrum detention basin. As such there are no anticipated downstream impacts. Refer to the **Appendix** for the Proposed Conditions Drainage Map.

Sub-Basin C2

This on-site sub-basin consists of an area of 17.03 acres, located in the central portion of the Site. Drainage flows overland from northeast to southwest where it is captured by proposed roadside ditches and is ultimately conveyed to proposed private stormwater pond C2 at DP 12. Improvements within this sub-basin include proposed public roads, and a proposed private full spectrum detention basin. The weighted imperviousness for this sub-basin is 12%. Runoff during the 5-year and 100-year events are 8.08 cfs and 34.64 cfs respectively. Due to the increase in sub-basin imperviousness, the 100-yr runoff for DP 12 (DP 9 in existing conditions) is anticipated to increase from 16.77 cfs to 34.64 cfs. The additional runoff will be collected and released at less than historic rates via a proposed private full spectrum detention basin. Flows from this basin will exit via proposed roadside ditches and culverts where it is ultimately captured by the existing detention ponds. The increase in flows will be mitigated by the proposed full spectrum detention basin C2 and released at less than historic rates. Refer to the **Appendix** for the Proposed Conditions Drainage Map.

Sub-Basin C3

This on-site sub-basin consists of an area of 3.96 acres, located in the central portion of the Site. Drainage flows overland from east to west where it flows offsite at DP 13 into offsite basin OS-C3 where flows travel overland into an existing roadside ditch and then north along Fletcherville Lane. Improvements within this sub-basin include proposed public roads. This sub-basin includes an approx. 6,530 sq ft improved area of roadway that will not be receiving water quality treatment. A detailed discussion regarding water quality treatment has been included in Step-2 of the Four Step Process. The weighted imperviousness for this sub-basin is 11%. Runoff during the 5-year and 100-year events are 2.36 cfs and 10.80 cfs respectively. In the proposed conditions, it is anticipated in a 100-yr storm event the total runoff for DP 13 (DP 10 in existing conditions) will reduce from 11.89 cfs to 10.80 cfs, as such there are no anticipated downstream impacts Refer to the **Appendix** for the Proposed Conditions Drainage Map.

Sub-Basin C4

This on-site sub-basin consists of an area of 6.37 acres, located in the northern central portion of the Site. Drainage flows overland from south to north where it flows offsite at DP 14. The weighted imperviousness for this sub-basin is 7%. Runoff during the 5-year and 100-year events are 2.83 cfs and 15.42 cfs respectively. Due to the slight increase in sub-basin imperviousness, the 100-yr runoff for DP 14 (DP 11 in existing conditions) increases from 13.87 cfs to 15.42 cfs. The additional runoff will sheet flow east across a nearly 700 ft wide heavily vegetated and established natural area. Any additional flows from this sub-basin will be negligible and is not anticipated to have any downstream impacts. Refer to the **Appendix** for the Proposed Conditions Drainage Map.

Unresolved from submittal 1 - WQ exclusions. State the sub-basins C4 and C5 will utilize the Large Lot exclusion like it is discussed in the sub-basin B-4 paragraph.

Sub-Basin C5

This on-site sub-basin consists of an area of 10.50 acres, located in the northern central portion of the Site. Drainage flows overland from south to north where it flows offsite at DP 15. The weighted imperviousness for this sub-basin is 7%. Runoff during the 5-year and 100-year events are 4.44 cfs and 24.20 cfs respectively. Due to the slight increase in sub-basin imperviousness, the 100-yr runoff for DP 15 (DP 12 in existing conditions) increases from 21.72 cfs to 24.20 cfs. The additional runoff will sheet flow east across a nearly 830 ft wide heavily vegetated and established natural area. Any additional flows from this sub-basin will be negligible and is not anticipated to have any downstream impacts. Refer to the **Appendix** for the Proposed Conditions Drainage Map.

Sub-Basin C6

This on-site sub-basin consists of an area of 21.29 acres, located in the eastern central portion of the Site. Improvements within this sub-basin include proposed roads, roadside ditches, a full spectrum detention basin, and culverts. Drainage flows overland from west to east where it gets captured by roadside ditches and ultimately flows to proposed private full spectrum detention basin C6 at DP 16. The weighted imperviousness for this sub-basin is 13%. Runoff during the 5-year and 100-year events are 12.27 cfs and 50.85 cfs respectively. Refer to the **Appendix** for the Proposed Conditions Drainage Map.

Sub-Basin D1

This on-site sub-basin consists of an area of 29.38 acres, located in the northeast portion of the Site. Improvements within this sub-basin include proposed roads, roadside ditches, a full spectrum detention basin, and culverts. Drainage flows overland from southwest to northeast where it gets captured by roadside ditches and ultimately flows to proposed private full spectrum detention basin D1 at DP 17. The weighted imperviousness for this sub-basin is 9%. Runoff during the 5-year and 100-year events are 13.56 cfs and 67.33 cfs respectively. Due to the increase in sub-basin imperviousness, the 100-yr runoff for DP 17 (DP 13 in existing conditions) is anticipated to increase from 56.62 cfs to 67.33 cfs. The additional runoff will be collected and released at less than historic rates via a proposed private full spectrum detention basin. Flows from this basin will outfall to the established vegetated area within the adjacent property to the east. There are no anticipated downstream impacts. Refer to the **Appendix** for the Proposed Conditions Drainage Map.

Sub-Basin OS-A1

The off-site sub-basin consists of an area of 4.06 acres, located in the western central portion of the drainage study area. Drainage flows overland from the northeast to southwest where it is captured by an existing drainage culvert at DP 18 and directed west of Elbert Road. The weighted imperviousness for this sub-basin is 25%. Runoff during the 5-year and 100-year events are 4.12 cfs and 12.86 cfs respectively. Refer to the **Appendix** for the Proposed Conditions Drainage Map.

Sub-Basin OS-A2

The off-site sub-basin consists of an area of 4.45 acres, located in the central portion of the drainage study area. Drainage flows overland from the north to south where it enters sub-basin A2 at DP 19 and follows the patterns described in sub-basin A2. The weighted imperviousness for this sub-basin is 7%. Runoff during the 5-year and 100-year events are 2.10 cfs and 11.46 cfs respectively. Refer to the **Appendix** for the Proposed Conditions Drainage Map.

Sub-Basin OS-C1

The off-site sub-basin consists of an area of 27.49 acres, located in the central portion of the drainage study area. Drainage flows overland from east to west where it enters the existing roadside ditch at Apex Ranch Road at DP 20 and is ultimately conveyed through an existing culvert to the existing detention pond just west of Fletcherville Road. The weighted imperviousness for this sub-basin is 9%. Runoff during the 5-year and 100-year events are 12.21 cfs and 59.93 cfs respectively. Refer to the **Appendix** for the Proposed Conditions Drainage Map.

Sub-Basin OS-C2

The off-site sub-basin consists of an area of 6.15 acres, located in the central portion of the drainage study area. Drainage flows overland from the east to west where it enters the existing roadside ditch at Apex Ranch Road at DP 21 and is ultimately conveyed through an existing culvert to the existing detention pond just west of Fletcherville Road. The weighted imperviousness for this sub-basin is 17%. Runoff during the 5-year and 100-year events are 4.26 cfs and 15.78 cfs respectively. Refer to the **Appendix** for the Proposed Conditions Drainage Map.

Sub-Basin OS-C3

The off-site sub-basin consists of an area of 21.89 acres, located in the northwest portion of the drainage study area. Drainage flows overland from the west to east where it enters the existing roadside ditch at Fletcherville Road and flows north at DP 22. The weighted imperviousness for this sub-basin is 11%. Runoff during the 5-year and 100-year events are 11.63 cfs and 51.77 cfs respectively. Refer to the **Appendix** for the Proposed Conditions Drainage Map.

DRAINAGE DESIGN CRITERIA

DEVELOPMENT CRITERIA REFERENCE

The proposed storm facilities are designed to be in compliance with the City of Colorado Springs and El Paso County “Drainage Criteria Manual (DCM)” dated October 2018 (“the MANUAL”), El Paso County “Engineering Criteria Manual” (“the Engineering Manual”), Chapter 6 and Section 3.2.1 of Chapter 13 of the City of Colorado Springs Drainage Criteria Manual dated May 2014 (“the Colorado Springs MANUAL”).

Site drainage is not significantly impacted by such constraints as utilities or existing development.

HYDROLOGIC CRITERIA

The 5-year and 100-year design storm events were used in determining rainfall and runoff for the proposed drainage system per chapter 6 of the CRITERIA. Table 6-2 of the CRITERIA is the source for rainfall data for the 5-year and 100-year design storm events. Design runoff was calculated using the Rational Method for developed conditions as established in the CRITERIA and MANUAL. Runoff coefficients for the proposed development were determined using Table 6-6 of the CRITERIA by calculating weighted impervious values for each specific site basin. The detention storage requirement was calculated using Full Spectrum Detention methods as specified in the CRITERIA and MANUAL.

HYDRAULIC CRITERIA

Applicable design methods were utilized to size the proposed ponds, and culverts, which includes the use of the UD-Detention spreadsheet, rational calculations spreadsheet, and FlowMaster, V8i software.

DETENTION

Six full spectrum detention ponds are proposed in order to maintain historic flows and water quality. Mile High Flood District’s UD-detention spreadsheet was utilized to design the preliminary sizing of each pond. Preliminary sizing table can be found below. Preliminary UD-Detention Sizing calculations can be found in the **Appendix**. The preliminary drainage maps show the general size and location of the proposed full spectrum detention ponds.

Pond Calculation Comparison Table

Pond	Basin Area (Acres)	WQCV Volume* (Ac-ft)	100YR Volume (Ac-ft)	Total Volume Required (Ac-ft)	Total Volume Provided (Ac-ft)
A2	58.27	0.120	1.679	2.346	3.722
B1	40.74	0.048	1.120	1.503	2.132
B8	62.83	0.069	1.680	2.207	3.484
C2	17.03	0.042	0.491	0.686	1.033
C6	21.29	0.061	0.626	0.891	1.463
D1	29.38	0.025	0.786	1.032	1.724

**WQCV volume is sized only for proposed impervious roadways*

As detailed in the Four-Step process. The majority of the site is to be exempt of water quality based on ECM Appendix I Section I.7.B.5: Large Lot Single Family exclusion, as such when sizing the proposed private full spectrum extended detention basins the WQCV was overridden based on calculated WQCV for the required roadway area only. The additional UD-Detention spreadsheets utilized to determine WQCV have been included in the **Appendix**. Final design and fully detailed MHFD UD-Detention Spreadsheet will be included in subsequent Final Drainage Report submittals including the final location, size and design of pond features such as the location and size of the emergency spillway, any downstream energy dissipation or design of outlet structures. These items will be coordinated in detail as part of the final drainage report.

CULVERT, CHANNEL, & SWALE SIZING

Detailed sizing of the road culvert crossings will be included in a subsequent Final Drainage Report. It is anticipated that 18"-72" pipes will be sufficient for the proposed culverts. In addition to the proposed culverts, there are to be roadside ditches along the proposed public roadways associate with the project. These will be analyzed to ensure they are hydraulically adequate at the time of Final Drainage Report submittal.

CHANNEL STABILIZATION

The Project intends on using natural swales to convey flow where appropriate. Proposed drainage easements have been proposed on the Preliminary Plan in locations where the natural channels convey flow a substantial amount of flow between properties. A detailed hydraulic analysis of these natural channels and any proposed improvements to the channels will be required a as a part of the future final drainage reports.

THE FOUR STEP PROCESS

The Project was designed in accordance with the four-step process to minimize adverse impacts of urbanization, as outlined in the El Paso County Engineering Manual for BMP selection as noted below:

Step 1. Employ Runoff Reduction Practices – The project is proposing a low-density residential development that will be designed to minimize the impact to the current existing terrain. Per Section I.7.1B of Appendix I of the ECM, the single-family residences fall under the large lot exemption as the total impervious area is less than 10% of the area. Homes are typically placed in the center of the lot and provide long distances for infiltration across natural terrain. The Site’s proposed paved roadways will increase the Site’s impervious area; however, roadside ditches and channels will be constructed to slow down the runoff velocity and reduce runoff peaks. The six proposed detention ponds will be used to capture stormwater, provide water quality treatment, and maintain flows discharging off site at or below historic levels.

Step 2. Provide a Water Quality Capture Volume – Permanent water quality measures and detention facilities will be necessary for the Project. Temporary water quality and erosion control measures will be provided during construction to prevent sediment laden water from discharging from the Site. Per ECM Appendix I Section I.7.B.5: Large Lot Single Family exclusion, most of the proposed site will be excluded from water quality, lot imperviousness shall be limited to 10 percent or less. Refer to **Appendix** for PBMP Tributary Areas map. Per ECM Appendix I Section 1.7.C.1.a., 20% of the development site or less than 1 acre can be excluded from providing water quality. As mentioned, 0.99 acres (43,197 sq ft of impervious area will not be able to be treated which is less than 20% of the overall site. Refer to the **Appendix** for the PBMP Tributary Areas that outlines the areas excluded. A table has been provided below which outlines the water quality condition for the different areas of the Site. In addition to the six proposed private full spectrum extended detention basins.

Condition	Total Area (AC)	Sub-Basins
On Site Flows Excluded from Water Quality (Exclusion I.7.1.B.5: Large Lot Single Family)	393.43	A1, A2, B1-B8, C1-C6, D1
On Site Flows, Flowing Offsite Not Receiving Water Quality (Exclusion I.7.1.C.1.a WQCV Standard)	0.99	B2, C1, C3
On Site Flows Receiving Water Quality Treatment On-Site (Roadways)	10.43	A1, A2, B1, B2, B6, C1-C3, C6, D1

Step 3 Stabilize Drainageways– Stabilizing proposed roadside ditches, swales, and channels by designing them with slopes that control the flow rates. Placement of riprap upstream and downstream of culverts to help reduce erosion of the roadside ditches. Check dams will be used in areas with steeper grades to slow the runoff. We anticipate this will minimize erosion. Existing drainage ways will be graded to reduce the velocity of the water to minimize erosion. A detailed hydraulic analysis of these natural channels and any proposed improvements to the channels will be required a as a part of the future final drainage reports.

Step 4. Implement Site Specific and Other Source Control BMPs – The erosion control construction BMPs of the Project were designed to reduce contamination. Source control BMPs include the use of vehicle tracking control, culvert protection, stockpile management, and stabilized staging areas.

DRAINAGE FEES

FEES

The project is within the Upper Black Squirrel Drainage Basin (CHBS2000), La Vega Ranch Drainage Basin (CHBR0400), East Kiowa Creek Drainage Basin (KIKI0400), and Bijou Creek Drainage Basin (BIBI0200) all four of which are not part of the El Paso County Drainage Basin Fee Program. As such, no drainage fees are due with this Project.

SUMMARY

This report has been prepared in accordance with El Paso County stormwater criteria. It outlines the Site design for the 5-year and 100-year storm events drainage system. The drainage design presented within this report conforms to the criteria presented in the MANUAL. Additionally, as the proposed pond release rates are to be designed less than historic rates, the Site runoff and storm drain facilities will not adversely affect the downstream and surrounding developments.

REFERENCES

1. Final Drainage Report for Apex Ranch Estates by Terra Nova Engineering, Inc. dated September 3, 2008
2. El Paso County “Engineering Criteria Manual” Volumes 1 & 2, dated October 31, 2018
3. Natural Resources Conservation Service, Web Soil Survey, dated June 21, 2023.
4. Urban Drainage and Flood Control District Drainage Criteria Manuals (UDFCDCM), (Volumes 1, 2 and 3), prepared by Wright-McLaughlin Engineers, June 2001, with latest revisions.
5. Flood Insurance Rate Map, El Paso County, Colorado and Incorporated Areas, Map Number 08041C0350G, Effective Date December 7, 2018, prepared by the Federal Emergency Management Agency (FEMA).

APPENDIX

APPENDIX A: VICINITY MAP

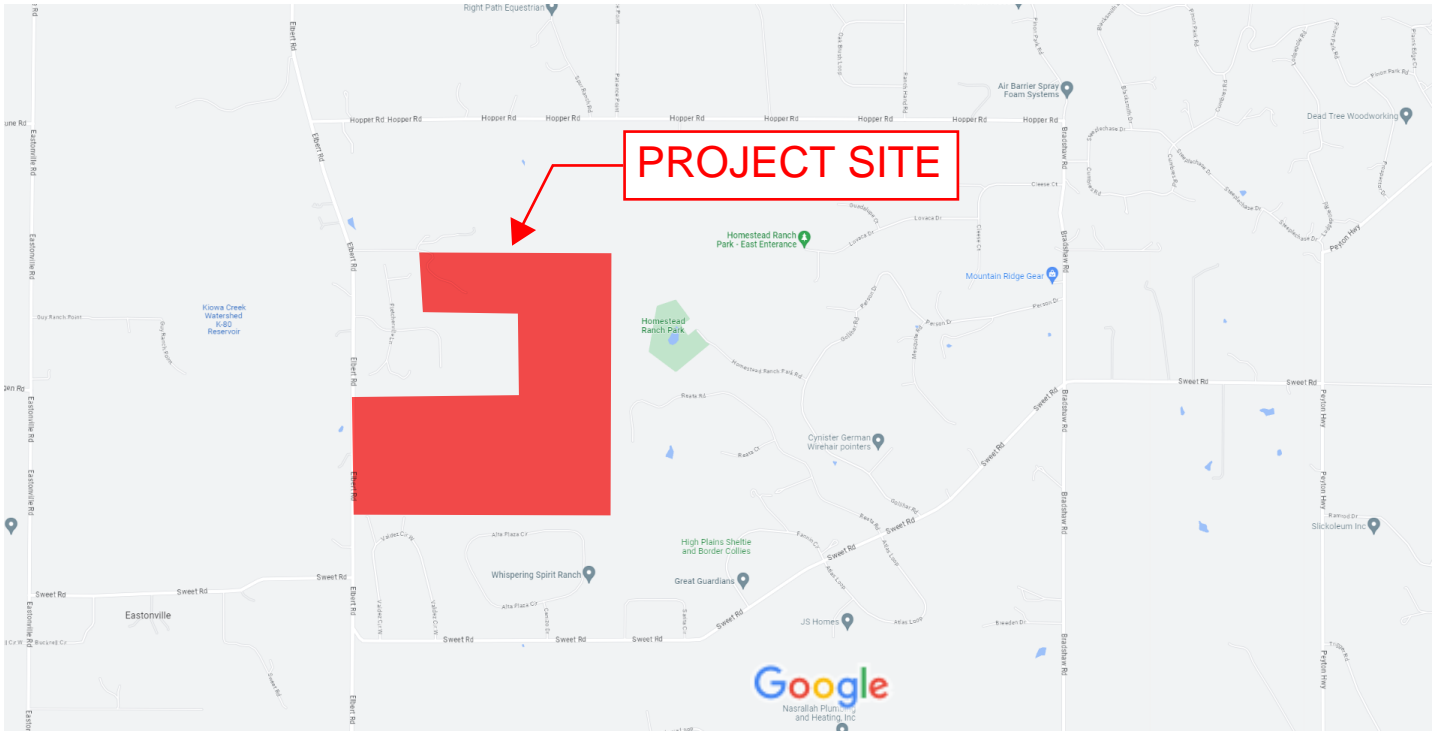

APPENDIX B: FEMA MAP & SOILS REPORT

NOTES TO USERS

This map is for use in administering the National Flood Insurance Program. It does not necessarily identify all areas subject to flooding, particularly from local drainage sources of small size. The community map repository should be consulted for possible updated or additional flood hazard information.

To obtain more detailed information in areas where **Base Flood Elevations (BFEs)** and/or **floodways** have been determined, users are encouraged to consult the Flood Profiles and Floodway Data and/or Summary of Stillwater Elevations tables contained within the Flood Insurance Study (FIS) report that accompanies this FIRM. Users should be aware that BFEs shown on the FIRM represent rounded whole-foot elevations. These BFEs are intended for flood insurance rating purposes only and should not be used as the sole source of flood elevation information. Accordingly, flood elevation data presented in the FIS report should be utilized in conjunction with the FIRM for purposes of construction and/or floodplain management.

Coastal Base Flood Elevations shown on this map apply only landward of 0.0' North American Vertical Datum of 1988 (NAVD88). Users of this FIRM should be aware that coastal flood elevations are also provided in the Summary of Stillwater Elevations table in the Flood Insurance Study report for this jurisdiction. Elevations shown in the Summary of Stillwater Elevations table should be used for construction and/or floodplain management purposes when they are higher than the elevations shown on this FIRM.

Boundaries of the **floodways** were computed at cross sections and interpolated between cross sections. The floodways were based on hydraulic considerations with regard to requirements of the National Flood Insurance Program. Floodway widths and other pertinent floodway data are provided in the Flood Insurance Study report for this jurisdiction.

Certain areas not in Special Flood Hazard Areas may be protected by **flood control structures**. Refer to section 2.4 "Flood Protection Measures" of the Flood Insurance Study report for information on flood control structures for this jurisdiction.

The **projection** used in the preparation of this map was Universal Transverse Mercator (UTM) zone 13. The **horizontal datum** was NAD83, GRS80 spheroid. Differences in datum, spheroid, projection or UTM zones zones used in the production of FIRMs for adjacent jurisdictions may result in slight positional differences in map features across jurisdiction boundaries. These differences do not affect the accuracy of this FIRM.

Flood elevations on this map are referenced to the **North American Vertical Datum of 1988 (NAVD88)**. These flood elevations must be compared to structure and ground elevations referenced to the same **vertical datum**. For information regarding conversion between the National Geodetic Vertical Datum of 1929 and the North American Vertical Datum of 1988, visit the National Geodetic Survey website at <http://www.ngs.noaa.gov/> or contact the National Geodetic Survey at the following address:

NGS Information Services
NOAA, NUNCS12
National Geodetic Survey
SSMC-3, #9202
1315 East-West Highway
Silver Spring, MD 20910-3282

To obtain current elevation, description, and/or location information for **bench marks** shown on this map, please contact the Information Services Branch of the National Geodetic Survey at (301) 713-3242 or visit its website at <http://www.ngs.noaa.gov/>.

Base Map information shown on this FIRM was provided in digital format by El Paso County, Colorado Springs Utilities, City of Fountain, Bureau of Land Management, National Oceanic and Atmospheric Administration, United States Geological Survey, and Anderson Consulting Engineers, Inc. These data are current as of 2006.

This map reflects more detailed and up-to-date **stream channel configurations and floodplain delineations** than those shown on the previous FIRM for this jurisdiction. The floodplains and floodways that were transferred from the previous FIRM may have been adjusted to conform to these new stream channel configurations. As a result, the Flood Profiles and Floodway Data tables in the Flood Insurance Study Report (which contains authoritative hydraulic data) may reflect stream channel distances that differ from what is shown on this map. The profile baselines depicted on this map represent the hydraulic modeling baselines that match the flood profiles and Floodway Data Tables if applicable, in the FIS report. As a result, the profile baselines may deviate significantly from the new base map channel representation and may appear outside of the floodplain.

Corporate limits shown on this map are based on the best data available at the time of publication. Because changes due to annexations or de-annexations may have occurred after this map was published, map users should contact appropriate community officials to verify current corporate limit locations.

Please refer to the separately printed **Map Index** for an overview map of the county showing the layout of map panels; community map repository addresses; and a Listing of Communities table containing National Flood Insurance Program dates for each community as well as a listing of the panels on which each community is located.

Contact **FEMA Map Service Center (MSC)** via the FEMA Map Information eXchange (FMIX) 1-877-336-2627 for information on available products associated with this FIRM. Available products may include previously issued Letters of Map Change, a Flood Insurance Study Report, and/or digital versions of this map. The MSC may also be reached by Fax at 1-800-358-9620 and its website at <http://www.msc.fema.gov/>.

If you have **questions about this map** or questions concerning the National Flood Insurance Program in general, please call 1-877-FEMA MAP (1-877-336-2627) or visit the FEMA website at <http://www.fema.gov/business/nfp>.

El Paso County Vertical Datum Offset Table

Flooding Source	Vertical Datum Offset (ft)
REFER TO SECTION 3.3 OF THE EL PASO COUNTY FLOOD INSURANCE STUDY FOR STREAM BY STREAM VERTICAL DATUM CONVERSION INFORMATION	

Panel Location Map

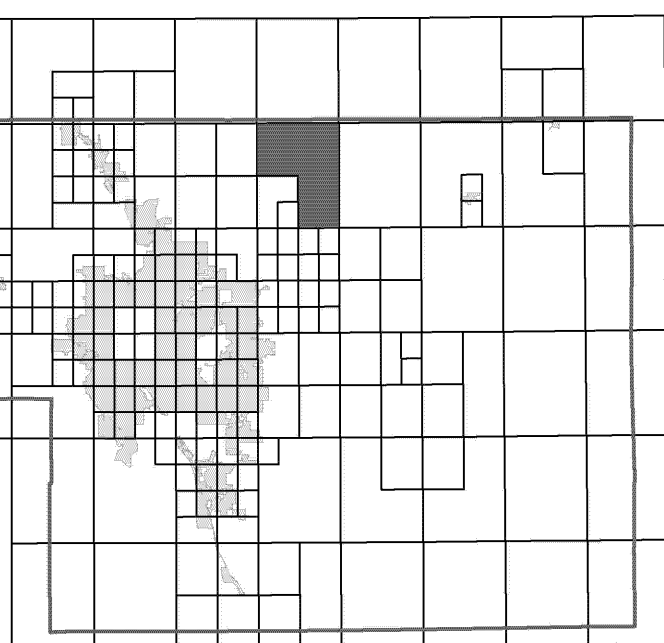

This Digital Flood Insurance Rate Map (DFIRM) was produced through a Cooperating Technical Partner (CTP) agreement between the State of Colorado Water Conservation Board (CWCB) and the Federal Emergency Management Agency (FEMA).



Additional Flood Hazard information and resources are available from local communities and the Colorado Water Conservation Board.

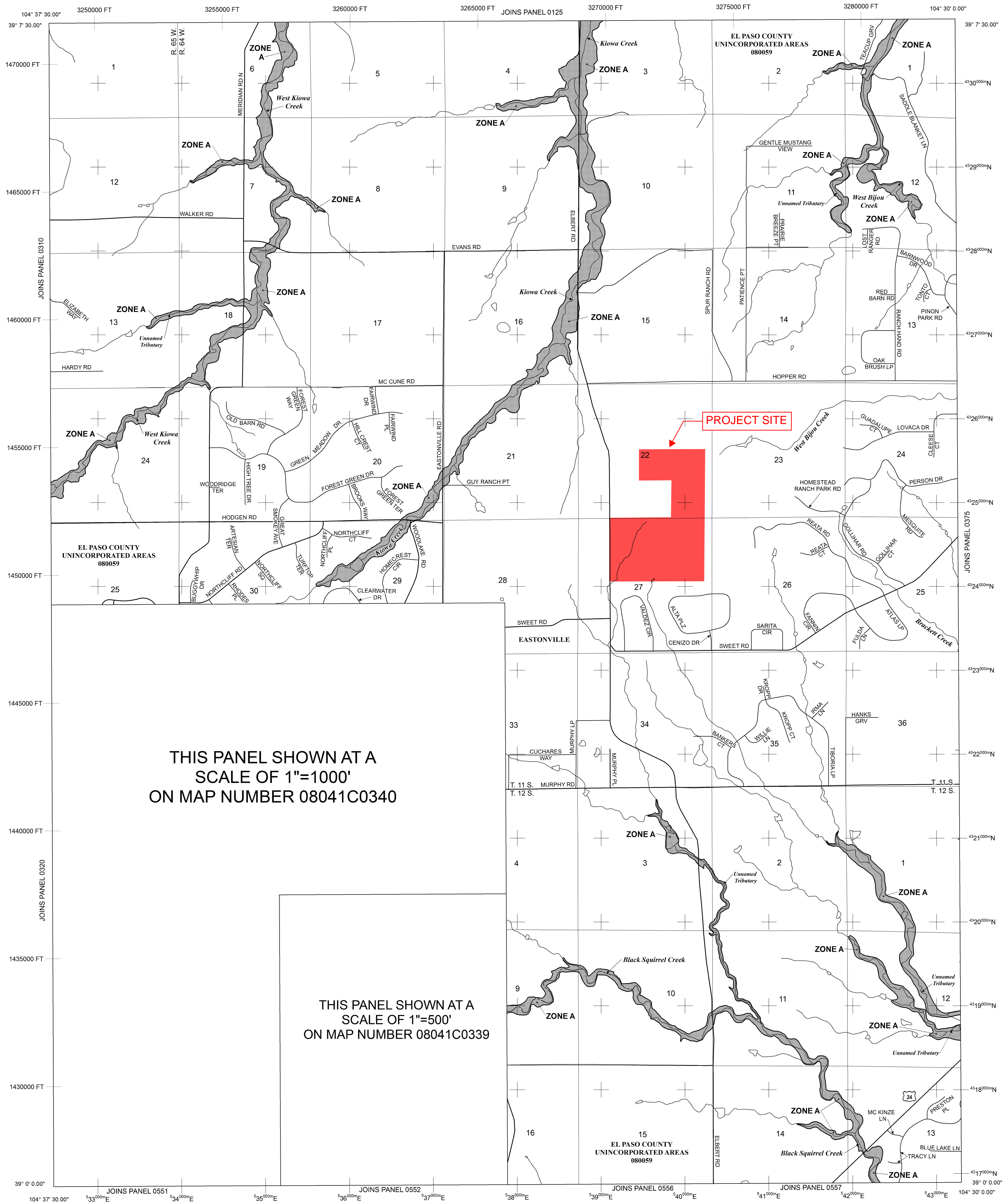

THIS PANEL SHOWN AT A
SCALE OF 1"=1000'
ON MAP NUMBER 08041C0340

THIS PANEL SHOWN AT A
SCALE OF 1"=500'
ON MAP NUMBER 08041C0339

LEGEND

SPECIAL FLOOD HAZARD AREAS (SFHAS) SUBJECT TO INUNDATION BY THE 1% ANNUAL CHANCE FLOOD

The 1% annual chance flood (100-year flood), also known as the base flood, is the flood that has a 1% chance of being equalled or exceeded in any given year. The Special Flood Hazard Area is the area subject to flooding by the 1% annual chance flood. Areas of Special Flood Hazard include Zones A, AE, AH, AO, AR, A99, V, and VE. The Base Flood Elevation is the water-surface elevation of the 1% annual chance flood.

ZONE A No Base Flood Elevations determined.
ZONE AE Base Flood Elevations determined.
ZONE AH Flood depths of 1 to 3 feet (usually areas of ponding); Base Flood Elevations determined.
ZONE AO Flood depths of 1 to 3 feet (usually sheet flow on sloping terrain); average depths determined. For areas of alluvial fan flooding, velocities also determined.
ZONE AR Special Flood Hazard Area Formerly protected from the 1% annual chance flood by a flood control system that was subsequently decertified. Zone AR indicates that the former flood control system is being restored to provide protection from the 1% annual chance or greater flood.
ZONE A99 Area to be protected from 1% annual chance flood by a Federal flood protection system under construction; no Base Flood Elevations determined.
ZONE V Coastal flood zone with velocity hazard (wave action); no Base Flood Elevations determined.
ZONE VE Coastal flood zone with velocity hazard (wave action); Base Flood Elevations determined.

FLOODWAY AREAS IN ZONE AE

The floodway is the channel of a stream plus any adjacent floodplain areas that must be kept free of encroachment so that the 1% annual chance flood can be carried without substantial increases in flood heights.

OTHER FLOOD AREAS

ZONE X Areas of 0.2% annual chance flood; areas of 1% annual chance flood with average depths of less than 1 foot, or with drainage areas less than 1 square mile; and areas protected by levees from 1% annual chance flood.

OTHER AREAS

ZONE X Areas determined to be outside the 0.2% annual chance floodplain.
ZONE D Areas in which flood hazards are undetermined, but possible.

COASTAL BARRIER RESOURCES SYSTEM (CBRS) AREAS

OTHERWISE PROTECTED AREAS (OPAs)

CBRS areas and OPAs are normally located within or adjacent to Special Flood Hazard Areas.

Floodplain boundary
 Floodway boundary
 Zone D Boundary
 CBRS and OPA boundary
 Boundary dividing Special Flood Hazard Areas of different Base Flood Elevations, flood depths or flood velocities.
 Base Flood Elevation line and value; elevation in feet* (EL 987)
 Base Flood Elevation value where uniform within zone; elevation in feet*

* Referenced to the North American Vertical Datum of 1988 (NAVD 88)

A Cross section line
23 Transsect line

57° 07' 30.00" Geographic coordinates referenced to the North American Datum of 1983 (NAD 83)
 42° 55' 00" 1000-meter Universal Transverse Mercator grid ticks, zone 13
 6000000 FT 5000-foot grid ticks; Colorado State Plane coordinate system, central zone (FIPS ZONE 0502), Lambert Conformal Conic Projection
 DX5510 Bench mark (see explanation in Notes to Users section of this FIRM map)
 M1.5 River Mile

MAP REPOSITORIES
 Refer to Map Repositories list on Map Index

EFFECTIVE DATE OF COUNTYWIDE FLOOD INSURANCE RATE MAP
MARCH 17, 1997

EFFECTIVE DATE(S) OF REVISION(S) TO THIS PANEL
DECEMBER 7, 2018 to update corporate limits, to change Base Flood Elevations and Special Flood Hazard Areas, to update map format, to add roads and road names, and to incorporate previously issued Letters of Map Revision.

For community map revision history prior to countywide mapping, refer to the Community Map History Table located in the Flood Insurance Study report for this jurisdiction.
 To determine if flood insurance is available in this community, contact your insurance agent or call the National Flood Insurance Program at 1-800-638-6620.

MAP SCALE 1" = 2000'

1000 0 2000 4000 FEET
 600 0 600 1200 METERS

NFIP **PANEL 0350G**

FIRM
FLOOD INSURANCE RATE MAP
EL PASO COUNTY, COLORADO AND INCORPORATED AREAS

PANEL 350 OF 1300
 (SEE MAP INDEX FOR FIRM PANEL LAYOUT)

CONTAINS:
 COMMUNITY NUMBER PANEL SUFFIX
 EL PASO COUNTY 08059 0350 0

Notice to User: The Map Number shown below should be used when placing map orders. The Community Number shown above should be used on insurance applications for the subject community.

MAP NUMBER 08041C0350G
MAP REVISED DECEMBER 7, 2018
 Federal Emergency Management Agency

Hydrologic Soil Group—El Paso County Area, Colorado

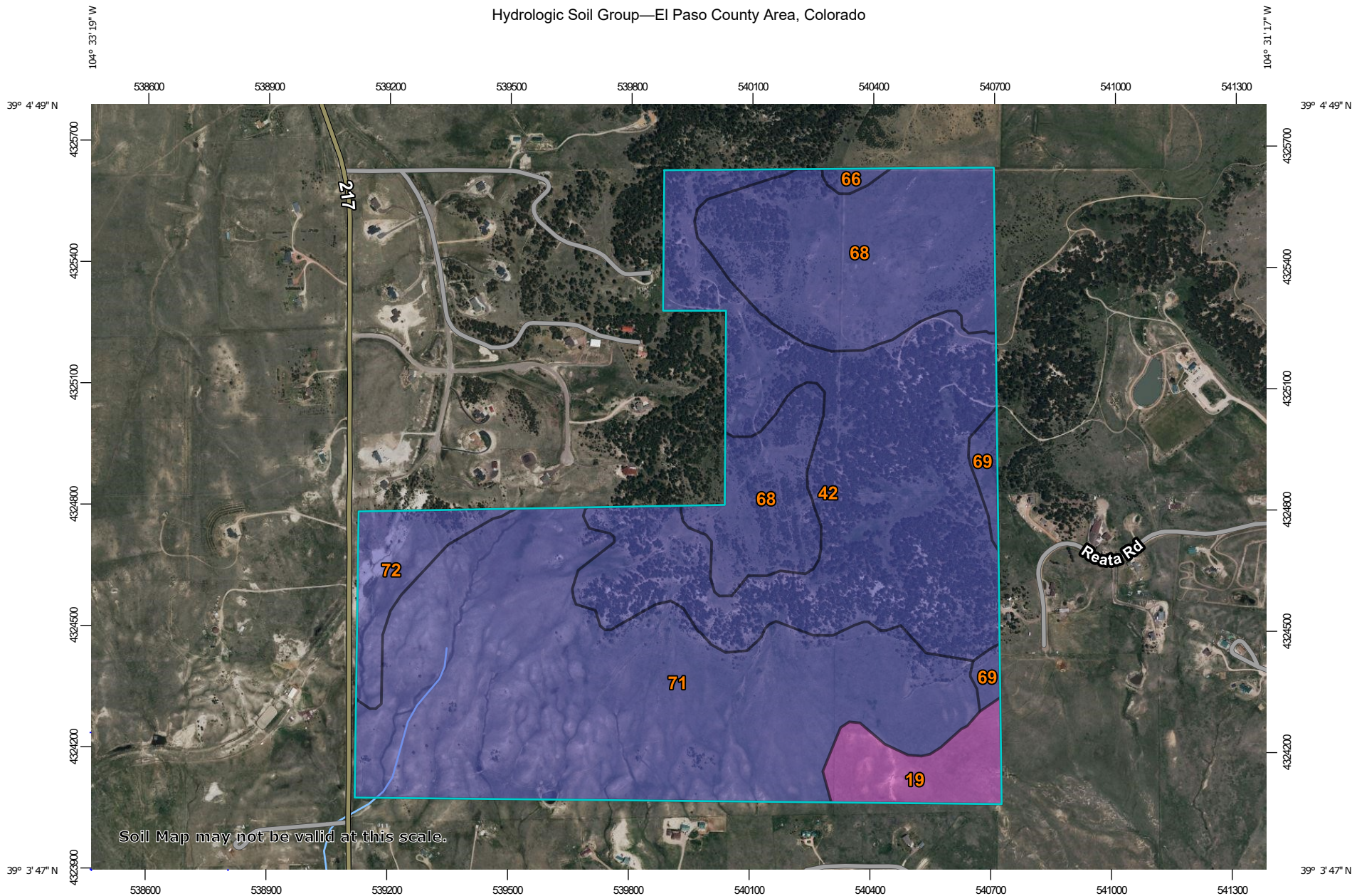

Soil Map may not be valid at this scale.

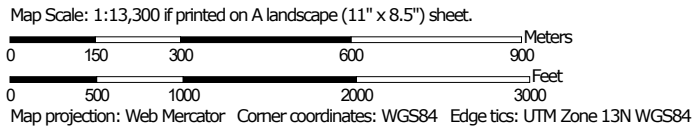

MAP LEGEND

Area of Interest (AOI)









 Area of Interest (AOI)

Soils

Soil Rating Polygons





-  A
-  A/D
-  B
-  B/D
-  C
-  C/D
-  D
-  Not rated or not available

Soil Rating Lines

-  A
-  A/D
-  B
-  B/D
-  C
-  C/D
-  D
-  Not rated or not available

Soil Rating Points





-  A
-  A/D
-  B
-  B/D

-  C
-  C/D
-  D
-  Not rated or not available

Water Features

 Streams and Canals

Transportation

-  Rails
-  Interstate Highways
-  US Routes
-  Major Roads
-  Local Roads

Background

 Aerial Photography

MAP INFORMATION

The soil surveys that comprise your AOI were mapped at 1:24,000.

Warning: Soil Map may not be valid at this scale.

Enlargement of maps beyond the scale of mapping can cause misunderstanding of the detail of mapping and accuracy of soil line placement. The maps do not show the small areas of contrasting soils that could have been shown at a more detailed scale.

Please rely on the bar scale on each map sheet for map measurements.

Source of Map: Natural Resources Conservation Service
 Web Soil Survey URL:
 Coordinate System: Web Mercator (EPSG:3857)

Maps from the Web Soil Survey are based on the Web Mercator projection, which preserves direction and shape but distorts distance and area. A projection that preserves area, such as the Albers equal-area conic projection, should be used if more accurate calculations of distance or area are required.

This product is generated from the USDA-NRCS certified data as of the version date(s) listed below.

Soil Survey Area: El Paso County Area, Colorado
 Survey Area Data: Version 20, Sep 2, 2022

Soil map units are labeled (as space allows) for map scales 1:50,000 or larger.

Date(s) aerial images were photographed: Jun 9, 2021—Jun 12, 2021

The orthophoto or other base map on which the soil lines were compiled and digitized probably differs from the background imagery displayed on these maps. As a result, some minor shifting of map unit boundaries may be evident.

Hydrologic Soil Group

Map unit symbol	Map unit name	Rating	Acres in AOI	Percent of AOI
19	Columbine gravelly sandy loam, 0 to 3 percent slopes	A	18.1	4.1%
42	Kettle-Rock outcrop complex	B	135.4	30.8%
66	Peyton sandy loam, 1 to 5 percent slopes	B	1.7	0.4%
68	Peyton-Pring complex, 3 to 8 percent slopes	B	91.1	20.7%
69	Peyton-Pring complex, 8 to 15 percent slopes	B	5.6	1.3%
71	Pring coarse sandy loam, 3 to 8 percent slopes	B	171.8	39.0%
72	Pring coarse sandy loam, 8 to 15 percent slopes	B	16.2	3.7%
Totals for Area of Interest			440.0	100.0%

Description

Hydrologic soil groups are based on estimates of runoff potential. Soils are assigned to one of four groups according to the rate of water infiltration when the soils are not protected by vegetation, are thoroughly wet, and receive precipitation from long-duration storms.

The soils in the United States are assigned to four groups (A, B, C, and D) and three dual classes (A/D, B/D, and C/D). The groups are defined as follows:

Group A. Soils having a high infiltration rate (low runoff potential) when thoroughly wet. These consist mainly of deep, well drained to excessively drained sands or gravelly sands. These soils have a high rate of water transmission.

Group B. Soils having a moderate infiltration rate when thoroughly wet. These consist chiefly of moderately deep or deep, moderately well drained or well drained soils that have moderately fine texture to moderately coarse texture. These soils have a moderate rate of water transmission.

Group C. Soils having a slow infiltration rate when thoroughly wet. These consist chiefly of soils having a layer that impedes the downward movement of water or soils of moderately fine texture or fine texture. These soils have a slow rate of water transmission.

Group D. Soils having a very slow infiltration rate (high runoff potential) when thoroughly wet. These consist chiefly of clays that have a high shrink-swell potential, soils that have a high water table, soils that have a claypan or clay layer at or near the surface, and soils that are shallow over nearly impervious material. These soils have a very slow rate of water transmission.

If a soil is assigned to a dual hydrologic group (A/D, B/D, or C/D), the first letter is for drained areas and the second is for undrained areas. Only the soils that in their natural condition are in group D are assigned to dual classes.

Rating Options

Aggregation Method: Dominant Condition

Component Percent Cutoff: None Specified

Tie-break Rule: Higher

APPENDIX C: HYDROLOGY



STANDARD FORM SF-1
RUNOFF COEFFICIENTS - IMPERVIOUS CALCULATION
 EXISTING CONDITIONS

PROJECT NAME: Overlook
 PROJECT NUMBER: 196239003
 CALCULATED BY: GKS
 CHECKED BY: KRK

DATE: #####

SOIL: B		RESIDENTIAL (>5AC)	PASTURE/MEADOW (SOIL GROUP A/B)	PAVEMENT							
LAND USE:		AREA	AREA	AREA	AREA						
2-YEAR COEFF:		0.05	0.02	0.89							
5-YEAR COEFF:		0.12	0.08	0.90							
10-YEAR COEFF:		0.20	0.15	0.92							
100-YEAR COEFF:		0.39	0.35	0.96							
IMPERVIOUS %:		7%	0%	100%							
DESIGN BASIN	DESIGN POINT	RESIDENTIAL (>5AC) AREA (AC)	PASTURE/MEADOW (SOIL GROUP A/B) AREA (AC)	PAVEMENT AREA (AC)	AREA (AC)	TOTAL AREA (AC)	C(2)	C(5)	C(10)	C(100)	Imp %
FDR Basins											
A1	1		18.28	1.64		19.92	0.09	0.15	0.21	0.40	8%
A2	2		60.84	0.66		61.50	0.03	0.09	0.16	0.36	1%
B1	3		45.75			45.75	0.02	0.08	0.15	0.35	0%
B2	4		42.42			42.42	0.02	0.08	0.15	0.35	0%
B3	5		18.62			18.62	0.02	0.08	0.15	0.35	0%
B3A	5A		31.03			31.03	0.02	0.08	0.15	0.35	0%
B4	6		8.59			8.59	0.02	0.08	0.15	0.35	0%
B5	7		8.95			8.95	0.02	0.08	0.15	0.35	0%
C1	8		53.41			53.41	0.02	0.08	0.15	0.35	0%
C2	9		8.47			8.47	0.02	0.08	0.15	0.35	0%
C3	10		5.55			5.55	0.02	0.08	0.15	0.35	0%
C4	11		6.40			6.40	0.02	0.08	0.15	0.35	0%
C5	12		10.50			10.50	0.02	0.08	0.15	0.35	0%
D1	13		29.73			29.73	0.02	0.08	0.15	0.35	0%
OS-A1	14			3.29	0.77	4.06	0.19	0.24	0.30	0.47	19%
OS-A2	15	4.45				4.45	0.05	0.12	0.20	0.39	7%
OS-C1	16	26.86			0.63	27.49	0.07	0.14	0.22	0.40	9%
OS-C2	17	5.48			0.67	6.15	0.14	0.20	0.28	0.45	17%
OS-C3	18	20.84			1.05	21.89	0.09	0.16	0.23	0.42	11%
TOTAL - OVERALL		57.63	351.83	5.42	0.00	414.88	0.04	0.10	0.17	0.36	2%
		14%	85%	1%	0%	100%					

Note: Land use coefficients sourced from City of Colorado Springs Drainage Criteria Manual, Volume 1, Table 6-6.

**STANDARD FORM SF-2
Time of Concentration**

PROJECT NAME: **Overlook**
 PROJECT NUMBER: **196239003**
 CALCULATED BY: **GKS**
 CHECKED BY: **KRK**

EXISTING CONDITIONS

DATE: 11/27/2023

SUB-BASIN DATA			INITIAL TIME (T _i)			TRAVEL TIME (T _t)					T _c CHECK (URBANIZED BASINS)				FINAL T _c	
DESIGN BASIN (1)	AREA Ac (2)	C5 (3)	LENGTH Ft (4)	SLOPE % (5)	T _i Min. (6)	LENGTH Ft. (7)	SLOPE % (8)	C _v (9)	VEL fps (11)	T _t Min. (12)	COMP. t _c (13)	TOTAL LENGTH (14)	TOTAL SLOPE (15)	TOTAL IMP. (16)	T _c Min. (17)	Min. (18)
FDR Basins																
A1	19.92	0.15	300	18.0%	11.5	2,066	5.7%	2.5	0.6	57.7	69.2	2366	7.3%	8%	23.1	23.1
A2	61.50	0.09	300	18.0%	12.3	3,677	5.7%	2.5	0.6	102.7	114.9	3977	6.6%	1%	32.1	32.1
B1	45.75	0.08	300	25.0%	11.1	2,577	6.5%	2.5	0.6	67.4	78.5	2877	8.4%		26.0	26.0
B2	42.42	0.08	300	6.9%	17.0	2,347	10.3%	2.5	0.8	48.8	65.8	2647	9.9%		24.7	24.7
B3	18.62	0.08	300	23.0%	11.4	1,968	9.9%	2.5	0.8	41.7	53.1	2268	11.6%		22.6	22.6
B3A	31.03	0.08	301	123.0%	6.5	1,969	109.9%	3.5	3.7	8.9	15.5	2270	111.6%		22.6	15.5
B4	8.59	0.08	300	2.0%	25.7	308	13.4%	2.5	0.9	5.6	31.3	608	7.8%		13.4	13.4
B5	8.95	0.08	300	2.5%	23.9	243	2.4%	2.5	0.4	10.5	34.3	543	2.5%		13.0	13.0
C1	53.41	0.08	300	1.6%	27.7	1,593	6.3%	2.5	0.6	42.3	70.0	1893	5.6%		20.5	20.5
C2	8.47	0.08	300	25.0%	11.1	887	4.9%	2.5	0.6	26.7	37.8	1187	10.0%		16.6	16.6
C3	5.55	0.08	300	6.9%	17.0	383	5.6%	2.5	0.6	10.8	27.8	683	6.2%		13.8	13.8
C4	6.40	0.08	300	5.9%	17.9	317	6.4%	2.5	0.6	8.4	26.3	617	6.2%		13.4	13.4
C5	10.50	0.08	300	2.5%	23.9	602	14.8%	2.5	1.0	10.4	34.3	902	10.7%		15.0	15.0
D1	29.73	0.08	300	1.5%	28.3	1,153	1.6%	2.5	0.3	60.8	89.1	1453	1.6%		18.1	18.1
OS-A1	4.06	0.24	300	5.0%	16.1	161	5.0%	2.5	0.6	4.8	20.9	461	5.0%		12.6	12.6
OS-A2	4.45	0.12	250	10.0%	13.2			2.5			13.2	250	10.0%	19%	11.4	11.4
OS-C1	27.49	0.14	300	25.0%	10.4	1,195	5.0%	2.5	0.6	35.6	46.1	1495	9.0%	9%	18.3	18.3
OS-C2	6.15	0.20	300	5.8%	15.9	865	5.8%	2.5	0.6	24.0	39.9	1165	5.8%	17%	16.5	16.5
OS-C3	21.89	0.16	300	6.9%	15.7	874	6.9%	2.5	0.7	22.2	37.9	1174	6.9%	11%	16.5	16.5

$$t_i = \frac{0.395(1.1 - C_5)\sqrt{L_i}}{S_0^{0.33}} \quad t_c = \frac{L}{180} + 10 \quad V = C_v S_w^{0.5}$$

Note: Conveyance coefficient from Table 6-7 of DCM



**STANDARD FORM SF-3
STORM DRAINAGE DESIGN - RATIONAL METHOD 2 YEAR EVENT**

PROJECT NAME: Overlook
PROJECT NUMBER: 196239003
CALCULATED BY: GKS
CHECKED BY: KRK

EXISTING CONDITIONS

DATE: 11/27/2023

STORM LINE	DESIGN POINT	DIRECT RUNOFF							TOTAL RUNOFF				STREET		PIPE		TRAVEL TIME			REMARKS	
		DESIGN BASIN	AREA (AC)	RUNOFF COEFF	t _c (min)	C*A(ac)	I (in/hr)	Q (cfs)	t _c (max)	S(C*A) (ac)	I (in/hr)	Q (cfs)	SLOPE (%)	STREET FLOW(cfs)	DESIGN FLOW(cfs)	SLOPE (%)	PIPE SIZE (in)	LENGTH (ft)	VELOCITY		t _t (min)
(1)	(2)	(3)	(4)	(5)	(6)	(7)	(8)	(9)	(10)	(11)	(12)	(13)	(14)	(15)	(16)	(17)	(18)	(19)	(20)	(21)	(22)
	1	A1	19.92	0.09	23.14	1.83	2.30	4.19													
	2	A2	61.50	0.03	32.09	1.80	1.91	3.44													
	3	B1	45.75	0.02	25.98	0.92	2.16	1.98													
	4	B2	42.42	0.02	24.71	0.85	2.22	1.88													
	5	B3	18.62	0.02	22.60	0.37	2.32	0.87													
	5A	B3A	31.03	0.02	15.47	0.62	2.78	1.72													
	6	B4	8.59	0.02	13.38	0.17	2.95	0.51													
	7	B5	8.95	0.02	13.02	0.18	2.98	0.53													
	8	C1	53.41	0.02	20.52	1.07	2.44	2.61													
	9	C2	8.47	0.02	16.59	0.17	2.69	0.46													
	10	C3	5.55	0.02	13.79	0.11	2.91	0.32													
	11	C4	6.40	0.02	13.43	0.13	2.94	0.38													
	12	C5	10.50	0.02	15.01	0.21	2.81	0.59													
	13	D1	29.73	0.02	18.07	0.59	2.59	1.54													
	14	OS-A1	4.06	0.19	11.39	0.75	3.14	2.36													
	15	OS-A2	4.45	0.05	18.31	0.22	2.58	0.57													
	16	OS-C1	27.49	0.07	18.31	1.90	2.58	4.90													
	17	OS-C2	6.15	0.14	16.47	0.87	2.70	2.35													
	18	OS-C3	21.89	0.09	16.52	1.98	2.70	5.33													

Note: Rainfall intensity from Figure 6-5 IDF Equations

$$I_2 = -1.19 \ln(t_{c,min}) + 6.035$$



**STANDARD FORM SF-3
STORM DRAINAGE DESIGN - RATIONAL METHOD 5 YEAR EVENT**

PROJECT NAME: Overlook
PROJECT NUMBER: 196239003
CALCULATED BY: GKS
CHECKED BY: KRK

EXISTING CONDITIONS

DATE: 11/27/2023

STORM LINE	DESIGN POINT	DIRECT RUNOFF							TOTAL RUNOFF				STREET		PIPE		TRAVEL TIME			REMARKS	
		DESIGN BASIN	AREA (AC)	RUNOFF COEFF	t _c (min)	C*A (ac)	I (in/hr)	Q (cfs)	t _c (max)	S(C*A) (ac)	I (in/hr)	Q (cfs)	SLOPE (%)	STREET FLOW(cfs)	DESIGN FLOW(cfs)	SLOPE (%)	PIPE SIZE (in)	LENGTH (ft)	VELOCITY		t _t (min)
(1)	(2)	(3)	(4)	(5)	(6)	(7)	(8)	(9)	(10)	(11)	(12)	(13)	(14)	(15)	(16)	(17)	(18)	(19)	(20)	(21)	(22)
	1	A1	19.92	0.15	23.14	2.94	2.87	8.43													
	2	A2	61.50	0.09	32.09	5.46	2.38	13.00													
	3	B1	45.75	0.08	25.98	3.66	2.70	9.87													
	4	B2	42.42	0.08	24.71	3.39	2.77	9.41													
	5	B3	18.62	0.08	22.60	1.49	2.91	4.33													
	5A	B3A	31.03	0.08	15.47	2.48	3.47	8.63													
	6	B4	8.59	0.08	13.38	0.69	3.69	2.54													
	7	B5	8.95	0.08	13.02	0.72	3.73	2.67													
	8	C1	53.41	0.08	20.52	4.27	3.05	13.04													
	9	C2	8.47	0.08	16.59	0.68	3.37	2.28													
	10	C3	5.55	0.08	13.79	0.44	3.65	1.62													
	11	C4	6.40	0.08	13.43	0.51	3.69	1.89													
	12	C5	10.50	0.08	15.01	0.84	3.52	2.96													
	13	D1	29.73	0.08	18.07	2.38	3.24	7.71													
	14	OS-A1	4.06	0.24	11.39	0.96	3.93	3.76													
	15	OS-A2	4.45	0.12	18.31	0.53	3.22	1.72													
	16	OS-C1	27.49	0.14	18.31	3.79	3.22	12.21													
	17	OS-C2	6.15	0.20	16.47	1.26	3.38	4.26													
	18	OS-C3	21.89	0.16	16.52	3.45	3.38	11.63													

Note: Rainfall intensity from Figure 6-5 IDF Equations

$$I_5 = -1.5 \ln(t_{c,min}) + 7.583$$



**STANDARD FORM SF-3
STORM DRAINAGE DESIGN - RATIONAL METHOD 100 YEAR EVENT**

PROJECT NAME: Overlook
PROJECT NUMBER: 196239003
CALCULATED BY: GKS
CHECKED BY: KRK

EXISTING CONDITIONS

DATE: 11/27/2023

STORM LINE	DESIGN POINT	DIRECT RUNOFF							TOTAL RUNOFF				STREET		PIPE			TRAVEL TIME			REMARKS
		DESIGN BASIN	AREA (AC)	RUNOFF COEFF	t _c (min)	C*A(ac)	I (in/hr)	Q (cfs)	t _c (max)	S(C*A) (ac)	I (in/hr)	Q (cfs)	SLOPE (%)	STREET FLOW(cfs)	DESIGN FLOW(cfs)	SLOPE (%)	PIPE SIZE (in)	LENGTH (ft)	VELOCIT Y	t _t (min)	
(1)	(2)	(3)	(4)	(5)	(6)	(7)	(8)	(9)	(10)	(11)	(12)	(13)	(14)	(15)	(16)	(17)	(18)	(19)	(20)	(21)	(22)
	1	A1	19.92	0.40	23.14	7.97	4.82	38.41													
	2	A2	61.50	0.36	32.09	21.93	3.99	87.58													
	3	B1	45.75	0.35	25.98	16.01	4.53	72.48													
	4	B2	42.42	0.35	24.71	14.85	4.65	69.09													
	5	B3	18.62	0.35	22.60	6.52	4.88	31.79													
	5A	B3A	31.03	0.35	15.47	10.86	5.83	63.35													
	6	B4	8.59	0.35	13.38	3.01	6.20	18.64													
	7	B5	8.95	0.35	13.02	3.13	6.27	19.63													
	8	C1	53.41	0.35	20.52	18.69	5.12	95.74													
	9	C2	8.47	0.35	16.59	2.96	5.66	16.77													
	10	C3	5.55	0.35	13.79	1.94	6.12	11.89													
	11	C4	6.40	0.35	13.43	2.24	6.19	13.87													
	12	C5	10.50	0.35	15.01	3.68	5.91	21.72													
	13	D1	29.73	0.35	18.07	10.41	5.44	56.62													
	14	OS-A1	4.06	0.47	11.39	1.89	6.60	12.49													
	15	OS-A2	4.45	0.39	18.31	1.74	5.41	9.39													
	16	OS-C1	27.49	0.40	18.31	11.08	5.41	59.93													
	17	OS-C2	6.15	0.45	16.47	2.78	5.67	15.78													
	18	OS-C3	21.89	0.42	16.52	9.14	5.67	51.77													

Note: Rainfall intensity from Figure 6-5 IDF Equations

$$I_{100} = -2.52 \ln(t_{c,min}) + 12.735$$



PROJECT NAME: Overlook
 PROJECT NUMBER: 196239003
 CALCULATED BY: GKS
 CHECKED BY: KRK

11/27/2023

EXISTING CONDITIONS RATIONAL CALCULATIONS SUMMARY

DESIGN POINT	TRIBUTARY BASINS	TRIBUTARY AREA (AC)	CFS			% IMPERVIOUS
			Q2	Q5	Q100	
PDR Basins						
1	A1	19.92	4.19	8.43	38.41	8%
2	A2	61.50	3.44	13.00	87.58	1%
3	B1	45.75	1.98	9.87	72.48	0%
4	B2	42.42	1.88	9.41	69.09	0%
5	B3	18.62	0.87	4.33	31.79	0%
5A	B3A	31.03	1.72	8.63	63.35	0%
6	B4	8.59	0.51	2.54	18.64	0%
7	B5	8.95	0.53	2.67	19.63	0%
8	C1	53.41	2.61	13.04	95.74	0%
9	C2	8.47	0.46	2.28	16.77	0%
10	C3	5.55	0.32	1.62	11.89	0%
11	C4	6.40	0.38	1.89	13.87	0%
12	C5	10.50	0.59	2.96	21.72	0%
13	D1	29.73	1.54	7.71	56.62	0%
14	OS-A1	4.06	2.36	3.76	12.49	19%
15	OS-A2	4.45	0.57	1.72	9.39	7%
16	OS-C1	27.49	4.90	12.21	59.93	9%
17	OS-C2	6.15	2.35	4.26	15.78	17%
18	OS-C3	21.89	5.33	11.63	51.77	11%
ON-SITE BASIN TOTAL						
BASIN A TOTAL		81.42	7.63	21.43	125.99	3%
BASIN B TOTAL		155.36	7.49	37.44	274.98	0%
BASIN C TOTAL		84.33	4.35	21.78	159.98	0%
BASIN D TOTAL		29.73	1.54	7.71	56.62	0%
ON-SITE TOTAL		350.84	21.01	88.37	617.56	1%
OFF-SITE BASIN TOTAL						
OFF-SITE BASIN A		8.51	2.93	5.48	21.87	13%
OFF-SITE BASIN C		55.53	12.58	28.11	127.48	11%
OFF-SITE TOTAL		64.04	15.52	33.59	149.36	11%
SITE TOTAL		414.88	36.53	121.96	766.92	2%

STANDARD FORM SF-1
 RUNOFF COEFFICIENTS - IMPERVIOUS CALCULATION
 PROPOSED CONDITIONS

PROJECT NAME: Overlook
 PROJECT NUMBER: 196239003
 CALCULATED BY: GKS
 CHECKED BY: KRK

DATE: 8/7/2023

SOIL: B		RESIDENTIAL (>5AC)	PASTURE/MEADOW (SOIL GROUP A/B)	PAVEMENT							
LAND USE:		AREA	AREA	AREA	AREA						
2-YEAR COEFF.		0.05	0.02	0.89							
5-YEAR COEFF.		0.12	0.08	0.90							
10-YEAR COEFF.		0.20	0.15	0.92							
100-YEAR COEFF.		0.39	0.35	0.96							
IMPERVIOUS %		7%	0%	100%							
DESIGN BASIN	DESIGN POINT	RESIDENTIAL (>5AC) AREA (AC)	PASTURE/MEADOW (SOIL GROUP A/B) AREA (AC)	PAVEMENT AREA (AC)	AREA (AC)	TOTAL AREA (AC)	C(2)	C(5)	C(10)	C(100)	Imp %
FDR Basins											
A1	1	17.91		1.64		19.55	0.12	0.19	0.26	0.44	15%
A2	2	55.40		2.87		58.27	0.09	0.16	0.24	0.42	12%
B1	3	39.58		1.16		40.74	0.07	0.14	0.22	0.41	10%
B2	4	15.66		0.34		16.00	0.07	0.14	0.22	0.40	9%
B3	5	19.11				19.11	0.05	0.12	0.20	0.39	7%
B4	6	8.50				8.50	0.05	0.12	0.20	0.39	7%
B5	7	8.95				8.95	0.05	0.12	0.20	0.39	7%
B6	8	51.65		1.66		53.31	0.08	0.14	0.22	0.41	10%
B7	9	2.46				2.46	0.05	0.12	0.20	0.39	7%
B8	10	9.52				9.52	0.05	0.12	0.20	0.39	7%
C1	11	25.38		0.53		25.91	0.07	0.14	0.21	0.40	9%
C2	12	16.03		1.00		17.03	0.10	0.17	0.24	0.42	12%
C3	13	3.80		0.16		3.96	0.08	0.15	0.23	0.41	11%
C4	14	6.37				6.37	0.05	0.12	0.20	0.39	7%
C5	15	10.50				10.50	0.05	0.12	0.20	0.39	7%
C6	16	19.82		1.47		21.29	0.11	0.17	0.25	0.43	13%
D1	17	28.79		0.59		29.38	0.07	0.14	0.21	0.40	9%
OS-A1	18	3.29		0.77		4.06	0.21	0.27	0.34	0.50	25%
OS-A2	19	4.45				4.45	0.05	0.12	0.20	0.39	7%
OS-C1	20	26.86		0.63		27.49	0.07	0.14	0.22	0.40	9%
OS-C2	21	5.48		0.67		6.15	0.14	0.20	0.28	0.45	17%
OS-C3	22	20.84		1.05		21.89	0.09	0.16	0.23	0.42	11%
TOTAL - OVERALL		400.35	0.00	14.54	0.00	414.89	0.08	0.15	0.23	0.41	10%
		96%	0%	4%	0%	100%					

Note: Land use coefficients sourced from City of Colorado Springs Drainage Criteria Manual, Volume 1, Table 6-6.

**STANDARD FORM SF-2
Time of Concentration**

PROJECT NAME: **Overlook**
 PROJECT NUMBER: **196239003**
 CALCULATED BY: **GKS**
 CHECKED BY: **KRK**

PROPOSED CONDITIONS

DATE: 8/7/2023

SUB-BASIN DATA			INITIAL TIME (T _i)			TRAVEL TIME (T _t)					T _c CHECK (URBANIZED BASINS)				FINAL T _c	
DESIGN BASIN (1)	AREA Ac (2)	C5 (3)	LENGTH Ft (4)	SLOPE % (5)	T _i Min. (6)	LENGTH Ft. (7)	SLOPE % (8)	C _v (9)	VEL fps (11)	T _t Min. (12)	COMP. t _c (13)	TOTAL LENGTH (14)	TOTAL SLOPE (15)	TOTAL IMP. (16)	T _c Min. (17)	Min.
FDR Basins																
A1	19.55	0.19	300	18.0%	11.1	2,066	5.0%	2.5	0.6	61.6	72.7	2366	6.6%	15%	23.1	23.1
A2	58.27	0.16	300	18.0%	11.4	4,100	4.0%	2.5	0.5	136.7	148.1	4400	5.0%	12%	34.4	34.4
B1	40.74	0.14	300	8.0%	15.2	2,000	4.5%	2.5	0.5	62.9	78.1	2300	5.0%	10%	22.8	22.8
B2	16.00	0.14	300	7.0%	16.0	500	6.0%	2.5	0.6	13.6	29.6	800	6.4%	9%	14.4	14.4
B3	19.11	0.12	300	21.0%	11.3	800	8.0%	2.5	0.7	18.9	30.1	1100	11.5%	7%	16.1	16.1
B4	8.50	0.12	300	2.0%	24.7	300	13.5%	2.5	0.9	5.4	30.1	600	7.8%	7%	13.3	13.3
B5	8.95	0.12	300	2.5%	22.9	250	2.5%	2.5	0.4	10.5	33.5	550	2.5%	7%	13.1	13.1
B6	53.31	0.14	300	22.0%	10.8	1,900	3.0%	2.5	0.4	73.1	84.0	2200	5.6%	10%	22.2	22.2
B7	2.46	0.12	300	6.0%	17.1	100	6.0%	2.2	0.5	3.1	20.2	400	6.0%	7%	12.2	12.2
B8	9.52	0.12	300	6.0%	17.1	300	10.0%	2.5	0.8	6.3	23.5	600	8.0%	7%	13.3	13.3
C1	25.91	0.14	300	10.0%	14.2	1,300	8.0%	2.5	0.7	30.6	44.9	1600	8.4%	9%	18.9	18.9
C2	17.03	0.17	140	28.0%	6.7	2,250	3.0%	2.5	0.4	86.6	93.3	2390	4.5%	12%	23.3	23.3
C3	3.96	0.15	200	12.5%	10.6	50	3.0%	2.5	0.4	1.9	12.5	250	10.6%	11%	11.4	11.4
C4	6.37	0.12	300	5.5%	17.6	300	6.0%	2.5	0.6	8.2	25.8	600	5.8%	7%	13.3	13.3
C5	10.50	0.12	300	9.5%	14.7	600	11.0%	2.5	0.8	12.1	26.8	900	10.5%	7%	15.0	15.0
C6	21.29	0.17	300	3.0%	20.4	1,000	3.0%	2.5	0.4	38.5	58.9	1300	3.0%	13%	17.2	17.2
D1	29.38	0.14	300	1.0%	30.6	825	2.0%	2.5	0.4	38.9	69.5	1125	1.7%	9%	16.3	16.3
OS-A1	4.06	0.27	300	5.0%	15.5	161	5.0%	2.5	0.6	4.8	20.3	461	5.0%	25%	12.6	12.6
OS-A2	4.45	0.12	250	10.0%	13.2			2.5			13.2	250	10.0%	7%	11.4	11.4
OS-C1	27.49	0.14	300	25.0%	10.4	1,195	5.0%	2.5	0.6	35.6	46.1	1495	9.0%	9%	18.3	18.3
OS-C2	6.15	0.20	300	5.8%	15.9	865	5.8%	2.5	0.6	24.0	39.9	1165	5.8%	17%	16.5	16.5
OS-C3	21.89	0.16	300	6.9%	15.7	874	6.9%	2.5	0.7	22.2	37.9	1174	6.9%	11%	16.5	16.5

$$t_i = \frac{0.395(1.1 - C_5)\sqrt{L_i}}{S_0^{0.33}} \quad t_c = \frac{L}{180} + 10 \quad V = C_p S_w^{0.5}$$

Note: Conveyance coefficient from Table 6-7 of DCM



**STANDARD FORM SF-3
STORM DRAINAGE DESIGN - RATIONAL METHOD 2 YEAR EVENT**

PROJECT NAME: Overlook
PROJECT NUMBER: 196239003
CALCULATED BY: GKS
CHECKED BY: KRK

PROPOSED CONDITIONS

DATE: 8/7/2023

STORM LINE	DESIGN POINT	DIRECT RUNOFF							TOTAL RUNOFF				STREET		PIPE			TRAVEL TIME			REMARKS
		DESIGN BASIN	AREA (AC)	RUNOFF COEFF	t _c (min)	C*A(ac)	I (in/hr)	Q (cfs)	t _c (max)	S(C*A) (ac)	I (in/hr)	Q (cfs)	SLOPE (%)	STREET FLOW(cfs)	DESIGN FLOW(cfs)	SLOPE (%)	PIPE SIZE (in)	LENGTH (ft)	VELOCITY	t _t (min)	
(1)	(2)	(3)	(4)	(5)	(6)	(7)	(8)	(9)	(10)	(11)	(12)	(13)	(14)	(15)	(16)	(17)	(18)	(19)	(20)	(21)	(22)
	1	A1	19.55	0.12	23.14	2.36	2.30	5.41													
	2	A2	58.27	0.09	34.44	5.32	1.82	9.71													
	3	B1	40.74	0.07	22.78	3.01	2.32	6.97													
	4	B2	16.00	0.07	14.44	1.09	2.86	3.10													
	5	B3	19.11	0.05	16.11	0.96	2.73	2.61													
	6	B4	8.50	0.05	13.33	0.43	2.95	1.25													
	7	B5	8.95	0.05	13.06	0.45	2.98	1.33													
	8	B6	53.31	0.08	22.22	4.06	2.34	9.52													
	9	B7	2.46	0.05	12.22	0.12	3.06	0.38													
	10	B8	9.52	0.05	13.33	0.48	2.95	1.41													
	11	C1	25.91	0.07	18.89	1.74	2.54	4.42													
	12	C2	17.03	0.10	23.28	1.69	2.29	3.87													
	13	C3	3.96	0.08	11.39	0.33	3.14	1.04													
	14	C4	6.37	0.05	13.33	0.32	2.95	0.94													
	15	C5	10.50	0.05	15.00	0.53	2.81	1.48													
	16	C6	21.29	0.11	17.22	2.30	2.65	6.09													
	17	D1	29.38	0.07	16.25	1.96	2.72	5.34													
	18	OS-A1	4.06	0.21	12.56	0.85	3.02	2.57													
	19	OS-A2	4.45	0.05	11.39	0.22	3.14	0.70													
	20	OS-C1	27.49	0.07	18.31	1.90	2.58	4.90													
	21	OS-C2	6.15	0.14	16.47	0.87	2.70	2.35													
	22	OS-C3	21.89	0.09	16.52	1.98	2.70	5.33													

Note: Rainfall intensity from Figure 6-5 IDF Equations

$$I_2 = -1.19 \ln(t_{c,min}) + 6.035$$



**STANDARD FORM SF-3
STORM DRAINAGE DESIGN - RATIONAL METHOD 5 YEAR EVENT**

PROJECT NAME: Overlook
PROJECT NUMBER: 196239003
CALCULATED BY: GKS
CHECKED BY: KRK

PROPOSED CONDITIONS

DATE: 8/7/2023

STORM LINE	DESIGN POINT	DIRECT RUNOFF							TOTAL RUNOFF				STREET		PIPE			TRAVEL TIME			REMARKS
		DESIGN BASIN	AREA (AC)	RUNOFF COEFF	t _c (min)	C*A(ac)	I (in/hr)	Q (cfs)	t _c (max)	S(C*A) (ac)	I (in/hr)	Q (cfs)	SLOPE (%)	STREET FLOW(cfs)	DESIGN FLOW(cfs)	SLOPE (%)	PIPE SIZE (in)	LENGTH (ft)	VELOCITY	t _t (min)	
(1)	(2)	(3)	(4)	(5)	(6)	(7)	(8)	(9)	(10)	(11)	(12)	(13)	(14)	(15)	(16)	(17)	(18)	(19)	(20)	(21)	(22)
	1	A1	19.55	0.19	23.14	3.63	2.87	10.41													
	2	A2	58.27	0.16	34.44	9.23	2.27	20.99													
	3	B1	40.74	0.14	22.78	5.79	2.89	16.77													
	4	B2	16.00	0.14	14.44	2.19	3.58	7.82													
	5	B3	19.11	0.12	16.11	2.29	3.41	7.83													
	6	B4	8.50	0.12	13.33	1.02	3.70	3.77													
	7	B5	8.95	0.12	13.06	1.07	3.73	4.01													
	8	B6	53.31	0.14	22.22	7.69	2.93	22.55													
	9	B7	2.46	0.12	12.22	0.30	3.83	1.13													
	10	B8	9.52	0.12	13.33	1.14	3.70	4.22													
	11	C1	25.91	0.14	18.89	3.52	3.18	11.18													
	12	C2	17.03	0.17	23.28	2.82	2.86	8.08													
	13	C3	3.96	0.15	11.39	0.60	3.93	2.36													
	14	C4	6.37	0.12	13.33	0.76	3.70	2.83													
	15	C5	10.50	0.12	15.00	1.26	3.52	4.44													
	16	C6	21.29	0.17	17.22	3.70	3.31	12.27													
	17	D1	29.38	0.14	16.25	3.99	3.40	13.56													
	18	OS-A1	4.06	0.27	12.56	1.09	3.79	4.12													
	19	OS-A2	4.45	0.12	11.39	0.53	3.93	2.10													
	20	OS-C1	27.49	0.14	18.31	3.79	3.22	12.21													
	21	OS-C2	6.15	0.20	16.47	1.26	3.38	4.26													
	22	OS-C3	21.89	0.16	16.52	3.45	3.38	11.63													

Note: Rainfall intensity from Figure 6-5 IDF Equations

$$I_5 = -1.5 \ln(t_{c,min}) + 7.583$$



**STANDARD FORM SF-3
STORM DRAINAGE DESIGN - RATIONAL METHOD 100 YEAR EVENT**

PROJECT NAME: Overlook
PROJECT NUMBER: 196239003
CALCULATED BY: GKS
CHECKED BY: KRK

PROPOSED CONDITIONS

DATE: 8/7/2023

STORM LINE	DESIGN POINT	DIRECT RUNOFF							TOTAL RUNOFF				STREET		PIPE			TRAVEL TIME			REMARKS
		DESIGN BASIN	AREA (AC)	RUNOFF COEFF	t _c (min)	C*A(ac)	I (in/hr)	Q (cfs)	t _c (max)	S(C*A) (ac)	I (in/hr)	Q (cfs)	SLOPE (%)	STREET FLOW(cfs)	DESIGN FLOW(cfs)	SLOPE (%)	PIPE SIZE (in)	LENGTH (ft)	VELOCITY	t _t (min)	
(1)	(2)	(3)	(4)	(5)	(6)	(7)	(8)	(9)	(10)	(11)	(12)	(13)	(14)	(15)	(16)	(17)	(18)	(19)	(20)	(21)	(22)
	1	A1	19.55	0.44	23.14	8.56	4.82	41.24													
	2	A2	58.27	0.42	34.44	24.36	3.82	92.96													
	3	B1	40.74	0.41	22.78	16.55	4.86	80.40													
	4	B2	16.00	0.40	14.44	6.43	6.01	38.64													
	5	B3	19.11	0.39	16.11	7.45	5.73	42.71													
	6	B4	8.50	0.39	13.33	3.32	6.21	20.58													
	7	B5	8.95	0.39	13.06	3.49	6.26	21.85													
	8	B6	53.31	0.41	22.22	21.74	4.92	106.95													
	9	B7	2.46	0.39	12.22	0.96	6.43	6.17													
	10	B8	9.52	0.39	13.33	3.71	6.21	23.05													
	11	C1	25.91	0.40	18.89	10.41	5.33	55.47													
	12	C2	17.03	0.42	23.28	7.21	4.80	34.64													
	13	C3	3.96	0.41	11.39	1.64	6.60	10.80													
	14	C4	6.37	0.39	13.33	2.48	6.21	15.42													
	15	C5	10.50	0.39	15.00	4.10	5.91	24.20													
	16	C6	21.29	0.43	17.22	9.14	5.56	50.85													
	17	D1	29.38	0.40	16.25	11.79	5.71	67.33													
	18	OS-A1	4.06	0.50	12.56	2.02	6.36	12.86													
	19	OS-A2	4.45	0.39	11.39	1.74	6.60	11.46													
	20	OS-C1	27.49	0.40	18.31	11.08	5.41	59.93													
	21	OS-C2	6.15	0.45	16.47	2.78	5.67	15.78													
	22	OS-C3	21.89	0.42	16.52	9.14	5.67	51.77													

Note: Rainfall intensity from Figure 6-5 IDF Equations

$$I_{100} = -2.52 \ln(t_{c,min}) + 12.735$$



PROJECT NAME: Overlook
 PROJECT NUMBER: 196239003
 CALCULATED BY: GKS
 CHECKED BY: KRK

8/7/2023

PROPOSED CONDITIONS RATIONAL CALCULATIONS SUMMARY

DESIGN POINT	TRIBUTARY BASINS	TRIBUTARY AREA (AC)	CFS			% IMPERVIOUS
			Q2	Q5	Q100	
PDR Basins						
1	A1	19.55	5.41	10.41	41.24	15%
2	A2	58.27	9.71	20.99	92.96	12%
3	B1	40.74	6.97	16.77	80.40	10%
4	B2	16.00	3.10	7.82	38.64	9%
5	B3	19.11	2.61	7.83	42.71	7%
6	B4	8.50	1.25	3.77	20.58	7%
7	B5	8.95	1.33	4.01	21.85	7%
8	B6	53.31	9.52	22.55	106.95	10%
9	B7	2.46	0.38	1.13	6.17	7%
10	B8	9.52	1.41	4.22	23.05	7%
11	C1	25.91	4.42	11.18	55.47	9%
12	C2	17.03	3.87	8.08	34.64	12%
13	C3	3.96	1.04	2.36	10.80	11%
14	C4	6.37	0.94	2.83	15.42	7%
15	C5	10.50	1.48	4.44	24.20	7%
16	C6	21.29	6.09	12.27	50.85	13%
17	D1	29.38	5.34	13.56	67.33	9%
18	OS-A1	4.06	2.57	4.12	12.86	25%
19	OS-A2	4.45	0.70	2.10	11.46	7%
20	OS-C1	27.49	4.90	12.21	59.93	9%
21	OS-C2	6.15	2.35	4.26	15.78	17%
22	OS-C3	21.89	5.33	11.63	51.77	11%
ON-SITE BASIN TOTAL						
BASIN A TOTAL		77.82	15.12	31.40	134.20	12%
BASIN B TOTAL		158.59	26.57	68.09	340.34	8%
BASIN C TOTAL		85.06	17.84	41.15	191.38	10%
BASIN D TOTAL		29.38	4.90	12.21	59.93	9%
ON-SITE TOTAL		350.85	49.75	122.80	599.06	10%
OFF-SITE BASIN TOTAL						
OFF-SITE BASIN A		8.51	3.27	6.22	24.32	15%
OFF-SITE BASIN C		55.53	12.58	28.11	127.48	11%
OFF-SITE TOTAL		64.04	15.85	34.33	151.80	12%
SITE TOTAL		414.89	65.60	157.13	750.86	10%

APPENDIX D: HYDRUALICS

DETENTION BASIN STAGE-STORAGE TABLE BUILDER

MHFD-Detention, Version 4.06 (July 2022)

Project: Overlook A2 Prelim Pond Sizing

Basin ID: _____

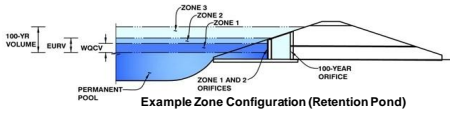

Watershed Information

Selected BMP Type =	EDB
Watershed Area =	58.27 acres
Watershed Length =	3,500 ft
Watershed Length to Centroid =	1,750 ft
Watershed Slope =	0.100 ft/ft Steep Slope > 0.06 ft/ft
Watershed Imperviousness =	12.00% percent
Percentage Hydrologic Soil Group A =	0.0% percent
Percentage Hydrologic Soil Group B =	100.0% percent
Percentage Hydrologic Soil Groups C/D =	0.0% percent
Target WQC Drain Time =	40.0 hours
Location for 1-hr Rainfall Depths =	Denver - Capitol Building

After providing required inputs above including 1-hour rainfall depths, click 'Run CUHP' to generate runoff hydrographs using the embedded Colorado Urban Hydrograph Procedure.

Water Quality Capture Volume (WOCV) =	0.120 acre-feet
Excess Urban Runoff Volume (EURV) =	0.667 acre-feet
2-yr Runoff Volume (P1 = 1.19 in.) =	0.873 acre-feet
5-yr Runoff Volume (P1 = 1.5 in.) =	1.836 acre-feet
10-yr Runoff Volume (P1 = 1.75 in.) =	2.787 acre-feet
25-yr Runoff Volume (P1 = 2 in.) =	4.448 acre-feet
50-yr Runoff Volume (P1 = 2.25 in.) =	5.593 acre-feet
100-yr Runoff Volume (P1 = 2.52 in.) =	7.228 acre-feet
500-yr Runoff Volume (P1 = 3.14 in.) =	10.226 acre-feet
Approximate 2-yr Detention Volume =	0.434 acre-feet
Approximate 5-yr Detention Volume =	0.670 acre-feet
Approximate 10-yr Detention Volume =	1.290 acre-feet
Approximate 25-yr Detention Volume =	1.747 acre-feet
Approximate 50-yr Detention Volume =	1.835 acre-feet
Approximate 100-yr Detention Volume =	2.346 acre-feet

Optional User Overrides

0.120	acre-feet
0.120	acre-feet
1.19	inches
1.50	inches
1.75	inches
2.00	inches
2.25	inches
2.52	inches
	inches

Define Zones and Basin Geometry

Zone 1 Volume (WOCV) =	0.120	acre-feet
Zone 2 Volume (EURV - Zone 1) =	0.547	acre-feet
Zone 3 Volume (100-year - Zones 1 & 2) =	1.679	acre-feet
Total Detention Basin Volume =	2.346	acre-feet
Initial Surcharge Volume (ISV) =	user	ft ³
Initial Surcharge Depth (ISD) =	user	ft
Total Available Detention Depth (H _{total}) =	user	ft
Depth of Trickle Channel (H _{TC}) =	user	ft
Slope of Trickle Channel (S _{TC}) =	user	ft/ft
Slopes of Main Basin Sides (S _{main}) =	user	H:V
Basin Length-to-Width Ratio (R _{L/W}) =	user	
Initial Surcharge Area (A _{ISV}) =	user	ft ²
Surcharge Volume Length (L _{ISV}) =	user	ft
Surcharge Volume Width (W _{ISV}) =	user	ft
Depth of Basin Floor (H _{FLOOR}) =	user	ft
Length of Basin Floor (L _{FLOOR}) =	user	ft
Width of Basin Floor (W _{FLOOR}) =	user	ft
Area of Basin Floor (A _{FLOOR}) =	user	ft ²
Volume of Basin Floor (V _{FLOOR}) =	user	ft ³
Depth of Main Basin (H _{MAIN}) =	user	ft
Length of Main Basin (L _{MAIN}) =	user	ft
Width of Main Basin (W _{MAIN}) =	user	ft
Area of Main Basin (A _{MAIN}) =	user	ft ²
Volume of Main Basin (V _{MAIN}) =	user	ft ³
Calculated Total Basin Volume (V _{total}) =	USER	acre-feet

Depth Increment =		ft		ft		ft		ft		ft		ft		ft	
Stage - Storage Description	Stage (ft)	Optional Override Stage (ft)	Length (ft)	Width (ft)	Area (ft ²)	Optional Override Area (ft ²)	Area (acre)	Volume (ft ³)	Volume (ac-ft)	Area (acre)	Volume (ft ³)	Volume (ac-ft)	Area (acre)	Volume (ft ³)	Volume (ac-ft)
Top of Micropool	--	0.00	--	--	--	23,106	0.530								
	--	1.00	--	--	--	25,662	0.589	24,384	0.560						
	--	2.00	--	--	--	28,319	0.650	51,375	1.179						
	--	3.00	--	--	--	31,076	0.713	81,072	1.861						
	--	4.00	--	--	--	33,934	0.779	113,577	2.607						
	--	5.00	--	--	--	36,892	0.847	148,990	3.420						

DETENTION BASIN STAGE-STORAGE TABLE BUILDER

MHFD-Detention, Version 4.06 (July 2022)

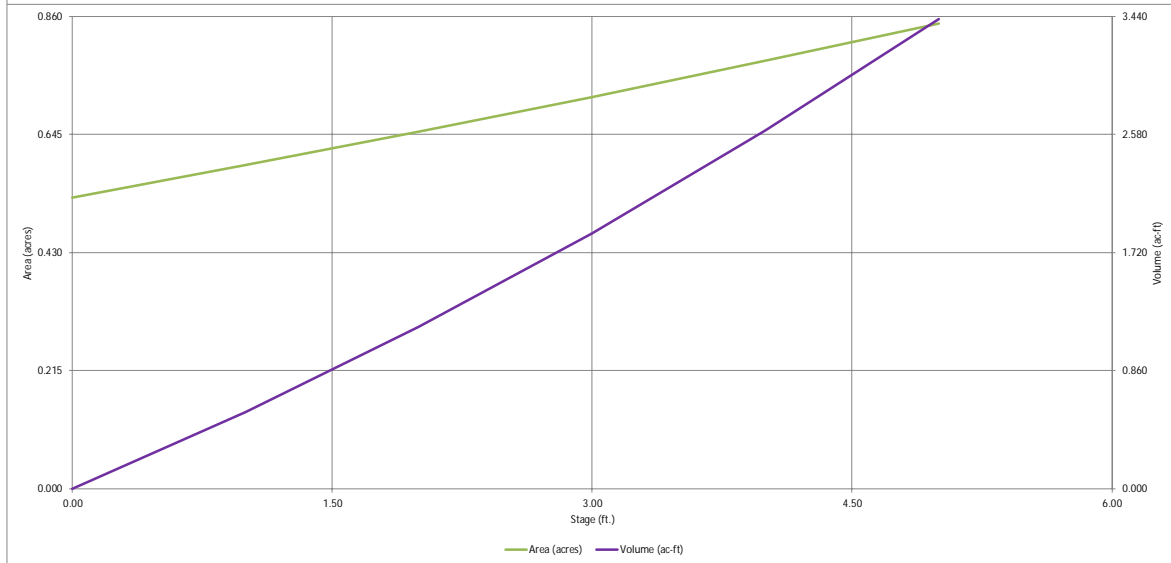
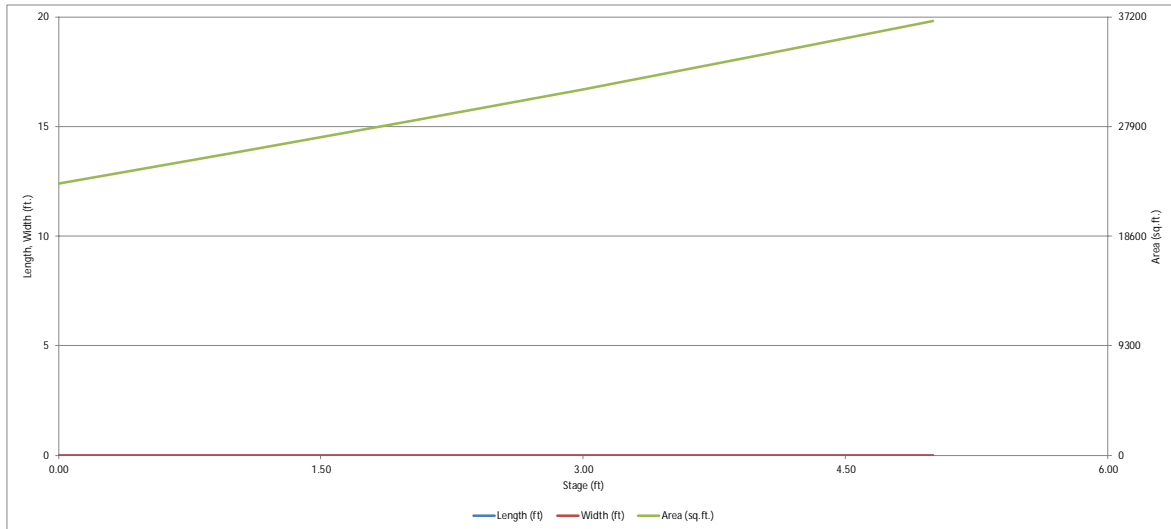

DETENTION BASIN STAGE-STORAGE TABLE BUILDER

MHFD-Detention, Version 4.06 (July 2022)

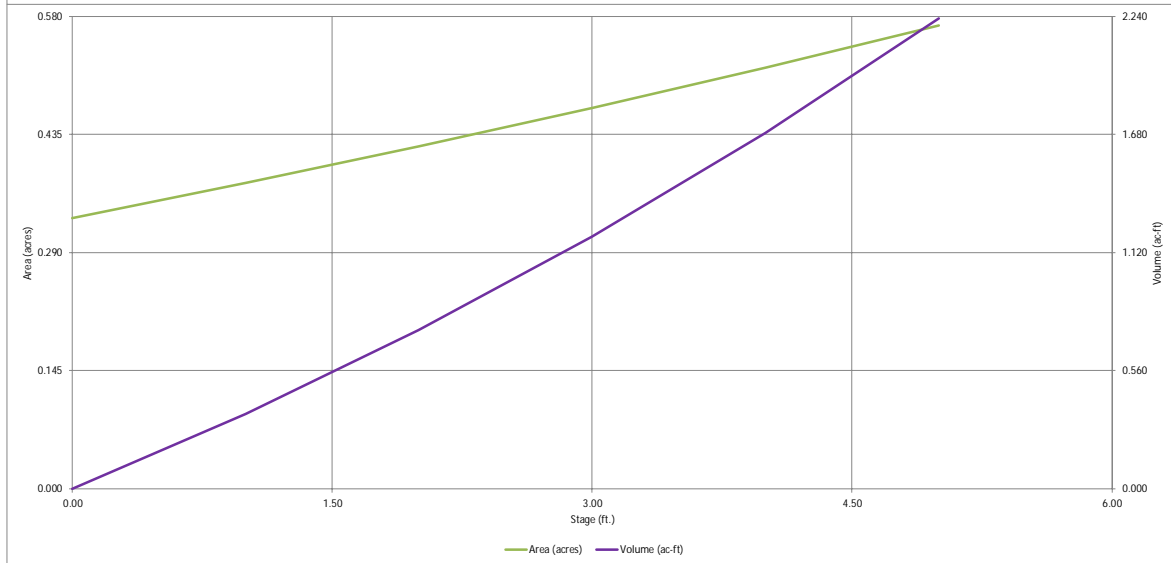
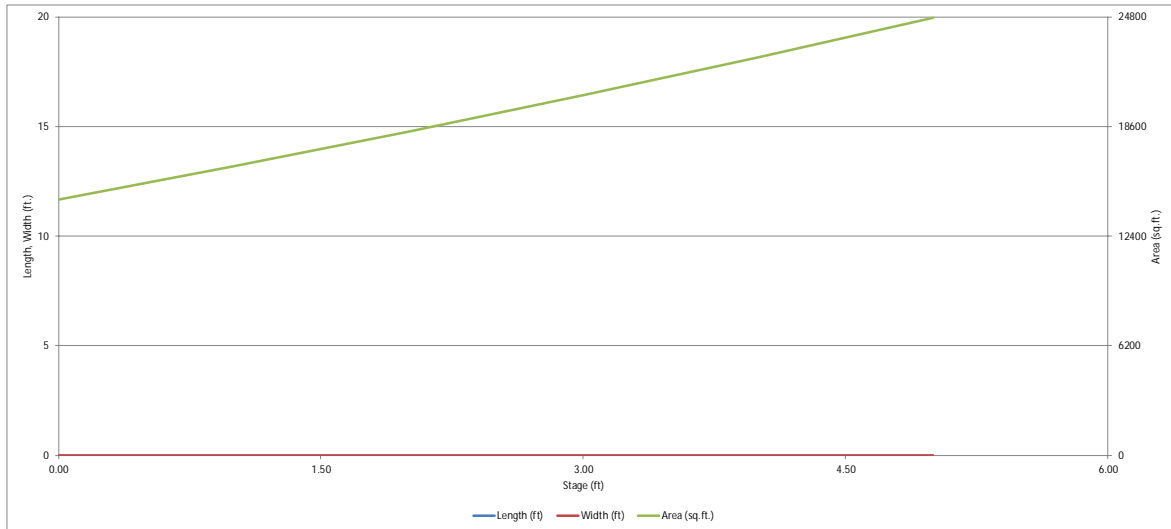

DETENTION BASIN STAGE-STORAGE TABLE BUILDER

MHFD-Detention, Version 4.06 (July 2022)

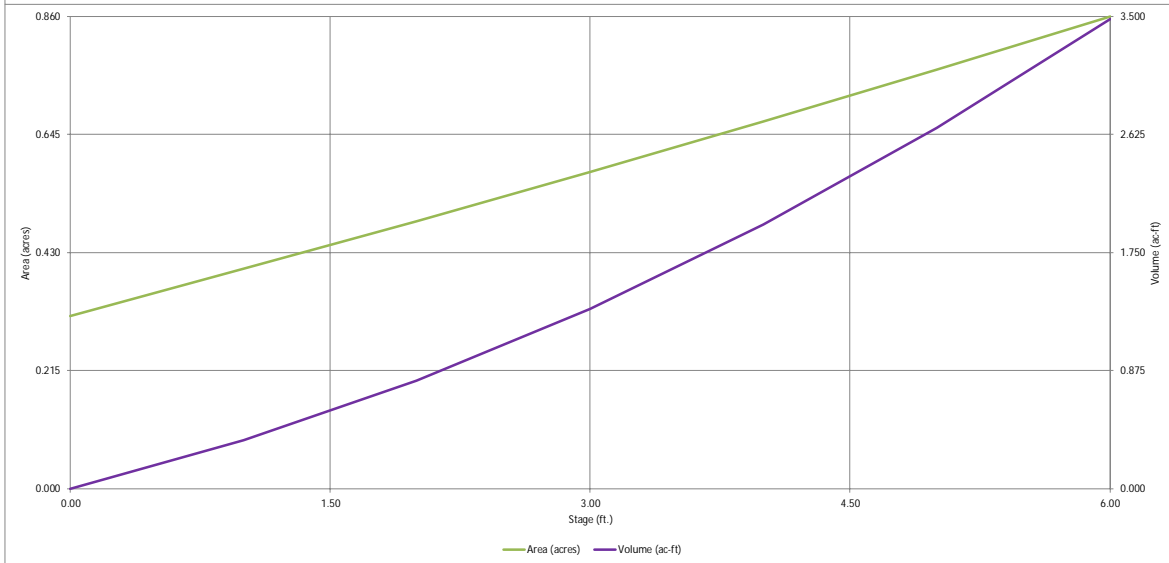
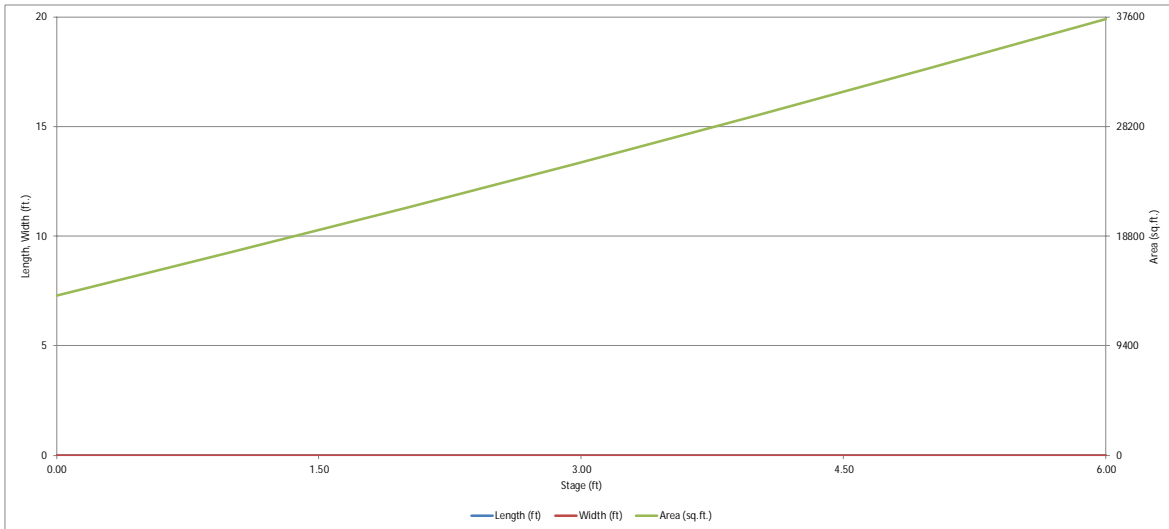

DETENTION BASIN STAGE-STORAGE TABLE BUILDER

MHFD-Detention, Version 4.06 (July 2022)

Project: Overlook C2 WOCV

Basin ID: _____

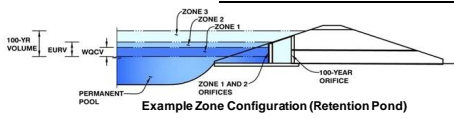

Example Zone Configuration (Retention Pond)

Watershed Information

Form fields for watershed information including Selected BMP Type, Watershed Area, Length, Slope, Imperviousness, and Soil Groups.

VOLUME USED IN POND SIZING

For providing required inputs above including 1-hour rainfall ins., click 'Run CUHP' to generate runoff hydrographs using the embedded Colorado Urban Hydrograph Procedure.

Form fields for water quality and detention volumes, including WQCVC, EURV, and various runoff volumes for different return periods.

Optional User Overrides

Form fields for optional user overrides for various volume and depth parameters.

Define Zones and Basin Geometry

Form fields for defining basin geometry, including storage volumes for zones, surcharge volume, and various dimensions of the basin floor and main basin.

Large table for stage-storage calculations with columns: Stage - Storage Description, Stage (ft), Optional Override Stage (ft), Length (ft), Width (ft), Area (ft^2), Optional Override Area (ft^2), Area (acre), Volume (ft^3), and Volume (ac-ft).

DETENTION BASIN STAGE-STORAGE TABLE BUILDER

MHFD-Detention, Version 4.06 (July 2022)

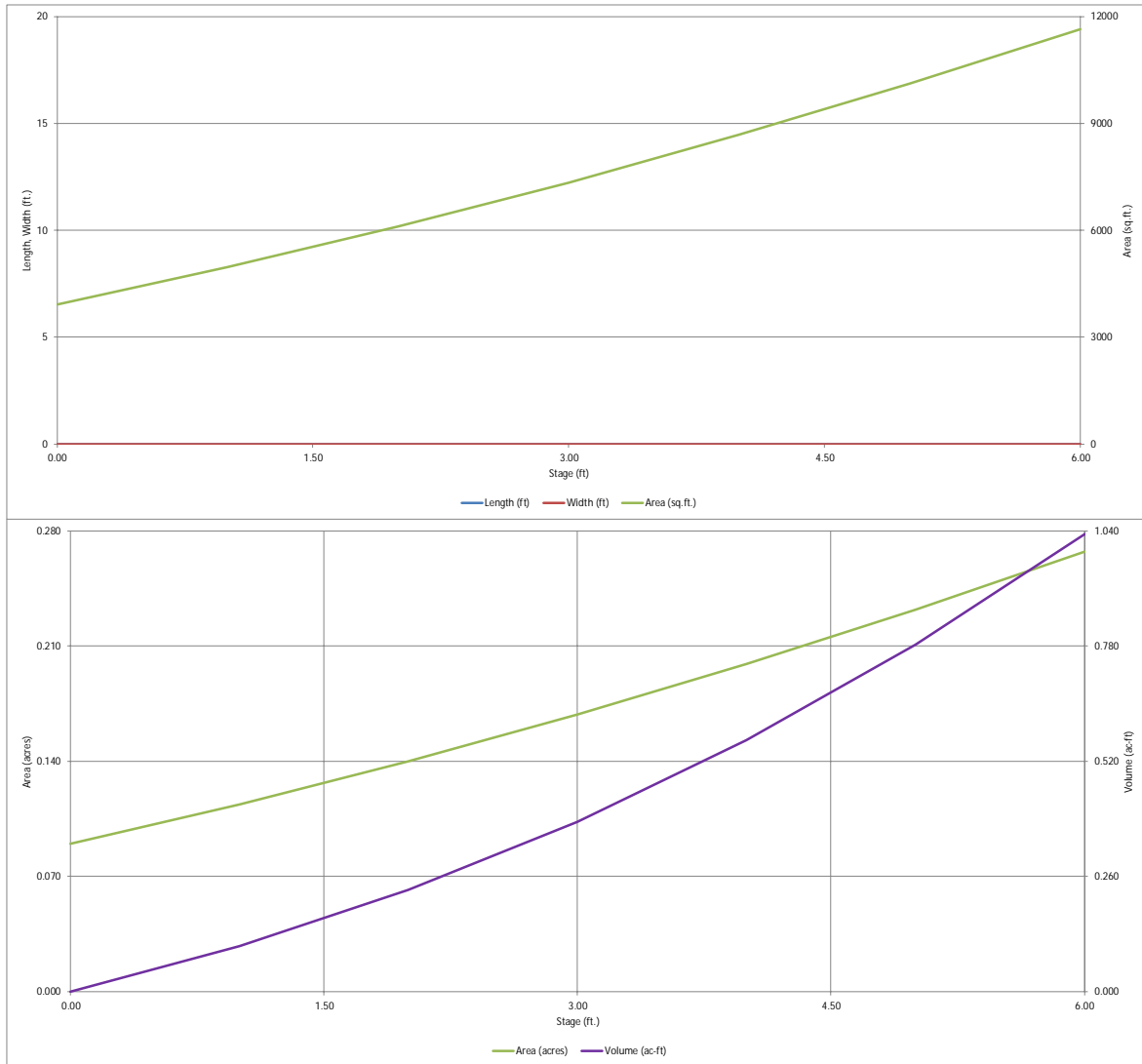

DETENTION BASIN STAGE-STORAGE TABLE BUILDER

MHFD-Detention, Version 4.06 (July 2022)

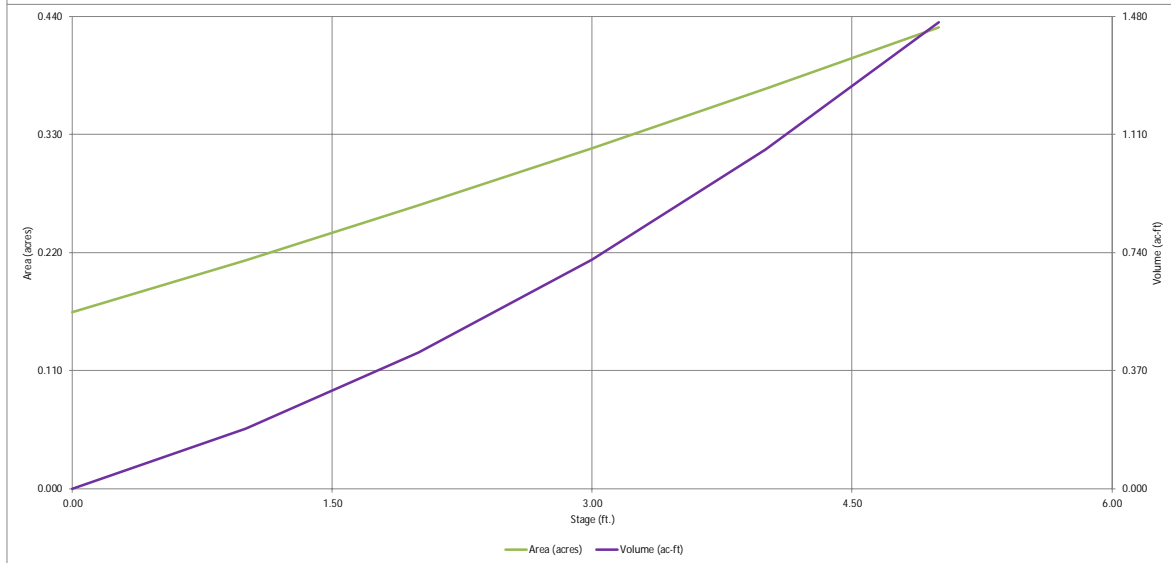
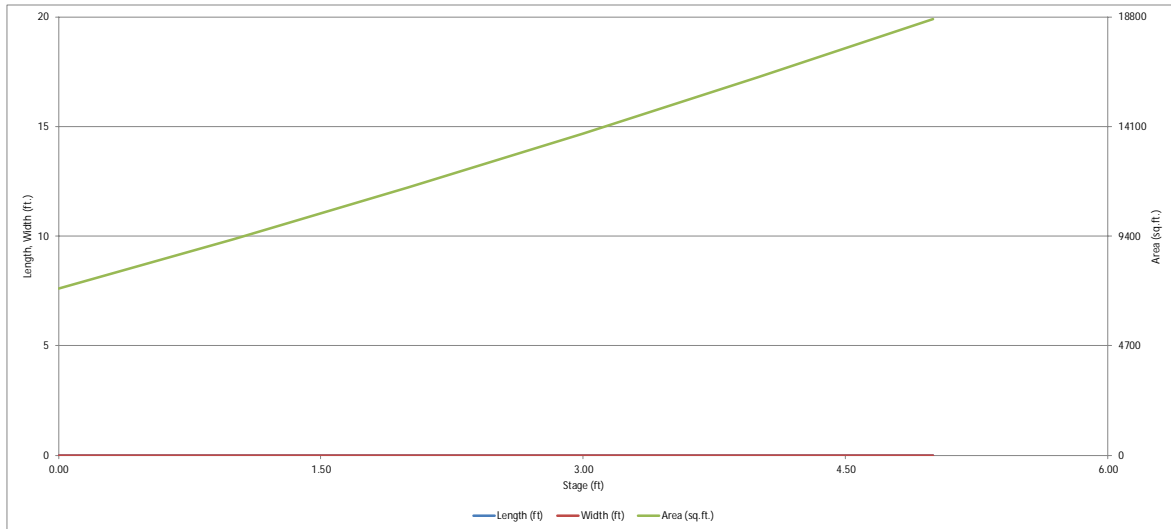

DETENTION BASIN STAGE-STORAGE TABLE BUILDER

MHFD-Detention, Version 4.06 (July 2022)

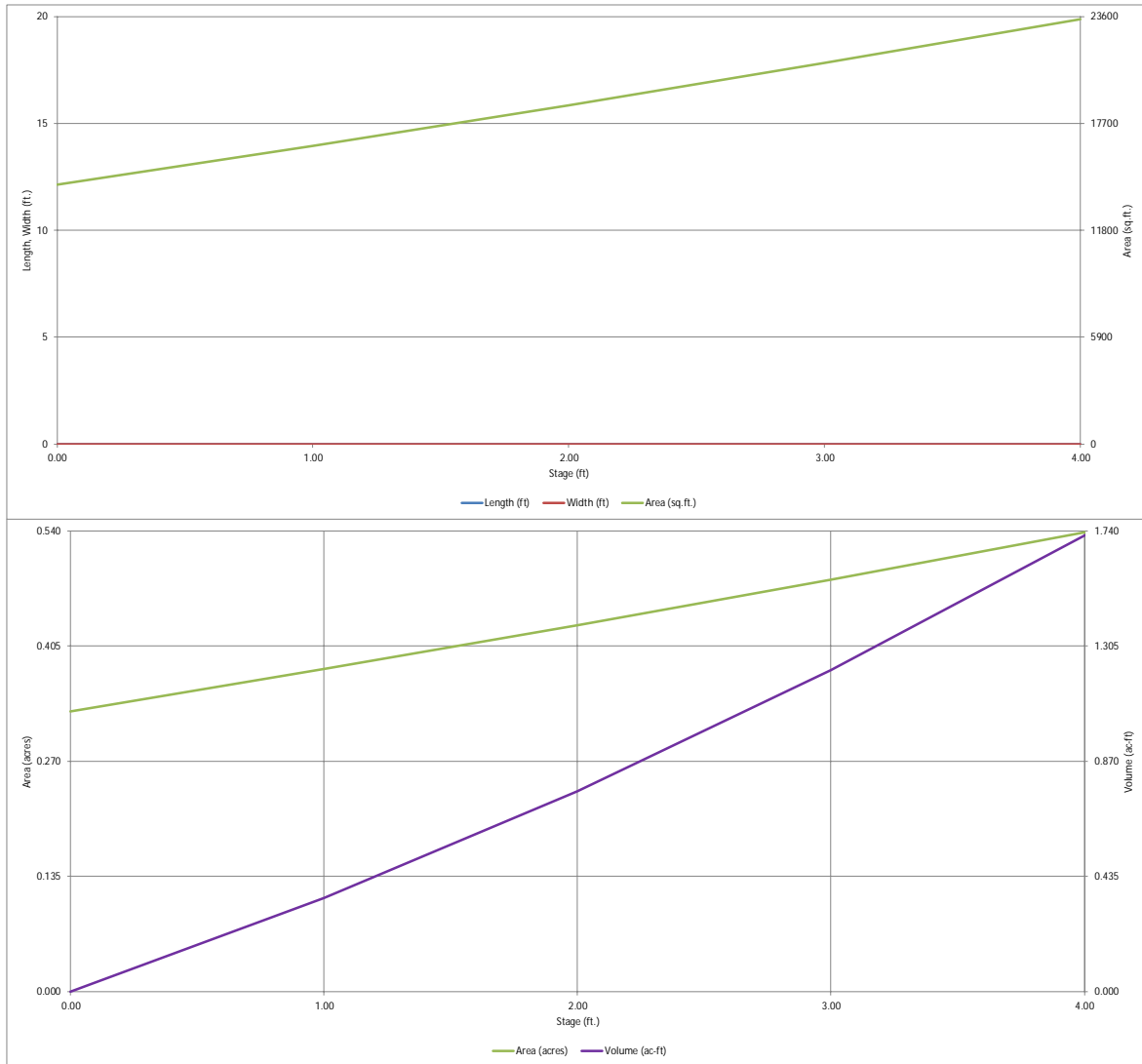

APPENDIX E: EL PASO COUNTY DRAINAGE BASIN MAP

Douglas County

Elbert County

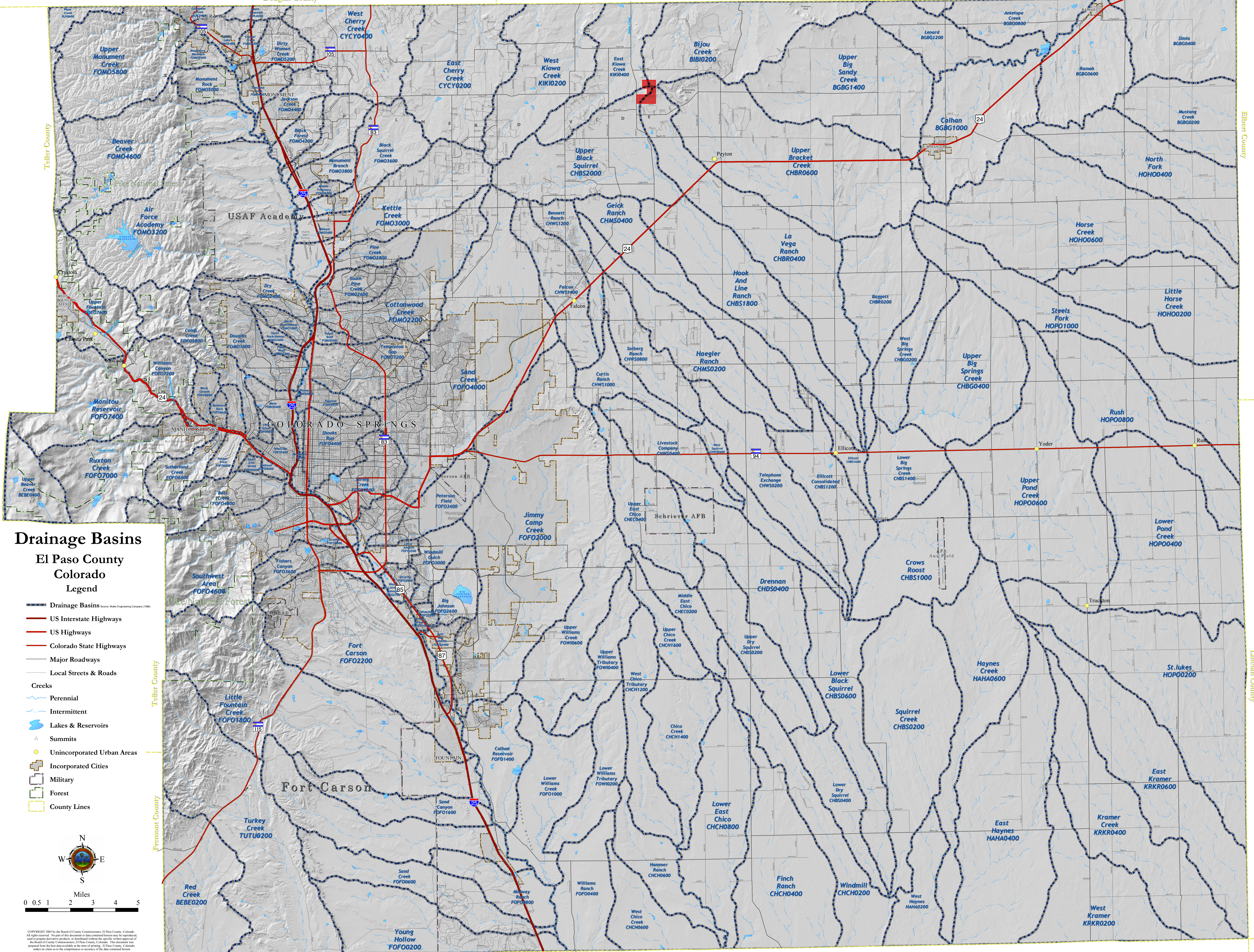

Drainage Basins

El Paso County Colorado Legend

- Drainage Basins (source: Muler Engineering Company 1986)
- US Interstate Highways
- US Highways
- Colorado State Highways
- Major Roadways
- Local Streets & Roads
- Creeks**
- Perennial
- Intermittent
- Lakes & Reservoirs
- Summits
- Unincorporated Urban Areas
- Incorporated Cities
- Military
- Forest
- County Lines



Copyright 2007 by the Board of County Commissioners, El Paso County, Colorado. All rights reserved. No part of this document or data contained herein may be reproduced or transmitted in any form or by any means, electronic or mechanical, including photocopying, recording, or by any information storage and retrieval system, without the prior written permission of the Board of County Commissioners, El Paso County, Colorado. This document was prepared from the best data available at the time of printing. El Paso County, Colorado, makes no claim as to the completeness or accuracy of the data contained herein.

APPENDIX F: APEX RANCH DRAINAGE REPORT

Design Procedure Form: Extended Detention Basin (EDB) - Sedimentation Facility

Designer: QUENTIN ARMIJO
 Company: TERRA NOVA ENG.
 Date: April 2, 2008
 Project: APEX RANCH ESTATES
 Location: PEYTON, CO

<p>1. Basin Storage Volume</p> <p>A) Tributary Area's Imperviousness Ratio ($i = I_a / 100$)</p> <p>B) Contributing Watershed Area (Area)</p> <p>C) Water Quality Capture Volume (WQCV) $(WQCV = 1.0 * (0.91 * I^3 - 1.19 * I^2 + 0.78 * I))$</p> <p>D) Design Volume: $Vol = (WQCV / 12) * Area * 1.2$</p>	<p>$I_a =$ <u>10.00</u> %</p> <p>$i =$ <u>0.10</u></p> <p>Area = <u>76.80</u> acres</p> <p>WQCV = <u>0.07</u> watershed inches</p> <p>Vol = <u>0.515</u> acre-feet</p>
<p>2. Outlet Works</p> <p>A) Outlet Type (Check One)</p> <p>B) Depth at Outlet Above Lowest Perforation (H)</p> <p>C) Required Maximum Outlet Area per Row, (A_o)</p> <p>D) Perforation Dimensions (enter one only): i) Circular Perforation Diameter OR ii) 2" Height Rectangular Perforation Width</p> <p>E) Number of Columns (nc, See Table 6a-1 For Maximum)</p> <p>F) Actual Design Outlet Area per Row (A_o)</p> <p>G) Number of Rows (nr)</p> <p>H) Total Outlet Area (A_{ot})</p>	<p><input checked="" type="checkbox"/> Orifice Plate <input type="checkbox"/> Perforated Riser Pipe Other: _____</p> <hr/> <p>H = <u>2.50</u> feet</p> <p>$A_o =$ <u>0.81</u> square inches</p> <p>D = <u>1.0000</u> inches, OR W = _____ inches</p> <p>$nc =$ <u>1</u> number</p> <p>$A_o =$ <u>0.79</u> square inches</p> <p>$nr =$ <u>8</u> number</p> <p>$A_{ot} =$ <u>5.89</u> square inches</p>
<p>3. Trash Rack</p> <p>A) Needed Open Area: $A_t = 0.5 * (\text{Figure 7 Value}) * A_{ot}$</p> <p>B) Type of Outlet Opening (Check One)</p> <p>C) For 2", or Smaller, Round Opening (Ref.: Figure 6a):</p> <p style="margin-left: 20px;">i) Width of Trash Rack and Concrete Opening (W_{conc}) from Table 6a-1</p> <p style="margin-left: 20px;">ii) Height of Trash Rack Screen (H_{TR})</p>	<p>$A_t =$ <u>200</u> square inches</p> <p><input checked="" type="checkbox"/> < 2" Diameter Round <input type="checkbox"/> 2" High Rectangular Other: _____</p> <hr/> <p>$W_{conc} =$ <u>9</u> inches</p> <p>$H_{TR} =$ <u>54</u> inches</p>

APEX RANCH ESTATES EL PASO COUNTY, COLORADO FINAL DRAINAGE MAP AUGUST 2008

412200006
COLLEEN KRASOVICH
3650 GARRISON ST
WHEAT RIDGE, CO.
ZONED A-35

DEVELOPED CONDITIONS

BASIN	ACRES	Q5 CFS	Q100 CFS
OS-1	72.1	45	102
OS-2	5.2	4	9
OS-3	21.9	13	29
OS-4	1.9	4	8
OS-5	0.7	1	3
A	28.2	29	64
B	0.6	2	3
C	6.9	6	12
D	4.7	4	9
E	10.0	8	18
G	4.7	5	10
H	13.0	10	22
I	4.2	4	8
J	4.4	5	11
K	23.2	22	50
M	18.2	15	33
N	4.2	5	10
O	4.0	4	9

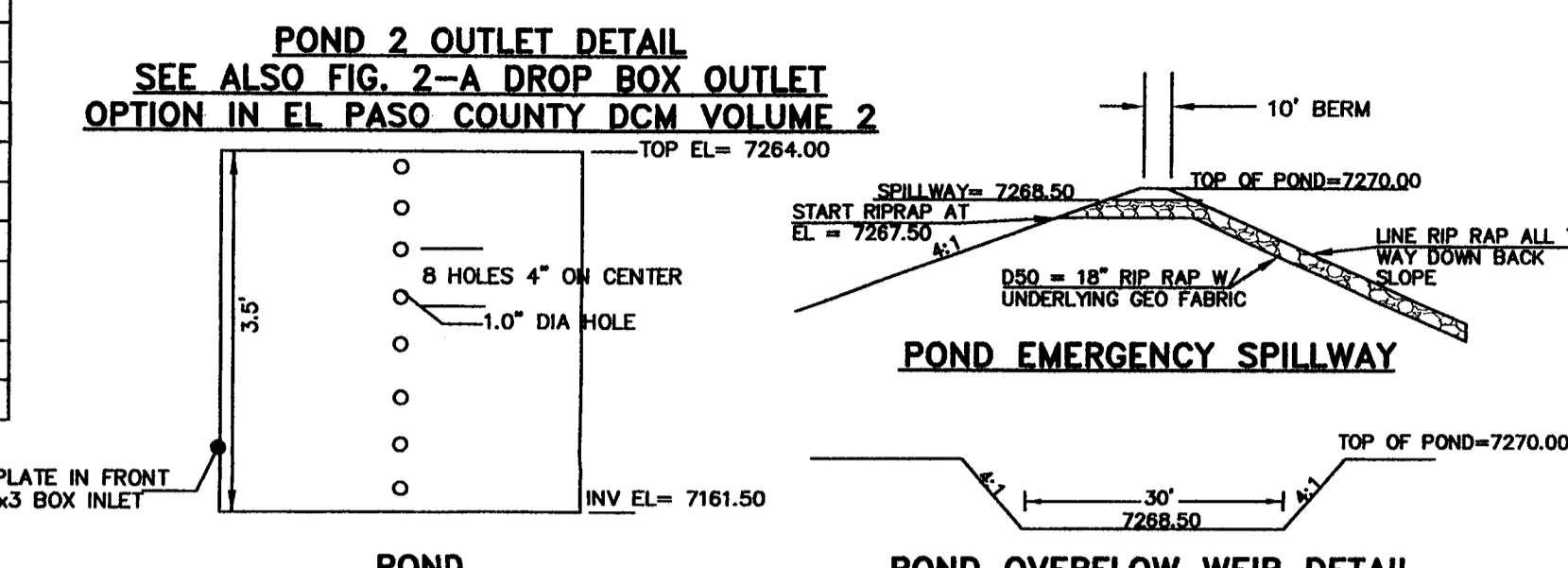
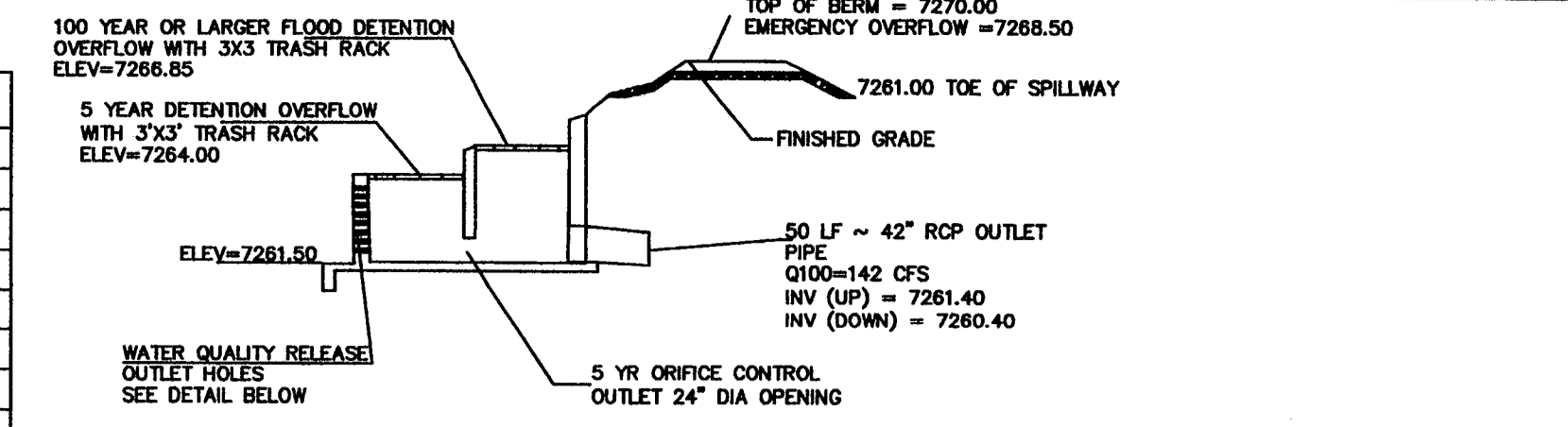

DESIGN POINT SUMMARY

DP	CONTRIBUTING BASINS	Q5 CFS	Q100 CFS
1	OS-1 & A	58	130
2	DP-1 & B	59	131
3	DP-2 & C	61	134
4	DP-3, D & E	68	148
5	DP-4, G & H	78	170
6	OS-2 & I	8	18
7	DP-5, DP-6, J & OS-4	87	188
8	OS-3 & K	29	64
9	DP-8, L, M, OS-5 & POND RELEASE	102	227
10	N & O	8	19

POND PERFORATED HOLE PATTERN

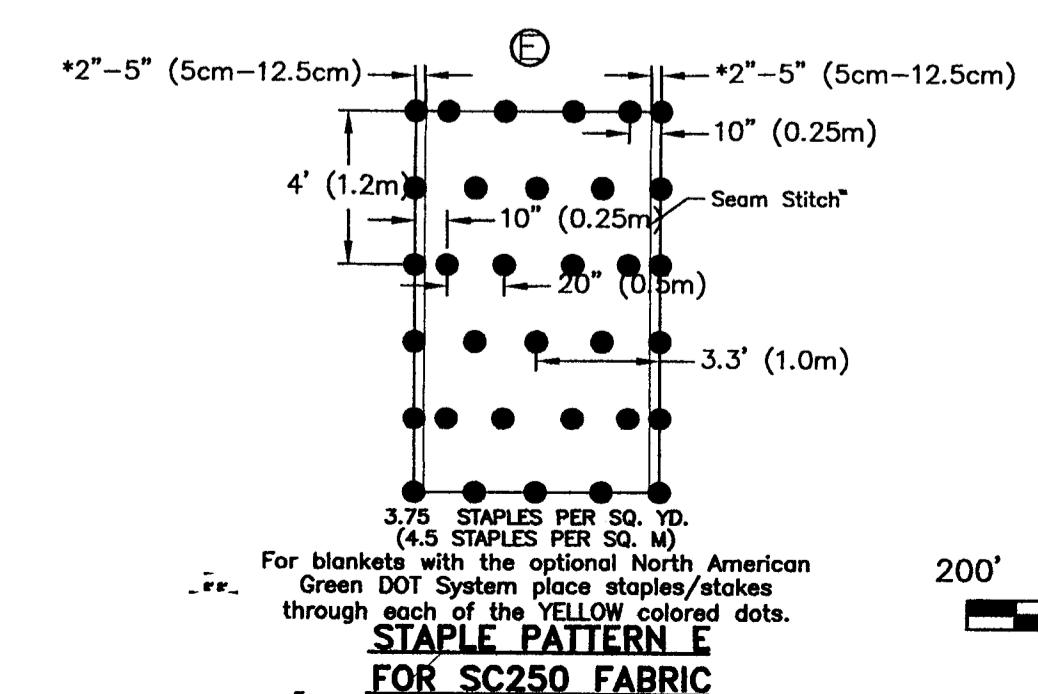
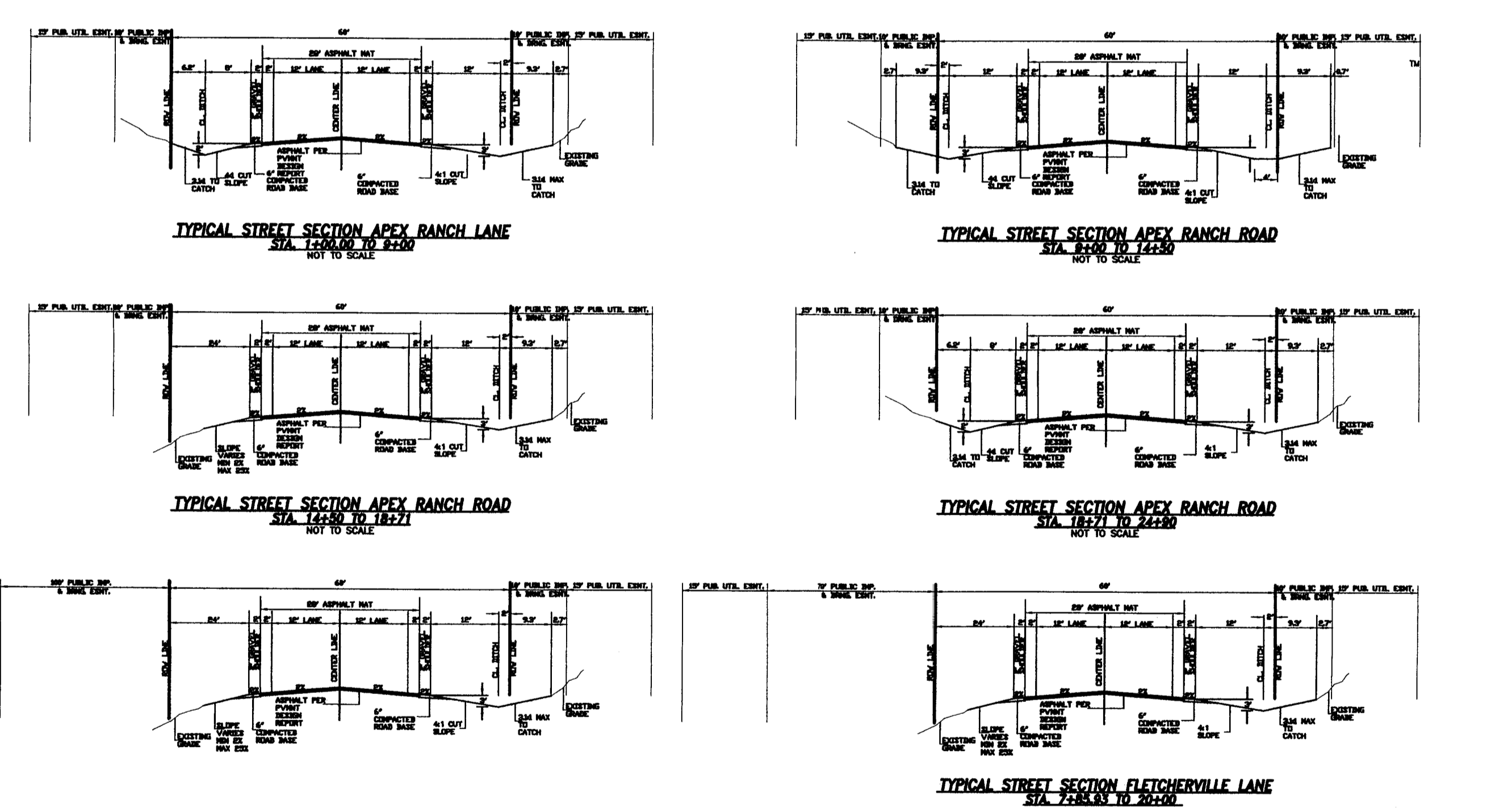
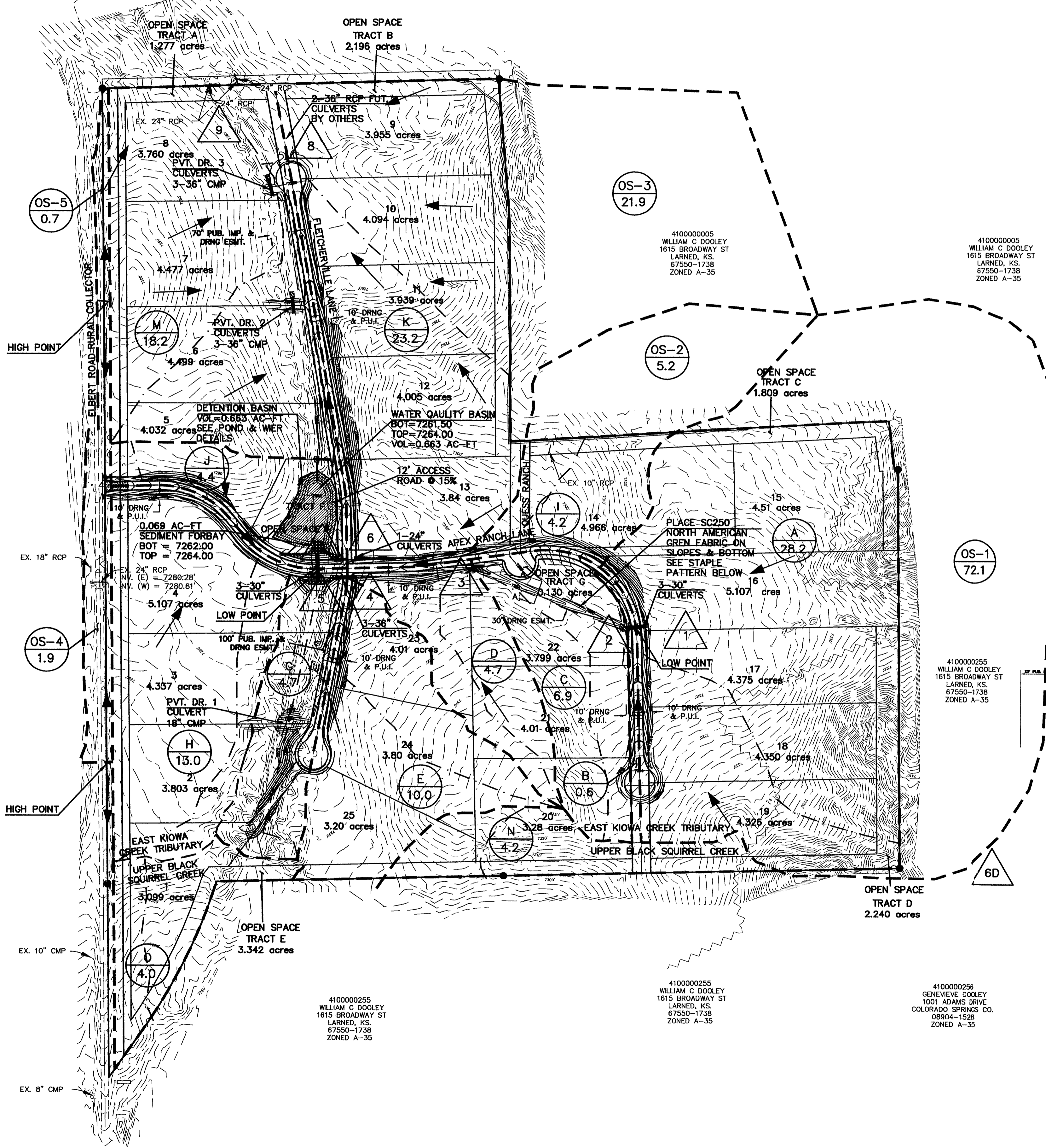
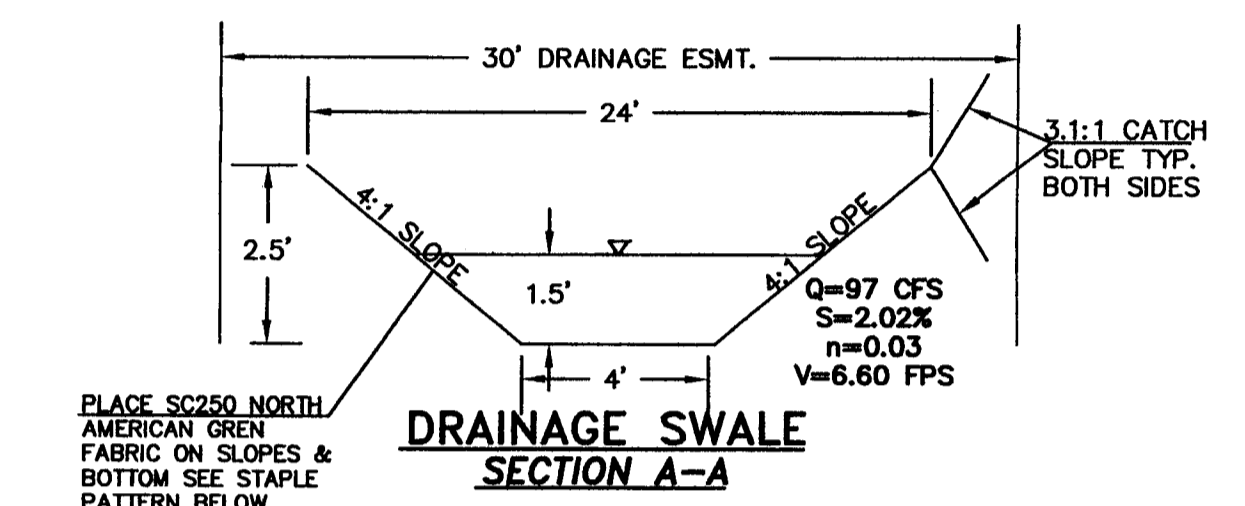

LEGEND

- EXISTING 10' CONTOUR
- EXISTING 2' CONTOUR
- PROPOSED 10' CONTOUR
- PROPOSED 2' CONTOUR
- PROPOSED CULVERT
- DIRECTION OF FLOW
- BASIN BOUNDARY
- TIME OF CONCENTRATION
- BASIN ID
- ACRES
- DESIGN POINT
- DETENTION AREA

DATE: 11/9/07
DESCRIPTION: REVISED PER COUNTY COMMENTS

REVISIONS:

UNTIL SUCH TIME AS THESE DRAWINGS ARE APPROVED BY THE APPROPRIATE TERRA NOVA ENGINEERING, INC. APPROVES THEIR USE ONLY FOR THE PURPOSES DESIGNATED BY WRITTEN AUTHORIZATION.

PREPARED FOR:
APEX RANCH ESTATES, LLC
ATTN: CRAIG MCCONNELL
P.O. BOX 267
PEYTON, COLORADO 80831

125 N. WAHSATCH AVE., SUITE 101
COLORADO SPRINGS, CO. 80903
OFFICE: 719-635-6422
FAX: 719-635-6426
www.tnainc.com

Terra Nova
Engineering, Inc.
Professional Engineer
No. 11515

APEX RANCH ESTATES
FINAL DRAINAGE MAP
DEVELOPED CONDITIONS

DESIGNED BY QNA
DRAWN BY LAE
CHECKED BY LDR

H-SCALE 1"=200'
V-SCALE





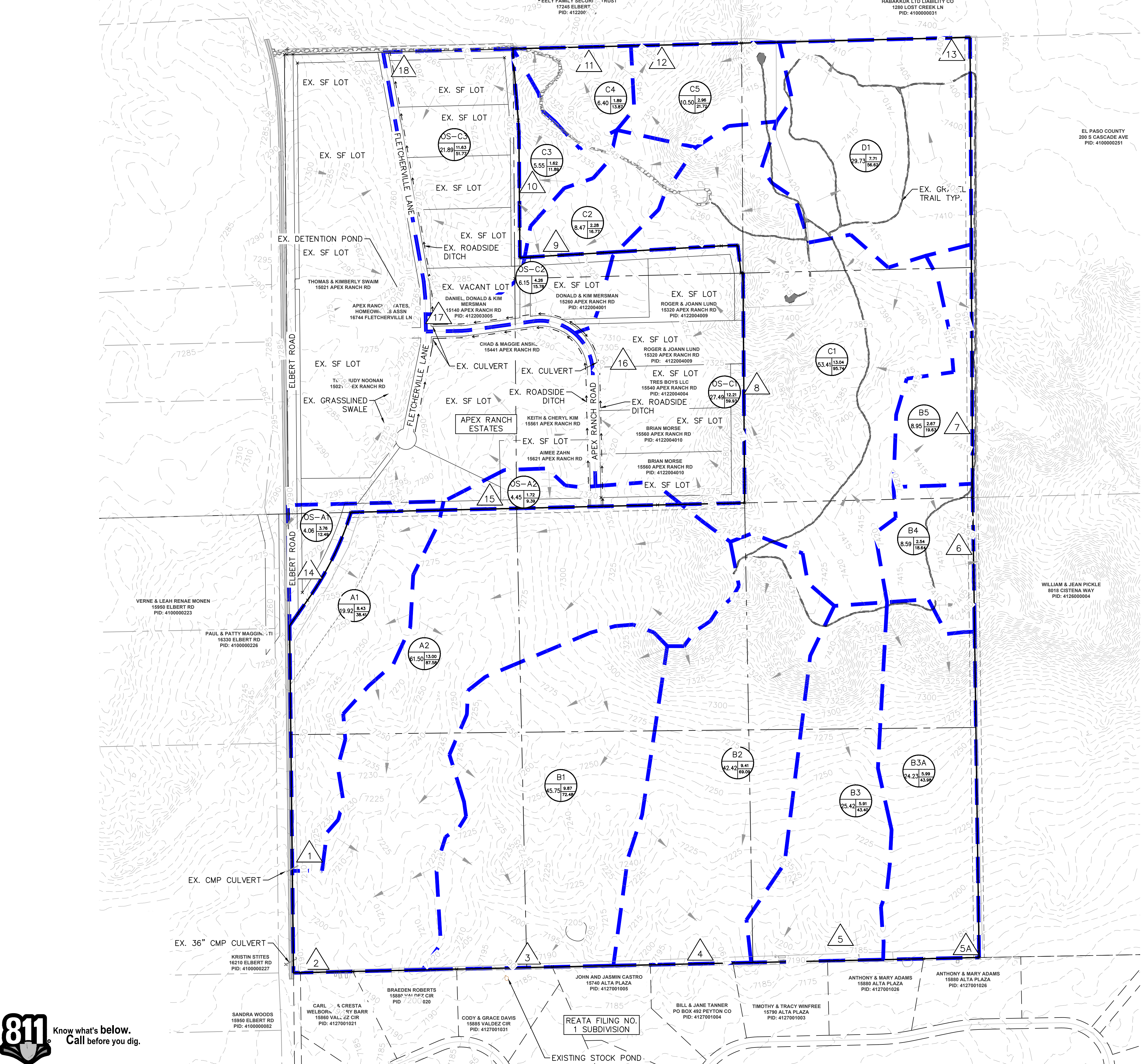

JOB NO. 0565.00
DATE ISSUED 8/26/08
SHEET NO. 1 OF 1

APPENDIX G: DRAINAGE MAPS

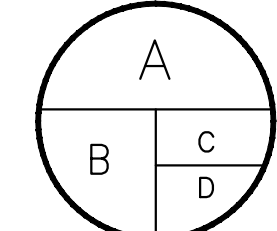
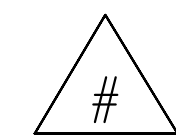
THIS DOCUMENT, TOGETHER WITH THE CONCEPTS AND DESIGNS PRESENTED HEREIN, AS AN INSTRUMENT OF SERVICE, IS INTENDED ONLY FOR THE SPECIFIC PURPOSE AND CLIENT FOR WHICH IT WAS PREPARED. REUSE OF AND IMPROPER RELIANCE ON THIS DOCUMENT WITHOUT WRITTEN AUTHORIZATION AND ADAPTATION BY KIMLEY-HORN AND ASSOCIATES, INC. SHALL BE WITHOUT LIABILITY TO KIMLEY-HORN AND ASSOCIATES, INC.

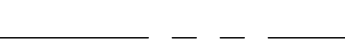

LEGEND

-  A = BASIN DESIGNATION
B = AREA (ACRES)
C = BASIN IMPERVIOUSNESS
D = 100YR DESIGN STORM RUNOFF (CFS)
-  # = DESIGN POINT
-  EXISTING FLOW DIRECTION
-  PROPERTY LINE
-  DRAINAGE BASIN BOUNDARY
-  EXISTING MAJOR CONTOUR
-  EXISTING MINOR CONTOUR

- A - Upper Black Squirrel Drainage Basin (CHBS2000)
- B - La Vega Ranch Drainage Basin (CHBR0400)
- C - East Kiowa Creek Drainage Basin (KIKI0400)
- D - Bijou Creek Drainage Basin (BIBI0200)

EXISTING CONDITIONS RATIONAL CALCULATIONS SUMMARY						
DESIGN POINT	TRIBUTARY BASINS	TRIBUTARY AREA (AC)	CFS			% IMPERVIOUS
			Q2	Q5	Q100	
PDR Basins						
1	A1	19.92	4.19	8.43	38.41	8%
2	A2	61.50	3.44	13.00	87.58	1%
3	B1	45.75	1.98	9.87	72.48	0%
4	B2	42.42	1.88	9.41	69.09	0%
5	B3	25.42	1.18	5.91	43.40	0%
5A	B3A	24.23	1.20	5.99	43.98	0%
6	B4	8.59	0.51	2.54	18.64	0%
7	B5	8.95	0.53	2.67	19.63	0%
8	C1	53.41	2.61	13.04	95.74	0%
9	C2	8.47	0.46	2.28	16.77	0%
10	C3	5.55	0.32	1.62	11.89	0%
11	C4	6.40	0.38	1.89	13.87	0%
12	C5	10.50	0.59	2.96	21.72	0%
13	D1	29.73	1.54	7.71	56.62	0%
14	OS-A1	4.06	2.36	3.76	12.49	19%
15	OS-A2	4.45	0.57	1.72	9.39	7%
16	OS-C1	27.49	4.90	12.21	59.93	9%
17	OS-C2	6.15	2.35	4.26	15.78	17%
18	OS-C3	21.89	5.33	11.63	51.77	11%
ON-SITE BASIN TOTAL						
BASIN A TOTAL		81.42	7.63	21.43	125.99	3%
BASIN B TOTAL		155.36	7.28	36.39	267.21	0%
BASIN C TOTAL		84.33	4.35	21.78	159.98	0%
BASIN D TOTAL		29.73	1.54	7.71	56.62	0%
ON-SITE TOTAL		350.84	20.80	87.31	609.79	1%
OFF-SITE BASIN TOTAL						
OFF-SITE BASIN A		6.51	2.93	5.48	21.87	13%
OFF-SITE BASIN C		55.53	12.58	28.11	127.48	11%
OFF-SITE TOTAL		64.04	15.52	33.59	149.36	11%
SITE TOTAL		414.88	36.32	120.90	759.15	2%

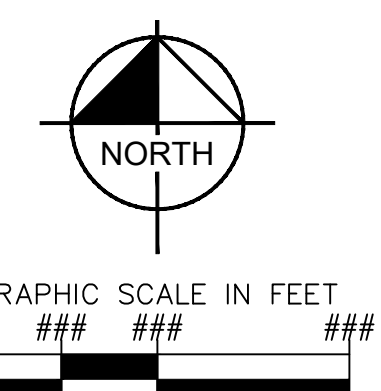

NO.
REVISION
BY
DATE



2023 KIMLEY-HORN AND ASSOCIATES, INC.
2 N NEVADA ST., SUITE 900
COLORADO SPRINGS, CO 80903 719-453-0180

DESIGNED BY: KRK
DRAWN BY: AJL
CHECKED BY: KRK
DATE: 11/27/23

OVERLOOK FILING NO. 1
EL PASO COUNTY, COLORADO
PRELIMINARY DESIGN PLANS
EXISTING DRAINAGE MAP

PRELIMINARY
FOR REVIEW ONLY
NOT FOR
CONSTRUCTION







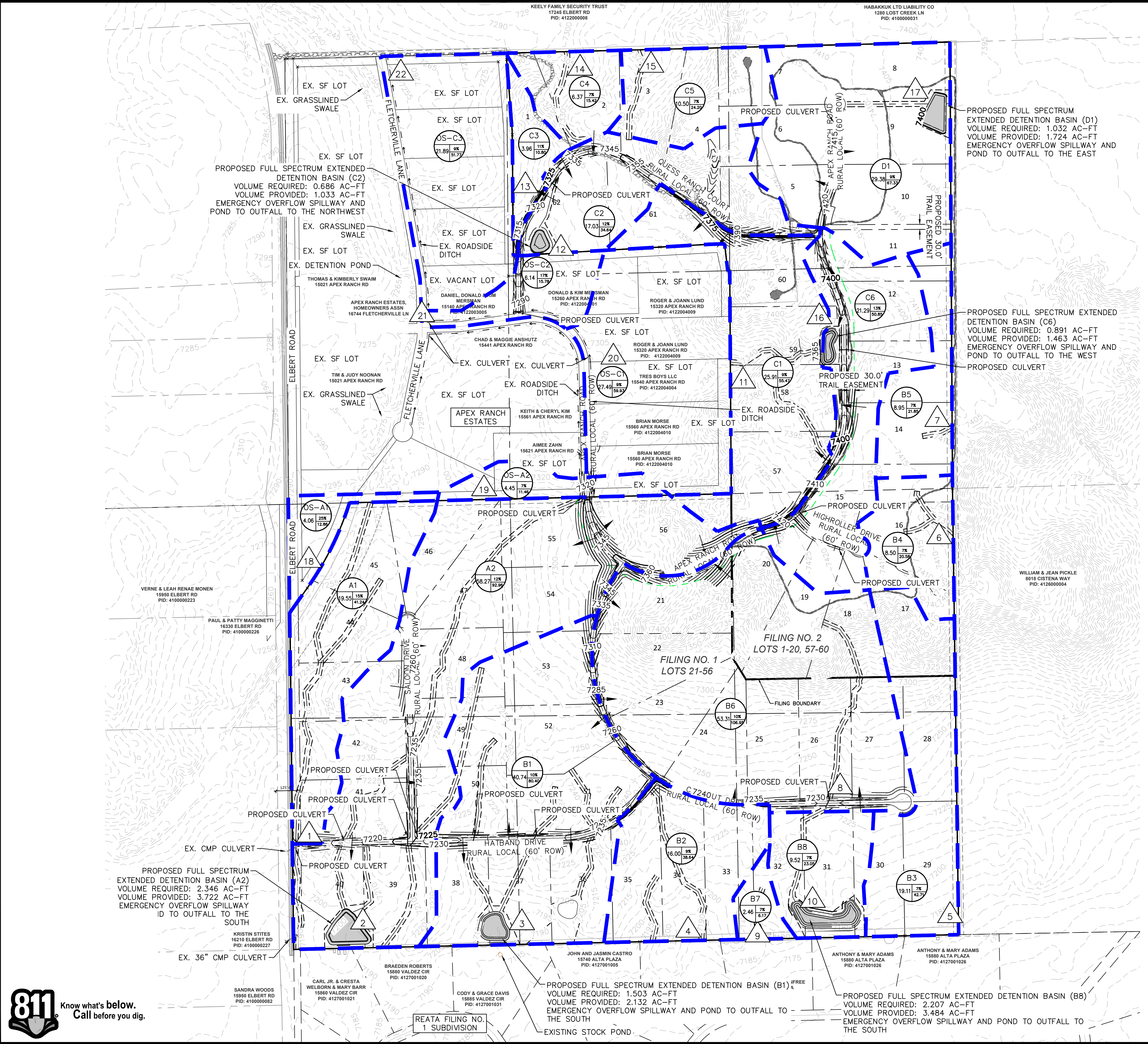

PROJECT NO.
196239003

SHEET
EX-1

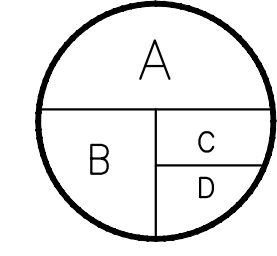
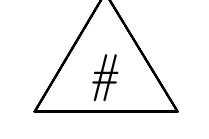
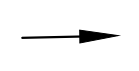
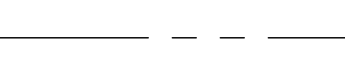
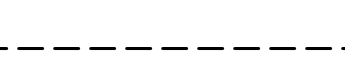
THIS DOCUMENT, TOGETHER WITH THE CONCEPTS AND DESIGNS PRESENTED HEREIN, AS AN INSTRUMENT OF SERVICE, IS INTENDED ONLY FOR THE SPECIFIC PURPOSE AND CLIENT FOR WHICH IT WAS PREPARED. REUSE OF AND IMPROPER RELIANCE ON THIS DOCUMENT WITHOUT WRITTEN AUTHORIZATION AND ADAPTATION BY KIMLEY-HORN AND ASSOCIATES, INC. SHALL BE WITHOUT LIABILITY TO KIMLEY-HORN AND ASSOCIATES, INC.

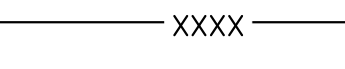

LEGEND

-  A = BASIN DESIGNATION
B = AREA (ACRES)
C = BASIN IMPERVIOUSNESS
D = 100YR DESIGN STORM RUNOFF (CFS)
-  # = DESIGN POINT
-  PROPOSED FLOW DIRECTION
-  PROPOSED PROPERTY LINE
-  EXISTING PROPERTY LINE
-  PROPOSED EASEMENT LINE
-  DRAINAGE BASIN BOUNDARY
-  EXISTING MAJOR CONTOUR
-  EXISTING MINOR CONTOUR
-  PROPOSED MAJOR CONTOUR
-  PROPOSED MINOR CONTOUR

EASEMENT NOTE

- ALL PROPOSED EASEMENTS ARE 30' DRAINAGE EASEMENTS UNLESS OTHERWISE NOTED

- A - Upper Branch Squirrel Drainage Basin (CHBS2000)
- B - La Vega Ranch Drainage Basin (CHBR0400)
- C - East Kiowa Creek Drainage Basin (KIKI0400)
- D - Bijou Creek Drainage Basin (BIBI0200)

PROPOSED CONDITIONS RATIONAL CALCULATIONS SUMMARY

DESIGN POINT	TRIBUTARY BASINS	TRIBUTARY AREA (AC)	CFS			% IMPERVIOUS
			Q2	Q5	Q100	
PDR Basins						
1	A1	19.55	5.41	10.41	41.24	15%
2	A2	58.27	9.71	20.99	92.96	12%
3	B1	40.74	6.97	16.77	80.40	10%
4	B2	16.00	3.10	7.82	38.64	9%
5	B3	19.11	2.61	7.83	42.71	7%
6	B4	8.50	1.25	3.77	20.58	7%
7	B5	8.95	1.33	4.01	21.85	7%
8	B6	53.31	9.52	22.55	106.95	10%
9	B7	2.46	0.38	1.13	6.17	7%
10	B8	9.52	1.41	4.22	23.05	7%
11	C1	25.91	4.42	11.18	55.47	9%
12	C2	17.03	3.87	8.08	34.64	12%
13	C3	3.96	1.04	2.36	10.80	11%
14	C4	6.37	0.94	2.83	15.42	7%
15	C5	10.50	1.48	4.44	24.20	7%
16	C6	21.29	6.09	12.27	50.85	13%
17	D1	29.38	5.34	13.56	67.33	9%
18	OS-A1	4.06	2.57	4.12	12.86	25%
19	OS-A2	4.45	0.70	2.10	11.46	7%
20	OS-C1	27.49	4.90	12.21	59.93	9%
21	OS-C2	6.15	2.35	4.26	15.78	17%
22	OS-C3	21.89	5.33	11.63	51.77	11%
ON-SITE BASIN TOTAL						
BASIN A TOTAL		77.82	15.12	31.40	134.20	12%
BASIN B TOTAL		158.59	26.57	68.09	340.34	8%
BASIN C TOTAL		85.06	17.84	41.15	191.38	10%
BASIN D TOTAL		29.38	4.90	12.21	59.93	9%
ON-SITE TOTAL		350.85	49.75	122.80	599.06	10%
OFF-SITE BASIN TOTAL						
OFF-SITE BASIN A		8.51	3.27	6.22	24.32	15%
OFF-SITE BASIN C		55.53	12.58	28.11	127.48	11%
OFF-SITE TOTAL		64.04	15.85	34.33	151.80	12%
SITE TOTAL		414.89	65.60	157.13	750.86	10%

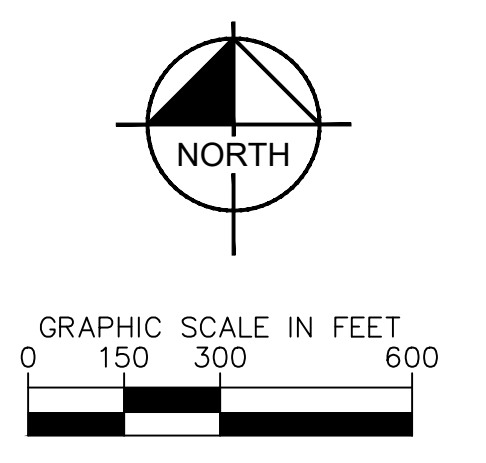

NO.	REVISION	BY	DATE	APPR

Kimley-Horn
 2023 KIMLEY-HORN AND ASSOCIATES, INC.
 2 N NEVADA ST., SUITE 900
 COLORADO SPRINGS, CO 80903 719-453-0180

DESIGNED BY: KRK
 DRAWN BY: AJL
 CHECKED BY: KRK
 DATE: 11/27/23

OVERLOOK FILING NO. 1
 EL PASO COUNTY, COLORADO
 PRELIMINARY DESIGN PLANS
PROPOSED DRAINAGE MAP

PRELIMINARY
 FOR REVIEW ONLY
 NOT FOR
 CONSTRUCTION

PROJECT NO.
196239003
 SHEET
EX-2

Drainage Basin Exhibit

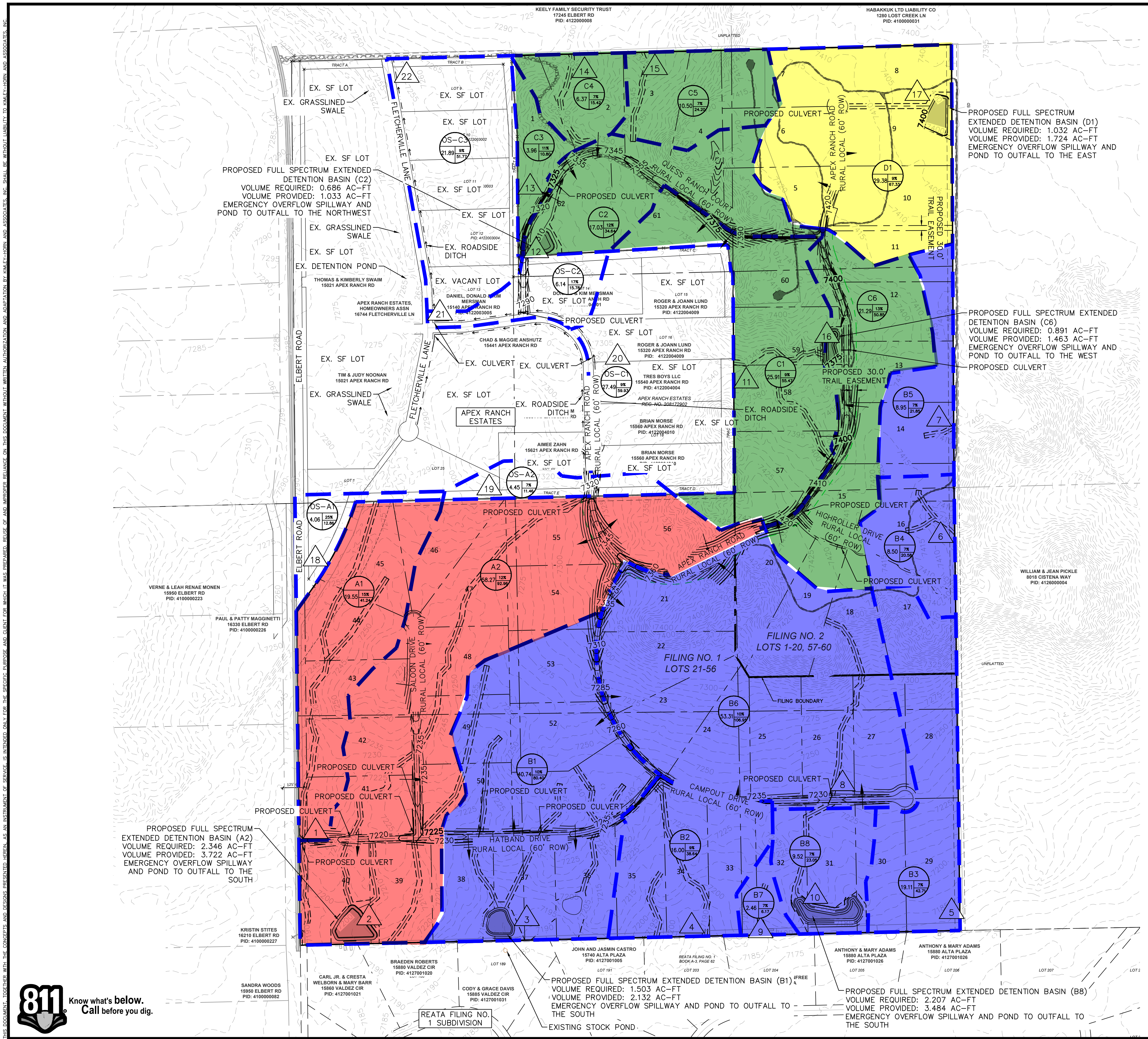

LEGEND

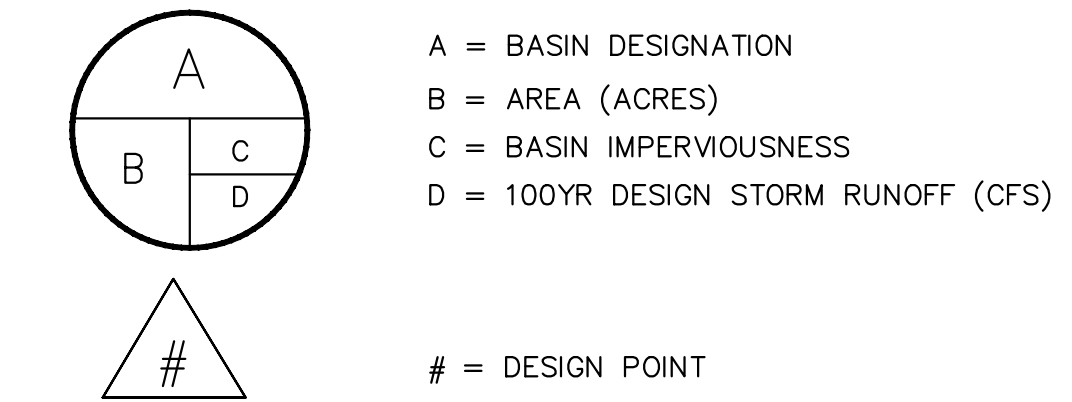

EASEMENT NOTE

1. ALL PROPOSED EASEMENTS ARE 30' DRAINAGE EASEMENTS UNLESS OTHERWISE NOTED

- A - Upper Black Squirrel Drainage Basin (CHBS2000)
- B - La Vega Ranch Drainage Basin (CHBR0400)
- C - East Kiowa Creek Drainage Basin (KIKI0400)
- D - Bijou Creek Drainage Basin (BIBI0200)

PROPOSED CONDITIONS RATIONAL CALCULATIONS SUMMARY

DESIGN POINT	TRIBUTARY BASINS	TRIBUTARY AREA (AC)	CFS			% IMPERVIOUS
			Q2	Q5	Q100	
PDR Basins						
1	A1	19.55	5.41	10.41	41.24	15%
2	A2	58.27	9.71	20.99	92.96	12%
3	B1	40.74	6.97	16.77	80.40	10%
4	B2	16.00	3.10	7.82	38.64	9%
5	B3	19.11	2.61	7.83	42.71	7%
6	B4	8.50	1.25	3.77	20.58	7%
7	B5	8.95	1.33	4.01	21.85	7%
8	B6	53.31	9.52	22.55	106.95	10%
9	B7	2.46	0.38	1.13	6.17	7%
10	B8	9.52	1.41	4.22	23.05	7%
11	C1	25.91	4.42	11.18	55.47	9%
12	C2	17.03	3.87	8.08	34.64	12%
13	C3	3.96	1.04	2.36	10.80	11%
14	C4	6.37	0.94	2.83	15.42	7%
15	C5	10.50	1.48	4.44	24.20	7%
16	C6	21.29	6.09	12.27	50.85	13%
17	D1	29.38	5.34	13.56	67.33	9%
18	OS-A1	4.06	2.57	4.12	12.86	25%
19	OS-A2	4.45	0.70	2.10	11.46	7%
20	OS-C1	27.49	4.90	12.21	59.93	9%
21	OS-C2	6.15	2.35	4.26	15.78	17%
22	OS-C3	21.89	5.33	11.63	51.77	11%
ON-SITE BASIN TOTAL						
BASIN A TOTAL		77.82	15.12	31.40	134.20	12%
BASIN B TOTAL		158.59	26.57	68.09	340.34	8%
BASIN C TOTAL		85.06	17.84	41.15	191.38	10%
BASIN D TOTAL		29.38	4.90	12.21	59.93	9%
ON-SITE TOTAL		350.85	49.75	122.80	599.06	10%
OFF-SITE BASIN TOTAL						
OFF-SITE BASIN A		8.51	3.27	6.22	24.32	15%
OFF-SITE BASIN C		55.53	12.58	28.11	127.48	11%
OFF-SITE TOTAL		64.04	15.85	34.33	151.80	12%
SITE TOTAL		414.89	65.60	157.13	750.86	10%

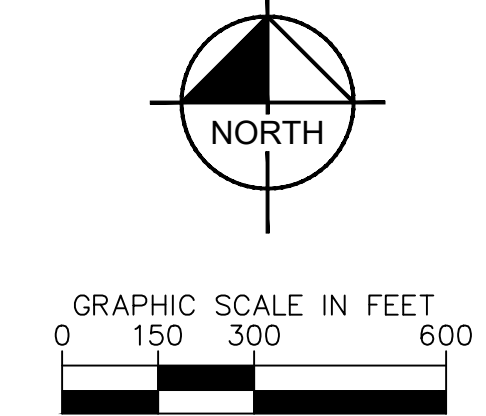

NO.
REVISION
BY
DATE

2023 KIMLEY-HORN AND ASSOCIATES, INC.
2 N NEVADA ST., SUITE 900
COLORADO SPRINGS, CO 80903 719-453-0180

DESIGNED BY: KRK
DRAWN BY: AJL
CHECKED BY: KRK
DATE: 11/27/23

OVERLOOK FILING NO. 1
EL PASO COUNTY, COLORADO
PRELIMINARY DESIGN PLANS
PROPOSED DRAINAGE MAP

PRELIMINARY
FOR REVIEW ONLY
NOT FOR
CONSTRUCTION

PROJECT NO.
196239003

SHEET

EX-2



THIS DOCUMENT, TOGETHER WITH THE CONCEPTS AND DESIGNS PRESENTED HEREIN, IS AN INSTRUMENT OF SERVICE. IT IS INTENDED ONLY FOR THE SPECIFIC PURPOSE AND CLIENT FOR WHICH IT WAS PREPARED. REUSE OF AND IMPROPER RELIANCE ON THIS DOCUMENT WITHOUT WRITTEN AUTHORIZATION AND ADAPTATION BY KIMLEY-HORN AND ASSOCIATES, INC. SHALL BE WITHOUT LIABILITY TO KIMLEY-HORN AND ASSOCIATES, INC.

THIS DOCUMENT, TOGETHER WITH THE CONCEPTS AND DESIGNS PRESENTED HEREIN, AS AN INSTRUMENT OF SERVICE, IS INTENDED ONLY FOR THE SPECIFIC PURPOSE AND CLIENT FOR WHICH IT WAS PREPARED. REUSE OF AND IMPROPER RELIANCE ON THIS DOCUMENT WITHOUT WRITTEN AUTHORIZATION AND ADAPTATION BY KIMLEY-HORN AND ASSOCIATES, INC. SHALL BE WITHOUT LIABILITY TO KIMLEY-HORN AND ASSOCIATES, INC.

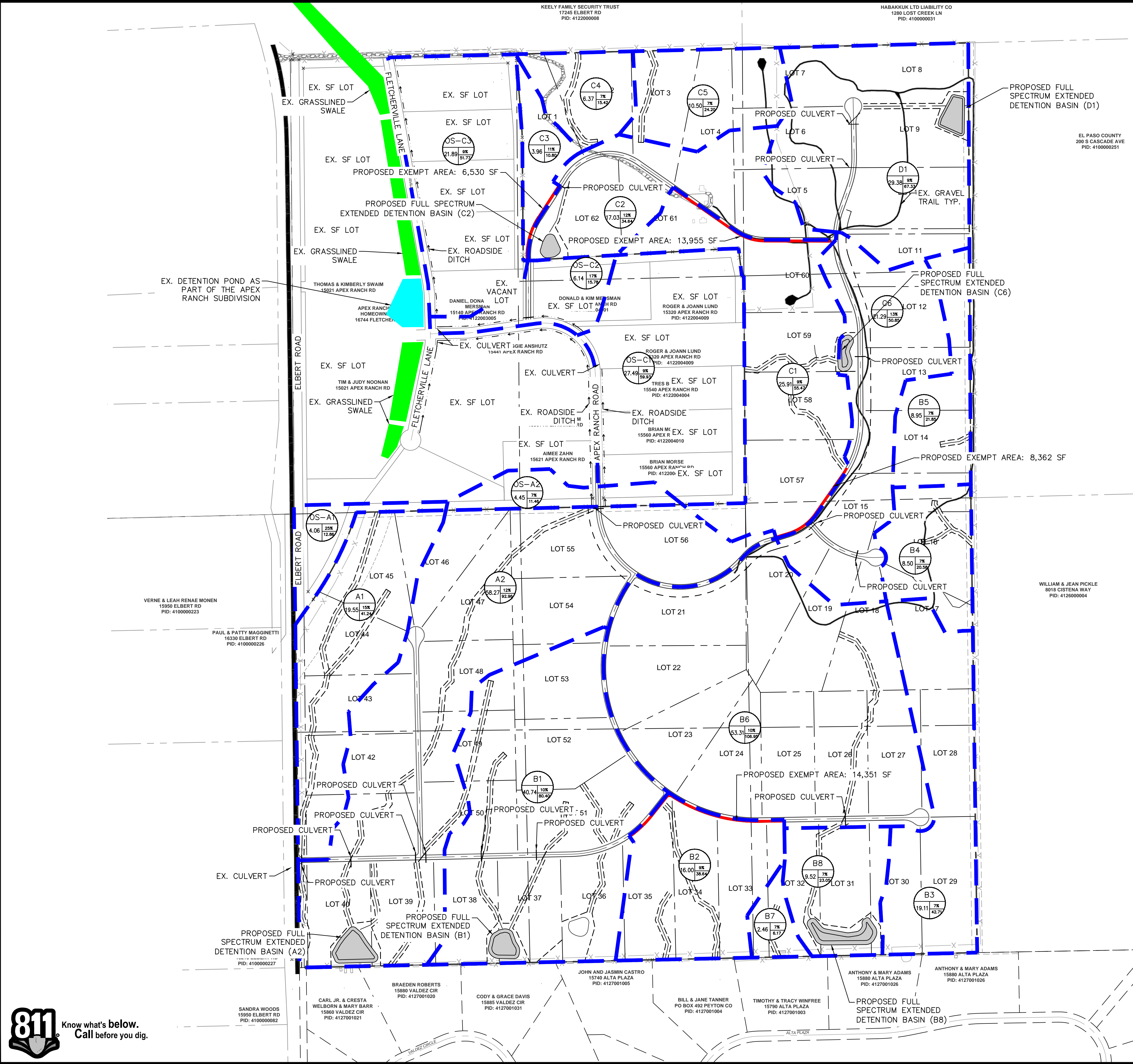

LEGEND

- | | |
|--|-------------------------------------|
| | A = BASIN DESIGNATION |
| | B = AREA (ACRES) |
| | C = BASIN IMPERVIOUSNESS |
| | D = 100YR DESIGN STORM RUNOFF (CFS) |
| | PROPOSED PROPERTY LINE |
| | EXISTING PROPERTY LINE |
| | PROPOSED EASEMENT LINE |
| | DRAINAGE BASIN BOUNDARY |
| | EXISTING STORMWATER POND |
| | EXISTING GRASSLINED DRAINAGE SWALE |
| | PROPOSED EXEMPT AREA |

EASEMENT NOTE

- ALL PROPOSED EASEMENTS ARE 30' DRAINAGE EASEMENTS UNLESS OTHERWISE NOTED

EXEMPT AREAS (ECM I.7.1.C.1)

BASIN B2	= ±14,351 SF
BASIN C1	= ±22,316 SF
BASIN C3	= ±6,530 SF
TOTAL	= ±43,197 SF (0.99 ACRES)

Please shade areas utilizing the large lot exclusion, treated areas, and any basins that will not be developed (ie existing off-site basins not effected by the project). So it is clear the areas that will be treated and all exempt areas including the excluded areas.

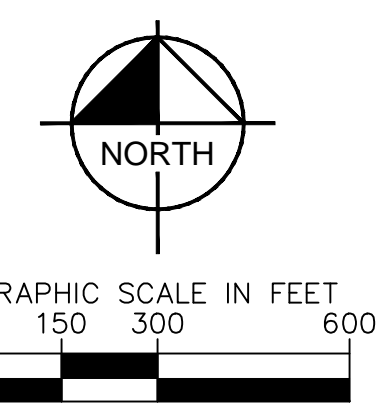

NO.	REVISION	BY	DATE

Kimley»Horn
 2023 KIMLEY-HORN AND ASSOCIATES, INC.
 2 N NEVADA ST., SUITE 900
 COLORADO SPRINGS, CO 80903 719-453-0180

DESIGNED BY: KRK
 DRAWN BY: AJL
 CHECKED BY: KRK
 DATE: 11/27/23

OVERLOOK FILING NO. 1
 EL PASO COUNTY, COLORADO
 PRELIMINARY DESIGN PLANS
 EXCLUSION EXHIBIT DRAINAGE MAP

PRELIMINARY
 FOR REVIEW ONLY
 NOT FOR
 CONSTRUCTION

 Kimley-Horn and Associates, Inc.

PROJECT NO.
 196239003
 SHEET
EX-3