



LSC TRANSPORTATION CONSULTANTS, INC.
2504 East Pikes Peak Avenue, Suite 304
Colorado Springs, CO 80909
(719) 633-2868
FAX (719) 633-5430
E-mail: lsc@lsctrans.com
Website: <http://www.lsctrans.com>

Sterling Ranch Sketch Plan Amendment #4
Sterling Ranch East Filing No. 7 Site Rezone
PCD File No.: SKP241 add P2415
Master Traffic Impact Study
Addendum/Technical Memorandum

Please ensure that the same versions are used for both SKP241 and P2415

(LSC #S244270)
October 25, 2024

Traffic Engineer's Statement

This traffic report and supporting information were prepared under my responsible charge and they comport with the standard of care. So far as is consistent with the standard of care, said report was prepared in general conformance with the criteria established by the County for traffic reports.



Developer's Statement

I, the Developer, have read and will comply with all commitments made on my behalf within this report.

[Signature]

11/5/2024
Date

Sterling Ranch Sketch Plan Amendment #4

Sterling Ranch East Filing No. 7 Site Rezone

Prepared for:
Loren J. Moreland
Vice President/ Project Manager
Classic SRJ
2138 Flying Horse Club Drive
Colorado Springs, CO 80921

OCTOBER 25, 2024

LSC Transportation Consultants
Prepared by: Kirstin D. Ferrin, P.E.
Reviewed by: Jeffrey C. Hodsdon, P.E.

LSC #S244270

PCD File No.: SKP241



CONTENTS

REPORT CONTENTS 1

RECENT TRAFFIC REPORTS 2

 Briargate-Stapleton Corridor Study/PPACG Model 2

STUDY AREA 3

 Sketch Plan 3

 Previous Sketch Plan Amendment - No. 3 3

 Currently Proposed Amendment No. 4 3

 Study-Area Access Plan 4

 Deviation Requests 5

EXISTING ROAD AND TRAFFIC CONDITIONS 5

 Existing Traffic Volumes 6

 Existing Levels of Service 6

 Safety and Accident Analysis 7

BASELINE CONDITIONS 7

TRIP GENERATION 8

TRIP DISTRIBUTION AND ASSIGNMENT 9

2045 TOTAL TRAFFIC 9

LEVEL OF SERVICE ANALYSIS 10

 Intersection #2: Vollmer Road/Arroya Lane 10

 Intersection #4: Vollmer Road/Briargate Parkway 10

 Intersection #5: Sterling Ranch Road/Briargate Parkway 10

 Intersection #6: Banning Lewis Parkway/Briargate Parkway 10

 Intersection #7: Dines Boulevard/Vollmer Road 11

 Intersection #8: Oak Park Drive/Sterling Ranch Road 11

 Intersection #9: Oak Park Drive/Banning Lewis Parkway 11

 Intersection #10: Dines Boulevard/Sterling Ranch Road 11

 Intersection #12: Vollmer Road/Marksheffel Road 11

 Intersection #13: Sterling Ranch Road/Marksheffel Road 12

ROADWAY FUNCTIONAL CLASSIFICATIONS AND LANEAGE 12

MTCP ROADWAY CORRIDOR PRESERVATION 12

AREA MTCP 2040 ROADWAY IMPROVEMENT PROJECTS 12

INTERSECTION APPROACH LANEAGE AND TRAFFIC CONTROL.....	12
ROADWAY IMPROVEMENTS SUMMARY TABLE	13
MULTI-MODAL AND TRANSPORTATION DEMAND MANAGEMENT (TDM) OPPORTUNITIES.....	13
CONCLUSIONS AND RECOMMENDATIONS	13
Trip Generation	13
Level of Service	13
Recommended Improvements.....	14
Enclosures:	14
Tables 1, 3a-3f, 4, and 5	
Appendix Table 1	
Figures 1-12	
Site-Generated Traffic Volumes at External Intersections	
MTCP Maps	
Traffic Count Reports	
Level of Service Reports	
Crash History	
Sketch Plan Amendment	



LSC TRANSPORTATION CONSULTANTS, INC.
2504 East Pikes Peak Avenue, Suite 304
Colorado Springs, CO 80909
(719) 633-2868
FAX (719) 633-5430
E-mail: lsc@lsctrans.com
Website: <http://www.lsctrans.com>

October 25, 2024

Loren J. Moreland | Vice President/Project Manager
Classic SRJ
2138 Flying Horse Club Drive
Colorado Springs, CO 80921

RE: Sterling Ranch Sketch Plan Amendment #4
Sterling Ranch East Filing No. 7 Site Rezone
El Paso County, Colorado
PCD File No.: [SKP241](#)
LSC #S244270

Dear Mr. Moreland:

LSC Transportation Consultants, Inc. has prepared this addendum/technical memorandum for the proposed Sterling Ranch East Filing No. 7 rezone and the Sterling Ranch Sketch Plan Amendment No. 4. LSC prepared a master traffic impact study (MTIS) for the entire Sterling Ranch development dated March 17, 2023 (approved version) ([SKP-22-004](#)) and as amended in the approved Sketch Plan Amendment No. 3 (and Traffic Technical Memorandum dated January 17, 2024 — PCD Filing Nos. [SKP235](#), [P239](#), [P2310](#), and [P2311](#) — which LSC prepared to accompany this most recently approved sketch plan amendment). As shown in Figure 1, Sterling Ranch is located east of Vollmer Road near Lochwinnoch Lane between the future extensions of Marksheffel Road and Stapleton Drive in El Paso County, Colorado.

REPORT CONTENTS

The preparation of this report included the following:

- A list of previous Sterling Ranch traffic reports and the context of this project;
- A summary of the proposed land use and access plan;
- The existing roadway and traffic conditions in the site's vicinity including the roadway widths, surface conditions, lane geometries, traffic controls, and posted speed limits;
- Existing traffic volume data;
- Estimates of projected long-term baseline traffic volumes;
- The projected average weekday and peak-hour vehicle trips to be generated by the proposed future development within the sketch plan area;

- The assignment of the projected sketch-plan site-generated traffic volumes to the area roadways;
- The projected long-term total traffic volumes on the area roadways;
- The projected levels of service at the key intersections within the study area;
- Master-study-level findings and recommendations for study-area roadways and intersections, including number of lanes, auxiliary turn lanes, intersection traffic control, etc.;
- The recommended street classifications; and
- Conclusions and recommendations.

RECENT TRAFFIC REPORTS

LSC and SM Rocha, LLC have completed multiple studies for individual filings and phases within or adjacent to Sterling Ranch. Appendix Table 1 contains a list of other traffic studies within Sterling Ranch and in the vicinity of the area of study completed within the past five years (that LSC is aware of). This study accounts for the land use, trip generation, and the roadway network included in these studies.

Briargate-Stapleton Corridor Study/PPACG Model

The El Paso County Department of Public Works recently released a draft traffic report prepared by Wilson & Company (December 9, 2021) as part of Briargate-Stapleton Corridor Study. The forecast 2045 total traffic volumes in that study were developed using the PPACG 2045 fiscally constrained RTP model, as well as reference studies including the *Black Forest Widening Project Traffic Impact Study* and traffic impact studies completed for the Wolf Ranch, The Ranch, Sterling Ranch, Highland Park, and Eagle Rising developments.

Sterling Ranch is included in the PPACG model as part of traffic analysis zones (TAZs) 238 and 842 (PPACG TAZs – not LSC-assigned, Sterling Ranch TAZs) These TAZs also include the areas planned to be developed as The Ranch and Percheron. The Sterling Ranch Sketch Plan is currently capped at 4,800 dwelling units. The Ranch Sketch Plan, located east of Sterling Ranch, shows the potential for up to 2,144 future dwelling units. Percheron will be capped at 2,650 dwelling units. The section of the Percheron development located within TAZs 238 and 842 located north of Woodmen Road will likely be developed with a maximum of 2,200 of those 2,650 dwelling units.

These three developments include the potential for a total of 9,144 potential dwelling units within the areas shown as TAZs 238 and 842. The 2045 PPACG model includes 8,900 households within these two TAZs. This is about 669 fewer dwelling units than could be developed within the area containing Sterling Ranch, The Ranch, and Percheron, based on the respective traffic studies. However, the maximum density may not be achieved for each of these projects and/or they may not all be fully built out by 2045.

STUDY AREA

Sketch Plan

The 1,444-acre Sterling Ranch Sketch Plan area is partially developed and planned to ultimately include a mix of residential, commercial, and educational land uses. Figure 2 shows the currently-proposed Sterling Ranch Sketch Plan Amendment No. 4 area (called out with the revision cloud). Table 1 shows a comparison of the land use assumed in the 2023 MTIS, the *Sterling Ranch Sketch Plan Amendment No. 3* Traffic Technical Memorandum, and the land uses proposed as part of the current Sketch Plan Amendment No. 4.

Figures 3a through 3f show the location of the current Sterling Ranch Sketch Plan TAZs (as defined by LSC for traffic analysis purposes) and detail sheets showing key sub areas within the Sterling Ranch development.

Previous Sketch Plan Amendment - No. 3

Although the number of residential dwelling units for Sterling Ranch is capped at 4,800, the Sketch Plan No. 3 memorandum presented a sensitivity analysis based on the maximum allowable number of units within the area north of Briargate Parkway and east of Sterling Ranch Road. This would require the number of units in the areas outside of the Amendment No. 3 area to be reduced by 118 units, but to be conservative, the sensitivity analysis assumed no changes (reduction in trip generation) to the land uses outside of this area.

Currently Proposed Amendment No. 4

At the request of Falcon School District 49 the elementary school site located south of Oak Park Drive between Sterling Ranch Road and Banning Lewis Parkway (TAZ 104 in the 2023 MTIS for Amendment No. 3) has been removed from the Sketch Plan. The 18-acre parcel is now planned to be rezoned for residential uses with a density of 5 to 8 dwelling units per acre. However, no change to the maximum number of residential dwelling units within overall Sterling Ranch development is proposed as part of the currently-proposed Sketch Plan Amendment.

Since completion of the MTIS, several of the residential parcels within Sterling Ranch have been approved, are under review, or are in the preliminary planning stages with a known number of dwelling units. Table 1 shows a comparison of the land use assumed for each parcel in the approved MTIS and based on the currently-proposed Amendment No. 4. There are three “mixed-use” parcels proposed within the Sterling Ranch Sketch Plan Area (TAZ 105 located southeast of Briargate/Vollmer, TAZ 106 located southwest of Briargate/Banning Lewis, and TAZ 107 located southeast of Marksheffel/Vollmer). The 2023 MTIS assumed about two thirds of each of these parcels would be developed for multi-family residential uses with a density of 25 dwelling units per acre and the remaining one third of the area would be developed for general

retail uses with a floor area ratio of about 0.25. About 80 percent of the area of each of these parcels is now anticipated to be developed for multi-family residential uses.

Table 1 assumes that these updated land-use planning assumptions for Amendment No. 4 area supersede the Amendment No. 3 “sensitivity analysis” land-use assumptions. Therefore, Table 1 shows a reduction in dwelling units within the Amendment No. 3 area to 1,238.

Study-Area Access Plan

Figure 4 shows the current access plan for **Briargate Parkway**. The access plan for the current Sketch Plan is consistent with the access plan shown in the 2023 Master TIS.

The *Briargate Parkway-Stapleton Road Corridor Study Appendix D: Access Control Plan* shows the access locations and intersection access restrictions along Briargate Parkway between Black Forest Road and Meridian Road. The currently-proposed Sterling Ranch Sketch Plan Amendment has several access points that are not included in the access control plan.

- The access control plan shows a right-in/right-out access to the south side of Briargate Parkway at Wheatland Drive between Vollmer Road and Sterling Ranch Road. The currently-proposed Sketch Plan Amendment shows a three-quarter movement access for the south leg and a right-in/right-out access on the north leg. A deviation request for this access point has been submitted and approved. Please include the PCD file number
- The access control plan shows a right-in/right-out access point north and south of Briargate Parkway between Wheatland Drive and Sterling Ranch Road. The currently-proposed sketch plan shows two offset three-quarter-movement (left-in/right-in/right-out only) access points.
- The access control plan shows the intersection of Briargate Parkway/Sterling Ranch Road as a three-leg intersection. The currently-proposed Sketch Plan includes a north leg at this future full-movement signal-controlled intersection.
- The currently-proposed Sketch Plan Amendment shows a right-in/right-out access to the north side of Briargate Parkway about 1,230 feet east of Sterling Ranch Road that is not shown on the access control plan.
- The access control plan shows a right-in/right-out access to the south side of Briargate Parkway just west of Banning Lewis Parkway. The currently-proposed Sketch Plan Amendment shows a right-in/right-out access to the north side of Briargate and a three-quarter-movement access to the south side of Briargate at approximately the same location (1,085 feet west of Banning Lewis Parkway).
- The access control plan shows the intersection of Briargate/Banning Lewis as a three-leg intersection. The currently-proposed Sketch Plan includes a north leg at this future full-movement signal-controlled intersection.

Deviation Requests

Any of the future proposed intersections that do not meet the intersection spacing criteria contained in the *El Paso County Engineering Criteria Manual (ECM)* will require deviation requests to those criteria in order to be approved by El Paso County. These deviation requests (if not already submitted/approved) will be submitted with future preliminary plans and/or final plats.

EXISTING ROAD AND TRAFFIC CONDITIONS

The adjacent streets are shown in Figure 1 and are described below. Copies of the *2016 El Paso County Major Transportation Corridors Plan (MTCP)*, *2040 Roadway Plan*, and *2016 MTCP 2060 Corridor Preservation Plan* with the site location identified on them have been attached to this report.

Vollmer Road is currently a five-lane urban street within the City of Colorado Springs limits between Black Forest Road and Cowpoke Road and a two-lane, rural, paved roadway north of Cowpoke Road extending to north of Hodgen Road. In the southbound direction, Vollmer Road has a posted speed limit of 45 miles per hour (mph). South of Cowpoke Road, Vollmer Road has a 40-mph posted speed limit. Note: The new Connect COS City of Colorado Springs transportation plan shows Vollmer as a Principal Arterial. The 2024 *MTCP* shows Vollmer Road as an Urban – Major Collector in the vicinity of the site. The South Vollmer Road improvements ([CDR2116](#)) which provide two through lanes in each direction on Vollmer Road in the vicinity of Marksheffel Road and The North Vollmer Road improvements ([CDR217](#)) which provide two through lanes in each direction on Vollmer Road in the vicinity of Briargate Parkway were recently completed.

Marksheffel Road is a Principal Arterial extending north from the City of Fountain to Woodmen Road. Marksheffel Road is planned to ultimately be widened to six lanes and extended north and west from Woodmen Road to connect to Research Parkway at Black Forest Road. The City of Colorado Springs has taken ownership and maintenance of Marksheffel Road.

The section of Marksheffel Road adjacent to Sterling Ranch is planned to be constructed on 107 feet of right-of-way to the City's required cross section(s) and criteria. The section of Marksheffel Road between Sterling Ranch Road and Vollmer Road has recently been completed and the section of Marksheffel Road southeast of Sterling Ranch Road (to connect to the segment recently constructed) will be completed by the end of 2024.

Briargate Parkway is classified as a four-to-six-lane, Urban Principal Arterial (four-lane in unincorporated El Paso County). Currently, it extends east from I-25 to Grand Lawn Circle (about one-half mile east of Powers Boulevard). Briargate Parkway is planned ultimately to extend to Towner Drive. The segment of Briargate Parkway between Vollmer Road and Wheatlands Drive was recently constructed and the segment between Wheatlands Drive and Sterling Ranch Road is planned to be constructed in the fall of 2024.

Sterling Ranch Road is a partially constructed Non-Residential Collector shown extending through the Sterling Ranch development between Marksheffel Road and the north end of the Sketch Plan area (just south of Arroya Lane). The segment south of Briargate Parkway will be constructed in the short term.

Existing Traffic Volumes

Figures 5a and 5b show the existing average weekday and peak-hour traffic volumes at the key study-area intersections. The peak-hour traffic volumes shown are based on manual turning-movement counts by LSC Transportation Consultants and All Traffic Data Services. The date of each count is shown in Figure 5b. The average weekday traffic volumes shown in Figure 5a are estimates by LSC, based on the manual peak-hour traffic-count data. The traffic-count sheets are attached.

Existing Levels of Service

Level of service (LOS) is a quantitative measure of the level of congestion or delay at an intersection. Level of service is indicated on a scale from “A” to “F.” LOS A represents control delay of less than 10 seconds for unsignalized intersections. LOS F represents control delay of more than 50 seconds for unsignalized intersections. Table 2 shows the level of service delay ranges.

Table 2: Intersection Levels of Service Delay Ranges

Level of Service	Signalized Intersections	Unsignalized Intersections
	Average Control Delay (seconds per vehicle)	Average Control Delay (seconds per vehicle) ⁽¹⁾
A	10.0 sec or less	10.0 sec or less
B	10.1-20.0 sec	10.1-15.0 sec
C	20.1-35.0 sec	15.1-25.0 sec
D	35.1-55.0 sec	25.1-35.0 sec
E	55.1-80.0 sec	35.1-50.0 sec
F	80.1 sec or more	50.1 sec or more

(1) For unsignalized intersections, if V/C ratio is greater than 1.0 the level of service is LOS F, regardless of the projected average control delay per vehicle.

The intersections have been analyzed based on the unsignalized-intersection analysis procedures from the *Highway Capacity Manual, 6th Edition* by the Transportation Research Board.

All movements at the stop-sign-controlled intersections of Vollmer/Dines and Vollmer/Marksheffel are currently operating at LOS B or better during the peak hours.

Safety and Accident Analysis

The Colorado State Patrol (CSP) provided LSC with crash history data for Vollmer Road between Tahiti Drive and Burgess Road from September 2019 through September 2022. During the reported time period, there were twelve reported crashes. Of the twelve reports, ten were single-vehicle non-intersection-related crashes on Vollmer Road. One crash involved a southbound vehicle that turned right onto Poco Road and crashed into several cars parked on Poco Road partially in the lane. The only intersection related crash occurred in June 2022. A vehicle heading northbound on Vollmer Road was slowing to turn left at Lochwinnoch Road and the vehicle behind them attempted to pass on the left side. The crash history data has been attached.

BASELINE CONDITIONS

Baseline traffic is the traffic estimated to be on the adjacent roadways and at adjacent intersections without the proposed development's trip generation of site-generated traffic volumes. Baseline traffic (for a specified horizon year) includes the through traffic and the traffic generated by nearby developments (existing and planned) but assumes zero traffic generated by land uses within Sterling Ranch, including traffic generated by existing developments within Sterling Ranch.

Figure 6a shows the projected 2045 baseline daily traffic volumes on key street segments at the key area intersections and Figure 6b shows the projected 2045 peak-hour baseline traffic volumes at the key area intersections. These volumes assume buildout of the area street network, including the completion of Marksheffel Road between Vollmer Road and Black Forest Road, Briargate Parkway between Meridian Road and Black Forest Road, and Sterling Ranch Road between Marksheffel Road and Briargate Parkway.

The 2045 baseline traffic volumes are estimates by LSC, based on the traffic projections, the *Briargate-Stapleton Corridor Study (Draft)* by Wilson & Company dated December 9, 2021. This report indicates that the Pikes Peak Area Council of Governments' (PPACG) 2045 regional model was utilized as a basis for the projections. Previous reports completed in the area were also used to estimate the future baseline/background traffic (see Appendix Table 1).

Figure 6c shows the lane geometry, traffic control, and level of service at the key area intersections for the long-term baseline scenario, and, as applicable, based on the 2045 baseline volumes. Figure 6c includes notes about known current and future improvements that will be in place in this future baseline scenario. This includes the Black Forest Road current construction project, planned TIP and PPRTA major transportation corridor capacity-improvement projects, and intersection improvements anticipated by planned developments as they develop.

TRIP GENERATION

The site-generated vehicle trips were estimated using the nationally-published trip-generation rates from *Trip Generation, 11th Edition, 2021* by the Institute of Transportation Engineers (ITE). Table 3a shows the trip-generation estimate for the overall Sterling Ranch Sketch Plan based on the land uses shown in the currently proposed Amendment No. 4. Table 3a also shows a comparison to the trip generation assumed in the approved 2023 MTIS for Sterling Ranch.

The total number of vehicle trips generated by the land uses has been reduced to account for the internal vehicle trips made within Sterling Ranch between land uses, without use of the external streets surrounding the site. Table 3a shows the number of internal trips assumed for each land use. Based on the number of residential dwelling units and the number of students at each school, about 60 percent of the school-related trips were assumed to be internal to the Sterling Ranch development. Based on the number of dwelling units and the size of the mixed-use parcels, about seven percent of the “shopping plaza” trips were assumed to be internal to the Sterling Ranch development. The residential internal trips were then balanced with the school and shopping plaza internal trips.

The total number of vehicle trips generated has also been reduced to take into account the “pass by” phenomena. A pass-by trip is made by a motorist who would already be on the adjacent roadways regardless of the proposed development, but who stops in at the site while passing by. The motorist would then continue on his or her way to a final destination in the original direction. The pass-by percentages shown on Table 3a are from the *Trip Generation Handbook - An ITE Proposed Recommended Practice, 3rd Edition, 2017* by ITE.

The Sterling Ranch Sketch Plan is projected to generate about 50,134 new external vehicle trips on the average weekday, with about half entering and half exiting the site during a 24-hour period. This is about 1,377 fewer daily trips than were estimated in the approved 2023 MTIS. During the morning peak hour, which generally occurs for one hour between 6:30 and 8:30 a.m., about 1,073 vehicles would enter and 2,459 vehicles would exit the site. This is about 112 fewer entering vehicles and one fewer exiting vehicle than was assumed in the approved 2023 MTIS. During the afternoon peak hour, which generally occurs for one hour between 4:15 and 6:15 p.m., about 3,090 vehicles would enter and 2,048 vehicles would exit the site. This is about 100 fewer entering vehicles and 113 fewer exiting vehicles than was assumed in the approved 2023 MTIS.

Tables 3b through 3f show the localized trip-generation change associated with the proposed Sketch Plan Amendment for several key sub areas within Sterling Ranch. The location of each sub area is shown in Figures 3b through 3f. Note: Table 3d includes the area of the currently proposed Filing No. 7 site rezone.

As shown in Tables 3a through 3f, although the overall number of external trips estimated to be generated by Sterling Ranch has decreased from what was assumed in the 2023 MTIS, the removal of one of the school sites and other land uses changes results in localized shifts in traffic

patterns that will increase some traffic movements within the Sterling Ranch Sketch Plan area. This addendum provides analysis of the major Collector/Collector and above intersections within and adjacent to the Sterling Ranch development to analyze these localized shifts with the proposed Sketch Plan Amendment.

TRIP DISTRIBUTION AND ASSIGNMENT

The directional distribution of the site-generated traffic volumes on the street and roadway system serving the site is one of the most important factors in determining the site's traffic impacts. The distribution estimates for residential-related traffic and non-residential-related traffic are shown in Figures 7 and 8, respectively. The directional-distribution estimates are based on the following factors: the location of the site with respect to the Colorado Springs metropolitan area, the planned access system for the site, the street and roadway system serving the site, and the land uses proposed for the site.

When the distribution percentages (from Figures 7 and 8) are applied to the new, external trip-generation estimates (from Table 3a), the resulting site-generated traffic volumes can be determined. The internal trips were assigned separately, based on the location of the residential dwelling units and school sites within Sterling Ranch. The pass-by trips for each of the mixed-use parcels were assigned separately, based on the projected 2045 baseline traffic volumes on the adjacent Arterial roadways.

Figure 9a shows the sum of the new external, internal, and pass-by site-generated average **weekday** traffic volumes due to the land uses within the overall Sterling Ranch Sketch Plan on key street segments within the study area. Figure 9b shows the sum of the new external, internal, and pass-by site-generated **peak-hour** traffic due to the land uses within the overall Sterling Ranch Sketch Plan at key study-area intersections. The site-generated traffic volumes at other intersections included in the 2023 MTIS are included in the appendix.

Figure 9c shows the site-generated traffic volumes at the key study area intersection due to the currently-proposed rezone of Sterling Ranch East Filing No. 7 only.

2045 TOTAL TRAFFIC

Figure 10a shows the projected 2045 total **daily** traffic volumes on key street segments and Figure 10b shows the projected 2045 total **peak-hour** traffic volumes at the key study-area intersections. These volumes are the sum of the 2045 baseline traffic volumes (from Figures 6a and 6b) and the site-generated traffic volumes (from Figures 9a and 9b).

Figure 10c shows the level of service analysis results for the key area intersections, based on the projected 2045 total volumes. The figure also shows the general intersection lane geometry and intersection traffic control used in the analysis.

LEVEL OF SERVICE ANALYSIS

The key area future signalized intersections have been analyzed to determine the projected intersection levels of service for 2045 baseline and total traffic scenarios for the morning and afternoon peak-hour periods using Synchro. The key area future stop-sign-controlled and modern-roundabout-controlled intersections have been analyzed based on the unsignalized-intersection analysis procedures from the *Highway Capacity Manual 6th Edition*. Figures 6c and 10c show the level of service analysis results. The level of service reports are attached.

Intersection #2: Vollmer Road/Arroya Lane

All movements at the stop-sign-controlled intersection of Vollmer/Arroya are projected to operate at LOS C or better during the peak hours based on the projected 2045 total traffic volumes.

Intersection #4: Vollmer Road/Briargate Parkway

The intersection of Vollmer/Briargate is projected to operate at an overall LOS C during the peak hours as a signalized intersection, based on the projected 2045 total traffic volumes shown in Figure 10b and the lane geometry shown in Figure 10c.

Intersection #5: Sterling Ranch Road/Briargate Parkway

The intersection of Sterling Ranch/Briargate is projected to operate at an overall LOS C during the peak hours as a signalized intersection, based on the projected 2045 total traffic volumes shown in Figure 10b and the lane geometry shown in Figure 10c.

Intersection #6: Banning Lewis Parkway/Briargate Parkway

The intersection of Banning Lewis/Briargate was analyzed only as a traffic signal-controlled intersection in the 2023 MTIS. This intersection may now potentially be constructed as a modern two-lane roundabout. The analysis was updated based on both potential traffic control options.

If the intersection of Banning Lewis/Briargate is constructed as a signal-controlled intersection, it is projected to operate at an overall LOS C during the peak hours based on the projected 2045 total traffic volumes shown in Figure 10b and the lane geometry shown in Figure 10c. The northbound left-turn movement is projected to operate at LOS E during the morning peak hour and LOS D during the afternoon peak hour. The westbound left-turn movement is projected to operate at LOS E during both the morning and afternoon peak hours.

If the intersection of Banning Lewis/Briargate is constructed as a modern two-lane roundabout, all approaches are projected to operate at LOS C or better during the peak hours based on the projected 2045 total traffic volumes.

Intersection #7: Dines Boulevard/Vollmer Road

The stop-sign-controlled intersection of Dines/Vollmer is projected to operate at LOS F, based on the projected 2045 total afternoon traffic volumes shown in Figure 10b and the lane geometry shown in Figure 10c. It is not uncommon for the minor-approach movements at an unsignalized intersection to operate at LOS E or F. The future traffic signals at Briargate/Vollmer and Marksheffel/Research/Vollmer will likely create additional gaps in the through traffic. These gaps generally reduce the side-street delay.

Intersection #8: Oak Park Drive/Sterling Ranch Road

By 2045, it was assumed that the future K-8 school planned for the parcel southwest of Briargate/Sterling Ranch would be constructed and that an exit-only access would be constructed aligning with the Oak Park/Sterling Ranch intersection. Based on the 2045 total traffic volumes shown in Figure 10b and the lane geometry shown in Figure 10c, the eastbound and westbound left-turn movements are projected to operate at LOS D during the morning peak hour and LOS C during the afternoon peak hour. This side-street level of service is based on the assumption of morning **school** peak-hour traffic coinciding with the general morning peak hour and the low peak-hour factor associated with projected school traffic.

Intersection #9: Oak Park Drive/Banning Lewis Parkway

The intersection of Banning Lewis Parkway/Oak Park Drive was analyzed as a signal-controlled full-movement intersection in the 2023 MTIS. This intersection is now planned to be restricted to three-quarter movement (left-in/right-in/right-out only). The intersection of Oak Park/Banning Lewis is projected to operate at LOS C or better for all movements during the peak hours based on the projected 2045 total traffic volumes as restricted stop-sign-controlled intersection.

Intersection #10: Dines Boulevard/Sterling Ranch Road

The intersection of Dines/Sterling Ranch is projected to operate at LOS D or better for all movements during the peak hours as a stop-sign-controlled intersection, based on the projected 2045 total traffic volumes shown in Figure 10b and the lane geometry shown in Figure 10c.

Intersection #12: Vollmer Road/Marksheffel Road

The intersection of Vollmer/Marksheffel is projected to operate at an overall LOS C or better during the peak hours as a signalized intersection, based on the projected 2045 total traffic volumes shown in Figure 10b and the lane geometry shown in Figure 10c.

Intersection #13: Sterling Ranch Road/Marksheffel Road

The intersection of Sterling Ranch/Marksheffel is projected to operate at an overall LOS C or better during the peak hours as a signalized intersection, based on the projected 2045 total traffic volumes shown in Figure 10b and the lane geometry shown in Figure 10c.

ROADWAY FUNCTIONAL CLASSIFICATIONS AND LANEAGE

Figure 11 shows the recommended functional classifications and number of through lanes for the streets in the study area. Figure 11 also shows a comparison of the projected average weekday traffic volume (ADT) and the design ADT from the *ECM* for the key street segments in the vicinity of the site. All of the projected weekday traffic volumes are below the design ADT volumes.

MTCP ROADWAY CORRIDOR PRESERVATION

Figure 11 is consistent with the *MTCP Corridor Preservation Plan (CPP)*. Aside from the 2045 classifications and number of lanes, the *MTCP 2065 Through Lane Requirements* shows Woodmen Road expansion to six lanes east of Banning Lewis Parkway and the Black Forest Road expansion to four lanes north of Briargate Parkway.

AREA MTCP 2040 ROADWAY IMPROVEMENT PROJECTS

The *El Paso County 2024 Major Transportation Corridors Plan Update* identified the following 2040 roadway improvement projects within the study area:

- 158: Vollmer Road from Marksheffel Road to Burgess Road as an Urban Major Collector I
- 166: Stapleton Drive from west of Vollmer Road to Towner Avenue as a 4-Lane Urban Principal Arterial
- 329: Stapleton Drive/Briargate Parkway: from Black Forest Road to west of Vollmer Road and a 4-Lane Urban Principal Arterial

INTERSECTION APPROACH LANEAGE AND TRAFFIC CONTROL

Figure 10c shows the recommended general intersection approach laneage including preliminary recommendations for left and or right auxiliary turn lanes (or dual lanes where shown). The figure also shows the anticipated traffic-control device that will likely be needed at each key intersection (i.e., stop-sign control, traffic-signal control, roundabout-intersection control, etc.). These general, master-TIS-level recommendations are based primarily on the roadway corridor number of through lanes, the auxiliary turn-lane thresholds in the *ECM*, and the 2045 capacity (LOS) analysis.

ROADWAY IMPROVEMENTS SUMMARY TABLE

A list of the roadway segment improvements is presented in Table 4. The location of each roadway segment is identified in Figure 12.

MULTI-MODAL AND TRANSPORTATION DEMAND MANAGEMENT (TDM) OPPORTUNITIES

The attached copy of the Sterling Ranch Sketch Plan Amendment shows the location of the planned major trails. Pedestrian plans will be part of preliminary plans. With urban development, sidewalks will be required on all streets. A detached sidewalk will be provided along the east side of Vollmer Road adjacent to the development and along Sterling Ranch Road, Briargate Parkway, and Marksheffel Road adjacent to the site. The county-road cross sections with shoulders in the *ECM* generally accommodate bicycles. The section of Vollmer Road within the City of Colorado Springs (generally from Black Forest Road to Cowpoke Road) has existing bicycle lanes and future improvements on Vollmer Road should be consistent.

CONCLUSIONS AND RECOMMENDATIONS

Trip Generation

The Sterling Ranch Sketch Plan (assuming Amendment No. 4) is projected to generate about 50,134 new external vehicle trips on the average weekday, with about half entering and half exiting the site during a 24-hour period. This is about 1,377 fewer daily trips than were estimated in the approved 2023 MTIS for Amendment No. 3. During the morning peak hour, which generally occurs for one hour between 6:30 and 8:30 a.m., about 1,073 vehicles would enter and 2,459 vehicles would exit the site. This is about 112 fewer entering vehicles and one fewer exiting vehicle than was assumed in the approved 2023 MTIS. During the afternoon peak hour, which generally occurs for one hour between 4:15 and 6:15 p.m., about 3,090 vehicles would enter and 2,048 vehicles would exit the site. This is about 100 fewer entering vehicles and 113 fewer exiting vehicles than was assumed in the approved 2023 MTIS.

Level of Service

All of the intersections analyzed are projected to operate at an overall satisfactory level of service (LOS D or better) during the peak hours, based on the projected 2045 total traffic volumes shown in Figure 10b and the lane geometry and traffic control show in Figure 10c except for the intersection of Vollmer/Dines (#7). The westbound left-turn movement is projected to operate at LOS F during the afternoon peak hour if the intersection remains a full-movement stop-sign-controlled intersection. It is not uncommon for minor-approach movements at an unsignalized intersection to operate at LOS E or F. The future traffic signals at Briargate/Vollmer and Marksheffel/Research/Vollmer will likely create additional gaps in the through traffic. These gaps generally reduce the side-street delay.

Recommended Improvements

Figure 10c shows the general/preliminary laneage requirements for the key study-area intersections. Table 4 shows a list of the roadway-segment improvements and Table 5 shows a list of intersection improvements. These recommendations are consistent with the recently published *Briargate-Stapleton Corridor Study (Draft)* by Wilson & Company dated December 9, 2021. Detailed lane geometry will be provided at the preliminary plan stage for individual developments. Generally, turn lanes, right-of-way, and cross sections of street segments will need to conform to *ECM* criteria. Right-of-way preservation may also be needed per the *MTCP 2065 Corridor Preservation Plan*.

The Sterling Ranch will be required to contribute a fair and equitable portion towards the onsite and offsite improvements. The contributions will be determined with subsequent submittals.

* * * * *

Please contact me if you have any questions regarding this report.

Sincerely,

LSC TRANSPORTATION CONSULTANTS, INC.

By Jeffrey C. Hodsdon, P.E.
Principal

JCH/KDF:jas

Enclosures: Tables 1, 3a-3f, 4, and 5
Appendix Table 1
Figures 1-12
Site-Generated Traffic Volumes at External Intersections
MTCP Maps
Traffic Count Reports
Level of Service Reports
Crash History
Sketch Plan Amendment

Tables 1, 3a-3f, 4, and 5



**Table 1
Sterling Ranch Sketch Plan Amendment No. 4
With Sterling Ranch East Filing No. 7 Rezone
Land Use Tabulation & Comparison**

Traffic Analysis Zone ⁽¹⁾	Name	Status	Land Use	Approved Master Traffic Impact Study (MTIS) ⁽²⁾		Sketch Plan Amendment #3 Sensitivity Analysis ⁽³⁾		Currently Proposed Amendment #4		Change from MTIS		Change from Amendment #3 Sensitivity Analysis	
				Quantity	Unit	Quantity	Unit	Quantity	Unit	Quantity	Unit	Quantity	Unit
Sterling Ranch West of the Creek													
Existing/Approved TAZs													
1	Branding Iron Fil No. 1	Existing	Residential 3-5 DU/Ac	51	DU ⁽⁴⁾	51	DU ⁽³⁾	51	DU	0	DU	0	DU
2	Homestead Fil No. 1	Existing	Residential 3-5 DU/Ac	72	DU	72	DU	72	DU	0	DU	0	DU
3	Homestead Fil No. 2	Existing	Residential 3-5 DU/Ac	104	DU	104	DU	104	DU	0	DU	0	DU
4	Branding Iron Fil No. 2	Existing	Residential 3-5 DU/Ac	75	DU	75	DU	75	DU	0	DU	0	DU
5	Copper Chase	Approved	Residential 5-8 DU/Ac	138	DU	138	DU	138	DU	0	DU	0	DU
6	Sterling Ranch Fil 2	Approved	Residential 3-5 DU/Ac	49	DU	49	DU	49	DU	0	DU	0	DU
7&8	Sterling Ranch Fil 3	Approved	Residential 3-5 DU/Ac	63	DU	63	DU	63	DU	0	DU	0	DU
9	Homestead North Fil 1	Approved	Residential 3-5 DU/Ac	73	DU	73	DU	73	DU	0	DU	0	DU
10	Sterling Ranch Fil 4 (north)	Approved	Residential 3-5 DU/Ac	50	DU	50	DU	50	DU	0	DU	0	DU
10	Sterling Ranch Fil 4 (south)	Approved	Residential 3-5 DU/Ac	98	DU	98	DU	98	DU	0	DU	0	DU
11	Homestead North Fil 2	Approved	Residential 3-5 DU/Ac	74	DU	74	DU	74	DU	0	DU	0	DU
12	Homestead North Fil 3	Approved	Residential 2 DU/Ac	77	DU	77	DU	77	DU	0	DU	0	DU
16	Sterling Ranch Filing 5	Approved	Residential 5-8 DU/Ac	82	DU	82	DU	72	DU	-10	DU	-10	DU
108	Industrial 5 Acres	Existing	Industrial (Lift Station)	---	---	---	---	---	---	0	---	0	---
				Residential	1,006 DU	1,006 DU	996 DU	-10 DU	-10 DU				
Future TAZs													
105	Mixed Use 14 Ac (SE Briargate/Vollmer)	Future	Mixed Use	51	KSF ⁽⁵⁾	51	KSF	35	KSF	-16	KSF	-16	KSF
				233	DU	233	DU	275	DU	42	DU	42	DU
107	Mixed Use 11 Acres (SE Marksheffel/Vollmer)	Future	Mixed Use	120	KSF	120	KSF	120	KSF	0	KSF	0	KSF
				Residential	233 DU	233 DU	275 DU	42 DU	42 DU				
				Commercial	171 KSF	171 KSF	155 KSF	-16 KSF	-16 KSF				
Sterling Ranch East Preliminary Plan 1 & Foursquare at Sterling Ranch East													
22 & 26	Sterling Ranch East Filing 1	Approved	Residential 3-5 DU/Ac	294	DU	294	DU	294	DU	0	DU	0	DU
18	Sterling Ranch East Filing 2	Approved	Residential 3-5 DU/Ac	280	DU	280	DU	42	DU	0	DU	0	DU
37	Sterling Ranch East Filing 4	Future	Residential 3-5 DU/Ac		238		DU						
17, 23 & 24	Sterling Ranch East Filing 3	Future	Residential 3-5 DU/Ac	168	DU	168	DU	187	DU	0	DU	187	DU
38			Residential 2 DU/Ac	19	DU	19	DU						
19	Foursquare at Sterling Ranch East	Approved	Residential 5-8 DU/Ac	158	DU	158	DU	158	DU	0	DU	0	DU
102	Future Elementary School	Future	Elementary School	600	students	600	students	600	students	0	Students	0	Students
103	K-8 School	Future	K-8 School	1,100	students	1,100	students	1100	students	0	Students	0	Students
				Residential	919 DU	919 DU	919 DU	0 DU	187 DU				
				School	1,700 students	1,700 students	1,700 students	0 students	0 students				
Sterling Ranch South of Oak Park Drive and East of Sterling Ranch East Filing No. 3													
25, 27, 28, 29, 31, & 33	Sterling Ranch East Fil 5	Approved	Residential 3-5 DU/Ac	603	DU	603	DU	160	DU	-130	DU	-130	DU
	Sterling Ranch East Fil 7	Future	Residential 3-5 DU/Ac					316	DU				
39	Sterling Ranch East Fil 7	Future	Residential 2 DU/Ac	18	DU	18	DU	15	DU				
104	Future PUD	Future	Elementary School	600	students	600	students	0	students	-600	Students	-600	Students
			Residential 5-8 DU/Ac	0	DU	0	DU	108	DU	108	DU	108	DU
				Residential	621 DU	621 DU	599 DU	-22 DU	-22 DU				
				School	600 students	600 students	0 students	-600 students	-600 students				
East of Sterling Ranch Road Between Oak Park Drive and South Briargate Parkway													
14, 15, 20 & 21	Village at Sterling Ranch East	Under Review	Detached Single Family	100	DU	100	DU	173	DU	-19	DU	-19	DU
			Attached Single Family	146	DU	146	DU	54	DU				
33	Future PUD	Future	Residential 3-5 DU/Ac	106	DU	106	DU	139	DU	33	DU	33	DU
106	Mixed Use 22 Ac (SW Briargate/Banning Lewis)	Future	Mixed Use	80	KSF	80	KSF	55	KSF	-25	KSF	-25	KSF
				367	DU	367	DU	425	DU	58	DU	58	DU
				Residential	719 DU	719 DU	791 DU	72 DU	72 DU				
				Commercial	80 KSF	80 KSF	55 KSF	-25 KSF	-25 KSF				
Approved Sketch Plan Amendment #3 Area (North of Briargate Parkway and East of Sterling Ranch East Filing Nos. 2 & 4 and Foursquare at Sterling Ranch East)													
30	Sterling Ranch East Filing 6	Future	Residential 3-5 DU/Ac	871	DU	715	DU	198	DU	-204	DU	-48	DU
34	Future Filings	Future Filings						62	DU				
35	Future Filings	Future Filings	Residential 3-5 DU/Ac					261	DU				
36	Future Filings	Future Filings		146	DU			146	DU				
101	Future Filings	Future	RR-2.5	431	DU	703	DU	8	DU	122	DU	-150	DU
			RR-0.5					39	DU				
			RS6000					506	DU				
				Residential	1,302 DU	1,418 DU	1,220 DU	-82 DU	-198 DU				
TOTAL STERLING RANCH SKETCH PLAN													
				Residential	4,800 DU	4,916 DU	4,800 DU	0 DU	-116 DU				
				Commercial	251 KSF	251 KSF	210 KSF	-41 KSF	-41 KSF				
				School	2,300 Students	2,300 Students	1,700 Students	-600 Students	-600 Students				

Notes:

- (1) See Figures 3a - 3f for Traffic Analysis Zone boundaries
- (2) Source: Sterling Ranch Sketch Plan Amendment Master Traffic Impact Study, March 17, 2023
- (3) Source: Sterling Ranch Sketch Plan 2023 Amendment and Rezone Traffic Technical Memorandum, January 17, 2024
- (4) DU = dwelling unit
- (5) KSF = thousand square feet of floor area

**Table 3a
Sterling Ranch Sketch Plan Amendment No. 4
With Sterling Ranch East Filing No. 7 Rezone
Overall Trip Generation Estimate**

Sterling Ranch Sketch Plan Area Internal Trip Calculations (Long-Term Scenario Only)

ITE Code	ITE Land Use	Quantity Unit	Trip Generation Rates ⁽¹⁾				Raw ITE Trip Generation (Individual Driveway Trips)					Internal Trips (%)					Total Internal Trips Generated					Total External Trips Generated					Passby Trips ⁽²⁾		New External Trips Generated Daily			
			Daily	AM Peak Hour		PM Peak Hour		Daily	AM Peak Hour		PM Peak Hour		Daily	AM Peak Hour		PM Peak Hour		Daily	AM Peak Hour		PM Peak Hour		Daily	In	Out	Daily						
				In	Out	In	Out		In	Out	In	Out		In	Out	In	Out		In	Out	In	Out					(%)	Daily				
Trip Generation Estimate Based on the Currently Proposed Sterling Ranch Sketch Plan Amendment																																
Non-Residential Land Uses																																
821	Shopping Plaza ⁽³⁾	210	KSF ⁽⁴⁾	67.52	1.07	0.66	2.54	2.65	14,179	225	138	534	556	7%	7%	7%	7%	7%	993	16	10	37	39	13,186	209	128	497	517	34%	4,483	8,703	
520	Elementary School	1,200	Students	2.27	0.40	0.34	0.07	0.09	2,724	480	408	88	104	60%	60%	30%	30%	60%	1,634	288	123	26	62	1,090	192	285	62	42	0%	0	1,090	
521	Middle School/Junior High	500	Students	2.10	0.36	0.31	0.07	0.08	1,050	181	154	36	39	60%	60%	30%	30%	60%	630	109	46	11	23	420	72	108	25	16	0%	0	420	
Total Non-Residential Land Uses									17,953	886	701	658	699						3,257	413	179	74	124	14,696	473	522	584	575				10,213
Residential Land Uses																																
210	Single-Family Detached Housing	4,009	DJ ⁽⁵⁾	9.43	0.18	0.53	0.59	0.35	37,805	702	2,105	2,374	1,394	8%	23%	18%	5%	5%	2,852	161	370	112	67	34,953	541	1,735	2,262	1,327	0%	0	34,953	
215	Single Family Attached Housing	91	DU	7.20	0.12	0.36	0.34	0.23	655	11	33	31	21	7%	27%	18%	3%	5%	49	3	6	1	1	606	8	27	30	20	0%	0	606	
220	Multifamily Housing (Low-Rise)	700	DU	6.74	0.10	0.30	0.32	0.19	4,718	67	213	225	132	8%	22%	17%	5%	5%	356	15	37	11	6	4,362	52	176	214	126	0%	0	4,362	
4,800 DU Total Residential Land Uses									43,178	780	2,350	2,630	1,548						3,257	179	413	124	74	14,696	522	473	575	584				39,921
Total									61,131	1,665	3,051	3,288	2,246						6,514	592	592	198	198	54,617	1,073	2,459	3,090	2,048		4,483		50,134
Trip Generation Estimate From the Sterling Ranch Sketch Plan Amendment Master Traffic Impact Study, March 17, 2023									65,406	1,987	3,262	3,449	2,420						8,536	802	802	259	259	56,870	1,185	2,460	3,190	2,161		5,359		51,511
Change in the Trip Generation Estimate									-4,275	-322	-211	-161	-174						-2,022	-210	-210	-61	-61	-2,253	-112	-1	-100	-113		-876		-1,377

Notes:
(1) Source: "Trip Generation, 11th Edition, 2021" by the Institute of Transportation Engineers (ITE)
(2) Source: "Trip Generation Handbook - An ITE Proposed Recommended Practice 3rd Edition, September 2017" by ITE
(3) Rates based on a shopping plaza with no supermarket
(4) KSF = thousand square feet of floor area
(5) DU = Dwelling Unit
Source: LSC Transportation Consultants, Inc.

Table 3b
Sterling Ranch Sketch Plan Amendment No. 4
With Sterling Ranch East Filing No. 7 Rezone
Trip Generation Comparison of the Sterling Ranch Sub Area West of the Creek⁽¹⁾

ITE Code	ITE Land Use	Quantity Unit	Trip Generation Rates ⁽²⁾						Sterling Ranch Sketch Plan Area Internal Trip Calculations (Long-Term Scenario Only)																					
			Daily		AM Peak Hour		PM Peak Hour		Raw ITE Trip Generation (Individual Driveway Trips)					Internal Trips (%)					Total Internal Trips Generated					Total External Trips Generated					New External Trips Generated	
			In	Out	In	Out	In	Out	Daily	AM Peak Hour In	AM Peak Hour Out	PM Peak Hour In	PM Peak Hour Out	Daily	AM	PM	Daily	AM Peak Hour In	AM Peak Hour Out	PM Peak Hour In	PM Peak Hour Out	Daily	AM Peak Hour In	AM Peak Hour Out	PM Peak Hour In	PM Peak Hour Out	Passby ⁽³⁾ (%)	Daily		
Trip Generation Estimate For Sterling Ranch Sub Area West of the Creek Based on the Currently Proposed Land Uses																														
210	Single-Family Detached Housing	996 DU ⁽⁴⁾	9.43	0.18	0.53	0.59	0.35	9,392	174	523	590	346	8%	23%	18%	5%	5%	709	40	92	28	17	8,683	134	431	562	329	0%	8,683	
220	Multifamily Housing (Low-Rise)	275 DU	6.74	0.10	0.30	0.32	0.19	1,854	26	84	88	52	8%	22%	17%	5%	5%	140	6	15	4	2	1,714	20	69	84	50	0%	1,714	
821	Shopping Plaza ⁽⁵⁾	155 KSF ⁽⁶⁾	67.52	1.07	0.66	2.54	2.65	10,466	166	102	394	410	7%	7%	7%	7%	7%	733	12	7	28	29	9,733	154	95	366	381	34%	6,424	
Total								21,711	367	708	1,072	809						1,582	58	114	60	48	20,129	309	594	1,012	761		16,821	
Trip Generation Estimate For Sterling Ranch Sub Area West of the Creek From the Sterling Ranch Sketch Plan Amendment Master Traffic Impact Study, March 17, 2023																														
210	Single-Family Detached Housing	1,006 DU	9.43	0.18	0.52	0.59	0.35	9,487	183	521	596	350	10%	30%	24%	6%	6%	935	54	125	37	22	8,552	129	396	559	328	0%	8,552	
220	Multifamily Housing (Low-Rise)	233 DU	6.74	0.10	0.30	0.32	0.19	1,570	22	71	75	44	10%	30%	24%	6%	6%	155	7	17	5	3	1,415	15	54	70	41	0%	1,415	
821	Shopping Plaza	171 KSF	67.52	1.07	0.66	2.54	2.65	11,546	183	112	435	453	7%	7%	7%	7%	7%	808	13	8	30	32	10,738	170	104	405	421	34%	7,087	
Total								22,603	389	704	1,105	846						1,898	74	150	72	57	20,705	315	554	1,033	789		17,054	
Change in the Trip Generation Estimate								-892	-22	4	-33	-38						-316	-16	-36	-12	-9	-576	-6	40	-21	-29		-233	

Notes:
(1) See Figure 2b for the location of the sub area
(2) Source: "Trip Generation, 11th Edition, 2021" by the Institute of Transportation Engineers (ITE)
(3) Source: "Trip Generation Handbook - An ITE Proposed Recommended Practice 3rd Edition, September 2017" by ITE
(4) DU = Dwelling Unit
(5) Rates based on a shopping plaza with no supermarket
(6) KSF = thousand square feet of floor area

Table 3c
Sterling Ranch Sketch Plan Amendment No. 4
With Sterling Ranch East Filing No. 7 Rezone
Trip Generation Comparison of Sterling Ranch East Preliminary Plan 1 & Foursquare at Sterling Ranch East Sub Area⁽¹⁾

ITE Code		ITE Land Use	Quantity Unit	Sterling Ranch Sketch Plan Area Internal Trip Calculations (Long-Term Scenario Only)																											
				Trip Generation Rates ⁽²⁾				Raw ITE Trip Generation (Individual Driveway Trips)					Internal Trips (%)					Total Internal Trips Generated					Total External Trips Generated					New External Trips Generated			
				Daily	AM Peak Hour		PM Peak Hour		Daily	AM Peak Hour		PM Peak Hour		Daily	AM		PM		Daily	AM Peak Hour		PM Peak Hour		Daily	AM Peak Hour		PM Peak Hour		Passby ⁽³⁾ (%)	Daily	
					In	Out	In	Out		In	Out	In	Out		In	Out	In	Out		In	Out	In	Out		In	Out	In	Out			
Trip Generation Estimate For Sterling Ranch East Preliminary Plan 1 & Foursquare at Sterling Ranch East Based on the Currently Proposed Land Uses																															
210	Single-Family Detached Housing	882	DU ⁽⁴⁾	9.43	0.18	0.53	0.59	0.35	8,317	154	463	522	307	8%	23%	18%	5%	5%	627	35	81	25	15	7,690	119	382	497	292	0%	7,690	
215	Single Family Attached Housing	37	DU ⁽⁴⁾	7.20	0.12	0.36	0.34	0.23	266	4	13	12	9	7%	27%	18%	3%	5%	20	1	2	0	0	246	3	11	12	9	0%	246	
520	Elementary School	1,200	Students	2.27	0.40	0.34	0.07	0.09	2,724	480	408	88	104	60%	60%	30%	30%	60%	1,634	288	123	26	62	1,090	192	285	62	42	0%	1,090	
521	Middle School/Junior High	500	Students	2.10	0.36	0.31	0.07	0.08	1,050	181	154	36	39	60%	60%	30%	30%	60%	630	109	46	11	23	420	72	108	25	16	0%	420	
Total				12,358	819	1,039	659	458											2,911	433	252	62	100	9,447	386	787	597	358		9,446	
Trip Generation Estimate For Sterling Ranch East Preliminary Plan 1 & Foursquare at Sterling Ranch East From the Sterling Ranch Sketch Plan Amendment Master Traffic Impact Study, March 17, 2023																															
210	Single-Family Detached Housing	919	DU	9.43	0.18	0.52	0.59	0.35	8,666	167	476	544	320	10%	30%	24%	6%	6%	854	50	114	34	20	7,812	117	362	510	300	0%	7,812	
520	Elementary School	1,200	Students	2.27	0.40	0.34	0.07	0.09	2,724	480	408	88	104	60%	60%	30%	30%	60%	1,634	288	123	26	62	1,090	192	285	62	42	0%	1,090	
521	Middle School/Junior High	500	Students	2.10	0.36	0.31	0.07	0.08	1,050	181	154	36	39	60%	60%	30%	30%	60%	630	109	46	11	23	420	72	108	25	16	0%	420	
Total				12,440	828	1,039	669	462												3,118	447	283	71	105	9,322	381	756	598	357		9,322
Change in the Trip Generation Estimate				-83	-8	0	-9	-4											-207	-14	-31	-9	-5	124	6	31	0	1		124	

Notes:
(1) See Figure 2c for the location of the sub area
(2) Source: "Trip Generation, 11th Edition, 2021" by the Institute of Transportation Engineers (ITE)
(3) Source: "Trip Generation Handbook - An ITE Proposed Recommended Practice 3rd Edition, September 2017" by ITE
(4) DU = Dwelling Unit
Source: LSC Transportation Consultants, Inc.

Table 3d
Sterling Ranch Sketch Plan Amendment No. 4
With Sterling Ranch East Filing No. 7 Rezone
Trip Generation Comparison of Sterling Ranch South of Oak Park Drive and East of Sterling Ranch East Filing No. 3⁽¹⁾

ITE Code	ITE Land Use	Quantity	Unit	Trip Generation Rates ⁽²⁾		Raw ITE Trip Generation (Individual Driveway Trips)					Sterling Ranch Sketch Plan Area Internal Trip Calculations (Long-Term Scenario Only)										New External Trips Generated									
				Daily	AM Peak Hour		PM Peak Hour		Daily	AM Peak Hour		PM Peak Hour		Internal Trips (%)					Total Internal Trips Generated					Total External Trips Generated					Passby ⁽³⁾ (%)	Daily
					In	Out	In	Out		In	Out	In	Out	Daily	In	Out	In	Out	Daily	In	Out	In	Out	Daily	In	Out	In	Out		
Trip Generation Estimate For Sterling Ranch East Filing No. 5 & Sterling Ranch East Filing No. 7 Based on the Currently Proposed Land Uses																														
Sterling Ranch East Filing No. 5																														
210	Single-Family Detached Housing	160	DU ⁽⁴⁾	9.43	0.18	0.53	0.59	0.35	1,509	28	84	95	56	8%	23%	18%	5%	5%	114	6	15	4	3	1,395	22	69	91	53	0%	1,395
Sterling Ranch East Filing No. 7																														
210	Single-Family Detached Housing	331	DU	9.43	0.18	0.53	0.59	0.35	3,121	58	174	196	115	8%	23%	18%	5%	5%	235	13	31	9	6	2,886	45	143	187	109	0%	2,886
TAZ 104 (Future PUD 5-8 DU/Acre)																														
210	Single-Family Detached Housing	108	DU	9.43	0.18	0.53	0.59	0.35	1,018	19	57	64	38	8%	23%	18%	5%	5%	77	4	10	3	2	941	15	47	61	36	0%	941
Total				5,649	105	314	355	208						426	23	56	16	11	5,223	82	258	339	197						5,222	
Trip Generation Estimate For Sterling Ranch East Filing No. 5 & Sterling Ranch East Filing No. 7 From the Sterling Ranch Sketch Plan Amendment Master Traffic Impact Study, March 17, 2023																														
210	Single-Family Detached Housing	621	DU	9.43	0.18	0.52	0.59	0.35	5,856	113	322	368	216	10%	30%	24%	6%	6%	577	34	77	23	13	5,279	79	245	345	203	0%	5,279
520	Elementary School	600	Students	2.27	0.40	0.34	0.07	0.09	1,362	240	204	44	52	60%	60%	30%	30%	60%	817	144	61	13	31	545	96	143	31	21	0%	545
Total				7,218	353	526	412	268						1,394	178	138	36	44	5,824	175	388	376	224						5,824	
Change in the Trip Generation Estimate				-1,569	-248	-211	-57	-59						-968	-155	-82	-20	-33	-601	-93	-129	-37	-26						-602	
Notes: (1) See Figure 2d for the location of the sub area (2) Source: "Trip Generation, 11th Edition, 2021" by the Institute of Transportation Engineers (ITE) (3) Source: "Trip Generation Handbook - An ITE Proposed Recommended Practice 3rd Edition, September 2017" by ITE (4) DU = Dwelling Unit Source: LSC Transportation Consultants, Inc.																														

Table 3e
Sterling Ranch Sketch Plan Amendment No. 4
With Sterling Ranch East Filing No. 7 Rezone
Trip Generation Comparison of the Sterling Ranch Sub Area East of Sterling Ranch Road Between Oak Park Drive and South Briargate Parkway⁽¹⁾

ITE Code		ITE Land Use	Quantity Unit	Sterling Ranch Sketch Plan Area Internal Trip Calculations (Long-Term Scenario Only)														New External Trips Generated														
				Trip Generation Rates ⁽²⁾					Raw ITE Trip Generation (Individual Driveway Trips)					Internal Trips (%)						Total Internal Trips Generated					Total External Trips Generated							
				Daily	AM Peak Hour		PM Peak Hour		Daily	AM Peak Hour		PM Peak Hour		Daily	AM		PM			Daily	AM Peak Hour		PM Peak Hour		Daily	AM Peak Hour		PM Peak Hour		Passby ⁽³⁾ (%)	Daily	
					In	Out	In	Out		In	Out	In	Out		In	Out	In				Out	In	Out	In		Out	In	Out				
Trip Generation Estimate For Sterling Ranch West of the Creek Based on the Currently Proposed Land Uses																																
210	Single-Family Detached Housing	312	DU ⁽⁴⁾	9.43	0.18	0.53	0.59	0.35	2,942	55	164	185	109	8%	23%	18%	5%	5%	222	13	29	9	5	2,720	42	135	176	104	0%	2,720		
215	Single Family Attached Housing	54	DU ⁽⁴⁾	7.20	0.12	0.36	0.34	0.23	389	6	19	18	13	7%	27%	18%	3%	5%	29	2	4	1	1	360	4	15	17	12	0%	360		
220	Multifamily Housing (Low-Rise)	425	DU	6.74	0.10	0.30	0.32	0.19	2,865	41	129	137	80	8%	22%	17%	5%	5%	216	9	22	7	4	2,649	32	107	130	76	0%	2,649		
821	Shopping Plaza ⁽⁵⁾	55	KSF ⁽⁶⁾	67.52	1.07	0.66	2.54	2.65	3,714	59	36	140	146	7%	7%	7%	7%	7%	260	4	3	10	10	3,454	55	33	130	136	34%	2,279		
Total									9,909	161	349	479	347						727	28	58	27	20	9,182	133	291	452	327		8,008		
Trip Generation Estimate For Sterling Ranch West of the Creek From the Sterling Ranch Sketch Plan Amendment Master Traffic Impact Study, March 17, 2023																																
210	Single-Family Detached Housing	206	DU	9.43	0.18	0.52	0.59	0.35	1,943	37	107	122	72	10%	30%	24%	6%	6%	191	11	26	8	4	1,752	26	81	114	68	0%	1,752		
215	Single Family Attached Housing	146	DU	7.20	0.15	0.33	0.32	0.25	1,051	22	48	47	36	10%	28%	25%	6%	6%	104	6	12	3	2	947	16	36	44	34	0%	947		
220	Multifamily Housing (Low-Rise)	367	DU	6.74	0.10	0.30	0.32	0.19	2,474	35	112	118	69	10%	30%	24%	6%	6%	243	10	27	7	4	2,231	25	85	111	65	0%	2,231		
821	Shopping Plaza	80	KSF	67.52	1.07	0.66	2.54	2.65	5,402	86	53	203	212	7%	7%	7%	7%	7%	378	6	4	14	15	5,024	80	49	189	197	34%	3,316		
Total									10,869	180	319	491	388						916	33	69	32	25	9,953	147	250	459	363		8,246		
Change in the Trip Generation Estimate									-960	-19	29	-11	-42						-189	-5	-11	-5	-5	-771	-14	40	-6	-37		-238		

Notes:
(1) See Figure 2e for the location of the sub area
(2) Source: "Trip Generation, 11th Edition, 2021" by the Institute of Transportation Engineers (ITE)
(3) Source: "Trip Generation Handbook - An ITE Proposed Recommended Practice 3rd Edition, September 2017" by ITE
(4) DU = Dwelling Unit
(5) Rates based on a shopping plaza with no supermarket
(6) KSF = thousand square feet of floor area

Table 3f
Sterling Ranch Sketch Plan Amendment No. 4
With Sterling Ranch East Filing No. 7 Rezone
Trip Generation Comparison of the Approved Sketch Plan Amendment #3 Area⁽¹⁾

ITE Code	ITE Land Use	Quantity Unit	Trip Generation Rates ⁽²⁾		Raw ITE Trip Generation (Individual Driveway Trips)					Sterling Ranch Sketch Plan Area Internal Trip Calculations (Long-Term Scenario Only)										New External Trips Generated									
			Daily	AM Peak Hour		PM Peak Hour		Daily	AM Peak Hour		PM Peak Hour		Internal Trips (%)					Total Internal Trips Generated					Total External Trips Generated					Passby ⁽³⁾ (%)	Daily
				In	Out	In	Out		In	Out	Daily	In	Out	In	Out	Daily	In	Out	In	Out	Daily	In	Out	In	Out				
Trip Generation Estimate For the Approved Sketch Plan Amendment #3 Area Based on the Currently Proposed Land Uses																													
210	Single-Family Detached Housing	1,220 DU ⁽⁴⁾	9.43	0.18	0.53	0.59	0.35	11,505	214	641	722	424	8%	23%	18%	5%	5%	868	49	113	34	20	10,637	165	528	688	404	0%	10,637
Trip Generation Estimate For the Approved Sketch Plan Amendment #3 Area From the Sterling Ranch Sketch Plan Amendment Master Traffic Impact Study, March 17, 2023																													
210	Single-Family Detached Housing	1,302 DU	9.43	0.18	0.52	0.59	0.35	12,278	237	674	771	453	10%	30%	24%	6%	6%	1,210	70	162	48	28	11,068	167	512	723	425	0%	11,068
Change in the Trip Generation Estimate			-773	-23	-34	-49	-29											-342	-21	-49	-14	-8	-431	-2	15	-35	-21		-431
Trip Generation Estimate For the Approved Sketch Plan Amendment #3 Area From the Sterling Ranch Sketch Plan 2023 Amendment and Rezone Traffic Technical Memorandum January 17, 2024																													
210	Single-Family Detached Housing	1,418 DU	9.43	0.18	0.53	0.59	0.35	13,372	248	744	840	493	10%	30%	24%	6%	6%	1,317	74	179	52	30	12,055	174	565	788	463	0%	12,055
Change in the Trip Generation Estimate			-1,867	-35	-104	-117	-69											-449	-25	-66	-18	-10	-1,418	-10	-38	-99	-59		-1,418

Notes:
(1) See Figure 2f for the location of the sub area
(2) Source: "Trip Generation, 11th Edition, 2021" by the Institute of Transportation Engineers (ITE)
(3) Source: "Trip Generation Handbook - An ITE Proposed Recommended Practice 3rd Edition, September 2017" by ITE
(4) DU = Dwelling Unit
Source: LSC Transportation Consultants, Inc.

Table 4

Roadway Segment Improvements

Sterling Ranch East Filing No. 7 Rezone and Sterling Ranch Plan Amendment No. 4

(Page 1 of 2)

Segment ID ⁽¹⁾ (See Figure 12 for map)	Improvement Description	Timing	Design ADT (vpd)	Projected 2044 ADT (vpd)	Responsibility
V1 (Short-Term) Northbound	UPDATE (November 2023): It is our understanding that a meeting(s) with JR Engineering/the applicant, City staff and County staff were held, that a short-term/interim improvement to segment V1 will not be required. The original LSC recommendation for this segment was for restriping. However, City staff indicated that the striped bike lane in the southbound direction needs to remain.	Updated November 2023 - It is our understanding that following a meeting with the City of Colorado Springs and El Paso County, a V1 interim shoulder improvement will no longer be required.	5,500 (Directional northbound)	16,970	N/A
V1 (Short-Term) Southbound			10,000 (Directional southbound)		
V1	Improve Vollmer Road between Dry Needle Place and the Sterling Ranch south boundary to a standard 4-Lane Urban Minor Arterial Cross Section (Add a second northbound through lane and painted center median) ⁽²⁾ 8/22/2024 Note: the 2024 MTCP shows Vollmer Road as an Urban – Major Collector	Intermediate-Term Future	20,000		Updated November 2023 Adjacent parcel owner which could potentially include: <ul style="list-style-type: none"> “Pioneer Landscape Center Parcel” (5300000742) (redevelopment is unlikely in the foreseeable future) “Schmidt Parcel” west of Vollmer Rd (5200000571) The triangular parcels southeast of Vollmer/Marksheffel (5232400001 and 5232400003)
V2	Improve Vollmer Road between the Sterling Ranch south boundary to Lochwinnoch Lane/Sterling property boundary to a standard 4-Lane Urban Minor Arterial Cross Section ⁽²⁾ 8/22/2024 Note: the 2024 MTCP shows Vollmer Road as an Urban – Major Collector	Updated September 2024: Complete	20,000 (Note: Existing Capacity 8,000 ⁽³⁾)	18,365	Sterling Ranch
V3	Short Term: Improve Vollmer Road from Lochwinnoch Lane to Sterling Ranch boundary (northeast of Glider Loop) to provide 36’ of pavement (existing pavement 1 approx. 23.38’) and stripe for one through lane and plus a 6’ paved, striped outside shoulder in each direction ⁽²⁾	Updated November 2023 – Future as required due to net increase traffic demand. The construction documents have been approved.	11,000 (Note: Existing Capacity 8,000)	18,265	Sterling Ranch
	Long Term: Improve Vollmer Road from Lochwinnoch Lane to Sterling Ranch boundary (northeast of Glider Loop) to a standard 4-Lane Urban Minor Arterial Cross Section ⁽²⁾ 8/22/2024 Note: the 2024 MTCP shows Vollmer Road as an Urban – Major Collector	Long-Term Future	20,000		By others - pursuant to the recent development agreement between Sterling Ranch and EPC.
V4	Improve Vollmer Road from Sterling Ranch boundary (northeast of Glider Loop) to Briargate Parkway to a standard 4-Lane Urban Minor Arterial Cross Section ⁽²⁾ Update November 2023 - with transition section to the existing two-lane section to the south as shown on the Vollmer North CDs. Improvements consist of curb and gutter on west side (as most of the east side is already built) and repaving.	Updated September 2024: Complete	20,000	16,125	Sterling Ranch
V5	Improve Vollmer Road from Briargate Parkway to Jane Kirkham Drive to a standard 4-Lane Urban Minor Arterial Cross Section ⁽²⁾ 8/22/2024 Note: the 2024 MTCP shows Vollmer Road as an Urban – Major Collector	Updated September 2024: Complete	20,000	11,505	Sterling Ranch
V6	Improve Vollmer Road from Jane Kirkham Drive to Sam Bass Drive to a standard 4-Lane Urban Minor Arterial Cross Section ⁽²⁾ 8/22/2024 Note: the 2024 MTCP shows Vollmer Road as an Urban – Major Collector	Updated September 2024: Complete	20,000	11,240	Sterling Ranch
V7	Improve Vollmer Road between Sam Bass Drive and Poco Road to a 4-lane Urban Minor Arterial but with necessary lane transitions, redirect tapers, etc. south of Poco to adequately transition between the 4-Lane Urban Minor Arterial Cross Section and the 2-Lane Rural Arterial Cross Section north of Poco Road. 8/22/2024 Note: the 2024 MTCP shows Vollmer Road as an Urban – Major Collector	Updated September 2024: Complete	20,000	10,605	Sterling Ranch
V8	Improve Vollmer Road from Poco Road to Burgess Road to a 2-Lane Urban – Major Collector Cross Section ⁽²⁾	Long-Term Future	20,000	9,335	El Paso County

Part 1/2 of this table (see Part 2 on next page)

Notes:

(1) See Figure 12

(2) Adequate transition/redirect tapers would be needed between the various cross sections on Vollmer Road. Based on the criteria contained in Table 2-29 of the *El Paso Engineering Criteria Manual* an appropriate taper ratio for a roadway with a design speed of 40 miles per hour is 20:1

(3) Source: Table 20 Road Impact Fee Study Updated November 16, 2016

Source: LSC Transportation Consultants, Inc. (October 2024)

Table 4

Roadway Segment Improvements

Sterling Ranch East Filing No. 7 Rezone and Sterling Ranch Plan Amendment No. 4

(Page 2 of 2)

Segment ID ⁽¹⁾ (See Figure 12 for map)	Improvement Description	Timing	Design ADT (vpd)	Projected 2042 ADT (vpd)	Responsibility
SR1	Construct Sterling Ranch Road as an Urban Major Collector from Marksheffel Road to Dines Boulevard	<u>Completed</u>	20,000	14,480	Sterling Ranch
SR2	Construct Sterling Ranch Road as an Urban Major Collector from Dines Boulevard to Briargate Parkway	Short-Term - with SRE Preliminary Plan 1	20,000	9,815	Sterling Ranch
SR3	Construct Sterling Ranch Road as an Urban Minor Collector from Briargate Parkway to Vancouver Street	Short-Term - with SRE Preliminary Plan 1	10,000	8,400	Sterling Ranch
SR4	Construct Sterling Ranch Road from Vancouver Street north to ultimate north terminus	Long-Term Future	10,000	4,260	Sterling Ranch
M1	Construct Marksheffel Road as an Urban Principal Arterial to City of Colorado Springs standards in 107' of right-of-way between Vollmer Road and Sterling Ranch Road	<u>Completed</u>	40,000	23,015	Sterling Ranch
M2	Construct Marksheffel Road as an Urban Principal Arterial to City of Colorado Springs standards in 107' of right-of-way between Sterling Ranch Road and the south boundary of the Sterling Ranch Master Plan Area. NOTE: With the completion of this improvement, the connection between Vollmer Road and Woodmen Road will be completed	To be completed in 2024	40,000	28,220	Sterling Ranch
M3	Construct Marksheffel Road between the south boundary of the Sterling Ranch Master Plan Area and Woodmen Road (Note this segment is located within the City of Colorado Springs)	<u>Completed</u> (by Others)	40,000	24,525	Others (Completed)
M4	Construct Marksheffel Road between Black Forest Road and Vollmer Road	Long-Term Future	40,000	27,910	Others
B1	Construct the full section of Briargate Parkway (4-Lane Principal Arterial) between Vollmer Road and Wheatland Drive	<u>Completed</u>	40,000	24,745	Sterling Ranch
B2	Construct Briargate Parkway (full section) as a 4-Lane Principal Arterial between Wheatland Drive and Sterling Ranch Road	Updated September 2024: In Progress Anticipated Completion Fall 2024	40,000	24,190	Sterling Ranch
B3	Construct Briargate Parkway as a 4-Lane Principal Arterial between Sterling Ranch Road and Banning Lewis Parkway	Intermediate Term	40,000	21,680	Sterling Ranch
B4	Construct Stapleton Road as a 4-Lane Principal Arterial between Banning Lewis Parkway and Meridian Road (including upgrade of existing rural two-lane segment between Towner and Meridian)	Long-Term Future	40,000	17,945	Others
B5	Construct Briargate Parkway as a 4-Lane Principal Arterial between its current terminus and Black Forest Road and between Black Forest Road and Vollmer Road	Long-Term Future	40,000	24,340	Others
BL1	Construct Banning Lewis Parkway as a 4-Lane Principal Arterial between the south Sterling Ranch boundary and Briargate Pkwy	Long-Term Future	40,000	20,320	Future - TBD with the future preliminary plan for that area - potentially, financial assurances for half-section, west-side half-section or full-section w/ cost recover may be required
BL2	Construct Banning Lewis Parkway as a 4-Lane Principal Arterial between Woodmen Road and the south Sterling Ranch boundary (Note this segment will be located within the City of Colorado Springs)	Long-Term Future	40,000	28,480	Others
W1	Widen Woodmen Road from 4-lane to 6-lane section from Powers Boulevard to US 24	Long-Term Future	72,000	66,690	Others

Part 2/2 of this table

Notes:

- (1) See Figure 12
- (2) Adequate transition/redirect tapers would be needed between the various cross sections on Vollmer Road. Based on the criteria contained in Table 2-29 of the *El Paso Engineering Criteria Manual*, an appropriate taper ratio for a roadway with a design speed of 40 miles per hour is 20:1
- (3) Source: Table 20 *Road Impact Fee Study Updated* November 16, 2016

Source: LSC Transportation Consultants, Inc. (October 2024)

Table 5
Intersection Improvements
Sterling Ranch East Filing No. 7 Rezone & Sterling Ranch Sketch Plan Amendment #4

Item #	Improvement	Trigger	Timing	Responsibility
4) Briargate Parkway/Vollmer Road				
1	Briargate Parkway: Two through lanes eastbound and westbound at intersection No. 4; ConnectCOS TIP Index No. 325; Construct new roadway connection, drainage, upgrade traffic signal, and multimodal features. PPRTA A List Project. Improvements on Briargate Parkway west of Vollmer Road as shown on Figure 10c are consistent with the improvements shown in the Briargate-Stapleton Corridor Study (DRAFT) by Wilson & Company dated December 9, 2021. These improvements will likely be completed with the extension of Briargate Parkway west of Vollmer Road and/or with development of the Jaynes property located east of Vollmer Road.			
5) Briargate Parkway/Sterling Ranch Road				
2	Construct an eastbound left-turn lane on Briargate Parkway approaching Sterling Ranch Road. The lane should be 435' long plus a 200' taper.	eastbound left-turn volume > 10 vph	Anticipated completion Fall 2024	Sterling Ranch
3	Construct an eastbound right-turn deceleration lane on Briargate Parkway approaching Sterling Ranch Road. The lane should be 235' long plus a 200' taper.	eastbound right-turn volume > 25 vph	Anticipated completion Fall 2024	Sterling Ranch
4	Construct a northbound to eastbound right-turn acceleration lane on Briargate Parkway at Sterling Ranch Road. The lane should be 580' long plus a 180' taper.	northbound right-turn volume > 50 vph	Long Term With development of the K-8 School Parcel (Tract M)	Sterling Ranch
5	Construct a westbound left-turn lane on Briargate Parkway approaching Sterling Ranch Road. The lane should be 285' long plus a 200' taper.	westbound left-turn volume > 10 vph	Long Term	Sterling Ranch
6	Construct an eastbound right-turn deceleration lane on Briargate Parkway approaching Sterling Ranch Road. The lane should be 235' long plus a 200' taper.	eastbound right-turn volume > 25 vph	Long Term	Sterling Ranch
7	Construct a southbound to westbound right-turn acceleration lane on Briargate Parkway at Sterling Ranch Road. The lane should be 580' long plus a 180' taper.	southbound right-turn volume > 50 vph	Anticipated completion Fall 2024	Sterling Ranch
6) Banning Lewis Parkway/Briargate Parkway				
8	Improvements on as shown on Figure 10c are consistent with the improvements shown in the Briargate-Stapleton Corridor Study (DRAFT) by Wilson & Company dated December 9, 2021. These improvements would not be needed if this intersection is constructed as a modern two-lane roundabout. Detailed recommendations are anticipated to be provided with future preliminary plan and/or final plat submittals.			
7) Vollmer/Dines				
9	Additional improvements may be needed as part of the Retreat at Prairie Ridge property development (PCD No. SKP225).			
8) Sterling Ranch Road/Oak Park Place				
10	Construct a southbound left-turn lane on Sterling Ranch Road approaching Oak Park Place. The lane should be 220' long plus a 160' taper.	southbound left-turn volume > 25 vph	With Future Filings (Villages at Sterling Ranch East)	Sterling Ranch
11	Construct a northbound right-turn deceleration lane on Sterling Ranch Road approaching Oak Park Place. The lane should be 155' long plus a 160' taper.	northbound right-turn volume > 50 vph	With Future Filings (Villages at Sterling Ranch East)	Sterling Ranch
9) Banning Lewis Parkway/Oak Park Place				
12	Construct a northbound left-turn lane on Banning Lewis Parkway approaching Oak Park Place. Detailed auxiliary turn lane lengths to be determined with future Preliminary Plan and/or Final Plat submittals.	northbound left-turn volume > 10 vph	With Future Filings	Sterling Ranch
13	Construct a southbound left-turn lane on Banning Lewis Parkway approaching Oak Park Place. Detailed auxiliary turn lane lengths to be determined with future Preliminary Plan and/or Final Plat submittals.	southbound right-turn volume > 25 vph	With Future Filings	Sterling Ranch
10) Sterling Ranch Road/Dines Boulevard				
14	No additional improvements are anticipated to be required			
12) Marksheffel Road/Vollmer Road				
15	Signalization of the intersection	Once warrants are met. The decision on timing of traffic signal installation rests with El Paso County Public Works.	Anticipated by buildout of Sterling Ranch East Phase 1 Preliminary Plan	This intersection may be eligible intersection under the fee impact program
13) Sterling Ranch Road/Marksheffel Road				
16	A westbound left-turn lane and eastbound right-turn lane may be required with development of the Rhetoric Parcel. See PCD No. PP2216			
17	Signalization of the intersection	Once warrants are met. The decision on timing of traffic signal installation rests with The City of Colorado Springs.	Anticipated by buildout of Sterling Ranch East Phase 1 Preliminary Plan	SRMD#3

Source: LSC Transportation Consultants, Inc. (October 2024)

Appendix Table 1



**Appendix Table 1
Area Traffic Impact Studies
Sterling Ranch Sketch Plan Amendment #4**

Study	PCD File No⁽¹⁾	Consultant	Date
Sterling Ranch Reports			
Sterling Ranch Updated Traffic Impact Analysis	SKP07007	LSC Transportation Consultants, Inc	June 5, 2008
Sterling Ranch Phase 1 Traffic Impact Study	P151	LSC Transportation Consultants, Inc	March 16, 2015
Sterling Ranch Phases 1-3 Transportation Memorandum	SP1415	LSC Transportation Consultants, Inc	October 2, 2017
Branding Iron at Sterling Ranch Filing No. 1 and Homestead at Sterling Ranch Filing No. 1 Transportation Memorandum	SF1724 SF1725	LSC Transportation Consultants, Inc	December 19, 2017
Sterling Ranch Filing No. 2 Transportation Memorandum	SF1820	LSC Transportation Consultants, Inc	April 3, 2018
Sterling Ranch Phase 2 Preliminary Plan Traffic Impact Study	SP203	LSC Transportation Consultants, Inc	December 20, 2018
Homestead at Sterling Ranch Filing No. 2 Transportation Memorandum	SF194	LSC Transportation Consultants, Inc	March 3, 2020
Branding Iron at Sterling Ranch Filing No. 2 Transportation Memorandum	SF1918	LSC Transportation Consultants, Inc	May 6, 2020
Sterling Ranch Filing No. 2 and Phase 2 Traffic Impact Study	SF2015 SP191	LSC Transportation Consultants, Inc	June 23, 2021
Sterling Ranch Filing No. 3 Transportation Memorandum	SF2132	LSC Transportation Consultants, Inc	April 19, 2022
Homestead North Phase 1 Updated Transportation Memorandum	SP208	LSC Transportation Consultants, Inc	January 11, 2022
Homestead North Filing No. 1 Traffic Technical Memorandum	SF2213	LSC Transportation Consultants, Inc	February 2, 2022
Homestead North Filing No. 2 Traffic Technical Memorandum	SF2218	LSC Transportation Consultants, Inc	April 15, 2022
Homestead North Filing 3 Traffic Impact Study	SF2229	LSC Transportation Consultants, Inc	June 17, 2022
The Villages at Sterling Ranch East Preliminary Plan/Traffic Generation Analysis	PUDSP226	SM Rocha, LLC	July 1, 2022
Sterling Ranch Sketch Plan Amendment Master Traffic Impact Study	SKP224	LSC Transportation Consultants, Inc	March 17, 2023
Sterling Ranch East - Rezoning & Preliminary Plan Traffic Impact Study	SP-22-004, P-22-012, P-22-013	LSC Transportation Consultants, Inc	March 17, 2023 ⁽²⁾
Sterling Ranch East Filing Nos 1 & 2 Traffic Technical Memorandum	SF2235 SF2237	LSC Transportation Consultants, Inc	February 10, 2023
Sterling Ranch Filing No. 4 Transportation Memorandum	SF2230	LSC Transportation Consultants, Inc	February 21, 2023
Foursquare at Sterling Ranch East Transportation Memorandum	SF2236	LSC Transportation Consultants, Inc	April 20, 2023
Copper Chase at Sterling Ranch Traffic Impact Study	PUDSP222	LSC Transportation Consultants, Inc	April 28, 2023
Sterling Ranch Filing No. 5 Traffic Impact Study	PUDSP-23-002	LSC Transportation Consultants, Inc	November 15, 2023
Sterling Ranch Sketch Plan 2023 Amendment & Rezone Traffic Technical Memorandum	SKP235, P239, P2311	LSC Transportation Consultants, Inc	January 17, 2024
Sterling Ranch East - Filing 5 Rezone & Preliminary Plan Traffic Impact Study	P237 & SP235	LSC Transportation Consultants, Inc	January 15, 2024
Villages at Sterling Ranch Traffic Impact Study	PUDSP226	LSC Transportation Consultants, Inc	August 21, 2024
Retreat at TimberRidge Reports			
The Retreat at TimberRidge Traffic Impact Analysis	PUD173	LSC Transportation Consultants, Inc	January 25, 2018
The Retreat at TimberRidge Preliminary Plan Traffic Technical Memorandum	SP182	LSC Transportation Consultants, Inc	June 29, 2018
The Retreat at TimberRidge Filing No. 1 Traffic Technical Memorandum	SF199	LSC Transportation Consultants, Inc	April 3, 2020
The Retreat at TimberRidge Filing No. 2 Updated Traffic Technical Memorandum	SF2121	LSC Transportation Consultants, Inc	October 4, 2021
The Retreat at TimberRidge Filing No. 3 Traffic Technical Memorandum	SF2241	LSC Transportation Consultants, Inc	November 15, 2023
The Retreat at TimberRidge Filing No. 4 Traffic Technical Memorandum	SF1827	LSC Transportation Consultants, Inc	February 21, 2024
Other Area Reports			
Wolf Ranch School Site Traffic Impact Study	OAR1720	Matrix Design Group, Inc.	5-May-17
The Ranch Sketch Plan Traffic Impact Analysis	SKP186	LSC Transportation Consultants, Inc	July 9, 2019
Lodge III Traffic Impact Study	OAR	LSC Transportation Consultants, Inc	December 13, 2019
Continental 613 Traffic Impact Study	OAR2177	LSC Transportation Consultants, Inc	July 16, 2021
Solace at Black Forest Traffic Impact and Access Analysis	OAR2134	LSC Transportation Consultants, Inc	August 13, 2021
Traffic Impact Study Addendum for Percheron	OAR2173	SM Rocha, LLC	October, 2021
Woodmen East Commercial Center Traffic Impact Analysis	OAR2191	LSC Transportation Consultants, Inc	December 8, 2021
Traffic Impact Study for Jaynes Property	SKP225	SM Rocha, LLC	May, 2022
Briargate-Stapleton Corridor Study (DRAFT)	briargate-stapleton.com	Wilson & Company	December 9, 2021
Sterling Recycling Facility Transportation Memorandum	PPR2341	LSC Transportation Consultants, Inc	August 24, 2023

Notes:

(1) Follow the links listed below to obtain the most recent version of each listed study. To obtain a copy of the version of each study used in preparing this report please contact LSC Transportation Consultants, Inc.

Source: LSC Transportation Consultants, Inc.

Figures 1-12



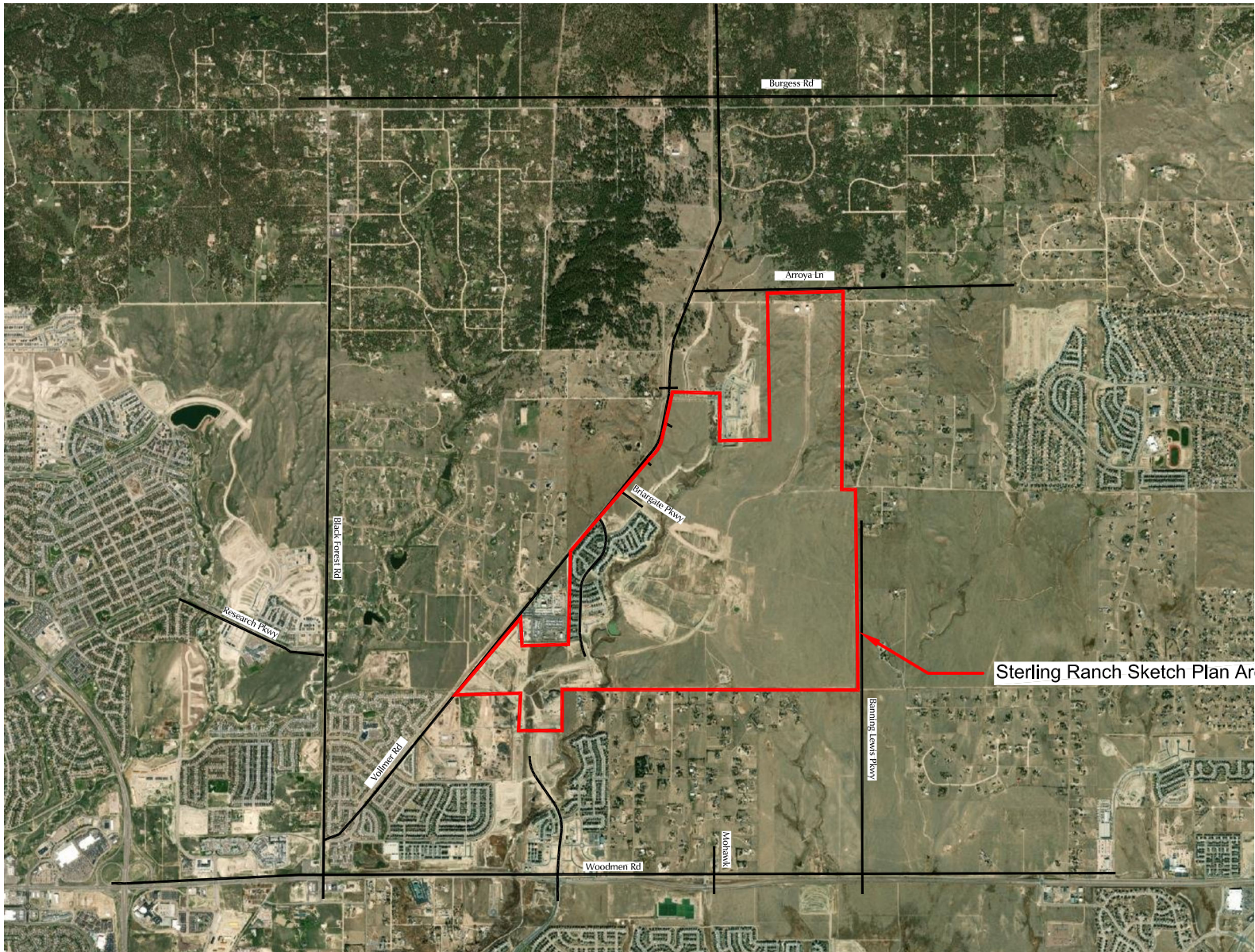

Sterling Ranch Sketch Plan Area

Figure 1

Vicinity

Sterling Ranch Sketch Plan Amendment No. 4 & Sterling Ranch East Filing No. 7 Zone Change (LSC# S244270)



SECTION 27, TOWNSHIP 12, RANGE 65 WEST OF THE 6TH P.M., EL PASO, CO

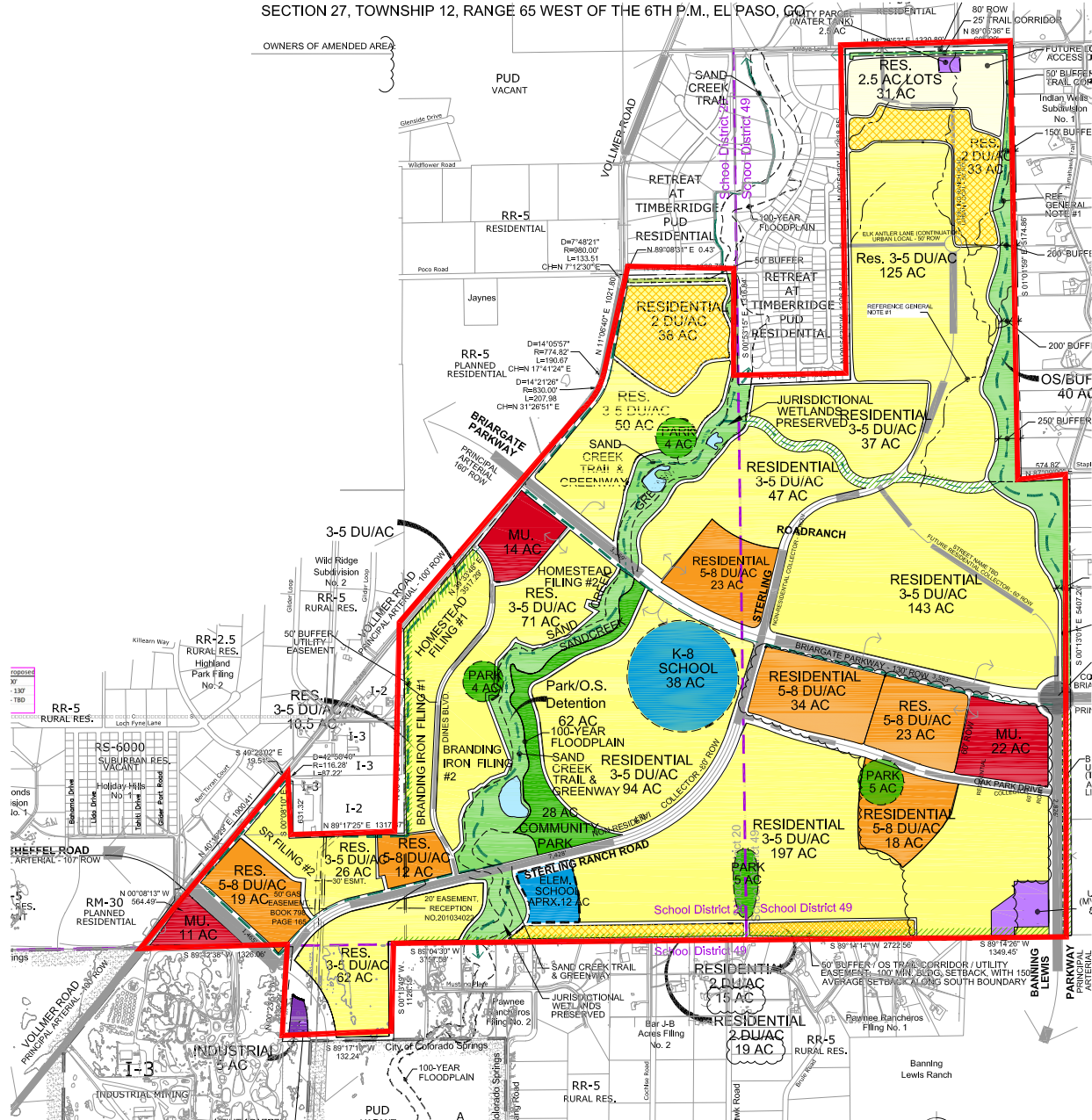

Approximate
Scale:
1" = 2,000'



Source: NES, Inc.
Date: 8/29/24

Sterling Ranch Sketch Plan Amendment No. 4 & Sterling Ranch East Filing No. 7 Zone Change (LSC# S244270)

Figure 2
Sketch Plan



Approximate
Scale:
1" = 2,000'

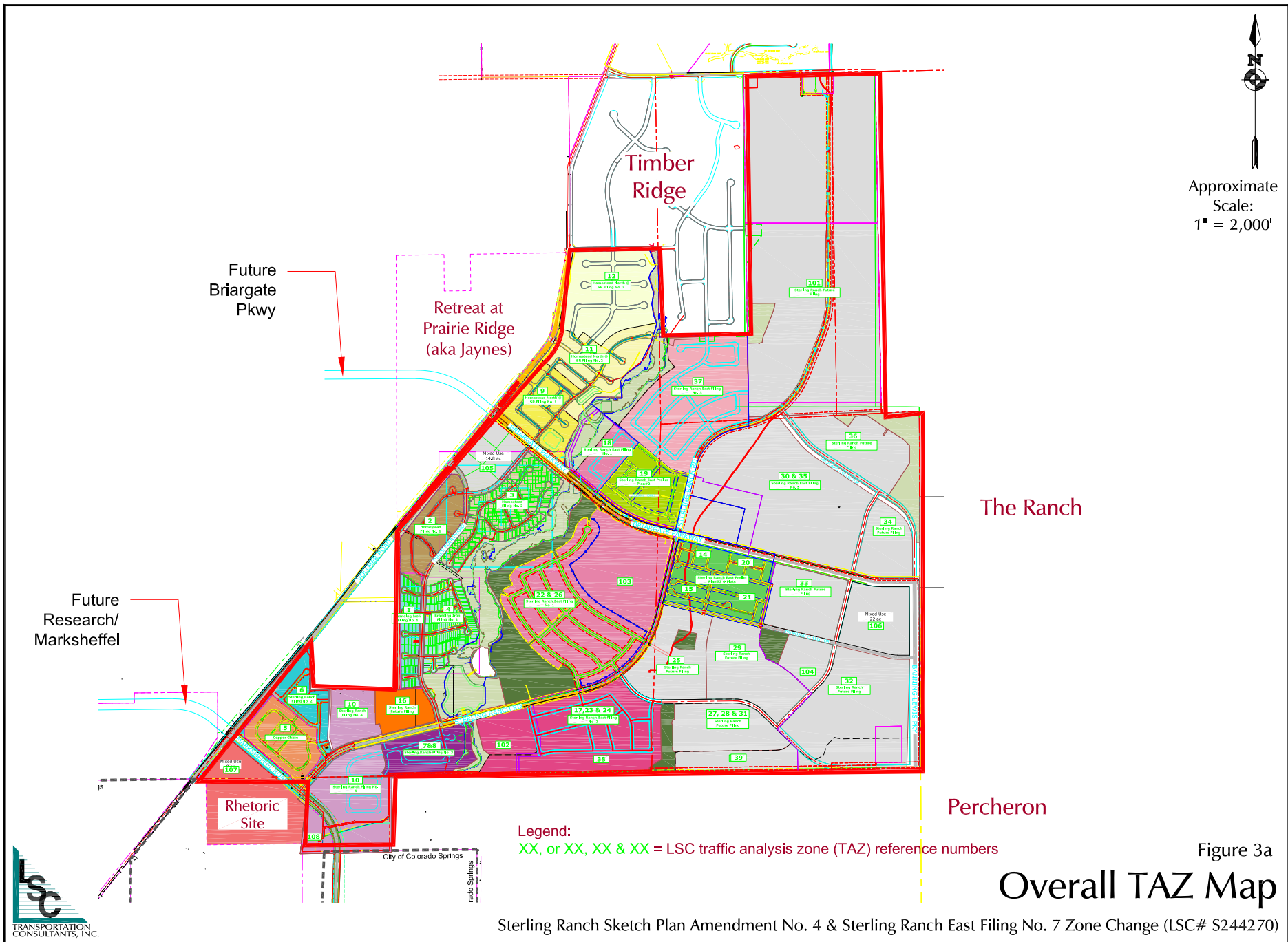

Legend:

XX, or XX, XX & XX = LSC traffic analysis zone (TAZ) reference numbers

The Ranch

Percheron

Figure 3a

Overall TAZ Map

Sterling Ranch Sketch Plan Amendment No. 4 & Sterling Ranch East Filing No. 7 Zone Change (LSC# S244270)





Approximate
Scale:
1" = 1,500'

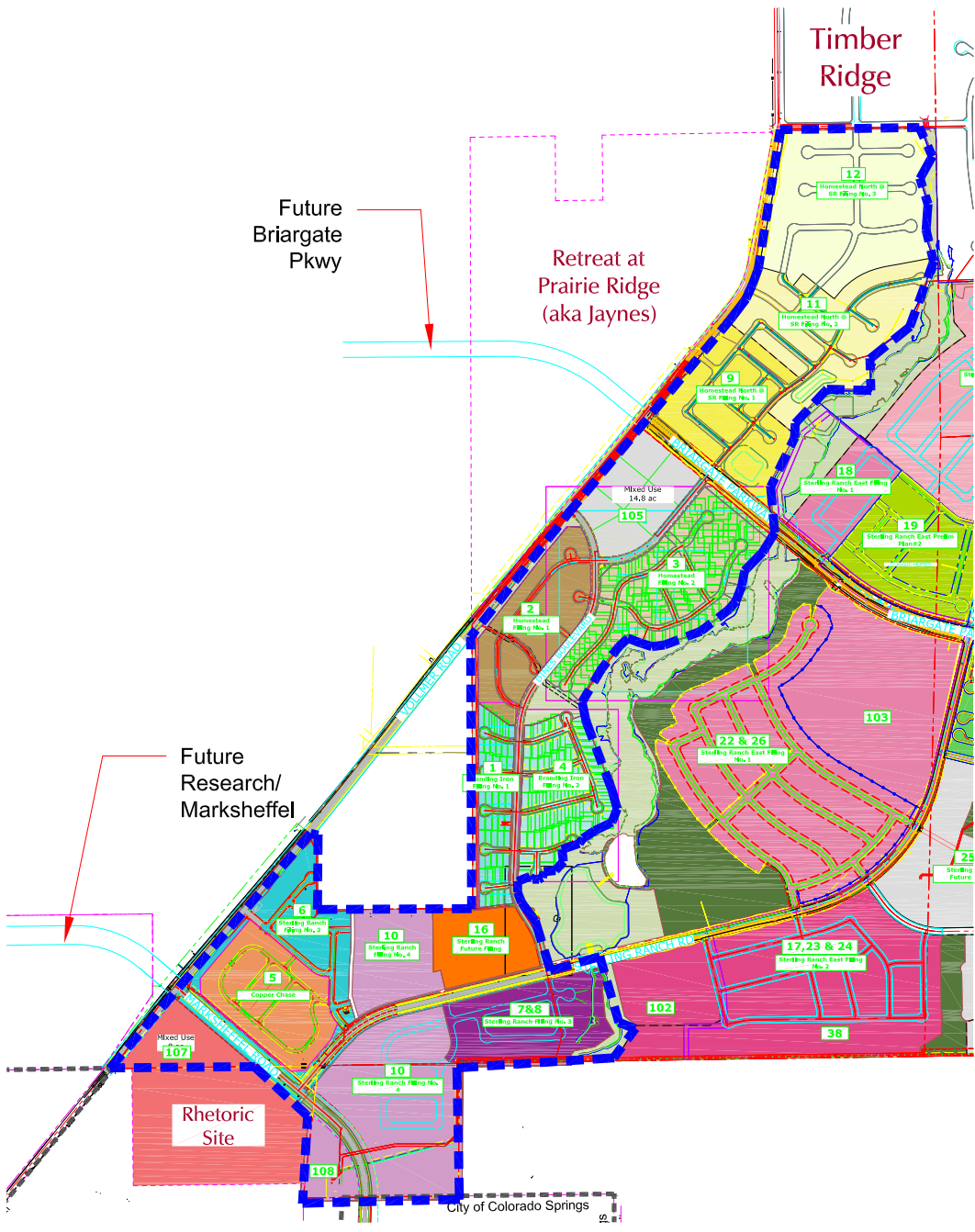

Legend:
XX, or XX, XX & XX = LSC traffic analysis zone (TAZ) reference numbers
■■■■■ = Boundary of the subject area of this figure

Figure 3b

TAZ Map - Sterling Ranch West of the Creek

Sterling Ranch Sketch Plan Amendment No. 4 & Sterling Ranch East Filing No. 7 Zone Change (LSC# S244270)





Approximate
Scale:
1" = 1,000'

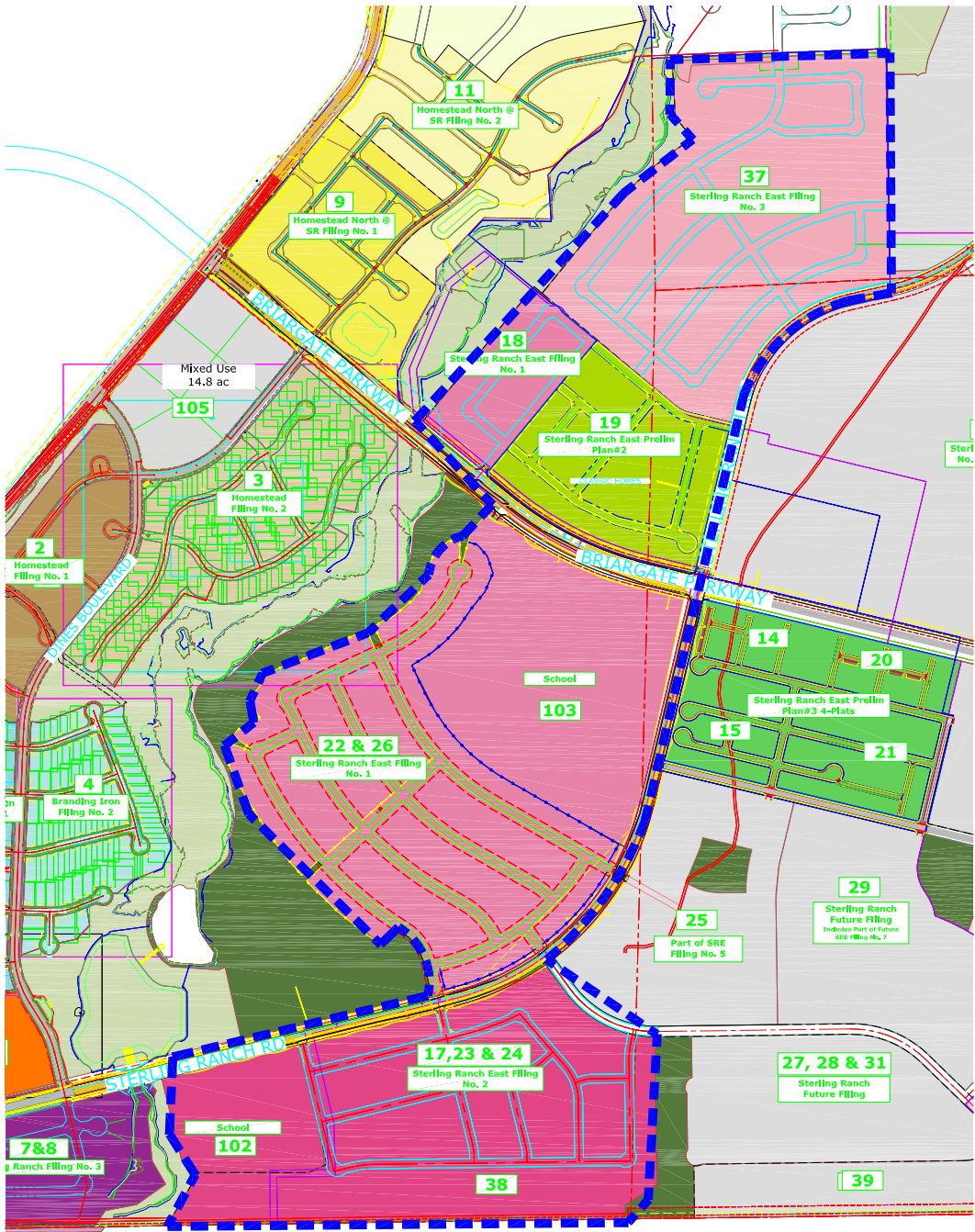

Legend:
XX, or XX, XX & XX = LSC traffic analysis zone (TAZ) reference numbers
■■■■■ = Boundary of the subject area of this figure

Figure 3c

TAZ Map - Sterling Ranch East Preliminary Plan 1 & Four Square at Sterling Ranch

Sterling Ranch Sketch Plan Amendment No. 4 & Sterling Ranch East Filling No. 7 Zone Change (LSC# S244270)



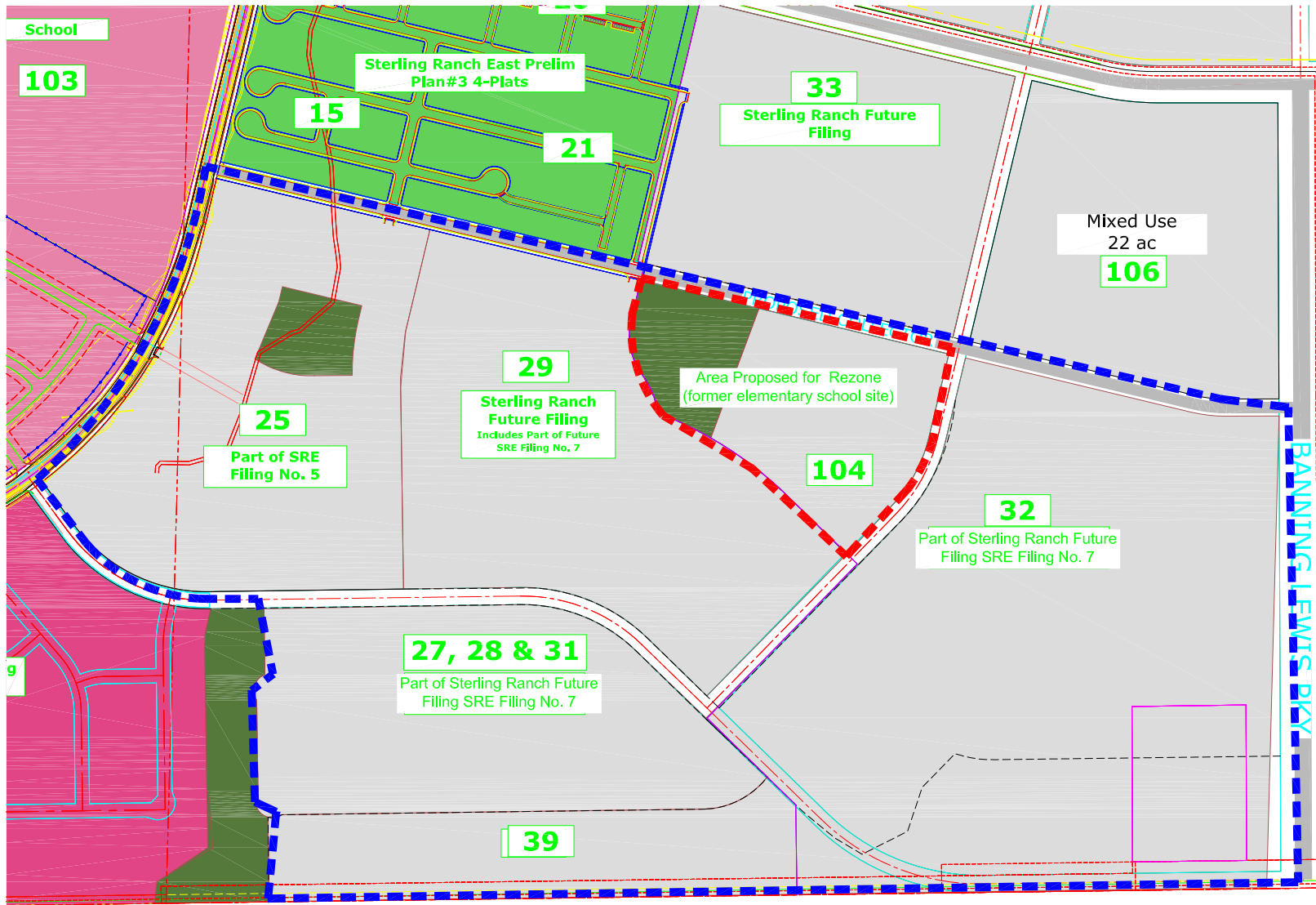

Approximate
Scale:
1" = 550'

Legend:
 XX, or XX, XX & XX = LSC traffic analysis zone (TAZ) reference numbers
 ■■■■■ = Boundary of the subject area of this figure



TAZ Map - South of Oak Park Drive

Figure 3d

Sterling Ranch Sketch Plan Amendment No. 4 & Sterling Ranch East Filing No. 7 Zone Change (LSC# S244270)

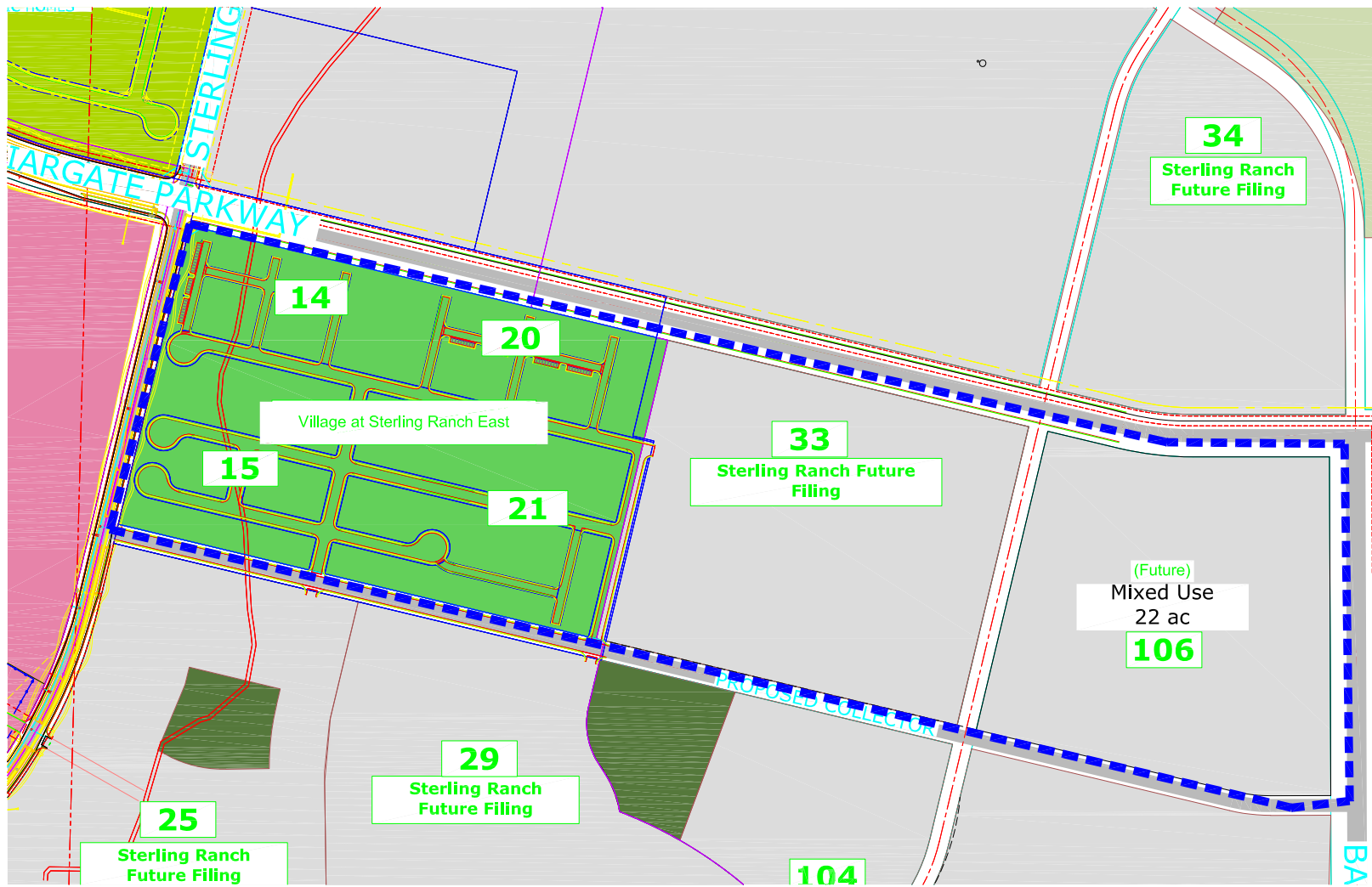

Approximate
Scale:
1" = 500'

Legend:
 XX, or XX, XX & XX = LSC traffic analysis zone (TAZ) reference numbers
 ■■■■■ = Boundary of the subject area of this figure

Figure 3e

TAZ Map - East of Sterling Ranch Road between Oak Park Drive and Briargate Parkway

Sterling Ranch Sketch Plan Amendment No. 4 & Sterling Ranch East Filing No. 7 Zone Change (LSC# S244270)



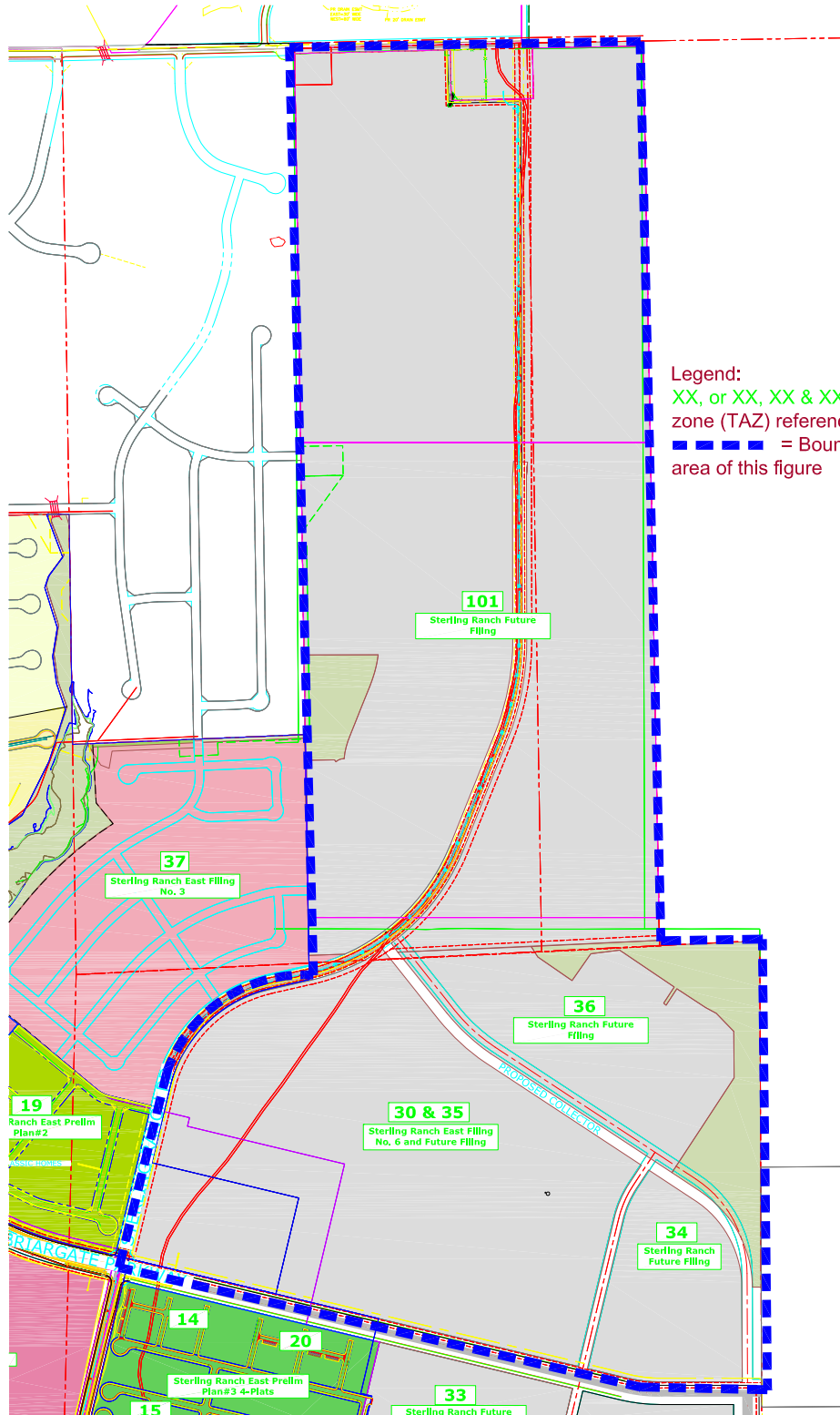

 Approximate
 Scale:
 1" = 1,000'

Legend:
 XX, or XX, XX & XX = LSC traffic analysis
 zone (TAZ) reference numbers
 = Boundary of the subject
 area of this figure

Figure 3f

TAZ Map - Sterling Ranch North of Briargate Parkway and east of Sterling Ranch East Preliminary Plan 1 and Four Square at Sterling Ranch



Sterling Ranch Sketch Plan Amendment No. 4 & Sterling Ranch East Filing No. 7 Zone Change (LSC# S244270)



Not to scale

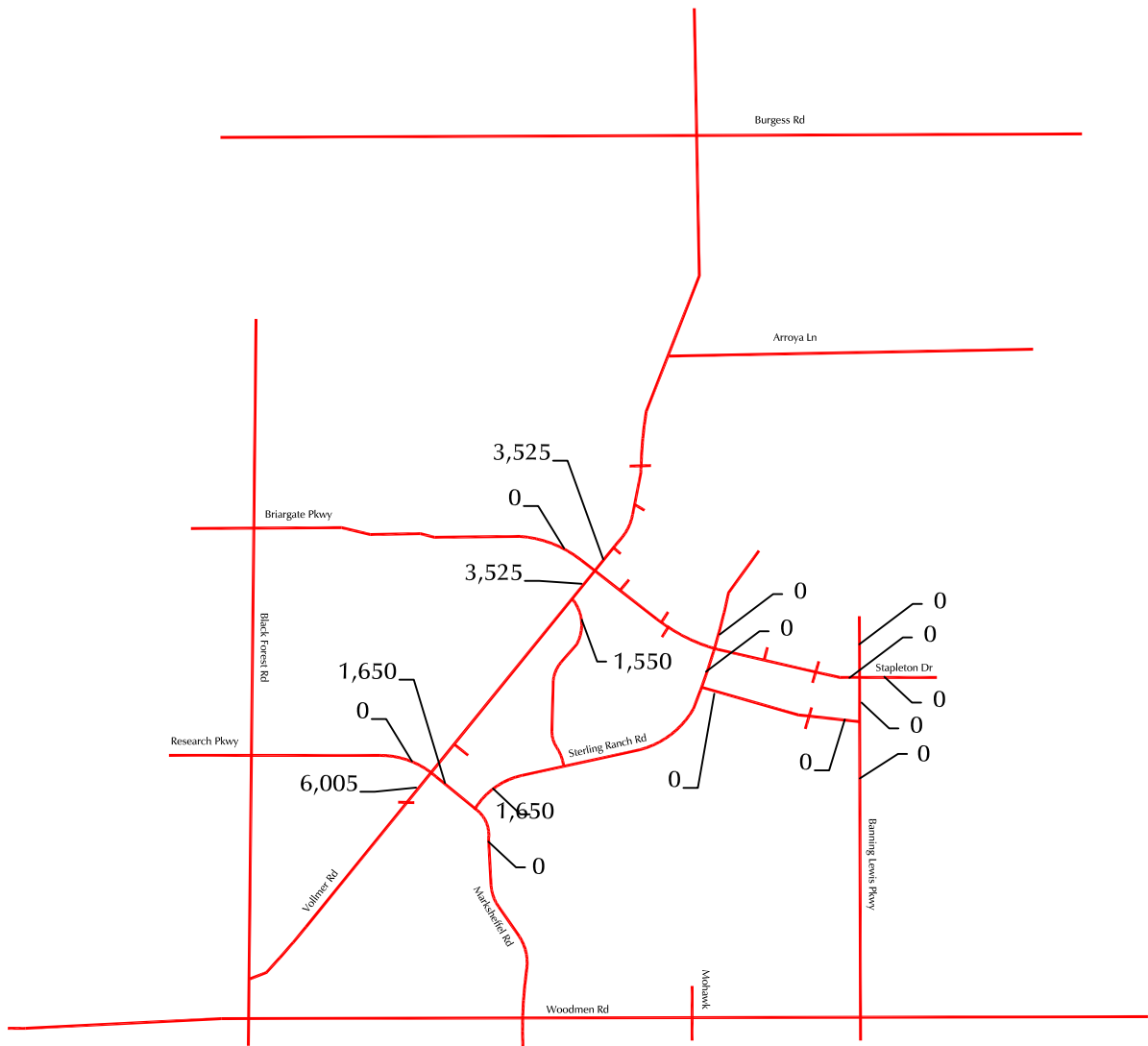

LEGEND:

XXX = Average Weekday Traffic (vehicles per day)

Counts are estimates by LSC based on factored turning movement count data shown on Figure 5b



Figure 5a
Existing ADTs

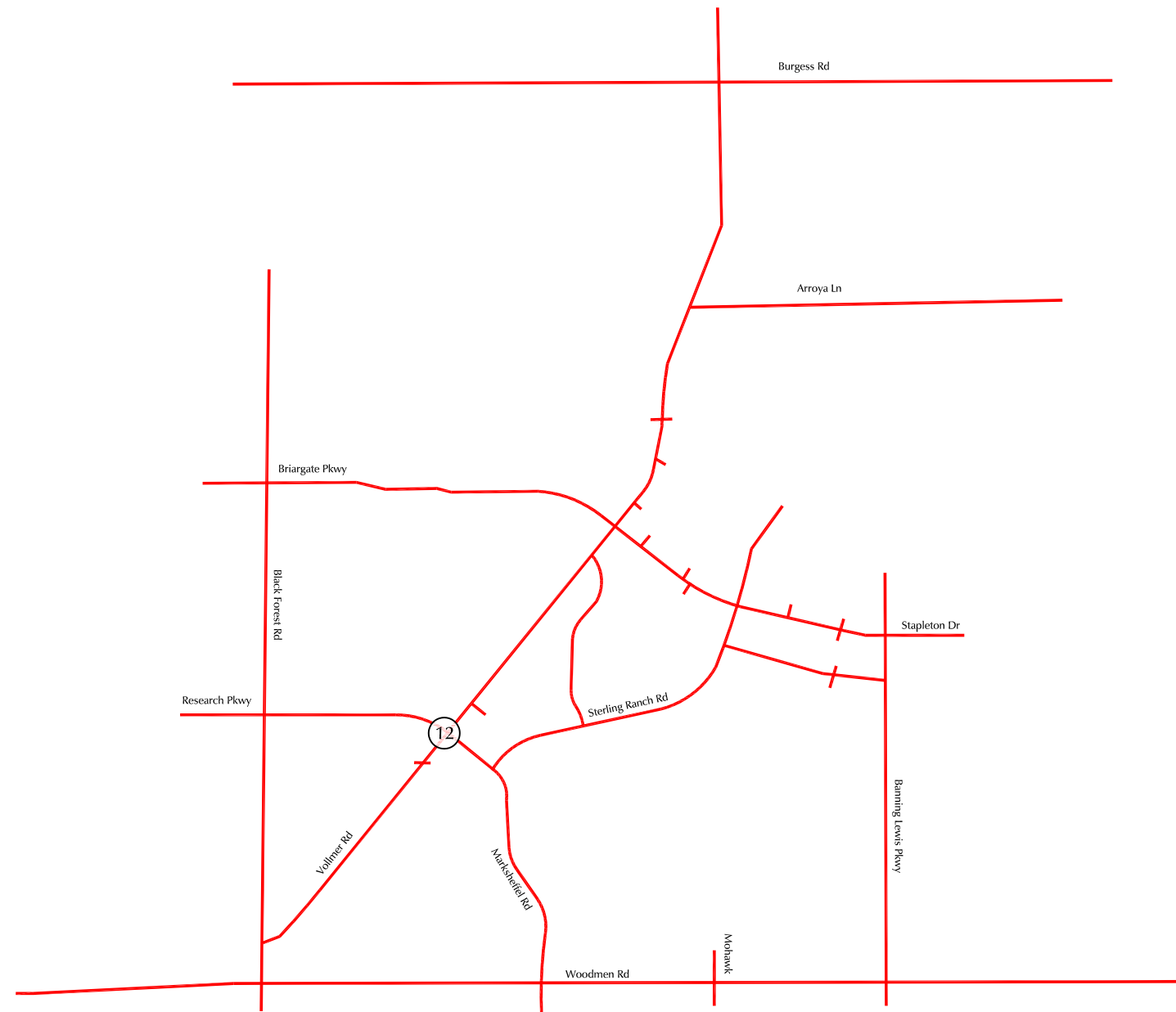
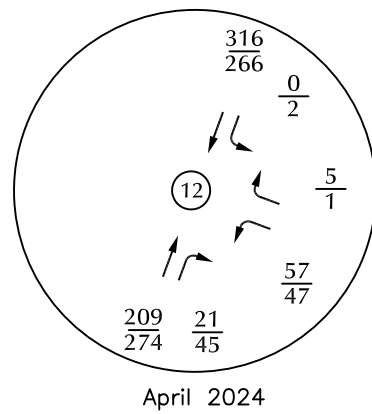

LEGEND: $\frac{XX}{XX} = \frac{\text{AM Peak-Hour Traffic (veh/hr)}}{\text{PM Peak-Hour Traffic (veh/hr)}}$



Figure 5b
Existing Peak-Hour Traffic
 Sterling Ranch Sketch Plan Amendment No. 4 & Sterling Ranch East Filing No. 7 Zone Change (LSC# S244270)

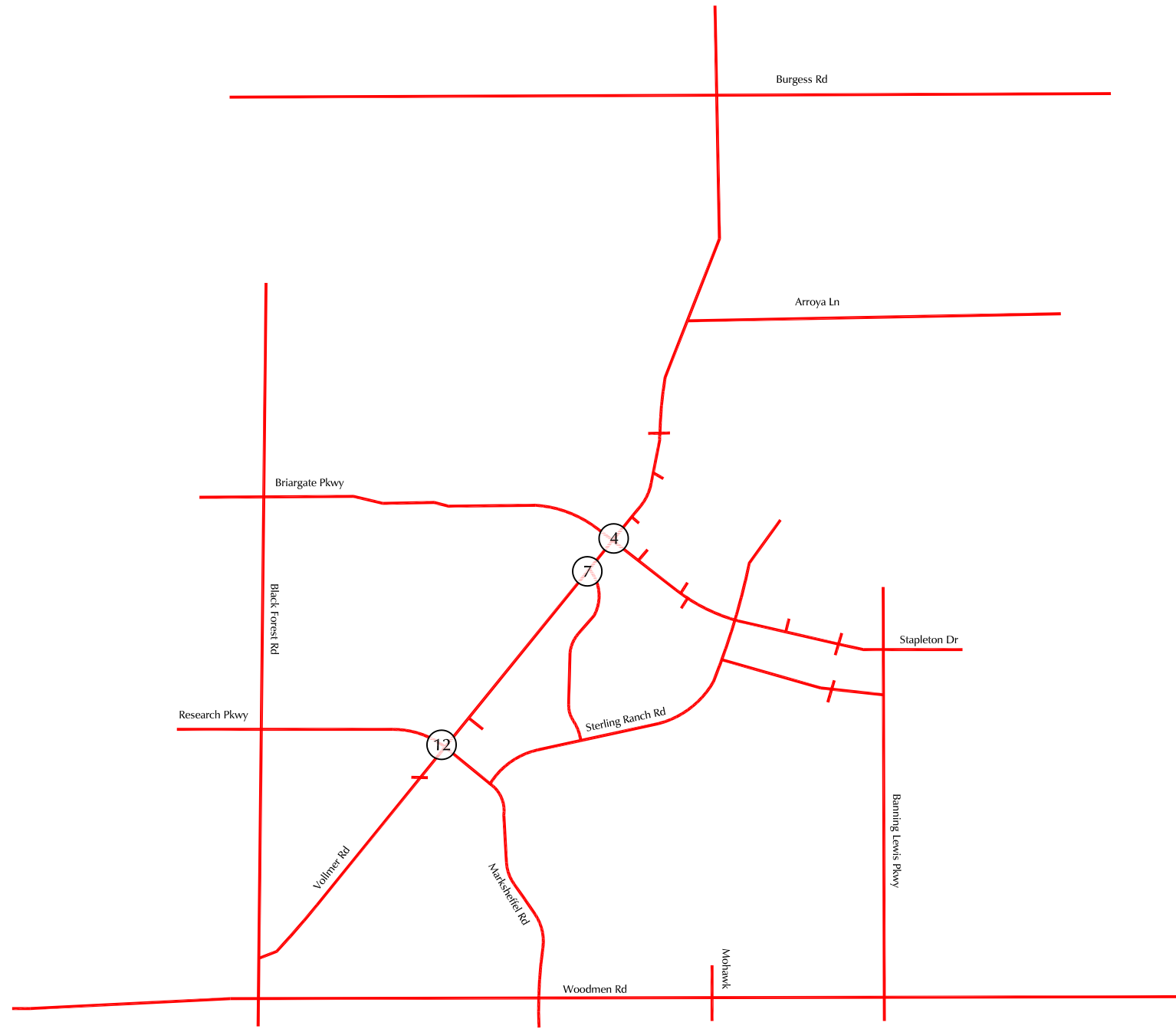
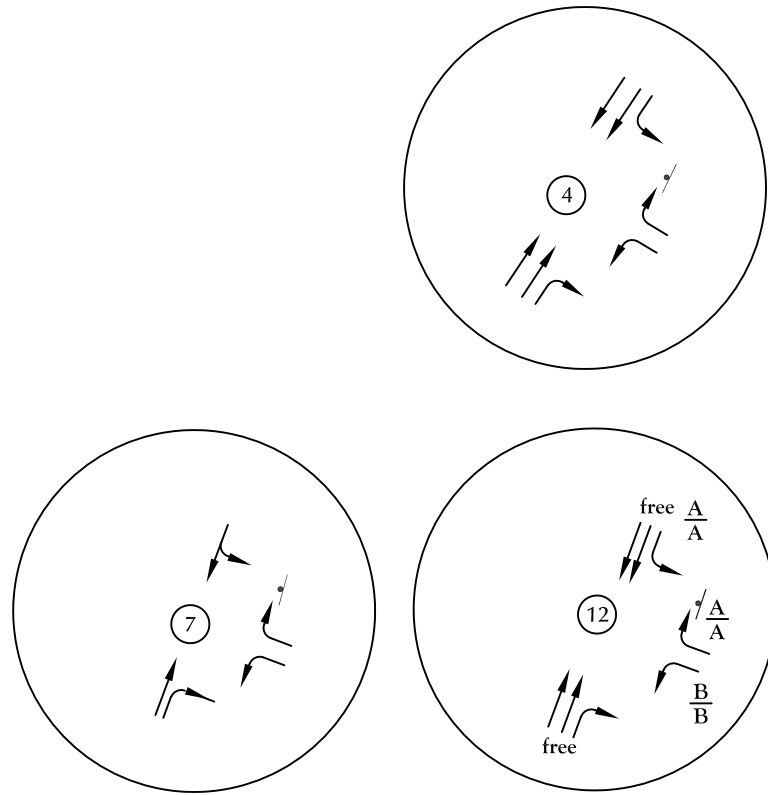

Not to scale

LEGEND:

$\frac{A}{B}$ = AM Individual Movement Peak-Hour Level of Service
 PM Individual Movement Peak-Hour Level of Service
 $\frac{C}{D}$ = AM Entire Intersection Peak-Hour Level of Service
 PM Entire Intersection Peak-Hour Level of Service

T = Stop Sign

☐ = Traffic Signal



Figure 5c
 Existing Lane Geometry,
 Traffic Control, and Level of Service

Sterling Ranch Sketch Plan Amendment No. 4 & Sterling Ranch East Filing No. 7 Zone Change (LSC# S244270)

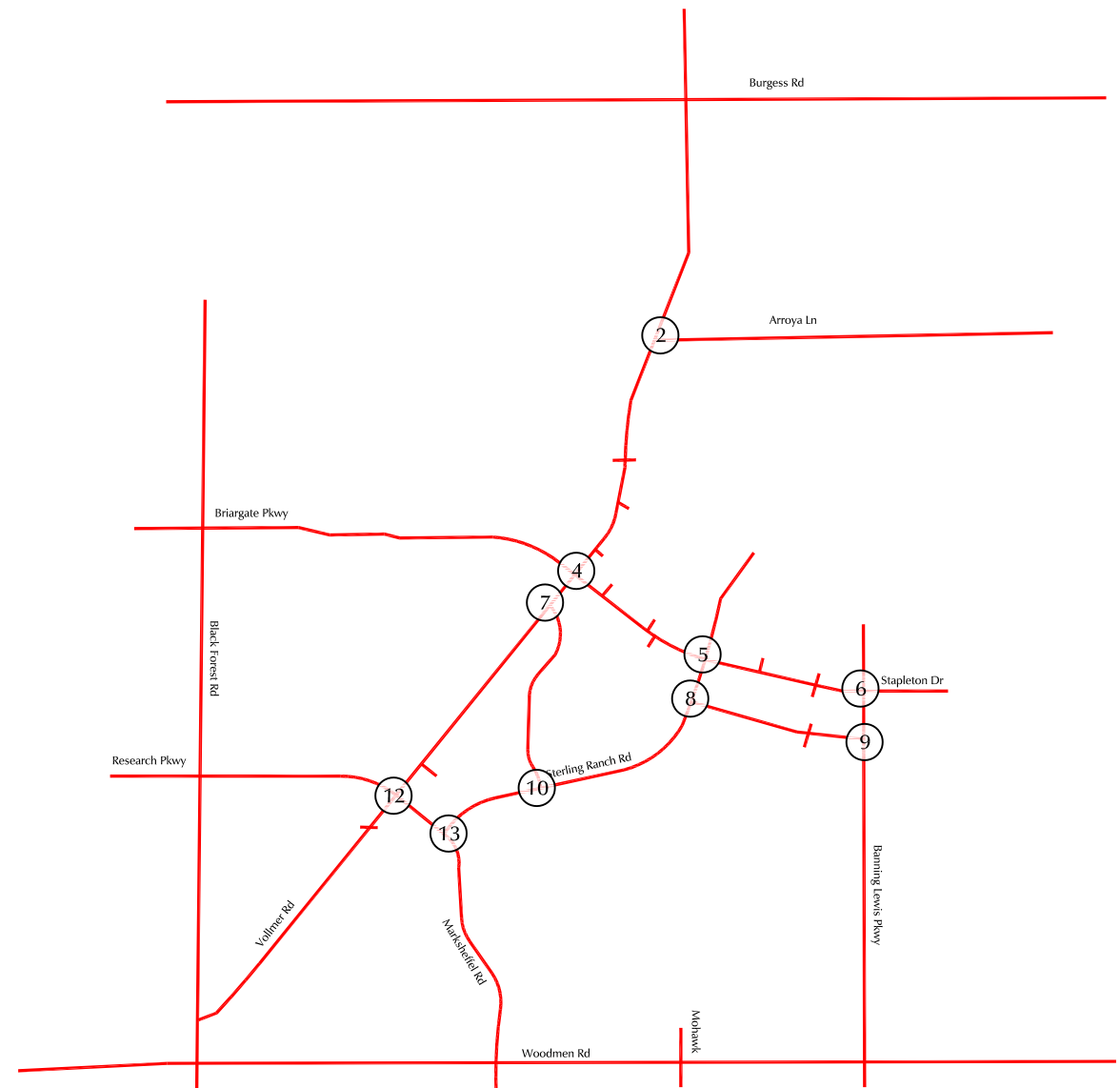
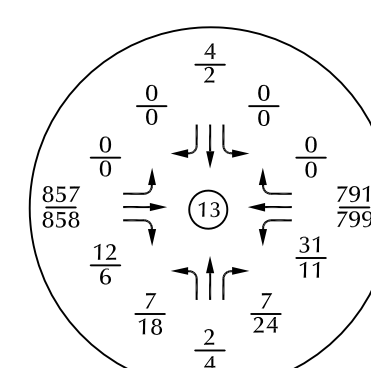
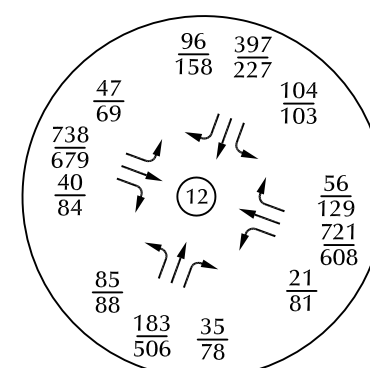
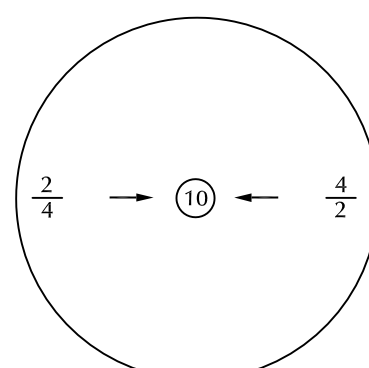
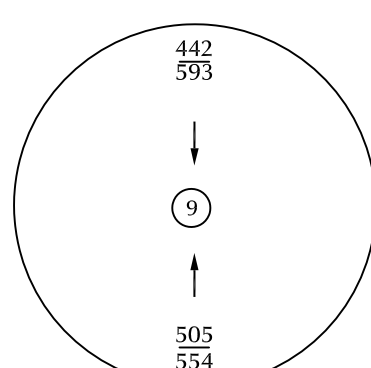
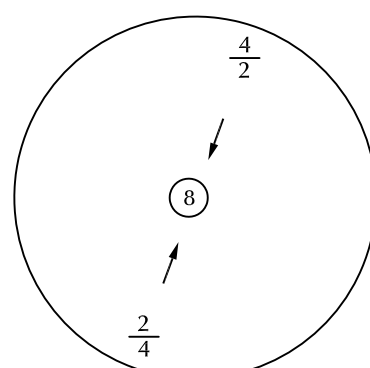
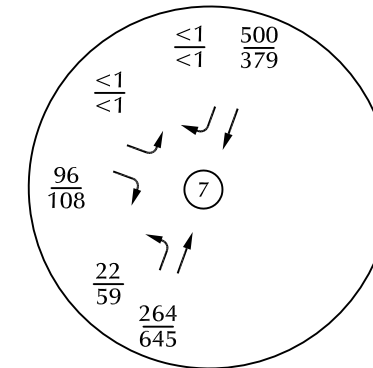
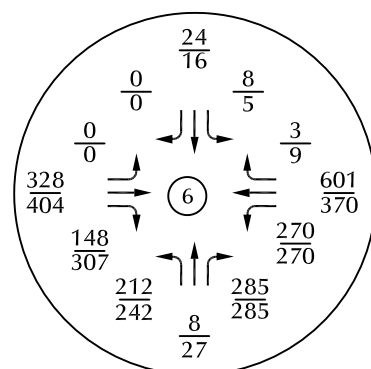
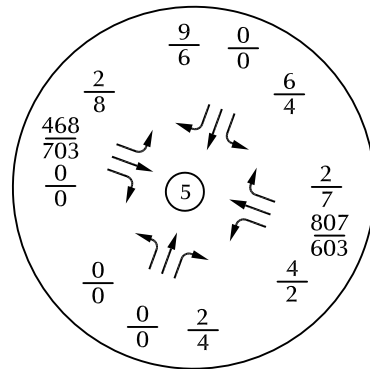
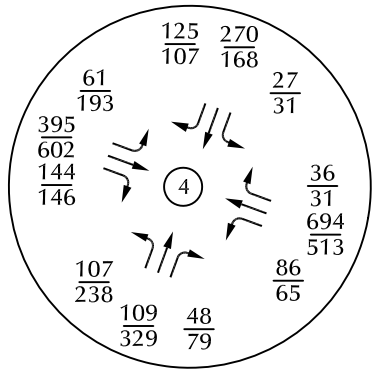
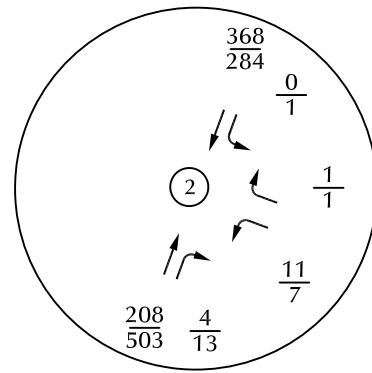

LEGEND: $\frac{XX}{XX}$ = AM Peak-Hour Traffic (veh/hr)
 $\frac{XX}{XX}$ = PM Peak-Hour Traffic (veh/hr)

Figure 6b
 2045 Baseline Peak-Hour Traffic

Sterling Ranch Sketch Plan Amendment No. 4 & Sterling Ranch East Filing No. 7 Zone Change (LSC# S244270)

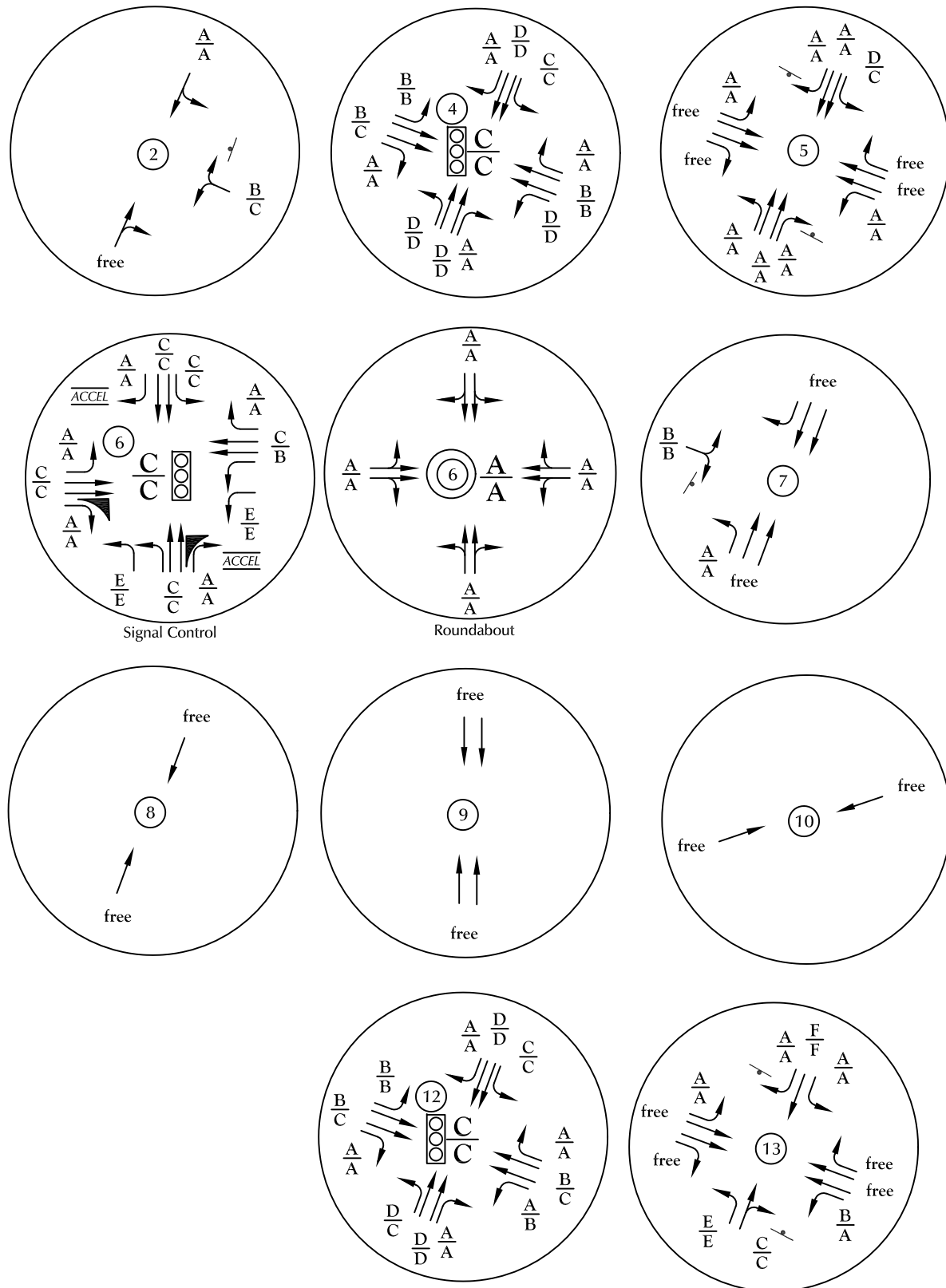

LEGEND:

$\frac{A}{B}$ = AM Individual Movement Peak-Hour Level of Service
 $\frac{C}{D}$ = AM Entire Intersection Peak-Hour Level of Service
 $\frac{B}{C}$ = PM Individual Movement Peak-Hour Level of Service
 $\frac{D}{A}$ = PM Entire Intersection Peak-Hour Level of Service

| = Stop Sign
 = Traffic Signal
 = Roundabout

Two through lanes northbound and southbound at intersection No. 3
 Widen Black Forest Rd. from Briargate Pkwy to Old Ranch Rd as a 4-lane principal arterial with bike and pedestrian facilities
 ConnectCOS TIP Index No. 479
 PPRTA B List Project. North of Old Ranch Road, EPC MCTP 2045 Roadway Classification Maps show as a four-lane Principal Arterial.

Two through lanes northbound and southbound at intersections Nos. 11, 14, 15
 Black Forest Widening Project - Under Construction

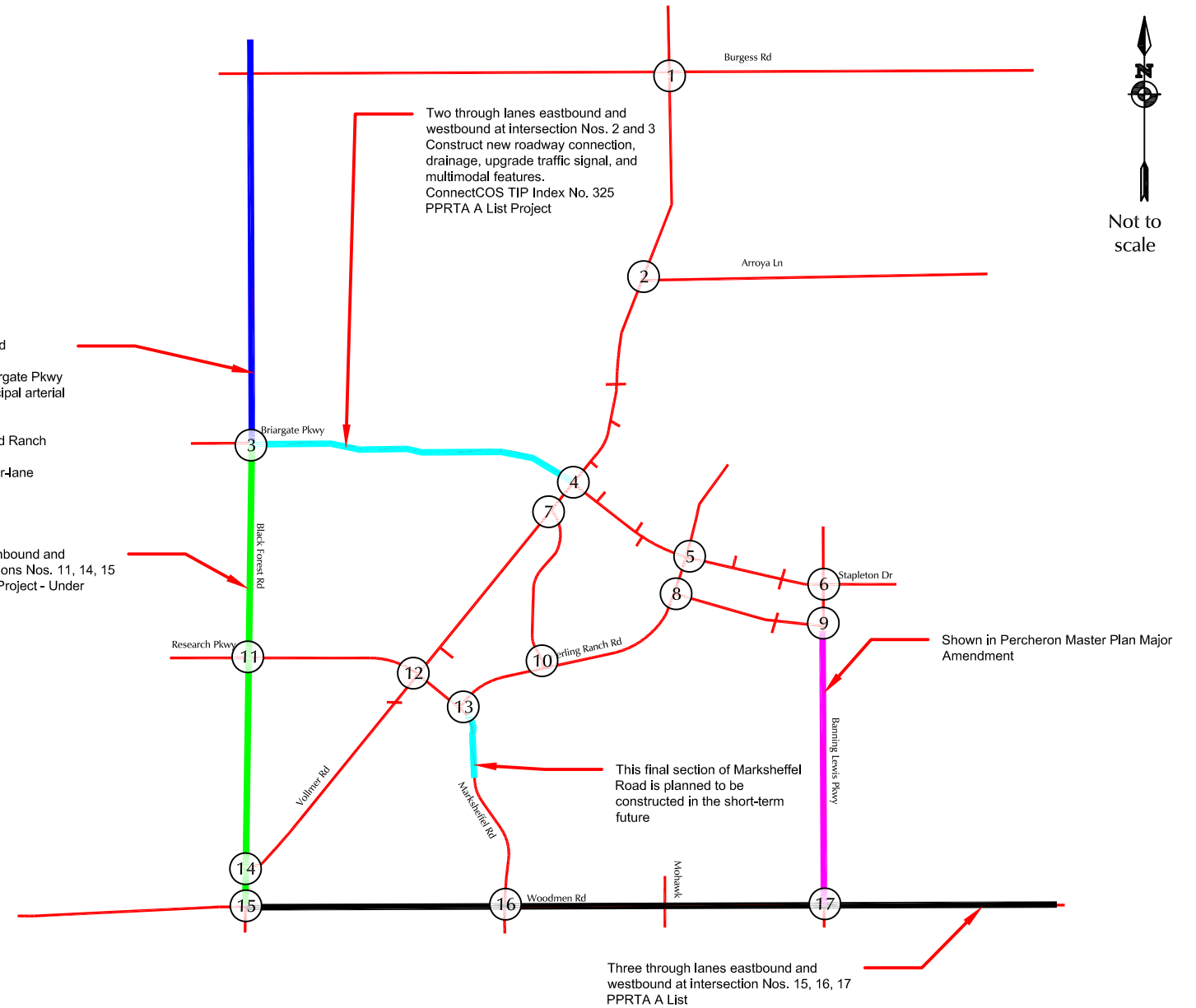
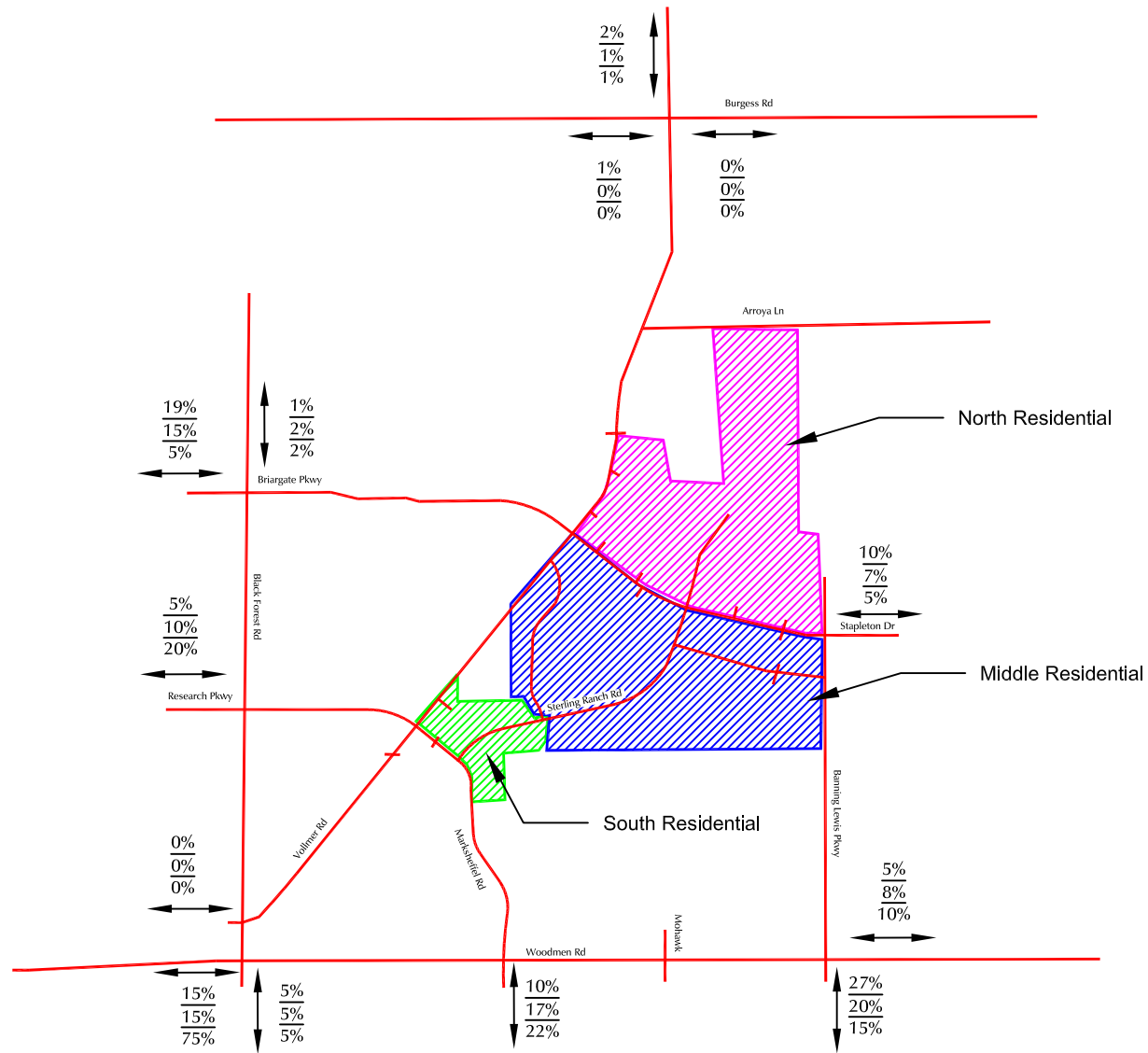

Figure 6c
 2045 Baseline Lane Geometry,
 Traffic Control, and Level of Service





Not to scale



LEGEND:

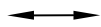

$\frac{XX\%}{XX\%} =$ Percent of North-Residential Trips
 $\frac{XX\%}{XX\%} =$ Percent of Middle-Residential Trips
 $\frac{XX\%}{XX\%} =$ Percent of South-Residential Trips

Buildout Long-Term Directional Distribution of Residential-Generated Traffic

Figure 7

Sterling Ranch Sketch Plan Amendment No. 4 & Sterling Ranch East Filing No. 7 Zone Change (LSC# S244270)



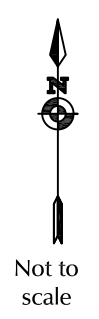
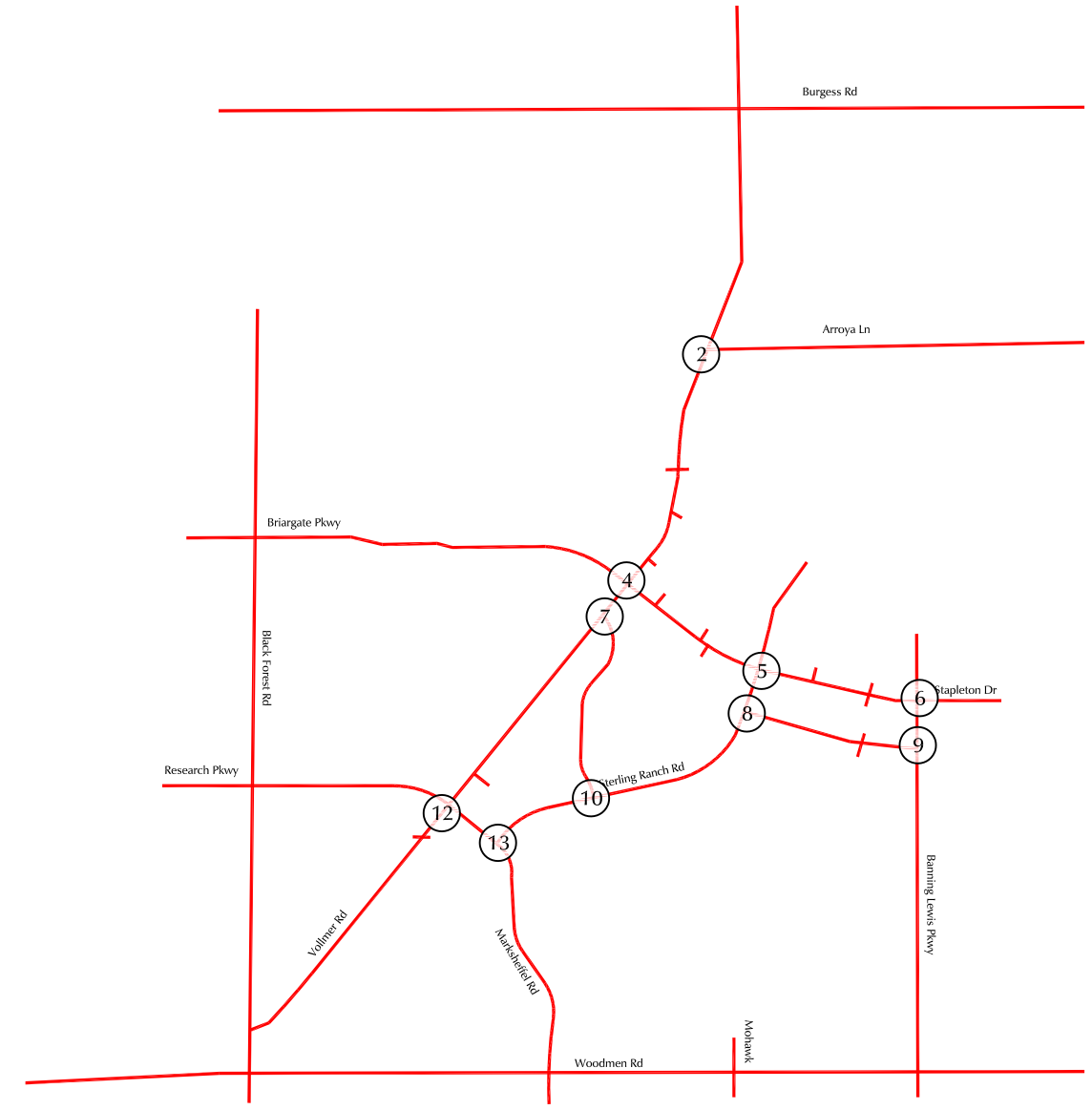
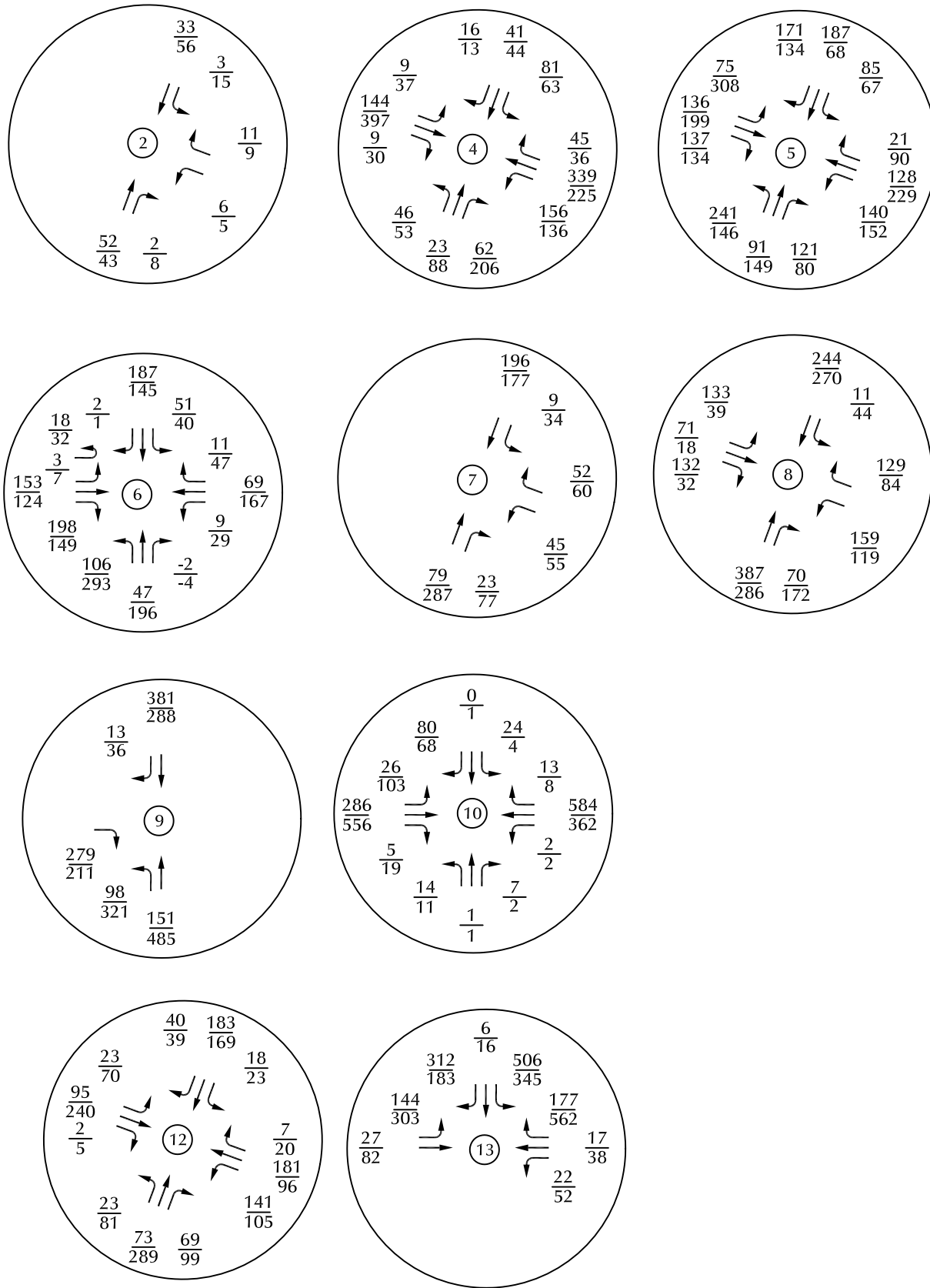

*The site-generated traffic volumes include traffic estimated to be generated by the existing land uses with the Sterling Ranch Sketch Plan



LEGEND: $\frac{XX}{XX} = \frac{\text{AM Peak-Hour Traffic (veh/hr)}}{\text{PM Peak-Hour Traffic (veh/hr)}}$

Figure 9b Entire Sterling Ranch Sketch Plan Generated Traffic Assuming Amendment No. 4*

Sterling Ranch Sketch Plan Amendment No. 4 & Sterling Ranch East Filing No. 7 Zone Change (LSC# S244270)

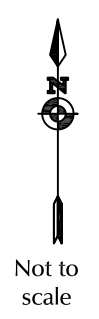
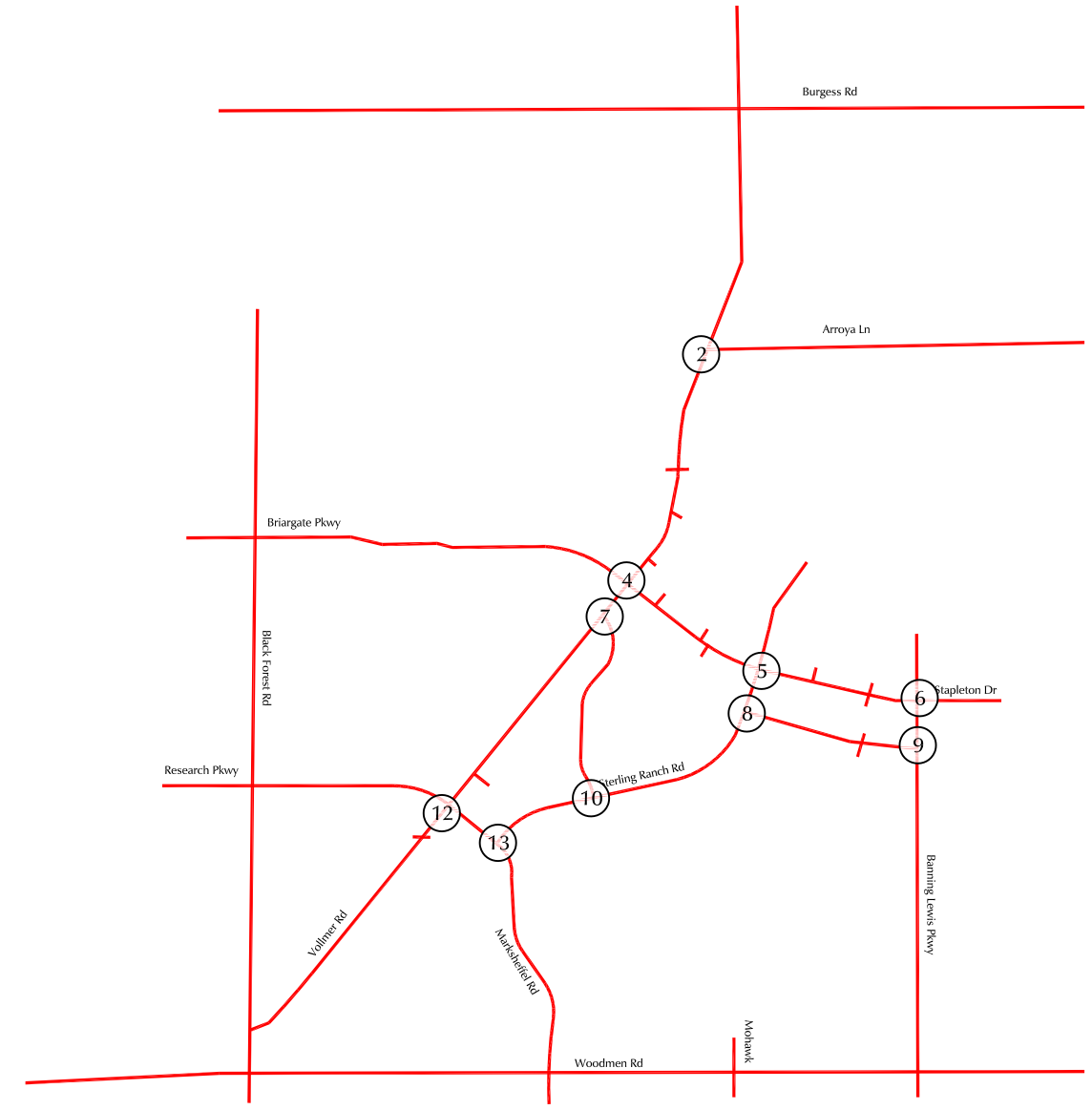
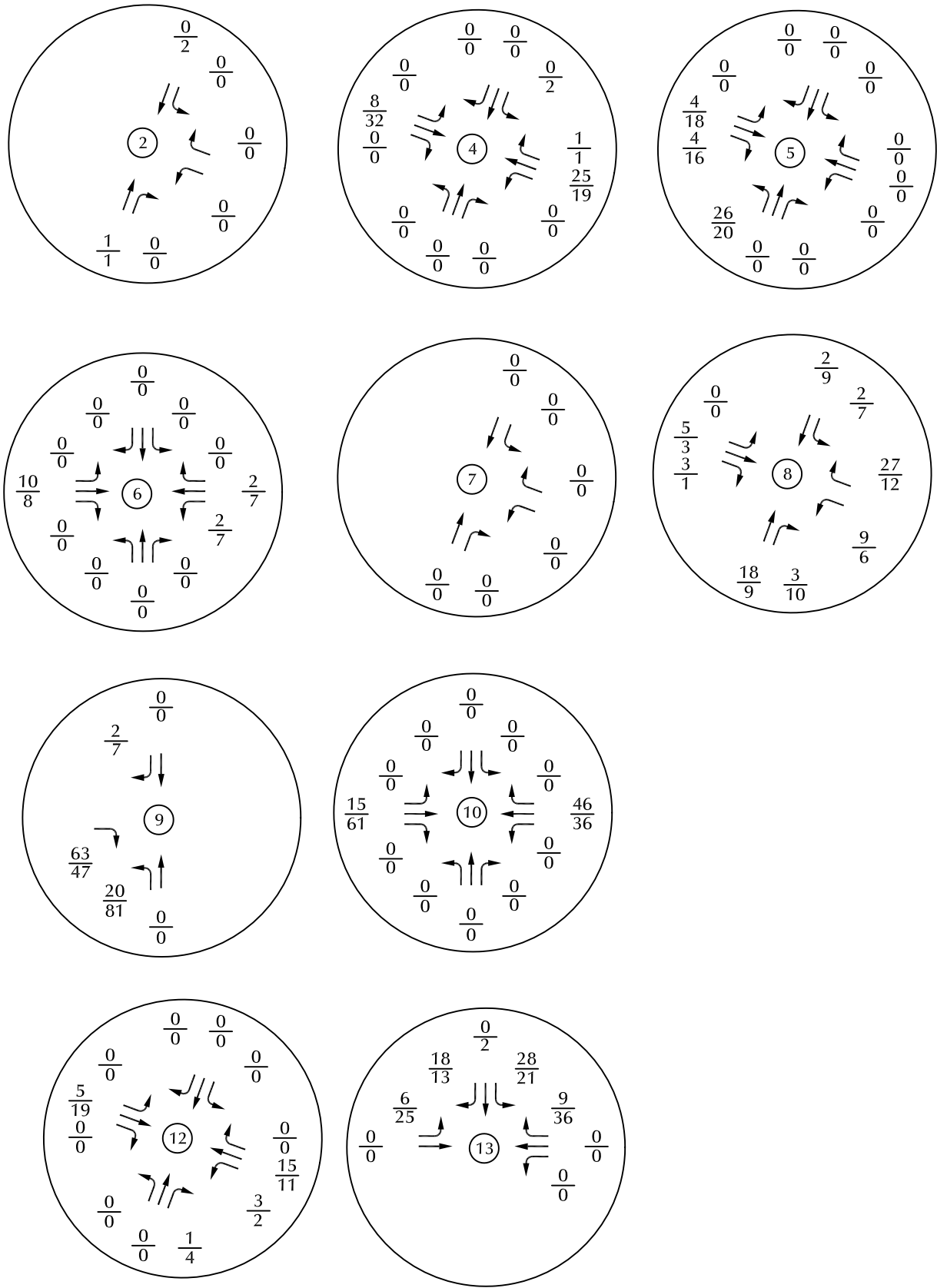

LEGEND: $\frac{XX}{XX} = \frac{\text{AM Peak-Hour Traffic (veh/hr)}}{\text{PM Peak-Hour Traffic (veh/hr)}}$

Site-Generated Peak-Hour Traffic - Sterling Ranch East Filing No. 7 Only

Sterling Ranch Sketch Plan Amendment No. 4 & Sterling Ranch East Filing No. 7 Zone Change (LSC# S244270)



Figure 9c



Not to scale

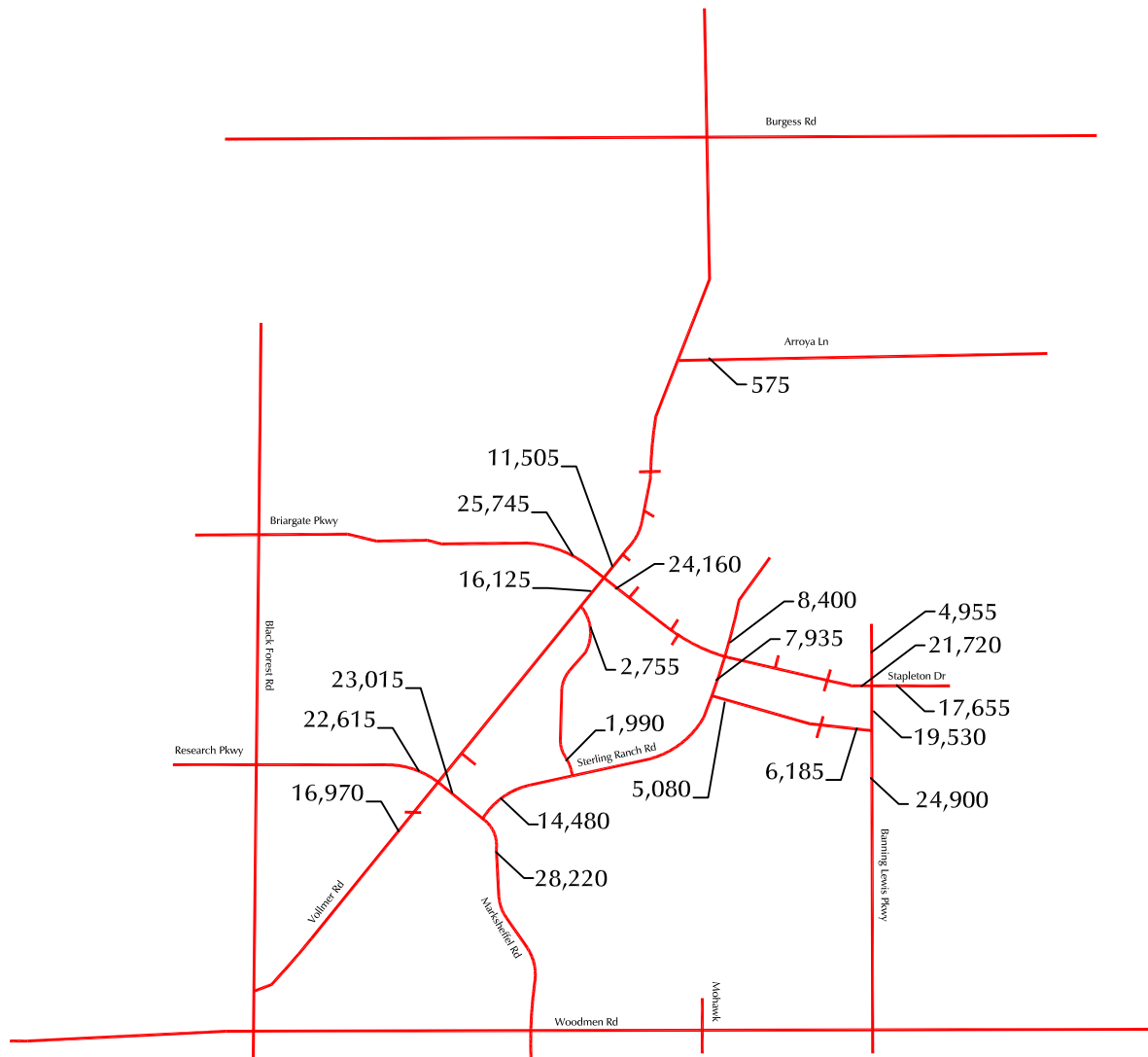

LEGEND:

XXX = Average Weekday Traffic (AWT)(vehicles per day)

Figure 10a 2045 Total Average Weekday Traffic

Sterling Ranch Sketch Plan Amendment No. 4 & Sterling Ranch East Filing No. 7 Zone Change (LSC# S244270)

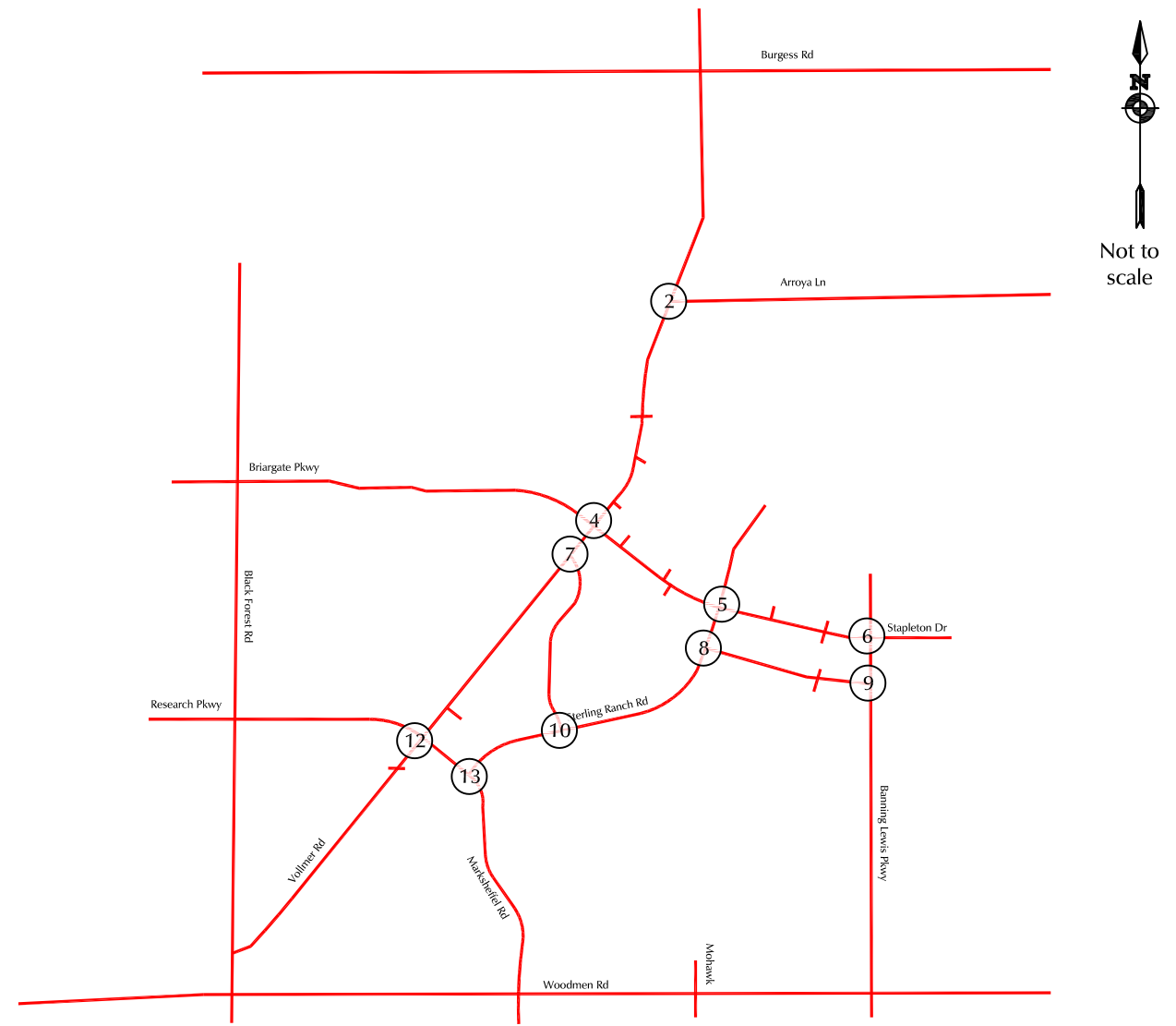
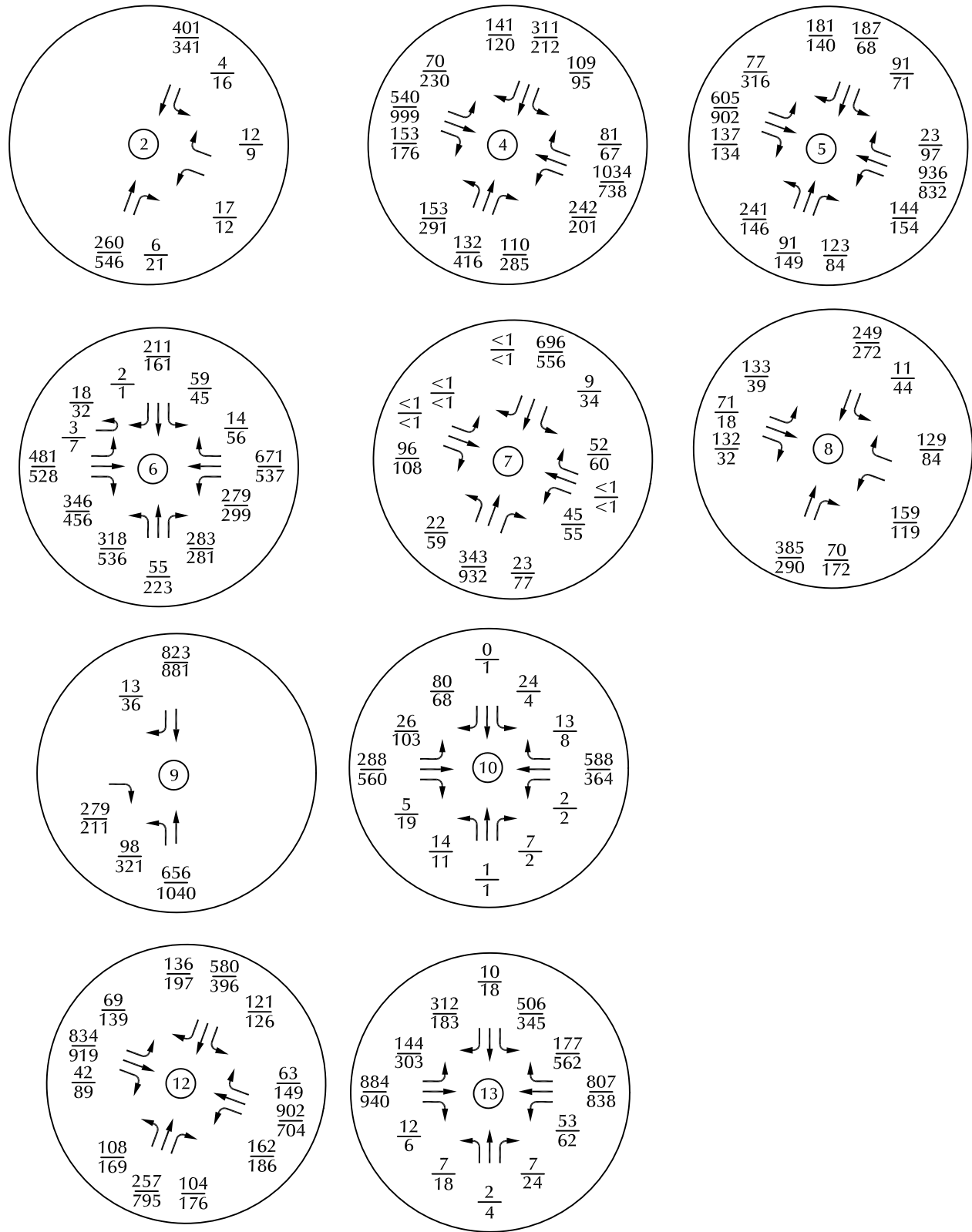

LEGEND: $\frac{XX}{XX}$ = AM Peak-Hour Traffic (veh/hr)
 $\frac{XX}{XX}$ = PM Peak-Hour Traffic (veh/hr)



Figure 10b
2045 Total Peak-Hour Traffic

Sterling Ranch Sketch Plan Amendment No. 4 & Sterling Ranch East Filing No. 7 Zone Change (LSC# S244270)

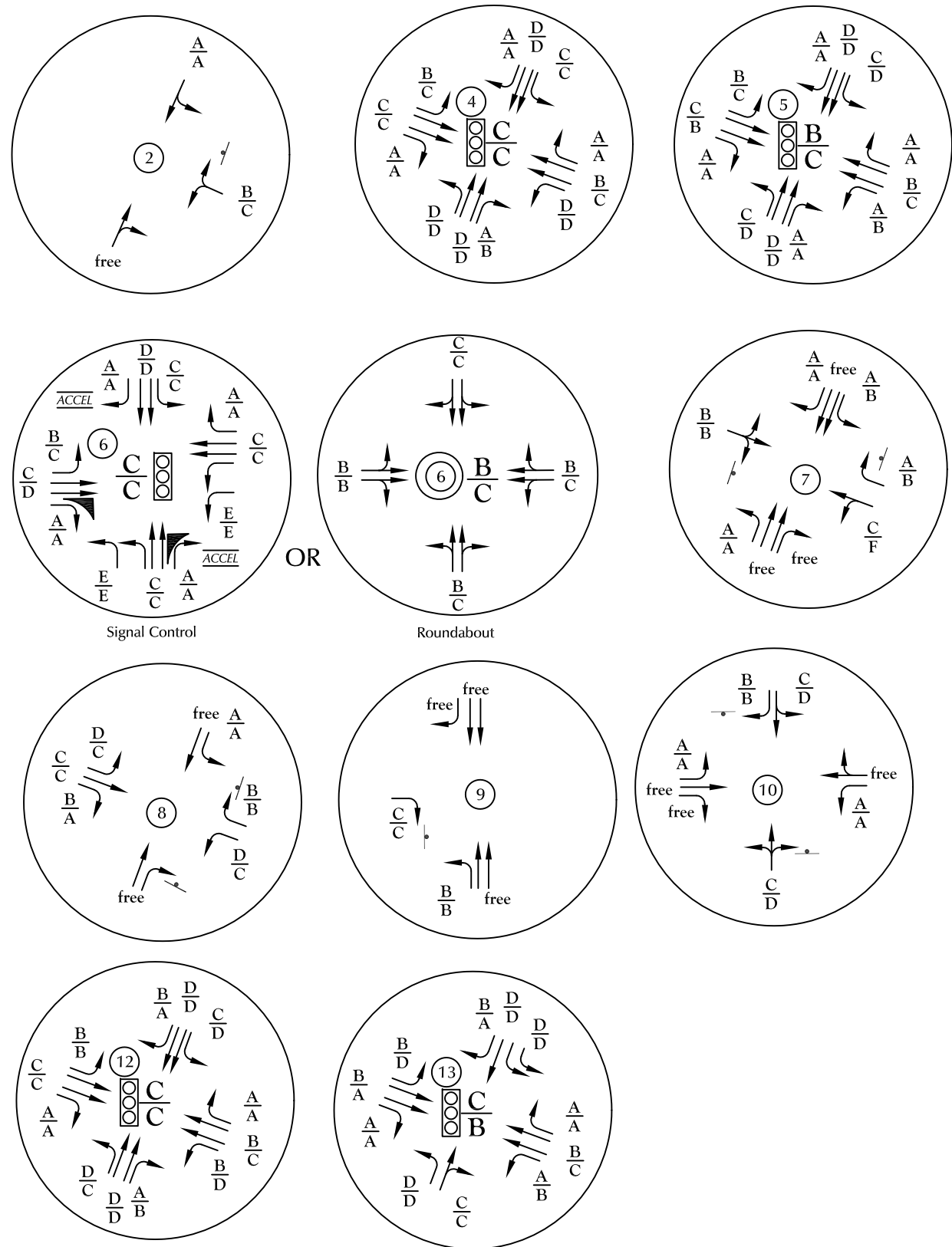

LEGEND:

$\frac{A}{B}$ = AM Individual Movement Peak-Hour Level of Service
 PM Individual Movement Peak-Hour Level of Service

$\frac{C}{D}$ = AM Entire Intersection Peak-Hour Level of Service
 PM Entire Intersection Peak-Hour Level of Service

⊥ = Stop Sign

= Traffic Signal

= Roundabout

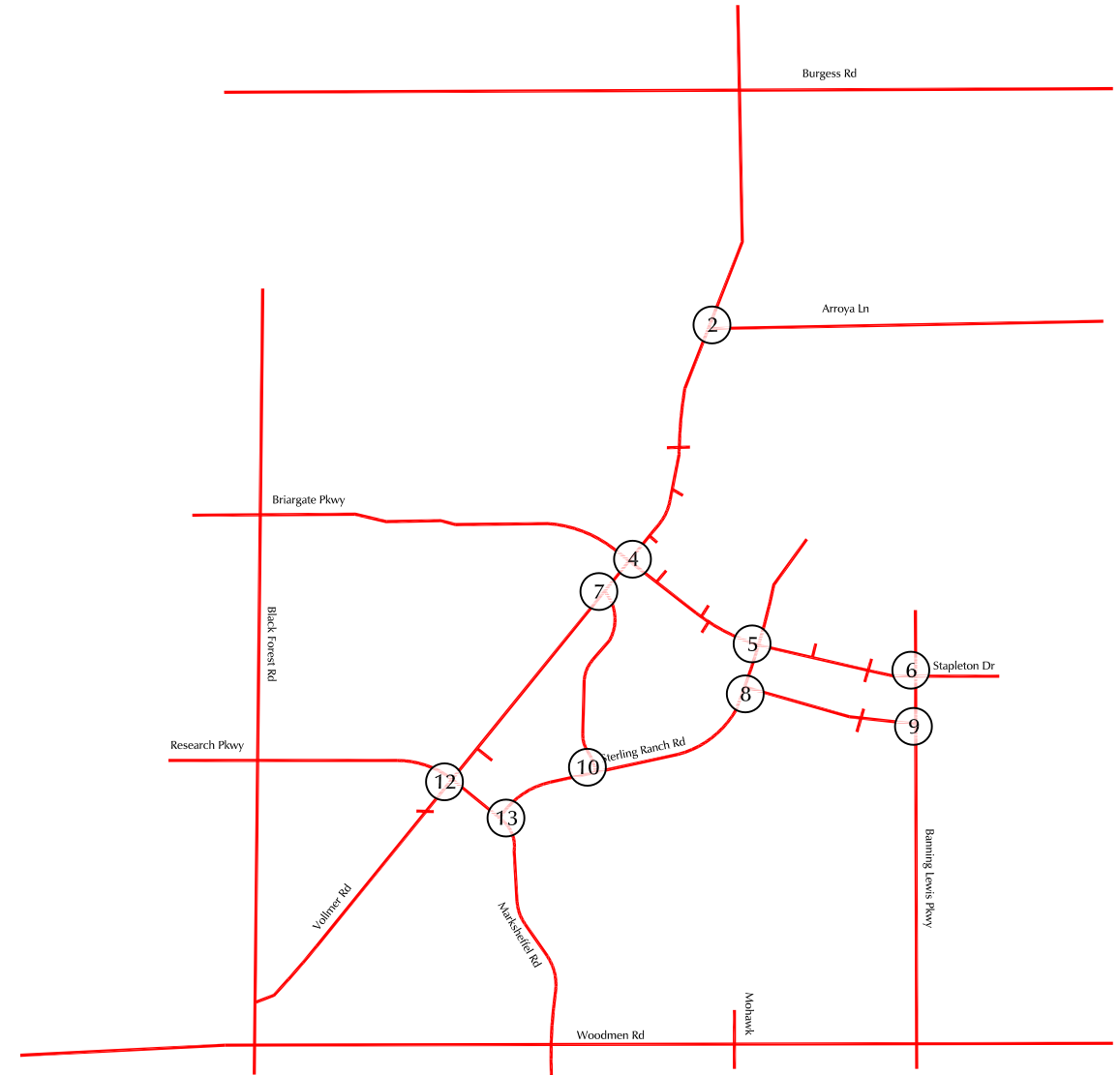

Not to scale

Figure 10c
 2045 Total Lane Geometry,
 Traffic Control, and Level of Service



Not to scale

LEGEND:

$\frac{XX,XXX}{XX,XXX}$ = $\frac{\text{Projected Average Daily Traffic}}{\text{Design Average Daily Traffic}}$

- 6-Lane Urban Expressway
- 4-Lane Urban Principal Arterial
- - - 4-Lane Principal Arterial (City of Colorado Springs Connect COS Plan)
- Urban Non-Residential Collector
- - - Urban Residential Collector

Should Dines be shown on this exhibit since it is a collector?

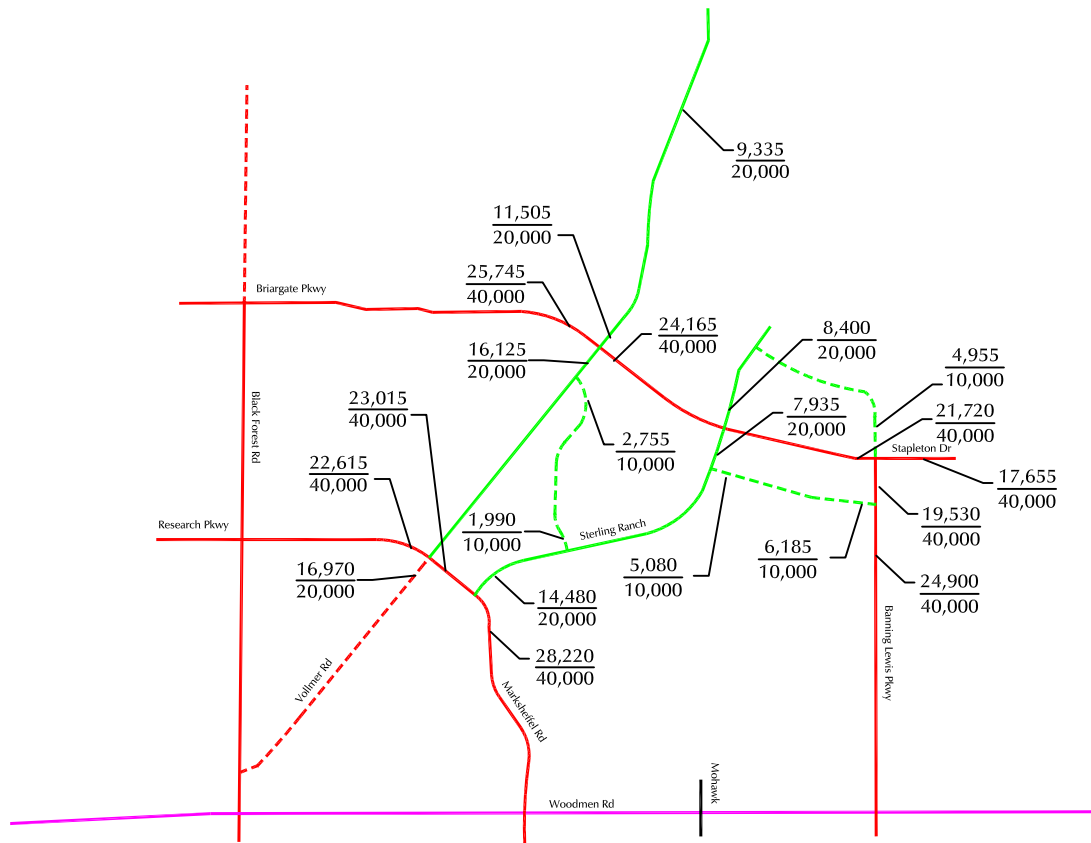

Proposed Roadway Functional Classification

Sterling Ranch Sketch Plan Amendment No. 4 & Sterling Ranch East Filing No. 7 Zone Change (LSC# S244270)

Figure 11

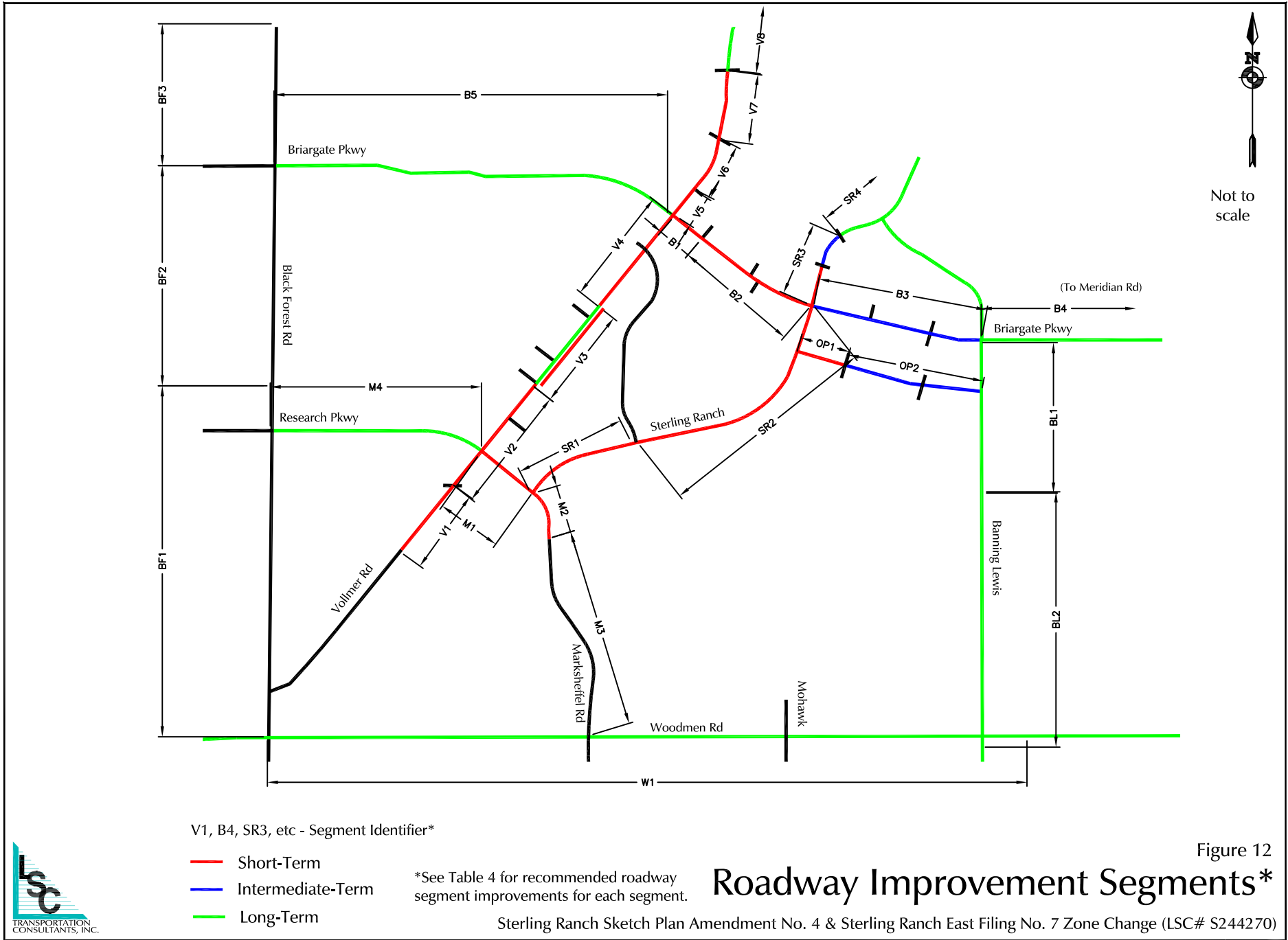

Figure 12

Roadway Improvement Segments*

Sterling Ranch Sketch Plan Amendment No. 4 & Sterling Ranch East Filing No. 7 Zone Change (LSC# S244270)

Sight-Generated Traffic Volumes at External Intersections



Intersection Graphic Report
Final Volume (Future Alternative)
AM LT Site Generated

Intersection #1: Vollmer /Burgess

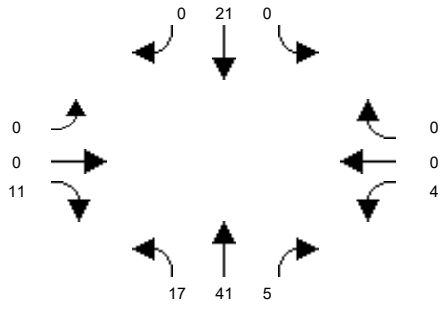

Intersection #3: Black Forest/Briargate

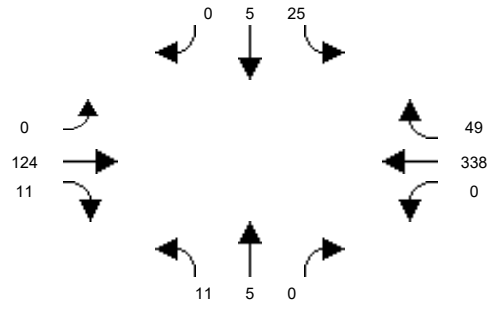

Intersection #11: Black Forest/Marksheffel

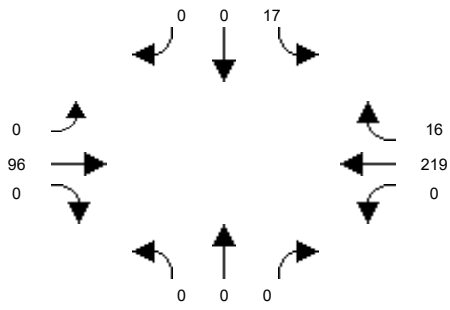

Intersection #14: Black Forest/Vollmer

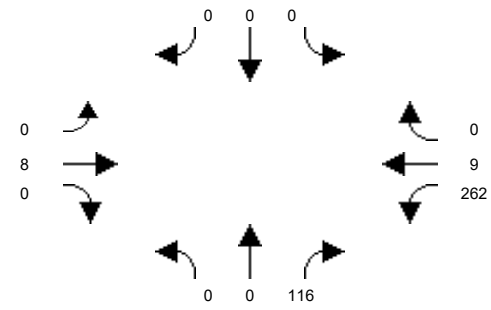

Intersection #15: Woodmen/Black Forest

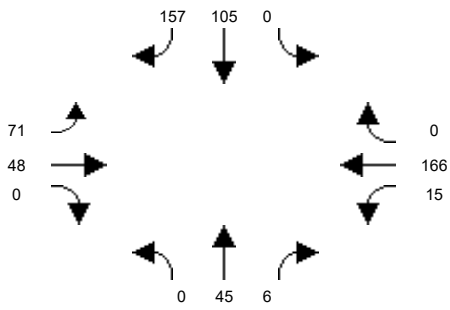

Intersection #16: Woodmen/Marksheffel

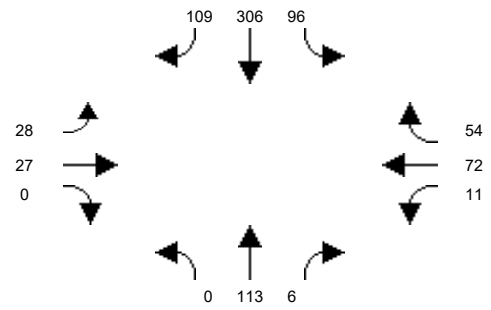

Intersection #17: Woodmen/Banning Lewis

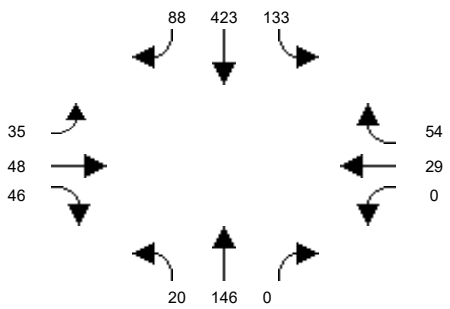

Intersection Graphic Report
Final Volume (Future Alternative)
PM LT Site Generated

Intersection #1: Vollmer /Burgess

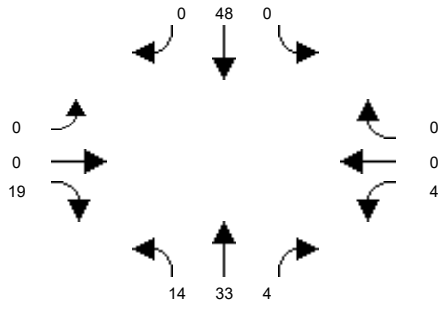

Intersection #3: Black Forest/Briargate

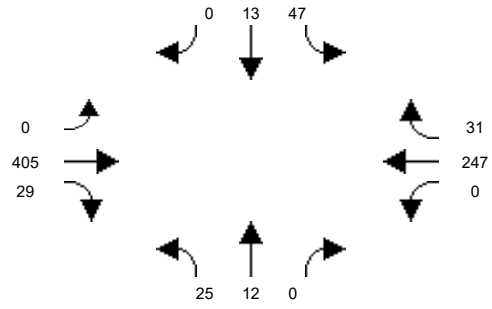

Intersection #11: Black Forest/Marksheffel

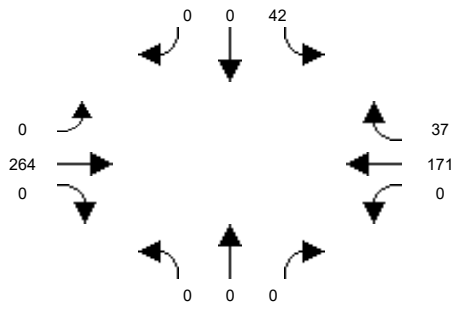

Intersection #14: Black Forest/Vollmer

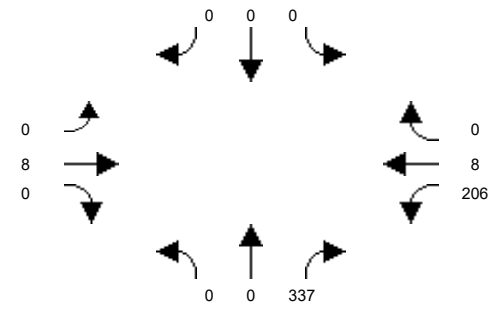

Intersection #15: Woodmen/Black Forest

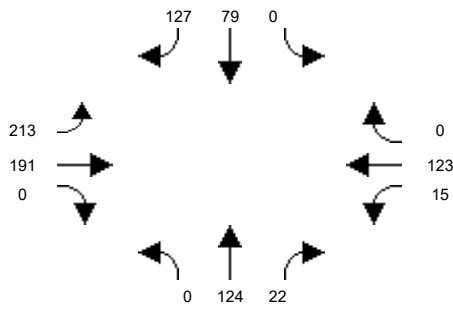

Intersection #16: Woodmen/Marksheffel

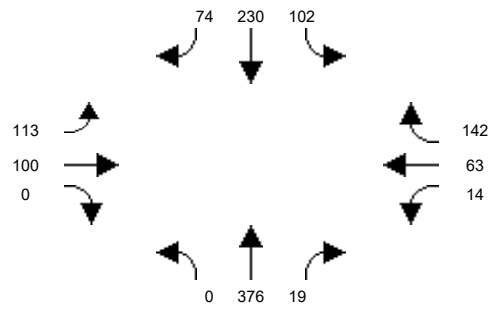

Intersection #17: Woodmen/Banning Lewis

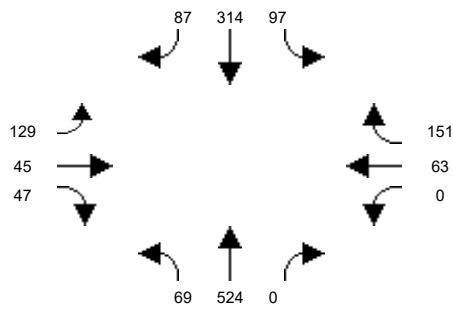

MTCP Maps



Figure 22. 2045 Roadway Functional Classifications

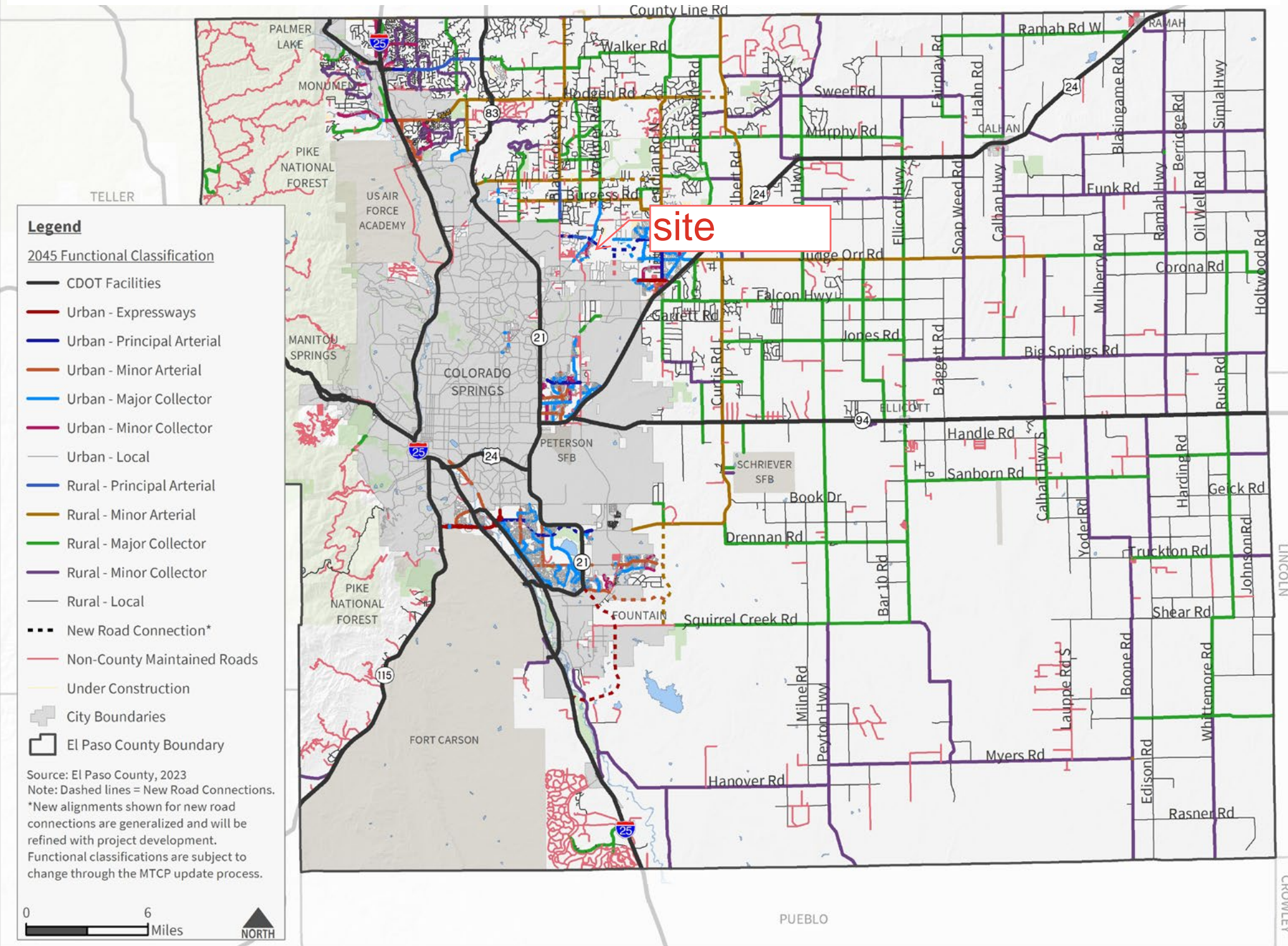

Figure 39. 2065 Corridor Preservation Plan

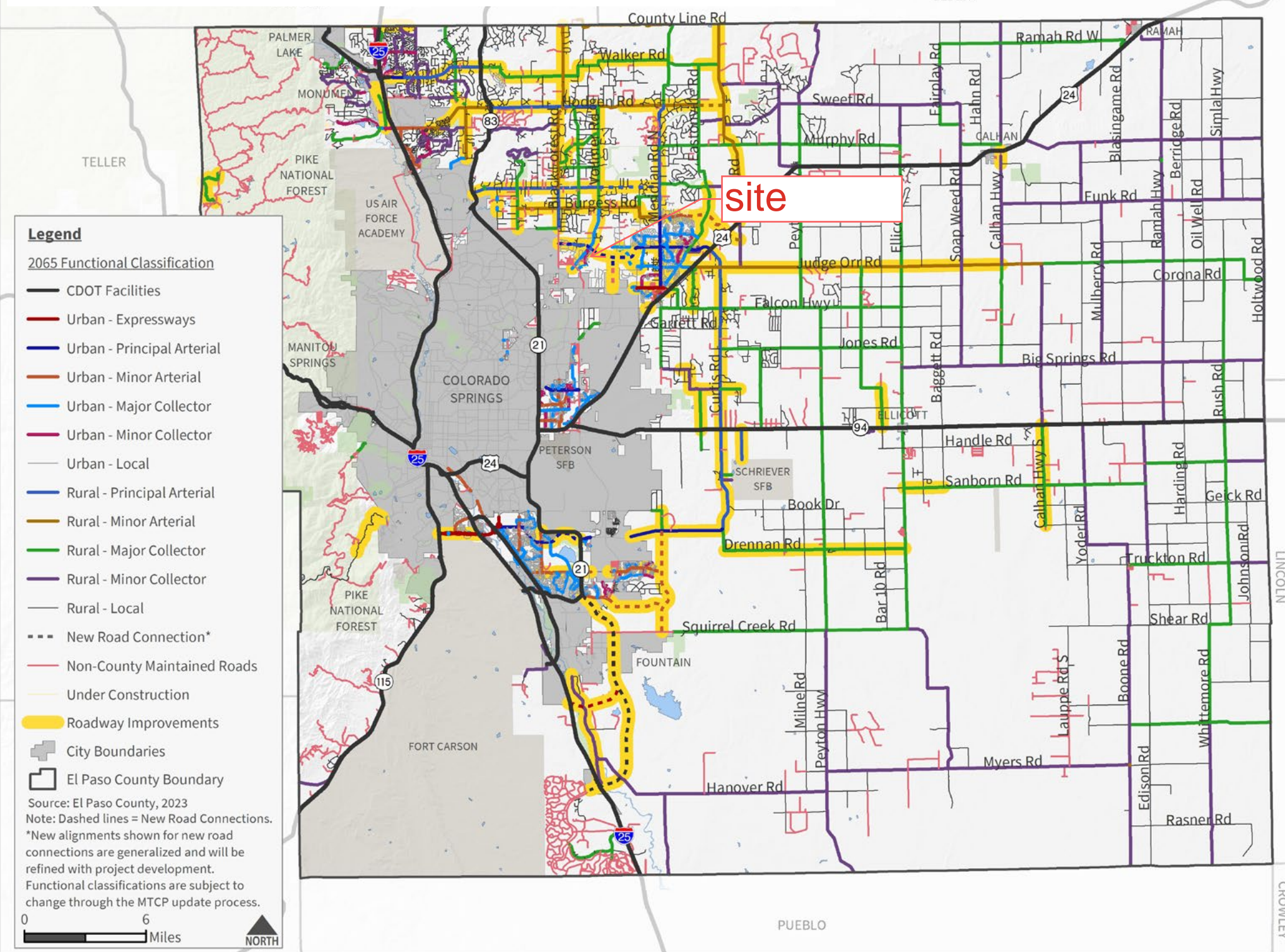
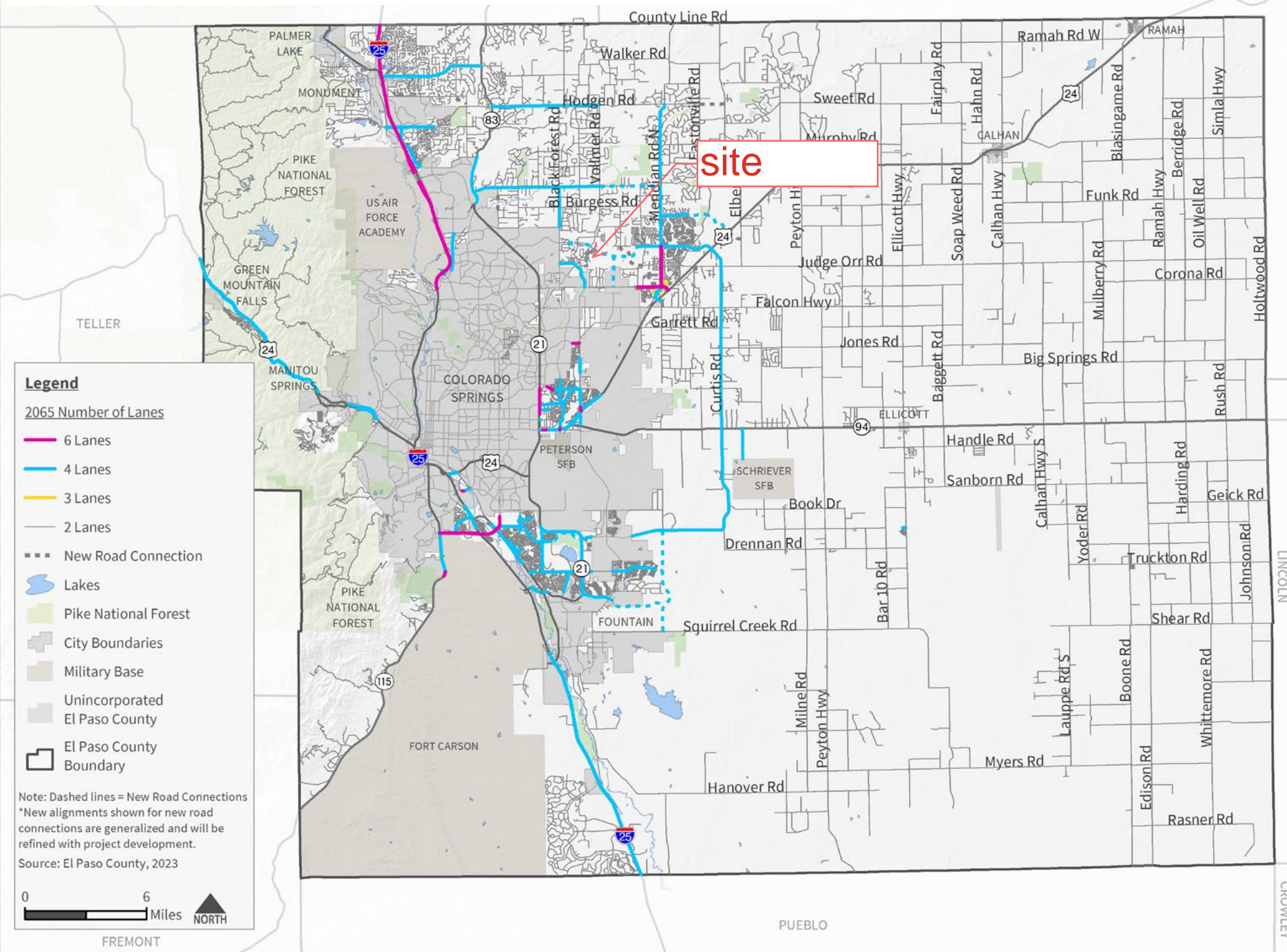

Figure 40. 2065 Through Lane Requirements



Traffic Counts



LSC Transportation Consultants, Inc.

2504 E. Pikes Peak Ave, Suite 304
 Colorado Springs, CO 80909
 719-633-2868

File Name : Vollmer Rd - Marksheffel Rd AM
 Site Code : S224580
 Start Date : 4/4/2024
 Page No : 1

Start Time	Vollmer Rd Southbound					Marksheffel Rd Westbound					Vollmer Rd Northbound					Eastbound					Int. Total
	Right	Thru	Left	Peds	App. Total	Right	Thru	Left	Peds	App. Total	Right	Thru	Left	Peds	App. Total	Right	Thru	Left	Peds	App. Total	
06:30	0	19	0	0	19	0	0	1	0	1	0	8	0	0	8	0	0	0	0	0	28
06:35	0	7	0	0	7	0	0	2	0	2	6	10	0	0	16	0	0	0	0	0	25
06:40	0	21	0	0	21	1	0	1	0	2	2	12	0	0	14	0	0	0	0	0	37
06:45	0	17	0	0	17	0	0	4	0	4	2	13	0	0	15	0	0	0	0	0	36
06:50	0	17	0	0	17	0	0	2	0	2	0	18	0	0	18	0	0	0	0	0	37
06:55	0	26	0	0	26	0	0	4	0	4	3	19	0	0	22	0	0	0	0	0	52
Total	0	107	0	0	107	1	0	14	0	15	13	80	0	0	93	0	0	0	0	0	215
07:00	0	20	0	0	20	1	0	6	0	7	2	16	0	0	18	0	0	0	0	0	45
07:05	0	28	0	0	28	1	0	5	0	6	5	17	0	0	22	0	0	0	0	0	56
07:10	0	25	0	0	25	1	0	4	0	5	1	20	0	0	21	0	0	0	0	0	51
07:15	0	22	0	0	22	0	0	5	0	5	1	11	0	0	12	0	0	0	0	0	39
07:20	0	37	0	0	37	0	0	4	0	4	0	12	0	0	12	0	0	0	0	0	53
07:25	0	32	0	0	32	0	0	4	0	4	0	13	0	0	13	0	0	0	0	0	49
07:30	0	28	0	0	28	0	0	6	0	6	0	17	0	0	17	0	0	0	0	0	51
07:35	0	31	0	0	31	1	0	3	0	4	0	16	0	0	16	0	0	0	0	0	51
07:40	0	23	0	0	23	1	0	4	0	5	2	22	0	0	24	0	0	0	0	0	52
07:45	0	22	0	0	22	0	0	9	0	9	1	19	0	0	20	0	0	0	0	0	51
07:50	0	27	0	0	27	0	0	5	0	5	4	16	0	0	20	0	0	0	0	0	52
07:55	0	21	0	0	21	0	0	2	0	2	5	30	0	0	35	0	0	0	0	0	58
Total	0	316	0	0	316	5	0	57	0	62	21	209	0	0	230	0	0	0	0	0	608
08:00	0	12	1	0	13	0	0	2	0	2	1	20	0	0	21	0	0	0	0	0	36
08:05	0	21	0	0	21	0	0	1	0	1	1	17	0	0	18	0	0	0	0	0	40
08:10	0	18	0	0	18	0	0	2	0	2	7	19	0	0	26	0	0	0	0	0	46
08:15	0	26	0	0	26	0	0	1	0	1	8	15	0	0	23	0	0	0	0	0	50
08:20	0	13	0	0	13	0	0	3	0	3	1	14	0	0	15	0	0	0	0	0	31
08:25	0	21	0	0	21	0	0	2	0	2	4	13	0	0	17	0	0	0	0	0	40
Grand Total	0	534	1	0	535	6	0	82	0	88	56	387	0	0	443	0	0	0	0	0	1066
Apprch %	0	99.8	0.2	0		6.8	0	93.2	0		12.6	87.4	0	0		0	0	0	0		
Total %	0	50.1	0.1	0	50.2	0.6	0	7.7	0	8.3	5.3	36.3	0	0	41.6	0	0	0	0	0	

LSC Transportation Consultants, Inc.

2504 E. Pikes Peak Ave, Suite 304
 Colorado Springs, CO 80909
 719-633-2868

File Name : Vollmer Rd - Marksheffel Rd AM

Site Code : S224580

Start Date : 4/4/2024

Page No : 2

Start Time	Vollmer Rd Southbound					Marksheffel Rd Westbound					Vollmer Rd Northbound					Eastbound					Int. Total
	Right	Thru	Left	Peds	App. Total	Right	Thru	Left	Peds	App. Total	Right	Thru	Left	Peds	App. Total	Right	Thru	Left	Peds	App. Total	
Peak Hour Analysis From 06:30 to 08:25 - Peak 1 of 1																					
Peak Hour for Entire Intersection Begins at 07:00																					
07:00	0	20	0	0	20	1	0	6	0	7	2	16	0	0	18	0	0	0	0	0	45
07:05	0	28	0	0	28	1	0	5	0	6	5	17	0	0	22	0	0	0	0	0	56
07:10	0	25	0	0	25	1	0	4	0	5	1	20	0	0	21	0	0	0	0	0	51
07:15	0	22	0	0	22	0	0	5	0	5	1	11	0	0	12	0	0	0	0	0	39
07:20	0	37	0	0	37	0	0	4	0	4	0	12	0	0	12	0	0	0	0	0	53
07:25	0	32	0	0	32	0	0	4	0	4	0	13	0	0	13	0	0	0	0	0	49
07:30	0	28	0	0	28	0	0	6	0	6	0	17	0	0	17	0	0	0	0	0	51
07:35	0	31	0	0	31	1	0	3	0	4	0	16	0	0	16	0	0	0	0	0	51
07:40	0	23	0	0	23	1	0	4	0	5	2	22	0	0	24	0	0	0	0	0	52
07:45	0	22	0	0	22	0	0	9	0	9	1	19	0	0	20	0	0	0	0	0	51
07:50	0	27	0	0	27	0	0	5	0	5	4	16	0	0	20	0	0	0	0	0	52
07:55	0	21	0	0	21	0	0	2	0	2	5	30	0	0	35	0	0	0	0	0	58
Total Volume	0	316	0	0	316	5	0	57	0	62	21	209	0	0	230	0	0	0	0	0	608
% App. Total	0	100	0	0		8.1	0	91.9	0		9.1	90.9	0	0		0	0	0	0		
PHF	.000	.712	.000	.000	.712	.417	.000	.528	.000	.574	.350	.581	.000	.000	.548	.000	.000	.000	.000	.000	.874

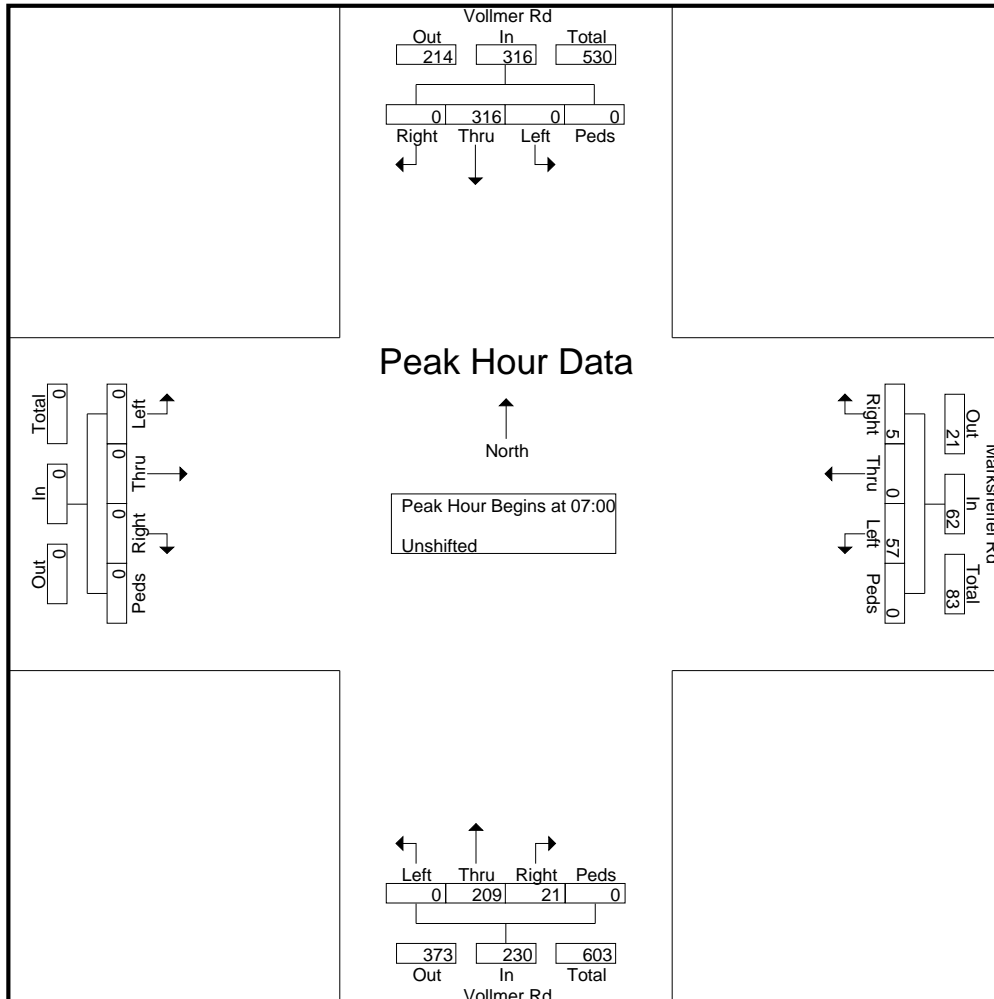

LSC Transportation Consultants, Inc.

2504 E. Pikes Peak Ave, Suite 304
 Colorado Springs, CO 80909
 719-633-2868

File Name : Vollmer Rd - Marksheffel Rd PM

Site Code : S224580

Start Date : 4/4/2024

Page No : 1

Start Time	Vollmer Rd Southbound					Marksheffel Rd Westbound					Vollmer Rd Northbound					Eastbound					Int. Total
	Right	Thru	Left	Peds	App. Total	Right	Thru	Left	Peds	App. Total	Right	Thru	Left	Peds	App. Total	Right	Thru	Left	Peds	App. Total	
16:00	0	26	0	0	26	0	0	0	0	0	1	22	0	0	23	0	0	0	0	0	49
16:05	0	20	0	0	20	0	0	1	0	1	3	25	0	0	28	0	0	0	0	0	49
16:10	0	21	0	0	21	0	0	4	0	4	6	23	0	0	29	0	0	0	0	0	54
16:15	0	21	1	0	22	0	0	4	0	4	4	24	0	0	28	0	0	0	0	0	54
16:20	0	16	0	0	16	1	0	1	0	2	2	26	0	0	28	0	0	0	0	0	46
16:25	0	26	0	0	26	0	0	6	0	6	2	13	0	0	15	0	0	0	0	0	47
16:30	0	24	0	0	24	0	0	3	0	3	3	22	0	0	25	0	0	0	0	0	52
16:35	0	19	0	0	19	0	0	2	0	2	1	29	0	0	30	0	0	0	0	0	51
16:40	0	23	0	0	23	0	0	3	0	3	4	23	0	0	27	0	0	0	0	0	53
16:45	0	22	1	0	23	0	0	6	0	6	6	22	0	0	28	0	0	0	0	0	57
16:50	0	24	0	0	24	0	0	3	0	3	5	26	0	0	31	0	0	0	0	0	58
16:55	0	18	0	0	18	0	0	5	0	5	2	24	0	0	26	0	0	0	0	0	49
Total	0	260	2	0	262	1	0	38	0	39	39	279	0	0	318	0	0	0	0	0	619
17:00	0	29	0	0	29	0	0	6	0	6	3	20	0	0	23	0	0	0	0	0	58
17:05	0	23	0	0	23	0	0	4	0	4	7	22	0	0	29	0	0	0	0	0	56
17:10	0	8	1	0	9	0	0	1	0	1	4	17	0	0	21	0	0	0	0	0	31
17:15	0	19	0	0	19	0	0	4	0	4	4	16	0	0	20	0	0	0	0	0	43
17:20	0	30	0	0	30	0	0	1	0	1	5	14	0	0	19	0	0	0	0	0	50
17:25	0	16	0	0	16	0	0	2	0	2	3	26	0	0	29	0	0	0	0	0	47
17:30	0	14	0	0	14	0	0	0	0	0	0	18	0	0	18	0	0	0	0	0	32
17:35	0	18	0	0	18	0	0	3	0	3	4	27	0	0	31	0	0	0	0	0	52
17:40	0	17	0	0	17	0	0	4	0	4	3	14	0	0	17	0	0	0	0	0	38
17:45	0	16	0	0	16	0	0	3	0	3	9	19	0	0	28	0	0	0	0	0	47
17:50	0	14	0	0	14	0	0	3	0	3	2	22	0	0	24	0	0	0	0	0	41
17:55	0	17	0	0	17	0	0	3	0	3	3	27	0	0	30	0	0	0	0	0	50
Total	0	221	1	0	222	0	0	34	0	34	47	242	0	0	289	0	0	0	0	0	545
Grand Total	0	481	3	0	484	1	0	72	0	73	86	521	0	0	607	0	0	0	0	0	1164
Apprch %	0	99.4	0.6	0		1.4	0	98.6	0		14.2	85.8	0	0		0	0	0	0		
Total %	0	41.3	0.3	0	41.6	0.1	0	6.2	0	6.3	7.4	44.8	0	0	52.1	0	0	0	0	0	

LSC Transportation Consultants, Inc.

2504 E. Pikes Peak Ave, Suite 304
 Colorado Springs, CO 80909
 719-633-2868

File Name : Vollmer Rd - Marksheffel Rd PM

Site Code : S224580

Start Date : 4/4/2024

Page No : 2

Start Time	Vollmer Rd Southbound					Marksheffel Rd Westbound					Vollmer Rd Northbound					Eastbound					Int. Total
	Right	Thru	Left	Peds	App. Total	Right	Thru	Left	Peds	App. Total	Right	Thru	Left	Peds	App. Total	Right	Thru	Left	Peds	App. Total	
Peak Hour Analysis From 16:00 to 17:55 - Peak 1 of 1																					
Peak Hour for Entire Intersection Begins at 16:10																					
16:10	0	21	0	0	21	0	0	4	0	4	6	23	0	0	29	0	0	0	0	0	54
16:15	0	21	1	0	22	0	0	4	0	4	4	24	0	0	28	0	0	0	0	0	54
16:20	0	16	0	0	16	1	0	1	0	2	2	26	0	0	28	0	0	0	0	0	46
16:25	0	26	0	0	26	0	0	6	0	6	2	13	0	0	15	0	0	0	0	0	47
16:30	0	24	0	0	24	0	0	3	0	3	3	22	0	0	25	0	0	0	0	0	52
16:35	0	19	0	0	19	0	0	2	0	2	1	29	0	0	30	0	0	0	0	0	51
16:40	0	23	0	0	23	0	0	3	0	3	4	23	0	0	27	0	0	0	0	0	53
16:45	0	22	1	0	23	0	0	6	0	6	6	22	0	0	28	0	0	0	0	0	57
16:50	0	24	0	0	24	0	0	3	0	3	5	26	0	0	31	0	0	0	0	0	58
16:55	0	18	0	0	18	0	0	5	0	5	2	24	0	0	26	0	0	0	0	0	49
17:00	0	29	0	0	29	0	0	6	0	6	3	20	0	0	23	0	0	0	0	0	58
17:05	0	23	0	0	23	0	0	4	0	4	7	22	0	0	29	0	0	0	0	0	56
Total Volume	0	266	2	0	268	1	0	47	0	48	45	274	0	0	319	0	0	0	0	0	635
% App. Total	0	99.3	0.7	0		2.1	0	97.9	0		14.1	85.9	0	0		0	0	0	0		
PHF	.000	.764	.167	.000	.770	.083	.000	.653	.000	.667	.536	.787	.000	.000	.858	.000	.000	.000	.000	.000	.912

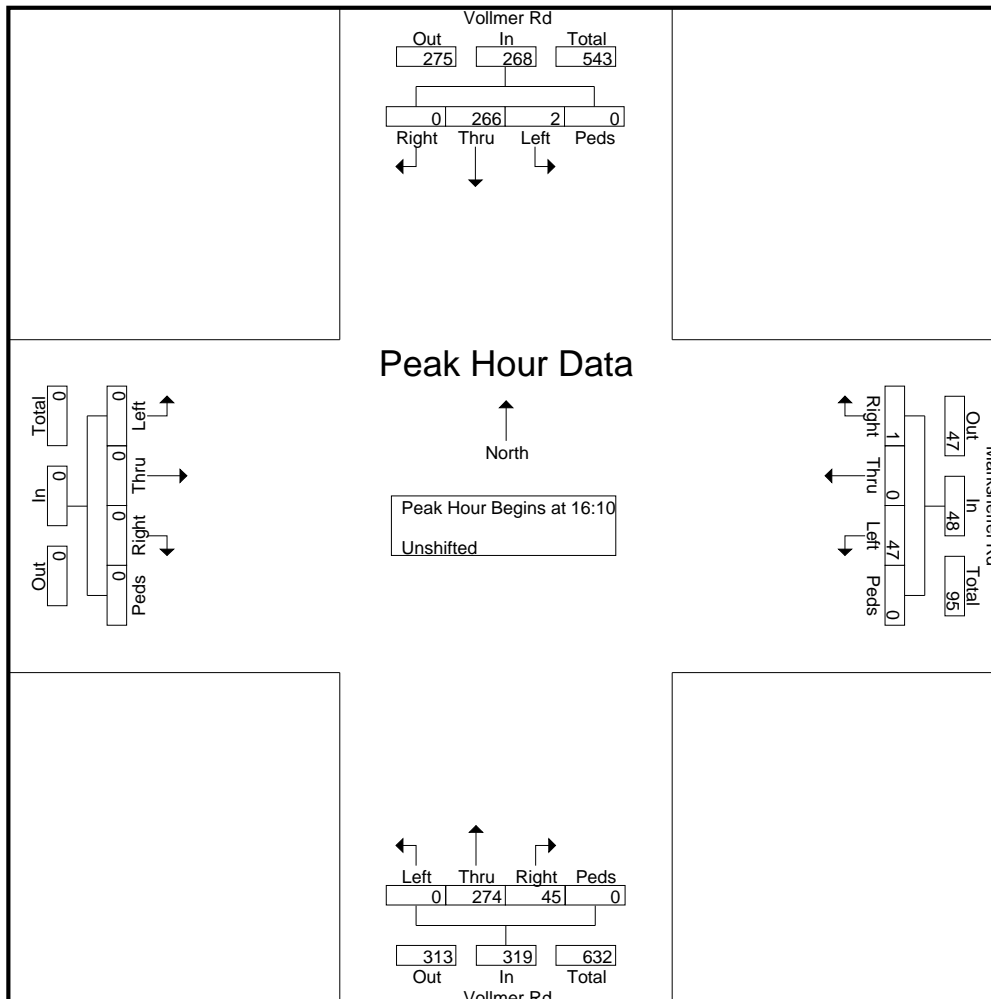

Vollmer Road North of Marksheffel Road

Site Code: 00244080

Station ID:

Location 1:

Location 2:

Location 3:

Location 4:

Comment 1:

Comment 2:

Comment 3:

Comment 4:

Latitude: 0.000000

Longitude: 0.000000

4/2/2024	NB	SB	Total
Time			
12:00 AM	*	*	0
1:00	*	*	0
2:00	*	*	0
3:00	*	*	0
4:00	*	*	0
5:00	*	*	0
6:00	*	*	0
7:00	*	*	0
8:00	*	*	0
9:00	*	*	0
10:00	*	*	0
11:00	*	*	0
12:00 PM	*	*	0
1:00	*	*	0
2:00	*	*	0
3:00	197	159	356
4:00	232	174	406
5:00	208	173	381
6:00	175	107	282
7:00	116	83	199
8:00	91	32	123
9:00	61	20	81
10:00	43	10	53
11:00	13	2	15
Total	1136	760	1896
Percent	59.9%	40.1%	
AM Peak			
Volume			
PM Peak	4:00	4:00	4:00
Volume	232	174	406

Vollmer Road North of Marksheffel Road

Site Code: 00244080

Station ID:

Location 1:

Location 2:

Location 3:

Location 4:

Comment 1:

Comment 2:

Comment 3:

Comment 4:

Latitude: 0.000000

Longitude: 0.000000

4/3/2024	NB	SB	Total
Time			
12:00 AM	7	2	9
1:00	1	5	6
2:00	1	2	3
3:00	5	9	14
4:00	8	20	28
5:00	13	51	64
6:00	88	149	237
7:00	164	333	497
8:00	182	209	391
9:00	141	184	325
10:00	127	159	286
11:00	143	192	335
12:00 PM	132	161	293
1:00	147	154	301
2:00	186	173	359
3:00	215	189	404
4:00	223	195	418
5:00	206	238	444
6:00	196	122	318
7:00	139	73	212
8:00	119	43	162
9:00	71	24	95
10:00	32	10	42
11:00	13	6	19
Total	2559	2703	5262
Percent	48.6%	51.4%	
AM Peak	8:00	7:00	7:00
Volume	182	333	497
PM Peak	4:00	5:00	5:00
Volume	223	238	444

Vollmer Road North of Marksheffel Road

Site Code: 00244080

Station ID:

Location 1:

Location 2:

Location 3:

Location 4:

Comment 1:

Comment 2:

Comment 3:

Comment 4:

Latitude: 0.000000

Longitude: 0.000000

4/4/2024	NB	SB	Total
Time			
12:00 AM	9	5	14
1:00	3	1	4
2:00	1	0	1
3:00	3	4	7
4:00	4	15	19
5:00	10	45	55
6:00	78	152	230
7:00	169	302	471
8:00	191	210	401
9:00	144	171	315
10:00	136	165	301
11:00	197	191	388
12:00 PM	174	175	349
1:00	168	178	346
2:00	173	194	367
3:00	227	201	428
4:00	250	231	481
5:00	218	198	416
6:00	34	19	53
7:00	*	*	0
8:00	*	*	0
9:00	*	*	0
10:00	*	*	0
11:00	*	*	0
Total	2189	2457	4646
Percent	47.1%	52.9%	
AM Peak	11:00	7:00	7:00
Volume	197	302	471
PM Peak	4:00	4:00	4:00
Volume	250	231	481
Grand Total	5884	5920	11804
Percent	49.8%	50.2%	
ADT		ADT: 5,172	AADT: 5,172

Location: 5 Vollmer Road & Dines Blvd AM

Date: Thursday, March 24, 2022

Peak Hour: 07:15 AM - 08:15 AM

Peak 15-Minutes: 07:45 AM - 08:00 AM

Peak Hour - All Vehicles

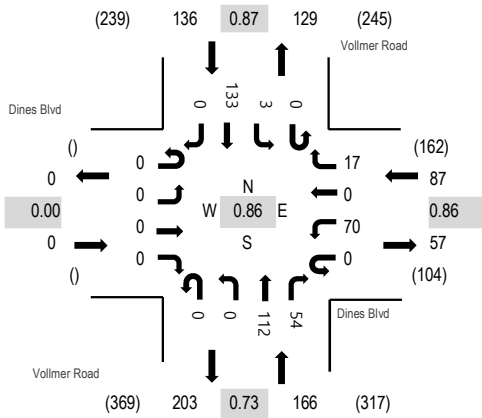

Peak Hour - Pedestrians/Bicycles on Crosswalk

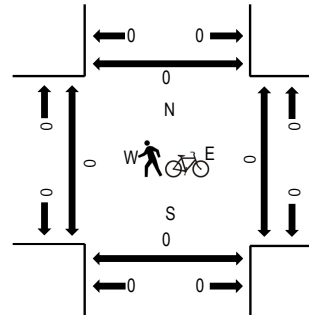

Note: Total study counts contained in parentheses.

Traffic Counts

Interval Start Time	Dines Blvd Eastbound				Dines Blvd Westbound				Vollmer Road Northbound				Vollmer Road Southbound				Total	Rolling Hour	Pedestrian Crossings			
	U-Turn	Left	Thru	Right	U-Turn	Left	Thru	Right	U-Turn	Left	Thru	Right	U-Turn	Left	Thru	Right			West	East	South	North
7:00 AM	0	0	0	0	0	11	0	1	0	0	25	14	0	2	16	0	69	370	0	0	0	0
7:15 AM	0	0	0	0	0	15	0	3	0	0	22	13	0	1	29	0	83	389	0	0	0	0
7:30 AM	0	0	0	0	0	21	0	5	0	0	27	13	0	0	39	0	105	381	0	0	0	0
7:45 AM	0	0	0	0	0	11	0	6	0	0	38	21	0	1	36	0	113	375	0	0	0	0
8:00 AM	0	0	0	0	0	23	0	3	0	0	25	7	0	1	29	0	88	348	0	0	0	0
8:15 AM	0	0	0	0	0	18	0	2	0	0	23	8	0	0	24	0	75		0	0	0	0
8:30 AM	0	0	0	0	0	23	0	1	1	0	28	13	1	2	30	0	99		0	0	0	0
8:45 AM	0	0	0	0	0	15	0	4	0	0	31	8	0	0	28	0	86		0	0	0	0
Count Total	0	0	0	0	0	137	0	25	1	0	219	97	1	7	231	0	718		0	0	0	0
Peak Hour	0	0	0	0	0	70	0	17	0	0	112	54	0	3	133	0	389		0	0	0	0



ALL TRAFFIC DATA SERVICES

(303) 216-2439

www.alltrafficdata.net

Location: 5 Vollmer Road & Dines Blvd PM

Date: Thursday, March 24, 2022

Peak Hour: 04:00 PM - 05:00 PM

Peak 15-Minutes: 04:00 PM - 04:15 PM

Peak Hour - All Vehicles

Peak Hour - Pedestrians/Bicycles on Crosswalk

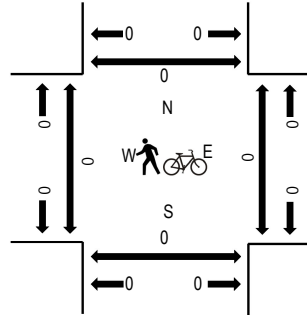
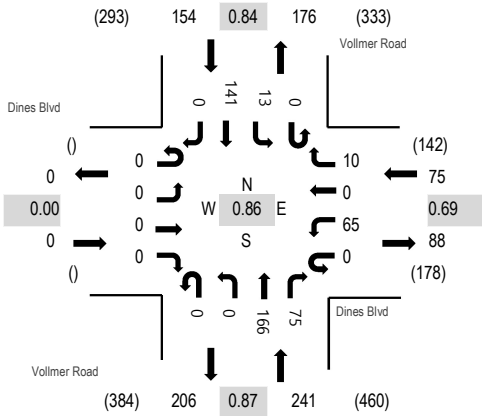

Note: Total study counts contained in parentheses.

Traffic Counts

Interval Start Time	Dines Blvd Eastbound				Dines Blvd Westbound				Vollmer Road Northbound				Vollmer Road Southbound				Total	Rolling Hour	Pedestrian Crossings			
	U-Turn	Left	Thru	Right	U-Turn	Left	Thru	Right	U-Turn	Left	Thru	Right	U-Turn	Left	Thru	Right			West	East	South	North
4:00 PM	0	0	0	0	0	24	0	3	0	0	46	18	0	2	44	0	137	470	0	0	0	0
4:15 PM	0	0	0	0	0	13	0	5	0	0	36	25	0	5	37	0	121	441	0	0	0	0
4:30 PM	0	0	0	0	0	12	0	2	0	0	35	11	0	3	30	0	93	436	0	0	0	0
4:45 PM	0	0	0	0	0	16	0	0	0	0	49	21	0	3	30	0	119	452	0	0	0	0
5:00 PM	0	0	0	0	0	14	0	5	0	0	42	18	0	2	27	0	108	425	0	0	0	0
5:15 PM	0	0	0	0	0	17	0	3	0	0	39	17	0	4	36	0	116		0	0	0	0
5:30 PM	0	0	0	0	0	12	0	1	0	0	36	21	0	8	31	0	109		0	0	0	0
5:45 PM	0	0	0	0	0	14	0	1	0	0	30	16	0	4	27	0	92		0	0	0	0
Count Total	0	0	0	0	0	122	0	20	0	0	313	147	0	31	262	0	895		0	0	0	0
Peak Hour	0	0	0	0	0	65	0	10	0	0	166	75	0	13	141	0	470		0	0	0	0

Peak Hour - All Vehicles

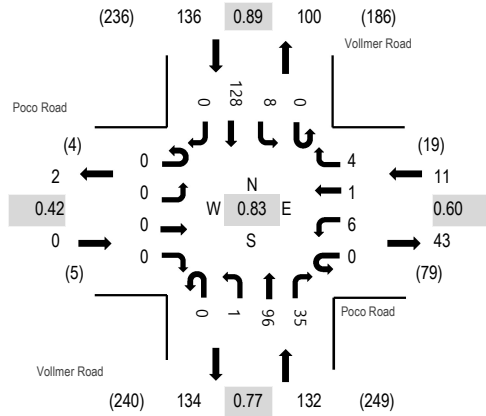

Note: Total study counts contained in parentheses.

Peak Hour - Pedestrians/Bicycles on Crosswalk

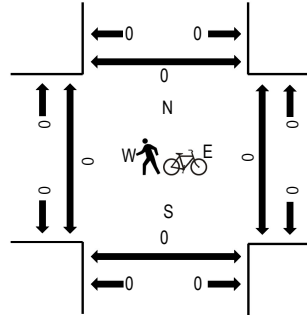

Traffic Counts

Interval Start Time	Poco Road Eastbound				Poco Road Westbound				Vollmer Road Northbound				Vollmer Road Southbound				Total	Rolling Hour	Pedestrian Crossings			
	U-Turn	Left	Thru	Right	U-Turn	Left	Thru	Right	U-Turn	Left	Thru	Right	U-Turn	Left	Thru	Right			West	East	South	North
7:00 AM	0	0	0	0	0	0	0	0	0	0	10	15	0	1	20	0	46	264	0	0	0	0
7:15 AM	0	0	0	0	0	1	0	2	0	0	18	8	0	2	27	0	58	279	0	0	0	0
7:30 AM	0	0	0	0	0	1	0	2	0	1	26	8	0	2	36	0	76	273	0	0	0	0
7:45 AM	0	0	0	0	0	4	0	0	0	0	34	9	0	4	33	0	84	265	0	0	0	0
8:00 AM	0	0	0	0	0	0	1	0	0	0	18	10	0	0	32	0	61	245	0	0	0	0
8:15 AM	0	0	0	0	0	1	0	1	0	0	24	3	0	0	23	0	52		0	0	0	0
8:30 AM	0	0	0	2	0	3	0	2	0	1	24	6	0	1	29	0	68		0	0	0	0
8:45 AM	0	2	0	1	0	1	0	0	0	1	23	10	0	0	26	0	64		0	0	0	0
Count Total	0	2	0	3	0	11	1	7	0	3	177	69	0	10	226	0	509		0	0	0	0
Peak Hour	0	0	0	0	0	6	1	4	0	1	96	35	0	8	128	0	279		0	0	0	0



ALL TRAFFIC DATA SERVICES

(303) 216-2439

www.alltrafficdata.net

Location: 6 Vollmer Road & Poco Road PM

Date: Thursday, March 24, 2022

Peak Hour: 04:00 PM - 05:00 PM

Peak 15-Minutes: 04:15 PM - 04:30 PM

Peak Hour - All Vehicles

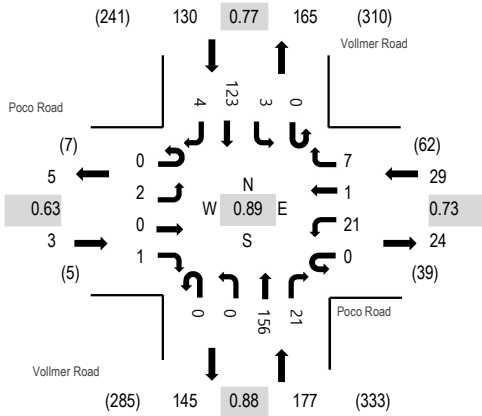

Peak Hour - Pedestrians/Bicycles on Crosswalk

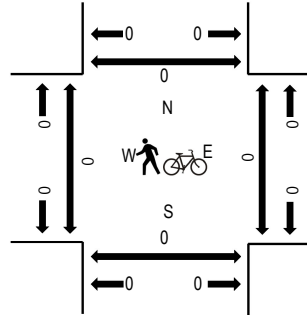

Note: Total study counts contained in parentheses.

Traffic Counts

Interval Start Time	Poco Road Eastbound				Poco Road Westbound				Vollmer Road Northbound				Vollmer Road Southbound				Total	Rolling Hour	Pedestrian Crossings			
	U-Turn	Left	Thru	Right	U-Turn	Left	Thru	Right	U-Turn	Left	Thru	Right	U-Turn	Left	Thru	Right			West	East	South	North
4:00 PM	0	0	0	0	0	8	1	4	0	0	41	4	0	1	29	2	90	339	0	0	0	0
4:15 PM	0	1	0	0	0	4	0	2	0	0	40	6	0	1	39	2	95	325	0	0	0	0
4:30 PM	0	0	0	0	0	2	0	0	0	0	32	3	0	1	28	0	66	313	0	0	0	0
4:45 PM	0	1	0	1	0	7	0	1	0	0	43	8	0	0	27	0	88	321	0	0	0	0
5:00 PM	0	0	0	2	0	6	0	1	0	0	44	3	0	0	20	0	76	302	0	0	0	0
5:15 PM	0	0	0	0	0	12	0	0	0	0	37	4	0	0	29	1	83		0	0	0	0
5:30 PM	0	0	0	0	0	6	0	2	0	0	33	3	0	1	29	0	74		0	0	0	0
5:45 PM	0	0	0	0	0	5	0	1	0	1	27	4	0	0	31	0	69		0	0	0	0
Count Total	0	2	0	3	0	50	1	11	0	1	297	35	0	4	232	5	641		0	0	0	0
Peak Hour	0	2	0	1	0	21	1	7	0	0	156	21	0	3	123	4	339		0	0	0	0

Level of Service Reports



Intersection						
Int Delay, s/veh	2.3					
Movement	WBL	WBR	NBT	NBR	SBL	SBT
Lane Configurations	↘	↗	↕↕	↗	↘	↕↕
Traffic Vol, veh/h	70	17	112	54	3	133
Future Vol, veh/h	70	17	112	54	3	133
Conflicting Peds, #/hr	0	0	0	0	0	0
Sign Control	Stop	Stop	Free	Free	Free	Free
RT Channelized	-	None	-	None	-	None
Storage Length	0	0	-	155	205	-
Veh in Median Storage, #	0	-	0	-	-	0
Grade, %	0	-	0	-	-	0
Peak Hour Factor	85	85	85	85	85	85
Heavy Vehicles, %	2	2	2	2	2	2
Mvmt Flow	82	20	132	64	4	156

Major/Minor	Minor1	Major1	Major2		
Conflicting Flow All	218	66	0	0	196
Stage 1	132	-	-	-	-
Stage 2	86	-	-	-	-
Critical Hdwy	6.84	6.94	-	-	4.14
Critical Hdwy Stg 1	5.84	-	-	-	-
Critical Hdwy Stg 2	5.84	-	-	-	-
Follow-up Hdwy	3.52	3.32	-	-	2.22
Pot Cap-1 Maneuver	750	984	-	-	1374
Stage 1	880	-	-	-	-
Stage 2	927	-	-	-	-
Platoon blocked, %			-	-	-
Mov Cap-1 Maneuver	748	984	-	-	1374
Mov Cap-2 Maneuver	752	-	-	-	-
Stage 1	880	-	-	-	-
Stage 2	924	-	-	-	-

Approach	WB	NB	SB
HCM Control Delay, s	10.1	0	0.2
HCM LOS	B		

Minor Lane/Major Mvmt	NBT	NBRWBLn1	WBLn2	SBL	SBT
Capacity (veh/h)	-	-	752	984	1374
HCM Lane V/C Ratio	-	-	0.11	0.02	0.003
HCM Control Delay (s)	-	-	10.4	8.7	7.6
HCM Lane LOS	-	-	B	A	A
HCM 95th %tile Q(veh)	-	-	0.4	0.1	0

Intersection						
Int Delay, s/veh	1.9					
Movement	WBL	WBR	NBT	NBR	SBL	SBT
Lane Configurations	↘	↗	↕↕	↗	↘	↕↕
Traffic Vol, veh/h	65	10	166	75	13	141
Future Vol, veh/h	65	10	166	75	13	141
Conflicting Peds, #/hr	0	0	0	0	0	0
Sign Control	Stop	Stop	Free	Free	Free	Free
RT Channelized	-	None	-	None	-	None
Storage Length	0	0	-	155	205	-
Veh in Median Storage, #	0	-	0	-	-	0
Grade, %	0	-	0	-	-	0
Peak Hour Factor	85	85	85	85	85	85
Heavy Vehicles, %	2	2	2	2	2	2
Mvmt Flow	76	12	195	88	15	166

Major/Minor	Minor1	Major1	Major2		
Conflicting Flow All	308	98	0	0	283
Stage 1	195	-	-	-	-
Stage 2	113	-	-	-	-
Critical Hdwy	6.84	6.94	-	-	4.14
Critical Hdwy Stg 1	5.84	-	-	-	-
Critical Hdwy Stg 2	5.84	-	-	-	-
Follow-up Hdwy	3.52	3.32	-	-	2.22
Pot Cap-1 Maneuver	660	939	-	-	1276
Stage 1	819	-	-	-	-
Stage 2	899	-	-	-	-
Platoon blocked, %			-	-	-
Mov Cap-1 Maneuver	652	939	-	-	1276
Mov Cap-2 Maneuver	684	-	-	-	-
Stage 1	819	-	-	-	-
Stage 2	888	-	-	-	-

Approach	WB	NB	SB
HCM Control Delay, s	10.6	0	0.7
HCM LOS	B		

Minor Lane/Major Mvmt	NBT	NBR	WBLn1	WBLn2	SBL	SBT
Capacity (veh/h)	-	-	684	939	1276	-
HCM Lane V/C Ratio	-	-	0.112	0.013	0.012	-
HCM Control Delay (s)	-	-	10.9	8.9	7.9	-
HCM Lane LOS	-	-	B	A	A	-
HCM 95th %tile Q(veh)	-	-	0.4	0	0	-

Intersection						
Int Delay, s/veh	0.3					
Movement	WBL	WBR	NBT	NBR	SBL	SBT
Lane Configurations						
Traffic Vol, veh/h	11	1	208	4	0	368
Future Vol, veh/h	11	1	208	4	0	368
Conflicting Peds, #/hr	0	0	0	0	0	0
Sign Control	Stop	Stop	Free	Free	Free	Free
RT Channelized	-	None	-	None	-	None
Storage Length	0	-	-	-	-	-
Veh in Median Storage, #	0	-	0	-	-	0
Grade, %	0	-	0	-	-	0
Peak Hour Factor	95	95	95	95	95	95
Heavy Vehicles, %	2	2	2	2	2	2
Mvmt Flow	12	1	219	4	0	387

Major/Minor	Minor1	Major1	Major2		
Conflicting Flow All	608	221	0	0	223
Stage 1	221	-	-	-	-
Stage 2	387	-	-	-	-
Critical Hdwy	6.42	6.22	-	-	4.12
Critical Hdwy Stg 1	5.42	-	-	-	-
Critical Hdwy Stg 2	5.42	-	-	-	-
Follow-up Hdwy	3.518	3.318	-	-	2.218
Pot Cap-1 Maneuver	459	819	-	-	1346
Stage 1	816	-	-	-	-
Stage 2	686	-	-	-	-
Platoon blocked, %			-	-	-
Mov Cap-1 Maneuver	459	819	-	-	1346
Mov Cap-2 Maneuver	459	-	-	-	-
Stage 1	816	-	-	-	-
Stage 2	686	-	-	-	-

Approach	WB	NB	SB
HCM Control Delay, s	12.8	0	0
HCM LOS	B		

Minor Lane/Major Mvmt	NBT	NBRWBLn1	SBL	SBT
Capacity (veh/h)	-	-	476	1346
HCM Lane V/C Ratio	-	-	0.027	-
HCM Control Delay (s)	-	-	12.8	0
HCM Lane LOS	-	-	B	A
HCM 95th %tile Q(veh)	-	-	0.1	0

Timings
4: Vollmer Rd & Briargate Pkwy

2045 Background Traffic
AM Peak Hour

Lane Group	EBL	EBT	EBR	WBL	WBT	WBR	NBL	NBT	NBR	SBL	SBT	SBR
Lane Configurations												
Traffic Volume (vph)	61	395	144	86	694	36	107	109	48	27	270	125
Future Volume (vph)	61	395	144	86	694	36	107	109	48	27	270	125
Turn Type	pm+pt	NA	Perm	Prot	NA	Perm	pm+pt	NA	Perm	pm+pt	NA	Perm
Protected Phases	5	2		1	6		3	8		7	4	
Permitted Phases	2		2			6	8		8	4		4
Detector Phase	5	2	2	1	6	6	3	8	8	7	4	4
Switch Phase												
Minimum Initial (s)	5.0	15.0	15.0	15.0	15.0	15.0	5.0	5.0	5.0	5.0	5.0	5.0
Minimum Split (s)	10.0	20.0	20.0	20.0	20.0	20.0	10.0	10.0	10.0	10.0	10.0	10.0
Total Split (s)	12.0	57.0	57.0	20.0	65.0	65.0	17.0	28.0	28.0	15.0	26.0	26.0
Total Split (%)	10.0%	47.5%	47.5%	16.7%	54.2%	54.2%	14.2%	23.3%	23.3%	12.5%	21.7%	21.7%
Yellow Time (s)	3.0	3.0	3.0	3.0	3.0	3.0	3.0	3.0	3.0	3.0	3.0	3.0
All-Red Time (s)	2.0	2.0	2.0	2.0	2.0	2.0	2.0	2.0	2.0	2.0	2.0	2.0
Lost Time Adjust (s)	0.0	0.0	0.0	0.0	0.0	0.0	0.0	0.0	0.0	0.0	0.0	0.0
Total Lost Time (s)	5.0	5.0	5.0	5.0	5.0	5.0	5.0	5.0	5.0	5.0	5.0	5.0
Lead/Lag	Lead	Lag	Lag	Lead	Lag	Lag	Lead	Lag	Lag	Lead	Lag	Lag
Lead-Lag Optimize?	Yes	Yes	Yes	Yes	Yes	Yes	Yes	Yes	Yes	Yes	Yes	Yes
Recall Mode	None	Max	Max	None	Max	Max	None	None	None	None	None	None
Act Effct Green (s)	59.6	54.3	54.3	15.1	60.6	60.6	29.0	22.4	22.4	21.2	14.3	14.3
Actuated g/C Ratio	0.54	0.50	0.50	0.14	0.55	0.55	0.27	0.20	0.20	0.19	0.13	0.13
v/c Ratio	0.15	0.23	0.18	0.19	0.37	0.04	0.41	0.15	0.11	0.10	0.61	0.39
Control Delay	10.1	18.2	3.5	45.4	15.7	0.1	36.1	39.0	0.5	31.0	51.6	7.9
Queue Delay	0.0	0.0	0.0	0.0	0.0	0.0	0.0	0.0	0.0	0.0	0.0	0.0
Total Delay	10.1	18.2	3.5	45.4	15.7	0.1	36.1	39.0	0.5	31.0	51.6	7.9
LOS	B	B	A	D	B	A	D	D	A	C	D	A
Approach Delay		13.7			18.1			30.7			37.3	
Approach LOS		B			B			C			D	

Intersection Summary

Cycle Length: 120
 Actuated Cycle Length: 109.4
 Natural Cycle: 60
 Control Type: Actuated-Uncoordinated
 Maximum v/c Ratio: 0.61
 Intersection Signal Delay: 22.3
 Intersection LOS: C
 Intersection Capacity Utilization 55.1%
 ICU Level of Service B
 Analysis Period (min) 15

Splits and Phases: 4: Vollmer Rd & Briargate Pkwy



Intersection												
Int Delay, s/veh	0.1											
Movement	EBL	EBT	EBR	WBL	WBT	WBR	NBL	NBT	NBR	SBL	SBT	SBR
Lane Configurations	↘	↑↑	↗	↘	↑↑	↗	↘	↑	↗	↘	↑	↗
Traffic Vol, veh/h	2	468	0	4	807	2	0	0	2	6	0	9
Future Vol, veh/h	2	468	0	4	807	2	0	0	2	6	0	9
Conflicting Peds, #/hr	0	0	0	0	0	0	0	0	0	0	0	0
Sign Control	Free	Free	Free	Free	Free	Free	Stop	Stop	Stop	Stop	Stop	Stop
RT Channelized	-	-	None	-	-	None	-	-	Free	-	-	Free
Storage Length	535	-	0	310	-	0	410	-	155	235	-	155
Veh in Median Storage, #	-	0	-	-	0	-	-	0	-	-	0	-
Grade, %	-	0	-	-	0	-	-	0	-	-	0	-
Peak Hour Factor	95	95	95	95	95	95	95	95	95	95	95	95
Heavy Vehicles, %	2	2	2	2	2	2	2	2	2	2	2	2
Mvmt Flow	2	493	0	4	849	2	0	0	2	6	0	9

Major/Minor	Major1			Major2			Minor1			Minor2		
Conflicting Flow All	851	0	0	493	0	0	930	1356	-	1108	1354	-
Stage 1	-	-	-	-	-	-	497	497	-	857	857	-
Stage 2	-	-	-	-	-	-	433	859	-	251	497	-
Critical Hdwy	4.14	-	-	4.14	-	-	7.54	6.54	-	7.54	6.54	-
Critical Hdwy Stg 1	-	-	-	-	-	-	6.54	5.54	-	6.54	5.54	-
Critical Hdwy Stg 2	-	-	-	-	-	-	6.54	5.54	-	6.54	5.54	-
Follow-up Hdwy	2.22	-	-	2.22	-	-	3.52	4.02	-	3.52	4.02	-
Pot Cap-1 Maneuver	783	-	-	1067	-	-	222	148	0	164	148	0
Stage 1	-	-	-	-	-	-	523	543	0	318	372	0
Stage 2	-	-	-	-	-	-	571	371	0	731	543	0
Platoon blocked, %	-	-	-	-	-	-	-	-	-	-	-	-
Mov Cap-1 Maneuver	783	-	-	1067	-	-	221	147	-	163	147	-
Mov Cap-2 Maneuver	-	-	-	-	-	-	221	147	-	163	147	-
Stage 1	-	-	-	-	-	-	521	541	-	317	371	-
Stage 2	-	-	-	-	-	-	569	370	-	729	541	-

Approach	EB	WB	NB	SB
HCM Control Delay, s	0	0	0	28
HCM LOS			A	D

Minor Lane/Major Mvmt	NBLn1	NBLn2	NBLn3	EBL	EBT	EBR	WBL	WBT	WBR	SBLn1	SBLn2	SBLn3
Capacity (veh/h)	-	-	-	783	-	-	1067	-	-	163	-	-
HCM Lane V/C Ratio	-	-	-	0.003	-	-	0.004	-	-	0.039	-	-
HCM Control Delay (s)	0	0	0	9.6	-	-	8.4	-	-	28	0	0
HCM Lane LOS	A	A	A	A	-	-	A	-	-	D	A	A
HCM 95th %tile Q(veh)	-	-	-	0	-	-	0	-	-	0.1	-	-

Timings
6: Banning Lewis Pkwy & Briargate Pkwy

2045 Background Traffic
AM Peak Hour

	→	↘	↙	←	↖	↗	↑	↘	↙	↓	Ø5
Lane Group	EBT	EBR	WBL	WBT	WBR	NBL	NBT	NBR	SBL	SBT	Ø5
Lane Configurations	↑↑	↑	↘↙	↑↑	↑	↘↙	↑↑	↑	↘	↑↑	
Traffic Volume (vph)	328	148	270	601	3	212	8	285	8	24	
Future Volume (vph)	328	148	270	601	3	212	8	285	8	24	
Turn Type	NA	Free	Prot	NA	Perm	Prot	NA	Free	pm+pt	NA	
Protected Phases	2		1	6		3	8		7	4	5
Permitted Phases		Free			6			Free	4		
Detector Phase	2		1	6	6	3	8		7	4	
Switch Phase											
Minimum Initial (s)	15.0		8.0	15.0	15.0	8.0	10.0		8.0	10.0	8.0
Minimum Split (s)	20.0		20.0	20.0	20.0	13.0	15.0		13.0	15.0	15.0
Total Split (s)	38.0		25.0	48.0	48.0	32.0	43.0		14.0	25.0	15.0
Total Split (%)	31.7%		20.8%	40.0%	40.0%	26.7%	35.8%		11.7%	20.8%	13%
Yellow Time (s)	3.0		3.0	3.0	3.0	3.0	3.0		3.0	3.0	3.0
All-Red Time (s)	2.0		2.0	2.0	2.0	2.0	2.0		2.0	2.0	2.0
Lost Time Adjust (s)	0.0		0.0	0.0	0.0	0.0	0.0		0.0	0.0	
Total Lost Time (s)	5.0		5.0	5.0	5.0	5.0	5.0		5.0	5.0	
Lead/Lag	Lag		Lead	Lag	Lag	Lead	Lag		Lead	Lag	Lead
Lead-Lag Optimize?	Yes		Yes	Yes	Yes	Yes	Yes		Yes	Yes	Yes
Recall Mode	C-Max		None	C-Max	C-Max	None	Max		None	Max	None
Act Effct Green (s)	37.8	120.0	15.2	58.0	58.0	13.1	49.4	120.0	41.9	33.9	
Actuated g/C Ratio	0.32	1.00	0.13	0.48	0.48	0.11	0.41	1.00	0.35	0.28	
v/c Ratio	0.31	0.10	0.66	0.37	0.00	0.59	0.01	0.19	0.02	0.03	
Control Delay	32.8	0.1	57.1	20.3	0.0	57.3	23.8	0.3	20.2	32.8	
Queue Delay	0.0	0.0	0.0	0.0	0.0	0.0	0.0	0.0	0.0	0.0	
Total Delay	32.8	0.1	57.1	20.3	0.0	57.3	23.8	0.3	20.2	32.8	
LOS	C	A	E	C	A	E	C	A	C	C	
Approach Delay	22.6			31.6			24.6			29.7	
Approach LOS	C			C			C			C	

Intersection Summary

Cycle Length: 120
 Actuated Cycle Length: 120
 Offset: 0 (0%), Referenced to phase 2:EBTL and 6:WBT, Start of Green
 Natural Cycle: 70
 Control Type: Actuated-Coordinated
 Maximum v/c Ratio: 0.66
 Intersection Signal Delay: 27.4
 Intersection LOS: C
 Intersection Capacity Utilization 48.5%
 ICU Level of Service A
 Analysis Period (min) 15

Splits and Phases: 6: Banning Lewis Pkwy & Briargate Pkwy

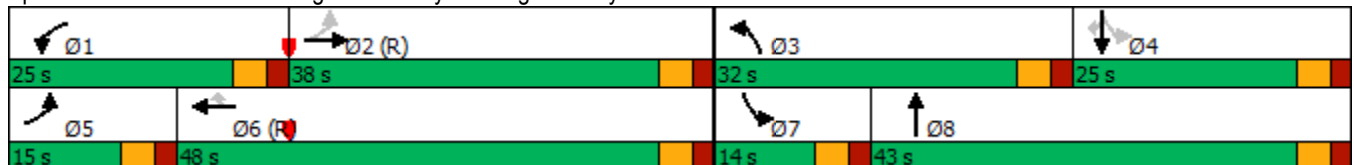

Intersection									
Intersection Delay, s/veh	6.9								
Intersection LOS	A								
Approach	EB		WB		NB		SB		
Entry Lanes	2		2		2		2		
Conflicting Circle Lanes	2		2		2		2		
Adj Approach Flow, veh/h	501		920		531		33		
Demand Flow Rate, veh/h	511		939		541		34		
Vehicles Circulating, veh/h	323		235		360		1163		
Vehicles Exiting, veh/h	873		666		474		11		
Ped Vol Crossing Leg, #/h	0		0		0		0		
Ped Cap Adj	1.000		1.000		1.000		1.000		
Approach Delay, s/veh	5.9		7.7		6.3		7.8		
Approach LOS	A		A		A		A		
Lane	Left	Right	Left	Right	Left	Right	Left	Right	
Designated Moves	LT	TR	LT	TR	LT	TR	LT	TR	
Assumed Moves	LT	TR	LT	TR	LT	R	LT	TR	
RT Channelized									
Lane Util	0.470	0.530	0.470	0.530	0.434	0.566	0.471	0.529	
Follow-Up Headway, s	2.667	2.535	2.667	2.535	2.667	2.535	2.667	2.535	
Critical Headway, s	4.645	4.328	4.645	4.328	4.645	4.328	4.645	4.328	
Entry Flow, veh/h	240	271	441	498	235	306	16	18	
Cap Entry Lane, veh/h	1003	1079	1087	1163	969	1046	463	528	
Entry HV Adj Factor	0.981	0.980	0.981	0.979	0.982	0.980	0.984	0.986	
Flow Entry, veh/h	236	266	433	488	231	300	16	18	
Cap Entry, veh/h	984	1058	1067	1139	952	1025	456	521	
V/C Ratio	0.239	0.251	0.406	0.428	0.242	0.293	0.035	0.034	
Control Delay, s/veh	6.0	5.8	7.7	7.6	6.2	6.4	8.4	7.3	
LOS	A	A	A	A	A	A	A	A	
95th %tile Queue, veh	1	1	2	2	1	1	0	0	

Intersection						
Int Delay, s/veh	1.4					
Movement	EBL	EBR	NBL	NBT	SBT	SBR
Lane Configurations	↘↗		↘	↑↑	↑↑	↘
Traffic Vol, veh/h	0	96	22	264	500	0
Future Vol, veh/h	0	96	22	264	500	0
Conflicting Peds, #/hr	0	0	0	0	0	0
Sign Control	Stop	Stop	Free	Free	Free	Free
RT Channelized	-	None	-	None	-	None
Storage Length	0	-	0	-	-	0
Veh in Median Storage, #	0	-	-	0	0	-
Grade, %	0	-	-	0	0	-
Peak Hour Factor	95	95	95	95	95	95
Heavy Vehicles, %	2	2	2	2	2	2
Mvmt Flow	0	101	23	278	526	0

Major/Minor	Minor2	Major1		Major2	
Conflicting Flow All	711	263	526	0	0
Stage 1	526	-	-	-	-
Stage 2	185	-	-	-	-
Critical Hdwy	6.84	6.94	4.14	-	-
Critical Hdwy Stg 1	5.84	-	-	-	-
Critical Hdwy Stg 2	5.84	-	-	-	-
Follow-up Hdwy	3.52	3.32	2.22	-	-
Pot Cap-1 Maneuver	368	735	1037	-	-
Stage 1	557	-	-	-	-
Stage 2	828	-	-	-	-
Platoon blocked, %				-	-
Mov Cap-1 Maneuver	360	735	1037	-	-
Mov Cap-2 Maneuver	450	-	-	-	-
Stage 1	545	-	-	-	-
Stage 2	828	-	-	-	-

Approach	EB	NB	SB
HCM Control Delay, s	10.7	0.7	0
HCM LOS	B		

Minor Lane/Major Mvmt	NBL	NBT	EBLn1	SBT	SBR
Capacity (veh/h)	1037	-	735	-	-
HCM Lane V/C Ratio	0.022	-	0.137	-	-
HCM Control Delay (s)	8.6	-	10.7	-	-
HCM Lane LOS	A	-	B	-	-
HCM 95th %tile Q(veh)	0.1	-	0.5	-	-

Timings
12: Vollmer Rd & Marksheffel Rd

2045 Background Traffic
AM Peak Hour

Lane Group	EBL	EBT	EBR	WBL	WBT	WBR	NBL	NBT	NBR	SBL	SBT	SBR
Lane Configurations												
Traffic Volume (vph)	47	738	40	21	721	56	85	183	35	104	397	96
Future Volume (vph)	47	738	40	21	721	56	85	183	35	104	397	96
Turn Type	pm+pt	NA	Perm	pm+pt	NA	Perm	pm+pt	NA	Perm	pm+pt	NA	Perm
Protected Phases	5	2		1	6		3	8		7	4	
Permitted Phases	2		2	6		6	8		8	4		4
Detector Phase	5	2	2	1	6	6	3	8	8	7	4	4
Switch Phase												
Minimum Initial (s)	5.0	5.0	5.0	5.0	5.0	5.0	5.0	10.0	10.0	5.0	10.0	10.0
Minimum Split (s)	10.0	23.0	23.0	10.0	23.0	23.0	10.0	23.0	23.0	10.0	23.0	23.0
Total Split (s)	12.0	66.0	66.0	12.0	66.0	66.0	12.0	30.0	30.0	12.0	30.0	30.0
Total Split (%)	10.0%	55.0%	55.0%	10.0%	55.0%	55.0%	10.0%	25.0%	25.0%	10.0%	25.0%	25.0%
Yellow Time (s)	3.0	3.0	3.0	3.0	3.0	3.0	3.0	3.0	3.0	3.0	3.0	3.0
All-Red Time (s)	2.0	2.0	2.0	2.0	2.0	2.0	2.0	2.0	2.0	2.0	2.0	2.0
Lost Time Adjust (s)	0.0	0.0	0.0	0.0	0.0	0.0	0.0	0.0	0.0	0.0	0.0	0.0
Total Lost Time (s)	5.0	5.0	5.0	5.0	5.0	5.0	5.0	5.0	5.0	5.0	5.0	5.0
Lead/Lag	Lead	Lag	Lag	Lead	Lag	Lag	Lead	Lag	Lag	Lead	Lag	Lag
Lead-Lag Optimize?	Yes	Yes	Yes	Yes	Yes	Yes	Yes	Yes	Yes	Yes	Yes	Yes
Recall Mode	None	C-Max	C-Max	None	C-Max	C-Max	None	Max	Max	None	Max	Max
Act Effct Green (s)	70.3	66.1	66.1	68.6	63.6	63.6	31.9	25.0	25.0	32.1	25.1	25.1
Actuated g/C Ratio	0.59	0.55	0.55	0.57	0.53	0.53	0.27	0.21	0.21	0.27	0.21	0.21
v/c Ratio	0.13	0.40	0.05	0.06	0.40	0.07	0.38	0.26	0.09	0.32	0.56	0.24
Control Delay	10.4	17.0	0.1	9.8	18.3	0.3	35.6	40.9	0.4	34.0	46.0	7.9
Queue Delay	0.0	0.0	0.0	0.0	0.0	0.0	0.0	0.0	0.0	0.0	0.0	0.0
Total Delay	10.4	17.0	0.1	9.8	18.3	0.3	35.6	40.9	0.4	34.0	46.0	7.9
LOS	B	B	A	A	B	A	D	D	A	C	D	A
Approach Delay		15.8			16.8			34.7			37.8	
Approach LOS		B			B			C			D	

Intersection Summary

Cycle Length: 120
 Actuated Cycle Length: 120
 Offset: 0 (0%), Referenced to phase 2:EBTL and 6:WBTL, Start of Green
 Natural Cycle: 70
 Control Type: Actuated-Coordinated
 Maximum v/c Ratio: 0.56
 Intersection Signal Delay: 23.6
 Intersection LOS: C
 Intersection Capacity Utilization 56.9%
 ICU Level of Service B
 Analysis Period (min) 15

Splits and Phases: 12: Vollmer Rd & Marksheffel Rd

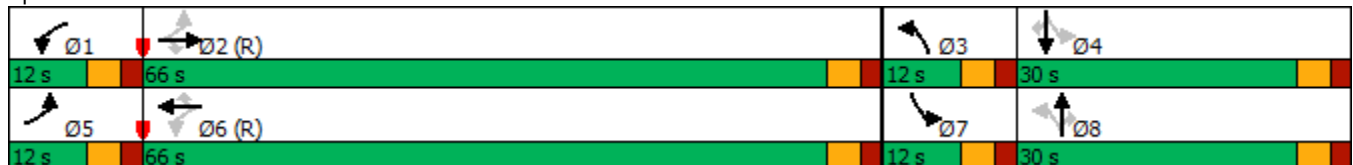

Intersection												
Int Delay, s/veh	0.6											
Movement	EBL	EBT	EBR	WBL	WBT	WBR	NBL	NBT	NBR	SBL	SBT	SBR
Lane Configurations												
Traffic Vol, veh/h	0	857	12	31	791	0	7	2	7	0	4	0
Future Vol, veh/h	0	857	12	31	791	0	7	2	7	0	4	0
Conflicting Peds, #/hr	0	0	0	0	0	0	0	0	0	0	0	0
Sign Control	Free	Free	Free	Free	Free	Free	Stop	Stop	Stop	Stop	Stop	Stop
RT Channelized	-	-	None	-	-	None	-	-	None	-	-	None
Storage Length	300	-	0	0	-	205	0	-	-	155	-	0
Veh in Median Storage, #	-	0	-	-	0	-	-	0	-	-	0	-
Grade, %	-	0	-	-	0	-	-	0	-	-	0	-
Peak Hour Factor	95	95	95	95	95	95	95	95	95	95	95	95
Heavy Vehicles, %	2	2	2	2	2	2	2	2	2	2	2	2
Mvmt Flow	0	902	13	33	833	0	7	2	7	0	4	0

Major/Minor	Major1			Major2			Minor1			Minor2		
Conflicting Flow All	833	0	0	915	0	0	1387	1801	451	1351	1814	417
Stage 1	-	-	-	-	-	-	902	902	-	899	899	-
Stage 2	-	-	-	-	-	-	485	899	-	452	915	-
Critical Hdwy	4.14	-	-	4.14	-	-	7.54	6.54	6.94	7.54	6.54	6.94
Critical Hdwy Stg 1	-	-	-	-	-	-	6.54	5.54	-	6.54	5.54	-
Critical Hdwy Stg 2	-	-	-	-	-	-	6.54	5.54	-	6.54	5.54	-
Follow-up Hdwy	2.22	-	-	2.22	-	-	3.52	4.02	3.32	3.52	4.02	3.32
Pot Cap-1 Maneuver	796	-	-	741	-	-	102	79	556	109	77	585
Stage 1	-	-	-	-	-	-	299	355	-	300	356	-
Stage 2	-	-	-	-	-	-	532	356	-	557	350	-
Platoon blocked, %	-	-	-	-	-	-	-	-	-	-	-	-
Mov Cap-1 Maneuver	796	-	-	741	-	-	94	75	556	102	74	585
Mov Cap-2 Maneuver	-	-	-	-	-	-	94	75	-	102	74	-
Stage 1	-	-	-	-	-	-	299	355	-	300	340	-
Stage 2	-	-	-	-	-	-	502	340	-	546	350	-

Approach	EB			WB			NB			SB		
HCM Control Delay, s	0			0.4			32.4			56.6		
HCM LOS							D			F		

Minor Lane/Major Mvmt	NBLn1	NBLn2	EBL	EBT	EBR	WBL	WBT	WBR	SBLn1	SBLn2	SBLn3
Capacity (veh/h)	94	229	796	-	-	741	-	-	-	74	-
HCM Lane V/C Ratio	0.078	0.041	-	-	-	0.044	-	-	-	0.057	-
HCM Control Delay (s)	46.5	21.4	0	-	-	10.1	-	-	0	56.6	0
HCM Lane LOS	E	C	A	-	-	B	-	-	A	F	A
HCM 95th %tile Q(veh)	0.2	0.1	0	-	-	0.1	-	-	-	0.2	-

Intersection						
Int Delay, s/veh	0.2					
Movement	WBL	WBR	NBT	NBR	SBL	SBT
Lane Configurations						
Traffic Vol, veh/h	7	1	503	13	1	284
Future Vol, veh/h	7	1	503	13	1	284
Conflicting Peds, #/hr	0	0	0	0	0	0
Sign Control	Stop	Stop	Free	Free	Free	Free
RT Channelized	-	None	-	None	-	None
Storage Length	0	-	-	-	-	-
Veh in Median Storage, #	0	-	0	-	-	0
Grade, %	0	-	0	-	-	0
Peak Hour Factor	95	95	95	95	95	95
Heavy Vehicles, %	2	2	2	2	2	2
Mvmt Flow	7	1	529	14	1	299

Major/Minor	Minor1	Major1	Major2			
Conflicting Flow All	837	536	0	0	543	0
Stage 1	536	-	-	-	-	-
Stage 2	301	-	-	-	-	-
Critical Hdwy	6.42	6.22	-	-	4.12	-
Critical Hdwy Stg 1	5.42	-	-	-	-	-
Critical Hdwy Stg 2	5.42	-	-	-	-	-
Follow-up Hdwy	3.518	3.318	-	-	2.218	-
Pot Cap-1 Maneuver	337	545	-	-	1026	-
Stage 1	587	-	-	-	-	-
Stage 2	751	-	-	-	-	-
Platoon blocked, %			-	-		-
Mov Cap-1 Maneuver	337	545	-	-	1026	-
Mov Cap-2 Maneuver	337	-	-	-	-	-
Stage 1	587	-	-	-	-	-
Stage 2	750	-	-	-	-	-

Approach	WB	NB	SB
HCM Control Delay, s	15.4	0	0
HCM LOS	C		

Minor Lane/Major Mvmt	NBT	NBRWBLn1	SBL	SBT
Capacity (veh/h)	-	-	354	1026
HCM Lane V/C Ratio	-	-	0.024	0.001
HCM Control Delay (s)	-	-	15.4	8.5
HCM Lane LOS	-	-	C	A
HCM 95th %tile Q(veh)	-	-	0.1	0

Timings
4: Vollmer Rd & Briargate Pkwy

2045 Background Traffic
PM Peak Hour

Lane Group	EBL	EBT	EBR	WBL	WBT	WBR	NBL	NBT	NBR	SBL	SBT	SBR
Lane Configurations												
Traffic Volume (vph)	193	602	146	65	513	31	238	329	79	31	168	107
Future Volume (vph)	193	602	146	65	513	31	238	329	79	31	168	107
Turn Type	pm+pt	NA	Perm	Prot	NA	Perm	pm+pt	NA	Perm	pm+pt	NA	Perm
Protected Phases	5	2		1	6		3	8		7	4	
Permitted Phases	2		2			6	8		8	4		4
Detector Phase	5	2	2	1	6	6	3	8	8	7	4	4
Switch Phase												
Minimum Initial (s)	5.0	15.0	15.0	15.0	15.0	15.0	8.0	5.0	5.0	5.0	5.0	5.0
Minimum Split (s)	10.0	20.0	20.0	20.0	20.0	20.0	13.0	10.0	10.0	10.0	10.0	10.0
Total Split (s)	12.0	53.0	53.0	20.0	61.0	61.0	22.0	28.0	28.0	19.0	25.0	25.0
Total Split (%)	10.0%	44.2%	44.2%	16.7%	50.8%	50.8%	18.3%	23.3%	23.3%	15.8%	20.8%	20.8%
Yellow Time (s)	3.0	3.0	3.0	3.0	3.0	3.0	3.0	3.0	3.0	3.0	3.0	3.0
All-Red Time (s)	2.0	2.0	2.0	2.0	2.0	2.0	2.0	2.0	2.0	2.0	2.0	2.0
Lost Time Adjust (s)	0.0	0.0	0.0	0.0	0.0	0.0	0.0	0.0	0.0	0.0	0.0	0.0
Total Lost Time (s)	5.0	5.0	5.0	5.0	5.0	5.0	5.0	5.0	5.0	5.0	5.0	5.0
Lead/Lag	Lead	Lag	Lag	Lead	Lag	Lag	Lead	Lag	Lag	Lead	Lag	Lag
Lead-Lag Optimize?	Yes	Yes	Yes	Yes	Yes	Yes	Yes	Yes	Yes	Yes	Yes	Yes
Recall Mode	None	Max	Max	None	Max	Max	None	None	None	None	None	None
Act Effct Green (s)	57.8	52.3	52.3	15.0	56.1	56.1	31.5	24.0	24.0	17.8	10.8	10.8
Actuated g/C Ratio	0.53	0.48	0.48	0.14	0.51	0.51	0.29	0.22	0.22	0.16	0.10	0.10
v/c Ratio	0.41	0.36	0.18	0.14	0.30	0.04	0.67	0.43	0.18	0.15	0.51	0.38
Control Delay	13.8	20.8	3.7	43.8	16.4	0.1	42.0	40.2	0.8	30.4	52.4	6.5
Queue Delay	0.0	0.0	0.0	0.0	0.0	0.0	0.0	0.0	0.0	0.0	0.0	0.0
Total Delay	13.8	20.8	3.7	43.8	16.4	0.1	42.0	40.2	0.8	30.4	52.4	6.5
LOS	B	C	A	D	B	A	D	D	A	C	D	A
Approach Delay		16.6			18.5			36.0			34.1	
Approach LOS		B			B			D			C	

Intersection Summary

Cycle Length: 120
 Actuated Cycle Length: 109.6
 Natural Cycle: 65
 Control Type: Actuated-Uncoordinated
 Maximum v/c Ratio: 0.67
 Intersection Signal Delay: 24.3
 Intersection LOS: C
 Intersection Capacity Utilization 63.6%
 ICU Level of Service B
 Analysis Period (min) 15

Splits and Phases: 4: Vollmer Rd & Briargate Pkwy



Intersection												
Int Delay, s/veh	0.1											
Movement	EBL	EBT	EBR	WBL	WBT	WBR	NBL	NBT	NBR	SBL	SBT	SBR
Lane Configurations	↘	↑↑	↗	↘	↑↑	↗	↘	↑	↗	↘	↑	↗
Traffic Vol, veh/h	8	703	0	2	603	7	0	0	4	4	0	6
Future Vol, veh/h	8	703	0	2	603	7	0	0	4	4	0	6
Conflicting Peds, #/hr	0	0	0	0	0	0	0	0	0	0	0	0
Sign Control	Free	Free	Free	Free	Free	Free	Stop	Stop	Stop	Stop	Stop	Stop
RT Channelized	-	-	None	-	-	None	-	-	Free	-	-	Free
Storage Length	535	-	0	310	-	0	410	-	155	235	-	155
Veh in Median Storage, #	-	0	-	-	0	-	-	0	-	-	0	-
Grade, %	-	0	-	-	0	-	-	0	-	-	0	-
Peak Hour Factor	95	95	95	95	95	95	95	95	95	95	95	95
Heavy Vehicles, %	2	2	2	2	2	2	2	2	2	2	2	2
Mvmt Flow	8	740	0	2	635	7	0	0	4	4	0	6

Major/Minor	Major1			Major2			Minor1			Minor2		
Conflicting Flow All	642	0	0	740	0	0	1078	1402	-	1025	1395	-
Stage 1	-	-	-	-	-	-	756	756	-	639	639	-
Stage 2	-	-	-	-	-	-	322	646	-	386	756	-
Critical Hdwy	4.14	-	-	4.14	-	-	7.54	6.54	-	7.54	6.54	-
Critical Hdwy Stg 1	-	-	-	-	-	-	6.54	5.54	-	6.54	5.54	-
Critical Hdwy Stg 2	-	-	-	-	-	-	6.54	5.54	-	6.54	5.54	-
Follow-up Hdwy	2.22	-	-	2.22	-	-	3.52	4.02	-	3.52	4.02	-
Pot Cap-1 Maneuver	939	-	-	862	-	-	173	139	0	189	140	0
Stage 1	-	-	-	-	-	-	366	414	0	431	469	0
Stage 2	-	-	-	-	-	-	664	465	0	609	414	0
Platoon blocked, %	-	-	-	-	-	-	-	-	-	-	-	-
Mov Cap-1 Maneuver	939	-	-	862	-	-	172	137	-	187	138	-
Mov Cap-2 Maneuver	-	-	-	-	-	-	172	137	-	187	138	-
Stage 1	-	-	-	-	-	-	363	410	-	427	468	-
Stage 2	-	-	-	-	-	-	662	464	-	604	410	-

Approach	EB			WB			NB			SB		
HCM Control Delay, s	0.1			0			0			24.7		
HCM LOS							A			C		

Minor Lane/Major Mvmt	NBLn1	NBLn2	NBLn3	EBL	EBT	EBR	WBL	WBT	WBR	SBLn1	SBLn2	SBLn3
Capacity (veh/h)	-	-	-	-	-	-	862	-	-	187	-	-
HCM Lane V/C Ratio	-	-	-	0.009	-	-	0.002	-	-	0.023	-	-
HCM Control Delay (s)	0	0	0	8.9	-	-	9.2	-	-	24.7	0	0
HCM Lane LOS	A	A	A	A	-	-	A	-	-	C	A	A
HCM 95th %tile Q(veh)	-	-	-	0	-	-	0	-	-	0.1	-	-

Timings
6: Banning Lewis Pkwy & Briargate Pkwy

2045 Background Traffic
PM Peak Hour

	→	↘	↙	←	↖	↗	↑	↘	↙	↓	Ø5
Lane Group	EBT	EBR	WBL	WBT	WBR	NBL	NBT	NBR	SBL	SBT	Ø5
Lane Configurations	↑↑	↑	↘↙	↑↑	↑	↘↙	↑↑	↑	↘↙	↑↑	
Traffic Volume (vph)	404	307	270	370	9	242	27	285	5	16	
Future Volume (vph)	404	307	270	370	9	242	27	285	5	16	
Turn Type	NA	Free	Prot	NA	Perm	Prot	NA	Free	pm+pt	NA	
Protected Phases	2		1	6		3	8		7	4	5
Permitted Phases		Free			6			Free	4		
Detector Phase	2		1	6	6	3	8		7	4	
Switch Phase											
Minimum Initial (s)	15.0		8.0	15.0	15.0	8.0	10.0		8.0	10.0	8.0
Minimum Split (s)	20.0		20.0	20.0	20.0	13.0	15.0		13.0	15.0	15.0
Total Split (s)	38.0		25.0	48.0	48.0	32.0	43.0		14.0	25.0	15.0
Total Split (%)	31.7%		20.8%	40.0%	40.0%	26.7%	35.8%		11.7%	20.8%	13%
Yellow Time (s)	3.0		3.0	3.0	3.0	3.0	3.0		3.0	3.0	3.0
All-Red Time (s)	2.0		2.0	2.0	2.0	2.0	2.0		2.0	2.0	2.0
Lost Time Adjust (s)	0.0		0.0	0.0	0.0	0.0	0.0		0.0	0.0	
Total Lost Time (s)	5.0		5.0	5.0	5.0	5.0	5.0		5.0	5.0	
Lead/Lag	Lag		Lead	Lag	Lag	Lead	Lag		Lead	Lag	Lead
Lead-Lag Optimize?	Yes		Yes	Yes	Yes	Yes	Yes		Yes	Yes	Yes
Recall Mode	C-Max		None	C-Max	C-Max	None	Max		None	Max	None
Act Effct Green (s)	37.8	120.0	15.2	58.0	58.0	14.2	49.4	120.0	40.8	32.8	
Actuated g/C Ratio	0.32	1.00	0.13	0.48	0.48	0.12	0.41	1.00	0.34	0.27	
v/c Ratio	0.38	0.20	0.66	0.23	0.01	0.63	0.02	0.19	0.01	0.02	
Control Delay	33.8	0.3	57.1	18.4	0.0	57.1	23.1	0.3	20.4	33.7	
Queue Delay	0.0	0.0	0.0	0.0	0.0	0.0	0.0	0.0	0.0	0.0	
Total Delay	33.8	0.3	57.1	18.4	0.0	57.1	23.1	0.3	20.4	33.7	
LOS	C	A	E	B	A	E	C	A	C	C	
Approach Delay	19.3			34.3			26.2			30.7	
Approach LOS	B			C			C			C	

Intersection Summary

Cycle Length: 120
 Actuated Cycle Length: 120
 Offset: 0 (0%), Referenced to phase 2:EBTL and 6:WBT, Start of Green
 Natural Cycle: 70
 Control Type: Actuated-Coordinated
 Maximum v/c Ratio: 0.66
 Intersection Signal Delay: 26.4
 Intersection LOS: C
 Intersection Capacity Utilization 46.3%
 ICU Level of Service A
 Analysis Period (min) 15

Splits and Phases: 6: Banning Lewis Pkwy & Briargate Pkwy

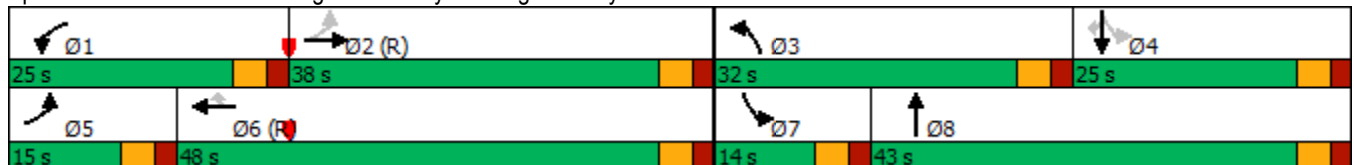

Intersection									
Intersection Delay, s/veh	7.1								
Intersection LOS	A								
Approach	EB		WB		NB		SB		
Entry Lanes	2		2		2		2		
Conflicting Circle Lanes	2		2		2		2		
Adj Approach Flow, veh/h	748		682		583		22		
Demand Flow Rate, veh/h	763		696		595		22		
Vehicles Circulating, veh/h	312		289		438		947		
Vehicles Exiting, veh/h	657		744		636		38		
Ped Vol Crossing Leg, #/h	0		0		0		0		
Ped Cap Adj	1.000		1.000		1.000		1.000		
Approach Delay, s/veh	7.3		6.7		7.3		6.3		
Approach LOS	A		A		A		A		
Lane	Left	Right	Left	Right	Left	Right	Left	Right	
Designated Moves	LT	TR	LT	TR	LT	TR	LT	TR	
Assumed Moves	LT	TR	LT	TR	LT	R	LT	TR	
RT Channelized									
Lane Util	0.471	0.529	0.470	0.530	0.486	0.514	0.455	0.545	
Follow-Up Headway, s	2.667	2.535	2.667	2.535	2.667	2.535	2.667	2.535	
Critical Headway, s	4.645	4.328	4.645	4.328	4.645	4.328	4.645	4.328	
Entry Flow, veh/h	359	404	327	369	289	306	10	12	
Cap Entry Lane, veh/h	1013	1089	1035	1111	902	979	565	635	
Entry HV Adj Factor	0.980	0.982	0.981	0.980	0.981	0.980	1.018	0.957	
Flow Entry, veh/h	352	397	321	362	283	300	10	11	
Cap Entry, veh/h	993	1070	1015	1088	885	959	575	608	
V/C Ratio	0.354	0.371	0.316	0.332	0.320	0.313	0.018	0.019	
Control Delay, s/veh	7.4	7.2	6.8	6.6	7.6	7.0	6.5	6.1	
LOS	A	A	A	A	A	A	A	A	
95th %tile Queue, veh	2	2	1	1	1	1	0	0	

Intersection						
Int Delay, s/veh	1.3					
Movement	EBL	EBR	NBL	NBT	SBT	SBR
Lane Configurations	↘↗		↘	↑↑	↑↑	↘
Traffic Vol, veh/h	0	108	59	645	379	0
Future Vol, veh/h	0	108	59	645	379	0
Conflicting Peds, #/hr	0	0	0	0	0	0
Sign Control	Stop	Stop	Free	Free	Free	Free
RT Channelized	-	None	-	None	-	None
Storage Length	0	-	0	-	-	0
Veh in Median Storage, #	0	-	-	0	0	-
Grade, %	0	-	-	0	0	-
Peak Hour Factor	95	95	95	95	95	95
Heavy Vehicles, %	2	2	2	2	2	2
Mvmt Flow	0	114	62	679	399	0

Major/Minor	Minor2	Major1	Major2			
Conflicting Flow All	863	200	399	0	-	0
Stage 1	399	-	-	-	-	-
Stage 2	464	-	-	-	-	-
Critical Hdwy	6.84	6.94	4.14	-	-	-
Critical Hdwy Stg 1	5.84	-	-	-	-	-
Critical Hdwy Stg 2	5.84	-	-	-	-	-
Follow-up Hdwy	3.52	3.32	2.22	-	-	-
Pot Cap-1 Maneuver	294	808	1156	-	-	-
Stage 1	647	-	-	-	-	-
Stage 2	599	-	-	-	-	-
Platoon blocked, %				-	-	-
Mov Cap-1 Maneuver	278	808	1156	-	-	-
Mov Cap-2 Maneuver	403	-	-	-	-	-
Stage 1	612	-	-	-	-	-
Stage 2	599	-	-	-	-	-

Approach	EB	NB	SB
HCM Control Delay, s	10.2	0.7	0
HCM LOS	B		

Minor Lane/Major Mvmt	NBL	NBT	EBLn1	SBT	SBR
Capacity (veh/h)	1156	-	808	-	-
HCM Lane V/C Ratio	0.054	-	0.141	-	-
HCM Control Delay (s)	8.3	-	10.2	-	-
HCM Lane LOS	A	-	B	-	-
HCM 95th %tile Q(veh)	0.2	-	0.5	-	-

Timings
12: Vollmer Rd & Marksheffel Rd

2045 Background Traffic
PM Peak Hour

Lane Group	EBL	EBT	EBR	WBL	WBT	WBR	NBL	NBT	NBR	SBL	SBT	SBR
Lane Configurations												
Traffic Volume (vph)	69	679	84	81	608	129	88	506	78	103	227	158
Future Volume (vph)	69	679	84	81	608	129	88	506	78	103	227	158
Turn Type	pm+pt	NA	Perm	pm+pt	NA	Perm	pm+pt	NA	Perm	pm+pt	NA	Perm
Protected Phases	5	2		1	6		3	8		7	4	
Permitted Phases	2		2	6		6	8		8	4		4
Detector Phase	5	2	2	1	6	6	3	8	8	7	4	4
Switch Phase												
Minimum Initial (s)	5.0	5.0	5.0	5.0	5.0	5.0	5.0	10.0	10.0	5.0	10.0	10.0
Minimum Split (s)	10.0	23.0	23.0	10.0	23.0	23.0	10.0	23.0	23.0	10.0	23.0	23.0
Total Split (s)	20.0	50.0	50.0	19.0	49.0	49.0	15.0	36.0	36.0	15.0	36.0	36.0
Total Split (%)	16.7%	41.7%	41.7%	15.8%	40.8%	40.8%	12.5%	30.0%	30.0%	12.5%	30.0%	30.0%
Yellow Time (s)	3.0	3.0	3.0	3.0	3.0	3.0	3.0	3.0	3.0	3.0	3.0	3.0
All-Red Time (s)	2.0	2.0	2.0	2.0	2.0	2.0	2.0	2.0	2.0	2.0	2.0	2.0
Lost Time Adjust (s)	0.0	0.0	0.0	0.0	0.0	0.0	0.0	0.0	0.0	0.0	0.0	0.0
Total Lost Time (s)	5.0	5.0	5.0	5.0	5.0	5.0	5.0	5.0	5.0	5.0	5.0	5.0
Lead/Lag	Lead	Lag	Lag	Lead	Lag	Lag	Lead	Lag	Lag	Lead	Lag	Lag
Lead-Lag Optimize?	Yes	Yes	Yes	Yes	Yes	Yes	Yes	Yes	Yes	Yes	Yes	Yes
Recall Mode	None	C-Max	C-Max	None	C-Max	C-Max	None	Max	Max	None	Max	Max
Act Effct Green (s)	59.6	52.9	52.9	60.4	53.3	53.3	40.7	31.8	31.8	41.3	32.1	32.1
Actuated g/C Ratio	0.50	0.44	0.44	0.50	0.44	0.44	0.34	0.26	0.26	0.34	0.27	0.27
v/c Ratio	0.19	0.46	0.12	0.24	0.41	0.17	0.22	0.57	0.16	0.39	0.25	0.30
Control Delay	15.1	25.6	2.8	15.6	24.5	4.2	25.8	41.2	3.8	28.8	35.7	6.8
Queue Delay	0.0	0.0	0.0	0.0	0.0	0.0	0.0	0.0	0.0	0.0	0.0	0.0
Total Delay	15.1	25.6	2.8	15.6	24.5	4.2	25.8	41.2	3.8	28.8	35.7	6.8
LOS	B	C	A	B	C	A	C	D	A	C	D	A
Approach Delay		22.4			20.4			34.8			24.9	
Approach LOS		C			C			C			C	

Intersection Summary

Cycle Length: 120
 Actuated Cycle Length: 120
 Offset: 0 (0%), Referenced to phase 2:EBTL and 6:WBTL, Start of Green
 Natural Cycle: 70
 Control Type: Actuated-Coordinated
 Maximum v/c Ratio: 0.57
 Intersection Signal Delay: 25.2
 Intersection LOS: C
 Intersection Capacity Utilization 59.6%
 ICU Level of Service B
 Analysis Period (min) 15

Splits and Phases: 12: Vollmer Rd & Marksheffel Rd

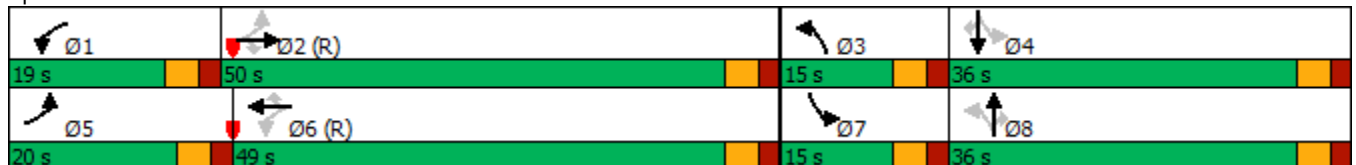

Intersection												
Int Delay, s/veh	0.9											
Movement	EBL	EBT	EBR	WBL	WBT	WBR	NBL	NBT	NBR	SBL	SBT	SBR
Lane Configurations	↙	↑↑	↗	↙	↑↑	↗	↙	↗		↙	↑	↗
Traffic Vol, veh/h	0	858	6	11	799	0	18	4	24	0	2	0
Future Vol, veh/h	0	858	6	11	799	0	18	4	24	0	2	0
Conflicting Peds, #/hr	0	0	0	0	0	0	0	0	0	0	0	0
Sign Control	Free	Free	Free	Free	Free	Free	Stop	Stop	Stop	Stop	Stop	Stop
RT Channelized	-	-	None	-	-	None	-	-	None	-	-	None
Storage Length	300	-	0	0	-	205	0	-	-	155	-	0
Veh in Median Storage, #	-	0	-	-	0	-	-	0	-	-	0	-
Grade, %	-	0	-	-	0	-	-	0	-	-	0	-
Peak Hour Factor	95	95	95	95	95	95	95	95	95	95	95	95
Heavy Vehicles, %	2	2	2	2	2	2	2	2	2	2	2	2
Mvmt Flow	0	903	6	12	841	0	19	4	25	0	2	0

Major/Minor	Major1		Major2		Minor1		Minor2					
Conflicting Flow All	841	0	0	909	0	0	1349	1768	452	1319	1774	421
Stage 1	-	-	-	-	-	-	903	903	-	865	865	-
Stage 2	-	-	-	-	-	-	446	865	-	454	909	-
Critical Hdwy	4.14	-	-	4.14	-	-	7.54	6.54	6.94	7.54	6.54	6.94
Critical Hdwy Stg 1	-	-	-	-	-	-	6.54	5.54	-	6.54	5.54	-
Critical Hdwy Stg 2	-	-	-	-	-	-	6.54	5.54	-	6.54	5.54	-
Follow-up Hdwy	2.22	-	-	2.22	-	-	3.52	4.02	3.32	3.52	4.02	3.32
Pot Cap-1 Maneuver	790	-	-	745	-	-	109	83	555	115	82	581
Stage 1	-	-	-	-	-	-	299	354	-	315	369	-
Stage 2	-	-	-	-	-	-	561	369	-	555	352	-
Platoon blocked, %	-	-	-	-	-	-	-	-	-	-	-	-
Mov Cap-1 Maneuver	790	-	-	745	-	-	106	82	555	104	81	581
Mov Cap-2 Maneuver	-	-	-	-	-	-	106	82	-	104	81	-
Stage 1	-	-	-	-	-	-	299	354	-	315	363	-
Stage 2	-	-	-	-	-	-	549	363	-	523	352	-

Approach	EB		WB		NB		SB	
HCM Control Delay, s	0		0.1		29.1		50.6	
HCM LOS					D		F	

Minor Lane/Major Mvmt	NBLn1	NBLn2	EBL	EBT	EBR	WBL	WBT	WBR	SBLn1	SBLn2	SBLn3
Capacity (veh/h)	106	304	790	-	-	745	-	-	-	81	-
HCM Lane V/C Ratio	0.179	0.097	-	-	-	0.016	-	-	-	0.026	-
HCM Control Delay (s)	46.2	18.1	0	-	-	9.9	-	-	0	50.6	0
HCM Lane LOS	E	C	A	-	-	A	-	-	A	F	A
HCM 95th %tile Q(veh)	0.6	0.3	0	-	-	0	-	-	-	0.1	-

Intersection						
Int Delay, s/veh	0.6					
Movement	WBL	WBR	NBT	NBR	SBL	SBT
Lane Configurations	W	W	T	T	T	T
Traffic Vol, veh/h	17	12	260	6	4	401
Future Vol, veh/h	17	12	260	6	4	401
Conflicting Peds, #/hr	0	0	0	0	0	0
Sign Control	Stop	Stop	Free	Free	Free	Free
RT Channelized	-	None	-	None	-	None
Storage Length	0	-	-	-	-	-
Veh in Median Storage, #	0	-	0	-	-	0
Grade, %	0	-	0	-	-	0
Peak Hour Factor	95	95	95	95	95	95
Heavy Vehicles, %	2	2	2	2	2	2
Mvmt Flow	18	13	274	6	4	422

Major/Minor	Minor1	Major1	Major2		
Conflicting Flow All	707	277	0	0	280
Stage 1	277	-	-	-	-
Stage 2	430	-	-	-	-
Critical Hdwy	6.42	6.22	-	-	4.12
Critical Hdwy Stg 1	5.42	-	-	-	-
Critical Hdwy Stg 2	5.42	-	-	-	-
Follow-up Hdwy	3.518	3.318	-	-	2.218
Pot Cap-1 Maneuver	402	762	-	-	1283
Stage 1	770	-	-	-	-
Stage 2	656	-	-	-	-
Platoon blocked, %			-	-	-
Mov Cap-1 Maneuver	400	762	-	-	1283
Mov Cap-2 Maneuver	400	-	-	-	-
Stage 1	770	-	-	-	-
Stage 2	653	-	-	-	-

Approach	WB	NB	SB
HCM Control Delay, s	12.7	0	0.1
HCM LOS	B		

Minor Lane/Major Mvmt	NBT	NBRWBLn1	SBL	SBT
Capacity (veh/h)	-	-	498	1283
HCM Lane V/C Ratio	-	-	0.061	0.003
HCM Control Delay (s)	-	-	12.7	7.8
HCM Lane LOS	-	-	B	A
HCM 95th %tile Q(veh)	-	-	0.2	0

Timings
4: Vollmer Rd & Briargate Pkwy

2045 Total Traffic
AM Peak Hour

Lane Group	EBL	EBT	EBR	WBL	WBT	WBR	NBL	NBT	NBR	SBL	SBT	SBR
Lane Configurations												
Traffic Volume (vph)	70	540	153	242	1034	81	153	132	110	109	311	141
Future Volume (vph)	70	540	153	242	1034	81	153	132	110	109	311	141
Turn Type	pm+pt	NA	Perm	Prot	NA	Perm	pm+pt	NA	Perm	pm+pt	NA	Perm
Protected Phases	5	2		1	6		3	8		7	4	
Permitted Phases	2		2			6	8		8	4		4
Detector Phase	5	2	2	1	6	6	3	8	8	7	4	4
Switch Phase												
Minimum Initial (s)	5.0	15.0	15.0	15.0	15.0	15.0	5.0	5.0	5.0	5.0	5.0	5.0
Minimum Split (s)	10.0	20.0	20.0	20.0	20.0	20.0	10.0	10.0	10.0	10.0	10.0	10.0
Total Split (s)	12.0	57.0	57.0	20.0	65.0	65.0	17.0	28.0	28.0	15.0	26.0	26.0
Total Split (%)	10.0%	47.5%	47.5%	16.7%	54.2%	54.2%	14.2%	23.3%	23.3%	12.5%	21.7%	21.7%
Yellow Time (s)	3.0	3.0	3.0	3.0	3.0	3.0	3.0	3.0	3.0	3.0	3.0	3.0
All-Red Time (s)	2.0	2.0	2.0	2.0	2.0	2.0	2.0	2.0	2.0	2.0	2.0	2.0
Lost Time Adjust (s)	0.0	0.0	0.0	0.0	0.0	0.0	0.0	0.0	0.0	0.0	0.0	0.0
Total Lost Time (s)	5.0	5.0	5.0	5.0	5.0	5.0	5.0	5.0	5.0	5.0	5.0	5.0
Lead/Lag	Lead	Lag	Lag	Lead	Lag	Lag	Lead	Lag	Lag	Lead	Lag	Lag
Lead-Lag Optimize?	Yes	Yes	Yes	Yes	Yes	Yes	Yes	Yes	Yes	Yes	Yes	Yes
Recall Mode	None	Max	Max	None	Max	Max	None	None	None	None	None	None
Act Effct Green (s)	58.8	52.1	52.1	15.0	62.8	62.8	29.3	18.0	18.0	25.4	16.0	16.0
Actuated g/C Ratio	0.51	0.46	0.46	0.13	0.55	0.55	0.26	0.16	0.16	0.22	0.14	0.14
v/c Ratio	0.26	0.34	0.20	0.57	0.56	0.09	0.60	0.24	0.31	0.36	0.66	0.42
Control Delay	12.4	21.5	3.7	52.9	19.7	1.8	42.0	43.2	4.7	34.7	53.4	9.8
Queue Delay	0.0	0.0	0.0	0.0	0.0	0.0	0.0	0.0	0.0	0.0	0.0	0.0
Total Delay	12.4	21.5	3.7	52.9	19.7	1.8	42.0	43.2	4.7	34.7	53.4	9.8
LOS	B	C	A	D	B	A	D	D	A	C	D	A
Approach Delay		17.0			24.5			31.9			38.8	
Approach LOS		B			C			C			D	

Intersection Summary

Cycle Length: 120
 Actuated Cycle Length: 114.5
 Natural Cycle: 60
 Control Type: Actuated-Uncoordinated
 Maximum v/c Ratio: 0.66
 Intersection Signal Delay: 26.2
 Intersection LOS: C
 Intersection Capacity Utilization 66.5%
 ICU Level of Service C
 Analysis Period (min) 15

Splits and Phases: 4: Vollmer Rd & Briargate Pkwy



Timings
5: Sterling Ranch Rd & Briargate Pkwy

2045 Total Traffic
AM Peak Hour

Lane Group	EBL	EBT	EBR	WBL	WBT	WBR	NBL	NBT	NBR	SBL	SBT	SBR
Lane Configurations												
Traffic Volume (vph)	77	605	137	144	936	23	241	91	123	91	187	181
Future Volume (vph)	77	605	137	144	936	23	241	91	123	91	187	181
Turn Type	pm+pt	NA	Perm	pm+pt	NA	Perm	pm+pt	NA	Free	pm+pt	NA	Free
Protected Phases	5	2		1	6		3	8		7	4	
Permitted Phases	2		2	6		6	8		Free	4		Free
Detector Phase	5	2	2	1	6	6	3	8		7	4	
Switch Phase												
Minimum Initial (s)	5.0	5.0	5.0	5.0	5.0	5.0	5.0	20.0		5.0	20.0	
Minimum Split (s)	10.0	10.0	10.0	10.0	10.0	10.0	10.0	25.0		10.0	25.0	
Total Split (s)	12.0	55.0	55.0	12.0	55.0	55.0	21.0	32.0		21.0	32.0	
Total Split (%)	10.0%	45.8%	45.8%	10.0%	45.8%	45.8%	17.5%	26.7%		17.5%	26.7%	
Yellow Time (s)	3.0	3.0	3.0	3.0	3.0	3.0	3.0	3.0		3.0	3.0	
All-Red Time (s)	2.0	2.0	2.0	2.0	2.0	2.0	2.0	2.0		2.0	2.0	
Lost Time Adjust (s)	0.0	0.0	0.0	0.0	0.0	0.0	0.0	0.0		0.0	0.0	
Total Lost Time (s)	5.0	5.0	5.0	5.0	5.0	5.0	5.0	5.0		5.0	5.0	
Lead/Lag	Lead	Lag	Lag	Lead	Lag	Lag	Lead	Lag		Lead	Lag	
Lead-Lag Optimize?	Yes	Yes	Yes	Yes	Yes	Yes	Yes	Yes		Yes	Yes	
Recall Mode	None	C-Max	C-Max	None	C-Max	C-Max	None	Max		None	Max	
Act Effct Green (s)	56.8	50.0	50.0	58.0	52.4	52.4	47.6	33.3	120.0	37.7	28.1	120.0
Actuated g/C Ratio	0.47	0.42	0.42	0.48	0.44	0.44	0.40	0.28	1.00	0.31	0.23	1.00
v/c Ratio	0.35	0.43	0.19	0.44	0.64	0.03	0.59	0.19	0.08	0.22	0.45	0.12
Control Delay	19.3	26.1	4.1	9.4	17.0	0.5	31.6	35.1	0.1	24.7	43.8	0.2
Queue Delay	0.0	0.0	0.0	0.0	0.0	0.0	0.0	0.0	0.0	0.0	0.0	0.0
Total Delay	19.3	26.1	4.1	9.4	17.0	0.5	31.6	35.1	0.1	24.7	43.8	0.2
LOS	B	C	A	A	B	A	C	D	A	C	D	A
Approach Delay		21.8			15.6			23.8			22.8	
Approach LOS		C			B			C			C	

Intersection Summary

Cycle Length: 120
 Actuated Cycle Length: 120
 Offset: 63 (53%), Referenced to phase 2:EBTL and 6:WBTL, Start of Green
 Natural Cycle: 70
 Control Type: Actuated-Coordinated
 Maximum v/c Ratio: 0.64
 Intersection Signal Delay: 19.9
 Intersection LOS: B
 Intersection Capacity Utilization 76.8%
 ICU Level of Service D
 Analysis Period (min) 15

Splits and Phases: 5: Sterling Ranch Rd & Briargate Pkwy

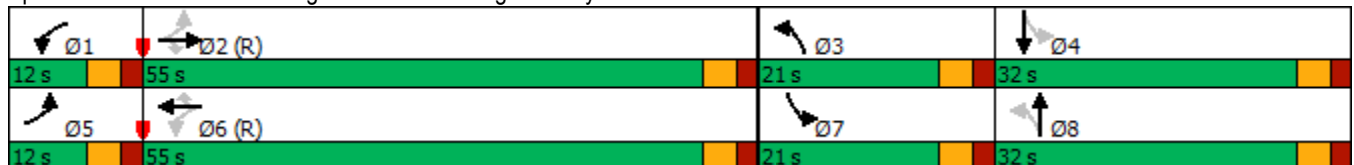

Timings
6: Banning Lewis Pkwy & Briargate Pkwy

2045 Total Traffic
AM Peak Hour

Lane Group	EBL	EBT	EBR	WBL	WBT	WBR	NBL	NBT	NBR	SBL	SBT	SBR
Lane Configurations												
Traffic Volume (vph)	21	481	346	279	671	14	318	55	283	59	211	2
Future Volume (vph)	21	481	346	279	671	14	318	55	283	59	211	2
Turn Type	pm+pt	NA	Free	Prot	NA	Perm	Prot	NA	Free	pm+pt	NA	Perm
Protected Phases	5	2		1	6		3	8		7	4	
Permitted Phases	2		Free			6			Free	4		4
Detector Phase	5	2		1	6	6	3	8		7	4	4
Switch Phase												
Minimum Initial (s)	8.0	15.0		8.0	15.0	15.0	8.0	10.0		8.0	10.0	10.0
Minimum Split (s)	15.0	20.0		20.0	20.0	20.0	13.0	15.0		13.0	15.0	15.0
Total Split (s)	15.0	38.0		25.0	48.0	48.0	32.0	43.0		14.0	25.0	25.0
Total Split (%)	12.5%	31.7%		20.8%	40.0%	40.0%	26.7%	35.8%		11.7%	20.8%	20.8%
Yellow Time (s)	3.0	3.0		3.0	3.0	3.0	3.0	3.0		3.0	3.0	3.0
All-Red Time (s)	2.0	2.0		2.0	2.0	2.0	2.0	2.0		2.0	2.0	2.0
Lost Time Adjust (s)	0.0	0.0		0.0	0.0	0.0	0.0	0.0		0.0	0.0	0.0
Total Lost Time (s)	5.0	5.0		5.0	5.0	5.0	5.0	5.0		5.0	5.0	5.0
Lead/Lag	Lead	Lag		Lead	Lag	Lag	Lead	Lag		Lead	Lag	Lag
Lead-Lag Optimize?	Yes	Yes		Yes	Yes	Yes	Yes	Yes		Yes	Yes	Yes
Recall Mode	None	C-Max		None	C-Max	C-Max	None	Max		None	Max	Max
Act Effct Green (s)	45.5	37.5	120.0	15.5	52.8	52.8	17.0	41.2	120.0	38.4	30.0	30.0
Actuated g/C Ratio	0.38	0.31	1.00	0.13	0.44	0.44	0.14	0.34	1.00	0.32	0.25	0.25
v/c Ratio	0.07	0.46	0.23	0.66	0.45	0.02	0.69	0.05	0.19	0.14	0.25	0.00
Control Delay	12.2	21.5	0.3	57.0	25.8	0.1	56.4	28.3	0.3	21.9	37.8	0.0
Queue Delay	0.0	0.0	0.0	0.0	0.0	0.0	0.0	0.0	0.0	0.0	0.0	0.0
Total Delay	12.2	21.5	0.3	57.0	25.8	0.1	56.4	28.3	0.3	21.9	37.8	0.0
LOS	B	C	A	E	C	A	E	C	A	C	D	A
Approach Delay		12.7			34.4			29.8			34.1	
Approach LOS		B			C			C			C	

Intersection Summary

Cycle Length: 120
 Actuated Cycle Length: 120
 Offset: 0 (0%), Referenced to phase 2:EBTL and 6:WBT, Start of Green
 Natural Cycle: 70
 Control Type: Actuated-Coordinated
 Maximum v/c Ratio: 0.69
 Intersection Signal Delay: 26.6
 Intersection LOS: C
 Intersection Capacity Utilization 59.3%
 ICU Level of Service B
 Analysis Period (min) 15

Splits and Phases: 6: Banning Lewis Pkwy & Briargate Pkwy

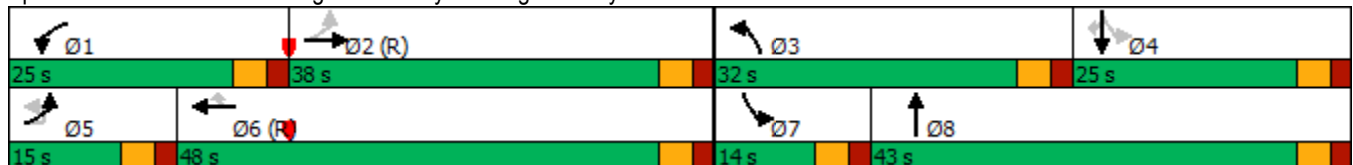

Intersection									
Intersection Delay, s/veh	11.7								
Intersection LOS	B								
Approach	EB		WB		NB		SB		
Entry Lanes	2		2		2		2		
Conflicting Circle Lanes	2		2		2		2		
Adj Approach Flow, veh/h	889		1015		691		288		
Demand Flow Rate, veh/h	906		1035		705		293		
Vehicles Circulating, veh/h	591		423		600		1381		
Vehicles Exiting, veh/h	1083		882		897		77		
Ped Vol Crossing Leg, #/h	0		0		0		0		
Ped Cap Adj	1.000		1.000		1.000		1.000		
Approach Delay, s/veh	12.6		11.0		10.1		15.7		
Approach LOS	B		B		B		C		
Lane	Left	Right	Left	Right	Left	Right	Left	Right	
Designated Moves	LT	TR	LT	TR	LT	TR	LT	TR	
Assumed Moves	LT	TR	LT	TR	LT	TR	LT	TR	
RT Channelized									
Lane Util	0.470	0.530	0.470	0.530	0.470	0.530	0.471	0.529	
Follow-Up Headway, s	2.667	2.535	2.667	2.535	2.667	2.535	2.667	2.535	
Critical Headway, s	4.645	4.328	4.645	4.328	4.645	4.328	4.645	4.328	
Entry Flow, veh/h	426	480	486	549	331	374	138	155	
Cap Entry Lane, veh/h	784	859	915	991	777	853	379	439	
Entry HV Adj Factor	0.980	0.981	0.981	0.980	0.981	0.979	0.979	0.983	
Flow Entry, veh/h	418	471	477	538	325	366	135	152	
Cap Entry, veh/h	768	843	898	971	762	835	371	432	
V/C Ratio	0.544	0.559	0.531	0.554	0.426	0.439	0.364	0.353	
Control Delay, s/veh	12.8	12.3	11.1	11.0	10.3	9.8	17.0	14.6	
LOS	B	B	B	B	B	A	C	B	
95th %tile Queue, veh	3	4	3	3	2	2	2	2	

Intersection												
Int Delay, s/veh	2.3											
Movement	EBL	EBT	EBR	WBL	WBT	WBR	NBL	NBT	NBR	SBL	SBT	SBR
Lane Configurations		↔			↔	↗	↖	↗	↖	↖	↗	↖
Traffic Vol, veh/h	0	0	96	45	0	52	22	343	23	9	696	0
Future Vol, veh/h	0	0	96	45	0	52	22	343	23	9	696	0
Conflicting Peds, #/hr	0	0	0	0	0	0	0	0	0	0	0	0
Sign Control	Stop	Stop	Stop	Stop	Stop	Stop	Free	Free	Free	Free	Free	Free
RT Channelized	-	-	None	-	-	None	-	-	None	-	-	None
Storage Length	-	-	-	-	-	0	0	-	155	205	-	0
Veh in Median Storage, #	-	0	-	-	0	-	-	0	-	-	0	-
Grade, %	-	0	-	-	0	-	-	0	-	-	0	-
Peak Hour Factor	95	95	95	95	95	95	95	95	95	95	95	95
Heavy Vehicles, %	2	2	2	2	2	2	2	2	2	2	2	2
Mvmt Flow	0	0	101	47	0	55	23	361	24	9	733	0

Major/Minor	Minor2		Minor1		Major1			Major2				
Conflicting Flow All	978	1182	367	792	1158	181	733	0	0	385	0	0
Stage 1	751	751	-	407	407	-	-	-	-	-	-	-
Stage 2	227	431	-	385	751	-	-	-	-	-	-	-
Critical Hdwy	7.54	6.54	6.94	7.54	6.54	6.94	4.14	-	-	4.14	-	-
Critical Hdwy Stg 1	6.54	5.54	-	6.54	5.54	-	-	-	-	-	-	-
Critical Hdwy Stg 2	6.54	5.54	-	6.54	5.54	-	-	-	-	-	-	-
Follow-up Hdwy	3.52	4.02	3.32	3.52	4.02	3.32	2.22	-	-	2.22	-	-
Pot Cap-1 Maneuver	205	188	630	280	195	831	868	-	-	1170	-	-
Stage 1	369	416	-	592	596	-	-	-	-	-	-	-
Stage 2	755	581	-	610	416	-	-	-	-	-	-	-
Platoon blocked, %								-	-	-	-	-
Mov Cap-1 Maneuver	187	182	630	229	188	831	868	-	-	1170	-	-
Mov Cap-2 Maneuver	187	182	-	229	188	-	-	-	-	-	-	-
Stage 1	359	413	-	577	581	-	-	-	-	-	-	-
Stage 2	687	566	-	508	413	-	-	-	-	-	-	-

Approach	EB		WB		NB			SB		
HCM Control Delay, s	11.8		16.7		0.5			0.1		
HCM LOS	B		C							

Minor Lane/Major Mvmt	NBL	NBT	NBR	EBLn1	WBLn1	WBLn2	SBL	SBT	SBR
Capacity (veh/h)	868	-	-	630	229	831	1170	-	-
HCM Lane V/C Ratio	0.027	-	-	0.16	0.207	0.066	0.008	-	-
HCM Control Delay (s)	9.3	-	-	11.8	24.8	9.6	8.1	-	-
HCM Lane LOS	A	-	-	B	C	A	A	-	-
HCM 95th %tile Q(veh)	0.1	-	-	0.6	0.8	0.2	0	-	-

Intersection												
Int Delay, s/veh	9.4											
Movement	EBL	EBT	EBR	WBL	WBT	WBR	NBL	NBT	NBR	SBL	SBT	SBR
Lane Configurations	↘	↑	↗	↘		↗		↑	↗	↘	↑	
Traffic Vol, veh/h	133	71	132	159	0	129	0	388	70	11	249	0
Future Vol, veh/h	133	71	132	159	0	129	0	388	70	11	249	0
Conflicting Peds, #/hr	0	0	0	0	0	0	0	0	0	0	0	0
Sign Control	Stop	Stop	Stop	Stop	Stop	Stop	Free	Free	Free	Free	Free	Free
RT Channelized	-	-	None	-	-	None	-	-	None	-	-	None
Storage Length	0	-	0	0	-	0	-	-	205	205	-	-
Veh in Median Storage, #	-	0	-	-	0	-	-	0	-	-	0	-
Grade, %	-	0	-	-	0	-	-	0	-	-	0	-
Peak Hour Factor	75	75	75	95	95	95	95	95	95	95	95	95
Heavy Vehicles, %	2	2	2	2	2	2	2	2	2	2	2	2
Mvmt Flow	177	95	176	167	0	136	0	408	74	12	262	0

Major/Minor	Minor2		Minor1		Major1			Major2				
Conflicting Flow All	799	768	262	830	-	408	-	0	0	482	0	0
Stage 1	286	286	-	408	-	-	-	-	-	-	-	-
Stage 2	513	482	-	422	-	-	-	-	-	-	-	-
Critical Hdwy	7.12	6.52	6.22	7.12	-	6.22	-	-	-	4.12	-	-
Critical Hdwy Stg 1	6.12	5.52	-	6.12	-	-	-	-	-	-	-	-
Critical Hdwy Stg 2	6.12	5.52	-	6.12	-	-	-	-	-	-	-	-
Follow-up Hdwy	3.518	4.018	3.318	3.518	-	3.318	-	-	-	2.218	-	-
Pot Cap-1 Maneuver	315	336	893	297	0	643	0	-	-	1081	-	0
Stage 1	813	717	-	620	0	-	0	-	-	-	-	0
Stage 2	544	553	-	665	0	-	0	-	-	-	-	0
Platoon blocked, %	1	1	1	1				-	-			
Mov Cap-1 Maneuver	246	333	893	196	-	643	-	-	-	1081	-	-
Mov Cap-2 Maneuver	344	426	-	327	-	-	-	-	-	-	-	-
Stage 1	813	709	-	620	-	-	-	-	-	-	-	-
Stage 2	429	553	-	458	-	-	-	-	-	-	-	-

Approach	EB		WB		NB			SB		
HCM Control Delay, s	17.6		20.3		0			0.4		
HCM LOS	C		C							

Minor Lane/Major Mvmt	NBT	NBR	EBLn1	EBLn2	EBLn3	WBLn1	WBLn2	SBL	SBT
Capacity (veh/h)	-	-	344	426	893	327	643	1081	-
HCM Lane V/C Ratio	-	-	0.516	0.222	0.197	0.512	0.211	0.011	-
HCM Control Delay (s)	-	-	26.1	15.8	10	27	12.1	8.4	-
HCM Lane LOS	-	-	D	C	B	D	B	A	-
HCM 95th %tile Q(veh)	-	-	2.8	0.8	0.7	2.8	0.8	0	-

Intersection						
Int Delay, s/veh	3.2					
Movement	EBL	EBR	NBL	NBT	SBT	SBR
Lane Configurations		↗	↘	↕	↕	↗
Traffic Vol, veh/h	0	279	98	656	823	13
Future Vol, veh/h	0	279	98	656	823	13
Conflicting Peds, #/hr	0	0	0	0	0	0
Sign Control	Stop	Stop	Free	Free	Free	Free
RT Channelized	-	None	-	None	-	None
Storage Length	-	0	200	-	-	0
Veh in Median Storage, #	0	-	-	0	0	-
Grade, %	0	-	-	0	0	-
Peak Hour Factor	95	95	95	95	95	95
Heavy Vehicles, %	2	2	2	2	2	2
Mvmt Flow	0	294	103	691	866	14

Major/Minor	Minor2	Major1	Major2		
Conflicting Flow All	-	433	880	0	0
Stage 1	-	-	-	-	-
Stage 2	-	-	-	-	-
Critical Hdwy	-	6.94	4.14	-	-
Critical Hdwy Stg 1	-	-	-	-	-
Critical Hdwy Stg 2	-	-	-	-	-
Follow-up Hdwy	-	3.32	2.22	-	-
Pot Cap-1 Maneuver	0	571	764	-	-
Stage 1	0	-	-	-	-
Stage 2	0	-	-	-	-
Platoon blocked, %				-	-
Mov Cap-1 Maneuver	-	571	764	-	-
Mov Cap-2 Maneuver	-	-	-	-	-
Stage 1	-	-	-	-	-
Stage 2	-	-	-	-	-

Approach	EB	NB	SB
HCM Control Delay, s	17.8	1.4	0
HCM LOS	C		

Minor Lane/Major Mvmt	NBL	NBT	EBLn1	SBT	SBR
Capacity (veh/h)	764	-	571	-	-
HCM Lane V/C Ratio	0.135	-	0.514	-	-
HCM Control Delay (s)	10.4	-	17.8	-	-
HCM Lane LOS	B	-	C	-	-
HCM 95th %tile Q(veh)	0.5	-	2.9	-	-

Intersection												
Int Delay, s/veh	2.3											
Movement	EBL	EBT	EBR	WBL	WBT	WBR	NBL	NBT	NBR	SBL	SBT	SBR
Lane Configurations	↘	↑	↗	↘	↗			↔			↖	↗
Traffic Vol, veh/h	26	288	5	2	588	13	14	1	7	24	0	80
Future Vol, veh/h	26	288	5	2	588	13	14	1	7	24	0	80
Conflicting Peds, #/hr	0	0	0	0	0	0	0	0	0	0	0	0
Sign Control	Free	Free	Free	Free	Free	Free	Stop	Stop	Stop	Stop	Stop	Stop
RT Channelized	-	-	None	-	-	None	-	-	None	-	-	None
Storage Length	205	-	155	205	-	-	-	-	-	-	-	155
Veh in Median Storage, #	-	0	-	-	0	-	-	0	-	-	0	-
Grade, %	-	0	-	-	0	-	-	0	-	-	0	-
Peak Hour Factor	95	95	95	95	95	95	95	95	95	95	95	95
Heavy Vehicles, %	2	2	2	2	2	2	2	2	2	2	2	2
Mvmt Flow	27	303	5	2	619	14	15	1	7	25	0	84

Major/Minor	Major1			Major2			Minor1			Minor2		
Conflicting Flow All	633	0	0	308	0	0	1029	994	303	994	992	626
Stage 1	-	-	-	-	-	-	357	357	-	630	630	-
Stage 2	-	-	-	-	-	-	672	637	-	364	362	-
Critical Hdwy	4.12	-	-	4.12	-	-	7.12	6.52	6.22	7.12	6.52	6.22
Critical Hdwy Stg 1	-	-	-	-	-	-	6.12	5.52	-	6.12	5.52	-
Critical Hdwy Stg 2	-	-	-	-	-	-	6.12	5.52	-	6.12	5.52	-
Follow-up Hdwy	2.218	-	-	2.218	-	-	3.518	4.018	3.318	3.518	4.018	3.318
Pot Cap-1 Maneuver	950	-	-	1253	-	-	212	245	737	224	246	484
Stage 1	-	-	-	-	-	-	661	628	-	470	475	-
Stage 2	-	-	-	-	-	-	445	471	-	655	625	-
Platoon blocked, %	-	-	-	-	-	-	-	-	-	-	-	-
Mov Cap-1 Maneuver	950	-	-	1253	-	-	171	238	737	216	239	484
Mov Cap-2 Maneuver	-	-	-	-	-	-	171	238	-	216	239	-
Stage 1	-	-	-	-	-	-	642	610	-	457	474	-
Stage 2	-	-	-	-	-	-	367	470	-	629	608	-

Approach	EB	WB	NB	SB
HCM Control Delay, s	0.7	0	22.4	16.3
HCM LOS			C	C

Minor Lane/Major Mvmt	NBLn1	EBL	EBT	EBR	WBL	WBT	WBR	SBLn1	SBLn2
Capacity (veh/h)	230	950	-	-	1253	-	-	216	484
HCM Lane V/C Ratio	0.101	0.029	-	-	0.002	-	-	0.117	0.174
HCM Control Delay (s)	22.4	8.9	-	-	7.9	-	-	23.9	14
HCM Lane LOS	C	A	-	-	A	-	-	C	B
HCM 95th %tile Q(veh)	0.3	0.1	-	-	0	-	-	0.4	0.6

Timings
12: Vollmer Rd & Marksheffel Rd

2045 Total Traffic
AM Peak Hour

Lane Group	EBL	EBT	EBR	WBL	WBT	WBR	NBL	NBT	NBR	SBL	SBT	SBR
Lane Configurations												
Traffic Volume (vph)	69	834	42	162	902	63	108	257	104	121	580	136
Future Volume (vph)	69	834	42	162	902	63	108	257	104	121	580	136
Turn Type	pm+pt	NA	Perm	pm+pt	NA	Perm	pm+pt	NA	Perm	pm+pt	NA	Perm
Protected Phases	5	2		1	6		3	8		7	4	
Permitted Phases	2		2	6		6	8		8	4		4
Detector Phase	5	2	2	1	6	6	3	8	8	7	4	4
Switch Phase												
Minimum Initial (s)	5.0	5.0	5.0	5.0	5.0	5.0	5.0	10.0	10.0	5.0	10.0	10.0
Minimum Split (s)	10.0	23.0	23.0	10.0	23.0	23.0	10.0	23.0	23.0	10.0	23.0	23.0
Total Split (s)	12.0	65.0	65.0	12.0	65.0	65.0	12.0	30.0	30.0	13.0	31.0	31.0
Total Split (%)	10.0%	54.2%	54.2%	10.0%	54.2%	54.2%	10.0%	25.0%	25.0%	10.8%	25.8%	25.8%
Yellow Time (s)	3.0	3.0	3.0	3.0	3.0	3.0	3.0	3.0	3.0	3.0	3.0	3.0
All-Red Time (s)	2.0	2.0	2.0	2.0	2.0	2.0	2.0	2.0	2.0	2.0	2.0	2.0
Lost Time Adjust (s)	0.0	0.0	0.0	0.0	0.0	0.0	0.0	0.0	0.0	0.0	0.0	0.0
Total Lost Time (s)	5.0	5.0	5.0	5.0	5.0	5.0	5.0	5.0	5.0	5.0	5.0	5.0
Lead/Lag	Lead	Lag	Lag	Lead	Lag	Lag	Lead	Lag	Lag	Lead	Lag	Lag
Lead-Lag Optimize?	Yes	Yes	Yes	Yes	Yes	Yes	Yes	Yes	Yes	Yes	Yes	Yes
Recall Mode	None	C-Max	C-Max	None	C-Max	C-Max	None	Max	Max	None	Max	Max
Act Effct Green (s)	66.7	60.0	60.0	68.0	62.4	62.4	32.1	25.1	25.1	33.9	26.0	26.0
Actuated g/C Ratio	0.56	0.50	0.50	0.57	0.52	0.52	0.27	0.21	0.21	0.28	0.22	0.22
v/c Ratio	0.24	0.50	0.05	0.53	0.52	0.08	0.66	0.37	0.26	0.40	0.80	0.33
Control Delay	12.1	21.2	0.1	17.4	11.8	0.3	50.7	42.4	8.9	34.9	53.4	11.8
Queue Delay	0.0	0.0	0.0	0.0	0.0	0.0	0.0	0.0	0.0	0.0	0.0	0.0
Total Delay	12.1	21.2	0.1	17.4	11.8	0.3	50.7	42.4	8.9	34.9	53.4	11.8
LOS	B	C	A	B	B	A	D	D	A	C	D	B
Approach Delay		19.6			12.0			36.9			44.0	
Approach LOS		B			B			D			D	

Intersection Summary

Cycle Length: 120
 Actuated Cycle Length: 120
 Offset: 0 (0%), Referenced to phase 2:EBTL and 6:WBTL, Start of Green
 Natural Cycle: 70
 Control Type: Actuated-Coordinated
 Maximum v/c Ratio: 0.80
 Intersection Signal Delay: 25.5
 Intersection LOS: C
 Intersection Capacity Utilization 70.7%
 ICU Level of Service C
 Analysis Period (min) 15

Splits and Phases: 12: Vollmer Rd & Marksheffel Rd

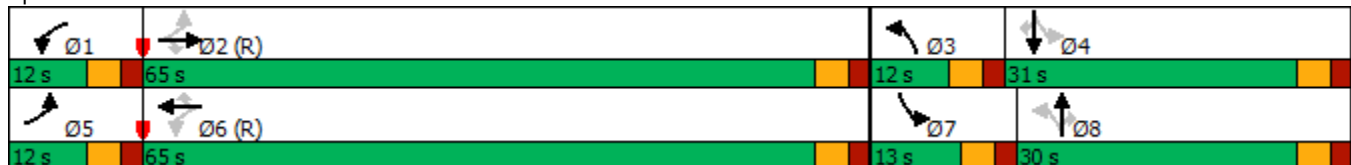

Timings
13: Sterling Ranch Rd & Marksheffel Rd

2045 Total Traffic
AM Peak Hour

Lane Group	EBL	EBT	EBR	WBL	WBT	WBR	NBL	NBT	SBL	SBT	SBR	
Lane Configurations												
Traffic Volume (vph)	144	884	12	53	807	177	7	2	506	10	312	
Future Volume (vph)	144	884	12	53	807	177	7	2	506	10	312	
Turn Type	pm+pt	NA	Perm	pm+pt	NA	Perm	pm+pt	NA	Prot	NA	Perm	
Protected Phases	5	2		1	6		3	8	7	4		
Permitted Phases	2		2	6		6	8				4	
Detector Phase	5	2	2	1	6	6	3	8	7	4	4	
Switch Phase												
Minimum Initial (s)	5.0	15.0	15.0	5.0	15.0	15.0	5.0	10.0	20.0	10.0	10.0	
Minimum Split (s)	10.0	20.0	20.0	10.0	20.0	20.0	10.0	15.0	25.0	20.0	20.0	
Total Split (s)	12.0	51.0	51.0	12.0	51.0	51.0	12.0	25.0	32.0	45.0	45.0	
Total Split (%)	10.0%	42.5%	42.5%	10.0%	42.5%	42.5%	10.0%	20.8%	26.7%	37.5%	37.5%	
Yellow Time (s)	3.0	3.0	3.0	3.0	3.0	3.0	3.0	3.0	3.0	3.0	3.0	
All-Red Time (s)	2.0	2.0	2.0	2.0	2.0	2.0	2.0	2.0	2.0	2.0	2.0	
Lost Time Adjust (s)	0.0	0.0	0.0	0.0	0.0	0.0	0.0	0.0	0.0	0.0	0.0	
Total Lost Time (s)	5.0	5.0	5.0	5.0	5.0	5.0	5.0	5.0	5.0	5.0	5.0	
Lead/Lag	Lead	Lag	Lag	Lead	Lag	Lag	Lead	Lag	Lead	Lag	Lag	
Lead-Lag Optimize?	Yes	Yes	Yes	Yes	Yes	Yes	Yes	Yes	Yes	Yes	Yes	
Recall Mode	None	C-Max	C-Max	None	C-Max	C-Max	None	None	None	None	None	
Act Effct Green (s)	81.6	73.6	73.6	76.0	69.1	69.1	8.0	10.0	23.6	24.3	24.3	
Actuated g/C Ratio	0.68	0.61	0.61	0.63	0.58	0.58	0.07	0.08	0.20	0.20	0.20	
v/c Ratio	0.36	0.43	0.01	0.15	0.42	0.19	0.06	0.06	0.79	0.03	0.59	
Control Delay	13.1	11.9	0.0	8.9	16.8	3.2	41.1	33.0	54.8	36.1	11.3	
Queue Delay	0.0	0.0	0.0	0.0	0.0	0.0	0.0	0.0	0.0	0.0	0.0	
Total Delay	13.1	11.9	0.0	8.9	16.8	3.2	41.1	33.0	54.8	36.1	11.3	
LOS	B	B	A	A	B	A	D	C	D	D	B	
Approach Delay		11.9			14.1			36.6		38.2		
Approach LOS		B			B			D		D		

Intersection Summary

Cycle Length: 120
 Actuated Cycle Length: 120
 Offset: 0 (0%), Referenced to phase 2:EBTL and 6:WBTL, Start of Green
 Natural Cycle: 75
 Control Type: Actuated-Coordinated
 Maximum v/c Ratio: 0.79
 Intersection Signal Delay: 20.3
 Intersection LOS: C
 Intersection Capacity Utilization 63.9%
 ICU Level of Service B
 Analysis Period (min) 15

Splits and Phases: 13: Sterling Ranch Rd & Marksheffel Rd

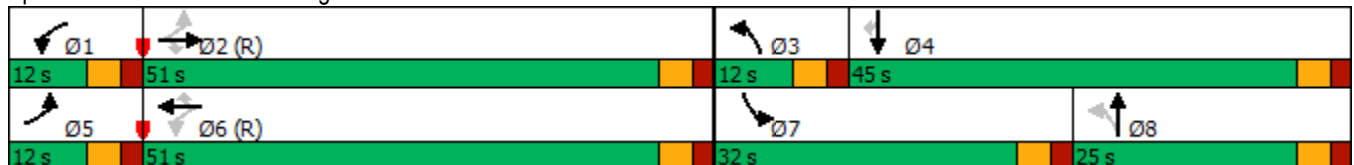

Intersection						
Int Delay, s/veh	0.5					
Movement	WBL	WBR	NBT	NBR	SBL	SBT
Lane Configurations	W	R	T	R	L	T
Traffic Vol, veh/h	12	9	546	21	16	341
Future Vol, veh/h	12	9	546	21	16	341
Conflicting Peds, #/hr	0	0	0	0	0	0
Sign Control	Stop	Stop	Free	Free	Free	Free
RT Channelized	-	None	-	None	-	None
Storage Length	0	-	-	-	-	-
Veh in Median Storage, #	0	-	0	-	-	0
Grade, %	0	-	0	-	-	0
Peak Hour Factor	95	95	95	95	95	95
Heavy Vehicles, %	2	2	2	2	2	2
Mvmt Flow	13	9	575	22	17	359

Major/Minor	Minor1	Major1	Major2		
Conflicting Flow All	979	586	0	0	597
Stage 1	586	-	-	-	-
Stage 2	393	-	-	-	-
Critical Hdwy	6.42	6.22	-	-	4.12
Critical Hdwy Stg 1	5.42	-	-	-	-
Critical Hdwy Stg 2	5.42	-	-	-	-
Follow-up Hdwy	3.518	3.318	-	-	2.218
Pot Cap-1 Maneuver	277	510	-	-	980
Stage 1	556	-	-	-	-
Stage 2	682	-	-	-	-
Platoon blocked, %			-	-	-
Mov Cap-1 Maneuver	271	510	-	-	980
Mov Cap-2 Maneuver	271	-	-	-	-
Stage 1	556	-	-	-	-
Stage 2	667	-	-	-	-

Approach	WB	NB	SB
HCM Control Delay, s	16.4	0	0.4
HCM LOS	C		

Minor Lane/Major Mvmt	NBT	NBRWBLn1	SBL	SBT
Capacity (veh/h)	-	-	339	980
HCM Lane V/C Ratio	-	-	0.065	0.017
HCM Control Delay (s)	-	-	16.4	8.7
HCM Lane LOS	-	-	C	A
HCM 95th %tile Q(veh)	-	-	0.2	0.1

Timings
4: Vollmer Rd & Briargate Pkwy

2045 Total Traffic
PM Peak Hour

Lane Group	EBL	EBT	EBR	WBL	WBT	WBR	NBL	NBT	NBR	SBL	SBT	SBR
Lane Configurations												
Traffic Volume (vph)	230	999	176	201	738	67	291	416	285	95	212	120
Future Volume (vph)	230	999	176	201	738	67	291	416	285	95	212	120
Turn Type	pm+pt	NA	Perm	Prot	NA	Perm	pm+pt	NA	Perm	pm+pt	NA	Perm
Protected Phases	5	2		1	6		3	8		7	4	
Permitted Phases	2		2			6	8		8	4		4
Detector Phase	5	2	2	1	6	6	3	8	8	7	4	4
Switch Phase												
Minimum Initial (s)	5.0	15.0	15.0	15.0	15.0	15.0	8.0	5.0	5.0	5.0	5.0	5.0
Minimum Split (s)	10.0	20.0	20.0	20.0	20.0	20.0	13.0	10.0	10.0	10.0	10.0	10.0
Total Split (s)	12.0	53.0	53.0	20.0	61.0	61.0	22.0	28.0	28.0	19.0	25.0	25.0
Total Split (%)	10.0%	44.2%	44.2%	16.7%	50.8%	50.8%	18.3%	23.3%	23.3%	15.8%	20.8%	20.8%
Yellow Time (s)	3.0	3.0	3.0	3.0	3.0	3.0	3.0	3.0	3.0	3.0	3.0	3.0
All-Red Time (s)	2.0	2.0	2.0	2.0	2.0	2.0	2.0	2.0	2.0	2.0	2.0	2.0
Lost Time Adjust (s)	0.0	0.0	0.0	0.0	0.0	0.0	0.0	0.0	0.0	0.0	0.0	0.0
Total Lost Time (s)	5.0	5.0	5.0	5.0	5.0	5.0	5.0	5.0	5.0	5.0	5.0	5.0
Lead/Lag	Lead	Lag	Lag	Lead	Lag	Lag	Lead	Lag	Lag	Lead	Lag	Lag
Lead-Lag Optimize?	Yes	Yes	Yes	Yes	Yes	Yes	Yes	Yes	Yes	Yes	Yes	Yes
Recall Mode	None	Max	Max	None	Max	Max	None	None	None	None	None	None
Act Effct Green (s)	55.1	48.1	48.1	15.0	56.1	56.1	35.3	20.4	20.4	24.3	14.1	14.1
Actuated g/C Ratio	0.48	0.42	0.42	0.13	0.49	0.49	0.31	0.18	0.18	0.21	0.12	0.12
v/c Ratio	0.66	0.68	0.24	0.47	0.45	0.09	0.81	0.67	0.58	0.39	0.51	0.38
Control Delay	25.2	30.2	4.5	50.4	20.4	1.2	50.9	49.5	11.0	33.0	50.6	7.0
Queue Delay	0.0	0.0	0.0	0.0	0.0	0.0	0.0	0.0	0.0	0.0	0.0	0.0
Total Delay	25.2	30.2	4.5	50.4	20.4	1.2	50.9	49.5	11.0	33.0	50.6	7.0
LOS	C	C	A	D	C	A	D	D	B	C	D	A
Approach Delay		26.1			25.1			38.7			34.4	
Approach LOS		C			C			D			C	

Intersection Summary

Cycle Length: 120
 Actuated Cycle Length: 113.8
 Natural Cycle: 80
 Control Type: Actuated-Uncoordinated
 Maximum v/c Ratio: 0.81
 Intersection Signal Delay: 30.0
 Intersection LOS: C
 Intersection Capacity Utilization 78.8%
 ICU Level of Service D
 Analysis Period (min) 15

Splits and Phases: 4: Vollmer Rd & Briargate Pkwy



Timings
5: Sterling Ranch Rd & Briargate Pkwy

2045 Total Traffic
PM Peak Hour

Lane Group	EBL	EBT	EBR	WBL	WBT	WBR	NBL	NBT	NBR	SBL	SBT	SBR
Lane Configurations												
Traffic Volume (vph)	316	902	134	154	832	97	146	149	84	71	68	140
Future Volume (vph)	316	902	134	154	832	97	146	149	84	71	68	140
Turn Type	pm+pt	NA	Perm	pm+pt	NA	Perm	pm+pt	NA	Free	pm+pt	NA	Free
Protected Phases	5	2		1	6		3	8		7	4	
Permitted Phases	2		2	6		6	8		Free	4		Free
Detector Phase	5	2	2	1	6	6	3	8		7	4	
Switch Phase												
Minimum Initial (s)	5.0	5.0	5.0	5.0	5.0	5.0	5.0	20.0		5.0	20.0	
Minimum Split (s)	10.0	23.0	23.0	10.0	23.0	23.0	10.0	25.0		10.0	25.0	
Total Split (s)	22.0	68.0	68.0	12.0	58.0	58.0	15.0	30.0		10.0	25.0	
Total Split (%)	18.3%	56.7%	56.7%	10.0%	48.3%	48.3%	12.5%	25.0%		8.3%	20.8%	
Yellow Time (s)	3.0	3.0	3.0	3.0	3.0	3.0	3.0	3.0		3.0	3.0	
All-Red Time (s)	2.0	2.0	2.0	2.0	2.0	2.0	2.0	2.0		2.0	2.0	
Lost Time Adjust (s)	0.0	0.0	0.0	0.0	0.0	0.0	0.0	0.0		0.0	0.0	
Total Lost Time (s)	5.0	5.0	5.0	5.0	5.0	5.0	5.0	5.0		5.0	5.0	
Lead/Lag	Lead	Lag	Lag	Lead	Lag	Lag	Lead	Lag		Lead	Lag	
Lead-Lag Optimize?	Yes	Yes	Yes	Yes	Yes	Yes	Yes	Yes		Yes	Yes	
Recall Mode	None	C-Max	C-Max	None	C-Max	C-Max	None	None		None	None	
Act Effct Green (s)	77.7	66.1	66.1	64.9	57.9	57.9	32.0	24.0	120.0	21.0	20.0	120.0
Actuated g/C Ratio	0.65	0.55	0.55	0.54	0.48	0.48	0.27	0.20	1.00	0.18	0.17	1.00
v/c Ratio	0.78	0.49	0.15	0.48	0.51	0.12	0.45	0.42	0.06	0.32	0.23	0.09
Control Delay	25.1	18.4	2.7	20.3	29.2	5.4	38.8	45.5	0.1	37.7	45.7	0.1
Queue Delay	0.0	0.0	0.0	0.0	0.0	0.0	0.0	0.0	0.0	0.0	0.0	0.0
Total Delay	25.1	18.4	2.7	20.3	29.2	5.4	38.8	45.5	0.1	37.7	45.7	0.1
LOS	C	B	A	C	C	A	D	D	A	D	D	A
Approach Delay		18.4			25.8			32.9			20.9	
Approach LOS		B			C			C			C	

Intersection Summary

Cycle Length: 120
 Actuated Cycle Length: 120
 Offset: 0 (0%), Referenced to phase 2:EBTL and 6:WBTL, Start of Green
 Natural Cycle: 80
 Control Type: Actuated-Coordinated
 Maximum v/c Ratio: 0.78
 Intersection Signal Delay: 23.0
 Intersection LOS: C
 Intersection Capacity Utilization 81.9%
 ICU Level of Service D
 Analysis Period (min) 15

Splits and Phases: 5: Sterling Ranch Rd & Briargate Pkwy

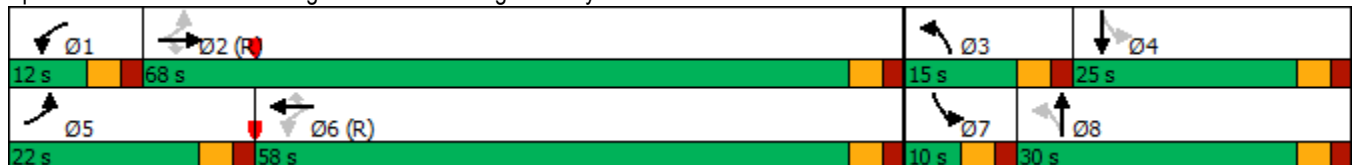

Timings
6: Banning Lewis Pkwy & Briargate Pkwy

2045 Total Traffic
PM Peak Hour

Lane Group	EBL	EBT	EBR	WBL	WBT	WBR	NBL	NBT	NBR	SBL	SBT	SBR
Lane Configurations												
Traffic Volume (vph)	39	528	456	299	537	56	536	223	281	45	161	1
Future Volume (vph)	39	528	456	299	537	56	536	223	281	45	161	1
Turn Type	pm+pt	NA	Free	Prot	NA	Perm	Prot	NA	Free	pm+pt	NA	Perm
Protected Phases	5	2		1	6		3	8		7	4	
Permitted Phases	2		Free			6			Free	4		4
Detector Phase	5	2		1	6	6	3	8		7	4	4
Switch Phase												
Minimum Initial (s)	8.0	15.0		8.0	15.0	15.0	8.0	10.0		8.0	10.0	10.0
Minimum Split (s)	15.0	20.0		20.0	20.0	20.0	13.0	15.0		13.0	15.0	15.0
Total Split (s)	15.0	38.0		25.0	48.0	48.0	32.0	43.0		14.0	25.0	25.0
Total Split (%)	12.5%	31.7%		20.8%	40.0%	40.0%	26.7%	35.8%		11.7%	20.8%	20.8%
Yellow Time (s)	3.0	3.0		3.0	3.0	3.0	3.0	3.0		3.0	3.0	3.0
All-Red Time (s)	2.0	2.0		2.0	2.0	2.0	2.0	2.0		2.0	2.0	2.0
Lost Time Adjust (s)	0.0	0.0		0.0	0.0	0.0	0.0	0.0		0.0	0.0	0.0
Total Lost Time (s)	5.0	5.0		5.0	5.0	5.0	5.0	5.0		5.0	5.0	5.0
Lead/Lag	Lead	Lag		Lead	Lag	Lag	Lead	Lag		Lead	Lag	Lag
Lead-Lag Optimize?	Yes	Yes		Yes	Yes	Yes	Yes	Yes		Yes	Yes	Yes
Recall Mode	None	C-Max		None	C-Max	C-Max	None	Max		None	Max	Max
Act Effct Green (s)	45.0	36.9	120.0	16.1	47.5	47.5	24.1	41.4	120.0	31.1	22.9	22.9
Actuated g/C Ratio	0.38	0.31	1.00	0.13	0.40	0.40	0.20	0.34	1.00	0.26	0.19	0.19
v/c Ratio	0.11	0.51	0.30	0.68	0.40	0.08	0.82	0.19	0.19	0.14	0.25	0.00
Control Delay	27.0	53.3	0.5	57.1	27.9	0.2	56.2	29.2	0.3	23.2	43.4	0.0
Queue Delay	0.0	0.0	0.0	0.0	0.0	0.0	0.0	0.0	0.0	0.0	0.0	0.0
Total Delay	27.0	53.3	0.5	57.1	27.9	0.2	56.2	29.2	0.3	23.2	43.4	0.0
LOS	C	D	A	E	C	A	E	C	A	C	D	A
Approach Delay		28.8			36.0			35.3			38.8	
Approach LOS		C			D			D			D	

Intersection Summary

Cycle Length: 120
 Actuated Cycle Length: 120
 Offset: 0 (0%), Referenced to phase 2:EBTL and 6:WBT, Start of Green
 Natural Cycle: 70
 Control Type: Actuated-Coordinated
 Maximum v/c Ratio: 0.82
 Intersection Signal Delay: 33.6
 Intersection LOS: C
 Intersection Capacity Utilization 63.4%
 ICU Level of Service B
 Analysis Period (min) 15

Splits and Phases: 6: Banning Lewis Pkwy & Briargate Pkwy

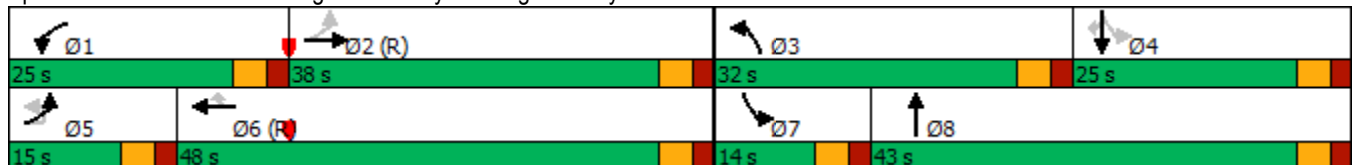

Intersection									
Intersection Delay, s/veh	19.2								
Intersection LOS	C								
Approach	EB		WB		NB		SB		
Entry Lanes	2		2		2		2		
Conflicting Circle Lanes	2		2		2		2		
Adj Approach Flow, veh/h	1076		939		1096		221		
Demand Flow Rate, veh/h	1098		957		1118		225		
Vehicles Circulating, veh/h	544		858		657		1505		
Vehicles Exiting, veh/h	1186		917		985		310		
Ped Vol Crossing Leg, #/h	0		0		0		0		
Ped Cap Adj	1.000		1.000		1.000		1.000		
Approach Delay, s/veh	14.8		23.5		20.3		16.0		
Approach LOS	B		C		C		C		
Lane	Left	Right	Left	Right	Left	Right	Left	Right	
Designated Moves	LT	TR	LT	TR	LT	TR	LT	TR	
Assumed Moves	LT	TR	LT	TR	L	TR	LT	TR	
RT Channelized									
Lane Util	0.470	0.530	0.470	0.530	0.513	0.487	0.471	0.529	
Follow-Up Headway, s	2.667	2.535	2.667	2.535	2.667	2.535	2.667	2.535	
Critical Headway, s	4.645	4.328	4.645	4.328	4.645	4.328	4.645	4.328	
Entry Flow, veh/h	516	582	450	507	573	545	106	119	
Cap Entry Lane, veh/h	818	894	613	685	738	812	338	395	
Entry HV Adj Factor	0.980	0.980	0.980	0.981	0.981	0.980	0.978	0.982	
Flow Entry, veh/h	506	570	441	498	562	534	104	117	
Cap Entry, veh/h	802	876	601	672	723	796	331	388	
V/C Ratio	0.631	0.651	0.734	0.740	0.777	0.671	0.314	0.301	
Control Delay, s/veh	15.0	14.7	24.4	22.7	23.9	16.6	17.3	14.7	
LOS	B	B	C	C	C	C	C	B	
95th %tile Queue, veh	5	5	6	7	8	5	1	1	

Intersection												
Int Delay, s/veh	6.5											
Movement	EBL	EBT	EBR	WBL	WBT	WBR	NBL	NBT	NBR	SBL	SBT	SBR
Lane Configurations		↔			↔	↗	↖	↗	↖	↖	↗	↗
Traffic Vol, veh/h	0	0	108	55	0	60	59	932	77	34	556	0
Future Vol, veh/h	0	0	108	55	0	60	59	932	77	34	556	0
Conflicting Peds, #/hr	0	0	0	0	0	0	0	0	0	0	0	0
Sign Control	Stop	Stop	Stop	Stop	Stop	Stop	Free	Free	Free	Free	Free	Free
RT Channelized	-	-	None	-	-	None	-	-	None	-	-	None
Storage Length	-	-	-	-	-	0	0	-	155	205	-	0
Veh in Median Storage, #	-	0	-	-	0	-	-	0	-	-	0	-
Grade, %	-	0	-	-	0	-	-	0	-	-	0	-
Peak Hour Factor	95	95	95	95	95	95	95	95	95	95	95	95
Heavy Vehicles, %	2	2	2	2	2	2	2	2	2	2	2	2
Mvmt Flow	0	0	114	58	0	63	62	981	81	36	585	0

Major/Minor	Minor2		Minor1		Major1		Major2					
Conflicting Flow All	1272	1843	293	1470	1762	491	585	0	0	1062	0	0
Stage 1	657	657	-	1105	1105	-	-	-	-	-	-	-
Stage 2	615	1186	-	365	657	-	-	-	-	-	-	-
Critical Hdwy	7.54	6.54	6.94	7.54	6.54	6.94	4.14	-	-	4.14	-	-
Critical Hdwy Stg 1	6.54	5.54	-	6.54	5.54	-	-	-	-	-	-	-
Critical Hdwy Stg 2	6.54	5.54	-	6.54	5.54	-	-	-	-	-	-	-
Follow-up Hdwy	3.52	4.02	3.32	3.52	4.02	3.32	2.22	-	-	2.22	-	-
Pot Cap-1 Maneuver	125	74	703	89	83	523	986	-	-	652	-	-
Stage 1	420	460	-	225	285	-	-	-	-	-	-	-
Stage 2	445	260	-	627	460	-	-	-	-	-	-	-
Platoon blocked, %								-	-	-	-	-
Mov Cap-1 Maneuver	100	65	703	68	73	523	986	-	-	652	-	-
Mov Cap-2 Maneuver	100	65	-	68	73	-	-	-	-	-	-	-
Stage 1	394	435	-	211	267	-	-	-	-	-	-	-
Stage 2	367	244	-	497	435	-	-	-	-	-	-	-

Approach	EB		WB		NB		SB	
HCM Control Delay, s	11.1		88.4		0.5		0.6	
HCM LOS	B		F					

Minor Lane/Major Mvmt	NBL	NBT	NBR	EBLn1	WBLn1	WBLn2	SBL	SBT	SBR
Capacity (veh/h)	986	-	-	703	68	523	652	-	-
HCM Lane V/C Ratio	0.063	-	-	0.162	0.851	0.121	0.055	-	-
HCM Control Delay (s)	8.9	-	-	11.1	170.8	12.8	10.8	-	-
HCM Lane LOS	A	-	-	B	F	B	B	-	-
HCM 95th %tile Q(veh)	0.2	-	-	0.6	4.1	0.4	0.2	-	-

HCM 6th TWSC
 8: Sterling Ranch Rd & School Access/Oak Park Dr

2045 Total Traffic
 PM Peak Hour

Intersection												
Int Delay, s/veh	4.1											
Movement	EBL	EBT	EBR	WBL	WBT	WBR	NBL	NBT	NBR	SBL	SBT	SBR
Lane Configurations	↘	↑	↗	↘		↗		↑	↗	↘	↑	
Traffic Vol, veh/h	39	18	32	119	0	84	0	290	172	44	272	0
Future Vol, veh/h	39	18	32	119	0	84	0	290	172	44	272	0
Conflicting Peds, #/hr	0	0	0	0	0	0	0	0	0	0	0	0
Sign Control	Stop	Stop	Stop	Stop	Stop	Stop	Free	Free	Free	Free	Free	Free
RT Channelized	-	-	None	-	-	None	-	-	None	-	-	None
Storage Length	0	-	0	0	-	0	-	-	205	205	-	-
Veh in Median Storage, #	-	0	-	-	0	-	-	0	-	-	0	-
Grade, %	-	0	-	-	0	-	-	0	-	-	0	-
Peak Hour Factor	95	95	95	95	95	95	95	95	95	95	95	95
Heavy Vehicles, %	2	2	2	2	2	2	2	2	2	2	2	2
Mvmt Flow	41	19	34	125	0	88	0	305	181	46	286	0

Major/Minor	Minor2		Minor1		Major1			Major2				
Conflicting Flow All	818	864	286	710	-	305	-	0	0	486	0	0
Stage 1	378	378	-	305	-	-	-	-	-	-	-	-
Stage 2	440	486	-	405	-	-	-	-	-	-	-	-
Critical Hdwy	7.12	6.52	6.22	7.12	-	6.22	-	-	-	4.12	-	-
Critical Hdwy Stg 1	6.12	5.52	-	6.12	-	-	-	-	-	-	-	-
Critical Hdwy Stg 2	6.12	5.52	-	6.12	-	-	-	-	-	-	-	-
Follow-up Hdwy	3.518	4.018	3.318	3.518	-	3.318	-	-	-	2.218	-	-
Pot Cap-1 Maneuver	307	289	*872	377	0	735	0	-	-	1077	-	0
Stage 1	724	650	-	705	0	-	0	-	-	-	-	0
Stage 2	596	551	-	695	0	-	0	-	-	-	-	0
Platoon blocked, %	1	1	1	1				-	-			
Mov Cap-1 Maneuver	261	276	*872	337	-	735	-	-	-	1077	-	-
Mov Cap-2 Maneuver	373	378	-	454	-	-	-	-	-	-	-	-
Stage 1	724	622	-	705	-	-	-	-	-	-	-	-
Stage 2	524	551	-	620	-	-	-	-	-	-	-	-

Approach	EB	WB	NB	SB
HCM Control Delay, s	13.3	13.7	0	1.2
HCM LOS	B	B		

Minor Lane/Major Mvmt	NBT	NBR	EBLn1	EBLn2	EBLn3	WBLn1	WBLn2	SBL	SBT
Capacity (veh/h)	-	-	373	378	872	454	735	1077	-
HCM Lane V/C Ratio	-	-	0.11	0.05	0.039	0.276	0.12	0.043	-
HCM Control Delay (s)	-	-	15.8	15	9.3	15.9	10.6	8.5	-
HCM Lane LOS	-	-	C	C	A	C	B	A	-
HCM 95th %tile Q(veh)	-	-	0.4	0.2	0.1	1.1	0.4	0.1	-

Notes
 ~: Volume exceeds capacity \$: Delay exceeds 300s +: Computation Not Defined *: All major volume in platoon

Intersection

Int Delay, s/veh 3.2

Movement	EBL	EBR	NBL	NBT	SBT	SBR
Lane Configurations		↗	↘	↕	↕	↗
Traffic Vol, veh/h	0	211	321	1040	881	36
Future Vol, veh/h	0	211	321	1040	881	36
Conflicting Peds, #/hr	0	0	0	0	0	0
Sign Control	Stop	Stop	Free	Free	Free	Free
RT Channelized	-	None	-	None	-	None
Storage Length	-	0	200	-	-	0
Veh in Median Storage, #	0	-	-	0	0	-
Grade, %	0	-	-	0	0	-
Peak Hour Factor	95	95	95	95	95	95
Heavy Vehicles, %	2	2	2	2	2	2
Mvmt Flow	0	222	338	1095	927	38

Major/Minor	Minor2	Major1	Major2		
Conflicting Flow All	-	464	965	0	-
Stage 1	-	-	-	-	-
Stage 2	-	-	-	-	-
Critical Hdwy	-	6.94	4.14	-	-
Critical Hdwy Stg 1	-	-	-	-	-
Critical Hdwy Stg 2	-	-	-	-	-
Follow-up Hdwy	-	3.32	2.22	-	-
Pot Cap-1 Maneuver	0	545	709	-	-
Stage 1	0	-	-	-	-
Stage 2	0	-	-	-	-
Platoon blocked, %				-	-
Mov Cap-1 Maneuver	-	545	709	-	-
Mov Cap-2 Maneuver	-	-	-	-	-
Stage 1	-	-	-	-	-
Stage 2	-	-	-	-	-

Approach	EB	NB	SB
HCM Control Delay, s	16.1	3.4	0
HCM LOS	C		

Minor Lane/Major Mvmt	NBL	NBT	EBLn1	SBT	SBR
Capacity (veh/h)	709	-	545	-	-
HCM Lane V/C Ratio	0.477	-	0.408	-	-
HCM Control Delay (s)	14.6	-	16.1	-	-
HCM Lane LOS	B	-	C	-	-
HCM 95th %tile Q(veh)	2.6	-	2	-	-

Intersection												
Int Delay, s/veh	2											
Movement	EBL	EBT	EBR	WBL	WBT	WBR	NBL	NBT	NBR	SBL	SBT	SBR
Lane Configurations	↙	↑	↗	↙	↗			↕			↕	↗
Traffic Vol, veh/h	103	560	19	2	364	8	11	1	2	4	1	68
Future Vol, veh/h	103	560	19	2	364	8	11	1	2	4	1	68
Conflicting Peds, #/hr	0	0	0	0	0	0	0	0	0	0	0	0
Sign Control	Free	Free	Free	Free	Free	Free	Stop	Stop	Stop	Stop	Stop	Stop
RT Channelized	-	-	None	-	-	None	-	-	None	-	-	None
Storage Length	205	-	155	205	-	-	-	-	-	-	-	155
Veh in Median Storage, #	-	0	-	-	0	-	-	0	-	-	0	-
Grade, %	-	0	-	-	0	-	-	0	-	-	0	-
Peak Hour Factor	95	95	95	95	95	95	95	95	95	95	95	95
Heavy Vehicles, %	2	2	2	2	2	2	2	2	2	2	2	2
Mvmt Flow	108	589	20	2	383	8	12	1	2	4	1	72

Major/Minor	Major1			Major2			Minor1			Minor2		
Conflicting Flow All	391	0	0	609	0	0	1233	1200	589	1208	1216	387
Stage 1	-	-	-	-	-	-	805	805	-	391	391	-
Stage 2	-	-	-	-	-	-	428	395	-	817	825	-
Critical Hdwy	4.12	-	-	4.12	-	-	7.12	6.52	6.22	7.12	6.52	6.22
Critical Hdwy Stg 1	-	-	-	-	-	-	6.12	5.52	-	6.12	5.52	-
Critical Hdwy Stg 2	-	-	-	-	-	-	6.12	5.52	-	6.12	5.52	-
Follow-up Hdwy	2.218	-	-	2.218	-	-	3.518	4.018	3.318	3.518	4.018	3.318
Pot Cap-1 Maneuver	1168	-	-	970	-	-	154	185	508	160	181	661
Stage 1	-	-	-	-	-	-	376	395	-	633	607	-
Stage 2	-	-	-	-	-	-	605	605	-	370	387	-
Platoon blocked, %	-	-	-	-	-	-	-	-	-	-	-	-
Mov Cap-1 Maneuver	1168	-	-	970	-	-	127	168	508	147	164	661
Mov Cap-2 Maneuver	-	-	-	-	-	-	127	168	-	147	164	-
Stage 1	-	-	-	-	-	-	341	359	-	575	606	-
Stage 2	-	-	-	-	-	-	537	604	-	333	351	-

Approach	EB	WB	NB	SB
HCM Control Delay, s	1.3	0	32.6	12.4
HCM LOS			D	B

Minor Lane/Major Mvmt	NBLn1	EBL	EBT	EBR	WBL	WBT	WBR	SBLn1	SBLn2
Capacity (veh/h)	145	1168	-	-	970	-	-	150	661
HCM Lane V/C Ratio	0.102	0.093	-	-	0.002	-	-	0.035	0.108
HCM Control Delay (s)	32.6	8.4	-	-	8.7	-	-	29.9	11.1
HCM Lane LOS	D	A	-	-	A	-	-	D	B
HCM 95th %tile Q(veh)	0.3	0.3	-	-	0	-	-	0.1	0.4

Timings
12: Vollmer Rd & Marksheffel Rd

2045 Total Traffic
PM Peak Hour

Lane Group	EBL	EBT	EBR	WBL	WBT	WBR	NBL	NBT	NBR	SBL	SBT	SBR
Lane Configurations												
Traffic Volume (vph)	139	919	89	186	704	149	169	795	176	126	396	197
Future Volume (vph)	139	919	89	186	704	149	169	795	176	126	396	197
Turn Type	pm+pt	NA	Perm	pm+pt	NA	Perm	pm+pt	NA	Perm	pm+pt	NA	Perm
Protected Phases	5	2		1	6		3	8		7	4	
Permitted Phases	2		2	6		6	8		8	4		4
Detector Phase	5	2	2	1	6	6	3	8	8	7	4	4
Switch Phase												
Minimum Initial (s)	5.0	5.0	5.0	5.0	5.0	5.0	5.0	10.0	10.0	5.0	10.0	10.0
Minimum Split (s)	10.0	23.0	23.0	10.0	23.0	23.0	10.0	23.0	23.0	10.0	23.0	23.0
Total Split (s)	20.0	50.0	50.0	19.0	49.0	49.0	15.0	38.0	38.0	13.0	36.0	36.0
Total Split (%)	16.7%	41.7%	41.7%	15.8%	40.8%	40.8%	12.5%	31.7%	31.7%	10.8%	30.0%	30.0%
Yellow Time (s)	3.0	3.0	3.0	3.0	3.0	3.0	3.0	3.0	3.0	3.0	3.0	3.0
All-Red Time (s)	2.0	2.0	2.0	2.0	2.0	2.0	2.0	2.0	2.0	2.0	2.0	2.0
Lost Time Adjust (s)	0.0	0.0	0.0	0.0	0.0	0.0	0.0	0.0	0.0	0.0	0.0	0.0
Total Lost Time (s)	5.0	5.0	5.0	5.0	5.0	5.0	5.0	5.0	5.0	5.0	5.0	5.0
Lead/Lag	Lead	Lag	Lag	Lead	Lag	Lag	Lead	Lag	Lag	Lead	Lag	Lag
Lead-Lag Optimize?	Yes	Yes	Yes	Yes	Yes	Yes	Yes	Yes	Yes	Yes	Yes	Yes
Recall Mode	None	C-Max	C-Max	None	C-Max	C-Max	None	Max	Max	None	Max	Max
Act Effct Green (s)	57.6	47.0	47.0	60.4	48.4	48.4	42.8	33.0	33.0	39.2	31.2	31.2
Actuated g/C Ratio	0.48	0.39	0.39	0.50	0.40	0.40	0.36	0.28	0.28	0.33	0.26	0.26
v/c Ratio	0.42	0.70	0.14	0.69	0.52	0.22	0.54	0.86	0.35	0.74	0.45	0.37
Control Delay	18.4	34.2	3.8	48.7	22.1	5.3	32.4	51.6	14.3	51.3	39.2	6.7
Queue Delay	0.0	0.0	0.0	0.0	0.0	0.0	0.0	0.0	0.0	0.0	0.0	0.0
Total Delay	18.4	34.2	3.8	48.7	22.1	5.3	32.4	51.6	14.3	51.3	39.2	6.7
LOS	B	C	A	D	C	A	C	D	B	D	D	A
Approach Delay		29.9			24.5			43.0			32.4	
Approach LOS		C			C			D			C	

Intersection Summary

Cycle Length: 120
 Actuated Cycle Length: 120
 Offset: 0 (0%), Referenced to phase 2:EBTL and 6:WBTL, Start of Green
 Natural Cycle: 70
 Control Type: Actuated-Coordinated
 Maximum v/c Ratio: 0.86
 Intersection Signal Delay: 32.6
 Intersection LOS: C
 Intersection Capacity Utilization 81.3%
 ICU Level of Service D
 Analysis Period (min) 15

Splits and Phases: 12: Vollmer Rd & Marksheffel Rd

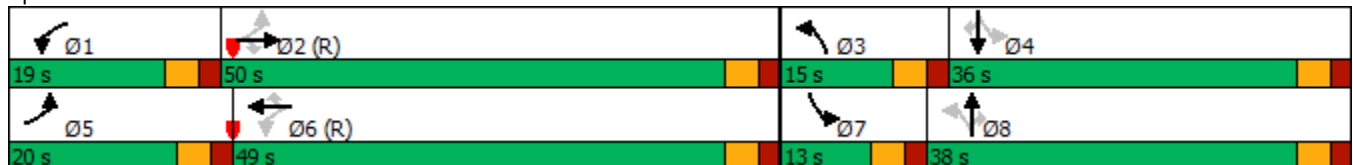

Timings
13: Sterling Ranch Rd & Marksheffel Rd

2045 Total Traffic
PM Peak Hour

Lane Group	EBL	EBT	EBR	WBL	WBT	WBR	NBL	NBT	SBL	SBT	SBR	
Lane Configurations												
Traffic Volume (vph)	303	940	6	62	838	562	18	4	345	18	183	
Future Volume (vph)	303	940	6	62	838	562	18	4	345	18	183	
Turn Type	pm+pt	NA	Perm	pm+pt	NA	Perm	pm+pt	NA	Prot	NA	Perm	
Protected Phases	5	2		1	6		3	8	7	4		
Permitted Phases	2		2	6		6	8				4	
Detector Phase	5	2	2	1	6	6	3	8	7	4	4	
Switch Phase												
Minimum Initial (s)	5.0	15.0	15.0	5.0	15.0	15.0	5.0	10.0	20.0	10.0	10.0	
Minimum Split (s)	10.0	20.0	20.0	10.0	20.0	20.0	10.0	15.0	25.0	20.0	20.0	
Total Split (s)	20.0	68.0	68.0	12.0	60.0	60.0	10.0	15.0	25.0	30.0	30.0	
Total Split (%)	16.7%	56.7%	56.7%	10.0%	50.0%	50.0%	8.3%	12.5%	20.8%	25.0%	25.0%	
Yellow Time (s)	3.0	3.0	3.0	3.0	3.0	3.0	3.0	3.0	3.0	3.0	3.0	
All-Red Time (s)	2.0	2.0	2.0	2.0	2.0	2.0	2.0	2.0	2.0	2.0	2.0	
Lost Time Adjust (s)	0.0	0.0	0.0	0.0	0.0	0.0	0.0	0.0	0.0	0.0	0.0	
Total Lost Time (s)	5.0	5.0	5.0	5.0	5.0	5.0	5.0	5.0	5.0	5.0	5.0	
Lead/Lag	Lead	Lag	Lag	Lead	Lag	Lag	Lead	Lag	Lead	Lag	Lag	
Lead-Lag Optimize?	Yes	Yes	Yes	Yes	Yes	Yes	Yes	Yes	Yes	Yes	Yes	
Recall Mode	None	C-Max	C-Max	None	C-Max	C-Max	None	None	None	None	None	
Act Effct Green (s)	81.0	71.6	71.6	69.3	62.7	62.7	11.0	10.0	20.0	25.0	25.0	
Actuated g/C Ratio	0.68	0.60	0.60	0.58	0.52	0.52	0.09	0.08	0.17	0.21	0.21	
v/c Ratio	0.75	0.47	0.01	0.19	0.48	0.53	0.13	0.18	0.63	0.05	0.40	
Control Delay	39.8	9.9	0.0	10.2	20.8	3.5	35.7	24.2	52.3	37.5	8.2	
Queue Delay	0.0	0.0	0.0	0.0	0.0	0.0	0.0	0.0	0.0	0.0	0.0	
Total Delay	39.8	9.9	0.0	10.2	20.8	3.5	35.7	24.2	52.3	37.5	8.2	
LOS	D	A	A	B	C	A	D	C	D	D	A	
Approach Delay		17.1			13.7			28.8		37.0		
Approach LOS		B			B			C		D		

Intersection Summary

Cycle Length: 120
 Actuated Cycle Length: 120
 Offset: 0 (0%), Referenced to phase 2:EBTL and 6:WBTL, Start of Green
 Natural Cycle: 90
 Control Type: Actuated-Coordinated
 Maximum v/c Ratio: 0.75
 Intersection Signal Delay: 19.0
 Intersection LOS: B
 Intersection Capacity Utilization 72.4%
 ICU Level of Service C
 Analysis Period (min) 15

Splits and Phases: 13: Sterling Ranch Rd & Marksheffel Rd

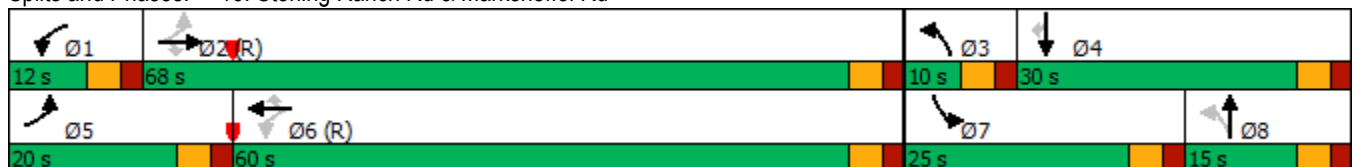

Crash History



AccidentDate	TotalVehicles	ReferencePointName	ReferencePointAtName	AccidentNarrative
2019-09-29	1	VOLLMER RD	GLIDER LP	Vehicle # 1 was traveling northbound Vollmer Road .8 miles north of Glider Loop. Vehicle # 1's right side tires dropped off the right side of the roadway as it entered a sharp left curve. Vehicle #1 lost control on the roadway for approximately 131' before it traveled approximately 100' off the right side of the roadway. Vehicle # 1 collided its rear with a barbed-wire fence. Vehicle # 1 was moved prior to investigation.
2019-10-01	1	VOLLMER RD	S POCO RD	Vehicle #1 was northbound on Vollmer Road in a left hand curve. Vehicle #1 ran off the right side of the road for 107.3'. Vehicle over corrected, reentered the roadway, spinning counter clockwise. Vehicle #1 was out of control for 98.5'. Vehicle #1 ran off the left side of the road for 99.8', rolling 1 1/2 times. Vehicle #1 came to rest on its top facing west.
2019-11-14	1	VOLLMER RD	GLIDER PL	Vehicle 1 was southbound on Vollmer Road south of Burgess Road. Vehicle 1 was travelling in excessive speed, when it failed to negotiate a right hand bend in the roadway. Vehicle left heavy left side tire skids marks for 115.8 feet in the northbound lane, afterwhich it traveled for 59.4 across the southbound lane. Vehicle 1 ran off the right side of the road for 130.9 feet where it began to overturn, airborne for 20.7 feet, colliding with the ground, traveled another 25.9 feet and rolled another 52.2 feet where it came to final rest facing east on its right side 23.9 feet from the west road edge.
2020-04-23	1	VOLLMER RD	WILDFLOWER RD	Vehicle #1 was traveling south on Vollmer Rd approaching Wildflower Rd. Vehicle #1 failed to navigate the slight left curve in the roadway at which point it ran off the right side of the road. Vehicle #1 crashed through the fence on the right side of the road, traveled southwest into the yard of 8455 Wildflower Rd, rolled, crashed into a well, and came to rest on its wheels facing south.
2020-05-26	1	VOLLMER	WILD FLOWER	Vehicle #1 was southbound on Vollmer. Driver of vehicle #1 lost control and went off the right side of the road and overturned. Vehicle #1 was moved prior to investigation.
2020-07-25	1	VOLLMER RD	POCO RD	Vehicle 1 was traveling in an easterly direction on Vollmer Road approaching a left curve. Vehicle 1 drove on the wrong side of the road to avoid a deceased raccoon in the middle of its lane. Vehicle 1 returned to its lane while navigating the curve. Vehicle 1's right tires dropped off the right edge of the road. Driver 1 pulled the wheel to the left causing Vehicle 1 to spin out of control. Driver 1 overcorrected to the right and the vehicle rolled 3/4 times off the right side of the road. Vehicle 1 came to final rest on top of a fence facing south on its right side.
2021-03-24	1	VOLLMER RD	POCO RD	Vehicle #1 was southbound on Vollmer Road just south of Poco Road. Vehicle #1 lost control on the icy covered roadway and slid off of the west edge of the roadway for approximately 50 feet while rotating 1/4 times clockwise. Vehicle #1 then collided with a barbed wire fence approximately 15 feet west of the road edge and overturned 1/4 times onto it's left. Vehicle #1 came to final rest on its left side, approximately 15 feet west of the road edge facing west.
2021-09-13	3	VOLLMER RD	POCO RD	Vehicle #1 was traveling southbound on Vollmer Road. Vehicle #2 was parked on Poco Road, facing east, just west of the intersection of Vollmer Rd. and Poco Rd. Vehicle #2 was partially in the lane and partially on what would be a shoulder, as the entire road is dirt. Vehicle #3 was parked likewise, behind vehicle #2. Vehicle #1 made a right hand turn, to travel westbound on Poco Rd. The left front of vehicle #1 crashed into the left front of vehicle #2. Vehicle #2, being on dirt, slid backwards into the front of vehicle #3. Both vehicles #2 and #3 were unoccupied. Vehicle #1 pulled through and pulled over further down Poco Road to a safe location.
2021-11-11	1	VOLLMER RD	POCO RD	Vehicle #1 was travelling northbound on Vollmer Rd approaching Poco Rd. Vehicle #1 failed to negotiate a curve to the left and travelled off the right side of the road. Vehicle #1 overcorrected to the left, travelled across both lanes of traffic, and drove off the left side of the road. Vehicle #1 rotated counter-clockwise and hit a trip point in the soft dirt. Vehicle #1 rolled 1 and 3/4 times, coming to rest on its left side facing southwest approximately 30 feet off the road. The driver of the vehicle was ejected out of the passenger window during the rollover and came to rest in the field approximately 50 feet northwest of the vehicle.
2022-04-07	1	VOLLMER RD	WILDFLOWER RD	Vehicle 1 was traveling southbound on Vollmer Rd approaching the intersection of Wildflower Rd. Vehicle 1 failed to negotiate a curve and drove off the right side of the roadway at the intersection of Wildflower Rd. Vehicle 1 drove approximately 19 feet off of the right side of the roadway impacting an embankment and came to final rest 85 feet south of Wildflower Rd on the southwest side of the intersection facing south.
2022-06-19	2	VOLLMER RD	LOCHWINNOCH LN	VEHICLE 1 WAS NORTHBOUND ON VOLLMER ROAD. VEHICLE 2 WAS NORTHBOUND ON VOLLMER ROAD, IN FRONT OF VEHICLE 1. VEHICLE 2 BEGAN TO SLOW TO MAKE A LEFT TURN ONTO LOCHWINNOCH ROAD. VEHICLE 1 ATTEMPTED TO PASS VEHICLE 2 ON THE LEFT SIDE IN A MARKED NO PASSING ZONE. VEHICLE 2 BEGAN TO MAKE THE LEFT TURN WHERE VEHICLE 2 WAS STRUCK IN THE FRONT DRIVERS SIDE, BY THE FRONT PASSENGER SIDE OF VEHICLE 1. THE COLLISION OCCURRED WITHIN THE SOUTHBOUND LANE OF VOLLMER ROAD. VEHICLE 1 THEN ROTATED 1/2 TIME CLOCKWISE ACROSS THE NORTHBOUND LANE. VEHICLE 1 THEN DROVE OFF THE NORTHBOUND SIDE OF THE ROAD AND OVERTURNED 1/2 TIME, COMING TO FINAL REST ON ITS ROOF FACING SOUTH. VEHICLE 2 CAME TO A CONTROLLED FINAL REST ON LOCHWINNOCH LN.
2022-07-03	1	VOLLMER RD	POCO RD	Motorcycle was traveling on Vollmer Rd headed northbound. Motorcycle traveled off the right side of the road. Motorcycle lost control and rolled multiple times, the rider was ejected. Motorcycle came to rest on the left side. Rider came to rest on his back.

Sketch Plan Amendment



STERLING RANCH SKETCH PLAN MINOR AMENDMENT

SECTION 27, TOWNSHIP 12, RANGE 65 WEST OF THE 6TH P.M., EL PASO, CO

CLASSIC SRJ LAND, LLC
2138 FLYING HORSE CLUB DRIVE
COLORADO SPRINGS, CO 80921

LAND USE LEGEND:

- 31 AC. RESIDENTIAL: 2.5 DU/AC, 9 D.U.
- 105 AC. RESIDENTIAL: 2 DU/AC, 151 D.U.
- 882 A.C. RESIDENTIAL: 3-5 DU/AC, 2,766 D.U.
- 129 AC. RESIDENTIAL: 5-8 DU/AC, 600 D.U.
- 47 AC. MIXED USE 8-25 DU/AC *, 600 D.U.
- 50 AC. ELEMENTARY / K-8 SCHOOL
- 18 AC. NEIGHBORHOOD PARK
- 28 AC. COMMUNITY PARK
- 62 AC. OPEN SPACE / PARK / GREENWAY
- 40 AC. OPEN SPACE / BUFFER
- 11.5 AC. UTILITY PARCEL
- 5 AC. INDUSTRIAL
- 35.5 AC. RIGHT-OF-WAY

TOTAL: 1,444 AC. TOTAL: 4,800 D.U. Max

* COMMERCIAL / MULTIFAMILY UP TO 25 DU/AC

SYMBOL LEGEND:

- ROAD
- FULL MOVEMENT ACCESS POINT
- 3/4 MOVEMENT
- RI/RO
- 100-YEAR FLOODPLAIN
- TRAIL
- BUFFER / OS TRAIL CORRIDOR / EASEMENT
- NEIGHBORHOOD PARK
- AQUATIC RESOURCES

LEGAL DESCRIPTION:

THE WEST HALF OF THE WEST HALF OF THE EAST HALF AND EAST HALF OF THE WEST HALF AND THE SOUTHWEST QUARTER OF THE SOUTHWEST QUARTER OF SECTION 27; THE EAST HALF OF THE SOUTHEAST QUARTER AND THAT PORTION OF THE SOUTHWEST QUARTER OF THE SOUTHWEST QUARTER LYING SOUTH AND EAST OF THE COUNTY ROAD KNOWN AS VOLLMER ROAD, OF SECTION 28, THE WEST HALF OF THE EAST HALF AND THE WEST HALF OF SECTION 34; THE EAST HALF AND THE EAST HALF OF THE SOUTHWEST QUARTER AND THE SOUTHWEST QUARTER OF THE SOUTHWEST QUARTER OF SECTION 33, AND ALL THAT PART OF THE NORTHWEST QUARTER OF SECTION 33 LYING SOUTH AND EAST OF THE COUNTY ROAD KNOWN AS VOLLMER ROAD, EXCEPT THAT PORTION OF THE SOUTHWEST QUARTER OF THE NORTHWEST QUARTER OF SAID SECTION 33 LYING SOUTH AND EAST OF SAID COUNTY ROAD AS DEEDED TO COLORADO INTERSTATE GAS COMPANY BY WARRANTY DEED RECORDED IN BOOK 1173 AT PAGE 359; AND THAT PORTION OF THE NORTHEAST QUARTER OF THE SOUTHEAST QUARTER AND THE SOUTHEAST QUARTER OF THE SOUTHWEST QUARTER LYING SOUTHWEST OF THE COUNTY ROAD KNOWN AS VOLLMER ROAD, OF SECTION 32, EXCEPT THAT PORTION OF THE NORTHEAST QUARTER OF THE SOUTHWEST QUARTER OF SAID SECTION 32 DEEDED TO I. MARCUS BROWN BY TRUSTEES' DEED RECORDED IN BOOK 3292 AT PAGE 168; ALL IN TOWNSHIP 12 SOUTH, RANGE 65 WEST OF THE 6TH P.M., EL PASO COUNTY, COLORADO LYING SOUTH AND EAST OF THE COUNTY ROAD (VOLLMER ROAD), ALSO: THE NORTHWEST QUARTER OF THE NORTHWEST QUARTER OF SECTION 4, TOWNSHIP 13 SOUTH, RANGE 65 WEST OF THE SIXTH PRINCIPAL MERIDIAN, LYING SOUTHERLY OF AN EXISTING EAST- WEST FENCE AS DESCRIBED IN SPECIAL WARRANTY DEED RECORDED DECEMBER 23, 2004 AT RECEPTION NO. 204209417, COUNTY OF EL PASO, STATE OF COLORADO, ALSO: THE SOUTHWEST QUARTER OF THE SOUTHWEST QUARTER OF THE SOUTHWEST QUARTER OF SECTION 32, TOWNSHIP 12 SOUTH, RANGE 65 WEST OF THE 6TH P.M., LYING SOUTHEASTERLY OF THE PUBLIC ROAD KNOWN AS VOLLMER ROAD, EL PASO COUNTY, COLORADO, AND CONTAINING 1443.695 ACRES MORE OR LESS.

AMENDED AREA DESCRIPTION:

THE APPROXIMATE AREA OF THIS AMENDMENT (SKP235) IS 53.5 ACRES.

- GENERAL NOTES:**
- THERE ARE AQUATIC RESOURCES ON THE SITE, PRESUMED TO BE NON-JURISDICTIONAL DUE TO THEIR LACK OF SURFACE WATER CONNECTION TO SAND CREEK TO THE WEST OR ANY OTHER DOWNSTREAM WOTUS. AN APPROVED JURISDICTIONAL DETERMINATION MAY BE NEEDED TO CONFIRM THE REGULATORY STATUS OF THE WETLANDS PRESENT. IF THESE WETLANDS ARE DETERMINED TO BE JURISDICTIONAL, A SECTION 404 PERMIT FROM THE USACE WOULD BE REQUIRED. REGARDLESS OF REGULATORY STATUS, THE WETLANDS ON THE SITE WILL BE IMPACTED BY DEVELOPMENT THROUGH FILL AND REGRADING. WETLAND AREAS WITHIN THE OPEN SPACE BUFFER ON THE EASTERN BOUNDARY WILL REMAIN LARGELY UNDISTURBED.

SKP224 CONDITION OF APPROVAL:

- APPLICANT HAS PROVIDED AN UPDATED TRAFFIC IMPACT STUDY WHICH LIMITS THE MAXIMUM DWELLING UNITS TO 4,800 WITH THE APPROVED 2022 SKETCH PLAN AMENDMENT (SKP224).

Overall Development Dwelling Unit Table

RULING	Plat File No.	Lot No.
Sterling Ranch Filing 2	SF2015	49
Sterling Ranch Filing 3	SF2132	63
Sterling Ranch Filing 3A	SF2413	3
Sterling Ranch Filing 4	SF2230	148
Copper Chase	SF2141	72
Branding Iron Filing 1	SF1724	138
Branding Iron Filing 2	SF1918	51
Homestead Filing 1	SF1725	72
Homestead Filing 2	SF194	104
Homestead North Filing 1	SF2213	73
Homestead North Filing 2	SF2218	74
Homestead North Filing 3	SF2229	77
Sterling Ranch East Filing 1	SF2235	294
Sterling Ranch East Filing 2	SF2237	42
FourSquare at Sterling Ranch	SF2236	158
TOTAL ENTITLED UNITS		1483
REMAINING DEVELOPABLE UNITS		3307
MAXIMUM ALLOWED DWELLING UNITS		4800

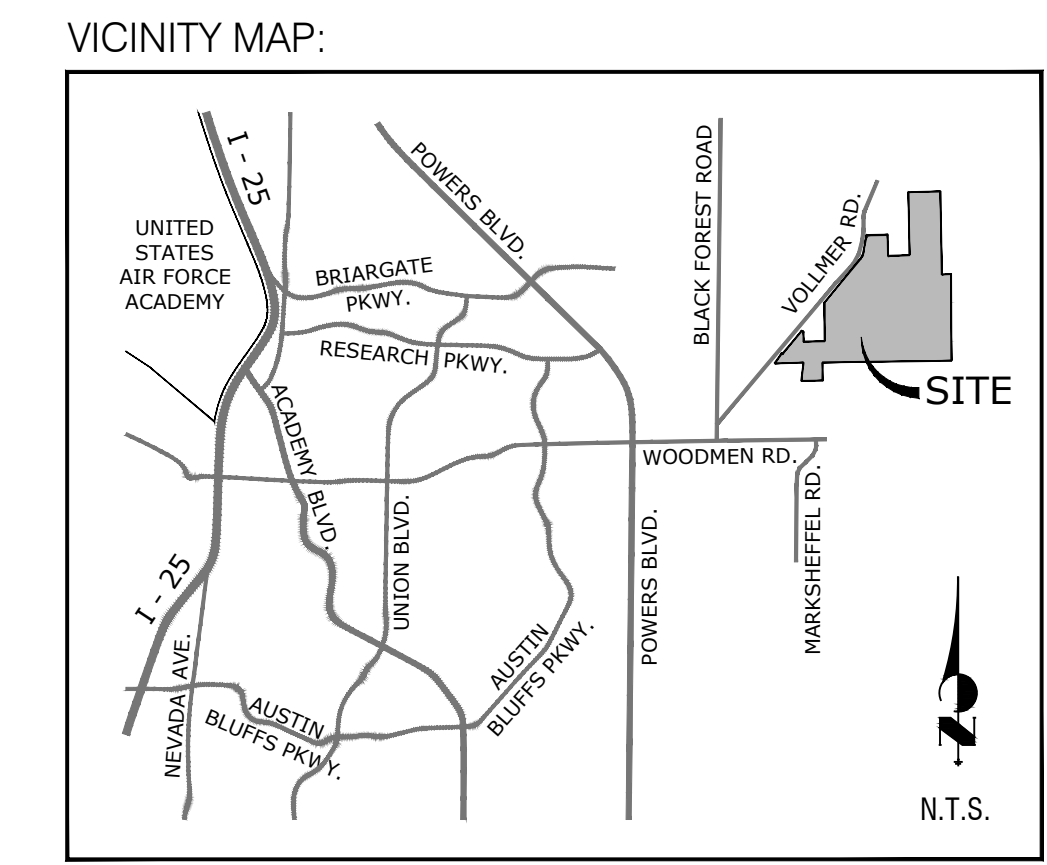

ROAD CLASSIFICATION TABLE

Roadway	Existing	2040 MTCP	2060 MTCP/CCP	Sterling Ranch Proposed
Voller Road	2 lane Collector - 60'	4 lane Minor - 100'	4 lane Minor - 100'	4 lane Minor - 100'
Briargate Parkway	4 lane Principal - 130'	4 lane Principal - 130'	4 lane Principal - 130'	4 lane Principal - 130'
Banning Lewis Ranch Parkway	4 lane Principal - 130'	4 lane Principal - 130'	4 lane Principal - 130'	4 lane Principal - TBD
Marksheffel Road	2 lane Principal - 130'	4 lane Principal - 130'	4 lane Principal - 130'	TBD *

*A deviation is approved for Marksheffel Road to be built to the City of Colorado Springs standards.

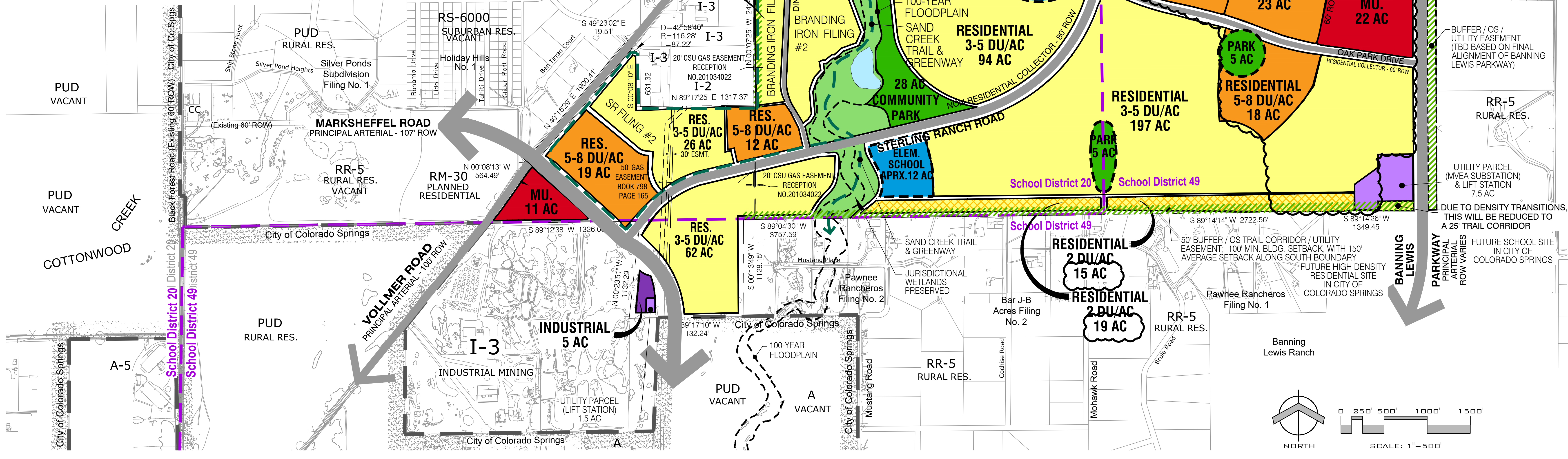

Land Planning
Landscape
Architecture
Urban Design

NES

N.E.S. Inc.
619 N. Cascade Avenue, Suite 200
Colorado Springs, CO 80903

Tel. 719.471.0073
Fax 719.471.0267

www.nescolorado.com

© 2012. All Rights Reserved.

STERLING RANCH SKETCH PLAN AMENDMENT #4

CLASSIC SRJ LAND, LLC.

DATE: 08/29/2024
PROJECT MGR: A. BARLOW
PREPARED BY: C. HEHLINGER

AMENDMENT #4

DATE	BY	DESCRIPTION