



ENTECH
ENGINEERING, INC.

505 ELKTON DRIVE
COLORADO SPRINGS, CO 80907
PHONE (719) 531-5599

**GEOLOGIC HAZARD/LAND USE STUDY, AND PSSI – ADDENDUM
ORIGINAL REPORT ENTECH JOB NO. 82556, DATED OCTOBER 31, 2006
STERLING RANCH SKETCH PLAN SUBMITAL
EL PASO COUNTY, COLORADO**

Prepared for:
Classic SRJ
2138 Flying Horse Club Drive
Colorado Springs, CO 80921

Attn: Loren Moreland



ENTECH
ENGINEERING, INC.

505 ELKTON DRIVE
COLORADO SPRINGS, CO 80907
PHONE (719) 531-5599

August 30, 2024
Revised September 12, 2024

Classic SRJ
2138 Flying Horse Club Drive
Colorado Springs, CO 80921

Attn: Loren Moreland

Re: Geologic Hazard/Land Use Study, and PSSI – Addendum
Original Report Entech Job No. 82556, dated October 31, 2006
Sterling Ranch – Sketch Plan Amendment #4
El Paso County, Colorado
Entech Job No. 220571

Dear Mr. Moreland:

A Geologic Hazard/Land Use Study and Preliminary Subsurface Soil Investigation was previously prepared by Entech Engineering, Inc., October 31, 2006, for the above referenced site (Reference 1, Appendix A). This addendum addresses updates made to the sketch plan. The area of the amendment is 212 acres and is located in the southeast portion of Sterling Ranch. The revised Sketch Plan area is shown on Figure 1.

The site was revisited by personnel of Entech Engineering, Inc., August 29, 2024. Current site conditions in the area of the site are generally consistent with what is described in the original Geologic Hazard Study by Entech (Reference 1, Appendix A). The grading and topography in the area of the proposed amendment appears to be relatively unchanged, except for minor areas that have been used as borrow fill placed in the developed portions of Sterling Ranch.

The *Geologic Map of the Falcon Northwest Quadrangle* distributed by the Colorado Geological Survey in 2003, is presented in Figure 2 (Reference 2). Site-specific geologic mapping was performed as a part of the Geologic Hazard Study by Entech (Reference 1) and is shown on the latest Sketch Plan Figure 3. The site is mapped as Qaf: Artificial Fill of Quaternary Age, Qal: Recent Alluvium of Quaternary Age, Qp: Piney Creek Alluvium of Quaternary Age, Qes: Eolian Sand of Quaternary Age, Qb: Broadway Alluvium of Pleistocene Age, Qlo: Louviers Alluvium of Quaternary Age, and the Dawson Formation of Tertiary to Cretaceous Age. The bedrock underlying the site is the Dawson Formation of Tertiary to Cretaceous Age (References 1 through 3). The updated Geology/Engineering Geology Map is presented in Figure 3.

The geologic constraints and hazards identified on this site include artificial fill (constraint), hydrocompaction (constraint), collapsible or loose soils (constraint), unstable slopes (hazard), potentially unstable slopes (constraint), expansive soils (constraint), floodplains (constraint), shallow bedrock (constraint), seasonally shallow groundwater areas (constraint), potentially seasonal shallow groundwater areas (constraint), and areas of ponded water (constraint). These constraints/hazards and recommended mitigation have been addressed in the Geologic Hazard Investigation, Appendix B. These constraints/hazards can be either avoided or mitigated through grading and proper design and construction practices.

The proposed building areas of the site are not mapped in any floodplain zones according to the FEMA Map Nos. 08041CO533G and 08041CO535G, December 7, 2018 (Reference 4, Figure 4). Sand Creek located through the central portion of Sterling Ranch has been mapped



in a floodplain zone that will be avoided by building sites. Lots adjacent to the floodplain, minor drainages or other low-lying areas may require drains to mitigate the potential for shallow groundwater during periods of high runoff. Finished floor must be a minimum of one foot above floodplain levels. Exact floodplain locations and drainage studies are beyond the scope of this report. Specific recommendations have been made in the Soil, Geology and Geologic Hazard Investigation (Reference 1, Appendix A). Additional investigation will be needed once development plans are prepared for the future filings.

It is our opinion the conclusions and recommendations in the Soil, Geology, Geologic Hazard and Preliminary Subsurface Soil Investigation remain valid and the report may be used for the proposed rezone.

We trust this has provided you with the information you required. If you have any questions or need additional information, please do not hesitate to contact us.

Respectfully Submitted,
ENTECH ENGINEERING, INC.

A handwritten signature in blue ink, appearing to read "Logan L. Langford".

Logan L. Langford, P.G.
Sr. Geologist

Reviewed by:



Joseph C. Goode, Jr., P.E.
President

Encl.

LLL/jcg

F:\AA Projects\2022\220571-Classic-Sterling Ranch E P.Plan No. 1-310-Soils Geology\SR Overall Site Update Letter\220571 SR Geohaz Addendum.docx



References

1. Entech Engineering, Inc. October 31, 2006. *Geologic Hazard/Land Use Study and Preliminary Subsurface Soil Investigation, Sterling Ranch, El Paso County, Colorado*. Entech Job No. 82556.
2. Madole, Richard F. 2003. *Geologic Map of the Falcon Northwest Quadrangle, El Paso County, Colorado*. Colorado Geological Survey. Open-File Report 03-8.
3. Trimble, Donald E. and Machette. Michael N., 1979. *Geologic Map of the Colorado Springs-Castle Rock Area, Front Range Urban Corridor, Colorado*. U.S. Geological Survey. Map I-847-F.
4. Federal Emergency Management Agency, December 7, 2018. *Flood Insurance Rate Maps for the City of Colorado Springs, Colorado*. Map Number 08041CO533G and 08041CO535G.

FIGURES

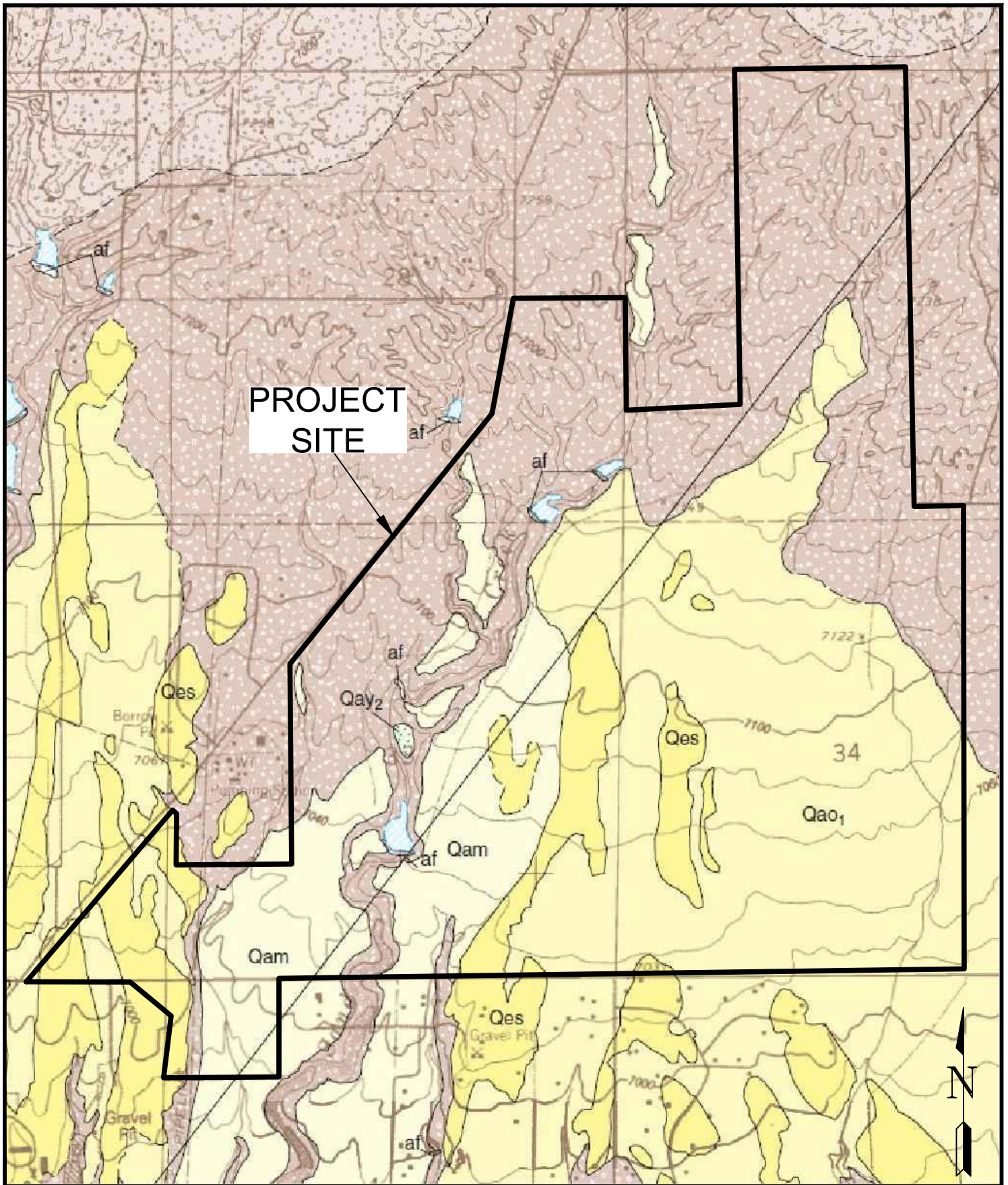

**PROJECT
SITE**



**GEOLOGIC MAP OF THE FALCON
NORTHWEST QUADRANGLE**
STERLING RANCH
CLASSIC SRJ

JOB NO.
220571

FIG. 2

LEGEND

- Qaf - Artificial Fill of Quaternary Age:
Man-made fill deposits.
- Qal - Recent Alluvium of Quaternary Age:
Recent stream deposits.
- Qp - Piney Creek Alluvium of Quaternary Age:
Stream deposited silty to clayey sands.
- Qes - Eolian Sands of Quaternary Age:
Wind blown sand deposits.
- Qb - Broadway Alluvium of Quaternary Age:
Terrace deposits of silty sands.
- Qlo - Louviers Alluvium of Quaternary Age:
Terrace deposits of silty to clayey sands.
- Tkd - Dawson Formation of Tertiary to Cretaceous Age:
Sandstone and Claystone.
- h - hydrocompaction
- pu - Potentially unstable slope
- us - unstable slope
- fp - floodplain
- psw - potentially seasonal shallow groundwater area
- sw - seasonal shallow groundwater area
- w - areas of ponded water
- B-2 - approximate test boring location and number
- P2 - approximate location and number of photos.

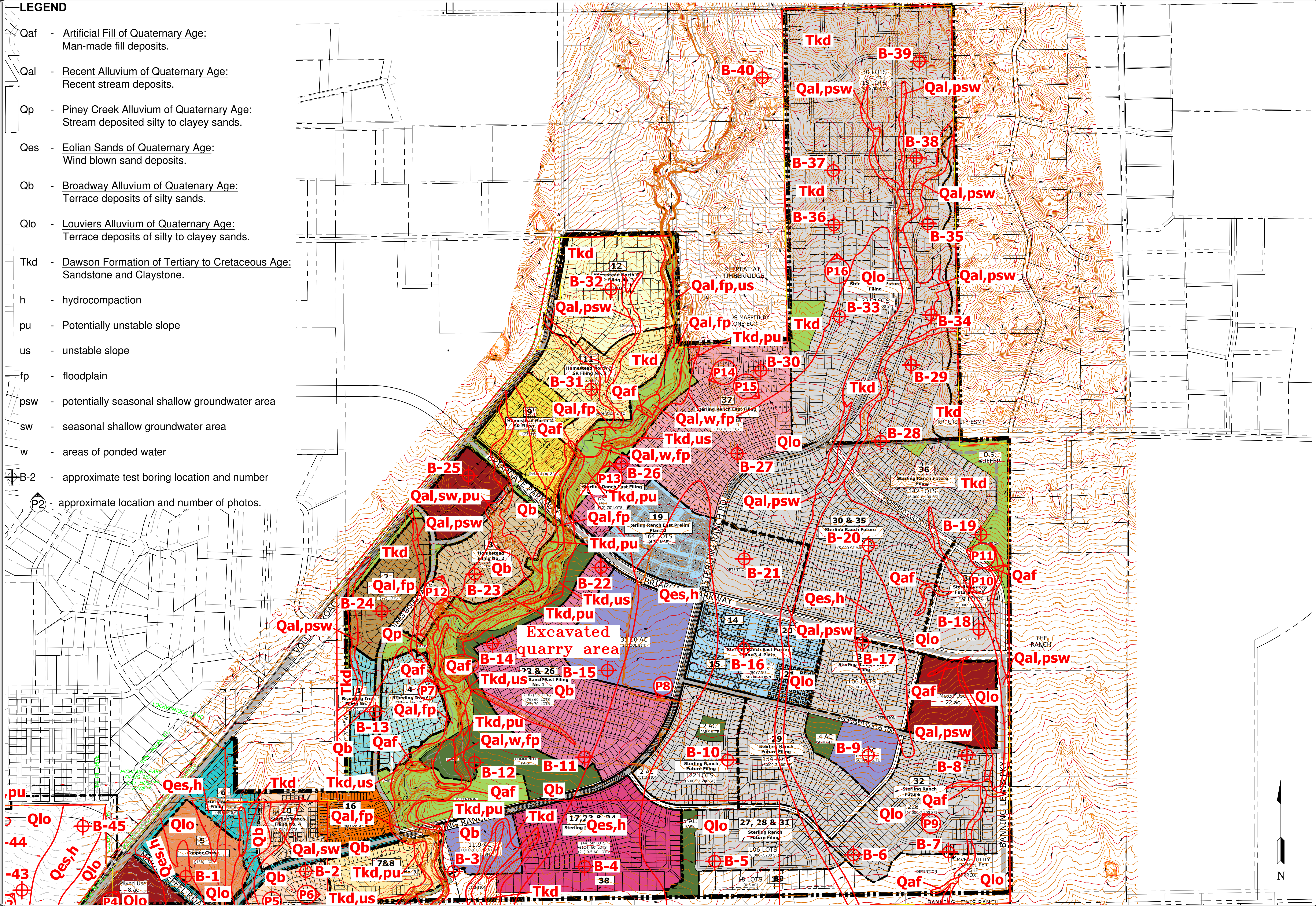

REVISION BY:

ENTTECH
ENGINEERING, INC.
505 ELKTON DRIVE
COLORADO SPRINGS, CO. 80907
(719) 531-5599

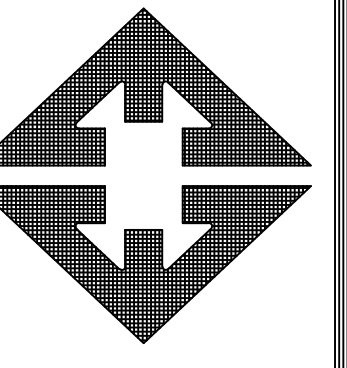

GEOLOGY/ ENGINEERING GEOLOGY MAP
STERLING RANCH - OVERALL SITE MAP
EL PASO COUNTY, CO.
FOR: CLASSIC SRJ

DRAWN BY: LLL
DESIGNED BY:
CHECKED BY:
DATE: 3/24/22
SCALE:
JOB NO.: 220571
FIGURE NO.:
3

STUDY

PROJECT
SITE

EL PASO
COUNTY

08041C0535G
280059
eff. 12/7/2018

08041C0533G
eff. 12/7/2018



FEMA FLOODPLAIN MAP

STERLING RANCH
CLASSIC SRJ

JOB NO.
220571

FIG. 4



**APPENDIX A: Entech Engineering, Inc., Geologic
Hazard/Land Use Study, and Preliminary Subsurface Soil
Investigation, Entech Job No. 82556**



ENTECH
ENGINEERING, INC.

505 ELKTON DRIVE
COLORADO SPRINGS, CO 80907
PHONE (719) 531-5599
FAX (719) 531-5238

**GEOLOGIC HAZARD / LAND USE STUDY
AND PRELIMINARY
SUBSURFACE SOIL INVESTIGATION
STERLING RANCH
EL PASO COUNTY, COLORADO**

Prepared for

Morley-Bentley Investments, LLC
15 N. Nevada Avenue
Colorado Springs, Colorado 80903

Attn: Virgil Sanchez

October 31, 2006

Respectfully Submitted,

ENTECH ENGINEERING, INC.

Kristen A. Andrew-Hoeser, P.G.
Engineering Geologist

Matthew W. Muzzy, P. E.
#24263

KAH/MWM/mf

Encl.
Entech Job No. 82556
2MSW/rep/2006/82556ghs/lus/pssi

Reviewed by:

Joseph C. Goode, Jr., P.E.
President



TABLE OF CONTENTS

1.0 SUMMARY	1
2.0 GENERAL SITE CONDITIONS AND PROJECT DESCRIPTION	2
3.0 SCOPE OF THE REPORT	3
4.0 FIELD INVESTIGATION	3
5.0 SOIL, GEOLOGY AND ENGINEERING GEOLOGY	4
5.1 General Geology	4
5.2 Soil Conservation Service	4
5.3 Robinson Study	6
5.4 Site Stratigraphy	7
5.5 Soil Conditions	9
5.6 Groundwater	11
6.0 ENGINEERING GEOLOGY - IDENTIFICATION AND MITIGATION OF GEOLOGIC HAZARDS	11
7.0 EROSION CONTROL	18
8.0 ECONOMIC MINERAL RESOURCES	19
9.0 RELEVANCE OF GEOLOGIC AND SITE CONDITIONS TO LAND USE PLANNING	19
10.0 CLOSURE	25
BIBLIOGRAPHY	27

TABLES

Table 1: Summary of Laboratory Test Results

Table 2: Summary of Geologic Units

Table 3: Summary of Depth to Groundwater and Bedrock

FIGURES

Figure 1: Vicinity Map

Figure 1: Vicinity Map

Figure 2: USGS Map

Figure 3: Test Boring Location Plan

Figure 4: SCS Map

Figures 5 through 9: SCS Soil Description

Figure 10: Robinson Study Geology Map

Figure 11: Robinson Study Engineering Geology Map

Figure 12: USGS Colorado Springs Geology Map

Figure 13: CGS Falcon NW Quadrangle Geology Map

Figure 14: Geology Map/ Engineering Geology Map

Figure 15: Floodplain Map

Figure 16: Typical Perimeter Drain Detail

Figure 17: Underslab Drainage Layer

Figure 18: Interceptor Drain Detail

Figure 19: Shallow Bedrock Map

Figure 20: Shallow Groundwater Areas Map

APPENDIX A: Site Photographs

APPENDIX B: Test Boring Logs

APPENDIX C: Laboratory Test Results

1.0 SUMMARY

Project Location:

The project lies in portions of Sections 27, 28, 32, 33 and 34, Township 12 South, Range 65 West and a portion of the NW ¼ of Section 4, Township 13 South, Range 65 West of the 6th Principal Meridian. The site majority of the site is located east of Vollmer Road and north of Woodmen Road in El Paso County, Colorado. A portion of the property lies between Black Forest Road and Vollmer Road.

Project Description:

Total acreage involved in the project is approximately 1400 acres. Grading and development plans were not available at the time of this report.

Scope of Report:

The report presents the results of our geologic investigation and treatment of engineering geologic hazard study. This report presents the results of our geologic reconnaissance, a review of available maps, aerial photographs and our conclusions with respect to the impacts of the geologic conditions on development. Preliminary foundation recommendations are also included.

Land Use and Engineering Geology:

Specific grading or development plans are not available at this time; however, the site was found to be suitable for development. Geologic conditions will impose some constraints on development. These include areas of artificial fill, hydrocompaction and loose or potentially collapsible soils, unstable slopes, potentially unstable slopes, expansive soils, floodplain, areas of ponded water, seasonally shallow groundwater areas and potentially seasonally shallow groundwater areas. Shallow bedrock will also be encountered on much of the site. Site conditions will be discussed in greater detail in this report. All recommendations are subject to the limitations discussed in the report.

2.0 GENERAL SITE CONDITIONS AND PROJECT DESCRIPTION

The site is located in portions of Sections 27, 28, 32, 33 and 34, Township 12 South, Range 65 West and a portion of the NW¼ of Section 4, Township 13 South, Range 65 West of the 6th Principal Meridian, in El Paso County, Colorado. The majority of the site is located east of Vollmer Road approximately one mile north of Woodmen Road. Approximately 40 acres is located between Black Forest Road and Vollmer Road. The location of the site is shown on the Vicinity Map, Figure 1.

The topography of the site is generally gently to moderately sloping to the south with some steep slopes along drainages in the extreme southwestern and central portions of the site. Sand Creek flows in a southerly direction through the central portion of the site and Cottonwood Creek flows in a southwesterly direction in the extreme southwestern portion of the site. No water was observed flowing in these creeks at the time of this investigation; however, areas of standing water were observed in portions of the drainages. Other minor drainages exist on the site. No water was observed flowing in any of the minor drainages at the time of this investigation. The area of the site is indicated on the USGS Map, Figure 2. Previous site uses have included sand and gravel quarrying, and grazing and pasture lands. Existing sand and gravel quarries are located in the extreme southwestern corner of the site and in the central portions of the site. The quarry in the central portion of the site was active at the time of this investigation. The site contains primarily low field grasses, weeds and with scattered deciduous trees and shrubs in the drainage areas. Site photographs, taken on September 6, 2006, are included in Appendix A. The approximate locations and directions of the photographs are indicated on the Geology Map, Figure 14.

Total acreage involved in the proposed development is approximately 1400 acres. Development and grading plans were not available at the time of this report.

3.0 SCOPE OF THE REPORT

The scope of this report will include the following:

- A geologic analysis of the site utilizing published geologic data, and subsurface soils information.
- Detailed site-specific mapping of major geographic and geologic features.
- Identification of geologic hazards and impacts on the proposed development.
- Recommended mitigation of geologic hazards where they affect development.
- Preliminary recommendations pertaining to foundations, floor slabs and concrete, and land use.

4.0 FIELD INVESTIGATION

Our field investigation consisted of the preparation of a geologic map of bedrock features and significant surficial deposits. The Soil Conservation Service (SCS) survey was reviewed to evaluate the site (Reference 1). Additionally A Geologic and Engineering Geologic Study prepared by Charles J. Robinson and Associates in 1977 for El Paso County Planning Department was reviewed to evaluate the site (Reference 2 through 4).

The positions of mappable units within the subject property are shown on the Geologic Map. Our mapping procedures involved field reconnaissance, measurements and interpretation. The same mapping procedures have also been utilized to produce the Engineering Geology Map which identifies pertinent geologic conditions affecting development.

Additionally, 45 test borings were drilled by Entech Engineering, Inc. as a part of the preliminary subsurface soil investigation for the site. The borings were drilled with a power driven continuous flight auger drill rig to 15 and 20 feet. Samples were obtained during drilling using the Standard Penetration Test, ASTM D-1586, utilizing a 2-inch O.D. Split Barrel Sampler and a California Sampler. Results of the penetration tests are shown on the drilling logs to the right of

the sampling point. The location of the test borings is shown on the Test Boring Location Plan, Figure 3 and on the Geology Map, Figure 14. The drilling logs are included in Appendix B.

Laboratory testing was performed to classify and determine the soils engineering characteristic. Laboratory tests included moisture content, ASTM D-2216, grain size analysis, ASTM D-422, and Atterberg Limits, ASTM D-4318. Swell tests included both FHA Swell Testing and Swell/Consolidation Testing. Results of the laboratory testing are included in Appendix C. A Summary of Laboratory Test Results is presented in Table 1.

Geologic Hazard Studies were performed by Entech Engineering, Inc. for Wolf Ranch which lies west of the site (References 5 and 6). Geologic Hazard Studies were also performed by Entech Engineering, Inc. for Highland Park which lies north and northwest of the site (References 7 and 8). Information from these reports was used in evaluating the site.

5.0 SOIL, GEOLOGY AND ENGINEERING GEOLOGY

5.1 General Geology

Physiographically, the site lies in the western portion of the Great Plains Physiographic Province. Approximately 10 miles to the west is a major structural feature known as Rampart Range Fault. This fault marks the boundary between the Great Plains Physiographic Province and the Southern Rocky Mountain Province. The site exists within the southern edge of a large structural feature known as the Denver Basin. Bedrock in the area tends to be gently dipping in a northeasterly direction (Reference 9). The rocks in the area of the site are sedimentary in nature, and typically Tertiary to Cretaceous in age. The bedrock underlying the site itself is the Dawson Formation. Overlying the Dawson Formation are unconsolidated deposits of artificial, residual, alluvial, and eolian soils. The site's stratigraphy will be discussed in more detail in Section 5.4.

5.2 Soil Conservation Service

The Soil Conservation Service (Reference 1) has mapped five soil types on the site (Figure 4). In general, the soils range from sandy and gravelly loam to loamy sand. Soils are described as follows:

<u>Soil Type</u>	<u>Description</u>
8	<u>Blakeland loamy sand, 1-9% slopes:</u> Dark grayish brown loamy sand and grading to pale brown sand. Permeability is rapid. Erosion is moderate with soil blowing hazard severe. Good potential for urban development.
9	<u>Blakeland Complex, 1-9% slopes:</u> Dark grayish brown loamy sand underlain by brown to pale brown loamy sand. This complex includes 60% Blakeland Soils, 30% Fluvaquentic Haplaquolls and 10% other soils. Permeability is rapid. Erosion hazard is moderate. Blakeland Soil has good potential for home sites. Limitation to development on Fluvaquentic Haplaquolls includes the hazard of flooding.
19	<u>Columbine gravelly sandy loam 0-3% slopes:</u> Grayish brown gravelly, sandy loam with a gravelly loamy sand subsoil. Permeability is very rapid. Erosion hazard is slight to moderate. Limitations to development include hazard of flooding in some areas.
71	<u>Pring coarse sandy loam, 3-8% slopes:</u> Dark grayish brown to brown coarse sandy loam. Permeability is rapid. Erosion hazard is moderate. Good potential for home sites.
85	<u>Stapleton – Bernal sandy loams:</u> Grayish brown sandy loam with sandy clay loam subsoil. Permeability is moderate to rapid. Erosion hazard is moderate. Limitations to development include frost action potential, slope, and depth to bedrock

Complete descriptions of the soils are presented in Figures 5 through 9. The soils have generally been described to have moderate to very rapid permeabilities. Limitations to development are varied on the different soil types and include frost action potential, depth to bedrock, slope, and the hazard of flooding. Possible hazards with soil erosion are present on the site. The erosion potential can be controlled with vegetation. The soils have been described to have slight to moderate erosion hazards, depending on soil type.

5.3 Robinson Study

A study performed by Charles S. Robinson and Associates, Inc. in 1977 for El Paso County Planning Department was reviewed for soils and engineering factors for land use (References 2 through 4). The Robinson Study Geology Map showing the site is presented in Figure 10. Geologic Units described on this site include al: Alluvium, Qp: Piney Creek Alluvium, Qes: Eolian Sand, and Tkd: Colluvium Dawson Formation. The Piney Creek Alluvium on this site has been redesignated by the Colorado Geological Survey (Reference 10) since the Robinson Mapping. It is currently considered areas of Piney Creek Alluvium with Broadway Alluvium and Louviers Alluvium. A Summary of Geologic Units and Engineering Factors for Land use from the Robinson Study is presented in Table 2. The Broadway Alluvium (Qb) and Louviers Alluvium (Qlo) have been included in the table and the discussion.

The recent Alluvium (al) is mapped within the major drainage on-site such as Cottonwood Creek and Sand Creek. These materials are described as poor for foundation stability and are subject to periodic flooding and erosion. Excavation and compaction are described as easy except where boulders occur.

The Piney Creek Alluvium (Qp) has been mapped on much of the site. These materials are described as good to poor for foundation stability. Expansive clays or high groundwater may be encountered in some areas. Potential geologic hazards also include steep slopes along stream channels that may be unstable. Excavation and compaction is described as easy. The Piney Creek Alluvium is a source of sand and gravel.

The Broadway Alluvium (Qb) is described as good for foundation stability. Steep slopes at the edges of terraces may occur that are unstable. Excavation and compaction are described as easy. The addition of fines may be needed to achieve proper compaction. The Broadway Alluvium is considered a source of sand and gravel.

The Louviers Alluvium (Qlo) is described as generally excellent for foundation stability. Expansive clays may occur locally. Excavation is described as easy and compaction as moderately easy. The Louviers Alluvium is considered a source of sand and gravel.

The Eolian Sand deposits (Qes) have been mapped on portions of the site. These are wind-deposited materials. They are described as fair to good for foundation stability. They are subject to wind erosion and hydrocompaction. Excavation is described as easy. Vibrating equipment may be necessary to achieve proper compaction. The Eolian Sand deposits are a source of commercial sand.

The Colluvium Dawson Formation (Tkd) is mapped in the northern portions of the site. These materials are described as fair to excellent for foundation stability. Expansive clays and claystone may be encountered and steep slopes may occur that may be unstable. Excavation and compaction are described as moderately difficult to difficult.

The Engineering Geology Maps from the Robinson Study were also reviewed. The Robinson Study Engineering Geology Map showing the site is presented in Figure 11. The majority of the site is mapped as 2A: Stable alluvium, colluvium and bedrock on gentle to moderate slopes (5% to 12%). Northeastern portions of the site are mapped as 3B: Expansive and potentially expansive soil and bedrock on flat to moderate slopes (0% to 12%). The western portions of the site are mapped as 1A: Stable alluvium and colluvium on flat to gentle slopes (0% to 5%). Scattered areas of 2D occur: Eolian deposits generally on flat to gentle slopes of upland areas. The northwestern portions of the site are mapped as 2E: Low terraces and valleys of minor tributary streams. Some of the drainages are mapped as 7A: Physiographic floodplain where erosion and deposition presently occur and is subject to recurrent flooding.

5.4 Site Stratigraphy

The Colorado Springs Geologic Map showing the site is presented in Figure 12 (Reference 11). The CGS Falcon NW Quadrangle Geologic Map showing the site is presented in Figure 12 (Referenced 10). The Geology Map prepared for the site is presented in Figure 13. Seven mappable units were identified on this site, which are identified as follows:

- **Qaf** **Artificial Fill of Quaternary Age:** These are man-made fill deposits. Some of the fill is associated with earthen dam embankments on-site. Other areas are associated with the quarrying and stockpiling that has occurred on-site.

- **Qal** **Recent Alluvium of Quaternary Age:** These are recent stream deposits that have been deposited along the valley floors and in the drainages that exist on-site, and in the main channels of Cottonwood Creek and Sand Creek. These materials consist of silty to clayey sands and sandy clays. Some of these alluviums may contain highly organic soils.

- **Qp** **Piney Creek Alluvium of Quaternary Age:** This is a stream deposited material typically occurring as terrace deposits along the main drainage of Cottonwood Creek and Sand Creek. The Piney Creek typically consists of dark brown silty to clayey sands and sandy clays.

- **Qes** **Eolian Sand of Quaternary Age:** These are deposits are fine to medium grained soil deposited by the action of the prevailing winds from the northwest. They typically occur as large dune deposits or narrow ridges. These soil types are typically tan to brown in color and tend to have a very uniform or well-sorted gradation. These materials tend to have a relatively high permeability and low density.

- **Qb** **Broadway Alluvium of Pleistocene Age:** These materials consist of stream terrace deposits. The Broadway Alluvium typically consists of silty to clayey gravelly sands. This deposit is usually highly stratified and may contain lenses of silt, clay or cobbles.

- **Qlo** **Louviers Alluvium of Quaternary Age:** These are alluvial terrace deposits which occur as yellowish brown silty to clayey sands with sandy clay lenses. Generally this deposit is well stratified and may contain lenses of clay, silt and gravel.

- **Tkd** **Dawson Formation of Tertiary to Cretaceous Age:** The Dawson formation typically consists of arkosic sandstone with interbedded fine-grained sandstone,

siltstone and claystone. Overlying this formation is a variable layer of residual and/or colluvium soils. The residual soils were derived from the in-situ weathering of the bedrock materials on-site. The colluvium soils have been transported by the action of sheetwash and gravity. This soil layer varied from 1 to 11 feet in the test borings. These soils consisted of silty to clayey sands and sandy clays.

The soils listed above were mapped from site specific mapping of the site, *the Reconnaissance Geologic Map of Colorado Springs and Vicinity, Colorado* by Scott and Wobus in 1973 (Figure 12), and the *Geologic Map of the Falcon NW Quadrangle* by Madole, 2003 (Figure 13, Reference 10). The Robinson Study prepared for El Paso County Planning Department in 1977 (Figure 10, Reference 2) and *The Geologic Map of the Colorado Springs-Castle Rock Area Front Range Urban Corridor, Colorado*, by Trimble and Machette, 1979 (Reference 12) were also used in mapping this site. The test borings from the subsurface investigation by Entech Engineering, Inc. were used in evaluating the site and are included in Appendix B of this report. A Summary of the Geologic Units mapped on this site by the Robinson Study is included in Table 2 (Reference 4).

5.5 Soil Conditions

Two soil and two rock types were encountered in the 45 borings drilled for the preliminary subsurface soil investigation: slightly silty to very clayey sand (Type 1); sandy to very sandy clay (Type 2); silty to clayey sandstone bedrock (Type 3); and sandy claystone bedrock (Type 4). Each material type was classified using the results of the laboratory testing and the Unified Soil Classification System (USCS). The bedrock encountered in the borings was classified as soil in that the upper bedrock zone could be penetrated using conventional soil drilling and sampling techniques.

Soil Type 1 was classified as slightly silty to very clayey sand (SM, SW-SM, SC-SM, SM-SP). The Type I sand was encountered at the ground surface in every boring except B-34, where no Type I sand was encountered. The thickness of the Type I sand ranged from not present to more than 20 feet depending on bore hole location. SPT N-values in the Type I sand ranged from 3 to 46 blows per foot (bpf) indicating the Type 1 sand to be very loose to dense in terms of in-place compactness. The median SPT N-value measured in the Type I sand was 19 bpf,

suggesting an overall medium dense condition. Water content and grain size testing of Type I sand samples resulted in water contents ranging from approximately 1 to 14 percent with approximately 6 to 44 percent of the particle sizes being smaller than the No. 200 sieve. One FHA swell test completed on a very clayey sample of the Type I sand resulted in a low expansion potential.

Soil Type 2 was classified as sandy to very sandy clay (CL). The Type 2 sandy clay was encountered in 11 of the 45 borings and was typically observed beneath or interbedded with the Type 1 sand. Thickness of the sandy clay ranged from not present to approximately 8 feet, depending on bore hole location. SPT N-values in the sandy clay ranged from 13 to 29 bpf with a median SPT N-value of 20 bpf indicating the Type 2 sandy clay to be generally stiff in terms of in-place consistency. Water content and grain size testing of the sandy clay showed it to have water contents ranging from approximately 5 to 19 percent with approximately 51 to 64 percent of the particle sizes smaller than No. 200 sieve. Atterberg Limits testing of 3 samples of sandy clay resulted in liquid limits ranging from 27 to 40 percent and plastic indices ranging from 13 to 25 percent. Swell/Consolidation and FHA Swell testing of the Type 2 sandy clay showed swell strains as high as 1.8 percent and swell pressures ranging from 455 to 4179 psf which suggests the sandy clay exhibits low to very high expansion potential.

Sulfate solubility testing was performed on one sample of the sandy clay, with a result of 0.10 percent soluble sulfate by dry weight. The soluble sulfate concentration suggests negligible to moderate sulfate degradation potential to exposed concrete.

Soil Type 3 was classified as silty sandstone bedrock (SM, SM-SW, SC). The sandstone was encountered in 42 of the 45 borings at depths ranging from approximately 1 to more than 19 feet bgs. The sandstone surface typically exhibited SPT N-values greater than 50 bpf indicating very dense in-place compactness. FHA Swell Testing of the sandstone resulted in swelling pressures ranging from 360 to 1014 psf. Swell/Consolidation testing of the silty sandstone resulted in swelling strains as high as 1.0 percent. The swell testing indicates a typically low expansion potential for the sandstone.

Soil Type 4 was classified as sandy claystone bedrock (CL). The claystone was encountered in 16 of the 45 borings. SPT N-values measured in the claystone typically indicated hard consistencies. Swell/Consolidation testing of the claystone resulted in a swelling strains ranging

from 0.3 to 2.7 percent and swelling pressures ranging from 846 to 1845 psf, which are indicative of a low to moderately high expansion potential.

A summary of the laboratory testing results for each of the soil and rock types is presented in Table 1 and a presentation of the overall laboratory results is included in Appendix C. A summary of the depth to bedrock and depth to groundwater encountered in the borings is included in Table 3.

5.6 Groundwater

Groundwater was encountered in 18 of the 45 borings at depths ranging from 3.5 feet to 19 feet below the ground surface. Groundwater was not encountered within 15 to 20 feet of the ground surface in any of the other test borings during or subsequent to drilling. The depth to ground water measured in the borings is presented in Table 3. Fluctuations in the groundwater conditions may occur due to conditions such as variations in rainfall, precipitation infiltration and development of nearby areas. Areas of floodplains and areas of seasonal and/or potentially seasonal shallow groundwater have been identified on the site. Figure 20 shows the areas where shallow groundwater (i.e. less than approximately 10 feet below ground surface) is expected.

6.0 ENGINEERING GEOLOGY - IDENTIFICATION AND MITIGATION OF GEOLOGIC HAZARDS

As mentioned previously, detailed mapping has been performed on this site to produce an Engineering Geology Map (Figure 14). This map shows the location of various geologic conditions of which the developers and planners should be cognizant during the planning, design and construction stages of the project. The hazards identified on this site include artificial fill, hydrocompaction, collapsible or loose soils, unstable slopes, potentially unstable slopes, expansive soils, floodplains, seasonally shallow groundwater areas, potentially seasonal shallow groundwater areas and areas of ponded water. The following hazards will need to be addressed during development of the site:

Expansive Soils

Expansive soils were encountered in some of the test borings drilled on-site. The site is classified in areas of low to moderate swell potential according to the *Map of Potentially Swelling Soil and Rock in the Front Range Urban Corridor, Colorado* by Hart, 1974 (Reference 13); however, very highly expansive soils have been encountered in some of the test borings drilled on the site. These areas are sporadic, therefore, none have been indicated on the map. Expansive clays and claystone, if encountered, can cause differential movement in the structure foundation.

Mitigation: Mitigation of expansive soils will require special foundation design. Overexcavation and replacement with non-expansive soils at a minimum 90% of its maximum Modified Proctor Dry Density, ASTM D-1557 is a suitable mitigation which is common in the area. Drilled piers are another option that is used in areas where highly expansive soils are encountered. Typical minimum pier depths are on the order of 20 feet or more and require penetration into the bedrock material a minimum of 4 to 6 feet, depending upon building loads. Another option is post tension slabs. Floor slabs on expansive soils should be expected to experience movement. Overexcavation and replacement has been successful in minimizing slab movements. The use of structural floors can be considered for basement construction on highly expansive clays. Final recommendations should be determined after additional investigation of each subdivision or building site.

Subsidence Area

Based on a review of a Subsidence Investigation Report for the Colorado Springs area by Dames and Moore, 1985 (Reference 14) and the mining report for the Colorado Springs coal field (Reference 15), the site is not undermined. The closest underground mines in the area are 6 miles to the southwest and the site is not mapped within any potential subsidence zones.

Slope Stability and Landslide Hazard

The majority of the slopes on-site are gently to moderately sloping and do not exhibit any past or potential unstable slopes or landslides. The steeply sloping areas along Cottonwood Creek have been identified as unstable slopes. Some of the steeper slopes along Sand

Creek have been identified as unstable and potentially unstable slopes. The mitigation recommendation for these areas is as follows:

Potentially Unstable Slopes

Some of the very steep slopes along the drainages have been identified as potentially unstable. Considerable care must be exercised in these areas not to create a condition which would tend to activate instability.

Mitigation: Building should be avoided in these areas. Proper control of drainage at both the surface and in the subsurface is extremely important. Areas of ponded water at the surface should be avoided above these slopes. Utility trenches, basement excavations and other subsurface features should not be permitted to become water traps which may promote saturation of the subsurface materials. A setback of 60 feet from the crest of these slopes is recommended.

Another option for mitigation is to stabilize the slopes. This may involve regrading the slope to no steeper than 3:1. Another option is the use of engineer-designed retaining walls. Where retaining walls are not used, erosion protection may be necessary to prevent undercutting by the creek during periods of high water.

Unstable Slopes: Some of the slopes along Cottonwood Creek and Sand Creek are mapped as unstable. In these areas, soil materials exist at slope angles too steep to support a load above the slope without failure to the slope. Erosion by the creek is also possible in some areas. Structures should be located a minimum of 60 feet away from the crest of the slopes, unless additional site-specific investigation and slope stability analysis is performed or the slopes are stabilized. Stabilization could involve regrading to a more stable slope angle, or the use of retaining walls, buttresses or tie backs. Should regrading be considered, slopes should be no steeper than 3:1. Erosion protection may also be required in some areas, particularly on the outside curves of the creek where active erosion takes place during periods of runoff.

Debris Fans

Based on-site observations, debris fans were not observed in this area.

Groundwater and Floodplain Areas

Areas within the drainages on-site have been identified as areas of seasonally high groundwater areas, potentially seasonally high groundwater areas and floodplains. Additionally, areas where ponded water accumulates also exist on-site. The Cottonwood Creek and Sand Creek drainages have been mapped as floodplain zones according to the FEMA Map Nos. 08041CO5298F, and 08041CO5358F, Figure 14 (Reference 16). These areas are discussed as follows:

Floodplain: Construction is not anticipated within the main channel of the Cottonwood Creek and Sand Creek floodways. It is anticipated any proposed construction within the floodplain zone would involve drainage improvements and channelization of the floodplain. Development within the floodplain will require approval of the Drainage Plan prior to construction. Building areas within the floodplain will require filling to raise the building area above floodplain and seasonally shallow groundwater levels. Mitigation for Seasonally Shallow Groundwater levels discussed below is recommended for construction in the floodplain zone. Finished floor levels must be one foot above the floodplain level. Exact floodplain locations and drainage studies are beyond the scope of this report.

Potentially Seasonal Shallow Groundwater: In these areas, we would anticipate the potential for periodically high subsurface moisture conditions and possible frost heave potential, depending on the soil conditions. Areas of shallow groundwater may exhibit unstable subgrade conditions in terms of bearing support of construction equipment during overlot grading.

Mitigation: In these locations, foundations subject to severe frost heave potential should penetrate sufficient depth so as to discourage the formation of ice lenses beneath foundations. At this location and elevation, a foundation depth for frost protection of 2.5 feet is recommended. In areas where high subsurface moisture conditions are anticipated periodically, a subsurface perimeter drain will be necessary to help prevent the intrusion of water into areas located below grade. A typical perimeter drain detail is presented in Figure 16. Structures should not block drainages. Swales should be created to intercept surface runoff and carry it safely around and away from structures. It is anticipated that the site grading may mitigate the drainages in some areas. The water table may be of sufficient depth to minimize the effects on buildings in some areas.

Seasonal High Groundwater Area: In these areas, high subsurface moisture conditions, frost heave potential and highly organic soils may exist, particularly on a seasonal basis. Seasonal high groundwater areas may also present an unstable subgrade condition in terms of providing bearing support of construction equipment during overlot grading.

Mitigation: In areas where development is desired, overlot grading may mitigate some areas. All organic material, soft or wet soils should be removed prior to any filling. The same mitigation recommendations for potentially seasonal shallow groundwater areas as discussed previously should be followed in these areas of seasonal shallow groundwater. In some areas, it may be necessary to dewater the excavation. Underslab drains or interceptor drains may be used in addition to perimeter drains to prevent the intrusion of water into areas below grade. Typical Drain Details are presented in Figures 16 through 18. It may be desirable to build up the building areas to raise the foundation further above the groundwater level. Any grading should be done in a manner that directs surface flow around construction to avoid areas of ponded water. Structures should not block drainages, but swales should be created to intercept surface runoff and carry it safely around and away from structures. Additional investigation will be necessary to determine the water depth and its affect on development. Areas other than those mapped could encounter groundwater that may affect shallow foundations on-site.

Areas of ponded water: These are areas where water ponds behind earthen dams on-site. It is anticipated these areas could be avoided by development unless regraded. Should construction be considered in these areas, regrading will be necessary in order to fill the area above the groundwater level. All soft or organic soils should be removed prior to filling. The same mitigation techniques for seasonal shallow groundwater areas are also recommended for these potential pond areas.

Artificial Fill

Areas of artificial fill were observed in areas of the site. Some areas of artificial fill are associated with earthen dams that exist on-site. Other areas are associated with quarrying and stock piling that has occurred on-site.

Mitigation: Where uncontrolled fill is encountered beneath foundations, mitigation will be necessary. Mitigation typically involves removal and recompaction at a minimum of 90% of its maximum Modified Proctor Dry Density, ASTM D-1557.

Hydrocompaction

Areas in which hydrocompaction have been identified are acceptable as building sites. In areas identified for this hazard classification, however, we anticipate a potential for settlement movements upon saturation of these surficial soils. The low density, uniform grain sized, windblown sand deposits are particularly susceptible to this type of phenomenon. Other material types may also be susceptible.

Mitigation: The potential for settlement movement is directly related to saturation of the soils below the foundation areas. Therefore, good surface and subsurface drainage is extremely critical in these areas in order to minimize the potential for saturation of these soils. The ground surface around all permanent structures should be positively sloped away from the structure to all points, and water must not be allowed to stand or pond anywhere on the site. We recommend that the ground surface within 10 feet of the structures be sloped away with a minimum gradient of five percent. If this is not possible on the upslope side of the structures, then a well-defined swale should be created to intercept the surface water and carry it quickly and safely around and away from the structures. Roof drains should be made to discharge well away from the structures and into areas of positive drainage. Where several structures are involved, the overall drainage design should be such that water directed away from one structure is not directed against an adjacent building. Planting and watering in the immediate vicinity of the structures, as well as general lawn irrigation, should be minimized.

Loose or Collapsible Soils

Areas of loose and collapsible soils were encountered in some of the test borings drilled on-site. These areas are sporadic, therefore, none have been indicated on the map. Consolidations ranging from 0.1% to 2.3% were measured on some of the soil samples tested. Areas of loose densities were encountered in the soil profiles of some of the test borings. Areas with low soil density may present unstable conditions in terms of supporting construction equipment during overlot grading.

Mitigation: Should loose or collapsible soils be encountered beneath foundations, removal and recompaction of the upper 2 to 3 feet with thorough moisture conditioning will be necessary. Where fill is required, it will be necessary to remove the loose soils prior to placement of the fill. Specific recommendations should be made after additional investigation of each building site.

Faults

The closest fault is the Rampart Range Fault, located approximately 10 miles to the west. No faults are mapped on the site itself. Previously, Colorado was mapped entirely within Seismic Zone 1, a very low seismic risk. Additionally, the International Residence Code (IRC), 2003, currently places this area in Design Category B, also a low seismic risk. According to a report by the Colorado Geological Survey by Kirkman and Rogers, 1981, (Reference 17) this area should be designed for Zone 2 due to more recent data on the potential for movement in this area, and any resultant earthquakes.

Dipping Bedrock

The bedrock underlying the site is the Dawson Formation of Tertiary to Cretaceous Age. The bedrock in this area is gently dipping a northeasterly direction according to the *Geologic Structure Map of the Pueblo 1x2 Quadrangle, South-Central Colorado* (1978) (Reference 9). The bedrock encountered in the test borings did not exhibit steeply dipping characteristics, therefore mitigation is not necessary.

Radioactivity

Radon levels for the area have been reported by the Colorado Geologic Survey in the Open-File, Report No. 91-4 (Reference 18). Radon levels ranging from 0 to 20 pci/l have been measured in the area. Only two readings have been taken in the area. One reading was between 4 and 10 pci/l and the other was less than 4 pci/l. The minimal information from this report is not sufficient to determine if radon levels are higher for this site. An occurrence of radioactive minerals has been identified 4 miles northwest of the site (Reference 19). This occurrence is associated with a limonite deposit in the Dawson Formation. The radioactivity hazard was researched by CTL/Thompson, Inc. for Wolf Ranch, west of the site (Reference 20). It was determined that the area lies within a zone that may have small deposits of low intensity radioactivity. No known occurrences exist on the site, however, radon gas originating in the bedrock underlying the site could migrate up into the upper soil profile.

Mitigation: The potential exists for radon gas to build up in areas of the site. Build-ups of radon gas can be mitigated by providing increased ventilation of basements and crawlspaces and sealing of joints. Specific requirements for mitigation should be based on-site specific testing after the site is constructed.

7.0 EROSION CONTROL

The soil types observed on the site are mildly to moderately susceptible to wind erosion, and moderately to highly susceptible to water erosion. A minor wind erosion and dust problem may be created for a short time during and immediately after construction. Should the problem be considered severe enough during this time, watering of the cut areas or the use of chemical palliative may be required to control dust. However, once construction has been completed, and vegetation reestablished, the potential for wind erosion should be considerably reduced.

With regard to water erosion, loosely compacted soils will be the most susceptible to water erosion, residually weathered soils and weathered bedrock materials become increasingly less susceptible to water erosion. For the typical soils observed on-site, allowable velocities or unvegetated and unlined earth channels would be on the order of 3 to 4 feet/second, depending upon the sediment load carried by the water. Permissible velocities may be increased through the use of vegetation to something on the order of 4 to 7 feet/second, depending upon the type of vegetation established. Should the anticipated velocities exceed these values, some form of channel lining material may be required to reduce erosion potential. These might consist of some of the synthetic channel lining materials on the market or conventional riprap.

In cases where ditch-lining materials are still insufficient to control erosion, small check dams or sediment traps may be required. The check dams will serve to reduce flow velocities, as well as provide small traps for containing sediment. The determination of the amount, location and placement of ditch linings, check dams and of the special erosion control features should be performed by or in conjunction with the drainage engineer who is more familiar with the flow quantities and velocities.

Cut and fill slope areas will be subjected primarily to sheetwash and rill erosion. Unchecked rill erosion can eventually lead to concentrated flows of water and gully erosion. The best means to combat this type of erosion is, where possible, the adequate re-vegetation of cut and fill slopes. Cut and fill slopes having gradients more than three (3) horizontal to one (1) vertical become increasingly more difficult to re-vegetate successfully. Therefore, recommendations pertaining to the vegetation of the cut and fill slopes may require input from a qualified landscape architect and/or the Soil Conservation Service.

8.0 ECONOMIC MINERAL RESOURCES

Some of the sandy materials on-site could be considered a low grade sand resource. According to the *El Paso County Aggregate Resource Evaluation Map* (Reference 21), portions of the site are mapped as upland and floodplain deposits. According to the *Atlas of Sand, Gravel and Quarry Aggregate Resources, Colorado Front Range Counties* distributed by the Colorado Geological Survey (Reference 22), portions of the site are mapped as A3 – Alluvial fan deposits: sand, A4 – Alluvial fan deposit; probable aggregate resource, U3 – Upland deposits: sand, and V3: valley fill deposits: sand. According to the *Evaluation of Mineral and Mineral Fuel Potential* (Reference 23), tracts in the area of the site have been mapped as “Good” for industrial minerals. Quarries exist on the site and in the area of the site for sand and gravel, particularly in the Eolian Sand and Alluvial deposits. Based on the depth of bedrock encountered in the test borings, it appears the majority of the thicker deposits have been excavated from the site. Thirteen out of 45 test borings have greater than 10 feet of sand or gravel materials overlying the bedrock materials.

According to the *Evaluation of Mineral and Mineral Fuel Potential of El Paso County State Mineral Lands* (Reference 23), the tracts in the area of the site have been mapped as “Poor” for coal resources and “Little or no Potential” metallic mineral resources.

The site has been mapped as “Fair” for oil and gas resources (Reference 23). No oil or gas fields have been discovered in the area of the site. The sedimentary rocks in the area lack the essential elements for oil or gas.

9.0 RELEVANCE OF GEOLOGIC AND SITE CONDITIONS TO LAND USE PLANNING

Site Conditions

The existing geologic and geotechnical conditions at the site will likely impose some constraints on the proposed development and construction. Avoidance or regrading can mitigate many hazards such as unstable slopes; low lying floodplain areas; areas of seasonal shallow

groundwater and potential seasonal shallow groundwater; and areas where ponded water can occur. Other constraints identified on the site such as hydrocompaction; loose or collapsible soils; expansive soils; artificial fill; and potential shallow groundwater can be mitigated through proper engineering design and construction. Geologic conditions and land use considerations for the site are presented in Table 2.

The majority of the soils at typical foundation depths consist of sands, clays, sandstone and claystone. Areas of shallow bedrock will be encountered on the site particularly in locations mapped as Tkd: Dawson Formation. Additionally, surficial deposits in many areas of the site have been removed in quarried areas where shallow bedrock will be encountered. A map of areas where shallow bedrock was encountered in the test borings is presented in Figure 19. Areas of shallow bedrock may be encountered during development other than those mapped. It is anticipated shallow bedrock will be encountered on most of this site. Excavation of the harder sandstone or claystone bedrock may be more difficult in some areas than others. Difficult excavation is anticipated in areas of shallow bedrock, particularly sandstone. Overlot grading and excavation for utility trenches and foundations will be affected by shallow bedrock. The use of track-mounted equipment will likely be required. Blasting may also be necessary where hard, cemented sandstone is encountered.

Expansive soils may be encountered in areas of this site. The expansive soils encountered in the test borings drilled on-site are sporadic, therefore, none have been indicated on the maps. Expansive soils, if encountered, will require special foundation design and/or overexcavation and replacement with non-expansive soil compacted to a minimum of 90 percent of the maximum dry density as determined by the Modified Proctor Test (ASTM D-1557). Other options include drilled piers or post tension slabs.

Areas of seasonal shallow groundwater may be encountered on the site. Seasonal high and potentially high groundwater areas may present localized unstable subgrade conditions with respect to supporting construction equipment during overlot grading. In shallow groundwater areas, drains may be necessary to control seepage within the foundation zone. Additional subsurface investigation is recommended when site grading and development plans are available to determine the depth to groundwater and its affects on construction. Site surface grading can eliminate some of the minor drainages/wet areas. Any soft or organic soils should

be removed prior to any fill or foundation construction. A map of High Groundwater Areas is presented in Figure 20.

The floodplain areas of the Cottonwood Creek and Sand Creek drainages exist on portions of the site. Should development be considered in the floodplain, channelization and drainage improvements would be necessary as well as raising building site grades above the floodplain level. Finished floor elevations must be a minimum of one foot above the floodplain level and drains may be necessary to help prevent the intrusion of water into areas below grade. Soft, potentially unstable soils were encountered in areas of the floodplain and will need mitigation in advance of building construction. Approval of a Drainage Plan will be necessary prior to construction in the floodplain zone. Specific floodplain location and drainage studies are beyond the scope of this report.

Areas of hydrocompaction were identified on the site where there is potential for soil settlement upon saturation. Good surface and subsurface drainage is critical in these areas to avoid accumulation of standing water and saturated conditions. The ground surface should be positively sloped away from structures at all points. Roof drains and gutter down spouts should be made to discharge well away from structures and planting and watering in the immediate vicinity of structures should be minimized.

Soft and/or collapsible soils were encountered in some of the test borings drilled on-site. These soils are sporadic; therefore, none have been indicated on the maps. All soft, collapsible, or wet soils should be mitigated prior to any construction or fill placement. Areas of soft, collapsible unstable or wet soils may present localized difficulties during overlot grading with respect to subgrade support for construction equipment.

Unstable slopes and potentially unstable slopes exist along Cottonwood Creek and Sand Creek. A minimum building setback of 60 feet is recommended from the crest of these slopes unless site-specific investigation or slope stability analysis is performed. Another option is to stabilize the slopes. Unstable and potentially unstable slopes can be typically mitigated by regrading to angles no steeper than 3 horizontal to 1 vertical or by construction of engineer-designed slope retaining walls. Erosion protection may be necessary along these slopes to prevent further erosion.

Areas of erosion (gullies) were observed along some of the tributary drainages on the site. Regrading and establishing vegetation may mitigate the majority of erosion potential after site grading and construction. Where erosion is more severe or continues, the use of check dams or sediment traps in the drainage ways may be necessary. Erosion control has been discussed in Section 7.0 of this report.

Preliminary Foundation Recommendations

Forty-five borings were spaced and drilled over approximately 1400 acres to conduct preliminary characterization of the site. By in large the borings encountered 1 to 20 feet of silty sand and sandy clay overlying sandstone and claystone bedrock. Of the four soil and rock types encountered in the borings, the silty sand and sandstone were the more predominant. Laboratory and field-testing of the silty sand and sandstone indicated low to moderate expansion potential and typically medium dense in-place soil compactness. The expansive potential and density condition of the silty sand suggest that shallow foundations consisting of spread footings can likely be used to satisfactorily support typical 1 and 2-story residential structures. When utilizing shallow foundations, foundation walls and footings should extend a minimum of 30 inches below the finished exterior site grade for frost protection. Reinforcement for foundation walls should be designed such that the walls can span a minimum of 10 feet unsupported distance under the building design load.

The less predominant sandy clay and claystone encountered in the borings typically exhibited low to very high expansion potentials. Shallow foundations (i.e. spread footings) can be also used in these areas provided overexcavation of the expansive materials from beneath the footings and floor slabs is conducted to mitigate the potentially expansive behavior of the soil and bedrock.

Soil and rock excavated from beneath footings and floor slabs should be replaced with non-expansive, mineral soil compacted to at least 90 percent of its maximum dry density as determined by ASTM –D-1557. Based on the conditions encountered in the borings drilled at the site, it is anticipated that overexcavated materials from the site can be reused as foundation fill provided the material is thoroughly moisture conditioned to within 2 percent of its ASTM D-1557 optimum water content prior to compaction.

Additional subsurface investigation is recommended for each building area as development plans for the site are finalized in order to better understand the in-place geotechnical conditions and in particular understand the soil/rock expansion potential for a specific area. Maximum allowable soil bearing capacities for each building area and need for foundation drainage should be determined as part of the additional subsurface investigation.

In the event areas of expansive soil and/or bedrock are encountered on the site which consistently exhibit moderate to very high expansion potentials, foundations consisting of post-tensioned grade supported floor slabs or drilled piers can be considered to mitigate the expansive conditions. Post-tensioned slabs would be designed to undergo total and differential movements as a result of the underlying expansive materials without causing distress to the supported structure. Drilled piers would extend through the site soils and into the site bedrock to a depth expected to be unaffected by expansion. Pier lengths would be predicated on soil depth and the expansion potential of both the soil and bedrock. Pier construction dewatering could be necessary in areas where groundwater is encountered. Temporary casing of pier holes could also be necessary to stabilize the walls of the pier holes during drilling and concrete placement. Additional subsurface investigation would be necessary to determine pier lengths for specific building areas and subgrade moduli would need to be determined for use in the post-tensioned slab design.

Floor Slabs

Floor slabs founded on expansive clays or on loose sands should be expected to experience movement. Removal and replacement of expansive soils with nonexpansive soils and/or removal and recompaction of loose, non-expansive granular soils is recommended to minimize slab movement. Grade supported floor slabs should be separated from structural portions of buildings and be allowed to move freely should movement of the supporting subgrade occur. Interior building partitions should be constructed in a manner such that they do not transmit floor slab movements to the roof or overlying floors. Fill placed below floor slabs should be non-expansive and compacted to a minimum of 90 percent of its maximum dry density as determined by the Modified Proctor Test (ASTM D-1557). In areas where only minimal slab movement can be tolerated, structurally supported floors should be considered.

Surface and Subsurface Drainage

Positive surface drainage must be maintained around all structures to minimize infiltration of surface water. A minimum ground surface slope of 5 percent in the first 10 feet adjacent to foundation walls for landscaped areas and 2 percent for paved areas is recommended. The use of drainage swales or interceptor drains may be necessary to direct runoff from the upslope side of structures. All roof drains and gutter downspouts should be extended to discharge well beyond the foundation backfill zone.

Subsurface perimeter drains positioned at footing grade are recommended for structures with useable space below the finished ground surface. If expansive soils are encountered in the foundation excavation, perimeter drains are recommended around the foundation. Depending on groundwater conditions, underslab or interceptor drains may also be necessary. Drains should consist of a perforated drainpipe, a gravel collection layer and approved filter fabric. All drains should be provided with a free flowing gravity outlet. If such an outlet is not available, a sump and pump water removal system will be necessary. Typical drain details are presented as Figures 16 through 19.

Backfill

Backfill placed around foundations and in utility trenches should be compacted to a minimum of 90 percent of the soil's maximum dry density as determined by the Modified Proctor Test (ASTM D-1557). Backfill material should be placed in horizontal lifts having compacted thicknesses of six inches or less and at water contents conducive to adequate compaction, usually ± 2 percent of the ASTM D-1557 optimum water content. Mechanical methods can be used for placement and compaction of backfill; however, use of heavy equipment near foundation walls should be avoided. No water flooding techniques of any type should be used for compaction of backfill on the site.

Trench backfilling should be performed in accordance with appropriate municipal and county earthwork standards and specifications. All excavating should be performed in accordance with OSHA guidelines.

Structural Fill

Any areas to receive fill should have all topsoil, organic material, or debris removed. Any previously placed uncontrolled fill should be recompacted prior to placing new fill. The fill receiving surface should be scarified and moisture conditioned to within 2 percent of its optimum water content and compacted to a minimum of 90 percent of its ASTM D-1557 maximum dry density prior to placing new fill. New fill should be placed in thin lifts not to exceed 6 inches after compaction while maintaining at least 90 percent of the maximum ASTM D-1557 dry density. Fill material should be free of vegetation or other unsuitable material and should not contain rocks or fragments greater than six (6) inches in size. Topsoil, strippings and/or other organic debris should not be mixed with the structural fill. Fill material should be placed at a water content conducive to compaction, usually ± 2 percent of the ASTM D-1557 optimum water content. Fill slopes should be constructed at angles no steeper than 3 horizontal to 1 vertical and be properly benched into existing soils to allow for complete and thorough compaction. The placement and compaction of fill should be observed and tested by a Soils Engineer during construction. Any import materials should be approved by a Soils Engineer prior to delivery to the site.

10.0 CLOSURE

It is our opinion that the existing geologic engineering and geologic conditions will impose some constraints on development and construction of the site. The geologic hazards identified on the site can either be avoided by development or satisfactorily mitigated through proper engineering design and construction practices. Development and Grading Plans should be reviewed prior to final approval.

It should be pointed out that because of the nature of data obtained by random sampling of such variable and non-homogeneous materials as soil and rock, it is important that we be informed of any differences observed between surface and subsurface conditions encountered in construction and those assumed in the body of this report. Reporting such discrepancies to Entech Engineering, Inc. soon after they are discovered would be greatly appreciated and could possibly help avoid construction and development problems. Additional investigation is

recommended as development and grading plans are finalized. Planning and design personnel should be made familiar with the contents of this report.

This report has been prepared for Morley – Bentley Investments, LLC for application to the proposed project in accordance with generally accepted geologic soil and engineering practices. No other warranty expressed or implied is made.

We trust this report has provided you with all the information you required. Should you require additional information, please do not hesitate to contact Entech Engineering, Inc.

BIBLIOGRAPHY

1. United States Department of Agriculture Soil Conservation Service. June 1981. *Soil Survey of El Paso County Area, Colorado*.
2. Charles S. Robinson and Associates, Inc. 1977. *Map of Potential Geologic Hazards and Surficial Deposits. Falcon NW*
3. Charles S. Robinson and Associates. 1977. *Environmental and Engineering Geologic Maps for Land Use. Falcon NW Quadrangle. Unpublished maps prepared for El Paso County Planning Department.*
4. Charles S. Robinson and Associates, Inc. 1977. *Table of Engineering and Engineering Factors for Land Use, El Paso County, Colorado.* From unpublished study prepared for El Paso County Planning Department.
5. Entech Engineering, Inc. July 27, 2001. *Geologic Hazard Study, Wolf Ranch, Colorado Springs, Colorado.* Entech Job No. 94160.
6. Entech Engineering, Inc. May 16, 2003. *Geologic Hazard/Land Use Study and Preliminary Subsurface Soil Investigation, Southeast Parcel, Wolf Ranch, Colorado Springs, Colorado.* Entech Job No. 74733.
7. Entech Engineering, Inc. July 31, 1997. *Soil, Geology and Wastewater Study, Gliderport No. 1, El Paso County, Colorado.* Entech Job No. 21747.1
8. Entech Engineering, Inc. December 18, 2000. *Soil, Geology and Wastewater Study, Highland Park Filing No. 2, El Paso County, Colorado.* Entech Job. No. 14210/21747A.
9. Scott, Glen R.; Taylor, Richard B.; Epis, Rudy C. and Wobus, Reinhard A. 1978. *Geologic Structure Map of the Pueblo 1°x2°, South-Central Colorado.* Sheet 2. U.S. Geologic Survey. Map I-1022.
10. Madole, Richard F. 2003. *Geologic Map of the Falcon NW Quadrangle, El Paso County, Colorado. Colorado Geological Survey.* Open-File Report 03-8.
11. Scott, Glen R. and Wobus, Reinhard A. 1973. *Reconnaissance Geologic Map of Colorado Springs and Vicinity, Colorado.* US Geological Survey. Map MP-482.
12. Trimble, Donald E. and Machette, Michael N. 1979. *Geologic Map of the Colorado Springs-Castle Rock area, Front Range Urban Corridor, Colorado.* U.S. Geological Survey. Map 1-847-F.
13. Hart, Stephen S. 1974. *Potentially Swelling Soil and Rock in the Front Range Urban Corridor, Colorado.* Colorado Springs – Castle Rock map. Colorado Geological Survey. Environmental Geology 7.
14. Dames and Moore. 1985. *Colorado Springs Subsidence Investigation.* State of Colorado Division of Mined Land Reclamation.

15. City of Colorado Springs Planning Department, August 1967. *Mining Report, Colorado Springs Coal Field.*
16. Federal Emergency Management Agency. March 17, 1997. *Flood Insurance Rate Maps for the City of Colorado Springs, Colorado.* Map Numbers 08041CO529F and 08041CO535F.
17. Kirkman, Robert M. and Rogers, William P. 1981. *Earthquake Potential in Colorado.* Colorado Geological Survey. Bulletin 43.
18. Colorado Geological Survey. 1991. *Results of the 1987-88 EPA Supported Radon Study in Colorado.* Open-file Report 91-4.
19. Nelson-Moore, James L.; Collins, Donna Bishop; and Hernbaker, Al. 1978. *Radioactive Mineral Occurrences of Colorado and Bibliography.* Colorado Geological Survey. Bulletin 40.
20. CTL/Thompson. April 22, 1997. *Reconnaissance Geologic Hazards Study, Wolf Ranch Master Plan Area, Colorado Springs, Colorado.* Job. No. CS-7272.
21. El Paso County Planning Department. December 1995. *El Paso County Aggregate Resource Evaluation Maps.*
22. Schwochow, S.D.; Shroba, R.R. and Wicklein, P.C. 1974. *Atlas of Sand, Gravel, and Quarry Aggregate Resources, Colorado Front Range Counties.* Colorado Geological Survey. Special Publication 5-B.
23. Keller, John W.; TerBest, Harry and Garrison, Rachel E. 2003. *Evaluation of Mineral and Mineral Fuel Potential of El Paso County State Mineral Lands Administered by the Colorado State Land Board.* Colorado Geological Survey. Open-File Report 03-07.

TABLES

TABLE 1

SUMMARY OF LABORATORY TEST RESULTS

CLIENT MORLEY BENTLEY
 PROJECT STERLING RANCH
 JOB NO. 82556

SOIL TYPE	TEST BORING NO.	DEPTH (FT)	WATER (%)	DRY DENSITY (PCF)	PASSING NO. 200 SIEVE (%)	LIQUID LIMIT (%)	PLASTIC INDEX (%)	SULFATE (WT %)	FHA SWELL (PSF)	SWELL/CONSOL (%)	UNIFIED CLASSIFICATION	SOIL DESCRIPTION
1	4	2-5			10.0	NV	NP	<0.01			SM-SW	SAND, SLIGHTLY SILTY
1	9	5			22.4						SM	SAND, SILTY
1	12	5			8.6						SM-SW	SAND, SLIGHTLY SILTY
1	17	2-3			11.7						SM-SP	SAND, SLIGHTLY SILTY
1	19	5			15.9						SM	SAND, SILTY
1	20	10			10.7						SM-SW	SAND, SLIGHTLY SILTY
1	25	2-5			8.4						SM-SW	SAND, SLIGHTLY SILTY
1	26	5			17.3						SM	SAND, SILTY
1	41	5			44.1	23	7		574		SC-SM	SAND, VERY CLAYEY-SILTY
1	42	2-3			7.4						SM-SW	SAND, SLIGHTLY SILTY
1	44	5-10			5.7						SM-SW	SAND, SLIGHTLY SILTY
2	7	5	5.6	98.0		29	13			-2.3	CL	CLAY, SANDY
2	13	2-3			54.6				455		CL	CLAY, VERY SANDY
2	21	7						0.10	4179		CL	CLAY, SANDY
2	23	7							1085		CL	CLAY, SANDY
2	27	9							2300		CL	CLAY, SANDY
2	31	5	27.9	95.4	64.2	40	25			1.8	CL	CLAY, SANDY
2	34	2-5			51.6	27	13				CL	CLAY, VERY SANDY
3	5	15	10.4	118.6		24	11			-0.1	SC	SANDSTONE, CLAYEY
3	6	15-20			14.8			0.01			SM	SANDSTONE, SILTY
3	11	10			17.1						SM	SANDSTONE, SILTY
3	13	10			36.0						SM	SANDSTONE, SILTY
3	14	5			20.4						SM	SANDSTONE, SILTY
3	18	15							456		SM	SANDSTONE, SILTY
3	22	5	23.3	100.7	21.1	NV	NP			0.0	SM	SANDSTONE, SILTY
3	28	5-10			17.8						SM	SANDSTONE, SILTY
3	29	7							485		SC	SANDSTONE, CLAYEY
3	30	10			9.1						SM-SW	SANDSTONE, SLIGHTLY SILTY
3	33	5			14.4						SM	SANDSTONE, SILTY
3	35	15			11.1						SM-SW	SANDSTONE, SLIGHTLY SILTY
3	36	2-5			18.7				1014		SC	SANDSTONE, CLAYEY

SOIL TYPE	TEST BORING NO.	DEPTH (FT)	WATER (%)	DRY DENSITY (PCF)	PASSING NO 200 SIEVE (%)	LIQUID LIMIT (%)	PLASTIC INDEX (%)	SULFATE (WT %)	FHA SWELL (PSF)	SWELL/ CONSOL (%)	UNIFIED CLASSIFICATION	SOIL DESCRIPTION
3	38	5			13.3						SM	SANDSTONE, SILTY
3	39	15	11.0	124.3	42.8	33	16			1.0	SC	SANDSTONE, VERY CLAYEY
3	40	2-3						360			SM-SC	SANDSTONE, SILTY, CLAYEY
4	1	5	13.4	117.8	68.1					0.9	CL	CLAYSTONE, SANDY
4	3	7			55.3	32	18		846		CL	CLAYSTONE, VERY SANDY
4	24	2-3							1757		CL	WEATHERED CLAYSTONE, SANDY
4	25	10							1845		CL	CLAYSTONE, SANDY
4	33	15	24.3	100.7	73.0	51	28			2.7	CH	CLAYSTONE, SANDY
4	40	15	14.8	117.6	71.5	38	16	0.00		1.0	CL	CLAYSTONE, SANDY
4	43	20	12.6	121.0						0.3	CL	CLAYSTONE, SANDY

Table 2: Summary of Geologic Units

MAP SYMBOL	MAP UNIT, DESCRIPTION & PHYSICAL CHARACTERISTICS	WORKABILITY	SURFACE DRAINAGE, ERODIBILITY & GROUNDWATER	SUITABILITY FOR WASTE DISPOSAL	FOUNDATION STABILITY	POTENTIAL GEOLOGIC HAZARDS	KNOWN, REPORTED & POSSIBLE GEOLOGIC RESOURCES
al	ALLUVIUM: Silt, sand, gravel and boulders in the bed of streams, on valley floors and in the lowest terraces along streams.	Excavation and compaction easy except where bouldery.	Infiltration: Medium to high. Runoff: Moderate. Subject to stream scour and stream bank erosion. Water table may be permanently or seasonally within a few feet of the surface.	Septic Systems: Unsatisfactory, generally within or adjacent to waterway and in area of seasonal high ground water. Dump sites: Unsatisfactory because of high ground water or seasonal flooding.	Poor, loose and erodible materials.	Deposits are subject to annual or periodic flooding. Low terrace banks may be undercut by stream erosion.	Source of sand and gravel.
Qp	PINEY CREEK ALLUVIUM: Organic rich clayey silt and sand with gravel, cobbles and boulders in terraces along most of the present streams. Locally alluvium, derived from expansive bedrock will have a low to high potential for swelling. Top of terraces is about 20 feet above stream level.	Excavation and compaction easy.	Infiltration: Medium to low. Runoff: Moderate to rapid. Locally water may stand in flat areas for several days following heavy precipitation. Moderately resistant to erosion. Water table may be permanently or seasonally within a few feet of the surface. Yield to wells range 1 to 100 gallons per minute. Along Fountain Creek south of Colorado Springs yield in excess of 1000 gallons per minute.	Septic Systems: Excellent to poor. In some areas ground water table may be too high.	Good to poor. May have expansive clay or high ground water in some areas.	Locally expansive soils; low areas may be subject to flooding. Steep slopes along stream channels may be unstable or undercut by stream erosion.	Source of sand and gravel.
Qb	BROADWAY ALLUVIUM: Gravely sand and silt with cobbles and boulders in terraces west of fountain and Monument Creeks, and coarse sand in terraces along streams joining from the east. Tops of terraces about 40 feet above major streams.	Excavation: Easy. Compaction: Easy where sufficient fines are available.	Infiltration: High. Runoff: Low. High to moderate resistance to erosion. Yield to wells range from 10 to 100 gallons per minute.	Septic System: Generally satisfactory if sufficient fines are available to provide adequate percolation rates. Dump Sites: Generally unsatisfactory because of high infiltration rates.	Good.	Sleep slopes at edges of terraces may be unstable.	Source of sand and gravel.

Table 2: Summary of Geologic Units (Continued)

MAP SYMBOL	MAP UNIT, DESCRIPTION & PHYSICAL CHARACTERISTICS	WORKABILITY	SURFACE DRAINAGE, ERODIBILITY & GROUNDWATER	SUITABILITY FOR WASTE DISPOSAL	FOUNDATION STABILITY	POTENTIAL GEOLOGIC HAZARDS	KNOWN, REPORTED & POSSIBLE GEOLOGIC RESOURCES
Qlo	LOUVIERS ALLUVIUM: Gravelly sand and silt with cobbles and boulders in terraces along Fountain and Monument Creek; coarse sand along tributaries from east. Locally may have clays with a low to high potential for swelling. Occurs as the major terrace at the confluence of Fountain and Monument Creeks. Top of terraces is about 70 feet above major streams.	Excavation: Easy Compaction: Moderately easy.	Infiltration: High except where clayey. Runoff: Low. Moderately to highly resistant to erosion. Yield to wells ranges from 10 to 100 gallons per minutes.	Septic Systems: Fair to poor dependent on adequate percolation rates. Dump Site: Unsatisfactory because of high infiltration rates.	Generally excellent. May have expansive clays locally.	Locally may have expansive clays.	Source of sand and gravel.
Qes	EOLIAN SAND (wind-deposited sand): Coarse to fine-grained sand. Occurs adjacent to streams and on upland ridges east of Monument and Fountain Creeks. Forms rolling upland surface in southeastern Colorado Springs and in Peterson Field area. Extensive deposits occur north and east of Falcon.	Excavation: Easy. Compaction: Vibratory equipment may be necessary for proper compaction.	Infiltration: Medium to high. Runoff: Low. Erodible by wind if vegetation is removed.	Septic Systems: Poor to fair depending on percolation rate. Dump Site: Unsatisfactory because of high infiltration rates.	Fair to good. May be subject to compaction.	Susceptible to wind erosion if vegetation is removed. May be subject to hydrocompaction. Walls of trenches may collapse if unsupported.	Source of commercial sand.

Table 2: Summary of Geologic Units (Continued)

MAP SYMBOL	MAP UNIT, DESCRIPTION & PHYSICAL CHARACTERISTICS	WORKABILITY	SURFACE DRAINAGE, ERODIBILITY & GROUNDWATER	SUITABILITY FOR WASTE DISPOSAL	FOUNDATION STABILITY	POTENTIAL GEOLOGIC HAZARDS	KNOWN, REPORTED & POSSIBLE GEOLOGIC RESOURCES
Tkd	COLLUVIUM DAWSON FORMATION (upper part) (includes areas of bedrock): Coarse-grained and pebbly arkosic sand, clay and silty derived from arkosic sandstone, claystone and shale. Claystone and shale may be expansive. Lowest unit of sandstone forms cliffs at Austin Bluffs, Pulpit Rock and Palmer Park.	Excavation and compaction moderately difficult to difficult in cliff forming units.	Infiltration: Medium to high. Runoff: Low to high in clays and shales. Highly erodible by gullying and slope wash. Yield to walls ranges from 4 to 500 gallons per minute.	Septic Systems: Excellent to poor, depending on percolation. Dump Sites: Unsuitable because of potential of polluting major ground water aquifers.	Fair to excellent. Clay and claystone may be expansive.	Expansive clay. Talus deposits form at base of cliffs and steep slopes may be unstable.	Locally may contain seams of lignite.

Table 3: Summary of Depth to Groundwater and Bedrock

Test Boring No.	Depth of Bedrock (ft.)	Depth to Groundwater (ft.)	Upper Soil Type	Geologic Unit
1	2	6	SM/CL	Qes/Tkd
2	4	11	SM/CL	Qb
3	7	>15	SM	Qb
4	6	>15	SM-SW	Qes
5	11	8.5	SM	Qlo
6	14	>20	SM	Qlo
7	14	>20	SM/CL	Qlo
8	14	>20	SM-SW	Qlo
9	19	>20	SM	Qlo
10	9	9	SW-SW	Qlo
11	9	14	SM-SW	Qlo/Qes
12	14	13.5	SM-SW	Qb
13	8	>15	CL/SC	Qb
14	4	>15	SM-SW	Qb
15	4	>15	SM	Qb
16	15	>20	SM	Qlo
17	>20	>20	SM-SP	Qes
18	8	7.5	SM	Qlo
19	7	>15	SM	Tkd
20	16	>20	SM	Qlo
21	8	10	SM	Qlo
22	4	3.5	SC	Qb
23	8	>15	SC	Qb
24	2	>15	SM/CL	Tkd
25	9	>15	SM-SW	Tkd
26	14	19	SM	Qlo
27	10	>15	SM	Qlo
28	2	>15	SM	Tkd
29	2	>15	SM	Tkd
30	6	11	SM/CL	Tkd
31	7	8	SM/CL	Tkd
32	11	11	SM/CL	Tkd
33	4	>15	SM	Qlo
34	8	6	CL	Qal/Tkd
35	3	>15	SM	Tkd
36	1	>15	SC	Tkd
37	2	>15	SM	Tkd
38	2	>15	SM	Tkd
39	3	>15	SM	Tkd
40	2	8	SM-SC	Tkd
41	6	9	SM/SC/CL	Qb
42	6	12	SM-SW	Qlo
43	16	>20	SM-SW	Qlo
44	18	11	SM-SW	Qlo
45	14	12.5	SM	Qes

FIGURES

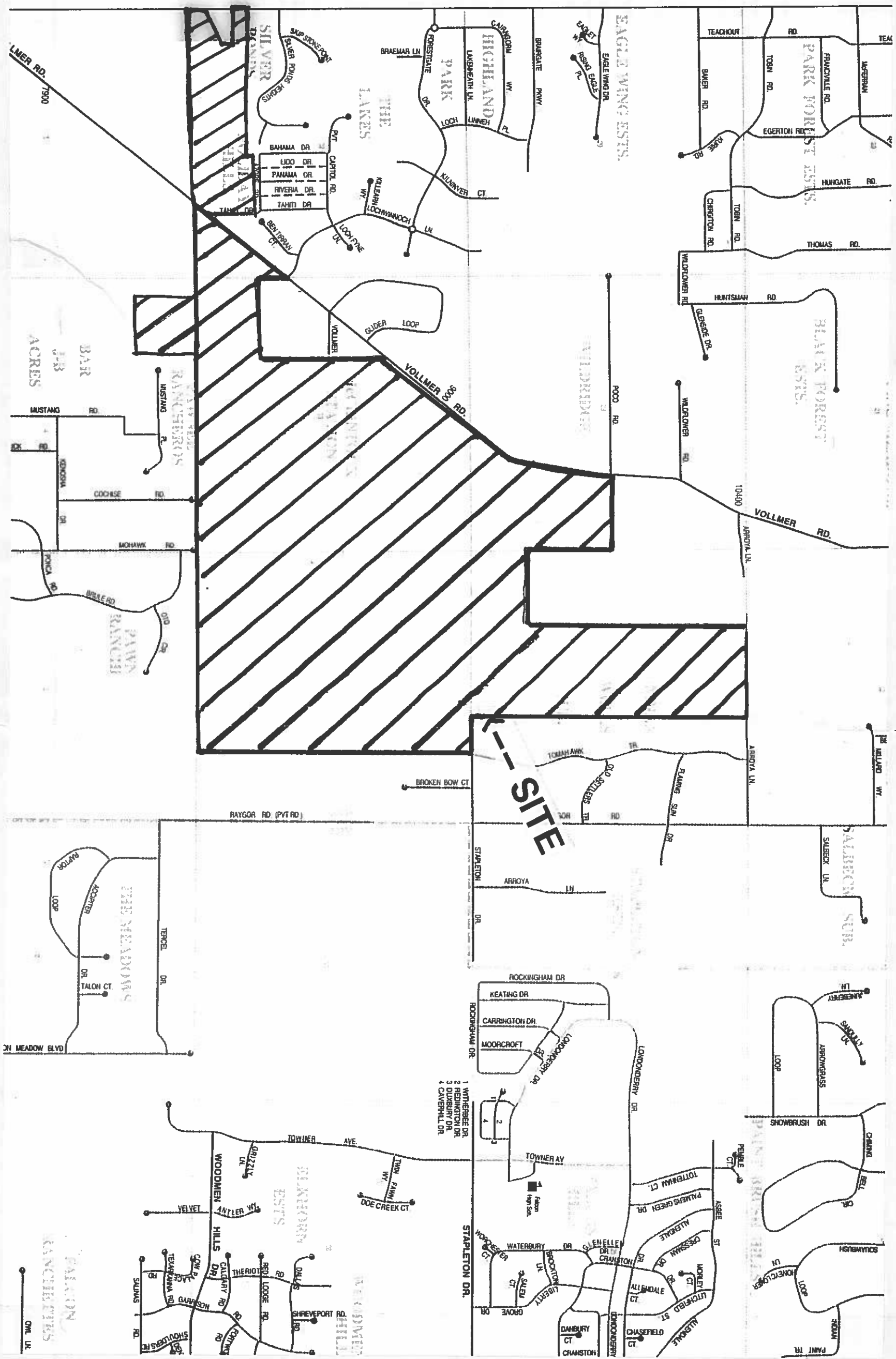

DATE	8/18/08
CHECKED	M. WILKS
SCALE	AS SHOWN
PROJECT NO.	025356
ISSUE NO.	7
REVISION	1

VICINITY MAP
STERLING RANCH
EL PASO COUNTY, CO.
FOR: MORLEY-BENTLEY
INVESTMENTS, LLC

ENTECH
ENGINEERING, INC.
505 ELKTON DRIVE
COLORADO SPRINGS, CO. 80907 (719) 531-5599

REVISION	BY

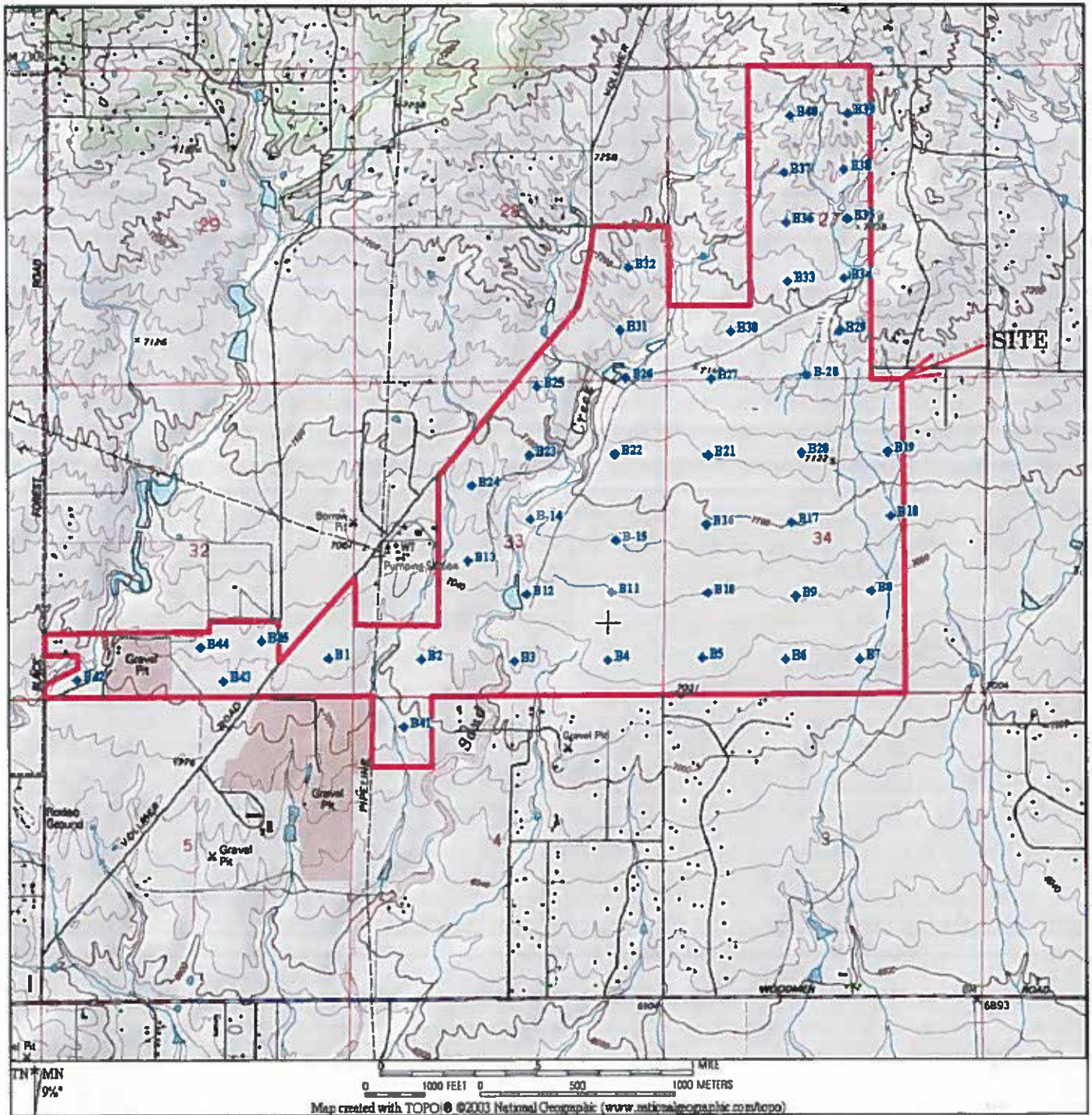

B1 - Approximate location of Test Borings



ENTECH
ENGINEERING, INC.
 505 ELKTON DRIVE
 COLORADO SPRINGS, CO. 80907 (719) 531-3599

Test Boring Location Map
 Sterling Ranch
 El Paso County, CO.
 FOR: Morley-Bentley Investments

DRAWN:
 KAH

DATE:
 9/8/06

CHECKED:

DATE:

JOB NO.:
 82556

FIG NO.:
 3

8—Blakeland loamy sand, 1 to 9 percent slopes. This deep, somewhat excessively drained soil formed in alluvial and eolian material derived from arkosic sedimentary rock on uplands. The average annual precipitation is about 15 inches, the average annual air temperature is about 47 degrees F, and the average frost-free period is about 135 days.

Typically, the surface layer is dark grayish brown loamy sand about 11 inches thick. The substratum, to a depth of 27 inches, is brown loamy sand; it grades to pale brown sand that extends to a depth of 60 inches.

Included with this soil in mapping are small areas of Bresser sandy loam, 0 to 3 percent slopes; Bresser sandy loam, 3 to 5 percent slopes; Truckton sandy loam, 0 to 3 percent slopes; Truckton sandy loam, 3 to 9 percent slopes; and Stapleton sandy loam, 3 to 8 percent slopes. In some areas, mainly north of Colorado Springs in the Cottonwood Creek area, arkosic beds of sandstone and shale are at a depth of 0 to 40 inches.

Permeability of this Blakeland soil is rapid. Effective rooting depth is 60 inches or more. Available water capacity is low to moderate. Organic matter content of the surface layer is medium. Surface runoff is slow, the hazard of erosion is moderate, and the hazard of soil blowing is severe.

Most areas of this soil are used for range, homesites, and wildlife habitat.

Native vegetation is dominantly western wheatgrass, side-oats grama, and needleandthread. This soil is best suited to deep-rooted grasses.

Proper range management is necessary to prevent excessive removal of plant cover from the soil. Interseeding improves the existing vegetation. Deferment of grazing in spring increases plant vigor and soil stability. Proper location of livestock watering facilities helps to control grazing.

Windbreaks and environmental plantings are fairly well suited to this soil. Blowing sand and low available water capacity are the main limitations for the establishment of trees and shrubs. The soil is so loose that trees need to be planted in shallow furrows and plant cover needs to be maintained between the rows. Supplemental irrigation may be needed to insure survival. Trees that are best suited and have good survival are Rocky Mountain juniper, eastern redcedar, ponderosa pine, and Siberian elm. Shrubs that are best suited are skunkbush sumac, lilac, and Siberian peashrub.

This soil is suited to wildlife habitat. It is best suited to habitat for openland and rangeland wildlife. Rangeland wildlife, such as pronghorn antelope, can be encouraged by developing livestock watering facilities, properly managing livestock grazing, and reseeding range where needed.

This soil has good potential for urban development. Soil blowing is a hazard if protective vegetation is removed. Special erosion control practices must be provided to minimize soil losses. Capability subclass VIe.



ENTECH
ENGINEERING, INC.

SCS SOIL DESCRIPTION

Drawn	Date	Checked	Date
-------	------	---------	------

Job No.
82556
Fig. No.

5

9—Blakeland complex, 1 to 9 percent slopes. This complex is on uplands, mostly in the Falcon area. The average annual precipitation is about 15 inches, the average annual air temperature is about 47 degrees F, and the frost-free period is about 135 days.

This complex is about 60 percent Blakeland loamy sand, about 30 percent Fluvaquentic Haplaquolls, and 10 percent other soils.

Included with these soils in mapping are areas of Columbine gravelly sandy loam, 0 to 3 percent slopes, Ellicott loamy coarse sand, 0 to 5 percent slopes, and Ustic Torrifluvents, loamy.

The Blakeland soil is in the more sloping areas. It is deep and somewhat excessively drained. It formed in sandy alluvium and eolian material derived from arkosic sedimentary rock. Typically, the surface layer is dark grayish brown loamy sand about 11 inches thick. The substratum, to a depth of 27 inches, is brown loamy sand; it grades to pale brown sand that extends to a depth of 60 inches or more.

Permeability of the Blakeland soil is rapid. The effective rooting depth is more than 60 inches. The available water capacity is moderate to low. Surface runoff is slow, and the hazard of erosion is moderate.

The Fluvaquentic Haplaquolls are in swale areas. They are deep, poorly drained soils. They formed in alluvium derived from arkosic sedimentary rock. Typically, the surface layer is brown. The texture is variable throughout. The water table is at a depth of 0 to 3 feet.

The Blakeland soil is well suited to deep-rooted grasses. Native vegetation is dominantly western wheatgrass, side-oats grama, and needleandthread. Rangeland vegetation on the Fluvaquentic Haplaquolls is dominantly tall grasses, including sand bluestem, switchgrass, prairie cordgrass, little bluestem, and sand reedgrass. Cattails and bulrushes are common in the swampy areas.

Proper range management is needed to prevent excess removal of plant cover from these soils. It is also needed to maintain the productive grasses. Interseeding improves the existing vegetation. Deferment of grazing during the growing season increases plant vigor and soil stability,

and it helps to maintain and improve range condition. Proper location of livestock watering facilities helps to control grazing of animals.

Windbreaks and environmental plantings are fairly well suited to these soils. Blowing sand and low available water capacity are the main limitations to the establishment of trees and shrubs. The soils are so loose that trees need to be planted in shallow furrows and plant cover needs to be maintained between the rows. Supplemental irrigation may be needed to insure survival. Trees that are best suited and have good survival are Rocky Mountain juniper, eastern redcedar, ponderosa pine, and Siberian elm. Shrubs that are best suited are skunkbush sumac, lilac, and Siberian peashrub.

The Blakeland soil is well suited to wildlife habitat. It is best suited to habitat for openland and rangeland wildlife. Rangeland wildlife, such as pronghorn antelope, can be encouraged by developing livestock watering facilities, properly managing livestock grazing, and reseeding range where needed. Wetland wildlife can be attracted to the Fluvaquentic Haplaquolls and the wetland habitat can be enhanced by several means. Shallow water developments can be created by digging or by blasting potholes to create open-water areas. Fencing to control livestock grazing is beneficial, and it allows wetland plants such as cattails, reed canarygrass, and rushes to grow. Control of unplanned burning and prevention of drainage that would remove water from the wetlands are good practices. Openland wildlife use the vegetation on these soils for nesting and escape cover. These shallow marsh areas are especially important for winter cover if natural vegetation is allowed to grow.

The Blakeland soil has good potential for homesites, roads, and streets. It needs to be protected from erosion when vegetation has been removed from building sites. The Fluvaquentic Haplaquolls have poor potential for homesites. Their main limitations for this use are the high water table and the hazard of flooding. Capability subclass VIe.



ENTECH
ENGINEERING, INC.

SCS SOIL DESCRIPTION

Drawn	Date	Checked	Date

Job No.

82556

Fig. No.

6

19—Columbine gravelly sandy loam, 0 to 3 percent slopes. This deep, well drained to excessively drained soil formed in coarse textured material on alluvial terraces and fans and on flood plains. Elevation ranges from 6,500 to 7,300 feet. The average annual precipitation is about 15 inches, the average annual air temperature is about 47 degrees F, and the average frost-free period is about 135 days.

Typically, the surface layer is grayish brown gravelly sandy loam about 14 inches thick. The underlying material is light yellowish brown very gravelly loamy sand.

Included with this soil in mapping are small areas of Stapleton sandy loam, 3 to 8 percent slopes; Blendon sandy loam, 0 to 3 percent slopes; Louviers silty clay loam, 3 to 18 percent slopes; and Fluvaquent Haplaquolls, nearly level. In places the parent arkose beds of sandstone or shale are at a depth of 0 to 40 inches.

Permeability of this Columbine soil is very rapid. Effective rooting depth is 60 inches or more. Available water capacity is low to moderate. Surface runoff is slow, and the hazard of erosion is slight to moderate.

This soil is used mainly for grazing livestock and for wildlife habitat. It is also used for homesites.

Native vegetation is mainly western wheatgrass, side-oats grama, needleandthread, and little bluestem. The main shrub is true mountainmahogany.

Proper location of livestock watering facilities helps to control grazing.

Windbreaks and environmental plantings are fairly well suited to this soil. Blowing sand and low available water capacity are the principal limitations to the establishment of trees and shrubs. The soil is so loose that trees need to be planted in the rows. Supplemental irrigation may be needed to insure survival. Trees that are best suited and have good survival are Rocky Mountain juniper, eastern redcedar, ponderosa pine, and Siberian elm. Shrubs that are best suited are skunkbush sumac, lilac, and Siberian peashrub.

Rangeland wildlife, such as pronghorn antelope, cottontail, coyote, and scaled quail, is best adapted to life on this droughty soil. Forage production is typically loam, and proper livestock grazing management is necessary if wildlife and livestock share the range. Livestock watering developments are also important and are used by various wildlife species.

The main limitation of this soil for urban development is a hazard of flooding in some areas. Care must be taken when locating septic tank absorption fields because of possible pollution as a result of the very rapid permeability of this soil. Capability subclass VIe.



ENTECH
ENGINEERING, INC.

SCS SOIL DESCRIPTION

Drawn	Date	Checked	Date
-------	------	---------	------

Job No.
82556
Fig. No.

7

71—Pring coarse sandy loam, 3 to 8 percent slopes. This deep, noncalcareous, well drained soil formed in sandy sediment derived from arkosic sedimentary rock on valley side slopes and on uplands. Elevation ranges from 6,800 to 7,600 feet. The average annual precipitation is about 17 inches, the average annual air temperature is about 43 degrees F, and the average frost-free period is about 120 days.

Typically, the surface layer is dark grayish brown coarse sandy loam about 4 inches thick. The substratum is dark grayish brown coarse sandy loam about 10 inches thick over pale brown gravelly sandy loam that extends to a depth of 60 inches or more.

Included with this soil in mapping are small areas of Alamosa loam, 1 to 3 percent slopes, along drainageways; Cruckton sandy loam, 1 to 9 percent slopes; Peyton sandy loam, 1 to 5 percent slopes; Peyton sandy loam, 5 to 9 percent slopes; and Tomah-Crowfoot loamy sands, 3 to 8 percent slopes. In some places arkose beds of sandstone and shale are at a depth of 0 to 40 inches.

Permeability of this Pring soil is rapid. Effective rooting depth is 60 inches or more. Available water capacity is moderate. Surface runoff is medium, and the hazard of erosion is moderate.

Almost all areas of this soil are used as rangeland. Some areas previously cultivated have been reseeded to grass. This soil is also used for wildlife habitat and homesites.

This soil is well suited to the production of native vegetation suitable for grazing by cattle and sheep. Rangeland vegetation is mainly mountain muhly, little bluestem, needleandthread, Parry oatgrass, and junegrass.

Deferment of grazing in spring helps to maintain vigor and production of the cool-season bunchgrasses. Fencing and properly locating livestock watering facilities help to control grazing.

Windbreaks and environmental plantings generally are suited to this soil. The hazard of soil blowing is the main limitation to the establishment of trees and shrubs. This limitation can be overcome by cultivating only in the tree rows and leaving a strip of vegetation between the rows. Supplemental irrigation may be needed when planting and during dry periods. Trees that are best suited and have good survival are Rocky Mountain juniper, eastern redcedar, ponderosa pine, Siberian elm, Russian-olive, and hackberry. Shrubs that are best suited are skunkbush sumac, lilac, and Siberian peashrub.

This soil is suited to habitat for openland and rangeland wildlife. Rangeland wildlife, such as pronghorn antelope, can be encouraged by developing livestock watering facilities, properly managing livestock grazing, and reseeding range where needed.

This soil is well suited for use as homesites. Erosion control practices are needed to control soil blowing and water erosion on construction sites where the ground cover has been removed. Capability subclass IVe.



ENTECH
ENGINEERING, INC.

SCS SOIL DESCRIPTION

Drawn	Date	Checked	Date
-------	------	---------	------

Job No.

82556

Fig. No.

8

85—Stapleton-Bernal sandy loams. 3 to 20 percent slopes. These gently sloping to moderately steep soils are on upland ridges and hills. Elevation ranges from about 6,500 to 6,800 feet. The average annual precipitation is about 15 inches, the average annual air temperature is about 47 degrees F, and the average frost-free period is about 135 days.

The Stapleton soil makes up about 40 percent of the complex, the Bernal soil about 30 percent, and included soils about 30 percent.

Included with these soils in mapping are areas of Blakeland loamy sand, 1 to 9 percent slopes; Louviers silty clay loam, 3 to 18 percent slopes; Travessilla-Rock outcrop complex, 3 to 90 percent slopes; Truckton sandy loam, 3 to 9 percent slopes; and small outcrops of arkose sandstone and shale.

The Stapleton soil is commonly on the lower part of slopes. It is deep and well drained. It formed in sandy alluvium derived from arkosic bedrock. Typically, the surface layer is grayish brown sandy loam about 11 inches thick. The subsoil is grayish brown gravelly sandy loam about 6 inches thick. The substratum extends to a depth of 60 inches or more. It is pale brown gravelly sandy loam in the upper part and grades to gravelly loamy sand in the lower part.

Permeability of the Stapleton soil is rapid. Effective rooting depth is 60 inches or more. Available water capacity is moderate. Surface runoff is medium, and the hazard of erosion is moderate.

The Bernal soil is commonly on ridges and hills. It is shallow and well drained. It formed in material weathered from sandstone and modified by eolian sediment. Typically, the surface layer is dark grayish brown sandy loam about 4 inches thick. The subsoil is brown sandy clay loam about 7 inches thick. The substratum is brown sandy loam about 2 inches thick. Hard, light colored sandstone is at a depth of about 13 inches.

Permeability of the Bernal soil is moderate. Effective rooting depth is 8 to 20 inches. Available water capacity is low. Surface runoff is medium, and the hazard of erosion is moderate.

The soils in this complex are used for grazing livestock, for wildlife habitat, and as homesites.

The native vegetation on the Stapleton soil is mainly western wheatgrass, side-oats grama, needleandthread, and little bluestem. The dominant shrub on this soil is true mountainmahogany. Yucca is present in some places.

The native vegetation on the Bernal soil is mainly blue grama, side-oats grama, western wheatgrass, Scribner needlegrass, and needleandthread. The dominant shrubs and trees are mountainmahogany, skunkbush sumac, and one-seeded juniper. There are lesser amounts of pinyon pine.

Deferred grazing late in summer and early in fall improves the condition of the range on the Stapleton soil. Careful management of plant cover is essential because of the difficulty of vegetating the Bernal soil. Properly locating livestock watering facilities helps to control grazing.

Windbreaks and environmental plantings generally are suited to the Stapleton soil. Soil blowing is the main limitation for the establishment of trees and shrubs. This limitation can be overcome by cultivating only in the tree rows and leaving a strip of vegetation between the rows. Supplemental irrigation may be needed when planting and during dry periods. Trees that are best suited and have good survival are Rocky Mountain juniper, eastern redcedar, ponderosa pine, Siberian elm, Russian-olive, and hackberry. Shrubs that are best suited are skunkbush sumac, lilac, and Siberian peashrub.

Windbreaks and environmental plantings generally are not suited to the Bernal soil. Onsite investigation is needed to determine if plantings are feasible.

Rangeland wildlife, such as antelope, cottontail, coyote, and scaled quail, is best adapted for life on the soils in this complex. Proper livestock grazing management is necessary if wildlife and livestock share the range. Livestock watering developments are also important, and they are used by various wildlife species.

The main limitations of the Stapleton soil for urban use are frost-action potential and slope. The main limitations of the Bernal soil are depth to bedrock, frost-action potential, and slope. Special designs for sites, buildings, and roads and streets are needed to control soil blowing and water erosion on construction sites where vegetation has been removed. Capability subclass VIe.



ENTECH
ENGINEERING, INC.

SCS SOIL DESCRIPTION

Drawn	Date	Checked	Date

JOB No.

82556

Fig. No.

9

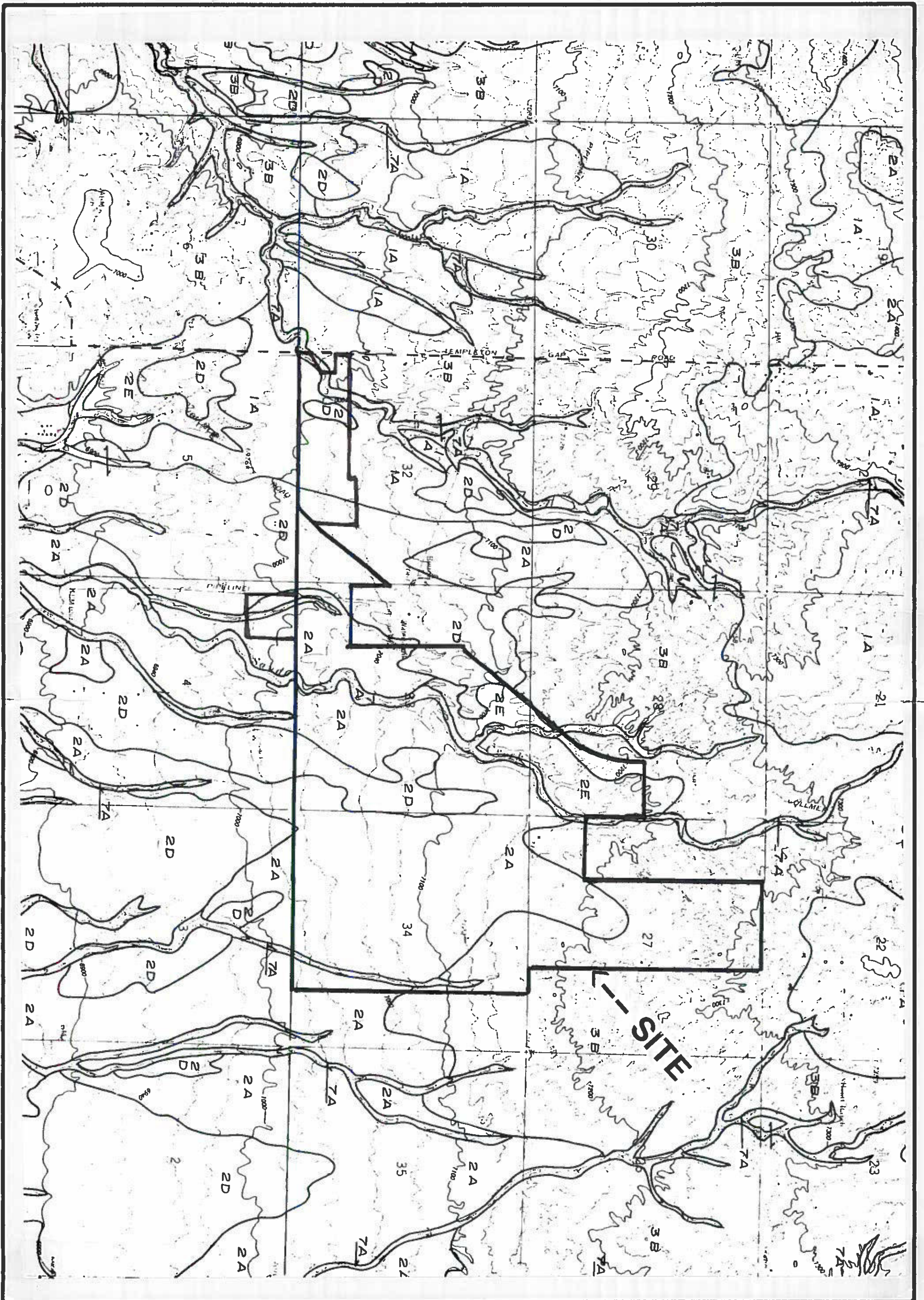

DATE	8/15/06
SCALE	AS SHOWN
DRAWN BY	AS SHOWN
CHECKED BY	AS SHOWN
PROJECT NO.	025556
ISSUE NO.	11

ROBINSON FALCON NW
 ENGINEERING GEOLOGY MAP
 STERLING RANCH
 EL PASO COUNTY, CO.
 FOR: MORLEY-BENTLEY
 INVESTMENTS, LLC



ENTECH
 ENGINEERING, INC.
 505 ELKTON DRIVE
 COLORADO SPRINGS, CO. 80907 (719) 531-5599

REVISION BY	

\\2006ESA\REPORTS\256\STERLING RANCH\ESA RPT SET(1 TO 1).dwg, USGS CO SP GEO, 8/15/2006 9:47:49 AM, 1:1

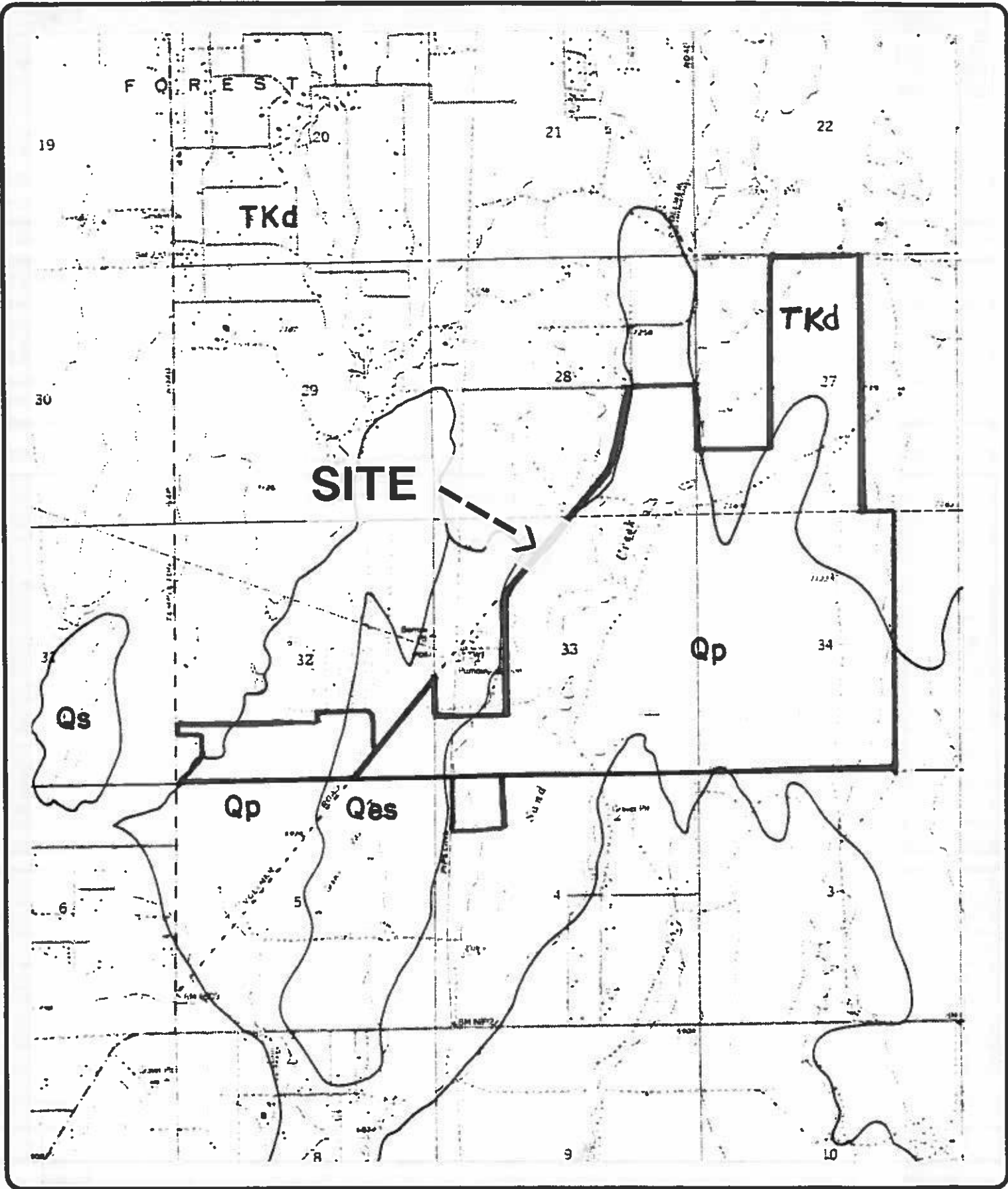



ENTECH
ENGINEERING, INC.
505 ELKTON DRIVE
COLORADO SPRINGS, CO. 80907 (719) 531-5599

USGS COLORADO SPRINGS GEOLOGY MAP
STERLING RANCH
EL PASO COUNTY, CO.
FOR: MORLEY-BENTLEY INVESTMENTS, LLC

DRAWN: M. WELLS	DATE: 8/15/06	CHECKED:	DATE:
--------------------	------------------	----------	-------

JOB NO.:
82556

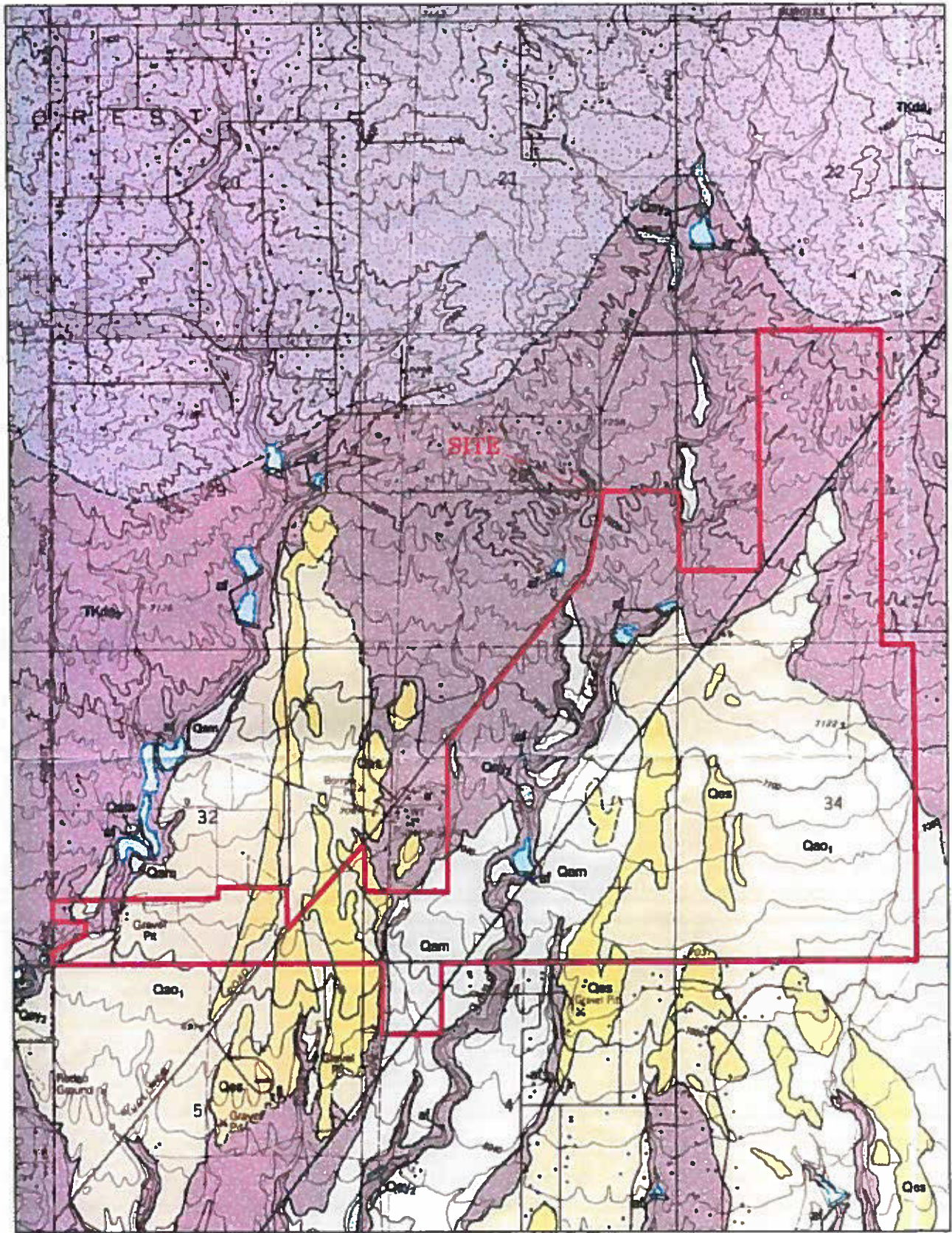
FIG NO.:
12



ENTECH
ENGINEERING, INC.
 505 ELKTON DRIVE
 COLORADO SPRINGS, CO. 80907 (719) 531-3599

CGS FALCON NW GEOLOGY MAP
Sterling Ranch
COLORADO SPRINGS, CO.
FOR: Morley-Bentley Investments

DRAWN:
 KAH

DATE:
 9/8/06

CHECKED:

DATE:

JOB NO.:
 82556

FIG NO.:
 13

LEGEND

- Qaf - Artificial Fill of Quaternary Age
- Man-made fill deposits
- Qal - Recent Alluvium of Quaternary Age
- Recent stream deposits
- Qp - New Creek Alluvium of Quaternary Age
- Stream deposits; silty to clayey sands
- Qes - Eolian Sands of Quaternary Age
- Wind blown sand deposits
- Qb - Brackney Alluvium of Quaternary Age
- Terrace deposits of silty sands
- Qlo - Louviers Alluvium of Quaternary Age
- Terrace deposits of silty to clayey sands
- Tkd - Dawson Formation of Tertiary to Cretaceous Age
- Sandstone and Conglomerate
- Hydrocorrosion
- Potentially unstable slope
- ps - unstable slope
- fp - floodplain
- psw - potentially seasonal shallow groundwater area
- sw - seasonal shallow groundwater area
- w - areas of ponded water
- B-2 - approximate test boring location and number
- approximate location and number of photos

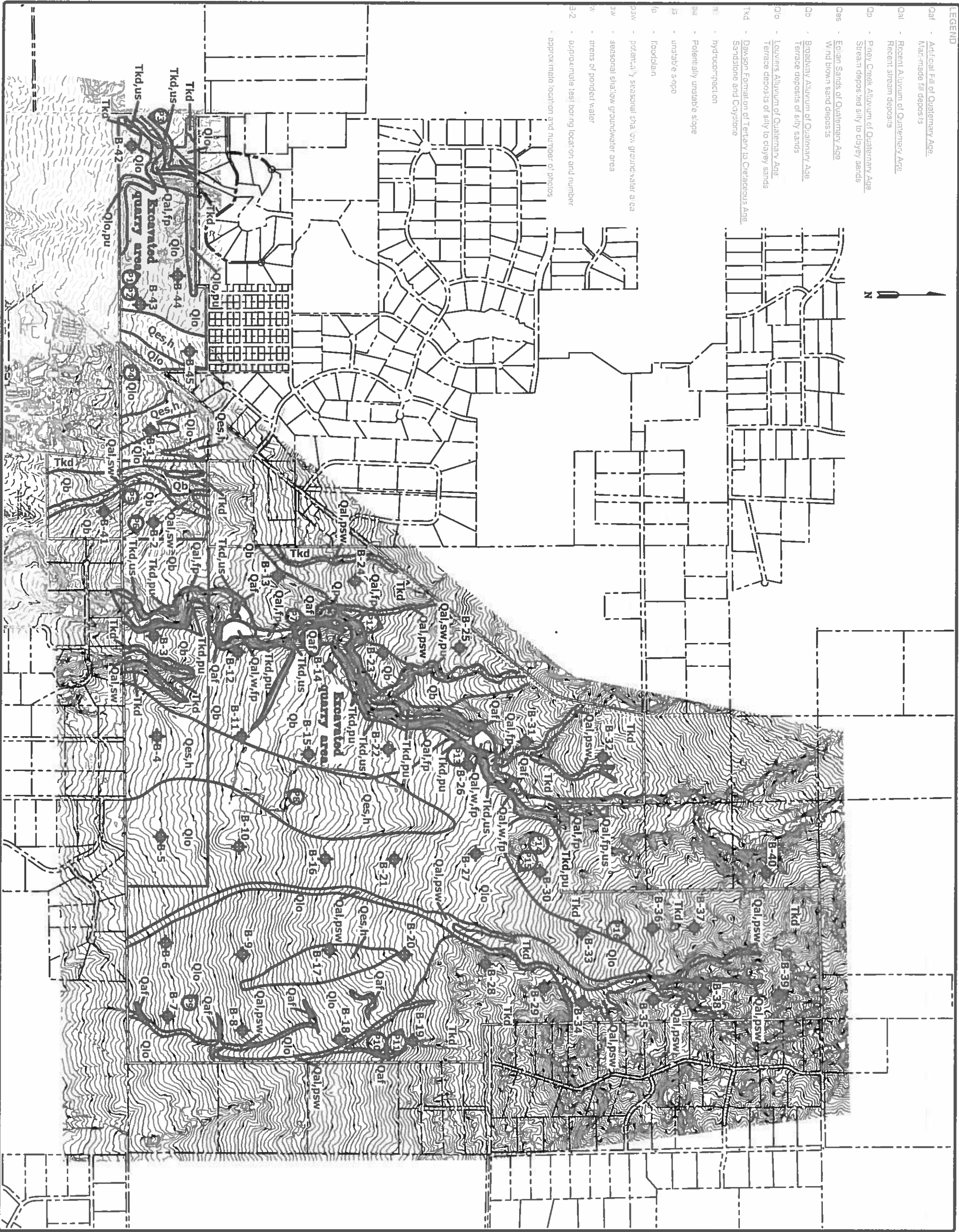

DATE	12/14/2014
PROJECT NO.	14
SCALE	AS SHOWN
DATE	12/14/2014
BY	AS SHOWN
CHECKED BY	AS SHOWN
APPROVED BY	AS SHOWN
DATE	12/14/2014
BY	AS SHOWN
CHECKED BY	AS SHOWN
APPROVED BY	AS SHOWN

GEOLOGY/ ENGINEERING GEOLOGY MAP
 STERLING RANCH
 EL PASO COUNTY, CO.
 FOR: MORLEY-BENTLEY INVESTMENTS

ENTECH
 ENGINEERING, INC.
 505 ELKTON DRIVE
 COLORADO SPRINGS, CO. 80907 (719) 531-5589

REVISION	BY	DATE

LEGEND

SPECIAL FLOOD HAZARD AREAS INUNDATE
BY 100-YEAR FLOOD

ZONE A No base flood elevations determined.

ZONE AE Base flood elevations determined.

ZONE AH Flood depths of 1 to 3 feet (usually areas of ponding); base flood elevations determined.

ZONE AO Flood depths of 1 to 3 feet (usually sheet flow on sloping terrain); average depths determined. For areas of alluvial fan flooding, velocities also determined.

ZONE A99 To be protected from 100-year flood by Federal flood protection system under construction; no base elevations determined.

ZONE V Coastal flood with velocity hazard (wave action); no base flood elevations determined.

ZONE VE Coastal flood with velocity hazard (wave action); base flood elevations determined.

FLOODWAY AREAS IN ZONE AE

OTHER FLOOD AREAS

ZONE X Areas of 500-year flood; areas of 100-year flood with average depths of less than 1 foot or with drainage areas less than 1 square mile; and areas protected by levees from 100-year flood.

OTHER AREAS

ZONE X Areas determined to be outside 500-year floodplain.

ZONE D Areas in which flood hazards are undetermined.

UNDEVELOPED COASTAL BARRIERS



Identified 1983 Coastal Barrier Areas



Identified 1990 Coastal Barrier Areas



Otherwise Protected Areas

Coastal barrier areas are normally located within or adjacent to Special Flood Hazard Areas.

Road Boundary

Floodway Boundary

Zone D Boundary



Boundary Dividing Special Flood Hazard Zones, and Boundary Dividing Areas of Different Coastal Base Flood Elevations Within Special Flood Hazard Zones.

513



(EL 967)

RM7 X

M2

97°07'30", 32°22'30"

Horizontal Coordinates Based on North American Datum of 1927 (NAD 27) Projection.

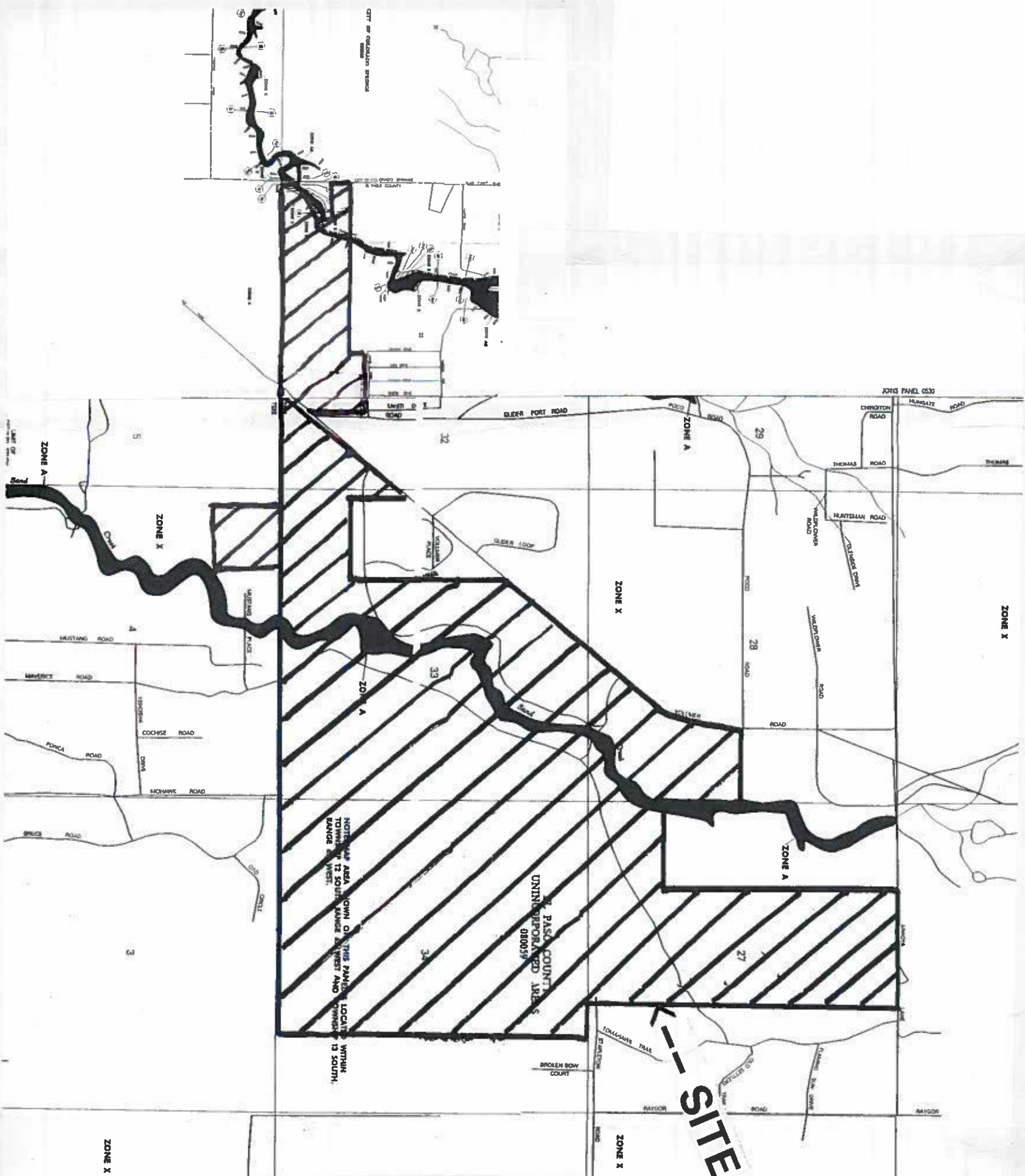

DATE	8/15/06
BY	AS SHOTEN
CHECKED	JOB NO. 025006
DRAWN	SCALE
M. WELLS	
15	

FLOODPLAIN MAP
 STERLING RANCH
 EL PASO COUNTY, CO.
 FOR: MORLEY-BENTLEY
 INVESTMENTS, LLC



ENTECH
 ENGINEERING, INC.
 505 ELKTON DRIVE
 COLORADO SPRINGS, CO. 80907 (719) 531-5599

REVISION BY	

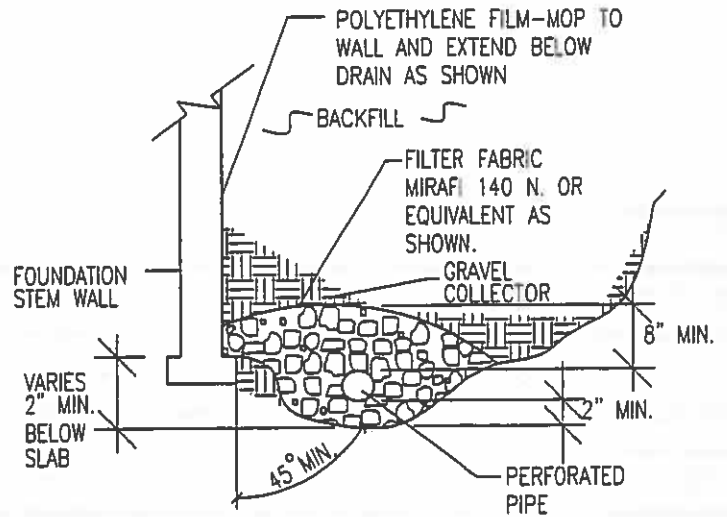
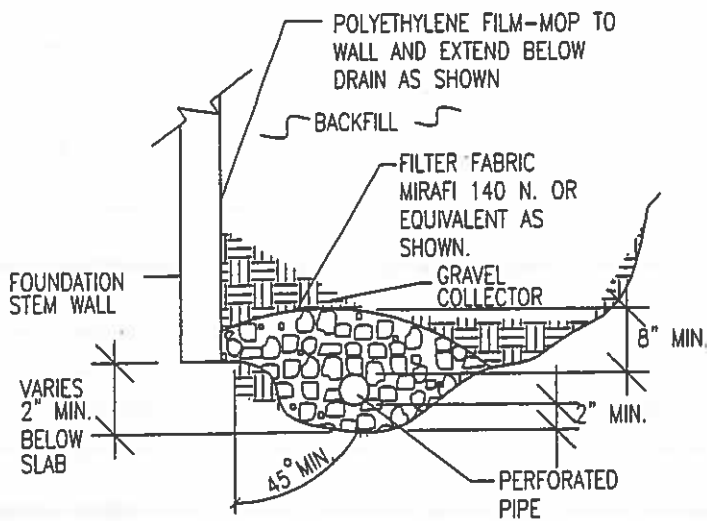

NOTES:

-GRAVEL SIZE IS RELATED TO DIAMETER OF PIPE PERFORATIONS-85% GRAVEL GREATER THAN 2x PERFORATION DIAMETER.

-PIPE DIAMETER DEPENDS UPON EXPECTED SEEPAGE. 4-INCH DIAMETER IS MOST OFTEN USED.

-ALL PIPE SHALL BE PERFORATED PLASTIC. THE DISCHARGE PORTION OF THE PIPE SHOULD BE NON-PERFORATED PIPE.

* -FLEXIBLE PIPE MAY BE USED UP TO 8 FEET IN DEPTH, IF SUCH PIPE IS DESIGNED TO WITHSTAND THE PRESSURES. RIGID PLASTIC PIPE WOULD OTHERWISE BE REQUIRED.

-MINIMUM GRADE FOR DRAIN PIPE TO BE 1% OR 3 INCHES OF FALL IN 25 FEET.

-DRAIN TO BE PROVIDED WITH A FREE GRAVITY OUTFALL, IF POSSIBLE. A SUMP AND PUMP MAY BE USED IF GRAVITY OUTFALL IS NOT AVAILABLE.



ENTECH
ENGINEERING, INC.
505 ELKTON DRIVE
COLORADO SPRINGS, CO. 80907 (719) 531-5599

PERIMETER DRAIN DETAIL

DRAWN:
R.J. OLSON

DATE:

DESIGNED:

CHECKED:

JOB NO.:

82556

FIG NO.:

16

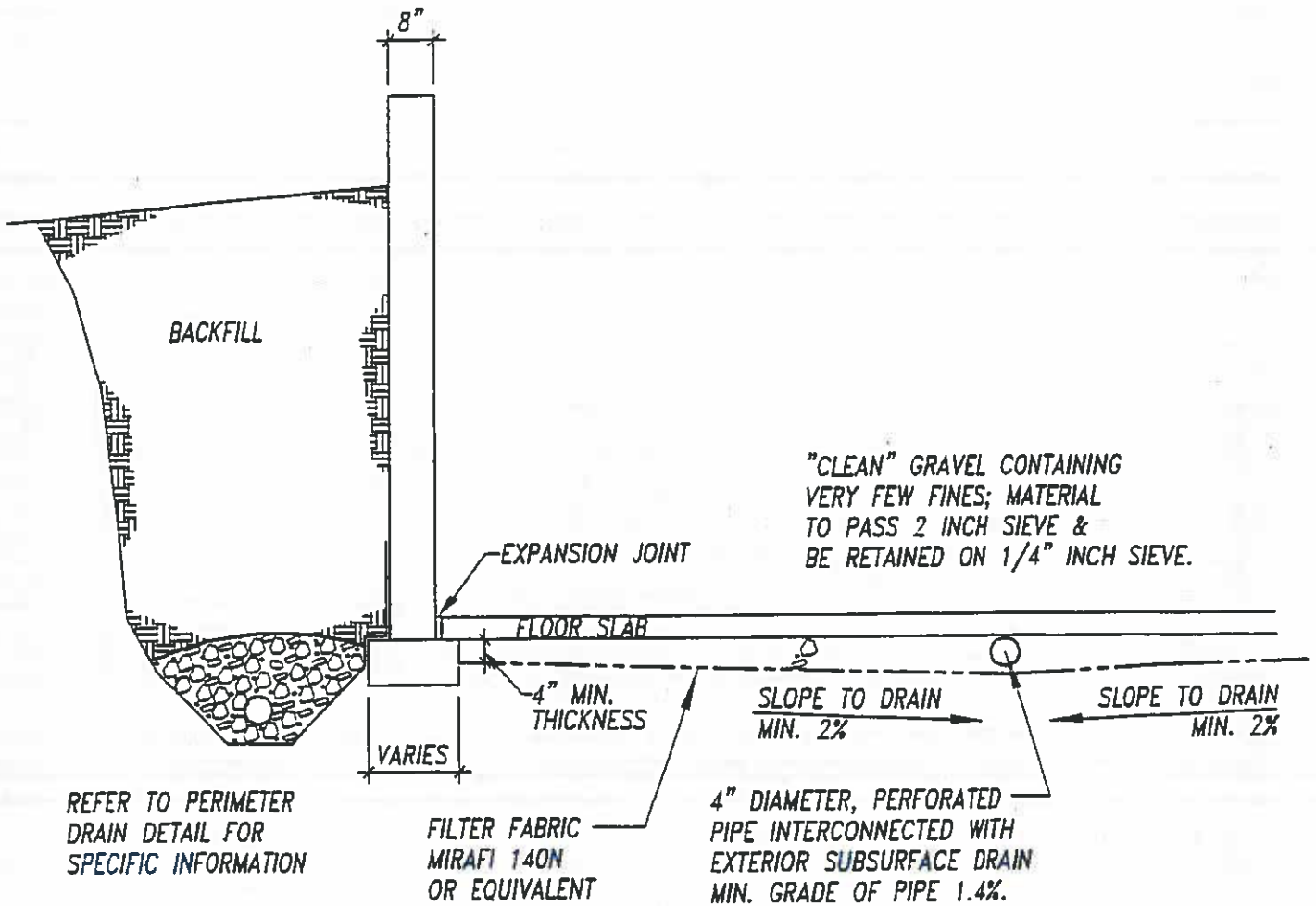

D:\C:\VIA\SAVE\AI 11

DRAWN	C. WALTON
CHECKED	
DATE	
SCALE	NTS
JOB NO.	82556
SHEET	17

TYP. UNDERSLAB DRAINAGE LAYER (CAPILLARY BREAK)



ENTECH
ENGINEERING, INC.
383 CLAYTON DRIVE
COLORADO SPRINGS, CO. 80907 (719) 531-2299

REVISION	BY

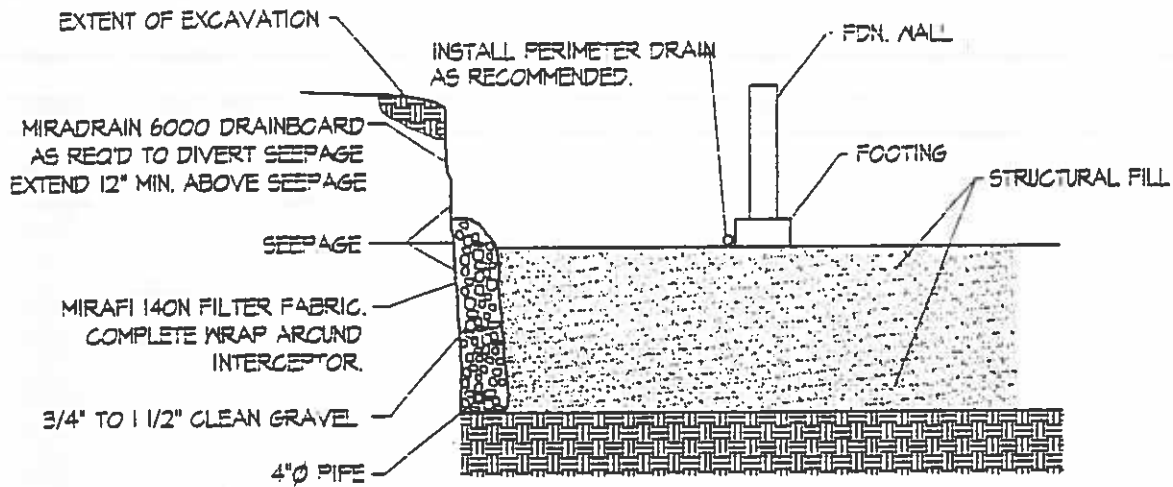

NOTE:
EXTEND INTERCEPTOR DRAIN TO DAYLIGHT

INTERCEPTOR DRAIN DETAIL

NTS.

OWNER	ENTECH
DATE	
SCALE	NTS
JOB NO.	02556
OF SHEETS	10 SHEETS

INTERCEPTOR DRAIN DETAIL



ENTECH
ENGINEERING, INC.
205 ELKTON DRIVE
COLORADO SPRINGS, CO. 80907 (719) 531-5399

REVISION	BY

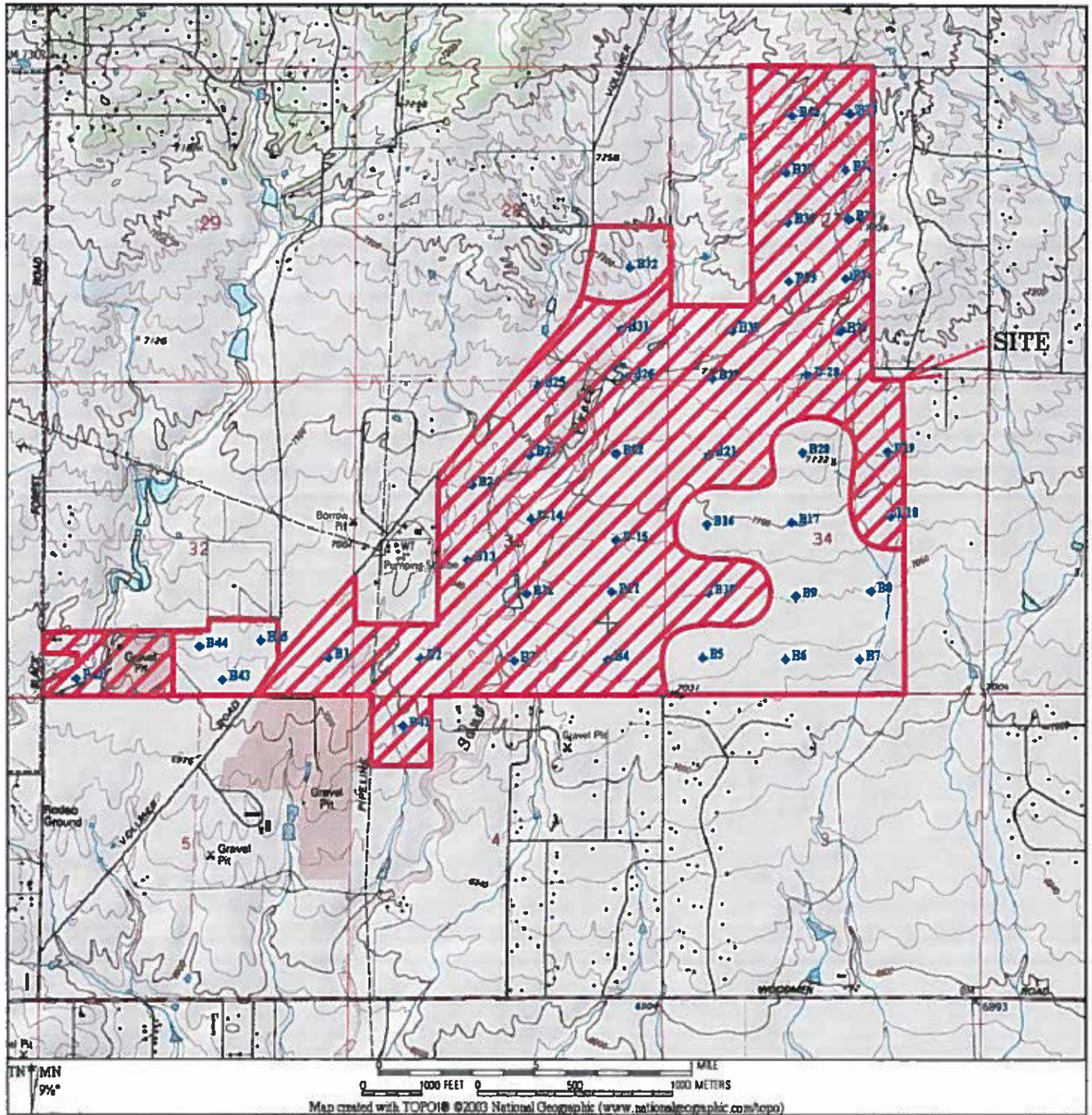

 Areas where shallow bedrock may be encountered



ENTECH
ENGINEERING, INC.
 505 ELKTON DRIVE
 COLORADO SPRINGS, CO. 80907 (719) 531-3599

Shallow Bedrock Map
 Sterling Ranch
 El Paso County, CO.
 FOR: Morley-Bentley Investments

DRAWN:
 KAH

DATE:
 9/8/06

CHECKED:

DATE:

JOB NO.:
 82556

FIG NO.:

19

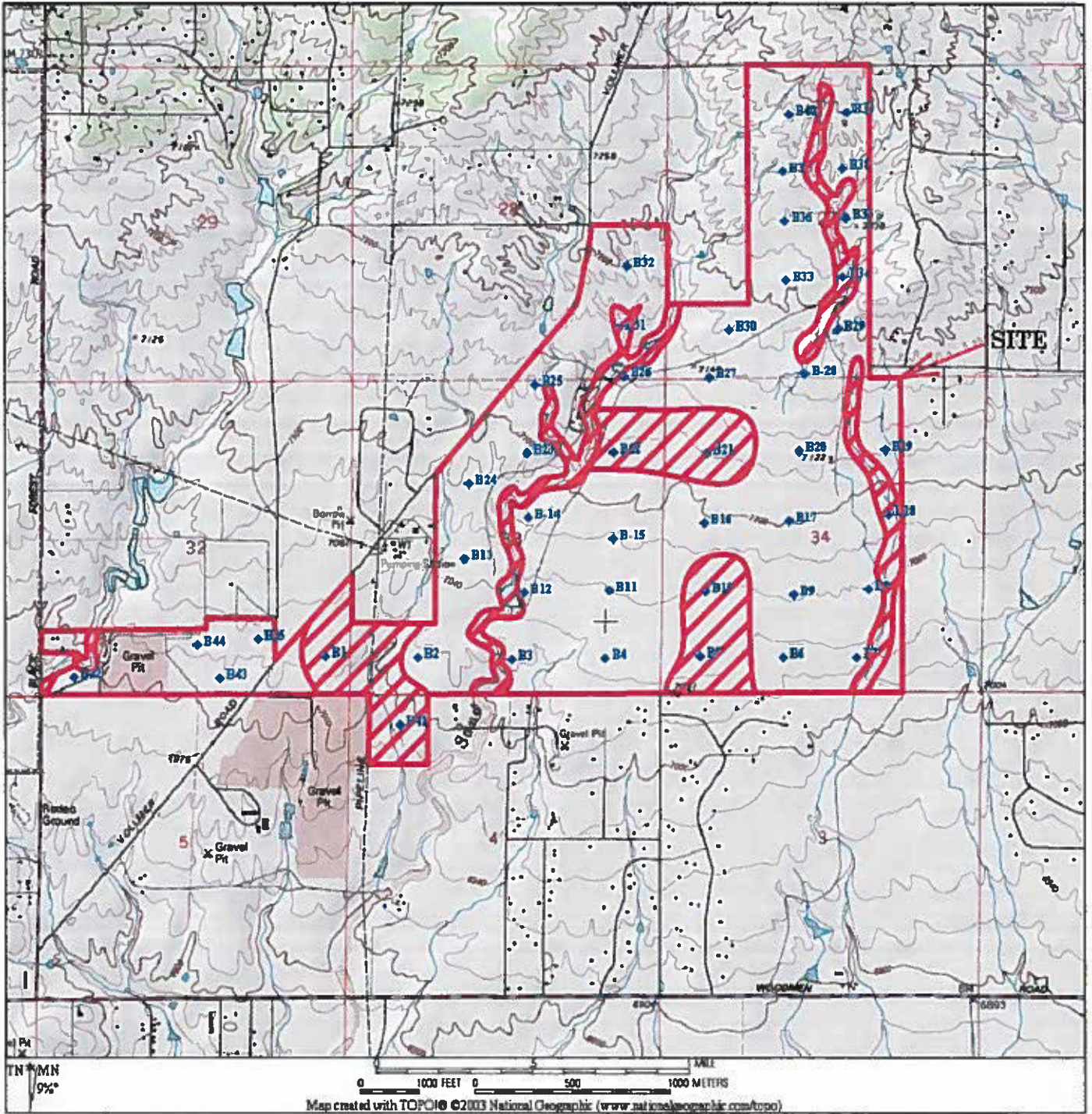

Areas where shallow groundwater may be encountered



ENTECH
ENGINEERING, INC.
 505 ELKTON DRIVE
 COLORADO SPRINGS, CO. 80907 (719) 531-5599

Shallow Groundwater Map
 Sterling Ranch
 El Paso County, CO.
 FOR: Morley-Bentley Investments

DRAWN:
 KAH

DATE:
 9/8/06

CHECKED:

DATE:

JOB NO.:
 82556

FIG NO.:

20

APPENDIX A: Site Photographs

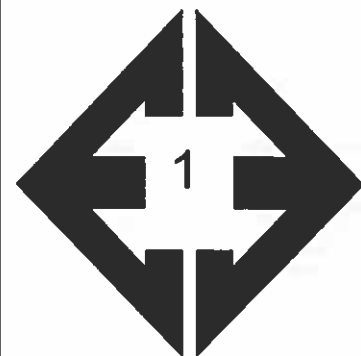

**Looking northwest from
southern portion of the
site.**

6 September 2006

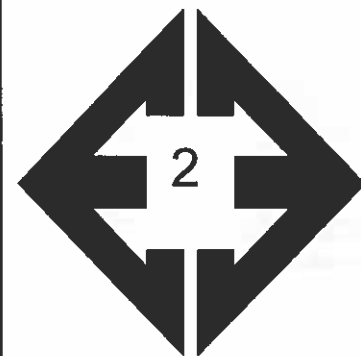

**Looking northeast
from southern portion
of the site.**

6 September 2006



**Looking southeast from
western portion of the
site.**

6 September 2006

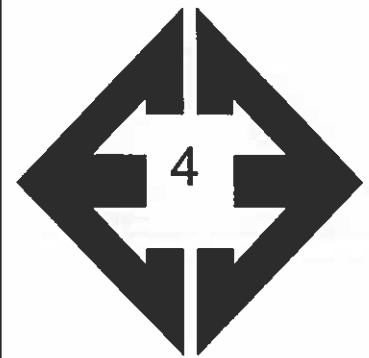

**Looking northeast
from southern portion
of site.**

6 September 2006

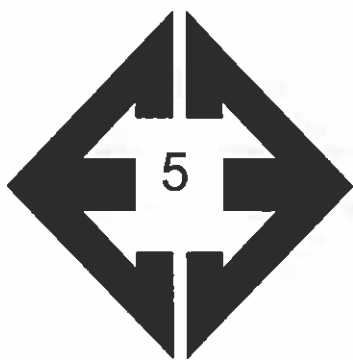
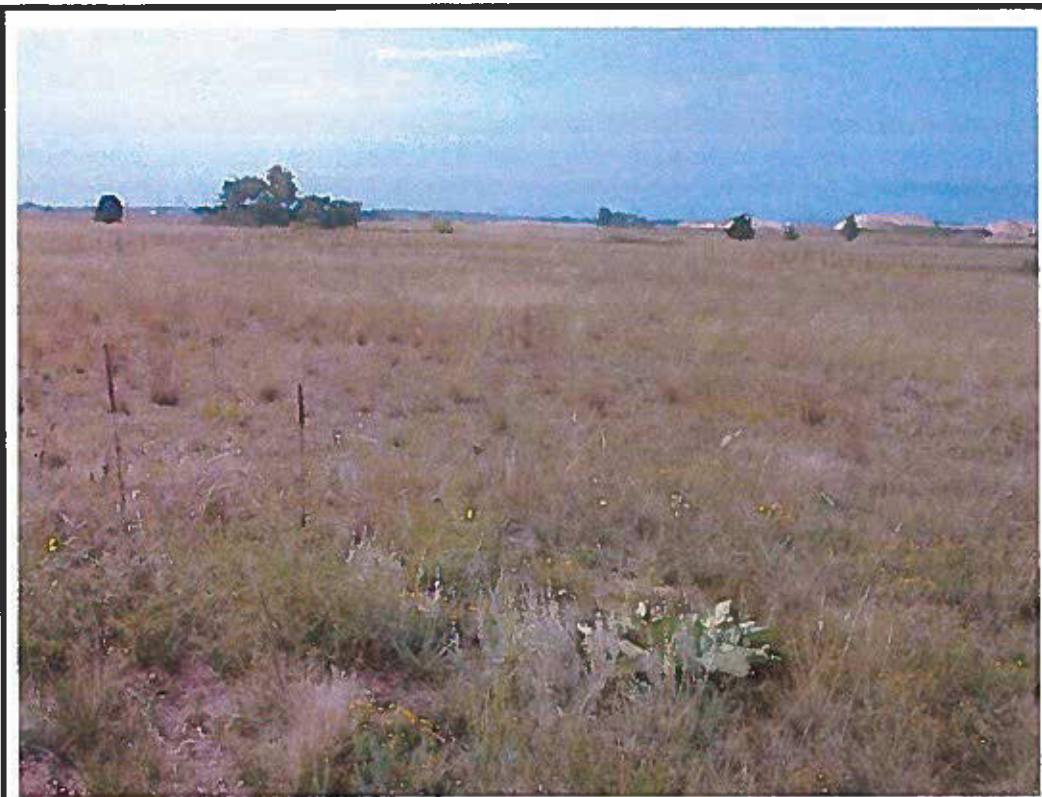

Looking south from southern portion of the site.

6 September 2006



Looking east from southern portion of the site

6 September 2006

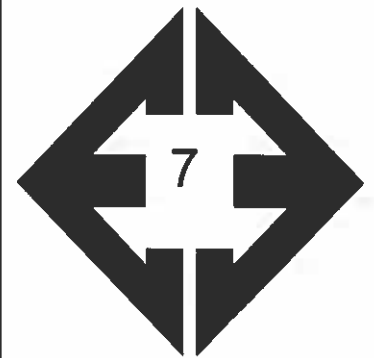

**Looking north from
western portion of the
site.**

6 September 2006

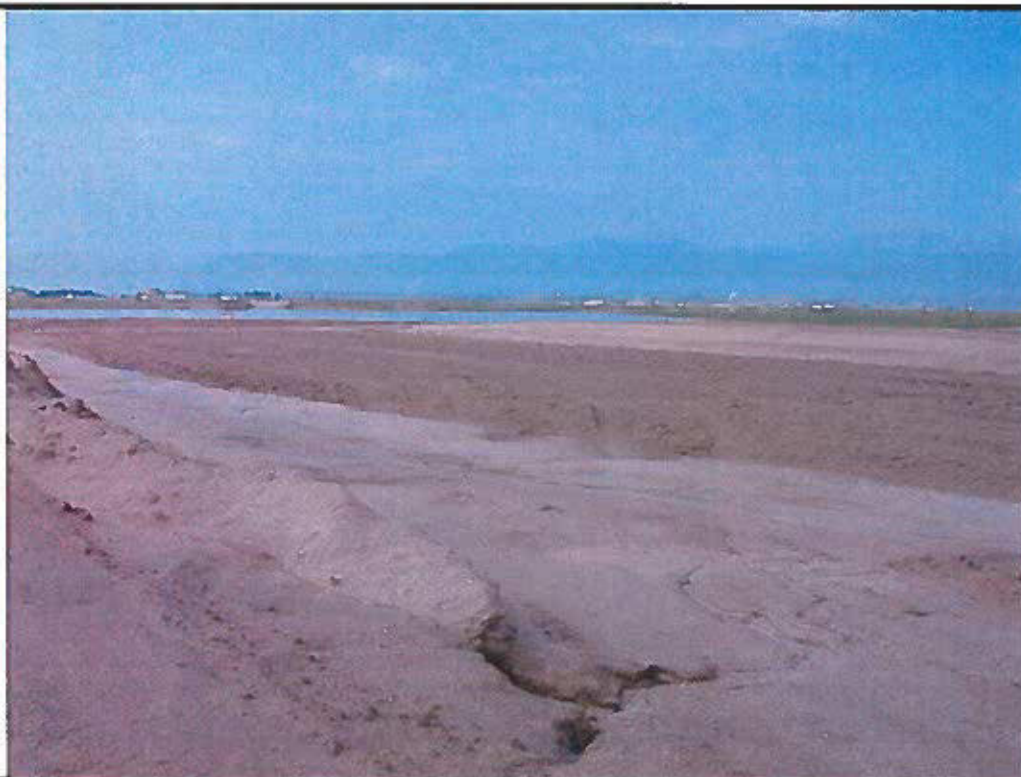

**Looking south at quarry
in central portion of the
site.**

6 September 2006

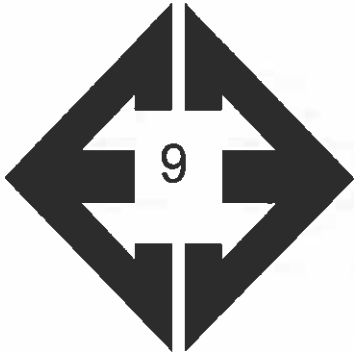

**Looking northwest from
southeast portion of the
site.**

6 September 2006

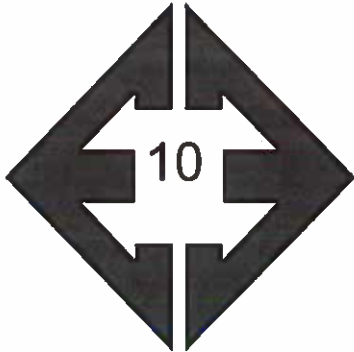

**Looking southwest from
eastern portion of the
site.**

6 September 2006

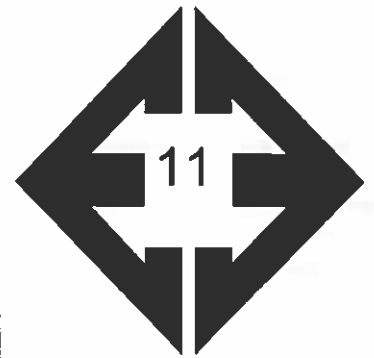

**Looking northwest from
eastern portion of the
site.**

6 September 2006



**Looking east at
drainages in west central
portion of the site.**

6 September 2006



Looking north at pond areas in northwest portion of the site.

6 September 2006

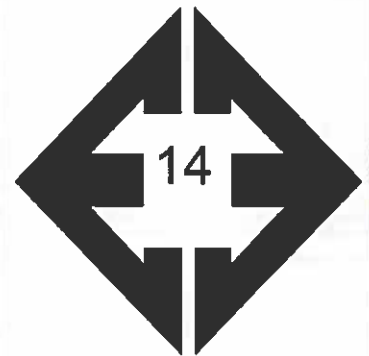

Looking southwest from north central portion of the site.

6 September 2006

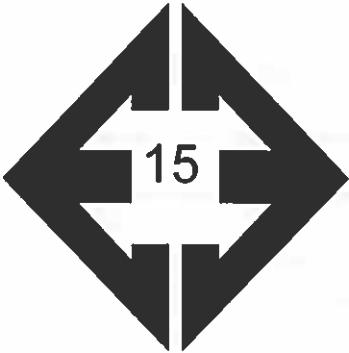

**Looking southeast from
north central portion of
the site.**

6 September 2006

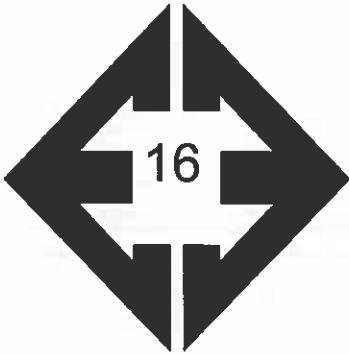

**Looking north from north
central portion of the
site.**

6 September 2006

APPENDIX B: Test Boring Logs

TEST BORING NO. 1
 DATE DRILLED 8/23/2006
 Job # 82556

TEST BORING NO. 2
 DATE DRILLED 8/23/2006
 CLIENT MORLEY BENTLEY
 LOCATION STERLING RANCH

REMARKS	Depth (ft)	Symbol	Samples	Blows per foot	Watercontent %	Soil Type	REMARKS	Depth (ft)	Symbol	Samples	Blows per foot	Watercontent %	Soil Type
WATER @ 6', 8/25/06							WATER @ 11', 8/25/06						
SAND, SILTY, TAN						1	SAND, SILTY, FINE TO COARSE GRAINED, DARK BROWN TO BROWN, MEDIUM DENSE, MOIST						
CLAYSTONE, SANDY, GRAY BROWN, HARD, MOIST	5			50	12.1	4	WEATHERED CLAYSTONE, SANDY, GRAY, VERY STIFF, MOIST	5			12	2.0	1
	6"			50	11.2	4					30	13.3	4
	10			50	13.1	4	SANDSTONE, CLAYEY, FINE TO COARSE GRAINED, LIGHT BROWN, VERY DENSE, MOIST TO VERY MOIST	10			50	11.1	3
	15			50	9.8	4		15			50	18.9	3
	5"										5"		
	20							20					



ENTECH
 ENGINEERING, INC.
 505 ELKTON DRIVE
 COLORADO SPRINGS, CO. 80907 (719) 531-5599

TEST BORING LOG

DRAWN:

DATE:

CHECKED:

DATE:

KAB

9/5/06

JOB NO.:

82556

FIG NO.:

B-1

TEST BORING NO. 3
 DATE DRILLED 8/4/2006
 Job # 82556

TEST BORING NO. 4
 DATE DRILLED 8/4/2006
 CLIENT MORLEY BENTLEY
 LOCATION STERLING RANCH

REMARKS	Depth (ft)	Symbol	Samples	Blows per foot	Watercontent %	Soil Type	REMARKS	Depth (ft)	Symbol	Samples	Blows per foot	Watercontent %	Soil Type
DRY TO 15', 8/7/06							DRY TO 15', 8/4/06 CAVED TO 14.5', 8/7/06, DRY						
SAND, SILTY, GRAVELLY, FINE TO COARSE GRAINED, DARK BROWN TO RED BROWN, MEDIUM DENSE, MOIST	5			17	5.6	1	SAND, SLIGHTLY SILTY, FINE TO COARSE GRAINED, DARK BROWN TO TAN, MEDIUM DENSE TO DENSE, MOIST	5			11	1.9	1
	5			29	8.3	1		5			37	6.2	1
CLAYSTONE, VERY SANDY, BROWN, MOIST			*	*	12.7	4	SANDSTONE, SILTY, FINE TO COARSE GRAINED, LIGHT GRAY, VERY DENSE, MOIST						
SANDSTONE, CLAYEY, FINE TO COARSE GRAINED, LIGHT BROWN, VERY DENSE, MOIST	10			50 6"	10.5	3		10			50 5"	8.0	3
	15			50 4"	9.4	3		15			50 4"	6.2	3
	20							20					

* - BULK SAMPLE TAKEN



ENTECH
 ENGINEERING, INC.
 505 ELKTON DRIVE
 COLORADO SPRINGS, CO. 80907 (719) 531-5599

TEST BORING LOG

DRAWN:	DATE:	CHECKED:	DATE:
		KANA	9/5/06

JOB NO.:
 82556
 FIG NO.:
 B-2

TEST BORING NO. 5
 DATE DRILLED 8/4/2006
 Job # 82556

TEST BORING NO. 6
 DATE DRILLED 8/4/2006
 CLIENT MORLEY BENTLEY
 LOCATION STERLING RANCH

REMARKS	Depth (ft)	Symbol	Samples	Blows per foot	Watercontent %	Soil Type	REMARKS	Depth (ft)	Symbol	Samples	Blows per foot	Watercontent %	Soil Type
WATER @ 8.5', 8/7/06							DRY TO 20', 8/4/06 CAVED TO 19.5', 8/7/06, DRY						
SAND, GRAVELLY, SILTY, FINE TO COARSE GRAINED, DARK BROWN TO TAN, LOOSE TO MEDIUM DENSE, MOIST TO DRY	5			8	3.9	1	SAND, SILTY, GRAVELLY, FINE TO COARSE GRAINED, DARK BROWN TO TAN, LOOSE TO DENSE, DRY TO MOIST	5			9	1.4	1
	5			17	1.8	1		5			9	4.2	1
CLAY, SILTY, LIGHT GRAY, STIFF, MOIST	10			15	12.2	2		10			30	6.7	1
SANDSTONE, CLAYEY, FINE TO COARSE GRAINED, LIGHT GRAY, VERY DENSE, MOIST	15			50	9.4	3	SANDSTONE, SILTY, FINE TO COARSE GRAINED, LIGHT GRAY, VERY DENSE, MOIST	15			50	7.9	3
				5"							10"		
	20			50	9.0	3		20			50	9.3	3
				3"							4"		



ENTECH
 ENGINEERING, INC.
 505 ELKTON DRIVE
 COLORADO SPRINGS, CO. 80907 (719) 531-5599

TEST BORING LOG

DRAWN:

DATE:

CHECKED:

DATE:

[Signature]

9/5/06

JOB NO.:

82556

FIG NO.:

B-3

TEST BORING NO. 7
 DATE DRILLED 8/4/2006
 Job # 82556

TEST BORING NO. 8
 DATE DRILLED 8/9/2006
 CLIENT MORLEY BENTLEY
 LOCATION STERLING RANCH

REMARKS	Depth (ft)	Symbol	Samples	Blows per foot	Watercontent %	Soil Type	REMARKS	Depth (ft)	Symbol	Samples	Blows per foot	Watercontent %	Soil Type
DRY TO 20', 8/7/06							DRY TO 20', 8/9/06 CAVED TO 19.5', 8/10/06, DRY						
SAND, SILTY, FINE TO COARSE GRAINED, DARK BROWN TO BROWN, MEDIUM DENSE, DRY CLAY, SANDY, BROWN, STIFF, MOIST	5			18	1.5	1	SAND, GRAVELLY, SLIGHTLY SILTY, FINE TO COARSE GRAINED, DARK BROWN TO TAN, LOOSE TO DENSE, MOIST	5			7	2.3	1
				22	15.8	2					10	8.9	1
SAND, SILTY, GRAVELLY, FINE TO COARSE GRAINED, LIGHT BROWN, MEDIUM DENSE, MOIST	10			26	6.0	1		10			30	8.5	1
				50	8.9	3	SANDSTONE, SILTY, FINE TO COARSE GRAINED, LIGHT BROWN TO BROWN, VERY DENSE, MOIST	15			50 10"	9.9	3
SANDSTONE, SILTY, FINE GRAINED, LIGHT GRAY, VERY DENSE, MOIST	15							20			50 4"		3
CLAYSTONE, SANDY, GRAY BROWN, VERY STIFF, MOIST	20			46	9.8	4							



ENTECH
 ENGINEERING, INC.
 505 ELKTON DRIVE
 COLORADO SPRINGS, CO. 80907 (719) 531-5399

TEST BORING LOG

DRAWN:

DATE:

CHECKED:

DATE:

[Signature]

9/5/06

JOB NO.:

82556

FIG NO.:

B-4

TEST BORING NO. 9
 DATE DRILLED 8/9/2006
 Job # 82556

TEST BORING NO. 10
 DATE DRILLED 8/9/2006
 CLIENT MORLEY BENTLEY
 LOCATION STERLING RANCH

REMARKS	Depth (ft)	Symbol	Samples	Blows per foot	Watercontent %	Soil Type	REMARKS	Depth (ft)	Symbol	Samples	Blows per foot	Watercontent %	Soil Type
DRY TO 20', 8/10/06							WATER @ 9', 8/10/06						
SAND, SILTY, FINE TO COARSE GRAINED, DARK BROWN TO BROWN, LOOSE TO DENSE, MOIST	5			15	4.0	1	SAND, SLIGHTLY SILTY, FINE TO COARSE GRAINED, LIGHT BROWN, MEDIUM DENSE, MOIST	5			13	2.9	1
	5			5	2.9	1		5			27	8.9	1
	10			17	3.8	1	SANDSTONE, SILTY, FINE TO COARSE GRAINED, GRAY, VERY DENSE, WET	10			50 8"	11.7	3
	15			30	10.4	1	CLAYSTONE, SANDY, GRAY, HARD, MOIST	15			50 3"	13.2	4
SANDSTONE, SILTY, FINE TO COARSE GRAINED, LIGHT GRAY, VERY DENSE, MOIST	20			50 11"	8.5	3		20					



ENTECH
 ENGINEERING, INC.
 505 ELKTON DRIVE
 COLORADO SPRINGS, CO. 80907 (719) 531-5599

TEST BORING LOG

DRAWN:

DATE:

CHECKED:

DATE:

BAH

9/15/06

JOB NO.:

82556

FIG NO.:

B-5

TEST BORING NO. 11
 DATE DRILLED 8/9/2006
 Job # 82556

TEST BORING NO. 12
 DATE DRILLED 8/4/2006
 CLIENT MORLEY BENTLEY
 LOCATION STERLING RANCH

REMARKS	Depth (ft)	Symbol	Samples	Blows per foot	Watercontent %	Soil Type	REMARKS	Depth (ft)	Symbol	Samples	Blows per foot	Watercontent %	Soil Type
WATER AT 14, 8/10/06							WATER @ 13.5', 8/7/06						
SAND, SLIGHTLY SILTY, FINE TO COARSE GRAINED, TAN, MEDIUM DENSE, MOIST	5			16	2.8	1	SAND, GRAVELLY, SLIGHTLY SILTY, FINE TO COARSE GRAINED, DARK BROWN TO TAN, MEDIUM DENSE, MOIST TO WET	5			15	3.0	1
	5			17	2.9	1		5			20	2.5	1
SANDSTONE, SILTY, FINE TO COARSE GRAINED, GRAY TO BROWN, VERY DENSE, MOIST TO WET	10			50 6"	7.2	3		10			24	13.2	1
	15			50 4"	10.6	3	CLAYSTONE, SANDY, LIGHT GRAY, HARD, MOIST	15			50	12.2	2
											*	16.0	2
	20						SANDSTONE, SILTY, FINE GRAINED, LIGHT GRAY, VERY DENSE, MOIST	20			50 5"	14.2	3

* - BULK SAMPLE TAKEN



ENTECH
 ENGINEERING, INC.
 505 ELKTON DRIVE
 COLORADO SPRINGS, CO. 80907 (719) 531-5599

TEST BORING LOG

DRAWN:

DATE:

CHECKED:

DATE:

[Signature]

9/15/06

JOB NO.:







82556

FIG NO.:

B-6

TEST BORING NO. 13
 DATE DRILLED 8/23/2006
 Job # 82556

TEST BORING NO. 14
 DATE DRILLED 8/14/2006
 CLIENT MORLEY BENTLEY
 LOCATION STERLING RANCH

REMARKS	Depth (ft)	Symbol	Samples	Blows per foot	Watercontent %	Soil Type	REMARKS	Depth (ft)	Symbol	Samples	Blows per foot	Watercontent %	Soil Type
DRY TO 15', 8/23/06 CAVED TO 13.5', 8/25/06, DRY							DRY TO 15', 8/14/06 CAVED TO 14.5', 8/16/06, DRY						
SAND, SILTY, BROWN CLAY, VERY SANDY, BROWN, STIFF, MOIST	5			20	5.6	1	SAND, GRAVELLY, SLIGHTLY SILTY, FINE TO COARSE GRAINED, TAN, MEDIUM DENSE, MOIST	5			14	4.4	1
				19	8.0	2	WEATHERED SANDSTONE, SILTY, FINE TO COARSE GRAINED, TAN, DENSE, MOIST				45	8.8	3
SANDSTONE, SILTY, FINE GRAINED, LIGHT GRAY, VERY DENSE, MOIST	10			50 6"	12.8	3	SANDSTONE, GRAVELLY, SILTY, FINE TO COARSE GRAINED, TAN, VERY DENSE, MOIST	10			50 5"	8.8	3
SANDSTONE, SILTY, FINE TO COARSE GRAINED, BROWN, VERY DENSE, MOIST	15			50 5"	8.5	3		15			50 5"	10.6	3
	20							20					



ENTECH
 ENGINEERING, INC.
 565 ELKTON DRIVE
 COLORADO SPRINGS, CO. 80907 (719) 531-5399

TEST BORING LOG

DRAWN:

DATE:

CHECKED:

DATE:

KAT

9/5/06

JOB NO.:

82556

FIG NO.:

B-7

TEST BORING NO. 15
 DATE DRILLED 8/14/2006
 Job # 82556

TEST BORING NO. 16
 DATE DRILLED 8/9/2006
 CLIENT MORLEY BENTLEY
 LOCATION STERLING RANCH

REMARKS	Depth (ft)	Symbol	Samples	Blows per foot	Watercontent %	Soil Type	REMARKS	Depth (ft)	Symbol	Samples	Blows per foot	Watercontent %	Soil Type
DRY TO 15', 8/16/06							DRY TO 20', 8/9/06 CAVED TO 19', 8/10/06, DRY						
SAND, SILTY, FINE TO COARSE GRAINED, TAN, MEDIUM DENSE, MOIST				12	11.6	1	SAND, SILTY, FINE TO COARSE GRAINED, BROWN TO TAN, MEDIUM DENSE TO DENSE, MOIST TO VERY MOIST				14	5.9	1
SANDSTONE, SILTY, FINE TO COARSE GRAINED, LIGHT GRAY TO BROWN, VERY DENSE, MOIST	5			50 9"	10.4	3		5			15	9.3	1
	10			50 5"	9.0	3		10			25	5.9	1
	15			50 4"	9.6	3	SANDSTONE, SILTY, FINE TO COARSE GRAINED, BROWN, VERY DENSE, MOIST	15			31	13.5	1
	20							20			50 3"	6.7	3



ENTECH
 ENGINEERING, INC.
 505 ELKTON DRIVE
 COLORADO SPRINGS, CO. 80907 (719) 531-5599

TEST BORING LOG

DRAWN:	DATE:	CHECKED: <i>R.A.</i>	DATE: 9/5/06
--------	-------	-------------------------	-----------------

JOB NO.:
82556
 FIG NO.:
B-8

TEST BORING NO. 17
 DATE DRILLED 8/9/2006
 Job # 82556

TEST BORING NO. 18
 DATE DRILLED 8/9/2006
 CLIENT MORLEY BENTLEY
 LOCATION STERLING RANCH

REMARKS	Depth (ft)	Symbol	Samples	Blows per foot	Watercontent %	Soil Type	REMARKS	Depth (ft)	Symbol	Samples	Blows per foot	Watercontent %	Soil Type
DRY TO 20', 8/10/06							WATER AT 7.5', 8/10/06						
SAND, SLIGHTLY SILTY, FINE TO COARSE GRAINED, DARK BROWN TO TAN, LOOSE TO DENSE, MOIST TO VERY MOIST	5			18	1.9	1	SAND, GRAVELLY, SILTY, FINE TO COARSE GRAINED, DARK BROWN TO TAN, MEDIUM DENSE TO DENSE, MOIST	5			27	7.3	1
	5			18	2.6	1		5			46	4.6	1
	10			8	12.8	1	SANDSTONE, SILTY, FINE GRAINED, GRAY TO BROWN, VERY DENSE, WET	10			50 7"	28.0	3
	15			26	7.8	1		15			50 5"	19.4	3
	20			32	12.9	1		20					



ENTECH
 ENGINEERING, INC.
 505 ELKTON DRIVE
 COLDFRASE SPRINGS, CO. 80907 (719) 531-5599

TEST BORING LOG

DRAWN:

DATE:

CHECKED:

DATE:

KAW

9/15/06

JOB NO.:

82556

FIG NO.:

B-9

TEST BORING NO. 19
 DATE DRILLED 8/10/2006
 Job # 82556

TEST BORING NO. 20
 DATE DRILLED 8/9/2006
 CLIENT MORLEY BENTLEY
 LOCATION STERLING RANCH

REMARKS	Depth (ft)	Symbol	Samples	Blows per foot	Watercontent %	Soil Type	REMARKS	Depth (ft)	Symbol	Samples	Blows per foot	Watercontent %	Soil Type
DRY TO 15', 8/10/06 CAVED TO 14.5', 8/11/06, DRY							DRY TO 20', 8/10/06						
SAND, SILTY, GRAVELLY, FINE TO COARSE GRAINED, LIGHT BROWN, LOOSE TO DENSE, DRY TO MOIST	5			5	1.7	1	SAND, GRAVELLY, SLIGHTLY SILTY, FINE TO COARSE GRAINED, BROWN TO TAN, MEDIUM DENSE, MOIST TO VERY MOIST	5			22	3.3	1
				30	5.6	1					24	3.1	1
SANDSTONE, GRAVELLY, SILTY, FINE TO COARSE GRAINED, GRAY, VERY DENSE, MOIST	10			50 5"	9.5	3		10			22	7.7	1
				50 4"	9.0	3					22	14.1	1
	20						SANDSTONE, GRAVELLY, SILTY, FINE TO COARSE GRAINED, TAN, VERY DENSE, MOIST	20			50 6"	11.5	3



ENTECH
 ENGINEERING, INC.
505 ELKTON DRIVE
 COLORADO SPRINGS, CO. 80907 (719) 531-5999

TEST BORING LOG

DRAWN:	DATE:	CHECKED:	DATE:
		<i>BAW</i>	9/5/06

JOB NO.:
82556

FIG NO.:
B-10

TEST BORING NO. 21
 DATE DRILLED 8/9/2006
 Job # 82556

TEST BORING NO. 22
 DATE DRILLED 8/9/2006
 CLIENT MORLEY BENTLEY
 LOCATION STERLING RANCH

REMARKS	Depth (ft)	Symbol	Samples	Blows per foot	Watercontent %	Soil Type	REMARKS	Depth (ft)	Symbol	Samples	Blows per foot	Watercontent %	Soil Type
WATER @ 10', 8/10/06							WATER @ 3.5', 8/10/06						
SAND, GRAVELLY, SILTY, FINE TO COARSE GRAINED, BROWN TO TAN, MEDIUM DENSE TO DENSE, MOIST	0-5	(Symbol)		24	1.6	1	SAND, GRAVELLY, CLAYEY, FINE TO COARSE GRAINED, TAN, MEDIUM DENSE, MOIST	0-5	(Symbol)		25	9.7	1
	5-10	(Symbol)		31	2.7	1	WEATHERED SANDSTONE, SILTY, FINE GRAINED, GRAY, DENSE, WET	5-10	(Symbol)		40	29.8	3
CLAY, SANDY, GREEN BROWN, MOIST	10-15	(Symbol)	*	*	16.9	2	SANDSTONE, SILTY, FINE TO COARSE GRAINED, DARK GRAY, VERY DENSE, WET	10-15	(Symbol)		50		3
SANDSTONE, CLAYEY, FINE TO COARSE GRAINED, BROWN, VERY DENSE, MOIST	15-20	(Symbol)	*	50	10.0	3		15-20	(Symbol)		50		3
				9"							3"		
CLAYSTONE, SANDY, GRAYISH BROWN, HARD, MOIST			*	*	10.8	3					50		3
			*	50	11.5	4					5"		
				6"	10.3	4							
* - BULK SAMPLE TAKEN													



ENTECH
 ENGINEERING, INC.
 505 ELKTON DRIVE
 COLORADO SPRINGS, CO. 80907 (719) 531-5599

TEST BORING LOG

DRAWN:

DATE:

CHECKED: *Carl*

DATE: 9/5/06

JOB NO.:

82556

FIG NO.:

B-11

TEST BORING NO. 23
 DATE DRILLED 8/16/2006
 Job # 82556

TEST BORING NO. 24
 DATE DRILLED 8/16/2006
 CLIENT MORLEY BENTLEY
 LOCATION STERLING RANCH

REMARKS	Depth (ft)	Symbol	Samples	Blows per foot	Watercontent %	Soil Type	REMARKS	Depth (ft)	Symbol	Samples	Blows per foot	Watercontent %	Soil Type	
DRY TO 15', 8/17/06							DRY TO 15', 8/16/06 CAVED TO 14.5', 8/17/06, DRY							
SAND, GRAVELLY, SILTY, FINE TO COARSE GRAINED, BROWN TO TAN, MEDIUM DENSE, MOIST				19	4.1	1	SAND, SILTY, BROWN						1	
SAND, CLAYEY, FINE TO COARSE GRAINED, BROWN, MEDIUM DENSE, MOIST	5			27	11.1	1	WEATHERED CLAYSTONE, SANDY, TAN, VERY STIFF, MOIST	5			39	16.2	4	
CLAY, SANDY, BROWN, MOIST			*		17.2	2	SANDSTONE, CLAYEY, FINE TO COARSE GRAINED, GRAY, VERY DENSE, MOIST				50	10.3	3	
CLAYSTONE, SANDY, GREEN BROWN, HARD, MOIST	10			50	18.6	4		10			50	9.7	3	
				10"			CLAYSTONE, SANDY, GRAY BROWN				5"			4
SANDSTONE, CLAYEY, FINE GRAINED, LIGHT BROWN, VERY DENSE, MOIST	15			50	11.9	3	SANDSTONE, SILTY, FINE TO MEDIUM GRAINED, TAN, VERY DENSE, MOIST	15			50	13.9	3	
				6"							5"			
* - BULK SAMPLE TAKEN	20							20						



ENTECH
 ENGINEERING, INC.
 505 ELKTON DRIVE
 COLORADO SPRINGS, CO. 80907 (719) 531-5599

TEST BORING LOG

DRAWN: DATE: CHECKED: DATE:
KH 9/15/06

JOB NO.:
 82556
 FIG NO.:
 B-12

TEST BORING NO. 25
 DATE DRILLED 8/16/2006
 Job # 82556

TEST BORING NO. 26
 DATE DRILLED 8/9/2006
 CLIENT MORLEY BENTLEY
 LOCATION STERLING RANCH

REMARKS	Depth (ft)	Symbol	Samples	Blows per foot	Watercontent %	Soil Type	REMARKS	Depth (ft)	Symbol	Samples	Blows per foot	Watercontent %	Soil Type
DRY TO 15', 8/16/06 CAVED TO 13.5', 8/17/06, DRY							WATER @ 19', 8/10/06						
SAND, GRAVELLY, SLIGHTLY SILTY, FINE TO COARSE GRAINED, BROWN TO TAN, MEDIUM DENSE, MOIST	5			15	2.2	1	SAND, GRAVELLY, SILTY, FINE TO COARSE GRAINED, BROWN TO TAN, MEDIUM DENSE TO DENSE, DRY TO MOIST	5			11	0.9	1
				16	2.6	1					17	2.8	1
WEATHERED TO FORMATIONAL CLAYSTONE, SANDY, GREEN BROWN, VERY STIFF TO HARD, MOIST	10			48	15.9	4		10			32	7.9	1
				50	15.6	4							
SANDSTONE, SILTY, FINE TO COARSE GRAINED, BLUE GRAY, VERY DENSE, MOIST	15			50	10.1	3	SANDSTONE, SILTY, GRAVELLY, FINE TO COARSE GRAINED, TAN, VERY DENSE, MOIST	15			50	8.4	3
				3"							4"		
	20							20			50	9.8	3
											4"		



ENTECH
 ENGINEERING, INC.
 505 ELKTON DRIVE
 COLORADO SPRINGS, CO. 80907 (719) 531-9599

TEST BORING LOG

DRAWN:

DATE:

CHECKED:

DATE:

East

9/15/06

JOB NO.:

02556

FIG NO.:

B-13

TEST BORING NO. 27
 DATE DRILLED 8/9/2006
 Job # 82556

TEST BORING NO. 28
 DATE DRILLED 8/10/2006
 CLIENT MORLEY BENTLEY
 LOCATION STERLING RANCH

REMARKS	Depth (ft)	Symbol	Samples	Blows per foot	Watercontent %	Soil Type	REMARKS	Depth (ft)	Symbol	Samples	Blows per foot	Watercontent %	Soil Type
DRY TO 15', 8/9/06 CAVED TO 14.5', 8/10/06, DRY							DRY TO 15', 8/10/06 CAVED TO 14.5', 8/11/06, DRY						
SAND, GRAVELLY, SILTY, FINE TO COARSE GRAINED, BROWN TO TAN, MEDIUM DENSE TO DENSE, MOIST	5			19	2.8	1	SAND, SILTY, DARK BROWN						1
				30	6.6	1	WEATHERED SANDSTONE, SILTY, TAN, MEDIUM DENSE, MOIST	5			25	7.1	3
				29	19.5	2	SANDSTONE, SILTY, FINE TO COARSE GRAINED, TAN, VERY DENSE, MOIST				50	6.8	3
CLAY, SANDY, GRAY, STIFF, MOIST	10			50	10.2	3		10			5"	5.9	3
SANDSTONE, GRAVELLY, CLAYEY, FINE TO COARSE GRAINED, GRAY BROWN, VERY DENSE, MOIST	15			50	10.4	3		15			50	8.1	3
				5"							4"		
	20							20					



ENTECH
 ENGINEERING, INC.
 505 ELKTON DRIVE
 COLORADO SPRINGS, CO. 80907 (719) 531-5599

TEST BORING LOG

DRAWN: DATE: CHECKED: DATE:
Law 9/5/06

JOB NO.:
 82556
 FIG NO.:
 B-14

TEST BORING NO. 29
 DATE DRILLED 8/10/2006
 Job # 82556

TEST BORING NO. 30
 DATE DRILLED 8/14/2006
 CLIENT MORLEY BENTLEY
 LOCATION STERLING RANCH

REMARKS	Depth (ft)	Symbol	Samples	Blows per foot	Watercontent %	Soil Type	REMARKS	Depth (ft)	Symbol	Samples	Blows per foot	Watercontent %	Soil Type
DRY TO 15', 8/10/06							WATER AT 11', 8/16/06						
SAND, SILTY, BROWN						1	SAND, SILTY, BROWN						1
						3	CLAY, SANDY, TAN, MOIST			*	13.0		2
SANDSTONE, SILTY, GRAVELLY, FINE TO COARSE GRAINED, LIGHT BROWN, VERY DENSE, MOIST	5			50 6"	2.3	3	SAND, GRAVELLY, SILTY, FINE TO COARSE GRAINED, TAN, MEDIUM DENSE TO DENSE, MOIST	5			24	3.4	1
SANDSTONE, CLAYEY, FINE TO COARSE GRAINED, GREEN BROWN, VERY DENSE, MOIST				50 5"	6.4	3	SANDSTONE, SLIGHTLY SILTY, FINE TO COARSE GRAINED, TAN, VERY DENSE, MOIST				34	6.6	1
	10			50 6"	7.6	3		10			50 5"	9.3	3
	15			50 4"	9.0	3	CLAYSTONE, SILTY, GREEN BROWN, HARD, MOIST	15			50 5"	17.2	4
* - BULK SAMPLE TAKEN							* - BULK SAMPLE TAKEN						



ENTECH
 ENGINEERING, INC.
 303 ELKTON DRIVE
 COLORADO SPRINGS, CO. 80907 (719) 531-5399

TEST BORING LOG

DRAWN:

DATE:

CHECKED:
KAG

DATE:
 9/15/06

JOB NO.:
 82556
 FIG NO.:
 B-15

TEST BORING NO. 31
 DATE DRILLED 8/14/2006
 Job # 82556

TEST BORING NO. 32
 DATE DRILLED 8/14/2006
 CLIENT MORLEY BENTLEY
 LOCATION STERLING RANCH

REMARKS	Depth (ft)	Symbol	Samples	Blows per foot	Watercontent %	Soil Type	REMARKS	Depth (ft)	Symbol	Samples	Blows per foot	Watercontent %	Soil Type
WATER AT 8', 8/16/06							WATER @ 11', 8/16/06						
SAND, SILTY, GRAVELLY, FINE TO COARSE GRAINED, DARK BROWN, MEDIUM DENSE, MOIST	5	[Symbol]		19	6.1	1	SAND, SILTY, BROWN CLAY, SANDY, BROWN						1
CLAY, SANDY, TAN, STIFF, MOIST	5	[Symbol]		24	18.8	2	SAND, GRAVELLY, SILTY, FINE TO COARSE GRAINED, TAN, MEDIUM DENSE, MOIST TO VERY MOIST	5	[Symbol]		37	5.0	1
											23	8.7	1
SANDSTONE, SILTY, FINE TO COARSE GRAINED, LIGHT GRAY, VERY DENSE, MOIST TO WET	10	[Symbol]		50 7"	12.6	3	SANDSTONE, SILTY, FINE TO COARSE GRAINED, LIGHT BROWN, VERY DENSE, VERY MOIST	10	[Symbol]		14	13.6	1
	15	[Symbol]		50 4"	10.4	3		15	[Symbol]		50 5"	17.5	3
	20	[Symbol]					CLAYSTONE, SILTY, LIGHT BROWN, HARD, MOIST	20	[Symbol]		* 50 5"	11.2	4
												10.8	4

* - BULK SAMPLE TAKEN



ENTECH
 ENGINEERING, INC.
 505 ELKTON DRIVE
 COLORADO SPRINGS, CO. 80907 (719) 531-3399

TEST BORING LOG

DRAWN:

DATE:

CHECKED:
KAW

DATE:
 9/5/06

JOB NO.:

82556

FIG NO.:

B-16

TEST BORING NO. 33
 DATE DRILLED 8/14/2006
 Job # 82556

TEST BORING NO. 34
 DATE DRILLED 8/10/2006
 CLIENT MORLEY BENTLEY
 LOCATION STERLING RANCH

REMARKS	Depth (ft)	Symbol	Samples	Blows per foot	Watercontent %	Soil Type	REMARKS	Depth (ft)	Symbol	Samples	Blows per foot	Watercontent %	Soil Type
DRY TO 15', 8/16/06							WATER @ 6', 8/11/06						
SAND, SILTY, FINE TO COARSE GRAINED, BROWN, MEDIUM DENSE, MOIST				22	3.9	1	CLAY, VERY SANDY, DARK BROWN TO BROWN, STIFF TO FIRM, MOIST				26	4.9	2
SANDSTONE, SILTY, GRAVELLY, FINE TO COARSE GRAINED, LIGHT BROWN, VERY DENSE, MOIST	5			50 10"	6.6	3		5			13	7.0	2
	10			50 7"	11.8	3	SANDSTONE, CLAYEY, FINE TO COARSE GRAINED, TAN, VERY DENSE, WET	10			50 6"	14.2	3
CLAYSTONE, SANDY, BROWN, HARD, MOIST	15			50 9"	24.8	4		15			50 5"	7.9	3
	20							20					



ENTECH
 ENGINEERING, INC.
505 ELKTON DRIVE
 COLORADO SPRINGS, CO. 80907 (719) 531-5599

TEST BORING LOG

DRAWN:

DATE:

CHECKED:

DATE:

[Signature] 9/15/06

JOB NO.:

82556

FIG NO.:

B-17

TEST BORING NO. 35
 DATE DRILLED 8/10/2006
 Job # 82556

TEST BORING NO. 36
 DATE DRILLED 8/14/2006
 CLIENT MORLEY BENTLEY
 LOCATION STERLING RANCH

REMARKS	Depth (ft)	Symbol	Samples	Blows per foot	Watercontent %	Soil Type	REMARKS	Depth (ft)	Symbol	Samples	Blows per foot	Watercontent %	Soil Type
DRY TO 15', 8/10/06 CAVED TO 14.5', 8/11/06, DRY							DRY TO 15', 8/14/06 CAVED TO 14', 8/16/06, DRY						
SAND, SILTY, FINE TO COARSE GRAINED, BROWN TO TAN, MEDIUM DENSE, MOIST SANDSTONE, SLIGHTLY SILTY, FINE TO COARSE GRAINED, LIGHT BROWN, VERY DENSE, MOIST	5			29	2.4	1	SAND, SILTY, BROWN SANDSTONE, GRAVELLY, CLAYEY, FINE TO COARSE GRAINED, LIGHT BROWN, VERY DENSE, MOIST	5			50	6.7	3
				50	7.6	3					7"	10.4	3
	10			50	8.6	3		10			50	8.8	3
				6"							5"		
	15			50	6.2	3		15			50	11.8	3
				4"							4"		
	20							20					



ENTECH
 ENGINEERING, INC.
 585 ELKTON DRIVE
 COLORADO SPRINGS, CO 80907 (719) 531-5599

TEST BORING LOG

DRAWN:

DATE:

CHECKED:

DATE:

[Signature] 9/5/06

JOB NO.:

82556

FIG NO.:

B-18

TEST BORING NO. 37
 DATE DRILLED 8/10/2006
 Job # 82556

TEST BORING NO. 38
 DATE DRILLED 8/10/2006
 CLIENT MORLEY BENTLEY
 LOCATION STERLING RANCH

REMARKS	Depth (ft)	Symbol	Samples	Blows per foot	Watercontent %	Soil Type	REMARKS	Depth (ft)	Symbol	Samples	Blows per foot	Watercontent %	Soil Type
DRY TO 15', 8/10/06 CAVED TO 14.5', 8/11/06, DRY							DRY TO 15', 8/10/06 CAVED TO 14.5', 8/11/06, DRY						
SAND, SILTY, BROWN						1	SAND, SILTY, BROWN						1
SANDSTONE, SILTY, FINE TO COARSE GRAINED, LIGHT BROWN, VERY DENSE, MOIST	5			50 7"	4.1	3	SANDSTONE, SILTY, GRAVELLY, FINE TO COARSE GRAINED, TAN, VERY DENSE, MOIST	5			50 8"	4.3	3
				50 5"	5.2	3					50 6"	5.5	3
CLAYEY LENSES	10			50 7"	10.2	3		10			50 4"	6.1	3
	15			50 4"	7.4	3		15			50 4"	9.3	3
	20							20					



ENTECH
 ENGINEERING, INC.
 505 ELKTON DRIVE
 COLORADO SPRINGS, CO 80907 (719) 531-5399

TEST BORING LOG

DRAWN:

DATE:

CHECKED:

DATE:

[Signature]

9/15/06

JOB NO.:

82556

FIG NO.:

B-19

TEST BORING NO. 39
 DATE DRILLED 8/10/2006
 Job # 82556

TEST BORING NO. 40
 DATE DRILLED 8/10/2006
 CLIENT MORLEY BENTLEY
 LOCATION STERLING RANCH

REMARKS	Depth (ft)	Symbol	Samples	Blows per foot	Watercontent %	Soil Type	REMARKS	Depth (ft)	Symbol	Samples	Blows per foot	Watercontent %	Soil Type
DRY TO 15', 8/10/06 CAVED TO 14.5', 8/11/06, DRY							DRY TO 15', 8/10/06 CAVED TO 14.5', 8/11/06, DRY						
SAND, SILTY, GRAVELLY, FINE TO COARSE GRAINED, TAN, MEDIUM DENSE, MOIST	5	[Symbol]		18	2.2	1	SAND, SILTY, BROWN						1
				50							50	6.7	3
				10"	9.6	3	SANDSTONE, SILTY, CLAYEY, GRAVELLY, FINE TO COARSE GRAINED, LIGHT BROWN, VERY DENSE, MOIST	5	[Symbol]		50	4.4	3
				*	11.0	3					5"		
	10	[Symbol]		50	10.2	3		10	[Symbol]		50	8.8	3
				7"							5"		
SANDSTONE, VERY CLAYEY, FINE TO COARSE GRAINED, TAN, VERY DENSE, MOIST	15	[Symbol]		50	11.1	3	CLAYSTONE, SANDY, BROWN, HARD, MOIST	15	[Symbol]		50	14.4	4
				5"							5"		
* - BULK SAMPLE TAKEN	20							20					



ENTECH
 ENGINEERING, INC.
 505 ELKTON DRIVE
 COLORADO SPRINGS, CO. 80907 (719) 531-5599

TEST BORING LOG

DRAWN:

DATE:

CHECKED:

DATE:

[Signature] 9/15/06

JOB NO.:

82556

FIG NO.:

B-26

TEST BORING NO. 41
 DATE DRILLED 8/23/2006
 Job # 82556

TEST BORING NO. 42
 DATE DRILLED 8/23/2006
 CLIENT MORLEY BENTLEY
 LOCATION STERLING RANCH

REMARKS	Depth (ft)	Symbol	Samples	Blows per foot	Watercontent %	Soil Type	REMARKS	Depth (ft)	Symbol	Samples	Blows per foot	Watercontent %	Soil Type
WATER @ 9', 8/25/06							WATER @ 12', 8/28/06						
SAND, SLIGHTLY SILTY, FINE TO COARSE GRAINED, BROWN, MEDIUM DENSE, MOIST				25	10.4	1	SAND, SLIGHTLY SILTY, FINE TO COARSE GRAINED, BROWN TO TAN, MEDIUM DENSE, MOIST				18	4.6	1
SAND, VERY CLAYEY, VERY SILTY, FINE TO COARSE GRAINED, GRAY, MEDIUM DENSE, MOIST	5			29	10.9	1		5			25	2.9	1
CLAYSTONE, SANDY, LIGHT GRAY			*		12.4	4	SANDSTONE, SILTY, FINE TO COARSE GRAINED, LIGHT GRAY, VERY DENSE, MOIST						
SANDSTONE, SILTY, FINE TO COARSE GRAINED, LIGHT GRAY, VERY DENSE, VERY MOIST	10			50 7"	11.3	3		10			50 5"	11.4	4
	15			50 7"	11.7	3		15			50 5"	5.0	4
	20							20					

* - BULK SAMPLE TAKEN



ENTECH
 ENGINEERING, INC.
 505 ELKTON DRIVE
 COLORADO SPRINGS, CO. 80907 (719) 531-5599

TEST BORING LOG

DRAWN:

DATE:

CHECKED:

DATE:

BA-8

9/5/06

JOB NO.:
82556

FIG NO.:
B-21

TEST BORING NO. 43
 DATE DRILLED 8/23/2006
 Job # 82556

TEST BORING NO. 44
 DATE DRILLED 8/23/2006
 CLIENT MORLEY BENTLEY
 LOCATION STERLING RANCH

REMARKS	Depth (ft)	Symbol	Samples	Blows per foot	Watercontent %	Soil Type	REMARKS	Depth (ft)	Symbol	Samples	Blows per foot	Watercontent %	Soil Type
DRY TO 20', 8/23/06 CAVED TO 17.5', 8/28/06, DRY							WATER @ 11', 8/28/06						
SAND, SLIGHTLY SILTY, FINE TO COARSE GRAINED, BROWN TO TAN, MEDIUM DENSE, MOIST	5			13	3.1	1	SAND, SLIGHTLY SILTY, FINE TO COARSE GRAINED, BROWN TO TAN, MEDIUM DENSE, MOIST TO WET	5			11	3.4	1
				19	6.0	1					17	5.0	1
	10			19	6.1	1		10			18	4.4	1
				18	15.6	2					22	10.5	1
CLAY, SANDY, GRAY, STIFF, MOIST CLAYSTONE, SANDY, GRAY, HARD, MOIST	15							15					
	20			50	9.5	4	SANDSTONE, SILTY, FINE TO COARSE GRAINED, LIGHT GRAY, VERY DENSE, VERY MOIST	20			50	13.4	3
				7"							7"		



ENTECH
 ENGINEERING, INC.
 505 ELKTON DRIVE
 COLORADO SPRINGS, CO. 80907 (719) 531-5599

TEST BORING LOG

DRAWN: DATE: CHECKED: DATE:
KAW 9/15/06

JOB NO.:

82556

FIG NO.:

B-22

TEST BORING NO. 45
 DATE DRILLED 8/23/2006
 Job # 82556

TEST BORING NO.
 DATE DRILLED
 CLIENT MORLEY BENTLEY
 LOCATION STERLING RANCH

REMARKS	Depth (ft)	Symbol	Samples	Blows per foot	Watercontent %	Soil Type	REMARKS	Depth (ft)	Symbol	Samples	Blows per foot	Watercontent %	Soil Type
WATER @ 12.5', 8/25/06													
SAND, SILTY, FINE TO COARSE GRAINED, BROWN TO TAN, MEDIUM DENSE, MOIST	5			18	6.0	1		5					
	10			20	4.5	1		10					
	15			24	5.8	1		15					
WEATHERED TO FORMATIONAL SANDSTONE, SILTY, FINE TO COARSE GRAINED, DENSE TO VERY DENSE, LIGHT GRAY, WET	20			33	13.8	3		20					
				50 7"	10.5	3							



ENTECH
 ENGINEERING, INC.
 505 ELKTON DRIVE
 COLORADO SPRINGS, CO. 80907 (719) 521-3599

TEST BORING LOG

DRAWN:

DATE:

CHECKED:

DATE:

K Per

9/5/06

JOB NO.:

82556

FIG NO.:

B-23

APPENDIX C: Laboratory Test Results

UNIFIED CLASSIFICATION SM-SW

SOIL TYPE # 1
TEST BORING # 4
DEPTH (FT) 2-5

CLIENT MORLEY BENTLEY

PROJECT STERLING RANCH
JOB NO. 82556
TEST BY DG

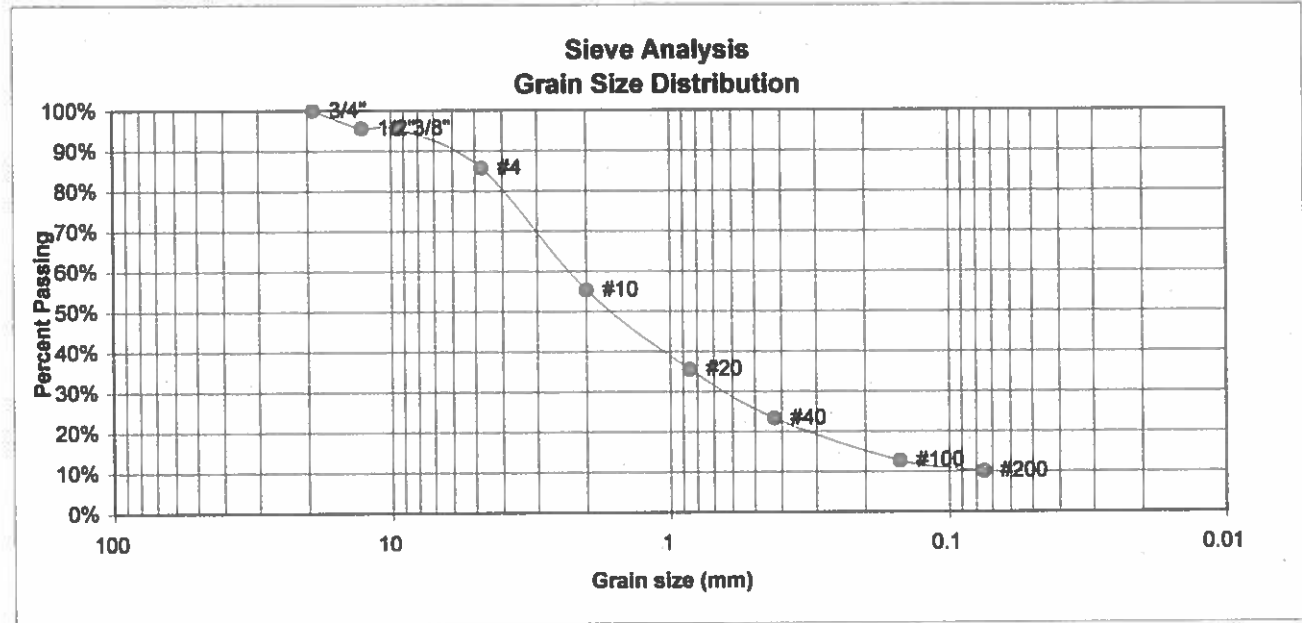

U.S. Sieve #	Percent Finer
3"	
1 1/2"	
3/4"	100.0%
1/2"	95.5%
3/8"	95.5%
4	85.7%
10	55.3%
20	35.6%
40	23.4%
100	12.7%
200	10.0%

Atterberg Limits
 Plastic Limit NP
 Liquid Limit NV
 Plastic Index NP

Swell
 Moisture at start
 Moisture at finish
 Moisture increase
 Initial dry density (pcf)
 Swell (psf)



**ENTECH
ENGINEERING, INC.**
 505 ELKTON DRIVE
 COLORADO SPRINGS, CO. 80907 (719) 531-5599

LABORATORY TEST RESULTS

DRAWN:	DATE:	CHECKED: <i>KLW</i>	DATE: 9/15/06
--------	-------	---------------------	---------------

JOB NO.: 82556

FIG NO.: C-1

UNIFIED CLASSIFICATION SM

SOIL TYPE # 1
TEST BORING # 9
DEPTH (FT) 5

CLIENT MORLEY BENTLEY

PROJECT STERLING RANCH
JOB NO. 82556
TEST BY DG

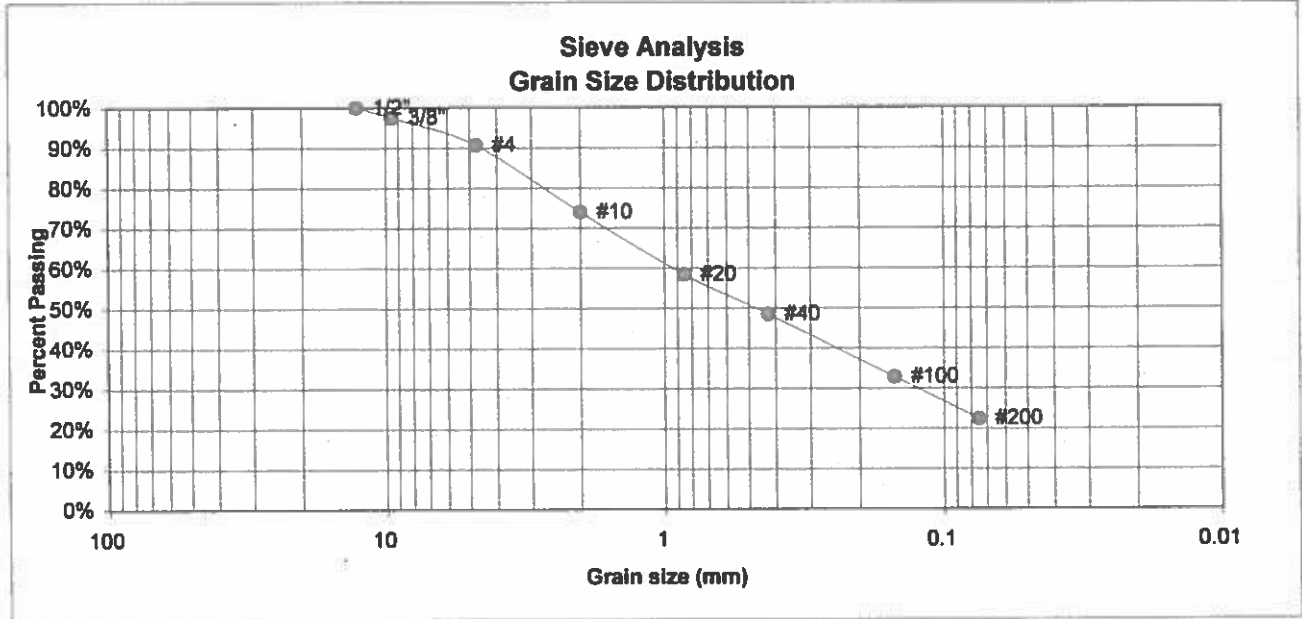

U.S. Sieve #	Percent Finer
3"	
1 1/2"	
3/4"	
1/2"	100.0%
3/8"	97.5%
4	90.7%
10	74.0%
20	58.4%
40	48.5%
100	32.9%
200	22.4%

Atterberg Limits
 Plastic Limit
 Liquid Limit
 Plastic Index

Swell
 Moisture at start
 Moisture at finish
 Moisture increase
 Initial dry density (pcf)
 Swell (psf)



ENTECH
ENGINEERING, INC.
 905 ELKTON DRIVE
 COLORADO SPRINGS, CO. 80907 (719) 531-3599

LABORATORY TEST RESULTS

DRAWN:

DATE:

CHECKED: *[Signature]*

DATE: 9/5/06

JOB NO.: 82556

FIG NO.: C-2

UNIFIED CLASSIFICATION SM-SW

CLIENT MORLEY BENTLEY

SOIL TYPE # 1

PROJECT STERLING RANCH

TEST BORING # 12

JOB NO. 82556

DEPTH (FT) 5

TEST BY DG

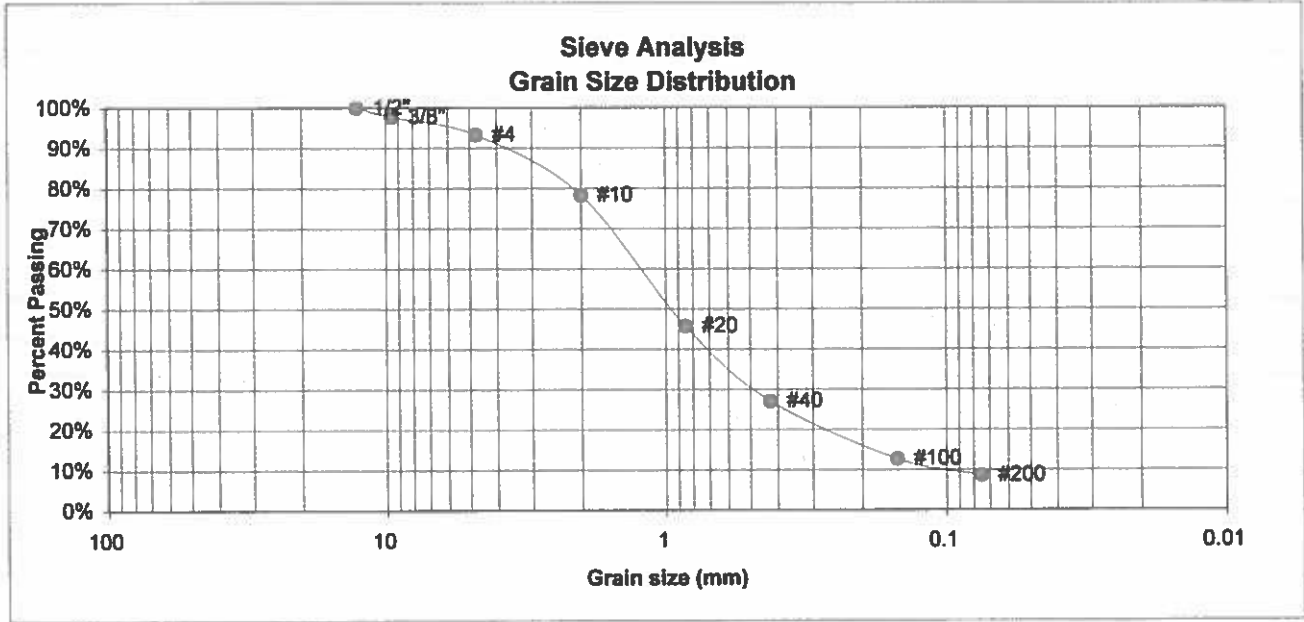

U.S. Sieve #	Percent Finer
3"	
1 1/2"	
3/4"	
1/2"	100.0%
3/8"	97.7%
4	93.2%
10	78.3%
20	45.7%
40	27.1%
100	12.7%
200	8.6%

Atterberg Limits
 Plastic Limit
 Liquid Limit
 Plastic Index

Swell
 Moisture at start
 Moisture at finish
 Moisture increase
 Initial dry density (pcf)
 Swell (psf)



ENTECH
ENGINEERING, INC.
 505 ELKTON DRIVE
 COLORADO SPRINGS, CO. 80907 (719) 531-5599

LABORATORY TEST RESULTS

DRAWN:	DATE:	CHECKED: <i>[Signature]</i>	DATE: 9/5/06
--------	-------	--------------------------------	-----------------

JOB NO.:
82556
 FIG NO.:
C-3

UNIFIED CLASSIFICATION SM-SP

SOIL TYPE # 1

TEST BORING # 17

DEPTH (FT) 2-3

CLIENT MORLEY BENTLEY

PROJECT STERLING RANCH

JOB NO. 82556

TEST BY DG

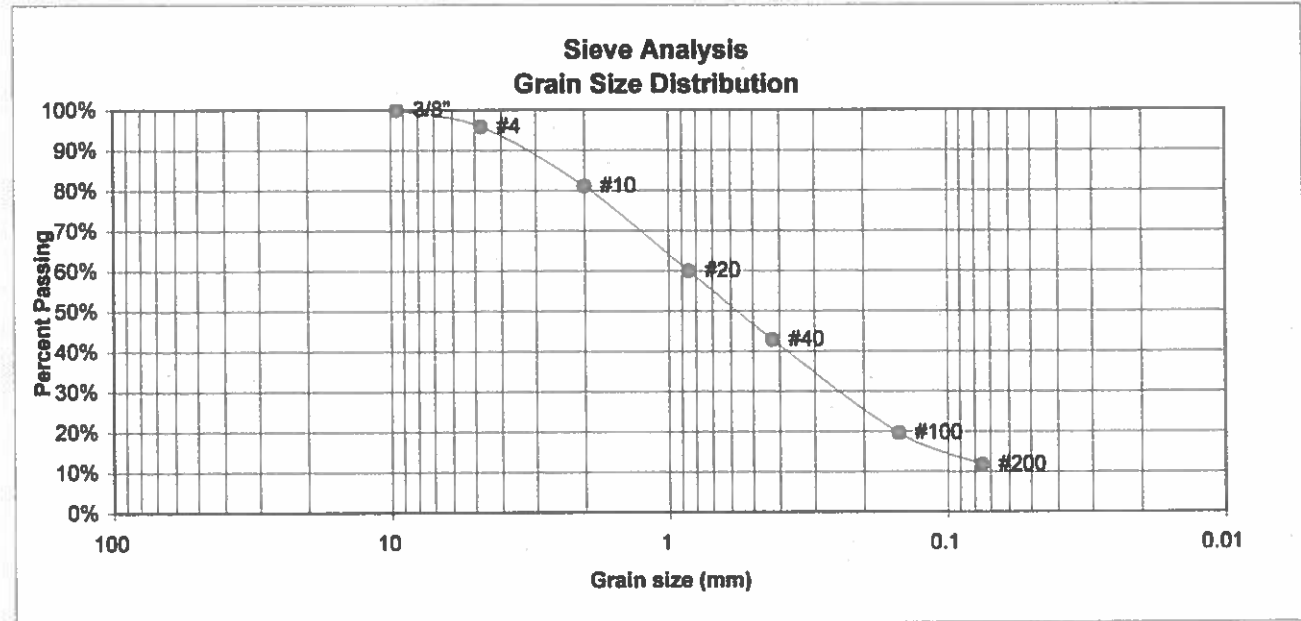

U.S. Sieve #	Percent Finer
3"	
1 1/2"	
3/4"	
1/2"	
3/8"	100.0%
4	95.8%
10	81.1%
20	60.0%
40	42.9%
100	19.6%
200	11.7%

Atterberg Limits
 Plastic Limit
 Liquid Limit
 Plastic Index

Swell
 Moisture at start
 Moisture at finish
 Moisture increase
 Initial dry density (pcf)
 Swell (psf)



ENTECH
ENGINEERING, INC.
 505 ELKTON DRIVE
 COLORADO SPRINGS, CO. 80907 (719) 531-5599

LABORATORY TEST RESULTS

DRAWN:

DATE:

CHECKED:

DATE:

[Signature]

9/15/06

JOB NO.:

82556

FIG NO.:

C-4

UNIFIED CLASSIFICATION SM
SOIL TYPE # 1
TEST BORING # 19
DEPTH (FT) 5

CLIENT MORLEY BENTLEY
PROJECT STERLING RANCH
JOB NO. 82556
TEST BY DG

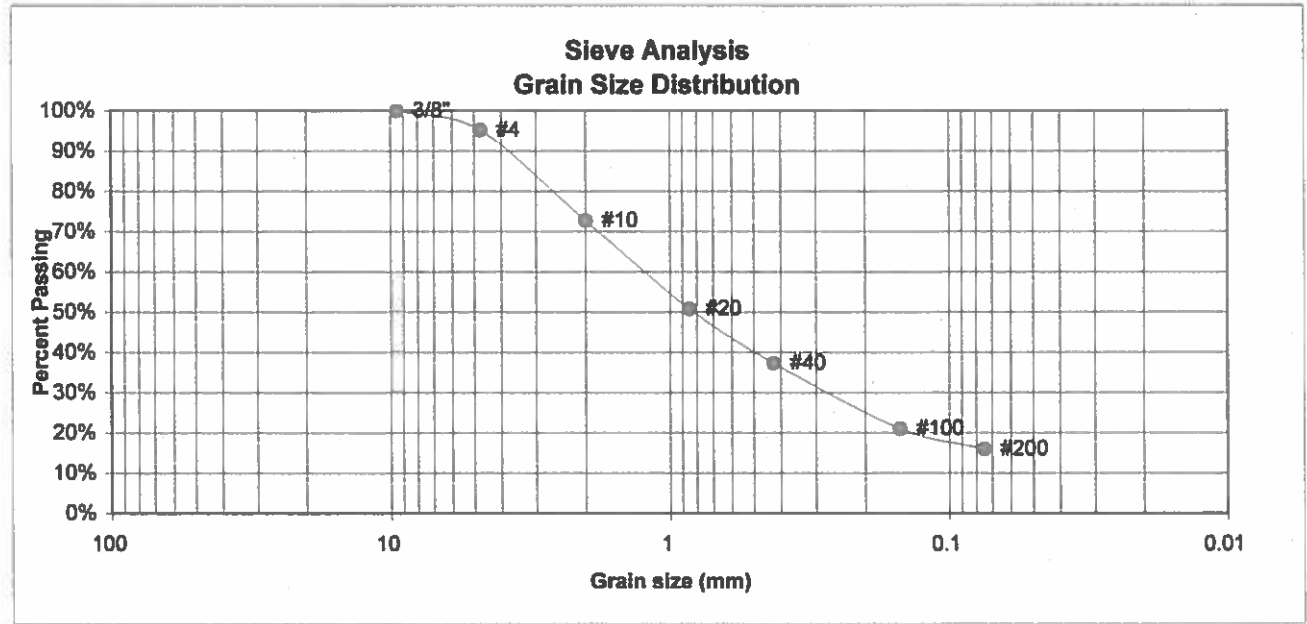

U.S. Sieve #	Percent Finer
3"	
1 1/2"	
3/4"	
1/2"	
3/8"	100.0%
4	95.2%
10	72.7%
20	50.8%
40	37.3%
100	21.0%
200	15.9%

Atterberg Limits
 Plastic Limit
 Liquid Limit
 Plastic Index

Swell
 Moisture at start
 Moisture at finish
 Moisture increase
 Initial dry density (pcf)
 Swell (psf)



ENTECH
ENGINEERING, INC.
505 ELKTON DRIVE
 COLORADO SPRINGS, CO. 80907 (719) 531-5599

LABORATORY TEST RESULTS

DRAWN:	DATE:	CHECKED: <i>[Signature]</i>	DATE: 9/5/06
--------	-------	--------------------------------	-----------------

JOB NO.:
 82556
 FIG NO.:
 C-5

UNIFIED CLASSIFICATION SM-SW

SOIL TYPE # 1
TEST BORING # 20
DEPTH (FT) 10

CLIENT MORLEY BENTLEY
PROJECT STERLING RANCH
JOB NO. 82556
TEST BY DG

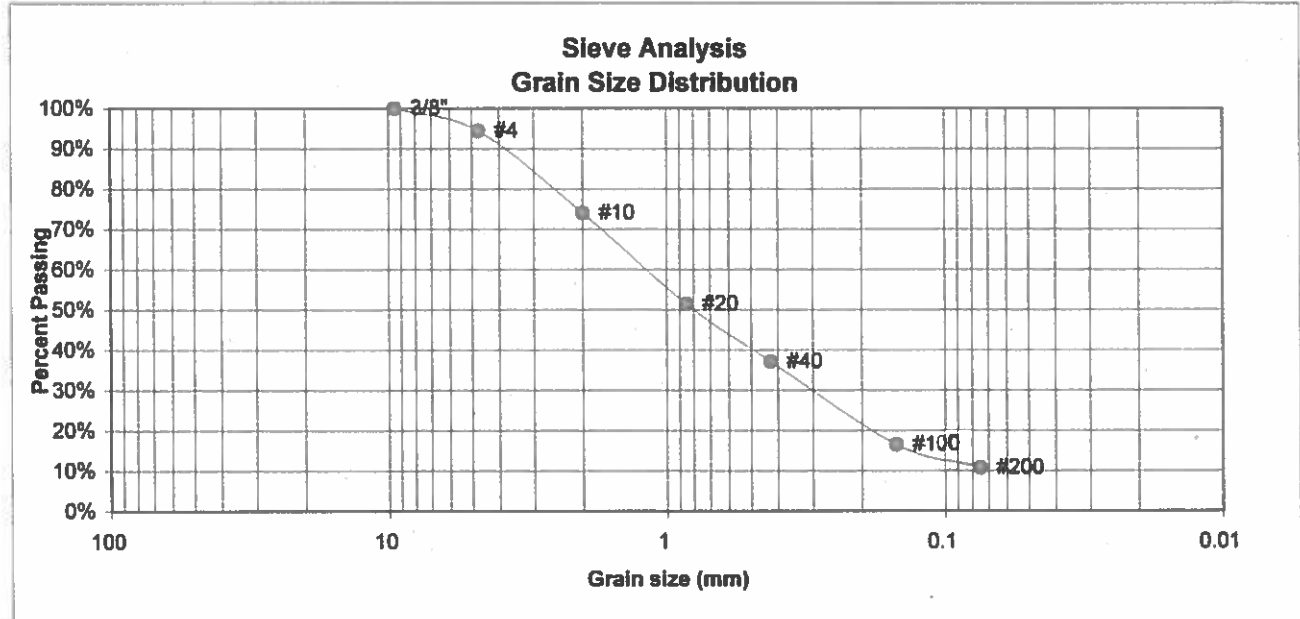

U.S. Sieve #	Percent Finer
3"	
1 1/2"	
3/4"	
1/2"	
3/8"	100.0%
4	94.4%
10	74.0%
20	51.4%
40	37.1%
100	16.5%
200	10.7%

Atterberg Limits
Plastic Limit
Liquid Limit
Plastic Index

Swell
Moisture at start
Moisture at finish
Moisture increase
Initial dry density (pcf)
Swell (psf)



**ENTECH
ENGINEERING, INC.**
545 ELKTON DRIVE
COLORADO SPRINGS, CO. 80907 (719) 531-5599

**LABORATORY TEST
RESULTS**

DRAWN:

DATE:

CHECKED:
lga

DATE:
9/5/06

JOB NO.:

82556

FIG NO.:

C-6

UNIFIED CLASSIFICATION SM-SW

CLIENT

MORLEY BENTLEY

SOIL TYPE #

1

PROJECT

STERLING RANCH

TEST BORING #

25

JOB NO.

82556

DEPTH (FT)

2-5

TEST BY

DG

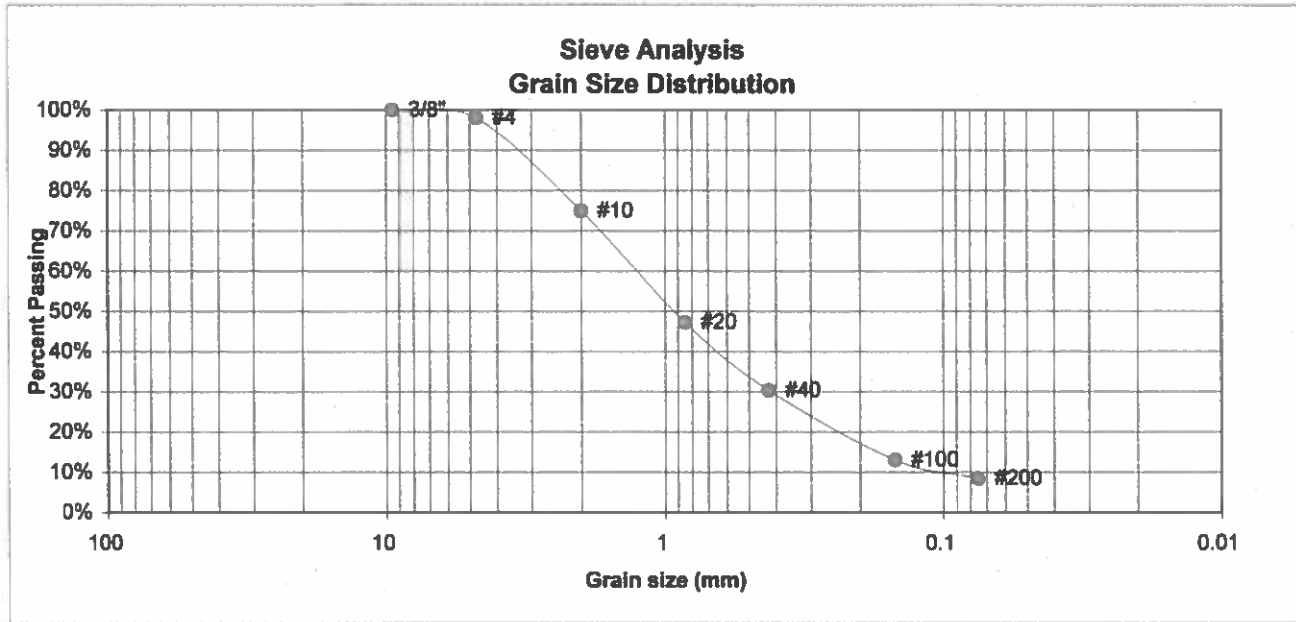

U.S. Sieve #	Percent Finer
3"	
1 1/2"	
3/4"	
1/2"	
3/8"	100.0%
4	98.0%
10	74.9%
20	47.2%
40	30.3%
100	13.0%
200	8.4%

Atterberg Limits
 Plastic Limit
 Liquid Limit
 Plastic Index

Swell
 Moisture at start
 Moisture at finish
 Moisture increase
 Initial dry density (pcf)
 Swell (psf)



**ENTECH
ENGINEERING, INC.**
 905 ELKTON DRIVE
 COLDFRIBO SPRINGS, CO. 80907 (719) 531-5599

**LABORATORY TEST
RESULTS**

DRAWN:

DATE:

CHECKED:

DATE:

Kta

9/5/06

JOB NO.:

82556

FIG NO.:

C-7

UNIFIED CLASSIFICATION SM

SOIL TYPE # 1
TEST BORING # 26
DEPTH (FT) 5

CLIENT

MORLEY BENTLEY

PROJECT

STERLING RANCH

JOB NO.

82556

TEST BY

DG

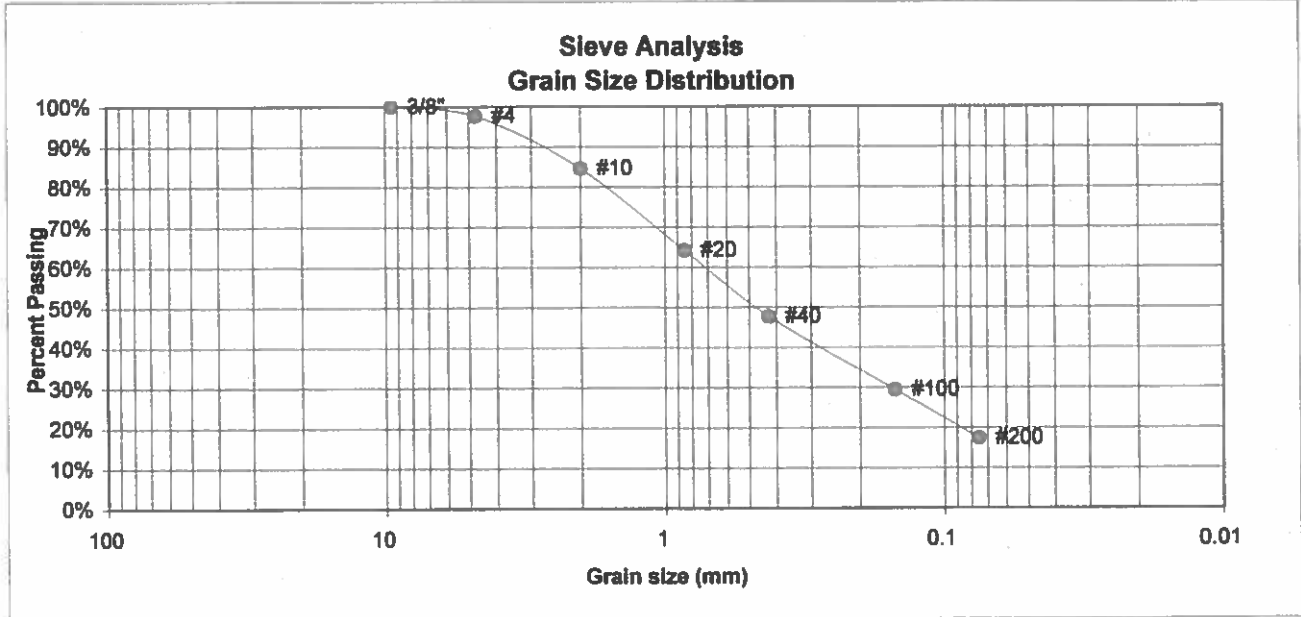

U.S. Sieve #	Percent Finer
3"	
1 1/2"	
3/4"	
1/2"	
3/8"	100.0%
4	97.7%
10	84.6%
20	64.2%
40	47.7%
100	29.4%
200	17.3%

Atterberg Limits
 Plastic Limit
 Liquid Limit
 Plastic Index

Swell
 Moisture at start
 Moisture at finish
 Moisture increase
 Initial dry density (pcf)
 Swell (psf)



ENTECH
ENGINEERING, INC.
 505 ELKTON DRIVE
 COLORADO SPRINGS, CO. 80907 (719) 531-3599

LABORATORY TEST RESULTS

DRAWN:

DATE:

CHECKED:

DATE:

[Signature]

9/5/06

JOB NO.:
82556

FIG NO.:
C-8

UNIFIED CLASSIFICATION SC-SM

SOIL TYPE # 1

TEST BORING # 41

DEPTH (FT) 5

CLIENT MORLEY BENTLEY

PROJECT STERLING RANCH

JOB NO. 82556

TEST BY DG

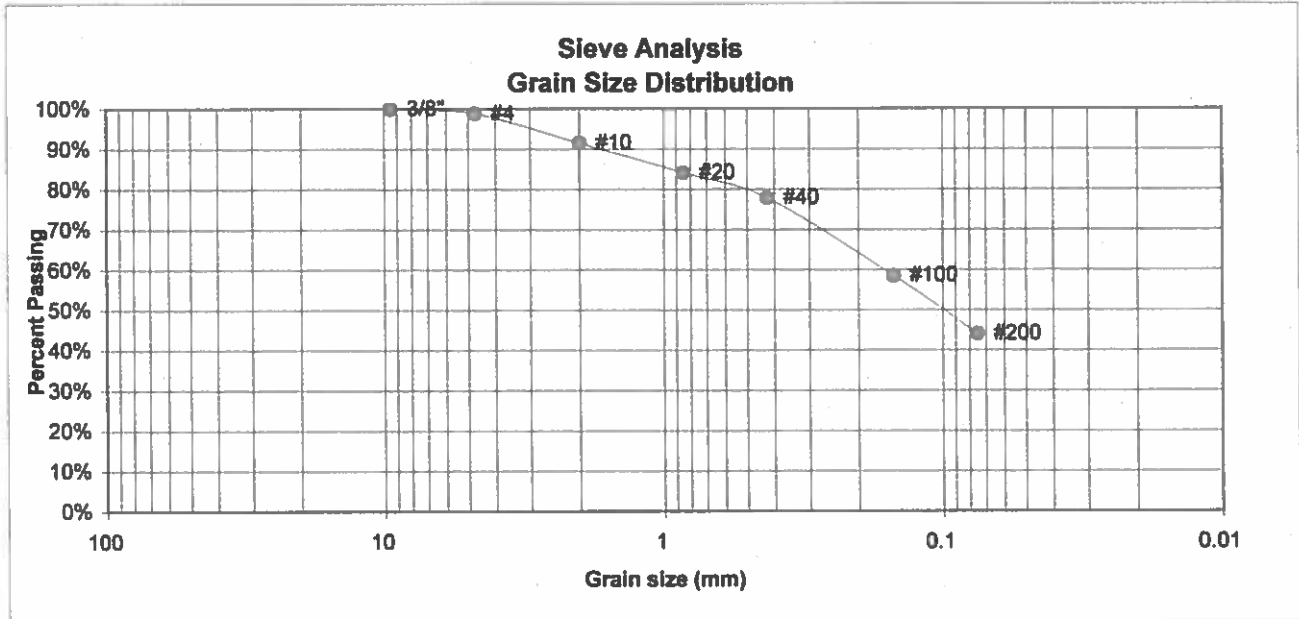

U.S. Sieve #	Percent Finer
3"	
1 1/2"	
3/4"	
1/2"	
3/8"	100.0%
4	98.8%
10	91.5%
20	84.1%
40	77.9%
100	58.5%
200	44.1%

Atterberg Limits	
Plastic Limit	16
Liquid Limit	23
Plastic Index	7

Swell	
Moisture at start	7.6%
Moisture at finish	18.1%
Moisture increase	10.5%
Initial dry density (pcf)	106
Swell (psf)	574



**ENTECH
ENGINEERING, INC.**
505 ELKTON DRIVE
COLORADO SPRINGS, CO. 80907 (719) 531-5599

**LABORATORY TEST
RESULTS**

DRAWN:	DATE:	CHECKED: <i>nan</i>	DATE: 9/5/06
--------	-------	------------------------	-----------------

JOB NO.:
82556
FIG NO.:
C-9

UNIFIED CLASSIFICATION SM-SW

SOIL TYPE # 1
TEST BORING # 42
DEPTH (FT) 2-3

CLIENT

PROJECT MORLEY BENTLEY
JOB NO. STERLING RANCH
TEST BY 82556
 DG

MORLEY BENTLEY

STERLING RANCH

82556

DG

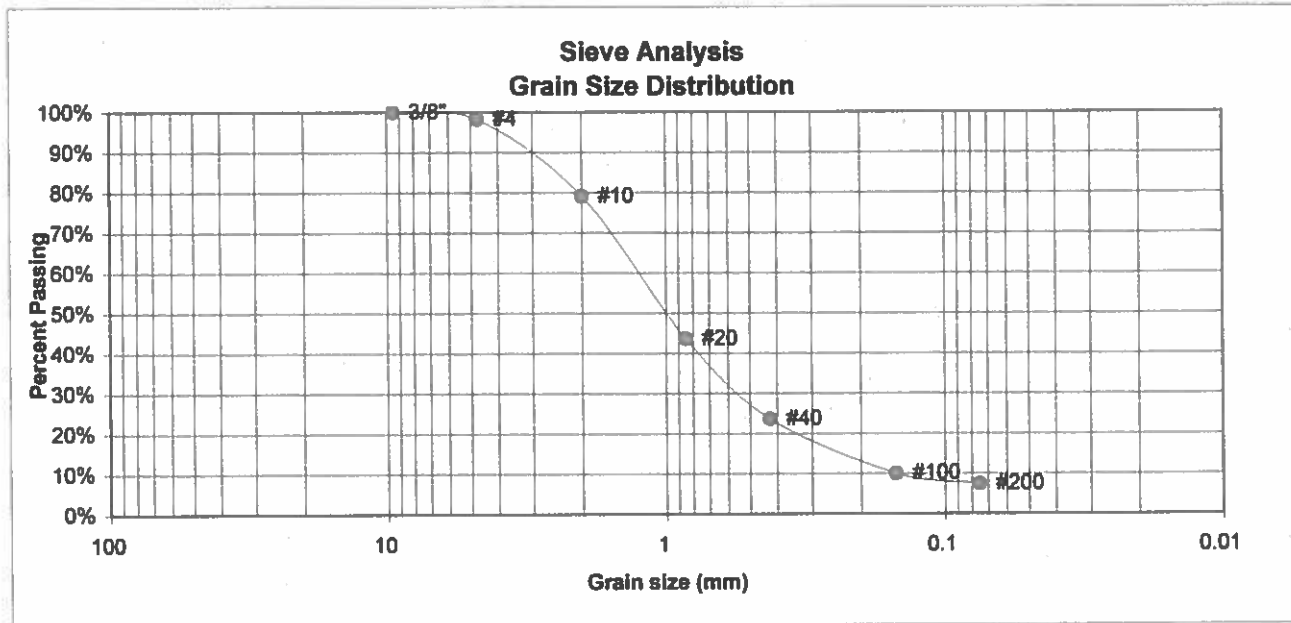

U.S. Sieve #	Percent Finer
3"	
1 1/2"	
3/4"	
1/2"	
3/8"	100.0%
4	98.2%
10	79.1%
20	43.6%
40	23.6%
100	10.1%
200	7.4%

Atterberg Limits
 Plastic Limit
 Liquid Limit
 Plastic Index

Swell
 Moisture at start
 Moisture at finish
 Moisture increase
 Initial dry density (pcf)
 Swell (psf)



ENTECH
ENGINEERING, INC.
 505 ELKTON DRIVE
 COLORADO SPRINGS, CO. 80907 (719) 531-5599

LABORATORY TEST RESULTS

DRAWN:

DATE:

CHECKED:

DATE:

KA

9/15/06

JOB NO.:

82556

FIG NO.:

C-10

UNIFIED CLASSIFICATION SM-SW

SOIL TYPE # 1

TEST BORING # 44

DEPTH (FT) 5-10

CLIENT MORLEY BENTLEY

PROJECT STERLING RANCH

JOB NO. 82556

TEST BY DG

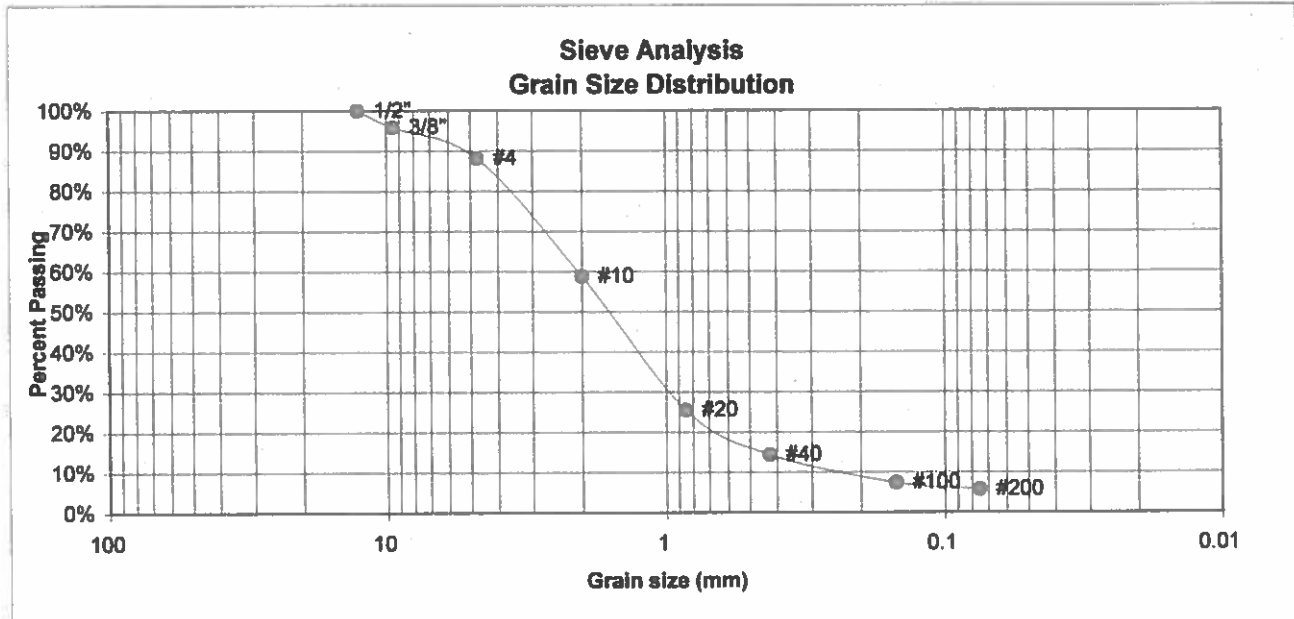

<u>U.S. Sieve #</u>	<u>Percent Finer</u>
3"	
1 1/2"	
3/4"	
1/2"	100.0%
3/8"	95.9%
4	88.2%
10	58.8%
20	25.5%
40	14.4%
100	7.4%
200	5.7%

Atterberg Limits
Plastic Limit
Liquid Limit
Plastic Index

Swell
Moisture at start
Moisture at finish
Moisture increase
Initial dry density (pcf)
Swell (psf)



ENTECH
ENGINEERING, INC.
505 ELKTON DRIVE
COLORADO SPRINGS, CO. 80907 (719) 531-5399

LABORATORY TEST RESULTS

DRAWN:

DATE:

CHECKED:

DATE:

KAH 9/15/06

JOB NO.:

82556

FIG NO.:

C-11

<u>UNIFIED CLASSIFICATION</u>	CL	<u>CLIENT</u>	MORLEY BENTLEY
<u>SOIL TYPE #</u>	2	<u>PROJECT</u>	STERLING RANCH
<u>TEST BORING #</u>	7	<u>JOB NO.</u>	82556
<u>DEPTH (FT)</u>	5	<u>TEST BY</u>	DG

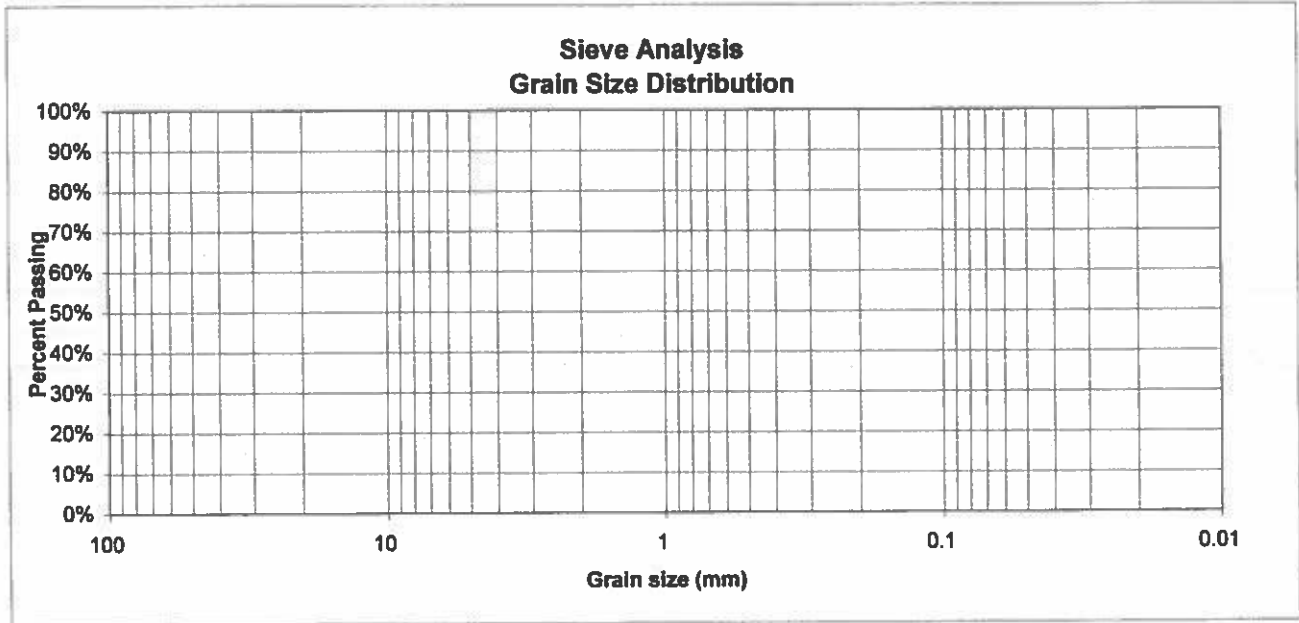

<u>U.S. Sieve #</u>	<u>Percent Finer</u>
3"	
1 1/2"	
3/4"	
1/2"	
3/8"	
4	
10	
20	
40	
100	
200	

<u>Atterberg Limits</u>	
Plastic Limit	16
Liquid Limit	29
Plastic Index	13

<u>Swell</u>	
Moisture at start	
Moisture at finish	
Moisture increase	
Initial dry density (pcf)	
Swell (psf)	



ENTECH
ENGINEERING, INC.
505 ELKTON DRIVE
COLORADO SPRINGS, CO. 80907 (719) 531-5599

**LABORATORY TEST
RESULTS**

DRAWN:

DATE:

CHECKED:

DATE:

[Signature]

9/5/06

JOB NO.:

82556

FIG NO.:

C-12

<u>UNIFIED CLASSIFICATION</u>	CL	<u>CLIENT</u>	MORLEY BENTLEY
<u>SOIL TYPE #</u>	2	<u>PROJECT</u>	STERLING RANCH
<u>TEST BORING #</u>	13	<u>JOB NO.</u>	82556
<u>DEPTH (FT)</u>	2-3	<u>TEST BY</u>	DG

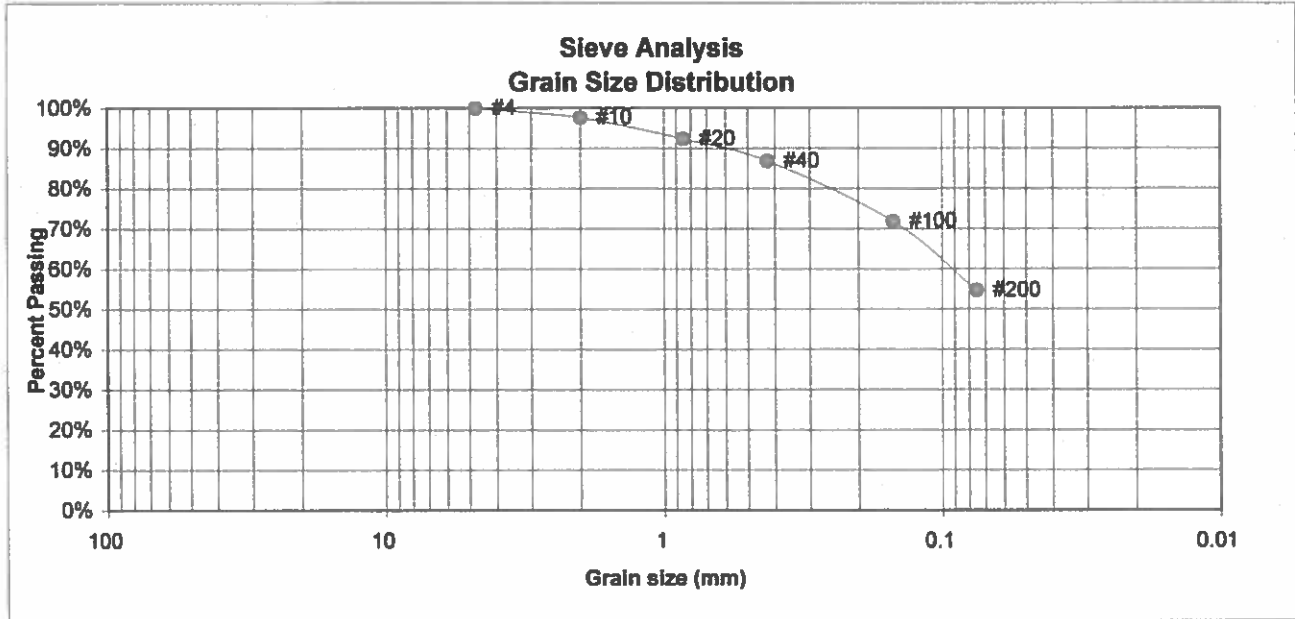

<u>U.S. Sieve #</u>	<u>Percent Finer</u>
3"	
1 1/2"	
3/4"	
1/2"	
3/8"	
4	100.0%
10	97.6%
20	92.3%
40	86.8%
100	71.8%
200	54.6%

Atterberg Limits
 Plastic Limit
 Liquid Limit
 Plastic Index

<u>Swell</u>	
Moisture at start	11.2%
Moisture at finish	19.4%
Moisture increase	8.2%
Initial dry density (pcf)	100
Swell (psf)	455



ENTECH
ENGINEERING, INC.
 585 ELKTON DRIVE
 COLORADO SPRINGS, CO. 80907 (719) 531-5599

**LABORATORY TEST
 RESULTS**

DRAWN:	DATE:	CHECKED:	DATE:
		<i>[Signature]</i>	9/15/06

JOB NO.:
82556
FIG NO.:
C-13

<u>UNIFIED CLASSIFICATION</u>	CL	<u>CLIENT</u>	MORLEY BENTLEY
<u>SOIL TYPE #</u>	2	<u>PROJECT</u>	STERLING RANCH
<u>TEST BORING #</u>	21	<u>JOB NO.</u>	82556
<u>DEPTH (FT)</u>	7	<u>TEST BY</u>	DG

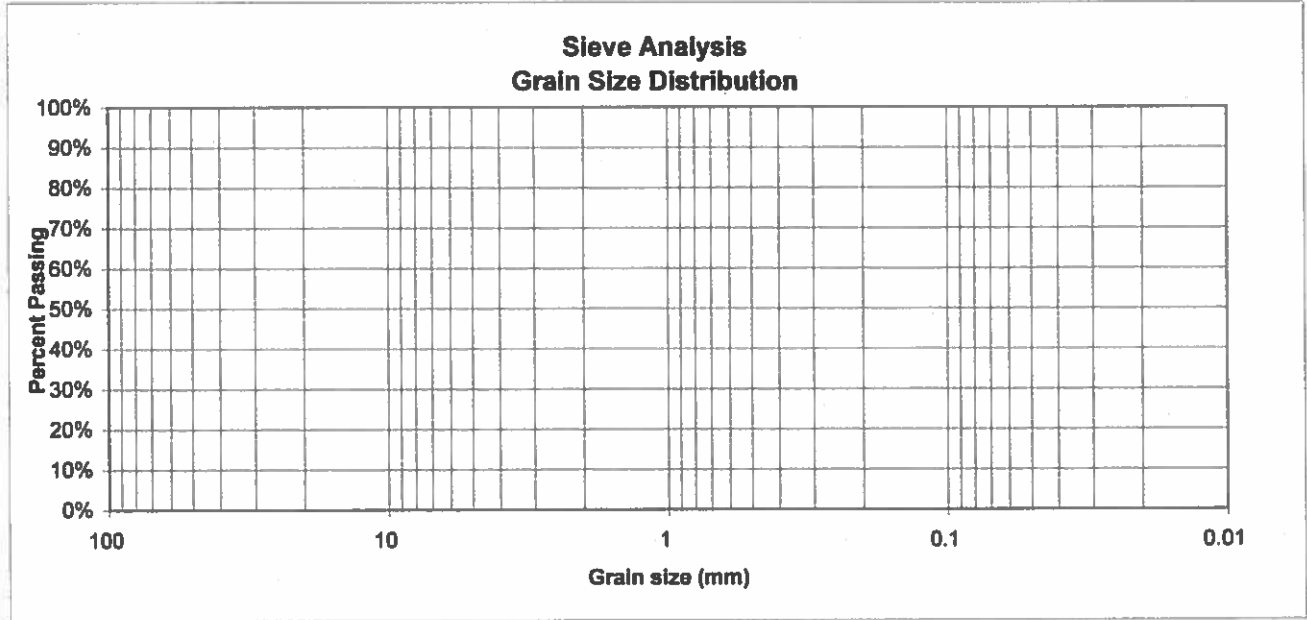

<u>U.S. Sieve #</u>	<u>Percent Finer</u>	<u>Atterberg Limits</u>	
3"		Plastic Limit	
1 1/2"		Liquid Limit	
3/4"		Plastic Index	
1/2"			
3/8"			
4		<u>Swell</u>	
10		Moisture at start	14.8%
20		Moisture at finish	21.0%
40		Moisture increase	6.2%
100		Initial dry density (pcf)	107
200		Swell (psf)	4179



ENTECH
ENGINEERING, INC.
565 ELKTON DRIVE
COLORADO SPRINGS, CO. 80907 (719) 531-3599

**LABORATORY TEST
RESULTS**

DRAWN:	DATE:	CHECKED:	DATE:
		<i>[Signature]</i>	9/5/06

JOB NO.:
82556

FIG NO.:
C-14

UNIFIED CLASSIFICATION CL
SOIL TYPE # 2
TEST BORING # 23
DEPTH (FT) 7

CLIENT MORLEY BENTLEY
PROJECT STERLING RANCH
JOB NO. 82556
TEST BY DG

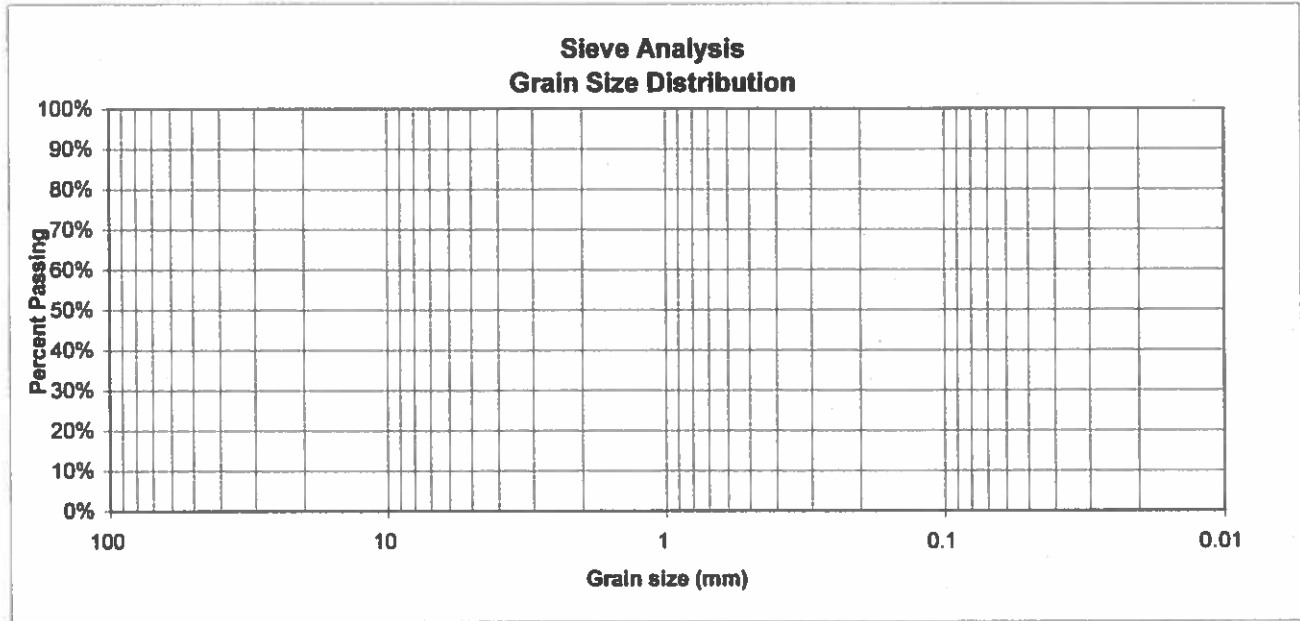

<u>U.S. Sieve #</u>	<u>Percent Finer</u>
3"	
1 1/2"	
3/4"	
1/2"	
3/8"	
4	
10	
20	
40	
100	
200	

**Atterberg
Limits**
 Plastic Limit
 Liquid Limit
 Plastic Index

Swell
 Moisture at start 10.8%
 Moisture at finish 23.4%
 Moisture increase 12.6%
 Initial dry density (pcf) 102
 Swell (psf) 1085



ENTECH
ENGINEERING, INC.
505 ELKTON DRIVE
 COLORADO SPRINGS, CO. 80907 (719) 531-5399

**LABORATORY TEST
RESULTS**

DRAWN:	DATE:	CHECKED: <i>KG</i>	DATE: 9/5/06
--------	-------	-----------------------	-----------------

JOB NO.:
 82556
 FIG NO.:
 C-15

<u>UNIFIED CLASSIFICATION</u>	CL	<u>CLIENT</u>	MORLEY BENTLEY
<u>SOIL TYPE #</u>	2	<u>PROJECT</u>	STERLING RANCH
<u>TEST BORING #</u>	27	<u>JOB NO.</u>	82556
<u>DEPTH (FT)</u>	9	<u>TEST BY</u>	DG

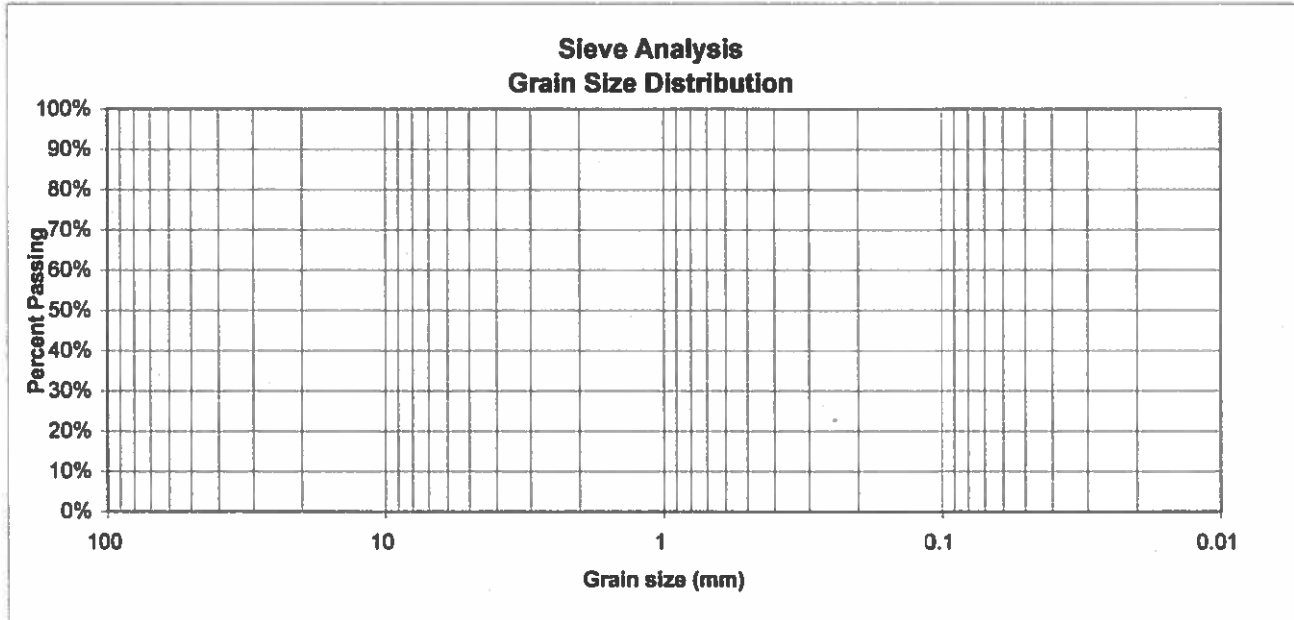

<u>U.S. Sieve #</u>	<u>Percent Finer</u>	<u>Atterberg Limits</u>	
3"		Plastic Limit	
1 1/2"		Liquid Limit	
3/4"		Plastic Index	
1/2"			
3/8"		<u>Swell</u>	
4		Moisture at start	13.7%
10		Moisture at finish	23.2%
20		Moisture increase	9.6%
40		Initial dry density (pcf)	103
100		Swell (psf)	2300
200			



ENTECH
ENGINEERING, INC.
505 ELKTON DRIVE
COLORADO SPRINGS, CO. 80907 (719) 531-5599

**LABORATORY TEST
RESULTS**

DRAWN:

DATE:

CHECKED:
DG

DATE:
9/5/06

JOB NO.:

82556

FIG NO.:

C-16

UNIFIED CLASSIFICATION CL
SOIL TYPE # 2
TEST BORING # 31
DEPTH (FT) 5

CLIENT MORLEY BENTLEY
PROJECT STERLING RANCH
JOB NO. 82556
TEST BY DG

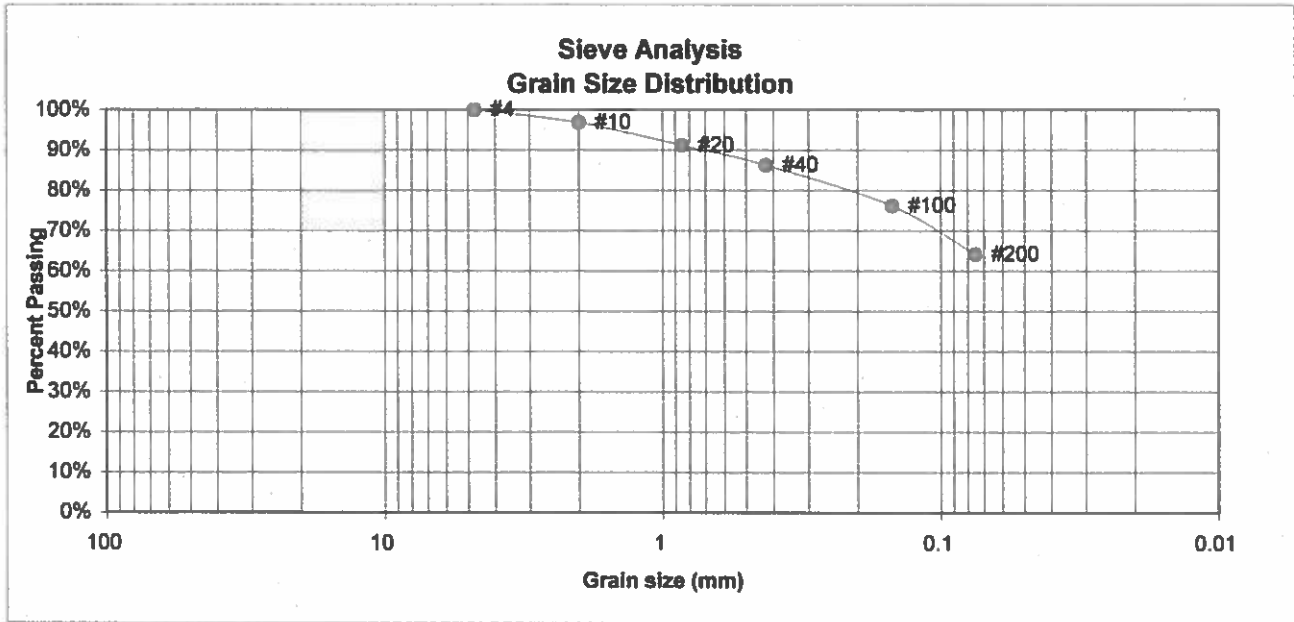

U.S. Sieve #	Percent Finer
3"	
1 1/2"	
3/4"	
1/2"	
3/8"	
4	100.0%
10	96.8%
20	91.2%
40	86.3%
100	76.2%
200	64.2%

Atterberg Limits
 Plastic Limit 15
 Liquid Limit 40
 Plastic Index 25

Swell
 Moisture at start
 Moisture at finish
 Moisture increase
 Initial dry density (pcf)
 Swell (psf)



ENTECH
ENGINEERING, INC.
505 ELKTON DRIVE
 COLORADO SPRINGS, CO. 80907 (719) 531-3599

LABORATORY TEST RESULTS

DRAWN:	DATE:	CHECKED:	DATE:
		<i>[Signature]</i>	9/5/06

JOB NO.:
 82556
 FIG NO.:
 C-17

<u>UNIFIED CLASSIFICATION</u> CL		<u>CLIENT</u>	MORLEY BENTLEY
<u>SOIL TYPE #</u>	2	<u>PROJECT</u>	STERLING RANCH
<u>TEST BORING #</u>	34	<u>JOB NO.</u>	82556
<u>DEPTH (FT)</u>	2-5	<u>TEST BY</u>	DG

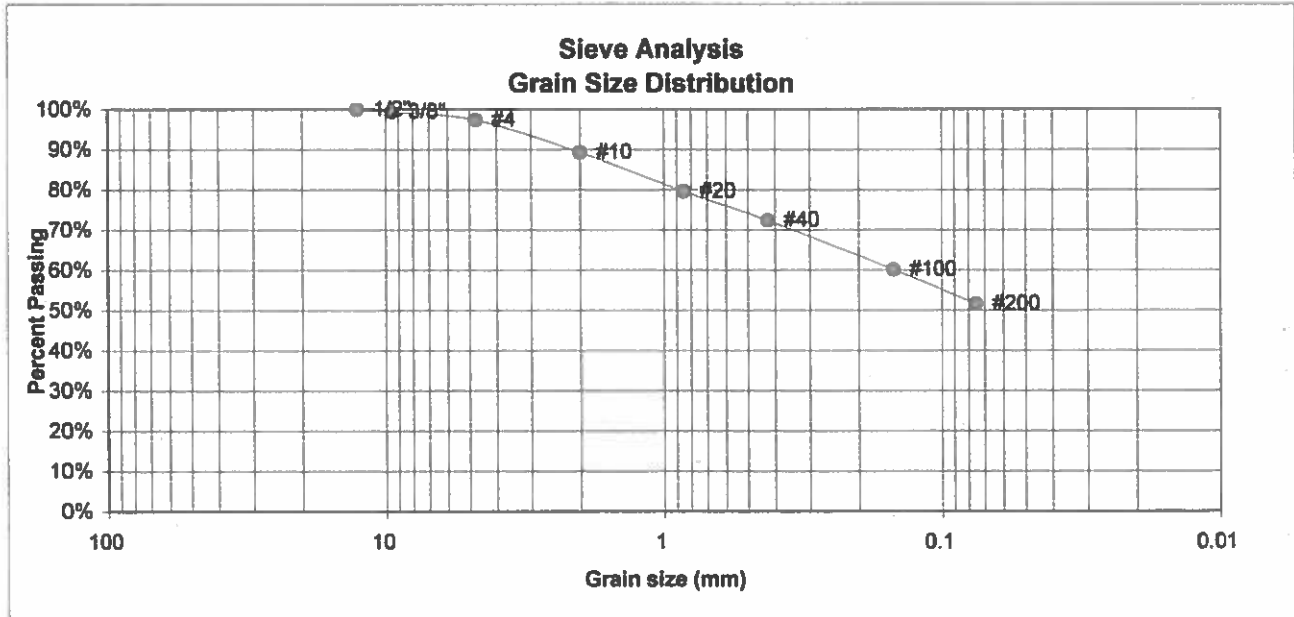

<u>U.S. Sieve #</u>	<u>Percent Finer</u>
3"	
1 1/2"	
3/4"	
1/2"	100.0%
3/8"	99.4%
4	97.4%
10	89.3%
20	79.6%
40	72.4%
100	60.1%
200	51.6%

<u>Atterberg Limits</u>	
Plastic Limit	14
Liquid Limit	27
Plastic Index	13

<u>Swell</u>	
Moisture at start	
Moisture at finish	
Moisture increase	
Initial dry density (pcf)	
Swell (psf)	



ENTECH
ENGINEERING, INC.
505 ELKTON DRIVE
COLORADO SPRINGS, CO. 80907 (719) 531-5599

**LABORATORY TEST
RESULTS**

DRAWN:

DATE:

CHECKED:
Wane

DATE:
9/5/06

JOB NO.:
82556

FIG NO.:
C-18

UNIFIED CLASSIFICATION SC
SOIL TYPE # 3
TEST BORING # 5
DEPTH (FT) 15

CLIENT MORLEY BENTLEY
PROJECT STERLING RANCH
JOB NO. 82556
TEST BY DG

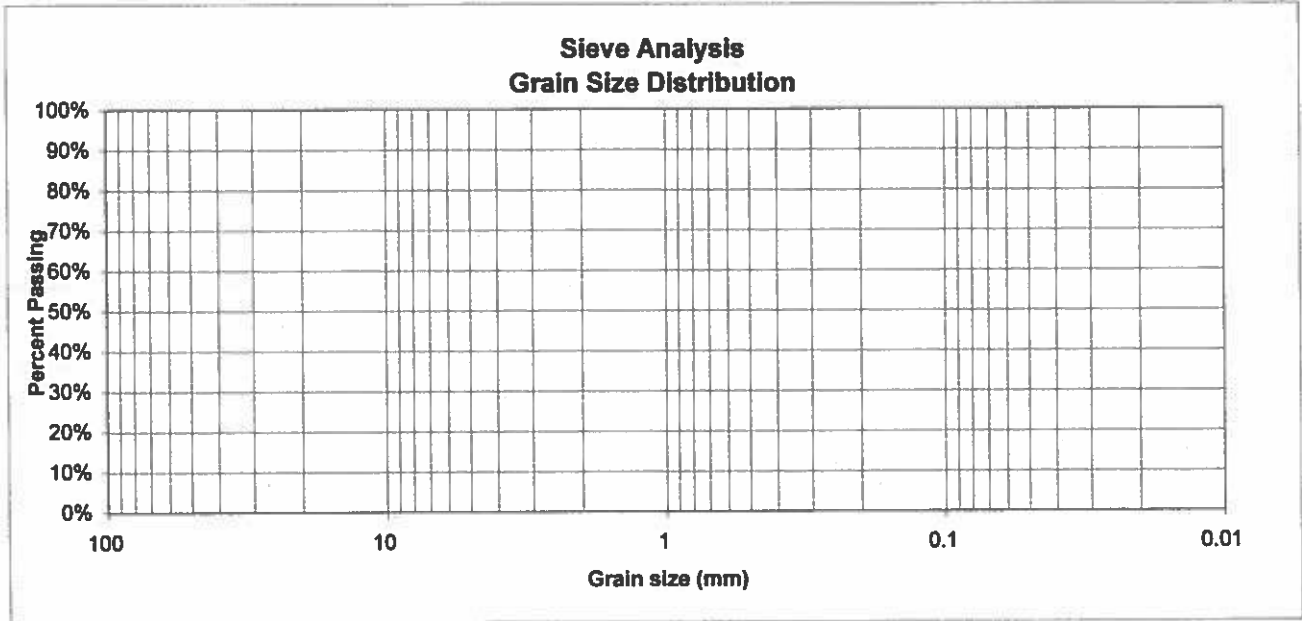

<u>U.S. Sieve #</u>	<u>Percent Finer</u>
3"	
1 1/2"	
3/4"	
1/2"	
3/8"	
4	
10	
20	
40	
100	
200	

Atterberg Limits
 Plastic Limit 13
 Liquid Limit 24
 Plastic Index 11

Swell
 Moisture at start
 Moisture at finish
 Moisture increase
 Initial dry density (pcf)
 Swell (psf)



ENTECH
ENGINEERING, INC.
505 ELKTON DRIVE
 COLORADO SPRINGS, CO. 80907 (719) 531-5599

**LABORATORY TEST
RESULTS**

DRAWN:	DATE:	CHECKED: <i>lsw</i>	DATE: 9/5/06
--------	-------	------------------------	-----------------

JOB NO.:
 82556
 FIG NO.:
 C-19

UNIFIED CLASSIFICATION SM
SOIL TYPE # 3
TEST BORING # 6
DEPTH (FT) 15-20

CLIENT MORLEY BENTLEY
PROJECT STERLING RANCH
JOB NO. 82556
TEST BY DG

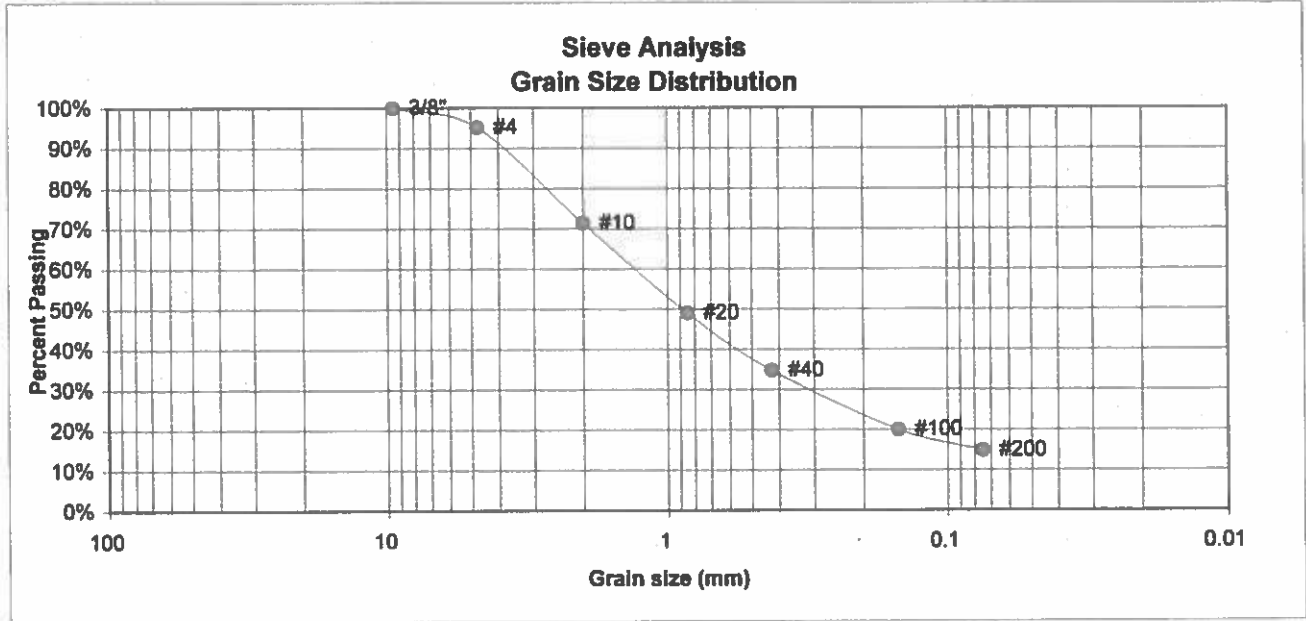

U.S. Sieve #	Percent Finer
3"	
1 1/2"	
3/4"	
1/2"	
3/8"	100.0%
4	95.2%
10	71.4%
20	49.1%
40	34.8%
100	20.0%
200	14.8%

Atterberg Limits
 Plastic Limit
 Liquid Limit
 Plastic Index

Swell
 Moisture at start
 Moisture at finish
 Moisture increase
 Initial dry density (pcf)
 Swell (psf)



ENTECH
ENGINEERING, INC.
505 ELKTON DRIVE
 COLORADO SPRINGS, CO. 80907 (719) 531-5399

LABORATORY TEST RESULTS

DRAWN:

DATE:

CHECKED:

DATE:

[Signature] 9/15/06

JOB NO.:

82556

FIG NO.:

C-20

UNIFIED CLASSIFICATION SM
SOIL TYPE # 3
TEST BORING # 11
DEPTH (FT) 10

CLIENT MORLEY BENTLEY
PROJECT STERLING RANCH
JOB NO. 82556
TEST BY DG

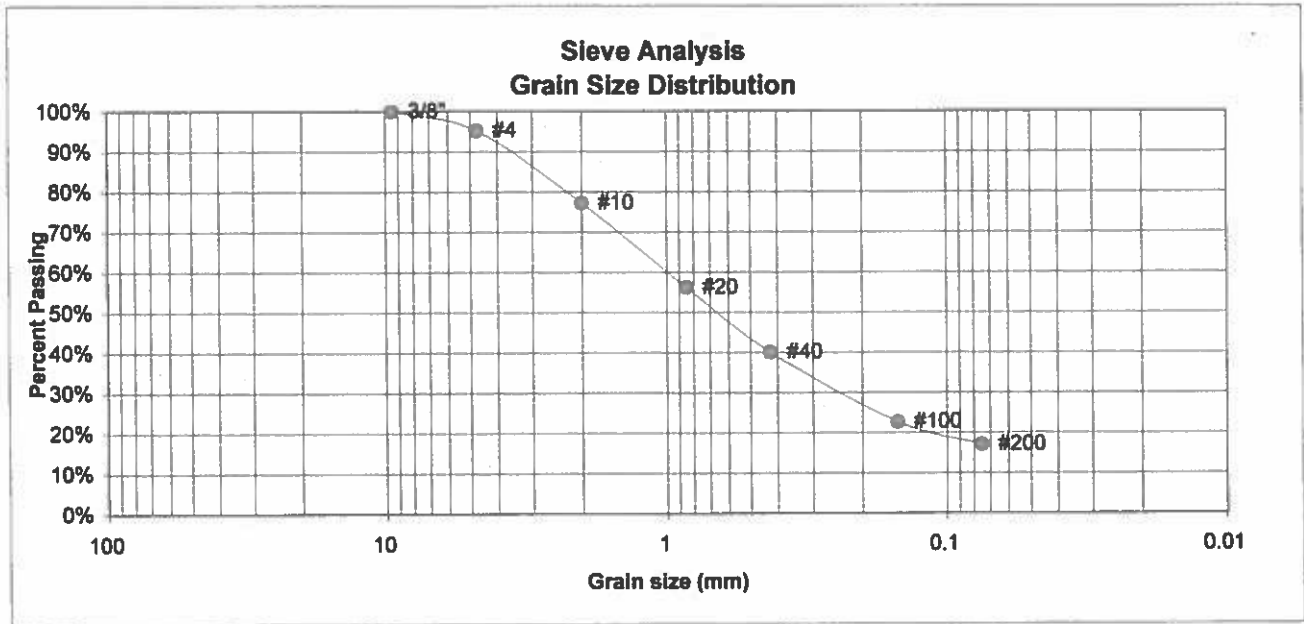

U.S. Sieve #	Percent Finer
3"	
1 1/2"	
3/4"	
1/2"	
3/8"	100.0%
4	95.2%
10	77.2%
20	56.2%
40	40.1%
100	22.7%
200	17.1%

Atterberg Limits
 Plastic Limit
 Liquid Limit
 Plastic Index

Swell
 Moisture at start
 Moisture at finish
 Moisture increase
 Initial dry density (pcf)
 Swell (psf)



ENTECH
ENGINEERING, INC.
 505 ELKTON DRIVE
 COLORADO SPRINGS, CO. 80907 (719) 531-5599

LABORATORY TEST RESULTS

DRAWN:	DATE:	CHECKED: <i>lan</i>	DATE: 9/5/06
--------	-------	---------------------	--------------

JOB NO.: 82556

FIG NO.: C-21

UNIFIED CLASSIFICATION SM
SOIL TYPE # 3
TEST BORING # 13
DEPTH (FT) 10

CLIENT MORLEY BENTLEY
PROJECT STERLING RANCH
JOB NO. 82556
TEST BY DG

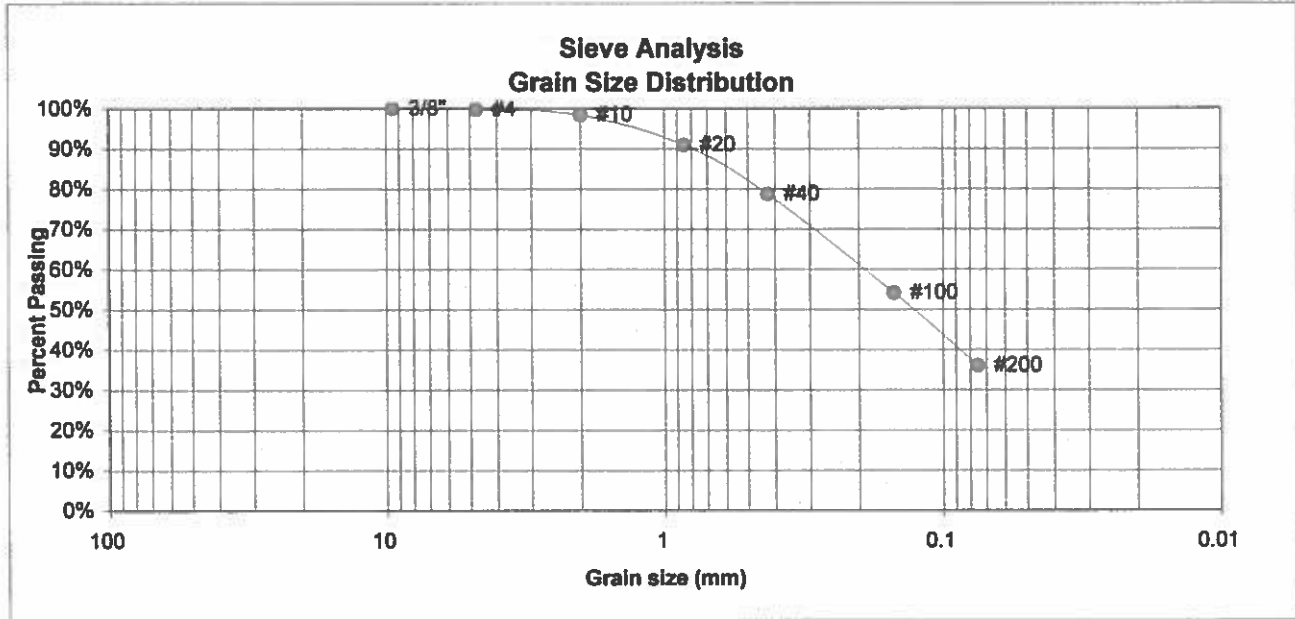

U.S. Sieve #	Percent Finer
3"	
1 1/2"	
3/4"	
1/2"	
3/8"	100.0%
4	99.8%
10	98.4%
20	90.9%
40	78.7%
100	54.1%
200	36.0%

Atterberg Limits
 Plastic Limit
 Liquid Limit
 Plastic Index

Swell
 Moisture at start
 Moisture at finish
 Moisture increase
 Initial dry density (pcf)
 Swell (psf)



ENTECH
ENGINEERING, INC.
505 ELKTON DRIVE
 COLORADO SPRINGS, CO. 80907 (719) 531-5599

LABORATORY TEST RESULTS

DRAWN:

DATE:

CHECKED:

DATE:

LA

9/5/06

JOB NO.:

82556

FIG NO.:

C-22

UNIFIED CLASSIFICATION SM
SOIL TYPE # 3
TEST BORING # 14
DEPTH (FT) 5

CLIENT MORLEY BENTLEY
PROJECT STERLING RANCH
JOB NO. 82556
TEST BY DG

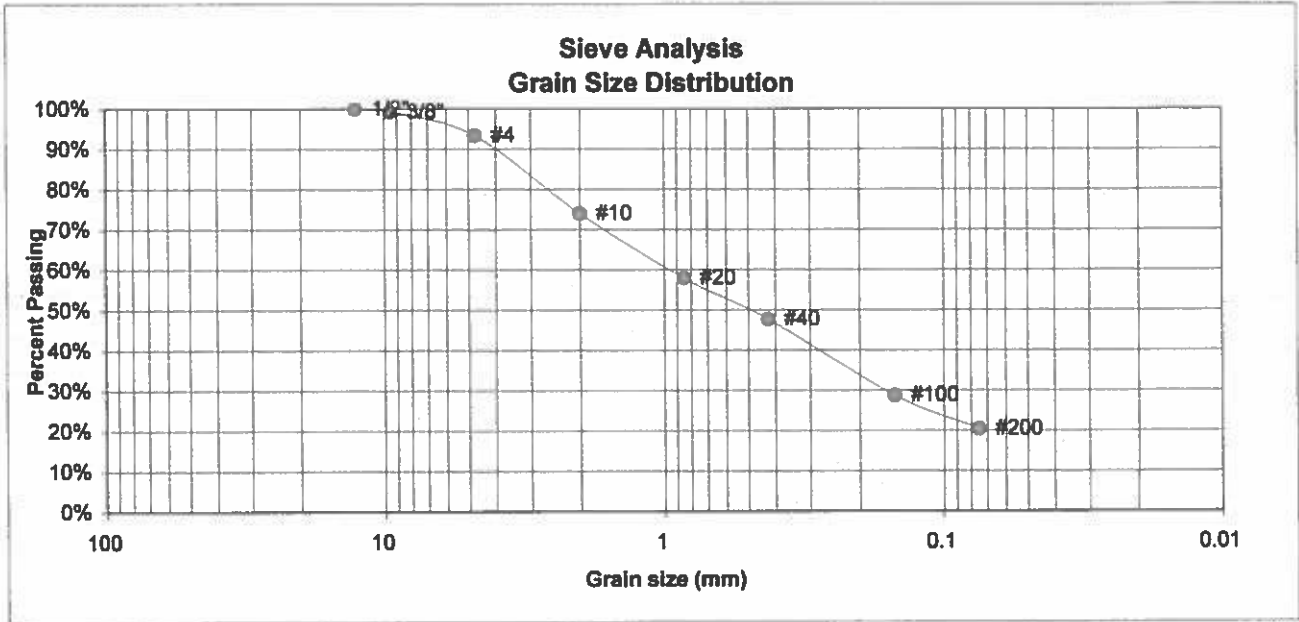

U.S. Sieve #	Percent Finer
3"	
1 1/2"	
3/4"	
1/2"	100.0%
3/8"	99.2%
4	93.4%
10	74.0%
20	57.9%
40	47.7%
100	28.7%
200	20.4%

Atterberg Limits
 Plastic Limit
 Liquid Limit
 Plastic Index

Swell
 Moisture at start
 Moisture at finish
 Moisture increase
 Initial dry density (pcf)
 Swell (psf)



ENTECH
ENGINEERING, INC.
305 ELKTON DRIVE
 COLORADO SPRINGS, CO. 80907 (719) 531-5399

LABORATORY TEST RESULTS

DRAWN:	DATE:	CHECKED: <i>KAH</i>	DATE: <i>9/15/06</i>
--------	-------	------------------------	-------------------------

JOB NO.:
82556

 FIG NO.:
C-23

UNIFIED CLASSIFICATION SM
SOIL TYPE # 3
TEST BORING # 18
DEPTH (FT) 15

CLIENT MORLEY BENTLEY
PROJECT STERLING RANCH
JOB NO. 82556
TEST BY DG

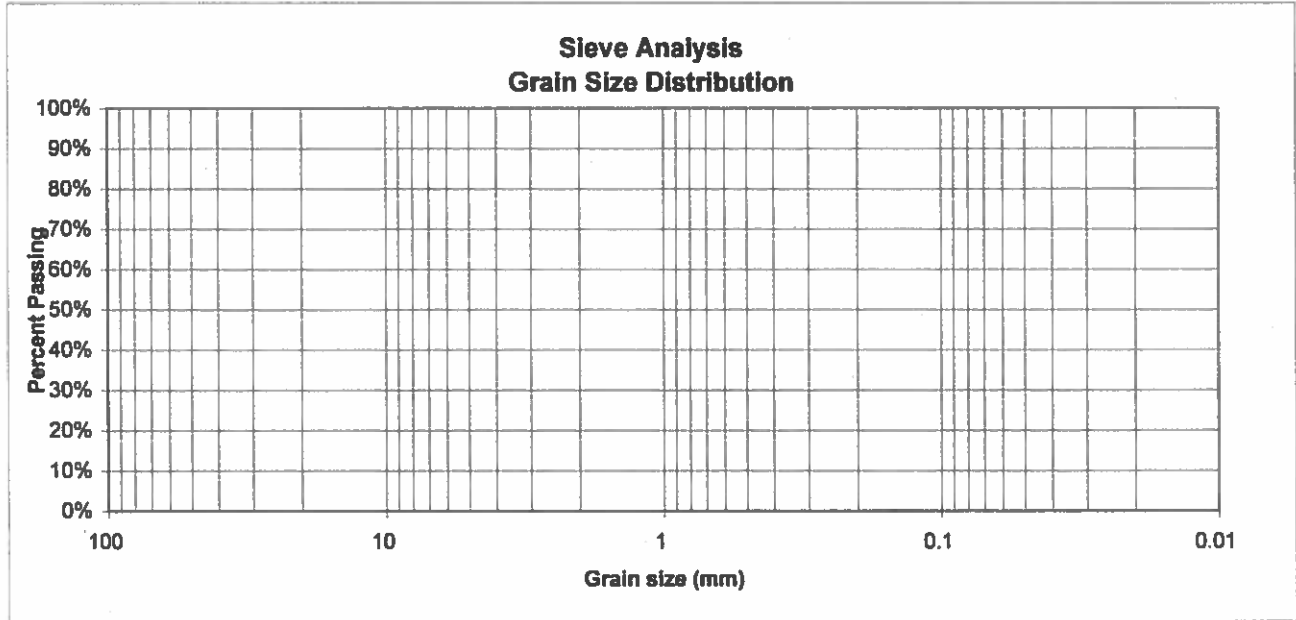

U.S. Sieve #	Percent Finer
3"	
1 1/2"	
3/4"	
1/2"	
3/8"	
4	
10	
20	
40	
100	
200	

**Atterberg
Limits**
 Plastic Limit
 Liquid Limit
 Plastic Index

Swell
 Moisture at start 12.6%
 Moisture at finish 23.0%
 Moisture increase 10.3%
 Initial dry density (pcf) 96
 Swell (psf) 456



ENTECH
ENGINEERING, INC.
505 ELKTON DRIVE
 COLORADO SPRINGS, CO. 80907 (719) 531-5599

**LABORATORY TEST
RESULTS**

DRAWN:

DATE:

CHECKED:

DATE:

Handwritten signature

9/15/06

JOB NO.:

82556

FIG NO.:

C-24

UNIFIED CLASSIFICATION SM
SOIL TYPE # 3
TEST BORING # 22
DEPTH (FT) 5

CLIENT MORLEY BENTLEY
PROJECT STERLING RANCH
JOB NO. 82556
TEST BY DG

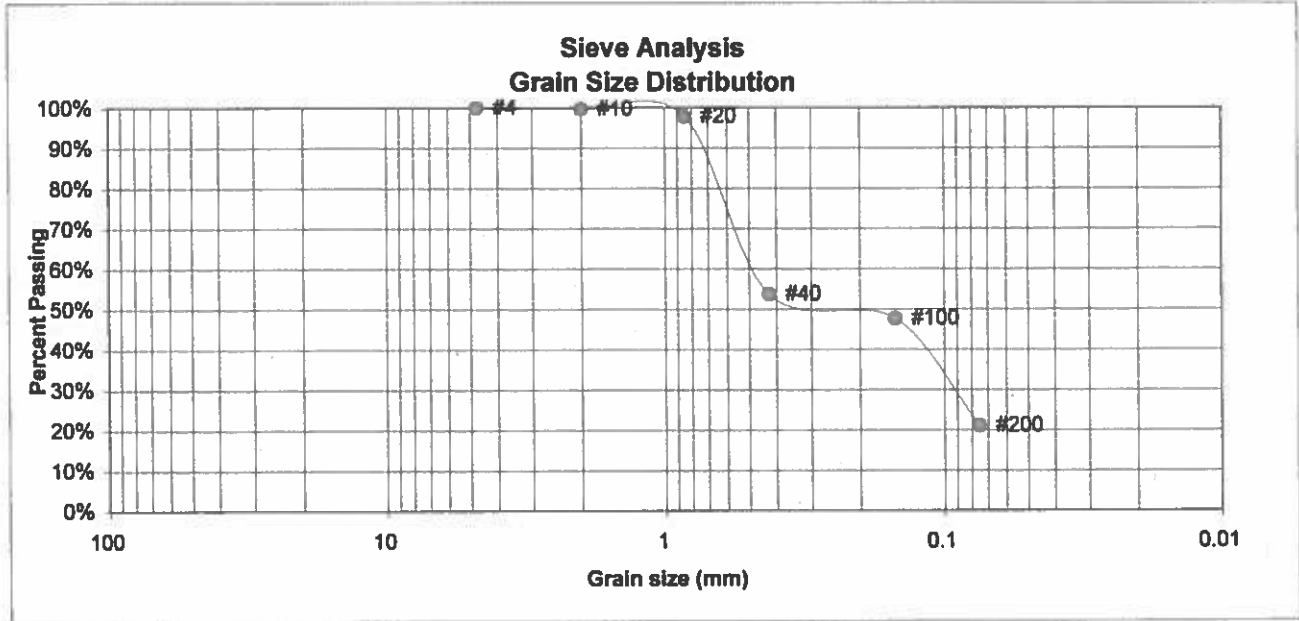

U.S. Sieve #	Percent Finer
3"	
1 1/2"	
3/4"	
1/2"	
3/8"	
4	100.0%
10	99.7%
20	97.8%
40	53.7%
100	47.7%
200	21.1%

Atterberg Limits
 Plastic Limit NP
 Liquid Limit NV
 Plastic Index NP

Swell
 Moisture at start
 Moisture at finish
 Moisture increase
 Initial dry density (pcf)
 Swell (psf)



**ENTECH
ENGINEERING, INC.**
 505 ELKTON DRIVE
 COLORADO SPRINGS, CO. 80907 (719) 531-5599

**LABORATORY TEST
RESULTS**

DRAWN:	DATE:	CHECKED: <i>kan</i>	DATE: 9/5/06
--------	-------	------------------------	-----------------

JOB NO.:
82556

FIG NO.:
C-25

UNIFIED CLASSIFICATION SM
SOIL TYPE # 3
TEST BORING # 28
DEPTH (FT) 5-10

CLIENT MORLEY BENTLEY
PROJECT STERLING RANCH
JOB NO. 82556
TEST BY DG

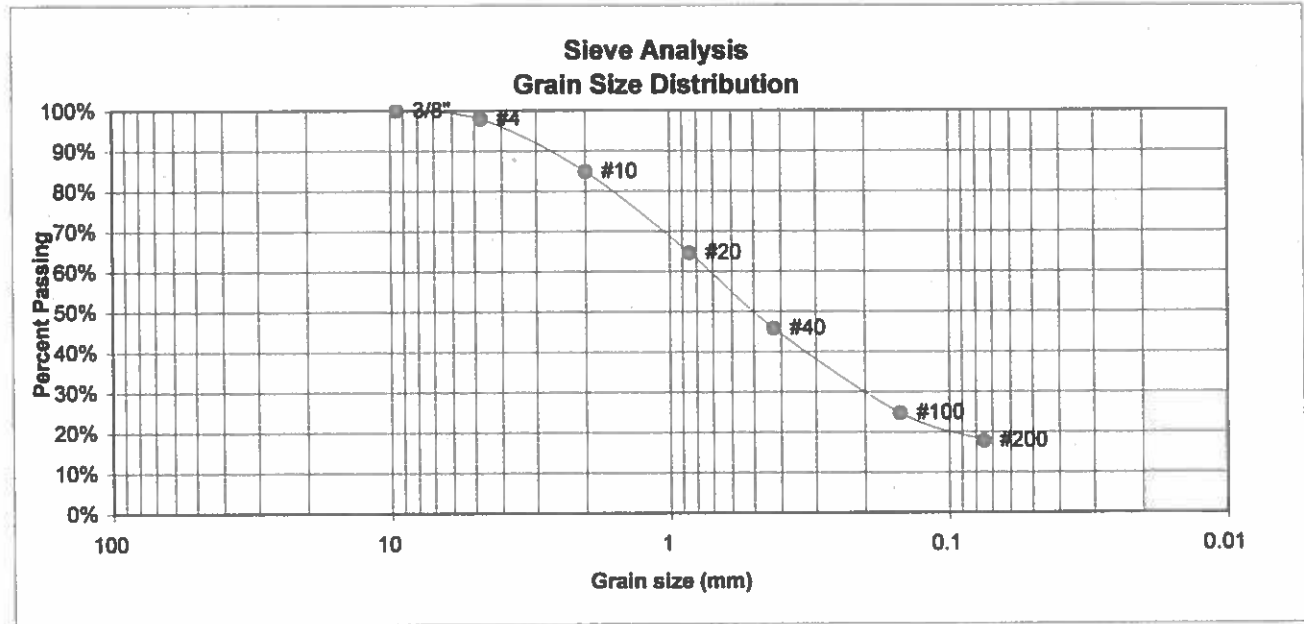

U.S. Sieve #	Percent Finer
3"	
1 1/2"	
3/4"	
1/2"	
3/8"	100.0%
4	97.9%
10	84.9%
20	64.6%
40	45.8%
100	24.6%
200	17.8%

Atterberg Limits
 Plastic Limit
 Liquid Limit
 Plastic Index

Swell
 Moisture at start
 Moisture at finish
 Moisture increase
 Initial dry density (pcf)
 Swell (psf)



ENTECH
ENGINEERING, INC.
 505 ELKTON DRIVE
 COLORADO SPRINGS, CO. 80907 (719) 531-5399

LABORATORY TEST RESULTS

DRAWN:	DATE:	CHECKED: <i>UAG</i>	DATE: 9/15/06
--------	-------	---------------------	---------------

JOB NO.: 82556
 FIG NO.: C-26

UNIFIED CLASSIFICATION SC

SOIL TYPE # 3

TEST BORING # 29

DEPTH (FT) 7

CLIENT

MORLEY BENTLEY

PROJECT

STERLING RANCH

JOB NO.

82556

TEST BY

DG

**Sieve Analysis
Grain Size Distribution**

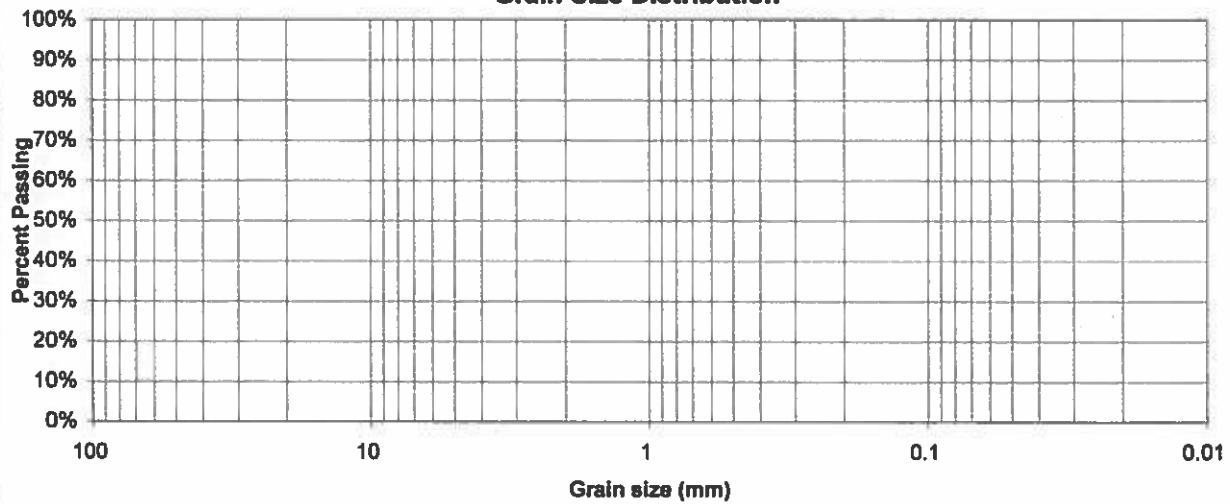

**U.S.
Sieve #**

**Percent
Finer**

**Atterberg
Limits**

- 3"
- 1 1/2"
- 3/4"
- 1/2"
- 3/8"
- 4
- 10
- 20
- 40
- 100
- 200

- Plastic Limit
- Liquid Limit
- Plastic Index

Swell

Moisture at start	8.5%
Moisture at finish	16.1%
Moisture increase	7.6%
Initial dry density (pcf)	111
Swell (psf)	485



**ENTECH
ENGINEERING, INC.**
505 ELKTON DRIVE
COLORADO SPRINGS, CO. 80907 (719) 531-5599

**LABORATORY TEST
RESULTS**

DRAWN:

DATE:

CHECKED:

DATE:

DG 9/5/06

JOB NO.:
82556

FIG NO.:
C-27

UNIFIED CLASSIFICATION SM-SW

SOIL TYPE # 3

TEST BORING # 30

DEPTH (FT) 10

CLIENT MORLEY BENTLEY

PROJECT STERLING RANCH

JOB NO. 82556

TEST BY DG

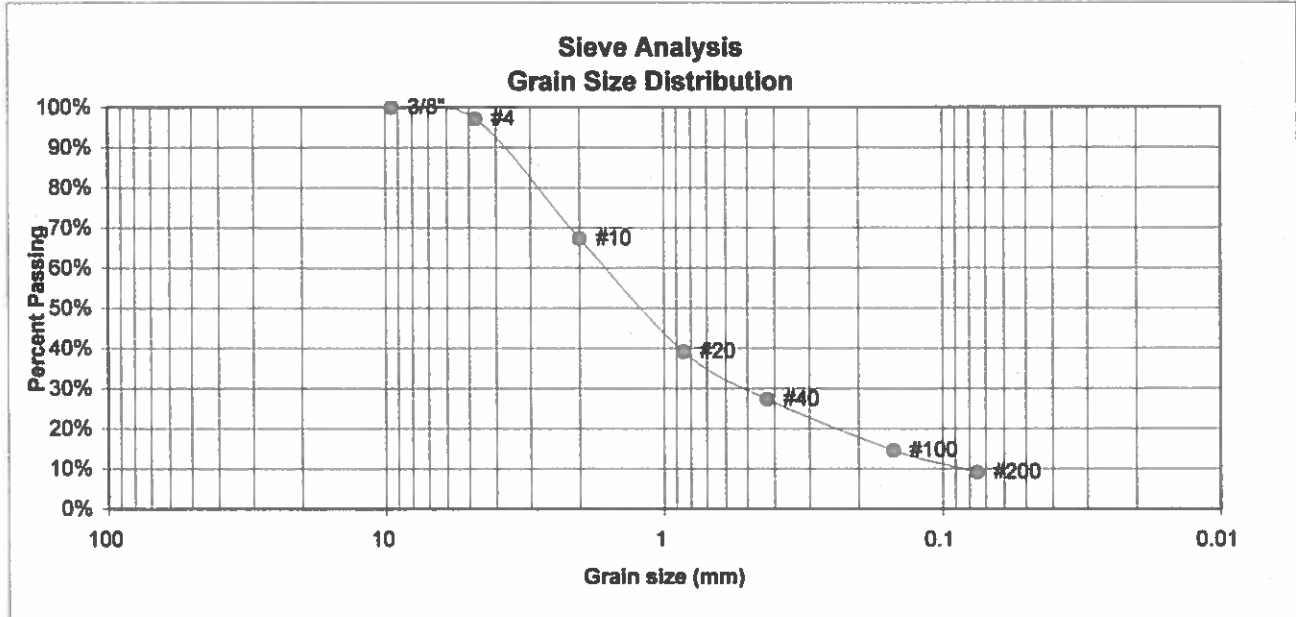

U.S. Sieve #	Percent Finer
3"	
1 1/2"	
3/4"	
1/2"	
3/8"	100.0%
4	97.2%
10	67.3%
20	39.1%
40	27.3%
100	14.6%
200	9.1%

Atterberg Limits
 Plastic Limit
 Liquid Limit
 Plastic Index

Swell
 Moisture at start
 Moisture at finish
 Moisture increase
 Initial dry density (pcf)
 Swell (psf)



**ENTECH
ENGINEERING, INC.**
 505 ELKTON DRIVE
 COLORADO SPRINGS, CO. 80907 (719) 531-5599

**LABORATORY TEST
RESULTS**

DRAWN:

DATE:

CHECKED:

DATE:

Deno 9/15/06

JOB NO.:

82556

FIG NO.:

C-28

UNIFIED CLASSIFICATION SM

SOIL TYPE # 3
TEST BORING # 33
DEPTH (FT) 5

CLIENT

MORLEY BENTLEY

PROJECT

STERLING RANCH

JOB NO.

82556

TEST BY

DG

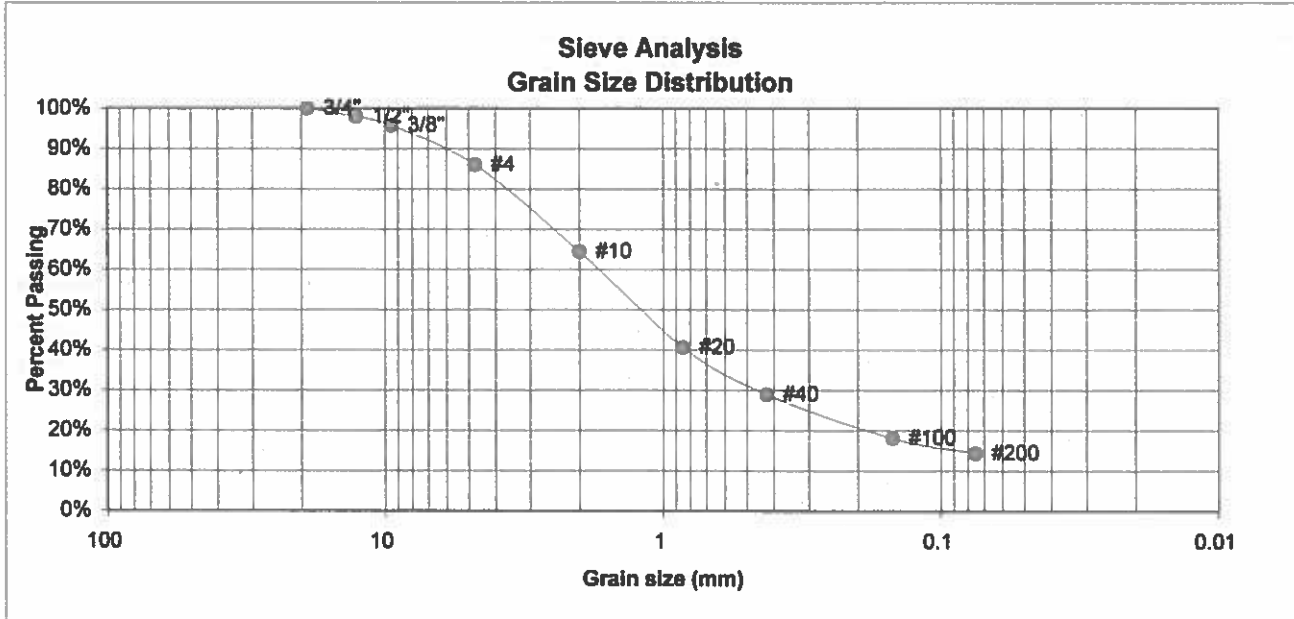
**U.S.
Sieve #****Percent
Finer**

3"	
1 1/2"	
3/4"	100.0%
1/2"	98.0%
3/8"	95.8%
4	86.0%
10	64.5%
20	40.6%
40	29.0%
100	18.1%
200	14.4%

**Atterberg
Limits**

Plastic Limit
 Liquid Limit
 Plastic Index

Swell

Moisture at start
 Moisture at finish
 Moisture increase
 Initial dry density (pcf)
 Swell (psf)



**ENTECH
ENGINEERING, INC.**
 505 ELKTON DRIVE
 COLORADO SPRINGS, CO. 80907 (719) 531-5599

**LABORATORY TEST
RESULTS**

DRAWN:

DATE:

CHECKED:

DATE:

Kan

9/15/06

JOB NO.:

82556

FIG NO.:

C-29

UNIFIED CLASSIFICATION	SM-SW	CLIENT	MORLEY BENTLEY
SOIL TYPE #	3	PROJECT	STERLING RANCH
TEST BORING #	35	JOB NO.	82556
DEPTH (FT)	15	TEST BY	DG

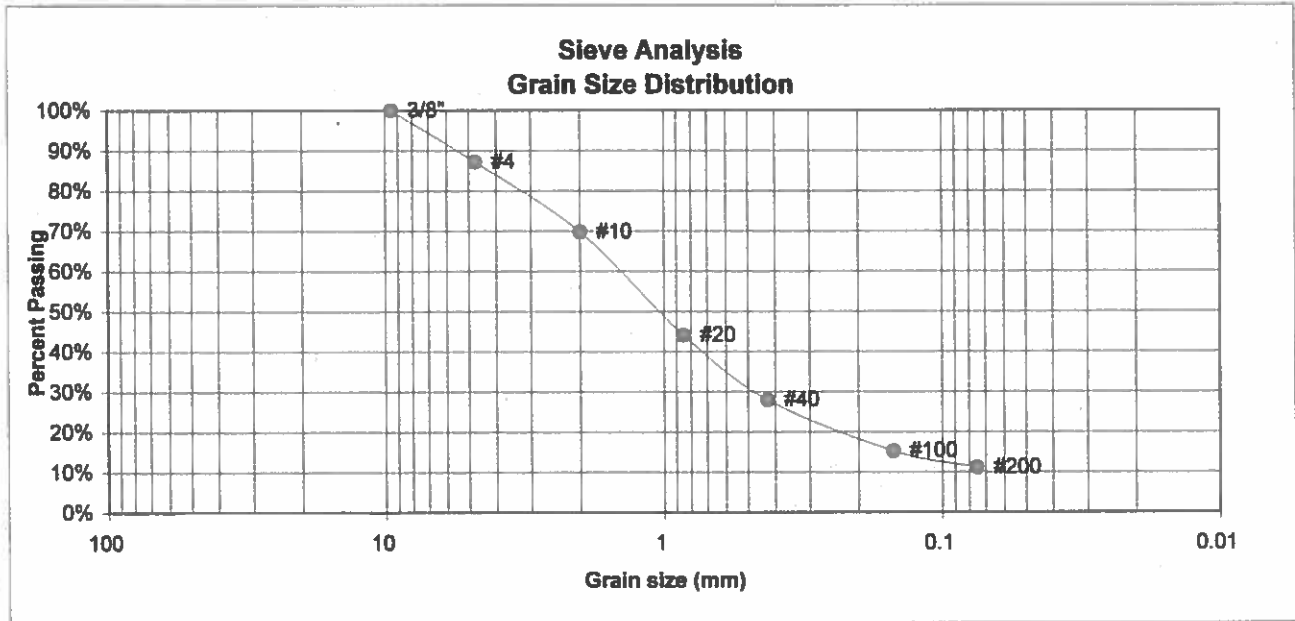

<u>U.S. Sieve #</u>	<u>Percent Finer</u>	<u>Atterberg Limits</u>
3"		Plastic Limit
1 1/2"		Liquid Limit
3/4"		Plastic Index
1/2"		
3/8"	100.0%	
4	87.2%	<u>Swell</u>
10	69.7%	Moisture at start
20	44.1%	Moisture at finish
40	27.9%	Moisture increase
100	15.2%	Initial dry density (pcf)
200	11.1%	Swell (psf)



**ENTECH
ENGINEERING, INC.**
505 CLAYTON DRIVE
COLORADO SPRINGS, CO. 80907 (719) 531-5599

**LABORATORY TEST
RESULTS**

DRAWN:

DATE:

CHECKED:

DATE:

LAN

9/5/06

JOB NO.:

82556

FIG NO.:

C-30

UNIFIED CLASSIFICATION SC
SOIL TYPE # 3
TEST BORING # 36
DEPTH (FT) 2-5

CLIENT MORLEY BENTLEY
PROJECT STERLING RANCH
JOB NO. 82556
TEST BY DG

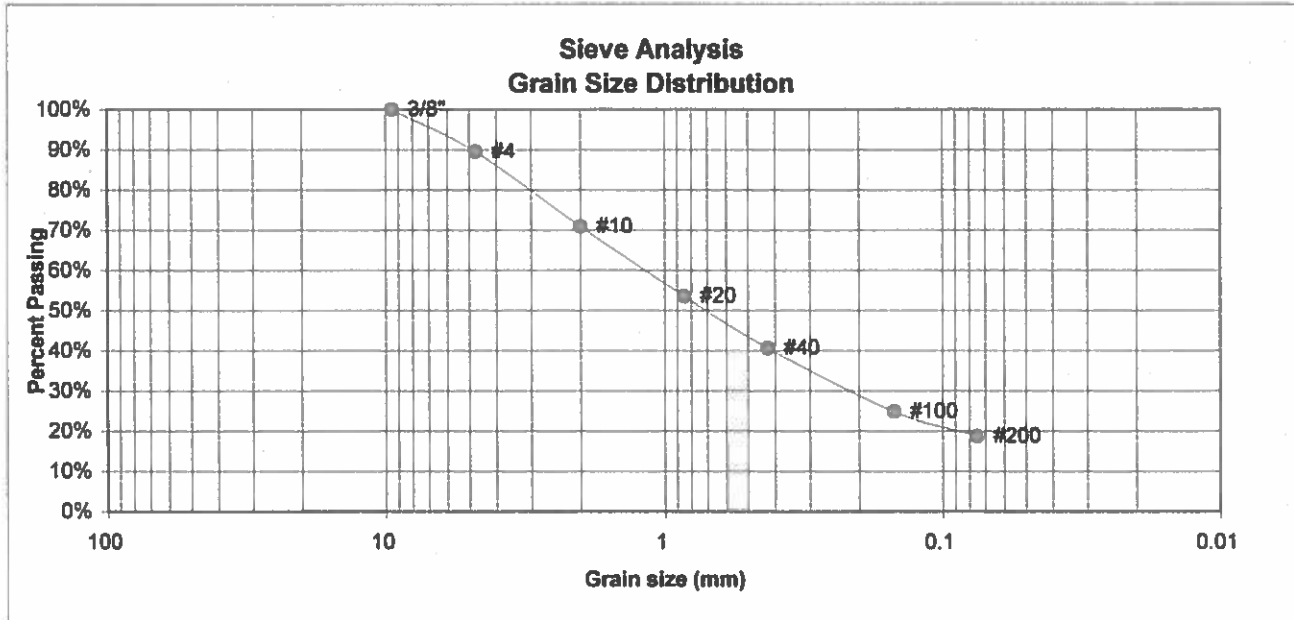

U.S. Sieve #	Percent Finer
3"	
1 1/2"	
3/4"	
1/2"	
3/8"	100.0%
4	89.5%
10	70.9%
20	53.6%
40	40.6%
100	24.9%
200	18.7%

Atterberg Limits
 Plastic Limit
 Liquid Limit
 Plastic Index

Swell

Moisture at start	10.3%
Moisture at finish	17.7%
Moisture increase	7.4%
Initial dry density (pcf)	108
Swell (psf)	1014



ENTECH
ENGINEERING, INC.
595 ELKTON DRIVE
 COLORADO SPRINGS, CO. 80907 (719) 531-5599

LABORATORY TEST RESULTS

DRAWN:

DATE:

CHECKED:

DATE:

Mw

9/15/06

JOB NO.:

82556

FIG NO.:

C-31

UNIFIED CLASSIFICATION SM
SOIL TYPE # 3
TEST BORING # 38
DEPTH (FT) 5

CLIENT MORLEY BENTLEY
PROJECT STERLING RANCH
JOB NO. 82556
TEST BY DG

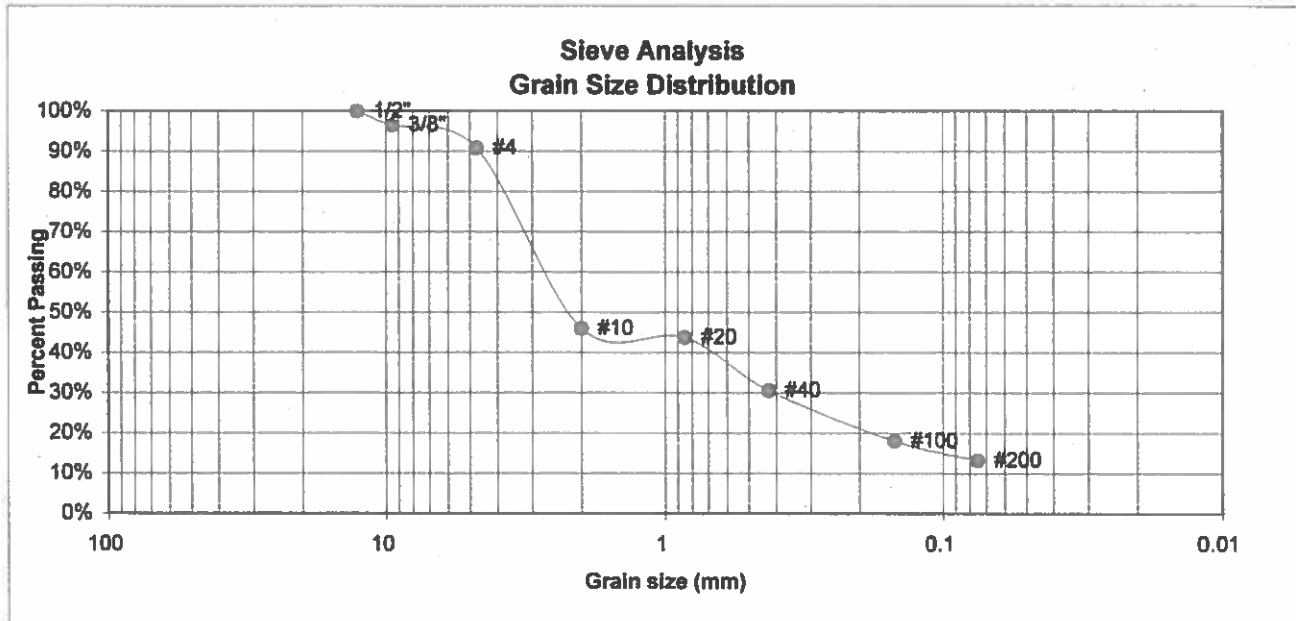

U.S. Sieve #	Percent Finer
3"	
1 1/2"	
3/4"	
1/2"	100.0%
3/8"	96.5%
4	90.8%
10	45.9%
20	43.7%
40	30.5%
100	18.0%
200	13.3%

Atterberg Limits
 Plastic Limit
 Liquid Limit
 Plastic Index

Swell
 Moisture at start
 Moisture at finish
 Moisture increase
 Initial dry density (pcf)
 Swell (psf)



ENTECH
ENGINEERING, INC.
 505 ELKTON DRIVE
 COLORADO SPRINGS, CO. 80907 (719) 531-5399

LABORATORY TEST RESULTS

DRAWN:

DATE:

CHECKED:

DATE:

Katt 9/15/06

JOB NO.:

82556

FIG NO.:

C-32

UNIFIED CLASSIFICATION SC
 SOIL TYPE # 3
 TEST BORING # 39
 DEPTH (FT) 15

CLIENT MORLEY BENTLEY
 PROJECT STERLING RANCH
 JOB NO. 82556
 TEST BY DG

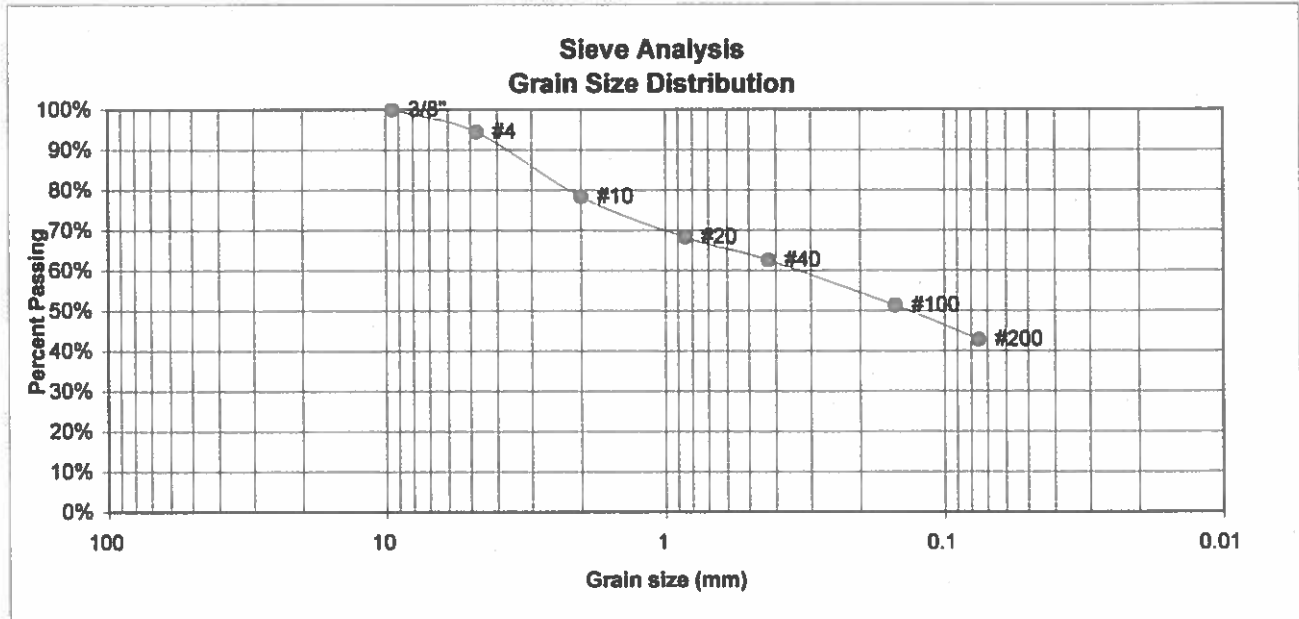

U.S. Sieve #	Percent Finer
3"	
1 1/2"	
3/4"	
1/2"	
3/8"	100.0%
4	94.4%
10	78.3%
20	68.2%
40	62.5%
100	51.2%
200	42.8%

Atterberg Limits

Plastic Limit	17
Liquid Limit	33
Plastic Index	16

Swell

Moisture at start
 Moisture at finish
 Moisture increase
 Initial dry density (pcf)
 Swell (psf)



**ENTECH
ENGINEERING, INC.**
 505 ELKTON DRIVE
 COLORADO SPRINGS, CO. 80907 (719) 531-5599

**LABORATORY TEST
RESULTS**

DRAWN:	DATE:	CHECKED: <i>[Signature]</i>	DATE: 9/15/06
--------	-------	--------------------------------	------------------

JOB NO.:
82556
 FIG NO.:
C-33

UNIFIED CLASSIFICATION SM-SC
SOIL TYPE # 3
TEST BORING # 40
DEPTH (FT) 2-3

CLIENT MORLEY BENTLEY
PROJECT STERLING RANCH
JOB NO. 82556
TEST BY DG

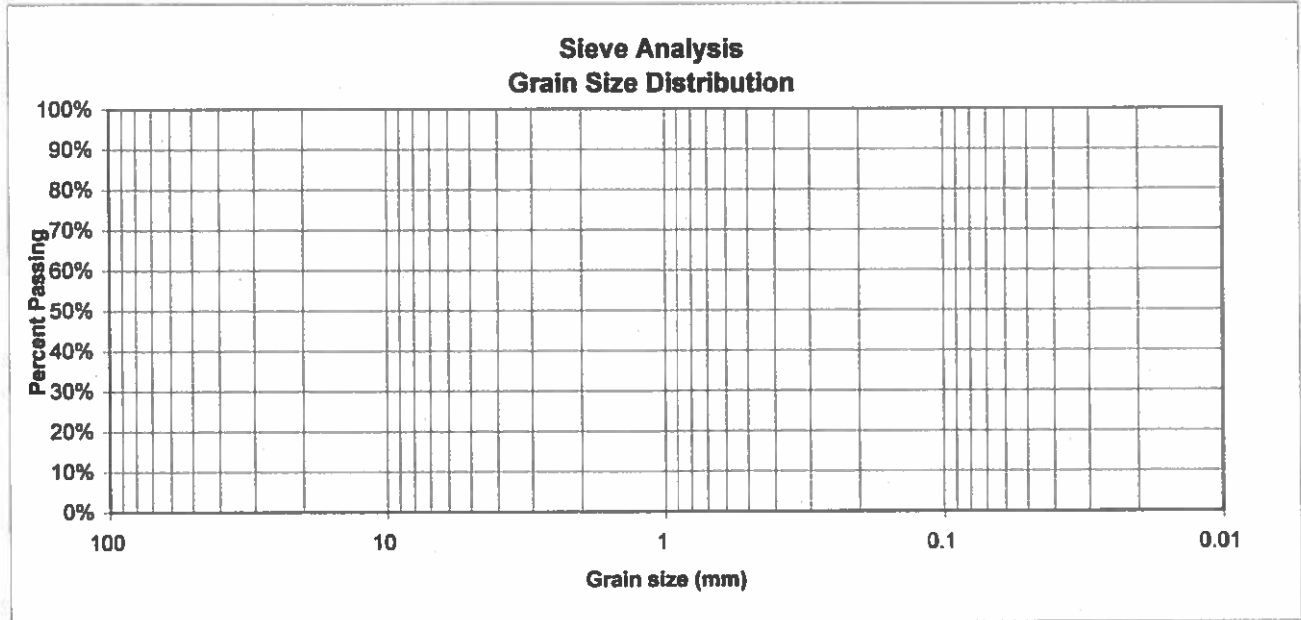

<u>U.S. Sieve #</u>	<u>Percent Finer</u>
3"	
1 1/2"	
3/4"	
1/2"	
3/8"	
4	
10	
20	
40	
100	
200	

**Atterberg
Limits**
 Plastic Limit
 Liquid Limit
 Plastic Index

Swell

Moisture at start	7.1%
Moisture at finish	19.7%
Moisture increase	12.6%
Initial dry density (pcf)	104
Swell (psf)	360



**ENTECH
ENGINEERING, INC.**
505 ELKTON DRIVE
 COLORADO SPRINGS, CO. 80907 (719) 531-5599

**LABORATORY TEST
RESULTS**

DRAWN:	DATE:	CHECKED: <i>NAK</i>	DATE: 9/15/06
--------	-------	------------------------	------------------

JOB NO.:
82556
 FIG NO.:
C-34

<u>UNIFIED CLASSIFICATION</u> CL		<u>CLIENT</u>	MORLEY BENTLEY
<u>SOIL TYPE #</u>	4	<u>PROJECT</u>	STERLING RANCH
<u>TEST BORING #</u>	1	<u>JOB NO.</u>	82556
<u>DEPTH (FT)</u>	5	<u>TEST BY</u>	DG

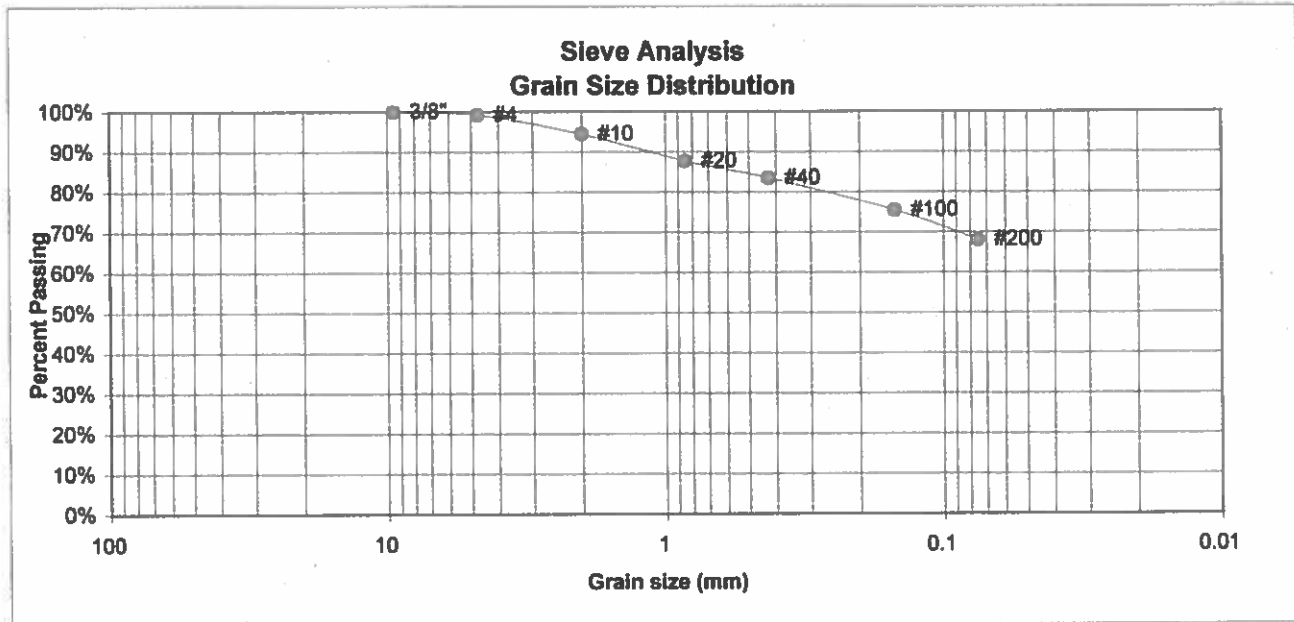

<u>U.S. Sieve #</u>	<u>Percent Finer</u>	<u>Atterberg Limits</u>
3"		Plastic Limit
1 1/2"		Liquid Limit
3/4"		Plastic Index
1/2"		
3/8"	100.0%	
4	99.2%	<u>Swell</u>
10	94.4%	Moisture at start
20	87.7%	Moisture at finish
40	83.5%	Moisture increase
100	75.5%	Initial dry density (pcf)
200	68.1%	Swell (psf)



LABORATORY TEST RESULTS

DRAWN:	DATE:	CHECKED:	DATE:
		LLA	9/5/06

JOB NO.:
82556
FIG NO.:
C-35

UNIFIED CLASSIFICATION CL
SOIL TYPE # 4
TEST BORING # 3
DEPTH (FT) 7

CLIENT MORLEY BENTLEY
PROJECT STERLING RANCH
JOB NO. 82556
TEST BY DG

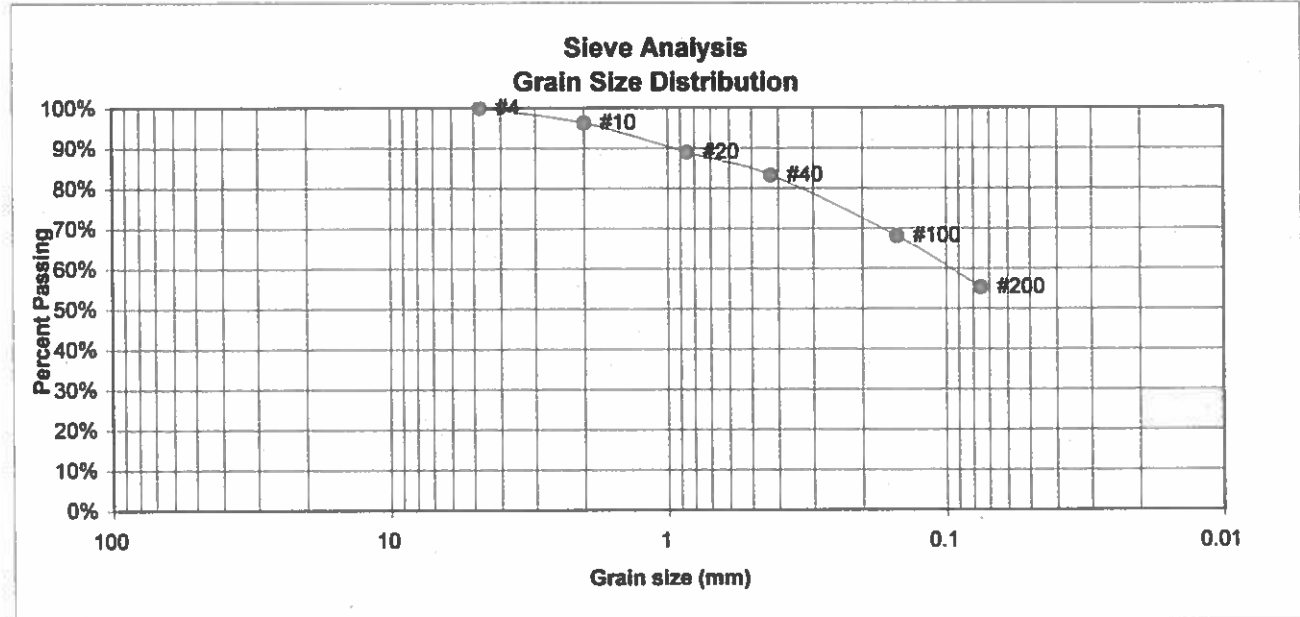

U.S. Sieve #	Percent Finer
3"	
1 1/2"	
3/4"	
1/2"	
3/8"	
4	100.0%
10	96.2%
20	89.0%
40	83.3%
100	68.1%
200	55.3%

Atterberg Limits	
Plastic Limit	14
Liquid Limit	32
Plastic Index	18

Swell	
Moisture at start	10.4%
Moisture at finish	18.3%
Moisture increase	8.0%
Initial dry density (pcf)	107
Swell (psf)	846



ENTECH
ENGINEERING, INC.
505 ELKTON DRIVE
 COLORADO SPRINGS, CO. 80907 (719) 531-5399

**LABORATORY TEST
RESULTS**

DRAWN:

DATE:

CHECKED:

DATE:

KA

9/5/06

JOB NO.:

82556

FIG NO.:

C-36

UNIFIED CLASSIFICATION CL
SOIL TYPE # 4
TEST BORING # 24
DEPTH (FT) 2-3

CLIENT MORLEY BENTLEY
PROJECT STERLING RANCH
JOB NO. 82556
TEST BY DG

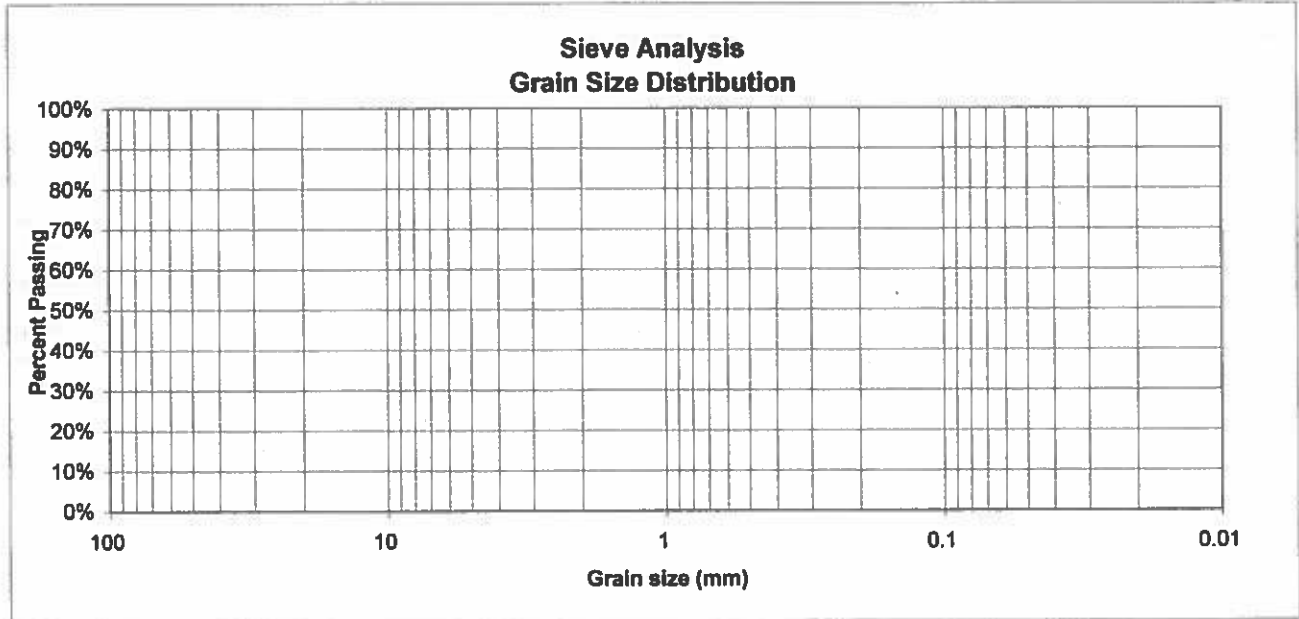

<u>U.S. Sieve #</u>	<u>Percent Finer</u>
3"	
1 1/2"	
3/4"	
1/2"	
3/8"	
4	
10	
20	
40	
100	
200	

Atterberg
Limits
 Plastic Limit
 Liquid Limit
 Plastic Index

Swell
 Moisture at start 13.0%
 Moisture at finish 25.1%
 Moisture increase 12.1%
 Initial dry density (pcf) 97
 Swell (psf) 1757



ENTECH
ENGINEERING, INC.
565 ELKTON DRIVE
 COLORADO SPRINGS, CO. 80907 (719) 531-5599

**LABORATORY TEST
RESULTS**

DRAWN:

DATE:

CHECKED:
BAH

DATE:
9/5/06

JOB NO.:
82556
 FIG NO.:
C-37

<u>UNIFIED CLASSIFICATION</u> CL		<u>CLIENT</u>	MORLEY BENTLEY
<u>SOIL TYPE #</u>	4	<u>PROJECT</u>	STERLING RANCH
<u>TEST BORING #</u>	25	<u>JOB NO.</u>	82556
<u>DEPTH (FT)</u>	10	<u>TEST BY</u>	DG

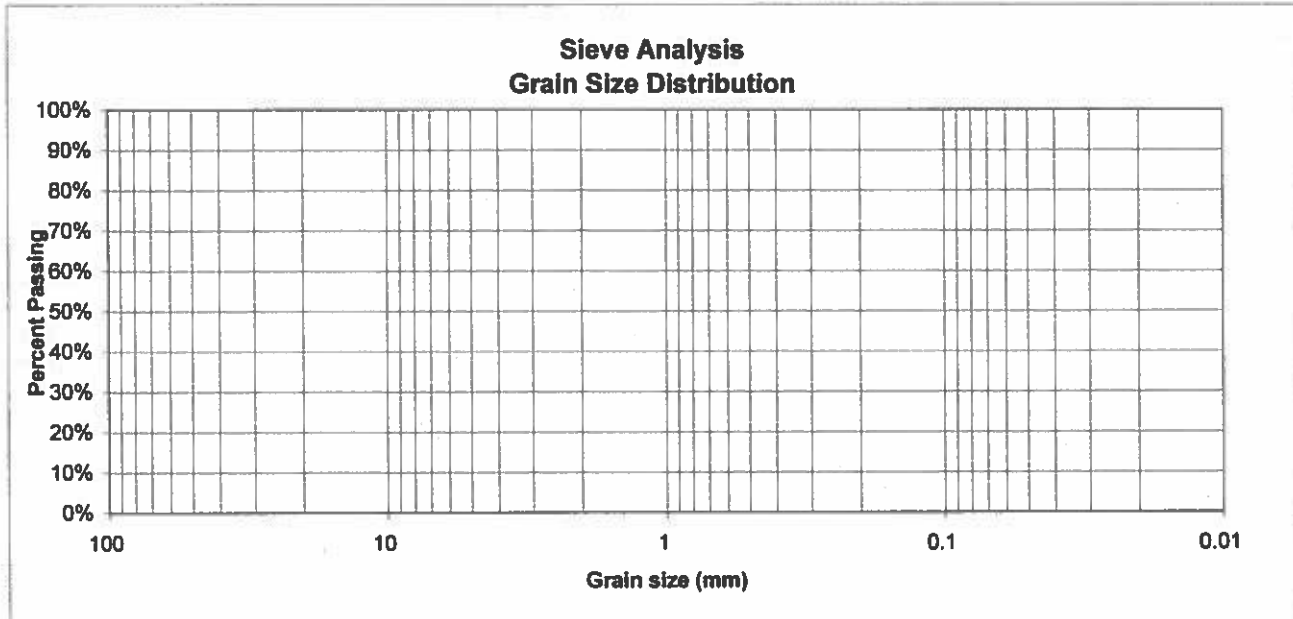

<u>U.S. Sieve #</u>	<u>Percent Finer</u>	<u>Atterberg Limits</u>	
3"		Plastic Limit	
1 1/2"		Liquid Limit	
3/4"		Plastic Index	
1/2"			
3/8"		<u>Swell</u>	
4		Moisture at start	11.2%
10		Moisture at finish	23.2%
20		Moisture increase	12.0%
40		Initial dry density (pcf)	99
100		Swell (psf)	1845
200			



ENTECH
ENGINEERING, INC.
365 ELKTON DRIVE
COLORADO SPRINGS, CO. 80907 (719) 531-5399

**LABORATORY TEST
RESULTS**

DRAWN:

DATE:

CHECKED:
[Signature]

DATE:
9/5/06

JOB NO.:

82556

FIG NO.:

C-38

UNIFIED CLASSIFICATION CH
SOIL TYPE # 4
TEST BORING # 33
DEPTH (FT) 15

CLIENT MORLEY BENTLEY
PROJECT STERLING RANCH
JOB NO. 82556
TEST BY DG

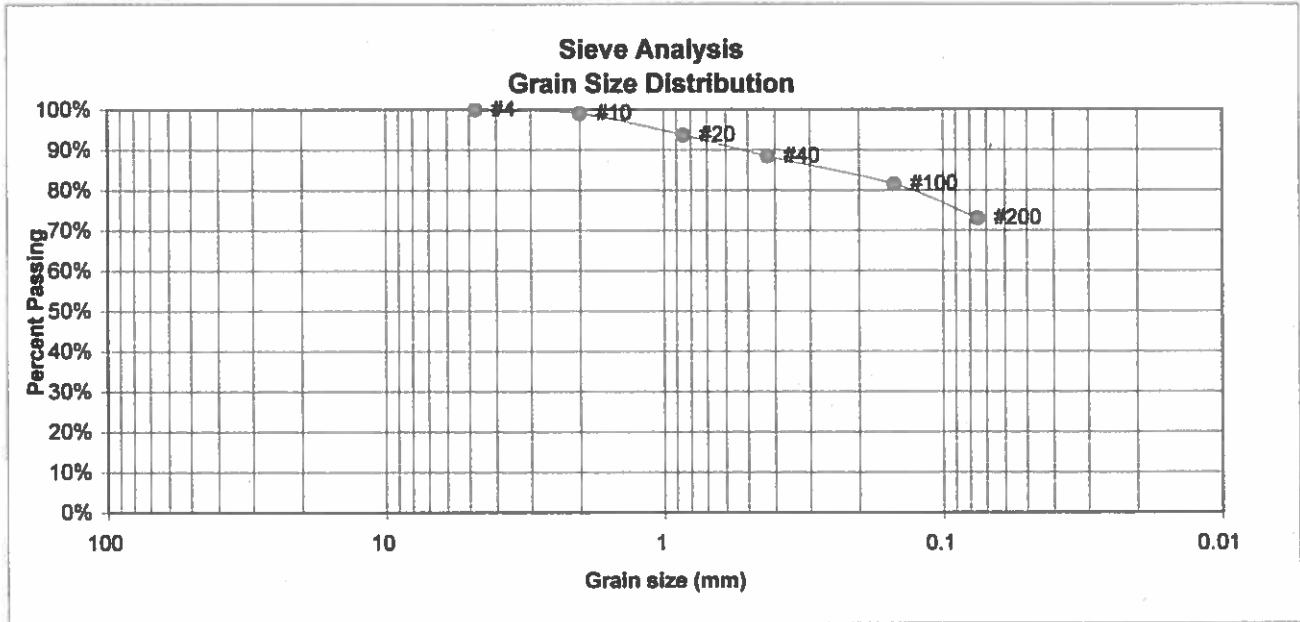

U.S. Sieve #	Percent Finer
3"	
1 1/2"	
3/4"	
1/2"	
3/8"	
4	100.0%
10	99.1%
20	93.7%
40	88.4%
100	81.5%
200	73.0%

Atterberg Limits

Plastic Limit	23
Liquid Limit	51
Plastic Index	28

Swell

Moisture at start
 Moisture at finish
 Moisture increase
 Initial dry density (pcf)
 Swell (psf)



ENTECH
ENGINEERING, INC.
 505 ELKTON DRIVE
 COLORADO SPRINGS, CO. 80907 (719) 531-5599

LABORATORY TEST RESULTS

DRAWN:

DATE:

CHECKED: *[Signature]*

DATE: 9/5/06

JOB NO.: 82556

FIG NO.: C-39

UNIFIED CLASSIFICATION CL
 SOIL TYPE # 4
 TEST BORING # 40
 DEPTH (FT) 15

CLIENT MORLEY BENTLEY
 PROJECT STERLING RANCH
 JOB NO. 82556
 TEST BY DG

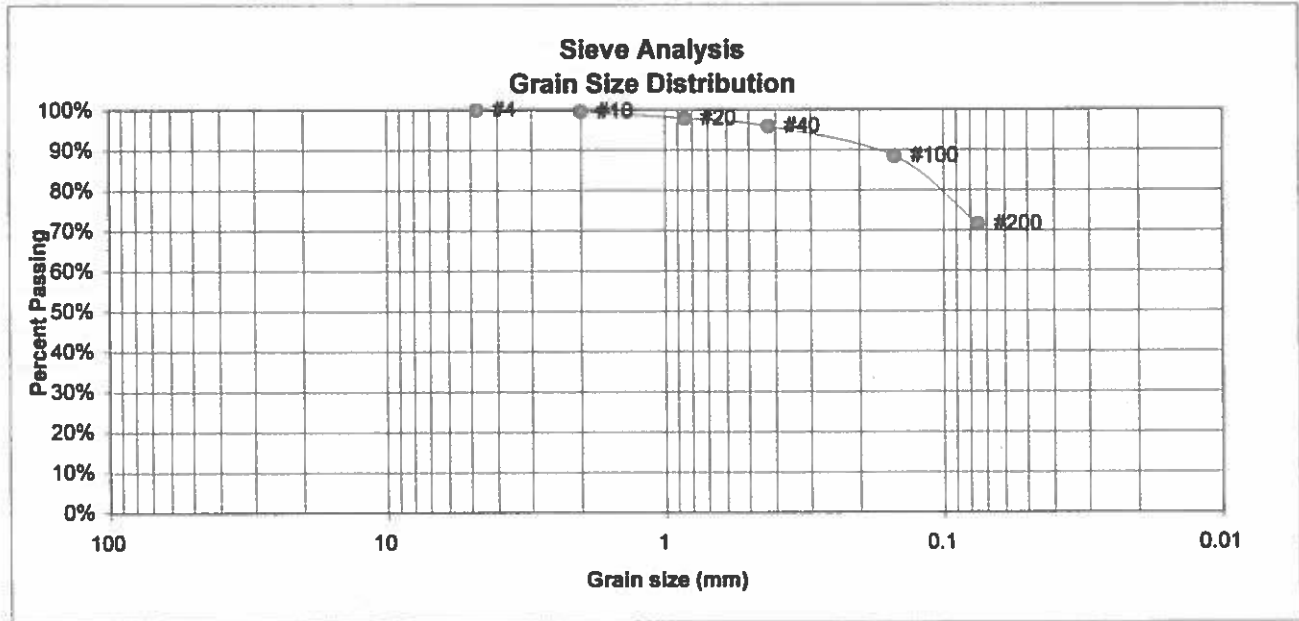

U.S. Sieve #	Percent Finer
3"	
1 1/2"	
3/4"	
1/2"	
3/8"	
4	100.0%
10	99.6%
20	97.9%
40	95.8%
100	88.4%
200	71.5%

Atterberg Limits	
Plastic Limit	22
Liquid Limit	38
Plastic Index	16

Swell	
Moisture at start	
Moisture at finish	
Moisture increase	
Initial dry density (pcf)	
Swell (psf)	



ENTECH
 ENGINEERING, INC.
 505 ELKTON DRIVE
 COLORADO SPRINGS, CO. 80907 (719) 531-5399

LABORATORY TEST RESULTS

DRAWN:	DATE:	CHECKED: <i>KSA</i>	DATE: 9/5/06
--------	-------	------------------------	-----------------

JOB NO.:
82556
 FIG NO.:
C-40

CONSOLIDATION TEST RESULTS

TEST BORING #	7	DEPTH(FT)	5
DESCRIPTION	CL	SOIL TYPE	2
NATURAL UNIT DRY WEIGHT (PCF)	98		
NATURAL MOISTURE CONTENT	5.6%		
SWELL/CONSOLIDATION (%)	-2.3%		

JOB NO. 82556
CLIENT MORLEY BENTLEY
PROJECT STERLING RANCH

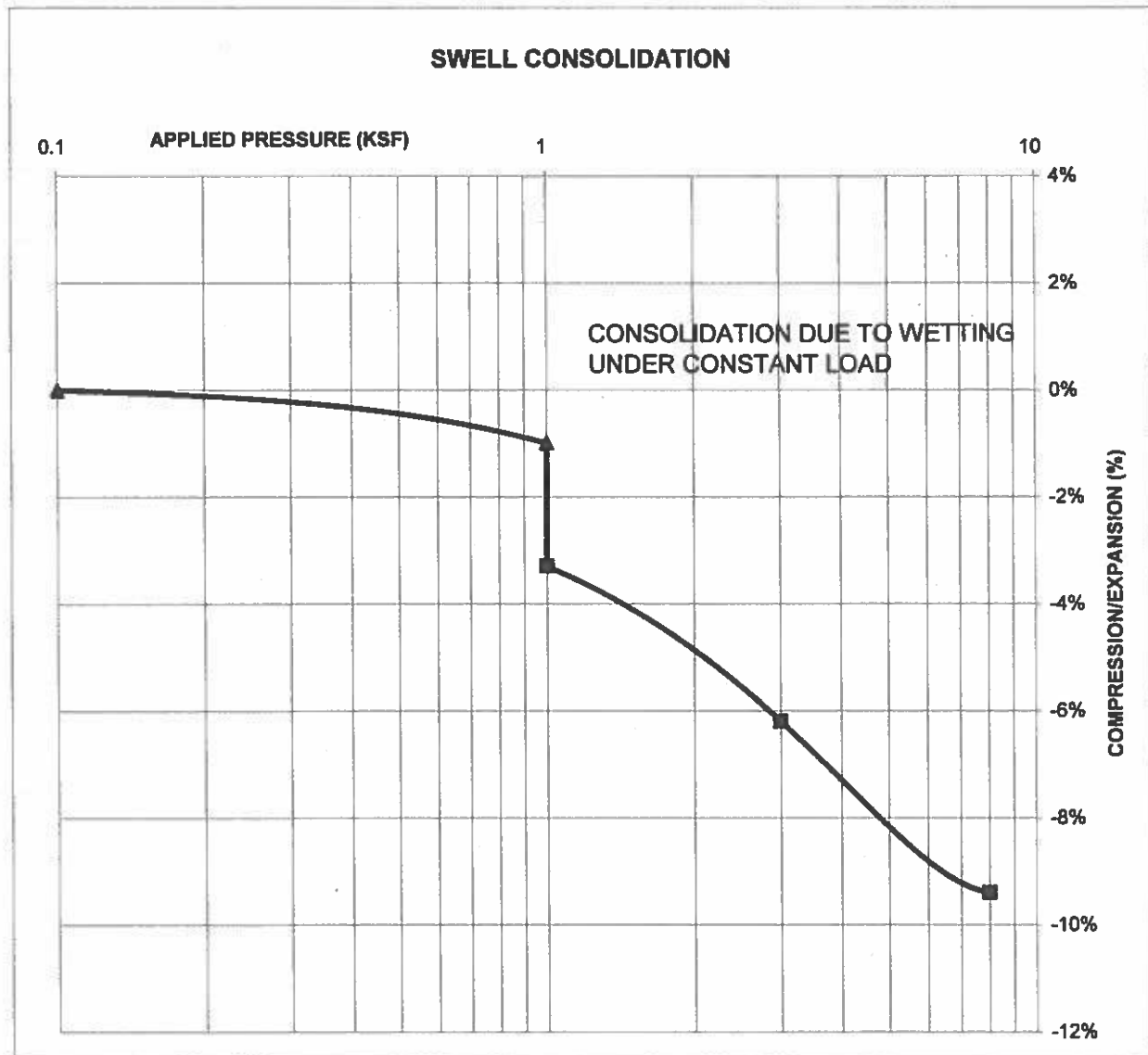

ENTECH
ENGINEERING, INC.
 505 ELKTON DRIVE
 COLORADO SPRINGS, CO. 80907 (719) 531-5399

**SWELL CONSOLIDATION
 TEST RESULTS**

DRAWN:

DATE:

CHECKED:

DATE:

LLH 9/15/06

JOB NO.:

82556

FIG NO.:

C-41

CONSOLIDATION TEST RESULTS

TEST BORING #	31	DEPTH(FT)	5
DESCRIPTION	CL	SOIL TYPE	2
NATURAL UNIT DRY WEIGHT (PCF)	95		
NATURAL MOISTURE CONTENT	27.9%		
SWELL/CONSOLIDATION (%)	1.8%		

JOB NO. 82556
CLIENT MORLEY BENTLEY
PROJECT STERLING RANCH

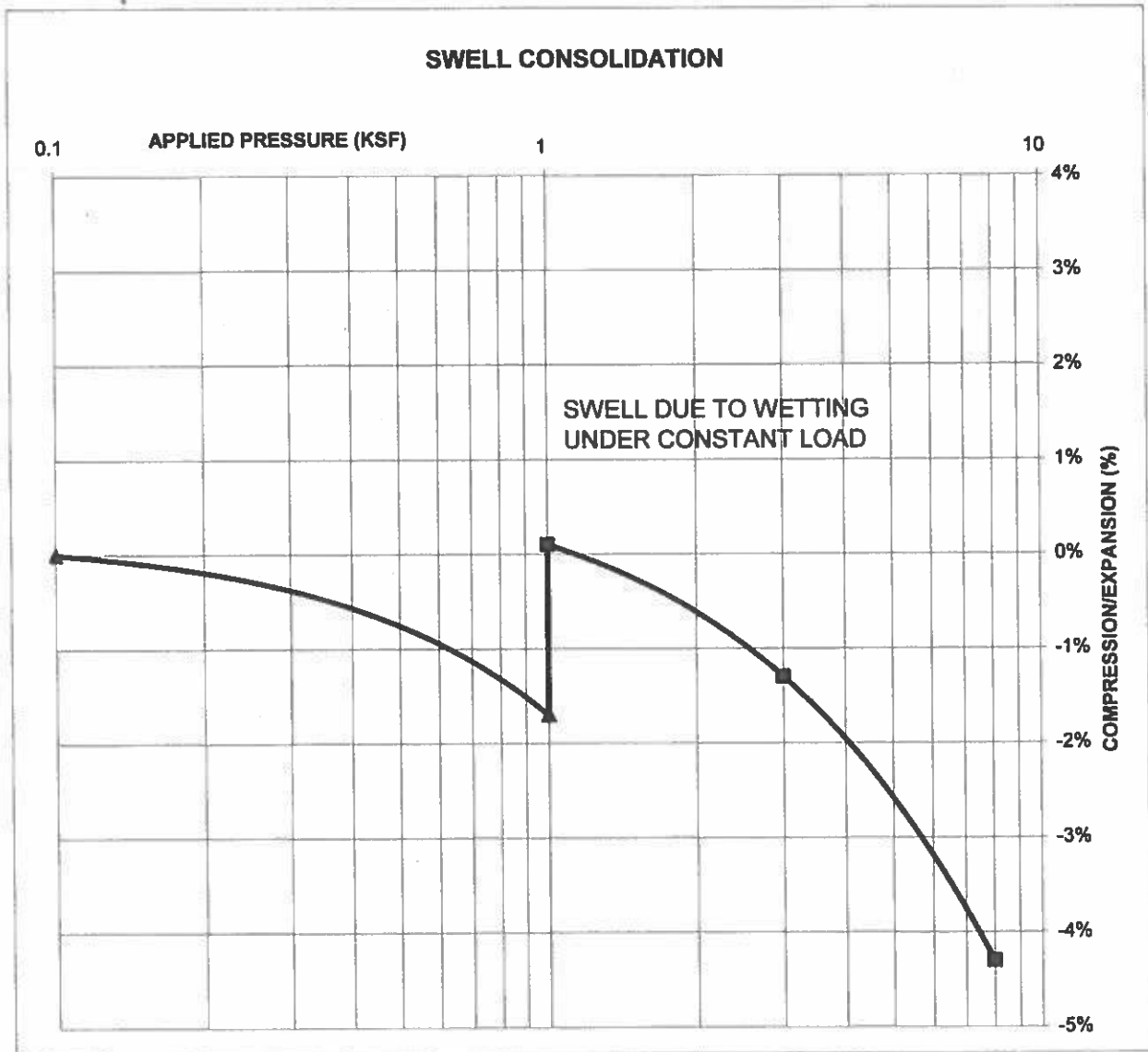

ENTECH
ENGINEERING, INC.
 505 ELKTON DRIVE
 COLORADO SPRINGS, CO. 80907 (719) 531-5599

**SWELL CONSOLIDATION
 TEST RESULTS**

DRAWN:

DATE:

CHECKED:

DATE:

KA 9/5/06

JOB NO.:

82556

FIG NO.:

C-42

CONSOLIDATION TEST RESULTS

TEST BORING #	5	DEPTH(FT)	15
DESCRIPTION	SC	SOIL TYPE	3
NATURAL UNIT DRY WEIGHT (PCF)	119		
NATURAL MOISTURE CONTENT	10.4%		
SWELL/CONSOLIDATION (%)	-0.1%		

JOB NO. 82556
CLIENT MORLEY BENTLEY
PROJECT STERLING RANCH

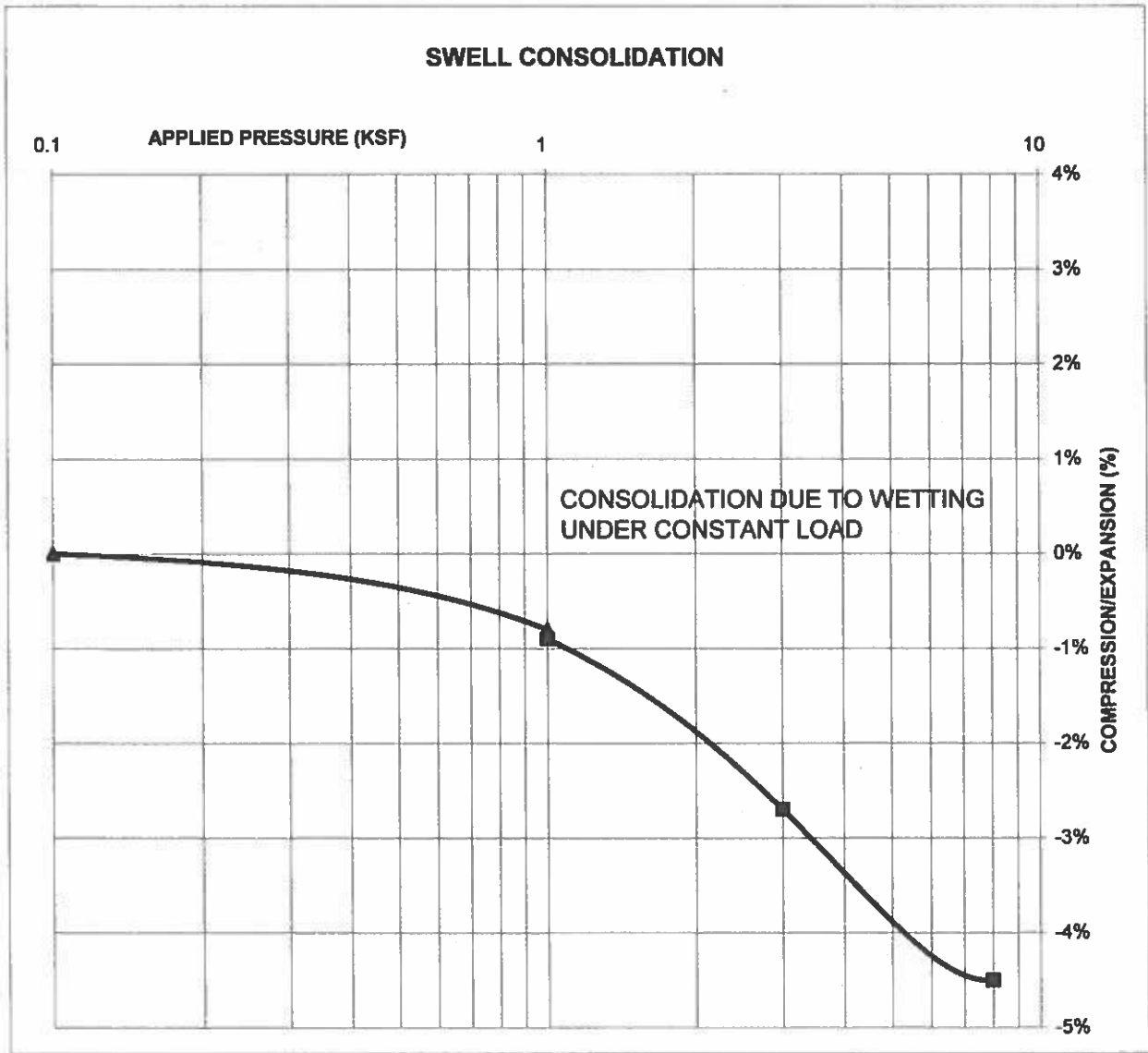

ENTECH
ENGINEERING, INC.
 505 ELKTON DRIVE
 COLORADO SPRINGS, CO. 80907 (719) 531-9999

**SWELL CONSOLIDATION
 TEST RESULTS**

DRAWN:

DATE:

CHECKED:
KWA

DATE:
 9/5/06

JOB NO.:

82556

FIG NO.:

C-43

CONSOLIDATION TEST RESULTS

TEST BORING #	22	DEPTH(FT)	5
DESCRIPTION	SM	SOIL TYPE	3
NATURAL UNIT DRY WEIGHT (PCF)	101		
NATURAL MOISTURE CONTENT	23.3%		
SWELL/CONSOLIDATION (%)	0.0%		

JOB NO. 82556
CLIENT MORLEY BENTLEY
PROJECT STERLING RANCH

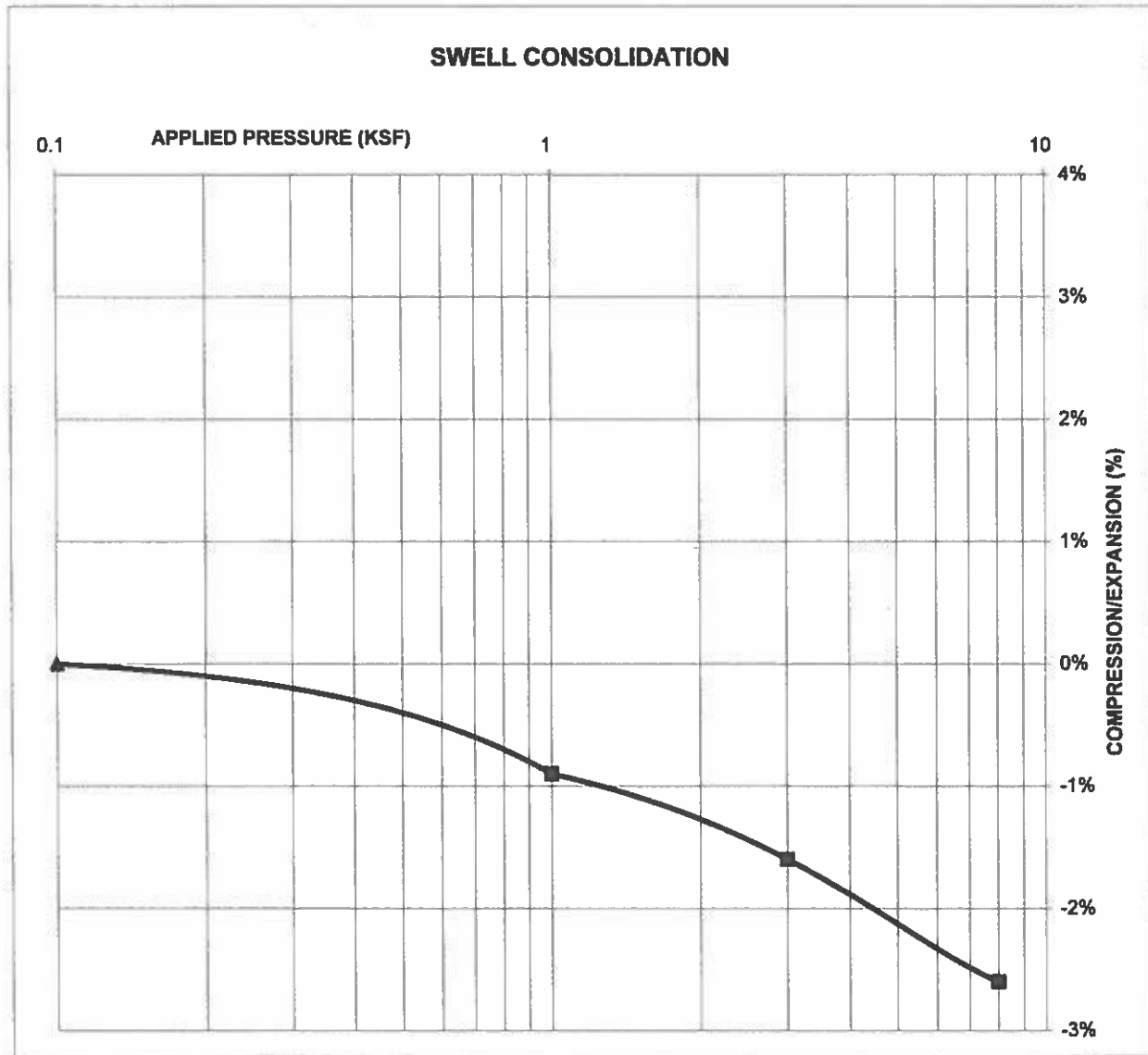

ENTECH
ENGINEERING, INC.
 505 ELKTON DRIVE
 COLORADO SPRINGS, CO. 80907 (719) 531-5599

**SWELL CONSOLIDATION
 TEST RESULTS**

DRAWN:

DATE:

CHECKED:

DATE:

han 9/5/06

JOB NO.:

FIG NO.:

CONSOLIDATION TEST RESULTS

TEST BORING #	39	DEPTH(FT)	15
DESCRIPTION	SC	SOIL TYPE	3
NATURAL UNIT DRY WEIGHT (PCF)	124		
NATURAL MOISTURE CONTENT	11.0%		
SWELL/CONSOLIDATION (%)	1.0%		

JOB NO. 82556
CLIENT MORLEY BENTLEY
PROJECT STERLING RANCH

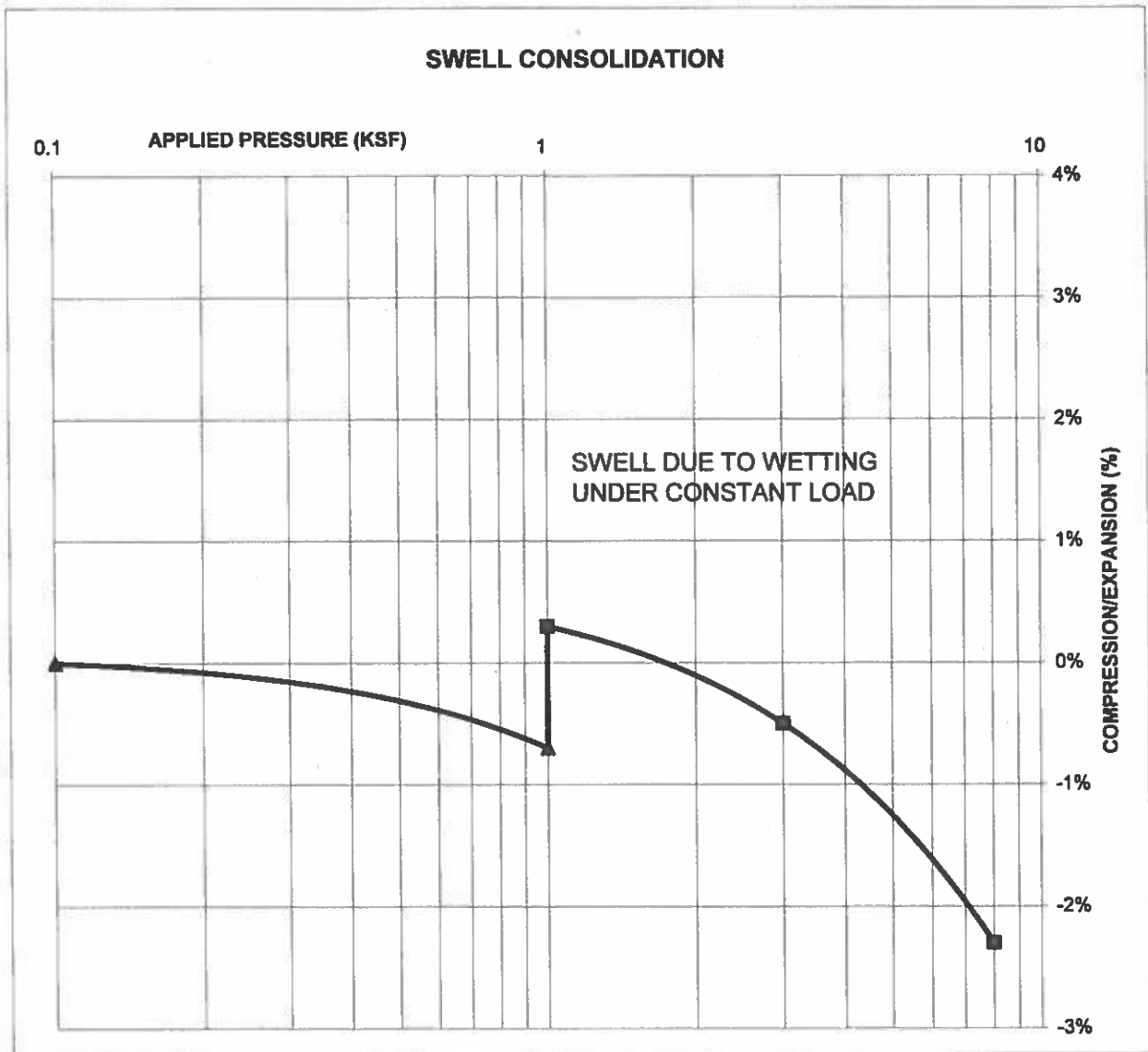

ENTECH
ENGINEERING, INC.
 505 ELKTON DRIVE
 COLORADO SPRINGS, CO. 80907 (719) 531-5599

**SWELL CONSOLIDATION
 TEST RESULTS**

DRAWN:

DATE:

CHECKED:

DATE:

[Signature] 9/5/06

JOB NO.:

82556

FIG NO.:

C-44

CONSOLIDATION TEST RESULTS

TEST BORING #	1	DEPTH(FT)	5
DESCRIPTION	CL	SOIL TYPE	4
NATURAL UNIT DRY WEIGHT (PCF)	118		
NATURAL MOISTURE CONTENT	13.4%		
SWELL/CONSOLIDATION (%)	0.9%		

JOB NO. 82556
CLIENT MORLEY BENTLEY
PROJECT STERLING RANCH

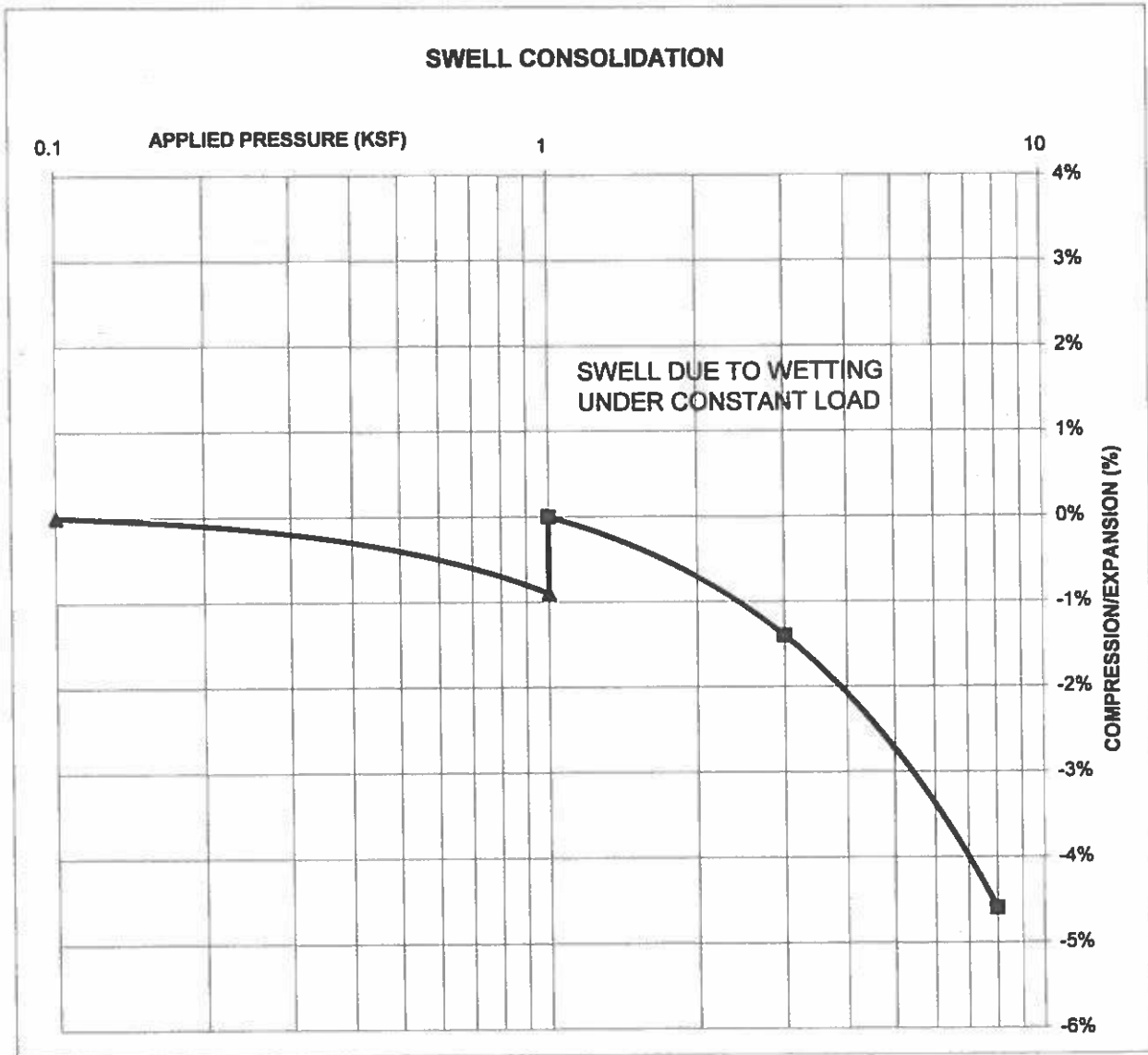

ENTECH
ENGINEERING, INC.
 505 ELKTON DRIVE
 COLORADO SPRINGS, CO. 80907 (719) 531-5599

SWELL CONSOLIDATION TEST RESULTS

DRAWN:

DATE:

CHECKED:

DATE:

W.A.

9/5/06

JOB NO.:

82556

FIG NO.:

C-45

CONSOLIDATION TEST RESULTS

TEST BORING #	33	DEPTH(FT)	15
DESCRIPTION	CH	SOIL TYPE	4
NATURAL UNIT DRY WEIGHT (PCF)			101
NATURAL MOISTURE CONTENT			24.3%
SWELL/CONSOLIDATION (%)			2.7%

JOB NO. 82556
CLIENT MORLEY BENTLEY
PROJECT STERLING RANCH

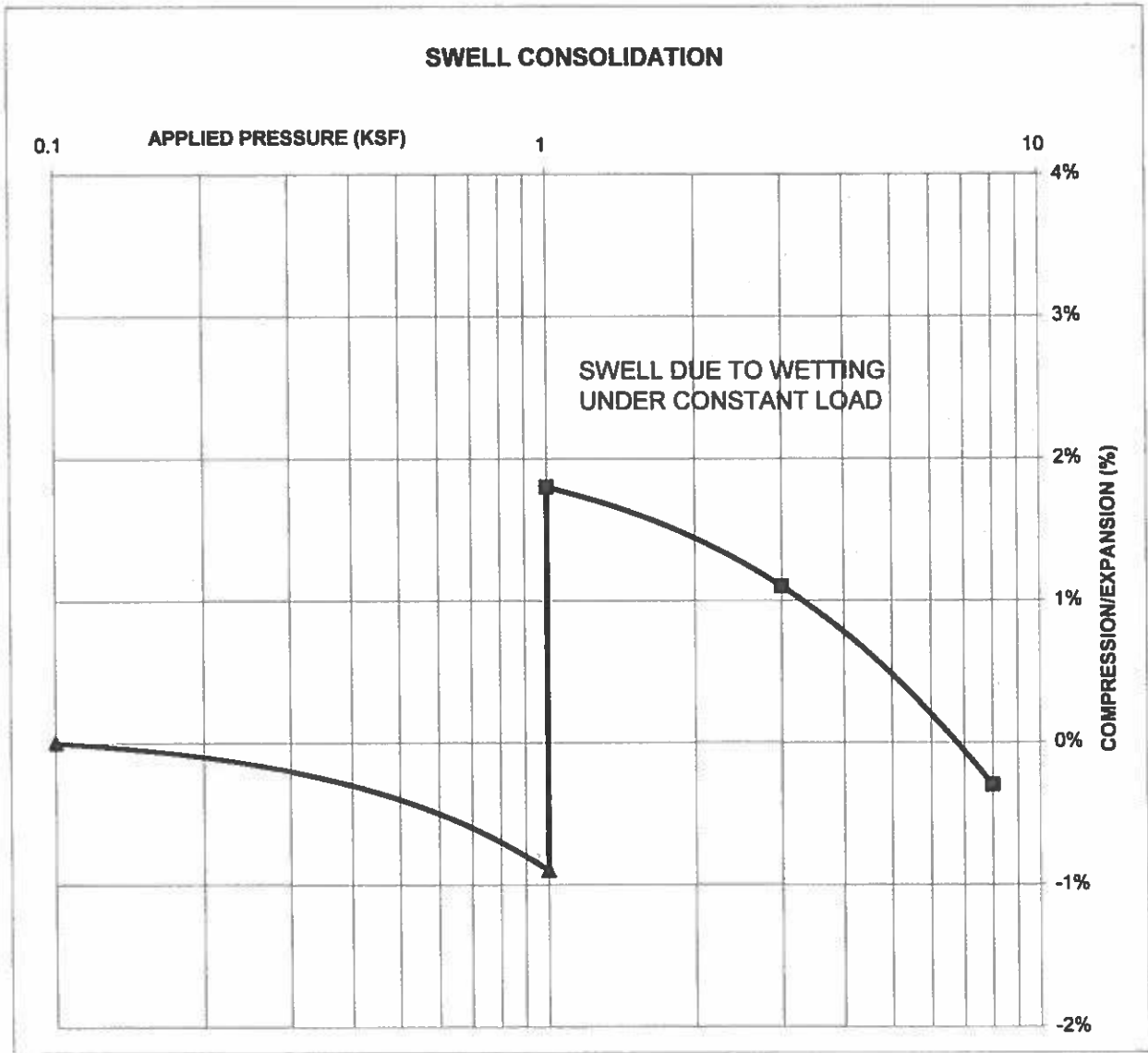

ENTECH
ENGINEERING, INC.
 505 ELKTON DRIVE
 COLORADO SPRINGS, CO. 80907 (719) 531-5599

**SWELL CONSOLIDATION
 TEST RESULTS**

DRAWN:

DATE:

CHECKED:

DATE:

MA 9/5/06

JOB NO.:

82556

FIG NO.:

C-46

CONSOLIDATION TEST RESULTS

TEST BORING #	40	DEPTH(FT)	15
DESCRIPTION	CL	SOIL TYPE	4
NATURAL UNIT DRY WEIGHT (PCF)	118		
NATURAL MOISTURE CONTENT	14.8%		
SWELL/CONSOLIDATION (%)	1.0%		

JOB NO. 82556
CLIENT MORLEY BENTLEY
PROJECT STERLING RANCH

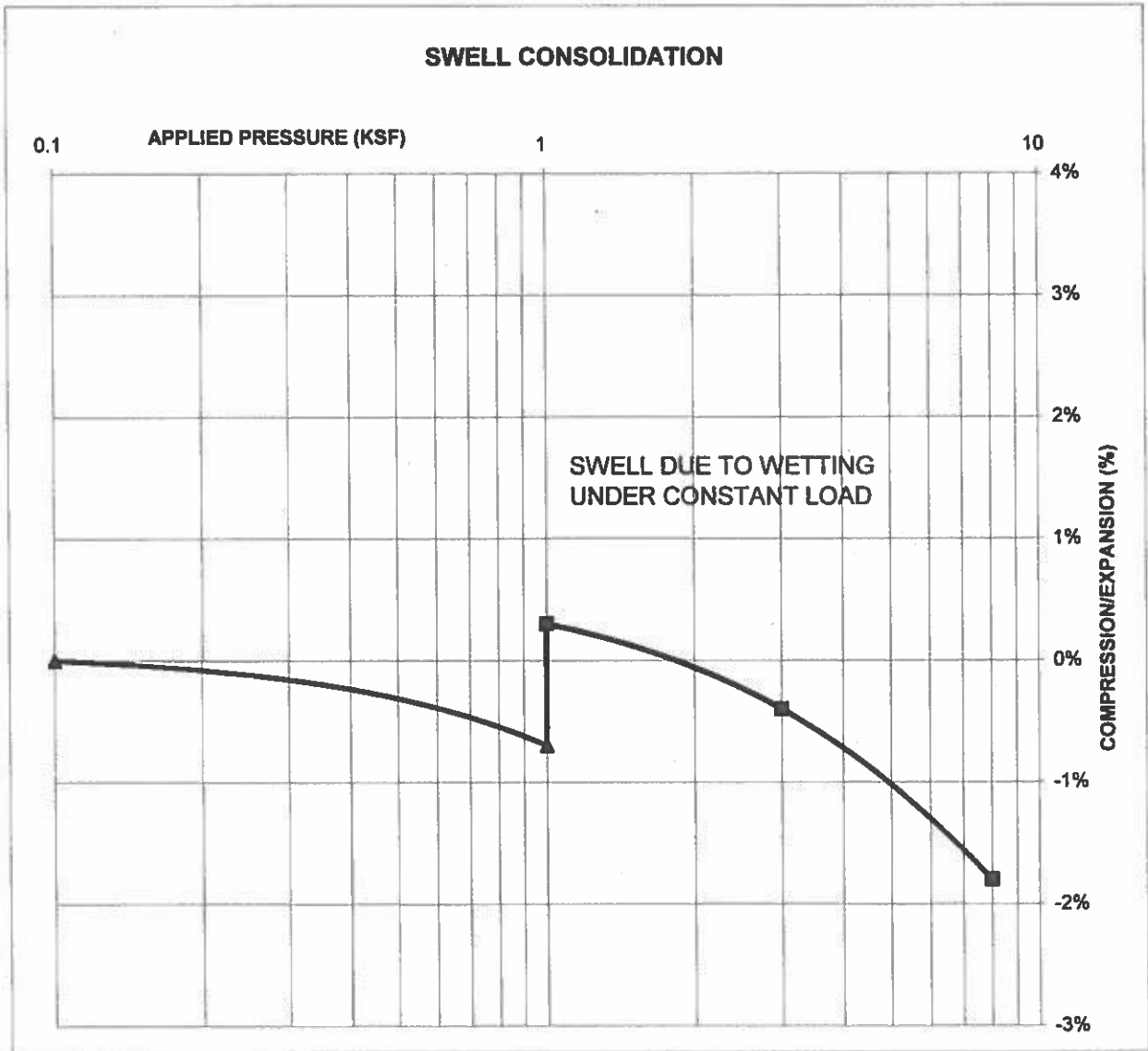

ENTECH
ENGINEERING, INC.
 505 ELKTON DRIVE
 COLORADO SPRINGS, CO. 80907 (719) 531-5399

**SWELL CONSOLIDATION
 TEST RESULTS**

DRAWN:	DATE:	CHECKED:	DATE:
		<i>[Signature]</i>	9/5/06

JOB NO.:
 82556
 FIG NO.:
 C-47

CONSOLIDATION TEST RESULTS

TEST BORING #	43	DEPTH(FT)	20
DESCRIPTION	CL	SOIL TYPE	4
NATURAL UNIT DRY WEIGHT (PCF)	121		
NATURAL MOISTURE CONTENT	12.6%		
SWELL/CONSOLIDATION (%)	0.3%		

JOB NO. 82556
CLIENT MORLEY BENTLEY
PROJECT STERLING RANCH

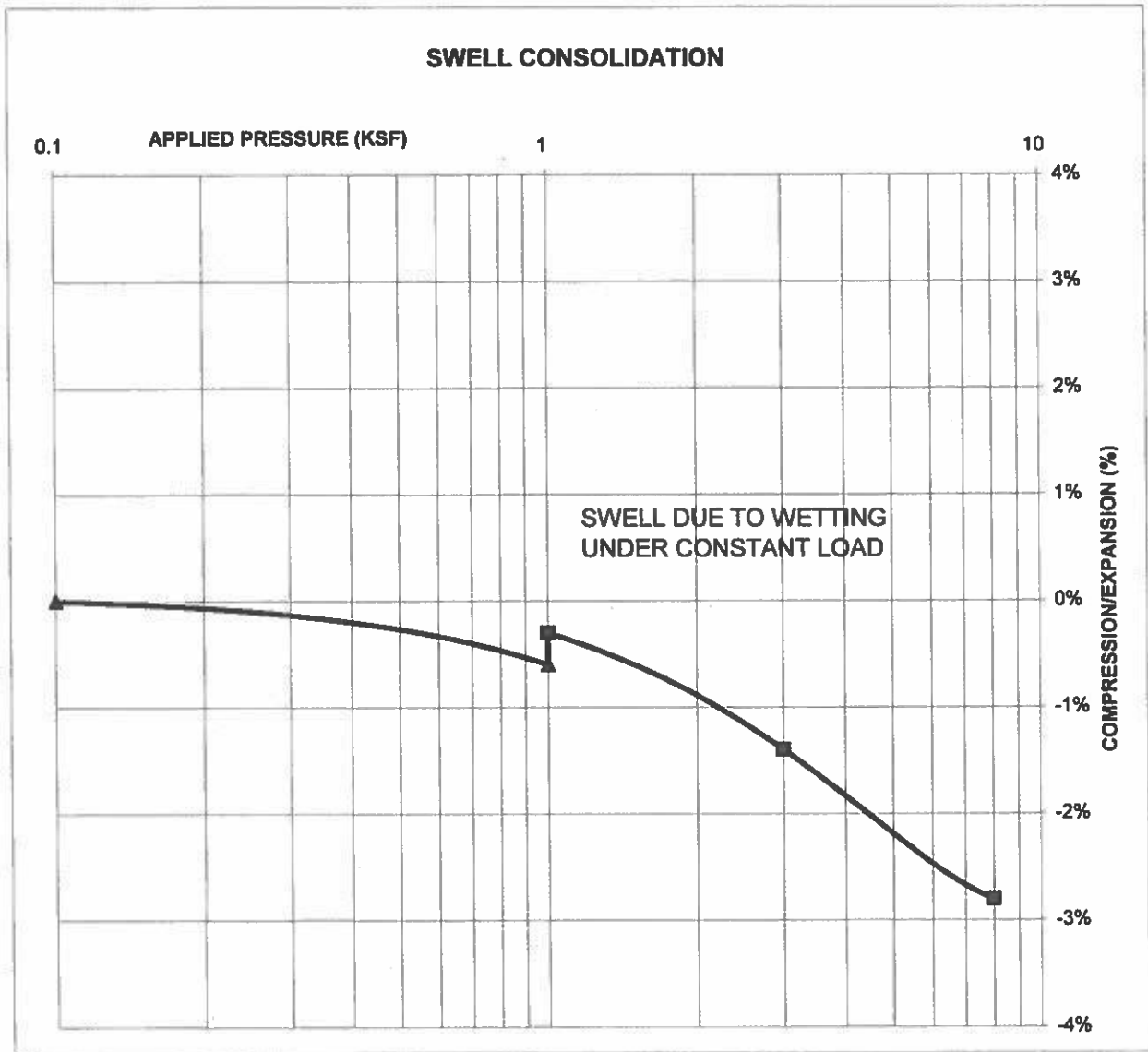

ENTECH
ENGINEERING, INC.
305 ELKTON DRIVE
 COLORADO SPRINGS, CO. 80907 (719) 531-5399

**SWELL CONSOLIDATION
 TEST RESULTS**

DRAWN:	DATE:	CHECKED:	DATE:
		<i>VJA</i>	9/5/06

JOB NO.:
 82556
 FIG NO.:
 C-4B

