

THE SHOP'S AT MERIDIAN RANCH

FILING NO. 1, LOT 4
 SITE DEVELOPMENT PLAN
 EL PASO COUNTY, COLORADO.
 FALCON, COLORADO

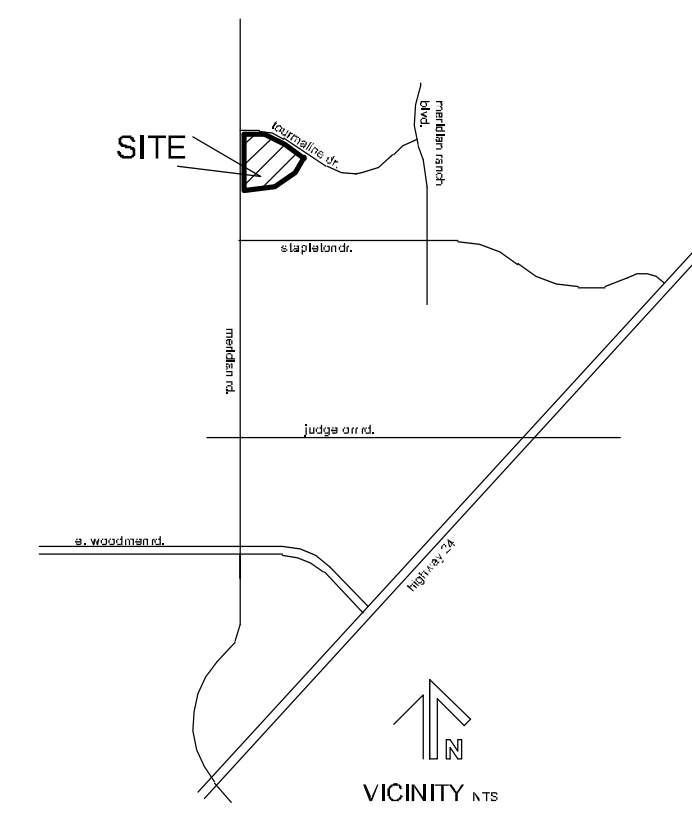
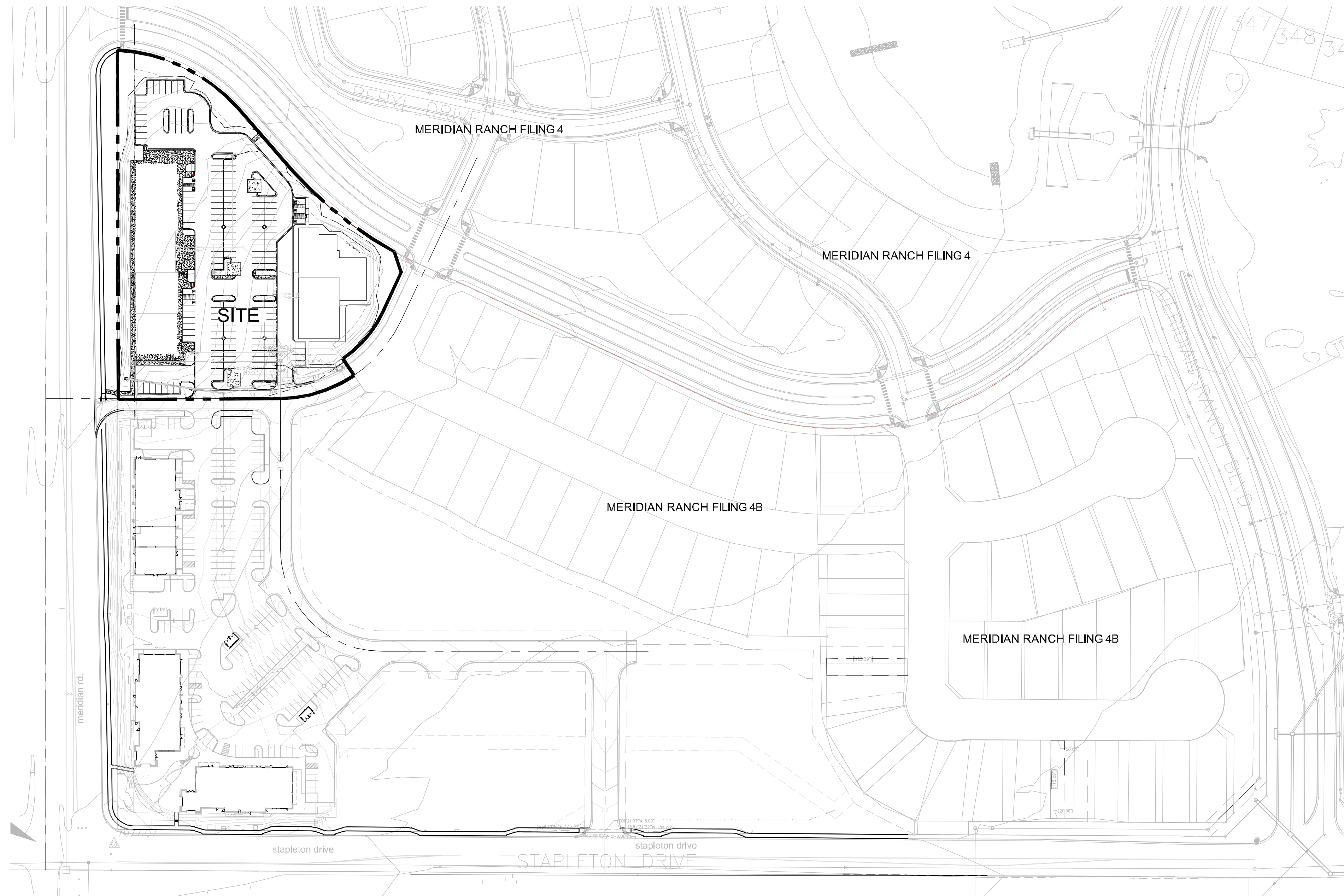

LEGAL:
 THE SHOPS AT MERIDIAN RANCH FILING NO. 1 LOT 4
 SITE DATA

tax schedule no.:	4230319054
area	3.43ac
ex zone	n/a
proposed zone	CR
ex use	vacant
proposed use	commercial center
master plan	Falcon/Peyton Small Area Plan
development schedule	SPRING 2019

LOT INFO

area	3.43ac
proposed use	commercial center
bdg area	29,390sf
max. bldg height	45'
prop. bldg height	44'
bdg setbacks	
front	25'
side	25'
rear	25'
%lot coverage	
bdgs	20% (29,390sf)
impervious	43% (64,383sf)
	37% (55,712sf)

PARKING

	retail D commercial center	retail E commercial center
use		
bdg area	17,450sf	11,940sf
ratio	1/250sf	1/250sf
required (incl h/c)	70 (incl 3h/c)	47 (incl 3h/c)
provided	99 (incl 3h/c)	47 (incl 3h/c)

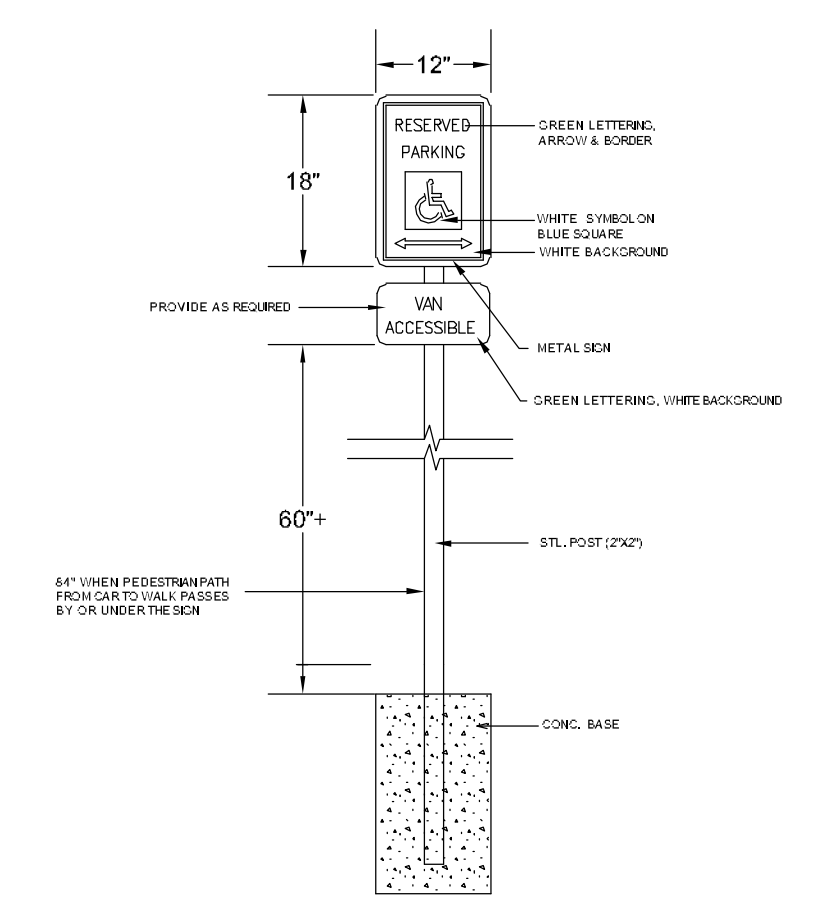

A ACCESSIBLE SIGNAGE DETAIL
 N.T.S.

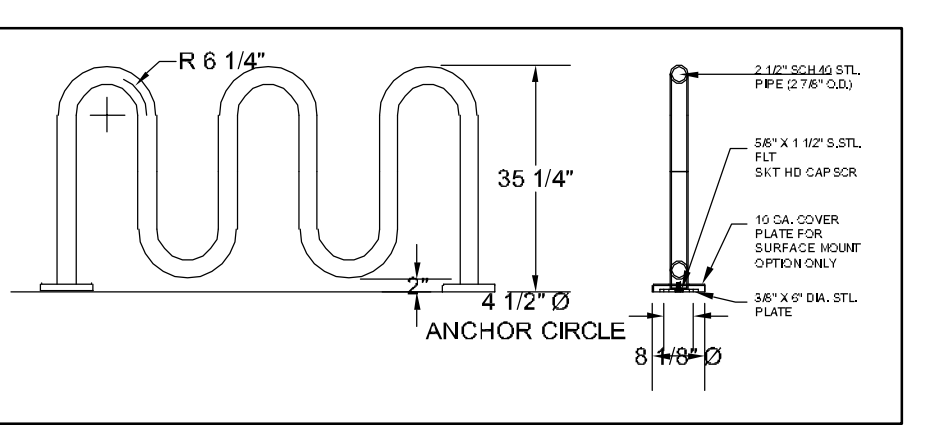

B BIKE LOOP
 N.T.S.

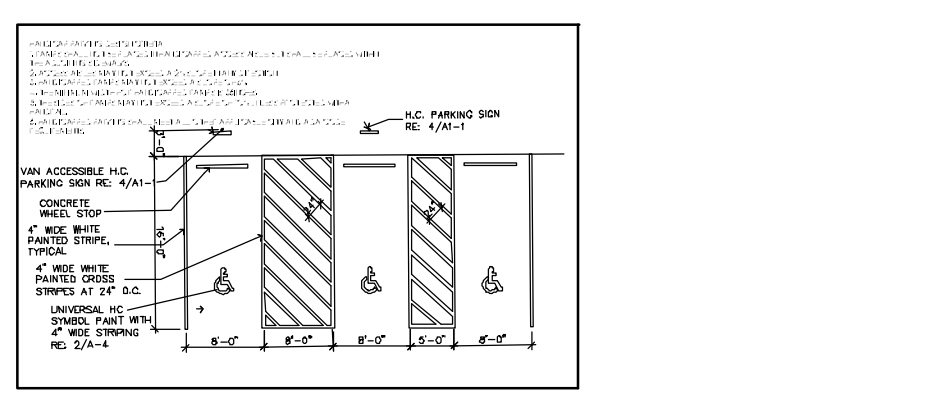

C TYPICAL HANDICAP PARKING DETAIL
 N.T.S.

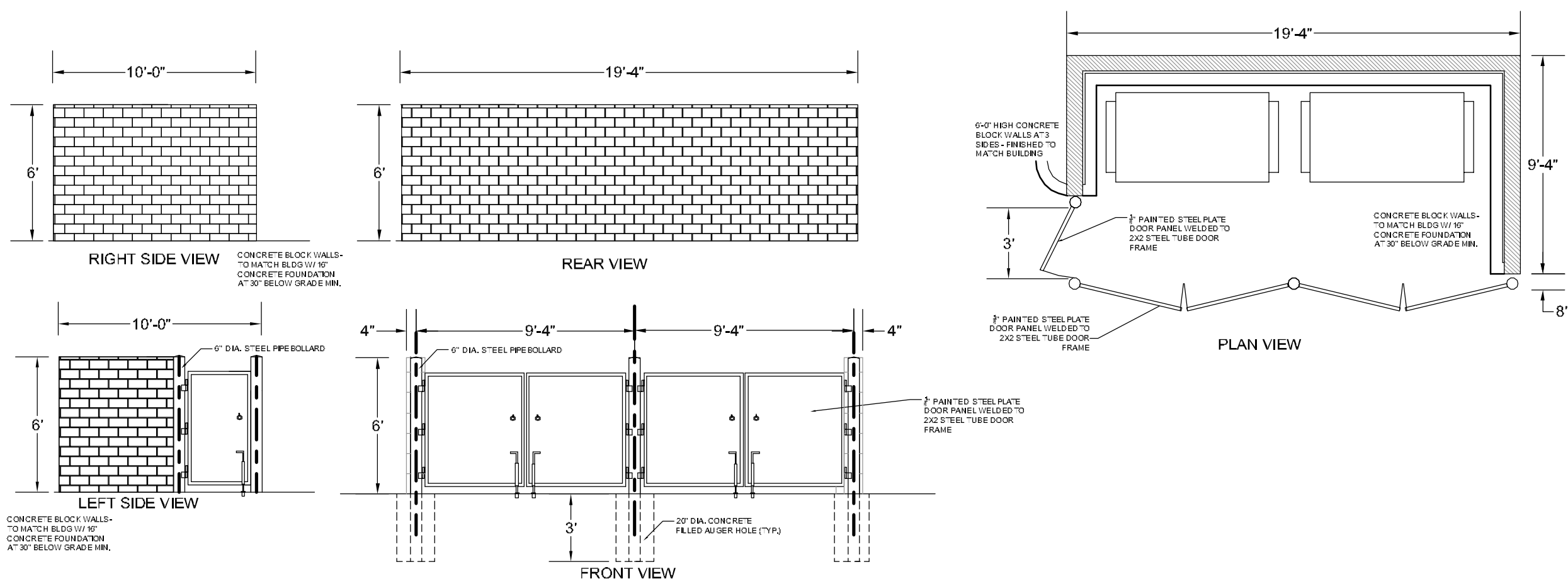
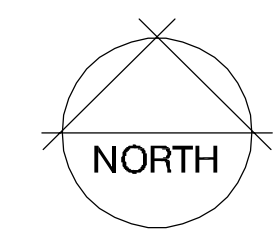
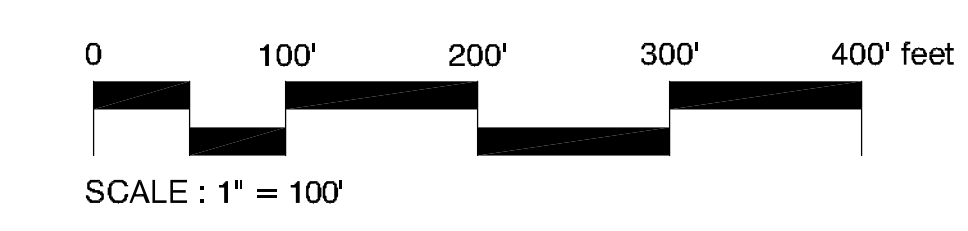

D TRASH ENCLOSURE
 N.T.S.

ADA DESIGN PROFESSIONAL STANDARD NOTE:
 The party responsible for this plan have familiarized themselves with all current accessibility criteria and specifications and the proposed plan reflects all site elements required by the applicable ADA Design Standards and Guidelines as published by the United States Department of Justice. Approval of this plan by the City of Colorado Springs does not assure compliance with the ADA or any other Federal or State accessibility laws or any regulations or guidelines enacted or promulgated under or with respect to such laws. Sole responsibility for compliance with Federal and State accessibility laws lies with the property owner.

SHEET INDEX

1.....	Site development plan
2.....	Landscape plan
3.....	Landscape details
4.....	Photometric plan
5.....	
6.....	
7.....	
8.....	

OWNER INFO

company name	SHOPS AT MERIDIAN RANCH LLC
address	P.O. BOX 80036
city/state	SAN DIEGO CA 91238
phone no	

YOW ARCHITECTS PC
 ARCHITECTURE & PLANNING
 115 S. Weber
 Colorado Springs, Colorado 475-8133

Shop's @ Meridian Ranch
 Site Development Plan
 Meridian Ranch
 Falcon, CO

Client:	18,115
Architect:	Planning
File:	Site development plan 2-11-19
Drawn by:	DBH
Date:	8/22/2018
Revised:	10/2/2018
	11/28/2018
	4-8-2019

DRAWING NO.
COVER
 SITE DEVELOPMENT
 PLAN