

FINAL DRAINAGE REPORT
for
WINDERMERE FILING NO. 1

Colorado Springs, CO

March 8, 2022

SF-21-026

Prepared for:

Eagle Development Company
212 N. Wahsatch Ave., Suite 301
Colorado Springs, CO 80903
Contact: Jeff Mark
(719) 635-3200

Prepared by:

Drexel, Barrell & Co.
3 South Seventh Street
Colorado Springs, CO 80905
Contact: Tim McConnell, P.E.
(719) 260-0887

TABLE OF CONTENTS

1.0	CERTIFICATION STATEMENTS	1
2.0	PURPOSE	2
3.0	GENERAL SITE DESCRIPTION	2
4.0	EXISTING HYDROLOGY	3
5.0	PROPOSED HYDROLOGY (RATIONAL METHOD) & HYDRAULIC SUMMARY	3
6.0	PROPOSED DETENTION/WATER QUALITY FACILITIES	10
7.0	EXISTING N. MARKSHEFFEL CULVERT	13
8.0	FOUR-STEP PROCESS	13
9.0	GEOTECHNICAL HAZARDS	14
10.0	FACILITY MAINTENANCE	15
11.0	CONSTRUCTION COST ESTIMATE	15
12.0	DRAINAGE/BRIDGE FEES	16
13.0	CONCLUSIONS	16
14.0	REFERENCES	17

APPENDICES

DRAINAGE REPORT BY CLASSIC
VICINITY MAP
SOILS MAP
FLOODPLAIN MAP
DRAINAGE CALCULATIONS
DRAINAGE MAP

FINAL DRAINAGE REPORT
for
WINDERMERE FILING NO. 1
Colorado Springs, Colorado

1.0 CERTIFICATION STATEMENTS

ENGINEER'S STATEMENT

The attached drainage plan and report were prepared under my direction and supervision and are correct to the best of my knowledge and belief. Said drainage report has been prepared according to the criteria established by El Paso County for drainage reports, and said report is in conformity with the master plan of the drainage basin. I accept responsibility for any liability caused by any negligent acts, errors or omission on my part in preparing this report.



Tim D. McConnell, P.E.
Colorado P.E. License No. 33797
For and on Behalf of Drexel, Barrell & Co.

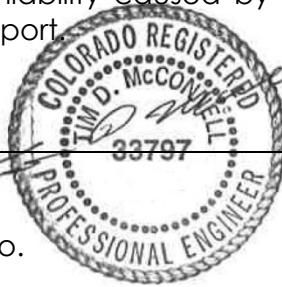

2/7/22
Date

DEVELOPER'S STATEMENT

I, the developer have read and will comply with all the requirements specified in this drainage report and plan.

Business Name: Eagle Development Company

By:

Jeff Mark

2/7/22
Date

Title:

President

Address:

212 N. Wahsatch Ave. #301
Colorado Springs, CO 80903

EL PASO COUNTY

Filed in accordance with the requirements of the El Paso County Land Development Code, Drainage Criteria Manual Volumes 1 and 2, and the Engineering Criteria Manual, as amended.

Jennifer Irvine, P.E. County Engineer/ECM Administrator

Date

CONDITIONS

2.0 PURPOSE

This report is prepared by Drexel, Barrel & Co in support of the Windermere Filing No. 1 subdivision. The purpose of this report is to identify onsite and offsite drainage patterns, storm sewer, inlet locations, and areas tributary to the site, and to safely route developed storm water runoff to adequate outfall facilities.

3.0 GENERAL SITE DESCRIPTION

Location

The site is located at the northwest corner of N. Carefree Cir. and Marksheffel Rd. - the E 1/2 of Section 29, Township 13 S, Range 65 W of the 6th P.M., El Paso County, Colorado.

The site is bound on the west by Antelope Ridge Dr., on the north by the Chateau at Antelope Ridge subdivision, on the east by Marksheffel Rd., and on the south by N. Carefree Cir.

Site Conditions

The site is approximately 52.1 acres in size and is proposed as a single family home subdivision. The proposed site development includes approximately 163 single-family residences. The site is currently undeveloped and is covered with native grass and vegetation. The site is located within the Sand Creek Drainage Basin. Historically, this site drains in all directions with a large hill in the southern half of the site and an existing temporary detention facility located at the northern end. There is a large roadside ditch adjacent to Marksheffel Road (M.D.D.P. DP-1x) that routes off-site (non-tributary to site facilities) runoff to the existing 24" CMP storm culvert under Marksheffel Road. This site was studied as part of the previously approved "Master Development Drainage Plan for Hilltop Subdivision El Paso County, Colorado" by URS Greiner, Inc. last revised February 1998.

Soils

According to the Soil Survey of El Paso County Area, Colorado, prepared by the U.S. Department of Agriculture Soil Conservation Service, the site is underlain by Truckton sandy loam, a type 'A' hydrologic soil. See appendix for map.

Climate

This area of El Paso County can be described as the foothills, with total precipitation amounts typical of a semi-arid region. Winters are generally cold and dry, and summers relatively warm and dry. Precipitation ranges from 12 to 14 inches per year, with the majority of this moisture occurring in the spring and summer in the form of rainfall. Thunderstorms are common during the summer months.

Floodplain Statement

According to the Federal Emergency Management Agency (FEMA) Flood Insurance Rate Map (FIRM) Panel #08041C0543 G (December 7, 2018) the project site is within a designated Zone X area described as "areas determined to be outside 500-year floodplain". A firmette map is included in the appendix.

4.0 EXISTING HYDROLOGY

The existing conditions have not changed. An existing detention facility located at the north end of the project has already been capturing flows from the Chateau at Antelope Ridge subdivision to the north. This temporary facility will be replaced with an expanded pond of larger capacity as part of this development. The expanded facility will meet current drainage criteria, including concrete forebays at all piped inflows, a concrete trickle channel at the bottom, an outlet structure and pipe that will reduce the release of flows, and a reinforced spillway on the east side of the facility.

Please refer to excerpts from the "Preliminary Drainage Report for Windermere," by Classic Consulting Engineers & Surveyors, October 2014 in the appendix for existing conditions description and drainage maps.

A table has been provided in the appendix for comparison of the rational method calculations that have been revised to meet current drainage criteria.

5.0 PROPOSED HYDROLOGY (RATIONAL METHOD) & HYDRAULIC SUMMARY

For the purposes of site specific analysis, the project site has been divided into several grouped drainage basins as shown on the proposed drainage plan in the appendix. A-, B-, and C-group basins represent the flows generated onsite. A number of offsite basins were also considered as part of this analysis and are described below.

The Rational Method was used to determine runoff quantities for the 5- and 100-year storm recurrence intervals. Mile High Flood District design software (MHFD-Detention v.4.03) and Flowmaster were used to identify pond and storm system sizing, and inlet capacity charts from the current drainage criteria manual used for inlet sizing (see appendix for calculations). See below for a summary runoff table and description of each design point.

Rational Method Runoff Summary

Onsite A-group basins and offsite Basins D-13, D-14, D-15, CT and WS represent flows that are captured by the full spectrum detention facility at the north end of the site.

Existing Design Point 7 (DP7) ($Q_5=15.9$ cfs and $Q_{100}=34.2$ cfs) represents flows generated by offsite basins D-13 and D-14 of Pronghorn Meadows Subdivision and Antelope Ridge Drive, on the west side of this project development. These flows were established by the "Preliminary Drainage Report for Windermere," by Classic Consulting Engineers & Surveyors, October 2014. An existing 25' Type R curb inlet intercepts these flows and

discharges to the east across Antelope Ridge Dr. This inlet and piping is to remain and will connect to the proposed inlet at Design Point A.

BASIN	AREA (AC)	Q5 (cfs)	Q100 (cfs)
WS	41.47	11.4	76.3
CT	42.07	90.6	174.3
D13	6.79	10.3	22.6
D14	3.88	6.3	13.2
D15	1.36	4.6	9.1
A1	1.56	3.2	7.1
A2	4.61	8.8	19.4
A3	2.18	5.2	11.2
A4	1.01	1.7	3.8
A5	1.98	4.3	9.5
A6	3.73	7.0	15.4
A7	1.56	3.0	6.6
A8	2.96	6.1	13.4
A9	1.86	4.0	8.7
A10	4.00	7.5	16.5
A11	2.67	5.3	11.8
A12	9.46	9.2	37.6
B1	3.33	7.2	16.0
B2	0.49	1.0	2.3
B3	5.86	11.5	25.3
B4	0.16	0.4	0.8
B5	1.05	0.8	4.4
C1	0.59	1.3	2.9
C2	3.58	2.4	13.5
C3	0.63	0.5	2.5
C4	1.79	2.1	6.9
C5	0.11	0.1	0.5
EXR	0.53	2.4	4.4
D16	2.73	4.9	10.7
NC1	0.43	1.9	3.4
NC2	1.61	5.1	9.8

DP	AREA (AC)	Q5 (cfs)	Q100 (cfs)
7	10.67	15.9	34.2
A	13.59	21.0	44.9
B	4.61	8.8	19.4
C	2.18	5.2	11.2
C1	20.38	29.5	63.5
D	1.01	1.7	3.8
D1	21.39	30.6	66.1
E	1.98	4.3	9.5
F	3.73	7.0	15.4
F1	27.10	38.2	82.8
G	1.56	3.0	6.6
H	2.96	6.1	13.4
H1	4.52	8.6	19.0
I	1.86	4.0	8.7
J	6.38	11.8	25.9
K	33.48	46.3	100.7
L	4.00	7.5	16.5
L1	37.48	51.4	111.8
M	2.67	5.3	11.8
M1	40.15	54.8	119.4
24	83.54	90.7	229.0
N	133.15	145.4	357.5
North Pond Release		1.8	66.0
0	437.97	190.5	682.4
O	3.82	8.1	17.9
R	10.89	19.9	46.2
South Pond Release		0.2	9.2
4	2.73	4.9	10.7
S	16.57	10.0	33.7
19	1.61	5.1	9.8
J1	18.18	15.1	43.5
20	18.61	17.0	46.9
V	0.11	0.1	0.5

Design Point A replaces existing Design Point 8 (DP-8) that was established by the "Preliminary Drainage Report for Windermere," by Classic Consulting Engineers & Surveyors, October 2014. This Design Point A is located at a low point on Antelope Ridge Dr. at an existing 10' sump inlet and represents combined flows from Basins D-15, offsite DP-7 (described above) and onsite basin A1. The existing inlet is proposed to be replaced in kind by an 10' Type R sump Inlet (A) due to a turn lane that will be installed on Antelope Ridge Dr. for access into the Windermere Subdivision. The flows generated by Basin A1 and Basin D15 will be captured in their entirety by the new inlet, combine with the piped flows from existing DP7 (DPA $Q_5=21.0$ cfs and $Q_{100}=44.9$ cfs) and flow to the northeast via 36" RCP storm sewer along Antelope Ridge Drive. An emergency overflow swale through Tract D will allow for flows to be directed to the north and east in the event of inlet blockage.

DP-B is located at a proposed 10' Type R at-grade Inlet (B) in Basin A2. The flows leave this inlet via a 24" storm pipe to the south towards DP-C. This design point represents the flows from Basin A2. The flows from Basin A2 are $Q_5=8.8$ cfs and $Q_{100}=19.4$ cfs. The proposed 10' Type R inlet (B) will capture $Q_5=9.5$ cfs and $Q_{100}=13.5$ cfs, with $Q_5=0.0$ cfs and $Q_{100}=6.4$ cfs bypass continuing along Borrowdale Lane to towards DP-E (See inlet summary in the appendix).

DP-C is located at a proposed 10' Type R at-grade inlet (C) in Basin A3. The flows leave this inlet via a 24" storm pipe to the northwest towards a proposed Type 2 storm manhole at DP-C1. The flows from Basin A3 are $Q_5=5.2$ cfs and $Q_{100}=11.2$ cfs. The proposed 10' Type R inlet (C) will capture all flows with no bypass.

DP-C1 is located at a proposed Type 2 storm manhole along Borrowdale Lane. This design point consists of all the flows from DPA-DPC, and discharges to the northeast via 36" RCP. The combined flows at DP-C1 are $Q_5=29.5$ cfs and $Q_{100}=63.5$ cfs.

DP-D is located at a proposed 5' Type R at grade inlet (D) in Basin A4. The flows leave this inlet via a 18" storm pipe and are conveyed to the northeast towards a proposed Type 2 manhole at DP-D1. The flows from Basin A4 are $Q_5=1.7$ cfs and $Q_{100}=3.8$ cfs. The proposed 5' Type R inlet (D) will capture all flows with no bypass.

DP-D1 is located at a proposed Type 2 storm manhole along Borrowdale Lane. This design point consists of all the flows from DPA-DPD, and discharges to the northeast via 36" RCP. The combined flows at DP-D1 are $Q_5=30.6$ cfs and $Q_{100}=66.1$ cfs.

DP-E is located at a proposed at-grade 15' Type R inlet (E) in Basin A5. The flows leave this inlet via an 24" storm pipe and are conveyed towards DP-F1 to the south. This design point represents the flows from Basin A5. The flows from Basin A5 are $Q_5=4.3$ cfs and $Q_{100}=9.5$ cfs. The proposed 15' Type R inlet (E) will capture all basin flows reaching this point from Basin A5 along with bypass flows from Inlet (B) ($Q_5=0.0$ cfs and $Q_{100}=6.4$ cfs.) with no further bypass downstream.

DP-F is located at a proposed at-grade 15' Type R inlet (F) in Basin A6. The flows leave this inlet via a 24" storm pipe and are conveyed towards the type 2 storm manhole at DP-F1 to the southwest. The flows from Basin A6 are $Q_5=7.0$ cfs and $Q_{100}=15.4$ cfs. The proposed 15' Type R inlet (F) will capture all flows reaching this point with no further bypass

downstream.

DP-F1 is located at a proposed Type 2 storm manhole along Borrowdale Lane. This design point consists of all the flows from DPA-DPF, and discharges to the northeast via 36" RCP. The combined flows at DP-F1 are $Q_5=38.2$ cfs and $Q_{100}=82.8$ cfs.

DP-G is located at a proposed at-grade 5' Type R inlet (L) in Basin A7. The flows leave this inlet via an 18" storm pipe and are conveyed towards DP-H1 to the west. This design point represents the flows from Basin A7. The flows from Basin A7 are $Q_5=3.0$ cfs and $Q_{100}=6.6$ cfs. The proposed 5' Type R inlet (L) will capture $Q_5=3.8$ cfs and $Q_{100}=6.0$ cfs, with $Q_5=0.0$ cfs and $Q_{100}=0.6$ cfs bypass continuing to the north along Wyedale Way towards Inlet (N).

DP-H is located at a proposed at-grade 10' Type R inlet (J) in Basin A8. The flows leave this inlet via a 30" storm pipe and are conveyed towards DP-H1 to the east. The flows from Basin A8 are $Q_5=6.1$ cfs and $Q_{100}=13.4$ cfs. The proposed 10' Type R inlet will capture $Q_5=7.0$ cfs and $Q_{100}=12.5$ cfs, with $Q_5=0.0$ cfs and $Q_{100}=0.9$ cfs bypass continuing along Borrowdale Lane to towards inlet (I).

DP-H1 is located at a proposed Type 2 storm manhole along Wyedale Way. This design point represents the flows from DPG-DPH, and discharges to the northwest via 30" RCP. The combined flows at DP-H1 are $Q_5=8.6$ cfs and $Q_{100}=19.0$ cfs.

DP-I is located at a proposed at-grade 10' Type R inlet (I) in Basin A9. The flows leave this inlet via a 24" storm pipe and are conveyed towards DP-J to the northeast. This design point represents the flows from Basin A9. The flows from Basin A9 are $Q_5=4.0$ cfs and $Q_{100}=8.7$ cfs. The proposed 10' Type R inlet will capture all basin flows reaching this point in addition to Inlet (J) bypass ($Q_5=0.0$ cfs and $Q_{100}=0.9$ cfs.) with no further bypass downstream.

DP-J is located at a proposed 24"x30" wye along Wyedale Way. The flows leave this wye via a 30" storm pipe which conveyed the flows towards DP-K. This design point captures all the flows from DPH1 and DP-I. The combined flows at DP-J are $Q_5=11.8$ cfs and $Q_{100}=25.9$ cfs.

DP-K is located at a proposed type 1 storm manhole, located at the intersection of Borrowdale Lane and Wyedale Way. The flows leave this manhole via a 43"x68" elliptical storm pipe and are conveyed towards DP-L1 to the northwest. This design point captures all the flows from DPF1 and DP-J. The combined flows at DP-K are $Q_5=46.3$ cfs and $Q_{100}=100.7$ cfs.

DP-L is located at a proposed sump 10' Type R inlet (M) at the low point on Wyedale Way in Basin 10. The flows leave this inlet via 30" storm pipe and are conveyed towards proposed type 1 storm manhole at DP-L1 to the northeast. The flows from Basin A10 are $Q_5=7.5$ cfs and $Q_{100}=16.5$ cfs. All flows will be captured by this inlet (M). In the emergency overflow/clogged condition flows will pond at this low point, ultimately crossing the crown of the street to be captured by inlet M, or onwards to the northeast through the open space tract towards the north pond,

DP-L1 is located at a proposed Type 1 storm manhole along Wyedale Way. This design point consists of all the flows from DPK and DPL, and discharges to the northeast via 43"x68" elliptical RCP. The combined flows at DP-L1 are $Q_5=51.4$ cfs and $Q_{100}=111.8$ cfs.

DP-M is located at a proposed sump 10' Type R inlet (N) at the low point on Wyedale Way in Basin 11. The flows leave this inlet via 30" storm pipe and are conveyed towards proposed type 1 storm manhole at DP-M1 to the southeast. The flows from Basin A11 are $Q_5=5.3$ cfs and $Q_{100}=11.8$ cfs. All flows will be captured by this inlet (N), with emergency overflow through a tract between lots 48 and 49 to the northeast towards the north pond.

DP-M1 is located at a proposed Type 1 storm manhole within Tract A. This design point consists of all the flows from DPL1 and DPM, and discharges to the northeast via 43"x68" elliptical RCP. The combined flows at DP-M1 are $Q_5=54.8$ cfs and $Q_{100}=119.4$ cfs. These flows continue to the northeast to discharge into the north pond.

Existing Design Point 24 (DP24) was established by the "Preliminary Drainage Report for Windermere," by Classic Consulting Engineers & Surveyors, October 2014, and consists of offsite area tributary to the existing detention facility along the northern project boundary. According to the aforementioned report, the runoff for basin WS was calculated at 2% (historic flow analysis) as all developed runoff is treated and released at historic rates within the Whispering Springs onsite facilities to the north. The tributary runoff for basin CT was calculated at 70%. The combined flows at DP-24 are $Q_5=90.7$ cfs and $Q_{100}=229.0$ cfs

DP-N is located at the bottom of the north proposed Full Spectrum EDB pond in Basin A12. The flows leave the pond via an outlet structure and a 36" storm pipe which conveys the flows to the roadside ditch along Marksheffel Rd. towards DP-T. This design point reflects all the flows from all "A" basins, offsite basins D-13 through D-15, and offsite flows entering the pond from offsite Basins CT and WS (DP24). The combined (undetained) flows at DP-N are $Q_5=145.4$ cfs and $Q_{100}=357.5$ cfs. The release rates for the north pond are $Q_5=1.8$ cfs and $Q_{100}=66.0$ cfs.

Onsite B-group basins represent flows that are captured by the full spectrum detention facility on the south end of the site.

DP-O is located at the proposed Type R sump inlets (10' West, 5' East) just south of the intersection of Mardale Lane and Wyedale Way. The flows leave the easterly inlet via a 24" storm pipe and are conveyed towards the proposed detention facility to the east. This design point captures all the flows from Basins B1 ($Q_5=7.2$ cfs and $Q_{100}=16.0$ cfs) and B2 ($Q_5=1.0$ cfs and $Q_{100}=2.3$ cfs). The flows at DP-O are $Q_5=8.1$ cfs and $Q_{100}=17.9$ cfs. Emergency overflow for these inlets is to the south and east towards the south detention facility.

Basin B3 covers the area of Tract B, to be developed at a future stage by replat. This basin will discharge by sheet flow overland to the east towards the south detention facility. Flows generated by Basin B3 are $Q_5=11.5$ cfs and $Q_{100}=25.3$ cfs.

Basin B4 covers the area along the back of Lots 70-73. Flows generated by this basin

($Q_5=0.4$ cfs and $Q_{100}=0.8$ cfs) will be captured by a 2'x6" concrete swale along the lot side of the screen wall located at the bottom of the slope. These flows are collected by a proposed private Type C Inlet and directed towards the south detention facility by private 12" PVC storm sewer.

Basin B5 covers the area of the proposed south detention facility. Flows generated by this basin ($Q_5=0.8$ cfs and $Q_{100}=4.4$ cfs) are absorbed directly by the pond.

DP-R is located at the bottom of the south proposed Full Spectrum EDB pond in Basin B5. The flows leave the pond via an outlet structure and an 18" storm pipe where the flows are conveyed to DP-S (described below). Design point DP-R captures all the flows from Basins B1 through B5. The combined (undetained) flows at DP-R are $Q_5=19.9$ cfs and $Q_{100}=46.2$ cfs. The release rates for the south pond are $Q_5=0.2$ cfs and $Q_{100}=9.2$ cfs, however final release rates will be determined in the future by others, and as previously discussed, will require a replat and a final drainage report analysis.

Onsite C-group basins represent flows that leave the project site without being treated for Water Quality and are captured by the existing storm system, see further description below and appendix for proposed drainage map indicating offsite basins.

North area – tributary to existing Marksheffel Rd culvert

Basin C1 covers the area along the back of Lots 58-69. Flows generated by this basin ($Q_5=1.3$ cfs and $Q_{100}=2.9$ cfs) will be captured by a 2'x6" concrete swale along the lot side of the sound wall located at the bottom of the slope. These flows are directed to the north and will discharge into the open swale along Marksheffel Road continuing north towards the existing 24" CMP culvert.

Basin C2 is located along the easterly project boundary along N. Marksheffel Road. A portion of this basin (0.30-acres) covers the rear of lots 53-57 along Wyedale Way, the remainder of this basin will be subject to some regrading but will otherwise remain undeveloped and be landscaped or reseeded. This basin generates flows of $Q_5=2.4$ cfs and $Q_{100}=13.5$ cfs that travel to the east and north or south, ultimately reaching the existing 24" CMP culvert under N. Marksheffel Road.

Basin C1 (0.59-acres) and a portion of basin C2 (0.30-acres) cover developed area that is not treated for Water Quality. As per El Paso County ECM App I.7.1.C.1, this area is less than 20% of site area or 1-acre, and is due to grading restrictions (an exclusion listed in ECM App I.7.1.B), the discharge of these flows offsite to the northern drainageway is permitted under County MS4 criteria.

DP-T is located at the existing 24" CMP culvert crossing at Marksheffel Road, and represents flows generated by Basins C1 & C2, detained flows released by the northern detention facility (DP-N) and the offsite flows from MDDP DP-1X. The combined flows at DP-T are $Q_5=190.5$ cfs and $Q_{100}=682.4$ cfs, which is less than the flows listed for this location in the MDDP ($Q_5=250$ cfs and $Q_{100}=852$ cfs). More information on the MDDP flows can be found in the "Preliminary Drainage Report for Windermere," by Classic Consulting Engineers & Surveyors, October 2014, in the appendix, in addition to further discussion below.

South area – tributary to existing N. Carefree/Marksheffel storm system

Basin C3 covers an area of 0.63-acres of pond embankment and is located along the southeasterly project boundary along N. Marksheffel Road. This basin generates flows of $Q_5=0.5$ cfs and $Q_{100}=2.5$ cfs that travel offsite to the east and ultimately south along N. Marksheffel Road towards the existing storm inlet at DP-S. As this basin is to remain undeveloped, the discharge of flows offsite is acceptable under MS4 criteria.

Existing Design Point 4 covers runoff from Basin D-16 of the Pronghorn Meadows Subdivision to the west of this project development. An existing 8' sump curb inlet intercepts the runoff ($Q_5=4.9$ cfs and $Q_{100}=10.7$ cfs) and directs it via existing 24" RCP across Antelope Ridge Drive, where it currently discharges into a roadside swale along N. Carefree Circle. Design and extension of this storm system to the east and connection to the existing storm sewer system at DP-S will be completed at the time of development of Tract B, and will be analyzed at that time by a final drainage report for Tract B.

Basin C4 is located along the southerly project boundary of Tract B along N. Carefree Circle and generates flows of $Q_5=2.1$ cfs and $Q_{100}=6.9$ cfs that travel to the south and ultimately combine with flows from Design Point 4 in a roadside swale traveling east along N. Carefree Circle towards DP-S.

A portion of basin C4 (0.72-acres) is conservatively assumed to cover future development of Tract B that will drain offsite and will not be treated for Water Quality. As per El Paso County ECM App I.7.1.C.1, this area is less than 20% of site area or 1-acre, and is due to grading restrictions (an exclusion listed in ECM App I.7.1.B), the discharge of these flows offsite to the southern drainageway is permitted under County MS4 criteria. This assumption of grading and future use will be required to be reviewed at the time of replat for future development of Tract B. To meet this criteria, this area will be required to remain impervious, or be redirected to drain to the detention pond.

DP-S is located at the existing area inlet in Basin C3. The flows leave this inlet via an existing 24" storm pipe that connects to the existing storm system in N. Carefree Cir., which then carries the flows to the south. This design point reflects the flows from Basins C3 & C4, detained flows released by the south detention facility, offsite Basin EXR, and offsite Basin D-16. The combined flows at DP-S are $Q_5=10.0$ cfs and $Q_{100}=33.7$ cfs, which is less than the existing condition at Ex. DP-6 of $Q_5=18.4$ cfs and $Q_{100}=42.6$ cfs.

Existing Design Point 19 represents the flows generated by offsite Basin NC2 ($Q_5=5.1$ cfs and $Q_{100}=9.8$ cfs), these flows are picked up by the existing 15' triple at-grade inlet just west of the intersection with N. Marksheffel Road. The flows then leave this inlet via an existing 18" storm pipe to the east, ultimately converging with the flows from DP-S at an existing manhole at existing design point J1.

Flows of $Q_5=15.1$ cfs and $Q_{100}=43.5$ cfs leave DP-J1 via an existing 24" storm pipe and are carried to the existing 10' sump inlet at Existing DP-20 in offsite Basin NC1. The flows leave this existing inlet via an existing 30" storm pipe ultimately traveling to the south via the Marksheffel Road storm system. Developed runoff rates at DP-20 ($Q_5=17.0$ cfs and $Q_{100}=46.9$ cfs) are less than those in the existing condition ($Q_5=24.2$ cfs and $Q_{100}=53.3$ cfs, thereby reducing impact to the existing storm sewer system.

Northwest area – along Antelope Ridge Drive

DP-V is located at the north end of the site on Antelope Ridge Dr. and exclusively covers right-of-way. This design point reflects all the flows from Basin C5 that exit the site and flow to the north along the curb and gutter in Antelope Ridge Dr. before being captured by the existing storm system. The flows from Basin C5 are $Q_5=0.1$ cfs and $Q_{100}=0.5$ cfs.

6.0 PROPOSED DETENTION/WATER QUALITY FACILITIES

North Detention Facility

The north detention facility has been designed to capture flows from the "A" basins, offsite basins D-13, D-14, D-15, CT and WS, and has been designed to meet full-spectrum detention criteria. During the overlot grading of the project, the pond was excavated to full volume in its entirety and a temporary outlet structure installed. Now that full build out of the project is underway, the outlet structure will be installed per the final design. See below for description of detention volume and pond characteristics, and the appendix for design calculations.

Tributary to North Pond		
Basin	Area	Impervious
Offsite		
D-13	6.79	20.2%
D-14	3.88	42.8%
D-15	1.36	100.0%
WS	41.47	2.0%
CT	42.07	70.0%
Onsite		
A1	1.56	65%
A2	4.61	65%
A3	2.18	65%
A4	1.01	65%
A5	1.98	65%
A6	3.73	65%
A7	1.56	65%
A8	2.96	65%
A9	1.86	65%
A10	4.00	65%
A11	2.67	65%
A12	9.46	13%
Total	133.15	40.7%

As noted above, a total of 133.15 acres is tributary to this north facility, with a composite imperviousness of 40.7% for the final fully developed condition. Required volumes are listed below.

	Imperviousness	Required Volume		
		WQCV	EURV	100-YR
FINAL	40.7%	2.02	5.90	9.94

The actual design pond volume at the proposed spillway stage is 12.6 acre-feet. Concrete forebays with energy dissipaters will be placed where the flows enter the pond on the south and the north sides of the pond. The flows will exit the forebays through a notch, discharging into the concrete trickle channel at the bottom of the pond. The trickle channel conveys the flows to the micropool. The outlet structure then releases the flows at a reduced flow rate with the use of a plate with orifice holes, into a 36" storm pipe. The pipe releases into a ditch that conveys the flows to an existing 24" CMP culvert under Marksheffel Rd. after which the flows continue in historic patterns to the east. See further discussion of the existing Marksheffel culvert below.

In accordance with El Paso County criteria, the modified Type C outlet structure with a permanent micropool will release the WQCV over a 40-hour period with release rates of $Q_5=1.8$ cfs and $Q_{100}=66.0$ cfs, less than the anticipated release of $Q_5=3.2$ cfs and $Q_{100}=80.7$ cfs established by the preliminary drainage report.

A 70-ft wide riprap emergency spillway will be located on the east side of the pond. In the event that water overtops the spillway, flow will discharge into the ditch along Marksheffel Rd.

Forebay volumes, micropool surface areas, outlet structures, discharge pipes and spillway design calculations are provided in the appendix.

The pond will have a 15' wide maintenance access that will provide access to the pond bottoms, forebays and outlet structures per ECM 3.3.3.K. Private maintenance agreements and O&M manuals will be established for these ponds as required by the County.

The existing channel along Marksheffel Rd. in the northeast portion of the project site will be aesthetically maintained by Windermere Metropolitan District and will be structurally maintained by the City of Colorado Springs/El Paso County. The slopes of the channel are such that it can be accessed for maintenance along Marksheffel Rd.

South Detention Facility

The south detention pond has been designed as a full-spectrum detention facility to capture flows from the "B" basins. With this Windermere Filing No. 1 development, Tract B is to remain undeveloped. Future development of Tract B will require a replat and final drainage report to confirm the pond capacity/discharge rates presented in this report.

Tributary to Sound Pond			
Basin	Area	Interim Imp %	Final Imp %
Onsite			
B1	3.33	65%	65%
B2	0.49	65%	65%
B3	5.86	0%	82%
B4	0.16	65%	65%
B5	1.05	0%	0%
Total	10.89	23.8%	68.0%

In order to minimize future grading within the detention facility area, the volume was based on an assumed final build-out watershed imperviousness of 68.0%, which considers Tract B (Basin B3) as potentially higher density than single-family residential. As part of the Windermere Filing 1 overlot grading, the pond has been excavated to full volume and the outlet structure and associated piping installed. Until full build-out occurs, an orifice plate (assuming full developed condition within the street right-of-way, but no further development) has been installed to allow for appropriate WQCV drain time.

A final orifice plate has been designed for the watershed imperviousness described above, however before installation can occur, the design will need to be confirmed based on the final development.

A total of 10.9 acres is tributary to this south facility, with a composite imperviousness of 23.8% for the interim condition and 68.0% for the final fully developed condition. Required volumes are listed below.

	Imperviousness	Approximate Req Volume		
		WQCV	EURV	100-YR
INTERIM	23.0%	0.12	0.24	0.50
FINAL	68.0%	0.24	0.93	1.37

The actual design pond volume at the proposed spillway stage is 1.15 acre-feet. A concrete forebay with an energy dissipater will be installed where the flows enter the pond. The volume of the forebay will be 3% of the WQCV volume for the pond. The flow will exit the forebay through a notch, discharging into the concrete trickle channel at the bottom of the pond. The trickle channel conveys the flows to the micropool. The outlet structure then releases the flows at a reduced flow rate with the use of a plate with orifice holes, into a proposed 18" pipe with restrictor plate, discharging into an existing storm inlet at the corner of N. Carefree Circle and Marksheffel Rd, after which the flows continue to the south via the existing storm sewer system.

In accordance with El Paso County criteria, the modified Type C outlet structure with a permanent micropool will release the WQCV over a 40-hour period. Switching out of the orifice plate will ensure that the WQCV release rate remains within criteria for the interim and fully developed conditions. The outlet structure will remain in place for the final condition and will result in release rates of $Q_5=0.2$ cfs and $Q_{100}=9.2$ cfs. For comparison, the existing basin EX-A released flow rates of $Q_5=11.3$ cfs and $Q_{100}=28.2$ cfs.

A 27-ft wide riprap emergency spillway will be located on the south side of the pond. In the event that water overtops the spillway, flow will discharge into existing Type C area inlet at the intersection of N. Carefree Cir and Marksheffel Rd, where it is then picked up by the existing storm system.

Interim and final calculations, including forebay volumes, micropool surface areas, outlet structures, discharge pipes and spillway design are provided in the appendix.

The pond will have a 15' wide maintenance access that will provide access to the pond bottoms, forebays and outlet structures per ECM 3.3.3.K. Private maintenance

agreements and O&M manuals will be established for these ponds as required by the County.

7.0 EXISTING N. MARKSHEFFEL CULVERT

The flows reaching the existing 24" CMP culvert under N. Marksheffel Road are discussed at length in the appendix report by Classic Consulting. To summarize:

<i>Condition (Design Point)</i>	<i>Runoff Rates</i>	
	<i>Q₅ (cfs)</i>	<i>Q₁₀₀ (cfs)</i>
MDDP (DP-1X)	250.0	852.0
EXISTING (DP-26 + Hilltop)	323.3	866.9
PROPOSED (DP-T)	190.5	682.4

The table above indicates that by detaining and releasing historic flow rates from both the proposed Windermere Filing No.1, and existing Hilltop subdivision to the north, the situation at the undersized culvert under Marksheffel is improved from the existing condition, and still within the rates established by the MDDP. No additional flows are being added to the ditch. The existing 24" CMP culvert however, is still grossly undersized resulting in road overtopping and localized flooding during major storm events. Improvements to the area are included in Master Planning for both El Paso County and the City of Colorado Springs.

The receiving ditch along the west side of Marksheffel has not been analyzed as part of this report. The ditch has been previously stabilized with riprap to handle the MDDP flows.

8.0 FOUR-STEP PROCESS

This project conforms to the City of Colorado Springs/El Paso County Four Step Process. The process focuses on reducing runoff volumes, treating the water quality capture volume (WQCV), stabilizing drainage ways, and implementing long-term source controls.

1. **Employ Runoff Reduction Practices:** Proposed impervious areas on this site (roofs, asphalt/sidewalk) will sheet flow across landscaped ground as much as possible to slow runoff and increase time of concentration prior to being conveyed to the proposed public streets and storm sewer system. This will minimize directly connected impervious areas within the project site.
2. **Implement BMP's that provide a Water Quality Capture Volume with slow release:** Runoff from this project will be treated through capture and slow release of the WQCV in two permanent Extended Detention Basin facilities designed per current City of Colorado Springs/El Paso County drainage criteria.
3. **Stabilize Drainage Ways:** Flows from the north pond are released into the ditch alongside Marksheffel Rd. This ditch has previously been stabilized with rip-rap to handle the MDDP flows of 852 cfs. Flows from the south pond are released directly into the existing storm sewer system and no stabilization will be necessary.
4. **Implement Site Specific and Other Source Control BMP's:** The site is proposed as a

residential development, and as such standard household source control will be utilized in order to minimize potential pollutants entering the storm system. Example source control measures consist of: garages for storage of household chemicals, trash receptacles for individual households and in common areas for pet waste. The need for Industrial and Commercial BMP's was considered, however per ECM 1.7.2.A the need for industrial and commercial BMPs are not applicable for this project.

9.0 GEOTECHNICAL HAZARDS

In accordance with geotechnical recommendations, the project design is intended to direct runoff away from structures, and into the receiving storm sewer system and water quality/detention basins. This will be accomplished by a variety of means, i.e. curb and gutter and storm sewer. Per "Soils and Geology Study, Windermere Subdivision" by RMG, October 26, 2020 (Revised January 18, 2021):

10.1 Soil and Rock Design Parameters

TB-6 (Job No. 142206, dated May 28, 2015) and TB-107 (Job No. 162062, last dated February 5, 2019) were located in the general vicinity of the proposed Full Spectrum Detention Basin, Tract A. TB-160 (Job No. 162062, last dated February 5, 2019) was located in the general vicinity of the proposed Private Full Spectrum Extended Detention Basin, Tract A. RMG has performed laboratory tests of soil from across the proposed development. Based upon Field and laboratory testing, the following soil and rock parameters are typical for the soils likely to be encountered, and are recommended for use in detention pond embankment design.

Soil Description	Unit Weight (lb/ft ³)	Friction Angle (degree)	Active Earth Pressure, Ka	Passive Earth Pressure, Kp	At Rest Earth Pressure, Ko
Silty to Clayey Sand (SC/SM)	105	30	0.33	3.0	0.50
Silty Sandstone	110	30	0.33	3.0	0.50
Sandy Claystone/ Siltstone	100	20	0.49	2.0	0.66

10.2 Embankment Recommendations

The proposed detention pond in Tract A is to be excavated approximately 40 plus feet below the surrounding ground surface on the western portion and approximately 11 feet above the surrounding ground surface on the eastern portion. Above grade embankments are to be constructed with 4:1 slopes. Embankments should be constructed in accordance with applicable sections of the El Paso County Engineering Criteria Manual, the El Paso County Drainage Criteria Manual, the El Paso County Land Development Code, and the geotechnical report recommendations.

10.0 FACILITY MAINTENANCE

Ownership and maintenance of all public facilities, generally located within the public right-of-way will be by El Paso County. Ownership and maintenance of all tracts and private facilities will be by the Sands Metropolitan District #4.

11.0 CONSTRUCTION COST ESTIMATE

NO.	DESCRIPTION	UNIT	QUANTITY	UNIT PRICE	COST
PUBLIC STORM SEWER SYSTEM (NON-REIMBURSABLE)					
1	18" RCP	LF	44	\$ 67.00	\$ 2,948.00
2	24" RCP	LF	132	\$ 81.00	\$ 10,692.00
3	30" RCP	LF	350	\$ 100.00	\$ 35,000.00
4	36" RCP	LF	1,017	\$ 124.00	\$ 126,108.00
5	43"X68" ELLIPTICAL RCP	LF	155	\$ 254.00	\$ 39,370.00
6	24"X30" PREFAB RCP WYE	EA	1	\$ 750.00	\$ 750.00
7	5' TYPE R INLET	EA	3	\$ 5,736.00	\$ 17,208.00
8	10' TYPE R INLET	EA	8	\$ 8,136.00	\$ 65,088.00
9	15' TYPE R INLET	EA	2	\$ 11,005.00	\$ 22,010.00
10	TYPE 1 MANHOLE	EA	2	\$ 12,034.00	\$ 24,068.00
11	TYPE 2 MANHOLE	EA	5	\$ 6,619.00	\$ 33,095.00
PUBLIC STORM SEWER SUBTOTAL					\$ 376,337.00
PRIVATE NORTH POND					
12	43"X68" ELLIPTICAL RCP	LF	168	\$ 254.00	\$ 42,672.00
13	TYPE 1 MANHOLE	EA	1	\$ 12,034.00	\$ 12,034.00
14	36" RCP OUTFALL	LF	137	\$ 124.00	\$ 16,988.00
15	OUTLET STRUCTURE	EA	1	\$ 15,000.00	\$ 15,000.00
16	MICROPOOL	EA	1	\$ 2,800.00	\$ 2,800.00
17	FOREBAY	EA	2	\$ 3,500.00	\$ 7,000.00
18	TRICKLE CHANNEL	LF	700	\$ 30.00	\$ 21,000.00
19	RIPRAP SPILLWAY	CY	420	\$ 40.00	\$ 16,800.00
20	MAINTENANCE ACCESS	LF	600	\$ 20.00	\$ 12,000.00
PRIVATE NORTH POND SUBTOTAL					\$ 146,294.00
PRIVATE SOUTH POND					
21	12" PVC	LF	82	\$ 81.00	\$ 6,642.00
22	TYPE C INLET	EA	107	\$ 4,802.00	\$ 4,802.00
23	24" RCP	LF	72	\$ 81.00	\$ 5,832.00
24	18" RCP OUTFALL	LF	107	\$ 67.00	\$ 7,169.00
25	OUTLET STRUCTURE	EA	1	\$ 10,000.00	\$ 10,000.00
26	MICROPOOL	EA	1	\$ 2,800.00	\$ 2,800.00
27	FOREBAY	EA	1	\$ 3,500.00	\$ 3,500.00
28	TRICKLE CHANNEL	LF	270	\$ 30.00	\$ 8,100.00
29	RIPRAP SPILLWAY	CY	135	\$ 40.00	\$ 5,400.00
30	MAINTENANCE ACCESS	LF	720	\$ 20.00	\$ 14,400.00
PRIVATE SOUTH POND SUBTOTAL					\$ 68,645.00
IMPROVEMENTS SUBTOTAL					\$ 591,276.00
10% CONTINGENCY					\$ 59,127.60
TOTAL					\$ 650,403.60

12.0 DRAINAGE/BRIDGE FEES

The project lies within the Sand Creek Drainage Basin and is previously unplatted, as such payment of drainage/bridge fees are required prior to recording of the Final Plat.

The 2021 Sand Creek Drainage Basin Fees are as follows:

Drainage fee \$20,387/impervious acre

Bridge Fee \$8,339/impervious acre

The percent imperviousness for this subdivision is calculated as follows:

35.74 acres residential subdivision	53% impervious
16.33 acres open space	0% impervious
<hr/> 52.07 acres	36.4% impervious

52.07 acres at 36.4% impervious = 18.94 impervious acres

Therefore, the following fees are due:

18.94 acres x \$20,387.00 = **\$386,129.78 drainage fee**

18.94 acres x \$8,339.00 = **\$157,940.66 bridge fee**

Tract B is considered as an open space tract for the purposes of this calculation. Future development of Tract B will require a replat and payment of drainage fees associated with the proposed impervious acreage.

13.0 CONCLUSIONS

The Windermere project has been designed in accordance with El Paso County criteria. The EDB/water quality ponds have been designed to limit the release of storm runoff. This development will not negatively impact the downstream facilities.

14.0 REFERENCES

The sources of information used in the development of this study are listed below:

1. City of Colorado Springs "Drainage Criteria Manual", 2016.
2. Urban Storm Drainage Criteria Manuals, Urban Drainage and Flood Control District. June 2001, Revised October 2019.
3. Soil Survey for Colorado Springs and El Paso County, Colorado, U.S. Department of Agriculture, Soil Conservation Service, June 1980.
4. "Flood Insurance Studies for Colorado Springs and El Paso County, Colorado", prepared by the Federal Emergency Management Agency (FEMA), 2018.
5. "Soils and Geology Study, Windermere Subdivision", prepared by RMG, October 26, 2020, Revised January 18, 2021.
6. "Final Drainage Report for Pronghorn Meadows, Filing 2," prepared by URS, July 2004.
7. "Final Drainage Report and Erosion Control Amendment for Chateau at Antelope Ridge," prepared by URS, September 9, 2002.
8. "Preliminary Drainage Report for Windermere & Final Drainage Report for Windermere Filing No. 1," prepared by Classic Consulting Engineers & Surveyors, October 2014.
9. "MDDP for Hilltop Subdivision," prepared by URS Greiner, Inc., November 1, 1996.
10. "Final Drainage Report Marksheffel Road from Constitution Ave. to Dublin Rd.," by CH2M Hill, dated May 2008 and Marksheffel Road Construction Drawings by Wilson & Company.

APPENDIX



Innovative Design. Classic Results.

**PRELIMINARY DRAINAGE REPORT
FOR WINDERMERE
&
FINAL DRAINAGE REPORT
FOR WINDERMERE FILING NO. 1**

October 2014

Prepared for:

**JAMES TODD STEPHENS
c/o WINDSOR RIDGE HOMES
4164 AUSTIN BLUFFS PKWY #361
COLORADO SPRINGS CO 80918**

Prepared by:

**CLASSIC CONSULTING ENGINEERS &
SURVEYORS
6385 CORPORATE DRIVE SUITE 101
COLORADO SPRINGS CO 80919
(719) 785-0790**

Job no. 2441.00

RECEIVED
JUN 18 2015
BY: *JMRL*



PRELIMINARY DRAINAGE REPORT FOR WINDERMERE & FINAL DRAINAGE REPORT FOR WINDERMERE FILING NO. 1

DRAINAGE REPORT STATEMENT

ENGINEER'S STATEMENT:

The attached drainage plan and report were prepared under my direction and supervision and are correct to the best of my knowledge and belief. Said drainage report has been prepared according to the criteria established by the El Paso County for drainage reports and said report is in conformity with the master plan of the drainage basin. I accept responsibility for any liability caused by any negligent acts, errors, or omissions on my part in preparing this report.

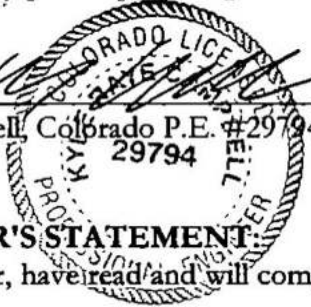

Kyle R Campbell, Colorado P.E. #29794
Date 6-18-15

DEVELOPER'S STATEMENT:

I, the developer, have read and will comply with all of the requirements specified in this drainage report and plan.

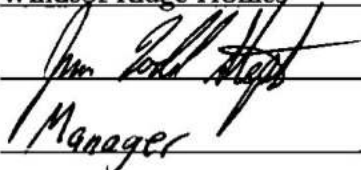
Business Name: Windsor Ridge Homes
By: 
Title: Manager
Address: 4164 Austin Bluffs Parkway #361
Colorado Springs, CO 80918

EL PASO COUNTY ONLY:

Filed in accordance with the requirements of the Drainage Criteria Manual, Volumes 1 and 2, El Paso County Engineering Criteria Manual and Land Development Code as amended.

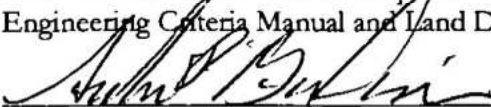

Andre P. Brackin, P.E.
County Engineer / ECM Administrator
Date 6-22-15

Conditions:



PRELIMINARY DRAINAGE REPORT FOR WINDERMERE & FINAL DRAINAGE REPORT FOR WINDERMERE FILING NO. 1

TABLE OF CONTENTS:

PURPOSE	Page 1
GENERAL DESCRIPTION	Page 1
EXISTING DRAINAGE CONDITIONS	Page 2
PROPOSED DRAINAGE CHARACTERISTICS	Page 6
EROSION CONTROL PLAN	Page 16
DRAINAGE CRITERIA	Page 16
FLOODPLAIN STATEMENT	Page 16
DRAINAGE AND BRIDGE FEES	Page 16
CONSTRUCTION COST OPINION	Page 17
SUMMARY	Page 18
REFERENCES	Page 19

APPENDICES

VICINITY MAP
SOILS MAP (S.C.S. SURVEY)
F.E.M.A. MAP
REFERENCE MATERIAL FROM ADJACENT STUDIES
EXISTING DRAINAGE CONDITIONS CALCULATIONS
DEVELOPED DRAINAGE CONDITIONS CALCULATIONS
FILING NO. 1 – FULL SPECTRUM EDB FINAL DESIGN
FILING NO. 2 – FULL SPECTRUM EDB PRELIMINARY DESIGN
CORESPONDANCE FROM YES! COMMUNITIES
DRAINAGE MAP



PRELIMINARY DRAINAGE REPORT FOR WINDERMERE & FINAL DRAINAGE REPORT FOR WINDERMERE FILING NO. 1

PURPOSE

This document is the Preliminary Drainage Report for the entire Windermere (Filings 1-3) development and the Final Drainage Report for Windermere Filing No. 1. The purpose of this report is to identify onsite and offsite drainage patterns, storm sewer, inlet locations, and areas tributary to the site, and to safely route developed storm water runoff to adequate detention and water quality facilities while releasing storm water at or below historic rates and in accordance with all applicable master drainage plans. This report will discuss the proposed storm system to be built with Filing 1 and the future system to be built with Filings 2 & 3. A Final Drainage Report will be needed for Filings 2 & 3 that will discuss the final construction details, and more specifically, the final design details of the proposed sub-regional public detention/water quality facility located at the north end of the site. Preliminary design of the sub-regional public facility is included in this report, along with the final design information for the Filing No. 1 detention/water quality facility located at the south-east corner of the site.

GENERAL DESCRIPTION

Windermere is a 52.07 acre single family home subdivision within the east half of Section 29, Township 13 South, Range 65 West of the 6th Principal Meridian in El Paso County, Colorado. The site is located on the east side of Antelope Ridge Drive just north of North Carefree Circle. The existing Chateau at Antelope Ridge subdivision sits directly north of the site, with Marksheffel Road bordering the east side of the site. The proposed development includes a total of 201 single-family residences and will be developed in three filings. Filing 1 includes 59 residential lots on approximately 15 acres. Filing 2 will include 70 lots on approximately 22 acres, and Filing 3 is 72 lots on approximately 15 acres.

The average soil condition of the entire site and tributary area to the proposed ponds reflects Hydrologic Group "B" (Truckton sandy loam) as determined by the "Soil Survey of El Paso County Area," prepared by the National Cooperative Soil Survey (see map in Appendix).



EXISTING DRAINAGE CONDITIONS

The site is located within the Sand Creek Drainage Basin. Historically, this site drains in all directions with a large hill in the southern half of the site and an existing temporary detention facility located at the northern end. There is a large roadside ditch adjacent to Marksheffel Road (M.D.D.P. DP-1X) that routes off-site (non-tributary to site facilities) runoff to the existing 24" CMP storm culvert under Marksheffel Road (Design Point 26). This site has been previously studied as part of the previously approved "Master Development Drainage Plan for Hilltop Subdivision El Paso County, Colorado" by URS Greiner, Inc. last revised February 1998. See below for detailed descriptions of the existing drainage conditions and see appendix for the Existing Conditions Drainage Map.

Design Point 4 - Existing ($Q_5 = 7.2$ cfs, $Q_{100} = 14.6$ cfs) consists of runoff from off-site Basin D-16, 2.73 acres of existing Pronghorn Meadows Subdivision, Antelope Ridge Drive, and North Carefree Circle. An existing 8' curb sump inlet intercepts the runoff with an existing 24" RCP conveying it directly onto the proposed site where a roadside ditch along N. Carefree Circle drains to the area drain at DP-6 (North West corner of Marksheffel Rd. and N. Carefree Cir.). The Basin D-16 characteristics and size was derived from the previously approved "Final Drainage Report for Pronghorn Meadows Filing 2," by URS, dated July 2004; "Preliminary Drainage Report for Pronghorn Meadows and Final Drainage Report for Pronghorn Meadows Filing No. 1," by URS, dated September 4, 2002; and also using observed field conditions and satellite imagery.

Design Point 6 - Existing ($Q_5 = 18.4$ cfs, $Q_{100} = 42.6$ cfs) consists of runoff from DP-4-EX, Basin EX-R, and Basin EX-A. Basin EX-R is 0.53 acres of existing Marksheffel Rd. and roadside ditch that drain to the existing grated area drain at DP-6. Basin EX-A is 13.20 acres of undeveloped Windermere property with historic runoff of $Q_5 = 11.3$ cfs and $Q_{100} = 28.2$ cfs. This historic runoff rate from Basin EX-A is used as the allowable release rate for the proposed Filing 1 detention/water quality facility located at this corner of the site. This cumulative historic and existing storm water runoff ($Q_5 = 18.4$ cfs, $Q_{100} = 42.6$ cfs) at this grated sump area drain inlet does not appear to have been quantified correctly in the design of the downstream Marksheffel Road storm sewer system as the outfall pipe from the existing grated inlet (24" RCP) only has a capacity of 16 cfs at 0.50% grade. The "Final Drainage Report Marksheffel Road from Constitution Ave. to Dublin Rd.," by CH2M Hill dated May 2008 was approved by El Paso County for the storm sewer improvement design associated with the expansion of Marksheffel Road. Construction plans



for the Marksheffel Rd. improvements were completed by Wilson & Company Engineers & Architects in accordance with the Final Drainage Report. On these construction plans (PPRTA Project #75174, Sheets 12 & 13) a 24" RCP (Pipe 6b, $Q_5 = 18.4$ cfs and $Q_{100} = 42.6$ cfs) was constructed to this existing area drain with a capacity listed as 16 cfs. It appears that the historic runoff from the proposed Windermere site (Basin EX-A) was not included in the downstream pipe sizing and construction. The Marksheffel Road Final Drainage Report by CH2M Hill states on page 13 that "Storm pipes are designed to convey the 10-year flow, except at sump locations where they are designed to convey the 100-year flow." A sump condition exists at this Design Point and at the adjacent N. Carefree Circle median inlet at DP-20. Therefore, it is our belief and understanding that the storm system should convey the entire 100 year historic and existing runoff at this location.

Design Point 7 - Existing ($Q_5 = 20.0$ cfs, $Q_{100} = 41.6$ cfs) consists of runoff from off-site Basins D-13 & D-14, 6.79 acres & 3.88 acres respectively of existing Pronghorn Meadows Subdivision and existing Antelope Ridge Drive. The previous approved reports for Pronghorn Meadows and existing field conditions were used to determine the tributary basin sizes and the results are in conformance to the previously approved reports. An existing 25' (field verified) Type R curb inlet intercepts all of this runoff and an existing storm pipe routes flows to the existing inlet at DP-8 prior to day lighting onto the proposed site. This developed runoff does not appear to be detained or treated for storm water quality before being released onto the Windermere site.

Design Point 8 - Existing ($Q_5 = 5.6$ cfs, $Q_{100} = 11.2$ cfs) consists of runoff from off-site Basin D-15, 1.36 acres of existing Antelope Ridge Drive, and from Basin EX-E, 1.10 acres of on-site undeveloped land that drains onto Antelope Ridge Drive. An existing 10' (field verified) Type R curb inlet intercepts all of this runoff and an existing 36" storm (Pipe 8) routes the combined runoff ($Q_5 = 24.7$ cfs and $Q_{100} = 50.9$ cfs) directly onto the proposed Windermere site. This runoff drains across the site to Design Point 26. This developed runoff also does not appear to have been detained or treated for water quality prior to releasing onto the proposed site.

Design Point 19 - Existing ($Q_5 = 6.7$ cfs, $Q_{100} = 12.5$ cfs) consists of runoff from off-site Basin NC-2, 1.49 acres of existing Antelope Ridge Drive and N. Carefree Circle. An existing 15' Type R at-grade curb inlet just west of Marksheffel Road intercepts a portion of this runoff ($Q_5 = 4.8$ cfs and $Q_{100} = 8.1$ cfs) and an



existing 18" storm (Pipe 6a) connects with Pipe 6B at an existing storm manhole. Pipe 6C is the 24" outfall pipe from this connection manhole and contains a combined runoff of $Q_5 = 21.6$ cfs and $Q_{100} = 47.9$ cfs. From the Marksheffel Rd. Construction Drawings, the capacity of the system at Pipe 6C is 16 cfs. Pipe 6C connects into the face of the median sump inlet at DP-20.

Design Point 20 - Existing ($Q_5 = 3.7$ cfs, $Q_{100} = 8.0$ cfs) consists of runoff from off-site Basin NC-1, 0.42 acres of existing N. Carefree Circle and Marksheffel Rd, and the flow-by from the at-grade inlet at Design Point 19. An existing 10' Type R sump median curb inlet intercepts all of this runoff and combines it with that from the incoming Pipe 6C. Pipe 7 represents the existing 30" outfall pipe from this inlet and contains a historic and existing runoff rate of $Q_5 = 24.2$ cfs and $Q_{100} = 53.3$ cfs. From the Marksheffel Rd. Construction Drawings, the capacity of the 30" Pipe 7 is 29 cfs. This runoff continues within the existing Marksheffel Rd. storm system to the south to downstream facilities.

Design Point 24 - Existing ($Q_5 = 111.3$ cfs, $Q_{100} = 199.7$ cfs) consists of off-site tributary area to the existing temporary detention facility located along the northern site boundary. The temporary detention facility was constructed in conjunction with the Chateau at Antelope Ridge subdivision located directly north of the proposed site. The tributary runoff at DP-24 is a combination of developed runoff from the Chateau at Antelope Ridge subdivision and detained release from the Whispering Springs Development, located west of Antelope Ridge Drive and the Chateau at Antelope Ridge subdivision. The "Preliminary Drainage Report for Whispering Springs Development and Final Drainage Report for Whispering Springs Filing No. 1," by Rockwell Consulting, Inc., dated August 2013 details the overall detained and water quality treated runoff that drains directly into the storm sewer system of the Chateau at Antelope Ridge. This runoff is described in this report as Basin WS, 41.47 acres with a release rate of $Q_5 = 47.3$ cfs and $Q_{100} = 66.4$ cfs (Design Point 10 from Whispering Springs Drainage Report).

DP-24 also contains the developed runoff from Basin CT, 42.07 acres of the existing Chateau at Antelope Ridge subdivision. The Basin CT characteristics and size was derived from the previously approved "Final Drainage Report and Erosion Control for Chateau at Antelope Ridge," by URS, approved January 21, 1999 as well as observed field conditions and satellite imagery. Basin CT produces a developed runoff rate of $Q_5 = 90.8$ cfs and $Q_{100} = 184.7$ cfs that drains to DP-24 and into the existing and proposed detention/water quality facility.



Design Point 25 - Existing ($Q_5 = 117.5$ cfs, $Q_{100} = 215.1$ cfs) consists of the total existing runoff into the existing temporary detention facility located along the northern site boundary. This runoff consists of DP-24, Basins EX-D (6.19 acres of on-site undeveloped land) and EX-F (3.15 acres of temporary detention pond area). Per the Hilltop Subdivision M.D.D.P., detention of developed runoff is required in order to maintain historic release rates under Marksheffel Road and to the east to the main Sand Creek channel. An existing 48" CMP serves as the temporary facility's outfall along with a riprap lined emergency overall spillway. The discharge pipe and portions of the embankment are located outside of the Tract A Temporary Detention Facility.

Design Point 26 - Existing ($Q_5 = 138.3$ cfs, $Q_{100} = 266.9$ cfs) consists of the total existing runoff to the existing 24" CMP Marksheffel Road culvert crossing from the north-west. This runoff is comprised of the DP-25 storm water and that from Basins EX-B and EX-C, 7.30 acres and 24.28 acres respectively of on-site undeveloped land that drains directly east to the Marksheffel Road ditch. This runoff quantity does not include that from the upstream Marksheffel Road ditch, described in the Hilltop MDDP as Design Point 1X. Per the Hilltop MDDP the existing runoff within the Marksheffel Rd. ditch is $Q_5 = 144$ cfs and $Q_{100} = 481$ cfs. However, with the "Final Drainage Report and Erosion Control Plans for Chateau at Antelope Ridge El Paso County, Colorado," by URS, dated December 18, 1998 discusses the Marksheffel Road ditch design and assumptions used; varying the flow within the ditch from 420 to 714.5 cfs. As stated in this previous report "these flows were added as each design point without considering routing to give a worst case scenario." This large range of flow rates was used as a very conservative channel design and does not reflect the actual (routed) flow within the Marksheffel ditch. The same December 1998 report included a HEC model to more accurately define the ditch runoff and determine the allowable release rate for the temporary pond. The flow of 521 cfs was used as the routed flow in the Marksheffel ditch.

However, the "Final Drainage Report and Erosion Control Amendment for Chateau at Antelope Ridge El Paso County, Colorado," by URS, dated September 9, 2002 was approved by El Paso County and discusses an increase in tributary runoff to this Marksheffel Rd. ditch (north of Barnes Road). This increase of 79 cfs directly transposed to the M.D.D.P. DP-1X results in a 100-yr historic runoff within the Marksheffel Ditch of 600 cfs (estimated 5 year increased flow to 185 cfs).



Design Point 26 directly correlates with M.D.D.P. DP-1C, which states a maximum flow rate in existing and developed conditions of $Q_5 = 250$ cfs and $Q_{100} = 852$ cfs that crosses under Marksheffel Road. Using a conservative approach by directly adding the M.D.D.P. DP-1X runoff (increased as previously stated) with the quantified DP-26 runoff from the proposed site analysis, a total runoff value can be compared with the M.D.D.P. allowable runoff rate at this culvert crossing of Marksheffel Road. In the current undeveloped conditions, the total runoff is $Q_5 = 323.3$ cfs and $Q_{100} = 866.9$ cfs. The 5 year & 100 year storm event runoffs are slightly higher than that quantified in the Chateau at Antelope Ridge Drainage Report due to conservatively assuming runoff drains directly into and out of the temporary facility at DP-25 since an outlet structure restricting runoff does not exist. The proposed developed conditions will ensure the runoff at DP-26 is less than the allowable rates per the M.D.D.P. ($Q_5 = 250$ cfs, $Q_{100} = 852$ cfs).

PROPOSED DRAINAGE CONDITIONS

Developed runoff from Windermere Development will be conveyed into the proposed storm sewer systems as shown on the Developed Conditions Drainage Map, and will outfall into two separate Public Full Spectrum Extended Detention Basin (EDB) Water Quality Facilities. All curb inlets are CDOT Type R, storm pipes are reinforced concrete pipe (RCP), and curbs are El Paso County Type A (6" vertical curb) and El Paso County Type C (ramp curb).

Per current El Paso County Drainage Criteria for stormwater capacity within street sections, the following applies:

<i>Street Type</i>	<i>Allowable – Initial Storm (5 yr)</i>	<i>Allowable–Major Storm (100 yr)</i>
Residential w/Ramp Curb	Flow spread to crown. Maximum of 20 cfs per side.	12" maximum depth at flowline with no adjacent flooding.
Residential w/Vertical Curb	6" allowable depth at flowline. Maximum of 34 cfs per side.	12" maximum depth at flowline with no adjacent flooding.
Collector Street	6" allowable depth at flowline, maximum of 34 cfs per side, no overtopping of crown.	12" maximum depth at flowline with no adjacent flooding.



For more exact allowable curb capacities for each curb and roadway type at varying street slopes the Curb Capacity Equations were used as shown on the charts located in the front of the Drainage Criteria Manual. At no times is curb capacity an issue due to the placement of at-grade inlets when needed.

Drainage from individual lots is assumed to travel in side-lot swales to the street. A detailed description of the developed runoff for Windermere, including the final design of Filing No. 1 is as follows:

Design Point 1 ($Q_5 = 13.1$ cfs, $Q_{100} = 26.2$ cfs) consists of runoff from Basin C, 4.20 acres of Filing No. 1 single family home lots, and the two Pronghorn Meadows Circle roadways. A proposed 15' at-grade inlet will intercept a portion of this runoff while the remaining continues within the curb and gutter to Design Point 2. Pipe 1 (24" RCP, $Q_5 = 8.9$ cfs and $Q_{100} = 15.6$ cfs) conveys the intercepted runoff south toward the detention/water quality facility at Design Point 5. As is typical throughout the proposed Windermere subdivision, all developed flows are within allowable street capacities for both 5 yr and 100 year events. For the minor event storm, the curb capacity of ramp curb at 1.5% is 13.8 cfs.

Design Point 2 ($Q_5 = 12.4$ cfs, $Q_{100} = 27.3$ cfs) consists of runoff from Basin B, 2.72 acres of Filing No. 1 single family home lots and adjacent residential roadways, and the flow-by from the at-grade inlet at DP-1. A proposed 15' sump inlet will intercept this runoff and combine with that from Pipe 1. Pipe 2 (30" RCP, $Q_5 = 20.9$ cfs and $Q_{100} = 41.9$ cfs) conveys the combined runoff south toward the detention/water quality facility at Design Point 5.

Design Point 3 ($Q_5 = 9.1$ cfs, $Q_{100} = 18.2$ cfs) consists of runoff from Basin A, 3.35 acres of Filing No. 1 single family home lots and adjacent residential roadways. A proposed 10' sump inlet will intercept this runoff and a 24" RCP (Pipe 3a) will connect to the storm main from DP-2. Pipe 3b (36" RCP, $Q_5 = 27.6$ cfs and $Q_{100} = 55.5$ cfs) conveys the combined runoff from the Filing No. 1 development into the proposed Full Spectrum Extended Detention Basin at Design Point 5.

Design Point 4 ($Q_5 = 7.2$ cfs, $Q_{100} = 14.6$ cfs) is exactly as described within the Existing Conditions portion of this report. The existing 24" RCP will be extended with a proposed 24" RCP (Pipe 4) and connected directly into the downstream Marksheffel Road storm sewer system.



Design Point 5 ($Q_5 = 28.1$ cfs, $Q_{100} = 56.8$ cfs) is the Filing No. 1 developed runoff into the proposed Private Full Spectrum Extended Detention Basin. This storm water consists of that from Pipe 3b and Basin P, 0.60 acres of the detention facility itself. The facility was designed using the sizing spreadsheet (See Appendix) and criteria from the Urban Drainage and Flood Control District (UDFCD). A total of 10.87 acres of Windermere Filing No. 1 is tributary to this facility, with a composite impervious value of 73.3%. A required Excess Urban Runoff Volume (EURV) of 0.893 acre-feet is required. This volume is provided under the top of outlet box opening (elevation 6570.00, within the orifice plate of the outlet box).

A concrete box forebay will be placed at the Pipe 3b entry point into the facility. Per the UDFCD sizing spreadsheet a 6" notch in the vertical wall of the forebay box is required. All pond structure details are included in the Filing No. 1 construction drawings. A 6' wide concrete trickle channel at 1.0% grade will be installed down the center of the basin to convey the low flows to the outlet box and limit erosion within the bottom of the facility. A 3.0% minimum basin bottom slope into the trickle channel is provided as per the UDFCD requirements.

The bottom of the detention basin is at an elevation of 6562.50 with the EURV provided at the elevation 6570.00. A 6' wide outlet box (4' deep opening) is proposed with a top of box at this 6570.00 elevation. For a Full Spectrum facility, the outlet box orifice holes within the front plate are to drain the EURV in 72 hours, resulting in the necessary orifice hole sizing of 1 column of 3/4" diameter circular holes. A 2.5' deep concrete bottom micropool is to be installed within the outlet structure, with a surface area of 107 square feet. A removable trash screen of 12" in width will be placed in front of the orifice plate to help prevent the orifice holes from clogging. A 24" RCP outlet, Pipe 5, will convey the facility's restricted release ($Q_5 = 0.63$ cfs, $Q_{100} = 9.77$ cfs) (historic from site is $Q_5 = 11.3$ cfs, $Q_{100} = 28.2$ cfs) to the existing 24" storm sewer pipe of the Marksheffel Road storm sewer system. See Design Point 6 for continued discussion of downstream system.

A 20' length emergency spillway located at elevation 6571.00 will pass the entire incoming 100-year storm event (56.8 cfs) at a flood depth less than 1.0' (0.84' using equation $Q = CLH^{0.5}$ from the DCM). Per the El Paso County Drainage Criteria Manual (DCM), the top of the pond berm shall be 2.0' higher than the flood depth water surface elevation, in this case at 6574.00. This emergency spillway will only be utilized in the case of a complete outlet box failure and will be constructed of riprap rock buried under top soil and re-



vegetated. Also, a 15' wide maintenance access road at 15% grade will be installed to the bottom of the facility from the interior roadway, Grizedale Terrace. By utilizing the Full Spectrum Outlet box design, the minor storm event release rates are significantly below historic levels, and the 100-year event is less than a third of the historic (allowable) runoff rate of the proposed site (Basin EX-A $Q_5 = 11.3$ cfs, $Q_{100} = 28.2$ cfs).

Maintenance of the Private detention/water quality structures and aesthetic maintenance of the facility will be by either the home owner's association or Windermere Metropolitan District 1 as is to be determined.

Initially, as a part of the early grading permit, a temporary sediment pond will be constructed in the same location as the ultimate detention and stormwater quality facility. The temporary sediment basin outlet pipe will ultimately be replaced with a formal outlet structure at the time of Filing No. 1 public street and storm construction. The storm outfalls into the ultimate pond will also be constructed along with the proposed perimeter retaining walls.

Design Point 6 ($Q_5 = 3.4$ cfs, $Q_{100} = 7.1$ cfs) consists of runoff from Basin R, 1.18 acres of existing Marksheffel Road, adjacent roadside swale, and proposed home lots that drain in the same pattern as existing Basin EX-R. The existing type D grated area drain must remain due to existing electric vaults being installed lower than the roadway intersection. However, this inlet must be relocated to the east in order to construct the N. Carefree sidewalk. The new Type D inlet intercepts all of this runoff and an 18" RCP conveys it to the storm outfall from the proposed detention/water quality facility at DP-5. Pipe 6b (24" RCP, $Q_5 = 10.3$ cfs, $Q_{100} = 29.4$ cfs) is the combined runoff rate from the Pond Outfall (Pipe 5), DP-6, and off-site DP-14 (Pipe 4). This 24" RCP connects to the existing 24" RCP of the Marksheffel Rd. storm system. Per the Existing Conditions analysis of this report, the allowable historic runoff rate to the existing 24" RCP is $Q_5 = 18.4$ cfs and $Q_{100} = 42.6$ cfs. As stated in the Existing Conditions section, the existing storm sewer system constructed with the Marksheffel Road improvements does not have the capacity (listed as 16 cfs) to convey even the reduced detained runoff. See Design Point 19 for continued discussion of the existing Marksheffel Road storm system.

Design Point 7 ($Q_5 = 20.0$ cfs, $Q_{100} = 41.6$ cfs) is the same as described in the Existing Conditions section of this report.



Design Point 8 ($Q_5 = 7.7$ cfs, $Q_{100} = 15.1$ cfs) consists of runoff from off-site Basin D-15, 1.36 acres of existing Antelope Ridge Drive, and from Basin E, 1.47 acres of the back yards of proposed single family home lots that drains onto Antelope Ridge Drive. The runoff at this location in the developed conditions is slightly higher than in the existing conditions; however the existing inlet and storm pipe have adequate capacity. The existing 10' Type R curb inlet intercepts all of this runoff and an existing 36" storm (Pipe 8) the previously daylighted onto the proposed site will be extended east within Borrowdale Lane and eventually to the detention/water quality facility at DP-25. This 36" Pipe 8 conveys runoff of $Q_5 = 26.4$ cfs and $Q_{100} = 54.1$ cfs.

Design Point 9 ($Q_5 = 12.9$ cfs, $Q_{100} = 26.0$ cfs) consists of runoff from Basin I, 4.44 acres of Filing No. 3 single family home lots and Ryedale Way. A proposed 20' at-grade inlet will intercept a portion of this runoff while the remaining continues within the curb and gutter to Design Point 10. Pipe 9 (24" RCP, $Q_5 = 9.0$ cfs and $Q_{100} = 16.0$ cfs) conveys the intercepted runoff to the 36" main from DP-8 (Pipe 10 36" RCP, $Q_5 = 32.4$ cfs and $Q_{100} = 64.7$ cfs). At no times within the proposed site is curb capacity an issue due to the placement of these at-grade storm inlets. For the minor event storm, the curb capacity of ramp curb at 4.0% is above the maximum of 20.0 cfs.

Design Point 10 ($Q_5 = 5.6$ cfs, $Q_{100} = 13.5$ cfs) consists of runoff from Basin N, 0.58 acres of Filing No. 3 single family home lots and Borrowdale Lane, and the flow-by from DP-9. A proposed 15' at-grade inlet will intercept the majority of this runoff while the remaining continues within the curb and gutter to Design Point 11. Pipe 11 (18" RCP, $Q_5 = 4.3$ cfs and $Q_{100} = 8.5$ cfs) conveys the intercepted runoff to the at-grade inlet at DP-11.

Design Point 11 ($Q_5 = 11.2$ cfs, $Q_{100} = 24.8$ cfs) consists of runoff from Basin J, 3.30 acres of single family home lots and Patterdale Place, and the flow-by from DP-10. A proposed 10' at-grade inlet will intercept a portion of this runoff while the remaining continues within the curb and gutter to the sump inlet at Design Point 15. Pipe 12 (24" RCP, $Q_5 = 9.8$ cfs and $Q_{100} = 16.4$ cfs) conveys the intercepted runoff from this at-grade inlet and that from the at-grade at DP-10 (Pipe 11) to the storm main. The outfall main (Pipe 13, 42" RCP, $Q_5 = 38.9$ cfs and $Q_{100} = 75.5$ cfs) continues east within Borrowdale Lane and ultimately to the proposed detention/water quality facility at DP-25.



Design Point 12 ($Q_5 = 11.0$ cfs, $Q_{100} = 22.4$ cfs) consists of runoff from Basin K, 3.74 acres of single family home lots and Pronghorn Meadows Circle. A proposed 20' at-grade inlet will intercept a portion of this runoff while the remaining continues within the curb and gutter to the sump inlet at Design Point 15. Pipe 16 (24" RCP, $Q_5 = 8.7$ cfs and $Q_{100} = 15.4$ cfs) conveys the intercepted runoff and connects to the 60" RCP storm main that drains into the detention/water quality facility at Design Point 25. For the minor event storm, the curb capacity of ramp curb at 1.5% is 13.8 cfs.

Design Point 14 ($Q_5 = 12.3$ cfs, $Q_{100} = 24.5$ cfs) consists of runoff from Basins F & Q, 2.85 acres and 1.70 acres respectively of single family home lots and adjacent residential roadways. A proposed 20' at-grade inlet will intercept a portion of this runoff while the remaining continues within the curb and gutter to the sump inlet at Design Point 15. Pipe 14 (24" RCP, $Q_5 = 8.8$ cfs and $Q_{100} = 15.1$ cfs) conveys the intercepted runoff from this at-grade inlet and connects to the 42" storm main (Pipe 15, $Q_5 = 45.9$ cfs and $Q_{100} = 87.4$ cfs).

Design Point 15 ($Q_5 = 20.5$ cfs, $Q_{100} = 50.7$ cfs) consists of runoff from Basin G, 3.97 acres of single family home lots and adjacent residential roadways, and the flow-by runoff from the at-grade inlets at Design Points 11, 12, & 14. A proposed 20' sump inlet will intercept all of this runoff with a 42" RCP lateral connecting with the 42" main within Borrowdale Lane at a proposed storm manhole.

Design Point 16 ($Q_5 = 10.4$ cfs, $Q_{100} = 20.8$ cfs) consists of runoff from Basin L, 3.86 acres of single family home lots, the Ryedale Way cul-de-sac, and Pronghorn Meadows Circle. A proposed 10' at-grade inlet will intercept a portion of this runoff while the remaining continues within the curb and gutter to the sump inlet at Design Point 17. Pipe 17 (18" RCP, $Q_5 = 6.5$ cfs and $Q_{100} = 9.3$ cfs) conveys the intercepted runoff and connects to the 60" RCP storm main (Pipe 22, $Q_5 = 78.1$ cfs and $Q_{100} = 158.1$ cfs) that drains into the detention/water quality facility at Design Point 23/25. For the minor event storm, the curb capacity of ramp curb at 1.5% is 13.8 cfs.

Design Point 17 ($Q_5 = 7.8$ cfs, $Q_{100} = 19.1$ cfs) consists of runoff from Basin H, 1.42 acres of single family home lots and adjacent residential roadways, and the flow-by runoff from the at-grade inlet at Design Point 16. A proposed 10' sump inlet will intercept all of this runoff with a 24" RCP (Pipe 20) connecting with the 42" lateral to DP-15. The 42" lateral combines with the 42" Borrowdale Lane main at a storm manhole at



the roadway intersection. Pipe 18 (60" RCP, $Q_5 = 67.7$ cfs and $Q_{100} = 141.5$ cfs) conveys the combined runoff to the north to DP-23.

Design Point 19 ($Q_5 = 10.4$ cfs, $Q_{100} = 20.7$ cfs) consists of runoff from off-site Basin NC-2, 1.49 acres of existing Antelope Ridge Drive and N. Carefree Circle, and from Basin D, 1.75 acres of landscaped areas and single family home lots. For arterial streets in the minor storm event, the maximum street capacity is 6" depth at flowline with 34 cfs per side while maintaining at least (1) 10' lane width free of water. For the major storm event the maximum street flow is 8" depth at flowline dependant on street grade. An existing 15' Type R at-grade curb inlet (at approx. 4% street grade) intercepts a portion of this runoff ($Q_5 = 9.0$ cfs and $Q_{100} = 12.8$ cfs) and an existing 18" storm (Pipe 6a) connects with Pipe 6B at an existing storm manhole. Pipe 6C is the 24" outfall pipe from this connection manhole and contains a combined runoff of $Q_5 = 17.5$ cfs and $Q_{100} = 39.7$ cfs. The storm water in the existing Marksheffel Road storm sewer system is less in the developed conditions than in the existing conditions due to the over-detention of the proposed development runoff at DP-5. Per the Marksheffel Rd. Construction Drawings, the capacity of the system at Pipe 6C is 16 cfs. Pipe 6C connects into the face of the median sump inlet at DP-20.

Design Point 20 ($Q_5 = 4.5$ cfs, $Q_{100} = 11.3$ cfs) consists of runoff from off-site Basin NC-1, 0.42 acres of existing N. Carefree Circle and Marksheffel Rd, and the flow-by from the at-grade inlet at Design Point 19. An existing 10' Type R sump curb inlet intercepts all of this runoff and combines it with that from the incoming Pipe 6C. Pipe 7 represents the existing 30" outfall pipe from this inlet and contains a developed runoff rate of $Q_5 = 21.2$ cfs and $Q_{100} = 48.9$ cfs (less than in the existing conditions). From the Marksheffel Rd. Construction Drawings, the capacity of the 30" Pipe 7 is 29 cfs. This runoff continues within the existing Marksheffel Rd. storm system to the south to downstream facilities.

Design Point 20-DS ($Q_5 = 33.8$ cfs, $Q_{100} = 84.5$ cfs) This design point quantifies the worst case surface storm runoff downstream of Design Point 20 if the existing Marksheffel Road storm system is at full capacity and the proposed facility overtops the emergency spillway. The quantity is a combination of the surface runoff at Design Point 20 and the theoretical difference in the listed capacity of Pipe 6C (16 cfs) and the total un-detained proposed developed runoff; which is a difference of $Q_5 = 29.3$ cfs and $Q_{100} = 73.2$ cfs. As previously mentioned, the allowable street runoff for arterial streets in the minor storm event is a max. 6" depth at flowline with 34 cfs per side while maintaining at least (1) 10' lane width free of water. For the



major storm event the maximum street flow is 8" depth at flowline dependant on street grade. Flowmaster gutter calculations are included in the Appendix of this report. The capacity of the arterial roadway (Marksheffel Rd.) downstream of the existing Marksheffel and N. Carefree intersection maintains acceptable flow depths, spreads, and overall flow rates as defined in the current Drainage Criteria Manual in the event of an entire 100-yr storm overtopping the spillway.

Design Point 23 ($Q_5 = 83.8$ cfs, $Q_{100} = 173.0$ cfs) consists of the total runoff from the Windermere development that drains into the northern proposed Public Full Spectrum Extended Detention Basin and Water Quality Facility to be constructed with Filing 2. A Final Drainage Report will be completed with Windermere Filings 2 & 3 that further detail the detention/water quality facility and address any changes made to this Preliminary Drainage Report for Filings 2 & 3. DP-23 represents the runoff from 49.32 acres (including Pond Basin M) of proposed Windermere on-site developed land at a calculated impervious value of 60.88%. A forebay will be constructed at this 60" RCP entry point into the facility with a concrete low flow trickle channel draining to the outlet box micropool.

As the existing temporary detention facility is located on property not owned or controlled by the Windermere developer, please find in the appendix a letter from the Tract A owner (Yes! Communities) acknowledging their willingness to work with the Windermere developer in converting this existing temporary private facility into a public facility.

Design Point 24 ($Q_5 = 111.3$ cfs, $Q_{100} = 199.7$ cfs) is described in the Existing Conditions section of this report. A forebay will be constructed at this channel entry point in the facility with a concrete low flow trickle channel within the middle of the pond bottom. For the design purposes of the proposed EDB facility at DP-25, this tributary runoff was calculated at the following impervious values: Basin WS 41.47 acres @ 2% (historic flow analysis since all developed runoff is treated and released at historic rates with Whispering Springs on-site facilities) and Basin CT 42.07 acres @ 70% (interpolated from previous reports and satellite imagery).

Design Point 25 ($Q_5 = 185.7$ cfs, $Q_{100} = 353.3$ cfs) consists of the combination of the existing tributary runoff (DP-24) with the developed runoff from the proposed Windermere site (DP-23) that collect in this proposed Public Full Spectrum Extended Detention Basin (EDB) Water Quality Facility. Per the Hilltop



Subdivision M.D.D.P., detention of developed runoff is required in order to maintain historic release rates under Marksheffel Road and to the east to the main Sand Creek channel. As mentioned in the Existing Conditions Section, there is currently a temporary detention pond located in this area constructed with the Chateau at Antelope Ridge development to the north. This facility was to be removed when the large regional Sand Creek detention facility was constructed to the south. This facility is no longer a feasible option due to multiple ownerships and lack of planned development to the east of Marksheffel Road. Therefore this permanent facility will ensure acceptable downstream runoff rates and the statement of this facility being temporary in the Chateau reports no longer applies. This Public EDB facility will be required with the development of Windermere Filing No. 2 and a Final Drainage Report will be completed at that time that will provide the final design of this facility. The following pond design/analysis has been completed with this Preliminary Drainage Report for Windermere:

The Extended Detention Basin (EDB) facility was designed using the sizing spreadsheet (See Appendix) and criteria from the Urban Drainage and Flood Control District (UDFCD). A total of 132.86 acres of land is tributary to this facility at a composite imperviousness of 45.4%. An Excess Urban Runoff Volume (EURV) of 6.548 acre-feet is required. This volume is provided under the top of outlet box opening (elevation 6576.50, within the orifice plate of the outlet box).

Forebays will be constructed at both Design Points 23 & 24 and will likely consist of riprap berms with small outlet pipes draining a concrete bottom forebay. Final details will be provided with the Windermere Filing No. 2 Final Drainage Report. An 8' wide concrete trickle channel at 0.50% grade will be installed down the center of the basin to convey the low flows to the outlet box and limit erosion within the bottom of the facility. A 3.0% minimum basin bottom slope into the trickle channel is provided as per the UDFCD requirements.

The bottom of the detention basin is at an elevation of 6571.00 with the EURV provided at the elevation 6576.50. A 20' wide outlet box (4' deep opening) is proposed with a top of box at this 6576.50 elevation. For a Full Spectrum facility, the outlet box orifice holes within the front plate are to drain the EURV in 72 hours, resulting in the necessary orifice hole sizing of 1 column of 1-7/8" diameter circular holes. A 2.5' deep concrete bottom micropool is to be installed within the outlet structure. A removable trash screen of 35" in width will be placed in front of the orifice plate to help prevent the orifice holes from clogging. A



54" RCP outlet, Pipe 23, will convey the facility's restricted release ($Q_5 = 3.22$ cfs, $Q_{100} = 80.70$ cfs) to the adjacent Marksheffel Road ditch, which drains to the existing 24" CMP culvert under Marksheffel Road (DP-26).

A 115' length emergency spillway located at elevation 6579.00 will pass the entire incoming 100-year storm event (353.3 cfs) at a flood depth less than 1.0'. Per the El Paso County Drainage Criteria Manual (DCM), the top of the pond berm shall be 2.0' higher than the flood depth water surface elevation, in this case at 6582.00. This emergency spillway will only be utilized in the case of a complete outlet box failure and will be constructed of riprap rock buried under top soil and re-vegetated. Also, a 15' wide maintenance access road at 12% grade will be installed to the bottom of the facility as per the DCM. By utilizing the Full Spectrum Outlet box design, the release rates are significantly below historic levels. A maximum allowable release rate from this facility can be conservatively calculated as the direct difference between the release rates at M.D.D.P. Design Points 1C & 1X; $Q_5 = 65$ cfs and $Q_{100} = 252$ cfs.

Maintenance of the Public detention/water quality structures is by El Paso County. Aesthetic maintenance of the facility will be by either the home owner's association or Windermere Metropolitan District 1 as is to be determined.

Design Point 26 ($Q_5 = 7.6$ cfs, $Q_{100} = 90.9$ cfs) consists of the total developed runoff to the existing 24" CMP Marksheffel Road culvert crossing from the north-west (proposed facility release and Basin S, 4.52 acres of single family homes and Marksheffel Road ditch). This runoff quantity does not include that from the upstream Marksheffel Road ditch.

Design Point 26 directly correlates with M.D.D.P. DP-1C, which states a maximum flow rate in existing and developed conditions of $Q_5 = 250$ cfs and $Q_{100} = 852$ cfs that crosses under Marksheffel Road. Using a conservative approach by directly adding the M.D.D.P. DP-1X runoff (increased as previously stated) with the quantified DP-26 runoff from the proposed site analysis, a total runoff value can be compared with the M.D.D.P. allowable runoff rate at this culvert crossing of Marksheffel Road. In the proposed developed conditions, the total runoff is $Q_5 = 192.6$ cfs and $Q_{100} = 690.9$ cfs. The proposed development and construction of a large public regional detention/water quality facility releases runoff to downstream



facilities below historic and allowable rates and therefore will not be detrimental to any downstream facilities.

EROSION CONTROL PLAN

Erosion control measures will be installed per the approved grading/erosion control plans and in accordance with the El Paso County Drainage Criteria Manual.

DRAINAGE CRITERIA

Hydrologic calculations were performed using the City of Colorado Springs/El Paso County Drainage Criteria Manual, as revised in November 1991 and October 1994. Stormwater quality analysis and Extended Detention Basin (EDB) design are per the Urban Drainage and Flood Control District Manual and UD-BMP Version 3.01 spreadsheet. The Rational Method was used to estimate stormwater runoff to the proposed inlets, storm sewer pipes, and detention/water quality facilities.

FLOODPLAIN STATEMENT

No portion of this site is located within a floodplain as determined by the Flood Insurance Rate Maps (F.I.R.M.) Map Number 08041C 0543F effective date, March 17, 1997 (See Appendix).

DRAINAGE AND BRIDGE FEES FILING NO. 1

The Windermere development is located in the Sand Creek Basin and consists of a total acreage of 52.068 acres with a total of 201 single family home lots (3.86 DU/Acre). Filing No. 1 will be platted at this time and contains a total of 14.957 acres. The 2014 El Paso County Drainage Fees are \$15,000 per impervious acre and the Bridge Fees are \$4,544 per impervious acre. An impervious value of 4 DU/Acre was applied (38%).

Drainage Fees Filing 1:

\$15,000/acre x 5.684 acres \$ 85,260.00

Bridge Fees Filing 1:

\$4,544/acre x 5.684 acres \$ 25,828.10

TOTALS: **\$ 111,088.10**

Fees or use of existing credits are due prior to plat recordation. Prior to issuance of building permits a plat will need to be recorded and appropriate drainage facility and erosion control assurances will need to be posted.



CONSTRUCTION COST OPINION – WINDERMERE FILING NO. 1

Private Drainage Facilities Non-Reimbursable

ITEM	DESCRIPTION	QUANTITY	UNIT	COST	COST
1.	Retaining Walls in Private Pond (Face foot)	1,789.00	FF	\$ 35	\$ 62,615.00
2.	Geotextile Fabric (Erosion Control) (Under riprap)	192.00	SY	\$ 5	\$ 960.00
3.	Rip Rap, d50 Size from 6" to 24"	192.00	CY	\$ 98	\$ 18,816.00
4.	Detention Facility Construction	1,760.00	CY	\$ 11	\$ 19,360.00
5.	Detention Outlet Structure	1.00	EA	\$18,000	\$ 18,000.00
6.	Detention Emergency Spillway	1.00	EA	\$ 2,000	\$ 2,000.00
SUB TOTAL					\$ 121,751.00
10% ENGINEERING					\$ 12,175.10
5% CONTINGENCIES					\$ 6,087.55
TOTAL					\$ 140,013.65

Public Drainage Facilities Non-Reimbursable

1.	10' Type R Inlet	1 EACH	\$6,680/EA	\$ 6,680.00
2.	15' Type R Inlet	2 EACH	\$7,422/EA	\$ 14,844.00
3.	Grated Inlet	1 EACH	\$3,440/EA	\$ 3,440.00
4.	18" RCP Storm Drain	54 LF	\$53/LF	\$ 2,862.00
5.	24" RCP Storm Drain	1,144 LF	\$58/LF	\$ 66,352.00
6.	30" RCP Storm Drain	44 LF	\$77/LF	\$ 3,388.00
7.	36" RCP Storm Drain	66 LF	\$95/LF	\$ 6,270.00
8.	36" FES	1 EA	\$1,200/EA	\$ 1,200.00
9.	Type I Storm MH (slab)	2 EACH	\$4,575/EA	\$ 9,150.00
10.	Type I Storm MH (box)	1 EACH	\$7,160/EA	\$ 7,160.00
SUB-TOTAL				\$ 121,346.00
10% ENGINEERING				\$ 12,134.60
5% CONTINGENCIES				\$ 6,067.30
TOTAL				\$ 139,547.90

Classic Consulting Engineers & Surveyors cannot and does not guarantee that the construction cost will not vary from these opinions of probable construction costs. These opinions represent our best judgment as design professionals familiar with the construction industry and this development in particular.



SUMMARY

Runoff for the proposed Windermere development is collected in on-site storm sewer systems and routed to two Public Full Spectrum Extended Detention Basin Water Quality facilities. This report describes the final design of the Filing No. 1 storm sewer system and detention/water quality pond. Preliminary design for the storm system and large regional facility at the north end of the site is included in the report. A final drainage report is required with the future Filing 2 & 3 of Windermere that will discuss final design of such facilities. The use of Full Spectrum outlet structures provides a release rate from the proposed facilities much less than historic and therefore the proposed Windermere development does not cause any downstream facility constraints. This report/development is in compliance with the Master Development Drainage Plan for Hilltop Subdivision, the Sand Creek Drainage Basin Planning Study, and the El Paso County Drainage Criteria Manual.

PREPARED BY:

Classic Consulting Engineers & Surveyors, LLC



Matthew Larson
Project Engineer

mal/244100/REPORTS/PDR-FDR-FIL1.doc



REFERENCES

1. City of Colorado Springs/County of El Paso Drainage Criteria Manual dated October 1991.
2. "Sand Creek Drainage Basin Planning Study," Kiowa Engineering Corp, dated March 1996.
3. "Master Development Drainage Plan for Hilltop Subdivision El Paso County, Colorado," by URS Greiner, Inc. prepared November 1, 1996 (last revised February 1998)
4. "Preliminary Drainage Report for Whispering Springs Development and Final Drainage Report for Whispering Springs Filing No. 1," by Rockwell Consulting, Inc. dated August 2013.
5. "Final Drainage Report and Erosion Control for Chateau at Antelope Ridge," by URS, dated December 1998.
6. "Preliminary Drainage Report for Pronghorn Meadows and Final Drainage Report for Pronghorn Meadows Filing No. 1," by URS, dated September 4, 2002.
7. "Final Drainage Report for Pronghorn Meadows Filing 2," by URS, dated July 2004.
8. "Final Drainage Report for Pronghorn Meadows Filing 3," by URS, dated May 2005.
9. 'North Carefree Circle Developed Drainage Basins Map,' by URS, dated February 2003.
10. "Final Drainage Report Marksheffel Road from Constitution Ave. to Dublin Rd.," by CH2M Hill, dated May 2008 and Marksheffel Road Construction Drawings by Wilson & Company.
11. Drainage Criteria Manual (Volume 3) latest revision April 2008, Urban Drainage and Flood Criteria District



APPENDIX

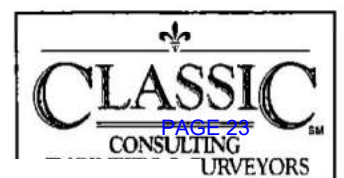

VICINITY MAP

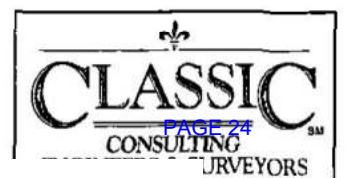

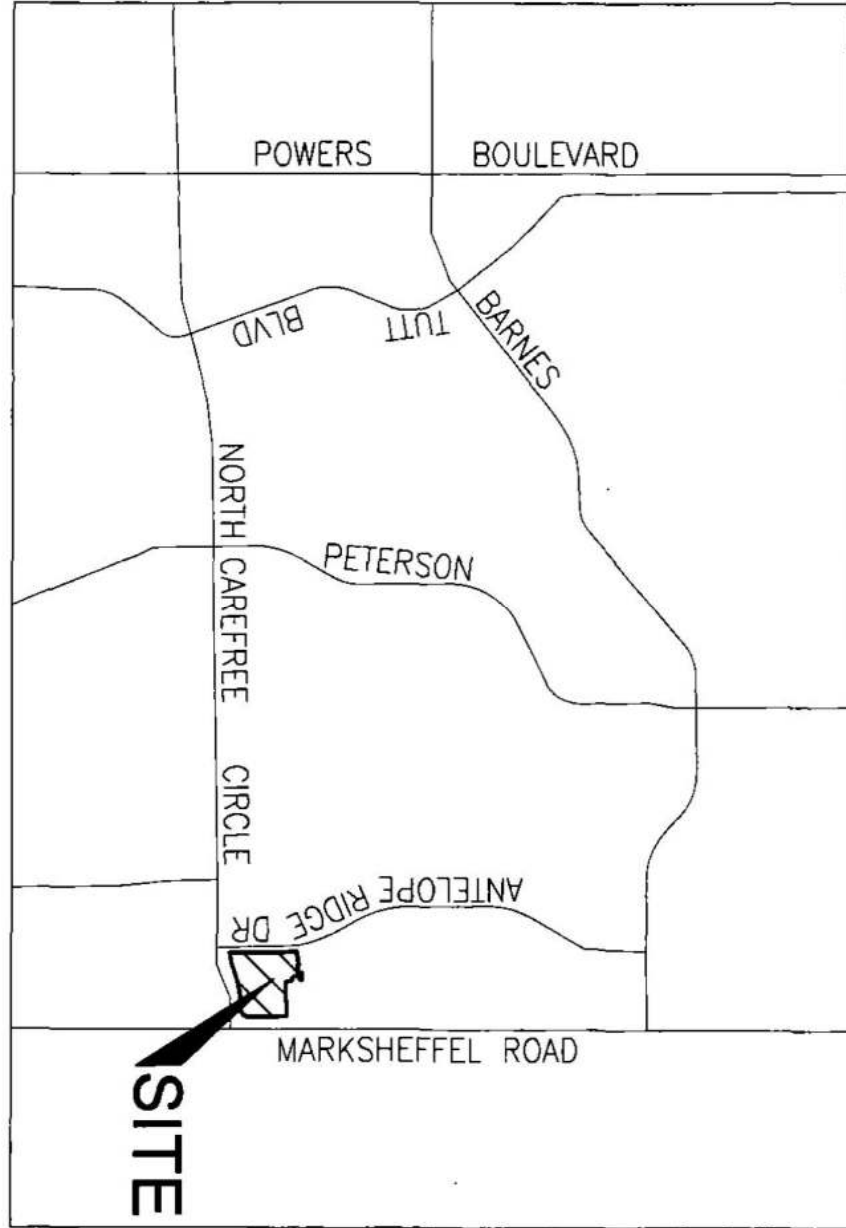

VICINITY MAP
N.T.S.



SOILS MAP (S.C.S SURVEY)

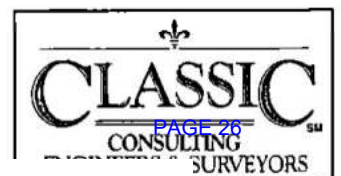

Soil Map—El Paso County Area, Colorado

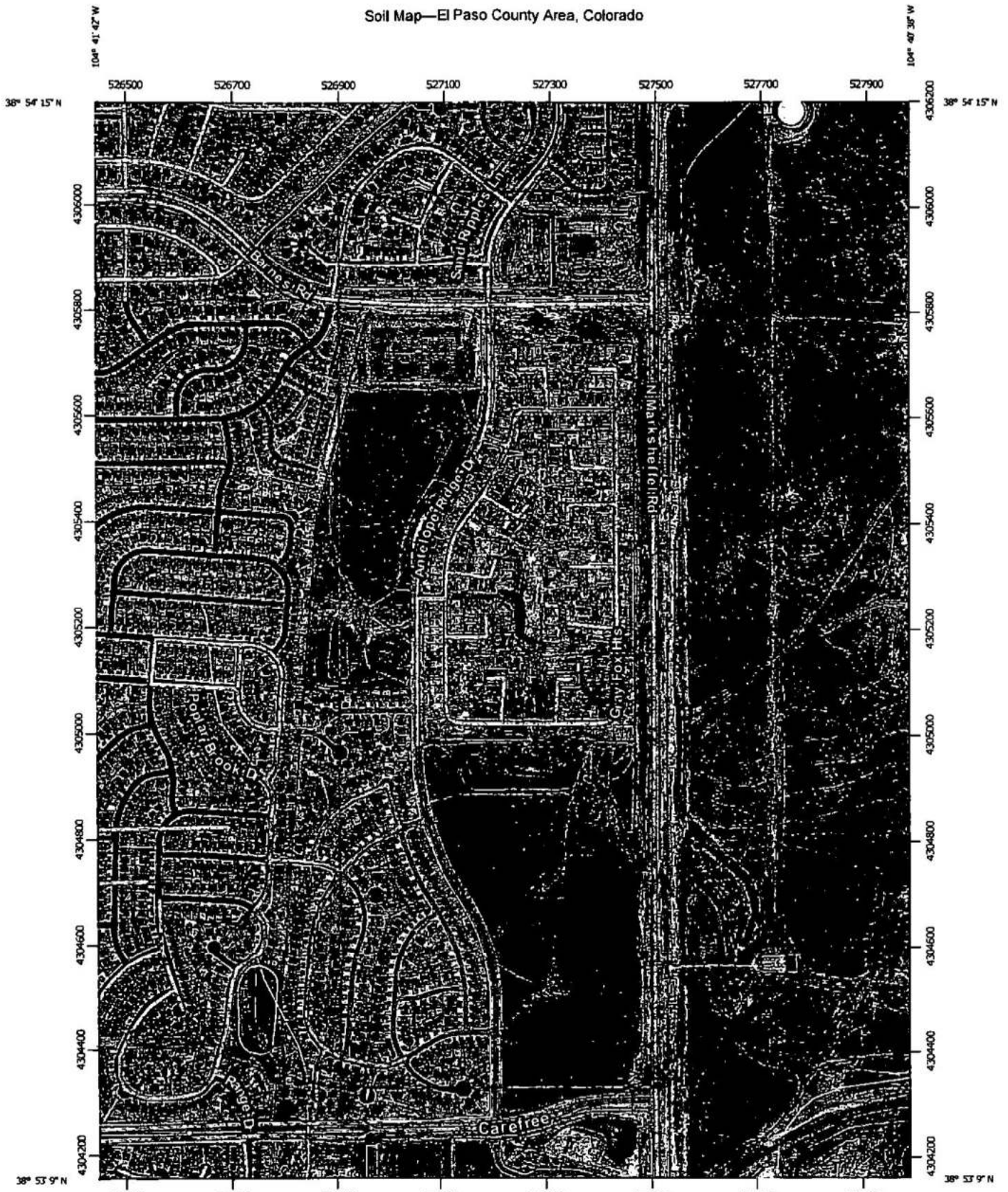

Map Scale: 1:9,950 if printed on A portrait (8.5" x 11") sheet.

0 100 200 400 600 Meters

0 450 900 1800 2700 Feet

Map projection: Web Mercator Corner coordinates: WGS84 Edge tics: UTM Zone 13N WGS84

MAP LEGEND

	Area of Interest (AOI)		Spoil Area
	Area of Interest (AOI)		Stony Spot
	Soil Map Unit Polygons		Very Stony Spot
	Soil Map Unit Lines		Wet Spot
	Soil Map Unit Points		Other
	Special Point Features		Special Line Features
	Blowout		Water Features
	Borrow Pit		Streams and Canals
	Clay Spot		Transportation
	Closed Depression		Interstate Highways
	Gravel Pit		US Routes
	Gravelly Spot		Major Roads
	Landfill		Local Roads
	Lava Flow		Background
	Marsh or swamp		Aerial Photography
	Mine or Quarry		
	Miscellaneous Water		
	Perennial Water		
	Rock Outcrop		
	Saline Spot		
	Sandy Spot		
	Severely Eroded Spot		
	Sinkhole		
	Slide or Slip		
	Sodic Spot		

MAP INFORMATION

The soil surveys that comprise your AOI were mapped at 1:24,000.
Warning: Soil Map may not be valid at this scale.
 Enlargement of maps beyond the scale of mapping can cause misunderstanding of the detail of mapping and accuracy of soil line placement. The maps do not show the small areas of contrasting soils that could have been shown at a more detailed scale.

Please rely on the bar scale on each map sheet for map measurements.

Source of Map: Natural Resources Conservation Service
 Web Soil Survey URL: <http://websoilsurvey.nrcs.usda.gov>
 Coordinate System: Web Mercator (EPSG:3857)

Maps from the Web Soil Survey are based on the Web Mercator projection, which preserves direction and shape but distorts distance and area. A projection that preserves area, such as the Albers equal-area conic projection, should be used if more accurate calculations of distance or area are required.

This product is generated from the USDA-NRCS certified data as of the version date(s) listed below.

Soil Survey Area: El Paso County Area, Colorado
 Survey Area Data: Version 10, Dec 23, 2013

Soil map units are labeled (as space allows) for map scales 1:50,000 or larger.

Date(s) aerial images were photographed: Apr 15, 2011—Sep 22, 2011

The orthophoto or other base map on which the soil lines were compiled and digitized probably differs from the background imagery displayed on these maps. As a result, some minor shifting of map unit boundaries may be evident.

Map Unit Legend

El Paso County Area, Colorado (CO625)			
Map Unit Symbol	Map Unit Name	Acres In AOI	Percent of AOI
97	Truckton sandy loam, 3 to 9 percent slopes	261.8	100.0%
Totals for Area of Interest		261.8	100.0%

F.E.M.A. MAP

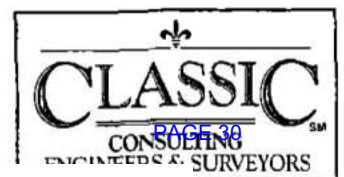

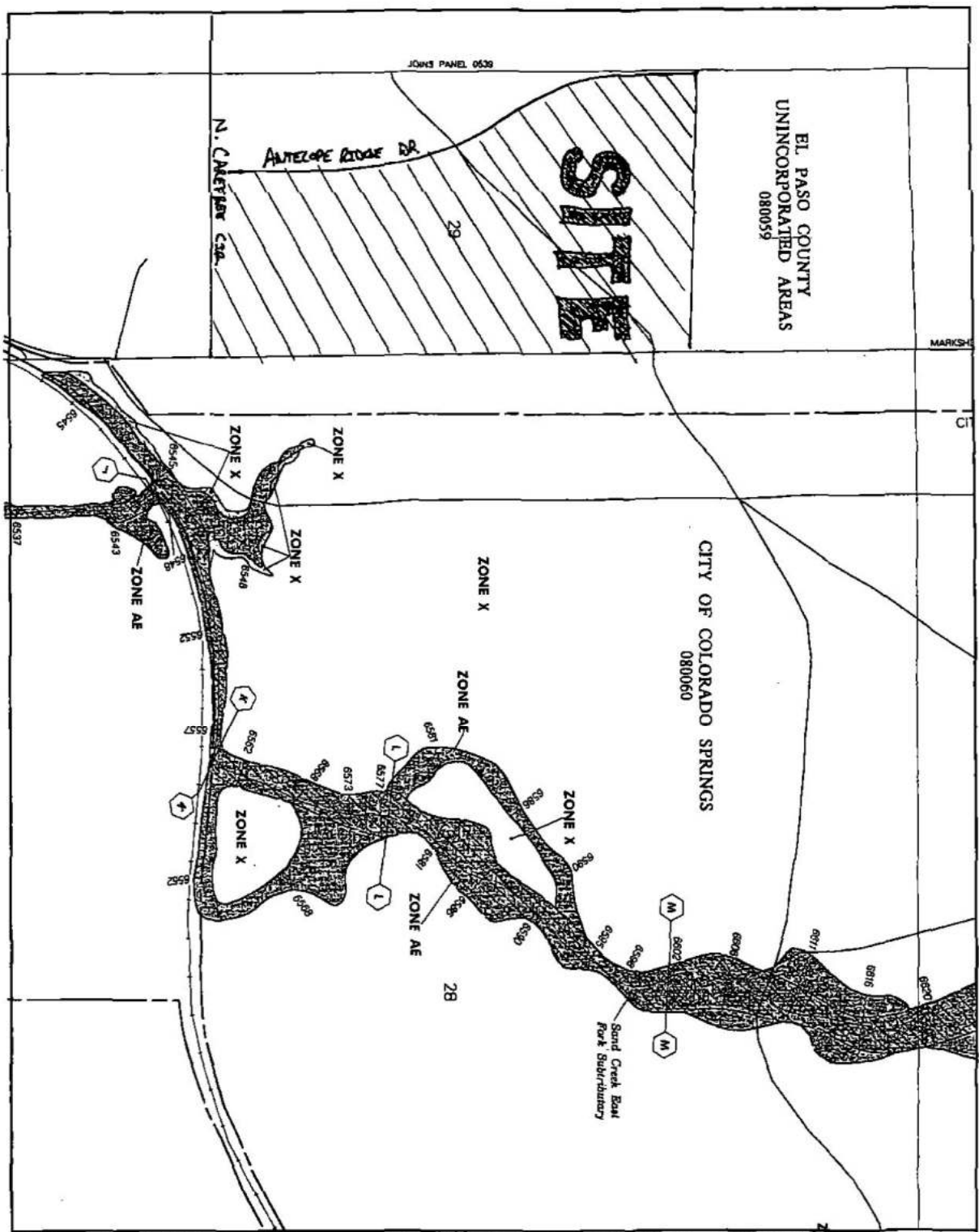

EL PASO COUNTY
UNINCORPORATED AREAS
080059

CITY OF COLORADO SPRINGS
080060

SITE



NATIONAL FLOOD INSURANCE PROGRAM

FIRM
FLOOD INSURANCE RATE MAP
EL PASO COUNTY,
COLORADO AND
INCORPORATED AREAS

PANEL 5A3 OF 1300
(SEE MAP INDEX FOR PANELS NOT PRINTED)

CONTACTS

COMMUNITY	NUMBER	EMAIL	SERVER
COLORADO SPRINGS, CO	8000	SAO	F
EL PASO COUNTY, UNINCORPORATED AREAS	8000	SAO	F

MAP NUMBER
0804105A3 F
EFFECTIVE DATE:
MARCH 17, 1997

Federal Emergency Management Agency



This is an official copy of a product of the above referenced firm only. It is not to be used for any other purpose. The Federal Emergency Management Agency and its contractors shall not be held responsible for any errors or omissions in this product. For the latest product information, contact the National Flood Insurance Program, Federal Emergency Management Agency, 1200 K Street, NW, Washington, DC 20543.

REFERENCE MATERIAL FROM ADJACENT STUDIES

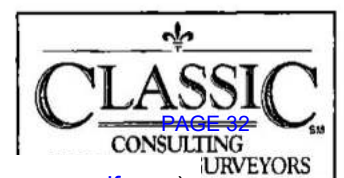

LEGEND

- - - - - CHANNEL/SWALE
- - - - - STORM SEWER
- BASH BOUNDARY
- | |
|---------|
| 0-5 |
| 200 200 |

 BASH No.
 by HISTORIC 100y HISTORIC
 by DEVELOPED 100y DEVELOPED
- | |
|---------|
| 5 |
| 100 100 |
| 200 200 |

 BASH No.
 by HISTORIC 100y HISTORIC
 by DEVELOPED 100y DEVELOPED
- | |
|---------|
| A |
| 100 100 |
| 200 200 |

 DESIGN PT
 by HISTORIC 100y HISTORIC
 by DEVELOPED 100y DEVELOPED
- | |
|---|
| — |
| — |

 EXISTING CULVERT
 PROPOSED CULVERT

SPRINGS RANCH

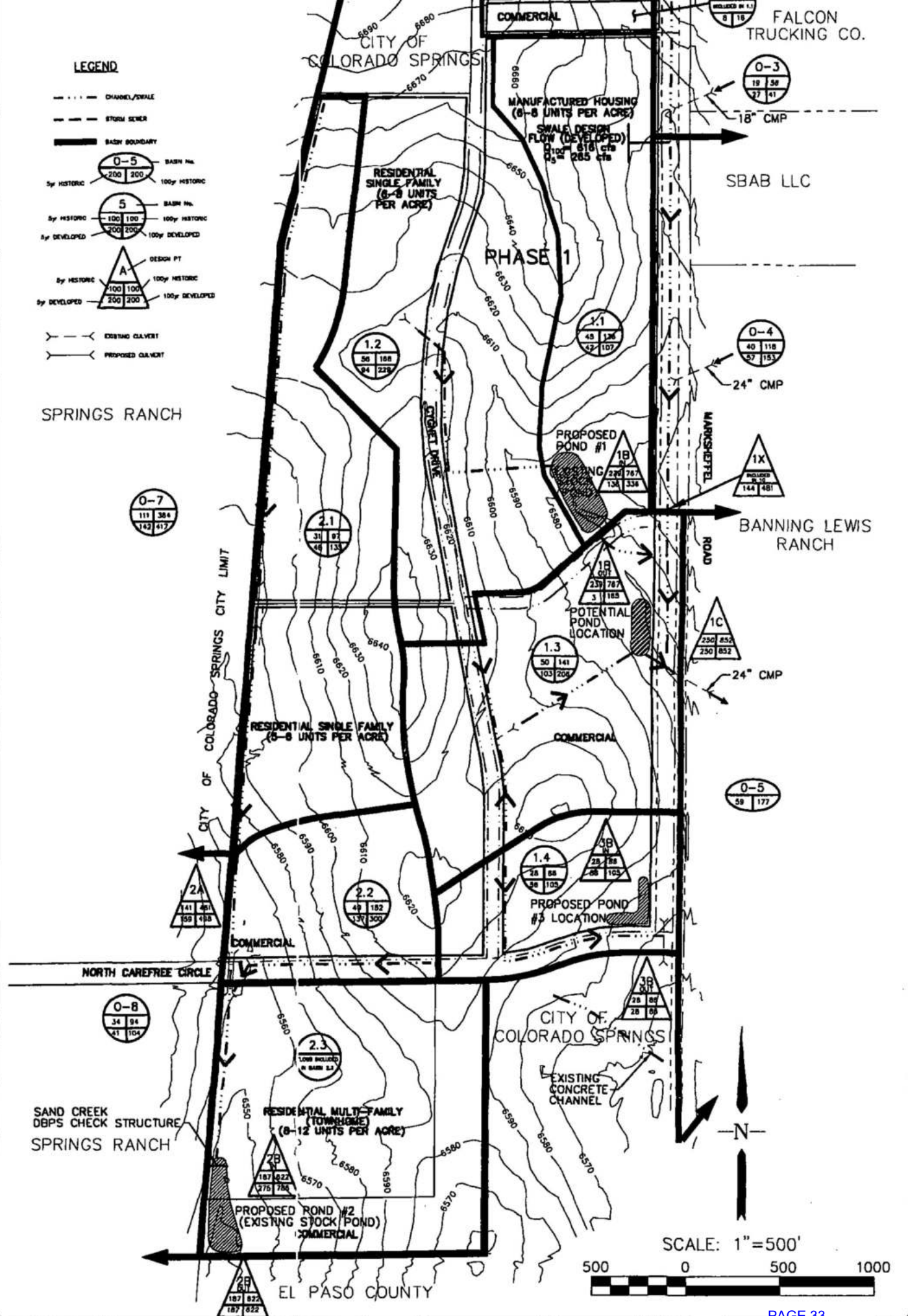

PRONGHORN MEADOWS DEVELOPED BASINS

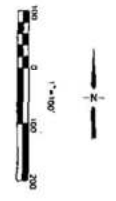

BASIN NO.	BASIN NAME	SURFACE FLOW		DIRT ELEV.	
		CONCENTRIC (sq ft)	PERCENTAGE	CONCENTRIC (sq ft)	PERCENTAGE
1	1-1	12	24	5	11
2	2-1	3	6	13	19
3	3-1	8	16	4	8
4	4-1	4	8	1	2
5	5-1	11	22	11	22
6	6-1	9	18	11	22
7	7-1	13	26	18	36
8	8-1	13	26	18	36
9	9-1	18	36	22	44

LEGEND

- PROPOSED CONTOURS
- DEVELOPED BASINS
- TOP LINE
- DIRECTION OF FLOW
- SHALLICE BASIN

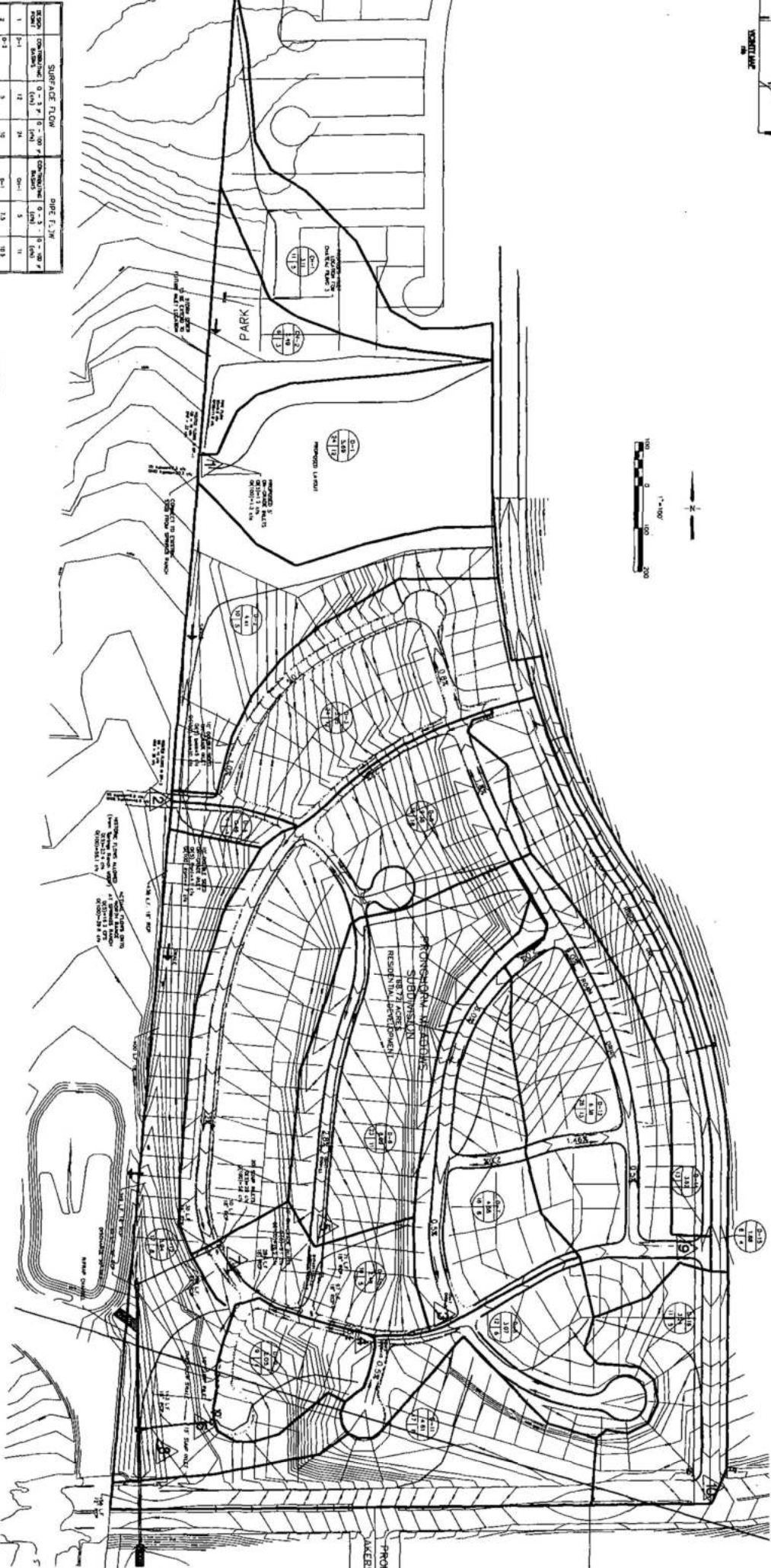

NO.	REVISION	DATE	BY	CHKD.

DESIGNED BY: [Name]	DATE: 5/1/02
DRAWN BY: [Name]	DATE: 3/1/02
CHECKED BY: [Name]	DATE: 3/27/02
SCALE: AS SHOWN	

PROJECT: PRONGHORN MEADOWS	SHEET: 111 OF 111
CLEAR: 1/1/02	JOB NO. 1333

NORTH CAREFREE CIRCLE DEVELOPED DRAINAGE BASINS

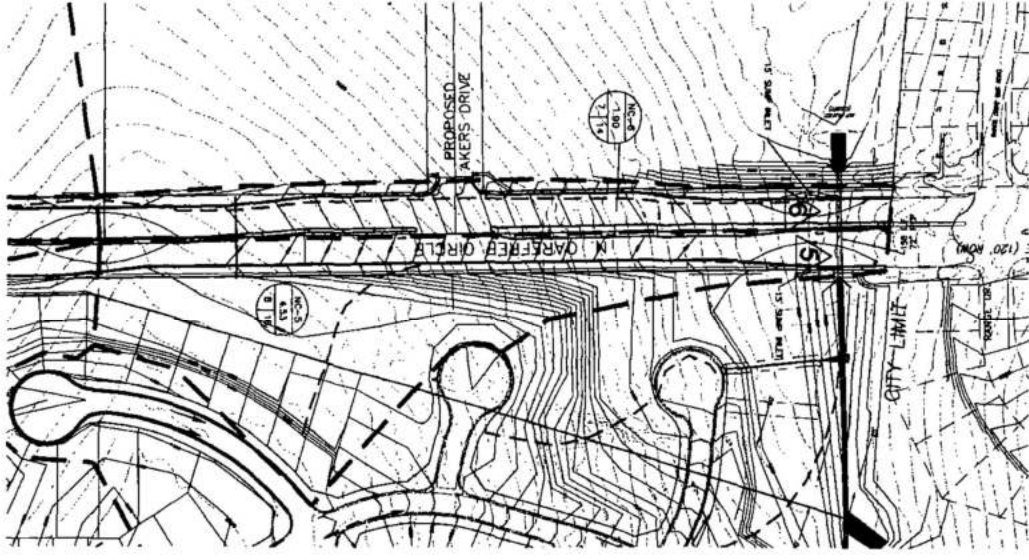
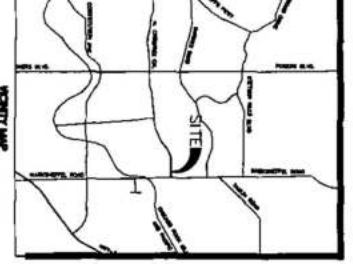

DESIGN POINT	CONTRIBUTING BASINS	SURFACE FLOW	
		0 - 5' F (in)	0 - 100' F (in)
1	DC-1B	7	14
2	DC-1B-1	22	48
3	DC-1B-2	27	57
4	DC-1B-3	28	60
5	DC-3	8	16
6	DC-4	7	14

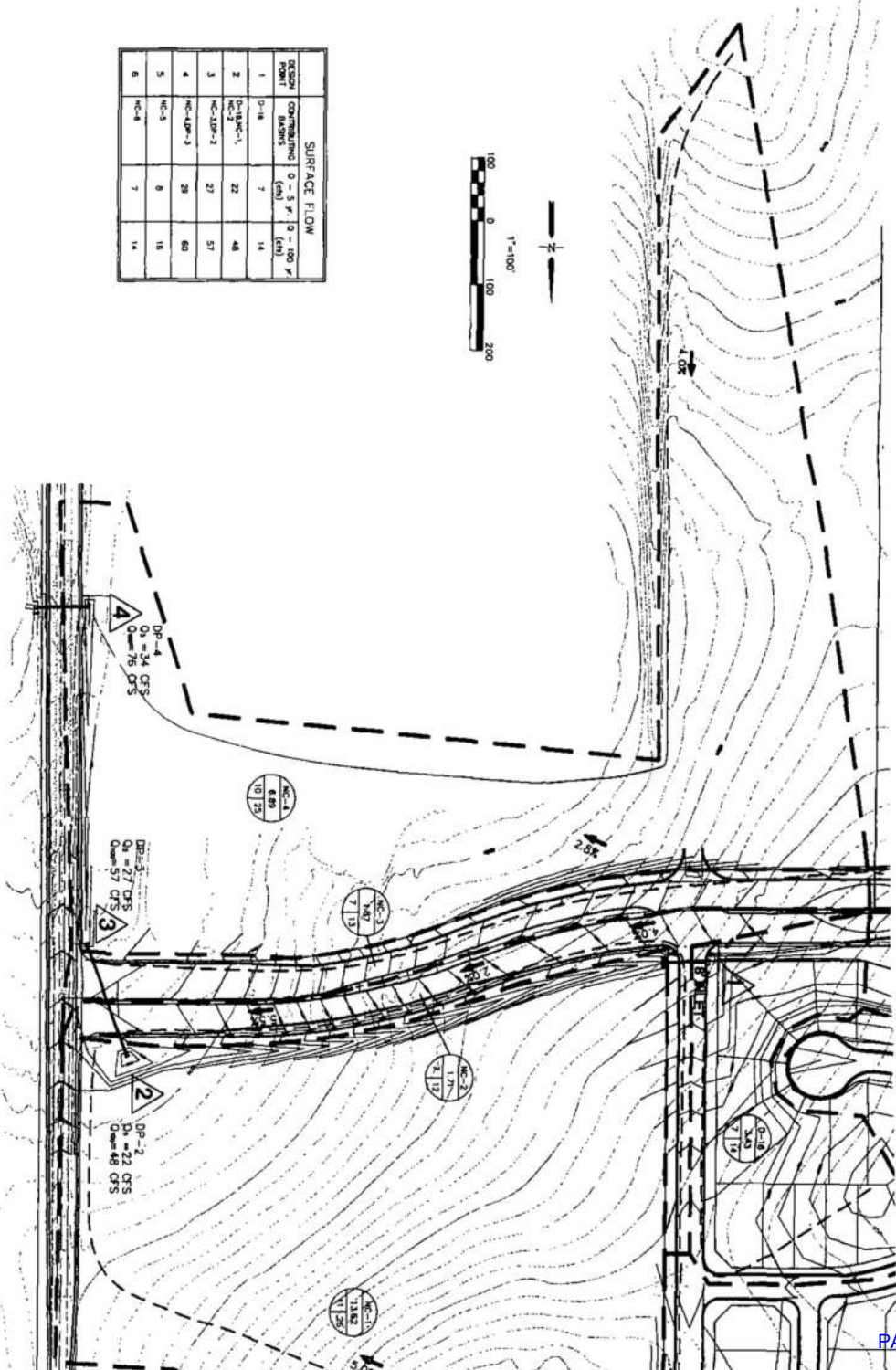
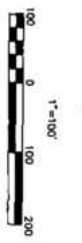

- LEGEND**
- PROPOSED CONTOURS
 - DEVELOPED BASINS
 - TOC LINE
 - DIRECTION OF FLOW
 - DRAINAGE BASIN AREA - 11.82
 - DESIGN POINT
 - DESIGN POINT DESIGNATION
 - 0 - 5' - 1R
 - 0 - 100' - 1R

NO.	REVISIONS	DESCRIPTION	DATE

ENGINEER	DATE
DESIGNED BY: DC	2/22/03
DRAWN BY: DC	2/13/03
CHECKED BY: CAC	2/14/03

48 HOURS BEFORE YOU DIG
CALL UTILITY LOCATORS
1-800-972-1987
(EXT. CODE 154) OF STATE DEPARTMENT

MATCH LINE STA 298+00

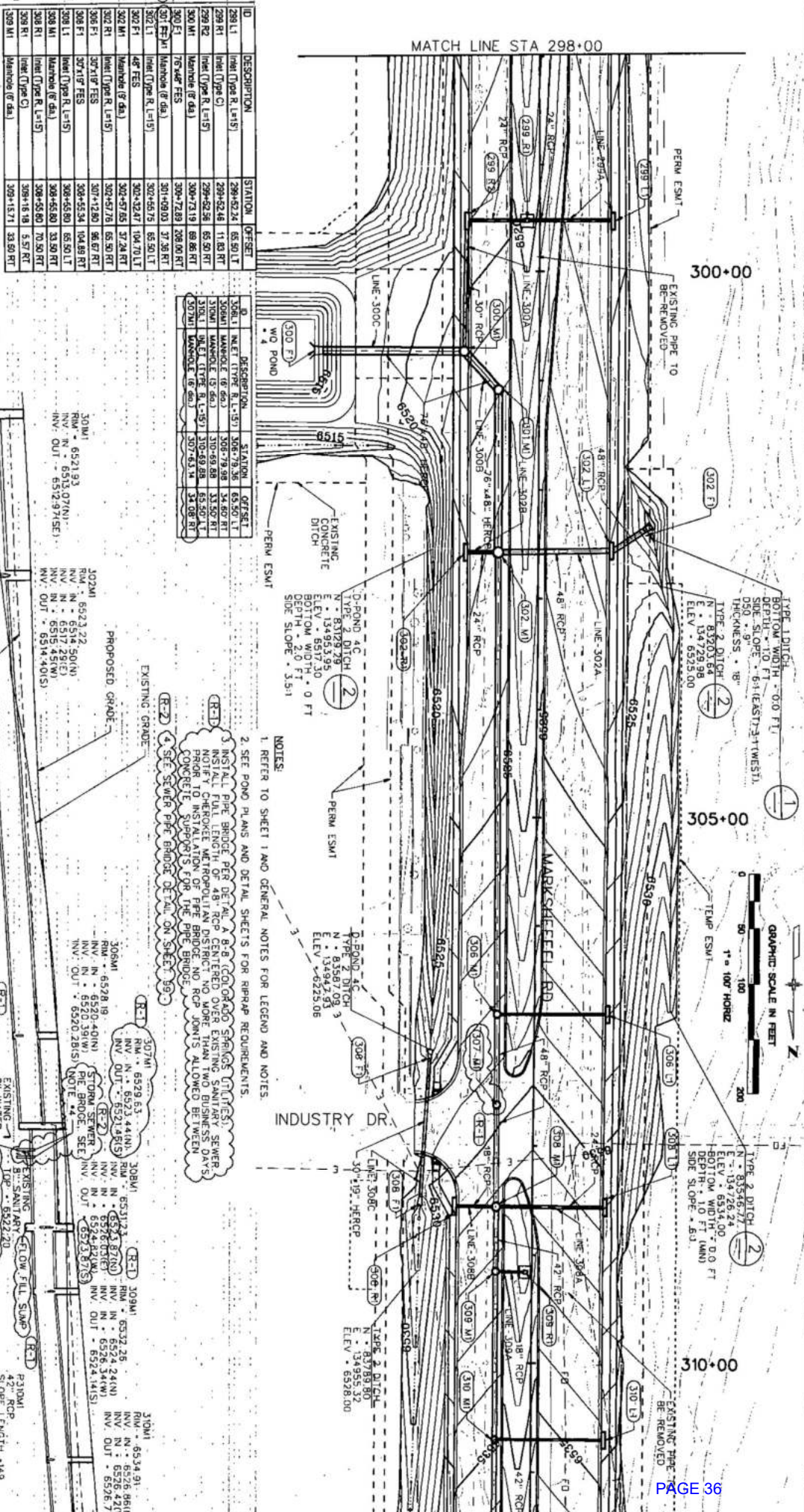

ID	DESCRIPTION	STATION	OFFSET	D	DESCRIPTION	STATION	OFFSET
298 L1	Manhole (R, L=15)	298+42.24	65.50 LT	308 L1	Manhole (R, L=15)	308+79.36	65.50 LT
299 R1	Manhole (R, L=15)	299+52.46	11.83 RT	309 M1	Manhole (S, dia)	310+69.89	53.50 RT
299 R2	Manhole (R, L=15)	299+52.26	65.50 RT	309 M2	Manhole (S, dia)	310+69.89	65.50 LT
300 M1	Manhole (R, L=15)	300+73.19	69.86 RT	310 M1	Manhole (S, dia)	307+63.14	34.08 RT
300 M2	Manhole (R, L=15)	300+72.89	208.00 RT	310 M2	Manhole (S, dia)	307+63.14	34.08 RT
301 ESM1	Manhole (R, L=15)	301+69.03	37.36 RT	310 ESM1	Manhole (R, L=15)	302+46.75	65.50 LT
302 L1	Manhole (R, L=15)	302+42.27	104.71 LT	302 F1	48" FES	302+42.27	104.71 LT
302 M1	Manhole (R, L=15)	302+47.25	37.26 RT	302 M1	Manhole (R, L=15)	302+47.25	37.26 RT
306 F1	307" FES	307+12.80	96.67 RT	306 F1	307" FES	307+12.80	96.67 RT
306 F2	307" FES	306+55.34	104.86 RT	306 F2	307" FES	306+55.34	104.86 RT
308 M1	Manhole (R, L=15)	308+45.80	65.50 LT	308 M1	Manhole (R, L=15)	308+45.80	65.50 LT
308 M2	Manhole (R, L=15)	308+45.80	70.50 RT	308 M2	Manhole (R, L=15)	308+45.80	70.50 RT
309 M1	Manhole (R, L=15)	309+16.19	5.57 RT	309 M1	Manhole (R, L=15)	309+16.19	5.57 RT
309 M2	Manhole (R, L=15)	309+15.71	33.60 RT	309 M2	Manhole (R, L=15)	309+15.71	33.60 RT

ID	DESCRIPTION	STATION	OFFSET
308 L1	Manhole (R, L=15)	308+79.36	65.50 LT
309 M1	Manhole (S, dia)	310+69.89	53.50 RT
309 M2	Manhole (S, dia)	310+69.89	65.50 LT
310 M1	Manhole (S, dia)	307+63.14	34.08 RT
310 M2	Manhole (S, dia)	307+63.14	34.08 RT

NOTES:
 1. REFER TO SHEET 1 AND GENERAL NOTES FOR LEGEND AND NOTES.
 2. SET POND PLANS AND DETAIL SHEETS FOR RR/RP REQUIREMENTS.
 3. INSTALL PIPE BRIDGE PER DETAIL 8-8 (CONCRETE SPRING JUNCTION).
 4. INSTALL FULL LENGTH OF 48" RCP CENTERED OVER EXISTING SANITARY SEWER.
 5. NOTIFY CHEMOKET METROPOLITAN DISTRICT NO MORE THAN TWO BUSINESS DAYS BEFORE INSTALLATION OF THE PIPE BRIDGE.
 6. RCP JOINTS ALLOWED BETWEEN CONCRETE INSTALLATIONS FOR THE PIPE BRIDGE.

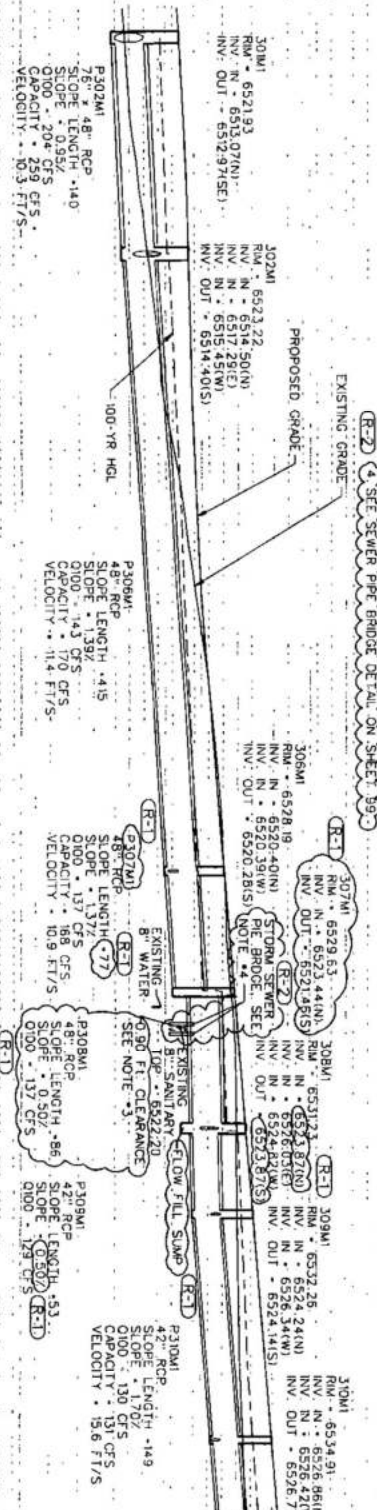

Computer File Information

Revision Date: 10/23/2007
 Initials: LMS
 Print Date: 08/25/2009
 Includes: ADH
 Name: dr.pdp4.dgn

Sheet Revisions

Date:	Comments	Int.
3/15/2011	Add 307M1 & Pipe Raise	CCS
4/8/2011	Add Storm Sewer Pipe Bridge	GMH
1/7/2011	Revised ID Table	GMH

EL PASO COUNTY

COURTROOM

WILSON & COMPANY

Engineers & Architects

3700 Main Building North
 El Paso, Texas 79906
 Phone: 719-628-8718
 Fax: 719-628-8718

As Constructed

No Revisions:
 Revised: GMH 12-2-11

Worksheet Road

Drainage Plan and Profile

Designer: CCS
 Checker: ADH
 Detailer: ADH

Structure Numbers

Sheet Subset: Drainage

Sheet Subset: 7 of 14

Proj

NOTES:
1. REFER TO SHEET 1 AND GENERAL NOTES FOR LEGEND AND NOTES.

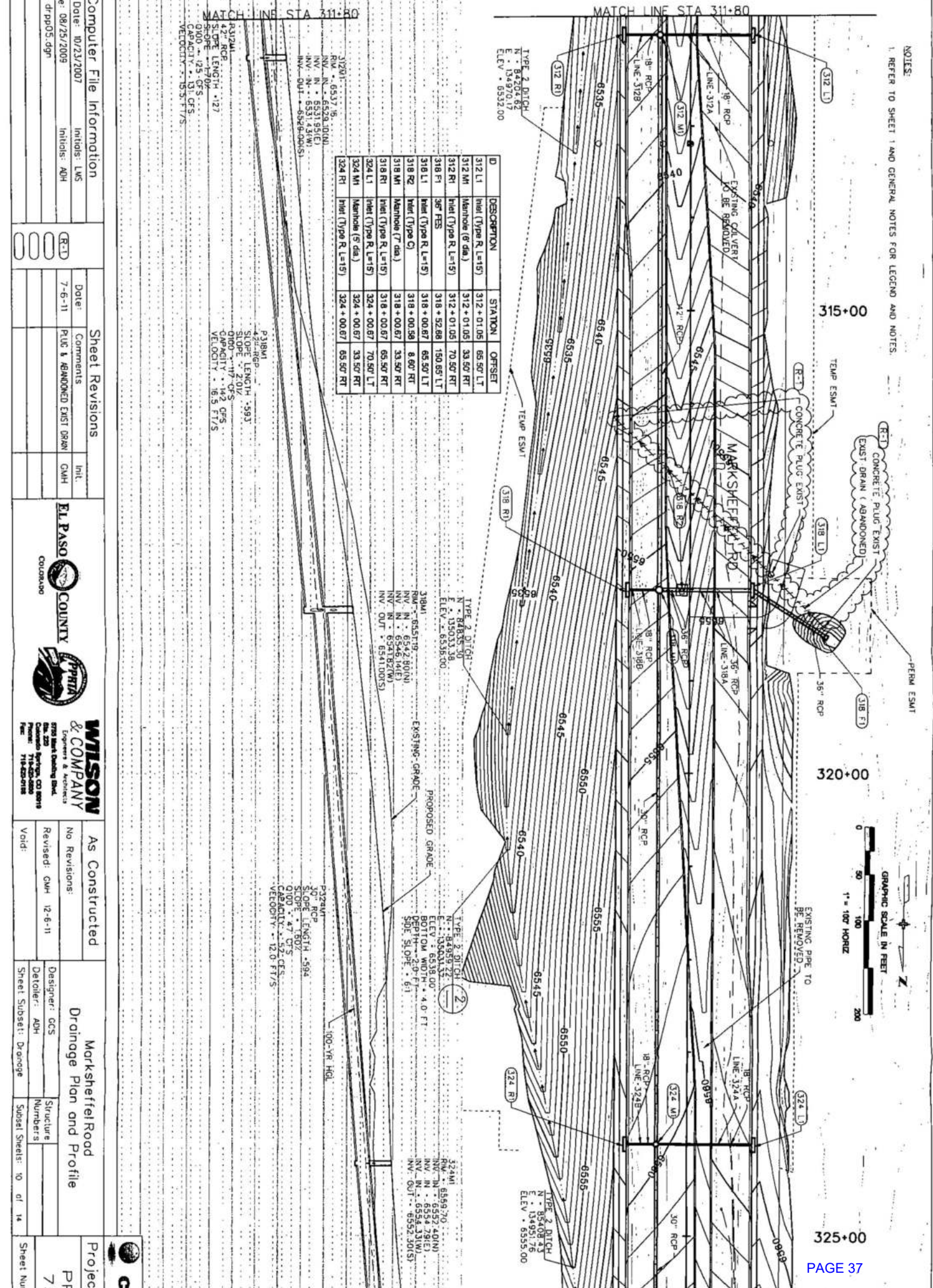
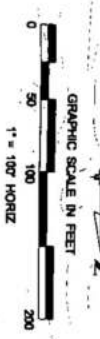

ID	DESCRIPTION	STATION	OFFSET
312 L1	Inlet (Type R, L=15)	312 + 01.05	65.50' LT
312 M1	Manhole (6' dia.)	312 + 01.05	33.50' RT
312 R1	Inlet (Type R, L=15)	312 + 01.05	70.50' RT
318 F1	36" FESS	318 + 52.88	150.65' LT
318 L1	Inlet (Type R, L=15)	318 + 00.67	65.50' LT
318 R2	Inlet (Type C)	318 + 00.58	8.60' RT
318 M1	Manhole (7' dia.)	318 + 00.67	33.50' RT
318 R1	Inlet (Type R, L=15)	318 + 00.67	65.50' RT
324 L1	Inlet (Type R, L=15)	324 + 00.67	70.50' LT
324 M1	Manhole (6' dia.)	324 + 00.67	33.50' RT
324 R1	Inlet (Type R, L=15)	324 + 00.67	65.50' RT

312M1
RW - 6533.15
INV. IN - 6533.10(N)
INV. IN - 6531.99(E)
INV. IN - 6531.43(W)
INV. OUT - 6529.00(S)

TYPE 2 DITCH
N - 6483.50
E - 135033.38
ELEV - 6538.50

TYPE 2 DITCH
N - 6483.50
E - 135033.38
ELEV - 6538.50

TYPE 2 DITCH
N - 65408.43
E - 134951.76
ELEV - 6555.00

312M1
RW - 6533.15
INV. IN - 6533.10(N)
INV. IN - 6531.99(E)
INV. IN - 6531.43(W)
INV. OUT - 6529.00(S)

P222M
SLOPE LENGTH - 593
SLOPE - 2.01V
Q100 - 117 CFS
Q100 - 117 CFS
CAPACITY - 16.5 F7/S
VELOCITY - 16.5 F7/S

P222M
SLOPE LENGTH - 594
SLOPE - 1.80V
Q100 - 47 CFS
Q100 - 47 CFS
CAPACITY - 52 CFS
VELOCITY - 12.0 F7/S

Computer File Information
Job Date: 10/23/2007
Date: 08/25/2009
Name: drp05.dgn

Sheet Revisions
Date: 7-6-11
Comments: PUC 1 ABANDONED EXIST DRAIN
Init: CMH



WILSON & COMPANY
Engineers & Architects
5700 Lake Dabney Blvd.
The 220 Building, 200 West
Colorado Avenue, Suite
1100-Denver, CO 80202
Tel: 303.733.4444

As Constructed
No Revisions:
Revised: CMH 12-6-11
Void:

Marksheffel Road
Drainage Plan and Profile
Designer: CCS
Detailer: ADH
Structure Numbers
Subset Sheets: 10 of 14

Projec
Pf
7

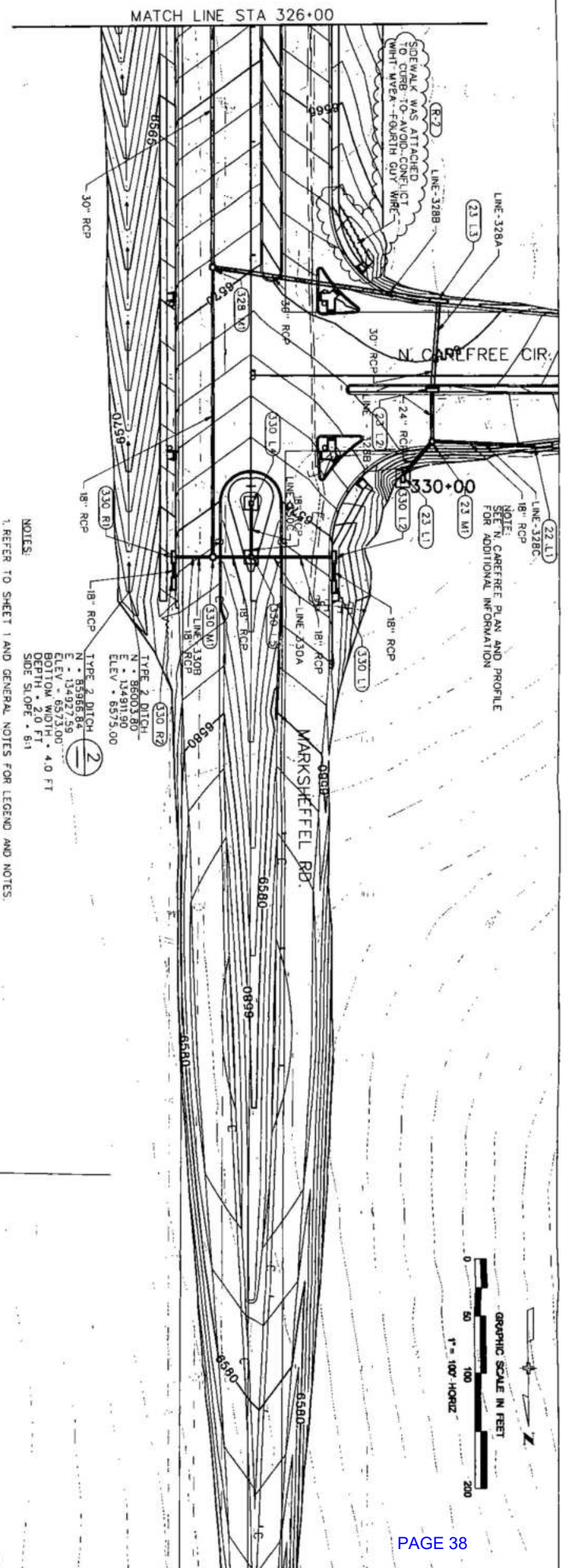

NOTES:
 1. REFER TO SHEET 1 AND GENERAL NOTES FOR LEGEND AND NOTES.

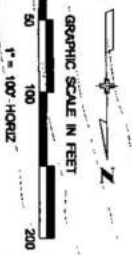

ID	DESCRIPTION	STATION	OFFSET
22 L1	Manhole (Type R, L=15)	22+25.23	57.79' LT
23 M1	Manhole (4' dia)	23+21.64	57.00' LT
23 L1	Manhole (Type D)	23+47.10	89.22' LT
23 L2	Manhole (Type R, L=10)	23+21.64	15.00' LT
23 L3	Manhole (Type R, L=15)	23+16.06	62.23' FT
328 M1	Manhole (6' dia)	325+10.74	33.50' FT
330 L1	Manhole (Type R, L=10)	330+87.57	70.50' LT
330 L2	Manhole (Type R, L=10)	330+62.07	70.50' LT
330 L3	Manhole (Type R, L=10)	330+62.12	0.26' LT
330 L4	Manhole (6' dia)	330+62.07	33.50' FT
330 R1	Manhole (6' dia)	330+62.07	33.50' FT
330 R2	Manhole (Type R, L=10)	330+65.07	65.50' FT

PROPOSED GRADE

228M1
 INV. IN. = 6560.81(N)
 INV. OUT. = 6559.41(S)

330M1
 INV. IN. = 6578.23
 INV. N. = 6578.81(E)
 INV. S. = 6568.61(W)
 INV. OUT. = 6568.51(S)

EXISTING GRADE

P328M1
 30" RCP
 SLOPE LENGTH = 405
 SLOPE = 3.23%
 O.D. = 38 CFS
 CAPACITY = 54 CFS
 VELOCITY = 11.9 FT/S

P330M1
 18" RCP
 SLOPE LENGTH = 246
 SLOPE = 3.23%
 O.D. = 14 CFS
 CAPACITY = 17 FT/S
 VELOCITY = 11.7 FT/S

MATCH LINE STA 326+00

MATCH LINE STA 326+00

Computer File Information

Creation Date: 10/23/2007
 Initials: SMK
 Date: 10/3/11
 Name: drpp06.dgn

Sheet Revisions

Date	Comments	Int.
3/25/10	Addendum 4	CCS
10/3/11	MOVED SIDEWALK	GMH

EL PASO COUNTY



WILSON & COMPANY

7700 Ross Building Blvd.
 El Paso, Texas, 79905
 Phone: 754-200-0100
 Fax: 754-200-0100

As Constructed

No Revisions:
 Revised: GMH 12-6-11
 Void:

Drainage Plan and Profile

Designer: CCS
 Checker: GMH
 Sheet Subst: Drainage

Proj

Structure Numbers
 Sheet 12 of 14

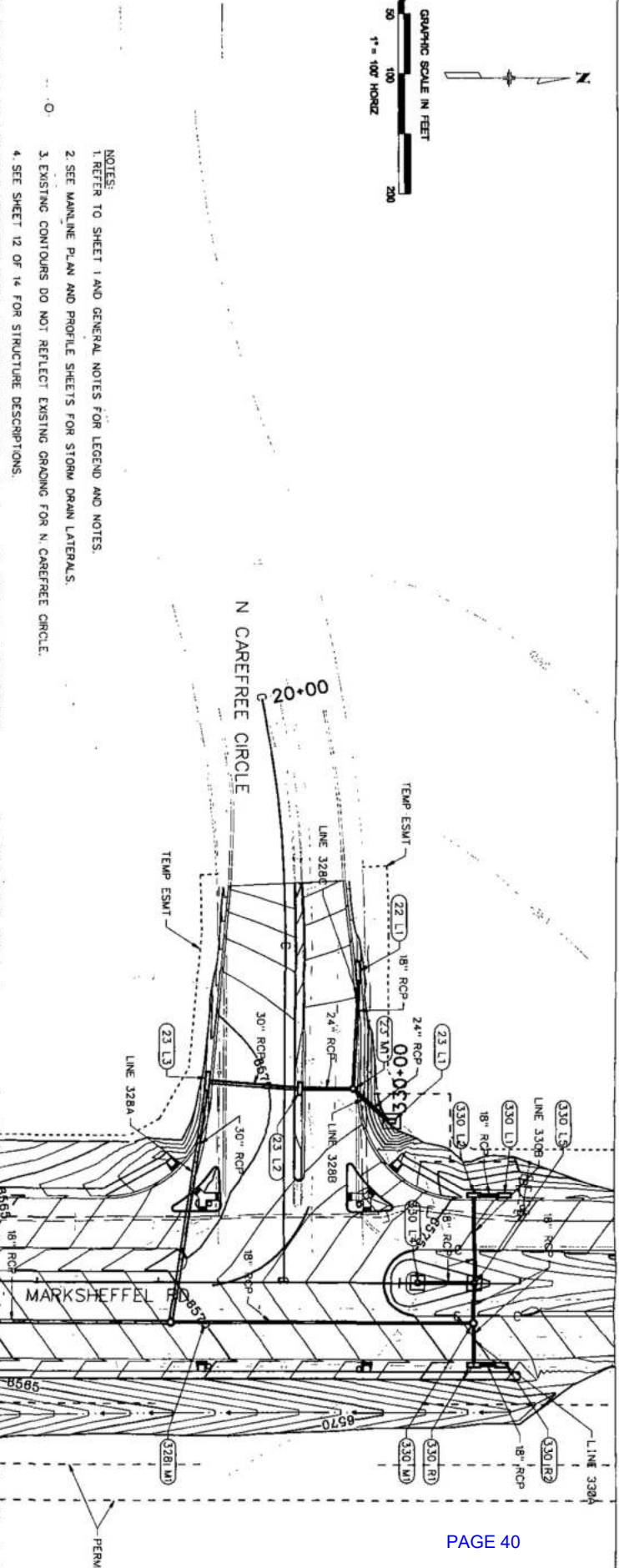
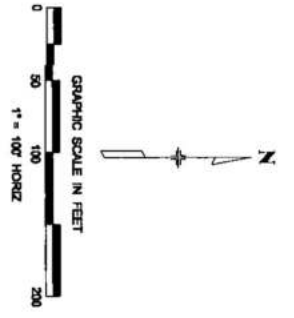

- NOTES:
1. REFER TO SHEET 1 AND GENERAL NOTES FOR LEGEND AND NOTES.
 2. SEE MAINLINE PLAN AND PROFILE SHEETS FOR STORM DRAIN LATERALS.
 3. EXISTING CONTOURS DO NOT REFLECT EXISTING GRADING FOR N. CAREFREE CIRCLE.
 4. SEE SHEET 12 OF 14 FOR STRUCTURE DESCRIPTIONS.

Computer File Information		Date:		As Constructed		Marksheffel Road Drainage Plan and Profile N. Carefree		Pro	
Creation Date: 02/06/2008	Initials: ADH	Date: 08/25/2009		MG Revisions: QM 12-12-11		Designer: GCS		Structure	
1st Date: 08/25/2009	Initials: ADH	Name: drpp17.dgn		Revised:		Detailer: ADH		Number's	
				Void:		Sheet Subset: Drainage		Sheet	
Sheet Revisions		Comments		Initials		Sheet Subsets: 14		of 14	



WILSON & COMPANY
Engineers & Architects
5700 Main Building Blvd.
Box 200 Springdale, CO 80781
Phone: 714-420-4118
Fax: 714-420-4118

TEMPORARY DETENTION POND CHATEAU AT ANTELOPE RIDGE

URS **Ernst Woodburn**
 DRAWN BY: [unclear]
 DATE: 09/03/07
 PROJ. NO.: 074311
 SHEET 11 OF 17

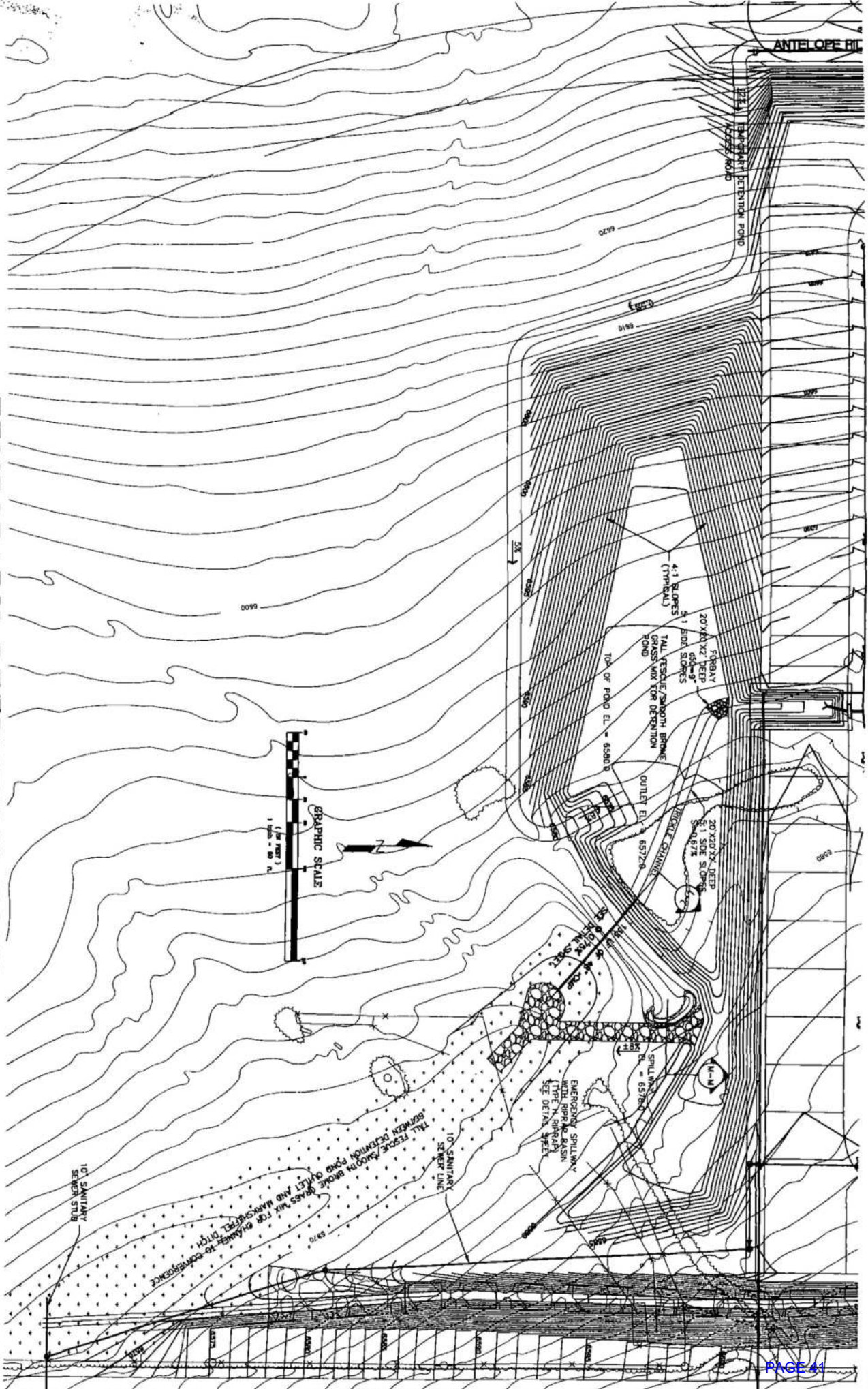

- ▲ = BASH EXISTENT - HISTORIC
- ▲ = 484.14 ACRES
- ▲ = 6000 SQ FT
- DIRECTION OF FLOW
- HISTORIC BASH BOUNDARY LINE
- - - DEVELOPING BASH BOUNDARY LINE
- - - BASH EXISTENT - DEVELOPER
- - - 4.2' - 484.14 ACRES
- PAVED LAKE

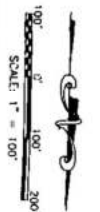
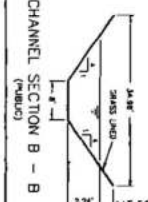
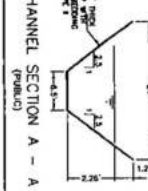
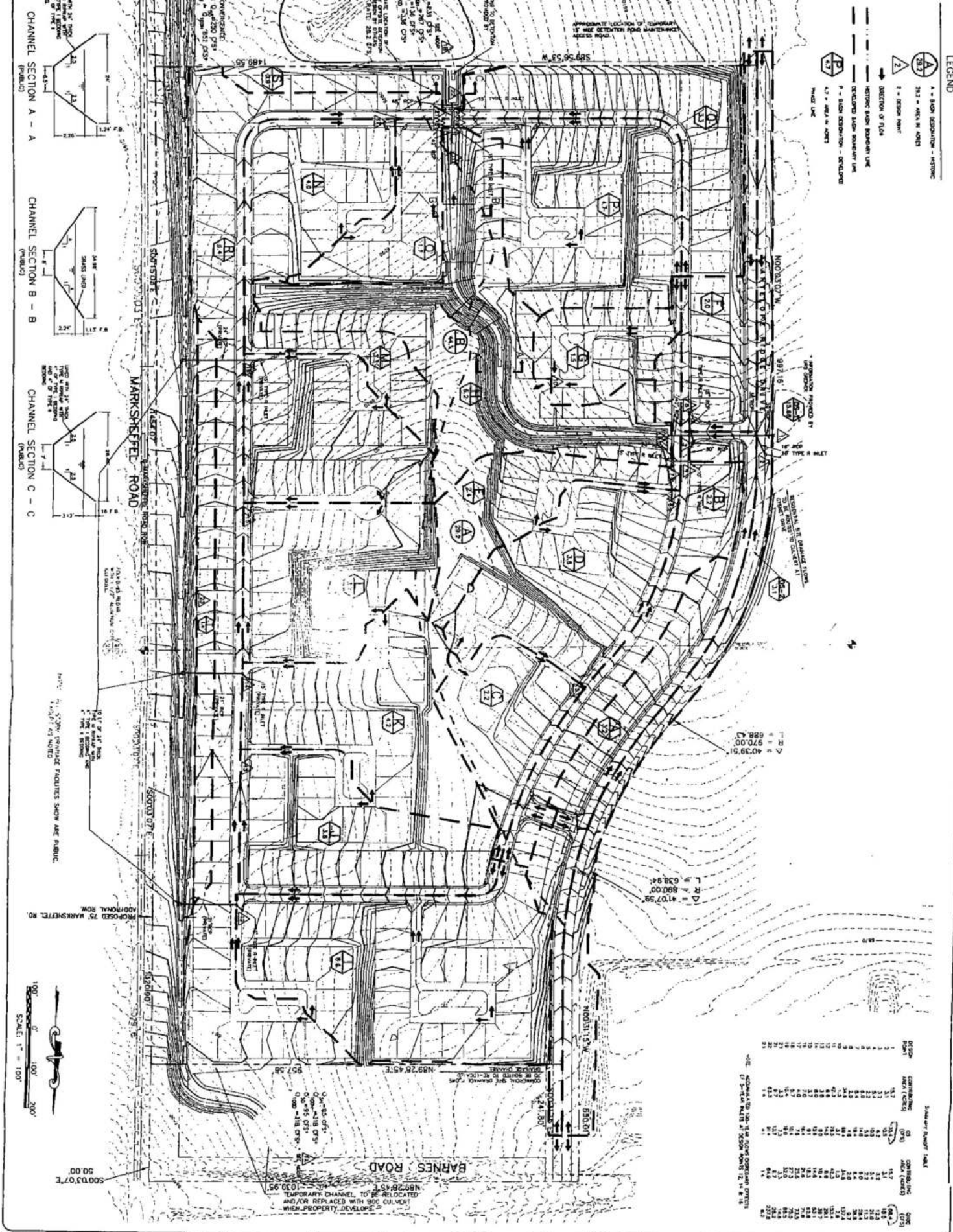

Project No.: CH1100
 Date of Issue: 11/11/98
 Designed by: GTW
 Drawn by: ATY
 Checked by: GTW
 CAD File No.: CH1100.DWG/CH11-1.DWG
 CAD File Date: 11/11/98 ATY

Sheet no.
 69 of 74

DCI
 DEVELOPMENT SERVICES GROUP, INC.
 11184 Huron Street, Suite 13
 Denver, Colorado 80234-3344
 (303) 280-9200 Fax: (303) 450-0917

Antelope Ridge
 El Paso County, Colorado.
 Final Construction Plans
 Final Drainage Plan

NO.	REVISIONS	DATE

3-SHEET POINT TABLE

POINT	CONTRIBUTING AREA (ACRES)	Q1 (CFD)	CONTRIBUTING AREA (ACRES)	Q2 (CFD)
1	13.7	11.1	14.7	11.8
2	13.7	11.1	14.7	11.8
3	13.7	11.1	14.7	11.8
4	13.7	11.1	14.7	11.8
5	13.7	11.1	14.7	11.8
6	13.7	11.1	14.7	11.8
7	13.7	11.1	14.7	11.8
8	13.7	11.1	14.7	11.8
9	13.7	11.1	14.7	11.8
10	13.7	11.1	14.7	11.8
11	13.7	11.1	14.7	11.8
12	13.7	11.1	14.7	11.8
13	13.7	11.1	14.7	11.8
14	13.7	11.1	14.7	11.8
15	13.7	11.1	14.7	11.8
16	13.7	11.1	14.7	11.8
17	13.7	11.1	14.7	11.8
18	13.7	11.1	14.7	11.8
19	13.7	11.1	14.7	11.8
20	13.7	11.1	14.7	11.8
21	13.7	11.1	14.7	11.8
22	13.7	11.1	14.7	11.8
23	13.7	11.1	14.7	11.8
24	13.7	11.1	14.7	11.8
25	13.7	11.1	14.7	11.8
26	13.7	11.1	14.7	11.8
27	13.7	11.1	14.7	11.8
28	13.7	11.1	14.7	11.8
29	13.7	11.1	14.7	11.8
30	13.7	11.1	14.7	11.8
31	13.7	11.1	14.7	11.8
32	13.7	11.1	14.7	11.8
33	13.7	11.1	14.7	11.8
34	13.7	11.1	14.7	11.8
35	13.7	11.1	14.7	11.8
36	13.7	11.1	14.7	11.8
37	13.7	11.1	14.7	11.8
38	13.7	11.1	14.7	11.8
39	13.7	11.1	14.7	11.8
40	13.7	11.1	14.7	11.8
41	13.7	11.1	14.7	11.8
42	13.7	11.1	14.7	11.8
43	13.7	11.1	14.7	11.8
44	13.7	11.1	14.7	11.8
45	13.7	11.1	14.7	11.8
46	13.7	11.1	14.7	11.8
47	13.7	11.1	14.7	11.8
48	13.7	11.1	14.7	11.8
49	13.7	11.1	14.7	11.8
50	13.7	11.1	14.7	11.8
51	13.7	11.1	14.7	11.8
52	13.7	11.1	14.7	11.8
53	13.7	11.1	14.7	11.8
54	13.7	11.1	14.7	11.8
55	13.7	11.1	14.7	11.8
56	13.7	11.1	14.7	11.8
57	13.7	11.1	14.7	11.8
58	13.7	11.1	14.7	11.8
59	13.7	11.1	14.7	11.8
60	13.7	11.1	14.7	11.8
61	13.7	11.1	14.7	11.8
62	13.7	11.1	14.7	11.8
63	13.7	11.1	14.7	11.8
64	13.7	11.1	14.7	11.8
65	13.7	11.1	14.7	11.8
66	13.7	11.1	14.7	11.8
67	13.7	11.1	14.7	11.8
68	13.7	11.1	14.7	11.8
69	13.7	11.1	14.7	11.8
70	13.7	11.1	14.7	11.8
71	13.7	11.1	14.7	11.8
72	13.7	11.1	14.7	11.8
73	13.7	11.1	14.7	11.8
74	13.7	11.1	14.7	11.8
75	13.7	11.1	14.7	11.8
76	13.7	11.1	14.7	11.8
77	13.7	11.1	14.7	11.8
78	13.7	11.1	14.7	11.8
79	13.7	11.1	14.7	11.8
80	13.7	11.1	14.7	11.8
81	13.7	11.1	14.7	11.8
82	13.7	11.1	14.7	11.8
83	13.7	11.1	14.7	11.8
84	13.7	11.1	14.7	11.8
85	13.7	11.1	14.7	11.8
86	13.7	11.1	14.7	11.8
87	13.7	11.1	14.7	11.8
88	13.7	11.1	14.7	11.8
89	13.7	11.1	14.7	11.8
90	13.7	11.1	14.7	11.8
91	13.7	11.1	14.7	11.8
92	13.7	11.1	14.7	11.8
93	13.7	11.1	14.7	11.8
94	13.7	11.1	14.7	11.8
95	13.7	11.1	14.7	11.8
96	13.7	11.1	14.7	11.8
97	13.7	11.1	14.7	11.8
98	13.7	11.1	14.7	11.8
99	13.7	11.1	14.7	11.8
100	13.7	11.1	14.7	11.8

DEVELOPED DRAINAGE BASIN TABLE

Basin	Area (Ac.)	Imperv. Area (Ac.)	Runoff Coef.	Peak Flow (CFS)
1	0.14	0.08	0.75	1.5
2	0.14	0.08	0.75	1.5
3	0.14	0.08	0.75	1.5
4	0.14	0.08	0.75	1.5
5	0.14	0.08	0.75	1.5
6	0.14	0.08	0.75	1.5
7	0.14	0.08	0.75	1.5
8	0.14	0.08	0.75	1.5
9	0.14	0.08	0.75	1.5
10	0.14	0.08	0.75	1.5
11	0.14	0.08	0.75	1.5
12	0.14	0.08	0.75	1.5
13	0.14	0.08	0.75	1.5
14	0.14	0.08	0.75	1.5
15	0.14	0.08	0.75	1.5
16	0.14	0.08	0.75	1.5
17	0.14	0.08	0.75	1.5
18	0.14	0.08	0.75	1.5
19	0.14	0.08	0.75	1.5
20	0.14	0.08	0.75	1.5
21	0.14	0.08	0.75	1.5
22	0.14	0.08	0.75	1.5
23	0.14	0.08	0.75	1.5
24	0.14	0.08	0.75	1.5
25	0.14	0.08	0.75	1.5
26	0.14	0.08	0.75	1.5
27	0.14	0.08	0.75	1.5
28	0.14	0.08	0.75	1.5
29	0.14	0.08	0.75	1.5
30	0.14	0.08	0.75	1.5
31	0.14	0.08	0.75	1.5
32	0.14	0.08	0.75	1.5
33	0.14	0.08	0.75	1.5
34	0.14	0.08	0.75	1.5
35	0.14	0.08	0.75	1.5
36	0.14	0.08	0.75	1.5
37	0.14	0.08	0.75	1.5
38	0.14	0.08	0.75	1.5
39	0.14	0.08	0.75	1.5
40	0.14	0.08	0.75	1.5
41	0.14	0.08	0.75	1.5
42	0.14	0.08	0.75	1.5
43	0.14	0.08	0.75	1.5
44	0.14	0.08	0.75	1.5
45	0.14	0.08	0.75	1.5
46	0.14	0.08	0.75	1.5
47	0.14	0.08	0.75	1.5
48	0.14	0.08	0.75	1.5
49	0.14	0.08	0.75	1.5
50	0.14	0.08	0.75	1.5
51	0.14	0.08	0.75	1.5
52	0.14	0.08	0.75	1.5
53	0.14	0.08	0.75	1.5
54	0.14	0.08	0.75	1.5
55	0.14	0.08	0.75	1.5
56	0.14	0.08	0.75	1.5
57	0.14	0.08	0.75	1.5
58	0.14	0.08	0.75	1.5
59	0.14	0.08	0.75	1.5
60	0.14	0.08	0.75	1.5
61	0.14	0.08	0.75	1.5
62	0.14	0.08	0.75	1.5
63	0.14	0.08	0.75	1.5
64	0.14	0.08	0.75	1.5
65	0.14	0.08	0.75	1.5
66	0.14	0.08	0.75	1.5
67	0.14	0.08	0.75	1.5
68	0.14	0.08	0.75	1.5
69	0.14	0.08	0.75	1.5
70	0.14	0.08	0.75	1.5

* GFDL FROM MAPS FROM SECTION 24.5
 ** BASE INFORMATION PROVIDED BY TOWN OF SPRINGFIELD FOR
 RECORD INFORMATION CLASSIFIED AS OPEN SPACE. THE TOWN OF SPRINGFIELD
 IS NOT RESPONSIBLE FOR ANY ERRORS OR OMISSIONS. DATE: 03/27/2013

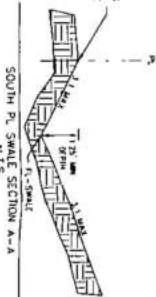
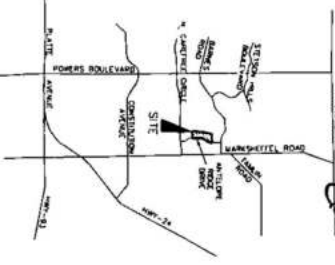

- LEGEND**
- EXISTING 2" CENTRAL
 - EXISTING 1" CENTRAL
 - PROPOSED 2" CENTRAL
 - PROPOSED 1" CENTRAL
 - EXISTING 18" DIA.
 - EXISTING 12" DIA.
 - IMPROVED SIDE
 - IMPROVED SIDE
 - EXISTING SIDE EXHAUSTION

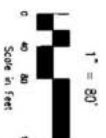

ROCKWELL CONSULTING, INC.
 CONSULTING ENGINEERS
 100 N. MAIN ST., SUITE 200
 SPRINGFIELD, MA 01103
 TEL: 413-261-1111
 FAX: 413-261-1112
 WWW.ROCKWELLCONSULTING.COM

WINDERING SPRINGS FILING NO. 1
 DEVELOPED DRAINAGE MAP
 SCALE: 1"=80'
 DRAWN BY: J. GUN
 CHECKED BY: J. GUN
 DATE: 7/20/13

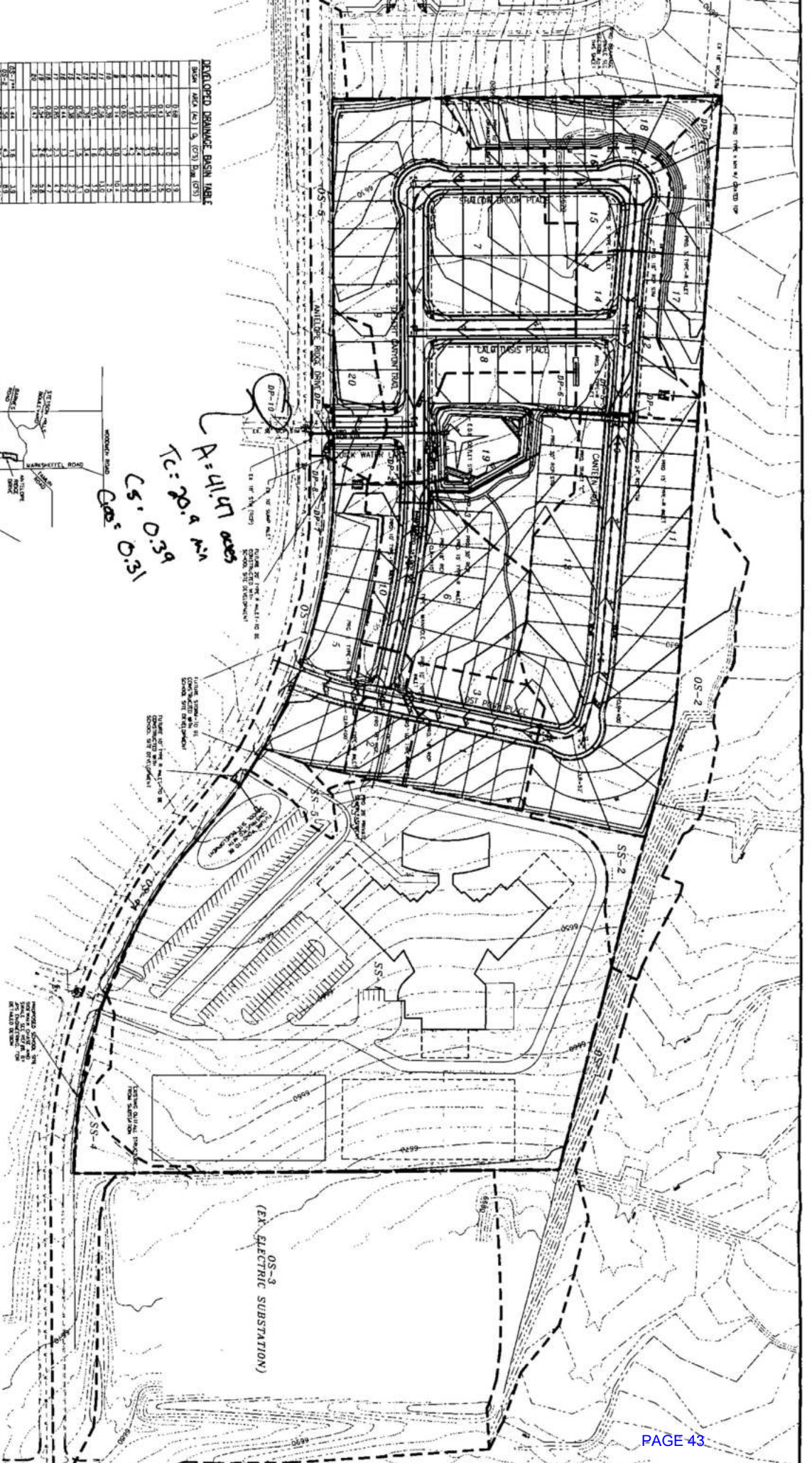

EXISTING DRAINAGE CONDITIONS CALCULATIONS

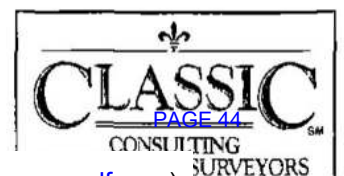

JOB NUMBER: 2441.00
DATE: 10/03/14
CALCULATED BY: MAL

EXISTING DRAINAGE CONDITIONS ~ BASIN RUNOFF COEFFICIENT SUMMARY

BASIN	TOTAL AREA (AC)	IMPERVIOUS AREA / STREETS				LANDSCAPE/UNDEVELOPED AREAS				WEIGHTED		WEIGHTED CA	
		AREA (AC)	C(5)	C(100)		AREA (AC)	C(5)	C(100)		C(5)	C(100)	CA(5)	CA(100)
EX-A	13.20	0.00	0.90	0.95		13.20	0.25	0.35	0.25	0.35	3.30	4.62	
EX-B	7.30	0.00	0.90	0.95		7.30	0.25	0.35	0.25	0.35	1.83	2.56	
EX-C	24.28	0.00	0.90	0.95		24.28	0.25	0.35	0.25	0.35	6.07	8.50	
EX-D	6.19	0.00	0.90	0.95		6.19	0.25	0.35	0.25	0.35	1.55	2.17	
EX-E	1.10	0.00	0.90	0.95		1.10	0.25	0.35	0.25	0.35	0.28	0.39	
EX-F	3.15	0.00	0.90	0.95		3.15	0.25	0.35	0.25	0.35	0.79	1.10	
EX-R	0.53	0.32	0.90	0.95	0.21	0.21	0.25	0.35	0.64	0.71	0.34	0.38	
D-13	6.79	1.37	0.90	0.95	5.42	0.53	0.25	0.35	0.60	0.70	4.11	4.77	
D-14	3.88	1.66	0.90	0.95	2.22	0.37	0.25	0.35	0.60	0.70	2.32	2.73	
D-15	1.36	1.36	0.90	0.95	0.00	0.25	0.25	0.35	0.90	0.95	1.22	1.29	
D-16	2.73	0.77	0.90	0.95	1.96	0.53	0.25	0.35	0.63	0.73	1.73	1.99	
NC-1	0.42	0.42	0.90	0.95	0.00	0.25	0.25	0.35	0.90	0.95	0.38	0.40	
NC-2	1.49	1.49	0.90	0.95	0.00	0.25	0.25	0.35	0.90	0.95	1.34	1.42	
WS	41.47		0.90	0.95		0.55	0.55	0.65	0.39	0.31	16.05	12.67	
CT	42.07	8.67	0.90	0.95	33.40	0.55	0.55	0.65	0.62	0.71	26.17	29.95	

JOB NAME: WINDERMERE
 JOB NUMBER: 2441.00
 DATE: 10/03/14
 CALC'D BY: MAL

EXISTING DRAINAGE CONDITIONS ~ BASIN RUNOFF SUMMARY

BASIN	WEIGHTED		OVERLAND			STREET / CHANNEL FLOW			TOTAL FLOWS						
	CA(5)	CA(100)	C(5) Length (ft)	Height (ft)	Tc (min)	Length (ft)	Slope (%)	Velocity (fps)	Tc (min)	Tc (min)	INTENSITY I(5) (in/hr)	INTENSITY I(100) (in/hr)	Q(5) (cfs)	Q(100) (cfs)	
EX-A	3.30	4.62	0.25	250	16	13.6	700	3.9%	6.9	1.7	15.3	3.43	6.10	11.3	28.2
EX-B	1.83	2.56	0.25	450	40	16.4	600	1.7%	4.5	2.2	18.6	3.13	5.56	5.7	14.2
EX-C	6.07	8.50	0.25	450	24	19.4	750	3.7%	6.7	1.9	21.3	2.92	5.19	17.7	44.1
EX-D	1.55	2.17	0.25	280	24	12.3	150	20.0%	15.7	0.2	12.5	3.75	6.68	5.8	14.5
EX-E	0.28	0.39	0.25	200	12	12.4	50	12.0%	12.1	0.1	12.5	3.75	6.67	1.0	2.6
EX-F	0.79	1.10	0.25	30	8	2.9	400	1.0%	3.5	1.9	5.0	5.10	9.07	4.0	10.0
EX-R	0.34	0.38	0.25	20	2	3.3	320	2.0%	4.9	1.1	5.0	5.10	9.07	1.7	3.4
D-13	4.11	4.77	0.25	270	21	13.3	1380	6.0%	8.6	2.7	16.0	3.36	5.98	13.8	28.5
D-14	2.32	2.73	0.25	125	2.5	14.1	1250	1.7%	4.6	4.6	18.7	3.12	5.54	7.2	15.1
D-15	1.22	1.29	0.25	25	1	5.0	2050	1.7%	4.6	7.5	12.5	3.75	6.66	4.6	8.6
D-16	1.73	1.99	0.53	200	10	8.9	350	3.5%	6.5	0.9	9.8	4.14	7.36	7.2	14.6
NC-1	0.38	0.40	0.25	10	2	1.9	25	3.5%	6.5	0.1	5.0	5.10	9.07	1.9	3.6
NC-2	1.34	1.42	0.25	15	2	2.6	1125	3.5%	6.5	2.9	5.5	4.98	8.86	6.7	12.5
WS	16.05	12.67	0.25			#DIV/0!		2.0%	4.9	0.0	20.9	2.95	5.24	47.3	66.4
CT	26.17	29.95	0.25	100	4	10.1	1450	2.0%	4.9	4.9	14.9	3.47	6.17	90.8	184.7

JOB NAME: WINDERMERE
 JOB NUMBER: 2441.00
 DATE: 10/04/14
 CALCULATED BY: MAL

EXISTING DRAINAGE CONDITIONS ~ SURFACE ROUTING SUMMARY

Design Points(s)	Contributing Basins	Equivalent CA(5)	Equivalent CA(100)	Maximum Tc	Intensity		Flow		Inlet Size
					I(5)	I(100)	Q(5)	Q(100)	
4	BASIN D-16	1.73	1.99	9.8	4.14	7.36	7.2	14.6	8' Existing Sump Inlet
6	BASIN EX-R + BASIN EX-A + DP-4-EXIST	5.37	6.98	15.3	3.43	6.10	18.4	42.6	Existing Type D Grated Inlet
7	BASIN D-13 & BASIN D-14	6.42	7.50	18.7	3.12	5.54	20.0	41.6	Existing 25' Type R Inlet
8	BASIN D-15 & BASIN EX-E	1.50	1.68	12.5	3.75	6.66	5.6	11.2	Existing 10' Type R Inlet
19	BASIN NC-2	1.34	1.42	5.5	4.98	8.86	6.7	12.5	15' Existing At-Grade Inlet
20	BASIN NC-1 + Flow-by DP-19	0.75	0.90	5.5	4.98	8.86	3.7	8.0	10' Existing sump median inlet
24	BASIN WS + BASIN CT	42.22	42.62	25.8	2.64	4.69	111.3	199.7	OFF-SITE TO POND
25	DP-24 + BASIN EX-D + BASIN EX-F	44.56	45.88	25.8	2.64	4.69	117.5	215.1	EXIST. TO POND
26	DP-25 + BASIN EX-B + BASIN EX-C	52.45	56.94	25.8	2.64	4.69	138.3	266.9	EXIST. TO MARKSHEFFEL (Not including Marksheffel Ditch)

JOB NAME: WINDERMERE
 JOB NUMBER: 2441.00
 DATE: 10/03/14
 CALCULATED BY: MAJ

* PIPES ARE LISTED AT MAXIMUM SIZE REQUIRED TO ACCOMMODATE Q100 FLOWS AT MINIMUM GRADE.
 REFER TO INDIVIDUAL PIPE SHEETS FOR HYDRAULIC INFORMATION.

EXISTING DRAINAGE CONDITIONS ~ PIPE ROUTING SUMMARY

Pipe Run	Contributing Basins	Equivalent CA(5)	Equivalent CA(100)	Maximum Tc	Intensity		Flow		Pipe Size*
					I(5)	I(100)	Q(5)	Q(100)	
6a	DP-19-EXIST (Intercept)	0.97	0.91	5.5	4.98	8.86	4.8	8.1	EX. 18" RCP
6b	DP-6	5.37	6.98	15.3	3.43	6.10	18.4	42.6	EX. 24" RCP
6c	PIPE 6a + PIPE 6b	6.34	7.90	15.5	3.41	6.06	21.6	47.9	EX. 24" RCP
7	PIPE 6C + DP-20-EXIST	7.09	8.80	15.5	3.41	6.06	24.2	53.3	EX. 30" RCP
8	DP-7-EXIST & DP-8-EXIST	7.92	9.18	18.7	3.12	5.54	24.7	50.9	EX. 36" RCP

EXISTING DRAINAGE CONDITIONS - BASIN RUNOFF COEFFICIENT SUMMARY

BASIN	TOTAL AREA (AC)	IMPERVIOUS AREA/STREETS			LANDSCAPE/UNDEVELOPED AREAS			WEIGHTED		WEIGHTED CA	
		AREA (AC)	C(5)	C(100)	AREA (AC)	C(5)	C(100)	C(5)	C(100)	CA(5)	CA(100)
EX-A	13.20	0.00	0.90	0.95	13.20	0.09	0.36	0.09	0.36	1.19	4.75
EX-B	7.30	0.00	0.90	0.95	7.30	0.09	0.36	0.09	0.36	0.66	2.63
EX-C	24.28	0.00	0.90	0.95	24.28	0.09	0.36	0.09	0.36	2.19	8.74
EX-D	6.19	0.00	0.90	0.95	6.19	0.09	0.36	0.09	0.36	0.56	2.23
EX-E	1.10	0.00	0.90	0.95	1.10	0.09	0.36	0.09	0.36	0.10	0.40
EX-F	3.15	0.00	0.90	0.95	3.15	0.09	0.36	0.09	0.36	0.28	1.13
EX-R	0.53	0.32	0.90	0.95	0.21	0.09	0.36	0.58	0.72	0.31	0.38
D-13	6.79	1.37	0.90	0.95	5.42	0.53	0.64	0.60	0.70	4.11	4.77
D-14	3.88	1.66	0.90	0.95	2.22	0.37	0.52	0.60	0.70	2.32	2.73
D-15	1.36	1.36	0.90	0.95	0.00	0.09	0.35	0.90	0.95	1.22	1.29
D-16	2.73	0.77	0.90	0.95	1.96	0.53	0.64	0.63	0.73	1.73	1.99
NC-1	0.42	0.42	0.90	0.95	0.00	0.09	0.36	0.90	0.95	0.38	0.40
NC-2	1.49	1.49	0.90	0.95	0.00	0.09	0.36	0.90	0.95	1.34	1.42
WS	41.47		0.90	0.95		0.09	0.36	0.21	0.46	8.68	19.06
CT	42.07	8.67	0.90	0.95	33.40	0.09	0.36	0.26	0.48	10.81	20.26

EXISTING DRAINAGE CONDITIONS - BASIN RUNOFF SUMMARY

BASIN	WEIGHTED CA		OVERLAND					STREET/CHANNEL FLOW				TC (min)	INTENSITY (in/hr)		TOTAL FLOWS (cfs)	
	CA(5)	CA(100)	C(5)	LENGTH (FT)	HEIGHT (FT)	SLOPE (%)	TC (MIN)	LENGTH (FT)	SLOPE (%)	VELOCITY (fps)	TC (min)	TOTAL	I (5)	I (100)	Q(5)	Q(100)
EX-A	1.19	4.75	0.09	250	16	6.40	15.8	700	3.9	6.9	1.7	17.5	3.22	5.42	3.8	25.7
EX-B	0.66	2.63	0.09	450	40	8.89	19.0	600	1.7	4.5	2.2	21.2	2.93	4.92	1.9	12.9
EX-C	2.19	8.74	0.09	450	24	5.33	22.5	750	3.7	6.7	1.9	24.3	2.72	4.57	5.9	39.9
EX-D	0.56	2.23	0.09	260	24	9.23	14.2	150	20	15.7	0.2	14.4	3.53	5.93	2.0	13.2
EX-E	0.10	0.40	0.09	200	12	6.00	14.4	50	12	12.1	0.1	14.5	3.52	5.91	0.3	2.3
EX-F	0.28	1.13	0.09	30	8	26.67	3.4	400	1	3.5	1.9	5.3	5.03	8.45	1.4	9.6
EX-R	0.31	0.38	0.58	20	2	10.00	2.0	320	2	4.9	1.1	3.1	5.67	9.52	1.7	3.6
D-13	4.11	4.77	0.60	270	21	7.78	7.5	1380	6	8.6	2.7	10.2	4.07	6.84	16.7	32.6
D-14	2.32	2.73	0.60	125	2.5	2.00	8.2	1250	1.7	4.6	4.5	12.7	3.72	6.26	8.6	17.1
D-15	1.22	1.29	0.90	25	1	4.00	1.2	2050	1.7	4.6	7.4	8.6	4.34	7.29	5.3	9.4
D-16	1.73	1.99	0.63	200	10	5.00	7.1	350	3.5	6.5	0.9	8.0	4.45	7.48	7.7	14.9
NC-1	0.38	0.40	0.90	10	2	20.00	0.4	25	3.5	6.5	0.1	0.5	6.70	11.25	2.5	4.5
NC-2	1.34	1.42	0.90	15	2	13.33	0.6	1125	3.5	6.5	2.9	3.5	5.54	9.30	7.4	13.2
WS	8.68	19.06	0.21									20.9	2.95	4.95	25.6	94.4
CT	10.81	20.26	0.26	100	4	4.00	9.7	1450	2	4.9	4.9	14.7	3.50	5.88	37.8	119.0

JOB NAME: WINDERMERE
 JOB NUMBER: 2441.00
 DATE: 10/03/14
 CALCULATED BY: MAL

DESIGN POINT **EX-8**

Total Flow: $Q_5 = \frac{6}{11}$ cfs
 $Q_{100} = \frac{6}{11}$ cfs

Maximum allowable ponding depth at sump:

$D_5 = 0.50$
 $D_{100} = 0.67$ (dmax)
 $Q_i = 1.7(Li+1.8(W))(dmax + w/12)^{1.85}$

Clogging Factor = 1.25
 $Li (1.25) =$ Length of inlet opening

5-Year Event: foot inlet required

100-Year Event: foot inlet required

EXISTING FT TYPE R INLET TO ACCEPT BOTH 5YR &
 100 YR DEVELOPED FLOWS AT THIS DESIGN POINT.

JOB NAME: WINDERMERE
 JOB NUMBER: 2441.00
 DATE: 10/03/14
 CALCULATED BY: MAL

DESIGN POINT	EX-19	100 YEAR FLOW			
Q(100)	12.5	I(100)	8.9		
DEPTH	0.35	Fr	2.46	Inlet size ? L(i) =	15
SPREAD	11.0	L(1)	20.8	If Li < L(2) then Qi =	9
CROSS SLOPE	2.0%	L(2)	12.5	If Li > L(2) then Qi =	8
STREET SLOPE	4.0%	L(3)	44.7	FB =	4.4
				CA(eqv.) =	0.50
5 YEAR FLOW					
Q(5)	6.7	I(5)	5.0		
DEPTH	0.30	Fr	2.35	Inlet size ? L(i) =	15
SPREAD	8.8	L(1)	15.8	If Li < L(2) then Qi =	6
CROSS SLOPE	2.0%	L(2)	9.5	If Li > L(2) then Qi =	5
STREET SLOPE	4.0%	L(3)	33.9	FB =	1.9
				CA(eqv.) =	0.37

JOB NAME: WINDERMERE
 JOB NUMBER: 2441.00
 DATE: 10/03/14
 CALCULATED BY: MAL

DESIGN POINT EX-20

Total Flow: $Q_5 = \frac{4}{8} \text{ cfs}$
 $Q_{100} = \frac{8}{8} \text{ cfs}$

Maximum allowable ponding depth at sump:

$D_5 = 0.50$
 $D_{100} = 0.50 \text{ (dmax)}$
 $Q_i = 1.7(L_i + 1.8(W))(d_{max} + w/12)^{1.85}$

Clogging Factor = 1.25
 $L_i (1.25) = \text{Length of inlet opening}$

5-Year Event: foot inlet required

100-Year Event: foot inlet required

EXISTING FT TYPE R INLET TO ACCEPT BOTH 5YR & 100 YR DEVELOPED FLOWS AT THIS DESIGN POINT.

DEVELOPED DRAINAGE CONDITIONS CALCULATIONS

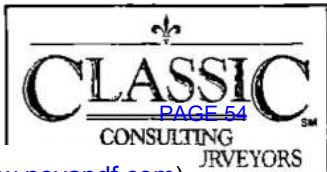

JOB NAME: WINDERMERE
JOB NUMBER: 2441.00
DATE: 10/03/14
CALCULATED BY: MAL

DEVELOPED CONDITIONS ~ BASIN RUNOFF COEFFICIENT SUMMARY

BASIN	TOTAL AREA (AC)	IMPERVIOUS AREA / STREETS			LANDSCAPE/UNDEVELOPED AREAS			WEIGHTED		WEIGHTED CA	
		AREA (AC)	C(5)	C(100)	AREA (AC)	C(5)	C(100)	C(5)	C(100)	CA(5)	CA(100)
A	3.35	0.88	0.90	0.95	2.47	0.60	0.7	0.68	0.77	2.27	2.57
B	2.72	0.56	0.90	0.95	2.16	0.60	0.7	0.66	0.75	1.80	2.04
C	4.20	1.10	0.90	0.95	3.10	0.60	0.7	0.68	0.77	2.85	3.22
D	1.75	1.08	0.60	0.70	0.67	0.25	0.35	0.47	0.57	0.82	0.99
E	1.47	0.21	0.90	0.95	1.26	0.51	0.61	0.57	0.66	0.83	0.97
F	2.85	0.76	0.90	0.95	2.09	0.60	0.7	0.68	0.77	1.94	2.19
G	3.97	0.67	0.90	0.95	3.30	0.60	0.7	0.65	0.74	2.58	2.95
H	1.42	0.43	0.90	0.95	0.99	0.60	0.7	0.69	0.78	0.98	1.10
I	4.44	1.12	0.90	0.95	3.32	0.56	0.66	0.65	0.73	2.87	3.26
J	3.30	0.74	0.90	0.95	2.56	0.60	0.7	0.67	0.76	2.20	2.50
K	3.74	0.61	0.90	0.95	3.13	0.60	0.7	0.65	0.74	2.43	2.77

JOB NAME: WINDERMERE
 JOB NUMBER: 2441.00
 DATE: 10/03/14
 CALCULATED BY: MAL

DEVELOPED CONDITIONS ~ BASIN RUNOFF COEFFICIENT SUMMARY

BASIN	TOTAL AREA (AC)	IMPERVIOUS AREA / STREETS				LANDSCAPE/UNDEVELOPED AREAS				WEIGHTED		WEIGHTED CA	
		AREA (AC)	C(5)	C(100)	AREA (AC)	C(5)	C(100)	C(5)	C(100)	CA(5)	CA(100)		
L	3.86	1.15	0.90	0.95	2.71	0.60	0.7	0.69	0.77	2.66	2.99		
M	9.96	0.00	0.90	0.95	9.96	0.25	0.35	0.25	0.35	2.49	3.49		
N	0.58	0.12	0.90	0.95	0.46	0.60	0.7	0.66	0.75	0.38	0.44		
P	0.60	0.00	0.90	0.95	0.60	0.25	0.35	0.25	0.35	0.15	0.21		
Q	1.70	0.62	0.90	0.95	1.08	0.60	0.7	0.71	0.79	1.21	1.35		
R	1.18	0.25	0.90	0.95	0.93	0.50	0.6	0.58	0.67	0.69	0.80		
S	4.52	1.55	0.60	0.70	2.97	0.25	0.35	0.37	0.47	1.67	2.12		
D-13	6.79	1.37	0.90	0.95	5.42	0.53	0.64	0.60	0.70	4.11	4.77		
D-14	3.88	1.66	0.90	0.95	2.22	0.37	0.52	0.60	0.70	2.32	2.73		
D-15	1.36	1.36	0.90	0.95	0.00	0.25	0.35	0.90	0.95	1.22	1.29		
D-16	2.73	0.77	0.90	0.95	1.96	0.53	0.64	0.63	0.73	1.73	1.99		
NC-1	0.42	0.42	0.90	0.95	0.00	0.25	0.35	0.90	0.95	0.38	0.40		
NC-2	1.49	1.49	0.90	0.95	0.00	0.25	0.35	0.90	0.95	1.34	1.42		
WS	41.47		0.90	0.95		0.55	0.65	0.39	0.31	16.05	12.67		
CT	42.07	8.67	0.90	0.95	33.40	0.55	0.65	0.62	0.71	26.17	29.95		

JOB NAME: WINDERMERE
 JOB NUMBER: 2441.00
 DATE: 10/03/14
 CALCD BY: MAIL

DEVELOPED CONDITIONS ~ BASIN RUNOFF SUMMARY

BASIN	WEIGHTED		OVERLAND				STREET / CHANNEL FLOW				TOTAL FLOWS				
	CA(5)	CA(100)	C(5) (ft)	Length (ft)	Height (ft)	Tc (min)	Length (ft)	Slope (%)	Velocity (fps)	Tc (min)	Tc (min)	I(5) (in/hr)	I(100) (in/hr)	Q(5) (cfs)	Q(100) (cfs)
A	2.27	2.57	0.6	170	5	8.5	680	2.2%	5.2	2.2	10.7	3.99	7.10	9.1	18.2
B	1.80	2.04	0.6	10	1	1.4	715	2.5%	5.5	2.2	5.0	5.10	9.07	9.2	18.5
C	2.85	3.22	0.6	50	1	5.3	790	3.5%	6.5	2.0	7.3	4.59	8.15	13.1	26.2
D	0.82	0.99	0.6	100	7	4.9	490	3.9%	6.9	1.2	6.1	4.84	8.60	3.9	8.5
E	0.83	0.97	0.6	60	4	3.9	400	1.5%	4.3	1.6	5.4	5.00	8.88	4.2	8.6
F	1.94	2.19	0.25	70	20	4.4	550	2.9%	6.0	1.5	5.9	4.87	8.67	9.4	18.9
G	2.58	2.95	0.6	190	12	7.0	480	1.5%	4.3	1.9	8.9	4.29	7.62	11.1	22.4
H	0.98	1.10	0.6	50	1	5.3	480	1.5%	4.3	1.9	7.1	4.62	8.21	4.5	9.0
I	2.87	3.26	0.6	120	8	5.5	800	2.8%	5.8	2.3	7.8	4.49	7.98	12.9	26.0
J	2.20	2.50	0.6	115	8	5.3	470	2.1%	5.1	1.5	6.8	4.68	8.31	10.3	20.7
K	2.43	2.77	0.6	50	1	5.3	945	4.0%	7.0	2.3	7.5	4.54	8.07	11.0	22.4

JOB NAME: WINDERMERE
 JOB NUMBER: 2441.00
 DATE: 10/03/14
 CALC'D BY: MAL

DEVELOPED CONDITIONS ~ BASIN RUNOFF SUMMARY

BASIN	WEIGHTED		OVERLAND			STREET / CHANNEL FLOW				TOTAL FLOWS					
	CA(5)	CA(100)	C(5)	Length (ft)	Height (ft)	Tc (min)	Length (ft)	Slope (%)	Velocity (fps)	Tc (min)	Tc (min)	I(5) (in/hr)	I(100) (in/hr)	Q(5) (cfs)	Q(100) (cfs)
L	266	299	0.6	130	3	8.1	1265	3.5%	6.5	3.2	11.3	3.91	6.95	10.4	20.8
M	249	349	0.25	170	54	6.6	760	0.5%	2.5	5.1	11.7	3.85	6.85	9.6	23.9
N	0.38	0.44	0.5	100	4	7.1	160	4.0%	7.0	0.4	7.5	4.54	8.08	1.7	3.5
P	0.15	0.21	0.25	90	22	5.3	0	1.0%	3.5	0.0	5.3	5.04	8.96	0.8	1.9
Q	1.21	1.35	0.25	145	10	10.1	530	4.5%	7.4	1.2	11.3	3.91	6.95	4.7	9.3
R	0.69	0.80	0.5	70	6	4.6	380	4.5%	7.4	0.9	5.5	4.99	8.86	3.4	7.1
S	1.67	2.12	0.25	100	14	6.7	720	1.8%	4.7	2.6	9.2	4.23	7.52	7.1	16.0
D-13	4.11	4.77	0.25	270	21	13.3	1380	6.0%	8.6	2.7	16.0	3.36	5.98	13.8	28.5
D-14	2.32	2.73	0.25	125	2.5	14.1	1250	1.7%	4.6	4.6	18.7	3.12	5.54	7.2	15.1
D-15	1.22	1.29	0.25	25	1	5.0	2050	1.7%	4.6	7.5	12.5	3.75	6.66	4.6	8.6
D-16	1.73	1.99	0.53	200	10	8.9	350	3.5%	6.5	0.9	9.8	4.14	7.36	7.2	14.6
NC-1	0.38	0.40	0.25	10	2	1.9	25	3.5%	6.5	0.1	5.0	5.10	9.07	1.9	3.6
NC-2	1.34	1.42	0.25	15	2	2.6	1125	3.5%	6.5	2.9	5.5	4.98	8.86	6.7	12.5
WS	16.05	12.67	0.25			#DIV/0!		2.0%	4.9	0.0	20.9	2.95	5.24	47.3	66.4
CT	26.17	29.95	0.25	100	4	10.1	1450	2.0%	4.9	4.9	14.9	3.47	6.17	90.8	184.7

JOB NAME: WINDERMERE
 JOB NUMBER: 2441.00
 DATE: 10/03/14
 CALCULATED BY: MAL

DEVELOPED CONDITIONS ~ SURFACE ROUTING SUMMARY

Design Point(s)	Contributing Basins	Equivalent CA(5)	Equivalent CA(100)	Maximum Tc	Intensity		Flow		Inlet Size
					I(5)	I(100)	Q(5)	Q(100)	
1	BASIN C	2.85	3.22	7.3	4.59	8.15	13.1	26.2	15' At-Grade Type R Inlet
2	BASIN B + Flow-by DP-1	2.70	3.35	7.3	4.59	8.15	12.4	27.3	15' Sump Type R Curb Inlet
3	BASIN A	2.27	2.57	10.7	3.99	7.10	9.1	18.2	10' Sump Type R Curb Inlet
4	BASIN D-16	1.73	1.99	9.8	4.14	7.36	7.2	14.6	8' Existing Sump Inlet
5	BASIN P + PIPE 3b	7.07	8.03	10.8	3.98	7.07	28.1	56.8	SWQ/DETENTION POND
6	BASIN R	0.69	0.80	5.5	4.99	8.86	3.4	7.1	Relocated Type D Grated Inlet
7	BASIN D-13 & BASIN D-14	6.42	7.50	18.7	3.12	5.54	20.0	41.6	Existing 25' Type R Inlet
8	BASIN D-15 & BASIN E	2.06	2.26	12.5	3.75	6.66	7.7	15.1	Existing 10' Type R Inlet
9	BASIN I	2.87	3.26	7.8	4.49	7.98	12.9	26.0	20' At-Grade Type R Inlet
10	BASIN N + Flow-by DP-9	1.24	1.69	7.8	4.49	7.98	5.6	13.5	15' At-Grade Type R Inlet

JOB NAME: WINDERMERE
 JOB NUMBER: 2441.00
 DATE: 10/03/14
 CALCULATED BY: MAI

DEVELOPED CONDITIONS ~ SURFACE ROUTING SUMMARY

Design Point(s)	Contributing Basins	Equivalent CA(5)	Equivalent CA(100)	Maximum Tc	Intensity			Flow		Inlet Size
					I(5)	I(100)	Q(5)	Q(100)		
11	BASIN J + Flow-by DP-10	2.49	3.12	7.8	4.49	7.98	11.2	24.8	10' At-Grade Type R Inlet	
12	BASIN K	2.43	2.77	7.5	4.54	8.07	11.0	22.4	20' At-Grade Type R Inlet	
14	BASIN F + BASIN Q	3.14	3.53	11.3	3.91	6.95	12.3	24.5	20' At-Grade Type R Inlet	
15	BASIN G + Flow-by DP-11 + Flow-by DP-12 + Flow-by DP-14	5.24	7.29	11.3	3.91	6.95	20.5	50.7	20' Sump Type R Inlet	
16	BASIN L	2.66	2.99	11.3	3.91	6.95	10.4	20.8	10' At-Grade Type R Inlet	
17	BASIN H + Flow-by DP-16	1.98	2.75	11.3	3.91	6.95	7.8	19.1	10' Sump Type R Curb Inlet	
19	BASIN NC-2 + BASIN D	2.16	2.41	6.1	4.84	8.60	10.4	20.7	15' Existing At-Grade Inlet	
20	BASIN NC-1 + Flow-by DP-19	0.93	1.31	6.1	4.84	8.60	4.5	11.3	10' Existing sump median Inlet	
23	PIPE 22 + BASIN M	28.22	32.77	20.6	2.97	5.28	83.8	173.0	WINDERMERE TO POND	
24	BASIN WS + BASIN CT	42.22	42.62	25.8	2.64	4.69	111.3	199.7	OFF-SITE TO POND	
25	DP-23 + DP-24	70.44	75.39	25.8	2.64	4.69	186.7	353.3	FILLING 2 POND TOTAL IN	
26	PIPE 23 + BASIN S	2.89	19.33	25.8	2.64	4.69	7.6	90.6	Developed to Marksheffel (Not Including Marksheffel Ditch)	

JOB NAME: WINDERMERE
 JOB NUMBER: 2441.00
 DATE: 10/03/14
 CALCULATED BY: MAL

* PIPES ARE LISTED AT MAXIMUM SIZE REQUIRED TO ACCOMMODATE Q100 FLOWS AT MINIMUM GRADE.
 REFER TO INDIVIDUAL PIPE SHEETS FOR HYDRAULIC INFORMATION.

DEVELOPED CONDITIONS ~ PIPE ROUTING SUMMARY

Pipe Run	Contributing Basins	Equivalent CA(5)	Equivalent CA(100)	Maximum Tc	Intensity		Flow		Pipe Size*
					I(5)	I(100)	Q(5)	Q(100)	
1	DP-1 (Intercept)	1.95	1.91	7.3	4.59	8.15	8.9	15.6	24" RCP
2	PIPE 1 + DP-2	4.65	5.26	7.8	4.49	7.98	20.9	41.9	30" RCP
3a	DP-3	2.27	2.57	10.7	3.99	7.10	9.1	18.2	24" RCP
3b	PIPE 2b + PIPE 3a	6.92	7.82	10.7	3.99	7.10	27.6	55.5	36" RCP
4	DP-4	1.73	1.99	9.8	4.14	7.36	7.2	14.6	EX. 24" RCP
5	POND RELEASE	0.16	1.38	10.8	3.98	7.07	0.6	9.8	24" RCP
6a	DP-19 (Intercept)	1.85	1.49	6.1	4.84	8.60	9.0	12.8	EX. 18" RCP
6b	PIPE 4 + PIPE 5 + DP-6	2.58	4.16	10.8	3.98	7.07	10.3	29.4	EX. 24" RCP
6c	PIPE 6a + PIPE 6b	4.43	5.65	11.0	3.95	7.02	17.5	39.7	EX. 24" RCP
7	PIPE 6C + DP-20	5.36	6.97	11.0	3.95	7.02	21.2	48.9	EX. 30" RCP
8	DP-7 & DP-8	8.48	9.76	18.7	3.12	5.54	26.4	54.1	36" RCP
9	DP-9 (Intercept)	2.01	2.00	7.8	4.49	7.98	9.0	16.0	24" RCP
10	PIPE 8 + PIPE 9	10.49	11.76	19.0	3.09	5.50	32.4	64.7	36" RCP

JOB NAME: WINDERMERE
 JOB NUMBER: 2441.00
 DATE: 10/03/14
 CALCULATED BY: MAL

* PIPES ARE LISTED AT MAXIMUM SIZE REQUIRED TO ACCOMMODATE Q100 FLOWS AT MINIMUM GRADE.
 REFER TO INDIVIDUAL PIPE SHEETS FOR HYDRAULIC INFORMATION.

DEVELOPED CONDITIONS ~ PIPE ROUTING SUMMARY

Pipe Run	Contributing Basins	Equivalent CA(5)	Equivalent CA(100)	Maximum Tc	Intensity		Flow		Pipe Size*
					I(5)	I(100)	Q(5)	Q(100)	
11	DP-10 (Intercepted)	0.95	1.07	7.8	4.49	7.98	4.3	8.5	18" RCP
12	PIPE 11 + DP-11 (Intercept.)	2.18	2.06	7.8	4.49	7.98	9.8	16.4	24" RCP
13	PIPE 10 + PIPE 12	12.67	13.82	19.2	3.07	5.46	38.9	75.5	42" RCP
14	DP-14 (Intercepted)	2.26	2.17	11.3	3.91	6.95	8.8	15.1	24" RCP
15	PIPE 13 + PIPE 14	14.92	16.00	19.2	3.07	5.46	45.9	87.4	42" RCP
16	DP-12 (Intercepted)	1.92	1.91	7.5	4.54	8.07	8.7	15.4	24" RCP
17	DP-16 (Intercepted)	1.66	1.34	11.3	3.91	6.95	6.5	9.3	18" RCP
18	PIPE 15 + PIPE 21	22.14	26.03	19.4	3.06	5.44	67.7	141.5	60" RCP
19	DP-15	5.24	7.29	11.3	3.91	6.95	20.5	50.7	36" RCP
20	DP-17	1.98	2.75	11.3	3.91	6.95	7.8	19.1	24" RCP
21	PIPE 19 + PIPE 20	7.22	10.04	11.3	3.91	6.95	28.2	69.8	42" RCP
22	PIPE 16 + PIPE 17 + PIPE 18	25.73	29.29	19.7	3.04	5.40	78.1	158.1	60" RCP
23	DP-25 POND RELEASE	1.22	17.21	25.8	2.64	4.69	3.2	80.6	54" RCP

JOB NAME:	WINDERMERE
JOB NUMBER:	2441.00
DATE:	10/03/14
CALCULATED BY:	MAL

DEVELOPED CONDITIONS ~ PIPE TRAVEL TIMES

PIPE RUN	STREET / CHANNEL FLOW				
	Pipe Diameter	Length	Slope	Velocity	Tc
	(ft)	(ft)	(%)	(fps)	(min)
1	2.0	220	1.0%	7.2	0.5
3b	3.0	60	1.0%	9.5	0.1
4	2.0	750	4.0%	14.4	0.9
8	3.0	300	3.0%	16.4	0.3
10	3.0	270	4.0%	18.9	0.2
15	3.5	250	4.0%	21.0	0.2
18	5.0	155	0.5%	9.4	0.3
22	5.0	490	0.5%	9.4	0.9

JOB NAME:	<u>WINDERMERE</u>
JOB NUMBER:	<u>2441.00</u>
DATE:	<u>10/03/14</u>
CALCULATED BY:	<u>MAL</u>

DESIGN POINT	1	100 YEAR FLOW			
Q(100)	26.2	I(100)	8.2		
DEPTH	0.52	Fr	1.68	Inlet size ? L(i) =	15
SPREAD	19.5	L(1)	25.3	If Li < L(2) then Qi =	16
CROSS SLOPE	2.0%	L(2)	15.2	If Li > L(2) then Qi =	16
STREET SLOPE	1.5%	L(3)	54.2	FB =	11
				CA(eqv.)=	1.31

5 YEAR FLOW					
Q(5)	13.1	I(5)	4.6		
DEPTH	0.42	Fr	1.60	Inlet size ? L(i) =	15
SPREAD	14.8	L(1)	18.1	If Li < L(2) then Qi =	11
CROSS SLOPE	2.0%	L(2)	10.9	If Li > L(2) then Qi =	9
STREET SLOPE	1.5%	L(3)	38.9	FB =	4
				CA(eqv.)=	0.90

JOB NAME: WINDERMERE
 JOB NUMBER: 2441.00
 DATE: 10/03/14
 CALCULATED BY: MAL

DESIGN POINT 2

Total Flow: $Q_5 = \frac{12}{27}$ cfs
 $Q_{100} = \frac{12}{27}$ cfs

Maximum allowable ponding depth at sump:

$D_5 = 0.50$
 $D_{100} = 0.67$ (dmax)
 $Q_i = 1.7(L_i + 1.8(W))(d_{max} + w/12)^{1.85}$

Clogging Factor = 1.25
 $L_i (1.25) =$ Length of inlet opening

5-Year Event: foot inlet required

100-Year Event: foot inlet required

INSTALL A PUBLIC FT D-10-R INLET TO ACCEPT BOTH 5YR & 100 YR DEVELOPED FLOWS AT THIS DESIGN POINT.

JOB NAME: WINDERMERE
 JOB NUMBER: 2441.00
 DATE: 10/03/14
 CALCULATED BY: MAL

DESIGN POINT 3

Total Flow: $Q_5 = \frac{9}{18}$ cfs
 $Q_{100} = \frac{18}{18}$ cfs

Maximum allowable ponding depth at sump:

$D_5 = 0.50$
 $D_{100} = 0.67$ (dmax)

$Q_i = 1.7(L_i + 1.8(W))(d_{max} + w/12)^{1.85}$

Clogging Factor = 1.25
 $L_i(1.25) = \text{Length of inlet opening}$

5-Year Event: foot inlet required

100-Year Event: foot inlet required

INSTALL A PUBLIC FT D-10-R INLET TO ACCEPT BOTH 5YR & 100 YR DEVELOPED FLOWS AT THIS DESIGN POINT.

JOB NAME: WINDERMERE
 JOB NUMBER: 2441.00
 DATE: 10/03/14
 CALCULATED BY: MAL

DESIGN POINT 4

Total Flow: $Q_5 = \underline{7}$ cfs
 $Q_{100} = \underline{15}$ cfs

Maximum allowable ponding depth at sump:

$D_5 = 0.50$
 $D_{100} = 0.67$ (dmax)
 $Q_i = 1.7(L_i + 1.8(W))(d_{max} + w/12)^{1.85}$

Clogging Factor = 1.25
 $L_i(1.25) =$ Length of inlet opening

5-Year Event: foot inlet required

100-Year Event: foot inlet required

EXISTING FT TYPE R INLET TO ACCEPT BOTH 5YR & 100 YR DEVELOPED FLOWS AT THIS DESIGN POINT.

JOB NAME:	<u>WINDERMERE</u>
JOB NUMBER:	<u>2441.00</u>
DATE:	<u>10/03/14</u>
CALCULATED BY:	<u>MAL</u>

DESIGN POINT	7
---------------------	----------

Total Flow: $Q_5 = \frac{20}{\text{cfs}}$
 $Q_{100} = \frac{42}{\text{cfs}}$

Maximum allowable ponding depth at sump:

$D_5 = 0.50$
 $D_{100} = 0.67 \text{ (dmax)}$
 $Q_i = 1.7(L_i + 1.8(W))(d_{\text{max}} + w/12)^{1.85}$

Clogging Factor = 1.25
 $L_i (1.25) = \text{Length of inlet opening}$

5-Year Event: foot inlet required

100-Year Event: foot inlet required

EXISTING FT TYPE R INLET TO ACCEPT BOTH 5YR & 100 YR DEVELOPED FLOWS AT THIS DESIGN POINT.

JOB NAME: WINDERMERE
 JOB NUMBER: 2441.00
 DATE: 10/03/14
 CALCULATED BY: MAL

DESIGN POINT 8

Total Flow: $Q_5 = \frac{8}{15}$ cfs
 $Q_{100} = \frac{15}{15}$ cfs

Maximum allowable ponding depth at sump:

$D_5 = 0.50$
 $D_{100} = 0.67$ (dmax)

$Q_i = 1.7(L_i + 1.8(W))(d_{max} + w/12)^{1.85}$

Clogging Factor = 1.25
 $L_i (1.25) = \text{Length of inlet opening}$

5-Year Event: foot inlet required

100-Year Event: foot inlet required

EXISTING FT TYPE R INLET TO ACCEPT BOTH 5YR & 100 YR DEVELOPED FLOWS AT THIS DESIGN POINT.

JOB NAME: WINDERMERE
 JOB NUMBER: 2441.00
 DATE: 10/03/14
 CALCULATED BY: MAL

DESIGN POINT 9 100 YEAR FLOW

Q(100)	26.0	I(100)	8.0		
DEPTH	0.44	Fr	2.63	Inlet size ? L(i) =	20
SPREAD	15.5	L(1)	31.4	If Li < L(2) then Qi =	17
CROSS SLOPE	2.0%	L(2)	18.9	If Li > L(2) then Qi =	16
STREET SLOPE	4.0%	L(3)	67.3	FB =	10
				CA(eqv.)=	1.25

5 YEAR FLOW

Q(5)	12.9	I(5)	4.5		
DEPTH	0.36	Fr	2.49	Inlet size ? L(i) =	20
SPREAD	11.8	L(1)	22.6	If Li < L(2) then Qi =	11
CROSS SLOPE	2.0%	L(2)	13.6	If Li > L(2) then Qi =	9
STREET SLOPE	4.0%	L(3)	48.4	FB =	4
				CA(eqv.)=	0.85

JOB NAME:	<i>WINDERMERE</i>
JOB NUMBER:	<i>2441.00</i>
DATE:	<i>10/03/14</i>
CALCULATED BY:	<i>MAL</i>

DESIGN POINT	10	100 YEAR FLOW			
Q(100)	13.5	I(100)	8.0		
DEPTH	0.36	Fr	2.48	Inlet size ? L(i) =	15
SPREAD	11.5	L(1)	22.0	If Li < L(2) then Qi =	9
CROSS SLOPE	2.0%	L(2)	13.2	If Li > L(2) then Qi =	9
STREET SLOPE	4.0%	L(3)	47.1	FB =	5
				CA(eqv.)=	0.62

5 YEAR FLOW					
Q(5)	5.6	I(5)	4.5		
DEPTH	0.28	Fr	2.28	Inlet size ? L(i) =	15
SPREAD	7.8	L(1)	13.6	If Li < L(2) then Qi =	6
CROSS SLOPE	2.0%	L(2)	8.2	If Li > L(2) then Qi =	4
STREET SLOPE	4.0%	L(3)	29.2	FB =	1
				CA(eqv.)=	0.29

JOB NAME: WINDERMERE
 JOB NUMBER: 2441.00
 DATE: 10/03/14
 CALCULATED BY: MAL

DESIGN POINT	11	100 YEAR FLOW			
Q(100)	24.8	I(100)	8.0		
DEPTH	0.44	Fr	2.63	Inlet size ? L(i) =	10
SPREAD	15.5	L(1)	31.4	If Li < L(2) then Qi =	8
CROSS SLOPE	2.0%	L(2)	18.9	If Li > L(2) then Qi =	12
STREET SLOPE	4.0%	L(3)	67.3	FB =	17
				CA(eqv.)=	2.12

5 YEAR FLOW					
Q(5)	11.2	I(5)	4.5		
DEPTH	0.34	Fr	2.45	Inlet size ? L(i) =	10
SPREAD	10.8	L(1)	20.3	If Li < L(2) then Qi =	6
CROSS SLOPE	2.0%	L(2)	12.2	If Li > L(2) then Qi =	6
STREET SLOPE	4.0%	L(3)	43.4	FB =	6
				CA(eqv.)=	1.26

JOB NAME: WINDERMERE
 JOB NUMBER: 2441.00
 DATE: 10/03/14
 CALCULATED BY: MAL

DESIGN POINT	12	100 YEAR FLOW			
Q(100)	22.4	I(100)	8.1		
DEPTH	0.50	Fr	1.67	Inlet size ? L(i) =	20
SPREAD	18.5	L(1)	23.7	If Li < L(2) then Qi =	19
CROSS SLOPE	2.0%	L(2)	14.3	If Li > L(2) then Qi =	15
STREET SLOPE	1.5%	L(3)	50.9	FB =	7
				CA(eqv.)=	0.86

5 YEAR FLOW					
Q(5)	11.0	I(5)	4.5		
DEPTH	0.40	Fr	1.58	Inlet size ? L(i) =	20
SPREAD	13.8	L(1)	16.7	If Li < L(2) then Qi =	13
CROSS SLOPE	2.0%	L(2)	10.0	If Li > L(2) then Qi =	9
STREET SLOPE	1.5%	L(3)	35.7	FB =	2
				CA(eqv.)=	0.50

JOB NAME: WINDERMERE
 JOB NUMBER: 2441.00
 DATE: 10/03/14
 CALCULATED BY: MAL

DESIGN POINT		14	100 YEAR FLOW		
Q(100)	24.5	I(100)	6.9		
DEPTH	0.44	Fr	2.63	Inlet size ? L(i) =	20
SPREAD	15.5	L(1)	31.4	If Li < L(2) then Qi =	16
CROSS SLOPE	2.0%	L(2)	18.9	If Li > L(2) then Qi =	15
STREET SLOPE	4.0%	L(3)	67.3	FB =	9
				CA(eqv.) =	1.36

5 YEAR FLOW					
Q(5)	12.3	I(5)	3.9		
DEPTH	0.35	Fr	2.47	Inlet size ? L(i) =	20
SPREAD	11.3	L(1)	21.4	If Li < L(2) then Qi =	11
CROSS SLOPE	2.0%	L(2)	12.9	If Li > L(2) then Qi =	9
STREET SLOPE	4.0%	L(3)	45.9	FB =	3
				CA(eqv.) =	0.89

JOB NAME: WINDERMERE
 JOB NUMBER: 2441.00
 DATE: 10/03/14
 CALCULATED BY: MAL

DESIGN POINT 15

Total Flow: $Q_5 = \underline{20}$ cfs
 $Q_{100} = \underline{51}$ cfs

Maximum allowable ponding depth at sump:

$D_5 = 0.50$
 $D_{100} = 0.87$ (dmax)
 $Q_i = 1.7(Li+1.8(W))(dmax + w/12)^{1.85}$

Clogging Factor = 1.25
 $Li (1.25) =$ Length of inlet opening

5-Year Event: foot inlet required

100-Year Event: foot inlet required

INSTALL A PUBLIC FT D-10-R INLET TO ACCEPT BOTH 5YR & 100 YR DEVELOPED FLOWS AT THIS DESIGN POINT.

JOB NAME: WINDERMERE
 JOB NUMBER: 2441.00
 DATE: 10/03/14
 CALCULATED BY: MAL

DESIGN POINT		16	100 YEAR FLOW		
Q(100)	20.8	I(100)	6.9		
DEPTH	0.48	Fr	1.65	Inlet size ? L(i) =	10
SPREAD	17.5	L(1)	22.2	If Li < L(2) then Qi =	9
CROSS SLOPE	2.0%	L(2)	13.4	If Li > L(2) then Qi =	11
STREET SLOPE	1.5%	L(3)	47.6	FB =	11
				CA(eqv.) =	1.64
5 YEAR FLOW					
Q(5)	10.4	I(5)	3.9		
DEPTH	0.38	Fr	1.55	Inlet size ? L(i) =	10
SPREAD	12.8	L(1)	15.2	If Li < L(2) then Qi =	7
CROSS SLOPE	2.0%	L(2)	9.2	If Li > L(2) then Qi =	6
STREET SLOPE	1.5%	L(3)	32.7	FB =	4
				CA(eqv.) =	1.00

JOB NAME: WINDERMERE
 JOB NUMBER: 2441.00
 DATE: 10/03/14
 CALCULATED BY: MAL

DESIGN POINT 17

Total Flow: $Q_5 = \underline{\quad 8 \text{ cfs}} \quad$
 $Q_{100} = \underline{\quad 19 \text{ cfs}} \quad$

Maximum allowable ponding depth at sump:

$D_5 = 0.50$
 $D_{100} = 0.67 \text{ (dmax)}$

$Q_i = 1.7(Li + 1.8(W))(dmax + w/12)^{1.85}$

Clogging Factor = 1.25
 $Li (1.25) = \text{Length of inlet opening}$

5-Year Event: foot inlet required

100-Year Event: foot inlet required

INSTALL A PUBLIC FT D-10-R INLET TO ACCEPT BOTH 5YR & 100 YR DEVELOPED FLOWS AT THIS DESIGN POINT.

JOB NAME:	WINDERMERE
JOB NUMBER:	2441.00
DATE:	10/03/14
CALCULATED BY:	MAL

DESIGN POINT	19	100 YEAR FLOW			
Q(100)	20.7	I(100)	8.6		
DEPTH	0.37	Fr	2.50	Inlet size ? L(i) =	15
SPREAD	12.0	L(1)	23.1	If Li < L(2) then Qi =	13
CROSS SLOPE	2.0%	L(2)	13.9	If Li > L(2) then Qi =	13
STREET SLOPE	4.0%	L(3)	49.6	FB =	7.9
				CA(eqv.)=	0.91

5 YEAR FLOW					
Q(5)	10.4	I(5)	4.8		
DEPTH	0.29	Fr	2.32	Inlet size ? L(i) =	15
SPREAD	8.3	L(1)	14.7	If Li < L(2) then Qi =	11
CROSS SLOPE	2.0%	L(2)	8.8	If Li > L(2) then Qi =	8
STREET SLOPE	4.0%	L(3)	31.5	FB =	2.7
				CA(eqv.)=	0.55

JOB NAME: WINDERMERE
 JOB NUMBER: 2441.00
 DATE: 10/03/14
 CALCULATED BY: MAL

DESIGN POINT 20

Total Flow: $Q_5 = \underline{5}$ cfs
 $Q_{100} = \underline{11}$ cfs

Maximum allowable ponding depth at sump:

$D_5 = 0.50$
 $D_{100} = 0.50$ (dmax)
 $Q_i = 1.7(Li + 1.8(W))(dmax + w/12)^{1.85}$

Clogging Factor = 1.25
 $Li(1.25) =$ Length of inlet opening

5-Year Event: foot inlet required
 100-Year Event: foot inlet required
 EXISTING FT TYPE R INLET TO ACCEPT BOTH 5YR & 100 YR DEVELOPED FLOWS AT THIS DESIGN POINT.

Design Point 20-DS

Worksheet for Gutter - 5yr

Project Description

Solve For Spread

Input Data

Channel Slope	0.02800	ft/ft
Discharge	33.80	ft ³ /s
Gutter Width	2.00	ft
Gutter Cross Slope	0.08	ft/ft
Road Cross Slope	0.02	ft/ft
Roughness Coefficient	0.013	

Results

Spread	20.07	ft
Flow Area	4.15	ft ²
Depth	0.53	ft
Gutter Depression	0.13	ft
Velocity	8.14	ft/s

Design Point 20-DS

Worksheet for Gutter - 100yr

Project Description

Solve For Spread

Input Data

Channel Slope	0.02800	ft/ft
Discharge	84.50	ft ³ /s
Gutter Width	2.00	ft
Gutter Cross Slope	0.08	ft/ft
Road Cross Slope	0.02	ft/ft
Roughness Coefficient	0.013	

Results

Spread	28.67	ft
Flow Area	8.34	ft ²
Depth	0.70	ft
Gutter Depression	0.13	ft
Velocity	10.13	ft/s

**FILING NO. 1 –
FULL SPECTRUM EDB FINAL DESIGN**

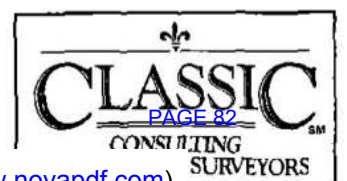

Design Procedure Form: Extended Detention Basin (EDB)

Sheet 1 of 4

Designer: M. Larson
Company: Classic Consulting
Date: October 4, 2014
Project: Windermere
Location: FILING NO. 1 POND

1. Basin Storage Volume

- A) Effective Imperviousness of Tributary Area, I_e
- B) Tributary Area's Imperviousness Ratio ($i = I_e / 100$)
- C) Contributing Watershed Area
- D) For Watersheds Outside of the Denver Region, Depth of Average Runoff Producing Storm
- E) Design Concept
(Select EURV when also designing for flood control)
- F) Design Volume (1.2 WQCV) Based on 40-hour Drain Time
($V_{DESIGN} = (1.0 * (0.91 * i^2 - 1.19 * i^2 + 0.78 * i) / 12 * Area * 1.2)$)
- G) For Watersheds Outside of the Denver Region, Water Quality Capture Volume (WQCV) Design Volume
($V_{WQCV\ OTHER} = (d_e * V_{DESIGN} / 0.43)$)
- H) User Input of Water Quality Capture Volume (WQCV) Design Volume
(Only if a different WQCV Design Volume is desired)
- I) Predominant Watershed NRCS Soil Group
- J) Excess Urban Runoff Volume (EURV) Design Volume
 For HSG A: $EURV_A = (0.1878i - 0.0104) * Area$
 For HSG B: $EURV_B = (0.1178i - 0.0042) * Area$
 For HSG C/D: $EURV_{C/D} = (0.1043i - 0.0031) * Area$

$I_e =$ 73.3 %

$i =$ 0.733

Area = 10.870 ac

$d_e =$ 0.42 in

Choose One

Water Quality Capture Volume (WQCV)

Excess Urban Runoff Volume (EURV)

$V_{DESIGN} =$ 0.318 ac-ft

$V_{DESIGN\ OTHER} =$ 0.309 ac-ft

$V_{DESIGN\ USER} =$ _____ ac-ft

Choose One

A

B

C / D

EURV = 0.893 ac-ft

- 2. Basin Shape: Length to Width Ratio
(A basin length to width ratio of at least 2:1 will improve TSS reduction.)

L : W = 2.0 : 1

3. Basin Side Slopes

- A) Basin Maximum Side Slopes
(Horizontal distance per unit vertical, 4:1 or flatter preferred)

$Z =$ 3.00 ft / ft
DIFFICULT TO MAINTAIN, INCREASE WHERE POSSIBLE

4. Inlet

- A) Describe means of providing energy dissipation at concentrated inflow locations:

Concrete box forebay

Design Procedure Form: Extended Detention Basin (EDB)

Sheet 2 of 4

Designer: M. Larson
Company: Classic Consulting
Date: October 4, 2014
Project: Windermera
Location: FILING NO. 1 POND

5. Forebay

- A) Minimum Forebay Volume
($V_{MIN} = 3\%$ of the WQCV)
- B) Actual Forebay Volume
- C) Forebay Depth
($D_F = 18$ inch maximum)
- D) Forebay Discharge
 - i) Undetained 100-year Peak Discharge
 - ii) Forebay Discharge Design Flow
($Q_F = 0.02 * Q_{100}$)
- E) Forebay Discharge Design

$V_{MIN} = 0.008$ ac-ft
 $V_F = 0.009$ ac-ft
 $D_F = 18.0$ in
 $Q_{100} = 57.00$ cfs
 $Q_F = 1.14$ cfs

Choose One

Berm With Pipe (flow too small for berm w/ pipe)
 Wall with Rect. Notch
 Wall with V-Notch Weir

- F) Discharge Pipe Size (minimum 3-inches)
- G) Rectangular Notch Width

Calculated $C_d =$ _____
 Calculated $W_N = 5.8$ in

6. Trickle Channel

- A) Type of Trickle Channel
- F) Slope of Trickle Channel

Choose One

Concrete
 Soft Bottom

$S = 0.0100$ ft / ft

7. Micropool and Outlet Structure

- A) Depth of Micropool (2.5-foot minimum)
- B) Surface Area of Microoool (10 ft² minimum)
- C) Outlet Type
- D) Depth of Design Volume (EURV or 1.2 WQCV) Based on the Design Concept Chosen Under 1. E.
- E) Volume to Drain Over Prescribed Time
- F) Drain Time
(Min T_D for WQCV= 40 hours; Max T_D for EURV= 72 hours)
- G) Recommended Maximum Outlet Area per Row, (A_o)
- H) Orifice Dimensions:
 - i) Circular Orifice Diameter or
 - ii) Width of 2" High Rectangular Orifice
- I) Number of Columns
- J) Actual Design Outlet Area per Row (A_o)
- K) Number of Rows (nr)
- L) Total Outlet Area (A_o)
- M) Depth of WQCV (H_{wocv})
(Estimate using actual stage-area-volume relationship and V_{wocv})
- N) Ensure Minimum 40 Hour Drain Time for WQCV

$D_M = 2.5$ ft
 $A_M = 107$ sq ft

Choose One

Orifice Plate
 Other (Describe):

$H = 7.00$ feet
 $EURV = 0.893$ ac-ft
 $T_D = 72$ hours
 $A_o = 0.47$ square inches
 $D_{orifice} = 3/4$ inches
 $W_{orifice} =$ _____ inches
 $n_c = 1$ number
 $A_o = 0.44$ square inches
 $n_r = 21$ number
 $A_o = 9.3$ square inches
 $H_{wocv} =$ _____ feet
 $T_{Dwocv} =$ _____ hours

Design Procedure Form: Extended Detention Basin (EDB)

Sheet 3 of 4

Designer: M. Larson
Company: Classic Consulting
Date: October 4, 2014
Project: Windermere
Location: FILING NO. 1 POND

8. Initial Surcharge Volume

- A) Depth of Initial Surcharge Volume
(Minimum recommended depth is 4 inches)
- B) Minimum Initial Surcharge Volume
(Minimum volume of 0.3% of the WQCV)
- C) Initial Surcharge Provided Above Micropool

$D_{IS} =$ 4.0 in

$V_{IS} =$ 34.4 cu ft

$V_s =$ 35.7 cu ft

9. Trash Rack

- A) Type of Water Quality Orifice Used
- B) Water Quality Screen Open Area: $A_t = 38.5 \cdot (e^{-0.065D}) \cdot A_o$
- C) For 2", or Smaller, **Circular Opening** (See Fact Sheet T-12):
 - i) Width of Water Quality Screen and Concrete Opening ($W_{opening}$)
 - ii) Height of Water Quality Screen (H_{TR})
 - iii) Type of Screen, Describe if "Other"

Choose One

Circular (up to 2" diameter)

Rectangular (2" high)

$A_t =$ 333 square inches

$W_{opening} =$ 12.0 inches

$H_{TR} =$ 112.0 inches

Choose One

S.S. Well Screen with 60% Open Area*

Other (Describe):

D) For 2" High **Rectangular Opening**

- i) Width of Rectangular Opening (W_{rect})
- ii) Width of Water Quality Screen Opening ($W_{opening}$)
- iii) Height of Water Quality Screen (H_{TR})
- iv) Type of Screen, Describe if "Other"
- v) Cross-bar Spacing
- vi) Minimum Bearing Bar Size

$W_{rect} =$ _____ inches

$W_{opening} =$ _____ ft

$H_{TR} =$ _____ ft

Choose One

Aluminum Amico-Klemp SR Series (or equal)

Other (Describe):

_____ inches

Design Procedure Form: Extended Detention Basin (EDB)

Sheet 4 of 4

Designer: M. Larson
Company: Classic Consulting
Date: October 4, 2014
Project: Windermere
Location: FILING NO. 1 POND

10. Overflow Embankment

A) Describe embankment protection for 100-year and greater overtopping:

B) Slope of Overflow Embankment
(Horizontal distance per unit vertical, 4:1 or flatter preferred)

$Z_e =$ 4.00 ft / ft

11. Vegetation

Choose One
 Irrigated
 Not Irrigated

12. Access

A) Describe Sediment Removal Procedures

Notes: _____

JOB NAME: WINDERMERE
 JOB NUMBER: 2441.00
 DATE: 10/04/14
 CALCULATED BY: MAL

FILING NO. 1 POND - EURV (TOP OF BOX)

POND SIZING WITH PONDPACK EQUATION:

INSERT POND DESIGN SIZE INFO: (RED)

POND ELEVATION :

(from lowest to highest)	6562.50
	6562.50
	6562.50
	6562.83
	6564.00
	6566.00
	6568.00
	6570.00

AREA (BTM to TOP):

	-	acres
	-	acres
	435	0.01 acres
	488	0.01 acres
	4,247	0.10 acres
	5,558	0.13 acres
	6,866	0.16 acres
	8,219	0.19 acres
	-	acres
	-	acres
	-	acres
	-	acres

PRELIMINARY SIZE:

VOLUME = $1/3\{(EL2-EL1)*(A1+A2+((A1*A2)^.5))\}$

CUMMULATIVE VOLUME:

-	AC-FT	from	6,563	to	6,563	-
-	AC-FT	from	6,563	to	6,563	0.00
0.00	AC-FT	from	6,563	to	6,563	0.06
0.05	AC-FT	from	6,563	to	6,564	0.28
0.22	AC-FT	from	6,564	to	6,566	0.56
0.28	AC-FT	from	6,566	to	6,568	0.90
0.34	AC-FT	from	6,568	to	6,570	0.90
-	AC-FT	from	6,570	to	-	0.90
-	AC-FT	from	-	to	-	0.90
-	AC-FT	from	-	to	-	0.90
-	AC-FT	from	-	to	-	0.90

*SIZING IS FOR PRELIMINARY PURPOSES ONLY.

VOLUME = **0.90 AC-FT**

APPROXIMATE SURFACE AREA REQUIREMENT

POND DEPTH (FT)	POND VOLUME			SURFACE AREA (SF)
	AC-FT	=	CF	
4	0.90	=	39,404	9,851
6	0.90	=	39,404	6,567
8	0.90	=	39,404	4,925
10	0.90	=	39,404	3,940

JOB NAME: WINDERMERE
 JOB NUMBER: 2441.00
 DATE: 10/04/14
 CALCULATED BY: MAL

FILING NO. 1 POND - VOLUME TO SPILLWAY

POND SIZING WITH PONDPACK EQUATION:
 INSERT POND DESIGN SIZE INFO: (RED)

POND ELEVATION :	
(from lowest to highest)	
6562.50	
6562.50	
6562.50	
6562.83	
6564.00	
6566.00	
6568.00	
6570.00	
6571.00	

AREA (BTM to TOP):		
	-	acres
	-	acres
435	0.010	acres
488	0.011	acres
4,247	0.098	acres
5,558	0.128	acres
6,866	0.158	acres
8,219	0.189	acres
10,977	0.252	acres
	-	acres
	-	acres
	-	acres

PRELIMINARY SIZE:

VOLUME = $1/3\{(EL2-EL1)\cdot(A1+A2+((A1\cdot A2)^{.5}))\}$

CUMMULATIVE VOLUME:

-	AC-FT	from	6,563	to	6,563	-
-	AC-FT	from	6,563	to	6,563	0.00
0.00	AC-FT	from	6,563	to	6,563	0.06
0.05	AC-FT	from	6,563	to	6,564	0.28
0.22	AC-FT	from	6,564	to	6,566	0.56
0.28	AC-FT	from	6,566	to	6,568	0.90
0.34	AC-FT	from	6,568	to	6,570	1.12
0.22	AC-FT	from	6,570	to	6,571	1.12
-	AC-FT	from	6,571	to	-	1.12
-	AC-FT	from	-	to	-	1.12
-	AC-FT	from	-	to	-	1.12

*SIZING IS FOR PRELIMINARY PURPOSES ONLY.

VOLUME = 1.12 AC-FT

APPROXIMATE SURFACE AREA REQUIREMENT

POND DEPTH (FT)	POND VOLUME			SURFACE AREA (SF)
	AC-FT	=	CF	
4	1.12	=	48,873	12,218
6	1.12	=	48,873	8,146
8	1.12	=	48,873	6,109
10	1.12	=	48,873	4,887

FILING NO. 1 - 5 YEAR

Project Summary

Title	WINDERMERE - FILING NO. 1
Engineer	MLARSON
Company	CCES
Date	10/3/2014

Notes	WINDERMERE - FILING NO. 1 5 YEAR POND ROUTING W/ STORMWATER QUALITY
-------	--

Table of Contents

	Master Network Summary	2
PO-1 (IN)	Level Pool Pond Routing Summary	3
FIL-1	Modified Rational Hydrograph	4

FILING NO. 1 - 5 YEAR

Subsection: Master Network Summary

Catchments Summary

Label	Scenario	Return Event (years)	Hydrograph Volume (ac-ft)	Time to Peak (hours)	Peak Flow (ft ³ /s)
FIL-1	Base	5	0.617	0.180	20.50

Node Summary

Label	Scenario	Return Event (years)	Hydrograph Volume (ac-ft)	Time to Peak (hours)	Peak Flow (ft ³ /s)
O-1	Base	5	0.607	0.550	0.63

Pond Summary

Label	Scenario	Return Event (years)	Hydrograph Volume (ac-ft)	Time to Peak (hours)	Peak Flow (ft ³ /s)	Maximum Water Surface Elevation (ft)	Maximum Pond Storage (ac-ft)
PO-1 (IN)	Base	5	0.619	0.200	20.50	(N/A)	(N/A)
PO-1 (OUT)	Base	5	0.607	0.550	0.63	6,568.19	0.599

FILING NO. 1 - 5 YEAR

Subsection: Level Pool Pond Routing Summary
 Label: PO-1 (IN)

Return Event: 5 years
 Storm Event: CO SPRINGS - 5 Year

Infiltration	
Infiltration Method (Computed)	No Infiltration

Initial Conditions	
Elevation (Water Surface, Initial)	6,562.50 ft
Volume (Initial)	0.000 ac-ft
Flow (Initial Outlet)	0.00 ft ³ /s
Flow (Initial Infiltration)	0.00 ft ³ /s
Flow (Initial, Total)	0.00 ft ³ /s
Time Increment	0.050 hours

Inflow/Outflow Hydrograph Summary			
Flow (Peak In)	20.50 ft ³ /s	Time to Peak (Flow, In)	0.200 hours
Flow (Peak Outlet)	0.63 ft ³ /s	Time to Peak (Flow, Outlet)	0.550 hours

Elevation (Water Surface, Peak)	6,568.19 ft
Volume (Peak)	0.599 ac-ft

Mass Balance (ac-ft)	
Volume (Initial)	0.000 ac-ft
Volume (Total Inflow)	0.619 ac-ft
Volume (Total Infiltration)	0.000 ac-ft
Volume (Total Outlet Outflow)	0.607 ac-ft
Volume (Retained)	0.010 ac-ft
Volume (Unrouted)	-0.002 ac-ft
Error (Mass Balance)	0.3 %

FILING NO. 1 - 5 YEAR

Subsection: Modified Rational Hydrograph

Return Event: 5 years

Label: FIL-1

Storm Event: CO SPRINGS - 5 Year

Modified Rational Method

Q = CiA * Unit Conversion; Where Conversion = 43560 / (12 * 3600)

Frequency (years)	C Coefficient	C Adjustment Factor	C Coefficient (Final)	Intensity (in/h)	Area (acres)	Flow (Peak) (ft ³ /s)
5	1.000	1.000	0.650	2.878	10.870	20.50

Peak Discharge	20.50 ft ³ /s
Time to Peak	0.300 hours
Hydrograph Volume	1.214 ac-ft

HYDROGRAPH ORDINATES (ft³/s)

Output Time Increment = 0.050 hours

Time on left represents time for first value in each row.

Time (hours)	Flow (ft ³ /s)	Flow (ft ³ /s)	Flow (ft ³ /s)	Flow (ft ³ /s)	Flow (ft ³ /s)
0.050	3.42	9.11	14.81	20.50	20.50
0.300	20.50	20.50	18.99	13.29	7.59
0.550	1.90	0.00	(N/A)	(N/A)	(N/A)

FILING NO. 1 - 5 YEAR

Index

F

FIL-1 (Modified Rational Hydrograph, 5 years)...4

M

Master Network Summary...2

P

PO-1 (IN) (Level Pool Pond Routing Summary, 5 years)...3

100-YR - FILING NO. 1

Project Summary

Title	WINDERMERE - FILING NO. 1
Engineer	MLARSON
Company	CCES
Date	10/3/2014

Notes	WINDERMERE - FILING NO. 1 100 YEAR POND ROUTING W/ STORMWATER QUALITY
-------	--

Table of Contents

	Master Network Summary	2
PO-1 (IN)	Level Pool Pond Routing Summary	3
FIL-1	Modified Rational Graph	4

100-YR - FILING NO. 1

Subsection: Master Network Summary

Catchments Summary

Label	Scenario	Return Event (years)	Hydrograph Volume (ac-ft)	Time to Peak (hours)	Peak Flow (ft ³ /s)
FIL-1	Base	100	1.126	0.180	46.07

Node Summary

Label	Scenario	Return Event (years)	Hydrograph Volume (ac-ft)	Time to Peak (hours)	Peak Flow (ft ³ /s)
O-1	Base	100	1.063	0.450	9.77

Pond Summary

Label	Scenario	Return Event (years)	Hydrograph Volume (ac-ft)	Time to Peak (hours)	Peak Flow (ft ³ /s)	Maximum Water Surface Elevation (ft)	Maximum Pond Storage (ac-ft)
PO-1 (IN)	Base	100	1.130	0.200	46.07	(N/A)	(N/A)
PO-1 (OUT)	Base	100	1.063	0.450	9.77	6,570.61	1.043

100-YR - FILING NO. 1

Subsection: Level Pool Pond Routing Summary
 Label: PO-1 (IN)

Return Event: 100 years
 Storm Event: CO SPRINGS - 100 Year

Infiltration	
Infiltration Method (Computed)	No Infiltration

Initial Conditions	
Elevation (Water Surface, Initial)	6,562.50 ft
Volume (Initial)	0.000 ac-ft
Flow (Initial Outlet)	0.00 ft ³ /s
Flow (Initial Infiltration)	0.00 ft ³ /s
Flow (Initial, Total)	0.00 ft ³ /s
Time Increment	0.050 hours

Inflow/Outflow Hydrograph Summary			
Flow (Peak In)	46.07 ft ³ /s	Time to Peak (Flow, In)	0.200 hours
Flow (Peak Outlet)	9.77 ft ³ /s	Time to Peak (Flow, Outlet)	0.450 hours

Elevation (Water Surface, Peak)	6,570.61 ft
Volume (Peak)	1.043 ac-ft

Mass Balance (ac-ft)	
Volume (Initial)	0.000 ac-ft
Volume (Total Inflow)	1.130 ac-ft
Volume (Total Infiltration)	0.000 ac-ft
Volume (Total Outlet Outflow)	1.063 ac-ft
Volume (Retained)	0.065 ac-ft
Volume (Unrouted)	-0.001 ac-ft
Error (Mass Balance)	0.1 %

100-YR - FILING NO. 1

Subsection: Modified Rational Graph

Return Event: 100 years

Label: FIL-1

Storm Event: CO SPRINGS - 100 Year

Method Type	Method T
Time of Duration (Modified Rational, Critical)	0.300 hours

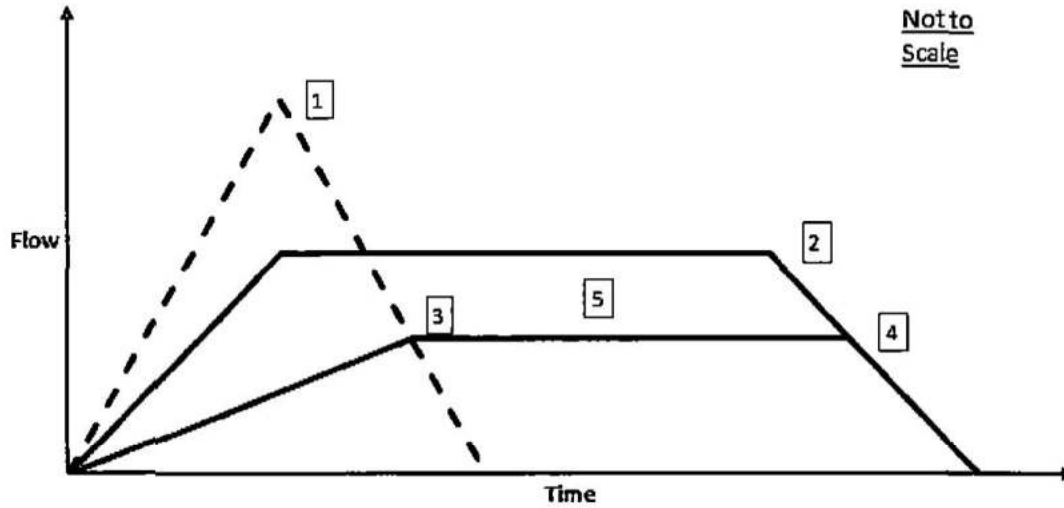

[1]	[2]
Time of Concentration (Modified Rational, Composite)	0.180 hours
Intensity (Modified Rational, Peak)	7.109 in/h
Flow (Modified Rational, Peak)	57.66 ft ³ /s
	Time of Duration (Modified Rational, Critical)
	0.300 hours
	Intensity (Modified Rational, Critical)
	5.680 in/h
	Flow (Modified Rational, Critical)
	46.07 ft ³ /s

[3]
First Outflow Breakpoint (Modified Rational, Method T)
0.379 hours
Flow (Modified Rational, Allowable)
25.80 ft ³ /s

[4]	[5]
Second Outflow Breakpoint (Modified Rational)	0.279 hours
Flow (Modified Rational, Allowable)	25.80 ft ³ /s
	Storage (Modified Rational, Estimated)
	0.524 ac-ft

100-YR - FILING NO. 1

Index

F

FIL-1 (Modified Rational Graph, 100 years)...4

M

Master Network Summary...2

P

PO-1 (IN) (Level Pool Pond Routing Summary, 100 years)...3

**FILING NO. 2 –
FULL SPECTRUM EDB PRELIMINARY DESIGN**

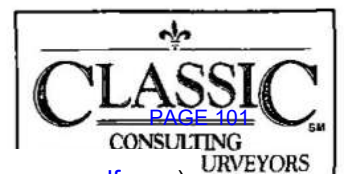

Design Procedure Form: Extended Detention Basin (EDB)

Sheet 1 of 4

Designer: M.Larson
Company: Classic Consulting
Date: October 4, 2014
Project: Windermere
Location: FILING NO. 2 REGIONAL FACILITY

1. Basin Storage Volume

- A) Effective Imperviousness of Tributary Area, i_p
- B) Tributary Area's Imperviousness Ratio ($i = i_p / 100$)
- C) Contributing Watershed Area
- D) For Watersheds Outside of the Denver Region, Depth of Average Runoff Producing Storm
- E) Design Concept
(Select EURV when also designing for flood control)
- F) Design Volume (1.2 WQCV) Based on 40-hour Drain Time
($V_{DESIGN} = (1.0 * (0.91 * i^2 - 1.19 * i + 0.78 * i) / 12 * Area * 1.2)$)
- G) For Watersheds Outside of the Denver Region, Water Quality Capture Volume (WQCV) Design Volume
($V_{WQCV\ OTHER} = (d_s * V_{DESIGN} / 0.43)$)
- H) User Input of Water Quality Capture Volume (WQCV) Design Volume
(Only if a different WQCV Design Volume is desired)
- I) Predominant Watershed NRCS Soil Group
- J) Excess Urban Runoff Volume (EURV) Design Volume
 For HSG A: $EURVA = (0.1878i - 0.0104) * Area$
 For HSG B: $EURVB = (0.1178i - 0.0042) * Area$
 For HSG C/D: $EURV_{C/D} = (0.1043i - 0.0031) * Area$

$i_p =$ 45.4 %
 $i =$ 0.454
 Area = 132.860 ac
 $d_s =$ 0.42 in

Choose One

Water Quality Capture Volume (WQCV)
 Excess Urban Runoff Volume (EURV)

$V_{DESIGN} =$ 2.577 ac-ft
 $V_{DESIGN\ OTHER} =$ 2.518 ac-ft
 $V_{DESIGN\ USER} =$ _____ ac-ft

Choose One

A
 B
 C/D

EURV = 6.548 ac-ft

- 2. Basin Shape: Length to Width Ratio
(A basin length to width ratio of at least 2:1 will improve TSS reduction.)

L : W = 2.0 : 1

3. Basin Side Slopes

- A) Basin Maximum Side Slopes
(Horizontal distance per unit vertical, 4:1 or flatter preferred)

Z = 4.00 ft / ft

4. Inlet

- A) Describe means of providing energy dissipation at concentrated inflow locations:

Forebay with depressed bottom and riprap berm.

Design Procedure Form: Extended Detention Basin (EDB)

Sheet 2 of 4

Designer: M.Larson
Company: Classic Consulting
Date: October 4, 2014
Project: Windermers
Location: FILING NO. 2 REGIONAL FACILITY

5. Forebay

A) Minimum Forebay Volume
($V_{MIN} = 3\%$ of the WQCV)

B) Actual Forebay Volume

C) Forebay Depth
($D_F = 30$ inch maximum)

D) Forebay Discharge

i) Undetained 100-year Peak Discharge

ii) Forebay Discharge Design Flow
($Q_F = 0.02 * Q_{100}$)

E) Forebay Discharge Design

F) Discharge Pipe Size: minimum 8-inches

G) Rectangular Notch Width

$V_{MIN} = 0.063$ ac-ft
 $V_F = 0.070$ ac-ft
 $D_F = 18.0$ in
 $Q_{100} = 199.70$ cfs
 $Q_F = 3.99$ cfs

Choose One

Berm With Pipe
 Wall with Rect. Notch
 Wall with V-Notch Weir

Calculated $D_p =$ _____ in

Calculated $W_N = 11.4$ in

6. Trickle Channel

A) Type of Trickle Channel

F) Slope of Trickle Channel

Choose One

Concrete
 Soft Bottom

$S = 0.0050$ ft / ft

7. Micropool and Outlet Structure

A) Depth of Micropool (2.5-foot minimum)

B) Surface Area of Micropool (10 ft² minimum)

C) Outlet Type

D) Depth of Design Volume (EURV or 1.2 WQCV) Based on the Design Concept Chosen Under 1.E.

E) Volume to Drain Over Prescribed Time

F) Drain Time
(Min T_D for WQCV= 40 hours; Max T_D for EURV= 72 hours)

G) Recommended Maximum Outlet Area per Row, (A_o)

H) Orifice Dimensions:

i) Circular Orifice Diameter or

ii) Width of 2" High Rectangular Orifice

I) Number of Columns

J) Actual Design Outlet Area per Row (A_{or})

K) Number of Rows (nr)

L) Total Outlet Area (A_{ot})

M) Depth of WQCV (H_{wocv})
(Estimate using actual stage-area-volume relationship and V_{wocv})

N) Ensure Minimum 40 Hour Drain Time for WQCV

$D_M = 2.5$ ft
 $A_M = 1000$ sq ft

Choose One

Orifice Plate
 Other (Describe):

$H = 5.50$ feet
 $EURV = 6.548$ ac-ft
 $T_D = 72$ hours
 $A_o = 3.73$ square inches
 $D_{orifice} = 1 - 1/2$ inches
 $W_{orifice} =$ _____ inches
 $n_c = 2$ number
 $A_{or} = 3.53$ square inches
 $n_r = 16$ number
 $A_{ot} = 58.3$ square inches
 $H_{wocv} =$ _____ feet
 $T_{D\ wocv} =$ _____ hours

Design Procedure Form: Extended Detention Basin (EDB)

Sheet 3 of 4

Designer: M. Larson
Company: Classic Consulting
Date: October 4, 2014
Project: Windermere
Location: FILING NO. 2 REGIONAL FACILITY

8 Initial Surcharge Volume

- A) Depth of Initial Surcharge Volume
(Minimum recommended depth is 4 inches)
- B) Minimum Initial Surcharge Volume
(Minimum volume of 0.3% of the WQCV)
- C) Initial Surcharge Provided Above Micropool

$D_{IS} = 4.0$ in

$V_{IS} = 280.7$ cu ft

$V_s = 333.3$ cu ft

9. Trash Rack

- A) Type of Water Quality Orifice Used
- B) Water Quality Screen Open Area: $A_T = 38.5 \cdot (e^{-0.005D}) \cdot A_{or}$
- C) For 2", or Smaller, **Circular Opening** (See Fact Sheet T-12):
 - i) Width of Water Quality Screen and Concrete Opening ($W_{opening}$)
 - ii) Height of Water Quality Screen (H_{TR})
 - iii) Type of Screen, Describe if "Other"

Choose One

Circular (up to 2" diameter)

Rectangular (2" high)

$A_T = 1,947$ square inches

$W_{opening} = 35.0$ inches

$H_{TR} = 94.0$ inches

Choose One

S.S. Well Screen with 60% Open Area

Other (Describe):

D) For 2" high Rectangular Opening

- i) Width of Rectangular Opening (W_{rect})
- ii) Width of Water Quality Screen Opening (W_{screen})
- iii) Height of Water Quality Screen (H_{TR})
- iv) Type of Screen Describe if "Other"

$W_{rect} =$ _____ inches

$W_{screen} =$ _____ ft

$H_{TR} =$ _____ ft

Choose One

Aluminum Amico-Klemp SR Series (or equal)

Other (Describe):

v) Cross-bar Spacing

_____ inches

vi) Minimum Bearing Bar Size

Design Procedure Form: Extended Detention Basin (EDB)

Sheet 4 of 4

Designer: M.Larson
Company: Classic Consulting
Date: October 4, 2014
Project: Windermere
Location: FILING NO. 2 REGIONAL FACILITY

10. Overflow Embankment

A) Describe embankment protection for 100-year and greater overtopping:

B) Slope of Overflow Embankment
(Horizontal distance per unit vertical, 4:1 or flatter preferred)

$Z_E = 4.00$ ft / ft

11. Vegetation

Choose One
 Irrigated
 Not Irrigated

12. Access

A) Describe Sediment Removal Procedures

Notes:

JOB NAME: WINDERMERE
 JOB NUMBER: 2441.00
 DATE: 10/04/14
 CALCULATED BY: MAL

FILING 2 - EURV (TOP OF BOX)

POND SIZING WITH PONDPACK EQUATION:
 ISERT POND DESIGN SIZE INFO: (RED)

POND ELEVATION :	
(from lowest to highest)	
	6571.00
	6571.00
	6572.00
	6574.00
	6576.00
	6576.50

AREA (BTM to TOP):		
	-	acres
4,724	0.11	acres
7,502	0.17	acres
49,737	1.14	acres
135,006	3.10	acres
153,596	3.53	acres
	-	acres
	-	acres
	-	acres
	-	acres
	-	acres
	-	acres
	-	acres

PRELIMINARY SIZE:						CUMMULATIVE VOLUME:	
VOLUME = $1/3\{(EL2-EL1)*(A1+A2+((A1*A2)^.5))\}$							
-	AC-FT	from	6,571	to	6,571		
0.14	AC-FT	from	6,571	to	6,572		0.14
1.16	AC-FT	from	6,572	to	6,574		1.30
4.04	AC-FT	from	6,574	to	6,576		5.34
1.64	AC-FT	from	6,576	to	6,577		6.98
-	AC-FT	from	6,577	to	-		6.98
-	AC-FT	from	-	to	-		6.98
-	AC-FT	from	-	to	-		6.98
-	AC-FT	from	-	to	-		6.98
-	AC-FT	from	-	to	-		6.98
-	AC-FT	from	-	to	-		6.98

*SIZING IS FOR PRELIMINARY PURPOSES ONLY.

VOLUME = **6.98 AC-FT**

APPROXIMATE SURFACE AREA REQUIREMENT

POND DEPTH (FT)	POND VOLUME			SURFACE AREA (SF)
	AC-FT	=	CF	
4	6.98	=	#####	75,980
6	6.98	=	#####	50,653
8	6.98	=	#####	37,990
10	6.98	=	#####	30,392

You created this PDF from an application that is not licensed to print to novaPDF printer (<http://www.novapdf.com>)

JOB NAME: WINDERMERE
 JOB NUMBER: 2441.00
 DATE: 10/04/14
 CALCULATED BY: MAL

FILING 2 VOLUME TO SPILLWAY

POND SIZING WITH PONDPACK EQUATION:
 ISERT POND DESIGN SIZE INFO: (RED)

POND ELEVATION :	
(from lowest to highest)	
	6571.00
	6571.00
	6572.00
	6574.00
	6576.00
	6578.00
	6579.00

AREA (BTM to TOP):		
	-	acres
4,724	0.108	acres
7,502	0.172	acres
49,737	1.142	acres
135,006	3.099	acres
198,782	4.563	acres
216,813	4.977	acres
	-	acres
	-	acres
	-	acres
	-	acres
	-	acres

PRELIMINARY SIZE:

VOLUME = $1/3\{(EL2-EL1)*(A1+A2+((A1*A2)^.5))\}$

CUMMULATIVE VOLUME:

-	AC-FT	from	6,571	to	6,571	
0.14	AC-FT	from	6,571	to	6,572	0.14
1.16	AC-FT	from	6,572	to	6,574	1.30
4.04	AC-FT	from	6,574	to	6,576	5.34
7.54	AC-FT	from	6,576	to	6,578	12.88
4.72	AC-FT	from	6,578	to	6,579	17.60
-	AC-FT	from	6,579	to	-	17.60
-	AC-FT	from	-	to	-	17.60
-	AC-FT	from	-	to	-	17.60
-	AC-FT	from	-	to	-	17.60
-	AC-FT	from	-	to	-	17.60

*SIZING IS FOR PRELIMINARY PURPOSES ONLY.

VOLUME = 17.60 AC-FT

APPROXIMATE SURFACE AREA REQUIREMENT

POND DEPTH (FT)	POND VOLUME			SURFACE AREA (SF)
	AC-FT	=	CF	
4	17.60	=	#####	191,654
6	17.60	=	#####	127,769
8	17.60	=	#####	95,827
10	17.60	=	#####	76,661

FILING NO. 2 - 5 YEAR

Project Summary

Title	WINDERMERE - FILING NO. 2
Engineer	MLARSON
Company	CCES
Date	10/3/2014

Notes	WINDERMERE - FILING NO. 2 5 YEAR POND ROUTING W/ STORMWATER QUALITY
-------	--

Table of Contents

	Master Network Summary	2
PO-1 (IN)	Level Pool Pond Routing Summary	3
DP-24	Modified Rational Graph	4

FILING NO. 2 - 5 YEAR

Subsection: Master Network Summary

Catchments Summary

Label	Scenario	Return Event (years)	Hydrograph Volume (ac-ft)	Time to Peak (hours)	Peak Flow (ft ³ /s)
DP-23	Base	5	2.827	0.343	68.85
DP-24	Base	5	4.237	0.430	102.88

Node Summary

Label	Scenario	Return Event (years)	Hydrograph Volume (ac-ft)	Time to Peak (hours)	Peak Flow (ft ³ /s)
O-1	Base	5	5.168	0.950	3.21

Pond Summary

Label	Scenario	Return Event (years)	Hydrograph Volume (ac-ft)	Time to Peak (hours)	Peak Flow (ft ³ /s)	Maximum Water Surface Elevation (ft)	Maximum Pond Storage (ac-ft)
PO-1 (IN)	Base	5	7.080	0.450	171.74	(N/A)	(N/A)
PO-1 (OUT)	Base	5	5.168	0.950	3.21	6,576.46	6.898

FILING NO. 2 - 5 YEAR

Subsection: Level Pool Pond Routing Summary
 Label: PO-1 (IN)

Return Event: 5 years
 Storm Event: CO SPRINGS - 5 Year

Infiltration	
Infiltration Method (Computed)	No Infiltration

Initial Conditions	
Elevation (Water Surface, Initial)	6,571.00 ft
Volume (Initial)	0.000 ac-ft
Flow (Initial Outlet)	0.00 ft ³ /s
Flow (Initial Infiltration)	0.00 ft ³ /s
Flow (Initial, Total)	0.00 ft ³ /s
Time Increment	0.050 hours

Inflow/Outflow Hydrograph Summary			
Flow (Peak In)	171.74 ft ³ /s	Time to Peak (Flow, In)	0.450 hours
Flow (Peak Outlet)	3.21 ft ³ /s	Time to Peak (Flow, Outlet)	0.950 hours

Elevation (Water Surface, Peak)	6,576.46 ft
Volume (Peak)	6.898 ac-ft

Mass Balance (ac-ft)	
Volume (Initial)	0.000 ac-ft
Volume (Total Inflow)	7.080 ac-ft
Volume (Total Infiltration)	0.000 ac-ft
Volume (Total Outlet Outflow)	5.168 ac-ft
Volume (Retained)	1.893 ac-ft
Volume (Unrouted)	-0.018 ac-ft
Error (Mass Balance)	0.3 %

FILING NO. 2 - 5 YEAR

Subsection: Modified Rational Graph
Label: DP-24

Return Event: 5 years
Storm Event: CO SPRINGS - 5 Year

Method Type	Method T
Time of Duration (Modified Rational, Critical)	0.500 hours

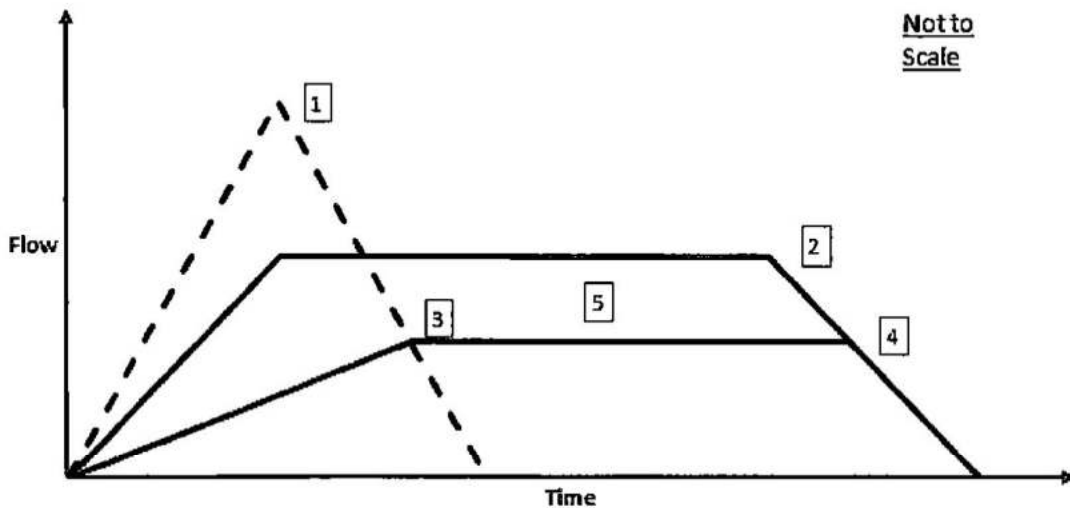

<p>[1]</p> <p>Time of Concentration (Modified Rational, Composite) 0.430 hours</p> <p>Intensity (Modified Rational, Peak) 2.638 in/h</p> <p>Flow (Modified Rational, Peak) 112.17 ft³/s</p>	<p>[2]</p> <p>Time of Duration (Modified Rational, Critical) 0.500 hours</p> <p>Intensity (Modified Rational, Critical) 2.420 in/h</p> <p>Flow (Modified Rational, Critical) 102.88 ft³/s</p>
--	--

<p>[3]</p> <p>First Outflow Breakpoint (Modified Rational, Method T) 0.700 hours</p> <p>Flow (Modified Rational, Allowable) 55.00 ft³/s</p>
--

<p>[4]</p> <p>Second Outflow Breakpoint (Modified Rational) 0.649 hours</p> <p>Flow (Modified Rational, Allowable) 55.00 ft³/s</p>	<p>[5]</p> <p>Storage (Modified Rational, Estimated) 2.022 ac-ft</p>
---	--

FILING NO. 2 - 5 YEAR

Index

D

DP-24 (*Modified Rational Graph, 5 years*)...4

M

Master Network Summary...2

P

PO-1 (IN) (*Level Pool Pond Routing Summary, 5 years*)...3

FILING 2 - 100 YEAR

Project Summary

Title	WINDERMERE - FILING NO. 2
Engineer	MLARSON
Company	CCES
Date	10/3/2014

Notes	WINDERMERE - FILING NO. 2 100 YEAR POND ROUTING W/ STORMWATER QUALITY
-------	--

Table of Contents

	Master Network Summary	2
PO-1 (IN)	Level Pool Pond Routing Summary	3
DP-24	Modified Rational Graph	4

FILING 2 - 100 YEAR

Subsection: Master Network Summary

Catchments Summary

Label	Scenario	Return Event (years)	Hydrograph Volume (ac-ft)	Time to Peak (hours)	Peak Flow (ft ³ /s)
DP-23	Base	100	5.847	0.343	142.39
DP-24	Base	100	7.620	0.430	185.05

Node Summary

Label	Scenario	Return Event (years)	Hydrograph Volume (ac-ft)	Time to Peak (hours)	Peak Flow (ft ³ /s)
O-1	Base	100	11.046	0.800	80.66

Pond Summary

Label	Scenario	Return Event (years)	Hydrograph Volume (ac-ft)	Time to Peak (hours)	Peak Flow (ft ³ /s)	Maximum Water Surface Elevation (ft)	Maximum Pond Storage (ac-ft)
PO-1 (IN)	Base	100	13.499	0.450	327.44	(N/A)	(N/A)
PO-1 (OUT)	Base	100	11.046	0.800	80.66	6,577.68	11.595

FILING 2 - 100 YEAR

Subsection: Level Pool Pond Routing Summary
 Label: PO-1 (IN)

Return Event: 100 years
 Storm Event: CO SPRINGS - 100 Year

Infiltration			
Infiltration Method (Computed)	No Infiltration		
Initial Conditions			
Elevation (Water Surface, Initial)	6,571.00 ft		
Volume (Initial)	0.000 ac-ft		
Flow (Initial Outlet)	0.00 ft ³ /s		
Flow (Initial Infiltration)	0.00 ft ³ /s		
Flow (Initial, Total)	0.00 ft ³ /s		
Time Increment	0.050 hours		
Inflow/Outflow Hydrograph Summary			
Flow (Peak In)	327.44 ft ³ /s	Time to Peak (Flow, In)	0.450 hours
Flow (Peak Outlet)	80.66 ft ³ /s	Time to Peak (Flow, Outlet)	0.800 hours
Peak Conditions			
Elevation (Water Surface, Peak)	6,577.68 ft		
Volume (Peak)	11.595 ac-ft		
Mass Balance (ac-ft)			
Volume (Initial)	0.000 ac-ft		
Volume (Total Inflow)	13.499 ac-ft		
Volume (Total Infiltration)	0.000 ac-ft		
Volume (Total Outlet Outflow)	11.046 ac-ft		
Volume (Retained)	2.415 ac-ft		
Volume (Unrouted)	-0.038 ac-ft		
Error (Mass Balance)	0.3 %		

FILING 2 - 100 YEAR

Subsection: Modified Rational Graph
Label: DP-24

Return Event: 100 years
Storm Event: CO SPRINGS - 100 Year

Method Type	Method T
Time of Duration (Modified Rational, Critical)	0.500 hours

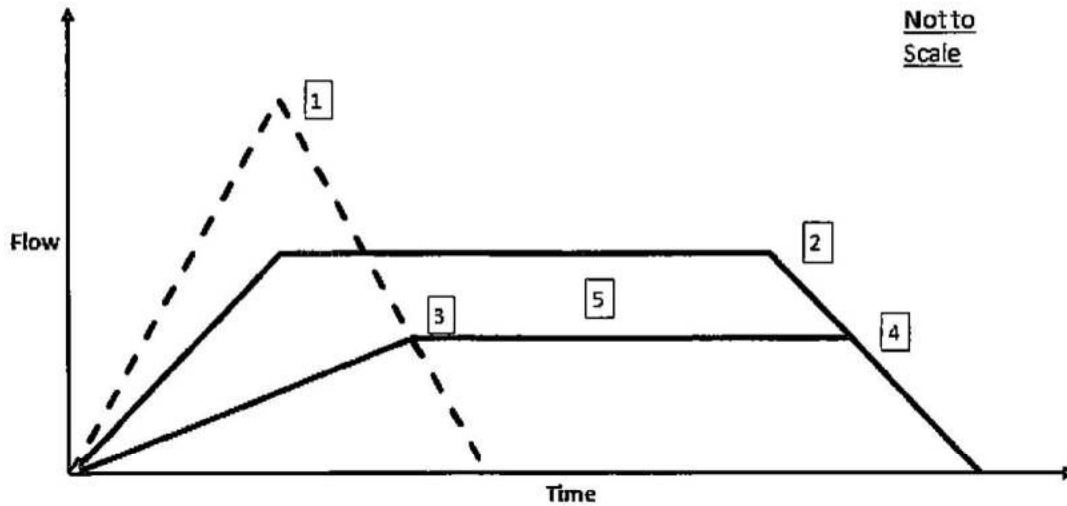

<p>[1]</p> <p>Time of Concentration (Modified Rational, Composite) 0.430 hours</p> <p>Intensity (Modified Rational, Peak) 4.696 in/h</p> <p>Flow (Modified Rational, Peak) 201.64 ft³/s</p>	<p>[2]</p> <p>Time of Duration (Modified Rational, Critical) 0.500 hours</p> <p>Intensity (Modified Rational, Critical) 4.310 in/h</p> <p>Flow (Modified Rational, Critical) 185.05 ft³/s</p>
<p>[3]</p> <p>First Outflow Breakpoint (Modified Rational, Method T) 0.612 hours</p> <p>Flow (Modified Rational, Allowable) 137.00 ft³/s</p>	
<p>[4]</p> <p>Second Outflow Breakpoint (Modified Rational) 0.568 hours</p> <p>Flow (Modified Rational, Allowable) 137.00 ft³/s</p>	<p>[5]</p> <p>Storage (Modified Rational, Estimated) 2.134 ac-ft</p>

FILING 2 - 100 YEAR

Index

D

DP-24 (Modified Rational Graph, 100 years)...4

M

Master Network Summary...2

P

PO-1 (IN) (Level Pool Pond Routing Summary, 100 years)...3

COORESPONDANCE FROM YES! COMMUNITIES

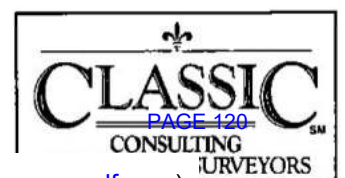



September 18, 2014

El Paso County
Development Services
2880 International Circle
Suite 110
Colorado Springs, CO 80910

ATTN: Ms. Kari Parsons – Project Manager/Planner II

RE: Proposed Windermere Development Public Detention and Stormwater Quality Facility

Dear Ms. Parsons:

Based upon a meeting with Mr. Campbell of Classic Consulting Engineers and Surveyors, LLC, a proposal was presented to create a regional public detention and SWQ facility in an area where our existing private facility currently resides. Based upon the multiple private and public drainage facilities (both existing and proposed) that drain to this area, we support the creation of one public facility.

While not required for the Windermere's initial Phase 1 area, we will continue to work with the adjacent southerly owner and their representatives as Phase 2 and 3 develop to support this effect.

If you have any questions or comments, please do not hesitate to call.

Sincerely,

Wally Moreland
Managing Director
YES! Communities

Ag/244100/public detention swq facility.docx

CC: Kyle R Campbell

YES! Communities, 2401 15th Street, Suite 200, Denver, CO 80202

Fax: (303) 468-0525

DRAINAGE MAP

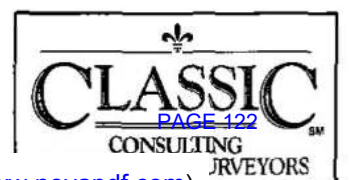

BASIN RUNOFF SUMMARY		
BASIN	Q5 (CFS)	Q100 (CFS)
EX-A	11.3	28.2
EX-B	5.7	14.2
EX-C	17.7	44.1
EX-D	5.8	14.5
EX-E	1.0	2.6
EX-F	4.0	10.0
EX-R	1.7	3.4
D-13	13.8	28.5
D-14	7.2	15.1
D-15	4.6	8.6
D-16	7.2	14.6
NC-1	1.9	3.6
NC-2	6.7	12.5
WS	47.3	66.4
CT	90.8	184.7

MDDP DP-1X
Q5 = 186 CFS
Q100 = 600 CFS
(SEE REPORT TEXT)

MDDP DP-1C
Q5 = 260 CFS
Q100 = 852 CFS

PIPE RUN SUMMARY			
PIPE	Q5 (CFS)	Q100 (CFS)	PIPE SIZE
6A	4.8	8.1	EX 18"
6B	18.4	42.6	EX 24"
6C	21.6	47.9	EX 24"
7	24.2	53.3	EX 30"
8	24.7	50.9	EX 36"

CHATEAU AT ANTELOPE
 RIDGE FILING NO. 2
 LOT 1

DESIGN POINT SUMMARY		
DESIGN POINT	Q5 (CFS)	Q100 (CFS)
4	7.2	14.6
5	18.4	42.6
6	20.0	41.6
7	5.6	11.2
8	6.7	12.5
19	3.7	8.0
20	111.3	199.7
24	117.5	215.1
25	138.3	266.9
26	138.3	266.9
		EX. TO MARKSHEFFEL RD.

WINDERMERE SPRINGS
 DEVELOPMENT

PROLOGONIA MEADOWS
 SUBDIVISION FILING NO. 1

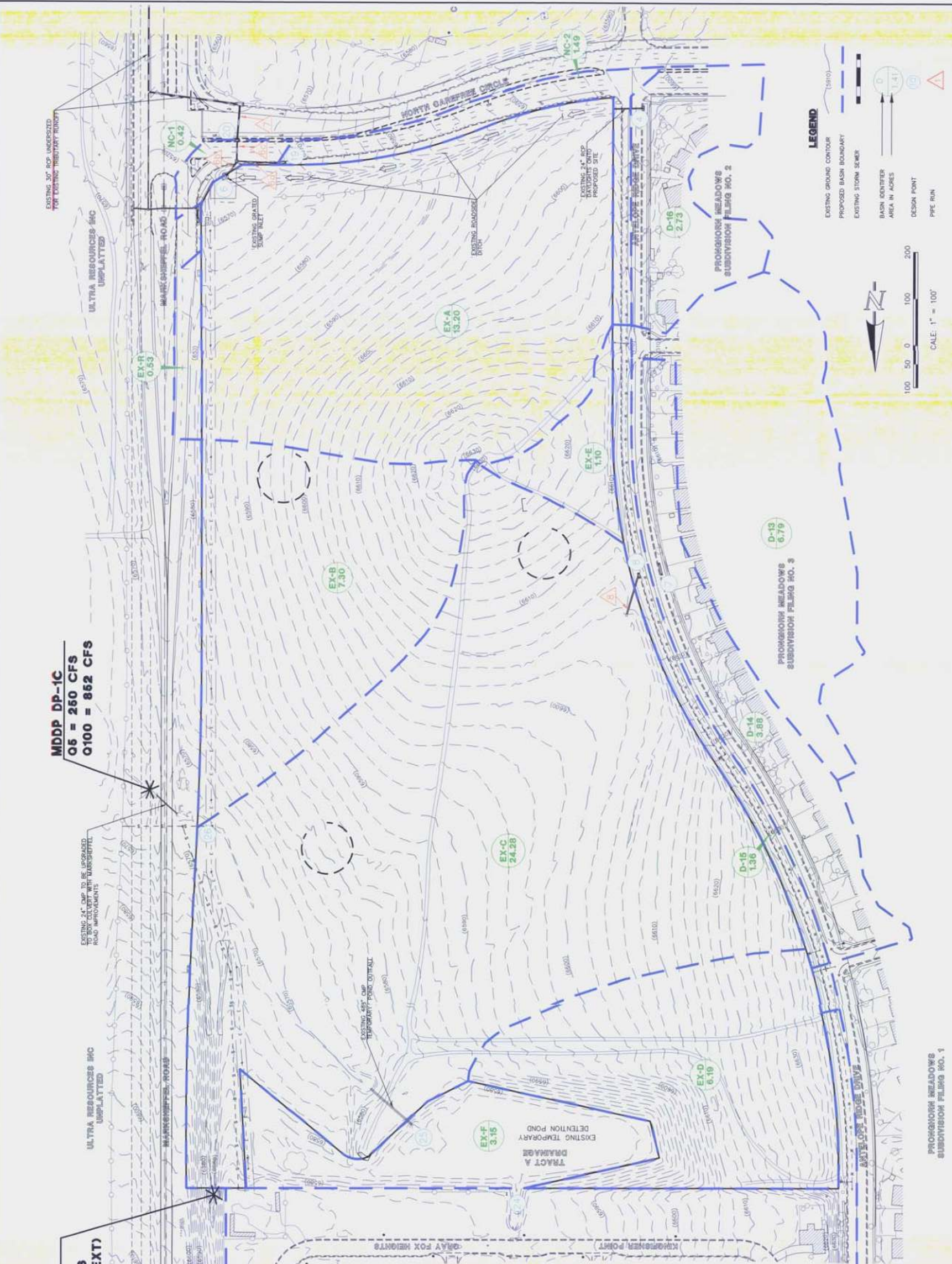

48 HOURS BEFORE YOU DIG,
 CALL UTILITY LOCATORS
811
 UTILITY NOTIFICATION OF COLORADO
 IT'S THE LAW

THE LOCATIONS OF EXISTING UNDERGROUND UTILITIES ARE SHOWN IN AN APPROXIMATE MANNER ONLY. THE CONTRACTOR SHALL DETERMINE THE EXACT LOCATION OF ALL EXISTING UTILITIES. THE CONTRACTOR SHALL BE FULLY RESPONSIBLE FOR ANY AND ALL DAMAGES WHICH MIGHT BE CAUSED BY HIS FAILURE TO EXACTLY LOCATE AND PRESERVE ANY AND ALL UNDERGROUND UTILITIES.

NO.	REVISION	DATE

REVIEW:
 PREPARED UNDER MY DIRECT SUPERVISION FOR AND ON BEHALF OF
 CLASSIC CONSULTING ENGINEERS AND SURVEYORS, LLC

KYLE R. CARPENTER, COLORADO P.E. #29794 DATE
 03/26/2014 (19)735-0396 (19)735-0296(e)

CLASSIC
 CONSULTING
 ENGINEERS & SURVEYORS

1000 Corporate Plaza, Suite 101
 Colorado Springs, Colorado 80910
 (719) 575-0396
 (719) 575-0296(e)

WINDERMERE EXISTING CONDITIONS DRAINAGE MAP			
PRELIMINARY DRAINAGE REPORT WINDERMERE			
FINAL DRAINAGE REPORT WINDERMERE FIL. NO. 1			
DESIGNED BY	SCALE	DATE	SHEET
DRAWN BY	MAL	(H) 1" = 100'	OF 1
CHECKED BY	(V) 1" = N/A	JOB NO.	2241.000

BASIN RUNOFF SUMMARY		
BASIN	Q5 (CFS)	Q100 (CFS)
A	9.1	18.2
B	9.2	18.5
C	13.1	26.2
D	3.9	8.5
E	4.2	8.6
F	9.4	18.9
G	11.1	22.4
H	4.5	9.0
I	12.9	26.0
J	10.3	20.7
K	11.0	22.4
L	10.4	20.8
M	9.6	23.9
N	1.7	3.5
P	0.8	1.9
R	4.7	9.3
S	7.1	16.0
D-13	13.8	28.5
D-14	7.2	15.1
D-15	4.6	8.6
D-16	7.2	14.6
NC-1	1.9	3.8
NC-2	6.7	12.5
WS	47.3	66.4
CT	90.8	184.7

MDDP DP-1C
Q5 = 250 CFS
Q100 = 862 CFS

MDDP DP-1X
Q5 = 185 CFS
Q100 = 600 CFS
(SEE REPORT TEXT)

DESIGN POINT SUMMARY		
DESIGN POINT	Q5 (CFS)	Q100 (CFS)
1	13.1	26.2
2	12.4	27.3
3	9.1	18.2
4	7.2	14.6
5	28.1	56.8
6	3.4	7.1
7	20.0	41.6
8	7.7	15.1
9	12.9	26.0
10	5.6	11.3
11	11.2	22.4
12	11.0	22.4
14	12.3	24.5
15	20.5	50.7
16	10.4	20.8
17	7.8	19.1
19	10.4	20.7
20	4.5	11.3
23	83.8	173.0
24	111.3	199.7
25	185.7	353.3
26	7.6	90.9

PIPE RUN SUMMARY		
PIPE	Q5 (CFS)	Q100 (CFS)
1	8.9	15.6
2	20.9	41.9
3A	9.1	18.2
3B	27.6	55.5
4	7.2	14.6
5	0.6	9.8
6A	9.0	12.8
6B	10.3	29.4
6C	17.5	39.7
7	21.2	48.9
8	26.4	54.1
9	9.0	16.0
10	32.4	64.7
11	4.3	8.5
12	9.8	16.4
13	38.9	75.5
14	8.8	15.1
15	45.9	87.4
16	8.7	15.4
17	6.5	9.3
18	87.7	141.5
19	20.5	50.7
20	7.8	19.1
21	28.2	69.8
22	78.1	158.1
23	3.2	80.6

PROPOSED FULL SPECTRUM DETENTION FACILITY INFORMATION			
FACILITY/D.P.	ELEV./TOP OF BOX (AC.-FT.)	EMERGENCY SPILLWAY ELEV./VOL.	100-YR W.S.E. Q5 (CFS) OUT Q100 (CFS) OUT
FILING 1/DP-5	6571.00 / 1.09 AC.-FT.	6570.61	0.63 9.77
FILING 2/DP-25	6548	6579.00 / 17.60 AC.-FT.	6577.68 3.22 80.70

48 HOURS BEFORE YOU DIG,
 CALL UTILITY LOCATORS
811
 UTILITY NOTIFICATION OF COLORADO
 IS THE LAW

REVIEW: _____ DATE _____
 PREPARED UNDER MY DIRECT SUPERVISION FOR AND ON BEHALF OF
 CLASSIC CONSULTING ENGINEERS AND SURVEYORS, LLC
 KYLE R. CAMPBELL, COLORADO P.E. #29784 DATE _____
 5305 Concord Drive, Suite 101 (797)785-0790
 Colorado Springs, Colorado 80919 (797)785-0790(x)

CLASSIC
 CONSULTING
 ENGINEERS & SURVEYORS

WINDERMERE
 DEVELOPED CONDITIONS DRAINAGE MAP
 PRELIMINARY DRAINAGE REPORT WINDERMERE
 FINAL DRAINAGE REPORT WINDERMERE FL. NO. 1

DESIGNED BY: MAL SCALE: 09/05/14
 DRAWN BY: MAL (W) 1" = 100' SHEET 1 OF 1
 CHECKED BY: (W) 1" = 100' N/A JOB NO: 2241.000

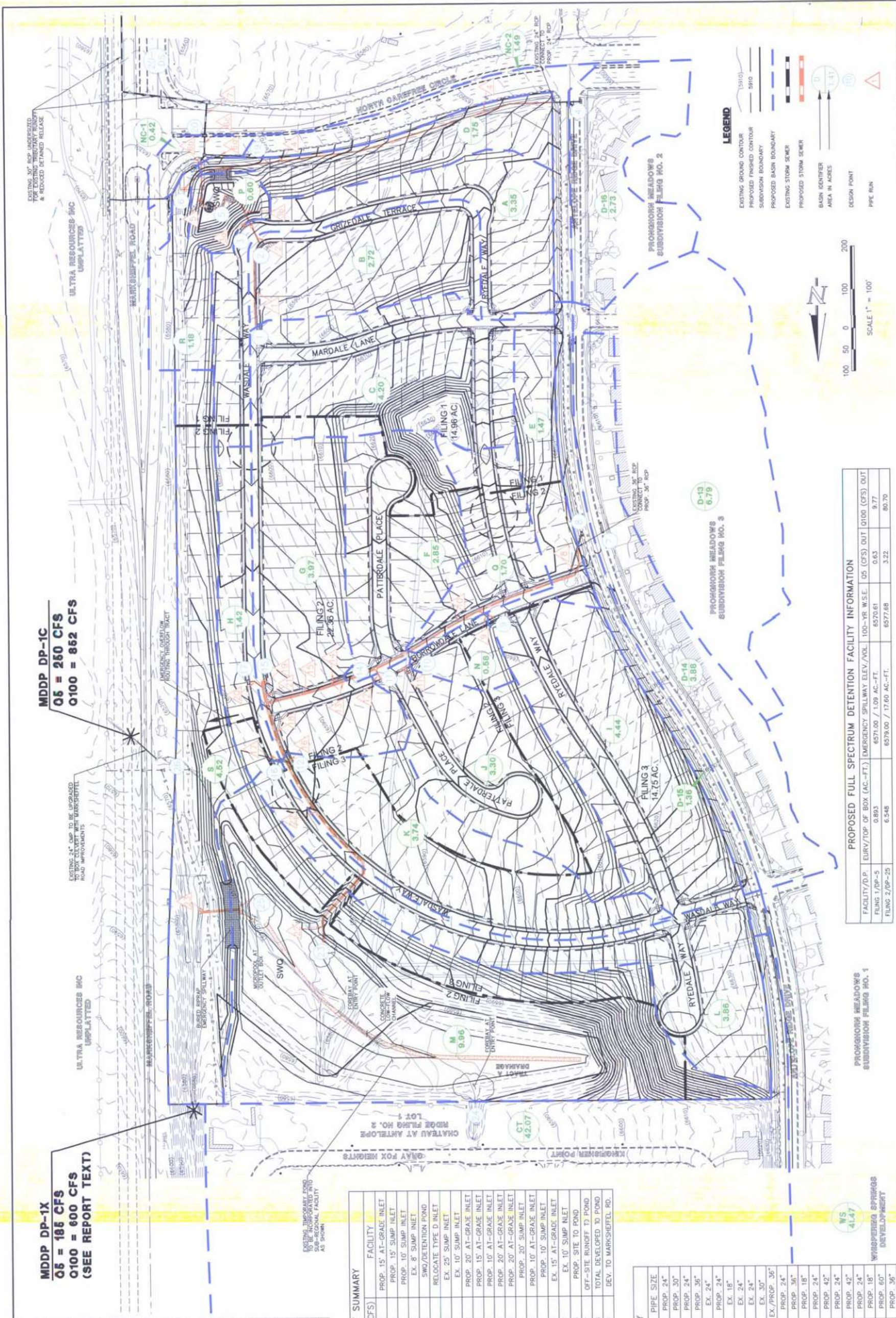

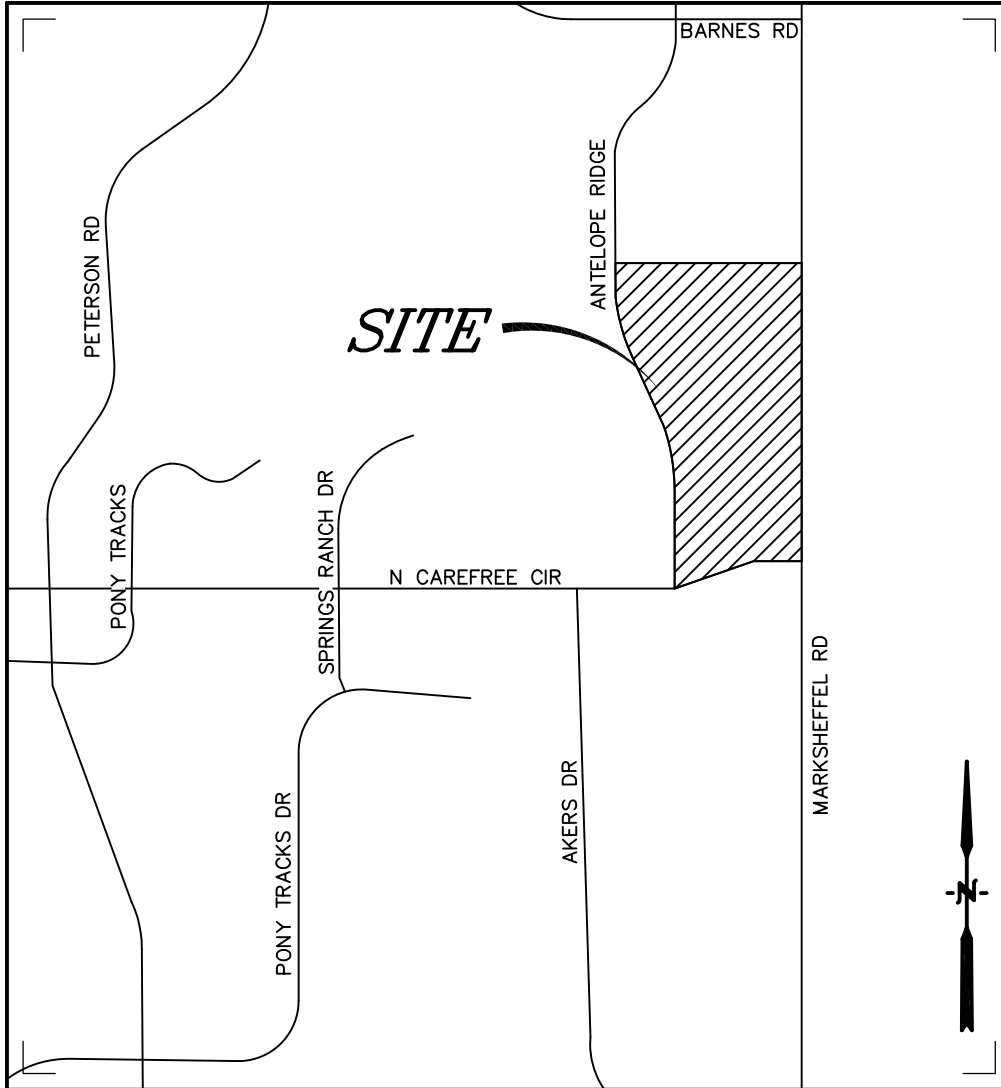

Vicinity Map
Not to scale

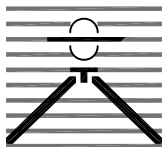

**WINDERMERE
COLORADO SPRINGS, CO
VICINITY MAP**

Drexel, Barrell & Co.
Engineers • Surveyors

DATE: _____
JOB NO:
21187-00CSCV

DWG. NO.
VMAP
PAGE 123
SHEET 1 OF 1

Hydrologic Soil Group—El Paso County Area, Colorado



Map Scale: 1:4,170 if printed on A portrait (8.5" x 11") sheet.

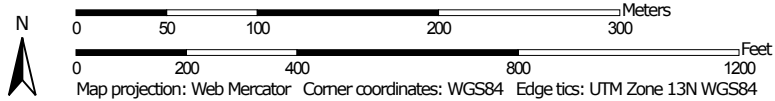

Natural Resources
Conservation Service

Web Soil Survey
National Cooperative Soil Survey

MAP LEGEND

Area of Interest (AOI)









 Area of Interest (AOI)

Soils

Soil Rating Polygons





-  A
-  A/D
-  B
-  B/D
-  C
-  C/D
-  D
-  Not rated or not available

Soil Rating Lines

-  A
-  A/D
-  B
-  B/D
-  C
-  C/D
-  D
-  Not rated or not available

Soil Rating Points





-  A
-  A/D
-  B
-  B/D

-  C
-  C/D
-  D
-  Not rated or not available

Water Features

 Streams and Canals

Transportation

-  Rails
-  Interstate Highways
-  US Routes
-  Major Roads
-  Local Roads

Background

 Aerial Photography

MAP INFORMATION

The soil surveys that comprise your AOI were mapped at 1:24,000.

Warning: Soil Map may not be valid at this scale.

Enlargement of maps beyond the scale of mapping can cause misunderstanding of the detail of mapping and accuracy of soil line placement. The maps do not show the small areas of contrasting soils that could have been shown at a more detailed scale.

Please rely on the bar scale on each map sheet for map measurements.

Source of Map: Natural Resources Conservation Service
 Web Soil Survey URL:
 Coordinate System: Web Mercator (EPSG:3857)

Maps from the Web Soil Survey are based on the Web Mercator projection, which preserves direction and shape but distorts distance and area. A projection that preserves area, such as the Albers equal-area conic projection, should be used if more accurate calculations of distance or area are required.

This product is generated from the USDA-NRCS certified data as of the version date(s) listed below.

Soil Survey Area: El Paso County Area, Colorado
 Survey Area Data: Version 15, Oct 10, 2017

Soil map units are labeled (as space allows) for map scales 1:50,000 or larger.

Date(s) aerial images were photographed: Apr 15, 2011—Jun 17, 2014

The orthophoto or other base map on which the soil lines were compiled and digitized probably differs from the background imagery displayed on these maps. As a result, some minor shifting of map unit boundaries may be evident.

Hydrologic Soil Group

Map unit symbol	Map unit name	Rating	Acres in AOI	Percent of AOI
97	Truckton sandy loam, 3 to 9 percent slopes	A	56.4	100.0%
Totals for Area of Interest			56.4	100.0%

Description

Hydrologic soil groups are based on estimates of runoff potential. Soils are assigned to one of four groups according to the rate of water infiltration when the soils are not protected by vegetation, are thoroughly wet, and receive precipitation from long-duration storms.

The soils in the United States are assigned to four groups (A, B, C, and D) and three dual classes (A/D, B/D, and C/D). The groups are defined as follows:

Group A. Soils having a high infiltration rate (low runoff potential) when thoroughly wet. These consist mainly of deep, well drained to excessively drained sands or gravelly sands. These soils have a high rate of water transmission.

Group B. Soils having a moderate infiltration rate when thoroughly wet. These consist chiefly of moderately deep or deep, moderately well drained or well drained soils that have moderately fine texture to moderately coarse texture. These soils have a moderate rate of water transmission.

Group C. Soils having a slow infiltration rate when thoroughly wet. These consist chiefly of soils having a layer that impedes the downward movement of water or soils of moderately fine texture or fine texture. These soils have a slow rate of water transmission.

Group D. Soils having a very slow infiltration rate (high runoff potential) when thoroughly wet. These consist chiefly of clays that have a high shrink-swell potential, soils that have a high water table, soils that have a claypan or clay layer at or near the surface, and soils that are shallow over nearly impervious material. These soils have a very slow rate of water transmission.

If a soil is assigned to a dual hydrologic group (A/D, B/D, or C/D), the first letter is for drained areas and the second is for undrained areas. Only the soils that in their natural condition are in group D are assigned to dual classes.

Rating Options

Aggregation Method: Dominant Condition

Component Percent Cutoff: None Specified



National Flood Hazard Layer FIRMette



104°41'24"W 38°53'34"N

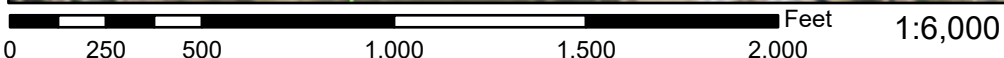
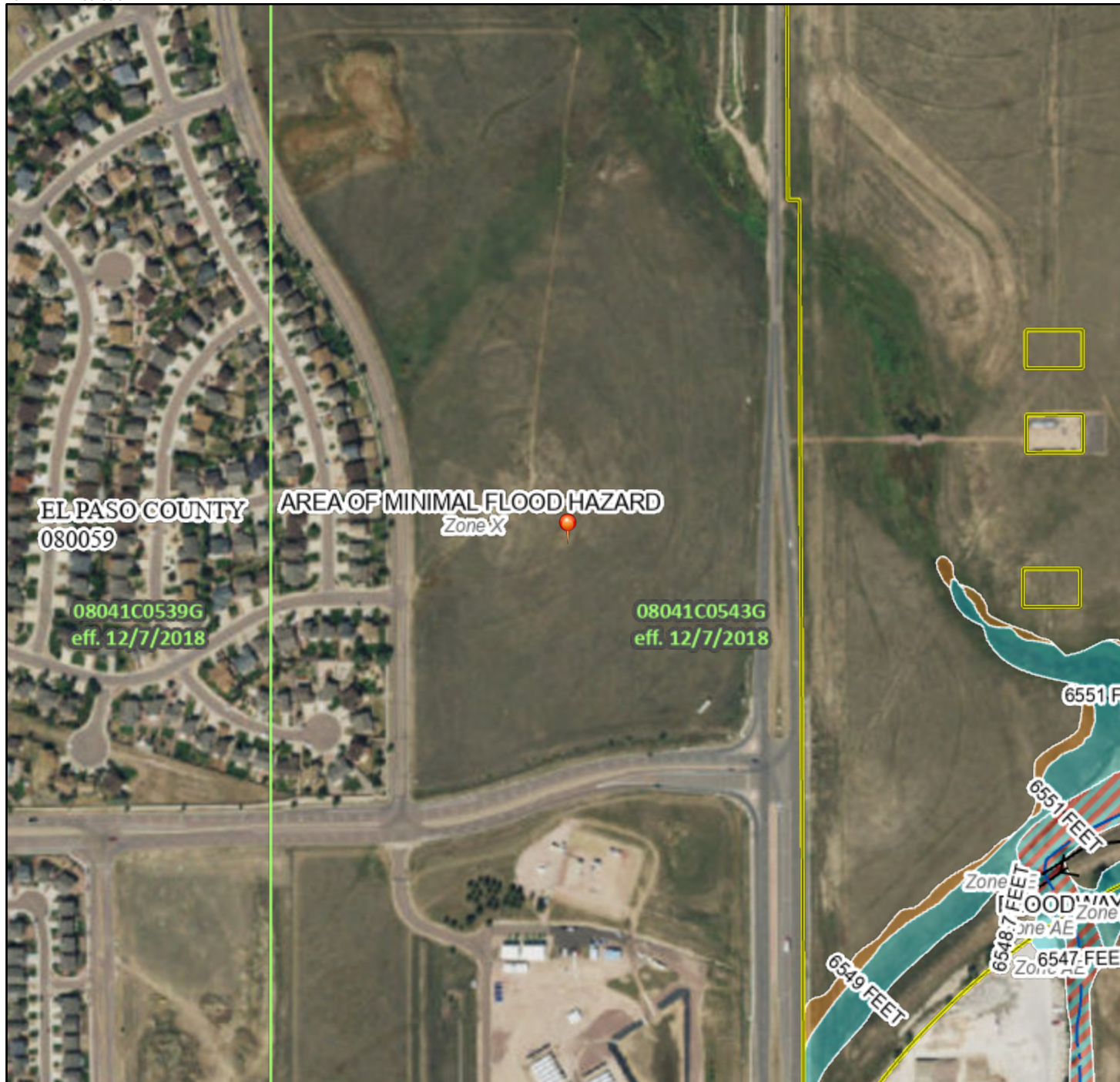

Basemap: USGS National Map: Orthoimagery: Data refreshed October, 2020

Legend

SEE FIS REPORT FOR DETAILED LEGEND AND INDEX MAP FOR FIRM PANEL LAYOUT

- | | | |
|------------------------------------|--|--|
| SPECIAL FLOOD HAZARD AREAS | | Without Base Flood Elevation (BFE)
<i>Zone A, V, A99</i> |
| | | With BFE or Depth <i>Zone AE, AO, AH, VE, AR</i> |
| | | Regulatory Floodway |
| OTHER AREAS OF FLOOD HAZARD | | 0.2% Annual Chance Flood Hazard, Areas of 1% annual chance flood with average depth less than one foot or with drainage areas of less than one square mile <i>Zone X</i> |
| | | Future Conditions 1% Annual Chance Flood Hazard <i>Zone X</i> |
| | | Area with Reduced Flood Risk due to Levee. See Notes. <i>Zone X</i> |
| | | Area with Flood Risk due to Levee <i>Zone D</i> |
| OTHER AREAS | | NO SCREEN Area of Minimal Flood Hazard <i>Zone X</i> |
| | | Effective LOMRs |
| GENERAL STRUCTURES | | Area of Undetermined Flood Hazard <i>Zone D</i> |
| | | Channel, Culvert, or Storm Sewer |
| OTHER FEATURES | | Levee, Dike, or Floodwall |
| | | 20.2 Cross Sections with 1% Annual Chance |
| MAP PANELS | | 17.5 Water Surface Elevation |
| | | Coastal Transect |
| | | Base Flood Elevation Line (BFE) |
| | | Limit of Study |
| | | Jurisdiction Boundary |
| | | Coastal Transect Baseline |
| MAP PANELS | | Profile Baseline |
| | | Hydrographic Feature |
| MAP PANELS | | Digital Data Available |
| | | No Digital Data Available |
| | | Unmapped |



The pin displayed on the map is an approximate point selected by the user and does not represent an authoritative property location.

This map complies with FEMA's standards for the use of digital flood maps if it is not void as described below. The basemap shown complies with FEMA's basemap accuracy standards

The flood hazard information is derived directly from the authoritative NFHL web services provided by FEMA. This map was exported on 9/8/2021 at 3:46 PM and does not reflect changes or amendments subsequent to this date and time. The NFHL and effective information may change or become superseded by new data over time.

This map image is void if the one or more of the following map elements do not appear: basemap imagery, flood zone labels, legend, scale bar, map creation date, community identifiers, FIRM panel number, and FIRM effective date. Map images for unmapped and unmodernized areas cannot be used for regulatory purposes.



September 18, 2020

Mr. Tim McConnell, PE
Principal / Regional Manager
Drexel, Barrell & Co.
3 S. 7th Street
Colorado Springs, CO 80905

Re: Proposed Windermere Development Pubic Detention and Stormwater Quality Facility

Dear Mr. McConnell,

Following to our recent correspondence, this is to confirm that YES Communities (YES) has no objection to proceeding forward with design and construction of a public detention pond and stormwater quality facility in conjunction with the proposed Windermere residential development currently under design. The specific property in question is owned by YES and is situated in the southwest quadrant of the intersection of Barnes Road on the north, and Marksheffel Road on the east. It is platted as Chateau at Antelope Ridge, Filing No. 2 in El Paso County, Colorado. The proposed pond location will be within Tract A, as situated on the south side of the property and which is currently used for storm water conveyance and detention. The Windermere property is located adjacent to the east, south, and west sides of Tract A.

It is understood that no adverse impacts to the existing homes and other infrastructure improvements within the YES property will be incurred with the proposed pond construction. The pond will serve local area drainage requirements from both the YES and Windermere properties. All pond improvements will be constructed and paid for by the Windermere developer. No financial burdens or liabilities will be incurred by YES with the work as proposed.

Please let us know if any additional information should be required. Thank you,

Sincerely,
YES Communities

Craig P. Schellbach, PE
Development Manager

c: Mike Askins

5605 N. MacArthur Blvd.; Suite 280; Irving, TX 75038
972-379-9610 | Email: cschellbach@yescommunities.com



PROJECT INFORMATION

PROJECT: Windermere
 PROJECT NO: 21187-01
 DESIGN BY: SBN
 REV. BY: TDM
 AGENCY: El Paso County
 REPORT TYPE: Final
 DATE: 1/5/2022



Drexel, Barrell & Co.

Soil Type: A			C2*	C5*	C10*	C100*	% IMPERV
Landscape/Lawn				0.15		0.50	0
Residential (<1/8 acre)				0.45		0.59	65
Asphalt/Sidewalk				0.90		0.96	100
PROPOSED							
SUB-BASIN	SURFACE DESIGNATION	AREA ACRE	COMPOSITE RUNOFF COEFFICIENTS				% IMPERV
			C2	C5	C10	C100	
WS	Historic Flow (interpolated)	41.47		0.09		0.36	2
	Residential (<1/8 acre)	0.00		0.45		0.59	65
	Asphalt/Sidewalk	0.00		0.90		0.96	100
	WEIGHTED AVERAGE			0.09		0.36	2%
TOTAL WS		41.47					
CT	Landscape/Lawn	0.00		0.15		0.50	0
	Residential (interpolated)	42.07		0.62		0.71	70
	Asphalt/Sidewalk	0.00		0.90		0.96	100
	WEIGHTED AVERAGE			0.62		0.71	70%
TOTAL CT		42.07					
D13	Landscape/Lawn	0.00		0.15		0.50	0
	Residential (<1/8 acre)	6.79		0.45		0.59	65
	Asphalt/Sidewalk	0.00		0.90		0.96	100
	WEIGHTED AVERAGE			0.45		0.59	65%
TOTAL D13		6.79					
D14	Landscape/Lawn	0.00		0.15		0.50	0
	Residential (<1/8 acre)	3.25		0.45		0.59	65
	Asphalt/Sidewalk	0.63		0.90		0.96	100
	WEIGHTED AVERAGE			0.52		0.65	71%
TOTAL D14		3.88					
D15	Landscape/Lawn	0.32		0.15		0.50	0
	Residential (<1/8 acre)	0.00		0.45		0.59	65
	Asphalt/Sidewalk	1.04		0.90		0.96	100
	WEIGHTED AVERAGE			0.72		0.85	76%
TOTAL D15		1.36					
A1	Landscape/Lawn	0.00		0.15		0.50	0
	Residential (<1/8 acre)	1.56		0.45		0.59	65
	Asphalt/Sidewalk	0.00		0.90		0.96	100
	WEIGHTED AVERAGE			0.45		0.59	65%
TOTAL A1		1.56					
A2	Landscape/Lawn	0.00		0.15		0.50	0
	Residential (<1/8 acre)	4.61		0.45		0.59	65
	Asphalt/Sidewalk	0.00		0.90		0.96	100
	WEIGHTED AVERAGE			0.45		0.59	65%
TOTAL A2		4.61					
A3	Landscape/Lawn	0.00		0.15		0.50	0
	Residential (<1/8 acre)	2.18		0.45		0.59	65

	Asphalt/Sidewalk	0.00		0.90		0.96	100
	WEIGHTED AVERAGE			0.45		0.59	65%
TOTAL A3		2.18					
A4	Landscape/Lawn	0.00		0.15		0.50	0
	Residential (<1/8 acre)	1.01		0.45		0.59	65
	Asphalt/Sidewalk	0.00		0.90		0.96	100
	WEIGHTED AVERAGE			0.45		0.59	65%
TOTAL A4		1.01					
A5	Landscape/Lawn	0.00		0.15		0.50	0
	Residential (<1/8 acre)	1.98		0.45		0.59	65
	Asphalt/Sidewalk	0.00		0.90		0.96	100
	WEIGHTED AVERAGE			0.45		0.59	65%
TOTAL A5		1.98					
A6	Landscape/Lawn	0.00		0.15		0.50	0
	Residential (<1/8 acre)	3.73		0.45		0.59	65
	Asphalt/Sidewalk	0.00		0.90		0.96	100
	WEIGHTED AVERAGE			0.45		0.59	65%
TOTAL A6		3.73					
A7	Landscape/Lawn	0.00		0.15		0.50	0
	Residential (<1/8 acre)	1.56		0.45		0.59	65
	Asphalt/Sidewalk	0.00		0.90		0.96	100
	WEIGHTED AVERAGE			0.45		0.59	65%
TOTAL A7		1.56					
A8	Landscape/Lawn	0.00		0.15		0.50	0
	Residential (<1/8 acre)	2.96		0.45		0.59	65
	Asphalt/Sidewalk	0.00		0.90		0.96	100
	WEIGHTED AVERAGE			0.45		0.59	65%
TOTAL A8		2.96					
A9	Landscape/Lawn	0.00		0.15		0.50	0
	Residential (<1/8 acre)	1.86		0.45		0.59	65
	Asphalt/Sidewalk	0.00		0.90		0.96	100
	WEIGHTED AVERAGE			0.45		0.59	65%
TOTAL A9		1.86					
A10	Landscape/Lawn	0.00		0.15		0.50	0
	Residential (<1/8 acre)	4.00		0.45		0.59	65
	Asphalt/Sidewalk	0.00		0.90		0.96	100
	WEIGHTED AVERAGE			0.45		0.59	65%
TOTAL A10		4.00					
A11	Landscape/Lawn	0.00		0.15		0.50	0
	Residential (<1/8 acre)	2.67		0.45		0.59	65
	Asphalt/Sidewalk	0.00		0.90		0.96	100
	WEIGHTED AVERAGE			0.45		0.59	65%
TOTAL A11		2.67					
A12	Landscape/Lawn	7.50		0.15		0.50	0
	Residential (<1/8 acre)	1.96		0.45		0.59	65
	Asphalt/Sidewalk	0.00		0.90		0.96	100
	WEIGHTED AVERAGE			0.21		0.52	13%
TOTAL A12		9.46					
B1	Landscape/Lawn	0.00		0.15		0.50	0
	Residential (<1/8 acre)	3.33		0.45		0.59	65
	Asphalt/Sidewalk	0.00		0.90		0.96	100
	WEIGHTED AVERAGE			0.45		0.59	65%
TOTAL B1		3.33					
B2	Landscape/Lawn	0.00		0.15		0.50	0
	Residential (<1/8 acre)	0.49		0.45		0.59	65
	Asphalt/Sidewalk	0.00		0.90		0.96	100
	WEIGHTED AVERAGE			0.45		0.59	65%

TOTAL B2		0.49				
B3	Landscape/Lawn	0.00		0.15		0.50
	Residential (<1/8 acre)	5.86		0.45		0.59
	Asphalt/Sidewalk	0.00		0.90		0.96
	WEIGHTED AVERAGE			0.45		0.59
TOTAL B3		5.86				65%
B4	Landscape/Lawn	0.00		0.15		0.50
	Residential (<1/8 acre)	0.16		0.45		0.59
	Asphalt/Sidewalk	0.00		0.90		0.96
	WEIGHTED AVERAGE			0.45		0.59
TOTAL B4		0.16				65%
B5	Landscape/Lawn	1.05		0.15		0.50
	Residential (<1/8 acre)	0.00		0.45		0.59
	Asphalt/Sidewalk	0.00		0.90		0.96
	WEIGHTED AVERAGE			0.15		0.50
TOTAL B5		1.05				0%
C1	Landscape/Lawn	0.00		0.15		0.50
	Residential (<1/8 acre)	0.59		0.45		0.59
	Asphalt/Sidewalk	0.00		0.90		0.96
	WEIGHTED AVERAGE			0.45		0.59
TOTAL C1		0.59				65%
C2	Landscape/Lawn	3.58		0.15		0.50
	Residential (<1/8 acre)	0.00		0.45		0.59
	Asphalt/Sidewalk	0.00		0.90		0.96
	WEIGHTED AVERAGE			0.15		0.50
TOTAL C2		3.58				0%
C3	Landscape/Lawn	0.63		0.15		0.50
	Residential (<1/8 acre)	0.00		0.45		0.59
	Asphalt/Sidewalk	0.00		0.90		0.96
	WEIGHTED AVERAGE			0.15		0.50
TOTAL C3		0.63				0%
C4	Landscape/Lawn	1.07		0.15		0.50
	Residential (<1/8 acre)	0.72		0.45		0.59
	Asphalt/Sidewalk	0.00		0.90		0.96
	WEIGHTED AVERAGE			0.27		0.54
TOTAL C4		1.79				26%
C5	Landscape/Lawn	0.11		0.15		0.50
	Residential (<1/8 acre)	0.00		0.45		0.59
	Asphalt/Sidewalk	0.00		0.90		0.96
	WEIGHTED AVERAGE			0.15		0.50
TOTAL C5		0.11				0%
NC2	Landscape/Lawn	0.27		0.15		0.50
	Residential (<1/8 acre)	0.00		0.45		0.59
	Asphalt/Sidewalk	1.34		0.90		0.96
	WEIGHTED AVERAGE			0.77		0.88
TOTAL NC2		1.61				83%
NC1	Landscape/Lawn	0.03		0.15		0.50
	Residential (<1/8 acre)	0.00		0.45		0.59
	Asphalt/Sidewalk	0.40		0.90		0.96
	WEIGHTED AVERAGE			0.85		0.93
TOTAL NC1		0.43				93%
D16	Landscape/Lawn	0.00		0.15		0.50
	Residential (<1/8 acre)	2.73		0.45		0.59
	Asphalt/Sidewalk	0.00		0.90		0.96
	WEIGHTED AVERAGE			0.45		0.59
TOTAL D16		2.73				65%
EXR	Landscape/Lawn	0.00		0.15		0.50

	Residential (<1/8 acre)	0.00		0.45		0.59	65
	Asphalt/Sidewalk	0.53		0.90		0.96	100
	WEIGHTED AVERAGE			0.90		0.96	100%
TOTAL EXR		0.53					
TOTAL SITE		55.17		1.02		0.57	48.6%
	ONSITE TO NORTH POND	37.58					52.0%
	OFFSITE BASINS TO NORTH POND	95.57					36.3%
	TOTAL TO NORTH POND	133.15					40.7%
	AREA TO SOUTH POND	10.89					58.8%

PROJECT INFORMATION

PROJECT: Windermere
 PROJECT NO: 21187-01
 DESIGN BY: SBN
 REV. BY: TDM
 AGENCY: El Paso County
 REPORT TYPE: Final
 DATE: 1/5/2022



RATIONAL METHOD CALCULATIONS FOR STORM WATER RUNOFF

PROPOSED TIME OF CONCENTRATION STANDARD FORM SF-2

SUB-BASIN DATA					INITIAL/OVERLAND TIME (t _i)				TRAVEL TIME (t _t)					PIPE TRAVEL TIME (t _p)				TIME OF CONC. t _c		FINAL t _c
BASIN	DESIGN PT.	C ₅	C ₁₀₀	AREA	LENGTH	HT	SLOPE	t _i	LENGTH	HT	SLOPE	VEL.	t _t	LENGTH	SLOPE	VEL.	t _p	COMP.	MINIMUM	t _c
				Ac	Ft	FT	%	Min	Ft	FT	%	FPS	Min	Ft	%	FPS	Min	t _c	t _c	Min
WS		0.09	0.36	41.47	100	2	2.0	14.7	1450	29	2.0	4.9	4.9					19.6	5	19.6
CT		0.62	0.71	42.07	100	4	4.0	5.5	1450	29	2.0	4.9	4.9					10.5	5	14.9
	24	0.36	0.54	83.54														19.6	5	19.6
D13		0.45	0.59	6.79	270	21	7.8	9.9	1380	83	6.0	8.6	2.7					12.6	5	16.0
D14		0.52	0.65	3.88	125	2.5	2.0	9.6	1250	12	1.0	4.6	4.5					14.1	5	18.7
D13+D14	7	0.48	0.61	10.67									18.7					18.7	5	18.7
D15		0.72	0.85	1.36	25	1	4.0	2.2	2050	20	1.0	7.5	4.6					6.8	5	6.8
A1		0.45	0.59	1.56	125	12	9.6	6.4	300	4	1.3	7.2	0.7					7.1	5	7.1
7+A1+D15	A	0.50	0.63	13.59									18.7	50	1	6.7	0.1	18.8	5	18.8
A2	B	0.45	0.59	4.61	100	5	5.1	7.1	1051	21	2.0	8.3	2.1					9.2	5	9.2
A3	C	0.48	0.62	2.18	35	1	3.5	4.5	600	16	2.6	9.4	1.1					5.6	5	5.6
A+B+C	C1	0.48	0.62	20.38										450	0.5	5.4	1.4	20.2	5	20.2
A4	D	0.45	0.59	1.01	100	1	1.0	12.2	205	10	4.8	12.8	0.3					12.4	5	12.4
C1+D	D1	0.48	0.62	21.39										220	4.0	15.3	0.2	20.4	5	20.4
A5	E	0.45	0.59	1.98	100	12	11.9	5.3	385	9	2.4	9.1	0.7					6.0	5	6.0
A6	F	0.45	0.59	3.73	100	3	3.0	8.4	790	32	4.0	11.7	1.1					9.6	5	9.6
D1+E+F	F1	0.47	0.61	27.10										90	3.5	14.3	0.1	20.6	5	20.6
A7	G	0.45	0.59	1.56	75	2	2.7	7.6	610	9	1.4	6.9	1.5					9.1	5	9.1
A8	H	0.45	0.59	2.96	100	10	10.4	5.6	740	11	1.5	7.2	1.7					7.3	5	7.3
G+H	H1	0.45	0.59	4.52										36	1.0	5.0	0.1	9.2	5	9.2
A9	I	0.45	0.59	1.86	100	10	10.5	5.6	460	8	1.6	7.4	1.0					6.6	5	6.6
H1+I	J	0.45	0.59	6.38										300	1.0	5.9	0.9	10.0	5	10.0
F1+J	K	0.47	0.61	33.48										275	3.5	12.7	0.4	20.9	5	20.9
A10	L	0.45	0.59	4.00	100	3	3.0	8.4	770	25	3.2	10.5	1.2					9.7	5	9.7

K+L	L1	0.47	0.61	37.48										115	1.0	9.3	0.2	21.1	5	21.1
A11	M	0.45	0.59	2.67	40	1	1.5	6.7	945	40	4.2	12.0	1.3					8.0	5	8.0
L1+A11	M1	0.47	0.60	40.15										35	1.0	9.3	0.1	21.2	5	21.2
A12		0.21	0.52	9.46	100	30	29.6	5.4	1005	18	1.8	8.3	2.0					7.4	5	7.4
M1+A12+24	N	0.38	0.56	133.15					260	4	1.4	8.3	0.5	180	3.5	14.3	0.2	21.9	5	21.9
B1		0.45	0.59	3.33	35	1	3.5	4.7	885	30	3.4	10.8	1.4					6.1	5	6.1
B2		0.45	0.59	0.49	50	2	4.0	5.4	725	20	2.8	9.8	1.2					6.6	5	6.6
B1+B2	O	0.45	0.59	3.82				6.6										6.6	5	6.6
B3		0.45	0.59	5.86	100	5	5.3	7.0	825	21	2.5	9.3	1.5					8.4	5	8.4
B4		0.45	0.59	0.16	50	17	33.3	2.7	185	2.7	1.5	4.0	0.8					3.4	5	5.0
B5	s. pond	0.15	0.50	1.05	85	24	28.5	5.4	75	4	5.3	14.3	0.1					5.5	5	5.5
DPO+B3+B4+B5	R	0.42	0.58	10.89					75	4	5.3	14.3	0.1	70	25.0	29.3	0.0	8.6	5	8.6
C3		0.15	0.50	0.63	60	12	20.0	5.1	455	15	3.3	5.6	1.3					6.4	5	6.4
C4		0.27	0.54	1.79	100	5	5.5	8.8	75	2	2.1	4.5	0.3					9.1	5	9.1
D16	4	0.45	0.59	2.73	200	10	5.0	10.1	350	12	3.5	6.5	0.9					11.0	5	11.0
EXR		0.90	0.96	0.53	20	2	10.0	0.8	320	6	2.0	4.9	1.1					1.9	5	5.0
	S	0.40	0.60	16.57										105	2.0	8.3	0.2	11.2	5	11.2
NC2	19	0.77	0.88	1.61					625	25	4.0	11.7	0.9					10.0	5	10.0
	J1	0.42	0.60	18.18										90	2	8.3	0.2	10.2	5	10.2
NC1		0.85	0.93	0.43	45	1	2.2	2.4	185	4	2.2	8.7	0.4					0.4	5	5.0
	20	0.45	0.62	18.61										45	2	9.6	0.1	10.2	5	10.2
C1		0.45	0.59	0.59	50	16.67	33.3	2.7	640	9.5	1.5	4.0	2.7					5.3	5	5.3
C2		0.15	0.50	3.58	100	13	13.0	7.6	90	7	7.8	8.7	0.2					7.7	5	7.7
	T	0.27	0.38	437.97														5.0	5	5.0
C5	V	0.15	0.50	0.11	35	6	15.9	4.2										4.2	5	5.0

PROJECT INFORMATION

PROJECT: Windermere
 PROJECT NO: 21187-01
 DESIGN BY: SBN
 REV. BY: TDM
 AGENCY: El Paso County
 REPORT TYPE: Final
 DATE: 1/5/2022



RATIONAL METHOD CALCULATIONS FOR STORM WATER RUNOFF

PROPOSED		RUNOFF			5 YR STORM		P1=	1.50
BASIN (S)	DESIGN POINT	AREA (AC)	DIRECT RUNOFF		C * A	I (IN/HR)	Q (CFS)	
			RUNOFF COEFF	t _c (MIN)				
WS		41.47	0.09	19.6	3.73	3.04	11.4	
CT		42.07	0.62	14.9	26.08	3.47	90.6	
	24	83.54	0.36	19.6	29.82	3.04	90.7	
D13		6.79	0.45	16.0	3.06	3.36	10.3	
D14		3.88	0.52	18.7	2.03	3.12	6.3	
	7	10.67	0.48	18.7	5.09	3.12	15.9	
D15		1.36	0.72	6.8	0.98	4.69	4.6	
A1		1.56	0.45	7.1	0.70	4.62	3.2	
	A	13.59	0.50	18.8	6.77	3.11	21.0	
A2	B	4.61	0.45	9.2	2.07	4.23	8.8	
A3	C	2.18	0.48	5.6	1.05	4.96	5.2	
	C1	20.38	0.48	20.2	9.82	3.00	29.5	
A4	D	1.01	0.45	12.4	0.45	3.76	1.7	
	D1	21.39	0.48	20.4	10.28	2.98	30.6	
A5	E	1.98	0.45	6.0	0.89	4.85	4.3	
A6	F	3.73	0.45	9.6	1.68	4.17	7.0	
	F1	27.10	0.47	20.6	12.85	2.97	38.2	
A7	G	1.56	0.45	9.1	0.70	4.26	3.0	
A8	H	2.96	0.45	7.3	1.33	4.58	6.1	
	H1	4.52	0.45	9.2	2.03	4.23	8.6	
A9	I	1.86	0.45	6.6	0.84	4.73	4.0	
	J	6.38	0.45	10.0	2.87	4.10	11.8	
	K	33.48	0.47	20.9	15.72	2.95	46.3	
A10	L	4.00	0.45	9.7	1.80	4.16	7.5	
	L1	37.48	0.47	21.1	17.52	2.93	51.4	
A11	M	2.67	0.45	8.0	1.20	4.45	5.3	
	M1	40.15	0.47	21.2	18.72	2.93	54.8	
A12		9.46	0.21	7.4	2.01	4.56	9.2	
	N	133.15	0.38	21.9	50.54	2.88	145.4	
North Pond Release							1.8	
	C1	0.59	0.45	5.3	0.26	5.02	1.3	
	C2	3.58	0.15	7.7	0.54	4.50	2.4	
	T	437.97					190.5	
B1		3.33	0.45	6.1	1.50	4.84	7.2	
B2		0.49	0.45	6.6	0.22	4.72	1.0	
	O	3.82	0.45	6.6	1.72	4.72	8.1	
B3		5.86	0.45	8.4	2.64	4.36	11.5	
B4		0.16	0.45	5.0	0.07	5.10	0.4	
B5		1.05	0.15	5.5	0.16	4.99	0.8	
	R	10.89	0.42	8.6	4.59	4.34	19.9	
South Pond Release							0.2	
	C3	0.63	0.15	6.4	0.10	4.77	0.5	
	C4	1.79	0.27	9.1	0.48	4.25	2.1	
D16	4	2.73	0.45	11.0	1.23	3.96	4.9	
EXR		0.53	0.90	5.0	0.48	5.10	2.4	
	S	16.57					10.0	
NC2	19	1.61	0.77	10.0	1.25	4.11	5.1	
	J1	18.18					15.1	
NC1		0.43	0.85	5.0	0.36	5.10	1.9	
	20	18.61					17.0	
C5	V	0.11	0.15	5.0	0.02	5.10	0.1	

PROJECT INFORMATION

PROJECT: Windermere
 PROJECT NO: 21187-01
 DESIGN BY: SBN
 REV. BY: TDM
 AGENCY: El Paso County
 REPORT TYPE: Final
 DATE: 1/5/2022



RATIONAL METHOD CALCULATIONS FOR STORM WATER RUNOFF

PROPOSED RUNOFF 100 YR STORM P1= 2.52

BASIN (S)	DESIGN POINT	AREA (AC)	DIRECT RUNOFF		C * A	I (IN/HR)	Q (CFS)
			RUNOFF COEFF	t _c (MIN)			
WS		41.47	0.36	19.6	14.93	5.11	76.3
CT		42.07	0.71	14.9	29.87	5.83	174.3
	24	83.54	0.54	19.6	44.80	5.11	229.0
D13		6.79	0.59	16.0	4.01	5.65	22.6
		3.88	0.65	18.7	2.52	5.24	13.2
D13+D14	7	10.67	0.61	18.7	6.53	5.24	34.2
D15		1.36	0.85	6.8	1.16	7.87	9.1
A1		1.56	0.59	7.1	0.92	7.77	7.1
	A	13.59	0.63	18.8	8.61	5.22	44.9
A2	B	4.61	0.59	9.2	2.72	7.11	19.4
A3	C	2.18	0.62	5.6	1.35	8.34	11.2
	C1	20.38	0.62	20.2	12.61	5.04	63.5
A4	D	1.01	0.59	12.4	0.60	6.32	3.8
	D1	21.39	0.62	20.4	13.21	5.01	66.1
A5	E	1.98	0.59	6.0	1.17	8.15	9.5
A6	F	3.73	0.59	9.6	2.20	7.01	15.4
	F1	27.10	0.61	20.6	16.58	4.99	82.8
A7	G	1.56	0.59	9.1	0.92	7.15	6.6
A8	H	2.96	0.59	7.3	1.75	7.70	13.4
	H1	4.52	0.59	9.2	2.67	7.11	19.0
A9	I	1.86	0.59	6.6	1.10	7.94	8.7
	J	6.38	0.59	10.0	3.76	6.88	25.9
	K	33.48	0.61	20.9	20.34	4.95	100.7
A10	L	4.00	0.59	9.7	2.36	6.98	16.5
	L1	37.48	0.61	21.1	22.70	4.92	111.8
A11	M	2.67	0.59	8.0	1.58	7.47	11.8
	M1	40.15	0.60	21.2	24.28	4.92	119.4
A12		9.46	0.52	7.4	4.91	7.67	37.6
	N	133.15	0.56	21.9	73.98	4.83	357.5
North Pond Release							66.0
	C1	0.59	0.59	5.3	0.35	8.43	2.9
	C2	3.58	0.50	7.7	1.79	7.55	13.5
	T	437.97					682.4
B1		3.33	0.59	6.1	1.96	8.12	16.0
B2		0.49	0.59	6.6	0.29	7.93	2.3
	O	3.82	0.59	6.6	2.26	7.93	17.9
B3		5.86	0.59	8.4	3.46	7.33	25.3
B4		0.16	0.59	5.0	0.09	8.58	0.8
B5		1.05	0.50	5.5	0.52	8.38	4.4
	R	10.89	0.58	8.6	6.33	7.29	46.2
South Pond Release							9.2
	C3	0.63	0.50	6.4	0.32	8.01	2.5
	C4	1.79	0.54	9.1	0.96	7.14	6.9
D16	4	2.73	0.59	11.0	1.61	6.65	10.7
EXR		0.53	0.96	5.0	0.51	8.58	4.4
	S	16.57	0.40	11.2	6.66	6.60	33.7
NC2	19	1.61	0.88	10.0	1.42	6.90	9.8
	J1	18.18	0.60	10.2	10.82	6.85	43.5
NC1		0.43	0.93	5.0	0.40	8.58	3.4
	20	18.61	0.45	10.2	8.30	6.83	46.9
C5	V	0.11	0.50	5.0	0.06	8.58	0.5

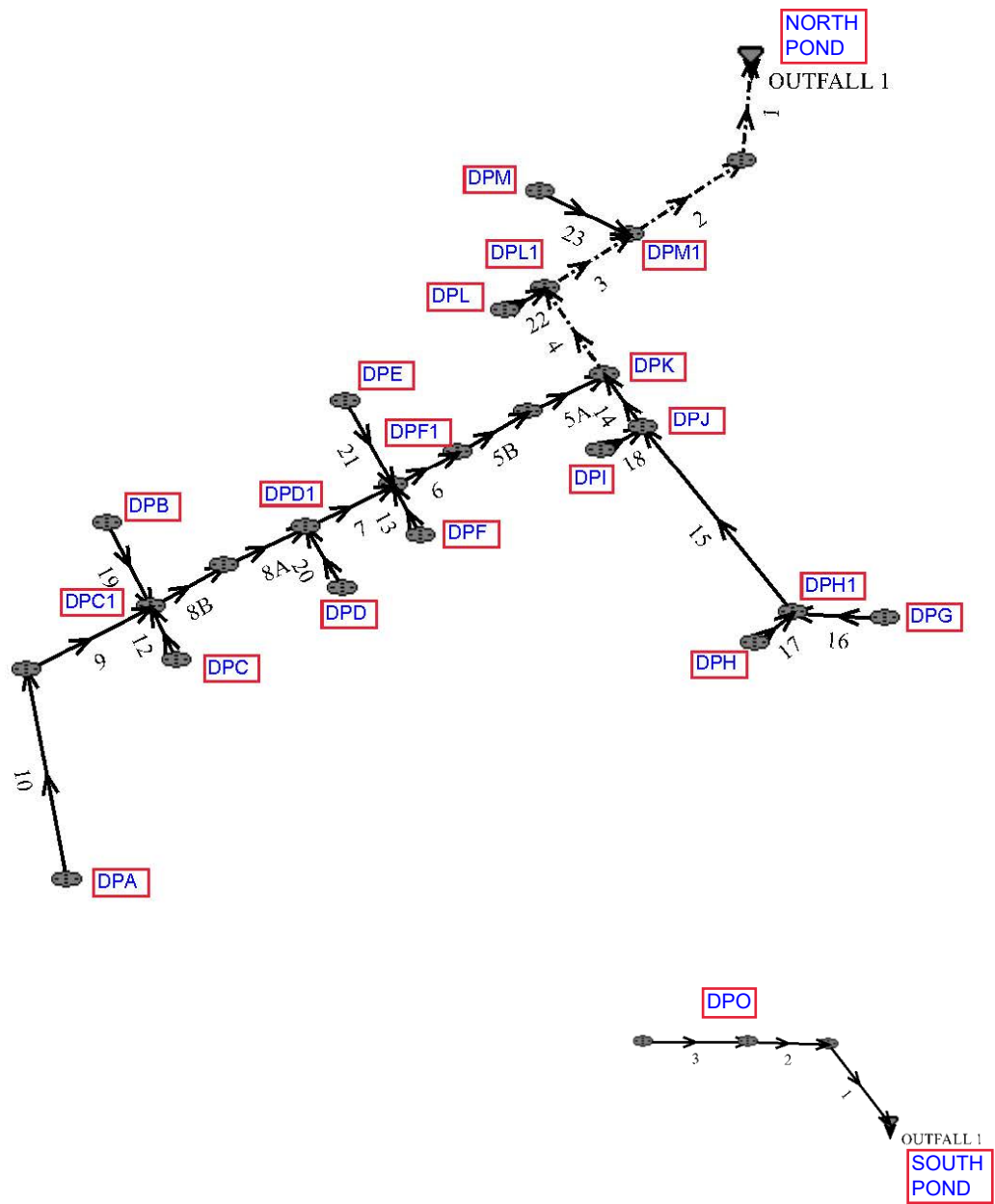

Program: UDSEWER Math Model Interface 2.1.1.4 Run Date: 2/9/2022 8:58:16 AM	<h2 style="margin: 0;">UDSewer Results Summary</h2> <p>Project Title: New UDSEWER System Module Project Description: Default system</p>
--	--

System Input Summary

Rainfall Parameters

Rainfall Return Period: 5
Rainfall Calculation Method: Formula

One Hour Depth (in): 1.50
Rainfall Constant "A": 28.5
Rainfall Constant "B": 10
Rainfall Constant "C": 0.786

Rational Method Constraints

Minimum Urban Runoff Coeff.: 0.20
Maximum Rural Overland Len. (ft): 500
Maximum Urban Overland Len. (ft): 300
Used UDFCD Tc. Maximum: No

Sizer Constraints

Minimum Sewer Size (in): 18.00
Maximum Depth to Rise Ratio: 0.90
Maximum Flow Velocity (fps): 18.0
Minimum Flow Velocity (fps): 2.0

Backwater Calculations:

Tailwater Elevation (ft): 6575.69

Manhole Input Summary:

		Given Flow		Sub Basin Information						
Element Name	Ground Elevation (ft)	Total Known Flow (cfs)	Local Contribution (cfs)	Drainage Area (Ac.)	Runoff Coefficient	5yr Coefficient	Overland Length (ft)	Overland Slope (%)	Gutter Length (ft)	Gutter Velocity (fps)
OUTFALL 1	6575.47	0.00	0.00	0.00	0.00	0.00	0.00	0.00	0.00	0.00
1	6581.88	54.80	0.00	0.00	0.00	0.00	0.00	0.00	0.00	0.00

2	6583.43	54.80	0.00	0.00	0.00	0.00	0.00	0.00	0.00	0.00
3	6583.03	51.40	0.00	0.00	0.00	0.00	0.00	0.00	0.00	0.00
4	6583.87	46.30	0.00	0.00	0.00	0.00	0.00	0.00	0.00	0.00
5A	6583.93	38.20	0.00	0.00	0.00	0.00	0.00	0.00	0.00	0.00
5B	6587.27	38.20	0.00	0.00	0.00	0.00	0.00	0.00	0.00	0.00
6	6592.86	38.20	0.00	0.00	0.00	0.00	0.00	0.00	0.00	0.00
14	6584.13	11.80	0.00	0.00	0.00	0.00	0.00	0.00	0.00	0.00
15	6586.77	8.60	0.00	0.00	0.00	0.00	0.00	0.00	0.00	0.00
16	6587.33	3.00	0.00	0.00	0.00	0.00	0.00	0.00	0.00	0.00
17	6587.15	6.10	0.00	0.00	0.00	0.00	0.00	0.00	0.00	0.00
18	6584.26	4.00	0.00	0.00	0.00	0.00	0.00	0.00	0.00	0.00
22	6583.41	7.50	0.00	0.00	0.00	0.00	0.00	0.00	0.00	0.00
23	6583.41	5.30	0.00	0.00	0.00	0.00	0.00	0.00	0.00	0.00

Manhole Output Summary:

Element Name	Local Contribution					Total Design Flow				Comment
	Overland Time (min)	Gutter Time (min)	Basin Tc (min)	Intensity (in/hr)	Local Contrib (cfs)	Coeff. Area	Intensity (in/hr)	Manhole Tc (min)	Peak Flow (cfs)	
OUTFALL 1	0.00	0.00	0.00	0.00	0.00	7.96	6.88	0.22	54.80	Surface Water Present (Upstream)
1	0.00	0.00	0.00	0.00	0.00	0.00	0.00	0.00	54.80	Surface Water Present (Downstream)
2	0.00	0.00	0.00	0.00	0.00	0.00	0.00	0.00	54.80	
3	0.00	0.00	0.00	0.00	0.00	0.00	0.00	0.00	51.40	
4	0.00	0.00	0.00	0.00	0.00	0.00	0.00	0.00	46.30	
5A	0.00	0.00	0.00	0.00	0.00	0.00	0.00	0.00	38.20	
5B	0.00	0.00	0.00	0.00	0.00	0.00	0.00	0.00	38.20	
6	0.00	0.00	0.00	0.00	0.00	0.00	0.00	0.00	38.20	
14	0.00	0.00	0.00	0.00	0.00	0.00	0.00	0.00	11.80	
15	0.00	0.00	0.00	0.00	0.00	0.00	0.00	0.00	8.60	
16	0.00	0.00	0.00	0.00	0.00	0.00	0.00	0.00	3.00	
17	0.00	0.00	0.00	0.00	0.00	0.00	0.00	0.00	6.10	
18	0.00	0.00	0.00	0.00	0.00	0.00	0.00	0.00	4.00	
22	0.00	0.00	0.00	0.00	0.00	0.00	0.00	0.00	7.50	
23	0.00	0.00	0.00	0.00	0.00	0.00	0.00	0.00	5.30	

Sewer Input Summary:

Element Name	Sewer Length (ft)	Elevation			Loss Coefficients			Given Dimensions		
		Downstream Invert (ft)	Slope (%)	Upstream Invert (ft)	Mannings n	Bend Loss	Lateral Loss	Cross Section	Rise (ft or in)	Span (ft or in)

1	51.12	6575.47	0.5	6575.73	0.014	0.03	0.00	ELLIPSE	43.00 in	68.00 in
2	116.91	6575.72	0.5	6576.30	0.014	0.38	0.00	ELLIPSE	43.00 in	68.00 in
3	42.20	6576.38	0.5	6576.59	0.014	0.05	0.00	ELLIPSE	43.00 in	68.00 in
4	113.08	6576.92	0.6	6577.60	0.014	1.32	0.00	ELLIPSE	43.00 in	68.00 in
5A	32.36	6578.19	1.8	6578.77	0.014	1.32	0.00	CIRCULAR	36.00 in	36.00 in
5B	89.17	6578.77	1.8	6580.38	0.014	0.05	0.00	CIRCULAR	36.00 in	36.00 in
6	145.96	6581.39	3.5	6586.50	0.014	0.05	0.00	CIRCULAR	36.00 in	36.00 in
14	27.22	6578.68	1.1	6578.98	0.014	0.05	0.00	CIRCULAR	30.00 in	30.00 in
15	297.18	6578.89	1.1	6582.16	0.014	0.05	0.00	CIRCULAR	30.00 in	30.00 in
16	36.48	6583.15	1.0	6583.51	0.014	0.38	0.00	CIRCULAR	18.00 in	18.00 in
17	7.73	6582.66	2.3	6582.84	0.014	1.32	0.00	CIRCULAR	24.00 in	24.00 in
18	9.62	6579.98	2.0	6580.17	0.014	0.38	0.00	CIRCULAR	18.00 in	18.00 in
22	7.70	6577.97	6.9	6578.50	0.014	0.05	0.00	CIRCULAR	30.00 in	30.00 in
23	18.34	6577.48	3.2	6578.07	0.014	0.38	0.00	CIRCULAR	30.00 in	30.00 in

Sewer Flow Summary:

Element Name	Full Flow Capacity		Critical Flow		Normal Flow				Flow (cfs)	Surcharged Length (ft)	Comment
	Flow (cfs)	Velocity (fps)	Depth (in)	Velocity (fps)	Depth (in)	Velocity (fps)	Froude Number	Flow Condition			
1	131.72	9.43	25.54	7.26	24.19	7.79	1.11	Supercritical	54.80	0.00	
2	131.72	9.43	25.54	7.26	24.19	7.79	1.11	Supercritical	54.80	0.00	
3	131.72	9.43	24.70	7.11	23.34	7.66	1.11	Supercritical	51.40	0.00	
4	144.29	10.33	23.38	6.89	20.97	7.96	1.23	Supercritical	46.30	0.00	
5A	83.32	11.79	24.13	7.58	17.11	11.53	1.93	Supercritical	38.20	0.00	
5B	83.32	11.79	24.13	7.58	17.11	11.53	1.93	Supercritical	38.20	0.00	
6	116.18	16.44	24.13	7.58	14.21	14.73	2.76	Supercritical	38.20	0.00	
14	40.05	8.16	13.82	5.34	11.16	7.10	1.51	Supercritical	11.80	0.00	
15	40.05	8.16	11.72	4.84	9.44	6.50	1.52	Supercritical	8.60	0.00	
16	9.78	5.53	7.90	4.02	6.84	4.87	1.32	Supercritical	3.00	0.00	
17	31.94	10.17	10.48	4.63	7.11	7.84	2.11	Supercritical	6.10	0.00	
18	13.74	7.78	9.18	4.41	6.65	6.74	1.86	Supercritical	4.00	0.00	
22	100.32	20.44	10.91	4.65	5.55	12.00	3.73	Supercritical	7.50	0.00	
23	68.32	13.92	9.12	4.20	5.65	8.26	2.54	Supercritical	5.30	0.00	

- A Froude number of 0 indicates that pressurized flow occurs (adverse slope or undersized pipe).
- If the sewer is not pressurized, full flow represents the maximum gravity flow in the sewer.
- If the sewer is pressurized, full flow represents the pressurized flow conditions.

Sewer Sizing Summary:

Element	Peak	Cross	Existing		Calculated		Used			Comment
			Rise	Span	Rise	Span	Rise	Span	Area	

Name	Flow (cfs)	Section							(ft^2)	
1	54.80	ELLIPSE	43.00 in	68.00 in	42.00 in	42.00 in	43.00 in	68.00 in	13.97	
2	54.80	ELLIPSE	43.00 in	68.00 in	42.00 in	42.00 in	43.00 in	68.00 in	13.97	
3	51.40	ELLIPSE	43.00 in	68.00 in	42.00 in	42.00 in	43.00 in	68.00 in	13.97	
4	46.30	ELLIPSE	43.00 in	68.00 in	36.00 in	36.00 in	43.00 in	68.00 in	13.97	
5A	38.20	CIRCULAR	36.00 in	36.00 in	27.00 in	27.00 in	36.00 in	36.00 in	7.07	
5B	38.20	CIRCULAR	36.00 in	36.00 in	27.00 in	27.00 in	36.00 in	36.00 in	7.07	
6	38.20	CIRCULAR	36.00 in	36.00 in	24.00 in	24.00 in	36.00 in	36.00 in	7.07	
14	11.80	CIRCULAR	30.00 in	30.00 in	21.00 in	21.00 in	30.00 in	30.00 in	4.91	
15	8.60	CIRCULAR	30.00 in	30.00 in	18.00 in	18.00 in	30.00 in	30.00 in	4.91	
16	3.00	CIRCULAR	18.00 in	18.00 in	18.00 in	18.00 in	18.00 in	18.00 in	1.77	
17	6.10	CIRCULAR	24.00 in	24.00 in	18.00 in	18.00 in	24.00 in	24.00 in	3.14	
18	4.00	CIRCULAR	18.00 in	18.00 in	18.00 in	18.00 in	18.00 in	18.00 in	1.77	
22	7.50	CIRCULAR	30.00 in	30.00 in	18.00 in	18.00 in	30.00 in	30.00 in	4.91	
23	5.30	CIRCULAR	30.00 in	30.00 in	18.00 in	18.00 in	30.00 in	30.00 in	4.91	

- Calculated diameter was determined by sewer hydraulic capacity rounded up to the nearest commercially available size.
- Sewer sizes should not decrease downstream.
- All hydraulics were calculated using the 'Used' parameters.

Grade Line Summary:

Tailwater Elevation (ft): 6575.69

Element Name	Invert Elev.		Downstream Manhole Losses		HGL		EGL		
	Downstream (ft)	Upstream (ft)	Bend Loss (ft)	Lateral Loss (ft)	Downstream (ft)	Upstream (ft)	Downstream (ft)	Friction Loss (ft)	Upstream (ft)
1	6575.47	6575.73	0.00	0.00	6577.49	6577.86	6578.43	0.24	6578.68
2	6575.72	6576.30	0.09	0.00	6578.23	6578.43	6578.77	0.48	6579.25
3	6576.38	6576.59	0.01	0.00	6578.64	6578.65	6579.26	0.18	6579.43
4	6576.92	6577.60	0.23	0.00	6579.13	6579.55	6579.66	0.63	6580.28
5A	6578.19	6578.77	0.60	0.00	6580.15	6580.85	6581.68	0.00	6581.68
5B	6578.77	6580.38	0.02	0.00	6580.87	6582.39	6582.27	1.02	6583.28
6	6581.39	6586.50	0.02	0.00	6582.58	6588.51	6585.94	3.46	6589.40
14	6578.68	6578.98	0.00	0.00	6579.61	6580.13	6580.39	0.18	6580.57
15	6578.89	6582.16	0.00	0.00	6580.47	6583.14	6580.58	2.92	6583.50
16	6583.15	6583.51	0.02	0.00	6583.72	6584.17	6584.08	0.34	6584.42
17	6582.66	6582.84	0.08	0.00	6583.25	6584.07	6584.21	0.00	6584.21
18	6579.98	6580.17	0.03	0.00	6580.59	6580.94	6581.13	0.11	6581.24
22	6577.97	6578.50	0.00	0.00	6578.65	6580.62	6580.67	0.00	6580.67
23	6577.48	6578.07	0.01	0.00	6579.22	6579.22	6579.25	0.06	6579.31

- Bend and Lateral losses only apply when there is an outgoing sewer. The system outfall, sewer #0, is not considered a sewer.
- Bend loss = Bend K * V_{fi} ^ 2/(2*g)
- Lateral loss = V_{fo} ^ 2/(2*g)- Junction Loss K * V_{fi} ^ 2/(2*g).
- Friction loss is always Upstream EGL - Downstream EGL.

Excavation Estimate:

The trench side slope is 1.0 ft/ft

The minimum trench width is 2.00 ft

Element Name	Length (ft)	Wall (in)	Bedding (in)	Bottom Width (ft)	Downstream			Upstream			Volume (cu. yd)	Comment
					Top Width (ft)	Trench Depth (ft)	Cover (ft)	Top Width (ft)	Trench Depth (ft)	Cover (ft)		
1	51.12	6.67	8.00	9.78	0.00	1.22	0.00	11.80	7.37	2.01	80.48	Sewer Too Shallow
2	116.91	6.67	8.00	9.78	11.83	7.39	2.03	13.76	8.35	2.99	344.04	
3	42.20	6.67	8.00	9.78	13.60	8.27	2.91	12.38	7.66	2.30	125.95	
4	113.08	6.67	8.00	9.78	11.72	7.33	1.97	12.04	7.49	2.13	308.15	
5A	32.36	4.00	6.00	6.67	9.36	6.52	2.35	8.32	5.99	1.83	51.48	
5B	89.17	4.00	6.00	6.67	8.31	5.99	1.82	11.78	7.72	3.56	162.86	
6	145.96	4.00	6.00	6.67	9.76	6.71	2.55	10.72	7.19	3.03	268.13	
14	27.22	3.50	6.00	6.08	8.88	5.98	2.40	8.80	5.94	2.36	38.48	
15	297.18	3.50	6.00	6.08	8.98	6.03	2.45	7.72	5.40	1.82	397.95	
16	36.48	2.50	4.00	4.92	6.75	4.17	1.92	7.14	4.36	2.11	29.73	
17	7.73	3.00	4.00	5.50	7.22	4.69	1.86	7.62	4.89	2.06	7.81	
18	9.62	2.50	4.00	4.92	7.80	4.69	2.44	7.68	4.63	2.38	8.88	
22	7.70	3.50	6.00	6.08	8.62	5.85	2.27	8.32	5.70	2.12	10.43	
23	18.34	3.50	6.00	6.08	10.39	6.74	3.16	9.18	6.13	2.55	28.98	

Total earth volume for sewer trenches = 1863 cubic yards.

- The trench was estimated to have a bottom width equal to the outer pipe diameter plus 36 inches.
- If the calculated width of the trench bottom is less than the minimum acceptable width, the minimum acceptable width was used.
- The sewer wall thickness is equal to: (equivalent diameter in inches/12)+1 inches
- The sewer bedding thickness is equal to:
 - Four inches for pipes less than 33 inches.
 - Six inches for pipes less than 60 inches.
 - Eight inches for all larger sizes.

Program: UDSEWER Math Model Interface 2.1.1.4 Run Date: 9/7/2021 7:11:54 AM	<h1>UDSewer Results Summary</h1> <p>Project Title: New UDSEWER System Module Project Description: Default system</p>
--	---

System Input Summary

Rainfall Parameters

Rainfall Return Period: 5
Rainfall Calculation Method: Formula

One Hour Depth (in): 1.50
Rainfall Constant "A": 28.5
Rainfall Constant "B": 10
Rainfall Constant "C": 0.786

Rational Method Constraints

Minimum Urban Runoff Coeff.: 0.20
Maximum Rural Overland Len. (ft): 500
Maximum Urban Overland Len. (ft): 300
Used UDFCD Tc. Maximum: No

Sizer Constraints

Minimum Sewer Size (in): 18.00
Maximum Depth to Rise Ratio: 0.90
Maximum Flow Velocity (fps): 18.0
Minimum Flow Velocity (fps): 2.0

Backwater Calculations:

Tailwater Elevation (ft): 6587.68

Manhole Input Summary:

		Given Flow		Sub Basin Information						
Element Name	Ground Elevation (ft)	Total Known Flow (cfs)	Local Contribution (cfs)	Drainage Area (Ac.)	Runoff Coefficient	5yr Coefficient	Overland Length (ft)	Overland Slope (%)	Gutter Length (ft)	Gutter Velocity (fps)
OUTFALL 1	6592.86	0.00	0.00	0.00	0.00	0.00	0.00	0.00	0.00	0.00
21	6593.12	4.30	0.00	0.00	0.00	0.00	0.00	0.00	0.00	0.00

7	6596.54	30.60	0.00	0.00	0.00	0.00	0.00	0.00	0.00	0.00
20	6596.83	1.70	0.00	0.00	0.00	0.00	0.00	0.00	0.00	0.00
8A	6600.15	29.50	0.00	0.00	0.00	0.00	0.00	0.00	0.00	0.00
8B	6603.84	29.50	0.00	0.00	0.00	0.00	0.00	0.00	0.00	0.00
12	6604.14	5.20	0.00	0.00	0.00	0.00	0.00	0.00	0.00	0.00
19	6604.14	8.80	0.00	0.00	0.00	0.00	0.00	0.00	0.00	0.00
13	6593.16	7.00	0.00	0.00	0.00	0.00	0.00	0.00	0.00	0.00

Manhole Output Summary:

Element Name	Local Contribution					Total Design Flow				Comment
	Overland Time (min)	Gutter Time (min)	Basin Tc (min)	Intensity (in/hr)	Local Contrib (cfs)	Coeff. Area	Intensity (in/hr)	Manhole Tc (min)	Peak Flow (cfs)	
OUTFALL 1	0.00	0.00	0.00	0.00	0.00	6.17	6.79	0.39	41.90	
21	0.00	0.00	0.00	0.00	0.00	0.00	0.00	0.00	4.30	
7	0.00	0.00	0.00	0.00	0.00	0.00	0.00	0.00	30.60	
20	0.00	0.00	0.00	0.00	0.00	0.00	0.00	0.00	1.70	
8A	0.00	0.00	0.00	0.00	0.00	0.00	0.00	0.00	29.50	
8B	0.00	0.00	0.00	0.00	0.00	0.00	0.00	0.00	29.50	
12	0.00	0.00	0.00	0.00	0.00	0.00	0.00	0.00	5.20	
19	0.00	0.00	0.00	0.00	0.00	0.00	0.00	0.00	8.80	
13	0.00	0.00	0.00	0.00	0.00	0.00	0.00	0.00	7.00	

Sewer Input Summary:

Element Name	Sewer Length (ft)	Elevation			Loss Coefficients			Given Dimensions		
		Downstream Invert (ft)	Slope (%)	Upstream Invert (ft)	Mannings n	Bend Loss	Lateral Loss	Cross Section	Rise (ft or in)	Span (ft or in)
21	30.74	6587.89	2.6	6588.69	0.014	1.00	0.00	CIRCULAR	24.00 in	24.00 in
7	101.44	6586.92	3.7	6590.67	0.014	0.05	0.00	CIRCULAR	36.00 in	36.00 in
20	7.73	6592.27	5.6	6592.70	0.014	1.00	0.00	CIRCULAR	18.00 in	18.00 in
8A	107.21	6590.72	3.6	6594.58	0.014	0.05	0.00	CIRCULAR	36.00 in	36.00 in
8B	108.31	6594.63	3.5	6598.42	0.014	0.05	0.00	CIRCULAR	36.00 in	36.00 in
12	7.67	6599.72	2.0	6599.87	0.014	1.00	0.00	CIRCULAR	24.00 in	24.00 in
19	30.67	6599.73	1.0	6600.04	0.014	1.00	0.00	CIRCULAR	24.00 in	24.00 in
13	7.53	6587.89	2.7	6588.09	0.014	1.00	0.00	CIRCULAR	24.00 in	24.00 in

Sewer Flow Summary:

Element Name	Full Flow Capacity		Critical Flow		Normal Flow				Flow (cfs)	Surcharged Length	Comment
	Flow (cfs)	Velocity (fps)	Depth (in)	Velocity (fps)	Depth (in)	Velocity (fps)	Froude Number	Flow Condition			

										(ft)	
21	33.96	10.81	8.74	4.16	5.77	7.40	2.24	Supercritical	4.30	0.00	
7	119.45	16.90	21.51	6.94	12.43	14.14	2.86	Supercritical	30.60	0.00	
20	23.14	13.10	5.88	3.39	3.30	7.65	3.08	Supercritical	1.70	0.00	
8A	117.83	16.67	21.10	6.85	12.28	13.86	2.82	Supercritical	29.50	0.00	
8B	116.18	16.44	21.10	6.85	12.37	13.72	2.78	Supercritical	29.50	0.00	
12	29.79	9.48	9.65	4.40	6.79	7.12	1.97	Supercritical	5.20	0.00	
19	21.06	6.70	12.70	5.22	10.82	6.40	1.36	Supercritical	8.80	0.00	
13	34.61	11.02	11.26	4.83	7.32	8.63	2.29	Supercritical	7.00	0.00	

- A Froude number of 0 indicates that pressured flow occurs (adverse slope or undersized pipe).
- If the sewer is not pressurized, full flow represents the maximum gravity flow in the sewer.
- If the sewer is pressurized, full flow represents the pressurized flow conditions.

Sewer Sizing Summary:

Element Name	Peak Flow (cfs)	Cross Section	Existing		Calculated		Used			Comment
			Rise	Span	Rise	Span	Rise	Span	Area (ft ²)	
21	4.30	CIRCULAR	24.00 in	24.00 in	18.00 in	18.00 in	24.00 in	24.00 in	3.14	
7	30.60	CIRCULAR	36.00 in	36.00 in	24.00 in	24.00 in	36.00 in	36.00 in	7.07	
20	1.70	CIRCULAR	18.00 in	18.00 in	18.00 in	18.00 in	18.00 in	18.00 in	1.77	
8A	29.50	CIRCULAR	36.00 in	36.00 in	24.00 in	24.00 in	36.00 in	36.00 in	7.07	
8B	29.50	CIRCULAR	36.00 in	36.00 in	24.00 in	24.00 in	36.00 in	36.00 in	7.07	
12	5.20	CIRCULAR	24.00 in	24.00 in	18.00 in	18.00 in	24.00 in	24.00 in	3.14	
19	8.80	CIRCULAR	24.00 in	24.00 in	18.00 in	18.00 in	24.00 in	24.00 in	3.14	
13	7.00	CIRCULAR	24.00 in	24.00 in	18.00 in	18.00 in	24.00 in	24.00 in	3.14	

- Calculated diameter was determined by sewer hydraulic capacity rounded up to the nearest commercially available size.
- Sewer sizes should not decrease downstream.
- All hydraulics were calculated using the 'Used' parameters.

Grade Line Summary:

Tailwater Elevation (ft): 6587.68

Element Name	Invert Elev.		Downstream Manhole Losses		HGL		EGL		
	Downstream (ft)	Upstream (ft)	Bend Loss (ft)	Lateral Loss (ft)	Downstream (ft)	Upstream (ft)	Downstream (ft)	Friction Loss (ft)	Upstream (ft)
21	6587.89	6588.69	0.00	0.00	6588.37	6589.42	6589.22	0.46	6589.69
7	6586.92	6590.67	0.00	0.00	6587.95	6592.46	6591.06	2.15	6593.21
20	6592.27	6592.70	0.01	0.00	6592.54	6593.38	6593.45	0.00	6593.45

8A	6590.72	6594.58	0.01	0.00	6592.48	6596.34	6594.73	2.34	6597.07
8B	6594.63	6598.42	0.01	0.00	6596.35	6600.18	6598.58	2.32	6600.91
12	6599.72	6599.87	0.04	0.00	6600.28	6600.92	6601.07	0.00	6601.07
19	6599.73	6600.04	0.12	0.00	6600.63	6601.10	6601.27	0.25	6601.52
13	6587.89	6588.09	0.00	0.00	6588.50	6589.52	6589.65	0.00	6589.65

- Bend and Lateral losses only apply when there is an outgoing sewer. The system outfall, sewer #0, is not considered a sewer.
- Bend loss = Bend K * V_{fi} ^ 2/(2*g)
- Lateral loss = V_{fo} ^ 2/(2*g)- Junction Loss K * V_{fi} ^ 2/(2*g).
- Friction loss is always Upstream EGL - Downstream EGL.

Excavation Estimate:

The trench side slope is 1.0 ft/ft

The minimum trench width is 2.00 ft

Element Name	Length (ft)	Wall (in)	Bedding (in)	Bottom Width (ft)	Downstream			Upstream			Volume (cu. yd)	Comment
					Top Width (ft)	Trench Depth (ft)	Cover (ft)	Top Width (ft)	Trench Depth (ft)	Cover (ft)		
21	30.74	3.00	4.00	5.50	8.94	5.55	2.72	7.86	5.01	2.18	35.56	
7	101.44	4.00	6.00	6.67	9.89	6.78	2.61	9.74	6.70	2.54	178.12	
20	7.73	2.50	4.00	4.92	8.05	4.81	2.56	7.76	4.67	2.42	7.32	
8A	107.21	4.00	6.00	6.67	9.64	6.65	2.49	9.14	6.40	2.24	180.23	
8B	108.31	4.00	6.00	6.67	9.04	6.35	2.19	8.84	6.25	2.09	173.78	
12	7.67	3.00	4.00	5.50	7.25	4.71	1.87	7.54	4.85	2.02	7.72	
19	30.67	3.00	4.00	5.50	7.21	4.69	1.86	7.20	4.68	1.85	30.11	
13	7.53	3.00	4.00	5.50	8.95	5.56	2.72	9.14	5.65	2.82	9.47	

Total earth volume for sewer trenches = 622 cubic yards.

- The trench was estimated to have a bottom width equal to the outer pipe diameter plus 36 inches.
- If the calculated width of the trench bottom is less than the minimum acceptable width, the minimum acceptable width was used.
- The sewer wall thickness is equal to: (equivalent diameter in inches/12)+1 inches
- The sewer bedding thickness is equal to:
 - Four inches for pipes less than 33 inches.
 - Six inches for pipes less than 60 inches.
 - Eight inches for all larger sizes.

Program: UDSEWER Math Model Interface 2.1.1.4 Run Date: 9/7/2021 7:15:14 AM	<h1>UDSewer Results Summary</h1> <p>Project Title: New UDSEWER System Module Project Description: Default system</p>
--	---

System Input Summary

Rainfall Parameters

Rainfall Return Period: 5
Rainfall Calculation Method: Formula

One Hour Depth (in): 1.50
Rainfall Constant "A": 28.5
Rainfall Constant "B": 10
Rainfall Constant "C": 0.786

Rational Method Constraints

Minimum Urban Runoff Coeff.: 0.20
Maximum Rural Overland Len. (ft): 500
Maximum Urban Overland Len. (ft): 300
Used UDFCD Tc. Maximum: No

Sizer Constraints

Minimum Sewer Size (in): 18.00
Maximum Depth to Rise Ratio: 0.90
Maximum Flow Velocity (fps): 18.0
Minimum Flow Velocity (fps): 2.0

Backwater Calculations:

Tailwater Elevation (ft): 6599.45

Manhole Input Summary:

		Given Flow		Sub Basin Information						
Element Name	Ground Elevation (ft)	Total Known Flow (cfs)	Local Contribution (cfs)	Drainage Area (Ac.)	Runoff Coefficient	5yr Coefficient	Overland Length (ft)	Overland Slope (%)	Gutter Length (ft)	Gutter Velocity (fps)
OUTFALL 1	6603.84	0.00	0.00	0.00	0.00	0.00	0.00	0.00	0.00	0.00
9	6611.72	21.00	0.00	0.00	0.00	0.00	0.00	0.00	0.00	0.00

10	6607.04	21.00	0.00	0.00	0.00	0.00	0.00	0.00	0.00	0.00
----	---------	-------	------	------	------	------	------	------	------	------

Manhole Output Summary:

Element Name	Local Contribution					Total Design Flow				Comment
	Overland Time (min)	Gutter Time (min)	Basin Tc (min)	Intensity (in/hr)	Local Contrib (cfs)	Coeff. Area	Intensity (in/hr)	Manhole Tc (min)	Peak Flow (cfs)	
OUTFALL 1	0.00	0.00	0.00	0.00	0.00	3.22	6.52	0.93	21.00	
9	0.00	0.00	0.00	0.00	0.00	0.00	0.00	0.00	21.00	
10	0.00	0.00	0.00	0.00	0.00	0.00	0.00	0.00	21.00	

Sewer Input Summary:

Element Name	Sewer Length (ft)	Elevation			Loss Coefficients			Given Dimensions		
		Downstream Invert (ft)	Slope (%)	Upstream Invert (ft)	Manning's n	Bend Loss	Lateral Loss	Cross Section	Rise (ft or in)	Span (ft or in)
9	166.22	6598.78	0.6	6599.78	0.014	0.05	0.00	CIRCULAR	36.00 in	36.00 in
10	268.70	6600.02	0.7	6601.90	0.014	0.29	0.00	CIRCULAR	36.00 in	36.00 in

Sewer Flow Summary:

Element Name	Full Flow Capacity		Critical Flow		Normal Flow				Flow (cfs)	Surcharged Length (ft)	Comment
	Flow (cfs)	Velocity (fps)	Depth (in)	Velocity (fps)	Depth (in)	Velocity (fps)	Froude Number	Flow Condition			
9	48.10	6.81	17.66	6.09	16.64	6.57	1.12	Supercritical	21.00	0.00	
10	51.96	7.35	17.66	6.09	15.93	6.96	1.22	Supercritical	21.00	0.00	

- A Froude number of 0 indicates that pressurized flow occurs (adverse slope or undersized pipe).
- If the sewer is not pressurized, full flow represents the maximum gravity flow in the sewer.
- If the sewer is pressurized, full flow represents the pressurized flow conditions.

Sewer Sizing Summary:

Element Name	Peak Flow (cfs)	Cross Section	Existing		Calculated		Used			Comment
			Rise	Span	Rise	Span	Rise	Span	Area (ft ²)	
9	21.00	CIRCULAR	36.00 in	36.00 in	27.00 in	27.00 in	36.00 in	36.00 in	7.07	
10	21.00	CIRCULAR	36.00 in	36.00 in	27.00 in	27.00 in	36.00 in	36.00 in	7.07	

- Calculated diameter was determined by sewer hydraulic capacity rounded up to the nearest commercially available size.
- Sewer sizes should not decrease downstream.

- All hydraulics were calculated using the 'Used' parameters.

Grade Line Summary:

Tailwater Elevation (ft): 6599.45

Element Name	Invert Elev.		Downstream Manhole Losses		HGL		EGL		
	Downstream (ft)	Upstream (ft)	Bend Loss (ft)	Lateral Loss (ft)	Downstream (ft)	Upstream (ft)	Downstream (ft)	Friction Loss (ft)	Upstream (ft)
9	6598.78	6599.78	0.00	0.00	6600.17	6601.25	6600.84	0.99	6601.83
10	6600.02	6601.90	0.04	0.00	6601.35	6603.37	6602.10	1.85	6603.95

- Bend and Lateral losses only apply when there is an outgoing sewer. The system outfall, sewer #0, is not considered a sewer.
- Bend loss = $Bend\ K * V_{fi}^2 / (2 * g)$
- Lateral loss = $V_{fo}^2 / (2 * g) - Junction\ Loss\ K * V_{fi}^2 / (2 * g)$.
- Friction loss is always Upstream EGL - Downstream EGL.

Excavation Estimate:

The trench side slope is 1.0 ft/ft

The minimum trench width is 2.00 ft

Element Name	Length (ft)	Wall (in)	Bedding (in)	Bottom Width (ft)	Downstream			Upstream			Volume (cu. yd)	Comment
					Top Width (ft)	Trench Depth (ft)	Cover (ft)	Top Width (ft)	Trench Depth (ft)	Cover (ft)		
9	166.22	4.00	6.00	6.67	8.11	5.89	1.72	21.88	12.77	8.61	562.72	
10	268.70	4.00	6.00	6.67	21.40	12.53	8.37	8.28	5.97	1.81	887.28	

Total earth volume for sewer trenches = 1450 cubic yards.

- The trench was estimated to have a bottom width equal to the outer pipe diameter plus 36 inches.
- If the calculated width of the trench bottom is less than the minimum acceptable width, the minimum acceptable width was used.
- The sewer wall thickness is equal to: (equivalent diameter in inches/12)+1 inches
- The sewer bedding thickness is equal to:
 - Four inches for pipes less than 33 inches.
 - Six inches for pipes less than 60 inches.
 - Eight inches for all larger sizes.

1-6

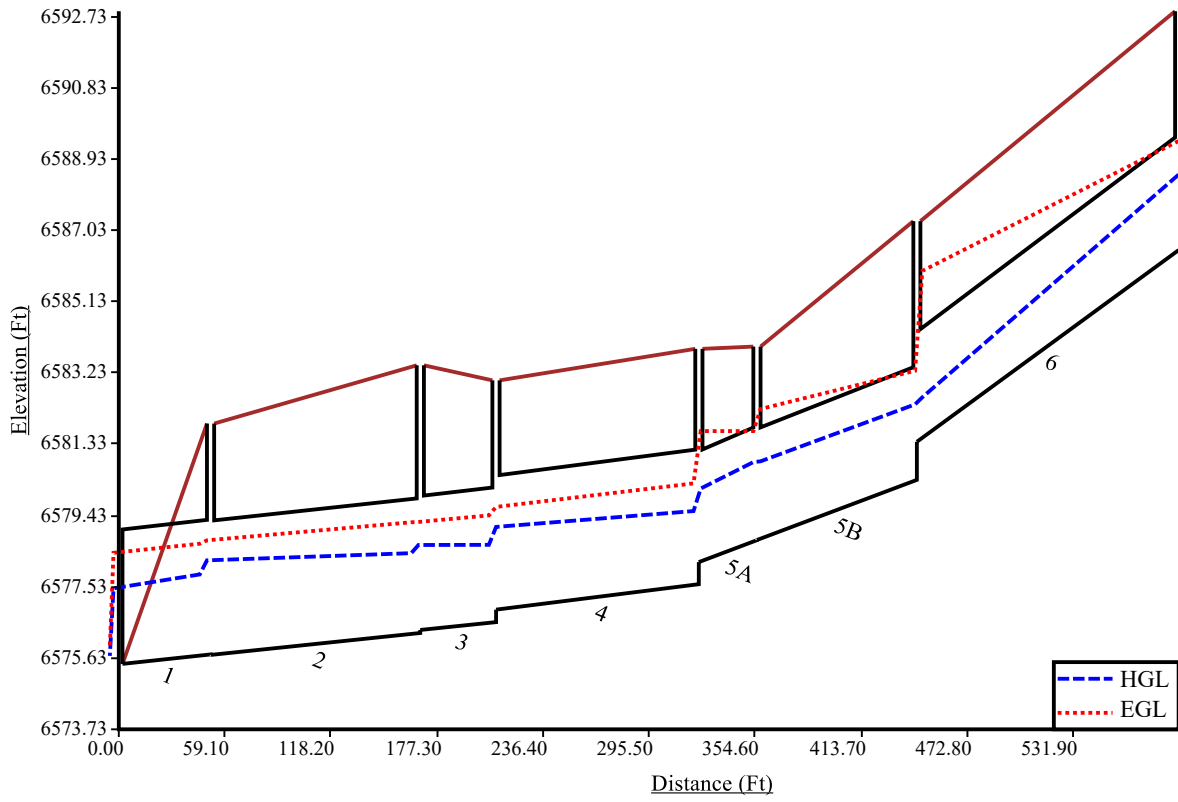

4-6

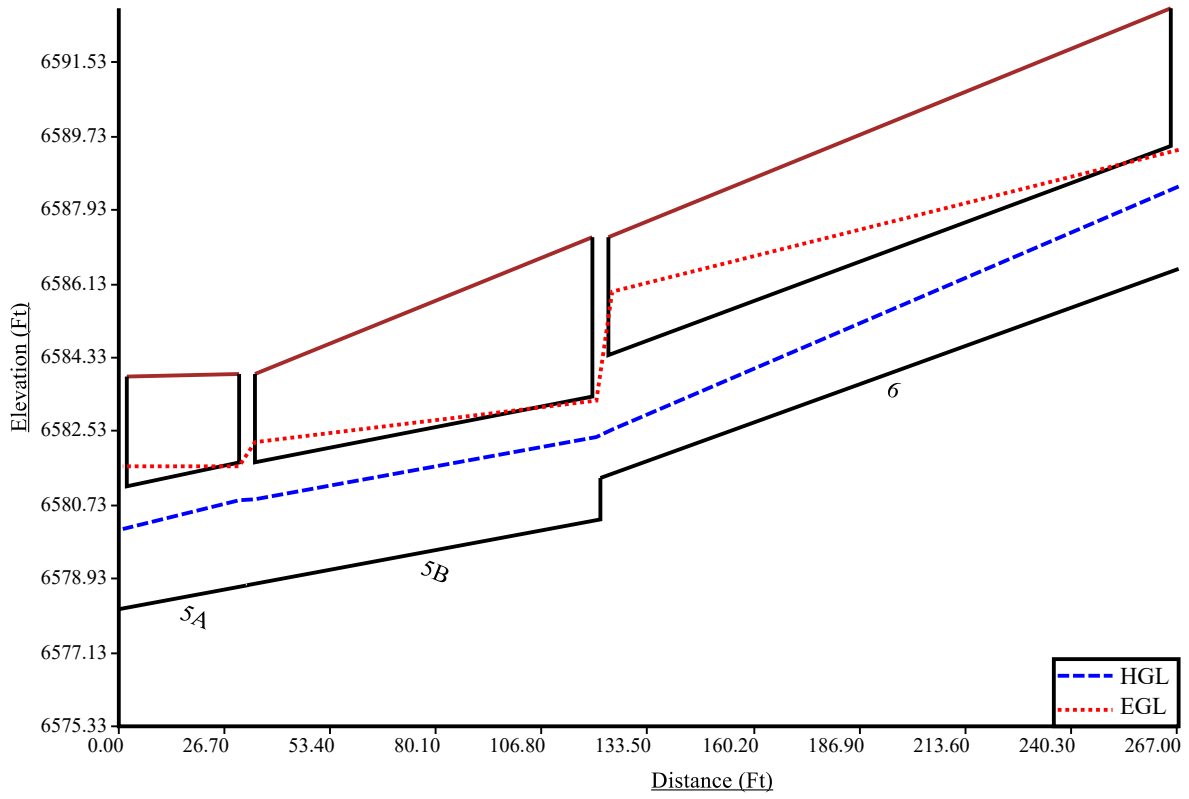

7-8

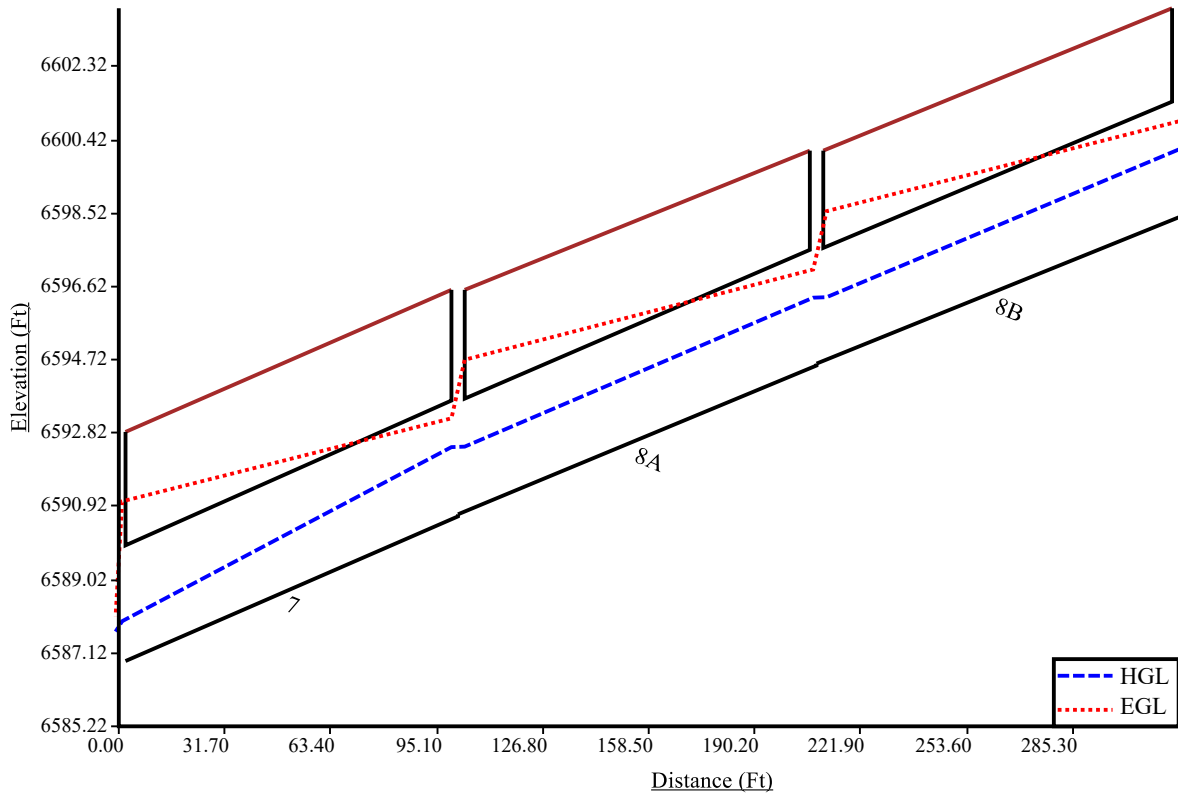

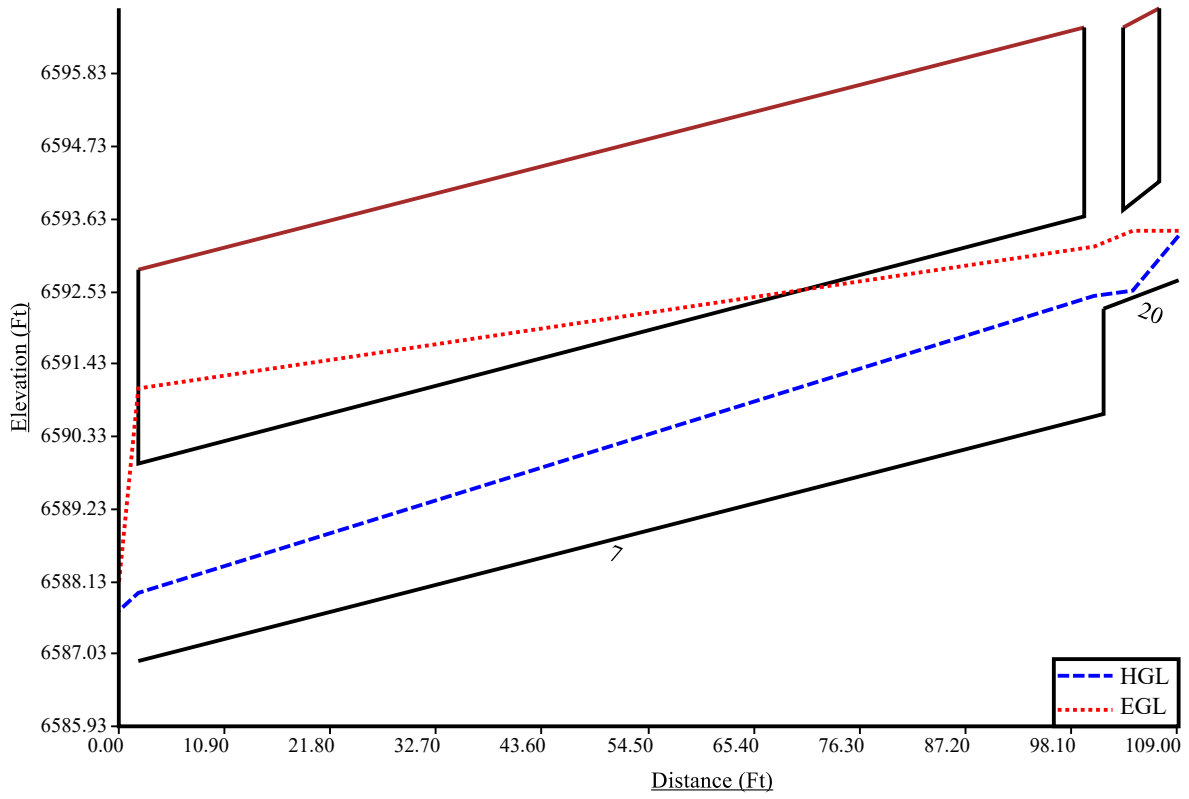

9-10

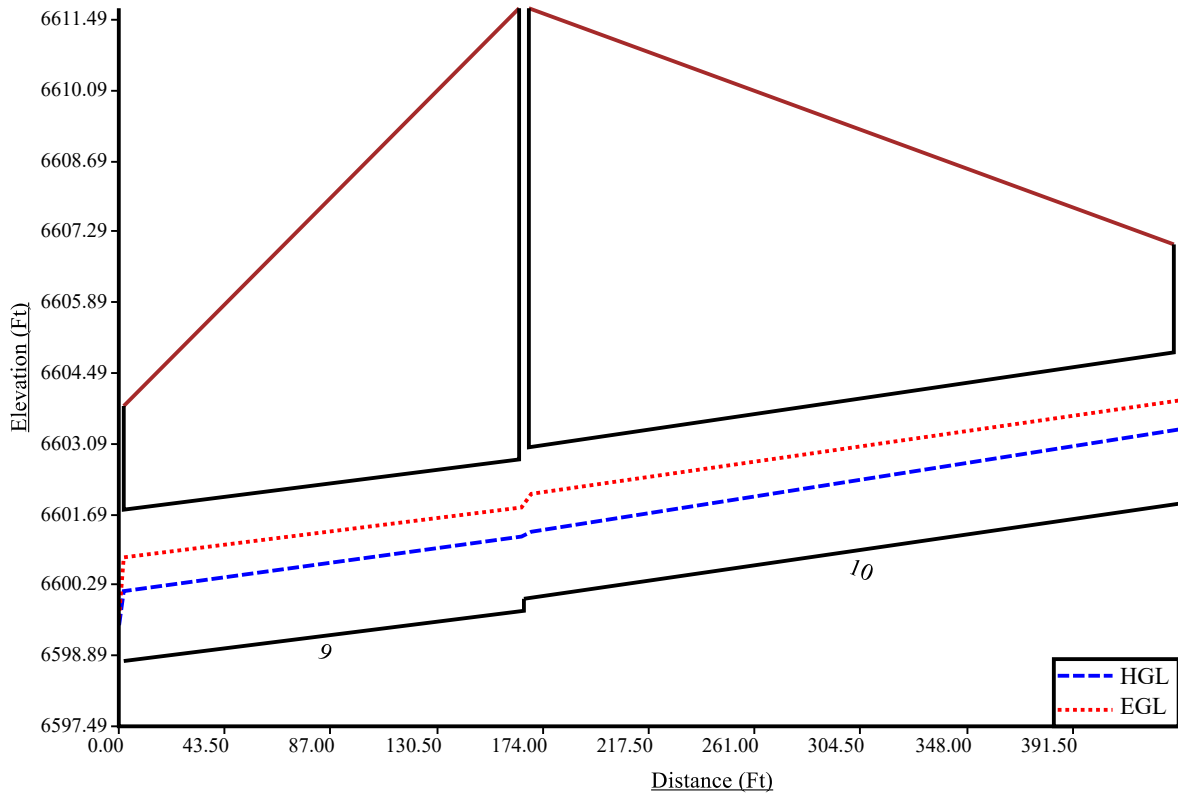

12

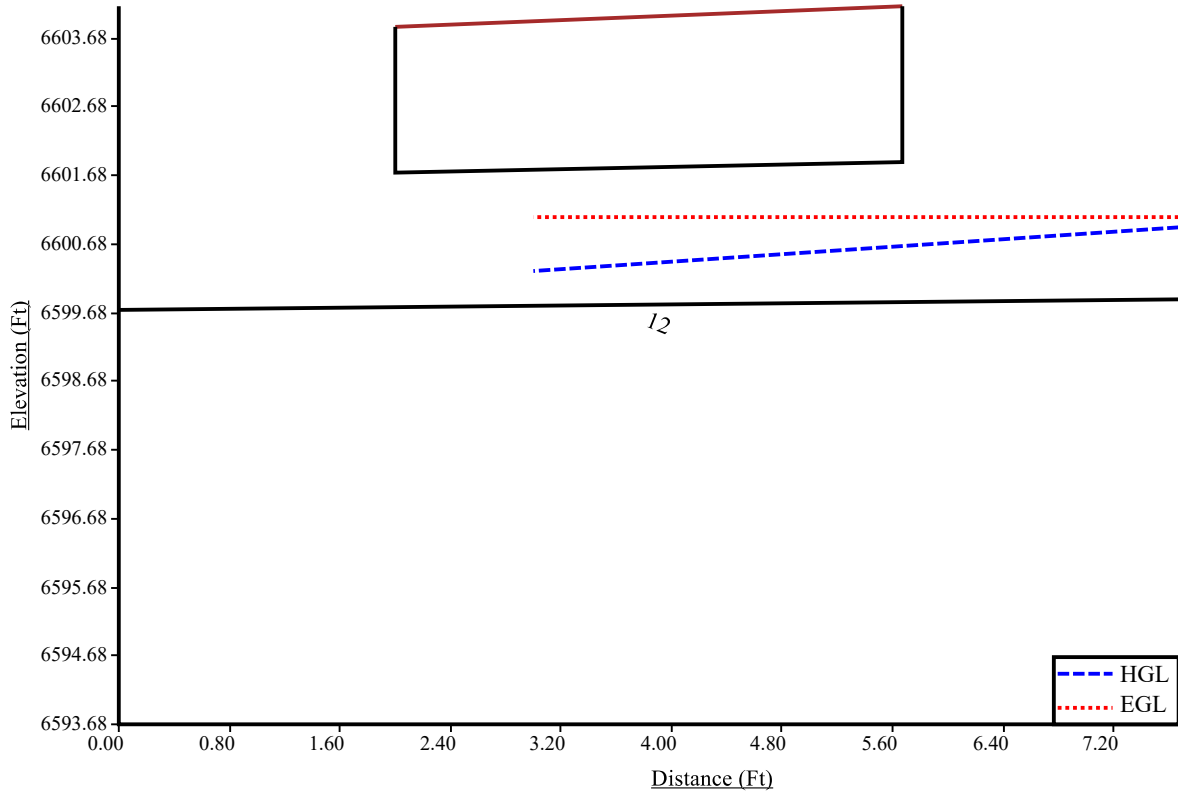

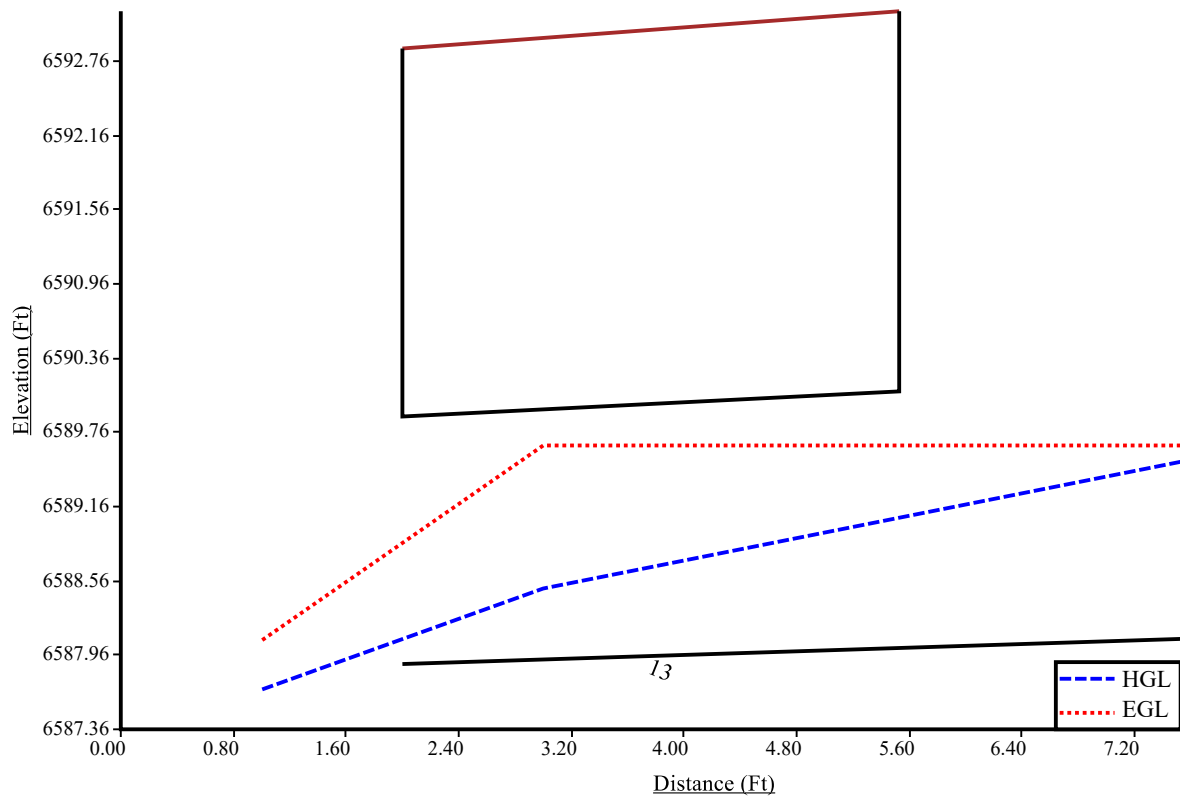

17

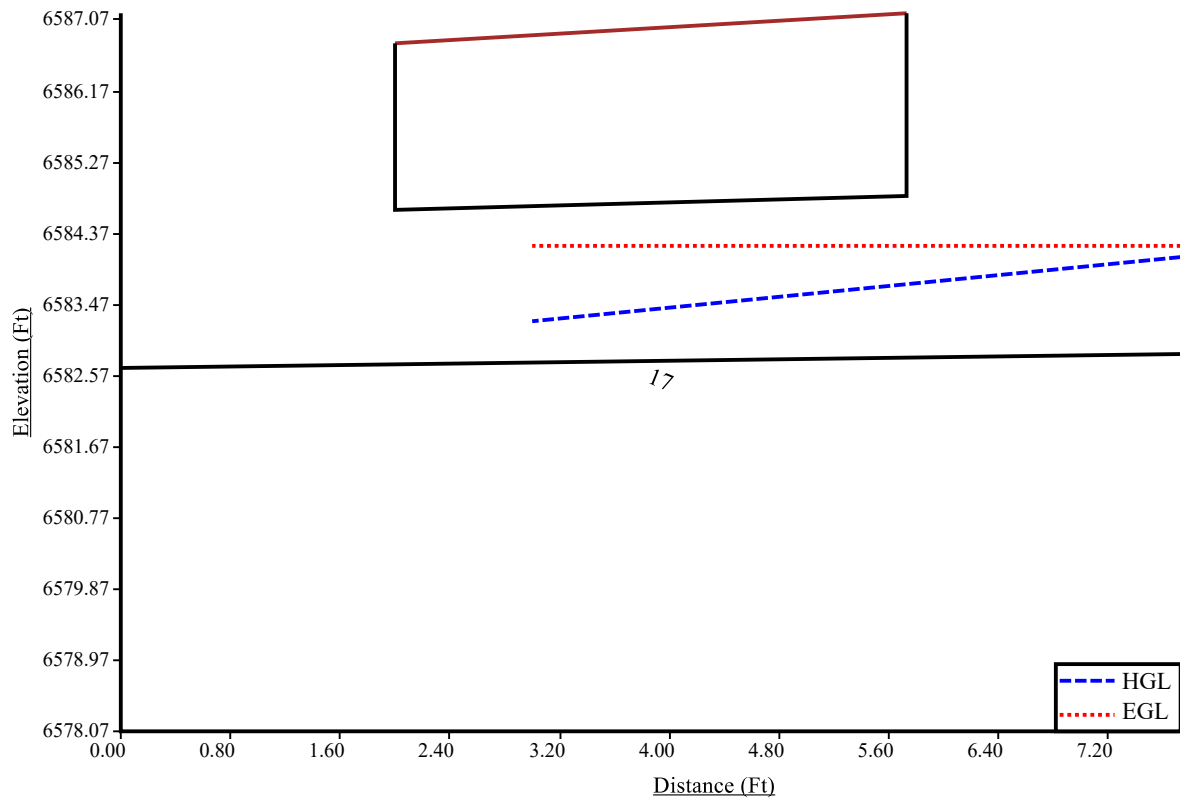

18

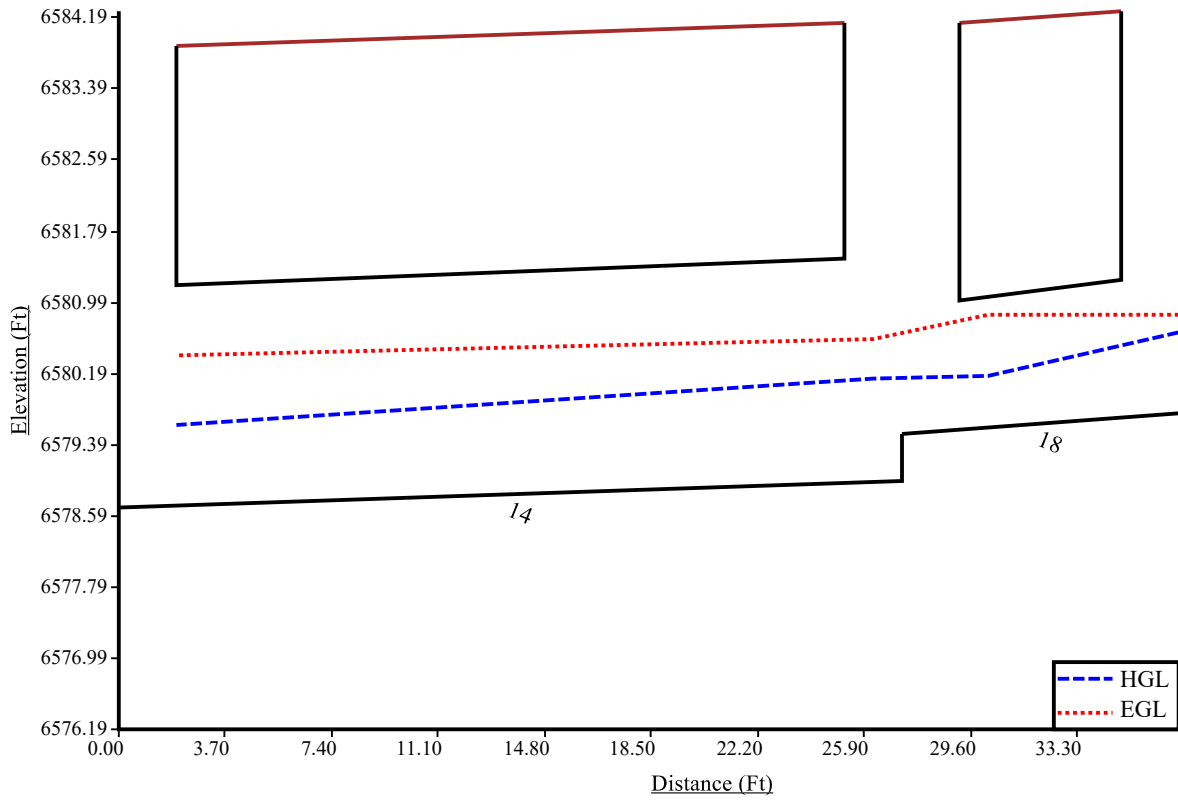

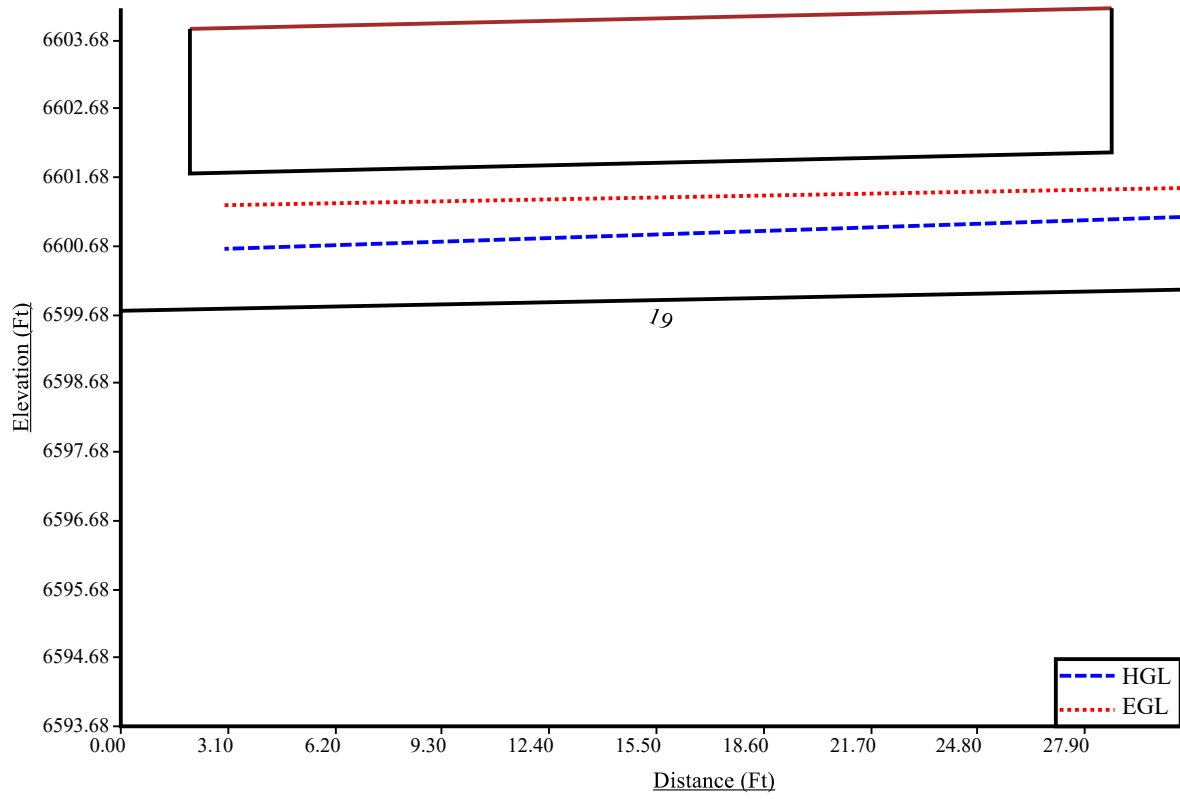

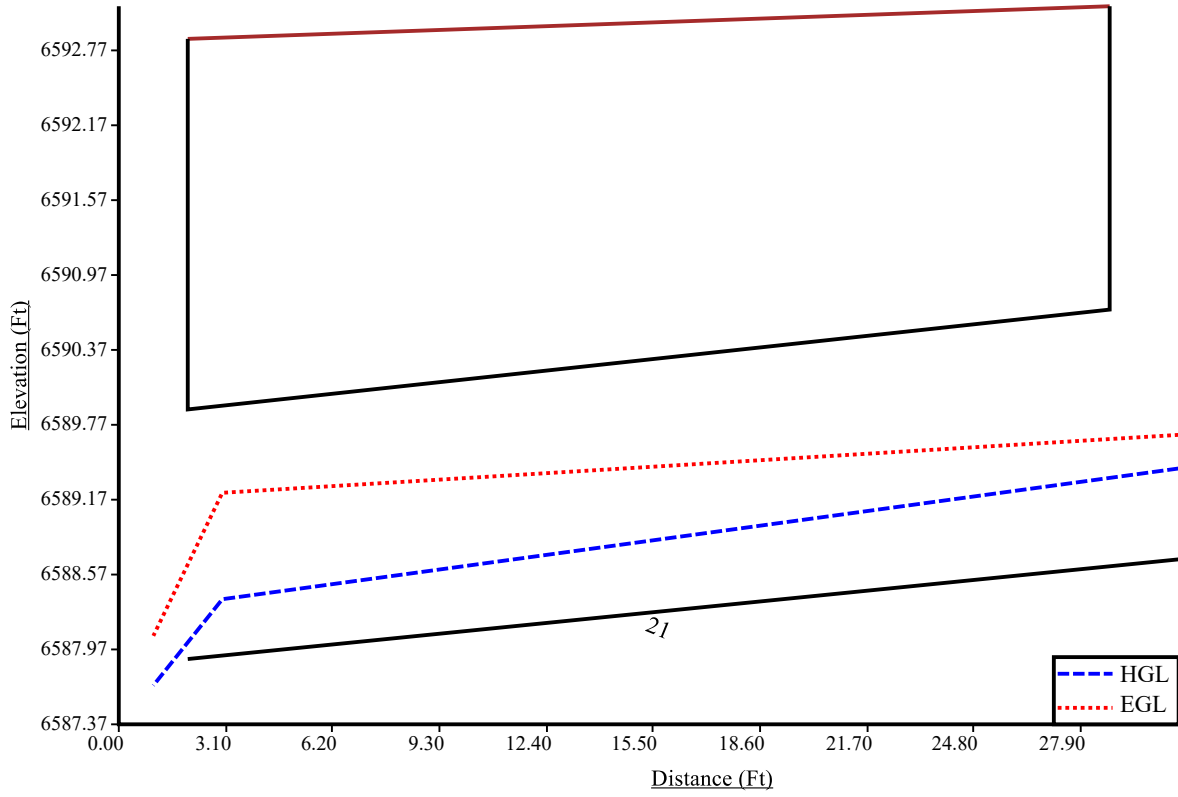

2-22

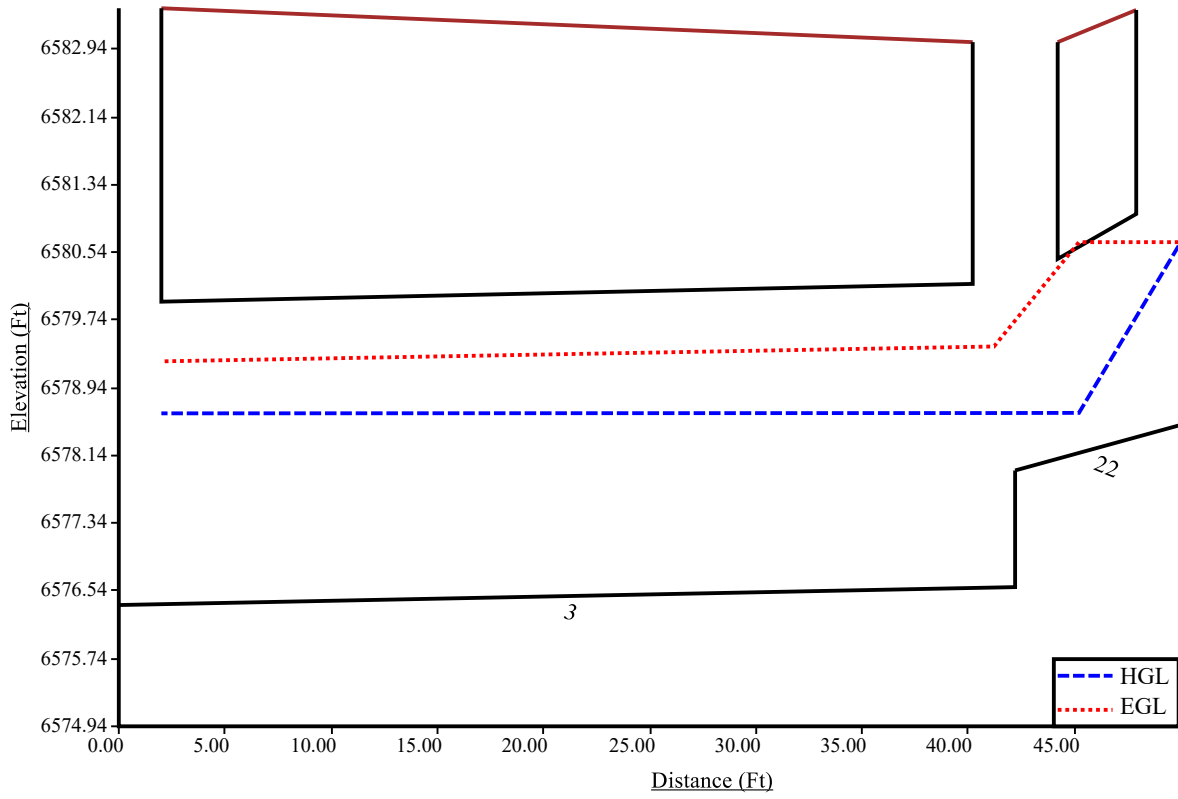

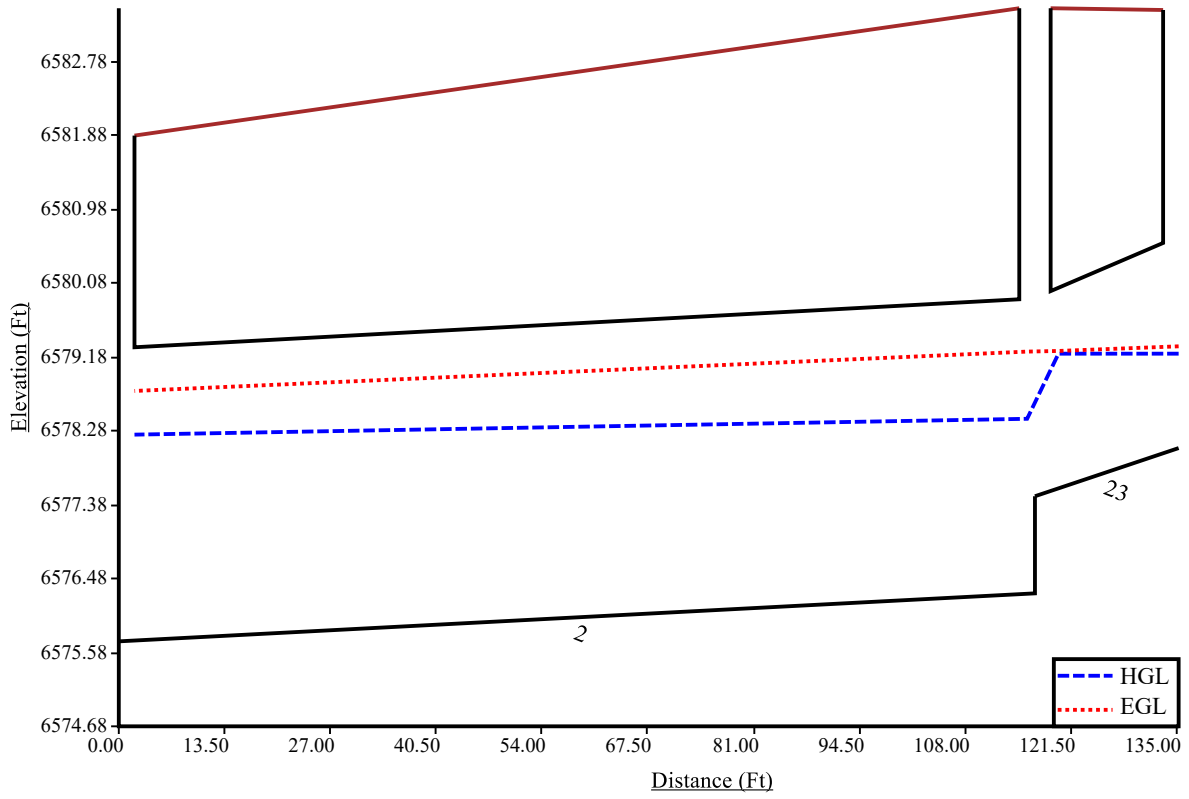

Program: UDSEWER Math Model Interface 2.1.1.4 Run Date: 2/9/2022 8:41:03 AM	<h2 style="margin: 0;">UDSewer Results Summary</h2> <p>Project Title: New UDSEWER System Module Project Description: Default system</p>
--	--

System Input Summary

Rainfall Parameters

Rainfall Return Period: 100
Rainfall Calculation Method: Formula

One Hour Depth (in): 2.52
Rainfall Constant "A": 28.5
Rainfall Constant "B": 10
Rainfall Constant "C": 0.786

Rational Method Constraints

Minimum Urban Runoff Coeff.: 0.20
Maximum Rural Overland Len. (ft): 500
Maximum Urban Overland Len. (ft): 300
Used UDFCD Tc. Maximum: No

Sizer Constraints

Minimum Sewer Size (in): 18.00
Maximum Depth to Rise Ratio: 0.90
Maximum Flow Velocity (fps): 18.0
Minimum Flow Velocity (fps): 2.0

Backwater Calculations:

Tailwater Elevation (ft): 6576.89

Manhole Input Summary:

		Given Flow		Sub Basin Information						
Element Name	Ground Elevation (ft)	Total Known Flow (cfs)	Local Contribution (cfs)	Drainage Area (Ac.)	Runoff Coefficient	5yr Coefficient	Overland Length (ft)	Overland Slope (%)	Gutter Length (ft)	Gutter Velocity (fps)
OUTFALL 1	6575.47	0.00	0.00	0.00	0.00	0.00	0.00	0.00	0.00	0.00
1	6581.88	119.40	0.00	0.00	0.00	0.00	0.00	0.00	0.00	0.00

2	6583.43	119.40	0.00	0.00	0.00	0.00	0.00	0.00	0.00	0.00
3	6583.03	111.80	0.00	0.00	0.00	0.00	0.00	0.00	0.00	0.00
4	6583.87	100.70	0.00	0.00	0.00	0.00	0.00	0.00	0.00	0.00
14	6584.13	25.90	0.00	0.00	0.00	0.00	0.00	0.00	0.00	0.00
15	6586.77	19.00	0.00	0.00	0.00	0.00	0.00	0.00	0.00	0.00
16	6587.33	6.60	0.00	0.00	0.00	0.00	0.00	0.00	0.00	0.00
17	6587.15	13.40	0.00	0.00	0.00	0.00	0.00	0.00	0.00	0.00
18	6584.26	8.70	0.00	0.00	0.00	0.00	0.00	0.00	0.00	0.00
22	6583.41	16.50	0.00	0.00	0.00	0.00	0.00	0.00	0.00	0.00
23	6583.41	11.80	0.00	0.00	0.00	0.00	0.00	0.00	0.00	0.00

Manhole Output Summary:

Element Name	Local Contribution					Total Design Flow				Comment
	Overland Time (min)	Gutter Time (min)	Basin Tc (min)	Intensity (in/hr)	Local Contrib (cfs)	Coeff. Area	Intensity (in/hr)	Manhole Tc (min)	Peak Flow (cfs)	
OUTFALL 1	0.00	0.00	0.00	0.00	0.00	10.24	11.66	0.10	119.40	Surface Water Present (Upstream)
1	0.00	0.00	0.00	0.00	0.00	0.00	0.00	0.00	119.40	Surface Water Present (Downstream)
2	0.00	0.00	0.00	0.00	0.00	0.00	0.00	0.00	119.40	
3	0.00	0.00	0.00	0.00	0.00	0.00	0.00	0.00	111.80	
4	0.00	0.00	0.00	0.00	0.00	0.00	0.00	0.00	100.70	
14	0.00	0.00	0.00	0.00	0.00	0.00	0.00	0.00	25.90	
15	0.00	0.00	0.00	0.00	0.00	0.00	0.00	0.00	19.00	
16	0.00	0.00	0.00	0.00	0.00	0.00	0.00	0.00	6.60	
17	0.00	0.00	0.00	0.00	0.00	0.00	0.00	0.00	13.40	
18	0.00	0.00	0.00	0.00	0.00	0.00	0.00	0.00	8.70	
22	0.00	0.00	0.00	0.00	0.00	0.00	0.00	0.00	16.50	
23	0.00	0.00	0.00	0.00	0.00	0.00	0.00	0.00	11.80	

Sewer Input Summary:

Element Name	Sewer Length (ft)	Elevation			Loss Coefficients			Given Dimensions		
		Downstream Invert (ft)	Slope (%)	Upstream Invert (ft)	Mannings n	Bend Loss	Lateral Loss	Cross Section	Rise (ft or in)	Span (ft or in)
1	51.12	6575.47	0.5	6575.73	0.014	0.03	0.00	ELLIPSE	43.00 in	68.00 in
2	116.91	6575.72	0.5	6576.30	0.014	0.38	0.00	ELLIPSE	43.00 in	68.00 in
3	42.20	6576.38	0.5	6576.59	0.014	0.05	0.00	ELLIPSE	43.00 in	68.00 in
4	113.08	6576.92	0.6	6577.60	0.014	1.32	0.00	ELLIPSE	43.00 in	68.00 in
14	27.22	6578.68	1.1	6578.98	0.014	0.05	0.00	CIRCULAR	30.00 in	30.00 in
15	297.18	6578.89	1.1	6582.16	0.014	0.05	0.00	CIRCULAR	30.00 in	30.00 in

16	36.48	6583.15	1.0	6583.51	0.014	0.38	0.00	CIRCULAR	18.00 in	18.00 in
17	7.73	6582.66	2.3	6582.84	0.014	1.32	0.00	CIRCULAR	24.00 in	24.00 in
18	9.62	6579.98	2.0	6580.17	0.014	0.38	0.00	CIRCULAR	18.00 in	18.00 in
22	7.70	6577.97	6.9	6578.50	0.014	0.05	0.00	CIRCULAR	30.00 in	30.00 in
23	18.34	6577.48	3.2	6578.07	0.014	0.38	0.00	CIRCULAR	30.00 in	30.00 in

Sewer Flow Summary:

Element Name	Full Flow Capacity		Critical Flow		Normal Flow				Flow (cfs)	Surcharged Length (ft)	Comment
	Flow (cfs)	Velocity (fps)	Depth (in)	Velocity (fps)	Depth (in)	Velocity (fps)	Froude Number	Flow Condition			
1	131.72	9.43	38.32	9.65	39.57	9.32	0.94	Subcritical	119.40	0.00	
2	131.72	9.43	38.32	9.65	39.57	9.32	0.94	Pressurized	119.40	116.91	
3	131.72	9.43	37.05	9.38	37.64	9.22	0.97	Pressurized	111.80	42.20	
4	144.29	10.33	35.10	8.99	32.92	9.70	1.13	Pressurized	100.70	113.08	
14	40.05	8.16	20.81	7.13	17.56	8.68	1.39	Pressurized	25.90	27.22	
15	40.05	8.16	17.73	6.29	14.54	8.05	1.46	Supercritical Jump	19.00	166.88	
16	9.78	5.53	11.93	5.31	10.83	5.94	1.20	Supercritical	6.60	0.00	
17	31.94	10.17	15.81	6.10	10.84	9.72	2.06	Supercritical	13.40	0.00	
18	13.74	7.78	13.70	6.03	10.39	8.23	1.72	Pressurized	8.70	9.62	
22	100.32	20.44	16.47	5.98	8.23	15.09	3.80	Pressurized	16.50	7.70	
23	68.32	13.92	13.82	5.34	8.44	10.42	2.59	Pressurized	11.80	18.34	

- A Froude number of 0 indicates that pressured flow occurs (adverse slope or undersized pipe).
- If the sewer is not pressurized, full flow represents the maximum gravity flow in the sewer.
- If the sewer is pressurized, full flow represents the pressurized flow conditions.

Sewer Sizing Summary:

Element Name	Peak Flow (cfs)	Cross Section	Existing		Calculated		Used			Comment
			Rise	Span	Rise	Span	Rise	Span	Area (ft ²)	
1	119.40	ELLIPSE	43.00 in	68.00 in	54.00 in	54.00 in	43.00 in	68.00 in	13.97	Existing height is smaller than the suggested height. Exceeds max. Depth/Rise
2	119.40	ELLIPSE	43.00 in	68.00 in	54.00 in	54.00 in	43.00 in	68.00 in	13.97	Existing height is smaller than the suggested height. Exceeds max. Depth/Rise
3	111.80	ELLIPSE	43.00 in	68.00 in	54.00 in	54.00 in	43.00 in	68.00 in	13.97	Existing height is smaller than the suggested height.
4	100.70	ELLIPSE	43.00 in	68.00 in	48.00 in	48.00 in	43.00 in	68.00 in	13.97	Existing height is smaller than the suggested height.
14	25.90	CIRCULAR	30.00 in	30.00 in	27.00 in	27.00 in	30.00 in	30.00 in	4.91	

15	19.00	CIRCULAR	30.00 in	30.00 in	24.00 in	24.00 in	30.00 in	30.00 in	4.91	
16	6.60	CIRCULAR	18.00 in	18.00 in	18.00 in	18.00 in	18.00 in	18.00 in	1.77	
17	13.40	CIRCULAR	24.00 in	24.00 in	18.00 in	18.00 in	24.00 in	24.00 in	3.14	
18	8.70	CIRCULAR	18.00 in	18.00 in	18.00 in	18.00 in	18.00 in	18.00 in	1.77	
22	16.50	CIRCULAR	30.00 in	30.00 in	18.00 in	18.00 in	30.00 in	30.00 in	4.91	
23	11.80	CIRCULAR	30.00 in	30.00 in	18.00 in	18.00 in	30.00 in	30.00 in	4.91	

- Calculated diameter was determined by sewer hydraulic capacity rounded up to the nearest commercially available size.
- Sewer sizes should not decrease downstream.
- All hydraulics were calculated using the 'Used' parameters.

Grade Line Summary:

Tailwater Elevation (ft): 6576.89

Element Name	Invert Elev.		Downstream Manhole Losses		HGL		EGL		
	Downstream (ft)	Upstream (ft)	Bend Loss (ft)	Lateral Loss (ft)	Downstream (ft)	Upstream (ft)	Downstream (ft)	Friction Loss (ft)	Upstream (ft)
1	6575.47	6575.73	0.00	0.00	6578.67	6579.05	6580.11	0.26	6580.38
2	6575.72	6576.30	0.43	0.00	6579.67	6580.16	6580.81	0.48	6581.29
3	6576.38	6576.59	0.05	0.00	6580.34	6580.50	6581.34	0.15	6581.49
4	6576.92	6577.60	1.07	0.00	6581.75	6582.08	6582.56	0.33	6582.89
14	6578.68	6578.98	0.02	0.00	6582.48	6582.60	6582.91	0.13	6583.03
15	6578.89	6582.16	0.01	0.00	6582.81	6583.64	6583.05	1.21	6584.25
16	6583.15	6583.51	0.08	0.00	6584.05	6584.50	6584.60	0.35	6584.94
17	6582.66	6582.84	0.37	0.00	6584.01	6584.74	6585.03	0.00	6585.03
18	6579.98	6580.17	0.14	0.00	6582.80	6582.88	6583.18	0.08	6583.25
22	6577.97	6578.50	0.01	0.00	6581.33	6581.34	6581.50	0.01	6581.51
23	6577.48	6578.07	0.03	0.00	6581.23	6581.25	6581.32	0.02	6581.34

- Bend and Lateral losses only apply when there is an outgoing sewer. The system outfall, sewer #0, is not considered a sewer.
- Bend loss = Bend K * V_{fi}² / (2 * g)
- Lateral loss = V_{fo}² / (2 * g) - Junction Loss K * V_{fi}² / (2 * g).
- Friction loss is always Upstream EGL - Downstream EGL.

Excavation Estimate:

The trench side slope is 1.0 ft/ft

The minimum trench width is 2.00 ft

Element Name	Length (ft)	Wall (in)	Bedding (in)	Bottom Width (ft)	Downstream			Upstream			Volume (cu. yd)	Comment
					Top Width (ft)	Trench Depth (ft)	Cover (ft)	Top Width (ft)	Trench Depth (ft)	Cover (ft)		

1	51.12	6.67	8.00	9.78	0.00	1.22	0.00	11.80	7.37	2.01	80.48	w r Too hallow
2	116.91	6.67	8.00	9.78	11.83	7.39	2.03	13.76	8.35	2.99	344.04	
3	42.20	6.67	8.00	9.78	13.60	8.27	2.91	12.38	7.66	2.30	125.95	
4	113.08	6.67	8.00	9.78	11.72	7.33	1.97	12.04	7.49	2.13	308.15	
14	27.22	3.50	6.00	6.08	8.88	5.98	2.40	8.80	5.94	2.36	38.48	
15	297.18	3.50	6.00	6.08	8.98	6.03	2.45	7.72	5.40	1.82	397.95	
16	36.48	2.50	4.00	4.92	6.75	4.17	1.92	7.14	4.36	2.11	29.73	
17	7.73	3.00	4.00	5.50	7.22	4.69	1.86	7.62	4.89	2.06	7.81	
18	9.62	2.50	4.00	4.92	7.80	4.69	2.44	7.68	4.63	2.38	8.88	
22	7.70	3.50	6.00	6.08	8.62	5.85	2.27	8.32	5.70	2.12	10.43	
23	18.34	3.50	6.00	6.08	10.39	6.74	3.16	9.18	6.13	2.55	28.98	

Total earth volume for sewer trenches = 1381 cubic yards.

- The trench was estimated to have a bottom width equal to the outer pipe diameter plus 36 inches.
- If the calculated width of the trench bottom is less than the minimum acceptable width, the minimum acceptable width was used.
- The sewer wall thickness is equal to: $(\text{equivalent diameter in inches}/12)+1$ inches
- The sewer bedding thickness is equal to:
 - Four inches for pipes less than 33 inches.
 - Six inches for pipes less than 60 inches.
 - Eight inches for all larger sizes.

Program: UDSEWER Math Model Interface 2.1.1.4 Run Date: 9/3/2021 12:37:40 PM	<h2 style="margin: 0;">UDSewer Results Summary</h2> <p>Project Title: New UDSEWER System Module Project Description: Default system</p>
---	--

System Input Summary

Rainfall Parameters

Rainfall Return Period: 100
Rainfall Calculation Method: Formula

One Hour Depth (in): 2.52
Rainfall Constant "A": 28.5
Rainfall Constant "B": 10
Rainfall Constant "C": 0.786

Rational Method Constraints

Minimum Urban Runoff Coeff.: 0.20
Maximum Rural Overland Len. (ft): 500
Maximum Urban Overland Len. (ft): 300
Used UDFCD Tc. Maximum: No

Sizer Constraints

Minimum Sewer Size (in): 18.00
Maximum Depth to Rise Ratio: 0.90
Maximum Flow Velocity (fps): 18.0
Minimum Flow Velocity (fps): 2.0

Backwater Calculations:

Tailwater Elevation (ft): 6580.34

Manhole Input Summary:

		Given Flow		Sub Basin Information						
Element Name	Ground Elevation (ft)	Total Known Flow (cfs)	Local Contribution (cfs)	Drainage Area (Ac.)	Runoff Coefficient	5yr Coefficient	Overland Length (ft)	Overland Slope (%)	Gutter Length (ft)	Gutter Velocity (fps)
OUTFALL 1	6583.87	0.00	0.00	0.00	0.00	0.00	0.00	0.00	0.00	0.00
5A	6583.93	82.80	0.00	0.00	0.00	0.00	0.00	0.00	0.00	0.00

5B	6587.27	82.80	0.00	0.00	0.00	0.00	0.00	0.00	0.00	0.00
6	6592.86	82.80	0.00	0.00	0.00	0.00	0.00	0.00	0.00	0.00
21	6593.12	9.50	0.00	0.00	0.00	0.00	0.00	0.00	0.00	0.00
7	6596.54	66.10	0.00	0.00	0.00	0.00	0.00	0.00	0.00	0.00
20	6596.83	3.80	0.00	0.00	0.00	0.00	0.00	0.00	0.00	0.00
8A	6600.15	63.00	0.00	0.00	0.00	0.00	0.00	0.00	0.00	0.00
8B	6603.84	63.50	0.00	0.00	0.00	0.00	0.00	0.00	0.00	0.00
12	6604.14	11.20	0.00	0.00	0.00	0.00	0.00	0.00	0.00	0.00
9	6611.72	44.90	0.00	0.00	0.00	0.00	0.00	0.00	0.00	0.00
10	6607.04	44.90	0.00	0.00	0.00	0.00	0.00	0.00	0.00	0.00
19	6604.14	19.40	0.00	0.00	0.00	0.00	0.00	0.00	0.00	0.00
13	6593.16	15.40	0.00	0.00	0.00	0.00	0.00	0.00	0.00	0.00

Manhole Output Summary:

Element Name	Local Contribution					Total Design Flow				Comment
	Overland Time (min)	Gutter Time (min)	Basin Tc (min)	Intensity (in/hr)	Local Contrib (cfs)	Coeff. Area	Intensity (in/hr)	Manhole Tc (min)	Peak Flow (cfs)	
OUTFALL 1	0.00	0.00	0.00	0.00	0.00	7.07	11.71	0.05	82.80	
5A	0.00	0.00	0.00	0.00	0.00	0.00	0.00	0.00	82.80	
5B	0.00	0.00	0.00	0.00	0.00	0.00	0.00	0.00	82.80	
6	0.00	0.00	0.00	0.00	0.00	0.00	0.00	0.00	82.80	
21	0.00	0.00	0.00	0.00	0.00	0.00	0.00	0.00	9.50	
7	0.00	0.00	0.00	0.00	0.00	0.00	0.00	0.00	66.10	
20	0.00	0.00	0.00	0.00	0.00	0.00	0.00	0.00	3.80	
8A	0.00	0.00	0.00	0.00	0.00	0.00	0.00	0.00	63.00	
8B	0.00	0.00	0.00	0.00	0.00	0.00	0.00	0.00	63.50	
12	0.00	0.00	0.00	0.00	0.00	0.00	0.00	0.00	11.20	
9	0.00	0.00	0.00	0.00	0.00	0.00	0.00	0.00	44.90	
10	0.00	0.00	0.00	0.00	0.00	0.00	0.00	0.00	44.90	
19	0.00	0.00	0.00	0.00	0.00	0.00	0.00	0.00	19.40	
13	0.00	0.00	0.00	0.00	0.00	0.00	0.00	0.00	15.40	

Sewer Input Summary:

Element Name	Sewer Length (ft)	Elevation			Loss Coefficients			Given Dimensions		
		Downstream Invert (ft)	Slope (%)	Upstream Invert (ft)	Mannings n	Bend Loss	Lateral Loss	Cross Section	Rise (ft or in)	Span (ft or in)
5A	32.36	6578.19	1.8	6578.77	0.014	1.00	0.00	CIRCULAR	36.00 in	36.00 in
5B	89.17	6578.77	1.8	6580.38	0.014	0.05	0.00	CIRCULAR	36.00 in	36.00 in
6	145.96	6581.39	3.5	6586.50	0.014	0.05	0.00	CIRCULAR	36.00 in	36.00 in
21	30.74	6587.89	2.6	6588.69	0.014	1.00	0.00	CIRCULAR	24.00 in	24.00 in

7	101.44	6586.92	3.7	6590.67	0.014	0.05	0.00	CIRCULAR	36.00 in	36.00 in
20	7.73	6592.27	5.6	6592.70	0.014	1.00	0.00	CIRCULAR	18.00 in	18.00 in
8A	107.21	6590.72	3.6	6594.58	0.014	0.05	0.00	CIRCULAR	36.00 in	36.00 in
8B	108.31	6594.63	3.5	6598.42	0.014	0.05	0.00	CIRCULAR	36.00 in	36.00 in
12	7.67	6599.72	2.0	6599.87	0.014	1.00	0.00	CIRCULAR	24.00 in	24.00 in
9	166.22	6598.78	0.6	6599.78	0.014	0.05	0.00	CIRCULAR	36.00 in	36.00 in
10	268.70	6600.02	0.7	6601.90	0.014	0.29	0.00	CIRCULAR	36.00 in	36.00 in
19	30.67	6599.73	1.0	6600.04	0.014	1.00	0.00	CIRCULAR	24.00 in	24.00 in
13	7.53	6587.89	2.7	6588.09	0.014	1.00	0.00	CIRCULAR	24.00 in	24.00 in

Sewer Flow Summary:

Element Name	Full Flow Capacity		Critical Flow		Normal Flow				Flow (cfs)	Surcharged Length (ft)	Comment
	Flow (cfs)	Velocity (fps)	Depth (in)	Velocity (fps)	Depth (in)	Velocity (fps)	Froude Number	Flow Condition			
5A	83.32	11.79	33.54	12.07	29.31	13.44	1.46	Supercritical	82.80	0.00	
5B	83.32	11.79	33.54	12.07	29.31	13.44	1.46	Supercritical	82.80	0.00	
6	116.18	16.44	33.54	12.07	22.46	17.85	2.49	Supercritical	82.80	0.00	
21	33.96	10.81	13.22	5.36	8.68	9.27	2.24	Pressurized	9.50	30.74	
7	119.45	16.90	31.22	10.15	19.12	17.33	2.70	Supercritical	66.10	0.00	
20	23.14	13.10	8.94	4.34	4.93	9.67	3.14	Pressurized	3.80	7.73	
8A	117.83	16.67	30.64	9.83	18.73	16.95	2.68	Supercritical	63.00	0.00	
8B	116.18	16.44	30.73	9.88	18.98	16.80	2.64	Supercritical	63.50	0.00	
12	29.79	9.48	14.41	5.69	10.20	8.81	1.94	Pressurized	11.20	7.67	
9	48.10	6.81	26.19	8.15	27.56	7.73	0.90	Subcritical Surcharged	44.90	153.91	
10	51.96	7.35	26.19	8.15	25.83	8.27	1.03	Supercritical	44.90	0.00	
19	21.06	6.70	19.00	7.27	18.16	7.61	1.10	Pressurized	19.40	30.67	
13	34.61	11.02	16.97	6.48	11.21	10.70	2.22	Pressurized	15.40	7.53	

- A Froude number of 0 indicates that pressured flow occurs (adverse slope or undersized pipe).
- If the sewer is not pressurized, full flow represents the maximum gravity flow in the sewer.
- If the sewer is pressurized, full flow represents the pressurized flow conditions.

Sewer Sizing Summary:

Element Name	Peak Flow (cfs)	Cross Section	Existing		Calculated		Used			Comment
			Rise	Span	Rise	Span	Rise	Span	Area (ft ²)	
5A	82.80	CIRCULAR	36.00 in	36.00 in	36.00 in	36.00 in	36.00 in	36.00 in	7.07	
5B	82.80	CIRCULAR	36.00 in	36.00 in	36.00 in	36.00 in	36.00 in	36.00 in	7.07	
6	82.80	CIRCULAR	36.00 in	36.00 in	33.00 in	33.00 in	36.00 in	36.00 in	7.07	
21	9.50	CIRCULAR	24.00 in	24.00 in	18.00 in	18.00 in	24.00 in	24.00 in	3.14	

7	66.10	CIRCULAR	36.00 in	36.00 in	30.00 in	30.00 in	36.00 in	36.00 in	7.07	
20	3.80	CIRCULAR	18.00 in	18.00 in	18.00 in	18.00 in	18.00 in	18.00 in	1.77	
8A	63.00	CIRCULAR	36.00 in	36.00 in	30.00 in	30.00 in	36.00 in	36.00 in	7.07	
8B	63.50	CIRCULAR	36.00 in	36.00 in	30.00 in	30.00 in	36.00 in	36.00 in	7.07	
12	11.20	CIRCULAR	24.00 in	24.00 in	18.00 in	18.00 in	24.00 in	24.00 in	3.14	
9	44.90	CIRCULAR	36.00 in	36.00 in	36.00 in	36.00 in	36.00 in	36.00 in	7.07	
10	44.90	CIRCULAR	36.00 in	36.00 in	36.00 in	36.00 in	36.00 in	36.00 in	7.07	
19	19.40	CIRCULAR	24.00 in	24.00 in	24.00 in	24.00 in	24.00 in	24.00 in	3.14	
13	15.40	CIRCULAR	24.00 in	24.00 in	18.00 in	18.00 in	24.00 in	24.00 in	3.14	

- Calculated diameter was determined by sewer hydraulic capacity rounded up to the nearest commercially available size.
- Sewer sizes should not decrease downstream.
- All hydraulics were calculated using the 'Used' parameters.

Grade Line Summary:

Tailwater Elevation (ft): 6580.34

Element Name	Invert Elev.		Downstream Manhole Losses		HGL		EGL		
	Downstream (ft)	Upstream (ft)	Bend Loss (ft)	Lateral Loss (ft)	Downstream (ft)	Upstream (ft)	Downstream (ft)	Friction Loss (ft)	Upstream (ft)
5A	6578.19	6578.77	0.00	0.00	6580.63	6581.56	6583.43	0.39	6583.83
5B	6578.77	6580.38	0.11	0.00	6581.67	6583.17	6584.02	1.42	6585.44
6	6581.39	6586.50	0.11	0.00	6583.28	6589.29	6588.21	3.35	6591.56
21	6587.89	6588.69	0.14	0.00	6591.56	6591.62	6591.70	0.06	6591.76
7	6586.92	6590.67	0.07	0.00	6589.36	6593.27	6593.17	1.70	6594.87
20	6592.27	6592.70	0.07	0.00	6594.87	6594.88	6594.94	0.01	6594.96
8A	6590.72	6594.58	0.06	0.00	6593.33	6597.13	6596.74	1.89	6598.63
8B	6594.63	6598.42	0.06	0.00	6597.20	6600.98	6600.59	1.90	6602.50
12	6599.72	6599.87	0.20	0.00	6602.50	6602.52	6602.69	0.02	6602.72
9	6598.78	6599.78	0.03	0.00	6601.90	6602.77	6602.53	0.87	6603.40
10	6600.02	6601.90	0.18	0.00	6602.95	6604.08	6603.58	1.53	6605.11
19	6599.73	6600.04	0.59	0.00	6602.50	6602.76	6603.09	0.26	6603.35
13	6587.89	6588.09	0.37	0.00	6591.56	6591.60	6591.93	0.04	6591.97

- Bend and Lateral losses only apply when there is an outgoing sewer. The system outfall, sewer #0, is not considered a sewer.
- Bend loss = Bend K * V_{fi}² / (2 * g)
- Lateral loss = V_{fo}² / (2 * g) - Junction Loss K * V_{fi}² / (2 * g).
- Friction loss is always Upstream EGL - Downstream EGL.

Excavation Estimate:

The trench side slope is 1.0 ft/ft
The minimum trench width is 2.00 ft

Element Name	Length (ft)	Wall (in)	Bedding (in)	Bottom Width (ft)	Downstream			Upstream			Volume (cu. yd)	Comment
					Top Width (ft)	Trench Depth (ft)	Cover (ft)	Top Width (ft)	Trench Depth (ft)	Cover (ft)		
5A	32.36	4.00	6.00	6.67	9.36	6.52	2.35	8.32	5.99	1.83	51.48	
5B	89.17	4.00	6.00	6.67	8.31	5.99	1.82	11.78	7.72	3.56	162.86	
6	145.96	4.00	6.00	6.67	9.76	6.71	2.55	10.72	7.19	3.03	268.13	
21	30.74	3.00	4.00	5.50	8.94	5.55	2.72	7.86	5.01	2.18	35.56	
7	101.44	4.00	6.00	6.67	9.89	6.78	2.61	9.74	6.70	2.54	178.12	
20	7.73	2.50	4.00	4.92	8.05	4.81	2.56	7.76	4.67	2.42	7.32	
8A	107.21	4.00	6.00	6.67	9.64	6.65	2.49	9.14	6.40	2.24	180.23	
8B	108.31	4.00	6.00	6.67	9.04	6.35	2.19	8.84	6.25	2.09	173.78	
12	7.67	3.00	4.00	5.50	7.25	4.71	1.87	7.54	4.85	2.02	7.72	
9	166.22	4.00	6.00	6.67	8.11	5.89	1.72	21.88	12.77	8.61	562.72	
10	268.70	4.00	6.00	6.67	21.40	12.53	8.37	8.28	5.97	1.81	887.28	
19	30.67	3.00	4.00	5.50	7.21	4.69	1.86	7.20	4.68	1.85	30.11	
13	7.53	3.00	4.00	5.50	8.95	5.56	2.72	9.14	5.65	2.82	9.47	

Total earth volume for sewer trenches = 2555 cubic yards.

- The trench was estimated to have a bottom width equal to the outer pipe diameter plus 36 inches.
- If the calculated width of the trench bottom is less than the minimum acceptable width, the minimum acceptable width was used.
- The sewer wall thickness is equal to: (equivalent diameter in inches/12)+1 inches
- The sewer bedding thickness is equal to:
 - Four inches for pipes less than 33 inches.
 - Six inches for pipes less than 60 inches.
 - Eight inches for all larger sizes.

1-16

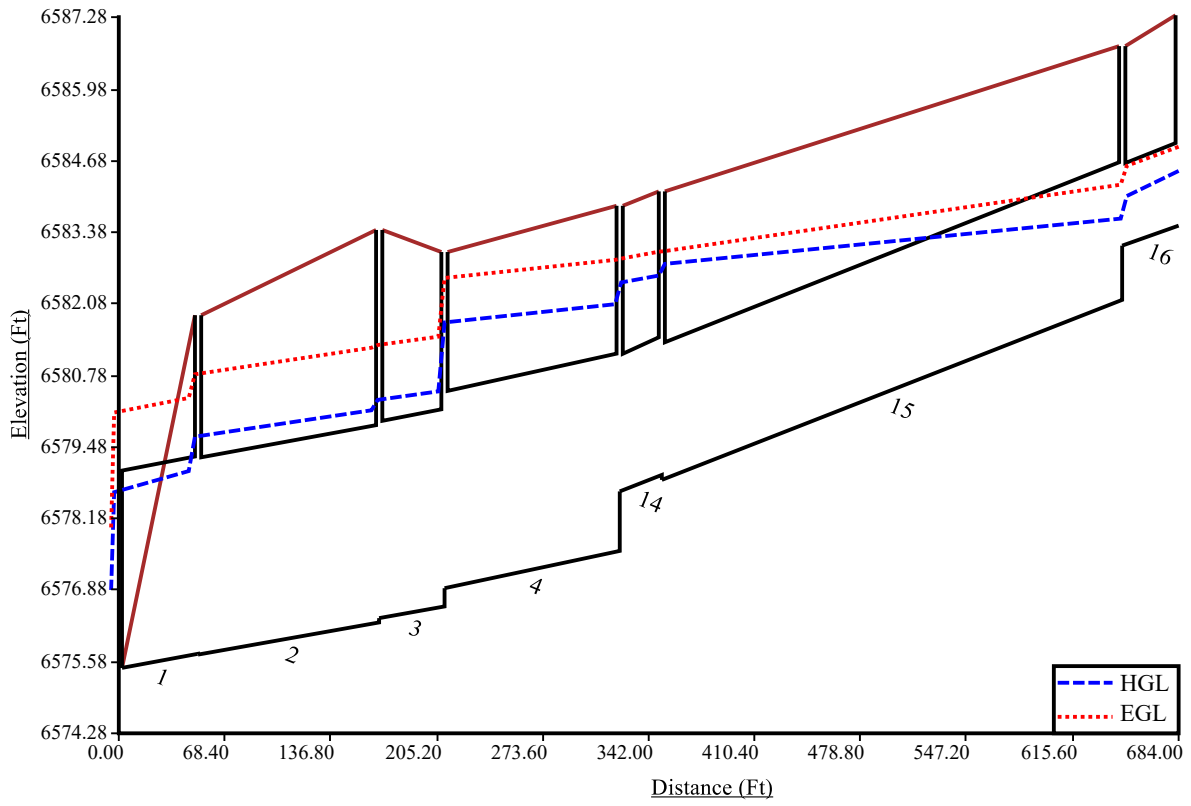

5-10

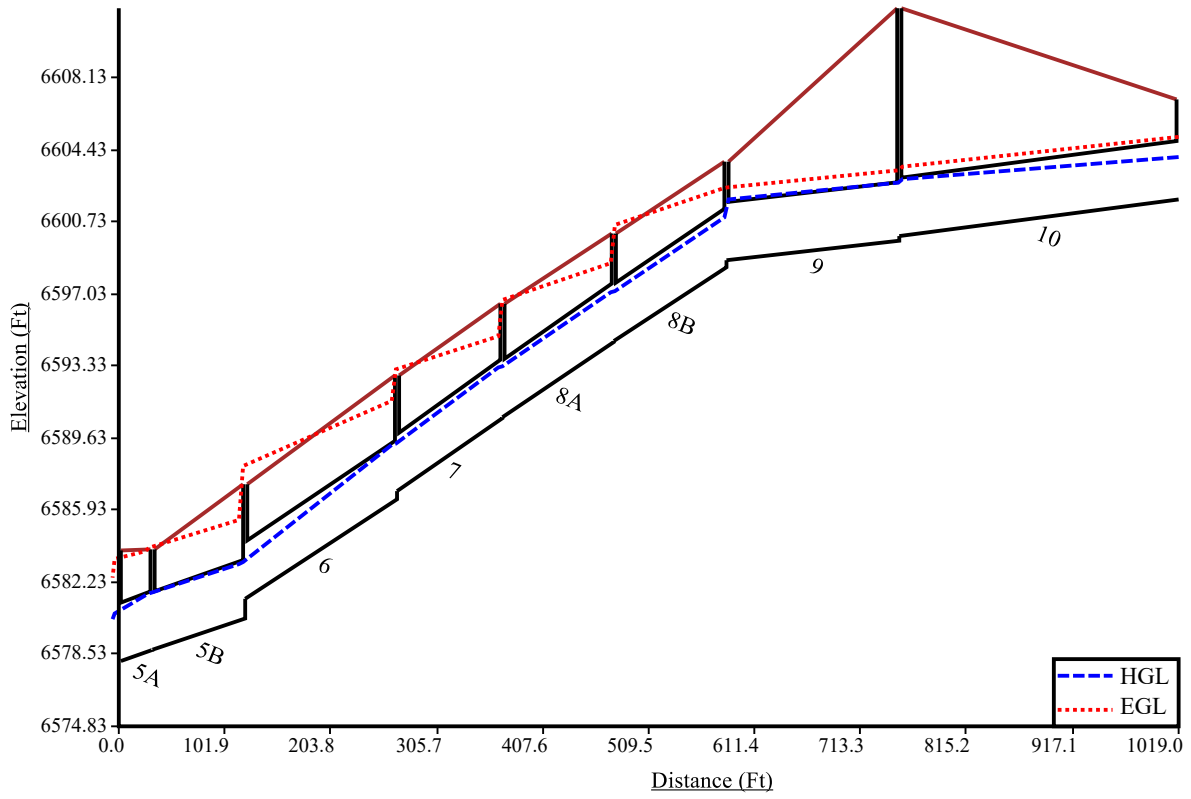

5-13

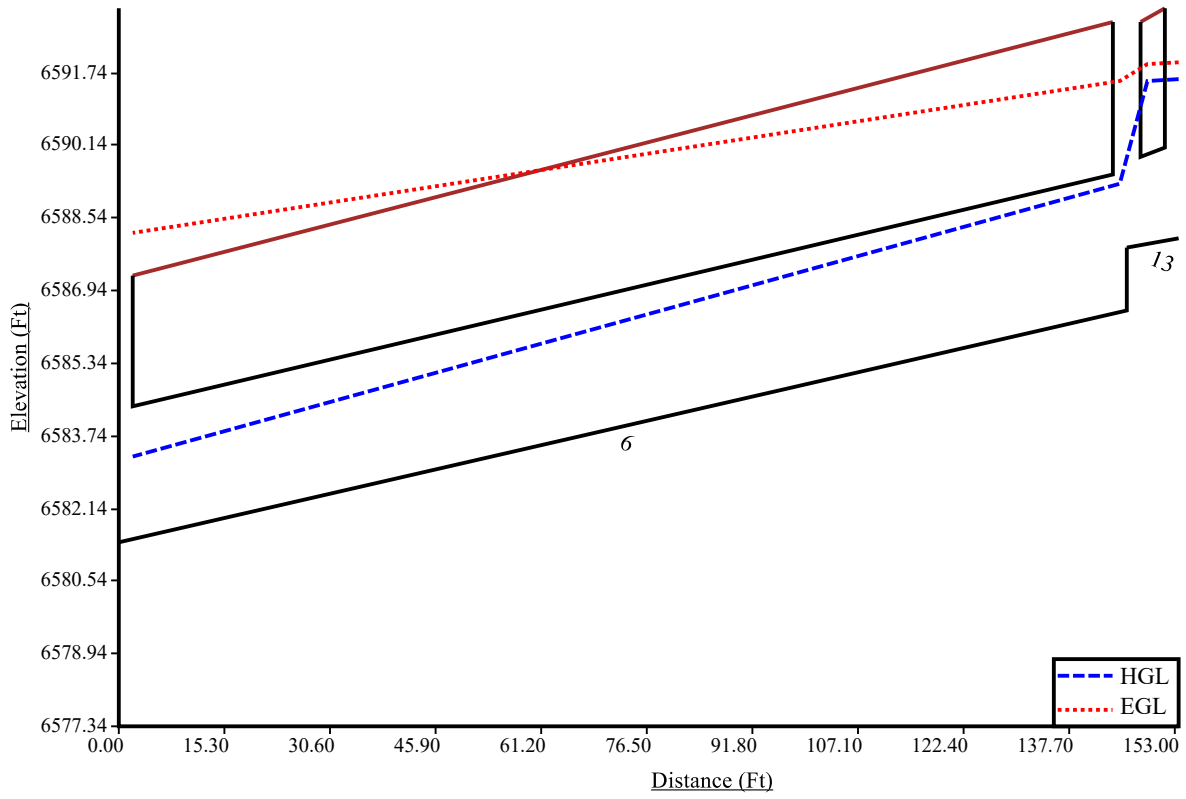

SB

8-12

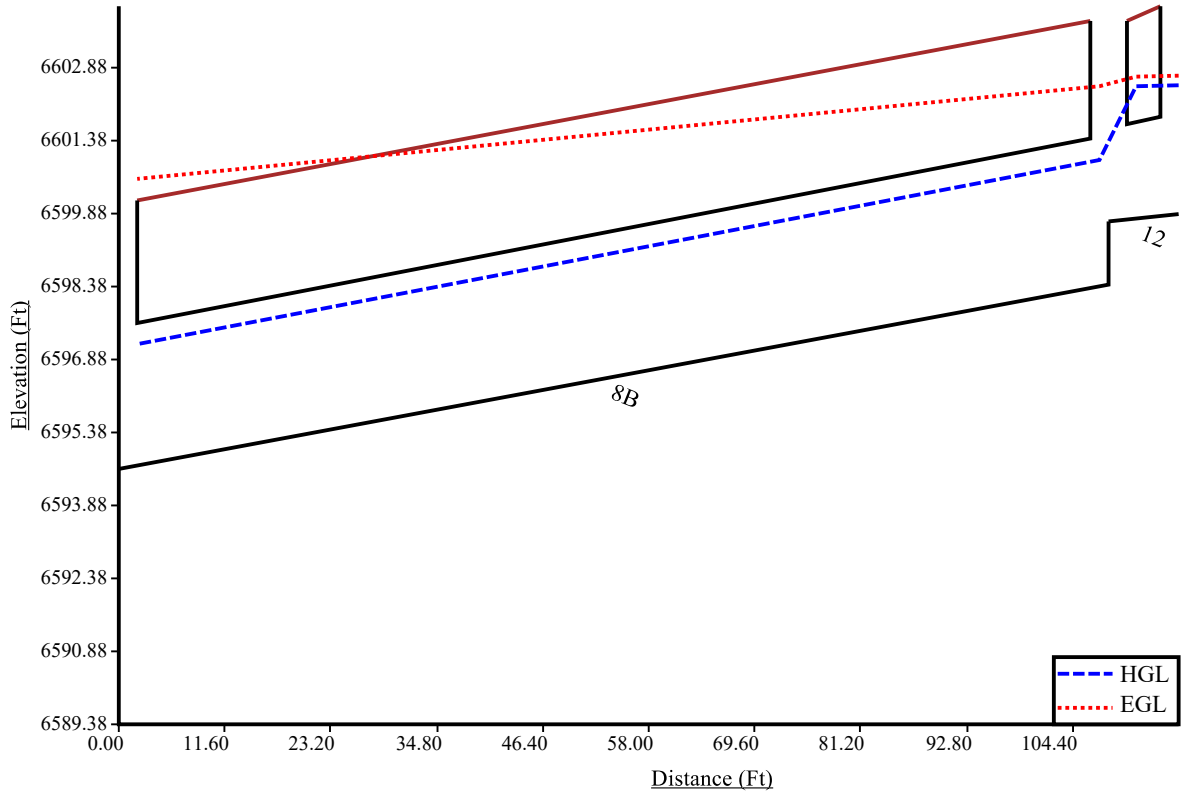

14-17

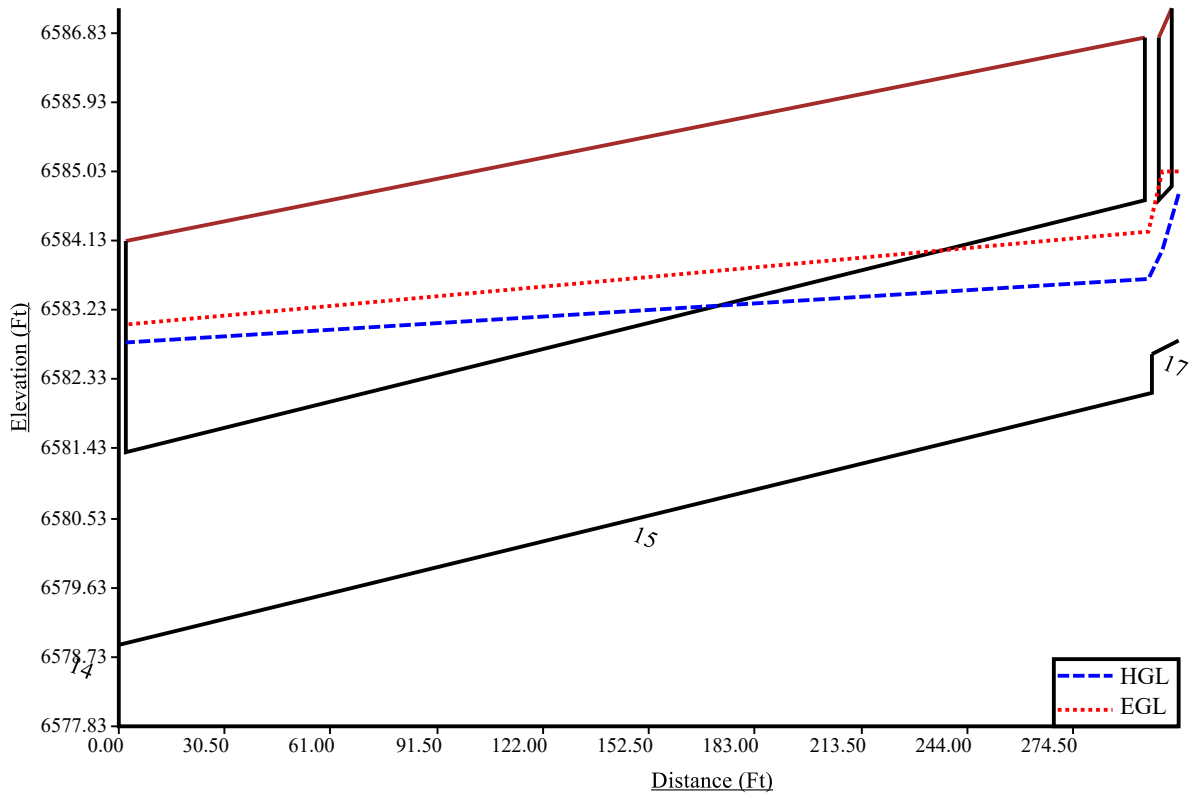

4-18

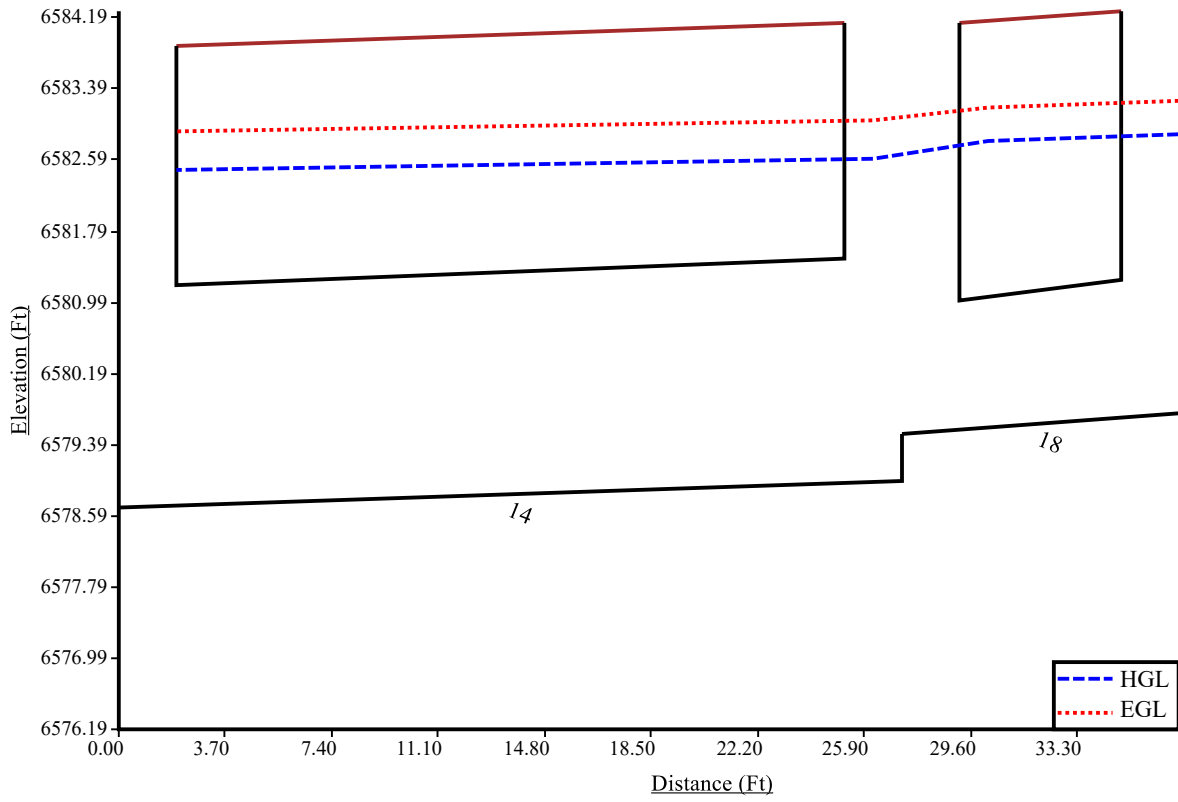

8-19

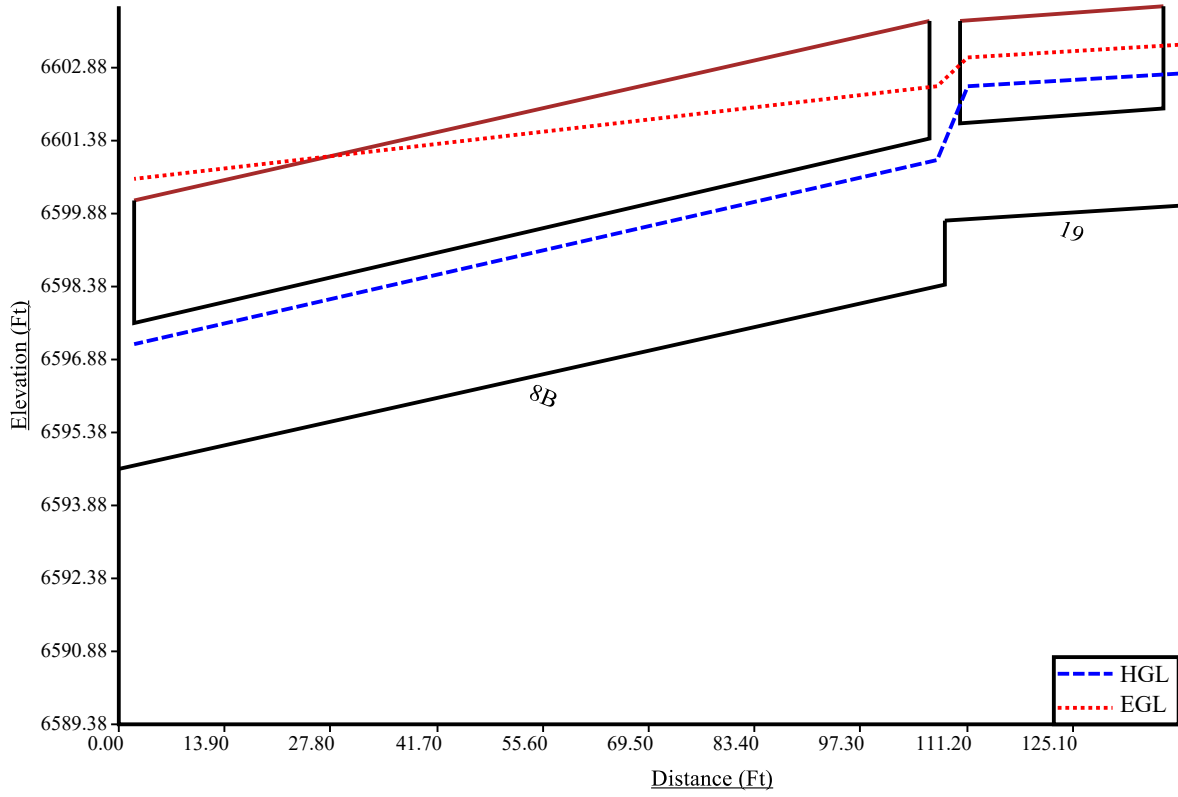

6-20

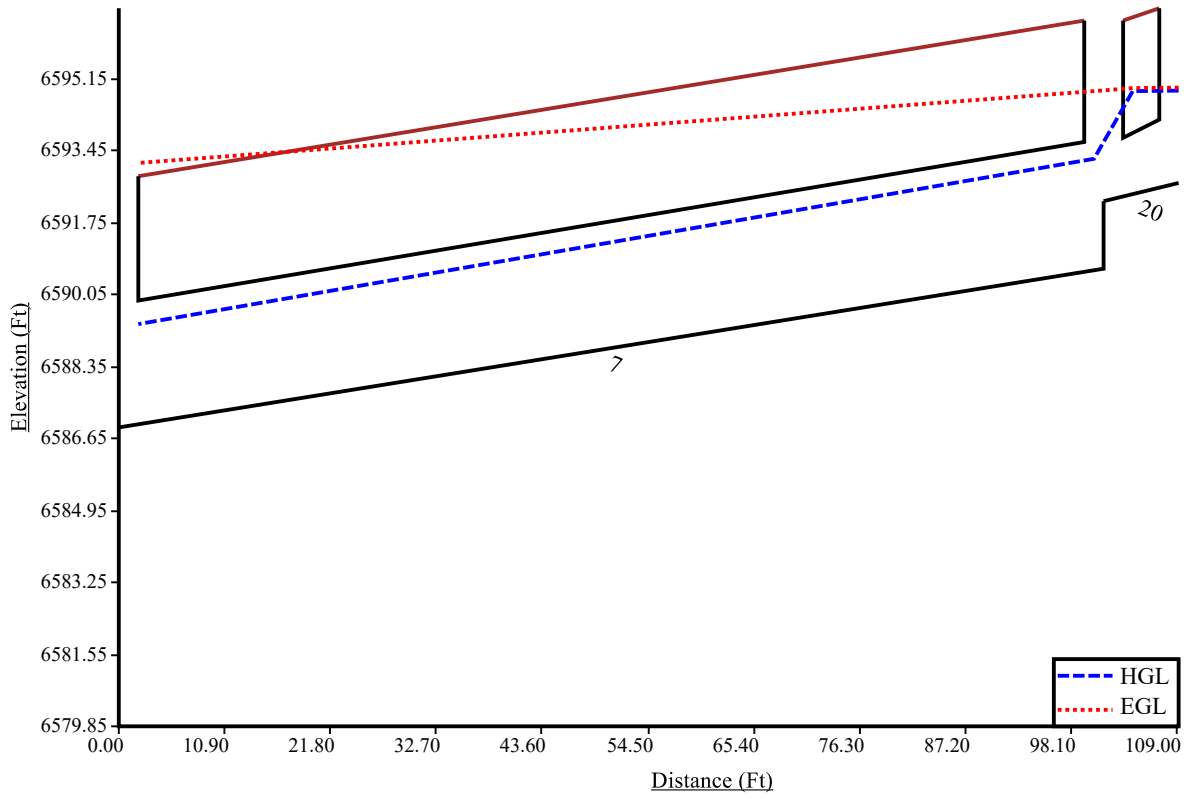

5-21

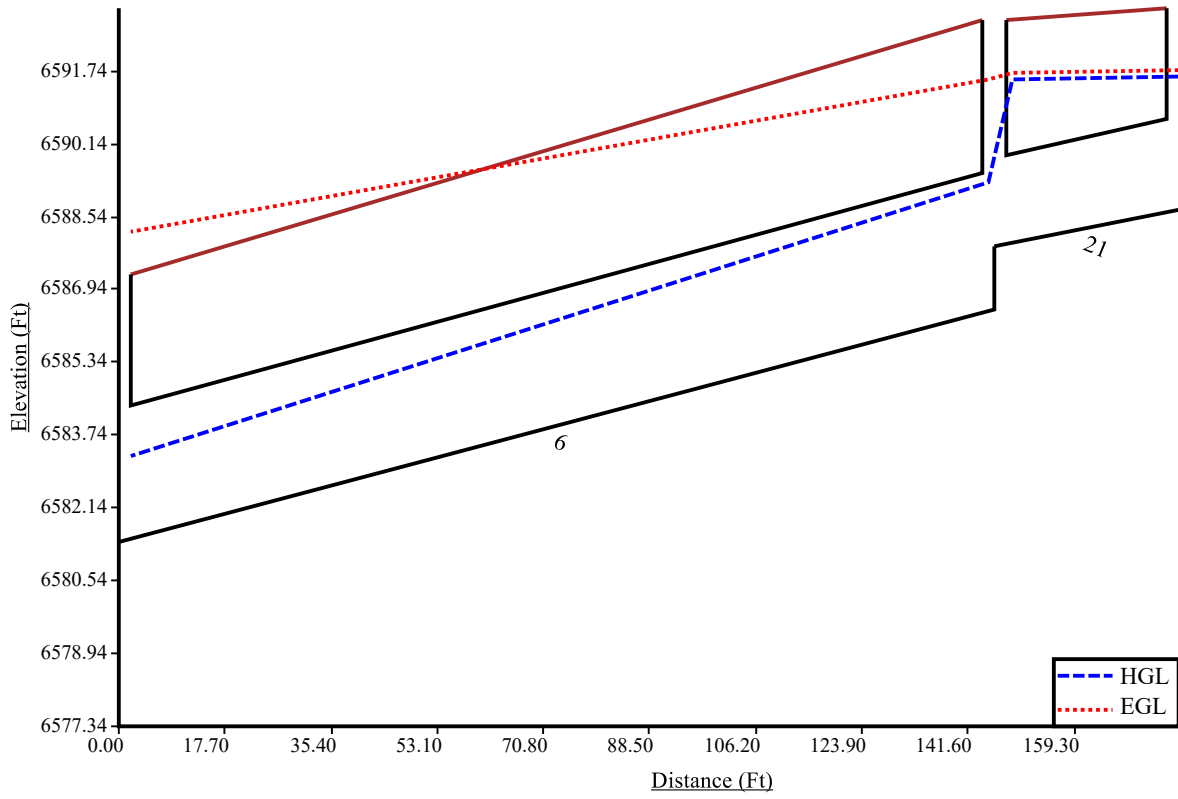

SB

2-22

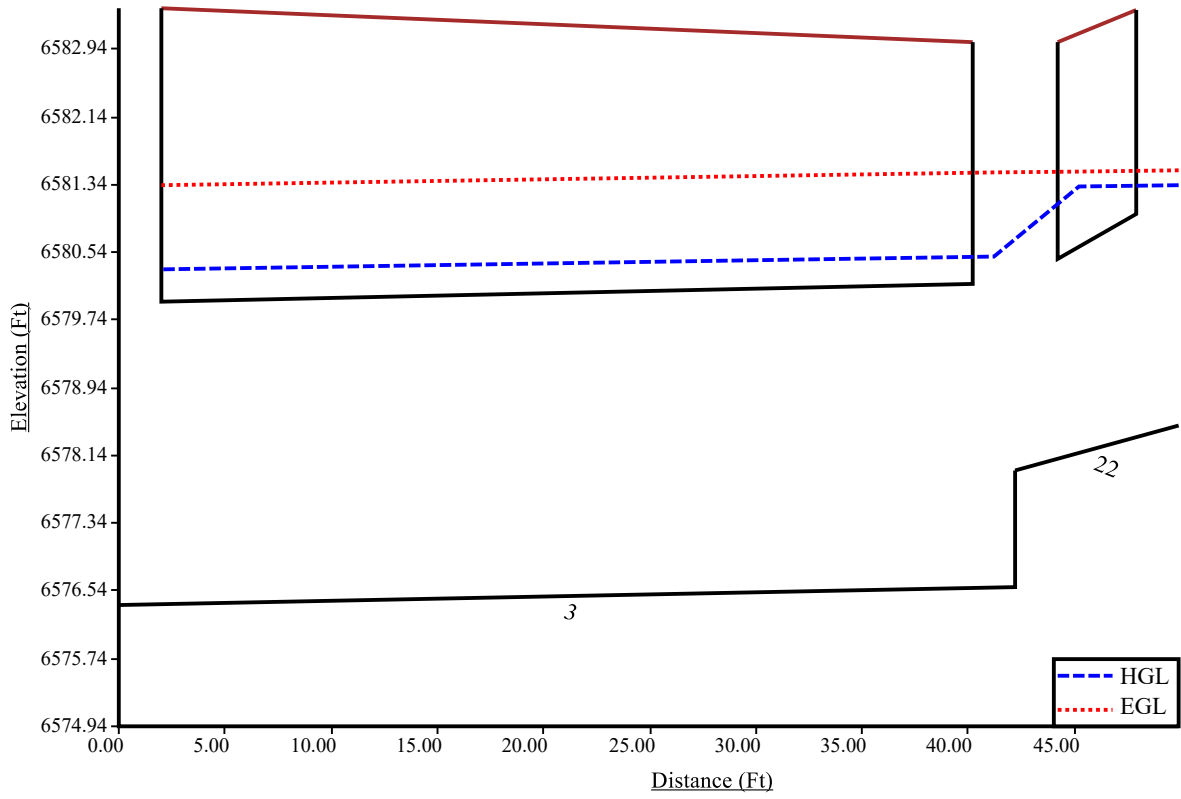

1-23

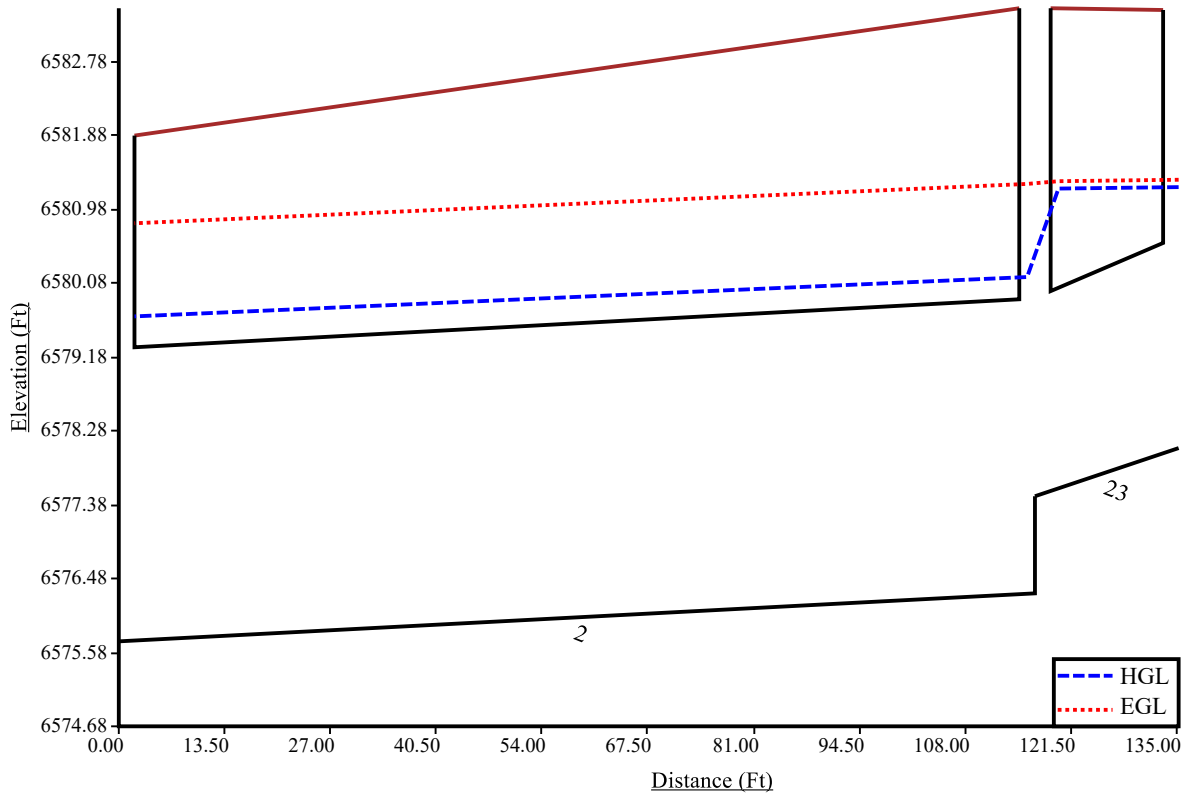

	(cfs)									
1	8.20	CIRCULAR	24.00 in	24.00 in	18.00 in	18.00 in	24.00 in	24.00 in	3.14	
2	8.20	CIRCULAR	24.00 in	24.00 in	18.00 in	18.00 in	24.00 in	24.00 in	3.14	
3	7.20	CIRCULAR	24.00 in	24.00 in	18.00 in	18.00 in	24.00 in	24.00 in	3.14	

- Calculated diameter was determined by sewer hydraulic capacity rounded up to the nearest commercially available size.
- Sewer sizes should not decrease downstream.
- All hydraulics were calculated using the 'Used' parameters.

Grade Line Summary:

Tailwater Elevation (ft): 6579.60

Element Name	Invert Elev.		Downstream Manhole Losses		HGL		EGL		
	Downstream (ft)	Upstream (ft)	Bend Loss (ft)	Lateral Loss (ft)	Downstream (ft)	Upstream (ft)	Downstream (ft)	Friction Loss (ft)	Upstream (ft)
1	6578.00	6580.24	0.00	0.00	6579.60	6581.26	6581.66	0.00	6581.66
2	6580.24	6585.00	0.04	0.00	6581.30	6586.02	6583.90	2.53	6586.42
3	6587.79	6588.10	0.00	0.00	6588.65	6589.05	6589.14	0.28	6589.42

- Bend and Lateral losses only apply when there is an outgoing sewer. The system outfall, sewer #0, is not considered a sewer.
- Bend loss = $Bend\ K * V_{fi}^2 / (2 * g)$
- Lateral loss = $V_{fo}^2 / (2 * g) - Junction\ Loss\ K * V_{fi}^2 / (2 * g)$.
- Friction loss is always Upstream EGL - Downstream EGL.

Excavation Estimate:

The trench side slope is 1.0 ft/ft

The minimum trench width is 2.00 ft

Element Name	Length (ft)	Wall (in)	Bedding (in)	Bottom Width (ft)	Downstream			Upstream			Volume (cu. yd)	Comment
					Top Width (ft)	Trench Depth (ft)	Cover (ft)	Top Width (ft)	Trench Depth (ft)	Cover (ft)		
1	22.76	3.00	4.00	5.50	0.00	0.58	0.00	8.52	5.34	2.51	14.70	Sewer Too Shallow
2	48.50	3.00	4.00	5.50	8.52	5.34	2.51	14.24	8.20	5.37	86.12	
3	38.26	3.00	4.00	5.50	8.65	5.41	2.58	7.90	5.03	2.20	43.47	

Total earth volume for sewer trenches = 144 cubic yards.

- The trench was estimated to have a bottom width equal to the outer pipe diameter plus 36 inches.
- If the calculated width of the trench bottom is less than the minimum acceptable width, the minimum acceptable width was used.
- The sewer wall thickness is equal to: $(\text{equivalent diameter in inches} / 12) + 1$ inches
- The sewer bedding thickness is equal to:
 - Four inches for pipes less than 33 inches.

- Six inches for pipes less than 60 inches.
- Eight inches for all larger sizes.

1-3

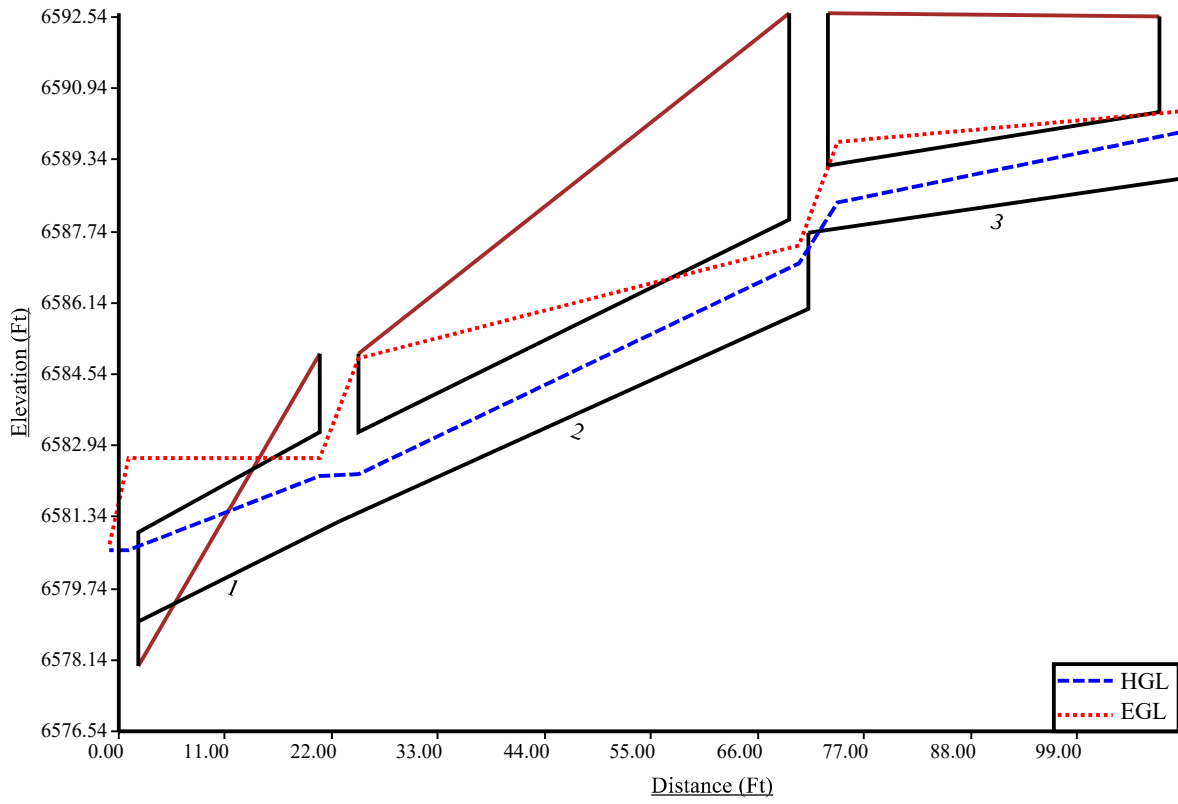

Name	Flow (cfs)	Section							(ft^2)	
1	18.30	CIRCULAR	24.00 in	24.00 in	18.00 in	18.00 in	24.00 in	24.00 in	3.14	
2	18.30	CIRCULAR	24.00 in	24.00 in	18.00 in	18.00 in	24.00 in	24.00 in	3.14	
3	16.00	CIRCULAR	24.00 in	24.00 in	24.00 in	24.00 in	24.00 in	24.00 in	3.14	

- Calculated diameter was determined by sewer hydraulic capacity rounded up to the nearest commercially available size.
- Sewer sizes should not decrease downstream.
- All hydraulics were calculated using the 'Used' parameters.

Grade Line Summary:

Tailwater Elevation (ft): 6580.00

Element Name	Invert Elev.		Downstream Manhole Losses		HGL		EGL		
	Downstream (ft)	Upstream (ft)	Bend Loss (ft)	Lateral Loss (ft)	Downstream (ft)	Upstream (ft)	Downstream (ft)	Friction Loss (ft)	Upstream (ft)
1	6578.00	6580.24	0.00	0.00	6580.00	6581.78	6580.53	2.02	6582.55
2	6580.24	6585.00	0.20	0.00	6581.98	6586.54	6585.97	1.34	6587.31
3	6587.79	6588.10	0.02	0.00	6589.21	6589.54	6589.91	0.31	6590.22

- Bend and Lateral losses only apply when there is an outgoing sewer. The system outfall, sewer #0, is not considered a sewer.
- Bend loss = $Bend\ K * V_{fi}^2 / (2 * g)$
- Lateral loss = $V_{fo}^2 / (2 * g) - Junction\ Loss\ K * V_{fi}^2 / (2 * g)$.
- Friction loss is always Upstream EGL - Downstream EGL.

Excavation Estimate:

The trench side slope is 1.0 ft/ft

The minimum trench width is 2.00 ft

Element Name	Length (ft)	Wall (in)	Bedding (in)	Bottom Width (ft)	Downstream			Upstream			Volume (cu. yd)	Comment
					Top Width (ft)	Trench Depth (ft)	Cover (ft)	Top Width (ft)	Trench Depth (ft)	Cover (ft)		
1	22.76	3.00	4.00	5.50	0.00	0.58	0.00	8.52	5.34	2.51	14.70	Sewer Too Shallow
2	48.50	3.00	4.00	5.50	8.52	5.34	2.51	14.24	8.20	5.37	86.12	
3	38.26	3.00	4.00	5.50	8.65	5.41	2.58	7.90	5.03	2.20	43.47	

Total earth volume for sewer trenches = 144 cubic yards.

- The trench was estimated to have a bottom width equal to the outer pipe diameter plus 36 inches.
- If the calculated width of the trench bottom is less than the minimum acceptable width, the minimum acceptable width was used.
- The sewer wall thickness is equal to: $(\text{equivalent diameter in inches} / 12) + 1$ inches
- The sewer bedding thickness is equal to:

- Four inches for pipes less than 33 inches.
- Six inches for pipes less than 60 inches.
- Eight inches for all larger sizes.

1-3

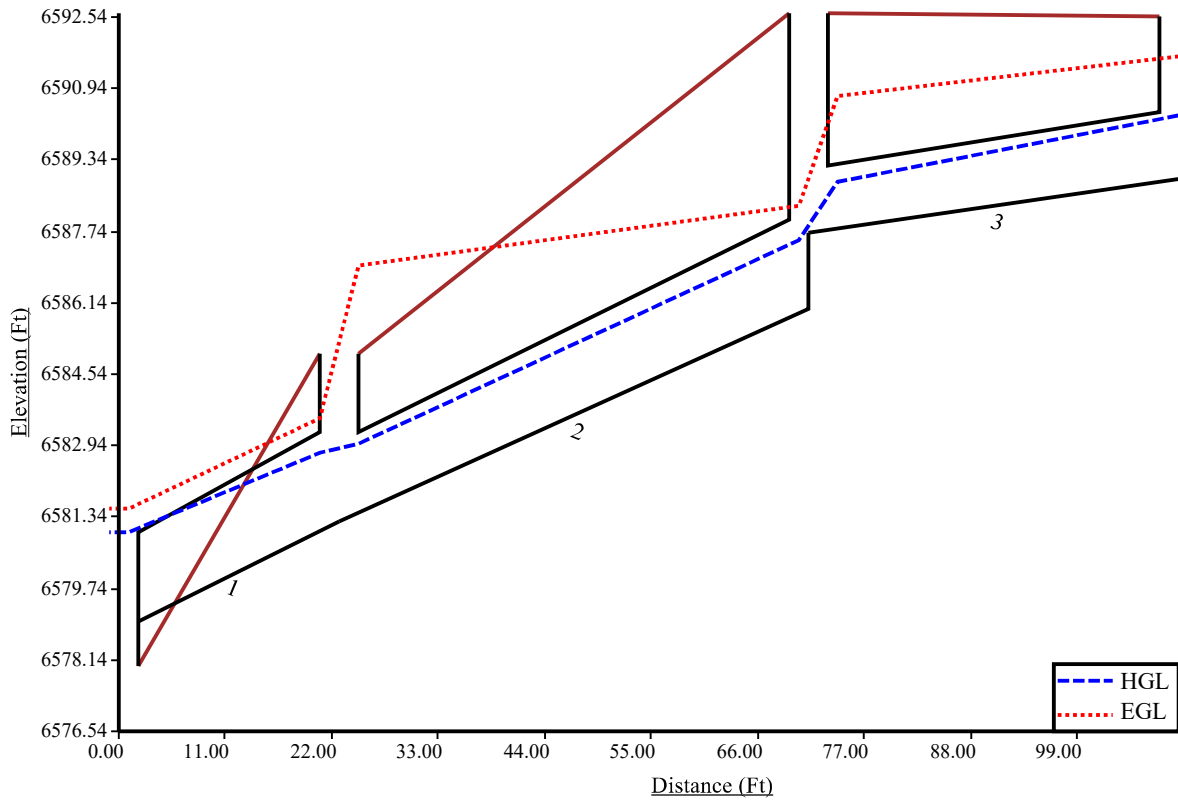
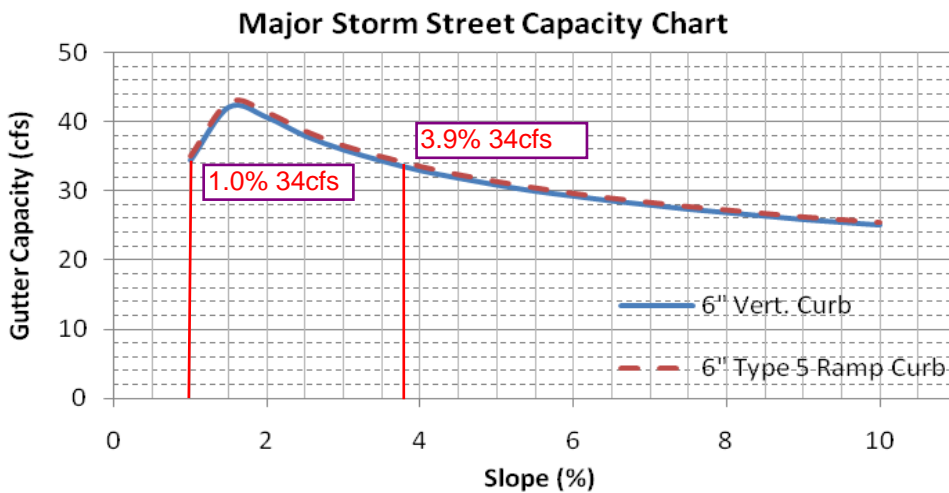
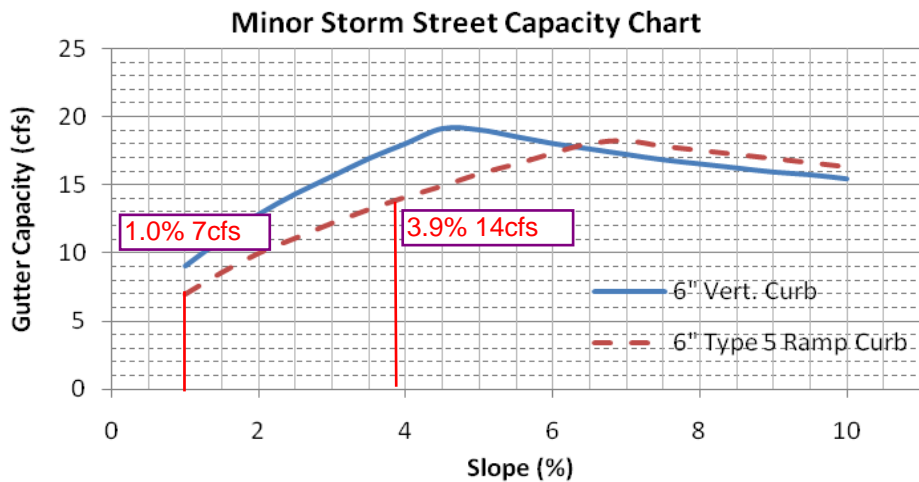
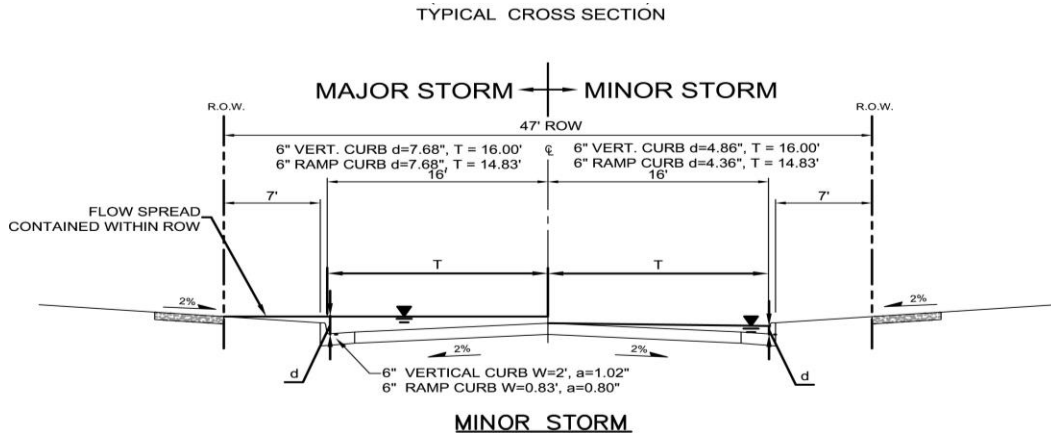
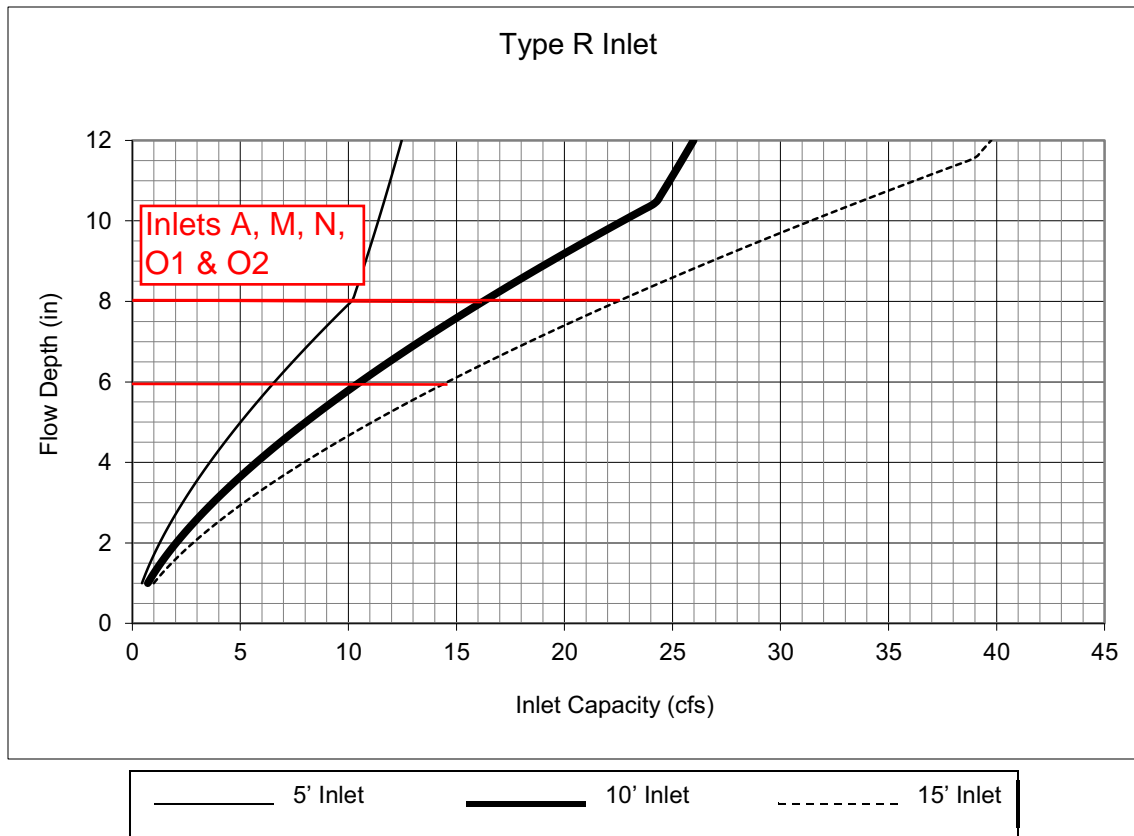

Figure 7-8. Street Capacity Charts Minor Residential (Detached Sidewalk)



These charts shall only be used for the standard street sections as shown. The capacity shown is based on 1/2 the street section as calculated by the UD-Inlet spreadsheets. Minor storm capacities are based on no crown overtopping, curb height or maximum allowable spread widths. Major storm capacities are based on flow being contained within the public right-of-way, including conveyance capacity behind the curb. The UDFCD Safety Reduction Factor was applied. An 'n_{STREET}' of 0.016 and 'n_{BACK}' of 0.020 was used. Calculations were done using UD-Inlet 3.00.xls, March, 2011.

Figure 8-11. Inlet Capacity Chart Sump Conditions , Curb Opening (Type R) Inlet



Notes:

1. The standard inlet parameters must apply to use this chart.

Figure 8-8. Inlet Capacity Chart Continuous Grade Conditions, Minor Residential (Local)
(Detached Sidewalk)

Street Section Data: Street Width Flowline to Flowline = 32'
Type of Curb and Gutter = 6" vertical

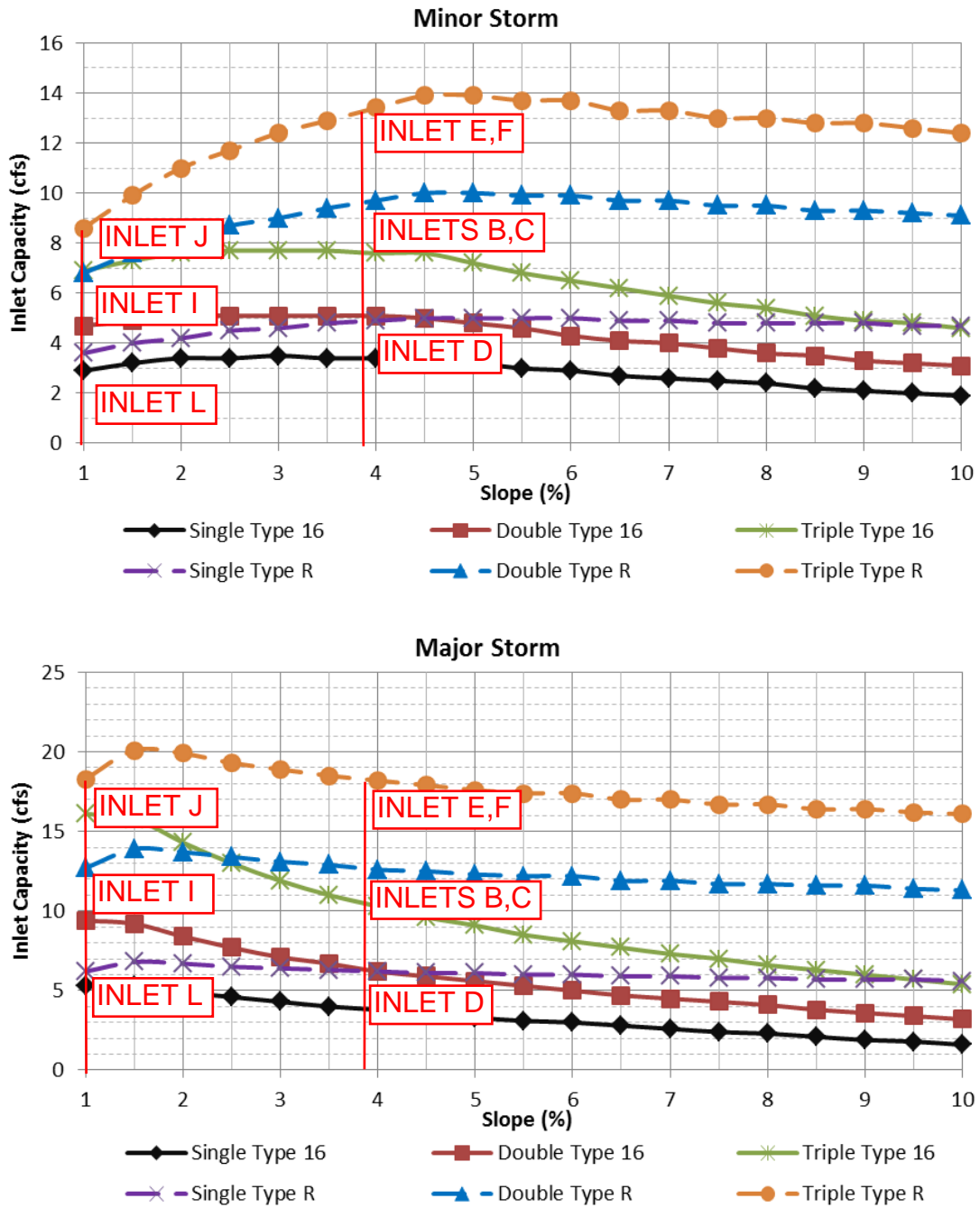

The standard street section parameters as defined in Chapter 7 must apply to use these charts. For non-standard sections, the inlet capacity shall be calculated using the UDFCD spreadsheets. The maximum spread width is limited by the curb height based on no curb overtopping during a minor storm and flow being contained within the public right-of-way during the major storm. Calculations were done using UD-Inlet 3.00.xls, Mar., 2011 with the default clogging factors.

Windermere Inlet Summary

Location	Inlet #	Basin/DP	Q5 (cfs)	Q100 (cfs)	Street grade %	Pro. Inlet Type	Q5 capture (cfs)	Q5 bypass (cfs)	Q5 % capture	Q100 capture (cfs)	Q100 bypass (cfs)	Q100 % capture	Downstream
DP8		Basin D15	4.5	8.6									
		Basin A1	3.2	7.1									
	A	Total	7.7	15.7	sump	10' Type R (S)	10.5	0.0	100%	16.0	0.0	100%	Sump ok
DPB	B	Basin A2	8.8	19.4	3.8%	10' Type R (AG)	9.5	0.0	100%	13.0	6.4	67%	Bypass to E
DPC	C	Basin A3	5.2	11.2	3.8%	10' Type R (AG)	9.5	0.0	100%	13.0	0.0	116%	Bypass to D
DPD		Basin A4	1.7	3.8									
		Inlet C Bypass	0.0	0.0									
	D	Total	1.7	3.8	3.9%	5' Type R (AG)	3.3	0.0	100%	6.2	0.0	100%	No Bypass
DPE		Basin A5	4.3	9.5									
		Inlet B Bypass	0.0	6.4									
	E	Total	4.3	15.9	3.9%	15' Type R (AG)	13.3	0.0	100%	18.0	0.0	100%	No Bypass
DPF		Basin A6	7.0	15.4									
		Inlet C Bypass	0.0	0.0									
	F	Total	7.0	15.4	3.9%	15' Type R (AG)	13.3	0.0	100%	18.0	0.0	100%	No Bypass
DPH	J	Basin A8	6.1	13.4	0.8%	10' Type R (AG)	7.0	0.0	100%	12.5	0.9	100%	Bypass to I
DPG	L	Basin A7	3.0	6.6	0.8%	5' Type R (AG)	3.8	0.0	100%	6.0	0.6	91%	Bypass to N
DPI		Basin A9	4.0	8.7									
		Inlet J Bypass	0.0	0.9									
	I	Total	4.0	9.7	1.0%	10' Type R (AG)	7.0	0.0	100%	12.5	0.0	100%	No Bypass
DPL		Basin A10	7.5	16.5									
	M	Total	7.5	16.5	Sump	15' Type R (S)	14.5	0.0	100%	22.5	0.0	100%	Sump ok
Basin A11		Basin A11	5.3	11.8									
		Inlet L Bypass	0.0	0.6									
	N	Total	5.3	12.3	Sump	10' Type R (S)	10.5	0.0	100%	16.0	0.0	100%	Sump ok
	O1	Basin B1	7.2	16.0									
		Total	7.2	16.0	3.9%	10' Type R (S)	16.0	0.0	100%	16.0	0.0	100%	No Bypass
	O2	Basin B2	1.0	2.3									
		Total	1.0	2.3	3.9%	5' Type R (S)	6.3	0.0	100%	6.3	0.0	100%	No Bypass

DETENTION BASIN STAGE-STORAGE TABLE BUILDER

MHFD-Detention, Version 4.04 (February 2021)

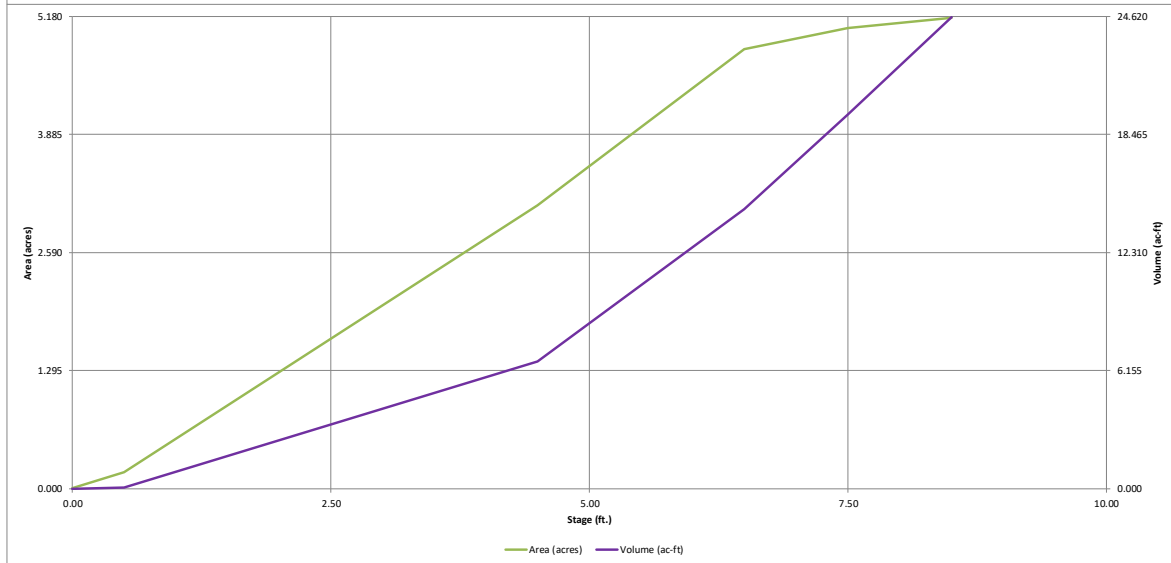
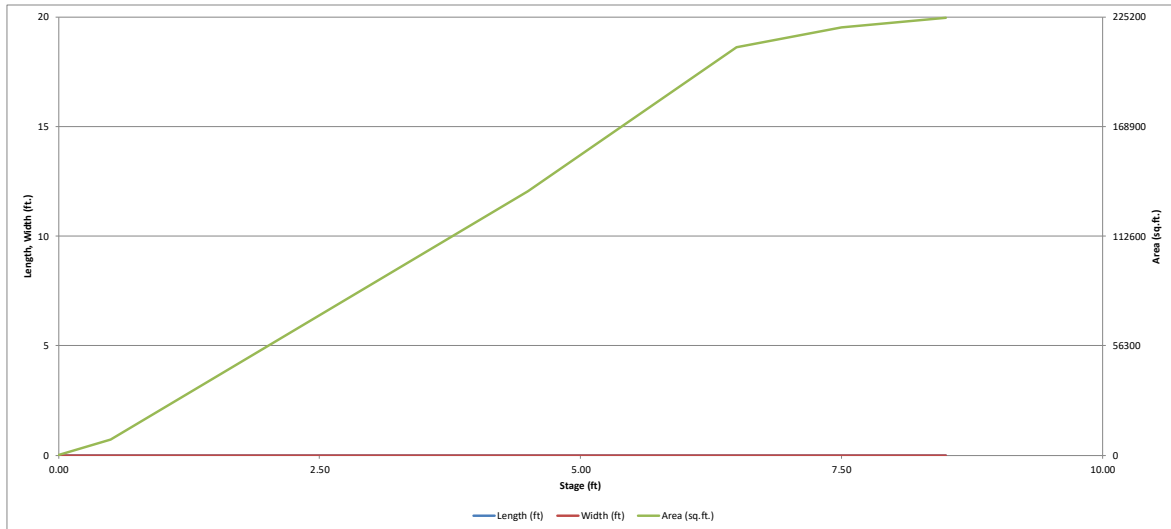

DETENTION BASIN OUTLET STRUCTURE DESIGN

MHFD-Detention, Version 4.04 (February 2021)

Project: Windermere Filing No. 1

Basin ID: North Pond

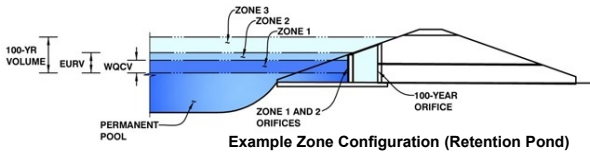

	Estimated Stage (ft)	Estimated Volume (ac-ft)	Outlet Type
Zone 1 (WQCV)	2.59	2.016	Orifice Plate
Zone 2 (EURV)	4.26	3.883	Orifice Plate
Zone 3 (100-year)	5.45	4.043	Weir&Pipe (Circular)
Total (all zones)		9.941	

User Input: Orifice at Underdrain Outlet (typically used to drain WQCV in a Filtration BMP)

Underdrain Orifice Invert Depth = ft (distance below the filtration media surface)
 Underdrain Orifice Diameter = inches

Calculated Parameters for Underdrain
 Underdrain Orifice Area = ft²
 Underdrain Orifice Centroid = feet

User Input: Orifice Plate with one or more orifices or Elliptical Slot Weir (typically used to drain WQCV and/or EURV in a sedimentation BMP)

Invert of Lowest Orifice = ft (relative to basin bottom at Stage = 0 ft)
 Depth at top of Zone using Orifice Plate = ft (relative to basin bottom at Stage = 0 ft)
 Orifice Plate: Orifice Vertical Spacing = inches
 Orifice Plate: Orifice Area per Row = inches

Calculated Parameters for Plate
 WQ Orifice Area per Row = ft²
 Elliptical Half-Width = feet
 Elliptical Slot Centroid = feet
 Elliptical Slot Area = ft²

User Input: Stage and Total Area of Each Orifice Row (numbered from lowest to highest)

	Row 1 (required)	Row 2 (optional)	Row 3 (optional)	Row 4 (optional)	Row 5 (optional)	Row 6 (optional)	Row 7 (optional)	Row 8 (optional)
Stage of Orifice Centroid (ft)	0.00	1.42	2.83					
Orifice Area (sq. inches)	11.00	11.00	11.00					

	Row 9 (optional)	Row 10 (optional)	Row 11 (optional)	Row 12 (optional)	Row 13 (optional)	Row 14 (optional)	Row 15 (optional)	Row 16 (optional)
Stage of Orifice Centroid (ft)								
Orifice Area (sq. inches)								

User Input: Vertical Orifice (Circular or Rectangular)

Invert of Vertical Orifice = ft (relative to basin bottom at Stage = 0 ft)
 Depth at top of Zone using Vertical Orifice = ft (relative to basin bottom at Stage = 0 ft)
 Vertical Orifice Diameter = inches

Calculated Parameters for Vertical Orifice
 Vertical Orifice Area = ft²
 Vertical Orifice Centroid = feet

User Input: Overflow Weir (Dropbox with Flat or Sloped Gate and Outlet Pipe OR Rectangular/Trapezoidal Weir (and No Outlet Pipe))

	Zone 3 Weir	Not Selected	
Overflow Weir Front Edge Height, H _o =	4.30	N/A	ft (relative to basin bottom at Stage = 0 ft)
Overflow Weir Front Edge Length =	6.75	N/A	feet
Overflow Weir Gate Slope =	0.00	N/A	H:V
Horiz. Length of Weir Sides =	6.75	N/A	feet
Overflow Gate Type =	Type C Gate	N/A	
Debris Clogging % =	50%	N/A	%

Calculated Parameters for Overflow Weir
 Height of Gate Upper Edge, H_t = feet
 Overflow Weir Slope Length = feet
 Gate Open Area / 100-yr Orifice Area =
 Overflow Gate Open Area w/o Debris = ft²
 Overflow Gate Open Area w/ Debris = ft²

User Input: Outlet Pipe w/ Flow Restriction Plate (Circular Orifice, Restrictor Plate, or Rectangular Orifice)

	Zone 3 Circular	Not Selected	
Depth to Invert of Outlet Pipe =	0.00	N/A	ft (distance below basin bottom at Stage = 0 ft)
Circular Orifice Diameter =	36.00	N/A	inches

Calculated Parameters for Outlet Pipe w/ Flow Restriction Plate
 Outlet Orifice Area = ft²
 Outlet Orifice Centroid = feet
 Half-Central Angle of Restrictor Plate on Pipe = radians

User Input: Emergency Spillway (Rectangular or Trapezoidal)

Spillway Invert Stage = ft (relative to basin bottom at Stage = 0 ft)
 Spillway Crest Length = feet
 Spillway End Slopes = H:V
 Freeboard above Max Water Surface = feet

Calculated Parameters for Spillway
 Spillway Design Flow Depth = feet
 Stage at Top of Freeboard = feet
 Basin Area at Top of Freeboard = acres
 Basin Volume at Top of Freeboard = acre-ft

Routed Hydrograph Results

The user can override the default CUHP hydrographs and runoff volumes by entering new values in the Inflow Hydrographs table (Columns W through AF).

	WQCV	EURV	2 Year	5 Year	10 Year	25 Year	50 Year	100 Year	500 Year
Design Storm Return Period =	N/A	N/A	1.19	1.50	1.75	2.00	2.25	2.52	3.49
One-Hour Rainfall Depth (in) =	2.016	5.899	4.477	6.022	7.245	9.501	11.710	14.604	24.649
CUHP Runoff Volume (acre-ft) =	N/A	N/A	4.477	6.022	7.245	9.501	11.710	14.604	24.649
Inflow Hydrograph Volume (acre-ft) =	N/A	N/A	1.4	2.7	3.8	35.3	69.5	113.7	257.4
CUHP Predevelopment Peak Q (cfs) =	N/A	N/A							
OPTIONAL Override Predevelopment Peak Q (cfs) =	N/A	N/A							
Predevelopment Unit Peak Flow, q (cfs/acre) =	N/A	N/A	0.01	0.02	0.03	0.26	0.52	0.85	1.93
Peak Inflow Q (cfs) =	N/A	N/A	76.6	105.2	127.2	182.0	232.6	297.1	501.8
Peak Outflow Q (cfs) =	1.0	1.8	1.6	1.8	6.7	20.3	38.5	67.6	189.1
Ratio Peak Outflow to Predevelopment Q =	N/A	N/A	N/A	0.7	1.8	0.6	0.6	0.6	0.7
Structure Controlling Flow =	Plate	Plate	Plate	Plate	Overflow Weir 1	Overflow Weir 1	Overflow Weir 1	Overflow Weir 1	Spillway
Max Velocity through Grate 1 (fps) =	N/A	N/A	N/A	N/A	0.2	0.6	1.2	2.06	2.4
Max Velocity through Grate 2 (fps) =	N/A	N/A	N/A	N/A	N/A	N/A	N/A	N/A	N/A
Time to Drain 97% of Inflow Volume (hours) =	38	66	59	68	71	69	68	65	59
Time to Drain 99% of Inflow Volume (hours) =	40	71	62	72	76	76	75	75	72
Maximum Ponding Depth (ft) =	2.59	4.26	3.64	4.20	4.53	4.86	5.19	5.61	6.64
Area at Maximum Ponding Depth (acres) =	1.71	2.94	2.48	2.88	3.13	3.42	3.69	4.06	4.85
Maximum Volume Stored (acre-ft) =	2.027	5.908	4.229	5.704	6.696	7.809	8.946	10.613	15.238

DETENTION BASIN OUTLET STRUCTURE DESIGN

MHFD-Detention, Version 4.04 (February 2021)

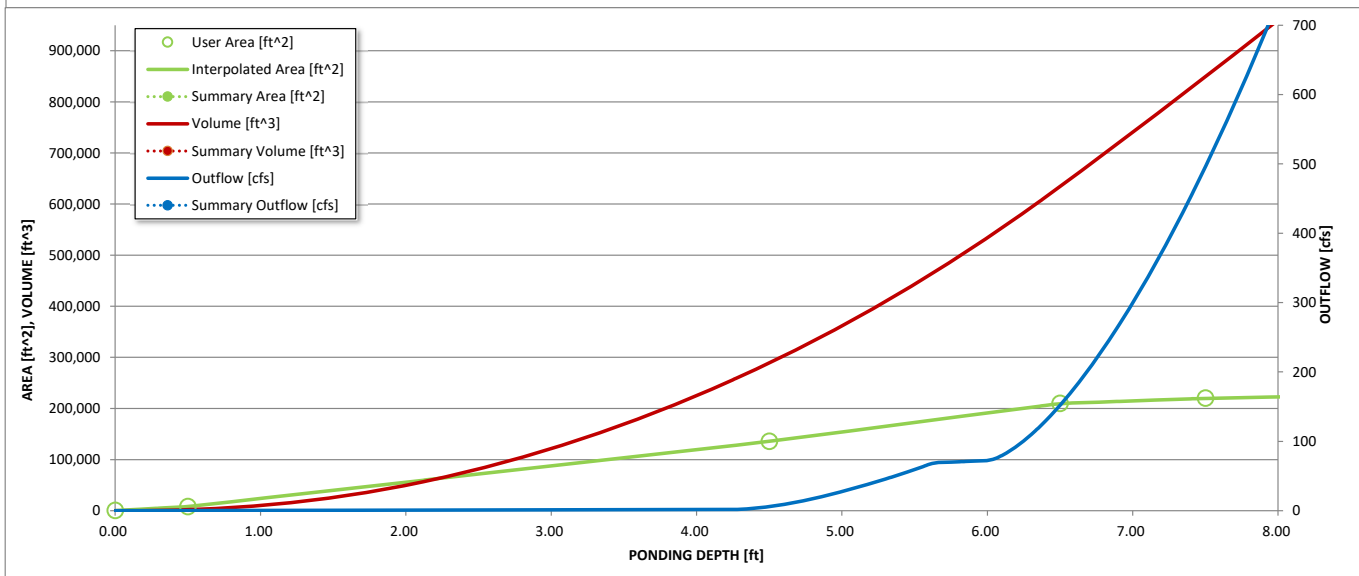
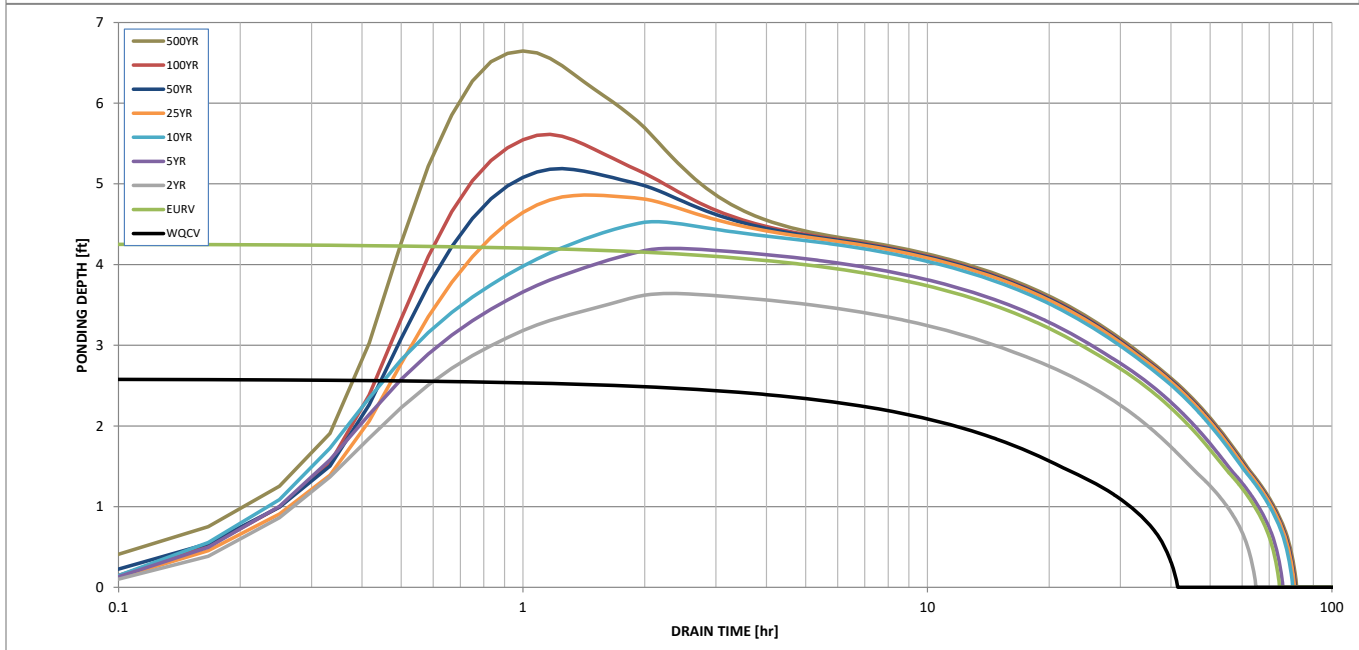
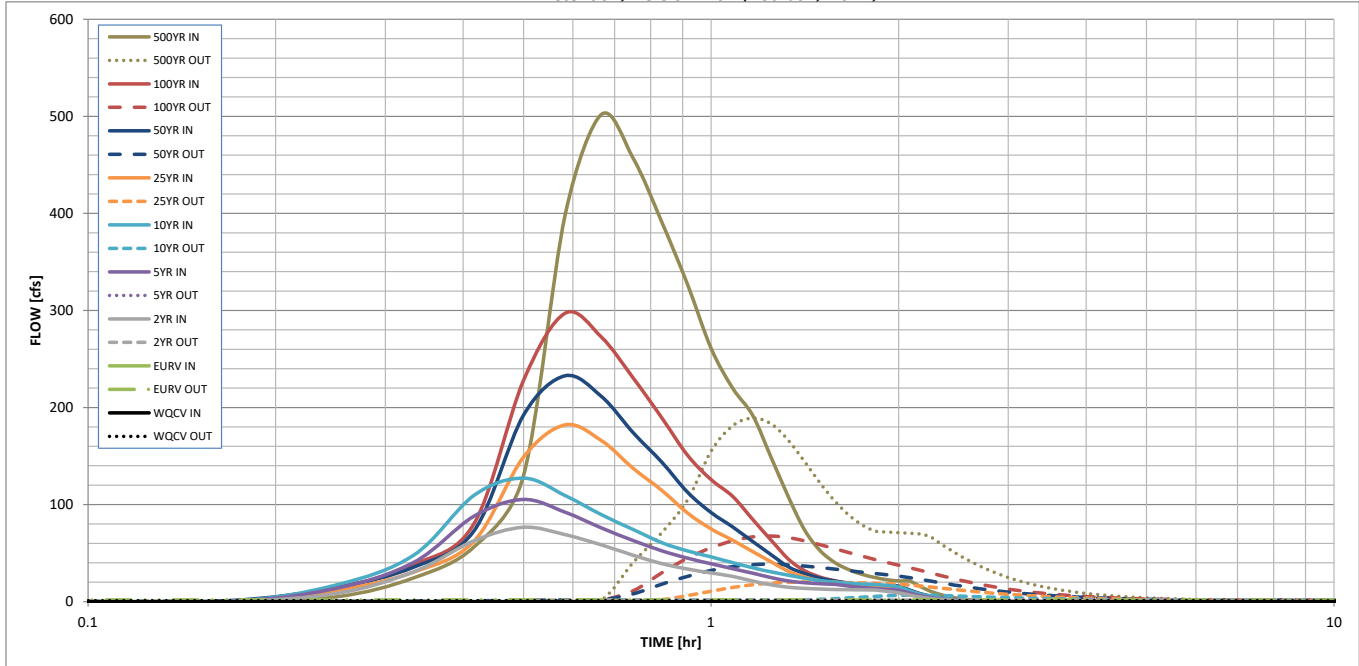

DETENTION BASIN OUTLET STRUCTURE DESIGN

Outflow Hydrograph Workbook Filename: _____

Inflow Hydrographs

The user can override the calculated inflow hydrographs from this workbook with inflow hydrographs developed in a separate program.

Time Interval	SOURCE	CUHP	CUHP	CUHP	CUHP	CUHP	CUHP	CUHP	CUHP	CUHP
	TIME	WQCV [cfs]	EURV [cfs]	2 Year [cfs]	5 Year [cfs]	10 Year [cfs]	25 Year [cfs]	50 Year [cfs]	100 Year [cfs]	500 Year [cfs]
5.00 min	0:00:00	0.00	0.00	0.00	0.00	0.00	0.00	0.00	0.00	0.00
	0:05:00	0.00	0.00	0.00	0.00	0.00	0.00	0.00	0.00	0.00
	0:10:00	0.00	0.00	0.00	0.00	0.00	0.00	0.97	0.10	4.89
	0:15:00	0.00	0.00	8.43	13.70	17.10	11.56	14.58	14.23	24.49
	0:20:00	0.00	0.00	30.74	40.52	47.99	30.48	35.64	38.25	56.56
	0:25:00	0.00	0.00	62.81	88.22	109.59	62.45	73.18	80.56	129.60
	0:30:00	0.00	0.00	76.61	105.23	127.22	148.81	191.98	227.72	398.73
	0:35:00	0.00	0.00	68.99	92.04	109.28	182.05	232.65	297.12	501.84
	0:40:00	0.00	0.00	58.41	75.95	89.55	166.00	211.44	272.59	456.80
	0:45:00	0.00	0.00	47.77	62.86	74.24	137.32	173.97	230.44	391.32
	0:50:00	0.00	0.00	39.18	52.44	60.72	114.76	143.79	189.60	326.66
	0:55:00	0.00	0.00	33.53	44.79	52.23	91.23	112.69	150.74	260.96
	1:00:00	0.00	0.00	29.56	39.09	46.05	74.92	91.80	125.68	219.78
	1:05:00	0.00	0.00	25.94	33.94	40.17	63.18	76.88	108.39	191.86
	1:10:00	0.00	0.00	21.24	29.29	34.83	51.49	61.91	84.72	147.77
	1:15:00	0.00	0.00	17.22	24.62	30.56	40.82	48.10	62.86	106.86
	1:20:00	0.00	0.00	14.80	21.26	27.21	31.00	35.52	43.30	72.52
	1:25:00	0.00	0.00	13.58	19.46	23.99	25.21	28.68	31.52	51.94
	1:30:00	0.00	0.00	12.90	18.42	21.62	21.22	23.98	25.08	39.92
	1:35:00	0.00	0.00	12.54	17.72	20.00	18.63	21.01	21.34	32.79
	1:40:00	0.00	0.00	12.28	16.02	18.87	16.87	18.99	18.84	27.95
	1:45:00	0.00	0.00	12.09	14.51	18.09	15.82	17.80	17.20	24.78
	1:50:00	0.00	0.00	11.95	13.46	17.55	15.05	16.92	16.03	22.54
	1:55:00	0.00	0.00	10.47	12.69	16.71	14.56	16.35	15.35	21.32
	2:00:00	0.00	0.00	9.08	11.79	15.16	14.25	16.01	15.14	20.99
	2:05:00	0.00	0.00	6.73	8.81	11.16	10.69	11.98	11.35	15.67
	2:10:00	0.00	0.00	4.66	6.09	7.69	7.32	8.20	7.80	10.72
	2:15:00	0.00	0.00	3.21	4.20	5.32	5.06	5.65	5.40	7.39
	2:20:00	0.00	0.00	2.20	2.82	3.61	3.43	3.82	3.65	4.97
	2:25:00	0.00	0.00	1.43	1.84	2.38	2.25	2.50	2.38	3.23
	2:30:00	0.00	0.00	0.91	1.22	1.56	1.51	1.67	1.58	2.13
	2:35:00	0.00	0.00	0.52	0.75	0.92	0.92	1.00	0.94	1.25
	2:40:00	0.00	0.00	0.24	0.40	0.46	0.47	0.50	0.47	0.61
	2:45:00	0.00	0.00	0.09	0.16	0.16	0.17	0.17	0.15	0.19
	2:50:00	0.00	0.00	0.02	0.03	0.02	0.01	0.00	0.00	0.00
	2:55:00	0.00	0.00	0.00	0.00	0.00	0.00	0.00	0.00	0.00
	3:00:00	0.00	0.00	0.00	0.00	0.00	0.00	0.00	0.00	0.00
	3:05:00	0.00	0.00	0.00	0.00	0.00	0.00	0.00	0.00	0.00
	3:10:00	0.00	0.00	0.00	0.00	0.00	0.00	0.00	0.00	0.00
	3:15:00	0.00	0.00	0.00	0.00	0.00	0.00	0.00	0.00	0.00
	3:20:00	0.00	0.00	0.00	0.00	0.00	0.00	0.00	0.00	0.00
	3:25:00	0.00	0.00	0.00	0.00	0.00	0.00	0.00	0.00	0.00
	3:30:00	0.00	0.00	0.00	0.00	0.00	0.00	0.00	0.00	0.00
	3:35:00	0.00	0.00	0.00	0.00	0.00	0.00	0.00	0.00	0.00
	3:40:00	0.00	0.00	0.00	0.00	0.00	0.00	0.00	0.00	0.00
	3:45:00	0.00	0.00	0.00	0.00	0.00	0.00	0.00	0.00	0.00
	3:50:00	0.00	0.00	0.00	0.00	0.00	0.00	0.00	0.00	0.00
	3:55:00	0.00	0.00	0.00	0.00	0.00	0.00	0.00	0.00	0.00
	4:00:00	0.00	0.00	0.00	0.00	0.00	0.00	0.00	0.00	0.00
	4:05:00	0.00	0.00	0.00	0.00	0.00	0.00	0.00	0.00	0.00
	4:10:00	0.00	0.00	0.00	0.00	0.00	0.00	0.00	0.00	0.00
	4:15:00	0.00	0.00	0.00	0.00	0.00	0.00	0.00	0.00	0.00
	4:20:00	0.00	0.00	0.00	0.00	0.00	0.00	0.00	0.00	0.00
	4:25:00	0.00	0.00	0.00	0.00	0.00	0.00	0.00	0.00	0.00
	4:30:00	0.00	0.00	0.00	0.00	0.00	0.00	0.00	0.00	0.00
	4:35:00	0.00	0.00	0.00	0.00	0.00	0.00	0.00	0.00	0.00
	4:40:00	0.00	0.00	0.00	0.00	0.00	0.00	0.00	0.00	0.00
	4:45:00	0.00	0.00	0.00	0.00	0.00	0.00	0.00	0.00	0.00
	4:50:00	0.00	0.00	0.00	0.00	0.00	0.00	0.00	0.00	0.00
	4:55:00	0.00	0.00	0.00	0.00	0.00	0.00	0.00	0.00	0.00
5:00:00	0.00	0.00	0.00	0.00	0.00	0.00	0.00	0.00	0.00	
5:05:00	0.00	0.00	0.00	0.00	0.00	0.00	0.00	0.00	0.00	
5:10:00	0.00	0.00	0.00	0.00	0.00	0.00	0.00	0.00	0.00	
5:15:00	0.00	0.00	0.00	0.00	0.00	0.00	0.00	0.00	0.00	
5:20:00	0.00	0.00	0.00	0.00	0.00	0.00	0.00	0.00	0.00	
5:25:00	0.00	0.00	0.00	0.00	0.00	0.00	0.00	0.00	0.00	
5:30:00	0.00	0.00	0.00	0.00	0.00	0.00	0.00	0.00	0.00	
5:35:00	0.00	0.00	0.00	0.00	0.00	0.00	0.00	0.00	0.00	
5:40:00	0.00	0.00	0.00	0.00	0.00	0.00	0.00	0.00	0.00	
5:45:00	0.00	0.00	0.00	0.00	0.00	0.00	0.00	0.00	0.00	
5:50:00	0.00	0.00	0.00	0.00	0.00	0.00	0.00	0.00	0.00	
5:55:00	0.00	0.00	0.00	0.00	0.00	0.00	0.00	0.00	0.00	
6:00:00	0.00	0.00	0.00	0.00	0.00	0.00	0.00	0.00	0.00	

DETENTION BASIN STAGE-STORAGE TABLE BUILDER

MHFD-Detention, Version 4.03 (May 2020)

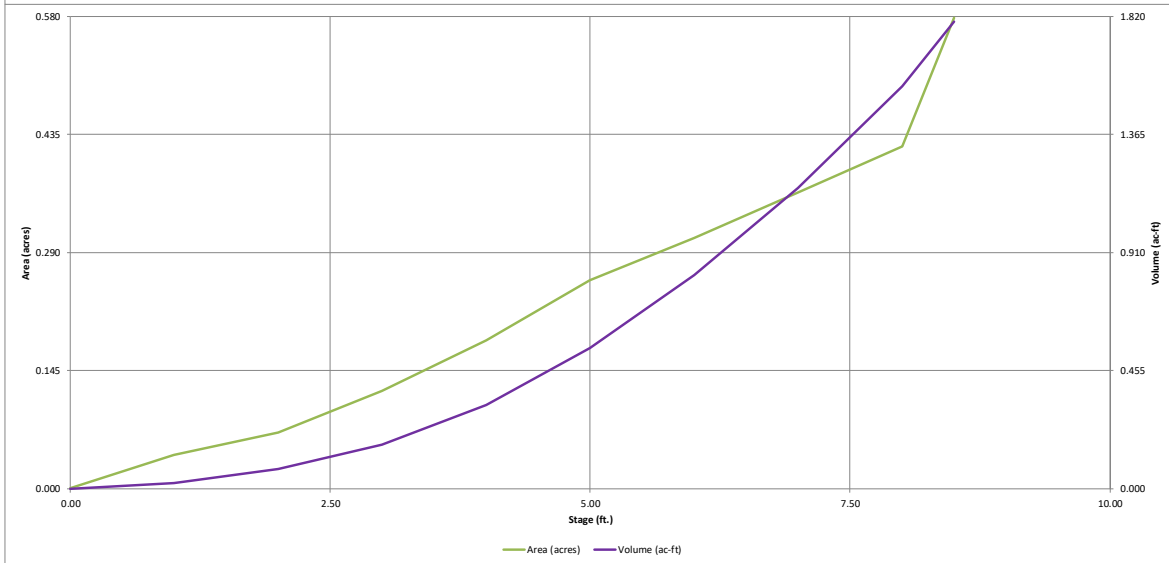
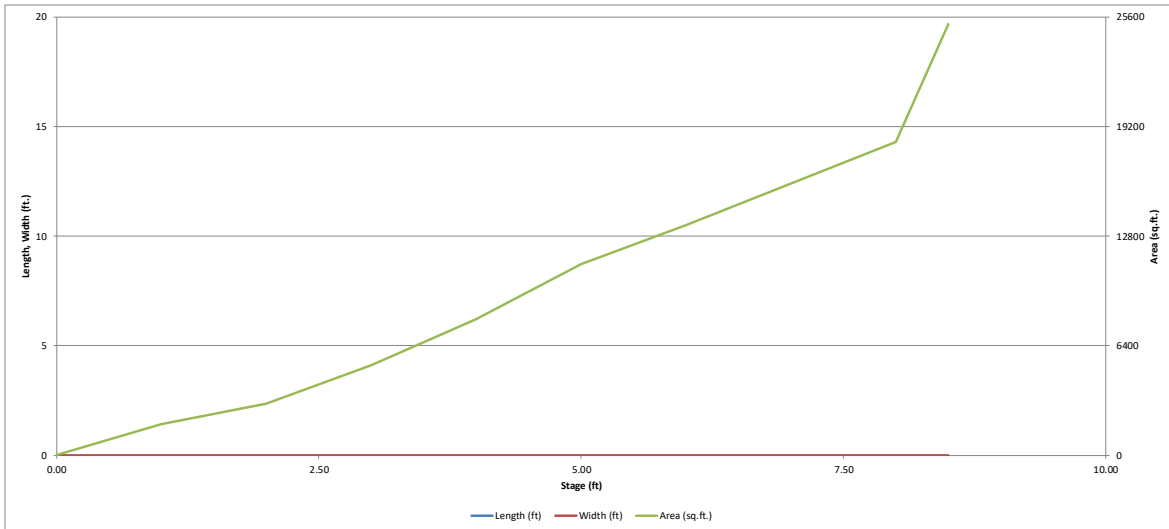

DETENTION BASIN OUTLET STRUCTURE DESIGN

MHFD-*Detention, Version 4.03 (May 2020)*

Project: Windermere Filing No. 1

Basin ID: South Pond - Interim Condition

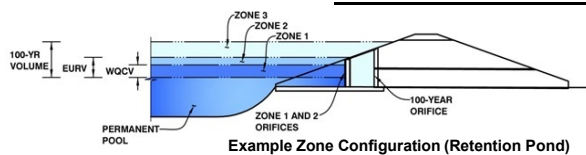

	Estimated Stage (ft)	Estimated Volume (ac-ft)	Outlet Type
Zone 1 (WQCV)	2.52	0.118	Orifice Plate
Zone 2 (EURV)	3.53	0.124	Orifice Plate
Zone 3 (100-year)	4.82	0.253	Weir&Pipe (Restrict)
Total (all zones)		0.496	

User Input: Orifice at Underdrain Outlet (typically used to drain WQCV in a Filtration BMP)

Underdrain Orifice Invert Depth =	<input type="text" value=""/>	ft (distance below the filtration media surface)
Underdrain Orifice Diameter =	<input type="text" value=""/>	inches

Calculated Parameters for Underdrain

Underdrain Orifice Area =	<input type="text" value=""/>	ft ²
Underdrain Orifice Centroid =	<input type="text" value=""/>	feet

User Input: Orifice Plate with one or more orifices or Elliptical Slot Weir (typically used to drain WQCV and/or EURV in a sedimentation BMP)

Invert of Lowest Orifice =	<input type="text" value="0.00"/>	ft (relative to basin bottom at Stage = 0 ft)
Depth at top of Zone using Orifice Plate =	<input type="text" value="3.53"/>	ft (relative to basin bottom at Stage = 0 ft)
Orifice Plate: Orifice Vertical Spacing =	<input type="text" value="25.40"/>	inches
Orifice Plate: Orifice Area per Row =	<input type="text" value="N/A"/>	inches

Calculated Parameters for Plate

WQ Orifice Area per Row =	<input type="text" value="N/A"/>	ft ²
Elliptical Half-Width =	<input type="text" value="N/A"/>	feet
Elliptical Slot Centroid =	<input type="text" value="N/A"/>	feet
Elliptical Slot Area =	<input type="text" value="N/A"/>	ft ²

User Input: Stage and Total Area of Each Orifice Row (numbered from lowest to highest)

	Row 1 (required)	Row 2 (optional)	Row 3 (optional)	Row 4 (optional)	Row 5 (optional)	Row 6 (optional)	Row 7 (optional)	Row 8 (optional)
Stage of Orifice Centroid (ft)	<input type="text" value="0.00"/>	<input type="text" value="1.18"/>	<input type="text" value="2.35"/>	<input type="text" value=""/>	<input type="text" value=""/>	<input type="text" value=""/>	<input type="text" value=""/>	<input type="text" value=""/>
Orifice Area (sq. inches)	<input type="text" value="0.67"/>	<input type="text" value="0.67"/>	<input type="text" value="0.67"/>	<input type="text" value=""/>	<input type="text" value=""/>	<input type="text" value=""/>	<input type="text" value=""/>	<input type="text" value=""/>

	Row 9 (optional)	Row 10 (optional)	Row 11 (optional)	Row 12 (optional)	Row 13 (optional)	Row 14 (optional)	Row 15 (optional)	Row 16 (optional)
Stage of Orifice Centroid (ft)	<input type="text" value=""/>	<input type="text" value=""/>	<input type="text" value=""/>	<input type="text" value=""/>	<input type="text" value=""/>	<input type="text" value=""/>	<input type="text" value=""/>	<input type="text" value=""/>
Orifice Area (sq. inches)	<input type="text" value=""/>	<input type="text" value=""/>	<input type="text" value=""/>	<input type="text" value=""/>	<input type="text" value=""/>	<input type="text" value=""/>	<input type="text" value=""/>	<input type="text" value=""/>

User Input: Vertical Orifice (Circular or Rectangular)

	Not Selected	Not Selected	
Invert of Vertical Orifice =	<input type="text" value="N/A"/>	<input type="text" value="N/A"/>	ft (relative to basin bottom at Stage = 0 ft)
Depth at top of Zone using Vertical Orifice =	<input type="text" value="N/A"/>	<input type="text" value="N/A"/>	ft (relative to basin bottom at Stage = 0 ft)
Vertical Orifice Diameter =	<input type="text" value="N/A"/>	<input type="text" value="N/A"/>	inches

Calculated Parameters for Vertical Orifice

	Not Selected	Not Selected	
Vertical Orifice Area =	<input type="text" value="N/A"/>	<input type="text" value="N/A"/>	ft ²
Vertical Orifice Centroid =	<input type="text" value="N/A"/>	<input type="text" value="N/A"/>	feet

User Input: Overflow Weir (Dropbox with Flat or Sloped Grate and Outlet Pipe OR Rectangular/Trapezoidal Weir (and No Outlet Pipe))

	Zone 3 Weir	Not Selected	
Overflow Weir Front Edge Height, H _o =	<input type="text" value="6.40"/>	<input type="text" value="N/A"/>	ft (relative to basin bottom at Stage = 0 ft)
Overflow Weir Front Edge Length =	<input type="text" value="3.92"/>	<input type="text" value="N/A"/>	feet
Overflow Weir Grate Slope =	<input type="text" value="0.00"/>	<input type="text" value="N/A"/>	H:V
Horiz. Length of Weir Sides =	<input type="text" value="3.92"/>	<input type="text" value="N/A"/>	feet
Overflow Grate Open Area % =	<input type="text" value="70%"/>	<input type="text" value="N/A"/>	%, grate open area/total area
Debris Clogging % =	<input type="text" value="50%"/>	<input type="text" value="N/A"/>	%

Calculated Parameters for Overflow Weir

	Zone 3 Weir	Not Selected	
Height of Grate Upper Edge, H _t =	<input type="text" value="6.40"/>	<input type="text" value="N/A"/>	feet
Overflow Weir Slope Length =	<input type="text" value="3.92"/>	<input type="text" value="N/A"/>	feet
Grate Open Area / 100-yr Orifice Area =	<input type="text" value="16.92"/>	<input type="text" value="N/A"/>	
Overflow Grate Open Area w/o Debris =	<input type="text" value="10.76"/>	<input type="text" value="N/A"/>	ft ²
Overflow Grate Open Area w/ Debris =	<input type="text" value="5.38"/>	<input type="text" value="N/A"/>	ft ²

User Input: Outlet Pipe w/ Flow Restriction Plate (Circular Orifice, Restrictor Plate, or Rectangular Orifice)

	Zone 3 Restrictor	Not Selected	
Depth to Invert of Outlet Pipe =	<input type="text" value="2.50"/>	<input type="text" value="N/A"/>	ft (distance below basin bottom at Stage = 0 ft)
Outlet Pipe Diameter =	<input type="text" value="18.00"/>	<input type="text" value="N/A"/>	inches
Restrictor Plate Height Above Pipe Invert =	<input type="text" value="7.00"/>	<input type="text" value=""/>	inches

Calculated Parameters for Outlet Pipe w/ Flow Restriction Plate

	Zone 3 Restrictor	Not Selected	
Outlet Orifice Area =	<input type="text" value="0.64"/>	<input type="text" value="N/A"/>	ft ²
Outlet Orifice Centroid =	<input type="text" value="0.34"/>	<input type="text" value="N/A"/>	feet
Half-Central Angle of Restrictor Plate on Pipe =	<input type="text" value="1.35"/>	<input type="text" value="N/A"/>	radians

User Input: Emergency Spillway (Rectangular or Trapezoidal)

Spillway Invert Stage =	<input type="text" value="6.94"/>	ft (relative to basin bottom at Stage = 0 ft)
Spillway Crest Length =	<input type="text" value="27.00"/>	feet
Spillway End Slopes =	<input type="text" value="4.00"/>	H:V
Freeboard above Max Water Surface =	<input type="text" value="1.00"/>	feet

Calculated Parameters for Spillway

Spillway Design Flow Depth =	<input type="text" value="0.55"/>	feet
Stage at Top of Freeboard =	<input type="text" value="8.49"/>	feet
Basin Area at Top of Freeboard =	<input type="text" value="0.58"/>	acres
Basin Volume at Top of Freeboard =	<input type="text" value="1.80"/>	acre-ft

Routed Hydrograph Results

The user can override the default CUHP hydrographs and runoff volumes by entering new values in the Inflow Hydrographs table (Columns W through AF).

	WQCV	EURV	2 Year	5 Year	10 Year	25 Year	50 Year	100 Year	500 Year
Design Storm Return Period =	N/A	N/A	1.19	1.50	1.75	2.00	2.25	2.52	3.49
One-Hour Rainfall Depth (in) =	N/A	N/A	1.19	1.50	1.75	2.00	2.25	2.52	3.49
CUHP Runoff Volume (acre-ft) =	0.118	0.243	0.156	0.221	0.279	0.448	0.608	0.825	1.590
Inflow Hydrograph Volume (acre-ft) =	N/A	N/A	0.156	0.221	0.279	0.448	0.608	0.825	1.590
CUHP Predevelopment Peak Q (cfs) =	N/A	N/A	0.1	0.2	0.3	2.9	5.6	9.1	20.5
OPTIONAL Override Predevelopment Peak Q (cfs) =	N/A	N/A							
Predevelopment Unit Peak Flow, q (cfs/acre) =	N/A	N/A	0.01	0.02	0.03	0.27	0.52	0.84	1.89
Peak Inflow Q (cfs) =	N/A	N/A	2.5	3.6	4.5	7.7	10.6	14.5	27.0
Peak Outflow Q (cfs) =	0.1	0.1	0.1	0.1	0.1	0.1	0.1	0.1	9.2
Ratio Peak Outflow to Predevelopment Q =	N/A	N/A	N/A	0.4	0.3	0.0	0.0	0.0	0.4
Structure Controlling Flow =	Plate	Plate	Plate	Plate	Plate	Plate	Plate	Plate	Outlet Plate 1
Max Velocity through Grate 1 (fps) =	N/A	N/A	N/A	N/A	N/A	N/A	N/A	N/A	0.8
Max Velocity through Grate 2 (fps) =	N/A	N/A	N/A	N/A	N/A	N/A	N/A	N/A	N/A
Time to Drain 97% of Inflow Volume (hours) =	38	53	44	51	57	71	83	99	103
Time to Drain 99% of Inflow Volume (hours) =	40	57	47	55	61	77	91	108	116
Maximum Ponding Depth (ft) =	2.51	3.53	2.76	3.27	3.64	4.53	5.17	5.93	6.91
Area at Maximum Ponding Depth (acres) =	0.10	0.15	0.11	0.14	0.16	0.22	0.27	0.30	0.36
Maximum Volume Stored (acre-ft) =	0.118	0.243	0.144	0.204	0.260	0.427	0.585	0.799	1.127

DETENTION BASIN OUTLET STRUCTURE DESIGN

MHFD-Detention, Version 4.00 (December 2019)

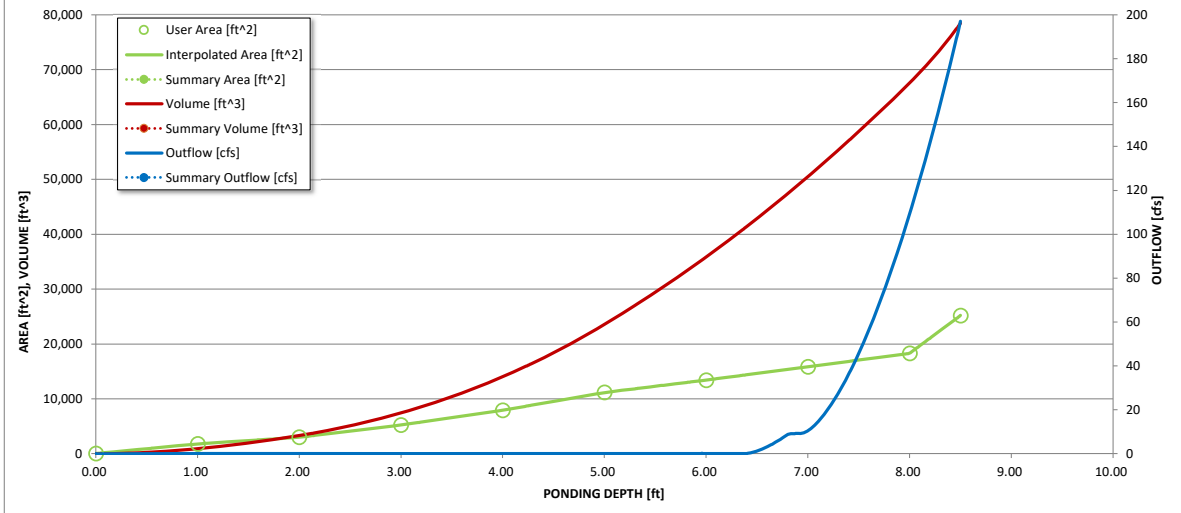
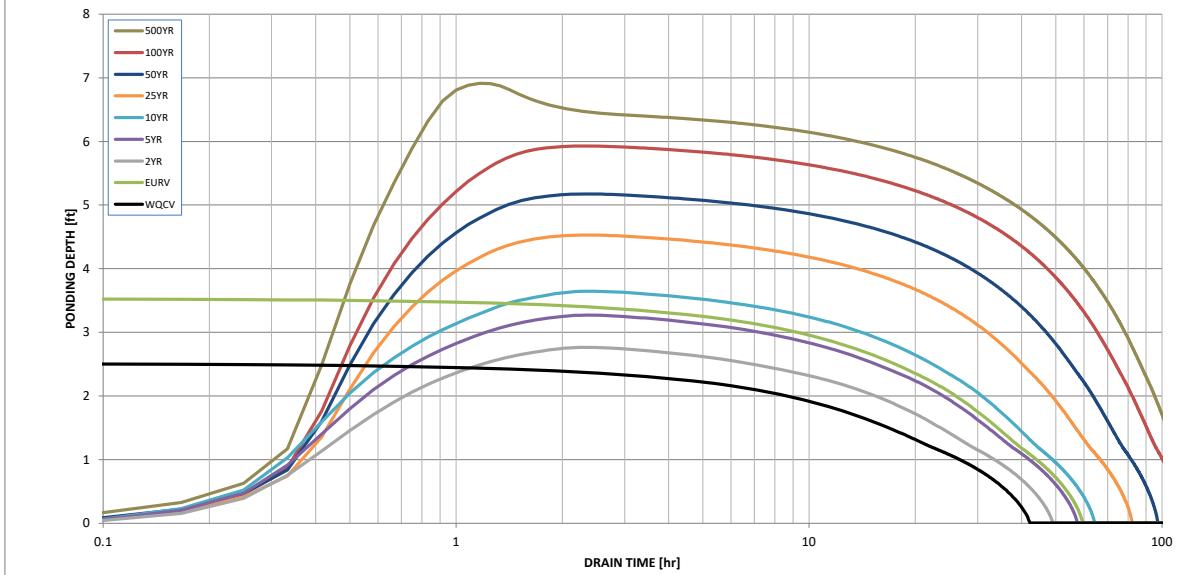
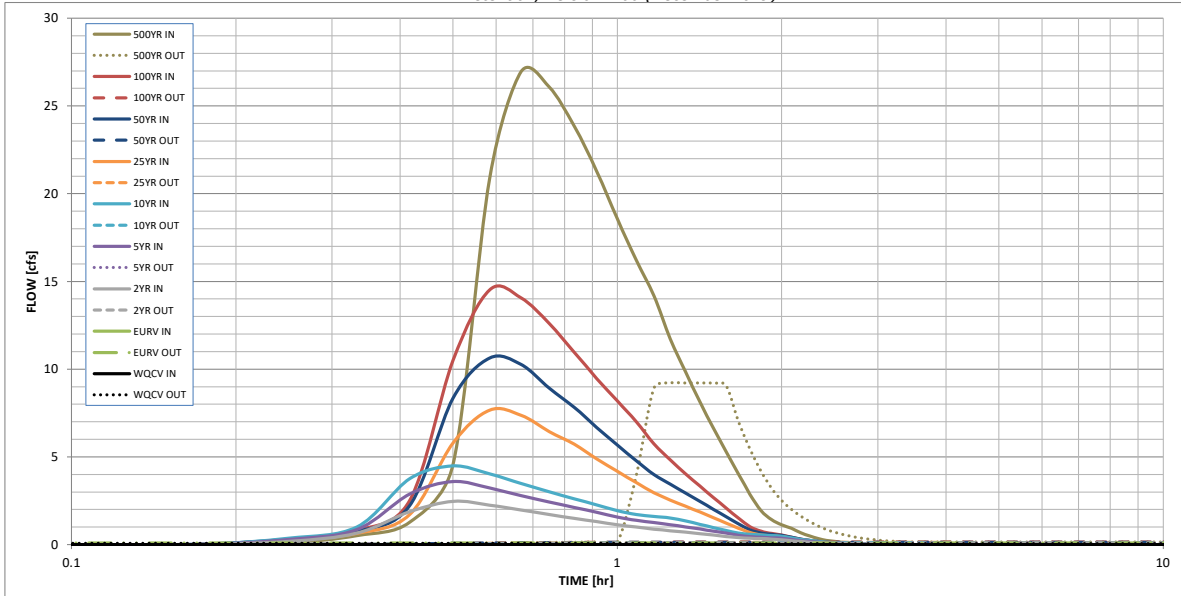

DETENTION BASIN OUTLET STRUCTURE DESIGN

Outflow Hydrograph Workbook Filename: _____

Inflow Hydrographs

The user can override the calculated inflow hydrographs from this workbook with inflow hydrographs developed in a separate program.

Time Interval	SOURCE	CUHP	CUHP	CUHP	CUHP	CUHP	CUHP	CUHP	CUHP	CUHP
	TIME	WQCV [cfs]	EURV [cfs]	2 Year [cfs]	5 Year [cfs]	10 Year [cfs]	25 Year [cfs]	50 Year [cfs]	100 Year [cfs]	500 Year [cfs]
5.00 min	0:00:00	0.00	0.00	0.00	0.00	0.00	0.00	0.00	0.00	0.00
	0:05:00	0.00	0.00	0.00	0.00	0.00	0.00	0.00	0.00	0.00
	0:10:00	0.00	0.00	0.00	0.00	0.00	0.00	0.02	0.00	0.10
	0:15:00	0.00	0.00	0.18	0.30	0.37	0.25	0.31	0.30	0.52
	0:20:00	0.00	0.00	0.66	0.86	1.01	0.64	0.75	0.80	1.28
	0:25:00	0.00	0.00	1.87	2.88	3.75	1.72	2.23	2.52	4.55
	0:30:00	0.00	0.00	2.47	3.59	4.48	5.79	8.34	10.48	20.89
	0:35:00	0.00	0.00	2.25	3.22	4.03	7.67	10.63	14.52	26.95
	0:40:00	0.00	0.00	1.98	2.79	3.48	7.36	10.26	14.06	26.08
	0:45:00	0.00	0.00	1.71	2.42	3.01	6.45	8.92	12.61	23.86
	0:50:00	0.00	0.00	1.50	2.13	2.62	5.72	7.82	10.97	21.29
	0:55:00	0.00	0.00	1.31	1.84	2.26	4.89	6.68	9.47	18.56
	1:00:00	0.00	0.00	1.13	1.57	1.94	4.17	5.67	8.18	16.22
	1:05:00	0.00	0.00	1.00	1.38	1.72	3.54	4.78	7.01	14.18
	1:10:00	0.00	0.00	0.89	1.26	1.61	2.96	3.99	5.75	11.72
	1:15:00	0.00	0.00	0.79	1.14	1.52	2.54	3.44	4.83	9.85
	1:20:00	0.00	0.00	0.71	1.01	1.35	2.18	2.93	4.04	8.14
	1:25:00	0.00	0.00	0.62	0.89	1.16	1.86	2.47	3.34	6.64
	1:30:00	0.00	0.00	0.54	0.77	0.97	1.53	2.02	2.69	5.30
	1:35:00	0.00	0.00	0.46	0.65	0.81	1.23	1.59	2.08	4.03
	1:40:00	0.00	0.00	0.40	0.53	0.66	0.94	1.18	1.51	2.87
	1:45:00	0.00	0.00	0.36	0.45	0.59	0.69	0.84	1.03	1.94
	1:50:00	0.00	0.00	0.35	0.42	0.55	0.56	0.66	0.76	1.43
	1:55:00	0.00	0.00	0.31	0.39	0.52	0.49	0.58	0.63	1.13
	2:00:00	0.00	0.00	0.28	0.36	0.48	0.46	0.53	0.55	0.93
	2:05:00	0.00	0.00	0.22	0.29	0.38	0.36	0.41	0.42	0.68
	2:10:00	0.00	0.00	0.18	0.23	0.30	0.28	0.32	0.31	0.49
	2:15:00	0.00	0.00	0.14	0.18	0.23	0.21	0.24	0.23	0.34
	2:20:00	0.00	0.00	0.11	0.14	0.18	0.16	0.18	0.17	0.24
	2:25:00	0.00	0.00	0.08	0.11	0.14	0.13	0.14	0.13	0.18
	2:30:00	0.00	0.00	0.06	0.08	0.10	0.09	0.11	0.10	0.14
	2:35:00	0.00	0.00	0.05	0.06	0.08	0.07	0.08	0.07	0.10
	2:40:00	0.00	0.00	0.04	0.05	0.06	0.05	0.06	0.06	0.08
	2:45:00	0.00	0.00	0.03	0.03	0.04	0.04	0.04	0.04	0.06
	2:50:00	0.00	0.00	0.02	0.02	0.03	0.03	0.03	0.03	0.04
	2:55:00	0.00	0.00	0.01	0.02	0.02	0.02	0.02	0.02	0.03
	3:00:00	0.00	0.00	0.01	0.01	0.01	0.01	0.01	0.01	0.02
	3:05:00	0.00	0.00	0.00	0.00	0.01	0.01	0.01	0.01	0.01
	3:10:00	0.00	0.00	0.00	0.00	0.00	0.00	0.00	0.00	0.00
	3:15:00	0.00	0.00	0.00	0.00	0.00	0.00	0.00	0.00	0.00
	3:20:00	0.00	0.00	0.00	0.00	0.00	0.00	0.00	0.00	0.00
	3:25:00	0.00	0.00	0.00	0.00	0.00	0.00	0.00	0.00	0.00
	3:30:00	0.00	0.00	0.00	0.00	0.00	0.00	0.00	0.00	0.00
	3:35:00	0.00	0.00	0.00	0.00	0.00	0.00	0.00	0.00	0.00
	3:40:00	0.00	0.00	0.00	0.00	0.00	0.00	0.00	0.00	0.00
	3:45:00	0.00	0.00	0.00	0.00	0.00	0.00	0.00	0.00	0.00
	3:50:00	0.00	0.00	0.00	0.00	0.00	0.00	0.00	0.00	0.00
	3:55:00	0.00	0.00	0.00	0.00	0.00	0.00	0.00	0.00	0.00
	4:00:00	0.00	0.00	0.00	0.00	0.00	0.00	0.00	0.00	0.00
	4:05:00	0.00	0.00	0.00	0.00	0.00	0.00	0.00	0.00	0.00
	4:10:00	0.00	0.00	0.00	0.00	0.00	0.00	0.00	0.00	0.00
	4:15:00	0.00	0.00	0.00	0.00	0.00	0.00	0.00	0.00	0.00
	4:20:00	0.00	0.00	0.00	0.00	0.00	0.00	0.00	0.00	0.00
	4:25:00	0.00	0.00	0.00	0.00	0.00	0.00	0.00	0.00	0.00
	4:30:00	0.00	0.00	0.00	0.00	0.00	0.00	0.00	0.00	0.00
	4:35:00	0.00	0.00	0.00	0.00	0.00	0.00	0.00	0.00	0.00
	4:40:00	0.00	0.00	0.00	0.00	0.00	0.00	0.00	0.00	0.00
	4:45:00	0.00	0.00	0.00	0.00	0.00	0.00	0.00	0.00	0.00
	4:50:00	0.00	0.00	0.00	0.00	0.00	0.00	0.00	0.00	0.00
	4:55:00	0.00	0.00	0.00	0.00	0.00	0.00	0.00	0.00	0.00
	5:00:00	0.00	0.00	0.00	0.00	0.00	0.00	0.00	0.00	0.00
	5:05:00	0.00	0.00	0.00	0.00	0.00	0.00	0.00	0.00	0.00
	5:10:00	0.00	0.00	0.00	0.00	0.00	0.00	0.00	0.00	0.00
	5:15:00	0.00	0.00	0.00	0.00	0.00	0.00	0.00	0.00	0.00
	5:20:00	0.00	0.00	0.00	0.00	0.00	0.00	0.00	0.00	0.00
	5:25:00	0.00	0.00	0.00	0.00	0.00	0.00	0.00	0.00	0.00
	5:30:00	0.00	0.00	0.00	0.00	0.00	0.00	0.00	0.00	0.00
	5:35:00	0.00	0.00	0.00	0.00	0.00	0.00	0.00	0.00	0.00
	5:40:00	0.00	0.00	0.00	0.00	0.00	0.00	0.00	0.00	0.00
	5:45:00	0.00	0.00	0.00	0.00	0.00	0.00	0.00	0.00	0.00
	5:50:00	0.00	0.00	0.00	0.00	0.00	0.00	0.00	0.00	0.00
	5:55:00	0.00	0.00	0.00	0.00	0.00	0.00	0.00	0.00	0.00
	6:00:00	0.00	0.00	0.00	0.00	0.00	0.00	0.00	0.00	0.00

DETENTION BASIN STAGE-STORAGE TABLE BUILDER

MHFD-Detention, Version 4.03 (May 2020)

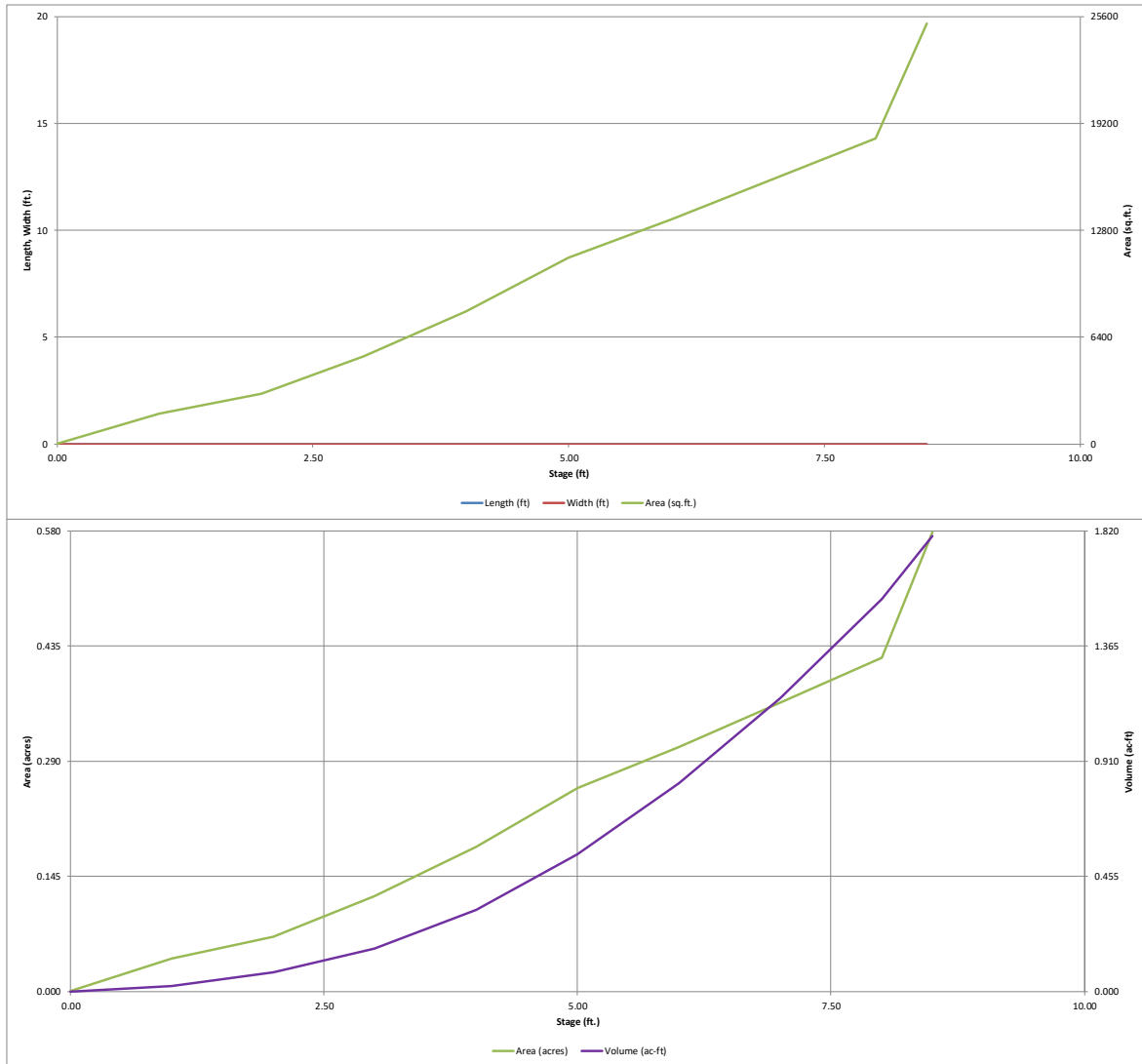

DETENTION BASIN OUTLET STRUCTURE DESIGN

MHFD-*Detention, Version 4.03 (May 2020)*

Project: Windermere South - FINAL

Basin ID:

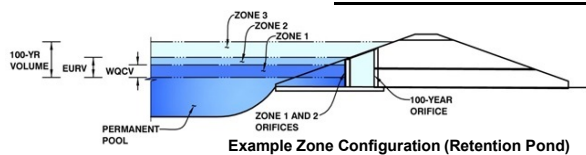

	Estimated Stage (ft)	Estimated Volume (ac-ft)	Outlet Type
Zone 1 (WQCV)	3.52	0.242	Orifice Plate
Zone 2 (EURV)	6.34	0.689	Orifice Plate
Zone 3 (100-year)	7.57	0.442	Weir&Pipe (Restrict)
Total (all zones)		1.373	

User Input: Orifice at Underdrain Outlet (typically used to drain WQCV in a Filtration BMP)

Underdrain Orifice Invert Depth =	<input type="text" value=""/>	ft (distance below the filtration media surface)
Underdrain Orifice Diameter =	<input type="text" value=""/>	inches

Calculated Parameters for Underdrain

Underdrain Orifice Area =	<input type="text" value=""/>	ft ²
Underdrain Orifice Centroid =	<input type="text" value=""/>	feet

User Input: Orifice Plate with one or more orifices or Elliptical Slot Weir (typically used to drain WQCV and/or EURV in a sedimentation BMP)

Invert of Lowest Orifice =	<input type="text" value="0.00"/>	ft (relative to basin bottom at Stage = 0 ft)
Depth at top of Zone using Orifice Plate =	<input type="text" value="6.34"/>	ft (relative to basin bottom at Stage = 0 ft)
Orifice Plate: Orifice Vertical Spacing =	<input type="text" value="25.40"/>	inches
Orifice Plate: Orifice Area per Row =	<input type="text" value="N/A"/>	inches

Calculated Parameters for Plate

WQ Orifice Area per Row =	<input type="text" value="N/A"/>	ft ²
Elliptical Half-Width =	<input type="text" value="N/A"/>	feet
Elliptical Slot Centroid =	<input type="text" value="N/A"/>	feet
Elliptical Slot Area =	<input type="text" value="N/A"/>	ft ²

User Input: Stage and Total Area of Each Orifice Row (numbered from lowest to highest)

	Row 1 (required)	Row 2 (optional)	Row 3 (optional)	Row 4 (optional)	Row 5 (optional)	Row 6 (optional)	Row 7 (optional)	Row 8 (optional)
Stage of Orifice Centroid (ft)	<input type="text" value="0.00"/>	<input type="text" value="2.11"/>	<input type="text" value="4.23"/>	<input type="text" value=""/>	<input type="text" value=""/>	<input type="text" value=""/>	<input type="text" value=""/>	<input type="text" value=""/>
Orifice Area (sq. inches)	<input type="text" value="1.24"/>	<input type="text" value="1.24"/>	<input type="text" value="1.24"/>	<input type="text" value=""/>	<input type="text" value=""/>	<input type="text" value=""/>	<input type="text" value=""/>	<input type="text" value=""/>

	Row 9 (optional)	Row 10 (optional)	Row 11 (optional)	Row 12 (optional)	Row 13 (optional)	Row 14 (optional)	Row 15 (optional)	Row 16 (optional)
Stage of Orifice Centroid (ft)	<input type="text" value=""/>	<input type="text" value=""/>	<input type="text" value=""/>	<input type="text" value=""/>	<input type="text" value=""/>	<input type="text" value=""/>	<input type="text" value=""/>	<input type="text" value=""/>
Orifice Area (sq. inches)	<input type="text" value=""/>	<input type="text" value=""/>	<input type="text" value=""/>	<input type="text" value=""/>	<input type="text" value=""/>	<input type="text" value=""/>	<input type="text" value=""/>	<input type="text" value=""/>

User Input: Vertical Orifice (Circular or Rectangular)

	Not Selected	Not Selected	
Invert of Vertical Orifice =	<input type="text" value="N/A"/>	<input type="text" value="N/A"/>	ft (relative to basin bottom at Stage = 0 ft)
Depth at top of Zone using Vertical Orifice =	<input type="text" value="N/A"/>	<input type="text" value="N/A"/>	ft (relative to basin bottom at Stage = 0 ft)
Vertical Orifice Diameter =	<input type="text" value="N/A"/>	<input type="text" value="N/A"/>	inches

Calculated Parameters for Vertical Orifice

	Not Selected	Not Selected	
Vertical Orifice Area =	<input type="text" value="N/A"/>	<input type="text" value="N/A"/>	ft ²
Vertical Orifice Centroid =	<input type="text" value="N/A"/>	<input type="text" value="N/A"/>	feet

User Input: Overflow Weir (Dropbox with Flat or Sloped Grate and Outlet Pipe OR Rectangular/Trapezoidal Weir (and No Outlet Pipe))

	Zone 3 Weir	Not Selected	
Overflow Weir Front Edge Height, H _o =	<input type="text" value="6.40"/>	<input type="text" value="N/A"/>	ft (relative to basin bottom at Stage = 0 ft)
Overflow Weir Front Edge Length =	<input type="text" value="3.92"/>	<input type="text" value="N/A"/>	feet
Overflow Weir Grate Slope =	<input type="text" value="0.00"/>	<input type="text" value="N/A"/>	H:V
Horiz. Length of Weir Sides =	<input type="text" value="3.92"/>	<input type="text" value="N/A"/>	feet
Overflow Grate Open Area % =	<input type="text" value="70%"/>	<input type="text" value="N/A"/>	%, grate open area/total area
Debris Clogging % =	<input type="text" value="50%"/>	<input type="text" value="N/A"/>	%

Calculated Parameters for Overflow Weir

	Zone 3 Weir	Not Selected	
Height of Grate Upper Edge, H _t =	<input type="text" value="6.40"/>	<input type="text" value="N/A"/>	feet
Overflow Weir Slope Length =	<input type="text" value="3.92"/>	<input type="text" value="N/A"/>	feet
Grate Open Area / 100-yr Orifice Area =	<input type="text" value="16.92"/>	<input type="text" value="N/A"/>	
Overflow Grate Open Area w/o Debris =	<input type="text" value="10.76"/>	<input type="text" value="N/A"/>	ft ²
Overflow Grate Open Area w/ Debris =	<input type="text" value="5.38"/>	<input type="text" value="N/A"/>	ft ²

User Input: Outlet Pipe w/ Flow Restriction Plate (Circular Orifice, Restrictor Plate, or Rectangular Orifice)

	Zone 3 Restrictor	Not Selected	
Depth to Invert of Outlet Pipe =	<input type="text" value="2.50"/>	<input type="text" value="N/A"/>	ft (distance below basin bottom at Stage = 0 ft)
Outlet Pipe Diameter =	<input type="text" value="18.00"/>	<input type="text" value="N/A"/>	inches
Restrictor Plate Height Above Pipe Invert =	<input type="text" value="7.00"/>	<input type="text" value=""/>	inches

Calculated Parameters for Outlet Pipe w/ Flow Restriction Plate

	Zone 3 Restrictor	Not Selected	
Outlet Orifice Area =	<input type="text" value="0.64"/>	<input type="text" value="N/A"/>	ft ²
Outlet Orifice Centroid =	<input type="text" value="0.34"/>	<input type="text" value="N/A"/>	feet
Half-Central Angle of Restrictor Plate on Pipe =	<input type="text" value="1.35"/>	<input type="text" value="N/A"/>	radians

User Input: Emergency Spillway (Rectangular or Trapezoidal)

Spillway Invert Stage =	<input type="text" value="6.94"/>	ft (relative to basin bottom at Stage = 0 ft)
Spillway Crest Length =	<input type="text" value="27.00"/>	feet
Spillway End Slopes =	<input type="text" value="4.00"/>	H:V
Freeboard above Max Water Surface =	<input type="text" value="1.00"/>	feet

Calculated Parameters for Spillway

Spillway Design Flow Depth =	<input type="text" value="0.55"/>	feet
Stage at Top of Freeboard =	<input type="text" value="8.49"/>	feet
Basin Area at Top of Freeboard =	<input type="text" value="0.58"/>	acres
Basin Volume at Top of Freeboard =	<input type="text" value="1.80"/>	acre-ft

Routed Hydrograph Results

The user can override the default CUHP hydrographs and runoff volumes by entering new values in the Inflow Hydrographs table (Columns W through AF).

	WQCV	EURV	2 Year	5 Year	10 Year	25 Year	50 Year	100 Year	500 Year
Design Storm Return Period =	N/A	N/A	1.19	1.50	1.75	2.00	2.25	2.52	3.49
One-Hour Rainfall Depth (in) =	N/A	N/A	1.19	1.50	1.75	2.00	2.25	2.52	3.49
CUHP Runoff Volume (acre-ft) =	0.242	0.931	0.641	0.838	0.996	1.198	1.395	1.633	2.459
Inflow Hydrograph Volume (acre-ft) =	N/A	N/A	0.641	0.838	0.996	1.198	1.395	1.633	2.459
CUHP Predevelopment Peak Q (cfs) =	N/A	N/A	0.1	0.2	0.3	2.9	5.6	9.1	20.5
OPTIONAL Override Predevelopment Peak Q (cfs) =	N/A	N/A							
Predevelopment Unit Peak Flow, q (cfs/acre) =	N/A	N/A	0.01	0.02	0.03	0.27	0.52	0.84	1.89
Peak Inflow Q (cfs) =	N/A	N/A	13.4	17.7	21.3	26.3	31.4	35.9	54.9
Peak Outflow Q (cfs) =	0.1	0.2	0.2	0.2	0.3	2.7	5.5	9.2	30.5
Ratio Peak Outflow to Predevelopment Q =	N/A	N/A	N/A	1.0	1.1	0.9	1.0	1.0	1.5
Structure Controlling Flow =	Plate	Plate	Plate	Plate	Overflow Weir 1	Overflow Weir 1	Overflow Weir 1	Outlet Plate 1	Spillway
Max Velocity through Grate 1 (fps) =	N/A	N/A	N/A	N/A	0.0	0.2	0.5	0.8	0.9
Max Velocity through Grate 2 (fps) =	N/A	N/A	N/A	N/A	N/A	N/A	N/A	N/A	N/A
Time to Drain 97% of Inflow Volume (hours) =	38	75	63	72	78	77	76	74	69
Time to Drain 99% of Inflow Volume (hours) =	40	81	68	77	84	84	83	83	80
Maximum Ponding Depth (ft) =	3.53	6.34	5.26	5.94	6.42	6.57	6.69	6.93	7.33
Area at Maximum Ponding Depth (acres) =	0.15	0.33	0.27	0.30	0.33	0.34	0.35	0.36	0.38
Maximum Volume Stored (acre-ft) =	0.243	0.931	0.609	0.802	0.954	1.008	1.046	1.134	1.282

DETENTION BASIN OUTLET STRUCTURE DESIGN

MHFD-Detention, Version 4.00 (December 2019)

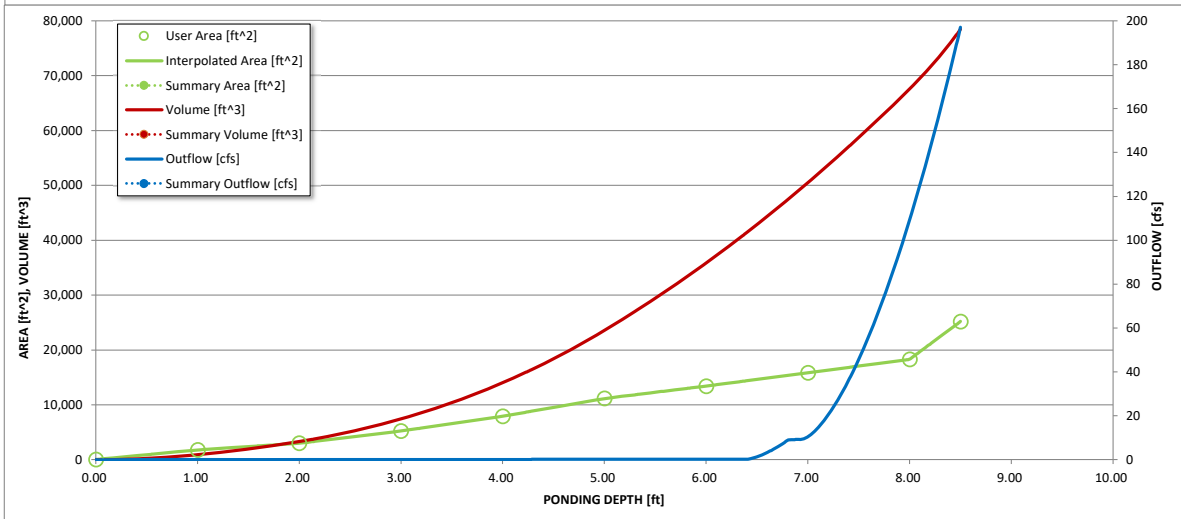
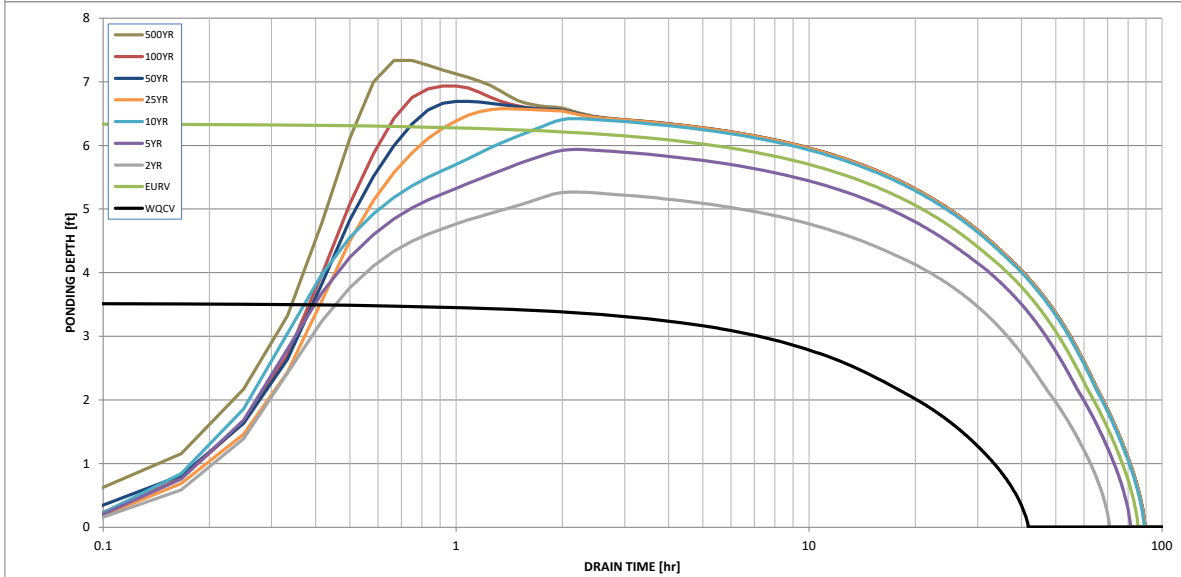
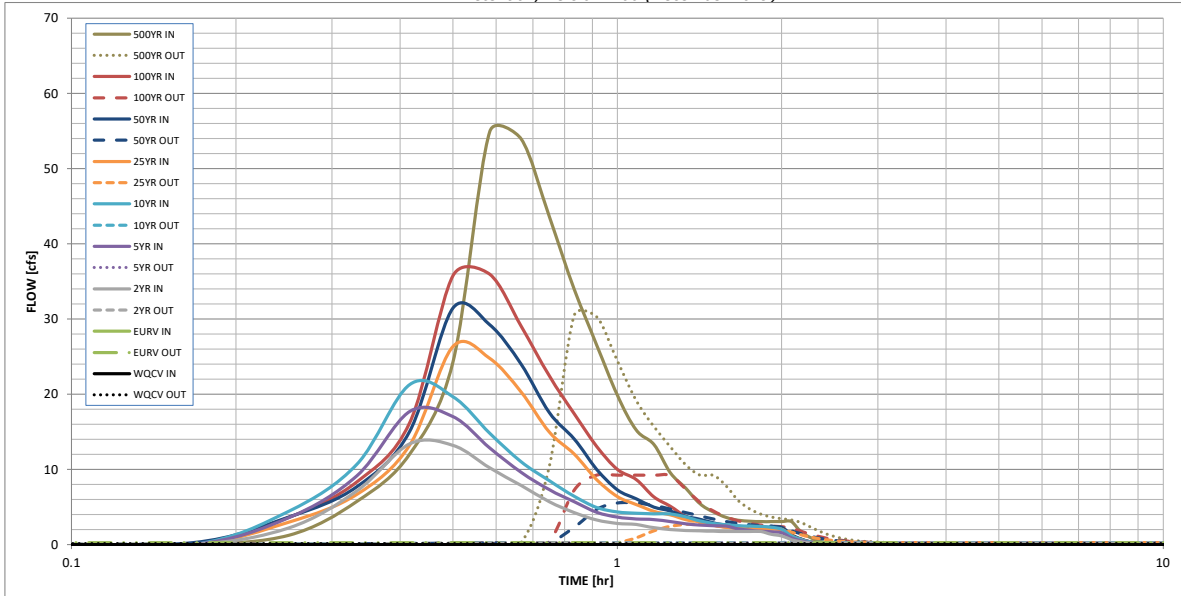

DETENTION BASIN OUTLET STRUCTURE DESIGN

Outflow Hydrograph Workbook Filename: _____

Inflow Hydrographs

The user can override the calculated inflow hydrographs from this workbook with inflow hydrographs developed in a separate program.

Time Interval	SOURCE	CUHP	CUHP	CUHP	CUHP	CUHP	CUHP	CUHP	CUHP	CUHP
	TIME	WQCV [cfs]	EURV [cfs]	2 Year [cfs]	5 Year [cfs]	10 Year [cfs]	25 Year [cfs]	50 Year [cfs]	100 Year [cfs]	500 Year [cfs]
5.00 min	0:00:00	0.00	0.00	0.00	0.00	0.00	0.00	0.00	0.00	0.00
	0:05:00	0.00	0.00	0.00	0.00	0.00	0.00	0.00	0.00	0.00
	0:10:00	0.00	0.00	0.00	0.00	0.00	0.00	0.25	0.02	1.24
	0:15:00	0.00	0.00	2.20	3.58	4.43	2.98	3.64	3.62	5.72
	0:20:00	0.00	0.00	7.15	9.15	10.68	6.68	7.69	8.35	12.02
	0:25:00	0.00	0.00	13.38	17.69	21.29	13.23	15.05	16.20	24.26
	0:30:00	0.00	0.00	13.20	16.99	19.67	26.35	31.45	35.75	54.89
	0:35:00	0.00	0.00	10.18	12.85	14.80	24.76	29.25	35.94	53.97
	0:40:00	0.00	0.00	7.86	9.61	11.02	20.31	24.00	29.05	43.65
	0:45:00	0.00	0.00	5.71	7.29	8.49	14.97	17.57	22.45	33.95
	0:50:00	0.00	0.00	4.27	5.70	6.40	12.02	14.05	17.39	26.56
	0:55:00	0.00	0.00	3.25	4.28	4.93	8.64	9.99	13.05	19.85
	1:00:00	0.00	0.00	2.81	3.64	4.33	6.38	7.27	9.99	15.21
	1:05:00	0.00	0.00	2.65	3.41	4.15	5.32	6.06	8.64	13.31
	1:10:00	0.00	0.00	2.23	3.33	4.09	4.41	4.99	6.33	9.55
	1:15:00	0.00	0.00	2.01	3.06	4.06	3.95	4.46	5.08	7.52
	1:20:00	0.00	0.00	1.88	2.76	3.68	3.31	3.73	3.74	5.42
	1:25:00	0.00	0.00	1.80	2.60	3.14	3.00	3.37	3.03	4.32
	1:30:00	0.00	0.00	1.76	2.50	2.81	2.55	2.87	2.57	3.60
	1:35:00	0.00	0.00	1.73	2.44	2.62	2.30	2.58	2.32	3.22
	1:40:00	0.00	0.00	1.73	2.08	2.51	2.16	2.42	2.24	3.10
	1:45:00	0.00	0.00	1.73	1.88	2.44	2.08	2.34	2.19	3.03
	1:50:00	0.00	0.00	1.73	1.76	2.41	2.05	2.30	2.19	3.03
	1:55:00	0.00	0.00	1.36	1.70	2.30	2.03	2.28	2.19	3.03
	2:00:00	0.00	0.00	1.15	1.57	2.02	2.03	2.28	2.19	3.03
	2:05:00	0.00	0.00	0.65	0.89	1.16	1.16	1.30	1.25	1.73
	2:10:00	0.00	0.00	0.36	0.50	0.65	0.66	0.74	0.71	0.98
	2:15:00	0.00	0.00	0.18	0.27	0.34	0.35	0.39	0.37	0.51
	2:20:00	0.00	0.00	0.08	0.13	0.16	0.18	0.20	0.19	0.26
	2:25:00	0.00	0.00	0.03	0.05	0.05	0.06	0.07	0.07	0.09
	2:30:00	0.00	0.00	0.00	0.00	0.00	0.00	0.00	0.00	0.00
	2:35:00	0.00	0.00	0.00	0.00	0.00	0.00	0.00	0.00	0.00
	2:40:00	0.00	0.00	0.00	0.00	0.00	0.00	0.00	0.00	0.00
	2:45:00	0.00	0.00	0.00	0.00	0.00	0.00	0.00	0.00	0.00
	2:50:00	0.00	0.00	0.00	0.00	0.00	0.00	0.00	0.00	0.00
	2:55:00	0.00	0.00	0.00	0.00	0.00	0.00	0.00	0.00	0.00
	3:00:00	0.00	0.00	0.00	0.00	0.00	0.00	0.00	0.00	0.00
	3:05:00	0.00	0.00	0.00	0.00	0.00	0.00	0.00	0.00	0.00
	3:10:00	0.00	0.00	0.00	0.00	0.00	0.00	0.00	0.00	0.00
	3:15:00	0.00	0.00	0.00	0.00	0.00	0.00	0.00	0.00	0.00
	3:20:00	0.00	0.00	0.00	0.00	0.00	0.00	0.00	0.00	0.00
	3:25:00	0.00	0.00	0.00	0.00	0.00	0.00	0.00	0.00	0.00
	3:30:00	0.00	0.00	0.00	0.00	0.00	0.00	0.00	0.00	0.00
	3:35:00	0.00	0.00	0.00	0.00	0.00	0.00	0.00	0.00	0.00
	3:40:00	0.00	0.00	0.00	0.00	0.00	0.00	0.00	0.00	0.00
	3:45:00	0.00	0.00	0.00	0.00	0.00	0.00	0.00	0.00	0.00
	3:50:00	0.00	0.00	0.00	0.00	0.00	0.00	0.00	0.00	0.00
	3:55:00	0.00	0.00	0.00	0.00	0.00	0.00	0.00	0.00	0.00
	4:00:00	0.00	0.00	0.00	0.00	0.00	0.00	0.00	0.00	0.00
	4:05:00	0.00	0.00	0.00	0.00	0.00	0.00	0.00	0.00	0.00
	4:10:00	0.00	0.00	0.00	0.00	0.00	0.00	0.00	0.00	0.00
	4:15:00	0.00	0.00	0.00	0.00	0.00	0.00	0.00	0.00	0.00
	4:20:00	0.00	0.00	0.00	0.00	0.00	0.00	0.00	0.00	0.00
	4:25:00	0.00	0.00	0.00	0.00	0.00	0.00	0.00	0.00	0.00
	4:30:00	0.00	0.00	0.00	0.00	0.00	0.00	0.00	0.00	0.00
	4:35:00	0.00	0.00	0.00	0.00	0.00	0.00	0.00	0.00	0.00
	4:40:00	0.00	0.00	0.00	0.00	0.00	0.00	0.00	0.00	0.00
	4:45:00	0.00	0.00	0.00	0.00	0.00	0.00	0.00	0.00	0.00
	4:50:00	0.00	0.00	0.00	0.00	0.00	0.00	0.00	0.00	0.00
	4:55:00	0.00	0.00	0.00	0.00	0.00	0.00	0.00	0.00	0.00
	5:00:00	0.00	0.00	0.00	0.00	0.00	0.00	0.00	0.00	0.00
	5:05:00	0.00	0.00	0.00	0.00	0.00	0.00	0.00	0.00	0.00
	5:10:00	0.00	0.00	0.00	0.00	0.00	0.00	0.00	0.00	0.00
	5:15:00	0.00	0.00	0.00	0.00	0.00	0.00	0.00	0.00	0.00
	5:20:00	0.00	0.00	0.00	0.00	0.00	0.00	0.00	0.00	0.00
	5:25:00	0.00	0.00	0.00	0.00	0.00	0.00	0.00	0.00	0.00
	5:30:00	0.00	0.00	0.00	0.00	0.00	0.00	0.00	0.00	0.00
	5:35:00	0.00	0.00	0.00	0.00	0.00	0.00	0.00	0.00	0.00
	5:40:00	0.00	0.00	0.00	0.00	0.00	0.00	0.00	0.00	0.00
	5:45:00	0.00	0.00	0.00	0.00	0.00	0.00	0.00	0.00	0.00
	5:50:00	0.00	0.00	0.00	0.00	0.00	0.00	0.00	0.00	0.00
	5:55:00	0.00	0.00	0.00	0.00	0.00	0.00	0.00	0.00	0.00
	6:00:00	0.00	0.00	0.00	0.00	0.00	0.00	0.00	0.00	0.00

North Pond (North Forebay)

FOREBAY VOLUME

Req'd V=3% x WQCV

Ex DP 24 Impervious Area
0.34 79.05

WQCV= 1.0826 ac-ft
V= 0.0325 ac-ft
Actual V 0.0409 ac-ft

FOREBAY RELEASE NOTCH WIDTH

5-YR NOTCH

Q=CLH^{3/2}

Q₁₀₀= 111.3 cfs
2% of Q= 2.23 cfs
C= 2.6
H (height of forebay wall)= 1 ft

L= 10 in
3 in min.

FOREBAY RELEASE NOTCH WIDTH

100-YR NOTCH

Q=CLH^{3/2}

Q₁₀₀= 199.7 cfs
2% of Q= 3.99 cfs
C= 2.6
H (height of forebay wall)= 1 ft

L= 18 in
3 in min.

North Pond (South Forebay)

FOREBAY VOLUME

Req'd V=3% x WQCV

DPM1 Impervious Area
0.65 40.15

WQCV= 0.8503 ac-ft
V= 0.0255 ac-ft
Actual V 0.0310 ac-ft

FOREBAY RELEASE NOTCH WIDTH

5-YR NOTCH

Q=CLH^{3/2}

Q₁₀₀= 54.8 cfs
2% of Q= 1.10 cfs
C= 2.6
H (height of forebay wall)= 1 ft

L= 5 in
3 in min.

FOREBAY RELEASE NOTCH WIDTH

100-YR NOTCH

Q=CLH^{3/2}

Q₁₀₀= 119.4 cfs
2% of Q= 2.39 cfs
C= 2.6
H (height of forebay wall)= 1 ft

L= 11 in
3 in min.

South Pond (Forebay)

FOREBAY VOLUME

Req'd V=3% x WQCV

From Detention spreadsheet

WQCV= 0.052 ac-ft
V= 0.0016 ac-ft
Actual V 0.0040 ac-ft

FOREBAY RELEASE NOTCH WIDTH

Q=CLH^{3/2}

Q₁₀₀= 17.9 cfs
2% of Q= 0.36 cfs
C= 2.6
H (height of forebay wall)= 1 ft

L= 2 in
3 in min.

Figure 13-12c. Emergency Spillway Protection

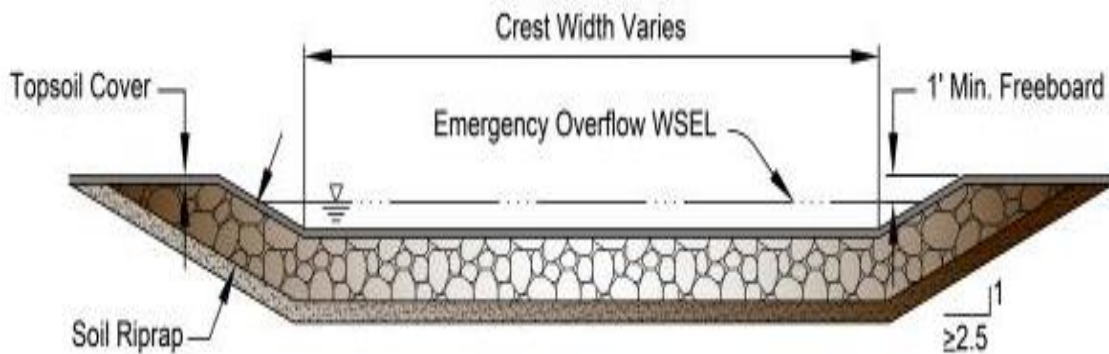
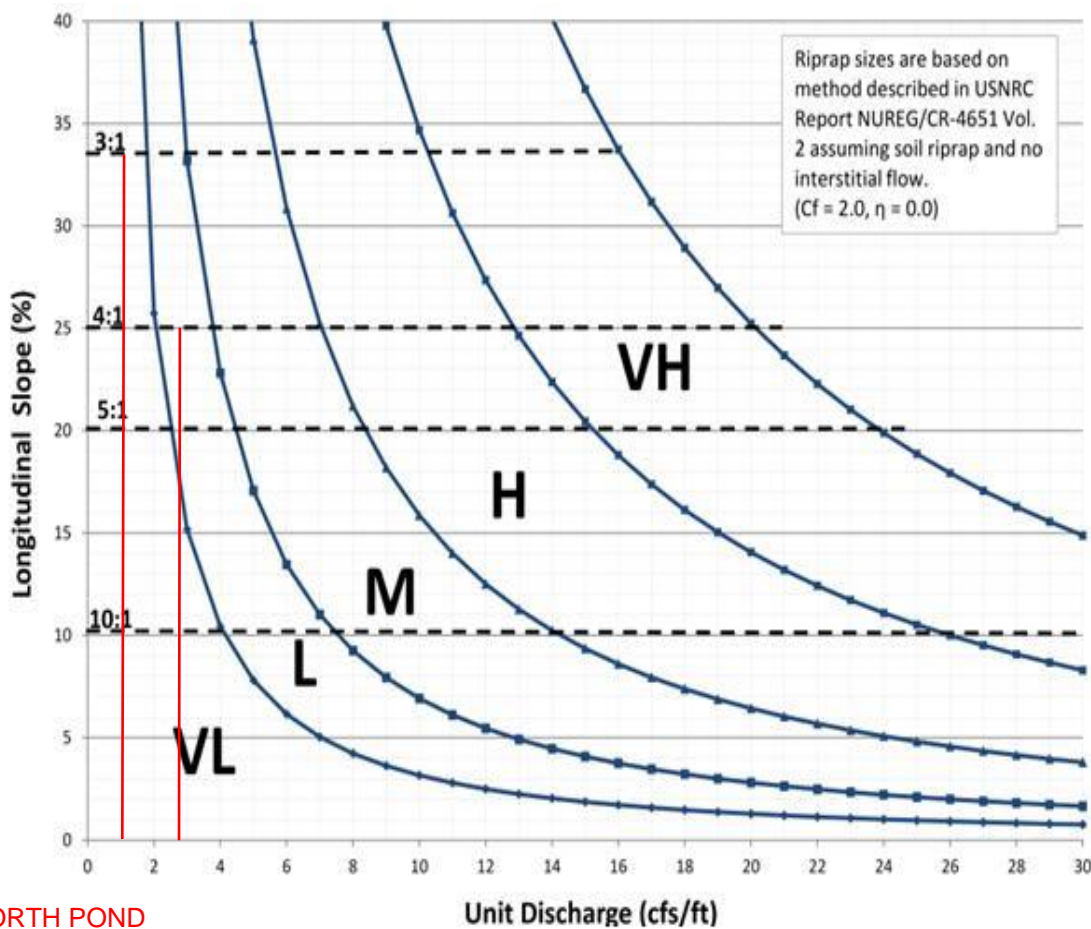

Figure 13-12d. Riprap Types for Emergency Spillway Protection



NORTH POND
 UNIT DISCHARGE= 194.1/70=2.7cfs
SOUTH POND
 UNIT DISCHARGE= 35.9/27= 1.3cfs

Determination of Culvert Headwater and Outlet Protection

Project: **Blue cells are for user data entry**
 Basin ID: **Green cells are calculated values**

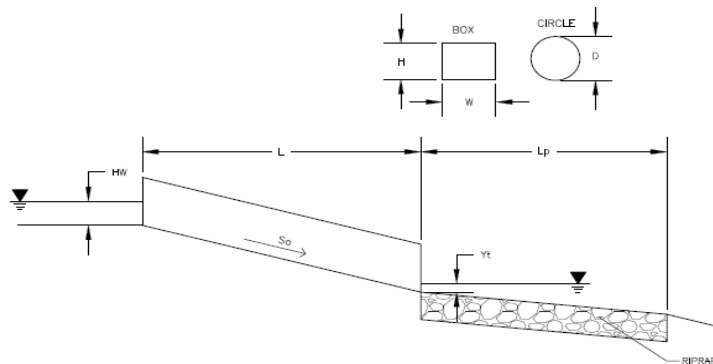

**NORTH DETENTION POND
OUTFALL PROTECTION**

Soil Type:
 Choose One: Sandy Non-Sandy

Design Information (Input):

Design Discharge	Q = <input style="background-color: #add8e6;" type="text" value="66"/> cfs
Circular Culvert:	
Barrel Diameter in Inches	D = <input style="background-color: #add8e6;" type="text" value="36"/> inches
Inlet Edge Type (Choose from pull-down list)	<input type="text" value="1.5 : 1 Beveled Edge"/> <input type="button" value="v"/>
Box Culvert:	OR
Barrel Height (Rise) in Feet	Height (Rise) = <input style="background-color: #add8e6;" type="text" value=""/>
Barrel Width (Span) in Feet	Width (Span) = <input style="background-color: #add8e6;" type="text" value=""/>
Inlet Edge Type (Choose from pull-down list)	<input type="text" value=""/> <input type="button" value="v"/>
Number of Barrels	No = <input style="background-color: #add8e6;" type="text" value="1"/>
Inlet Elevation	Elev IN = <input style="background-color: #add8e6;" type="text" value="6571.5"/> ft
Outlet Elevation OR Slope	Elev OUT = <input style="background-color: #add8e6;" type="text" value="6570.6"/> ft
Culvert Length	L = <input style="background-color: #add8e6;" type="text" value="136.7"/> ft
Manning's Roughness	n = <input style="background-color: #add8e6;" type="text" value="0.012"/>
Bend Loss Coefficient	k_b = <input style="background-color: #add8e6;" type="text" value="0"/>
Exit Loss Coefficient	k_x = <input style="background-color: #add8e6;" type="text" value="1"/>
Tailwater Surface Elevation	Elev Y_t = <input style="background-color: #add8e6;" type="text" value=""/>
Max Allowable Channel Velocity	V = <input style="background-color: #add8e6;" type="text" value="5"/> ft/s

Required Protection (Output):

Tailwater Surface Height	Y_t = <input style="background-color: #90ee90;" type="text" value="1.20"/> ft
Flow Area at Max Channel Velocity	A_t = <input style="background-color: #90ee90;" type="text" value="13.20"/> ft ²
Culvert Cross Sectional Area Available	A = <input style="background-color: #90ee90;" type="text" value="7.07"/> ft ²
Entrance Loss Coefficient	k_e = <input style="background-color: #90ee90;" type="text" value="0.20"/>
Friction Loss Coefficient	k_f = <input style="background-color: #90ee90;" type="text" value="0.84"/>
Sum of All Losses Coefficients	k_s = <input style="background-color: #90ee90;" type="text" value="2.04"/> ft
Culvert Normal Depth	Y_n = <input style="background-color: #90ee90;" type="text" value="2.22"/> ft
Culvert Critical Depth	Y_c = <input style="background-color: #90ee90;" type="text" value="2.60"/> ft
Tailwater Depth for Design	d = <input style="background-color: #90ee90;" type="text" value="2.80"/> ft
Adjusted Diameter OR Adjusted Rise	D_a = <input style="background-color: #90ee90;" type="text" value="-"/> ft
Expansion Factor	$1/(2*\tan(\theta))$ = <input style="background-color: #90ee90;" type="text" value="3.25"/>
Flow/Diameter ^{2.5} OR Flow/(Span * Rise ^{1.5})	Q/D ^{2.5} = <input style="background-color: #90ee90;" type="text" value="4.23"/> ft ^{0.5} /s
Froude Number	Fr = <input style="background-color: #90ee90;" type="text" value="-"/> Pressure flow!
Tailwater/Adjusted Diameter OR Tailwater/Adjusted Rise	Y_t/D = <input style="background-color: #90ee90;" type="text" value="0.40"/>
Inlet Control Headwater	HW_i = <input style="background-color: #90ee90;" type="text" value="4.63"/> ft
Outlet Control Headwater	HW_o = <input style="background-color: #90ee90;" type="text" value="4.66"/> ft
Design Headwater Elevation	HW = <input style="background-color: #90ee90;" type="text" value="6,576.16"/> ft
Headwater/Diameter OR Headwater/Rise Ratio	HW/D = <input style="background-color: #90ee90;" type="text" value="1.55"/> HW/D > 1.5!
Minimum Theoretical Riprap Size	d_{50} = <input style="background-color: #90ee90;" type="text" value="11"/> in
Nominal Riprap Size	d_{50} = <input style="background-color: #90ee90;" type="text" value="12"/> in
UDFCD Riprap Type	Type = <input style="background-color: #90ee90;" type="text" value="M"/>
Length of Protection	L_p = <input style="background-color: #90ee90;" type="text" value="27"/> ft
Width of Protection	T = <input style="background-color: #90ee90;" type="text" value="12"/> ft

Cross Section

Cross Section for Rectangular Channel

Project Description

Worksheet	Sound wall chas
Flow Element	Rectangular Cha
Method	Manning's Form
Solve For	Channel Depth

2'X6" CONCRETE CHASE
AT SOUND WALL ALONG
MARKSHEFFEL ROAD

Section Data

Mannings Coeff	0.015
Slope	010000 ft/ft
Depth	0.36 ft
Bottom Width	2.00 ft
Discharge	2.90 cfs

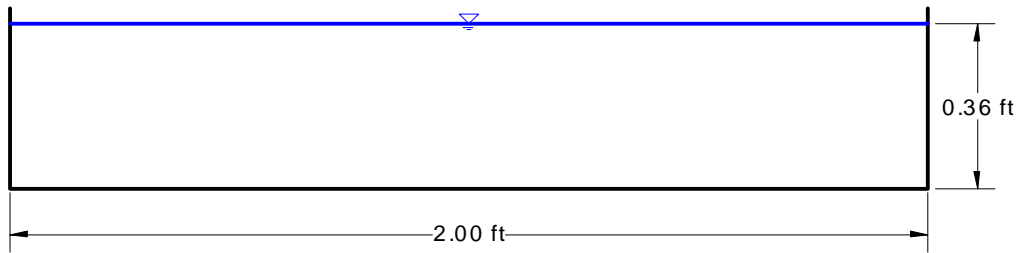

V:1
H:1
NTS

Worksheet

Worksheet for Trapezoidal Channel

Project Description	
Worksheet	Tract A overflow
Flow Element	Trapezoidal Cha
Method	Manning's Form
Solve For	Channel Depth

SUMP INLET OVERFLOW AT TRACT A TOWARDS NORTH DETENTION POND.

ASSUMES WORST CASE ALL FLOWS FROM BASINS A10 AND A11 OVERTOPPING CURB AND TRAVELING THROUGH 30-FT WIDE TRACT A BETWEEN LOTS 48 AND 49. FLOW DEPTH FOR THIS SCENARIO, AS LISTED LEFT IS 0.48-FT

Input Data	
Mannings Coeff	0.030
Slope	010000 ft/ft
Left Side Slope	5.00 V : H
Right Side Slope	5.00 V : H
Bottom Width	15.00 ft
Discharge	28.30 cfs

Results	
Depth	0.57 ft
Flow Area	8.7 ft ²
Wetted Perim	16.17 ft
Top Width	15.23 ft
Critical Depth	0.48 ft
Critical Slope	0.017964 ft/ft
Velocity	3.27 ft/s
Velocity Head	0.17 ft
Specific Enerç	0.74 ft
Froude Numb	0.76
Flow Type	Subcritical

Worksheet

Worksheet for Trapezoidal Channel

Project Description	
Worksheet	Tract D overflow
Flow Element	Trapezoidal Cha
Method	Manning's Form
Solve For	Channel Depth

SUMP INLET OVERFLOW AT TRACT D.

ASSUMES WORST CASE ALL FLOWS FROM BASINS D15 AND A1 OVERTOPPING CURB AND TRAVELING THROUGH 40-FT WIDE TRACT D NORTH OF LOT 14. FLOW DEPTH FOR THIS SCENARIO, AS LISTED LEFT IS 0.29-FT

Input Data	
Mannings Coeffic	0.030
Slope	010000 ft/ft
Left Side Slope	3.00 V : H
Right Side Slope	3.00 V : H
Bottom Width	18.00 ft
Discharge	16.20 cfs

Results	
Depth	0.36 ft
Flow Area	6.6 ft ²
Wetted Perim	18.77 ft
Top Width	18.24 ft
Critical Depth	0.29 ft
Critical Slope	0.020405 ft/ft
Velocity	2.46 ft/s
Velocity Head	0.09 ft
Specific Enerç	0.46 ft
Froude Numb	0.72
Flow Type	Subcritical

LEGEND

PROPOSED INTERMEDIATE CONTOUR
 PROPOSED INDEX CONTOUR
 EX. INTERMEDIATE CONTOUR
 EX. INDEX CONTOUR
 PROPOSED STORM SEWER
 PROPOSED INLET

BASIN BOUNDARY
 FLOW DIRECTION
 DESIGN POINT

BASIN

AREA (ACRE)

Q5 (cfs)
 Q100 (cfs)

SCALE: 1"=100'

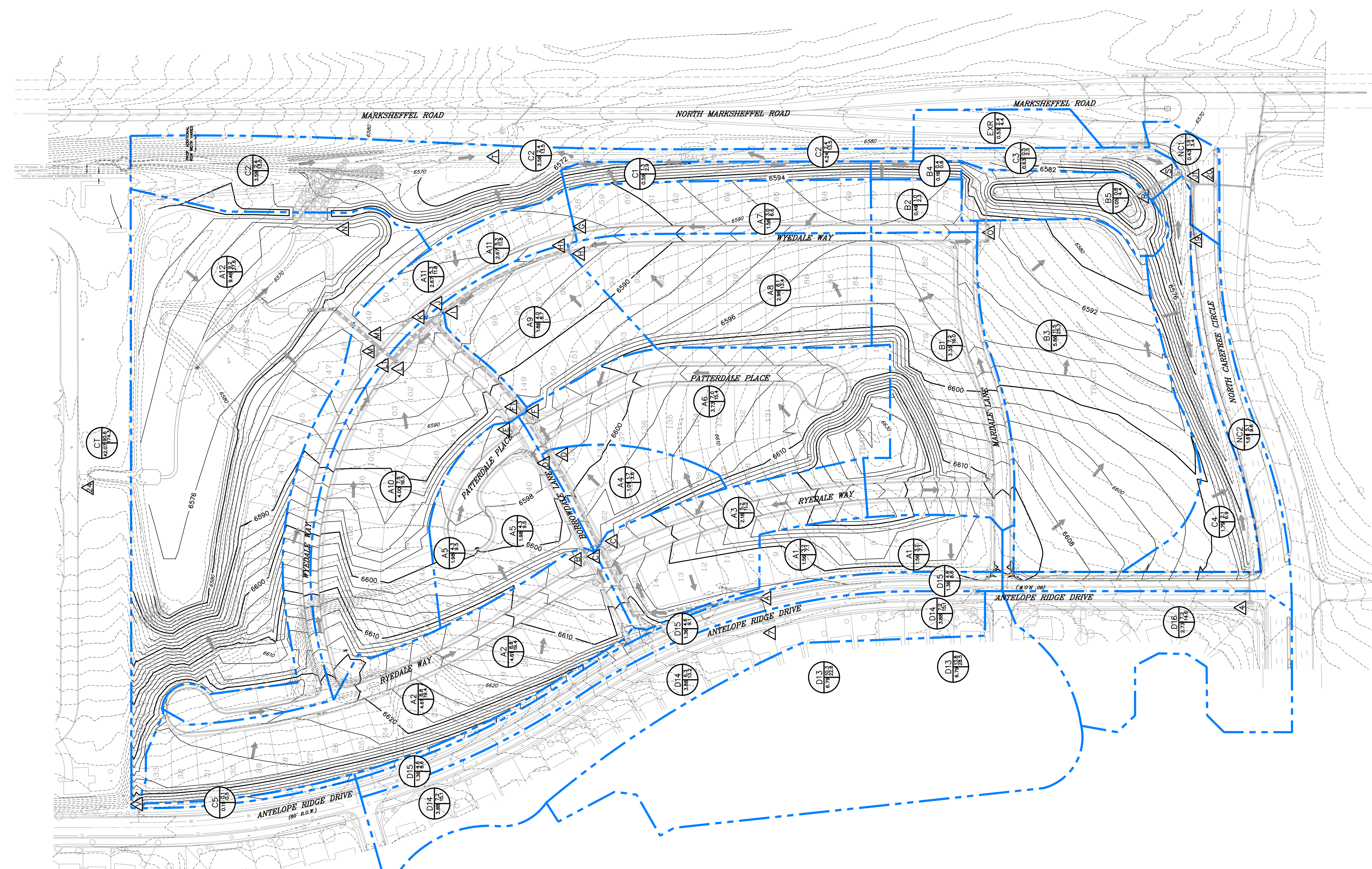

PREPARED BY:

DREXEL, BARRELL & CO.
 Engineers • Surveyors
 3 SOUTH 7TH STREET
 COLORADO SPGS, COLORADO 80905
 CONTACT: TIM D. MCCONNELL, P.E.
 (719)260-0887
 BOULDER • COLORADO SPRINGS • GREELEY

CLIENT:

THE LANDHUIS COMPANY
 212 N. WAHSATCH AVE., #301
 COLORADO SPRINGS, CO 80903
 (719) 635-3200
 CONTACT: JEFF MARK

DRAINAGE MAP FOR
WINDERMERE
 FILING NO. 1
 N. MARKSHEFFEL ROAD
 EL PASO COUNTY, COLORADO

ISSUE	DATE
INITIAL ISSUE	7-9-21
RESUBMITTAL	1-5-22

DESIGNED BY: SBN
 DRAWN BY: SBN
 CHECKED BY: TDM
 FILE NAME:

PREPARED UNDER MY DIRECT SUPERVISION FOR AND ON BEHALF OF DREXEL, BARRELL & CO.

DRAWING SCALE:
 HORIZONTAL: 1" = 100'
 VERTICAL: N/A

OVERALL PROPOSED DRAINAGE MAP

PROJECT NO. 21187-01CSCV
 DRAWING NO.

DR1
 SHEET: 1 OF 5

LEGEND

PROPOSED INTERMEDIATE CONTOUR
 PROPOSED INDEX CONTOUR
 EX. INTERMEDIATE CONTOUR
 EX. INDEX CONTOUR
 PROPOSED STORM SEWER
 PROPOSED INLET
 PROPOSED FLARED END SECTION
 PROPOSED SITE LIGHTING

EX. MANHOLE
 EX. STORM SEWER
 BASIN BOUNDARY
 EXISTING FLOWPATH
 FLOW DIRECTION
 DESIGN POINT

AREA (ACRE)
 Q5 (cfs)
 Q100 (cfs)

BASIN

DEVELOPED AREA DRAINING OFFSITE SEE SHEET DR4

DP	AREA (AC)	Q5 (cfs)	Q100 (cfs)
7	10.67	15.9	34.2
A	13.59	21.0	44.9
B	4.61	8.8	19.4
C	2.18	5.2	11.2
C1	20.38	29.5	63.5
D	1.01	1.7	3.8
D1	21.39	30.6	66.1
E	1.98	4.3	9.5
F	3.73	7.0	15.4
F1	27.10	38.2	82.8
G	1.56	3.0	6.6
H	2.96	6.1	13.4
H1	4.52	8.6	19.0
I	1.86	4.0	8.7
J	6.38	11.8	25.9
K	33.48	46.3	100.7
L	4.00	7.5	16.5
L1	37.48	51.4	111.8

DP	AREA (AC)	Q5 (cfs)	Q100 (cfs)
M	2.67	5.3	11.8
M1	40.15	54.8	119.4
24	83.54	90.7	229.0
N	133.15	145.4	357.5
North Pond Release	1.8	66.0	
T	437.97	190.5	682.4
O	3.82	8.1	17.9
R	10.89	19.9	46.2
South Pond Release	0.2	9.2	
4	2.73	4.9	10.7
S	16.57	10.0	33.7
19	1.61	5.1	9.8
J1	18.18	15.1	43.5
20	18.61	17.0	46.9
V	0.11	0.1	0.5

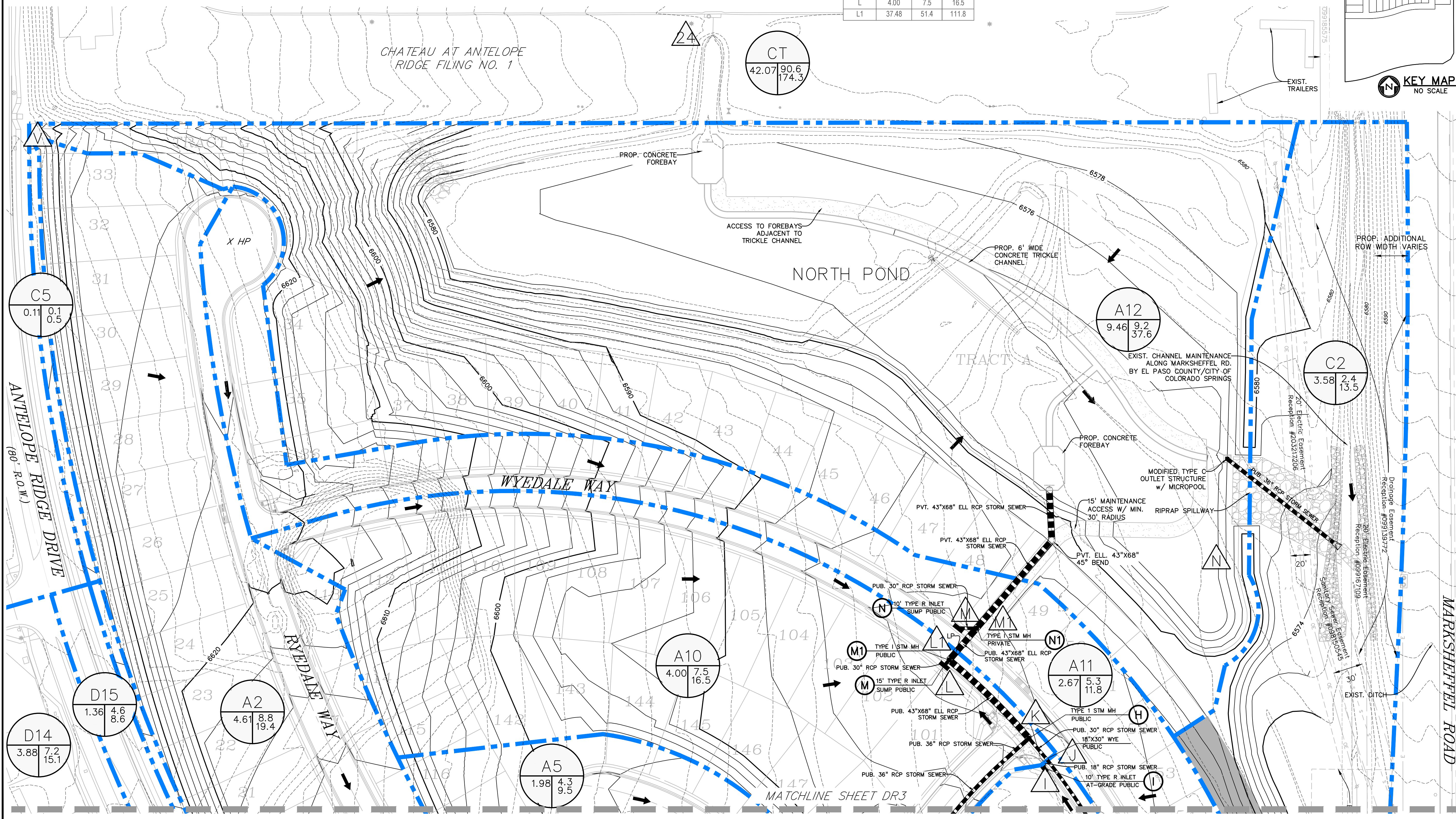
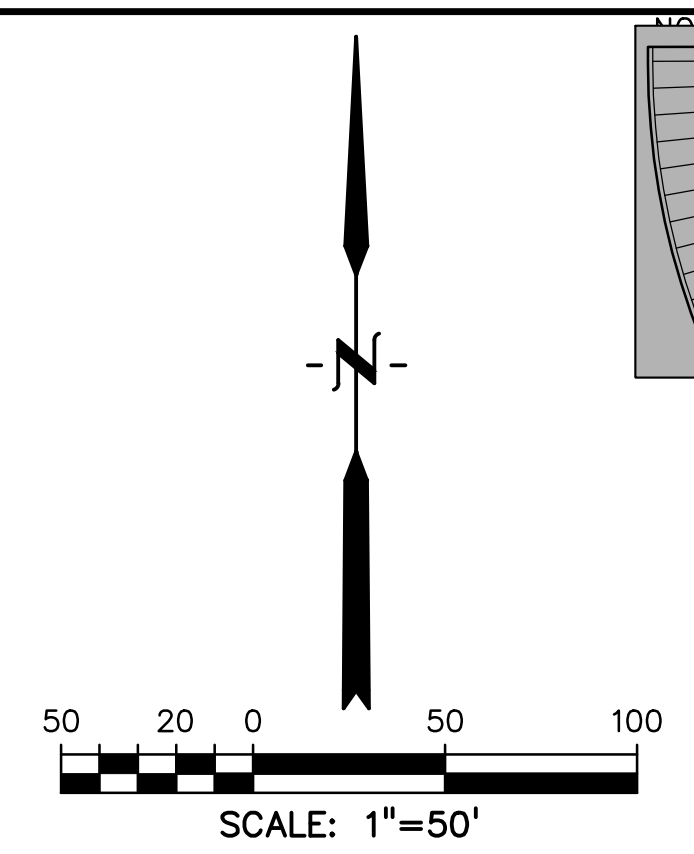

PREPARED BY:

 DREXEL, BARRELL & CO.
 Engineers & Surveyors
 3 SOUTH 7TH STREET
 COLORADO SPGS, COLORADO 80905
 CONTACT: TIM D. MCCONNELL, P.E.
 (719)260-0887
 BOULDER • COLORADO SPRINGS • GREELEY

CLIENT:

 THE LANDHUIS COMPANY
 212 N. WAHSATCH AVE., #301
 COLORADO SPRINGS, CO 80903
 (719) 635-3200
 CONTACT: JEFF MARK

DRAINAGE MAP FOR
WINDERMERE
 FILING NO. 1
 N. MARKSHEFFEL ROAD
 EL PASO COUNTY, COLORADO

ISSUE	DATE
INITIAL ISSUE	7-9-21
RESUBMITTAL	1-5-22
DESIGNED BY:	SBN
DRAWN BY:	SBN
CHECKED BY:	TDM
FILE NAME:	

PREPARED UNDER MY DIRECT SUPERVISION FOR AND ON BEHALF OF DREXEL, BARRELL & CO.

DRAWING SCALE:
 HORIZONTAL: 1" = 50'
 VERTICAL: N/A

PROPOSED DRAINAGE MAP
 PROJECT NO. 21187-01CSCV
 DRAWING NO.

DR2
 SHEET: 2 OF 5

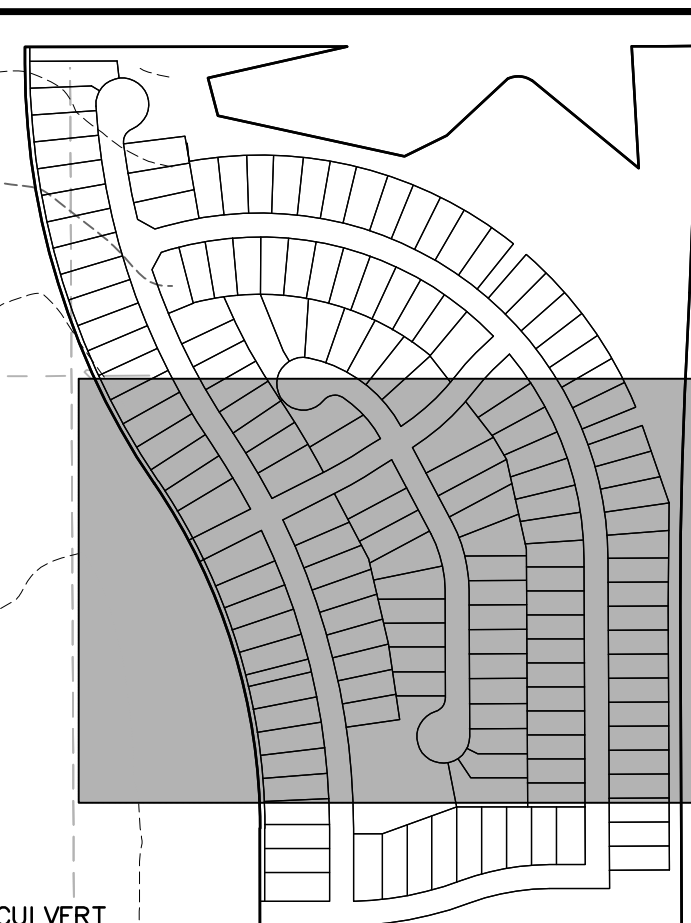
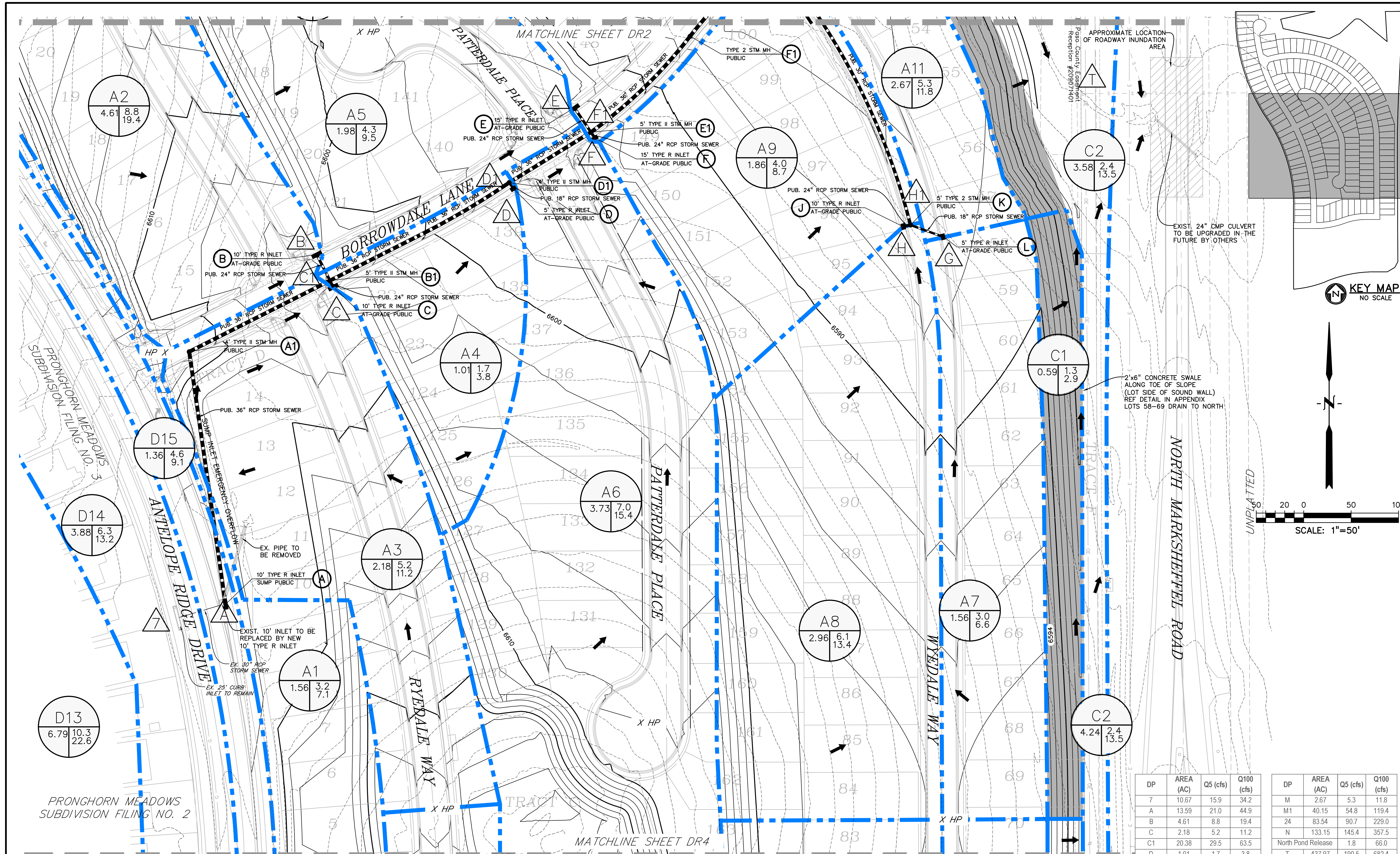

811 Know what's below.
Call before you dig.
CALL 3-BUSINESS DAYS IN ADVANCE BEFORE YOU DIG, GRADE, OR EXCAVATE FOR THE MARKING OF UNDERGROUND MEMBER UTILITIES.

LEGEND

PROPOSED INTERMEDIATE CONTOUR	EX. MANHOLE	AREA (ACRE)	BASIN
PROPOSED INDEX CONTOUR	EX. STORM SEWER	Q5 (cfs)	Q100 (cfs)
EX. INTERMEDIATE CONTOUR		Q100 (cfs)	
EX. INDEX CONTOUR			
PROPOSED STORM SEWER	BASIN BOUNDARY		
PROPOSED INLET	FLOW DIRECTION		
PROPOSED FLARED END SECTION	DESIGN POINT		
PROPOSED SITE LIGHTING			

NOTE:
SEE "PRELIMINARY DRAINAGE REPORT FOR WINDERMERE," BY CLASSIC CONSULTING ENGINEERS & SURVEYORS, OCTOBER 2014 FOR EXISTING DRAINAGE MAP AND CALCULATIONS INCLUDING BASINS D13, D14, D15 AND THEIR DESIGN POINTS

DP	AREA (AC)	Q5 (cfs)	Q100 (cfs)
A	10.67	15.9	34.2
A	13.59	21.0	44.9
B	4.61	8.8	19.4
C	2.18	5.2	11.2
C1	20.38	29.5	63.5
D	1.01	1.7	3.8
D1	21.39	30.6	66.1
E	1.98	4.3	9.5
F	3.73	7.0	15.4
F1	27.10	38.2	82.8
G	1.56	3.0	6.6
H	2.96	6.1	13.4
H1	4.52	8.6	19.0
I	1.86	4.0	8.7
J	6.38	11.8	25.9
K	33.48	46.3	100.7
L	4.00	7.5	16.5
L1	37.48	51.4	111.8

DP	AREA (AC)	Q5 (cfs)	Q100 (cfs)
M	2.67	5.3	11.8
M1	40.15	54.8	119.4
N	133.15	145.4	357.5
North Pond Release		1.8	66.0
T	437.97	190.5	682.4
O	3.82	8.1	17.9
R	10.89	19.9	46.2
South Pond Release		0.2	9.2
4	2.73	4.9	10.7
S	16.57	10.0	33.7
19	1.61	5.1	9.8
J1	18.18	15.1	43.5
20	18.61	17.0	46.9
V	0.11	0.1	0.5

PREPARED BY:

DREXEL, BARRELL & CO.
 Engineers & Surveyors
 3 SOUTH 7TH STREET
 COLORADO SPGS, COLORADO 80905
 CONTACT: TIM D. MCCONNELL, P.E.
 (719) 260-0887
 BOULDER • COLORADO SPRINGS • GREELEY

CLIENT:

THE LANDHUIS COMPANY
 212 N. WAHSATCH AVE., #301
 COLORADO SPRINGS, CO 80903
 (719) 635-3200
 CONTACT: JEFF MARK

DRAINAGE MAP FOR WINDERMERE FILING NO. 1
 N. MARKSHEFFEL ROAD
 EL PASO COUNTY, COLORADO

ISSUE	DATE
INITIAL ISSUE	7-9-21
RESUBMITTAL	1-5-22

DESIGNED BY: SBN
 DRAWN BY: SBN
 CHECKED BY: TDM
 FILE NAME:

PREPARED UNDER MY DIRECT SUPERVISION FOR AND ON BEHALF OF DREXEL, BARRELL & CO.

DRAWING SCALE:
 HORIZONTAL: 1" = 50'
 VERTICAL: N/A

PROPOSED DRAINAGE MAP

PROJECT NO. 21187-01CSCV
 DRAWING NO.

DR3

SHEET: 3 OF 5

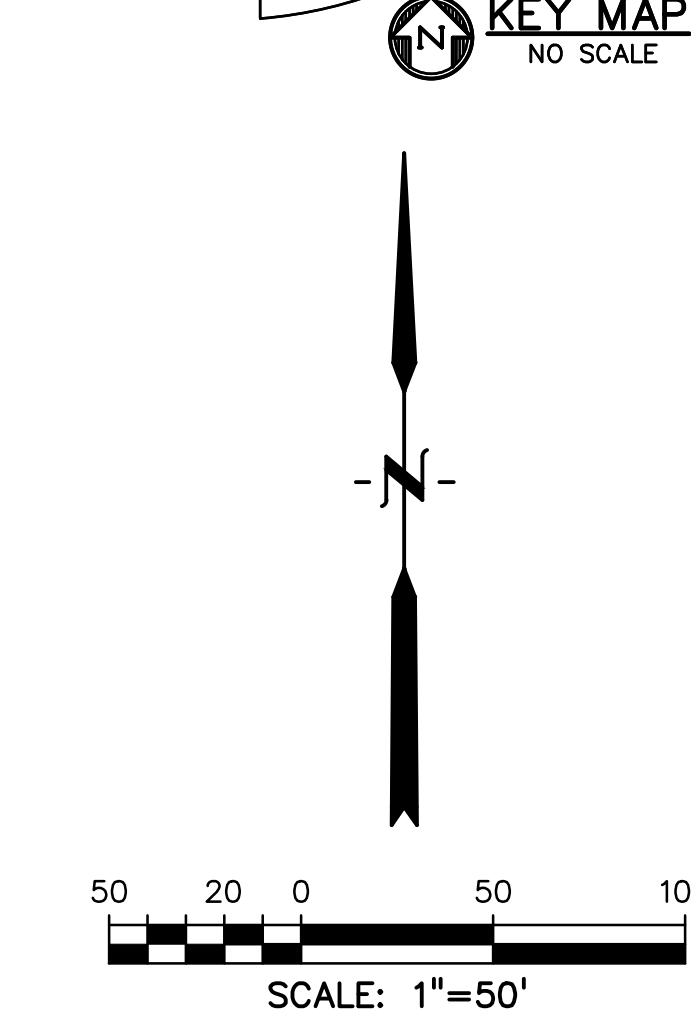
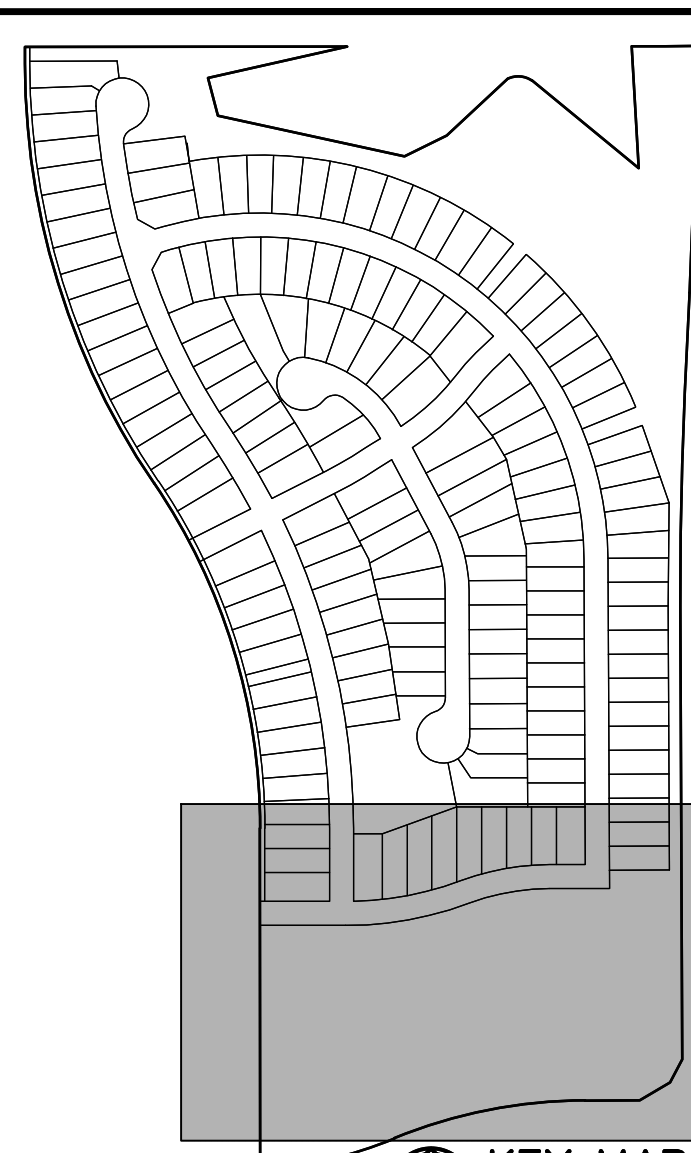
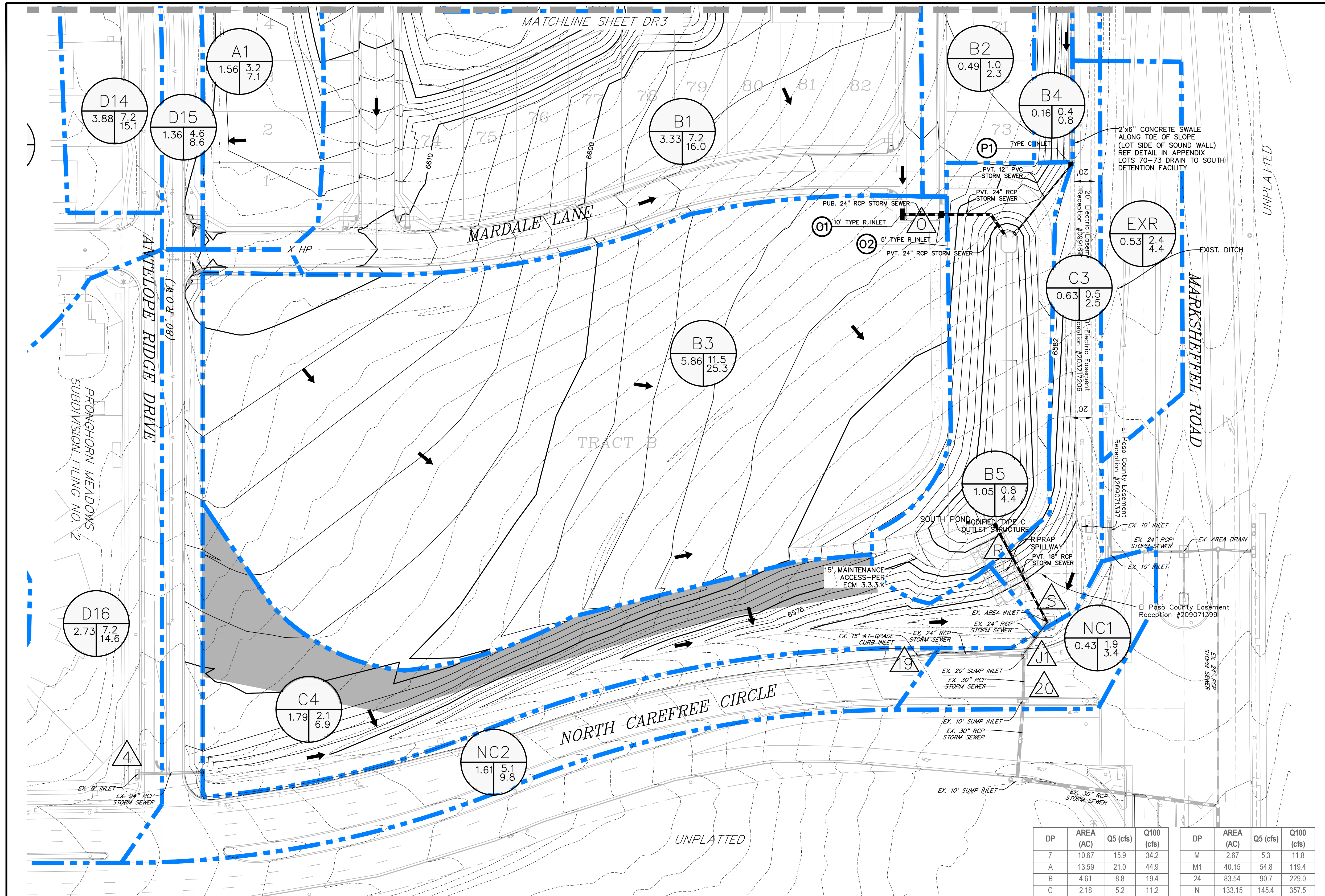

PREPARED BY:



CLIENT:

THE LANDHUIS COMPANY
 212 N. WAHSATCH AVE., #301
 COLORADO SPRINGS, CO 80903
 (719) 635-3200
 CONTACT: JEFF MARK

DRAINAGE MAP FOR
WINDERMERE
 FILING NO. 1
 N. MARKSHEFFEL ROAD
 EL PASO COUNTY, COLORADO

ISSUE	DATE
INITIAL ISSUE	7-9-21
RESUBMITTAL	1-5-22

DESIGNED BY: SBN
 DRAWN BY: SBN
 CHECKED BY: TDM
 FILE NAME:

PREPARED UNDER MY DIRECT SUPERVISION FOR AND ON BEHALF OF DREXEL, BARRELL & CO.

DRAWING SCALE:
 HORIZONTAL: 1" = 50'
 VERTICAL: N/A

PROPOSED DRAINAGE MAP

PROJECT NO. 21187-01CSCV
 DRAWING NO.

DR4

SHEET: 4 OF 5

LEGEND

- PROPOSED INTERMEDIATE CONTOUR
- PROPOSED INDEX CONTOUR
- EX. INTERMEDIATE CONTOUR
- EX. INDEX CONTOUR
- PROPOSED STORM SEWER
- PROPOSED INLET
- PROPOSED FLARED END SECTION
- PROPOSED SITE LIGHTING
- EX. MANHOLE
- EX. STORM SEWER
- BASIN BOUNDARY
- FLOW DIRECTION
- DESIGN POINT
- BASIN
- DEVELOPED AREA DRAINING OFFSITE SEE SHEET DR4

DP	AREA (AC)	Q5 (cfs)	Q100 (cfs)
7	10.67	15.9	34.2
A	13.59	21.0	44.9
B	4.61	8.8	19.4
C	2.18	5.2	11.2
C1	20.38	29.5	63.5
D	1.01	1.7	3.8
D1	21.39	30.6	66.1
E	1.98	4.3	9.5
F	3.73	7.0	15.4
F1	27.10	38.2	82.8
G	1.56	3.0	6.6
H	2.96	6.1	13.4
H1	4.52	8.6	19.0
I	1.86	4.0	8.7
J	6.38	11.8	25.9
K	33.48	46.3	100.7
L	4.00	7.5	16.5
L1	37.48	51.4	111.8

DP	AREA (AC)	Q5 (cfs)	Q100 (cfs)
M	2.67	5.3	11.8
M1	40.15	54.8	119.4
24	83.54	90.7	229.0
N	133.15	145.4	357.5
North Pond Release	1.8	66.0	
T	437.97	190.5	682.4
O	3.82	8.1	17.9
R	10.89	19.9	46.2
South Pond Release	0.2	9.2	
4	2.73	4.9	10.7
S	16.57	10.0	33.7
19	1.61	5.1	9.8
J1	18.18	15.1	43.5
20	18.61	17.0	46.9
V	0.11	0.1	0.5

NOTE:
 SEE "PRELIMINARY DRAINAGE REPORT FOR WINDERMERE," BY CLASSIC CONSULTING ENGINEERS & SURVEYORS, OCTOBER 2014 FOR EXISTING DRAINAGE MAP AND CALCULATIONS INCLUDING BASINS D16, NC1, NC2 AND THEIR DESIGN POINTS

811 Know what's below.
 Call before you dig.
 CALL 3-BUSINESS DAYS IN ADVANCE BEFORE YOU DIG, GRADE, OR EXCAVATE FOR THE MARKING OF UNDERGROUND MEMBER UTILITIES.

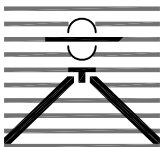
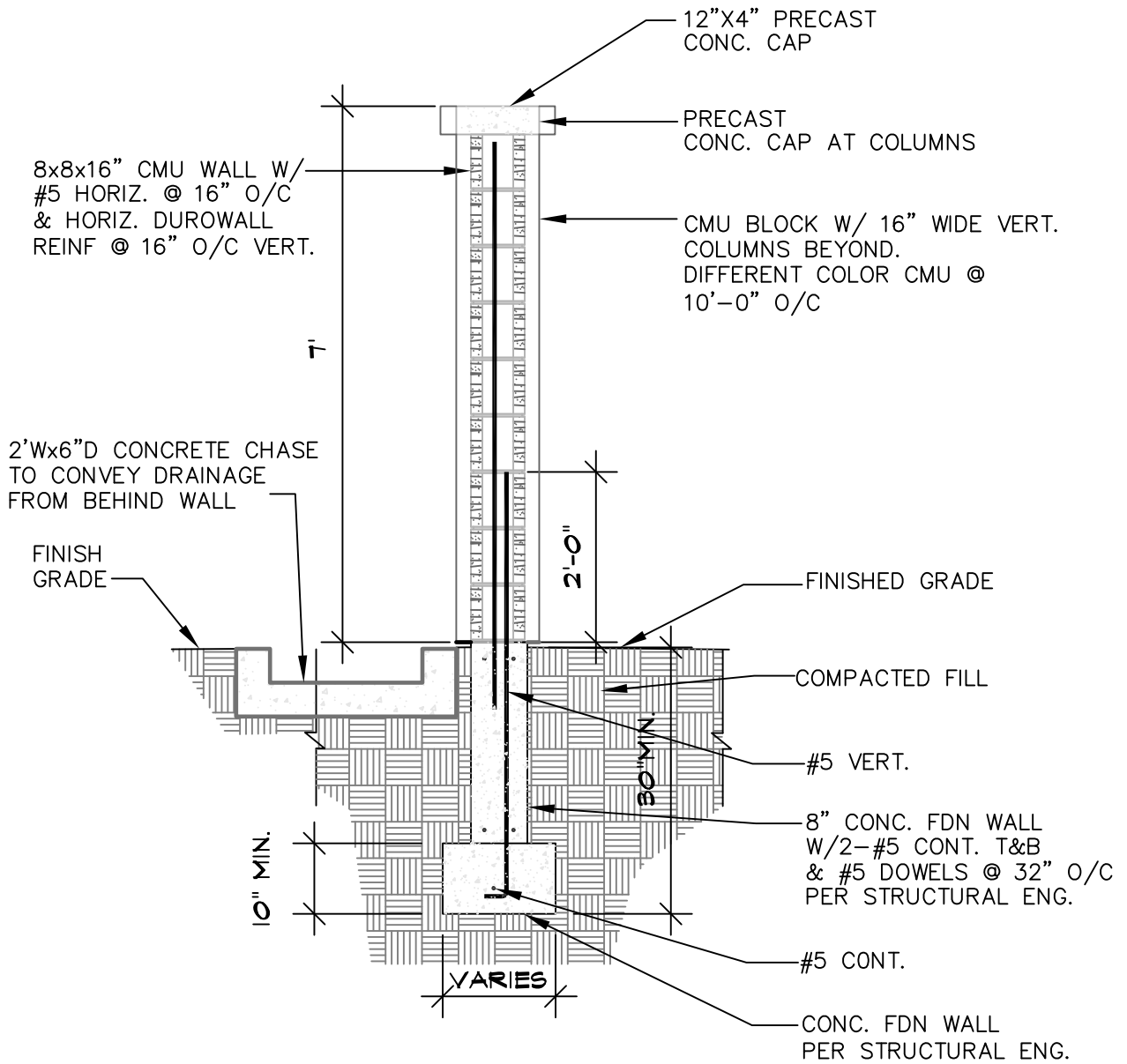

**WINDERMERE
COLORADO SPRINGS, CO
SOUND WALL CHASE**

Drexel, Barrell & Co.
Engineers • Surveyors

DATE: _____
JOB NO:
21187-00CSCV

DWG. NO.
EX1
SHEET 1 OF 1