



**ENTECH**  
ENGINEERING, INC.

505 ELKTON DRIVE  
COLORADO SPRINGS, CO 80907  
PHONE (719) 531-5599  
FAX (719) 531-5238

**SOIL, GEOLOGY, AND GEOLOGIC HAZARD  
SPRINGS AT WATERVIEW EAST  
SOUTH POWERS BOULEVARD AND BRADLEY ROAD  
EL PASO COUNTY, COLORADO**

Prepared for

**Dakota Springs Engineering, Inc.**  
31 North Tejon Street, Suite 500  
Colorado Springs, Colorado 80903

Attn: Charles K. Cothorn

April 25, 2017  
Revised February 21, 2018

Respectfully Submitted,

ENTECH ENGINEERING, INC.

Logan L. Langford  
Geologist

LLL/nc

Encl.

Entech Job No. 170039  
AAprojects/2017/170039 countysoil/geo

Reviewed by:

Joseph C. Goodie, Jr., P.E.  
President

Professional Engineer  
JOSEPH COLLIN GOODIE  
23725  
2/21/18  
COLORADO LICENSED

**TABLE OF CONTENTS**

1.0 SUMMARY ..... 1  
2.0 GENERAL SITE CONDITIONS AND PROJECT DESCRIPTION .....2  
3.0 SCOPE OF THE REPORT .....2  
4.0 FIELD INVESTIGATION .....3  
5.0 SOIL, GEOLOGY AND ENGINEERING GEOLOGY .....3  
    5.1 General Geology .....3  
    5.2 Soil Conservation Survey .....4  
    5.3 Site Stratigraphy .....4  
    5.4 Soil Conditions .....5  
    5.5 Groundwater .....6  
6.0 ENGINEERING GEOLOGY – IDENTIFICATION AND MITIGATION OF GEOLOGIC HAZARDS .....7  
    6.1 Relevance of Geologic Conditions to Land Use Planning .....8  
7.0 ECONOMIC MINERAL RESOURCES .....9  
8.0 EROSION CONTROL ..... 10  
9.0 DETENTION FACILITIES ..... 11  
10.0 CLOSURE ..... 13  
BIBLIOGRAPHY ..... 14

**TABLES**

Table 1: Summary of Laboratory Test Results

**FIGURES**

- Figure 1: Vicinity Map
- Figure 2: USGS Map
- Figure 3: Development Plan/Test Boring Location Map
- Figure 4: Soil Survey Map
- Figure 5: Elsmere Quadrangle Geology Map
- Figure 6: Geology Map/Engineering Geology
- Figure 7: Floodplain Map
- Figure 8: Typical Perimeter Drain Details

- APPENDIX A: Site Photographs
- APPENDIX B: Test Boring Logs and Profile Hole Logs
- APPENDIX C: Laboratory Test Results
- APPENDIX D: Soil Survey Descriptions

## **1.0 SUMMARY**

### ***Project Location***

The project lies in a portion of the W½ of Section 9, Township 15 South, Range 65 West of the 6<sup>th</sup> Principal Meridian in El Paso County, Colorado. The site is located approximately 2½ miles east of Security-Widefield, Colorado.

### ***Project Description***

Total acreage involved in the project is approximately 178 acres. The proposed site development consists of seven hundred and thirteen (713) single-family residential lots, eight (8) commercial lots, and twelve (12) tracts within the development for several parks and two detention ponds. The development will utilize municipal sewer and water.

### ***Scope of Report***

This report presents the results of our geologic evaluation and treatment of engineering geologic hazard study.

### ***Land Use and Engineering Geology***

This site was found to be suitable for the proposed development. Areas were encountered where the geologic conditions will impose constraints on development and land use. These include areas of collapsible soils, highly expansive soils, potential seasonal shallow groundwater, and shallow bedrock. Based on the proposed development plan, it appears that these areas will have impact on the development. These conditions will be discussed in greater detail in the report.

In general, it is our opinion that the development can be achieved if the observed geologic conditions on site can be properly mitigated with site grading and engineering design. All recommendations are subject to the limitations discussed in the report.

## **2.0 GENERAL SITE CONDITIONS AND PROJECT DESCRIPTION**

The site is located in a portion of the W½ of Section 9, Township 15 South, Range 65 West of the 6<sup>th</sup> Principal Meridian in El Paso County, Colorado. The site is located approximately 2½ miles east of Security-Widefield, Colorado, at the southeastern corner of South Powers Boulevard and Bradley Road. The location of the site is as shown on the Vicinity Map, Figure 1.

The topography of the site is generally gradually to moderately sloping to the south, with a small ridge along the western portion of the site. The drainages on site flow in southerly direction through the eastern portion of the site. Water was not observed in the drainages at the time of this investigation. The site boundaries are indicated on the USGS Map, Figure 2. Previous land uses have included grazing and pasture land. The site contains primarily field grasses, weeds, cacti, and yuccas. Site photographs, taken March 7, 2017, are included in Appendix A.

Total acreage involved in the proposed development is approximately 178 acres. The proposed site development consists of seven hundred and thirteen (713) single-family residential lots, eight (8) commercial lots, and twelve (12) tracts within the development for several parks and two detention ponds. The proposed lots are approximately 5,500 to 14,000 square feet each. The area will be serviced municipal sewer and water. Significant site grading to develop the site is anticipated. The proposed Development Plan is presented in Figure 3.

## **3.0 SCOPE OF THE REPORT**

The scope of the report will include the following:

- A general geologic analysis utilizing published geologic data. Detailed site-specific mapping will be conducted to obtain general information in respect to major geographic and geologic features, geologic descriptions and their effects on the development of the property.

## **4.0 FIELD INVESTIGATION**

Our field investigation consisted of the preparation of a geologic map of any bedrock features and significant surficial deposits. The Natural Resource Conservation Service (NRCS), previously the Soil Conservation Service (SCS) survey was also reviewed to evaluate the site. The position of mappable units within the subject property are shown on the Geologic Map. Our mapping procedures involved both field reconnaissance and measurements and air photo reconnaissance and interpretation. The same mapping procedures have also been utilized to produce the Engineering Geology Map which identified pertinent geologic conditions affecting development. The field mapping was performed by personnel of Entech Engineering, Inc. on March 7, 2017.

Ten (10) Test Borings were performed on the site to determine general soil and bedrock characteristics. The locations of the test borings are indicated on the Development Plan/Test Boring Location Map, Figure 3. The Test Boring Logs are presented in Appendix B. Results of this testing will be discussed later in this report.

Laboratory testing was also performed on some of the soils to classify and determine the soils engineering characteristics. Laboratory tests included grain-size analysis, ASTM D-422, and Atterberg Limits, ASTM D-4318. Swell/Consolidation and FHA Swell Testing to evaluate expansion potential. Sulfate testing was performed on selected samples to evaluate potential for below grade concrete degradation due to sulfate attack. Results of the laboratory testing are included in Appendix C. A Summary of Laboratory Test Results is presented in Table 1.

## **5.0 SOIL, GEOLOGY AND ENGINEERING GEOLOGY**

### ***5.1 General Geology***

Physiographically, the site lies in the western portion of the Great Plains Physiographic Province. Approximately 9 miles to the west is a major structural feature known as the Ute Pass Fault. This fault marks the boundary between the Great Plains Physiographic Province and the

Southern Rocky Mountain Province. The site exists within the southeastern edge of a large structural feature known as the Denver Basin. Bedrock in the area tends to be very gently

dipping in a northeasterly direction (Reference 1). The rocks in the area of the site are sedimentary in nature and typically Upper Cretaceous in age. The bedrock underlying the site consists of the Pierre Shale Formation. Overlying this formation are unconsolidated deposits of residual soils, and alluvial soils of Quaternary Age. The alluvial soils were deposited by water along the drainages on-site. The site's stratigraphy will be discussed in more detail in Section 5.3.

### **5.2 Soil Conservation Survey**

The Natural Resource Conservation Service (Reference 2), previously the Soil Conservation Service (Reference 3) has mapped six soil types on the site (Figure 4). In general, the soils classify as loamy sand, sandy loam, loam, and clay loam. The soils are described as follows:

<u>Type</u>	<u>Description</u>
8	Blakeland Loamy Sand, 0 to 3% slopes
31	Fort Collins Loam, 3 to 8% slopes
52	Manzanst Clay Loam, 0 to 3% slopes
56	Nelson-Tassel Fine Sandy Loams, 3 to 18% slopes
86	Stoneham Sandy Loam, 3 to 8% slopes
108	Wiley Silty Loam, 3 to 9% slopes

Complete descriptions of each soil type are presented in Appendix D. The soils have generally been described to have moderate to moderately rapid permeabilities. Possible hazards with soil erosion are present on the site. The erosion potential can be controlled with vegetation. The majority of the soils have been described to have slight to moderate erosion hazards.

### **5.3 Site Stratigraphy**

The Elsmere Quadrangle Geology Map showing the site is presented in Figure 5 (Reference 4). The Geology Map prepared for the site is presented in Figure 6. Two mappable units were identified on this site which are described as follows:

- Qal Recent Alluvium of Holocene Age:** These are recent deposits that have been deposited along the drainages on-site.
- Kp Pierre Shale of Cretaceous Age:** This formation consists of olive brown to gray claystone and shale. These materials were deposited in a marine environment associated with the Cretaceous Seaway. Typically, there is a layer of residually weathered soil present above the Pierre Shale. The soils and bedrock associated with this formation are typically expansive.

The soils listed above were mapped from site-specific mapping, the *Geologic Map of the Elsmere Quadrangle* distributed by the Colorado Geological Survey in 2002 (Reference 4), the *Geologic Map of the Colorado Springs-Castle Rock Area*, distributed by the US Geological Survey in 1979 (Reference 5), and the *Geologic Map of the Denver 1<sup>o</sup> x 2<sup>o</sup> Quadrangle*, distributed by the US Geological Survey in 1981 (Reference 6). The Test Borings and Profile Holes were also used in evaluating the site and are included in Appendix B. The Geology Map prepared for the site is presented in Figure 6.

#### **5.4 Soil Conditions**

The soils and bedrock encountered in the Profile Holes can be grouped into three general soil types. The soils were classified using the Unified Soil Classification System (USCS).

Soil Type 1 is very clayey sand (SC), encountered in all of Test Boring No. 7 at the existing surface to a depth of 8 feet bgs. These soils were encountered at medium dense states and moist conditions. The sample tested had 49 percent passing the No. 200 Sieve.

Soil Type 2 is sandy clay (CL), encountered in nine of test borings at the existing ground surface and extending to depths ranging from 3 to 20 feet bgs. These soils were encountered at firm to very stiff consistencies and moist conditions. Samples tested had 65 to 99 percent passing the No. 200 Sieve. Atterberg Limits Testing resulted in liquid limits of 29 to 38 and plastic indexes of 14 to 21. FHA Swell testing resulted in expansion pressures ranging from 690 to 1340 psf. Swell/Consolidation Testing on select samples resulted in a consolidation of 0.3 percent, and a swell of 6.4 percent. These results indicate the clay soils have a low consolidation potential and a moderate to very high expansion potential. Sulfate testing resulted in less than 0.01 to 0.6

percent sulfate by weight indicating the clay exhibits negligible potential for below grade concrete degradation.

Soil Type 3 is sandy claystone and shale (CL), encountered in nine of the test borings at depths ranging from 3 to 14 feet and extending to the termination of the test borings (20 feet). The claystone and shale were encountered at very stiff to hard consistencies and at moist conditions. Samples tested had 85 to 98 percent passing the No. 200 Sieve. Atterberg Limits Testing resulted in liquid limits of 43 to 54 and plastic indexes of 23 to 29. FHA Swell testing resulted in an expansion pressure of 1880 psf. Swell/Consolidation Testing resulted in swells of 2.0 to 3.8 percent. These results indicate that the claystone and shale bedrock have a moderate to high expansion potential. Sulfate testing resulted in 0.29 to 0.32 percent sulfate by weight indicating the clay exhibits severe potential for below grade concrete degradation.

The Test Boring Logs are presented in Appendix B. Laboratory Test Results are presented in Appendix C. A Summary of Laboratory Test Results is presented in Table 1.

### ***5.5 Groundwater***

Groundwater was not encountered in the test borings which were drilled to depths of 20 feet. Areas of potential seasonal shallow groundwater water have been mapped along the drainages on-site. These areas are discussed in the following section. Fluctuation in groundwater conditions may occur due to variations in rainfall and other factors not readily apparent at this time.

It should be noted that in the sandy materials on site, some groundwater conditions might be encountered due to the variability in the soil profile. Isolated sand and gravel layers within the soils, sometimes only a few feet in thickness and width, can carry water in the subsurface. Groundwater may also flow on top of the underlying bedrock. Builders and planners should be cognizant of the potential for the occurrence of such subsurface water features during construction on-site and deal with each individual problem as necessary at the time of construction.



## **6.0 ENGINEERING GEOLOGY – IDENTIFICATION AND MITIGATION OF GEOLOGIC HAZARDS**

As mentioned previously, detailed mapping has been performed on this site to produce an Engineering Geology Map (Figure 6). This map shows the location of various geologic conditions of which the developers should be cognizant during the planning, design and construction stages of the project. These hazards and the recommended mitigation techniques are as follows:

### Collapsible Soils

The majority of the soils encountered on-site do not exhibit collapsible characteristics, however, areas of soils with consolidation potential were encountered in the test borings drilled on site.

Mitigation: Should loose or collapsible soils be encountered beneath foundations, recompaction and moisture conditioning of the upper 2 to 3 feet of soil at 95% of its maximum Modified Proctor Dry Density ASTM D-1557 will be required. Exterior flatwork and parking areas may also experience movement. Proofrolling and recompaction of soft areas should be performed during site work.

### Expansive Soils

Expansive soils are common in the area, and were encountered in the test borings. Swells ranged from low to very high. The clay, claystone and shale, if encountered beneath foundations, can cause differential movement in the structure foundation. These occurrences should be identified and dealt with on an individual basis or possibly mitigated during site grading.

Mitigation Should expansive soils be encountered beneath the foundation, mitigation will be necessary. Mitigation of expansive soils will require special foundation design. Overexcavation and replacement with non-expansive soils at a minimum of 95% of its maximum Modified Proctor Dry Density, ASTM D-1557 is a suitable mitigation, which is common in the area. Floor slabs on expansive soils should be expected to experience movement. Overexcavation and replacement has been successful in minimizing slab movements. Overexcavation depths of 4 to 6 feet are anticipated for the site. Mitigation may also include moisture conditioning and recompaction of the clay soils. The use of structural floors should be considered for basement construction on highly expansive clays.

Drilled piers are another option that is used in areas where highly expansive soils are encountered. Typical minimum pier depths are on the order of 25 feet or more and require penetration into the bedrock material a minimum of 4 to 6 feet, depending upon building loads. Final recommendations should be determined after additional investigation of the lots.

#### Groundwater and Floodplain Areas

Areas within the drainages on-site have been identified as areas of potential seasonally shallow groundwater areas. Water was not flowing in any of the drainages at the time of this investigation. The site is not mapped within floodplain zones according to the FEMA Map No. 08041CO768F, Figure 9 (Reference 7). These areas are discussed as follows:

#### Potentially Seasonal Shallow Groundwater

In these areas, we would anticipate the potential for periodically high subsurface moisture conditions and possible frost heave potential, depending on the soil conditions.

Mitigation In these locations, foundations in areas subject to severe frost heave potential should penetrate sufficient depth so as to discourage the formation of ice lenses beneath foundations. At this location and elevation, a foundation depth for frost protection of 2.5 feet is recommended. In areas where high subsurface moisture conditions are anticipated periodically, a subsurface perimeter drain will be necessary to help prevent the intrusion of water into areas located below grade. A typical perimeter drain detail is presented in Figure 16. Additionally, swales should be created to intercept surface runoff and carry it safely around and away from structures. It is anticipated that the site grading will likely mitigate the drainages on site.

### ***6.1 Relevance of Geologic Conditions to Land Use Planning***

As mentioned earlier in this report, we understand that the development will consist of single family residential and commercial lots. It is our opinion that the existing geologic and engineering geologic conditions will impose some constraints on the proposed development and construction. The most significant problems affecting development will be those associated with the expansive soils and shallow bedrock on-site that can be mitigated with special designs. Other hazards on site may be satisfactorily mitigated through proper engineering design and construction practices.

The upper materials are typically at medium dense states and firm to very stiff consistencies. Loose soils if encountered at foundation depth will require mitigation. Foundations anticipated for the site are standard spread footings in conjunction with overexcavation in areas of expansive soils. Excavation of the sand and clay soils is anticipated to be moderate to difficult with rubber-tired equipment, excavation of claystone and shale will likely require track-mounted equipment. Expansive soils will require special foundation design and/or overexcavation. These soils will not prohibit development.

Areas of potential seasonally shallow groundwater were observed in the in the eastern portion of the site. These areas will likely be mitigated with site grading and proper stormwater planning.

In summary, development of the site can be achieved if the items mentioned above are mitigated. These items can be mitigated through proper design and construction or through avoidance. Additional subsurface soil investigation is recommended prior to construction.

## **7.0 ECONOMIC MINERAL RESOURCES**

According to the *El Paso County Aggregate Resource Evaluation Map* (Reference 8), the area is not mapped with any aggregate deposits. According to the *Atlas of Sand, Gravel and Quarry Aggregate Resources, Colorado Front Range Counties* distributed by the Colorado Geological Survey (Reference 9), areas of the site are not mapped with any resources. According to the *Evaluation of Mineral and Mineral Fuel Potential* (Reference 10), the area of the site has been mapped as "Fair" for industrial minerals. However, considering the clayey silty nature of the soils, they would be considered to have little significance as an economic resource.

According to the *Evaluation of Mineral and Mineral Fuel Potential of El Paso County State Mineral Lands* (Reference 10), the site is mapped within the Denver Basin Coal Region. However, the area of the site has been mapped as "Poor" for coal resources. No active or inactive mines have been mapped in the area of the site. No metallic mineral resources have been mapped on-site (Reference 10).

The site has been mapped as "Fair" for oil and gas resources (Reference 10). No oil or gas fields have been discovered in the area of the site. The sedimentary rocks in the area may lack

the geologic structure for trapping oil or gas; therefore, it may not be considered a significant resource. Hydraulic fracturing is a new method that is being used to extract oil and gas from rocks. It utilizes pressurized fluid to extract oil and gas from rocks that would not normally be productive. The area of the site has not been explored to determine if the rocks underlying the site would be commercially viable utilizing hydraulic fracturing. The practice of hydraulic fracturing has come under review due to concerns about environmental impacts, health and safety.

## **8.0 EROSION CONTROL**

The soil types observed on the site are mildly to highly susceptible to wind erosion, and moderately to highly susceptible to water erosion. A minor wind erosion and dust problem may be created for a short time during and immediately after construction. Should the problem be considered severe enough during this time, watering of the cut areas or the use of chemical palliative may be required to control dust. However, once construction has been completed and vegetation re-established, the potential for wind erosion should be considerably reduced.

With regard to water erosion, loosely compacted soils will be the most susceptible to water erosion, residually weathered soils become increasingly less susceptible to water erosion. For the typical soils observed on-site, allowable velocities on unvegetated and unlined earth channels would be on the order of 3 to 4 feet/second, depending upon the sediment load carried by the water. Permissible velocities may be increased through the use of vegetation to something on the order of 4 to 7 feet/second, depending upon the type of vegetation established. Should the anticipated velocities exceed these values, some form of channel lining material may be required to reduce erosion potential. These might consist of some of the synthetic channel lining materials on the market or conventional riprap. In cases where ditch-lining materials are still insufficient to control erosion, small check dams or sediment traps may be required. The check dams will serve to reduce flow velocities, as well as provide small traps for containing sediment. The determination of the amount, location and placement of ditch linings, check dams and of the special erosion control features should be performed by or in conjunction with the drainage engineer who is more familiar with the flow quantities and velocities.

Cut and fill slope areas will be subjected primarily to sheetwash and rill erosion. Unchecked rill erosion can eventually lead to concentrated flows of water and gully erosion. The best means to combat this type of erosion is, where possible, the adequate re-vegetation of cut and fill slopes. Cut and fill slopes having gradients more than three (3) horizontal to one (1) vertical become increasingly more difficult to revegetate successfully. Therefore, recommendations pertaining to the vegetation of the cut and fill slopes may require input from a qualified landscape architect and/or the Soil Conservation Service.

## **9.0 DETENTION FACILITIES**

Two detention ponds will be constructed within the Springs at Waterview East Subdivision. One pond is proposed along the west side of the subdivision, located in Tract H, east of Powers Boulevard and the second pond is proposed near the southeast corner of the subdivision, located in Tract E. A Subsurface Soil Investigation was conducted in this area on this property and the findings are included in this report. This report section provides recommendations for constructing detention ponds based on our investigation, laboratory testing, and requirements specified in the El Paso County Engineering Criteria Manual and the El Paso County Drainage Criteria Manual.

The soils in the vicinity of the west pond, Tract H, were recovered from Test Boring No. 8 and soils in Test Boring Nos. 3 and 4 were drilled in the vicinity of the east pond, Tract E. The location of the test borings and the test boring logs are included in this report. The soils recovered from Test Boring Nos. 3 and 4 were determined to consist of 4 to 7 feet of sandy clay overlying sandy claystone with underlying shale encountered in Test Boring No. 3. The soils recovered from Test Boring No. 8 were determined to consist of 9 feet of sandy clay overlying sandy claystone. Groundwater was not encountered in the test borings as noted on the test boring logs.

The west detention pond has been designed to store approximately 5.8 acre-feet at an approximate depth of 7.9 feet and a maximum surface area of 1.5 acres. Approximately 10 feet of fill is proposed for the west pond and the embankments are estimated at less than 8 feet in

height with 3:1 side slopes. The east detention pond has been designed to store approximately 5.8 acre-feet at an approximate depth of 8.1 feet and a maximum surface area of 4.1 acres. Approximately 2 feet of fill is proposed for the east pond and the embankments are estimated at less than 10 feet in height with 3:1 side slopes.

Sandy clay overlies the claystone and based on samples tested from other test borings on the site determined the soil to contain between approximately 65 and 99 percent of the materials passing a No. 200 sieve (CL). Samples of clay resulted in Liquid Limits between 29 and 38 and Plastic Indexes between 14 and 21, and exhibiting a negligible exposure to soluble sulfate attack on buried concrete structures in contact with the clay. Laboratory testing on samples of claystone determined the soil to contain between 86 and 98 of the materials passing a No. 200 sieve (CL). Samples of claystone resulted in Liquid Limits between 43 and 54 and Plastic Indexes between 23 and 29. The claystone exhibits a severe exposure to soluble sulfate attack on buried concrete structures in contact with the claystone. Site sandy clays will be used to fill both Tracts for the detention facilities.

The detention pond design parameters and geometry shall conform to the requirements specified in the El Paso County Engineering Criteria Manual and the El Paso County Drainage Criteria Manual. Sandy clay will likely be used for overlot and pond embankment construction (with 3:1 side slopes) with a soil bearing capacity of 2,000 psf, and soil mitigation may be required for expansive site clays. The embankment foundation shall be fully exposed and observed by personnel of Entech to determine mitigation requirements, if any, prior to constructing the embankment. Groundwater is not expected at the proposed embankment foundation elevations. The embankment fill shall be properly benched into the existing slopes and observed by personnel of Entech prior to fill placement. The embankment soils shall be compacted to the requirements of structural fill at a minimum of 95 percent of the soils maximum Standard Dry Density as determined by ASTM D-698 at -1 to +3 percent of the soils optimum moisture content. Based on the suggested compaction efforts for the embankment soils and the expected foundation soils, it is likely that embankment settlement will be less than 5 percent of the embankment height. Seepage through the embankment should be minimal due to the limited 3-day detention time and the ability for the outlet structure to release the stored waters in 10 hours for both ponds.

## **10.0 CLOSURE**

It is our opinion that the existing geologic engineering and geologic conditions will impose some constraints on development and construction of the site. The majority of these conditions can be mitigated through proper engineering design and construction practices. The proposed development and use is consistent with anticipated geologic and engineering geologic conditions.

It should be pointed out that because of the nature of data obtained by random sampling of such variable and non-homogeneous materials as soil and rock, it is important that we be informed of any differences observed between surface and subsurface conditions encountered in construction and those assumed in the body of this report. Individual investigations for building sites will be required prior to construction. Construction and design personnel should be made familiar with the contents of this report. Reporting such discrepancies to Entech Engineering, Inc. soon after they are discovered would be greatly appreciated and could possibly help avoid construction and development problems.

This report has been prepared for Dakota Springs, Engineering, Inc. for application to the proposed project in accordance with generally accepted geologic soil and engineering practices. No other warranty expressed or implied is made.

We trust that this report has provided you with all the information that you required. Should you require additional information, please do not hesitate to contact Entech Engineering, Inc.

## BIBLIOGRAPHY

1. Bryant, Bruce; McGrew, Laura W, and Wabus, Reinhard A. 1981. *Geologic Structure Map of the Denver 1° x 2° Quadrangle, North-Central Colorado*. Sheet 2. U.S. Geologic Survey. Map I-1163.
2. Natural Resource Conservation Service, September 23, 2016. *Web Soil Survey*. United States Department Agriculture, <http://websoilsurvey.sc.egov.usda.gov/App/HomePage.htm>.
3. United States Department of Agriculture Soil Conservation Service. June 1981. *Soil Survey of El Paso County Area, Colorado*.
4. Madole, Richard F. and Thorson, Jon P., 2003. *Geologic Map of the Elsmere Quadrangle, El Paso County, Colorado*. Colorado Geological Survey. Open-File Report 02-2.
5. Trimble, Donald E. and Machette, Michael N. 1979. *Geologic Map of the Colorado Springs-Castle Rock Area, Front Range Urban Corridor, Colorado*. USGS, Map I-857-F.
6. Bryant, Bruce; McGrew, Laura W. and Wobus, Reinhard A. 1981. *Geologic Map of the Denver 1° x 2° Quadrangle, North-Central Colorado*. U.S. Geologic Survey. Map 1-1163.
7. Federal Emergency Management Agency. March 17, 1997. *Flood Insurance Rate Maps for El Paso County, Colorado and Incorporated Areas*. Map Number 08041CO764F
8. El Paso County Planning Development. December 1995. *El Paso County Aggregate Resource Evaluation Maps*.
9. Schwochow, S.D.; Shroba, R.R. and Wicklein, P.C. 1974. *Atlas of Sand, Gravel, and Quarry Aggregate Resources, Colorado Front Range Counties*. Colorado Geological Survey. Special Publication 5-B.
10. Keller, John W.; TerBest, Harry and Garrison, Rachel E. 2003. *Evaluation of Mineral and Mineral Fuel Potential of El Paso County State Mineral Lands Administered by the Colorado State Land Board*. Colorado Geological Survey. Open-File Report 03-07.



## TABLES

**TABLE 1**  
**SUMMARY OF LABORATORY TEST RESULTS**

CLIENT DAKOTA SPRINGS ENGINEERING  
 PROJECT SPRINGS AT WATERVIEW  
 JOB NO. 170039

SOIL TYPE	TEST BORING NO.	DEPTH (FT)	WATER (%)	DRY DENSITY (PCF)	PASSING NO. 200 SIEVE (%)	LIQUID LIMIT (%)	PLASTIC INDEX (%)	SULFATE (WT %)	FHA SWELL (PSF)	SWELL/CONSOL (%)	UNIFIED CLASSIFICATION	SOIL DESCRIPTION
1	7	5			48.6						SC	SAND, VERY CLAYEY
2	1	5	13.7	120.8	93.1	38	21			6.4	CL	CLAY, SANDY
2	2	10	8.3	104.8	64.6	29	14			-0.3	CL	CLAY, SANDY
2	3	2-3			87.0			0.06	690		CL	CLAY, SANDY
2	5	2-3			96.0						CL	CLAY, SANDY
2	6	2-3			77.6			<0.01	980		CL	CLAY, SANDY
2	9	5	16.9	98.0	93.0					1.6	CL	CLAY, SANDY
2	10	5			98.8				1340		CL	CLAY, SANDY
3	4	5	16.9	113.6	86.6	54	29			3.4	CH	CLAYSTONE, SANDY
3	5	10	17.7	109.3	86.0	43	23			2.0	CL	CLAYSTONE, SANDY
3	6	20	19.0	111.0	98.3					3.8	CL	CLAYSTONE, SANDY
3	7	15			85.3			0.29			CL	CLAYSTONE, SANDY
3	8	10			87.6			0.32	1880		CL	CLAYSTONE, SANDY

**Table 2: Summary of Depth of Fill, and Depth to Bedrock and Groundwater Depths**

Test Boring No.	Depth of Fill (ft.)	Depth to Bedrock (ft.)	Depth to Groundwater (ft.)
1	N/A	9	N/A
2	N/A	N/A	N/A
3	N/A	7	N/A
4	N/A	4	N/A
5	N/A	3	N/A
6	N/A	14	N/A
7	N/A	8	N/A
8	N/A	9	N/A
9	N/A	14	N/A
10	N/A	3	N/A

## FIGURES

**ENTECH**  
ENGINEERING, INC.  
505 ELKTON DRIVE  
COLORADO SPRINGS, CO. 80907 (719) 531-5599

VICINITY MAP  
SPRINGS AT WATERVIEW EAST  
POWERS BOULEVARD AND BRADLEY ROAD  
EL PASO COUNTY, CO.  
FOR: DAKOTA SPRINGS ENGINEERING, INC.

DRAWN: LLL	DATE: 2/15/18	CHECKED:	DATE:
---------------	------------------	----------	-------

JOB NO.:  
170039

FIG NO.:  
1

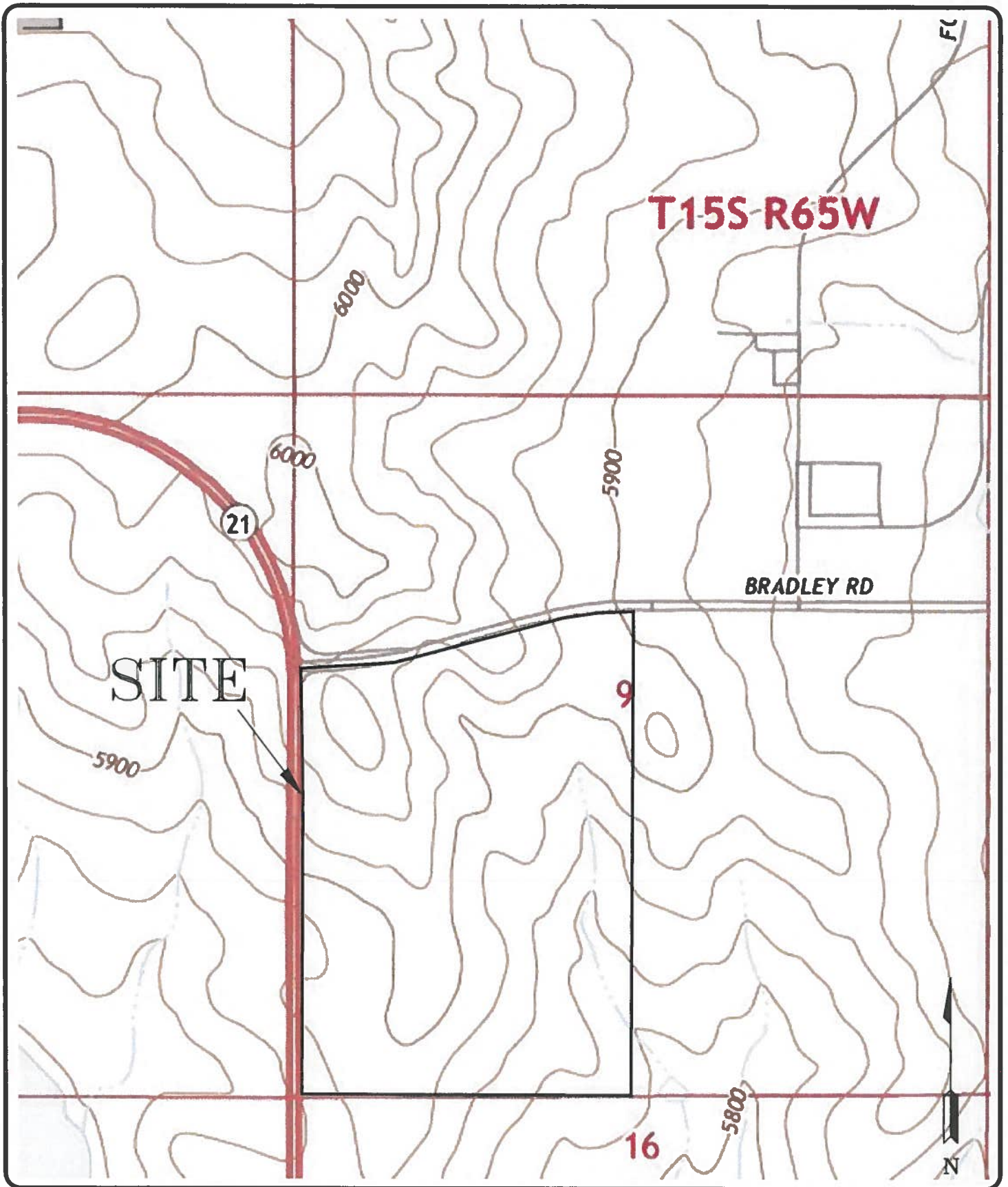

**ENTECH**  
**ENGINEERING, INC.**  
 505 ELKTON DRIVE  
 COLORADO SPRINGS, CO. 80907 (719) 531-5599

USGS MAP  
 SPRINGS AT WATERVIEW EAST  
 POWERS BOULEVARD AND BRADLEY ROAD  
 EL PASO COUNTY, CO.  
 FOR: DAKOTA SPRINGS ENGINEERING, INC.

DRAWN:  
 LLL

DATE:  
 2/15/18

CHECKED:

DATE:

JOB NO.:  
 170039

FIG NO.:  
 2

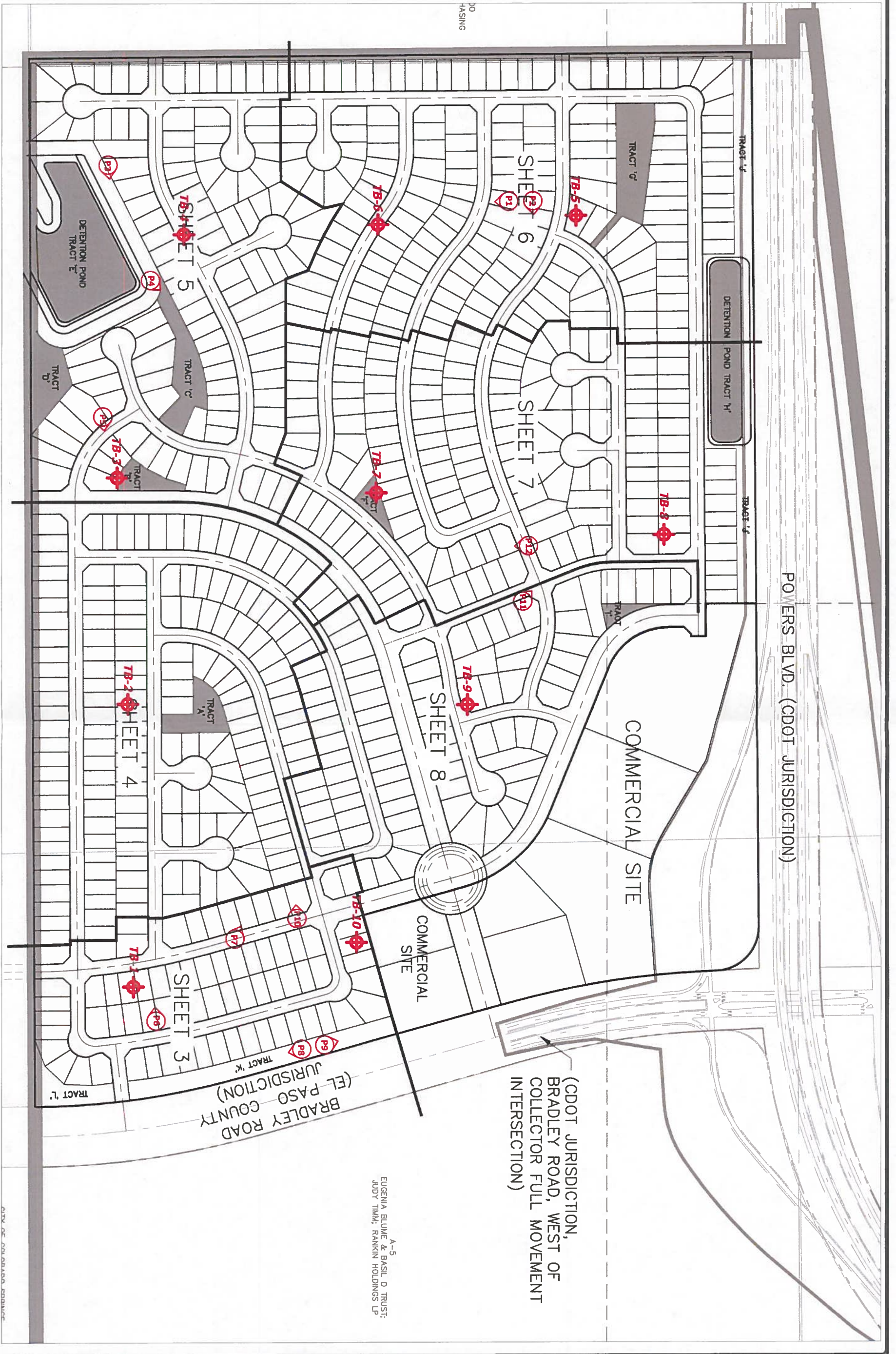

 TB - APPROXIMATE TEST BORING LOCATION AND NUMBER  
 P1 - APPROXIMATE PHOTOGRAPH LOCATION AND NUMBER

A-5  
 EUGENIA BLUME & BASIL D TRUST;  
 JUDY TAMM; RANKIN HOLDINGS LP

DATE	2/15/16
SOIL	AS SHOWN
JOB NO.	1700398
SCALE	AS SHOWN
3	

SITE PLAN/TEST BORING LOCATION MAP  
 S POWERS BOULEVARD AND BRADLEY ROAD  
 EL PASO COUNTY, CO.  
 FOR: DAKOTA SPRINGS ENGINEERING, INC.

**ENTECH**  
 ENGINEERING, INC.  
 505 ELKTON DRIVE  
 COLORADO SPRINGS, CO. 80907 (719) 531-5599

REVISION	BY

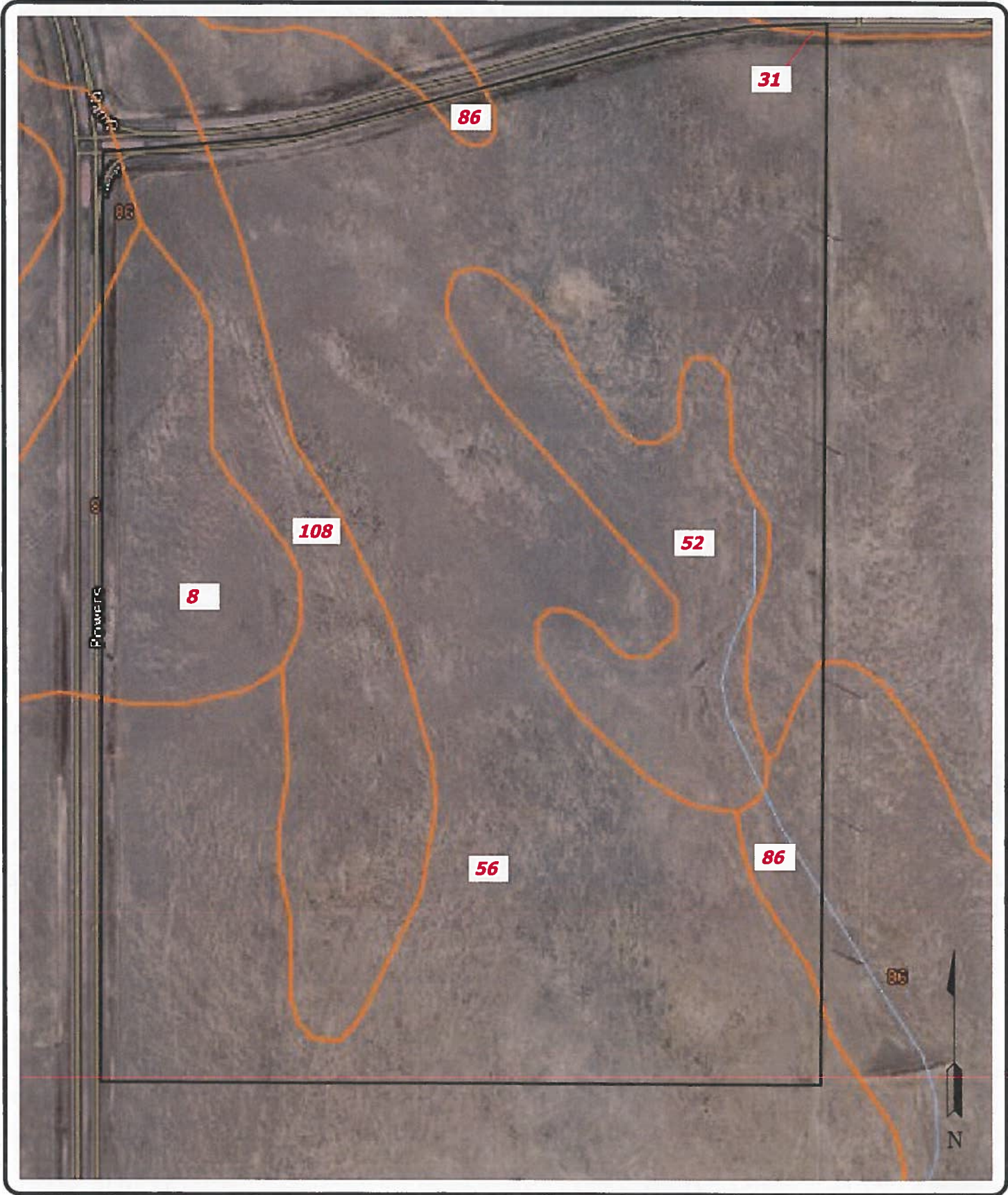

**ENTECH**  
**ENGINEERING, INC.**  
 505 ELKTON DRIVE  
 COLORADO SPRINGS, CO. 80907 (719) 531-8599

SOIL SURVEY MAP  
 SPRINGS AT WATERVIEW EAST  
 POWERS BOULEVARD AND BRADLEY ROAD  
 EL PASO COUNTY, CO.  
 FOR: DAKOTA SPRINGS ENGINEERING, INC.

DRAWN:  
 LLL

DATE:  
 2/15/18

CHECKED:

DATE:

JOB NO.:  
 170039

FIG NO.:  
 4



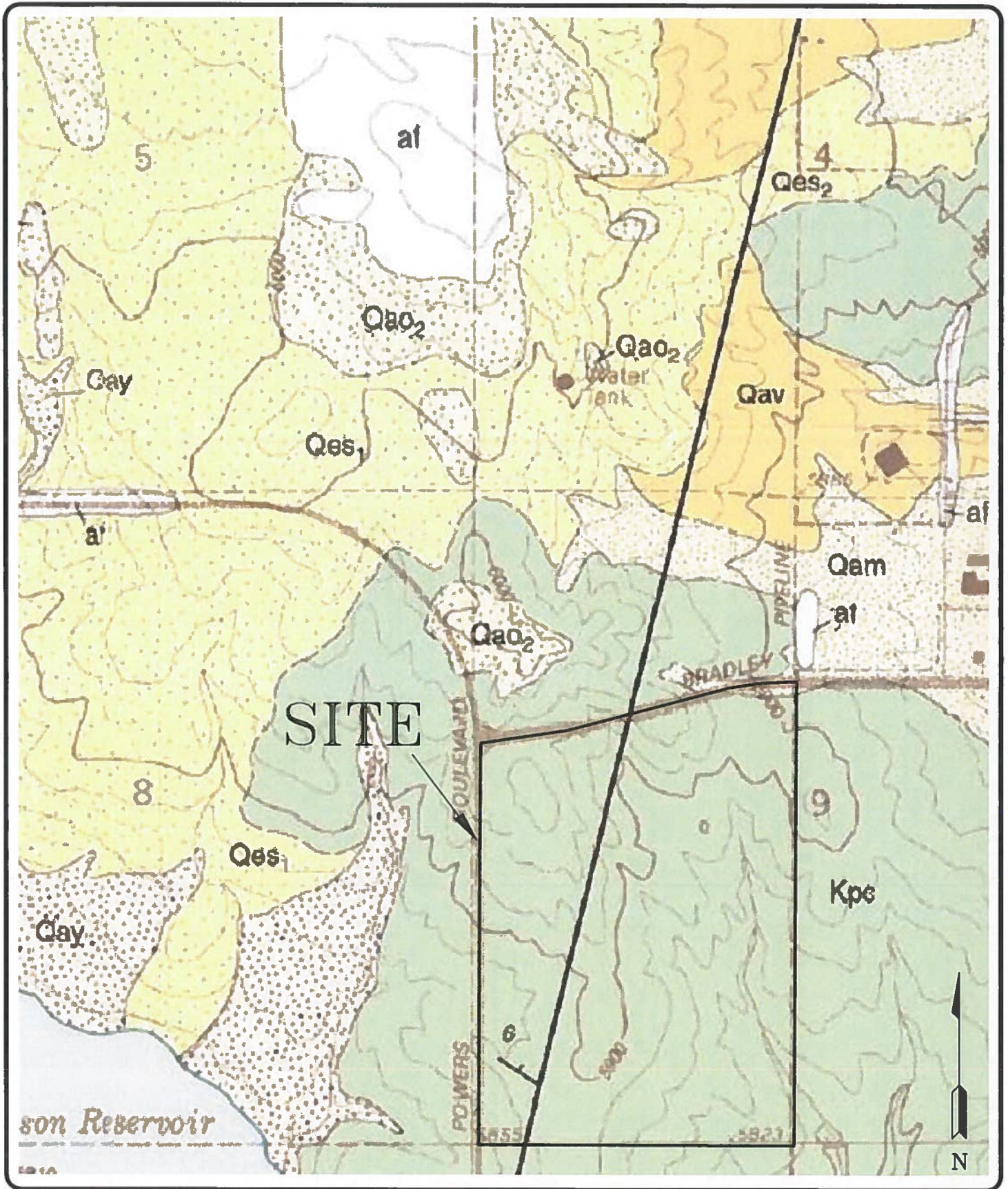

**ENTECH**  
ENGINEERING, INC.  
505 ELKTON DRIVE  
COLORADO SPRINGS, CO. 80907 (719) 531-5599

ELSMERE QUADRANGLE GEOLOGY MAP  
SPRINGS AT WATERVIEW EAST  
POWERS BOULEVARD AND BRADLEY ROAD  
EL PASO COUNTY CO.  
FOR: DAKOTA SPRINGS ENGINEERING, INC.

DRAWN:  
LLL

DATE:  
2/15/18

CHECKED:

DATE:

JOB NO.:  
170039

FIG NO.:  
5





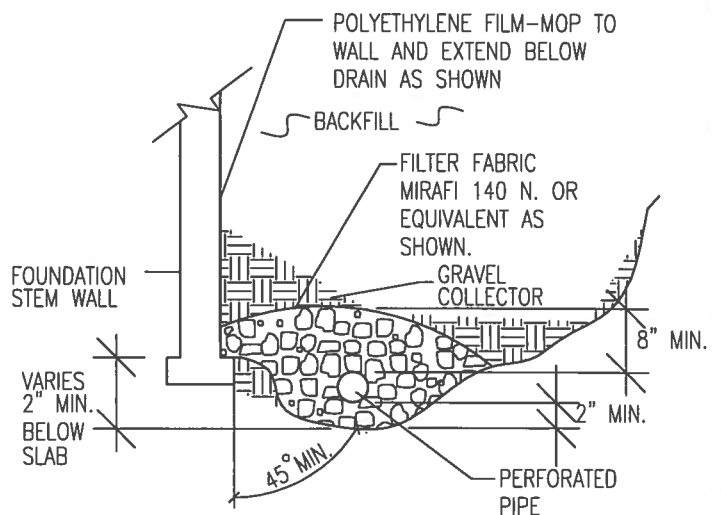
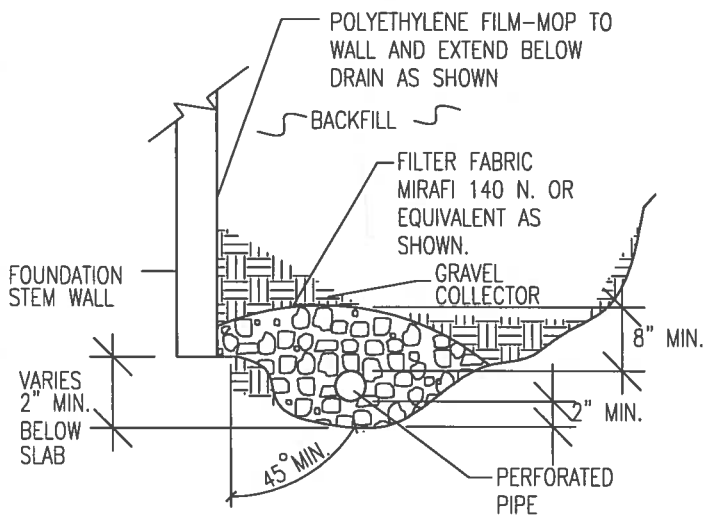

NOTES:

-GRAVEL SIZE IS RELATED TO DIAMETER OF PIPE PERFORATIONS-85% GRAVEL GREATER THAN 2x PERFORATION DIAMETER.

-PIPE DIAMETER DEPENDS UPON EXPECTED SEEPAGE. 4-INCH DIAMETER IS MOST OFTEN USED.

-ALL PIPE SHALL BE PERFORATED PLASTIC. THE DISCHARGE PORTION OF THE PIPE SHOULD BE NON-PERFORATED PIPE.

-FLEXIBLE PIPE MAY BE USED UP TO 8 FEET IN DEPTH, IF SUCH PIPE IS DESIGNED TO WITHSTAND THE PRESSURES. RIGID PLASTIC PIPE WOULD OTHERWISE BE REQUIRED.

-MINIMUM GRADE FOR DRAIN PIPE TO BE 1% OR 3 INCHES OF FALL IN 25 FEET.

-DRAIN TO BE PROVIDED WITH A FREE GRAVITY OUTFALL, IF POSSIBLE. A SUMP AND PUMP MAY BE USED IF GRAVITY OUT FALL IS NOT AVAILABLE.



**ENTECH**  
ENGINEERING, INC.  
505 ELKTON DRIVE  
COLORADO SPRINGS, CO. 80907 (719) 531-5599

*PERIMETER DRAIN DETAIL*

DRAWN:

DATE:

DESIGNED:

DS

CHECKED:

LLL

JOB NO.:

170039

FIG NO.:

8

## **APPENDIX A: Site Photographs**

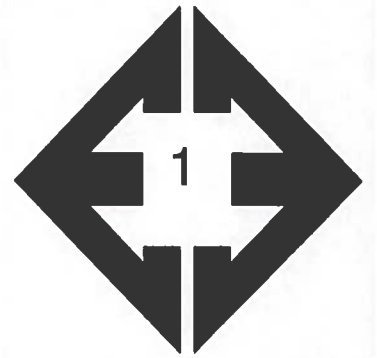

**Looking east from the southwestern portion of the site.**

March 7, 2017

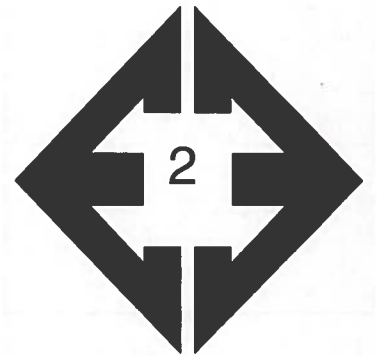

**Looking north from the southwestern portion of the site.**

March 7, 2017



**Looking north from the  
southeast portion of  
the site.**

March 7, 2017



**Looking northwest  
from the southeast  
portion of the site.**

March 7, 2017



**Looking north from the eastern side of the site.**

March 7, 2017



**Looking south from the northeastern portion of the site.**

March 7, 2017





**Looking southwest  
from the northeastern  
portion of the site.**

March 7, 2017



**Looking east from the  
northern portion of the  
site.**

March 7, 2017

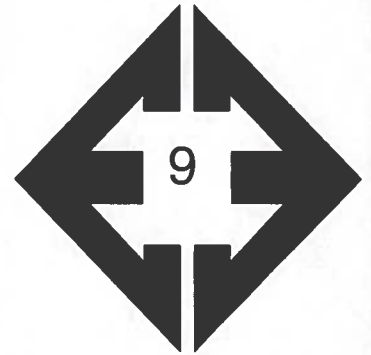

**Looking west from the northern portion of the site.**

March 7, 2017

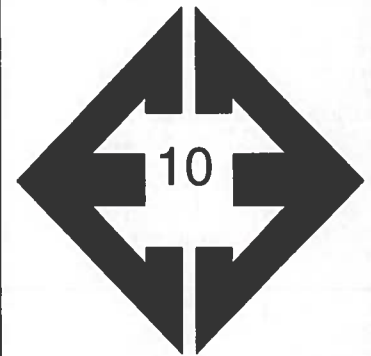

**Looking south from the northern portion of the site.**

March 7, 2017

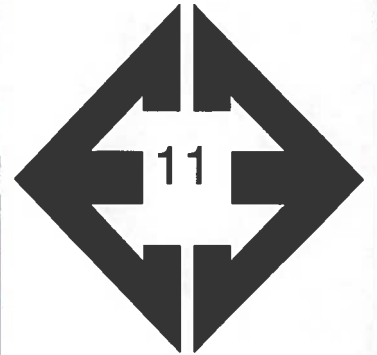

**Looking southwest  
from the western  
portion of the site.**

February 10, 2017



**Looking east from the  
western portion of the  
site.**

March 7, 2017

## **APPENDIX B: Test Boring Logs**

TEST BORING NO. 1  
 DATE DRILLED 1/30/2017  
 Job # 170039

TEST BORING NO. 2  
 DATE DRILLED 1/30/2017  
 CLIENT DAKOTA SPRINGS ENGINEERING  
 LOCATION SPRINGS AT WATERVIEW

REMARKS

REMARKS

DRY TO 19.5', 1/31/17  
 CLAY, SANDY, GRAY BROWN,  
 STIFF TO VERY STIFF, MOIST

DRY TO 20', 1/31/17  
 CLAY, SANDY, STIFF TO  
 SOFT, MOIST

CLAYSTONE, SANDY, GRAY  
 BROWN, HARD, MOIST

Depth (ft)	Symbol	Samples	Blows per foot	Watercontent %	Soil Type	Depth (ft)	Symbol	Samples	Blows per foot	Watercontent %	Soil Type
0						0					
5			24	9.6	2	5			18	7.5	2
5			35	13.2	2	5			22	9.1	2
10			50	13.4	3	10			14	8.8	2
			8"								
15			50	12.5	3	15			11	15.8	2
			6"								
20			50	18.6	3	20			7	19.5	2
			6"								



**ENTECH**  
**ENGINEERING, INC.**

505 ELKTON DRIVE  
 COLORADO SPRINGS, COLORADO 80907

TEST BORING LOG

DRAWN:

DATE:

CHECKED:

DATE:

LLL

4/12/17

JOB NO.:  
 170039

FIG NO.:  
 B- 1

TEST BORING NO. 3  
 DATE DRILLED 1/30/2017  
 Job # 170039

TEST BORING NO. 4  
 DATE DRILLED 1/30/2017  
 CLIENT DAKOTA SPRINGS ENGINEERING  
 LOCATION SPRINGS AT WATERVIEW

REMARKS	Depth (ft)	Symbol	Samples	Blows per foot	Watercontent %	Soil Type	REMARKS	Depth (ft)	Symbol	Samples	Blows per foot	Watercontent %	Soil Type
DRY TO 19.5', 1/31/17 CLAY, SANDY, TAN, STIFF TO VERY STIFF, MOIST							DRY TO 19.5', 1/31/17 CLAY, SANDY, GRAY BROWN, STIFF, MOIST						
	5			29	11.9	2					27	15.7	2
	5			47	14.3	2	CLAYSTONE, SANDY, GRAY BROWN, HARD, MOIST	5			50 10"	13.8	3
CLAYSTONE, SANDY, GRAY BROWN, HARD, MOIST	10			50 10"	15.5	3		10			50 9"	14.5	3
	15			50 7"	15.8	3		15			50 7"	14.4	3
SHALE, DARK BROWN, HARD, MOIST	20			50 6"	12.7	3		20			50 6"	13.2	3



**ENTECH**  
**ENGINEERING, INC.**

505 ELKTON DRIVE  
 COLORADO SPRINGS, COLORADO 80907

**TEST BORING LOG**

DRAWN:

DATE:

CHECKED:  
 LLL

DATE:  
 4/12/17

JOB NO.:  
 170039

FIG NO.:  
 B- 2

TEST BORING NO. 5  
 DATE DRILLED 1/30/2017  
 Job # 170039

TEST BORING NO. 6  
 DATE DRILLED 1/30/2017  
 CLIENT DAKOTA SPRINGS ENGINEERING  
 LOCATION SPRINGS AT WATERVIEW

REMARKS

REMARKS

DRY TO 19', 1/31/17  
 CLAY, SANDY, GRAY BROWN,  
 VERY STIFF, MOIST  
  
 CLAYSTONE, SANDY, GRAY  
 BROWN, HARD, MOIST

DRY TO 19', 1/31/17  
 CLAY, SANDY, TAN, STIFF,  
 MOIST  
  
  
  
  
  
  
  
 CLAYSTONE, SANDY, TAN,  
 HARD, MOIST

Depth (ft)	Symbol	Samples	Blows per foot	Watercontent %	Soil Type	Depth (ft)	Symbol	Samples	Blows per foot	Watercontent %	Soil Type
0						0					
5			44	11.6	2	5			20	7.9	2
5			50 11"	12.5	3	5			19	9.8	2
10			50 6"	12.4	3	10			25	12.9	2
15			50 6"	15.3	3	15			50 7"	15.9	3
20			50 6"	13.4	3	20			50 6"	15.5	3



**ENTECH**  
**ENGINEERING, INC.**

505 ELKTON DRIVE  
 COLORADO SPRINGS, COLORADO 80907

**TEST BORING LOG**

DRAWN:

DATE:

CHECKED:  
*LLL*

DATE:  
*4/2/17*

JOB NO.:  
 170039

FIG NO.:  
 B- 3

TEST BORING NO. 7  
 DATE DRILLED 1/30/2017  
 Job # 170039

TEST BORING NO. 8  
 DATE DRILLED 1/30/2017  
 CLIENT DAKOTA SPRINGS ENGINEERING  
 LOCATION SPRINGS AT WATERVIEW

REMARKS

REMARKS

DRY TO 19', 1/31/17

SAND, VERY CLAYEY, FINE  
 GRAINED, TAN, MEDIUM  
 DENSE, MOIST

CLAYSTONE, SANDY, BROWN,  
 HARD, MOIST

Depth (ft)	Symbol	Samples	Blows per foot	Watercontent %	Soil Type
5			15	5.3	1
5			17	5.2	1
10			50 10"	16.8	3
15			50 8"	15.8	3
20			50 8"	15.2	3

DRY TO 19', 1/31/17

CLAY, SANDY, TAN, STIFF TO  
 VERY STIFF, MOIST

CLAYSTONE, SANDY, GRAY  
 BROWN, HARD, MOIST

Depth (ft)	Symbol	Samples	Blows per foot	Watercontent %	Soil Type
5			15	14.8	2
5			36	18.4	2
10			50 9"	12.7	3
15			50 7"	16.0	3
20			50 7"	18.2	3



**ENTECH**  
**ENGINEERING, INC.**

505 ELKTON DRIVE  
 COLORADO SPRINGS, COLORADO 80907

TEST BORING LOG

DRAWN:	DATE:	CHECKED: LLL	DATE: 1/12/17
--------	-------	-----------------	------------------

JOB NO.:  
170039

FIG NO.:  
B- 4



TEST BORING NO. 9  
 DATE DRILLED 1/30/2017  
 Job # 170039

TEST BORING NO. 10  
 DATE DRILLED 1/30/2017  
 CLIENT DAKOTA SPRINGS ENGINEERING  
 LOCATION SPRINGS AT WATERVIEW

REMARKS	Depth (ft)	Symbol	Samples	Blows per foot	Watercontent %	Soil Type	REMARKS	Depth (ft)	Symbol	Samples	Blows per foot	Watercontent %	Soil Type
DRY TO 20', 1/31/17 CLAY, SANDY, GRAY BROWN, FIRM TO STIFF, MOIST							DRY TO 20', 1/31/17 CLAY, SANDY, GRAY BROWN, STIFF, MOIST						
	5			13	11.8	2					18	13.4	2
	5			19	13.5	2	CLAYSTONE, SANDY, GRAY BROWN, HARD TO VERY STIFF, MOIST	5			50	10.3	3
	10			17	14.1	2		10			50 7"	16.5	3
CLAYSTONE, SANDY, GRAY BROWN, HARD TO VERY STIFF, MOIST	15			50	17.4	3		15			50 6"	16.7	3
WEATHERED ZONE	20			44	15.8	3	WEATHERED ZONE	20			45	20.0	3



**ENTECH**  
**ENGINEERING, INC.**

505 ELKTON DRIVE  
 COLORADO SPRINGS, COLORADO 80907

**TEST BORING LOG**

DRAWN:	DATE:	CHECKED:	DATE:
		LLL	4/12/17

JOB NO.:  
 170039

FIG NO.:  
 B- 5

## **APPENDIX C: Laboratory Test Results**

UNIFIED CLASSIFICATION	SC	CLIENT	DAKOTA SPRINGS ENGINEERING
SOIL TYPE #	1	PROJECT	SPRINGS AT WATERVIEW
TEST BORING #	7	JOB NO.	170039
DEPTH (FT)	5	TEST BY	BL

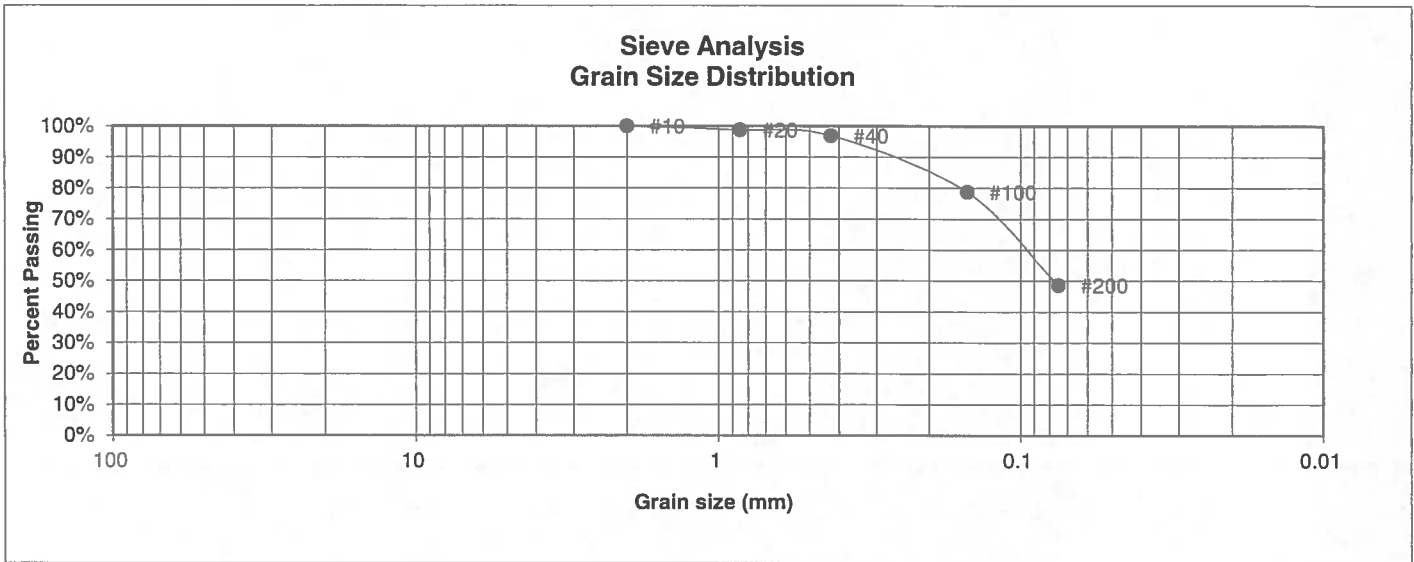

U.S. Sieve #	Percent Finer
3"	
1 1/2"	
3/4"	
1/2"	
3/8"	
4	
10	100.0%
20	98.8%
40	96.9%
100	78.7%
200	48.6%

Atterberg Limits  
 Plastic Limit  
 Liquid Limit  
 Plastic Index

Swell  
 Moisture at start  
 Moisture at finish  
 Moisture increase  
 Initial dry density (pcf)  
 Swell (psf)



**ENTECH  
ENGINEERING, INC.**

505 ELKTON DRIVE  
COLORADO SPRINGS, COLORADO 80907

**LABORATORY TEST  
RESULTS**

DRAWN:	DATE:	CHECKED:	DATE:
		<i>h</i>	2/20/17

JOB NO.:  
170039

FIG NO.:  
C-1

UNIFIED CLASSIFICATION	CL	CLIENT	DAKOTA SPRINGS ENGINEERING
SOIL TYPE #	2	PROJECT	SPRINGS AT WATERVIEW
TEST BORING #	1	JOB NO.	170039
DEPTH (FT)	5	TEST BY	BL

**Sieve Analysis  
Grain Size Distribution**

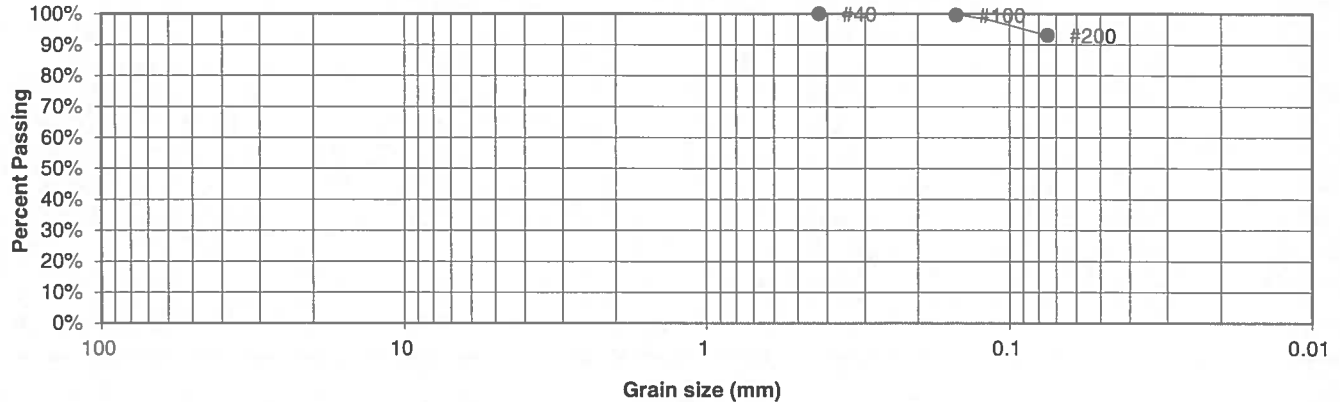

U.S. Sieve #	Percent Finer
3"	
1 1/2"	
3/4"	
1/2"	
3/8"	
4	
10	
20	
40	100.0%
100	99.6%
200	93.1%

Atterberg Limits	
Plastic Limit	17
Liquid Limit	38
Plastic Index	21

Swell	
Moisture at start	
Moisture at finish	
Moisture increase	
Initial dry density (pcf)	
Swell (psf)	



**ENTECH ENGINEERING, INC.**  
505 ELKTON DRIVE  
COLORADO SPRINGS, COLORADO 80907

**LABORATORY TEST RESULTS**

DRAWN:	DATE:	CHECKED:	DATE:
		<i>[Signature]</i>	2/10/07

JOB NO.: 170039  
FIG NO.: C-2

<u>UNIFIED CLASSIFICATION</u>	CL	<u>CLIENT</u>	DAKOTA SPRINGS ENGINEERING
<u>SOIL TYPE #</u>	2	<u>PROJECT</u>	SPRINGS AT WATERVIEW
<u>TEST BORING #</u>	2	<u>JOB NO.</u>	170039
<u>DEPTH (FT)</u>	10	<u>TEST BY</u>	BL

**Sieve Analysis  
Grain Size Distribution**

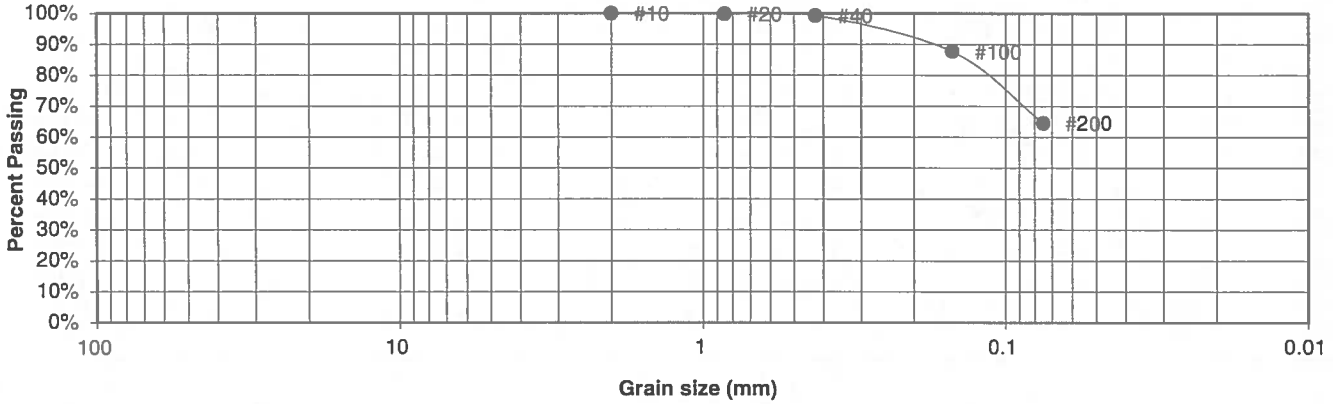

<u>U.S. Sieve #</u>	<u>Percent Finer</u>
3"	
1 1/2"	
3/4"	
1/2"	
3/8"	
4	
10	100.0%
20	99.8%
40	99.3%
100	87.7%
200	64.6%

<u>Atterberg Limits</u>	
Plastic Limit	15
Liquid Limit	29
Plastic Index	14

<u>Swell</u>	
Moisture at start	
Moisture at finish	
Moisture increase	
Initial dry density (pcf)	
Swell (psf)	



**ENTECH  
ENGINEERING, INC.**

505 ELKTON DRIVE  
COLORADO SPRINGS, COLORADO 80907

**LABORATORY TEST  
RESULTS**

DRAWN:	DATE:	CHECKED:	DATE:
		<i>[Signature]</i>	2/20/07

JOB NO.:  
170039

FIG NO.:  
C-3

<u>UNIFIED CLASSIFICATION</u>	CL	<u>CLIENT</u>	DAKOTA SPRINGS ENGINEERING
<u>SOIL TYPE #</u>	2	<u>PROJECT</u>	SPRINGS AT WATERVIEW
<u>TEST BORING #</u>	3	<u>JOB NO.</u>	170039
<u>DEPTH (FT)</u>	2-3	<u>TEST BY</u>	BL

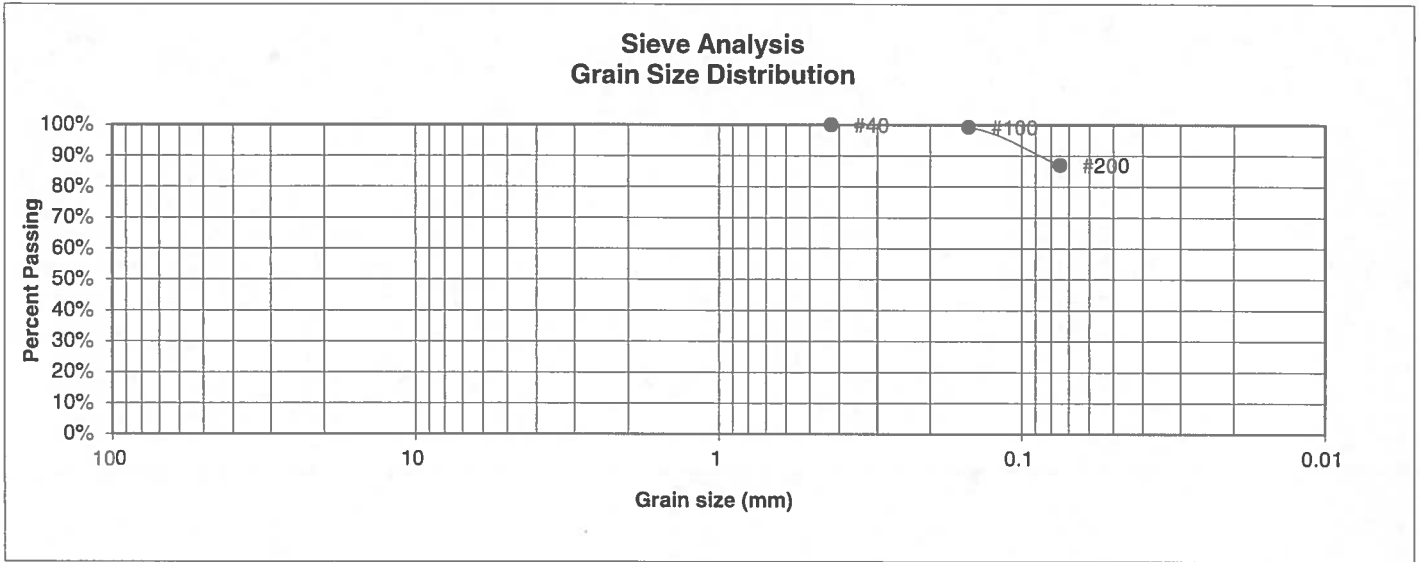

<u>U.S. Sieve #</u>	<u>Percent Finer</u>
3"	
1 1/2"	
3/4"	
1/2"	
3/8"	
4	
10	
20	
40	100.0%
100	99.3%
200	87.0%

Atterberg Limits  
 Plastic Limit  
 Liquid Limit  
 Plastic Index

<u>Swell</u>	
Moisture at start	19.8%
Moisture at finish	23.3%
Moisture increase	3.5%
Initial dry density (pcf)	102
Swell (psf)	690



**ENTECH  
ENGINEERING, INC.**

505 ELKTON DRIVE  
COLORADO SPRINGS, COLORADO 80907

**LABORATORY TEST  
RESULTS**

DRAWN:	DATE:	CHECKED: <i>h</i>	DATE: 2/10/07
--------	-------	-------------------	---------------

JOB NO.:  
170039

FIG NO.:  
C-4

<u>UNIFIED CLASSIFICATION</u>	CL	<u>CLIENT</u>	DAKOTA SPRINGS ENGINEERING
<u>SOIL TYPE #</u>	2	<u>PROJECT</u>	SPRINGS AT WATERVIEW
<u>TEST BORING #</u>	5	<u>JOB NO.</u>	170039
<u>DEPTH (FT)</u>	2-3	<u>TEST BY</u>	BL

**Sieve Analysis  
Grain Size Distribution**

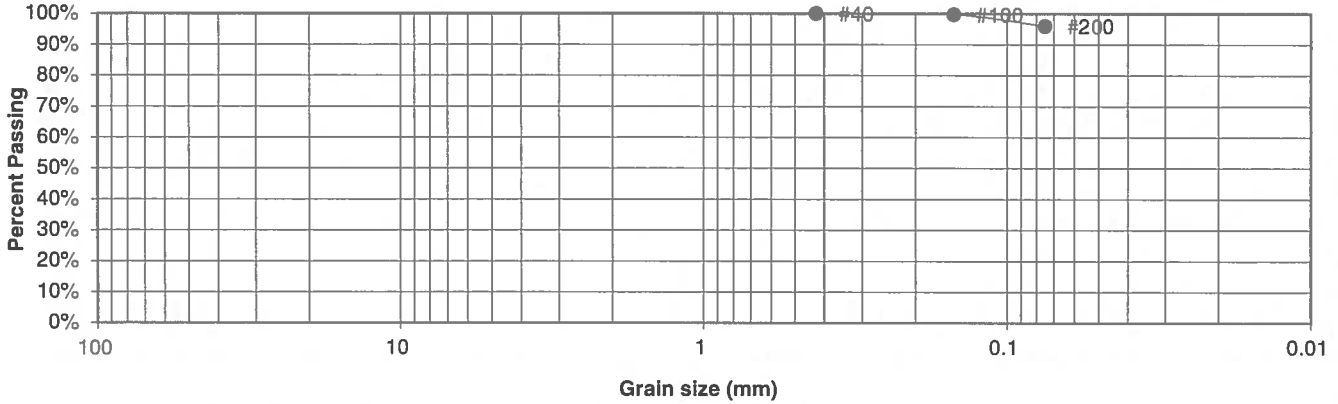

<u>U.S. Sieve #</u>	<u>Percent Finer</u>
3"	
1 1/2"	
3/4"	
1/2"	
3/8"	
4	
10	
20	
40	100.0%
100	99.7%
200	96.0%

Atterberg Limits  
 Plastic Limit  
 Liquid Limit  
 Plastic Index

Swell  
 Moisture at start  
 Moisture at finish  
 Moisture increase  
 Initial dry density (pcf)  
 Swell (psf)



**ENTECH  
ENGINEERING, INC.**

505 ELKTON DRIVE  
COLORADO SPRINGS, COLORADO 80907

**LABORATORY TEST  
RESULTS**

DRAWN:	DATE:	CHECKED:	DATE:
		<i>[Signature]</i>	2/10/12

JOB NO.:  
170039

FIG NO.:  
C-5

<b>UNIFIED CLASSIFICATION</b>	CL	<b>CLIENT</b>	DAKOTA SPRINGS ENGINEERING
<b>SOIL TYPE #</b>	2	<b>PROJECT</b>	SPRINGS AT WATERVIEW
<b>TEST BORING #</b>	6	<b>JOB NO.</b>	170039
<b>DEPTH (FT)</b>	2-3	<b>TEST BY</b>	BL

**Sieve Analysis  
Grain Size Distribution**

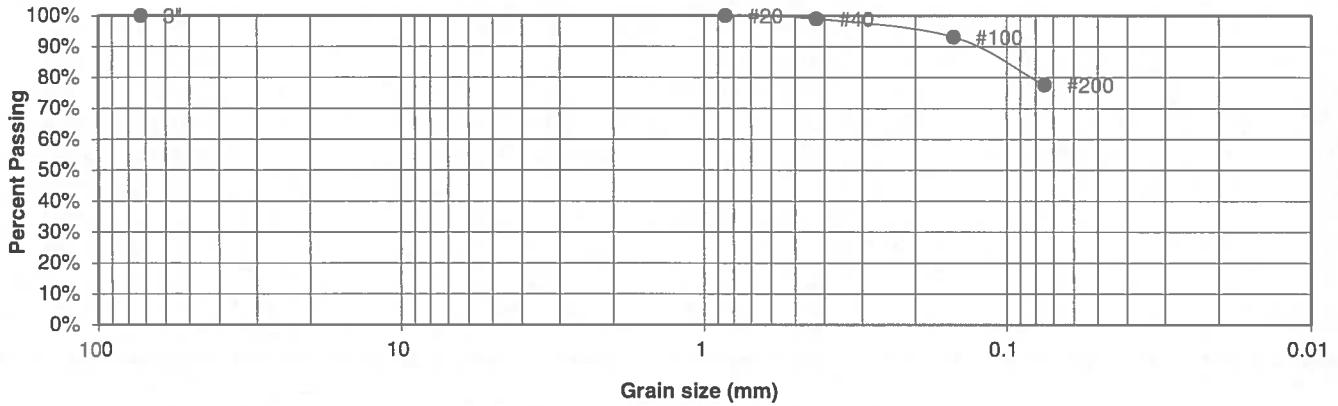

U.S. Sieve #	Percent Finer
3"	100.0%
1 1/2"	
3/4"	
1/2"	
3/8"	
4	
10	
20	100.0%
40	99.0%
100	93.1%
200	77.6%

**Atterberg Limits**  
 Plastic Limit  
 Liquid Limit  
 Plastic Index

<b>Swell</b>	
Moisture at start	11.7%
Moisture at finish	22.5%
Moisture increase	10.8%
Initial dry density (pcf)	102
Swell (psf)	980



**ENTECH  
ENGINEERING, INC.**

505 ELKTON DRIVE  
COLORADO SPRINGS, COLORADO 80907

**LABORATORY TEST  
RESULTS**

DRAWN:	DATE:	CHECKED:	DATE:
		<i>[Signature]</i>	2/10/17

JOB NO.:  
170039

FIG NO.:  
C-6



UNIFIED CLASSIFICATION	CL	CLIENT	DAKOTA SPRINGS ENGINEERING
SOIL TYPE #	2	PROJECT	SPRINGS AT WATERVIEW
TEST BORING #	9	JOB NO.	170039
DEPTH (FT)	5	TEST BY	BL

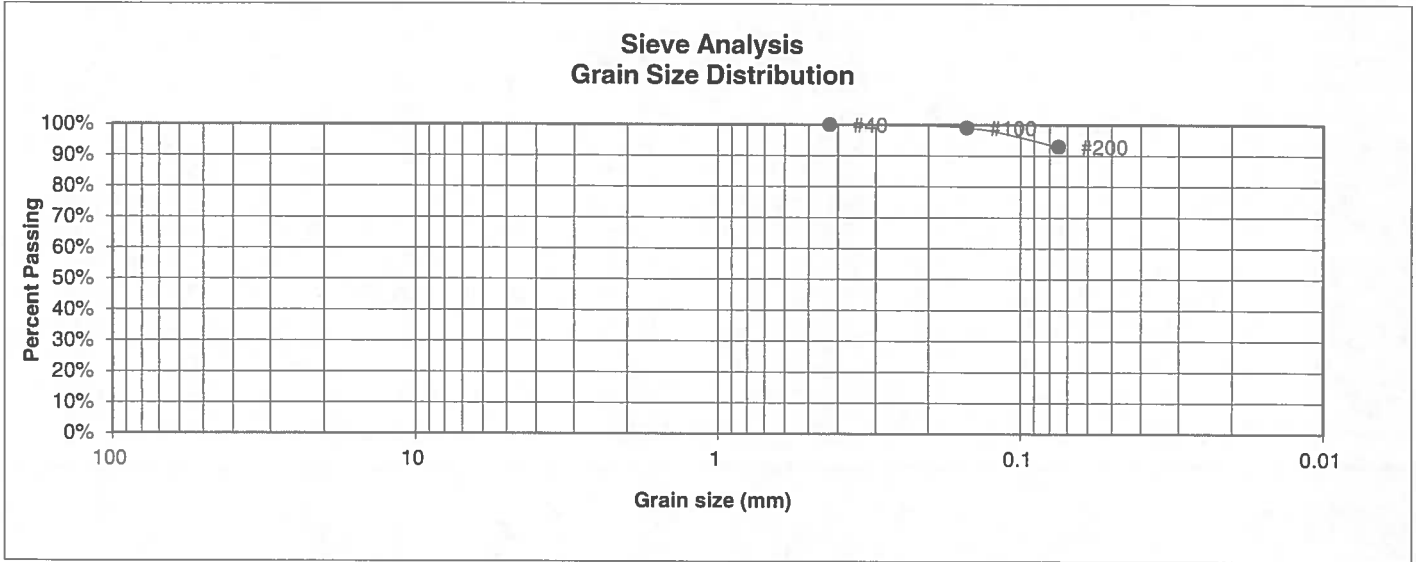

U.S. Sieve #	Percent Finer
3"	
1 1/2"	
3/4"	
1/2"	
3/8"	
4	
10	
20	
40	100.0%
100	99.1%
200	93.0%

Atterberg Limits  
 Plastic Limit  
 Liquid Limit  
 Plastic Index

Swell  
 Moisture at start  
 Moisture at finish  
 Moisture increase  
 Initial dry density (pcf)  
 Swell (psf)



**ENTECH  
ENGINEERING, INC.**

505 ELKTON DRIVE  
COLORADO SPRINGS, COLORADO 80907

**LABORATORY TEST  
RESULTS**

DRAWN:	DATE:	CHECKED:	DATE:
		<i>[Signature]</i>	2/20/09

JOB NO.:  
170039

FIG NO.:  
C-7



<u>UNIFIED CLASSIFICATION</u>	CH	<u>CLIENT</u>	DAKOTA SPRINGS ENGINEERING
<u>SOIL TYPE #</u>	3	<u>PROJECT</u>	SPRINGS AT WATERVIEW
<u>TEST BORING #</u>	4	<u>JOB NO.</u>	170039
<u>DEPTH (FT)</u>	5	<u>TEST BY</u>	BL

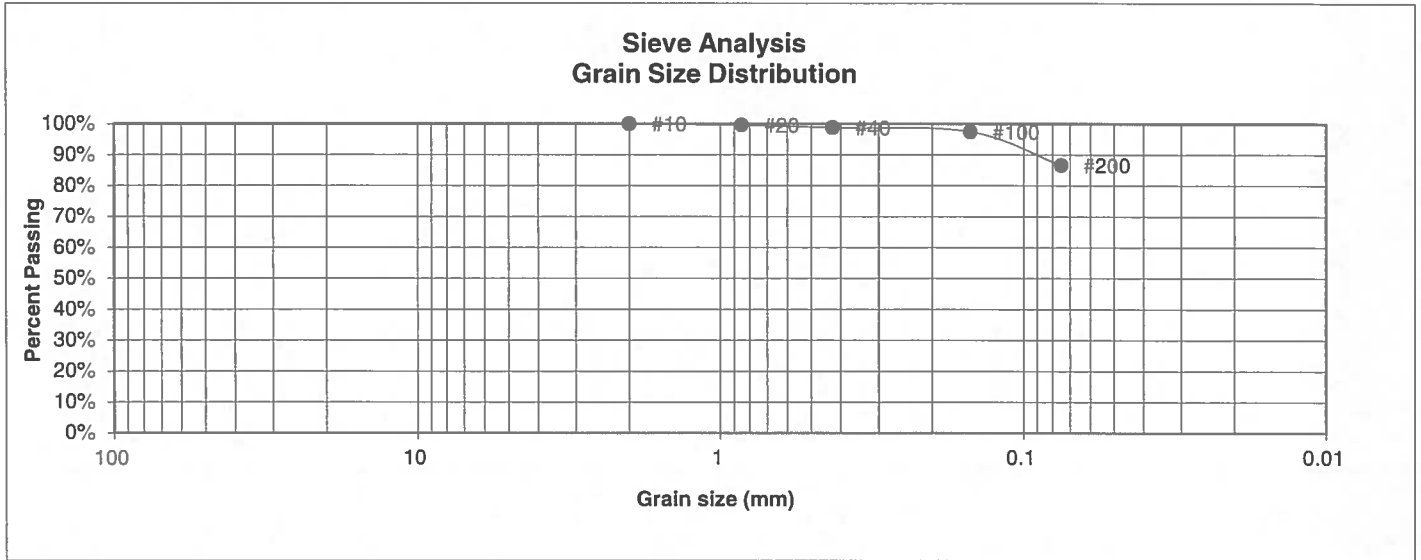

<u>U.S. Sieve #</u>	<u>Percent Finer</u>
3"	
1 1/2"	
3/4"	
1/2"	
3/8"	
4	
10	100.0%
20	99.6%
40	98.8%
100	97.5%
200	86.6%

<u>Atterberg Limits</u>	
Plastic Limit	25
Liquid Limit	54
Plastic Index	29

<u>Swell</u>	
Moisture at start	
Moisture at finish	
Moisture increase	
Initial dry density (pcf)	
Swell (psf)	



**ENTECH  
ENGINEERING, INC.**  
505 ELKTON DRIVE  
COLORADO SPRINGS, COLORADO 80907

**LABORATORY TEST  
RESULTS**

DRAWN:	DATE:	CHECKED: <i>am</i>	DATE: <i>2/22/17</i>
--------	-------	--------------------	----------------------

JOB NO.:  
170039

FIG NO.:  
C-9

<u>UNIFIED CLASSIFICATION</u>	CL	<u>CLIENT</u>	DAKOTA SPRINGS ENGINEERING
<u>SOIL TYPE #</u>	3	<u>PROJECT</u>	SPRINGS AT WATERVIEW
<u>TEST BORING #</u>	5	<u>JOB NO.</u>	170039
<u>DEPTH (FT)</u>	10	<u>TEST BY</u>	BL

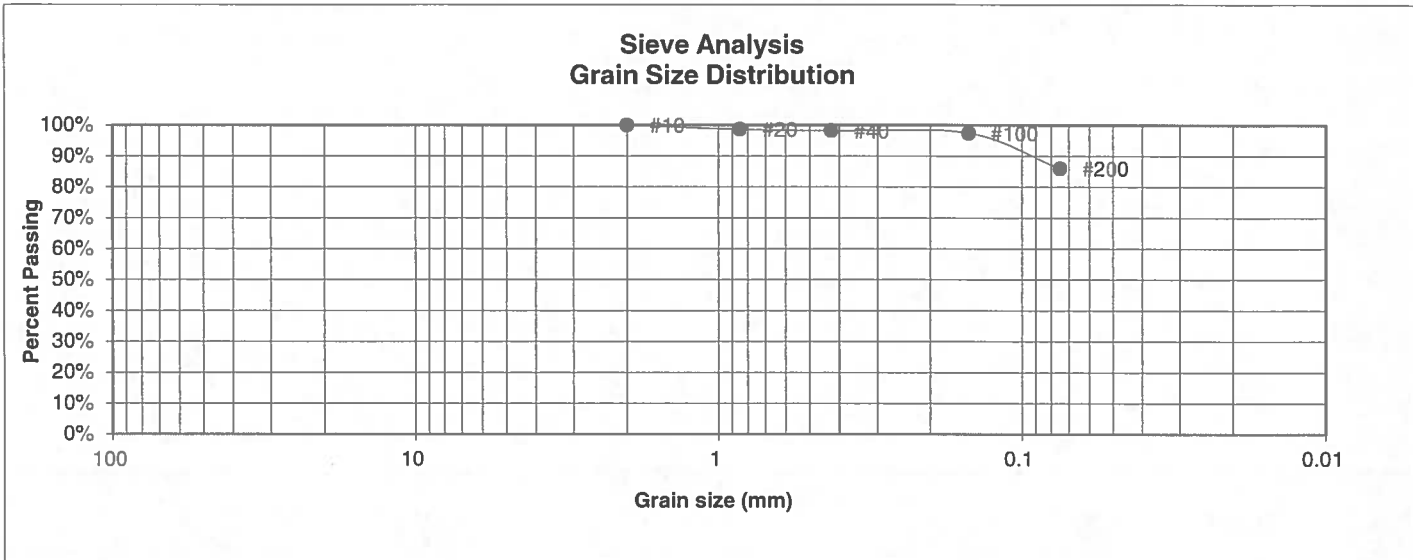

<u>U.S. Sieve #</u>	<u>Percent Finer</u>
3"	
1 1/2"	
3/4"	
1/2"	
3/8"	
4	
10	100.0%
20	98.6%
40	98.2%
100	97.5%
200	86.0%

<u>Atterberg Limits</u>	
Plastic Limit	20
Liquid Limit	43
Plastic Index	23

<u>Swell</u>	
Moisture at start	
Moisture at finish	
Moisture increase	
Initial dry density (pcf)	
Swell (psf)	



**ENTECH ENGINEERING, INC.**  
505 ELKTON DRIVE  
COLORADO SPRINGS, COLORADO 80907

**LABORATORY TEST RESULTS**

DRAWN:	DATE:	CHECKED:	DATE:
		<i>[Signature]</i>	2/10/17

JOB NO.: 170039  
FIG NO.: C-10

<u>UNIFIED CLASSIFICATION</u>	CL	<u>CLIENT</u>	DAKOTA SPRINGS ENGINEERING
<u>SOIL TYPE #</u>	3	<u>PROJECT</u>	SPRINGS AT WATERVIEW
<u>TEST BORING #</u>	6	<u>JOB NO.</u>	170039
<u>DEPTH (FT)</u>	20	<u>TEST BY</u>	BL

**Sieve Analysis  
Grain Size Distribution**

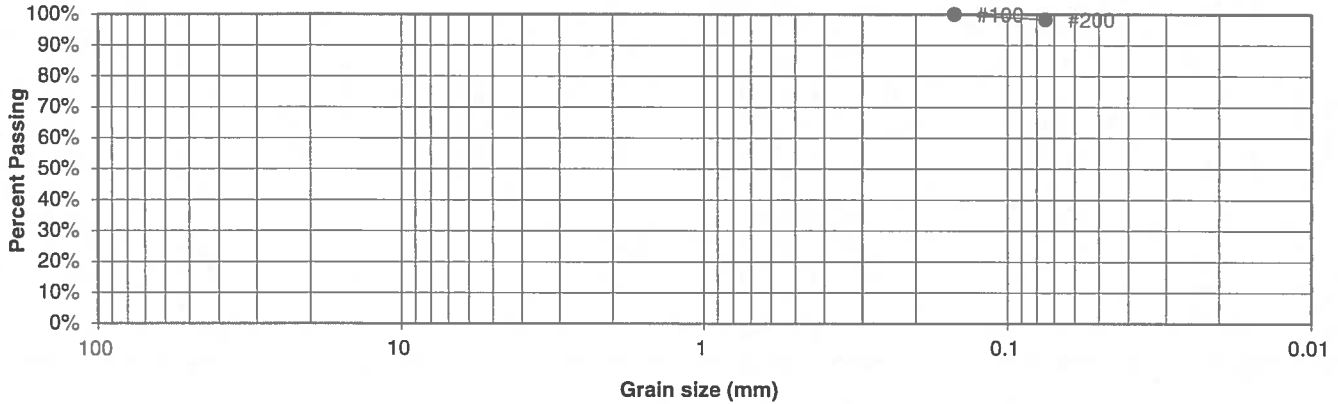

<u>U.S. Sieve #</u>	<u>Percent Finer</u>
3"	
1 1/2"	
3/4"	
1/2"	
3/8"	
4	
10	
20	
40	
100	100.0%
200	98.3%

Atterberg Limits  
 Plastic Limit  
 Liquid Limit  
 Plastic Index

Swell  
 Moisture at start  
 Moisture at finish  
 Moisture increase  
 Initial dry density (pcf)  
 Swell (psf)



**ENTECH  
ENGINEERING, INC.**

505 ELKTON DRIVE  
COLORADO SPRINGS, COLORADO 80907

**LABORATORY TEST  
RESULTS**

DRAWN:	DATE:	CHECKED: <i>BL</i>	DATE: <i>2/10/07</i>
--------	-------	--------------------	----------------------

JOB NO.:  
170039

FIG NO.:  
C-11

<u>UNIFIED CLASSIFICATION</u>	CL	<u>CLIENT</u>	DAKOTA SPRINGS ENGINEERING
<u>SOIL TYPE #</u>	3	<u>PROJECT</u>	SPRINGS AT WATERVIEW
<u>TEST BORING #</u>	7	<u>JOB NO.</u>	170039
<u>DEPTH (FT)</u>	15	<u>TEST BY</u>	BL

**Sieve Analysis  
Grain Size Distribution**

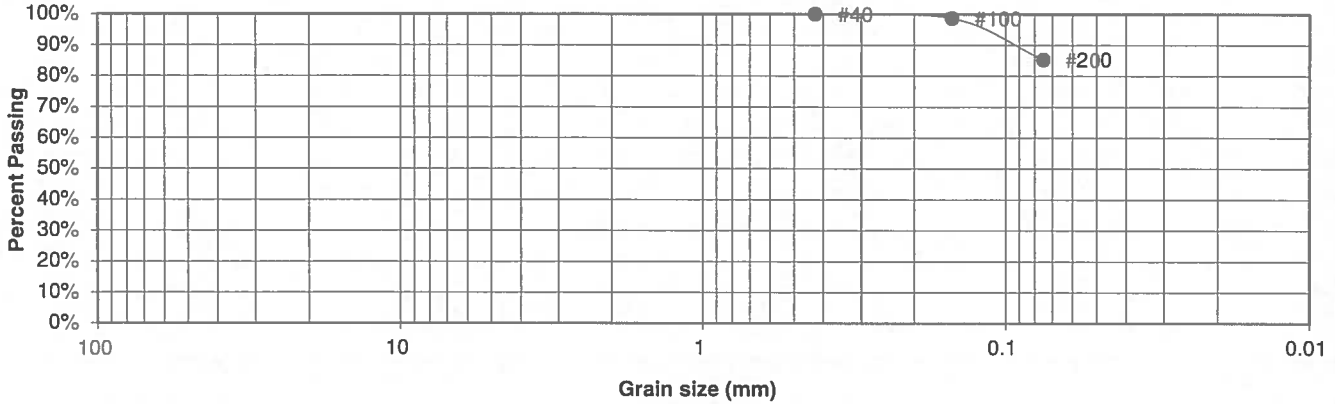

<u>U.S. Sieve #</u>	<u>Percent Finer</u>
3"	
1 1/2"	
3/4"	
1/2"	
3/8"	
4	
10	
20	
40	100.0%
100	98.7%
200	85.3%

Atterberg Limits  
 Plastic Limit  
 Liquid Limit  
 Plastic Index

Swell  
 Moisture at start  
 Moisture at finish  
 Moisture increase  
 Initial dry density (pcf)  
 Swell (psf)



**ENTECH  
ENGINEERING, INC.**

505 ELKTON DRIVE  
COLORADO SPRINGS, COLORADO 80907

**LABORATORY TEST  
RESULTS**

DRAWN:	DATE:	CHECKED:	DATE:
		<i>A</i>	2/20/17

JOB NO.:  
170039

FIG NO.:  
C-12

<u>UNIFIED CLASSIFICATION</u>	CL	<u>CLIENT</u>	DAKOTA SPRINGS ENGINEERING
<u>SOIL TYPE #</u>	3	<u>PROJECT</u>	SPRINGS AT WATERVIEW
<u>TEST BORING #</u>	8	<u>JOB NO.</u>	170039
<u>DEPTH (FT)</u>	10	<u>TEST BY</u>	BL

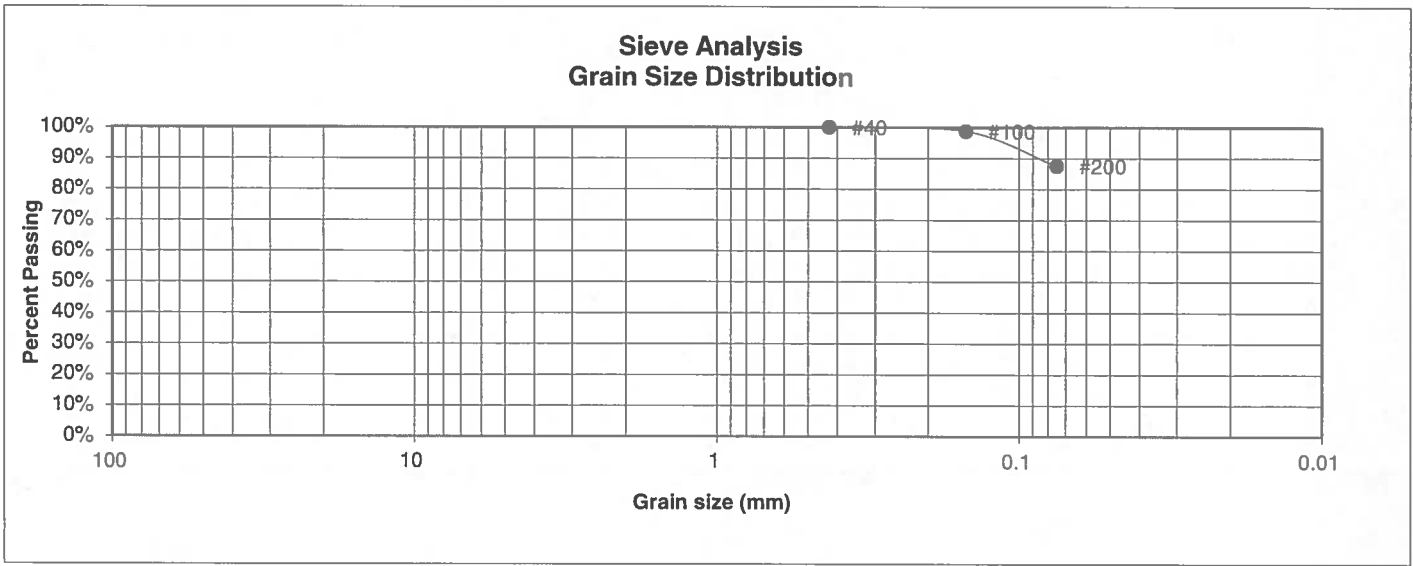

<u>U.S. Sieve #</u>	<u>Percent Finer</u>
3"	
1 1/2"	
3/4"	
1/2"	
3/8"	
4	
10	
20	
40	100.0%
100	98.8%
200	87.6%

Atterberg Limits  
 Plastic Limit  
 Liquid Limit  
 Plastic Index

<u>Swell</u>	
Moisture at start	13.4%
Moisture at finish	24.2%
Moisture increase	10.8%
Initial dry density (pcf)	102
Swell (psf)	1880



**ENTECH  
ENGINEERING, INC.**

505 ELKTON DRIVE  
COLORADO SPRINGS, COLORADO 80907

**LABORATORY TEST  
RESULTS**

DRAWN:	DATE:	CHECKED:	DATE:
		<i>[Signature]</i>	2/20/17

JOB NO.:  
170039

FIG NO.:  
C-13

**CONSOLIDATION TEST RESULTS**

TEST BORING #	1	DEPTH(ft)	5
DESCRIPTION	CL	SOIL TYPE	2
NATURAL UNIT DRY WEIGHT (PCF)			121
NATURAL MOISTURE CONTENT			13.7%
SWELL/CONSOLIDATION (%)			6.4%

JOB NO. 170039  
 CLIENT DAKOTA SPRINGS ENGINEERING  
 PROJECT SPRINGS AT WATERVIEW

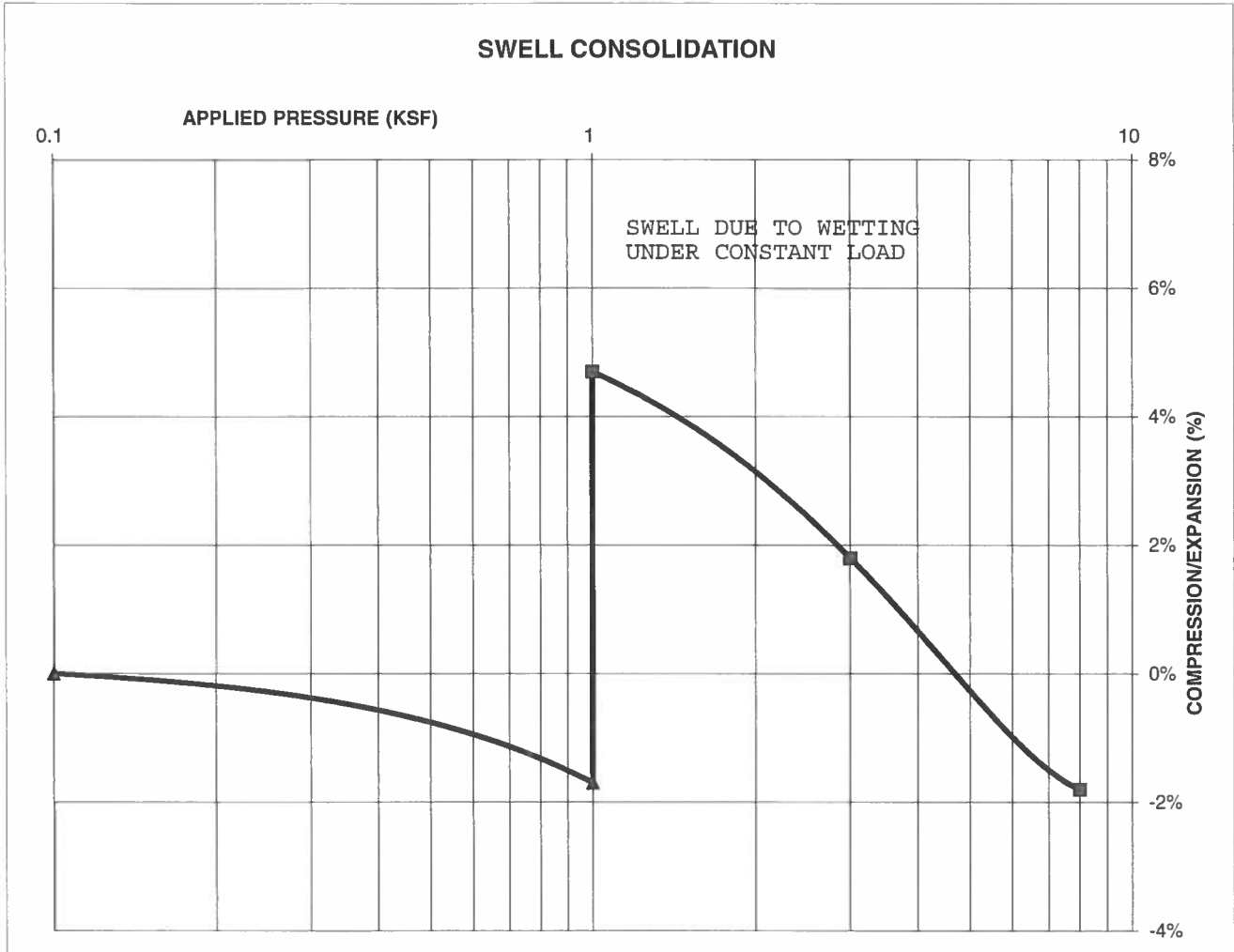

**ENTECH  
ENGINEERING, INC.**

505 ELKTON DRIVE  
 COLORADO SPRINGS, COLORADO 80907

**SWELL CONSOLIDATION  
TEST RESULTS**

DRAWN:

DATE:

CHECKED:  
LLL

DATE:  
2/14/17

JOB NO.:  
170039

FIG NO.:

C-14



**CONSOLIDATION TEST RESULTS**

TEST BORING #	2	DEPTH(ft)	10
DESCRIPTION	CL	SOIL TYPE	2
NATURAL UNIT DRY WEIGHT (PCF)			105
NATURAL MOISTURE CONTENT			8.3%
SWELL/CONSOLIDATION (%)			-0.3%

JOB NO. 170039  
 CLIENT DAKOTA SPRINGS ENGINEERING  
 PROJECT SPRINGS AT WATERVIEW

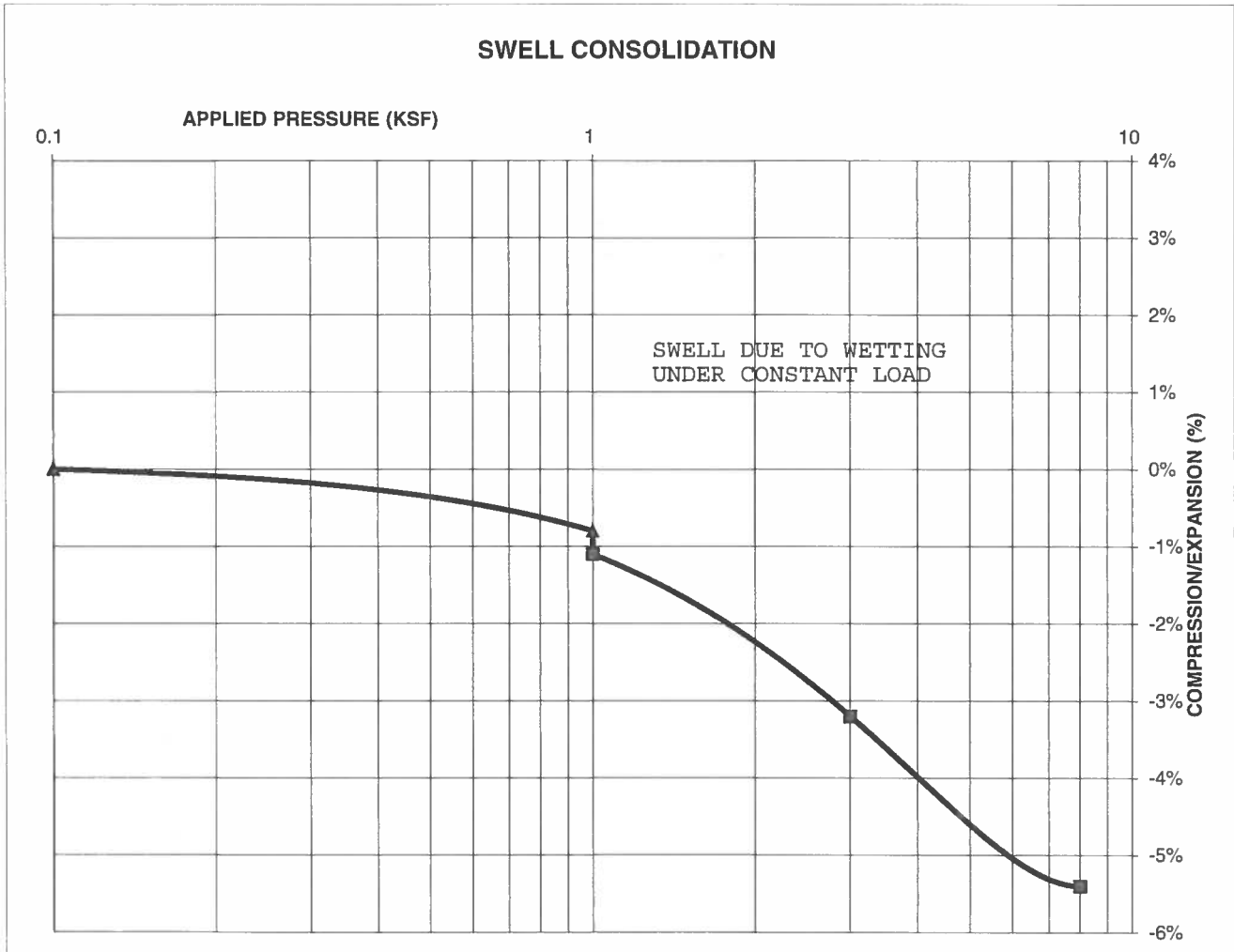

**ENTECH  
 ENGINEERING, INC.**

505 ELKTON DRIVE  
 COLORADO SPRINGS, COLORADO 80907

**SWELL CONSOLIDATION  
 TEST RESULTS**

DRAWN:

DATE:

CHECKED:  
 LLL

DATE:  
 2/14/17

JOB NO.:  
 170039

FIG NO.:  
 C-15

**CONSOLIDATION TEST RESULTS**

TEST BORING #	9	DEPTH(ft)	5
DESCRIPTION	CL	SOIL TYPE	2
NATURAL UNIT DRY WEIGHT (PCF)			98
NATURAL MOISTURE CONTENT			16.9%
SWELL/CONSOLIDATION (%)			1.6%

JOB NO. 170039  
 CLIENT DAKOTA SPRINGS ENGINEERING  
 PROJECT SPRINGS AT WATERVIEW

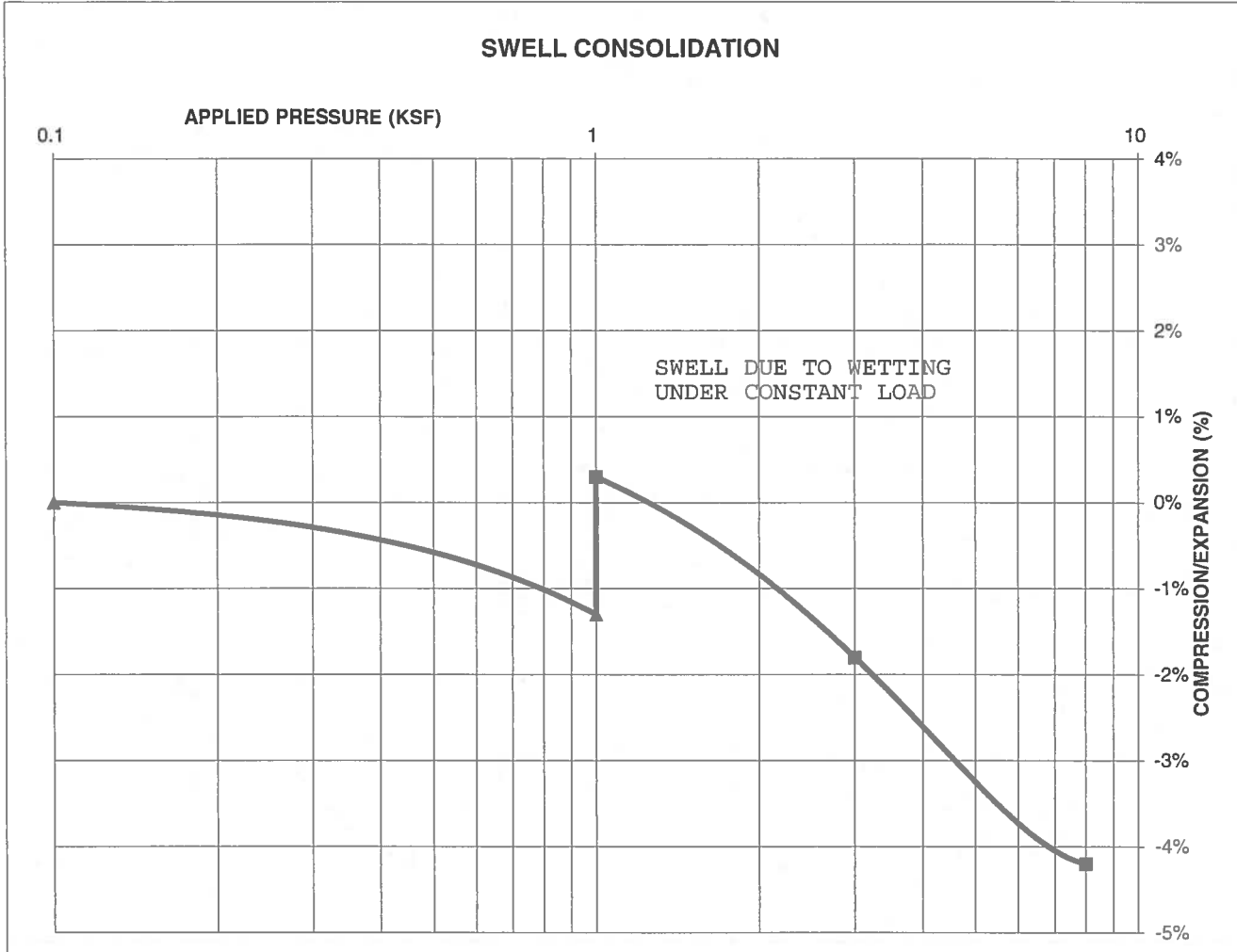

**ENTECH  
ENGINEERING, INC.**

505 ELKTON DRIVE  
 COLORADO SPRINGS, COLORADO 80907

**SWELL CONSOLIDATION  
TEST RESULTS**

DRAWN:

DATE:

CHECKED:  
LLL

DATE:  
2/14/17

JOB NO.:  
170039

FIG NO.:  
C-16

**CONSOLIDATION TEST RESULTS**

TEST BORING #	4	DEPTH(ft)	5
DESCRIPTION	CH	SOIL TYPE	3
NATURAL UNIT DRY WEIGHT (PCF)	114		
NATURAL MOISTURE CONTENT	16.9%		
SWELL/CONSOLIDATION (%)	3.4%		

JOB NO. 170039  
 CLIENT DAKOTA SPRINGS ENGINEERING  
 PROJECT SPRINGS AT WATERVIEW



**ENTECH  
ENGINEERING, INC.**

505 ELKTON DRIVE  
 COLORADO SPRINGS, COLORADO 80907

SWELL CONSOLIDATION  
 TEST RESULTS

DRAWN:

DATE:

CHECKED:  
 LLL

DATE:  
 2/14/17

JOB NO.:  
 170039

FIG NO.:  
 C-17

**CONSOLIDATION TEST RESULTS**

TEST BORING #	5	DEPTH(ft)	10
DESCRIPTION	CL	SOIL TYPE	3
NATURAL UNIT DRY WEIGHT (PCF)			109
NATURAL MOISTURE CONTENT			17.7%
SWELL/CONSOLIDATION (%)			2.0%

JOB NO. 170039  
 CLIENT DAKOTA SPRINGS ENGINEERING  
 PROJECT SPRINGS AT WATERVIEW

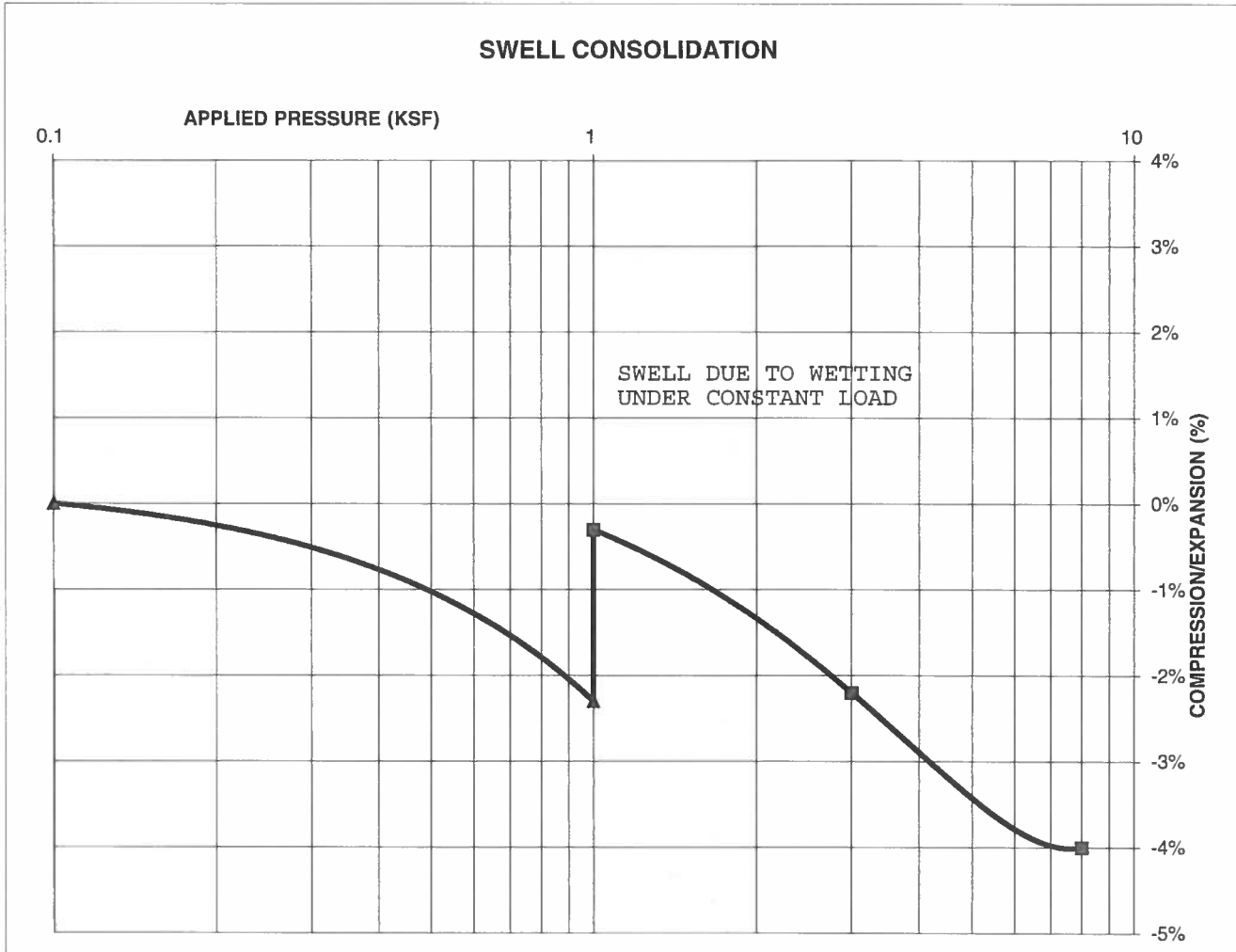

**ENTECH**  
**ENGINEERING, INC.**

505 ELKTON DRIVE  
 COLORADO SPRINGS, COLORADO 80907

SWELL CONSOLIDATION  
 TEST RESULTS

DRAWN:

DATE:

CHECKED:  
 LLL

DATE:  
 2/14/17

JOB NO.:  
 170039

FIG NO.:  
 C-18

**CONSOLIDATION TEST RESULTS**

TEST BORING #	6	DEPTH(ft)	20
DESCRIPTION	CL	SOIL TYPE	3
NATURAL UNIT DRY WEIGHT (PCF)			111
NATURAL MOISTURE CONTENT			19.0%
SWELL/CONSOLIDATION (%)			3.8%

JOB NO. 170039  
 CLIENT DAKOTA SPRINGS ENGINEERING  
 PROJECT SPRINGS AT WATERVIEW

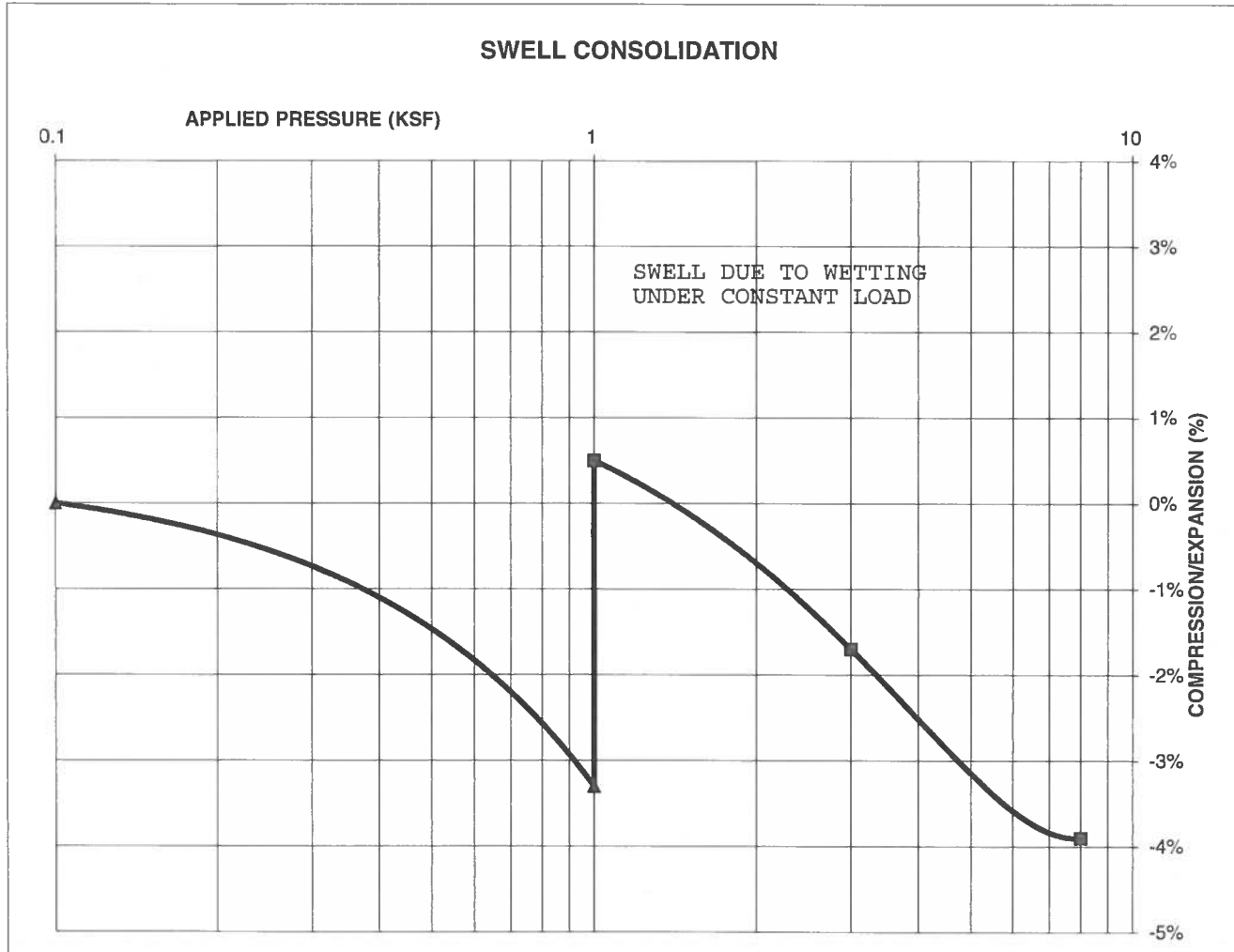

**ENTECH  
ENGINEERING, INC.**

505 ELKTON DRIVE  
 COLORADO SPRINGS, COLORADO 80907

**SWELL CONSOLIDATION  
TEST RESULTS**

DRAWN:

DATE:

CHECKED:  
LLL

DATE:  
2/14/17

JOB NO.:  
170039

FIG NO.:  
C-19



## **APPENDIX D: Soil Survey Descriptions**

## El Paso County Area, Colorado

### 8—Blakeland loamy sand, 1 to 9 percent slopes

#### Map Unit Setting

*National map unit symbol:* 369v  
*Elevation:* 4,600 to 5,800 feet  
*Mean annual precipitation:* 14 to 16 inches  
*Mean annual air temperature:* 46 to 48 degrees F  
*Frost-free period:* 125 to 145 days  
*Farmland classification:* Not prime farmland

#### Map Unit Composition

*Blakeland and similar soils:* 85 percent  
*Estimates are based on observations, descriptions, and transects of the mapunit.*

#### Description of Blakeland

##### Setting

*Landform:* Flats, hills  
*Landform position (three-dimensional):* Side slope, talf  
*Down-slope shape:* Linear  
*Across-slope shape:* Linear  
*Parent material:* Alluvium derived from sedimentary rock and/or eolian deposits derived from sedimentary rock

##### Typical profile

*A - 0 to 11 inches:* loamy sand  
*AC - 11 to 27 inches:* loamy sand  
*C - 27 to 60 inches:* sand

##### Properties and qualities

*Slope:* 1 to 9 percent  
*Depth to restrictive feature:* More than 80 inches  
*Natural drainage class:* Somewhat excessively drained  
*Runoff class:* Low  
*Capacity of the most limiting layer to transmit water (Ksat):* High to very high (5.95 to 19.98 in/hr)  
*Depth to water table:* More than 80 inches  
*Frequency of flooding:* None  
*Frequency of ponding:* None  
*Calcium carbonate, maximum in profile:* 5 percent  
*Available water storage in profile:* Low (about 4.5 inches)

##### Interpretive groups

*Land capability classification (irrigated):* 3e  
*Land capability classification (nonirrigated):* 6e  
*Hydrologic Soil Group:* A  
*Ecological site:* Sandy Foothill (R049BY210CO)  
*Hydric soil rating:* No



### Minor Components

#### Other soils

*Percent of map unit:*  
*Hydric soil rating:* No

#### Pleasant

*Percent of map unit:*  
*Landform:* Depressions  
*Hydric soil rating:* Yes

## Data Source Information

Soil Survey Area: El Paso County Area, Colorado  
Survey Area Data: Version 14, Sep 23, 2016

## El Paso County Area, Colorado

### 31—Fort Collins loam, 3 to 8 percent slopes

#### Map Unit Setting

*National map unit symbol:* 3684  
*Elevation:* 5,200 to 6,500 feet  
*Mean annual precipitation:* 14 to 16 inches  
*Mean annual air temperature:* 48 to 52 degrees F  
*Farmland classification:* Not prime farmland

#### Map Unit Composition

*Fort collins and similar soils:* 85 percent  
*Estimates are based on observations, descriptions, and transects of the mapunit.*

#### Description of Fort Collins

##### Setting

*Landform:* Hills  
*Landform position (three-dimensional):* Side slope  
*Down-slope shape:* Linear  
*Across-slope shape:* Linear  
*Parent material:* Loamy alluvium

##### Typical profile

*A - 0 to 9 inches:* loam  
*Bt - 9 to 16 inches:* clay loam  
*Bk - 16 to 21 inches:* clay loam  
*Ck - 21 to 60 inches:* loam

##### Properties and qualities

*Slope:* 3 to 8 percent  
*Depth to restrictive feature:* More than 80 inches  
*Natural drainage class:* Well drained  
*Runoff class:* Medium  
*Capacity of the most limiting layer to transmit water (Ksat):*  
Moderately high to high (0.57 to 2.00 in/hr)  
*Depth to water table:* More than 80 inches  
*Frequency of flooding:* None  
*Frequency of ponding:* None  
*Calcium carbonate, maximum in profile:* 15 percent  
*Salinity, maximum in profile:* Nonsaline to very slightly saline (0.0 to 2.0 mmhos/cm)  
*Available water storage in profile:* High (about 10.1 inches)

##### Interpretive groups

*Land capability classification (irrigated):* None specified  
*Land capability classification (nonirrigated):* 6e  
*Hydrologic Soil Group:* B  
*Ecological site:* Loamy Plains (R067BY002CO)  
*Other vegetative classification:* LOAMY PLAINS (069AY006CO)

*Hydric soil rating:* No

**Minor Components**

**Pleasant**

*Percent of map unit:*

*Landform:* Depressions

*Hydric soil rating:* Yes

**Other soils**

*Percent of map unit:*

*Hydric soil rating:* No

**Data Source Information**

Soil Survey Area: El Paso County Area, Colorado  
Survey Area Data: Version 14, Sep 23, 2016

## El Paso County Area, Colorado

### 52—Manzanst clay loam, 0 to 3 percent slopes

#### Map Unit Setting

*National map unit symbol:* 2w4nr  
*Elevation:* 4,060 to 6,660 feet  
*Mean annual precipitation:* 14 to 16 inches  
*Mean annual air temperature:* 50 to 54 degrees F  
*Frost-free period:* 130 to 170 days  
*Farmland classification:* Prime farmland if irrigated

#### Map Unit Composition

*Manzanst and similar soils:* 85 percent  
*Minor components:* 15 percent  
*Estimates are based on observations, descriptions, and transects of the mapunit.*

#### Description of Manzanst

##### Setting

*Landform:* Terraces, drainageways  
*Landform position (three-dimensional):* Tread  
*Down-slope shape:* Linear  
*Across-slope shape:* Linear, concave  
*Parent material:* Clayey alluvium derived from shale

##### Typical profile

*A - 0 to 3 inches:* clay loam  
*Bt - 3 to 12 inches:* clay  
*Btk - 12 to 37 inches:* clay  
*Bk1 - 37 to 52 inches:* clay  
*Bk2 - 52 to 79 inches:* clay

##### Properties and qualities

*Slope:* 0 to 3 percent  
*Depth to restrictive feature:* More than 80 inches  
*Natural drainage class:* Well drained  
*Capacity of the most limiting layer to transmit water (Ksat):*  
Moderately low to moderately high (0.06 to 0.20 in/hr)  
*Depth to water table:* More than 80 inches  
*Frequency of flooding:* None  
*Frequency of ponding:* None  
*Calcium carbonate, maximum in profile:* 15 percent  
*Gypsum, maximum in profile:* 3 percent  
*Salinity, maximum in profile:* Slightly saline (4.0 to 7.0 mmhos/cm)  
*Sodium adsorption ratio, maximum in profile:* 10.0  
*Available water storage in profile:* High (about 9.0 inches)

##### Interpretive groups

*Land capability classification (irrigated):* 3e  
*Land capability classification (nonirrigated):* 4c

*Hydrologic Soil Group:* C  
*Ecological site:* Saline Overflow (R067BY037CO)  
*Hydric soil rating:* No

### **Minor Components**

#### **Ritoazul**

*Percent of map unit:* 7 percent  
*Landform:* Drainageways, interfluves  
*Landform position (three-dimensional):* Rise  
*Down-slope shape:* Linear  
*Across-slope shape:* Linear  
*Ecological site:* Clayey Plains (R067BY042CO)  
*Hydric soil rating:* No

#### **Arvada**

*Percent of map unit:* 6 percent  
*Landform:* Drainageways, interfluves  
*Down-slope shape:* Linear  
*Across-slope shape:* Linear  
*Ecological site:* Salt Flat (R067XY033CO)  
*Hydric soil rating:* No

#### **Wiley**

*Percent of map unit:* 2 percent  
*Landform:* Interfluves  
*Down-slope shape:* Linear  
*Across-slope shape:* Linear  
*Ecological site:* Loamy Plains (R067BY002CO)  
*Hydric soil rating:* No

## **Data Source Information**

Soil Survey Area: El Paso County Area, Colorado  
Survey Area Data: Version 14, Sep 23, 2016

## El Paso County Area, Colorado

### 56—Nelson-Tassel fine sandy loams, 3 to 18 percent slopes

#### Map Unit Setting

*National map unit symbol:* 3690  
*Elevation:* 5,600 to 6,400 feet  
*Mean annual precipitation:* 12 to 14 inches  
*Mean annual air temperature:* 48 to 52 degrees F  
*Frost-free period:* 135 to 155 days  
*Farmland classification:* Not prime farmland

#### Map Unit Composition

*Nelson and similar soils:* 45 percent  
*Tassel and similar soils:* 30 percent  
*Estimates are based on observations, descriptions, and transects of the mapunit.*

#### Description of Nelson

##### Setting

*Landform:* Hills  
*Landform position (three-dimensional):* Crest, side slope  
*Down-slope shape:* Linear  
*Across-slope shape:* Linear  
*Parent material:* Calcareous residuum weathered from interbedded sedimentary rock

##### Typical profile

*A - 0 to 5 inches:* fine sandy loam  
*Ck - 5 to 23 inches:* fine sandy loam  
*Cr - 23 to 27 inches:* weathered bedrock

##### Properties and qualities

*Slope:* 3 to 12 percent  
*Depth to restrictive feature:* 20 to 40 inches to paralithic bedrock  
*Natural drainage class:* Well drained  
*Runoff class:* Medium  
*Capacity of the most limiting layer to transmit water (Ksat):*  
Moderately low to high (0.06 to 2.00 in/hr)  
*Depth to water table:* More than 80 inches  
*Frequency of flooding:* None  
*Frequency of ponding:* None  
*Calcium carbonate, maximum in profile:* 10 percent  
*Salinity, maximum in profile:* Nonsaline to very slightly saline (0.0 to 2.0 mmhos/cm)  
*Available water storage in profile:* Very low (about 2.8 inches)

##### Interpretive groups

*Land capability classification (irrigated):* 4e  
*Land capability classification (nonirrigated):* 6e  
*Hydrologic Soil Group:* B

*Ecological site:* Shaly Plains (R067BY045CO)  
*Other vegetative classification:* SHALY PLAINS (069AY046CO)  
*Hydric soil rating:* No

### **Description of Tassel**

#### **Setting**

*Landform:* Hills  
*Landform position (three-dimensional):* Crest, side slope  
*Down-slope shape:* Linear  
*Across-slope shape:* Linear  
*Parent material:* Calcareous slope alluvium over residuum  
weathered from sandstone

#### **Typical profile**

*A - 0 to 4 inches:* fine sandy loam  
*C - 4 to 10 inches:* fine sandy loam  
*Cr - 10 to 14 inches:* weathered bedrock

#### **Properties and qualities**

*Slope:* 3 to 18 percent  
*Depth to restrictive feature:* 6 to 20 inches to paralithic bedrock  
*Natural drainage class:* Well drained  
*Runoff class:* Medium  
*Capacity of the most limiting layer to transmit water (Ksat):*  
Moderately high (0.20 to 0.60 in/hr)  
*Depth to water table:* More than 80 inches  
*Frequency of flooding:* None  
*Frequency of ponding:* None  
*Calcium carbonate, maximum in profile:* 10 percent  
*Available water storage in profile:* Very low (about 1.2 inches)

#### **Interpretive groups**

*Land capability classification (irrigated):* None specified  
*Land capability classification (nonirrigated):* 6s  
*Hydrologic Soil Group:* D  
*Ecological site:* Shaly Plains (R067BY045CO)  
*Other vegetative classification:* SHALY PLAINS (069AY046CO)  
*Hydric soil rating:* No

### **Minor Components**

#### **Other soils**

*Percent of map unit:*  
*Hydric soil rating:* No

#### **Pleasant**

*Percent of map unit:*  
*Landform:* Depressions

*Hydric soil rating:* Yes

## **Data Source Information**

Soil Survey Area: El Paso County Area, Colorado  
Survey Area Data: Version 14, Sep 23, 2016



## El Paso County Area, Colorado

### 86—Stoneham sandy loam, 3 to 8 percent slopes

#### Map Unit Setting

*National map unit symbol:* 36b2  
*Elevation:* 5,100 to 6,500 feet  
*Mean annual precipitation:* 13 to 15 inches  
*Mean annual air temperature:* 48 to 52 degrees F  
*Frost-free period:* 135 to 155 days  
*Farmland classification:* Not prime farmland

#### Map Unit Composition

*Stoneham and similar soils:* 85 percent  
*Estimates are based on observations, descriptions, and transects of the mapunit.*

#### Description of Stoneham

##### Setting

*Landform:* Hills  
*Landform position (three-dimensional):* Side slope  
*Down-slope shape:* Linear  
*Across-slope shape:* Linear  
*Parent material:* Calcareous loamy alluvium

##### Typical profile

*A - 0 to 4 inches:* sandy loam  
*Bt - 4 to 8 inches:* sandy clay loam  
*Btk - 8 to 11 inches:* sandy clay loam  
*Ck - 11 to 60 inches:* loam

##### Properties and qualities

*Slope:* 3 to 8 percent  
*Depth to restrictive feature:* More than 80 inches  
*Natural drainage class:* Well drained  
*Runoff class:* Medium  
*Capacity of the most limiting layer to transmit water (Ksat):*  
Moderately high to high (0.60 to 2.00 in/hr)  
*Depth to water table:* More than 80 inches  
*Frequency of flooding:* None  
*Frequency of ponding:* None  
*Calcium carbonate, maximum in profile:* 15 percent  
*Salinity, maximum in profile:* Nonsaline to very slightly saline (0.0 to 2.0 mmhos/cm)  
*Available water storage in profile:* High (about 9.5 inches)

##### Interpretive groups

*Land capability classification (irrigated):* 3e  
*Land capability classification (nonirrigated):* 4e  
*Hydrologic Soil Group:* B  
*Ecological site:* Sandy Plains (R067BY024CO)

*Other vegetative classification:* SANDY PLAINS (069AY026CO)

*Hydric soil rating:* No

**Minor Components**

**Pleasant**

*Percent of map unit:*

*Landform:* Depressions

*Hydric soil rating:* Yes

**Other soils**

*Percent of map unit:*

*Hydric soil rating:* No

**Data Source Information**

Soil Survey Area: El Paso County Area, Colorado

Survey Area Data: Version 14, Sep 23, 2016

## El Paso County Area, Colorado

### 108—Wiley silt loam, 3 to 9 percent slopes

#### Map Unit Setting

*National map unit symbol:* 367b  
*Elevation:* 5,200 to 6,200 feet  
*Mean annual precipitation:* 12 to 14 inches  
*Mean annual air temperature:* 48 to 52 degrees F  
*Frost-free period:* 135 to 155 days  
*Farmland classification:* Not prime farmland

#### Map Unit Composition

*Wiley and similar soils:* 85 percent  
*Estimates are based on observations, descriptions, and transects of the mapunit.*

#### Description of Wiley

##### Setting

*Landform:* Hills  
*Landform position (three-dimensional):* Side slope  
*Down-slope shape:* Linear  
*Across-slope shape:* Linear  
*Parent material:* Calcareous silty eolian deposits

##### Typical profile

*A - 0 to 4 inches:* silt loam  
*Bt - 4 to 16 inches:* silt loam  
*Bk - 16 to 60 inches:* silt loam

##### Properties and qualities

*Slope:* 3 to 9 percent  
*Depth to restrictive feature:* More than 80 inches  
*Natural drainage class:* Well drained  
*Runoff class:* Medium  
*Capacity of the most limiting layer to transmit water (Ksat):*  
Moderately high to high (0.60 to 2.00 in/hr)  
*Depth to water table:* More than 80 inches  
*Frequency of flooding:* None  
*Frequency of ponding:* None  
*Calcium carbonate, maximum in profile:* 15 percent  
*Salinity, maximum in profile:* Nonsaline to very slightly saline (0.0 to 2.0 mmhos/cm)  
*Available water storage in profile:* High (about 11.5 inches)

##### Interpretive groups

*Land capability classification (irrigated):* 4e  
*Land capability classification (nonirrigated):* 6e  
*Hydrologic Soil Group:* B  
*Ecological site:* Loamy Plains (R067BY002CO)  
*Other vegetative classification:* LOAMY PLAINS (069AY006CO)

*Hydric soil rating:* No

**Minor Components**

**Pleasant**

*Percent of map unit:*

*Landform:* Depressions

*Hydric soil rating:* Yes

**Other soils**

*Percent of map unit:*

*Hydric soil rating:* No

**Data Source Information**

Soil Survey Area: El Paso County Area, Colorado  
Survey Area Data: Version 14, Sep 23, 2016