

STORMWATER MANAGEMENT PLAN
For
**WIDEFIELD WATER AND
SANITATION DISTRICT**

**ROLLING HILLS 2MG POTABLE
WATER TANK**

PCD PROJECT NUMBER: PPR-21-006

April 2021



QUALIFIED STORMWATER MANAGER:

Name: _____

Company: _____

Address: _____

CONTRACTOR

Name: _____

Company: _____

Address: _____

Prepared By:



CONSULTANTS, INC.

STORMWATER MANAGEMENT PLAN

Widefield Water and Sanitation District
Rolling Hills 2MG Potable Water Tank

Table of Contents

1	PROJECT CONTACTS.....	2
2	SITE LOCATION AND DESCRIPTION	3
2.1	Site Location	3
2.2	Description OF CONSTRUCTION	3
2.3	Sequence of Construction Activities	4
2.4	Estimates of Excavation.....	4
2.5	Drainage Characteristics	5
2.6	Soils Description	5
2.7	Existing Vegetation and Percent Ground Cover	5
2.8	Potential Pollution Sources	5
2.9	Allowable Non-Stormwater Discharge	6
2.10	Receiving Water and Stream Crossings	6
2.11	SWMP Map.....	6
3	BEST MANAGEMENT PRACTICES.....	6
3.1	Erosion and Sediment Controls.....	6
3.2	Final Stabilization and Long-Term Storm Water Management	6
3.3	Material Handling and Spill Prevention.....	7
3.4	Pollutant Prevention Control Measures.....	7
3.5	Inspection and Maintenance.....	8
3.6	SWMP Availability and Revisions	9

Appendix A – General Permit Application

Appendix B – Contractor Sequence of Activities

Appendix C – Operation and Maintenance Inspection Record

Appendix D – Completed Operation and Maintenance Inspection Records

Appendix E – Standard Control Measures/BMP Details

Appendix F – Spill Prevention Plan

1 PROJECT CONTACTS

Applicant/Owner Information

Name: Widefield Water and Sanitation District
Address: 8495 Fontaine Blvd., Colorado Springs, CO 80925
Contact: Brandon Bernard, Water Department Manager
Telephone: 719-464-2051
Fax: 719-392-4328

Prepared by

Name: JDS-Hydro Consultants, Inc.
Address: 5540 Tech Center Dr., Ste. 100, Colorado Springs, CO 80919
Contact: Gwen Dall, P.E.
Telephone: 719-227-0072 ext. 109
Email: gdall@jdshydro.com

Designated Operator

Name: Widefield Water and Sanitation District
Address: 8495 Fontaine Blvd., Colorado Springs, CO 80925
Contact: Brandon Bernard, Water Department Manager
Telephone: 719-464-2051

Qualified Stormwater Manager

Name: TBD
Address: TBD
Contact: TBD
Telephone: TBD

Contractor

Name: TBD
Address: TBD
Contact: TBD
Telephone: TBD

2 **SITE LOCATION AND DESCRIPTION**

2.1 **Site Location**

The subject facility is a proposed water storage tank site to serve development in the Widefield Water and Sanitation District. The Rolling Hills Tank site is located on a 3.47 acre easement within the property described in El Paso County Schedule 5500000385 in the Northwest ¼ of Section 2, Township 15 South, Range 65 West of the 6th Principle Meridian. The vicinity map below shows the proposed water storage tank site location:



VICINITY MAP
SCALE: N.T.S.

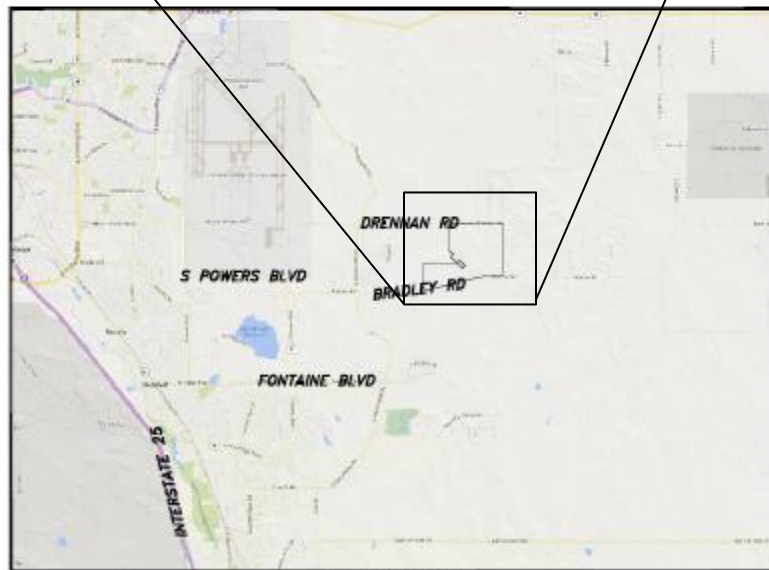

LOCATION MAP
SCALE: N.T.S.

2.2 **Description of Construction**

The project generally includes the construction of a new concrete tank including all excavation, concrete work, appurtenances, backfill, and site work related to tank installation and operation. Disturbed areas are generally grazing lands and all disturbed areas will be re-vegetated. The project is located southwest of the intersection of South Meridian Road and Drennan Road in El Paso County, CO. The inlet pipeline connecting the tank to

the existing distribution system will be completed in a separate project. Future tanks and booster pump station are planned for the site but a separate site development plan will be submitted when additional tanks or a pump station are added.

Tank installation will generally consist of grading and excavation necessary to prepare a level area to install a concrete tank measuring 98.5 feet in diameter, excavation of inlet/outlet piping penetrations, drain and overflow lines and discharge structure. Site improvements include fencing, a level area around the tank for operation and maintenance access, an access road from Drennan Road to the site, landscaping and stormwater control and detention structures.

2.3 Sequence of Construction Activities

The sequence of construction activities will be based upon site contractor timing and scheduling. Upon site contractor selection, contractor to include a sequence of activities schedule in the section provided in Appendix B of this report. A typical sequence of events is included below.

Description	Time Frame
Construction Staking	April 2021 – May 2021
Erosion Control BMPs	May 2021 – April 2022
Clearing and Grubbing	May 2021 - June 2021
Construction of Access Road	May 2021 - June 2021
Excavation and Installation of Drainage Basin	May 2021 - June 2021
Excavation and Installation of Tank Pipe Penetrations	May 2021 - June 2021
Subgrade Preparation and Tank Foundation Installation	May 2021 - June 2021
Concrete Tank Installation	June 2021 - September 2021
Drain and Overflow Structure Installation	June 2021 - September 2021
Backfill and Grading	July 2021 - September 2021
Final Grading	September 2021 - October 2021
Revegetation	November 2021 – April 2022

The anticipated time period for site excavation and grading operations is to start April 2021 with final site stabilization by spring 2022. This time schedule could vary depending on construction schedules. This project will not require any phasing.

2.4 Estimates of Excavation

The total acreage of disturbed land for the proposed tank site, access road, and detention structure is approximately 2.18 acres. All disturbance and grading will take place within temporary and permanent easement boundaries. The total volume of earthwork cut/fill operations is more than 500 CY.

2MG Water Storage Tank Site

Cut: 1210.22 cu. yds.
 Fill: 580.23 (*1.15 for fluff) = 667.26 cu. yds.
 Net Cut: 542.96 cu. yds.

Access Road

Cut: 316.29 cu. yds.
 Fill: 323.09 (*1.15 for fluff) = 371.55 cu. yds.
 Net Fill: 55.26 cu. yds.

Detention Structure

Cut: 469.66 cu. yds.
 Fill: 2.35 (*1.15 for fluff) = 2.70 cu. yds.
 Net Cut: 466.96 cu. yds.

2.5 Drainage Characteristics

The developed land for the potable water tank will occur on the 3.472 acre easement, located at the high point of the surrounding area and is not impacted from off-site flows. An access road from Drennan Rd. will serve the tank site. Historically, a portion of the site drains to the west and enters Franceville Tributary either by entering the roadside ditch along Drennan Road and flowing west or by overland flow and a portion of the site drains to the southeast and enters the Jimmy Camp East Tributary. There are no existing drainage facilities (storm pipes, inlets, culverts, etc.) on the site. The site is entirely outside the 100-year floodplain.

The addition of the water tank will add 7,620 square feet of new impervious area based on the roof of the tank. The gravel access road up to the tank and 15 ft clear area around the tank will add 30,700 square feet. Proposed drainage will be conveyed from the tank access road and drainage swale, tank roof, and 15 ft gravel access area to a vegetated drainage swale adjacent to the access road to a sand filter basin (SFB) located at a natural low point before discharging off-site and into the East Fork Tributary drainage basin. The proposed SFB will treat additional drainage produced from impervious areas that will be added to the site as a result of the tank construction including the tank roof and gravel areas. The SFB provides full spectrum detention and will be used to treat the Water Quality Capture Volume (WQCV) and detain the 100-yr flood event to pre-development release rates before leaving the site. The SFB is based on a drain time of 12 hours for the WQCV and 10-yr and 100-year release rate based on draining at 90% of predevelopment flows.

The SFB is included in the access road easement and language was included in the easement that the structure may only be abandoned when the future Rolling Hills Ranch Development agrees to accept and treat the developed runoff from the site.

Approximately 500 LF of the access road drains to the northwest and into the Drennan Rd. drainage ditch. The access road location was driven by grade restraints at the intersection of Drennan Rd and to limit excavation in the exposed sandstone. Prior to the proposed development, the Drennan Rd. roadside ditch only captured flow from the road north of the proposed access road. With the addition of the access road, drainage from approximately 500 LF of the access road and a small undeveloped area north of the proposed access road will flow into the proposed drainage swale adjacent to the access road. This additional flow will then be conveyed to the proposed access road culvert.

2.6 Soils Description

Soils for this project are delineated as Tassel fine sandy loam, 3 to 18 percent slopes (89) and are characterized as Hydrologic Soil Group D (high runoff potential when thoroughly wet). Soils were mapped using the NRCS Web Soil Survey. According to a geotechnical evaluation report by Vivid Engineering Group, dated 1/7/2021, site soils were comprised predominately of Piney Creek Alluvium deposits of mostly clayey and silty sand underlain by interbedded sandstone, claystone, and shale bedrock of the Pierre Shale Formation. A total of eleven (11) exploratory borings within or near the general area to be occupied by the proposed tank and drainage basin were drilled to depths ranging from approximately 15 to 45 feet below the existing ground surface. The ground surface consists of gently rolling topography and was covered predominantly with grasses and yucca plants.

2.7 Existing Vegetation and Percent Ground Cover

A field survey was conducted on June 2, 2020 by a qualified biologist and vegetation found within the project area includes grass and herbaceous species typical of vegetative assemblages in pastures routinely grazed by livestock. These species include buffalo grass (*Bouteloua dactyloides*), grama grass (*Bouteloua* sp.), Texas croton (*Croton texensis*), prairie sage (*Artemisia ludoviciana*) and yellow sweetclover (*Melilotus officinale*). Prickly pear (*Opuntia* sp.), cholla (*Cylindropuntia* sp.), and yucca (*Yucca glauca*) were also observed. No trees were found in the project area. Percent groundcover varies on the site between 50% and 70%.

2.8 Potential Pollution Sources

Pollutant sources which shall be evaluated for potential to contribute pollutants to stormwater discharge from the subject site may include the following:

- Disturbed and stored soils
- Vehicle tracking of sediments
- Management of contaminated soils
- Loading and unloading operations
- Outdoor storage activities (building materials, utility piping and appurtenances, chemicals, fertilizer, etc.)
- Vehicle and equipment maintenance and fueling
- Significant dust or particulate generating processes
- Onsite waste management practices (waste piles, liquid wastes, and dumpsters)
- Concrete truck/equipment washing, including the concrete truck chute associated fixtures and equipment
- Non-industrial waste sources such as worker trash and portable toilets
- Other areas or procedures where potential spills can occur

2.9 Allowable Non-Stormwater Discharge

Construction dewatering is not anticipated within the limits of construction since no groundwater was encountered during soils testing for the geotechnical report. Should it be required, BMPs shall be implemented immediately and the contractor shall obtain a Construction Dewatering Permit from the CDPHE and comply with all conditions of the permit.

2.10 Receiving Water and Stream Crossings

There are no existing drainage facilities on the site. A portion of the site drains to the west and enters Franceville Tributary either by entering the roadside ditch along Drennan Road and flowing west or by overland flow. A proposed sand filter basin with a 15” RCP outfall will drain to the East Fork Tributary drainage basin. No springs, streams, wetlands, or other surface water are within the project boundaries.

3 *BEST MANAGEMENT PRACTICES*

3.1 Erosion and Sediment Controls

All erosion and sediment control measures will be implemented in a manner that will protect properties and public facilities from the adverse effects of erosion and sedimentation as a result of construction activities. Control measures include any best management practice or other method used to prevent or reduce the discharge of pollutants to state waters. Control measures include, but are not limited to, best management practices. Control measures can include other methods such as the installation, operation, and maintenance of structural controls and treatment devices. To prevent an increase in sediment load downstream of the Site, control measures will be implemented during the construction life of this project. Silt fencing will be placed in areas shown on the approved grading and erosion control plan. Roadways shall be inspected to ensure that sediment from on-site construction activity is not being discharged with stormwater. A vehicle tracking control pad will be required to aid in minimizing soil tracking onto roadways. All disturbed areas will be reseeded with a native seed mix and watered until a mature stand is established. All disturbed areas will be protected by silt fence, diversion swales, erosion control logs and erosion control blankets until such time as the site has been revegetated. Additional methods will include brooms and shovels to relocate small amounts of soil erosion. There will be no asphalt or concrete batch plants located on the site.

3.2 SWMP Map

A Grading & Erosion Control (GEC) Plan was prepared and submitted for the proposed construction and should be used in conjunction with the design drawings. Location of erosion control facilities are shown on the plans. The GEC Plan will serve as the SWMP site map. It includes limits of disturbance, flow arrows that depict stormwater flow directions on-site and runoff direction, areas of cut/fill, proposed stockpile areas, proposed material storage areas, proposed waste accumulation areas, concrete washout areas, locations of all structural control measures, locations of all non-structural control measures, locations of streams or drainageways. The GEC Plan will be amended as needed to implement additional control measures over and above those included. All construction control measures/BMP details are included in Appendix E. Further information can be found in the El Paso County DCM, Volume 2 and ECM.

3.3 Final Stabilization and Long-Term Storm Water Management

Soil erosion control measures for all slopes, channels, ditches, or any disturbed land area shall be completed within twenty-one (21) calendar days after final grading, or final earth disturbance, has been completed. Disturbed areas and stockpiles which are not at final grade, but will remain dormant for longer than 30 days, shall also be mulched within 21 days after interim grading. An area that is going to remain in an interim state for more than 60 days shall also be seeded. All temporary soil erosion control measures and BMPs shall be maintained until permanent soil erosion control measures are implemented.

Vegetative cover density shall be a minimum of 70% of pre-disturbed levels to be considered stabilized.

Long term stormwater quality management will be handled by the proposed on-site sand filter basin (SFB). The SFB provides full spectrum detention and will be used to treat the Water Quality Capture Volume (WQCV) and detain the 100-yr flood event to pre-development release rates before leaving the site. The SFB is based on a drain time of 12 hours for the WQCV and 10-yr and 100-year release rate based on draining at 90% of predevelopment flows.

This project does not rely on control measures owned or operated by another entity.

3.4 Material Handling and Spill Prevention

During construction, the largest possible source of non-storm water pollution would be leakage of oils and other fluids from construction equipment and vehicles. Equipment fueling and maintenance shall be performed in a designated fueling area which will be established to contain any spill resulting from fueling, maintenance, or repair of equipment. Absorbent materials and containers for the storage of used absorbent material will be nearby. Place debris, overburden, soil stockpiles and waste materials away from areas of runoff.

Practices to reduce the potential for pollution in stormwater runoff from the site must be included in a spill prevention plan to be provided by the contractor. Included in the spill prevention plan shall be:

- Notification procedures to be used in the event of an accident
- Instructions for clean-up procedures and identification of a spill kit location
- Provisions for adsorbents to be made available for use in fuel areas and for containers to be available for used adsorbents
- Procedures for properly washing out concrete truck chutes and other equipment in a manner and location so that the materials and wash water cannot discharge from the site

The spill prevention plan will be included in Appendix F.

3.5 Pollutant Prevention Control Measures

There are several Best Management Practices than can be employed to prevent or mitigate the source of pollutants and contamination of storm water runoff. Some of these are:

- Wind erosion shall be controlled by spraying site roadways and/or temporary stabilization of material stockpiles. Each dump truck hauling material to or from the site will be required to be covered with a tarpaulin.
- If needed, snow removal and/or stockpiling will be considered prior to placement at the site. Snow stockpiles must be kept away from any stormwater conveyance system (i.e. inlets, ponds, outfall locations, road surfaces, etc.)
- All refuse dumpsters and receptacles shall be equipped with functional lids to prevent rain and snow from entering. Lids must be closed when dumpsters and receptacles are not actively in use. Construction trash and debris removal from the site will be regularly scheduled.
- Storage containers, drums, and bags shall be stored away from direct traffic routes to prevent accidental spills. Ensure packages and containers are intact.
- Bulk storage of petroleum products or other liquid chemicals that is 55 gallons or greater must have secondary containment or equivalent protection to contain spills and prevent spilled material from entering state waters.
- Empty drums shall be covered to prevent collection of precipitation.

- Containers shall be stored on pallets to prevent corrosion of containers, which can result when containers come in contact with moisture on the ground.
- Tracking control must be implemented by the contractor to prevent unnecessary soil from entering paved surfaces. The measures to be used will be preventing equipment in the construction area from moving off-site. If the contractor cannot do this, then a vehicle tracking pad will be required according to El Paso County specifications. Brooms and shovels may be required for tracking control.
- Portable restroom facilities will be used by the construction crew during the construction phase. Portable restroom facilities will be located a minimum of 10 feet from stormwater inlets and 50 feet from state waters. They will be secured at all four corners to prevent overturning and cleaned on a weekly basis. They will be inspected daily for spills.

The contractor is certainly not limited to these measures which may require adjusting the BMP's as the project progresses and implement further controls as prudence and good judgment deem necessary.

3.6 Qualified Stormwater Manager

The Qualified Stormwater Manager is an individual knowledgeable in the principles and practices of erosion and sediment control and pollution prevention and has the skills to assess conditions at construction sites that could impact stormwater quality and the effectiveness of stormwater controls implemented to meet the requirements of the stormwater discharges associated with construction activity permit. A copy of the signed SWMP permit application is included in Appendix A.

3.7 Inspection and Maintenance

A thorough inspection of the storm water management system shall be performed every 14 days as well as within 24 hours of any rain or snowmelt event that causes surface erosion. If any system deficiencies are noted, correction actions must begin immediately. Documentation of inspection must be made available if requested. Areas to be inspected for evidence or, or the potential for, pollutants leaving the construction site boundaries and discharging to state waters include:

- Construction site perimeter
- All disturbed areas
- Designated haul routes
- Material and waste storage areas exposed to precipitation
- Locations where stormwater has the potential to discharge offsite
- Locations where vehicles exit the site

In addition, implemented control measures shall be inspected to confirm they are in operational condition and are adequate to minimize pollutant discharges. Repairs and maintenance may include, but are not limited to, the following:

- Erosion of side slopes shall be repaired.
- Silt fences shall be cleaned whenever sediment has reached a depth of six (6) inches at the fence, and broken wooden parts or torn fabric shall be repaired or replaced.
- Any accumulated trash or debris shall be removed from these protected areas.

An Operation and Maintenance Inspection Record form is included in Appendix C. The following items must be documented by contractor as part of the site inspections and kept within this report. Completed inspected records shall be kept in Appendix D of this SWMP and kept onsite.

- Inspection date
- Name(s), title(s), and signature(s) of personnel making inspection
- Weather conditions at the time of inspection
- Phase of construction at the time of inspection
- Estimated acreage of disturbance at the time of inspection
- Location(s) of discharges of sediment or other pollutants from site
- Location(s) of control measures that need to be maintained
- Location(s) of control measures that fail to operate as designed or proved inadequate

- Location(s) where additional control measures are needed that were not in place at time of inspection
- Description of the minimum inspection frequency utilized when conducting each inspection
- Deviations from the minimum inspection schedule
- Signed statement of compliance added to the report after corrective action has been implemented

30-day inspections must take place on this site where construction activity is complete, but vegetative cover is still being established.

3.8 SWMP Availability and Revisions

A hardcopy of this SWMP is to be retained onsite or be onsite when construction activities are occurring at the site unless another location is approved by the Division. Records of the SWMP changes made that includes the date and identification of the changes must be kept at the site within this report. The SWMP should be viewed as a “living document” throughout the lifetime of the project. This SWMP shall be revised by informing Engineer of deviations to original plan. Engineer will then update this report and all applicable drawings, forms, tables, etc. as deemed necessary. Revisions to the SWMP are required when the following occurs:

- A change in design, construction, operation, or maintenance of the site requiring implementation of new or revised control measures
- The SWMP proves ineffective in controlling pollutants in stormwater runoff in compliance with the permit conditions
- Control measures identified in the SWMP are no longer necessary and are removed
- Corrective actions are taken onsite that result in a change to the SWMP

The provisions of the SWMP as written and updated must be implemented from commencement of construction activity until final stabilization is complete.

3.9 Non-Stormwater Discharges

Note that a SWMP permit covers stormwater discharges from construction activity and does not include the following: uncontaminated springs, concrete washout water, or landscape irrigation return flow. Discharges resulting from emergency firefighting activities are authorized by a SWMP permit.

***APPENDIX A – General Permit Application
(When Complete)***

***APPENDIX B – Contractor Sequence of Activities
(When Complete)***

APPENDIX C – O&M Inspection Record Templates

CONSTRUCTION STORMWATER SITE INSPECTION REPORT

Facility Name		Permittee					
Date of Inspection		Weather Conditions					
Permit Certification #		Disturbed Acreage					
Phase of Construction		Inspector Title					
Inspector Name							
Is the above inspector a qualified stormwater manager? (permittee is responsible for ensuring that the inspector is a qualified stormwater manager)			<table border="1" style="width: 100%; border-collapse: collapse;"> <tr> <td style="width: 50%; text-align: center;">YES</td> <td style="width: 50%; text-align: center;">NO</td> </tr> <tr> <td style="text-align: center;"><input type="checkbox"/></td> <td style="text-align: center;"><input type="checkbox"/></td> </tr> </table>	YES	NO	<input type="checkbox"/>	<input type="checkbox"/>
YES	NO						
<input type="checkbox"/>	<input type="checkbox"/>						

INSPECTION FREQUENCY					
Check the box that describes the minimum inspection frequency utilized when conducting each inspection					
At least one inspection every 7 calendar days	<input type="checkbox"/>				
At least one inspection every 14 calendar days, with post-storm event inspections conducted within 24 hours after the end of any precipitation or snowmelt event that causes surface erosions	<input type="checkbox"/>				
<ul style="list-style-type: none"> • This is this a post-storm event inspection. Event Date: _____ 	<input type="checkbox"/>				
Reduced inspection frequency - Include site conditions that warrant reduced inspection frequency	<input type="checkbox"/>				
<ul style="list-style-type: none"> • Post-storm inspections at temporarily idle sites 	<input type="checkbox"/>				
<ul style="list-style-type: none"> • Inspections at completed sites/area 	<input type="checkbox"/>				
<ul style="list-style-type: none"> • Winter conditions exclusion 	<input type="checkbox"/>				
Have there been any deviations from the minimum inspection schedule? If yes, describe below.	<table border="1" style="width: 100%; border-collapse: collapse;"> <tr> <td style="width: 50%; text-align: center;">YES</td> <td style="width: 50%; text-align: center;">NO</td> </tr> <tr> <td style="text-align: center;"><input type="checkbox"/></td> <td style="text-align: center;"><input type="checkbox"/></td> </tr> </table>	YES	NO	<input type="checkbox"/>	<input type="checkbox"/>
YES	NO				
<input type="checkbox"/>	<input type="checkbox"/>				

INSPECTION REQUIREMENTS*
i. Visually verify all implemented control measures are in effective operational condition and are working as designed in the specifications
ii. Determine if there are new potential sources of pollutants
iii. Assess the adequacy of control measures at the site to identify areas requiring new or modified control measures to minimize pollutant discharges
iv. Identify all areas of non-compliance with the permit requirements, and if necessary, implement corrective action
*Use the attached Control Measures Requiring Routine Maintenance and Inadequate Control Measures Requiring Corrective Action forms to document results of this assessment that trigger either maintenance or corrective actions

AREAS TO BE INSPECTED			
Is there evidence of, or the potential for, pollutants leaving the construction site boundaries, entering the stormwater drainage system or discharging to state waters at the following locations?			
	NO	YES	If "YES" describe discharge or potential for discharge below. Document related maintenance, inadequate control measures and corrective actions Inadequate Control Measures Requiring Corrective Action form
Construction site perimeter	<input type="checkbox"/>	<input type="checkbox"/>	
All disturbed areas	<input type="checkbox"/>	<input type="checkbox"/>	
Designated haul routes	<input type="checkbox"/>	<input type="checkbox"/>	
Material and waste storage areas exposed to precipitation	<input type="checkbox"/>	<input type="checkbox"/>	
Locations where stormwater has the potential to discharge offsite	<input type="checkbox"/>	<input type="checkbox"/>	
Locations where vehicles exit the site	<input type="checkbox"/>	<input type="checkbox"/>	
Other: _____	<input type="checkbox"/>	<input type="checkbox"/>	

REPORTING REQUIREMENTS

The permittee shall report the following circumstances orally within twenty-four (24) hours from the time the permittee becomes aware of the circumstances, and shall mail to the division a written report containing the information requested within five (5) working days after becoming aware of the following circumstances. The division may waive the written report required if the oral report has been received within 24 hours.

All Noncompliance Requiring 24-Hour Notification per Part II.L.6 of the Permit		
a. Endangerment to Health or the Environment Circumstances leading to any noncompliance which may endanger health or the environment regardless of the cause of the incident (See Part II.L.6.a of the Permit) <i>This category would primarily result from the discharge of pollutants in violation of the permit</i>		
b. Numeric Effluent Limit Violations <ul style="list-style-type: none"> o Circumstances leading to any unanticipated bypass which exceeds any effluent limitations (See Part II.L.6.b of the Permit) o Circumstances leading to any upset which causes an exceedance of any effluent limitation (See Part II.L.6.c of the Permit) o Daily maximum violations (See Part II.L.6.d of the Permit) <i>Numeric effluent limits are very uncommon in certifications under the COR400000 general permit. This category of noncompliance only applies if numeric effluent limits are included in a permit certification.</i>		

Has there been an incident of noncompliance requiring 24-hour notification?	NO	YES	
	<input type="checkbox"/>	<input type="checkbox"/>	If "YES" document below

Date and Time of Incident	Location	Description of Noncompliance	Description of Corrective Action	Date and Time of 24 Hour Oral Notification	Date of 5 Day Written Notification *

*Attach copy of 5 day written notification to report. Indicate if written notification was waived, including the name of the division personnel who granted waiver.

After adequate corrective action(s) and maintenance have been taken, or where a report does not identify any incidents requiring corrective action or maintenance, the individual(s) designated as the Qualified Stormwater Manager, shall sign and certify the below statement:

"I verify that, to the best of my knowledge and belief, all corrective action and maintenance items identified during the inspection are complete, and the site is currently in compliance with the permit."

Name of Qualified Stormwater Manager

Title of Qualified Stormwater Manager

Signature of Qualified Stormwater Manager

Date

Notes/Comments

***APPENDIX D – Completed O&M Inspection
Records (When Complete)***

APPENDIX E – Standard Control Measures/BMP Details

Check Dam

What it is

Check dams are small, temporary or permanent dams constructed across a drainage ditch, swale or channel to reduce the velocity of concentrated flows and to trap sediment eroded from upstream. Check dams can be constructed out of rocks, gravel-filled sandbags or straw bales.



When and Where to use it

- In open channels that receive flow from drainage between 1 and 10 acres.
- In steeply sloped swales.
- In swales that need protection during the establishment of grasses or prior to installation of a non-erodible lining.

When and Where NOT to use it

- In live streams.
- In channels that receive flow from drainage areas greater than 10 acres.
- In channels that will be overtopped by flow once the dams are constructed.

Construction Detail and Maintenance Requirements

Figure CD-1 provides a construction detail and maintenance requirements for a check dam.

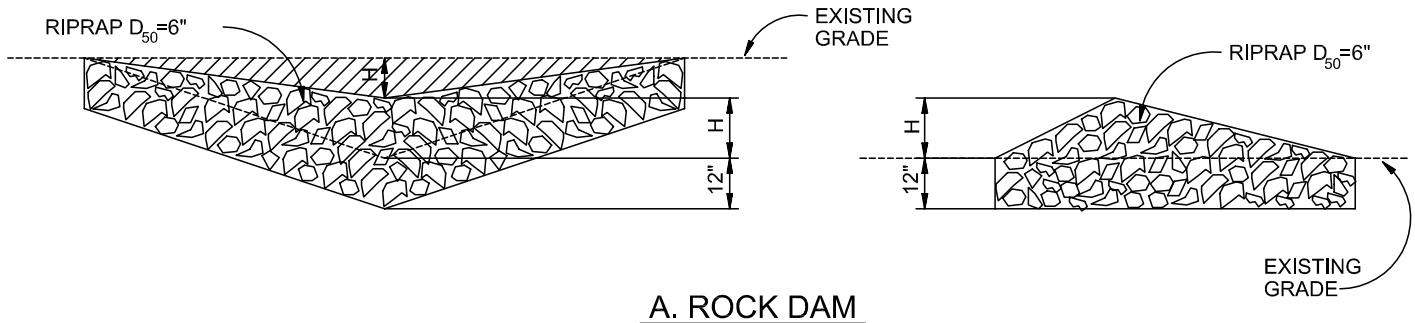

A. ROCK DAM

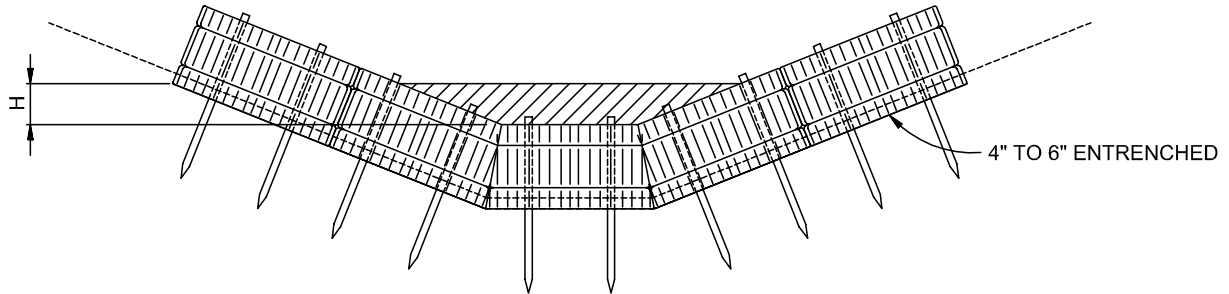

B. STRAW BALE CHECK DAM
(SEE STRAW BALE BARRIER INSTALLATION)

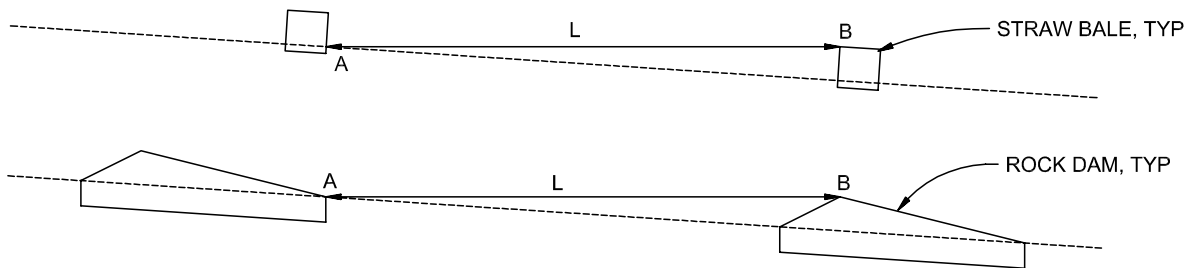

L= THE DISTANCE SUCH THAT POINTS A AND B ARE AT THE SAME ELEVATION.

C. SPACING CHECK DAMS

CHECK DAM

NTS

CHECK DAM NOTES

INSTALLATION REQUIREMENTS

1. STRAW BALES USED AS CHECK DAMS ARE TO MEET THE REQUIREMENTS STATED IN FIGURE SBB-2.
2. THE "H" DIMENSION SHALL BE SELECTED TO PROVIDE WEIR FLOW CONVEYANCE FOR 2-YEAR FLOW OR GREATER.

MAINTENANCE REQUIREMENTS

1. REGULAR INSPECTIONS ARE TO BE MADE OF ALL CHECK DAMS, ESPECIALLY AFTER STORM EVENTS.
2. REPLACE STONE AS NECESSARY TO MAINTAIN THE CORRECT HEIGHT OF THE DAM.
3. ACCUMULATED SEDIMENT AND DEBRIS IS TO BE REMOVED FROM BEHIND THE DAMS AFTER EACH STORM OR WHEN 1/2 OF THE ORIGINAL HEIGHT OF THE DAM IS REACHED.
3. CHECK DAMS ARE TO REMAIN IN PLACE AND OPERATIONAL UNTIL THE DRAINAGE AREA AND CHANNEL ARE PERMANENTLY STABILIZED.
4. WHEN CHECK DAMS ARE REMOVED THE CHANNEL LINING OR VEGETATION IS TO BE RESTORED.

Erosion Control Blankets

What it is

Erosion control blankets are geotextiles or filter fabrics that are used to stabilize soils, steep slopes and drainage channels.

TYPES OF EROSION CONTROL BLANKETS

- WOVEN OR BONDED SYNTHETIC MATERIALS SUCH AS POLYPROPELENE, POLYESTER, POLYETHEYLENE, NYLON, POLYVINYL CHLORIDE, GLASS AND VARIOUS MIXTURES OF THESE.
- MULCH MATTING MADE FROM JUTE OR OTHER WOOD FIBER THAT HAS BEEN FORMED INTO SHEETS.
- NETTING MADE FROM JUTE OR OTHER WOOD FIBER, PLASTIC, PAPER, OR COTTON USED TO HOLD MULCH AND MATTING TO THE GROUND.
- BLANKETS OF WOVEN STRAW MULCH WITH A SYNTHETIC LAYER OR NET.



When and Where to use it

- In temporary and permanent swales.
- To protect recently seeded slopes.
- In drainageway channels.

When and Where NOT to use it

- In swales with slopes greater than 5 percent or with stormwater velocities > 8 feet per second.

Installation and Maintenance Requirements

Installation requirements are provided in Figures ECB-1 and ECB-2.

Maintenance requirements include regular inspections to determine if fabric is damaged or has come loose, and appropriate repairs or replacement of damaged materials.

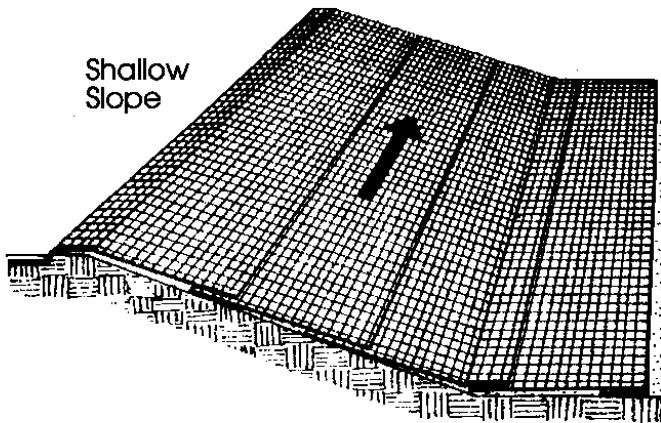

Shallow Slope

On shallow slopes, strips of netting may be applied across the slope.

Where there is a berm at the top of the slope, bring the netting over the berm and anchor it behind the berm.

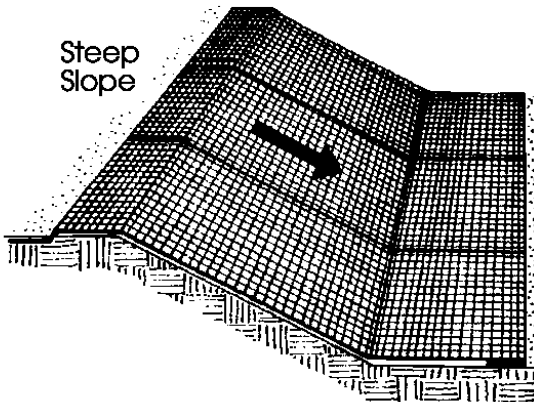

Steep Slope

On steep slopes, apply strips of netting parallel to the direction of flow and anchor securely.

Bring netting down to a level area before terminating the installation. Turn the end under 6" and staple at 12" intervals.

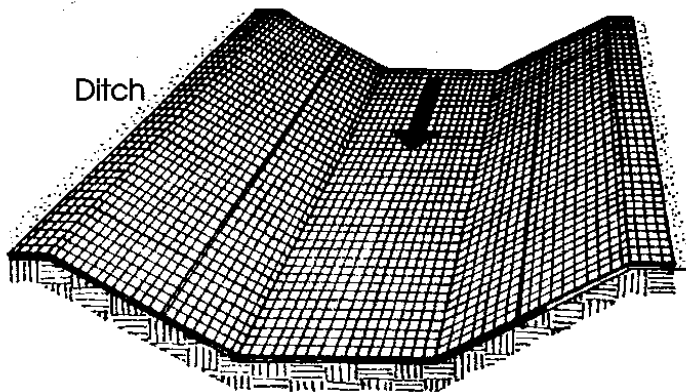
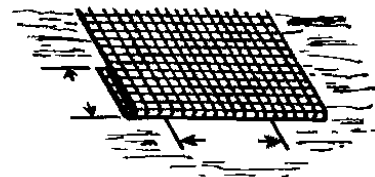

Ditch

In ditches, apply netting parallel to the direction of flow. Use check slots every 15 feet. Do not join strips in the center of the ditch.

From: Virginia Soil and Water Conservation Commission, 1985

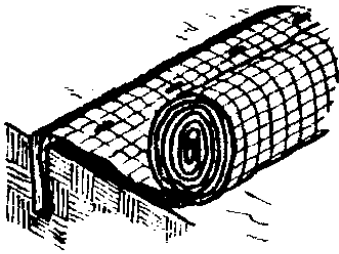

Anchor Slot: Bury the up-channel end of the net in a 6" deep trench. Tamp the soil firmly. Staple at 12" intervals across the net.

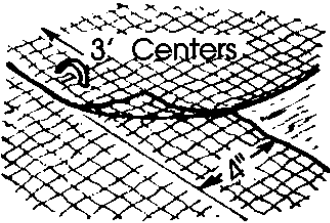

Overlap: Overlap edges of the strips at least 4". Staple every 3 feet down the center of the strip.

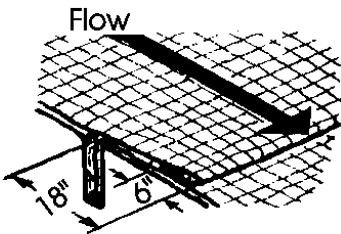
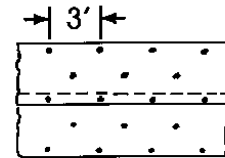

Joining Strips: Insert the new roll of net in a trench, as with the Anchor Slot. Overlap the up-channel end of the previous roll 18" and turn the end under 6". Staple the end of the previous roll just below the anchor slot and at the end at 12" intervals.

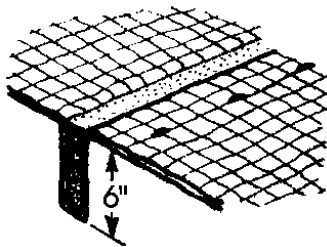

Check Slots: On erodible soils or steep slopes, check slots should be made every 15 feet. Insert a fold of the net into a 6" trench and tamp firmly. Staple at 12" intervals across the net. Lay the net smoothly on the surface of the soil - do not stretch the net, and do not allow wrinkles.

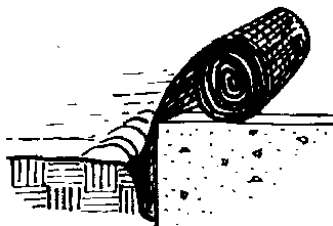

Anchoring Ends At Structures: Place the end of the net in a 6" slot on the up-channel side of the structure. Fill the trench and tamp firmly. Roll the net up the channel. Place staples at 12" intervals along the anchor end of the net.

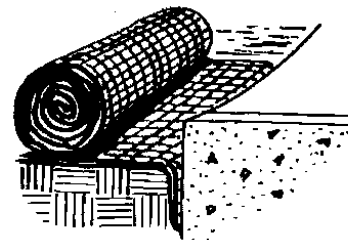

From: Virginia Soil and Water Conservation Commission, 1985

City of Colorado Springs
Storm Water Quality

Figure ECB-2
Erosion Control Blanket
Installation Requirements

Silt Fence

What it is

A silt fence is a temporary sediment barrier constructed of filter fabric stretched across supporting posts. The bottom edge of the fabric is entrenched and covered with backfill.



When and Where to use it

- On the down gradient perimeters of a construction site.
- On a contour to control overland sheet flow.
- At the top or toe of a steep slope.
- As a form of inlet protection (see inlet protection factsheet).

Figure SF-1 depicts five cases where the use of silt fence is appropriate.

When and Where NOT to use it

- In areas of concentrated flows such as in ditches, swales or channels that drain areas greater than 1.0 acre.
- At the top of a slope or at high points which do not receive any drainage flows.



This photo reveals a silt fence that has become unentrenched because it was not securely installed.



This photo illustrates what will happen to a silt fence if it is installed in an area of concentrated flow.

Construction Detail and Maintenance Requirements

Figure SF-2 provides a construction detail and maintenance requirements for a silt fence.

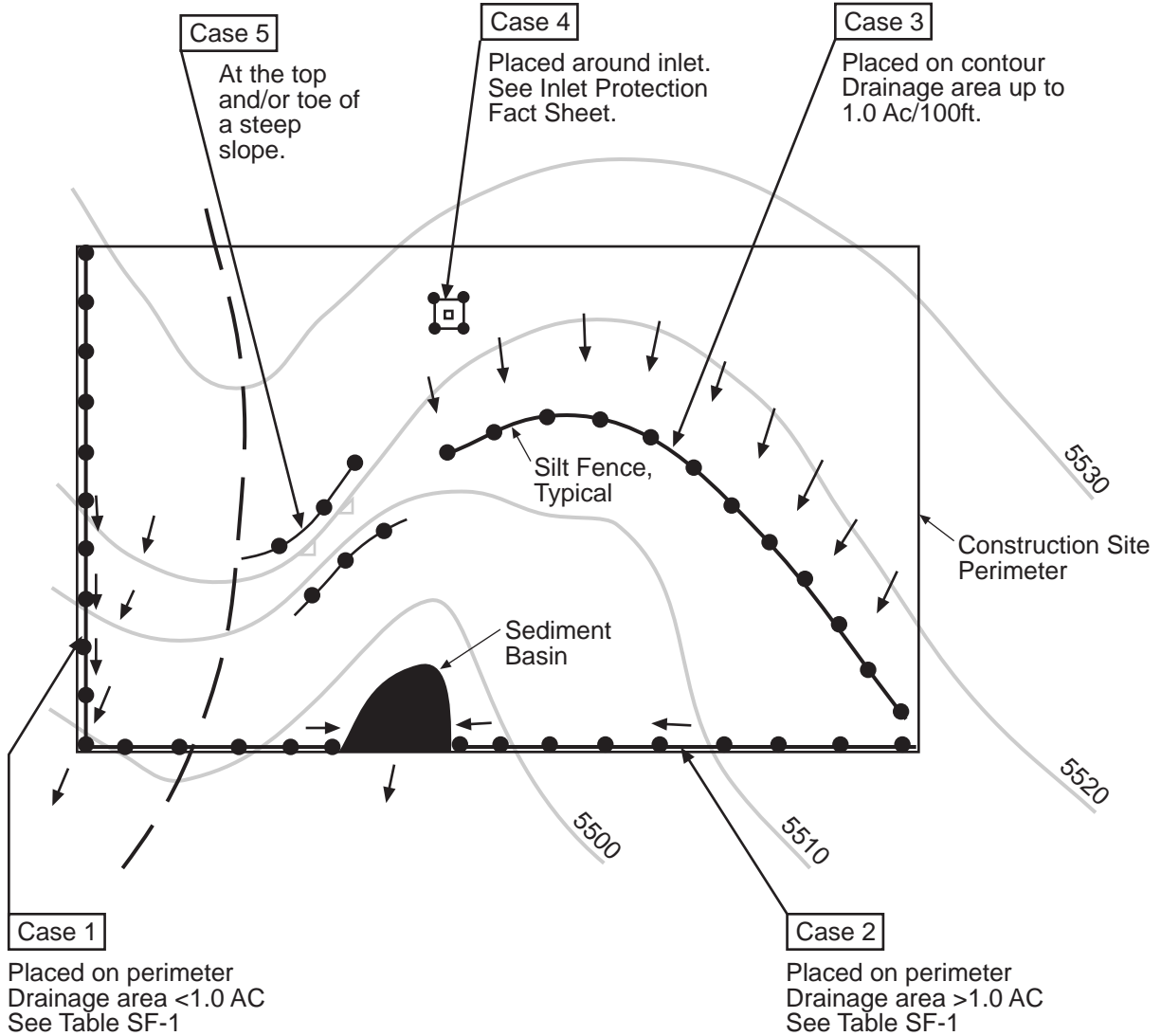

Table SF-1

Silt Fence Used as Perimeter Control	Case 1		Case 2 DA > 1.0 AC
	DA < 0.25 AC	0.25 < DA < 1 AC	
Continuous Grade	OK ⁽¹⁾	OK ⁽¹⁾	OK ⁽¹⁾
Area of Concentrated Flow	OK	NO ⁽²⁾	NO ⁽³⁾

(1) Temporary Swale or Straw Bale Barrier may be used as alternative to a Silt Fence.

(2) Check Dam may also be used as alternative to Silt Fence at low point.

(3) Sediment Basin is required for concentrated flow from drainage areas > 1.0 AC.

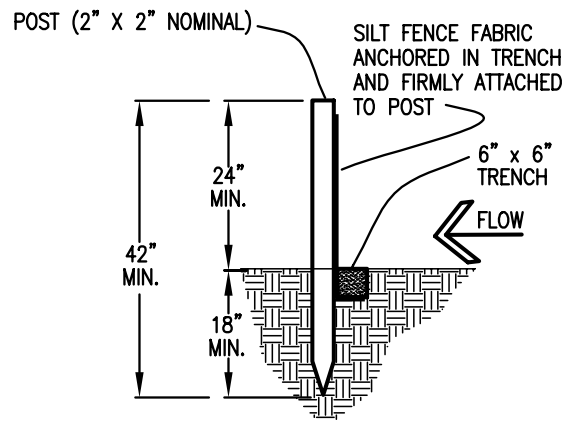
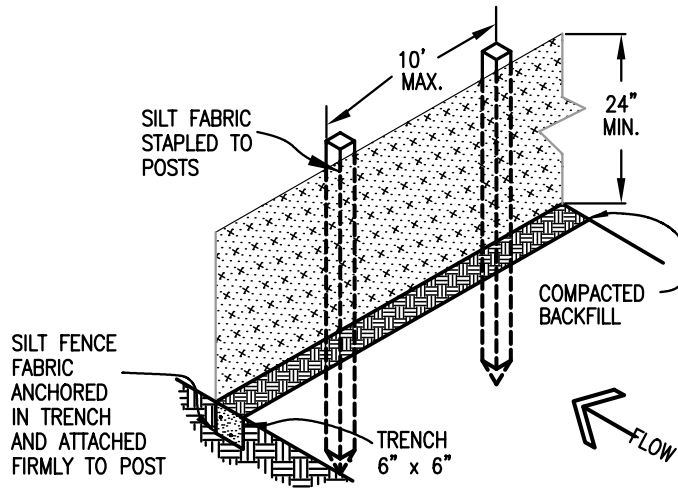

SILT FENCE

SILT FENCE NOTES

INSTALLATION REQUIREMENTS

1. SILT FENCES SHALL BE INSTALLED PRIOR TO ANY LAND DISTURBING ACTIVITIES.
2. WHEN JOINTS ARE NECESSARY, SILT FENCE GEOTEXTILE SHALL BE SPLICED TOGETHER ONLY AT SUPPORT POST AND SECURELY SEALED.
3. METAL POSTS SHALL BE "STUDDED TEE" OR "U" TYPE WITH MINIMUM WEIGHT OF 1.33 POUNDS PER LINEAR FOOT. WOOD POSTS SHALL HAVE A MINIMUM DIAMETER OR CROSS SECTION DIMENSION OF 2 INCHES.
4. THE FILTER MATERIAL SHALL BE FASTENED SECURELY TO METAL OR WOOD POSTS USING WIRE TIES, OR TO WOOD POSTS WITH 3/4" LONG #9 HEAVY-DUTY STAPLES. THE SILT FENCE GEOTEXTILE SHALL NOT BE STAPLED TO EXISTING TREES.
5. WHILE NOT REQUIRED, WIRE MESH FENCE MAY BE USED TO SUPPORT THE GEOTEXTILE. WIRE FENCE SHALL BE FASTENED SECURELY TO THE UPSLOPE SIDE OF THE POSTS USING HEAVY-DUTY WIRE STAPLES AT LEAST 3/4" LONG, TIE WIRES OR HOG RINGS. THE WIRE SHALL EXTEND INTO THE TRENCH A MINIMUM OF 6" AND SHALL NOT EXTEND MORE THAN 3' ABOVE THE ORIGINAL GROUND SURFACE.

6. ALONG THE TOE OF FILLS, INSTALL THE SILT FENCE ALONG A LEVEL CONTOUR AND PROVIDE AN AREA BEHIND THE FENCE FOR RUNOFF TO POND AND SEDIMENT TO SETTLE. A MINIMUM DISTANCE OF 5 FEET FROM THE TOE OF THE FILL IS RECOMMENDED.
7. THE HEIGHT OF THE SILT FENCE FROM THE GROUND SURFACE SHALL BE MINIMUM OF 24 INCHES AND SHALL NOT EXCEED 36 INCHES; HIGHER FENCES MAY INPOUND VOLUMES OF WATER SUFFICIENT TO CAUSE FAILURE OF THE STRUCTURE.

MAINTENANCE REQUIREMENTS

1. CONTRACTOR SHALL INSPECT SILT FENCES IMMEDIATELY AFTER EACH RAINFALL, AT LEAST DAILY DURING PROLONGED RAINFALL, AND WEEKLY DURING PERIODS OF NO RAINFALL. DAMAGED, COLLAPSED, UNENTRENCHED OR INEFFECTIVE SILT FENCES SHALL BE PROMPTLY REPAIRED OR REPLACED.
2. SEDIMENT SHALL BE REMOVED FROM BEHIND SILT FENCE WHEN IT ACCUMULATES TO HALF THE EXPOSED GEOTEXTILE HEIGHT.
3. SILT FENCES SHALL BE REMOVED WHEN ADEQUATE VEGETATIVE COVER IS ATTAINED AS APPROVED BY THE CITY.

Top View of Silt Fence Posts Detail

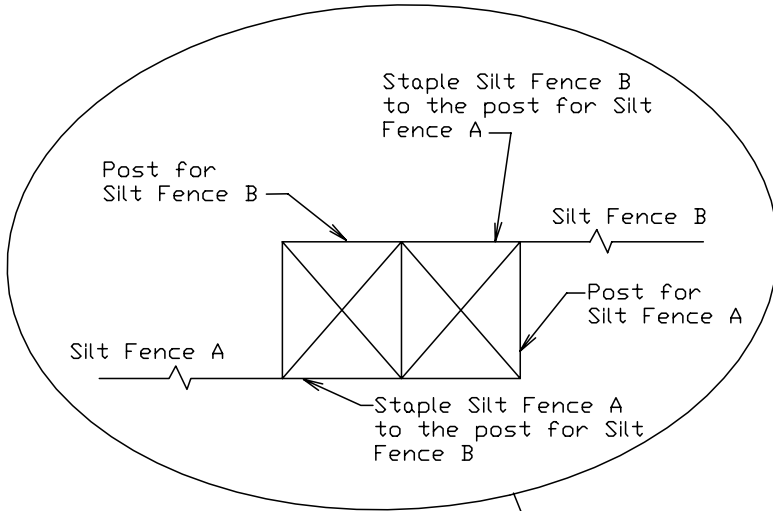

Refer to "Top View of Silt Fence Posts Detail"

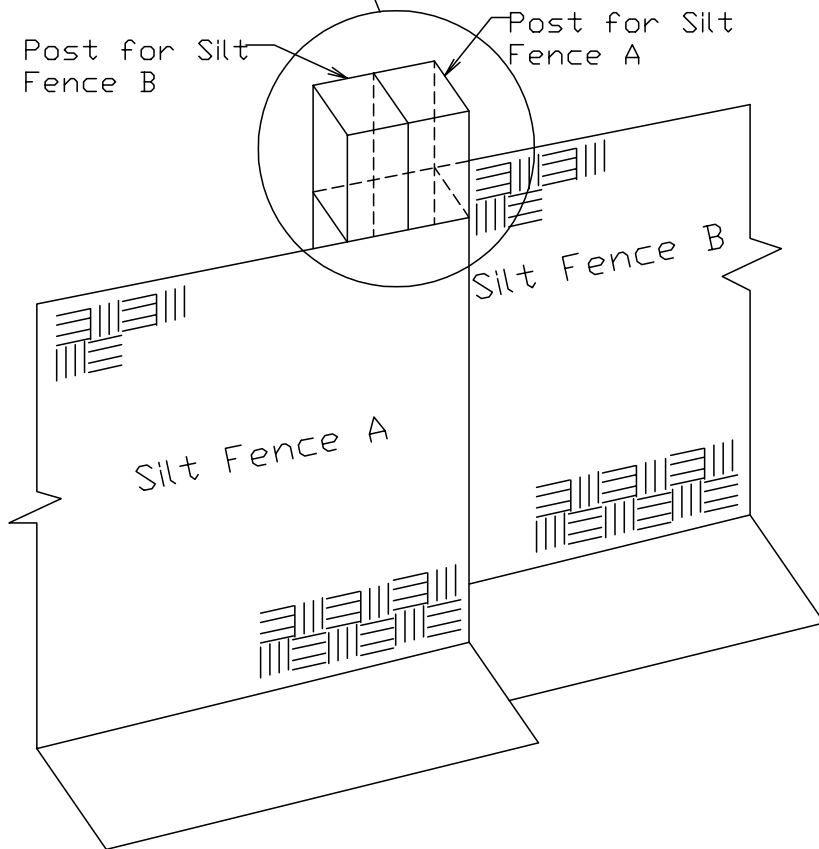

Vehicle Tracking

What it is

Vehicle tracking refers to the stabilization of construction entrances, roads, parking areas, and staging areas to prevent the tracking of sediment from the construction site.



When and Where to use it

- All points where vehicles exit the construction site onto a public road.
- Construction entrance/exit should be located at permanent access locations if at all possible.
- Construction roads and parking areas.
- Loading and unloading areas.
- Storage and staging areas.
- Where trailers are parked.
- Any construction area that receives high vehicular traffic.

When and Where NOT to use it

- The vehicle tracking area should not be located in areas that are wet or where soils erode easily.



This picture shows an unstabilized entrance where dirt is being tracked onto a public road.

Construction Details and Maintenance Requirements

Figure VT-1 and VT-2 provide construction details and maintenance requirements for vehicle tracking.

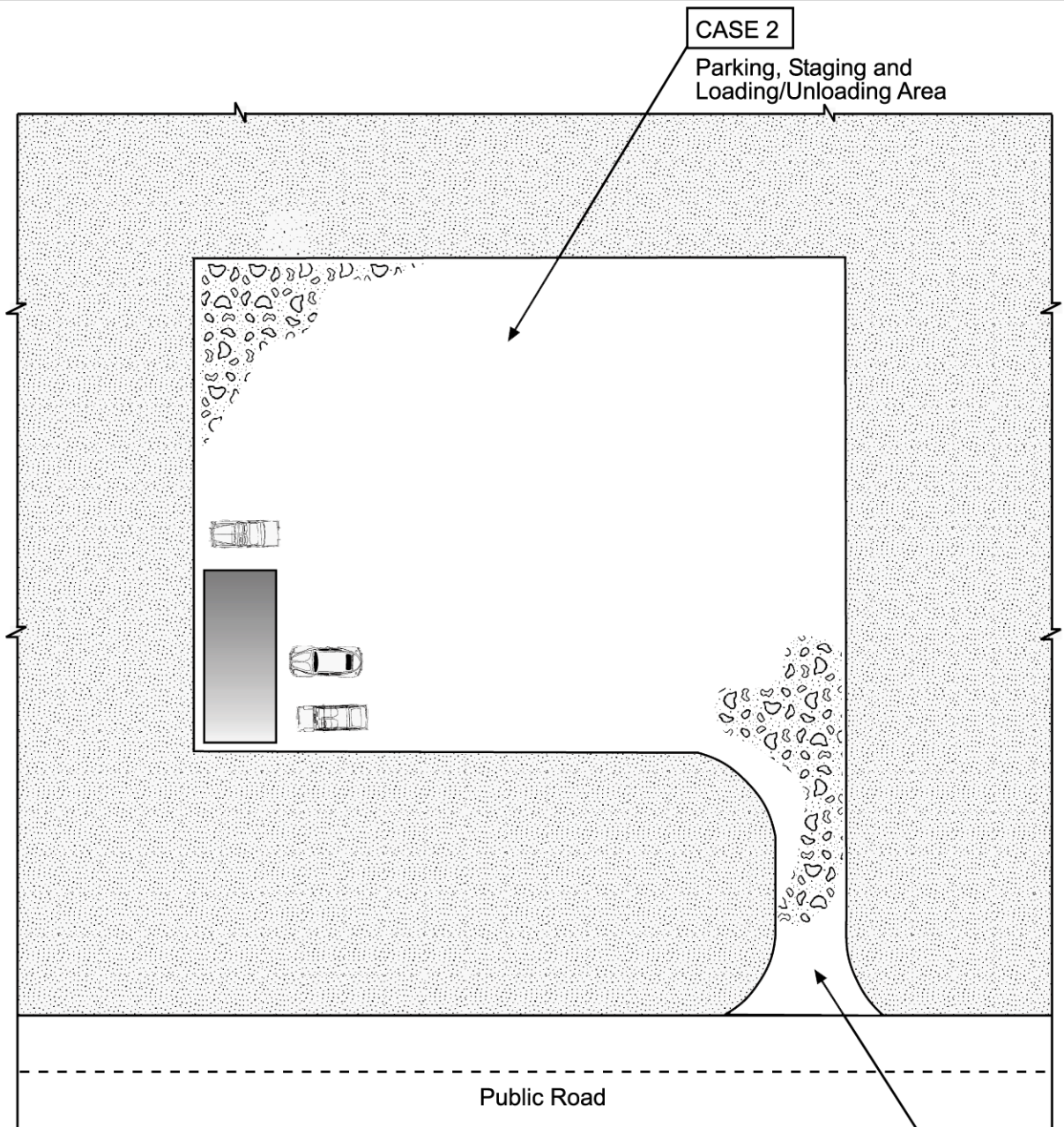
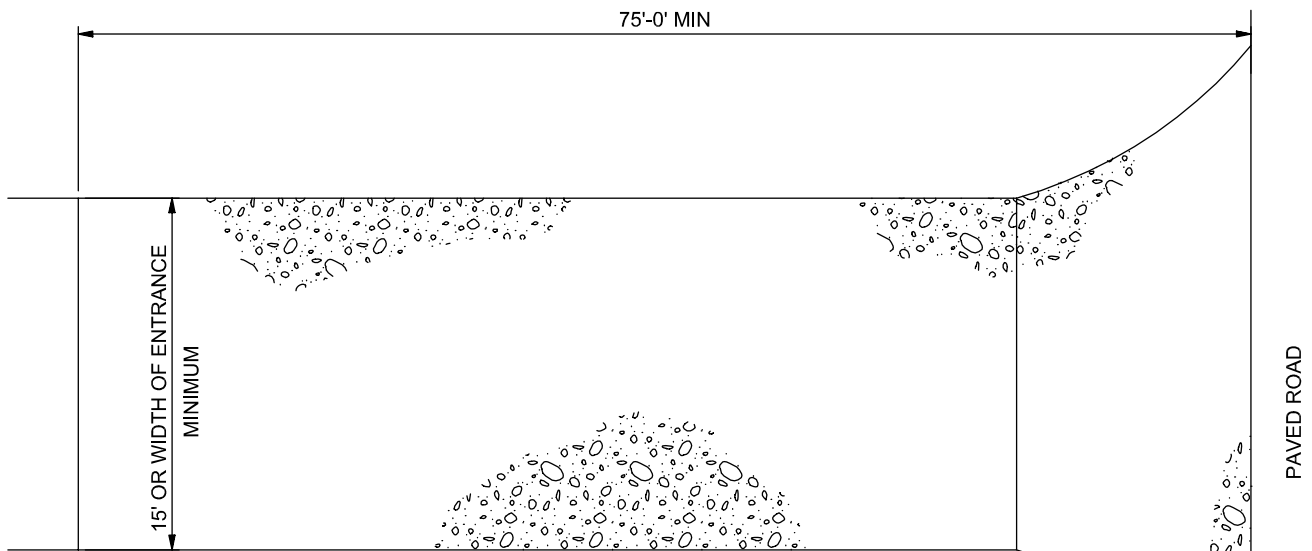

Table VT-1

	Case 1	Case 2
Gravel Thickness	9"	3"
Filter Fabric	YES	NO

CASE 1
Construction Entrance



PLAN

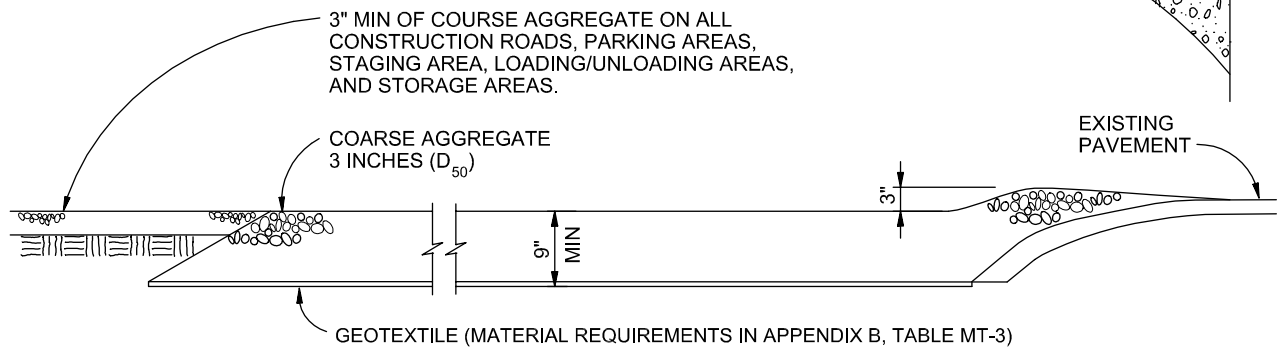

SECTION

VEHICLE TRACKING

NTS

VEHICLE TRACKING NOTES

INSTALLATION REQUIREMENTS

1. ALL ENTRANCES TO THE CONSTRUCTION SITE ARE TO BE STABILIZED PRIOR TO CONSTRUCTION BEGINNING.
2. CONSTRUCTION ENTRANCES ARE TO BE BUILT WITH AN APRON TO ALLOW FOR TURNING TRAFFIC, BUT SHOULD NOT BE BUILT OVER EXISTING PAVEMENT EXCEPT FOR A SLIGHT OVERLAP.
3. AREAS TO BE STABILIZED ARE TO BE PROPERLY GRADED AND COMPACTED PRIOR TO LAYING DOWN GEOTEXTILE AND STONE.
4. CONSTRUCTION ROADS, PARKING AREAS, LOADING/UNLOADING ZONES, STORAGE AREAS, AND STAGING AREAS ARE TO BE STABILIZED.
5. CONSTRUCTION ROADS ARE TO BE BUILT TO CONFORM TO SITE GRADES, BUT SHOULD NOT HAVE SIDE SLOPES OR ROAD GRADES THAT ARE EXCESSIVELY STEEP.

MAINTENANCE REQUIREMENTS

1. REGULAR INSPECTIONS ARE TO BE MADE OF ALL STABILIZED AREAS, ESPECIALLY AFTER STORM EVENTS.
2. STONES ARE TO BE REAPPLIED PERIODICALLY AND WHEN REPAIR IS NECESSARY.
3. SEDIMENT TRACKED ONTO PAVED ROADS IS TO BE REMOVED DAILY BY SHOVELING OR SWEEPING. SEDIMENT IS NOT TO BE WASHED DOWN STORM SEWER DRAINS.
4. STORM SEWER INLET PROTECTION IS TO BE IN PLACE, INSPECTED, AND CLEANED IF NECESSARY.
5. OTHER ASSOCIATED SEDIMENT CONTROL MEASURES ARE TO BE INSPECTED TO ENSURE GOOD WORKING CONDITION.

City of Colorado Springs
Stormwater Quality

Figure VT-2
Vehicle Tracking

Application Examples

Description

Concrete waste management involves designating and properly managing a specific area of the construction site as a concrete washout area. A concrete washout area can be created using one of several approaches designed to receive wash water from washing of tools and concrete mixer chutes, liquid concrete waste from dump trucks, mobile batch mixers, or pump trucks. Three basic approaches are available: excavation of a pit in the ground, use of an above ground storage area, or use of prefabricated haul-away concrete washout containers. Surface discharges of concrete washout water from construction sites are prohibited.



Photograph CWA-1. Example of concrete washout area. Note gravel tracking pad for access and sign.

Appropriate Uses

Concrete washout areas must be designated on all sites that will generate concrete wash water or liquid concrete waste from onsite concrete mixing or concrete delivery.

Because pH is a pollutant of concern for washout activities, when unlined pits are used for concrete washout, the soil must have adequate buffering capacity to result in protection of state groundwater standards; otherwise, a liner/containment must be used. The following management practices are recommended to prevent an impact from unlined pits to groundwater:

- The use of the washout site should be temporary (less than 1 year), and
- The washout site should be not be located in an area where shallow groundwater may be present, such as near natural drainages, springs, or wetlands.

Design and Installation

Concrete washout activities must be conducted in a manner that does not contribute pollutants to surface waters or stormwater runoff. Concrete washout areas may be lined or unlined excavated pits in the ground, commercially manufactured prefabricated washout containers, or aboveground holding areas constructed of berms, sandbags or straw bales with a plastic liner.

Although unlined washout areas may be used, lined pits may be required to protect groundwater under certain conditions.

Do not locate an unlined washout area within 400 feet of any natural drainage pathway or waterbody or within 1,000 feet of any wells or drinking water sources. Even for lined concrete washouts, it is advisable to locate the facility away from waterbodies and drainage paths. If site constraints make these

Concrete Washout Area	
Functions	
Erosion Control	No
Sediment Control	No
Site/Material Management	Yes

setbacks infeasible or if highly permeable soils exist in the area, then the pit must be installed with an impermeable liner (16 mil minimum thickness) or surface storage alternatives using prefabricated concrete washout devices or a lined aboveground storage area should be used.

Design details with notes are provided in Detail CWA-1 for pits and CWA-2 for aboveground storage areas. Pre-fabricated concrete washout container information can be obtained from vendors.

Maintenance and Removal

A key consideration for concrete washout areas is to ensure that adequate signage is in place identifying the location of the washout area. Part of inspecting and maintaining washout areas is ensuring that adequate signage is provided and in good repair and that the washout area is being used, as opposed to washout in non-designated areas of the site.

Remove concrete waste in the washout area, as needed to maintain BMP function (typically when filled to about two-thirds of its capacity). Collect concrete waste and deliver offsite to a designated disposal location.

Upon termination of use of the washout site, accumulated solid waste, including concrete waste and any contaminated soils, must be removed from the site to prevent on-site disposal of solid waste. If the wash water is allowed to evaporate and the concrete hardens, it may be recycled.



Photograph CWA-2. Prefabricated concrete washout. Photo courtesy of CDOT.



Photograph CWA-3. Earthen concrete washout. Photo courtesy of CDOT.

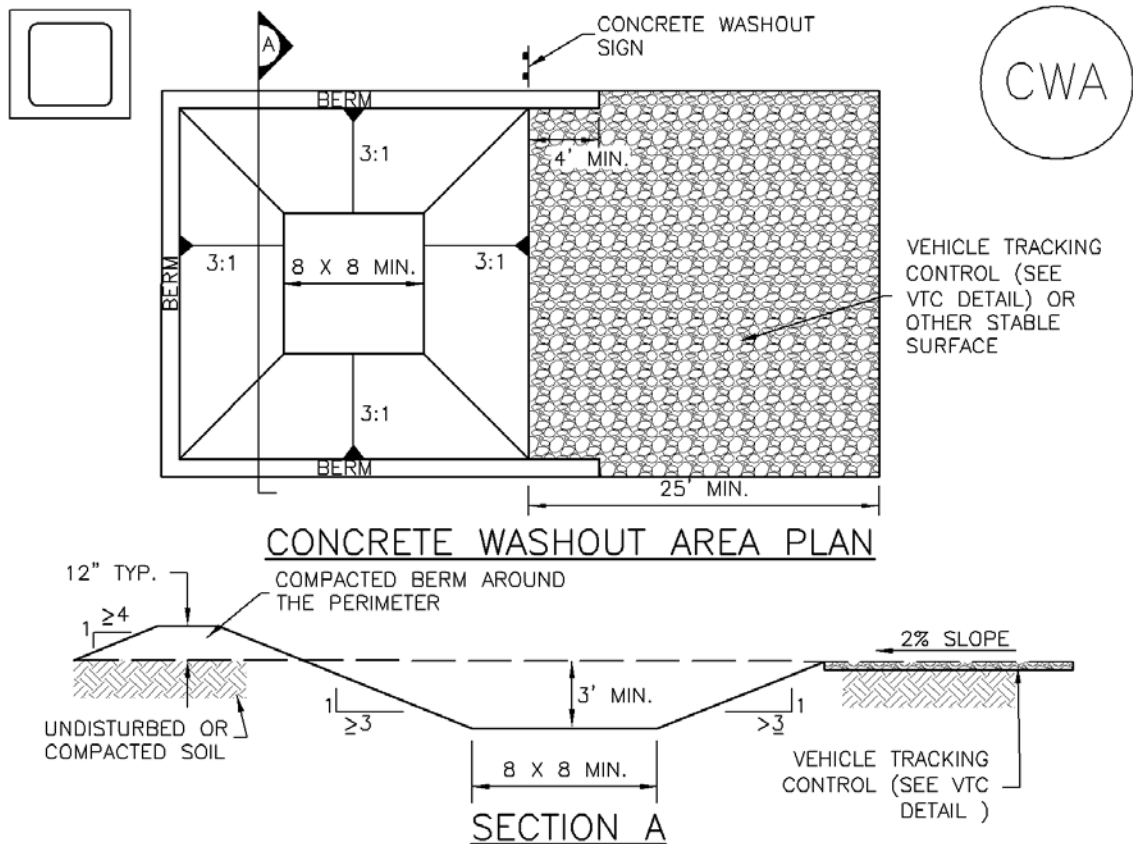

CWA-1. CONCRETE WASHOUT AREA

CWA INSTALLATION NOTES

1. SEE PLAN VIEW FOR:
-CWA INSTALLATION LOCATION.
2. DO NOT LOCATE AN UNLINED CWA WITHIN 400' OF ANY NATURAL DRAINAGE PATHWAY OR WATERBODY. DO NOT LOCATE WITHIN 1,000' OF ANY WELLS OR DRINKING WATER SOURCES. IF SITE CONSTRAINTS MAKE THIS INFEASIBLE, OR IF HIGHLY PERMEABLE SOILS EXIST ON SITE, THE CWA MUST BE INSTALLED WITH AN IMPERMEABLE LINER (16 MIL MIN. THICKNESS) OR SURFACE STORAGE ALTERNATIVES USING PREFABRICATED CONCRETE WASHOUT DEVICES OR A LINED ABOVE GROUND STORAGE ARE SHOULD BE USED.
3. THE CWA SHALL BE INSTALLED PRIOR TO CONCRETE PLACEMENT ON SITE.
4. CWA SHALL INCLUDE A FLAT SUBSURFACE PIT THAT IS AT LEAST 8' BY 8' SLOPES LEADING OUT OF THE SUBSURFACE PIT SHALL BE 3:1 OR FLATTER. THE PIT SHALL BE AT LEAST 3' DEEP.
5. BERM SURROUNDING SIDES AND BACK OF THE CWA SHALL HAVE MINIMUM HEIGHT OF 1'.
6. VEHICLE TRACKING PAD SHALL BE SLOPED 2% TOWARDS THE CWA.
7. SIGNS SHALL BE PLACED AT THE CONSTRUCTION ENTRANCE, AT THE CWA, AND ELSEWHERE AS NECESSARY TO CLEARLY INDICATE THE LOCATION OF THE CWA TO OPERATORS OF CONCRETE TRUCKS AND PUMP RIGS.
8. USE EXCAVATED MATERIAL FOR PERIMETER BERM CONSTRUCTION.

CWA MAINTENANCE NOTES

1. INSPECT BMPs EACH WORKDAY, AND MAINTAIN THEM IN EFFECTIVE OPERATING CONDITION. MAINTENANCE OF BMPs SHOULD BE PROACTIVE, NOT REACTIVE. INSPECT BMPs AS SOON AS POSSIBLE (AND ALWAYS WITHIN 24 HOURS) FOLLOWING A STORM THAT CAUSES SURFACE EROSION, AND PERFORM NECESSARY MAINTENANCE.

2. FREQUENT OBSERVATIONS AND MAINTENANCE ARE NECESSARY TO MAINTAIN BMPs IN EFFECTIVE OPERATING CONDITION. INSPECTIONS AND CORRECTIVE MEASURES SHOULD BE DOCUMENTED THOROUGHLY.

3. WHERE BMPs HAVE FAILED, REPAIR OR REPLACEMENT SHOULD BE INITIATED UPON DISCOVERY OF THE FAILURE.

4. THE CWA SHALL BE REPAIRED, CLEANED, OR ENLARGED AS NECESSARY TO MAINTAIN CAPACITY FOR CONCRETE WASTE. CONCRETE MATERIALS, ACCUMULATED IN PIT, SHALL BE REMOVED ONCE THE MATERIALS HAVE REACHED A DEPTH OF 2'.

5. CONCRETE WASHOUT WATER, WASTED PIECES OF CONCRETE AND ALL OTHER DEBRIS IN THE SUBSURFACE PIT SHALL BE TRANSPORTED FROM THE JOB SITE IN A WATER-TIGHT CONTAINER AND DISPOSED OF PROPERLY.

6. THE CWA SHALL REMAIN IN PLACE UNTIL ALL CONCRETE FOR THE PROJECT IS PLACED.

7. WHEN THE CWA IS REMOVED, COVER THE DISTURBED AREA WITH TOP SOIL, SEED AND MULCH OR OTHERWISE STABILIZED IN A MANNER APPROVED BY THE LOCAL JURISDICTION.

(DETAIL ADAPTED FROM DOUGLAS COUNTY, COLORADO AND THE CITY OF PARKER, COLORADO, NOT AVAILABLE IN AUTOCAD).

NOTE: MANY JURISDICTIONS HAVE BMP DETAILS THAT VARY FROM UDFCD STANDARD DETAILS. CONSULT WITH LOCAL JURISDICTIONS AS TO WHICH DETAIL SHOULD BE USED WHEN DIFFERENCES ARE NOTED.

APPENDIX F – Spill Prevention Plan