

DRAINAGE LETTER REPORT

for

CRAWFORD APARTMENTS TRACT A, FOUNTAIN VALLEY RANCH FILING NO. 6B

Prepared for:

Aime Ventures LLC
1900 E. Pikes Peak Avenue
Colorado Springs, CO 80909

October 17, 2022
Revised August 24, 2023

Prepared by:

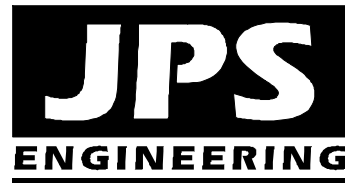

19 E. Willamette Ave.
Colorado Springs, CO 80903
(719)-477-9429
www.jpsengr.com

JPS Project No. 122102
PCD File No. SF-235

I. INTRODUCTION

A. Property Location and Description

Aime Ventures LLC is proposing to construct a new Apartment Building on a vacant 1.2-acre lot on the north side of Crawford Avenue in the Security area of El Paso County. The property is platted as Tract A, Fountain Valley Ranch Filing No. 6B (El Paso County Assessor's Parcel No. 65131-25-009), located at the intersection of Crawford Avenue and Kittery Drive.

The site was recently re-zoned to Multi-Family (RM-30), and the property adjoins developed commercial and residential properties on all sides.

Crawford Avenue is a fully improved public collector street along the south boundary of the site. A shared private access drive enters the south boundary of this property and extends easterly through the southeast corner of the property, providing shared access to the existing School District 3 Federal Credit Union on the adjoining lot to the east (Tract B, Fountain Valley Ranch Filing No. 6B).

The adjoining properties along the west and north boundaries of this property are existing single-family residential properties platted as Lots 14-22, Fountain Valley Ranch Filing No. 6B.

The proposed Site Development Plan consists of a new 21,106 square-foot, 2-story apartment building with associated parking and site improvements. Access will be provided by the existing shared driveway connection to Crawford Avenue along the southern boundary of the site.

The total disturbed area associated with this project is approximately 0.94 acres. Recognizing that the land disturbance is under one acre, water quality facilities are not required as the project is not classified as an "applicable construction activity" in accordance with Section I.6.1 of the El Paso County Engineering Criteria Manual (ECM).

B. Scope

In support of the Site Development Plan and Final Plat submittals to El Paso County, this report is intended to meet the requirements of a Drainage Letter Report in accordance with El Paso County drainage criteria. This report will provide a summary of site drainage issues impacting the proposed development. The report is based on the guidelines and criteria presented in the City of Colorado Springs and El Paso County "Drainage Criteria Manual."

C. References

City of Colorado Springs & El Paso County "Drainage Criteria Manual, Volumes 1 and 2," revised May, 2014.

El Paso County “Engineering Criteria Manual,” December 13, 2016.

KLH Engineering, Inc., “Fountain Valley Ranch Filing 6B, Final Drainage Study,” July 21, 1995.

II. EXISTING AND PROPOSED DRAINAGE CONDITIONS

According to the Natural Resources Conservation Service (NRCS) Web Soil Survey for this site, the majority of the on-site soils are comprised of “Truckton sandy loam” soils, and these well drained soils are classified as hydrologic soils group “A” (high infiltration rate; see Appendix A).

The on-site soils along the east side of the property are comprised of “Blendon sandy loam” soils, and these moderately well drained soils are classified as hydrologic soils group “B” (moderate infiltration rate).

Subdivision Drainage Report

Drainage planning for this site was previously addressed in the “Fountain Valley Ranch Filing 6B, Final Drainage Study” by KLH Engineering, Inc. dated July 21, 1995 (see excerpts in Appendix A).

The subject property is located within “Basin 250” as delineated in the subdivision drainage report, and developed flows from this basin are depicted as flowing southeasterly to a public storm sewer system at the intersection of Crawford Avenue and Grinnell Boulevard. The existing storm sewer system includes a 20’ Type R Storm Inlet at the northwest corner of the intersection, with a 30” storm sewer extending east across Grinnell Boulevard. The Credit Union site flows southeasterly to an existing 10’ Type R Storm Inlet at the southeast corner of Tract B, with a 30” storm sewer extending southeasterly across Grinnell Boulevard. Both of these storm sewer pipes discharge into the existing Grinnell drainage channel, which is a concrete-lined channel flowing south along the east side of Grinnell Boulevard.

The subdivision drainage report by KLH delineated Basin 250 as the area encompassing the planned commercial Tracts A and B and the adjoining row of rear lots of the single-family residential lots along the north and west boundaries of these tracts. The subdivision drainage report assumed an impervious area of 85 percent for the planned commercial development on Tracts A and B, and calculated the total developed peak flows for Basin 250 as $Q_5 = 7.4$ cfs and $Q_{100} = 14.0$ cfs.

Existing Site Drainage Conditions

Surface drainage from this site flows southeasterly into a public storm sewer system draining to the existing Grinnell Channel, which flows south to existing downstream

facilities within the Big Johnson Drainage Basin, ultimately flowing into Fountain Creek (ultimate receiving water).

As shown on the enclosed “Existing Conditions Drainage Plan” (Figure EX1), Tract A has been delineated as Basin A (1.15 acres), and surface drainage from Basin A flows southeasterly by sheet flow to Design Point #1 at the southeast corner of the property. Tract A is impacted by off-site drainage from the rear yards of the existing residential lots along the north and west boundaries of the site, and the off-site drainage area has been delineated as Basin OA1 (0.5 acres). Off-site drainage from Basin OA1 combines with drainage from Basin A flowing southeasterly to Design Point #1, with existing peak flows calculated as $Q_5 = 1.3$ cfs and $Q_{100} = 4.7$ cfs.

The existing Credit Union on Tract B adjoining the east boundary of the Tract A site has been delineated as Basin B (1.5 acres), which sheet flows southeasterly to an existing 10' Type R Storm Inlet at the southeast corner of Tract B.

Drainage from Basins OA1, A, and B combines at Design Point #2, with existing peak flows calculated as $Q_5 = 3.8$ cfs and $Q_{100} = 10.5$ cfs.

Proposed Site Drainage Conditions

As shown on the enclosed Drainage Plan (Figure D1), the developed area of this project is limited to approximately 0.98 acres. The developed site has been delineated as Basin A (1.15 acres), and surface drainage from Basin A will continue to flow southeasterly by sheet flow, drainage swales, private storm sewer pipes, and curb and gutter to Design Point #1 at the southeast corner of the property. Off-site drainage from Basin OA1 will continue to combine with developed on-site drainage from Basin A, flowing southeasterly to Design Point #1, with developed peak flows calculated as $Q_5 = 3.7$ cfs and $Q_{100} = 7.6$ cfs.

As noted on the enclosed Developed Drainage Plan (Figure D1), the proposed development has a calculated impervious area of 66 percent, which is lower than the impervious percentage of 85 percent that was assumed in the previously approved subdivision drainage report by KLH.

Drainage from Basins OA1, A, and B will continue to combine at Design Point #2, with developed peak flows calculated as $Q_5 = 6.1$ cfs and $Q_{100} = 13.3$ cfs. Design Point #2 is equivalent to the developed flow from “Basin 250” as described in the subdivision drainage report, which calculated developed peak flows of $Q_5 = 7.4$ cfs and $Q_{100} = 14.0$ cfs for this basin.

Recognizing that the calculated flows are slightly lower than the flows calculated in the previously approved subdivision drainage report, the existing downstream storm sewer system and drainage channel provide a suitable outfall for drainage from this site.

Hydrologic calculations for the site are detailed in Appendix B, and peak flows are identified on Figures EX1 and D1 (Appendix C).

III. DRAINAGE PLANNING FOUR STEP PROCESS

El Paso County Drainage Criteria require drainage planning to include a Four Step Process for receiving water protection that focuses on reducing runoff volumes, treating the water quality capture volume (WQCV), stabilizing drainageways, and implementing long-term source controls. The Four Step Process has been implemented as follows in the planning of this project:

Step 1: Employ Runoff Reduction Practices

- **Minimize Impacts:** The proposed site development consists of a new multi-family apartment building on a platted infill tract which has been previously planned for full commercial development. This infill project will have minimal drainage impacts in comparison to new development of an unplatted site.

Step 2: Stabilize Drainageways

- There are no drainage channels directly adjacent to this project site.
- The existing Grinnell Channel downstream of this property is a stable, concrete-lined channel.

Step 3: Provide Water Quality Capture Volume (WQCV)

- This site is excluded from permanent Water Quality control measure requirements based on the disturbed area remaining under one acre.

Step 4: Consider Need for Industrial and Commercial BMPs

- The Owner is responsible for maintaining proper housekeeping practices and spill containment procedures.

IV. FLOODPLAIN IMPACTS

Floodplain limits in vicinity of this site are delineated in the applicable Flood Insurance Rate Map, FIRM Panel No. 08041C0951G dated December 7, 2018 (FIRM exhibit enclosed in Appendix C). This site is not impacted by any delineated 100-year FEMA floodplain limits.

V. STORMWATER DETENTION AND WATER QUALITY

No stormwater detention is required based on the previous drainage planning for this subdivision having accounted for developed impervious areas higher than the currently proposed site development.

As previously discussed, this site is excluded from permanent water quality control measure requirements based on the disturbed area being smaller than one acre.

VI. DRAINAGE BASIN FEES

The site lies within the Big Johnson Drainage Basin (FOF02600). No public drainage improvements are required for development of this site. Required drainage fees have been paid during the previous subdivision platting process, so there are no applicable drainage fees required with the Site Development Plan.

VII. SUMMARY

The developed drainage patterns associated with the proposed Crawford Apartments project at the intersection of Crawford Avenue and Kittery Drive (Tract A, Fountain Valley Ranch Filing No. 6B) will remain consistent with the established drainage conditions for this subdivision. The existing stormwater outfalls are functioning properly, including the existing public storm sewer system at the intersection of Crawford Avenue and Grinnell Boulevard. Proper establishment and maintenance of positive drainage within the site, in conjunction with proper erosion control practices, will ensure that this developed site has no significant adverse impact on downstream or surrounding areas.

APPENDIX A

EXCERPTS FROM SUBDIVISION DRAINAGE REPORT

**- FOUNTAIN VALLEY RANCH -
FILING 6B**

FINAL DRAINAGE STUDY

**EL PASO COUNTY, COLORADO
July 21, 1995**

Prepared for:

**New Generation Homes, Inc.
3 Widefield Boulevard
Colorado Springs, Colorado 80911**

Prepared by:

**KLH Engineering, Inc.
208 Sutton Lane
Colorado Springs, CO 80907
KLH # 94549.00**

FILING 6B:

General Discussion:

This drainage study analyzes the Filing 6B area in additional detail. Basins and design points will be situated in the final drainage study so as to provide flow rates to all street intersections (see the developed drainage plan). The lower regions of Filing 6B will contain a higher concentration of basins and design points. This will give us a better comparison between the actual and allowable street flows (see the Street Capacity chart in the Appendix).

All of the drainage in the southeast 55% of FVR 6B will drain by street or pipe flow to the southeast corner of the site. A portion of this flow will be collected as pipe flow and conveyed to the Grinnell Channel. The remainder will become street flow within Grinnell Street. The proposed land use densities are less than originally planned in the previous drainage studies by RBD. Originally there were 4000 to 6000 sf residential lots and much more commercial land than is currently proposed. The Proposed residential lots range from 8000 to 12000 sf. The total flows to Grinnell Street and the Grinnell Channel are also less than originally planned. These flows are summarized on a sketch in the appendix and are compared to the original flows used to design the channel.

The runoff from the northwest 40% of the site will drain out of the subdivision, through undeveloped land (future FVR 6C) to the Windmill Gulch Detention Pond No. 5.

A small portion of the subdivision will drain into FVR 6A. This will be rear lot flow which was accounted for in the FVR 6A drainage study.

The Appendix contains the following hydrologic information:

- Hydrologic Spread Sheet
 - Time of Concentration Section
 - Runoff Coefficients Section
- Excerpt from the report titled "Storm Drainage From Fountain Valley Ranch Subdivision To McRae Reservoir"
- Excerpt from the "Final Drainage Report - Windmill Gulch (from Bradley Road to Fountain Creek)

III. HYDRAULIC ANALYSIS:

The existing inlets along Grinnell Street were analyzed and the results are in the Street Capacity and Inlet Design charts in the appendix. The existing street flows in Grinnell Street are within acceptable levels as outlined in the Drainage Criteria Manual.

The Appendix contains the following hydraulic information:

- Street Capacity Spread Sheet
- Street Capacity Charts for 36' and 40' wide streets
- Inlet Design Spread Sheet
- copies of existing storm drain facilities with original hydraulic calculations

Much of the interior drainage makes its way to the intersection of Modell Drive and Seawell Drive. Street capacities reach their limits right at the intersection where sump inlets are proposed. At the northwest corner (DP230, Q5/Q100 = 16/32 cfs) a 20' Type R inlet will be installed. The centerline of the street, at the low point of the vertical curve, is set at the 100 year ponding depth to capture the 100 year runoff.

At the southeast corner (DP245, Q5/Q100 = 12/23 cfs) a 15' Type R inlet will be installed. This inlet will capture the 5 and 100 year runoff. The 100 year ponding depth will be 0.64'. An emergency overflow swale will be situated right behind this inlet should blockage or an extreme storm event occur. This overflow swale will continue to the southeast, through a private Drainage/Utility/Access Easement, through the edge of a commercial lot and on to Grinnell Street. The two lots adjacent to this easement will have the minimum finished floor elevations set at least 1 foot higher than the expected 100 year water surface elevation.

A 24" RCP will connect the two above inlets. A 30" RCP will drain both of these inlets which is represented by DP248. This 30" RCP will drain into an existing 10' inlet. The existing 30" RCP that drains this inlet will be supplemented with a 24" RCP that will connect to an existing 20' inlet in the north half of Crawford Avenue (see the sketch in the Appendix). With only slight modification, the network of existing outfall pipes that drain into the Grinnell Channel provide adequate capacity to drain the 100 year flows at DP250. The remaining 5/100 year street runoff in Grinnell Street is 1/8 cfs (DP OS-11), well within the allowable street capacity.

VI. COST ESTIMATE

DRAINAGE FEES:

Fountain Valley Ranch Filing 6B contains 41.17 acres. The required fees for Fountain Valley Ranch Filing 6B are as follows:

There are approximately 12.52 acres in the Windmill Gulch Basin.

Basin Fees:

Facilities:	12.52 acres X \$ 6,210 = \$ 77,749
Land:	12.52 acres X \$ 633 = \$ <u>7,925</u>
Sub-Total	\$ 85,674

Bridge Fees:	12.52 acres X \$ 126 = \$ <u>1,577</u>
Total	\$ 87,251

There are approximately 26.36 acres in the Crews Gulch Basin.

Basin Fees:

Facilities:	26.36 acres X \$ 6,751 = \$ 177,956
Land:	26.36 acres X \$ 49 = \$ <u>1,292</u>
Sub-Total	\$ 179,248

Bridge Fees:	26.36 acres X \$ 554 = \$ <u>14,603</u>
Total	\$ 193,851

There are approximately 2.29 acres in the Widefield Basin. There are no land or bridge fees in the Widefield Basin.

Basin Fees:

Drainage:	2.29 acres X \$ 6,162 = \$ 14,111
-----------	-----------------------------------

New Generation Homes has basin credits that exceed the required Drainage Basin Fees for both the Windmill Gulch Drainage Basin (\$85,674) and the Crews Gulch Drainage Basin (\$179,248), therefore, these fees do not need to be paid. The Bridge Fees for the Crews Gulch and Windmill Gulch Basins as well as the Widefield Basin fees will be paid at time of platting. The analysis of the flow split between the Crews Gulch Basin and the Widefield Basin is provided in the Appendix.

CONSTRUCTION COSTS:

The storm drain system proposed for the platted area of FVR 6B is shown on the Developed Drainage Plan. The estimated costs for these public improvements are approximately \$ 28,158. Erosion control costs are \$ 18,510 and are considered private and non reimbursable. See the cost estimate on the following table. Appropriate financial assurances for the drainage improvements and for the erosion control will be provided. These financial assurances will be separate from the above Basin Fees.

HYDROLOGIC SPREAD SHEET
Fountain Valley Ranch Filing 6B
Rational Method

BASIN No.	AREA Ac.	PEAK FLOW (CFS) 5 Year 10 Year		TIME OF CONCENTRATION																INTENSITY 5 Year 100 Year		RUNOFF COEFF 5 Year 100 Year							
				OVERLAND FLOW					NATURAL CHANNEL FLOW					STREET FLOW					PIPE OR STREET FLOW2										
				L FL.	H FL.	Slope %	C10	Tt Min.	L FL.	H FL.	Slope %	Vel FPS	Tt Min.	L FL.	H FL.	Slope %	Vel FPS	Tt Min.	L FL.					H FL.	Slope %	Vel FPS	Tt Min.	Tc Min.	
DEVELOPED FLOW:																													
On-Site:																													
205	1.39	2.6	5.2	150	3.0	0.020	0.25	15.5													17.8	3.1	5.4	0.60	0.70				
210	1.92	3.9	7.9	150	4.5	0.030	0.25	13.5													15.0	3.4	5.9	0.60	0.70				
212	0.95	2.3	4.7	60	1.8	0.030	0.25	8.6													9.8	4.1	7.1	0.60	0.70				
215	0.58	1.5	3.1	40	1.2	0.030	0.25	7.0													8.4	4.3	7.6	0.60	0.70				
220	1.72	3.5	7.0	150	4.8	0.032	0.25	13.3							240	7.3	0.030	4	1.0		15.2	3.4	5.9	0.60	0.70				
225	2.39	4.4	8.9	150	3.0	0.020	0.25	15.5							400	15.0	0.038	5	1.3		18.2	3.1	5.3	0.60	0.70				
230	3.43	6.5	13.0	150	3.0	0.020	0.25	15.5							250	8.0	0.032	4	1.0		17.4	3.1	5.5	0.60	0.70				
235	3.65	7.2	13.8	150	3.0	0.020	0.25	15.5							330	3.0	0.009	2.5	2.2		18.8	3.0	5.3	0.66	0.72				
240	1.92	3.8	7.8	100	2.0	0.020	0.25	12.6							750	26.8	0.036	4.5	2.8		15.4	3.3	5.8	0.60	0.70				
245	1.03	2.2	4.3	100	2.0	0.020	0.25	12.6							350	13.8	0.039	4	1.5		14.1	3.5	6.1	0.60	0.70				
250	3.33	7.4	14.0	250	5.0	0.020	0.45	15.3							500	12.0	0.024	3	2.8		18.1	3.1	5.4	0.73	0.78				
260	0.66	1.4	2.8	70	1.4	0.020	0.25	10.6							410	13.0	0.032	5	1.4		11.9	3.8	6.6	0.55	0.65				
262	0.66	1.4	2.8	70	1.4	0.020	0.25	10.6							410	13.0	0.032	5	1.4		11.9	3.8	6.6	0.55	0.65				
270	4.68	3.3	7.8	500	19.0	0.038	0.25	22.9	250	7.0	0.028	0.7	6.0								28.8	2.4	4.1	0.30	0.40				
305	2.18	4.5	8.5	200	4.0	0.020	0.25	17.9							250	4.0	0.016	2.8	1.5		19.4	3.0	5.2	0.70	0.75				
310	3.81	5.9	11.8	220	4.4	0.020	0.25	18.8							100	1.0	0.010	2	0.8	780	7.0	0.009	2.2	5.9	25.5	2.5	4.5	0.60	0.70
315	2.71	4.7	9.5	150	3.0	0.020	0.25	15.5							400	1.9	0.005	2.3	2.9	250	3.1	0.012	2.2	1.9	20.3	2.9	5.1	0.60	0.70
320	3.41	6.2	12.4	100	2.0	0.020	0.25	12.6							930	12.0	0.013	2.5	6.2		18.8	3.0	5.3	0.60	0.70				
322	0.35	0.8	1.6	70	1.4	0.020	0.25	10.6							100	2.0	0.020	3.5	0.5		11.1	3.9	6.8	0.60	0.70				
325	0.92	1.9	3.8	80	1.6	0.020	0.25	11.3							500	6.2	0.012	2.2	3.8		15.1	3.4	5.9	0.60	0.70				
DP 215	3.45	6.9	13.9																	Tt from basin 210:	15.0	15.6	3.3	5.8	0.60	0.70			
DP 220	3.11	5.8	11.7																	Tt from basin 205:	17.8	17.8	3.1	5.4	0.60	0.70			
DP 225	5.50	9.9	19.9												400	15.0	0.038	5	1.3		17.8	19.1	3.0	5.2	0.60	0.70			
DP 230	8.93	16.1	32.4																	Tt from DP 225:	19.1	19.1	3.0	5.2	0.60	0.70			
DP 240	5.57	9.7	19.0												750	26.8	0.036	4.5	2.8		18.8	21.6	2.8	4.9	0.62	0.70			
DP 245	6.60	11.7	22.9																	Tt from Basin 235:	18.8	21.6	2.8	4.9	0.62	0.70			
DP 248	15.53	26.7	53.2																	Tt from DP 240:	21.6	21.6	2.8	4.9	0.63	0.71			
DP 250	16.86	33.9	66.3																	Tt from DP 240:	21.6	21.6	2.8	4.9	0.62	0.70			
DP 310	5.99	9.7	19.1												350	10.0	0.029	5	1.2		21.6	22.8	2.7	4.7	0.66	0.74			
DP 315	8.70	13.9	27.5																	Tt from DP 245:	21.6	22.8	2.7	4.7	0.66	0.74			
DP 320	12.11	19.1	37.9																	Tt from basin 310:	25.5	25.5	2.5	4.5	0.64	0.71			
DP 322	13.38	20.7	41.2																	Tt from DP 310:	25.5	25.5	2.5	4.5	0.62	0.70			
															200	4.0	0.020	4	0.8		25.5	26.3	2.5	4.4	0.62	0.70			
																				Tt from DP 310:	25.5	26.3	2.5	4.4	0.62	0.70			
Off-Site:																													
OS-5	7.81	19.6	36.3	100	2	0.020	0.25	12.6	100	3	0.030	0.90	2.6	500	12	0.024	3.5	2.4		17.6	3.1	5.4	0.81	0.86					
OS-6	0.41	0.9	1.8	66	1.5	0.023	0.25	9.8						400	7	0.018	3	2.2		12.1	3.7	6.5	0.60	0.67					
OS-7	1.03	3.1	6.0	20	0.5	0.025	0.25	5.3						750	28	0.037	4.5	2.8		8.0	4.4	7.7	0.69	0.75					
OS-8	0.41	1.3	2.6	20	0.5	0.025	0.25	5.3						300	10	0.033	4.5	1.1		6.4	4.8	8.4	0.68	0.75					
OS-9	0.83	2.5	4.8	20	0.5	0.025	0.25	5.3						650	16	0.025	4	2.7		8.0	4.4	7.7	0.69	0.75					
OS-10	0.83	1.8	3.5	66	-2	0.030	0.25	9.0						900	22	0.024	3.6	4.2		13.1	3.6	6.3	0.61	0.68					
OS-11	1.96	3.9	7.6	100	4	0.020	0.25	17.9						650	17	0.026	3.5	3.1		21.0	2.8	5.0	0.71	0.78					
DP OS-6	8.22	20.3	37.8																	Tt from Basin OS-5:	17.6	17.6	3.1	5.4	0.79	0.85			
DP OS-7	13.91	20.0	38.9																	Tt from Basin 270:	28.8	28.8	2.4	4.1	0.60	0.67			
DP OS-8	15.00	20.6	40.2												300	10	0.033	4.4	1.1		28.8	29.9	2.3	4.1	0.59	0.66			
DP OS-9	16.49	21.2	41.5												630	16	0.025	4	2.6		29.9	32.5	2.2	3.9	0.58	0.65			
DP OS-10	4.28	8.0	15.9												580	16	0.028	4	2.4		15.6	18.0	3.1	5.4	0.60	0.69			
DPOS10.1	39.61	52.8	104.2																	Tt from DP 215:	15.6	18.0	3.1	5.4	0.60	0.69			
DP OS-11	41.59	55.6	109.7																	Tt from DP OS-9:	32.5	32.5	2.2	3.9	0.60	0.68			
																				Tt from DP OS-9:	32.5	32.5	2.2	3.9	0.60	0.68			

Note: 1) Peak Flow = C*I*A = Runoff Coefficient * Intensity * Area
 2) The Runoff Coefficient may be a composit value. (See table below)
 3) The Intensity is derived from Figure 5-1 in the DCM (modified for the 5/10/100 year storms).
 4) The overland travel time (Tt) is derived from the formula in section 5.2.3 in the DCM: $Tt = 1.87(1.1 - C10)(L^0.5)(S^-0.33)$
 5) The Mannings equation is used to calculate the travel times of natural channels (0.03 < n < 0.05), street flow (n = 0.16) and pipe flow (n = 0.13).
 6) The Time of Concentration (Tc) is the sum of all the appropriate Tt's.

File: Hydro6B.wql 1/2 10-Jul-95

RUNOFF COEFFICIENTS
Fountain Valley Ranch Filing 6B

BASIN No.	AREA Ac.	Land Use #1:					Land Use #2:					Land Use #3:					COMPOSITE RUNOFF COEFF		
		Description	Soil	Area Ac.	Area %	C	Description	Soil	Area Ac.	Area %	C	Description	Soil	Area Ac.	Area %	C	5 Year	100 Year	
																			5 Year
DEVELOPED FLOW:																			
On-Site:																			
205	1.39	1/5 ac. residential	A/B	1.18	85	0.55	0.65	streets	A/B	0.21	15	0.90	0.95					0.60	0.70
210	1.92	1/5 ac. residential	A/B	1.63	85	0.55	0.65	streets	A/B	0.29	15	0.90	0.95					0.60	0.70
212	0.95	1/5 ac. residential	A/B	0.81	85	0.55	0.65	streets	A/B	0.14	15	0.90	0.95					0.60	0.70
215	0.58	1/5 ac. residential	A/B	0.49	85	0.55	0.65	streets	A/B	0.09	15	0.90	0.95					0.60	0.70
220	1.72	1/5 ac. residential	A/B	1.46	85	0.55	0.65	streets	A/B	0.26	15	0.90	0.95					0.60	0.70
225	2.39	1/5 ac. residential	A/B	2.03	85	0.55	0.65	streets	A/B	0.36	15	0.90	0.95					0.60	0.70
230	3.43	1/5 ac. residential	A/B	2.92	85	0.55	0.65	streets	A/B	0.51	15	0.90	0.95					0.60	0.70
235	3.65	1/5 ac. residential	A/B	1.10	30	0.55	0.65	school	A/B	2.56	70	0.70	0.75					0.66	0.72
240	1.92	1/5 ac. residential	A/B	1.63	85	0.55	0.65	streets	A/B	0.29	15	0.90	0.95					0.60	0.70
245	1.03	1/5 ac. residential	A/B	0.88	85	0.55	0.65	streets	A/B	0.15	15	0.90	0.95					0.60	0.70
250	3.33	res/rear-lot/334slap	A/B	0.73	22	0.46	0.55	office/comm/95slap	A/B	2.60	78	0.80	0.85					0.73	0.78
260	0.66	1/5 ac. residential	A/B	0.66	100	0.55	0.65											0.55	0.65
262	0.66	1/5 ac. residential	A/B	0.66	100	0.55	0.65											0.55	0.65
270	4.68	park	A/B	4.68	100	0.30	0.40											0.30	0.40
305	2.18	school	A/B	2.18	100	0.70	0.75											0.70	0.75
310	3.81	1/5 ac. residential	A/B	3.24	85	0.55	0.65	streets	A/B	0.57	15	0.90	0.95					0.60	0.70
315	2.71	1/5 ac. residential	A/B	2.30	85	0.55	0.65	streets	A/B	0.41	15	0.90	0.95					0.60	0.70
320	3.41	1/5 ac. residential	A/B	2.90	85	0.55	0.65	streets	A/B	0.51	15	0.90	0.95					0.60	0.70
322	0.35	1/5 ac. residential	A/B	0.30	85	0.55	0.65	streets	A/B	0.05	15	0.90	0.95					0.60	0.70
325	0.92	1/5 ac. residential	A/B	0.78	85	0.55	0.65	streets	A/B	0.14	15	0.90	0.95					0.60	0.70
DP 215	3.45	1/5 ac. residential	A/B	2.93	85	0.55	0.65	streets	A/B	0.52	15	0.90	0.95					0.60	0.70
DP 220	3.11	1/5 ac. residential	A/B	2.64	85	0.55	0.65	streets	A/B	0.47	15	0.90	0.95					0.60	0.70
DP 225	5.50	1/5 ac. residential	A/B	4.67	85	0.55	0.65	streets	A/B	0.83	15	0.90	0.95					0.60	0.70
DP 230	8.93	1/5 ac. residential	A/B	7.59	85	0.55	0.65	streets	A/B	1.34	15	0.90	0.95					0.60	0.70
DP 240	5.57	1/5 ac. residential	A/B	2.73	49	0.55	0.65	streets	A/B	0.29	5	0.55	0.65	school	A/B	2.56	46	0.70	0.75
DP 245	6.60	1/5 ac. residential	A/B	3.61	55	0.55	0.65	streets	A/B	0.44	7	0.90	0.95	school	A/B	2.56	39	0.70	0.75
DP 248	15.53	1/5 ac. residential	A/B	11.20	72	0.55	0.65	streets	A/B	1.78	11	0.90	0.95	school	A/B	2.56	16	0.70	0.75
DP 250	18.86	1/5 ac. residential	A/B	11.20	59	0.55	0.65	streets	A/B	1.78	9	0.90	0.95	office/comm/school	A/B	5.89	31	0.80	0.85
DP 310	5.99	1/5 ac. residential	A/B	3.24	54	0.55	0.65	streets	A/B	0.57	10	0.90	0.95	school	A/B	2.18	36	0.70	0.75
DP 315	8.70	1/5 ac. residential	A/B	5.54	64	0.55	0.65	streets	A/B	0.98	11	0.90	0.95	school	A/B	2.18	25	0.70	0.75
DP 320	12.11	1/5 ac. residential	A/B	8.48	70	0.55	0.65	streets	A/B	1.45	12	0.90	0.95	school	A/B	2.18	18	0.70	0.75
DP 322	13.38	1/5 ac. residential	A/B	9.56	71	0.55	0.65	streets	A/B	1.65	12	0.90	0.95	school	A/B	2.18	16	0.70	0.75
Off-Site:																			
OS-5	7.81	business/industrial	A/B	7.42	95	0.80	0.85	streets	A/B	0.39	5	0.90	0.95					0.81	0.86
OS-6	0.41	landscaping	A/B	0.19	46	0.25	0.35	streets	A/B	0.22	54	0.90	0.95					0.60	0.67
OS-7	1.03	landscaping	A/B	0.34	33	0.25	0.35	streets	A/B	0.69	67	0.90	0.95					0.69	0.75
OS-8	0.41	landscaping	A/B	0.14	34	0.25	0.35	streets	A/B	0.27	66	0.90	0.95					0.68	0.75
OS-9	0.83	landscaping	A/B	0.27	33	0.25	0.35	streets	A/B	0.56	67	0.90	0.95					0.69	0.75
OS-10	0.83	landscaping	A/B	0.37	45	0.25	0.35	streets	A/B	0.46	55	0.90	0.95					0.61	0.68
OS-11	1.96	1/5 ac. residential	A/B	0.98	50	0.55	0.65	streets	A/B	0.59	10	0.90	0.95	business	A/B	0.39	20	0.80	0.85
DP OS-6	8.22	business/industrial	A/B	7.42	90	0.80	0.85	streets	A/B	0.61	7	0.90	0.95	landscaping	A/B	0.19	2	0.25	0.35
DP OS-7	13.93	business/industrial	A/B	7.42	53	0.80	0.85	streets	A/B	1.30	9	0.90	0.95	landscaping	A/B	5.21	37	0.25	0.35
DP OS-8	15.00	business/industrial	A/B	7.42	49	0.80	0.85	streets	A/B	1.57	10	0.90	0.95	landscaping	A/B	6.01	40	0.25	0.35
DP OS-9	16.49	business/industrial	A/B	7.42	45	0.80	0.85	streets	A/B	2.13	13	0.90	0.95	landscaping	A/B	6.94	42	0.25	0.35
DP OS-10	4.28	1/5 ac. residential	A/B	2.93	68	0.55	0.65	streets	A/B	0.98	23	0.90	0.95	landscaping	A/B	0.37	9	0.25	0.35
DPOS10.1	39.63	business/industrial	A/B	13.31	34	0.80	0.85	141 ac/86% resid	A/B	19.01	48	0.60	0.69	landscaping	A/B	7.31	18	0.25	0.35
DP OS-11	41.59	business/industrial	A/B	13.70	33	0.80	0.85	141 ac/86% resid	A/B	20.58	49	0.60	0.69	landscaping	A/B	7.31	18	0.25	0.35

Note: 1) The Runoff Coefficient values are derived from Table 5-1 in the DCM.

APPENDIX B
DRAINAGE CALCULATIONS

Hydrologic Soil Group—El Paso County Area, Colorado
(Crawford Apartment Site)

MAP LEGEND

Area of Interest (AOI)









 Area of Interest (AOI)

Soils

Soil Rating Polygons





-  A
-  A/D
-  B
-  B/D
-  C
-  C/D
-  D
-  Not rated or not available

Soil Rating Lines

-  A
-  A/D
-  B
-  B/D
-  C
-  C/D
-  D
-  Not rated or not available

Soil Rating Points

-  A
-  A/D
-  B
-  B/D

-  C
-  C/D
-  D
-  Not rated or not available

Water Features

 Streams and Canals

Transportation

-  Rails
-  Interstate Highways
-  US Routes
-  Major Roads
-  Local Roads

Background

 Aerial Photography

MAP INFORMATION

The soil surveys that comprise your AOI were mapped at 1:24,000.

Warning: Soil Map may not be valid at this scale.

Enlargement of maps beyond the scale of mapping can cause misunderstanding of the detail of mapping and accuracy of soil line placement. The maps do not show the small areas of contrasting soils that could have been shown at a more detailed scale.

Please rely on the bar scale on each map sheet for map measurements.

Source of Map: Natural Resources Conservation Service
Web Soil Survey URL:
Coordinate System: Web Mercator (EPSG:3857)

Maps from the Web Soil Survey are based on the Web Mercator projection, which preserves direction and shape but distorts distance and area. A projection that preserves area, such as the Albers equal-area conic projection, should be used if more accurate calculations of distance or area are required.

This product is generated from the USDA-NRCS certified data as of the version date(s) listed below.

Soil Survey Area: El Paso County Area, Colorado
Survey Area Data: Version 19, Aug 31, 2021

Soil map units are labeled (as space allows) for map scales 1:50,000 or larger.

Date(s) aerial images were photographed: Aug 14, 2018—Sep 23, 2018

The orthophoto or other base map on which the soil lines were compiled and digitized probably differs from the background imagery displayed on these maps. As a result, some minor shifting of map unit boundaries may be evident.

Hydrologic Soil Group

Map unit symbol	Map unit name	Rating	Acres in AOI	Percent of AOI
10	Blendon sandy loam, 0 to 3 percent slopes	B	0.5	38.5%
97	Truckton sandy loam, 3 to 9 percent slopes	A	0.8	61.5%
Totals for Area of Interest			1.4	100.0%

Description

Hydrologic soil groups are based on estimates of runoff potential. Soils are assigned to one of four groups according to the rate of water infiltration when the soils are not protected by vegetation, are thoroughly wet, and receive precipitation from long-duration storms.

The soils in the United States are assigned to four groups (A, B, C, and D) and three dual classes (A/D, B/D, and C/D). The groups are defined as follows:

Group A. Soils having a high infiltration rate (low runoff potential) when thoroughly wet. These consist mainly of deep, well drained to excessively drained sands or gravelly sands. These soils have a high rate of water transmission.

Group B. Soils having a moderate infiltration rate when thoroughly wet. These consist chiefly of moderately deep or deep, moderately well drained or well drained soils that have moderately fine texture to moderately coarse texture. These soils have a moderate rate of water transmission.

Group C. Soils having a slow infiltration rate when thoroughly wet. These consist chiefly of soils having a layer that impedes the downward movement of water or soils of moderately fine texture or fine texture. These soils have a slow rate of water transmission.

Group D. Soils having a very slow infiltration rate (high runoff potential) when thoroughly wet. These consist chiefly of clays that have a high shrink-swell potential, soils that have a high water table, soils that have a claypan or clay layer at or near the surface, and soils that are shallow over nearly impervious material. These soils have a very slow rate of water transmission.

If a soil is assigned to a dual hydrologic group (A/D, B/D, or C/D), the first letter is for drained areas and the second is for undrained areas. Only the soils that in their natural condition are in group D are assigned to dual classes.

Rating Options

Aggregation Method: Dominant Condition

Component Percent Cutoff: None Specified

Tie-break Rule: Higher

Table 6-6. Runoff Coefficients for Rational Method

(Source: UDFCD 2001)

Land Use or Surface Characteristics	Percent Impervious	Runoff Coefficients											
		2-year		5-year		10-year		25-year		50-year		100-year	
		HSG A&B	HSG C&D	HSG A&B	HSG C&D	HSG A&B	HSG C&D	HSG A&B	HSG C&D	HSG A&B	HSG C&D	HSG A&B	HSG C&D
Business													
Commercial Areas	95	0.79	0.80	0.81	0.82	0.83	0.84	0.85	0.87	0.87	0.88	0.88	0.89
Neighborhood Areas	70	0.45	0.49	0.49	0.53	0.53	0.57	0.58	0.62	0.60	0.65	0.62	0.68
Residential													
1/8 Acre or less	65	0.41	0.45	0.45	0.49	0.49	0.54	0.54	0.59	0.57	0.62	0.59	0.65
1/4 Acre	40	0.23	0.28	0.30	0.35	0.36	0.42	0.42	0.50	0.46	0.54	0.50	0.58
1/3 Acre	30	0.18	0.22	0.25	0.30	0.32	0.38	0.39	0.47	0.43	0.52	0.47	0.57
1/2 Acre	25	0.15	0.20	0.22	0.28	0.30	0.36	0.37	0.46	0.41	0.51	0.46	0.56
1 Acre	20	0.12	0.17	0.20	0.26	0.27	0.34	0.35	0.44	0.40	0.50	0.44	0.55
Industrial													
Light Areas	80	0.57	0.60	0.59	0.63	0.63	0.66	0.66	0.70	0.68	0.72	0.70	0.74
Heavy Areas	90	0.71	0.73	0.73	0.75	0.75	0.77	0.78	0.80	0.80	0.82	0.81	0.83
Parks and Cemeteries	7	0.05	0.09	0.12	0.19	0.20	0.29	0.30	0.40	0.34	0.46	0.39	0.52
Playgrounds	13	0.07	0.13	0.16	0.23	0.24	0.31	0.32	0.42	0.37	0.48	0.41	0.54
Railroad Yard Areas	40	0.23	0.28	0.30	0.35	0.36	0.42	0.42	0.50	0.46	0.54	0.50	0.58
Undeveloped Areas													
Historic Flow Analysis-- Greenbelts, Agriculture	2	0.03	0.05	0.09	0.16	0.17	0.26	0.26	0.38	0.31	0.45	0.36	0.51
Pasture/Meadow	0	0.02	0.04	0.08	0.15	0.15	0.25	0.25	0.37	0.30	0.44	0.35	0.50
Forest	0	0.02	0.04	0.08	0.15	0.15	0.25	0.25	0.37	0.30	0.44	0.35	0.50
Exposed Rock	100	0.89	0.89	0.90	0.90	0.92	0.92	0.94	0.94	0.95	0.95	0.96	0.96
Offsite Flow Analysis (when landuse is undefined)	45	0.26	0.31	0.32	0.37	0.38	0.44	0.44	0.51	0.48	0.55	0.51	0.59
Streets													
Paved	100	0.89	0.89	0.90	0.90	0.92	0.92	0.94	0.94	0.95	0.95	0.96	0.96
Gravel	80	0.57	0.60	0.59	0.63	0.63	0.66	0.66	0.70	0.68	0.72	0.70	0.74
Drive and Walks	100	0.89	0.89	0.90	0.90	0.92	0.92	0.94	0.94	0.95	0.95	0.96	0.96
Roofs	90	0.71	0.73	0.73	0.75	0.75	0.77	0.78	0.80	0.80	0.82	0.81	0.83
Lawns	0	0.02	0.04	0.08	0.15	0.15	0.25	0.25	0.37	0.30	0.44	0.35	0.50

3.2 Time of Concentration

One of the basic assumptions underlying the Rational Method is that runoff is a function of the average rainfall rate during the time required for water to flow from the hydraulically most remote part of the drainage area under consideration to the design point. However, in practice, the time of concentration can be an empirical value that results in reasonable and acceptable peak flow calculations.

For urban areas, the time of concentration (t_c) consists of an initial time or overland flow time (t_i) plus the travel time (t_r) in the storm sewer, paved gutter, roadside drainage ditch, or drainage channel. For non-urban areas, the time of concentration consists of an overland flow time (t_i) plus the time of travel in a concentrated form, such as a swale or drainageway. The travel portion (t_r) of the time of concentration can be estimated from the hydraulic properties of the storm sewer, gutter, swale, ditch, or drainageway. Initial time, on the other hand, will vary with surface slope, depression storage, surface cover, antecedent rainfall, and infiltration capacity of the soil, as well as distance of surface flow. The time of concentration is represented by Equation 6-7 for both urban and non-urban areas.

$$t_c = t_i + t_t \quad (\text{Eq. 6-7})$$

Where:

t_c = time of concentration (min)

t_i = overland (initial) flow time (min)

t_t = travel time in the ditch, channel, gutter, storm sewer, etc. (min)

3.2.1 Overland (Initial) Flow Time

The overland flow time, t_i , may be calculated using Equation 6-8.

$$t_i = \frac{0.395(1.1 - C_5)\sqrt{L}}{S^{0.33}} \quad (\text{Eq. 6-8})$$

Where:

t_i = overland (initial) flow time (min)

C_5 = runoff coefficient for 5-year frequency (see Table 6-6)

L = length of overland flow (300 ft maximum for non-urban land uses, 100 ft maximum for urban land uses)

S = average basin slope (ft/ft)

Note that in some urban watersheds, the overland flow time may be very small because flows quickly concentrate and channelize.

3.2.2 Travel Time

For catchments with overland and channelized flow, the time of concentration needs to be considered in combination with the travel time, t_t , which is calculated using the hydraulic properties of the swale, ditch, or channel. For preliminary work, the overland travel time, t_t , can be estimated with the help of Figure 6-25 or Equation 6-9 (Guo 1999).

$$V = C_v S_w^{0.5} \quad (\text{Eq. 6-9})$$

Where:

V = velocity (ft/s)

C_v = conveyance coefficient (from Table 6-7)

S_w = watercourse slope (ft/ft)

Table 6-7. Conveyance Coefficient, C_v

Type of Land Surface	C_v
Heavy meadow	2.5
Tillage/field	5
Riprap (not buried)*	6.5
Short pasture and lawns	7
Nearly bare ground	10
Grassed waterway	15
Paved areas and shallow paved swales	20

* For buried riprap, select C_v value based on type of vegetative cover.

The travel time is calculated by dividing the flow distance (in feet) by the velocity calculated using Equation 6-9 and converting units to minutes.

The time of concentration (t_c) is then the sum of the overland flow time (t_i) and the travel time (t_t) per Equation 6-7.

3.2.3 First Design Point Time of Concentration in Urban Catchments

Using this procedure, the time of concentration at the first design point (typically the first inlet in the system) in an urbanized catchment should not exceed the time of concentration calculated using Equation 6-10. The first design point is defined as the point where runoff first enters the storm sewer system.

$$t_c = \frac{L}{180} + 10 \quad (\text{Eq. 6-10})$$

Where:

t_c = maximum time of concentration at the first design point in an urban watershed (min)

L = waterway length (ft)

Equation 6-10 was developed using the rainfall-runoff data collected in the Denver region and, in essence, represents regional “calibration” of the Rational Method. Normally, Equation 6-10 will result in a lesser time of concentration at the first design point and will govern in an urbanized watershed. For subsequent design points, the time of concentration is calculated by accumulating the travel times in downstream drainageway reaches.

3.2.4 Minimum Time of Concentration

If the calculations result in a t_c of less than 10 minutes for undeveloped conditions, it is recommended that a minimum value of 10 minutes be used. The minimum t_c for urbanized areas is 5 minutes.

3.2.5 Post-Development Time of Concentration

As Equation 6-8 indicates, the time of concentration is a function of the 5-year runoff coefficient for a drainage basin. Typically, higher levels of imperviousness (higher 5-year runoff coefficients) correspond to shorter times of concentration, and lower levels of imperviousness correspond to longer times of

Figure 6-5. Colorado Springs Rainfall Intensity Duration Frequency

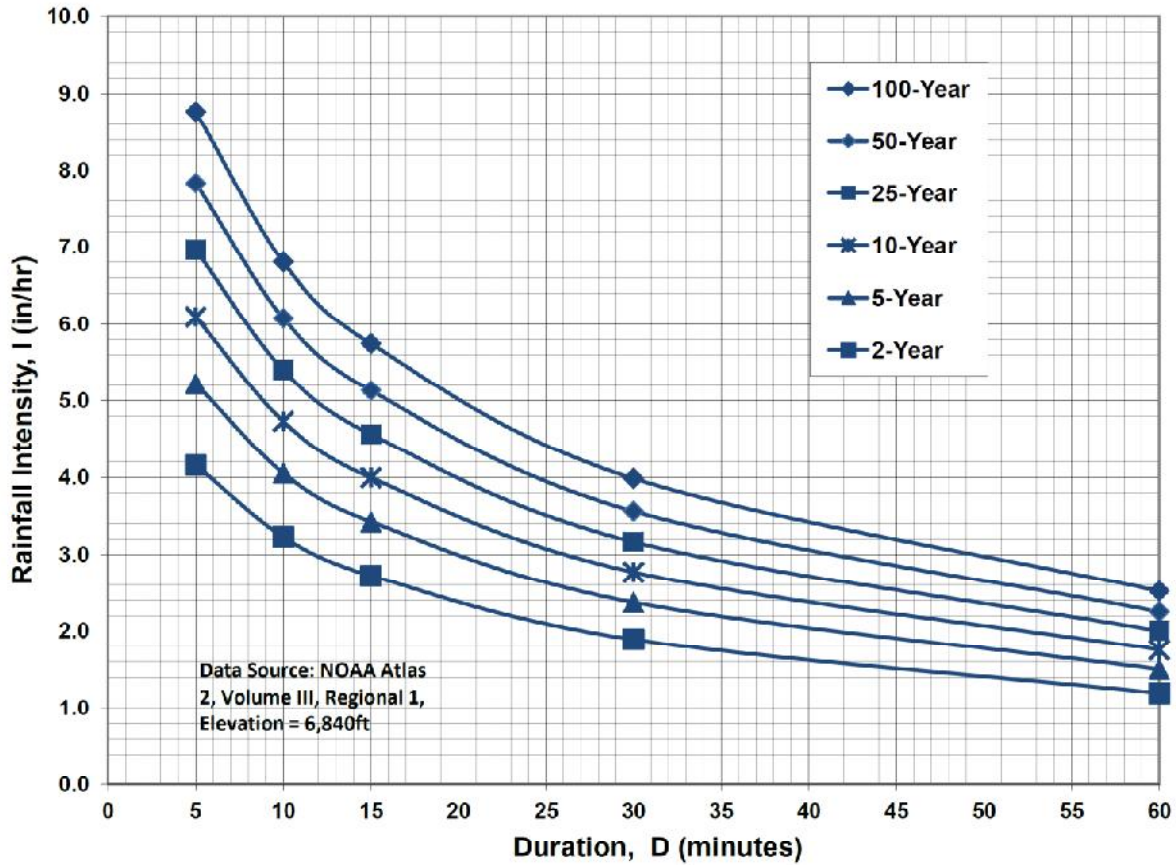

IDF Equations

$$I_{100} = -2.52 \ln(D) + 12.735$$

$$I_{50} = -2.25 \ln(D) + 11.375$$

$$I_{25} = -2.00 \ln(D) + 10.111$$

$$I_{10} = -1.75 \ln(D) + 8.847$$

$$I_5 = -1.50 \ln(D) + 7.583$$

$$I_2 = -1.19 \ln(D) + 6.035$$

Note: Values calculated by equations may not precisely duplicate values read from figure.

**CRAWFORD APARTMENTS
COMPOSITE RUNOFF COEFFICIENTS**

EXISTING CONDITIONS

5-YEAR C-VALUES											
BASIN	TOTAL AREA (AC)	AREA (AC)	SUB-AREA 1 DEVELOPMENT/ COVER	C	AREA (AC)	SUB-AREA 2 DEVELOPMENT/ COVER	C	AREA (AC)	SUB-AREA 3 DEVELOPMENT/ COVER	C	WEIGHTED C VALUE
OA1	0.50	0.50	SF RESIDENTIAL	0.45							0.450
A	1.15	1.15	VACANT	0.08							0.080
OA1,A	1.65										0.192
B	1.50	0.69	BUILDING / PAVEMENT	0.90	0.81	LANDSCAPE	0.08				0.457
OA1,A,B	3.15										0.318
100-YEAR C-VALUES											
BASIN	TOTAL AREA (AC)	AREA (AC)	SUB-AREA 1 DEVELOPMENT/ COVER	C	AREA (AC)	SUB-AREA 2 DEVELOPMENT/ COVER	C	AREA (AC)	SUB-AREA 3 DEVELOPMENT/ COVER	C	WEIGHTED C VALUE
OA1	0.50	0.50	SF RESIDENTIAL	0.59							0.590
A	1.15	1.15	VACANT	0.35							0.350
OA1,A	1.65										0.423
B	1.50	0.69	BUILDING / PAVEMENT	0.96	0.81	LANDSCAPE	0.35				0.631
OA1,A,B	3.15										0.522

DEVELOPED CONDITIONS

5-YEAR C-VALUES											
BASIN	TOTAL AREA (AC)	AREA (AC)	SUB-AREA 1 DEVELOPMENT/ COVER	C	AREA (AC)	SUB-AREA 2 DEVELOPMENT/ COVER	C	AREA (AC)	SUB-AREA 3 DEVELOPMENT/ COVER	C	WEIGHTED C VALUE
OA1	0.50	0.50	SF RESIDENTIAL	0.45							0.450
A	1.15	0.76	BUILDING / PAVEMENT	0.90	0.39	LANDSCAPE	0.08				0.622
OA1,A	1.65										0.570
B	1.50	0.69	BUILDING / PAVEMENT	0.90	0.81	LANDSCAPE	0.08				0.457
OA1,A,B	3.15										0.516
100-YEAR C-VALUES											
BASIN	TOTAL AREA (AC)	AREA (AC)	SUB-AREA 1 DEVELOPMENT/ COVER	C	AREA (AC)	SUB-AREA 2 DEVELOPMENT/ COVER	C	AREA (AC)	SUB-AREA 3 DEVELOPMENT/ COVER	C	WEIGHTED C VALUE
OA1	0.50	0.50	SF RESIDENTIAL	0.59							0.590
A	1.15	0.76	BUILDING / PAVEMENT	0.96	0.39	LANDSCAPE	0.35				0.753
OA1,A	1.65										0.704
B	1.50	0.69	BUILDING / PAVEMENT	0.96	0.81	LANDSCAPE	0.35				0.631
OA1,A,B	3.15										0.669

* REFER TO SITE IMPERVIOUS AREA CALCULATIONS ON SH. D1

**CRAWFORD APARTMENTS - TRACT A, FOUNTAIN VALLEY RANCH FILING NO. 6A
RATIONAL METHOD**

EXISTING CONDITION FLOWS

BASIN	DESIGN POINT	AREA (AC)	C		Overland Flow			Channel flow					TOTAL T _c ⁽⁴⁾ (MIN)	TOTAL T _c ⁽⁴⁾ (MIN)	INTENSITY ⁽⁵⁾		PEAK FLOW	
			5-YEAR	100-YEAR	LENGTH (FT)	SLOPE (FT/FT)	T _{co} ⁽¹⁾ (MIN)	CHANNEL LENGTH (FT)	CONVEYANCE COEFFICIENT C	SLOPE (FT/FT)	SCS ⁽²⁾ VELOCITY (FT/S)	T _t ⁽³⁾ (MIN)			5-YR (IN/HR)	100-YR (IN/HR)	Q5 ⁽⁶⁾ (CFS)	Q100 ⁽⁶⁾ (CFS)
			OA1	OA1	0.50	0.450	0.590	40	0.020	6.0							0.0	6.0
A	A	1.15	0.080	0.350			0.0	285	5	0.035	0.94	5.1	5.1	5.1	5.15	8.64	0.47	3.48
OA1,A	1	1.65	0.192	0.423									11.1	11.1	3.98	6.68	1.26	4.66
B	B	1.50	0.457	0.631			0.0	235	20	0.021	2.90	1.4	1.4	5.0	5.17	8.68	3.54	8.21
OA1,A,B	2	3.15	0.318	0.522									12.4	12.4	3.81	6.39	3.81	10.51

DEVELOPED FLOWS

BASIN	DESIGN POINT	AREA (AC)	C		Overland Flow			Channel flow					TOTAL T _c ⁽⁴⁾ (MIN)	TOTAL T _c ⁽⁴⁾ (MIN)	INTENSITY ⁽⁵⁾		PEAK FLOW	
			5-YEAR	100-YEAR	LENGTH (FT)	SLOPE (FT/FT)	T _{co} ⁽¹⁾ (MIN)	CHANNEL LENGTH (FT)	CONVEYANCE COEFFICIENT C	SLOPE (FT/FT)	SCS ⁽²⁾ VELOCITY (FT/S)	T _t ⁽³⁾ (MIN)			5-YR (IN/HR)	100-YR (IN/HR)	Q5 ⁽⁶⁾ (CFS)	Q100 ⁽⁶⁾ (CFS)
			OA1	OA1	0.50	0.450	0.590	40	0.020	6.0							0.0	6.0
A	A	1.15	0.622	0.753	35	0.029	3.6	340	20	0.022	2.97	1.9	5.5	5.5	5.01	8.42	3.59	7.29
OA1,A	1	1.65	0.570	0.704									11.5	11.5	3.92	6.58	3.68	7.64
B	B	1.50	0.457	0.631			0.0	235	20	0.021	2.90	1.4	1.4	5.0	5.17	8.68	3.54	8.21
OA1,A,B	2	3.15	0.516	0.669									12.9	12.9	3.75	6.30	6.10	13.27

1) OVERLAND FLOW T_{co} = (0.395*(1.1-RUNOFF COEFFICIENT))*(OVERLAND FLOW LENGTH^(0.5))/(SLOPE^(0.333))

2) SCS VELOCITY = C * ((SLOPE(FT/FT)^0.5)

C = 2.5 FOR HEAVY MEADOW

C = 5 FOR TILLAGE/FIELD

C = 7 FOR SHORT PASTURE AND LAWNS

C = 10 FOR NEARLY BARE GROUND

C = 15 FOR GRASSED WATERWAY

C = 20 FOR PAVED AREAS AND SHALLOW PAVED SWALES

3) MANNING'S CHANNEL TRAVEL TIME = L/V (WHEN CHANNEL VELOCITY IS KNOWN)

4) T_c = T_{co} + T_t

*** IF TOTAL TIME OF CONCENTRATION IS LESS THAN 5 MINUTES, THEN 5 MINUTES IS USED

5) INTENSITY BASED ON I-D-F EQUATIONS IN CITY OF COLORADO SPRINGS DRAINAGE CRITERIA MANUAL

$$I_5 = -1.5 * \ln(T_c) + 7.583$$

$$I_{100} = -2.52 * \ln(T_c) + 12.735$$

6) Q = C_iA

APPENDIX C

FIGURES

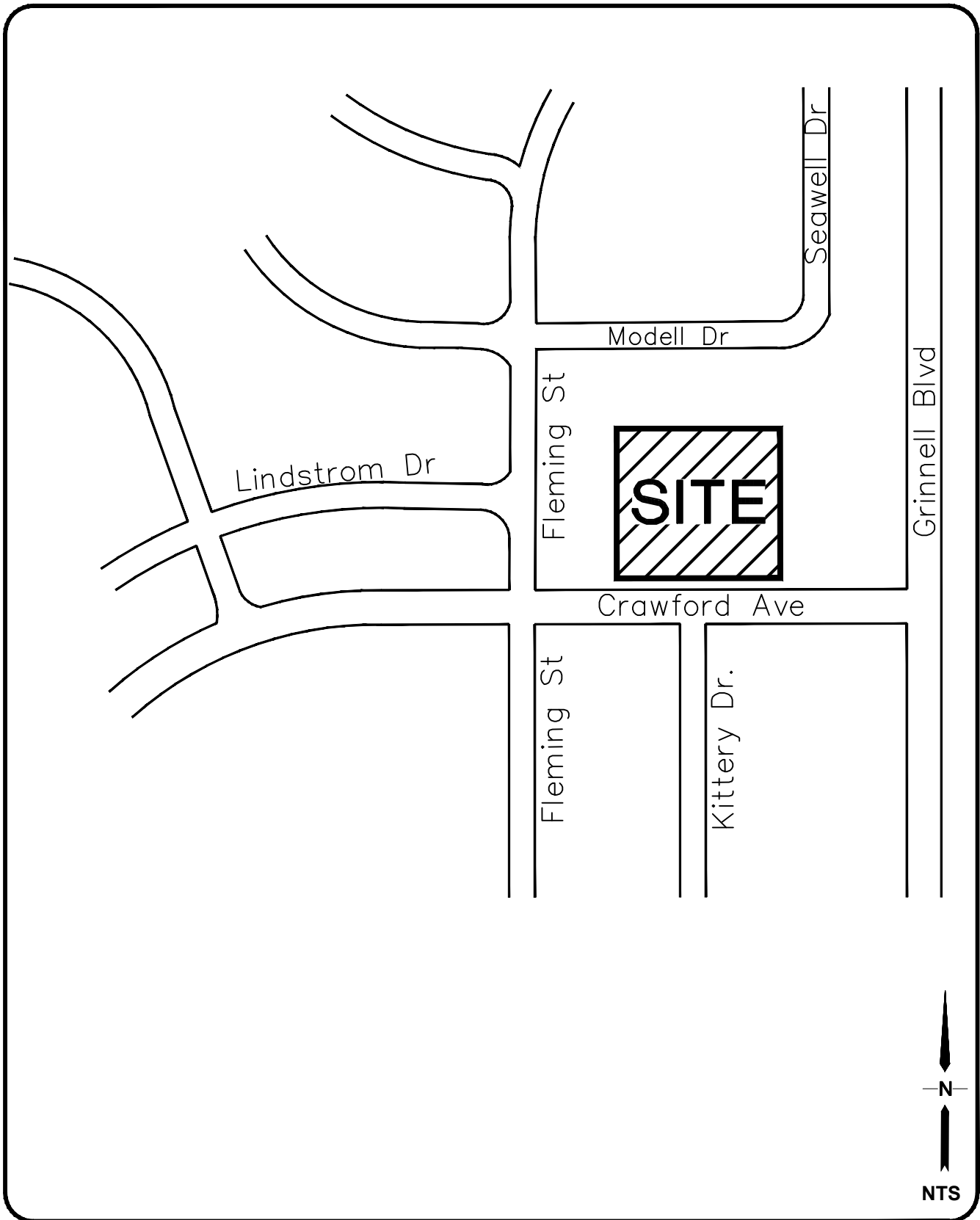

VICINITY MAP

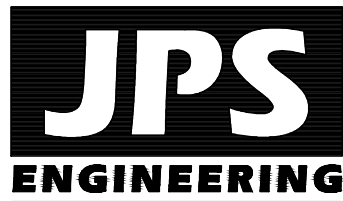

CRAWFORD APARTMENTS
TRACT A, FOUNTAIN VALLEY RANCH FIL. NO. 6B

FIGURE A1

JPS PROJ NO. 122102

National Flood Hazard Layer FIRMette



104°43'32"W 38°45'12"N

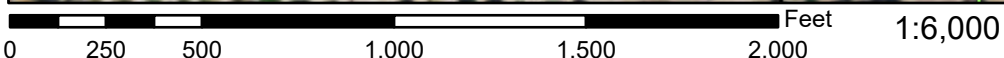
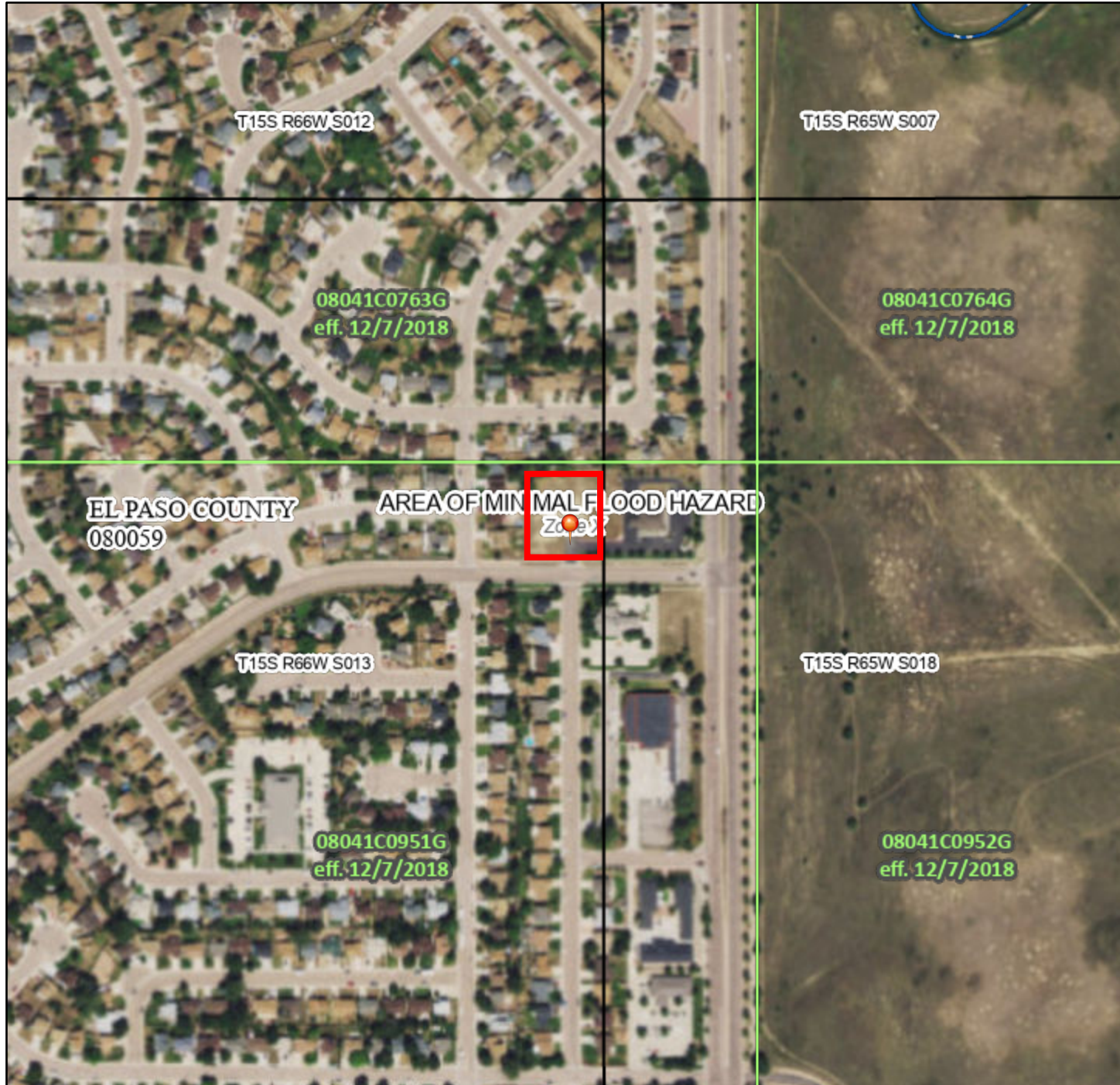

104°42'55"W 38°44'44"N

Basemap: USGS National Map: Orthoimagery: Data refreshed October, 2020

Legend

SEE FIS REPORT FOR DETAILED LEGEND AND INDEX MAP FOR FIRM PANEL LAYOUT

SPECIAL FLOOD HAZARD AREAS		Without Base Flood Elevation (BFE) Zone A, V, A99
		With BFE or Depth Zone AE, AO, AH, VE, AR
		Regulatory Floodway
OTHER AREAS OF FLOOD HAZARD		0.2% Annual Chance Flood Hazard, Areas of 1% annual chance flood with average depth less than one foot or with drainage areas of less than one square mile Zone X
		Future Conditions 1% Annual Chance Flood Hazard Zone X
		Area with Reduced Flood Risk due to Levee. See Notes. Zone X
		Area with Flood Risk due to Levee Zone D
OTHER AREAS		NO SCREEN Area of Minimal Flood Hazard Zone X
		Effective LOMRs
GENERAL STRUCTURES		Area of Undetermined Flood Hazard Zone D
		Channel, Culvert, or Storm Sewer
		Levee, Dike, or Floodwall
OTHER FEATURES		20.2 Cross Sections with 1% Annual Chance
		17.5 Water Surface Elevation
		Coastal Transect
		Base Flood Elevation Line (BFE)
		Limit of Study
		Jurisdiction Boundary
MAP PANELS		Coastal Transect Baseline
		Profile Baseline
		Hydrographic Feature
		Digital Data Available
		No Digital Data Available
		Unmapped
		The pin displayed on the map is an approximate point selected by the user and does not represent an authoritative property location.



This map complies with FEMA's standards for the use of digital flood maps if it is not void as described below. The basemap shown complies with FEMA's basemap accuracy standards

The flood hazard information is derived directly from the authoritative NFHL web services provided by FEMA. This map was exported on **11/14/2022 at 1:12 PM** and does not reflect changes or amendments subsequent to this date and time. The NFHL and effective information may change or become superseded by new data over time.

This map image is void if the one or more of the following map elements do not appear: basemap imagery, flood zone labels, legend, scale bar, map creation date, community identifiers, FIRM panel number, and FIRM effective date. Map images for unmapped and unmodernized areas cannot be used for regulatory purposes.

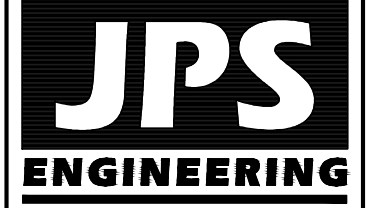
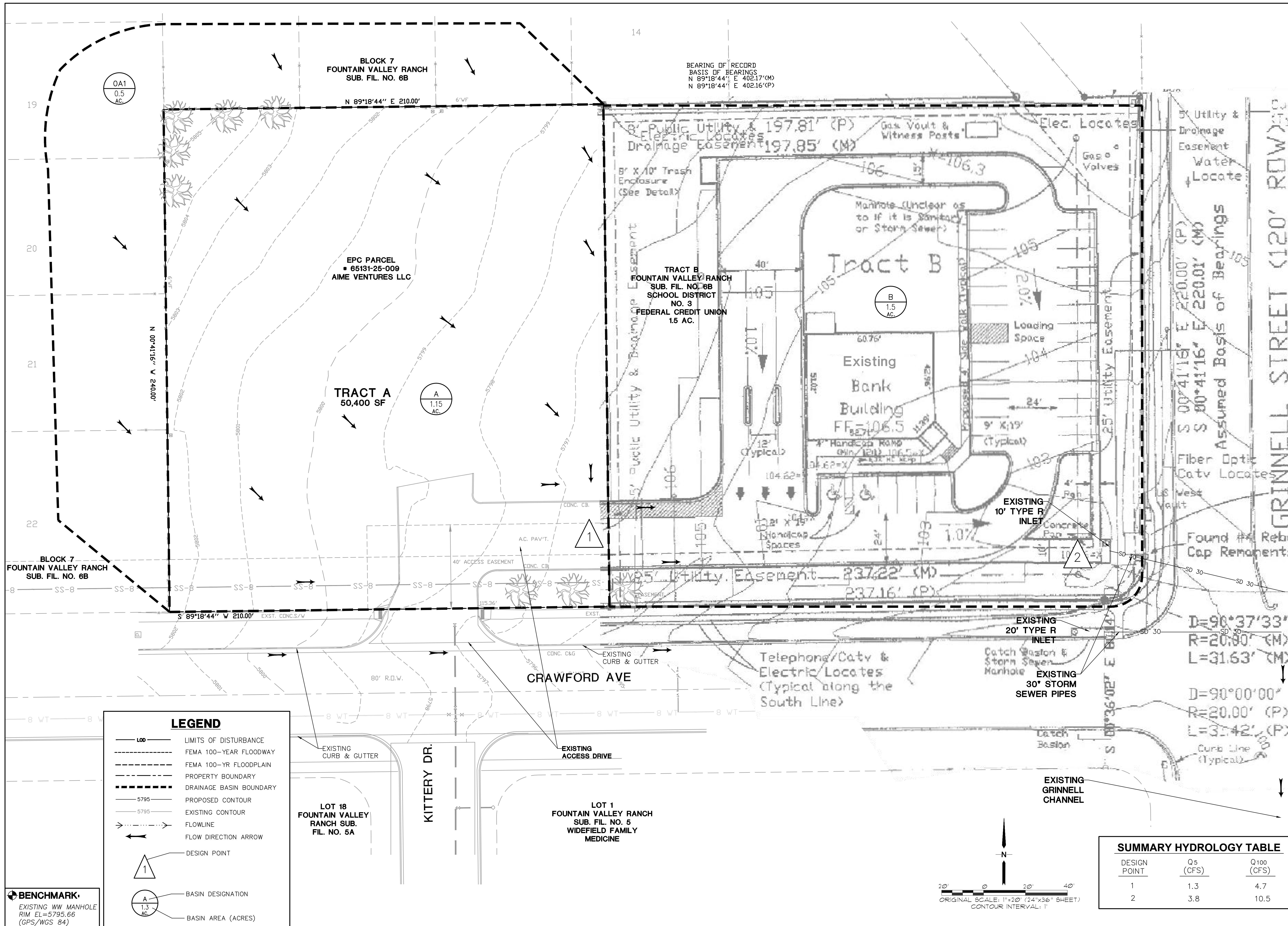

19 E. Willamette Ave.
 Colorado Springs, CO
 80903
 PH: 719-477-9429
 FAX: 719-471-0766
 www.jpseng.com

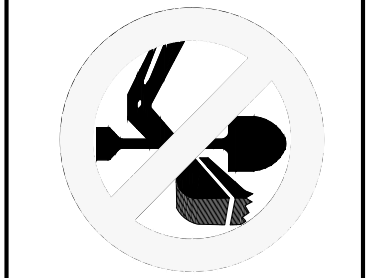

CALL UTILITY NOTIFICATION
 CENTER OF COLORADO
 1-800-922-1987
 CALL 2-BUSINESS DAYS IN ADVANCE
 BEFORE YOU DIG, GRADE, OR EXCAVATE
 FOR THE MARKING OF UNDERGROUND
 MEMBER UTILITIES.

No.	REVISION	BY	DATE

**CRAWFORD APARTMENTS
 TRACT A, FOUNTAIN VALLEY RANCH FIL. NO. 6B**

**EXISTING CONDITIONS
 DRAINAGE PLAN**

DESIGN POINT	Q5 (CFS)	Q100 (CFS)
1	1.3	4.7
2	3.8	10.5

HORIZ. SCALE: 1"=20'	DRAWN: PV
VERT. SCALE: N/A	DESIGNED: JPS
SURVEYED: WATTS	CHECKED: JPS
CREATED: 08/29/22	LAST MODIFIED: 08/24/23
PROJECT NO: 122102	MODIFIED BY: PV
SHEET:	

EX1

BENCHMARK:
 EXISTING W/W MANHOLE
 RIM EL=5795.66
 (GPS/WGS 84)

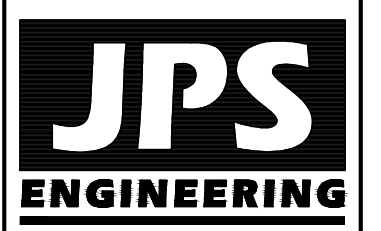
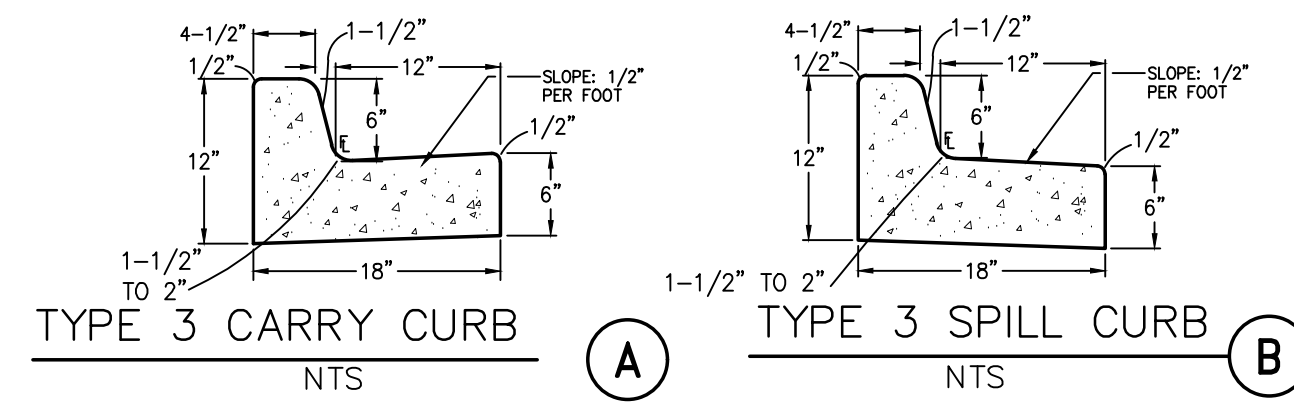
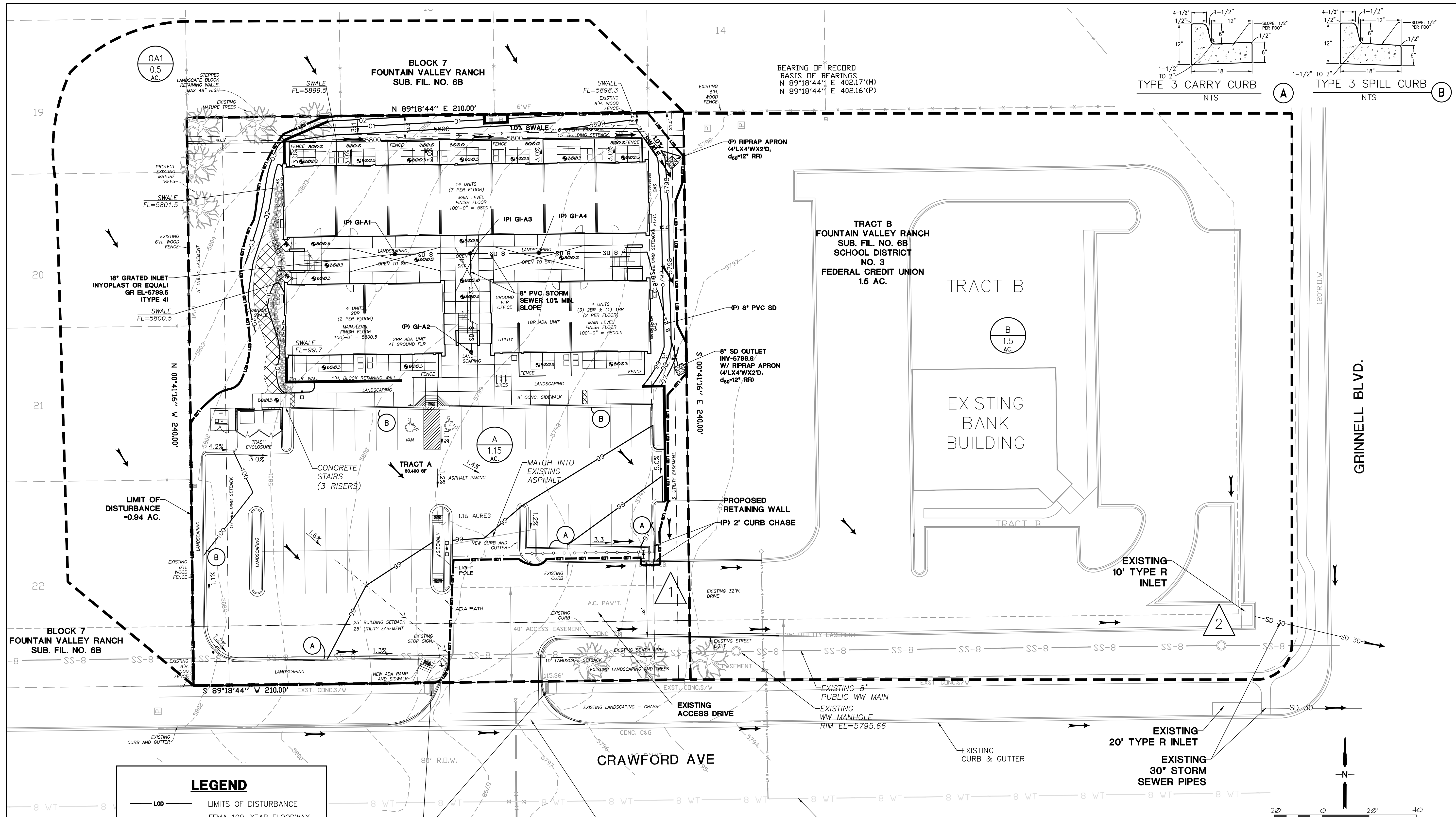

19 E. Willamette Ave.
 Colorado Springs, CO 80903
 PH: 719-477-9429
 FAX: 719-471-0766
 www.jpsengr.com

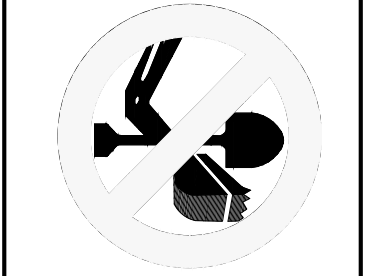

CALL UTILITY NOTIFICATION
 CENTER OF COLORADO
 1-800-922-1987
 CALL 2-BUSINESS DAYS IN ADVANCE
 BEFORE YOU DIG, GRADE, OR EXCAVATE
 FOR THE MARKING OF UNDERGROUND
 MEMBER UTILITIES.

No.	REVISION	BY	DATE

**CRAWFORD APARTMENTS
 TRACT A, FOUNTAIN VALLEY RANCH FIL. NO. 6B**

**DEVELOPED
 DRAINAGE PLAN**

LEGEND

- 100 — LIMITS OF DISTURBANCE
- - - - - FEMA 100-YEAR FLOODWAY
- - - - - FEMA 100-YR FLOODPLAIN
- - - - - PROPERTY BOUNDARY
- - - - - DRAINAGE BASIN BOUNDARY
- 5795 — PROPOSED CONTOUR
- 5795 — EXISTING CONTOUR
- — FLOWLINE
- ← — FLOW DIRECTION ARROW
- (E) — EXISTING
- (P) — PROPOSED
- GI — GRATED INLET (18" NYOPLAST OR EQUAL)
- △ — DESIGN POINT
- — BASIN DESIGNATION
- — BASIN AREA (ACRES)

BENCHMARK
 EXISTING WW MANHOLE
 RIM EL=5795.66
 (GPS/WGS 84)

IMPERVIOUS AREA CALCULATIONS:
 TOTAL BASIN A AREA = 1.15 AC.

SURFACE TYPE	AREA
SIDEWALK	4,713 SF
BUILDING	8,688 SF
ASPHALT	19,668 SF
TOTAL IMPERVIOUS AREA	33,069 SF = 0.76 AC

= 66%

8" STORM SEWER TABLE

INLET	GR EL	INVERT	DS LENGTH	DS SLOPE
A1	5799.5	5797.5	32	0.6%
A2	5799.5	5797.5	42	0.5%
A3	5799.5	5797.3	29	0.5%
A4	5799.5	5797.15	95	0.57%

SUMMARY HYDROLOGY TABLE

DESIGN POINT	Q5 (CFS)	Q100 (CFS)
1	3.7	7.6
2	6.1	13.3

IMPERVIOUS AREA CALCULATIONS:
 TOTAL BASIN B AREA = 1.5 AC.

SURFACE TYPE	AREA
SIDEWALK	1,061 SF
BUILDING	6,162 SF
ASPHALT	22,714 SF
TOTAL IMPERVIOUS AREA	29,937 SF = 0.69 AC

= 46%

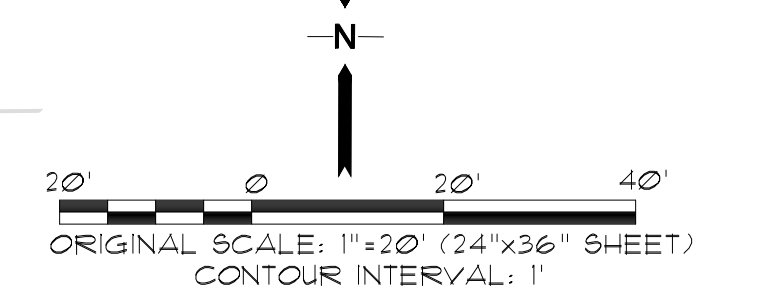
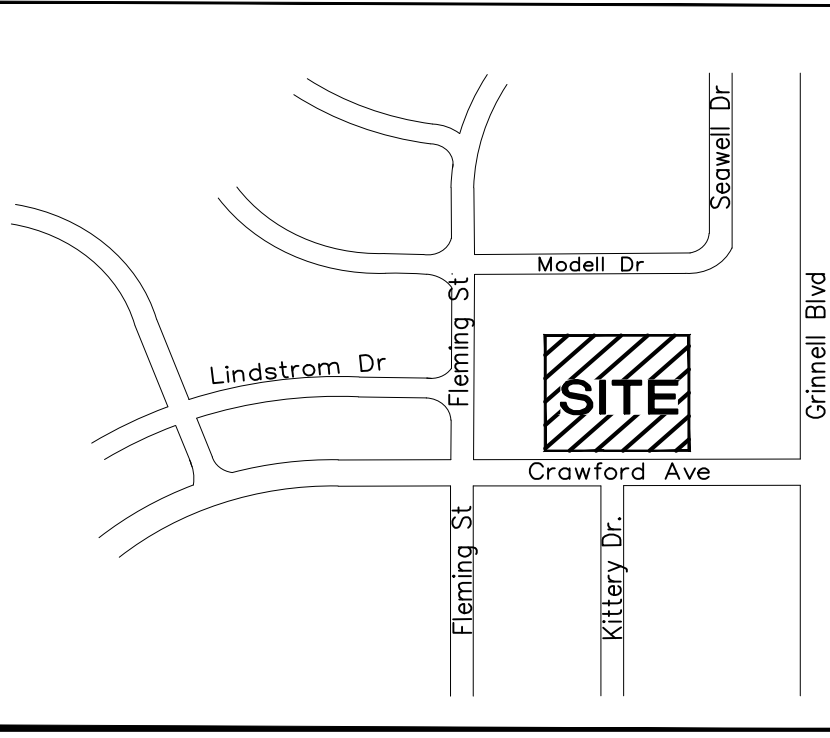

HORZ. SCALE: 1"=20'	DRAWN: PV
VERT. SCALE: N/A	DESIGNED: JPS
SURVEYED: WATTS	CHECKED: JPS
CREATED: 08/29/22	LAST MODIFIED: 08/24/23
PROJECT NO: 122102	MODIFIED BY: PV
SHEET:	

D1