

Traffic Impact Study

Crawford Apartments

El Paso County, Colorado

PCD File No. SKP221 and P221

Add PPR-2257



Prepared for:

Aime Ventures, LLC

Kimley»Horn

T R A F F I C I M P A C T S T U D Y

Traffic Engineer's Statement

The attached traffic report and supporting information were prepared under my responsible charge and they comport with the standard of care. So far as is consistent with the standard of care, said report was prepared in general conformance with the criteria established by the County for traffic reports.



Jeffrey R. Planck, P.E., PE #53006

April 8, 2022
Date

Developer's Statement

I, the Developer, have read and will comply with all commitments made on my behalf within this report.

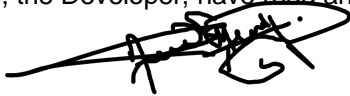

Christel Aime, CEO
Aime Ventures, LLC
1900 E. Pikes Peak Avenue, Suite #3
Colorado Springs, CO 80909

Date

Crawford Apartments

PCE File No. SKP221 and P221

El Paso County, Colorado

Prepared for
Aime Ventures, LLC
1900 E. Pikes Peak Avenue
Suite #3
Colorado Springs, Colorado 80909

Prepared by
Kimley-Horn and Associates, Inc.
4582 South Ulster Street
Suite 1500
Denver, Colorado 80237
(303) 228-2300



April 2022

This document, together with the concepts and designs presented herein, as an instrument of service, is intended only for the specific purpose and client for which it was prepared. Reuse of and improper reliance on this document without written authorization and adaptation by Kimley-Horn and Associates, Inc. shall be without liability to Kimley-Horn and Associates, Inc.

TABLE OF CONTENTS

TABLE OF CONTENTS	i
LIST OF TABLES	ii
LIST OF FIGURES	ii
1.0 EXECUTIVE SUMMARY	1
2.0 INTRODUCTION	3
3.0 EXISTING AND FUTURE CONDITIONS	5
3.1 Existing Study Area	5
3.2 Existing Roadway Network	5
3.3 Existing Traffic Volumes	9
3.4 Unspecified Development Traffic Growth	9
4.0 PROJECT TRAFFIC CHARACTERISTICS	13
4.1 Trip Generation	13
4.2 Trip Distribution	14
4.3 Traffic Assignment	14
4.4 Total (Background Plus Project) Traffic	14
5.0 TRAFFIC OPERATIONS ANALYSIS	19
5.1 Analysis Methodology	19
5.2 Key Intersection Operational Analysis	20
5.3 El Paso County Turn Lane Requirement Analysis	22
5.4 Vehicle Queuing Analysis	24
5.5 Roadway Classifications	25
5.6 Sight Distance Evaluation	25
5.7 Bicycle and Pedestrian Access	25
5.8 Road Impact Fees	26
5.9 Improvement Summary	26
6.0 CONCLUSIONS AND RECOMMENDATIONS	29

APPENDICES

- Appendix A – Intersection Count Sheets
- Appendix B – Future Traffic Projections
- Appendix C – Adjacent Traffic Study Documents
- Appendix D – Trip Generation Worksheets
- Appendix E – Intersection Analysis Worksheets
- Appendix F – Queue Analysis Worksheets
- Appendix G – Conceptual Site Plan

LIST OF TABLES

Table 1 – Crawford Apartments Traffic Generation	13
Table 2 – Level of Service Definitions	19
Table 3 – Crawford Avenue & Kittery Drive (#1) LOS Results	21
Table 4 – Crawford Avenue & Grinnell Boulevard (#2) LOS Results	22
Table 5 – Turn Lane Queuing Analysis Results.....	24
Table 6 – Road Impact Fees	26

LIST OF FIGURES

Figure 1 – Vicinity Map.....	4
Figure 2 – Existing Geometry and Control.....	8
Figure 3 – 2021 Existing Traffic Volumes.....	10
Figure 4 – 2023 Background Traffic Volumes.....	11
Figure 5 – 2045 Background Traffic Volumes.....	12
Figure 6 – Project Trip Distribution.....	15
Figure 7 – Project Traffic Assignment	16
Figure 8 – 2023 Total Traffic Volumes	17
Figure 9 – 2045 Total Traffic Volumes	18
Figure 10 – Circulation Plan.....	27
Figure 11 – Recommended Geometry and Control.....	28

1.0 EXECUTIVE SUMMARY

This report has been prepared to document the results of a Traffic Impact Study for Crawford Apartments proposed to be located on the north side of Crawford Avenue at the Kittery Drive intersection in El Paso County, Colorado. Crawford Apartments is proposed to include 22 multifamily housing units. It is expected that Crawford Apartments will be completed in the next couple of years; therefore, analysis was conducted for the 2023 short-term buildout horizon as well as the 2045 long-term twenty-year planning horizon.

The purpose of this traffic study is to identify project traffic generation characteristics to determine potential project traffic related impacts on the local street system and to develop the necessary mitigation measures required for the identified traffic impacts. The following intersections were incorporated into this traffic study in accordance with El Paso County standards and requirements:

- Crawford Avenue and Kittery Drive (#1)
- Crawford Avenue and Grinnell Boulevard (#2)

It should be noted that the adjacent intersections of Bradley Road/Grinnell Boulevard and Fontaine Boulevard/Grinnell Boulevard do not meet the County criteria (project does not contribute 30 percent increase in volume) for being included in the study area. Regional access to Crawford Apartments will be provided by US Highway 85 (US-85) and Powers Boulevard (SH-21). Primary access will be provided by Grinnell Boulevard. Direct access will be provided by the existing full movement access at the north leg of the Crawford Avenue and Kittery Drive intersection.

Crawford Apartments is expected to generate approximately 218 weekday daily trips, with 30 of these trips occurring during the morning peak hour and 32 of these trips occurring during the afternoon peak hour.

Based on the analysis presented in this report, Kimley-Horn believes Crawford Apartments will be successfully incorporated into the existing and future roadway network. Analysis of the existing street network, the proposed project development, and expected traffic volumes resulted in the following conclusions and recommendations:

- Based on El Paso County standards, the northbound left turn length requirements at the Crawford Avenue and Grinnell Boulevard intersection are 365 feet plus a 220-foot taper. Since vehicle queues are only calculated with 50 feet of storage and to avoid reconstructing the existing raised median for only an additional 65 feet of length, it is recommended that the existing median for the northbound left turn lane at Crawford Avenue and Grinnell Boulevard intersection remain in the current condition. A deviation request should be submitted at the subdivision state of the development. However, the northbound left turn lane at the Crawford Avenue and Grinnell Boulevard intersection should be restriped from approximately 150 feet to 300 feet of length.
- To meet El Paso County standards, it is recommended that the southbound right turn lane at the intersection of Crawford Avenue and Grinnell Boulevard be restriped to 365 feet with a 220-foot taper.
- Any on-site or offsite improvements should be incorporated into the Civil Drawings and conform to standards of El Paso County and the Manual on Uniform Traffic Control Devices (MUTCD) – 2009 Edition.

2.0 INTRODUCTION

Kimley-Horn and Associates, Inc. has prepared this report to document the results of a Traffic Impact Study for Crawford Apartments proposed to be located on the north side of Crawford Avenue at the Kittery Drive intersection in El Paso County, Colorado. A vicinity map illustrating the Crawford Apartments development location is shown in **Figure 1**. Crawford Apartments is proposed to include 22 multifamily housing units. A conceptual site plan is attached in **Appendix G**. It is expected that Crawford Apartments will be completed in the next couple of years; therefore, analysis was conducted for the 2023 short-term buildout horizon as well as the 2045 long-term twenty-year planning horizon.

The purpose of this traffic study is to identify project traffic generation characteristics to determine potential project traffic related impacts on the local street system and to develop the necessary mitigation measures required for the identified traffic impacts. The following intersections were incorporated into this traffic study in accordance with El Paso County standards and requirements:

- Crawford Avenue and Kittery Drive (#1)
- Crawford Avenue and Grinnell Boulevard (#2)

Regional access to Crawford Apartments will be provided by US Highway 85 (US-85) and Powers Boulevard (SH-21). Primary access will be provided by Grinnell Boulevard. Direct access will be provided by the existing full movement access at the north leg of the Crawford Avenue and Kittery Drive intersection.

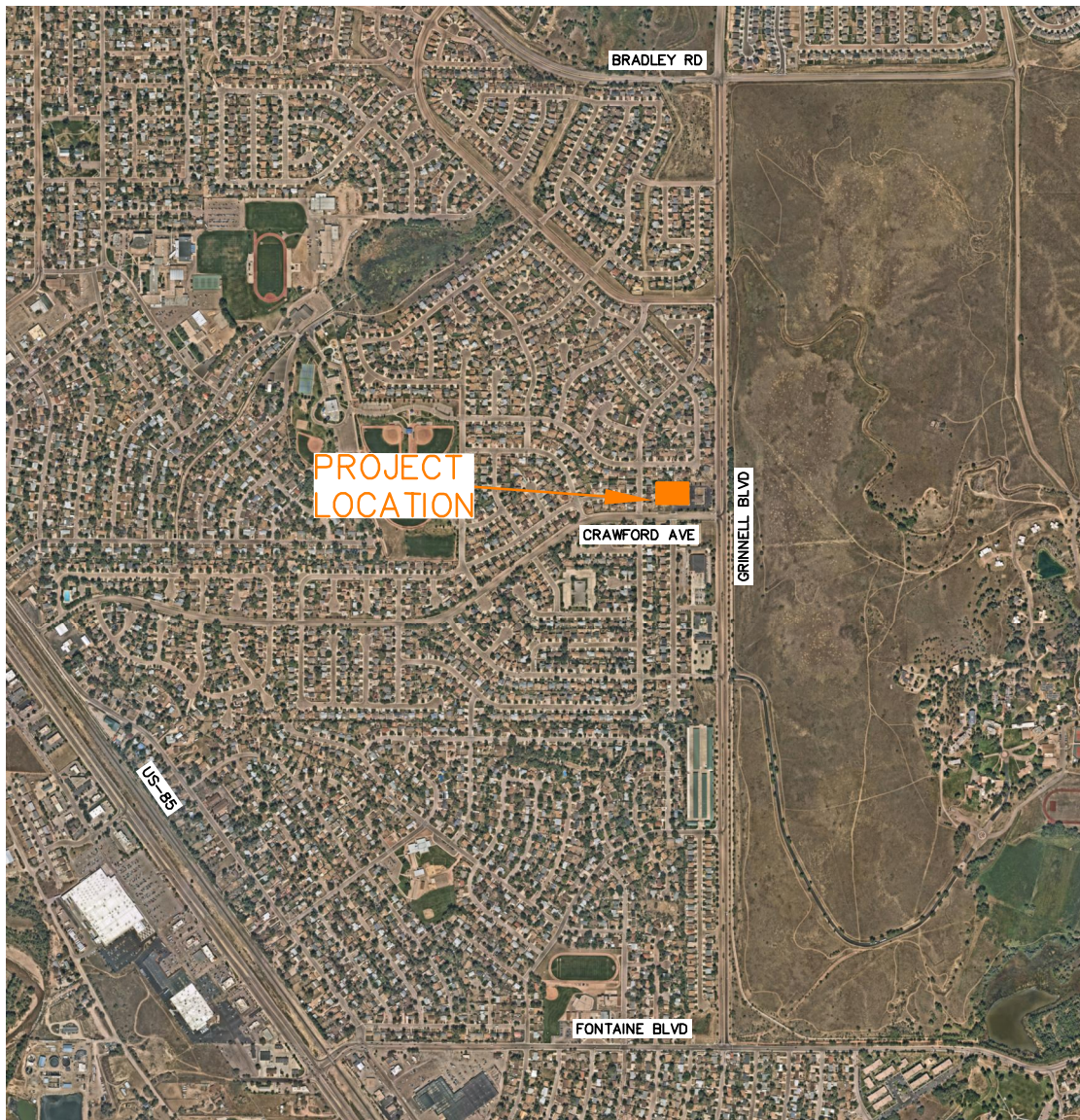

CRAWFORD APARTMENTS
EL PASO COUNTY, COLORADO
VICINITY MAP

FIGURE 1

3.0 EXISTING AND FUTURE CONDITIONS

3.1 Existing Study Area

The existing site is comprised of vacant land. The site is surrounded on the north, south, and west sides by single family houses. Directly east of the site is a bank which shares the access to the site.

3.2 Existing Roadway Network

Grinnell Boulevard extends in the north-south direction with two through lanes in each direction, a raised median, and is classified as a minor arterial. The posted speed limit along Grinnell Boulevard near the site is 50 miles per hour. Crawford Avenue extends eastbound and westbound direction as a two-lane roadway with a posted speed limit of 30 miles per hour and is classified as a residential collector street. Kittery Drive extends in the north-south direction as a two-lane roadway and is classified as a local street.

The unsignalized intersection of Crawford Avenue and Kittery Drive (#1) operates with stop control on the northbound and southbound Kittery Drive approaches. The north leg currently provides access to a bank and will provide access to the project site. The eastbound and westbound approaches consist of a two-way left turn lane and a shared through/right turn lane. The northbound and southbound approaches consist of one shared lane for all movements. An aerial photo of the existing intersection configuration is below (north is up - typical).



Crawford Avenue and Kittery Drive (#1)

The signalized intersection of Crawford Avenue and Grinnell Boulevard (#2) operates with protected-permissive left turn phasing on the northbound approach. The eastbound approach consists of a left turn lane and a right turn lane. The northbound approach provides a left turn lane and two through lanes while the southbound approach consists of two through lanes and a right turn lane. An aerial photo of the existing intersection configuration is below.

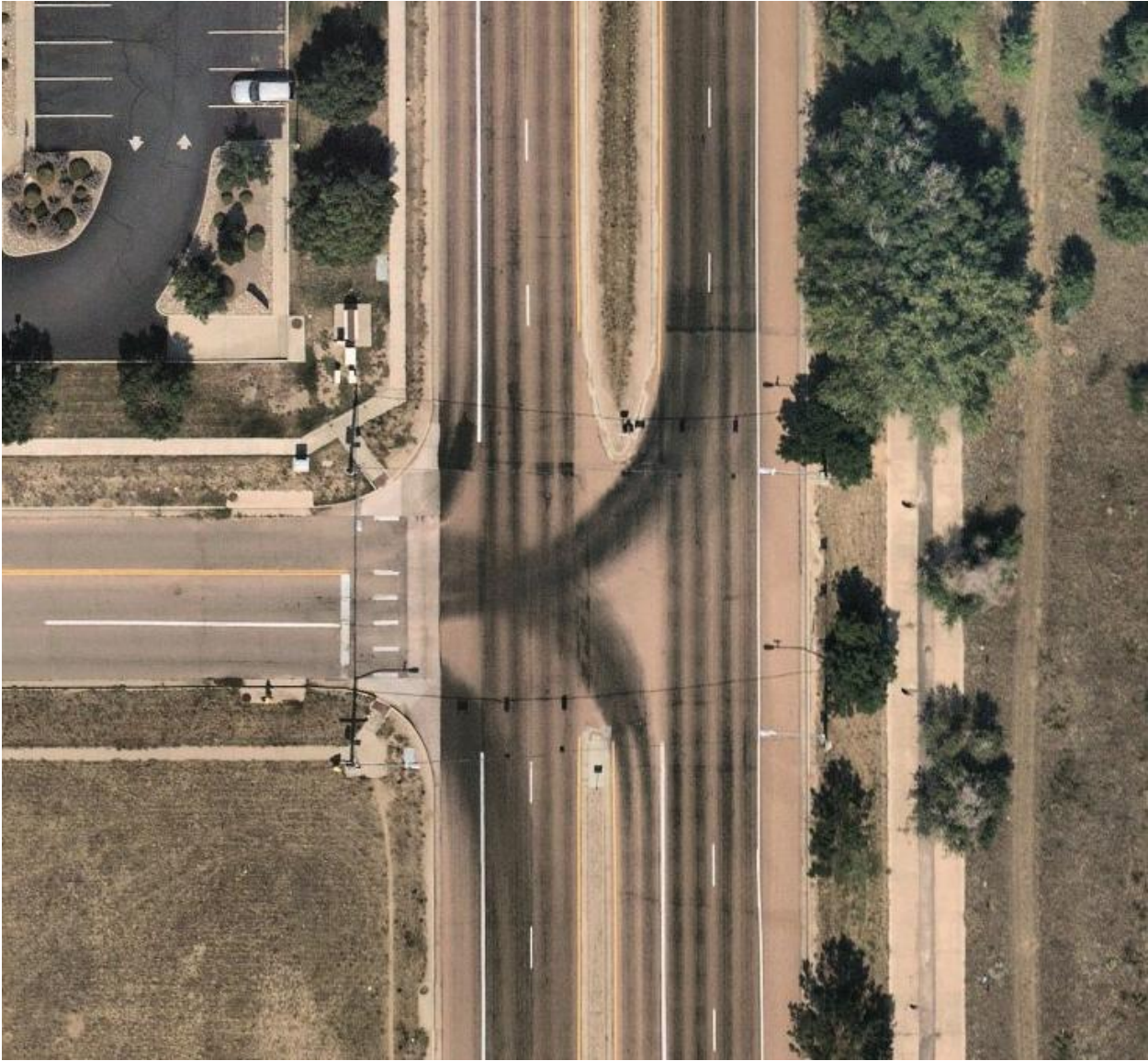

Crawford Avenue and Grinnell Boulevard (#2)

The intersection lane configuration and control for the study area intersections are shown in **Figure 2**.

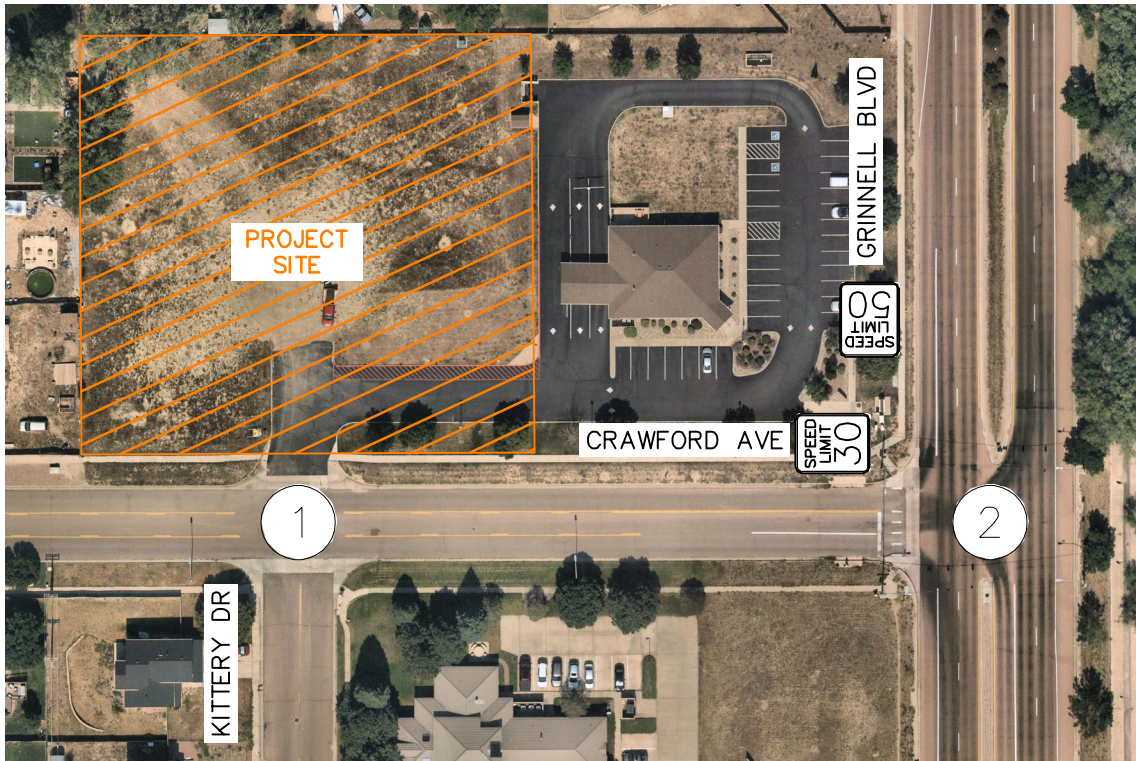
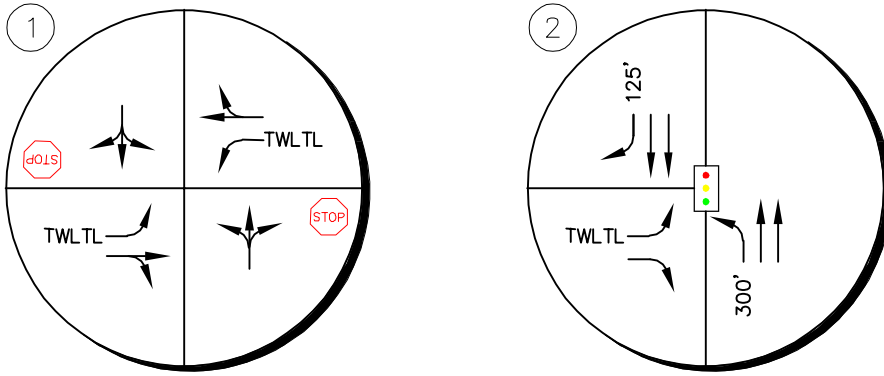

LEGEND

- (X) Study Area Key Intersection
- [Traffic Light Icon] Signalized Intersection
- [STOP Sign Icon] Stop Controlled Approach
- [Speed Limit Sign Icon] Roadway Speed Limit
- [Arrow Icon] 100' Turn Lane Length (feet)

CRAWFORD APARTMENTS
 EL PASO COUNTY, COLORADO
 EXISTING GEOMETRY AND CONTROL

FIGURE 2

3.3 Existing Traffic Volumes

Existing turning movement counts were conducted at the study area key intersections on Wednesday, December 8, 2021 during the morning and afternoon peak hours. The counts were conducted during the morning and afternoon peak hours of adjacent street traffic in 15-minute intervals from 7:00 AM to 9:00 AM and 4:00 PM to 6:00 PM on this count date. The existing intersection traffic volumes are shown in **Figure 3** with count sheets provided in **Appendix A**.

3.4 Unspecified Development Traffic Growth

According to traffic projections from the El Paso County 2016 Major Transportation Corridor Plan Update (MTCP) traffic model, the area surrounding the site is expected to have an average 25-year growth factor of 1.50. This growth factor equates to an annual growth rate of 1.62 percent. Future traffic volume projections and growth rate calculations are provided in **Appendix B**. This annual growth rate was used to estimate short-term 2023 and long-term 2045 traffic volume projections at the key intersections. In addition, project traffic from the proposed Peak Innovation Park was added to the 2045 background traffic volumes. Supporting documents from the Peak Innovation Park Traffic Impact Study are included in **Appendix C**. The calculated background traffic volumes for 2023 and 2045 are shown in **Figure 4** and **Figure 5**, respectively.

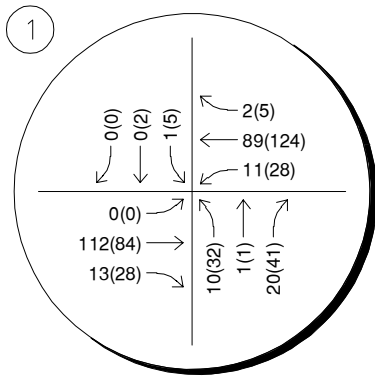

Wednesday, December 8, 2021
7:00 to 8:00AM (4:15 to 5:15PM)

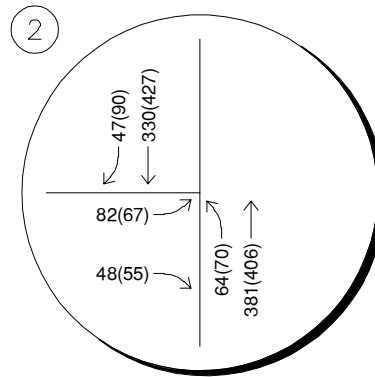

Wednesday, December 8, 2021
7:00 to 8:00AM (4:30 to 5:30PM)

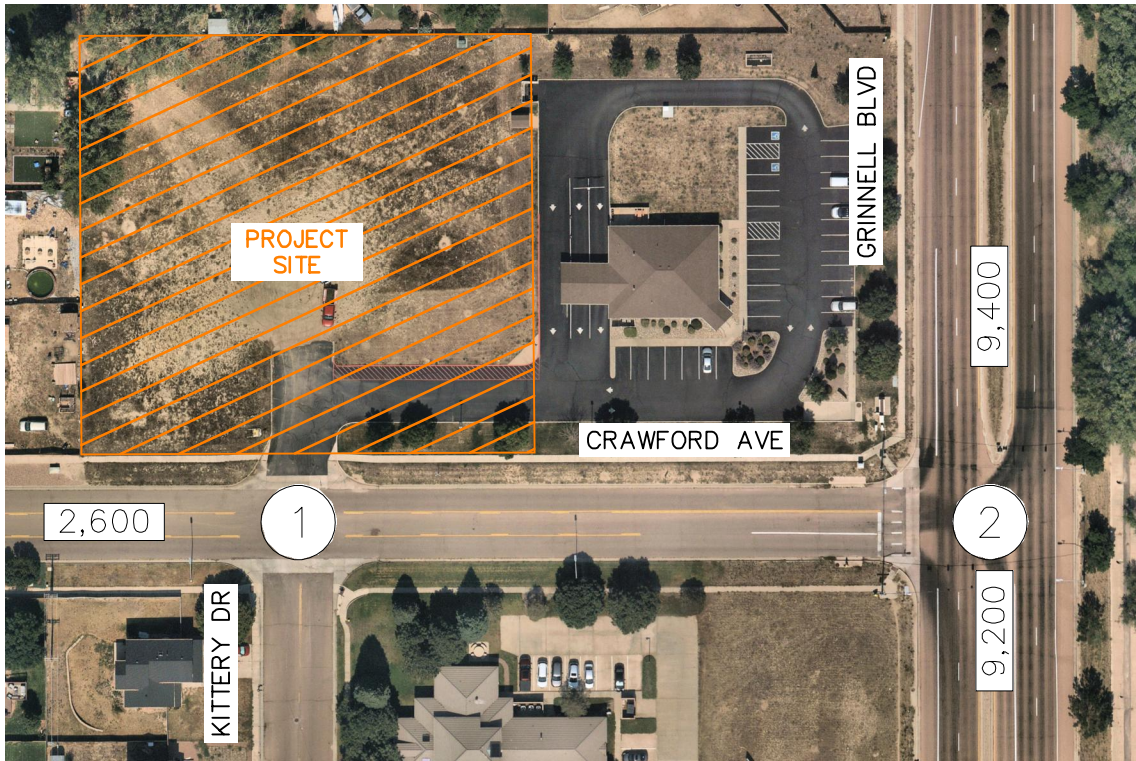

LEGEND

- Study Area Key Intersection
- xxx(XXX) Weekday AM(PM) Peak Hour Traffic Volumes
- Estimated Daily Traffic Volume

CRAWFORD APARTMENTS
EL PASO COUNTY, COLORADO
2021 EXISTING TRAFFIC VOLUMES

FIGURE 3

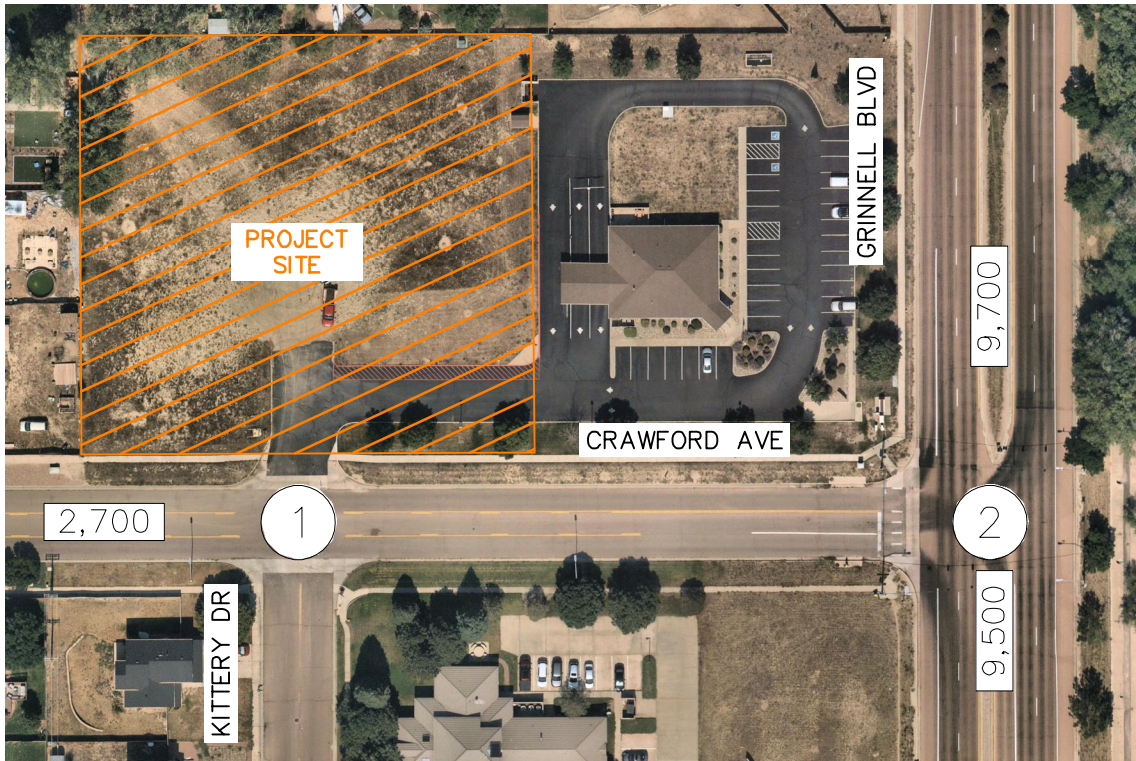
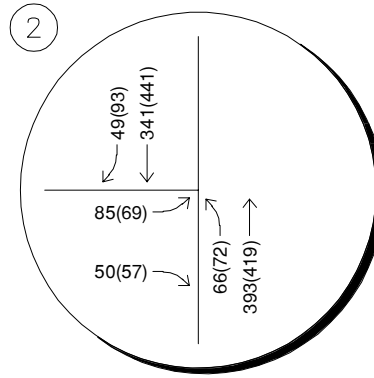
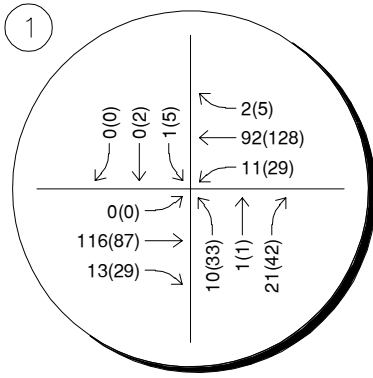

LEGEND

- (X) Study Area Key Intersection
- xxx(XXX) Weekday AM(PM) Peak Hour Traffic Volumes
- xx,x00 Estimated Daily Traffic Volume

CRAWFORD APARTMENTS
 EL PASO COUNTY, COLORADO
 2023 BACKGROUND TRAFFIC VOLUMES

FIGURE 4

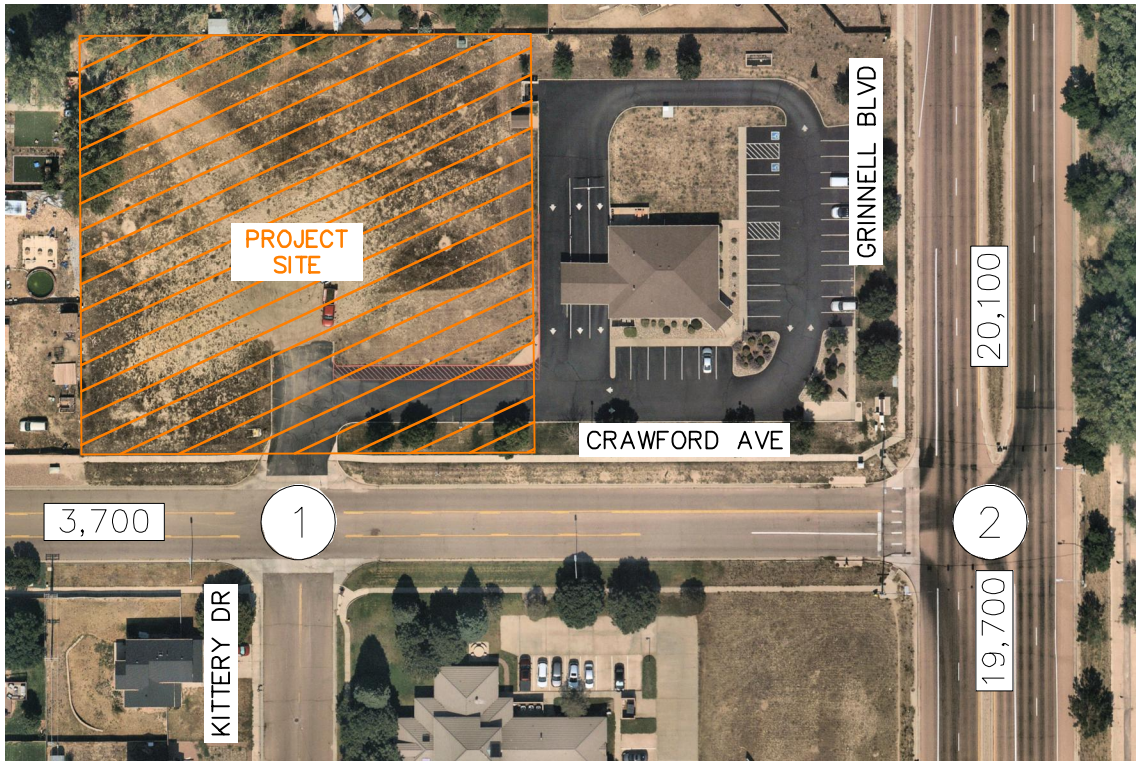
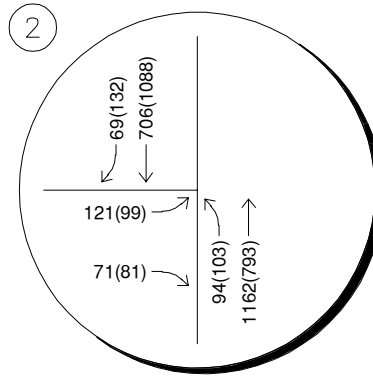
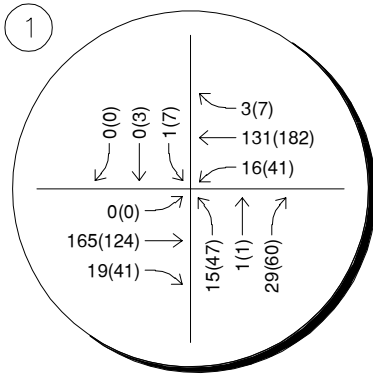

LEGEND

(X) Study Area Key Intersection

xxx(XXX) Weekday AM(PM)
Peak Hour Traffic Volumes

xx,x00 Estimated Daily Traffic Volume

CRAWFORD APARTMENTS
 EL PASO COUNTY, COLORADO
 2045 BACKGROUND TRAFFIC VOLUMES

FIGURE 5

4.0 PROJECT TRAFFIC CHARACTERISTICS

4.1 Trip Generation

Site-generated traffic estimates are determined through a process known as trip generation. Rates and equations are applied to the proposed land use to estimate traffic generated by the development during a specific time interval. The acknowledged source for trip generation rates is the *Trip Generation Manual*¹ published by the Institute of Transportation Engineers (ITE). ITE has established trip rates in nationwide studies of similar land uses. For this study, Kimley-Horn used the ITE Trip Generation Report fitted curve equations that applies to Multifamily Low-Rise Housing (ITE Land Use Code 220), for traffic associated with the development.

Crawford Apartments is expected to generate approximately 218 weekday daily trips, with 30 of these trips occurring during the morning peak hour and 32 of these trips occurring during the afternoon peak hour. Calculations were based on the procedure and information provided in the ITE *Trip Generation Manual, 11th Edition – Volume 1: User’s Guide and Handbook, 2021*. **Table 1** summarizes the estimated trip generation for the Crawford Apartments. The trip generation worksheets are included in **Appendix D**.

Table 1 – Crawford Apartments Traffic Generation

Land Use and Size	Weekday Vehicle Trips						
	Daily	AM Peak Hour			PM Peak Hour		
		In	Out	Total	In	Out	Total
Multifamily Low-Rise Housing (ITE 220) – 22 Dwelling Units	218	7	23	30	20	12	32

¹ Institute of Transportation Engineers, *Trip Generation Manual*, Eleventh Edition, Washington DC, 2021.

4.2 Trip Distribution

Distribution of site traffic on the street system was based on the area street system characteristics, existing traffic patterns, existing and anticipated surrounding demographic information, existing and anticipated surrounding employment areas, and the proposed access system for the project. Due to the residential nature of the site, a cursory observation of the number of office/businesses within an approximate 12-mile radius of the site and commercial properties within a 5-mile radius of the site was utilized as a basis for trip distribution. It is believed that residents travelling from the site will mainly travel along Grinnell Boulevard to access Powers Boulevard, Fontaine Boulevard, and CanAm Highway. Finally, relatively low employment opportunities and commercial sites exist directly west of the site as shown by the small distribution along Crawford Avenue to the west. It is also believed that access to the CanAm Highway is better served by travelling along Grinnell Boulevard. The directional distribution of traffic is a means to quantify the percentage of site-generated traffic that approaches the site from a given direction and departs the site back to the original source. The project trip distribution for the proposed development is illustrated in **Figure 6**.

4.3 Traffic Assignment

Crawford Apartments traffic assignment was obtained by applying the project trip distribution to the estimated traffic generation of the development shown in **Table 1**. Traffic assignment is shown in **Figure 7**.

4.4 Total (Background Plus Project) Traffic

Site traffic volumes were added to the background volumes to represent estimated traffic conditions for the short-term 2023 buildout horizon and long-term 2045 twenty-year planning horizon. These total traffic volumes for the study area are illustrated for the 2023 and 2045 horizon years in **Figures 8** and **9**, respectively.

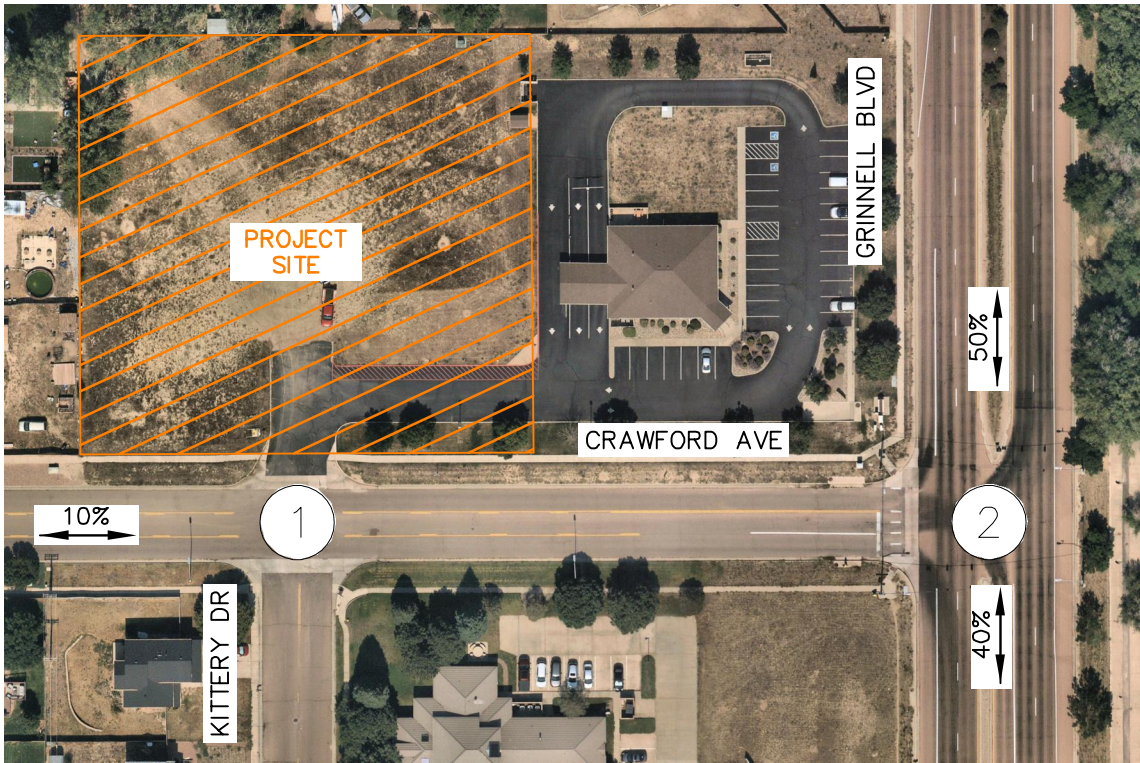
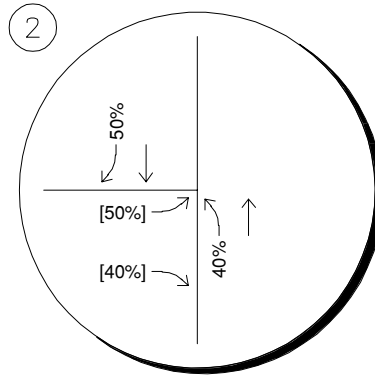
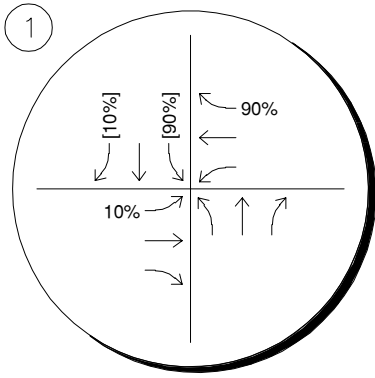

LEGEND

- (X) Study Area Key Intersection
- XX% External Trip Distribution Percentage
- XX%[XX%] Entering[Exiting] Trip Distribution Percentage

CRAWFORD APARTMENTS
 EL PASO COUNTY, COLORADO
 PROJECT TRIP DISTRIBUTION

FIGURE 6

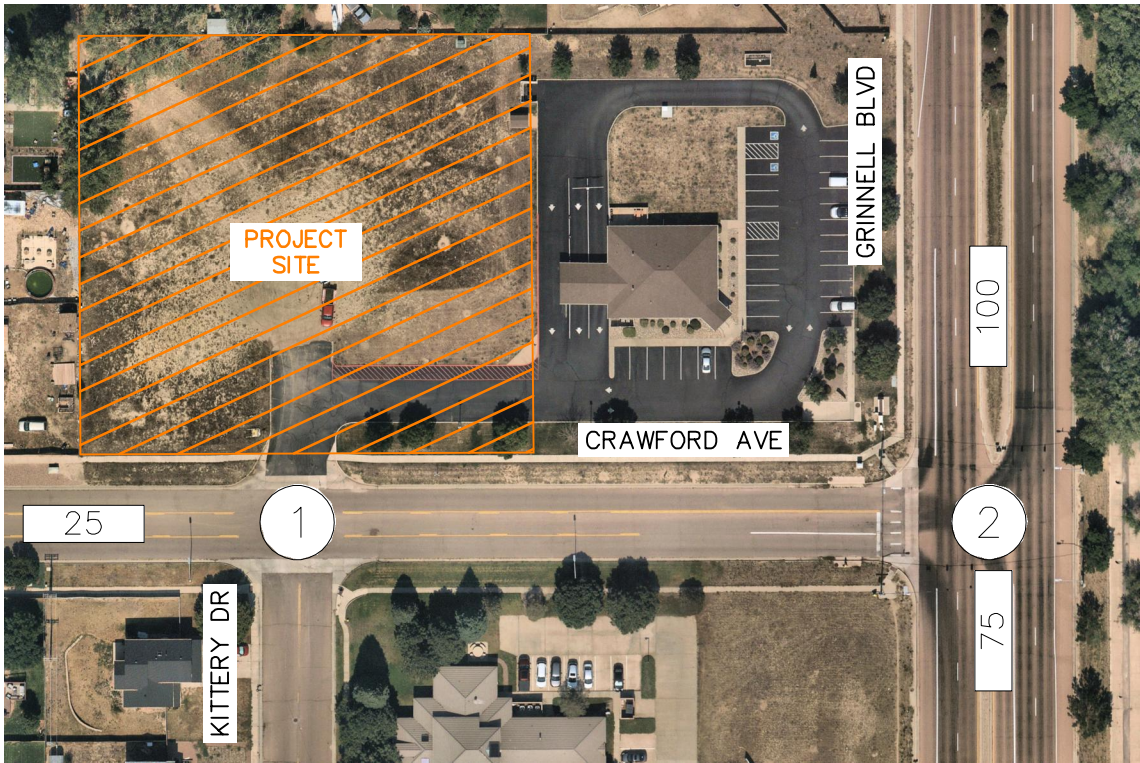
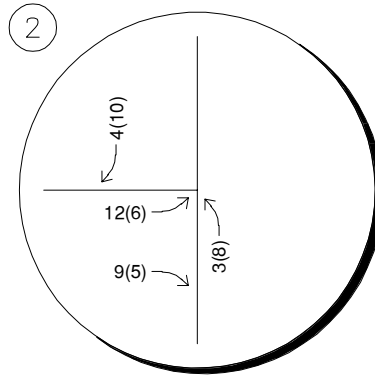
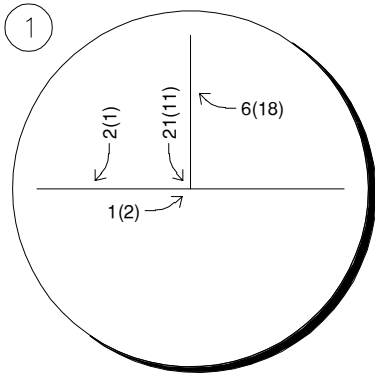

LEGEND

- X Study Area Key Intersection
- xxx(XXX) Weekday AM(PM)
Peak Hour Traffic Volumes
- xx,x00 Estimated Daily Traffic Volume

CRAWFORD APARTMENTS
 EL PASO COUNTY, COLORADO
 PROJECT TRAFFIC ASSIGNMENT

FIGURE 7

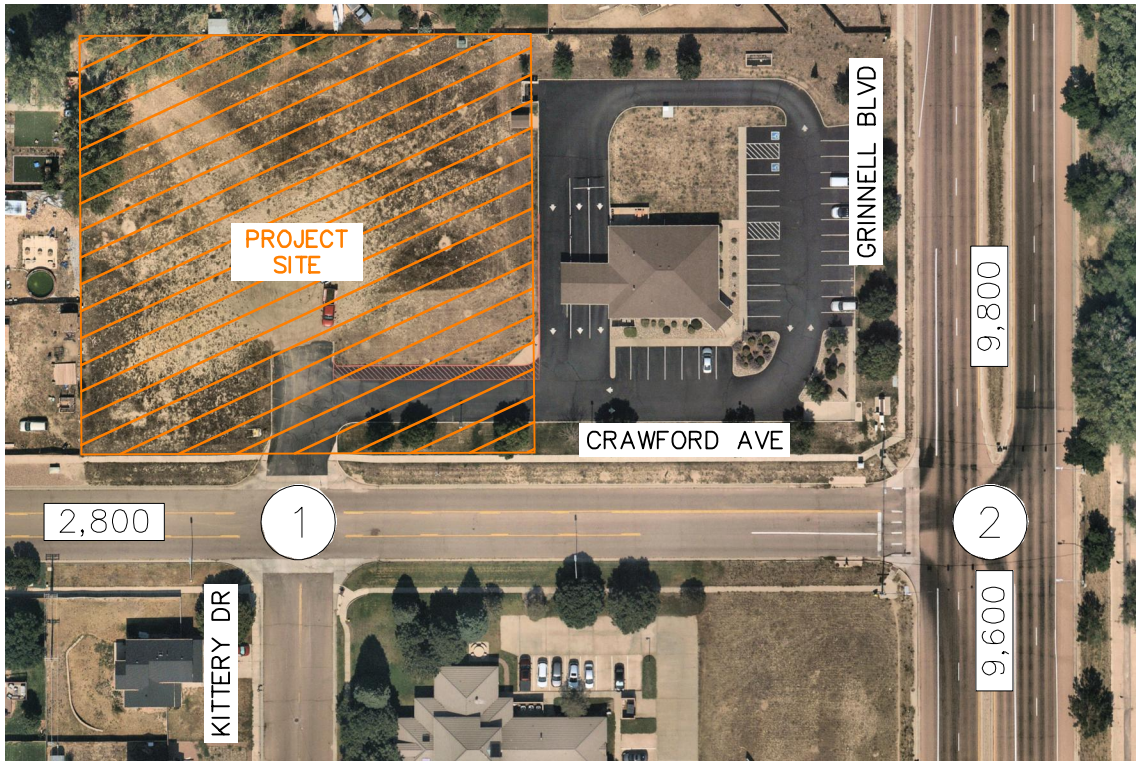
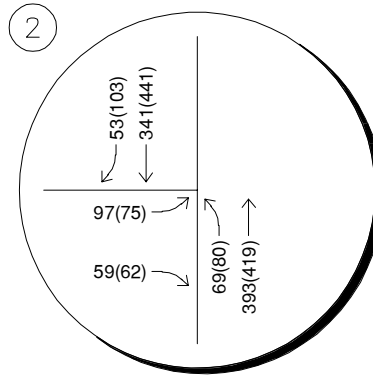
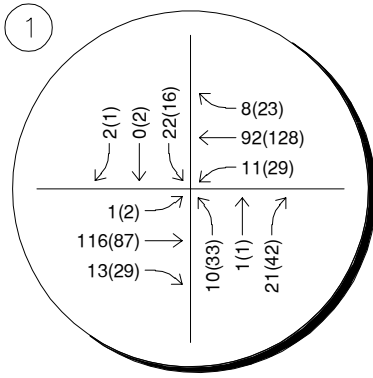

LEGEND

- (X) Study Area Key Intersection
- xxx(XXX) Weekday AM(PM) Peak Hour Traffic Volumes
- [xx,x00] Estimated Daily Traffic Volume

CRAWFORD APARTMENTS
 EL PASO COUNTY, COLORADO
 2023 TOTAL TRAFFIC VOLUMES

FIGURE 8

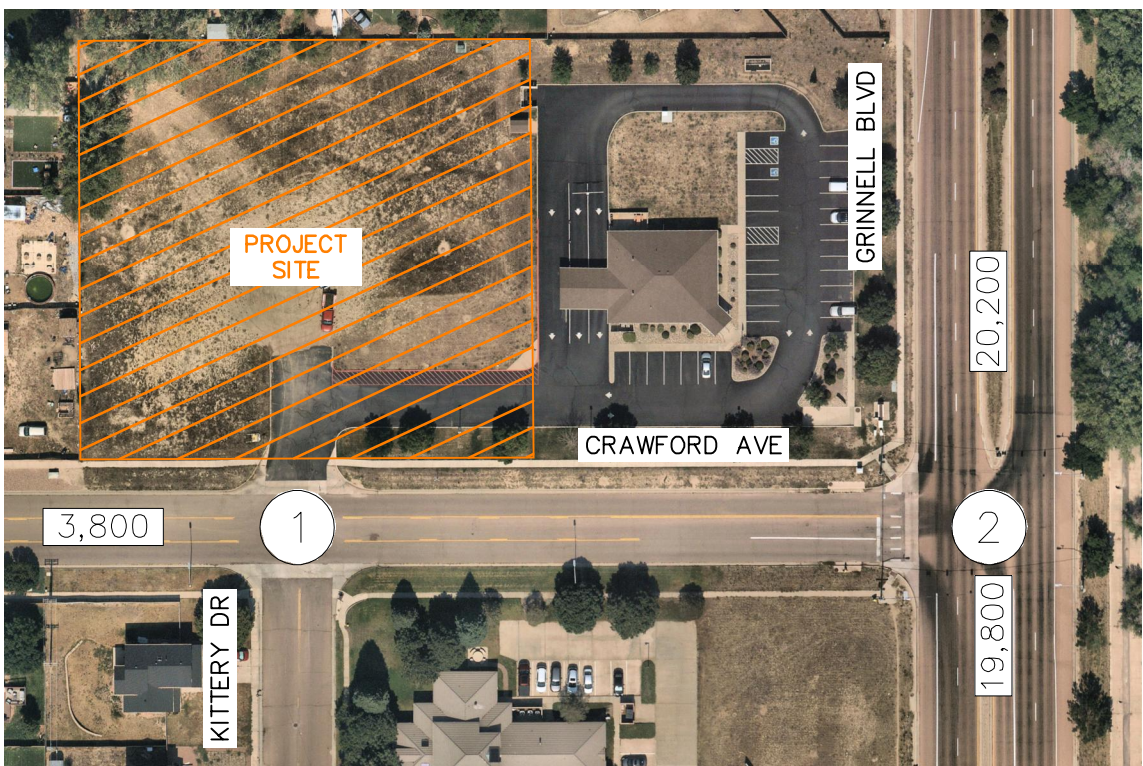
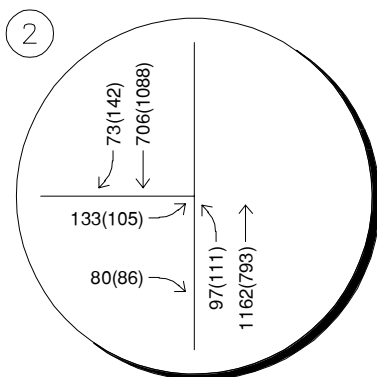
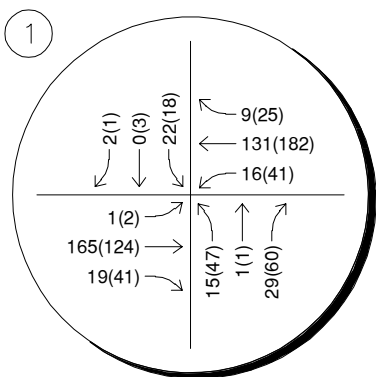

LEGEND

- (X) Study Area Key Intersection
- xxx(XXX) Weekday AM(PM) Peak Hour Traffic Volumes
- xx,x00 Estimated Daily Traffic Volume

CRAWFORD APARTMENTS
 EL PASO COUNTY, COLORADO
 2045 TOTAL TRAFFIC VOLUMES

FIGURE 9

5.0 TRAFFIC OPERATIONS ANALYSIS

Kimley-Horn’s analysis of traffic operations in the site vicinity was conducted to determine potential capacity deficiencies in the 2023 and 2045 development horizons at the identified key intersections. The acknowledged source for determining overall capacity is the current edition of the *Highway Capacity Manual (HCM)*².

5.1 Analysis Methodology

Capacity analysis results are listed in terms of Level of Service (LOS). LOS is a qualitative term describing operating conditions a driver will experience while traveling on a particular street or highway during a specific time interval. It ranges from A (very little delay) to F (long delays and congestion). Based on El Paso County standards, the threshold for acceptable LOS is not less than LOS D during peak hours. **Table 2** shows the definition of level of service for signalized and unsignalized intersections.

Table 2 – Level of Service Definitions

Level of Service	Signalized Intersection Average Total Delay (sec/veh)	Unsignalized Intersection Average Total Delay (sec/veh)
A	≤ 10	≤ 10
B	> 10 and ≤ 20	> 10 and ≤ 15
C	> 20 and ≤ 35	> 15 and ≤ 25
D	> 35 and ≤ 55	> 25 and ≤ 35
E	> 55 and ≤ 80	> 35 and ≤ 50
F	> 80	> 50

Definitions provided from the Highway Capacity Manual, Sixth Edition, Transportation Research Board, 2016.

Study area intersections were analyzed based on average total delay analysis for signalized and unsignalized intersections. Under the unsignalized analysis, the LOS for a two-way stop-controlled intersection is determined by the computed or measured control delay and is defined for each minor movement. LOS for a two-way stop-controlled intersection is not defined for the intersection as a whole. LOS for signalized, roundabout, and four-way stop controlled intersections are defined for each approach and for the overall intersection.

² Transportation Research Board, *Highway Capacity Manual*, Sixth Edition, Washington DC, 2016.

5.2 Key Intersection Operational Analysis

Calculations for the operational level of service at the key intersections for the study area are provided in **Appendix E**. The existing year analysis is based on the lane geometry and intersection control shown in **Figure 2**. Existing peak hour factors were utilized in the existing and 2023 horizon analysis years while the HCM urban standard of 0.92 was used for the long-term 2045 horizon analysis. Based on increased national attention given to establishing appropriate yellow and all-red clearance intervals to improve intersection safety, these have been calculated and are applied for approaches at the signalized intersection. The increase in yellow and all red time sacrifices intersection capacity for improved safety. Synchro traffic analysis software was used to analyze the signalized, and unsignalized key intersections for HCM level of service.

Crawford Avenue and Kittery Drive (#1)

The unsignalized intersection of Crawford Avenue and Kittery Drive (#1) operates with stop control on the northbound and southbound Kittery Drive approaches. The north leg will provide access to the project site. The intersection movements operate acceptably at LOS B or better during both peak hours under existing conditions. With project traffic, all movements are anticipated to continue operating at an acceptable LOS B or better during the peak hours throughout the 2045 horizon. Therefore, no modifications to the existing control or lane configurations are proposed at this intersection. **Table 3** provides the results of the LOS analysis conducted at this intersection.

Table 3 – Crawford Avenue & Kittery Drive (#1) LOS Results

Scenario	AM Peak Hour		PM Peak Hour	
	Delay (sec/veh)	LOS	Delay (sec/veh)	LOS
2021 Existing				
Northbound Approach	9.5	A	9.9	A
Eastbound Left	0.0	A	0.0	A
Westbound Left	7.5	A	7.5	A
Southbound Approach	10.0	B	10.4	B
2023 Background				
Northbound Approach	9.5	A	9.9	A
Eastbound Left	0.0	A	0.0	A
Westbound Left	7.6	A	7.5	A
Southbound Approach	10.0	B	10.5	B
2023 Background Plus Project				
Northbound Approach	9.5	A	10.0	B
Eastbound Left	7.5	A	7.6	A
Westbound Left	7.6	A	7.5	A
Southbound Approach	10.1	B	10.5	B
2045 Background				
Northbound Approach	9.9	A	10.7	B
Eastbound Left	0.0	A	0.0	A
Westbound Left	7.7	A	7.7	A
Southbound Approach	10.4	B	11.3	B
2045 Background Plus Project				
Northbound Approach	9.9	A	10.8	B
Eastbound Left	7.5	A	7.7	A
Westbound Left	7.7	A	7.7	A
Southbound Approach	10.5	B	11.4	B

Crawford Avenue and Grinnell Boulevard (#2)

The signalized intersection of Crawford Avenue and Grinnell Boulevard (#2) operates with protected-permissive left turn phasing on the northbound approach. The intersection operates acceptably at LOS A during both peak hours under existing conditions. With project traffic, all movements are anticipated to continue operating at an acceptable level of service throughout the 2045 horizon. Therefore, no modifications to the existing control or lane configurations are recommended at this intersection. **Table 4** provides the results of the LOS analysis conducted at this intersection.

Table 4 – Crawford Avenue & Grinnell Boulevard (#2) LOS Results

Scenario	AM Peak Hour		PM Peak Hour	
	Delay (sec/veh)	LOS	Delay (sec/veh)	LOS
2021 Existing	9.1	A	8.2	A
2023 Background	9.1	A	8.2	A
2023 Background Plus Project	9.1	A	8.6	A
2045 Background	8.5	A	8.8	A
2045 Background Plus Project	9.1	A	9.1	A

5.3 El Paso County Turn Lane Requirement Analysis

The El Paso County ECM was used to determine if left and right turn lanes are warranted along Crawford Avenue and Grinnell Boulevard. El Paso County classifies Grinnell Boulevard as a Minor Arterial roadway. Crawford Avenue has the characteristics of an urban residential collector street. According to El Paso County ECM guidelines for minor arterials and lower classifications, a left turn lane is required for any access with a projected peak hour left turning volume of 25 vehicles per hour or greater, a right turn lane is required for any access with a projected peak hour right turning volume of 50 vehicles per hour or greater, and a right turn acceleration lane is generally not required.

Crawford Avenue and Kittery Drive:

- A westbound right turn lane **is not** warranted at this intersection based on projected 2045 total traffic volumes being 27 westbound right turns during the peak hour and the threshold being 50 vehicles per hour.

- An eastbound left turn lane exists but **is not** warranted at this intersection based on projected 2045 total traffic volumes being two (2) eastbound left turns during the peak hour and the threshold being 25 vehicles per hour. This eastbound left turn lane is incorporated within an existing two-way left turn lane and no modifications are recommended to this turn lane.

Crawford Avenue and Grinnell Boulevard:

- An eastbound left turn lane exists and **is** warranted at this intersection based on existing traffic volumes being 82 eastbound left turns during the peak hour and the threshold being 25 vehicles per hour. The existing eastbound left turn lane is a continuous two-way left turn lane. Therefore, this left turn lane meets El Paso County Standards.
- An eastbound right turn lane exists and **is** warranted at this intersection based on existing traffic volumes being 55 eastbound right turns during the peak hour and the threshold being 50 vehicles per hour. The existing eastbound right turn lane is continuous; therefore, this right turn lane meets El Paso County Standards.
- A northbound left turn lane exists and **is** warranted at this intersection based on projected 2023 total traffic volumes being 81 northbound left turns during the peak hour and the threshold being 25 vehicles per hour. The existing northbound left turn lane is currently striped with approximately 150 feet of length but provides stacking distance of approximately 300 feet plus a 200-foot taper. Based on a design speed of 55-miles per hour from ECM Table 2-26, the deceleration lane length is 265 feet, plus a 220-foot taper. Additionally, 100 feet of storage is required by El Paso County ECM Table 2-30 due to the peak hour volume. Therefore, the northbound left turn length requirements at this intersection are 365 feet plus a 220-foot taper. Since vehicle queues are only calculated with 50 feet of storage and to avoid reconstructing the existing raised median for only an additional 65 feet of length, it is recommended that the existing median for the northbound left turn lane at Crawford Avenue and Grinnell Boulevard intersection remain in the current condition. A deviation request should be submitted at the subdivision state of the development. However, the northbound left turn lane at the Crawford Avenue and Grinnell Boulevard intersection should be restriped from approximately 150 feet to 300 feet of length.

- A southbound right turn lane exists and **is** warranted at this intersection based on projected 2023 total traffic volumes being 104 southbound right turns during the peak hour and the threshold being 50 vehicles per hour. The existing southbound right turn lane is 150 feet with a 150-foot taper. Based on the 55-mile per hour design speed, the deceleration lane length is 265 feet, plus a 220-foot taper. Additionally, 100 feet of storage is required by El Paso County due to the peak hour volume. Therefore, this right turn lane should be restriped to provide a length of 365 feet plus a 220-foot taper.

5.4 Vehicle Queuing Analysis

A vehicle queuing analysis was conducted for the study area intersections. The queuing analysis was performed using Synchro presenting the results of the 95th percentile queue lengths. Results are shown in the following **Table 5** with calculations provided within the level of service operational sheets of **Appendix E** for unsignalized intersections and **Appendix F** for signalized intersections.

Table 5 – Turn Lane Queuing Analysis Results

Intersection Turn Lane	Existing Turn Lane Length (feet)	2023 Calculated Queue (feet)	2023 Recommended Length (feet)	2045 Calculated Queue (feet)	2045 Recommended Length (feet)
Crawford Ave & Kittery Dr (#1)					
Eastbound Left	TWLTL	25'	TWLTL	25'	TWLTL
Westbound Left	TWLTL	25'	TWLTL	25'	TWLTL
Crawford Ave & Grinnell Blvd (#2)					
Eastbound Left	TWLTL	104'	TWLTL	133'	TWLTL
Northbound Left	300'	25'	300'	34'	300'
Southbound Right	125'	25'	365'+220'T (EC)	35'	365'+220'T (EC)

TWLTL = Two-Way Left Turn Lane; **Blue** Text = Recommendation; EC = El Paso County Standard

As shown in the table above all queues are managed in the available storage length throughout the 2045 horizon with project traffic. However, to meet El Paso County standards, it is recommended that the southbound right turn lane at the intersection of Crawford Avenue and Grinnell Boulevard (#2) be restriped to 365 feet with a 220-foot taper by 2023.

5.5 Roadway Classifications

Grinnell Boulevard is expected to be under the El Paso County average daily traffic threshold standard of 20,000 vehicles per day for a minor arterial. Likewise, Crawford Avenue is expected to be under the El Paso County average daily threshold standard of 10,000 vehicles per day for an urban residential collector in 2023. Attached **Figure 10** illustrates the street classification map for roadways internal and external to the Crawford Apartments project.

5.6 Sight Distance Evaluation

It is recommended that sight triangles be provided at site access along Crawford Avenue to give drivers exiting the site a clear view of oncoming traffic. Landscaping and objects within sight triangles must not obstruct drivers' views of the adjacent travel lanes. El Paso County ECM design intersection sight distances for left turn and right turn from stop (from Table 2-35) were evaluated at the Crawford Avenue access.

According to Table 2-35 (Entering Sight Distance for Driveways) from ECM and a posted speed limit of 30 miles per hour along Crawford Avenue, the intersection sight distance for a vehicle turning left and right from stop along a two-lane roadway is 300 feet. Therefore, all obstructions for left turning vehicles from stop should be clear to the right within the triangle created with a vertex point located 10 feet from the edge of the major road traveled way and a line-of-sight distance of 300 feet located in the middle of the eastbound through lane along Crawford Avenue. Likewise, all obstructions for right turning vehicles from stop should be clear to the left within the triangle created with a vertex point located 10 feet from the edge of the major road traveled way and a line-of-sight distance of 300 feet located in the middle of the westbound through lane along Crawford Avenue. As this access is located approximately 220 feet from Fleming Street, sight distances of 300 feet will not be provided for vehicles entering Crawford Avenue from Fleming Street; however, these vehicles from Fleming Street will be forced to stop at Crawford Avenue and will be traveling at speeds much slower than 30 miles per hour once entering Crawford Avenue. Therefore, it is believed that the proposed access along Crawford Avenue is appropriately located to provide necessary sight distances.

5.7 Bicycle and Pedestrian Access

Sidewalks are provided along both sides of Crawford Avenue and Kittery Drive south of Crawford Avenue. A sidewalk is provided on the west side of Grinnell Boulevard north of Crawford Avenue

and on the east side of Grinnell Boulevard south of Crawford Avenue. Adjacent to the site, there are not any designated bicycle lanes along Crawford Avenue, Kittery Drive, or Grinnell Boulevard.

5.8 Road Impact Fees

Road impact fees were evaluated based on the El Paso County Road Impact Fee Schedule. Based on these fee schedule guidelines, the fee per multi-family dwelling unit is \$2,407. Therefore, the road impact fee for the proposed 22 multi-family residences is expected to be \$52,954. Road impact fee calculations are shown in **Table 6**. During the final plat process, the project team will determine if the impact fees are paid up front or if the property will be included in one of the available public improvement districts with reduced upfront costs. The project team will determine payment methods with the final plat.

Table 6 – Road Impact Fees

Use	Units	Fee / Unit	Total Fee
Multi-Family Housing	22	\$2,407	\$52,954

5.9 Improvement Summary

Based on the results of the intersection operational and vehicle queuing analysis, the key intersection recommended improvements and control are shown in **Figure 11**. It should be noted that the El Paso County Major Transportation Corridors Plan does not identify any improvements in the site vicinity. However, Grinnell Boulevard between Powers Boulevard and Bradley Road is planned to be widened from two lanes to four lanes by 2040.

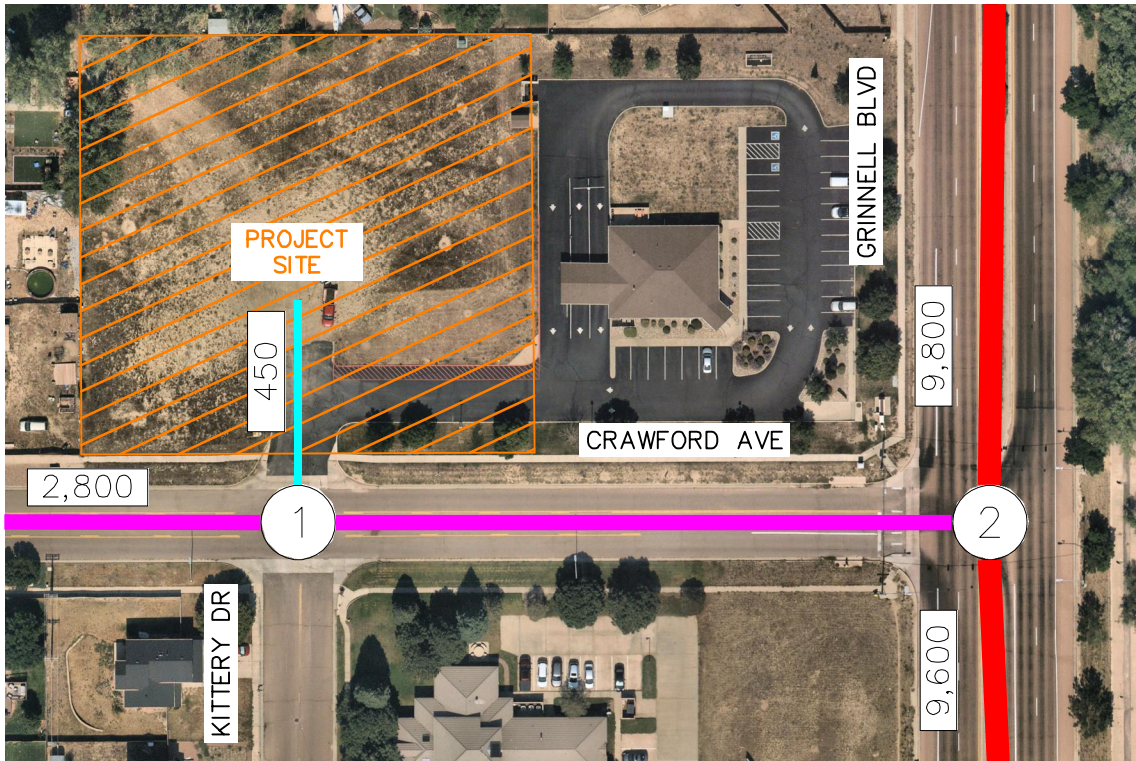
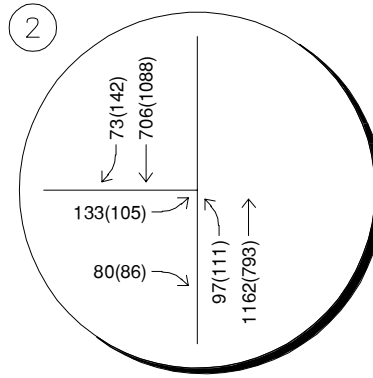
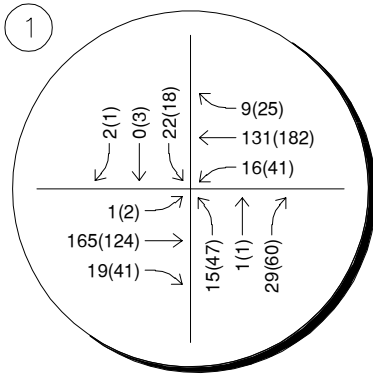

LEGEND

- MINOR ARTERIAL
- MAJOR COLLECTOR
- PRIVATE ACCESS
- XX,X00 ESTIMATED 2023 DAILY TRAFFIC VOLUME

CRAWFORD APARTMENTS
 EL PASO COUNTY, COLORADO
 CIRCULATION PLAN

FIGURE 10

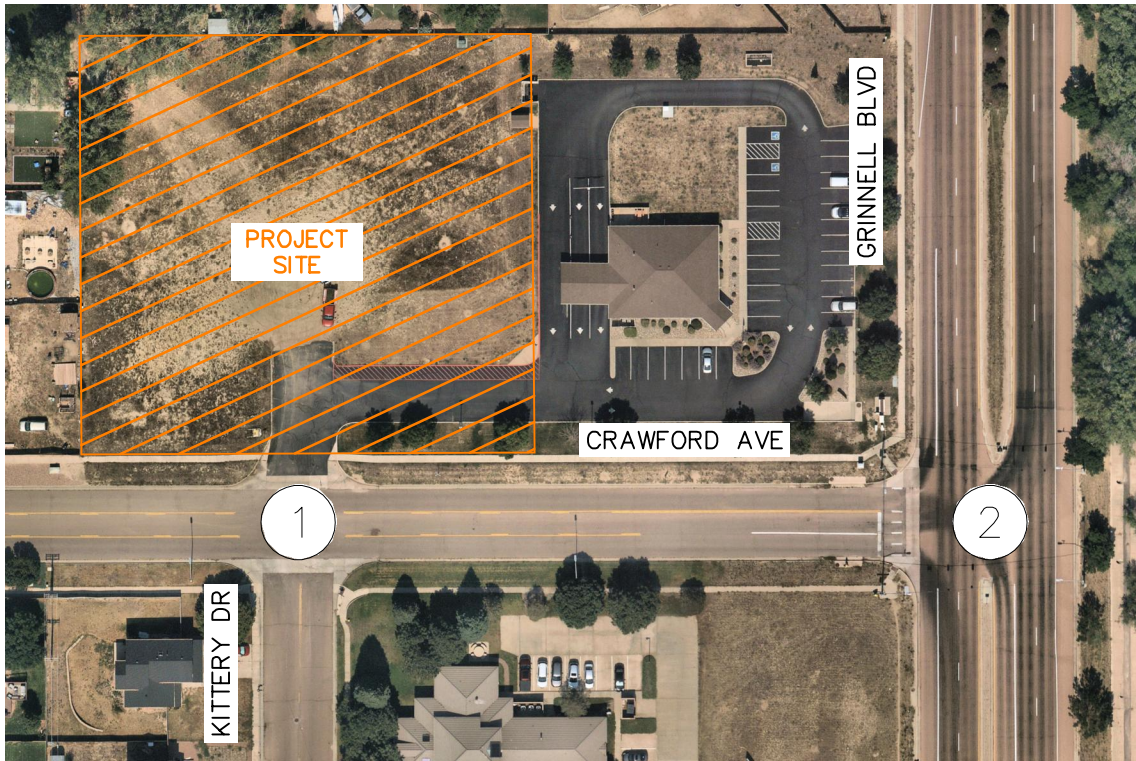
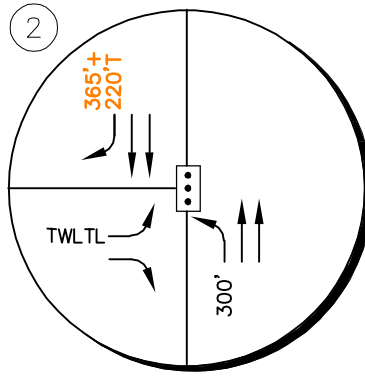
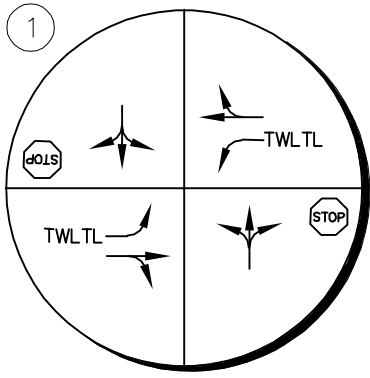

LEGEND

- (X) Study Area Key Intersection
- [Signal Icon] Signalized Intersection
- [STOP Icon] Stop Controlled Approach
- ← Improvement
- ↪ 100' Turn Lane Length (feet)

CRAWFORD APARTMENTS
 EL PASO COUNTY, COLORADO
 2023 RECOMMENDED GEOMETRY
 AND CONTROL

FIGURE 11

6.0 CONCLUSIONS AND RECOMMENDATIONS

Based on the analysis presented in this report, Kimley-Horn believes Crawford Apartments will be successfully incorporated into the existing and future roadway network. Analysis of the existing street network, the proposed project development, and expected traffic volumes resulted in the following conclusions and recommendations:

- Based on El Paso County standards, the northbound left turn length requirements at the Crawford Avenue and Grinnell Boulevard intersection are 365 feet plus a 220-foot taper. Since vehicle queues are only calculated with 50 feet of storage and to avoid reconstructing the existing raised median for only an additional 65 feet of length, it is recommended that the existing median for the northbound left turn lane at Crawford Avenue and Grinnell Boulevard intersection remain in the current condition. A deviation request should be submitted at the subdivision state of the development. However, the northbound left turn lane at the Crawford Avenue and Grinnell Boulevard intersection should be restriped from approximately 150 feet to 300 feet of length.
- To meet El Paso County standards, it is recommended that the southbound right turn lane at the intersection of Crawford Avenue and Grinnell Boulevard be restriped to 365 feet with a 220-foot taper.
- Any on-site or offsite improvements should be incorporated into the Civil Drawings and conform to standards of El Paso County and the Manual on Uniform Traffic Control Devices (MUTCD) – 2009 Edition.

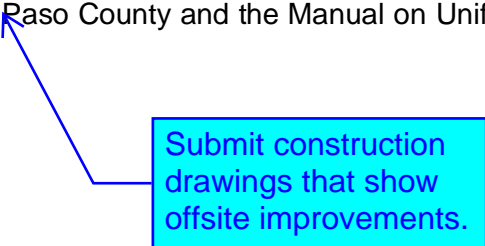

Submit construction drawings that show offsite improvements.

APPENDICES

APPENDIX A

Intersection Count Sheets

Kittery Dr Crawford Ave



Date: 12/08/2021
 Count Period: 7:00 AM to 9:00 AM
 Peak Hour: 7:00 AM to 8:00 AM

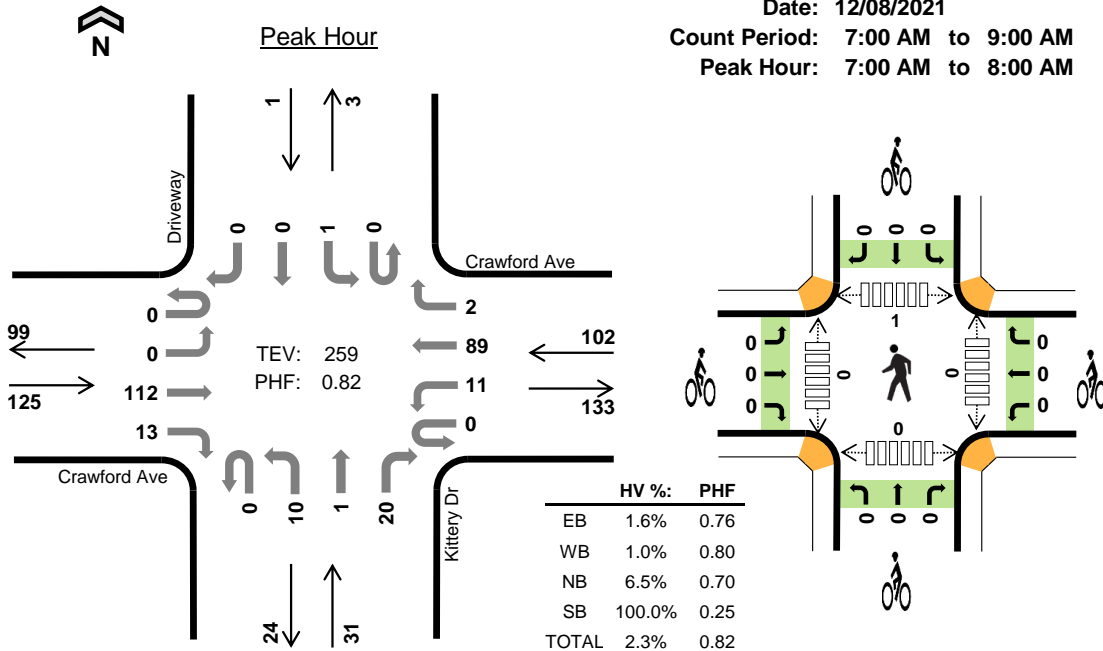

Two-Hour Count Summaries

Interval Start	Crawford Ave Eastbound				Crawford Ave Westbound				Kittery Dr Northbound				Driveway Southbound				15-min Total	Rolling One Hour	
	UT	LT	TH	RT	UT	LT	TH	RT	UT	LT	TH	RT	UT	LT	TH	RT			
7:00 AM	0	0	32	3	0	2	30	0	0	5	1	5	0	1	0	0	79	0	
7:15 AM	0	0	36	5	0	1	20	1	0	3	0	5	0	0	0	0	71	0	
7:30 AM	0	0	21	3	0	5	15	0	0	2	0	8	0	0	0	0	54	0	
7:45 AM	0	0	23	2	0	3	24	1	0	0	0	2	0	0	0	0	55	259	
8:00 AM	0	1	24	3	0	10	26	1	0	1	0	4	0	0	0	1	71	251	
8:15 AM	0	0	25	8	0	5	17	1	0	6	0	3	0	0	0	1	66	246	
8:30 AM	0	0	21	7	0	6	16	0	0	5	0	7	0	1	0	0	63	255	
8:45 AM	0	0	17	6	0	8	6	2	0	3	0	6	0	0	0	0	48	248	
Count Total	0	1	199	37	0	40	154	6	0	25	1	40	0	2	0	2	507	0	
Peak Hour	All	0	0	112	13	0	11	89	2	0	10	1	20	0	1	0	0	259	0
	HV	0	0	1	1	0	0	1	0	0	1	1	0	0	1	0	0	6	0
	HV%	-	-	1%	8%	-	0%	1%	0%	-	10%	100%	0%	-	100%	-	-	2%	0

Note: Two-hour count summary volumes include heavy vehicles but exclude bicycles in overall count.

Interval Start	Heavy Vehicle Totals					Bicycles					Pedestrians (Crossing Leg)				
	EB	WB	NB	SB	Total	EB	WB	NB	SB	Total	East	West	North	South	Total
7:00 AM	0	0	2	1	3	0	0	0	0	0	0	0	0	0	0
7:15 AM	0	0	0	0	0	0	0	0	0	0	0	0	1	0	1
7:30 AM	2	0	0	0	2	0	0	0	0	0	0	0	0	0	0
7:45 AM	0	1	0	0	1	0	0	0	0	0	0	0	0	0	0
8:00 AM	0	0	0	0	0	0	0	0	0	0	0	0	0	2	2
8:15 AM	0	0	0	0	0	0	0	0	0	0	0	0	0	0	0
8:30 AM	0	2	0	0	2	0	0	0	0	0	0	0	1	0	1
8:45 AM	2	1	0	0	3	0	0	0	0	0	0	0	0	0	0
Count Total	4	4	2	1	11	0	0	0	0	0	0	0	2	2	4
Peak Hour	2	1	2	1	6	0	0	0	0	0	0	0	1	0	1

Two-Hour Count Summaries - Heavy Vehicles																		
Interval Start	Crawford Ave				Crawford Ave				Kittery Dr				Driveway				15-min Total	Rolling One Hour
	Eastbound				Westbound				Northbound				Southbound					
	UT	LT	TH	RT	UT	LT	TH	RT	UT	LT	TH	RT	UT	LT	TH	RT		
7:00 AM	0	0	0	0	0	0	0	0	0	1	1	0	0	1	0	0	3	0
7:15 AM	0	0	0	0	0	0	0	0	0	0	0	0	0	0	0	0	0	0
7:30 AM	0	0	1	1	0	0	0	0	0	0	0	0	0	0	0	0	2	0
7:45 AM	0	0	0	0	0	0	1	0	0	0	0	0	0	0	0	0	1	6
8:00 AM	0	0	0	0	0	0	0	0	0	0	0	0	0	0	0	0	0	3
8:15 AM	0	0	0	0	0	0	0	0	0	0	0	0	0	0	0	0	0	3
8:30 AM	0	0	0	0	0	1	1	0	0	0	0	0	0	0	0	0	2	3
8:45 AM	0	0	1	1	0	1	0	0	0	0	0	0	0	0	0	0	3	5
Count Total	0	0	2	2	0	2	2	0	0	1	1	0	0	1	0	0	11	0
Peak Hour	0	0	1	1	0	0	1	0	0	1	1	0	0	1	0	0	6	0
Two-Hour Count Summaries - Bikes																		
Interval Start	Crawford Ave			Crawford Ave			Kittery Dr			Driveway			15-min Total	Rolling One Hour				
	Eastbound			Westbound			Northbound			Southbound								
	LT	TH	RT	LT	TH	RT	LT	TH	RT	LT	TH	RT						
7:00 AM	0	0	0	0	0	0	0	0	0	0	0	0	0	0				
7:15 AM	0	0	0	0	0	0	0	0	0	0	0	0	0	0				
7:30 AM	0	0	0	0	0	0	0	0	0	0	0	0	0	0				
7:45 AM	0	0	0	0	0	0	0	0	0	0	0	0	0	0				
8:00 AM	0	0	0	0	0	0	0	0	0	0	0	0	0	0				
8:15 AM	0	0	0	0	0	0	0	0	0	0	0	0	0	0				
8:30 AM	0	0	0	0	0	0	0	0	0	0	0	0	0	0				
8:45 AM	0	0	0	0	0	0	0	0	0	0	0	0	0	0				
Count Total	0	0	0	0	0	0	0	0	0	0	0	0	0	0				
Peak Hour	0	0	0	0	0	0	0	0	0	0	0	0	0	0				
<i>Note: U-Turn volumes for bikes are included in Left-Turn, if any.</i>																		

Kittery Dr Crawford Ave



Date: 12/08/2021
 Count Period: 4:00 PM to 6:00 PM
 Peak Hour: 4:15 PM to 5:15 PM

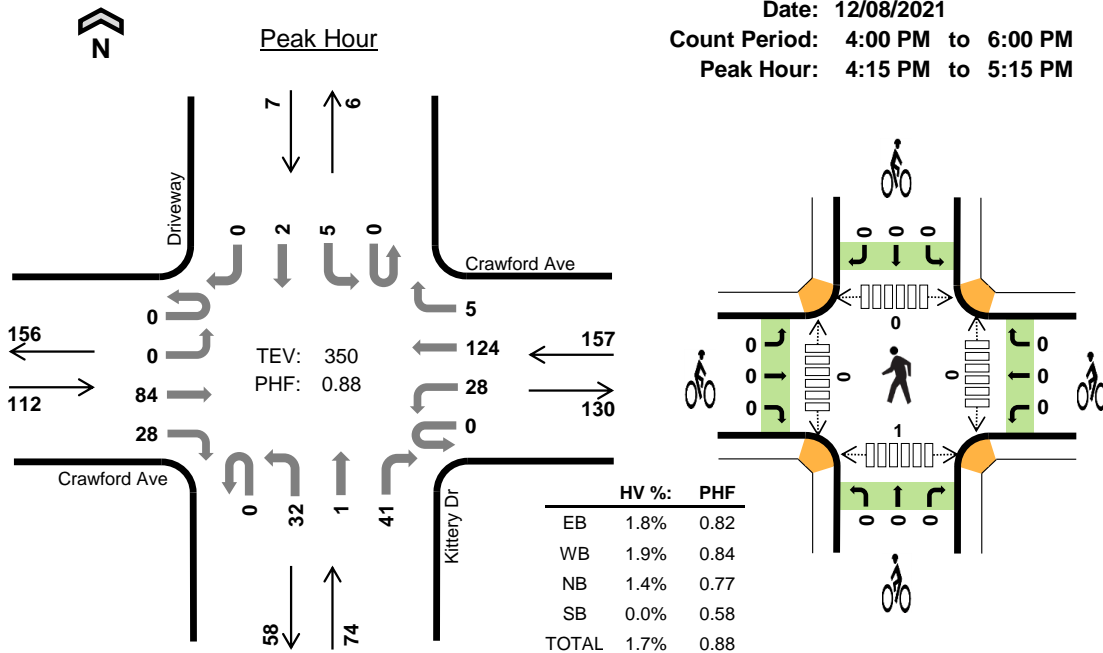

Two-Hour Count Summaries

Interval Start	Crawford Ave Eastbound				Crawford Ave Westbound				Kittery Dr Northbound				Driveway Southbound				15-min Total	Rolling One Hour	
	UT	LT	TH	RT	UT	LT	TH	RT	UT	LT	TH	RT	UT	LT	TH	RT			
4:00 PM	0	0	23	8	0	7	24	1	0	6	0	6	0	1	0	0	76	0	
4:15 PM	0	0	21	7	0	8	27	2	0	14	0	10	0	2	1	0	92	0	
4:30 PM	0	0	25	9	0	11	33	3	0	5	1	10	0	1	1	0	99	0	
4:45 PM	0	0	16	4	0	6	31	0	0	8	0	13	0	2	0	0	80	347	
5:00 PM	0	0	22	8	0	3	33	0	0	5	0	8	0	0	0	0	79	350	
5:15 PM	0	0	19	10	0	4	40	0	0	5	0	6	0	0	0	0	84	342	
5:30 PM	0	1	13	2	0	2	29	0	0	7	0	4	0	1	1	0	60	303	
5:45 PM	0	0	17	2	0	3	32	0	0	3	0	3	0	0	0	1	61	284	
Count Total	0	1	156	50	0	44	249	6	0	53	1	60	0	7	3	1	631	0	
Peak Hour	All	0	0	84	28	0	28	124	5	0	32	1	41	0	5	2	0	350	0
	HV	0	0	2	0	0	1	2	0	0	0	0	1	0	0	0	0	6	0
	HV%	-	-	2%	0%	-	4%	2%	0%	-	0%	0%	2%	-	0%	0%	-	2%	0

Note: Two-hour count summary volumes include heavy vehicles but exclude bicycles in overall count.

Interval Start	Heavy Vehicle Totals					Bicycles					Pedestrians (Crossing Leg)				
	EB	WB	NB	SB	Total	EB	WB	NB	SB	Total	East	West	North	South	Total
4:00 PM	1	0	0	0	1	0	0	0	0	0	0	0	0	0	0
4:15 PM	0	3	1	0	4	0	0	0	0	0	0	0	0	0	0
4:30 PM	1	0	0	0	1	0	0	0	0	0	0	0	0	1	1
4:45 PM	0	0	0	0	0	0	0	0	0	0	0	0	0	0	0
5:00 PM	1	0	0	0	1	0	0	0	0	0	0	0	0	0	0
5:15 PM	1	0	0	0	1	0	0	0	0	0	0	0	0	0	0
5:30 PM	1	0	1	0	2	0	0	0	0	0	0	0	0	1	1
5:45 PM	0	0	0	0	0	0	0	0	0	0	0	0	0	0	0
Count Total	5	3	2	0	10	0	0	0	0	0	0	0	0	2	2
Peak Hour	2	3	1	0	6	0	0	0	0	0	0	0	0	1	1

Two-Hour Count Summaries - Heavy Vehicles																		
Interval Start	Crawford Ave				Crawford Ave				Kittery Dr				Driveway				15-min Total	Rolling One Hour
	Eastbound				Westbound				Northbound				Southbound					
	UT	LT	TH	RT	UT	LT	TH	RT	UT	LT	TH	RT	UT	LT	TH	RT		
4:00 PM	0	0	1	0	0	0	0	0	0	0	0	0	0	0	0	0	1	0
4:15 PM	0	0	0	0	0	1	2	0	0	0	0	1	0	0	0	0	4	0
4:30 PM	0	0	1	0	0	0	0	0	0	0	0	0	0	0	0	0	1	0
4:45 PM	0	0	0	0	0	0	0	0	0	0	0	0	0	0	0	0	0	6
5:00 PM	0	0	1	0	0	0	0	0	0	0	0	0	0	0	0	0	1	6
5:15 PM	0	0	1	0	0	0	0	0	0	0	0	0	0	0	0	0	1	3
5:30 PM	0	0	1	0	0	0	0	0	0	1	0	0	0	0	0	0	2	4
5:45 PM	0	0	0	0	0	0	0	0	0	0	0	0	0	0	0	0	0	4
Count Total	0	0	5	0	0	1	2	0	0	1	0	1	0	0	0	0	10	0
Peak Hour	0	0	2	0	0	1	2	0	0	0	0	1	0	0	0	0	6	0
Two-Hour Count Summaries - Bikes																		
Interval Start	Crawford Ave			Crawford Ave			Kittery Dr			Driveway			15-min Total	Rolling One Hour				
	Eastbound			Westbound			Northbound			Southbound								
	LT	TH	RT	LT	TH	RT	LT	TH	RT	LT	TH	RT						
4:00 PM	0	0	0	0	0	0	0	0	0	0	0	0	0	0	0	0	0	0
4:15 PM	0	0	0	0	0	0	0	0	0	0	0	0	0	0	0	0	0	0
4:30 PM	0	0	0	0	0	0	0	0	0	0	0	0	0	0	0	0	0	0
4:45 PM	0	0	0	0	0	0	0	0	0	0	0	0	0	0	0	0	0	0
5:00 PM	0	0	0	0	0	0	0	0	0	0	0	0	0	0	0	0	0	0
5:15 PM	0	0	0	0	0	0	0	0	0	0	0	0	0	0	0	0	0	0
5:30 PM	0	0	0	0	0	0	0	0	0	0	0	0	0	0	0	0	0	0
5:45 PM	0	0	0	0	0	0	0	0	0	0	0	0	0	0	0	0	0	0
Count Total	0	0	0	0	0	0	0	0	0	0	0	0	0	0	0	0	0	0
Peak Hour	0	0	0	0	0	0	0	0	0	0	0	0	0	0	0	0	0	0
<i>Note: U-Turn volumes for bikes are included in Left-Turn, if any.</i>																		

Grinnell Blvd Crawford Ave



Peak Hour

Date: 12/08/2021
Count Period: 7:00 AM to 9:00 AM
Peak Hour: 7:00 AM to 8:00 AM

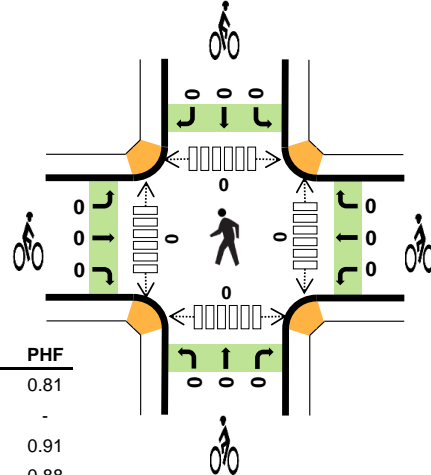
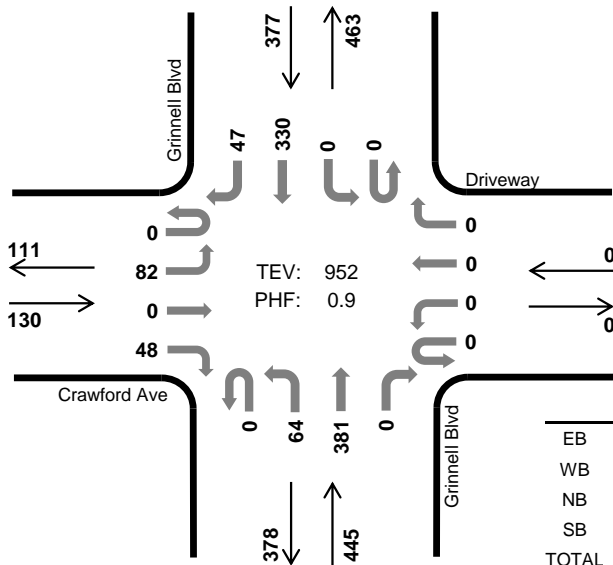

	HV %:	PHF
EB	1.5%	0.81
WB	-	-
NB	1.6%	0.91
SB	2.1%	0.88
TOTAL	1.8%	0.90

Two-Hour Count Summaries

Interval Start	Crawford Ave				Driveway				Grinnell Blvd				Grinnell Blvd				15-min Total	Rolling One Hour	
	Eastbound		Westbound		Northbound		Southbound		UT	LT	TH	RT	UT	LT	TH	RT			
7:00 AM	0	18	0	19	0	0	0	0	0	25	95	0	0	0	83	9	249	0	
7:15 AM	0	29	0	11	0	0	0	0	0	14	108	0	0	0	94	8	264	0	
7:30 AM	0	22	0	9	0	0	0	0	0	13	108	0	0	0	69	7	228	0	
7:45 AM	0	13	0	9	0	0	0	0	0	12	70	0	0	0	84	23	211	952	
8:00 AM	0	15	0	13	0	0	0	0	0	15	86	0	0	0	69	19	217	920	
8:15 AM	0	16	0	13	0	0	0	0	0	12	77	0	0	0	74	9	201	857	
8:30 AM	0	17	0	12	0	0	0	0	0	10	74	0	0	0	76	12	201	830	
8:45 AM	0	13	0	7	0	0	0	0	0	10	53	0	0	0	80	12	175	794	
Count Total	0	143	0	93	0	0	0	0	0	111	671	0	0	0	629	99	1,746	0	
Peak Hour	All	0	82	0	48	0	0	0	0	0	64	381	0	0	0	330	47	952	0
	HV	0	1	0	1	0	0	0	0	0	1	6	0	0	0	8	0	17	0
	HV%	-	1%	-	2%	-	-	-	-	-	2%	2%	-	-	-	2%	0%	2%	0

Note: Two-hour count summary volumes include heavy vehicles but exclude bicycles in overall count.

Interval Start	Heavy Vehicle Totals					Bicycles					Pedestrians (Crossing Leg)				
	EB	WB	NB	SB	Total	EB	WB	NB	SB	Total	East	West	North	South	Total
7:00 AM	1	0	1	2	4	0	0	0	0	0	0	0	0	0	0
7:15 AM	0	0	2	2	4	0	0	0	0	0	0	0	0	0	0
7:30 AM	1	0	3	1	5	0	0	0	0	0	0	0	0	0	0
7:45 AM	0	0	1	3	4	0	0	0	0	0	0	0	0	0	0
8:00 AM	0	0	1	4	5	0	0	0	0	0	0	0	0	0	0
8:15 AM	0	0	4	4	8	0	0	0	0	0	0	0	0	0	0
8:30 AM	0	0	1	4	5	0	0	0	0	0	0	0	0	0	0
8:45 AM	1	0	0	3	4	0	0	0	0	0	0	2	0	0	2
Count Total	3	0	13	23	39	0	0	0	0	0	0	2	0	0	2
Peak Hour	2	0	7	8	17	0	0	0	0	0	0	0	0	0	0

Two-Hour Count Summaries - Heavy Vehicles																		
Interval Start	Crawford Ave				Driveway				Grinnell Blvd				Grinnell Blvd				15-min Total	Rolling One Hour
	Eastbound				Westbound				Northbound				Southbound					
	UT	LT	TH	RT	UT	LT	TH	RT	UT	LT	TH	RT	UT	LT	TH	RT		
7:00 AM	0	1	0	0	0	0	0	0	0	0	1	0	0	0	2	0	4	0
7:15 AM	0	0	0	0	0	0	0	0	0	0	2	0	0	0	2	0	4	0
7:30 AM	0	0	0	1	0	0	0	0	0	0	3	0	0	0	1	0	5	0
7:45 AM	0	0	0	0	0	0	0	0	0	1	0	0	0	0	3	0	4	17
8:00 AM	0	0	0	0	0	0	0	0	0	0	1	0	0	0	4	0	5	18
8:15 AM	0	0	0	0	0	0	0	0	0	0	4	0	0	0	4	0	8	22
8:30 AM	0	0	0	0	0	0	0	0	0	1	0	0	0	0	3	1	5	22
8:45 AM	0	0	0	1	0	0	0	0	0	0	0	0	0	0	1	2	4	22
Count Total	0	1	0	2	0	0	0	0	0	2	11	0	0	0	20	3	39	0
Peak Hour	0	1	0	1	0	0	0	0	0	1	6	0	0	0	8	0	17	0
Two-Hour Count Summaries - Bikes																		
Interval Start	Crawford Ave			Driveway			Grinnell Blvd			Grinnell Blvd			15-min Total	Rolling One Hour				
	Eastbound			Westbound			Northbound			Southbound								
	LT	TH	RT	LT	TH	RT	LT	TH	RT	LT	TH	RT						
7:00 AM	0	0	0	0	0	0	0	0	0	0	0	0	0	0	0	0	0	0
7:15 AM	0	0	0	0	0	0	0	0	0	0	0	0	0	0	0	0	0	0
7:30 AM	0	0	0	0	0	0	0	0	0	0	0	0	0	0	0	0	0	0
7:45 AM	0	0	0	0	0	0	0	0	0	0	0	0	0	0	0	0	0	0
8:00 AM	0	0	0	0	0	0	0	0	0	0	0	0	0	0	0	0	0	0
8:15 AM	0	0	0	0	0	0	0	0	0	0	0	0	0	0	0	0	0	0
8:30 AM	0	0	0	0	0	0	0	0	0	0	0	0	0	0	0	0	0	0
8:45 AM	0	0	0	0	0	0	0	0	0	0	0	0	0	0	0	0	0	0
Count Total	0	0	0	0	0	0	0	0	0	0	0	0	0	0	0	0	0	0
Peak Hour	0	0	0	0	0	0	0	0	0	0	0	0	0	0	0	0	0	0
<i>Note: U-Turn volumes for bikes are included in Left-Turn, if any.</i>																		

Grinnell Blvd Crawford Ave



Peak Hour

Date: 12/08/2021
Count Period: 4:00 PM to 6:00 PM
Peak Hour: 4:30 PM to 5:30 PM

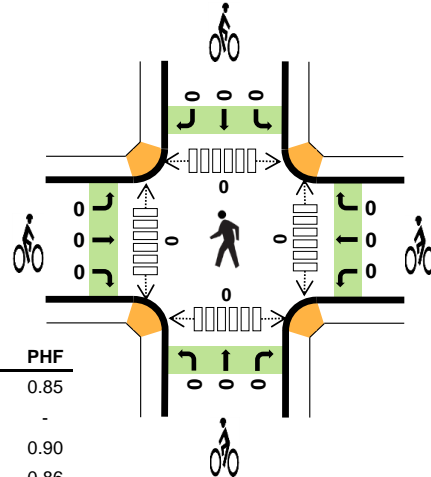
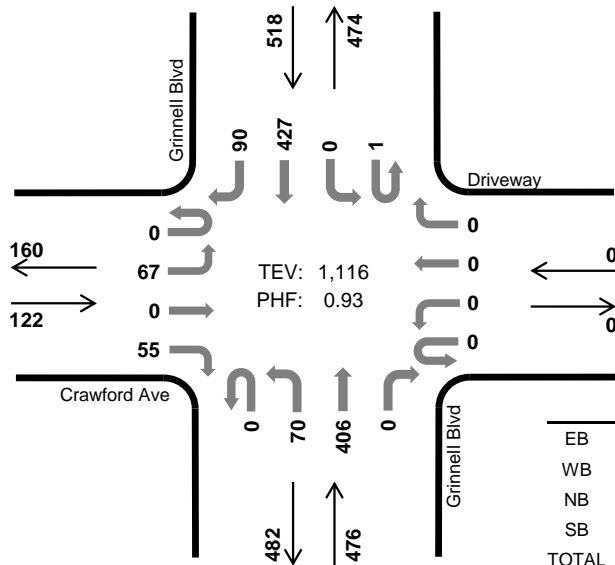

	HV %:	PHF
EB	2.5%	0.85
WB	-	-
NB	2.1%	0.90
SB	0.8%	0.86
TOTAL	1.5%	0.93

Two-Hour Count Summaries

Interval Start	Crawford Ave				Driveway				Grinnell Blvd				Grinnell Blvd				15-min Total	Rolling One Hour	
	Eastbound		Westbound		Northbound		Southbound		UT	LT	TH	RT	UT	LT	TH	RT			
4:00 PM	0	17	0	14	0	0	0	0	1	14	88	0	0	0	106	16	256	0	
4:15 PM	0	14	0	19	0	0	0	0	1	10	96	0	0	0	102	27	269	0	
4:30 PM	0	18	0	18	0	0	0	0	0	18	96	0	0	0	125	25	300	0	
4:45 PM	0	19	0	11	0	0	0	0	0	14	90	0	0	0	105	23	262	1,087	
5:00 PM	0	18	0	12	0	0	0	0	0	16	110	0	0	0	107	18	281	1,112	
5:15 PM	0	12	0	14	0	0	0	0	0	22	110	0	1	0	90	24	273	1,116	
5:30 PM	0	8	0	9	0	0	0	0	1	9	98	0	0	0	120	19	264	1,080	
5:45 PM	0	16	0	8	0	0	0	0	0	17	113	0	0	0	90	18	262	1,080	
Count Total	0	122	0	105	0	0	0	0	3	120	801	0	1	0	845	170	2,167	0	
Peak Hour	All	0	67	0	55	0	0	0	0	0	70	406	0	1	0	427	90	1,116	0
	HV	0	0	0	3	0	0	0	0	0	0	10	0	0	0	4	0	17	0
	HV%	-	0%	-	5%	-	-	-	-	-	0%	2%	-	0%	-	1%	0%	2%	0

Note: Two-hour count summary volumes include heavy vehicles but exclude bicycles in overall count.

Interval Start	Heavy Vehicle Totals					Bicycles					Pedestrians (Crossing Leg)				
	EB	WB	NB	SB	Total	EB	WB	NB	SB	Total	East	West	North	South	Total
4:00 PM	1	0	4	6	11	0	0	0	0	0	0	0	0	0	0
4:15 PM	1	0	2	8	11	0	0	0	0	0	0	0	0	0	0
4:30 PM	1	0	5	1	7	0	0	0	0	0	0	0	0	0	0
4:45 PM	0	0	2	1	3	0	0	0	0	0	0	0	0	0	0
5:00 PM	1	0	2	1	4	0	0	0	0	0	0	0	0	0	0
5:15 PM	1	0	1	1	3	0	0	0	0	0	0	0	0	0	0
5:30 PM	1	0	2	0	3	0	0	0	0	0	0	0	0	0	0
5:45 PM	1	0	1	0	2	0	0	0	0	0	0	0	0	0	0
Count Total	7	0	19	18	44	0	0	0	0	0	0	0	0	0	0
Peak Hour	3	0	10	4	17	0	0	0	0	0	0	0	0	0	0

Two-Hour Count Summaries - Heavy Vehicles																		
Interval Start	Crawford Ave				Driveway				Grinnell Blvd				Grinnell Blvd				15-min Total	Rolling One Hour
	Eastbound				Westbound				Northbound				Southbound					
	UT	LT	TH	RT	UT	LT	TH	RT	UT	LT	TH	RT	UT	LT	TH	RT		
4:00 PM	0	0	0	1	0	0	0	0	0	0	4	0	0	0	5	1	11	0
4:15 PM	0	1	0	0	0	0	0	0	0	0	2	0	0	0	6	2	11	0
4:30 PM	0	0	0	1	0	0	0	0	0	0	5	0	0	0	1	0	7	0
4:45 PM	0	0	0	0	0	0	0	0	0	0	2	0	0	0	1	0	3	32
5:00 PM	0	0	0	1	0	0	0	0	0	0	2	0	0	0	1	0	4	25
5:15 PM	0	0	0	1	0	0	0	0	0	0	1	0	0	0	1	0	3	17
5:30 PM	0	1	0	0	0	0	0	0	0	0	2	0	0	0	0	0	3	13
5:45 PM	0	1	0	0	0	0	0	0	0	0	1	0	0	0	0	0	2	12
Count Total	0	3	0	4	0	0	0	0	0	0	19	0	0	0	15	3	44	0
Peak Hour	0	0	0	3	0	0	0	0	0	0	10	0	0	0	4	0	17	0

Two-Hour Count Summaries - Bikes																	
Interval Start	Crawford Ave			Driveway			Grinnell Blvd			Grinnell Blvd			15-min Total	Rolling One Hour			
	Eastbound			Westbound			Northbound			Southbound							
	LT	TH	RT	LT	TH	RT	LT	TH	RT	LT	TH	RT					
4:00 PM	0	0	0	0	0	0	0	0	0	0	0	0	0	0	0	0	0
4:15 PM	0	0	0	0	0	0	0	0	0	0	0	0	0	0	0	0	0
4:30 PM	0	0	0	0	0	0	0	0	0	0	0	0	0	0	0	0	0
4:45 PM	0	0	0	0	0	0	0	0	0	0	0	0	0	0	0	0	0
5:00 PM	0	0	0	0	0	0	0	0	0	0	0	0	0	0	0	0	0
5:15 PM	0	0	0	0	0	0	0	0	0	0	0	0	0	0	0	0	0
5:30 PM	0	0	0	0	0	0	0	0	0	0	0	0	0	0	0	0	0
5:45 PM	0	0	0	0	0	0	0	0	0	0	0	0	0	0	0	0	0
Count Total	0	0	0	0	0	0	0	0	0	0	0	0	0	0	0	0	0
Peak Hour	0	0	0	0	0	0	0	0	0	0	0	0	0	0	0	0	0

Note: U-Turn volumes for bikes are included in Left-Turn, if any.

APPENDIX B

Future Traffic Projections

MTCP Growth Rate: Crawford Apartments

Location	2015 AADT	2040 AADT	Growth Factor	Growth Rate
Grinnell Blvd N/O Crawford Ave	12000	18000	1.50	1.64%
Grinnell Blvd S/O Crawford Ave	11000	16400	1.49	1.61%
Total	23000	34400	1.50	1.62%

APPENDIX C

Adjacent Traffic Study Documents

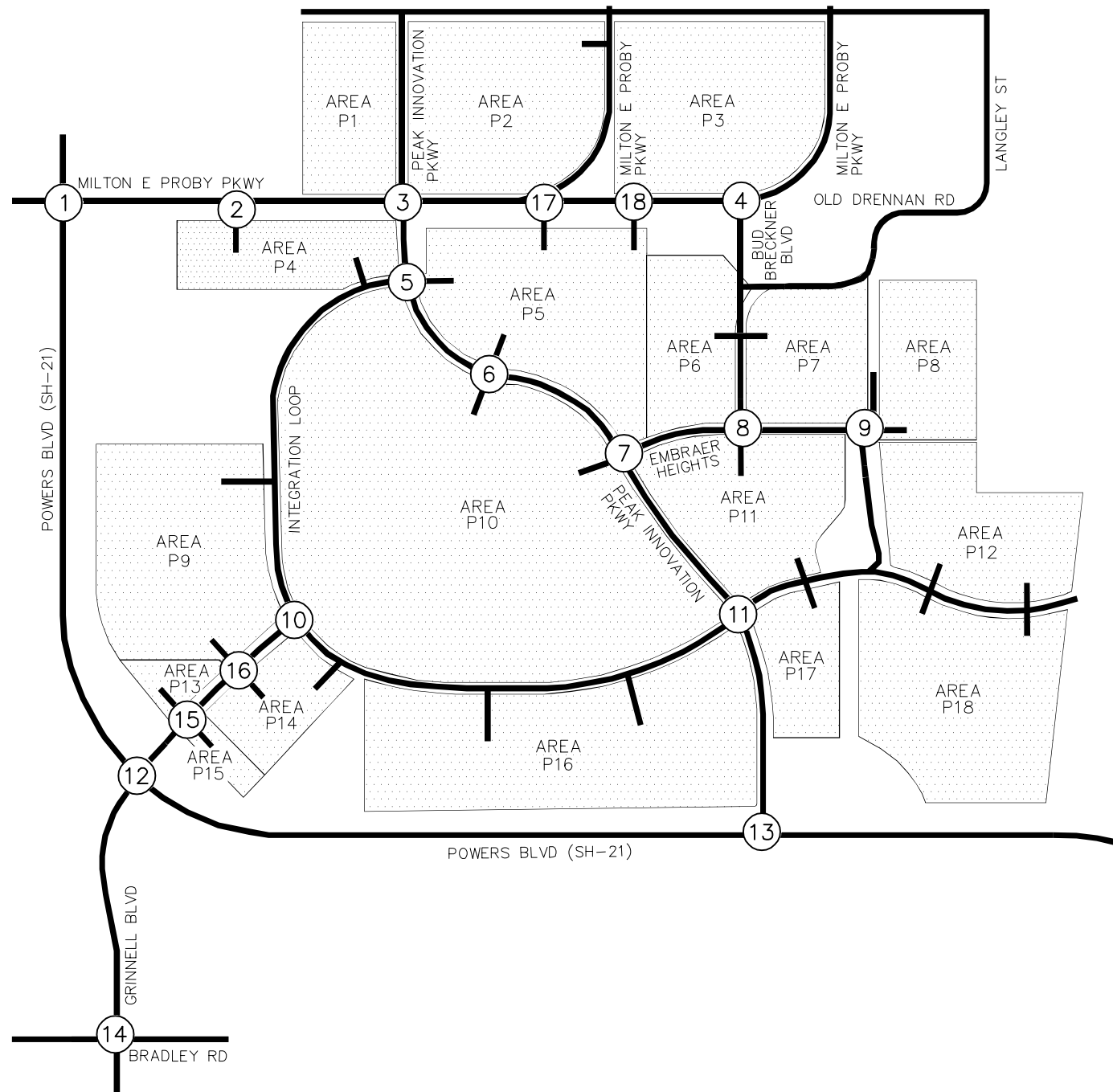

1 MILTON E PROBY PKWY / POWERS BLVD (SH-21) ↓ 360(179) ↗ 1447(405) ↖ 437(1142) ↘ 437(1142) ↙ 83(146) → 1467(417) ↖ 228(237) ↘ 340(167) ↗ 228(237) ↙ 208(138)	2 MILTON E PROBY PKWY / RIRO ACCESS ← 965(2466)	3 MILTON E PROBY PKWY / PEAK INNOVATION PKWY ↖ 163(239) ↗ 10(15) ↘ 31(45) ↙ 251(631) ↙ 10(15) ↘ 37(53) ↖ 256(202) ↗ 552(1596) ↘ 753(287) ↙ 32(25) ↙ 1905(286) ↘ 57(45)	4 MILTON E PROBY PKWY / BUD BRECKNER BLVD → 331(294) ↖ 51(301) ↘ 443(34)	5 PEAK INNOVATION PKWY / INTEGRATION LOOP ↖ 176(95) ↗ 31(46) ↘ 1762(258) ↙ 23(34) ↙ 35(31) ↘ 8(11) ↖ 285(213) ↗ 81(271) ↘ 35(31) ↙ 325(1408) ↙ 326(42) ↘ 12(10)
6 PEAK INNOVATION PKWY / ACCESS ↖ 15(23) ↗ 79(66) ↘ 10(15) ↙ 280(895) ↙ 41(61) ↖ 24(21) ↗ 123(772) ↘ 10665(220) ↙ 10(15) ↙ 993(58) ↘ 25(154) ↖ 25(154) ↗ 25(154) ↙ 199(12) ↘ 25(154)	7 PEAK INNOVATION PKWY / EMBRAER HEIGHTS ↖ 497(29) ↗ 32(186) ↘ 411(398) ↙ 10(15) ↙ 232(21) ↘ 26(159) ↖ 62(386) ↗ 298(17) ↘ 10(15) ↙ 478(414) ↙ 37(231) ↘ 205(13)	8 EMBRAER HEIGHTS / BUD BRECKNER BLVD ↖ 21(133) ↗ 15(77) ↘ 96(6) ↙ 12(59) ↙ 91(13) ↘ 5(5) ↖ 171(10) ↗ 24(149) ↘ 74(11) ↙ 12(75) ↙ 192(11) ↘ 5(5)	9 EMBRAER HEIGHTS / ACCESS ↖ 5(5) ↗ 3(13) ↘ 10(15) ↙ 26(134) ↙ 13(3) ↘ 2(13) ↖ 2(2) ↗ 2(2) ↘ 158(21) ↙ 10(15) ↙ 5(5) ↘ 17(1)	10 GRINNELL BLVD / INTEGRATION LOOP ↖ 370(443) ↗ 141(243) ↘ 28(25) ↙ 15(20) ↖ 661(227) ↗ 141(243) ↘ 413(188) ↙ 15(20)
11 PEAK INNOVATION PKWY / INTEGRATION LOOP ↖ 37(10) ↗ 32(167) ↘ 236(756) ↙ 14(68) ↙ 195(26) ↘ 74(379) ↖ 9(36) ↗ 150(64) ↘ 81(9) ↙ 947(230) ↙ 101(136) ↘ 446(60)	12 POWERS BLVD (SH-21) / GRINNELL BLVD ↖ 419(297) ↗ 145(90) ↘ 811(511) ↙ 44(154) ↙ 121(66) ↘ 52(260) ↖ 537(320) ↗ 193(124) ↘ 159(27) ↙ 689(223) ↙ 83(146) ↘ 319(38)	13 PEAK INNOVATION PKWY / POWERS BLVD (SH-21) ↖ 81(401) ↗ 1049(288) ↘ 325(856) ↙ 160(103) ↖ 480(66) ↗ 602(196) ↘ 121(66)	14 BRADLEY RD / GRINNELL BLVD ↖ 221(460) ↗ 602(196) ↘ 221(460)	15 GRINNELL BLVD / SOUTH ACCESS ↖ 56(62) ↗ 19(21) ↘ 19(21) ↙ 19(22) ↙ 666(727) ↘ 5(4) ↖ 57(65) ↗ 1174(454) ↘ 142(115) ↙ 127(86) ↖ 13(7) ↗ 13(7)
16 GRINNELL BLVD / NORTH ACCESS ↖ 182(83) ↗ 64(31) ↘ 52(24) ↙ 401(612) ↖ 193(94) ↗ 84(31) ↘ 989(364) ↙ 8(3)	17 MILTON E PROBY WEST RIRO ACCESS → 758(281) ↖ 23(34) ↘ 59(52)	18 MILTON E PROBY EAST RIRO ACCESS → 757(294) ↖ 23(34) ↘ 24(21)		

LEGEND

(X) Study Area Key Intersection

XXX(XXX) Weekday AM(PM)
Peak Hour Traffic Volumes

PEAK INNOVATION PARK
FULL BUILDOUT 2045 PROJECT TRAFFIC ASSIGNMENT

FIGURE 11

APPENDIX D

Trip Generation Worksheets

Project Crawford Apartments
 Subject Trip Generation for Multifamily Housing (Low-Rise)
 Designed by TES Date December 30, 2021 Job No. 196345000
 Checked by _____ Date _____ Sheet No. _____ of _____

TRIP GENERATION MANUAL TECHNIQUES

ITE Trip Generation Manual 11th Edition, Fitted Curve Equations

Land Use Code - Multifamily Housing (Low-Rise) (220)

Independent Variable - Dwelling Units (X)

$$X = 22$$

T = Average Vehicle Trip Ends

Peak Hour of Adjacent Street Traffic, One Hour Between 7 and 9 a.m. (200 Series Page 255)

$(T) = 0.31 (X) + 22.85$	Directional Distribution:	24% ent.	76% exit.
$(T) = 0.31 * (22.0) + 22.85$	T = 30	Average Vehicle Trip Ends	
	7 entering	23 exiting	
	7 + 23 = 30		

Peak Hour of Adjacent Street Traffic, One Hour Between 4 and 6 p.m. (200 Series Page 256)

$(T) = 0.43 (X) + 20.55$	Directional Distribution:	63% ent.	37% exit.
$(T) = 0.43 * (22.0) + 20.55$	T = 32	Average Vehicle Trip Ends	
	20 entering	12 exiting	
	20 + 12 = 32		

Weekday (200 Series Page 254)

$(T) = 6.41 (X) + 75.31$	Directional Distribution:	50% ent.	50% exit.
$(T) = 6.41 * (22.0) + 75.31$	T = 218	Average Vehicle Trip Ends	
	109 entering	109 exiting	
	109 + 109 = 218		

APPENDIX E

Intersection Analysis Worksheets

Intersection												
Int Delay, s/veh	1.5											
Movement	EBL	EBT	EBR	WBL	WBT	WBR	NBL	NBT	NBR	SBL	SBT	SBR
Lane Configurations	↖	↗		↖	↗			↕			↕	
Traffic Vol, veh/h	0	112	13	11	89	2	10	1	20	1	0	0
Future Vol, veh/h	0	112	13	11	89	2	10	1	20	1	0	0
Conflicting Peds, #/hr	0	0	0	0	0	0	0	0	0	0	0	0
Sign Control	Free	Free	Free	Free	Free	Free	Stop	Stop	Stop	Stop	Stop	Stop
RT Channelized	-	-	None	-	-	None	-	-	None	-	-	None
Storage Length	50	-	-	50	-	-	-	-	-	-	-	-
Veh in Median Storage, #	-	0	-	-	0	-	-	2	-	-	2	-
Grade, %	-	0	-	-	0	-	-	0	-	-	0	-
Peak Hour Factor	82	82	82	82	82	82	82	82	82	82	82	82
Heavy Vehicles, %	2	2	2	2	2	2	2	2	2	2	2	2
Mvmt Flow	0	137	16	13	109	2	12	1	24	1	0	0

Major/Minor	Major1			Major2			Minor1			Minor2		
Conflicting Flow All	111	0	0	153	0	0	281	282	145	294	289	110
Stage 1	-	-	-	-	-	-	145	145	-	136	136	-
Stage 2	-	-	-	-	-	-	136	137	-	158	153	-
Critical Hdwy	4.12	-	-	4.12	-	-	7.12	6.52	6.22	7.12	6.52	6.22
Critical Hdwy Stg 1	-	-	-	-	-	-	6.12	5.52	-	6.12	5.52	-
Critical Hdwy Stg 2	-	-	-	-	-	-	6.12	5.52	-	6.12	5.52	-
Follow-up Hdwy	2.218	-	-	2.218	-	-	3.518	4.018	3.318	3.518	4.018	3.318
Pot Cap-1 Maneuver	1479	-	-	1428	-	-	671	627	902	658	621	943
Stage 1	-	-	-	-	-	-	858	777	-	867	784	-
Stage 2	-	-	-	-	-	-	867	783	-	844	771	-
Platoon blocked, %	-	-	-	-	-	-	-	-	-	-	-	-
Mov Cap-1 Maneuver	1479	-	-	1428	-	-	666	621	902	635	615	943
Mov Cap-2 Maneuver	-	-	-	-	-	-	754	688	-	727	680	-
Stage 1	-	-	-	-	-	-	858	777	-	867	777	-
Stage 2	-	-	-	-	-	-	859	776	-	820	771	-

Approach	EB			WB			NB			SB		
HCM Control Delay, s	0			0.8			9.5			10		
HCM LOS							A			B		

Minor Lane/Major Mvmt	NBLn1	EBL	EBT	EBR	WBL	WBT	WBR	SBLn1
Capacity (veh/h)	840	1479	-	-	1428	-	-	727
HCM Lane V/C Ratio	0.045	-	-	-	0.009	-	-	0.002
HCM Control Delay (s)	9.5	0	-	-	7.5	-	-	10
HCM Lane LOS	A	A	-	-	A	-	-	B
HCM 95th %tile Q(veh)	0.1	0	-	-	0	-	-	0

Intersection												
Int Delay, s/veh	2.9											
Movement	EBL	EBT	EBR	WBL	WBT	WBR	NBL	NBT	NBR	SBL	SBT	SBR
Lane Configurations	↖	↗		↖	↗			↕			↕	
Traffic Vol, veh/h	0	84	28	28	124	5	32	1	41	5	2	0
Future Vol, veh/h	0	84	28	28	124	5	32	1	41	5	2	0
Conflicting Peds, #/hr	0	0	0	0	0	0	0	0	0	0	0	0
Sign Control	Free	Free	Free	Free	Free	Free	Stop	Stop	Stop	Stop	Stop	Stop
RT Channelized	-	-	None	-	-	None	-	-	None	-	-	None
Storage Length	50	-	-	50	-	-	-	-	-	-	-	-
Veh in Median Storage, #	-	0	-	-	0	-	-	2	-	-	2	-
Grade, %	-	0	-	-	0	-	-	0	-	-	0	-
Peak Hour Factor	88	88	88	88	88	88	88	88	88	88	88	88
Heavy Vehicles, %	2	2	2	2	2	2	2	2	2	2	2	2
Mvmt Flow	0	95	32	32	141	6	36	1	47	6	2	0

Major/Minor	Major1			Major2			Minor1			Minor2		
Conflicting Flow All	147	0	0	127	0	0	320	322	111	343	335	144
Stage 1	-	-	-	-	-	-	111	111	-	208	208	-
Stage 2	-	-	-	-	-	-	209	211	-	135	127	-
Critical Hdwy	4.12	-	-	4.12	-	-	7.12	6.52	6.22	7.12	6.52	6.22
Critical Hdwy Stg 1	-	-	-	-	-	-	6.12	5.52	-	6.12	5.52	-
Critical Hdwy Stg 2	-	-	-	-	-	-	6.12	5.52	-	6.12	5.52	-
Follow-up Hdwy	2.218	-	-	2.218	-	-	3.518	4.018	3.318	3.518	4.018	3.318
Pot Cap-1 Maneuver	1435	-	-	1459	-	-	633	595	942	611	585	903
Stage 1	-	-	-	-	-	-	894	804	-	794	730	-
Stage 2	-	-	-	-	-	-	793	728	-	868	791	-
Platoon blocked, %	-	-	-	-	-	-	-	-	-	-	-	-
Mov Cap-1 Maneuver	1435	-	-	1459	-	-	621	582	942	570	572	903
Mov Cap-2 Maneuver	-	-	-	-	-	-	710	654	-	682	644	-
Stage 1	-	-	-	-	-	-	894	804	-	794	714	-
Stage 2	-	-	-	-	-	-	773	712	-	824	791	-

Approach	EB			WB			NB			SB		
HCM Control Delay, s	0			1.3			9.9			10.4		
HCM LOS							A			B		

Minor Lane/Major Mvmt	NBLn1	EBL	EBT	EBR	WBL	WBT	WBR	SBLn1
Capacity (veh/h)	821	1435	-	-	1459	-	-	671
HCM Lane V/C Ratio	0.102	-	-	-	0.022	-	-	0.012
HCM Control Delay (s)	9.9	0	-	-	7.5	-	-	10.4
HCM Lane LOS	A	A	-	-	A	-	-	B
HCM 95th %tile Q(veh)	0.3	0	-	-	0.1	-	-	0

Intersection												
Int Delay, s/veh	1.5											
Movement	EBL	EBT	EBR	WBL	WBT	WBR	NBL	NBT	NBR	SBL	SBT	SBR
Lane Configurations	↖	↗		↖	↗			↕			↕	
Traffic Vol, veh/h	0	116	13	11	92	2	10	1	21	1	0	0
Future Vol, veh/h	0	116	13	11	92	2	10	1	21	1	0	0
Conflicting Peds, #/hr	0	0	0	0	0	0	0	0	0	0	0	0
Sign Control	Free	Free	Free	Free	Free	Free	Stop	Stop	Stop	Stop	Stop	Stop
RT Channelized	-	-	None	-	-	None	-	-	None	-	-	None
Storage Length	50	-	-	50	-	-	-	-	-	-	-	-
Veh in Median Storage, #	-	0	-	-	0	-	-	2	-	-	2	-
Grade, %	-	0	-	-	0	-	-	0	-	-	0	-
Peak Hour Factor	82	82	82	82	82	82	82	82	82	82	82	82
Heavy Vehicles, %	2	2	2	2	2	2	2	2	2	2	2	2
Mvmt Flow	0	141	16	13	112	2	12	1	26	1	0	0

Major/Minor	Major1		Major2		Minor1			Minor2				
Conflicting Flow All	114	0	0	157	0	0	288	289	149	302	296	113
Stage 1	-	-	-	-	-	-	149	149	-	139	139	-
Stage 2	-	-	-	-	-	-	139	140	-	163	157	-
Critical Hdwy	4.12	-	-	4.12	-	-	7.12	6.52	6.22	7.12	6.52	6.22
Critical Hdwy Stg 1	-	-	-	-	-	-	6.12	5.52	-	6.12	5.52	-
Critical Hdwy Stg 2	-	-	-	-	-	-	6.12	5.52	-	6.12	5.52	-
Follow-up Hdwy	2.218	-	-	2.218	-	-	3.518	4.018	3.318	3.518	4.018	3.318
Pot Cap-1 Maneuver	1475	-	-	1423	-	-	664	621	898	650	616	940
Stage 1	-	-	-	-	-	-	854	774	-	864	782	-
Stage 2	-	-	-	-	-	-	864	781	-	839	768	-
Platoon blocked, %	-	-	-	-	-	-	-	-	-	-	-	-
Mov Cap-1 Maneuver	1475	-	-	1423	-	-	659	615	898	626	610	940
Mov Cap-2 Maneuver	-	-	-	-	-	-	749	684	-	721	676	-
Stage 1	-	-	-	-	-	-	854	774	-	864	775	-
Stage 2	-	-	-	-	-	-	856	774	-	814	768	-

Approach	EB	WB	NB	SB
HCM Control Delay, s	0	0.8	9.5	10
HCM LOS			A	B

Minor Lane/Major Mvmt	NBLn1	EBL	EBT	EBR	WBL	WBT	WBR	SBLn1
Capacity (veh/h)	838	1475	-	-	1423	-	-	721
HCM Lane V/C Ratio	0.047	-	-	-	0.009	-	-	0.002
HCM Control Delay (s)	9.5	0	-	-	7.6	-	-	10
HCM Lane LOS	A	A	-	-	A	-	-	B
HCM 95th %tile Q(veh)	0.1	0	-	-	0	-	-	0

Intersection												
Int Delay, s/veh	2.9											
Movement	EBL	EBT	EBR	WBL	WBT	WBR	NBL	NBT	NBR	SBL	SBT	SBR
Lane Configurations	↖	↗		↖	↗			↕			↕	
Traffic Vol, veh/h	0	87	29	29	128	5	33	1	42	5	2	0
Future Vol, veh/h	0	87	29	29	128	5	33	1	42	5	2	0
Conflicting Peds, #/hr	0	0	0	0	0	0	0	0	0	0	0	0
Sign Control	Free	Free	Free	Free	Free	Free	Stop	Stop	Stop	Stop	Stop	Stop
RT Channelized	-	-	None	-	-	None	-	-	None	-	-	None
Storage Length	50	-	-	50	-	-	-	-	-	-	-	-
Veh in Median Storage, #	-	0	-	-	0	-	-	2	-	-	2	-
Grade, %	-	0	-	-	0	-	-	0	-	-	0	-
Peak Hour Factor	88	88	88	88	88	88	88	88	88	88	88	88
Heavy Vehicles, %	2	2	2	2	2	2	2	2	2	2	2	2
Mvmt Flow	0	99	33	33	145	6	38	1	48	6	2	0

Major/Minor	Major1			Major2			Minor1			Minor2		
Conflicting Flow All	151	0	0	132	0	0	331	333	116	354	346	148
Stage 1	-	-	-	-	-	-	116	116	-	214	214	-
Stage 2	-	-	-	-	-	-	215	217	-	140	132	-
Critical Hdwy	4.12	-	-	4.12	-	-	7.12	6.52	6.22	7.12	6.52	6.22
Critical Hdwy Stg 1	-	-	-	-	-	-	6.12	5.52	-	6.12	5.52	-
Critical Hdwy Stg 2	-	-	-	-	-	-	6.12	5.52	-	6.12	5.52	-
Follow-up Hdwy	2.218	-	-	2.218	-	-	3.518	4.018	3.318	3.518	4.018	3.318
Pot Cap-1 Maneuver	1430	-	-	1453	-	-	622	587	936	601	577	899
Stage 1	-	-	-	-	-	-	889	800	-	788	725	-
Stage 2	-	-	-	-	-	-	787	723	-	863	787	-
Platoon blocked, %		-	-		-	-						
Mov Cap-1 Maneuver	1430	-	-	1453	-	-	610	573	936	560	564	899
Mov Cap-2 Maneuver	-	-	-	-	-	-	703	648	-	675	638	-
Stage 1	-	-	-	-	-	-	889	800	-	788	708	-
Stage 2	-	-	-	-	-	-	767	706	-	818	787	-

Approach	EB			WB			NB			SB		
HCM Control Delay, s	0			1.3			9.9			10.5		
HCM LOS							A			B		

Minor Lane/Major Mvmt	NBLn1	EBL	EBT	EBR	WBL	WBT	WBR	SBLn1
Capacity (veh/h)	814	1430	-	-	1453	-	-	664
HCM Lane V/C Ratio	0.106	-	-	-	0.023	-	-	0.012
HCM Control Delay (s)	9.9	0	-	-	7.5	-	-	10.5
HCM Lane LOS	A	A	-	-	A	-	-	B
HCM 95th %tile Q(veh)	0.4	0	-	-	0.1	-	-	0

Intersection												
Int Delay, s/veh	2.1											
Movement	EBL	EBT	EBR	WBL	WBT	WBR	NBL	NBT	NBR	SBL	SBT	SBR
Lane Configurations	↖	↗		↖	↗			↕			↕	
Traffic Vol, veh/h	1	116	13	11	92	8	10	1	21	22	0	2
Future Vol, veh/h	1	116	13	11	92	8	10	1	21	22	0	2
Conflicting Peds, #/hr	0	0	0	0	0	0	0	0	0	0	0	0
Sign Control	Free	Free	Free	Free	Free	Free	Stop	Stop	Stop	Stop	Stop	Stop
RT Channelized	-	-	None	-	-	None	-	-	None	-	-	None
Storage Length	50	-	-	50	-	-	-	-	-	-	-	-
Veh in Median Storage, #	-	0	-	-	0	-	-	2	-	-	2	-
Grade, %	-	0	-	-	0	-	-	0	-	-	0	-
Peak Hour Factor	82	82	82	82	82	82	82	82	82	82	82	82
Heavy Vehicles, %	2	2	2	2	2	2	2	2	2	2	2	2
Mvmt Flow	1	141	16	13	112	10	12	1	26	27	0	2

Major/Minor	Major1			Major2			Minor1			Minor2		
Conflicting Flow All	122	0	0	157	0	0	295	299	149	308	302	117
Stage 1	-	-	-	-	-	-	151	151	-	143	143	-
Stage 2	-	-	-	-	-	-	144	148	-	165	159	-
Critical Hdwy	4.12	-	-	4.12	-	-	7.12	6.52	6.22	7.12	6.52	6.22
Critical Hdwy Stg 1	-	-	-	-	-	-	6.12	5.52	-	6.12	5.52	-
Critical Hdwy Stg 2	-	-	-	-	-	-	6.12	5.52	-	6.12	5.52	-
Follow-up Hdwy	2.218	-	-	2.218	-	-	3.518	4.018	3.318	3.518	4.018	3.318
Pot Cap-1 Maneuver	1465	-	-	1423	-	-	657	613	898	644	611	935
Stage 1	-	-	-	-	-	-	851	772	-	860	779	-
Stage 2	-	-	-	-	-	-	859	775	-	837	766	-
Platoon blocked, %	-	-	-	-	-	-	-	-	-	-	-	-
Mov Cap-1 Maneuver	1465	-	-	1423	-	-	650	607	898	620	605	935
Mov Cap-2 Maneuver	-	-	-	-	-	-	743	679	-	717	673	-
Stage 1	-	-	-	-	-	-	850	771	-	859	772	-
Stage 2	-	-	-	-	-	-	849	768	-	811	765	-

Approach	EB			WB			NB			SB		
HCM Control Delay, s	0.1			0.7			9.5			10.1		
HCM LOS							A			B		

Minor Lane/Major Mvmt	NBLn1	EBL	EBT	EBR	WBL	WBT	WBR	SBLn1
Capacity (veh/h)	835	1465	-	-	1423	-	-	731
HCM Lane V/C Ratio	0.047	0.001	-	-	0.009	-	-	0.04
HCM Control Delay (s)	9.5	7.5	-	-	7.6	-	-	10.1
HCM Lane LOS	A	A	-	-	A	-	-	B
HCM 95th %tile Q(veh)	0.1	0	-	-	0	-	-	0.1

Intersection												
Int Delay, s/veh	3											
Movement	EBL	EBT	EBR	WBL	WBT	WBR	NBL	NBT	NBR	SBL	SBT	SBR
Lane Configurations	↖	↗		↖	↗			↕			↕	
Traffic Vol, veh/h	2	87	29	29	128	23	33	1	42	16	2	1
Future Vol, veh/h	2	87	29	29	128	23	33	1	42	16	2	1
Conflicting Peds, #/hr	0	0	0	0	0	0	0	0	0	0	0	0
Sign Control	Free	Free	Free	Free	Free	Free	Stop	Stop	Stop	Stop	Stop	Stop
RT Channelized	-	-	None	-	-	None	-	-	None	-	-	None
Storage Length	50	-	-	50	-	-	-	-	-	-	-	-
Veh in Median Storage, #	-	0	-	-	0	-	-	2	-	-	2	-
Grade, %	-	0	-	-	0	-	-	0	-	-	0	-
Peak Hour Factor	88	88	88	88	88	88	88	88	88	88	88	88
Heavy Vehicles, %	2	2	2	2	2	2	2	2	2	2	2	2
Mvmt Flow	2	99	33	33	145	26	38	1	48	18	2	1

Major/Minor	Major1			Major2			Minor1			Minor2		
Conflicting Flow All	171	0	0	132	0	0	346	357	116	368	360	158
Stage 1	-	-	-	-	-	-	120	120	-	224	224	-
Stage 2	-	-	-	-	-	-	226	237	-	144	136	-
Critical Hdwy	4.12	-	-	4.12	-	-	7.12	6.52	6.22	7.12	6.52	6.22
Critical Hdwy Stg 1	-	-	-	-	-	-	6.12	5.52	-	6.12	5.52	-
Critical Hdwy Stg 2	-	-	-	-	-	-	6.12	5.52	-	6.12	5.52	-
Follow-up Hdwy	2.218	-	-	2.218	-	-	3.518	4.018	3.318	3.518	4.018	3.318
Pot Cap-1 Maneuver	1406	-	-	1453	-	-	608	569	936	588	567	887
Stage 1	-	-	-	-	-	-	884	796	-	779	718	-
Stage 2	-	-	-	-	-	-	777	709	-	859	784	-
Platoon blocked, %	-	-	-	-	-	-	-	-	-	-	-	-
Mov Cap-1 Maneuver	1406	-	-	1453	-	-	595	555	936	547	553	887
Mov Cap-2 Maneuver	-	-	-	-	-	-	691	634	-	666	631	-
Stage 1	-	-	-	-	-	-	883	795	-	778	701	-
Stage 2	-	-	-	-	-	-	756	693	-	813	783	-

Approach	EB			WB			NB			SB		
HCM Control Delay, s	0.1			1.2			10			10.5		
HCM LOS							B			B		

Minor Lane/Major Mvmt	NBLn1	EBL	EBT	EBR	WBL	WBT	WBR	SBLn1
Capacity (veh/h)	807	1406	-	-	1453	-	-	671
HCM Lane V/C Ratio	0.107	0.002	-	-	0.023	-	-	0.032
HCM Control Delay (s)	10	7.6	-	-	7.5	-	-	10.5
HCM Lane LOS	B	A	-	-	A	-	-	B
HCM 95th %tile Q(veh)	0.4	0	-	-	0.1	-	-	0.1

Intersection												
Int Delay, s/veh	1.5											
Movement	EBL	EBT	EBR	WBL	WBT	WBR	NBL	NBT	NBR	SBL	SBT	SBR
Lane Configurations	↖	↗		↖	↗			↕			↕	
Traffic Vol, veh/h	0	165	19	16	131	3	15	1	29	1	0	0
Future Vol, veh/h	0	165	19	16	131	3	15	1	29	1	0	0
Conflicting Peds, #/hr	0	0	0	0	0	0	0	0	0	0	0	0
Sign Control	Free	Free	Free	Free	Free	Free	Stop	Stop	Stop	Stop	Stop	Stop
RT Channelized	-	-	None	-	-	None	-	-	None	-	-	None
Storage Length	50	-	-	50	-	-	-	-	-	-	-	-
Veh in Median Storage, #	-	0	-	-	0	-	-	2	-	-	2	-
Grade, %	-	0	-	-	0	-	-	0	-	-	0	-
Peak Hour Factor	92	92	92	92	92	92	92	92	92	92	92	92
Heavy Vehicles, %	2	2	2	2	2	2	2	2	2	2	2	2
Mvmt Flow	0	179	21	17	142	3	16	1	32	1	0	0

Major/Minor	Major1			Major2			Minor1			Minor2		
Conflicting Flow All	145	0	0	200	0	0	368	369	190	384	378	144
Stage 1	-	-	-	-	-	-	190	190	-	178	178	-
Stage 2	-	-	-	-	-	-	178	179	-	206	200	-
Critical Hdwy	4.12	-	-	4.12	-	-	7.12	6.52	6.22	7.12	6.52	6.22
Critical Hdwy Stg 1	-	-	-	-	-	-	6.12	5.52	-	6.12	5.52	-
Critical Hdwy Stg 2	-	-	-	-	-	-	6.12	5.52	-	6.12	5.52	-
Follow-up Hdwy	2.218	-	-	2.218	-	-	3.518	4.018	3.318	3.518	4.018	3.318
Pot Cap-1 Maneuver	1437	-	-	1372	-	-	588	560	852	574	554	903
Stage 1	-	-	-	-	-	-	812	743	-	824	752	-
Stage 2	-	-	-	-	-	-	824	751	-	796	736	-
Platoon blocked, %	-	-	-	-	-	-	-	-	-	-	-	-
Mov Cap-1 Maneuver	1437	-	-	1372	-	-	583	553	852	547	547	903
Mov Cap-2 Maneuver	-	-	-	-	-	-	699	645	-	665	635	-
Stage 1	-	-	-	-	-	-	812	743	-	824	743	-
Stage 2	-	-	-	-	-	-	814	742	-	765	736	-

Approach	EB			WB			NB			SB		
HCM Control Delay, s	0			0.8			9.9			10.4		
HCM LOS							A			B		

Minor Lane/Major Mvmt	NBLn1	EBL	EBT	EBR	WBL	WBT	WBR	SBLn1
Capacity (veh/h)	789	1437	-	-	1372	-	-	665
HCM Lane V/C Ratio	0.062	-	-	-	0.013	-	-	0.002
HCM Control Delay (s)	9.9	0	-	-	7.7	-	-	10.4
HCM Lane LOS	A	A	-	-	A	-	-	B
HCM 95th %tile Q(veh)	0.2	0	-	-	0	-	-	0

Intersection												
Int Delay, s/veh	3.1											
Movement	EBL	EBT	EBR	WBL	WBT	WBR	NBL	NBT	NBR	SBL	SBT	SBR
Lane Configurations	↖	↗		↖	↗			↕			↕	
Traffic Vol, veh/h	0	124	41	41	182	7	47	1	60	7	3	0
Future Vol, veh/h	0	124	41	41	182	7	47	1	60	7	3	0
Conflicting Peds, #/hr	0	0	0	0	0	0	0	0	0	0	0	0
Sign Control	Free	Free	Free	Free	Free	Free	Stop	Stop	Stop	Stop	Stop	Stop
RT Channelized	-	-	None	-	-	None	-	-	None	-	-	None
Storage Length	50	-	-	50	-	-	-	-	-	-	-	-
Veh in Median Storage, #	-	0	-	-	0	-	-	2	-	-	2	-
Grade, %	-	0	-	-	0	-	-	0	-	-	0	-
Peak Hour Factor	92	92	92	92	92	92	92	92	92	92	92	92
Heavy Vehicles, %	2	2	2	2	2	2	2	2	2	2	2	2
Mvmt Flow	0	135	45	45	198	8	51	1	65	8	3	0

Major/Minor	Major1			Major2			Minor1			Minor2		
Conflicting Flow All	206	0	0	180	0	0	452	454	158	483	472	202
Stage 1	-	-	-	-	-	-	158	158	-	292	292	-
Stage 2	-	-	-	-	-	-	294	296	-	191	180	-
Critical Hdwy	4.12	-	-	4.12	-	-	7.12	6.52	6.22	7.12	6.52	6.22
Critical Hdwy Stg 1	-	-	-	-	-	-	6.12	5.52	-	6.12	5.52	-
Critical Hdwy Stg 2	-	-	-	-	-	-	6.12	5.52	-	6.12	5.52	-
Follow-up Hdwy	2.218	-	-	2.218	-	-	3.518	4.018	3.318	3.518	4.018	3.318
Pot Cap-1 Maneuver	1365	-	-	1396	-	-	518	502	887	494	490	839
Stage 1	-	-	-	-	-	-	844	767	-	716	671	-
Stage 2	-	-	-	-	-	-	714	668	-	811	750	-
Platoon blocked, %	-	-	-	-	-	-	-	-	-	-	-	-
Mov Cap-1 Maneuver	1365	-	-	1396	-	-	503	486	887	446	474	839
Mov Cap-2 Maneuver	-	-	-	-	-	-	625	588	-	591	576	-
Stage 1	-	-	-	-	-	-	844	767	-	716	650	-
Stage 2	-	-	-	-	-	-	688	647	-	750	750	-

Approach	EB	WB	NB	SB
HCM Control Delay, s	0	1.4	10.7	11.3
HCM LOS			B	B

Minor Lane/Major Mvmt	NBLn1	EBL	EBT	EBR	WBL	WBT	WBR	SBLn1
Capacity (veh/h)	747	1365	-	-	1396	-	-	586
HCM Lane V/C Ratio	0.157	-	-	-	0.032	-	-	0.019
HCM Control Delay (s)	10.7	0	-	-	7.7	-	-	11.3
HCM Lane LOS	B	A	-	-	A	-	-	B
HCM 95th %tile Q(veh)	0.6	0	-	-	0.1	-	-	0.1

Intersection												
Int Delay, s/veh	2											
Movement	EBL	EBT	EBR	WBL	WBT	WBR	NBL	NBT	NBR	SBL	SBT	SBR
Lane Configurations	↖	↗		↖	↗			↕			↕	
Traffic Vol, veh/h	1	165	19	16	131	9	15	1	29	22	0	2
Future Vol, veh/h	1	165	19	16	131	9	15	1	29	22	0	2
Conflicting Peds, #/hr	0	0	0	0	0	0	0	0	0	0	0	0
Sign Control	Free	Free	Free	Free	Free	Free	Stop	Stop	Stop	Stop	Stop	Stop
RT Channelized	-	-	None	-	-	None	-	-	None	-	-	None
Storage Length	50	-	-	50	-	-	-	-	-	-	-	-
Veh in Median Storage, #	-	0	-	-	0	-	-	2	-	-	2	-
Grade, %	-	0	-	-	0	-	-	0	-	-	0	-
Peak Hour Factor	92	92	92	92	92	92	92	92	92	92	92	92
Heavy Vehicles, %	2	2	2	2	2	2	2	2	2	2	2	2
Mvmt Flow	1	179	21	17	142	10	16	1	32	24	0	2

Major/Minor	Major1			Major2			Minor1			Minor2		
Conflicting Flow All	152	0	0	200	0	0	374	378	190	389	383	147
Stage 1	-	-	-	-	-	-	192	192	-	181	181	-
Stage 2	-	-	-	-	-	-	182	186	-	208	202	-
Critical Hdwy	4.12	-	-	4.12	-	-	7.12	6.52	6.22	7.12	6.52	6.22
Critical Hdwy Stg 1	-	-	-	-	-	-	6.12	5.52	-	6.12	5.52	-
Critical Hdwy Stg 2	-	-	-	-	-	-	6.12	5.52	-	6.12	5.52	-
Follow-up Hdwy	2.218	-	-	2.218	-	-	3.518	4.018	3.318	3.518	4.018	3.318
Pot Cap-1 Maneuver	1429	-	-	1372	-	-	583	554	852	570	550	900
Stage 1	-	-	-	-	-	-	810	742	-	821	750	-
Stage 2	-	-	-	-	-	-	820	746	-	794	734	-
Platoon blocked, %	-	-	-	-	-	-	-	-	-	-	-	-
Mov Cap-1 Maneuver	1429	-	-	1372	-	-	576	547	852	543	543	900
Mov Cap-2 Maneuver	-	-	-	-	-	-	693	640	-	662	632	-
Stage 1	-	-	-	-	-	-	809	741	-	820	741	-
Stage 2	-	-	-	-	-	-	808	737	-	763	733	-

Approach	EB			WB			NB			SB		
HCM Control Delay, s	0			0.8			9.9			10.5		
HCM LOS							A			B		

Minor Lane/Major Mvmt	NBLn1	EBL	EBT	EBR	WBL	WBT	WBR	SBLn1
Capacity (veh/h)	786	1429	-	-	1372	-	-	677
HCM Lane V/C Ratio	0.062	0.001	-	-	0.013	-	-	0.039
HCM Control Delay (s)	9.9	7.5	-	-	7.7	-	-	10.5
HCM Lane LOS	A	A	-	-	A	-	-	B
HCM 95th %tile Q(veh)	0.2	0	-	-	0	-	-	0.1

Intersection												
Int Delay, s/veh	3.2											
Movement	EBL	EBT	EBR	WBL	WBT	WBR	NBL	NBT	NBR	SBL	SBT	SBR
Lane Configurations	↖	↗		↖	↗			↕			↕	
Traffic Vol, veh/h	2	124	41	41	182	25	47	1	60	18	3	1
Future Vol, veh/h	2	124	41	41	182	25	47	1	60	18	3	1
Conflicting Peds, #/hr	0	0	0	0	0	0	0	0	0	0	0	0
Sign Control	Free	Free	Free	Free	Free	Free	Stop	Stop	Stop	Stop	Stop	Stop
RT Channelized	-	-	None	-	-	None	-	-	None	-	-	None
Storage Length	50	-	-	50	-	-	-	-	-	-	-	-
Veh in Median Storage, #	-	0	-	-	0	-	-	2	-	-	2	-
Grade, %	-	0	-	-	0	-	-	0	-	-	0	-
Peak Hour Factor	92	92	92	92	92	92	92	92	92	92	92	92
Heavy Vehicles, %	2	2	2	2	2	2	2	2	2	2	2	2
Mvmt Flow	2	135	45	45	198	27	51	1	65	20	3	1

Major/Minor	Major1			Major2			Minor1			Minor2		
Conflicting Flow All	225	0	0	180	0	0	466	477	158	497	486	212
Stage 1	-	-	-	-	-	-	162	162	-	302	302	-
Stage 2	-	-	-	-	-	-	304	315	-	195	184	-
Critical Hdwy	4.12	-	-	4.12	-	-	7.12	6.52	6.22	7.12	6.52	6.22
Critical Hdwy Stg 1	-	-	-	-	-	-	6.12	5.52	-	6.12	5.52	-
Critical Hdwy Stg 2	-	-	-	-	-	-	6.12	5.52	-	6.12	5.52	-
Follow-up Hdwy	2.218	-	-	2.218	-	-	3.518	4.018	3.318	3.518	4.018	3.318
Pot Cap-1 Maneuver	1344	-	-	1396	-	-	507	487	887	483	481	828
Stage 1	-	-	-	-	-	-	840	764	-	707	664	-
Stage 2	-	-	-	-	-	-	705	656	-	807	747	-
Platoon blocked, %	-	-	-	-	-	-	-	-	-	-	-	-
Mov Cap-1 Maneuver	1344	-	-	1396	-	-	491	471	887	435	465	828
Mov Cap-2 Maneuver	-	-	-	-	-	-	614	575	-	582	569	-
Stage 1	-	-	-	-	-	-	839	763	-	706	643	-
Stage 2	-	-	-	-	-	-	678	635	-	745	746	-

Approach	EB			WB			NB			SB		
HCM Control Delay, s	0.1			1.3			10.8			11.4		
HCM LOS							B			B		

Minor Lane/Major Mvmt	NBLn1	EBL	EBT	EBR	WBL	WBT	WBR	SBLn1
Capacity (veh/h)	740	1344	-	-	1396	-	-	588
HCM Lane V/C Ratio	0.159	0.002	-	-	0.032	-	-	0.041
HCM Control Delay (s)	10.8	7.7	-	-	7.7	-	-	11.4
HCM Lane LOS	B	A	-	-	A	-	-	B
HCM 95th %tile Q(veh)	0.6	0	-	-	0.1	-	-	0.1

Timings
2: Grinnell Blvd & Crawford Ave

2021 Existing AM
12/30/2021



Lane Group	EBL	EBR	NBL	NBT	SBT	SBR
Lane Configurations	↖	↗	↖	↑↑	↑↑	↗
Traffic Volume (vph)	82	48	64	381	330	47
Future Volume (vph)	82	48	64	381	330	47
Turn Type	Prot	Perm	pm+pt	NA	NA	Perm
Protected Phases	4		5	2	6	
Permitted Phases		4	2			6
Detector Phase	4	4	5	2	6	6
Switch Phase						
Minimum Initial (s)	5.0	5.0	5.0	5.0	5.0	5.0
Minimum Split (s)	23.0	23.0	11.0	22.5	22.5	22.5
Total Split (s)	31.0	31.0	19.0	59.0	40.0	40.0
Total Split (%)	34.4%	34.4%	21.1%	65.6%	44.4%	44.4%
Yellow Time (s)	3.5	3.5	4.5	4.5	4.5	4.5
All-Red Time (s)	1.5	1.5	1.5	1.0	1.5	1.5
Lost Time Adjust (s)	0.0	0.0	0.0	0.0	0.0	0.0
Total Lost Time (s)	5.0	5.0	6.0	5.5	6.0	6.0
Lead/Lag			Lead		Lag	Lag
Lead-Lag Optimize?			Yes		Yes	Yes
Recall Mode	None	None	None	C-Max	C-Max	C-Max
Act Effect Green (s)	10.0	10.0	71.2	72.8	62.3	62.3
Actuated g/C Ratio	0.11	0.11	0.79	0.81	0.69	0.69
v/c Ratio	0.46	0.24	0.09	0.15	0.15	0.05
Control Delay	44.4	12.9	3.3	2.8	7.1	2.6
Queue Delay	0.0	0.0	0.0	0.0	0.0	0.0
Total Delay	44.4	12.9	3.3	2.8	7.1	2.6
LOS	D	B	A	A	A	A
Approach Delay	32.8			2.9	6.5	
Approach LOS	C			A	A	

Intersection Summary

Cycle Length: 90
 Actuated Cycle Length: 90
 Offset: 0 (0%), Referenced to phase 2:NBT and 6:SBT, Start of Green
 Natural Cycle: 60
 Control Type: Actuated-Coordinated
 Maximum v/c Ratio: 0.46
 Intersection Signal Delay: 8.4
 Intersection Capacity Utilization 32.0%
 Analysis Period (min) 15
 Intersection LOS: A
 ICU Level of Service A

Splits and Phases: 2: Grinnell Blvd & Crawford Ave



HCM 6th Signalized Intersection Summary
2: Grinnell Blvd & Crawford Ave

2021 Existing AM
12/30/2021



Movement	EBL	EBR	NBL	NBT	SBT	SBR
Lane Configurations						
Traffic Volume (veh/h)	82	48	64	381	330	47
Future Volume (veh/h)	82	48	64	381	330	47
Initial Q (Qb), veh	0	0	0	0	0	0
Ped-Bike Adj(A_pbT)	1.00	1.00	1.00			1.00
Parking Bus, Adj	1.00	1.00	1.00	1.00	1.00	1.00
Work Zone On Approach	No			No	No	
Adj Sat Flow, veh/h/ln	1870	1870	1870	1870	1870	1870
Adj Flow Rate, veh/h	91	53	71	423	367	52
Peak Hour Factor	0.90	0.90	0.90	0.90	0.90	0.90
Percent Heavy Veh, %	2	2	2	2	2	2
Cap, veh/h	132	117	796	2856	2456	1095
Arrive On Green	0.07	0.07	0.05	0.80	0.69	0.69
Sat Flow, veh/h	1781	1585	1781	3647	3647	1585
Grp Volume(v), veh/h	91	53	71	423	367	52
Grp Sat Flow(s),veh/h/ln	1781	1585	1781	1777	1777	1585
Q Serve(g_s), s	4.5	2.9	0.9	2.4	3.2	0.9
Cycle Q Clear(g_c), s	4.5	2.9	0.9	2.4	3.2	0.9
Prop In Lane	1.00	1.00	1.00			1.00
Lane Grp Cap(c), veh/h	132	117	796	2856	2456	1095
V/C Ratio(X)	0.69	0.45	0.09	0.15	0.15	0.05
Avail Cap(c_a), veh/h	515	458	972	2856	2456	1095
HCM Platoon Ratio	1.00	1.00	1.00	1.00	1.00	1.00
Upstream Filter(l)	1.00	1.00	1.00	1.00	1.00	1.00
Uniform Delay (d), s/veh	40.7	39.9	2.9	2.0	4.8	4.4
Incr Delay (d2), s/veh	6.3	2.7	0.0	0.1	0.1	0.1
Initial Q Delay(d3),s/veh	0.0	0.0	0.0	0.0	0.0	0.0
%ile BackOfQ(50%),veh/ln	2.2	2.6	0.2	0.5	1.0	0.3
Unsig. Movement Delay, s/veh						
LnGrp Delay(d),s/veh	47.0	42.6	2.9	2.1	4.9	4.5
LnGrp LOS	D	D	A	A	A	A
Approach Vol, veh/h	144			494	419	
Approach Delay, s/veh	45.4			2.2	4.9	
Approach LOS	D			A	A	
Timer - Assigned Phs		2		4	5	6
Phs Duration (G+Y+Rc), s		78.3		11.7	10.2	68.2
Change Period (Y+Rc), s		* 6		5.0	6.0	6.0
Max Green Setting (Gmax), s		* 54		26.0	13.0	34.0
Max Q Clear Time (g_c+I1), s		4.4		6.5	2.9	5.2
Green Ext Time (p_c), s		3.2		0.4	0.1	2.7
Intersection Summary						
HCM 6th Ctrl Delay			9.1			
HCM 6th LOS			A			
Notes						
* HCM 6th computational engine requires equal clearance times for the phases crossing the barrier.						

Timings
2: Grinnell Blvd & Crawford Ave

2021 Existing PM
12/30/2021



Lane Group	EBL	EBR	NBL	NBT	SBT	SBR
Lane Configurations	↖	↗	↖	↑↑	↑↑	↗
Traffic Volume (vph)	67	55	70	406	427	90
Future Volume (vph)	67	55	70	406	427	90
Turn Type	Prot	Perm	pm+pt	NA	NA	Perm
Protected Phases	4		5	2	6	
Permitted Phases		4	2			6
Detector Phase	4	4	5	2	6	6
Switch Phase						
Minimum Initial (s)	5.0	5.0	5.0	5.0	5.0	5.0
Minimum Split (s)	23.0	23.0	11.0	22.5	22.5	22.5
Total Split (s)	29.0	29.0	19.0	61.0	42.0	42.0
Total Split (%)	32.2%	32.2%	21.1%	67.8%	46.7%	46.7%
Yellow Time (s)	3.5	3.5	4.5	4.5	4.5	4.5
All-Red Time (s)	1.5	1.5	1.5	1.0	1.5	1.5
Lost Time Adjust (s)	0.0	0.0	0.0	0.0	0.0	0.0
Total Lost Time (s)	5.0	5.0	6.0	5.5	6.0	6.0
Lead/Lag			Lead		Lag	Lag
Lead-Lag Optimize?			Yes		Yes	Yes
Recall Mode	None	None	None	C-Max	C-Max	C-Max
Act Effect Green (s)	9.0	9.0	72.1	73.7	63.2	63.2
Actuated g/C Ratio	0.10	0.10	0.80	0.82	0.70	0.70
v/c Ratio	0.41	0.28	0.10	0.15	0.18	0.09
Control Delay	44.0	13.6	3.0	2.6	6.8	1.9
Queue Delay	0.0	0.0	0.0	0.0	0.0	0.0
Total Delay	44.0	13.6	3.0	2.6	6.8	1.9
LOS	D	B	A	A	A	A
Approach Delay	30.3			2.6	5.9	
Approach LOS	C			A	A	

Intersection Summary

Cycle Length: 90
 Actuated Cycle Length: 90
 Offset: 0 (0%), Referenced to phase 2:NBTL and 6:SBT, Start of Green
 Natural Cycle: 60
 Control Type: Actuated-Coordinated
 Maximum v/c Ratio: 0.41
 Intersection Signal Delay: 7.2
 Intersection Capacity Utilization 34.3%
 Analysis Period (min) 15
 Intersection LOS: A
 ICU Level of Service A

Splits and Phases: 2: Grinnell Blvd & Crawford Ave



HCM 6th Signalized Intersection Summary
2: Grinnell Blvd & Crawford Ave

2021 Existing PM
12/30/2021



Movement	EBL	EBR	NBL	NBT	SBT	SBR
Lane Configurations						
Traffic Volume (veh/h)	67	55	70	406	427	90
Future Volume (veh/h)	67	55	70	406	427	90
Initial Q (Qb), veh	0	0	0	0	0	0
Ped-Bike Adj(A_pbT)	1.00	1.00	1.00			1.00
Parking Bus, Adj	1.00	1.00	1.00	1.00	1.00	1.00
Work Zone On Approach	No			No	No	
Adj Sat Flow, veh/h/ln	1870	1870	1870	1870	1870	1870
Adj Flow Rate, veh/h	72	59	75	437	459	97
Peak Hour Factor	0.93	0.93	0.93	0.93	0.93	0.93
Percent Heavy Veh, %	2	2	2	2	2	2
Cap, veh/h	112	99	724	2896	2492	1112
Arrive On Green	0.06	0.06	0.05	0.82	0.70	0.70
Sat Flow, veh/h	1781	1585	1781	3647	3647	1585
Grp Volume(v), veh/h	72	59	75	437	459	97
Grp Sat Flow(s),veh/h/ln	1781	1585	1781	1777	1777	1585
Q Serve(g_s), s	3.6	3.3	0.9	2.3	4.0	1.8
Cycle Q Clear(g_c), s	3.6	3.3	0.9	2.3	4.0	1.8
Prop In Lane	1.00	1.00	1.00			1.00
Lane Grp Cap(c), veh/h	112	99	724	2896	2492	1112
V/C Ratio(X)	0.64	0.59	0.10	0.15	0.18	0.09
Avail Cap(c_a), veh/h	475	423	898	2896	2492	1112
HCM Platoon Ratio	1.00	1.00	1.00	1.00	1.00	1.00
Upstream Filter(I)	1.00	1.00	1.00	1.00	1.00	1.00
Uniform Delay (d), s/veh	41.2	41.1	2.7	1.8	4.6	4.3
Incr Delay (d2), s/veh	6.1	5.5	0.1	0.1	0.2	0.2
Initial Q Delay(d3),s/veh	0.0	0.0	0.0	0.0	0.0	0.0
%ile BackOfQ(50%),veh/ln	1.7	3.0	0.2	0.5	1.3	0.5
Unsig. Movement Delay, s/veh						
LnGrp Delay(d),s/veh	47.3	46.6	2.8	1.9	4.8	4.4
LnGrp LOS	D	D	A	A	A	A
Approach Vol, veh/h	131			512	556	
Approach Delay, s/veh	47.0			2.0	4.7	
Approach LOS	D			A	A	
Timer - Assigned Phs		2		4	5	6
Phs Duration (G+Y+Rc), s		79.4		10.6	10.2	69.1
Change Period (Y+Rc), s		* 6		5.0	6.0	6.0
Max Green Setting (Gmax), s		* 56		24.0	13.0	36.0
Max Q Clear Time (g_c+I1), s		4.3		5.6	2.9	6.0
Green Ext Time (p_c), s		3.3		0.3	0.1	3.6
Intersection Summary						
HCM 6th Ctrl Delay			8.2			
HCM 6th LOS			A			
Notes						
* HCM 6th computational engine requires equal clearance times for the phases crossing the barrier.						

Timings
2: Grinnell Blvd & Crawford Ave



Lane Group	EBL	EBR	NBL	NBT	SBT	SBR
Lane Configurations	↖	↗	↖	↑↑	↑↑	↗
Traffic Volume (vph)	85	50	66	393	341	49
Future Volume (vph)	85	50	66	393	341	49
Turn Type	Prot	Perm	pm+pt	NA	NA	Perm
Protected Phases	4		5	2	6	
Permitted Phases		4	2			6
Detector Phase	4	4	5	2	6	6
Switch Phase						
Minimum Initial (s)	5.0	5.0	5.0	5.0	5.0	5.0
Minimum Split (s)	23.0	23.0	11.0	22.5	22.5	22.5
Total Split (s)	35.0	35.0	20.0	55.0	35.0	35.0
Total Split (%)	38.9%	38.9%	22.2%	61.1%	38.9%	38.9%
Yellow Time (s)	3.5	3.5	4.5	4.5	4.5	4.5
All-Red Time (s)	1.5	1.5	1.5	1.0	1.5	1.5
Lost Time Adjust (s)	0.0	0.0	0.0	0.0	0.0	0.0
Total Lost Time (s)	5.0	5.0	6.0	5.5	6.0	6.0
Lead/Lag			Lead		Lag	Lag
Lead-Lag Optimize?			Yes		Yes	Yes
Recall Mode	None	None	None	C-Max	C-Max	C-Max
Act Effect Green (s)	10.1	10.1	71.1	72.7	62.1	62.1
Actuated g/C Ratio	0.11	0.11	0.79	0.81	0.69	0.69
v/c Ratio	0.47	0.25	0.10	0.15	0.16	0.05
Control Delay	44.5	12.7	3.3	2.9	7.2	2.6
Queue Delay	0.0	0.0	0.0	0.0	0.0	0.0
Total Delay	44.5	12.7	3.3	2.9	7.2	2.6
LOS	D	B	A	A	A	A
Approach Delay	32.6			3.0	6.6	
Approach LOS	C			A	A	

Intersection Summary

Cycle Length: 90
 Actuated Cycle Length: 90
 Offset: 0 (0%), Referenced to phase 2:NBTL and 6:SBT, Start of Green
 Natural Cycle: 60
 Control Type: Actuated-Coordinated
 Maximum v/c Ratio: 0.47
 Intersection Signal Delay: 8.5
 Intersection Capacity Utilization 32.5%
 Analysis Period (min) 15
 Intersection LOS: A
 ICU Level of Service A

Splits and Phases: 2: Grinnell Blvd & Crawford Ave

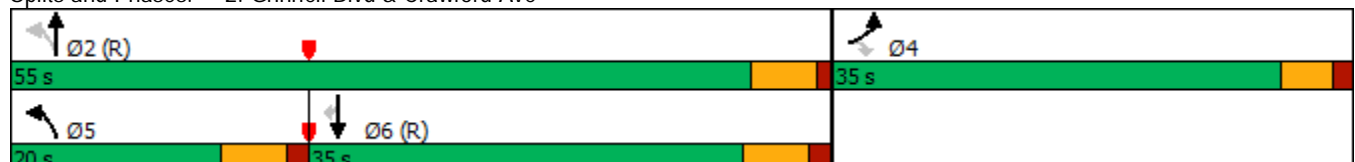

HCM 6th Signalized Intersection Summary
2: Grinnell Blvd & Crawford Ave

2023 Background AM
12/30/2021



Movement	EBL	EBR	NBL	NBT	SBT	SBR
Lane Configurations						
Traffic Volume (veh/h)	85	50	66	393	341	49
Future Volume (veh/h)	85	50	66	393	341	49
Initial Q (Qb), veh	0	0	0	0	0	0
Ped-Bike Adj(A_pbT)	1.00	1.00	1.00			1.00
Parking Bus, Adj	1.00	1.00	1.00	1.00	1.00	1.00
Work Zone On Approach	No			No	No	
Adj Sat Flow, veh/h/ln	1870	1870	1870	1870	1870	1870
Adj Flow Rate, veh/h	94	52	73	437	379	54
Peak Hour Factor	0.90	0.90	0.90	0.90	0.90	0.90
Percent Heavy Veh, %	2	2	2	2	2	2
Cap, veh/h	135	120	785	2849	2447	1091
Arrive On Green	0.08	0.08	0.05	0.80	0.69	0.69
Sat Flow, veh/h	1781	1585	1781	3647	3647	1585
Grp Volume(v), veh/h	94	52	73	437	379	54
Grp Sat Flow(s),veh/h/ln	1781	1585	1781	1777	1777	1585
Q Serve(g_s), s	4.6	2.8	0.9	2.5	3.3	1.0
Cycle Q Clear(g_c), s	4.6	2.8	0.9	2.5	3.3	1.0
Prop In Lane	1.00	1.00	1.00			1.00
Lane Grp Cap(c), veh/h	135	120	785	2849	2447	1091
V/C Ratio(X)	0.69	0.43	0.09	0.15	0.15	0.05
Avail Cap(c_a), veh/h	594	528	979	2849	2447	1091
HCM Platoon Ratio	1.00	1.00	1.00	1.00	1.00	1.00
Upstream Filter(l)	1.00	1.00	1.00	1.00	1.00	1.00
Uniform Delay (d), s/veh	40.6	39.7	2.9	2.0	4.9	4.5
Incr Delay (d2), s/veh	6.3	2.4	0.1	0.1	0.1	0.1
Initial Q Delay(d3),s/veh	0.0	0.0	0.0	0.0	0.0	0.0
%ile BackOfQ(50%),veh/ln	2.2	2.6	0.3	0.6	1.1	0.3
Unsig. Movement Delay, s/veh						
LnGrp Delay(d),s/veh	46.8	42.2	3.0	2.1	5.0	4.6
LnGrp LOS	D	D	A	A	A	A
Approach Vol, veh/h	146			510	433	
Approach Delay, s/veh	45.2			2.3	5.0	
Approach LOS	D			A	A	
Timer - Assigned Phs		2		4	5	6
Phs Duration (G+Y+Rc), s		78.2		11.8	10.2	68.0
Change Period (Y+Rc), s		* 6		5.0	6.0	6.0
Max Green Setting (Gmax), s		* 50		30.0	14.0	29.0
Max Q Clear Time (g_c+I1), s		4.5		6.6	2.9	5.3
Green Ext Time (p_c), s		3.3		0.4	0.1	2.7

Intersection Summary

HCM 6th Ctrl Delay	9.1
HCM 6th LOS	A

Notes

* HCM 6th computational engine requires equal clearance times for the phases crossing the barrier.

Timings
2: Grinnell Blvd & Crawford Ave



Lane Group	EBL	EBR	NBL	NBT	SBT	SBR
Lane Configurations	↖	↗	↖	↑↑	↑↑	↗
Traffic Volume (vph)	69	57	72	419	441	93
Future Volume (vph)	69	57	72	419	441	93
Turn Type	Prot	Perm	pm+pt	NA	NA	Perm
Protected Phases	4		5	2	6	
Permitted Phases		4	2			6
Detector Phase	4	4	5	2	6	6
Switch Phase						
Minimum Initial (s)	5.0	5.0	5.0	5.0	5.0	5.0
Minimum Split (s)	23.0	23.0	11.0	22.5	22.5	22.5
Total Split (s)	29.0	29.0	18.0	61.0	43.0	43.0
Total Split (%)	32.2%	32.2%	20.0%	67.8%	47.8%	47.8%
Yellow Time (s)	3.5	3.5	4.5	4.5	4.5	4.5
All-Red Time (s)	1.5	1.5	1.5	1.0	1.5	1.5
Lost Time Adjust (s)	0.0	0.0	0.0	0.0	0.0	0.0
Total Lost Time (s)	5.0	5.0	6.0	5.5	6.0	6.0
Lead/Lag			Lead		Lag	Lag
Lead-Lag Optimize?			Yes		Yes	Yes
Recall Mode	None	None	None	C-Max	C-Max	C-Max
Act Effect Green (s)	9.1	9.1	72.0	73.6	63.0	63.0
Actuated g/C Ratio	0.10	0.10	0.80	0.82	0.70	0.70
v/c Ratio	0.41	0.28	0.11	0.16	0.19	0.09
Control Delay	44.1	13.4	3.1	2.6	6.9	1.9
Queue Delay	0.0	0.0	0.0	0.0	0.0	0.0
Total Delay	44.1	13.4	3.1	2.6	6.9	1.9
LOS	D	B	A	A	A	A
Approach Delay	30.2			2.7	6.0	
Approach LOS	C			A	A	

Intersection Summary

Cycle Length: 90
 Actuated Cycle Length: 90
 Offset: 0 (0%), Referenced to phase 2:NBT and 6:SBT, Start of Green
 Natural Cycle: 60
 Control Type: Actuated-Coordinated
 Maximum v/c Ratio: 0.41
 Intersection Signal Delay: 7.2
 Intersection Capacity Utilization 34.7%
 Analysis Period (min) 15
 Intersection LOS: A
 ICU Level of Service A

Splits and Phases: 2: Grinnell Blvd & Crawford Ave

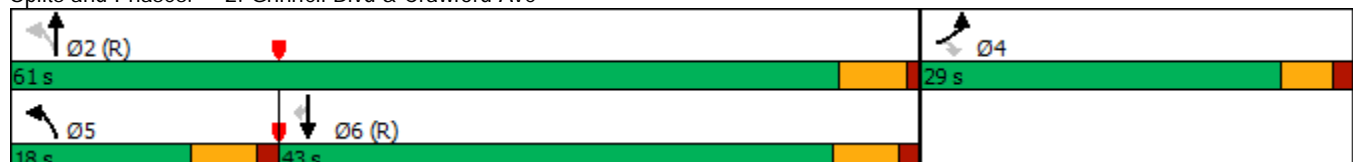

HCM 6th Signalized Intersection Summary
2: Grinnell Blvd & Crawford Ave

2023 Background PM
12/30/2021



Movement	EBL	EBR	NBL	NBT	SBT	SBR
Lane Configurations						
Traffic Volume (veh/h)	69	57	72	419	441	93
Future Volume (veh/h)	69	57	72	419	441	93
Initial Q (Qb), veh	0	0	0	0	0	0
Ped-Bike Adj(A_pbT)	1.00	1.00	1.00			1.00
Parking Bus, Adj	1.00	1.00	1.00	1.00	1.00	1.00
Work Zone On Approach	No			No	No	
Adj Sat Flow, veh/h/ln	1870	1870	1870	1870	1870	1870
Adj Flow Rate, veh/h	74	61	77	451	474	100
Peak Hour Factor	0.93	0.93	0.93	0.93	0.93	0.93
Percent Heavy Veh, %	2	2	2	2	2	2
Cap, veh/h	114	102	712	2891	2486	1109
Arrive On Green	0.06	0.06	0.05	0.81	0.70	0.70
Sat Flow, veh/h	1781	1585	1781	3647	3647	1585
Grp Volume(v), veh/h	74	61	77	451	474	100
Grp Sat Flow(s),veh/h/ln	1781	1585	1781	1777	1777	1585
Q Serve(g_s), s	3.7	3.4	0.9	2.4	4.2	1.8
Cycle Q Clear(g_c), s	3.7	3.4	0.9	2.4	4.2	1.8
Prop In Lane	1.00	1.00	1.00			1.00
Lane Grp Cap(c), veh/h	114	102	712	2891	2486	1109
V/C Ratio(X)	0.65	0.60	0.11	0.16	0.19	0.09
Avail Cap(c_a), veh/h	475	423	865	2891	2486	1109
HCM Platoon Ratio	1.00	1.00	1.00	1.00	1.00	1.00
Upstream Filter(l)	1.00	1.00	1.00	1.00	1.00	1.00
Uniform Delay (d), s/veh	41.1	41.0	2.7	1.8	4.7	4.3
Incr Delay (d2), s/veh	6.0	5.6	0.1	0.1	0.2	0.2
Initial Q Delay(d3),s/veh	0.0	0.0	0.0	0.0	0.0	0.0
%ile BackOfQ(50%),veh/ln	1.8	3.1	0.2	0.5	1.3	0.5
Unsig. Movement Delay, s/veh						
LnGrp Delay(d),s/veh	47.2	46.6	2.8	1.9	4.9	4.5
LnGrp LOS	D	D	A	A	A	A
Approach Vol, veh/h	135			528	574	
Approach Delay, s/veh	46.9			2.0	4.8	
Approach LOS	D			A	A	
Timer - Assigned Phs		2		4	5	6
Phs Duration (G+Y+Rc), s		79.2		10.8	10.3	69.0
Change Period (Y+Rc), s		* 6		5.0	6.0	6.0
Max Green Setting (Gmax), s		* 56		24.0	12.0	37.0
Max Q Clear Time (g_c+I1), s		4.4		5.7	2.9	6.2
Green Ext Time (p_c), s		3.4		0.3	0.1	3.8

Intersection Summary

HCM 6th Ctrl Delay	8.2
HCM 6th LOS	A

Notes

* HCM 6th computational engine requires equal clearance times for the phases crossing the barrier.

Timings
2: Grinnell Blvd & Crawford Ave

2023 Total AM
01/06/2022



Lane Group	EBL	EBR	NBL	NBT	SBT	SBR
Lane Configurations	↖	↗	↖	↑↑	↑↑	↗
Traffic Volume (vph)	97	59	69	393	341	53
Future Volume (vph)	97	59	69	393	341	53
Turn Type	Prot	Perm	pm+pt	NA	NA	Perm
Protected Phases	4		5	2	6	
Permitted Phases		4	2			6
Detector Phase	4	4	5	2	6	6
Switch Phase						
Minimum Initial (s)	5.0	5.0	5.0	5.0	5.0	5.0
Minimum Split (s)	23.0	23.0	11.0	22.5	22.5	22.5
Total Split (s)	32.0	32.0	20.0	58.0	38.0	38.0
Total Split (%)	35.6%	35.6%	22.2%	64.4%	42.2%	42.2%
Yellow Time (s)	3.5	3.5	4.5	4.5	4.5	4.5
All-Red Time (s)	1.5	1.5	1.5	1.0	1.5	1.5
Lost Time Adjust (s)	0.0	0.0	0.0	0.0	0.0	0.0
Total Lost Time (s)	5.0	5.0	6.0	5.5	6.0	6.0
Lead/Lag			Lead		Lag	Lag
Lead-Lag Optimize?			Yes		Yes	Yes
Recall Mode	None	None	None	C-Max	C-Max	C-Max
Act Effect Green (s)	10.8	10.8	70.5	72.1	61.4	61.4
Actuated g/C Ratio	0.12	0.12	0.78	0.80	0.68	0.68
v/c Ratio	0.51	0.27	0.10	0.15	0.16	0.05
Control Delay	44.7	11.9	3.6	3.1	7.6	2.7
Queue Delay	0.0	0.0	0.0	0.0	0.0	0.0
Total Delay	44.7	11.9	3.6	3.1	7.6	2.7
LOS	D	B	A	A	A	A
Approach Delay	32.3			3.2	6.9	
Approach LOS	C			A	A	

Intersection Summary

Cycle Length: 90
 Actuated Cycle Length: 90
 Offset: 0 (0%), Referenced to phase 2:NBTL and 6:SBT, Start of Green
 Natural Cycle: 60
 Control Type: Actuated-Coordinated
 Maximum v/c Ratio: 0.51
 Intersection Signal Delay: 9.1
 Intersection Capacity Utilization 33.1%
 Analysis Period (min) 15
 Intersection LOS: A
 ICU Level of Service A

Splits and Phases: 2: Grinnell Blvd & Crawford Ave

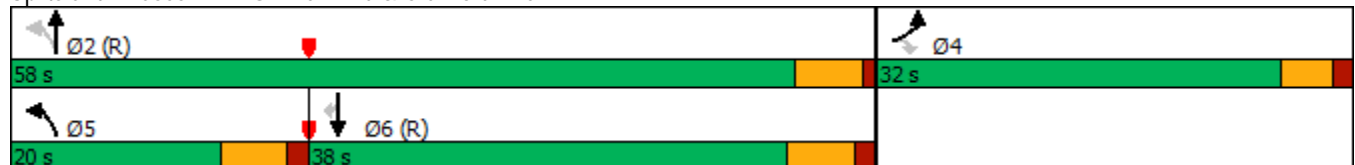

HCM 6th Signalized Intersection Summary
2: Grinnell Blvd & Crawford Ave

2023 Total AM
01/06/2022



Movement	EBL	EBR	NBL	NBT	SBT	SBR
Lane Configurations						
Traffic Volume (veh/h)	97	59	69	393	341	53
Future Volume (veh/h)	97	59	69	393	341	53
Initial Q (Qb), veh	0	0	0	0	0	0
Ped-Bike Adj(A_pbT)	1.00	1.00	1.00			1.00
Parking Bus, Adj	1.00	1.00	1.00	1.00	1.00	1.00
Work Zone On Approach	No			No	No	
Adj Sat Flow, veh/h/ln	1870	1870	1870	1870	1870	1870
Adj Flow Rate, veh/h	108	33	77	437	379	59
Peak Hour Factor	0.90	0.90	0.90	0.90	0.90	0.90
Percent Heavy Veh, %	2	2	2	2	2	2
Cap, veh/h	147	131	776	2825	2420	1079
Arrive On Green	0.08	0.08	0.05	0.80	0.68	0.68
Sat Flow, veh/h	1781	1585	1781	3647	3647	1585
Grp Volume(v), veh/h	108	33	77	437	379	59
Grp Sat Flow(s),veh/h/ln	1781	1585	1781	1777	1777	1585
Q Serve(g_s), s	5.3	1.8	1.0	2.6	3.4	1.1
Cycle Q Clear(g_c), s	5.3	1.8	1.0	2.6	3.4	1.1
Prop In Lane	1.00	1.00	1.00			1.00
Lane Grp Cap(c), veh/h	147	131	776	2825	2420	1079
V/C Ratio(X)	0.73	0.25	0.10	0.15	0.16	0.05
Avail Cap(c_a), veh/h	534	476	968	2825	2420	1079
HCM Platoon Ratio	1.00	1.00	1.00	1.00	1.00	1.00
Upstream Filter(l)	1.00	1.00	1.00	1.00	1.00	1.00
Uniform Delay (d), s/veh	40.3	38.7	3.1	2.2	5.1	4.8
Incr Delay (d2), s/veh	6.8	1.0	0.1	0.1	0.1	0.1
Initial Q Delay(d3),s/veh	0.0	0.0	0.0	0.0	0.0	0.0
%ile BackOfQ(50%),veh/ln	2.6	1.6	0.3	0.6	1.1	0.3
Unsig. Movement Delay, s/veh						
LnGrp Delay(d),s/veh	47.2	39.7	3.2	2.3	5.3	4.9
LnGrp LOS	D	D	A	A	A	A
Approach Vol, veh/h	141			514	438	
Approach Delay, s/veh	45.4			2.4	5.2	
Approach LOS	D			A	A	
Timer - Assigned Phs		2		4	5	6
Phs Duration (G+Y+Rc), s		77.6		12.4	10.3	67.3
Change Period (Y+Rc), s		* 6		5.0	6.0	6.0
Max Green Setting (Gmax), s		* 53		27.0	14.0	32.0
Max Q Clear Time (g_c+I1), s		4.6		7.3	3.0	5.4
Green Ext Time (p_c), s		3.3		0.3	0.1	2.8
Intersection Summary						
HCM 6th Ctrl Delay			9.1			
HCM 6th LOS			A			
Notes						
* HCM 6th computational engine requires equal clearance times for the phases crossing the barrier.						

Timings
2: Grinnell Blvd & Crawford Ave

2023 Total PM
01/06/2022



Lane Group	EBL	EBR	NBL	NBT	SBT	SBR
Lane Configurations	↖	↗	↖	↑↑	↑↑	↗
Traffic Volume (vph)	75	62	80	419	441	103
Future Volume (vph)	75	62	80	419	441	103
Turn Type	Prot	Perm	pm+pt	NA	NA	Perm
Protected Phases	4		5	2	6	
Permitted Phases		4	2			6
Detector Phase	4	4	5	2	6	6
Switch Phase						
Minimum Initial (s)	5.0	5.0	5.0	5.0	5.0	5.0
Minimum Split (s)	23.0	23.0	11.0	22.5	22.5	22.5
Total Split (s)	29.0	29.0	18.0	61.0	43.0	43.0
Total Split (%)	32.2%	32.2%	20.0%	67.8%	47.8%	47.8%
Yellow Time (s)	3.5	3.5	4.5	4.5	4.5	4.5
All-Red Time (s)	1.5	1.5	1.5	1.0	1.5	1.5
Lost Time Adjust (s)	0.0	0.0	0.0	0.0	0.0	0.0
Total Lost Time (s)	5.0	5.0	6.0	5.5	6.0	6.0
Lead/Lag			Lead		Lag	Lag
Lead-Lag Optimize?			Yes		Yes	Yes
Recall Mode	None	None	None	C-Max	C-Max	C-Max
Act Effect Green (s)	9.5	9.5	71.7	73.3	62.6	62.6
Actuated g/C Ratio	0.11	0.11	0.80	0.81	0.70	0.70
v/c Ratio	0.44	0.30	0.12	0.16	0.19	0.10
Control Delay	44.2	12.9	3.2	2.7	7.1	1.9
Queue Delay	0.0	0.0	0.0	0.0	0.0	0.0
Total Delay	44.2	12.9	3.2	2.7	7.1	1.9
LOS	D	B	A	A	A	A
Approach Delay	30.1			2.8	6.2	
Approach LOS	C			A	A	

Intersection Summary

Cycle Length: 90
 Actuated Cycle Length: 90
 Offset: 0 (0%), Referenced to phase 2:NBT and 6:SBT, Start of Green
 Natural Cycle: 60
 Control Type: Actuated-Coordinated
 Maximum v/c Ratio: 0.44
 Intersection Signal Delay: 7.5
 Intersection Capacity Utilization 35.0%
 Analysis Period (min) 15
 Intersection LOS: A
 ICU Level of Service A

Splits and Phases: 2: Grinnell Blvd & Crawford Ave



HCM 6th Signalized Intersection Summary
2: Grinnell Blvd & Crawford Ave

2023 Total PM
01/06/2022



Movement	EBL	EBR	NBL	NBT	SBT	SBR
Lane Configurations						
Traffic Volume (veh/h)	75	62	80	419	441	103
Future Volume (veh/h)	75	62	80	419	441	103
Initial Q (Qb), veh	0	0	0	0	0	0
Ped-Bike Adj(A_pbT)	1.00	1.00	1.00			1.00
Parking Bus, Adj	1.00	1.00	1.00	1.00	1.00	1.00
Work Zone On Approach	No			No	No	
Adj Sat Flow, veh/h/ln	1870	1870	1870	1870	1870	1870
Adj Flow Rate, veh/h	81	67	86	451	474	111
Peak Hour Factor	0.93	0.93	0.93	0.93	0.93	0.93
Percent Heavy Veh, %	2	2	2	2	2	2
Cap, veh/h	123	109	704	2875	2463	1099
Arrive On Green	0.07	0.07	0.05	0.81	0.69	0.69
Sat Flow, veh/h	1781	1585	1781	3647	3647	1585
Grp Volume(v), veh/h	81	67	86	451	474	111
Grp Sat Flow(s),veh/h/ln	1781	1585	1781	1777	1777	1585
Q Serve(g_s), s	4.0	3.7	1.1	2.5	4.3	2.1
Cycle Q Clear(g_c), s	4.0	3.7	1.1	2.5	4.3	2.1
Prop In Lane	1.00	1.00	1.00			1.00
Lane Grp Cap(c), veh/h	123	109	704	2875	2463	1099
V/C Ratio(X)	0.66	0.61	0.12	0.16	0.19	0.10
Avail Cap(c_a), veh/h	475	423	854	2875	2463	1099
HCM Platoon Ratio	1.00	1.00	1.00	1.00	1.00	1.00
Upstream Filter(l)	1.00	1.00	1.00	1.00	1.00	1.00
Uniform Delay (d), s/veh	40.9	40.7	2.9	1.9	4.9	4.6
Incr Delay (d2), s/veh	5.9	5.5	0.1	0.1	0.2	0.2
Initial Q Delay(d3),s/veh	0.0	0.0	0.0	0.0	0.0	0.0
%ile BackOfQ(50%),veh/ln	1.9	3.4	0.3	0.5	1.4	0.6
Unsig. Movement Delay, s/veh						
LnGrp Delay(d),s/veh	46.8	46.2	2.9	2.0	5.1	4.7
LnGrp LOS	D	D	A	A	A	A
Approach Vol, veh/h	148			537	585	
Approach Delay, s/veh	46.6			2.1	5.0	
Approach LOS	D			A	A	
Timer - Assigned Phs		2		4	5	6
Phs Duration (G+Y+Rc), s		78.8		11.2	10.4	68.4
Change Period (Y+Rc), s		* 6		5.0	6.0	6.0
Max Green Setting (Gmax), s		* 56		24.0	12.0	37.0
Max Q Clear Time (g_c+I1), s		4.5		6.0	3.1	6.3
Green Ext Time (p_c), s		3.4		0.4	0.1	3.8
Intersection Summary						
HCM 6th Ctrl Delay			8.6			
HCM 6th LOS			A			
Notes						
* HCM 6th computational engine requires equal clearance times for the phases crossing the barrier.						

Timings
2: Grinnell Blvd & Crawford Ave



Lane Group	EBL	EBR	NBL	NBT	SBT	SBR
Lane Configurations	↖	↗	↖	↑↑	↑↑	↗
Traffic Volume (vph)	121	71	94	1162	706	69
Future Volume (vph)	121	71	94	1162	706	69
Turn Type	Prot	Perm	pm+pt	NA	NA	Perm
Protected Phases	4		5	2	6	
Permitted Phases		4	2			6
Detector Phase	4	4	5	2	6	6
Switch Phase						
Minimum Initial (s)	5.0	5.0	5.0	5.0	5.0	5.0
Minimum Split (s)	23.0	23.0	11.0	22.5	22.5	22.5
Total Split (s)	27.0	27.0	14.0	63.0	49.0	49.0
Total Split (%)	30.0%	30.0%	15.6%	70.0%	54.4%	54.4%
Yellow Time (s)	3.5	3.5	4.5	4.5	4.5	4.5
All-Red Time (s)	1.5	1.5	1.5	1.0	1.5	1.5
Lost Time Adjust (s)	0.0	0.0	0.0	0.0	0.0	0.0
Total Lost Time (s)	5.0	5.0	6.0	5.5	6.0	6.0
Lead/Lag			Lead		Lag	Lag
Lead-Lag Optimize?			Yes		Yes	Yes
Recall Mode	None	None	None	C-Max	C-Max	C-Max
Act Effect Green (s)	12.1	12.1	66.9	67.4	56.2	56.2
Actuated g/C Ratio	0.13	0.13	0.74	0.75	0.62	0.62
v/c Ratio	0.57	0.28	0.21	0.49	0.35	0.08
Control Delay	45.1	10.7	4.7	5.6	10.1	2.7
Queue Delay	0.0	0.0	0.0	0.0	0.0	0.0
Total Delay	45.1	10.7	4.7	5.6	10.1	2.7
LOS	D	B	A	A	B	A
Approach Delay	32.3			5.5	9.4	
Approach LOS	C			A	A	

Intersection Summary

Cycle Length: 90
 Actuated Cycle Length: 90
 Offset: 0 (0%), Referenced to phase 2:NBTL and 6:SBT, Start of Green
 Natural Cycle: 60
 Control Type: Actuated-Coordinated
 Maximum v/c Ratio: 0.57
 Intersection Signal Delay: 9.2
 Intersection Capacity Utilization 47.6%
 Analysis Period (min) 15
 Intersection LOS: A
 ICU Level of Service A

Splits and Phases: 2: Grinnell Blvd & Crawford Ave

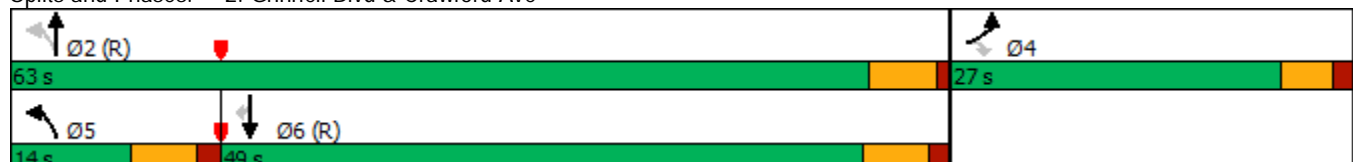

HCM 6th Signalized Intersection Summary
2: Grinnell Blvd & Crawford Ave

2045 Background AM
12/30/2021



Movement	EBL	EBR	NBL	NBT	SBT	SBR
Lane Configurations						
Traffic Volume (veh/h)	121	71	94	1162	706	69
Future Volume (veh/h)	121	71	94	1162	706	69
Initial Q (Qb), veh	0	0	0	0	0	0
Ped-Bike Adj(A_pbT)	1.00	1.00	1.00			1.00
Parking Bus, Adj	1.00	1.00	1.00	1.00	1.00	1.00
Work Zone On Approach	No			No	No	
Adj Sat Flow, veh/h/ln	1870	1870	1870	1870	1870	1870
Adj Flow Rate, veh/h	134	79	104	1291	784	77
Peak Hour Factor	0.90	0.90	0.90	0.90	0.90	0.90
Percent Heavy Veh, %	2	2	2	2	2	2
Cap, veh/h	179	159	533	2763	2343	1045
Arrive On Green	0.10	0.10	0.05	0.78	0.66	0.66
Sat Flow, veh/h	1781	1585	1781	3647	3647	1585
Grp Volume(v), veh/h	134	79	104	1291	784	77
Grp Sat Flow(s),veh/h/ln	1781	1585	1781	1777	1777	1585
Q Serve(g_s), s	6.6	4.2	1.5	11.4	8.7	1.6
Cycle Q Clear(g_c), s	6.6	4.2	1.5	11.4	8.7	1.6
Prop In Lane	1.00	1.00	1.00			1.00
Lane Grp Cap(c), veh/h	179	159	533	2763	2343	1045
V/C Ratio(X)	0.75	0.50	0.20	0.47	0.33	0.07
Avail Cap(c_a), veh/h	435	387	600	2763	2343	1045
HCM Platoon Ratio	1.00	1.00	1.00	1.00	1.00	1.00
Upstream Filter(l)	1.00	1.00	1.00	1.00	1.00	1.00
Uniform Delay (d), s/veh	39.4	38.3	4.2	3.5	6.7	5.5
Incr Delay (d2), s/veh	6.2	2.4	0.2	0.6	0.4	0.1
Initial Q Delay(d3),s/veh	0.0	0.0	0.0	0.0	0.0	0.0
%ile BackOfQ(50%),veh/ln	3.1	3.9	0.4	2.9	3.0	0.5
Unsig. Movement Delay, s/veh						
LnGrp Delay(d),s/veh	45.5	40.7	4.3	4.1	7.1	5.6
LnGrp LOS	D	D	A	A	A	A
Approach Vol, veh/h	213			1395	861	
Approach Delay, s/veh	43.7			4.1	7.0	
Approach LOS	D			A	A	
Timer - Assigned Phs		2		4	5	6
Phs Duration (G+Y+Rc), s		76.0		14.0	10.6	65.3
Change Period (Y+Rc), s		* 6		5.0	6.0	6.0
Max Green Setting (Gmax), s		* 58		22.0	8.0	43.0
Max Q Clear Time (g_c+I1), s		13.4		8.6	3.5	10.7
Green Ext Time (p_c), s		13.6		0.5	0.1	6.6

Intersection Summary

HCM 6th Ctrl Delay	8.5
HCM 6th LOS	A

Notes

* HCM 6th computational engine requires equal clearance times for the phases crossing the barrier.

Timings
2: Grinnell Blvd & Crawford Ave



Lane Group	EBL	EBR	NBL	NBT	SBT	SBR
Lane Configurations	↖	↗	↖	↑↑	↑↑	↗
Traffic Volume (vph)	99	81	103	793	1088	132
Future Volume (vph)	99	81	103	793	1088	132
Turn Type	Prot	Perm	pm+pt	NA	NA	Perm
Protected Phases	4		5	2	6	
Permitted Phases		4	2			6
Detector Phase	4	4	5	2	6	6
Switch Phase						
Minimum Initial (s)	5.0	5.0	5.0	5.0	5.0	5.0
Minimum Split (s)	23.0	23.0	11.0	22.5	22.5	22.5
Total Split (s)	24.0	24.0	12.0	66.0	54.0	54.0
Total Split (%)	26.7%	26.7%	13.3%	73.3%	60.0%	60.0%
Yellow Time (s)	3.5	3.5	4.5	4.5	4.5	4.5
All-Red Time (s)	1.5	1.5	1.5	1.0	1.5	1.5
Lost Time Adjust (s)	0.0	0.0	0.0	0.0	0.0	0.0
Total Lost Time (s)	5.0	5.0	6.0	5.5	6.0	6.0
Lead/Lag			Lead		Lag	Lag
Lead-Lag Optimize?			Yes		Yes	Yes
Recall Mode	None	None	None	C-Max	C-Max	C-Max
Act Effect Green (s)	10.7	10.7	68.3	68.8	57.6	57.6
Actuated g/C Ratio	0.12	0.12	0.76	0.76	0.64	0.64
v/c Ratio	0.50	0.33	0.31	0.32	0.52	0.13
Control Delay	44.8	11.5	5.5	3.9	11.1	2.9
Queue Delay	0.0	0.0	0.0	0.0	0.0	0.0
Total Delay	44.8	11.5	5.5	3.9	11.1	2.9
LOS	D	B	A	A	B	A
Approach Delay	29.8			4.1	10.2	
Approach LOS	C			A	B	

Intersection Summary

Cycle Length: 90
 Actuated Cycle Length: 90
 Offset: 0 (0%), Referenced to phase 2:NBTL and 6:SBT, Start of Green
 Natural Cycle: 65
 Control Type: Actuated-Coordinated
 Maximum v/c Ratio: 0.52
 Intersection Signal Delay: 9.4
 Intersection Capacity Utilization 55.4%
 Analysis Period (min) 15
 Intersection LOS: A
 ICU Level of Service B

Splits and Phases: 2: Grinnell Blvd & Crawford Ave



HCM 6th Signalized Intersection Summary
2: Grinnell Blvd & Crawford Ave

2045 Background PM
12/30/2021



Movement	EBL	EBR	NBL	NBT	SBT	SBR
Lane Configurations						
Traffic Volume (veh/h)	99	81	103	793	1088	132
Future Volume (veh/h)	99	81	103	793	1088	132
Initial Q (Qb), veh	0	0	0	0	0	0
Ped-Bike Adj(A_pbT)	1.00	1.00	1.00			1.00
Parking Bus, Adj	1.00	1.00	1.00	1.00	1.00	1.00
Work Zone On Approach	No			No	No	
Adj Sat Flow, veh/h/ln	1870	1870	1870	1870	1870	1870
Adj Flow Rate, veh/h	106	87	111	853	1170	142
Peak Hour Factor	0.93	0.93	0.93	0.93	0.93	0.93
Percent Heavy Veh, %	2	2	2	2	2	2
Cap, veh/h	150	133	389	2821	2399	1070
Arrive On Green	0.08	0.08	0.05	0.79	0.67	0.67
Sat Flow, veh/h	1781	1585	1781	3647	3647	1585
Grp Volume(v), veh/h	106	87	111	853	1170	142
Grp Sat Flow(s),veh/h/ln	1781	1585	1781	1777	1777	1585
Q Serve(g_s), s	5.2	4.8	1.5	5.9	14.4	2.9
Cycle Q Clear(g_c), s	5.2	4.8	1.5	5.9	14.4	2.9
Prop In Lane	1.00	1.00	1.00			1.00
Lane Grp Cap(c), veh/h	150	133	389	2821	2399	1070
V/C Ratio(X)	0.71	0.65	0.29	0.30	0.49	0.13
Avail Cap(c_a), veh/h	376	335	415	2821	2399	1070
HCM Platoon Ratio	1.00	1.00	1.00	1.00	1.00	1.00
Upstream Filter(I)	1.00	1.00	1.00	1.00	1.00	1.00
Uniform Delay (d), s/veh	40.1	39.9	5.0	2.5	7.1	5.2
Incr Delay (d2), s/veh	6.0	5.3	0.4	0.3	0.7	0.3
Initial Q Delay(d3),s/veh	0.0	0.0	0.0	0.0	0.0	0.0
%ile BackOfQ(50%),veh/ln	2.5	4.4	0.4	1.4	4.8	0.9
Unsig. Movement Delay, s/veh						
LnGrp Delay(d),s/veh	46.2	45.2	5.4	2.8	7.8	5.5
LnGrp LOS	D	D	A	A	A	A
Approach Vol, veh/h	193			964	1312	
Approach Delay, s/veh	45.7			3.1	7.6	
Approach LOS	D			A	A	
Timer - Assigned Phs		2		4	5	6
Phs Duration (G+Y+Rc), s		77.4		12.6	10.7	66.7
Change Period (Y+Rc), s		* 6		5.0	6.0	6.0
Max Green Setting (Gmax), s		* 61		19.0	6.0	48.0
Max Q Clear Time (g_c+I1), s		7.9		7.2	3.5	16.4
Green Ext Time (p_c), s		7.5		0.4	0.1	11.4

Intersection Summary

HCM 6th Ctrl Delay	8.8
HCM 6th LOS	A

Notes

* HCM 6th computational engine requires equal clearance times for the phases crossing the barrier.

Timings
2: Grinnell Blvd & Crawford Ave

2045 Total AM
01/06/2022



Lane Group	EBL	EBR	NBL	NBT	SBT	SBR
Lane Configurations	↖	↗	↖	↑↑	↑↑	↗
Traffic Volume (vph)	133	80	97	1162	706	73
Future Volume (vph)	133	80	97	1162	706	73
Turn Type	Prot	Perm	pm+pt	NA	NA	Perm
Protected Phases	4		5	2	6	
Permitted Phases		4	2			6
Detector Phase	4	4	5	2	6	6
Switch Phase						
Minimum Initial (s)	5.0	5.0	5.0	5.0	5.0	5.0
Minimum Split (s)	23.0	23.0	11.0	22.5	22.5	22.5
Total Split (s)	27.0	27.0	14.0	63.0	49.0	49.0
Total Split (%)	30.0%	30.0%	15.6%	70.0%	54.4%	54.4%
Yellow Time (s)	3.5	3.5	4.5	4.5	4.5	4.5
All-Red Time (s)	1.5	1.5	1.5	1.0	1.5	1.5
Lost Time Adjust (s)	0.0	0.0	0.0	0.0	0.0	0.0
Total Lost Time (s)	5.0	5.0	6.0	5.5	6.0	6.0
Lead/Lag			Lead		Lag	Lag
Lead-Lag Optimize?			Yes		Yes	Yes
Recall Mode	None	None	None	C-Max	C-Max	C-Max
Act Effect Green (s)	12.8	12.8	66.2	66.7	55.4	55.4
Actuated g/C Ratio	0.14	0.14	0.74	0.74	0.62	0.62
v/c Ratio	0.59	0.30	0.22	0.49	0.36	0.08
Control Delay	45.1	9.9	5.0	5.9	10.5	2.8
Queue Delay	0.0	0.0	0.0	0.0	0.0	0.0
Total Delay	45.1	9.9	5.0	5.9	10.5	2.8
LOS	D	A	A	A	B	A
Approach Delay	31.9			5.9	9.8	
Approach LOS	C			A	A	

Intersection Summary

Cycle Length: 90
 Actuated Cycle Length: 90
 Offset: 0 (0%), Referenced to phase 2:NBT and 6:SBT, Start of Green
 Natural Cycle: 60
 Control Type: Actuated-Coordinated
 Maximum v/c Ratio: 0.59
 Intersection Signal Delay: 9.7
 Intersection Capacity Utilization 48.2%
 Analysis Period (min) 15
 Intersection LOS: A
 ICU Level of Service A

Splits and Phases: 2: Grinnell Blvd & Crawford Ave

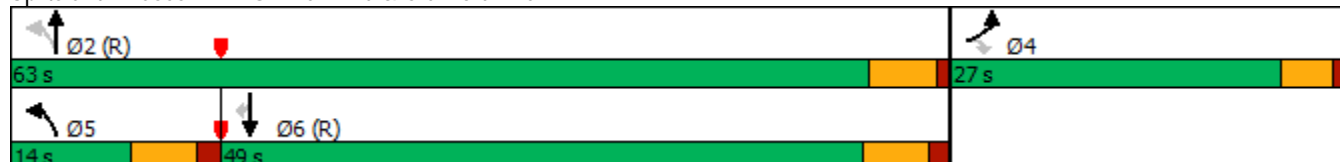

HCM 6th Signalized Intersection Summary
2: Grinnell Blvd & Crawford Ave

2045 Total AM
01/06/2022



Movement	EBL	EBR	NBL	NBT	SBT	SBR
Lane Configurations						
Traffic Volume (veh/h)	133	80	97	1162	706	73
Future Volume (veh/h)	133	80	97	1162	706	73
Initial Q (Qb), veh	0	0	0	0	0	0
Ped-Bike Adj(A_pbT)	1.00	1.00	1.00			1.00
Parking Bus, Adj	1.00	1.00	1.00	1.00	1.00	1.00
Work Zone On Approach	No			No	No	
Adj Sat Flow, veh/h/ln	1870	1870	1870	1870	1870	1870
Adj Flow Rate, veh/h	148	89	108	1291	784	81
Peak Hour Factor	0.90	0.90	0.90	0.90	0.90	0.90
Percent Heavy Veh, %	2	2	2	2	2	2
Cap, veh/h	194	172	525	2733	2312	1031
Arrive On Green	0.11	0.11	0.05	0.77	0.65	0.65
Sat Flow, veh/h	1781	1585	1781	3647	3647	1585
Grp Volume(v), veh/h	148	89	108	1291	784	81
Grp Sat Flow(s),veh/h/ln	1781	1585	1781	1777	1777	1585
Q Serve(g_s), s	7.3	4.8	1.6	11.9	8.9	1.7
Cycle Q Clear(g_c), s	7.3	4.8	1.6	11.9	8.9	1.7
Prop In Lane	1.00	1.00	1.00			1.00
Lane Grp Cap(c), veh/h	194	172	525	2733	2312	1031
V/C Ratio(X)	0.76	0.52	0.21	0.47	0.34	0.08
Avail Cap(c_a), veh/h	435	387	591	2733	2312	1031
HCM Platoon Ratio	1.00	1.00	1.00	1.00	1.00	1.00
Upstream Filter(l)	1.00	1.00	1.00	1.00	1.00	1.00
Uniform Delay (d), s/veh	39.0	37.9	4.4	3.8	7.1	5.8
Incr Delay (d2), s/veh	6.1	2.4	0.2	0.6	0.4	0.1
Initial Q Delay(d3),s/veh	0.0	0.0	0.0	0.0	0.0	0.0
%ile BackOfQ(50%),veh/ln	3.5	4.3	0.5	3.1	3.1	0.5
Unsig. Movement Delay, s/veh						
LnGrp Delay(d),s/veh	45.1	40.2	4.6	4.4	7.5	5.9
LnGrp LOS	D	D	A	A	A	A
Approach Vol, veh/h	237			1399	865	
Approach Delay, s/veh	43.3			4.4	7.3	
Approach LOS	D			A	A	
Timer - Assigned Phs		2		4	5	6
Phs Duration (G+Y+Rc), s		75.2		14.8	10.7	64.5
Change Period (Y+Rc), s		* 6		5.0	6.0	6.0
Max Green Setting (Gmax), s		* 58		22.0	8.0	43.0
Max Q Clear Time (g_c+I1), s		13.9		9.3	3.6	10.9
Green Ext Time (p_c), s		13.6		0.6	0.1	6.6
Intersection Summary						
HCM 6th Ctrl Delay			9.1			
HCM 6th LOS			A			
Notes						
* HCM 6th computational engine requires equal clearance times for the phases crossing the barrier.						

Timings
2: Grinnell Blvd & Crawford Ave

2045 Total PM
01/06/2022



Lane Group	EBL	EBR	NBL	NBT	SBT	SBR
Lane Configurations	↖	↗	↖	↑↑	↑↑	↗
Traffic Volume (vph)	105	86	111	793	1088	142
Future Volume (vph)	105	86	111	793	1088	142
Turn Type	Prot	Perm	pm+pt	NA	NA	Perm
Protected Phases	4		5	2	6	
Permitted Phases		4	2			6
Detector Phase	4	4	5	2	6	6
Switch Phase						
Minimum Initial (s)	5.0	5.0	5.0	5.0	5.0	5.0
Minimum Split (s)	23.0	23.0	11.0	22.5	22.5	22.5
Total Split (s)	23.0	23.0	15.0	67.0	52.0	52.0
Total Split (%)	25.6%	25.6%	16.7%	74.4%	57.8%	57.8%
Yellow Time (s)	3.5	3.5	4.5	4.5	4.5	4.5
All-Red Time (s)	1.5	1.5	1.5	1.0	1.5	1.5
Lost Time Adjust (s)	0.0	0.0	0.0	0.0	0.0	0.0
Total Lost Time (s)	5.0	5.0	6.0	5.5	6.0	6.0
Lead/Lag			Lead		Lag	Lag
Lead-Lag Optimize?			Yes		Yes	Yes
Recall Mode	None	None	None	C-Max	C-Max	C-Max
Act Effect Green (s)	11.0	11.0	68.0	68.5	54.8	54.8
Actuated g/C Ratio	0.12	0.12	0.76	0.76	0.61	0.61
v/c Ratio	0.52	0.33	0.34	0.32	0.54	0.15
Control Delay	45.0	11.2	6.0	4.0	12.2	3.1
Queue Delay	0.0	0.0	0.0	0.0	0.0	0.0
Total Delay	45.0	11.2	6.0	4.0	12.2	3.1
LOS	D	B	A	A	B	A
Approach Delay	29.8			4.3	11.1	
Approach LOS	C			A	B	

Intersection Summary

Cycle Length: 90
 Actuated Cycle Length: 90
 Offset: 0 (0%), Referenced to phase 2:NBTL and 6:SBT, Start of Green
 Natural Cycle: 65
 Control Type: Actuated-Coordinated
 Maximum v/c Ratio: 0.54
 Intersection Signal Delay: 10.0
 Intersection LOS: A
 Intersection Capacity Utilization 56.2%
 ICU Level of Service B
 Analysis Period (min) 15

Splits and Phases: 2: Grinnell Blvd & Crawford Ave



HCM 6th Signalized Intersection Summary
2: Grinnell Blvd & Crawford Ave

2045 Total PM
01/06/2022



Movement	EBL	EBR	NBL	NBT	SBT	SBR
Lane Configurations						
Traffic Volume (veh/h)	105	86	111	793	1088	142
Future Volume (veh/h)	105	86	111	793	1088	142
Initial Q (Qb), veh	0	0	0	0	0	0
Ped-Bike Adj(A_pbT)	1.00	1.00	1.00			1.00
Parking Bus, Adj	1.00	1.00	1.00	1.00	1.00	1.00
Work Zone On Approach	No			No	No	
Adj Sat Flow, veh/h/ln	1870	1870	1870	1870	1870	1870
Adj Flow Rate, veh/h	113	92	119	853	1170	153
Peak Hour Factor	0.93	0.93	0.93	0.93	0.93	0.93
Percent Heavy Veh, %	2	2	2	2	2	2
Cap, veh/h	157	140	385	2806	2382	1062
Arrive On Green	0.09	0.09	0.05	0.79	0.67	0.67
Sat Flow, veh/h	1781	1585	1781	3647	3647	1585
Grp Volume(v), veh/h	113	92	119	853	1170	153
Grp Sat Flow(s),veh/h/ln	1781	1585	1781	1777	1777	1585
Q Serve(g_s), s	5.6	5.1	1.6	6.0	14.6	3.2
Cycle Q Clear(g_c), s	5.6	5.1	1.6	6.0	14.6	3.2
Prop In Lane	1.00	1.00	1.00			1.00
Lane Grp Cap(c), veh/h	157	140	385	2806	2382	1062
V/C Ratio(X)	0.72	0.66	0.31	0.30	0.49	0.14
Avail Cap(c_a), veh/h	356	317	469	2806	2382	1062
HCM Platoon Ratio	1.00	1.00	1.00	1.00	1.00	1.00
Upstream Filter(l)	1.00	1.00	1.00	1.00	1.00	1.00
Uniform Delay (d), s/veh	40.0	39.7	5.3	2.6	7.3	5.4
Incr Delay (d2), s/veh	6.1	5.2	0.5	0.3	0.7	0.3
Initial Q Delay(d3),s/veh	0.0	0.0	0.0	0.0	0.0	0.0
%ile BackOfQ(50%),veh/ln	2.7	4.6	0.5	1.4	4.9	1.0
Unsig. Movement Delay, s/veh						
LnGrp Delay(d),s/veh	46.0	44.9	5.7	2.9	8.0	5.7
LnGrp LOS	D	D	A	A	A	A
Approach Vol, veh/h				972	1323	
Approach Delay, s/veh				3.2	7.8	
Approach LOS				A	A	
Timer - Assigned Phs		2		4	5	6
Phs Duration (G+Y+Rc), s		77.1		12.9	10.7	66.3
Change Period (Y+Rc), s		* 6		5.0	6.0	6.0
Max Green Setting (Gmax), s		* 62		18.0	9.0	46.0
Max Q Clear Time (g_c+I1), s		8.0		7.6	3.6	16.6
Green Ext Time (p_c), s		7.5		0.4	0.1	11.2

Intersection Summary

HCM 6th Ctrl Delay	9.1
HCM 6th LOS	A

Notes

* HCM 6th computational engine requires equal clearance times for the phases crossing the barrier.

APPENDIX F

Queues Analysis Worksheets

Queues
2: Grinnell Blvd & Crawford Ave

2023 Total AM
01/06/2022



Lane Group	EBL	EBR	NBL	NBT	SBT	SBR
Lane Group Flow (vph)	108	66	77	437	379	59
v/c Ratio	0.51	0.27	0.10	0.15	0.16	0.05
Control Delay	44.7	11.9	3.6	3.1	7.6	2.7
Queue Delay	0.0	0.0	0.0	0.0	0.0	0.0
Total Delay	44.7	11.9	3.6	3.1	7.6	2.7
Queue Length 50th (ft)	58	0	9	27	43	0
Queue Length 95th (ft)	104	35	23	50	76	16
Internal Link Dist (ft)	335			167	125	
Turn Bay Length (ft)	50		300			125
Base Capacity (vph)	531	521	833	2834	2416	1099
Starvation Cap Reductn	0	0	0	0	0	0
Spillback Cap Reductn	0	0	0	0	0	0
Storage Cap Reductn	0	0	0	0	0	0
Reduced v/c Ratio	0.20	0.13	0.09	0.15	0.16	0.05

Intersection Summary

Queues
2: Grinnell Blvd & Crawford Ave

2023 Total PM
01/06/2022



Lane Group	EBL	EBR	NBL	NBT	SBT	SBR
Lane Group Flow (vph)	81	67	86	451	474	111
v/c Ratio	0.44	0.30	0.12	0.16	0.19	0.10
Control Delay	44.2	12.9	3.2	2.7	7.1	1.9
Queue Delay	0.0	0.0	0.0	0.0	0.0	0.0
Total Delay	44.2	12.9	3.2	2.7	7.1	1.9
Queue Length 50th (ft)	44	0	9	26	54	0
Queue Length 95th (ft)	85	36	23	46	90	21
Internal Link Dist (ft)	335			167	125	
Turn Bay Length (ft)	50		300			125
Base Capacity (vph)	472	471	775	2881	2460	1134
Starvation Cap Reductn	0	0	0	0	0	0
Spillback Cap Reductn	0	0	0	0	0	0
Storage Cap Reductn	0	0	0	0	0	0
Reduced v/c Ratio	0.17	0.14	0.11	0.16	0.19	0.10

Intersection Summary

Queues
2: Grinnell Blvd & Crawford Ave

2045 Total AM
01/06/2022



Lane Group	EBL	EBR	NBL	NBT	SBT	SBR
Lane Group Flow (vph)	148	89	108	1291	784	81
v/c Ratio	0.59	0.30	0.22	0.49	0.36	0.08
Control Delay	45.1	9.9	5.0	5.9	10.5	2.8
Queue Delay	0.0	0.0	0.0	0.0	0.0	0.0
Total Delay	45.1	9.9	5.0	5.9	10.5	2.8
Queue Length 50th (ft)	80	0	14	128	113	0
Queue Length 95th (ft)	133	38	34	211	183	21
Internal Link Dist (ft)	335			167	125	
Turn Bay Length (ft)	50		300			125
Base Capacity (vph)	432	454	512	2622	2178	1005
Starvation Cap Reductn	0	0	0	0	0	0
Spillback Cap Reductn	0	0	0	0	0	0
Storage Cap Reductn	0	0	0	0	0	0
Reduced v/c Ratio	0.34	0.20	0.21	0.49	0.36	0.08

Intersection Summary

Queues
2: Grinnell Blvd & Crawford Ave

2045 Total PM
01/06/2022



Lane Group	EBL	EBR	NBL	NBT	SBT	SBR
Lane Group Flow (vph)	113	92	119	853	1170	153
v/c Ratio	0.52	0.33	0.34	0.32	0.54	0.15
Control Delay	45.0	11.2	6.0	4.0	12.2	3.1
Queue Delay	0.0	0.0	0.0	0.0	0.0	0.0
Total Delay	45.0	11.2	6.0	4.0	12.2	3.1
Queue Length 50th (ft)	61	0	14	63	185	6
Queue Length 95th (ft)	109	41	33	106	289	35
Internal Link Dist (ft)	335			167	125	
Turn Bay Length (ft)	50		300			125
Base Capacity (vph)	354	390	384	2691	2154	1011
Starvation Cap Reductn	0	0	0	0	0	0
Spillback Cap Reductn	0	0	0	0	0	0
Storage Cap Reductn	0	0	0	0	0	0
Reduced v/c Ratio	0.32	0.24	0.31	0.32	0.54	0.15

Intersection Summary

APPENDIX G

Conceptual Site Plan

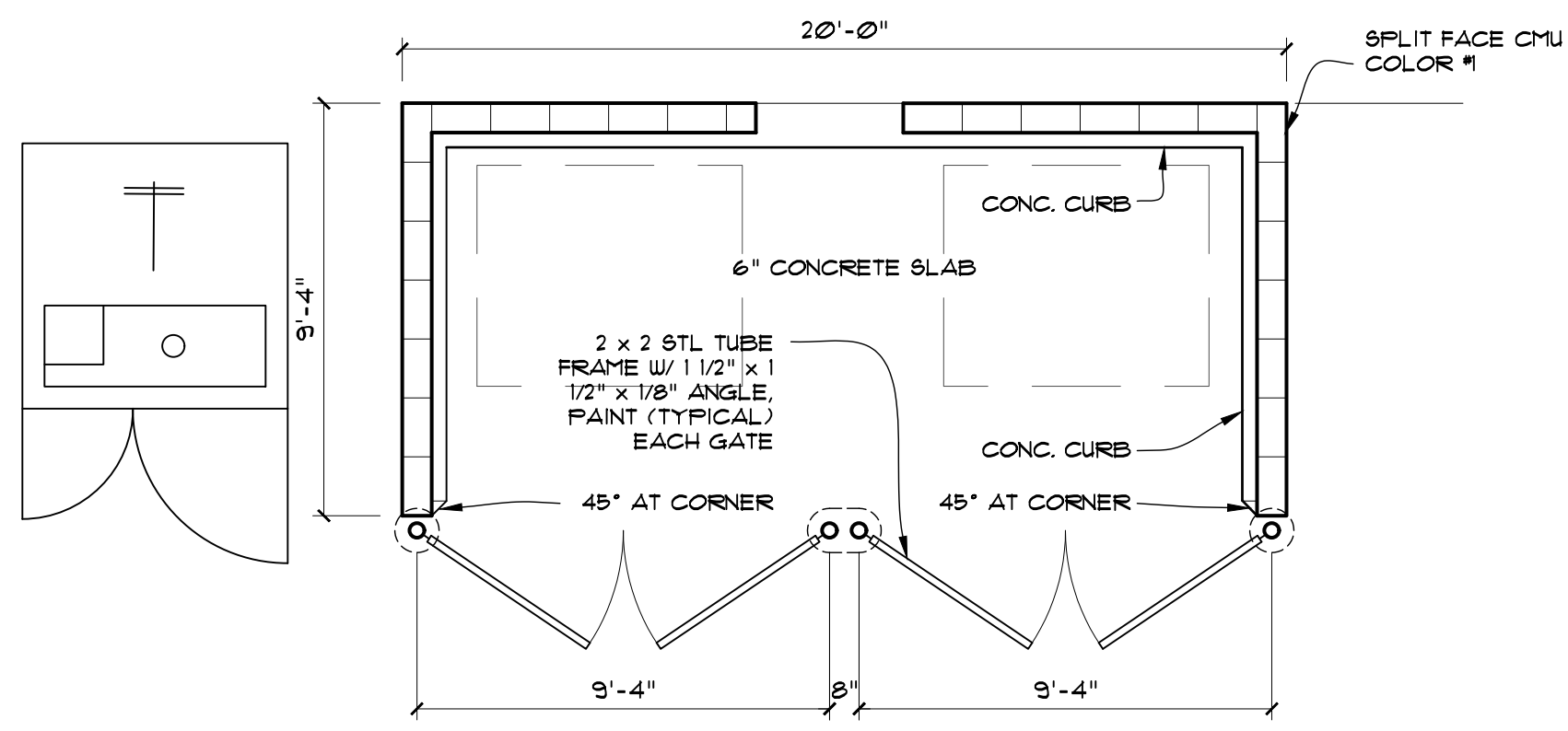

11 PLAN - TRASH ENCLOSURE
 A100 SCALE: 1/4" - 1'-0"

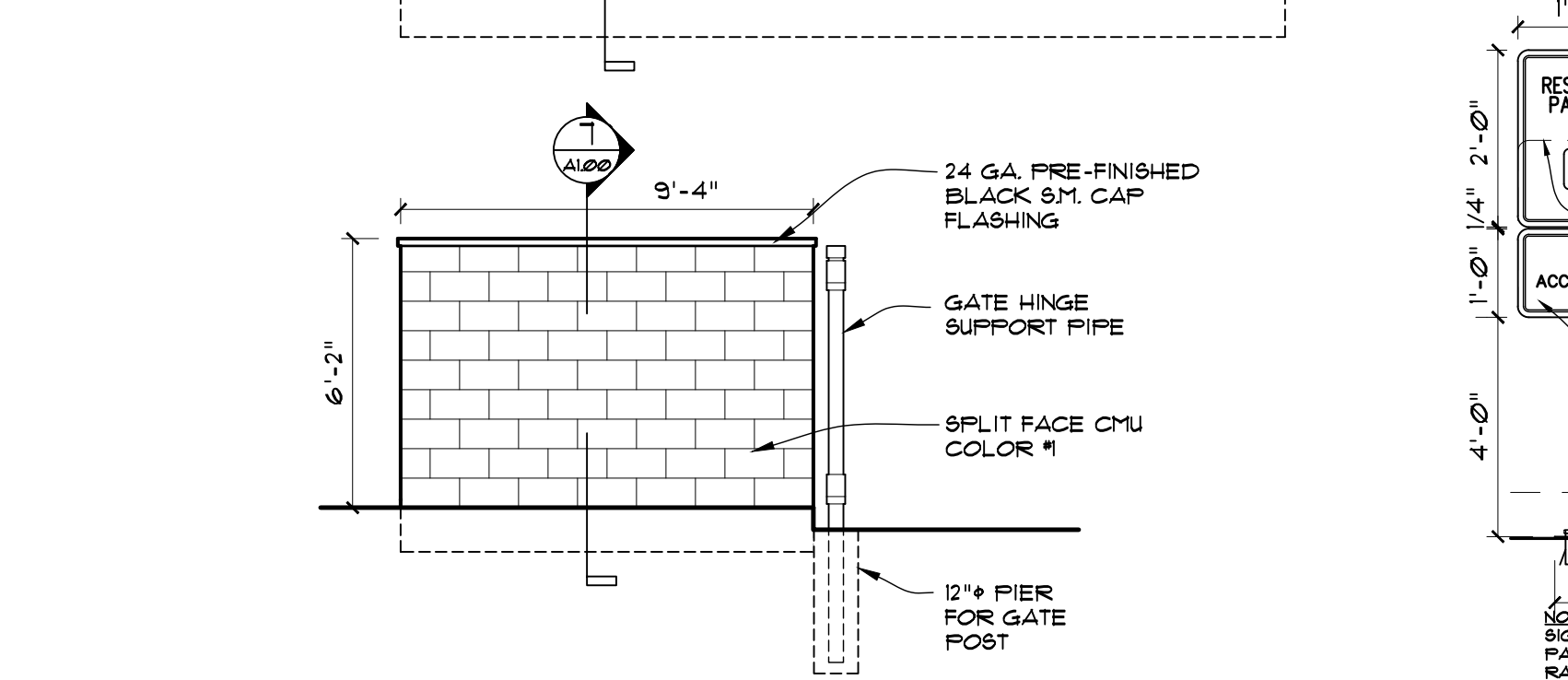
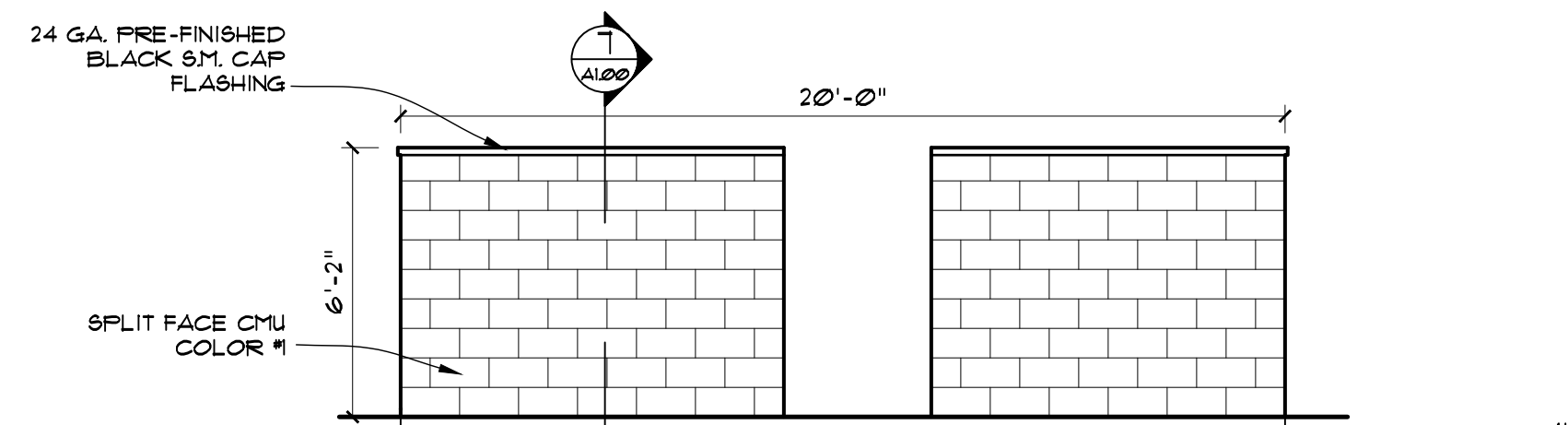
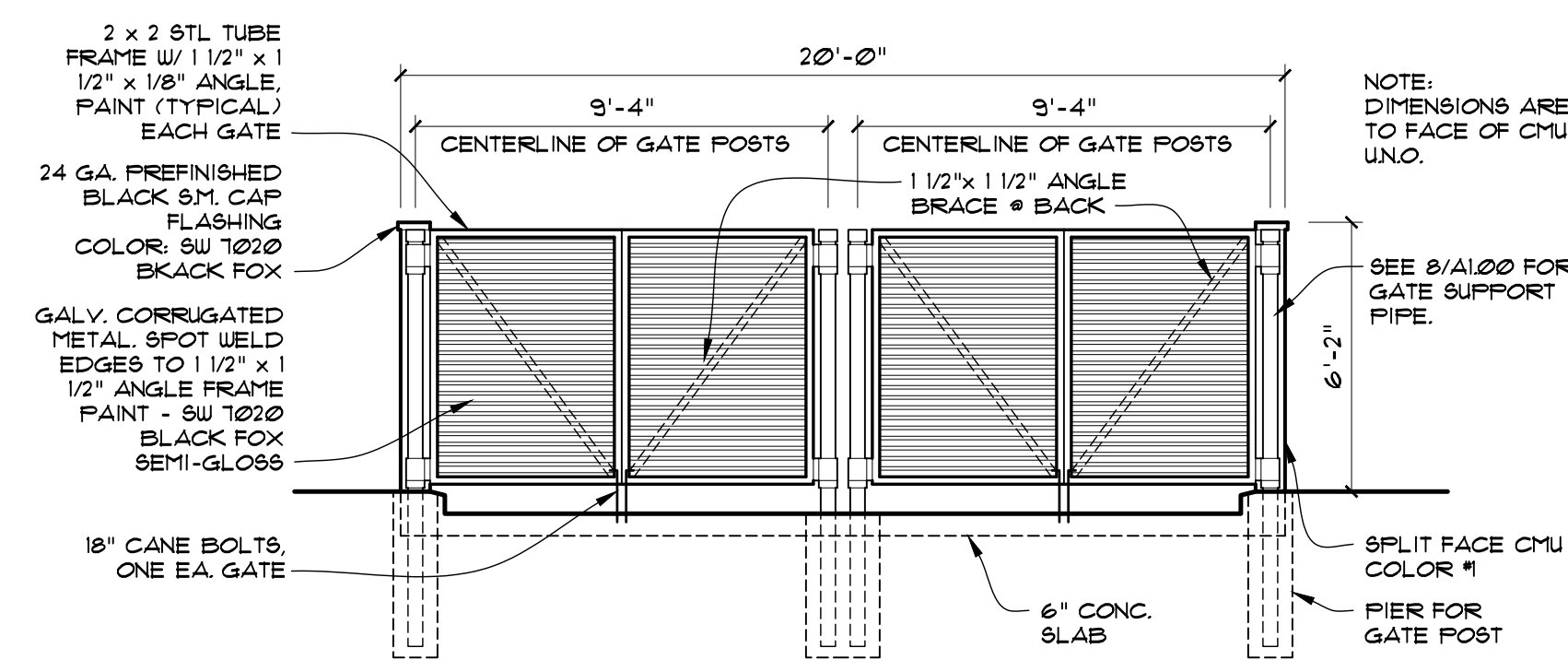

10 ELEVATION - TRASH ENCLOSURE
 A100 SCALE: 1/4" - 1'-0"

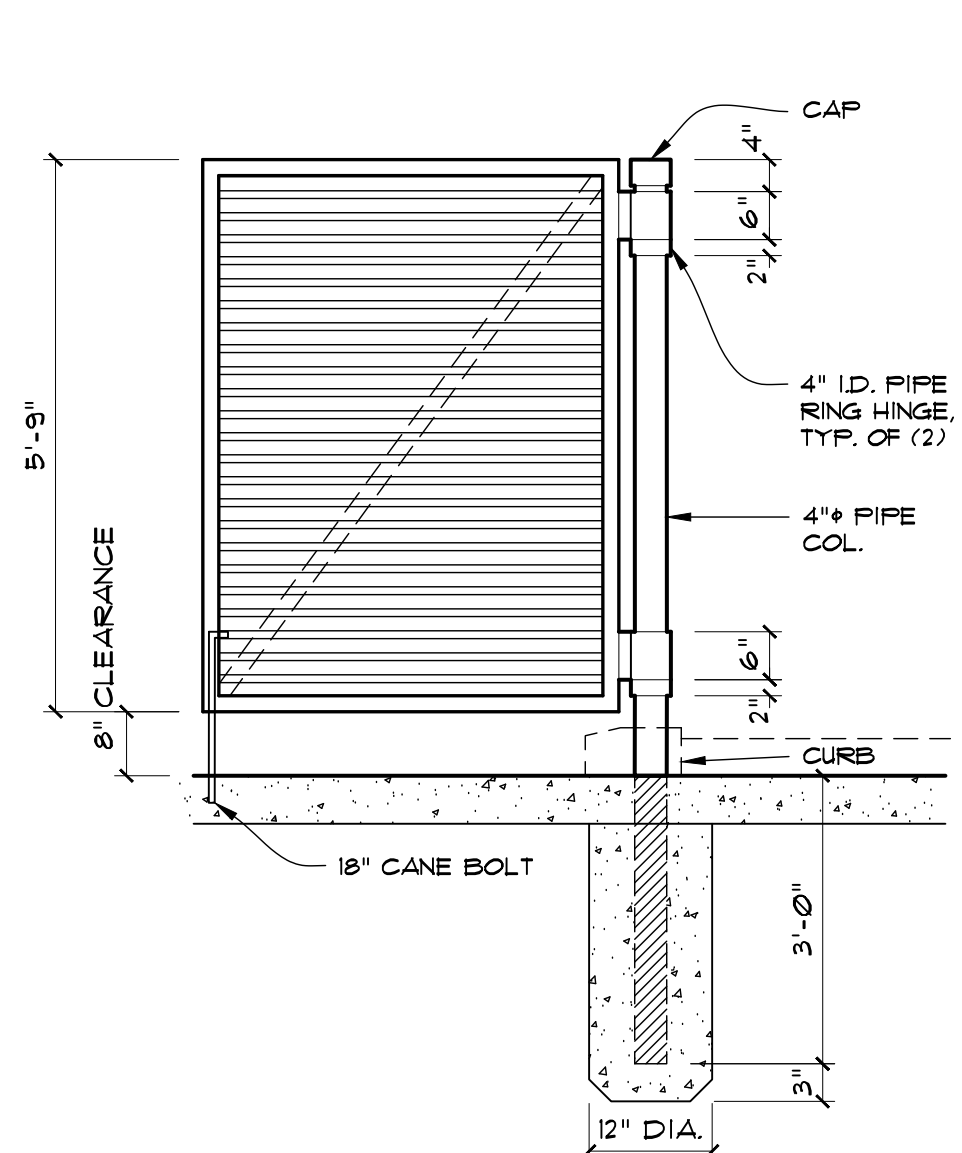

8 DETAIL - GATE
 A100 SCALE: 1/2" - 1'-0"

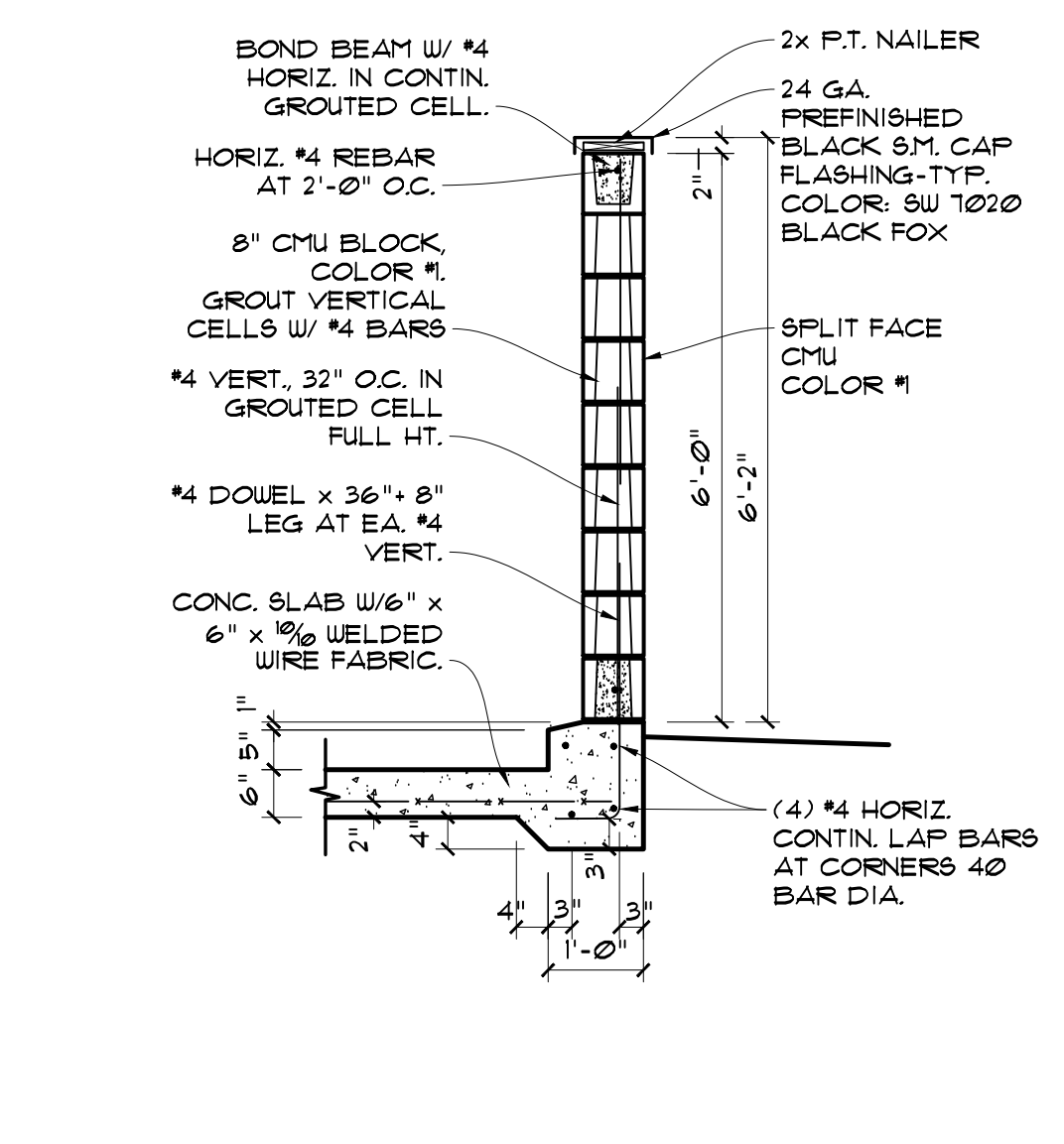

7 DETAIL - WALL
 A100 SCALE: 1/2" - 1'-0"

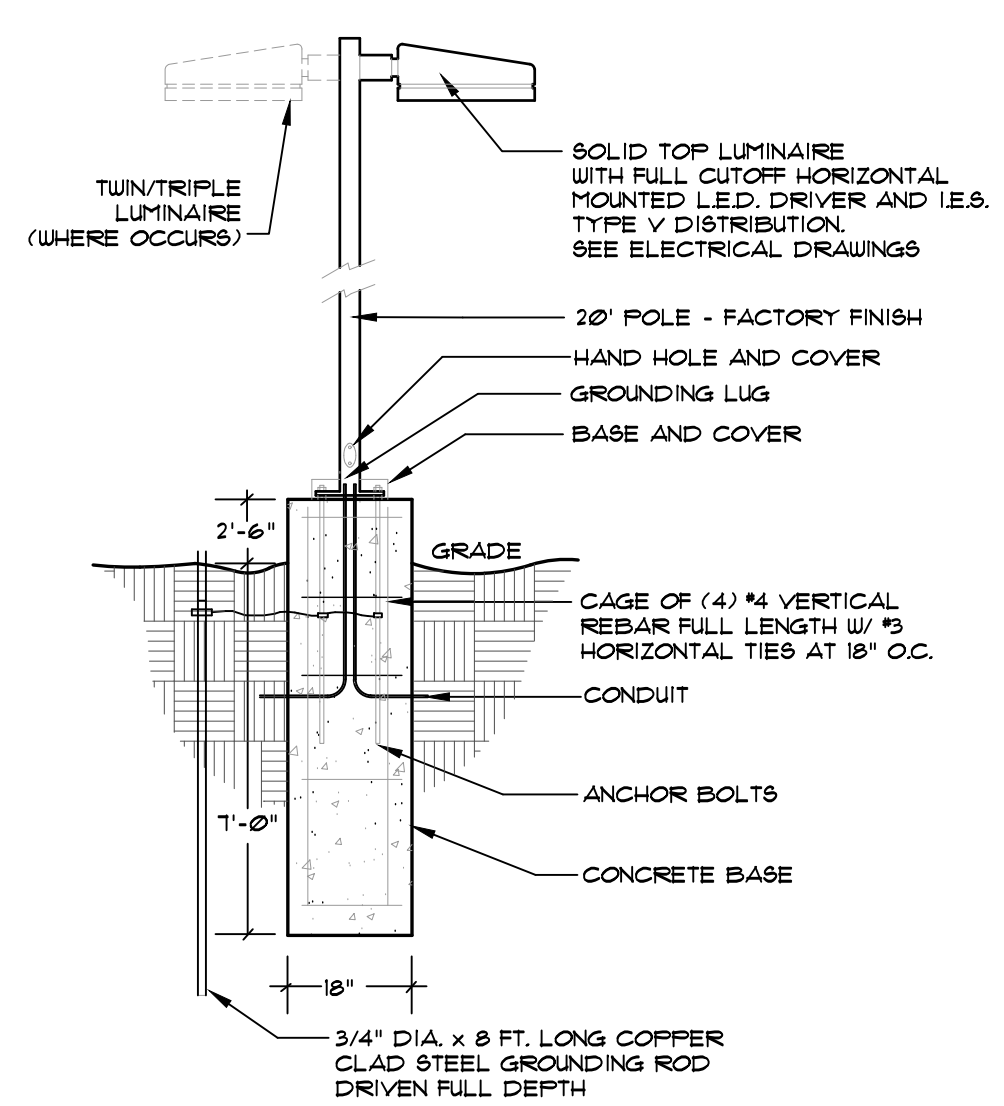

6 DETAIL - LIGHT POLE
 A100 SCALE: 1/4" - 1'-0"

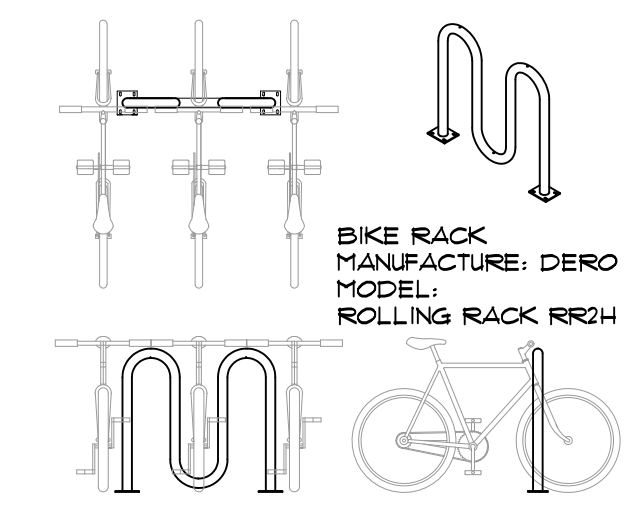

5 DETAIL - BIKE
 A100 SCALE: 1/4" - 1'-0"

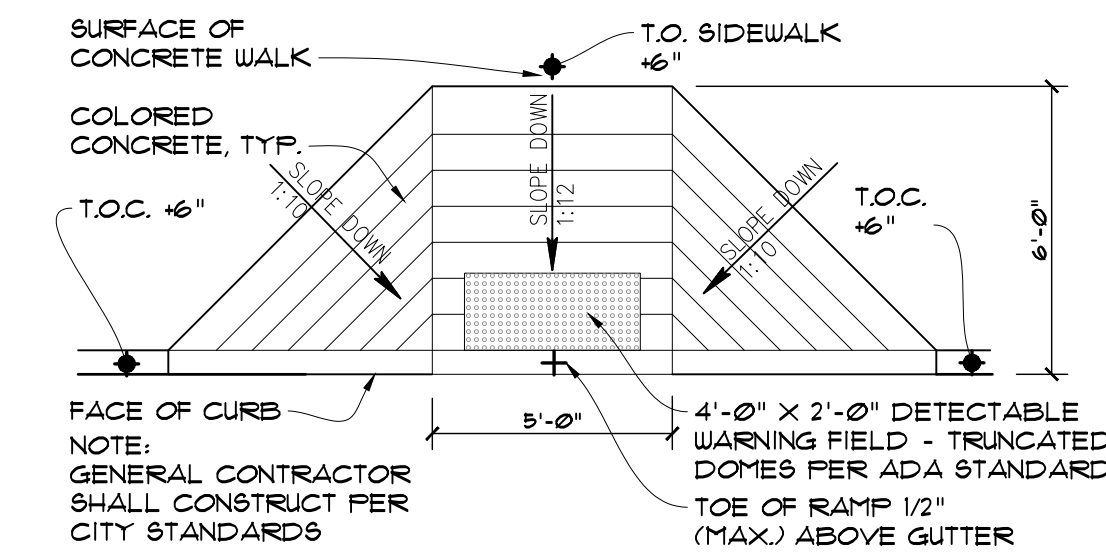

3 DETAIL - HC RAMP
 A100 SCALE: 1/4" - 1'-0"

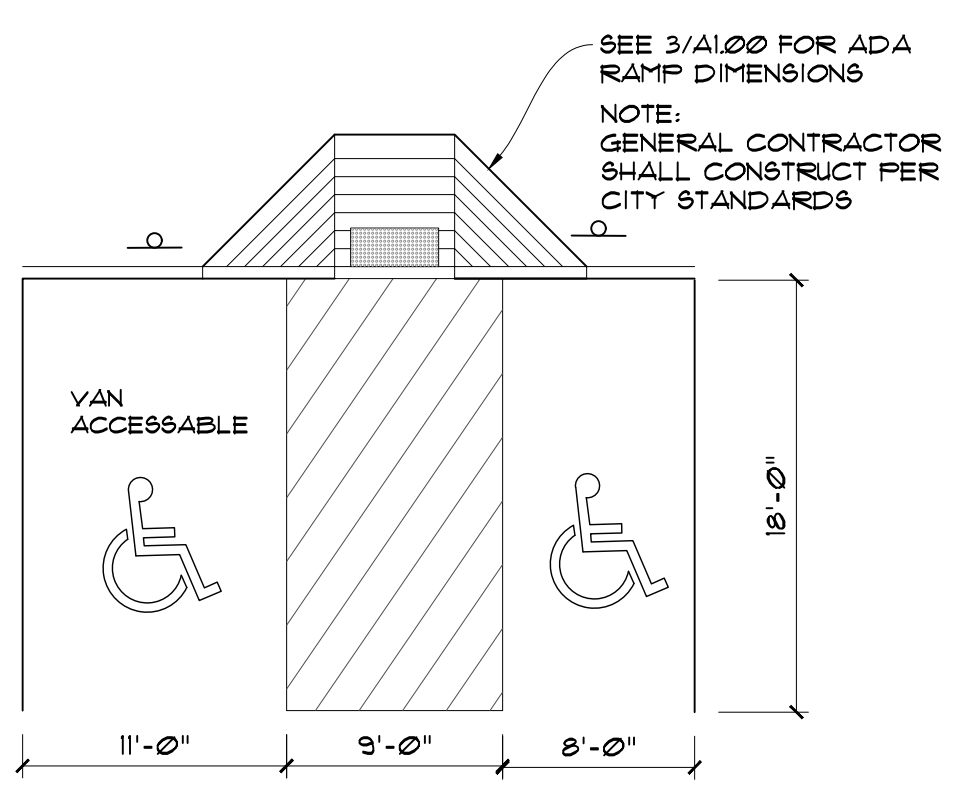

2 DETAIL - HC PARKING
 A100 SCALE: 1/4" - 1'-0"

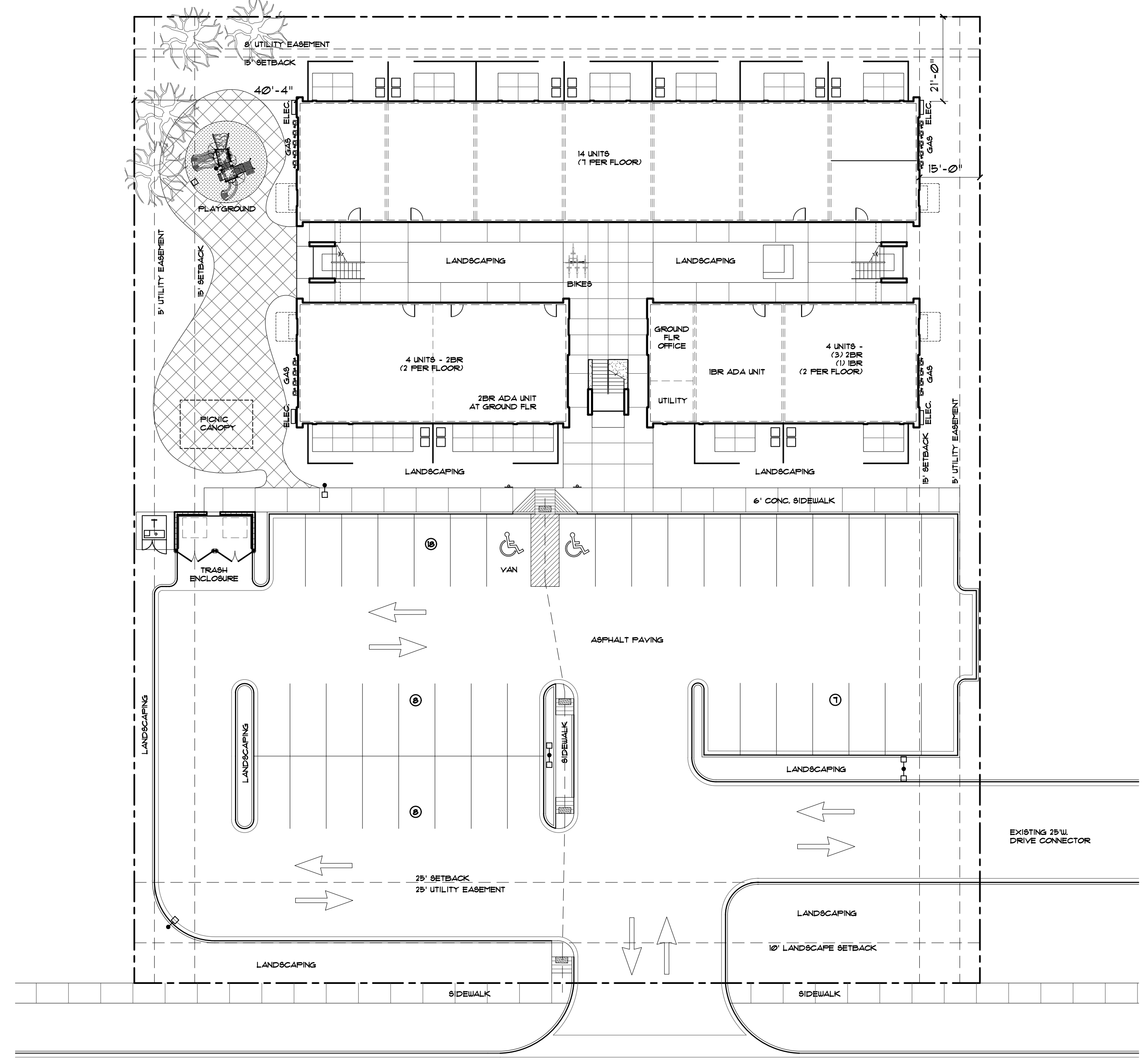

PARKING:

14 1BR UNITS X 1.5	= 21
8 2BR UNITS X 2	= 16
TOTAL PARKING REQ'D	= 37
TOTAL PARKING PROVIDE	= 41

1 PLAN - SITE PLAN
 A100 SCALE: 1" = 20'