

CRAWFORD AVE. MULTIFAMILY
PRELIMINARY LANDSCAPE
TRACT A OF FOUNTAIN VALLEY RANCH FILING NO. 6B
 SITUATED IN THE NORTHEAST QUARTER OF SECTION 13, TOWNSHIP 15 SOUTH, RANGE 66 WEST OF THE
 6TH P.M., CITY OF FOUNTAIN, COUNTY OF EL PASO, STATE OF COLORADO

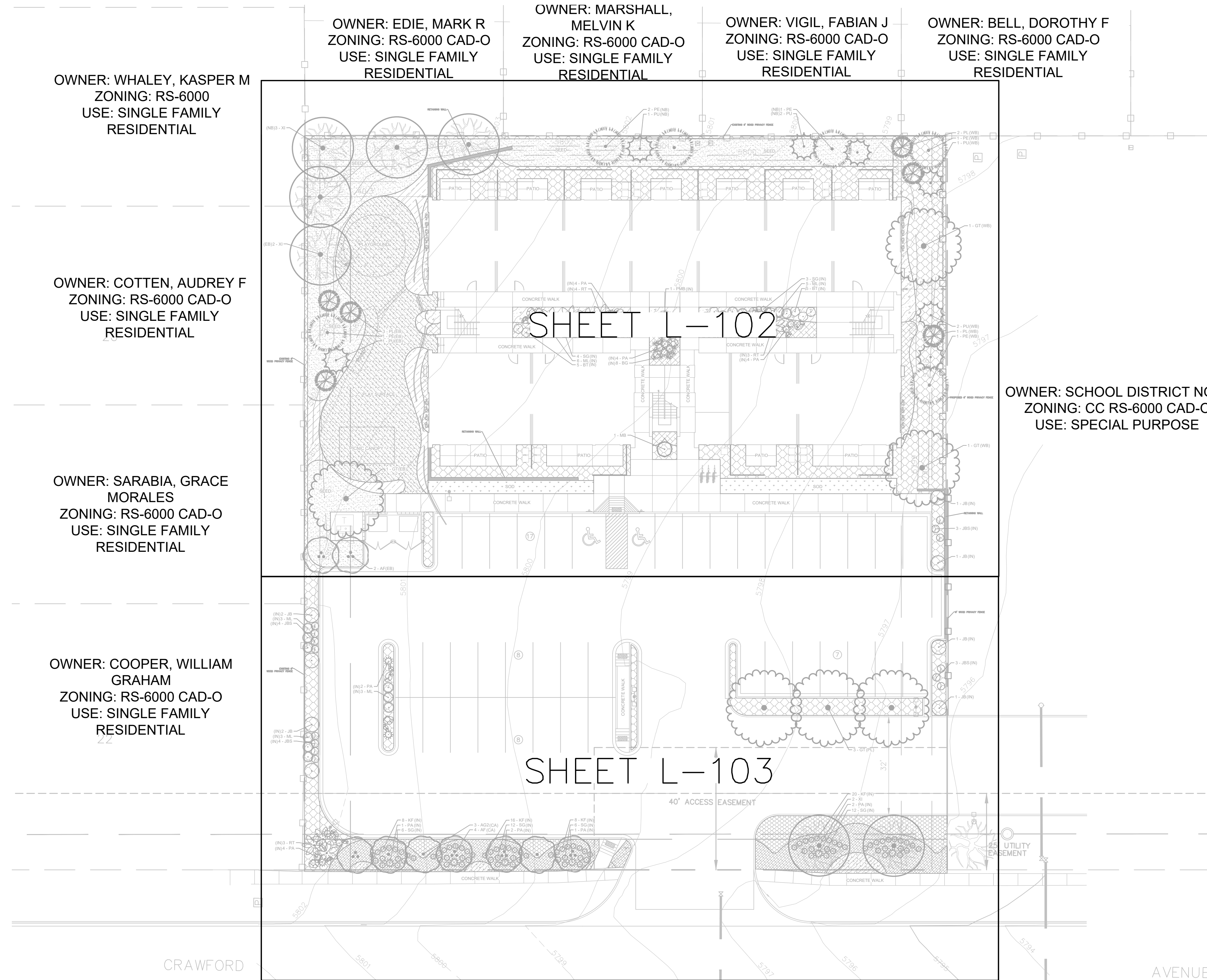

OWNER: WHALEY, KASPER M
 ZONING: RS-6000
 USE: SINGLE FAMILY
 RESIDENTIAL

OWNER: COTTEN, AUDREY F
 ZONING: RS-6000 CAD-O
 USE: SINGLE FAMILY
 RESIDENTIAL

OWNER: SARABIA, GRACE
 MORALES
 ZONING: RS-6000 CAD-O
 USE: SINGLE FAMILY
 RESIDENTIAL

OWNER: COOPER, WILLIAM
 GRAHAM
 ZONING: RS-6000 CAD-O
 USE: SINGLE FAMILY
 RESIDENTIAL

OWNER: EDIE, MARK R
 ZONING: RS-6000 CAD-O
 USE: SINGLE FAMILY
 RESIDENTIAL

OWNER: MARSHALL,
 MELVIN K
 ZONING: RS-6000 CAD-O
 USE: SINGLE FAMILY
 RESIDENTIAL

OWNER: VIGIL, FABIAN J
 ZONING: RS-6000 CAD-O
 USE: SINGLE FAMILY
 RESIDENTIAL

OWNER: BELL, DOROTHY F
 ZONING: RS-6000 CAD-O
 USE: SINGLE FAMILY
 RESIDENTIAL

OWNER: SCHOOL DISTRICT NO.
 ZONING: CC RS-6000 CAD-O
 USE: SPECIAL PURPOSE

OWNER: KEAS, BENJAMIN S
 ZONING: RS-6000 CAD-O
 USE: SINGLE FAMILY
 RESIDENTIAL

OWNER: ENDICOTT, LINCOLN M
 ZONING: RS-6000 CAD-O
 USE: SINGLE FAMILY
 RESIDENTIAL

OWNER: WIDFIELD FAMILY
 MEDICINE LLC
 ZONING: CC CAD-O
 USE: SPECIAL PURPOSE

K:\COO5_LAI196345000 - Crawford Ave Multifamily CADD\PlanSheets\DF Set\DP_LA.dwg Nov 17, 2022 11:13am

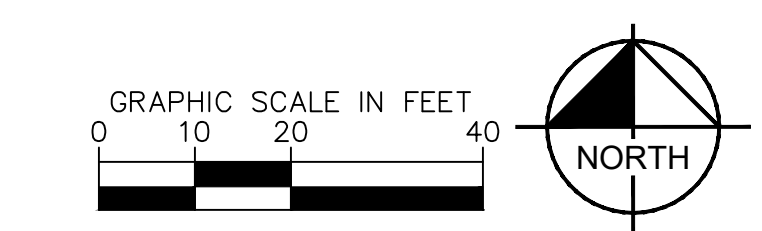

LANDSCAPE SHEET INDEX
 SHEET L-101 OF L-105

CRAWFORD AVE. MULTIFAMILY

PRELIMINARY LANDSCAPE

TRACT A OF FOUNTAIN VALLEY RANCH FILING NO. 6B

SITUATED IN THE NORTHEAST QUARTER OF SECTION 13, TOWNSHIP 15 SOUTH, RANGE 66 WEST OF THE
6TH P.M., CITY OF FOUNTAIN, COUNTY OF EL PASO, STATE OF COLORADO

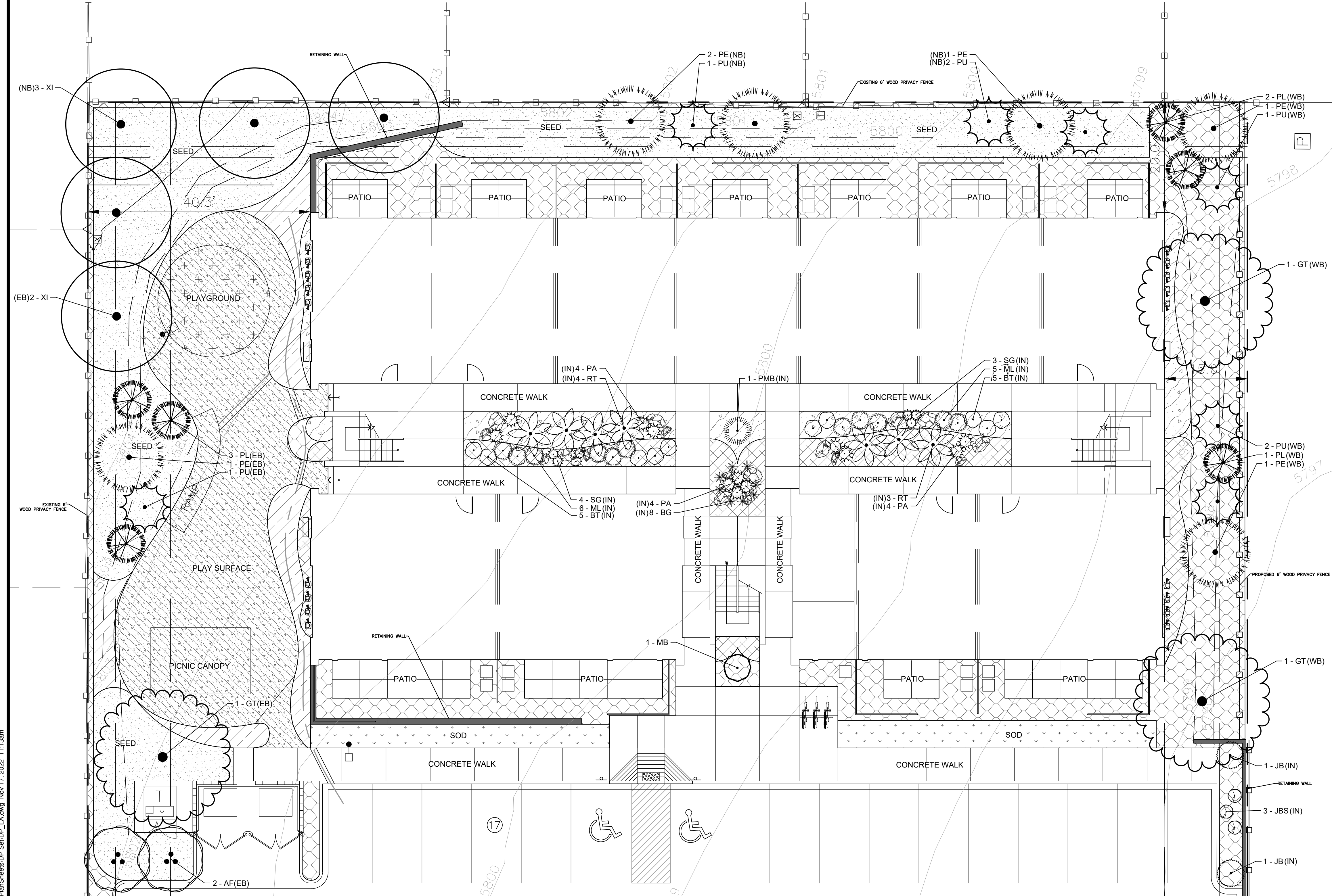

PLANT SCHEDULE

TREES	CODE	QTY	BOTANICAL / COMMON NAME
	XI	7	----- / EXISTING TREE TO REMAIN
DECIDUOUS TREES			
	AF	6	ACER GINNALA 'FLAME' / FLAME AMUR MAPLE
	AG2	3	AMELANCHIER X GRANDIFLORA 'AUTUMN BRILLIANCE' / AUTUMN BRILLIANCE APPLE SERVICEBERRY
	GT	6	GLEDITSIA TRIACANTHOS INERMIS 'SUNBURST' / SUNBURST HONEY LOCUST
	MB	1	MALUS X 'RED BARRON' / RED BARRON CRABAPPLE
EVERGREEN TREES			
	PE	6	PINUS EDULIS / PINON PINE
	PL	6	PINUS LEUCODERMIS 'SATELLIT' / SATELIT BOSNIAN PINE
	PU	7	PICEA PUNGENS 'BABY BLUE EYES' / BABY BLUE EYES COLORADO BLUE SPRUCE
DECIDUOUS SHRUBS			
	BT	10	BERBERIS THUNBERGII 'CHERRY BOMB' / RED LEAF JAPANESE BARBERRY
	PA	24	PEROVSKIA ABROTANOIDES / RUSSIAN SAGE
	RT	10	RHUS TYPHINA / STAGHORN SUMAC
	SG	43	SPIRAEA X BUMALDA 'GOLDFLAME' / GOLDFLAME SPIREA
EVERGREEN SHRUBS			
	JB	8	JUNIPERUS SABINA 'BROADMOOR' / BROADMOOR JUNIPER
	JBS	14	JUNIPERUS SQUAMATA 'BLUE STAR' / BLUE STAR JUNIPER
	PMB	1	PINUS MUGO 'BIG TUNA' / BIG TUNA MUGO PINE
GRASSES			
	BG	8	BOUTELOUA GRACILIS 'BLONDE AMBITION' / BLONDE AMBITION BLUE GRAMA
	KF	52	CALAMAGROSTIS X ACUTIFLORA / KARL FORESTER FEATHER REED GRASS
	ML	20	MUHLENBERGIA CAPILLARIS 'LENCA' / REGAL MIST® PINK MUHLY GRASS
GROUND COVERS			
	B2	506 SF	CRUSHER FINES / BREEZE
	FS	2,274 SF	PLAYGROUND GROUND MATERIAL / FALL SURFACE
	ROCK	2,130 SF	1-1/2" CIMARRON GRANITE / ROCK MULCH
	ROCK2	788 SF	1-1/2" REGAL ROSE / ROCK MULCH
	ROCK3	5,793 SF	1-1/2" SADDLEBACK SWIRL ROCK MULCH / ROCK MULCH SUBMIT SAMPLE FOR REVIEW AND APPROVAL PRIOR TO INSTALLATION.
	SEED2	3,360 SF	KENTUCKY BLUE GRASS MIX
	SEED3	521 SF	KENTUCKY BLUE GRASS SOD

MATCHLINE; SEE SHEET L-103

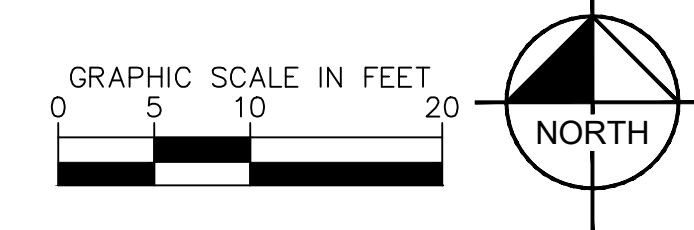

K:\COB_LAI196345000 - Crawford Ave Multifamily CADD\PlanSheets\DF Set\DP_LA.dwg Nov 17, 2022 11:13:38am

CRAWFORD AVE. MULTIFAMILY
PRELIMINARY LANDSCAPE
TRACT A OF FOUNTAIN VALLEY RANCH FILING NO. 6B
 SITUATED IN THE NORTHEAST QUARTER OF SECTION 13, TOWNSHIP 15 SOUTH, RANGE 66 WEST OF THE
 6TH P.M., CITY OF FOUNTAIN, COUNTY OF EL PASO, STATE OF COLORADO

MATCHLINE; SEE SHEET L-102

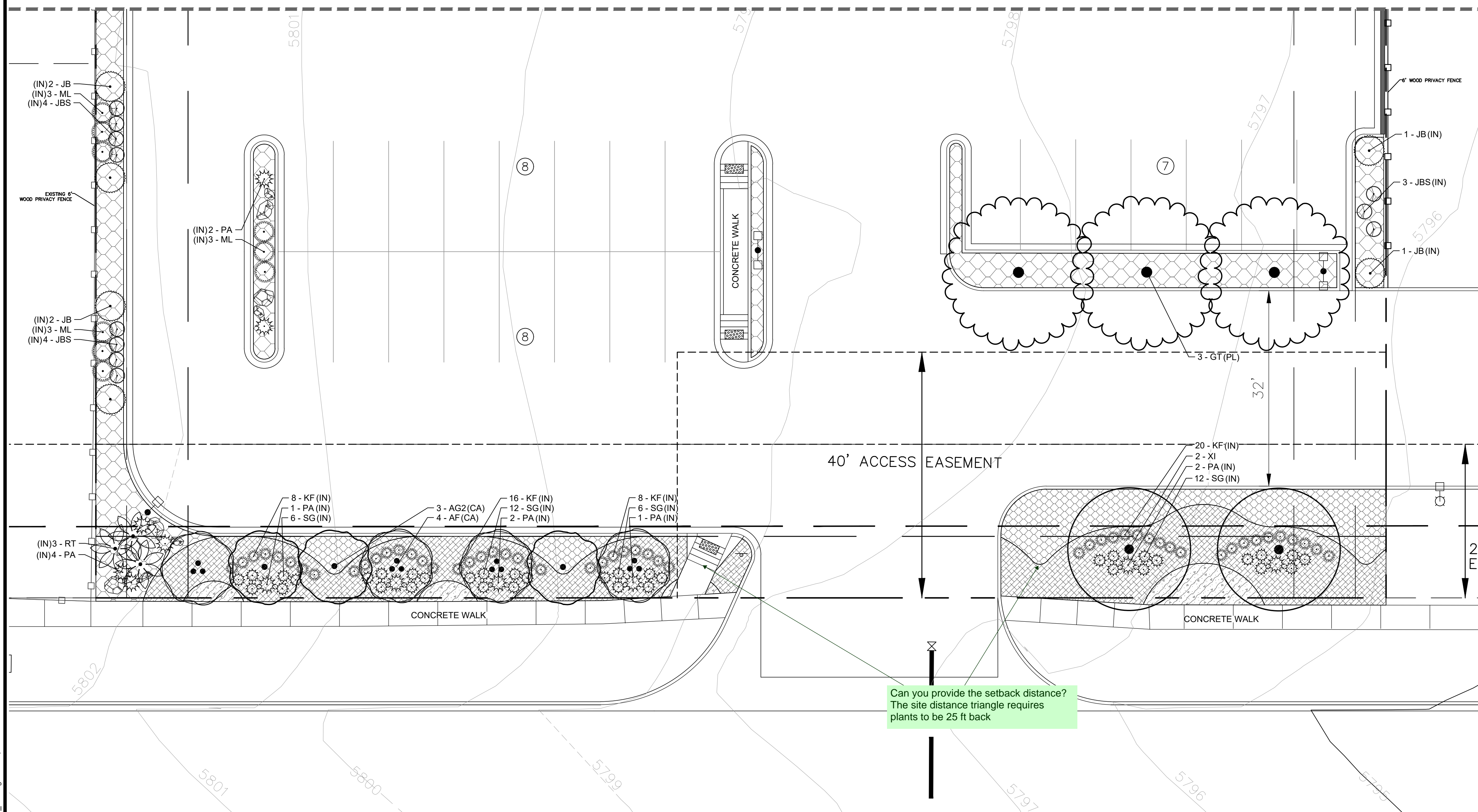

PLANT SCHEDULE			
TREES	CODE	QTY	BOTANICAL / COMMON NAME
	XI	7	----- / EXISTING TREE TO REMAIN
DECIDUOUS TREES	CODE	QTY	BOTANICAL / COMMON NAME
	AF	6	ACER GINNALA 'FLAME' / FLAME AMUR MAPLE
	AG2	3	AMELANCHIER X GRANDIFLORA 'AUTUMN BRILLIANCE' / AUTUMN BRILLIANCE APPLE SERVICEBERRY
	GT	6	GLEDITSIA TRIACANTHOS INERMIS 'SUNBURST' / SUNBURST HONEY LOCUST
	MB	1	MALLUS X 'RED BARRON' / RED BARRON CRABAPPLE
EVERGREEN TREES	CODE	QTY	BOTANICAL / COMMON NAME
	PE	6	PINUS EDULIS / PINON PINE
	PL	6	PINUS LEUCODERMIS 'SATELLIT' / SATELIT BOSNIAN PINE
	PU	7	PICEA PUNGENS 'BABY BLUE EYES' / BABY BLUE EYES COLORADO BLUE SPRUCE
DECIDUOUS SHRUBS	CODE	QTY	BOTANICAL / COMMON NAME
	BT	10	BERBERIS THUNBERGII 'CHERRY BOMB' / RED LEAF JAPANESE BARBERRY
	PA	24	PEROVSKIA ABROTANOIDES / RUSSIAN SAGE
	RT	10	RHUS TYPHINA / STAGHORN SUMAC
	SG	43	SPIRAEA X BUMALDA 'GOLDFLAME' / GOLDFLAME SPIREA
EVERGREEN SHRUBS	CODE	QTY	BOTANICAL / COMMON NAME
	JB	8	JUNIPERUS SABINA 'BROADMOOR' / BROADMOOR JUNIPER
	JBS	14	JUNIPERUS SQUAMATA 'BLUE STAR' / BLUE STAR JUNIPER
	PMB	1	PINUS MUGO 'BIG TUNA' / BIG TUNA MUGO PINE
GRASSES	CODE	QTY	BOTANICAL / COMMON NAME
	BG	8	BOUTELOUA GRACILIS 'BLONDE AMBITION' / BLONDE AMBITION BLUE GRAMA
	KF	52	CALAMAGROSTIS X ACUTIFLORA / KARL FORESTER FEATHER REED GRASS
	ML	20	MUHLENBERGIA CAPILLARIS 'LENCA' / REGAL MIST® PINK MUHLY GRASS
GROUND COVERS	CODE	QTY	BOTANICAL / COMMON NAME
	BZ	506 SF	CRUSHER FINES / BREEZE
	FS	2,274 SF	PLAYGROUND GROUND MATERIAL / FALL SURFACE
	ROCK	2,130 SF	1-1/2" CIMARRON GRANITE / ROCK MULCH
	ROCK2	788 SF	1-1/2" REGAL ROSE / ROCK MULCH
	ROCK3	5,793 SF	1-1/2" SADDLEBACK SWIRL ROCK MULCH / ROCK MULCH SUBMIT SAMPLE FOR REVIEW AND APPROVAL PRIOR TO INSTALLATION.
	SEED2	3,360 SF	KENTUCKY BLUE GRASS MIX
	SEED3	521 SF	KENTUCKY BLUE GRASS SOD

Can you provide the setback distance?
 The site distance triangle requires
 plants to be 25 ft back

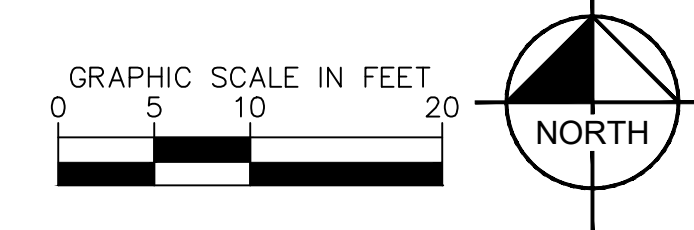

K:\COO5_LAI196345000 - Crawford Ave Multifamily CAD\DP\PlanSheets\DP_SerIDP_LA.dwg Nov 17, 2022 11:13:38am

CRAWFORD AVE. MULTIFAMILY PRELIMINARY LANDSCAPE TRACT A OF FOUNTAIN VALLEY RANCH FILING NO. 6B

SITUATED IN THE NORTHEAST QUARTER OF SECTION 13, TOWNSHIP 15 SOUTH, RANGE 66 WEST OF THE

GENERAL LANDSCAPE SPECIFICATIONS 6TH P.M., CITY OF FOUNTAIN, COUNTY OF EL PASO, STATE OF COLORADO

- A. SCOPE OF WORK**
- THE WORK CONSISTS OF: FURNISHING ALL LABOR, MATERIALS, EQUIPMENT, TOOLS, TRANSPORTATION, AND ANY OTHER APPURTENANCES NECESSARY FOR THE COMPLETION OF THIS PROJECT AS SHOWN ON THE DRAWINGS AND AS SPECIFIED HEREIN.
 - WORK SHALL INCLUDE MAINTENANCE AND WATERING OF ALL CONTRACT PLANTING AREAS UNTIL CERTIFICATION OF ACCEPTANCE BY THE OWNER.
- B. PROTECTION OF EXISTING STRUCTURES**
- ALL EXISTING BUILDINGS, WALKS, WALLS, PAVING, PIPING, OTHER SITE CONSTRUCTION ITEMS, AND PLANTING ALREADY COMPLETED OR ESTABLISHED AND DESIGNATED TO REMAIN SHALL BE PROTECTED FROM DAMAGE BY THE CONTRACTOR UNLESS OTHERWISE SPECIFIED. ALL DAMAGE RESULTING FROM NEGLIGENCE SHALL BE REPAIRED OR REPLACED TO THE SATISFACTION OF THE OWNER, AT NO COST TO THE OWNER.
 - THE CONTRACTOR SHALL BE RESPONSIBLE FOR MAINTAINING ALL NECESSARY BEST MANAGEMENT PRACTICES (BMP) DEVICES ACCORDING TO ALL REGULATORY AGENCY'S STANDARDS THROUGHOUT THE DURATION OF ALL CONSTRUCTION ACTIVITIES.
 - THE CONTRACTOR SHALL BE RESPONSIBLE FOR ANY MAINTENANCE OF TRAFFIC (MOT) THAT MAY BE REQUIRED FOR THE PROJECT.
 - THE CONTRACTOR SHALL BE RESPONSIBLE FOR LOCATING ALL UTILITIES, WHETHER PUBLIC OR PRIVATE, PRIOR TO EXCAVATION. THE OWNER AND DESIGN PROFESSIONAL SHALL NOT BE RESPONSIBLE FOR THE ACCURACY AND COMPLETENESS OF ANY SUCH INFORMATION OR DATA. THE CONTRACTOR SHALL HAVE FULL RESPONSIBILITY FOR: REVIEWING AND CHECKING ALL SUCH INFORMATION AND DATA; LOCATING ALL UNDERGROUND FACILITIES DURING CONSTRUCTION; THE SAFETY AND PROTECTION THEREOF; REPAIRING ANY DAMAGE THERETO RESULTING FROM THE WORK. THE COST OF ALL WILL BE CONSIDERED AS HAVING BEEN INCLUDED IN THE CONTRACT PRICE. THE CONTRACTOR SHALL NOTIFY ANY AFFECTED UTILITY COMPANIES OR AGENCIES IN WRITING AT LEAST 48 HOURS PRIOR TO BEGINNING CONSTRUCTION.
- C. PROTECTION OF EXISTING PLANT MATERIALS**
- THE CONTRACTOR SHALL BE RESPONSIBLE FOR ALL UNAUTHORIZED CUTTING OR DAMAGE TO TREES AND SHRUBS EXISTING OR OTHERWISE, CAUSED BY CARELESS EQUIPMENT OPERATION, MATERIAL STOCKPILING, ETC.. THIS SHALL INCLUDE COMPACTION BY DRIVING OR PARKING INSIDE THE DRIP-LINE AND SPILLING OIL, GASOLINE, OR OTHER DELETERIOUS MATERIALS WITHIN THE DRIP-LINE. NO MATERIALS SHALL BE BURNED ON SITE. EXISTING TREES KILLED OR DAMAGED SO THAT THEY ARE MISSHAPEN AND/OR UNUSABLE SHALL BE REPLACED AT THE COST TO THE CONTRACTOR OF FOUR HUNDRED DOLLARS (\$400) PER CALIPER INCH ON AN ESCALATING SCALE WHICH ADDS AN ADDITIONAL TWENTY (20) PERCENT PER INCH OVER FOUR (4) INCHES CALIPER AS FIXED AND AGREED LIQUIDATED DAMAGES. CALIPER SHALL BE MEASURED SIX (6) INCHES ABOVE GROUND LEVEL FOR TREES UP TO AND INCLUDING FOUR (4) INCHES IN CALIPER AND TWELVE (12) INCHES ABOVE GROUND LEVEL FOR TREES OVER FOUR (4) INCHES IN CALIPER.
 - SEE TREE MITIGATION PLAN AND NOTES, IF APPLICABLE.
- D. MATERIALS**
- GENERAL**
MATERIAL SAMPLES LISTED BELOW SHALL BE SUBMITTED FOR APPROVAL, ON SITE OR AS DETERMINED BY THE OWNER. UPON APPROVAL, DELIVERY OF MATERIALS MAY COMMENCE.

MATERIAL	SAMPLE SIZE
MULCH	ONE (1) CUBIC FOOT
TOPSOIL MIX	ONE (1) CUBIC FOOT
PLANTS	ONE (1) OF EACH VARIETY (OR TAGGED IN NURSERY)
 - PLANT MATERIALS**
a. FURNISH NURSERY-GROWN PLANTS TRUE TO GENUS, SPECIES, VARIETY, CULTIVAR, STEM FORM, SHEARING, AND OTHER FEATURES INDICATED IN PLANT SCHEDULE SHOWN ON DRAWINGS AND COMPLYING WITH ANSI Z60.1 AND THE COLORADO NURSERY ACT; AND WITH HEALTHY ROOT SYSTEMS DEVELOPED BY TRANSPLANTING OR ROOT PRUNING. PROVIDE WELL-SHAPED, FULLY BRANCHED, HEALTHY, VIGOROUS STOCK, DENSELY FOLIATED WHEN IN LEAF AND FREE OF DISEASE, PESTS, EGGS, LARVAE, AND DEFECTS SUCH AS KNOTS, SUN SCALD, INJURIES, ABRASIONS, AND DISFIGUREMENT.
b. TREES FOR PLANTING IN ROWS SHALL BE UNIFORM IN SIZE AND SHAPE.
c. NO SUBSTITUTIONS SHALL BE MADE WITHOUT WRITTEN PERMISSION FROM THE PROJECT LANDSCAPE ARCHITECT. ANY ROW TREES MUST BE APPROVED BY OFFICE OF THE CITY FORESTER.
d. PROVIDE PLANTS OF SIZES, GRADES, AND BALL OR CONTAINER SIZES COMPLYING WITH ANSI Z60.1 AND COLORADO NURSERY ACT FOR TYPES AND FORM OF PLANTS REQUIRED. PLANTS OF A LARGER SIZE MAY BE USED IF ACCEPTABLE TO PROJECT LANDSCAPE ARCHITECT WITH A PROPORTIONATE INCREASE IN SIZE OF ROOTS OR BALLS.
e. PLANTS SHALL BE SUBJECT TO INSPECTION AND APPROVAL AT THE PLACE OF GROWTH, OR UPON DELIVERY TO THE SITE, AS DETERMINED BY THE OWNER, FOR QUALITY, SIZE, AND VARIETY. SUCH APPROVAL SHALL NOT IMPAIR THE RIGHT OF INSPECTION AND REJECTION AT THE SITE DURING PROGRESS OF THE WORK OR AFTER COMPLETION FOR SIZE AND CONDITION OF ROOT BALLS OR ROOTS, LATENT DEFECTS OR INJURIES. REJECTED PLANTS SHALL BE REMOVED IMMEDIATELY FROM THE SITE. NOTICE REQUESTING INSPECTION SHALL BE SUBMITTED IN WRITING BY THE CONTRACTOR AT LEAST ONE (1) WEEK PRIOR TO ANTICIPATED DATE.
f. TREES WITH DAMAGED, CROOKED, OR MULTIPLE LEADERS; TIGHT VERTICAL BRANCHES WHERE BARK IS SQUEEZED BETWEEN TWO BRANCHES OR BETWEEN BRANCH AND TRUNK ("INCLUDED BARK"); CROSSING TRUNKS; CUT-OFF LIMBS MORE THAN 1/2 INCH (19 MM) IN DIAMETER; OR WITH STEM GIRDLING ROOTS WILL BE REJECTED.
g. FURNISH TREES AND SHRUBS WITH ROOTS BALLS MEASURED FROM TOP OF ROOT BALL, WHICH SHALL BEGIN AT ROOT FLARE ACCORDING TO ANSI Z60.1 AND COLORADO NURSERY ACT. ROOT FLARE SHALL BE VISIBLE BEFORE PLANTING.
h. LABEL AT LEAST ONE PLANT OF EACH VARIETY, SIZE, AND CALIPER WITH A SECURELY ATTACHED, WATERPROOF TAG BEARING LEGIBLE DESIGNATION OF COMMON NAME AND FULL SCIENTIFIC NAME, INCLUDING GENUS AND SPECIES, INCLUDE NOMENCLATURE FOR HYBRID, VARIETY, OR CULTIVAR, IF APPLICABLE FOR THE PLANT AS SHOWN ON DRAWINGS.
i. IF FORMAL ARRANGEMENTS OR CONSECUTIVE ORDER OF PLANTS IS SHOWN ON DRAWINGS, SELECT STOCK FOR UNIFORM HEIGHT AND SPREAD, AND NUMBER THE LABELS TO ASSURE SYMMETRY IN PLANTING.
- E. SOIL MIXTURE**
- CONTRACTOR SHALL TEST EXISTING SOIL AND AMEND AS NECESSARY IN ACCORDANCE WITH THE GUIDELINES BELOW:
 - SOIL MIXTURE SHALL CONSIST OF TWO PARTS OF TOPSOIL AND ONE PART SAND, AS DESCRIBED BELOW. CONTRACTOR TO SUBMIT SAMPLES AND PH TESTING RESULTS OF SOIL MIXTURE FOR OWNER'S REPRESENTATIVE APPROVAL PRIOR TO PLANT INSTALLATION OPERATIONS COMMENCE.
a. TOPSOIL FOR USE IN PREPARING SOIL MIXTURE FOR BACKFILLING PLANT OPENINGS SHALL BE FERTILE, FRIABLE, AND OF A LOAMY CHARACTER; REASONABLY FREE OF SUBSOIL, CLAY LUMPS, BRUSH WEEDS AND OTHER LITTER; FREE OF ROOTS, STUMPS, STONES LARGER THAN 2" IN ANY DIRECTION, AND OTHER EXTRANEOUS OR TOXIC MATTER HARMFUL TO PLANT GROWTH. IT SHALL CONTAIN THREE (3) TO FIVE (5) PERCENT DECOMPOSED ORGANIC MATTER, HAVE A PH BETWEEN 5.5 AND 8.0, AND SOLUBLE SALTS LESS THAN 3.0 MMHOS/CM. SUBMIT SOIL SAMPLE AND PH TESTING RESULTS FOR APPROVAL.
b. SAND SHALL BE COARSE, CLEAN, WELL-DRAINING, NATIVE SAND.
 - TREES SHALL BE PLANTED IN THE EXISTING NATIVE SOIL ON SITE, UNLESS DETERMINED TO BE UNSUITABLE - AT WHICH POINT THE CONTRACTOR SHALL CONTACT THE PROJECT LANDSCAPE ARCHITECT TO DISCUSS ALTERNATE RECOMMENDATION PRIOR TO PLANTING.
- F. WATER**
- WATER NECESSARY FOR PLANTING AND MAINTENANCE SHALL BE OF SATISFACTORY QUALITY TO SUSTAIN ADEQUATE PLANT GROWTH AND SHALL NOT CONTAIN HARMFUL, NATURAL OR MAN-MADE ELEMENTS DETRIMENTAL TO PLANTS. WATER MEETING THE ABOVE STANDARD SHALL BE OBTAINED ON THE SITE FROM THE OWNER, IF AVAILABLE, AND THE CONTRACTOR SHALL BE RESPONSIBLE TO MAKE ARRANGEMENTS FOR ITS USE BY HIS TANKS, HOSES, SPRINKLERS, ETC.. IF SUCH WATER IS NOT AVAILABLE AT THE SITE, THE CONTRACTOR SHALL PROVIDE SATISFACTORY WATER FROM SOURCES OFF THE SITE AT NO ADDITIONAL COST TO THE OWNER.
* WATERING/IRRIGATION RESTRICTIONS MAY APPLY - REFER TO PROPERTY'S JURISDICTIONAL AUTHORITY.
- G. FERTILIZER**
- CONTRACTOR SHALL PROVIDE FERTILIZER APPLICATION SCHEDULE TO OWNER, AS APPLICABLE TO SOIL TYPE, PLANT INSTALLATION TYPE, AND SITE'S PROPOSED USE. SUGGESTED FERTILIZER TYPES SHALL BE ORGANIC OR OTHERWISE NATURALLY-DERIVED.
* FERTILIZER RESTRICTIONS MAY APPLY - REFER TO PROPERTY'S JURISDICTIONAL AUTHORITY.
- H. MULCH**
- MULCH MATERIAL SHALL BE MOISTENED AT THE TIME OF APPLICATION TO PREVENT WIND DISPLACEMENT, AND APPLIED AT A DEPTH OF THREE (3) INCHES CLEAR MULCH FROM EACH PLANT'S CROWN (BASE) OR AS SHOWN IN PLANTING DETAILS. MULCH SHALL BE DOUBLE SHREDDED HARDWOOD MULCH. DYED MULCH IS NOT ACCEPTABLE. SUBMIT SAMPLES TO PROJECT LANDSCAPE ARCHITECT FOR APPROVAL. MULCH SHALL BE PROVIDED OVER THE ENTIRE AREA OF EACH SHRUB BED, GROUND COVER, VINE BED, AND TREE RING (6" MINIMUM) PLANTED UNDER THIS CONTRACT, AS WELL AS FOR ANY EXISTING LANDSCAPE AREAS AS SHOWN ON PLANS.
- I. DIGGING AND HANDLING**
- ALL TREES SPECIFIED SHALL BE BALLED AND BURLAPPED (B&B) UNLESS OTHERWISE APPROVED BY PROJECT LANDSCAPE ARCHITECT.
 - PROTECT ROOTS OR ROOT BALLS OF PLANTS AT ALL TIMES FROM SUN, DRYING WINDS, WATER AND FREEZING, AS NECESSARY UNTIL PLANTING. PLANT MATERIALS SHALL BE ADEQUATELY PACKED TO PREVENT DAMAGE DURING TRANSIT. TREES TRANSPORTED MORE THAN TEN (10) MILES OR WHICH ARE NOT PLANTED WITHIN THREE (3) DAYS OF DELIVERY TO THE SITE SHALL BE SPRAYED WITH AN ANTITRANSPIRANT PRODUCT ("WILT-PRO" OR EQUAL) TO MINIMIZE TRANSPIRATIONAL WATER LOSS.
 - B&B AND FIELD GROWN (FG) PLANTS SHALL BE DUG WITH FIRM, NATURAL BALLS OF SOIL OF SUFFICIENT SIZE TO ENCOMPASS THE FIBROUS AND FEEDING ROOTS OF THE PLANTS. NO PLANTS MOVED WITH A ROOT BALL SHALL BE PLANTED IF THE BALL IS CRACKED OR BROKEN. PLANTS SHALL NOT BE HANDLED BY STEMS.
- J. CONTAINER GROWN STOCK**
- ALL CONTAINER GROWN MATERIAL SHALL BE HEALTHY, VIGOROUS, WELL-ROOTED PLANTS ESTABLISHED IN THE CONTAINER IN WHICH THEY ARE SOLD. THE PLANTS SHALL HAVE TOPS WHICH ARE OF GOOD QUALITY AND ARE IN A HEALTHY GROWING CONDITION.
 - AN ESTABLISHED CONTAINER GROWN PLANT SHALL BE TRANSPLANTED INTO A CONTAINER AND GROWN IN THAT CONTAINER SUFFICIENTLY LONG ENOUGH FOR THE NEW FIBROUS ROOTS TO HAVE DEVELOPED SO THAT THE ROOT MASS WILL RETAIN ITS SHAPE AND HOLD TOGETHER WHEN REMOVED FROM THE CONTAINER. CONTAINER GROWN STOCK SHALL NOT BE HANDLED BY THEIR STEMS.
 - ROOT BOUND PLANTS ARE NOT ACCEPTABLE AND WILL BE REJECTED.
- K. MATERIALS LIST**
- QUANTITIES NECESSARY TO COMPLETE THE WORK ON THE DRAWINGS SHALL BE FURNISHED BY THE CONTRACTOR. QUANTITY ESTIMATES HAVE BEEN MADE CAREFULLY, BUT THE LANDSCAPE ARCHITECT OR OWNER ASSUMES NO LIABILITY FOR OMISSIONS OR ERRORS. SHOULD A DISCREPANCY OCCUR BETWEEN THE PLANS AND THE PLANT LIST QUANTITY, THE PLANS SHALL GOVERN. ALL DIMENSIONS AND/OR SIZES SPECIFIED SHALL BE THE MINIMUM ACCEPTABLE SIZE.
- L. FINE GRADING**
- FINE GRADING UNDER THIS CONTRACT SHALL CONSIST OF FINAL FINISHED GRADING OF LAWN AND PLANTING AREAS THAT HAVE BEEN DISTURBED DURING CONSTRUCTION.
 - THE CONTRACTOR SHALL FINE GRADE THE LAWN AND PLANTING AREAS TO BRING THE ROUGH GRADE UP TO FINAL FINISHED GRADE ALLOWING FOR THICKNESS OF SOD AND/OR MULCH DEPTH.
 - ALL PLANTING AREAS SHALL BE GRADED AND MAINTAINED FOR POSITIVE DRAINAGE TO SURFACE/SUBSURFACE STORM DRAIN SYSTEMS. AREAS ADJACENT TO BUILDINGS SHALL SLOPE AWAY FROM THE BUILDINGS, REFER TO CIVIL ENGINEER'S PLANS FOR FINAL GRADES, IF APPLICABLE.
- M. PLANTING PROCEDURES**
- THE CONTRACTOR SHALL CLEAN WORK AND SURROUNDING AREAS OF ALL RUBBISH OR OBJECTIBLE MATTER DAILY. ALL MORTAR, CEMENT, BUILDING MATERIALS, AND TOXIC MATERIAL SHALL BE COMPLETELY REMOVED FROM PLANTING AREAS. THESE MATERIALS SHALL NOT BE MIXED WITH THE SOIL. SHOULD THE CONTRACTOR FIND SUCH SOIL CONDITIONS IN PLANTING AREAS WHICH WILL ADVERSELY AFFECT THE PLANT GROWTH, THE CONTRACTOR SHALL IMMEDIATELY CALL IT TO THE ATTENTION OF THE OWNER'S REPRESENTATIVE. FAILURE TO DO SO BEFORE PLANTING SHALL MAKE THE CORRECTIVE MEASURES THE RESPONSIBILITY OF THE CONTRACTOR.
 - VERIFY LOCATIONS OF ALL UTILITIES, CONDUITS, SUPPLY LINES AND CABLES, INCLUDING BUT NOT LIMITED TO: ELECTRIC, GAS (LINES AND TANKS), WATER, SANITARY SEWER, STORMWATER SYSTEMS, CABLE, AND TELEPHONE. PROPERLY MAINTAIN AND PROTECT EXISTING UTILITIES. CALL COLORADO (811) TO LOCATE UTILITIES AT LEAST 48 HOURS PRIOR TO CONSTRUCTION.
 - CONTRACTOR IS RESPONSIBLE TO REMOVE ALL EXISTING AND IMPORTED LIMEROCK AND LIMEROCK SUB-BASE FROM ALL PLANTING AREAS TO A MINIMUM DEPTH OF 36" OR TO NATIVE SOIL. CONTRACTOR IS RESPONSIBLE TO BACKFILL THESE PLANTING AREAS TO ROUGH FINISHED GRADE WITH CLEAN TOPSOIL FROM AN ON-SITE SOURCE OR AN IMPORTED SOURCE. IF LIMEROCK OR OTHER ADVERSE CONDITIONS OCCUR IN PLANTED AREAS AFTER 36" DEEP EXCAVATION BY THE CONTRACTOR, AND POSITIVE DRAINAGE CAN NOT BE ACHIEVED, CONTRACTOR SHALL UTILIZE POOR DRAINAGE CONDITION PLANTING DETAIL.
 - FURNISH NURSERY'S CERTIFICATE OF COMPLIANCE WITH ALL REQUIREMENTS AS SPECIFIED HEREIN. INSPECT AND SELECT PLANT MATERIALS BEFORE PLANTS ARE DUG AT NURSERY OR GROWING SITE.
 - COMPLY WITH APPLICABLE FEDERAL, STATE, COUNTY, AND LOCAL REGULATIONS GOVERNING LANDSCAPE MATERIALS AND WORK. UPON ARRIVAL AT THE SITE, PLANTS SHALL BE THOROUGHLY WATERED AND PROPERLY MAINTAINED UNTIL PLANTED. PLANTS STORED ON-SITE SHALL NOT REMAIN UNPLANTED OR APPROPRIATELY HEATED IN FOR A PERIOD EXCEEDING TWENTY-FOUR (24) HOURS. AT ALL TIMES WORKMANLIKE METHODS CUSTOMARY IN ACCEPTED HORTICULTURAL PRACTICES AS USED IN THE TRADE SHALL BE EXERCISED.
 - WORK SHALL BE COORDINATED WITH OTHER TRADES TO PREVENT CONFLICTS. COORDINATE PLANTING WITH IRRIGATION WORK TO ASSURE AVAILABILITY OF WATER AND PROPER LOCATION OF IRRIGATION APPURTENANCES AND PLANTS.
 - ALL PLANTING OPENINGS SHALL BE EXCAVATED TO SIZE AND DEPTH IN ACCORDANCE WITH ANSI Z60.1-2014 AMERICAN STANDARD FOR NURSERY STOCK.
 - TEST ALL TREE OPENINGS WITH WATER BEFORE PLANTING TO ASSURE PROPER DRAINAGE PERCOLATION IS AVAILABLE. NO ALLOWANCE WILL BE MADE FOR LOST PLANTS DUE TO IMPROPER DRAINAGE. IF POOR DRAINAGE EXISTS, UTILIZE "POOR DRAINAGE CONDITION" PLANTING DETAIL.
 - TREES SHALL BE SET PLUMB AND HELD IN POSITION UNTIL THE PLANTING MIXTURE HAS BEEN FLUSHED INTO PLACE WITH A SLOW, FULL HOSE STREAM. ALL PLANTING SHALL BE PERFORMED BY PERSONNEL FAMILIAR WITH PLANTING PROCEDURES AND UNDER THE SUPERVISION OF A QUALIFIED LANDSCAPE FOREMAN.
 - PRIOR TO EXCAVATION OF TREE OPENINGS, AN AREA EQUAL TO TWO TIMES THE DIAMETER OF THE ROOT BALL SHALL BE ROTO-TILLED TO A DEPTH EQUAL TO THE DEPTH OF THE ROOT BALL.
 - EXCAVATION OF TREE OPENINGS SHALL BE PERFORMED USING EXTREME CARE TO AVOID DAMAGE TO SURFACE AND SUBSURFACE ELEMENTS SUCH AS UTILITIES OR HARDSCAPE ELEMENTS, FOOTERS AND PREPARED SUB-BASES.
 - IN CONTINUOUS SHRUB AND GROUND COVER BEDS, THE ROTO-TILLED PERIMETER SHOULD EXTEND TO A DISTANCE OF ONE FOOT BEYOND THE DIAMETER OF A SINGLE ROOT BALL. THE BED SHALL BE TILLED TO A DEPTH EQUAL TO THE ROOT BALL DEPTH PLUS 6".
 - TREE OPENINGS FOR WELL DRAINED SOILS SHALL BE DUG SO THAT THE BOTTOM OF THE ROOT BALL WILL REST ON UNDISTURBED SOIL AND THE TOP OF THE ROOT BALL WILL BE FLUSH WITH FINISH GRADE. IN POORLY DRAINED SOILS THE TREE OPENING SHALL BE DUG SO THAT THE ROOT BALL RESTS ON UNDISTURBED SOIL AND THE TOP OF THE ROOT BALL IS 1" ABOVE FINISH GRADE. PLANT PIT WALLS SHALL BE SCARIFIED PRIOR TO PLANT INSTALLATION.
 - TAKE ALL NECESSARY PRECAUTIONS TO AVOID DAMAGE TO BUILDINGS AND BUILDING STRUCTURES WHILE INSTALLING TREES.
 - SOIL MIXTURE SHALL BE AS SPECIFIED IN SECTION 'E'.
 - TREES AND SHRUBS SHALL BE SET STRAIGHT AT AN ELEVATION THAT, AFTER SETTLEMENT, THE PLANT CROWN WILL STAND ONE (1) TO TWO (2) INCHES ABOVE GRADE. EACH PLANT SHALL BE SET IN THE CENTER OF THE PIT. SOIL MIXTURE SHALL BE BACK-FILLED, THOROUGHLY TAMPED AROUND THE BALL, AND SETTLED BY WATER (AFTER TAMPING).
 - AMEND PINE AND OAK PLANT OPENINGS WITH ECTOMYCORRHIZAL SOIL APPLICATION PER MANUFACTURER'S RECOMMENDATION. ALL OTHER PLANT OPENINGS SHALL BE AMENDED WITH ENDOMYCORRHIZAL SOIL APPLICATION PER MANUFACTURER'S RECOMMENDATION. PROVIDE PRODUCT INFORMATION SUBMITTAL PER TO INOCULATION.
- N. LAWN SODDING**
- THE WORK CONSISTS OF LAWN BED PREPARATION, SOIL PREPARATION, AND SODDING COMPLETE, IN STRICT ACCORDANCE WITH THE SPECIFICATIONS AND THE APPLICABLE DRAWINGS TO PRODUCE A TURF GRASS LAWN ACCEPTABLE TO THE OWNER.
a. THE CONTRACTOR SHALL SOD ALL AREAS THAT ARE NOT PAVED OR PLANTED AS DESIGNATED ON THE DRAWINGS WITHIN THE CONTRACT LIMITS, UNLESS SPECIFICALLY NOTED OTHERWISE.
b. SOD PANELS SHALL BE LAID TIGHTLY TOGETHER SO AS TO MAKE A SOLID SODDED LAWN AREA. SOD SHALL BE LAID UNIFORMLY AGAINST THE EDGES OF ALL CURBS AND OTHER HARDSCAPE ELEMENTS, PAVED AND PLANTED AREAS. ADJACENT TO BUILDINGS, A 2" INCH STONE MULCH STRIP SHALL BE PROVIDED. IMMEDIATELY FOLLOWING SOD LAYING, THE LAWN AREAS SHALL BE ROLLED WITH A LAWN ROLLER CUSTOMARILY USED FOR SUCH PURPOSES, AND THEN THOROUGHLY IRRIGATED. IF, IN THE OPINION OF THE OWNER, TOP-DRESSING IS NECESSARY AFTER ROLLING TO FILL THE VOIDS BETWEEN THE SOD PANELS AND TO EVEN OUT INCONSISTENCIES IN THE SOD, CLEAN SAND, AS APPROVED BY THE OWNER'S REPRESENTATIVE, SHALL BE UNIFORMLY SPREAD OVER THE ENTIRE SURFACE OF THE SOD AND THOROUGHLY WATERED IN. FERTILIZE INSTALLED SOD AS ALLOWED BY PROPERTY'S JURISDICTIONAL AUTHORITY.
 - DURING DELIVERY, PRIOR TO, AND DURING THE PLANTING OF THE LAWN AREAS, THE SOD PANELS SHALL AT ALL TIMES BE PROTECTED FROM EXCESSIVE DRYING AND UNNECESSARY EXPOSURE OF THE ROOTS TO THE SUN. ALL SOD SHALL BE STACKED SO AS NOT TO BE DAMAGED BY SWEATING OR EXCESSIVE HEAT AND MOISTURE.
 - LAWN MAINTENANCE
a. WITHIN THE CONTRACT LIMITS, THE CONTRACTOR SHALL PRODUCE A DENSE, WELL ESTABLISHED LAWN. THE CONTRACTOR SHALL BE RESPONSIBLE FOR THE REPAIR AND RE-SODDING OF ALL ERODED, SUNKEN OR BARE SPOTS (LARGER THAN 12"X12") UNTIL CERTIFICATION OF ACCEPTANCE BY THE OWNER'S REPRESENTATIVE. REPAIRED SODDING SHALL BE ACCOMPLISHED AS IN THE ORIGINAL WORK, INCLUDING REGRADING IF NECESSARY.
b. CONTRACTOR SHALL BE RESPONSIBLE FOR ESTABLISHING AND MAINTAINING SOD/LAWN UNTIL ACCEPTANCE BY THE OWNER'S REPRESENTATIVE. PRIOR TO AND UPON ACCEPTANCE, CONTRACTOR TO PROVIDE WATERING/IRRIGATION SCHEDULE TO OWNER. OBSERVE ALL APPLICABLE WATERING RESTRICTIONS AS SET FORTH BY THE PROPERTY'S JURISDICTIONAL AUTHORITY.
- O. EDGING**
- CONTRACTOR SHALL INSTALL 4"x2" ROLLED TOP STEEL EDGING BETWEEN ALL SOD/SEED AREAS AND PLANTING BEDS.
- P. CLEANUP**
- UPON COMPLETION OF ALL PLANTING WORK AND BEFORE FINAL ACCEPTANCE, THE CONTRACTOR SHALL REMOVE ALL MATERIAL, EQUIPMENT, AND DEBRIS RESULTING FROM CONTRACTORS WORK. ALL PAVED AREAS SHALL BE CLEANED AND THE SITE LEFT IN A NEAT AND ACCEPTABLE CONDITION AS APPROVED BY THE OWNER'S REPRESENTATIVE.
- Q. PLANT MATERIAL MAINTENANCE**
- ALL PLANTS AND PLANTING INCLUDED UNDER THIS CONTRACT SHALL BE MAINTAINED BY WATERING, CULTIVATING, SPRAYING, PRUNING, AND ALL OTHER OPERATIONS (SUCH AS RE-STAKING OR REPAIRING GUY SUPPORTS) NECESSARY TO INSURE A HEALTHY PLANT CONDITION BY THE CONTRACTOR UNTIL CERTIFICATION OF ACCEPTANCE BY THE OWNER'S REPRESENTATIVE.
- R. FINAL INSPECTION AND ACCEPTANCE OF WORK**
- FINAL INSPECTION AT THE END OF THE WARRANTY PERIOD SHALL BE ON PLANTING, CONSTRUCTION AND ALL OTHER INCIDENTAL WORK PERTAINING TO THIS CONTRACT. ANY REPLACEMENT AT THIS TIME SHALL BE SUBJECT TO THE SAME ONE (1) YEAR WARRANTY (OR AS SPECIFIED BY THE LANDSCAPE ARCHITECT OR OWNER IN WRITING) BEGINNING WITH THE TIME OF REPLACEMENT AND ENDING WITH THE SAME INSPECTION AND ACCEPTANCE HEREIN DESCRIBED.
- S. WARRANTY**
- THE LIFE AND SATISFACTORY CONDITION OF ALL PLANT MATERIAL INSTALLED (INCLUDING SOD) BY THE LANDSCAPE CONTRACTOR SHALL BE WARRANTED BY THE CONTRACTOR FOR A MINIMUM OF ONE (1) CALENDAR YEAR COMMENCING AT THE TIME OF CERTIFICATION OF ACCEPTANCE BY THE OWNER'S REPRESENTATIVE.
2. ANY PLANT NOT FOUND IN A HEALTHY GROWING CONDITION AT THE END OF THE WARRANTY PERIOD SHALL BE REMOVED FROM THE SITE AND REPLACED AS SOON AS WEATHER CONDITIONS PERMIT. ALL REPLACEMENTS SHALL BE PLANTS OF THE SAME KIND AND SIZE AS SPECIFIED IN THE PLANT LIST. THEY SHALL BE FURNISHED PLANTED AND MULCHED AS SPECIFIED AT NO ADDITIONAL COST TO THE OWNER.
3. IN THE EVENT THE OWNER DOES NOT CONTRACT WITH THE CONTRACTOR FOR LANDSCAPE AND IRRIGATION MAINTENANCE, THE CONTRACTOR SHOULD VISIT THE PROJECT SITE PERIODICALLY DURING THE ONE (1) YEAR WARRANTY PERIOD TO EVALUATE MAINTENANCE PROCEDURES BEING PERFORMED BY THE OWNER. CONTRACTOR SHALL NOTIFY THE OWNER IN WRITING OF MAINTENANCE PROCEDURES OR CONDITIONS WHICH THREATEN VIGOROUS AND HEALTHY PLANT GROWTH.
- T. PARKING LOT ISLAND NOTE**
- THE SOIL OF ANY PLANTER WITHIN THE PARKING LOT SHALL BE STRUCTURALLY RENOVATED (TILLED) OR REMOVED TO A DEPTH OF THIRTY INCHES (30") AND REPLACED WITH AN ACCEPTABLE GROWING MEDIUM FOR THE SPECIES INDICATED FOR INSTALLATION.
- U. MAINTENANCE**
- LANDSCAPE IMPROVEMENTS AND MAINTENANCE SHALL BE THE RESPONSIBILITY OF THE OWNER, AND/OR THEIR ASSIGNS.
2. ALL STREET TREES AND STREETScape IMPROVEMENTS LOCATED IN THE R.O.W. WILL BE MAINTAINED BY THE ADJUTING PROPERTY OWNER.

K:\COCS_LAI196345000 - Crawford Ave Multifamily CAD/PlanSheets/DF_S&IDP_LA.dwg Nov 17, 2022 11:13:38am



© 2022 KIMLEY-HORN AND ASSOCIATES, INC.
2 NORTH NEVADA AVENUE, 9TH FLOOR
COLORADO SPRINGS, COLORADO 80903 (719) 453-0180

LANDSCAPE NOTES
SHEET L-104 OF L-105

CRAWFORD AVE. MULTIFAMILY PRELIMINARY LANDSCAPE TRACT A OF FOUNTAIN VALLEY RANCH FILING NO. 6B SITUATED IN THE NORTHEAST QUARTER OF SECTION 13, TOWNSHIP 15 SOUTH, RANGE 66 WEST OF THE 6TH P.M., CITY OF FOUNTAIN, COUNTY OF EL PASO, STATE OF COLORADO

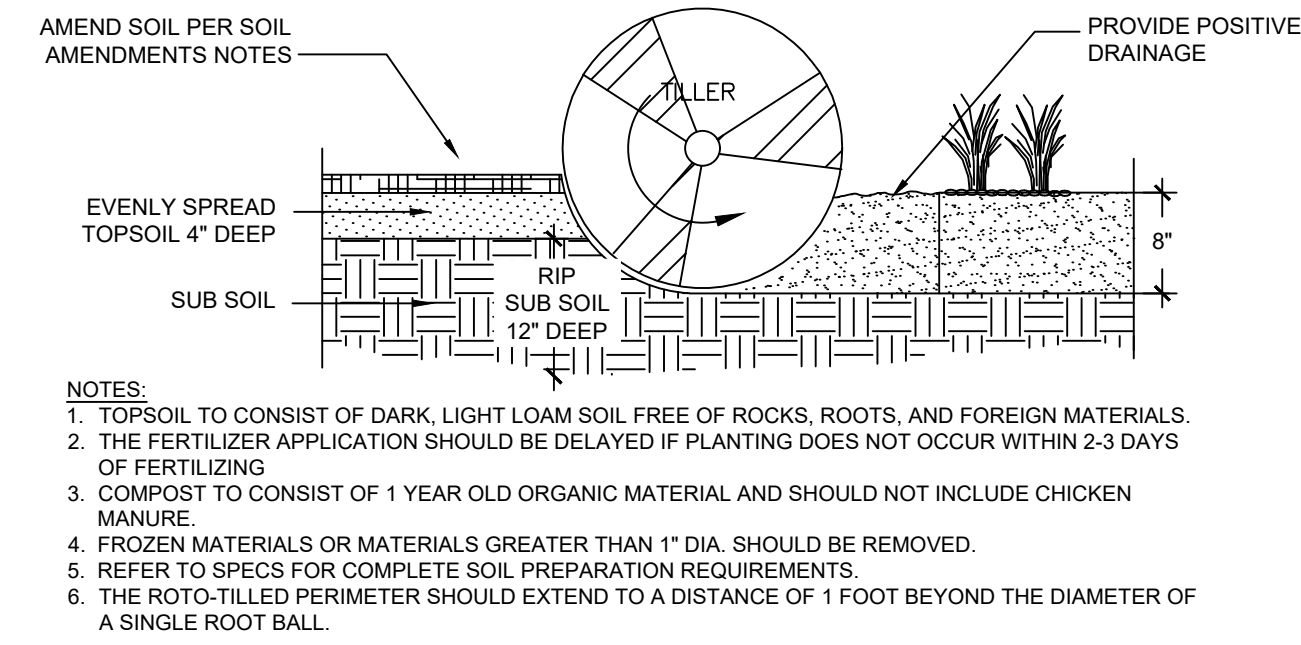

1 SOIL PREP
NTS 196-345-000-01

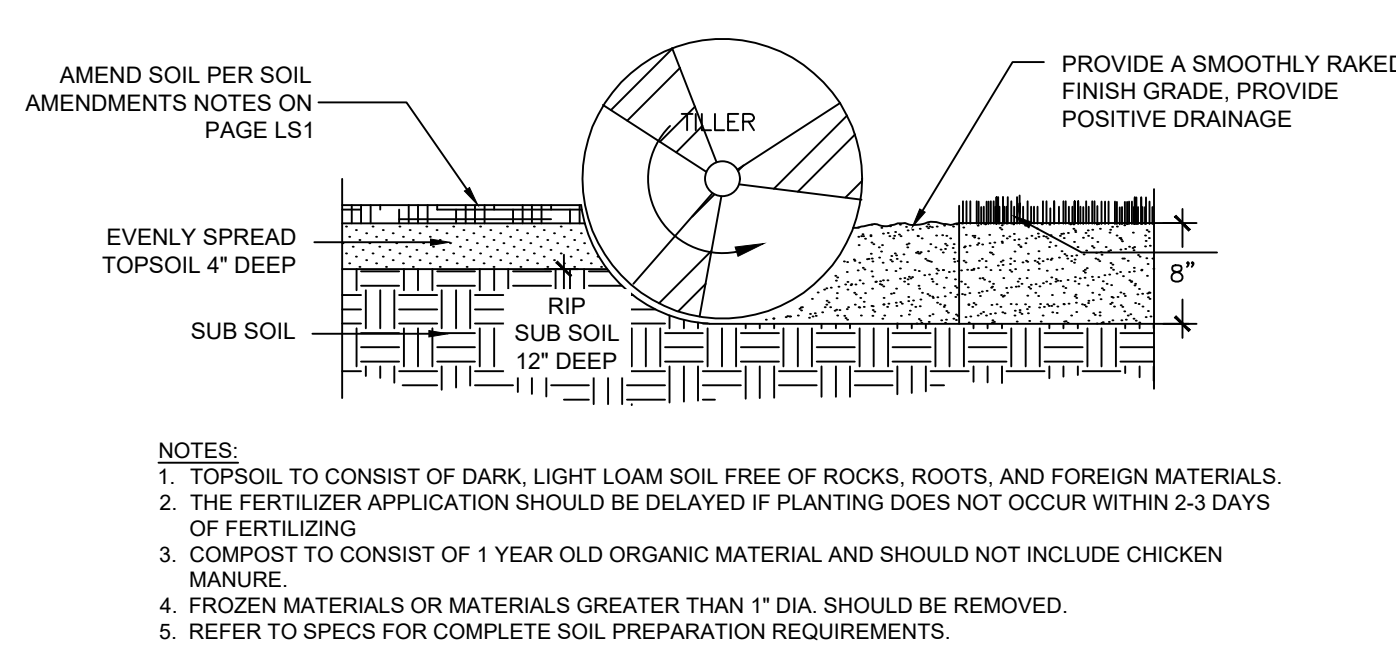

4 SOIL PREPARATION - SOD AREAS
NTS 196-345-000-04

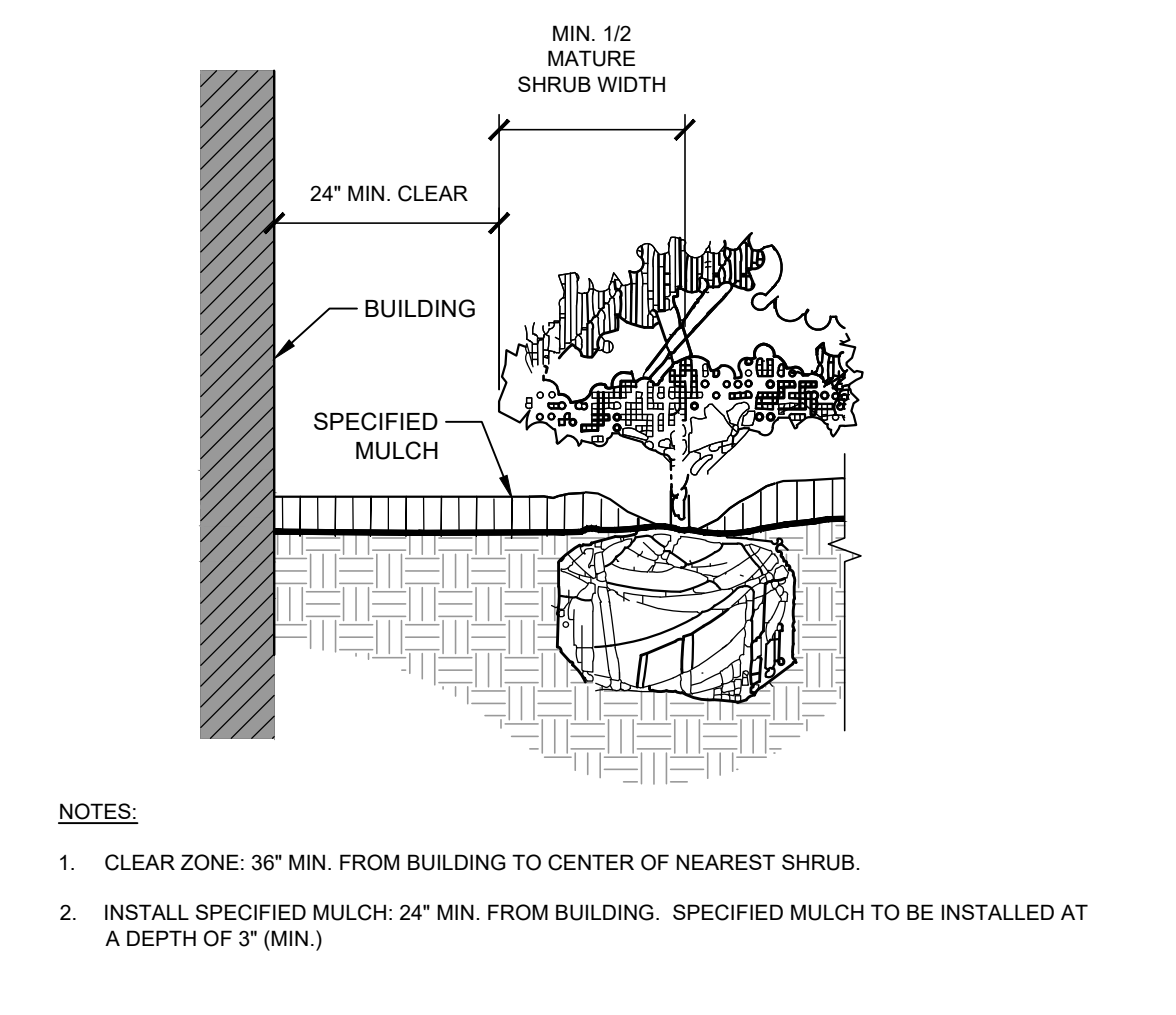

7 PLANTINGS ADJACENT TO BUILDINGS
NTS 196-345-000-07

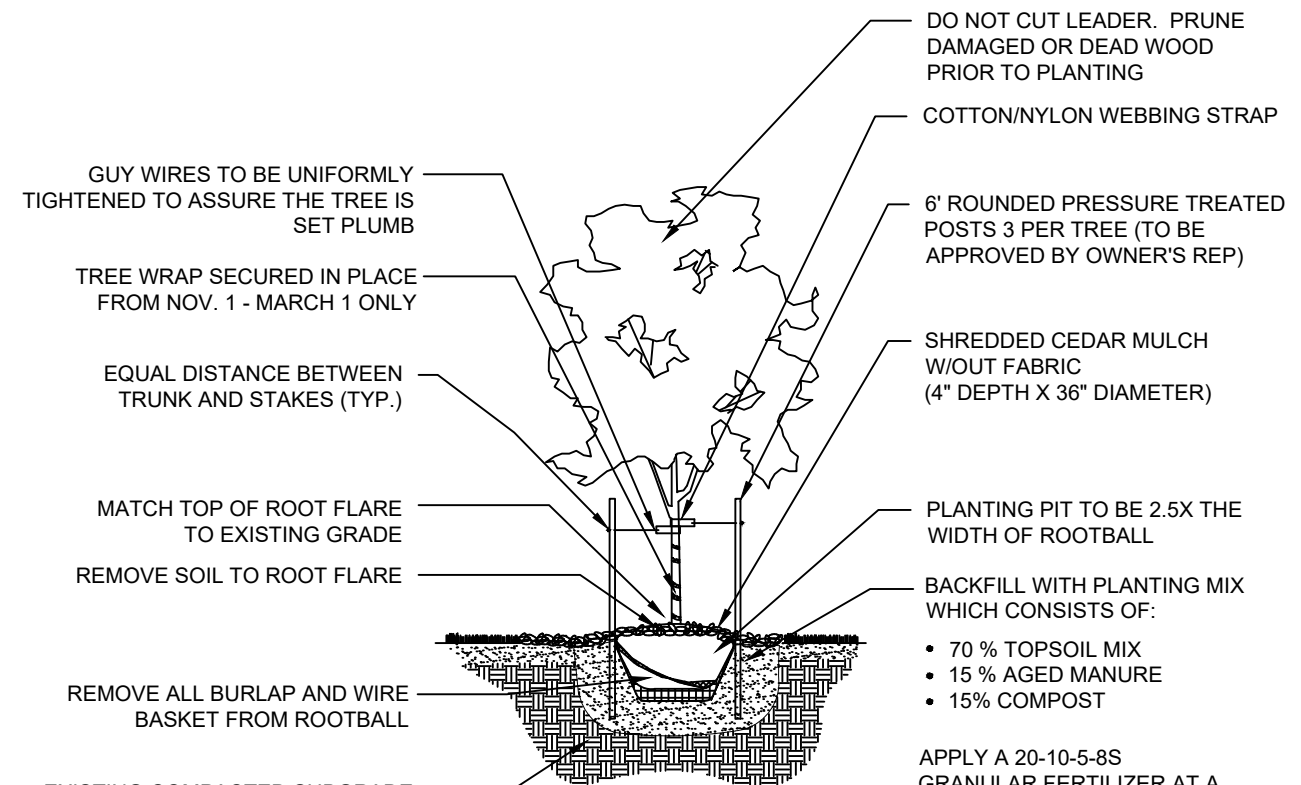

2 DECIDUOUS TREE PLANTING
NTS 196-345-000-02

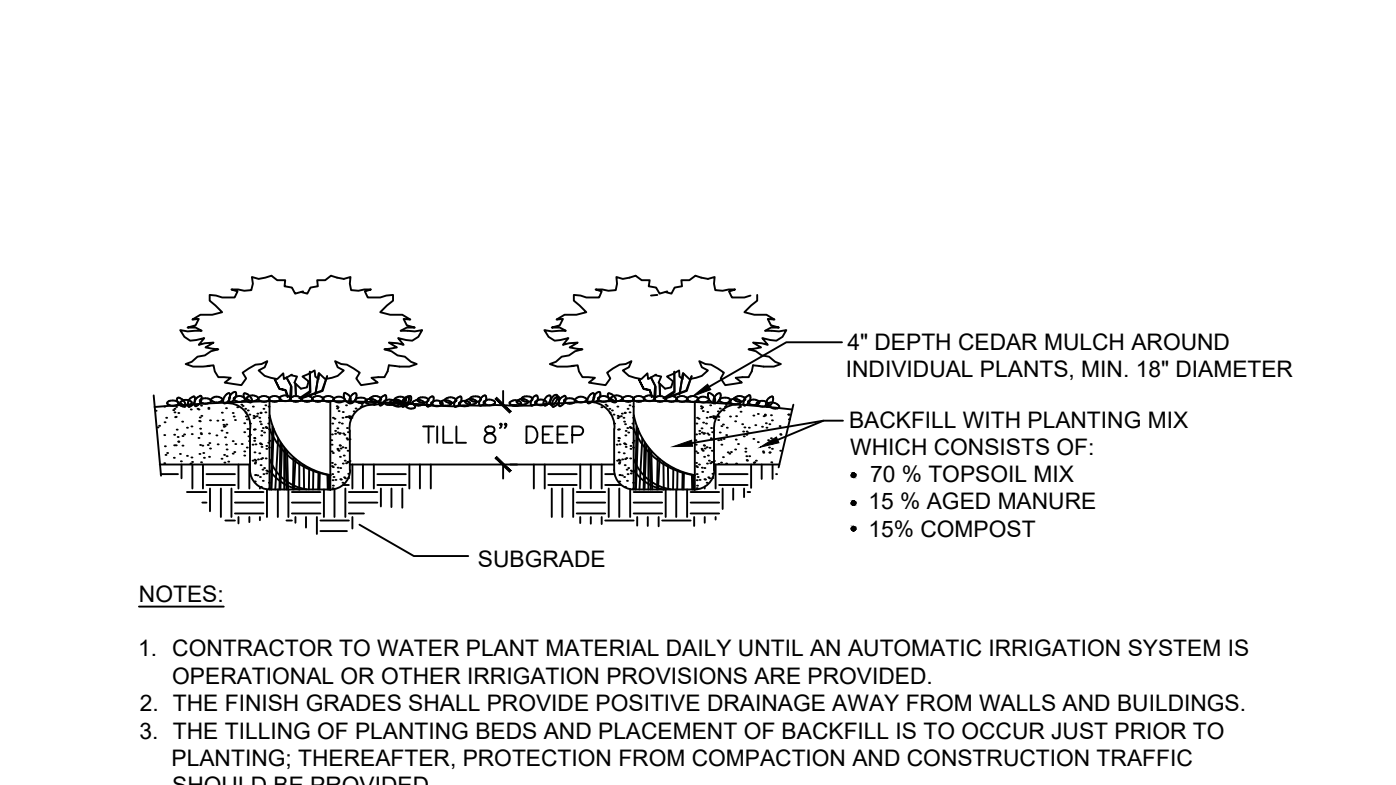

5 SHRUB PLANTING
NTS 196-345-000-05

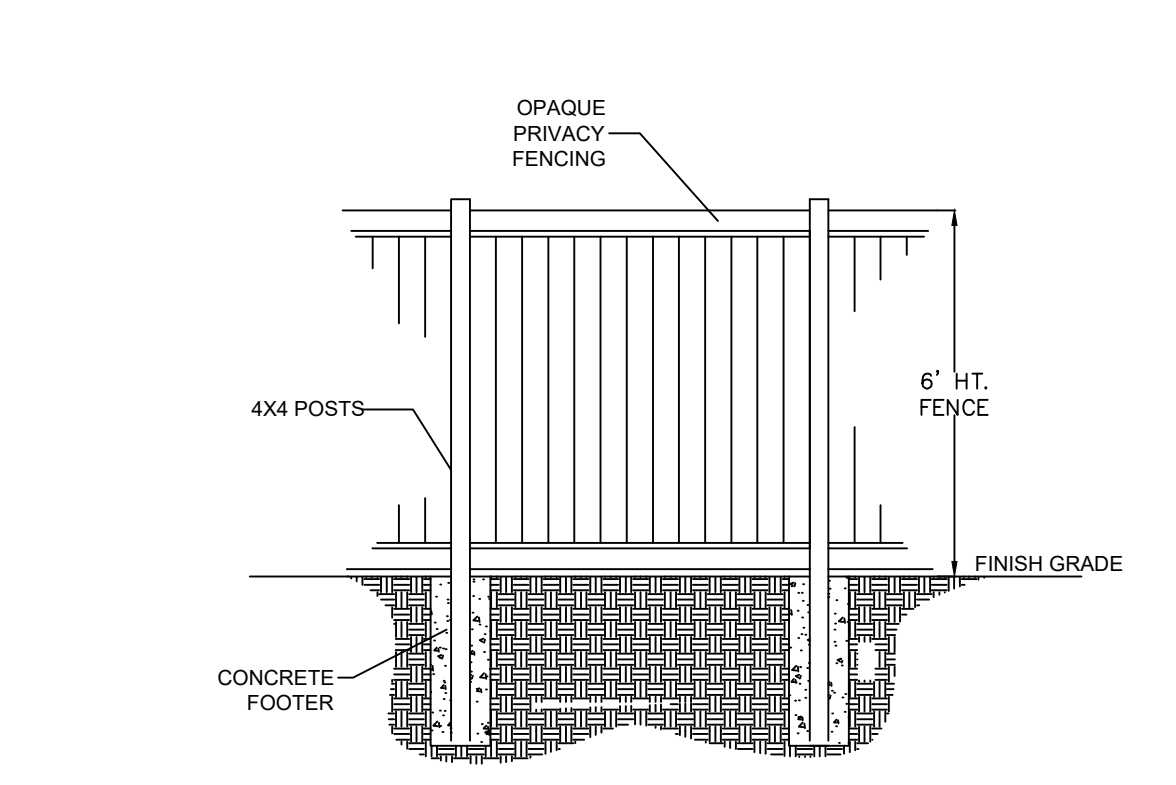

8 PRIVACY FENCE
NTS 196-345-000-07

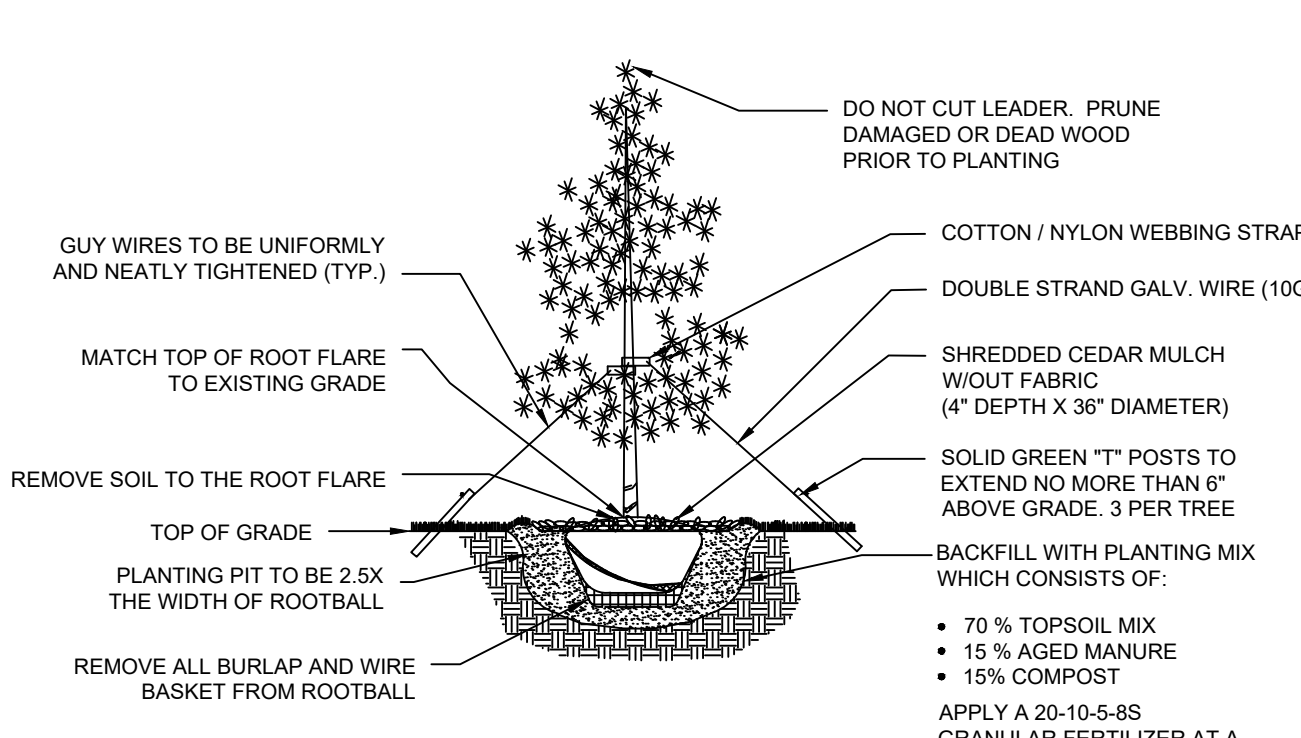

3 EVERGREEN TREE PLANTING
NTS 196-345-000-03

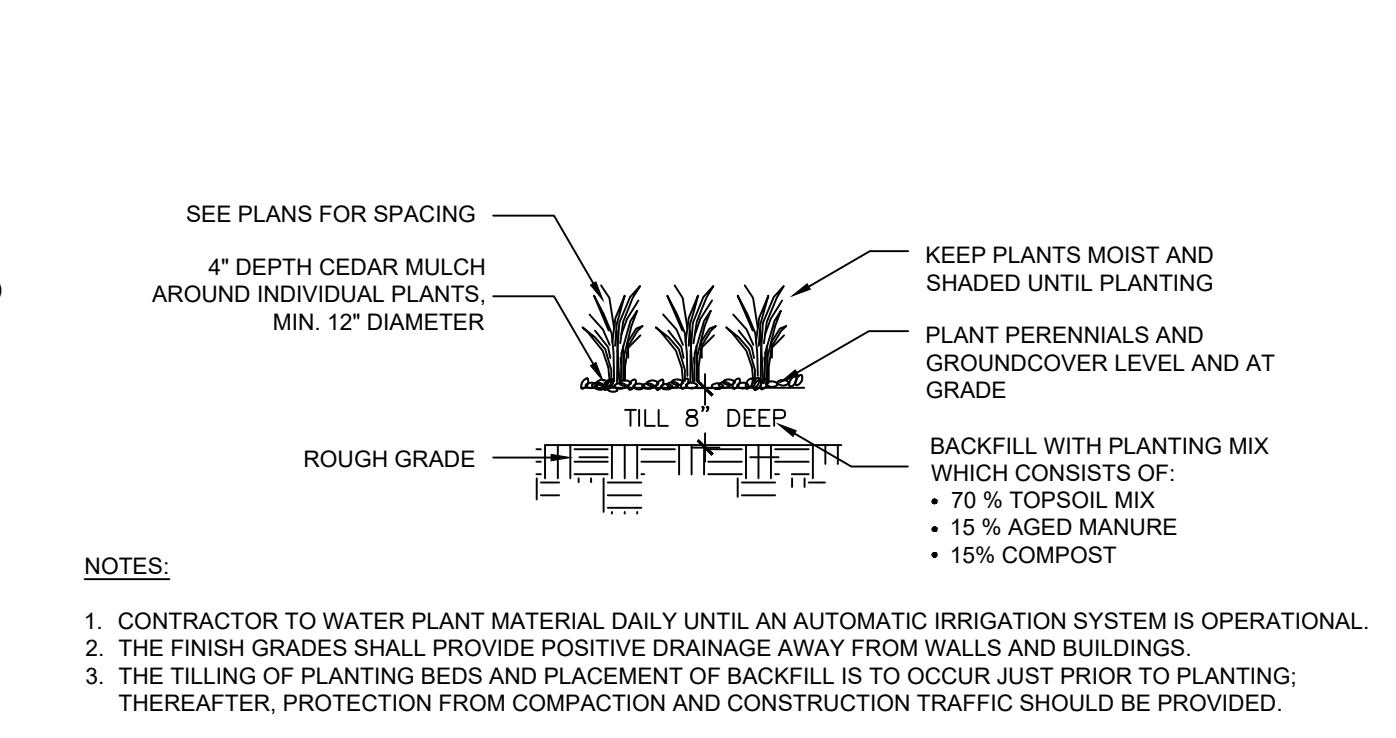

6 GRASS AND PERENNIAL PLANTING
NTS 196-345-000-06

PLANT SCHEDULE									
SYMBOL	CODE	QTY	PLANT COMMON NAME	PLANT SIZE	PLANT SPECIES	PLANT HEIGHT	PLANT WIDTH	PLANT SPACING	PLANT NOTES
...

LANDSCAPE SETBACKS AND BUFFERS				
STREET NAME OR BOUNDARY:	CRAWFORD AVE	EAST BNDY	NORTH BNDY	WEST BNDY
ZONE DISTRICT BOUNDARY:	YES	YES	YES	YES
STREET CLASSIFICATION:	NONARTERIAL	N/A	N/A	N/A
SETBACK DEPTH REQUIRED / PROVIDED:	10' / 10'	15' / 15'	15' / 15'	15' / 15'
LINEAR FOOTAGE:	210'	241'	210'	241'
TREE PER FEET REQ.:	1 TREE PER 30 LF	1 TREE PER 25 LF	1 TREE PER 25 LF	1 TREE PER 25 LF
NUMBER OF TREES REQ. / PROV.:	7 / 7	10 / 10	9 / 9	10 / 10
EVERGREEN TREES REQ. / PROV.:	N/A	4 / 8	3 / 6	4 / 5
SHRUB SUBSTITUTES REQ. / PROV.:	N/A	N/A	N/A	N/A
ORN. GRASS SUBSTITUTES REQ. / PROV.:	N/A	N/A	N/A	N/A
OPAQUE SCREEN REQ. / PROV.:	N/A	241' / 190'	210' / 210'	241' / 241'
PLANT ABBREVIATION DENOTED ON PLAN:	CA	EB	NB	WB
% GROUND PLANE VEG. REQ. / PROV.:	75% / 75%	75% / 75%	75% / 75%	75% / 75%

INTERNAL LANDSCAPING	
NET SITE AREA:	50,335 SF (1.56 AC)
PERCENT MINIMUM INTERNAL AREA:	15%
INTERNAL LANDSCAPE AREA REQ. / PROV.:	7,551 SF / 12,578 SF
TREE PER FEET REQ.:	1 TREE PER 500 SF
INTERNAL TREES REQ. / PROV.:	16 / 1
SHRUB SUBSTITUTES REQ. / PROV.:	110 / 110
ORN. GRASS SUBSTITUTES REQ. / PROV.:	80 / 80
PLANT ABBREVIATION DENOTED ON PLAN:	IN
% GROUND PLANE VEG. REQ. / PROV.:	75% / 75%

In your plans you depict 7 trees already on the property in addition to more, why is 1 provided?

PARKING LOT LANDSCAPING	
NUMBER OF VEHICLE SPACES PROVIDED:	40
SHADE TREES REQUIRED:	1 TREE PER 15 STALLS
SHADE TREES REQ. / PROV.:	3 / 3
PARKING LOT FRONTAGES:	SOUTH
LENGTH OF FRONTAGE:	61'
LENGTH OF 3' TALL SCREENING PLANTS REQ. / PROV.:	41' / 59'
LENGTH OF BERM OR FENCE REQ. / PROV.:	N/A
PLANT ABBREVIATION DENOTED ON PLAN:	PL

K:\COCS_LAI\196345000 - Crawford Ave Multifamily CAD\PlanSheets\DF Set\DP_LA.dwg Nov 17, 2022 11:13:38am



© 2022 KIMLEY-HORN AND ASSOCIATES, INC.
2 NORTH NEVADA AVENUE, 9TH FLOOR
COLORADO SPRINGS, COLORADO 80903 (719) 453-0180

LANDSCAPE DETAILS
SHEET L-105 OF L-105