

PRELIMINARY & FINAL DRAINAGE PLAN

PONDEROSA AT LORSON RANCH FILING NO 3 EL PASO COUNTY, COLORADO

**NOVEMBER, 2019
REV. JANUARY 15, 2020
REV. APRIL 8, 2020**

Prepared for:

Lorson, LLC
212 N. Wahsatch Ave, Suite 301
Colorado Springs, Colorado 80903
(719) 635-3200

Prepared by:

Core Engineering Group, LLC
15004 1ST Avenue South
Burnsville, MN 55306
(719) 570-1100

Project No. 100.050
PUD/SP 19-010



CORE

ENGINEERING GROUP

TABLE OF CONTENTS

<i>ENGINEER'S STATEMENT</i>	1
<i>OWNER'S STATEMENT</i>	1
<i>FLOODPLAIN STATEMENT</i>	1
<i>1.0 LOCATION and DESCRIPTION</i>	2
<i>2.0 DRAINAGE CRITERIA</i>	2
<i>3.0 EXISTING HYDROLOGICAL CONDITIONS</i>	3
<i>4.0 DEVELOPED HYDROLOGICAL CONDITIONS</i>	4
<i>5.0 HYDRAULIC SUMMARY</i>	8
<i>6.0 DETENTION and WATER QUALITY PONDS</i>	11
<i>7.0 FOUR STEP PROCESS</i>	12
<i>8.0 DRAINAGE and BRIDGE FEES</i>	12
<i>9.0 CONCLUSIONS</i>	14
<i>10.0 REFERENCES</i>	14

APPENDIX A

VICINITY MAP

SCS SOILS INFORMATION

FEMA FIRM MAP

APPENDIX B

HYDROLOGY CALCULATIONS

APPENDIX C

HYDRAULIC CALCULATIONS

APPENDIX D

STORM SEWER SCHEMATIC and HYDRAFLOW STORM SEWER CALCS

APPENDIX E

POND CALCULATIONS

BACK POCKET

EXISTING CONDITIONS DRAINAGE MAP

DEVELOPED CONDITIONS DRAINAGE MAP

POND A3 OUTLET STRUCTURE

ENGINEER'S STATEMENT

The attached drainage plan and report were prepared under my direction and supervision and are correct to the best of my knowledge and belief. Said drainage report has been prepared according to the criteria established by El Paso County for drainage reports and said report is in conformity with the master plan of the drainage basin. I accept responsibility for any liability caused by any negligent acts, errors, or omissions on my part in preparing this report.

Richard L. Schindler, P.E. #33997
For and on Behalf of Core Engineering Group, LLC

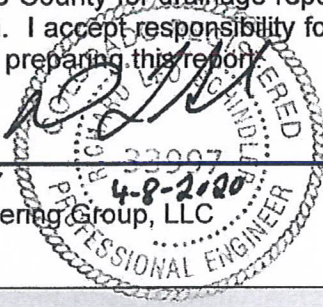

Date

OWNER'S STATEMENT

I, the Owner, have read and will comply with all the requirements specified in the drainage report and plan.

JM+LL, LLC
Jan

4/6/20
Date

Business Name

By

Authorized Signing Agent

Title

212 N. Wabatch Ave.

Address

Colorado Springs, CO 80903

FLOODPLAIN STATEMENT

To the best of my knowledge and belief, this development is not located within a designated floodplain as shown on Flood Insurance Rate Map Panel No. 08041C0957G, Dated December 7, 2018. (See Appendix A, FEMA FIRM Exhibit)

Richard L. Schindler, #33997,
For and on Behalf of Core Engineering Group, LLC

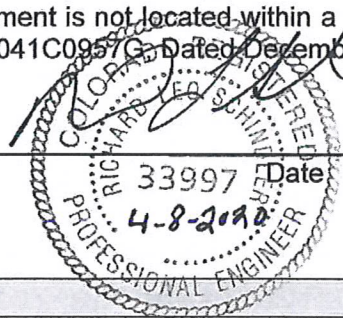

Date

EL PASO COUNTY

Filed in accordance with the requirements of the Drainage Criteria Manual, Volumes 1 and 2, El Paso County Engineering Criteria Manual and Land Development Code as amended.

Jennifer Irvine, P.E. , County Engineer / ECM Administrator

Date

Conditions:

1.0 LOCATION and DESCRIPTION

Ponderosa at Lorson Ranch Filing No. 3 is located north and east of the intersection of Fontaine Boulevard and Old Glory Drive in El Paso County Colorado. The site is located on approximately 10.38 acres of vacant land. Future plans are to develop this site into 90 single family attached lots. The land is currently owned by Love-in-Action and will be developed by Lorson LLC. Planned development of this area will consist of single-family attached lots.

The site is located in the Southwest $\frac{1}{4}$ of Section 23, Township 15 South and Range 65 West of the 6th Principal Meridian; it is currently zoned PUD. The property is bounded on the north and west by Old Glory Drive, on the south and east by Ponderosa Filing No. 1, a single-family development. For reference, a vicinity map is included in Appendix A of this report.

Ponderosa at Lorson Ranch Filing No. 3 is located within the **“Jimmy Camp Creek Drainage Basin”**, which is a fee basin and is part of the “Jimmy Camp Creek Drainage Basin Planning Study”, prepared by Kiowa Engineering Corp., Colorado Springs, CO.

2.0 DRAINAGE CRITERIA

The supporting drainage design and calculations were performed in accordance with the City of Colorado Springs and El Paso County “Drainage Criteria Manual (DCM)”, dated November, 1991, the El Paso County “Engineering Criteria Manual”, and the UDFCD “Urban Storm Drainage Criteria Manual” Volumes 1, 2 and 3. No deviations from these published criteria are requested for this site. The proposed improvements to the Lorson Ranch Development are in substantial compliance with the “Jimmy Camp Creek Drainage Basin Planning Study”, prepared by Kiowa Engineering Corp., Colorado Springs, CO.

Conformance with applicable Drainage Basin Planning Studies

There is an existing (unapproved) DBPS for Jimmy Camp Creek prepared by Wilson & Company in 1987, and is referenced in this report. The only major drainage improvements required for this study area according to the 1987 Wilson study was the reconstruction of Jimmy Camp Creek. In 2005 Jimmy Camp Creek was reconstructed and armored from the south limits of Lorson Ranch to the north limits. On March 9, 2015 a new DBPS for Jimmy Camp Creek and the East Tributary was completed by Kiowa Engineering which also confirms the creek reconstruction done in 2005. All drainage from this site flows to Jimmy Camp Creek.

Conformance with Lorson Ranch MDDP1 by Pentacor Engineering

Lorson Ranch MDDP1 (October 26, 2006) includes this preliminary plan area. This PDR/FDR conforms to the MDDP1 for Lorson Ranch and is referenced in this report. The major infrastructure required for this site per the MDDP1 was constructed in 2006 and includes storm sewer in Fontaine Boulevard, storm sewer in Old Glory Drive, and downstream Pond A1. The only pond not constructed as required by the MDDP1 is Pond A3 which will be constructed and located on this site. Detention/WQ Pond A3 is within this preliminary plan area and will be designed/constructed as part of this project.

The Rational Method as outlined in Section 6.3.0 of the May 2014 “Drainage Criteria Manual” and in Section 3.2.8.F of the El Paso County “Engineering Criteria Manual” was used for basins less than 130 acres to determine the rainfall and runoff conditions for the proposed development of the site. The runoff rates for the 5-year initial storm and 100-year major design storm were calculated.

Current updates to the Drainage Criteria manual for El Paso County states that if detention is necessary, Full Spectrum Detention will be included in the design, proposed detention Pond A3 will require Full Spectrum Detention and will be included for this development.

3.0 EXISTING HYDROLOGICAL CONDITIONS

The site is currently undeveloped with native vegetation (grass with no shrubs) and moderate slopes in a southerly direction. Runoff is directed overland to an existing storm system in Old Glory Drive and the existing drainage ditch located on the east and southeast edge of the site. Runoff from the existing ditch is directed southwesterly to the previously mentioned existing storm system in Old Glory Drive via 36" RCP's to an existing detention facility, located on the north side of Fontaine Boulevard, adjacent to Jimmy Camp Creek. The soils across the site consists of the Fort Collins loam, a deep somewhat excessively drained soil with 0 - 3% slopes, and the Manzanola clay loam, also a deep well drained soil with 1 – 3% slopes according to the Soil Survey of El Paso County Area. A majority of these soils are type C, and a small portion consist of soil type B. These soil types will be used for the hydrologic conditions. Offsite drainage enters the property at the existing drainage ditch from basin OS1 via an existing 36" RCP. See Appendix A for SCS Soils Map.

Table 3.1: SCS Soils Survey.

Soil	Hydro. Group	Shrink/Swell Potential	Permeability	Surface Runoff Potential	Erosion Hazard
30-Fort Collins Loam (22%)	B	Low	Moderate	Medium	Moderate
52-Manzanola Clay Loam (78%)	C	Moderate to High	Slow	Medium	Moderate

The following off-site and on-site current condition basins are briefly discussed as follows:

Basin EX1

This basin encompasses the entire site. Runoff is directed southwesterly and southerly to Old Glory Drive and the existing drainage ditch and is routed to the storm system in Old Glory Drive via an existing 36" RCP. The peak flow from this 10.26 acre basin is 5.4cfs for the 5-year storm event and 29.1cfs for the 100-year storm event. See Hydraflow modeling in the appendix.

Basin OS1

This basin encompasses portions of Old Glory and adjacent areas from Pioneer Landing Filing No. 1 and Ponderosa Filing No. 1. Runoff is directed west in the street to two existing inlets that drain to an existing 36" RCP storm sewer flowing south. The existing 36" storm sewer flows into an existing swale draining southwest to Design Point B. The total existing flow from this basin is 9.8cfs for the 5-year storm event and 21.9cfs for the 100-year storm event. See Hydraflow modeling in the appendix.

Basin A4 and Existing Pond A4

Pond A4 was built in 2010 as part of Pioneer Landing at Lorson Ranch Filing No. 1 and accepts flow from Basin A4. This pond is an existing standard detention basin and does not include provisions for Water Quality. Water Quality is provided downstream in Existing Pond A1 located at Jimmy Camp Creek and Fontaine Boulevard. The as-built flow was calculated in July, 2010 by Core Engineering Group and was calculated to have a 5 year release rate of 3.6cfs and 100 year release rate of 20.5cfs. This flows south in storm sewer to Design Point A. See Hydraflow modeling in the appendix.

Existing Flow at Design Pt. A.

Design Point A is located in the NE corner of this site and is the total flow from an existing 36" storm sewer draining into an existing swale on the east side of the site. The flows were calculated using a hydraulic modeling program called Hydraflow Hydrographs and include flows from Pond A4 and Basin OS1. The existing 5 year flow is 10.4cfs and the existing 100 year flow is 23.0cfs at this design point flowing in an existing 36" storm sewer. See Hydraflow modeling in the appendix.

Existing Flow at Design Pt. B.

Design Point B is located in the SW corner of this site and is the total flow into an existing 36" storm sewer draining to Old Glory Drive. The flows were calculated using a hydraulic modeling program called Hydraflow Hydrographs and include flows from Pond A4, Basin OS1, and Basin EX1. The existing 5 year flow is 14.0cfs and the existing 100 year flow is 46.3cfs at this design point flowing in an existing 36" storm sewer. The 36" storm sewer was designed to accept 54cfs of flow in the 100-year storm event per the Fontaine/Old Glory Final Drainage Report prepared in 2006 by Pentacor Engineering. See Hydraflow modeling in the appendix.

4.0 DEVELOPED HYDROLOGICAL CONDITIONS

Hydrology for the **Ponderosa at Lorson Ranch Filing No. 3** drainage report was based on the City of Colorado Springs/El Paso County Drainage Criteria. Basins that lie within this project were determined and the 5-year and 100-year peak discharges for the developed conditions have been presented in this report. Based on these flows, storm inlets will be added if the street capacity is exceeded.

The site was divided into four (4) major basins (A-D), twenty-four (24) sub-basins and fifteen (15) design points.

The time of concentration for each basin was developed using an overland, ditch, street and pipe flow components. The maximum overland flow length for developed conditions was limited to 100 feet. Travel time velocities ranged from 2 to 6 feet per second. The travel time calculations are included in the back of this report.

Runoff coefficients for the various land uses were obtained from the City of Colorado Springs/El Paso County Drainage Criteria Manual.

The hydrology analysis necessary for sizing the storm sewer system is preliminary only and will be finalized when the construction documents are prepared.

Drainage concepts for each of the sub-basins and basins are briefly discussed as follow:

Sub-Basin A1

This basin is located on the south side of Whitewolf Point; runoff from the proposed townhomes directs flow north to Whitewolf Point. These flows are then routed easterly in Whitewolf Point and then north in Winter Gem Grove to design point 1; a proposed 5' type "R" inlet located in a low spot on the west side of Winter Gem Grove, this inlet will be discussed in greater detail under the hydraulic summary part of this report. The peak developed flow from this basin is 1.2cfs for the 5-year storm event and 2.2cfs for the 100-year storm event. Runoff is then routed east in a proposed 18" RCP.

Sub-Basin A2

This basin is located on the north side of Whitewolf Point; runoff from the proposed townhomes directs flow south to Whitewolf Point. These flows are then routed easterly in Whitewolf Point and then north in Winter Gem Grove to design point 1; a proposed 5' type "R" inlet located in a low spot on the west side of Winter Gem Grove, this inlet will be discussed in greater detail under the hydraulic summary part of this report. The peak developed flow from this basin is 2.6cfs for the 5-year storm event and 4.8cfs for the 100-year storm event. Runoff is then routed east in a proposed 18" RCP.

Sub-Basin A3

This basin is located north of Whitewolf Point and on the south side of Old Glory Drive; runoff from the rooftops of Lots 27 through 36 directs flow north to an underground collection system, flow is then conveyed easterly via 275' of 12" PVC storm drain at a minimum of 0.50% slope to design point 1; a proposed 5' type "R" inlet located in a low spot on the west side of Winter Gem Grove, this inlet will be discussed in greater detail under the hydraulic summary part of this report. The peak developed flow

from this basin is 0.8cfs for the 5-year storm event and 1.5cfs for the 100-year storm event. Runoff is then routed east in a proposed 18" RCP.

Sub-Basin A4

This basin is located on the east side of Winter Gem Grove; runoff from the proposed townhomes directs flow west to Winter Gem Grove. These flows are then routed north in Winter Gem Grove to design point 3; a proposed 5' type "R" inlet located in a low spot on the east side of Winter Gem Grove, this inlet will be discussed in greater detail under the hydraulic summary part of this report. The peak developed flow from this basin is 0.8cfs for the 5-year storm event and 1.4cfs for the 100-year storm event. Runoff is then routed east in a proposed 18" RCP.

Sub-Basin A5

This basin is located east of Winter Gem Grove and on the south side of Old Glory Drive; runoff from the rooftops of proposed Lots 37 through 40 directs flow north to an underground collection system, flow is then conveyed easterly via an 8" PVC storm drain at a minimum of 0.50% slope to design point 4; a proposed manhole located east of Winter Gem Grove and south of Old Glory Drive, this manhole will be discussed in greater detail under the hydraulic summary part of this report. The peak developed flow from this basin is 0.4cfs for the 5-year storm event and 0.8cfs for the 100-year storm event. Runoff is then routed southeasterly in a proposed 18" RCP, then southerly in a 36" RCP.

Sub-Basin A6

This basin is located east of Winter Gem Grove and the south of Old Glory Drive; runoff from the proposed townhomes directs flow east to design point 5; a proposed 5' type "R" inlet located in a low spot on the east side of the private drive, this inlet will be discussed in greater detail under the hydraulic summary part of this report. The peak developed flow from this basin is 1.2cfs for the 5-year storm event and 2.2cfs for the 100-year storm event. Runoff is then routed east in a proposed 18" RCP, then southerly in a 36" RCP.

Sub-Basin A7

This basin is located east of Winter Gem Grove and south of Old Glory Drive; runoff from the rooftops of proposed Lots 41 through 44 and Lots 84 through 87 and directs flow easterly to an underground collection system, flow is then conveyed northerly via a 12" PVC storm drain at a minimum of 0.50% slope to the previously mentioned proposed 5' type "R" inlet in sub-basin A6, this will be discussed in greater detail under the hydraulic summary part of this report. The peak developed flow from this basin is 1.0cfs for the 5-year storm event and 1.8cfs for the 100-year storm event. Runoff is then routed east in a proposed 18" RCP, then southerly in a 36" RCP.

Sub-Basin B1

This basin contains the easterly half (½) of Old Glory Drive from the most easterly edge of the property to the southerly portion of Winter Gem Grove. Runoff is directed to the street and flows will be intercepted by the existing inlets located on Old Glory Drive. The peak developed flow from this basin is 3.3cfs for the 5-year storm event and 5.9cfs for the 100-year storm event. Runoff is then routed southerly within the street and storm drain system.

Sub-Basin B2

This basin contains the easterly half (½) of Old Glory Drive from the southerly portion of Winter Gem Grove to the southerly edge of the property. Runoff is directed to the street and flows will be intercepted by the existing inlets located on Old Glory Drive. The peak developed flow from this basin is 2.2cfs for the 5-year storm event and 4.0cfs for the 100-year storm event. Runoff is then routed southerly within the street and storm drain system.

Sub-Basin C1

This basin is located west of Whitewolf Point and on the east side of Old Glory Drive; runoff from the rooftops of proposed Lots 20 through 26 and directs flow west to an underground collection system,

flow is then conveyed southerly to design point 7. The peak developed flow from this basin is 0.6cfs for the 5-year storm event and 1.0cfs for the 100-year storm event.

Sub-Basin C2

This basin is located west of Whitewolf Point and on the east side of Old Glory Drive; runoff from the rooftops of Lots 7 through 19 directs flow southwest to an underground collection system, flow is then conveyed southerly to design point 7. The peak developed flow from this basin is 1.1cfs for the 5-year storm event and 1.9cfs for the 100-year storm event. Runoff is then routed south in a proposed 18" RCP.

Sub-Basin C3

This basin is located on the northwest side of Whitewolf Point; runoff from the proposed townhomes directs flow southeast to Whitewolf Point. These flows are then routed southerly in Whitewolf Point and then westerly in Winter Gem Grove to design point 7. The peak developed flow from this basin is 3.8cfs for the 5-year storm event and 6.9cfs for the 100-year storm event. Runoff is then routed southerly in a proposed 18" RCP.

Sub-Basin C4

This basin is located on the southeast side of Whitewolf Point; runoff from the proposed townhomes directs flow northwesterly to Whitewolf Point. These flows are then routed southerly in Whitewolf Point and then westerly in Winter Gem Grove to design point 7. The peak developed flow from this basin is 3.3cfs for the 5-year storm event and 5.9cfs for the 100-year storm event. Runoff is then routed southerly in a proposed 18" RCP.

Sub-Basin C5

This basin is located between Whitewolf Point and Winter Gem Grove; runoff from the rooftops of Lots 45 through 47 and Lots 81 through 83, is directed to an underground collection system, this collection system is located between the units, flow is then conveyed to a proposed inlet in Sub-Basin C5. The peak developed flow from this basin is 0.6cfs for the 5-year storm event and 1.2cfs for the 100-year storm event. Runoff is then routed southwesterly in a proposed 12" PVC storm pipe.

Sub-Basin C6

This basin is located between Whitewolf Point and Winter Gem Grove; runoff from the rooftops of Lots 48 through 51 and Lots 78 through 80, is directed to an underground collection system, this collection system is located between the units, flow is then conveyed southwesterly via 12" PVC storm drain at a minimum of 0.50% to a proposed manhole at design point 9, this design point will be discussed in greater detail under the hydraulic summary part of this report. The peak developed flow from this basin is 0.7cfs for the 5-year storm event and 1.3cfs for the 100-year storm event. Runoff is then routed southwesterly in a proposed 12" PVC storm pipe.

Sub-Basin C7

This basin is located between Whitewolf Point and Winter Gem Grove; runoff from the rooftops of Lots 52 through 58 and Lots 75 through 77, is directed to an underground collection system, this collection system is located between the units, flow is then conveyed southerly via 12" PVC storm drain at a minimum of 0.50% to a proposed manhole at design point 10, this design point will be discussed in greater detail under the hydraulic summary part of this report. The peak developed flow from this basin is 1.0cfs for the 5-year storm event and 1.9cfs for the 100-year storm event.

Sub-Basin C8

This basin is located between Whitewolf Point and Winter Gem Grove; runoff from the rooftops of Lots 59 through 64 and Lots 72 through 74, is directed to an underground collection system, this collection system is located between the units, flow is then conveyed southerly to a proposed area inlet in Sub-Basin C8, flow will then continue southerly to design point 11 in Winter Gem Grove via 15" HDPE at a minimum of 0.80% slope, this design point will be discussed in greater detail under the hydraulic

summary part of this report. The peak developed flow from this basin is 0.9cfs for the 5-year storm event and 1.7cfs for the 100-year storm event.

Sub-Basin C9

This basin is located on the west and northerly side of Winter Gem Grove; runoff from the proposed townhomes directs flow easterly and southerly to Winter Gem Grove. These flows are then routed south and southwesterly in Winter Gem Grove to design point 13 located in a low spot on the north side of Winter Gem Grove. The peak developed flow from this basin is 2.6cfs for the 5-year storm event and 4.7cfs for the 100-year storm event.

Sub-Basin C10

This basin is located on the northerly side of Winter Gem Grove; runoff from the proposed townhomes directs flow southerly to Winter Gem Grove. These flows are then routed east and southwesterly in Winter Gem Grove to design point 13. The peak developed flow from this basin is 1.8cfs for the 5-year storm event and 3.3cfs for the 100-year storm event.

Sub-Basin C11

This basin is located on the easterly and southerly side of Winter Gem Grove; runoff from the proposed townhomes directs flow westerly and northerly to Winter Gem Grove. These flows are then routed east and southwesterly in Winter Gem Grove to a proposed 5' type "R" inlet located in a low spot on the southeast side of Winter Gem Grove. The peak developed flow from this basin is 2.7cfs for the 5-year storm event and 4.9cfs for the 100-year storm event.

Sub-Basin C12

This basin is located southeast of Winter Gem Grove; runoff from the proposed townhomes and parking lot flows southwest via an underground collection system and curb/gutter to the southwest side of the parking area to a 5' Type R inlet. The peak developed flow from this basin is 0.9cfs for the 5-year storm event and 1.7cfs for the 100-year storm event.

Sub-Basin C13

This basin is located southeast of Winter Gem Grove; runoff from the rooftops of Lots 65 through 71 is directed southeasterly to an underground collection system, flow is then conveyed southwesterly and southerly via 12" PVC storm drain at a minimum of 0.50% slope to a proposed storm drain manhole in Sub Basin C13. The peak developed flow from this basin is 0.7cfs for the 5-year storm event and 1.3cfs for the 100-year storm event.

Sub-Basin C14

This basin is located south of Winter Gem Grove; runoff from the proposed townhomes directs flow southerly to design point 15 on the southeast side of the private drive. The peak developed flow from this basin is 1.8cfs for the 5-year storm event and 3.3cfs for the 100-year storm event. Runoff is then routed south in a proposed 30" RCP to proposed detention pond A3.

Sub-Basin C15

This basin is located south of Winter Gem Grove and east of Old Glory Drive; runoff from the rooftops of Lots 1 through 6 is directed westerly to an underground collection system, flow is then conveyed southeasterly and easterly via 12" PVC storm drain at a minimum of 0.50% slope to design point 15. The peak developed flow from this basin is 0.5cfs for the 5-year storm event and 0.8cfs for the 100-year storm event.

Basin D

This basin is located on the east and southeast portion of the site and is open space and backyards. The peak developed flow from this basin is 1.5cfs for the 5-year storm event and 8.2cfs for the 100-year storm. Flows are directed to an existing 6' deep drainage ditch runoff and then conveyed south and southeasterly to proposed detention pond A3. This pond will be discussed in greater detail under the Detention Pond summary of this report.

5.0 HYDRAULIC SUMMARY

The sizing of the hydraulic structures was prepared by using the *StormSewers* computer software programs developed by Intellisolve, which conforms to the methods outlined in the "City of Colorado Springs/El Paso County Drainage Criteria Manual".

It is the intent of this Preliminary and Final Drainage Report to use the proposed curb/gutter and storm sewer to convey runoff to the proposed detention pond A3. Pipe size, Inlet size and locations are shown on the developed conditions drainage map. See Appendix C for detailed hydraulic calculations and the storm sewer model.

Design Point 1

Design point 1 includes surface flow from basins A1 and A2 and the combined peak flow at this low point on the west side of Winter Gem Grove was used to size the proposed 5' type "R" inlet. Design point 1 contains 0.91 acres and generates a peak developed flow of 3.9cfs for the 5-year storm event and 7.0cfs for the 100-year storm event. Inlet 7 is a 5' type "R" inlet in a sump condition. The street capacity of Winter Gem Grove at 0.5% slope is 6.3cfs (5-yr) and 26.4cfs (100-yr). The street capacity is not exceeded.

Design Point 2

Design point 2 is pipe flow under Winter Gem Grove and includes inlet flow from design point 1 and pipe flow from basin A3, and the combined peak flow at this low point on the east side of Winter Gem Grove was used to size the proposed 18" RCP at a minimum of 0.50%. Design point 2 generates a peak developed flow of 4.7cfs for the 5-year storm event and 8.5cfs for the 100-year storm event. These flows will be routed easterly via proposed 18" RCP at a minimum of 0.50% slope and is designed to handle the flow from this design point.

Design Point 3a

Design point 3a includes surface flow from basin A4 at a low point on the East side of Winter Gem Grove was used to size the proposed 5' type "R" inlet. Design point 3a contains 0.18 acres and generates a peak developed flow of 0.8cfs for the 5-year storm event and 1.4cfs for the 100-year storm event. Inlet 6 is a 5' type "R" inlet in a sump condition. The street capacity of Winter Gem Grove at 0.5% slope is 6.3cfs (5-yr) and 26.4cfs (100-yr). The street capacity is not exceeded.

Design Point 3

Design point 3 includes upstream flow from design point 2 and 3a. Design point 3 is the pipe flow which is 5.5cfs for the 5-year storm event and 9.9cfs for the 100-year storm event. These flows will be routed easterly via proposed 18" RCP at a minimum of 0.50% slope and is designed to handle the flow from this design point.

Design Point 4

Design point 4 includes upstream flow from design point 3 and basin A5. Design point 4 generates a peak developed flow of 5.9cfs for the 5-year storm event and 10.7cfs for the 100-year storm event. These flows will be routed easterly via proposed 18" RCP to storm manhole 6 at a minimum of 0.50% slope and is designed to handle the flow from this design point.

Design Point 5

Basin A6 surface flows to Inlet 8 which is a 5' type "R" inlet in a sump condition. The inlet is sized for 2.2cfs in the 100-year event for a sump condition. Design point 5 includes upstream flow from design point 4, Basin A6, Basin A7, and flow from an existing 36" storm sewer in Old Glory Drive (see Design Pt. A, existing conditions). Design point 5 generates a peak developed flow of 18.5cfs for the 5-year storm event and 37.7cfs for the 100-year storm event. Runoff is then routed southerly via the proposed

36" RCP to the pipe outlet then conveyed southwesterly within an existing 6' deep drainage ditch to proposed detention pond A3.

Design Point 6

Design point 6 includes upstream flow from basins C1 and C2 and was used to size the proposed 12" PVC at a minimum of 0.60%. Design point 6 contains generates a peak developed flow of 1.6cfs for the 5-year storm event and 2.9cfs for the 100-year storm event. These flows will be routed southerly via proposed 12" PVC to inlet 2. This PVC pipe is designed to handle the flow to design point 6.

Design Point 7

Design point 7 is surface flow and includes upstream flow from basins C3 and C4 and the located on the north side of Winter Gem Grove and was used to size the proposed 10' type "R" inlet on a continuous grade. Design point 7 generates a peak developed flow of 7.0cfs for the 5-year storm event and 12.8cfs for the 100-year storm event. Inlet 2 is a 10' type "R" inlet on a continuous grade. This 10' inlet intercepts 5.9cfs at a 1.20% grade with 1.1cfs flowby for the 5-year storm event and intercepts 8.1cfs at a 1.20% grade with 4.7cfs flowby for the 100-year storm event, these flowbys are then directed to Old Glory Drive, The intercepted flows will be routed southerly to storm manhole 2 via proposed 18" RCP at a minimum of 0.90% slope, this pipe is designed to handle the flow from this design point. The street capacity of Winter Gem Grove at 1.2% slope is 9.0cfs (5-yr) and 37.3cfs (100-yr). The street capacity is not exceeded.

Design Point 8

Design point 8 is pipe flow and includes upstream flow from design point 6 and design point 7 and was used to size the proposed 18" RCP at a minimum of 0.80%. Design point 8 generates a peak developed flow of 7.5cfs for the 5-year storm event and 11.0cfs for the 100-year storm event. These flows will be routed easterly via proposed 18" RCP to storm manhole 1 at a minimum of 0.90% slope and is designed to handle the flow from this design point.

Design Point 9

Design point 9 includes upstream flow from basins C5 and C6 and was used to size the proposed 12" PVC at a minimum of 0.50%. Design point 9 contains 0.32 acres and generates a peak developed flow of 1.4cfs for the 5-year storm event and 2.5cfs for the 100-year storm event. These flows will be routed southerly via proposed 12" PVC to a proposed manhole at design point 10. This PVC pipe at a minimum of 0.50% slope and is designed to handle the flow to design point 10.

Design Point 10

Design point 10 includes upstream flow from design point 9 (C5- C6) and basin C7 and was used to size the proposed 15" HDPE at a minimum of 0.50%. Design point 10 contains 0.56 acres and generates a peak developed flow of 2.4cfs for the 5-year storm event and 4.3cfs for the 100-year storm event. These flows will be routed southerly via proposed 15" HDPE at a minimum of 0.50% slope to Design Point 10a, then will flow southerly to design point 11 in Winter Gem Grove.

Design Point 10a

Design point 10a is the same flow as Design Point 11 which includes upstream flow from design point 10 and basin C8 and was used to size the proposed 15" HDPE at a minimum of 0.80%. Design point 10a generates a peak developed flow of 3.3cfs for the 5-year storm event and 6.0cfs for the 100-year storm event. These flows will be routed southerly via proposed 15" HDPE at a minimum of 0.80% slope to design point 11 in Winter Gem Grove.

Design Point 11

Design point 11 is the same flow as Design Point 10a and was used to size the proposed 18" RCP at a minimum of 0.60%. Design point 11 generates a peak developed flow of 3.3cfs for the 5-year storm event and 6.0cfs for the 100-year storm event. These flows will be routed westerly via proposed 18" RCP to storm manhole 1 at a minimum of 0.60% slope and is designed to handle the flow from this design point.

Design Point 12

Design point 12 is the pipe flow which includes upstream flow from design point 8 and 11. Design point 12 generates a peak developed flow of 10.8cfs for the 5-year storm event and 17.0cfs for the 100-year storm event. These flows will be routed southerly via proposed 24" RCP to proposed inlet 1 located in basin C14 at a minimum of 0.80% slope and is designed to handle the flow from this design point.

Design Point 13

Design point 13 includes upstream flow from basins C9 and C10 and the combined peak flow at this low point on the north side of Winter Gem Grove was used to size the proposed inlet. Design point 13 generates a peak developed flow of 4.0cfs for the 5-year storm event and 7.4cfs for the 100-year storm event. Inlet 5 is a 5' type "R" inlet in a sump condition. These flows will be routed southeasterly via proposed 18" RCP at a minimum slope of 0.60% slope to proposed inlet 4, this pipe is designed to handle the flow from this design point. The street capacity of Winter Gem Grove at 0.7% slope is 7.5cfs (5-yr) and 31.2cfs (100-yr). The street capacity is not exceeded.

Design Point 14a

Design point 14a includes upstream flow from basin C11 at a low point on the south side of Winter Gem Grove and was used to size the proposed inlet. Design point 14a generates a peak developed flow of 2.7cfs for the 5-year storm event and 4.9cfs for the 100-year storm event. Inlet 4 is a 5' type "R" inlet in a sump condition, runoff from this basin was used to size this inlet. These flows will be routed southeasterly. The street capacity of Winter Gem Grove at 0.7% slope is 7.5cfs (5-yr) and 31.2cfs (100-yr). The street capacity is not exceeded.

Design Point 14

Design point 14 is pipe flow and includes upstream flow from design point 13 and 14a. Design point 14 generates a peak developed flow of 6.7cfs for the 5-year storm event and 12.3cfs for the 100-year storm event. The peak flow will be routed southeasterly to storm manhole 4 via 24" RCP at a minimum slope of 0.50%. These flows will continue to proposed detention pond A3.

Design Point 14b

Design point 14b includes upstream flow from basins C12 at a low point in a proposed parking lot. Design point 14b generates a peak developed flow of 0.9cfs for the 5-year storm event and 1.7cfs for the 100-year storm event. Inlet 3 is a 5' type "R" inlet in a sump condition. These flows will be routed southeasterly.

Design Point 14c

Design point 14c is pipe flow and includes upstream flow from design point 14 and 14b. Design point 14c generates a peak developed flow of 7.6cfs for the 5-year storm event and 14.0cfs for the 100-year storm event. The peak flow will be routed southeasterly via 24" RCP at a minimum slope of 0.50%. These flows will continue to detention pond A3.

Design Point 14d

Design point 14d is pipe flow and includes upstream flow from design point 14c and Basin C13. Design point 14d generates a peak developed flow of 8.3cfs for the 5-year storm event and 15.3cfs for the 100-year storm event. The peak flow will be routed southeasterly via 24" RCP at a minimum slope of 0.50%. These flows will continue to detention pond A3.

Design Point 15

Design point 15 includes upstream flow from basins C14 and C15. Design point 15 generates a peak developed flow of 2.7cfs for the 5-year storm event and 4.8cfs for the 100-year storm event. Inlet 1 located at the south edge of the parking lot, south of Winter Gem Grove in basin C15 is a 5' type "R" inlet in a sump condition, runoff from this basin was used to size this inlet. Design point 15 flows will be

routed southerly via 30" RCP at a minimum slope of 0.60% slope. These flows will continue to proposed detention pond A3.

Design Point 15a

Design point 15a is pipe flow and includes upstream flow from design point 12, 14d, and 15. Design point 15a generates a peak developed flow of 21.4cfs for the 5-year storm event and 36.4cfs for the 100-year storm event. The peak flow will be routed southeasterly via 30" RCP at a minimum slope of 0.60% to detention pond A3.

Design Point 16

Design point 16 is the total flow into an existing 36" RCP that connects to the storm sewer system in Old Glory Drive in the SW corner of this site. Design point 16 generates a peak developed flow of 10.9cfs for the 5-year storm event and 30.4cfs for the 100-year storm event. The flow was calculated by adding the outflow from Pond A3 and flow from Existing Design Point A (10.0cfs/23.0cfs) that flows through Pond A3. The 36" storm sewer was designed to accept 54cfs of flow in the 100-year storm event per the Fontaine/Old Glory Final Drainage Report prepared in 2006 by Pentacor Engineering.

Storm Sewer Notes

Storm sewer within the streets in this subdivision and Pond A3 will be owned/maintained by the Lorson Ranch Metropolitan District since these are private streets. Roof drain connections will be owned/maintained by the Homeowners Association. See Grading Plan.

6.0 DETENTION AND WATER QUALITY POND

Detention and Storm Water Quality for Ponderosa at Lorson Ranch Filing No. 3 is required per El Paso County criteria. We have implemented the Full Spectrum approach for detention for Ponderosa at Lorson Ranch Filing No. 3 per the Denver Urban Drainage Districts specifications. There is one proposed detention pond with full spectrum detention for this project site. Nearly all runoff from this site will flow to the on-site pond which will incorporate storm water quality features prior to discharge into downstream storm sewer.

Full Spectrum Pond Construction Requirements

Design calculations for full spectrum ponds will include a 10' wide gravel access road on a 15' wide bench at a maximum 10% slope to the pond outlet structures. The final design of full spectrum ponds consists of an outlet structure, storm sewer outfall to Old Glory Drive, concrete low flow channel, sediment forebay, and overflow weir. Soil borings for this project can be found in the geotechnical report for Ponderosa at Lorson Ranch Filing No. 3 prepared by RMG.

Detention Pond A3 (Full Spectrum Design)

This is an on-site permanent full spectrum extended detention pond that includes water quality and discharges downstream into existing storm sewer in Old Glory Drive. Pond A3 is designed using the UDCF Full Spectrum spreadsheets and is sized for the drainage of this site only (10.1ac). Pond A3 outlet structure is a standard 3'x19.25' full spectrum sloped outlet structure designed by the full spectrum spreadsheets to match pre-developed rates for 10.1acres. Offsite flow entering this site from Existing Design Point A will be allowed to flow through Pond A3 and will be captured by a three-cell CDOT Type D inlet set slightly above the full spectrum outlet structure elevation. The 3-cell CDOT Type D inlets will collect the offsite flow and discharge it directly into an existing 36" storm sewer connecting to the storm sewer system in Old Glory Drive. The full spectrum print outs are in the appendix of this report. See map in appendix for watershed areas.

- Watershed Ares: 10.1 acres
- Watershed Imperviousness: 52%
- Hydrologic Soils Group B (22%) and Group C/D (78%)
- Forebay: 0.005ac-ft, 18" depth

- Zone 1 WQCV: 0.162ac-ft, WSEL: 5709.78, 0.1cfs
- Zone 2 EURV: 0.452ac-ft, WSEL: 5711.06, Top EURV wall set at 5711.82, 3'x3" outlet with 0:1 slope, 0.4cfs
- (5-yr): 0.600ac-ft, WSEL: 5711.49, 0.5cfs
- Zone 3 (100-yr): 1.114ac-ft, WSEL: 5712.56, 7.4cfs
- Pipe Outlet: 18" RCP with restrictor plate up 7.75"
- Overflow Spillway: 3-cell CDOT Type D inlet connected to 36" stm, flow depth=0.7'
- Pre-development release rate into creek compliance from full spectrum pond spreadsheets
- Pond Bottom Elevation: 5707.77

Water Quality Design

Water quality will be provided by one permanent extended detention basin (Pond A3) for this site.

Pond A3 Emergency Overflow

Pond A3's emergency Overflow structure consists of a three-cell CDOT Type D inlet attached to and set slightly above the full spectrum outlet structure elevation. The 3-cell CDOT Type D inlets will discharge flow directly into an existing 36" storm sewer flowing into the storm sewer system in Old Glory Drive. Pond A3's emergency overflow structure was sized by adding the on-site undetained fully developed 100-year flows (24.2cfs) to the offsite 100-year flows from Existing Design Point A (23cfs) for a total flow of 47.2cfs with a flow depth of 5.8inches above the top of the Type D inlets. The existing 36" storm sewer was designed to accept 54cfs of flow in the 100-year storm event per the Fontaine/Old Glory Final Drainage Report prepared in 2006 by Pentacor Engineering.

7.0 FOUR STEP PROCESS

The site has been developed to minimize wherever possible the rate of developed runoff that will leave the site and to provide water quality management for the runoff produced by the site as proposed on the development plan. The following four step process should be considered and incorporated into the storm water collection system and storage facilities where applicable.

Step 1: Employ Runoff Reduction Practices

Ponderosa at Lorson Ranch Filing No. 3 has employed several methods of reducing runoff.

- The street configuration was laid out to minimize the length of streets. Many streets are straight and perpendicular resulting in lots with less wasted space.
- Open space tracts of land act as a buffer between houses and the street
- The entire site drains to a WQ pond.
- The proposed HOA will maintain common area landscaping.
- Full Spectrum Detention Pond A3 (extended detention basin) will be constructed. The full spectrum detention ponds mimics existing storm discharges

Step 2: Stabilize Drainageways

Jimmy Camp Creek is a major drainageway located west of this site. JCC has been stabilized per county criteria in 2006. The design included a natural sand channel bottom and armored sides.

Step 3: Provide Water Quality Control Volume (WQCV)

Treatment and slow release of the water quality capture volume (WQCV) is required. Ponderosa at Lorson Ranch Filing No. 3 will utilize Pond A3 which is a full spectrum stormwater detention pond including Water Quality Capture Volume and a full spectrum detention/WQ outlet structure.

Step 4: Consider Need for Industrial and Commercial BMP's or Other Specialized BMP's

This site is a residential site and does not contain commercial or industrial development. There are no potential sources of contaminants that could be introduced to the County's MS4. During construction the source control will be provided with the proper installation of erosion control BMPs to limit erosion and transport of sediment. Area disturbed by construction will be seeded and mulched. Cut and fill slopes will be reseeded, and the slopes equal to or greater than three-to-one will be protected with erosion control fabric. Silt fences will be placed at the bottom of re-vegetated and rough graded slopes. Inlet protection will be used around proposed inlets. In addition, temporary sediment basins will be constructed so runoff will be treated prior to discharge. Construction BMPs in the form of vehicle tracking control, sediment basins, concrete washout area, rock socks, buffers, and silt fences will be utilized to protect receiving waters.

8.0 DRAINAGE AND BRIDGE FEES

Ponderosa at Lorson Ranch Filing No. 3 is located within the Jimmy Camp Creek drainage basin which is currently a fee basin in El Paso County. Current El Paso County regulations require drainage and bridge fees to be paid for platting of land as part of the plat recordation process. Lorson Ranch Metro District will be constructing the major drainage infrastructure as part of the district improvements.

The drainage/bridge fees for this site have previously been paid in 2006 as part of the Ponderosa at Lorson Ranch Filing No. 1 final plat. The following table provides a breakdown of the drainage fees that have been paid for this site in 2006.

Table 8.1: Drainage/Bridge Fees Paid For This Site in 2006

The 2006 Drainage fee was \$9,185 and bridge fee was \$333 per impervious acre

Type of Land Use	Total Area (ac)	Imperviousness	Drainage Fee	Bridge Fee	Surety Fee
Residential	10.03	50%	\$46,062	\$1,670	0

Table 8.2: Public Drainage Facility Costs (non-reimbursable)

Item	Quantity	Unit	Unit Cost	Item Total
18" Storm	792	LF	\$40	\$31,680
24" Storm	484	LF	\$50	\$24,200
30" Storm	33	LF	\$60	\$1,980
36" Storm	293	LF	\$70	\$20,510
15" HDPE	85	EA	\$30	\$6,000
5' Inlet	7	EA	\$3,000	\$21,000
10' Inlet	1	EA	\$4,000	\$4,000
MH	8	EA	\$5,000	\$40,000
36" FES	1	EA	\$2,000	\$2,000
			Sub-Total	\$145,370
			Eng/Cont 15%)	\$21,806
			Total Est. Cost	\$167,176

Table 8.3: Private Drainage Facility Costs (non-reimbursable)

Item	Quantity	Unit	Unit Cost	Item Total
12" PVC	2390	LF	\$20	\$47,800.00
15" HDPE	88	LF	\$25	\$2,200.00
Manholes	7	EA	\$250	\$1,750.00
Area Inlets	1	EA	\$150	\$150.00
			Subtotal	\$51,900.00
			Eng/Cont 15%)	\$7,785
			Total Est. Cost	\$59,685

Table 8.4: Lorson Ranch Metro District Drainage Facility Costs (non-reimbursable)

Item	Quantity	Unit	Unit Cost	Item Total
Full Spectrum Ponds and Outlet	1	LS	\$40,000	\$40,000
			Subtotal	\$40,000
			Eng/Cont (15%)	\$6,000
			Total Est. Cost	\$46,000

9.0 CONCLUSIONS

This drainage report has been prepared in accordance with the City of Colorado Springs/El Paso County Drainage Criteria Manual. The proposed development and drainage infrastructure will not cause adverse impacts to adjacent properties or properties located downstream. Several key aspects of the development discussed above are summarized as follows:

- Developed runoff will be conveyed via curb/gutter and storm sewer facilities
- Jimmy Camp Creek has been realigned within Lorson Ranch.

10.0 REFERENCES

1. City of Colorado Springs/El Paso County Drainage Criteria Manual DCM, dated November, 1991
2. Soil Survey of El Paso County Area, Colorado by USDA, SCS
3. City of Colorado Springs "Drainage Criteria Manual, Volume 2
4. El Paso County "Engineering Criteria Manual"
5. Lorson Ranch MDDP1, October 26, 2006 by Pentacor Engineering.
6. Final Drainage Report for Fontaine Boulevard, Old Glory Drive, and Marksheffel Road Phase 1 Improvements, Dated February 6, 2006, Revised September 7, 2006, by Pentacor Engineering.
7. DBPS for Jimmy Camp Creek prepared by Wilson & Company, 1987
8. Jimmy Camp Creek Drainage Basin Planning Study, Dated March 9, 2015, by Kiowa Engineering Corporation
9. El Paso County Resolution #15-042, El Paso County adoption of Chapter 6 and Section 3.2.1 of the City of Colorado Springs Drainage Criteria Manual dated May, 2014.

APPENDIX A – VICINTIY MAP, SOILS MAP, FEMA MAP

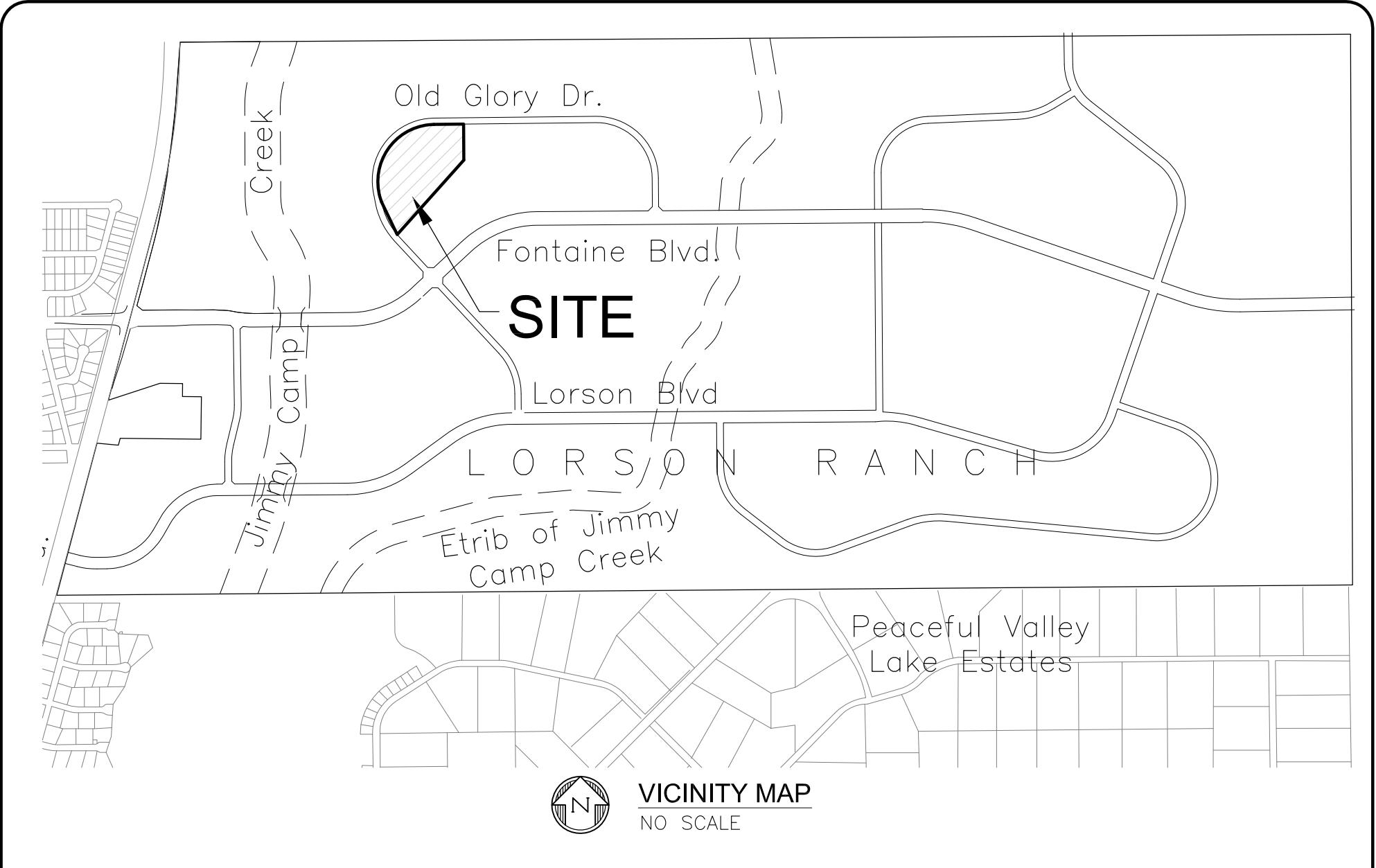

VICINITY MAP
NO SCALE



CORE
ENGINEERING GROUP

15004 1ST AVE. S.
BURNSVILLE, MN 55306
PH: 719.570.1100

CONTACT: RICHARD L. SCHINDLER, P.E.
EMAIL: Rich@ceg1.com

PONDEROSA AT LORSON RANCH FILING NO. 3
VICINITY MAP

SCALE:
NTS

DATE:
NOVEMBER, 2019

FIGURE NO.
--

National Flood Hazard Layer FIRMette



Legend

SEE FIS REPORT FOR DETAILED LEGEND AND INDEX MAP FOR FIRM PANEL LAYOUT

SPECIAL FLOOD HAZARD AREAS		Without Base Flood Elevation (BFE) <i>Zone A, V, A99</i>
		With BFE or Depth <i>Zone AE, AO, AH, VE, AR</i>
		Regulatory Floodway
OTHER AREAS OF FLOOD HAZARD		0.2% Annual Chance Flood Hazard, Areas of 1% annual chance flood with average depth less than one foot or with drainage areas of less than one square mile <i>Zone X</i>
		Future Conditions 1% Annual Chance Flood Hazard <i>Zone X</i>
		Area with Reduced Flood Risk due to Levee. See Notes. <i>Zone X</i>
		Area with Flood Risk due to Levee <i>Zone D</i>
OTHER AREAS		NO SCREEN Area of Minimal Flood Hazard <i>Zone X</i>
		Effective LOMRs
GENERAL STRUCTURES		Area of Undetermined Flood Hazard <i>Zone D</i>
		Channel, Culvert, or Storm Sewer
		Levee, Dike, or Floodwall
OTHER FEATURES		20.2 Cross Sections with 1% Annual Chance Water Surface Elevation
		17.5 Cross Sections with 1% Annual Chance Water Surface Elevation
		Coastal Transect
		Base Flood Elevation Line (BFE)
		Limit of Study
MAP PANELS		Jurisdiction Boundary
		Coastal Transect Baseline
		Profile Baseline
		Hydrographic Feature
		Digital Data Available
		No Digital Data Available
		Unmapped



The pin displayed on the map is an approximate point selected by the user and does not represent an authoritative property location.

This map complies with FEMA's standards for the use of digital flood maps if it is not void as described below. The basemap shown complies with FEMA's basemap accuracy standards

The flood hazard information is derived directly from the authoritative NFHL web services provided by FEMA. This map was exported on **11/4/2019 at 9:03:31 AM** and does not reflect changes or amendments subsequent to this date and time. The NFHL and effective information may change or become superseded by new data over time.

This map image is void if the one or more of the following map elements do not appear: basemap imagery, flood zone labels, legend, scale bar, map creation date, community identifiers, FIRM panel number, and FIRM effective date. Map images for unmapped and unmodernized areas cannot be used for regulatory purposes.



PANEL #08041C0957G
December 7, 2018

USGS The National Map: Orthoimagery. Data refreshed April, 2019.



38°44'15.33"N

104°38'4.97"W

Soil Map—El Paso County Area, Colorado
(Ponderosa at Lorson Ranch Fil. No. 3)

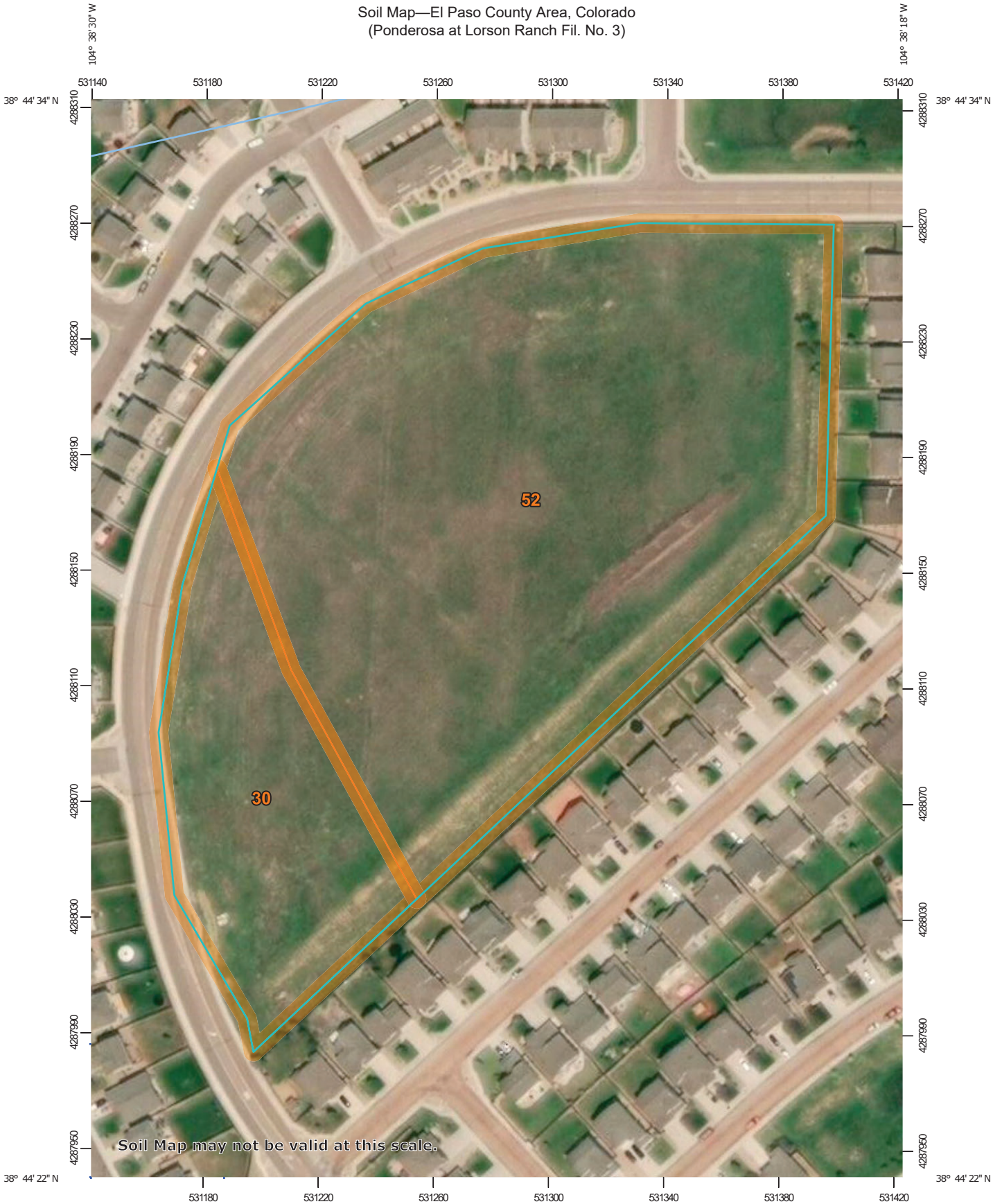

Map Scale: 1:1,820 if printed on A portrait (8.5" x 11") sheet.

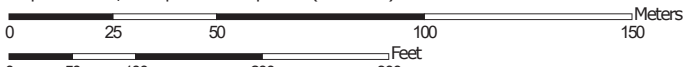

Map projection: Web Mercator Corner coordinates: WGS84 Edge tics: UTM Zone 13N WGS84







































Natural Resources
Conservation Service

Web Soil Survey
National Cooperative Soil Survey

8/22/2019
Page 1 of 3

MAP LEGEND

 Area of Interest (AOI)	 Spoil Area
 Soil Map Unit Polygons	 Stony Spot
 Soil Map Unit Lines	 Very Stony Spot
 Soil Map Unit Points	 Wet Spot
 Special Point Features	 Other
 Blowout	 Special Line Features
 Borrow Pit	Water Features
 Clay Spot	 Streams and Canals
 Closed Depression	Transportation
 Gravel Pit	 Rails
 Gravelly Spot	 Interstate Highways
 Landfill	 US Routes
 Lava Flow	 Major Roads
 Marsh or swamp	 Local Roads
 Mine or Quarry	Background
 Miscellaneous Water	 Aerial Photography
 Perennial Water	
 Rock Outcrop	
 Saline Spot	
 Sandy Spot	
 Severely Eroded Spot	
 Sinkhole	
 Slide or Slip	
 Sodic Spot	

MAP INFORMATION

The soil surveys that comprise your AOI were mapped at 1:24,000.

Warning: Soil Map may not be valid at this scale.
Enlargement of maps beyond the scale of mapping can cause misunderstanding of the detail of mapping and accuracy of soil line placement. The maps do not show the small areas of contrasting soils that could have been shown at a more detailed scale.

Please rely on the bar scale on each map sheet for map measurements.

Source of Map: Natural Resources Conservation Service
Web Soil Survey URL:
Coordinate System: Web Mercator (EPSG:3857)

Maps from the Web Soil Survey are based on the Web Mercator projection, which preserves direction and shape but distorts distance and area. A projection that preserves area, such as the Albers equal-area conic projection, should be used if more accurate calculations of distance or area are required.

This product is generated from the USDA-NRCS certified data as of the version date(s) listed below.

Soil Survey Area: El Paso County Area, Colorado
Survey Area Data: Version 16, Sep 10, 2018
Soil map units are labeled (as space allows) for map scales 1:50,000 or larger.

Date(s) aerial images were photographed: Apr 12, 2017—Nov 17, 2017

The orthophoto or other base map on which the soil lines were compiled and digitized probably differs from the background imagery displayed on these maps. As a result, some minor shifting of map unit boundaries may be evident.

Map Unit Legend

Map Unit Symbol	Map Unit Name	Acres in AOI	Percent of AOI
30	Fort Collins loam, 0 to 3 percent slopes	2.2	21.7%
52	Manzanst clay loam, 0 to 3 percent slopes	7.9	78.3%
Totals for Area of Interest		10.1	100.0%

APPENDIX B – HYDROLOGY CALCULATIONS



Standard Form SF-2. Storm Drainage System Design (Rational Method Procedure)

Calculated By: Leonard Beasley
 Date: October 29, 2019
 Checked By: Leonard Beasley

Job No: 100.050
 Project: Ponderosa at Lorson Ranch Filing No. 3
 Design Storm: **5 - Year Event**

Street or Basin	Design Point	Direct Runoff							Total Runoff				Street		Pipe			Travel Time			Remarks
		Area Design	Area (A)	Runoff Coeff. (C)	t_c	CA	i	Q	t_c	$\Sigma (CA)$	i	Q	Slope	Street Flow	Design Flow	Slope	Pipe Size	Length	Velocity	t_t	
			ac.			min.		in/hr	cfs	min		in/hr	cfs	%	cfs	cfs	%	in	ft	ft/sec	
A1			0.29	0.82	5.0	0.24	5.17	1.2													
A2			0.62	0.82	5.0	0.51	5.17	2.6													
A1-A2	1	0.91							5.0	0.75	5.17	3.9									
A3			0.19	0.82	5.0	0.16	5.17	0.8													
A1-A3	2	1.10							5.0	0.90	5.17	4.7									
A4			0.18	0.82	5.0	0.15	5.17	0.8													
A1-A4	3	1.28							5.0	1.05	5.17	5.4									
A5			0.10	0.82	5.0	0.08	5.17	0.4													
A1-A5	4	1.38							5.0	1.13	5.17	5.8									
A6			0.28	0.82	5.0	0.23	5.17	1.2													
A1-A6	5	1.66							5.0	1.36	5.17	7.0									
A7			0.23	0.82	5.0	0.19	5.17	1.0													
A		1.89							5.0	1.55	5.17	8.0									
B1			0.82	0.90	7.9	0.74	4.49	3.3													
B2			0.49	0.90	5.3	0.44	5.08	2.2													
B		1.31							10.9	1.18	4.00	4.7									



Standard Form SF-2. Storm Drainage System Design (Rational Method Procedure)

Calculated By: Leonard Beasley
 Date: October 29, 2019
 Checked By: Leonard Beasley

Job No: 100.050
 Project: Ponderosa at Lorson Ranch Filing No. 3
 Design Storm: **5 - Year Event**

Street or Basin	Design Point	Direct Runoff							Total Runoff				Street		Pipe			Travel Time			Remarks
		Area Design	Area (A)	Runoff Coeff. (C)	t_c	CA	i	Q	t_c	$\Sigma (CA)$	i	Q	Slope	Street Flow	Design Flow	Slope	Pipe Size	Length	Velocity	t_t	
			ac.			min.		in/hr	cfs	min		in/hr	cfs	%	cfs	cfs	%	in	ft	ft/sec	
C1			0.13	0.82	5.0	0.11	5.17	0.6													
C2			0.25	0.82	5.0	0.21	5.17	1.1													
C1-C2	6	0.38							5.0	0.31	5.17	1.6									
C3			0.93	0.82	5.7	0.76	4.98	3.8													
C4			0.81	0.82	5.9	0.66	4.91	3.3													
C3-C4	7	1.74							5.9	1.43	4.91	7.0									
C1-C4	8	2.12							5.9	1.74	4.91	8.5									
C5			0.15	0.82	5.0	0.12	5.17	0.6													
C6			0.17	0.82	5.0	0.14	5.17	0.7													
C5-C6	9	0.32							5.0	0.26	5.17	1.4									
C7			0.24	0.82	5.0	0.20	5.17	1.0													
C5-C7	10	0.56							5.0	0.46	5.17	2.4									
C8			0.22	0.82	5.0	0.18	5.17	0.9													
C5-C8	11	0.78							5.0	0.64	5.17	3.3									
C1-C8	12	2.90							5.9	2.38	4.91	11.7									
C9			0.61	0.82	5.0	0.50	5.17	2.6													



Standard Form SF-2. Storm Drainage System Design (Rational Method Procedure)

Calculated By: Leonard Beasley
 Date: October 29, 2019
 Checked By: Leonard Beasley

Job No: 100.050
 Project: Ponderosa at Lorson Ranch Filing No. 3
 Design Storm: **5 - Year Event**

Street or Basin	Design Point	Direct Runoff							Total Runoff				Street		Pipe			Travel Time			Remarks
		Area Design	Area (A)	Runoff Coeff. (C)	t_c	CA	i	Q	t_c	$\Sigma (CA)$	i	Q	Slope	Street Flow	Design Flow	Slope	Pipe Size	Length	Velocity	t_t	
			ac.			min.		in/hr	cfs	min		in/hr	cfs	%	cfs	cfs	%	in	ft	ft/sec	
C10			0.43	0.82	5.0	0.35	5.17	1.8													
C9-C10	13	1.04							6.6	0.85	4.75	4.0									
C11			0.67	0.82	6.0	0.55	4.89	2.7													
C9-C11	14	1.71							6.6	1.40	4.75	6.7									
C12			0.22	0.82	5.0	0.18	5.17	0.9													
C13			0.17	0.82	5.0	0.14	5.17	0.7													
C14			0.45	0.82	5.7	0.37	4.98	1.8													
C15			0.11	0.82	5.0	0.09	5.17	0.5													
C13-C15	15	0.73							5.7	0.60	4.98	3.0									
C		5.56							8.0	4.56	4.47	20.4									
D			2.93	0.15	15.4	0.44	3.48	1.5													



Standard Form SF-2. Storm Drainage System Design (Rational Method Procedure)

Calculated By: Leonard Beasley
 Date: October 29, 2019
 Checked By: Leonard Beasley

Job No: 100.050
 Project: Ponderosa at Lorson Ranch Filing No. 3
 Design Storm: **100 - Year Event**

Street or Basin	Design Point	Direct Runoff							Total Runoff				Street		Pipe			Travel Time			Remarks
		Area Design	Area (A)	Runoff Coeff. (C)	t_c	CA	i	Q	t_c	Σ (CA)	i	Q	Slope	Street Flow	Design Flow	Slope	Pipe Size	Length	Velocity	t_t	
			ac.		min.		in/hr	cfs	min		in/hr	cfs	%	cfs	cfs	%	in	ft	ft/sec	min	
A1			0.29	0.89	5.0	0.26	8.68	2.2													
A2			0.62	0.89	5.0	0.55	8.68	4.8													
A1-A2	1	0.91							5.0	0.81	8.68	7.0									
A3			0.19	0.89	5.0	0.17	8.68	1.5													
A1-A3	2	1.10							5.0	0.98	8.68	8.5									
A4			0.18	0.89	5.0	0.16	8.68	1.4													
A1-A4	3	1.28							5.0	1.14	8.68	9.9									
A5			0.10	0.89	5.0	0.09	8.68	0.8													
A1-A5	4	1.38							5.0	1.23	8.68	10.7									
A6			0.28	0.89	5.0	0.25	8.68	2.2													
A1-A6		1.66							5.0	1.48	8.68	12.8									
A7			0.23	0.89	5.0	0.20	8.68	1.8													
A Basins		1.89							5.0	1.68	8.68	14.6									
B1			0.82	0.96	7.9	0.79	7.53	5.9													
B2			0.49	0.96	5.3	0.47	8.53	4.0													
B Basins		1.31							10.9	1.26	6.71	8.4									



Standard Form SF-2. Storm Drainage System Design (Rational Method Procedure)

Calculated By: Leonard Beasley
 Date: October 29, 2019
 Checked By: Leonard Beasley

Job No: 100.050
 Project: Ponderosa at Lorson Ranch Filing No. 3
 Design Storm: **100 - Year Event**

Street or Basin	Design Point	Direct Runoff							Total Runoff				Street		Pipe			Travel Time			Remarks
		Area Design	Area (A)	Runoff Coeff. (C)	t_c	CA	i	Q	t_c	Σ (CA)	i	Q	Slope	Street Flow	Design Flow	Slope	Pipe Size	Length	Velocity	tt	
			ac.			min.		in/hr	cfs	min		in/hr	cfs	%	cfs	cfs	%	in	ft	ft/sec	
C1			0.13	0.89	5.0	0.12	8.68	1.0													
C2			0.25	0.89	5.0	0.22	8.68	1.9													
C1-C2	6	0.38							5.0	0.34	8.68	2.9									
C3			0.93	0.89	5.7	0.83	8.36	6.9													
C4			0.81	0.89	5.9	0.72	8.25	5.9													
C3-C4	7	1.74							5.9	1.55	8.25	12.8									
C1-C4	8	2.12							5.9	1.89	8.25	15.6									
C5			0.15	0.89	5.0	0.13	8.68	1.2													
C6			0.17	0.89	5.0	0.15	8.68	1.3													
C5-C6	9	0.32							5.0	0.28	8.68	2.5									
C7			0.24	0.89	5.0	0.21	8.68	1.9													
C5-C7	10	0.56							5.0	0.50	8.68	4.3									
C8			0.22	0.89	5.0	0.20	8.68	1.7													
C5-C8	11	0.78							5.0	0.69	8.68	6.0									
C1-C8	12	2.90							5.9	2.58	8.25	21.3									
C9			0.61	0.89	5.0	0.54	8.68	4.7													



Standard Form SF-2. Storm Drainage System Design (Rational Method Procedure)

Calculated By: Leonard Beasley
 Date: October 29, 2019
 Checked By: Leonard Beasley

Job No: 100.050
 Project: Ponderosa at Lorson Ranch Filing No. 3
 Design Storm: **100 - Year Event**

Street or Basin	Design Point	Direct Runoff							Total Runoff				Street		Pipe			Travel Time			Remarks
		Area Design	Area (A)	Runoff Coeff. (C)	t_c	CA	i	Q	t_c	Σ (CA)	i	Q	Slope	Street Flow	Design Flow	Slope	Pipe Size	Length	Velocity	t_t	
			ac.			min.		in/hr	cfs	min		in/hr	cfs	%	cfs	cfs	%	in	ft	ft/sec	
C10			0.43	0.89	5.0	0.38	8.68	3.3													
C9-C10	13	1.04							6.6	0.93	7.97	7.4									
C11			0.67	0.89	6.0	0.60	8.21	4.9													
C9-C11	14	1.71							6.6	1.52	7.97	12.1									
C12			0.22	0.89	5.0	0.20	8.68	1.7													
C13			0.17	0.89	5.0	0.15	8.68	1.3													
C14			0.45	0.89	5.7	0.40	8.36	3.3													
C15			0.11	0.89	5.0	0.10	8.68	0.8													
C13-C15	15	0.73							5.7	0.65	8.36	5.4									
C		5.43							8.0	4.95	7.51	37.1									
D			2.93	0.48	15.4	1.41	5.85	8.2													



Standard Form SF-1. Time of Concentration-Proposed

Calculated By: Leonard Beasley
 Date: October 29, 2019
 Checked By: Leonard Beasley

Job No: 100.050
 Project: Ponderosa at Lorson Ranch Filing No. 3

Sub-Basin Data				Initial Overland Time (t _i)				Travel Time (t _t)					t _c Check (urbanized Basins)		Final t _c
BASIN or DESIGN	C ₅	AREA (A) acres	NRCS Convey.	LENGTH (L) feet	SLOPE (S) %	VELOCITY (V) ft/sec	t _i minutes	LENGTH (L) feet	SLOPE (S) %	VELOCITY (V) ft/sec	t _t minutes	Computed t _c Minutes	TOTAL LENGTH (L) feet	Regional t _c =(L/180)+10 minutes	USDCM Recommended T _c =t _i +t _t (min)
A1	0.82	0.29	20.0	16.00	1.80%	0.16	1.67	73.00	0.70%	1.67	0.73				
			20.0					110.00	1.00%	2.00	0.92	3.32	199.00	11.11	3.32
A2	0.82	0.62	20.0	17.00	1.70%	0.16	1.76	75.00	1.50%	2.45	0.51				
			20.0					258.00	0.70%	1.67	2.57	4.84	350.00	11.94	4.84
A3	0.82	0.19	8"	2.00	2.00%	0.06	0.57	75.00	1.00%	3.47	0.36				
			8"					184.00	1.00%	3.47	0.88	1.81	184.00	11.02	1.81
A4	0.82	0.18	20.0	20.00	2.00%	0.18	1.81	170.00	0.74%	1.72	1.65	3.45	190.00	11.06	3.45
A5	0.82	0.10	8"	2.00	2.00%	0.06	0.57	15.00	1.00%	3.47	0.07				
			8"					104.00	1.00%	3.47	0.50	1.14	104.00	10.58	1.14
A6	0.82	0.28	20.0	2.00	2.00%	0.06	0.57	22.00	4.00%	4.00	0.09				
			20.0					126.00	1.60%	2.53	0.83	1.49	150.00	10.83	1.49
A7	0.82	0.23	8"	2.00	2.00%	0.06	0.57	36.00	1.00%	3.47	0.17				
			8"					120.00	1.00%	3.47	0.58	1.32	120.00	10.67	1.32
B1	0.90	0.82	20.0	34.00	2.00%	0.34	1.68	698.00	0.88%	1.88	6.20	7.88	732.00	14.07	7.88
B2	0.90	0.49	20.0	10.00	2.00%	0.18	0.91	507.00	0.92%	1.92	4.40	5.31	517.00	12.87	5.31
B	0.90	1.31	20.0	34.00	2.00%	0.34	1.68	1040.00	0.88%	1.88	9.24	10.91	1074.00	15.97	10.91



Standard Form SF-1. Time of Concentration-Proposed

Calculated By: Leonard Beasley
 Date: October 29, 2019
 Checked By: Leonard Beasley

Job No: 100.050
 Project: Ponderosa at Lorson Ranch Filing No. 3

Sub-Basin Data				Initial Overland Time (t _i)				Travel Time (t _t)					t _c Check (urbanized Basins)		Final t _c
BASIN or DESIGN	C ₅	AREA (A) acres	NRCS Convey.	LENGTH (L) feet	SLOPE (S) %	VELOCITY (V) ft/sec	t _i minutes	LENGTH (L) feet	SLOPE (S) %	VELOCITY (V) ft/sec	t _t minutes	Computed t _c Minutes	TOTAL LENGTH (L) feet	Regional t _c =(L/180)+10 minutes	USDCM Recommended t _c =t _i +t _t (min)
C1	0.82	0.13	8"	2.00	2.00%	0.06	0.57	10.00	0.50%	2.46	0.07				
			12"					150.00	0.50%	3.21	0.78	1.42	150.00	10.83	1.42
C2	0.82	0.25	8"	2.00	2.00%	0.06	0.57	23.00	0.50%	2.46	0.16				
			12"					378.00	0.50%	3.21	1.96	2.69	378.00	12.10	2.69
C1-C2	0.82	0.38	8"	2.00	2.00%	0.06	0.57	10.00	0.50%	2.46	0.07				
			12"					620.00	0.50%	3.21	3.22	3.86	620.00	13.44	3.86
C3	0.82	0.93	20.0	7.00	2.00%	0.11	1.07	83.00	1.00%	2.00	0.69				
			20.0					484.00	1.06%	2.06	3.92	5.68	574.00	13.19	5.68
C4	0.82	0.81	20.0	17.00	2.00%	0.17	1.66	73.00	1.04%	2.04	0.60				
			20.0					441.00	1.00%	2.00	3.68	5.94	531.00	12.95	5.94
C3-C4	0.82	0.81	20.0	17.00	2.00%	0.17	1.66	73.00	1.04%	2.04	0.60				
			20.0					471.00	1.00%	2.00	3.93	6.19	561.00	13.12	6.19
C5	0.82	0.15	8"	2.00	2.00%	0.06	0.57	14.00	0.50%	2.46	0.09				
			12"					85.00	0.50%	3.21	0.44	1.11	85.00	10.47	1.11
C6	0.82	0.17	8"	2.00	2.00%	0.06	0.57	23.00	0.50%	2.46	0.16	0.73	25.00	10.14	0.73
C7	0.82	0.24	8"	2.00	2.00%	0.06	0.57	114.00	0.50%	2.46	0.77				
			12"					66.00	0.50%	3.21	0.34	1.69	182.00	11.01	1.69



Standard Form SF-1. Time of Concentration-Proposed

Calculated By: Leonard Beasley
 Date: October 29, 2019
 Checked By: Leonard Beasley

Job No: 100.050
 Project: Ponderosa at Lorson Ranch Filing No. 3

Sub-Basin Data				Initial Overland Time (t _i)				Travel Time (t _t)					t _c Check (urbanized Basins)		Final t _c
BASIN or DESIGN	C ₅	AREA (A) acres	NRCS Convey.	LENGTH (L) feet	SLOPE (S) %	VELOCITY (V) ft/sec	t _i minutes	LENGTH (L) feet	SLOPE (S) %	VELOCITY (V) ft/sec	t _t minutes	Computed t _c Minutes	TOTAL LENGTH (L) feet	Regional t _c tc=(L/180)+10 minutes	USDCM Recommended tc=ti+tt (min)
C8	0.82	0.22	8"	2.00	2.00%	0.06	0.57	120.00	0.50%	2.46	0.81				
			12"					77.00	0.50%	3.21	0.40	1.78	77.00	10.43	1.78
C5-C8	0.82	0.78	8"	2.00	2.00%	0.06	0.57	23.00	0.50%	2.46	0.16				
			12"					507.00	0.50%	3.21	2.63	3.36	507.00	12.82	3.36
C9	0.82	0.61	20.0	22.00	2.00%	0.19	1.89	311.00	0.70%	1.67	3.10	4.98	333.00	11.85	4.98
C10	0.82	0.43	20.0	26.00	2.00%	0.21	2.06	93.00	0.60%	1.55	1.00				
			20.0					100.00	0.70%	1.67	1.00	4.06	219.00	11.22	4.06
C9-C10	0.82	1.04	20.0	22.00	2.00%	0.19	1.89	476.00	0.70%	1.67	4.74	6.63	498.00	12.77	6.63
C11	0.82	0.67	20.0	19.00	2.00%	0.18	1.75	512.00	1.00%	2.00	4.27	6.02	531.00	12.95	6.02
C12	0.82	0.22	8"	2.00	2.00%	0.06	0.57	6.00	0.50%	2.46	0.04				
			12"					113.00	0.50%	3.21	0.59	1.20	121.00	10.67	1.20
C13	0.82	0.17	8"	2.00	2.00%	0.06	0.57	6.00	0.50%	2.46	0.04				
			12"					100.00	0.50%	3.21	0.52	1.13	108.00	10.60	1.13
C14	0.82	0.45	20.0	84.00	1.00%	0.30	4.63	154.00	1.50%	2.45	1.05	5.68	238.00	11.32	5.68
C15	0.82	0.11	8"	2.00	2.00%	0.06	0.57	5.00	0.50%	2.46	0.03				
			12"					242.00	0.50%	3.21	1.26	1.86	249.00	11.38	1.86

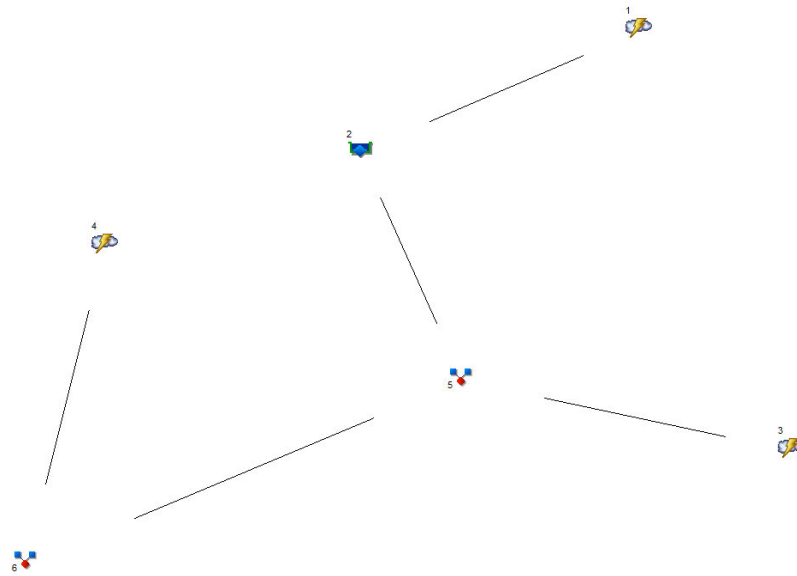

Legend

<u>Hyd.</u>	<u>Origin</u>	<u>Description</u>
1	Rational	Pond A4 inflow from Basin A4
2	Reservoir	Pond Outflow A4
3	Rational	old glory road, OS1
4	Rational	Basin EX1
5	Combine	flow from north-Des, Pt A
6	Combine	total flow at design pt. B

Hydrograph Summary Report

Hyd. No.	Hydrograph type (origin)	Peak flow (cfs)	Time interval (min)	Time to peak (min)	Volume (cuft)	Inflow hyd(s)	Maximum elevation (ft)	Maximum storage (cuft)	Hydrograph description	
1	Rational	45.56	1	17	46,473	---	-----	-----	Pond A4 flow from Basin A4	
2	Reservoir	3.585	1	33	46,404	1	5717.69	55,008	Pond Outflow A4	
3	Rational	9.950	1	10	5,970	---	-----	-----	Basin OS1	
4	Rational	5.328	1	15	4,796	---	-----	-----	Basin EX1	
5	Combine	10.40	1	10	52,374	2, 3,	-----	-----	Des. Pt A	
6	Combine	13.95	1	10	57,169	4, 5	-----	-----	Design Pt. B	
100.050pdr-pond-5-asbuilt (1).gpw					Return Period: 5 Year			Tuesday, Nov 12 2019, 1:05 PM		

Hydrograph Summary Report

Hyd. No.	Hydrograph type (origin)	Peak flow (cfs)	Time interval (min)	Time to peak (min)	Volume (cuft)	Inflow hyd(s)	Maximum elevation (ft)	Maximum storage (cuft)	Hydrograph description	
1	Rational	92.16	1	17	94,003	---	-----	-----	Pond A4 inflow from Basin A4	
2	Reservoir	20.47	1	30	82,745	1	5718.54	81,222	Pond Outflow A4	
3	Rational	22.29	1	11	14,711	---	-----	-----	old glory road, OS1	
4	Rational	30.35	1	15	27,315	---	-----	-----	Basin EX1	
5	Combine	22.78	1	11	97,456	2, 3,	-----	-----	flow from north-Des, Pt A	
6	Combine	46.34	1	15	124,772	4, 5	-----	-----	total flow at design pt. B	
100.050pdr-pond-100-asbuilt (1).gpw					Return Period: 100 Year			Tuesday, Nov 12 2019, 12:59 PM		

Hydrograph Plot

Hydraflow Hydrographs by Intelisolve

Monday, Jan 13 2020, 4:27 PM

Hyd. No. 1

Pond A4 flow from Basin A4

Hydrograph type	= Rational	Peak discharge	= 45.56 cfs
Storm frequency	= 5 yrs	Time interval	= 1 min
Drainage area	= 21.140 ac	Runoff coeff.	= 0.66
Intensity	= 3.266 in/hr	Tc by User	= 17.00 min
IDF Curve	= Colorado Springs - El Paso County.IDF	Asc/Rec limb fact	= 1/1

Hydrograph Volume = 46,473 cuft

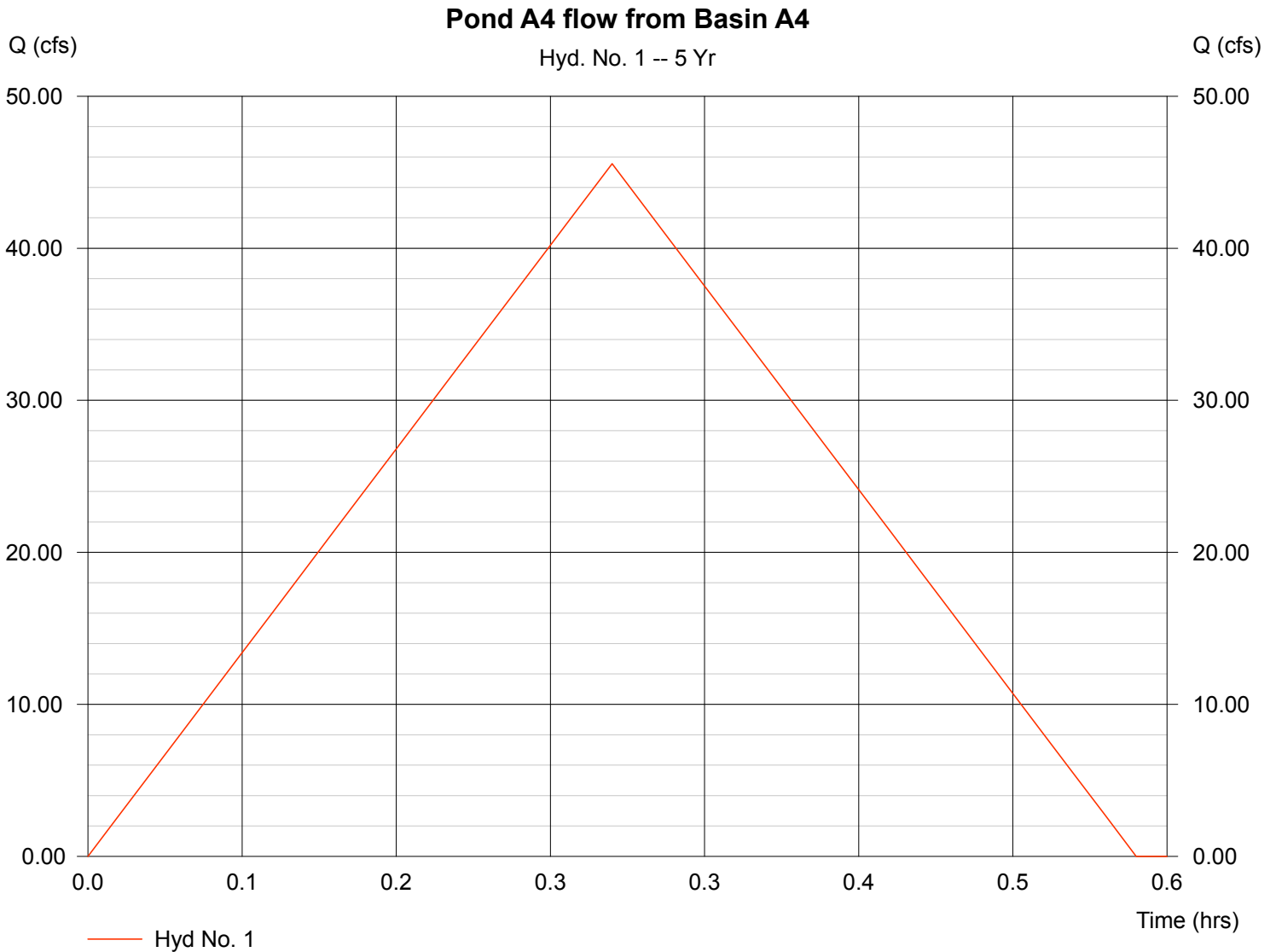

Hydrograph Plot

Hydraflow Hydrographs by Intelisolve

Monday, Jan 13 2020, 4:27 PM

Hyd. No. 2

Pond Outflow A4

Hydrograph type = Reservoir
Storm frequency = 5 yrs
Inflow hyd. No. = 1
Reservoir name = Pond A4

Peak discharge = 3.585 cfs
Time interval = 1 min
Max. Elevation = 5717.69 ft
Max. Storage = 55,008 cuft

Storage Indication method used. Wet pond routing start elevation = 5716.00 ft.

Hydrograph Volume = 46,404 cuft

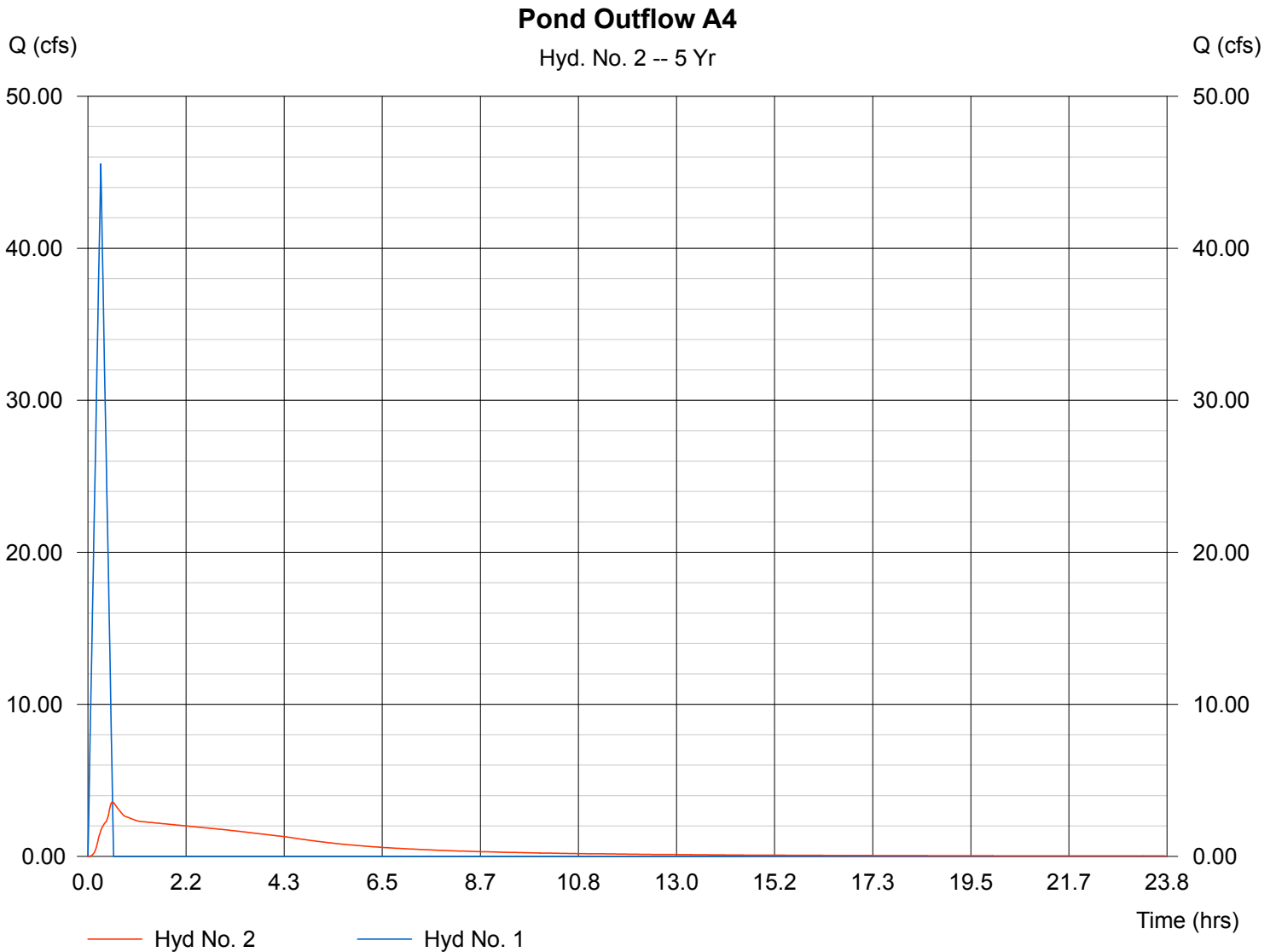

Hydrograph Plot

Hyd. No. 3

Basin OS1

Hydrograph type	= Rational	Peak discharge	= 9.950 cfs
Storm frequency	= 5 yrs	Time interval	= 1 min
Drainage area	= 4.950 ac	Runoff coeff.	= 0.49
Intensity	= 4.102 in/hr	Tc by User	= 10.00 min
IDF Curve	= Colorado Springs - El Paso County.IDF	Asc/Rec limb fact	= 1/1

Hydrograph Volume = 5,970 cuft

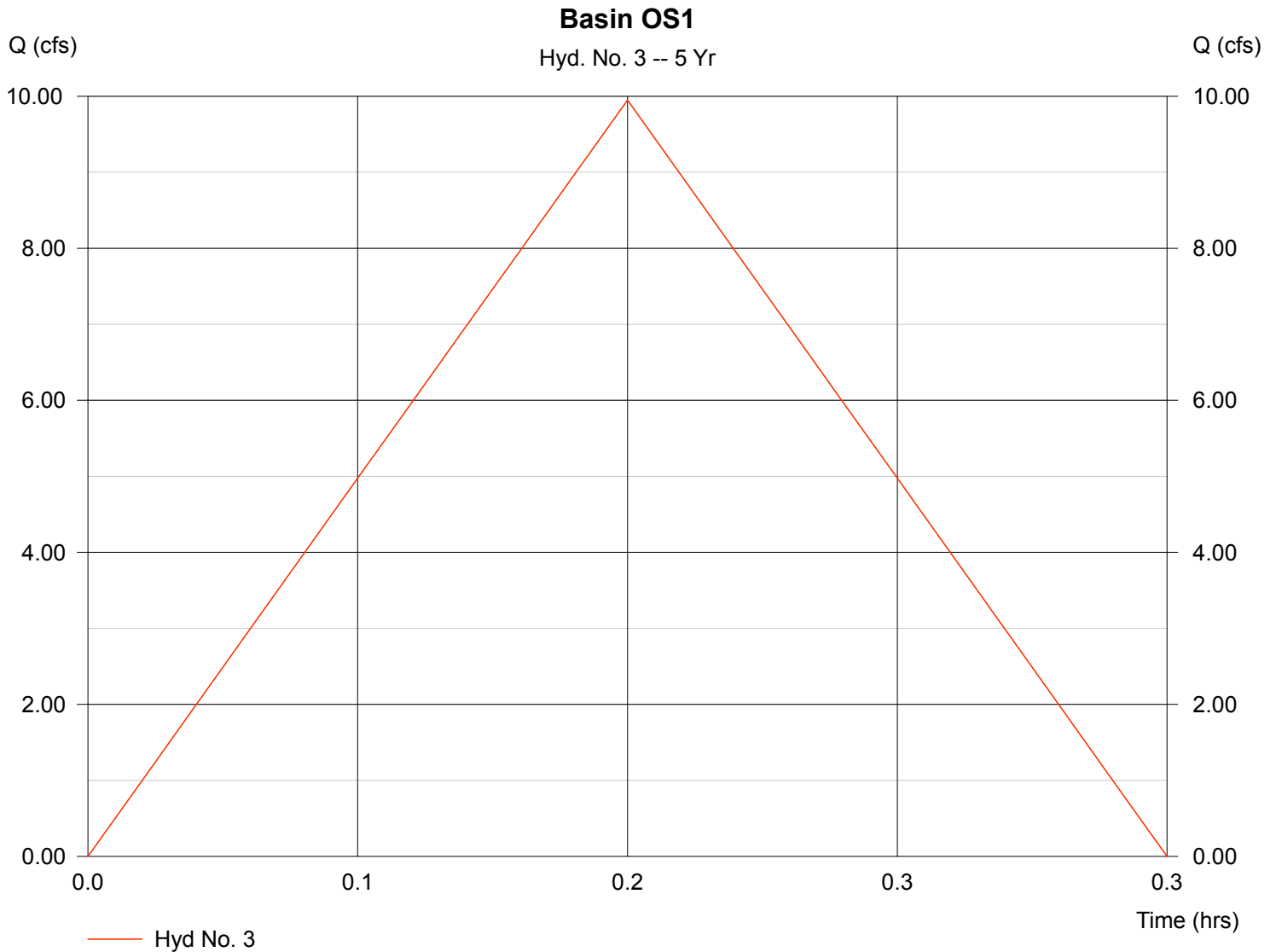

Hydrograph Plot

Hydraflow Hydrographs by Intelisolve

Monday, Jan 13 2020, 4:27 PM

Hyd. No. 4

Basin EX1

Hydrograph type	= Rational	Peak discharge	= 5.328 cfs
Storm frequency	= 5 yrs	Time interval	= 1 min
Drainage area	= 10.260 ac	Runoff coeff.	= 0.15
Intensity	= 3.462 in/hr	Tc by User	= 15.00 min
IDF Curve	= Colorado Springs - El Paso County.IDF	Asc/Rec limb fact	= 1/1

Hydrograph Volume = 4,796 cuft

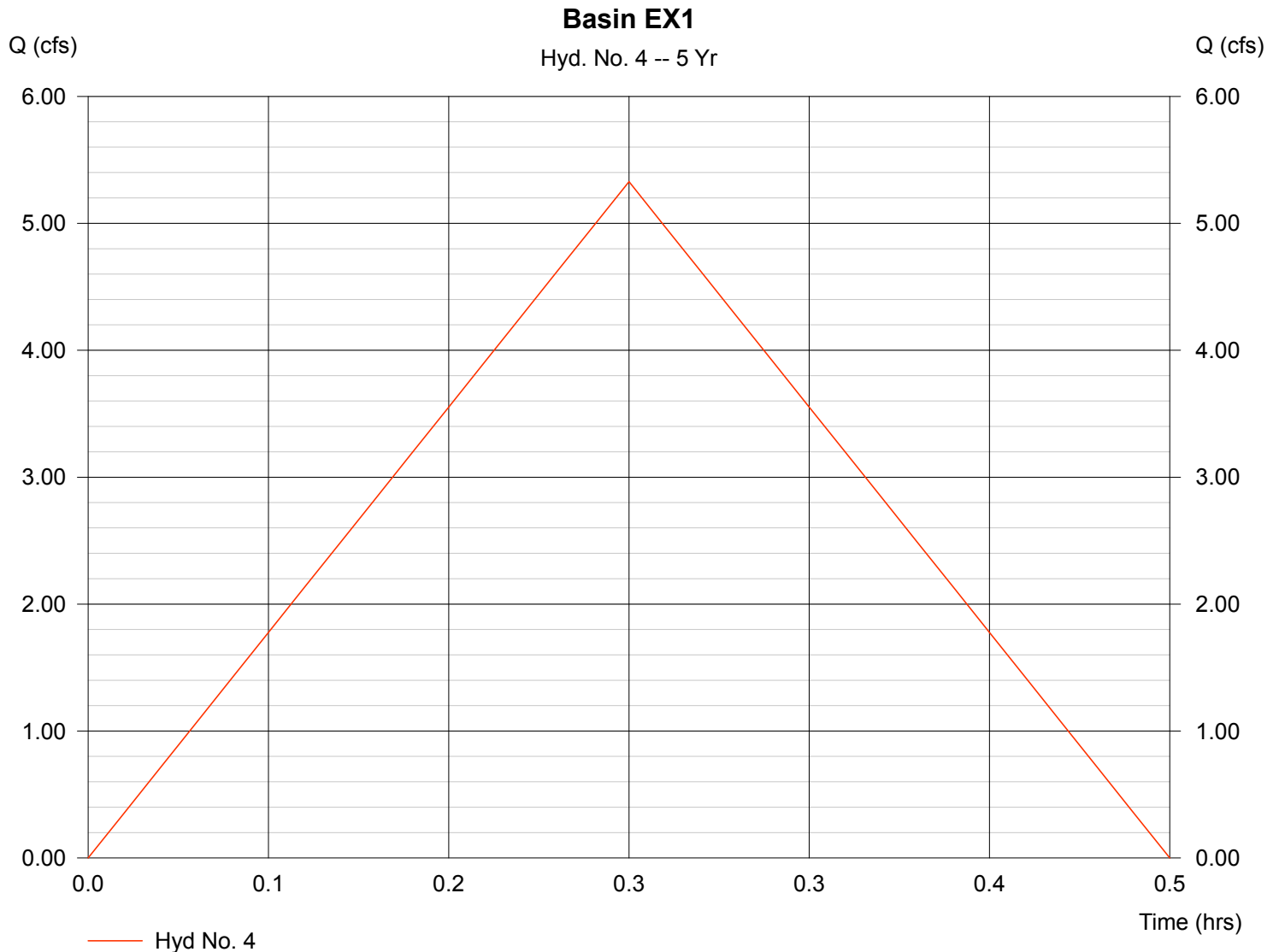

Hydrograph Plot

Hydraflow Hydrographs by Intelisolve

Monday, Jan 13 2020, 4:27 PM

Hyd. No. 5

Des. Pt A

Hydrograph type = Combine
Storm frequency = 5 yrs
Inflow hyds. = 2, 3

Peak discharge = 10.40 cfs
Time interval = 1 min

Hydrograph Volume = 52,374 cuft

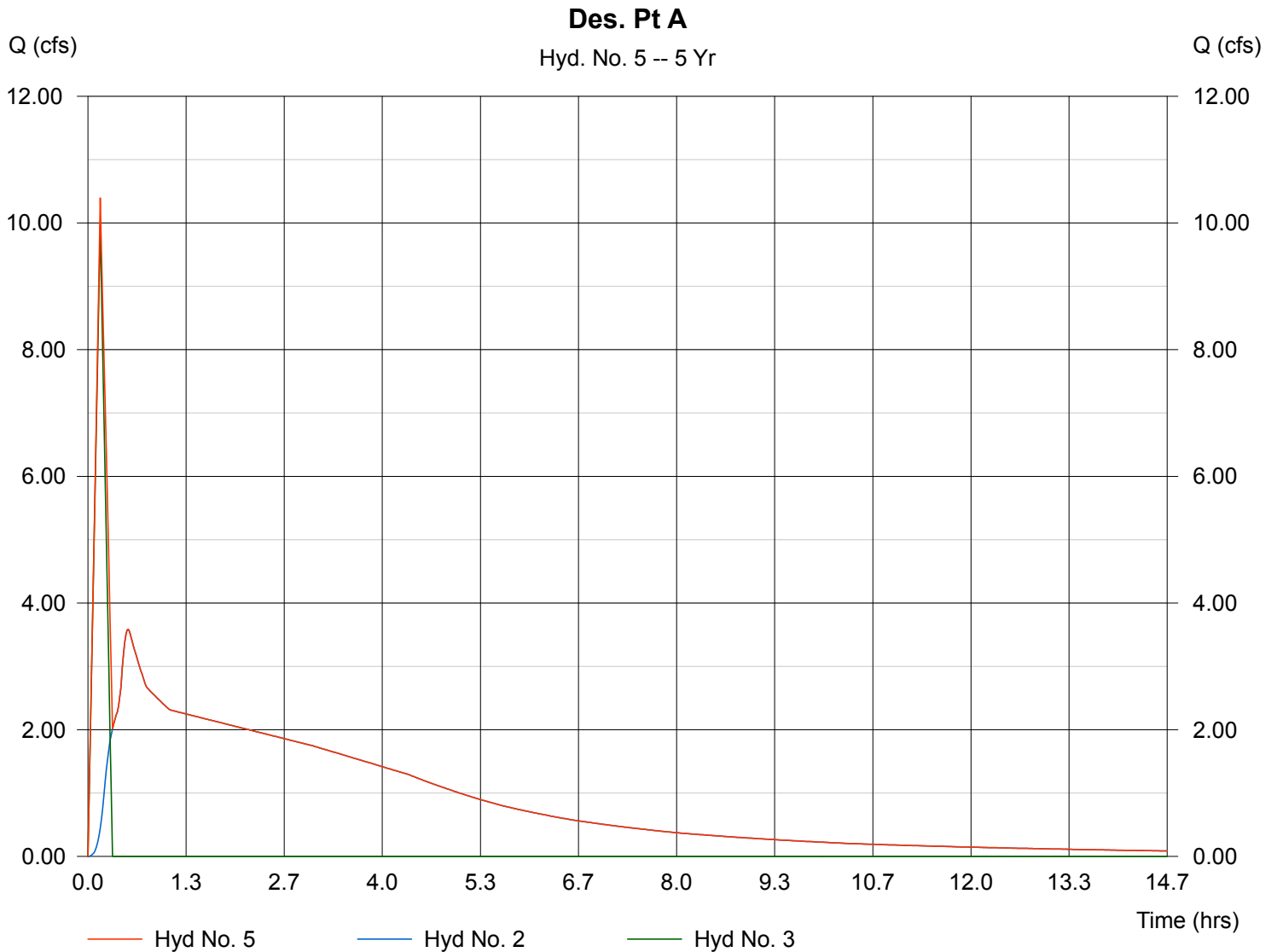

Hydrograph Plot

Hydraflow Hydrographs by Intelisolve

Monday, Jan 13 2020, 4:27 PM

Hyd. No. 6

Design Pt. B

Hydrograph type = Combine
Storm frequency = 5 yrs
Inflow hyds. = 4, 5

Peak discharge = 13.95 cfs
Time interval = 1 min

Hydrograph Volume = 57,169 cuft

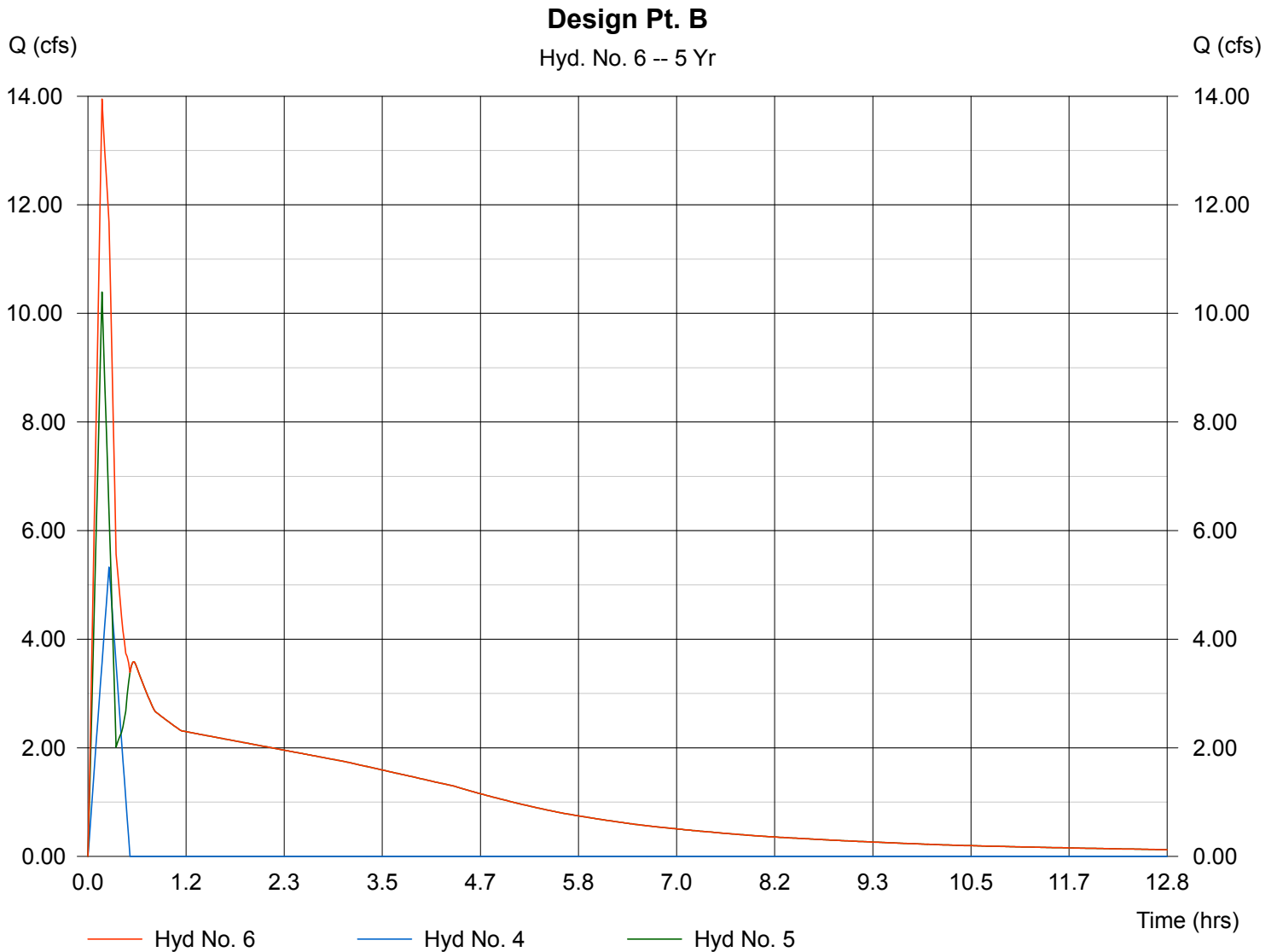

Hydrograph Plot

Hydraflow Hydrographs by Intelisolve

Monday, Jan 13 2020, 4:24 PM

Hyd. No. 1

Pond A4 inflow from Basin A4

Hydrograph type	= Rational	Peak discharge	= 92.16 cfs
Storm frequency	= 100 yrs	Time interval	= 1 min
Drainage area	= 21.140 ac	Runoff coeff.	= 0.75
Intensity	= 5.813 in/hr	Tc by User	= 17.00 min
IDF Curve	= Colorado Springs - El Paso County.IDF	Asc/Rec limb fact	= 1/1

Hydrograph Volume = 94,003 cuft

Pond A4 inflow from Basin A4

Hyd. No. 1 -- 100 Yr

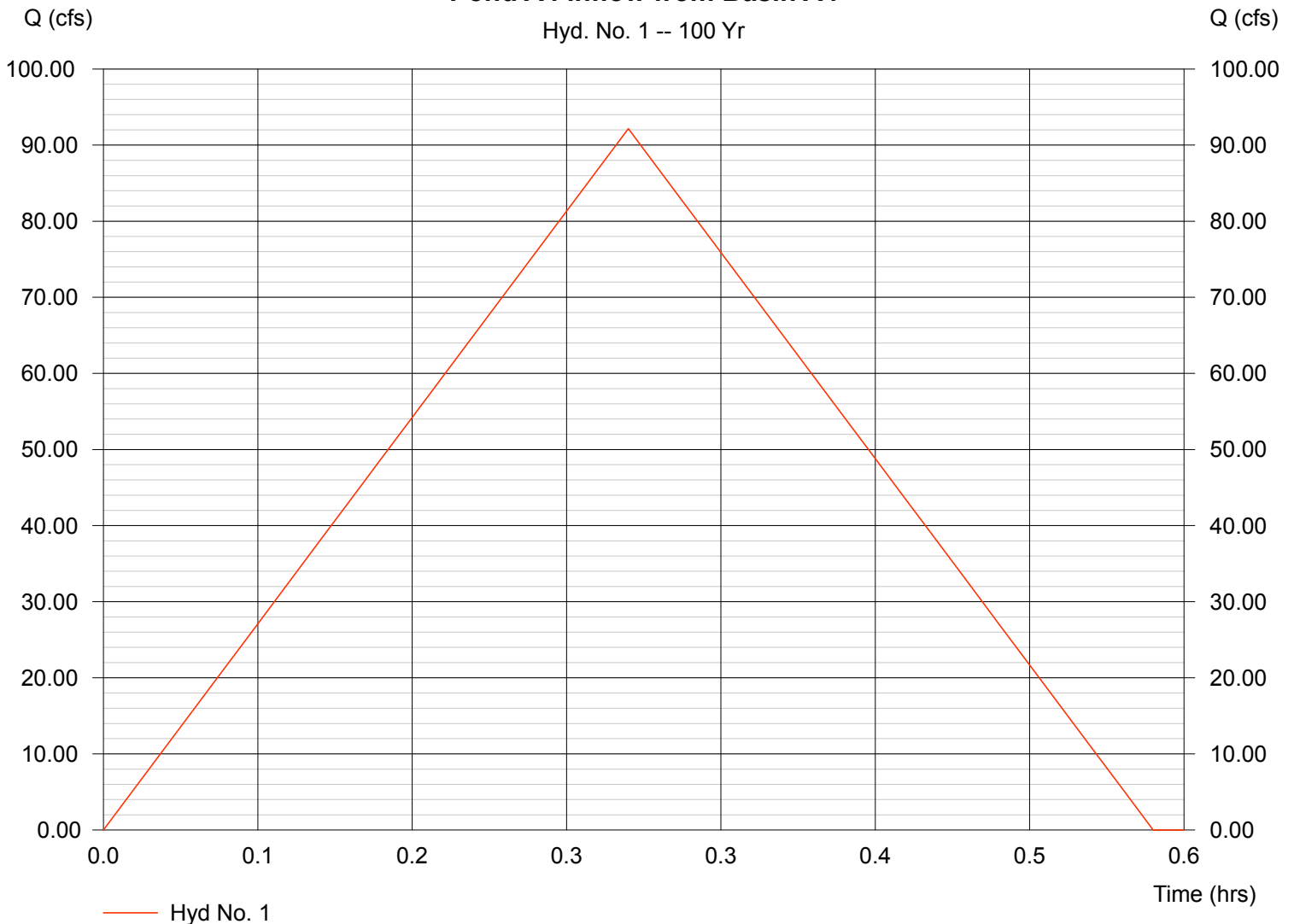

Hydrograph Plot

Hydraflow Hydrographs by Intelisolve

Monday, Jan 13 2020, 4:24 PM

Hyd. No. 2

Pond Outflow A4

Hydrograph type = Reservoir
Storm frequency = 100 yrs
Inflow hyd. No. = 1
Reservoir name = Pond A4

Peak discharge = 20.47 cfs
Time interval = 1 min
Max. Elevation = 5718.54 ft
Max. Storage = 81,222 cuft

Storage Indication method used. Wet pond routing start elevation = 5715.30 ft.

Hydrograph Volume = 82,745 cuft

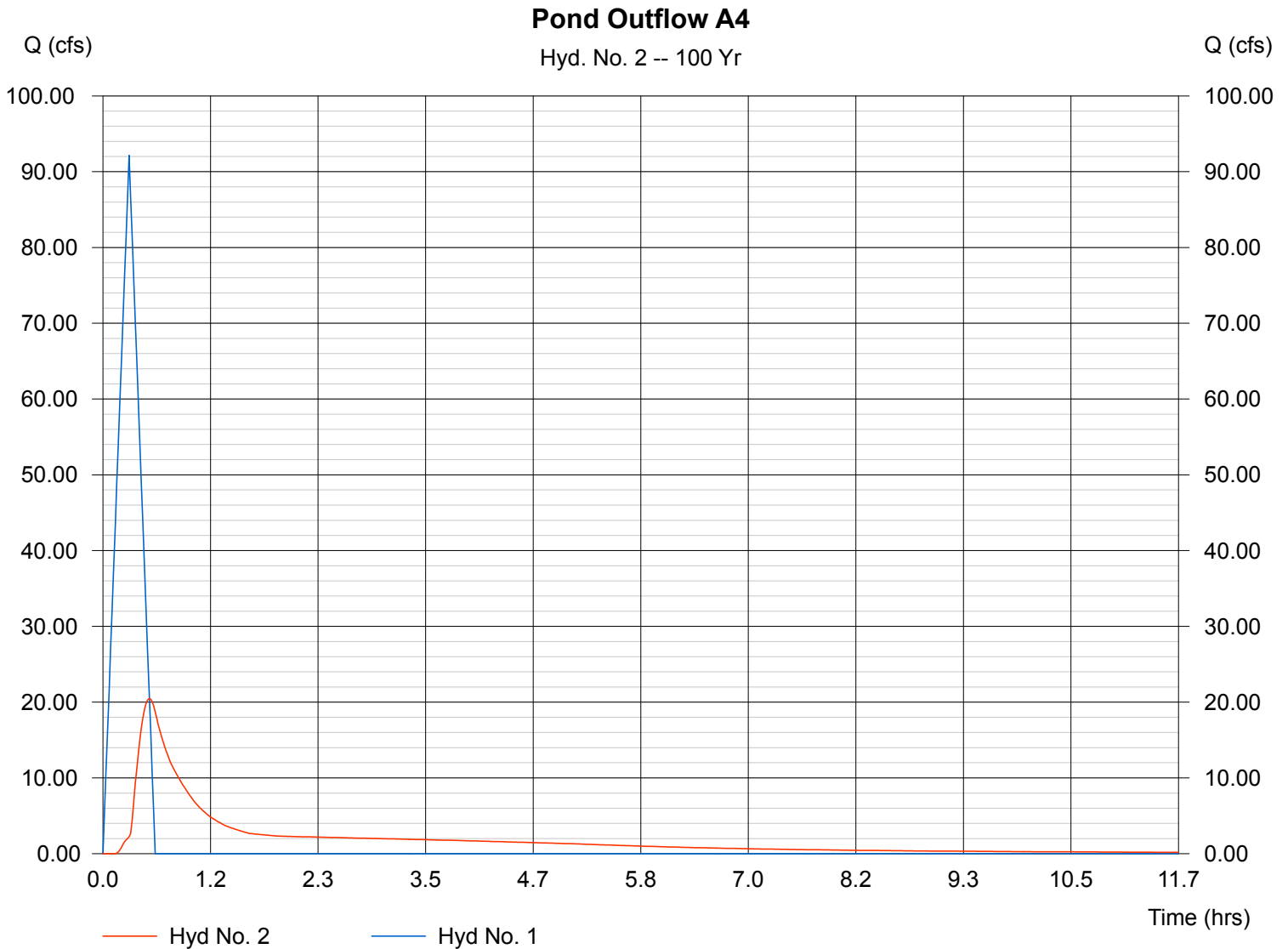

Hydrograph Plot

Hydraflow Hydrographs by Intelisolve

Monday, Jan 13 2020, 4:24 PM

Hyd. No. 3

old glory road, OS1

Hydrograph type	= Rational	Peak discharge	= 22.29 cfs
Storm frequency	= 100 yrs	Time interval	= 1 min
Drainage area	= 4.950 ac	Runoff coeff.	= 0.64
Intensity	= 7.036 in/hr	Tc by User	= 11.00 min
IDF Curve	= Colorado Springs - El Paso County.IDF	Asc/Rec limb fact	= 1/1

Hydrograph Volume = 14,711 cuft

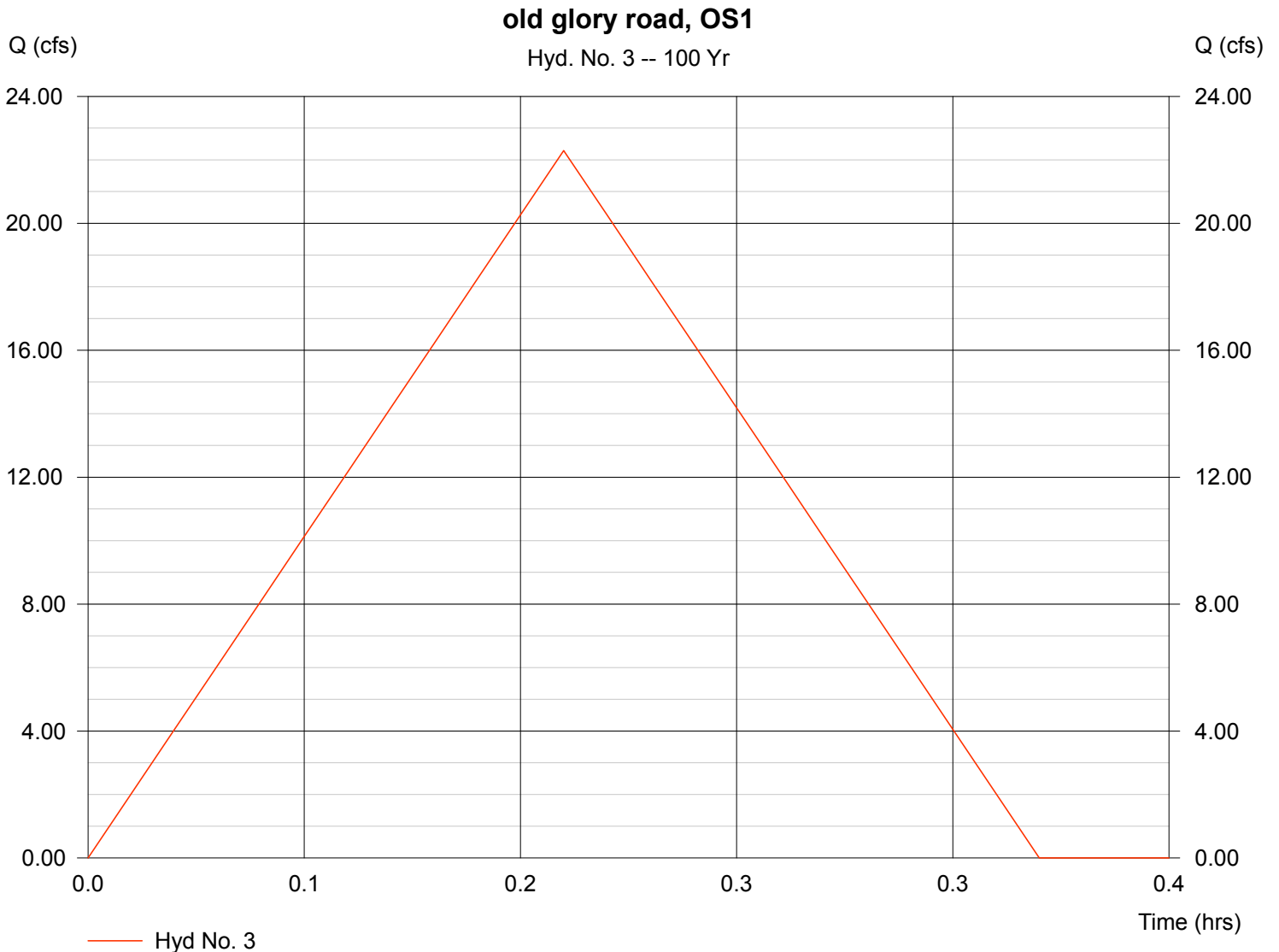

Hydrograph Plot

Hydraflow Hydrographs by Intelisolve

Monday, Jan 13 2020, 4:24 PM

Hyd. No. 4

Basin EX1

Hydrograph type	= Rational	Peak discharge	= 30.35 cfs
Storm frequency	= 100 yrs	Time interval	= 1 min
Drainage area	= 10.260 ac	Runoff coeff.	= 0.48
Intensity	= 6.163 in/hr	Tc by User	= 15.00 min
IDF Curve	= Colorado Springs - El Paso County.IDF	Asc/Rec limb fact	= 1/1

Hydrograph Volume = 27,315 cuft

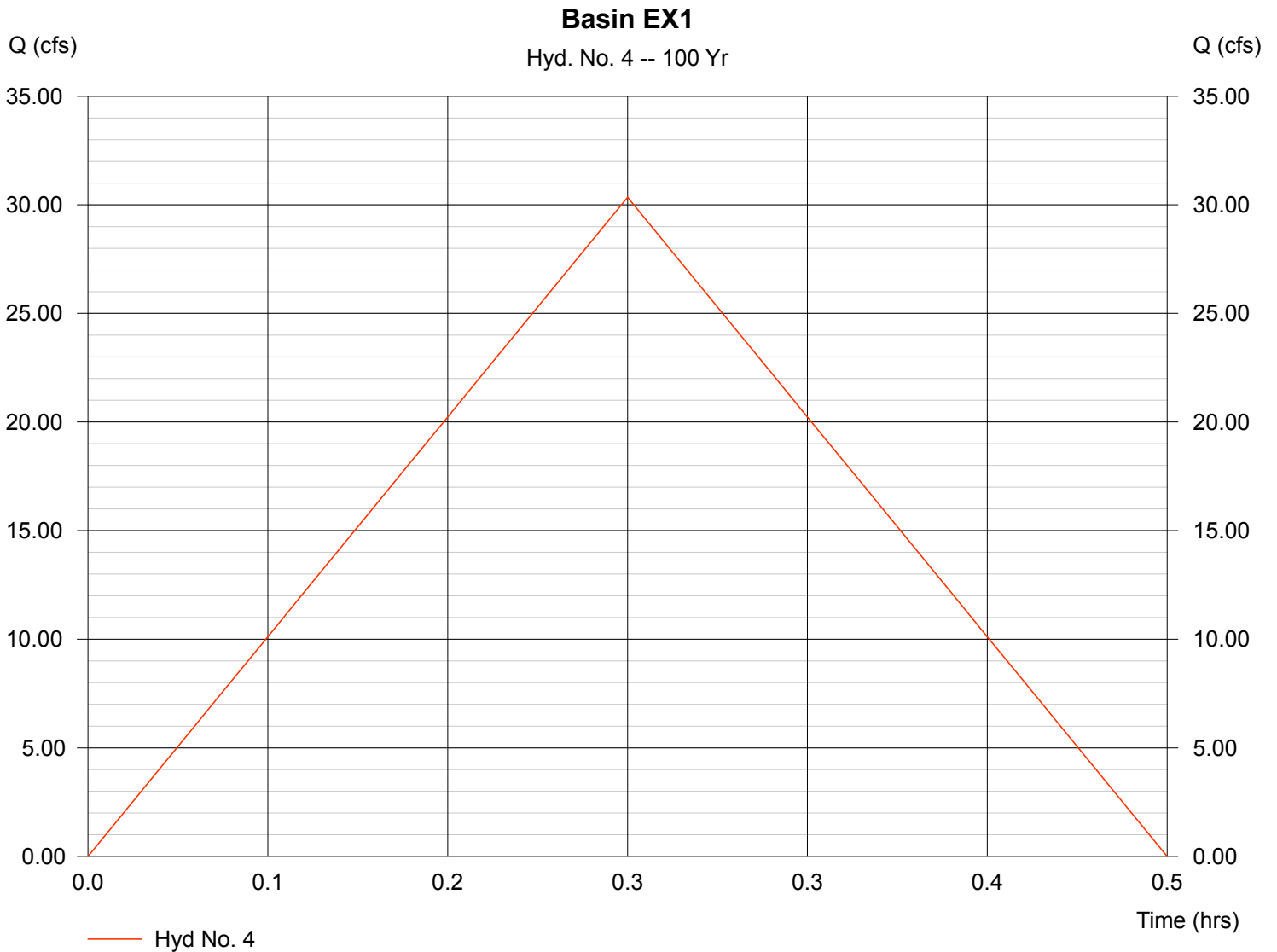

Hydrograph Plot

Hydraflow Hydrographs by Intelisolve

Monday, Jan 13 2020, 4:24 PM

Hyd. No. 5

flow from north-Des, Pt A

Hydrograph type = Combine
Storm frequency = 100 yrs
Inflow hyds. = 2, 3

Peak discharge = 22.78 cfs
Time interval = 1 min

Hydrograph Volume = 97,456 cuft

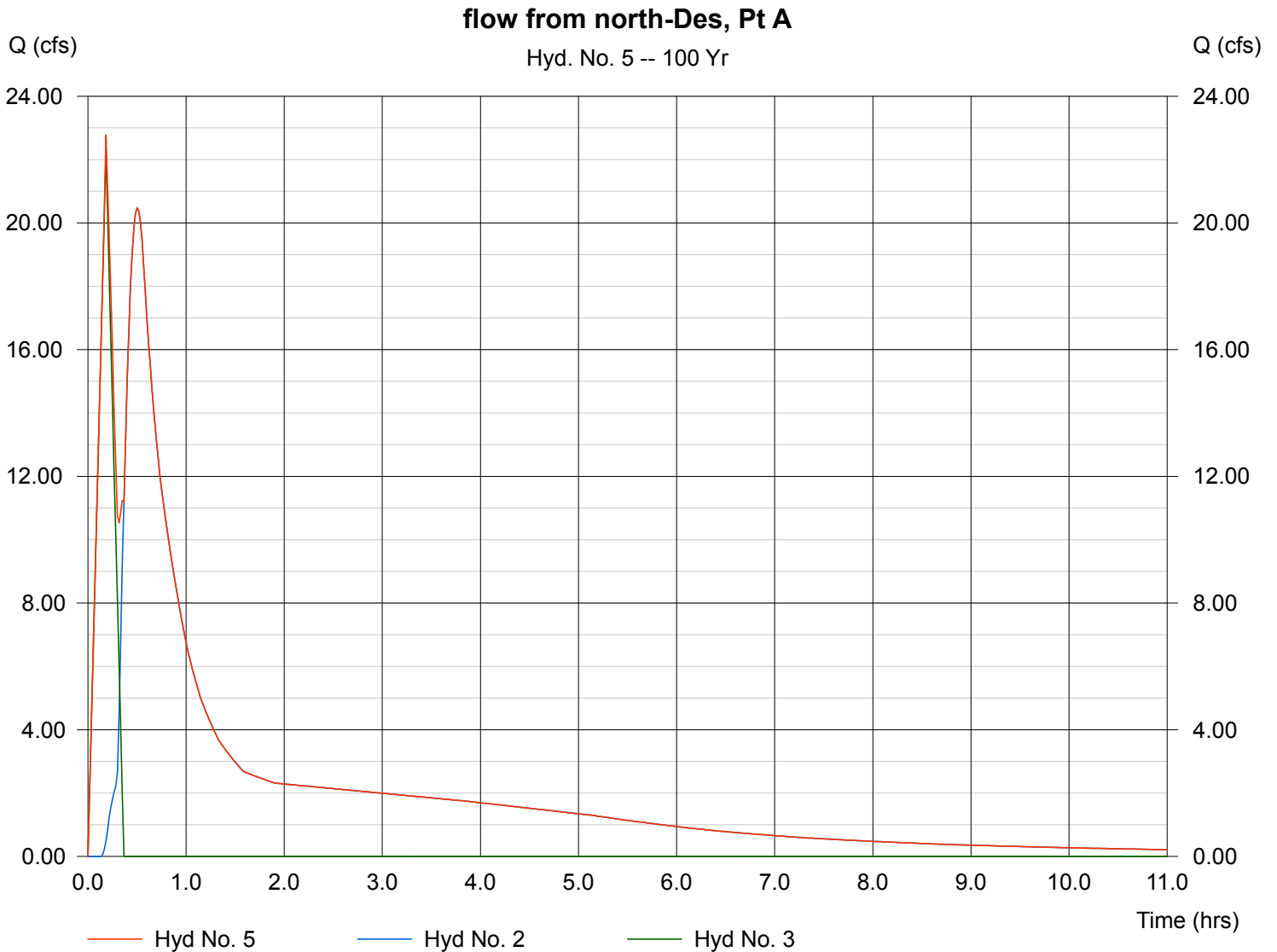

Hydrograph Plot

Hydraflow Hydrographs by Intelisolve

Monday, Jan 13 2020, 4:24 PM

Hyd. No. 6

total flow at design pt. B

Hydrograph type = Combine
Storm frequency = 100 yrs
Inflow hyds. = 4, 5

Peak discharge = 46.34 cfs
Time interval = 1 min

Hydrograph Volume = 124,772 cuft

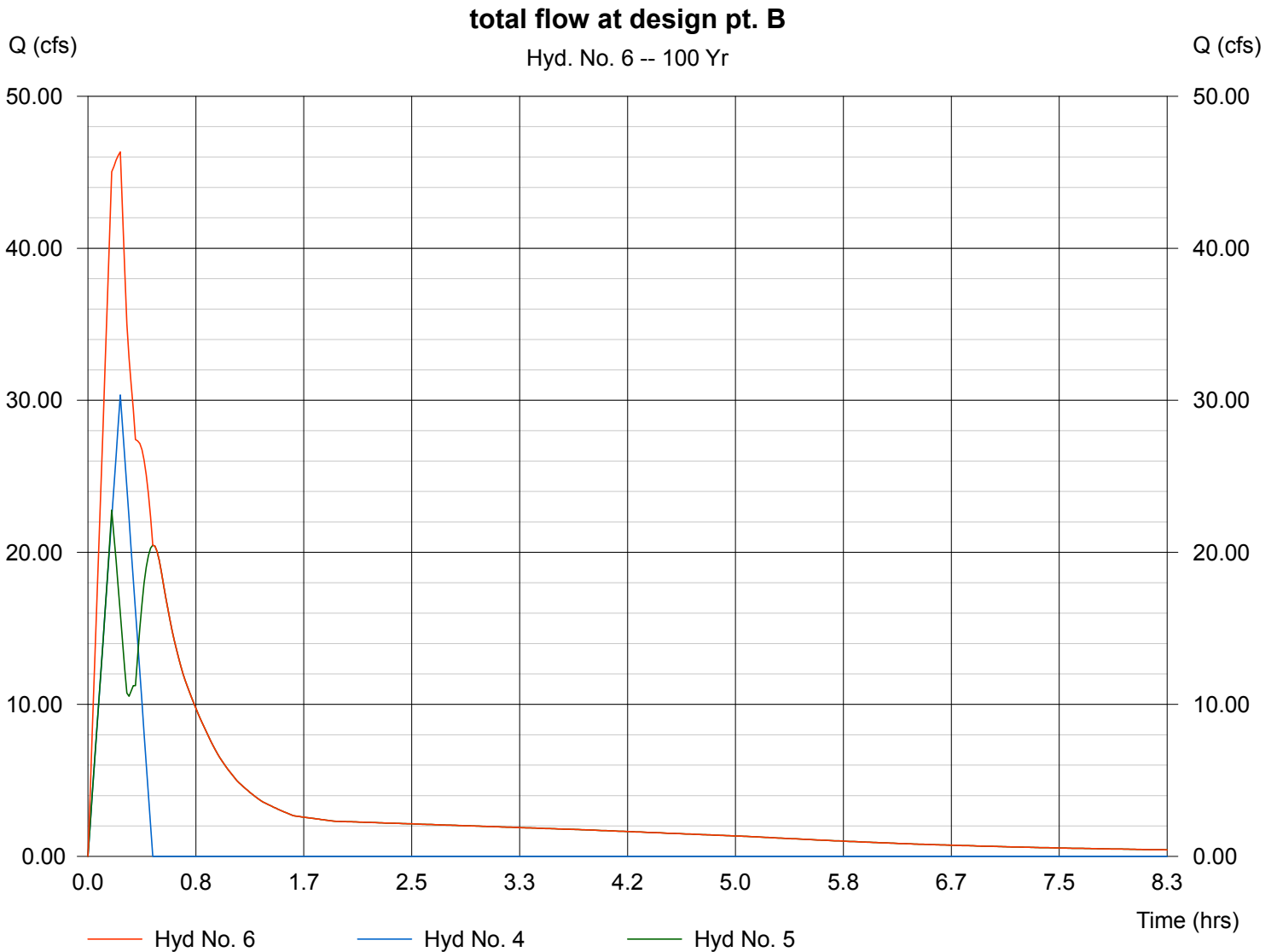

APPENDIX C – HYDRAULIC CALCULATIONS

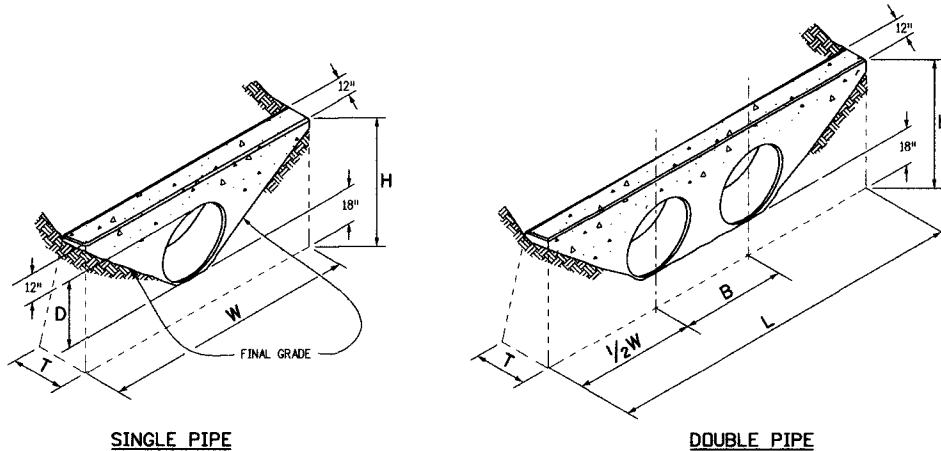

SINGLE PIPE

DOUBLE PIPE

CONCRETE HEADWALL INSTALLATIONS
SEE STANDARD PLAN M-601-10 FOR REINFORCING DETAILS.

PIPE	TYPE	MATERIAL	PIPE DIAMETER (AND EQUIVALENT DIAMETER) (IN.)											
			18		24		30		36		42		48	
			SINGLE	DOUBLE	SINGLE	DOUBLE	SINGLE	DOUBLE	SINGLE	DOUBLE	SINGLE	DOUBLE	SINGLE	DOUBLE
CIRCULAR	RIGID		1.0	1.3	1.5	2.0	2.0	2.7	2.8	3.6	3.6	4.6	4.6	6.0
	FLEXIBLE		1.1	1.4	1.6	2.1	2.2	3.0	3.0	4.0	3.9	5.3	5.0	6.8
ELLIPTICAL	RIGID		23 x 14		30 x 19		38 x 24		45 x 29		53 x 34		60 x 36	
			0.9	1.2	1.3	1.6	1.7	2.2	2.3	2.9	2.9	3.7	3.5	4.4
ARCH	METAL		22 x 13		29 x 18		36 x 22		43 x 27		50 x 31		58 x 36	
			0.9	1.3	1.4	1.9	1.8	2.4	2.4	3.4	3.2	4.4	3.4	5.0

CONCRETE QUANTITIES FOR ONE CONCRETE HEADWALL (CUBIC YARDS)

THICKNESS	MATERIAL	PIPE DIAMETER (IN.)					
		18	24	30	36	42	48
4"	CONCRETE	0.4	0.8	1.2			
6"	CONCRETE				2.6	3.6	4.7
18"	RIPRAP	2.0	3.5	5.4	7.8	10.7	13.9

PIPE OUTLET PAVING (CUBIC YARDS)

NOTE: VOLUME OCCUPIED BY PIPE HAS BEEN DEDUCTED.

GENERAL NOTES

- FOR SIZE AND LOCATION OF PIPES, SEE THE PLANS.
- ALL CONCRETE SHALL BE CLASS B.
- FOOTINGS IN ROCK SHALL BE POURED OUT TO ROCK AND NOT FORMED IN ACCORDANCE WITH SUBSECTION 601.09(d).
- EXPOSED CONCRETE CORNERS SHALL BE CHAMFERED 3/4 IN.
- HEADWALL SHALL HAVE REINFORCING STEEL INSTALLED IN A PATTERN SIMILAR TO STANDARD PLAN M-601-10.
- THE COST OF REINFORCING STEEL SHALL BE INCLUDED IN THE WORK UNLESS THE STEEL QUANTITIES ARE LISTED IN THE PLANS AND ARE PAID FOR SEPARATELY.

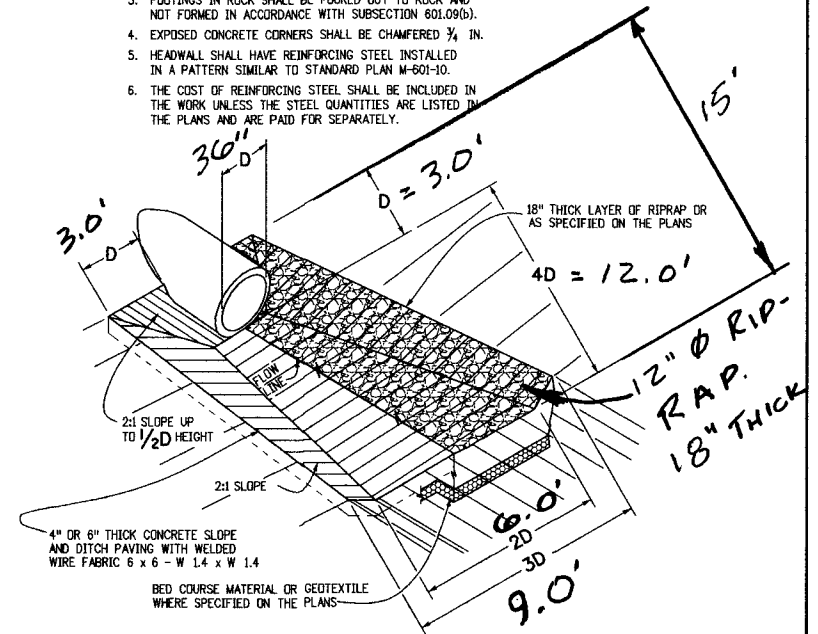

PIPE OUTLET PAVING
MAY BE USED WITH MULTIPLE PIPES.

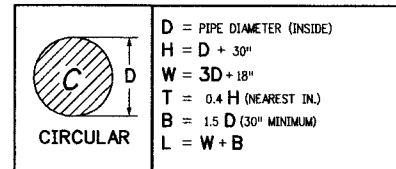

CIRCULAR TYPE OF PIPE HEADWALL DIMENSIONS

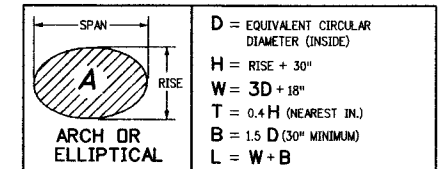

ARCH OR ELLIPTICAL TYPE OF PIPE HEADWALL DIMENSIONS

Computer File Information	
Creation Date: 07/31/19	
Designer Initials: JBK	(R-X)
Last Modification Date: 07/31/19	(R-X)
Detailer Initials: LTA	(R-X)
CAD Ver.: MicroStation V8 Scale: Not to Scale Units: English	(R-X)

Sheet Revisions	
Date:	Comments

Colorado Department of Transportation
2829 West Howard Place
CDOT HQ, 3rd Floor
Denver, CO 80204
Phone: 303-757-9021 FAX: 303-757-9868

Project Development Branch **JBK**

HEADWALLS AND PIPE OUTLET PAVING

Issued by the Project Development Branch; July 31, 2019

STANDARD PLAN NO.
M-601-12
Standard Sheet No. 1 of 1
Project Sheet Number:

$$H_a = \frac{(H + Y_n)}{2}$$

Equation 9-19

Where the maximum value of H_a shall not exceed H , and:

D_a = parameter to use in place of D in Figure 9-38 when flow is supercritical (ft)

D_c = diameter of circular culvert (ft)

H_a = parameter to use in place of H in Figure 9-39 when flow is supercritical (ft)

H = height of rectangular culvert (ft)

Y_n = normal depth of supercritical flow in the culvert (ft)

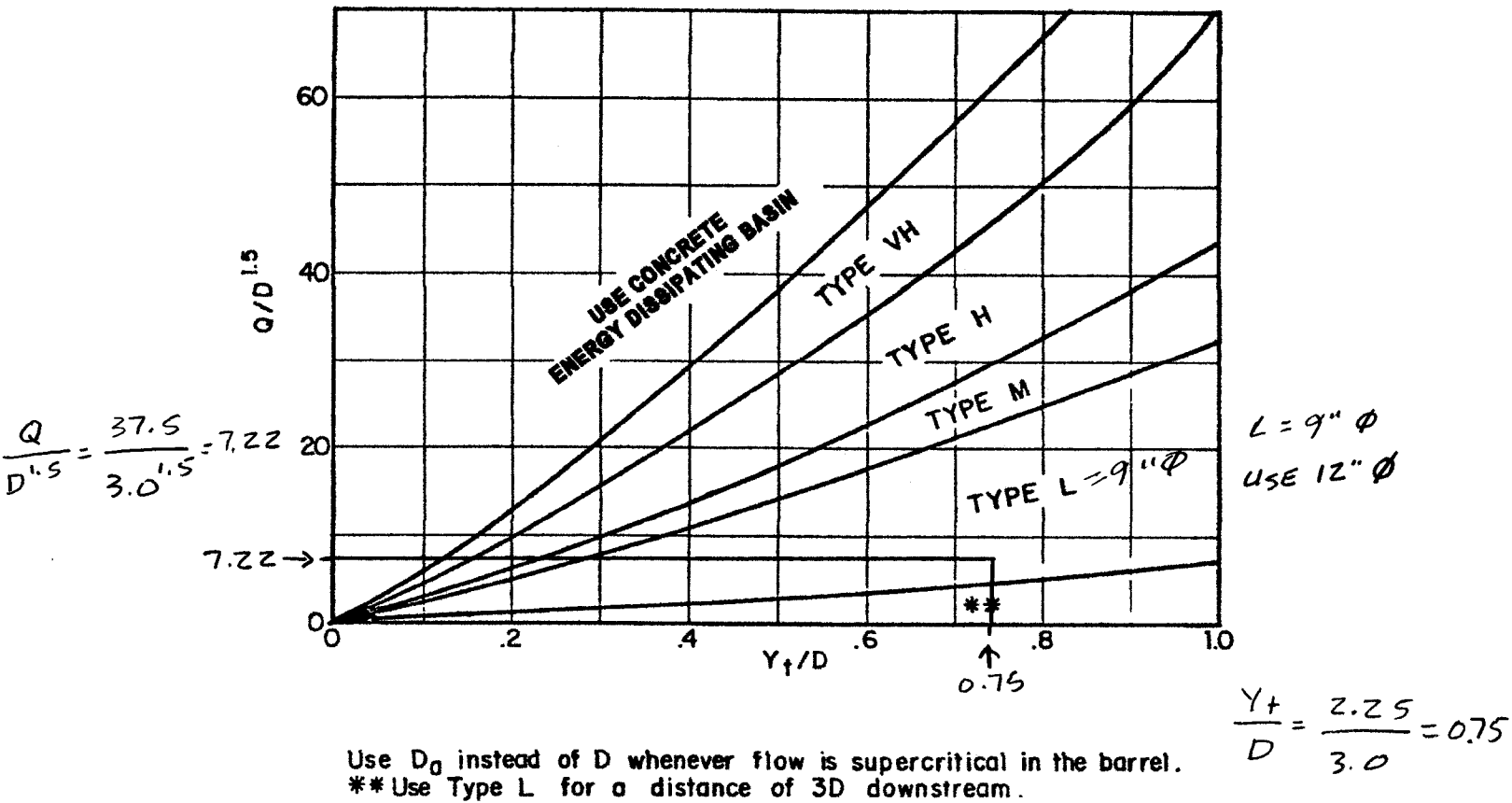
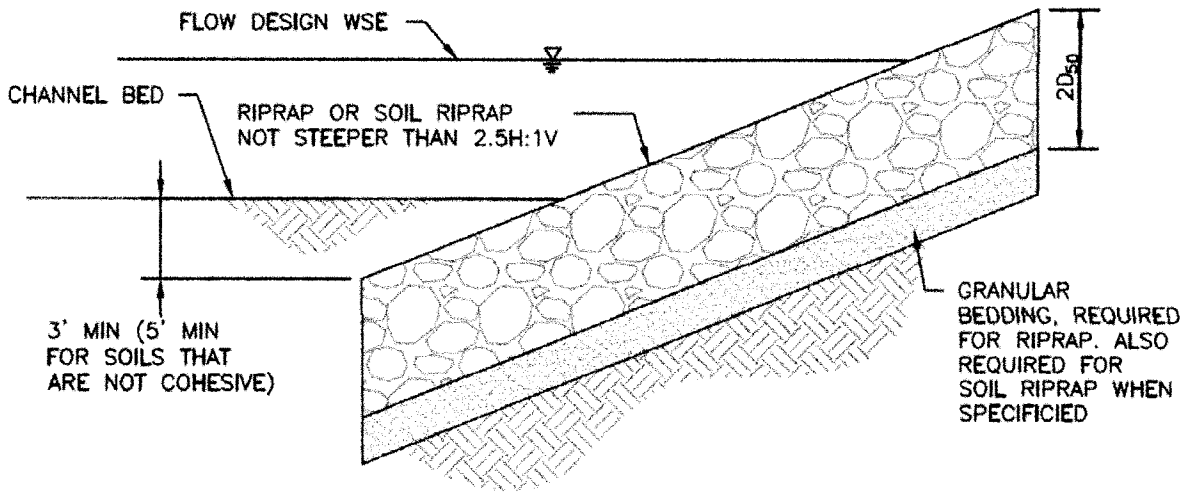

Figure 9-38. Riprap erosion protection at circular conduit outlet (valid for $Q/D2.5 \leq 6.0$)



RIPRAP DESIGNATION	% SMALLER THAN GIVEN SIZE BY WEIGHT	INTERMEDIATE ROCK DIMENSION (INCHES)	D ₅₀ * (INCHES)
TYPE VL	70 - 100	12	6
	50 - 70	9	
	35 - 50	6	
	2 - 10	2	
TYPE L	70 - 100	15	9
	50 - 70	12	
	35 - 50	9	
	2 - 10	3	
TYPE M	70 - 100	21	12
	50 - 70	18	
	35 - 50	12	
	2 - 10	4	
TYPE H	70 - 100	30	18
	50 - 70	24	
	35 - 50	18	
	2 - 10	6	

*D₅₀ = MEAN ROCK SIZE

Figure 8-34. Riprap and soil riprap placement and gradation (part 1 of 3)

INLET 1

INLET IN A SUMP OR SAG LOCATION

Version 4.05 Released March 2017

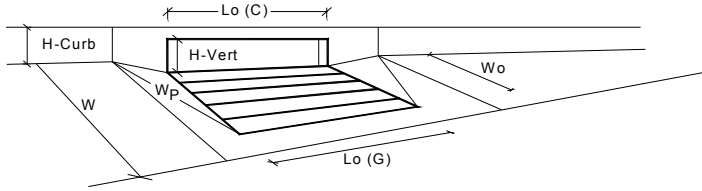

Design Information (Input)	MINOR	MAJOR	
Type of Inlet	CDOT Type R Curb Opening		
Local Depression (additional to continuous gutter depression 'a' from above)	3.00	3.00	inches
Number of Unit Inlets (Grate or Curb Opening)	1	1	
Water Depth at Flowline (outside of local depression)	4.0	4.9	inches
Grate Information	MINOR	MAJOR	<input checked="" type="checkbox"/> Override Depths
Length of a Unit Grate	N/A	N/A	feet
Width of a Unit Grate	N/A	N/A	feet
Area Opening Ratio for a Grate (typical values 0.15-0.90)	N/A	N/A	
Clogging Factor for a Single Grate (typical value 0.50 - 0.70)	N/A	N/A	
Grate Weir Coefficient (typical value 2.15 - 3.60)	N/A	N/A	
Grate Orifice Coefficient (typical value 0.60 - 0.80)	N/A	N/A	
Curb Opening Information	MINOR	MAJOR	
Length of a Unit Curb Opening	5.00	5.00	feet
Height of Vertical Curb Opening in Inches	6.00	6.00	inches
Height of Curb Orifice Throat in Inches	6.00	6.00	inches
Angle of Throat (see USDCM Figure ST-5)	63.40	63.40	degrees
Side Width for Depression Pan (typically the gutter width of 2 feet)	2.00	2.00	feet
Clogging Factor for a Single Curb Opening (typical value 0.10)	0.10	0.10	
Curb Opening Weir Coefficient (typical value 2.3-3.7)	3.60	3.60	
Curb Opening Orifice Coefficient (typical value 0.60 - 0.70)	0.67	0.67	
Low Head Performance Reduction (Calculated)	MINOR	MAJOR	
Depth for Grate Midwidth	N/A	N/A	ft
Depth for Curb Opening Weir Equation	0.16	0.24	ft
Combination Inlet Performance Reduction Factor for Long Inlets	0.51	0.63	
Curb Opening Performance Reduction Factor for Long Inlets	1.00	1.00	
Grated Inlet Performance Reduction Factor for Long Inlets	N/A	N/A	
Total Inlet Interception Capacity (assumes clogged condition)	MINOR	MAJOR	
Q_a	1.8	3.3	cfs
Q_{PEAK REQUIRED}	1.8	3.3	cfs

Inlet Capacity IS GOOD for Minor and Major Storms(>Q PEAK)

INLET 2

INLET ON A CONTINUOUS GRADE

Version 4.05 Released March 2017

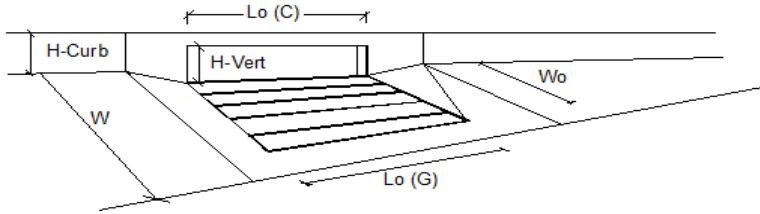

Design Information (Input)	MINOR	MAJOR	
Type of Inlet	CDOT Type R Curb Opening		
Local Depression (additional to continuous gutter depression 'a')	3.0	3.0	inches
Total Number of Units in the Inlet (Grate or Curb Opening)	1	1	
Length of a Single Unit Inlet (Grate or Curb Opening)	10.00	10.00	ft
Width of a Unit Grate (cannot be greater than W, Gutter Width)	N/A	N/A	ft
Clogging Factor for a Single Unit Grate (typical min. value = 0.5)	N/A	N/A	
Clogging Factor for a Single Unit Curb Opening (typical min. value = 0.1)	0.10	0.10	
Street Hydraulics: OK - Q < Allowable Street Capacity			
Design Discharge for Half of Street (from Sheet Inlet Management)			
Water Spread Width	7.0	12.8	cfs
Water Depth at Flowline (outside of local depression)	14.0	17.0	ft
Water Depth at Street Crown (or at T _{MAX})	4.9	5.8	inches
Ratio of Gutter Flow to Design Flow	0.0	0.2	inches
Discharge outside the Gutter Section W, carried in Section T _x	0.424	0.332	
Discharge within the Gutter Section W	4.0	8.6	cfs
Discharge Behind the Curb Face	3.0	4.2	cfs
Flow Area within the Gutter Section W	0.0	0.0	cfs
Velocity within the Gutter Section W	0.65	0.80	sq ft
Water Depth for Design Condition	4.6	5.3	fps
	7.9	8.8	inches
Grate Analysis (Calculated)			
Total Length of Inlet Grate Opening	N/A	N/A	ft
Ratio of Grate Flow to Design Flow	N/A	N/A	
Under No-Clogging Condition			
Minimum Velocity Where Grate Splash-Over Begins	N/A	N/A	fps
Interception Rate of Frontal Flow	N/A	N/A	
Interception Rate of Side Flow	N/A	N/A	
Interception Capacity	N/A	N/A	cfs
Under Clogging Condition			
Clogging Coefficient for Multiple-unit Grate Inlet	N/A	N/A	
Clogging Factor for Multiple-unit Grate Inlet	N/A	N/A	
Effective (unclogged) Length of Multiple-unit Grate Inlet	N/A	N/A	ft
Minimum Velocity Where Grate Splash-Over Begins	N/A	N/A	fps
Interception Rate of Frontal Flow	N/A	N/A	
Interception Rate of Side Flow	N/A	N/A	
Actual Interception Capacity	N/A	N/A	cfs
Carry-Over Flow = Q_o - Q_a (to be applied to curb opening or next d/s inlet)	N/A	N/A	cfs
Curb or Slotted Inlet Opening Analysis (Calculated)			
Equivalent Slope S _e (based on grate carry-over)	0.100	0.082	ft/ft
Required Length L _T to Have 100% Interception	14.93	22.18	ft
Under No-Clogging Condition			
Effective Length of Curb Opening or Slotted Inlet (minimum of L, L _T)	10.00	10.00	ft
Interception Capacity	6.0	8.4	cfs
Under Clogging Condition			
Clogging Coefficient	1.25	1.25	
Clogging Factor for Multiple-unit Curb Opening or Slotted Inlet	0.06	0.06	
Effective (Unclogged) Length	8.75	8.75	ft
Actual Interception Capacity	5.9	8.1	cfs
Carry-Over Flow = Q_{b(GRATE)} - Q_a	1.1	4.7	cfs
Summary			
Total Inlet Interception Capacity	5.9	8.1	cfs
Total Inlet Carry-Over Flow (flow bypassing inlet)	1.1	4.7	cfs
Capture Percentage = Q_a/Q_o =	84	63	%

INLET 3

INLET IN A SUMP OR SAG LOCATION

Version 4.05 Released March 2017

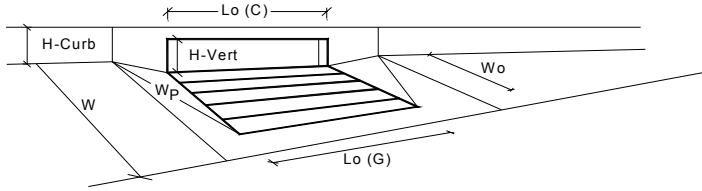

Design Information (Input)		MINOR		MAJOR	
Type of Inlet	CDOT Type R Curb Opening	Type = CDOT Type R Curb Opening			
Local Depression (additional to continuous gutter depression 'a' from above)		a_{local} =	3.00	3.00	inches
Number of Unit Inlets (Grate or Curb Opening)		No =	1	1	
Water Depth at Flowline (outside of local depression)		Ponding Depth =	3.3	3.9	inches
Grate Information		MINOR		MAJOR <input checked="" type="checkbox"/> Override Depths	
Length of a Unit Grate		$L_o (G)$ =	N/A	N/A	feet
Width of a Unit Grate		W_o =	N/A	N/A	feet
Area Opening Ratio for a Grate (typical values 0.15-0.90)		A_{ratio} =	N/A	N/A	
Clogging Factor for a Single Grate (typical value 0.50 - 0.70)		$C_r (G)$ =	N/A	N/A	
Grate Weir Coefficient (typical value 2.15 - 3.60)		$C_w (G)$ =	N/A	N/A	
Grate Orifice Coefficient (typical value 0.60 - 0.80)		$C_o (G)$ =	N/A	N/A	
Curb Opening Information		MINOR		MAJOR	
Length of a Unit Curb Opening		$L_o (C)$ =	5.00	5.00	feet
Height of Vertical Curb Opening in Inches		H_{vert} =	6.00	6.00	inches
Height of Curb Orifice Throat in Inches		H_{throat} =	6.00	6.00	inches
Angle of Throat (see USDCM Figure ST-5)		Theta =	63.40	63.40	degrees
Side Width for Depression Pan (typically the gutter width of 2 feet)		W_p =	2.00	2.00	feet
Clogging Factor for a Single Curb Opening (typical value 0.10)		$C_r (C)$ =	0.10	0.10	
Curb Opening Weir Coefficient (typical value 2.3-3.7)		$C_w (C)$ =	3.60	3.60	
Curb Opening Orifice Coefficient (typical value 0.60 - 0.70)		$C_o (C)$ =	0.67	0.67	
Low Head Performance Reduction (Calculated)		MINOR		MAJOR	
Depth for Grate Midwidth		d_{grate} =	N/A	N/A	ft
Depth for Curb Opening Weir Equation		d_{curb} =	0.11	0.16	ft
Combination Inlet Performance Reduction Factor for Long Inlets		$RF_{Combination}$ =	0.42	0.50	
Curb Opening Performance Reduction Factor for Long Inlets		RF_{Curb} =	0.97	1.00	
Grated Inlet Performance Reduction Factor for Long Inlets		RF_{Grate} =	N/A	N/A	
Total Inlet Interception Capacity (assumes clogged condition)		MINOR		MAJOR	
		Q_a =	0.9	1.7	cfs
Inlet Capacity IS GOOD for Minor and Major Storms(>Q PEAK)		$Q_{PEAK REQUIRED}$ =	0.9	1.7	cfs

INLET 4

INLET IN A SUMP OR SAG LOCATION

Version 4.05 Released March 2017

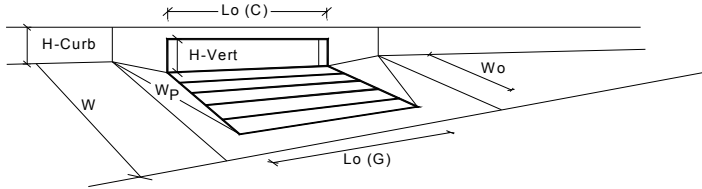

Design Information (Input)		MINOR		MAJOR	
Type of Inlet	CDOT Type R Curb Opening	Type = CDOT Type R Curb Opening			
Local Depression (additional to continuous gutter depression 'a' from above)		a_{local} = 3.00	3.00	inches	
Number of Unit Inlets (Grate or Curb Opening)		No = 1	1		
Water Depth at Flowline (outside of local depression)		Ponding Depth = 4.5	5.8	inches	
Grate Information		MINOR		MAJOR <input checked="" type="checkbox"/> Override Depths	
Length of a Unit Grate		$L_o (G)$ = N/A	N/A	feet	
Width of a Unit Grate		W_o = N/A	N/A	feet	
Area Opening Ratio for a Grate (typical values 0.15-0.90)		A_{ratio} = N/A	N/A		
Clogging Factor for a Single Grate (typical value 0.50 - 0.70)		$C_r (G)$ = N/A	N/A		
Grate Weir Coefficient (typical value 2.15 - 3.60)		$C_w (G)$ = N/A	N/A		
Grate Orifice Coefficient (typical value 0.60 - 0.80)		$C_o (G)$ = N/A	N/A		
Curb Opening Information		MINOR		MAJOR	
Length of a Unit Curb Opening		$L_o (C)$ = 5.00	5.00	feet	
Height of Vertical Curb Opening in Inches		H_{vert} = 6.00	6.00	inches	
Height of Curb Orifice Throat in Inches		H_{throat} = 6.00	6.00	inches	
Angle of Throat (see USDCM Figure ST-5)		Theta = 63.40	63.40	degrees	
Side Width for Depression Pan (typically the gutter width of 2 feet)		W_p = 2.00	2.00	feet	
Clogging Factor for a Single Curb Opening (typical value 0.10)		$C_r (C)$ = 0.10	0.10		
Curb Opening Weir Coefficient (typical value 2.3-3.7)		$C_w (C)$ = 3.60	3.60		
Curb Opening Orifice Coefficient (typical value 0.60 - 0.70)		$C_o (C)$ = 0.67	0.67		
Low Head Performance Reduction (Calculated)		MINOR		MAJOR	
Depth for Grate Midwidth		d_{grate} = N/A	N/A	ft	
Depth for Curb Opening Weir Equation		d_{curb} = 0.21	0.32	ft	
Combination Inlet Performance Reduction Factor for Long Inlets		$RF_{Combination}$ = 0.58	0.74		
Curb Opening Performance Reduction Factor for Long Inlets		RF_{Curb} = 1.00	1.00		
Grated Inlet Performance Reduction Factor for Long Inlets		RF_{Grate} = N/A	N/A		
Total Inlet Interception Capacity (assumes clogged condition)		MINOR		MAJOR	
		Q_a = 2.7	4.9	cfs	
Inlet Capacity IS GOOD for Minor and Major Storms(>Q PEAK)		$Q_{PEAK REQUIRED}$ = 2.7	4.9	cfs	

INLET 5

INLET IN A SUMP OR SAG LOCATION

Version 4.05 Released March 2017

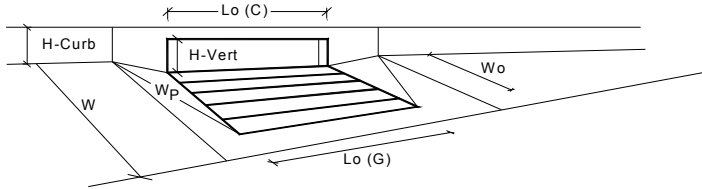

Design Information (Input)		MINOR		MAJOR	
Type of Inlet	CDOT Type R Curb Opening	Type = CDOT Type R Curb Opening			
Local Depression (additional to continuous gutter depression 'a' from above)		a_{local} =	3.00	3.00	inches
Number of Unit Inlets (Grate or Curb Opening)		No =	1	1	
Water Depth at Flowline (outside of local depression)		Ponding Depth =	5.3	7.0	inches
Grate Information		MINOR		MAJOR <input checked="" type="checkbox"/> Override Depths	
Length of a Unit Grate		$L_o (G)$ =	N/A	N/A	feet
Width of a Unit Grate		W_o =	N/A	N/A	feet
Area Opening Ratio for a Grate (typical values 0.15-0.90)		A_{ratio} =	N/A	N/A	
Clogging Factor for a Single Grate (typical value 0.50 - 0.70)		$C_r (G)$ =	N/A	N/A	
Grate Weir Coefficient (typical value 2.15 - 3.60)		$C_w (G)$ =	N/A	N/A	
Grate Orifice Coefficient (typical value 0.60 - 0.80)		$C_o (G)$ =	N/A	N/A	
Curb Opening Information		MINOR		MAJOR	
Length of a Unit Curb Opening		$L_o (C)$ =	5.00	5.00	feet
Height of Vertical Curb Opening in Inches		H_{vert} =	6.00	6.00	inches
Height of Curb Orifice Throat in Inches		H_{throat} =	6.00	6.00	inches
Angle of Throat (see USDCM Figure ST-5)		Theta =	63.40	63.40	degrees
Side Width for Depression Pan (typically the gutter width of 2 feet)		W_p =	2.00	2.00	feet
Clogging Factor for a Single Curb Opening (typical value 0.10)		$C_r (C)$ =	0.10	0.10	
Curb Opening Weir Coefficient (typical value 2.3-3.7)		$C_w (C)$ =	3.60	3.60	
Curb Opening Orifice Coefficient (typical value 0.60 - 0.70)		$C_o (C)$ =	0.67	0.67	
Low Head Performance Reduction (Calculated)		MINOR		MAJOR	
Depth for Grate Midwidth		d_{grate} =	N/A	N/A	ft
Depth for Curb Opening Weir Equation		d_{curb} =	0.28	0.41	ft
Combination Inlet Performance Reduction Factor for Long Inlets		$RF_{Combination}$ =	0.68	0.89	
Curb Opening Performance Reduction Factor for Long Inlets		RF_{Curb} =	1.00	1.00	
Grated Inlet Performance Reduction Factor for Long Inlets		RF_{Grate} =	N/A	N/A	
Total Inlet Interception Capacity (assumes clogged condition)		MINOR		MAJOR	
		Q_a =	4.0	7.4	cfs
Inlet Capacity IS GOOD for Minor and Major Storms(>Q PEAK)		$Q_{PEAK\ REQUIRED}$ =	4.0	7.4	cfs

INLET 6

INLET IN A SUMP OR SAG LOCATION

Version 4.05 Released March 2017

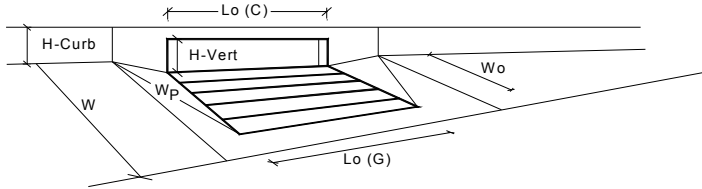

Design Information (Input)		MINOR		MAJOR	
Type of Inlet	CDOT Type R Curb Opening	Type = CDOT Type R Curb Opening			
Local Depression (additional to continuous gutter depression 'a' from above)		a_{local} =	3.00	3.00	inches
Number of Unit Inlets (Grate or Curb Opening)		No =	1	1	
Water Depth at Flowline (outside of local depression)		Ponding Depth =	3.2	3.6	inches
Grate Information		MINOR		MAJOR	
Length of a Unit Grate		$L_o (G)$ =	N/A	N/A	feet
Width of a Unit Grate		W_o =	N/A	N/A	feet
Area Opening Ratio for a Grate (typical values 0.15-0.90)		A_{ratio} =	N/A	N/A	
Clogging Factor for a Single Grate (typical value 0.50 - 0.70)		$C_r (G)$ =	N/A	N/A	
Grate Weir Coefficient (typical value 2.15 - 3.60)		$C_w (G)$ =	N/A	N/A	
Grate Orifice Coefficient (typical value 0.60 - 0.80)		$C_o (G)$ =	N/A	N/A	
Curb Opening Information		MINOR		MAJOR	
Length of a Unit Curb Opening		$L_o (C)$ =	5.00	5.00	feet
Height of Vertical Curb Opening in Inches		H_{vert} =	6.00	6.00	inches
Height of Curb Orifice Throat in Inches		H_{throat} =	6.00	6.00	inches
Angle of Throat (see USDCM Figure ST-5)		Theta =	63.40	63.40	degrees
Side Width for Depression Pan (typically the gutter width of 2 feet)		W_p =	2.00	2.00	feet
Clogging Factor for a Single Curb Opening (typical value 0.10)		$C_r (C)$ =	0.10	0.10	
Curb Opening Weir Coefficient (typical value 2.3-3.7)		$C_w (C)$ =	3.60	3.60	
Curb Opening Orifice Coefficient (typical value 0.60 - 0.70)		$C_o (C)$ =	0.67	0.67	
Low Head Performance Reduction (Calculated)		MINOR		MAJOR	
Depth for Grate Midwidth		d_{grate} =	N/A	N/A	ft
Depth for Curb Opening Weir Equation		d_{curb} =	0.10	0.14	ft
Combination Inlet Performance Reduction Factor for Long Inlets		$RF_{Combination}$ =	0.41	0.47	
Curb Opening Performance Reduction Factor for Long Inlets		RF_{Curb} =	0.95	1.00	
Grated Inlet Performance Reduction Factor for Long Inlets		RF_{Grate} =	N/A	N/A	
Total Inlet Interception Capacity (assumes clogged condition)		MINOR		MAJOR	
		Q_a =	0.8	1.4	cfs
Inlet Capacity IS GOOD for Minor and Major Storms(>Q PEAK)		$Q_{PEAK REQUIRED}$ =	0.8	1.4	cfs

INLET 7

INLET IN A SUMP OR SAG LOCATION

Version 4.05 Released March 2017

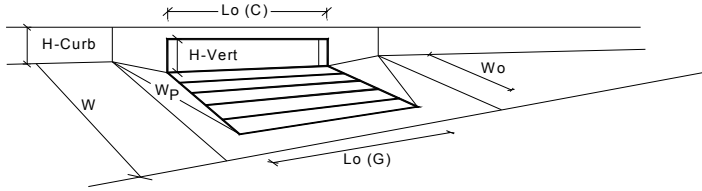

Design Information (Input)	MINOR	MAJOR	
Type of Inlet	CDOT Type R Curb Opening		
Local Depression (additional to continuous gutter depression 'a' from above)	$a_{local} = 3.00$	3.00	inches
Number of Unit Inlets (Grate or Curb Opening)	$N_o = 1$	1	
Water Depth at Flowline (outside of local depression)	$Ponding\ Depth = 5.3$	6.8	inches
Grate Information	MINOR	MAJOR	
Length of a Unit Grate	$L_o (G) = N/A$	N/A	feet
Width of a Unit Grate	$W_o = N/A$	N/A	feet
Area Opening Ratio for a Grate (typical values 0.15-0.90)	$A_{ratio} = N/A$	N/A	
Clogging Factor for a Single Grate (typical value 0.50 - 0.70)	$C_r (G) = N/A$	N/A	
Grate Weir Coefficient (typical value 2.15 - 3.60)	$C_w (G) = N/A$	N/A	
Grate Orifice Coefficient (typical value 0.60 - 0.80)	$C_o (G) = N/A$	N/A	
Curb Opening Information	MINOR	MAJOR	
Length of a Unit Curb Opening	$L_o (C) = 5.00$	5.00	feet
Height of Vertical Curb Opening in Inches	$H_{vert} = 6.00$	6.00	inches
Height of Curb Orifice Throat in Inches	$H_{throat} = 6.00$	6.00	inches
Angle of Throat (see USDCM Figure ST-5)	$\Theta = 63.40$	63.40	degrees
Side Width for Depression Pan (typically the gutter width of 2 feet)	$W_p = 2.00$	2.00	feet
Clogging Factor for a Single Curb Opening (typical value 0.10)	$C_r (C) = 0.10$	0.10	
Curb Opening Weir Coefficient (typical value 2.3-3.7)	$C_w (C) = 3.60$	3.60	
Curb Opening Orifice Coefficient (typical value 0.60 - 0.70)	$C_o (C) = 0.67$	0.67	
Low Head Performance Reduction (Calculated)	MINOR	MAJOR	
Depth for Grate Midwidth	$d_{grate} = N/A$	N/A	ft
Depth for Curb Opening Weir Equation	$d_{curb} = 0.28$	0.40	ft
Combination Inlet Performance Reduction Factor for Long Inlets	$RF_{Combination} = 0.68$	0.87	
Curb Opening Performance Reduction Factor for Long Inlets	$RF_{Curb} = 1.00$	1.00	
Grated Inlet Performance Reduction Factor for Long Inlets	$RF_{Grate} = N/A$	N/A	
Total Inlet Interception Capacity (assumes clogged condition)	MINOR	MAJOR	
	$Q_a = 4.0$	7.0	cfs
Inlet Capacity IS GOOD for Minor and Major Storms(>Q PEAK)	$Q_{PEAK\ REQUIRED} = 3.9$	7.0	cfs

INLET 8

INLET IN A SUMP OR SAG LOCATION

Version 4.05 Released March 2017

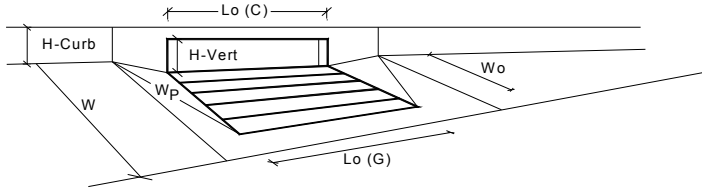

Design Information (Input)		MINOR		MAJOR	
Type of Inlet	CDOT Type R Curb Opening	Type = CDOT Type R Curb Opening			
Local Depression (additional to continuous gutter depression 'a' from above)		a_{local} = 3.00	3.00	inches	
Number of Unit Inlets (Grate or Curb Opening)		No = 1	1		
Water Depth at Flowline (outside of local depression)		Ponding Depth = 3.5	4.2	inches	
Grate Information		MINOR		MAJOR <input checked="" type="checkbox"/> Override Depths	
Length of a Unit Grate		$L_o (G)$ = N/A	N/A	feet	
Width of a Unit Grate		W_o = N/A	N/A	feet	
Area Opening Ratio for a Grate (typical values 0.15-0.90)		A_{ratio} = N/A	N/A		
Clogging Factor for a Single Grate (typical value 0.50 - 0.70)		$C_r (G)$ = N/A	N/A		
Grate Weir Coefficient (typical value 2.15 - 3.60)		$C_w (G)$ = N/A	N/A		
Grate Orifice Coefficient (typical value 0.60 - 0.80)		$C_o (G)$ = N/A	N/A		
Curb Opening Information		MINOR		MAJOR	
Length of a Unit Curb Opening		$L_o (C)$ = 5.00	5.00	feet	
Height of Vertical Curb Opening in Inches		H_{vert} = 6.00	6.00	inches	
Height of Curb Orifice Throat in Inches		H_{throat} = 6.00	6.00	inches	
Angle of Throat (see USDCM Figure ST-5)		Theta = 63.40	63.40	degrees	
Side Width for Depression Pan (typically the gutter width of 2 feet)		W_p = 2.00	2.00	feet	
Clogging Factor for a Single Curb Opening (typical value 0.10)		$C_r (C)$ = 0.10	0.10		
Curb Opening Weir Coefficient (typical value 2.3-3.7)		$C_w (C)$ = 3.60	3.60		
Curb Opening Orifice Coefficient (typical value 0.60 - 0.70)		$C_o (C)$ = 0.67	0.67		
Low Head Performance Reduction (Calculated)		MINOR		MAJOR	
Depth for Grate Midwidth		d_{grate} = N/A	N/A	ft	
Depth for Curb Opening Weir Equation		d_{curb} = 0.13	0.19	ft	
Combination Inlet Performance Reduction Factor for Long Inlets		$RF_{combination}$ = 0.45	0.54		
Curb Opening Performance Reduction Factor for Long Inlets		RF_{curb} = 0.99	1.00		
Grated Inlet Performance Reduction Factor for Long Inlets		RF_{grate} = N/A	N/A		
Total Inlet Interception Capacity (assumes clogged condition)		MINOR		MAJOR	
		Q_a = 1.2	2.2	cfs	
Inlet Capacity IS GOOD for Minor and Major Storms(>Q PEAK)		$Q_{PEAK\ REQUIRED}$ = 1.2	2.2	cfs	

APPENDIX D – STORM SEWER SCHEMATIC & HYDRAFLOW CALCULATIONS

STORM SCHEMATIC

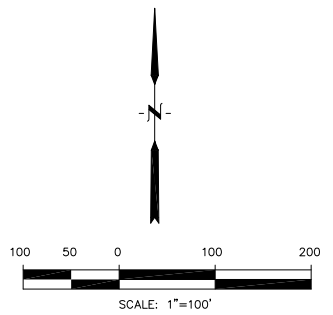
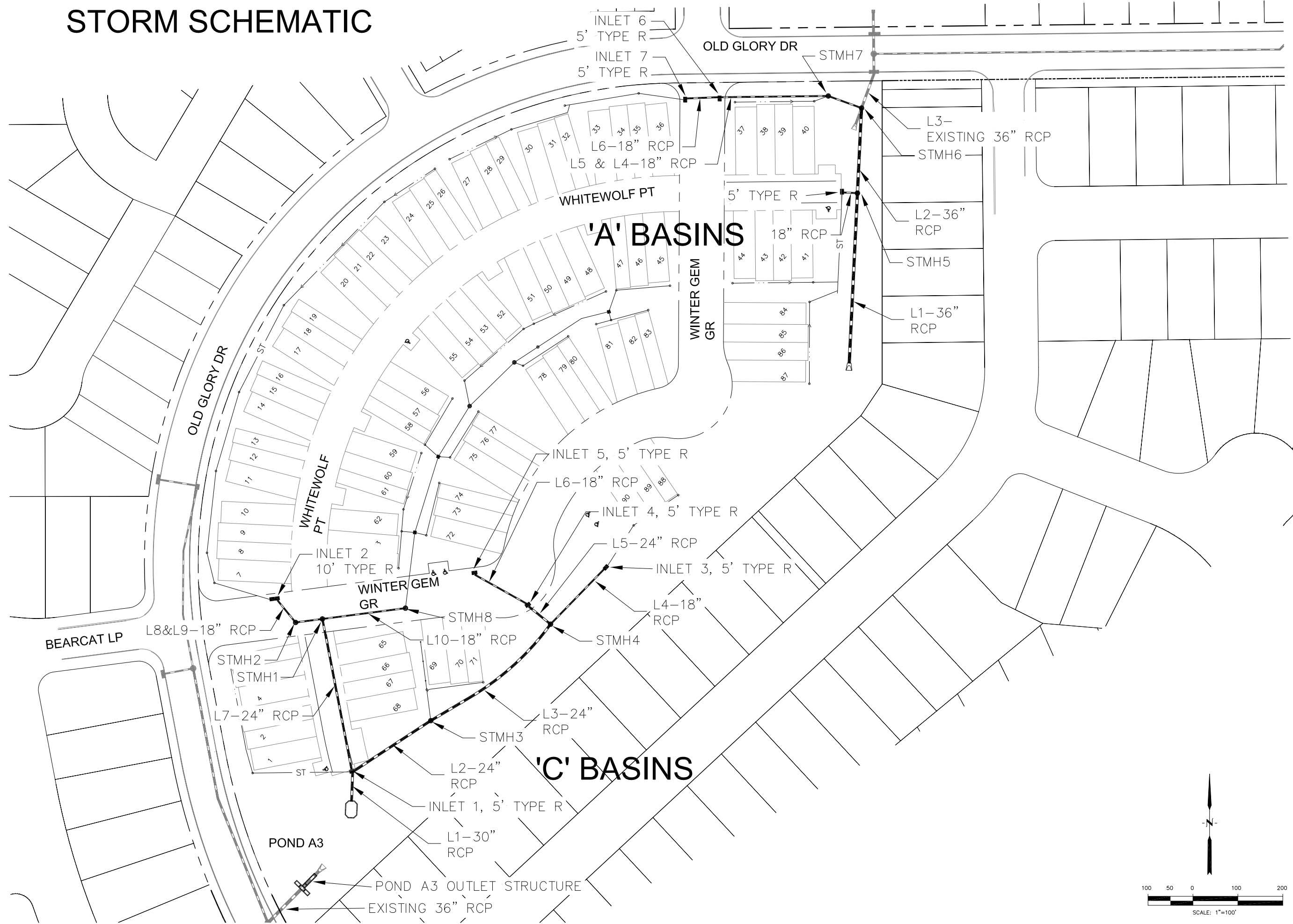

<p>CORE ENGINEERING GROUP 15004 1ST AVE. S. BURNSVILLE, MN 55306 PH: 719.570.1100 CONTACT: RICHARD L. SCHINDLER, P.E. EMAIL: Rich@cegi.com</p>	
DATE	APRIL, 2020
DESCRIPTION	STORM SEWER SCHEMATIC
PROJECT NO.	100.050
PROJECT	PONDEROSA AT LORSON RANCH FILING NO. 3 212 N. WAHSATCH AVE., SUITE 301 COLORADO SPRINGS, COLORADO 80903 EL PASO COUNTY, COLORADO PREPARED FOR: LORSON, LLC CONTACT: JEFF MARK
DRAWN:	RLS
DESIGNED:	LAB
CHECKED:	LAB
STORM SEWER SCHEMATIC PONDEROSA AT LORSON RANCH FILING NO. 3	
SHEET NUMBER 1	
TOTAL SHEETS: 1	

P: 100.100.050 | Drawings: 100.050-storm-schematic.dwg | Rev: 05 | 2020 | 12.03am

Storm Sewer Summary Report

Line No.	Line ID	Flow rate (cfs)	Line size (in)	Line length (ft)	Invert EL Dn (ft)	Invert EL Up (ft)	Line slope (%)	HGL down (ft)	HGL up (ft)	Minor loss (ft)	HGL Junct (ft)	Dns line No.
1	L1, 197.4, 36"@0.50	18.50	36 c	197.0	5712.25	5713.24	0.503	5713.73	5714.61	n/a	5714.61 j	End
2	L2- 94.9, 36"@0.50%	16.30	36 c	94.9	5713.24	5713.71	0.495	5715.07	5715.06	0.42	5715.47	1
3	L3, 40.6, 36"@0.33%	10.40	36 c	40.6	5713.71	5713.84	0.320	5715.83	5715.84	0.07	5715.91	2
4	L4, 39.4, 18"@0.50%	5.90	18 c	39.4	5715.21	5715.41	0.508	5716.21	5716.41	0.14	5716.55	2
5	L5-123.1, 18"@0.50	5.50	18 c	123.1	5715.41	5716.02	0.495	5716.74	5717.04	0.14	5717.18	4
6	L6-34', 18"@0.50%	4.70	18 c	34.0	5716.02	5716.19	0.500	5717.28	5717.32	0.17	5717.49	5

Project File: 100.050 Basin A, 5yr flow.stm	Number of lines: 6	Run Date: 11-12-2019
---	--------------------	----------------------

NOTES: c = cir; e = ellip; b = box; Return period = 5 Yrs. ; j - Line contains hyd. jump.

Storm Sewer Summary Report

Line No.	Line ID	Flow rate (cfs)	Line size (in)	Line length (ft)	Invert EL Dn (ft)	Invert EL Up (ft)	Line slope (%)	HGL down (ft)	HGL up (ft)	Minor loss (ft)	HGL Junct (ft)	Dns line No.
1	L1, 197.4, 36"@0.50	37.70	36 c	197.0	5712.25	5713.24	0.503	5714.50	5715.21	n/a	5715.34 j	End
2	L2- 94.9, 36"@0.50%	33.70	36 c	94.9	5713.24	5713.71	0.495	5715.91	5716.04	0.38	5716.42	1
3	L3, 40.6, 36"@0.33%	23.00	36 c	40.6	5713.71	5713.84	0.320	5716.75	5716.80	0.08	5716.88	2
4	L4, 39.4, 18"@0.50%	10.70	18 c	39.4	5715.21	5715.41	0.508	5716.71*	5717.12*	0.23	5717.35	2
5	L5-123.1, 18"@0.50	9.90	18 c	123.1	5715.41	5716.02	0.495	5717.43*	5718.52*	0.24	5718.77	4
6	L6-34', 18"@0.50%	8.50	18 c	34.0	5716.02	5716.19	0.500	5718.90*	5719.12*	0.18	5719.30	5

Project File: 100.050 Basin A, 100yr flow.stm	Number of lines: 6	Run Date: 11-12-2019
---	--------------------	----------------------

NOTES: c = cir; e = ellip; b = box; Return period = 100 Yrs. ; *Surcharged (HGL above crown). ; j - Line contains hyd. jump.

Storm Sewer Summary Report

Line No.	Line ID	Flow rate (cfs)	Line size (in)	Line length (ft)	Invert EL Dn (ft)	Invert EL Up (ft)	Line slope (%)	HGL down (ft)	HGL up (ft)	Minor loss (ft)	HGL Junct (ft)	Dns line No.
1	L1, 30"RCP@0.60%	21.40	30 c	32.5	5709.00	5709.20	0.616	5711.05	5711.08	0.23	5711.30	End
2	L2, 24"RCP@0.50%	8.30	24 c	104.6	5709.50	5710.02	0.497	5711.60	5711.71	0.02	5711.73	1
3	L3, 24"RCP@0.50%	7.60	24 c	172.7	5710.12	5710.99	0.504	5711.78	5712.01	0.26	5712.27	2
4	L4, 18"RCP@0.60%	0.90	18 c	88.3	5711.49	5712.02	0.600	5712.58	5712.59	0.02	5712.60	3
5	L5, 24"RCP@0.60%	6.70	24 c	34.9	5711.09	5711.30	0.601	5712.37	5712.36	0.12	5712.48	3
6	L6, 18"RCP@1.00%	4.00	18 c	66.3	5711.80	5712.46	0.996	5712.65	5713.22	n/a	5713.22 j	5
7	L7, 24"RCP@0.80%	10.80	24 c	173.6	5709.50	5710.89	0.801	5711.58	5712.05	n/a	5712.05 j	1
8	L8, 18"RCP@0.90%	7.50	18 c	42.7	5711.38	5711.76	0.889	5712.36	5712.81	0.25	5713.06	7
9	L9, 18"RCP@0.90%	7.50	18 c	27.0	5711.86	5712.10	0.890	5713.28	5713.34	0.18	5713.52	8
10	L10, 18"@0.60%	3.30	18 c	93.2	5711.38	5711.94	0.601	5712.50	5712.64	n/a	5712.69 j	7

Project File: 100.050 Basin C, 5yr flow (1).stm	Number of lines: 10	Run Date: 11-12-2019
---	---------------------	----------------------

NOTES: c = cir; e = ellip; b = box; Return period = 5 Yrs. ; j - Line contains hyd. jump.

Storm Sewer Summary Report

Line No.	Line ID	Flow rate (cfs)	Line size (in)	Line length (ft)	Invert EL Dn (ft)	Invert EL Up (ft)	Line slope (%)	HGL down (ft)	HGL up (ft)	Minor loss (ft)	HGL Junct (ft)	Dns line No.
1	L1, 30"RCP@0.60%	36.40	30 c	32.5	5709.00	5709.20	0.616	5711.05	5711.45	0.48	5711.92	End
2	L2, 24"RCP@0.50%	15.30	24 c	104.6	5709.50	5710.02	0.497	5712.51*	5712.99*	0.06	5713.04	1
3	L3, 24"RCP@0.50%	14.00	24 c	172.7	5710.12	5710.99	0.504	5713.10*	5713.76*	0.23	5714.00	2
4	L4, 18"RCP@0.60%	1.70	18 c	88.3	5711.49	5712.02	0.600	5714.29*	5714.31*	0.01	5714.32	3
5	L5, 24"RCP@0.60%	12.30	24 c	34.9	5711.09	5711.30	0.601	5714.07*	5714.17*	0.12	5714.29	3
6	L6, 18"RCP@1.00%	7.40	18 c	66.3	5711.80	5712.46	0.996	5714.29*	5714.62*	0.14	5714.75	5
7	L7, 24"RCP@0.80%	17.00	24 c	173.6	5709.50	5710.89	0.801	5712.42*	5713.40*	0.23	5713.63	1
8	L8, 18"RCP@0.90%	11.00	18 c	42.7	5711.38	5711.76	0.889	5713.63*	5714.10*	0.30	5714.40	7
9	L9, 18"RCP@0.90%	11.00	18 c	27.0	5711.86	5712.10	0.890	5714.40*	5714.70*	0.30	5715.00	8
10	L10, 18"@0.60%	6.00	18 c	93.2	5711.38	5711.94	0.601	5713.91*	5714.21*	0.04	5714.25	7

Project File: 100.050 Basin C, 100yr flow (1).stm	Number of lines: 10	Run Date: 11-12-2019
---	---------------------	----------------------

NOTES: c = cir; e = ellip; b = box; Return period = 100 Yrs. ; *Surcharged (HGL above crown).

APPENDIX E – POND CALCULATIONS

Weir Report

forebay weir

Rectangular Weir

Crest = Sharp
Bottom Length (ft) = 6.00
Total Depth (ft) = 0.25

Highlighted

Depth (ft) = 0.25
Q (cfs) = 2.498
Area (sqft) = 1.50
Velocity (ft/s) = 1.67
Top Width (ft) = 6.00

Calculations

Weir Coeff. Cw = 3.33
Compute by: Known Depth
Known Depth (ft) = 0.25

Initial Flow = 2.01cfs
opening meets design criteria

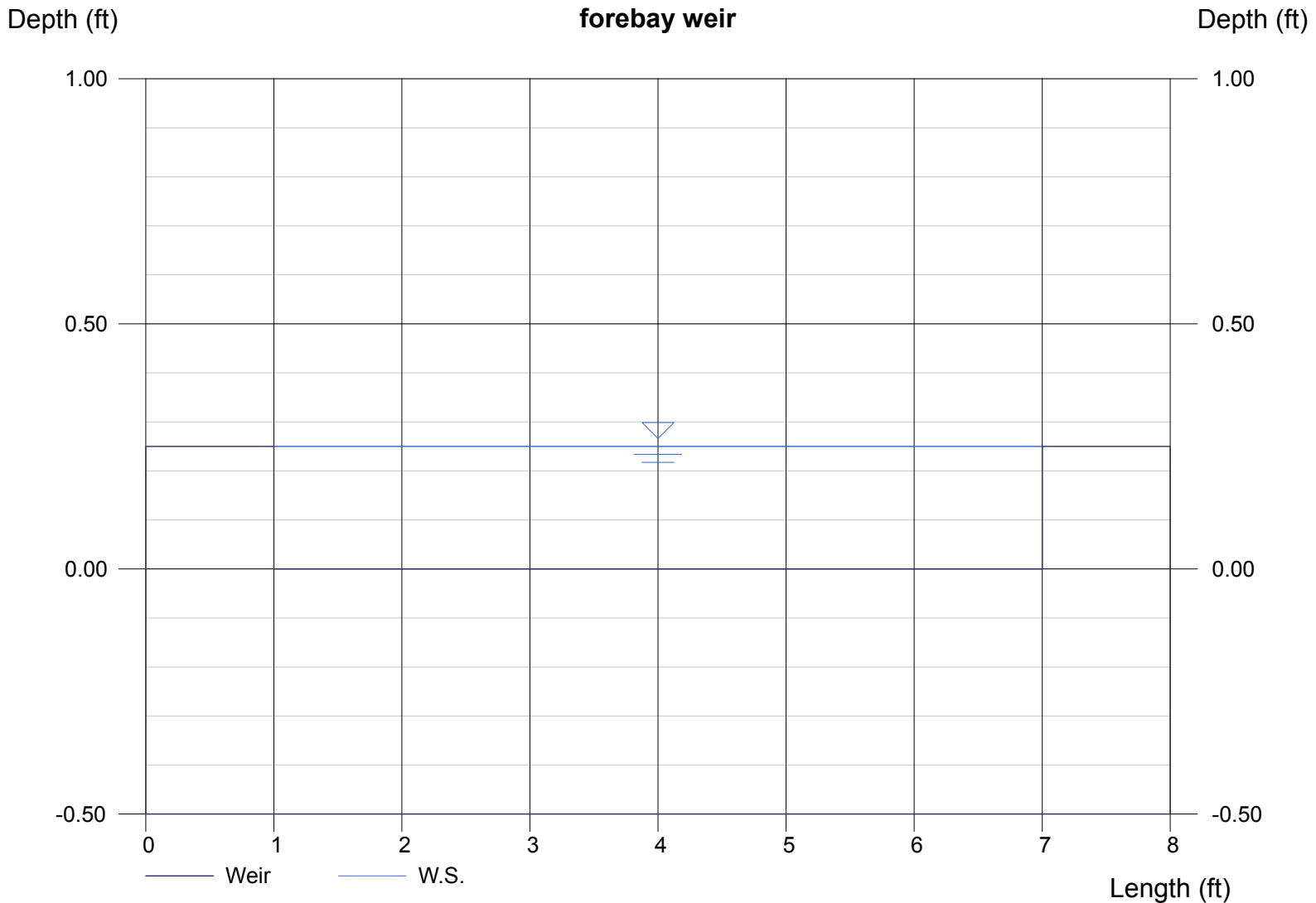

Channel Report

Hydraflow Express by Intelisolve

Thursday, Oct 24 2019, 10:22 AM

Pond A3 low flow channel

Rectangular

Bottom Width (ft) = 2.00
Total Depth (ft) = 0.50

Invert Elev (ft) = 100.00
Slope (%) = 0.50
N-Value = 0.013

Highlighted

Depth (ft) = 0.50
Q (cfs) = 3.884
Area (sqft) = 1.00
Velocity (ft/s) = 3.88
Wetted Perim (ft) = 3.00
Crit Depth, Y_c (ft) = 0.49
Top Width (ft) = 2.00
EGL (ft) = 0.73

Calculations

Compute by: Known Depth
Known Depth (ft) = 0.50

Q100=24cfs
1% of Q100=2.4cfs min. design flow

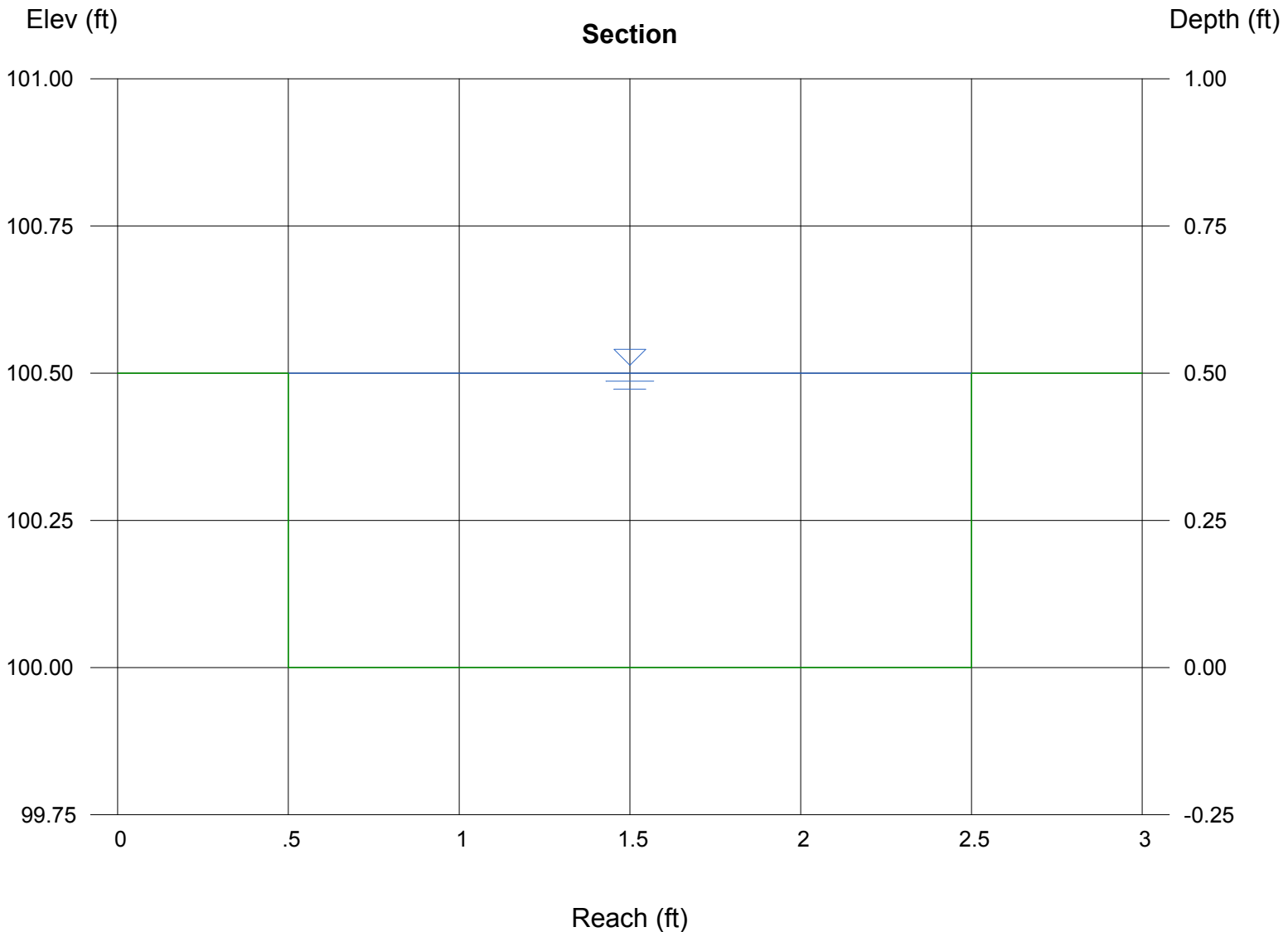

DETENTION BASIN STAGE-STORAGE TABLE BUILDER

UD-Detention, Version 3.07 (February 2017)

Project:
Basin ID: Pond A3

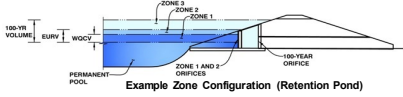

Example Zone Configuration (Retention Pond)

Required Volume Calculation

Selected BMP Type =	EDB	
Watershed Area =	10.10	acres
Watershed Length =	1,000	ft
Watershed Slope =	0.010	ft/ft
Watershed Imperviousness =	52.00%	percent
Percentage Hydrologic Soil Group A =	0.0%	percent
Percentage Hydrologic Soil Group B =	22.0%	percent
Percentage Hydrologic Soil Groups C/D =	78.0%	percent
Desired WQCV Drain Time =	40.0	hours
Location for 1-hr Rainfall Depths =	User Input	
Water Quality Capture Volume (WQCV) =	0.178	acre-feet
Excess Urban Runoff Volume (EURV) =	0.513	acre-feet
2-yr Runoff Volume (P1 = 1.19 in.) =	0.467	acre-feet
5-yr Runoff Volume (P1 = 1.5 in.) =	0.676	acre-feet
10-yr Runoff Volume (P1 = 1.75 in.) =	0.872	acre-feet
25-yr Runoff Volume (P1 = 2 in.) =	1.184	acre-feet
50-yr Runoff Volume (P1 = 2.25 in.) =	1.416	acre-feet
100-yr Runoff Volume (P1 = 2.52 in.) =	1.710	acre-feet
500-yr Runoff Volume (P1 = 0 in.) =	0.000	acre-feet
Approximate 2-yr Detention Volume =	0.438	acre-feet
Approximate 5-yr Detention Volume =	0.637	acre-feet
Approximate 10-yr Detention Volume =	0.748	acre-feet
Approximate 25-yr Detention Volume =	0.810	acre-feet
Approximate 50-yr Detention Volume =	0.840	acre-feet
Approximate 100-yr Detention Volume =	0.946	acre-feet

Optional User Override	1-hr Precipitation	
	1.19	inches
	1.50	inches
	1.75	inches
	2.00	inches
	2.25	inches
	2.52	inches
		inches

Stage-Storage Calculation

Zone 1 Volume (WQCV) =	0.178	acre-feet
Zone 2 Volume (EURV - Zone 1) =	0.334	acre-feet
Zone 3 (100yr + 1/2 WQCV - Zones 1 & 2) =	0.522	acre-feet
Total Detention Basin Volume =	1.035	acre-feet
Initial Surcharge Volume (SV) =	user	ft³
Initial Surcharge Depth (SD) =	user	ft
Total Available Detention Depth (H _{total}) =	user	ft
Depth of Trickle Channel (H _{tc}) =	user	ft
Slope of Trickle Channel (S _{tc}) =	user	ft/ft
Slopes of Main Basin Sides (S _{mbin}) =	user	ft/v
Basin Length-to-Width Ratio (R _{l/w}) =	user	
Initial Surcharge Area (A _{sv}) =	user	ft²
Surcharge Volume Length (L _{sv}) =	user	ft
Surcharge Volume Width (W _{sv}) =	user	ft
Depth of Basin Floor (H _{u00n}) =	user	ft
Length of Basin Floor (L _{u00n}) =	user	ft
Width of Basin Floor (W _{u00n}) =	user	ft
Area of Basin Floor (A _{u00n}) =	user	ft²
Volume of Basin Floor (V _{u00n}) =	user	ft³
Depth of Main Basin (H _{m00n}) =	user	ft
Length of Main Basin (L _{m00n}) =	user	ft
Width of Main Basin (W _{m00n}) =	user	ft
Area of Main Basin (A _{m00n}) =	user	ft²
Volume of Main Basin (V _{m00n}) =	user	ft³
Calculated Total Basin Volume (V _{total}) =	user	acre-feet

Depth Increment = <input type="text" value="2"/>	B	A	C	D	E	F	G	H	I
Stage - Storage Description	Stage (ft)	Optional Override Stage (ft)	Length (ft)	Width (ft)	Area (ft²)	Optional Override Area (ft²)	Area (acre)	Volume (ft³)	Volume (ac-ft)
Top of Micropool	--	0.00	--	--	--	20	0.000	--	--
5708.1	--	0.33	--	--	--	450	0.010	73	0.002
5709	--	1.23	--	--	--	4,829	0.111	2,405	0.055
5710	--	2.23	--	--	--	7,607	0.175	8,671	0.199
5711	--	3.23	--	--	--	13,064	0.300	19,007	0.436
5712	--	4.23	--	--	--	20,628	0.474	35,853	0.823
5713	--	5.23	--	--	--	29,434	0.676	60,883	1.398
5714	--	6.23	--	--	--	30,000	0.689	90,600	2.080

Detention Basin Outlet Structure Design

UD-Detention, Version 3.07 (February 2017)

Project: _____

Basin ID: _____

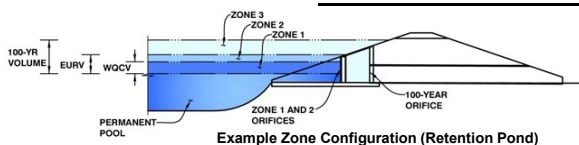

Example Zone Configuration (Retention Pond)

	Stage (ft)	Zone Volume (ac-ft)	Outlet Type
Zone 1 (WQCV)	2.11	0.178	Orifice Plate
Zone 2 (EURV)	3.47	0.334	Rectangular Orifice
(100+1/2WQCV)	4.65	0.522	Weir&Pipe (Restrict)
		1.035	Total

User Input: Orifice at Underdrain Outlet (typically used to drain WQCV in a Filtration BMP)

Underdrain Orifice Invert Depth = ft (distance below the filtration media surface)
 Underdrain Orifice Diameter = inches

Calculated Parameters for Underdrain

Underdrain Orifice Area = ft²
 Underdrain Orifice Centroid = feet

User Input: Orifice Plate with one or more orifices or Elliptical Slot Weir (typically used to drain WQCV and/or EURV in a sedimentation BMP)

Invert of Lowest Orifice = ft (relative to basin bottom at Stage = 0 ft)
 Depth at top of Zone using Orifice Plate = ft (relative to basin bottom at Stage = 0 ft)
 Orifice Plate: Orifice Vertical Spacing = inches
 Orifice Plate: Orifice Area per Row = sq. inches (diameter = 1 inch)

Calculated Parameters for Plate

WQ Orifice Area per Row = ft²
 Elliptical Half-Width = feet
 Elliptical Slot Centroid = feet
 Elliptical Slot Area = ft²

User Input: Stage and Total Area of Each Orifice Row (numbered from lowest to highest)

	Row 1 (required)	Row 2 (optional)	Row 3 (optional)	Row 4 (optional)	Row 5 (optional)	Row 6 (optional)	Row 7 (optional)	Row 8 (optional)
Stage of Orifice Centroid (ft)	0.00	0.70	1.41					
Orifice Area (sq. inches)	0.83	0.83	0.83					

	Row 9 (optional)	Row 10 (optional)	Row 11 (optional)	Row 12 (optional)	Row 13 (optional)	Row 14 (optional)	Row 15 (optional)	Row 16 (optional)
Stage of Orifice Centroid (ft)								
Orifice Area (sq. inches)								

User Input: Vertical Orifice (Circular or Rectangular)

	Zone 2 Rectangular	Not Selected	
Invert of Vertical Orifice =	<input type="text" value="2.11"/>	<input type="text" value="N/A"/>	ft (relative to basin bottom at Stage = 0 ft)
Depth at top of Zone using Vertical Orifice =	<input type="text" value="3.47"/>	<input type="text" value="N/A"/>	ft (relative to basin bottom at Stage = 0 ft)
Vertical Orifice Height =	<input type="text" value="2.00"/>	<input type="text" value="N/A"/>	inches
Vertical Orifice Width =	<input type="text" value="4.10"/>	<input type="text" value="N/A"/>	inches

Calculated Parameters for Vertical Orifice

	Zone 2 Rectangular	Not Selected	
Vertical Orifice Area =	<input type="text" value="0.06"/>	<input type="text" value="N/A"/>	ft ²
Vertical Orifice Centroid =	<input type="text" value="0.08"/>	<input type="text" value="N/A"/>	feet

User Input: Overflow Weir (Dropbox) and Grate (Flat or Sloped)

	Zone 3 Weir	Not Selected	
Overflow Weir Front Edge Height, Ho =	<input type="text" value="4.05"/>	<input type="text" value="N/A"/>	ft (relative to basin bottom at Stage = 0 ft)
Overflow Weir Front Edge Length =	<input type="text" value="3.00"/>	<input type="text" value="N/A"/>	feet
Overflow Weir Slope =	<input type="text" value="0.00"/>	<input type="text" value="N/A"/>	H:V (enter zero for flat grate)
Horiz. Length of Weir Sides =	<input type="text" value="3.00"/>	<input type="text" value="N/A"/>	feet
Overflow Grate Open Area % =	<input type="text" value="80%"/>	<input type="text" value="N/A"/>	%, grate open area/total area
Debris Clogging % =	<input type="text" value="50%"/>	<input type="text" value="N/A"/>	%

Calculated Parameters for Overflow Weir

	Zone 3 Weir	Not Selected	
Height of Grate Upper Edge, H ₁ =	<input type="text" value="4.05"/>	<input type="text" value="N/A"/>	feet
Over Flow Weir Slope Length =	<input type="text" value="3.00"/>	<input type="text" value="N/A"/>	feet
Grate Open Area / 100-yr Orifice Area =	<input type="text" value="9.89"/>	<input type="text" value="N/A"/>	should be ≥ 4
Overflow Grate Open Area w/o Debris =	<input type="text" value="7.20"/>	<input type="text" value="N/A"/>	ft ²
Overflow Grate Open Area w/ Debris =	<input type="text" value="3.60"/>	<input type="text" value="N/A"/>	ft ²

User Input: Outlet Pipe w/ Flow Restriction Plate (Circular Orifice, Restrictor Plate, or Rectangular Orifice)

	Zone 3 Restrictor	Not Selected	
Depth to Invert of Outlet Pipe =	<input type="text" value="0.00"/>	<input type="text" value="N/A"/>	ft (distance below basin bottom at Stage = 0 ft)
Outlet Pipe Diameter =	<input type="text" value="18.00"/>	<input type="text" value="N/A"/>	inches
Restrictor Plate Height Above Pipe Invert =	<input type="text" value="7.75"/>	<input type="text" value="N/A"/>	inches

Calculated Parameters for Outlet Pipe w/ Flow Restriction Plate

	Zone 3 Restrictor	Not Selected	
Outlet Orifice Area =	<input type="text" value="0.73"/>	<input type="text" value="N/A"/>	ft ²
Outlet Orifice Centroid =	<input type="text" value="0.37"/>	<input type="text" value="N/A"/>	feet
Half-Central Angle of Restrictor Plate on Pipe =	<input type="text" value="1.43"/>	<input type="text" value="N/A"/>	radians

User Input: Emergency Spillway (Rectangular or Trapezoidal)

Spillway Invert Stage = ft (relative to basin bottom at Stage = 0 ft)
 Spillway Crest Length = feet
 Spillway End Slopes = H:V
 Freeboard above Max Water Surface = feet

Calculated Parameters for Spillway

Spillway Design Flow Depth = feet
 Stage at Top of Freeboard = feet
 Basin Area at Top of Freeboard = acres

Routed Hydrograph Results

	WQCV	EURV	2 Year	5 Year	10 Year	25 Year	50 Year	100 Year	500 Year
Design Storm Return Period =									
One-Hour Rainfall Depth (in) =	0.53	1.07	1.19	1.50	1.75	2.00	2.25	2.52	0.00
Calculated Runoff Volume (acre-ft) =	0.178	0.513	0.467	0.676	0.872	1.184	1.416	1.710	0.000
OPTIONAL Override Runoff Volume (acre-ft) =									
Inflow Hydrograph Volume (acre-ft) =	0.178	0.512	0.466	0.675	0.872	1.183	1.415	1.709	#N/A
Predevelopment Unit Peak Flow, q (cfs/acre) =	0.00	0.00	0.01	0.08	0.26	0.64	0.86	1.13	0.00
Predevelopment Peak Q (cfs) =	0.0	0.0	0.1	0.8	2.6	6.5	8.7	11.4	0.0
Peak Inflow Q (cfs) =	2.6	7.4	6.7	9.7	12.4	16.8	20.1	24.2	#N/A
Peak Outflow Q (cfs) =	0.1	0.4	0.4	0.5	1.0	5.3	7.1	7.4	#N/A
Ratio Peak Outflow to Predevelopment Q =	N/A	N/A	N/A	0.6	0.4	0.8	0.8	0.6	#N/A
Structure Controlling Flow =	Plate	Vertical Orifice 1	Vertical Orifice 1	Vertical Orifice 1	Overflow Grate 1	Overflow Grate 1	Outlet Plate 1	Outlet Plate 1	#N/A
Max Velocity through Grate 1 (fps) =	N/A	N/A	N/A	N/A	0.1	0.7	0.9	0.9	#N/A
Max Velocity through Grate 2 (fps) =	N/A	N/A	N/A	N/A	N/A	N/A	N/A	N/A	#N/A
Time to Drain 97% of Inflow Volume (hours) =	38	47	46	49	51	48	46	44	#N/A
Time to Drain 99% of Inflow Volume (hours) =	40	52	51	55	58	56	55	54	#N/A
Maximum Ponding Depth (ft) =	2.01	3.29	3.14	3.72	4.11	4.35	4.49	4.79	#N/A
Area at Maximum Ponding Depth (acres) =	0.16	0.31	0.29	0.38	0.45	0.50	0.53	0.58	#N/A
Maximum Volume Stored (acre-ft) =	0.162	0.452	0.410	0.600	0.767	0.876	0.953	1.114	#N/A

Detention Basin Outlet Structure Design

UD-Detention, Version 3.07 (February 2017)

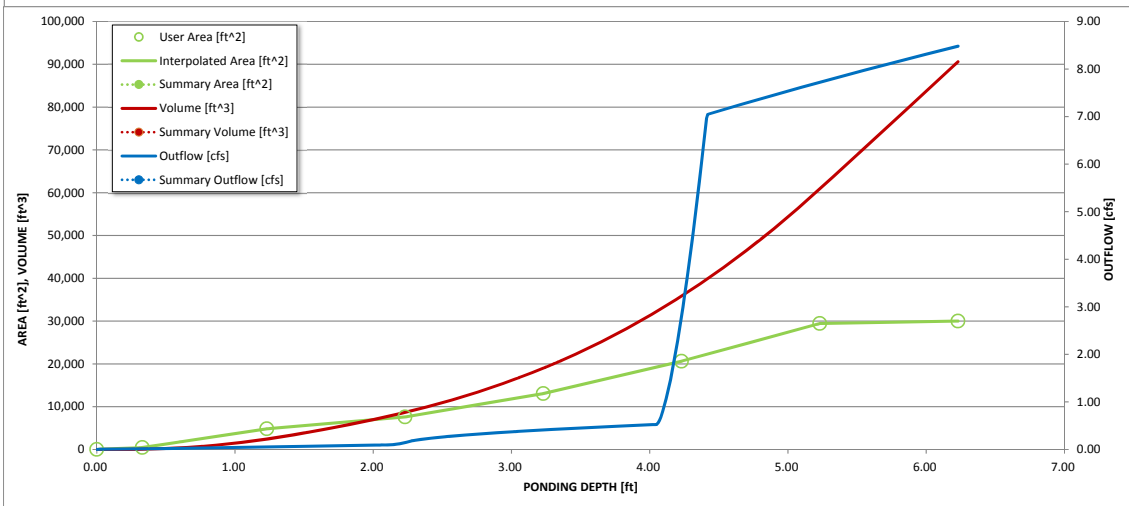
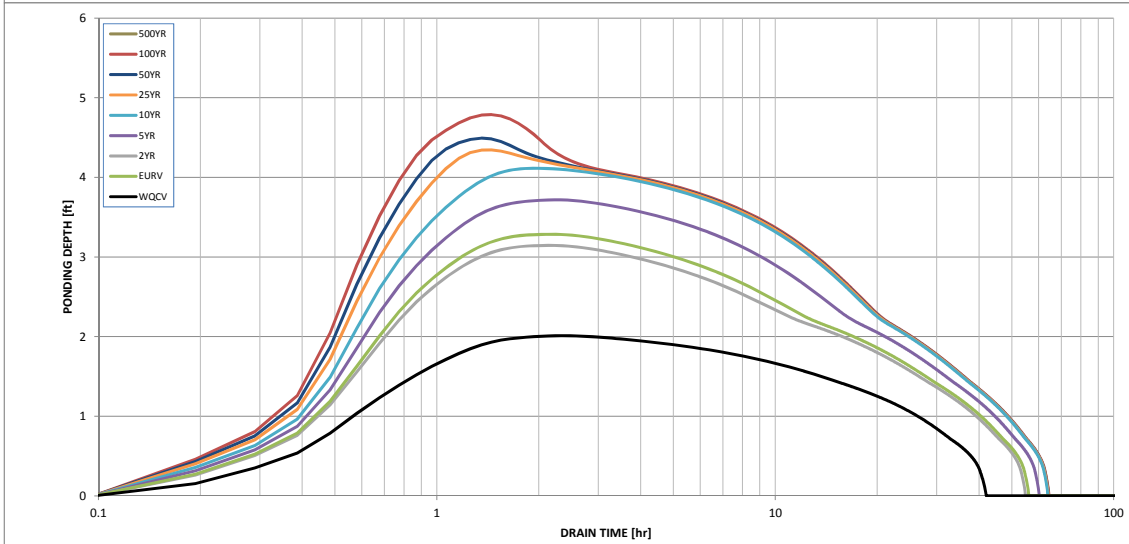
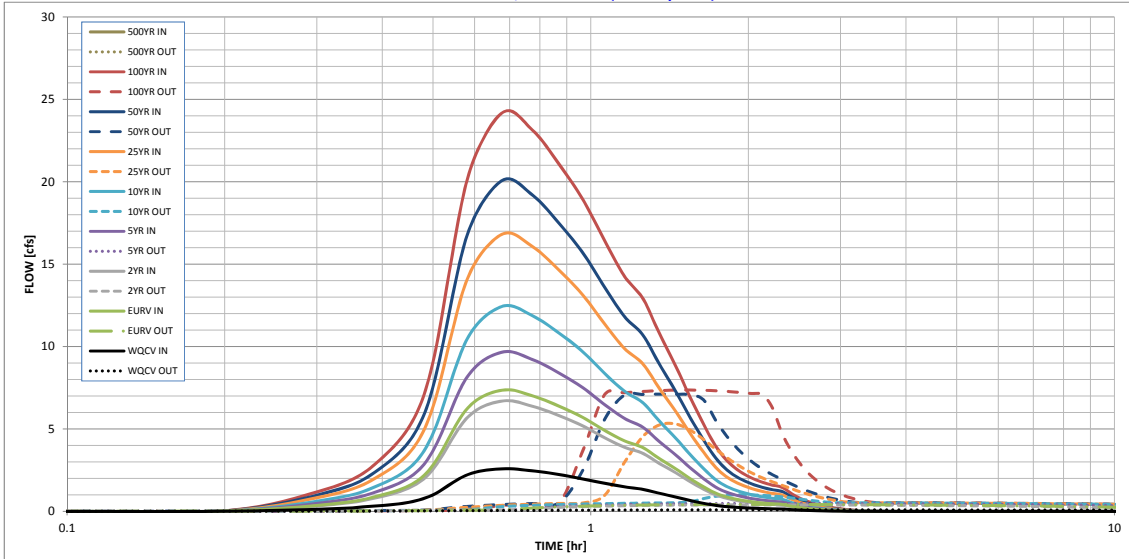

S-A-V-D Chart Axis Override

	X-axis	Left Y-Axis	Right Y-Axis
minimum bound			
maximum bound			

Design Procedure Form: Extended Detention Basin (EDB)

UD-BMP (Version 3.07, March 2018)

Sheet 1 of 3

Designer: Richard Schindler
Company: Core Engineering Group
Date: October 24, 2019
Project: Ponderosa at Lorson Ranch Filing No. 3
Location: Pond A3

<p>1. Basin Storage Volume</p> <p>A) Effective Imperviousness of Tributary Area, I_a</p> <p>B) Tributary Area's Imperviousness Ratio ($i = I_a / 100$)</p> <p>C) Contributing Watershed Area</p> <p>D) For Watersheds Outside of the Denver Region, Depth of Average Runoff Producing Storm</p> <p>E) Design Concept (Select EURV when also designing for flood control)</p> <p>F) Design Volume (WQCV) Based on 40-hour Drain Time ($V_{DESIGN} = (1.0 * (0.91 * i^3 - 1.19 * i^2 + 0.78 * i) / 12 * Area)$)</p> <p>G) For Watersheds Outside of the Denver Region, Water Quality Capture Volume (WQCV) Design Volume ($V_{WQCV\ OTHER} = (d_6 * (V_{DESIGN} * 0.43))$)</p> <p>H) User Input of Water Quality Capture Volume (WQCV) Design Volume (Only if a different WQCV Design Volume is desired)</p> <p>I) NRCS Hydrologic Soil Groups of Tributary Watershed i) Percentage of Watershed consisting of Type A Soils ii) Percentage of Watershed consisting of Type B Soils iii) Percentage of Watershed consisting of Type C/D Soils</p> <p>J) Excess Urban Runoff Volume (EURV) Design Volume For HSG A: $EURV_A = 1.68 * i^{1.28}$ For HSG B: $EURV_B = 1.36 * i^{1.08}$ For HSG C/D: $EURV_{C/D} = 1.20 * i^{1.08}$</p> <p>K) User Input of Excess Urban Runoff Volume (EURV) Design Volume (Only if a different EURV Design Volume is desired)</p>	<p>$I_a =$ <input type="text" value="52.0"/> %</p> <p>$i =$ <input type="text" value="0.520"/></p> <p>Area = <input type="text" value="10.100"/> ac</p> <p>$d_6 =$ <input type="text" value=""/></p> <div style="border: 1px solid black; padding: 5px; margin: 5px 0;"> <p>Choose One</p> <p><input checked="" type="radio"/> Water Quality Capture Volume (WQCV)</p> <p><input type="radio"/> Excess Urban Runoff Volume (EURV)</p> </div> <p>$V_{DESIGN} =$ <input type="text" value="0.178"/> ac-ft</p> <p>$V_{DESIGN\ OTHER} =$ <input type="text" value=""/> ac-ft</p> <p>$V_{DESIGN\ USER} =$ <input type="text" value=""/> ac-ft</p> <p>HSG $A =$ <input type="text" value=""/> % HSG $B =$ <input type="text" value=""/> % HSG $C/D =$ <input type="text" value=""/> %</p> <p>EURV$_{DESIGN} =$ <input type="text" value=""/> ac-ft</p> <p>EURV$_{DESIGN\ USER} =$ <input type="text" value=""/> ac-ft</p>
<p>2. Basin Shape: Length to Width Ratio (A basin length to width ratio of at least 2:1 will improve TSS reduction.)</p>	<p>L : W = <input type="text" value="2.0"/> : 1</p>
<p>3. Basin Side Slopes</p> <p>A) Basin Maximum Side Slopes (Horizontal distance per unit vertical, 4:1 or flatter preferred)</p>	<p>Z = <input type="text" value="4.00"/> ft / ft</p>
<p>4. Inlet</p> <p>A) Describe means of providing energy dissipation at concentrated inflow locations:</p>	<p>_____</p> <p>_____</p> <p>_____</p>
<p>5. Forebay</p> <p>A) Minimum Forebay Volume ($V_{MIN} =$ <input type="text" value="3%"/> of the WQCV)</p> <p>B) Actual Forebay Volume</p> <p>C) Forebay Depth ($D_F =$ <input type="text" value="18"/> inch maximum)</p> <p>D) Forebay Discharge</p> <p style="margin-left: 20px;">i) Undetained 100-year Peak Discharge</p> <p style="margin-left: 20px;">ii) Forebay Discharge Design Flow ($Q_F = 0.02 * Q_{100}$)</p> <p>E) Forebay Discharge Design</p> <p>F) Discharge Pipe Size (minimum 8-inches)</p> <p>G) Rectangular Notch Width</p>	<p>$V_{MIN} =$ <input type="text" value="0.005"/> ac-ft</p> <p>$V_F =$ <input type="text" value="0.005"/> ac-ft</p> <p>$D_F =$ <input type="text" value="18.0"/> in</p> <p>$Q_{100} =$ <input type="text" value="24.20"/> cfs</p> <p>$Q_F =$ <input type="text" value="0.48"/> cfs</p> <div style="border: 1px solid black; padding: 5px; margin: 5px 0;"> <p>Choose One</p> <p><input type="radio"/> Berm With Pipe</p> <p><input checked="" type="radio"/> Wall with Rect. Notch</p> <p><input type="radio"/> Wall with V-Notch Weir</p> </div> <p style="color: blue; margin-left: 20px;">Flow too small for berm w/ pipe</p> <p>Calculated $D_P =$ <input type="text" value=""/> in</p> <p>Calculated $W_N =$ <input type="text" value="4.5"/> in</p>

Design Procedure Form: Extended Detention Basin (EDB)

Sheet 2 of 3

Designer: Richard Schindler
Company: Core Engineering Group
Date: October 24, 2019
Project: Ponderosa at Lorson Ranch Filing No. 3
Location: Pond A3

<p>6. Trickle Channel</p> <p>A) Type of Trickle Channel</p> <p>F) Slope of Trickle Channel</p>	<div style="border: 1px solid black; padding: 2px; margin-bottom: 5px;"> Choose One <input checked="" type="radio"/> Concrete <input type="radio"/> Soft Bottom </div> <p>S = <input style="width: 50px;" type="text" value="0.0050"/> ft / ft</p>
<p>7. Micropool and Outlet Structure</p> <p>A) Depth of Micropool (2.5-foot minimum)</p> <p>B) Surface Area of Micropool (10 ft² minimum)</p> <p>C) Outlet Type</p> <p>D) Smallest Dimension of Orifice Opening Based on Hydrograph Routing (Use UD-Detention)</p> <p>E) Total Outlet Area</p>	<p>D_M = <input style="width: 50px;" type="text" value="2.5"/> ft</p> <p>A_M = <input style="width: 50px;" type="text" value="43"/> sq ft</p> <div style="border: 1px solid black; padding: 2px; margin-bottom: 5px;"> Choose One <input checked="" type="radio"/> Orifice Plate <input type="radio"/> Other (Describe): </div> <hr/> <hr/> <p>D_{orifice} = <input style="width: 50px;" type="text" value="1.00"/> inches</p> <p>A_{orifice} = <input style="width: 50px;" type="text" value="2.49"/> square inches</p>
<p>8. Initial Surcharge Volume</p> <p>A) Depth of Initial Surcharge Volume (Minimum recommended depth is 4 inches)</p> <p>B) Minimum Initial Surcharge Volume (Minimum volume of 0.3% of the WQCV)</p> <p>C) Initial Surcharge Provided Above Micropool</p>	<p>D_{IS} = <input style="width: 50px;" type="text" value="4"/> in</p> <p>V_{IS} = <input style="width: 50px;" type="text" value="23"/> cu ft</p> <p>V_s = <input style="width: 50px;" type="text" value="14.3"/> cu ft</p>
<p>9. Trash Rack</p> <p>A) Water Quality Screen Open Area: $A_t = A_{ot} * 38.5 * (e^{-0.095D})$</p> <p>B) Type of Screen (If specifying an alternative to the materials recommended in the USDCM, indicate "other" and enter the ratio of the total open area to the total screen area for the material specified.)</p> <p style="margin-left: 40px;">Other (Y/N): <input style="width: 80px;" type="text" value="y"/></p> <p>C) Ratio of Total Open Area to Total Area (only for type 'Other')</p> <p>D) Total Water Quality Screen Area (based on screen type)</p> <p>E) Depth of Design Volume (EURV or WQCV) (Based on design concept chosen under 1E)</p> <p>F) Height of Water Quality Screen (H_{TR})</p> <p>G) Width of Water Quality Screen Opening (W_{opening}) (Minimum of 12 inches is recommended)</p>	<p>A_t = <input style="width: 50px;" type="text" value="87"/> square inches</p> <div style="border: 1px solid black; padding: 2px; margin-bottom: 5px; width: 100%;"> Other (Please describe below) </div> <p>wellscreen stainless</p> <hr/> <hr/> <p>User Ratio = <input style="width: 50px;" type="text" value="0.6"/></p> <p>A_{total} = <input style="width: 50px;" type="text" value="145"/> sq. in. Based on type 'Other' screen ratio</p> <p>H = <input style="width: 50px;" type="text" value="2.01"/> feet</p> <p>H_{TR} = <input style="width: 50px;" type="text" value="52.12"/> inches</p> <p>W_{opening} = <input style="width: 50px;" type="text" value="12.0"/> inches VALUE LESS THAN RECOMMENDED MIN. WIDTH. WIDTH HAS BEEN SET TO 12 INCHES.</p>

Design Procedure Form: Extended Detention Basin (EDB)

Designer: Richard Schindler
Company: Core Engineering Group
Date: October 24, 2019
Project: Ponderosa at Lorson Ranch Filing No. 3
Location: Pond A3

<p>10. Overflow Embankment</p> <p>A) Describe embankment protection for 100-year and greater overtopping:</p> <p>B) Slope of Overflow Embankment (Horizontal distance per unit vertical, 4:1 or flatter preferred)</p>	<p>_____</p> <p>_____</p> <p>_____</p> <p>Ze = <input type="text" value=""/> ft / ft</p>
<p>11. Vegetation</p>	<p>Choose One</p> <p><input type="radio"/> Irrigated</p> <p><input type="radio"/> Not Irrigated</p>
<p>12. Access</p> <p>A) Describe Sediment Removal Procedures</p>	<p>_____</p> <p>_____</p> <p>_____</p> <p>_____</p> <p>_____</p>

Notes: _____

Figure 8.1. Allowable Inlet Capacity— Sump Conditions

Note: See Section 8.3.2 for assumptions.

Type 16 and Type 14 Inlets for Sump Conditions

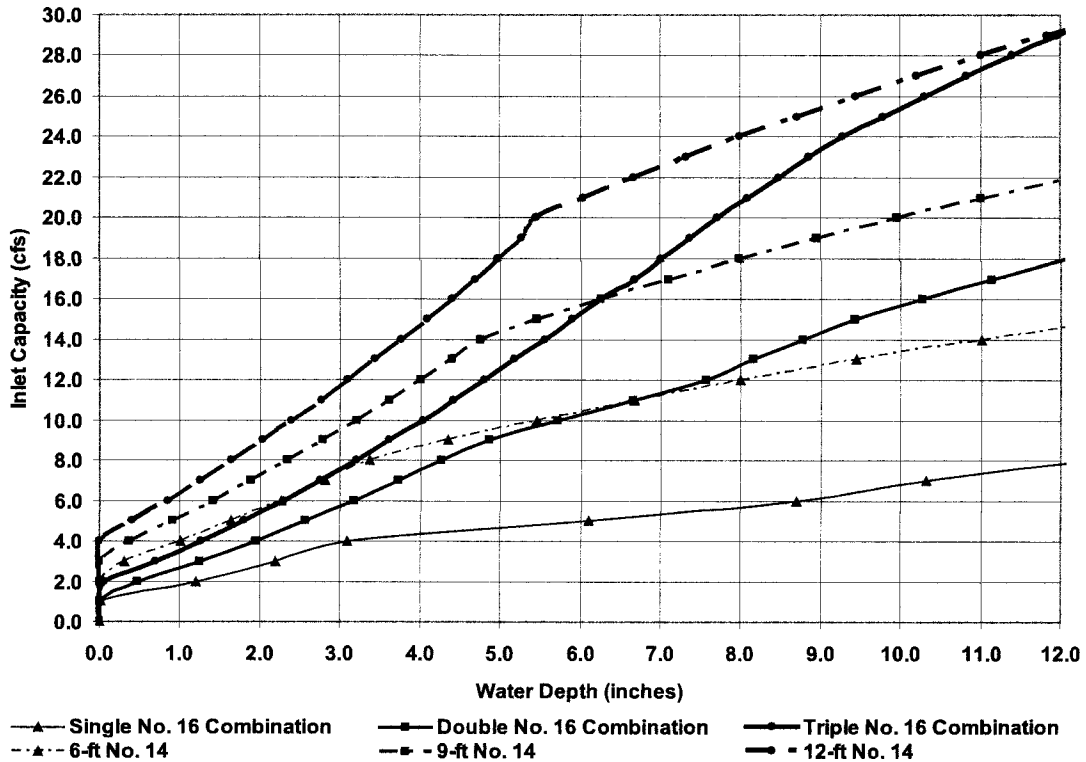

Allowable Inlet Capacity for Type C and D Inlets for Sump Conditions

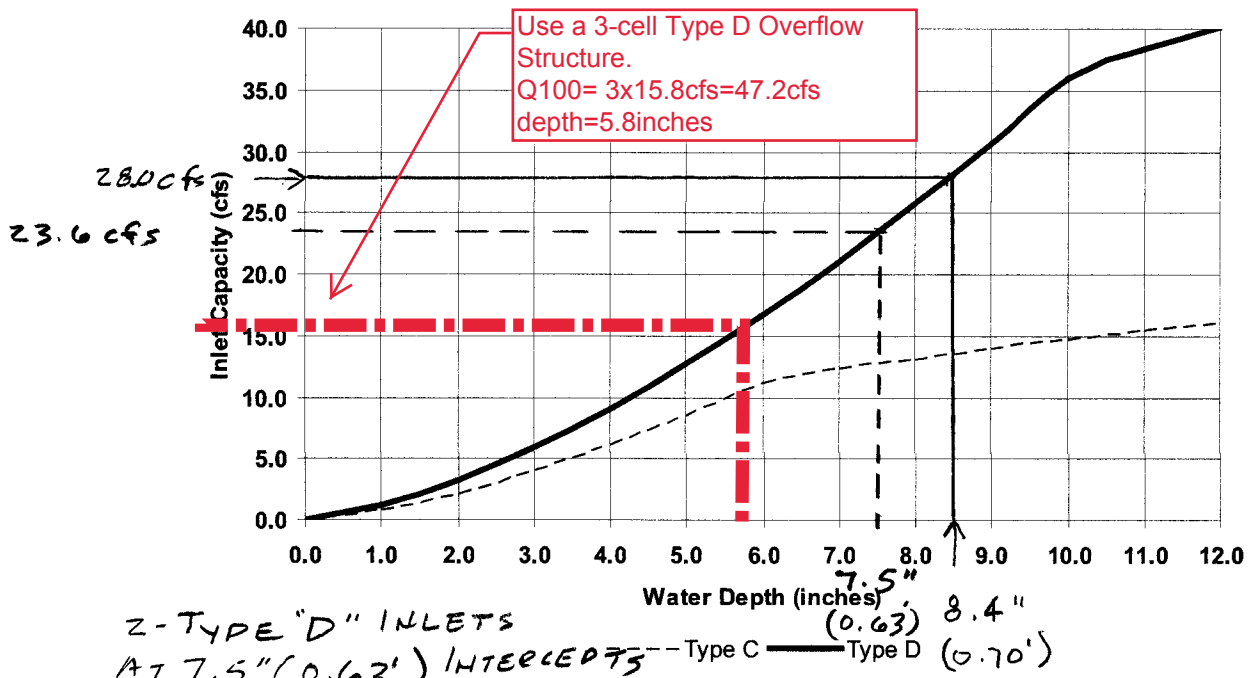

program is used to size inlets, copies of the input and output listings must be provided in both hard copy and electronic format.)

8.3.2 Assumptions for Figures 8.1 and 8.2

Capacity curves are presented in Figures 8.1 and 8.2 for No. 14, No. 16 Combination, Type C, and Type D inlets. Figure 8.2 on-grade capacity curves only apply when street flow is at the **maximum allowable depth**. For lower gutter depths, the inlet interception rate will decrease. No. 14 and No. 16 Combination inlets may be used in either on-grade or sump conditions. Type C and D inlets may only be used in sump conditions.

The following assumptions were used for developing these curves using UD INLET:

- Local depression at No. 14 inlets is 3 inches.
- Local depression at No. 16 combination inlets is 2 inches.
- A clogging factor of 0.1 was applied to the curb openings (No. 14 and No. 16 combination inlets).
- A clogging factor of 0.7 was applied for single grate inlets (No. 16 combination inlet).

Type C and D charts were developed using orifice and weir equations with the following assumptions:

- The orifice coefficient is 0.67.
- The weir coefficient is 3.0.
- A clogging factor of 0.5 was used for the orifice for the Type C inlet.
- A clogging factor of 0.38 was used for the orifice for the Type D inlet.
- A clogging factor of 0.1 was used for the weir for Type C and D inlets.

8.3.3 Inlet Location and Spacing

Inlets are required in the following locations:

- Sumps.
- Median breaks (e.g., where traffic turns across the median).
- Areas where street capacity (e.g., allowable design flow spread) would be exceeded without them.
- Upstream of pedestrian curb ramps with less than 1 percent slope on the curb return when a storm sewer is available (See Figure 8.3 for example).

Other criteria and guidelines with regard to design and placement of inlets include:

MAP POCKET

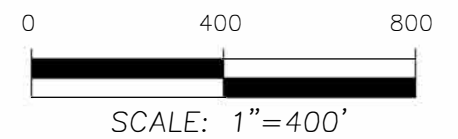
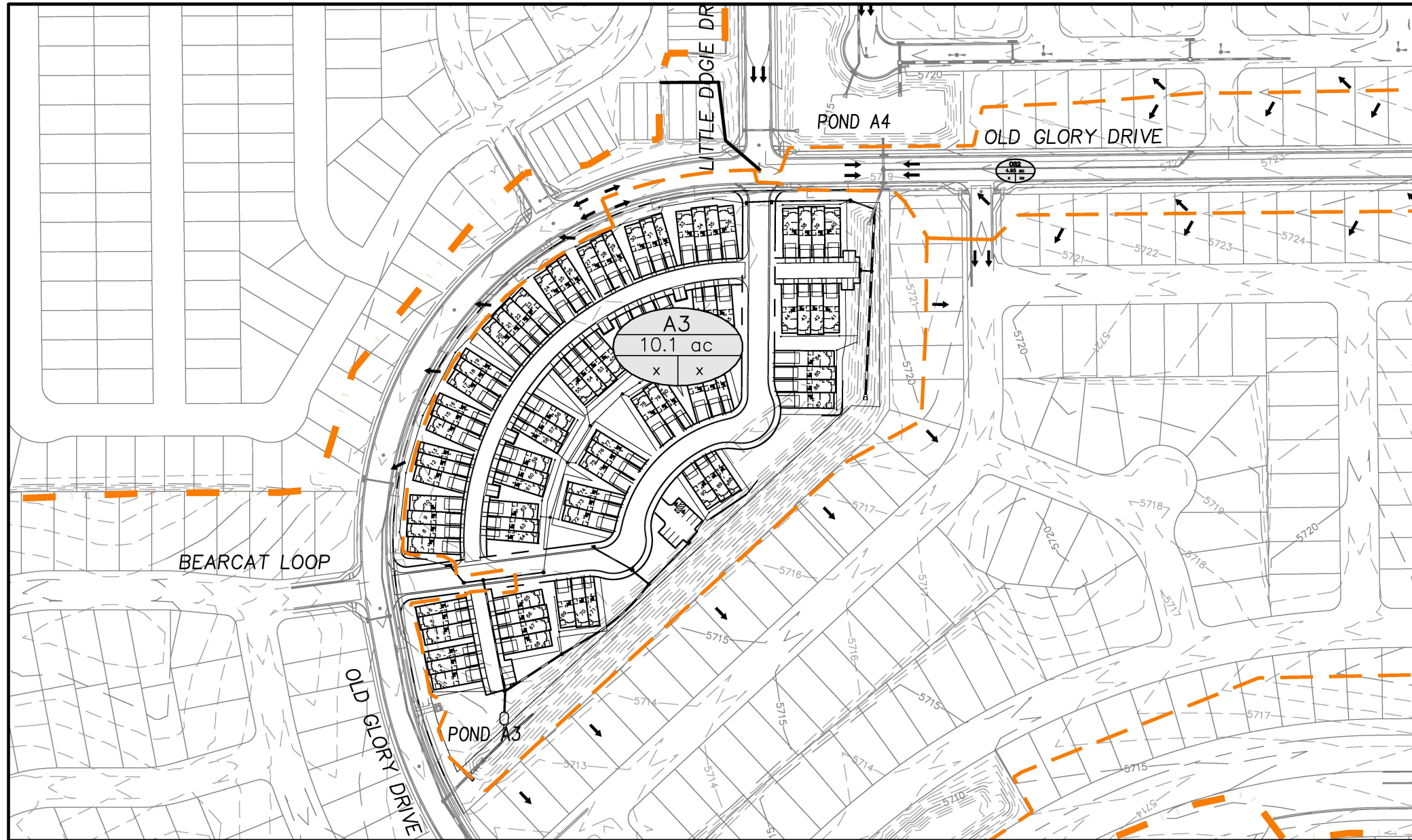







CORE
ENGINEERING GROUP
15004 1ST AVENUE S.
BURNSVILLE, MN 55306
PH: 719.570.1100
CONTACT: RICHARD L. SCHINDLER, P.E.
EMAIL: Rich@ceg1.com

PONDEROSA AT LORSON RANCH FILING NO. 3
WATER QUALITY & POND TRIBUTARY AREAS

SCALE: NTS	DATE: APRIL, 2020	FIGURE NO. 1
---------------	----------------------	-----------------

DESIGN POINT SUMMARY TABLE			
DESIGN POINT	RUNOFF 5 YR (CFS)	RUNOFF 100 YR (CFS)	COMMENTS
A	10.4	23.0	FLOW FROM HYDRAFLOW HYDRAULIC MODEL
B	14.0	46.3	FLOW FROM HYDRAFLOW HYDRAULIC MODEL

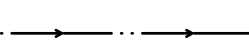
LEGEND

-  BASIN BOUNDARY
-  BASIN DESIGN POINT
-  BASIN I.D.
ACREAGE
5 YR/100 YR CFS
-  DIRECTION OF FLOW
-  EXISTING CONTOUR
-  TIME OF CONCENTRATION

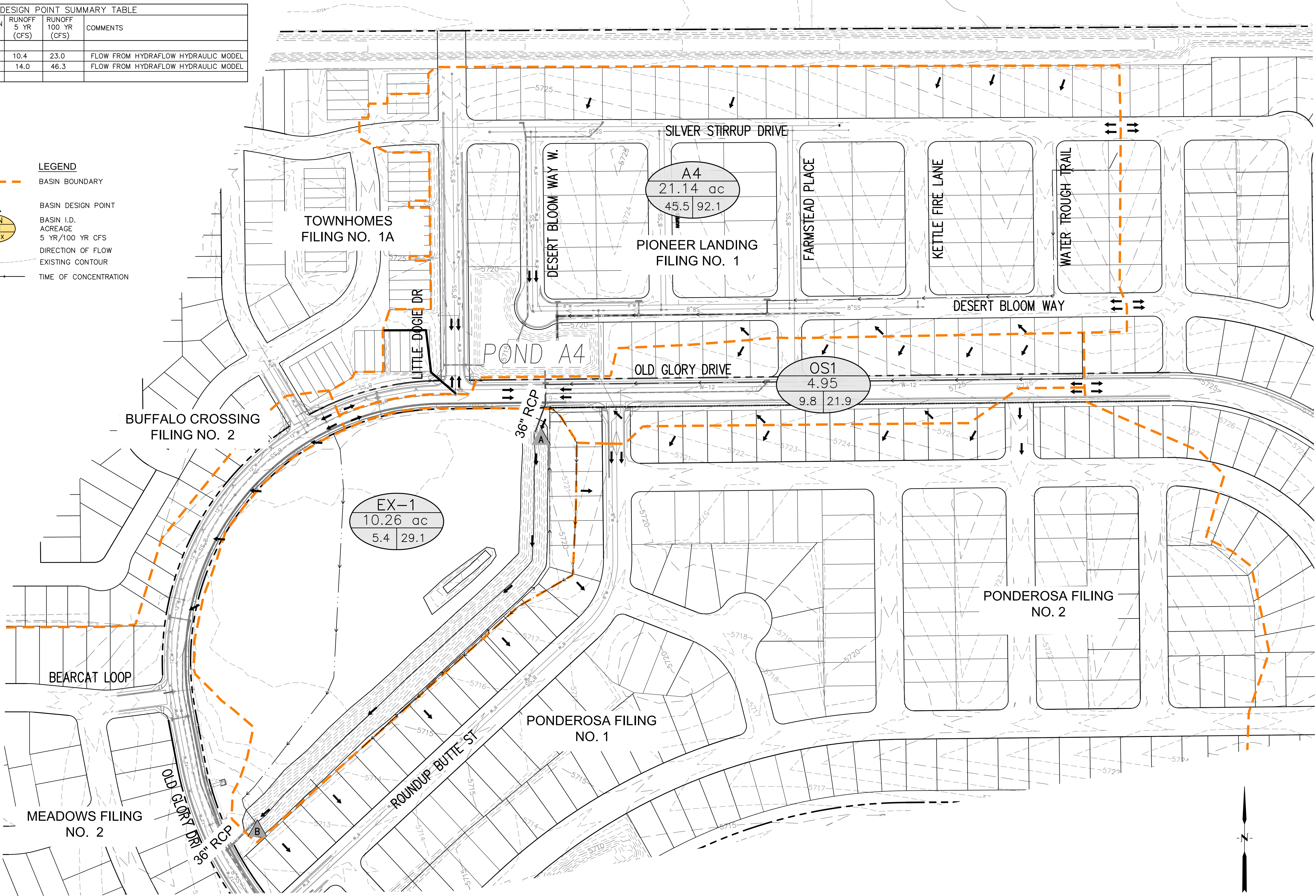

CORE ENGINEERING GROUP
 15004 151ST WENUE^{US}
 PHE 719 570 1100
 CONTACT: RICHARD L. SCHINDLER, P.E.
 EMAIL: Rich@ceeg.com

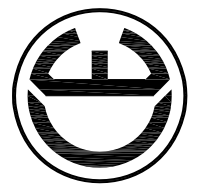

DATE: _____
 DESCRIPTION: _____
 NO. _____
 PROJECT: PONDERSOSA FILING NO. 3
 BEARCAT LOOP - OLD GLORY DRIVE
 EL PASO COUNTY, COLORADO
 PREPARED FOR: LORSON LLC
 212 NORTH WAHATCH AVE, SUITE 301
 COLORADO SPRINGS, COLORADO 80903 (719) 635-3200
 CONTACT: KEF MARK

DRAWN: LAB
 LAB
 CHECKED: LAB
 RLS

EXISTING CONDITIONS
PONDERSOSA AT LORSON RANCH FIL. NO. 3

DATE: APRIL 8, 2020
 PROJECT NO. 100.050
 SHEET NUMBER 1
 TOTAL SHEETS: 1

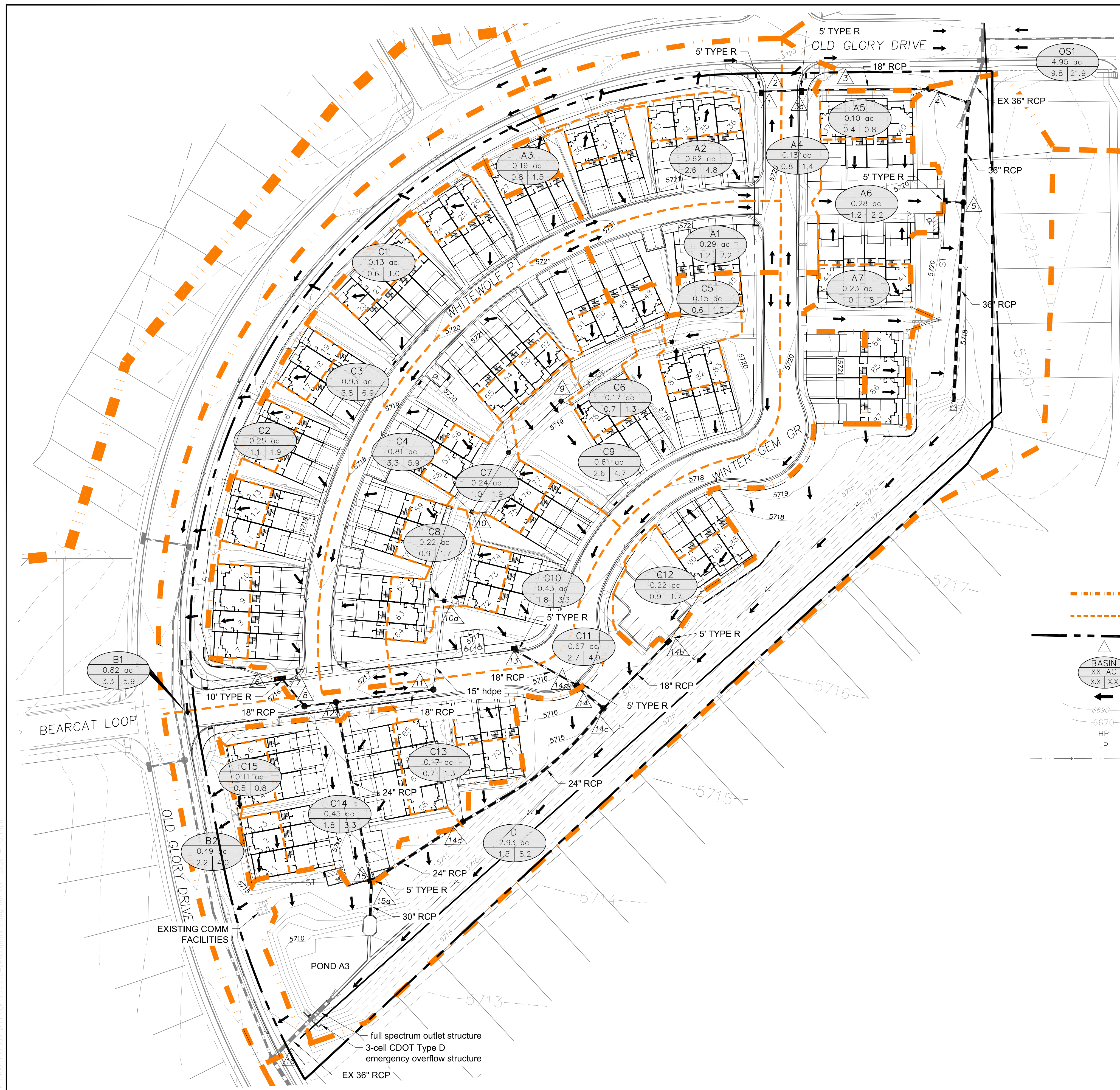

RUNOFF SUMMARY				
DP	AREA	Qs	Q100	CONTRIBUTING AREA / NOTES
1	0.91	3.9	7.0	A1-A2 & 5' Inlet @ A2
2	1.10	4.7	8.5	Pipe Flow
3a	0.18	0.8	1.4	flow at inlet
3	1.28	5.5	9.9	Pipe Flow
4	1.38	5.9	10.7	Pipe Flow
5	18.5	37.7	37.7	Pipe Flow into swale
6	0.38	1.6	2.9	12" PVC Flow
7	1.74	7.0	12.8	C3-C4, 10' Inlet @ C3
8		7.5	11.0	18" Pipe Flow
9	0.32	1.4	2.5	C5-C6, 12" PVC Flow
10	0.56	2.4	4.3	Pipe Flow
10a&11	0.78	3.3	6.0	Pipe Flow
12		10.8	17.0	Pipe Flow
13	1.04	4.0	7.4	C9-C10 & 5' Inlet @ C10, 18" Pipe Flow
14	1.71	6.7	12.3	C9-C11, 18" Pipe Flow
14a	0.67	2.7	4.9	flow at inlet
14b		0.9	1.7	flow at inlet
14c		7.6	14.0	Pipe Flow
14d		8.3	15.3	Pipe Flow
15	0.56	2.7	4.8	flow at inlet
15a		21.4	36.4	Pipe Flow into Pond
16		10.9	30.4	Flow from Pond A3 and Ex. Des. Pt A in Existing 36" RCP

- LEGEND**
- DRAINAGE MAJOR BASIN BOUNDARY
 - DRAINAGE MINOR BASIN BOUNDARY
 - SITE BOUNDARY
 - DESIGN POINT
 - BASIN I.D. ACREAGE
 - 5 YR/100 YR CFS DIRECTION OF FLOW
 - EXISTING CONTOUR
 - PROPOSED CONTOUR
 - HIGH POINT
 - LOW POINT
 - TIME OF CONCENTRATION

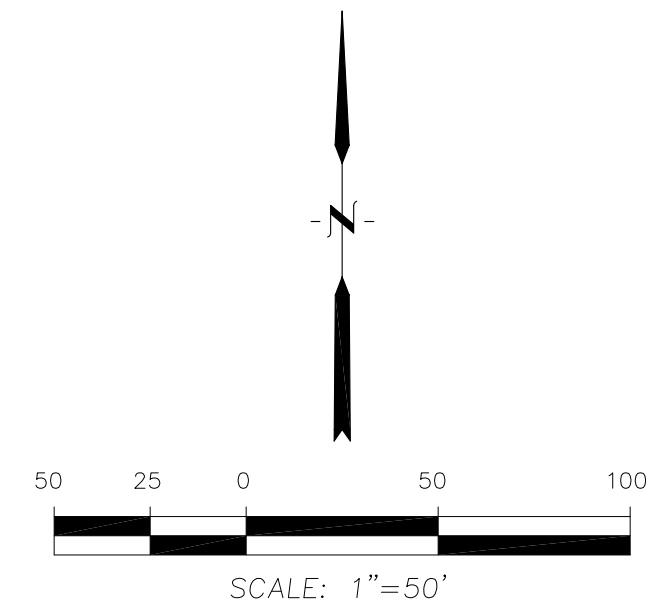

CORE ENGINEERING GROUP
 15004 1ST AVE. S.
 BURNSVILLE, MN 55306
 PH: 719.570.1100
 CONTACT: RICHARD L. SCHINDLER, P.E.
 EMAIL: Rich@cegi.com

DATE

DESCRIPTION

NO.

PREPARED FOR: **LORSON, LLC**
 212 N. WANSATCH AVE. SUITE 307
 COLORADO SPRING, COLORADO 80903
 CONTACT: JEFF MARK

DRAWN: RLS
 DESIGNED: LAB
 CHECKED: LAB

PROJECT: **LORSON RANCH**
 OLD GLORY ROAD
 EL PASO COUNTY, COLORADO

DEVELOPED CONDITIONS DRAINAGE PLAN
PONDEROSA at LORSON RANCH
FILING NO. 3

DATE
APR 8, 2020

PROJECT NO.
100.050

SHEET NUMBER
1

TOTAL SHEETS: **1**

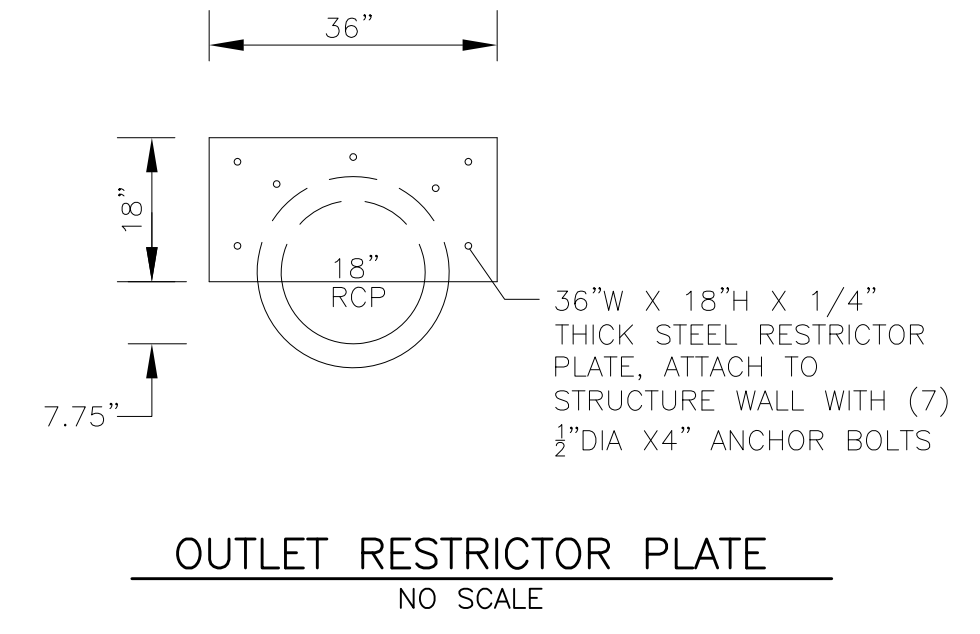
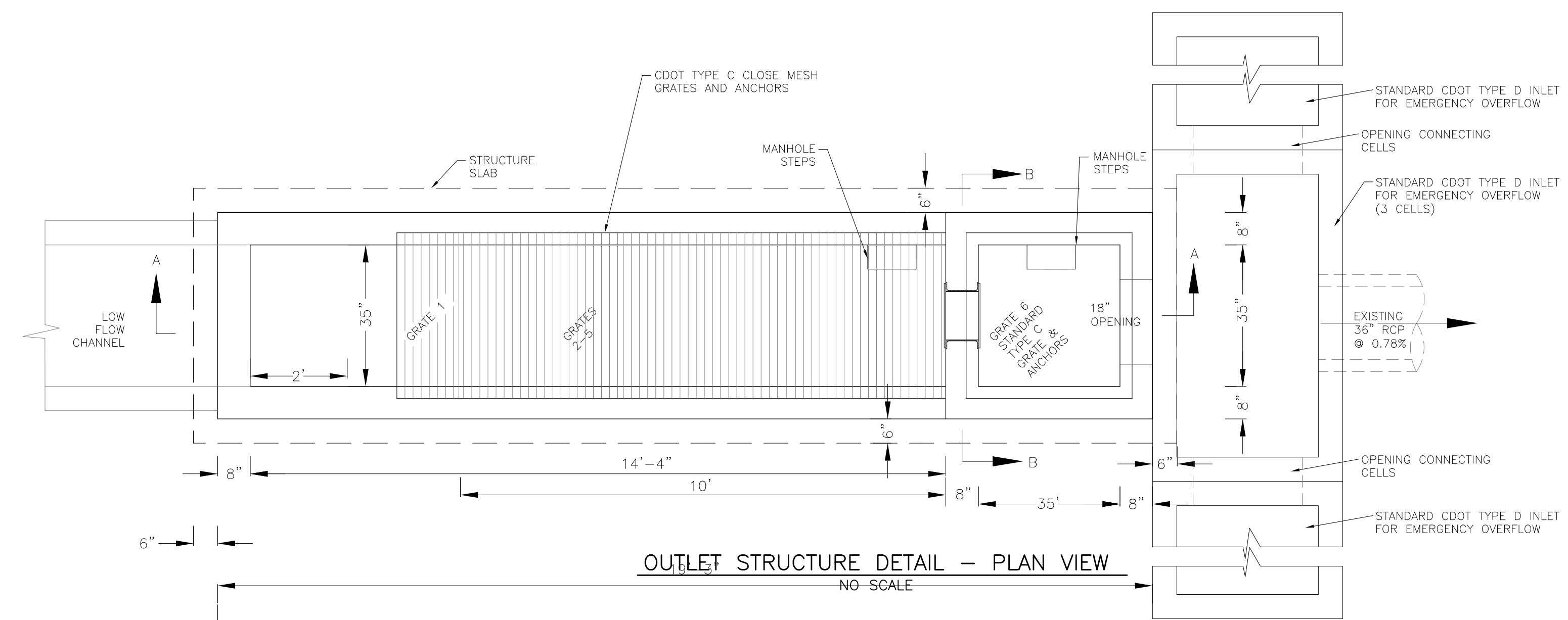
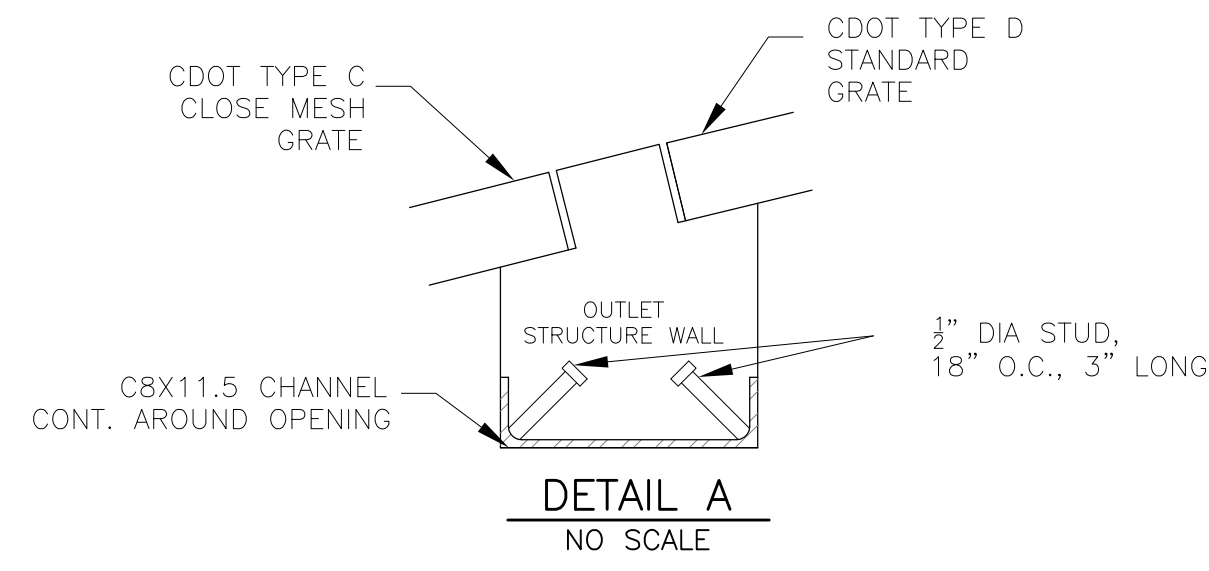

NOTE:
AFTER CONCRETE STRUCTURE HAS BEEN POURED
ALL GRATE DIMENSIONS SHALL BE FIELD VERIFIED
PRIOR TO GRATE CONSTRUCTION

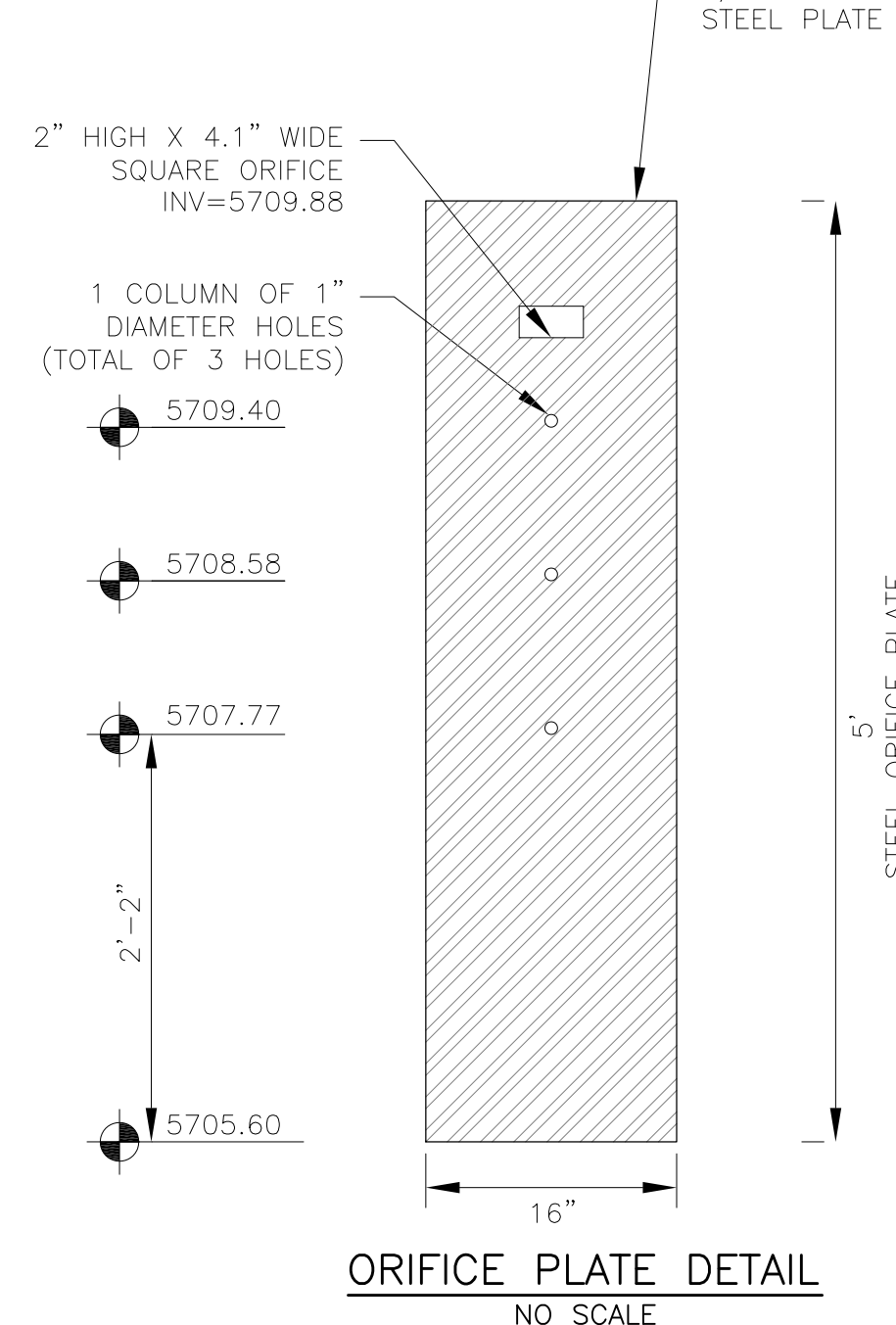
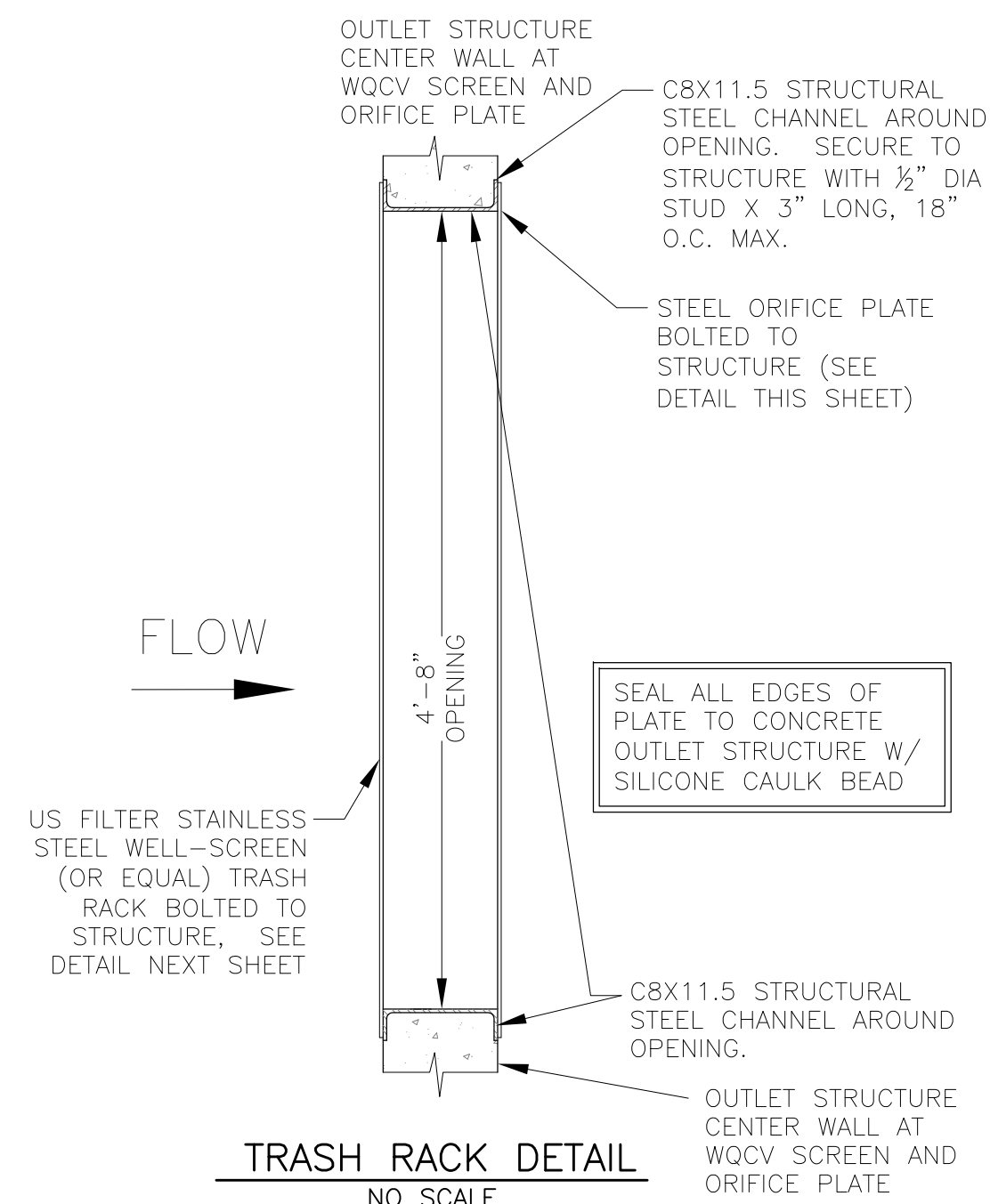
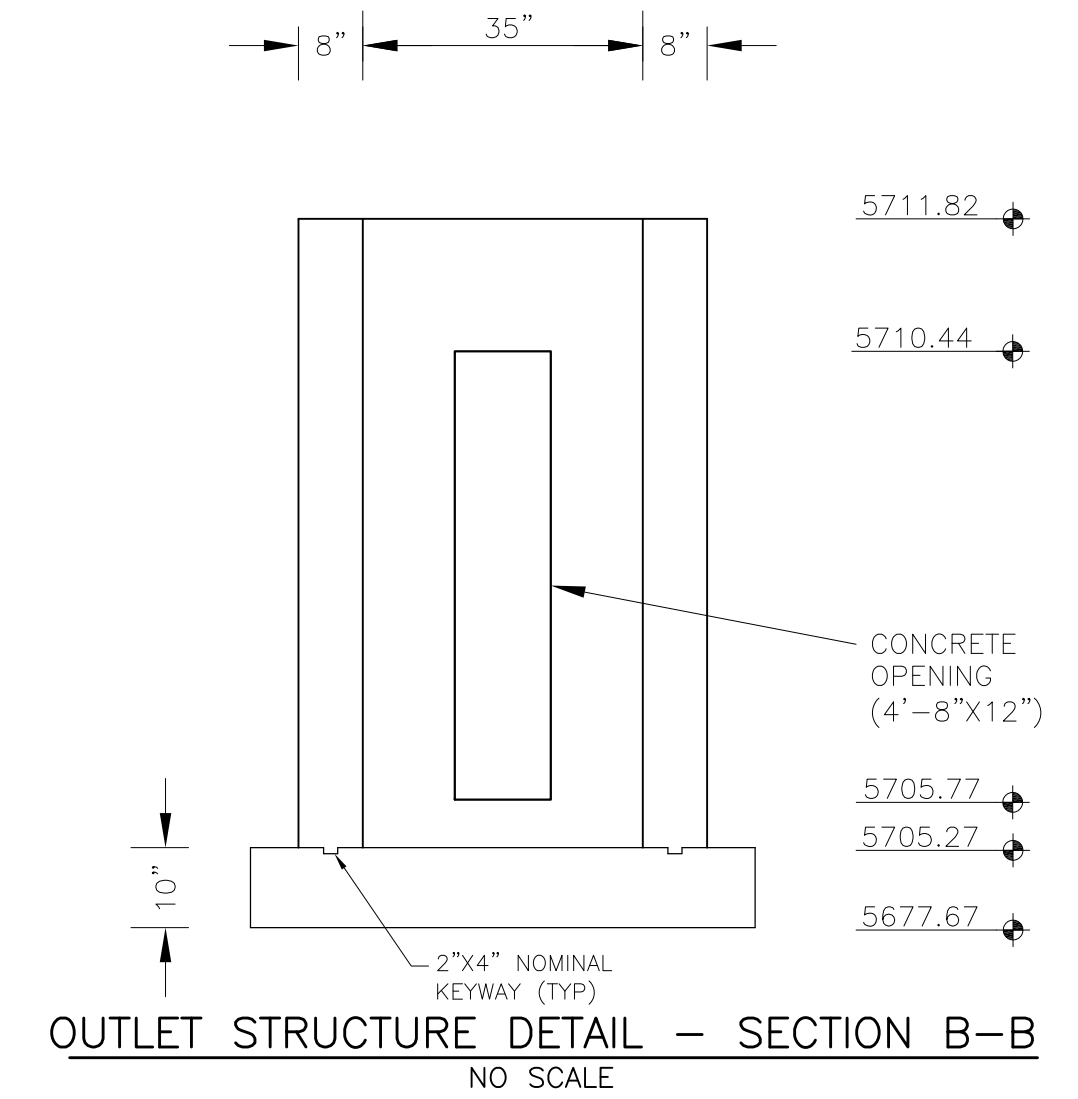
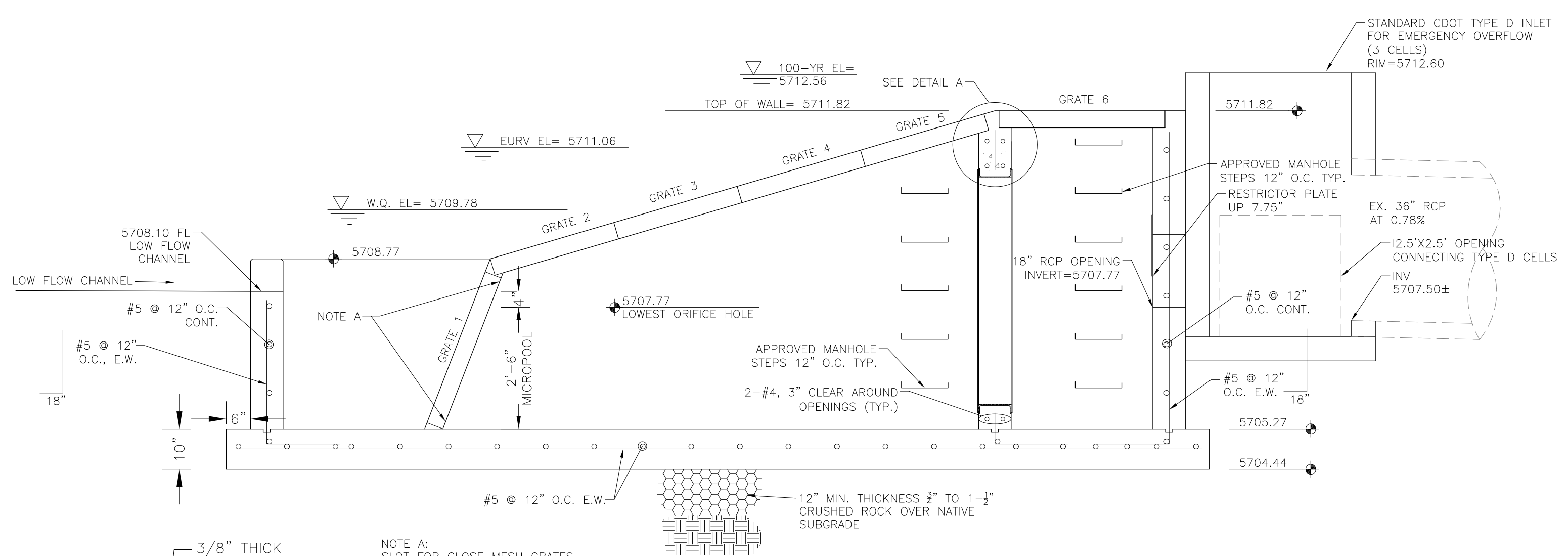
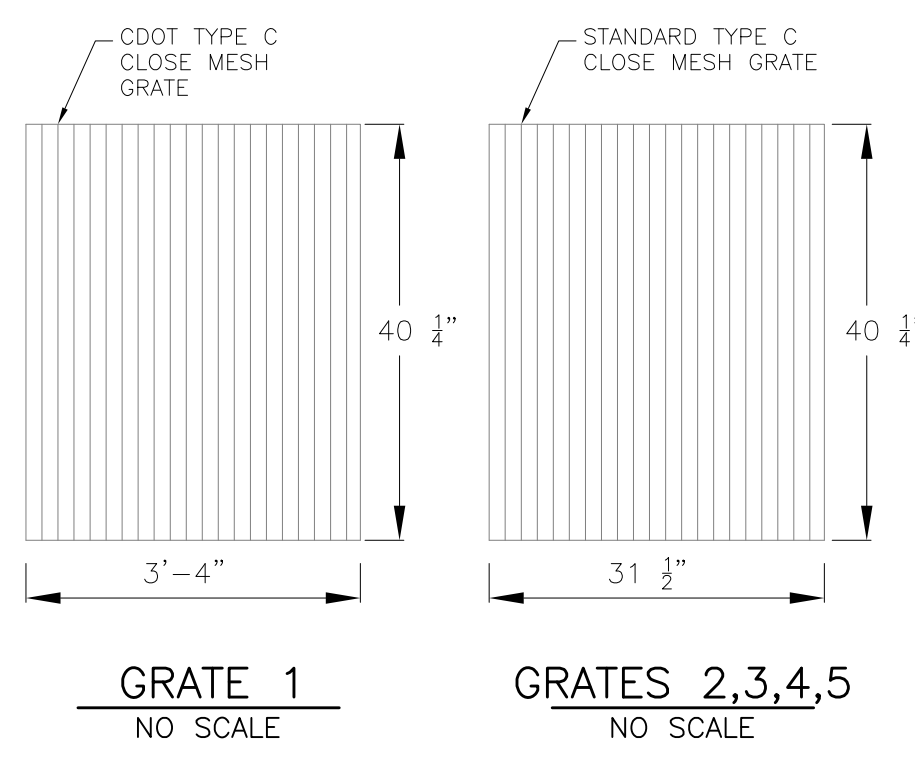

OUTLET STRUCTURE, FOREBAY, AND DRAIN CHANNEL NOTES:

- PRIOR TO CONSTRUCTION, CONTRACTOR SHALL PROVIDE SHOP DRAWINGS FOR ALL COMPONENTS OF THE OUTLET STRUCTURE.
 - GRADE 60 REINFORCING STEEL REQUIRED. SEE TABLE FOR THE MINIMUM LAP SPLICE LENGTH FOR REINFORCING BARS. ALL REINFORCING STEEL SHALL HAVE A TWO-INCH MINIMUM CLEARANCE FROM EDGE OF CONCRETE, UNLESS OTHERWISE NOTED.
- | BAR SIZE | #4 | #5 | #6 |
|--------------------|-------|-------|-------|
| MIN. SPLICE LENGTH | 1'-3" | 1'-7" | 2'-0" |
- CONCRETE FOR THE OUTLET STRUCTURE AND FOREBAY SHALL BE CDOT CLASS D CONCRETE.
 - CONCRETE FOR DRAIN CHANNELS SHALL BE CDOT CLASS B CONCRETE
 - EXPANSION JOINT MATERIAL SHALL MEET AASHTO SPECIFICATION M-213. EXPANSION JOINT MATERIAL SHALL BE 1/2" THICK, SHALL EXTEND THE FULL DEPTH OF CONTACT SURFACE AND THE JOINT SHALL BE SEALED, REFER TO DETAILS.
 - ALL EXPOSED CONCRETE CORNERS SHALL HAVE A 3/8" CHAMFER UNLESS OTHERWISE NOTED.
 - SUBGRADE TO BE 12" THICK CLEAN FILL COMPACTED TO 95% STANDARD PROCTOR DENSITY PER ASTM M698 UNDER STRUCTURE.
 - REFER TO POND DETAILS FOR PRESEDIMENTATION/FOREBAY DESIGN.
 - ENGINEER SHALL BE NOTIFIED PRIOR TO BEGINNING CONSTRUCTION OF OUTLET STRUCTURE TO SCHEDULE OBSERVATION VISITS FOR STRUCTURES.

- WQCV WELL-SCREEN NOTES:**
- Well-Screen shall be stainless steel and attached by stainless steel bolts along edge of the mounting frame.
 - WQCV Well Screen
 - Type of Screen: Stainless steel #93 Vee Wire (Johnson Vee Wire (tm) Stainless Steel Screen or equivalent with 60% open area)
 - Screen slot opening dimension: 0.139" (Screen #93 Vee Wire Slot Opening)
 - Type and Size of Support Rod: 1E 0.074"x0.50"
 - Spacing of Support Rod (O.C.): 1.0 Inch
 - Total Screen Thickness: 0.655"
 - Carbon Steel Holding Frame Type: 3/4" x 1.0" angle

