

TRAFFIC IMPACT STUDY

For

**Schmidt Property
El Paso County, Colorado**

September 2022

Add "PCD File No. P-22-022"

Prepared for:

N.E.S. Inc.
619 N Cascade Avenue, Suite 200
Colorado Springs, CO 80903

Prepared by:



SM ROCHA, LLC
TRAFFIC AND TRANSPORTATION CONSULTANTS

6 South Tejon Street, Suite 515
Colorado Springs, Colorado 80903
(719) 203-6639

Project Engineer / Manager:
Brandon Wilson, EIT / Mike Rocha, Principal

Engineer in Responsible Charge:
Fred Lantz, PE



Provide signature blocks for design engineer and developer. See attached document for example.



Table of Contents

I. Introduction 1

 Project Overview 1

 Study Area Boundaries 1

 Site Description 1

 Existing and Committed Surface Transportation Network 5

II. Existing Traffic Conditions 6

 Peak Hour Intersection Levels of Service – Existing Traffic 8

 Existing Traffic Analysis Results 8

III. Future Traffic Conditions Without Proposed Development..... 9

 Peak Hour Intersection Levels of Service – Background Traffic 12

 Background Traffic Analysis Results – Year 2024 12

 Background Traffic Analysis Results – Year 2040 12

IV. Proposed Project Traffic 13

 Trip Generation 13

 Adjustments to Trip Generation Rates 14

 Trip Distribution 14

 Trip Assignment 14

V. Future Traffic Conditions With Proposed Developments 17

 Total Traffic Auxiliary Lane Analysis 17

VI. Project Impacts 20

 Peak Hour Intersection Levels of Service – Total Traffic 20

 Total Traffic Analysis Results Upon Development Build-Out 21

 Queue Length Analysis 22

VII. Conclusion 23

List of Figures

Figure 1 – Location.....3
Figure 2 – Conceptual Site Plan.....4
Figure 3 – Existing Traffic Volumes & Intersection Geometry7
Figure 4 – Background Traffic Volumes & Intersection Geometry – Year 2027..... 10
Figure 5 – Background Traffic Volumes & Intersection Geometry – Year 2040..... 11
Figure 6A – Distribution and Site-Generated Assignment – Year 2027 15
Figure 6B – Distribution and Site-Generated Assignment – Year 2040..... 16
Figure 7 – Total Traffic Volumes & Intersection Geometry – Year 2027..... 18
Figure 8 – Total Traffic Volumes & Intersection Geometry – Year 2040..... 19

List of Tables

Table 1 – Intersection Capacity Analysis Summary – Existing Traffic 8
Table 2 – Intersection Capacity Analysis Summary – Background Traffic – Year 2024 12
Table 3 – Intersection Capacity Analysis Summary – Background Traffic – Year 2040 12
Table 4 – Trip Generation Rates 13
Table 5 – Trip Generation Summary 13
Table 6 – Intersection Capacity Analysis Summary – Total Traffic – Year 2027 20
Table 7 – Intersection Capacity Analysis Summary – Total Traffic – Year 2040 21

Appendices

APPENDIX A TRAFFIC COUNT DATA
APPENDIX B LEVEL OF SERVICE DEFINITIONS
APPENDIX C CAPACITY WORKSHEETS

I. Introduction

Project Overview

This traffic impact study is provided as a planning document and addresses the capacity, geometric, and control requirements associated with the development entitled Schmidt Property.

This assumed residential development consists of an estimated 714 dwelling units. The 23.8-acre development is located along the south side of (future) Marksheffel Road and near the southwest corner of Vollmer Road intersection with Tahiti Drive in El Paso County, Colorado.

Does not match area shown in letter of intent

Study Area Boundaries

The study area to be examined in this analysis encompasses Vollmer Road near the existing intersection with Tahiti Drive and future Marksheffel Road as well as primary site access.

Figure 1 illustrates location of the site and study in

Provide calculations showing that the study area includes all affected intersections per ECM Appendix B.2.3. Provide justification for omitting the following intersections: Black Forest Rd & Vollmer Rd, Cowpoke Rd & Vollmer Rd, and Dry Needle Place & Vollmer Rd.

Site Description

Land for the development is currently vacant and surrounded by a mix of commercial, residential, and open space land uses.

The rezone development is conceptual and is subject to change. However, for purposes of this analysis, the development assumes the new construction of approximately 714 multifamily residential dwelling units. It should be noted that the land use density described is estimated based on an assumed maximum density allowed per zoning (30 dwelling units per acre) in relation to the known acreage allocated for development at this time.

Considering the conceptual nature of the development, future access will likely include multiple access drives along future Brush Top Road (extended). These access locations are subject to change and therefore were not considered within this analysis. For purposes of this analysis, primary points of entry to the overall development area are envisioned at the following locations:

Clarify statement. Vollmer Road is already existing.

- One full-movement access serving as the west leg of the Vollmer Road and Marksheffel Road intersection.
- One full-movement access on Marksheffel Road at northwest corner of development site (approximately 1,480 feet west of Vollmer Road, measured from centerline). This access is intended to serve as the future collector roadway (Brush Top Road) connection between Marksheffel Road and Trails at Forest Meadows Subdivision.

It is anticipated that development construction would be phased with completion by end of Year 2040. However, specific phasing details are undefined at this time. For purposes of this analysis, initial development phasing is assumed to include the new construction of 480 multifamily residential dwelling units completed by Year 2027, with development buildout completed by Year 2040.

General site and access locations are shown on Figure 1.

A conceptual site plan, as prepared by NES Inc., is shown on Figure 2. This plan is provided for illustrative purposes only.

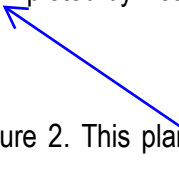

State if development buildout includes the entire 714 dwelling units. Page 1 states the analysis assumes 714 dwelling units, and this page states otherwise. Please revise.



Not to Scale



Figure 1
SITE LOCATION
September 2022
Page 3

SCHMIDT PROPERTY
Traffic Impact Study

SM ROCHA, LLC
Traffic and Transportation Consultants





Not to Scale

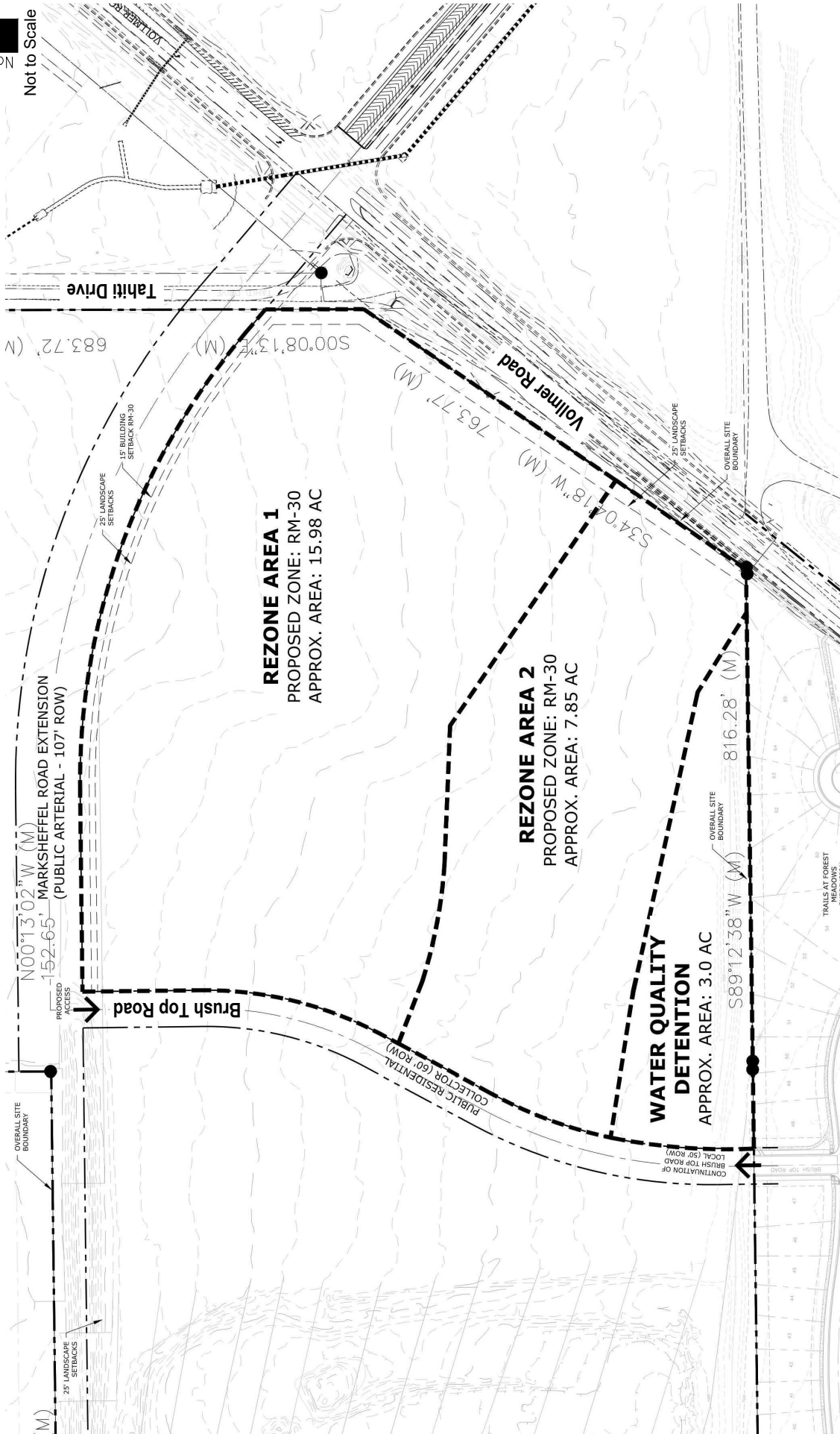

Figure 2
CONCEPTUAL SITE PLAN
September 2022
Page 4

SCHMIDT PROPERTY
Traffic Impact Study

SM ROCHA, LLC
Traffic and Transportation Consultants



Existing and Committed Surface Transportation Network

Discuss dedication of right-of-way for Vollmer Road.

Within the study area, Vollmer Road is the primary roadway that will accommodate traffic to and from the proposed development. The secondary roadways include Tahiti Drive, and Marksheffel Road. A brief description of each roadway, based on the County's 2040 Major Transportation Corridors Plan (MTCP)¹ and Engineering Criteria Manual (ECM)², is provided below:

Vollmer Road is a north-south rural roadway having two through lanes (one lane in each direction) with shared turn lanes at the intersection within the study area. Vollmer Road provides a posted speed limit of 45 MPH. Pursuant to the County's MTCP it is understood that Vollmer Road is envisioned to be a minor arterial roadway with four through lanes upon build-out.

Tahiti Drive (at time of this study) is a north-south rural unpaved roadway having two through lanes (one lane in each direction) with shared turn lanes at the intersection within the study area. Tahiti Drive is unclassified in County's MTCP. However, per Standard Drawing 2-10 of the County ECM and the roadway's estimated ROW width, Tahiti Drive is assumed to be classified as a local roadway with a posted speed limit of 45 MPH. It is anticipated that Tahiti Drive will be closed as part of this proposed development and as area development occurs to allow for construction of Marksheffel Road (extension) to the west of Vollmer Road.

Marksheffel Road is a future east-west principal arterial roadway having a build-out cross-section of six through lanes (three lanes in each direction) with exclusive turn lanes at intersections within the study area pursuant to the County's MTCP. Marksheffel Road is anticipated to provide a posted speed limit of 45 MPH based on the County ECM. It is understood that ownership and maintenance of Marksheffel Road will be assumed by the City of Colorado Springs and specific design requirements are therefore to be pursuant to the City's engineering standards and specifications. For analysis purposes, and to remain consistent with assumptions made in previously approved traffic reports within the area, it is assumed that Marksheffel Road will be constructed as a four-lane roadway ending at Vollmer Road by Year 2027. It is uncertain as to when build-out for Marksheffel Road to six through lanes may occur depending on continued area development. Therefore, Year 2040 analysis conditions assume Marksheffel to remain a four-lane roadway and will be extended west of Vollmer Road. This assumption provides for a conservative analysis.

Existing study intersections operate under a stop-controlled condition. A stop-controlled intersection is defined as a roadway intersection where vehicle rights-of-way are controlled by one or more "STOP" signs. It is however understood that the future intersections of Marksheffel Road with Vollmer Road will be signalized upon surrounding area build-out or when signal warrants are met. For analysis purposes signalization is assumed to occur by Year 2040.

¹ El Paso County 2016 Major Transportation Corridors Plan Update, Felsburg Holt & Ullevig, December 2016.

² El Paso County Engineering Criteria Manual, El Paso County, December 2016.

Update section describing Marksheffel Road. It will be per city criteria, as city will be taking ownership. Marksheffel Road must be consistent with the approved cross-section east of Vollmer Road. "68' wide pavement mat, four 11' thru lanes, 12' center turn lane, two 6' shoulders, 10' trail on south of Marksheffel and 6' sidewalk on north of Marksheffel."

II. Existing Traffic Conditions

Morning (AM) and afternoon (PM) peak hour traffic counts were collected at the intersection of Vollmer Road with Tahiti Drive. Counts were collected on March 24, 2022, with AM peak hour counts being collected during the period of 7:00 a.m. to 9:00 a.m. and PM peak hour counts being collected during the period of 4:00 p.m. to 6:00 p.m.

Average daily traffic (ADT) 24-hour traffic volumes shown for Vollmer Road were obtained from the City of Colorado Springs Web Mapping Application Traffic Counts data map.

Collected and referenced counts representing existing traffic volumes and existing intersection geometry are shown on Figure 3. Traffic count data is included for reference in Appendix A.



Not to Scale

Vollmer Road

Tahiti Drive

(7,970)

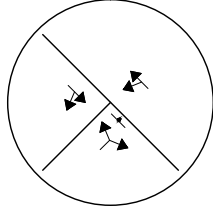
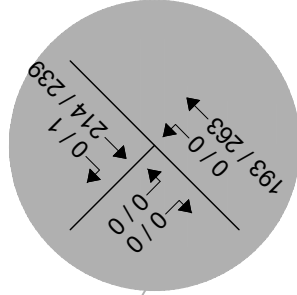

LEGEND

-  Study Intersection Volumes
-  Study Intersection Lane Geometry
-  Development Site

SCHMIDT PROPERTY
Traffic Impact Study



SM ROCHA, LLC
Traffic and Transportation Consultants

Figure 3
EXISTING TRAFFIC
Volumes & Intersection Geometry
AM / PM Peak Hour
(ADT) : Average Daily Traffic

Peak Hour Intersection Levels of Service – Existing Traffic

The Signalized and Unsignalized Intersection Analysis techniques, as published in the Highway Capacity Manual (HCM), 6th Edition, by the Transportation Research Board and as incorporated into the SYNCHRO computer program, were used to analyze the study intersections for existing and future traffic conditions. These nationally accepted techniques allow for the determination of intersection level of service (LOS) based on the congestion and delay of each traffic movement.

Level of service is a method of measurement used by transportation professionals to quantify a driver's perception of travel conditions that include travel time, number of stops, and total amount of stopped delay experienced on a roadway network. The HCM categorizes level of service into a range from "A" which indicates little, if any, vehicle delay, to "F" which indicates a level of operation considered unacceptable to most drivers. These levels of service grades with brief descriptions of the operating condition, for unsignalized and signalized intersections, are included for reference in Appendix B and have been used throughout this study.

The level of service analyses results for existing conditions are summarized in Table 1.

Intersection capacity worksheets developed for this study are provided in Appendix C.

Table 1 – Intersection Capacity Analysis Summary – Existing Traffic

INTERSECTION LANE GROUPS	LEVEL OF SERVICE	
	AM PEAK HOUR	PM PEAK HOUR
Vollmer Road / Tahiti Drive (Stop-Controlled) Northeastbound Left and Through Southbound Left and Right	A A	A A

Key: Stop-Controlled Intersection: Level of Service

Existing Traffic Analysis Results

Under existing conditions, operational analysis shows that the unsignalized intersection of Vollmer Road with Tahiti Drive has turning movement operations at LOS A during both the morning and afternoon peak traffic hours.

List all approved traffic studies referenced. Provide project file numbers.

III. Future Traffic Conditions Without Proposed Development

Background traffic is the traffic projected to be on area roadways without consideration of the proposed development. Background traffic includes traffic generated by development of vacant parcels in the area.

To account for projected traffic from adjacent developments not yet built, Year 2027 and Year 2040 background traffic conditions utilize estimated peak hour and 24-hour daily traffic volumes from the traffic study prepared for Rhetoric Development³ and approved area traffic studies, as provided by the County’s Electronic Development Application Review Program (EDARP). This referenced traffic study includes traffic generation for the surrounding development area (primarily Sterling Ranch) as analyzed by various traffic engineering consultants.

Traffic study for Rhetoric Development submitted under PCD File No. P2216 was not approved.

Total traffic volumes as defined in Figures 7 and 8 of the 2022 Rhetoric Development traffic study were used to define background traffic conditions for purposes of this analysis. As reference, population growth estimates provided by the Pikes Peak Area Council of Governments’ (PPACG) 2045 Long Range Transportation Plan⁴, estimates an annual growth rate of approximately two percent for the immediate development area.

Pursuant to the proposed and committed area roadway improvements discussed in Section I, Year 2027 background traffic conditions assume the completion of Marksheffel Road east of Vollmer Road. For analysis purposes, and to remain consistent with intersection geometry assumptions utilized in previous traffic reports, study intersections were analyzed as stop-controlled conditions. Vollmer Road is assumed to be widened in the southbound direction to provide two through lanes and the Tahiti Drive intersection is anticipated to be closed with existing traffic volumes utilizing alternative routes to the north.

Year 2040 background traffic conditions assume the completion of Marksheffel Road to the west of Vollmer Road, and the intersection of Marksheffel Road with Vollmer Road is assumed to be signalized. Widening of Vollmer Road to provide four through lanes (two lanes in each direction) is also assumed.

Future Year 2040 signal timing parameters for the intersections of Marksheffel Road with Vollmer Road were assumed based on the possible signal head configuration and allowable movements, and pursuant to typical signal timing data described within the County’s ECM. Timings were used throughout this study to the best extent possible to remain consistent with typical County signal coordination plans.

Projected background traffic volumes and intersection geometry for Years 2027 and 2040 are shown on Figure 4 and Figure 5, respectively.

³ Rhetoric Site Traffic Impact Study, SM Rocha, LLC, September 2022.

⁴ Moving Forward 2045: Pikes Peak Area Regional Transportation Plan, PPACG, January 2020.



Not to Scale

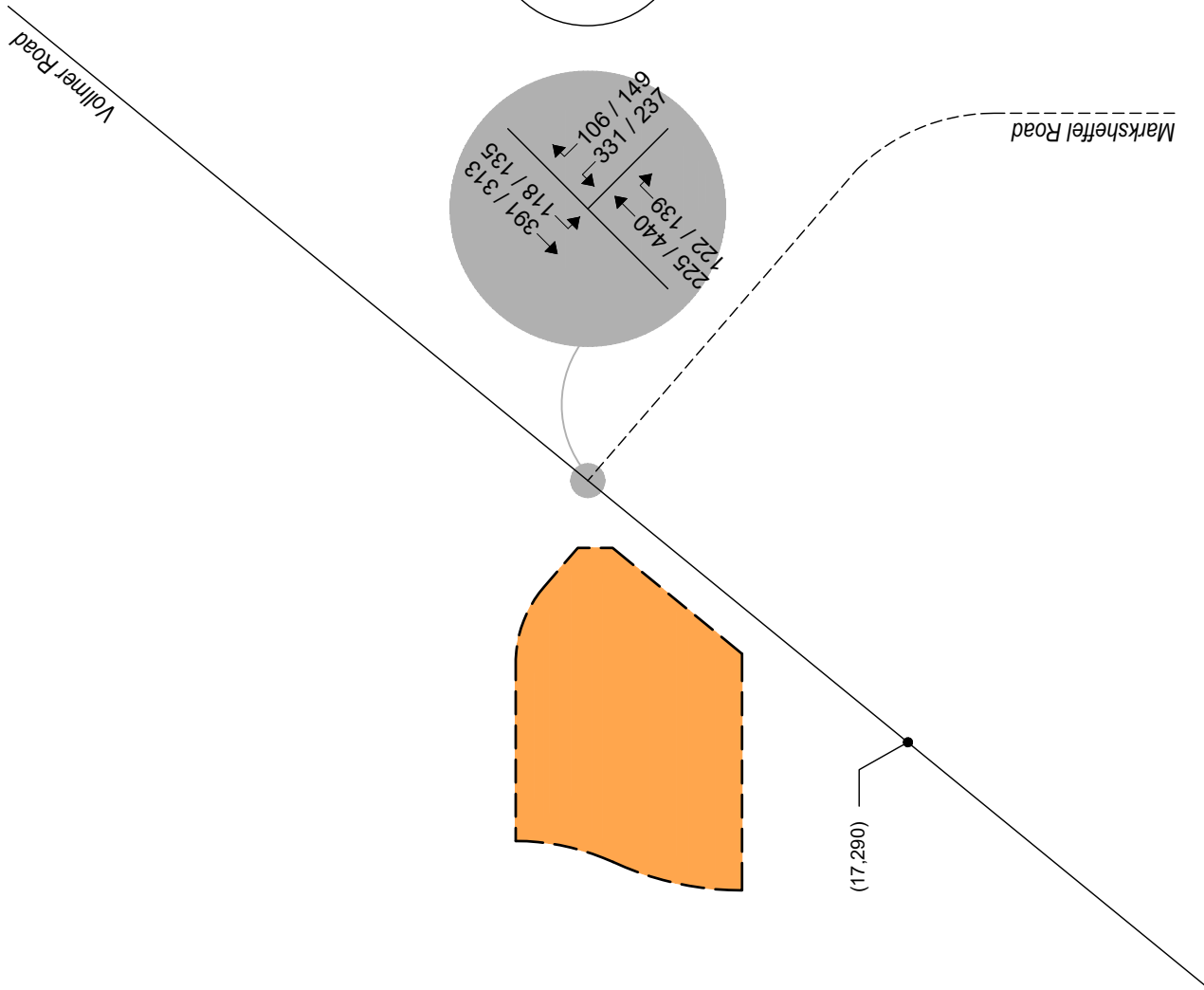

Figure 4
BACKGROUND TRAFFIC - YEAR 2027
 Volumes & Intersection Geometry
 AM / PM Peak Hour
 (ADT) : Average Daily Traffic

SCHMIDT PROPERTY
 Traffic Impact Study



SM ROCHA, LLC
 Traffic and Transportation Consultants



Not to Scale

Vollmer Road

Markshoeffel Road

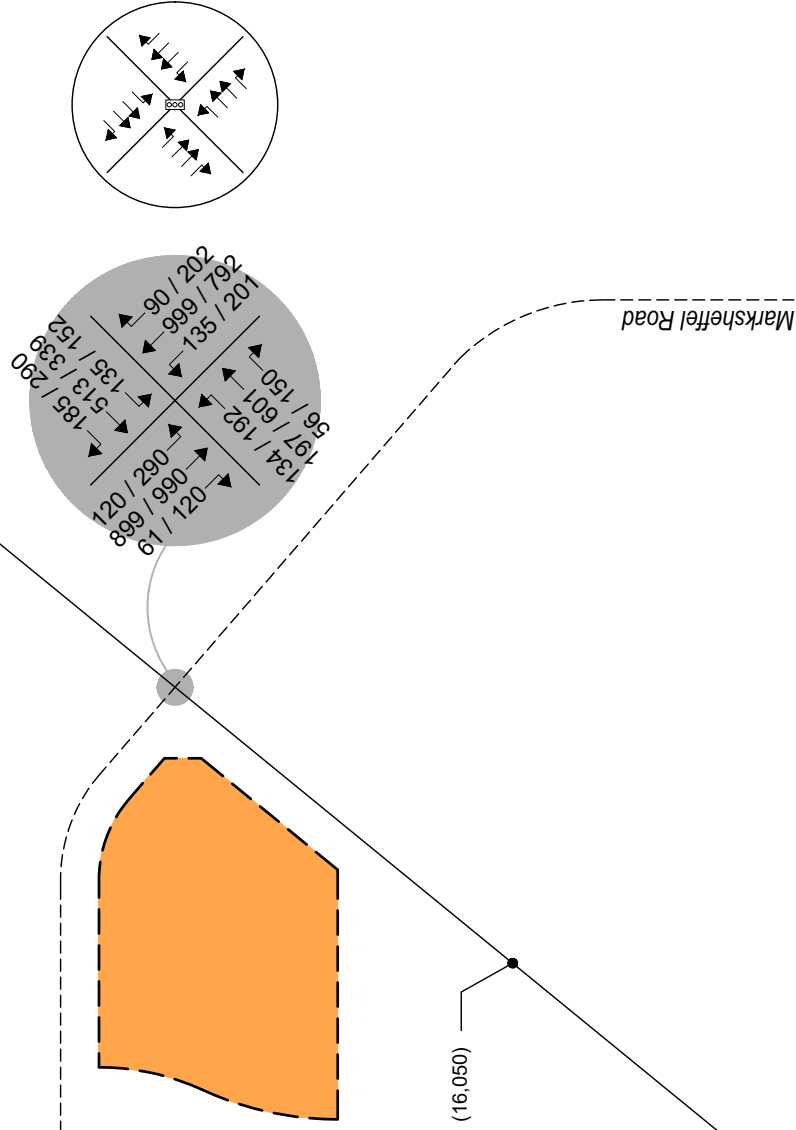

LEGEND

- Study Intersection
- Study Intersection Lane Geometry
- Development Site

SCHMIDT PROPERTY
Traffic Impact Study



SM ROCHA, LLC
Traffic and Transportation Consultants

Figure 5
BACKGROUND TRAFFIC - YEAR 2040
Volumes & Intersection Geometry
AM / PM Peak Hour
(ADT) : Average Daily Traffic

Peak Hour Intersection Levels of Service – Background Traffic

As with existing traffic conditions, the operations of study intersections were analyzed under background conditions, without the proposed development, using the SYNCHRO computer program.

Background traffic level of service analysis results for Year 2027 are listed in Table 2. Year 2040 operational results are summarized in Table 3.

Definitions of levels of service are given in Appendix B. Intersection capacity worksheets are provided in Appendix C.

Table 2 – Intersection Capacity Analysis Summary – Background Traffic – Year 2024

INTERSECTION LANE GROUPS	LEVEL OF SERVICE	
	AM PEAK HOUR	PM PEAK HOUR
Vollmer Road / Marksheffel Road (Stop-Controlled)		
Westbound Left	F	F
Westbound Right	B	B
Southbound Left	A	A

Key: Stop-Controlled Intersection: Level of Service

Background Traffic Analysis Results – Year 2027

Year 2027 background traffic analysis indicates that the unsignalized intersection of Vollmer Road with Marksheffel Road has turning movement operations at or better than LOS B during both the AM and PM peak traffic hours. Exceptions would include the westbound left turning movement which operates at LOS F during either peak traffic hour. The LOS F operations are attributed to the through traffic volume along Marksheffel Road and the stop-controlled nature of the intersection. In order to provide mitigation for the poor operations along the minor road approach, signalization is an option which is anticipated to achieve acceptable levels of service.

Table 3 – Intersection Capacity Analysis Summary – Background Traffic – Year 2040

INTERSECTION LANE GROUPS	LEVEL OF SERVICE	
	AM PEAK HOUR	PM PEAK HOUR
Vollmer Road / Marksheffel Road (Signalized)	C (31.2)	D (36.9)

Key: Signalized Intersection: Level of Service (Control Delay in sec/veh)

Background Traffic Analysis Results – Year 2040

By Year 2040 and without the proposed development, the study intersection of Vollmer Road with Marksheffel Road experiences overall LOS C operations during the AM peak traffic hour and LOS D during the PM peak traffic hour.

IV. Proposed Project Traffic

Trip Generation

Standard traffic generation characteristics compiled by the Institute of Transportation Engineers (ITE) in their report entitled Trip Generation Manual, 11th Edition, were applied to the assumed land use in order to estimate average daily traffic (ADT), AM Peak Hour, and PM Peak Hour vehicle trips. A vehicle trip is defined as a one-way vehicle movement from a point of origin to a point of destination.

The ITE land use code 220 (Multifamily Housing (Low-Rise)) was used for estimating trip generation because of its best fit to the assumed land use description.

As actual land uses, densities, or site plans within the Schmidt Property become defined over time, it is expected that traffic generation characteristics considered within this study will need to be updated by more specific traffic analyses or studies to help assess what, if any, transportation improvements are needed to mitigate potential traffic impacts.

Trip generation rates used in this study are presented in Table 4.

Table 4 – Trip Generation Rates

ITE CODE	LAND USE	UNIT	TRIP GENERATION RATES						
			24 HOUR	AM PEAK HOUR			PM PEAK HOUR		
				ENTER	EXIT	TOTAL	ENTER	EXIT	TOTAL
220	Multifamily Housing (Low-Rise)	DU	6.74	0.10	0.30	0.40	0.32	0.19	0.51

Key: DU = Dwelling Units

Table 5 illustrates projected ADT, AM Peak Hour, and PM Peak Hour traffic volumes likely generated by the assumed development upon build-out.

Table 5 – Trip Generation Summary

ITE CODE	LAND USE	SIZE	DU	TOTAL TRIPS GENERATED						
				24 HOUR	AM PEAK HOUR			PM PEAK HOUR		
					ENTER	EXIT	TOTAL	ENTER	EXIT	TOTAL
220	Multifamily Housing (Low-Rise)	714	DU	4,812	69	217	286	229	135	364
<i>Total:</i>				4,812	69	217	286	229	135	364

Key: DU = Dwelling Units

Note: All data and calculations above are subject to being rounded to nearest value.

Upon build-out, Table 5 illustrates that the assumed development has the potential to generate approximately 4,812 daily vehicle trips with 286 of those occurring during the morning peak hour and 364 during the afternoon peak hour.

Adjustments to Trip Generation Rates

A development of this type is not likely to attract trips from within area land uses nor pass-by or diverted link trips from the adjacent roadway system, therefore no trip reduction was taken in this analysis.

Trip Distribution

The initial and overall directional distribution of site-generated traffic was determined based on the location of development site within the County, proposed and existing area land uses, allowed turning movements, and available roadway network. Directional distribution used for analysis also complies with the referenced Rhetoric Development traffic study and previously approved traffic studies for the adjacent ongoing development areas.

Trip distribution patterns for the initial phase of development are shown on Figure 6A.

Overall, long-term, trip distribution patterns for development build-out are shown on Figure 6B.

Trip Assignment

The construction of this development is assumed to be phased with the initial phase being completed by 2027 and entailing an approximate 16-acre portion of residential (480 dwelling units) area located immediately adjacent to future Marksheffel Road.

Trip assignment is how generated and distributed vehicle trips are expected to be loaded onto the available roadway network.

Applying trip distribution patterns to site-generated traffic provides the initial site-generated trip assignments for Year 2027 shown on Figure 6A, and overall trip assignments Year 2040 are shown on Figure 6B.



Not to Scale

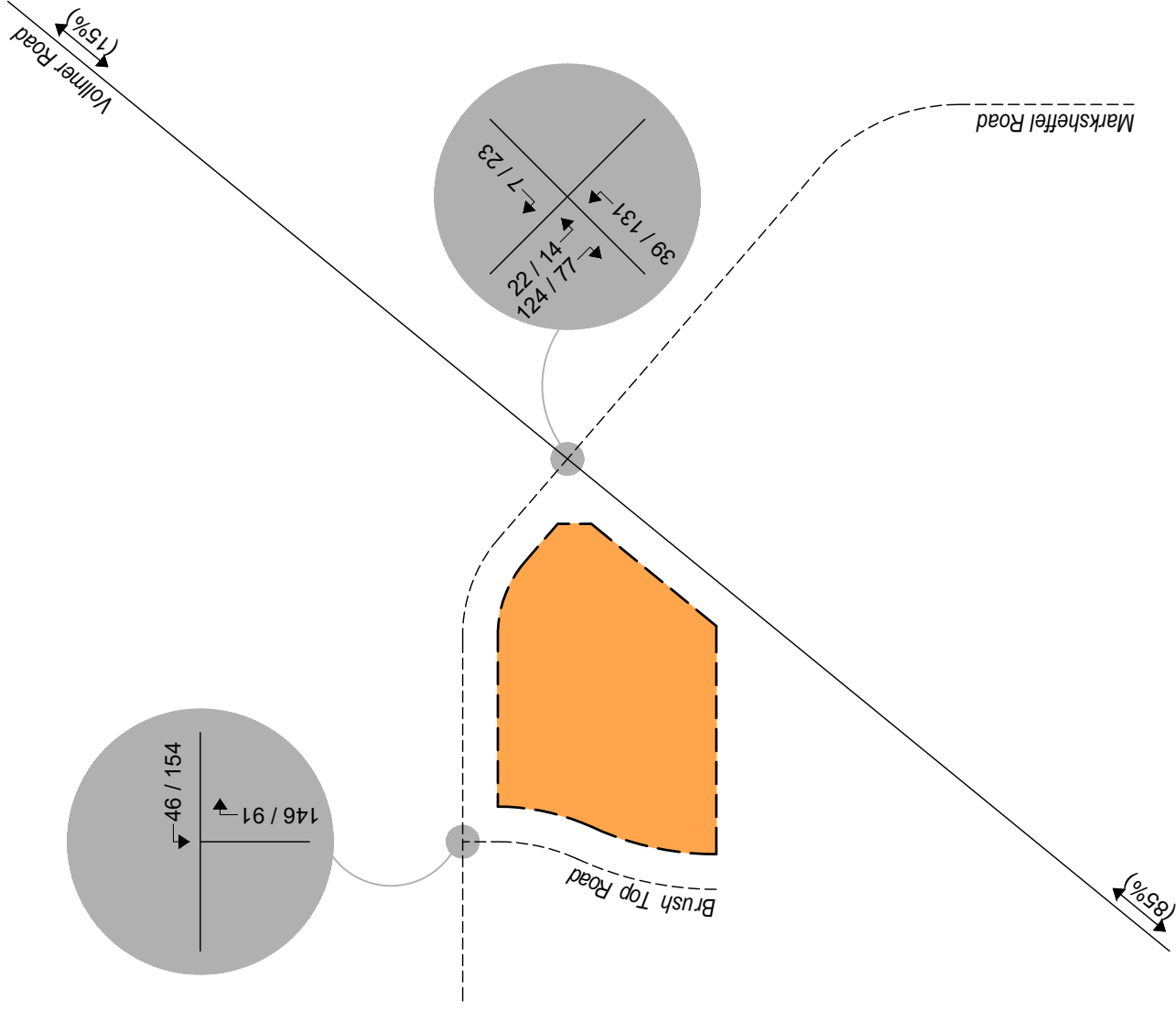

LEGEND

- Study Intersection
- Volumes
- Development Site

Figure 6A
SITE DEVELOPMENT DISTRIBUTION - YEAR 2027
 (%) : Overall

SITE-GENERATED
 AM / PM Peak Hour

SCHMIDT PROPERTY
 Traffic Impact Study



SM ROCHA, LLC
 Traffic and Transportation Consultants



Not to Scale

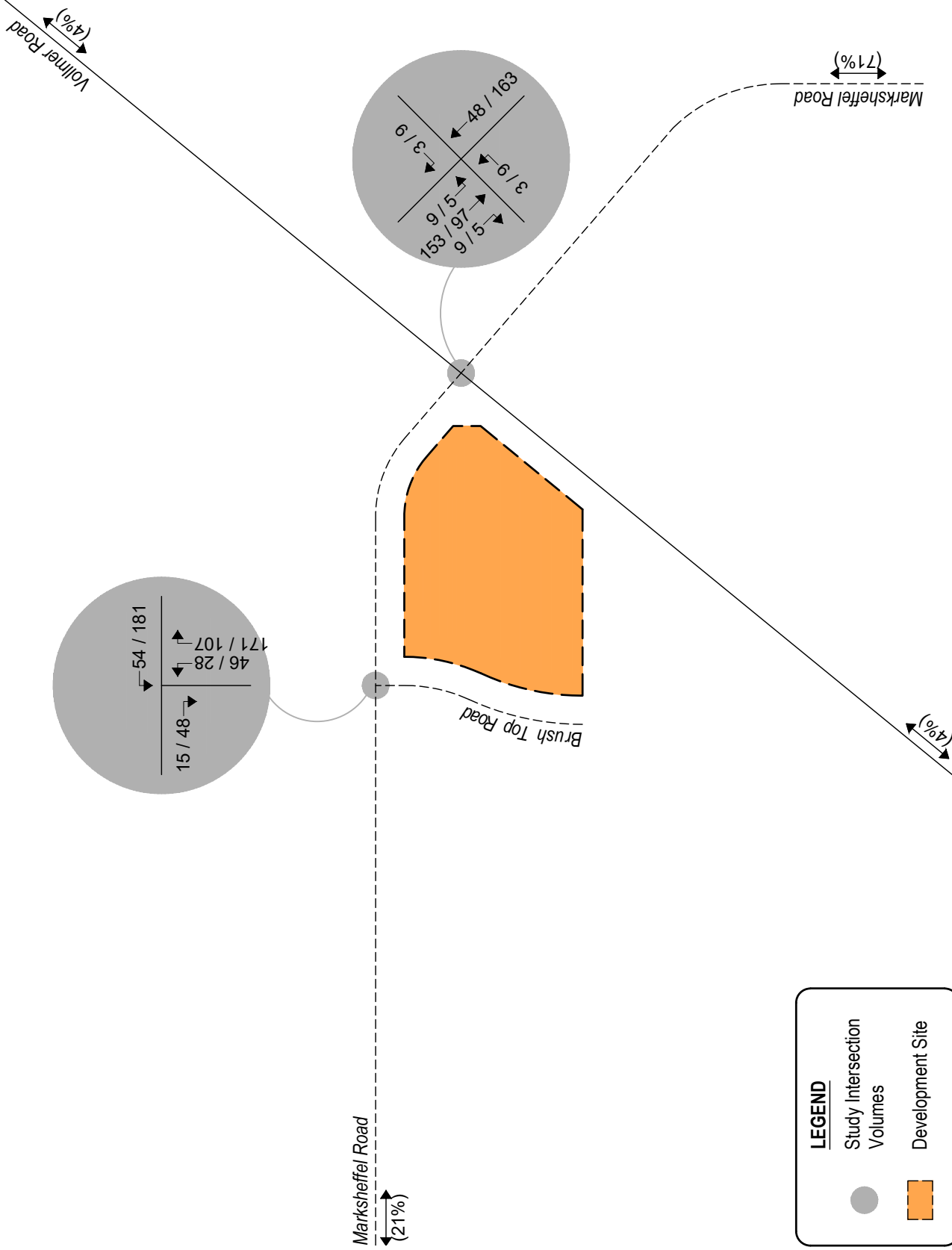

Figure 6B
SITE DEVELOPMENT DISTRIBUTION - YEAR 2040
(%) : Overall

SITE-GENERATED
AM / PM Peak Hour

SCHMIDT PROPERTY
Traffic Impact Study



SM ROCHA, LLC
Traffic and Transportation Consultants

V. Future Traffic Conditions With Proposed Developments

2040

Total traffic is the traffic projected to be on area roadways with consideration of the proposed development. Total traffic includes background traffic projections for Years 2027 and 2042 with consideration of site-generated traffic. For analysis purposes, it was assumed that development construction would be completed by end of Year 2040.

Pursuant to area roadway improvement discussions provided in Section III, Year 2027 and Year 2040 total traffic conditions assume no additional roadway improvements to accommodate regional transportation demands than that described for each background analysis year. Roadway improvements associated with site development are expected to be limited to site access and frontage as required by the governing agency. An exception is Marksheffel Road where the construction of a partial roadway section (two through lanes with shared center turn lane) is envisioned with the initial phase of site development.

Projected Year 2027 total traffic volumes and intersection geometry are shown in Figure 7. Figure 8 shows projected total traffic volumes and intersection geometry for Year 2040.

Total Traffic Auxiliary Lane Analysis

Auxiliary lanes for site development accesses were based on the County's ECM.

Considering development build-out, an evaluation of auxiliary lane requirements, pursuant to Section 2.3.7 of the County's ECM, reveals that a southbound right turn deceleration lane along Vollmer Road at Marksheffel Road is required since the southbound right turn ingress volume exceeds the 25 vehicles per hour threshold. Dedicated right turn lanes were also assumed along the future, ultimate section of Marksheffel Road at Vollmer Road and (future) Brush Top Road.

Section 2.3.7 of the County's ECM also concludes that exclusive left turn deceleration lanes are required along ultimate Marksheffel Road at Vollmer Road and Brush Top Road since the projected left turn ingress volumes exceed the County's threshold of 10 vehicles per hour.

Due to the conservative analysis performed throughout this study and the conceptual nature of assumed site development, it is expected that auxiliary lane requirements evaluated within this study will need to be updated by more specific traffic analyses or studies as actual area development occurs, to help assess if transportation improvements are needed to meet the County's vehicle volume thresholds.

Discuss the need for an exclusive left turn lane on Vollmer Road northbound.

List ECM criteria for stacking, storage, and taper for every affected auxiliary lane and access. State whether criteria can be met, if criteria cannot be met state that and provide modifications to meet criteria.

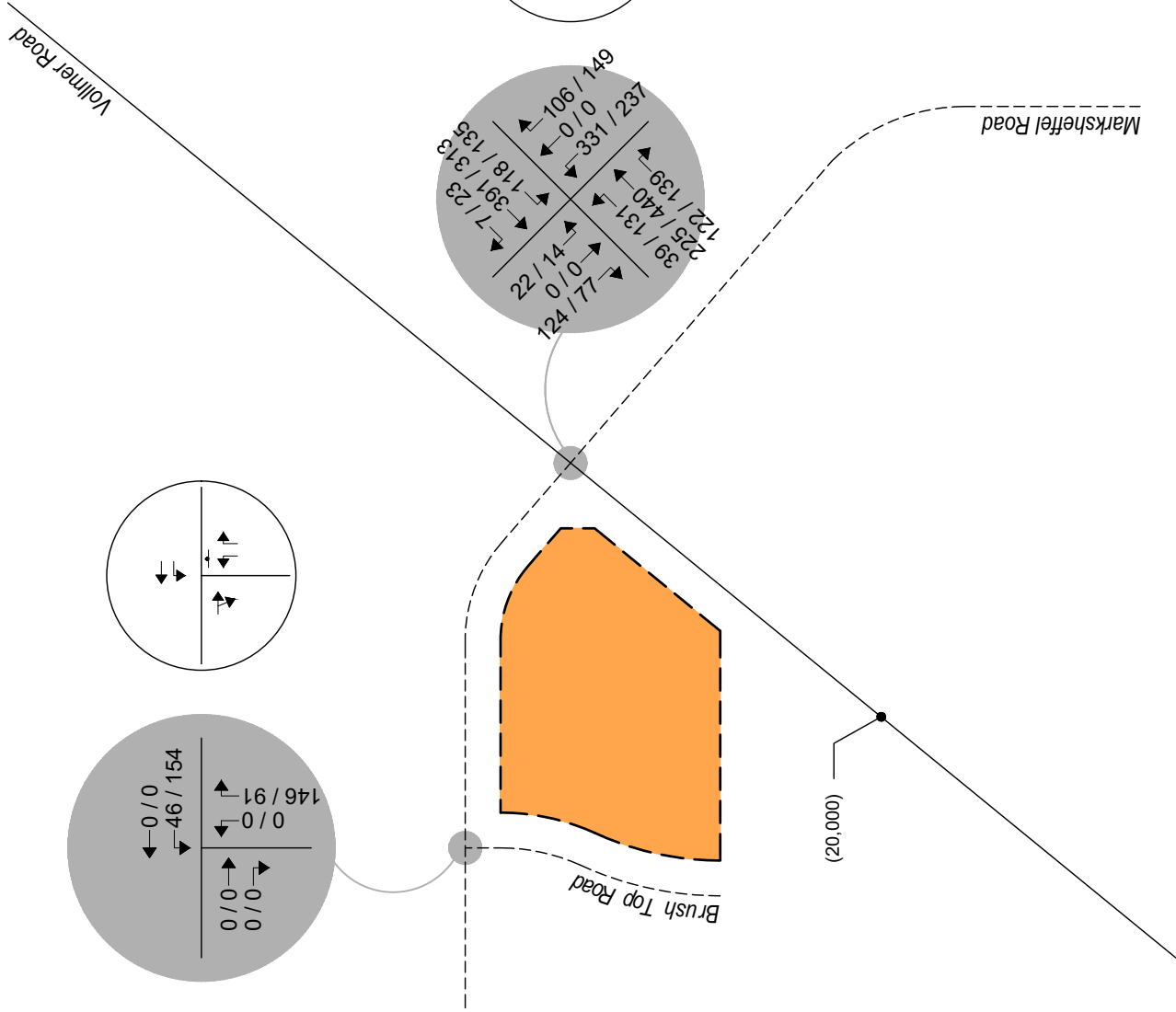

LEGEND

- Study Intersection Volumes
- Study Intersection Lane Geometry
- Development Site

SCHMIDT PROPERTY
Traffic Impact Study



SM ROCHA, LLC
Traffic and Transportation Consultants

Figure 7
TOTAL TRAFFIC - YEAR 2027
Volumes & Intersection Geometry
AM / PM Peak Hour
(ADT) : Average Daily Traffic

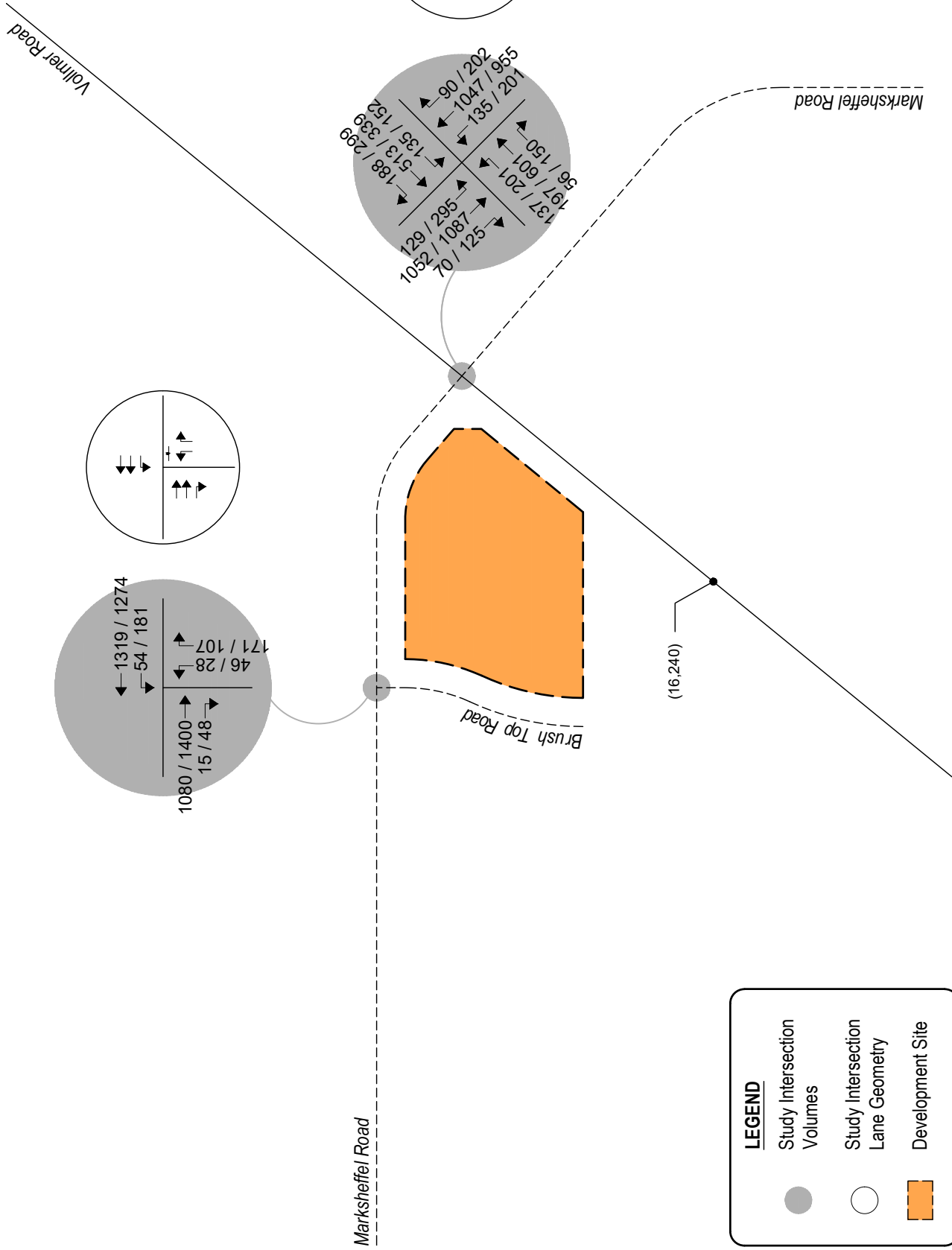

LEGEND

- Study Intersection Volumes
- Study Intersection Lane Geometry
- Development Site

Figure 8
TOTAL TRAFFIC - YEAR 2040
 Volumes & Intersection Geometry
 AM / PM Peak Hour
 (ADT) : Average Daily Traffic

SCHMIDT PROPERTY
 Traffic Impact Study



SM ROCHA, LLC
 Traffic and Transportation Consultants

VI. Project Impacts

The analyses and procedures described in this study were performed in accordance with the latest HCM and are based upon the worst-case conditions that occur during a typical weekday upon build-out of site development and analyzed land uses. Therefore, study intersections are likely to operate with traffic conditions better than those described within this study, which represent the peak hours of weekday operations only.

Peak Hour Intersection Levels of Service – Total Traffic

As with background traffic, the operations of the study intersections were analyzed under projected total traffic conditions using the SYNCHRO computer program. Total traffic level of service analysis results for Years 2027 and 2040 are summarized in Table 6 and Table 7, respectively.

Definitions of levels of service are given in Appendix B. Intersection capacity worksheets are provided in Appendix C.

Table 6 – Intersection Capacity Analysis Summary – Total Traffic – Year 2027

INTERSECTION LANE GROUPS	LEVEL OF SERVICE	
	AM PEAK HOUR	PM PEAK HOUR
Vollmer Road / Marksheffel Road (Stop-Controlled)		
Eastbound Left	E	F
Eastbound Through	A	A
Eastbound Right	B	A
Westbound Left	F	F
Westbound Through	A	A
Westbound Right	B	B
Northbound Left	A	A
Southbound Left	A	A
Marksheffel Road / Brush Top Road (Stop-Controlled)		
Westbound Left	A	A
Northbound Right	A	A

Key: Stop-Controlled Intersection: Level of Service

Table 7 – Intersection Capacity Analysis Summary – Total Traffic – Year 2040

INTERSECTION LANE GROUPS	LEVEL OF SERVICE	
	AM PEAK HOUR	PM PEAK HOUR
Vollmer Road / Marksheffel Road (Signalized)	D (35.7)	D (42.0)
Marksheffel Road / Brush Top Road (Stop-Controlled)		
Westbound Left	B	C
Northbound Left	F	F
Northbound Right	C	C

Key: Signalized Intersection: Level of Service (Control Delay in sec/veh)
 Stop-Controlled Intersection: Level of Service

Total Traffic Analysis Results Upon Development Build-Out

Table 7 illustrates how, by Year 2040 and upon assumed development build-out, the signalized intersection of Vollmer Road with Marksheffel Road shows an overall LOS D operation during both the morning and afternoon peak traffic hours. Compared to the background traffic analysis, the traffic generated by the proposed development is not expected to significantly change the operations of the study intersection.

The stop-controlled intersection of Marksheffel Road with Brush Top Road is projected to have morning and afternoon peak traffic hour turning movement operations at or better than LOS C. Exceptions would include the northbound left turning movement which operates at LOS F during either peak traffic hour. The LOS F operations are attributed to the through traffic volume along Marksheffel Road and the stop-controlled nature of the intersection. This poor operation occurs for the minor leg approach and is not expected to negatively impact the operations of Marksheffel Road. While signalization is a potential mitigating solution, it is recommended that as actual land uses and densities become defined within the overall area, intersection operational analyses will need to be updated to help assess if transportation improvements are needed to mitigate potential traffic impacts.

It is to be noted that it is not uncommon for unsignalized movements to or from an arterial roadway, in urban areas, to operate with noticeable delays during peak traffic hours. It is, however, likely that turn movements will operate better than the results obtained with this HCM Two-Way Stop-Control (TWSC) level of service analysis would indicate, as the HCM analysis may not accurately account for the effect of vehicle platooning and gaps caused by upstream signals. Upstream signal controls along Marksheffel Road will tend to create additional gaps in the traffic stream for turning movements at Brush Top Road and will most likely provide mitigation to the LOS F operation projected during both peak traffic hours.

Queue Length Analysis

Queue lengths for the study intersections were analyzed using Year 2040 total traffic conditions. The analysis yields estimate of 95th percentile queue lengths, which have only a five percent probability of being exceeded during the analysis time period. An average vehicle length of 25 feet was assumed. Queue lengths were modeled and are included with the Synchro worksheets in Appendix C.

When considering how the proposed development is conceptual in nature, no significant queue lengths at the study intersections were indicated. The greatest on-site queue length anticipated at the Marksheffel Road with Vollmer Road intersection occurs during the afternoon peak hour. The queue length is approximately fifteen vehicles for the northbound left turn movement, which may require the existing turn lane to be extended to accommodate project 95th percentile queuing.

At the Marksheffel Road intersection with Brush Top Road, the greatest on-site queue length anticipated is approximately five vehicles during either peak traffic hour.

Due to the conservative analysis performed throughout this study and the conceptual nature of assumed site development, it is expected that vehicle queue lengths evaluated within this study will need to be updated by more specific traffic analyses or studies as actual area development occurs, to help assess if transportation improvements are needed.

VII. Conclusion

This traffic impact study is provided as a planning document and addressed the capacity, geometric, and control requirements associated with the development entitled Schmidt Property. This assumed residential development consists of an estimated 714 dwelling units. The 23.8-acre development is located along the south side of (future) Marksheffel Road and near the southwest corner of Vollmer Road intersection with Tahiti Drive in El Paso County, Colorado.

26.75 ac



The study area examined in this analysis encompassed Vollmer Road near the existing intersection with Tahiti Drive and future Marksheffel Road as well as primary site access.

Analysis was conducted for critical AM Peak Hour and PM Peak Hour traffic operations for existing traffic conditions, Year 2027 and Year 2040 background traffic conditions, and Year 2027 and Year 2040 total traffic conditions.

Analysis of existing traffic conditions indicates that the unsignalized intersection of Vollmer Road with Tahiti Drive has turning movement operations at LOS A during both the morning and afternoon peak traffic hours.

Without the proposed development, Year 2027 background operational analysis shows that the unsignalized intersection of Vollmer Road with Marksheffel Road has turning movement operations at or better than LOS B during both the AM and PM peak traffic hours. Exceptions would include the westbound left turning movement which operates at LOS F during either peak traffic hour. The LOS F operations are attributed to the through traffic volume along Marksheffel Road and the stop-controlled nature of the intersection. In order to provide mitigation for the poor operations along the minor road approach, signalization is an option which is anticipated to provide for acceptable levels of service.

By Year 2040 and without the proposed development, the study intersection of Vollmer Road with Marksheffel Road experiences overall LOS C operations during the AM peak traffic hour and LOS D during the PM peak traffic hour.

Analysis of future traffic conditions indicates that the addition of site-generated traffic is expected to create minimal impact to traffic operations for the existing and surrounding roadway system upon roadway and intersection control improvements assumed within this analysis. With all conservative assumptions defined in this analysis, the study intersection of Vollmer Road with Marksheffel Road is projected to operate at future levels of service comparable to Year 2040 background traffic conditions. Proposed site access has long-term operations at LOS C or better during peak traffic periods and upon build-out, with exception to the northbound left turn movement. The LOS F operation shown for the northbound left turn movement is attributed to the through volume along Marksheffel Road and the stop-controlled nature of the intersection. While signalization is a potential mitigating solution, it is recommended that as actual land uses and densities become defined within the overall area, intersection operational analyses will need to be updated to help assess if transportation improvements are needed to mitigate potential traffic impacts.

Per Appendix B.6.1A provide a table identifying all proposed and future improvements required, location of improvements, and responsible parties.

Provide a cost breakdown for applicable Road Impact Fees. State the developer's choice for payment.

State whether any of the proposed improvements are reimbursable under the current Major Transportation Corridor Plan (MTCP).

Provide information for pedestrian sidewalks, per ECM Chapter 2, Vollmer Road requires sidewalks. Provide sidewalk width, spacing from roadway, detached/attached to meet ECM criteria.

Legacy Peak Elementary and The Center for Modern Learning is within 2 miles of the property's boundary. Per ECM Appendix B.4 school routing plans shall be developed per the MUTCD between the project and school. Include all schools within 2 miles of the property's boundary.

Per ECM Section B.2.4.A include discussion on safety and accident analysis

APPENDIX A

Traffic Count Data



ALL TRAFFIC DATA SERVICES

(303) 216-2439

www.alltrafficdata.net

Location: 3 Vollmer Road & Tahiti Drive AM

Date: Thursday, March 24, 2022

Peak Hour: 07:45 AM - 08:45 AM

Peak 15-Minutes: 07:45 AM - 08:00 AM

Peak Hour - All Vehicles

Peak Hour - Pedestrians/Bicycles on Crosswalk

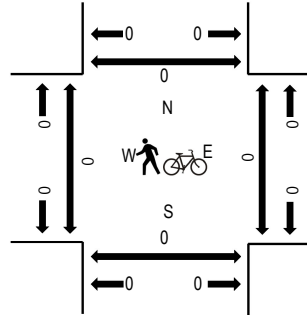
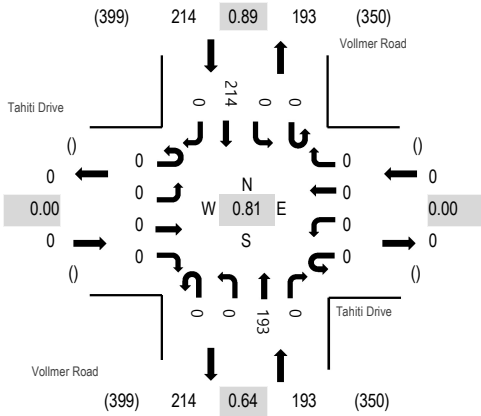

Note: Total study counts contained in parentheses.

Traffic Counts

Interval Start Time	Tahiti Drive Eastbound				Tahiti Drive Westbound				Vollmer Road Northbound			Vollmer Road Southbound				Total	Rolling Hour	Pedestrian Crossings					
	U-Turn	Left	Thru	Right	U-Turn	Left	Thru	Right	U-Turn	Left	Thru	Right	U-Turn	Left	Thru			Right	West	East	South	North	
7:00 AM	0	0	0	0	0	0	0	0	0	0	42	0	0	0	0	30	0	72	374	0	0	0	0
7:15 AM	0	0	0	0	0	0	0	0	0	0	33	0	0	0	0	47	0	80	400	0	0	0	0
7:30 AM	0	0	0	0	0	0	0	0	0	0	41	0	0	0	0	55	0	96	400	0	0	0	0
7:45 AM	0	0	0	0	0	0	0	0	0	0	75	0	0	0	0	51	0	126	407	0	0	0	0
8:00 AM	0	0	0	0	0	0	0	0	0	0	37	0	0	0	0	61	0	98	375	0	0	0	0
8:15 AM	0	0	0	0	0	0	0	0	0	0	34	0	0	0	0	46	0	80		0	0	0	0
8:30 AM	0	0	0	0	0	0	0	0	0	0	47	0	0	0	0	56	0	103		0	0	0	0
8:45 AM	0	0	0	0	0	0	0	0	0	0	41	0	0	0	0	53	0	94		0	0	0	0
Count Total	0	0	0	0	0	0	0	0	0	0	350	0	0	0	0	399	0	749		0	0	0	0
Peak Hour	0	0	0	0	0	0	0	0	0	0	193	0	0	0	0	214	0	407		0	0	0	0



ALL TRAFFIC DATA SERVICES

(303) 216-2439

www.alltrafficdata.net

Location: 3 Vollmer Road & Tahiti Drive PM

Date: Thursday, March 24, 2022

Peak Hour: 04:00 PM - 05:00 PM

Peak 15-Minutes: 04:00 PM - 04:15 PM

Peak Hour - All Vehicles

Peak Hour - Pedestrians/Bicycles on Crosswalk

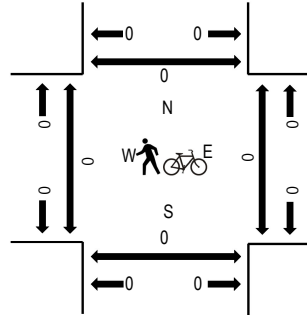
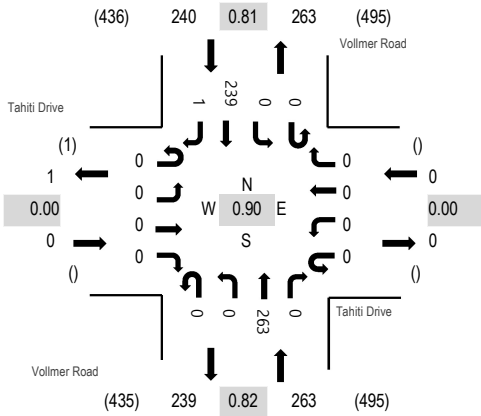

Note: Total study counts contained in parentheses.

Traffic Counts

Interval Start Time	Tahiti Drive Eastbound				Tahiti Drive Westbound				Vollmer Road Northbound			Vollmer Road Southbound				Total	Rolling Hour	Pedestrian Crossings					
	U-Turn	Left	Thru	Right	U-Turn	Left	Thru	Right	U-Turn	Left	Thru	Right	U-Turn	Left	Thru			Right	West	East	South	North	
4:00 PM	0	0	0	0	0	0	0	0	0	0	66	0	0	0	0	73	1	140	503	0	0	0	0
4:15 PM	0	0	0	0	0	0	0	0	0	0	68	0	0	0	0	52	0	120	467	0	0	0	0
4:30 PM	0	0	0	0	0	0	0	0	0	0	49	0	0	0	0	63	0	112	463	0	0	0	0
4:45 PM	0	0	0	0	0	0	0	0	0	0	80	0	0	0	0	51	0	131	453	0	0	0	0
5:00 PM	0	0	0	0	0	0	0	0	0	0	55	0	0	0	0	49	0	104	428	0	0	0	0
5:15 PM	0	0	0	0	0	0	0	0	0	0	62	0	0	0	0	54	0	116		0	0	0	0
5:30 PM	0	0	0	0	0	0	0	0	0	0	54	0	0	0	0	48	0	102		0	0	0	0
5:45 PM	0	0	0	0	0	0	0	0	0	0	61	0	0	0	0	45	0	106		0	0	0	0
Count Total	0	0	0	0	0	0	0	0	0	0	495	0	0	0	0	435	1	931		0	0	0	0
Peak Hour	0	0	0	0	0	0	0	0	0	0	263	0	0	0	0	239	1	503		0	0	0	0

APPENDIX B

Level of Service Definitions

The following information can be found in the Highway Capacity Manual, Transportation Research Board, 2016: Chapter 19 – Signalized Intersections and Chapter 20 – Two-Way Stop Controlled Intersections.

Automobile Level of Service (LOS) for Signalized Intersections

Levels of service are defined to represent reasonable ranges in control delay.

LOS A

Describes operations with a control delay of 10 s/veh or less and a volume-to-capacity ratio no greater than 1.0. This level is typically assigned when the volume-to-capacity ratio is low and either progression is exceptionally favorable or the cycle length is very short. If it is due to favorable progression, most vehicles arrive during the green indication and travel through the intersection without stopping.

LOS B

Describes operations with control delay between 10 and 20 s/veh and a volume-to-capacity ratio no greater than 1.0. This level is typically assigned when the volume-to-capacity ratio is low and either progression is highly favorable or the cycle length is short. More vehicles stop than with LOS A.

LOS C

Describes operations with control delay between 20 and 35 s/veh and a volume-to-capacity ratio no greater than 1.0. This level is typically assigned when progression is favorable or the cycle length is moderate. Individual *cycle failures* (i.e., one or more queued vehicles are not able to depart as a result of insufficient capacity during the cycle) may begin to appear at this level. The number of vehicles stopping is significant, although many vehicles still pass through the intersection without stopping.

LOS D

Describes operations with control delay between 35 and 55 s/veh and a volume-to-capacity ratio no greater than 1.0. This level is typically assigned when the volume-to-capacity ratio is high and either progression is ineffective or the cycle length is long. Many vehicles stop and individual cycle failures are noticeable.

LOS E

Describes operations with control delay between 55 and 80 s/veh and a volume-to-capacity ratio no greater than 1.0. This level is typically assigned when the volume-to-capacity ratio is high, progression is unfavorable, and the cycle length is long. Individual cycle failures are frequent.

LOS F

Describes operations with control delay exceeding 80 s/veh or a volume-to-capacity ratio greater than 1.0. This level is typically assigned when the volume-to-capacity ratio is very high, progression is very poor, and the cycle length is long. Most cycles fail to clear the queue.

Level of Service (LOS) for Unsignalized TWSC Intersections

Level of Service (v/c ≤ 1.0)	Average Control Delay (s/veh)
A	0 - 10
B	> 10 - 15
C	> 15 - 25
D	> 25 - 35
E	> 35 - 50
F	> 50

APPENDIX C

Capacity Worksheets

HCM 6th TWSC
1: Vollmer Road & Tahiti Drive

Existing Traffic Volumes
AM Peak Hour

Intersection						
Int Delay, s/veh	0					
Movement	SBL	SBR	NEL	NET	SWT	SWR
Lane Configurations	T			T		
Traffic Vol, veh/h	0	0	0	193	214	0
Future Vol, veh/h	0	0	0	193	214	0
Conflicting Peds, #/hr	0	0	0	0	0	0
Sign Control	Stop	Stop	Free	Free	Free	Free
RT Channelized	-	None	-	None	-	None
Storage Length	0	-	-	-	-	-
Veh in Median Storage, #	0	-	-	0	0	-
Grade, %	0	-	-	0	0	-
Peak Hour Factor	92	92	92	92	92	92
Heavy Vehicles, %	2	2	2	2	2	2
Mvmt Flow	0	0	0	210	233	0

Major/Minor	Minor2	Major1	Major2			
Conflicting Flow All	443	233	233	0	-	0
Stage 1	233	-	-	-	-	-
Stage 2	210	-	-	-	-	-
Critical Hdwy	6.42	6.22	4.12	-	-	-
Critical Hdwy Stg 1	5.42	-	-	-	-	-
Critical Hdwy Stg 2	5.42	-	-	-	-	-
Follow-up Hdwy	3.518	3.318	2.218	-	-	-
Pot Cap-1 Maneuver	572	806	1335	-	-	-
Stage 1	806	-	-	-	-	-
Stage 2	825	-	-	-	-	-
Platoon blocked, %				-	-	-
Mov Cap-1 Maneuver	572	806	1335	-	-	-
Mov Cap-2 Maneuver	572	-	-	-	-	-
Stage 1	806	-	-	-	-	-
Stage 2	825	-	-	-	-	-

Approach	SB	NE	SW
HCM Control Delay, s	0	0	0
HCM LOS	A		

Minor Lane/Major Mvmt	NEL	NET	SBLn1	SWT	SWR
Capacity (veh/h)	1335	-	-	-	-
HCM Lane V/C Ratio	-	-	-	-	-
HCM Control Delay (s)	0	-	0	-	-
HCM Lane LOS	A	-	A	-	-
HCM 95th %tile Q(veh)	0	-	-	-	-

HCM 6th TWSC
1: Vollmer Road & Tahiti Drive

Existing Traffic Volumes
PM Peak Hour

Intersection						
Int Delay, s/veh	0					
Movement	SBL	SBR	NEL	NET	SWT	SWR
Lane Configurations	T			T		
Traffic Vol, veh/h	0	0	0	263	239	1
Future Vol, veh/h	0	0	0	263	239	1
Conflicting Peds, #/hr	0	0	0	0	0	0
Sign Control	Stop	Stop	Free	Free	Free	Free
RT Channelized	-	None	-	None	-	None
Storage Length	0	-	-	-	-	-
Veh in Median Storage, #	0	-	-	0	0	-
Grade, %	0	-	-	0	0	-
Peak Hour Factor	92	92	92	92	92	92
Heavy Vehicles, %	2	2	2	2	2	2
Mvmt Flow	0	0	0	286	260	1

Major/Minor	Minor2	Major1	Major2			
Conflicting Flow All	547	261	261	0	-	0
Stage 1	261	-	-	-	-	-
Stage 2	286	-	-	-	-	-
Critical Hdwy	6.42	6.22	4.12	-	-	-
Critical Hdwy Stg 1	5.42	-	-	-	-	-
Critical Hdwy Stg 2	5.42	-	-	-	-	-
Follow-up Hdwy	3.518	3.318	2.218	-	-	-
Pot Cap-1 Maneuver	498	778	1303	-	-	-
Stage 1	783	-	-	-	-	-
Stage 2	763	-	-	-	-	-
Platoon blocked, %				-	-	-
Mov Cap-1 Maneuver	498	778	1303	-	-	-
Mov Cap-2 Maneuver	498	-	-	-	-	-
Stage 1	783	-	-	-	-	-
Stage 2	763	-	-	-	-	-

Approach	SB	NE	SW
HCM Control Delay, s	0	0	0
HCM LOS	A		

Minor Lane/Major Mvmt	NEL	NET	SBLn1	SWT	SWR
Capacity (veh/h)	1303	-	-	-	-
HCM Lane V/C Ratio	-	-	-	-	-
HCM Control Delay (s)	0	-	0	-	-
HCM Lane LOS	A	-	A	-	-
HCM 95th %tile Q(veh)	0	-	-	-	-

HCM 6th TWSC
1: Vollmer Road & Marksheffel Road

Background Traffic Volumes
AM Peak Hour - Year 2027

Intersection						
Int Delay, s/veh	27.5					
Movement	NWL	NWR	NET	NER	SWL	SWT
Lane Configurations	↘	↗	↑	↗	↘	↑↑
Traffic Vol, veh/h	331	106	225	122	118	391
Future Vol, veh/h	331	106	225	122	118	391
Conflicting Peds, #/hr	0	0	0	0	0	0
Sign Control	Stop	Stop	Free	Free	Free	Free
RT Channelized	-	None	-	None	-	None
Storage Length	0	0	-	150	150	-
Veh in Median Storage, #	0	-	0	-	-	0
Grade, %	0	-	0	-	-	0
Peak Hour Factor	92	92	92	92	92	92
Heavy Vehicles, %	2	2	2	2	2	2
Mvmt Flow	360	115	245	133	128	425

Major/Minor	Minor1	Major1	Major2		
Conflicting Flow All	714	245	0	0	378
Stage 1	245	-	-	-	-
Stage 2	469	-	-	-	-
Critical Hdwy	6.63	6.23	-	-	4.13
Critical Hdwy Stg 1	5.43	-	-	-	-
Critical Hdwy Stg 2	5.83	-	-	-	-
Follow-up Hdwy	3.519	3.319	-	-	2.219
Pot Cap-1 Maneuver	382	793	-	-	1179
Stage 1	795	-	-	-	-
Stage 2	597	-	-	-	-
Platoon blocked, %			-	-	-
Mov Cap-1 Maneuver	~ 340	793	-	-	1179
Mov Cap-2 Maneuver	~ 340	-	-	-	-
Stage 1	795	-	-	-	-
Stage 2	532	-	-	-	-

Approach	NW	NE	SW
HCM Control Delay, s	78.9	0	2
HCM LOS	F		

Minor Lane/Major Mvmt	NET	NER	NWL	n1	NWL	n2	SWL	SWT
Capacity (veh/h)	-	-	340	793	1179	-	-	-
HCM Lane V/C Ratio	-	-	1.058	0.145	0.109	-	-	-
HCM Control Delay (s)	-	-	100.9	10.3	8.4	-	-	-
HCM Lane LOS	-	-	F	B	A	-	-	-
HCM 95th %tile Q(veh)	-	-	12.9	0.5	0.4	-	-	-

Notes
 ~: Volume exceeds capacity \$: Delay exceeds 300s +: Computation Not Defined *: All major volume in platoon

Intersection						
Int Delay, s/veh	25					
Movement	NWL	NWR	NET	NER	SWL	SWT
Lane Configurations	↙	↗	↑	↗	↙	↑↑
Traffic Vol, veh/h	237	149	440	139	135	313
Future Vol, veh/h	237	149	440	139	135	313
Conflicting Peds, #/hr	0	0	0	0	0	0
Sign Control	Stop	Stop	Free	Free	Free	Free
RT Channelized	-	None	-	None	-	None
Storage Length	0	0	-	150	150	-
Veh in Median Storage, #	0	-	0	-	-	0
Grade, %	0	-	0	-	-	0
Peak Hour Factor	92	92	92	92	92	92
Heavy Vehicles, %	2	2	2	2	2	2
Mvmt Flow	258	162	478	151	147	340

Major/Minor	Minor1	Major1	Major2			
Conflicting Flow All	942	478	0	0	629	0
Stage 1	478	-	-	-	-	-
Stage 2	464	-	-	-	-	-
Critical Hdwy	6.63	6.23	-	-	4.13	-
Critical Hdwy Stg 1	5.43	-	-	-	-	-
Critical Hdwy Stg 2	5.83	-	-	-	-	-
Follow-up Hdwy	3.519	3.319	-	-	2.219	-
Pot Cap-1 Maneuver	276	586	-	-	951	-
Stage 1	623	-	-	-	-	-
Stage 2	600	-	-	-	-	-
Platoon blocked, %			-	-		
Mov Cap-1 Maneuver	~ 233	586	-	-	951	-
Mov Cap-2 Maneuver	~ 233	-	-	-	-	-
Stage 1	623	-	-	-	-	-
Stage 2	507	-	-	-	-	-

























Approach	NW	NE	SW
HCM Control Delay, s	88.2	0	2.9
HCM LOS	F		

Minor Lane/Major Mvmt	NET	NER	NWL	N1	NWL	N2	SWL	SWT
Capacity (veh/h)	-	-	233	586	951	-	-	-
HCM Lane V/C Ratio	-	-	1.106	0.276	0.154	-	-	-
HCM Control Delay (s)	-	-	135.1	13.5	9.5	-	-	-
HCM Lane LOS	-	-	F	B	A	-	-	-
HCM 95th %tile Q(veh)	-	-	11.5	1.1	0.5	-	-	-

Notes
 ~: Volume exceeds capacity \$: Delay exceeds 300s +: Computation Not Defined *: All major volume in platoon

Timings
1: Vollmer Road & Marksheffel Road

Background Traffic Volumes
AM Peak Hour - Year 2040

												
Lane Group	SEL	SET	SER	NWL	NWT	NWR	NEL	NET	NER	SWL	SWT	SWR
Lane Configurations												
Traffic Volume (vph)	120	899	61	135	999	90	134	197	56	135	513	185
Future Volume (vph)	120	899	61	135	999	90	134	197	56	135	513	185
Satd. Flow (prot)	1770	3539	1583	1770	3539	1583	1770	3539	1583	1770	3539	1583
Flt Permitted	0.126			0.103			0.241			0.618		
Satd. Flow (perm)	235	3539	1583	192	3539	1583	449	3539	1583	1151	3539	1583
Satd. Flow (RTOR)			142			142			142			201
Lane Group Flow (vph)	130	977	66	147	1086	98	146	214	61	147	558	201
Turn Type	pm+pt	NA	Perm	pm+pt	NA	Perm	pm+pt	NA	Perm	pm+pt	NA	Perm
Protected Phases	1	6		5	2		7	4		3	8	
Permitted Phases	6		6	2		2	4		4	8		8
Detector Phase	1	6	6	5	2	2	7	4	4	3	8	8
Switch Phase												
Minimum Initial (s)	5.0	5.0	5.0	5.0	5.0	5.0	5.0	5.0	5.0	5.0	5.0	5.0
Minimum Split (s)	10.0	24.0	24.0	10.0	24.0	24.0	10.0	24.0	24.0	10.0	24.0	24.0
Total Split (s)	15.0	40.0	40.0	15.0	40.0	40.0	15.0	30.0	30.0	15.0	30.0	30.0
Total Split (%)	15.0%	40.0%	40.0%	15.0%	40.0%	40.0%	15.0%	30.0%	30.0%	15.0%	30.0%	30.0%
Yellow Time (s)	3.0	4.0	4.0	3.0	4.0	4.0	3.0	4.0	4.0	3.0	4.0	4.0
All-Red Time (s)	2.0	2.0	2.0	2.0	2.0	2.0	2.0	2.0	2.0	2.0	2.0	2.0
Lost Time Adjust (s)	0.0	0.0	0.0	0.0	0.0	0.0	0.0	0.0	0.0	0.0	0.0	0.0
Total Lost Time (s)	5.0	6.0	6.0	5.0	6.0	6.0	5.0	6.0	6.0	5.0	6.0	6.0
Lead/Lag	Lead	Lag	Lag	Lead	Lag	Lag	Lead	Lag	Lag	Lead	Lag	Lag
Lead-Lag Optimize?	Yes	Yes	Yes	Yes	Yes	Yes	Yes	Yes	Yes	Yes	Yes	Yes
Recall Mode	None	C-Max	C-Max	Max	C-Max	C-Max	None	Min	Min	None	Min	Min
Act Effct Green (s)	43.8	34.0	34.0	51.2	38.8	38.8	31.5	20.9	20.9	31.3	20.8	20.8
Actuated g/C Ratio	0.44	0.34	0.34	0.51	0.39	0.39	0.32	0.21	0.21	0.31	0.21	0.21
v/c Ratio	0.55	0.81	0.10	0.47	0.79	0.14	0.55	0.29	0.14	0.35	0.76	0.41
Control Delay	23.0	36.6	0.3	22.1	33.5	1.9	29.4	33.7	0.6	23.8	44.1	7.3
Queue Delay	0.0	0.0	0.0	0.0	0.0	0.0	0.0	0.0	0.0	0.0	0.0	0.0
Total Delay	23.0	36.6	0.3	22.1	33.5	1.9	29.4	33.7	0.6	23.8	44.1	7.3
LOS	C	D	A	C	C	A	C	C	A	C	D	A
Approach Delay		33.0			29.9			27.4			32.7	
Approach LOS		C			C			C			C	
Queue Length 50th (ft)	41	295	0	47	326	0	62	60	0	63	175	0
Queue Length 95th (ft)	80	376	0	108	#469	14	104	90	0	104	227	55
Internal Link Dist (ft)		548			642			667			525	
Turn Bay Length (ft)	150		150	150		150	150		150	150		150
Base Capacity (vph)	260	1203	631	313	1373	700	275	849	487	428	849	532
Starvation Cap Reductn	0	0	0	0	0	0	0	0	0	0	0	0
Spillback Cap Reductn	0	0	0	0	0	0	0	0	0	0	0	0
Storage Cap Reductn	0	0	0	0	0	0	0	0	0	0	0	0
Reduced v/c Ratio	0.50	0.81	0.10	0.47	0.79	0.14	0.53	0.25	0.13	0.34	0.66	0.38

Intersection Summary









Cycle Length: 100
 Actuated Cycle Length: 100
 Offset: 0 (0%), Referenced to phase 2:NWTL and 6:SETL, Start of Green, Master Intersection
 Natural Cycle: 75
 Control Type: Actuated-Coordinated

Timings
 1: Vollmer Road & Marksheffel Road

Background Traffic Volumes
 AM Peak Hour - Year 2040

Maximum v/c Ratio: 0.81
 Intersection Signal Delay: 31.2 Intersection LOS: C
 Intersection Capacity Utilization 74.2% ICU Level of Service D
 Analysis Period (min) 15
 # 95th percentile volume exceeds capacity, queue may be longer.
 Queue shown is maximum after two cycles.

Splits and Phases: 1: Vollmer Road & Marksheffel Road

 Ø1	 Ø2 (R)	 Ø3	 Ø4
15 s	40 s	15 s	30 s
 Ø5	 Ø6 (R)	 Ø7	 Ø8
15 s	40 s	15 s	30 s

Timings
1: Vollmer Road & Marksheffel Road

Background Traffic Volumes
PM Peak Hour - Year 2040

Lane Group	SEL	SET	SER	NWL	NWT	NWR	NEL	NET	NER	SWL	SWT	SWR
Lane Configurations												
Traffic Volume (vph)	290	990	120	201	792	202	192	601	150	152	339	290
Future Volume (vph)	290	990	120	201	792	202	192	601	150	152	339	290
Satd. Flow (prot)	1770	3539	1583	1770	3539	1583	1770	3539	1583	1770	3539	1583
Flt Permitted	0.176			0.093			0.338			0.189		
Satd. Flow (perm)	328	3539	1583	173	3539	1583	630	3539	1583	352	3539	1583
Satd. Flow (RTOR)			118			151			131			315
Lane Group Flow (vph)	315	1076	130	218	861	220	209	653	163	165	368	315
Turn Type	pm+pt	NA	Perm	pm+pt	NA	Perm	pm+pt	NA	Perm	pm+pt	NA	Perm
Protected Phases	1	6		5	2		7	4		3	8	
Permitted Phases	6		6	2		2	4		4	8		8
Detector Phase	1	6	6	5	2	2	7	4	4	3	8	8
Switch Phase												
Minimum Initial (s)	5.0	5.0	5.0	5.0	5.0	5.0	5.0	5.0	5.0	5.0	5.0	5.0
Minimum Split (s)	10.0	24.0	24.0	10.0	24.0	24.0	10.0	24.0	24.0	10.0	24.0	24.0
Total Split (s)	25.0	50.0	50.0	20.0	45.0	45.0	20.0	35.0	35.0	15.0	30.0	30.0
Total Split (%)	20.8%	41.7%	41.7%	16.7%	37.5%	37.5%	16.7%	29.2%	29.2%	12.5%	25.0%	25.0%
Yellow Time (s)	3.0	4.0	4.0	3.0	4.0	4.0	3.0	4.0	4.0	3.0	4.0	4.0
All-Red Time (s)	2.0	2.0	2.0	2.0	2.0	2.0	2.0	2.0	2.0	2.0	2.0	2.0
Lost Time Adjust (s)	0.0	0.0	0.0	0.0	0.0	0.0	0.0	0.0	0.0	0.0	0.0	0.0
Total Lost Time (s)	5.0	6.0	6.0	5.0	6.0	6.0	5.0	6.0	6.0	5.0	6.0	6.0
Lead/Lag	Lead	Lag	Lag	Lead	Lag	Lag	Lead	Lag	Lag	Lead	Lag	Lag
Lead-Lag Optimize?	Yes	Yes	Yes	Yes	Yes	Yes	Yes	Yes	Yes	Yes	Yes	Yes
Recall Mode	None	C-Max	C-Max	Max	C-Max	C-Max	None	Min	Min	None	Min	Min
Act Effct Green (s)	63.2	44.0	44.0	60.7	43.3	43.3	41.4	26.6	26.6	33.5	22.6	22.6
Actuated g/C Ratio	0.53	0.37	0.37	0.51	0.36	0.36	0.34	0.22	0.22	0.28	0.19	0.19
v/c Ratio	0.81	0.83	0.20	0.68	0.67	0.33	0.60	0.83	0.36	0.77	0.55	0.57
Control Delay	34.6	41.3	6.5	40.0	36.7	11.6	35.6	54.7	12.4	52.4	47.4	8.9
Queue Delay	0.0	0.0	0.0	0.0	0.0	0.0	0.0	0.0	0.0	0.0	0.0	0.0
Total Delay	34.6	41.3	6.5	40.0	36.7	11.6	35.6	54.7	12.4	52.4	47.4	8.9
LOS	C	D	A	D	D	B	D	D	B	D	D	A
Approach Delay		36.9			33.0			44.0			34.1	
Approach LOS		D			C			D			C	
Queue Length 50th (ft)	127	395	6	114	310	37	115	252	20	89	136	0
Queue Length 95th (ft)	#251	485	47	#238	388	102	177	318	77	#168	185	79
Internal Link Dist (ft)		573			633			652			528	
Turn Bay Length (ft)	150		150	150		150	150		150	150		150
Base Capacity (vph)	420	1297	655	320	1277	667	365	855	481	216	707	568
Starvation Cap Reductn	0	0	0	0	0	0	0	0	0	0	0	0
Spillback Cap Reductn	0	0	0	0	0	0	0	0	0	0	0	0
Storage Cap Reductn	0	0	0	0	0	0	0	0	0	0	0	0
Reduced v/c Ratio	0.75	0.83	0.20	0.68	0.67	0.33	0.57	0.76	0.34	0.76	0.52	0.55

Intersection Summary









Cycle Length: 120
 Actuated Cycle Length: 120
 Offset: 0 (0%), Referenced to phase 2:NWTL and 6:SETL, Start of Green, Master Intersection
 Natural Cycle: 80
 Control Type: Actuated-Coordinated

Timings
 1: Vollmer Road & Marksheffel Road

Background Traffic Volumes
 PM Peak Hour - Year 2040

Maximum v/c Ratio: 0.83
 Intersection Signal Delay: 36.9 Intersection LOS: D
 Intersection Capacity Utilization 81.9% ICU Level of Service D
 Analysis Period (min) 15
 # 95th percentile volume exceeds capacity, queue may be longer.
 Queue shown is maximum after two cycles.

Splits and Phases: 1: Vollmer Road & Marksheffel Road

 Ø1	 45 s	 Ø3	 Ø4
25 s		15 s	35 s
 Ø5	 Ø6 (R)	 Ø7	 Ø8
20 s	50 s	20 s	30 s

HCM 6th TWSC
1: Vollmer Road & Marksheffel Road

Total Traffic Volumes
AM Peak Hour - Year 2027

Intersection												
Int Delay, s/veh	83.7											
Movement	SEL	SET	SER	NWL	NWT	NWR	NEL	NET	NER	SWL	SWT	SWR
Lane Configurations	↘	↑	↗	↘	↑	↗	↘	↑	↗	↘	↑↑	↗
Traffic Vol, veh/h	22	0	124	331	0	106	39	225	122	118	391	7
Future Vol, veh/h	22	0	124	331	0	106	39	225	122	118	391	7
Conflicting Peds, #/hr	0	0	0	0	0	0	0	0	0	0	0	0
Sign Control	Stop	Stop	Stop	Stop	Stop	Stop	Free	Free	Free	Free	Free	Free
RT Channelized	-	-	None	-	-	None	-	-	None	-	-	None
Storage Length	235	-	235	235	-	235	235	-	150	150	-	235
Veh in Median Storage, #	-	0	-	-	0	-	-	0	-	-	0	-
Grade, %	-	0	-	-	0	-	-	0	-	-	0	-
Peak Hour Factor	92	92	92	92	92	92	92	92	92	92	92	92
Heavy Vehicles, %	2	2	2	2	2	2	2	2	2	2	2	2
Mvmt Flow	24	0	135	360	0	115	42	245	133	128	425	8

Major/Minor	Minor2		Minor1		Major1			Major2				
Conflicting Flow All	1134	1143	213	798	1018	245	433	0	0	378	0	0
Stage 1	681	681	-	329	329	-	-	-	-	-	-	-
Stage 2	453	462	-	469	689	-	-	-	-	-	-	-
Critical Hdwy	7.33	6.53	6.93	7.33	6.53	6.23	4.13	-	-	4.13	-	-
Critical Hdwy Stg 1	6.53	5.53	-	6.13	5.53	-	-	-	-	-	-	-
Critical Hdwy Stg 2	6.13	5.53	-	6.53	5.53	-	-	-	-	-	-	-
Follow-up Hdwy	3.519	4.019	3.319	3.519	4.019	3.319	2.219	-	-	2.219	-	-
Pot Cap-1 Maneuver	168	199	793	~290	237	793	1125	-	-	1179	-	-
Stage 1	407	449	-	683	646	-	-	-	-	-	-	-
Stage 2	585	564	-	545	446	-	-	-	-	-	-	-
Platoon blocked, %								-	-	-	-	-
Mov Cap-1 Maneuver	128	171	793	~215	203	793	1125	-	-	1179	-	-
Mov Cap-2 Maneuver	128	171	-	~215	203	-	-	-	-	-	-	-
Stage 1	392	400	-	658	622	-	-	-	-	-	-	-
Stage 2	481	543	-	403	397	-	-	-	-	-	-	-

Approach	SE		NW		NE		SW	
HCM Control Delay, s	14.9		276.6		0.8		1.9	
HCM LOS	B		F					

Minor Lane/Major Mvmt	NEL	NET	NERNWLn1	NWLn2	NWLn3	SELn1	SELn2	SELn3	SWL	SWT	SWR	
Capacity (veh/h)	1125	-	-	215	-	793	128	-	793	1179	-	-
HCM Lane V/C Ratio	0.038	-	-	1.673	-	0.145	0.187	-	0.17	0.109	-	-
HCM Control Delay (s)	8.3	-	-	\$361.9	0	10.3	39.5	0	10.5	8.4	-	-
HCM Lane LOS	A	-	-	F	A	B	E	A	B	A	-	-
HCM 95th %tile Q(veh)	0.1	-	-	23.8	-	0.5	0.7	-	0.6	0.4	-	-

Notes
 ~: Volume exceeds capacity \$: Delay exceeds 300s +: Computation Not Defined *: All major volume in platoon

HCM 6th TWSC
2: Brush Top Road & Marksheffel Road

Total Traffic Volumes
AM Peak Hour - Year 2027

Intersection						
Int Delay, s/veh	8.5					
Movement	EBT	EBR	WBL	WBT	NBL	NBR
Lane Configurations	↗		↖	↑	↖	↗
Traffic Vol, veh/h	0	0	46	0	0	146
Future Vol, veh/h	0	0	46	0	0	146
Conflicting Peds, #/hr	0	0	0	0	0	0
Sign Control	Free	Free	Free	Free	Stop	Stop
RT Channelized	-	None	-	None	-	None
Storage Length	-	-	235	-	155	0
Veh in Median Storage, #	0	-	-	0	0	-
Grade, %	0	-	-	0	0	-
Peak Hour Factor	92	92	92	92	92	92
Heavy Vehicles, %	2	2	2	2	2	2
Mvmt Flow	0	0	50	0	0	159

Major/Minor	Major1	Major2	Minor1		
Conflicting Flow All	0	0	1	0	101
Stage 1	-	-	-	-	1
Stage 2	-	-	-	-	100
Critical Hdwy	-	-	4.12	-	6.42
Critical Hdwy Stg 1	-	-	-	-	5.42
Critical Hdwy Stg 2	-	-	-	-	5.42
Follow-up Hdwy	-	-	2.218	-	3.518
Pot Cap-1 Maneuver	-	-	1622	-	898
Stage 1	-	-	-	-	1022
Stage 2	-	-	-	-	924
Platoon blocked, %	-	-	-	-	-
Mov Cap-1 Maneuver	-	-	1622	-	870
Mov Cap-2 Maneuver	-	-	-	-	814
Stage 1	-	-	-	-	1022
Stage 2	-	-	-	-	895

Approach	EB	WB	NB
HCM Control Delay, s	0	7.3	8.9
HCM LOS			A

Minor Lane/Major Mvmt	NBLn1	NBLn2	EBT	EBR	WBL	WBT
Capacity (veh/h)	-	1084	-	-	1622	-
HCM Lane V/C Ratio	-	0.146	-	-	0.031	-
HCM Control Delay (s)	0	8.9	-	-	7.3	-
HCM Lane LOS	A	A	-	-	A	-
HCM 95th %tile Q(veh)	-	0.5	-	-	0.1	-

HCM 6th TWSC
1: Vollmer Road & Marksheffel Road

Total Traffic Volumes
PM Peak Hour - Year 2027

Intersection												
Int Delay, s/veh	110.8											
Movement	SEL	SET	SER	NWL	NWT	NWR	NEL	NET	NER	SWL	SWT	SWR
Lane Configurations	↙	↑	↗	↙	↑	↗	↙	↑	↗	↙	↑↑	↗
Traffic Vol, veh/h	14	0	77	237	0	149	131	440	139	135	313	23
Future Vol, veh/h	14	0	77	237	0	149	131	440	139	135	313	23
Conflicting Peds, #/hr	0	0	0	0	0	0	0	0	0	0	0	0
Sign Control	Stop	Stop	Stop	Stop	Stop	Stop	Free	Free	Free	Free	Free	Free
RT Channelized	-	-	None	-	-	None	-	-	None	-	-	None
Storage Length	235	-	235	235	-	235	235	-	150	150	-	235
Veh in Median Storage, #	-	0	-	-	0	-	-	0	-	-	0	-
Grade, %	-	0	-	-	0	-	-	0	-	-	0	-
Peak Hour Factor	92	92	92	92	92	92	92	92	92	92	92	92
Heavy Vehicles, %	2	2	2	2	2	2	2	2	2	2	2	2
Mvmt Flow	15	0	84	258	0	162	142	478	151	147	340	25

Major/Minor	Minor2		Minor1		Major1		Major2					
Conflicting Flow All	1553	1547	170	1226	1421	478	365	0	0	629	0	0
Stage 1	634	634	-	762	762	-	-	-	-	-	-	-
Stage 2	919	913	-	464	659	-	-	-	-	-	-	-
Critical Hdwy	7.33	6.53	6.93	7.33	6.53	6.23	4.13	-	-	4.13	-	-
Critical Hdwy Stg 1	6.53	5.53	-	6.13	5.53	-	-	-	-	-	-	-
Critical Hdwy Stg 2	6.13	5.53	-	6.53	5.53	-	-	-	-	-	-	-
Follow-up Hdwy	3.519	4.019	3.319	3.519	4.019	3.319	2.219	-	-	2.219	-	-
Pot Cap-1 Maneuver	84	114	845	~ 145	136	586	1192	-	-	951	-	-
Stage 1	435	472	-	396	413	-	-	-	-	-	-	-
Stage 2	324	351	-	548	460	-	-	-	-	-	-	-
Platoon blocked, %	-	-	-	-	-	-	-	-	-	-	-	-
Mov Cap-1 Maneuver	49	85	845	~ 105	101	586	1192	-	-	951	-	-
Mov Cap-2 Maneuver	49	85	-	~ 105	101	-	-	-	-	-	-	-
Stage 1	383	399	-	349	364	-	-	-	-	-	-	-
Stage 2	207	309	-	417	389	-	-	-	-	-	-	-

Approach	SE	NW	NE	SW
HCM Control Delay, s	24.9	\$ 463.7	1.6	2.7
HCM LOS	C	F		

Minor Lane/Major Mvmt	NEL	NET	NERNWLn1	NWLn1	NWLn2	NWLn3	SELn1	SELn2	SELn3	SWL	SWT	SWR
Capacity (veh/h)	1192	-	-	105	-	586	49	-	845	951	-	-
HCM Lane V/C Ratio	0.119	-	-	2.453	-	0.276	0.311	-	0.099	0.154	-	-
HCM Control Delay (s)	8.4	-	-	\$ 746.8	0	13.5	108.6	0	9.7	9.5	-	-
HCM Lane LOS	A	-	-	F	A	B	F	A	A	A	-	-
HCM 95th %tile Q(veh)	0.4	-	-	23.2	-	1.1	1.1	-	0.3	0.5	-	-

Notes
 ~: Volume exceeds capacity \$: Delay exceeds 300s +: Computation Not Defined *: All major volume in platoon

HCM 6th TWSC
2: Brush Top Road & Marksheffel Road

Total Traffic Volumes
PM Peak Hour - Year 2027

Intersection						
Int Delay, s/veh	7.9					
Movement	EBT	EBR	WBL	WBT	NBL	NBR
Lane Configurations	↗		↖	↑	↖	↗
Traffic Vol, veh/h	0	0	154	0	0	91
Future Vol, veh/h	0	0	154	0	0	91
Conflicting Peds, #/hr	0	0	0	0	0	0
Sign Control	Free	Free	Free	Free	Stop	Stop
RT Channelized	-	None	-	None	-	None
Storage Length	-	-	235	-	155	0
Veh in Median Storage, #	0	-	-	0	0	-
Grade, %	0	-	-	0	0	-
Peak Hour Factor	92	92	92	92	92	92
Heavy Vehicles, %	2	2	2	2	2	2
Mvmt Flow	0	0	167	0	0	99

























Major/Minor	Major1	Major2	Minor1		
Conflicting Flow All	0	0	1	0	335
Stage 1	-	-	-	-	1
Stage 2	-	-	-	-	334
Critical Hdwy	-	-	4.12	-	6.42
Critical Hdwy Stg 1	-	-	-	-	5.42
Critical Hdwy Stg 2	-	-	-	-	5.42
Follow-up Hdwy	-	-	2.218	-	3.518
Pot Cap-1 Maneuver	-	-	1622	-	660
Stage 1	-	-	-	-	1022
Stage 2	-	-	-	-	725
Platoon blocked, %	-	-	-	-	-
Mov Cap-1 Maneuver	-	-	1622	-	592
Mov Cap-2 Maneuver	-	-	-	-	587
Stage 1	-	-	-	-	1022
Stage 2	-	-	-	-	650

Approach	EB	WB	NB
HCM Control Delay, s	0	7.5	8.7
HCM LOS			A

Minor Lane/Major Mvmt	NBLn1	NBLn2	EBT	EBR	WBL	WBT
Capacity (veh/h)	-	1084	-	-	1622	-
HCM Lane V/C Ratio	-	0.091	-	-	0.103	-
HCM Control Delay (s)	0	8.7	-	-	7.5	-
HCM Lane LOS	A	A	-	-	A	-
HCM 95th %tile Q(veh)	-	0.3	-	-	0.3	-

Timings
1: Vollmer Road & Marksheffel Road

Total Traffic Volumes
AM Peak Hour - Year 2040

												
Lane Group	SEL	SET	SER	NWL	NWT	NWR	NEL	NET	NER	SWL	SWT	SWR
Lane Configurations												
Traffic Volume (vph)	129	1052	70	135	1047	90	137	197	56	135	513	188
Future Volume (vph)	129	1052	70	135	1047	90	137	197	56	135	513	188
Satd. Flow (prot)	1770	3539	1583	1770	3539	1583	1770	3539	1583	1770	3539	1583
Flt Permitted	0.118			0.103			0.241			0.618		
Satd. Flow (perm)	220	3539	1583	192	3539	1583	449	3539	1583	1151	3539	1583
Satd. Flow (RTOR)			142			142			142			204
Lane Group Flow (vph)	140	1143	76	147	1138	98	149	214	61	147	558	204
Turn Type	pm+pt	NA	Perm	pm+pt	NA	Perm	pm+pt	NA	Perm	pm+pt	NA	Perm
Protected Phases	1	6		5	2		7	4		3	8	
Permitted Phases	6		6	2		2	4		4	8		8
Detector Phase	1	6	6	5	2	2	7	4	4	3	8	8
Switch Phase												
Minimum Initial (s)	5.0	5.0	5.0	5.0	5.0	5.0	5.0	5.0	5.0	5.0	5.0	5.0
Minimum Split (s)	10.0	24.0	24.0	10.0	24.0	24.0	10.0	24.0	24.0	10.0	24.0	24.0
Total Split (s)	15.0	40.0	40.0	15.0	40.0	40.0	15.0	30.0	30.0	15.0	30.0	30.0
Total Split (%)	15.0%	40.0%	40.0%	15.0%	40.0%	40.0%	15.0%	30.0%	30.0%	15.0%	30.0%	30.0%
Yellow Time (s)	3.0	4.0	4.0	3.0	4.0	4.0	3.0	4.0	4.0	3.0	4.0	4.0
All-Red Time (s)	2.0	2.0	2.0	2.0	2.0	2.0	2.0	2.0	2.0	2.0	2.0	2.0
Lost Time Adjust (s)	0.0	0.0	0.0	0.0	0.0	0.0	0.0	0.0	0.0	0.0	0.0	0.0
Total Lost Time (s)	5.0	6.0	6.0	5.0	6.0	6.0	5.0	6.0	6.0	5.0	6.0	6.0
Lead/Lag	Lead	Lag	Lag	Lead	Lag	Lag	Lead	Lag	Lag	Lead	Lag	Lag
Lead-Lag Optimize?	Yes	Yes	Yes	Yes	Yes	Yes	Yes	Yes	Yes	Yes	Yes	Yes
Recall Mode	None	C-Max	C-Max	Max	C-Max	C-Max	None	Min	Min	None	Min	Min
Act Effct Green (s)	43.9	34.0	34.0	51.1	38.6	38.6	31.5	20.9	20.9	31.3	20.8	20.8
Actuated g/C Ratio	0.44	0.34	0.34	0.51	0.39	0.39	0.32	0.21	0.21	0.31	0.21	0.21
v/c Ratio	0.60	0.95	0.12	0.47	0.83	0.14	0.56	0.29	0.14	0.35	0.76	0.42
Control Delay	26.1	49.4	0.4	22.1	35.7	1.9	29.7	33.7	0.6	23.8	44.1	7.3
Queue Delay	0.0	0.0	0.0	0.0	0.0	0.0	0.0	0.0	0.0	0.0	0.0	0.0
Total Delay	26.1	49.4	0.4	22.1	35.7	1.9	29.7	33.7	0.6	23.8	44.1	7.3
LOS	C	D	A	C	D	A	C	C	A	C	D	A
Approach Delay		44.3			31.8			27.5			32.6	
Approach LOS		D			C			C			C	
Queue Length 50th (ft)	44	370	0	47	351	0	64	60	0	63	175	0
Queue Length 95th (ft)	94	#510	2	108	#507	14	105	90	0	104	227	56
Internal Link Dist (ft)		1526			642			667			525	
Turn Bay Length (ft)	150		150	150		150	150		150	150		150
Base Capacity (vph)	255	1203	631	312	1367	698	275	849	487	428	849	534
Starvation Cap Reductn	0	0	0	0	0	0	0	0	0	0	0	0
Spillback Cap Reductn	0	0	0	0	0	0	0	0	0	0	0	0
Storage Cap Reductn	0	0	0	0	0	0	0	0	0	0	0	0
Reduced v/c Ratio	0.55	0.95	0.12	0.47	0.83	0.14	0.54	0.25	0.13	0.34	0.66	0.38

Intersection Summary









Cycle Length: 100
 Actuated Cycle Length: 100
 Offset: 0 (0%), Referenced to phase 2:NWTL and 6:SETL, Start of Green, Master Intersection
 Natural Cycle: 75
 Control Type: Actuated-Coordinated

Timings
 1: Vollmer Road & Marksheffel Road

Total Traffic Volumes
 AM Peak Hour - Year 2040

Maximum v/c Ratio: 0.95
 Intersection Signal Delay: 35.7 Intersection LOS: D
 Intersection Capacity Utilization 76.7% ICU Level of Service D
 Analysis Period (min) 15
 # 95th percentile volume exceeds capacity, queue may be longer.
 Queue shown is maximum after two cycles.

Splits and Phases: 1: Vollmer Road & Marksheffel Road

 Ø1	 Ø2 (R)	 Ø3	 Ø4
15 s	40 s	15 s	30 s
 Ø5	 Ø6 (R)	 Ø7	 Ø8
15 s	40 s	15 s	30 s

HCM 6th TWSC
2: Brush Top Road & Marksheffel Road

Total Traffic Volumes
AM Peak Hour - Year 2040

Intersection						
Int Delay, s/veh	6.6					
Movement	EBT	EBR	WBL	WBT	NBL	NBR
Lane Configurations	↑↑	↑	↓	↑↑	↓	↑
Traffic Vol, veh/h	1080	15	54	1319	46	171
Future Vol, veh/h	1080	15	54	1319	46	171
Conflicting Peds, #/hr	0	0	0	0	0	0
Sign Control	Free	Free	Free	Free	Stop	Stop
RT Channelized	-	None	-	None	-	None
Storage Length	-	235	235	-	155	0
Veh in Median Storage, #	0	-	-	0	0	-
Grade, %	0	-	-	0	0	-
Peak Hour Factor	92	92	92	92	92	92
Heavy Vehicles, %	2	2	2	2	2	2
Mvmt Flow	1174	16	59	1434	50	186

Major/Minor	Major1	Major2	Minor1	Minor2	Minor3
Conflicting Flow All	0	0	1190	0	2009
Stage 1	-	-	-	-	1174
Stage 2	-	-	-	-	835
Critical Hdwy	-	-	4.14	-	6.84
Critical Hdwy Stg 1	-	-	-	-	5.84
Critical Hdwy Stg 2	-	-	-	-	5.84
Follow-up Hdwy	-	-	2.22	-	3.52
Pot Cap-1 Maneuver	-	-	582	-	51
Stage 1	-	-	-	-	256
Stage 2	-	-	-	-	386
Platoon blocked, %	-	-	-	-	-
Mov Cap-1 Maneuver	-	-	582	-	~ 46
Mov Cap-2 Maneuver	-	-	-	-	~ 46
Stage 1	-	-	-	-	256
Stage 2	-	-	-	-	347

























Approach	EB	WB	NB
HCM Control Delay, s	0	0.5	78
HCM LOS			F

Minor Lane/Major Mvmt	NBLn1	NBLn2	EBT	EBR	WBL	WBT
Capacity (veh/h)	46	453	-	-	582	-
HCM Lane V/C Ratio	1.087	0.41	-	-	0.101	-
HCM Control Delay (s)	299.5	18.4	-	-	11.9	-
HCM Lane LOS	F	C	-	-	B	-
HCM 95th %tile Q(veh)	4.6	2	-	-	0.3	-

Notes
~: Volume exceeds capacity \$: Delay exceeds 300s +: Computation Not Defined *: All major volume in platoon

Timings
1: Vollmer Road & Marksheffel Road

Total Traffic Volumes
PM Peak Hour - Year 2040









												
Lane Group	SEL	SET	SER	NWL	NWT	NWR	NEL	NET	NER	SWL	SWT	SWR
Lane Configurations												
Traffic Volume (vph)	295	1087	125	201	955	202	201	601	150	152	339	299
Future Volume (vph)	295	1087	125	201	955	202	201	601	150	152	339	299
Satd. Flow (prot)	1770	3539	1583	1770	3539	1583	1770	3539	1583	1770	3539	1583
Flt Permitted	0.091			0.096			0.333			0.190		
Satd. Flow (perm)	170	3539	1583	179	3539	1583	620	3539	1583	354	3539	1583
Satd. Flow (RTOR)			118			125			131			309
Lane Group Flow (vph)	321	1182	136	218	1038	220	218	653	163	165	368	325
Turn Type	pm+pt	NA	Perm	pm+pt	NA	Perm	pm+pt	NA	Perm	pm+pt	NA	Perm
Protected Phases	1	6		5	2		7	4		3	8	
Permitted Phases	6		6	2		2	4		4	8		8
Detector Phase	1	6	6	5	2	2	7	4	4	3	8	8
Switch Phase												
Minimum Initial (s)	5.0	5.0	5.0	5.0	5.0	5.0	5.0	5.0	5.0	5.0	5.0	5.0
Minimum Split (s)	10.0	24.0	24.0	10.0	24.0	24.0	10.0	24.0	24.0	10.0	24.0	24.0
Total Split (s)	25.0	50.0	50.0	20.0	45.0	45.0	20.0	35.0	35.0	15.0	30.0	30.0
Total Split (%)	20.8%	41.7%	41.7%	16.7%	37.5%	37.5%	16.7%	29.2%	29.2%	12.5%	25.0%	25.0%
Yellow Time (s)	3.0	4.0	4.0	3.0	4.0	4.0	3.0	4.0	4.0	3.0	4.0	4.0
All-Red Time (s)	2.0	2.0	2.0	2.0	2.0	2.0	2.0	2.0	2.0	2.0	2.0	2.0
Lost Time Adjust (s)	0.0	0.0	0.0	0.0	0.0	0.0	0.0	0.0	0.0	0.0	0.0	0.0
Total Lost Time (s)	5.0	6.0	6.0	5.0	6.0	6.0	5.0	6.0	6.0	5.0	6.0	6.0
Lead/Lag	Lead	Lag	Lag	Lead	Lag	Lag	Lead	Lag	Lag	Lead	Lag	Lag
Lead-Lag Optimize?	Yes	Yes	Yes	Yes	Yes	Yes	Yes	Yes	Yes	Yes	Yes	Yes
Recall Mode	None	C-Max	C-Max	Max	C-Max	C-Max	None	Min	Min	None	Min	Min
Act Effct Green (s)	64.7	44.0	44.0	60.0	41.8	41.8	41.6	26.6	26.6	33.3	22.4	22.4
Actuated g/C Ratio	0.54	0.37	0.37	0.50	0.35	0.35	0.35	0.22	0.22	0.28	0.19	0.19
v/c Ratio	0.91	0.91	0.21	0.68	0.84	0.35	0.62	0.83	0.36	0.77	0.56	0.59
Control Delay	61.9	47.7	7.1	39.7	44.4	14.8	36.5	54.7	12.4	52.3	47.6	10.6
Queue Delay	0.0	0.0	0.0	0.0	0.0	0.0	0.0	0.0	0.0	0.0	0.0	0.0
Total Delay	61.9	47.7	7.1	39.7	44.4	14.8	36.5	54.7	12.4	52.3	47.6	10.6
LOS	E	D	A	D	D	B	D	D	B	D	D	B
Approach Delay		47.1			39.3			44.2			34.5	
Approach LOS		D			D			D			C	
Queue Length 50th (ft)	188	454	9	112	402	53	121	252	20	89	136	10
Queue Length 95th (ft)	#359	#588	51	#234	#525	120	185	318	77	#168	185	94
Internal Link Dist (ft)		1516			633			652			528	
Turn Bay Length (ft)	150		150	150		150	150		150	150		150
Base Capacity (vph)	365	1297	655	321	1232	632	363	855	481	216	707	563
Starvation Cap Reductn	0	0	0	0	0	0	0	0	0	0	0	0
Spillback Cap Reductn	0	0	0	0	0	0	0	0	0	0	0	0
Storage Cap Reductn	0	0	0	0	0	0	0	0	0	0	0	0
Reduced v/c Ratio	0.88	0.91	0.21	0.68	0.84	0.35	0.60	0.76	0.34	0.76	0.52	0.58
Intersection Summary												
Cycle Length: 120												
Actuated Cycle Length: 120												
Offset: 0 (0%), Referenced to phase 2:NWTL and 6:SETL, Start of Green, Master Intersection												
Natural Cycle: 90												
Control Type: Actuated-Coordinated												

Timings
 1: Vollmer Road & Marksheffel Road

Total Traffic Volumes
 PM Peak Hour - Year 2040

Maximum v/c Ratio: 0.91
 Intersection Signal Delay: 42.0 Intersection LOS: D
 Intersection Capacity Utilization 86.1% ICU Level of Service E
 Analysis Period (min) 15
 # 95th percentile volume exceeds capacity, queue may be longer.
 Queue shown is maximum after two cycles.

Splits and Phases: 1: Vollmer Road & Marksheffel Road

 Ø1	 45 s	 Ø3	 Ø4
25 s		15 s	35 s
 Ø5	 Ø6 (R)	 Ø7	 Ø8
20 s	50 s	20 s	30 s

HCM 6th TWSC
2: Brush Top Road & Marksheffel Road

Total Traffic Volumes
PM Peak Hour - Year 2040

Intersection						
Int Delay, s/veh	15.6					
Movement	EBT	EBR	WBL	WBT	NBL	NBR
Lane Configurations	↑↑	↑	↓	↑↑	↓	↑
Traffic Vol, veh/h	1400	48	181	1274	28	107
Future Vol, veh/h	1400	48	181	1274	28	107
Conflicting Peds, #/hr	0	0	0	0	0	0
Sign Control	Free	Free	Free	Free	Stop	Stop
RT Channelized	-	None	-	None	-	None
Storage Length	-	235	235	-	155	0
Veh in Median Storage, #	0	-	-	0	0	-
Grade, %	0	-	-	0	0	-
Peak Hour Factor	92	92	92	92	92	92
Heavy Vehicles, %	2	2	2	2	2	2
Mvmt Flow	1522	52	197	1385	30	116

Major/Minor	Major1	Major2	Minor1			
Conflicting Flow All	0	0	1574	0	2609	761
Stage 1	-	-	-	-	1522	-
Stage 2	-	-	-	-	1087	-
Critical Hdwy	-	-	4.14	-	6.84	6.94
Critical Hdwy Stg 1	-	-	-	-	5.84	-
Critical Hdwy Stg 2	-	-	-	-	5.84	-
Follow-up Hdwy	-	-	2.22	-	3.52	3.32
Pot Cap-1 Maneuver	-	-	415	-	~ 20	348
Stage 1	-	-	-	-	166	-
Stage 2	-	-	-	-	285	-
Platoon blocked, %	-	-	-	-	-	-
Mov Cap-1 Maneuver	-	-	415	-	~ 11	348
Mov Cap-2 Maneuver	-	-	-	-	~ 11	-
Stage 1	-	-	-	-	166	-
Stage 2	-	-	-	-	150	-

Approach	EB	WB	NB
HCM Control Delay, s	0	2.6	\$ 323.6
HCM LOS			F

Minor Lane/Major Mvmt	NBLn1	NBLn2	EBT	EBR	WBL	WBT
Capacity (veh/h)	11	348	-	-	415	-
HCM Lane V/C Ratio	2.767	0.334	-	-	0.474	-
HCM Control Delay (s)	\$ 1481.8	20.5	-	-	21.3	-
HCM Lane LOS	F	C	-	-	C	-
HCM 95th %tile Q(veh)	4.8	1.4	-	-	2.5	-

Notes
~: Volume exceeds capacity \$: Delay exceeds 300s +: Computation Not Defined *: All major volume in platoon

File Attachment (1)



Subject: File Attachment
Page Label: 2
Author: Carlos
Date: 11/3/2022 4:37:48 PM
Status:
Color: ■
Layer:
Space:

Highlight (1)



Subject: Highlight
Page Label: 4
Author: Carlos
Date: 11/8/2022 11:18:31 AM
Status:
Color: ■
Layer:
Space:

One full-movement access serving as the west leg of the Vollmer Road

Text Box (22)



Subject: Text Box
Page Label: 8
Author: CDurham
Date: 11/14/2022 3:19:41 PM
Status:
Color: ■
Layer:
Space:

Update section describing Marksheffel Road. It will be per city criteria, as city will be taking ownership. Marksheffel Road must be consistent with the approved cross-section east of Vollmer Road. "68' wide pavement mat, four 11' thru lanes, 12' center turn lane, two 6' shoulders, 10' trail on south of Marksheffel and 6' sidewalk on north of Marksheffel."

r 2027

Subject: Text Box
Page Label: 15
Author: CDurham
Date: 11/14/2022 3:30:45 PM
Status:
Color: ■
Layer:
Space:

2027

ed for crit
r 2027
itions

Subject: Text Box
Page Label: 26
Author: CDurham
Date: 11/14/2022 3:39:42 PM
Status:
Color: ■
Layer:
Space:

2027

MI Peak r
al 2040 b

Subject: Text Box
Page Label: 26
Author: CDurham
Date: 11/14/2022 3:39:54 PM
Status:
Color: ■
Layer:
Space:

2040

TRAFFIC C
2040

Subject: Text Box
Page Label: 26
Author: CDurham
Date: 11/14/2022 3:40:03 PM
Status:
Color: ■
Layer:
Space:

2040

ATIONS FOR
2027

Subject: Text Box
Page Label: 26
Author: CDurham
Date: 11/14/2022 3:40:09 PM
Status:
Color: ■
Layer:
Space:

2027

2027 b
with Mark

Subject: Text Box
Page Label: 26
Author: CDurham
Date: 11/14/2022 3:40:21 PM
Status:
Color: ■
Layer:
Space:

2027

2040 a
offal Doc

Subject: Text Box
Page Label: 26
Author: CDurham
Date: 11/14/2022 3:41:43 PM
Status:
Color: ■
Layer:
Space:

2040

Illmer KOE
2040)e
r during n

Subject: Text Box
Page Label: 26
Author: CDurham
Date: 11/14/2022 3:42:13 PM
Status:
Color: ■
Layer:
Space:

2040

Per ECM Section B.2.4.A include discussion on safety and accident analysis

Subject: Text Box
Page Label: 27
Author: CDurham
Date: 11/14/2022 3:44:24 PM
Status:
Color: ■
Layer:
Space:

Per ECM Section B.2.4.A include discussion on safety and accident analysis

Table of Contents

- 1 Introduction
- 2 Project Overview
- 3 Study Area
- 4 Planning and Land Use

Subject: Text Box
Page Label: 2
Author: Carlos
Date: 11/14/2022 4:25:53 PM
Status:
Color: ■
Layer:
Space:

Provide signature blocks for design engineer and developer. See attached document for example.

Legacy Peak Elementary and The Center for Modern Learning is within 2 miles of the property's boundary. Per ECM Appendix B.4 school routing plans shall be developed per the MUTCD between the project and school. Include all schools within 2 miles of the property's boundary.

Subject: Text Box
Page Label: 27
Author: Carlos
Date: 11/14/2022 4:27:49 PM
Status:
Color: ■
Layer:
Space:

Legacy Peak Elementary and The Center for Modern Learning is within 2 miles of the property's boundary. Per ECM Appendix B.4 school routing plans shall be developed per the MUTCD between the project and school. Include all schools within 2 miles of the property's boundary.

September 2022
Add "PCD File No. P-22-022"

Subject: Text Box
Page Label: 1
Author: Carlos
Date: 11/3/2022 4:36:58 PM
Status:
Color: ■
Layer:
Space:

Add "PCD File No. P-22-022"

September 2022
Discuss dedication of right-of-way for Vollmer Road.
will accommodate traffic to and from Tahiti Drive, and Marksheffel Road. A 40 Major Transportation Corridors Plan

Subject: Text Box
Page Label: 8
Author: Carlos
Date: 11/7/2022 4:21:45 PM
Status:
Color: ■
Layer:
Space:

Discuss dedication of right-of-way for Vollmer Road.

Provide a cost breakdown for applicable Road Impact Fees. State the developer's choice for payment.

Subject: Text Box
Page Label: 27
Author: Carlos
Date: 11/8/2022 1:40:32 PM
Status:
Color: ■
Layer:
Space:

Provide a cost breakdown for applicable Road Impact Fees. State the developer's choice for payment.

Discuss the need for an exclusive left turn lane on Vollmer Road northbound.

Subject: Text Box
Page Label: 20
Author: Carlos
Date: 11/8/2022 1:54:36 PM
Status:
Color: ■
Layer:
Space:

Discuss the need for an exclusive left turn lane on Vollmer Road northbound.



Subject: Text Box
Page Label: 20
Author: Carlos
Date: 11/8/2022 1:56:01 PM
Status:
Color: ■
Layer:
Space:

List ECM criteria for stacking, storage, and taper for every affected auxiliary lane and access. State whether criteria can be met, if criteria cannot be met state that and provide modifications to meet criteria.



Subject: Text Box
Page Label: 27
Author: Carlos
Date: 11/8/2022 1:57:49 PM
Status:
Color: ■
Layer:
Space:

State whether any of the proposed improvements are reimbursable under the current Major Transportation Corridor Plan (MTCP).

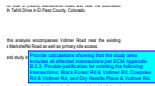

Subject: Text Box
Page Label: 4
Author: Carlos
Date: 11/8/2022 11:12:56 AM
Status:
Color: ■
Layer:
Space:

Provide calculations showing that the study area includes all affected intersections per ECM Appendix B.2.3. Provide justification for omitting the following intersections: Black Forest Rd & Vollmer Rd, Cowpoke Rd & Vollmer Rd, and Dry Needle Place & Vollmer Rd.



Subject: Text Box
Page Label: 12
Author: Carlos
Date: 11/8/2022 11:31:50 AM
Status:
Color: ■
Layer:
Space:

Traffic study for Rhetoric Development submitted under PCD File No. P2216 was not approved.



Subject: Text Box
Page Label: 27
Author: Carlos
Date: 11/8/2022 12:02:53 PM
Status:
Color: ■
Layer:
Space:

Per Appendix B.6.1A provide a table identifying all proposed and future improvements required, location of improvements, and responsible parties.

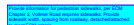

Subject: Text Box
Page Label: 27
Author: Carlos
Date: 11/8/2022 2:44:24 PM
Status:
Color: ■
Layer:
Space:

Provide information for pedestrian sidewalks, per ECM Chapter 2, Vollmer Road requires sidewalks. Provide sidewalk width, spacing from roadway, detached/attached to meet ECM criteria.