



LSC TRANSPORTATION CONSULTANTS, INC.
2504 East Pikes Peak Avenue, Suite 304
Colorado Springs, CO 80909
(719) 633-2868
FAX (719) 633-5430
E-mail: lsc@lsctrans.com
Website: <http://www.lsctrans.com>

Grandview Reserve Phases 2 & 3
Preliminary Plan & PUD
Traffic Impact Analysis
(LSC #S234340)
December 21, 2023
PUDSP-23-006

Traffic Engineer's Statement

This traffic report and supporting information were prepared under my responsible charge and they comport with the standard of care. So far as is consistent with the standard of care, said report was prepared in general conformance with the criteria established by the County for traffic reports.



Developer's Statement

I, the Developer, have read and will comply with all commitments made on my behalf within this report.

Bryan Reed

12/22/23
Date

Grandview Reserve Phases 2 & 3

Traffic Impact Analysis

Prepared for:
Mr. Phil Stuepfert
HR Green
5619 DTC Parkway – Suite 1150
Greenwood Village, CO 80111

DECEMBER 21, 2023

LSC Transportation Consultants, Inc.

Prepared by: Jeffrey C. Hodsdon, P.E. and Kirstin D. Ferrin, P.E.

LSC # S234340



CONTENTS

REPORT CONTENTS 1

PREVIOUS TRAFFIC REPORTS..... 2

LAND USE AND ACCESS 2

 Approved Land Use – Phase 1 2

 Phases 2 and 3 - Currently Proposed Preliminary Plan and PUD/Site Plan..... 2

 Site Access..... 3

 Pedestrian and Bicycle Accommodations..... 3

 Sight Distance Analysis..... 4

 Intersection Sight Distance 4

 Stopping Sight Distance at Intersections 4

ROADWAY AND TRAFFIC CONDITIONS..... 4

 Area Roadways..... 4

 Existing Traffic Volumes 6

 Existing Levels of Service..... 6

 Safety Analysis 7

SHORT-TERM (YEAR 2026) BACKGROUND TRAFFIC 8

INTERMEDIATE-TERM (YEAR 2033) BACKGROUND TRAFFIC 9

2043 BACKGROUND TRAFFIC 9

TRIP GENERATION..... 10

DIRECTIONAL DISTRIBUTION AND ASSIGNMENT 10

TOTAL TRAFFIC..... 11

 Short-Term (Year 2026)..... 11

 Intermediate-Term (Year 2033) 11

 Long-Term (Year 2043)..... 11

PROJECTED LEVELS OF SERVICE 12

 Rex Road/Eastonville Road (Intersection #1) 12

 Rex Road/Ivybridge Boulevard (Intersection #2)..... 12

 Rex Road/Potential Future North Access (Planned Public Street) (Intersection #3)..... 12

 Rex Road/Phase 2 West Access (Planned Public Street) (Intersection #4) 12

 Rex Road/Phase 2 East Intersection (Planned Public Street) (Intersection #5) 12

 Rex Road/Phase 3 Access (Planned Public Street) (Intersection #6) 13

 Rex Road Intersection #7 and #8..... 13

US Highway 24/Rex Road (Intersection #9).....	13
Eastonville Road/Dawlish Drive (Intersection #10)	13
Eastonville Road/Brixham Drive (Intersection #11).....	13
Londonderry Drive/Eastonville Road (Intersection #12)	13
Stapleton Drive/Eastonville Road (Intersection #13)	14
US Highway 24 /Stapleton Drive (Intersection #14).....	14
FUNCTIONAL CLASSIFICATIONS AND LANEAGE.....	14
MULTI-MODAL AND PEDESTRIAN/BIKE TRANSPORTATION	15
TRANSPORTATION IMPROVEMENT FEE PROGRAM	15
Project Fees.....	15
Potentially Reimbursable Improvements Under the MTCP Fee Program	16
ROADWAY IMPROVEMENTS	16
Enclosures:.....	17
Tables 2-3	
Figures 1-16	
Traffic Count Reports	
Level of Service Reports	
Appendix Table 1	
MTCP Maps	
Map 15 Bicycle and Pedestrian Network Improvements	
Crash History Data	
Figure 13 from the <i>Grandview Reserve Phase 1 Updated Traffic Impact Analysis</i>	



LSC TRANSPORTATION CONSULTANTS, INC.
2504 East Pikes Peak Avenue, Suite 304
Colorado Springs, CO 80909
(719) 633-2868
FAX (719) 633-5430
E-mail: lsc@lsctrans.com
Website: <http://www.lsctrans.com>

December 21, 2023

Mr. Phil Stuepfert
HR Green
5619 DTC Parkway – Suite 1150
Greenwood Village, CO 80111

RE: Grandview Reserve Phases 2 & 3
El Paso County, Colorado
Traffic Impact Analysis
LSC # S234340

Dear Phil:

In response to your request, LSC Transportation Consultants, Inc. has prepared this traffic impact analysis for Phases 2 and 3 of the Grandview Reserve development in El Paso County, Colorado. As shown in Figure 1, the Phase 2 and 3 areas are located south of the future Rex Road and east of the approved Phase 1 area.

REPORT CONTENTS

This report is being submitted as part of a Preliminary Plan/PUD submittal for Phases 2 and 3.

The report contains the following:

- The traffic count data and street conditions;
- Short-term, intermediate-term and 2043 baseline/background traffic-volume estimates;
- The projected average weekday and peak-hour vehicle trips to be generated by the site;
- The assignment of the site's projected traffic volumes to the key area streets and intersections for the short, intermediate, and long term and the resulting total traffic volumes for the short, intermediate, and long term;
- The resulting traffic impacts including level of service analysis at key intersections; and
- Findings and recommendations.

PREVIOUS TRAFFIC REPORTS

LSC completed a Master Traffic Impact Study (TIS) for Grandview Reserve (Sketch Plan) dated December 15, 2020 ([SKP201](#)). That report assumed the initial development would occur on the parcels on the east end of the overall development with access to US Highway 24 (US Hwy 24) only. Initial development, Phase 1 (approved) and Phases 2 & 3 (current application), has since been shown to occur on the west side of the master plan area with access only to Eastonville Road and the initial segment of Rex Road east of Eastonville (i.e., the road connection to US Highway 24 will be implemented later with future phases beyond Phase 3). LSC also completed a traffic impact study for the first phase of the Grandview Reserve ([PUDSP2110](#)), dated May 9, 2022.

A list of other traffic studies in the area of study completed within the past five years (that LSC is aware of) is attached for reference. This study accounts for the land use, trip generation, and the roadway network included in these studies. The older previous area studies generally assumed Rex Road would not extend from Eastonville Road to US Hwy 24 in the 20-year horizon as is now planned. The older previous studies also assumed fewer dwelling units on this site.

A traffic report, entitled *Eastonville Road Project Conceptual Design Report* was also recently completed for Eastonville Road by Wilson & Company (for El Paso County).

LAND USE AND ACCESS

Approved Land Use – Phase 1

Figure 2a shows the approved site plan (Preliminary Plan and PUD) for Phase 1 of Grandview Reserve. This phase includes 565 lots for single-family homes, an 11.2-acre church site, and an “amenity center”. Construction of the first homes within Phase 1 is anticipated in 2024. By 2026, the first two filings which include about 169 lots for single-family homes are anticipated to be completed and by 2033 it was assumed that Phase 1 would be built out.

Phases 2 and 3 - Currently Proposed Preliminary Plan and PUD/Site Plan

Figure 2a also shows the currently proposed site plan for Phases 2 and 3 of Grandview Reserve. Phase 2 is planned to include 224 townhomes and 194 duplexes and is anticipated to be completed by 2026. Phase 3 is planned to include 224 lots for single-family homes and is anticipated to be constructed between 2026 and 2033. The Phase 2 and 3 plans are consistent with the land uses assumed for this same area in the Master TIS.

Site Access

Three new public-street connections are proposed to an extension of Rex Road as part of Phase 2 and 3. Figure 2b shows the proposed intersection spacing on Rex Road.

Based on the criteria contained in the El Paso County *Engineering Criteria Manual (ECM)*, the required intersection spacing for Minor Arterial roadways is $\frac{1}{4}$ mile (1,320 feet). The proposed public-street access points to Eastonville Road meet the intersection spacing criteria. The Phase 1 TIS assumed a potential future access for parcels north of Rex Road about 650 feet east of Ivybridge Drive and 875 feet west of the first new proposed access point for Phase 1 (Ivybridge Boulevard). This future access would require a deviation to the *ECM* standards.

Figure 2c shows the planned internal street connections between Phase 1 and Phases 2/3, the street connections to the portion of Rex Road to be constructed, and phasing/timing of connections to the Phase 1 street network. The master-planned road connection to US Highway 24 will be completed later with future phases (beyond Phase 3).

One change is proposed to the **Phase 1** street network as part of the current planning for Phases 2 and 3. As noted in the attached copy of Figure 13 from the *Grandview Reserve Phase 1 Updated Traffic Impact Analysis (PUDSP-21-010)* dated May 9, 2022, Dawlish Drive is now planned to be classified as an Urban Residential Collector from Eastonville Road to Ivybridge Drive. This change has been made as part of the site design and planning process to ensure interim Phases 2 and 3 trips/traffic volumes can be accommodated by the previously planned Phase 1 streets.

Pedestrian and Bicycle Accommodations

There are two existing school sites located within two miles of the site, Falcon High School and Meridian Ranch Elementary. A future K-8 school is planned just north of Falcon High School. These schools are located north of Londonderry Drive and west of Eastonville Road. There is also a regional park located just west of the site.

The likely pedestrian path to the school and park sites is Eastonville Road to Londonderry Drive. There are currently sidewalks and school crossings on Londonderry Drive. There are currently no sidewalks on Eastonville Road. However, the *2016 Major Transportation Corridors Plan (MTCP)* shows a proposed primary regional trail along this corridor. The cross section for Eastonville Road north of Stapleton Drive recommended in the *Eastonville Road Conceptual Design Report* dated April 2021 includes an 8-foot detached meandering sidewalk on both sides of the roadway. The Grandview Reserve site plan includes a trail located outside of the Eastonville right-of-way but within their 30-foot landscape buffer to meet the regional trail requirement. Figure 2a shows the location of the proposed regional trail and other proposed trails within the Grandview Reserve development. All of the internal streets within the Phases 1 through 3 area will have sidewalks.

Sight Distance Analysis

Figures 3a and 3b shows sight-distance analysis at the proposed Phase 2 intersections with Rex Road (intersection #4 and Intersection #5).

Intersection Sight Distance

Based on the planned design speed of 40 miles per hour (mph) for Rex Road and the criteria contained in Table 2-21 of the *ECM*, the required intersection sight distance at these access points is 445 feet.

Stopping Sight Distance at Intersections

Based on the criteria contained in Table 2-17 of the *ECM*, the required stopping sight distance approaching this intersection is 305 feet (for grades less than three percent). As shown in Figures 3a and 3b the *ECM* criteria can be met at both of the intersections analyzed.

The Phase 3 intersection was not analyzed for sight distance as it is planned to be constructed as a one-lane modern roundabout. Detailed roundabout design reports will be included in future submissions. The roundabout design report will include detailed intersection and stopping sight distance evaluation for the roundabout intersection and intersection approaches.

ROADWAY AND TRAFFIC CONDITIONS

Area Roadways

The major roadways in the site's vicinity are shown in Figure 1 and are described below. Copies of the 2016 El Paso County *Major Transportation Corridors Plan (MTCP) 2040 Roadway Plan*, and 2016 *MTCP 2060 Corridor Preservation Plan (CPP)* with the site location identified on them have been attached to this report.

Eastonville Road extends northeast from Meridian Road to past Hodgen Road. It is shown as a two-lane Minor Arterial on the El Paso County *Major Transportation Corridors Plan* and the *Preserved Corridor Network Plan*. Eastonville Road has a three-lane cross-section (one through lane in each direction plus a center two-way, left-turn lane) from Woodmen Hills Drive to Snaffle Bit Road (approximately midway between Judge Orr Road and Stapleton Road). Eastonville Road is a two-lane roadway north and south of this section. Eastonville Road is currently unpaved north of Londonderry Drive. Pikes Peak Rural Transportation Authority (PPRTA)-funded improvements are anticipated in the future at the intersection of Eastonville Road and Stapleton Drive that would likely add northbound and southbound left-turn lanes. The posted speed limit north of Stapleton Drive is 35 mph.

Rex Road extends east from Goodson Road to Estate Ridge Drive within the Meridian Ranch development. Rex Road is classified as an Urban Minor Arterial in the *2016 El Paso County Major Transportation Corridors Plan (MTCP) 2040 Roadway Plan*. The posted speed limit on Rex Road is 45 mph between Meridian Road and Mount Gateway Drive and 35 mph east of Mount Gateway Drive. Rex Road is currently being constructed as a 2-lane Urban Minor Arterial from its existing terminus at Estate Ridge Drive to Eastonville Road. The new section is anticipated to be open to traffic by spring 2024.

A short section is also proposed to be constructed east of Eastonville Road in the short-term future as part of the approved Grandview Reserve Phase 1 development. A roundabout is constructed as part of the Grandview Reserve Phase 1 development. As part of Phases 2 and 3, Rex Road is planned to be extended farther to the southeast adjacent to and along with these phases. The master-planned, Rex Road connection to US Highway 24 will be completed later with future phases (beyond Phase 3).

This ultimate, master-planned, Rex Road connection and an associated new intersection with US Highway 24 has been approved and “Access-Permitted” by CDOT in coordination with El Paso County, the Colorado Department of Transportation (CDOT), and other local agencies. The CDOT access permit notice-to-proceed (NTP) has not yet been requested by the applicant and has not been issued. The permit will likely need to be extended (per CDOT requirements) given the proposed phasing of this Preliminary Plan/PUD.

US Highway 24 (US Hwy 24) is generally a two-lane State Highway extending east/west across Colorado connecting the Buena Vista, Colorado Springs, and Limon areas. US Hwy 24 is planned to be widened to four lanes through the Falcon area. The US Hwy 24 PEL identifies this widening as a high priority with a timeline of less than 10 years. US Hwy 24 in the vicinity is classified as an EX – Expressway/Major Bypass by the Colorado Department of Transportation (CDOT). US Hwy 24 is shown as a four-lane Principal Arterial on the *MTCP* and the *Preserved Corridor Network Plan*. The posted speed limit on US Hwy 24 adjacent to the site is 65 miles per hour (mph).

Stapleton Drive is shown as an Urban four-lane Principal Arterial on the *El Paso County Major Transportation Corridors Plan* and *El Paso County Corridor Preservation Plan (CPP)*. Stapleton Drive extends east from Towner Drive to US Hwy 24. Stapleton continues southeast, then south as Curtis Road. It is planned to be ultimately extended west to connect with the Briargate Parkway extension. Stapleton Drive currently is a half-section of a four-lane, Principal Arterial street (one through lane in each direction) between Meridian Road and US Hwy 24. The posted speed limit between Eastonville Road and US Hwy 24 is 45 mph.

Existing Traffic Volumes

Figure 4a shows the existing morning and afternoon peak-hour traffic volumes at the intersections of Stapleton/US 24, Stapleton/Eastonville, and Londonderry/Eastonville. These volumes are based on manual intersection turning-movement counts conducted by LSC in April 2021 (Eastonville/Londonderry), October 2021 (Stapleton/Eastonville), and January 2023 (Stapleton/US Hwy 24).

The morning peak hour at the intersection of Stapleton/US Hwy 24 and Stapleton/Eastonville occurred from 6:45 a.m. to 7:40 a.m. The morning peak hour at the intersection of Eastonville/Londonderry occurred from 7:00 a.m. to 8:00 a.m. The afternoon peak hour at all three intersections occurred from 4:00 p.m. to 5:00 p.m. The northbound left-turn and eastbound right-turn volume at the intersection of Eastonville/Londonderry were adjusted (increased) to account for the minor differences due to seasonal variations and/or the difference in the peak hour. The count-data sheets are attached for reference.

Existing Levels of Service

Level of service (LOS) is a quantitative measure of the level of delay at an intersection. Level of service is indicated on a scale from “A” to “F.” LOS A represents control delay of less than 10 seconds for unsignalized and signalized intersections. LOS F represents control delay of more than 50 seconds for unsignalized intersections and more than 80 seconds for signalized intersections. Table 1 shows the level of service delay ranges.

Table 1: Intersection Levels of Service Delay Ranges

Level of Service	Signalized Intersections	Unsignalized Intersections
	Average Control Delay (seconds per vehicle)	Average Control Delay (seconds per vehicle) ⁽¹⁾
A	10 sec or less	10 sec or less
B	10-20 sec	10-15 sec
C	20-35 sec	15-25 sec
D	35-55 sec	25-35 sec
E	55-80 sec	35-50 sec
F	80 sec or more	50 sec or more

(1) For unsignalized intersections if V/C ratio is greater than 1.0 the level of service is LOS F regardless of the projected average control delay per vehicle.

Figure 4b presents the results of the existing intersection level of service analysis based on the unsignalized method of analysis procedures from the *Highway Capacity Manual, 6th Edition* by the Transportation Research Board. The peak-hour factors used for each approach are based on the traffic volumes for the peak fifteen minutes of the entire intersection. If the peak 15 minutes for an approach occurs during an interval other than the peak 15 minutes of the entire

intersection, the suggested peak-hour value based on the total approach volume from Table 9-1 of the Synchro Studio 10 User Guide was used instead. The level of service reports are attached.

The eastbound and westbound left-turn and through lanes at the two-way, stop-sign-controlled intersection of US 24/Stapleton are currently operating at LOS E or LOS F during the peak hours.

The eastbound approach at the two-way, stop-sign-controlled intersection of Stapleton/Eastonville is currently operating at LOS F during the morning peak hour and LOS C during the afternoon peak hour.

The eastbound left-turn movement at the two-way, stop-sign-controlled intersection of Eastonville/Londonderry is currently operating at a LOS D during the morning peak hour and LOS B during the afternoon peak hour.

Safety Analysis

The Colorado State Patrol provided LSC with three years of vehicle-crash data for Eastonville Road between Stapleton Drive and Latigo Boulevard.

There were eight reported crashes at the intersection of Eastonville/Stapleton the past three years, three in 2021, three in 2022, and two in 2023. All of these crashes are likely susceptible to correction by a traffic-control signal. In order to meet a traffic-signal warrant based on crash experience, there needs to be at least five crashes susceptible to correction within a 12-month period. However, there was no 12-month period in the past three years with more than four crashes reported, therefore this intersection does not currently meet this warrant.

One additional crash was reported along this corridor. The location of the accident is not clear. However, as the road surface code was reported as "dirt" it was assumed to have occurred at a location north of Londonderry Drive. This crash was a single-vehicle crash that lost control while traveling northbound.

It should be noted that the short-term improvements to Eastonville Road, currently in the planning and preliminary design stage, will likely improve the safety of the entire corridor.

The intersection sight distance analysis included within this report is also a component of the overall traffic safety analysis. Please refer to the sight distance analysis section for details.

SHORT-TERM (YEAR 2026) BACKGROUND TRAFFIC

Background traffic is the traffic estimated to be on the adjacent roadways and at adjacent intersections without the proposed development's trip generation of site-generated traffic volumes. Background traffic includes the through traffic and the traffic generated by nearby developments but assumes zero traffic generated by the site. Figure 5a shows the projected short-term (Year 2026) background traffic volumes.

The addition of new roadways, notably the future completion of Rex Road east to Eastonville Road, will greatly affect the existing traffic patterns. In lieu of a general/"blanket" growth rate, LSC has developed small-area traffic models for Meridian Ranch, Waterbury, and the Latigo Trails as part of previous work completed in the area. The results of these modeling efforts have been combined to estimate the background traffic volumes. These background traffic volumes have been based on the existing traffic volumes (from Figure 4a) plus increases in traffic due to regional growth, including buildout of the following subdivisions in the vicinity of the site:

- The existing and currently proposed subdivisions within Waterbury (located just south of the Grandview Reserve);
- Meridian Ranch Filings 1-3 and Filings 6-8;
- Meridian Ranch Estates Filings 2-3;
- Meridian Ranch Filing 11;
- Stonebridge at Meridian Ranch Filings 1, 2, and 3;
- Meridian Ranch Filing 9;
- The Vistas at Meridian Ranch Filing 1;
- WindingWalk at Meridian Ranch Filing 1;
- The Enclave at Stonebridge at Meridian Ranch;
- The Estates at Rolling Hills Ranch Filing Nos. 1 and 2;
- The Rolling Hills Ranch at Meridian Ranch PUD; and
- Grandview Reserve Phase 1 Filings 1 and 2 (considered background traffic for purposes of this report)

The **short-term** background traffic volumes assume Rex Road extended from its existing terminus in Meridian Ranch east to Eastonville (by Meridian Ranch) but **not** further east. The **short-term** background volumes also assume only the street connections within Filings 1 and 2 of Phase 1, as shown in Figure 2c, have been constructed by 2026.

Figure 5b shows the lane geometry, traffic control, and level of service at the key area intersections, based on the short-term background volumes, and laneage/traffic control needed to accommodate background traffic including Grandview Phase 1 Filings 1 and 2.

INTERMEDIATE-TERM (YEAR 2033) BACKGROUND TRAFFIC

Figure 6a shows the projected intermediate-term (Year 2033) background traffic volumes. These background traffic volumes have been based on the short-term (Year 2026) traffic volumes (from Figure 5a) plus increases in traffic due to general regional growth, including buildout of the following subdivisions in the vicinity of the site:

- Sanctuary at Meridian Ranch
- Rolling Hills Ranch North
- Latigo Trails Filing Nos. 1 and 2
- Grandview Reserve Phase 1

Figure 6b shows the lane geometry, traffic control, and level of service at the key area intersections, based on the intermediate-term background volumes.

2043 BACKGROUND TRAFFIC Per ECM Appendix Section B.2.2, Long Range Horizon is 20-25 years out. Please update so Long term analysis fits within this time frame.

Figure 7a shows the projected 2043 background-traffic volumes. The small-area model was also used to develop these volumes. In addition to the 2033 background traffic and developments assumed to be developed by 2033, the 2043 background traffic volumes assume trips generated by/traffic volumes estimated for buildout of:

- The Meridian Ranch development including buildout of the proposed school site located north of Falcon High School,
- Grandview Reserve (except trips to be generated by land uses within the Phases 2 and 3 area, as these trips are included in the “site-generated traffic.”),
- The Waterbury Phase 1 and 2 developments to the southeast
- Latigo Trails and estimated buildout trips that may be generated by future development of the area generally north of Rex Road between Eastonville Road and US Hwy 24. This analysis assumes trip generation based on future development of 2 ½-acre residential lots.

The 2043 background-traffic scenario assumes Stapleton Drive extended west to connect with the Briargate Parkway extension and Rex Road extended east through the future phases of Grandview Reserve to US Hwy 24.

Figure 7b shows the lane geometry, traffic control, and level of service at the key area intersections, based on the 2043 background volumes.

TRIP GENERATION

The site-generated vehicle trips were estimated using the nationally published trip-generation rates from *Trip Generation, 11th Edition, 2021* by the Institute of Transportation Engineers (ITE). Table 2 shows the trip-generation estimates.

Grandview Reserve Phases 2 is expected to generate about 3,010 new external vehicle trips on the average weekday, with about half entering and half exiting the site during a 24-hour period. During the morning peak hour of the adjacent street traffic, which occurs between 6:45 and 7:45 a.m., about 50 vehicles would enter and 150 vehicles would exit the site. During the afternoon peak hour of the adjacent street traffic, which occurs between 4:00 and 5:00 p.m., about 141 vehicles would enter and 98 vehicles would exit the site.

Grandview Reserve Phases 3 is expected to generate about 3,036 new external vehicle trips on the average weekday, with about half entering and half exiting the site during a 24-hour period. During the morning peak hour of the adjacent street traffic, about 56 vehicles would enter and 169 vehicles would exit the site. During the afternoon peak hour of the adjacent street traffic, about 191 vehicles would enter and 112 vehicles would exit the site.

DIRECTIONAL DISTRIBUTION AND ASSIGNMENT

The directional distribution of the site-generated traffic volumes on the area roadways is an important factor in determining the site's traffic impacts. Figures 8 and 9 show the short-term and long-term directional-distribution estimates for the site-generated traffic volumes, respectively. The estimates have been based on the following factors: distribution estimates from the Master Study and the Phase 1 study (with adjustments, as needed), the recent traffic-count data; the site's proposed land use; the site's proposed access points; the phased interim and buildout Grandview internal street network; and the phasing of the existing and future area Collector and Arterial public roadway system serving the site.

The short-term directional-distribution estimate assumes Rex Road has been extended from its existing terminus to the Phase 3 Grandview Reserve access but not further east. The long-term directional distribution assumes buildout of the area street network including the extension of Rex Road east to US Hwy 24 and Stapleton Drive/Briargate Parkway west to Black Forest Road.

When the distribution percentages (from Figures 8 and 9) were applied to the trip-generation estimates (from Table 2), the short-term and intermediate-term site-generated traffic volumes on the area roadways were determined. Figure 10 shows the short-term Phase-2-only generated traffic volumes. Figure 11 shows the intermediate-term Phases 2- and 3-generated traffic volumes. Figure 12 shows the long-term Phases 2- and 3-generated traffic volumes.

TOTAL TRAFFIC

Short-Term (Year 2026)

Figure 13a shows the projected short-term (Year 2026) total-traffic volumes. The short-term total-traffic volumes are the sum of the short-term background-traffic volumes (from Figure 5a) plus the short-term Phase 2-generated traffic volumes (from Figure 10). The 2026 total traffic volumes assume only filing 1 and 2 of Grandview Reserve Phase 1 and Grandview Reserve Phase 2 have been constructed by 2026.

Figure 13b shows the lane geometry, traffic control, and level of service at the key area intersections, based on the short-term (Year 2026) total volumes. The short-term scenario assumes Rex Road has been constructed only to the east Phase 2 access (Intersection #5) and assumes only the internal streets within Grandview Phase 1 filings 1 and 2 have been constructed.

Intermediate-Term (Year 2033)

Figure 14a shows the projected intermediate-term (Year 2033) total-traffic volumes. The intermediate-term total-traffic volumes are the sum of the intermediate-term background-traffic volumes (from Figures 6a) plus the intermediate-term Phases 2- and 3-generated traffic volumes (from Figure 10). The 2033 total traffic volumes assume buildout of Grandview Reserve Phases 1 through 3 by 2033.

Figure 14b shows the lane geometry, traffic control, and level of service at the key area intersections, based on the intermediate-term (Year 2033) total volumes. The intermediate-term scenario assumes Rex Road has been constructed only to the Phase 3 access (Intersection #6) and assumes all the internal streets within Grandview Phase 1 and 2 have been constructed.

Long-Term (Year 2043)

Figure 15a show the projected 2043 total-traffic volumes. The 2043 total-traffic volumes are the sum of the 2043 background-traffic volumes (from Figures 7a) plus the long-term Phases 2- and 3-generated traffic volumes (from Figure 11).

Figure 15b shows the lane geometry, traffic control, and level of service at the key area intersections, based on the 2043 total volumes.

PROJECTED LEVELS OF SERVICE

The key area intersections and site-access points have been analyzed to determine the projected future levels of service based on the unsignalized method of analysis procedures from the *Highway Capacity Manual, 6th Edition* by the Transportation Research Board and Synchro signalized intersection procedures. Based on the criteria contained in the *ECM*, a peak-hour factor of 0.85 was used for the short-term (Year 2026) and intermediate-term (Year 2033) analysis, except for those intersections whose existing peak-hour factor calculated from traffic counts conducted by LSC was higher than 0.85. In those cases, the existing peak-hour factor was used. A peak-hour factor of 0.95 was used for the long-term (Year 2043). Two percent heavy vehicles were assumed for both the Year 2026 and Year 2043 analysis. The results of the analysis are contained in Figures 5b, 6b, 7b, 12b, 13b, 14b, and 15b. The level of service reports are attached.

What about the 2033 analysis?

Rex Road/Eastonville Road (Intersection #1)

The intersection of Rex/Eastonville Road is planned to be constructed as a modern one-lane roundabout as part of the approved Grandview Reserve Phase 1 development. All approaches at this intersection are projected to operate at LOS D or better through 2043.

Rex Road/Ivybridge Boulevard (Intersection #2)

The intersection of Rex Road/Ivybridge Boulevard is projected to operate at LOS C or better for all movements based on the projected 2043 total traffic volumes as a two-way, stop-sign-controlled “T” intersection. This access to Rex Road is intended to remain a “T” intersection in perpetuity. If future access is needed for the parcels north of Rex Road, it was assumed this access would occur via a second “T” intersection east of Ivybridge.

Rex Road/Potential Future North Access (Planned Public Street) (Intersection #3)

If future access is needed for parcels north of Rex Road, it was assumed that this intersection would be a stop-sign controlled “T” intersection. All movements at this intersection are projected to operate at LOS C or better through 2043.

Rex Road/Phase 2 West Access (Planned Public Street) (Intersection #4)

The proposed west access for Phase 2 is proposed to operate at LOS B or better for all movements through 2043 as a stop-sign controlled intersection.

Rex Road/Phase 2 East Intersection (Planned Public Street) (Intersection #5)

The proposed east access for Phase 2 is proposed to operate at LOS C or better for all movements through 2043 as a stop-sign controlled intersection.

Rex Road/Phase 3 Access (Planned Public Street) (Intersection #6)

The proposed Phase 3 access to Rex Road is planned to be constructed as a modern one-lane roundabout. All approaches are projected to operate at LOS D or better through 2043 if a bypass lane is provided for the westbound-to-northbound movement.

Rex Road Intersection #7 and #8

Intersections #7 and #8 were not analyzed as part of this report as they are not planned as part of the currently proposed Phases 2 and 3. Detailed analysis will be provided with future submissions.

US Highway 24/Rex Road (Intersection #9)

For what Phase is this intersection expected to be constructed?

The intersection of US Highway 24/Rex Road is not planned to be constructed as part of Phase 1. By 2043, it was assumed that Rex Road would be constructed from Eastonville to US Hwy 24 and that intersection with US Hwy 24 would be constructed as a signal-controlled, channelized "T" intersection. All movements are projected to operate at LOS D, based on the projected 2041 total traffic volumes.

Eastonville Road/Dawlish Drive (Intersection #10)

The intersection of Eastonville Road/Dawlish Drive is planned to be constructed as a one-lane modern roundabout as part of the Grandview Reserve Phase 1 development. All approaches are projected to operate at LOS C or better through 2043.

Eastonville Road/Brixham Drive (Intersection #11)

The future stop-sign-controlled intersection of Eastonville Road/Brixham Drive is projected to operate at LOS C or better for all movements during the peak hours as a stop-sign-controlled "T" intersection, based on the short-term (Year 2026) total traffic volumes. By 2043, the westbound left-turn movement is projected to operate at LOS D during the peak hours.

Londonderry Drive/Eastonville Road (Intersection #12)

It is our understanding that the intersection of Londonderry/Eastonville is planned to be reconstructed as a modern roundabout as part of a PPRTA project. The intersection is projected to operate at LOS D or better for all approaches through 2043 as a modern roundabout.

Stapleton Drive/Eastonville Road (Intersection #13)

The eastbound approach at the intersection of Stapleton/Eastonville is currently operating at LOS F during the morning peak hour. Improvements to Eastonville from Snaffle Bit north to Rex Road in the vicinity of the site are under design as part of the PPRTA Eastonville Phase 1 project. It is our understanding that the intersection is planned to be converted to a modern one-lane roundabout in the short term. All approaches are projected to operate at LOS D or better based on the projected 2026 total traffic volumes.

By 2033, it was assumed that Stapleton Drive would be constructed to its full Principal Arterial cross section and that the roundabout at the intersection of Stapleton/Eastonville would be expanded to two lanes. Based on the estimated roundabout lane geometry and projected volumes, all approaches are projected to operate at LOS D or better through 2043.

US Highway 24 /Stapleton Drive (Intersection #14)

The intersection of US Hwy 24/Stapleton is currently stop-sign controlled. The northbound and southbound left-turn movements and the northbound through movements are currently operating at LOS F during the peak hours. This intersection is planned to be signalized in the (potentially near-term) future. Once signalized, all movements are projected to operate at LOS D or better during the peak hours, based on the projected short-term total, intermediate-term total and 2043 total traffic volumes.

FUNCTIONAL CLASSIFICATIONS AND LANEAGE

Figure 16 shows the recommended functional classifications for internal streets within Phases 1 through 3 and for the roadways in the vicinity of the site. The functional classifications for the major transportation corridors in the vicinity and number of through lanes are consistent with the current El Paso County *MTCP* and the Grandview Reserve Sketch Plan TIS report.

The projected average daily traffic on Eastonville Road north of Stapleton Drive is 20,000 vpd based on the projected 2043 total traffic volumes. The projected daily traffic volumes on this section of Eastonville Road are at the design ADT of 20,000 vpd for an Urban Minor Arterial given in Table 2-6 of the El Paso County Engineering Criteria Manual (*ECM*).

The projected average daily traffic on Rex Road just east of Eastonville Road is 5,600 vpd based on the projected intermediate-term (Year 2033) total traffic and 10,750 vpd based on the projected 2043 total traffic volumes. The projected daily traffic volumes on this section of Rex Road are below the design ADT of 20,000 vpd for an Urban Minor Arterial given in Table 2-6 of the *ECM*.

The projected average daily traffic volumes on Ivybridge Drive just south of Rex Road is 1,430 vpd based on the projected intermediate-term (Year 2033) total traffic volumes and 2,180 vpd based

on the projected 2043 total traffic volumes. The projected daily traffic volumes on Ivybridge Boulevard are below the design ADT of 10,000 vpd for an Urban Residential Collector given in Table 2-6 of the *ECM*.

The projected average daily traffic volumes on Dawlish Drive between Eastonville Road and Zelda Street is 5,050 vehicles per day (vpd) based on the projected intermediate-term (Year 2033) total traffic volumes and 3,740 vpd based on the projected 2043 total traffic volumes. The projected daily traffic volumes on this section of Dawlish Drive are below the design ADT of 10,000 vpd for an Urban Residential Collector given in Table 2-6 of the *ECM*.

The projected average daily traffic volumes on Dawlish Drive between Zelda Street and Ivybridge Boulevard is between 1,995 and 3,140 vpd based on the projected intermediate-term (Year 2033) total traffic and between 1,595 and 1,825 vpd based on the projected 2043 total traffic volumes. The projected daily traffic volumes on this section of Dawlish Drive are below the design ADT of 10,000 vpd for an Urban Residential Collector given in Table 2-6 of the *ECM*.

MULTI-MODAL AND PEDESTRIAN/BIKE TRANSPORTATION

- A park n' ride facility is planned for a site near Meridian Road and US Hwy 24.
- The Rock Island Regional Trail passes adjacent to the site.
- Many of the area County roads have been or will be upgraded to provide paved shoulders for cyclists. Stapleton and Elbert Road are shown as future "bike routes".
- The *MTCP* shows a future primary regional trail along Eastonville Road. Another future primary regional trail is shown extending west from Eastonville Road through Meridian Ranch.
- The US Hwy 24 PEL study also includes multi-modal elements.
- All of the internal streets within Grandview Reserve Phases 1 through 3 will have sidewalks that will connect to Rex Road and/or Eastonville Road. The proposed trail system shown in Figure 2 will also connect to the future Waterbury development to the south in addition to connections to Rex Road and Eastonville Road.

TRANSPORTATION IMPROVEMENT FEE PROGRAM

Project Fees

This project will be required to participate in the El Paso County Road Improvement Fee Program. Grandview Reserve **will join the ten-mil PID**. The ten-mil PID building-permit fee portion associated with this option is \$1,458 per multi-family dwelling unit and \$1,221 per single-family dwelling unit. The total building-permit fee would be \$609,944 for the 418 townhomes and duplexes within Phase 2 and \$393,162 for the 322 single-family lots within Phase 3. It is likely that this amount would be paid incrementally with building permits associated with several individual final-plat applications.

Potentially Reimbursable Improvements Under the MTCP Fee Program

Nearby improvement projects potentially reimbursable under the Fee Program are (From MTCP Map No. 13):

- MTCP Project No. U19: Eastonville Road
- MTCP Project No. N4: Rex Road (extended between Eastonville & US Highway 24)
- MTCP Project No C12: Stapleton Road
- Also, potentially intersection improvements and traffic signals/roundabouts at major MTCP roadway intersections per fee program guidelines
- Also, potentially intersection improvements and traffic signals (or CDOT traffic signal escrows)/roundabouts at US 24 intersections with Rex Road and/or Stapleton Road per fee program guidelines

ROADWAY IMPROVEMENTS

The attached Table 3 presents the Phases 2 and 3 recommended roadway improvements.

- Based on the 2043 total traffic volumes shown in Figure 12a and the criteria contained in the El Paso County *Engineering Criteria Manual (ECM)*, a westbound left-turn lane will be required on Rex Road approaching the Phase 2 west access (Intersection #4). This lane should be 205 feet long plus a 160-foot taper.
- Based on the 2043 total traffic volumes shown in Figure 12a and the criteria contained in the El Paso County *Engineering Criteria Manual (ECM)*, a westbound left-turn lane will be required on Rex Road approaching the Phase 2 east access (Intersection #5). This lane should be 255 feet long plus a 160-foot taper.
- The proposed access for Phase 3 to Rex Road (Intersection #6) should be constructed as a one-lane roundabout. A westbound right-turn bypass lane will likely be needed in the future when the north leg of the intersection is constructed.

* * * * *

Provide a section on Queuing Analysis, MTCP 2040 Improvement Projects & Auxiliary Turn Lanes

Include section discussing deviations. Per roadways sections shown on preliminary plan, some local roads are shown having a 65' ROW, which would require a deviation. Also, the section for Rex Road does not match county standard. Indicate if a deviation has been approved, is being reviewed, etc.

Please contact me if you have any questions regarding this report.

Respectfully Submitted,

LSC TRANSPORTATION CONSULTANTS, INC.

By: Jeffrey C. Hodsdon, P.E.
Principal

JCH/KDF:jas

Enclosures: Tables 2-3
Figures 1-16
Traffic Count Reports
Level of Service Reports
Appendix Table 1
MTCP Maps
Map 15 Bicycle and Pedestrian Network Improvements
Crash History Data
Figure 13 from the *Grandview Reserve Phase 1 Updated Traffic Impact Analysis*

Tables 2-3



**Table 2
Trip Generation Estimate
Grandview Reserve Phase 2 Preliminary Plan**

Phase	Land Use Code	Land Use Description	Trip Generation Units	Trip Generation Rates ⁽¹⁾					Total Trips Generated				
				Average Weekday Traffic	Morning Peak Hour		Afternoon Peak Hour		Average Weekday Traffic	Morning Peak Hour		Afternoon Peak Hour	
					In	Out	In	Out		In	Out	In	Out
Short-Term Trip Generation Estimate													
2	215	Single Family Attached Housing	418 DU ⁽²⁾	7.20	0.12	0.36	0.34	0.23	3,010	50	150	141	98
Intermediate-Term and Long-Term Trip Generation Estimate													
2	215	Single Family Attached Housing	418 DU	7.20	0.12	0.36	0.34	0.23	3,010	50	150	141	98
3	210	Single-Family Detached Housing	322 DU	9.43	0.18	0.53	0.59	0.35	3,036	56	169	191	112
			740 DU						6,046	106	319	332	210

Notes:

(1) Source: "Trip Generation, 11th Edition, 2021" by the Institute of Transportation Engineers (ITE).

(2) DU = dwelling unit

Table 3 Grandview Reserve Phases 2 and 3 Roadway Improvements				
Item #	Improvement	Trigger	Timing	Responsibility
Roadway Segment Improvements				
1	Eastonville Road: Stapleton to Londonderry final grading and paving	dependent on PPRTA funding priorities	TBD by EPC; PPRTA "A-List" Project	PPRTA
2	Eastonville Road: Londonderry to Rex final grading and paving	With Grandview Reserve development	With Grandview Reserve Phase 1	Grandview Reserve
3	Falcon Regional Trail: Construct east of Eastonville Road along the Phase 1 frontage	With Grandview Reserve development	With Grandview Reserve Phase 1	Grandview Reserve
4	Eastonville: Road Rex to Latigo initial grading and paving	Average Daily Traffic > 200 vehicles per day (ECM); Average Daily Traffic > 300 vehicles per day (fee study trigger)	Existing Deficiency; TBD by EPC; PPRTA list shows as an "A-List" project, however, this segment is shown as a future "Phase II" in the Wilson Eastonville Study	PPRT and/or with funds from developer escrows, and/or Fee Program funds or bonds
5	Eastonville Road: Rex to Latigo upgrade to an Urban Minor Arterial (per MTCP) (note: 2016 MTCP shows "Rural") Future phase of the PPRTA project	Average Daily Traffic > 600 vehicles per day ⁽¹⁾	TBD by EPC; PPRTA Phase II (Per Wilson Study)	PPRT and/or with funds from developer escrows, and/or Fee Program funds or bonds
6	Eastonville Road: Stapleton to Grandview Reserve south boundary upgrade to 4-Lane Rural Minor Arterial (per MTCP) (Project plan shows a three-lane cross section)	average daily traffic > 20,000 vehicles per day	dependent on PPRTA funding priorities	PPRTA
7	Rex Road: Construct new road segment from Eastonville to first access point east of Eastonville Road (Ivybridge Boulevard)	With Grandview Reserve development	With Grandview Reserve Phase 1	Grandview Reserve
8	Rex Road: Construct new road segment from Eastonville to first access point Ivybridge Drive to Phase 3 access (Intersection #6)	With Grandview Reserve development	With Grandview Reserve Phases 2 and 3	Grandview Reserve
8	Rex Road: Construct new road segment from Intersection #6 to US Hwy 24 Adequate right-of-way should be reserved to allow for the construction of left-turn and right-turn deceleration lanes at all potential future access points	With Grandview Reserve development	With future Grandview Reserve filings	Grandview Reserve
9	Rex Road: Construct new segment from Estate Ridge to Eastonville	With adjacent Meridian Ranch development	Will be completed late 2023 and open to traffic by spring 2024	Meridian Ranch
10	Stapleton Drive: Meridian Road to Eastonville Road complete southern (eastbound) half	average daily traffic > 18,000 vehicles per day	Shown in 2040 MTCP	El Paso County
11	Stapleton Drive: Eastonville Road to US 24 complete southern (eastbound) half	average daily traffic > 18,000 vehicles per day	Shown in 2040 MTCP	Waterbury Metro District
Intersections Improvements				
Intersection #1 Eastonville Road/Rex Road				
12	Construct as modern one-lane roundabout	With Grandview Reserve Phase 1	With Grandview Reserve Phase 1	PPRTA/El Paso County ⁽¹⁾
Intersection #2 Rex Road/Ivybridge Boulevard				
13	Construct an eastbound right-turn deceleration lane on Rex Road approaching Ivybridge	eastbound right-turn volume > 50 vph	With Grandview Reserve Phase 1	Grandview Reserve
14	Stripe the planned center median on Rex Road for a westbound left-turn deceleration lane-approaching Ivybridge	westbound left-turn volume > 25 vph	With Grandview Reserve Phase 1	Grandview Reserve
Intersection #4 Rex Road/Phase 2 West Access				
15	Stripe the planned center median on Rex Road for a westbound left-turn deceleration lane-approaching the west Phase 2 access	westbound left-turn volume > 25 vph	With Grandview Reserve Phase 2	Grandview Reserve
Intersection #5 Rex Road/Phase 2 East Access				
16	Stripe the planned center median on Rex Road for a westbound left-turn deceleration lane on Rex Road approaching the east Phase 2 access	westbound left-turn volume > 25 vph	With Grandview Reserve Phase 2	Grandview Reserve
Intersection #6 Rex Road/Phase 3 Access				
17	Construct as a modern one-lane roundabout	With the construction of Rex Road to the Grandview Reserve Phase 3 access	With Grandview Reserve Phase 3	Grandview Reserve
Intersection #9 US Hwy 24/Rex Road Intersection (Per CDOT Access Permit No. 221088)				
18	Construct the intersection of US Hwy 24 as a channelized-T type intersection with a northeastbound left-turn deceleration lane and a northeastbound left-turn acceleration lane on US Hwy 24	With the opening of the access	With future Grandview Reserve filings	Grandview Reserve
19	Construct a second northeastbound left-turn deceleration lane on US Hwy 24 approaching Rex	Once the intersection is traffic signal controlled and level of service and/or queueing issues arise	With future Grandview Reserve filings	Grandview Reserve
20	Construct a southwestbound right-turn deceleration lane on US Hwy 24 approaching Rex	southwestbound right-turn volume > 10 vph	With future Grandview Reserve filings	Grandview Reserve
21	Construct a southwestbound right-turn acceleration lane on US Hwy 24 at Rex	southeastbound right-turn volume > 10 vph	With future Grandview Reserve filings	Grandview Reserve
22	Signalization of the intersection of US Hwy 24/Rex. The channelized-T configuration shall be retained and the signal would be a "directional signal" ⁽²⁾	When Traffic Signal Warrant(s) are met. The decision on timing of traffic signal installation rests with the Colorado Department of Transportation	Long-Term Future (to be evaluated with each filing)	Grandview Reserve
Intersection #10 Eastonville Road/Dawlish Drive				
23	Construct as a modern one-lane roundabout	With Grandview Reserve Phase 1	With Grandview Reserve Phase 1	Grandview Reserve
Intersection #11 Eastonville Road/Brixham Drive				
24	Construct a northbound right-turn deceleration lane on Eastonville approaching Brixham (Not needed if constructed as a modern roundabout. Intersection control is to be determined with the final plat)	northbound right-turn volume > 50 vph	With Grandview Reserve Phase 1	Grandview Reserve
25	Construct a southbound left-turn deceleration lane on Eastonville approaching Brixham	southbound left-turn volume > 25 vph	With Grandview Reserve Phase 1	Grandview Reserve
Intersection #12 Eastonville Road/Londonderry Drive				
26	Reconstruct as modern one-lane roundabout	Short-Term (under design as part of the Eastonville PPRTA Phase 1 project)		PPRTA Eastonville Phase 1 Project/El Paso County
Intersection #13 Eastonville Road/Stapleton Drive				
27	Reconstruct as modern one-lane (expandable) roundabout	Short-Term (under design as part of the Eastonville PPRTA Phase 1 project)		PPRTA Eastonville Phase 1 Project/El Paso County
28	Expand to multi-lane modern roundabout	With Improvement #11: Stapleton Drive - US Hwy 24 to Eastonville Road complete southern (eastbound) half		El Paso County
Intersection #14 Stapleton Drive/US Hwy 24 Intersection				
29	Convert from Two-Way, Stop-Sign Control to Signal Control	When Traffic Signal Warrant(s) are met. The decision on timing of traffic signal installation rests with the Colorado Department of Transportation	Anticipated in the short-term. It is our understanding that this is on the CDOT list of intersections planned for signalization.	CDOT; along with any available escrow collected from area developments through the access permitting process
30	Add northeast-bound dual left-turn lane	As needed with future developments (Will require Stapleton Drive to be widened to two westbound through lanes between US Hwy 24 and Dumont Dr)	Anticipated in the short-term	Area developments as required or potentially escrow participation toward future improvements.
31	Add other dual left-turn lanes	As needed with future developments (Will require Items Stapleton and US Hwy 24 widened to two through lanes in all directions)	Future	Area developments as required
32	Potential long-term capacity upgrades (jughandle, a Jr Interchange, etc.)	When level of service degrades below acceptable levels	Shown in US Highway 24 PEL Study;	CDOT; along with any available escrow collected from area developments-through the access permitting process.
Notes:				
(1) These thresholds are utilized in the Fee Study for determination of inclusion of improvements in the Fee Program costs.				
(2) Signal escrow amounts may be required in lieu of signal installation with future residential filings and/or commercial development applications- this will be determined by future TIS Reports and CDOT requirements from review of those future TIS reports.				
Source: LSC Transportation Consultants, Inc. (December 2023)				

Figures 1-16



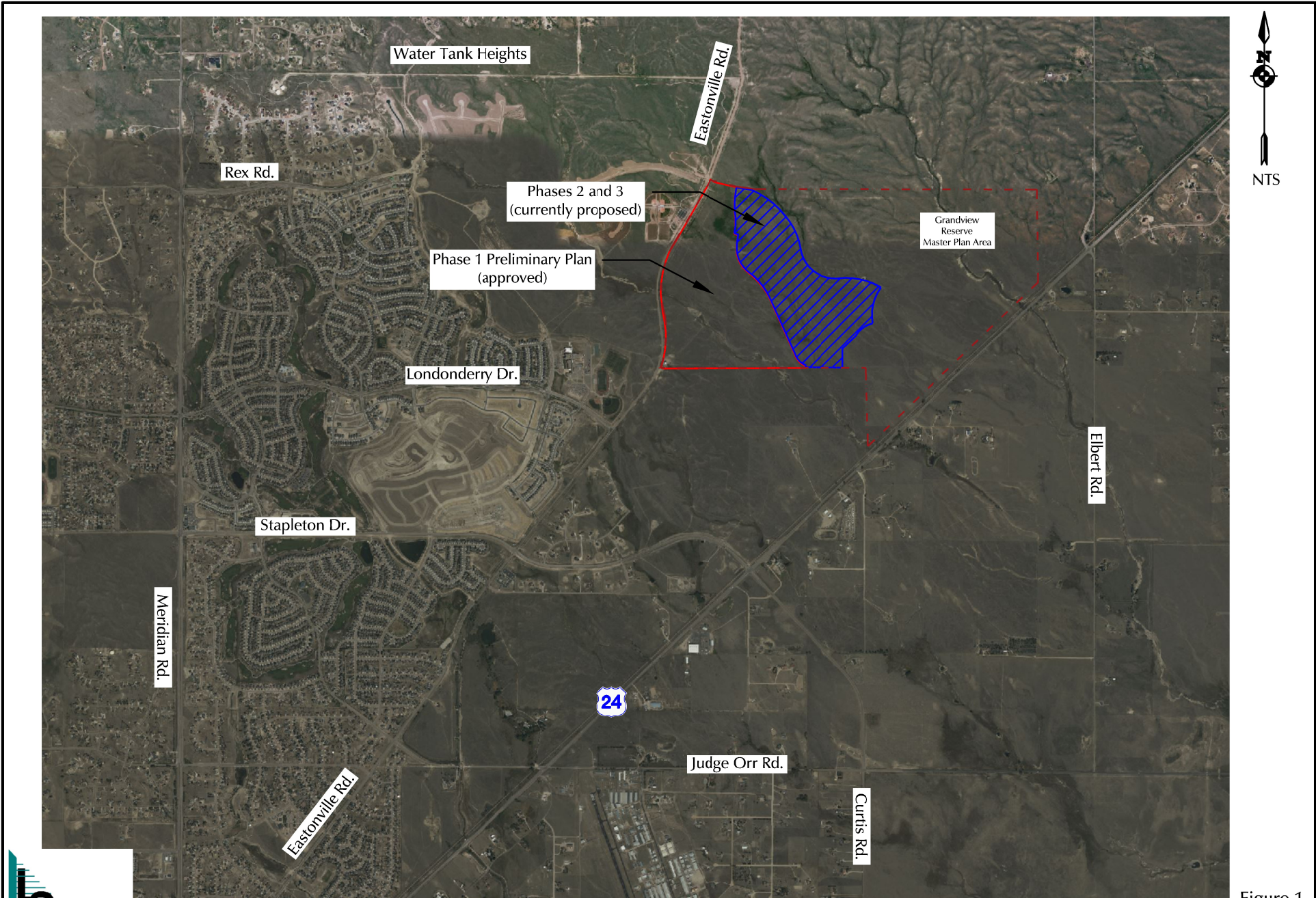

Figure 1

Vicinity Map

Grandview Reserve Phases 2 and 3 (LSC # S234340)



1" = 200'
scale

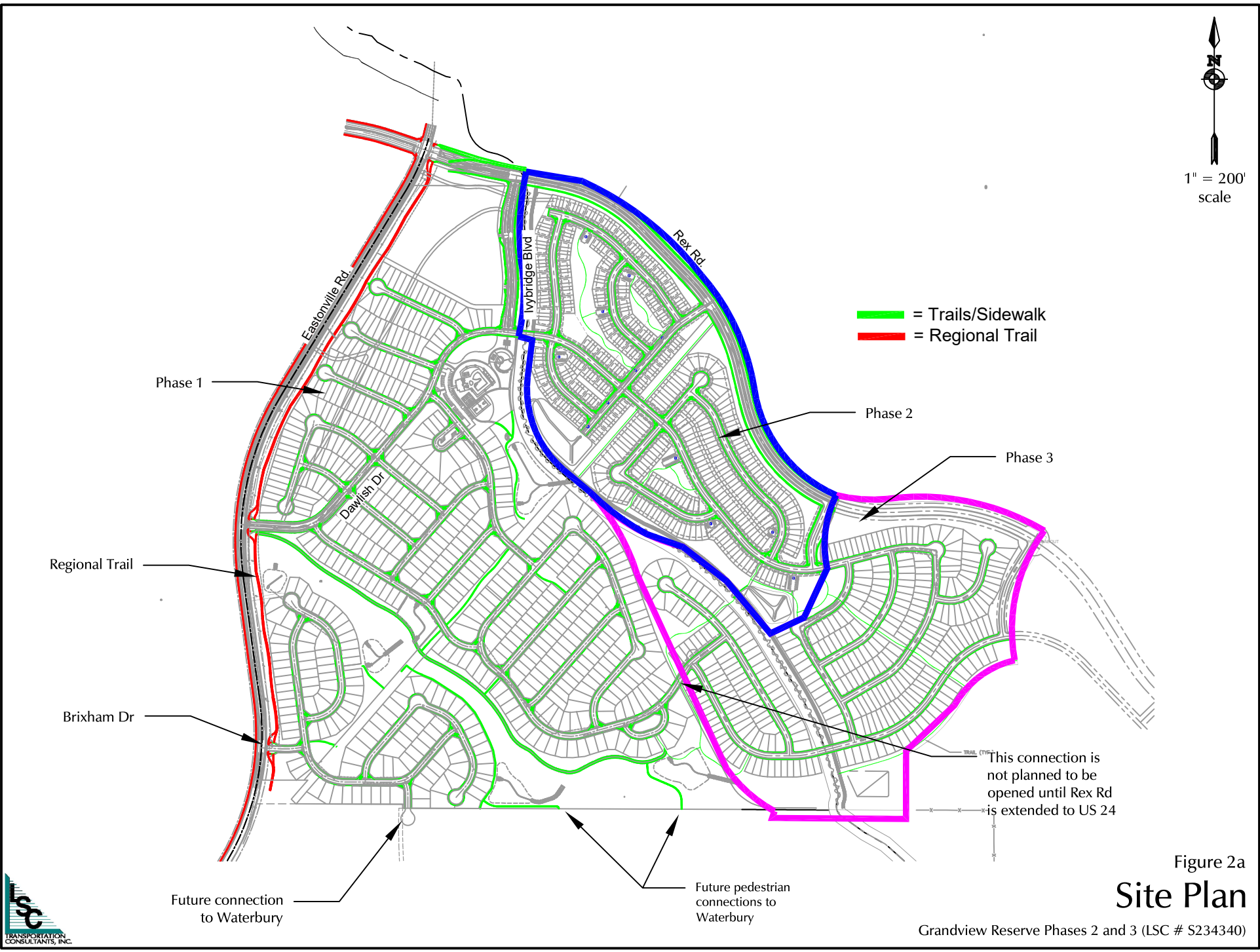

Figure 2a
Site Plan

Grandview Reserve Phases 2 and 3 (LSC # S234340)



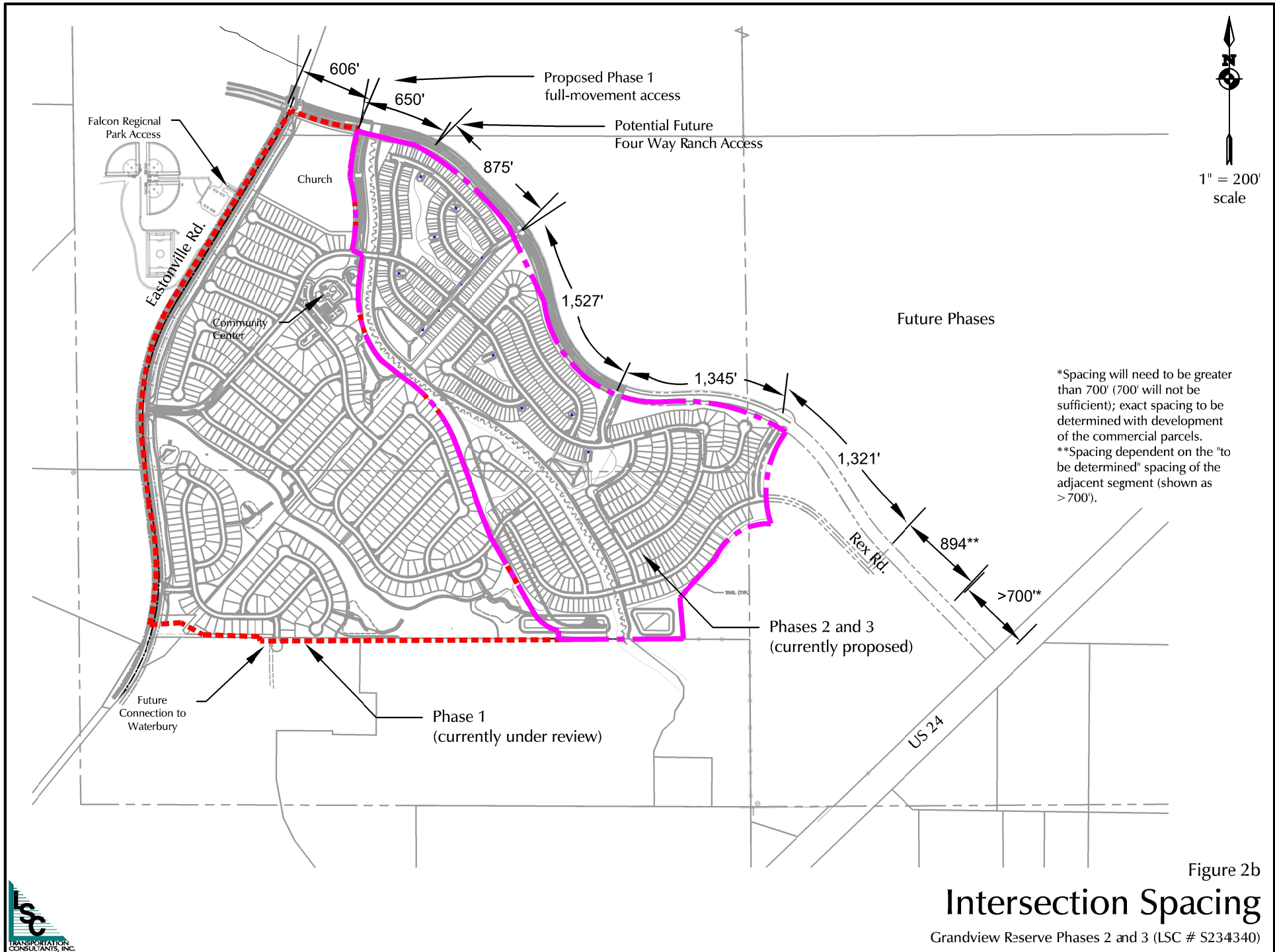
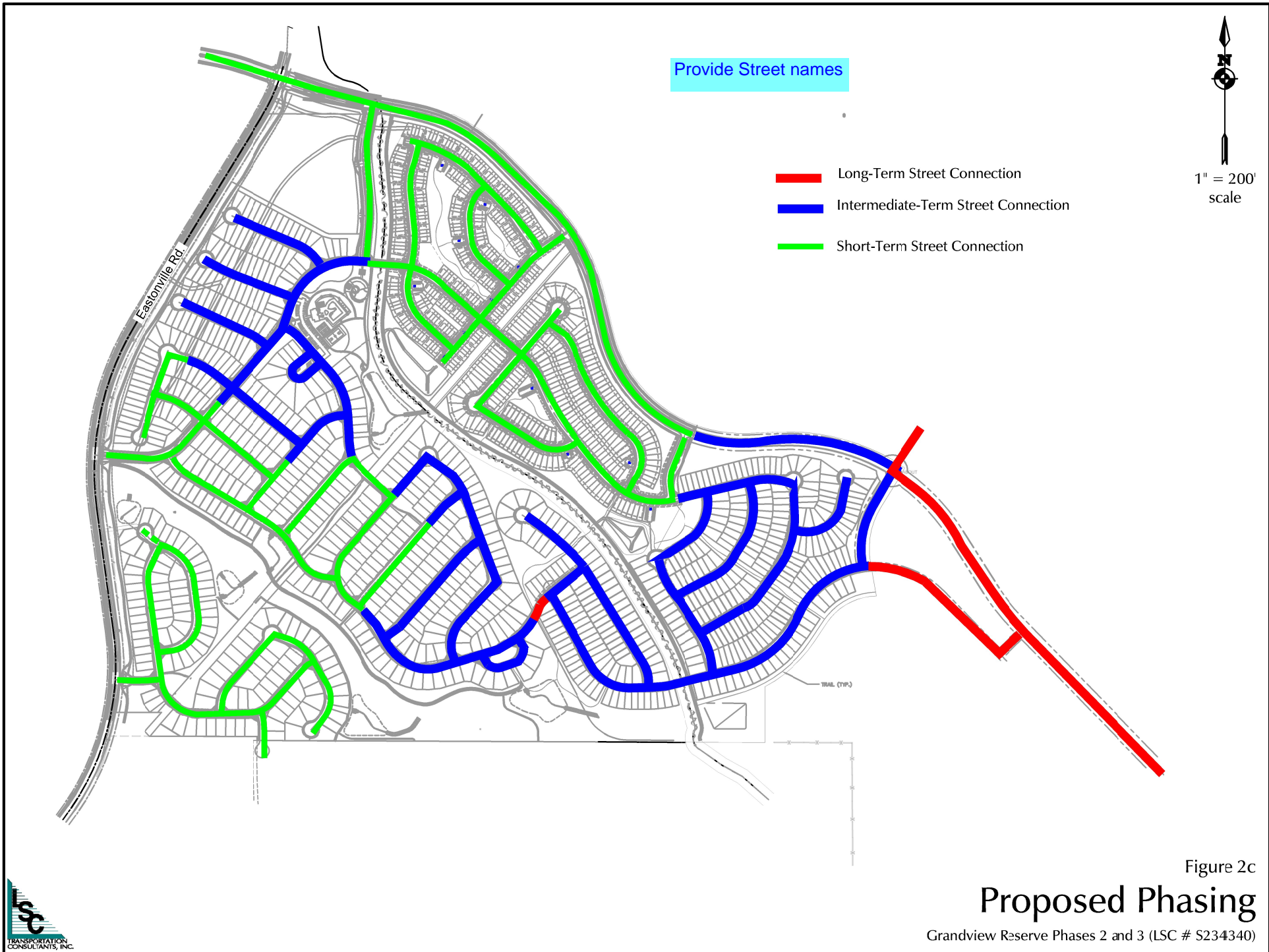

Figure 2b

Intersection Spacing

Grandview Reserve Phases 2 and 3 (LSC # S234340)





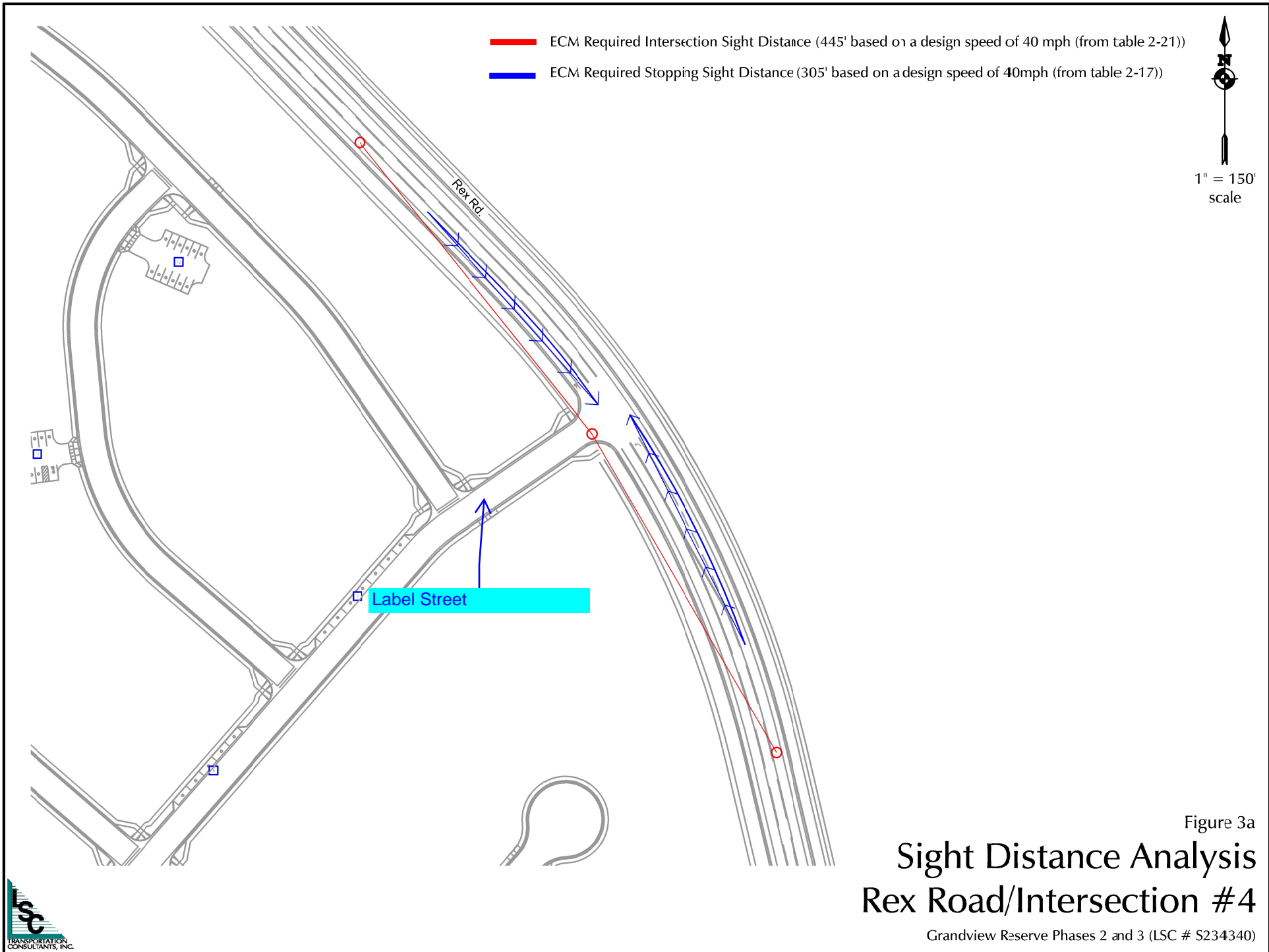

- ECM Required Intersection Sight Distance (445' based on a design speed of 40 mph (from table 2-21))
- ECM Required Stopping Sight Distance (305' based on a design speed of 40mph (from table 2-17))



1" = 150'
scale

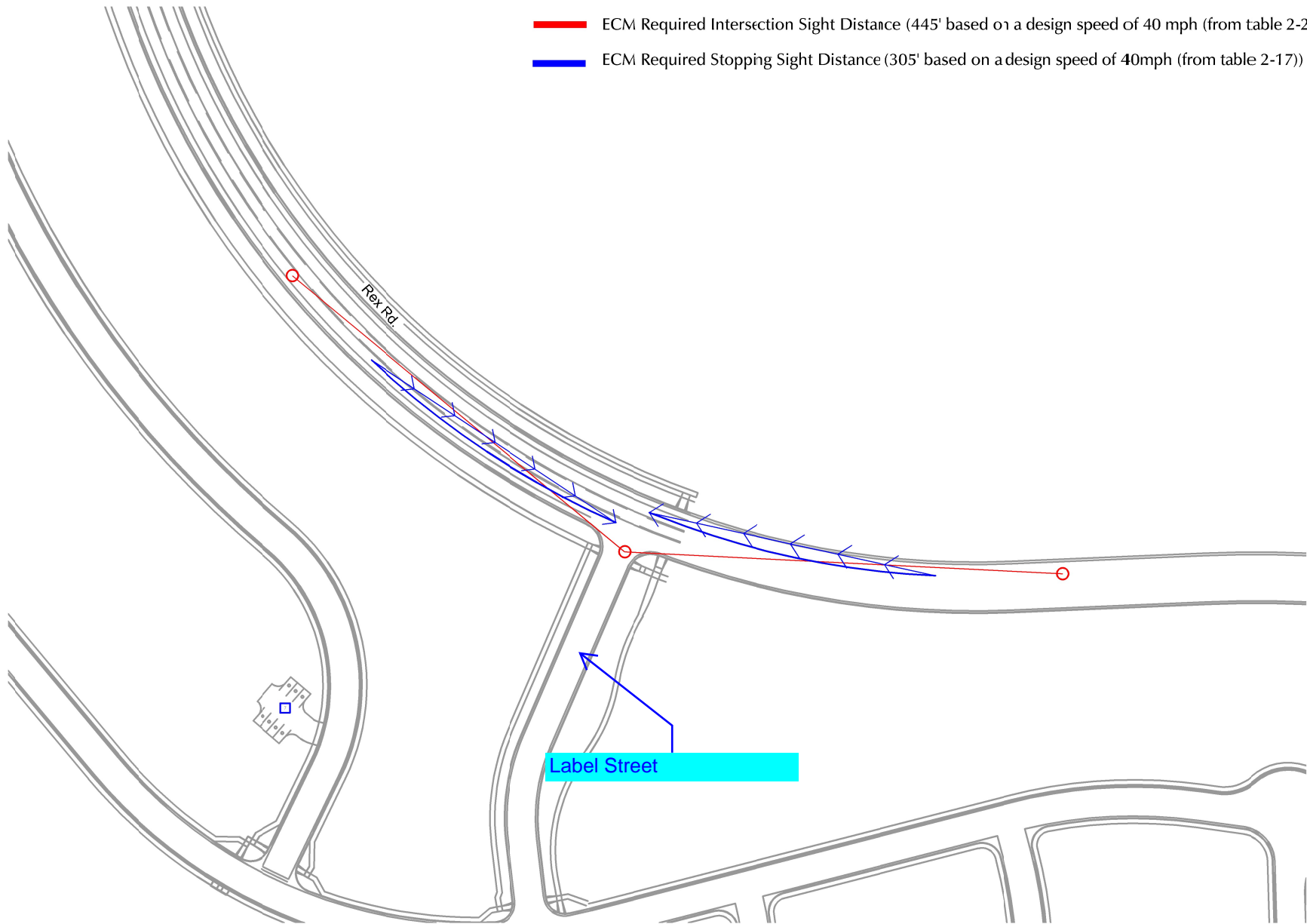
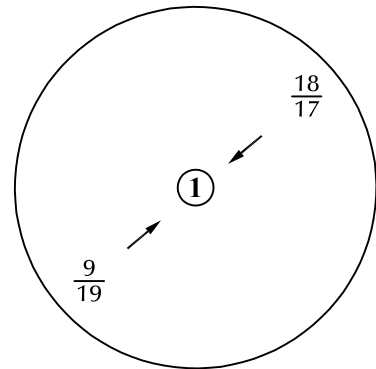

Figure 3b

Sight Distance Analysis Rex Road/Intersection #5

Grandview Reserve Phases 2 and 3 (LSC # S234340)



Intentionally
②
Left Blank

Intentionally
③
Left Blank

Intentionally
④
Left Blank

Intentionally
⑤
Left Blank

Intentionally
⑥
Left Blank

Intentionally
⑦
Left Blank

Intentionally
⑧
Left Blank

Intentionally
⑨
Left Blank

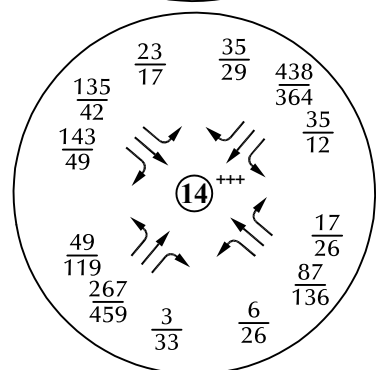
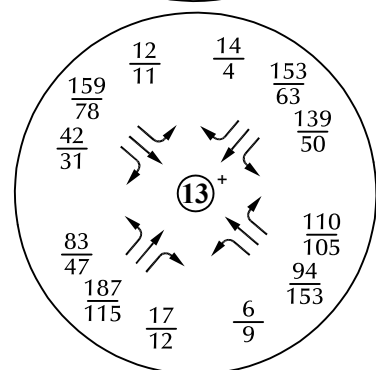
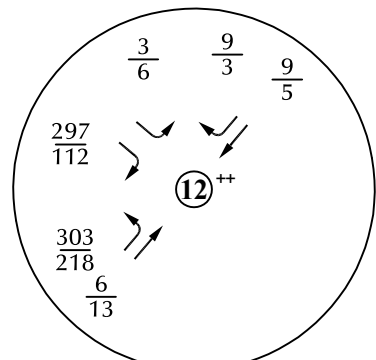
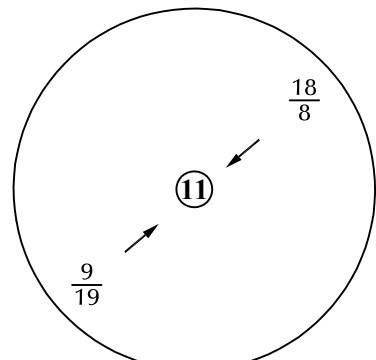
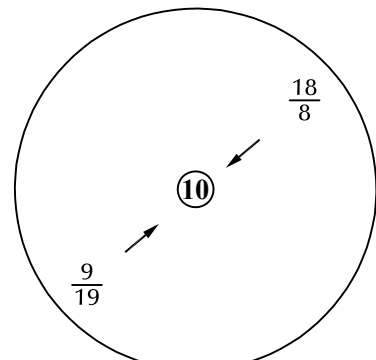

LEGEND:

$\frac{XX}{XX}$ = AM Weekday Peak-Hour Traffic (vehicles per hour)
 $\frac{XX}{XX}$ = PM Weekday Peak-Hour Traffic (vehicles per hour)
 X,XXX= Annual Average Daily Traffic (vehicles per day)



* Estimate by LSC

** CDOT 2022 Average Annual Daily Traffic

+ Based on counts by LSC October 2021

**Based on counts by LSC April 2021. The northbound left-turn and eastbound right-turn volumes have been adjusted based on the more recent counts at Stapleton/Eastonville.

+++ Based on counts by LSC January 2023

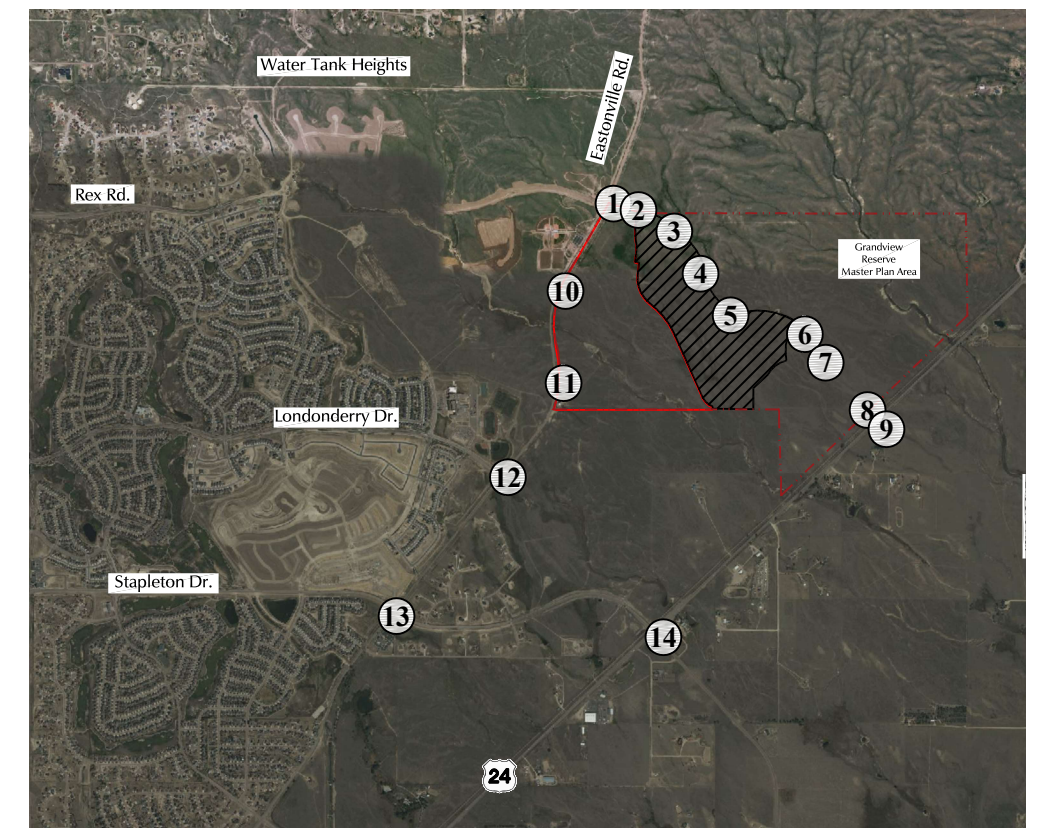

Figure 4a
Existing Traffic

Grandview Reserve Phases 2 and 3 (LSC # S234340)



LEGEND:
 Traffic Control Used in the Analysis:
 ↓ = Stop Sign
 [Traffic Signal Icon] = Traffic Signal
 LOS Analysis Results:
 $\frac{A}{B}$ = AM Individual Movement Peak-Hour Level of Service
 $\frac{B}{B}$ = PM Individual Movement Peak-Hour Level of Service
 $\frac{C}{C}$ = AM Entire Intersection Peak-Hour Level of Service
 $\frac{C}{C}$ = PM Entire Intersection Peak-Hour Level of Service



Intentionally
 ①
 Left Blank

Intentionally
 ②
 Left Blank

Intentionally
 ③
 Left Blank

Intentionally
 ④
 Left Blank

Intentionally
 ⑤
 Left Blank

Intentionally
 ⑥
 Left Blank

Intentionally
 ⑦
 Left Blank

Intentionally
 ⑧
 Left Blank

Intentionally
 ⑨
 Left Blank

Intentionally
 ⑩
 Left Blank

Intentionally
 ⑪
 Left Blank

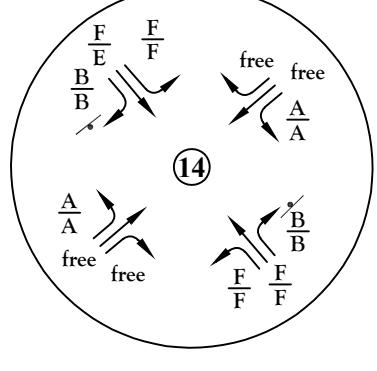
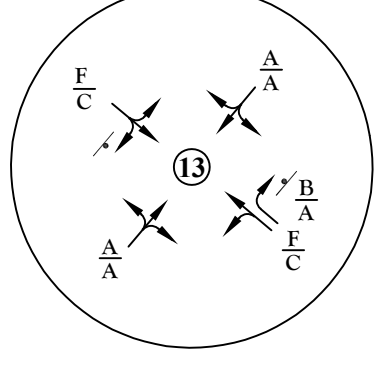
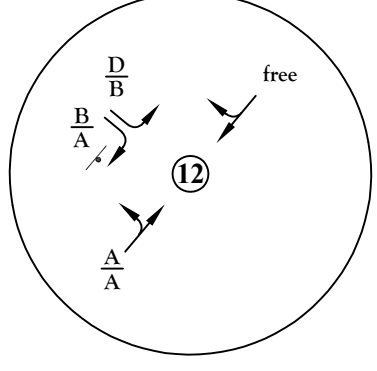
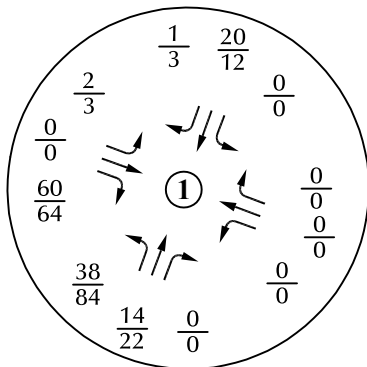

Figure 4b
 Existing Lane Geometry, Traffic Control, and Level of Service

Grandview Reserve Phases 2 and 3 (LSC # S234340)





Intentionally
②
Left Blank

Intentionally
③
Left Blank

Intentionally
④
Left Blank

Intentionally
⑤
Left Blank

Intentionally
⑥
Left Blank

Intentionally
⑦
Left Blank

Intentionally
⑧
Left Blank

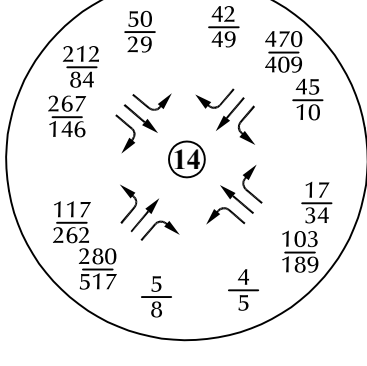
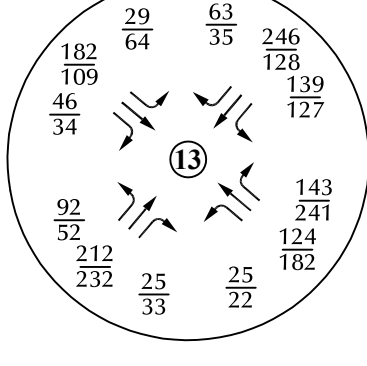
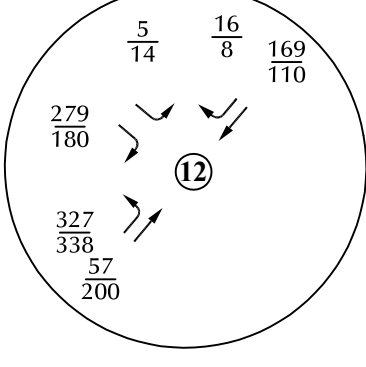
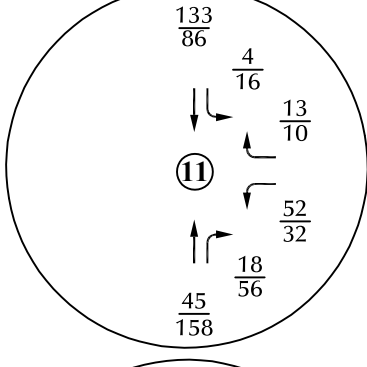
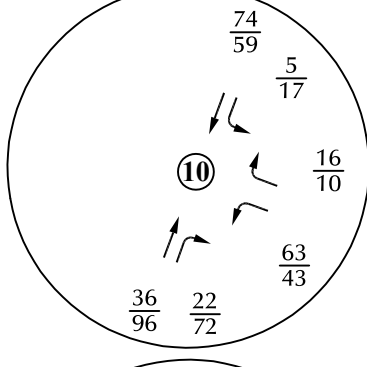
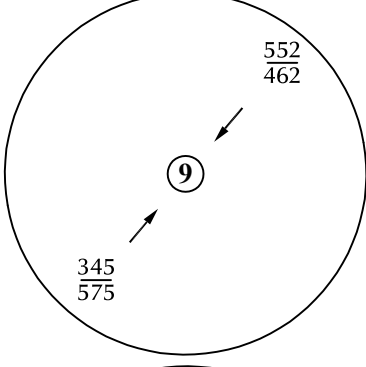

LEGEND:
 $\frac{XX}{XX}$ = AM Weekday Peak-Hour Traffic (vehicles per hour)
 $\frac{XX}{XX}$ = PM Weekday Peak-Hour Traffic (vehicles per hour)
 X,XXX= Annual Average Daily Traffic (vehicles per day)

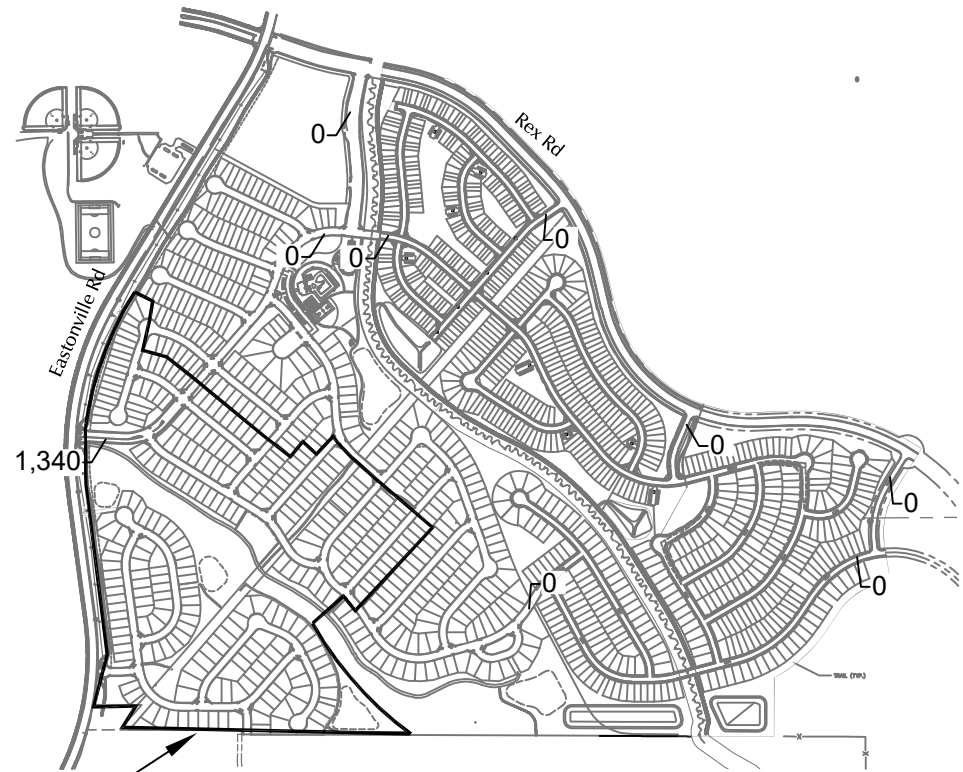
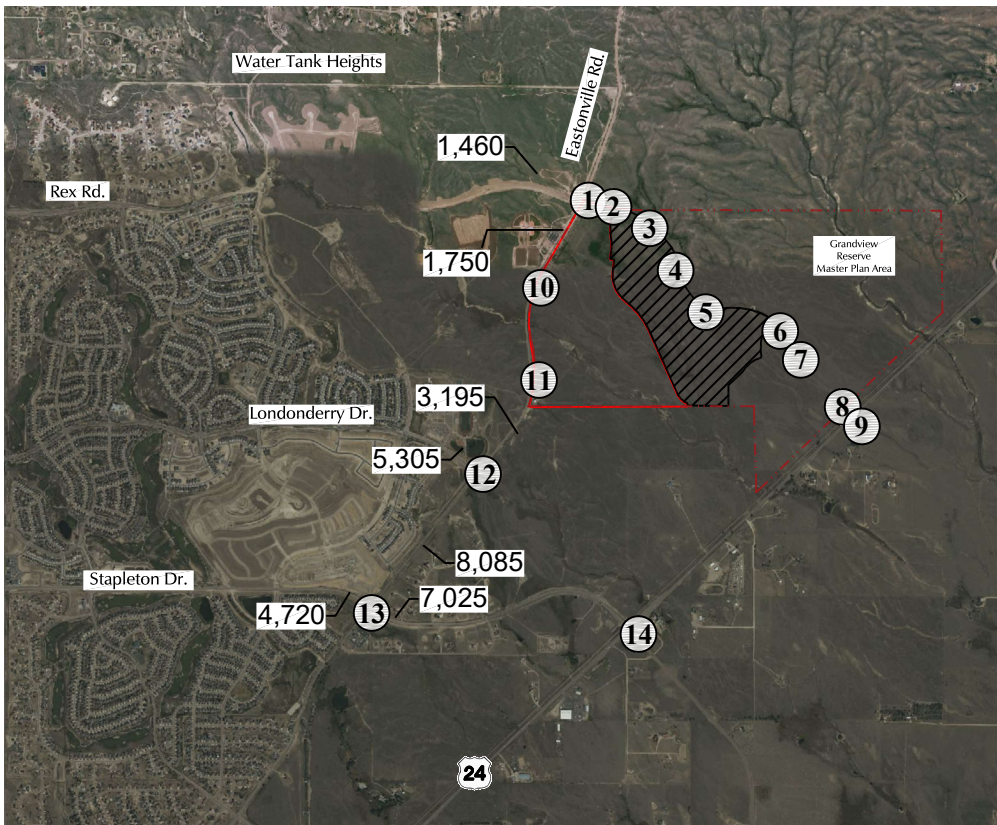

Phase 1 Filings 1 and 2

Figure 5a
Year 2026

Background Traffic*

* Assumes buildout of Grandview Reserve Phase 1, filings 1 and 2 only.

Grandview Reserve Phases 2 and 3 (LSC # S234340)



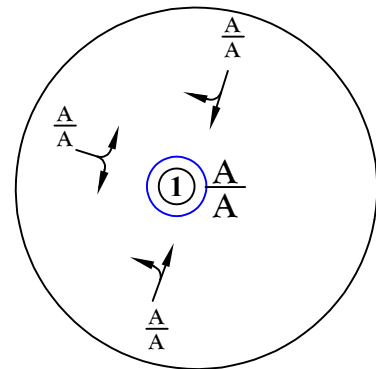

Intentionally
②
Left Blank

Intentionally
③
Left Blank

Intentionally
④
Left Blank

Intentionally
⑤
Left Blank

Intentionally
⑥
Left Blank

Intentionally
⑦
Left Blank

Intentionally
⑧
Left Blank

Intentionally
⑨
Left Blank

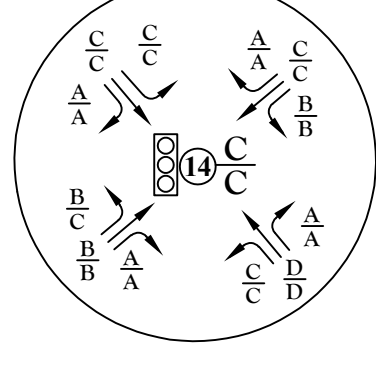
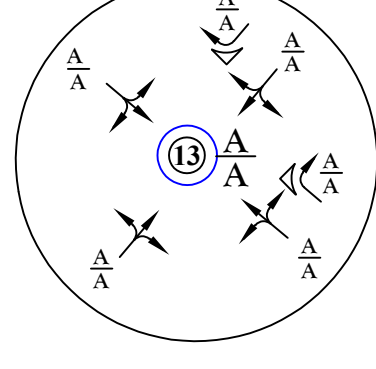
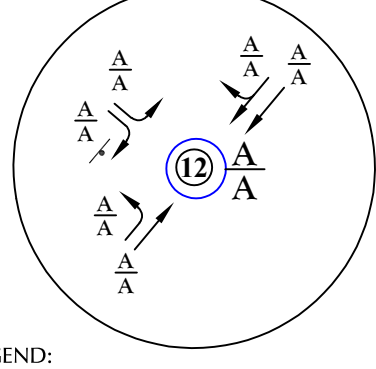
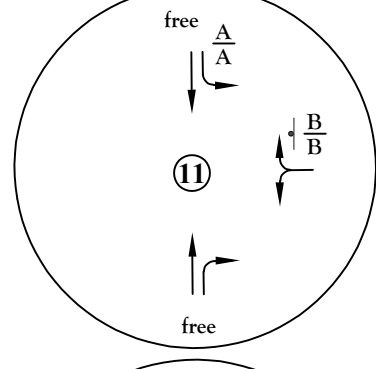
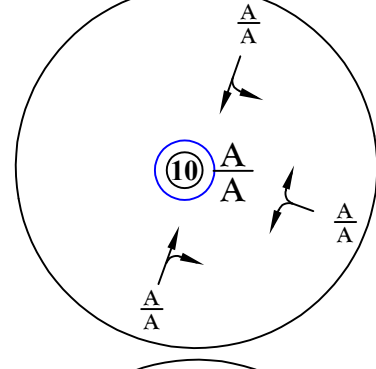

LEGEND:
 Traffic Control Used in the Analysis:
 | = Stop Sign
 [] = Traffic Signal
 LOS Analysis Results:
 A/B = AM Individual Movement Peak-Hour Level of Service
 PM Individual Movement Peak-Hour Level of Service
 A/C = AM Entire Intersection Peak-Hour Level of Service
 PM Entire Intersection Peak-Hour Level of Service
 (Circled Number) = Modern Roundabout

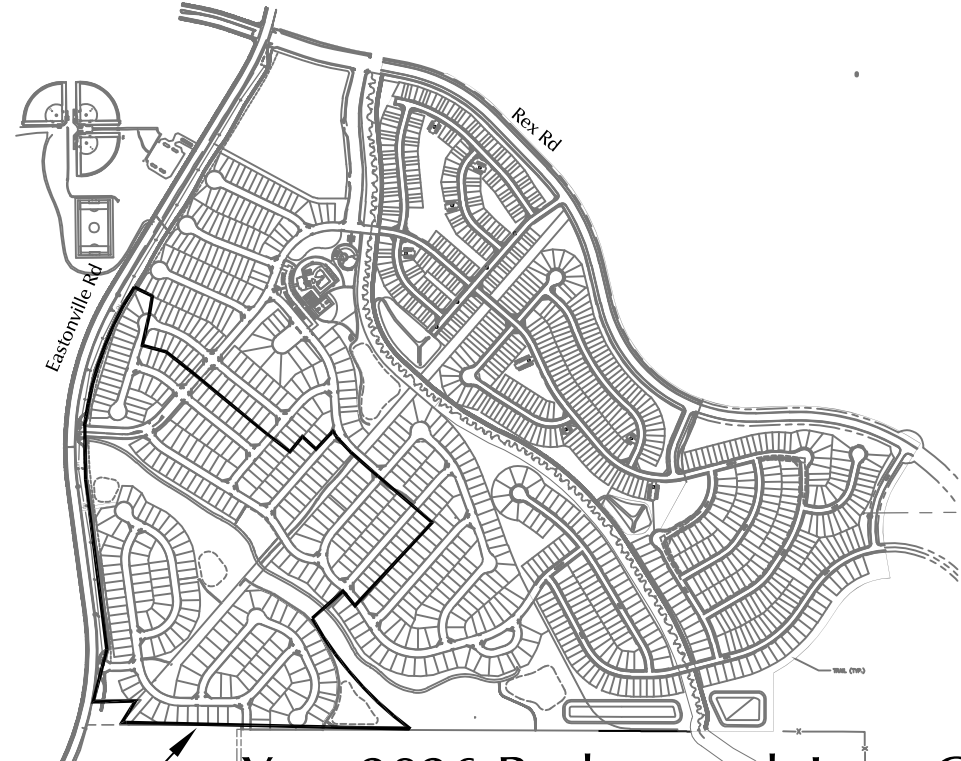
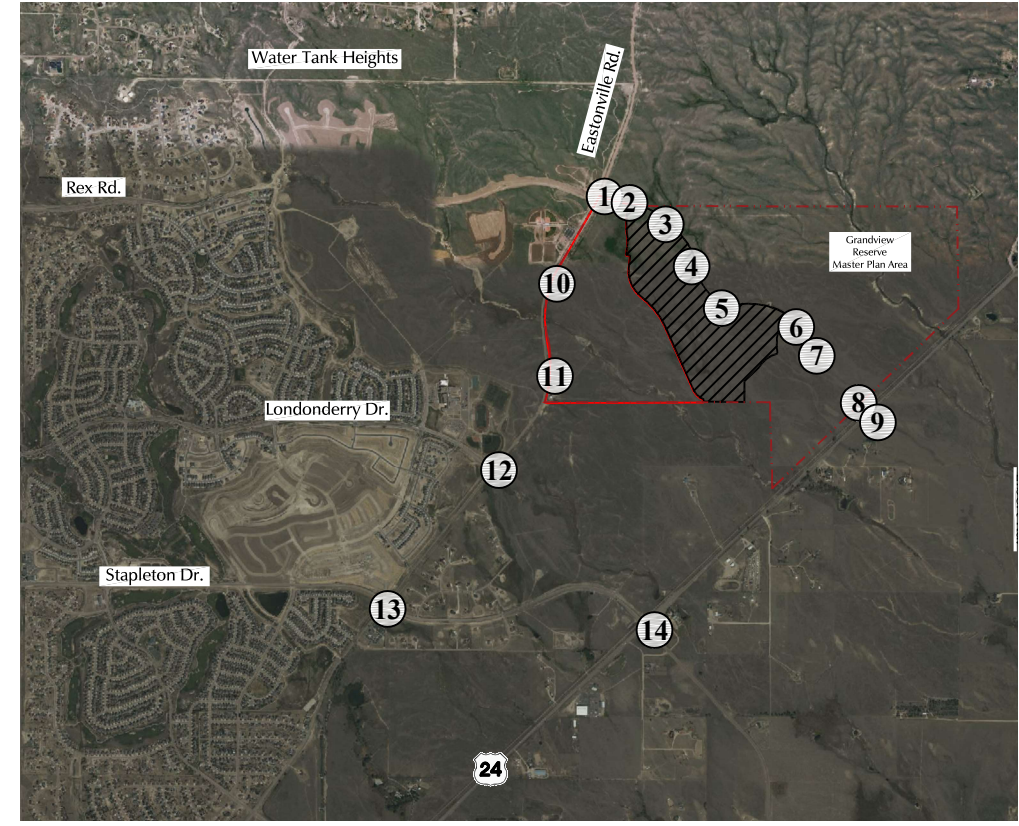

Year 2026 Background Lane Geometry,
Traffic Control, and Levels of Service*

Figure 5b

* Assumes buildout of Grandview Reserve Phase 1, filings 1 and 2 only.

Grandview Reserve Phases 2 and 3 (LSC # S234340)



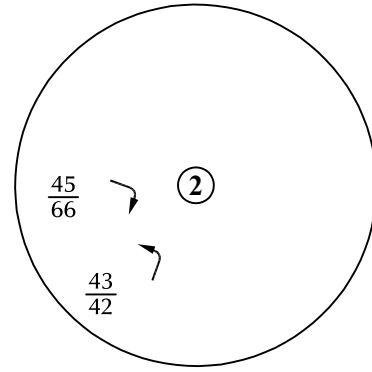
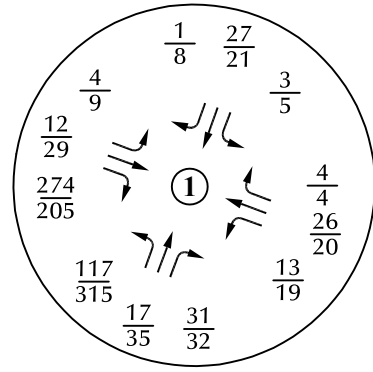

Intentionally
③
Left Blank

Intentionally
④
Left Blank

Intentionally
⑤
Left Blank

Intentionally
⑥
Left Blank

Intentionally
⑦
Left Blank

Intentionally
⑧
Left Blank

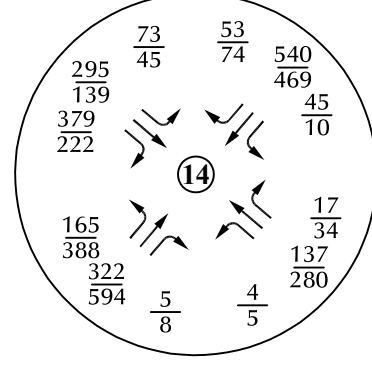
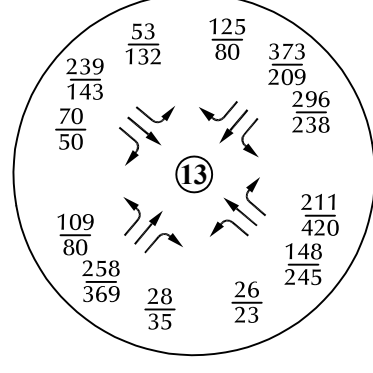
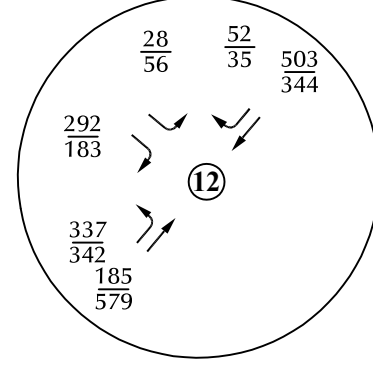
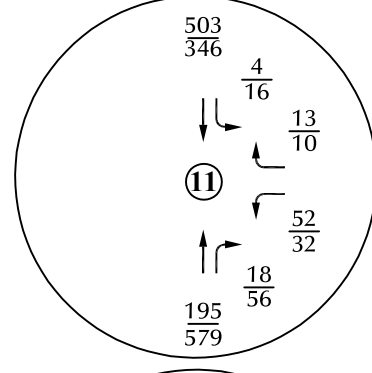
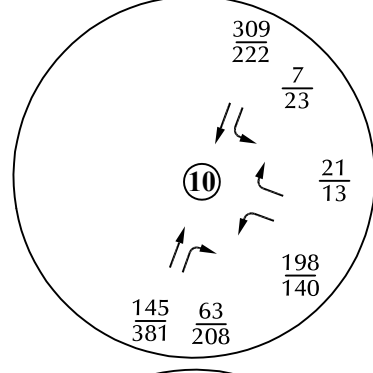
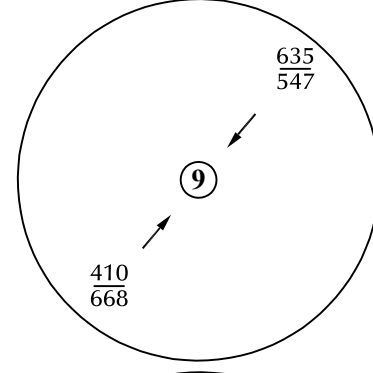

LEGEND:
 $\frac{XX}{XX}$ = AM Weekday Peak-Hour Traffic (vehicles per hour)
 $\frac{XX}{XX}$ = PM Weekday Peak-Hour Traffic (vehicles per hour)
 X,XXX= Annual Average Daily Traffic (vehicles per day)

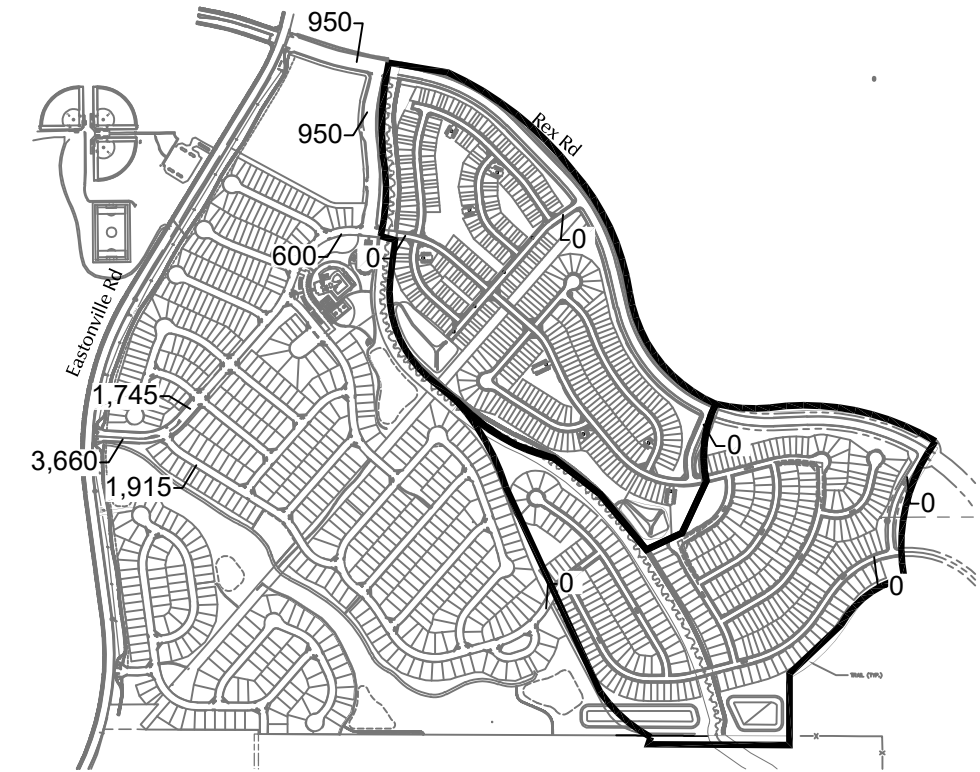
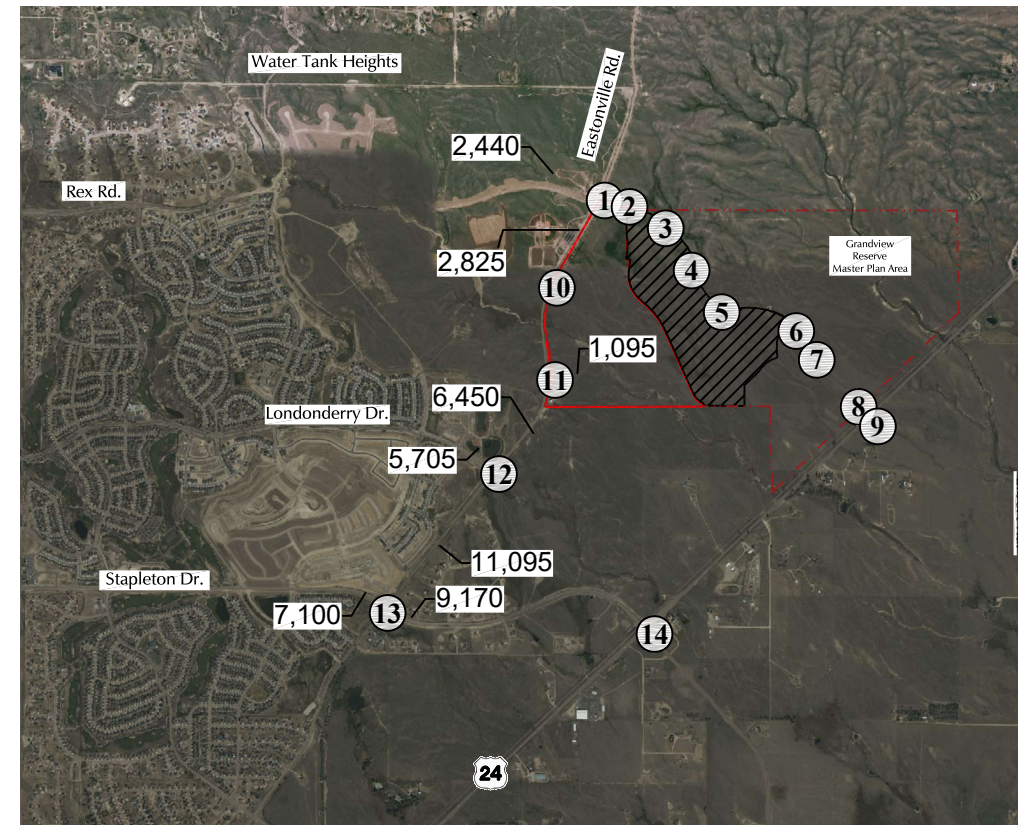
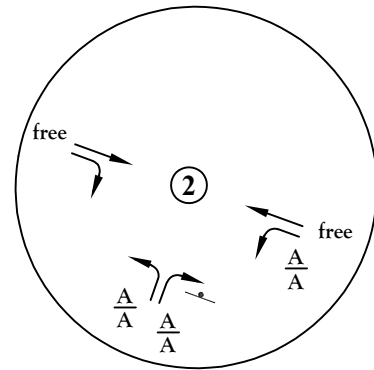
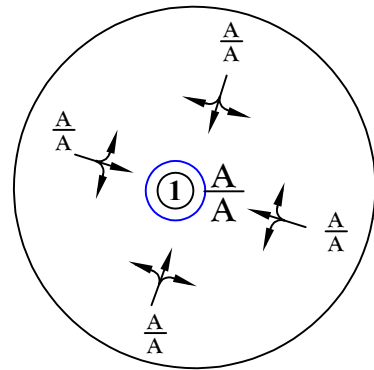

Figure 6a
 Year 2033
 Background Traffic*

* Assumes buildout of Grandview Reserve Phase 1

Grandview Reserve Phases 2 and 3 (LSC # S234340)





Intentionally
③
Left Blank

Intentionally
④
Left Blank

Intentionally
⑤
Left Blank

Intentionally
⑥
Left Blank

Intentionally
⑦
Left Blank

Intentionally
⑧
Left Blank

Intentionally
⑨
Left Blank

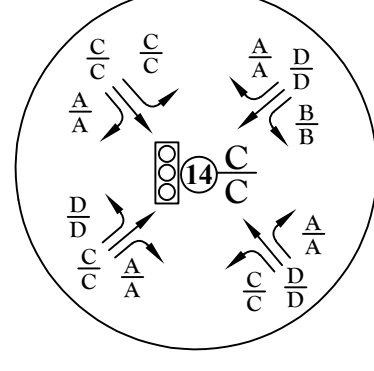
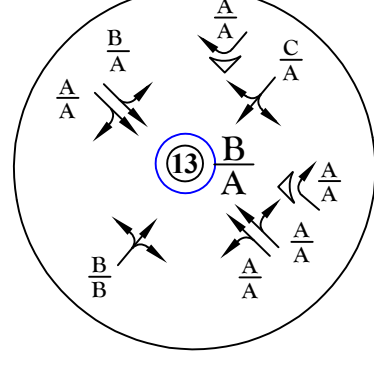
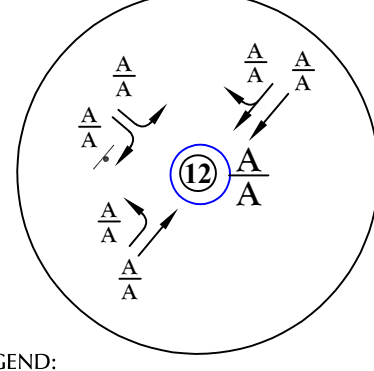
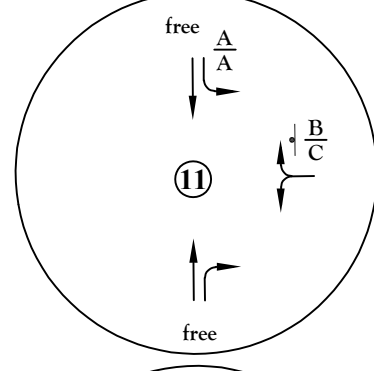
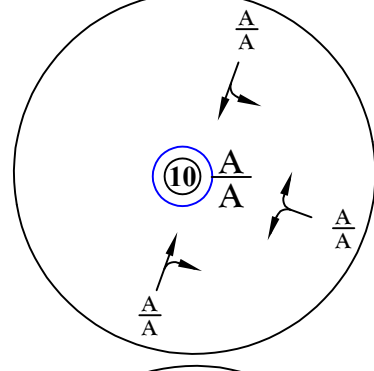

LEGEND:
Traffic Control Used in the Analysis:
↓ = Stop Sign
ⓞ = Traffic Signal
LOS Analysis Results:
A/A = AM Individual Movement Peak-Hour Level of Service
B/B = PM Individual Movement Peak-Hour Level of Service
C/C = AM Entire Intersection Peak-Hour Level of Service
D/D = PM Entire Intersection Peak-Hour Level of Service
ⓞ = Modern Roundabout

LEGEND:
 $\frac{XX}{XX}$ = AM Weekday Peak-Hour Traffic (vehicles per hour)
 $\frac{XX}{XX}$ = PM Weekday Peak-Hour Traffic (vehicles per hour)
X,XXX = Annual Average Daily Traffic (vehicles per day)

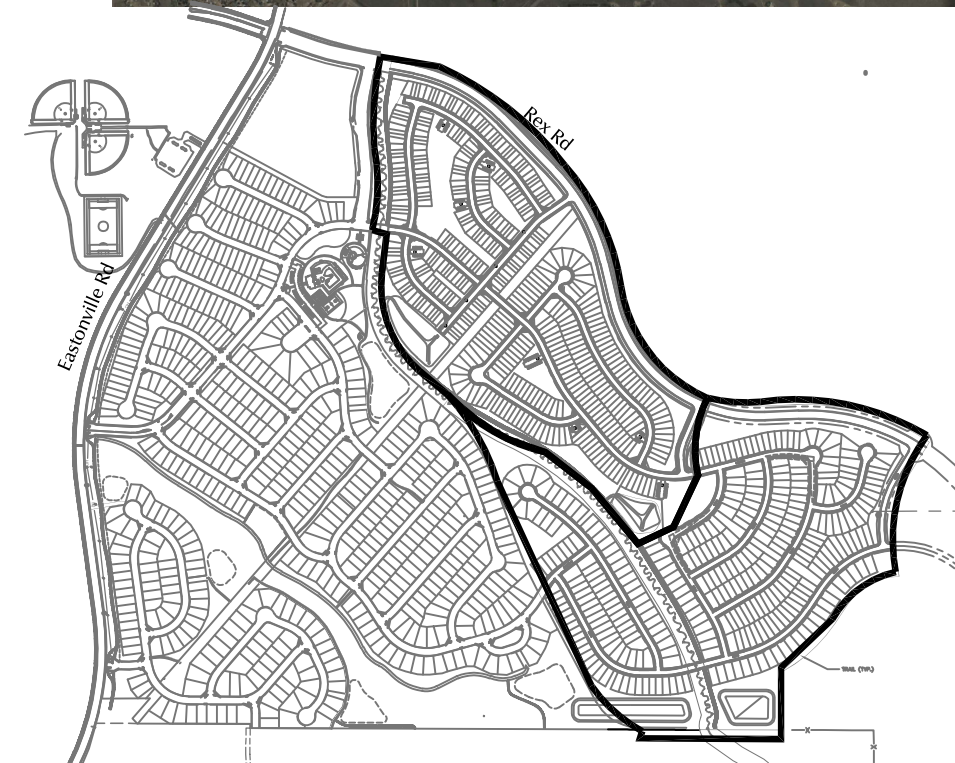
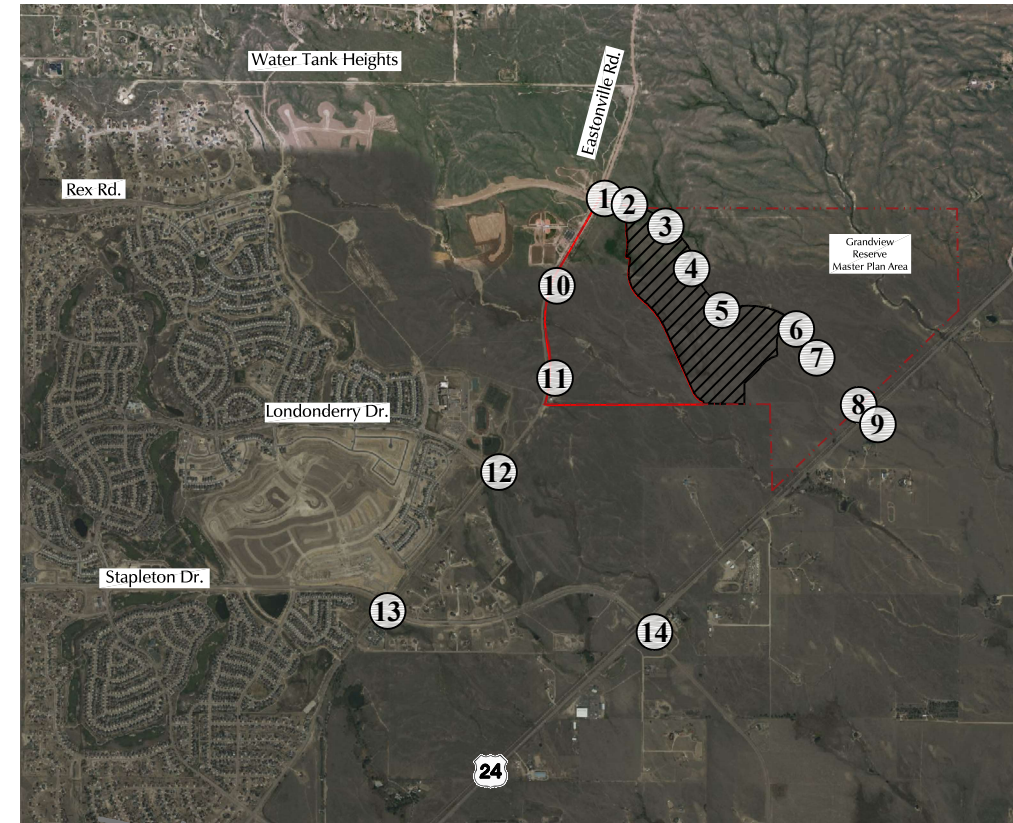
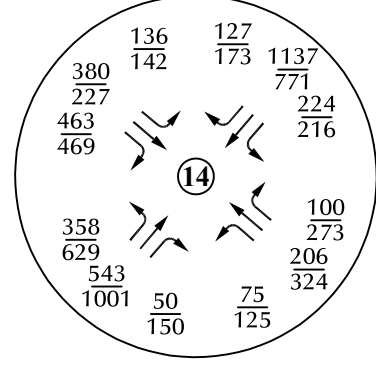
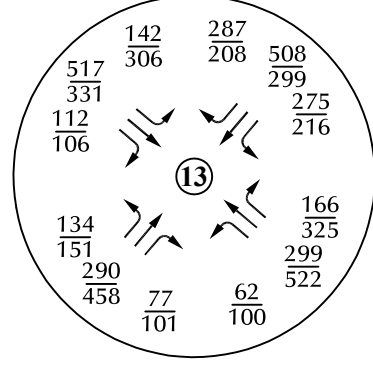
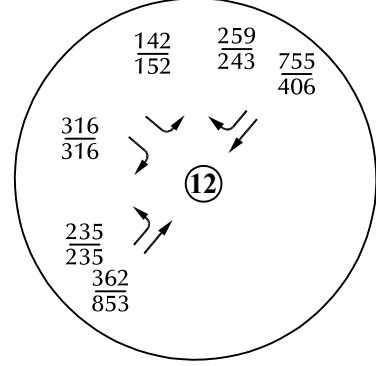
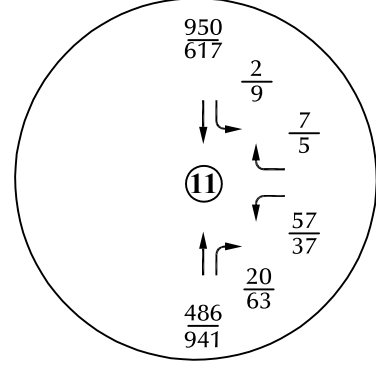
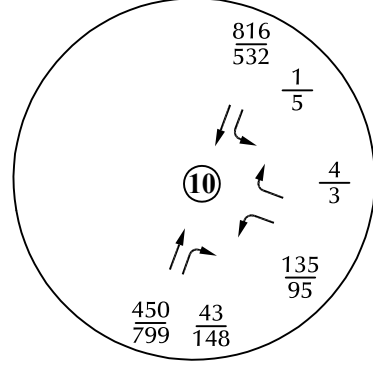
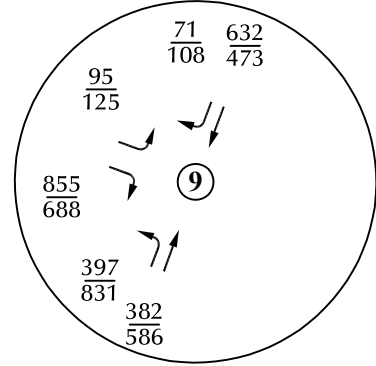
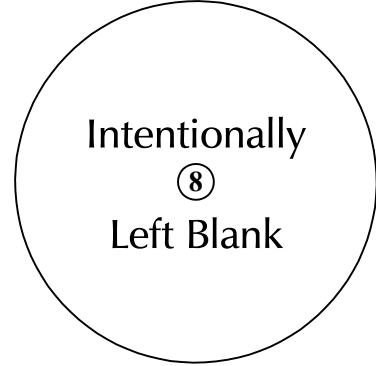
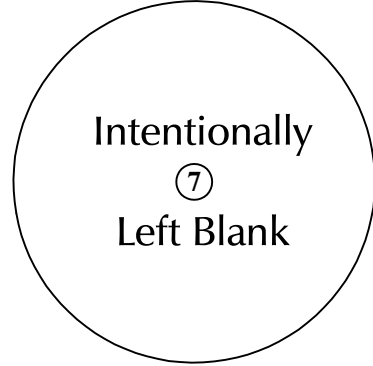
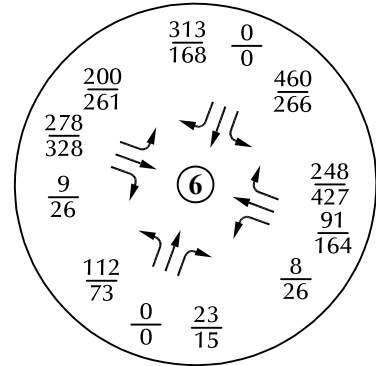
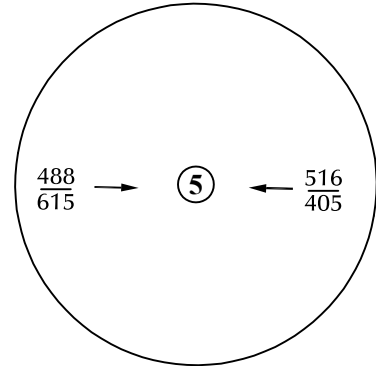
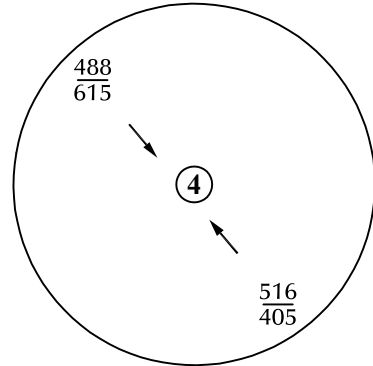
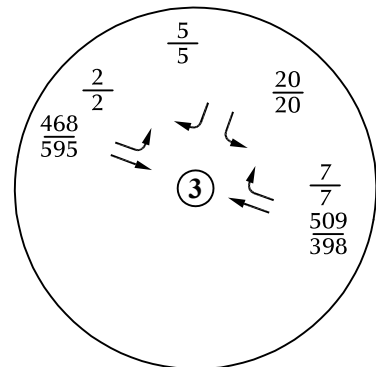
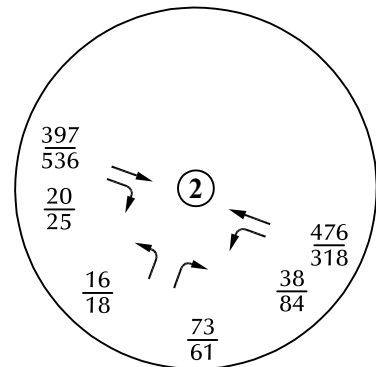
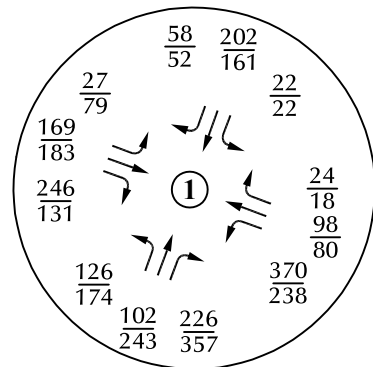

Figure 6b
2033 Background Traffic* Lane Geometry,
Traffic Control, and Levels of Service

* Assumes buildout of Grandview Reserve Phase 1



LEGEND:
 $\frac{XX}{XX}$ = AM Weekday Peak-Hour Traffic (vehicles per hour)
 $\frac{XX}{XX}$ = PM Weekday Peak-Hour Traffic (vehicles per hour)
 X,XXX= Annual Average Daily Traffic (vehicles per day)

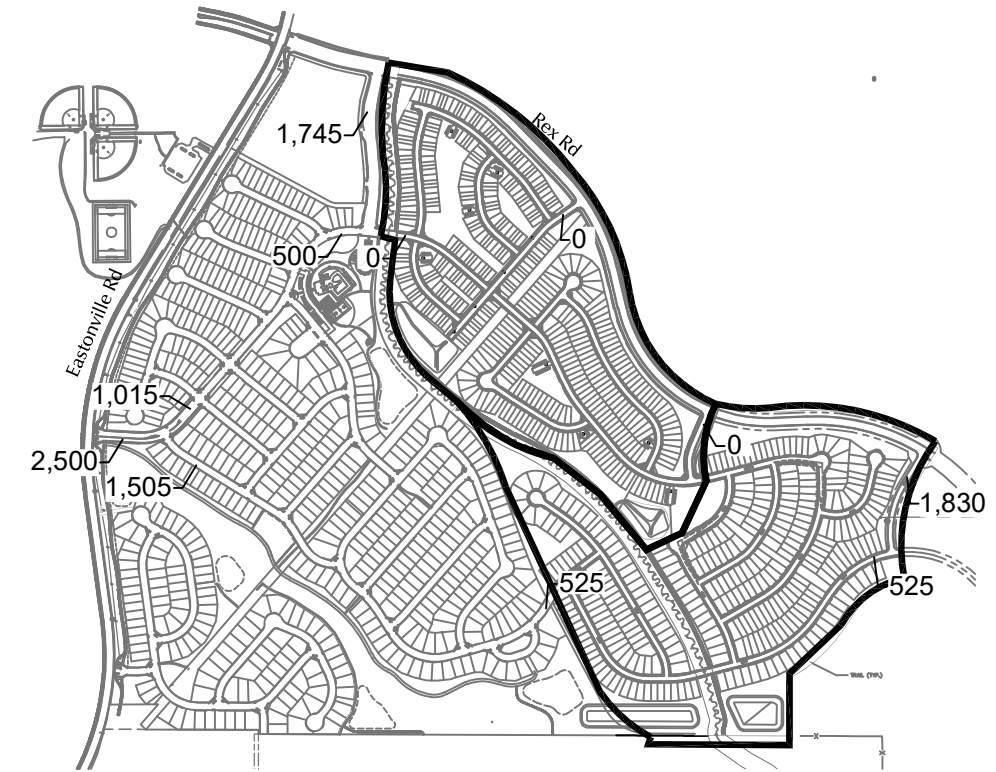
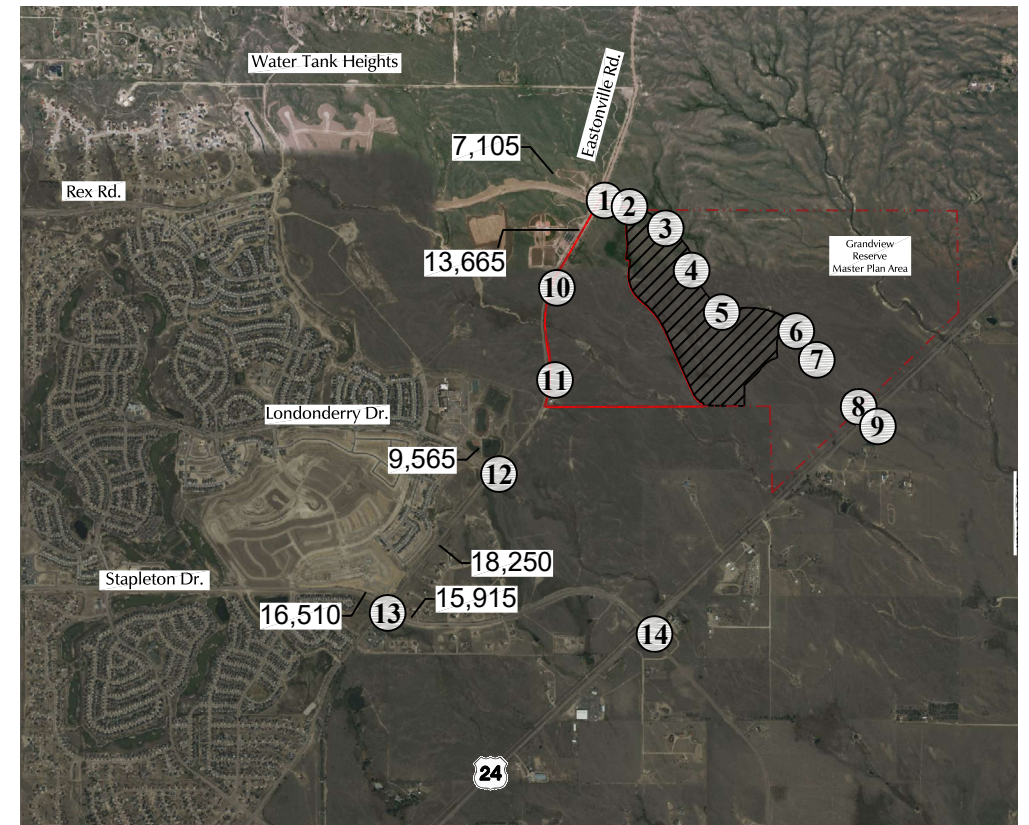
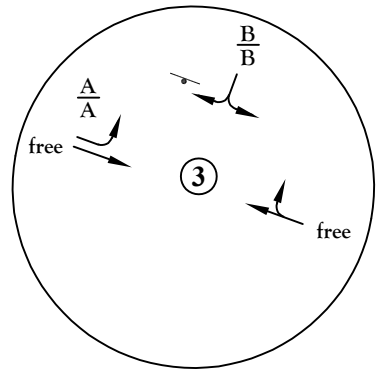
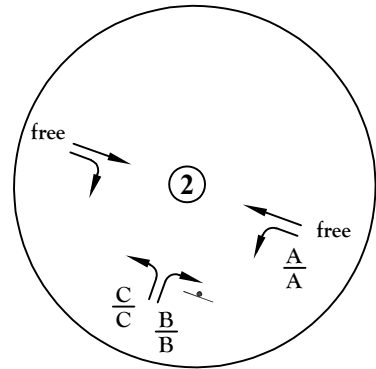
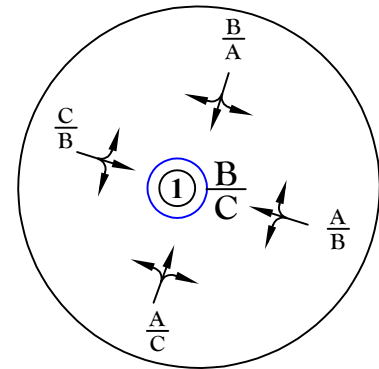
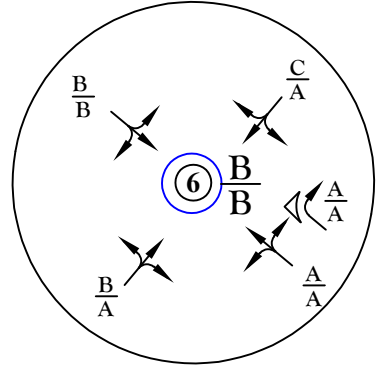

Figure 7a
 Year 2043
 Background Traffic
 Grandview Reserve Phases 2 and 3 (LSC # S234340)



Intentionally
④
Left Blank



Intentionally
⑤
Left Blank

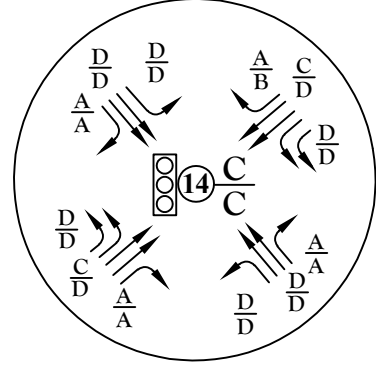
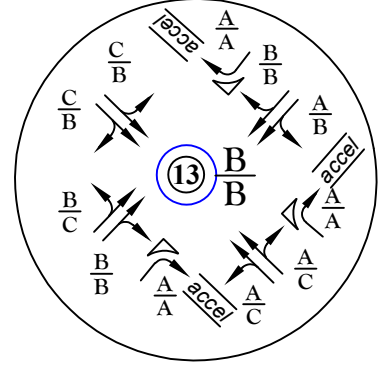
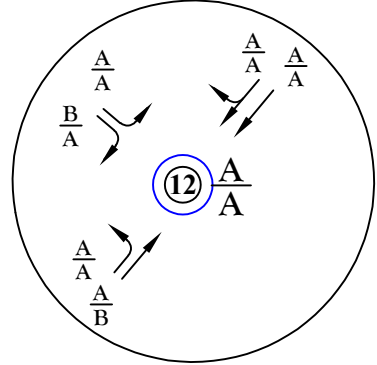
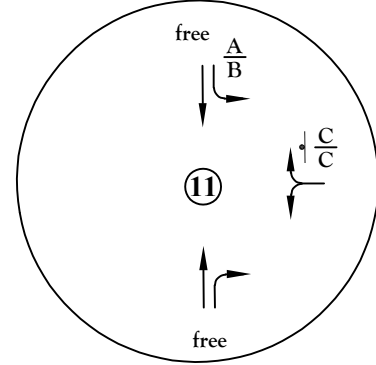
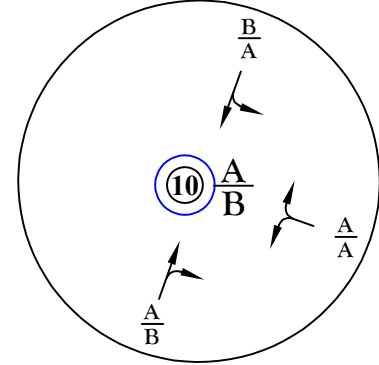
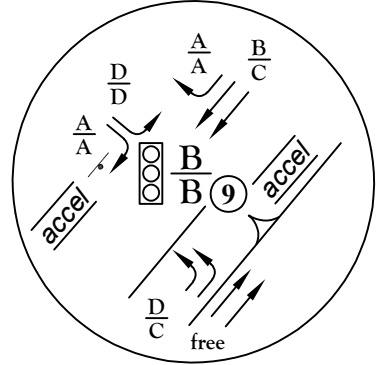

Intentionally
⑦
Left Blank

Intentionally
⑧
Left Blank



LEGEND:
Traffic Control Used in the Analysis:
 = Stop Sign
 = Traffic Signal
 LOS Analysis Results:
 $\frac{A}{B}$ = AM Individual Movement Peak-Hour Level of Service
 $\frac{C}{C}$ = PM Individual Movement Peak-Hour Level of Service
 $\frac{C}{C}$ = AM Entire Intersection Peak-Hour Level of Service
 $\frac{C}{C}$ = PM Entire Intersection Peak-Hour Level of Service
 = Modern Roundabout

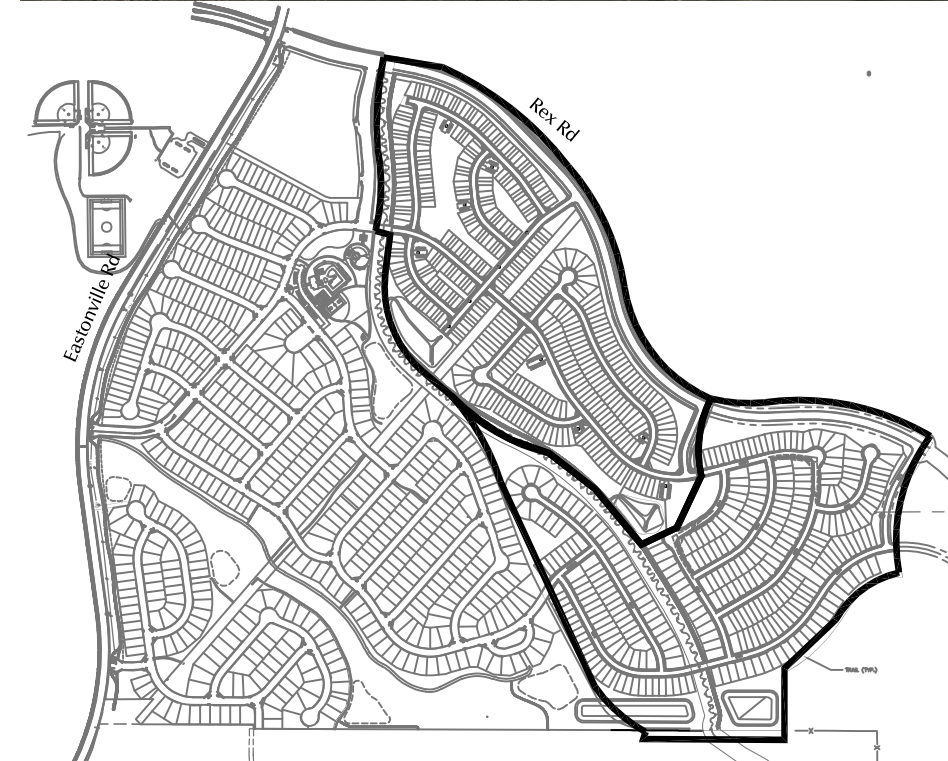

Figure 7b
 2043 Background Lane Geometry,
 Traffic Control, and Levels of Service
 Grandview Reserve Phases 2 and 3 (LSC # S234340)

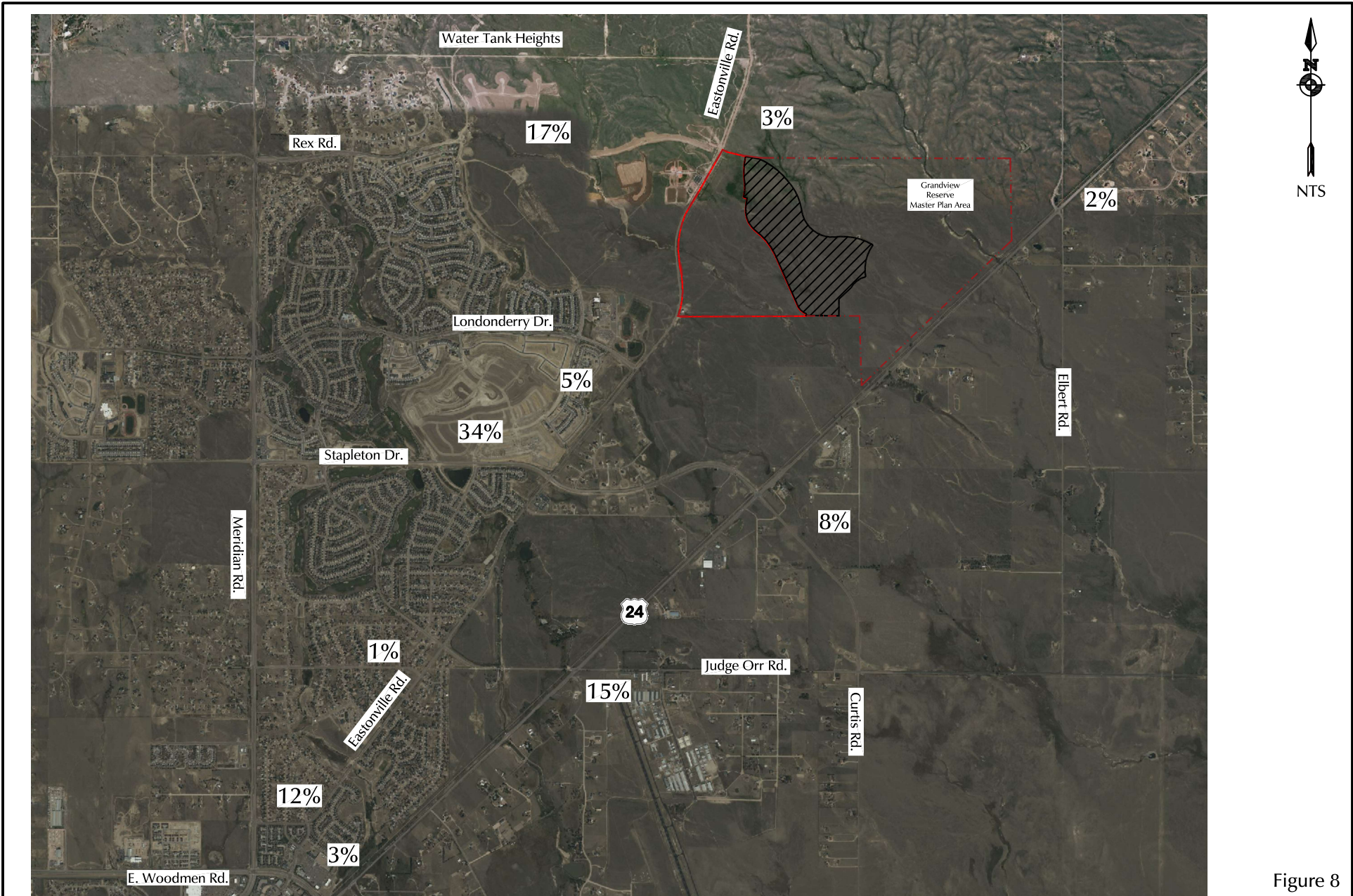

Figure 8

Short-Term Directional Distribution of Site-Generated Traffic

Grandview Reserve Phases 2 and 3 (LSC # S234340)



LEGEND:

XX% = Percent Directional Distribution

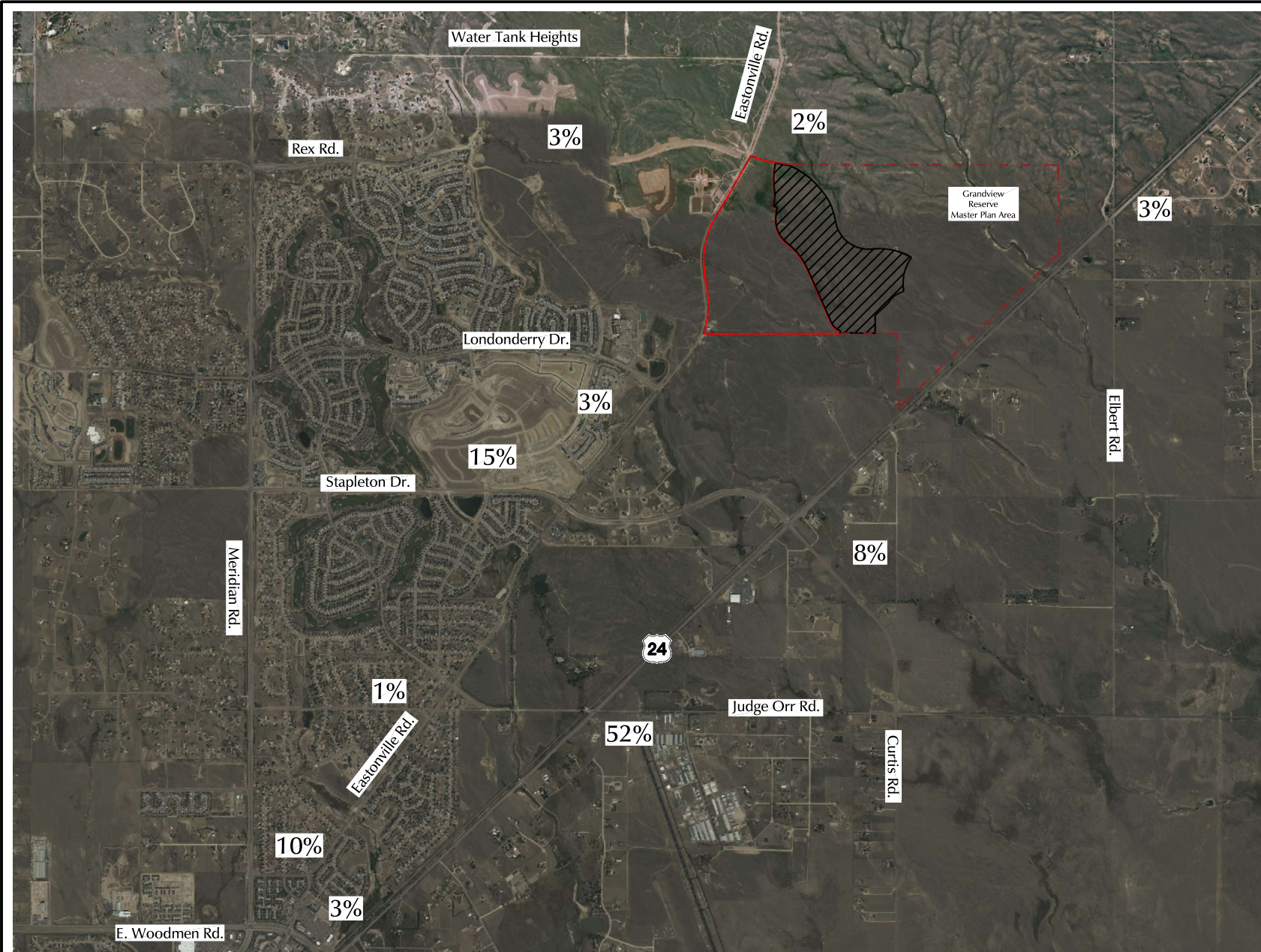

Figure 9

Long-Term Directional Distribution of Site-Generated Traffic

Grandview Reserve Phases 2 and 3 (LSC # S234340)



LEGEND:

XX% = Percent Directional Distribution

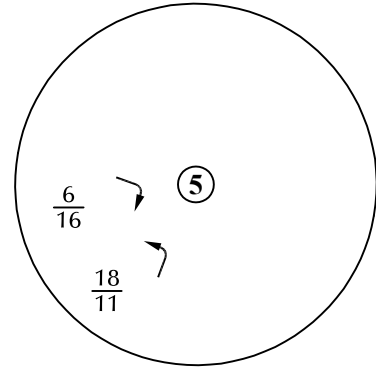
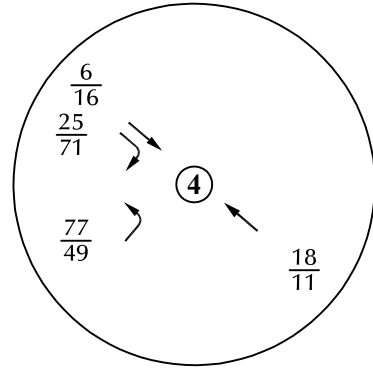
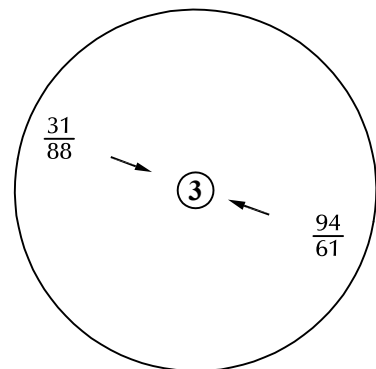
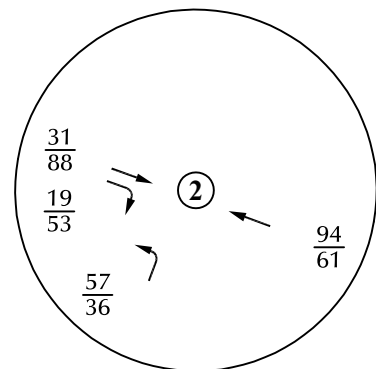
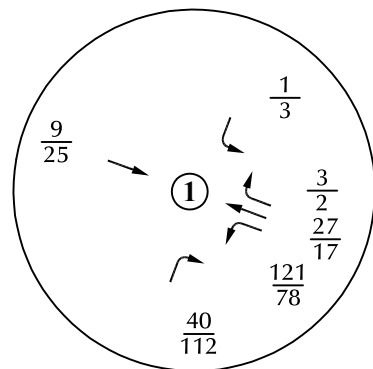

Intentionally
⑥
Left Blank

Intentionally
⑦
Left Blank

Intentionally
⑧
Left Blank

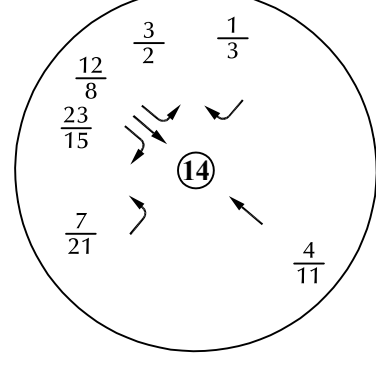
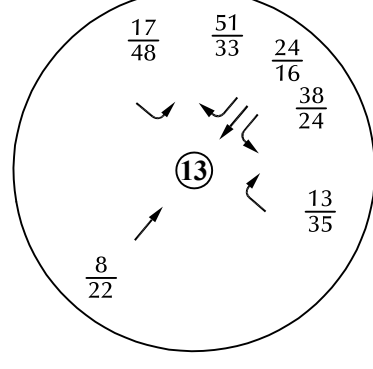
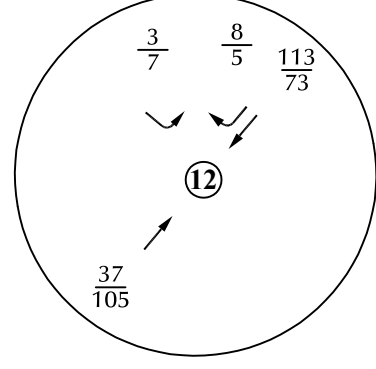
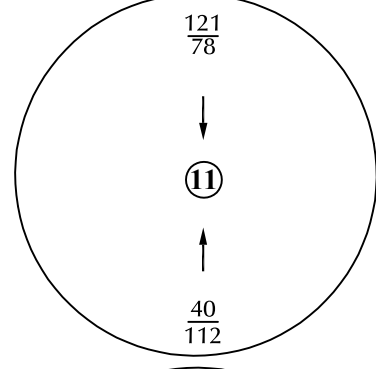
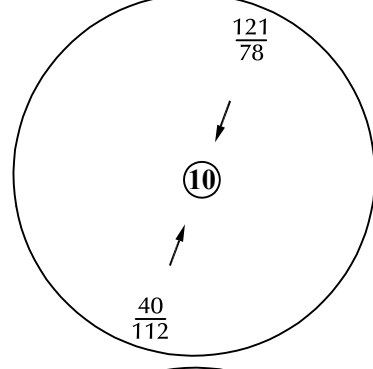
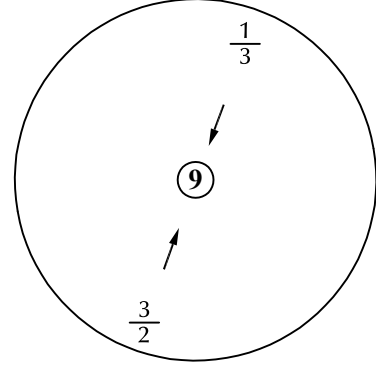

LEGEND:

$\frac{XX}{XX}$ = AM Weekday Peak-Hour Traffic (vehicles per hour)

$\frac{XX}{XX}$ = PM Weekday Peak-Hour Traffic (vehicles per hour)

X,XXX= Annual Average Daily Traffic (vehicles per day)

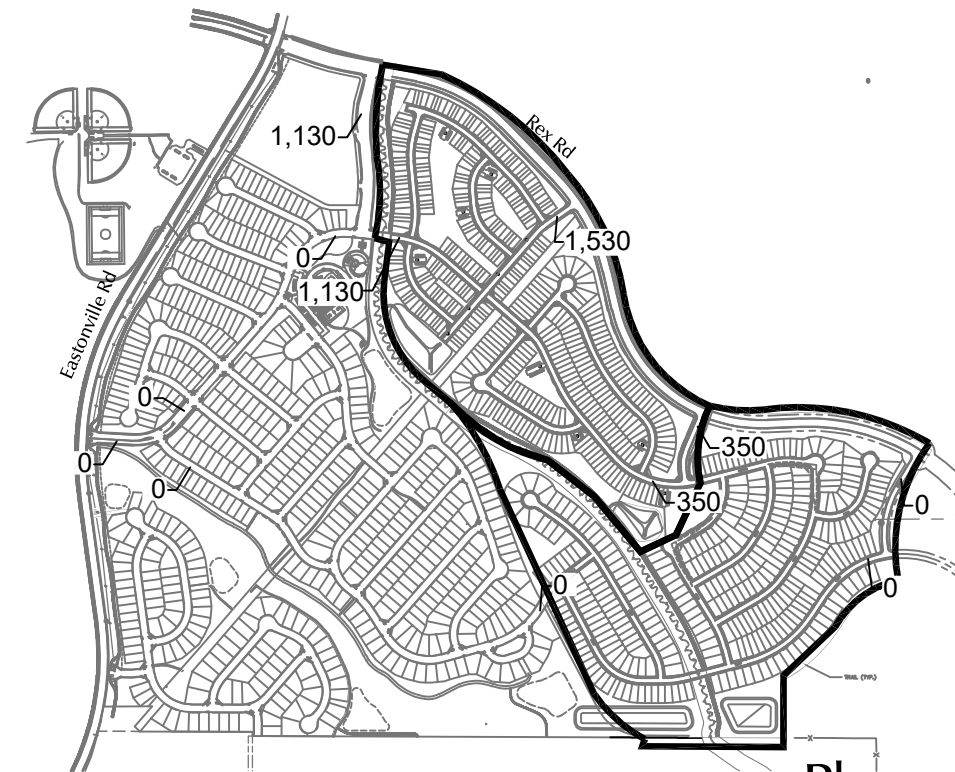
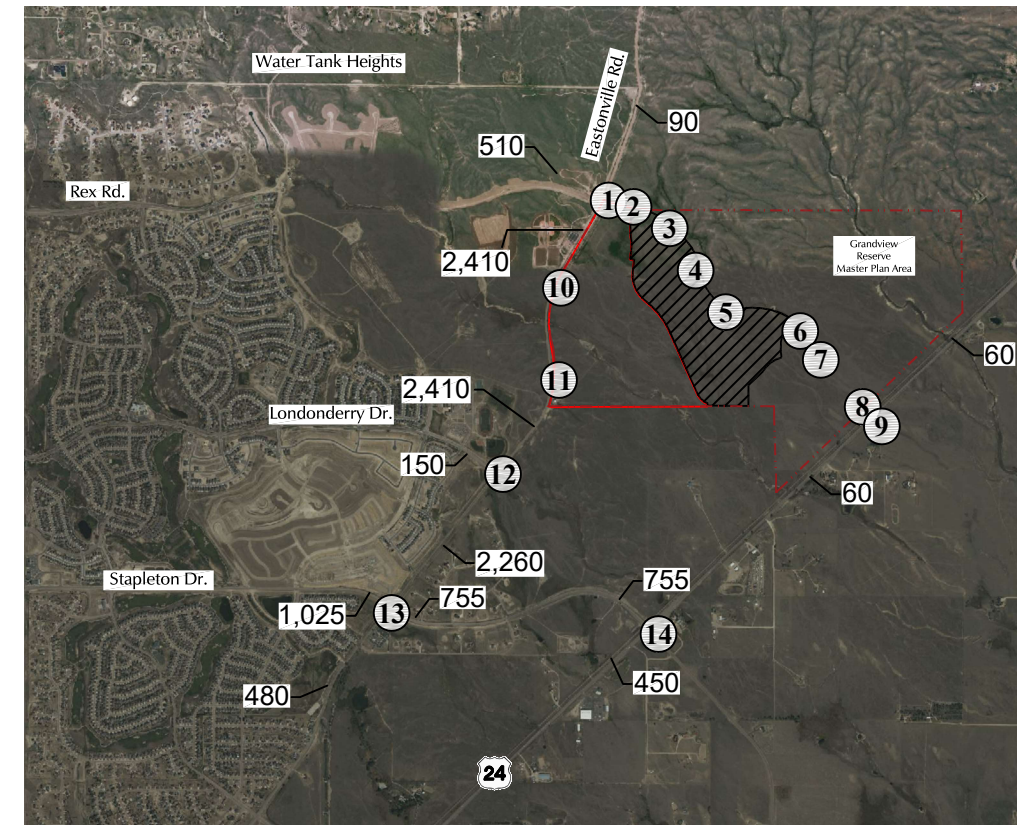
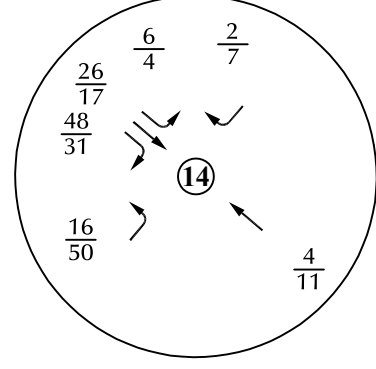
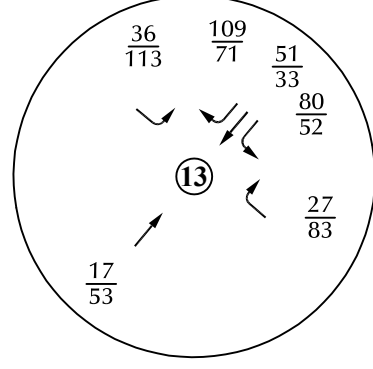
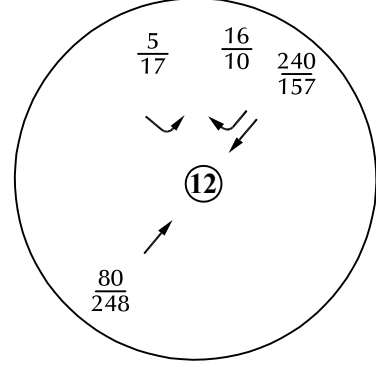
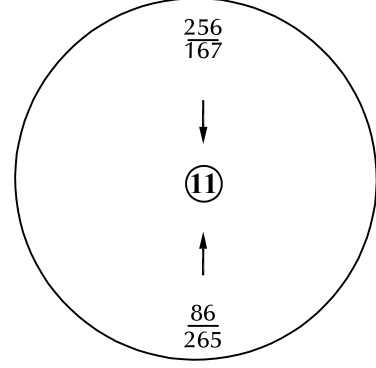
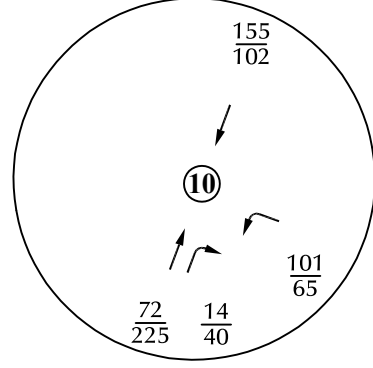
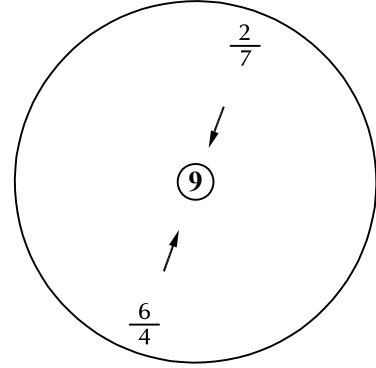
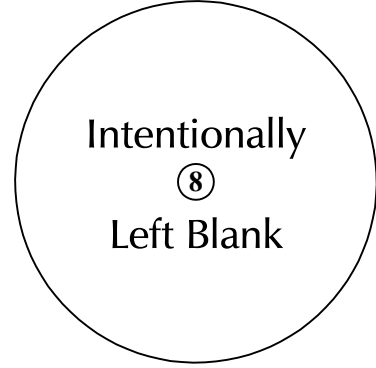
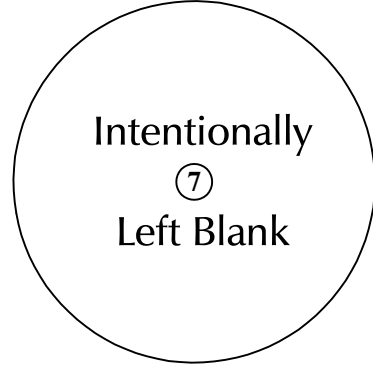
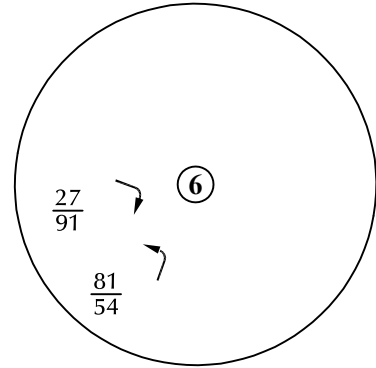
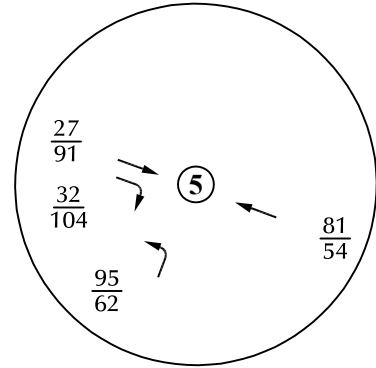
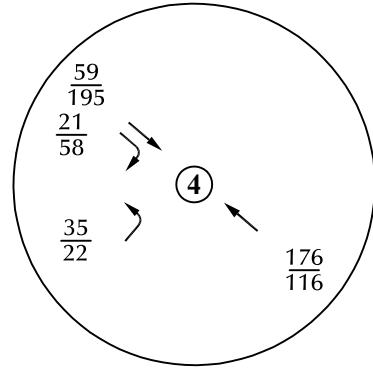
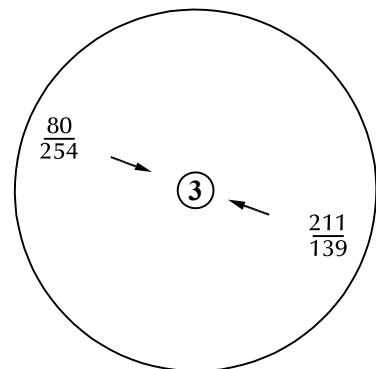
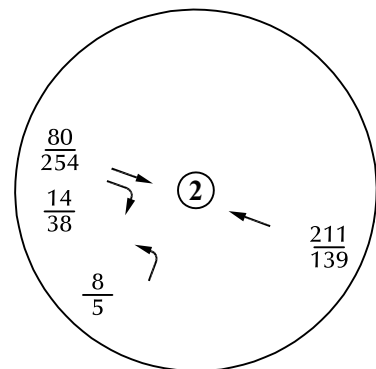
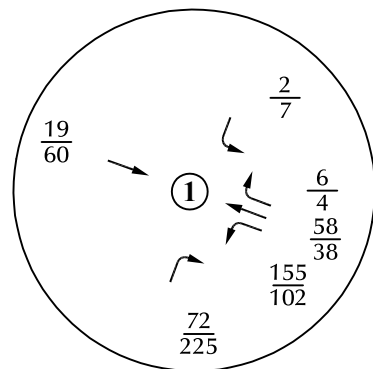

Figure 10

Phase 2 Short-Term Site-Generated Traffic

Grandview Reserve Phases 2 and 3 (LSC # S234340)



LEGEND:

$\frac{XX}{XX}$ = AM Weekday Peak-Hour Traffic (vehicles per hour)
 $\frac{XX}{XX}$ = PM Weekday Peak-Hour Traffic (vehicles per hour)
 X,XXX= Annual Average Daily Traffic (vehicles per day)

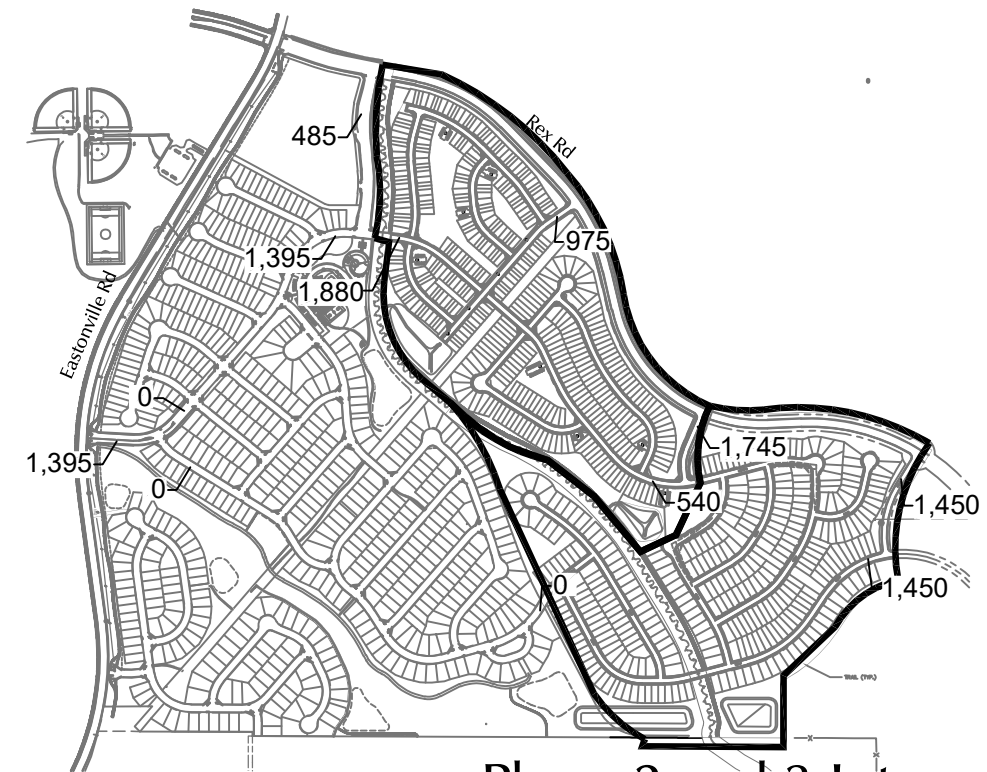
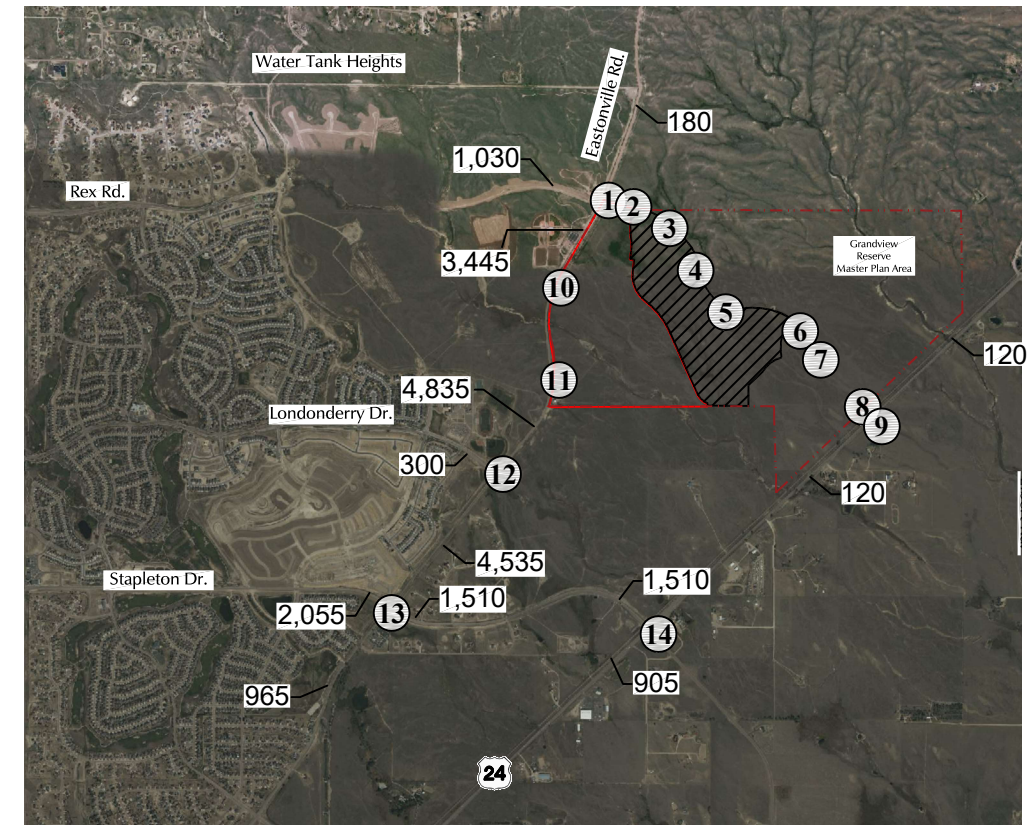
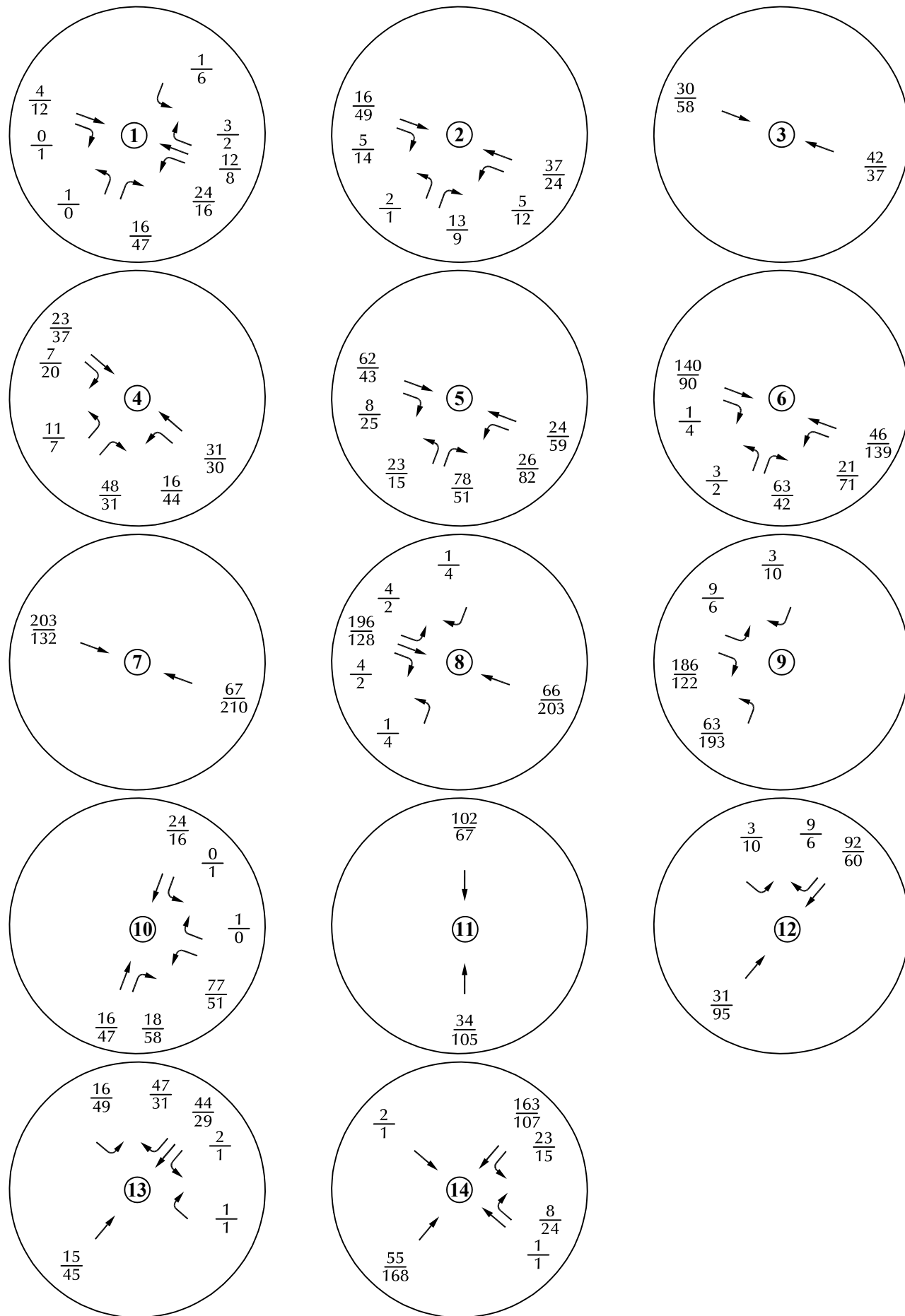

Figure 11

Phase 2 and 3 Intermediate-Term Site-Generated Traffic

Grandview Reserve Phases 2 and 3 (LSC # S234340)



LEGEND:

$\frac{XX}{XX}$ = AM Weekday Peak-Hour Traffic (vehicles per hour)
 $\frac{XX}{XX}$ = PM Weekday Peak-Hour Traffic (vehicles per hour)
 X,XXX= Annual Average Daily Traffic (vehicles per day)

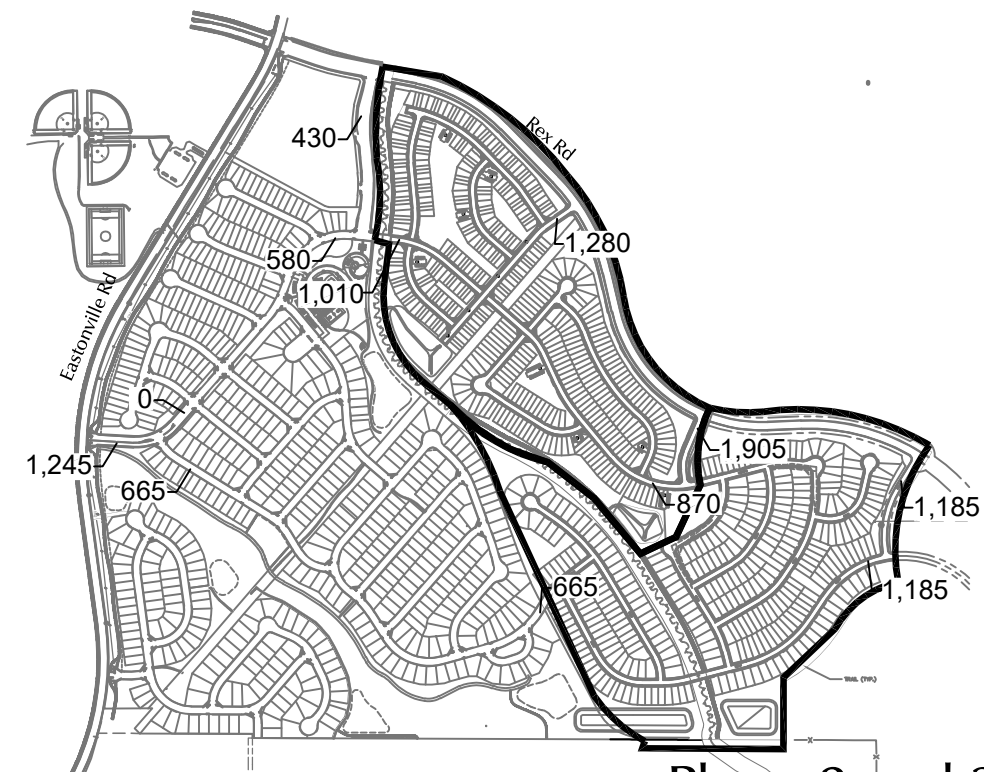
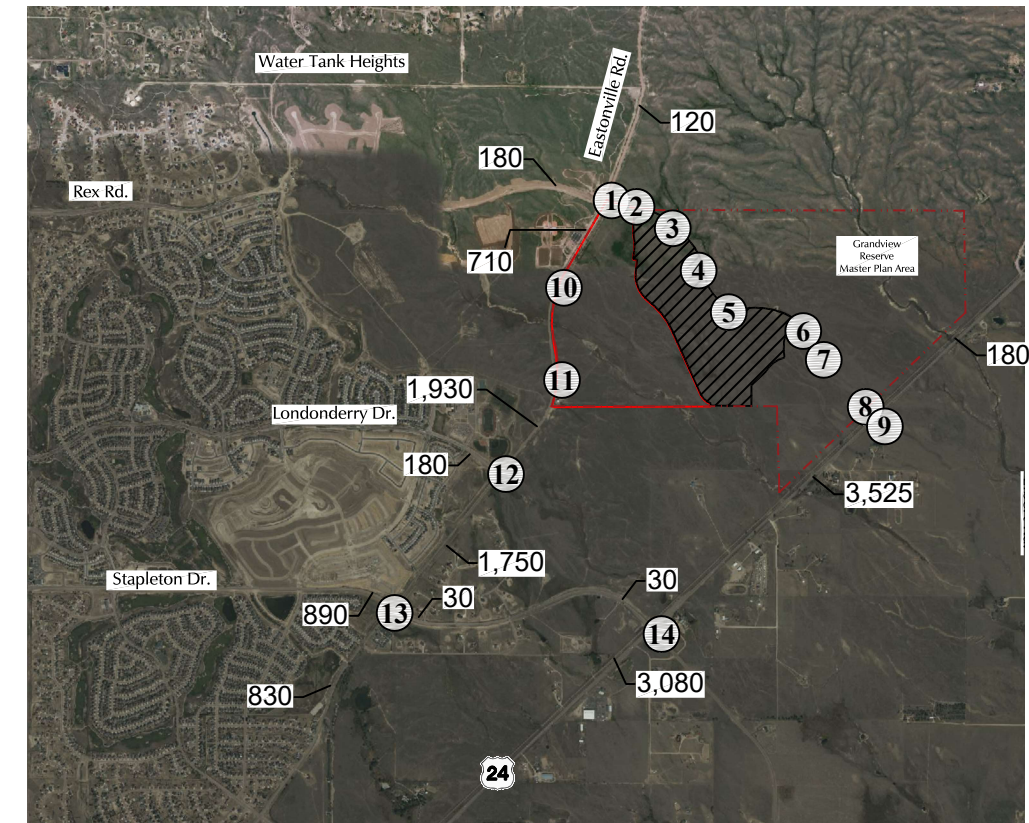
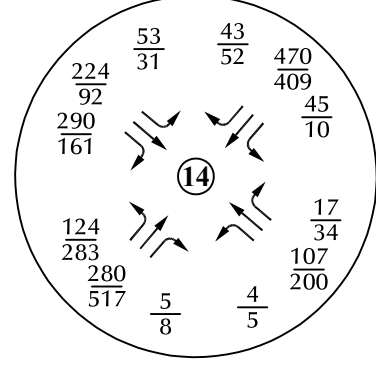
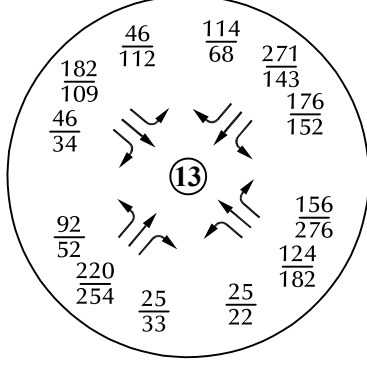
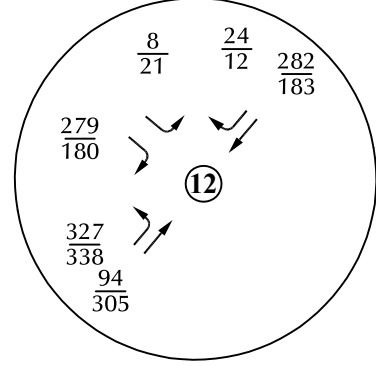
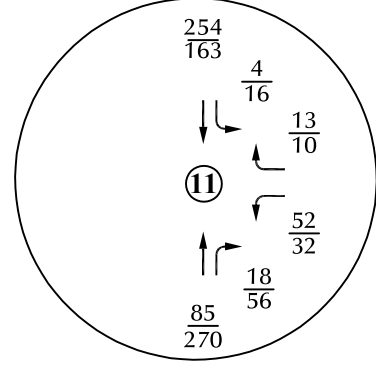
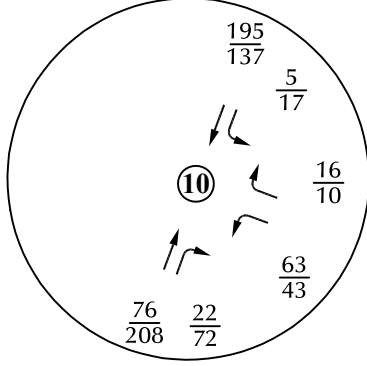
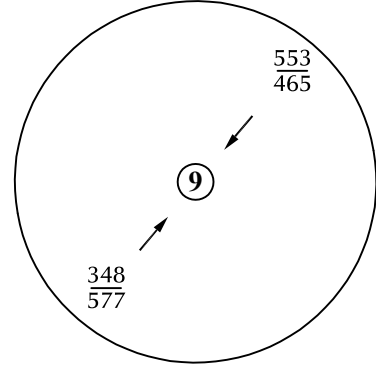
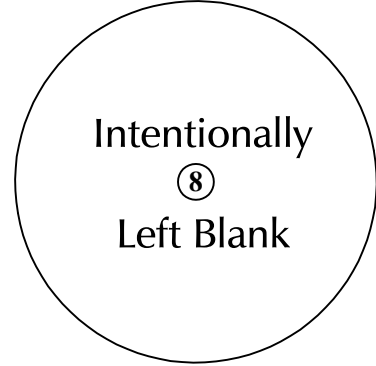
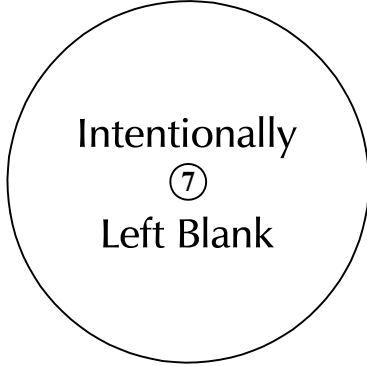
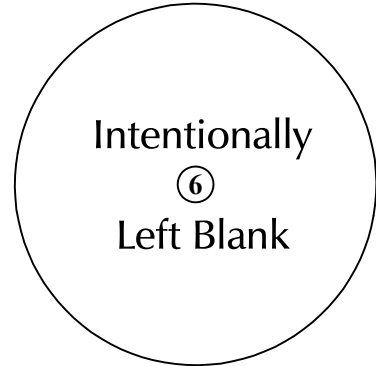
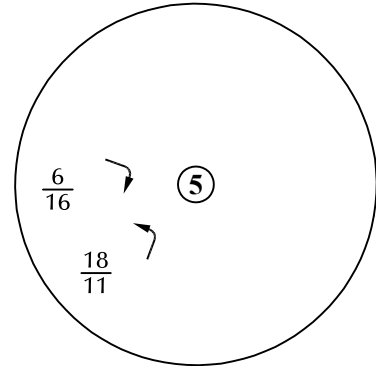
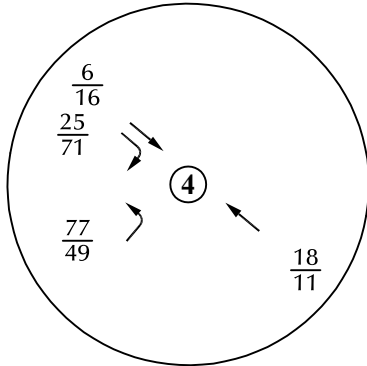
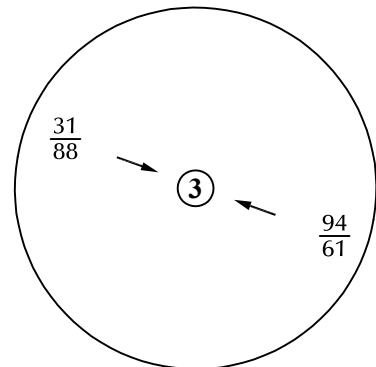
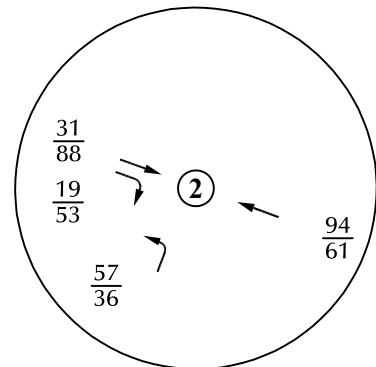
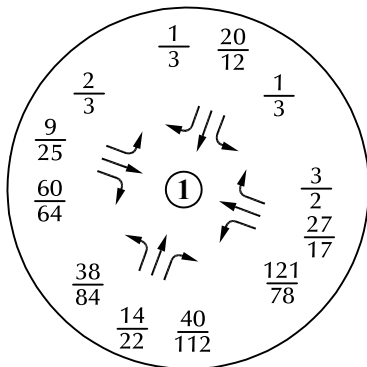
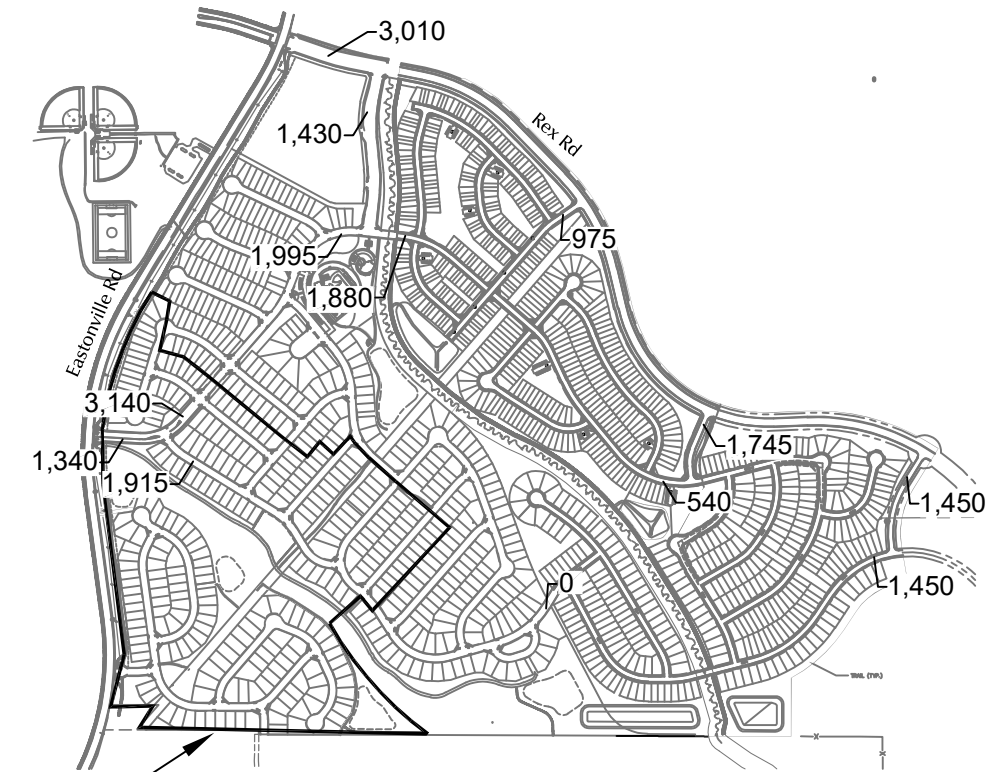
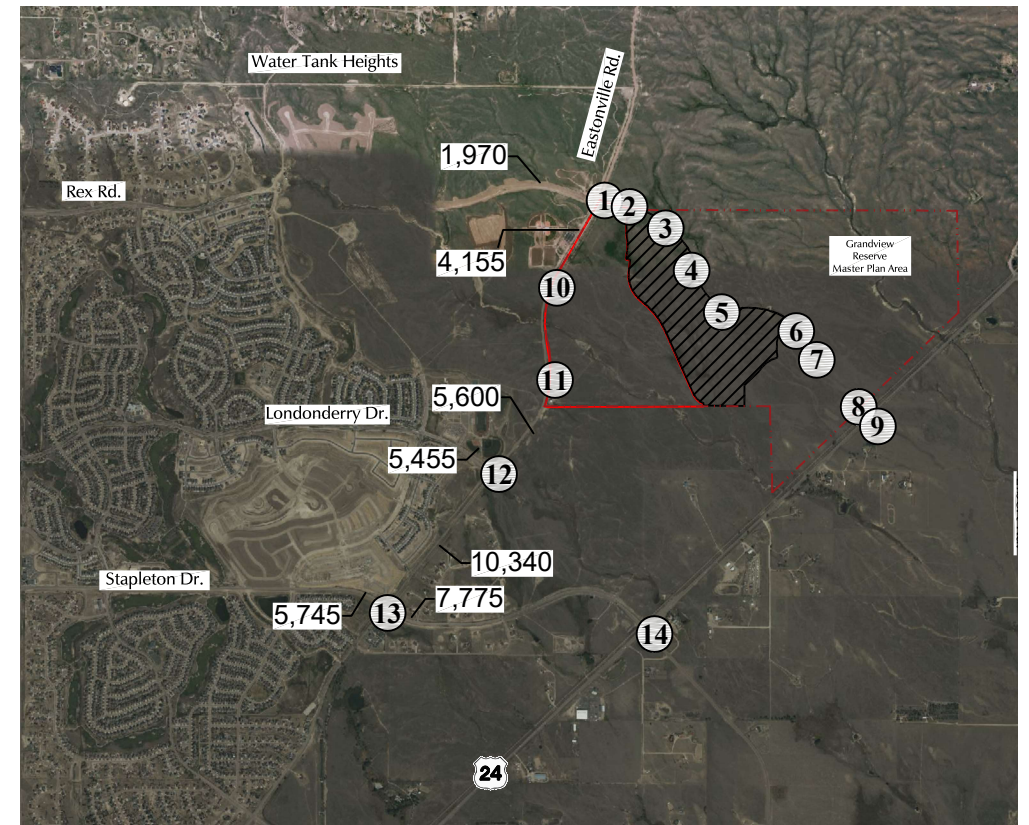

Figure 12
 Phase 2 and 3 Long-Term
 Site-Generated Traffic

Grandview Reserve Phases 2 and 3 (LSC # S234340)



LEGEND:
 $\frac{XX}{XX}$ = AM Weekday Peak-Hour Traffic (vehicles per hour)
 $\frac{XX}{XX}$ = PM Weekday Peak-Hour Traffic (vehicles per hour)
 X,XXX = Annual Average Daily Traffic (vehicles per day)



Phase 1 Filings 1 and 2

Figure 13a
 Year 2026 Total Traffic*
 Grandview Reserve Phases 2 and 3 (LSC # S234340)

* Assumes buildout of Grandview Reserve Phase 1, filings 1 and 2 only, and Grandview Reserve Phase 2



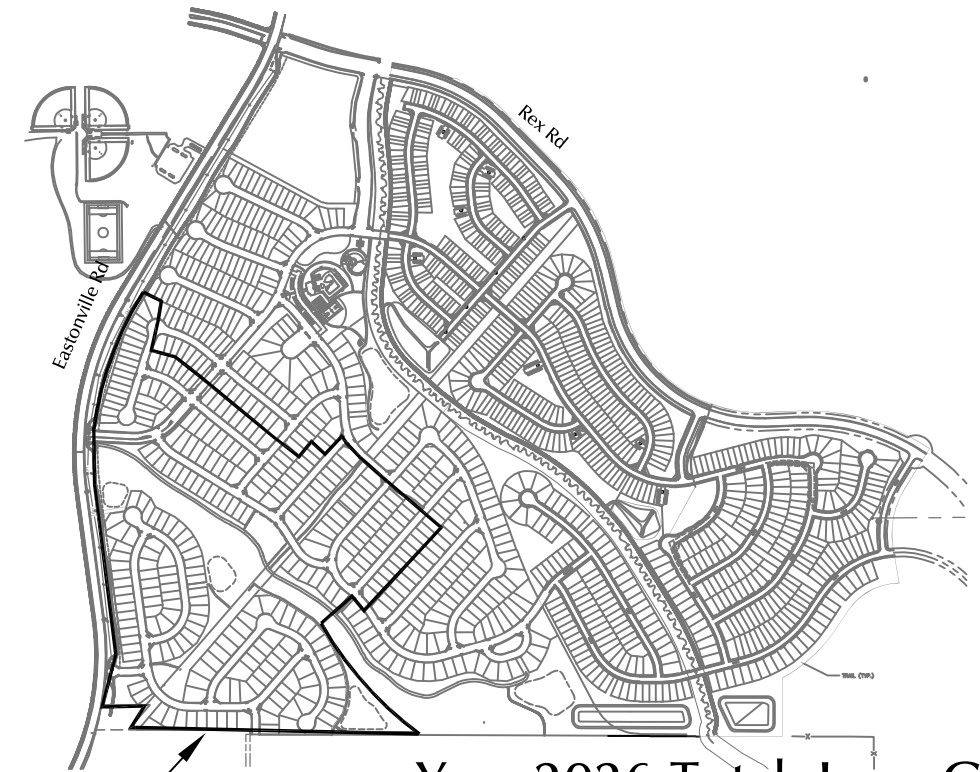
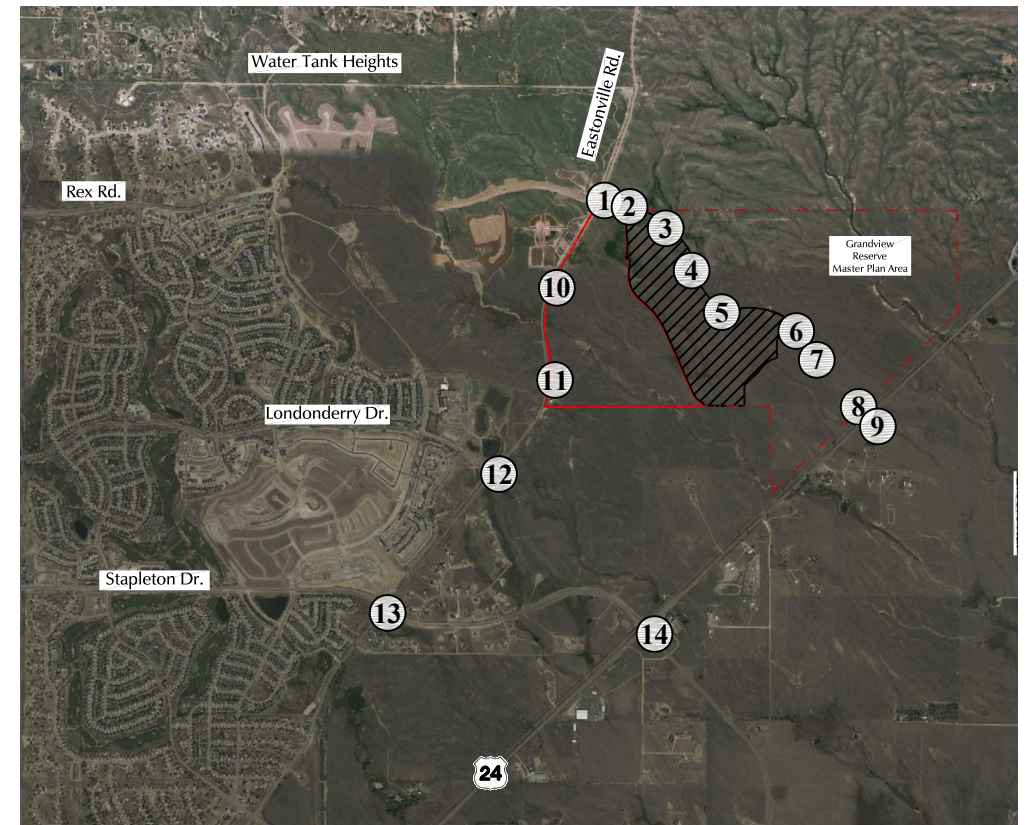
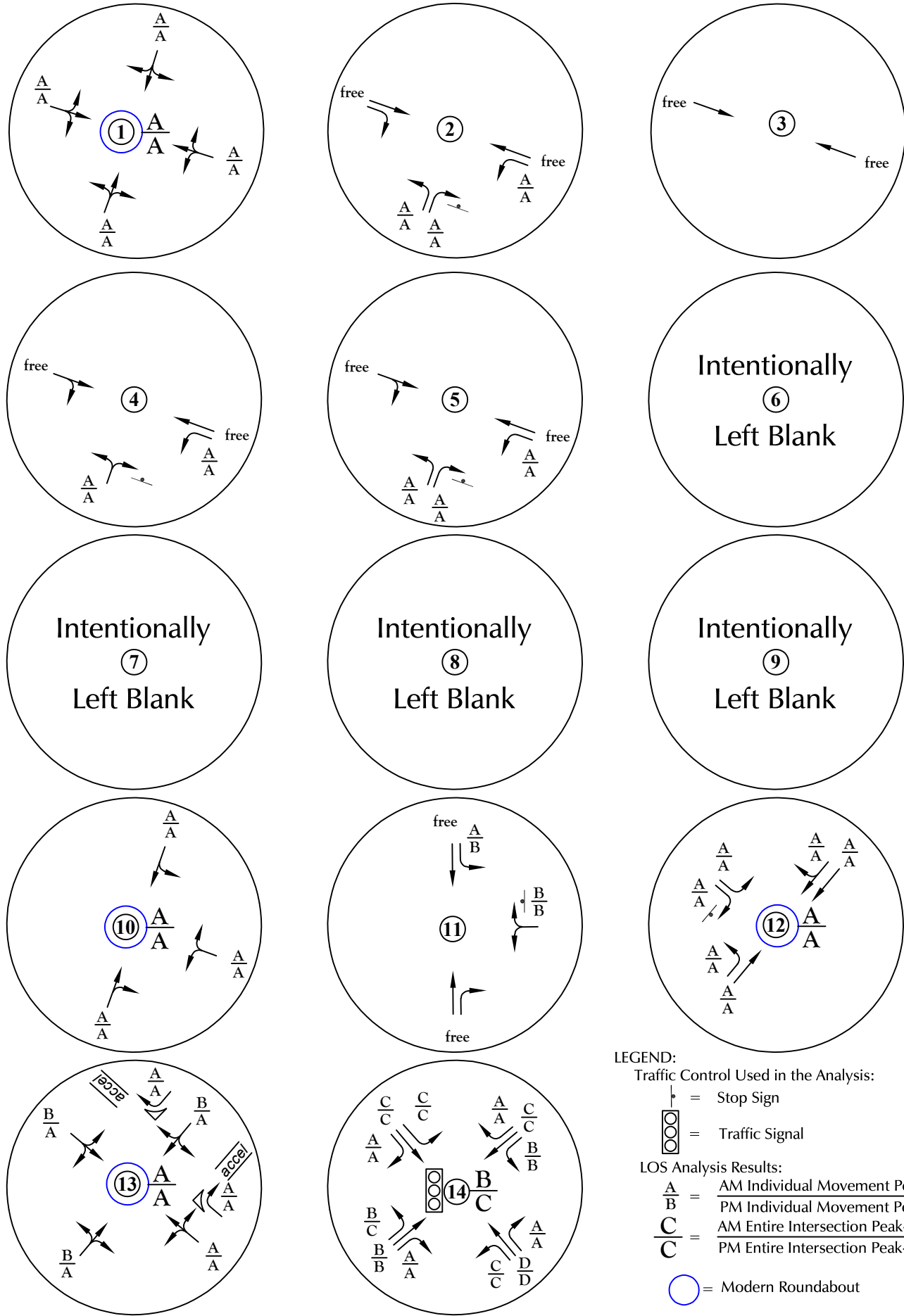

LEGEND:
 Traffic Control Used in the Analysis:
 | = Stop Sign
 [] = Traffic Signal
 LOS Analysis Results:
 A/B = AM Individual Movement Peak-Hour Level of Service
 PM Individual Movement Peak-Hour Level of Service
 C/C = AM Entire Intersection Peak-Hour Level of Service
 PM Entire Intersection Peak-Hour Level of Service
 (O) = Modern Roundabout

Phase 1 Filings 1 and 2

Figure 13b
 Year 2026 Total Lane Geometry,
 Traffic Control, and Levels of Service*

* Assumes buildout of Grandview Reserve Phase 1, filings 1 and 2 only, and Grandview Reserve Phase 2.



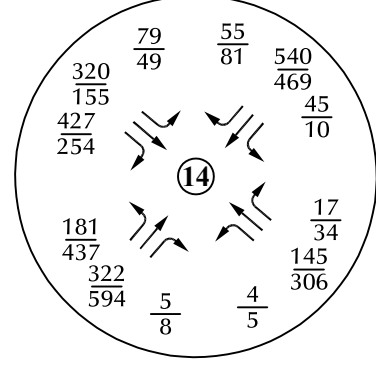
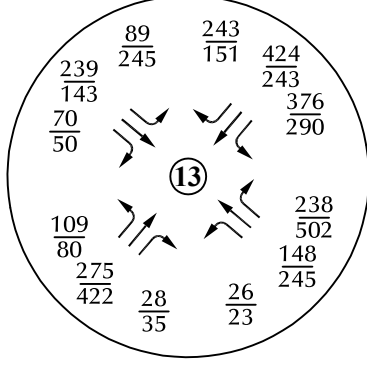
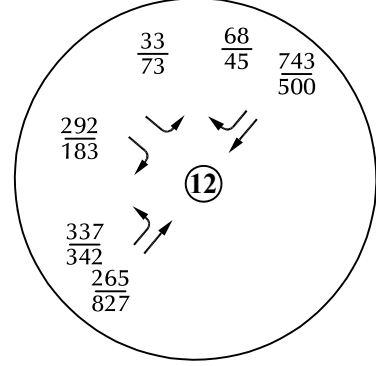
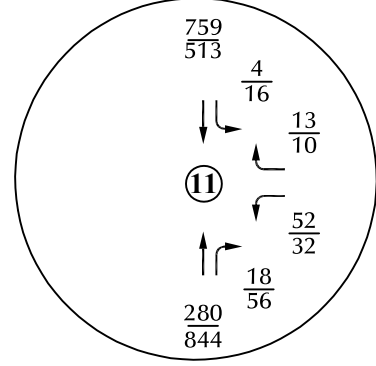
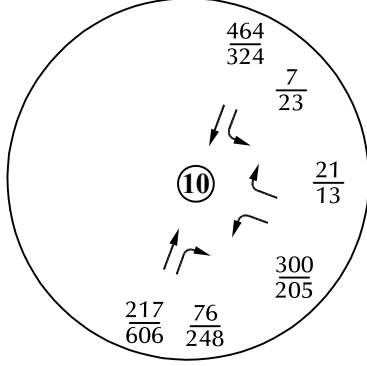
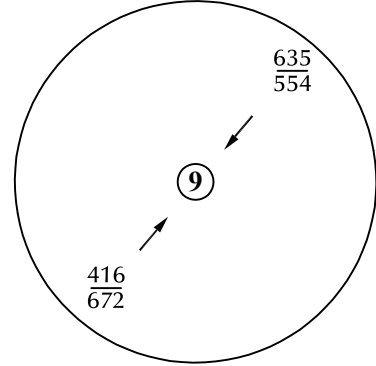
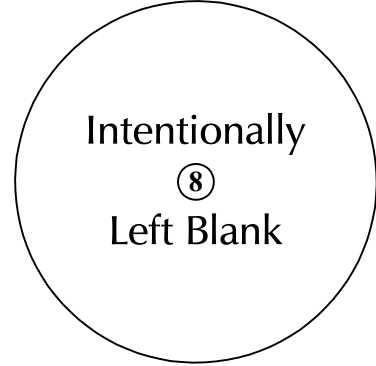
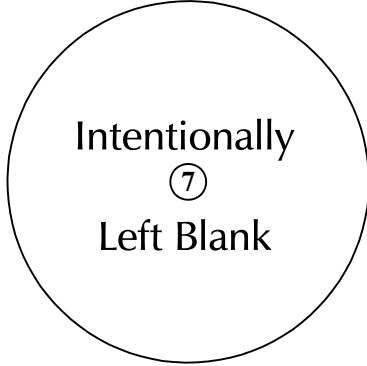
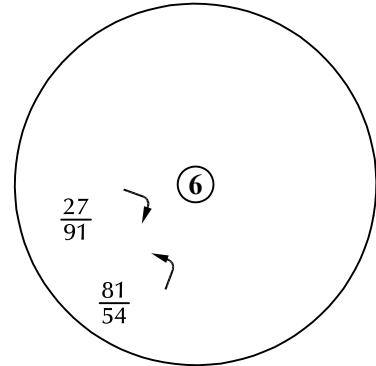
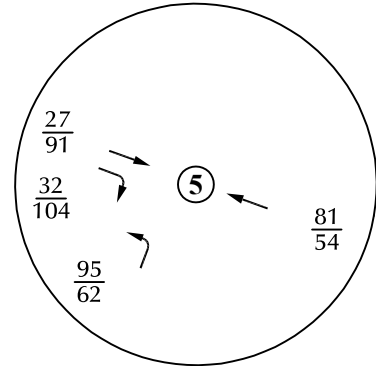
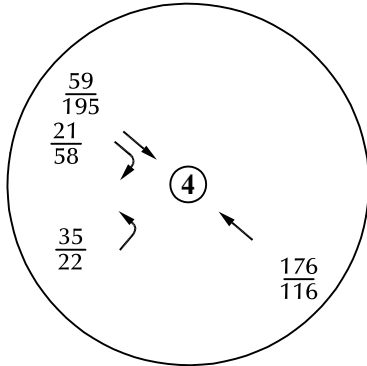
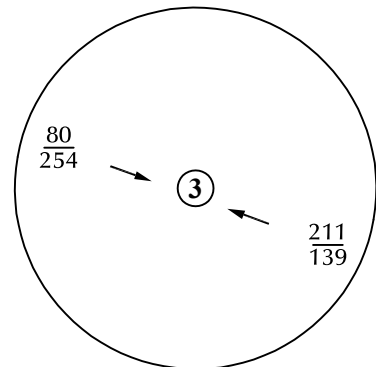
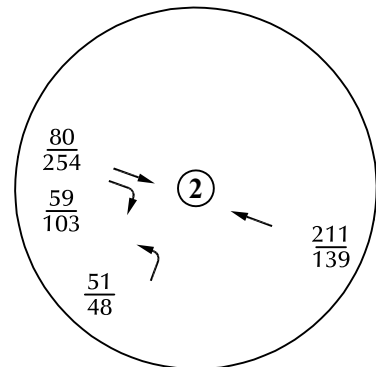
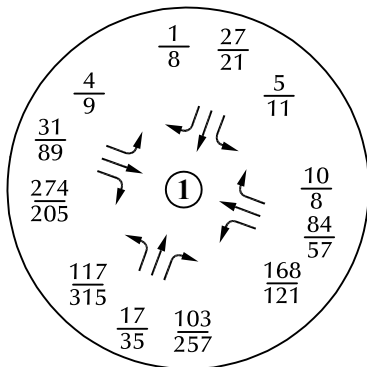

LEGEND:
 $\frac{XX}{XX}$ = AM Weekday Peak-Hour Traffic (vehicles per hour)
 $\frac{XX}{XX}$ = PM Weekday Peak-Hour Traffic (vehicles per hour)
 X,XXX= Annual Average Daily Traffic (vehicles per day)

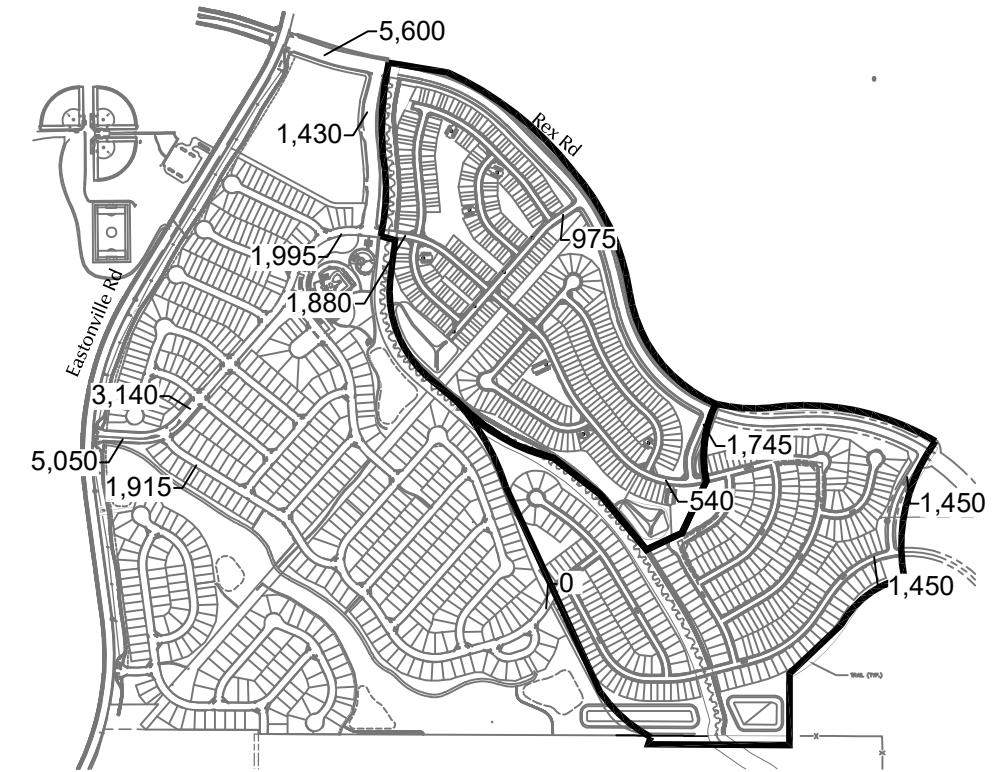
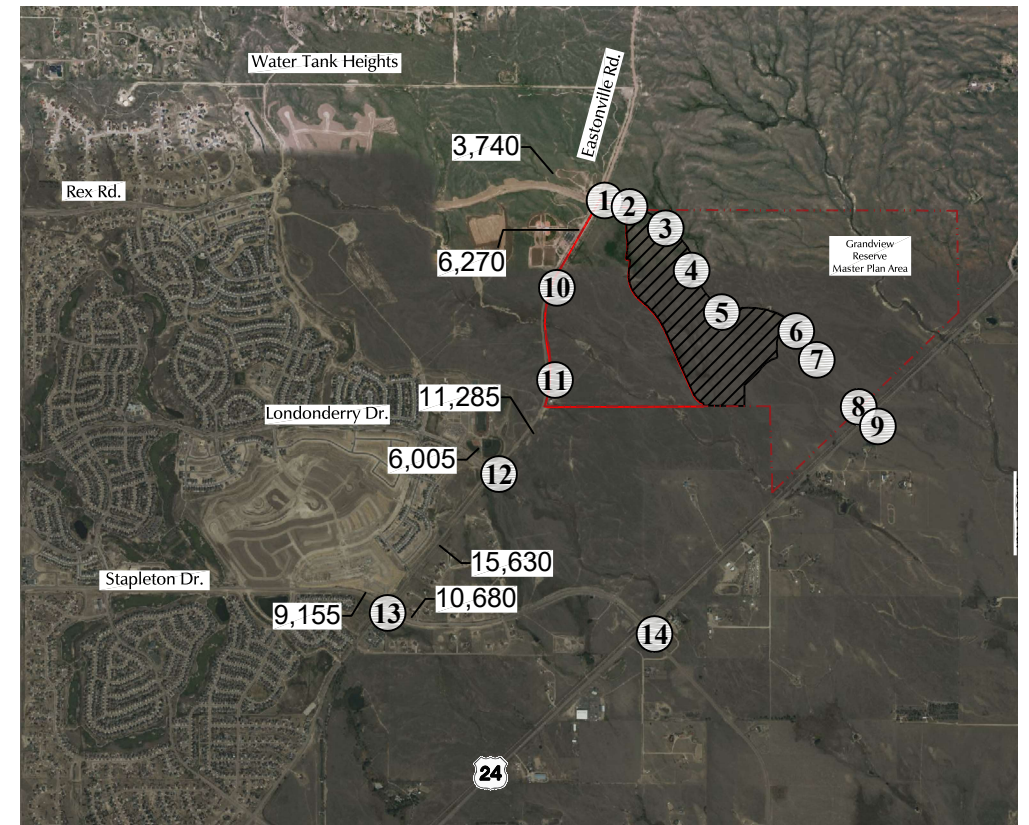

Figure 14a
Year 2033 Total Traffic*
 Grandview Reserve Phases 2 and 3 (LSC # S234340)

* Assumes buildout of Grandview Reserve Phases 1, 2, and 3



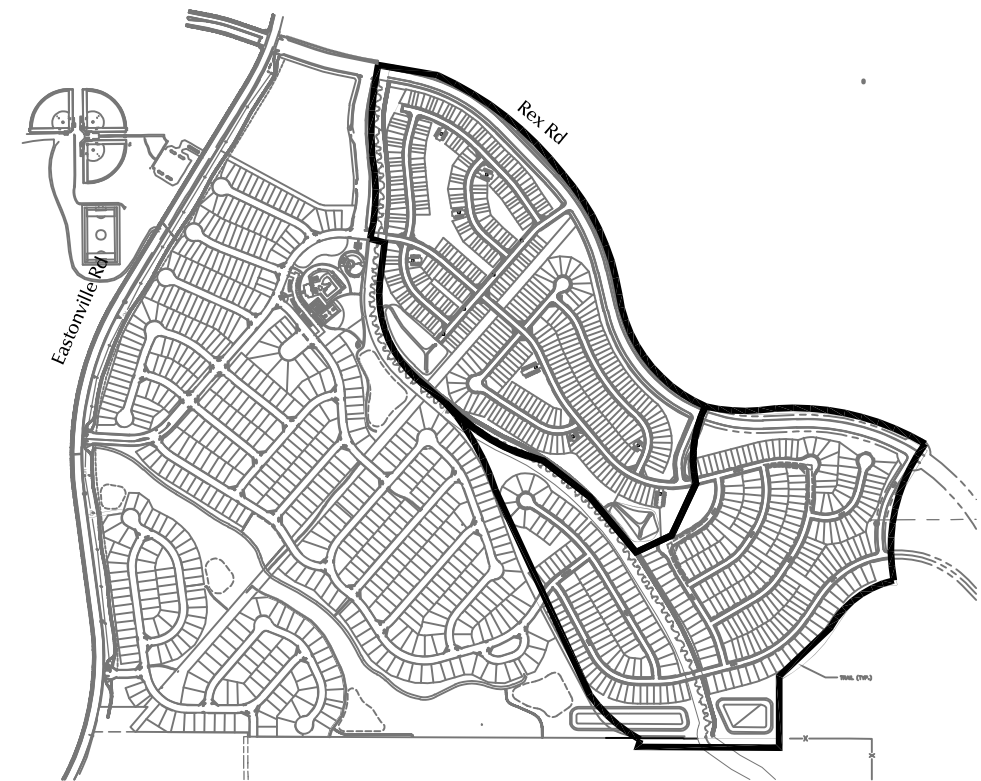
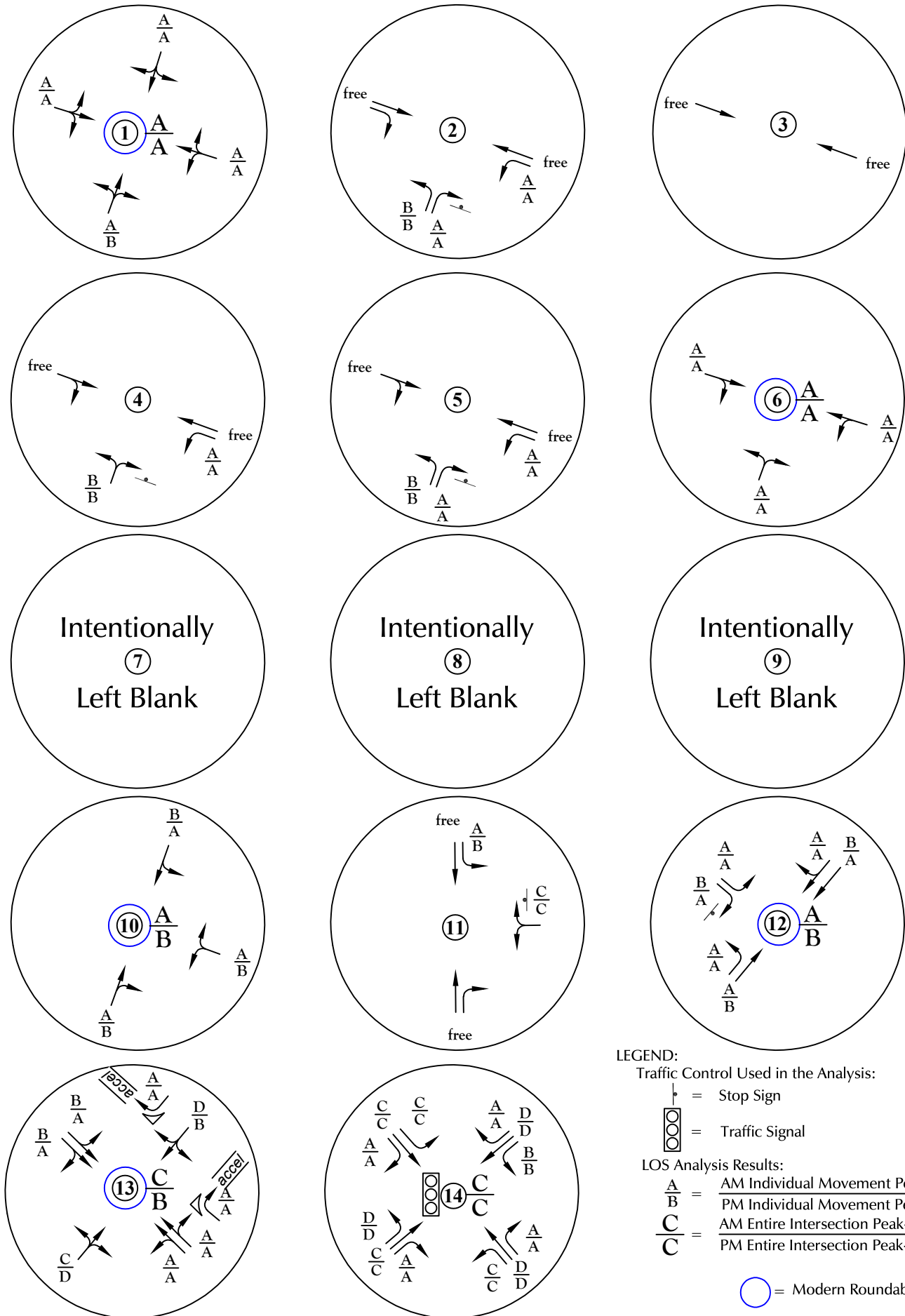
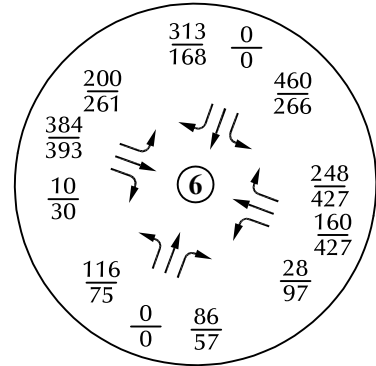
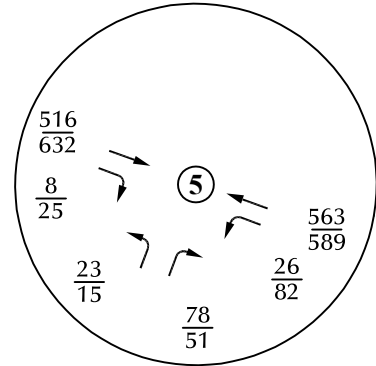
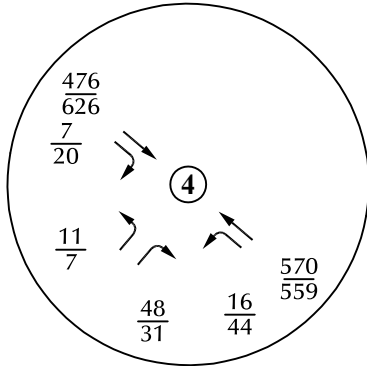
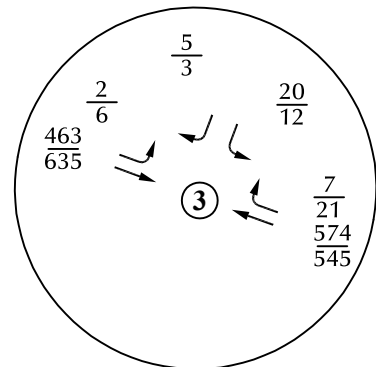
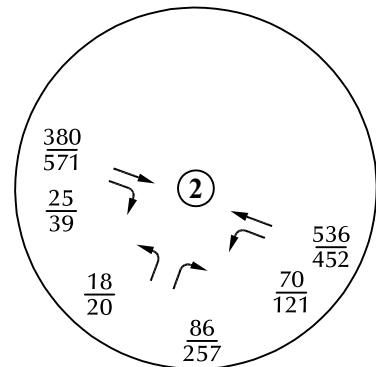
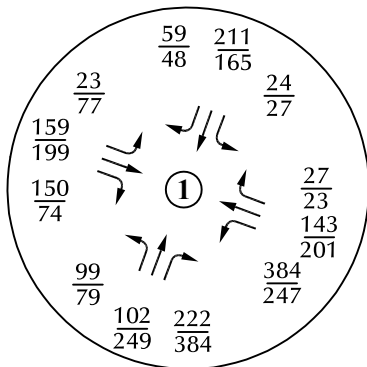

Figure 14b
 Year 2033 Total Lane Geometry,
 Traffic Control, and Levels of Service*

Grandview Reserve Phases 2 and 3 (LSC # S234340)

* Assumes buildout of Grandview Reserve Phases 1, 2, and 3





Intentionally
⑦
Left Blank

Intentionally
⑧
Left Blank

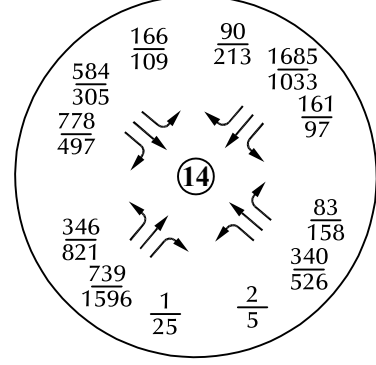
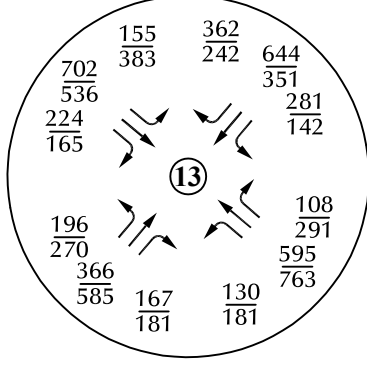
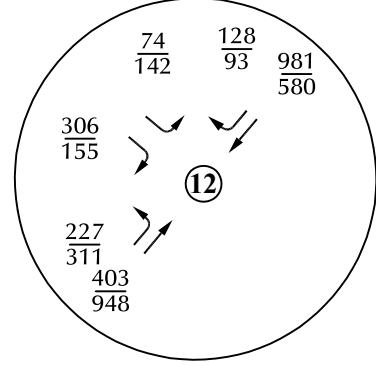
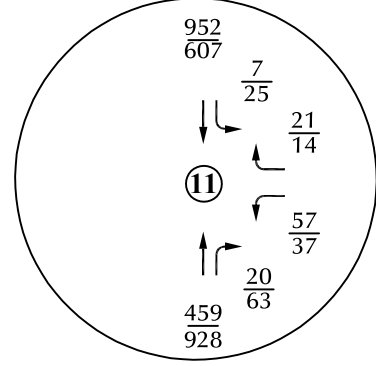
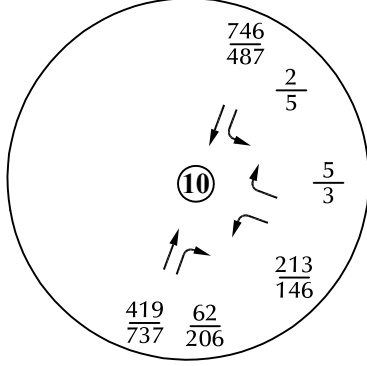
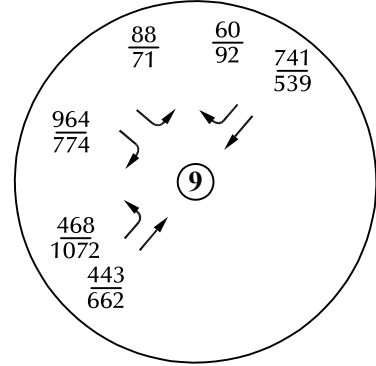

LEGEND:
 XX = AM Weekday Peak-Hour Traffic (vehicles per hour)
 XX = PM Weekday Peak-Hour Traffic (vehicles per hour)
 X,XXX = Annual Average Daily Traffic (vehicles per day)

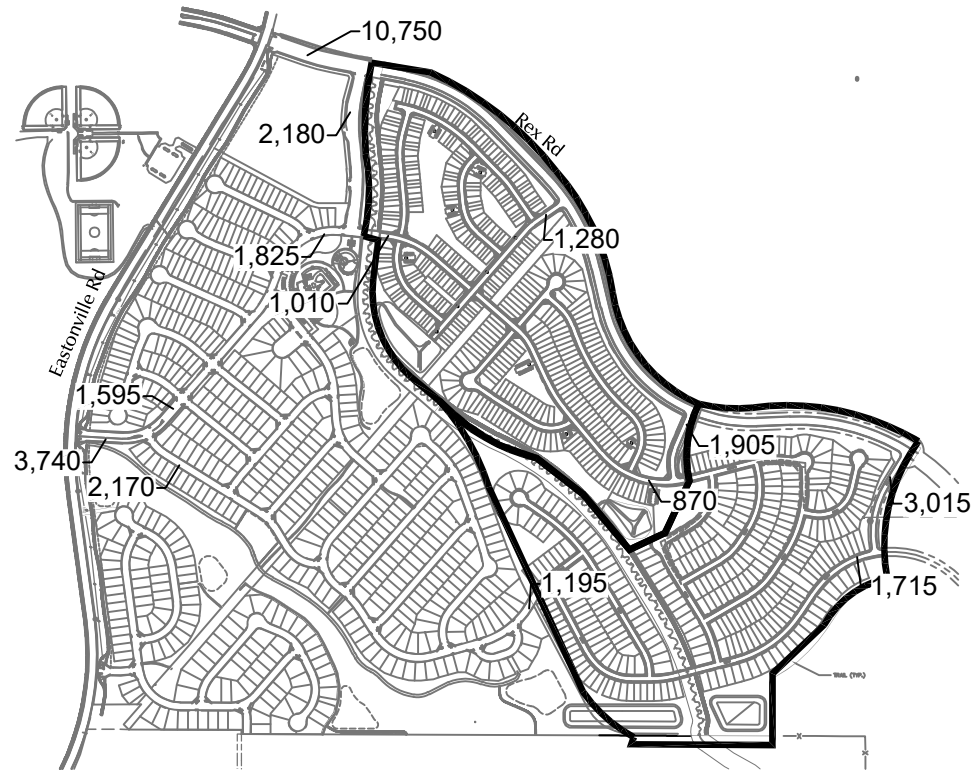
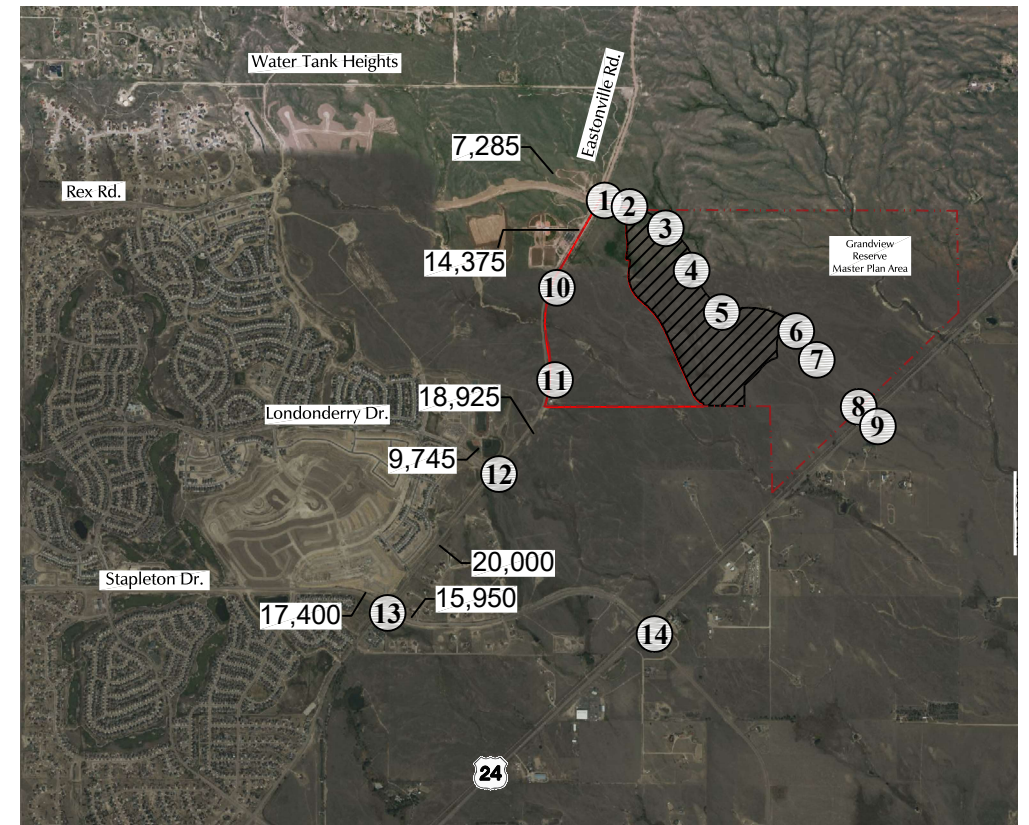
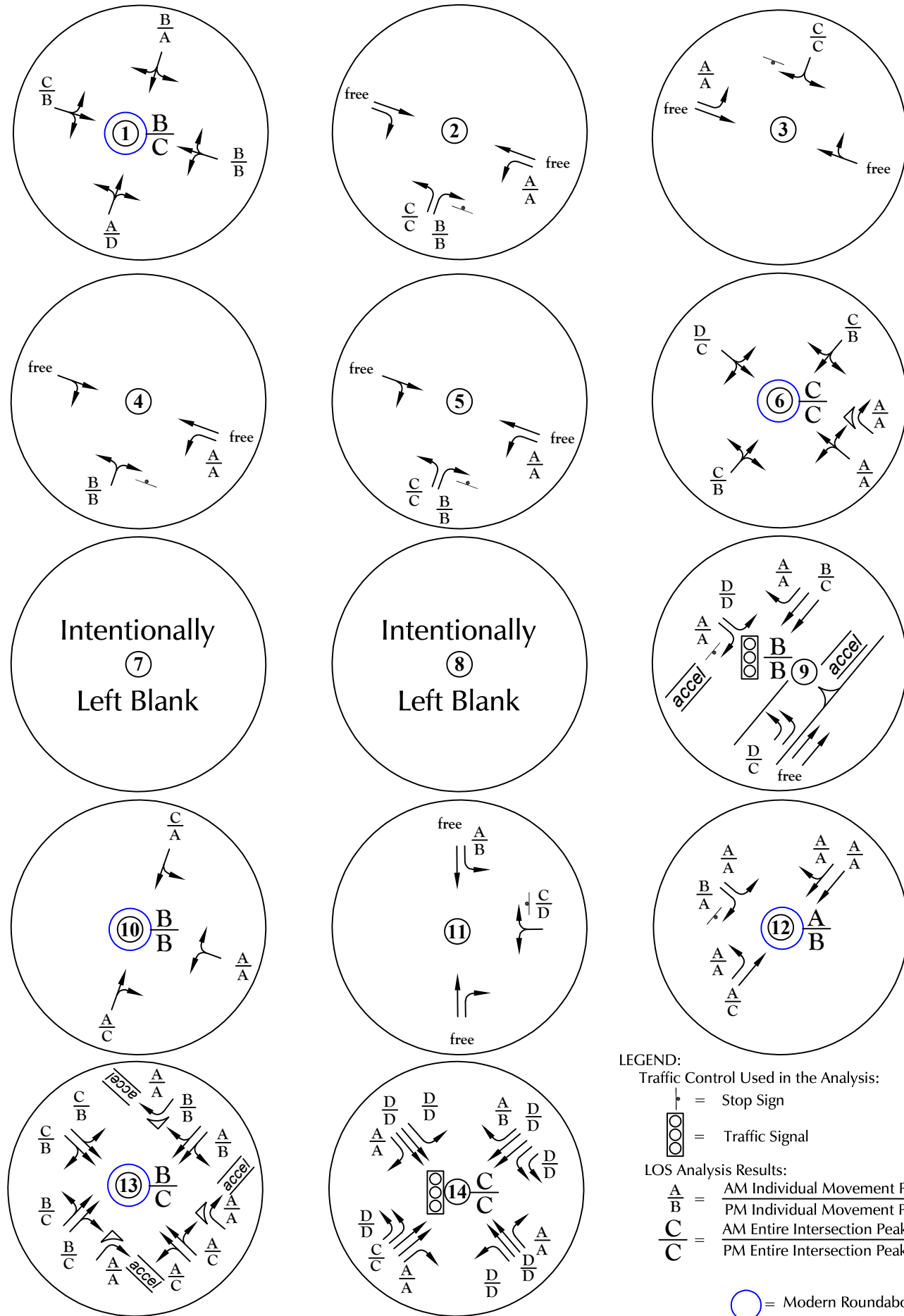

Figure 15a
 Year 2043 Total Traffic
 Grandview Reserve Phases 2 and 3 (LSC # S234340)





LEGEND:
 Traffic Control Used in the Analysis:
 — = Stop Sign
 [] = Traffic Signal
 LOS Analysis Results:
 A/B = AM Individual Movement Peak-Hour Level of Service
 PM Individual Movement Peak-Hour Level of Service
 A/C = AM Entire Intersection Peak-Hour Level of Service
 PM Entire Intersection Peak-Hour Level of Service
 ○ = Modern Roundabout

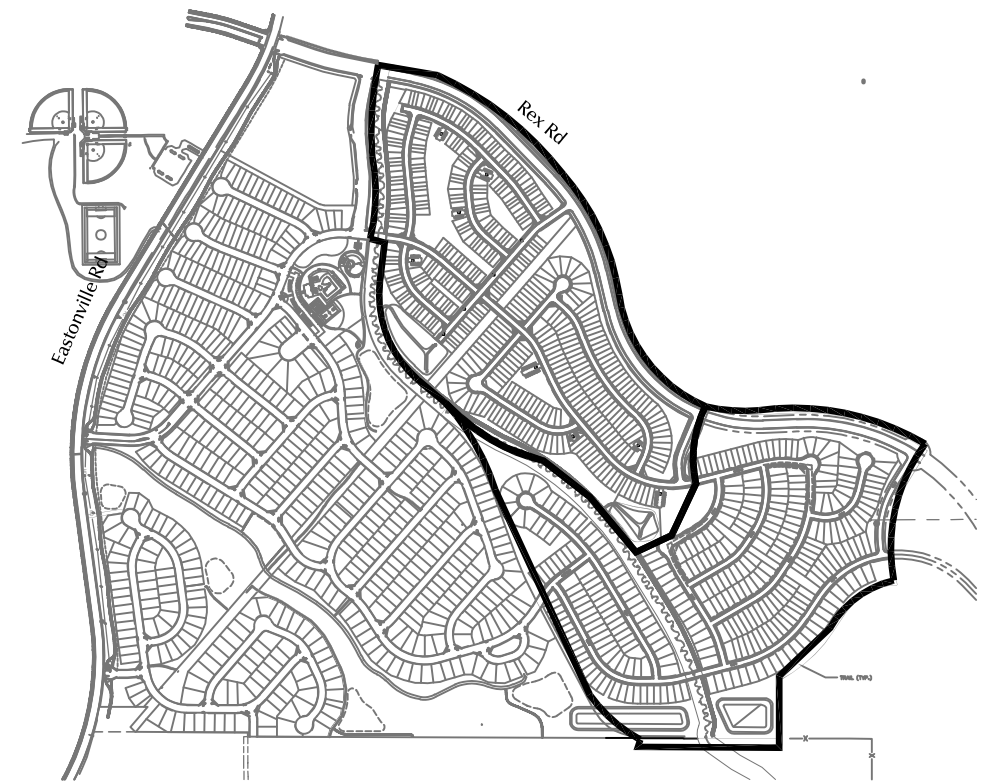
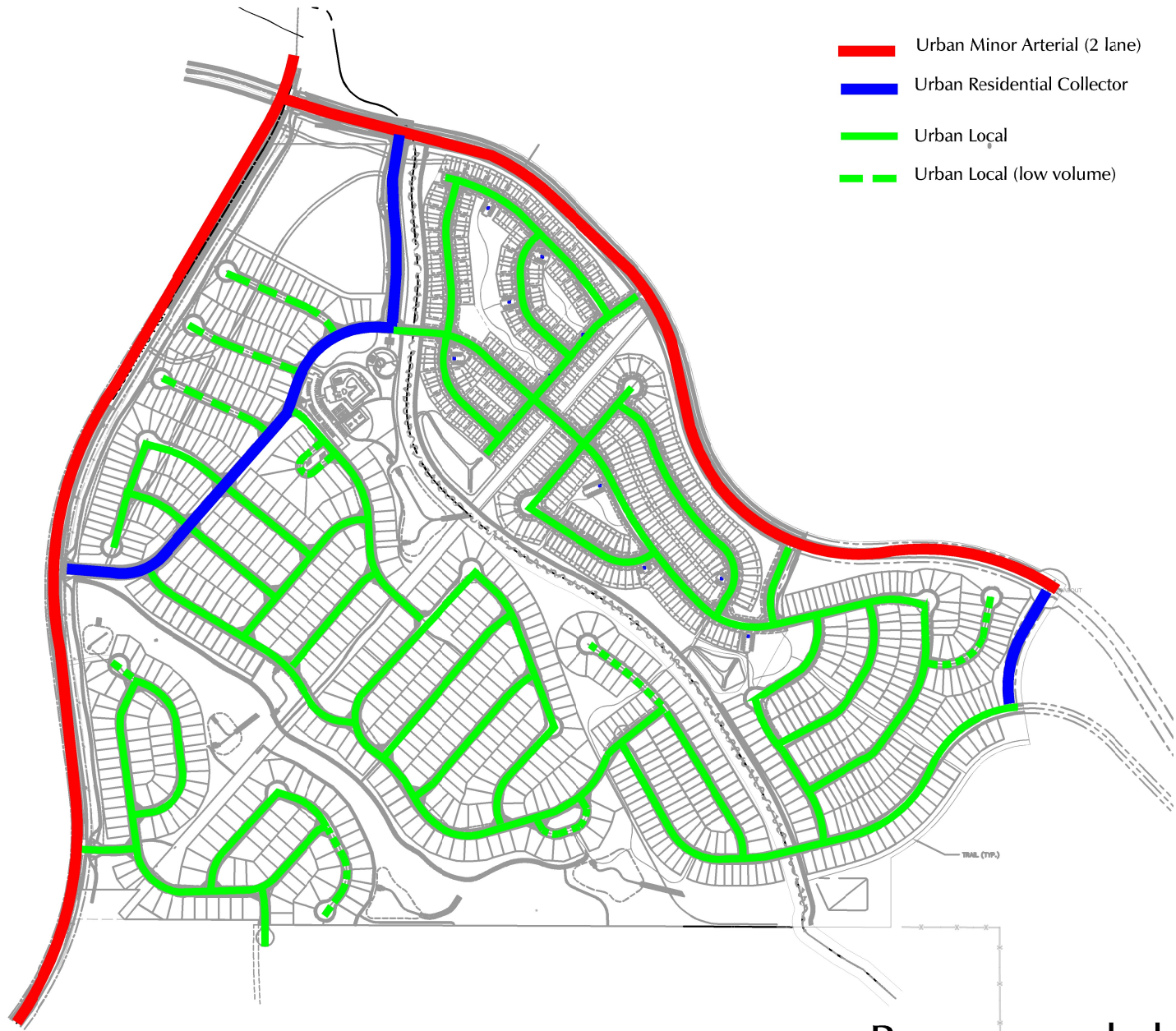

Figure 15b
 Year 2043 Total Lane Geometry,
 Traffic Control, and Levels of Service
 Grandview Reserve Phases 2 and 3 (LSC # S234340)



- █ Urban Minor Arterial (2 lane)
- █ Urban Residential Collector
- █ Urban Local
- - - Urban Local (low volume)



1" = 200'
scale

Figure 16
**Recommended Street
 Classification**

Grandview Reserve Phases 2 and 3 (LSC # S234340)

Traffic Counts



LSC Transportation Consultants, Inc.

2504 E. Pikes Peak Ave, Suite 304
 Colorado Springs, CO 80909
 719-633-2868

File Name : Hwy 24 - Stapleton Dr AM PM

Site Code : S224640

Start Date : 1/10/2023

Page No : 1

Groups Printed- Unshifted

Start Time	Hwy 24 Southbound					Stapleton Dr Westbound					Hwy 24 Northbound					Stapleton Dr Eastbound					Int. Total
	Right	Thru	Left	Peds	App. Total	Right	Thru	Left	Peds	App. Total	Right	Thru	Left	Peds	App. Total	Right	Thru	Left	Peds	App. Total	
06:30	1	29	1	0	31	0	1	1	0	2	1	7	1	0	9	20	11	1	0	32	74
06:35	0	33	0	0	33	1	4	0	0	5	0	12	0	0	12	11	11	2	0	24	74
06:40	0	35	2	0	37	1	0	0	0	1	0	13	2	0	15	16	8	2	0	26	79
06:45	3	41	3	0	47	1	6	3	0	10	1	22	4	0	27	13	9	2	0	24	108
06:50	3	32	1	0	36	1	3	0	0	4	1	15	7	0	23	14	7	1	0	22	85
06:55	2	22	1	0	25	2	8	0	0	10	0	24	6	0	30	16	13	0	0	29	94
Total	9	192	8	0	209	6	22	4	0	32	3	93	20	0	116	90	59	8	0	157	514
07:00	4	35	3	0	42	2	6	0	0	8	0	29	2	0	31	7	13	1	0	21	102
07:05	4	33	4	0	41	1	10	0	0	11	0	22	4	0	26	7	11	6	0	24	102
07:10	0	33	3	0	36	4	11	1	0	16	0	30	5	0	35	15	12	2	0	29	116
07:15	2	36	2	0	40	4	14	1	0	19	0	29	7	0	36	13	15	3	0	31	126
07:20	4	46	1	0	51	1	6	0	0	7	0	30	4	0	34	11	13	1	0	25	117
07:25	5	51	8	0	64	0	7	0	0	7	0	28	0	0	28	10	7	1	0	18	117
07:30	2	34	2	0	38	0	7	0	0	7	1	16	6	0	23	9	20	2	0	31	99
07:35	6	40	5	0	51	0	9	1	0	10	0	9	2	0	11	12	7	2	0	21	93
07:40	4	31	1	0	36	0	7	2	0	9	0	9	3	0	12	5	9	0	0	14	71
07:45	1	31	1	0	33	2	5	1	0	8	0	13	6	0	19	6	17	2	0	25	85
07:50	3	21	4	0	28	0	5	0	0	5	1	18	1	0	20	10	15	2	0	27	80
07:55	2	15	3	0	20	1	1	0	0	2	0	16	4	0	20	8	5	1	0	14	56
Total	37	406	37	0	480	15	88	6	0	109	2	249	44	0	295	113	144	23	0	280	1164
08:00	3	39	2	0	44	0	6	0	0	6	0	10	5	0	15	4	10	2	0	16	81
08:05	1	30	0	0	31	1	2	1	0	4	2	19	5	0	26	4	6	4	0	14	75
08:10	2	27	2	0	31	2	2	1	0	5	0	13	4	0	17	5	6	0	0	11	64
08:15	4	31	0	0	35	5	1	2	0	8	0	7	5	0	12	8	5	2	0	15	70
08:20	5	22	3	0	30	1	7	0	0	8	0	3	3	0	6	7	4	1	0	12	56
08:25	4	34	1	0	39	0	2	0	0	2	1	14	0	0	15	4	7	5	0	16	72
*** BREAK ***																					
Total	19	183	8	0	210	9	20	4	0	33	3	66	22	0	91	32	38	14	0	84	418
*** BREAK ***																					
16:00	2	26	0	0	28	3	7	1	0	11	0	41	13	0	54	3	3	4	0	10	103
16:05	3	25	0	0	28	4	6	0	0	10	0	46	15	0	61	1	2	5	0	8	107
16:10	3	32	0	0	35	2	8	0	0	10	3	35	15	0	53	6	4	2	0	12	110
16:15	3	36	1	0	40	3	9	1	0	13	4	45	7	0	56	4	1	2	0	7	116
16:20	0	31	3	0	34	1	7	1	0	9	2	46	15	0	63	4	2	1	0	7	113
16:25	1	24	1	0	26	2	11	0	0	13	3	47	8	0	58	5	10	3	0	18	115
16:30	1	23	0	0	24	0	10	2	0	12	1	42	7	0	50	5	3	2	0	10	96
16:35	2	32	1	0	35	1	5	1	0	7	4	34	4	0	42	2	1	1	0	4	88
16:40	5	29	1	0	35	2	13	0	0	15	1	29	7	0	37	4	9	1	0	14	101
16:45	3	31	2	0	36	5	10	3	0	18	2	31	13	0	46	3	2	2	0	7	107
16:50	1	32	1	0	34	2	11	0	0	13	4	39	7	0	50	6	4	2	0	12	109

LSC Transportation Consultants, Inc.

2504 E. Pikes Peak Ave, Suite 304
 Colorado Springs, CO 80909
 719-633-2868

File Name : Hwy 24 - Stapleton Dr AM PM

Site Code : S224640

Start Date : 1/10/2023

Page No : 2

Groups Printed- Unshifted

Start Time	Hwy 24 Southbound					Stapleton Dr Westbound					Hwy 24 Northbound					Stapleton Dr Eastbound					Int. Total
	Right	Thru	Left	Peds	App. Total	Right	Thru	Left	Peds	App. Total	Right	Thru	Left	Peds	App. Total	Right	Thru	Left	Peds	App. Total	
16:55	5	29	1	0	35	3	15	2	0	20	3	31	15	0	49	2	4	2	0	8	112
Total	29	350	11	0	390	28	112	11	0	151	27	466	126	0	619	45	45	27	0	117	1277
17:00	3	22	0	0	25	0	20	0	0	20	1	37	13	0	51	8	1	0	0	9	105
17:05	2	30	0	0	32	4	6	1	0	11	7	47	14	0	68	2	4	0	0	6	117
17:10	3	45	1	0	49	3	19	1	0	23	1	31	9	0	41	4	1	1	0	6	119
17:15	3	29	1	0	33	1	4	1	0	6	0	46	7	0	53	3	1	1	0	5	97
17:20	3	27	1	0	31	4	11	1	0	16	3	34	8	0	45	3	5	2	0	10	102
17:25	3	21	0	0	24	3	2	0	0	5	0	30	11	0	41	2	4	2	0	8	78
17:30	3	18	0	0	21	5	8	0	0	13	2	43	8	0	53	1	3	0	0	4	91
17:35	3	17	0	0	20	2	6	0	0	8	0	33	14	0	47	2	1	3	0	6	81
17:40	1	18	0	0	19	2	6	2	0	10	1	32	6	0	39	0	1	3	0	4	72
17:45	4	24	1	0	29	2	4	1	0	7	1	51	7	0	59	3	2	1	0	6	101
17:50	1	13	0	0	14	1	6	1	0	8	0	48	13	0	61	2	5	3	0	10	93
17:55	3	18	0	0	21	3	7	0	0	10	1	23	9	0	33	4	7	2	0	13	77
Total	32	282	4	0	318	30	99	8	0	137	17	455	119	0	591	34	35	18	0	87	1133
Grand Total	126	1413	68	0	1607	88	341	33	0	462	52	1329	331	0	1712	314	321	90	0	725	4506
Apprch %	7.8	87.9	4.2	0		19	73.8	7.1	0		3	77.6	19.3	0		43.3	44.3	12.4	0		
Total %	2.8	31.4	1.5	0	35.7	2	7.6	0.7	0	10.3	1.2	29.5	7.3	0	38	7	7.1	2	0	16.1	

LSC Transportation Consultants, Inc.

2504 E. Pikes Peak Ave, Suite 304
 Colorado Springs, CO 80909
 719-633-2868

File Name : Hwy 24 - Stapleton Dr AM PM
 Site Code : S224640
 Start Date : 1/10/2023
 Page No : 3

Start Time	Hwy 24 Southbound					Stapleton Dr Westbound					Hwy 24 Northbound					Stapleton Dr Eastbound					Int. Total
	Right	Thru	Left	Peds	App. Total	Right	Thru	Left	Peds	App. Total	Right	Thru	Left	Peds	App. Total	Right	Thru	Left	Peds	App. Total	
Peak Hour Analysis From 06:30 to 17:55 - Peak 1 of 1																					
Peak Hour for Entire Intersection Begins at 16:15																					
16:15	3	36	1	0	40	3	9	1	0	13	4	45	7	0	56	4	1	2	0	7	116
16:20	0	31	3	0	34	1	7	1	0	9	2	46	15	0	63	4	2	1	0	7	113
16:25	1	24	1	0	26	2	11	0	0	13	3	47	8	0	58	5	10	3	0	18	115
16:30	1	23	0	0	24	0	10	2	0	12	1	42	7	0	50	5	3	2	0	10	96
16:35	2	32	1	0	35	1	5	1	0	7	4	34	4	0	42	2	1	1	0	4	88
16:40	5	29	1	0	35	2	13	0	0	15	1	29	7	0	37	4	9	1	0	14	101
16:45	3	31	2	0	36	5	10	3	0	18	2	31	13	0	46	3	2	2	0	7	107
16:50	1	32	1	0	34	2	11	0	0	13	4	39	7	0	50	6	4	2	0	12	109
16:55	5	29	1	0	35	3	15	2	0	20	3	31	15	0	49	2	4	2	0	8	112
17:00	3	22	0	0	25	0	20	0	0	20	1	37	13	0	51	8	1	0	0	9	105
17:05	2	30	0	0	32	4	6	1	0	11	7	47	14	0	68	2	4	0	0	6	117
17:10	3	45	1	0	49	3	19	1	0	23	1	31	9	0	41	4	1	1	0	6	119
Total Volume	29	364	12	0	405	26	136	12	0	174	33	459	119	0	611	49	42	17	0	108	1298
% App. Total	7.2	89.9	3	0		14.9	78.2	6.9	0		5.4	75.1	19.5	0		45.4	38.9	15.7	0		
PHF	.483	.674	.333	.000	.689	.433	.567	.333	.000	.630	.393	.814	.661	.000	.749	.510	.350	.472	.000	.500	.909

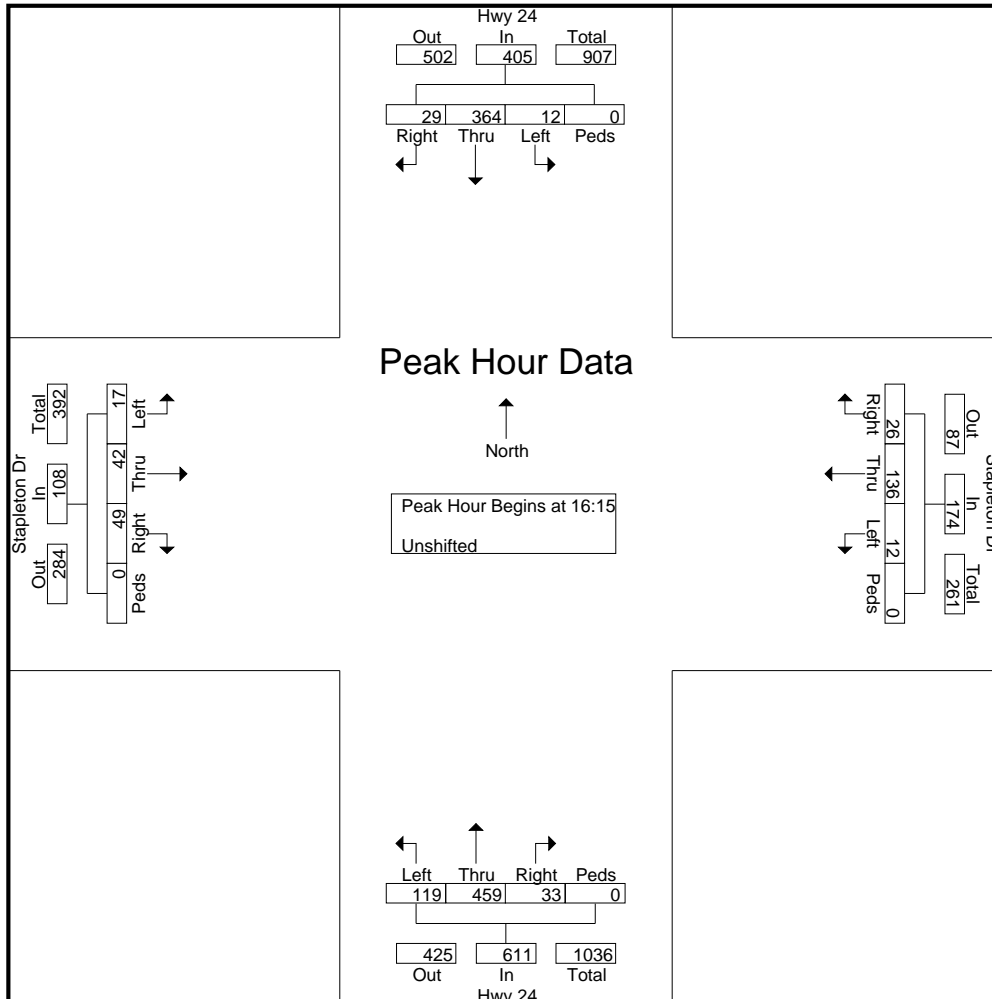

LSC Transportation Consultants, Inc.

2504 E. Pikes Peak Ave, Suite 304
 Colorado Springs, CO 80909
 719-633-2868

File Name : Eastonville Rd - Stapleton Dr AM
 Site Code : S214870
 Start Date : 10/7/2021
 Page No : 1

Groups Printed- Unshifted

Start Time	Eastonville Rd Southbound					Stapleton Dr Westbound					Eastonville Rd Northbound					Stapleton Dr Eastbound					Int. Total
	L	T	R	U	App. Total	L	T	R	U	App. Total	L	T	R	U	App. Total	L	T	R	U	App. Total	
06:30 AM	29	8	0	0	37	0	18	8	0	26	2	14	0	0	16	3	32	2	0	37	116
06:45 AM	36	19	2	0	57	0	11	20	0	31	5	18	1	0	24	5	51	8	0	64	176
Total	65	27	2	0	94	0	29	28	0	57	7	32	1	0	40	8	83	10	0	101	292
07:00 AM	31	36	6	0	73	0	16	43	0	59	13	76	2	0	91	2	27	6	0	35	258
07:15 AM	48	67	4	0	119	3	25	34	0	62	33	69	3	0	105	3	36	13	0	52	338
07:30 AM	24	31	2	0	57	3	42	13	0	58	32	24	11	0	67	2	45	15	0	62	244
07:45 AM	15	17	0	0	32	0	20	8	0	28	16	14	1	1	32	0	36	15	0	51	143
Total	118	151	12	0	281	6	103	98	0	207	94	183	17	1	295	7	144	49	0	200	983
08:00 AM	11	14	1	1	27	2	20	11	0	33	8	10	1	0	19	1	24	12	0	37	116
08:15 AM	23	10	0	1	34	1	18	12	0	31	18	9	0	0	27	2	12	11	0	25	117
08:30 AM	12	8	2	0	22	0	18	6	0	24	4	6	2	0	12	3	21	3	0	27	85
Grand Total	229	210	17	2	458	9	188	155	0	352	131	240	21	1	393	21	284	85	0	390	1593
Apprch %	50	45.9	3.7	0.4		2.6	53.4	44	0		33.3	61.1	5.3	0.3		5.4	72.8	21.8	0		
Total %	14.4	13.2	1.1	0.1	28.8	0.6	11.8	9.7	0	22.1	8.2	15.1	1.3	0.1	24.7	1.3	17.8	5.3	0	24.5	

LSC Transportation Consultants, Inc.

2504 E. Pikes Peak Ave, Suite 304
 Colorado Springs, CO 80909
 719-633-2868

File Name : Eastonville Rd - Stapleton Dr AM

Site Code : S214870

Start Date : 10/7/2021

Page No : 3

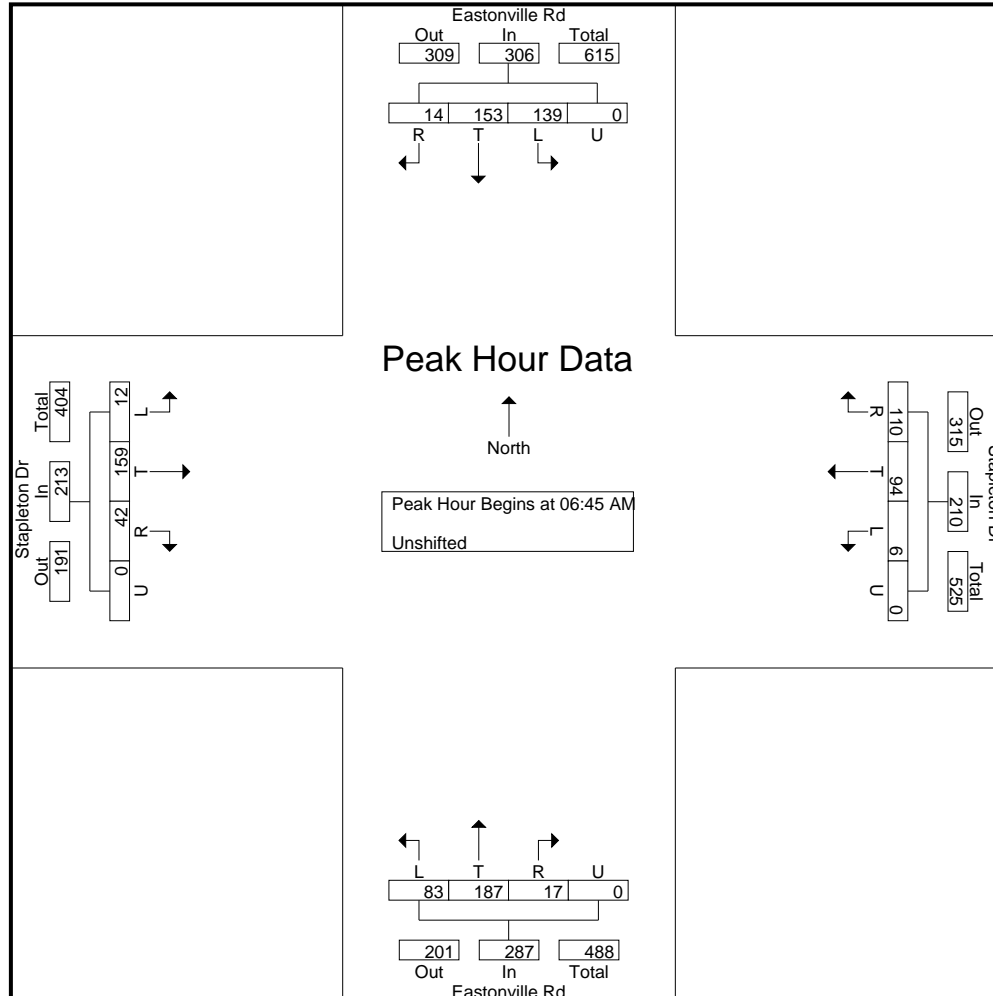

LSC Transportation Consultants, Inc.

2504 E. Pikes Peak Ave, Suite 304
 Colorado Springs, CO 80909
 719-633-2868

File Name : Eastonville Rd - Stapleton Dr PM
 Site Code : S214870
 Start Date : 10/7/2021
 Page No : 1

Groups Printed- Unshifted

Start Time	Eastonville Rd Southbound					Stapleton Dr Westbound					Eastonville Rd Northbound					Stapleton Dr Eastbound					Int. Total
	L	T	R	U	App. Total	L	T	R	U	App. Total	L	T	R	U	App. Total	L	T	R	U	App. Total	
04:00 PM	9	15	2	0	26	1	42	25	0	68	11	23	3	0	37	1	25	8	0	34	165
04:15 PM	9	20	0	2	31	6	38	27	0	71	6	25	5	0	36	3	23	9	0	35	173
04:30 PM	11	12	0	0	23	1	39	31	0	71	17	40	2	1	60	2	16	8	0	26	180
04:45 PM	21	16	2	0	39	1	34	22	0	57	13	27	2	0	42	5	14	6	0	25	163
Total	50	63	4	2	119	9	153	105	0	267	47	115	12	1	175	11	78	31	0	120	681
05:00 PM	13	27	2	0	42	3	40	18	0	61	5	24	4	0	33	4	18	3	0	25	161
05:15 PM	11	27	2	0	40	2	28	29	0	59	11	25	2	0	38	2	21	3	0	26	163
05:30 PM	14	19	2	0	35	4	30	15	0	49	11	30	2	0	43	0	26	8	0	34	161
05:45 PM	14	15	1	0	30	3	32	13	0	48	10	32	0	0	42	3	26	5	0	34	154
Total	52	88	7	0	147	12	130	75	0	217	37	111	8	0	156	9	91	19	0	119	639
06:00 PM	12	23	5	0	40	2	31	19	0	52	9	22	3	0	34	5	15	1	0	21	147
Grand Total	114	174	16	2	306	23	314	199	0	536	93	248	23	1	365	25	184	51	0	260	1467
Apprch %	37.3	56.9	5.2	0.7		4.3	58.6	37.1	0		25.5	67.9	6.3	0.3		9.6	70.8	19.6	0		
Total %	7.8	11.9	1.1	0.1	20.9	1.6	21.4	13.6	0	36.5	6.3	16.9	1.6	0.1	24.9	1.7	12.5	3.5	0	17.7	

LSC Transportation Consultants, Inc.

2504 E. Pikes Peak Ave, Suite 304
 Colorado Springs, CO 80909
 719-633-2868

File Name : Eastonville Rd - Stapleton Dr PM

Site Code : S214870

Start Date : 10/7/2021

Page No : 3

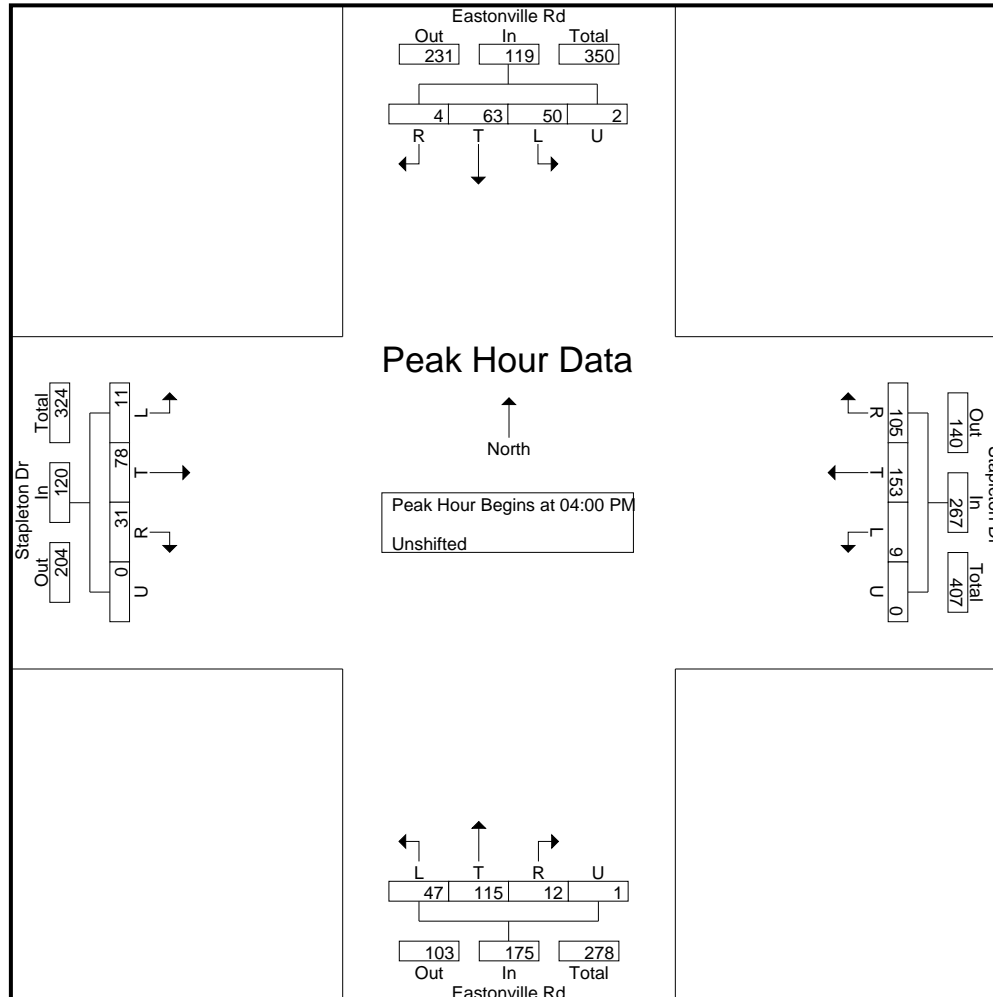

LSC Transportation Consultants, Inc.

2504 E. Pikes Peak Ave, Suite 304
Colorado Springs, CO 80909
719-633-2868

File Name : Eastonville Rd -Londonderry Dr AM
Site Code : S214250
Start Date : 4/15/2021
Page No : 1

Groups Printed- Unshifted

Start Time	Eastonville Rd Southbound					Westbound					Eastonville Rd Northbound					Londonderry Dr Eastbound					Int. Total
	L	T	R	U	App. Total	L	T	R	U	App. Total	L	T	R	U	App. Total	L	T	R	U	App. Total	
07:00 AM	0	2	2	0	4	0	0	0	0	0	44	2	0	0	46	0	0	31	0	31	81
07:15 AM	0	2	3	0	5	0	0	0	0	0	96	1	0	0	97	0	0	74	0	74	176
07:30 AM	0	2	2	0	4	0	0	0	0	0	22	2	0	0	24	0	0	54	0	54	82
07:45 AM	0	3	2	0	5	0	0	0	0	0	28	1	0	0	29	3	0	37	1	41	75
Total	0	9	9	0	18	0	0	0	0	0	190	6	0	0	196	3	0	196	1	200	414
08:00 AM	0	1	5	0	6	0	0	0	0	0	24	1	0	0	25	0	0	18	0	18	49
08:15 AM	0	0	2	0	2	0	0	0	0	0	24	2	0	0	26	2	0	37	1	40	68
08:30 AM	0	1	0	0	1	0	0	0	0	0	13	1	0	0	14	2	0	23	0	25	40
08:45 AM	0	7	2	0	9	0	0	0	0	0	13	5	0	0	18	0	0	12	0	12	39
Total	0	9	9	0	18	0	0	0	0	0	74	9	0	0	83	4	0	90	1	95	196
Grand Total	0	18	18	0	36	0	0	0	0	0	264	15	0	0	279	7	0	286	2	295	610
Apprch %	0	50	50	0		0	0	0	0		94.6	5.4	0	0		2.4	0	96.9	0.7		
Total %	0	3	3	0	5.9	0	0	0	0	0	43.3	2.5	0	0	45.7	1.1	0	46.9	0.3	48.4	

LSC Transportation Consultants, Inc.

2504 E. Pikes Peak Ave, Suite 304
 Colorado Springs, CO 80909
 719-633-2868

File Name : Eastonville Rd -Londonderry Dr AM
 Site Code : S214250
 Start Date : 4/15/2021
 Page No : 3

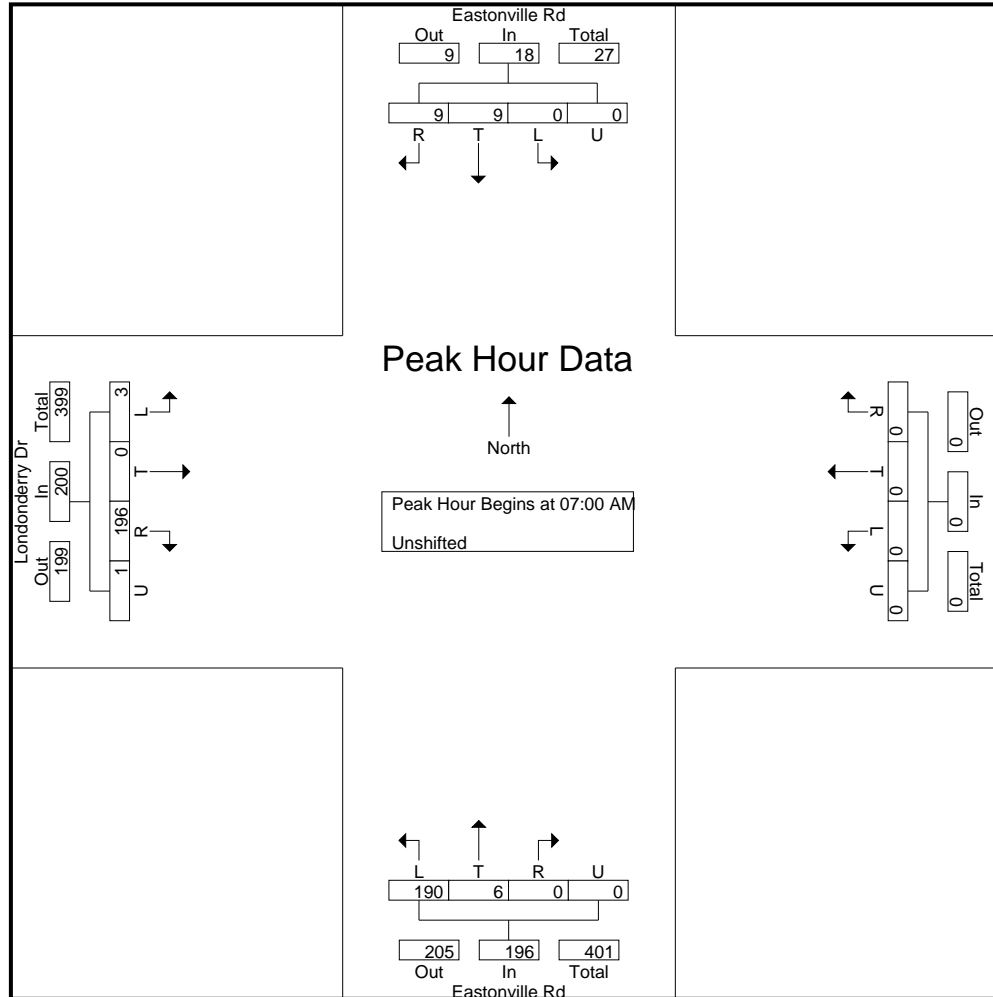

LSC Transportation Consultants, Inc.

2504 E. Pikes Peak Ave, Suite 304
Colorado Springs, CO 80909
719-633-2868

File Name : Eastonville Rd -Londonderry Dr PM
Site Code : S214250
Start Date : 4/15/2021
Page No : 1

Groups Printed- Unshifted

Start Time	Eastonville Rd Southbound					Westbound					Eastonville Rd Northbound					Londonderry Dr Eastbound					Int. Total
	L	T	R	U	App. Total	L	T	R	U	App. Total	L	T	R	U	App. Total	L	T	R	U	App. Total	
04:00 PM	0	2	1	0	3	0	0	0	0	0	47	1	0	0	48	2	0	27	0	29	80
04:15 PM	0	1	0	0	1	0	0	0	0	0	36	3	0	0	39	2	0	19	0	21	61
04:30 PM	0	1	1	0	2	0	0	0	0	0	40	2	0	0	42	0	0	15	0	15	59
04:45 PM	0	1	1	0	2	0	0	0	0	0	36	7	0	0	43	2	0	13	0	15	60
Total	0	5	3	0	8	0	0	0	0	0	159	13	0	0	172	6	0	74	0	80	260
05:00 PM	0	2	2	0	4	0	0	0	0	0	36	1	0	0	37	0	0	12	0	12	53
05:15 PM	0	4	0	0	4	0	0	0	0	0	31	1	0	0	32	1	0	8	0	9	45
05:30 PM	0	1	0	0	1	0	0	0	0	0	35	3	0	1	39	0	0	7	0	7	47
05:45 PM	0	2	0	0	2	0	0	0	0	0	24	2	0	0	26	0	0	15	0	15	43
Total	0	9	2	0	11	0	0	0	0	0	126	7	0	1	134	1	0	42	0	43	188
Grand Total	0	14	5	0	19	0	0	0	0	0	285	20	0	1	306	7	0	116	0	123	448
Apprch %	0	73.7	26.3	0		0	0	0	0		93.1	6.5	0	0.3		5.7	0	94.3	0		
Total %	0	3.1	1.1	0	4.2	0	0	0	0	0	63.6	4.5	0	0.2	68.3	1.6	0	25.9	0	27.5	

LSC Transportation Consultants, Inc.

2504 E. Pikes Peak Ave, Suite 304
 Colorado Springs, CO 80909
 719-633-2868

File Name : Eastonville Rd -Londonderry Dr PM
 Site Code : S214250
 Start Date : 4/15/2021
 Page No : 3

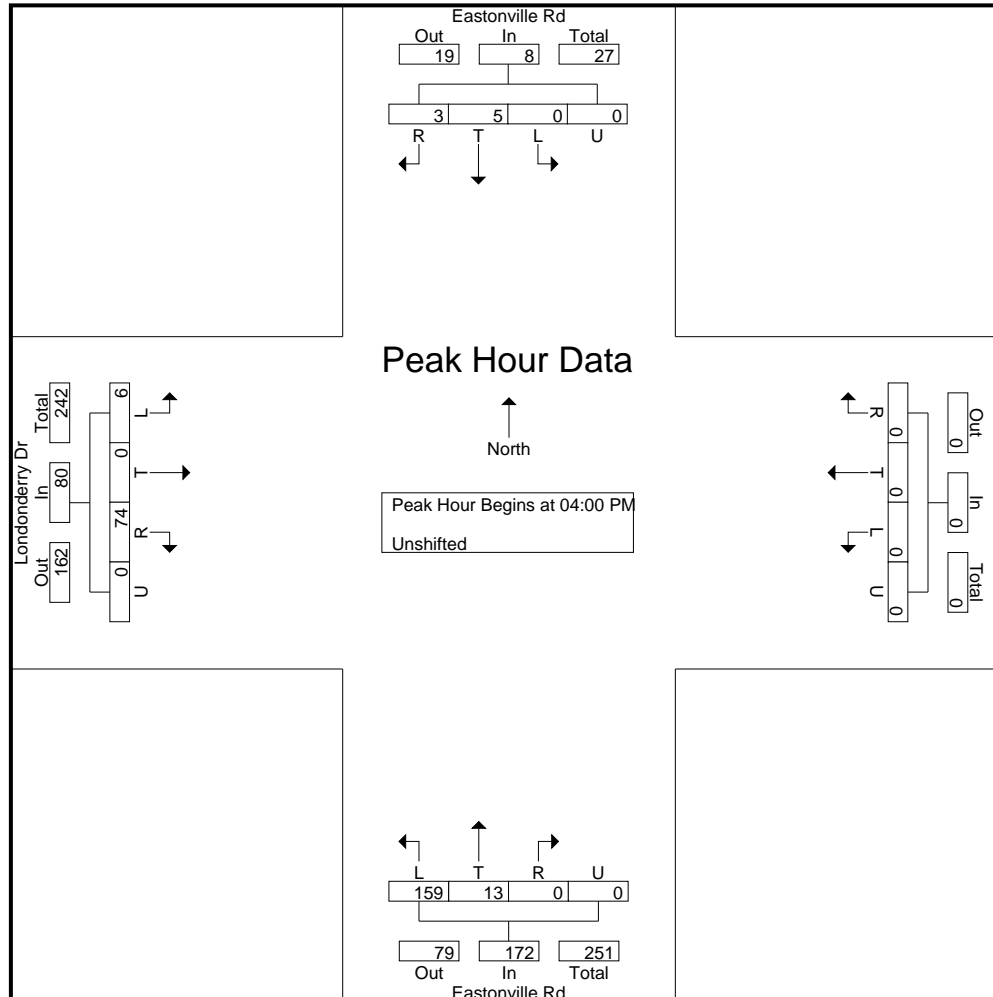

Level of Service Reports



Intersection						
Int Delay, s/veh	9.3					
Movement	EBL	EBR	NBL	NBT	SBT	SBR
Lane Configurations						
Traffic Vol, veh/h	3	297	303	6	9	9
Future Vol, veh/h	3	297	303	6	9	9
Conflicting Peds, #/hr	0	0	0	0	0	0
Sign Control	Stop	Stop	Free	Free	Free	Free
RT Channelized	-	None	-	None	-	None
Storage Length	0	0	-	-	-	-
Veh in Median Storage, #	0	-	-	0	0	-
Grade, %	0	-	-	0	0	-
Peak Hour Factor	67	67	51	51	90	90
Heavy Vehicles, %	2	2	2	2	2	2
Mvmt Flow	4	443	594	12	10	10

Major/Minor	Minor2	Major1		Major2	
Conflicting Flow All	1215	15	20	0	0
Stage 1	15	-	-	-	-
Stage 2	1200	-	-	-	-
Critical Hdwy	6.42	6.22	4.12	-	-
Critical Hdwy Stg 1	5.42	-	-	-	-
Critical Hdwy Stg 2	5.42	-	-	-	-
Follow-up Hdwy	3.518	3.318	2.218	-	-
Pot Cap-1 Maneuver	200	1065	1596	-	-
Stage 1	1008	-	-	-	-
Stage 2	285	-	-	-	-
Platoon blocked, %				-	-
Mov Cap-1 Maneuver	125	1065	1596	-	-
Mov Cap-2 Maneuver	125	-	-	-	-
Stage 1	630	-	-	-	-
Stage 2	285	-	-	-	-

Approach	EB	NB	SB
HCM Control Delay, s	11	8.4	0
HCM LOS	B		

Minor Lane/Major Mvmt	NBL	NBT	EBLn1	EBLn2	SBT	SBR
Capacity (veh/h)	1596	-	125	1065	-	-
HCM Lane V/C Ratio	0.372	-	0.036	0.416	-	-
HCM Control Delay (s)	8.6	0	34.9	10.8	-	-
HCM Lane LOS	A	A	D	B	-	-
HCM 95th %tile Q(veh)	1.8	-	0.1	2.1	-	-

HCM 6th TWSC
13: Eastonville Rd & Stapleton Dr

Existing Traffic
AM Peak Hour

Intersection												
Int Delay, s/veh	108.7											
Movement	EBL	EBT	EBR	WBL	WBT	WBR	NBL	NBT	NBR	SBL	SBT	SBR
Lane Configurations		↕			↕	↕		↕			↕	
Traffic Vol, veh/h	12	159	42	6	94	110	83	187	17	139	153	14
Future Vol, veh/h	12	159	42	6	94	110	83	187	17	139	153	14
Conflicting Peds, #/hr	0	0	0	0	0	0	0	0	0	0	0	0
Sign Control	Stop	Stop	Stop	Stop	Stop	Stop	Free	Free	Free	Free	Free	Free
RT Channelized	-	-	None	-	-	None	-	-	None	-	-	None
Storage Length	-	-	-	-	-	250	-	-	-	-	-	-
Veh in Median Storage, #	-	0	-	-	0	-	-	0	-	-	0	-
Grade, %	-	0	-	-	0	-	-	0	-	-	0	-
Peak Hour Factor	87	87	87	85	85	85	68	68	68	64	64	64
Heavy Vehicles, %	2	2	2	2	2	2	2	2	2	2	2	2
Mvmt Flow	14	183	48	7	111	129	122	275	25	217	239	22

Major/Minor	Minor2		Minor1		Major1			Major2				
Conflicting Flow All	1336	1228	250	1332	1227	288	261	0	0	300	0	0
Stage 1	684	684	-	532	532	-	-	-	-	-	-	-
Stage 2	652	544	-	800	695	-	-	-	-	-	-	-
Critical Hdwy	7.12	6.52	6.22	7.12	6.52	6.22	4.12	-	-	4.12	-	-
Critical Hdwy Stg 1	6.12	5.52	-	6.12	5.52	-	-	-	-	-	-	-
Critical Hdwy Stg 2	6.12	5.52	-	6.12	5.52	-	-	-	-	-	-	-
Follow-up Hdwy	3.518	4.018	3.318	3.518	4.018	3.318	2.218	-	-	2.218	-	-
Pot Cap-1 Maneuver	130	~ 178	789	131	178	751	1303	-	-	1261	-	-
Stage 1	439	449	-	531	526	-	-	-	-	-	-	-
Stage 2	457	519	-	379	444	-	-	-	-	-	-	-
Platoon blocked, %								-	-	-	-	-
Mov Cap-1 Maneuver	22	~ 126	789	-	126	751	1303	-	-	1261	-	-
Mov Cap-2 Maneuver	22	~ 126	-	-	126	-	-	-	-	-	-	-
Stage 1	389	358	-	471	467	-	-	-	-	-	-	-
Stage 2	256	460	-	139	354	-	-	-	-	-	-	-

Approach	EB	WB	NB	SB
HCM Control Delay, s	\$ 606.5		2.3	3.8
HCM LOS	F	-		

Minor Lane/Major Mvmt	NBL	NBT	NBR	EBLn1	WBLn1	WBLn2	SBL	SBT	SBR
Capacity (veh/h)	1303	-	-	114	-	751	1261	-	-
HCM Lane V/C Ratio	0.094	-	-	2.148	-	0.172	0.172	-	-
HCM Control Delay (s)	8	0	-	\$ 606.5	-	10.8	8.4	0	-
HCM Lane LOS	A	A	-	F	-	B	A	A	-
HCM 95th %tile Q(veh)	0.3	-	-	20.8	-	0.6	0.6	-	-

Notes
 ~: Volume exceeds capacity \$: Delay exceeds 300s +: Computation Not Defined *: All major volume in platoon

Intersection												
Int Delay, s/veh	14.7											
Movement	EBL	EBT	EBR	WBL	WBT	WBR	NBL	NBT	NBR	SBL	SBT	SBR
Lane Configurations	↖	↗	↖	↖	↗	↖	↖	↗	↖	↖	↗	↖
Traffic Vol, veh/h	23	135	143	6	87	17	49	267	3	35	438	35
Future Vol, veh/h	23	135	143	6	87	17	49	267	3	35	438	35
Conflicting Peds, #/hr	0	0	0	0	0	0	0	0	0	0	0	0
Sign Control	Stop	Stop	Stop	Stop	Stop	Stop	Free	Free	Free	Free	Free	Free
RT Channelized	-	-	None	-	-	None	-	-	None	-	-	None
Storage Length	185	-	325	225	-	225	1000	-	0	785	-	785
Veh in Median Storage, #	-	0	-	-	0	-	-	0	-	-	0	-
Grade, %	-	0	-	-	0	-	-	0	-	-	0	-
Peak Hour Factor	89	89	89	65	65	65	76	76	76	92	92	92
Heavy Vehicles, %	2	2	2	2	2	2	2	2	2	2	2	2
Mvmt Flow	26	152	161	9	134	26	64	351	4	38	476	38

Major/Minor	Minor2		Minor1		Major1		Major2					
Conflicting Flow All	1113	1035	476	1207	1069	351	514	0	0	355	0	0
Stage 1	552	552	-	479	479	-	-	-	-	-	-	-
Stage 2	561	483	-	728	590	-	-	-	-	-	-	-
Critical Hdwy	7.12	6.52	6.22	7.12	6.52	6.22	4.12	-	-	4.12	-	-
Critical Hdwy Stg 1	6.12	5.52	-	6.12	5.52	-	-	-	-	-	-	-
Critical Hdwy Stg 2	6.12	5.52	-	6.12	5.52	-	-	-	-	-	-	-
Follow-up Hdwy	3.518	4.018	3.318	3.518	4.018	3.318	2.218	-	-	2.218	-	-
Pot Cap-1 Maneuver	186	232	589	160	221	692	1052	-	-	1204	-	-
Stage 1	518	515	-	568	555	-	-	-	-	-	-	-
Stage 2	512	553	-	415	495	-	-	-	-	-	-	-
Platoon blocked, %	-	-	-	-	-	-	-	-	-	-	-	-
Mov Cap-1 Maneuver	78	211	589	45	201	692	1052	-	-	1204	-	-
Mov Cap-2 Maneuver	78	211	-	45	201	-	-	-	-	-	-	-
Stage 1	486	499	-	533	521	-	-	-	-	-	-	-
Stage 2	344	519	-	203	479	-	-	-	-	-	-	-

Approach	EB		WB		NB		SB	
HCM Control Delay, s	37.2		49		1.3		0.6	
HCM LOS	E		E					

Minor Lane/Major Mvmt	NBL	NBT	NBR	EBLn1	EBLn2	EBLn3	WBLn1	WBLn2	WBLn3	SBL	SBT	SBR
Capacity (veh/h)	1052	-	-	78	211	589	45	201	692	1204	-	-
HCM Lane V/C Ratio	0.061	-	-	0.331	0.719	0.273	0.205	0.666	0.038	0.032	-	-
HCM Control Delay (s)	8.6	-	-	72.5	56.4	13.4	104.6	52.7	10.4	8.1	-	-
HCM Lane LOS	A	-	-	F	F	B	F	F	B	A	-	-
HCM 95th %tile Q(veh)	0.2	-	-	1.2	4.7	1.1	0.7	4	0.1	0.1	-	-

Intersection						
Int Delay, s/veh	7.7					
Movement	EBL	EBR	NBL	NBT	SBT	SBR
Lane Configurations						
Traffic Vol, veh/h	6	112	218	13	5	3
Future Vol, veh/h	6	112	218	13	5	3
Conflicting Peds, #/hr	0	0	0	0	0	0
Sign Control	Stop	Stop	Free	Free	Free	Free
RT Channelized	-	None	-	None	-	None
Storage Length	0	0	-	-	-	-
Veh in Median Storage, #	0	-	-	0	0	-
Grade, %	0	-	-	0	0	-
Peak Hour Factor	83	83	79	79	78	78
Heavy Vehicles, %	2	2	2	2	2	2
Mvmt Flow	7	135	276	16	6	4

Major/Minor	Minor2	Major1		Major2	
Conflicting Flow All	576	8	10	0	0
Stage 1	8	-	-	-	-
Stage 2	568	-	-	-	-
Critical Hdwy	6.42	6.22	4.12	-	-
Critical Hdwy Stg 1	5.42	-	-	-	-
Critical Hdwy Stg 2	5.42	-	-	-	-
Follow-up Hdwy	3.518	3.318	2.218	-	-
Pot Cap-1 Maneuver	479	1074	1610	-	-
Stage 1	1015	-	-	-	-
Stage 2	567	-	-	-	-
Platoon blocked, %				-	-
Mov Cap-1 Maneuver	396	1074	1610	-	-
Mov Cap-2 Maneuver	396	-	-	-	-
Stage 1	839	-	-	-	-
Stage 2	567	-	-	-	-

Approach	EB	NB	SB
HCM Control Delay, s	9.1	7.3	0
HCM LOS	A		

Minor Lane/Major Mvmt	NBL	NBT	EBLn1	EBLn2	SBT	SBR
Capacity (veh/h)	1610	-	396	1074	-	-
HCM Lane V/C Ratio	0.171	-	0.018	0.126	-	-
HCM Control Delay (s)	7.7	0	14.3	8.8	-	-
HCM Lane LOS	A	A	B	A	-	-
HCM 95th %tile Q(veh)	0.6	-	0.1	0.4	-	-

HCM 6th TWSC
13: Eastonville Rd & Stapleton Dr

Existing Traffic
PM Peak Hour

Intersection												
Int Delay, s/veh	9.5											
Movement	EBL	EBT	EBR	WBL	WBT	WBR	NBL	NBT	NBR	SBL	SBT	SBR
Lane Configurations		↕			↕	↕		↕			↕	
Traffic Vol, veh/h	11	78	31	9	153	105	47	115	12	50	63	4
Future Vol, veh/h	11	78	31	9	153	105	47	115	12	50	63	4
Conflicting Peds, #/hr	0	0	0	0	0	0	0	0	0	0	0	0
Sign Control	Stop	Stop	Stop	Stop	Stop	Stop	Free	Free	Free	Free	Free	Free
RT Channelized	-	-	None	-	-	None	-	-	None	-	-	None
Storage Length	-	-	-	-	-	250	-	-	-	-	-	-
Veh in Median Storage, #	-	0	-	-	0	-	-	0	-	-	0	-
Grade, %	-	0	-	-	0	-	-	0	-	-	0	-
Peak Hour Factor	83	83	83	94	94	94	74	74	74	83	83	83
Heavy Vehicles, %	2	2	2	2	2	2	2	2	2	2	2	2
Mvmt Flow	13	94	37	10	163	112	64	155	16	60	76	5

Major/Minor	Minor2		Minor1			Major1		Major2				
Conflicting Flow All	628	498	79	555	492	163	81	0	0	171	0	0
Stage 1	199	199	-	291	291	-	-	-	-	-	-	-
Stage 2	429	299	-	264	201	-	-	-	-	-	-	-
Critical Hdwy	7.12	6.52	6.22	7.12	6.52	6.22	4.12	-	-	4.12	-	-
Critical Hdwy Stg 1	6.12	5.52	-	6.12	5.52	-	-	-	-	-	-	-
Critical Hdwy Stg 2	6.12	5.52	-	6.12	5.52	-	-	-	-	-	-	-
Follow-up Hdwy	3.518	4.018	3.318	3.518	4.018	3.318	2.218	-	-	2.218	-	-
Pot Cap-1 Maneuver	395	474	981	442	478	882	1517	-	-	1406	-	-
Stage 1	803	736	-	717	672	-	-	-	-	-	-	-
Stage 2	604	666	-	741	735	-	-	-	-	-	-	-
Platoon blocked, %								-	-	-	-	-
Mov Cap-1 Maneuver	229	431	981	330	435	882	1517	-	-	1406	-	-
Mov Cap-2 Maneuver	229	431	-	330	435	-	-	-	-	-	-	-
Stage 1	765	703	-	683	640	-	-	-	-	-	-	-
Stage 2	375	635	-	590	702	-	-	-	-	-	-	-

Approach	EB		WB			NB		SB		
HCM Control Delay, s	16.4		15.3			2		3.3		
HCM LOS	C		C							

Minor Lane/Major Mvmt	NBL	NBT	NBR	EBLn1	WBLn1	WBLn2	SBL	SBT	SBR
Capacity (veh/h)	1517	-	-	460	427	882	1406	-	-
HCM Lane V/C Ratio	0.042	-	-	0.314	0.404	0.127	0.043	-	-
HCM Control Delay (s)	7.5	0	-	16.4	19	9.7	7.7	0	-
HCM Lane LOS	A	A	-	C	C	A	A	A	-
HCM 95th %tile Q(veh)	0.1	-	-	1.3	1.9	0.4	0.1	-	-

Intersection												
Int Delay, s/veh	22.5											
Movement	EBL	EBT	EBR	WBL	WBT	WBR	NBL	NBT	NBR	SBL	SBT	SBR
Lane Configurations	↖	↗	↖	↖	↗	↖	↖	↗	↖	↖	↗	↖
Traffic Vol, veh/h	17	42	49	26	136	26	119	459	33	12	364	29
Future Vol, veh/h	17	42	49	26	136	26	119	459	33	12	364	29
Conflicting Peds, #/hr	0	0	0	0	0	0	0	0	0	0	0	0
Sign Control	Stop	Stop	Stop	Stop	Stop	Stop	Free	Free	Free	Free	Free	Free
RT Channelized	-	-	None	-	-	None	-	-	None	-	-	None
Storage Length	185	-	325	225	-	225	1000	-	0	785	-	785
Veh in Median Storage, #	-	0	-	-	0	-	-	0	-	-	0	-
Grade, %	-	0	-	-	0	-	-	0	-	-	0	-
Peak Hour Factor	84	84	84	83	83	83	86	86	86	87	87	87
Heavy Vehicles, %	2	2	2	2	2	2	2	2	2	2	2	2
Mvmt Flow	20	50	58	31	164	31	138	534	38	14	418	33

Major/Minor	Minor2		Minor1		Major1		Major2					
Conflicting Flow All	1373	1294	418	1327	1289	534	451	0	0	572	0	0
Stage 1	446	446	-	810	810	-	-	-	-	-	-	-
Stage 2	927	848	-	517	479	-	-	-	-	-	-	-
Critical Hdwy	7.12	6.52	6.22	7.12	6.52	6.22	4.12	-	-	4.12	-	-
Critical Hdwy Stg 1	6.12	5.52	-	6.12	5.52	-	-	-	-	-	-	-
Critical Hdwy Stg 2	6.12	5.52	-	6.12	5.52	-	-	-	-	-	-	-
Follow-up Hdwy	3.518	4.018	3.318	3.518	4.018	3.318	2.218	-	-	2.218	-	-
Pot Cap-1 Maneuver	123	163	635	132	164	546	1109	-	-	1001	-	-
Stage 1	591	574	-	374	393	-	-	-	-	-	-	-
Stage 2	322	378	-	541	555	-	-	-	-	-	-	-
Platoon blocked, %	-	-	-	-	-	-	-	-	-	-	-	-
Mov Cap-1 Maneuver	-	141	635	78	~ 142	546	1109	-	-	1001	-	-
Mov Cap-2 Maneuver	-	141	-	78	~ 142	-	-	-	-	-	-	-
Stage 1	518	566	-	328	344	-	-	-	-	-	-	-
Stage 2	139	331	-	442	547	-	-	-	-	-	-	-

Approach	EB	WB	NB	SB
HCM Control Delay, s		146.3	1.7	0.3
HCM LOS	-	F		

Minor Lane/Major Mvmt	NBL	NBT	NBR	EBLn1	EBLn2	EBLn3	WBLn1	WBLn2	WBLn3	SBL	SBT	SBR
Capacity (veh/h)	1109	-	-	-	141	635	78	142	546	1001	-	-
HCM Lane V/C Ratio	0.125	-	-	-	0.355	0.092	0.402	1.154	0.057	0.014	-	-
HCM Control Delay (s)	8.7	-	-	-	43.9	11.2	79.2	184.8	12	8.6	-	-
HCM Lane LOS	A	-	-	-	E	B	F	F	B	A	-	-
HCM 95th %tile Q(veh)	0.4	-	-	-	1.5	0.3	1.6	9.3	0.2	0	-	-

Notes
 ~: Volume exceeds capacity \$: Delay exceeds 300s +: Computation Not Defined *: All major volume in platoon

Intersection				
Intersection Delay, s/veh	3.1			
Intersection LOS	A			
Approach	EB	WB	NB	SB
Entry Lanes	1	1	1	1
Conflicting Circle Lanes	1	1	1	1
Adj Approach Flow, veh/h	73	0	61	25
Demand Flow Rate, veh/h	74	0	62	25
Vehicles Circulating, veh/h	24	64	2	46
Vehicles Exiting, veh/h	47	0	96	18
Ped Vol Crossing Leg, #/h	0	0	0	0
Ped Cap Adj	1.000	1.000	1.000	1.000
Approach Delay, s/veh	3.1	0.0	3.0	2.9
Approach LOS	A	-	A	A
Lane	Left	Left	Left	Left
Designated Moves	LTR	LTR	LTR	LTR
Assumed Moves	LTR	LTR	LTR	LTR
RT Channelized				
Lane Util	1.000	1.000	1.000	1.000
Follow-Up Headway, s	2.609	2.609	2.609	2.609
Critical Headway, s	4.976	4.976	4.976	4.976
Entry Flow, veh/h	74	0	62	25
Cap Entry Lane, veh/h	1346	1293	1377	1317
Entry HV Adj Factor	0.986	1.000	0.979	0.981
Flow Entry, veh/h	73	0	61	25
Cap Entry, veh/h	1328	1293	1348	1292
V/C Ratio	0.055	0.000	0.045	0.019
Control Delay, s/veh	3.1	2.8	3.0	2.9
LOS	A	A	A	A
95th %tile Queue, veh	0	0	0	0

Intersection			
Intersection Delay, s/veh	3.2		
Intersection LOS	A		
Approach	WB	NB	SB
Entry Lanes	1	1	1
Conflicting Circle Lanes	2	2	2
Adj Approach Flow, veh/h	93	68	93
Demand Flow Rate, veh/h	94	70	95
Vehicles Circulating, veh/h	43	6	75
Vehicles Exiting, veh/h	33	164	62
Ped Vol Crossing Leg, #/h	0	0	0
Ped Cap Adj	1.000	1.000	1.000
Approach Delay, s/veh	3.2	3.0	3.3
Approach LOS	A	A	A
Lane	Left	Left	Left
Designated Moves	LR	TR	LT
Assumed Moves	LR	TR	LT
RT Channelized			
Lane Util	1.000	1.000	1.000
Follow-Up Headway, s	2.535	2.535	2.535
Critical Headway, s	4.328	4.328	4.328
Entry Flow, veh/h	94	70	95
Cap Entry Lane, veh/h	1369	1413	1332
Entry HV Adj Factor	0.989	0.974	0.982
Flow Entry, veh/h	93	68	93
Cap Entry, veh/h	1355	1376	1308
V/C Ratio	0.069	0.050	0.071
Control Delay, s/veh	3.2	3.0	3.3
LOS	A	A	A
95th %tile Queue, veh	0	0	0

Intersection						
Int Delay, s/veh	2.6					
Movement	WBL	WBR	NBT	NBR	SBL	SBT
Lane Configurations	↘↙		↑	↗↘	↘	↑
Traffic Vol, veh/h	52	13	45	18	4	133
Future Vol, veh/h	52	13	45	18	4	133
Conflicting Peds, #/hr	0	0	0	0	0	0
Sign Control	Stop	Stop	Free	Free	Free	Free
RT Channelized	-	None	-	None	-	None
Storage Length	0	-	-	155	205	-
Veh in Median Storage, #	0	-	0	-	-	0
Grade, %	0	-	0	-	-	0
Peak Hour Factor	85	85	85	85	85	85
Heavy Vehicles, %	2	2	2	2	2	2
Mvmt Flow	61	15	53	21	5	156

Major/Minor	Minor1	Major1	Major2			
Conflicting Flow All	219	53	0	0	74	0
Stage 1	53	-	-	-	-	-
Stage 2	166	-	-	-	-	-
Critical Hdwy	6.42	6.22	-	-	4.12	-
Critical Hdwy Stg 1	5.42	-	-	-	-	-
Critical Hdwy Stg 2	5.42	-	-	-	-	-
Follow-up Hdwy	3.518	3.318	-	-	2.218	-
Pot Cap-1 Maneuver	769	1014	-	-	1526	-
Stage 1	970	-	-	-	-	-
Stage 2	863	-	-	-	-	-
Platoon blocked, %			-	-		-
Mov Cap-1 Maneuver	767	1014	-	-	1526	-
Mov Cap-2 Maneuver	758	-	-	-	-	-
Stage 1	970	-	-	-	-	-
Stage 2	860	-	-	-	-	-

Approach	WB	NB	SB
HCM Control Delay, s	10	0	0.2
HCM LOS	B		

Minor Lane/Major Mvmt	NBT	NBRWBLn1	SBL	SBT
Capacity (veh/h)	-	-	798	1526
HCM Lane V/C Ratio	-	-	0.096	0.003
HCM Control Delay (s)	-	-	10	7.4
HCM Lane LOS	-	-	B	A
HCM 95th %tile Q(veh)	-	-	0.3	0

Intersection							
Intersection Delay, s/veh	5.2						
Intersection LOS	A						
Approach	EB		NB		SB		
Entry Lanes	2		2		2		
Conflicting Circle Lanes	2		2		2		
Adj Approach Flow, veh/h	334		452		218		
Demand Flow Rate, veh/h	341		461		222		
Vehicles Circulating, veh/h	203		6		393		
Vehicles Exiting, veh/h	412		538		74		
Ped Vol Crossing Leg, #/h	0		0		0		
Ped Cap Adj	1.000		1.000		1.000		
Approach Delay, s/veh	5.6		5.0		4.8		
Approach LOS	A		A		A		
Lane	Left	Right	Left	Right	Left	Right	
Designated Moves	L	TR	L	TR	LT	TR	
Assumed Moves	L	TR	L	TR	LT	TR	
RT Channelized							
Lane Util	0.018	0.982	0.852	0.148	0.468	0.532	
Follow-Up Headway, s	2.667	2.535	2.667	2.535	2.667	2.535	
Critical Headway, s	4.645	4.328	4.645	4.328	4.645	4.328	
Entry Flow, veh/h	6	335	393	68	104	118	
Cap Entry Lane, veh/h	1120	1195	1342	1413	940	1017	
Entry HV Adj Factor	1.000	0.979	0.980	0.980	0.985	0.979	
Flow Entry, veh/h	6	328	385	67	102	116	
Cap Entry, veh/h	1120	1170	1315	1385	926	996	
V/C Ratio	0.005	0.280	0.293	0.048	0.111	0.116	
Control Delay, s/veh	3.3	5.7	5.3	3.0	4.9	4.7	
LOS	A	A	A	A	A	A	
95th %tile Queue, veh	0	1	1	0	0	0	

Intersection						
Intersection Delay, s/veh	7.2					
Intersection LOS	A					
Approach	EB	WB	NB	SB		
Entry Lanes	1	1	1	1		
Conflicting Circle Lanes	1	1	1	1		
Adj Approach Flow, veh/h	302	343	386	527		
Demand Flow Rate, veh/h	308	350	394	537		
Vehicles Circulating, veh/h	492	399	420	289		
Vehicles Exiting, veh/h	259	415	380	289		
Ped Vol Crossing Leg, #/h	0	0	0	0		
Ped Cap Adj	1.000	1.000	1.000	1.000		
Approach Delay, s/veh	8.8	3.0	9.4	7.5		
Approach LOS	A	A	A	A		
Lane	Left	Left	Bypass	Left	Left	Bypass
Designated Moves	LTR	LT	R	LTR	LT	R
Assumed Moves	LTR	LT	R	LTR	LT	R
RT Channelized			Free			Free
Lane Util	1.000	1.000	1.000	1.000	1.000	
Follow-Up Headway, s	2.609	2.609	2.609	2.609	2.609	
Critical Headway, s	4.976	4.976	171	4.976	4.976	75
Entry Flow, veh/h	308	179	1938	394	462	1938
Cap Entry Lane, veh/h	835	919	0.980	899	1028	0.980
Entry HV Adj Factor	0.980	0.978	168	0.980	0.981	74
Flow Entry, veh/h	302	175	1900	386	453	1900
Cap Entry, veh/h	818	898	0.088	881	1008	0.039
V/C Ratio	0.369	0.195	0.0	0.438	0.450	0.0
Control Delay, s/veh	8.8	5.9	A	9.4	8.7	A
LOS	A	A	0	A	A	0
95th %tile Queue, veh	2	1		2	2	

Timings
14: US 24 & Stapleton Dr

2026 Background Traffic
AM Peak Hour

Lane Group	EBL	EBT	EBR	WBL	WBT	WBR	NBL	NBT	NBR	SBL	SBT	SBR
Lane Configurations												
Traffic Volume (vph)	50	212	267	4	103	17	117	280	5	45	470	42
Future Volume (vph)	50	212	267	4	103	17	117	280	5	45	470	42
Turn Type	pm+pt	NA	Free	pm+pt	NA	Free	pm+pt	NA	Perm	pm+pt	NA	Perm
Protected Phases	5	2		1	6		3	8		7	4	
Permitted Phases	2		Free	6		Free	8		8	4		4
Detector Phase	5	2		1	6		3	8	8	7	4	4
Switch Phase												
Minimum Initial (s)	5.0	5.0		5.0	5.0		5.0	5.0	5.0	5.0	15.0	15.0
Minimum Split (s)	10.0	10.0		10.0	10.0		10.0	10.0	10.0	10.0	20.0	20.0
Total Split (s)	12.0	30.0		12.0	30.0		12.0	66.0	66.0	12.0	66.0	66.0
Total Split (%)	10.0%	25.0%		10.0%	25.0%		10.0%	55.0%	55.0%	10.0%	55.0%	55.0%
Yellow Time (s)	3.0	3.0		3.0	3.0		3.0	3.0	3.0	3.0	3.0	3.0
All-Red Time (s)	2.0	2.0		2.0	2.0		2.0	2.0	2.0	2.0	2.0	2.0
Lost Time Adjust (s)	0.0	0.0		0.0	0.0		0.0	0.0	0.0	0.0	0.0	0.0
Total Lost Time (s)	5.0	5.0		5.0	5.0		5.0	5.0	5.0	5.0	5.0	5.0
Lead/Lag	Lead	Lag		Lead	Lag		Lead	Lag	Lag	Lead	Lag	Lag
Lead-Lag Optimize?	Yes	Yes		Yes	Yes		Yes	Yes	Yes	Yes	Yes	Yes
Recall Mode	None	C-Max		None	C-Max		None	Max	Max	None	Max	Max
Act Effct Green (s)	36.1	34.7	120.0	32.1	27.4	120.0	69.2	63.6	63.6	67.5	61.0	61.0
Actuated g/C Ratio	0.30	0.29	1.00	0.27	0.23	1.00	0.58	0.53	0.53	0.56	0.51	0.51
v/c Ratio	0.16	0.44	0.19	0.02	0.28	0.01	0.33	0.33	0.01	0.09	0.54	0.05
Control Delay	23.2	29.0	0.2	29.2	41.8	0.0	12.3	18.0	0.0	10.2	23.0	0.1
Queue Delay	0.0	0.0	0.0	0.0	0.0	0.0	0.0	0.0	0.0	0.0	0.0	0.0
Total Delay	23.2	29.0	0.2	29.2	41.8	0.0	12.3	18.0	0.0	10.2	23.0	0.1
LOS	C	C	A	C	D	A	B	B	A	B	C	A
Approach Delay		13.9			35.6			16.1			20.2	
Approach LOS		B			D			B			C	

Intersection Summary

Cycle Length: 120
 Actuated Cycle Length: 120
 Offset: 0 (0%), Referenced to phase 2:EBTL and 6:WBTL, Start of Green
 Natural Cycle: 60
 Control Type: Actuated-Coordinated
 Maximum v/c Ratio: 0.54
 Intersection Signal Delay: 18.3 Intersection LOS: B
 Intersection Capacity Utilization 54.9% ICU Level of Service A
 Analysis Period (min) 15

Splits and Phases: 14: US 24 & Stapleton Dr

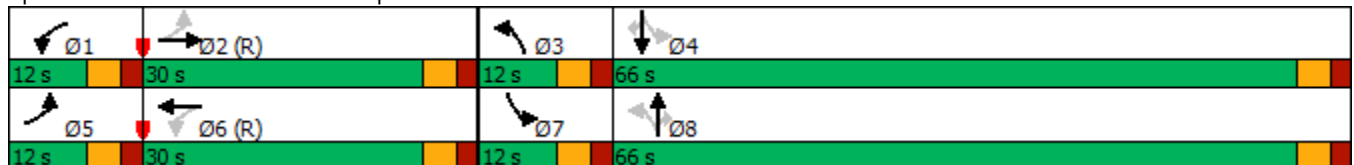

Intersection				
Intersection Delay, s/veh	3.3			
Intersection LOS	A			
Approach	EB	WB	NB	SB
Entry Lanes	1	1	1	1
Conflicting Circle Lanes	1	1	1	1
Adj Approach Flow, veh/h	79	0	125	18
Demand Flow Rate, veh/h	80	0	128	18
Vehicles Circulating, veh/h	14	132	4	101
Vehicles Exiting, veh/h	105	0	90	31
Ped Vol Crossing Leg, #/h	0	0	0	0
Ped Cap Adj	1.000	1.000	1.000	1.000
Approach Delay, s/veh	3.1	0.0	3.4	3.1
Approach LOS	A	-	A	A
Lane	Left	Left	Left	Left
Designated Moves	LTR	LTR	LTR	LTR
Assumed Moves	LTR	LTR	LTR	LTR
RT Channelized				
Lane Util	1.000	1.000	1.000	1.000
Follow-Up Headway, s	2.609	2.609	2.609	2.609
Critical Headway, s	4.976	4.976	4.976	4.976
Entry Flow, veh/h	80	0	128	18
Cap Entry Lane, veh/h	1360	1206	1374	1245
Entry HV Adj Factor	0.988	1.000	0.980	0.985
Flow Entry, veh/h	79	0	125	18
Cap Entry, veh/h	1343	1206	1347	1226
V/C Ratio	0.059	0.000	0.093	0.014
Control Delay, s/veh	3.1	3.0	3.4	3.1
LOS	A	A	A	A
95th %tile Queue, veh	0	0	0	0

Intersection			
Intersection Delay, s/veh	3.6		
Intersection LOS	A		
Approach	WB	NB	SB
Entry Lanes	1	1	1
Conflicting Circle Lanes	2	2	2
Adj Approach Flow, veh/h	64	203	91
Demand Flow Rate, veh/h	65	207	92
Vehicles Circulating, veh/h	118	20	53
Vehicles Exiting, veh/h	109	125	130
Ped Vol Crossing Leg, #/h	0	0	0
Ped Cap Adj	1.000	1.000	1.000
Approach Delay, s/veh	3.3	3.8	3.2
Approach LOS	A	A	A
Lane	Left	Left	Left
Designated Moves	LR	TR	LT
Assumed Moves	LR	TR	LT
RT Channelized			
Lane Util	1.000	1.000	1.000
Follow-Up Headway, s	2.535	2.535	2.535
Critical Headway, s	4.328	4.328	4.328
Entry Flow, veh/h	65	207	92
Cap Entry Lane, veh/h	1285	1396	1358
Entry HV Adj Factor	0.985	0.979	0.985
Flow Entry, veh/h	64	203	91
Cap Entry, veh/h	1265	1367	1337
V/C Ratio	0.051	0.148	0.068
Control Delay, s/veh	3.3	3.8	3.2
LOS	A	A	A
95th %tile Queue, veh	0	1	0

Intersection						
Int Delay, s/veh	1.6					
Movement	WBL	WBR	NBT	NBR	SBL	SBT
Lane Configurations	↘↗		↑	↗↘	↘↗	↑
Traffic Vol, veh/h	32	10	158	56	16	86
Future Vol, veh/h	32	10	158	56	16	86
Conflicting Peds, #/hr	0	0	0	0	0	0
Sign Control	Stop	Stop	Free	Free	Free	Free
RT Channelized	-	None	-	None	-	None
Storage Length	0	-	-	155	205	-
Veh in Median Storage, #	0	-	0	-	-	0
Grade, %	0	-	0	-	-	0
Peak Hour Factor	83	83	83	83	83	83
Heavy Vehicles, %	2	2	2	2	2	2
Mvmt Flow	39	12	190	67	19	104

Major/Minor	Minor1	Major1	Major2		
Conflicting Flow All	332	190	0	0	257
Stage 1	190	-	-	-	-
Stage 2	142	-	-	-	-
Critical Hdwy	6.42	6.22	-	-	4.12
Critical Hdwy Stg 1	5.42	-	-	-	-
Critical Hdwy Stg 2	5.42	-	-	-	-
Follow-up Hdwy	3.518	3.318	-	-	2.218
Pot Cap-1 Maneuver	663	852	-	-	1308
Stage 1	842	-	-	-	-
Stage 2	885	-	-	-	-
Platoon blocked, %			-	-	-
Mov Cap-1 Maneuver	653	852	-	-	1308
Mov Cap-2 Maneuver	689	-	-	-	-
Stage 1	842	-	-	-	-
Stage 2	872	-	-	-	-

Approach	WB	NB	SB
HCM Control Delay, s	10.4	0	1.2
HCM LOS	B		

Minor Lane/Major Mvmt	NBT	NBRWBLn1	SBL	SBT
Capacity (veh/h)	-	-	722	1308
HCM Lane V/C Ratio	-	-	0.07	0.015
HCM Control Delay (s)	-	-	10.4	7.8
HCM Lane LOS	-	-	B	A
HCM 95th %tile Q(veh)	-	-	0.2	0

Intersection						
Intersection Delay, s/veh	4.7					
Intersection LOS	A					
Approach	EB		NB		SB	
Entry Lanes	2		2		2	
Conflicting Circle Lanes	2		2		2	
Adj Approach Flow, veh/h	228		633		138	
Demand Flow Rate, veh/h	232		646		141	
Vehicles Circulating, veh/h	132		16		406	
Vehicles Exiting, veh/h	415		348		256	
Ped Vol Crossing Leg, #/h	0		0		0	
Ped Cap Adj	1.000		1.000		1.000	
Approach Delay, s/veh	4.2		4.9		4.4	
Approach LOS	A		A		A	
Lane	Left	Right	Left	Right	Left	Right
Designated Moves	L	TR	L	TR	LT	TR
Assumed Moves	L	TR	L	TR	LT	TR
RT Channelized						
Lane Util	0.069	0.931	0.628	0.372	0.468	0.532
Follow-Up Headway, s	2.667	2.535	2.667	2.535	2.667	2.535
Critical Headway, s	4.645	4.328	4.645	4.328	4.645	4.328
Entry Flow, veh/h	16	216	406	240	66	75
Cap Entry Lane, veh/h	1195	1269	1330	1401	929	1006
Entry HV Adj Factor	1.000	0.981	0.980	0.980	0.986	0.978
Flow Entry, veh/h	16	212	398	235	65	73
Cap Entry, veh/h	1195	1246	1304	1373	916	984
V/C Ratio	0.013	0.170	0.305	0.171	0.071	0.075
Control Delay, s/veh	3.1	4.3	5.5	4.0	4.6	4.3
LOS	A	A	A	A	A	A
95th %tile Queue, veh	0	1	1	1	0	0

Intersection						
Intersection Delay, s/veh	5.2					
Intersection LOS	A					
Approach	EB	WB	NB	SB		
Entry Lanes	1	1	1	1		
Conflicting Circle Lanes	1	1	1	1		
Adj Approach Flow, veh/h	238	484	345	315		
Demand Flow Rate, veh/h	243	493	352	322		
Vehicles Circulating, veh/h	307	390	343	284		
Vehicles Exiting, veh/h	260	305	206	332		
Ped Vol Crossing Leg, #/h	0	0	0	0		
Ped Cap Adj	1.000	1.000	1.000	1.000		
Approach Delay, s/veh	6.0	3.0	7.7	5.5		
Approach LOS	A	A	A	A		
Lane	Left	Left	Bypass	Left	Left	Bypass
Designated Moves	LTR	LT	R	LTR	LT	R
Assumed Moves	LTR	LT	R	LTR	LT	R
RT Channelized			Free			Free
Lane Util	1.000	1.000		1.000	1.000	
Follow-Up Headway, s	2.609	2.609		2.609	2.609	
Critical Headway, s	4.976	4.976	267	4.976	4.976	39
Entry Flow, veh/h	243	226	1938	352	283	1938
Cap Entry Lane, veh/h	1009	927	0.980	973	1033	0.980
Entry HV Adj Factor	0.981	0.982	262	0.980	0.980	38
Flow Entry, veh/h	238	222	1900	345	277	1900
Cap Entry, veh/h	990	911	0.138	953	1012	0.020
V/C Ratio	0.241	0.244	0.0	0.362	0.274	0.0
Control Delay, s/veh	6.0	6.4	A	7.7	6.3	A
LOS	A	A	0	A	A	0
95th %tile Queue, veh	1	1		2	1	

Timings
14: US 24 & Stapleton Dr

2026 Background Traffic
PM Peak Hour

Lane Group	EBL	EBT	EBR	WBL	WBT	WBR	NBL	NBT	NBR	SBL	SBT	SBR
Lane Configurations												
Traffic Volume (vph)	29	84	146	5	189	34	262	517	8	10	409	49
Future Volume (vph)	29	84	146	5	189	34	262	517	8	10	409	49
Turn Type	pm+pt	NA	Free	pm+pt	NA	Free	pm+pt	NA	Perm	pm+pt	NA	Perm
Protected Phases	5	2		1	6		3	8		7	4	
Permitted Phases	2		Free	6		Free	8		8	4		4
Detector Phase	5	2		1	6		3	8	8	7	4	4
Switch Phase												
Minimum Initial (s)	5.0	5.0		5.0	5.0		5.0	5.0	5.0	5.0	15.0	15.0
Minimum Split (s)	10.0	10.0		10.0	10.0		10.0	10.0	10.0	10.0	20.0	20.0
Total Split (s)	12.0	30.0		12.0	30.0		12.0	66.0	66.0	12.0	66.0	66.0
Total Split (%)	10.0%	25.0%		10.0%	25.0%		10.0%	55.0%	55.0%	10.0%	55.0%	55.0%
Yellow Time (s)	3.0	3.0		3.0	3.0		3.0	3.0	3.0	3.0	3.0	3.0
All-Red Time (s)	2.0	2.0		2.0	2.0		2.0	2.0	2.0	2.0	2.0	2.0
Lost Time Adjust (s)	0.0	0.0		0.0	0.0		0.0	0.0	0.0	0.0	0.0	0.0
Total Lost Time (s)	5.0	5.0		5.0	5.0		5.0	5.0	5.0	5.0	5.0	5.0
Lead/Lag	Lead	Lag		Lead	Lag		Lead	Lag	Lag	Lead	Lag	Lag
Lead-Lag Optimize?	Yes	Yes		Yes	Yes		Yes	Yes	Yes	Yes	Yes	Yes
Recall Mode	None	C-Max		None	C-Max		None	Max	Max	None	Max	Max
Act Effct Green (s)	36.1	34.7	120.0	33.5	29.8	120.0	72.1	70.7	70.7	66.8	61.0	61.0
Actuated g/C Ratio	0.30	0.29	1.00	0.28	0.25	1.00	0.60	0.59	0.59	0.56	0.51	0.51
v/c Ratio	0.14	0.19	0.11	0.02	0.49	0.03	0.66	0.55	0.01	0.03	0.50	0.07
Control Delay	25.0	28.0	0.1	29.2	44.6	0.0	20.7	18.1	0.0	10.1	22.1	0.1
Queue Delay	0.0	0.0	0.0	0.0	0.0	0.0	0.0	0.0	0.0	0.0	0.0	0.0
Total Delay	25.0	28.0	0.1	29.2	44.6	0.0	20.7	18.1	0.0	10.1	22.1	0.1
LOS	C	C	A	C	D	A	C	B	A	B	C	A
Approach Delay		12.0			37.6			18.8			19.6	
Approach LOS		B			D			B			B	

Intersection Summary

Cycle Length: 120
 Actuated Cycle Length: 120
 Offset: 0 (0%), Referenced to phase 2:EBTL and 6:WBTL, Start of Green
 Natural Cycle: 60
 Control Type: Actuated-Coordinated
 Maximum v/c Ratio: 0.66
 Intersection Signal Delay: 20.5
 Intersection LOS: C
 Intersection Capacity Utilization 66.8%
 ICU Level of Service C
 Analysis Period (min) 15

Splits and Phases: 14: US 24 & Stapleton Dr

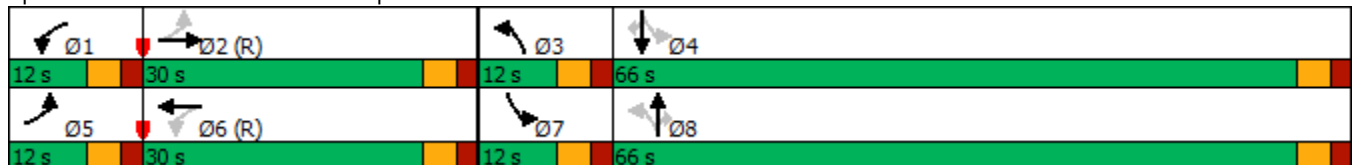

Intersection				
Intersection Delay, s/veh	4.5			
Intersection LOS	A			
Approach	EB	WB	NB	SB
Entry Lanes	1	1	1	1
Conflicting Circle Lanes	1	1	1	1
Adj Approach Flow, veh/h	341	51	194	37
Demand Flow Rate, veh/h	347	52	198	38
Vehicles Circulating, veh/h	52	166	23	188
Vehicles Exiting, veh/h	174	55	376	30
Ped Vol Crossing Leg, #/h	0	0	0	0
Ped Cap Adj	1.000	1.000	1.000	1.000
Approach Delay, s/veh	5.1	3.5	3.9	3.5
Approach LOS	A	A	A	A
Lane	Left	Left	Left	Left
Designated Moves	LTR	LTR	LTR	LTR
Assumed Moves	LTR	LTR	LTR	LTR
RT Channelized				
Lane Util	1.000	1.000	1.000	1.000
Follow-Up Headway, s	2.609	2.609	2.609	2.609
Critical Headway, s	4.976	4.976	4.976	4.976
Entry Flow, veh/h	347	52	198	38
Cap Entry Lane, veh/h	1309	1165	1348	1139
Entry HV Adj Factor	0.982	0.988	0.978	0.983
Flow Entry, veh/h	341	51	194	37
Cap Entry, veh/h	1285	1151	1318	1120
V/C Ratio	0.265	0.045	0.147	0.033
Control Delay, s/veh	5.1	3.5	3.9	3.5
LOS	A	A	A	A
95th %tile Queue, veh	1	0	1	0

Intersection						
Int Delay, s/veh	4.4					
Movement	EBT	EBR	WBL	WBT	NBL	NBR
Lane Configurations	↔		↔	↑	↔	↔
Traffic Vol, veh/h	0	45	0	0	43	0
Future Vol, veh/h	0	45	0	0	43	0
Conflicting Peds, #/hr	0	0	0	0	0	0
Sign Control	Free	Free	Free	Free	Stop	Stop
RT Channelized	-	None	-	None	-	None
Storage Length	-	-	155	-	205	0
Veh in Median Storage, #	0	-	-	0	0	-
Grade, %	0	-	-	0	0	-
Peak Hour Factor	85	85	85	85	85	85
Heavy Vehicles, %	2	2	2	2	2	2
Mvmt Flow	0	53	0	0	51	0

Major/Minor	Major1	Major2	Minor1		
Conflicting Flow All	0	0	53	0	28
Stage 1	-	-	-	-	27
Stage 2	-	-	-	-	1
Critical Hdwy	-	-	4.12	-	6.42
Critical Hdwy Stg 1	-	-	-	-	5.42
Critical Hdwy Stg 2	-	-	-	-	5.42
Follow-up Hdwy	-	-	2.218	-	3.518
Pot Cap-1 Maneuver	-	-	1553	-	987
Stage 1	-	-	-	-	996
Stage 2	-	-	-	-	1022
Platoon blocked, %	-	-	-	-	-
Mov Cap-1 Maneuver	-	-	1553	-	987
Mov Cap-2 Maneuver	-	-	-	-	907
Stage 1	-	-	-	-	996
Stage 2	-	-	-	-	1022

Approach	EB	WB	NB
HCM Control Delay, s	0	0	9.2
HCM LOS			A

Minor Lane/Major Mvmt	NBLn1	NBLn2	EBT	EBR	WBL	WBT
Capacity (veh/h)	907	-	-	-	1553	-
HCM Lane V/C Ratio	0.056	-	-	-	-	-
HCM Control Delay (s)	9.2	0	-	-	0	-
HCM Lane LOS	A	A	-	-	A	-
HCM 95th %tile Q(veh)	0.2	-	-	-	0	-

Intersection			
Intersection Delay, s/veh	5.3		
Intersection LOS	A		
Approach	WB	NB	SB
Entry Lanes	1	1	1
Conflicting Circle Lanes	2	2	2
Adj Approach Flow, veh/h	258	245	372
Demand Flow Rate, veh/h	264	249	379
Vehicles Circulating, veh/h	174	8	238
Vehicles Exiting, veh/h	83	609	199
Ped Vol Crossing Leg, #/h	0	0	0
Ped Cap Adj	1.000	1.000	1.000
Approach Delay, s/veh	4.9	4.0	6.3
Approach LOS	A	A	A
Lane	Left	Left	Left
Designated Moves	LR	TR	LT
Assumed Moves	LR	TR	LT
RT Channelized			
Lane Util	1.000	1.000	1.000
Follow-Up Headway, s	2.535	2.535	2.535
Critical Headway, s	4.328	4.328	4.328
Entry Flow, veh/h	264	249	379
Cap Entry Lane, veh/h	1225	1410	1160
Entry HV Adj Factor	0.977	0.982	0.981
Flow Entry, veh/h	258	245	372
Cap Entry, veh/h	1197	1386	1138
V/C Ratio	0.216	0.177	0.327
Control Delay, s/veh	4.9	4.0	6.3
LOS	A	A	A
95th %tile Queue, veh	1	1	1

Intersection						
Int Delay, s/veh	1.2					
Movement	WBL	WBR	NBT	NBR	SBL	SBT
Lane Configurations	↘↙		↑	↗↘	↘	↑
Traffic Vol, veh/h	52	13	195	18	4	503
Future Vol, veh/h	52	13	195	18	4	503
Conflicting Peds, #/hr	0	0	0	0	0	0
Sign Control	Stop	Stop	Free	Free	Free	Free
RT Channelized	-	None	-	None	-	None
Storage Length	0	-	-	155	205	-
Veh in Median Storage, #	0	-	0	-	-	0
Grade, %	0	-	0	-	-	0
Peak Hour Factor	85	85	85	85	85	85
Heavy Vehicles, %	2	2	2	2	2	2
Mvmt Flow	61	15	229	21	5	592

Major/Minor	Minor1	Major1	Major2		
Conflicting Flow All	831	229	0	0	250
Stage 1	229	-	-	-	-
Stage 2	602	-	-	-	-
Critical Hdwy	6.42	6.22	-	-	4.12
Critical Hdwy Stg 1	5.42	-	-	-	-
Critical Hdwy Stg 2	5.42	-	-	-	-
Follow-up Hdwy	3.518	3.318	-	-	2.218
Pot Cap-1 Maneuver	340	810	-	-	1316
Stage 1	809	-	-	-	-
Stage 2	547	-	-	-	-
Platoon blocked, %			-	-	-
Mov Cap-1 Maneuver	339	810	-	-	1316
Mov Cap-2 Maneuver	440	-	-	-	-
Stage 1	809	-	-	-	-
Stage 2	545	-	-	-	-

Approach	WB	NB	SB
HCM Control Delay, s	13.8	0	0.1
HCM LOS	B		

Minor Lane/Major Mvmt	NBT	NBRWBLn1	SBL	SBT
Capacity (veh/h)	-	-	484	1316
HCM Lane V/C Ratio	-	-	0.158	0.004
HCM Control Delay (s)	-	-	13.8	7.7
HCM Lane LOS	-	-	B	A
HCM 95th %tile Q(veh)	-	-	0.6	0

Intersection						
Intersection Delay, s/veh	6.9					
Intersection LOS	A					
Approach	EB		NB		SB	
Entry Lanes	2		2		2	
Conflicting Circle Lanes	2		2		2	
Adj Approach Flow, veh/h	377		614		653	
Demand Flow Rate, veh/h	385		626		666	
Vehicles Circulating, veh/h	604		34		404	
Vehicles Exiting, veh/h	466		955		256	
Ped Vol Crossing Leg, #/h	0		0		0	
Ped Cap Adj	1.000		1.000		1.000	
Approach Delay, s/veh	9.0		5.0		7.5	
Approach LOS	A		A		A	
Lane	Left	Right	Left	Right	Left	Right
Designated Moves	L	TR	L	TR	LT	TR
Assumed Moves	L	TR	L	TR	LT	TR
RT Channelized						
Lane Util	0.088	0.912	0.645	0.355	0.470	0.530
Follow-Up Headway, s	2.667	2.535	2.667	2.535	2.667	2.535
Critical Headway, s	4.645	4.328	4.645	4.328	4.645	4.328
Entry Flow, veh/h	34	351	404	222	313	353
Cap Entry Lane, veh/h	774	850	1308	1380	931	1007
Entry HV Adj Factor	0.971	0.980	0.980	0.980	0.981	0.981
Flow Entry, veh/h	33	344	396	218	307	346
Cap Entry, veh/h	752	833	1282	1353	913	988
V/C Ratio	0.044	0.413	0.309	0.161	0.336	0.350
Control Delay, s/veh	5.2	9.4	5.6	4.0	7.6	7.3
LOS	A	A	A	A	A	A
95th %tile Queue, veh	0	2	1	1	1	2

Intersection									
Intersection Delay, s/veh 11.2									
Intersection LOS B									
Approach	EB		WB			NB		SB	
Entry Lanes	2		2			1		1	
Conflicting Circle Lanes	2		2			2		2	
Adj Approach Flow, veh/h	425		453			465		934	
Demand Flow Rate, veh/h	434		462			475		953	
Vehicles Circulating, veh/h	835		504			705		340	
Vehicles Exiting, veh/h	308		676			564		373	
Ped Vol Crossing Leg, #/h	0		0			0		0	
Ped Cap Adj	1.000		1.000			1.000		1.000	
Approach Delay, s/veh	9.9		2.4			14.8		14.3	
Approach LOS	A		A			B		B	
Lane	Left	Right	Left	Right	Bypass	Left	Left	Bypass	
Designated Moves	LT	TR	LT	TR	R	LTR	LT	R	
Assumed Moves	LT	TR	LT	TR	R	LTR	LT	R	
RT Channelized					Free			Free	
Lane Util	0.470	0.530	0.469	0.531		1.000	1.000		
Follow-Up Headway, s	2.667	2.535	2.667	2.535		2.535	2.535		
Critical Headway, s	4.645	4.328	4.645	4.328	253	4.328	4.328	150	
Entry Flow, veh/h	204	230	98	111	1938	475	803	1938	
Cap Entry Lane, veh/h	626	698	849	925	0.980	780	1064	0.980	
Entry HV Adj Factor	0.980	0.980	0.981	0.977	248	0.979	0.980	147	
Flow Entry, veh/h	200	225	96	108	1900	465	787	1900	
Cap Entry, veh/h	614	684	833	904	0.131	763	1043	0.077	
V/C Ratio	0.326	0.329	0.115	0.120	0.0	0.609	0.755	0.0	
Control Delay, s/veh	10.3	9.5	5.5	5.1	A	14.8	17.0	A	
LOS	B	A	A	A	0	B	C	0	
95th %tile Queue, veh	1	1	0	0		4	7		

Timings
14: US 24 & Stapleton Dr

2033 Background Traffic
AM Peak Hour

Lane Group	EBL	EBT	EBR	WBL	WBT	WBR	NBL	NBT	NBR	SBL	SBT	SBR
Lane Configurations												
Traffic Volume (vph)	73	295	379	4	137	17	165	322	5	45	540	53
Future Volume (vph)	73	295	379	4	137	17	165	322	5	45	540	53
Turn Type	pm+pt	NA	Free	pm+pt	NA	Free	Prot	NA	Perm	pm+pt	NA	Perm
Protected Phases	5	2		1	6		3	8		7	4	
Permitted Phases	2		Free	6		Free			8	4		4
Detector Phase	5	2		1	6		3	8	8	7	4	4
Switch Phase												
Minimum Initial (s)	5.0	10.0		5.0	5.0		15.0	5.0	5.0	5.0	15.0	15.0
Minimum Split (s)	10.0	15.0		10.0	10.0		20.0	10.0	10.0	10.0	20.0	20.0
Total Split (s)	10.0	37.0		10.0	37.0		20.0	63.0	63.0	10.0	53.0	53.0
Total Split (%)	8.3%	30.8%		8.3%	30.8%		16.7%	52.5%	52.5%	8.3%	44.2%	44.2%
Yellow Time (s)	3.0	3.0		3.0	3.0		3.0	3.0	3.0	3.0	3.0	3.0
All-Red Time (s)	2.0	2.0		2.0	2.0		2.0	2.0	2.0	2.0	2.0	2.0
Lost Time Adjust (s)	0.0	0.0		0.0	0.0		0.0	0.0	0.0	0.0	0.0	0.0
Total Lost Time (s)	5.0	5.0		5.0	5.0		5.0	5.0	5.0	5.0	5.0	5.0
Lead/Lag	Lead	Lag		Lead	Lag		Lead	Lag	Lag	Lead	Lag	Lag
Lead-Lag Optimize?	Yes	Yes		Yes	Yes		Yes	Yes	Yes	Yes	Yes	Yes
Recall Mode	None	C-Max		None	C-Max		None	Max	Max	None	Max	Max
Act Effct Green (s)	41.0	40.0	120.0	38.0	34.0	120.0	15.0	60.0	60.0	53.0	48.0	48.0
Actuated g/C Ratio	0.34	0.33	1.00	0.32	0.28	1.00	0.12	0.50	0.50	0.44	0.40	0.40
v/c Ratio	0.22	0.53	0.27	0.02	0.31	0.01	0.45	0.41	0.01	0.10	0.79	0.08
Control Delay	20.7	27.3	0.4	25.8	36.7	0.0	52.4	21.1	0.0	13.3	37.9	0.2
Queue Delay	0.0	0.0	0.0	0.0	0.0	0.0	0.0	0.0	0.0	0.0	0.0	0.0
Total Delay	20.7	27.3	0.4	25.8	36.7	0.0	52.4	21.1	0.0	13.3	37.9	0.2
LOS	C	C	A	C	D	A	D	C	A	B	D	A
Approach Delay		13.0			32.4			31.4			33.0	
Approach LOS		B			C			C			C	

Intersection Summary

Cycle Length: 120
 Actuated Cycle Length: 120
 Offset: 0 (0%), Referenced to phase 2:EBTL and 6:WBTL, Start of Green
 Natural Cycle: 90
 Control Type: Actuated-Coordinated
 Maximum v/c Ratio: 0.79
 Intersection Signal Delay: 25.2
 Intersection LOS: C
 Intersection Capacity Utilization 77.3%
 ICU Level of Service D
 Analysis Period (min) 15

Splits and Phases: 14: US 24 & Stapleton Dr

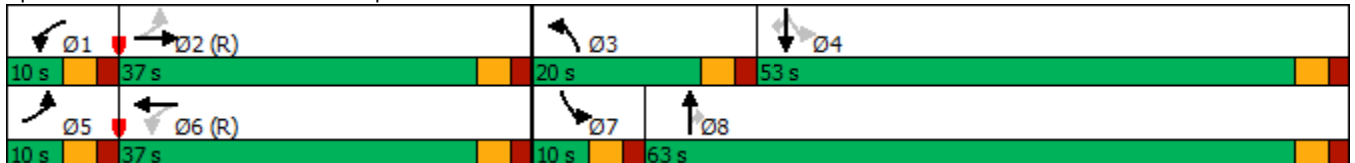

Intersection				
Intersection Delay, s/veh	5.4			
Intersection LOS	A			
Approach	EB	WB	NB	SB
Entry Lanes	1	1	1	1
Conflicting Circle Lanes	1	1	1	1
Adj Approach Flow, veh/h	286	51	450	40
Demand Flow Rate, veh/h	292	51	459	41
Vehicles Circulating, veh/h	53	431	52	424
Vehicles Exiting, veh/h	411	80	293	58
Ped Vol Crossing Leg, #/h	0	0	0	0
Ped Cap Adj	1.000	1.000	1.000	1.000
Approach Delay, s/veh	4.7	4.6	6.1	4.5
Approach LOS	A	A	A	A
Lane	Left	Left	Left	Left
Designated Moves	LTR	LTR	LTR	LTR
Assumed Moves	LTR	LTR	LTR	LTR
RT Channelized				
Lane Util	1.000	1.000	1.000	1.000
Follow-Up Headway, s	2.609	2.609	2.609	2.609
Critical Headway, s	4.976	4.976	4.976	4.976
Entry Flow, veh/h	292	51	459	41
Cap Entry Lane, veh/h	1307	889	1309	895
Entry HV Adj Factor	0.981	0.991	0.981	0.988
Flow Entry, veh/h	286	51	450	40
Cap Entry, veh/h	1282	881	1283	884
V/C Ratio	0.223	0.057	0.351	0.046
Control Delay, s/veh	4.7	4.6	6.1	4.5
LOS	A	A	A	A
95th %tile Queue, veh	1	0	2	0

Intersection						
Int Delay, s/veh	3.6					
Movement	EBT	EBR	WBL	WBT	NBL	NBR
Lane Configurations						
Traffic Vol, veh/h	0	66	0	0	42	0
Future Vol, veh/h	0	66	0	0	42	0
Conflicting Peds, #/hr	0	0	0	0	0	0
Sign Control	Free	Free	Free	Free	Stop	Stop
RT Channelized	-	None	-	None	-	None
Storage Length	-	-	155	-	205	0
Veh in Median Storage, #	0	-	-	0	0	-
Grade, %	0	-	-	0	0	-
Peak Hour Factor	83	83	83	83	83	83
Heavy Vehicles, %	2	2	2	2	2	2
Mvmt Flow	0	80	0	0	51	0

Major/Minor	Major1	Major2	Minor1		
Conflicting Flow All	0	0	80	0	41
Stage 1	-	-	-	-	40
Stage 2	-	-	-	-	1
Critical Hdwy	-	-	4.12	-	6.42
Critical Hdwy Stg 1	-	-	-	-	5.42
Critical Hdwy Stg 2	-	-	-	-	5.42
Follow-up Hdwy	-	-	2.218	-	3.518
Pot Cap-1 Maneuver	-	-	1518	-	970
Stage 1	-	-	-	-	982
Stage 2	-	-	-	-	1022
Platoon blocked, %	-	-	-	-	-
Mov Cap-1 Maneuver	-	-	1518	-	970
Mov Cap-2 Maneuver	-	-	-	-	894
Stage 1	-	-	-	-	982
Stage 2	-	-	-	-	1022

Approach	EB	WB	NB
HCM Control Delay, s	0	0	9.3
HCM LOS			A

Minor Lane/Major Mvmt	NBLn1	NBLn2	EBT	EBR	WBL	WBT
Capacity (veh/h)	894	-	-	-	1518	-
HCM Lane V/C Ratio	0.057	-	-	-	-	-
HCM Control Delay (s)	9.3	0	-	-	0	-
HCM Lane LOS	A	A	-	-	A	-
HCM 95th %tile Q(veh)	0.2	-	-	-	0	-

Intersection			
Intersection Delay, s/veh	7.0		
Intersection LOS	A		
Approach	WB	NB	SB
Entry Lanes	1	1	1
Conflicting Circle Lanes	2	2	2
Adj Approach Flow, veh/h	185	710	295
Demand Flow Rate, veh/h	188	724	301
Vehicles Circulating, veh/h	468	29	172
Vehicles Exiting, veh/h	285	444	484
Ped Vol Crossing Leg, #/h	0	0	0
Ped Cap Adj	1.000	1.000	1.000
Approach Delay, s/veh	5.8	8.1	5.2
Approach LOS	A	A	A
Lane	Left	Left	Left
Designated Moves	LR	TR	LT
Assumed Moves	LR	TR	LT
RT Channelized			
Lane Util	1.000	1.000	1.000
Follow-Up Headway, s	2.535	2.535	2.535
Critical Headway, s	4.328	4.328	4.328
Entry Flow, veh/h	188	724	301
Cap Entry Lane, veh/h	954	1386	1227
Entry HV Adj Factor	0.984	0.980	0.979
Flow Entry, veh/h	185	710	295
Cap Entry, veh/h	939	1358	1201
V/C Ratio	0.197	0.523	0.245
Control Delay, s/veh	5.8	8.1	5.2
LOS	A	A	A
95th %tile Queue, veh	1	3	1

Intersection						
Int Delay, s/veh	0.8					
Movement	WBL	WBR	NBT	NBR	SBL	SBT
Lane Configurations	Y		↑	↑	↑	↑
Traffic Vol, veh/h	32	10	579	56	16	346
Future Vol, veh/h	32	10	579	56	16	346
Conflicting Peds, #/hr	0	0	0	0	0	0
Sign Control	Stop	Stop	Free	Free	Free	Free
RT Channelized	-	None	-	None	-	None
Storage Length	0	-	-	155	205	-
Veh in Median Storage, #	0	-	0	-	-	0
Grade, %	0	-	0	-	-	0
Peak Hour Factor	83	83	83	83	83	83
Heavy Vehicles, %	2	2	2	2	2	2
Mvmt Flow	39	12	698	67	19	417

Major/Minor	Minor1	Major1	Major2		
Conflicting Flow All	1153	698	0	0	765
Stage 1	698	-	-	-	-
Stage 2	455	-	-	-	-
Critical Hdwy	6.42	6.22	-	-	4.12
Critical Hdwy Stg 1	5.42	-	-	-	-
Critical Hdwy Stg 2	5.42	-	-	-	-
Follow-up Hdwy	3.518	3.318	-	-	2.218
Pot Cap-1 Maneuver	218	440	-	-	848
Stage 1	494	-	-	-	-
Stage 2	639	-	-	-	-
Platoon blocked, %			-	-	-
Mov Cap-1 Maneuver	213	440	-	-	848
Mov Cap-2 Maneuver	347	-	-	-	-
Stage 1	494	-	-	-	-
Stage 2	625	-	-	-	-

Approach	WB	NB	SB
HCM Control Delay, s	16.4	0	0.4
HCM LOS	C		

Minor Lane/Major Mvmt	NBT	NBRWBLn1	SBL	SBT
Capacity (veh/h)	-	-	365	848
HCM Lane V/C Ratio	-	-	0.139	0.023
HCM Control Delay (s)	-	-	16.4	9.3
HCM Lane LOS	-	-	C	A
HCM 95th %tile Q(veh)	-	-	0.5	0.1

Intersection						
Intersection Delay, s/veh	6.8					
Intersection LOS	A					
Approach	EB		NB		SB	
Entry Lanes	2		2		2	
Conflicting Circle Lanes	2		2		2	
Adj Approach Flow, veh/h	281		1083		446	
Demand Flow Rate, veh/h	286		1105		455	
Vehicles Circulating, veh/h	413		67		410	
Vehicles Exiting, veh/h	452		632		762	
Ped Vol Crossing Leg, #/h	0		0		0	
Ped Cap Adj	1.000		1.000		1.000	
Approach Delay, s/veh	5.5		7.4		6.2	
Approach LOS	A		A		A	
Lane	Left	Right	Left	Right	Left	Right
Designated Moves	L	TR	L	TR	LT	TR
Assumed Moves	L	TR	L	TR	LT	TR
RT Channelized						
Lane Util	0.234	0.766	0.371	0.629	0.470	0.530
Follow-Up Headway, s	2.667	2.535	2.667	2.535	2.667	2.535
Critical Headway, s	4.645	4.328	4.645	4.328	4.645	4.328
Entry Flow, veh/h	67	219	410	695	214	241
Cap Entry Lane, veh/h	923	1000	1269	1341	926	1002
Entry HV Adj Factor	0.985	0.982	0.980	0.980	0.979	0.981
Flow Entry, veh/h	66	215	402	681	210	236
Cap Entry, veh/h	909	981	1244	1315	907	983
V/C Ratio	0.073	0.219	0.323	0.518	0.231	0.240
Control Delay, s/veh	4.6	5.8	5.9	8.2	6.3	6.0
LOS	A	A	A	A	A	A
95th %tile Queue, veh	0	1	1	3	1	1

Intersection									
Intersection Delay, s/veh	7.4								
Intersection LOS	A								
Approach	EB		WB		NB		SB		
Entry Lanes	2		2		1		1		
Conflicting Circle Lanes	2		2		2		2		
Adj Approach Flow, veh/h	373		748		526		573		
Demand Flow Rate, veh/h	380		763		537		585		
Vehicles Circulating, veh/h	521		653		586		385		
Vehicles Exiting, veh/h	360		470		315		564		
Ped Vol Crossing Leg, #/h	0		0		0		0		
Ped Cap Adj	1.000		1.000		1.000		1.000		
Approach Delay, s/veh	6.4		2.6		14.1		7.9		
Approach LOS	A		A		B		A		
Lane	Left	Right	Left	Right	Bypass	Left	Left	Bypass	
Designated Moves	LT	TR	LT	TR	R	LTR	LT	R	
Assumed Moves	LT	TR	LT	TR	R	LTR	LT	R	
RT Channelized					Free			Free	
Lane Util	0.471	0.529	0.471	0.529	1.000		1.000		
Follow-Up Headway, s	2.667	2.535	2.667	2.535	2.535		2.535		
Critical Headway, s	4.645	4.328	4.645	4.328	466	4.328	4.328	89	
Entry Flow, veh/h	179	201	140	157	1938	537	496	1938	
Cap Entry Lane, veh/h	836	912	740	815	0.980	863	1024	0.980	
Entry HV Adj Factor	0.979	0.983	0.976	0.981	457	0.979	0.981	87	
Flow Entry, veh/h	175	198	137	154	1900	526	486	1900	
Cap Entry, veh/h	818	896	722	800	0.241	845	1004	0.046	
V/C Ratio	0.214	0.220	0.189	0.193	0.0	0.622	0.485	0.0	
Control Delay, s/veh	6.7	6.3	7.1	6.5	A	14.1	9.3	A	
LOS	A	A	A	A	1	B	A	0	
95th %tile Queue, veh	1	1	1	1		4	3		

Timings
14: US 24 & Stapleton Dr

2033 Background Traffic
PM Peak Hour

Lane Group	EBL	EBT	EBR	WBL	WBT	WBR	NBL	NBT	NBR	SBL	SBT	SBR
Lane Configurations												
Traffic Volume (vph)	45	139	222	5	280	34	388	594	8	10	469	74
Future Volume (vph)	45	139	222	5	280	34	388	594	8	10	469	74
Turn Type	pm+pt	NA	Free	pm+pt	NA	Free	Prot	NA	Perm	pm+pt	NA	Perm
Protected Phases	5	2		1	6		3	8		7	4	
Permitted Phases	2		Free	6		Free			8	4		4
Detector Phase	5	2		1	6		3	8	8	7	4	4
Switch Phase												
Minimum Initial (s)	5.0	5.0		5.0	5.0		20.0	5.0	5.0	5.0	16.0	16.0
Minimum Split (s)	10.0	10.0		10.0	10.0		25.0	10.0	10.0	10.0	21.0	21.0
Total Split (s)	12.0	34.0		12.0	34.0		33.0	62.0	62.0	12.0	41.0	41.0
Total Split (%)	10.0%	28.3%		10.0%	28.3%		27.5%	51.7%	51.7%	10.0%	34.2%	34.2%
Yellow Time (s)	3.0	3.0		3.0	3.0		3.0	3.0	3.0	3.0	3.0	3.0
All-Red Time (s)	2.0	2.0		2.0	2.0		2.0	2.0	2.0	2.0	2.0	2.0
Lost Time Adjust (s)	0.0	0.0		0.0	0.0		0.0	0.0	0.0	0.0	0.0	0.0
Total Lost Time (s)	5.0	5.0		5.0	5.0		5.0	5.0	5.0	5.0	5.0	5.0
Lead/Lag	Lead	Lag		Lead	Lag		Lead	Lag	Lag	Lead	Lag	Lag
Lead-Lag Optimize?	Yes	Yes		Yes	Yes		Yes	Yes	Yes	Yes	Yes	Yes
Recall Mode	None	C-Max		None	C-Max		None	Max	Max	None	Max	Max
Act Effct Green (s)	40.1	38.7	120.0	36.1	31.4	120.0	22.0	66.7	66.7	47.8	42.0	42.0
Actuated g/C Ratio	0.33	0.32	1.00	0.30	0.26	1.00	0.18	0.56	0.56	0.40	0.35	0.35
v/c Ratio	0.28	0.28	0.17	0.02	0.69	0.03	0.72	0.67	0.01	0.04	0.83	0.13
Control Delay	25.8	27.4	0.2	26.4	49.5	0.0	52.8	23.8	0.0	13.8	45.6	0.4
Queue Delay	0.0	0.0	0.0	0.0	0.0	0.0	0.0	0.0	0.0	0.0	0.0	0.0
Total Delay	25.8	27.4	0.2	26.4	49.5	0.0	52.8	23.8	0.0	13.8	45.6	0.4
LOS	C	C	A	C	D	A	D	C	A	B	D	A
Approach Delay		12.4			43.9			34.9			39.0	
Approach LOS		B			D			C			D	

Intersection Summary

Cycle Length: 120
 Actuated Cycle Length: 120
 Offset: 0 (0%), Referenced to phase 2:EBTL and 6:WBTL, Start of Green
 Natural Cycle: 90
 Control Type: Actuated-Coordinated
 Maximum v/c Ratio: 0.83
 Intersection Signal Delay: 33.1
 Intersection LOS: C
 Intersection Capacity Utilization 76.9%
 ICU Level of Service D
 Analysis Period (min) 15

Splits and Phases: 14: US 24 & Stapleton Dr

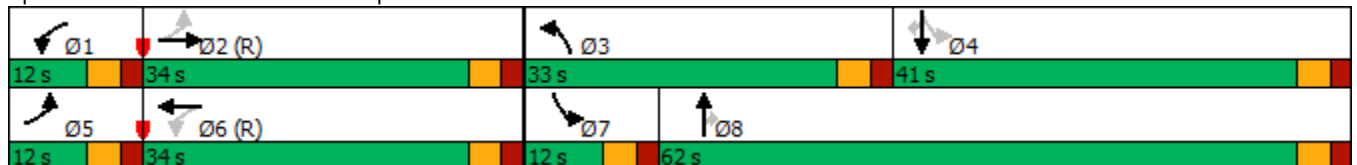

Intersection				
Intersection Delay, s/veh	11.6			
Intersection LOS	B			
Approach	EB	WB	NB	SB
Entry Lanes	1	1	1	1
Conflicting Circle Lanes	1	1	1	1
Adj Approach Flow, veh/h	465	517	478	297
Demand Flow Rate, veh/h	475	528	488	302
Vehicles Circulating, veh/h	637	274	234	638
Vehicles Exiting, veh/h	303	448	878	163
Ped Vol Crossing Leg, #/h	0	0	0	0
Ped Cap Adj	1.000	1.000	1.000	1.000
Approach Delay, s/veh	17.7	9.6	8.4	10.8
Approach LOS	C	A	A	B
Lane	Left	Left	Left	Left
Designated Moves	LTR	LTR	LTR	LTR
Assumed Moves	LTR	LTR	LTR	LTR
RT Channelized				
Lane Util	1.000	1.000	1.000	1.000
Follow-Up Headway, s	2.609	2.609	2.609	2.609
Critical Headway, s	4.976	4.976	4.976	4.976
Entry Flow, veh/h	475	528	488	302
Cap Entry Lane, veh/h	721	1043	1087	720
Entry HV Adj Factor	0.980	0.979	0.979	0.983
Flow Entry, veh/h	465	517	478	297
Cap Entry, veh/h	706	1022	1064	707
V/C Ratio	0.659	0.506	0.449	0.420
Control Delay, s/veh	17.7	9.6	8.4	10.8
LOS	C	A	A	B
95th %tile Queue, veh	5	3	2	2

Intersection						
Int Delay, s/veh	1.4					
Movement	EBT	EBR	WBL	WBT	NBL	NBR
Lane Configurations	↔		↔	↑	↔	↔
Traffic Vol, veh/h	397	20	38	476	16	73
Future Vol, veh/h	397	20	38	476	16	73
Conflicting Peds, #/hr	0	0	0	0	0	0
Sign Control	Free	Free	Free	Free	Stop	Stop
RT Channelized	-	None	-	None	-	None
Storage Length	-	-	155	-	205	0
Veh in Median Storage, #	0	-	-	0	0	-
Grade, %	0	-	-	0	0	-
Peak Hour Factor	92	92	92	92	92	92
Heavy Vehicles, %	2	2	2	2	2	2
Mvmt Flow	432	22	41	517	17	79

Major/Minor	Major1	Major2	Minor1		
Conflicting Flow All	0	0	454	0	1042 443
Stage 1	-	-	-	-	443 -
Stage 2	-	-	-	-	599 -
Critical Hdwy	-	-	4.12	-	6.42 6.22
Critical Hdwy Stg 1	-	-	-	-	5.42 -
Critical Hdwy Stg 2	-	-	-	-	5.42 -
Follow-up Hdwy	-	-	2.218	-	3.518 3.318
Pot Cap-1 Maneuver	-	-	1107	-	254 615
Stage 1	-	-	-	-	647 -
Stage 2	-	-	-	-	549 -
Platoon blocked, %	-	-	-	-	-
Mov Cap-1 Maneuver	-	-	1107	-	245 615
Mov Cap-2 Maneuver	-	-	-	-	376 -
Stage 1	-	-	-	-	647 -
Stage 2	-	-	-	-	529 -

Approach	EB	WB	NB
HCM Control Delay, s	0	0.6	12.3
HCM LOS			B

Minor Lane/Major Mvmt	NBLn1	NBLn2	EBT	EBR	WBL	WBT
Capacity (veh/h)	376	615	-	-	1107	-
HCM Lane V/C Ratio	0.046	0.129	-	-	0.037	-
HCM Control Delay (s)	15	11.7	-	-	8.4	-
HCM Lane LOS	C	B	-	-	A	-
HCM 95th %tile Q(veh)	0.1	0.4	-	-	0.1	-

Intersection						
Int Delay, s/veh	0.4					
Movement	EBL	EBT	WBT	WBR	SBL	SBR
Lane Configurations						
Traffic Vol, veh/h	2	468	509	7	20	5
Future Vol, veh/h	2	468	509	7	20	5
Conflicting Peds, #/hr	0	0	0	0	0	0
Sign Control	Free	Free	Free	Free	Stop	Stop
RT Channelized	-	None	-	None	-	None
Storage Length	155	-	-	-	0	-
Veh in Median Storage, #	-	0	0	-	0	-
Grade, %	-	0	0	-	0	-
Peak Hour Factor	92	92	92	92	92	92
Heavy Vehicles, %	2	2	2	2	2	2
Mvmt Flow	2	509	553	8	22	5

Major/Minor	Major1	Major2	Minor2		
Conflicting Flow All	561	0	-	0	1070 557
Stage 1	-	-	-	-	557 -
Stage 2	-	-	-	-	513 -
Critical Hdwy	4.12	-	-	-	6.42 6.22
Critical Hdwy Stg 1	-	-	-	-	5.42 -
Critical Hdwy Stg 2	-	-	-	-	5.42 -
Follow-up Hdwy	2.218	-	-	-	3.518 3.318
Pot Cap-1 Maneuver	1010	-	-	-	245 530
Stage 1	-	-	-	-	574 -
Stage 2	-	-	-	-	601 -
Platoon blocked, %		-	-	-	
Mov Cap-1 Maneuver	1010	-	-	-	245 530
Mov Cap-2 Maneuver	-	-	-	-	379 -
Stage 1	-	-	-	-	573 -
Stage 2	-	-	-	-	601 -

Approach	EB	WB	SB
HCM Control Delay, s	0	0	14.6
HCM LOS			B

Minor Lane/Major Mvmt	EBL	EBT	WBT	WBR	SBLn1
Capacity (veh/h)	1010	-	-	-	402
HCM Lane V/C Ratio	0.002	-	-	-	0.068
HCM Control Delay (s)	8.6	-	-	-	14.6
HCM Lane LOS	A	-	-	-	B
HCM 95th %tile Q(veh)	0	-	-	-	0.2

Intersection					
Intersection Delay, s/veh	13.6				
Intersection LOS	B				
Approach	EB	WB	NB	SB	
Entry Lanes	1	1	1	1	
Conflicting Circle Lanes	1	1	1	1	
Adj Approach Flow, veh/h	513	365	142	813	
Demand Flow Rate, veh/h	523	372	144	830	
Vehicles Circulating, veh/h	502	335	1008	226	
Vehicles Exiting, veh/h	554	817	17	215	
Ped Vol Crossing Leg, #/h	0	0	0	0	
Ped Cap Adj	1.000	1.000	1.000	1.000	
Approach Delay, s/veh	14.9	5.3	11.9	16.8	
Approach LOS	B	A	B	C	
Lane	Left	Left	Bypass	Left	Left
Designated Moves	LTR	LT	R	LTR	LTR
Assumed Moves	LTR	LT	R	LTR	LTR
RT Channelized			Yield		
Lane Util	1.000	1.000		1.000	1.000
Follow-Up Headway, s	2.609	2.609		2.609	2.609
Critical Headway, s	4.976	4.976	266	4.976	4.976
Entry Flow, veh/h	523	106	1108	144	830
Cap Entry Lane, veh/h	827	981	0.980	494	1096
Entry HV Adj Factor	0.981	0.982	261	0.986	0.980
Flow Entry, veh/h	513	104	1086	142	813
Cap Entry, veh/h	811	963	0.240	487	1073
V/C Ratio	0.632	0.108	5.6	0.292	0.757
Control Delay, s/veh	14.9	4.7	A	11.9	16.8
LOS	B	A	1	B	C
95th %tile Queue, veh	5	0		1	8

Timings
9: US 24 & Rex Rd

2043 Background Traffic
AM Peak Hour



Lane Group	EBL	EBR	NBL	NBT	SBT	SBR
Lane Configurations	↖	↗	↖↗	↕	↕	↗
Traffic Volume (vph)	95	855	397	382	632	71
Future Volume (vph)	95	855	397	382	632	71
Turn Type	Prot	Free	Prot	NA	NA	Perm
Protected Phases	6!		7	Free!	8	
Permitted Phases		Free				8
Detector Phase	6		7		8	8
Switch Phase						
Minimum Initial (s)	5.0		5.0		5.0	5.0
Minimum Split (s)	20.0		10.0		20.0	20.0
Total Split (s)	23.0		49.0		48.0	48.0
Total Split (%)	19.2%		40.8%		40.0%	40.0%
Yellow Time (s)	3.0		3.0		3.0	3.0
All-Red Time (s)	2.0		2.0		2.0	2.0
Lost Time Adjust (s)	0.0		0.0		0.0	0.0
Total Lost Time (s)	5.0		5.0		5.0	5.0
Lead/Lag			Lead		Lag	Lag
Lead-Lag Optimize?			Yes		Yes	Yes
Recall Mode	Max		None		C-Max	C-Max
Act Effct Green (s)	18.0	120.0	20.2	120.0	66.8	66.8
Actuated g/C Ratio	0.15	1.00	0.17	1.00	0.56	0.56
v/c Ratio	0.38	0.57	0.72	0.11	0.34	0.08
Control Delay	50.7	1.5	54.5	0.1	15.6	3.5
Queue Delay	0.0	0.0	0.0	0.0	0.0	0.0
Total Delay	50.7	1.5	54.5	0.1	15.6	3.5
LOS	D	A	D	A	B	A
Approach Delay	6.4			28.2	14.4	
Approach LOS	A			C	B	

Intersection Summary

Cycle Length: 120
 Actuated Cycle Length: 120
 Offset: 50 (42%), Referenced to phase 8:SBT, Start of Green
 Natural Cycle: 55
 Control Type: Actuated-Coordinated
 Maximum v/c Ratio: 0.72
 Intersection Signal Delay: 15.6
 Intersection LOS: B
 Intersection Capacity Utilization 45.7%
 ICU Level of Service A
 Analysis Period (min) 15
 ! Phase conflict between lane groups.

Splits and Phases: 9: US 24 & Rex Rd

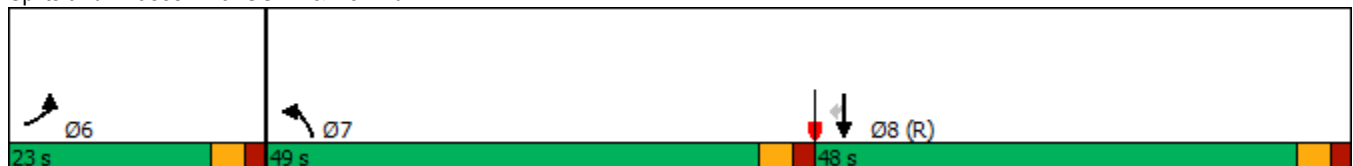

Intersection			
Intersection Delay, s/veh	9.8		
Intersection LOS	A		
Approach	WB	NB	SB
Entry Lanes	1	1	1
Conflicting Circle Lanes	2	2	2
Adj Approach Flow, veh/h	146	519	860
Demand Flow Rate, veh/h	149	529	877
Vehicles Circulating, veh/h	483	1	145
Vehicles Exiting, veh/h	47	1021	487
Ped Vol Crossing Leg, #/h	0	0	0
Ped Cap Adj	1.000	1.000	1.000
Approach Delay, s/veh	5.4	6.0	12.9
Approach LOS	A	A	B
Lane	Left	Left	Left
Designated Moves	LR	TR	LT
Assumed Moves	LR	TR	LT
RT Channelized			
Lane Util	1.000	1.000	1.000
Follow-Up Headway, s	2.535	2.535	2.535
Critical Headway, s	4.328	4.328	4.328
Entry Flow, veh/h	149	529	877
Cap Entry Lane, veh/h	942	1419	1255
Entry HV Adj Factor	0.980	0.980	0.980
Flow Entry, veh/h	146	519	860
Cap Entry, veh/h	923	1391	1231
V/C Ratio	0.158	0.373	0.699
Control Delay, s/veh	5.4	6.0	12.9
LOS	A	A	B
95th %tile Queue, veh	1	2	6

Intersection						
Int Delay, s/veh	1.2					
Movement	WBL	WBR	NBT	NBR	SBL	SBT
Lane Configurations	Y		↑	↑	↑	↑
Traffic Vol, veh/h	57	21	472	20	7	945
Future Vol, veh/h	57	21	472	20	7	945
Conflicting Peds, #/hr	0	0	0	0	0	0
Sign Control	Stop	Stop	Free	Free	Free	Free
RT Channelized	-	None	-	None	-	None
Storage Length	0	-	-	155	205	-
Veh in Median Storage, #	0	-	0	-	-	0
Grade, %	0	-	0	-	-	0
Peak Hour Factor	95	95	95	95	95	95
Heavy Vehicles, %	2	2	2	2	2	2
Mvmt Flow	60	22	497	21	7	995

Major/Minor	Minor1	Major1	Major2		
Conflicting Flow All	1506	497	0	0	518
Stage 1	497	-	-	-	-
Stage 2	1009	-	-	-	-
Critical Hdwy	6.42	6.22	-	-	4.12
Critical Hdwy Stg 1	5.42	-	-	-	-
Critical Hdwy Stg 2	5.42	-	-	-	-
Follow-up Hdwy	3.518	3.318	-	-	2.218
Pot Cap-1 Maneuver	133	573	-	-	1048
Stage 1	611	-	-	-	-
Stage 2	352	-	-	-	-
Platoon blocked, %			-	-	-
Mov Cap-1 Maneuver	132	573	-	-	1048
Mov Cap-2 Maneuver	257	-	-	-	-
Stage 1	611	-	-	-	-
Stage 2	350	-	-	-	-

Approach	WB	NB	SB
HCM Control Delay, s	21.3	0	0.1
HCM LOS	C		

Minor Lane/Major Mvmt	NBT	NBRWBLn1	SBL	SBT
Capacity (veh/h)	-	-	302	1048
HCM Lane V/C Ratio	-	-	0.272	0.007
HCM Control Delay (s)	-	-	21.3	8.5
HCM Lane LOS	-	-	C	A
HCM 95th %tile Q(veh)	-	-	1.1	0

Intersection						
Intersection Delay, s/veh	8.4					
Intersection LOS	A					
Approach	EB		NB		SB	
Entry Lanes	2		2		2	
Conflicting Circle Lanes	2		2		2	
Adj Approach Flow, veh/h	482		613		1062	
Demand Flow Rate, veh/h	492		625		1083	
Vehicles Circulating, veh/h	805		152		252	
Vehicles Exiting, veh/h	530		1145		525	
Ped Vol Crossing Leg, #/h	0		0		0	
Ped Cap Adj	1.000		1.000		1.000	
Approach Delay, s/veh	11.0		5.4		8.9	
Approach LOS	B		A		A	
Lane	Left	Right	Left	Right	Left	Right
Designated Moves	L	TR	L	TR	LT	TR
Assumed Moves	L	TR	L	TR	LT	TR
RT Channelized						
Lane Util	0.309	0.691	0.403	0.597	0.470	0.530
Follow-Up Headway, s	2.667	2.535	2.667	2.535	2.667	2.535
Critical Headway, s	4.645	4.328	4.645	4.328	4.645	4.328
Entry Flow, veh/h	152	340	252	373	509	574
Cap Entry Lane, veh/h	644	716	1174	1248	1071	1146
Entry HV Adj Factor	0.980	0.979	0.980	0.980	0.981	0.981
Flow Entry, veh/h	149	333	247	366	499	563
Cap Entry, veh/h	631	702	1150	1224	1050	1124
V/C Ratio	0.236	0.475	0.215	0.299	0.475	0.501
Control Delay, s/veh	8.6	12.1	5.1	5.7	8.9	8.9
LOS	A	B	A	A	A	A
95th %tile Queue, veh	1	3	1	1	3	3

Intersection											
Intersection Delay, s/veh 12.7											
Intersection LOS B											
Approach	EB		WB			NB			SB		
Entry Lanes	2		2			2			2		
Conflicting Circle Lanes	2		2			2			2		
Adj Approach Flow, veh/h	810		549			519			1121		
Demand Flow Rate, veh/h	826		559			530			1144		
Vehicles Circulating, veh/h	903		598			999			531		
Vehicles Exiting, veh/h	465		848			730			454		
Ped Vol Crossing Leg, #/h	0		0			0			0		
Ped Cap Adj	1.000		1.000			1.000			1.000		
Approach Delay, s/veh	20.0		6.8			11.7			10.7		
Approach LOS	C		A			B			B		
Lane	Left	Right	Left	Right	Bypass	Left	Right	Bypass	Left	Right	Bypass
Designated Moves	LT	TR	LT	TR	R	LT	TR	R	L	LTR	R
Assumed Moves	LT	TR	LT	TR	R	LT	TR	R	L	TR	R
RT Channelized					Yield			Yield			Yield
Lane Util	0.470	0.530	0.470	0.530		0.470	0.530		0.350	0.650	
Follow-Up Headway, s	2.667	2.535	2.667	2.535		2.667	2.535		2.667	2.535	
Critical Headway, s	4.645	4.328	4.645	4.328	172	4.645	4.328	83	4.645	4.328	307
Entry Flow, veh/h	388	438	182	205	868	210	237	581	293	544	859
Cap Entry Lane, veh/h	588	659	779	854	0.980	539	607	0.980	828	904	0.980
Entry HV Adj Factor	0.981	0.980	0.981	0.982	169	0.980	0.980	81	0.980	0.980	301
Flow Entry, veh/h	381	429	178	201	851	206	232	570	287	533	842
Cap Entry, veh/h	577	646	764	839	0.198	528	595	0.142	811	886	0.358
V/C Ratio	0.660	0.665	0.234	0.240	6.3	0.390	0.390	8.1	0.354	0.602	8.4
Control Delay, s/veh	20.8	19.2	7.3	6.8	A	13.1	11.8	A	8.6	13.0	A
LOS	C	C	A	A	1	B	B	0	A	B	2
95th %tile Queue, veh	5	5	1	1		2	2		2	4	

Timings
14: US 24 & Stapleton Dr

2043 Background Traffic
AM Peak Hour

Lane Group	EBL	EBT	EBR	WBL	WBT	WBR	NBL	NBT	NBR	SBL	SBT	SBR
Lane Configurations												
Traffic Volume (vph)	136	378	463	75	201	100	358	543	50	224	1137	127
Future Volume (vph)	136	378	463	75	201	100	358	543	50	224	1137	127
Turn Type	pm+pt	NA	Free	pm+pt	NA	Free	Prot	NA	Perm	Prot	NA	Perm
Protected Phases	5	2		1	6		3	8		7	4	
Permitted Phases	2		Free	6		Free			8			4
Detector Phase	5	2		1	6		3	8	8	7	4	4
Switch Phase												
Minimum Initial (s)	5.0	10.0		8.0	5.0		20.0	5.0	5.0	20.0	15.0	15.0
Minimum Split (s)	10.0	15.0		13.0	10.0		25.0	10.0	10.0	25.0	20.0	20.0
Total Split (s)	15.0	25.0		15.0	25.0		30.0	60.0	60.0	25.0	50.0	50.0
Total Split (%)	12.0%	20.0%		12.0%	20.0%		24.0%	48.0%	48.0%	20.0%	40.0%	40.0%
Yellow Time (s)	3.0	3.0		3.0	3.0		3.0	3.0	3.0	3.0	3.0	3.0
All-Red Time (s)	2.0	2.0		2.0	2.0		2.0	2.0	2.0	2.0	2.0	2.0
Lost Time Adjust (s)	0.0	0.0		0.0	0.0		0.0	0.0	0.0	0.0	0.0	0.0
Total Lost Time (s)	5.0	5.0		5.0	5.0		5.0	5.0	5.0	5.0	5.0	5.0
Lead/Lag	Lead	Lag		Lead	Lag		Lead	Lag	Lag	Lead	Lag	Lag
Lead-Lag Optimize?	Yes	Yes		Yes	Yes		Yes	Yes	Yes	Yes	Yes	Yes
Recall Mode	None	C-Max		None	C-Max		None	Max	Max	None	Max	Max
Act Effct Green (s)	31.4	23.4	125.0	29.5	20.3	125.0	20.9	55.0	55.0	20.0	54.1	54.1
Actuated g/C Ratio	0.25	0.19	1.00	0.24	0.16	1.00	0.17	0.44	0.44	0.16	0.43	0.43
v/c Ratio	0.48	0.60	0.31	0.33	0.37	0.07	0.66	0.37	0.07	0.43	0.76	0.18
Control Delay	41.6	52.1	0.5	38.3	48.9	0.1	54.5	24.2	0.2	50.1	34.1	4.3
Queue Delay	0.0	0.0	0.0	0.0	0.0	0.0	0.0	0.0	0.0	0.0	0.0	0.0
Total Delay	41.6	52.1	0.5	38.3	48.9	0.1	54.5	24.2	0.2	50.1	34.1	4.3
LOS	D	D	A	D	D	A	D	C	A	D	C	A
Approach Delay		26.2			33.8			34.4			34.0	
Approach LOS		C			C			C			C	

Intersection Summary

Cycle Length: 125
 Actuated Cycle Length: 125
 Offset: 64 (51%), Referenced to phase 2:EBTL and 6:WBTL, Start of Green
 Natural Cycle: 90
 Control Type: Actuated-Coordinated
 Maximum v/c Ratio: 0.76
 Intersection Signal Delay: 32.0
 Intersection LOS: C
 Intersection Capacity Utilization 79.1%
 ICU Level of Service D
 Analysis Period (min) 15

Splits and Phases: 14: US 24 & Stapleton Dr

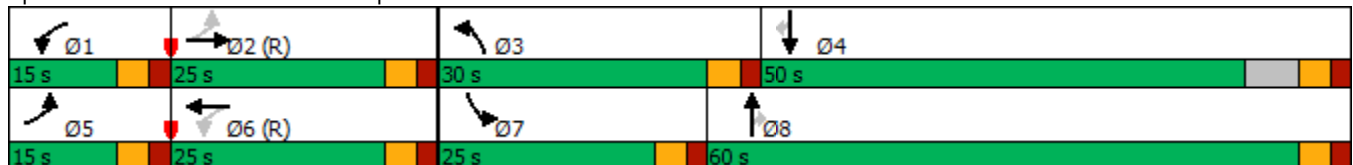

Intersection				
Intersection Delay, s/veh	15.4			
Intersection LOS	C			
Approach	EB	WB	NB	SB
Entry Lanes	1	1	1	1
Conflicting Circle Lanes	1	1	1	1
Adj Approach Flow, veh/h	414	354	815	247
Demand Flow Rate, veh/h	423	361	832	251
Vehicles Circulating, veh/h	451	533	305	529
Vehicles Exiting, veh/h	329	604	569	365
Ped Vol Crossing Leg, #/h	0	0	0	0
Ped Cap Adj	1.000	1.000	1.000	1.000
Approach Delay, s/veh	10.6	10.5	22.1	8.2
Approach LOS	B	B	C	A
Lane	Left	Left	Left	Left
Designated Moves	LTR	LTR	LTR	LTR
Assumed Moves	LTR	LTR	LTR	LTR
RT Channelized				
Lane Util	1.000	1.000	1.000	1.000
Follow-Up Headway, s	2.609	2.609	2.609	2.609
Critical Headway, s	4.976	4.976	4.976	4.976
Entry Flow, veh/h	423	361	832	251
Cap Entry Lane, veh/h	871	801	1011	804
Entry HV Adj Factor	0.979	0.981	0.979	0.983
Flow Entry, veh/h	414	354	815	247
Cap Entry, veh/h	853	786	990	790
V/C Ratio	0.486	0.451	0.823	0.312
Control Delay, s/veh	10.6	10.5	22.1	8.2
LOS	B	B	C	A
95th %tile Queue, veh	3	2	10	1

Intersection						
Int Delay, s/veh	1.8					
Movement	EBT	EBR	WBL	WBT	NBL	NBR
Lane Configurations	↶		↷	↶	↷	↷
Traffic Vol, veh/h	536	25	84	318	18	61
Future Vol, veh/h	536	25	84	318	18	61
Conflicting Peds, #/hr	0	0	0	0	0	0
Sign Control	Free	Free	Free	Free	Stop	Stop
RT Channelized	-	None	-	None	-	None
Storage Length	-	-	155	-	205	0
Veh in Median Storage, #	0	-	-	0	0	-
Grade, %	0	-	-	0	0	-
Peak Hour Factor	92	92	92	92	92	92
Heavy Vehicles, %	2	2	2	2	2	2
Mvmt Flow	583	27	91	346	20	66

Major/Minor	Major1	Major2	Minor1			
Conflicting Flow All	0	0	610	0	1125	597
Stage 1	-	-	-	-	597	-
Stage 2	-	-	-	-	528	-
Critical Hdwy	-	-	4.12	-	6.42	6.22
Critical Hdwy Stg 1	-	-	-	-	5.42	-
Critical Hdwy Stg 2	-	-	-	-	5.42	-
Follow-up Hdwy	-	-	2.218	-	3.518	3.318
Pot Cap-1 Maneuver	-	-	969	-	227	503
Stage 1	-	-	-	-	550	-
Stage 2	-	-	-	-	592	-
Platoon blocked, %	-	-	-	-	-	-
Mov Cap-1 Maneuver	-	-	969	-	206	503
Mov Cap-2 Maneuver	-	-	-	-	342	-
Stage 1	-	-	-	-	550	-
Stage 2	-	-	-	-	536	-

Approach	EB	WB	NB
HCM Control Delay, s	0	1.9	13.9
HCM LOS			B

Minor Lane/Major Mvmt	NBLn1	NBLn2	EBT	EBR	WBL	WBT
Capacity (veh/h)	342	503	-	-	969	-
HCM Lane V/C Ratio	0.057	0.132	-	-	0.094	-
HCM Control Delay (s)	16.2	13.2	-	-	9.1	-
HCM Lane LOS	C	B	-	-	A	-
HCM 95th %tile Q(veh)	0.2	0.5	-	-	0.3	-

Intersection						
Int Delay, s/veh	0.4					
Movement	EBL	EBT	WBT	WBR	SBL	SBR
Lane Configurations						
Traffic Vol, veh/h	2	595	398	7	20	5
Future Vol, veh/h	2	595	398	7	20	5
Conflicting Peds, #/hr	0	0	0	0	0	0
Sign Control	Free	Free	Free	Free	Stop	Stop
RT Channelized	-	None	-	None	-	None
Storage Length	155	-	-	-	0	-
Veh in Median Storage, #	-	0	0	-	0	-
Grade, %	-	0	0	-	0	-
Peak Hour Factor	92	92	92	92	92	92
Heavy Vehicles, %	2	2	2	2	2	2
Mvmt Flow	2	647	433	8	22	5

Major/Minor	Major1	Major2	Minor2
Conflicting Flow All	441	0	0 1088 437
Stage 1	-	-	- 437 -
Stage 2	-	-	- 651 -
Critical Hdwy	4.12	-	- 6.42 6.22
Critical Hdwy Stg 1	-	-	- 5.42 -
Critical Hdwy Stg 2	-	-	- 5.42 -
Follow-up Hdwy	2.218	-	- 3.518 3.318
Pot Cap-1 Maneuver	1119	-	- 239 620
Stage 1	-	-	- 651 -
Stage 2	-	-	- 519 -
Platoon blocked, %	-	-	-
Mov Cap-1 Maneuver	1119	-	- 239 620
Mov Cap-2 Maneuver	-	-	- 370 -
Stage 1	-	-	- 650 -
Stage 2	-	-	- 519 -

Approach	EB	WB	SB
HCM Control Delay, s	0	0	14.6
HCM LOS			B

Minor Lane/Major Mvmt	EBL	EBT	WBT	WBR	SBLn1
Capacity (veh/h)	1119	-	-	-	402
HCM Lane V/C Ratio	0.002	-	-	-	0.068
HCM Control Delay (s)	8.2	-	-	-	14.6
HCM Lane LOS	A	-	-	-	B
HCM 95th %tile Q(veh)	0	-	-	-	0.2

Intersection					
Intersection Delay, s/veh	10.1				
Intersection LOS	B				
Approach	EB	WB	NB	SB	
Entry Lanes	1	1	1	1	
Conflicting Circle Lanes	1	1	1	1	
Adj Approach Flow, veh/h	647	649	93	457	
Demand Flow Rate, veh/h	660	662	95	467	
Vehicles Circulating, veh/h	314	359	918	283	
Vehicles Exiting, veh/h	436	654	56	280	
Ped Vol Crossing Leg, #/h	0	0	0	0	
Ped Cap Adj	1.000	1.000	1.000	1.000	
Approach Delay, s/veh	13.7	7.7	9.1	8.7	
Approach LOS	B	A	A	A	
Lane	Left	Left	Bypass	Left	Left
Designated Moves	LTR	LT	R	LTR	LTR
Assumed Moves	LTR	LT	R	LTR	LTR
RT Channelized			Yield		
Lane Util	1.000	1.000		1.000	1.000
Follow-Up Headway, s	2.609	2.609		2.609	2.609
Critical Headway, s	4.976	4.976	458	4.976	4.976
Entry Flow, veh/h	660	204	1037	95	467
Cap Entry Lane, veh/h	1002	957	0.980	541	1034
Entry HV Adj Factor	0.980	0.978	449	0.979	0.979
Flow Entry, veh/h	647	200	1017	93	457
Cap Entry, veh/h	982	936	0.442	530	1012
V/C Ratio	0.659	0.213	8.5	0.176	0.452
Control Delay, s/veh	13.7	6.0	A	9.1	8.7
LOS	B	A	2	A	A
95th %tile Queue, veh	5	1		1	2

Timings
9: US 24 & Rex Rd

2043 Background Traffic
PM Peak Hour



Lane Group	EBL	EBR	NBL	NBT	SBT	SBR
Lane Configurations	↖	↗	↖↗	↑↑	↑↑	↗
Traffic Volume (vph)	125	688	831	586	473	108
Future Volume (vph)	125	688	831	586	473	108
Turn Type	Prot	Free	Prot	NA	NA	Perm
Protected Phases	6!		7	Free!	8	
Permitted Phases		Free				8
Detector Phase	6		7		8	8
Switch Phase						
Minimum Initial (s)	5.0		5.0		5.0	5.0
Minimum Split (s)	20.0		10.0		20.0	20.0
Total Split (s)	24.0		52.0		44.0	44.0
Total Split (%)	20.0%		43.3%		36.7%	36.7%
Yellow Time (s)	3.0		3.0		3.0	3.0
All-Red Time (s)	2.0		2.0		2.0	2.0
Lost Time Adjust (s)	0.0		0.0		0.0	0.0
Total Lost Time (s)	5.0		5.0		5.0	5.0
Lead/Lag			Lead		Lag	Lag
Lead-Lag Optimize?			Yes		Yes	Yes
Recall Mode	Max		None		C-Max	C-Max
Act Effct Green (s)	19.0	120.0	37.0	120.0	49.0	49.0
Actuated g/C Ratio	0.16	1.00	0.31	1.00	0.41	0.41
v/c Ratio	0.47	0.46	0.83	0.17	0.34	0.16
Control Delay	52.2	1.0	31.7	0.1	26.3	5.2
Queue Delay	0.0	0.0	0.0	0.0	0.0	0.0
Total Delay	52.2	1.0	31.7	0.1	26.3	5.2
LOS	D	A	C	A	C	A
Approach Delay	8.9			18.9	22.3	
Approach LOS	A			B	C	

Intersection Summary

Cycle Length: 120
 Actuated Cycle Length: 120
 Offset: 50 (42%), Referenced to phase 8:SBT, Start of Green
 Natural Cycle: 60
 Control Type: Actuated-Coordinated
 Maximum v/c Ratio: 0.83
 Intersection Signal Delay: 16.7
 Intersection LOS: B
 Intersection Capacity Utilization 55.4%
 ICU Level of Service B
 Analysis Period (min) 15

! Phase conflict between lane groups.

Splits and Phases: 9: US 24 & Rex Rd



Intersection			
Intersection Delay, s/veh	10.4		
Intersection LOS	B		
Approach	WB	NB	SB
Entry Lanes	1	1	1
Conflicting Circle Lanes	2	2	2
Adj Approach Flow, veh/h	103	997	565
Demand Flow Rate, veh/h	105	1017	576
Vehicles Circulating, veh/h	858	5	102
Vehicles Exiting, veh/h	164	673	861
Ped Vol Crossing Leg, #/h	0	0	0
Ped Cap Adj	1.000	1.000	1.000
Approach Delay, s/veh	7.1	12.5	7.2
Approach LOS	A	B	A
Lane	Left	Left	Left
Designated Moves	LR	TR	LT
Assumed Moves	LR	TR	LT
RT Channelized			
Lane Util	1.000	1.000	1.000
Follow-Up Headway, s	2.535	2.535	2.535
Critical Headway, s	4.328	4.328	4.328
Entry Flow, veh/h	105	1017	576
Cap Entry Lane, veh/h	685	1414	1302
Entry HV Adj Factor	0.981	0.981	0.981
Flow Entry, veh/h	103	997	565
Cap Entry, veh/h	672	1387	1277
V/C Ratio	0.153	0.719	0.442
Control Delay, s/veh	7.1	12.5	7.2
LOS	A	B	A
95th %tile Queue, veh	1	7	2

Intersection						
Int Delay, s/veh	0.9					
Movement	WBL	WBR	NBT	NBR	SBL	SBT
Lane Configurations	Y		↑	↑	↑	↑
Traffic Vol, veh/h	37	14	932	63	25	601
Future Vol, veh/h	37	14	932	63	25	601
Conflicting Peds, #/hr	0	0	0	0	0	0
Sign Control	Stop	Stop	Free	Free	Free	Free
RT Channelized	-	None	-	None	-	None
Storage Length	0	-	-	155	205	-
Veh in Median Storage, #	0	-	0	-	-	0
Grade, %	0	-	0	-	-	0
Peak Hour Factor	95	95	95	95	95	95
Heavy Vehicles, %	2	2	2	2	2	2
Mvmt Flow	39	15	981	66	26	633

Major/Minor	Minor1	Major1	Major2		
Conflicting Flow All	1666	981	0	0	1047
Stage 1	981	-	-	-	-
Stage 2	685	-	-	-	-
Critical Hdwy	6.42	6.22	-	-	4.12
Critical Hdwy Stg 1	5.42	-	-	-	-
Critical Hdwy Stg 2	5.42	-	-	-	-
Follow-up Hdwy	3.518	3.318	-	-	2.218
Pot Cap-1 Maneuver	106	303	-	-	665
Stage 1	363	-	-	-	-
Stage 2	500	-	-	-	-
Platoon blocked, %			-	-	-
Mov Cap-1 Maneuver	102	303	-	-	665
Mov Cap-2 Maneuver	234	-	-	-	-
Stage 1	363	-	-	-	-
Stage 2	481	-	-	-	-

Approach	WB	NB	SB
HCM Control Delay, s	23.3	0	0.4
HCM LOS	C		

Minor Lane/Major Mvmt	NBT	NBRWBLn1	SBL	SBT
Capacity (veh/h)	-	-	250	665
HCM Lane V/C Ratio	-	-	0.215	0.04
HCM Control Delay (s)	-	-	23.3	10.6
HCM Lane LOS	-	-	C	B
HCM 95th %tile Q(veh)	-	-	0.8	0.1

Intersection						
Intersection Delay, s/veh	9.4					
Intersection LOS	A					
Approach	EB		NB		SB	
Entry Lanes	2		2		2	
Conflicting Circle Lanes	2		2		2	
Adj Approach Flow, veh/h	493		1135		667	
Demand Flow Rate, veh/h	503		1158		680	
Vehicles Circulating, veh/h	419		163		252	
Vehicles Exiting, veh/h	513		759		1069	
Ped Vol Crossing Leg, #/h	0		0		0	
Ped Cap Adj	1.000		1.000		1.000	
Approach Delay, s/veh	6.8		12.3		6.3	
Approach LOS	A		B		A	
Lane	Left	Right	Left	Right	Left	Right
Designated Moves	L	TR	L	TR	LT	TR
Assumed Moves	L	TR	L	TR	LT	TR
RT Channelized						
Lane Util	0.324	0.676	0.218	0.782	0.471	0.529
Follow-Up Headway, s	2.667	2.535	2.667	2.535	2.667	2.535
Critical Headway, s	4.645	4.328	4.645	4.328	4.645	4.328
Entry Flow, veh/h	163	340	252	906	320	360
Cap Entry Lane, veh/h	918	995	1162	1236	1071	1146
Entry HV Adj Factor	0.982	0.979	0.980	0.980	0.979	0.982
Flow Entry, veh/h	160	333	247	888	313	353
Cap Entry, veh/h	901	974	1139	1212	1048	1125
V/C Ratio	0.178	0.342	0.217	0.733	0.299	0.314
Control Delay, s/veh	5.7	7.3	5.1	14.3	6.4	6.2
LOS	A	A	A	B	A	A
95th %tile Queue, veh	1	2	1	7	1	1

Intersection											
Intersection Delay, s/veh 13.3											
Intersection LOS B											
Approach	EB		WB			NB			SB		
Entry Lanes	2		2			2			2		
Conflicting Circle Lanes	2		2			2			2		
Adj Approach Flow, veh/h	771		976			743			744		
Demand Flow Rate, veh/h	786		996			758			758		
Vehicles Circulating, veh/h	645		967			897			813		
Vehicles Exiting, veh/h	706		580			534			805		
Ped Vol Crossing Leg, #/h	0		0			0			0		
Ped Cap Adj	1.000		1.000			1.000			1.000		
Approach Delay, s/veh	11.8		16.4			13.4			10.7		
Approach LOS	B		C			B			B		
Lane	Left	Right	Left	Right	Bypass	Left	Right	Bypass	Left	Right	Bypass
Designated Moves	LT	TR	LT	TR	R	LT	TR	R	L	LTR	R
Assumed Moves	LT	TR	LT	TR	R	LT	TR	R	L	TR	R
RT Channelized					Yield			Yield			Yield
Lane Util	0.469	0.531	0.470	0.530		0.471	0.529		0.418	0.582	
Follow-Up Headway, s	2.667	2.535	2.667	2.535		2.667	2.535		2.667	2.535	
Critical Headway, s	4.645	4.328	4.645	4.328	345	4.645	4.328	108	4.645	4.328	220
Entry Flow, veh/h	369	417	306	345	607	306	344	764	225	313	672
Cap Entry Lane, veh/h	746	821	555	624	0.980	591	662	0.980	639	711	0.980
Entry HV Adj Factor	0.982	0.980	0.980	0.981	338	0.979	0.982	106	0.982	0.980	216
Flow Entry, veh/h	362	409	300	338	595	300	338	749	221	307	658
Cap Entry, veh/h	732	804	544	612	0.568	579	651	0.142	628	698	0.328
V/C Ratio	0.495	0.508	0.552	0.553	16.5	0.517	0.519	6.3	0.352	0.440	9.8
Control Delay, s/veh	12.1	11.5	17.2	15.7	C	15.3	14.0	A	10.6	11.4	A
LOS	B	B	C	C	4	C	B	0	B	B	1
95th %tile Queue, veh	3	3	3	3		3	3		2	2	

Timings
14: US 24 & Stapleton Dr

2043 Background Traffic
PM Peak Hour

Lane Group	EBL	EBT	EBR	WBL	WBT	WBR	NBL	NBT	NBR	SBL	SBT	SBR
Lane Configurations												
Traffic Volume (vph)	142	221	469	125	320	273	629	1001	150	216	771	173
Future Volume (vph)	142	221	469	125	320	273	629	1001	150	216	771	173
Turn Type	pm+pt	NA	Free	pm+pt	NA	Free	Prot	NA	Perm	Prot	NA	Perm
Protected Phases	5	2		1	6		3	8		7	4	
Permitted Phases	2		Free	6		Free			8			4
Detector Phase	5	2		1	6		3	8	8	7	4	4
Switch Phase												
Minimum Initial (s)	5.0	10.0		4.0	5.0		8.0	5.0	5.0	10.0	15.0	15.0
Minimum Split (s)	10.0	15.0		9.0	10.0		13.0	10.0	10.0	15.0	20.0	20.0
Total Split (s)	12.0	25.0		12.0	25.0		36.0	65.0	65.0	18.0	47.0	47.0
Total Split (%)	10.0%	20.8%		10.0%	20.8%		30.0%	54.2%	54.2%	15.0%	39.2%	39.2%
Yellow Time (s)	3.0	3.0		3.0	3.0		3.0	3.0	3.0	3.0	3.0	3.0
All-Red Time (s)	2.0	2.0		2.0	2.0		2.0	2.0	2.0	2.0	2.0	2.0
Lost Time Adjust (s)	0.0	0.0		0.0	0.0		0.0	0.0	0.0	0.0	0.0	0.0
Total Lost Time (s)	5.0	5.0		5.0	5.0		5.0	5.0	5.0	5.0	5.0	5.0
Lead/Lag	Lead	Lag		Lead	Lag		Lead	Lag	Lag	Lead	Lag	Lag
Lead-Lag Optimize?	Yes	Yes		Yes	Yes		Yes	Yes	Yes	Yes	Yes	Yes
Recall Mode	None	C-Max		None	C-Max		None	Max	Max	None	Max	Max
Act Effct Green (s)	27.0	20.0	120.0	27.0	20.0	120.0	27.5	60.9	60.9	12.1	45.5	45.5
Actuated g/C Ratio	0.22	0.17	1.00	0.22	0.17	1.00	0.23	0.51	0.51	0.10	0.38	0.38
v/c Ratio	0.67	0.40	0.31	0.49	0.57	0.18	0.84	0.59	0.18	0.65	0.59	0.26
Control Delay	43.6	38.3	0.6	43.0	50.4	0.3	54.5	22.6	2.9	50.1	41.0	12.8
Queue Delay	0.0	0.0	0.0	0.0	0.0	0.0	0.0	0.0	0.0	0.0	0.0	0.0
Total Delay	43.6	38.3	0.6	43.0	50.4	0.3	54.5	22.6	2.9	50.1	41.0	12.8
LOS	D	D	A	D	D	A	D	C	A	D	D	B
Approach Delay		17.9			30.1			32.2			38.5	
Approach LOS		B			C			C			D	

Intersection Summary

Cycle Length: 120
 Actuated Cycle Length: 120
 Offset: 0 (0%), Referenced to phase 2:EBTL and 6:WBTL, Start of Green
 Natural Cycle: 65
 Control Type: Actuated-Coordinated
 Maximum v/c Ratio: 0.84
 Intersection Signal Delay: 30.8
 Intersection LOS: C
 Intersection Capacity Utilization 72.6%
 ICU Level of Service C
 Analysis Period (min) 15

Splits and Phases: 14: US 24 & Stapleton Dr

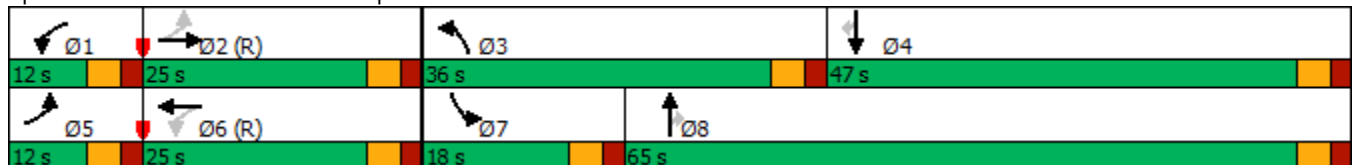

Intersection				
Intersection Delay, s/veh	3.7			
Intersection LOS	A			
Approach	EB	WB	NB	SB
Entry Lanes	1	1	1	1
Conflicting Circle Lanes	1	1	1	1
Adj Approach Flow, veh/h	84	178	108	26
Demand Flow Rate, veh/h	85	182	110	26
Vehicles Circulating, veh/h	170	64	14	224
Vehicles Exiting, veh/h	80	60	241	22
Ped Vol Crossing Leg, #/h	0	0	0	0
Ped Cap Adj	1.000	1.000	1.000	1.000
Approach Delay, s/veh	3.8	4.0	3.3	3.5
Approach LOS	A	A	A	A
Lane	Left	Left	Left	Left
Designated Moves	LTR	LTR	LTR	LTR
Assumed Moves	LTR	LTR	LTR	LTR
RT Channelized				
Lane Util	1.000	1.000	1.000	1.000
Follow-Up Headway, s	2.609	2.609	2.609	2.609
Critical Headway, s	4.976	4.976	4.976	4.976
Entry Flow, veh/h	85	182	110	26
Cap Entry Lane, veh/h	1160	1293	1360	1098
Entry HV Adj Factor	0.986	0.980	0.979	0.982
Flow Entry, veh/h	84	178	108	26
Cap Entry, veh/h	1144	1267	1332	1078
V/C Ratio	0.073	0.141	0.081	0.024
Control Delay, s/veh	3.8	4.0	3.3	3.5
LOS	A	A	A	A
95th %tile Queue, veh	0	0	0	0

Intersection						
Int Delay, s/veh	2.8					
Movement	EBT	EBR	WBL	WBT	NBL	NBR
Lane Configurations	↔		↔	↑	↔	↔
Traffic Vol, veh/h	31	19	0	94	57	0
Future Vol, veh/h	31	19	0	94	57	0
Conflicting Peds, #/hr	0	0	0	0	0	0
Sign Control	Free	Free	Free	Free	Stop	Stop
RT Channelized	-	None	-	None	-	None
Storage Length	-	-	155	-	205	0
Veh in Median Storage, #	0	-	-	0	0	-
Grade, %	0	-	-	0	0	-
Peak Hour Factor	85	85	85	85	85	85
Heavy Vehicles, %	2	2	2	2	2	2
Mvmt Flow	36	22	0	111	67	0

Major/Minor	Major1	Major2	Minor1			
Conflicting Flow All	0	0	58	0	158	47
Stage 1	-	-	-	-	47	-
Stage 2	-	-	-	-	111	-
Critical Hdwy	-	-	4.12	-	6.42	6.22
Critical Hdwy Stg 1	-	-	-	-	5.42	-
Critical Hdwy Stg 2	-	-	-	-	5.42	-
Follow-up Hdwy	-	-	2.218	-	3.518	3.318
Pot Cap-1 Maneuver	-	-	1546	-	833	1022
Stage 1	-	-	-	-	975	-
Stage 2	-	-	-	-	914	-
Platoon blocked, %	-	-	-	-	-	-
Mov Cap-1 Maneuver	-	-	1546	-	833	1022
Mov Cap-2 Maneuver	-	-	-	-	807	-
Stage 1	-	-	-	-	975	-
Stage 2	-	-	-	-	914	-

Approach	EB	WB	NB
HCM Control Delay, s	0	0	9.9
HCM LOS			A

Minor Lane/Major Mvmt	NBLn1	NBLn2	EBT	EBR	WBL	WBT
Capacity (veh/h)	807	-	-	-	1546	-
HCM Lane V/C Ratio	0.083	-	-	-	-	-
HCM Control Delay (s)	9.9	0	-	-	0	-
HCM Lane LOS	A	A	-	-	A	-
HCM 95th %tile Q(veh)	0.3	-	-	-	0	-

Intersection						
Int Delay, s/veh	5.7					
Movement	EBT	EBR	WBL	WBT	NBL	NBR
Lane Configurations						
Traffic Vol, veh/h	6	25	0	18	77	0
Future Vol, veh/h	6	25	0	18	77	0
Conflicting Peds, #/hr	0	0	0	0	0	0
Sign Control	Free	Free	Free	Free	Stop	Stop
RT Channelized	-	None	-	None	-	None
Storage Length	-	155	305	-	0	-
Veh in Median Storage, #	0	-	-	0	0	-
Grade, %	0	-	-	0	0	-
Peak Hour Factor	85	85	85	85	85	85
Heavy Vehicles, %	2	2	2	2	2	2
Mvmt Flow	7	29	0	21	91	0

Major/Minor	Major1	Major2	Minor1		
Conflicting Flow All	0	0	36	0	28
Stage 1	-	-	-	-	7
Stage 2	-	-	-	-	21
Critical Hdwy	-	-	4.12	-	6.42
Critical Hdwy Stg 1	-	-	-	-	5.42
Critical Hdwy Stg 2	-	-	-	-	5.42
Follow-up Hdwy	-	-	2.218	-	3.518
Pot Cap-1 Maneuver	-	-	1575	-	987
Stage 1	-	-	-	-	1016
Stage 2	-	-	-	-	1002
Platoon blocked, %	-	-	-	-	-
Mov Cap-1 Maneuver	-	-	1575	-	987
Mov Cap-2 Maneuver	-	-	-	-	910
Stage 1	-	-	-	-	1016
Stage 2	-	-	-	-	1002

Approach	EB	WB	NB
HCM Control Delay, s	0	0	9.4
HCM LOS			A

Minor Lane/Major Mvmt	NBLn1	EBT	EBR	WBL	WBT
Capacity (veh/h)	910	-	-	1575	-
HCM Lane V/C Ratio	0.1	-	-	-	-
HCM Control Delay (s)	9.4	-	-	0	-
HCM Lane LOS	A	-	-	A	-
HCM 95th %tile Q(veh)	0.3	-	-	0	-

Intersection						
Int Delay, s/veh	6.5					
Movement	EBT	EBR	WBL	WBT	NBL	NBR
Lane Configurations						
Traffic Vol, veh/h	0	6	0	0	18	0
Future Vol, veh/h	0	6	0	0	18	0
Conflicting Peds, #/hr	0	0	0	0	0	0
Sign Control	Free	Free	Free	Free	Stop	Stop
RT Channelized	-	None	-	None	-	None
Storage Length	-	-	305	-	0	0
Veh in Median Storage, #	0	-	-	0	0	-
Grade, %	0	-	-	0	0	-
Peak Hour Factor	85	85	85	85	85	85
Heavy Vehicles, %	2	2	2	2	2	2
Mvmt Flow	0	7	0	0	21	0

Major/Minor	Major1	Major2	Minor1		
Conflicting Flow All	0	0	7	0	5
Stage 1	-	-	-	-	4
Stage 2	-	-	-	-	1
Critical Hdwy	-	-	4.12	-	6.42
Critical Hdwy Stg 1	-	-	-	-	5.42
Critical Hdwy Stg 2	-	-	-	-	5.42
Follow-up Hdwy	-	-	2.218	-	3.518
Pot Cap-1 Maneuver	-	-	1614	-	1017
Stage 1	-	-	-	-	1019
Stage 2	-	-	-	-	1022
Platoon blocked, %	-	-	-	-	-
Mov Cap-1 Maneuver	-	-	1614	-	1017
Mov Cap-2 Maneuver	-	-	-	-	930
Stage 1	-	-	-	-	1019
Stage 2	-	-	-	-	1022

Approach	EB	WB	NB
HCM Control Delay, s	0	0	9
HCM LOS			A

Minor Lane/Major Mvmt	NBLn1	NBLn2	EBT	EBR	WBL	WBT
Capacity (veh/h)	930	-	-	-	1614	-
HCM Lane V/C Ratio	0.023	-	-	-	-	-
HCM Control Delay (s)	9	0	-	-	0	-
HCM Lane LOS	A	A	-	-	A	-
HCM 95th %tile Q(veh)	0.1	-	-	-	0	-

Intersection			
Intersection Delay, s/veh	3.8		
Intersection LOS	A		
Approach	WB	NB	SB
Entry Lanes	1	1	1
Conflicting Circle Lanes	2	2	2
Adj Approach Flow, veh/h	93	115	235
Demand Flow Rate, veh/h	94	118	240
Vehicles Circulating, veh/h	91	6	75
Vehicles Exiting, veh/h	33	309	110
Ped Vol Crossing Leg, #/h	0	0	0
Ped Cap Adj	1.000	1.000	1.000
Approach Delay, s/veh	3.3	3.3	4.3
Approach LOS	A	A	A
Lane	Left	Left	Left
Designated Moves	LR	TR	LT
Assumed Moves	LR	TR	LT
RT Channelized			
Lane Util	1.000	1.000	1.000
Follow-Up Headway, s	2.535	2.535	2.535
Critical Headway, s	4.328	4.328	4.328
Entry Flow, veh/h	94	118	240
Cap Entry Lane, veh/h	1314	1413	1332
Entry HV Adj Factor	0.989	0.976	0.981
Flow Entry, veh/h	93	115	235
Cap Entry, veh/h	1300	1380	1307
V/C Ratio	0.072	0.084	0.180
Control Delay, s/veh	3.3	3.3	4.3
LOS	A	A	A
95th %tile Queue, veh	0	0	1

Intersection						
Int Delay, s/veh	1.7					
Movement	WBL	WBR	NBT	NBR	SBL	SBT
Lane Configurations	Y		↑	↑	↑	↑
Traffic Vol, veh/h	52	13	85	18	4	254
Future Vol, veh/h	52	13	85	18	4	254
Conflicting Peds, #/hr	0	0	0	0	0	0
Sign Control	Stop	Stop	Free	Free	Free	Free
RT Channelized	-	None	-	None	-	None
Storage Length	0	-	-	155	205	-
Veh in Median Storage, #	0	-	0	-	-	0
Grade, %	0	-	0	-	-	0
Peak Hour Factor	85	85	85	85	85	85
Heavy Vehicles, %	2	2	2	2	2	2
Mvmt Flow	61	15	100	21	5	299

Major/Minor	Minor1	Major1	Major2		
Conflicting Flow All	409	100	0	0	121
Stage 1	100	-	-	-	-
Stage 2	309	-	-	-	-
Critical Hdwy	6.42	6.22	-	-	4.12
Critical Hdwy Stg 1	5.42	-	-	-	-
Critical Hdwy Stg 2	5.42	-	-	-	-
Follow-up Hdwy	3.518	3.318	-	-	2.218
Pot Cap-1 Maneuver	599	956	-	-	1467
Stage 1	924	-	-	-	-
Stage 2	745	-	-	-	-
Platoon blocked, %			-	-	-
Mov Cap-1 Maneuver	597	956	-	-	1467
Mov Cap-2 Maneuver	637	-	-	-	-
Stage 1	924	-	-	-	-
Stage 2	743	-	-	-	-

Approach	WB	NB	SB
HCM Control Delay, s	10.9	0	0.1
HCM LOS	B		

Minor Lane/Major Mvmt	NBT	NBRWBLn1	SBL	SBT
Capacity (veh/h)	-	-	683	1467
HCM Lane V/C Ratio	-	-	0.112	0.003
HCM Control Delay (s)	-	-	10.9	7.5
HCM Lane LOS	-	-	B	A
HCM 95th %tile Q(veh)	-	-	0.4	0

Intersection							
Intersection Delay, s/veh	5.6						
Intersection LOS	A						
Approach	EB		NB		SB		
Entry Lanes	2		2		2		
Conflicting Circle Lanes	2		2		2		
Adj Approach Flow, veh/h	337		496		360		
Demand Flow Rate, veh/h	344		506		368		
Vehicles Circulating, veh/h	339		9		393		
Vehicles Exiting, veh/h	422		674		122		
Ped Vol Crossing Leg, #/h	0		0		0		
Ped Cap Adj	1.000		1.000		1.000		
Approach Delay, s/veh	6.5		4.9		5.6		
Approach LOS	A		A		A		
Lane	Left	Right	Left	Right	Left	Right	
Designated Moves	L	TR	L	TR	LT	TR	
Assumed Moves	L	TR	L	TR	LT	TR	
RT Channelized							
Lane Util	0.026	0.974	0.777	0.223	0.470	0.530	
Follow-Up Headway, s	2.667	2.535	2.667	2.535	2.667	2.535	
Critical Headway, s	4.645	4.328	4.645	4.328	4.645	4.328	
Entry Flow, veh/h	9	335	393	113	173	195	
Cap Entry Lane, veh/h	988	1065	1339	1409	940	1017	
Entry HV Adj Factor	1.000	0.979	0.980	0.980	0.979	0.979	
Flow Entry, veh/h	9	328	385	111	169	191	
Cap Entry, veh/h	988	1042	1311	1382	921	996	
V/C Ratio	0.009	0.315	0.294	0.080	0.184	0.192	
Control Delay, s/veh	3.7	6.6	5.3	3.2	5.7	5.4	
LOS	A	A	A	A	A	A	
95th %tile Queue, veh	0	1	1	0	1	1	

Intersection						
Intersection Delay, s/veh	8.0					
Intersection LOS	A					
Approach	EB	WB	NB	SB		
Entry Lanes	1	1	1	1		
Conflicting Circle Lanes	1	1	1	1		
Adj Approach Flow, veh/h	322	359	396	660		
Demand Flow Rate, veh/h	328	367	404	673		
Vehicles Circulating, veh/h	566	429	484	289		
Vehicles Exiting, veh/h	259	459	410	319		
Ped Vol Crossing Leg, #/h	0	0	0	0		
Ped Cap Adj	1.000	1.000	1.000	1.000		
Approach Delay, s/veh	10.3	3.0	10.7	8.0		
Approach LOS	B	A	B	A		
Lane	Left	Left	Bypass	Left	Left	Bypass
Designated Moves	LTR	LT	R	LTR	LT	R
Assumed Moves	LTR	LT	R	LTR	LT	R
RT Channelized			Free			Free
Lane Util	1.000	1.000	1.000	1.000	1.000	
Follow-Up Headway, s	2.609	2.609	2.609	2.609	2.609	
Critical Headway, s	4.976	4.976	188	4.976	4.976	137
Entry Flow, veh/h	328	179	1938	404	536	1938
Cap Entry Lane, veh/h	775	891	0.980	842	1028	0.980
Entry HV Adj Factor	0.981	0.978	184	0.980	0.981	134
Flow Entry, veh/h	322	175	1900	396	526	1900
Cap Entry, veh/h	760	871	0.097	825	1008	0.071
V/C Ratio	0.423	0.201	0.0	0.480	0.522	0.0
Control Delay, s/veh	10.3	6.2	A	10.7	10.0	A
LOS	B	A	0	B	B	0
95th %tile Queue, veh	2	1		3	3	

Timings
14: US 24 & Stapleton Dr

2026 Total Traffic
AM Peak Hour

Lane Group	EBL	EBT	EBR	WBL	WBT	WBR	NBL	NBT	NBR	SBL	SBT	SBR
Lane Configurations												
Traffic Volume (vph)	53	224	290	4	107	17	124	280	5	45	470	43
Future Volume (vph)	53	224	290	4	107	17	124	280	5	45	470	43
Turn Type	pm+pt	NA	Free	pm+pt	NA	Free	pm+pt	NA	Perm	pm+pt	NA	Perm
Protected Phases	5	2		1	6		3	8		7	4	
Permitted Phases	2		Free	6		Free	8		8	4		4
Detector Phase	5	2		1	6		3	8	8	7	4	4
Switch Phase												
Minimum Initial (s)	5.0	10.0		5.0	5.0		5.0	5.0	5.0	5.0	15.0	15.0
Minimum Split (s)	10.0	15.0		13.0	10.0		25.0	10.0	10.0	25.0	20.0	20.0
Total Split (s)	12.0	30.0		12.0	30.0		12.0	66.0	66.0	12.0	66.0	66.0
Total Split (%)	10.0%	25.0%		10.0%	25.0%		10.0%	55.0%	55.0%	10.0%	55.0%	55.0%
Yellow Time (s)	3.0	3.0		3.0	3.0		3.0	3.0	3.0	3.0	3.0	3.0
All-Red Time (s)	2.0	2.0		2.0	2.0		2.0	2.0	2.0	2.0	2.0	2.0
Lost Time Adjust (s)	0.0	0.0		0.0	0.0		0.0	0.0	0.0	0.0	0.0	0.0
Total Lost Time (s)	5.0	5.0		5.0	5.0		5.0	5.0	5.0	5.0	5.0	5.0
Lead/Lag	Lead	Lag		Lead	Lag		Lead	Lag	Lag	Lead	Lag	Lag
Lead-Lag Optimize?	Yes	Yes		Yes	Yes		Yes	Yes	Yes	Yes	Yes	Yes
Recall Mode	None	C-Max		None	C-Max		None	Max	Max	None	Max	Max
Act Effct Green (s)	36.1	34.7	120.0	32.1	27.4	120.0	69.2	63.6	63.6	67.5	61.0	61.0
Actuated g/C Ratio	0.30	0.29	1.00	0.27	0.23	1.00	0.58	0.53	0.53	0.56	0.51	0.51
v/c Ratio	0.18	0.47	0.21	0.02	0.30	0.01	0.35	0.33	0.01	0.09	0.54	0.05
Control Delay	23.4	29.5	0.3	29.2	42.0	0.0	12.6	18.0	0.0	10.1	23.0	0.1
Queue Delay	0.0	0.0	0.0	0.0	0.0	0.0	0.0	0.0	0.0	0.0	0.0	0.0
Total Delay	23.4	29.5	0.3	29.2	42.0	0.0	12.6	18.0	0.0	10.1	23.0	0.1
LOS	C	C	A	C	D	A	B	B	A	B	C	A
Approach Delay		14.0			36.0			16.1			20.2	
Approach LOS		B			D			B			C	

Intersection Summary

Cycle Length: 120
 Actuated Cycle Length: 120
 Offset: 0 (0%), Referenced to phase 2:EBTL and 6:WBTL, Start of Green
 Natural Cycle: 90
 Control Type: Actuated-Coordinated
 Maximum v/c Ratio: 0.54
 Intersection Signal Delay: 18.3
 Intersection LOS: B
 Intersection Capacity Utilization 55.9%
 ICU Level of Service B
 Analysis Period (min) 15

Splits and Phases: 14: US 24 & Stapleton Dr

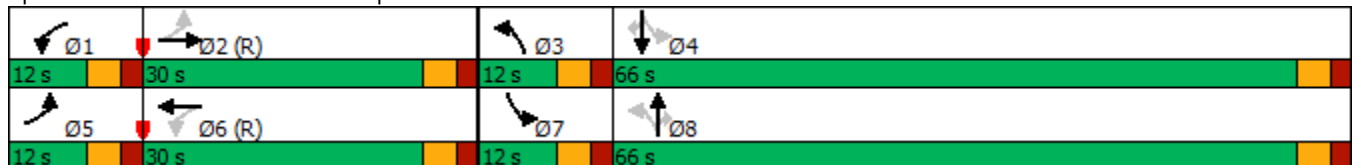

Intersection				
Intersection Delay, s/veh	4.1			
Intersection LOS	A			
Approach	EB	WB	NB	SB
Entry Lanes	1	1	1	1
Conflicting Circle Lanes	1	1	1	1
Adj Approach Flow, veh/h	108	114	257	22
Demand Flow Rate, veh/h	110	116	263	22
Vehicles Circulating, veh/h	112	132	38	215
Vehicles Exiting, veh/h	125	169	184	33
Ped Vol Crossing Leg, #/h	0	0	0	0
Ped Cap Adj	1.000	1.000	1.000	1.000
Approach Delay, s/veh	3.7	3.9	4.4	3.5
Approach LOS	A	A	A	A
Lane	Left	Left	Left	Left
Designated Moves	LTR	LTR	LTR	LTR
Assumed Moves	LTR	LTR	LTR	LTR
RT Channelized				
Lane Util	1.000	1.000	1.000	1.000
Follow-Up Headway, s	2.609	2.609	2.609	2.609
Critical Headway, s	4.976	4.976	4.976	4.976
Entry Flow, veh/h	110	116	263	22
Cap Entry Lane, veh/h	1231	1206	1327	1108
Entry HV Adj Factor	0.986	0.979	0.979	0.988
Flow Entry, veh/h	108	114	257	22
Cap Entry, veh/h	1213	1181	1299	1094
V/C Ratio	0.089	0.096	0.198	0.020
Control Delay, s/veh	3.7	3.9	4.4	3.5
LOS	A	A	A	A
95th %tile Queue, veh	0	0	1	0

Intersection						
Int Delay, s/veh	1.5					
Movement	EBT	EBR	WBL	WBT	NBL	NBR
Lane Configurations	↔		↔	↑	↔	↔
Traffic Vol, veh/h	88	53	0	61	36	0
Future Vol, veh/h	88	53	0	61	36	0
Conflicting Peds, #/hr	0	0	0	0	0	0
Sign Control	Free	Free	Free	Free	Stop	Stop
RT Channelized	-	None	-	None	-	None
Storage Length	-	-	155	-	205	0
Veh in Median Storage, #	0	-	-	0	0	-
Grade, %	0	-	-	0	0	-
Peak Hour Factor	83	83	83	83	83	83
Heavy Vehicles, %	2	2	2	2	2	2
Mvmt Flow	106	64	0	73	43	0

Major/Minor	Major1	Major2	Minor1		
Conflicting Flow All	0	0	170	0	211 138
Stage 1	-	-	-	-	138 -
Stage 2	-	-	-	-	73 -
Critical Hdwy	-	-	4.12	-	6.42 6.22
Critical Hdwy Stg 1	-	-	-	-	5.42 -
Critical Hdwy Stg 2	-	-	-	-	5.42 -
Follow-up Hdwy	-	-	2.218	-	3.518 3.318
Pot Cap-1 Maneuver	-	-	1407	-	777 910
Stage 1	-	-	-	-	889 -
Stage 2	-	-	-	-	950 -
Platoon blocked, %	-	-	-	-	-
Mov Cap-1 Maneuver	-	-	1407	-	777 910
Mov Cap-2 Maneuver	-	-	-	-	771 -
Stage 1	-	-	-	-	889 -
Stage 2	-	-	-	-	950 -

Approach	EB	WB	NB
HCM Control Delay, s	0	0	9.9
HCM LOS			A

Minor Lane/Major Mvmt	NBLn1	NBLn2	EBT	EBR	WBL	WBT
Capacity (veh/h)	771	-	-	-	1407	-
HCM Lane V/C Ratio	0.056	-	-	-	-	-
HCM Control Delay (s)	9.9	0	-	-	0	-
HCM Lane LOS	A	A	-	-	A	-
HCM 95th %tile Q(veh)	0.2	-	-	-	0	-

Intersection						
Int Delay, s/veh	3.1					
Movement	EBT	EBR	WBL	WBT	NBL	NBR
Lane Configurations						
Traffic Vol, veh/h	16	71	0	11	49	0
Future Vol, veh/h	16	71	0	11	49	0
Conflicting Peds, #/hr	0	0	0	0	0	0
Sign Control	Free	Free	Free	Free	Stop	Stop
RT Channelized	-	None	-	None	-	None
Storage Length	-	155	305	-	0	-
Veh in Median Storage, #	0	-	-	0	0	-
Grade, %	0	-	-	0	0	-
Peak Hour Factor	83	83	83	83	83	83
Heavy Vehicles, %	2	2	2	2	2	2
Mvmt Flow	19	86	0	13	59	0

Major/Minor	Major1	Major2	Minor1		
Conflicting Flow All	0	0	105	0	32
Stage 1	-	-	-	-	19
Stage 2	-	-	-	-	13
Critical Hdwy	-	-	4.12	-	6.42
Critical Hdwy Stg 1	-	-	-	-	5.42
Critical Hdwy Stg 2	-	-	-	-	5.42
Follow-up Hdwy	-	-	2.218	-	3.518
Pot Cap-1 Maneuver	-	-	1486	-	982
Stage 1	-	-	-	-	1004
Stage 2	-	-	-	-	1010
Platoon blocked, %	-	-	-	-	-
Mov Cap-1 Maneuver	-	-	1486	-	982
Mov Cap-2 Maneuver	-	-	-	-	908
Stage 1	-	-	-	-	1004
Stage 2	-	-	-	-	1010

Approach	EB	WB	NB
HCM Control Delay, s	0	0	9.2
HCM LOS			A

Minor Lane/Major Mvmt	NBLn1	EBT	EBR	WBL	WBT
Capacity (veh/h)	908	-	-	1486	-
HCM Lane V/C Ratio	0.065	-	-	-	-
HCM Control Delay (s)	9.2	-	-	0	-
HCM Lane LOS	A	-	-	A	-
HCM 95th %tile Q(veh)	0.2	-	-	0	-

Intersection						
Int Delay, s/veh	3.5					
Movement	EBT	EBR	WBL	WBT	NBL	NBR
Lane Configurations						
Traffic Vol, veh/h	0	16	0	0	11	0
Future Vol, veh/h	0	16	0	0	11	0
Conflicting Peds, #/hr	0	0	0	0	0	0
Sign Control	Free	Free	Free	Free	Stop	Stop
RT Channelized	-	None	-	None	-	None
Storage Length	-	-	305	-	0	0
Veh in Median Storage, #	0	-	-	0	0	-
Grade, %	0	-	-	0	0	-
Peak Hour Factor	83	83	83	83	83	83
Heavy Vehicles, %	2	2	2	2	2	2
Mvmt Flow	0	19	0	0	13	0

Major/Minor	Major1	Major2	Minor1	Minor2	Minor3
Conflicting Flow All	0	0	19	0	11
Stage 1	-	-	-	-	10
Stage 2	-	-	-	-	1
Critical Hdwy	-	-	4.12	-	6.42
Critical Hdwy Stg 1	-	-	-	-	5.42
Critical Hdwy Stg 2	-	-	-	-	5.42
Follow-up Hdwy	-	-	2.218	-	3.518
Pot Cap-1 Maneuver	-	-	1597	-	1009
Stage 1	-	-	-	-	1013
Stage 2	-	-	-	-	1022
Platoon blocked, %	-	-	-	-	-
Mov Cap-1 Maneuver	-	-	1597	-	1009
Mov Cap-2 Maneuver	-	-	-	-	924
Stage 1	-	-	-	-	1013
Stage 2	-	-	-	-	1022

Approach	EB	WB	NB
HCM Control Delay, s	0	0	9
HCM LOS			A

Minor Lane/Major Mvmt	NBLn1	NBLn2	EBT	EBR	WBL	WBT
Capacity (veh/h)	924	-	-	-	1597	-
HCM Lane V/C Ratio	0.014	-	-	-	-	-
HCM Control Delay (s)	9	0	-	-	0	-
HCM Lane LOS	A	A	-	-	A	-
HCM 95th %tile Q(veh)	0	-	-	-	0	-

Intersection			
Intersection Delay, s/veh	4.3		
Intersection LOS	A		
Approach	WB	NB	SB
Entry Lanes	1	1	1
Conflicting Circle Lanes	2	2	2
Adj Approach Flow, veh/h	64	338	185
Demand Flow Rate, veh/h	65	345	188
Vehicles Circulating, veh/h	256	20	53
Vehicles Exiting, veh/h	109	221	268
Ped Vol Crossing Leg, #/h	0	0	0
Ped Cap Adj	1.000	1.000	1.000
Approach Delay, s/veh	3.7	4.7	3.8
Approach LOS	A	A	A
Lane	Left	Left	Left
Designated Moves	LR	TR	LT
Assumed Moves	LR	TR	LT
RT Channelized			
Lane Util	1.000	1.000	1.000
Follow-Up Headway, s	2.535	2.535	2.535
Critical Headway, s	4.328	4.328	4.328
Entry Flow, veh/h	65	345	188
Cap Entry Lane, veh/h	1142	1396	1358
Entry HV Adj Factor	0.985	0.980	0.982
Flow Entry, veh/h	64	338	185
Cap Entry, veh/h	1125	1368	1334
V/C Ratio	0.057	0.247	0.138
Control Delay, s/veh	3.7	4.7	3.8
LOS	A	A	A
95th %tile Queue, veh	0	1	0

Intersection						
Int Delay, s/veh	1.1					
Movement	WBL	WBR	NBT	NBR	SBL	SBT
Lane Configurations	Y		↑	↑	↑	↑
Traffic Vol, veh/h	32	10	270	56	16	163
Future Vol, veh/h	32	10	270	56	16	163
Conflicting Peds, #/hr	0	0	0	0	0	0
Sign Control	Stop	Stop	Free	Free	Free	Free
RT Channelized	-	None	-	None	-	None
Storage Length	0	-	-	155	205	-
Veh in Median Storage, #	0	-	0	-	-	0
Grade, %	0	-	0	-	-	0
Peak Hour Factor	83	83	83	83	83	83
Heavy Vehicles, %	2	2	2	2	2	2
Mvmt Flow	39	12	325	67	19	196

Major/Minor	Minor1	Major1	Major2		
Conflicting Flow All	559	325	0	0	392
Stage 1	325	-	-	-	-
Stage 2	234	-	-	-	-
Critical Hdwy	6.42	6.22	-	-	4.12
Critical Hdwy Stg 1	5.42	-	-	-	-
Critical Hdwy Stg 2	5.42	-	-	-	-
Follow-up Hdwy	3.518	3.318	-	-	2.218
Pot Cap-1 Maneuver	490	716	-	-	1167
Stage 1	732	-	-	-	-
Stage 2	805	-	-	-	-
Platoon blocked, %			-	-	-
Mov Cap-1 Maneuver	482	716	-	-	1167
Mov Cap-2 Maneuver	566	-	-	-	-
Stage 1	732	-	-	-	-
Stage 2	792	-	-	-	-

Approach	WB	NB	SB
HCM Control Delay, s	11.6	0	0.7
HCM LOS	B		

Minor Lane/Major Mvmt	NBT	NBRWBLn1	SBL	SBT
Capacity (veh/h)	-	-	596	1167
HCM Lane V/C Ratio	-	-	0.085	0.017
HCM Control Delay (s)	-	-	11.6	8.1
HCM Lane LOS	-	-	B	A
HCM 95th %tile Q(veh)	-	-	0.3	0.1

Intersection						
Intersection Delay, s/veh	5.1					
Intersection LOS	A					
Approach	EB		NB		SB	
Entry Lanes	2		2		2	
Conflicting Circle Lanes	2		2		2	
Adj Approach Flow, veh/h	237		757		229	
Demand Flow Rate, veh/h	242		772		233	
Vehicles Circulating, veh/h	219		25		406	
Vehicles Exiting, veh/h	420		435		391	
Ped Vol Crossing Leg, #/h	0		0		0	
Ped Cap Adj	1.000		1.000		1.000	
Approach Delay, s/veh	4.6		5.2		4.9	
Approach LOS	A		A		A	
Lane	Left	Right	Left	Right	Left	Right
Designated Moves	L	TR	L	TR	LT	TR
Assumed Moves	L	TR	L	TR	LT	TR
RT Channelized						
Lane Util	0.107	0.893	0.526	0.474	0.472	0.528
Follow-Up Headway, s	2.667	2.535	2.667	2.535	2.667	2.535
Critical Headway, s	4.645	4.328	4.645	4.328	4.645	4.328
Entry Flow, veh/h	26	216	406	366	110	123
Cap Entry Lane, veh/h	1104	1179	1319	1390	929	1006
Entry HV Adj Factor	0.962	0.981	0.980	0.980	0.977	0.985
Flow Entry, veh/h	25	212	398	359	107	121
Cap Entry, veh/h	1061	1157	1293	1363	908	991
V/C Ratio	0.024	0.183	0.308	0.263	0.118	0.122
Control Delay, s/veh	3.6	4.7	5.6	4.9	5.1	4.7
LOS	A	A	A	A	A	A
95th %tile Queue, veh	0	1	1	1	0	0

Intersection						
Intersection Delay, s/veh	5.8					
Intersection LOS	A					
Approach	EB	WB	NB	SB		
Entry Lanes	1	1	1	1		
Conflicting Circle Lanes	1	1	1	1		
Adj Approach Flow, veh/h	293	522	369	394		
Demand Flow Rate, veh/h	300	532	377	401		
Vehicles Circulating, veh/h	350	472	427	284		
Vehicles Exiting, veh/h	260	332	222	414		
Ped Vol Crossing Leg, #/h	0	0	0	0		
Ped Cap Adj	1.000	1.000	1.000	1.000		
Approach Delay, s/veh	7.1	3.0	9.2	5.5		
Approach LOS	A	A	A	A		
Lane	Left	Left	Bypass	Left	Left	Bypass
Designated Moves	LTR	LT	R	LTR	LT	R
Assumed Moves	LTR	LT	R	LTR	LT	R
RT Channelized			Free			Free
Lane Util	1.000	1.000	1.000	1.000	1.000	
Follow-Up Headway, s	2.609	2.609	2.609	2.609	2.609	
Critical Headway, s	4.976	4.976	306	4.976	4.976	75
Entry Flow, veh/h	300	226	1938	377	326	1938
Cap Entry Lane, veh/h	966	853	0.980	893	1033	0.980
Entry HV Adj Factor	0.978	0.982	300	0.980	0.981	74
Flow Entry, veh/h	293	222	1900	369	320	1900
Cap Entry, veh/h	945	838	0.158	875	1014	0.039
V/C Ratio	0.311	0.265	0.0	0.422	0.316	0.0
Control Delay, s/veh	7.1	7.2	A	9.2	6.8	A
LOS	A	A	1	A	A	0
95th %tile Queue, veh	1	1		2	1	

Timings
14: US 24 & Stapleton Dr

2026 Total Traffic
PM Peak Hour

Lane Group	EBL	EBT	EBR	WBL	WBT	WBR	NBL	NBT	NBR	SBL	SBT	SBR
Lane Configurations												
Traffic Volume (vph)	31	92	161	5	200	34	283	517	8	10	409	52
Future Volume (vph)	31	92	161	5	200	34	283	517	8	10	409	52
Turn Type	pm+pt	NA	Free	pm+pt	NA	Free	pm+pt	NA	Perm	pm+pt	NA	Perm
Protected Phases	5	2		1	6		3	8		7	4	
Permitted Phases	2		Free	6		Free	8		8	4		4
Detector Phase	5	2		1	6		3	8	8	7	4	4
Switch Phase												
Minimum Initial (s)	5.0	5.0		5.0	5.0		5.0	5.0	5.0	5.0	15.0	15.0
Minimum Split (s)	10.0	10.0		10.0	10.0		10.0	10.0	10.0	10.0	20.0	20.0
Total Split (s)	12.0	30.0		12.0	30.0		12.0	66.0	66.0	12.0	66.0	66.0
Total Split (%)	10.0%	25.0%		10.0%	25.0%		10.0%	55.0%	55.0%	10.0%	55.0%	55.0%
Yellow Time (s)	3.0	3.0		3.0	3.0		3.0	3.0	3.0	3.0	3.0	3.0
All-Red Time (s)	2.0	2.0		2.0	2.0		2.0	2.0	2.0	2.0	2.0	2.0
Lost Time Adjust (s)	0.0	0.0		0.0	0.0		0.0	0.0	0.0	0.0	0.0	0.0
Total Lost Time (s)	5.0	5.0		5.0	5.0		5.0	5.0	5.0	5.0	5.0	5.0
Lead/Lag	Lead	Lag		Lead	Lag		Lead	Lag	Lag	Lead	Lag	Lag
Lead-Lag Optimize?	Yes	Yes		Yes	Yes		Yes	Yes	Yes	Yes	Yes	Yes
Recall Mode	None	C-Max		None	C-Max		None	Max	Max	None	Max	Max
Act Effct Green (s)	36.1	34.7	120.0	33.5	29.8	120.0	72.1	70.7	70.7	66.8	61.0	61.0
Actuated g/C Ratio	0.30	0.29	1.00	0.28	0.25	1.00	0.60	0.59	0.59	0.56	0.51	0.51
v/c Ratio	0.15	0.20	0.12	0.02	0.52	0.03	0.71	0.55	0.01	0.03	0.50	0.07
Control Delay	25.2	28.2	0.1	29.2	45.4	0.0	23.5	18.1	0.0	10.1	22.1	0.4
Queue Delay	0.0	0.0	0.0	0.0	0.0	0.0	0.0	0.0	0.0	0.0	0.0	0.0
Total Delay	25.2	28.2	0.1	29.2	45.4	0.0	23.5	18.1	0.0	10.1	22.1	0.4
LOS	C	C	A	C	D	A	C	B	A	B	C	A
Approach Delay		12.0			38.6			19.8			19.4	
Approach LOS		B			D			B			B	

Intersection Summary

Cycle Length: 120
 Actuated Cycle Length: 120
 Offset: 0 (0%), Referenced to phase 2:EBTL and 6:WBTL, Start of Green
 Natural Cycle: 60
 Control Type: Actuated-Coordinated
 Maximum v/c Ratio: 0.71
 Intersection Signal Delay: 21.0 Intersection LOS: C
 Intersection Capacity Utilization 68.6% ICU Level of Service C
 Analysis Period (min) 15

Splits and Phases: 14: US 24 & Stapleton Dr

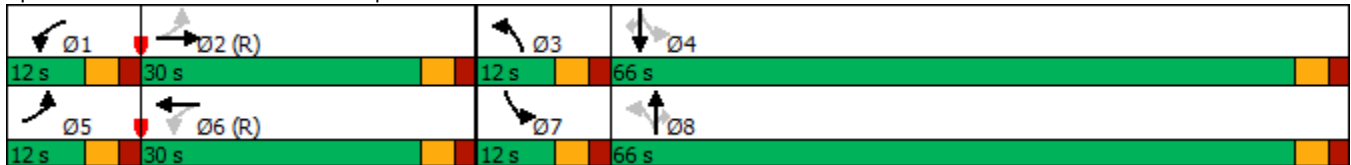

Intersection				
Intersection Delay, s/veh	5.8			
Intersection LOS	A			
Approach	EB	WB	NB	SB
Entry Lanes	1	1	1	1
Conflicting Circle Lanes	1	1	1	1
Adj Approach Flow, veh/h	363	309	279	39
Demand Flow Rate, veh/h	370	315	284	40
Vehicles Circulating, veh/h	241	166	48	444
Vehicles Exiting, veh/h	243	166	563	37
Ped Vol Crossing Leg, #/h	0	0	0	0
Ped Cap Adj	1.000	1.000	1.000	1.000
Approach Delay, s/veh	6.9	5.7	4.6	4.6
Approach LOS	A	A	A	A
Lane	Left	Left	Left	Left
Designated Moves	LTR	LTR	LTR	LTR
Assumed Moves	LTR	LTR	LTR	LTR
RT Channelized				
Lane Util	1.000	1.000	1.000	1.000
Follow-Up Headway, s	2.609	2.609	2.609	2.609
Critical Headway, s	4.976	4.976	4.976	4.976
Entry Flow, veh/h	370	315	284	40
Cap Entry Lane, veh/h	1079	1165	1314	877
Entry HV Adj Factor	0.982	0.981	0.981	0.984
Flow Entry, veh/h	363	309	279	39
Cap Entry, veh/h	1060	1143	1289	863
V/C Ratio	0.343	0.270	0.216	0.046
Control Delay, s/veh	6.9	5.7	4.6	4.6
LOS	A	A	A	A
95th %tile Queue, veh	2	1	1	0

Intersection

Int Delay, s/veh 1.4

Movement	EBT	EBR	WBL	WBT	NBL	NBR
Lane Configurations	↔		↔	↑	↔	↔
Traffic Vol, veh/h	80	59	0	211	51	0
Future Vol, veh/h	80	59	0	211	51	0
Conflicting Peds, #/hr	0	0	0	0	0	0
Sign Control	Free	Free	Free	Free	Stop	Stop
RT Channelized	-	None	-	None	-	None
Storage Length	-	-	155	-	205	0
Veh in Median Storage, #	0	-	-	0	0	-
Grade, %	0	-	-	0	0	-
Peak Hour Factor	85	85	85	85	85	85
Heavy Vehicles, %	2	2	2	2	2	2
Mvmt Flow	94	69	0	248	60	0

Major/Minor

	Major1	Major2	Minor1			
Conflicting Flow All	0	0	163	0	377	129
Stage 1	-	-	-	-	129	-
Stage 2	-	-	-	-	248	-
Critical Hdwy	-	-	4.12	-	6.42	6.22
Critical Hdwy Stg 1	-	-	-	-	5.42	-
Critical Hdwy Stg 2	-	-	-	-	5.42	-
Follow-up Hdwy	-	-	2.218	-	3.518	3.318
Pot Cap-1 Maneuver	-	-	1416	-	625	921
Stage 1	-	-	-	-	897	-
Stage 2	-	-	-	-	793	-
Platoon blocked, %	-	-	-	-	-	-
Mov Cap-1 Maneuver	-	-	1416	-	625	921
Mov Cap-2 Maneuver	-	-	-	-	665	-
Stage 1	-	-	-	-	897	-
Stage 2	-	-	-	-	793	-

Approach

	EB	WB	NB
HCM Control Delay, s	0	0	11
HCM LOS			B

Minor Lane/Major Mvmt

	NBLn1	NBLn2	EBT	EBR	WBL	WBT
Capacity (veh/h)	665	-	-	-	1416	-
HCM Lane V/C Ratio	0.09	-	-	-	-	-
HCM Control Delay (s)	11	0	-	-	0	-
HCM Lane LOS	B	A	-	-	A	-
HCM 95th %tile Q(veh)	0.3	-	-	-	0	-

Intersection

Int Delay, s/veh 1.2

Movement	EBT	EBR	WBL	WBT	NBL	NBR
Lane Configurations						
Traffic Vol, veh/h	59	21	0	176	35	0
Future Vol, veh/h	59	21	0	176	35	0
Conflicting Peds, #/hr	0	0	0	0	0	0
Sign Control	Free	Free	Free	Free	Stop	Stop
RT Channelized	-	None	-	None	-	None
Storage Length	-	155	305	-	0	-
Veh in Median Storage, #	0	-	-	0	0	-
Grade, %	0	-	-	0	0	-
Peak Hour Factor	85	85	85	85	85	85
Heavy Vehicles, %	2	2	2	2	2	2
Mvmt Flow	69	25	0	207	41	0

Major/Minor

	Major1	Major2	Minor1		
Conflicting Flow All	0	0	94	0	276
Stage 1	-	-	-	-	69
Stage 2	-	-	-	-	207
Critical Hdwy	-	-	4.12	-	6.42
Critical Hdwy Stg 1	-	-	-	-	5.42
Critical Hdwy Stg 2	-	-	-	-	5.42
Follow-up Hdwy	-	-	2.218	-	3.518
Pot Cap-1 Maneuver	-	-	1500	-	714
Stage 1	-	-	-	-	954
Stage 2	-	-	-	-	828
Platoon blocked, %	-	-	-	-	-
Mov Cap-1 Maneuver	-	-	1500	-	714
Mov Cap-2 Maneuver	-	-	-	-	722
Stage 1	-	-	-	-	954
Stage 2	-	-	-	-	828

Approach

	EB	WB	NB
HCM Control Delay, s	0	0	10.3
HCM LOS			B

Minor Lane/Major Mvmt

	NBLn1	EBT	EBR	WBL	WBT
Capacity (veh/h)	722	-	-	1500	-
HCM Lane V/C Ratio	0.057	-	-	-	-
HCM Control Delay (s)	10.3	-	-	0	-
HCM Lane LOS	B	-	-	A	-
HCM 95th %tile Q(veh)	0.2	-	-	0	-

Intersection

Int Delay, s/veh 4.1

Movement	EBT	EBR	WBL	WBT	NBL	NBR
Lane Configurations	↔		↔	↑	↔	↔
Traffic Vol, veh/h	27	32	0	81	95	0
Future Vol, veh/h	27	32	0	81	95	0
Conflicting Peds, #/hr	0	0	0	0	0	0
Sign Control	Free	Free	Free	Free	Stop	Stop
RT Channelized	-	None	-	None	-	None
Storage Length	-	-	305	-	0	0
Veh in Median Storage, #	0	-	-	0	0	-
Grade, %	0	-	-	0	0	-
Peak Hour Factor	85	85	85	85	85	85
Heavy Vehicles, %	2	2	2	2	2	2
Mvmt Flow	32	38	0	95	112	0

Major/Minor

	Major1	Major2	Minor1		
Conflicting Flow All	0	0	70	0	146
Stage 1	-	-	-	-	51
Stage 2	-	-	-	-	95
Critical Hdwy	-	-	4.12	-	6.42
Critical Hdwy Stg 1	-	-	-	-	5.42
Critical Hdwy Stg 2	-	-	-	-	5.42
Follow-up Hdwy	-	-	2.218	-	3.518
Pot Cap-1 Maneuver	-	-	1531	-	846
Stage 1	-	-	-	-	971
Stage 2	-	-	-	-	929
Platoon blocked, %	-	-	-	-	-
Mov Cap-1 Maneuver	-	-	1531	-	846
Mov Cap-2 Maneuver	-	-	-	-	818
Stage 1	-	-	-	-	971
Stage 2	-	-	-	-	929

Approach

	EB	WB	NB
HCM Control Delay, s	0	0	10.1
HCM LOS			B

Minor Lane/Major Mvmt

	NBLn1	NBLn2	EBT	EBR	WBL	WBT
Capacity (veh/h)	818	-	-	-	1531	-
HCM Lane V/C Ratio	0.137	-	-	-	-	-
HCM Control Delay (s)	10.1	0	-	-	0	-
HCM Lane LOS	B	A	-	-	A	-
HCM 95th %tile Q(veh)	0.5	-	-	-	0	-

Intersection			
Intersection Delay, s/veh	2.9		
Intersection LOS	A		
Approach	EB	WB	NB
Entry Lanes	1	0	0
Conflicting Circle Lanes	1	1	1
Adj Approach Flow, veh/h	32	0	0
Demand Flow Rate, veh/h	33	0	0
Vehicles Circulating, veh/h	0	97	0
Vehicles Exiting, veh/h	97	0	33
Ped Vol Crossing Leg, #/h	0	0	0
Ped Cap Adj	1.000	1.000	1.000
Approach Delay, s/veh	2.9	0.0	0.0
Approach LOS	A	-	-
Lane	Left	Bypass	
Designated Moves	TR	R	
Assumed Moves	TR	R	
RT Channelized		Yield	
Lane Util	1.000		
Follow-Up Headway, s	2.609		
Critical Headway, s	4.976	0	
Entry Flow, veh/h	33	0	
Cap Entry Lane, veh/h	1380	0.980	
Entry HV Adj Factor	0.970	0	
Flow Entry, veh/h	32	0	
Cap Entry, veh/h	1338	0.000	
V/C Ratio	0.024	0.0	
Control Delay, s/veh	2.9	-	
LOS	A	0	
95th %tile Queue, veh	0		

Intersection			
Intersection Delay, s/veh	7.7		
Intersection LOS	A		
Approach	WB	NB	SB
Entry Lanes	1	1	1
Conflicting Circle Lanes	2	2	2
Adj Approach Flow, veh/h	378	344	554
Demand Flow Rate, veh/h	386	351	565
Vehicles Circulating, veh/h	260	8	360
Vehicles Exiting, veh/h	99	917	285
Ped Vol Crossing Leg, #/h	0	0	0
Ped Cap Adj	1.000	1.000	1.000
Approach Delay, s/veh	6.6	4.7	10.3
Approach LOS	A	A	B
Lane	Left	Left	Left
Designated Moves	LR	TR	LT
Assumed Moves	LR	TR	LT
RT Channelized			
Lane Util	1.000	1.000	1.000
Follow-Up Headway, s	2.535	2.535	2.535
Critical Headway, s	4.328	4.328	4.328
Entry Flow, veh/h	386	351	565
Cap Entry Lane, veh/h	1138	1410	1046
Entry HV Adj Factor	0.979	0.980	0.981
Flow Entry, veh/h	378	344	554
Cap Entry, veh/h	1115	1382	1025
V/C Ratio	0.339	0.249	0.540
Control Delay, s/veh	6.6	4.7	10.3
LOS	A	A	B
95th %tile Queue, veh	2	1	3

Intersection						
Int Delay, s/veh	1.1					
Movement	WBL	WBR	NBT	NBR	SBL	SBT
Lane Configurations	↘↙		↑	↗↘	↘↙	↑
Traffic Vol, veh/h	52	13	280	18	4	759
Future Vol, veh/h	52	13	280	18	4	759
Conflicting Peds, #/hr	0	0	0	0	0	0
Sign Control	Stop	Stop	Free	Free	Free	Free
RT Channelized	-	None	-	None	-	None
Storage Length	0	-	-	155	205	-
Veh in Median Storage, #	0	-	0	-	-	0
Grade, %	0	-	0	-	-	0
Peak Hour Factor	85	85	85	85	85	85
Heavy Vehicles, %	2	2	2	2	2	2
Mvmt Flow	61	15	329	21	5	893

Major/Minor	Minor1	Major1	Major2		
Conflicting Flow All	1232	329	0	0	350
Stage 1	329	-	-	-	-
Stage 2	903	-	-	-	-
Critical Hdwy	6.42	6.22	-	-	4.12
Critical Hdwy Stg 1	5.42	-	-	-	-
Critical Hdwy Stg 2	5.42	-	-	-	-
Follow-up Hdwy	3.518	3.318	-	-	2.218
Pot Cap-1 Maneuver	196	712	-	-	1209
Stage 1	729	-	-	-	-
Stage 2	396	-	-	-	-
Platoon blocked, %			-	-	-
Mov Cap-1 Maneuver	195	712	-	-	1209
Mov Cap-2 Maneuver	310	-	-	-	-
Stage 1	729	-	-	-	-
Stage 2	394	-	-	-	-

Approach	WB	NB	SB
HCM Control Delay, s	18.2	0	0
HCM LOS	C		

Minor Lane/Major Mvmt	NBT	NBRWBLn1	SBL	SBT
Capacity (veh/h)	-	-	349	1209
HCM Lane V/C Ratio	-	-	0.219	0.004
HCM Control Delay (s)	-	-	18.2	8
HCM Lane LOS	-	-	C	A
HCM 95th %tile Q(veh)	-	-	0.8	0

Intersection						
Intersection Delay, s/veh	9.0					
Intersection LOS	A					
Approach	EB		NB		SB	
Entry Lanes	2		2		2	
Conflicting Circle Lanes	2		2		2	
Adj Approach Flow, veh/h	383		708		954	
Demand Flow Rate, veh/h	391		722		973	
Vehicles Circulating, veh/h	891		40		404	
Vehicles Exiting, veh/h	486		1242		358	
Ped Vol Crossing Leg, #/h	0		0		0	
Ped Cap Adj	1.000		1.000		1.000	
Approach Delay, s/veh	13.4		5.2		10.1	
Approach LOS	B		A		B	
Lane	Left	Right	Left	Right	Left	Right
Designated Moves	L	TR	L	TR	LT	TR
Assumed Moves	L	TR	L	TR	LT	TR
RT Channelized						
Lane Util	0.102	0.898	0.560	0.440	0.470	0.530
Follow-Up Headway, s	2.667	2.535	2.667	2.535	2.667	2.535
Critical Headway, s	4.645	4.328	4.645	4.328	4.645	4.328
Entry Flow, veh/h	40	351	404	318	457	516
Cap Entry Lane, veh/h	595	666	1301	1373	931	1007
Entry HV Adj Factor	0.975	0.980	0.980	0.980	0.981	0.979
Flow Entry, veh/h	39	344	396	312	448	505
Cap Entry, veh/h	580	653	1275	1346	913	987
V/C Ratio	0.067	0.527	0.311	0.232	0.491	0.512
Control Delay, s/veh	7.0	14.1	5.6	4.6	10.1	10.0
LOS	A	B	A	A	B	A
95th %tile Queue, veh	0	3	1	1	3	3

Intersection									
Intersection Delay, s/veh 17.0									
Intersection LOS C									
Approach	EB		WB			NB		SB	
Entry Lanes	2		2			1		1	
Conflicting Circle Lanes	2		2			2		2	
Adj Approach Flow, veh/h	468		485			485		1216	
Demand Flow Rate, veh/h	478		495			495		1240	
Vehicles Circulating, veh/h	992		568			845		340	
Vehicles Exiting, veh/h	308		772			625		437	
Ped Vol Crossing Leg, #/h	0		0			0		0	
Ped Cap Adj	1.000		1.000			1.000		1.000	
Approach Delay, s/veh	12.9		2.4			21.1		22.8	
Approach LOS	B		A			C		C	
Lane	Left	Right	Left	Right	Bypass	Left	Left	Bypass	
Designated Moves	LT	TR	LT	TR	R	LTR	LT	R	
Assumed Moves	LT	TR	LT	TR	R	LTR	LT	R	
RT Channelized			Free					Free	
Lane Util	0.471	0.529	0.469	0.531	1.000	1.000	1.000		
Follow-Up Headway, s	2.667	2.535	2.667	2.535	2.535	2.535	2.535		
Critical Headway, s	4.645	4.328	4.645	4.328	286	4.328	4.328	280	
Entry Flow, veh/h	225	253	98	111	1938	495	960	1938	
Cap Entry Lane, veh/h	542	611	801	876	0.980	692	1064	0.980	
Entry HV Adj Factor	0.978	0.981	0.981	0.977	280	0.979	0.980	275	
Flow Entry, veh/h	220	248	96	108	1900	485	941	1900	
Cap Entry, veh/h	530	600	785	856	0.147	678	1043	0.145	
V/C Ratio	0.415	0.414	0.122	0.127	0.0	0.715	0.903	0.0	
Control Delay, s/veh	13.6	12.3	5.8	5.4	A	21.1	29.4	A	
LOS	B	B	A	A	1	C	D	1	
95th %tile Queue, veh	2	2	0	0		6	13		

Intersection				
Intersection Delay, s/veh	8.6			
Intersection LOS	A			
Approach	EB	WB	NB	SB
Entry Lanes	1	1	1	1
Conflicting Circle Lanes	1	1	1	1
Adj Approach Flow, veh/h	357	218	714	47
Demand Flow Rate, veh/h	364	222	728	48
Vehicles Circulating, veh/h	183	431	131	591
Vehicles Exiting, veh/h	455	428	416	62
Ped Vol Crossing Leg, #/h	0	0	0	0
Ped Cap Adj	1.000	1.000	1.000	1.000
Approach Delay, s/veh	6.3	6.7	10.6	5.5
Approach LOS	A	A	B	A
Lane	Left	Left	Left	Left
Designated Moves	LTR	LTR	LTR	LTR
Assumed Moves	LTR	LTR	LTR	LTR
RT Channelized				
Lane Util	1.000	1.000	1.000	1.000
Follow-Up Headway, s	2.609	2.609	2.609	2.609
Critical Headway, s	4.976	4.976	4.976	4.976
Entry Flow, veh/h	364	222	728	48
Cap Entry Lane, veh/h	1145	889	1207	755
Entry HV Adj Factor	0.980	0.980	0.981	0.989
Flow Entry, veh/h	357	218	714	47
Cap Entry, veh/h	1123	872	1184	747
V/C Ratio	0.318	0.250	0.603	0.064
Control Delay, s/veh	6.3	6.7	10.6	5.5
LOS	A	A	B	A
95th %tile Queue, veh	1	1	4	0

Intersection						
Int Delay, s/veh	1.1					
Movement	EBT	EBR	WBL	WBT	NBL	NBR
Lane Configurations	↔		↔	↑	↔	↔
Traffic Vol, veh/h	254	103	0	139	48	0
Future Vol, veh/h	254	103	0	139	48	0
Conflicting Peds, #/hr	0	0	0	0	0	0
Sign Control	Free	Free	Free	Free	Stop	Stop
RT Channelized	-	None	-	None	-	None
Storage Length	-	-	155	-	205	0
Veh in Median Storage, #	0	-	-	0	0	-
Grade, %	0	-	-	0	0	-
Peak Hour Factor	83	83	83	83	83	83
Heavy Vehicles, %	2	2	2	2	2	2
Mvmt Flow	306	124	0	167	58	0

Major/Minor	Major1	Major2	Minor1		
Conflicting Flow All	0	0	430	0	535 368
Stage 1	-	-	-	-	368 -
Stage 2	-	-	-	-	167 -
Critical Hdwy	-	-	4.12	-	6.42 6.22
Critical Hdwy Stg 1	-	-	-	-	5.42 -
Critical Hdwy Stg 2	-	-	-	-	5.42 -
Follow-up Hdwy	-	-	2.218	-	3.518 3.318
Pot Cap-1 Maneuver	-	-	1129	-	506 677
Stage 1	-	-	-	-	700 -
Stage 2	-	-	-	-	863 -
Platoon blocked, %	-	-	-	-	-
Mov Cap-1 Maneuver	-	-	1129	-	506 677
Mov Cap-2 Maneuver	-	-	-	-	577 -
Stage 1	-	-	-	-	700 -
Stage 2	-	-	-	-	863 -

Approach	EB	WB	NB
HCM Control Delay, s	0	0	11.9
HCM LOS			B

Minor Lane/Major Mvmt	NBLn1	NBLn2	EBT	EBR	WBL	WBT
Capacity (veh/h)	577	-	-	-	1129	-
HCM Lane V/C Ratio	0.1	-	-	-	-	-
HCM Control Delay (s)	11.9	0	-	-	0	-
HCM Lane LOS	B	A	-	-	A	-
HCM 95th %tile Q(veh)	0.3	-	-	-	0	-

Intersection						
Int Delay, s/veh	0.6					
Movement	EBT	EBR	WBL	WBT	NBL	NBR
Lane Configurations						
Traffic Vol, veh/h	195	58	0	116	22	0
Future Vol, veh/h	195	58	0	116	22	0
Conflicting Peds, #/hr	0	0	0	0	0	0
Sign Control	Free	Free	Free	Free	Stop	Stop
RT Channelized	-	None	-	None	-	None
Storage Length	-	155	305	-	0	-
Veh in Median Storage, #	0	-	-	0	0	-
Grade, %	0	-	-	0	0	-
Peak Hour Factor	83	83	83	83	83	83
Heavy Vehicles, %	2	2	2	2	2	2
Mvmt Flow	235	70	0	140	27	0

Major/Minor	Major1	Major2	Minor1			
Conflicting Flow All	0	0	305	0	375	235
Stage 1	-	-	-	-	235	-
Stage 2	-	-	-	-	140	-
Critical Hdwy	-	-	4.12	-	6.42	6.22
Critical Hdwy Stg 1	-	-	-	-	5.42	-
Critical Hdwy Stg 2	-	-	-	-	5.42	-
Follow-up Hdwy	-	-	2.218	-	3.518	3.318
Pot Cap-1 Maneuver	-	-	1256	-	626	804
Stage 1	-	-	-	-	804	-
Stage 2	-	-	-	-	887	-
Platoon blocked, %	-	-	-	-	-	-
Mov Cap-1 Maneuver	-	-	1256	-	626	804
Mov Cap-2 Maneuver	-	-	-	-	668	-
Stage 1	-	-	-	-	804	-
Stage 2	-	-	-	-	887	-

Approach	EB	WB	NB
HCM Control Delay, s	0	0	10.6
HCM LOS			B

Minor Lane/Major Mvmt	NBLn1	EBT	EBR	WBL	WBT
Capacity (veh/h)	668	-	-	1256	-
HCM Lane V/C Ratio	0.04	-	-	-	-
HCM Control Delay (s)	10.6	-	-	0	-
HCM Lane LOS	B	-	-	A	-
HCM 95th %tile Q(veh)	0.1	-	-	0	-

Intersection						
Int Delay, s/veh	2.1					
Movement	EBT	EBR	WBL	WBT	NBL	NBR
Lane Configurations						
Traffic Vol, veh/h	91	104	0	54	62	0
Future Vol, veh/h	91	104	0	54	62	0
Conflicting Peds, #/hr	0	0	0	0	0	0
Sign Control	Free	Free	Free	Free	Stop	Stop
RT Channelized	-	None	-	None	-	None
Storage Length	-	-	305	-	0	0
Veh in Median Storage, #	0	-	-	0	0	-
Grade, %	0	-	-	0	0	-
Peak Hour Factor	83	83	83	83	83	83
Heavy Vehicles, %	2	2	2	2	2	2
Mvmt Flow	110	125	0	65	75	0

Major/Minor	Major1	Major2	Minor1			
Conflicting Flow All	0	0	235	0	238	173
Stage 1	-	-	-	-	173	-
Stage 2	-	-	-	-	65	-
Critical Hdwy	-	-	4.12	-	6.42	6.22
Critical Hdwy Stg 1	-	-	-	-	5.42	-
Critical Hdwy Stg 2	-	-	-	-	5.42	-
Follow-up Hdwy	-	-	2.218	-	3.518	3.318
Pot Cap-1 Maneuver	-	-	1332	-	750	871
Stage 1	-	-	-	-	857	-
Stage 2	-	-	-	-	958	-
Platoon blocked, %	-	-	-	-	-	-
Mov Cap-1 Maneuver	-	-	1332	-	750	871
Mov Cap-2 Maneuver	-	-	-	-	749	-
Stage 1	-	-	-	-	857	-
Stage 2	-	-	-	-	958	-

Approach	EB	WB	NB
HCM Control Delay, s	0	0	10.3
HCM LOS			B

Minor Lane/Major Mvmt	NBLn1	NBLn2	EBT	EBR	WBL	WBT
Capacity (veh/h)	749	-	-	-	1332	-
HCM Lane V/C Ratio	0.1	-	-	-	-	-
HCM Control Delay (s)	10.3	0	-	-	0	-
HCM Lane LOS	B	A	-	-	A	-
HCM 95th %tile Q(veh)	0.3	-	-	-	0	-

Intersection			
Intersection Delay, s/veh	3.3		
Intersection LOS	A		
Approach	EB	WB	NB
Entry Lanes	1	0	0
Conflicting Circle Lanes	1	1	1
Adj Approach Flow, veh/h	110	0	0
Demand Flow Rate, veh/h	112	0	0
Vehicles Circulating, veh/h	0	66	0
Vehicles Exiting, veh/h	66	0	112
Ped Vol Crossing Leg, #/h	0	0	0
Ped Cap Adj	1.000	1.000	1.000
Approach Delay, s/veh	3.3	0.0	0.0
Approach LOS	A	-	-
Lane	Left	Bypass	
Designated Moves	TR	R	
Assumed Moves	TR	R	
RT Channelized		Yield	
Lane Util	1.000		
Follow-Up Headway, s	2.609		
Critical Headway, s	4.976	0	
Entry Flow, veh/h	112	0	
Cap Entry Lane, veh/h	1380	0.980	
Entry HV Adj Factor	0.982	0	
Flow Entry, veh/h	110	0	
Cap Entry, veh/h	1355	0.000	
V/C Ratio	0.081	0.0	
Control Delay, s/veh	3.3	-	
LOS	A	0	
95th %tile Queue, veh	0		

Intersection			
Intersection Delay, s/veh 11.7			
Intersection LOS B			
Approach	WB	NB	SB
Entry Lanes	1	1	1
Conflicting Circle Lanes	2	2	2
Adj Approach Flow, veh/h	263	1029	418
Demand Flow Rate, veh/h	268	1050	427
Vehicles Circulating, veh/h	745	29	252
Vehicles Exiting, veh/h	334	650	761
Ped Vol Crossing Leg, #/h	0	0	0
Ped Cap Adj	1.000	1.000	1.000
Approach Delay, s/veh	9.3	14.2	7.0
Approach LOS	A	B	A
Lane	Left	Left	Left
Designated Moves	LR	TR	LT
Assumed Moves	LR	TR	LT
RT Channelized			
Lane Util	1.000	1.000	1.000
Follow-Up Headway, s	2.535	2.535	2.535
Critical Headway, s	4.328	4.328	4.328
Entry Flow, veh/h	268	1050	427
Cap Entry Lane, veh/h	754	1386	1146
Entry HV Adj Factor	0.981	0.980	0.979
Flow Entry, veh/h	263	1029	418
Cap Entry, veh/h	740	1358	1123
V/C Ratio	0.356	0.758	0.373
Control Delay, s/veh	9.3	14.2	7.0
LOS	A	B	A
95th %tile Queue, veh	2	8	2

Intersection						
Int Delay, s/veh	0.8					
Movement	WBL	WBR	NBT	NBR	SBL	SBT
Lane Configurations	Y		↑	↑	↑	↑
Traffic Vol, veh/h	32	10	844	56	16	513
Future Vol, veh/h	32	10	844	56	16	513
Conflicting Peds, #/hr	0	0	0	0	0	0
Sign Control	Stop	Stop	Free	Free	Free	Free
RT Channelized	-	None	-	None	-	None
Storage Length	0	-	-	155	205	-
Veh in Median Storage, #	0	-	0	-	-	0
Grade, %	0	-	0	-	-	0
Peak Hour Factor	83	83	83	83	83	83
Heavy Vehicles, %	2	2	2	2	2	2
Mvmt Flow	39	12	1017	67	19	618

Major/Minor	Minor1	Major1	Major2		
Conflicting Flow All	1673	1017	0	0	1084
Stage 1	1017	-	-	-	-
Stage 2	656	-	-	-	-
Critical Hdwy	6.42	6.22	-	-	4.12
Critical Hdwy Stg 1	5.42	-	-	-	-
Critical Hdwy Stg 2	5.42	-	-	-	-
Follow-up Hdwy	3.518	3.318	-	-	2.218
Pot Cap-1 Maneuver	105	288	-	-	643
Stage 1	349	-	-	-	-
Stage 2	516	-	-	-	-
Platoon blocked, %			-	-	-
Mov Cap-1 Maneuver	102	288	-	-	643
Mov Cap-2 Maneuver	232	-	-	-	-
Stage 1	349	-	-	-	-
Stage 2	501	-	-	-	-

Approach	WB	NB	SB
HCM Control Delay, s	23.7	0	0.3
HCM LOS	C		

Minor Lane/Major Mvmt	NBT	NBRWBLn1	SBL	SBT
Capacity (veh/h)	-	-	243	643
HCM Lane V/C Ratio	-	-	0.208	0.03
HCM Control Delay (s)	-	-	23.7	10.8
HCM Lane LOS	-	-	C	B
HCM 95th %tile Q(veh)	-	-	0.8	0.1

Intersection						
Intersection Delay, s/veh	10.1					
Intersection LOS	B					
Approach	EB		NB		SB	
Entry Lanes	2		2		2	
Conflicting Circle Lanes	2		2		2	
Adj Approach Flow, veh/h	301		1375		641	
Demand Flow Rate, veh/h	307		1402		654	
Vehicles Circulating, veh/h	600		88		410	
Vehicles Exiting, veh/h	464		819		1080	
Ped Vol Crossing Leg, #/h	0		0		0	
Ped Cap Adj	1.000		1.000		1.000	
Approach Delay, s/veh	6.7		12.0		7.4	
Approach LOS	A		B		A	
Lane	Left	Right	Left	Right	Left	Right
Designated Moves	L	TR	L	TR	LT	TR
Assumed Moves	L	TR	L	TR	LT	TR
RT Channelized						
Lane Util	0.287	0.713	0.292	0.708	0.469	0.531
Follow-Up Headway, s	2.667	2.535	2.667	2.535	2.667	2.535
Critical Headway, s	4.645	4.328	4.645	4.328	4.645	4.328
Entry Flow, veh/h	88	219	410	992	307	347
Cap Entry Lane, veh/h	777	853	1245	1318	926	1002
Entry HV Adj Factor	0.977	0.982	0.980	0.980	0.982	0.979
Flow Entry, veh/h	86	215	402	973	301	340
Cap Entry, veh/h	760	837	1221	1292	909	982
V/C Ratio	0.113	0.257	0.329	0.753	0.332	0.346
Control Delay, s/veh	5.9	7.1	6.0	14.5	7.6	7.3
LOS	A	A	A	B	A	A
95th %tile Queue, veh	0	1	1	8	1	2

Intersection									
Intersection Delay, s/veh10.8									
Intersection LOS B									
Approach	EB		WB		NB		SB		
Entry Lanes	2		2		1		1		
Conflicting Circle Lanes	2		2		2		2		
Adj Approach Flow, veh/h	503		837		584		743		
Demand Flow Rate, veh/h	513		854		596		757		
Vehicles Circulating, veh/h	615		845		776		385		
Vehicles Exiting, veh/h	360		527		352		756		
Ped Vol Crossing Leg, #/h	0		0		0		0		
Ped Cap Adj	1.000		1.000		1.000		1.000		
Approach Delay, s/veh	8.5		2.9		26.9		8.7		
Approach LOS	A		A		D		A		
Lane	Left	Right	Left	Right	Bypass	Left	Left	Bypass	
Designated Moves	LT	TR	LT	TR	R	LTR	LT	R	
Assumed Moves	L	TR	LT	TR	R	LTR	LT	R	
RT Channelized					Free			Free	
Lane Util	0.561	0.439	0.471	0.529		1.000	1.000		
Follow-Up Headway, s	2.667	2.535	2.667	2.535		2.535	2.535		
Critical Headway, s	4.645	4.328	4.645	4.328	557	4.328	4.328	167	
Entry Flow, veh/h	288	225	140	157	1938	596	590	1938	
Cap Entry Lane, veh/h	767	842	620	692	0.980	734	1024	0.980	
Entry HV Adj Factor	0.979	0.981	0.976	0.981	546	0.980	0.981	164	
Flow Entry, veh/h	282	221	137	154	1900	584	579	1900	
Cap Entry, veh/h	751	826	605	679	0.287	719	1004	0.086	
V/C Ratio	0.376	0.267	0.226	0.227	0.0	0.812	0.576	0.0	
Control Delay, s/veh	9.5	7.3	8.8	8.0	A	26.9	11.2	A	
LOS	A	A	A	A	1	D	B	0	
95th %tile Queue, veh	2	1	1	1		9	4		

Timings
14: US 24 & Stapleton Dr

2033 Total Traffic
PM Peak Hour

Lane Group	EBL	EBT	EBR	WBL	WBT	WBR	NBL	NBT	NBR	SBL	SBT	SBR
Lane Configurations												
Traffic Volume (vph)	49	155	254	5	306	34	437	594	8	10	469	81
Future Volume (vph)	49	155	254	5	306	34	437	594	8	10	469	81
Turn Type	pm+pt	NA	Free	pm+pt	NA	Free	Prot	NA	Perm	pm+pt	NA	Perm
Protected Phases	5	2		1	6		3	8		7	4	
Permitted Phases	2		Free	6		Free			8	4		4
Detector Phase	5	2		1	6		3	8	8	7	4	4
Switch Phase												
Minimum Initial (s)	5.0	5.0		5.0	5.0		5.0	5.0	5.0	5.0	15.0	15.0
Minimum Split (s)	10.0	10.0		10.0	10.0		10.0	10.0	10.0	10.0	20.0	20.0
Total Split (s)	12.0	34.0		12.0	34.0		33.0	62.0	62.0	12.0	41.0	41.0
Total Split (%)	10.0%	28.3%		10.0%	28.3%		27.5%	51.7%	51.7%	10.0%	34.2%	34.2%
Yellow Time (s)	3.0	3.0		3.0	3.0		3.0	3.0	3.0	3.0	3.0	3.0
All-Red Time (s)	2.0	2.0		2.0	2.0		2.0	2.0	2.0	2.0	2.0	2.0
Lost Time Adjust (s)	0.0	0.0		0.0	0.0		0.0	0.0	0.0	0.0	0.0	0.0
Total Lost Time (s)	5.0	5.0		5.0	5.0		5.0	5.0	5.0	5.0	5.0	5.0
Lead/Lag	Lead	Lag		Lead	Lag		Lead	Lag	Lag	Lead	Lag	Lag
Lead-Lag Optimize?	Yes	Yes		Yes	Yes		Yes	Yes	Yes	Yes	Yes	Yes
Recall Mode	None	C-Max		None	C-Max		None	Max	Max	None	Max	Max
Act Effct Green (s)	40.1	38.7	120.0	36.1	31.4	120.0	22.8	66.7	66.7	47.0	41.2	41.2
Actuated g/C Ratio	0.33	0.32	1.00	0.30	0.26	1.00	0.19	0.56	0.56	0.39	0.34	0.34
v/c Ratio	0.35	0.31	0.19	0.02	0.76	0.03	0.78	0.67	0.01	0.04	0.84	0.14
Control Delay	27.9	27.9	0.2	26.4	53.1	0.0	54.6	23.8	0.0	14.3	47.9	0.8
Queue Delay	0.0	0.0	0.0	0.0	0.0	0.0	0.0	0.0	0.0	0.0	0.0	0.0
Total Delay	27.9	27.9	0.2	26.4	53.1	0.0	54.6	23.8	0.0	14.3	47.9	0.8
LOS	C	C	A	C	D	A	D	C	A	B	D	A
Approach Delay		12.6			47.4			36.6			40.5	
Approach LOS		B			D			D			D	

Intersection Summary

Cycle Length: 120
 Actuated Cycle Length: 120
 Offset: 0 (0%), Referenced to phase 2:EBTL and 6:WBTL, Start of Green
 Natural Cycle: 90
 Control Type: Actuated-Coordinated
 Maximum v/c Ratio: 0.84
 Intersection Signal Delay: 34.4
 Intersection LOS: C
 Intersection Capacity Utilization 74.1%
 ICU Level of Service D
 Analysis Period (min) 15

Splits and Phases: 14: US 24 & Stapleton Dr

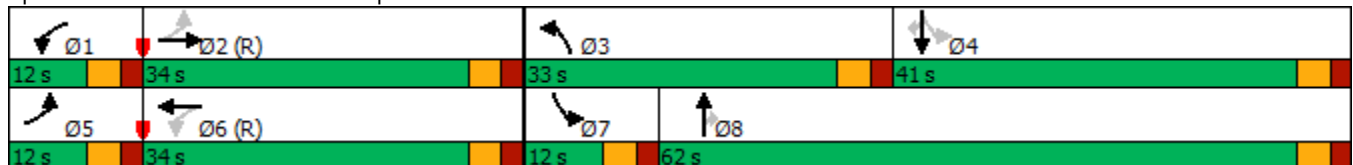

Intersection				
Intersection Delay, s/veh	12.4			
Intersection LOS	B			
Approach	EB	WB	NB	SB
Entry Lanes	1	1	1	1
Conflicting Circle Lanes	1	1	1	1
Adj Approach Flow, veh/h	469	559	496	298
Demand Flow Rate, veh/h	479	570	506	303
Vehicles Circulating, veh/h	664	274	239	677
Vehicles Exiting, veh/h	316	471	904	167
Ped Vol Crossing Leg, #/h	0	0	0	0
Ped Cap Adj	1.000	1.000	1.000	1.000
Approach Delay, s/veh	19.2	10.4	8.7	11.5
Approach LOS	C	B	A	B
Lane	Left	Left	Left	Left
Designated Moves	LTR	LTR	LTR	LTR
Assumed Moves	LTR	LTR	LTR	LTR
RT Channelized				
Lane Util	1.000	1.000	1.000	1.000
Follow-Up Headway, s	2.609	2.609	2.609	2.609
Critical Headway, s	4.976	4.976	4.976	4.976
Entry Flow, veh/h	479	570	506	303
Cap Entry Lane, veh/h	701	1043	1081	692
Entry HV Adj Factor	0.980	0.980	0.980	0.983
Flow Entry, veh/h	469	559	496	298
Cap Entry, veh/h	687	1023	1060	680
V/C Ratio	0.683	0.546	0.468	0.438
Control Delay, s/veh	19.2	10.4	8.7	11.5
LOS	C	B	A	B
95th %tile Queue, veh	5	3	3	2

Intersection

Int Delay, s/veh 1.6

Movement	EBT	EBR	WBL	WBT	NBL	NBR
Lane Configurations	↔		↔	↑	↔	↔
Traffic Vol, veh/h	414	25	43	513	18	86
Future Vol, veh/h	414	25	43	513	18	86
Conflicting Peds, #/hr	0	0	0	0	0	0
Sign Control	Free	Free	Free	Free	Stop	Stop
RT Channelized	-	None	-	None	-	None
Storage Length	-	-	155	-	205	0
Veh in Median Storage, #	0	-	-	0	0	-
Grade, %	0	-	-	0	0	-
Peak Hour Factor	92	92	92	92	92	92
Heavy Vehicles, %	2	2	2	2	2	2
Mvmt Flow	450	27	47	558	20	93

Major/Minor

	Major1	Major2	Minor1		
Conflicting Flow All	0	0	477	0	1116
Stage 1	-	-	-	-	464
Stage 2	-	-	-	-	652
Critical Hdwy	-	-	4.12	-	6.42
Critical Hdwy Stg 1	-	-	-	-	5.42
Critical Hdwy Stg 2	-	-	-	-	5.42
Follow-up Hdwy	-	-	2.218	-	3.518
Pot Cap-1 Maneuver	-	-	1085	-	230
Stage 1	-	-	-	-	633
Stage 2	-	-	-	-	518
Platoon blocked, %	-	-	-	-	-
Mov Cap-1 Maneuver	-	-	1085	-	220
Mov Cap-2 Maneuver	-	-	-	-	352
Stage 1	-	-	-	-	633
Stage 2	-	-	-	-	496

Approach

	EB	WB	NB
HCM Control Delay, s	0	0.7	12.7
HCM LOS			B

Minor Lane/Major Mvmt

	NBLn1	NBLn2	EBT	EBR	WBL	WBT
Capacity (veh/h)	352	598	-	-	1085	-
HCM Lane V/C Ratio	0.056	0.156	-	-	0.043	-
HCM Control Delay (s)	15.8	12.1	-	-	8.5	-
HCM Lane LOS	C	B	-	-	A	-
HCM 95th %tile Q(veh)	0.2	0.6	-	-	0.1	-

Intersection						
Int Delay, s/veh	0.4					
Movement	EBL	EBT	WBT	WBR	SBL	SBR
Lane Configurations	↘	↑	↗		↘	
Traffic Vol, veh/h	2	497	551	7	20	5
Future Vol, veh/h	2	497	551	7	20	5
Conflicting Peds, #/hr	0	0	0	0	0	0
Sign Control	Free	Free	Free	Free	Stop	Stop
RT Channelized	-	None	-	None	-	None
Storage Length	155	-	-	-	0	-
Veh in Median Storage, #	-	0	0	-	0	-
Grade, %	-	0	0	-	0	-
Peak Hour Factor	92	92	92	92	92	92
Heavy Vehicles, %	2	2	2	2	2	2
Mvmt Flow	2	540	599	8	22	5

Major/Minor	Major1	Major2	Minor2		
Conflicting Flow All	607	0	-	0	1147 603
Stage 1	-	-	-	-	603 -
Stage 2	-	-	-	-	544 -
Critical Hdwy	4.12	-	-	-	6.42 6.22
Critical Hdwy Stg 1	-	-	-	-	5.42 -
Critical Hdwy Stg 2	-	-	-	-	5.42 -
Follow-up Hdwy	2.218	-	-	-	3.518 3.318
Pot Cap-1 Maneuver	971	-	-	-	220 499
Stage 1	-	-	-	-	546 -
Stage 2	-	-	-	-	582 -
Platoon blocked, %		-	-	-	
Mov Cap-1 Maneuver	971	-	-	-	220 499
Mov Cap-2 Maneuver	-	-	-	-	357 -
Stage 1	-	-	-	-	545 -
Stage 2	-	-	-	-	582 -

Approach	EB	WB	SB
HCM Control Delay, s	0	0	15.2
HCM LOS			C

Minor Lane/Major Mvmt	EBL	EBT	WBT	WBR	SBLn1
Capacity (veh/h)	971	-	-	-	379
HCM Lane V/C Ratio	0.002	-	-	-	0.072
HCM Control Delay (s)	8.7	-	-	-	15.2
HCM Lane LOS	A	-	-	-	C
HCM 95th %tile Q(veh)	0	-	-	-	0.2

Intersection						
Int Delay, s/veh	0.8					
Movement	EBT	EBR	WBL	WBT	NBL	NBR
Lane Configurations						
Traffic Vol, veh/h	510	7	16	547	11	48
Future Vol, veh/h	510	7	16	547	11	48
Conflicting Peds, #/hr	0	0	0	0	0	0
Sign Control	Free	Free	Free	Free	Stop	Stop
RT Channelized	-	None	-	None	-	None
Storage Length	-	155	305	-	0	-
Veh in Median Storage, #	0	-	-	0	0	-
Grade, %	0	-	-	0	0	-
Peak Hour Factor	95	95	95	95	95	95
Heavy Vehicles, %	2	2	2	2	2	2
Mvmt Flow	537	7	17	576	12	51

Major/Minor	Major1	Major2	Minor1		
Conflicting Flow All	0	0	544	0	1147 537
Stage 1	-	-	-	-	537 -
Stage 2	-	-	-	-	610 -
Critical Hdwy	-	-	4.12	-	6.42 6.22
Critical Hdwy Stg 1	-	-	-	-	5.42 -
Critical Hdwy Stg 2	-	-	-	-	5.42 -
Follow-up Hdwy	-	-	2.218	-	3.518 3.318
Pot Cap-1 Maneuver	-	-	1025	-	220 544
Stage 1	-	-	-	-	586 -
Stage 2	-	-	-	-	542 -
Platoon blocked, %	-	-	-	-	-
Mov Cap-1 Maneuver	-	-	1025	-	216 544
Mov Cap-2 Maneuver	-	-	-	-	353 -
Stage 1	-	-	-	-	586 -
Stage 2	-	-	-	-	533 -

Approach	EB	WB	NB
HCM Control Delay, s	0	0.2	13.3
HCM LOS			B

Minor Lane/Major Mvmt	NBLn1	EBT	EBR	WBL	WBT
Capacity (veh/h)	494	-	-	1025	-
HCM Lane V/C Ratio	0.126	-	-	0.016	-
HCM Control Delay (s)	13.3	-	-	8.6	-
HCM Lane LOS	B	-	-	A	-
HCM 95th %tile Q(veh)	0.4	-	-	0.1	-

Intersection						
Int Delay, s/veh	1.3					
Movement	EBT	EBR	WBL	WBT	NBL	NBR
Lane Configurations						
Traffic Vol, veh/h	550	8	26	540	23	78
Future Vol, veh/h	550	8	26	540	23	78
Conflicting Peds, #/hr	0	0	0	0	0	0
Sign Control	Free	Free	Free	Free	Stop	Stop
RT Channelized	-	None	-	None	-	None
Storage Length	-	-	305	-	0	0
Veh in Median Storage, #	0	-	-	0	0	-
Grade, %	0	-	-	0	0	-
Peak Hour Factor	95	95	95	95	95	95
Heavy Vehicles, %	2	2	2	2	2	2
Mvmt Flow	579	8	27	568	24	82

Major/Minor	Major1	Major2	Minor1		
Conflicting Flow All	0	0	587	0	1205 583
Stage 1	-	-	-	-	583 -
Stage 2	-	-	-	-	622 -
Critical Hdwy	-	-	4.12	-	6.42 6.22
Critical Hdwy Stg 1	-	-	-	-	5.42 -
Critical Hdwy Stg 2	-	-	-	-	5.42 -
Follow-up Hdwy	-	-	2.218	-	3.518 3.318
Pot Cap-1 Maneuver	-	-	988	-	203 512
Stage 1	-	-	-	-	558 -
Stage 2	-	-	-	-	535 -
Platoon blocked, %	-	-	-	-	-
Mov Cap-1 Maneuver	-	-	988	-	198 512
Mov Cap-2 Maneuver	-	-	-	-	336 -
Stage 1	-	-	-	-	558 -
Stage 2	-	-	-	-	521 -

Approach	EB	WB	NB
HCM Control Delay, s	0	0.4	14.1
HCM LOS			B

Minor Lane/Major Mvmt	NBLn1	NBLn2	EBT	EBR	WBL	WBT
Capacity (veh/h)	336	512	-	-	988	-
HCM Lane V/C Ratio	0.072	0.16	-	-	0.028	-
HCM Control Delay (s)	16.5	13.4	-	-	8.7	-
HCM Lane LOS	C	B	-	-	A	-
HCM 95th %tile Q(veh)	0.2	0.6	-	-	0.1	-

Intersection					
Intersection Delay, s/veh	19.9				
Intersection LOS	C				
Approach	EB	WB	NB	SB	
Entry Lanes	1	1	1	1	
Conflicting Circle Lanes	1	1	1	1	
Adj Approach Flow, veh/h	662	434	213	813	
Demand Flow Rate, veh/h	675	443	217	830	
Vehicles Circulating, veh/h	524	339	1158	301	
Vehicles Exiting, veh/h	607	1036	41	215	
Ped Vol Crossing Leg, #/h	0	0	0	0	
Ped Cap Adj	1.000	1.000	1.000	1.000	
Approach Delay, s/veh	27.1	5.5	20.0	21.6	
Approach LOS	D	A	C	C	
Lane	Left	Left	Bypass	Left	Left
Designated Moves	LTR	LT	R	LTR	LTR
Assumed Moves	LTR	LT	R	LTR	LTR
RT Channelized			Yield		
Lane Util	1.000	1.000		1.000	1.000
Follow-Up Headway, s	2.609	2.609		2.609	2.609
Critical Headway, s	4.976	4.976	266	4.976	4.976
Entry Flow, veh/h	675	177	1108	217	830
Cap Entry Lane, veh/h	809	977	0.980	424	1015
Entry HV Adj Factor	0.981	0.978	261	0.982	0.980
Flow Entry, veh/h	662	173	1086	213	813
Cap Entry, veh/h	793	955	0.240	416	994
V/C Ratio	0.835	0.181	5.6	0.512	0.818
Control Delay, s/veh	27.1	5.5	A	20.0	21.6
LOS	D	A	1	C	C
95th %tile Queue, veh	10	1		3	9

Timings
9: US 24 & Rex Rd

2043 Total Traffic
AM Peak Hour



Lane Group	EBL	EBR	NBL	NBT	SBT	SBR
Lane Configurations	↖	↗	↖↗	↑↑	↑↑	↗
Traffic Volume (vph)	104	1042	460	382	632	74
Future Volume (vph)	104	1042	460	382	632	74
Turn Type	Prot	Free	Prot	NA	NA	Perm
Protected Phases	6!		7	Free!	8	
Permitted Phases		Free				8
Detector Phase	6		7		8	8
Switch Phase						
Minimum Initial (s)	5.0		5.0		5.0	5.0
Minimum Split (s)	20.0		10.0		20.0	20.0
Total Split (s)	23.0		49.0		48.0	48.0
Total Split (%)	19.2%		40.8%		40.0%	40.0%
Yellow Time (s)	3.0		3.0		3.0	3.0
All-Red Time (s)	2.0		2.0		2.0	2.0
Lost Time Adjust (s)	0.0		0.0		0.0	0.0
Total Lost Time (s)	5.0		5.0		5.0	5.0
Lead/Lag			Lead		Lag	Lag
Lead-Lag Optimize?			Yes		Yes	Yes
Recall Mode	Max		None		C-Max	C-Max
Act Effct Green (s)	18.0	120.0	22.6	120.0	64.4	64.4
Actuated g/C Ratio	0.15	1.00	0.19	1.00	0.54	0.54
v/c Ratio	0.41	0.69	0.75	0.11	0.35	0.09
Control Delay	51.5	2.5	53.5	0.1	17.1	3.7
Queue Delay	0.0	0.0	0.0	0.0	0.0	0.0
Total Delay	51.5	2.5	53.5	0.1	17.1	3.7
LOS	D	A	D	A	B	A
Approach Delay	6.9			29.6	15.7	
Approach LOS	A			C	B	

Intersection Summary

Cycle Length: 120
 Actuated Cycle Length: 120
 Offset: 50 (42%), Referenced to phase 8:SBT, Start of Green
 Natural Cycle: 55
 Control Type: Actuated-Coordinated
 Maximum v/c Ratio: 0.75
 Intersection Signal Delay: 16.3
 Intersection LOS: B
 Intersection Capacity Utilization 48.0%
 ICU Level of Service A
 Analysis Period (min) 15
 ! Phase conflict between lane groups.

Splits and Phases: 9: US 24 & Rex Rd

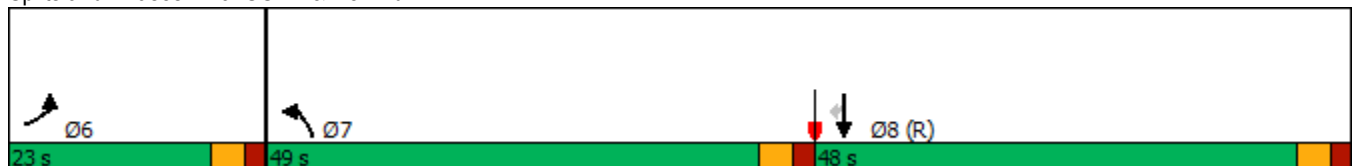

Intersection			
Intersection Delay, s/veh	11.9		
Intersection LOS	B		
Approach	WB	NB	SB
Entry Lanes	1	1	1
Conflicting Circle Lanes	2	2	2
Adj Approach Flow, veh/h	229	556	886
Demand Flow Rate, veh/h	233	567	904
Vehicles Circulating, veh/h	501	2	228
Vehicles Exiting, veh/h	68	1130	506
Ped Vol Crossing Leg, #/h	0	0	0
Ped Cap Adj	1.000	1.000	1.000
Approach Delay, s/veh	6.5	6.3	16.7
Approach LOS	A	A	C
Lane	Left	Left	Left
Designated Moves	LR	TR	LT
Assumed Moves	LR	TR	LT
RT Channelized			
Lane Util	1.000	1.000	1.000
Follow-Up Headway, s	2.535	2.535	2.535
Critical Headway, s	4.328	4.328	4.328
Entry Flow, veh/h	233	567	904
Cap Entry Lane, veh/h	928	1418	1170
Entry HV Adj Factor	0.983	0.981	0.980
Flow Entry, veh/h	229	556	886
Cap Entry, veh/h	912	1391	1147
V/C Ratio	0.251	0.400	0.773
Control Delay, s/veh	6.5	6.3	16.7
LOS	A	A	C
95th %tile Queue, veh	1	2	8

Intersection						
Int Delay, s/veh	1.2					
Movement	WBL	WBR	NBT	NBR	SBL	SBT
Lane Configurations	Y		↑	↑	↑	↑
Traffic Vol, veh/h	57	21	506	20	7	1046
Future Vol, veh/h	57	21	506	20	7	1046
Conflicting Peds, #/hr	0	0	0	0	0	0
Sign Control	Stop	Stop	Free	Free	Free	Free
RT Channelized	-	None	-	None	-	None
Storage Length	0	-	-	155	205	-
Veh in Median Storage, #	0	-	0	-	-	0
Grade, %	0	-	0	-	-	0
Peak Hour Factor	95	95	95	95	95	95
Heavy Vehicles, %	2	2	2	2	2	2
Mvmt Flow	60	22	533	21	7	1101

Major/Minor	Minor1	Major1	Major2		
Conflicting Flow All	1648	533	0	0	554
Stage 1	533	-	-	-	-
Stage 2	1115	-	-	-	-
Critical Hdwy	6.42	6.22	-	-	4.12
Critical Hdwy Stg 1	5.42	-	-	-	-
Critical Hdwy Stg 2	5.42	-	-	-	-
Follow-up Hdwy	3.518	3.318	-	-	2.218
Pot Cap-1 Maneuver	109	547	-	-	1016
Stage 1	588	-	-	-	-
Stage 2	314	-	-	-	-
Platoon blocked, %			-	-	-
Mov Cap-1 Maneuver	108	547	-	-	1016
Mov Cap-2 Maneuver	229	-	-	-	-
Stage 1	588	-	-	-	-
Stage 2	312	-	-	-	-

Approach	WB	NB	SB
HCM Control Delay, s	24	0	0.1
HCM LOS	C		

Minor Lane/Major Mvmt	NBT	NBRWBLn1	SBL	SBT
Capacity (veh/h)	-	-	271	1016
HCM Lane V/C Ratio	-	-	0.303	0.007
HCM Control Delay (s)	-	-	24	8.6
HCM Lane LOS	-	-	C	A
HCM 95th %tile Q(veh)	-	-	1.2	0

Intersection						
Intersection Delay, s/veh	9.2					
Intersection LOS	A					
Approach	EB		NB		SB	
Entry Lanes	2		2		2	
Conflicting Circle Lanes	2		2		2	
Adj Approach Flow, veh/h	486		647		1168	
Demand Flow Rate, veh/h	496		660		1192	
Vehicles Circulating, veh/h	904		156		252	
Vehicles Exiting, veh/h	540		1244		564	
Ped Vol Crossing Leg, #/h	0		0		0	
Ped Cap Adj	1.000		1.000		1.000	
Approach Delay, s/veh	12.7		5.7		9.8	
Approach LOS	B		A		A	
Lane	Left	Right	Left	Right	Left	Right
Designated Moves	L	TR	L	TR	LT	TR
Assumed Moves	L	TR	L	TR	LT	TR
RT Channelized						
Lane Util	0.315	0.685	0.382	0.618	0.470	0.530
Follow-Up Headway, s	2.667	2.535	2.667	2.535	2.667	2.535
Critical Headway, s	4.645	4.328	4.645	4.328	4.645	4.328
Entry Flow, veh/h	156	340	252	408	560	632
Cap Entry Lane, veh/h	588	659	1169	1244	1071	1146
Entry HV Adj Factor	0.981	0.979	0.980	0.980	0.981	0.980
Flow Entry, veh/h	153	333	247	400	549	619
Cap Entry, veh/h	576	645	1146	1219	1050	1123
V/C Ratio	0.265	0.516	0.215	0.328	0.523	0.551
Control Delay, s/veh	9.8	14.0	5.1	6.0	9.7	9.8
LOS	A	B	A	A	A	A
95th %tile Queue, veh	1	3	1	1	3	3

Intersection											
Intersection Delay, s/veh 14.0											
Intersection LOS B											
Approach	EB		WB			NB			SB		
Entry Lanes	2		2			2			2		
Conflicting Circle Lanes	2		2			2			2		
Adj Approach Flow, veh/h	827		549			534			1219		
Demand Flow Rate, veh/h	843		559			545			1244		
Vehicles Circulating, veh/h	952		630			1018			531		
Vehicles Exiting, veh/h	465		850			777			486		
Ped Vol Crossing Leg, #/h	0		0			0			0		
Ped Cap Adj	1.000		1.000			1.000			1.000		
Approach Delay, s/veh	23.0		7.1			12.3			11.7		
Approach LOS	C		A			B			B		
Lane	Left	Right	Left	Right	Bypass	Left	Right	Bypass	Left	Right	Bypass
Designated Moves	LT	TR	LT	TR	R	LT	TR	R	L	LTR	R
Assumed Moves	LT	TR	LT	TR	R	LT	TR	R	L	TR	R
RT Channelized					Yield			Yield			Yield
Lane Util	0.470	0.530	0.470	0.530		0.470	0.530		0.333	0.667	
Follow-Up Headway, s	2.667	2.535	2.667	2.535		2.667	2.535		2.667	2.535	
Critical Headway, s	4.645	4.328	4.645	4.328	172	4.645	4.328	83	4.645	4.328	358
Entry Flow, veh/h	396	447	182	205	841	217	245	580	295	591	859
Cap Entry Lane, veh/h	562	632	756	831	0.980	529	598	0.980	828	904	0.980
Entry HV Adj Factor	0.982	0.981	0.981	0.982	169	0.981	0.979	81	0.980	0.980	351
Flow Entry, veh/h	389	438	178	201	824	213	240	569	289	579	842
Cap Entry, veh/h	552	620	741	816	0.205	519	585	0.142	811	886	0.417
V/C Ratio	0.704	0.707	0.241	0.247	6.5	0.410	0.410	8.1	0.356	0.654	9.4
Control Delay, s/veh	24.1	22.1	7.6	7.1	A	13.7	12.4	A	8.7	14.6	A
LOS	C	C	A	A	1	B	B	0	A	B	2
95th %tile Queue, veh	6	6	1	1		2	2		2	5	

Timings
14: US 24 & Stapleton Dr

2043 Total Traffic
AM Peak Hour

Lane Group	EBL	EBT	EBR	WBL	WBT	WBR	NBL	NBT	NBR	SBL	SBT	SBR
Lane Configurations												
Traffic Volume (vph)	136	380	463	75	201	108	358	598	50	247	1299	127
Future Volume (vph)	136	380	463	75	201	108	358	598	50	247	1299	127
Turn Type	pm+pt	NA	Free	pm+pt	NA	Free	Prot	NA	Perm	Prot	NA	Perm
Protected Phases	5	2		1	6		3	8		7	4	
Permitted Phases	2		Free	6		Free			8			4
Detector Phase	5	2		1	6		3	8	8	7	4	4
Switch Phase												
Minimum Initial (s)	5.0	10.0		8.0	5.0		20.0	5.0	5.0	20.0	15.0	15.0
Minimum Split (s)	10.0	15.0		13.0	10.0		25.0	10.0	10.0	25.0	20.0	20.0
Total Split (s)	15.0	25.0		15.0	25.0		30.0	60.0	60.0	25.0	50.0	50.0
Total Split (%)	12.0%	20.0%		12.0%	20.0%		24.0%	48.0%	48.0%	20.0%	40.0%	40.0%
Yellow Time (s)	3.0	3.0		3.0	3.0		3.0	3.0	3.0	3.0	3.0	3.0
All-Red Time (s)	2.0	2.0		2.0	2.0		2.0	2.0	2.0	2.0	2.0	2.0
Lost Time Adjust (s)	0.0	0.0		0.0	0.0		0.0	0.0	0.0	0.0	0.0	0.0
Total Lost Time (s)	5.0	5.0		5.0	5.0		5.0	5.0	5.0	5.0	5.0	5.0
Lead/Lag	Lead	Lag		Lead	Lag		Lead	Lag	Lag	Lead	Lag	Lag
Lead-Lag Optimize?	Yes	Yes		Yes	Yes		Yes	Yes	Yes	Yes	Yes	Yes
Recall Mode	None	C-Max		None	C-Max		None	Max	Max	None	Max	Max
Act Effct Green (s)	31.4	23.4	125.0	29.5	20.3	125.0	20.9	55.0	55.0	20.0	54.1	54.1
Actuated g/C Ratio	0.25	0.19	1.00	0.24	0.16	1.00	0.17	0.44	0.44	0.16	0.43	0.43
v/c Ratio	0.48	0.60	0.31	0.33	0.37	0.07	0.66	0.40	0.07	0.47	0.87	0.18
Control Delay	41.6	52.2	0.5	38.3	48.9	0.1	54.5	24.8	0.2	51.0	39.6	4.3
Queue Delay	0.0	0.0	0.0	0.0	0.0	0.0	0.0	0.0	0.0	0.0	0.0	0.0
Total Delay	41.6	52.2	0.5	38.3	48.9	0.1	54.5	24.8	0.2	51.0	39.6	4.3
LOS	D	D	A	D	D	A	D	C	A	D	D	A
Approach Delay		26.3			33.1			34.2			38.6	
Approach LOS		C			C			C			D	

Intersection Summary

Cycle Length: 125
 Actuated Cycle Length: 125
 Offset: 64 (51%), Referenced to phase 2:EBTL and 6:WBTL, Start of Green
 Natural Cycle: 90
 Control Type: Actuated-Coordinated
 Maximum v/c Ratio: 0.87
 Intersection Signal Delay: 33.9
 Intersection LOS: C
 Intersection Capacity Utilization 85.2%
 ICU Level of Service E
 Analysis Period (min) 15

Splits and Phases: 14: US 24 & Stapleton Dr

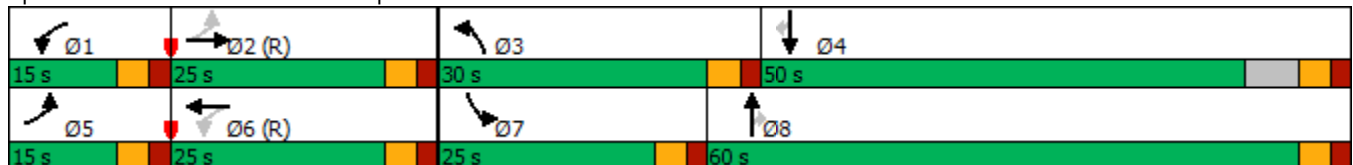

Intersection				
Intersection Delay, s/veh	18.8			
Intersection LOS	C			
Approach	EB	WB	NB	SB
Entry Lanes	1	1	1	1
Conflicting Circle Lanes	1	1	1	1
Adj Approach Flow, veh/h	427	381	864	250
Demand Flow Rate, veh/h	436	388	882	255
Vehicles Circulating, veh/h	471	533	321	554
Vehicles Exiting, veh/h	338	669	586	367
Ped Vol Crossing Leg, #/h	0	0	0	0
Ped Cap Adj	1.000	1.000	1.000	1.000
Approach Delay, s/veh	11.3	11.2	28.7	8.6
Approach LOS	B	B	D	A
Lane	Left	Left	Left	Left
Designated Moves	LTR	LTR	LTR	LTR
Assumed Moves	LTR	LTR	LTR	LTR
RT Channelized				
Lane Util	1.000	1.000	1.000	1.000
Follow-Up Headway, s	2.609	2.609	2.609	2.609
Critical Headway, s	4.976	4.976	4.976	4.976
Entry Flow, veh/h	436	388	882	255
Cap Entry Lane, veh/h	854	801	995	784
Entry HV Adj Factor	0.979	0.982	0.979	0.979
Flow Entry, veh/h	427	381	864	250
Cap Entry, veh/h	836	787	974	768
V/C Ratio	0.511	0.484	0.887	0.325
Control Delay, s/veh	11.3	11.2	28.7	8.6
LOS	B	B	D	A
95th %tile Queue, veh	3	3	12	1

Intersection						
Int Delay, s/veh	2					
Movement	EBT	EBR	WBL	WBT	NBL	NBR
Lane Configurations	↔		↔	↑	↔	↔
Traffic Vol, veh/h	585	39	97	343	20	70
Future Vol, veh/h	585	39	97	343	20	70
Conflicting Peds, #/hr	0	0	0	0	0	0
Sign Control	Free	Free	Free	Free	Stop	Stop
RT Channelized	-	None	-	None	-	None
Storage Length	-	-	155	-	205	0
Veh in Median Storage, #	0	-	-	0	0	-
Grade, %	0	-	-	0	0	-
Peak Hour Factor	92	92	92	92	92	92
Heavy Vehicles, %	2	2	2	2	2	2
Mvmt Flow	636	42	105	373	22	76

Major/Minor	Major1	Major2	Minor1		
Conflicting Flow All	0	0	678	0	1240 657
Stage 1	-	-	-	-	657 -
Stage 2	-	-	-	-	583 -
Critical Hdwy	-	-	4.12	-	6.42 6.22
Critical Hdwy Stg 1	-	-	-	-	5.42 -
Critical Hdwy Stg 2	-	-	-	-	5.42 -
Follow-up Hdwy	-	-	2.218	-	3.518 3.318
Pot Cap-1 Maneuver	-	-	914	-	193 465
Stage 1	-	-	-	-	516 -
Stage 2	-	-	-	-	558 -
Platoon blocked, %	-	-	-	-	-
Mov Cap-1 Maneuver	-	-	914	-	171 465
Mov Cap-2 Maneuver	-	-	-	-	308 -
Stage 1	-	-	-	-	516 -
Stage 2	-	-	-	-	494 -

Approach	EB	WB	NB
HCM Control Delay, s	0	2.1	15
HCM LOS			C

Minor Lane/Major Mvmt	NBLn1	NBLn2	EBT	EBR	WBL	WBT
Capacity (veh/h)	308	465	-	-	914	-
HCM Lane V/C Ratio	0.071	0.164	-	-	0.115	-
HCM Control Delay (s)	17.6	14.3	-	-	9.5	-
HCM Lane LOS	C	B	-	-	A	-
HCM 95th %tile Q(veh)	0.2	0.6	-	-	0.4	-

Intersection

Int Delay, s/veh 0.3

Movement EBL EBT WBT WBR SBL SBR

Lane Configurations						
Traffic Vol, veh/h	2	653	434	7	20	5
Future Vol, veh/h	2	653	434	7	20	5
Conflicting Peds, #/hr	0	0	0	0	0	0
Sign Control	Free	Free	Free	Free	Stop	Stop
RT Channelized	-	None	-	None	-	None
Storage Length	155	-	-	-	0	-
Veh in Median Storage, #	-	0	0	-	0	-
Grade, %	-	0	0	-	0	-
Peak Hour Factor	92	92	92	92	92	92
Heavy Vehicles, %	2	2	2	2	2	2
Mvmt Flow	2	710	472	8	22	5

Major/Minor Major1 Major2 Minor2

Conflicting Flow All	480	0	-	0	1190	476
Stage 1	-	-	-	-	476	-
Stage 2	-	-	-	-	714	-
Critical Hdwy	4.12	-	-	-	6.42	6.22
Critical Hdwy Stg 1	-	-	-	-	5.42	-
Critical Hdwy Stg 2	-	-	-	-	5.42	-
Follow-up Hdwy	2.218	-	-	-	3.518	3.318
Pot Cap-1 Maneuver	1082	-	-	-	207	589
Stage 1	-	-	-	-	625	-
Stage 2	-	-	-	-	485	-
Platoon blocked, %		-	-	-		
Mov Cap-1 Maneuver	1082	-	-	-	207	589
Mov Cap-2 Maneuver	-	-	-	-	341	-
Stage 1	-	-	-	-	624	-
Stage 2	-	-	-	-	485	-

Approach EB WB SB

HCM Control Delay, s	0	0	15.4
HCM LOS			C

Minor Lane/Major Mvmt EBL EBT WBT WBR SBLn1

Capacity (veh/h)	1082	-	-	-	372
HCM Lane V/C Ratio	0.002	-	-	-	0.073
HCM Control Delay (s)	8.3	-	-	-	15.4
HCM Lane LOS	A	-	-	-	C
HCM 95th %tile Q(veh)	0	-	-	-	0.2

Intersection						
Int Delay, s/veh	0.8					
Movement	EBT	EBR	WBL	WBT	NBL	NBR
Lane Configurations						
Traffic Vol, veh/h	652	20	44	434	7	31
Future Vol, veh/h	652	20	44	434	7	31
Conflicting Peds, #/hr	0	0	0	0	0	0
Sign Control	Free	Free	Free	Free	Stop	Stop
RT Channelized	-	None	-	None	-	None
Storage Length	-	155	305	-	0	-
Veh in Median Storage, #	0	-	-	0	0	-
Grade, %	0	-	-	0	0	-
Peak Hour Factor	95	95	95	95	95	95
Heavy Vehicles, %	2	2	2	2	2	2
Mvmt Flow	686	21	46	457	7	33

Major/Minor	Major1	Major2	Minor1		
Conflicting Flow All	0	0	707	0	1235 686
Stage 1	-	-	-	-	686 -
Stage 2	-	-	-	-	549 -
Critical Hdwy	-	-	4.12	-	6.42 6.22
Critical Hdwy Stg 1	-	-	-	-	5.42 -
Critical Hdwy Stg 2	-	-	-	-	5.42 -
Follow-up Hdwy	-	-	2.218	-	3.518 3.318
Pot Cap-1 Maneuver	-	-	891	-	195 447
Stage 1	-	-	-	-	500 -
Stage 2	-	-	-	-	579 -
Platoon blocked, %	-	-	-	-	-
Mov Cap-1 Maneuver	-	-	891	-	185 447
Mov Cap-2 Maneuver	-	-	-	-	323 -
Stage 1	-	-	-	-	500 -
Stage 2	-	-	-	-	549 -

Approach	EB	WB	NB
HCM Control Delay, s	0	0.9	14.5
HCM LOS			B

Minor Lane/Major Mvmt	NBLn1	EBT	EBR	WBL	WBT
Capacity (veh/h)	417	-	-	891	-
HCM Lane V/C Ratio	0.096	-	-	0.052	-
HCM Control Delay (s)	14.5	-	-	9.3	-
HCM Lane LOS	B	-	-	A	-
HCM 95th %tile Q(veh)	0.3	-	-	0.2	-

Intersection						
Int Delay, s/veh	1.4					
Movement	EBT	EBR	WBL	WBT	NBL	NBR
Lane Configurations						
Traffic Vol, veh/h	658	25	82	464	15	51
Future Vol, veh/h	658	25	82	464	15	51
Conflicting Peds, #/hr	0	0	0	0	0	0
Sign Control	Free	Free	Free	Free	Stop	Stop
RT Channelized	-	None	-	None	-	None
Storage Length	-	-	305	-	0	0
Veh in Median Storage, #	0	-	-	0	0	-
Grade, %	0	-	-	0	0	-
Peak Hour Factor	95	95	95	95	95	95
Heavy Vehicles, %	2	2	2	2	2	2
Mvmt Flow	693	26	86	488	16	54

Major/Minor	Major1	Major2	Minor1		
Conflicting Flow All	0	0	719	0	1366 706
Stage 1	-	-	-	-	706 -
Stage 2	-	-	-	-	660 -
Critical Hdwy	-	-	4.12	-	6.42 6.22
Critical Hdwy Stg 1	-	-	-	-	5.42 -
Critical Hdwy Stg 2	-	-	-	-	5.42 -
Follow-up Hdwy	-	-	2.218	-	3.518 3.318
Pot Cap-1 Maneuver	-	-	882	-	162 436
Stage 1	-	-	-	-	489 -
Stage 2	-	-	-	-	514 -
Platoon blocked, %	-	-	-	-	-
Mov Cap-1 Maneuver	-	-	882	-	146 436
Mov Cap-2 Maneuver	-	-	-	-	284 -
Stage 1	-	-	-	-	489 -
Stage 2	-	-	-	-	464 -

Approach	EB	WB	NB
HCM Control Delay, s	0	1.4	15.3
HCM LOS			C

Minor Lane/Major Mvmt	NBLn1	NBLn2	EBT	EBR	WBL	WBT
Capacity (veh/h)	284	436	-	-	882	-
HCM Lane V/C Ratio	0.056	0.123	-	-	0.098	-
HCM Control Delay (s)	18.4	14.4	-	-	9.5	-
HCM Lane LOS	C	B	-	-	A	-
HCM 95th %tile Q(veh)	0.2	0.4	-	-	0.3	-

Intersection					
Intersection Delay, s/veh	14.9				
Intersection LOS	B				
Approach	EB	WB	NB	SB	
Entry Lanes	1	1	1	1	
Conflicting Circle Lanes	1	1	1	1	
Adj Approach Flow, veh/h	748	869	139	457	
Demand Flow Rate, veh/h	763	886	142	467	
Vehicles Circulating, veh/h	390	361	1016	509	
Vehicles Exiting, veh/h	586	797	137	280	
Ped Vol Crossing Leg, #/h	0	0	0	0	
Ped Cap Adj	1.000	1.000	1.000	1.000	
Approach Delay, s/veh	23.5	8.8	12.0	13.1	
Approach LOS	C	A	B	B	
Lane	Left	Left	Bypass	Left	Left
Designated Moves	LTR	LT	R	LTR	LTR
Assumed Moves	LTR	LT	R	LTR	LTR
RT Channelized			Yield		
Lane Util	1.000	1.000		1.000	1.000
Follow-Up Headway, s	2.609	2.609		2.609	2.609
Critical Headway, s	4.976	4.976	458	4.976	4.976
Entry Flow, veh/h	763	428	1037	142	467
Cap Entry Lane, veh/h	927	955	0.980	490	821
Entry HV Adj Factor	0.981	0.980	449	0.979	0.979
Flow Entry, veh/h	748	420	1017	139	457
Cap Entry, veh/h	909	936	0.442	479	803
V/C Ratio	0.823	0.448	8.5	0.290	0.569
Control Delay, s/veh	23.5	9.2	A	12.0	13.1
LOS	C	A	2	B	B
95th %tile Queue, veh	9	2		1	4

Timings
9: US 24 & Rex Rd

2043 Total Traffic
PM Peak Hour



Lane Group	EBL	EBR	NBL	NBT	SBT	SBR
Lane Configurations	↖	↗	↖↗	↑↑	↑↑	↗
Traffic Volume (vph)	131	810	1024	586	473	117
Future Volume (vph)	131	810	1024	586	473	117
Turn Type	Prot	Free	Prot	NA	NA	Perm
Protected Phases	6!		7	Free!	8	
Permitted Phases		Free				8
Detector Phase	6		7		8	8
Switch Phase						
Minimum Initial (s)	5.0		5.0		5.0	5.0
Minimum Split (s)	20.0		10.0		20.0	20.0
Total Split (s)	24.0		52.0		44.0	44.0
Total Split (%)	20.0%		43.3%		36.7%	36.7%
Yellow Time (s)	3.0		3.0		3.0	3.0
All-Red Time (s)	2.0		2.0		2.0	2.0
Lost Time Adjust (s)	0.0		0.0		0.0	0.0
Total Lost Time (s)	5.0		5.0		5.0	5.0
Lead/Lag			Lead		Lag	Lag
Lead-Lag Optimize?			Yes		Yes	Yes
Recall Mode	Max		None		C-Max	C-Max
Act Effct Green (s)	19.0	120.0	43.0	120.0	43.0	43.0
Actuated g/C Ratio	0.16	1.00	0.36	1.00	0.36	0.36
v/c Ratio	0.49	0.54	0.88	0.17	0.39	0.19
Control Delay	52.9	1.3	30.3	0.1	30.7	5.8
Queue Delay	0.0	0.0	0.0	0.0	0.0	0.0
Total Delay	52.9	1.3	30.3	0.1	30.7	5.8
LOS	D	A	C	A	C	A
Approach Delay	8.5			19.5	25.7	
Approach LOS	A			B	C	

Intersection Summary

Cycle Length: 120
 Actuated Cycle Length: 120
 Offset: 50 (42%), Referenced to phase 8:SBT, Start of Green
 Natural Cycle: 65
 Control Type: Actuated-Coordinated
 Maximum v/c Ratio: 0.88
 Intersection Signal Delay: 17.4
 Intersection LOS: B
 Intersection Capacity Utilization 61.2%
 ICU Level of Service B
 Analysis Period (min) 15

! Phase conflict between lane groups.

Splits and Phases: 9: US 24 & Rex Rd



Intersection			
Intersection Delay, s/veh	12.8		
Intersection LOS	B		
Approach	WB	NB	SB
Entry Lanes	1	1	1
Conflicting Circle Lanes	2	2	2
Adj Approach Flow, veh/h	157	1108	582
Demand Flow Rate, veh/h	160	1130	594
Vehicles Circulating, veh/h	909	5	157
Vehicles Exiting, veh/h	226	746	912
Ped Vol Crossing Leg, #/h	0	0	0
Ped Cap Adj	1.000	1.000	1.000
Approach Delay, s/veh	8.6	15.9	8.0
Approach LOS	A	C	A
Lane	Left	Left	Left
Designated Moves	LR	TR	LT
Assumed Moves	LR	TR	LT
RT Channelized			
Lane Util	1.000	1.000	1.000
Follow-Up Headway, s	2.535	2.535	2.535
Critical Headway, s	4.328	4.328	4.328
Entry Flow, veh/h	160	1130	594
Cap Entry Lane, veh/h	656	1414	1243
Entry HV Adj Factor	0.981	0.981	0.981
Flow Entry, veh/h	157	1108	582
Cap Entry, veh/h	643	1387	1219
V/C Ratio	0.244	0.799	0.478
Control Delay, s/veh	8.6	15.9	8.0
LOS	A	C	A
95th %tile Queue, veh	1	9	3

Intersection						
Int Delay, s/veh	0.9					
Movement	WBL	WBR	NBT	NBR	SBL	SBT
Lane Configurations	Y		↑	↑	↑	↑
Traffic Vol, veh/h	37	14	1037	63	25	668
Future Vol, veh/h	37	14	1037	63	25	668
Conflicting Peds, #/hr	0	0	0	0	0	0
Sign Control	Stop	Stop	Free	Free	Free	Free
RT Channelized	-	None	-	None	-	None
Storage Length	0	-	-	155	205	-
Veh in Median Storage, #	0	-	0	-	-	0
Grade, %	0	-	0	-	-	0
Peak Hour Factor	95	95	95	95	95	95
Heavy Vehicles, %	2	2	2	2	2	2
Mvmt Flow	39	15	1092	66	26	703

Major/Minor	Minor1	Major1	Major2		
Conflicting Flow All	1847	1092	0	0	1158
Stage 1	1092	-	-	-	-
Stage 2	755	-	-	-	-
Critical Hdwy	6.42	6.22	-	-	4.12
Critical Hdwy Stg 1	5.42	-	-	-	-
Critical Hdwy Stg 2	5.42	-	-	-	-
Follow-up Hdwy	3.518	3.318	-	-	2.218
Pot Cap-1 Maneuver	82	261	-	-	603
Stage 1	322	-	-	-	-
Stage 2	464	-	-	-	-
Platoon blocked, %			-	-	-
Mov Cap-1 Maneuver	78	261	-	-	603
Mov Cap-2 Maneuver	205	-	-	-	-
Stage 1	322	-	-	-	-
Stage 2	444	-	-	-	-

Approach	WB	NB	SB
HCM Control Delay, s	26.8	0	0.4
HCM LOS	D		

Minor Lane/Major Mvmt	NBT	NBRWBLn1	SBL	SBT
Capacity (veh/h)	-	-	218	603
HCM Lane V/C Ratio	-	-	0.246	0.044
HCM Control Delay (s)	-	-	26.8	11.2
HCM Lane LOS	-	-	D	B
HCM 95th %tile Q(veh)	-	-	0.9	0.1

Intersection						
Intersection Delay, s/veh	11.6					
Intersection LOS	B					
Approach	EB		NB		SB	
Entry Lanes	2		2		2	
Conflicting Circle Lanes	2		2		2	
Adj Approach Flow, veh/h	502		1235		737	
Demand Flow Rate, veh/h	512		1260		751	
Vehicles Circulating, veh/h	484		172		252	
Vehicles Exiting, veh/h	519		824		1180	
Ped Vol Crossing Leg, #/h	0		0		0	
Ped Cap Adj	1.000		1.000		1.000	
Approach Delay, s/veh	7.4		16.3		6.7	
Approach LOS	A		C		A	
Lane	Left	Right	Left	Right	Left	Right
Designated Moves	L	TR	L	TR	LT	TR
Assumed Moves	L	TR	L	TR	LT	TR
RT Channelized						
Lane Util	0.336	0.664	0.200	0.800	0.470	0.530
Follow-Up Headway, s	2.667	2.535	2.667	2.535	2.667	2.535
Critical Headway, s	4.645	4.328	4.645	4.328	4.645	4.328
Entry Flow, veh/h	172	340	252	1008	353	398
Cap Entry Lane, veh/h	865	941	1152	1227	1071	1146
Entry HV Adj Factor	0.983	0.979	0.980	0.980	0.981	0.981
Flow Entry, veh/h	169	333	247	988	346	390
Cap Entry, veh/h	850	922	1129	1203	1050	1124
V/C Ratio	0.199	0.361	0.219	0.822	0.330	0.347
Control Delay, s/veh	6.3	7.9	5.2	19.1	6.8	6.6
LOS	A	A	A	C	A	A
95th %tile Queue, veh	1	2	1	10	1	2

Intersection											
Intersection Delay, s/veh 15.3											
Intersection LOS C											
Approach	EB		WB			NB			SB		
Entry Lanes	2		2			2			2		
Conflicting Circle Lanes	2		2			2			2		
Adj Approach Flow, veh/h	820		977			790			807		
Demand Flow Rate, veh/h	836		997			806			823		
Vehicles Circulating, veh/h	677		1064			948			813		
Vehicles Exiting, veh/h	706		581			565			902		
Ped Vol Crossing Leg, #/h	0		0			0			0		
Ped Cap Adj	1.000		1.000			1.000			1.000		
Approach Delay, s/veh	13.3		19.8			15.8			11.3		
Approach LOS	B		C			C			B		
Lane	Left	Right	Left	Right	Bypass	Left	Right	Bypass	Left	Right	Bypass
Designated Moves	LT	TR	LT	TR	R	LT	TR	R	L	LTR	R
Assumed Moves	LT	TR	LT	TR	R	LT	TR	R	L	TR	R
RT Channelized					Yield			Yield			Yield
Lane Util	0.470	0.530	0.470	0.530		0.470	0.530		0.396	0.604	
Follow-Up Headway, s	2.667	2.535	2.667	2.535		2.667	2.535		2.667	2.535	
Critical Headway, s	4.645	4.328	4.645	4.328	346	4.645	4.328	108	4.645	4.328	253
Entry Flow, veh/h	393	443	306	345	550	328	370	763	226	344	672
Cap Entry Lane, veh/h	724	799	507	575	0.980	564	634	0.980	639	711	0.980
Entry HV Adj Factor	0.981	0.981	0.980	0.981	339	0.981	0.980	106	0.982	0.980	248
Flow Entry, veh/h	385	435	300	338	539	322	363	748	222	337	658
Cap Entry, veh/h	710	784	497	564	0.629	554	622	0.142	628	698	0.377
V/C Ratio	0.543	0.555	0.603	0.600	20.5	0.581	0.583	6.3	0.354	0.484	10.6
Control Delay, s/veh	13.6	12.9	20.7	18.5	C	18.0	16.5	A	10.6	12.3	B
LOS	B	B	C	C	4	C	C	0	B	B	2
95th %tile Queue, veh	3	3	4	4		4	4		2	3	

Timings
14: US 24 & Stapleton Dr

2043 Total Traffic
PM Peak Hour

Lane Group	EBL	EBT	EBR	WBL	WBT	WBR	NBL	NBT	NBR	SBL	SBT	SBR
Lane Configurations												
Traffic Volume (vph)	142	222	469	125	321	298	629	1170	150	232	878	173
Future Volume (vph)	142	222	469	125	321	298	629	1170	150	232	878	173
Turn Type	pm+pt	NA	Free	pm+pt	NA	Free	Prot	NA	Perm	Prot	NA	Perm
Protected Phases	5	2		1	6		3	8		7	4	
Permitted Phases	2		Free	6		Free			8			4
Detector Phase	5	2		1	6		3	8	8	7	4	4
Switch Phase												
Minimum Initial (s)	5.0	10.0		4.0	5.0		8.0	5.0	5.0	10.0	15.0	15.0
Minimum Split (s)	10.0	15.0		9.0	10.0		13.0	10.0	10.0	15.0	20.0	20.0
Total Split (s)	12.0	25.0		12.0	25.0		36.0	65.0	65.0	18.0	47.0	47.0
Total Split (%)	10.0%	20.8%		10.0%	20.8%		30.0%	54.2%	54.2%	15.0%	39.2%	39.2%
Yellow Time (s)	3.0	3.0		3.0	3.0		3.0	3.0	3.0	3.0	3.0	3.0
All-Red Time (s)	2.0	2.0		2.0	2.0		2.0	2.0	2.0	2.0	2.0	2.0
Lost Time Adjust (s)	0.0	0.0		0.0	0.0		0.0	0.0	0.0	0.0	0.0	0.0
Total Lost Time (s)	5.0	5.0		5.0	5.0		5.0	5.0	5.0	5.0	5.0	5.0
Lead/Lag	Lead	Lag		Lead	Lag		Lead	Lag	Lag	Lead	Lag	Lag
Lead-Lag Optimize?	Yes	Yes		Yes	Yes		Yes	Yes	Yes	Yes	Yes	Yes
Recall Mode	None	C-Max		None	C-Max		None	Max	Max	None	Max	Max
Act Effct Green (s)	27.0	20.0	120.0	27.0	20.0	120.0	27.5	60.8	60.8	12.2	45.5	45.5
Actuated g/C Ratio	0.22	0.17	1.00	0.22	0.17	1.00	0.23	0.51	0.51	0.10	0.38	0.38
v/c Ratio	0.67	0.40	0.31	0.49	0.57	0.20	0.84	0.69	0.18	0.70	0.67	0.26
Control Delay	43.8	38.4	0.6	43.0	50.4	0.3	54.5	25.1	2.9	51.0	40.8	11.0
Queue Delay	0.0	0.0	0.0	0.0	0.0	0.0	0.0	0.0	0.0	0.0	0.0	0.0
Total Delay	43.8	38.4	0.6	43.0	50.4	0.3	54.5	25.1	2.9	51.0	40.8	11.0
LOS	D	D	A	D	D	A	D	C	A	D	D	B
Approach Delay		18.0			29.1			32.9			38.6	
Approach LOS		B			C			C			D	

Intersection Summary

Cycle Length: 120
 Actuated Cycle Length: 120
 Offset: 0 (0%), Referenced to phase 2:EBTL and 6:WBTL, Start of Green
 Natural Cycle: 70
 Control Type: Actuated-Coordinated
 Maximum v/c Ratio: 0.84
 Intersection Signal Delay: 31.2
 Intersection LOS: C
 Intersection Capacity Utilization 75.6%
 ICU Level of Service D
 Analysis Period (min) 15

Splits and Phases: 14: US 24 & Stapleton Dr

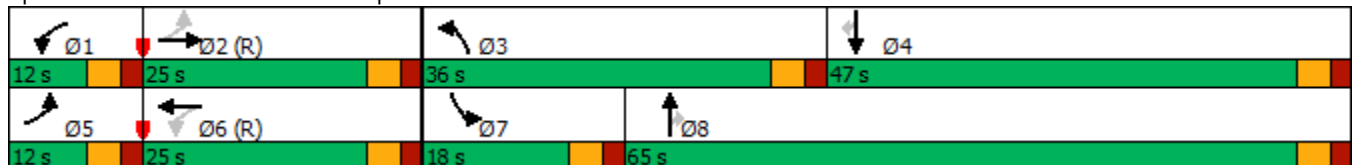

Appendix Table 1



Appendix Table 1
Area Traffic Impact Studies by LSC
Grandview Reserve Phases 2 and 3

Study	Date
4-Way Ranch/Waterbury	
4-Way Ranch Updated TIA	January 29, 2009
Waterbury PUD Development Plan Updated TIA	January 10, 2013
Waterbury Filing Nos. 1 and 2 TIA	December 18, 2020
4-Way Ranch Commercial Master Traffic Impact Analysis	December 20, 2022
4-Way Ranch Commercial Phase 1 Traffic Technical Memorandum	November 30, 2023
Meridian Ranch	
Meridian Ranch Sketch Plan TIA	April 11, 2011
Meridian Ranch Filing 11 Updated TIA	November 26, 2013
Stonebridge at Meridian Ranch Filing No. 1 Updated TIA	April 23, 2014
Stonebridge at Meridian Ranch Transportation Memorandum	July 28, 2015
Meridian Ranch Filing 8 Updated TIA	December 23, 2014
Meridian Ranch Filing 9 Updated TIA	May 21, 2015
Meridian Ranch Sketch Plan 2015 Amendment TIA	July 30, 2015
The Vistas at Meridian Ranch TIA	March 24, 2016
Meridian Ranch Estates Filing No. 2 Transportation Memorandum	August 27, 2015
The Vistas at Meridian Ranch Updated Transportation Memorandum	June 20, 2017
Londonderry Drive Pedestrian Operations and Safety Study	February 8, 2017
Stonebridge Filing 3 at Meridian Ranch Updated TIA	March 20, 2017
Meridian Ranch Sketch Plan 2017 Amendment TIA	October 3, 2017
WindingWalk at Meridian Ranch and The Enclave at Stonebridge at Meridian Ranch Updated Traffic Impact Analysis	May 10, 2018
Rolling Hills Ranch at Meridian Ranch PUDSP Traffic Impact Analysis	June 29, 2020
The Estates at Rolling Hills Ranch Filing No. 1 Traffic Impact Analysis	May 13, 2020
Rolling Hills Ranch at Meridian Ranch Filing No. 1 Traffic Impact Analysis	July 14, 2020
The Estates at Rolling Hills Ranch Filing No. 2 Traffic Impact Study	October 8, 2020
Rolling Hills Ranch at Meridian Ranch Filing No. 2 Transportation Memorandum	December 29, 2020
Rolling Hills Ranch at Meridian Ranch Filing No. 3 Transportation Memorandum	June 29, 2021
Meridian Ranch 2021 Sketch Plan Amendment Traffic Impact Study	June 25, 2021
The Sanctuary at Meridian Ranch Transportation Memorandum	May 3, 2022
Rolling Hills Ranch North PUD Transportation Memorandum	October 30, 2023
Grandview Reserve	
Grandview Reserve Updated Master TIA	December 5, 2020
Grandview Reserve Phase 1 TIA	March 8, 2022
Meadowlake Ranch	
Meadowlake Ranch Traffic Impact Analysis	May 29, 2019
Latigo Preserve	
Latigo Preserve Filing No. 10	March 31, 2022
<i>Source: LSC Transportation Consultants, Inc.</i>	
<i>Dec-23</i>	

MTCP Maps



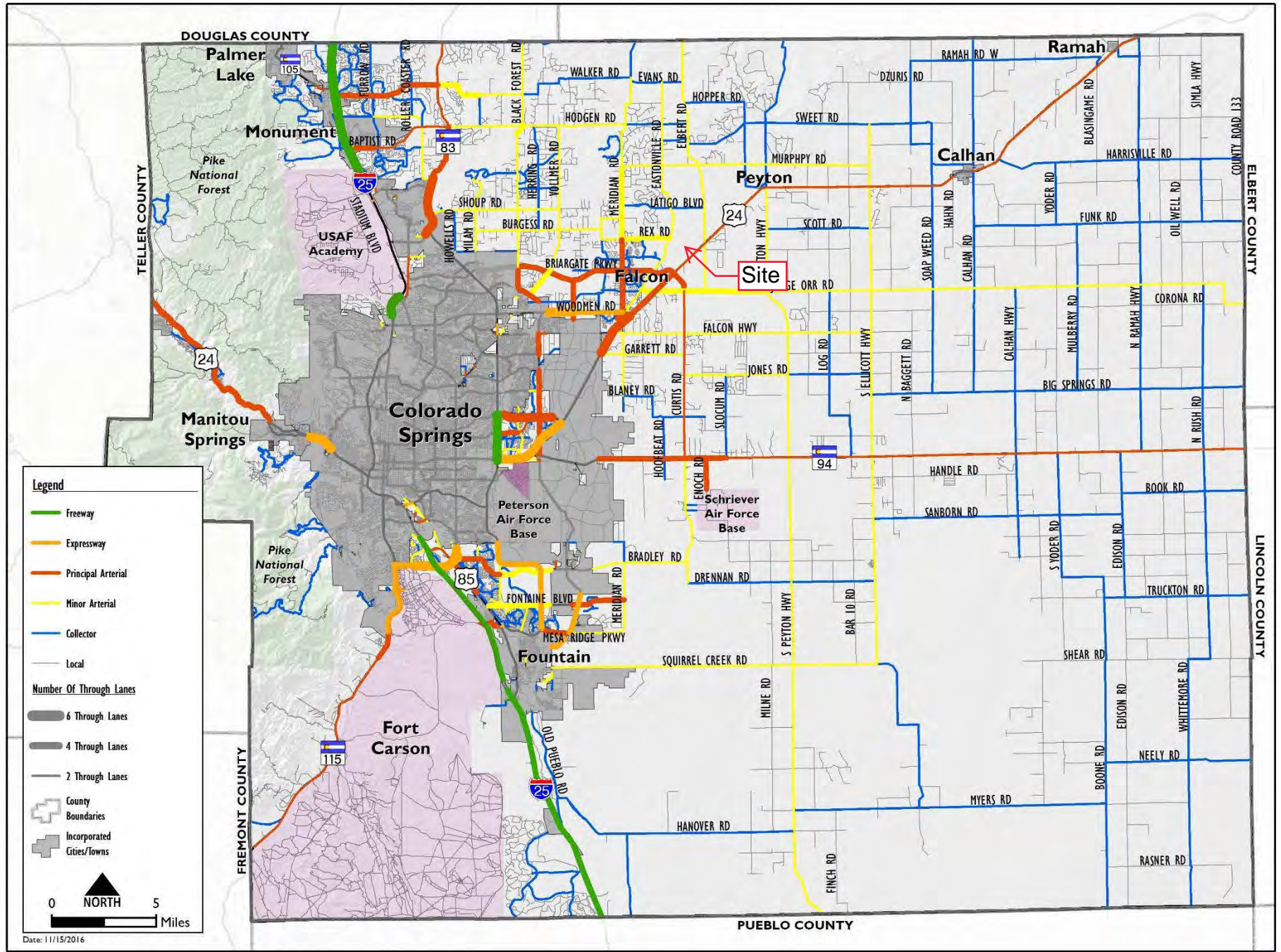

Map 14: 2040 Roadway Plan (Classification and Lanes)

Map 17: 2060 Corridor Preservation

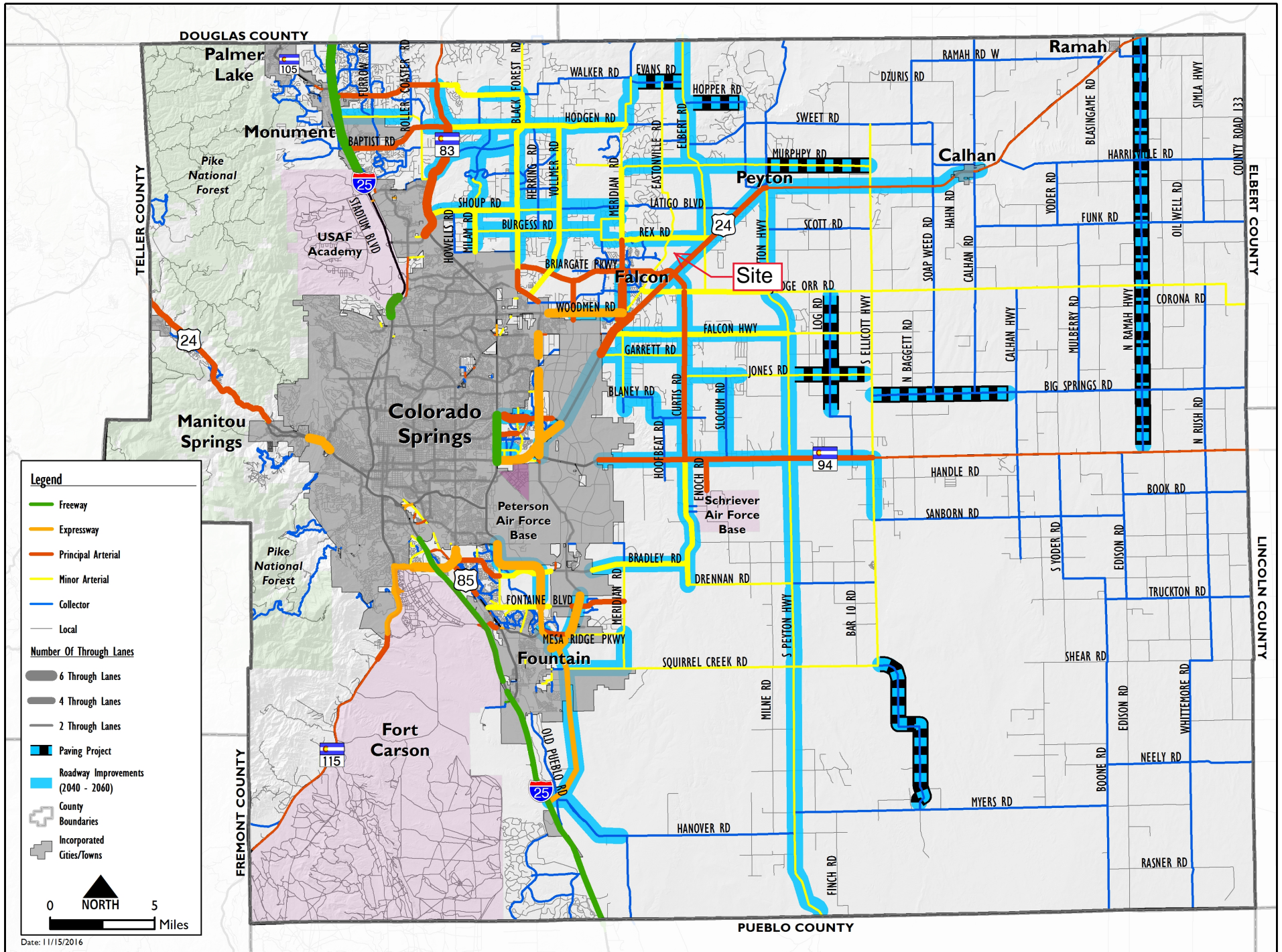

Map 15 Bicycle and Pedestrian Network Improvements



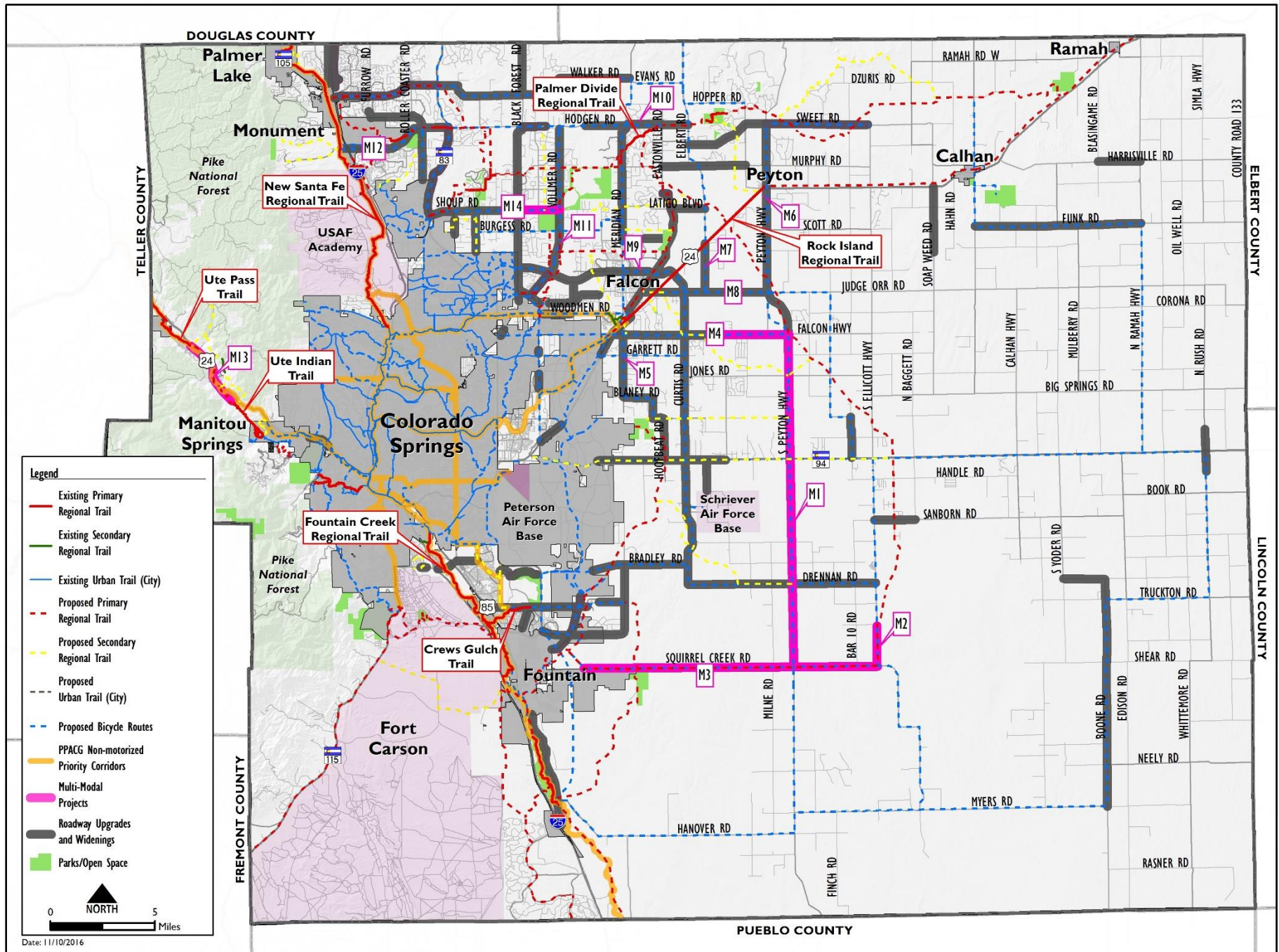

Map 15: Bicycle and Pedestrian Network and Improvements

Crash History



AccidentDate	AccidentTime	TotalVehicles	LocationRoadName	NumberInjured	FIP	ReferencePointAtName	AccidentNarrative
2021-01-29	18:25	2	EASTONVILLE	0	Property	STAPLETON DR	Vehicle 1 was westbound on Stapleton Drive at the stop sign of Eastonville Road. Vehicle 2 was southbound on Eastonville Drive approaching the intersection. The intersection has a stop sign for eastbound and westbound traffic on Stapleton Drive. Vehicle 1 proceeded from the stop sign into the intersection. The front end of Vehicle 2 collided with the right side of Vehicle 1 in the
2021-05-07	11:30	2	EASTONVILLE	1	Injury	STAPLETON DR	Vehicle 1 was westbound on Stapleton Dr at Eastonville Rd. Vehicle 2 was southbound on Eastonville Rd at Stapleton Dr. Vehicle 1 failed to yield right of way and proceeded from a stop sign. Vehicle 1 collided its front with the side of vehicle 2. Both vehicles were
2021-11-04	22:40	1	EASTONVILLE	0	Property		Vehicle #1 was traveling northbound on Eastonville road approaching a left turn. Vehicle #1 lost control on the dirt road and rotated counterclockwise before rolling 3/4 time, then coming to rest on its left side off the left side of the roadway facing south.
2021-12-17	10:55	2	EASTONVILLE	0	Property	STAPLETON DR	Vehicle 1 was westbound on Stapleton Dr at Eastonville Rd. Vehicle 2 was northbound on Eastonville Rd at Stapleton Dr. Vehicle 1 failed to stop at a stop sign and entered the intersection. Vehicle 1 collided its front with the side of vehicle 2. Both vehicles were
2022-02-03	13:25	2	EASTONVILLE	0	Property	STAPLETON DR	Vehicle 1 was westbound on Stapleton Dr at Eastonville Rd. Vehicle 2 was northbound on Eastonville Rd at Stapleton Dr. Vehicle 1 failed to stop at a stop sign and entered the intersection in front of vehicle 2. Vehicle 2 collided its front with the side of vehicle 1. Vehicle 2 began to rotate counter clockwise and collided its side with the side of vehicle 1's trailer. Vehicle 2 came to a rest facing
2022-07-15	17:09	2	EASTONVILLE	0	Property	STAPLETON DR	Vehicle 1 was stopped at a controlled stop sign facing southeast on Stapleton Dr. at the intersection of Eastonville Rd. Vehicle 2 was traveling southwest on Eastonville Rd near Stapleton Dr. Vehicle 1 proceeded straight through the intersection. Vehicle 2 struck the
2022-12-05	16:07	2	EASTONVILLE	0	Property	STAPLETON DR	Vehicle #2 was traveling northbound on Eastonville Road in the #1 lane and was stopped at the stop sign at Stapleton Drive and Eastonville Road. Vehicle #1 was traveling northbound on Eastonville in the #1 lane and was stopped at the stop sign behind Vehicle #2 at Stapleton Drive and Eastonville. Vehicle #1 started to advance forward, but Vehicle #2 was still stopped. Vehicle #1 struck it's
2023-03-22	19:10	2	EASTONVILLE	0	Property	STAPLETON DR	Vehicle #1 was traveling east on Stapleton Dr approaching Eastonville Rd. Vehicle #2 was traveling southwest on Eastonville Rd approaching Stapleton Dr. Vehicle #1 failed to stop at the stop sign on Stapleton Dr at Eastonville Rd and failed to yield the right of way to Vehicle #2. Vehicle #1 entered the intersection of Stapleton Dr at Eastonville Rd in front of Vehicle #2, at which point the driver
2023-07-02	13:29	2	EASTONVILLE	0	Property	STAPLETON DR	Vehicle 1 was west bound on Stapleton Drive, stopped at the intersection with Eastonville Road in El Paso County, Colorado. Vehicle 2 was south bound on Eastonville Road, approaching the same intersection. Vehicle 1 entered the intersection to proceed straight. Vehicle 2 swerved to the right and the front right corner of Vehicle 1 hit the front left corner of Vehicle 2, in the intersection. Both

Additional Attachments

Figure 13 from the *Grandview Reserve Phase 1 Updated Traffic Impact Analysis*



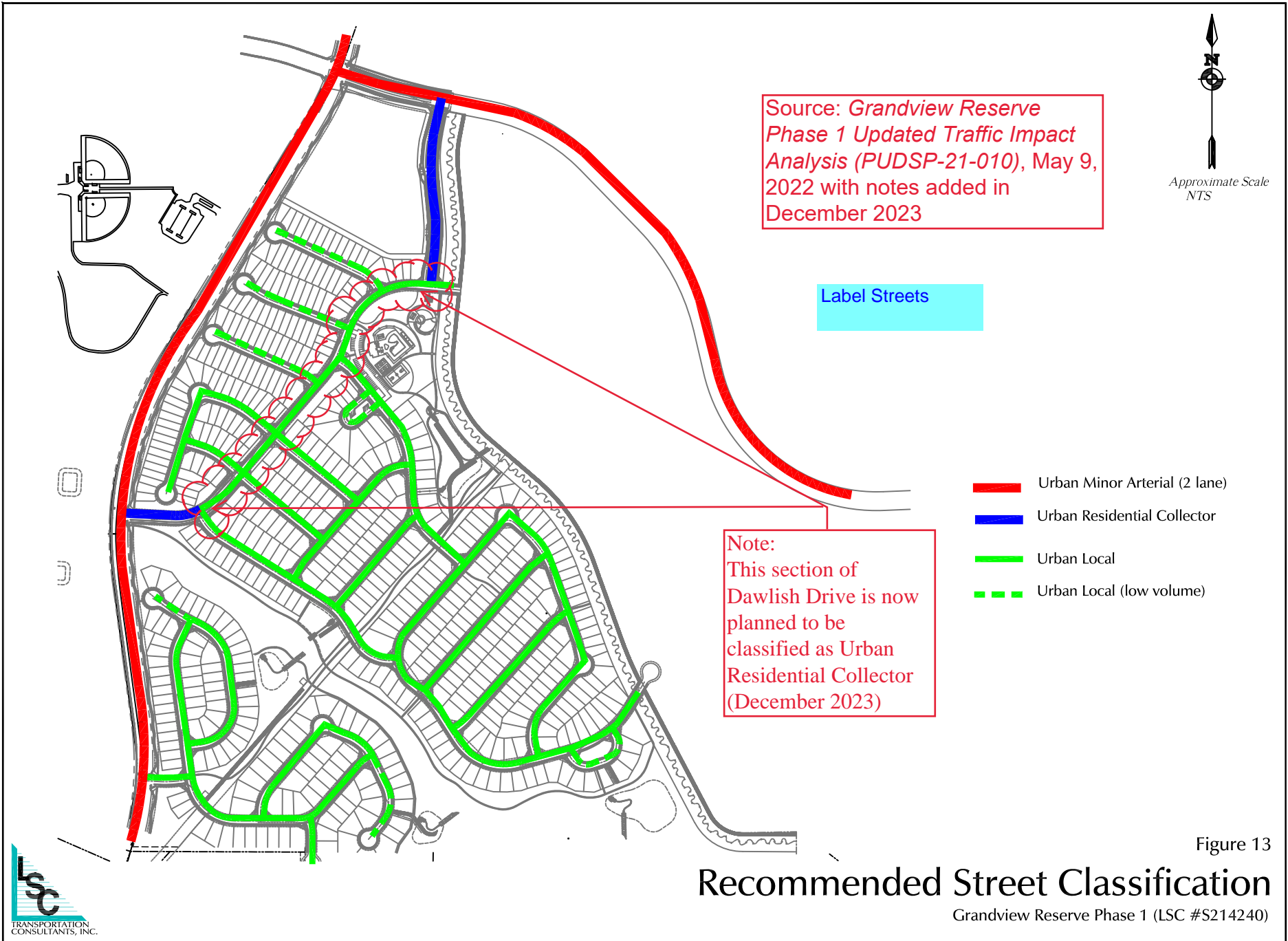

Figure 13

Recommended Street Classification

Grandview Reserve Phase 1 (LSC #S214240)

V1_Traffic Impact Study Review 1.pdf

Callout (4)

analysis based on the uncalibrated method of analysis procedures from the 1995 edition of the Transportation Research Board and Synthetic Signatures. Based on the criteria contained in the ITE's peak-hour factor (PHF) criteria (from 2000) and intermediate-term (from 2003) criteria, except for one existing peak-hour factor calculated from traffic counts conducted by I-75 in those cases, the existing peak-hour factor was used. A peak-hour factor of 0.85 was used for the 2003 data. The results of the analysis are contained in Figures 10, 11 and 12. The results of the analysis are attached.

Multi Road Intersection #1

1 of 10: Eastonville Road is planned to be constructed as a median one-way street in the approved Eastonville Road Phase 1 development. All approval is for operation at 150 D or better through 2041.

High Roadway Intersection #2

Subject: Callout
Page Label: 16
Author: CDurham
Date: 1/29/2024 1:15:51 PM
Status:
Color: ■
Layer:
Space:

What about the 2033 analysis?

as part of this report as they are not planned as part of 3. Detailed analysis will be provided with future

90

For what Phase is this intersection expected to be constructed?

1 of 10: Eastonville Road is planned to be constructed as a median one-way street in the approved Eastonville Road Phase 1 development. All approval is for operation at 150 D or better through 2041.

Subject: Callout
Page Label: 17
Author: CDurham
Date: 1/29/2024 1:18:36 PM
Status:
Color: ■
Layer:
Space:

For what Phase is this intersection expected to be constructed?

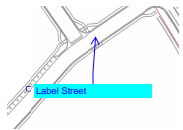

Subject: Callout
Page Label: 30
Author: CDurham
Date: 1/29/2024 2:49:36 PM
Status:
Color: ■
Layer:
Space:

Label Street

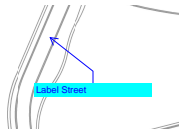

Subject: Callout
Page Label: 31
Author: CDurham
Date: 1/29/2024 2:49:50 PM
Status:
Color: ■
Layer:
Space:

Label Street

Highlight (1)

channelized "T"
ected 2041 tot:

Subject: Highlight
Page Label: 17
Author: CDurham
Date: 1/29/2024 1:18:01 PM
Status:
Color: ■
Layer:
Space:

d 2041

Text Box (6)

ember 21, 2023
PUDSP-23-006

Subject: Text Box
Page Label: 1
Author: CDurham
Date: 1/29/2024 3:20:53 PM
Status:
Color: ■
Layer:
Space:

PUDSP-23-006

shown in table, due to general regional growth, including but not limited to the area shown in the table.

Subject: Text Box
Page Label: 13
Author: CDurham
Date: 1/29/2024 1:13:16 PM
Status:
Color: ■
Layer:
Space:

Per ECM Appendix Section B.2.2, Long Range Horizon is 20-25 years out. Please update so Long term analysis fits within this time frame.

the new planning, with context and level of service at the time area for the alternative-use background colors.

Subject: Text Box
Page Label: 20
Author: CDurham
Date: 1/29/2024 3:25:52 PM
Status:
Color: ■
Layer:
Space:

Provide a section on Queuing Analysis, MTCP 2040 Improvement Projects & Auxiliary Turn Lanes

Provide a section on Queuing Analysis, MTCP 2040 Improvement Projects & Auxiliary Turn Lanes

future when the north leg of t

Subject: Text Box
Page Label: 29
Author: CDurham
Date: 1/29/2024 2:48:58 PM
Status:
Color: ■
Layer:
Space:

Provide Street names

Provide Street names

Subject: Text Box
Page Label: 189
Author: CDurham
Date: 1/29/2024 3:05:40 PM
Status:
Color: ■
Layer:
Space:

Label Streets

Label Streets

Subject: Text Box
Page Label: 20
Author: CDurham
Date: 1/29/2024 3:36:33 PM
Status:
Color: ■
Layer:
Space:

Include section discussing deviations. Per roadways sections shown on preliminary plan, some local roads are shown having a 65' ROW, which would require a deviation. Also, the section for Rex Road does not match county standard. Indicate if a deviation has been approved, is being reviewed, etc.

Include section discussing deviations. Per roadways sections shown on preliminary plan, some local roads are shown having a 65' ROW, which would require a deviation. Also, the section for Rex Road does not match county standard. Indicate if a deviation has been approved, is being reviewed, etc.