



LSC TRANSPORTATION CONSULTANTS, INC.  
2504 East Pikes Peak Avenue, Suite 304  
Colorado Springs, CO 80909  
(719) 633-2868  
FAX (719) 633-5430  
E-mail: [lsc@lsctrans.com](mailto:lsc@lsctrans.com)  
Website: <http://www.lsctrans.com>

Grandview Reserve Phases 2 & 3  
Preliminary Plan & PUD  
Traffic Impact Analysis  
PUDSP-23-006 & PUDSP-24-001  
(LSC #S234340)  
August 13, 2024

**Traffic Engineer's Statement**

This traffic report and supporting information were prepared under my responsible charge and they comport with the standard of care. So far as is consistent with the standard of care, said report was prepared in general conformance with the criteria established by the County for traffic reports.

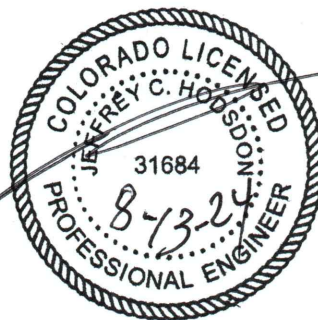

**Developer's Statement**

I, the Developer, have read and will comply with all commitments made on my behalf within this report.

Boyan Rudo

8/15/24  
Date

# Grandview Reserve Phases 2 & 3

## Traffic Impact Analysis

Prepared for:  
Mr. Phil Stuepfert  
HR Green  
5619 DTC Parkway – Suite 1150  
Greenwood Village, CO 80111

AUGUST 13, 2024

---

LSC Transportation Consultants, Inc.

Prepared by: Jeffrey C. Hodsdon, P.E. and Kirstin D. Ferrin, P.E.

LSC # S234340



CONTENTS

REPORT CONTENTS ..... 1

PREVIOUS TRAFFIC REPORTS ..... 2

LAND USE AND ACCESS..... 2

    Approved Land Use – Phase 1 ..... 2

    Phases 2 and 3 - Currently Proposed Preliminary Plan and PUD/Site Plan ..... 2

    Site Access..... 3

    Pedestrian and Bicycle Accommodations..... 3

    Sight Distance Analysis..... 4

        Intersection Sight Distance ..... 4

        Stopping Sight Distance at Intersections ..... 4

ROADWAY AND TRAFFIC CONDITIONS ..... 4

    Area Roadways..... 4

    Existing Traffic Volumes ..... 6

    Existing Levels of Service ..... 6

    Londonderry Drive/Eastonville Road (Intersection #12) ..... 7

    Stapleton Drive/Eastonville Road (Intersection #13) ..... 7

    US Highway 24/Stapleton Drive (Intersection #14)..... 7

    Eastonville Road/Meridian Ranch Boulevard/Judge Orr Road (Intersection #15)..... 7

    Eastonville Road/McLaughlin Road (Intersection #16) ..... 8

    Safety Analysis ..... 8

SHORT-TERM (YEAR 2026) BACKGROUND TRAFFIC ..... 8

INTERMEDIATE-TERM (YEAR 2033) BACKGROUND TRAFFIC..... 9

2045 BACKGROUND TRAFFIC..... 10

TRIP GENERATION..... 10

DIRECTIONAL DISTRIBUTION AND ASSIGNMENT ..... 11

TOTAL TRAFFIC..... 11

    Short-Term (Year 2026) ..... 11

    Intermediate-Term (Year 2033) ..... 12

    Long-Term (Year 2045) ..... 12

PROJECTED LEVELS OF SERVICE ..... 12

    Rex Road/Eastonville Road (Intersection #1) ..... 13

    Rex Road/Ivybridge Boulevard (Intersection #2)..... 13

    Rex Road/Potential Future North Access (Planned Public Street) (Intersection #3)..... 13

Rex Road/Edenvale Place (Planned Public Street) (Intersection #4).....	13
Rex Road/Grange Trail (Planned Public Street) (Intersection #5) .....	13
Rex Road/Wishaw Place (Planned Public Street) (Intersection #6).....	13
Rex Road Intersections #7 and #8.....	13
US Highway 24/Rex Road (Intersection #9).....	14
Eastonville Road/Dawlish Drive (Intersection #10) .....	14
Eastonville Road/Brixham Drive (Intersection #11) .....	14
Londonderry Drive/Eastonville Road (Intersection #12) .....	14
Stapleton Drive/Eastonville Road (Intersection #13) .....	14
US Highway 24/Stapleton Drive (Intersection #14).....	15
Eastonville Road/Meridian Ranch Boulevard/Judge Orr Road (Intersection #15).....	15
Eastonville Road/McLaughlin Road (Intersection #16) .....	15
QUEUING ANALYSIS .....	15
FUNCTIONAL CLASSIFICATIONS AND LANEAGE.....	16
MULTI-MODAL AND PEDESTRIAN/BIKE TRANSPORTATION .....	17
DEVIATIONS TO ECM CRITERIA .....	17
TRANSPORTATION IMPROVEMENT FEE PROGRAM .....	17
Project Fees.....	17
Potentially Reimbursable Improvements Under the MTCP Fee Program.....	18
ROADWAY IMPROVEMENTS.....	18
Enclosures: .....	19
Tables 2-3	
Figures 1-16	
Rex/Wishaw Roundabout Exhibits	
Traffic Count Reports	
Level of Service Reports	
Queuing Reports	
Appendix Table 1	
MTCP Maps	
Map 15 Bicycle and Pedestrian Network Improvements	
Rex Road Proposed Cross Section	
Crash History Data	
Figure 13 from the <i>Grandview Reserve Phase 1 Updated Traffic Impact Analysis</i>	



**LSC TRANSPORTATION CONSULTANTS, INC.**  
2504 East Pikes Peak Avenue, Suite 304  
Colorado Springs, CO 80909  
(719) 633-2868  
FAX (719) 633-5430  
E-mail: [lsc@lsctrans.com](mailto:lsc@lsctrans.com)  
Website: <http://www.lsctrans.com>

August 13, 2024

Mr. Phil Stuepfert  
HR Green  
5619 DTC Parkway – Suite 1150  
Greenwood Village, CO 80111

RE: Grandview Reserve Phases 2 & 3  
El Paso County, Colorado  
Traffic Impact Analysis  
LSC # S234340

Dear Phil:

In response to your request, LSC Transportation Consultants, Inc. has prepared this traffic impact analysis for Phases 2 and 3 of the Grandview Reserve development in El Paso County, Colorado. As shown in Figure 1, the Phase 2 and 3 areas are located south of the future Rex Road and east of the approved Phase 1 area.

## **REPORT CONTENTS**

This report is being submitted as part of a Preliminary Plan/PUD submittal for Phases 2 and 3.

The report contains the following:

- The traffic count data and street conditions;
- Short-term, intermediate-term and 2045 baseline/background traffic-volume estimates;
- The projected average weekday and peak-hour vehicle trips to be generated by the site;
- The assignment of the site's projected traffic volumes to the key area streets and intersections for the short, intermediate, and long term and the resulting total traffic volumes for the short, intermediate, and long term;
- The resulting traffic impacts including level of service analysis at key intersections; and
- Findings and recommendations.

## **PREVIOUS TRAFFIC REPORTS**

LSC completed a Master Traffic Impact Study (TIS) for Grandview Reserve (Sketch Plan) dated December 15, 2020 ([SKP201](#)). That report assumed the initial development would occur on the parcels on the east end of the overall development with access to US Highway 24 (US Hwy 24) only. Initial development, Phase 1 (approved) and Phases 2 & 3 (current application), has since been shown to occur on the west side of the master plan area with access only to Eastonville Road and the initial segment of Rex Road east of Eastonville (i.e., the road connection to US Highway 24 will be implemented later with future phases beyond Phase 3). LSC also completed a traffic impact study for the first phase of the Grandview Reserve ([PUDSP2110](#)), dated May 9, 2022.

A list of other traffic studies in the area of study completed within the past five years (that LSC is aware of) is attached for reference. This study accounts for the land use, trip generation, and the roadway network included in these studies. The older previous area studies generally assumed Rex Road would not extend from Eastonville Road to US Hwy 24 in the 20-year horizon as is now planned. The older previous studies also assumed fewer dwelling units on this site.

A traffic report, entitled *Eastonville Road Project Conceptual Design Report* was also recently completed for Eastonville Road by Wilson & Company (for El Paso County).

## **LAND USE AND ACCESS**

### **Approved Land Use – Phase 1**

Figure 2a shows the approved site plan (Preliminary Plan and PUD) for Phase 1 of Grandview Reserve. This phase includes 565 lots for single-family homes, an 11.2-acre church site, and an “amenity center”. Construction of the first homes within Phase 1 is anticipated in 2024. By 2026, the first two filings which include about 169 lots for single-family homes are anticipated to be completed and by 2033 it was assumed that Phase 1 would be built out.

### **Phases 2 and 3 - Currently Proposed Preliminary Plan and PUD/Site Plan**

Figure 2a also shows the currently proposed site plan for Phases 2 and 3 of Grandview Reserve. Phase 2 is planned to include 224 townhomes and 206 duplexes and is anticipated to be completed by 2026. Phase 3 is planned to include 322 lots for single-family homes and is anticipated to be constructed between 2026 and 2033. Phase 3 also includes a 25-acre school site. The Phase 2 and 3 plans are generally consistent with the land uses assumed for this same area in the Master TIS. The one notable change is that the Master TIS assumed the school site was located north of Rex Road and the school site is now planned to be located south of Rex Road. As no additional information about the school site is known at this time, the same school type and number of students assumed in the Master TIS was assumed for this report. This report also assumes the former school site north of Rex Road will be developed with the same number of residential dwelling units as was assumed in the Master TIS for the area that includes the currently-proposed school site south of Rex Road.

## Site Access

Three new public-street connections (Edenvale Place, Grange Trail, and Wishaw Place) are proposed to an extension of Rex Road as part of Phase 2 and 3. Figure 2b shows the proposed intersection spacing on Rex Road.

Based on the criteria contained in the El Paso County *Engineering Criteria Manual (ECM)*, the required intersection spacing for Minor Arterial roadways is  $\frac{1}{4}$  mile (1,320 feet). The proposed public-street access points to Eastonville Road meet the intersection spacing criteria. The Phase 1 TIS assumed a potential future access for parcels north of Rex Road about 650 feet east of Ivybridge Drive and 875 feet west of the first new proposed access point for Phase 1 (Ivybridge Boulevard). This future access would require a deviation to the *ECM* standards.

Figure 2c shows the planned internal street connections between Phase 1 and Phases 2/3, the street connections to the portion of Rex Road to be constructed, and phasing/timing of connections to the Phase 1 street network. The master-planned road connection to US Highway 24 will be completed later with future phases (beyond Phase 3).

One change is proposed to the **Phase 1** street network as part of the current planning for Phases 2 and 3. As noted in the attached copy of Figure 13 from the *Grandview Reserve Phase 1 Updated Traffic Impact Analysis (PUDSP-21-010)* dated May 9, 2022, Dawlish Drive is now planned to be classified as an Urban Residential Collector from Eastonville Road to Ivybridge Drive. This change has been made as part of the site design and planning process to ensure interim Phases 2 and 3 trips/traffic volumes can be accommodated by the previously planned Phase 1 streets.

## Pedestrian and Bicycle Accommodations

There are two existing school sites located within two miles of the site, Falcon High School and Meridian Ranch Elementary. A future K-8 school is planned just north of Falcon High School. These schools are located north of Londonderry Drive and west of Eastonville Road. There is also a regional park located just west of the site.

The likely pedestrian path to the school and park sites is Eastonville Road to Londonderry Drive. There are currently sidewalks and school crossings on Londonderry Drive. There are currently no sidewalks on Eastonville Road. However, the *2016 Major Transportation Corridors Plan (MTCP)* shows a proposed primary regional trail along this corridor. The cross section for Eastonville Road north of Stapleton Drive recommended in the *Eastonville Road Conceptual Design Report* dated April 2021 includes an 8-foot detached meandering sidewalk on both sides of the roadway. The Grandview Reserve site plan includes a trail located outside of the Eastonville right-of-way but within their 30-foot landscape buffer to meet the regional trail requirement. Figure 2a shows the location of the proposed regional trail and other proposed trails within the Grandview Reserve development. All of the internal streets within the Phases 1 through 3 area will have sidewalks.

## **Sight Distance Analysis**

Figures 3a and 3b shows sight-distance analysis at the proposed Phase 2 intersections with Rex Road (#4 Rex/Edenvale and #5 Rex/Grange).

### Intersection Sight Distance

Based on the planned design speed of 40 miles per hour (mph) for Rex Road and the criteria contained in Table 2-21 of the *ECM*, the required intersection sight distance at these access points is 445 feet.

### Stopping Sight Distance at Intersections

Based on the criteria contained in Table 2-17 of the *ECM*, the required stopping sight distance approaching this intersection is 305 feet (for grades less than three percent). As shown in Figures 3a and 3b the *ECM* criteria can be met at both of the intersections analyzed.

The Phase 3 intersection (#6 Rex/Wishaw) was not analyzed for sight distance as it is planned to be constructed as a one-lane modern roundabout. Detailed roundabout design reports are attached.

## **ROADWAY AND TRAFFIC CONDITIONS**

### **Area Roadways**

The major roadways in the site's vicinity are shown in Figure 1 and are described below. Copies of the 2024 El Paso County Major Transportation Corridors Plan (*MTCP*) 2045 Roadway Plan, and 2024 *MTCP* 2065 Corridor Preservation Plan (*CPP*) with the site location identified on them have been attached to this report.

**Eastonville Road** extends northeast from Meridian Road to past Hodgen Road. It is shown as a two-lane, Rural Major Collector north of Bandanero Drive and a two-lane, Urban Major Collector south of Bandanero Drive on the 2045 Roadway Functional Classifications and Lane Requirements figures and the *Corridor Preservation Plan* Functional Classifications and Through Lane Requirements figures. Eastonville Road has a three-lane cross-section (one through lane in each direction plus a center two-way, left-turn lane) from Woodmen Hills Drive to Snaffle Bit Road (approximately midway between Judge Orr Road and Stapleton Road). Eastonville Road is a two-lane roadway north and south of this section. Eastonville Road is currently unpaved north of Londonderry Drive. Pikes Peak Rural Transportation Authority (PPRTA)-funded improvements are anticipated in the future at the intersection of Eastonville Road and Stapleton Drive that would likely add northbound and southbound left-turn lanes. The posted speed limit north of Stapleton Drive is 35 mph.



**Rex Road** extends east from Goodson Road to Estate Ridge Drive within the Meridian Ranch development. Rex Road is classified as a Two-Lane, Urban Minor Arterial in the *2024 El Paso County Major Transportation Corridors Plan (MTCP) 2045 Roadway Functional Classifications and Lane Requirements* figure. The *2065 Corridor Preservation Plan Functional Classifications and Through Lane Requirements* figures show Rex Road as a four-lane facility between Meridian Road and US Highway 24. The posted speed limit on Rex Road is 45 mph between Meridian Road and Mount Gateway Drive and 35 mph east of Mount Gateway Drive. Rex Road is currently being constructed as a 2-lane Urban Minor Arterial from its existing terminus at Estate Ridge Drive to Eastonville Road. The new section is anticipated to be open to traffic by the end of 2024.

A short section is also proposed to be constructed east of Eastonville Road in the short-term future as part of the approved Grandview Reserve Phase 1 development. A roundabout is planned to be constructed at the intersection of Rex Road/Eastonville Road as part of the Grandview Reserve Phase 1 development. As part of Phases 2 and 3, Rex Road is planned to be extended farther to the southeast adjacent to and along with these phases. A graphic showing the proposed cross section has been attached. This cross section will require a deviation to the criteria contained in the *El Paso County Engineering Criteria Manual (ECM)* because the *ECM* does not provide a standard cross section for an Urban, **Two-Lane**, Minor Arterial street (although an Urban, Two-Lane, Minor Arterial is an official classification in the *2024 MTCP*). In the future, Rex Road is planned to be constructed southeast through Grandview Reserve and will intersect US Highway 24 as part of future development (beyond Phase 3) within the Grandview Reserve Sketch Plan area, coordination with El Paso County, the Colorado Department of Transportation (CDOT), and other local agencies and associated applications to CDOT. The *2024 MTCP* shows a 2045 extension from US Highway 24 to Elbert Road.

This ultimate, master-planned, Rex Road connection and an associated new intersection with US Highway 24 has been approved and “Access-Permitted” by CDOT in coordination with El Paso County, the Colorado Department of Transportation (CDOT), and other local agencies. The CDOT access permit notice-to-proceed (NTP) has not yet been requested by the applicant and has not been issued. The permit will likely need to be extended (per CDOT requirements) given the proposed phasing of this Preliminary Plan/PUD.

**US Highway 24 (US Hwy 24)** is generally a two-lane State Highway extending east/west across Colorado connecting the Buena Vista, Colorado Springs, and Limon areas. US Hwy 24 is planned to be widened to four lanes through the Falcon area. The US Hwy 24 PEL identifies this widening as a high priority with a timeline of less than 10 years. US Hwy 24 in the vicinity is classified as an EX – Expressway/Major Bypass by the Colorado Department of Transportation (CDOT). US Hwy 24 is shown as a four-lane Principal Arterial on the *MTCP* and the *Preserved Corridor Network Plan*. The posted speed limit on US Hwy 24 adjacent to the site is 65 miles per hour (mph).

**Stapleton Road/Drive** is shown as an Urban, Two-lane Principal Arterial on the *2024 El Paso County Major Transportation Corridors Plan 2045 Roadway Functional Classifications and Lane Requirements* figures. The *2065 Corridor Preservation Plan Functional Classifications and*

Through Lane Requirements figures show Stapleton Drive/Road as a four-lane facility for its entire length - between Judge Orr Road and Black Forest Road. Stapleton extends east from Towner Drive to US Hwy 24. Stapleton Road continues southeast, then south to Judge Orr road (at which point it continues south as Curtis Road). To the west, it is planned to be ultimately extended west to connect with the Briargate Parkway extension. Stapleton currently is a half-section of a four-lane, Principal Arterial street (one through lane in each direction) between Meridian Road and US Hwy 24. The posted speed limit between Eastonville Road and US Hwy 24 is 45 mph.

### **Existing Traffic Volumes**

Figure 4a shows the existing morning and afternoon peak-hour traffic volumes at the intersections of Stapleton/US 24, Stapleton/Eastonville, and Londonderry/Eastonville. These volumes are based on manual intersection turning-movement counts conducted by LSC in April 2021 (Eastonville/Londonderry), October 2021 (Stapleton/Eastonville), January 2023 (Stapleton/US Hwy 24), June 2022 (Eastonville/Meridian Ranch/Judge Orr), and July 2024 (Eastonville/McLaughlin).

The morning peak hour at the intersection of Stapleton/US Hwy 24 and Stapleton/Eastonville occurred from 6:45 a.m. to 7:40 a.m. The morning peak hour at the intersection of Eastonville/Londonderry occurred from 7:00 a.m. to 8:00 a.m. The afternoon peak hour at all three intersections occurred from 4:00 p.m. to 5:00 p.m. The northbound left-turn and eastbound right-turn volume at the intersection of Eastonville/Londonderry were adjusted (increased) to account for the minor differences due to seasonal variations and/or the difference in the peak hour. The count-data sheets are attached for reference.

### **Existing Levels of Service**

Level of service (LOS) is a quantitative measure of the level of delay at an intersection. Level of service is indicated on a scale from "A" to "F." LOS A represents control delay of less than 10 seconds for unsignalized and signalized intersections. LOS F represents control delay of more than 50 seconds for unsignalized intersections and more than 80 seconds for signalized intersections. Table 1 shows the level of service delay ranges.

**Table 1: Intersection Levels of Service Delay Ranges**

Level of Service	Signalized Intersections	Unsignalized Intersections
	Average Control Delay (seconds per vehicle)	Average Control Delay (seconds per vehicle) <sup>(1)</sup>
A	10 sec or less	10 sec or less
B	10-20 sec	10-15 sec
C	20-35 sec	15-25 sec
D	35-55 sec	25-35 sec
E	55-80 sec	35-50 sec
F	80 sec or more	50 sec or more

(1) For unsignalized intersections if V/C ratio is greater than 1.0 the level of service is LOS F regardless of the projected average control delay per vehicle.

Figure 4b presents the results of the existing intersection level of service analysis based on the unsignalized method of analysis procedures from the *Highway Capacity Manual, 6<sup>th</sup> Edition* by the Transportation Research Board. The peak-hour factors used for each approach are based on the traffic volumes for the peak fifteen minutes of the entire intersection. If the peak 15 minutes for an approach occurs during an interval other than the peak 15 minutes of the entire intersection, the suggested peak-hour value based on the total approach volume from Table 9-1 of the Synchro Studio 10 User Guide was used instead. The level of service reports are attached.

**Londonderry Drive/Eastonville Road (Intersection #12)**

The eastbound left-turn movement at the two-way, stop-sign-controlled intersection of Eastonville/Londonderry is currently operating at a LOS D during the morning peak hour and LOS B during the afternoon peak hour.

**Stapleton Drive/Eastonville Road (Intersection #13)**

The eastbound approach at the two-way, stop-sign-controlled intersection of Stapleton/Eastonville is currently operating at LOS F during the morning peak hour and LOS C during the afternoon peak hour.

**US Highway 24/Stapleton Drive (Intersection #14)**

The eastbound and westbound left-turn and through lanes at the two-way, stop-sign-controlled intersection of US 24/Stapleton are currently operating at LOS E or LOS F during the peak hours.

**Eastonville Road/Meridian Ranch Boulevard/Judge Orr Road (Intersection #15)**

All movements at the all-way, stop-sign-controlled intersection of Eastonville/Meridian Ranch/Judge Orr are currently operating at LOS C or better during the peak hours.

### **Eastonville Road/McLaughlin Road (Intersection #16)**

All movements at the stop-sign-controlled intersection of Eastonville/McLaughlin are currently operating at LOS C or better during the peak hours.

#### **Safety Analysis**

The Colorado State Patrol provided LSC with three years of vehicle-crash data for Eastonville Road between Stapleton Drive and Latigo Boulevard.

There were eight reported crashes at the intersection of Eastonville/Stapleton the past three years, three in 2021, three in 2022, and two in 2023. All of these crashes are likely susceptible to correction by a traffic-control signal. In order to meet a traffic-signal warrant based on crash experience, there needs to be at least five crashes susceptible to correction within a 12-month period. However, there was no 12-month period in the past three years with more than four crashes reported, therefore this intersection does not currently meet this warrant.

One additional crash was reported along this corridor. The location of the accident is not clear. However, as the road surface code was reported as “dirt” it was assumed to have occurred at a location north of Londonderry Drive. This crash was a single-vehicle crash that lost control while traveling northbound.

It should be noted that the short-term improvements to Eastonville Road, currently in the planning and preliminary design stage, will likely improve the safety of the entire corridor.

The intersection sight distance analysis included within this report is also a component of the overall traffic safety analysis. Please refer to the sight distance analysis section for details.

#### **SHORT-TERM (YEAR 2026) BACKGROUND TRAFFIC**

Background traffic is the traffic estimated to be on the adjacent roadways and at adjacent intersections without the proposed development’s trip generation of site-generated traffic volumes. Background traffic includes the through traffic and the traffic generated by nearby developments but assumes zero traffic generated by the site. Figure 5a shows the projected short-term (Year 2026) background traffic volumes.

The addition of new roadways, notably the future completion of Rex Road east to Eastonville Road, will greatly affect the existing traffic patterns. In lieu of a general/“blanket” growth rate, LSC has developed small-area traffic models for Meridian Ranch, Waterbury, and the Latigo Trails as part of previous work completed in the area. The results of these modeling efforts have been combined to estimate the background traffic volumes. These background traffic volumes have

been based on the existing traffic volumes (from Figure 4a) plus increases in traffic due to regional growth, including buildout of the following subdivisions in the vicinity of the site:

- The existing and currently proposed subdivisions within Waterbury (located just south of the Grandview Reserve);
- Meridian Ranch Filings 1-3 and Filings 6-8;
- Meridian Ranch Estates Filings 2-3;
- Meridian Ranch Filing 11;
- Stonebridge at Meridian Ranch Filings 1, 2, and 3;
- Meridian Ranch Filing 9;
- The Vistas at Meridian Ranch Filing 1;
- WindingWalk at Meridian Ranch Filing 1;
- The Enclave at Stonebridge at Meridian Ranch;
- The Estates at Rolling Hills Ranch Filing Nos. 1 and 2;
- The Rolling Hills Ranch at Meridian Ranch PUD; and
- Grandview Reserve Phase 1 Filings 1 and 2 (considered background traffic for purposes of this report)

The **short-term** background traffic volumes assume Rex Road extended from its existing terminus in Meridian Ranch east to Eastonville (by Meridian Ranch) but **not** further east. The **short-term** background volumes also assume only the street connections within Filings 1 and 2 of Phase 1, as shown in Figure 2c, have been constructed by 2026.

Figure 5b shows the lane geometry, traffic control, and level of service at the key area intersections, based on the short-term background volumes, and laneage/traffic control needed to accommodate background traffic including Grandview Phase 1 Filings 1 and 2.

### **INTERMEDIATE-TERM (YEAR 2033) BACKGROUND TRAFFIC**

Figure 6a shows the projected intermediate-term (Year 2033) background traffic volumes. These background traffic volumes have been based on the short-term (Year 2026) traffic volumes (from Figure 5a) plus increases in traffic due to general regional growth, including buildout of the following subdivisions in the vicinity of the site:

- Sanctuary at Meridian Ranch
- Rolling Hills Ranch North
- Latigo Trails Filing Nos. 1 and 2
- Grandview Reserve Phase 1

Figure 6b shows the lane geometry, traffic control, and level of service at the key area intersections, based on the intermediate-term background volumes.

## 2045 BACKGROUND TRAFFIC

Figure 7a shows the projected 2045 background-traffic volumes. The small-area model was also used to develop these volumes. In addition to the 2033 background traffic and developments assumed to be developed by 2033, the 2045 background traffic volumes assume trips generated by/traffic volumes estimated for buildout of:

- The Meridian Ranch development including buildout of the proposed school site located north of Falcon High School;
- Grandview Reserve (except trips to be generated by land uses within the Phases 2 and 3 area, as these trips are included in the “site-generated traffic”);
- The Waterbury Phase 1 and 2 developments to the southeast ; and
- Latigo Trails and estimated buildout trips that may be generated by future development of the area generally north of Rex Road between Eastonville Road and US Hwy 24. This analysis assumes trip generation based on future development of 2 ½-acre residential lots.

The 2045 background-traffic scenario assumes Stapleton Drive extended west to connect with the Briargate Parkway extension and Rex Road extended east through the future phases of Grandview Reserve to US Hwy 24.

Figure 7b shows the lane geometry, traffic control, and level of service at the key area intersections, based on the 2045 background volumes.

## TRIP GENERATION

The site-generated vehicle trips were estimated using the nationally published trip-generation rates from *Trip Generation, 11<sup>th</sup> Edition, 2021* by the Institute of Transportation Engineers (ITE). Table 2 shows the trip-generation estimates.

Grandview Reserve Phases 2 is expected to generate about 3,096 new external vehicle trips on the average weekday, with about half entering and half exiting the site during a 24-hour period. During the morning peak hour of the adjacent street traffic, which occurs between 6:45 and 7:45 a.m., about 52 vehicles would enter and 155 vehicles would exit the site. During the afternoon peak hour of the adjacent street traffic, which occurs between 4:00 and 5:00 p.m., about 145 vehicles would enter and 100 vehicles would exit the site.

The residential portion of the Grandview Reserve Phases 3 is expected to generate about 3,036 new external vehicle trips on the average weekday, with about half entering and half exiting the site during a 24-hour period. During the morning peak hour of the adjacent street traffic, about 56 vehicles would enter and 169 vehicles would exit the site. During the afternoon peak hour of the adjacent street traffic, about 191 vehicles would enter and 112 vehicles would exit the site.

The school site as assumed to be developed as a charter school with 500 students. Ten percent of the school trips were assumed to be internal to the Grandview Reserve master plan area. This is consistent with the assumptions used in the Master TIS. The school site is expected to generate about 1,849 new external vehicle trips on the average weekday, with about half entering and half exiting the site during a 24-hour period. During the morning peak hour of the adjacent street traffic, which occurs between 6:45 and 7:45 a.m., about 283 vehicles would enter and 222 vehicles would exit the school site. During the afternoon peak hour of the adjacent street traffic, which occurs between 4:00 and 5:00 p.m., about 60 vehicles would enter and 70 vehicles would exit the school site

### **DIRECTIONAL DISTRIBUTION AND ASSIGNMENT**

The directional distribution of the site-generated traffic volumes on the area roadways is an important factor in determining the site's traffic impacts. Figures 8 and 9 show the short-term and long-term directional-distribution estimates for the site-generated traffic volumes, respectively. The estimates have been based on the following factors: distribution estimates from the Master Study and the Phase 1 study (with adjustments, as needed), the recent traffic-count data; the site's proposed land use; the site's proposed access points; the phased interim and buildout Grandview internal street network; and the phasing of the existing and future area Collector and Arterial public roadway system serving the site.

The short-term directional-distribution estimate assumes Rex Road has been extended from its existing terminus to Wishaw Place but not further east. The long-term directional distribution assumes buildout of the area street network including the extension of Rex Road east to US Hwy 24 and Stapleton Drive/Briargate Parkway west to Black Forest Road.

When the distribution percentages (from Figures 8 and 9) were applied to the trip-generation estimates (from Table 2), the short-term and intermediate-term site-generated traffic volumes on the area roadways were determined. Figure 10 shows the short-term Phase-2-only generated traffic volumes. Figure 11 shows the intermediate-term Phases 2- and 3-generated traffic volumes. Figure 12 shows the long-term Phases 2- and 3-generated traffic volumes.

### **TOTAL TRAFFIC**

#### **Short-Term (Year 2026)**

Figure 13a shows the projected short-term (Year 2026) total-traffic volumes. The short-term total-traffic volumes are the sum of the short-term background-traffic volumes (from Figure 5a) plus the short-term Phase 2-generated traffic volumes (from Figure 10). The 2026 total traffic volumes assume only filing 1 and 2 of Grandview Reserve Phase 1 and Grandview Reserve Phase 2 have been constructed by 2026.

Figure 13b shows the lane geometry, traffic control, and level of service at the key area intersections, based on the short-term (Year 2026) total volumes. The short-term scenario assumes Rex Road has been constructed only to Grange Trail (Intersection #5) and assumes only the internal streets within Grandview Phase 1 filings 1 and 2 have been constructed.

### **Intermediate-Term (Year 2033)**

Figure 14a shows the projected intermediate-term (Year 2033) total-traffic volumes. The intermediate-term total-traffic volumes are the sum of the intermediate-term background-traffic volumes (from Figures 6a) plus the intermediate-term Phases 2- and 3-generated traffic volumes (from Figure 10). The 2033 total traffic volumes assume buildout of Grandview Reserve Phases 1 through 3 by 2033.

Figure 14b shows the lane geometry, traffic control, and level of service at the key area intersections, based on the intermediate-term (Year 2033) total volumes. The intermediate-term scenario assumes Rex Road has been constructed only to the Phase 3 access (Intersection #6) and assumes all the internal streets within Grandview Phase 1 and 2 have been constructed.

### **Long-Term (Year 2045)**

Figure 15a show the projected 2045 total-traffic volumes. The 2045 total-traffic volumes are the sum of the 2045 background-traffic volumes (from Figures 7a) plus the long-term Phases 2- and 3-generated traffic volumes (from Figure 11).

Figure 15b shows the lane geometry, traffic control, and level of service at the key area intersections, based on the 2045 total volumes.

## **PROJECTED LEVELS OF SERVICE**

The key area intersections and site-access points have been analyzed to determine the projected future levels of service based on the unsignalized method of analysis procedures from the *Highway Capacity Manual, 6<sup>th</sup> Edition* by the Transportation Research Board and Synchro signalized intersection procedures. Based on the criteria contained in the *ECM*, a peak-hour factor of 0.85 was used for the short-term (Year 2026) and intermediate-term (Year 2033) analysis, except for those intersections whose existing peak-hour factor calculated from traffic counts conducted by LSC was higher than 0.85. In those cases, the existing peak-hour factor was used. A peak-hour factor of 0.95 was used for the long-term (Year 2045). Two percent heavy vehicles were assumed for the Year 2026, Year 2033, and Year 2045 analysis. The results of the analysis are contained in Figures 5b, 6b, 7b, 12b, 13b, 14b, and 15b. The level of service reports are attached.



### **Rex Road/Eastonville Road (Intersection #1)**

The intersection of Rex/Eastonville Road is planned to be constructed as a modern one-lane roundabout as part of the approved Grandview Reserve Phase 1 development. All approaches at this intersection are projected to operate at LOS D or better through 2045.

### **Rex Road/Ivybridge Boulevard (Intersection #2)**

The intersection of Rex Road/Ivybridge Boulevard is projected to operate at LOS C or better for all movements based on the projected 2045 total traffic volumes as a two-way, stop-sign-controlled "T" intersection. This access to Rex Road is intended to remain a "T" intersection in perpetuity. If future access is needed for the parcels north of Rex Road, it was assumed this access would occur via a second "T" intersection east of Ivybridge.

### **Rex Road/Potential Future North Access (Planned Public Street) (Intersection #3)**

If future access is needed for parcels north of Rex Road, it was assumed that this intersection would be a stop-sign controlled "T" intersection. All movements at this intersection are projected to operate at LOS C or better through 2045.

### **Rex Road/Edenvale Place (Planned Public Street) (Intersection #4)**

The intersection of Rex Road/Edenvale Place is proposed to operate at LOS B or better for all movements through 2045 as a stop-sign controlled intersection.

### **Rex Road/Grange Trail (Planned Public Street) (Intersection #5)**

The intersection of Rex Road/Grange Trail is proposed to operate at LOS C or better for all movements through 2045 as a stop-sign controlled intersection.

### **Rex Road/Wishaw Place (Planned Public Street) (Intersection #6)**

The intersection of Rex Road/Wishaw Place is planned to be constructed as a modern one-lane roundabout. All approaches are projected to operate at LOS D or better through 2045 if a bypass lane is provided for the westbound-to-northbound movement.

### **Rex Road Intersections #7 and #8**

Intersections #7 and #8 were not analyzed as part of this report as they are not planned as part of the currently proposed Phases 2 and 3. Detailed analysis will be provided with future submissions.

### **US Highway 24/Rex Road (Intersection #9)**

The intersection of US Highway 24/Rex Road is not planned to be constructed as part of Phases 1 through 3 and was therefore not analyzed in the 2026 and 2033 scenarios. By 2045, it was assumed that Rex Road would be constructed from Wishaw Place to US Hwy 24 as part of a future phase and that intersection with US Hwy 24 would be constructed as a signal-controlled, channelized “T” intersection. All movements are projected to operate at LOS D, based on the projected 2045 total traffic volumes.

### **Eastonville Road/Dawlish Drive (Intersection #10)**

The intersection of Eastonville Road/Dawlish Drive is planned to be constructed as a one-lane modern roundabout as part of the Grandview Reserve Phase 1 development. All approaches are projected to operate at LOS C or better through 2045.

### **Eastonville Road/Brixham Drive (Intersection #11)**

The future stop-sign-controlled intersection of Eastonville Road/Brixham Drive is projected to operate at LOS C or better for all movements during the peak hours as a stop-sign-controlled “T” intersection, based on the short-term (Year 2026) total traffic volumes. By 2045, the westbound left-turn movement is projected to operate at LOS D during the peak hours.

### **Londonderry Drive/Eastonville Road (Intersection #12)**

It is our understanding that the intersection of Londonderry/Eastonville is planned to be reconstructed as a modern roundabout as part of a PPRTA project. The intersection is projected to operate at LOS D or better for all approaches through 2045 as a modern roundabout.

### **Stapleton Drive/Eastonville Road (Intersection #13)**

The eastbound approach at the intersection of Stapleton/Eastonville is currently operating at LOS F during the morning peak hour. Improvements to Eastonville from Snaffle Bit north to Rex Road in the vicinity of the site are under design as part of the PPRTA Eastonville Phase 1 project. It is our understanding that the intersection is planned to be converted to a modern one-lane roundabout in the short term. All approaches are projected to operate at LOS D or better based on the projected 2026 total traffic volumes.

By 2033, it was assumed that Stapleton Drive would be constructed to its full Principal Arterial cross section and that the roundabout at the intersection of Stapleton/Eastonville would be expanded to two lanes. Based on the estimated roundabout lane geometry and projected volumes, all approaches are projected to operate at LOS D or better through 2045.

### **US Highway 24/Stapleton Drive (Intersection #14)**

The intersection of US Hwy 24/Stapleton is currently stop-sign controlled. The northbound and southbound left-turn movements and the northbound through movements are currently operating at LOS F during the peak hours. This intersection is planned to be signalized in the (potentially near-term) future. Once signalized, all movements are projected to operate at LOS D or better during the peak hours, based on the projected short-term total, intermediate-term total and 2045 total traffic volumes.

### **Eastonville Road/Meridian Ranch Boulevard/Judge Orr Road (Intersection #15)**

All movements at the all-way, stop-sign-controlled intersection of Eastonville/Meridian Ranch/Judge Orr are projected to operate at LOS D or better during the peak hours, based on the 2026 background and total traffic volumes. By 2033, the southwest-bound shared through and right lane is projected to operate at LOS E during the afternoon peak hour, based on the projected total traffic volumes. By 2045, multiple lanes are projected to operate at LOS F during the peak hours, based on both the background and total traffic volumes if this intersection remains all-way, stop-sign controlled. All movements at this intersection are projected to operate at LOS D or better through 2045 if it is converted to traffic-signal control or if it reconstructed as a modern one-lane roundabout.

### **Eastonville Road/McLaughlin Road (Intersection #16)**

All movements at the stop-sign-controlled intersection of Eastonville/McLaughlin are projected to operate at LOS D or better during the peak hours, based on the 2026 and 2033 background and total traffic volumes. By 2045, the northbound left-turn lane and shared through and right-turn lane are projected to LOS E during the afternoon peak hour, based on the projected background traffic volumes, and LOS F during the afternoon peak hour, based on the projected total traffic volumes. All movements at this intersection are projected to operate at LOS C or better through 2045 if it is converted to traffic-signal control and LOS B or better if it reconstructed as a modern one-lane roundabout. As noted in section 6.2.2 of the *Eastonville Road Project Traffic Impact Study* it may not be feasible for this intersection to be signalized, due to the proximity to the intersection with Meridian Road.

### **QUEUING ANALYSIS**

A queuing analysis was performed using Synchro/SimTraffic for the two new full-movement intersections to Rex Road (Grange Trail and Edenvale Place) to determine the projected queue lengths, based on the 2045 total traffic volumes. The simulation was run five times. The queuing reports are attached. These queuing results have been used to develop auxiliary turn-lane recommendations.

The projected maximum westbound left-turn queue on Rex Road is 48-feet approaching Edenvale Place and 76-feet approaching Grange Trail.

## **FUNCTIONAL CLASSIFICATIONS AND LANEAGE**

Figure 16 shows the recommended functional classifications for internal streets within Phases 1 through 3 and for the roadways in the vicinity of the site. The functional classifications for the major transportation corridors in the vicinity and number of through lanes are consistent with the 2024 El Paso County *MTCP* and the Grandview Reserve Sketch Plan TIS report.

The projected average daily traffic on Eastonville Road north of Stapleton Drive is 20,265 vpd based on the projected 2045 total traffic volumes. The projected daily traffic volumes on this section of Eastonville Road are at the design ADT of 20,000 vpd for an Urban Minor Arterial given in Table 2-6 of the El Paso County Engineering Criteria Manual (*ECM*).

The projected average daily traffic on Rex Road just east of Eastonville Road is 7,500 vpd based on the projected intermediate-term (Year 2033) total traffic and 11,180 vpd based on the projected 2045 total traffic volumes. The projected daily traffic volumes on this section of Rex Road are below the design ADT of 20,000 vpd for an Urban Minor Arterial given in Table 2-6 of the *ECM*.

The projected average daily traffic volumes on Ivybridge Drive just south of Rex Road is 1,435 vpd based on the projected intermediate-term (Year 2033) total traffic volumes and 2,180 vpd based on the projected 2045 total traffic volumes. The projected daily traffic volumes on Ivybridge Boulevard are below the design ADT of 10,000 vpd for an Urban Residential Collector given in Table 2-6 of the *ECM*.

The projected average daily traffic volumes on Dawlish Drive between Eastonville Road and Zelda Street is 5,100 vehicles per day (vpd) based on the projected intermediate-term (Year 2033) total traffic volumes and 3,765 vpd based on the projected 2045 total traffic volumes. The projected daily traffic volumes on this section of Dawlish Drive are below the design ADT of 10,000 vpd for an Urban Residential Collector given in Table 2-6 of the *ECM*.

The projected average daily traffic volumes on Dawlish Drive between Zelda Street and Ivybridge Boulevard is between 2,030 and 3,180 vpd based on the projected intermediate-term (Year 2033) total traffic and between 1,610 and 1,840 vpd based on the projected 2045 total traffic volumes. The projected daily traffic volumes on this section of Dawlish Drive are below the design ADT of 10,000 vpd for an Urban Residential Collector given in Table 2-6 of the *ECM*.

## MULTI-MODAL AND PEDESTRIAN/BIKE TRANSPORTATION

- A park n' ride facility is planned for a site near Meridian Road and US Hwy 24.
- The Rock Island Regional Trail passes adjacent to the site.
- Many of the area County roads have been or will be upgraded to provide paved shoulders for cyclists. Stapleton and Elbert Road are shown as future "bike routes".
- The 2024 *MTCP* shows multiuse shoulders (greater than 4 feet) along Stapleton Road Londonderry Drive and Eastonville south of Stapleton Road (to Snaffle Bit Road).
- The 2024 *MTCP* includes an *Unincorporated El Paso County Targeted Sidewalk Gap Analysis (MTCP Figure 33)*. This area is one of the focus areas with missing sidewalks along Eastonville Road, Stapleton Road, and the east end of Londonderry Drive.
- The *MTCP* shows a future primary regional trail along Eastonville Road. Another future primary regional trail is shown extending west from Eastonville Road though Meridian Ranch.
- The US Hwy 24 PEL study also includes multi-modal elements. The 2024 *MTCP* shows the Rock Island Trail along Highway 24.
- All of the internal streets within Grandview Reserve Phases 1 through 3 will have sidewalks that will connect to Rex Road and/or Eastonville Road. The proposed trail system shown in Figure 2 will also connect to the future Waterbury development to the south in addition to connections to Rex Road and Eastonville Road.

## DEVIATIONS TO ECM CRITERIA

The following deviations to the criteria contained in the El Paso County *Engineering Manual (ECM)* have been submitted as part of this application:

- Cross section of an Urban Minor Arterial for Rex Road adjacent to the site.
- **Typical Urban Local cross section: The roadway where this modified section would be utilized will be an entry road for the subdivision. The increased right-of-way width will allow for a detached sidewalk which will allow for an enhancement of the landscaping along the entryway.**
- Two waivers to the requirement for all "T" intersections to have a minimum of three access ramps.

Please submit this deviation; did not see it with this round of submittals

## TRANSPORTATION IMPROVEMENT FEE PROGRAM

### Project Fees

This project will be required to participate in the El Paso County Road Improvement Fee Program. Grandview Reserve will join the ten-mil PID. The ten-mil PID building-permit fee portion associated with this option is \$1,458 per multi-family dwelling unit and \$1,221 per single-family dwelling unit. The total building-permit fee would be \$626,940 for the 430 townhomes and duplexes within Phase 2 and \$393,162 for the 322 single-family lots within Phase 3. It is likely

that this amount would be paid incrementally with building permits associated with several individual final-plat applications.

### **Potentially Reimbursable Improvements Under the MTCP Fee Program**

Nearby improvement projects potentially reimbursable under the Fee Program are (From *MTCP* Map No. 13):

- *MTCP* Project No. 137: Eastonville Road – Bandanero Drive to Latigo Boulevard
- *MTCP* Project No. 487: Eastonville Road – McLaughlin Road to Bandanero Drive
- *MTCP* Project No. 404 Rex Road - Eastonville to US Highway 24
- *MTCP* Project No. 401 Rex Road between US Highway 24 & Elbert Road
- Also, potentially intersection improvements and traffic signals/roundabouts at major *MTCP* roadway intersections per fee program guidelines
- Also, potentially intersection improvements and traffic signals (or CDOT traffic signal escrows)/roundabouts at US 24 intersections with Rex Road and/or Stapleton Road per fee program guidelines

### **ROADWAY IMPROVEMENTS**

The attached Table 3 presents the Phases 2 and 3 recommended roadway improvements.

- Based on the 2045 total traffic volumes shown in Figure 12a and the criteria contained in the El Paso County *Engineering Criteria Manual (ECM)*, a westbound left-turn lane will be required on Rex Road approaching Edenvale Place (Intersection #4). This lane should be 205 feet long plus a 160-foot taper.
- Based on the 2045 total traffic volumes shown in Figure 12a and the criteria contained in the El Paso County *Engineering Criteria Manual (ECM)*, a westbound left-turn lane will be required on Rex Road approaching Grange Trail (Intersection #5). This lane should be 255 feet long plus a 160-foot taper.
- The intersection of Rex Road and Wishaw Place (Intersection #6) should be constructed as a one-lane roundabout. A westbound right-turn bypass lane will likely be needed in the future when the north leg of the intersection is constructed.

\* \* \* \* \*

(this section left blank intentionally)

Please contact me if you have any questions regarding this report.

Respectfully Submitted,

LSC TRANSPORTATION CONSULTANTS, INC.

By: Jeffrey C. Hodsdon, P.E.  
Principal

JCH/KDF:jas

Enclosures: Tables 2-3  
Figures 1-16  
Rex/Wishaw Roundabout Exhibits  
Traffic Count Reports  
Level of Service Reports  
Queuing Reports  
Appendix Table 1  
MTCP Maps  
Map 15 Bicycle and Pedestrian Network Improvements  
Rex Road Proposed Cross Section  
Crash History Data  
Figure 13 from the *Grandview Reserve Phase 1 Updated Traffic Impact Analysis*

# Tables 2-3





**Table 2  
Trip Generation Estimate  
Grandview Reserve Phases 2 & 3 Preliminary Plans**

Phase	Land Use Code	Land Use Description	Trip Generation Units	Trip Generation Rates <sup>(1)</sup>					Total Trips Generated					Internal Trips	External Trips Generated				
				Average Weekday Traffic	Morning Peak Hour In	Morning Peak Hour Out	Afternoon Peak Hour In	Afternoon Peak Hour Out	Average Weekday Traffic	Morning Peak Hour In	Morning Peak Hour Out	Afternoon Peak Hour In	Afternoon Peak Hour Out		Average Weekday Traffic	Morning Peak Hour In	Morning Peak Hour Out	Afternoon Peak Hour In	Afternoon Peak Hour Out
<b>Short-Term Trip Generation Estimate</b>																			
2	215	Single Family Attached Housing	430 DU <sup>(2)</sup>	7.20	0.12	0.36	0.34	0.23	3,096	52	155	145	100	0%	3,096	52	155	145	100
<b>Intermediate-Term and Long-Term Trip Generation Estimate</b>																			
2	215	Single Family Attached Housing	430 DU	7.20	0.12	0.36	0.34	0.23	3,096	52	155	145	100	0%	3,096	52	155	145	100
3	210	Single-Family Detached Housing	322 DU	9.43	0.18	0.53	0.59	0.35	3,036	56	169	191	112	0%	3,036	56	169	191	112
	534	Private School	500 Students	4.11	0.57	0.44	0.12	0.14	2,055	283	222	60	70	10%	1,849	255	200	54	63
									<b>8,187</b>	<b>391</b>	<b>546</b>	<b>396</b>	<b>282</b>		<b>7,981</b>	<b>363</b>	<b>524</b>	<b>390</b>	<b>275</b>

Notes:

(1) Source: "Trip Generation, 11th Edition, 2021" by the Institute of Transportation Engineers (ITE).

(2) DU = dwelling unit

Source: LSC Transportation Consultants, Inc.

Jul-24

Table 3 Grandview Reserve Phases 2 and 3 Roadway Improvements				
Item #	Improvement	Trigger	Timing	Responsibility
<b>Roadway Segment Improvements</b>				
1	Eastonville Road: Stapleton to Londonderry final grading and paving	dependent on PPRTA funding priorities	TBD by EPC; PPRTA "A-List" Project	PPRTA
2	Eastonville Road: Londonderry to Rex final grading and paving	With Grandview Reserve development	With Grandview Reserve Phase 1	Grandview Reserve
3	Falcon Regional Trail: Construct east of Eastonville Road along the Phase 1 frontage	With Grandview Reserve development	With Grandview Reserve Phase 1	Grandview Reserve
4	Eastonville: Road Rex to Latigo initial grading and paving	Average Daily Traffic > 200 vehicles per day (ECM); Average Daily Traffic > 300 vehicles per day (fee study trigger)	Existing Deficiently; TBD by EPC; PPRTA list shows as an "A-List" project, however, this segment is shown as a future "Phase II" in the Wilson Eastonville Study	PPRT and/or with funds from developer escrows, and/or Fee Program funds or bonds
5	Eastonville Road: Rex to Latigo upgrade to a Rural Major Collector	Average Daily Traffic > 600 vehicles per day <sup>(1)</sup>	TBD by EPC; PPRTA Phase II (Per Wilson Study)	PPRT and/or with funds from developer escrows, and/or Fee Program funds or bonds
6	Eastonville Road: Stapleton to Grandview Reserve south boundary upgrade to a Rural Major Collector	average daily traffic > 20,000 vehicles per day	dependent on PPRTA funding priorities	PPRTA
7	Rex Road: Construct-new road segment from Eastonville to first access point east of Eastonville Road (Ivybridge Boulevard)	With Grandview Reserve development	With Grandview Reserve Phase 1	Grandview Reserve
8	Rex Road: Construct new road segment from Eastonville to first access point Ivybridge Drive to Phase 3 access (Intersection #6)	With Grandview Reserve development	With Grandview Reserve Phases 2 and 3	Grandview Reserve
8	Rex Road: Construct new road segment from Intersection #6 to US Hwy 24 Adequate right-of-way should be reserved to allow for the construction of left-turn and right-turn deceleration lanes at all potential future access points	With Grandview Reserve development	With future Grandview Reserve filings	Grandview Reserve
9	Rex Road: Construct new segment from Estate Ridge to Eastonville	With adjacent Meridian Ranch development	Will be completed late 2023 and open to traffic by spring 2024	Meridian Ranch
10	Stapleton Drive: Meridian Road to Eastonville Road complete southern (eastbound) half	average daily traffic > 18,000 vehicles per day	Shown in 2040 MTCP	EI Paso County
11	Stapleton Drive: Eastonville Road to US 24 complete southern (eastbound) half	average daily traffic > 18,000 vehicles per day	Shown in 2040 MTCP	Waterbury Metro District
<b>Intersections Improvements</b>				
<b>Intersection #1 Eastonville Road/Rex Road</b>				
12	Construct as modern one-lane roundabout	With Grandview Reserve Phase 1	With Grandview Reserve Phase 1	PPRTA/EI Paso County <sup>(1)</sup>
<b>Intersection #2 Rex Road/Ivybridge Boulevard</b>				
13	Construct an eastbound right-turn deceleration lane on Rex Road approaching Ivybridge	eastbound right-turn volume > 50 vph	With Grandview Reserve Phase 1	Grandview Reserve
14	Stripe the planned center median on Rex Road for a westbound left-turn deceleration lane-approaching Ivybridge	westbound left-turn volume > 25 vph	With Grandview Reserve Phase 1	Grandview Reserve
<b>Intersection #4 Rex Road/Edenvale Place</b>				
15	Stripe the planned center median on Rex Road for a westbound left-turn deceleration lane-approaching Edenvale Place	westbound left-turn volume > 25 vph	With Grandview Reserve Phase 2	Grandview Reserve
<b>Intersection #5 Rex Road/Grange Trail</b>				
16	Stripe the planned center median on Rex Road for a westbound left-turn deceleration lane on Rex Road approaching Grange Trail	westbound left-turn volume > 25 vph	With Grandview Reserve Phase 2	Grandview Reserve
<b>Intersection #6 Rex Road/Wishaw Place</b>				
17	Construct as a modern one-lane roundabout	With the construction of Rex Road to the Grandview Reserve Phase 3 access	With Grandview Reserve Phase 3	Grandview Reserve
<b>Intersection #9 US Hwy 24/Rex Road Intersection (Per CDOT Access Permit No. 221088)</b>				
18	Construct the intersection of US Hwy 24 as a channelized-T type intersection with a northeastbound left-turn deceleration lane and a northeastbound left-turn acceleration lane on US Hwy 24	With the opening of the access	With future Grandview Reserve filings	Grandview Reserve
19	Construct a second northeastbound left-turn deceleration lane on US Hwy 24 approaching Rex	Once the intersection is traffic signal controlled and level of service and/or queuing issues arise	With future Grandview Reserve filings	Grandview Reserve
20	Construct a southwestbound right-turn deceleration lane on US Hwy 24 approaching Rex	southwestbound right-turn volume > 10 vph	With future Grandview Reserve filings	Grandview Reserve
21	Construct a southwestbound right-turn acceleration lane on US Hwy 24 at Rex	southeastbound right-turn volume > 10 vph	With future Grandview Reserve filings	Grandview Reserve
22	Signalization of the intersection of US Hwy 24/Rex. The channelized-T configuration shall be retained and the signal would be a "directional signal" <sup>(2)</sup>	When Traffic Signal Warrant(s) are met. The decision on timing of traffic signal installation rests with the Colorado Department of Transportation	Long-Term Future (to be evaluated with each filing)	Grandview Reserve
<b>Intersection #10 Eastonville Road/Dawlish Drive</b>				
23	Construct as a modern one-lane roundabout	With Grandview Reserve Phase 1	With Grandview Reserve Phase 1	Grandview Reserve
<b>Intersection #11 Eastonville Road/Brixham Drive</b>				
24	Construct a northbound right-turn deceleration lane on Eastonville approaching Brixham (Not needed if constructed as a modern roundabout. Intersection control is to be determined with the final plat)	northbound right-turn volume > 50 vph	With Grandview Reserve Phase 1	Grandview Reserve
25	Construct a southbound left-turn deceleration lane on Eastonville approaching Brixham	southbound left-turn volume > 25 vph	With Grandview Reserve Phase 1	Grandview Reserve
<b>Intersection #12 Eastonville Road/Londonderry Drive</b>				
26	Reconstruct as modern one-lane roundabout	Short-Term (under design as part of the Eastonville PPRTA Phase 1 project)		PPRTA Eastonville Phase 1 Project/EI Paso County
<b>Intersection #13 Eastonville Road/Stapleton Drive</b>				
27	Reconstruct as modern one-lane (expandable) roundabout	Short-Term (under design as part of the Eastonville PPRTA Phase 1 project)		PPRTA Eastonville Phase 1 Project/EI Paso County
28	Expand to multi-lane modern roundabout	With Improvement #11: Stapleton Drive - US Hwy 24 to Eastonville Road complete southern (eastbound) half		EI Paso County
<b>Intersection #14 Stapleton Drive/US Hwy 24 Intersection</b>				
29	Convert from Two-Way, Stop-Sign Control to Signal Control	When Traffic Signal Warrant(s) are met. The decision on timing of traffic signal installation rests with the Colorado Department of Transportation	Anticipated in the short-term. It is our understanding that this is on the CDOT list of intersections planned for signalization.	CDOT; along with any available escrow collected from area developments through the access permitting process
30	Add northeast-bound dual left-turn lane	As needed with future developments (Will require Stapleton Drive to be widened to two westbound through lanes between US Hwy 24 and Dumont Dr)	Anticipated in the short-term	Area developments as required or potentially escrow participation toward future improvements.
31	Add other dual left-turn lanes	As needed with future developments (Will require Items Stapleton and US Hwy 24 widened to two through lanes in all directions)	Future	Area developments as required
32	Potential long-term capacity upgrades (jughandle, a Jr Interchange, etc.)	When level of service degrades below acceptable levels	Shown in US Highway 24 PEL Study;	CDOT; along with any available escrow collected from area developments-through the access permitting process.
<b>Intersection #15 Eastonville Road/Meridian Ranch Boulevard/Judge Orr Road</b>				
33	Convert to traffic signal control or reconstruct as a modern one-lane roundabout	When level of service degrades below acceptable levels	Shown in US Highway 24 PEL Study;	PPRTA Eastonville Phase 2 Project
<b>Intersection #16 Eastonville Road/McLaughlin Road</b>				
34	Convert to traffic signal control or reconstruct as a modern one-lane roundabout	When level of service degrades below acceptable levels	Shown in US Highway 24 PEL Study;	PPRTA Eastonville Phase 2 Project
Notes:				
(1) These thresholds are utilized in the Fee Study for determination of inclusion of improvements in the Fee Program costs.				
(2) Signal escrow amounts may be required in lieu of signal installation with future residential filings and/or commercial development applications- this will be determined by future TIS Reports and CDOT requirements from review of those future TIS reports.				
Source: LSC Transportation Consultants, Inc. (August 2024)				

# Figures 1-16

---



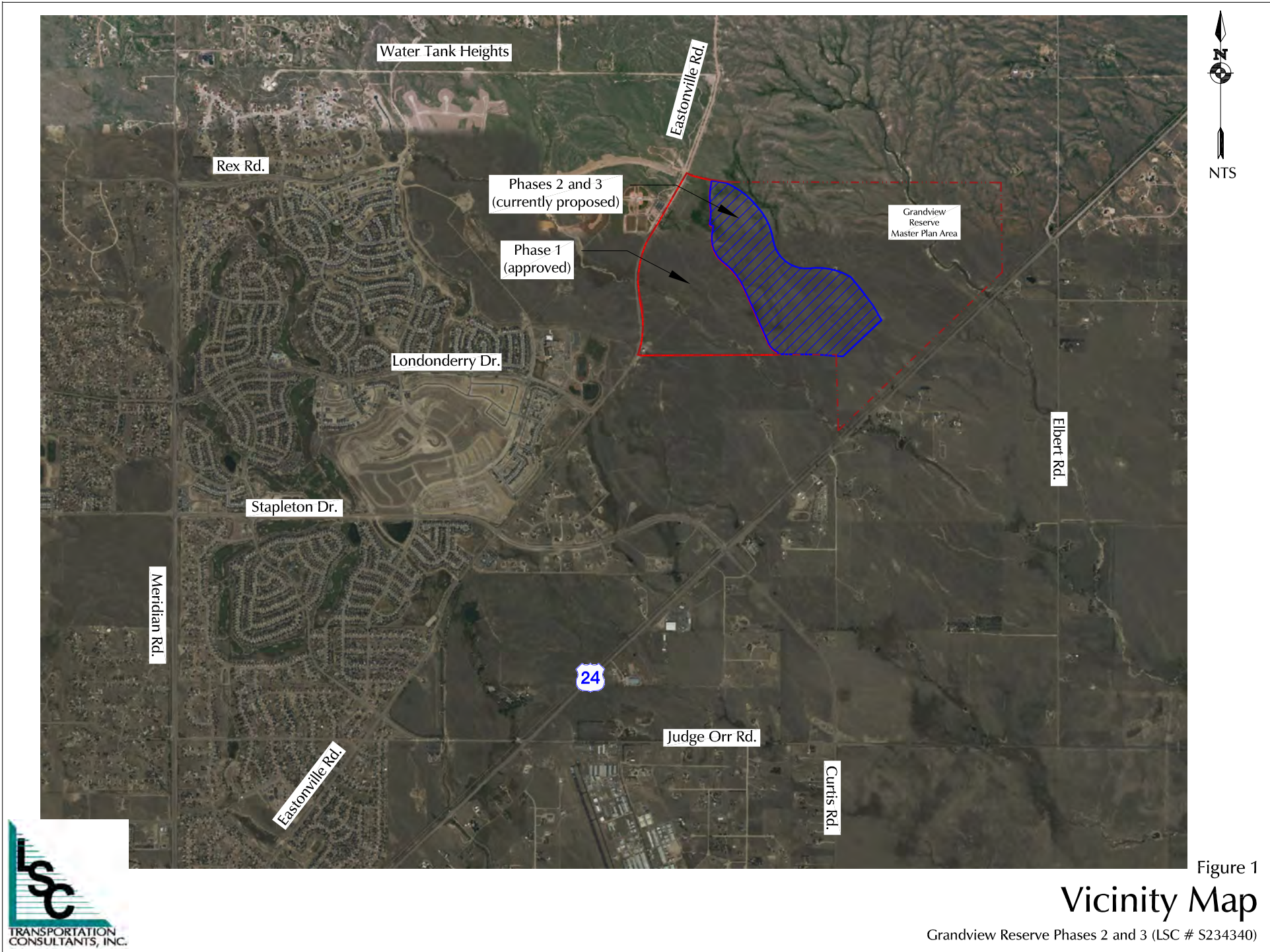

Figure 1  
**Vicinity Map**  
 Grandview Reserve Phases 2 and 3 (LSC # S234340)

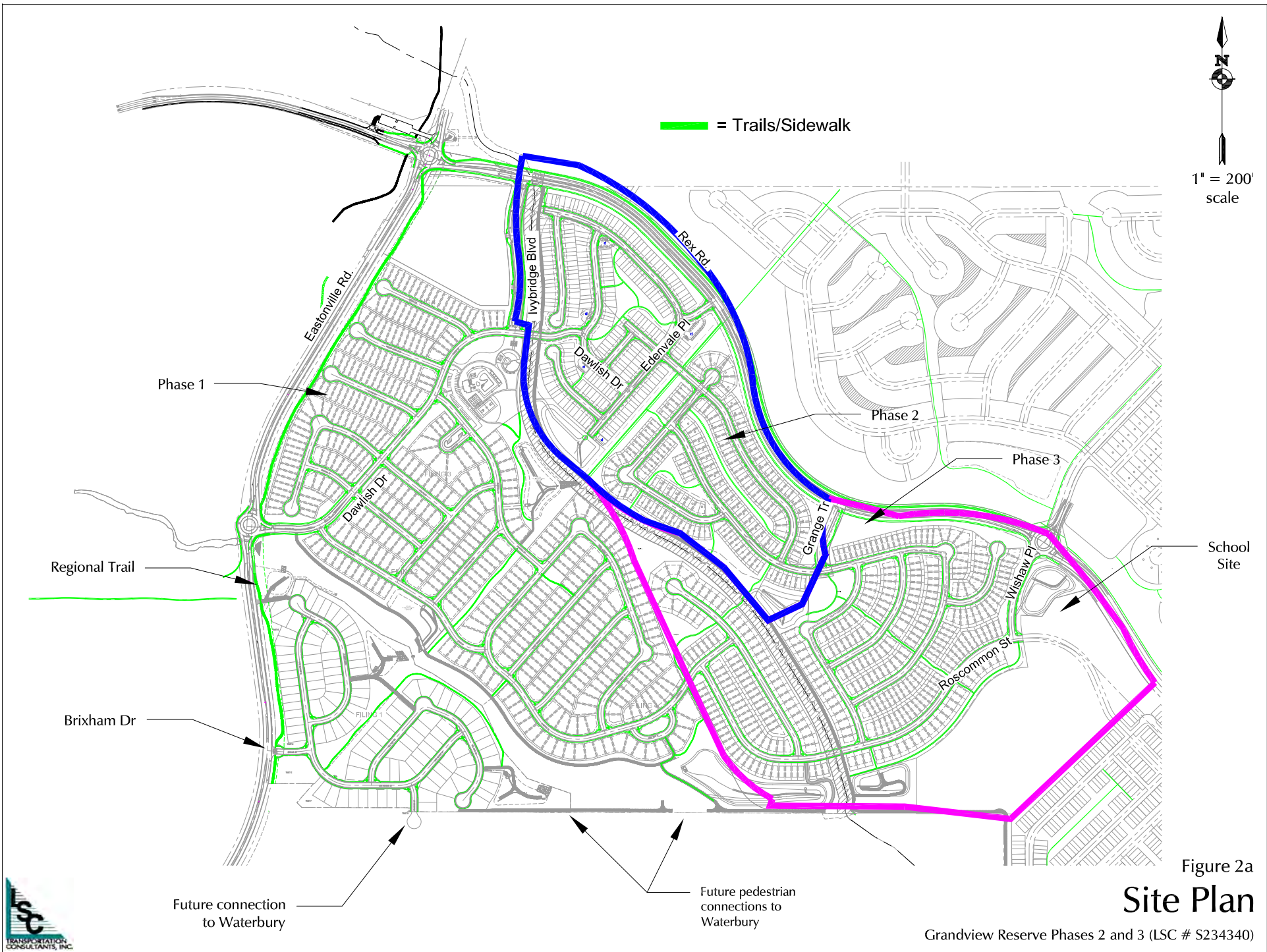
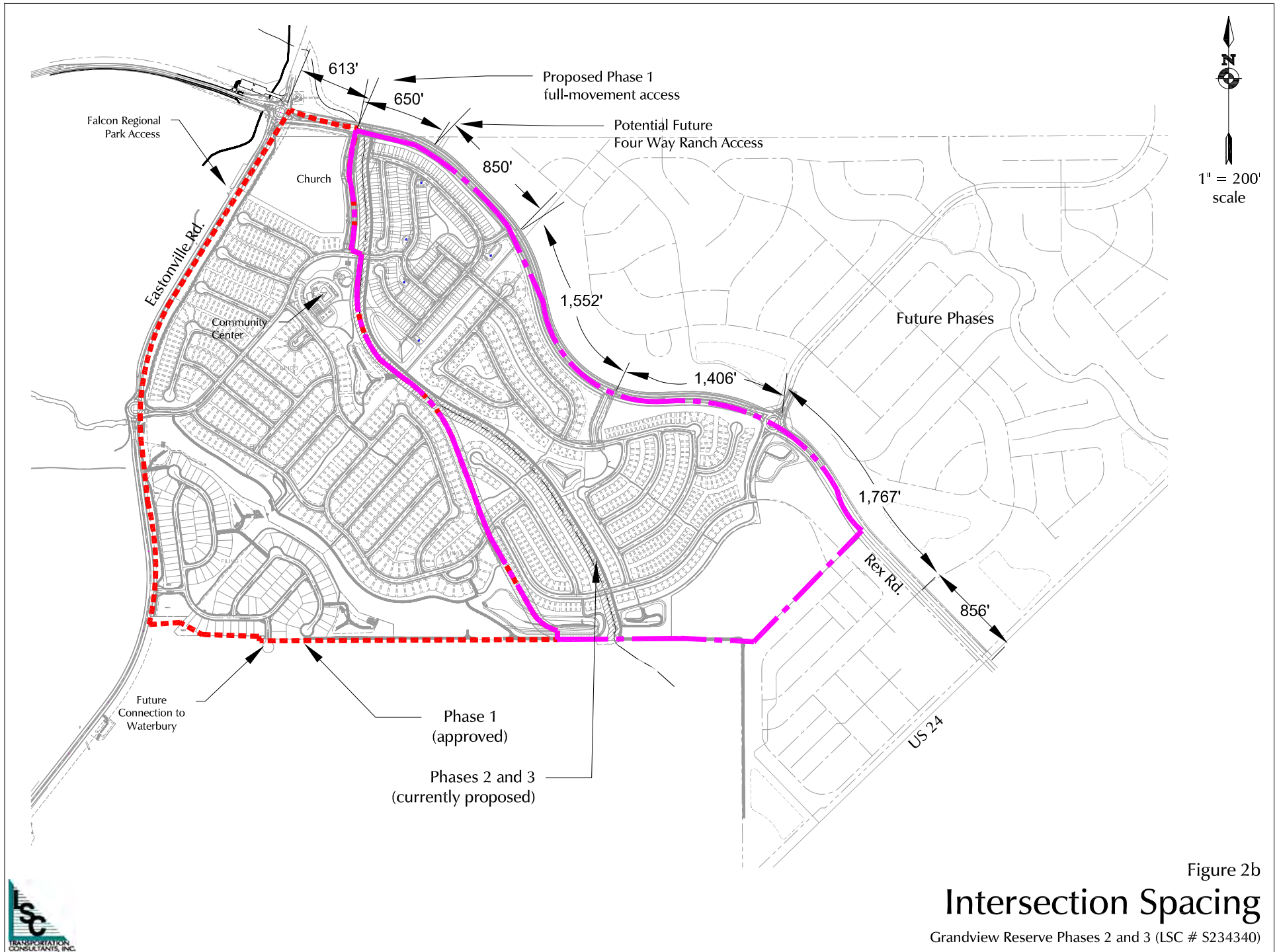
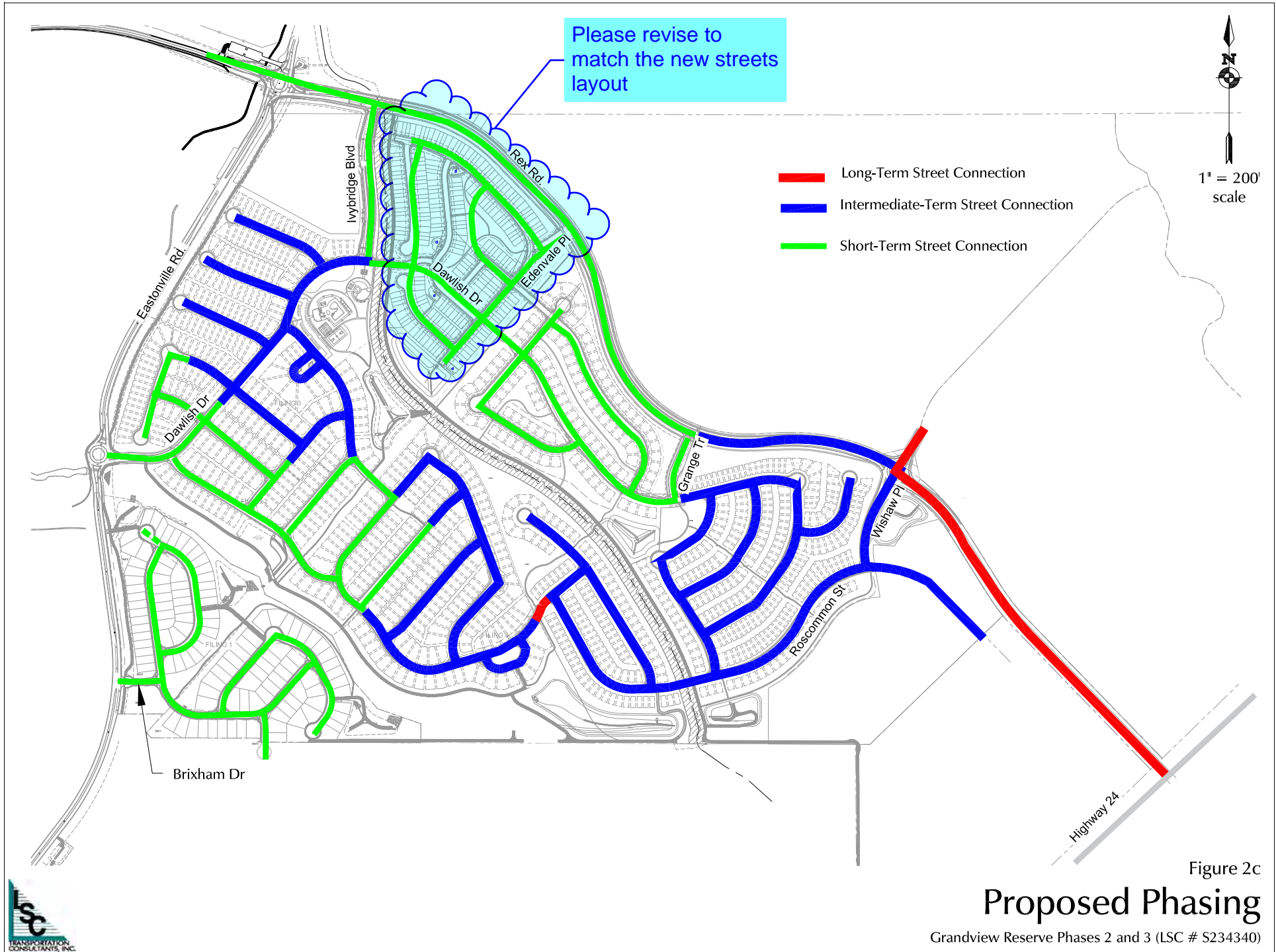

Figure 2a  
**Site Plan**

Grandview Reserve Phases 2 and 3 (LSC # S234340)







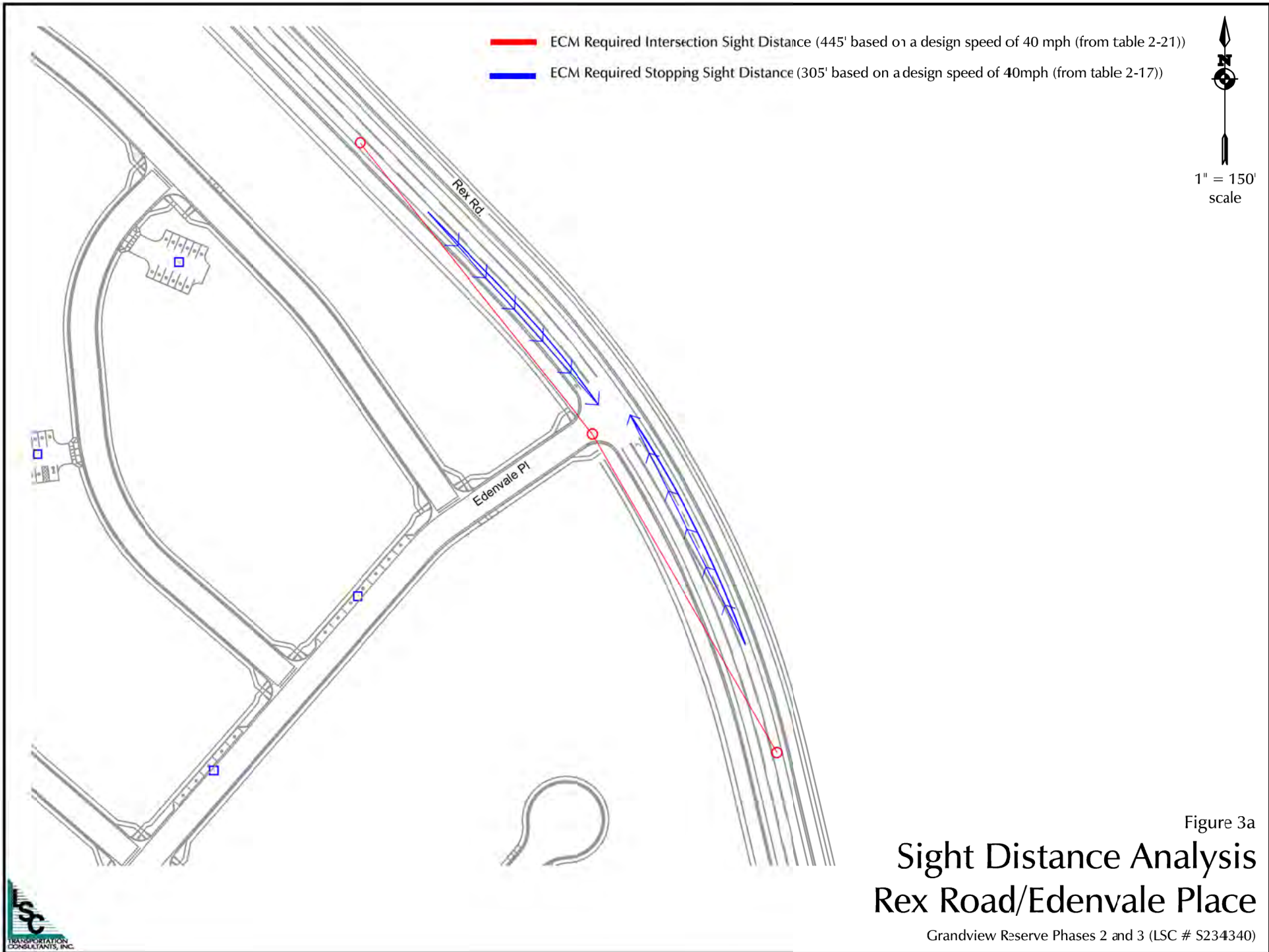



- ECM Required Intersection Sight Distance (445' based on a design speed of 40 mph (from table 2-21))
- ECM Required Stopping Sight Distance (305' based on a design speed of 40mph (from table 2-17))



1" = 150'  
scale

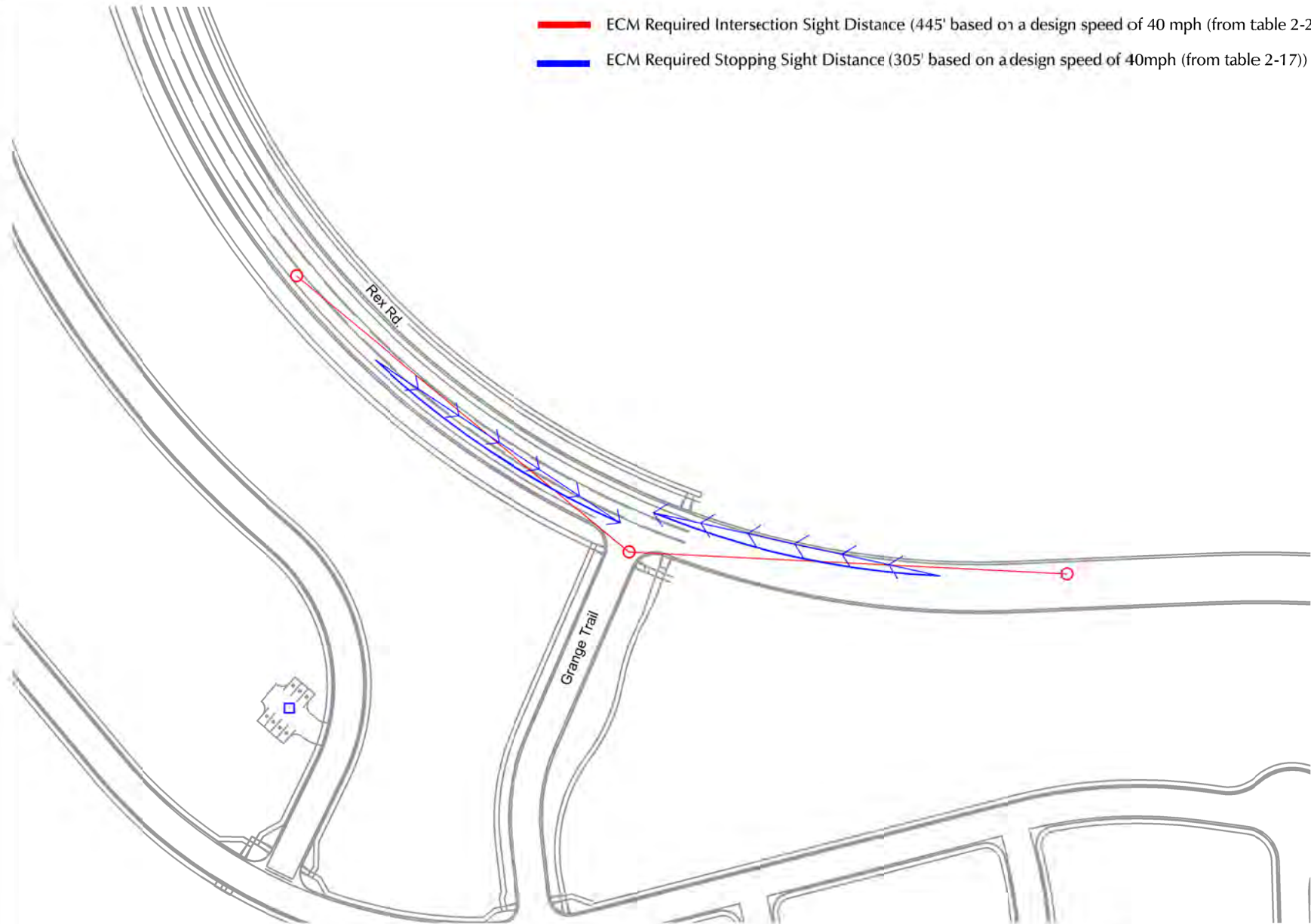
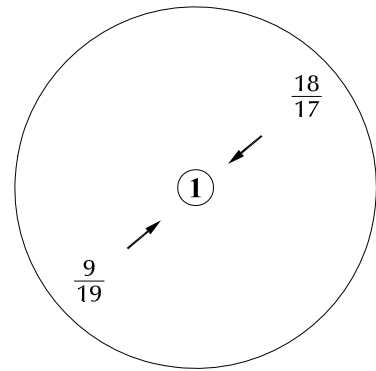

Figure 3b

# Sight Distance Analysis Rex Road/Grange Trail

Grandview Reserve Phases 2 and 3 (LSC # S234340)





Intentionally  
②  
Left Blank

Intentionally  
③  
Left Blank

Intentionally  
④  
Left Blank

Intentionally  
⑤  
Left Blank

Intentionally  
⑥  
Left Blank

Intentionally  
⑧  
Left Blank

Intentionally  
⑨  
Left Blank

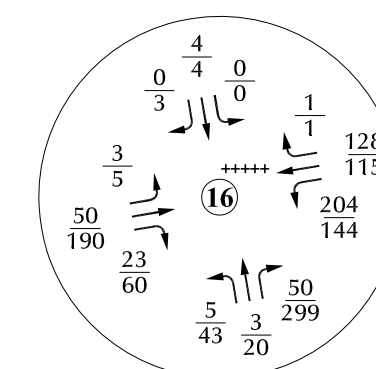
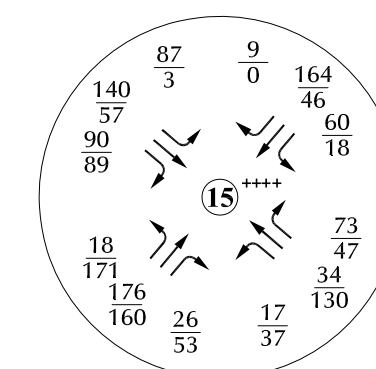
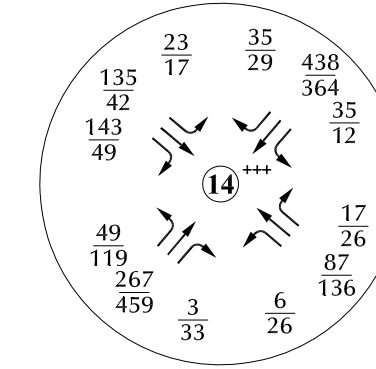
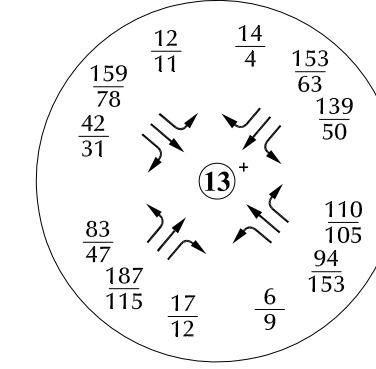
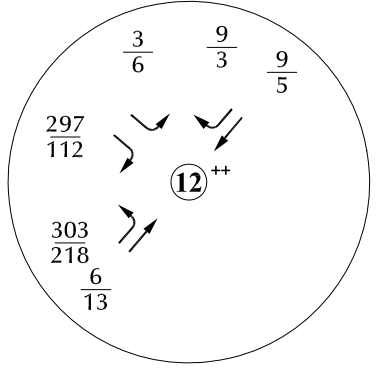
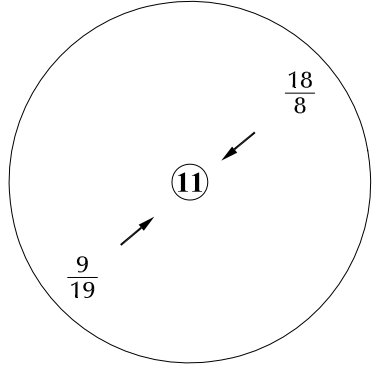
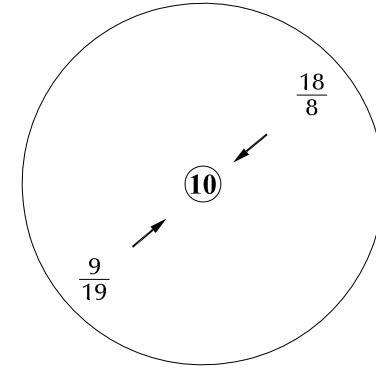

LEGEND:

- $\frac{XX}{XX}$  = AM Weekday Peak-Hour Traffic (vehicles per hour)
- $\frac{XX}{XX}$  = PM Weekday Peak-Hour Traffic (vehicles per hour)
- X,XXX= Annual Average Daily Traffic (vehicles per day)



\* Estimate by LSC

\*\* CDOT 2022 Average Annual Daily Traffic

\* Based on counts by LSC October 2021

\*\*Based on counts by LSC April 2021. The northbound left-turn and eastbound right-turn volumes have been adjusted based on the more recent counts at Stapleton/Eastonville.

+++ Based on counts by LSC January 2023

++++Based on counts by LSC June 2022 and by AllTraffic Data Services Inc. February 2020

+++++Based on Counts by LSC July 2024



Figure 4a  
Existing Traffic

Grandview Reserve Phases 2 and 3 (LSC # S234340)

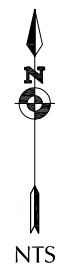

LEGEND:  
 Traffic Control Used in the Analysis:  
 ↓ = Stop Sign  
 ⊞ = Traffic Signal  
 LOS Analysis Results:  
 $\frac{A}{B}$  = AM Individual Movement Peak-Hour Level of Service  
 $\frac{B}{B}$  = PM Individual Movement Peak-Hour Level of Service  
 $\frac{C}{C}$  = AM Entire Intersection Peak-Hour Level of Service  
 $\frac{C}{C}$  = PM Entire Intersection Peak-Hour Level of Service

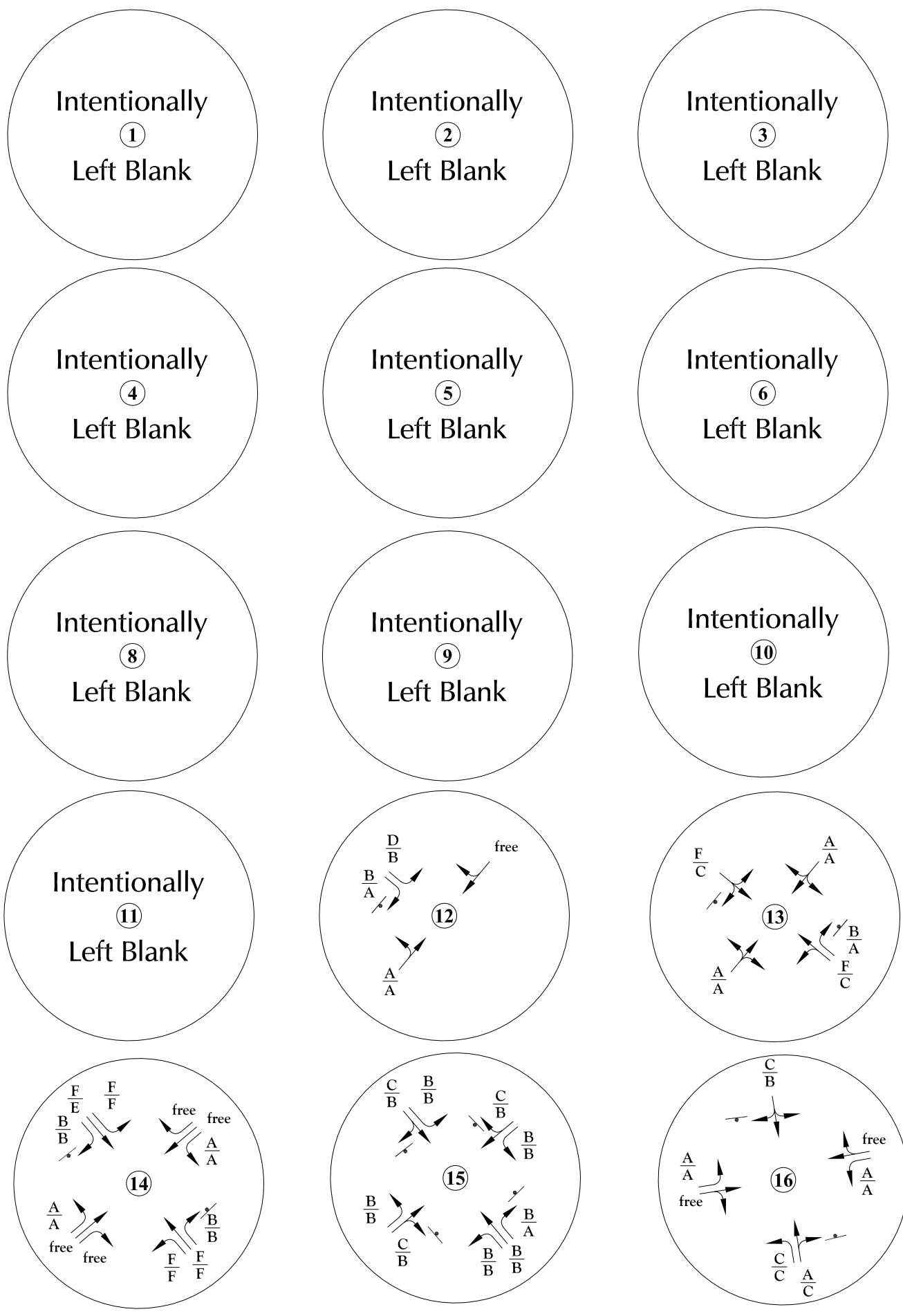
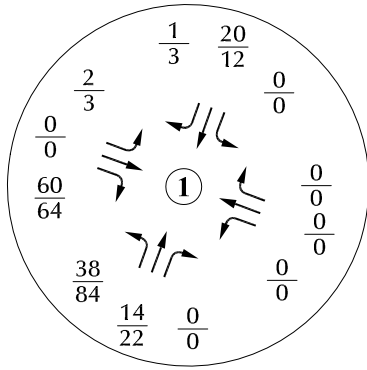

Figure 4b  
 Existing Lane Geometry, Traffic Control, and Level of Service

Grandview Reserve Phases 2 and 3 (LSC # S234340)





Intentionally  
②  
Left Blank

Intentionally  
③  
Left Blank

Intentionally  
④  
Left Blank

Intentionally  
⑤  
Left Blank

Intentionally  
⑥  
Left Blank

Intentionally  
⑧  
Left Blank

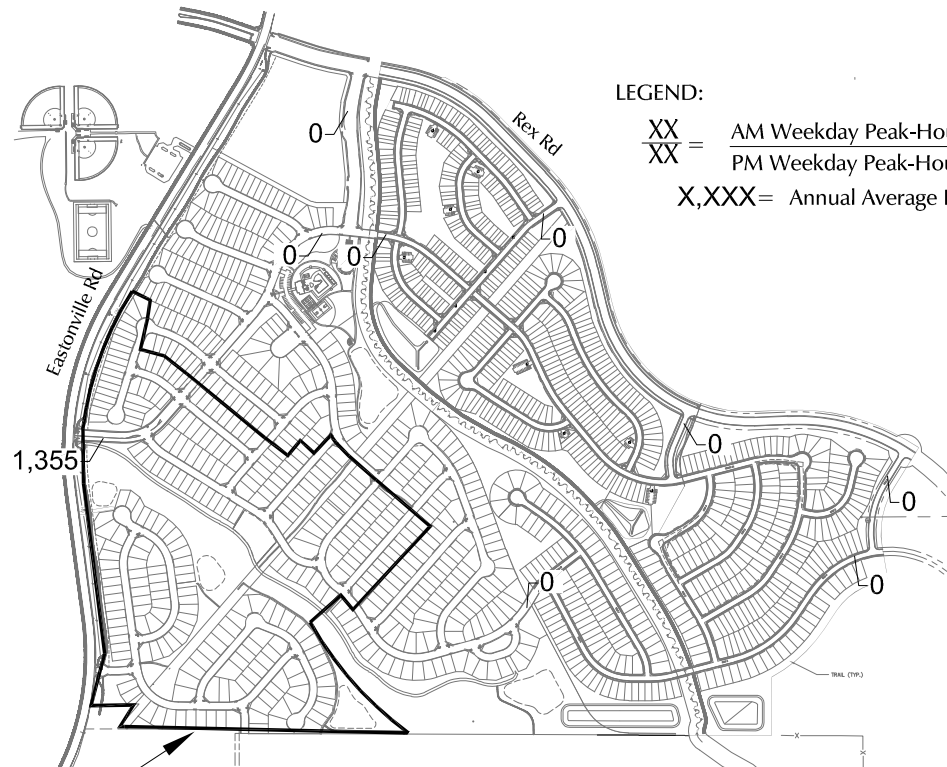
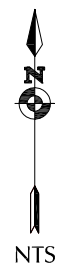
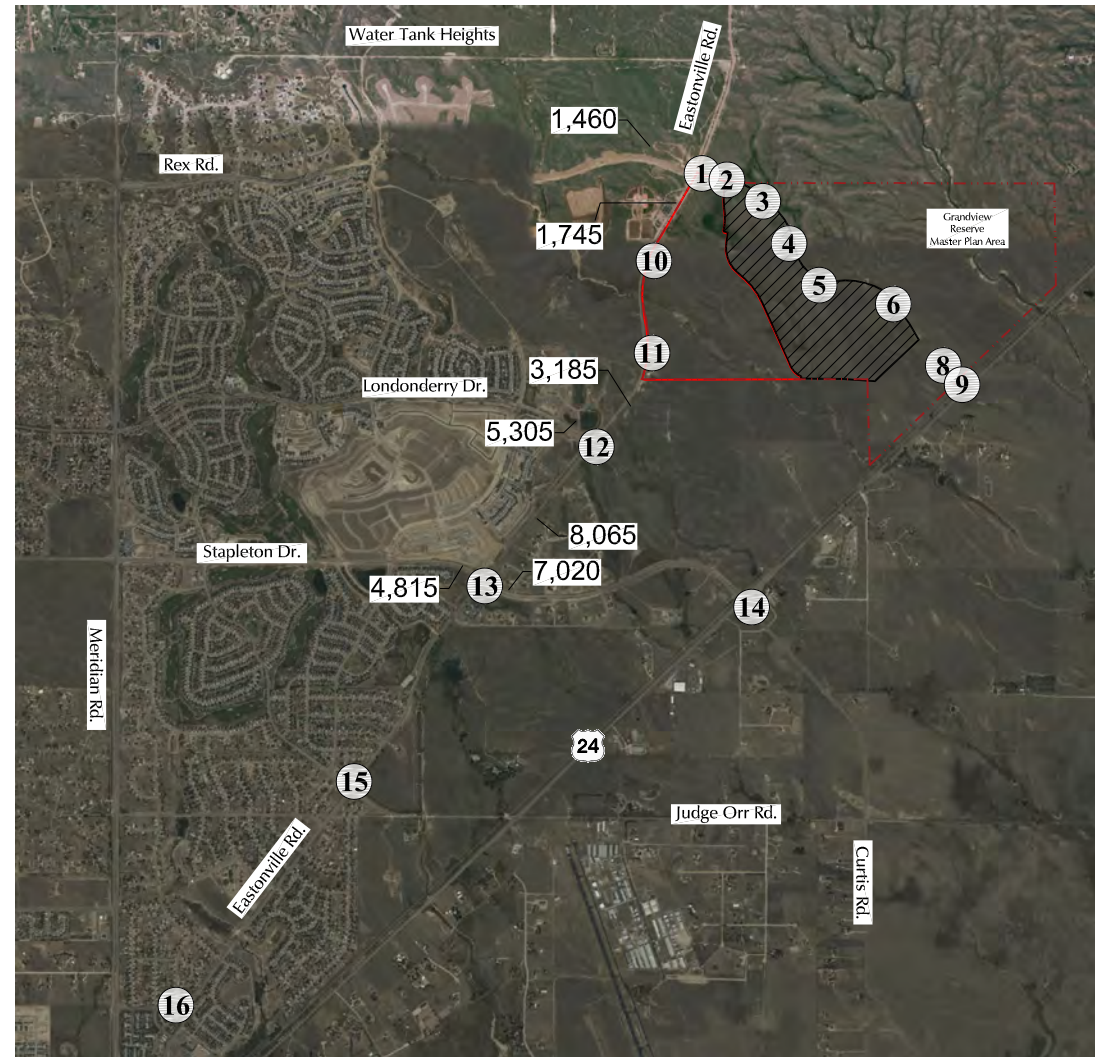
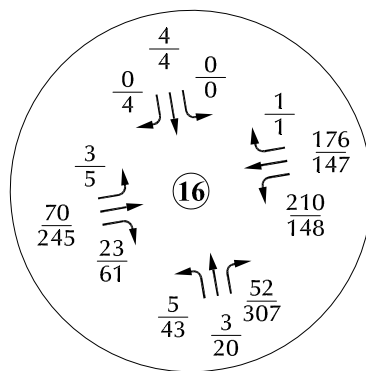
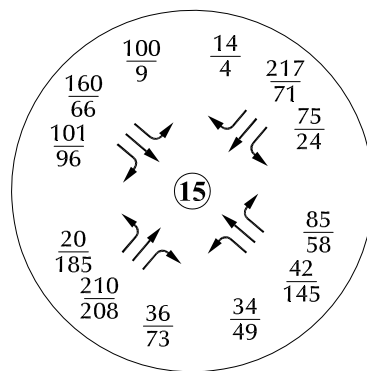
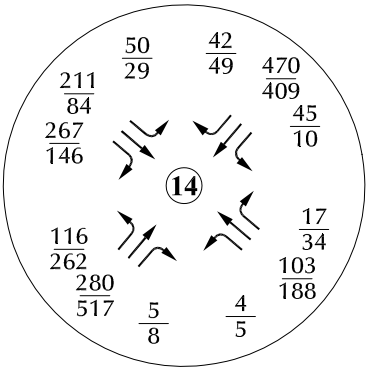
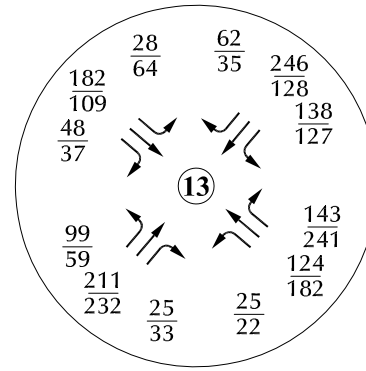
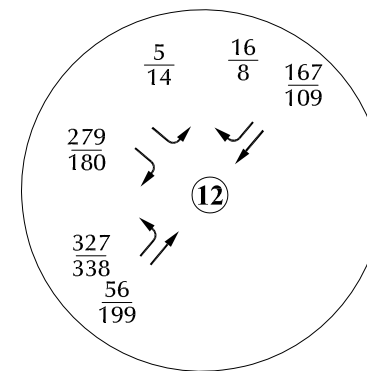
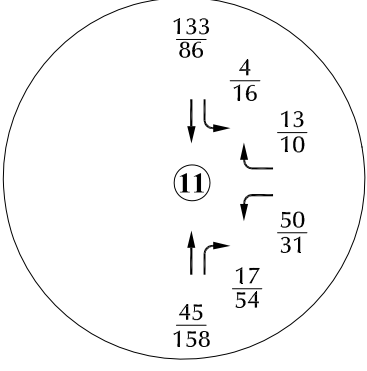
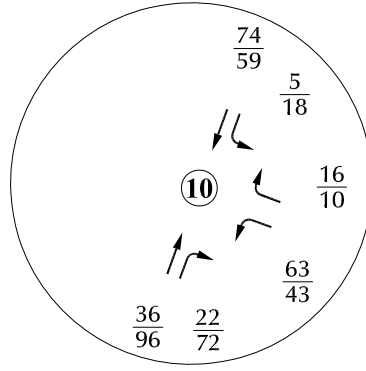
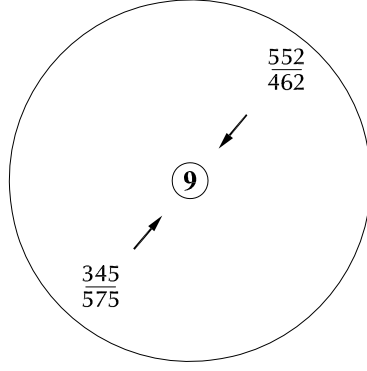

LEGEND:  
 XX = AM Weekday Peak-Hour Traffic (vehicles per hour)  
 XX = PM Weekday Peak-Hour Traffic (vehicles per hour)  
 X,XXX = Annual Average Daily Traffic (vehicles per day)

Phase 1 Filings 1 and 2

\* Assumes buildout of Grandview Reserve Phase 1, filings 1 and 2 only.

Figure 5a  
 Year 2026  
 Background Traffic\*  
 Grandview Reserve Phases 2 and 3 (LSC # S234340)



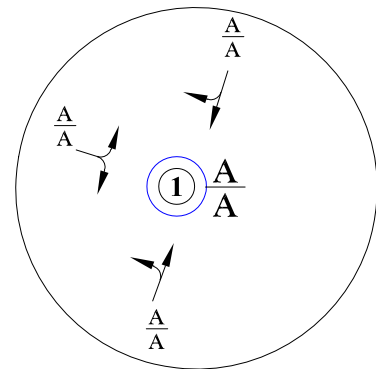

Intentionally  
②  
Left Blank

Intentionally  
③  
Left Blank

Intentionally  
④  
Left Blank

Intentionally  
⑤  
Left Blank

Intentionally  
⑥  
Left Blank

Intentionally  
⑧  
Left Blank

Intentionally  
⑨  
Left Blank

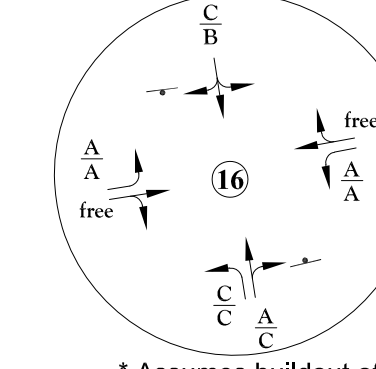
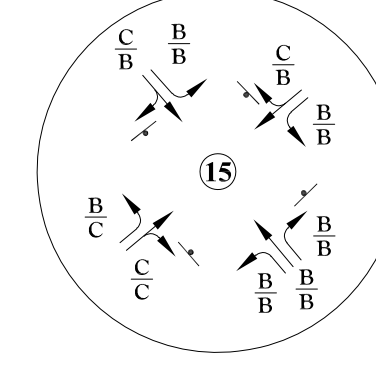
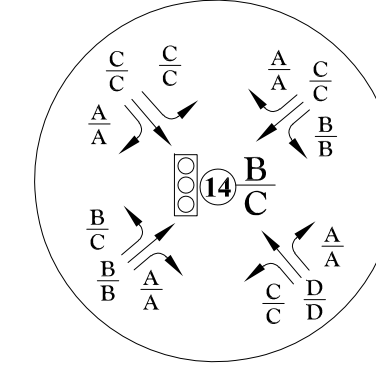
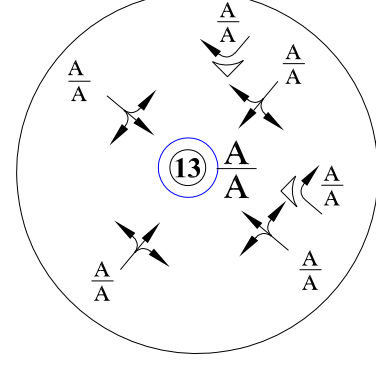
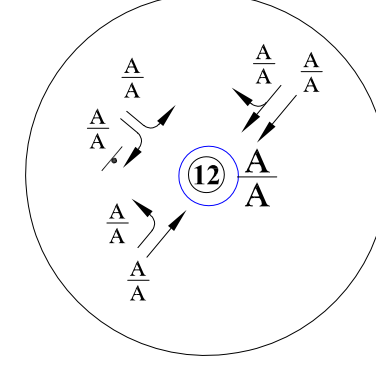
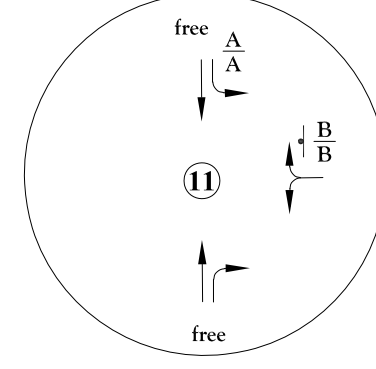
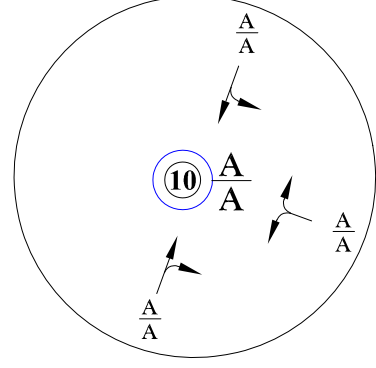

LEGEND:  
 Traffic Control Used in the Analysis:  
 ↓ = Stop Sign  
 ○ = Traffic Signal  
 ○ = Modern Roundabout  
 LOS Analysis Results:  
 A/A = AM Individual Movement Peak-Hour Level of Service  
 B/B = PM Individual Movement Peak-Hour Level of Service  
 C/C = AM Entire Intersection Peak-Hour Level of Service  
 C/C = PM Entire Intersection Peak-Hour Level of Service

Figure 5b  
 Year 2026 Background Lane Geometry,  
 Traffic Control, and Levels of Service\*

\* Assumes buildout of Grandview Reserve Phase 1, filings 1 and 2 only.



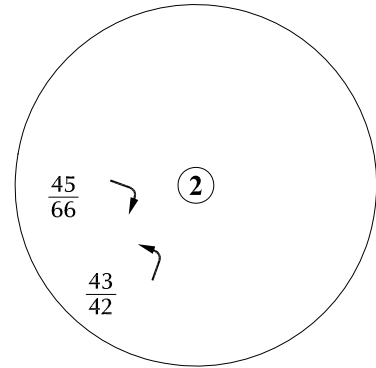
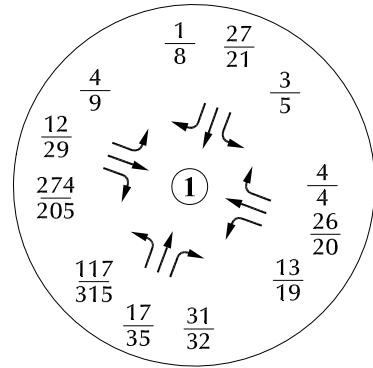

Intentionally  
③  
Left Blank

Intentionally  
④  
Left Blank

Intentionally  
⑤  
Left Blank

Intentionally  
⑥  
Left Blank

Intentionally  
⑧  
Left Blank

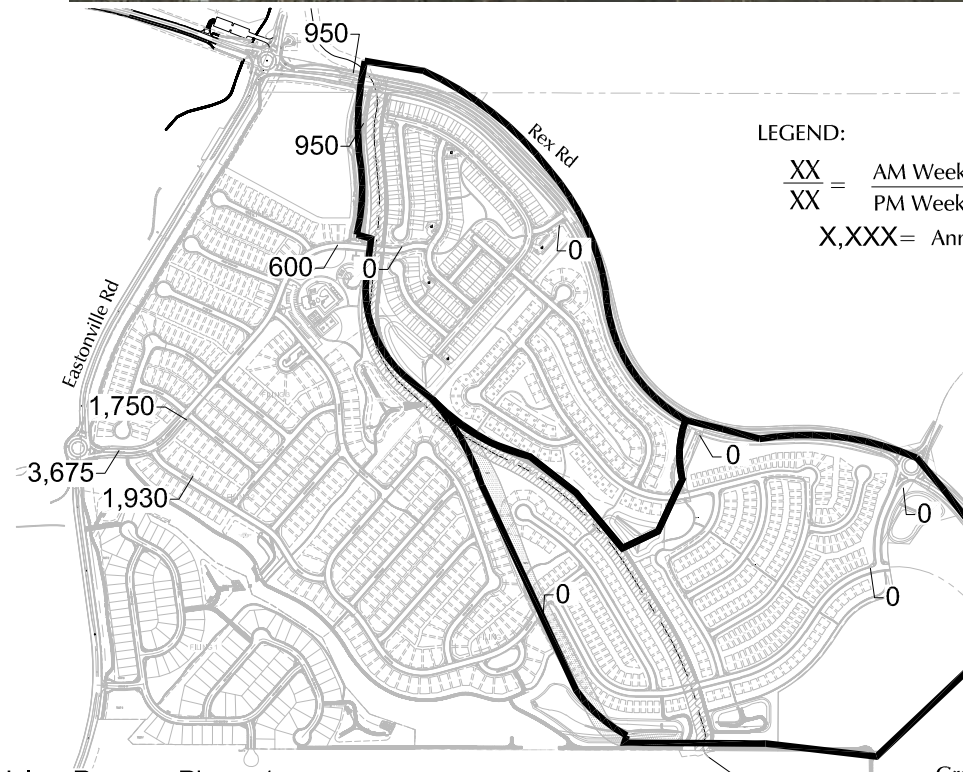
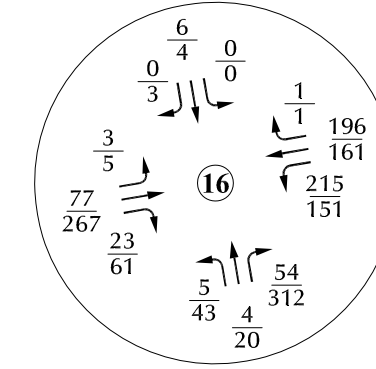
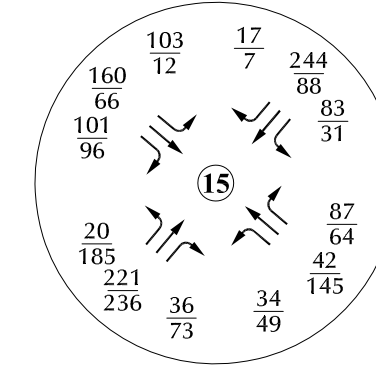
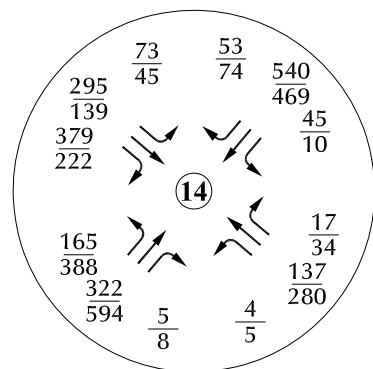
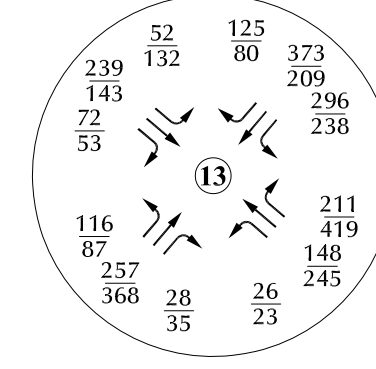
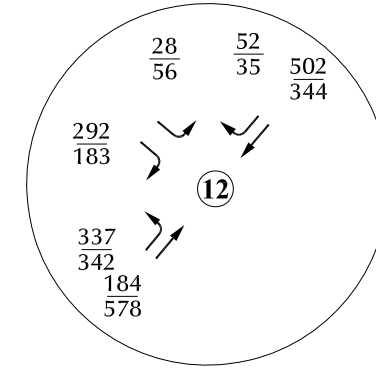
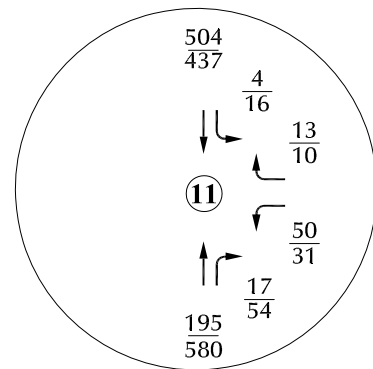
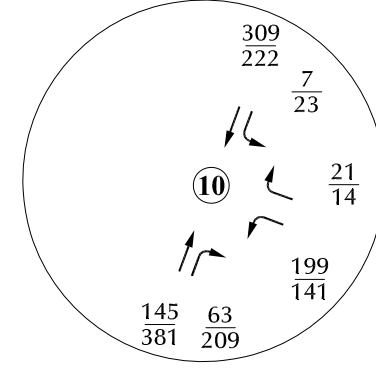
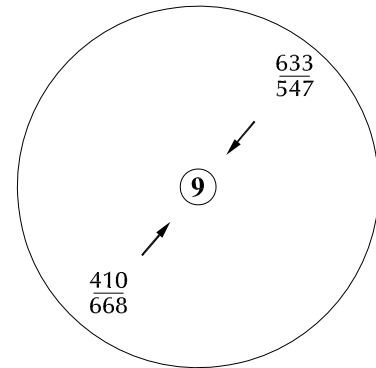

LEGEND:  
 XX = AM Weekday Peak-Hour Traffic (vehicles per hour)  
 XX = PM Weekday Peak-Hour Traffic (vehicles per hour)  
 X,XXX = Annual Average Daily Traffic (vehicles per day)

\* Assumes buildout of Grandview Reserve Phase 1

Figure 6a  
 Year 2033  
 Background Traffic\*  
 Grandview Reserve Phases 2 and 3 (LSC # S234340)



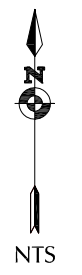

LEGEND:  
 $\frac{XX}{XX}$  = AM Weekday Peak-Hour Traffic (vehicles per hour)  
 $\frac{XX}{XX}$  = PM Weekday Peak-Hour Traffic (vehicles per hour)  
 X,XXX = Annual Average Daily Traffic (vehicles per day)

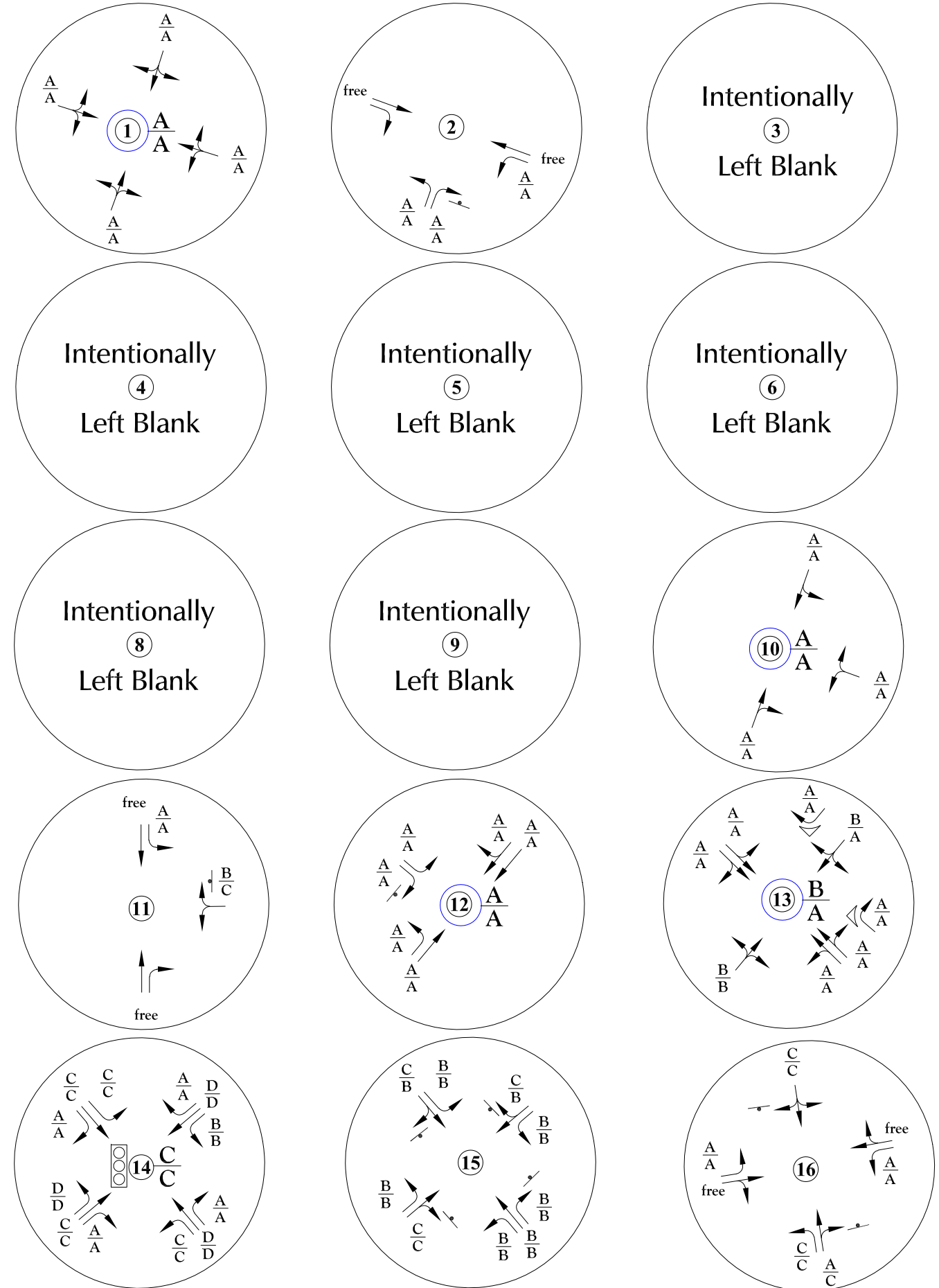

LEGEND:  
 Traffic Control Used in the Analysis:  
 T = Stop Sign      O = Modern Roundabout  
 TTT = Traffic Signal  
 LOS Analysis Results:  
 $\frac{A}{A}$  = AM Individual Movement Peak-Hour Level of Service  
 $\frac{B}{B}$  = PM Individual Movement Peak-Hour Level of Service  
 $\frac{C}{C}$  = AM Entire Intersection Peak-Hour Level of Service  
 $\frac{C}{C}$  = PM Entire Intersection Peak-Hour Level of Service

\* Assumes buildout of Grandview Reserve Phase 1

Figure 6b  
 2033 Background Traffic\* Lane Geometry,  
 Traffic Control, and Levels of Service

Grandview Reserve Phases 2 and 3 (LSC # S234340)



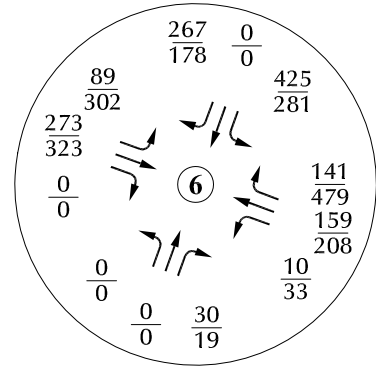
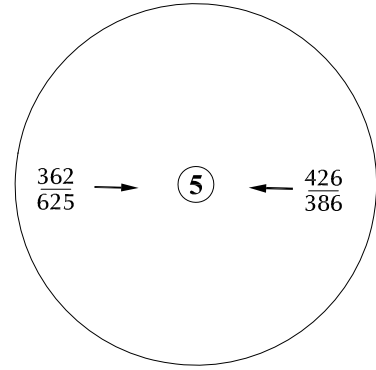
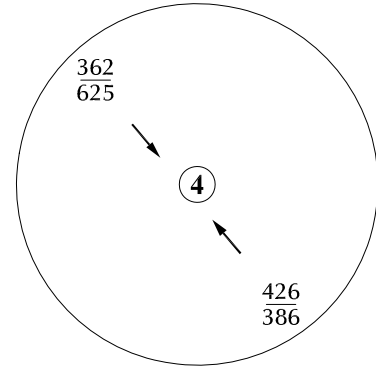
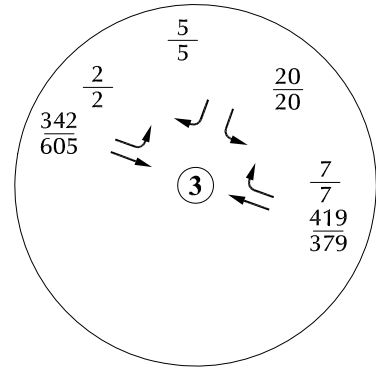
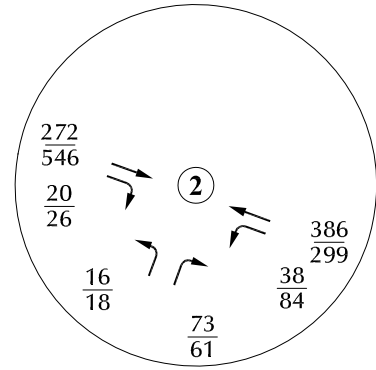
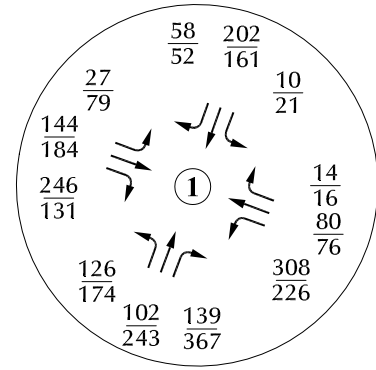

Intentionally  
⑧  
Left Blank

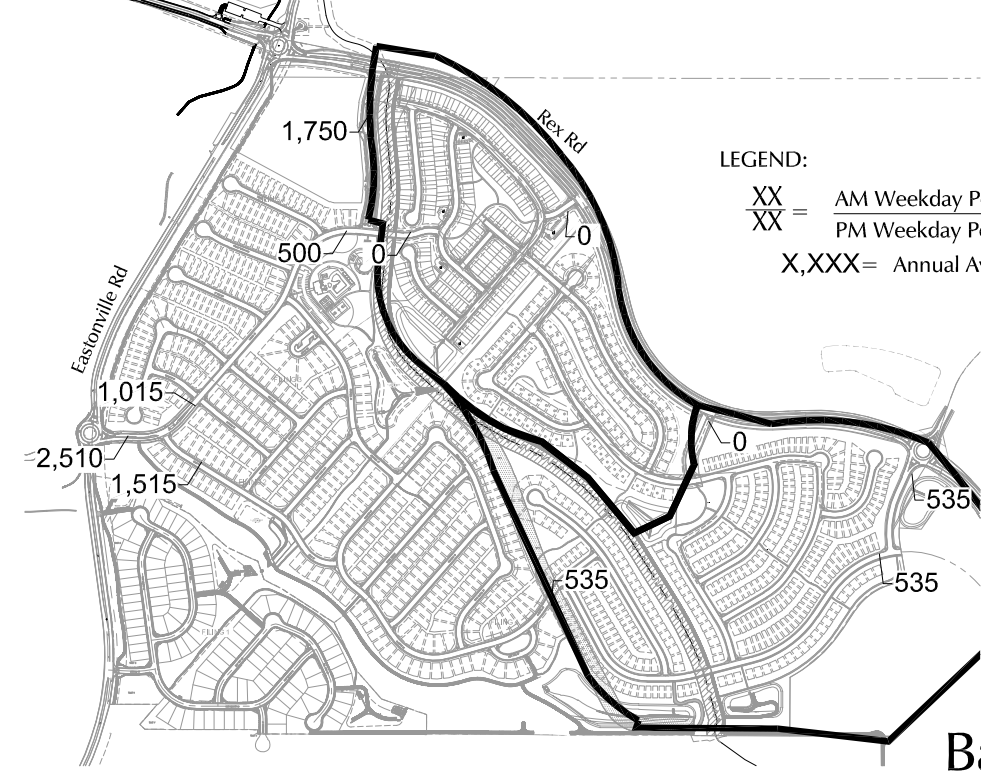
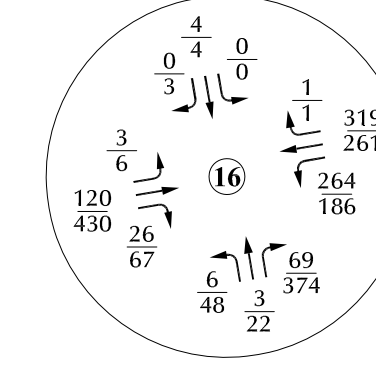
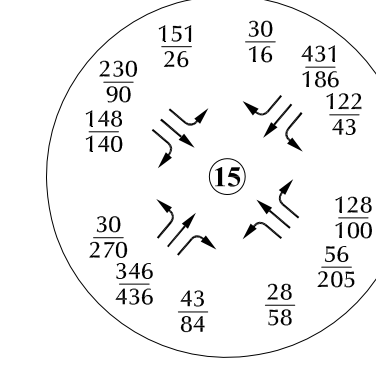
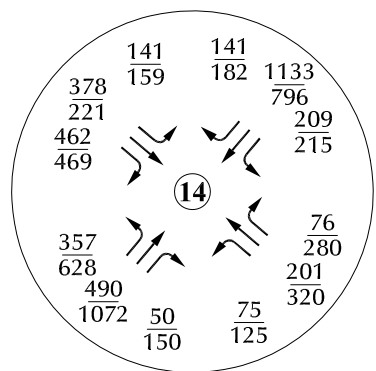
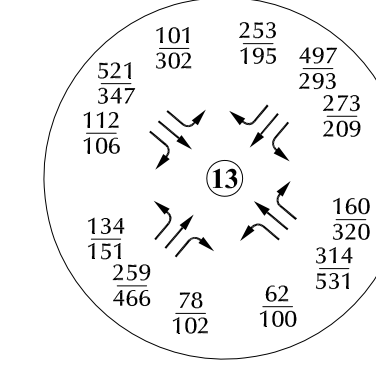
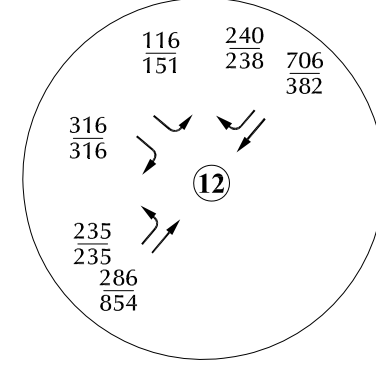
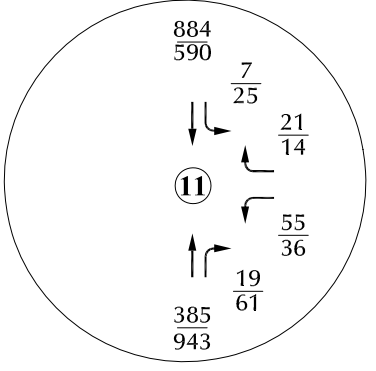
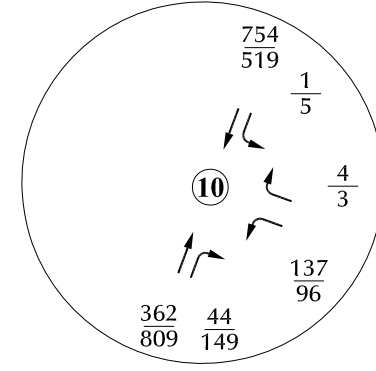
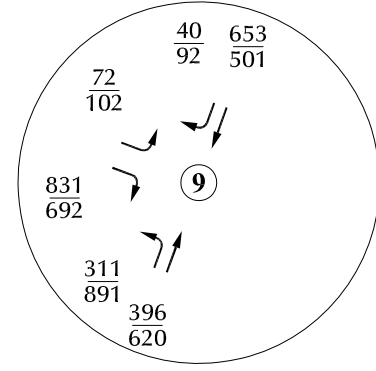

LEGEND:  
XX = AM Weekday Peak-Hour Traffic (vehicles per hour)  
XX = PM Weekday Peak-Hour Traffic (vehicles per hour)  
X,XXX = Annual Average Daily Traffic (vehicles per day)

Figure 7a  
Year 2045  
Background Traffic  
Grandview Reserve Phases 2 and 3 (LSC # S234340)





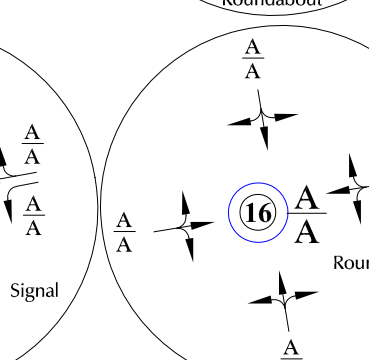
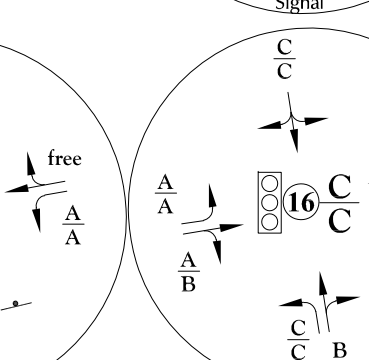
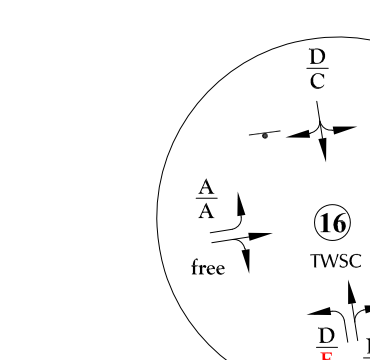
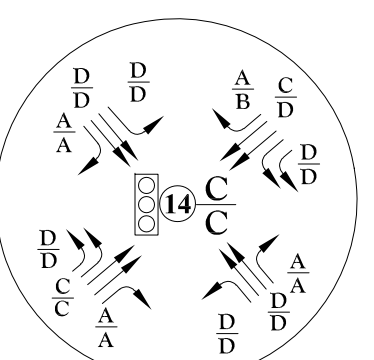
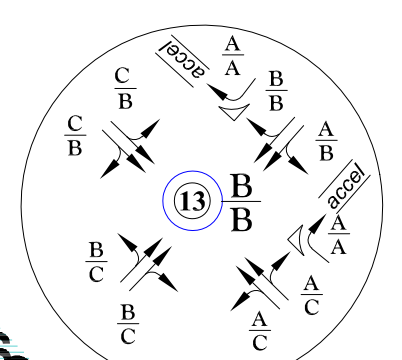
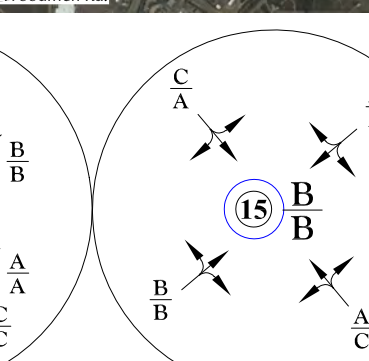
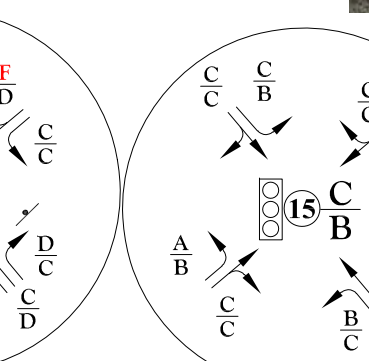
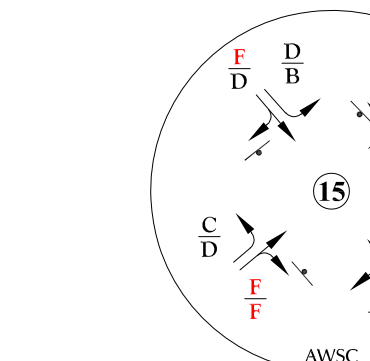
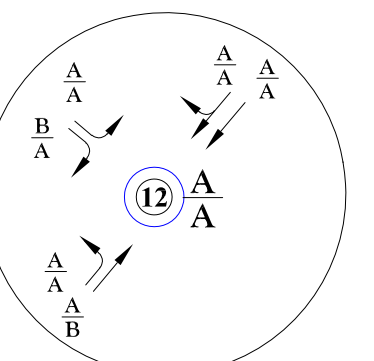
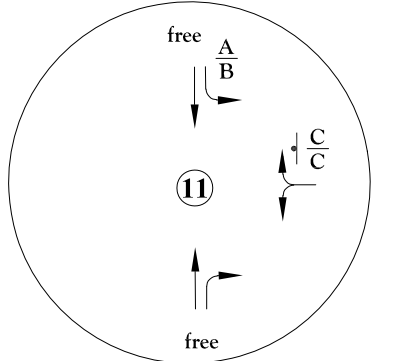
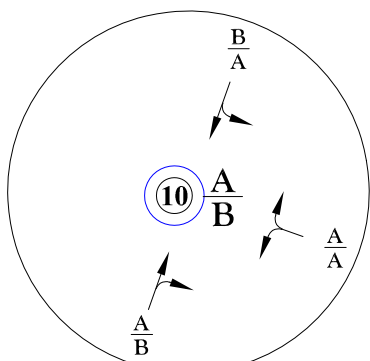
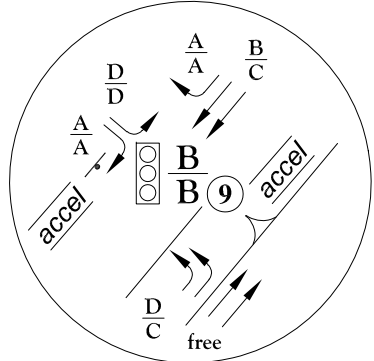
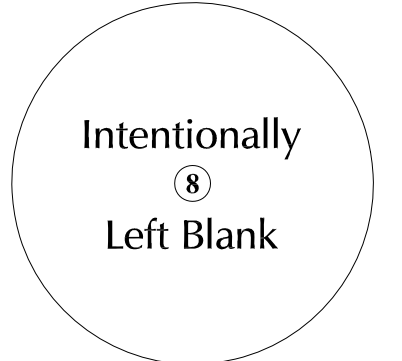
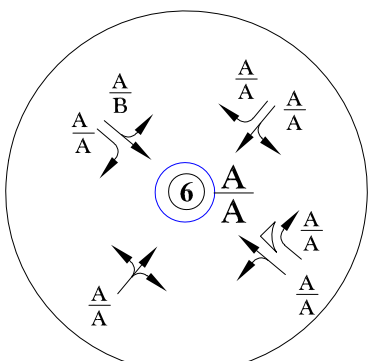
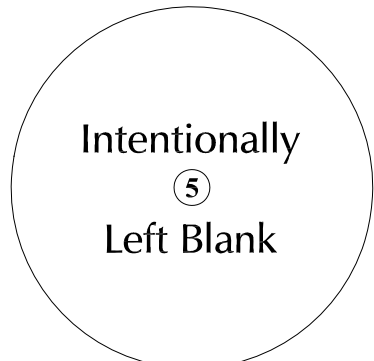
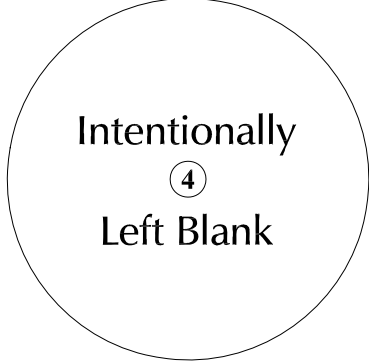
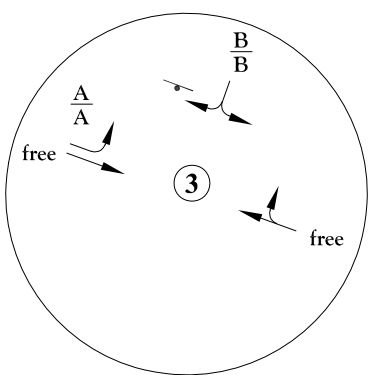
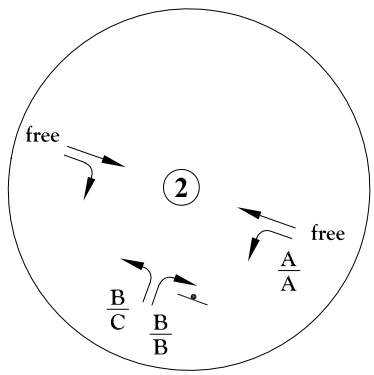
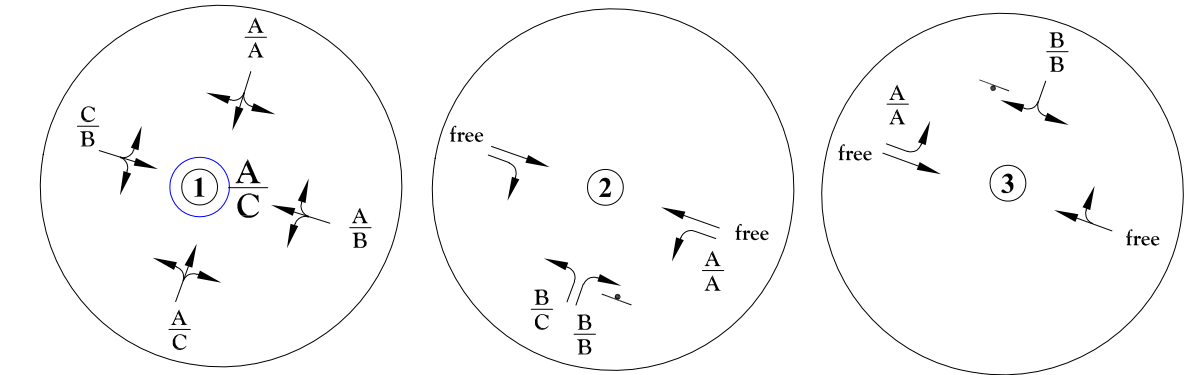
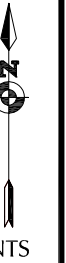

LEGEND:  
 Traffic Control Used in the Analysis:  
 T = Stop Sign  
 T = Traffic Signal  
 O = Modern Roundabout

LOS Analysis Results:  
 A/A = AM Individual Movement Peak-Hour Level of Service  
 B/B = PM Individual Movement Peak-Hour Level of Service  
 C/C = AM Entire Intersection Peak-Hour Level of Service  
 C/C = PM Entire Intersection Peak-Hour Level of Service

Figure 7b  
 2045 Background Lane Geometry,  
 Traffic Control, and Levels of Service





Figure 8

# Short-Term Directional Distribution of Site-Generated Traffic

Grandview Reserve Phases 2 and 3 (LSC # S234340)



LEGEND:

XX% = Percent Directional Distribution

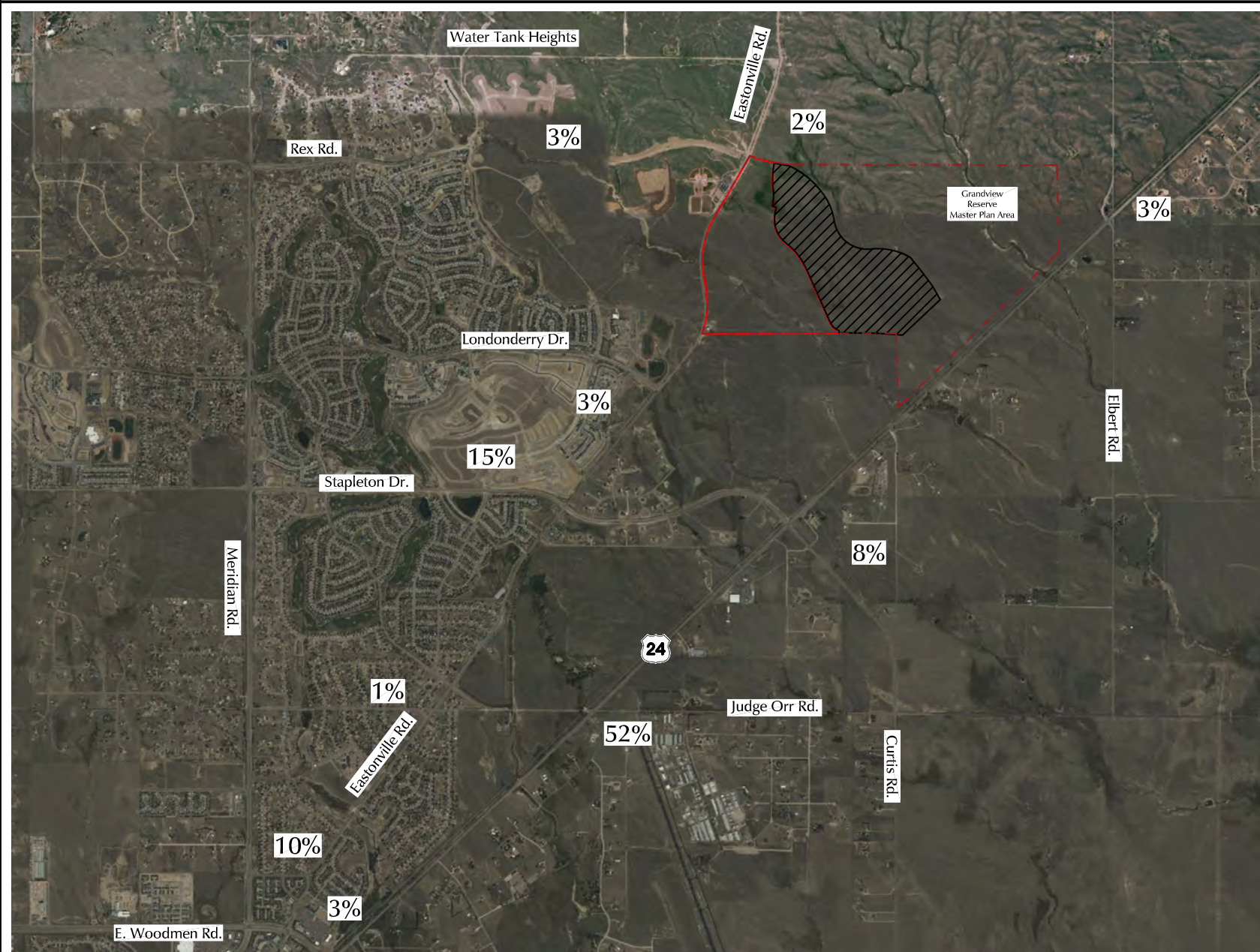

Figure 9

## Long-Term Directional Distribution of Site-Generated Traffic

Grandview Reserve Phases 2 and 3 (LSC # S234340)



LEGEND:

XX% = Percent Directional Distribution

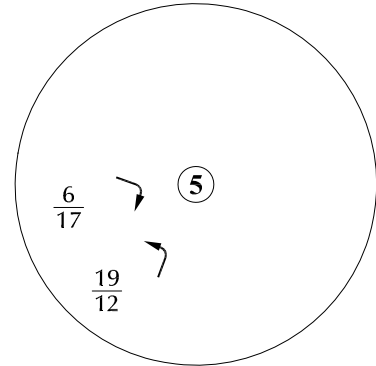
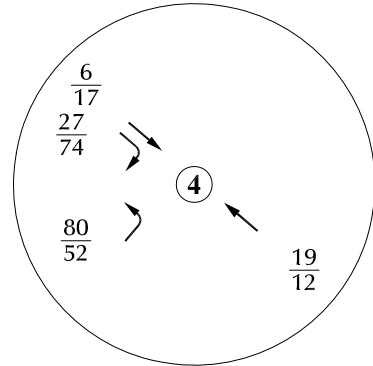
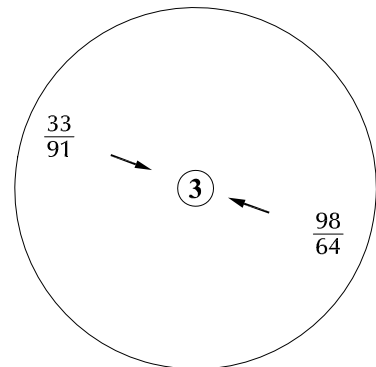
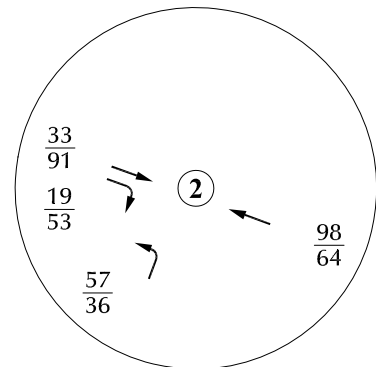
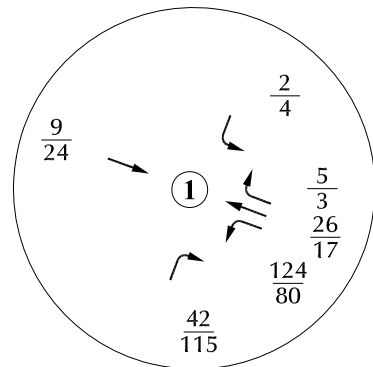

Intentionally  
⑥  
Left Blank

Intentionally  
⑧  
Left Blank

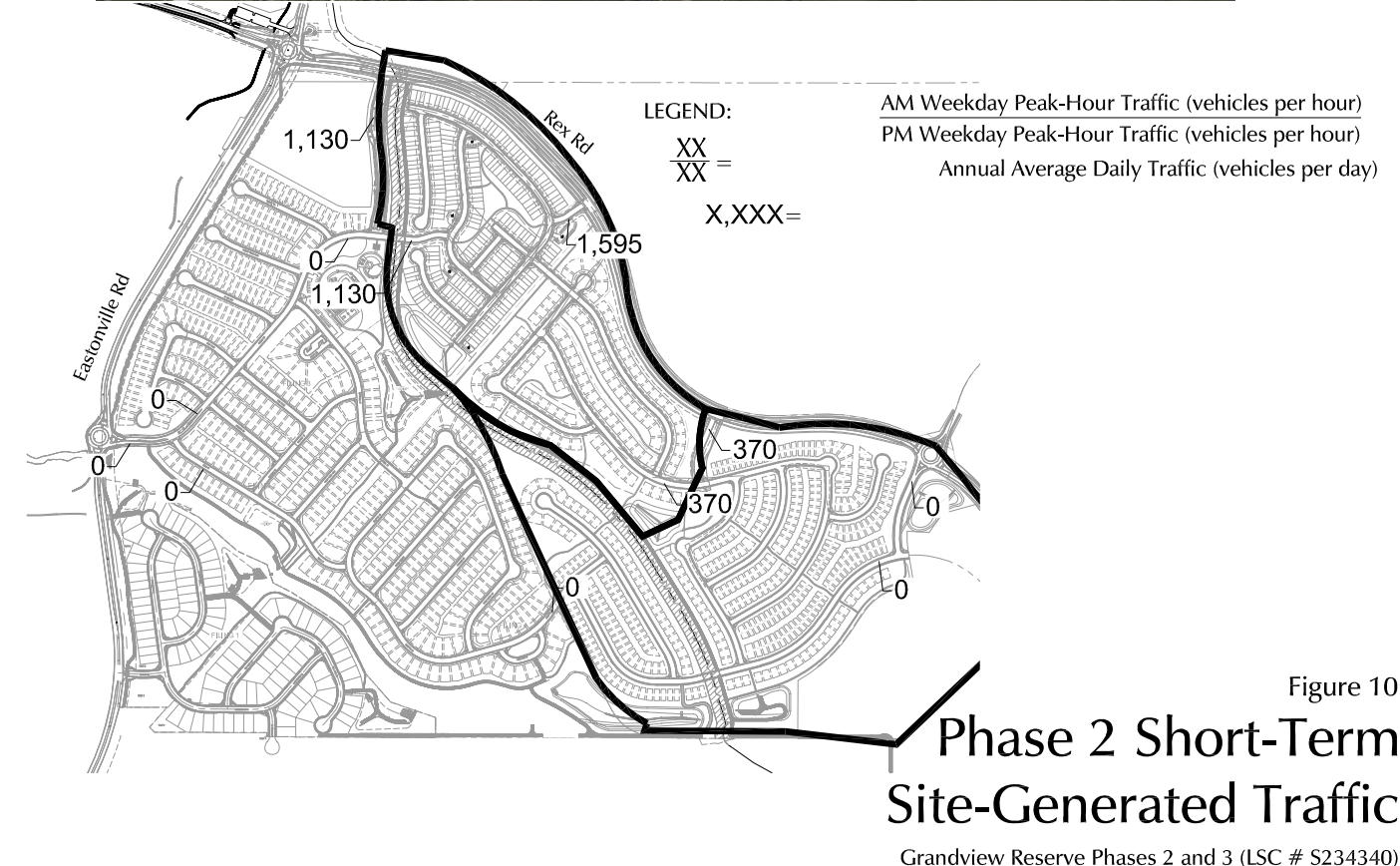
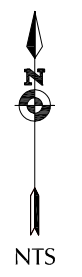
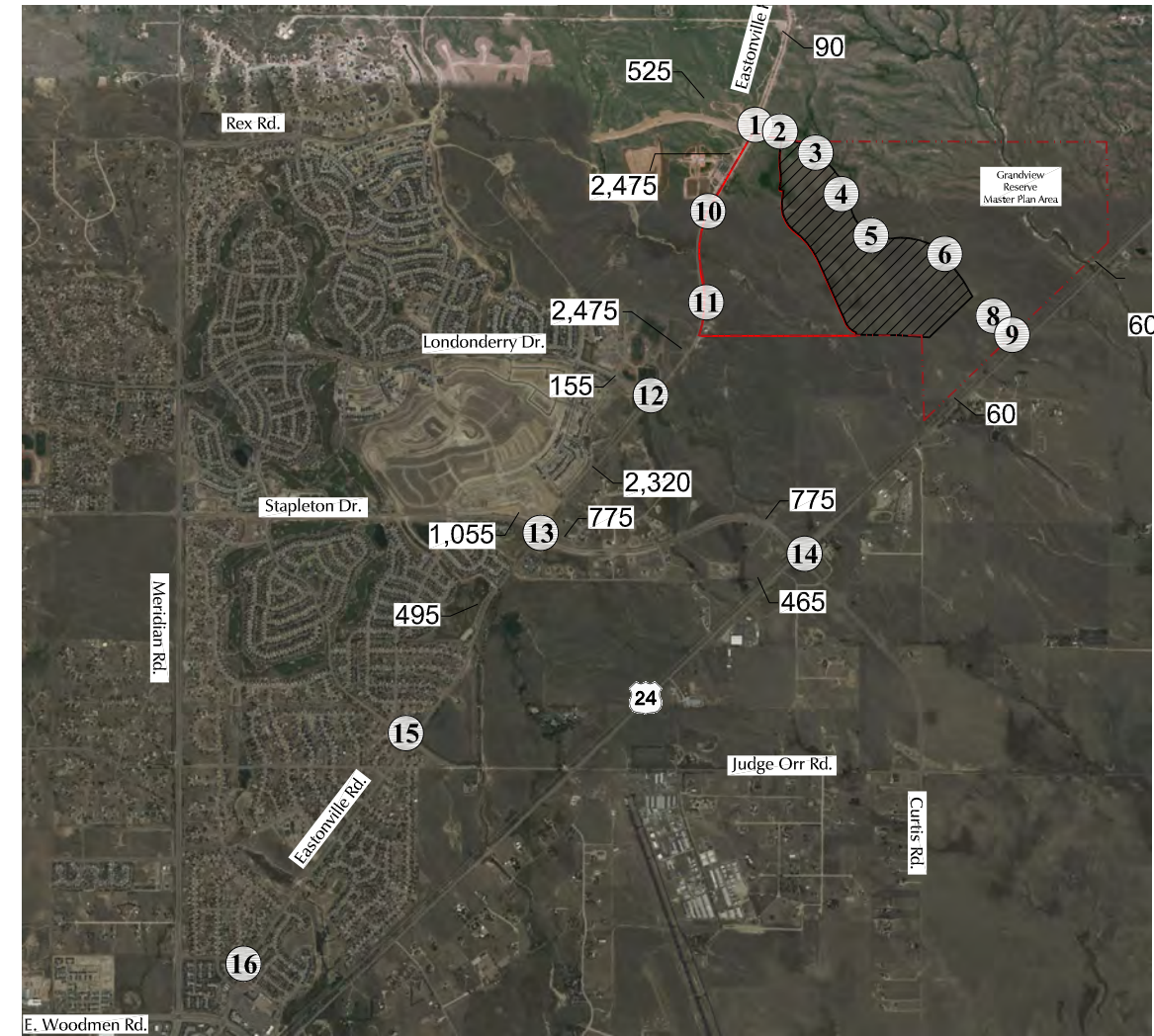
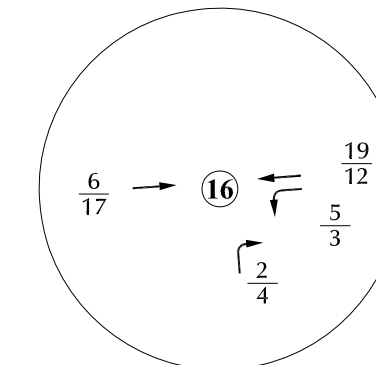
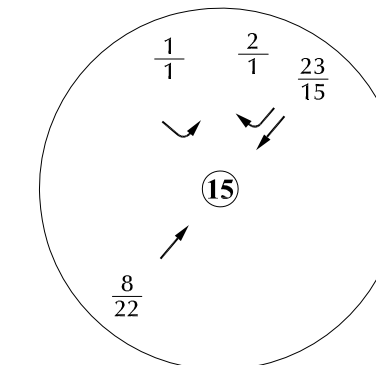
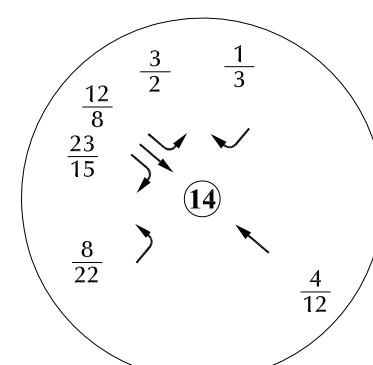
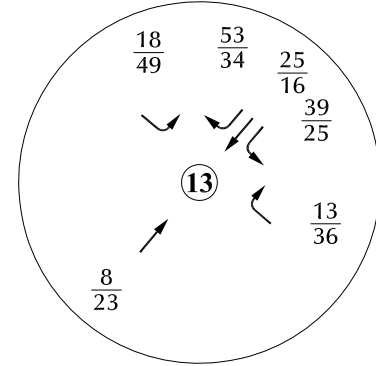
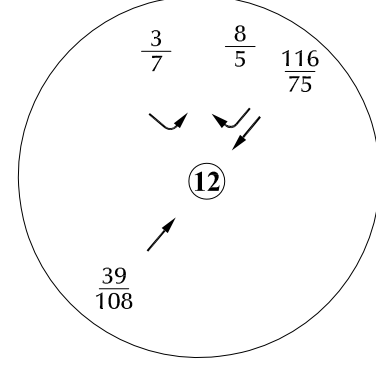
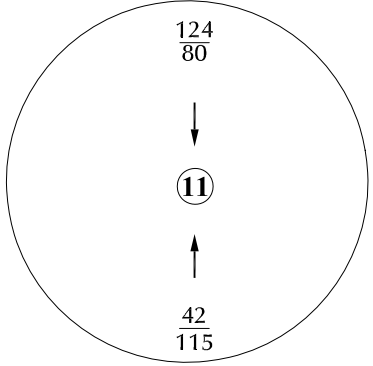
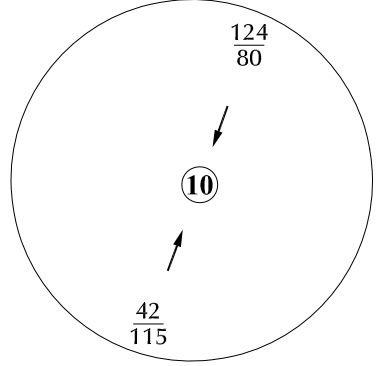
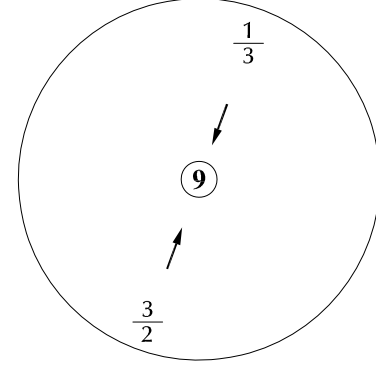
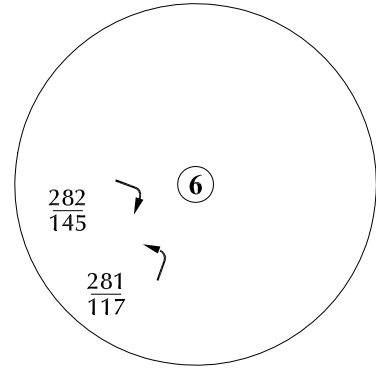
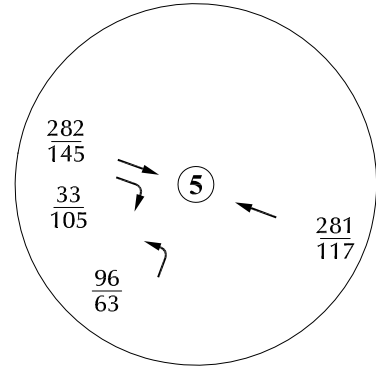
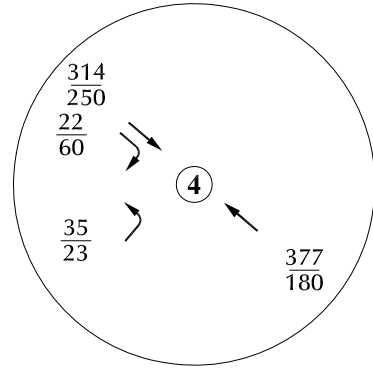
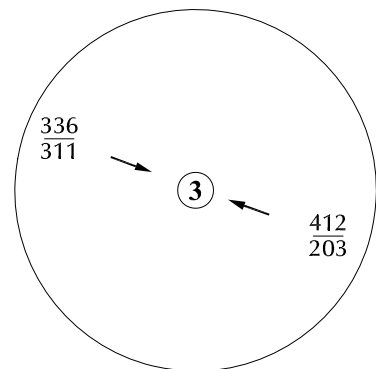
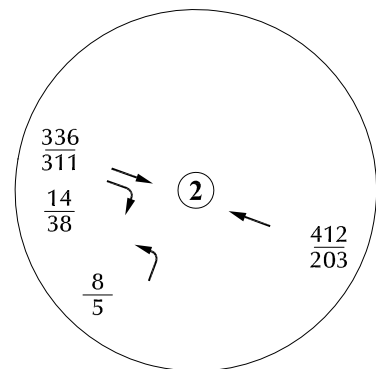
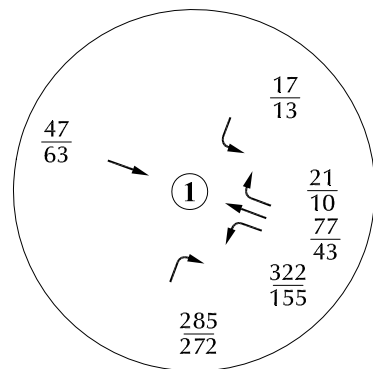
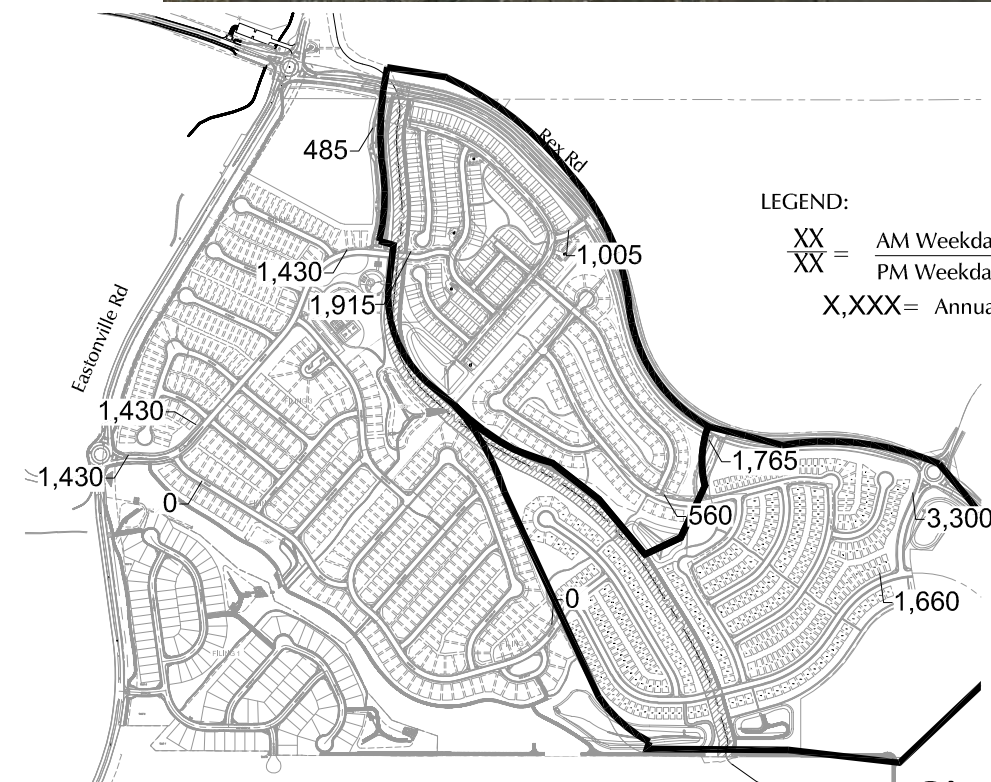
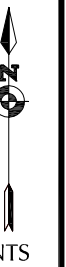
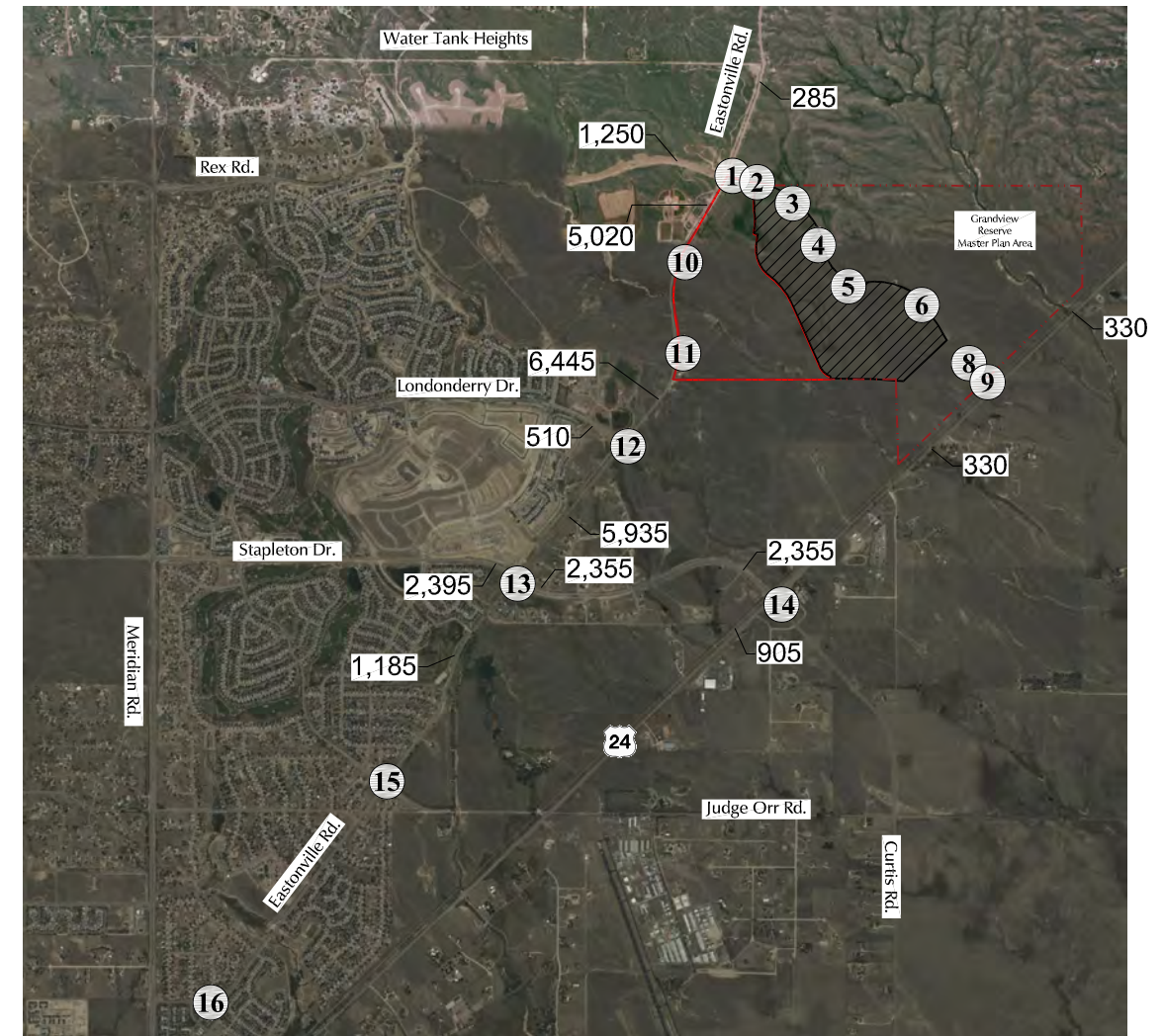
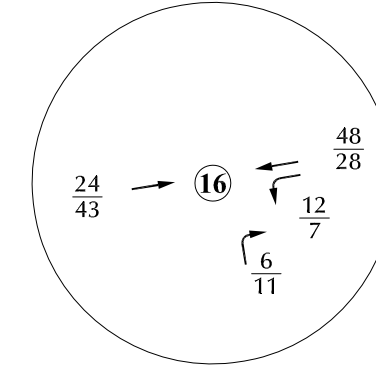
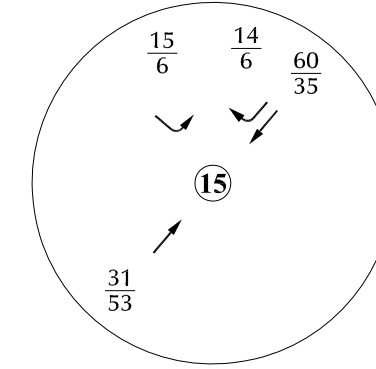
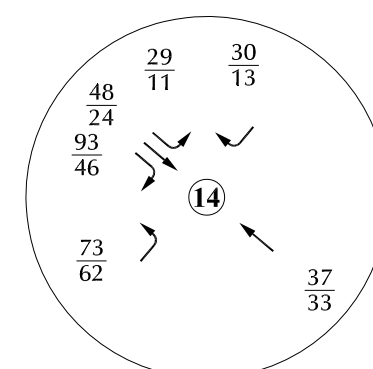
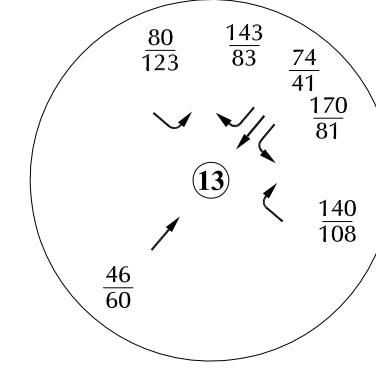
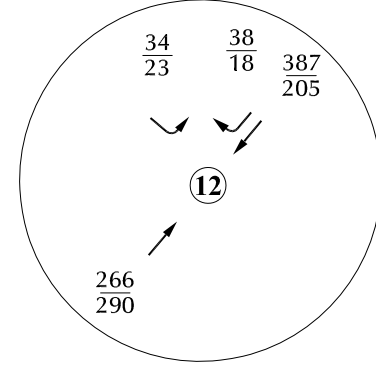
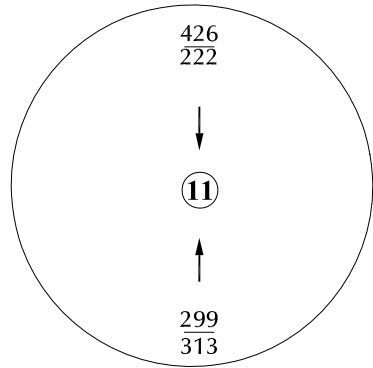
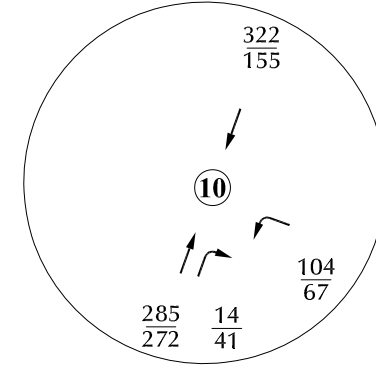
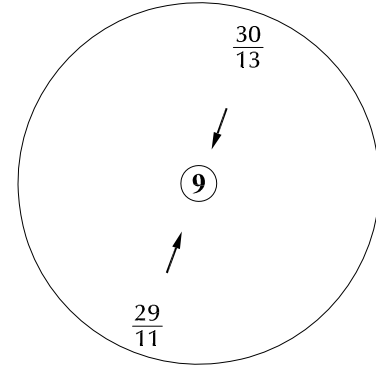

Figure 10  
 Phase 2 Short-Term  
 Site-Generated Traffic  
 Grandview Reserve Phases 2 and 3 (LSC # S234340)



Intentionally  
⑧  
Left Blank



LEGEND:  
 $\frac{XX}{XX}$  = AM Weekday Peak-Hour Traffic (vehicles per hour)  
 $\frac{XX}{XX}$  = PM Weekday Peak-Hour Traffic (vehicles per hour)  
 X,XXX = Annual Average Daily Traffic (vehicles per day)

Figure 11  
 Phase 2 and 3  
 Intermediate-Term  
 Site-Generated Traffic  
 Grandview Reserve Phases 2 and 3 (LSC # S234340)



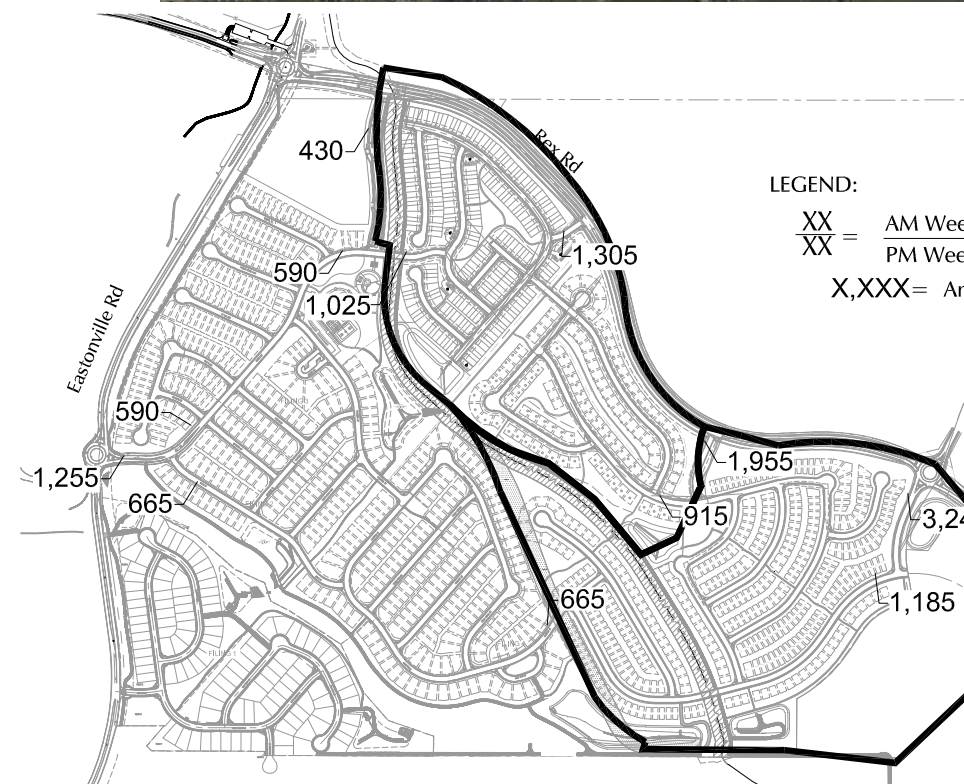
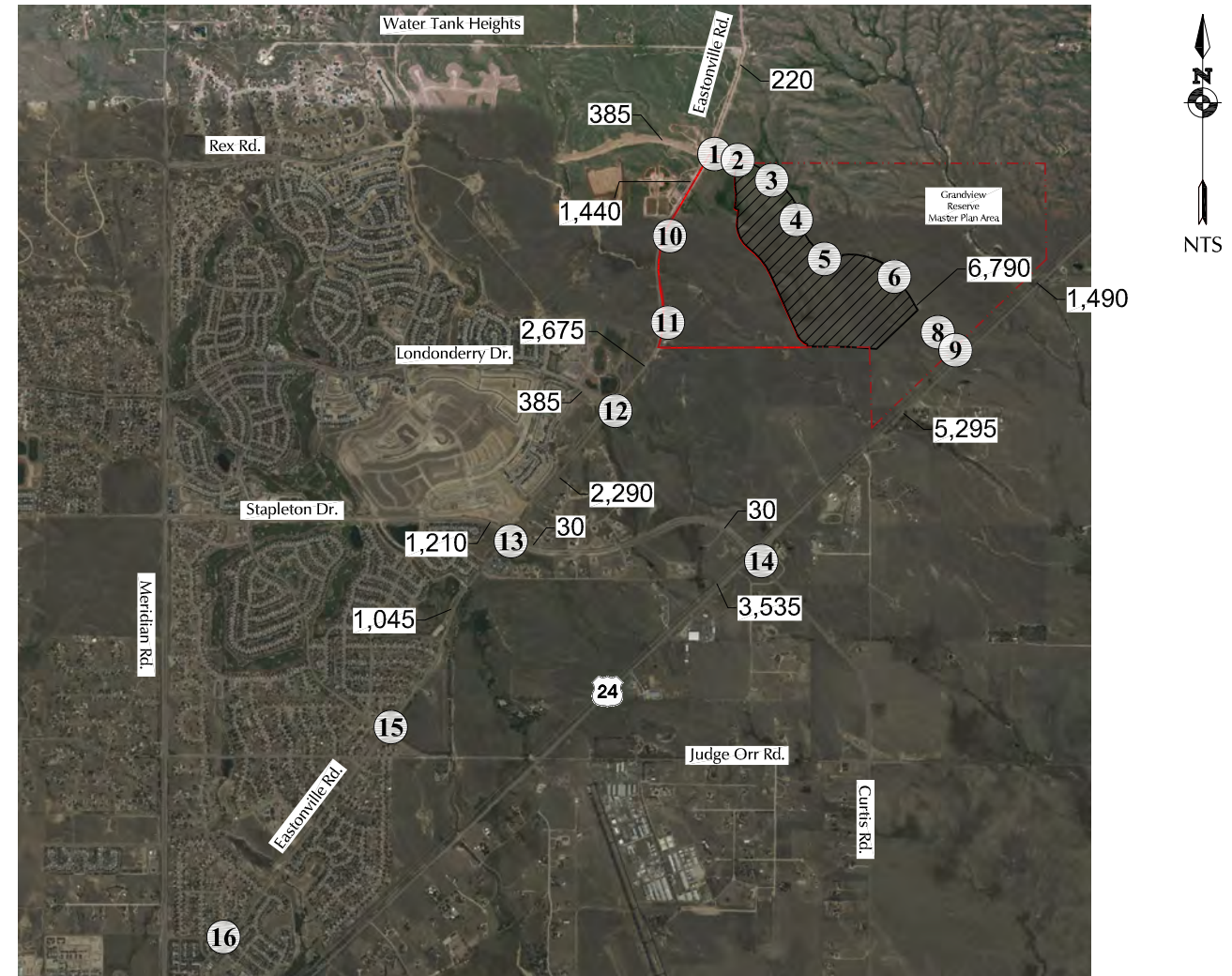
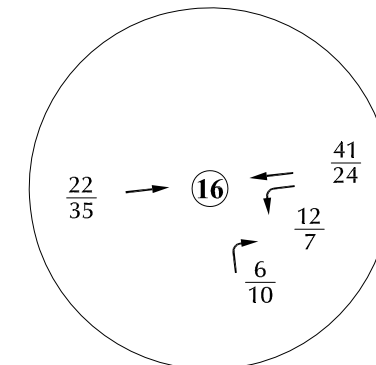
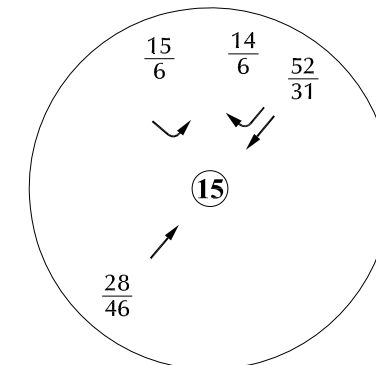
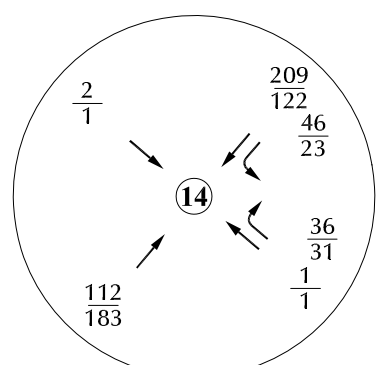
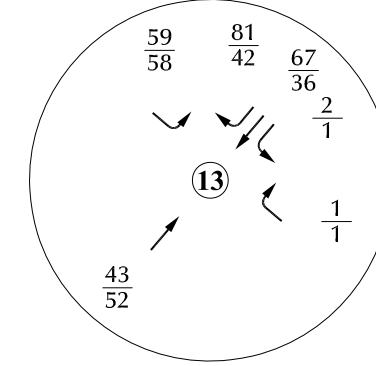
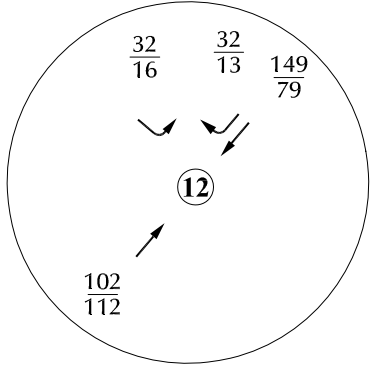
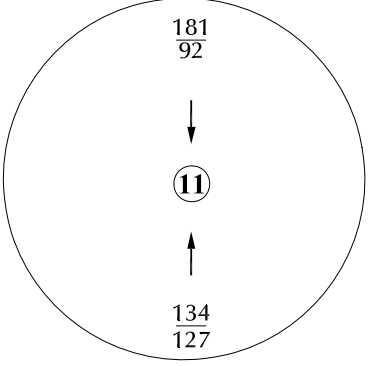
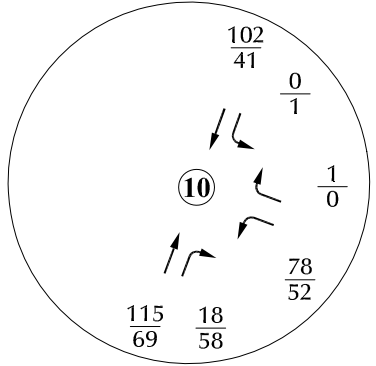
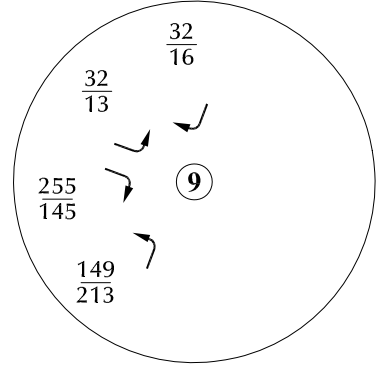
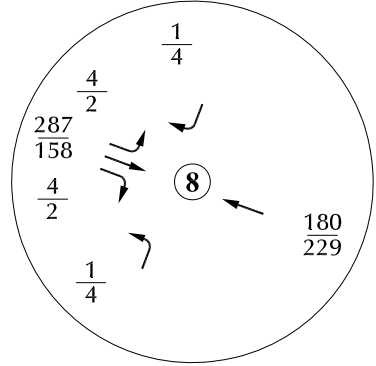
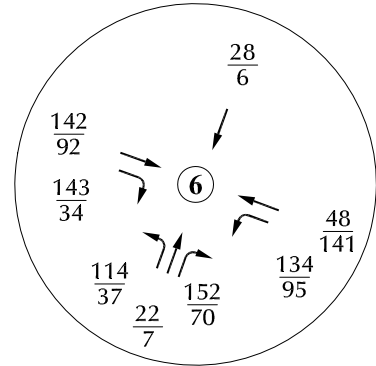
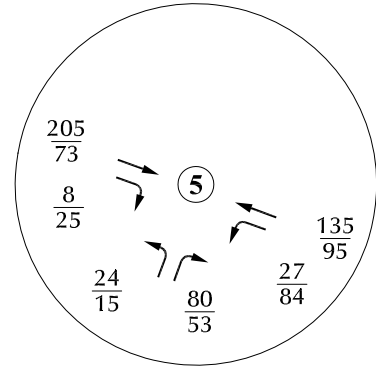
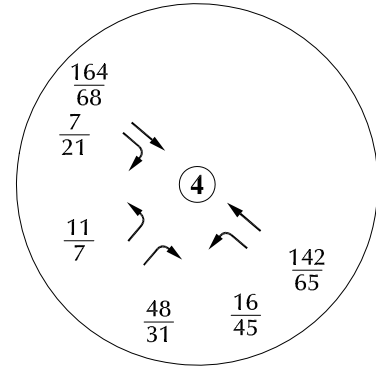
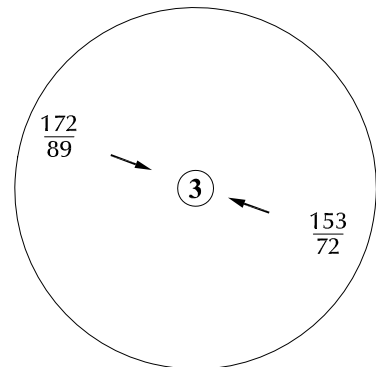
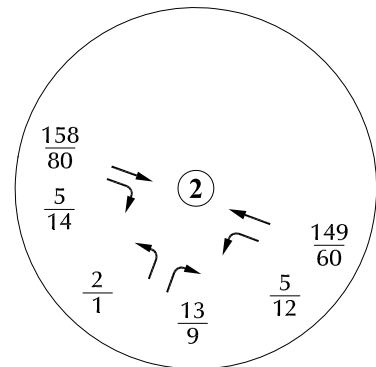
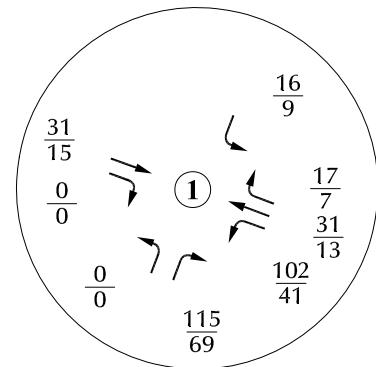

LEGEND:  
 XX = AM Weekday Peak-Hour Traffic (vehicles per hour)  
 XX = PM Weekday Peak-Hour Traffic (vehicles per hour)  
 X,XXX = Annual Average Daily Traffic (vehicles per day)

Figure 12  
 Phase 2 and 3  
 Long-Term  
 Site-Generated Traffic  
 Grandview Reserve Phases 2 and 3 (LSC # S234340)

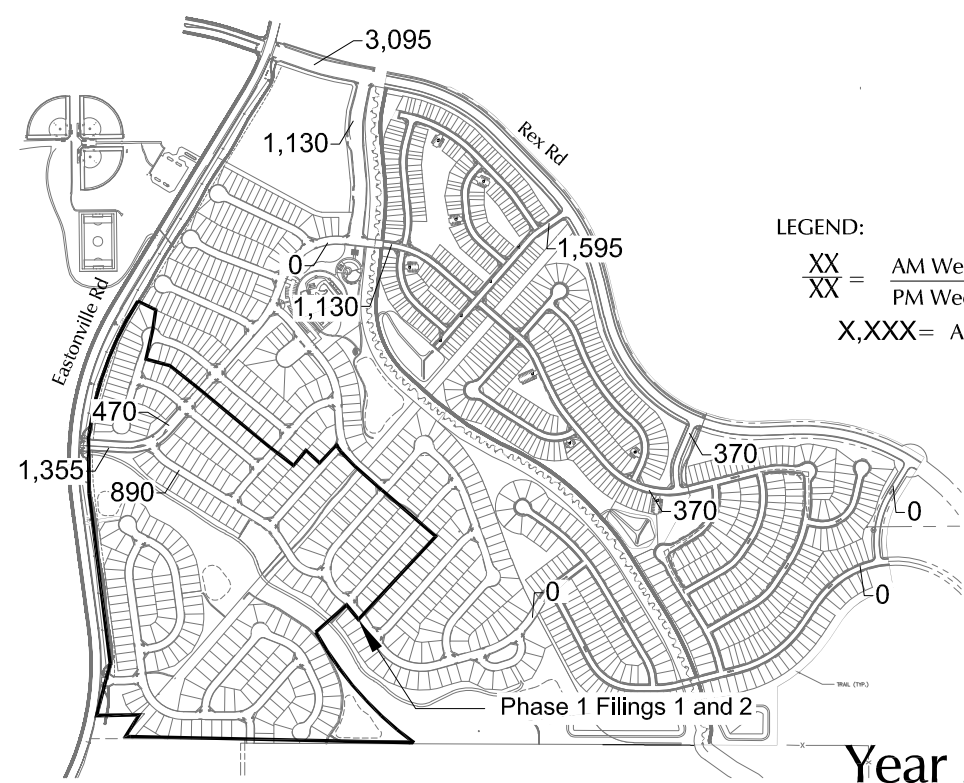
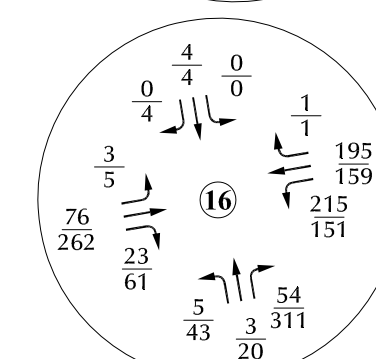
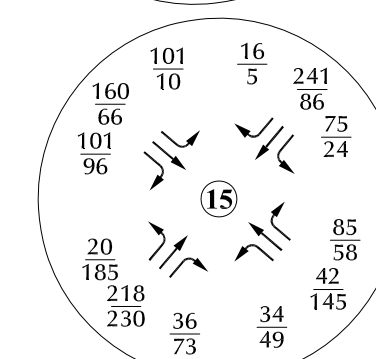
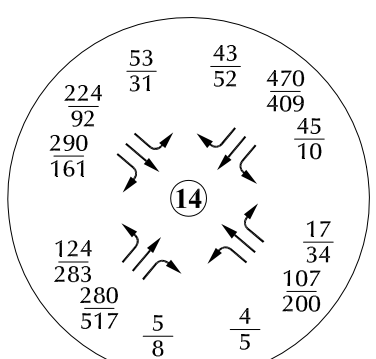
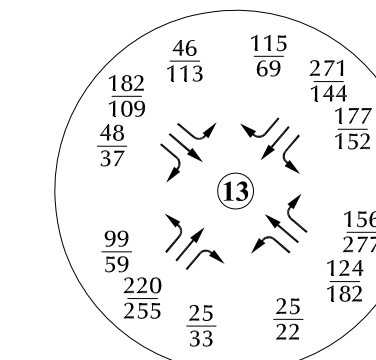
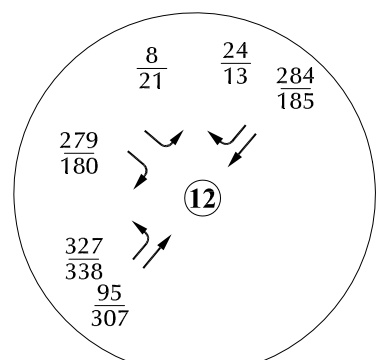
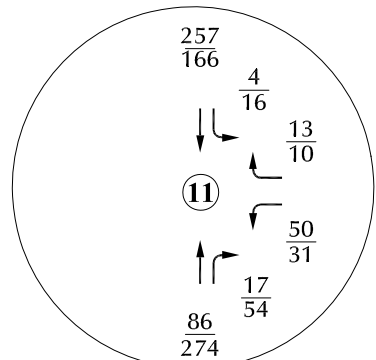
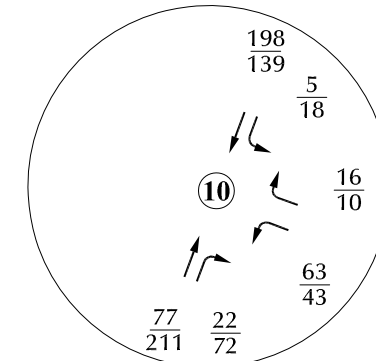
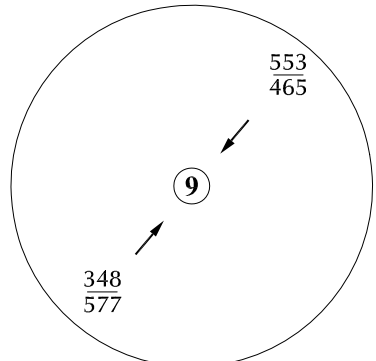
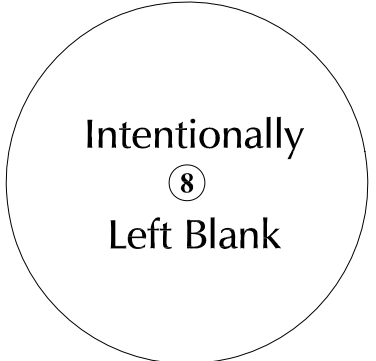
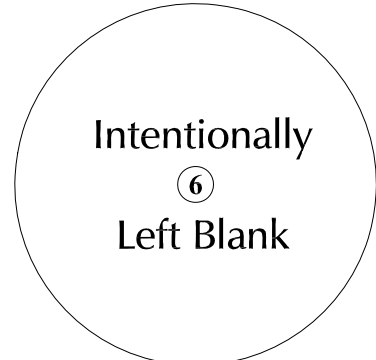
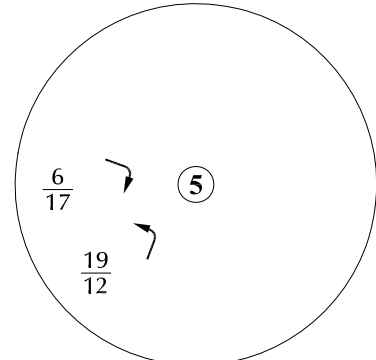
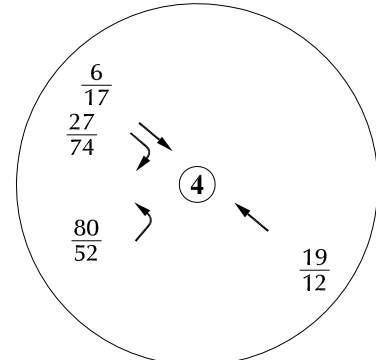
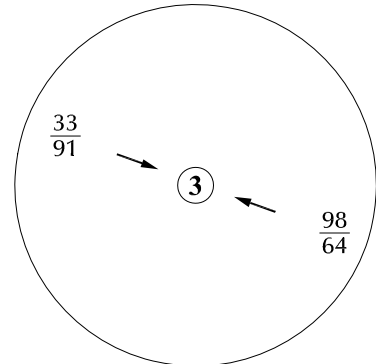
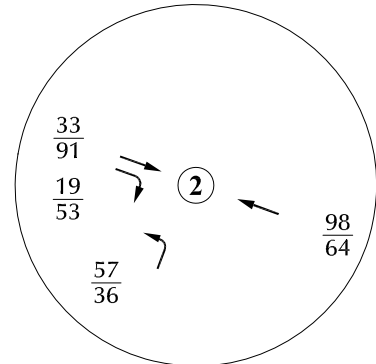
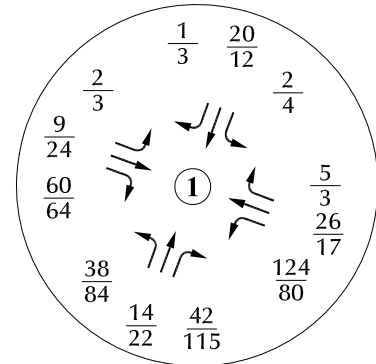

LEGEND:  
 XX/XX = AM Weekday Peak-Hour Traffic (vehicles per hour)  
 XX/XX = PM Weekday Peak-Hour Traffic (vehicles per hour)  
 X,XXX = Annual Average Daily Traffic (vehicles per day)

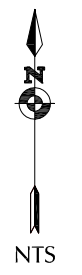

\* Assumes buildout of Grandview Reserve Phase 1, filings 1 and 2 only, and Grandview Reserve Phase 2

Figure 13a  
 Year 2026 Total Traffic\*  
 Grandview Reserve Phases 2 and 3 (LSC # S234340)

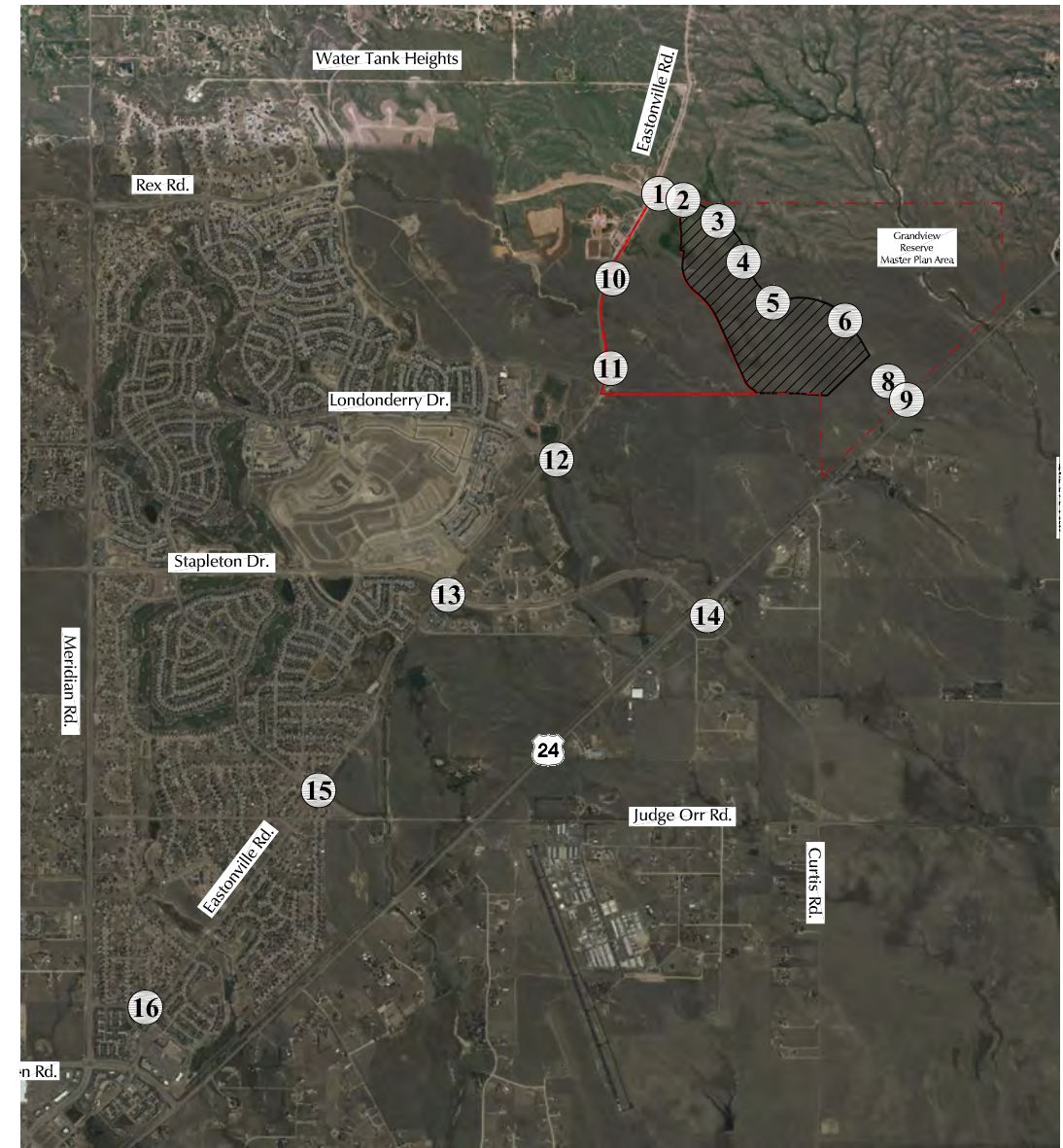
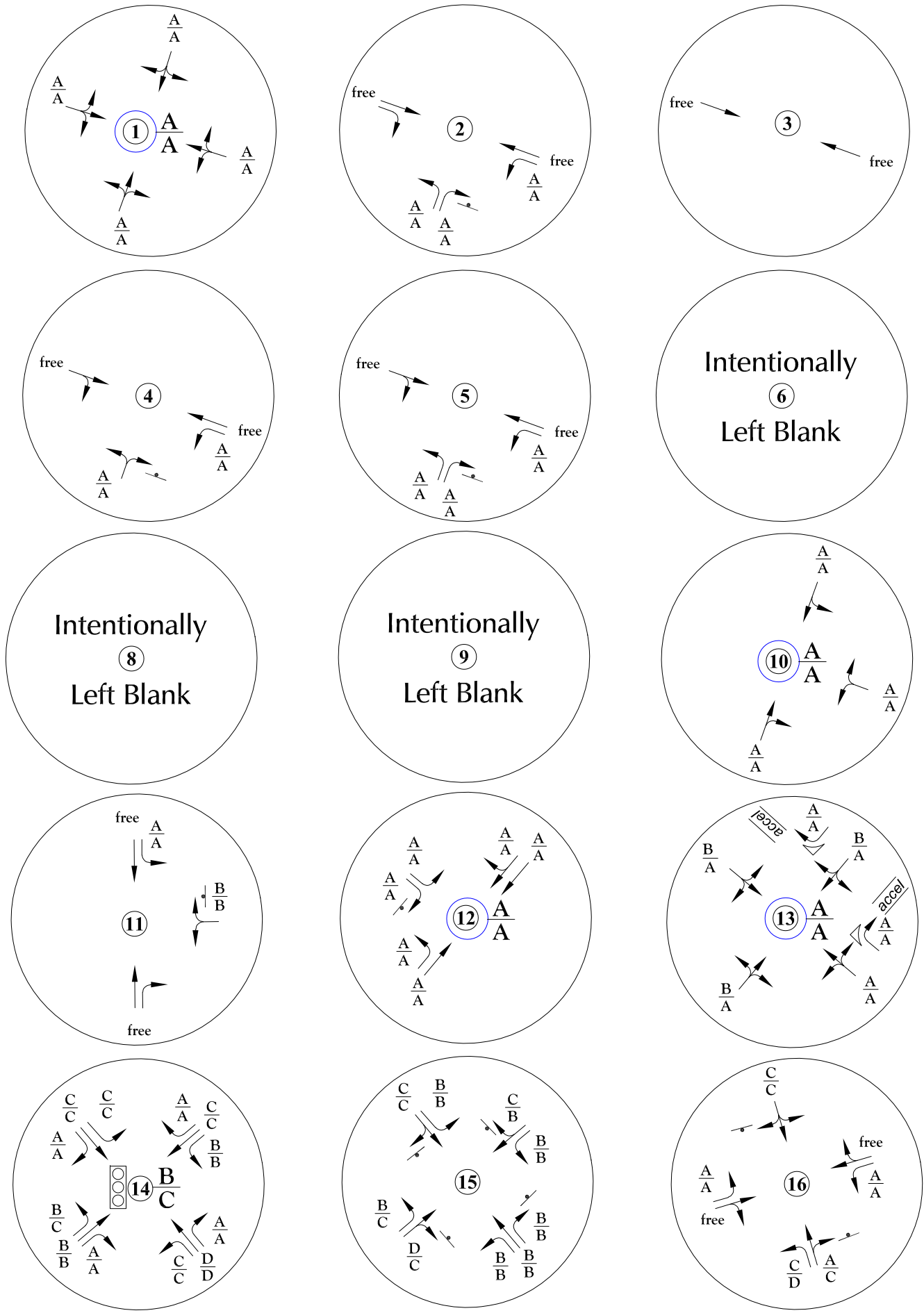
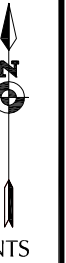

**LEGEND:**

Traffic Control Used in the Analysis:

- = Stop Sign
- = Traffic Signal

LOS Analysis Results:

- $\frac{A}{A}$  = AM Individual Movement Peak-Hour Level of Service
- $\frac{B}{B}$  = PM Individual Movement Peak-Hour Level of Service
- $\frac{C}{C}$  = AM Entire Intersection Peak-Hour Level of Service
- $\frac{C}{C}$  = PM Entire Intersection Peak-Hour Level of Service

= Modern Roundabout

Figure 13b  
 Year 2026 Total Lane Geometry,  
 Traffic Control, and Levels of Service\*

\* Assumes buildout of Grandview Reserve Phase 1, filings 1 and 2 only, and Grandview Reserve Phase 2.





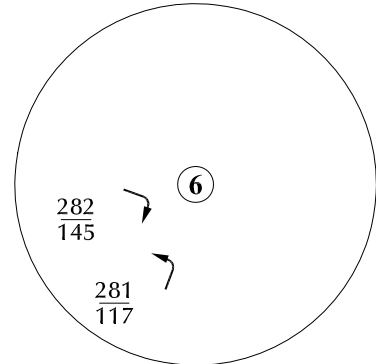
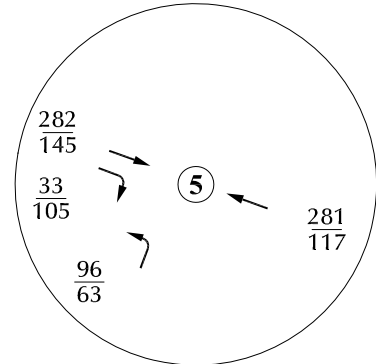
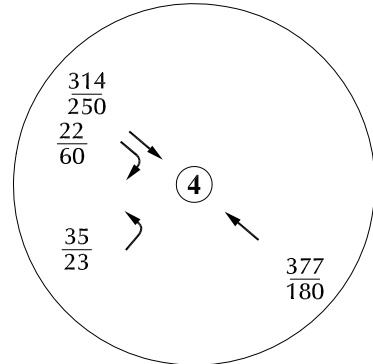
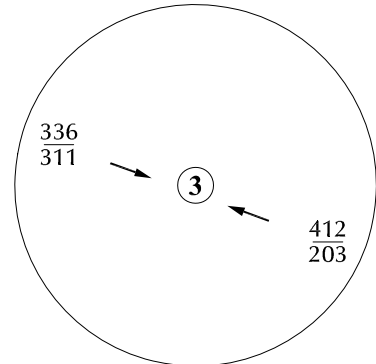
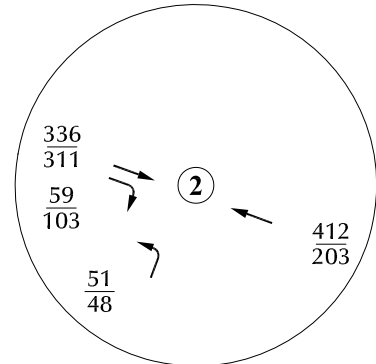
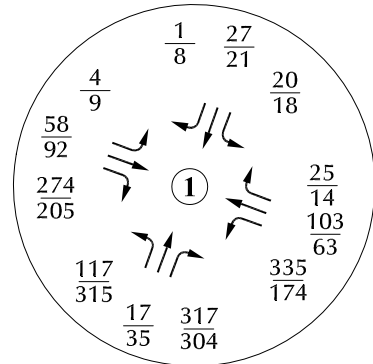

Intentionally  
⑧  
Left Blank

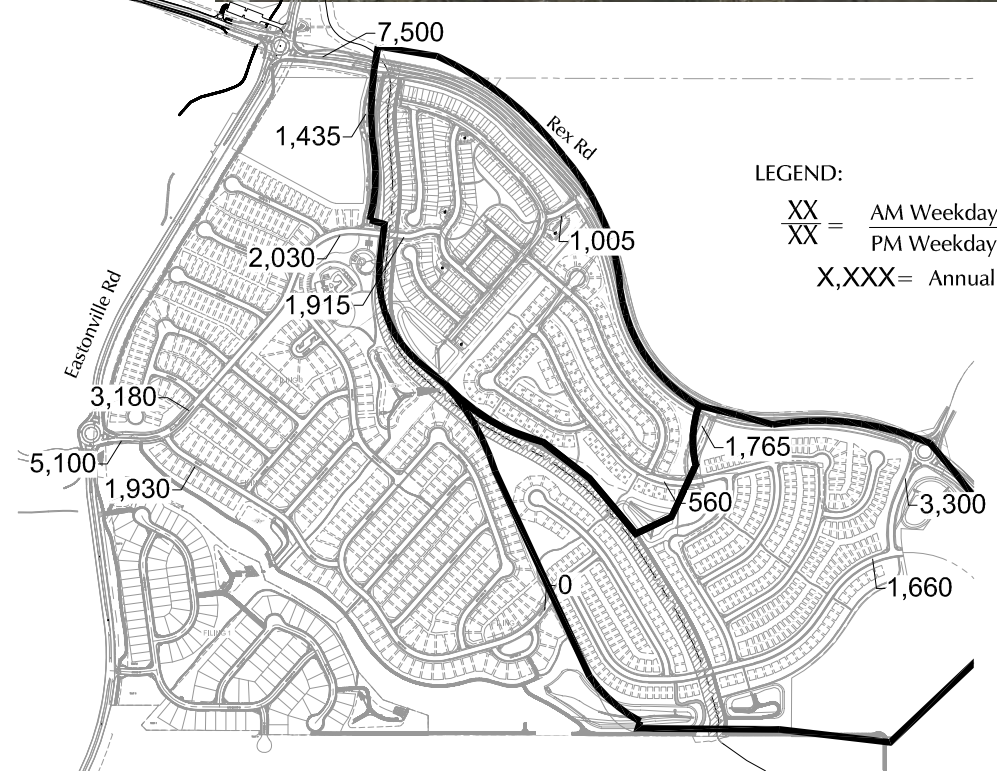
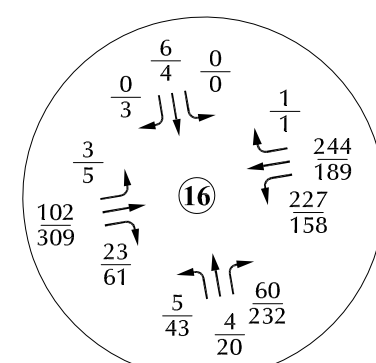
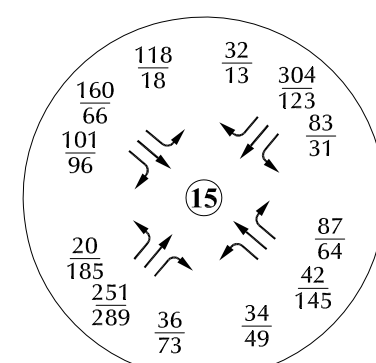
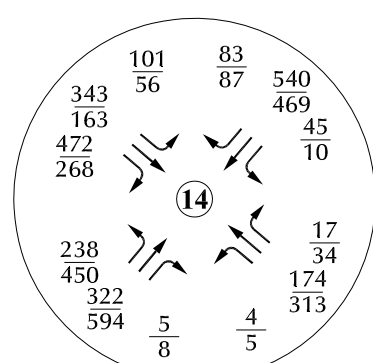
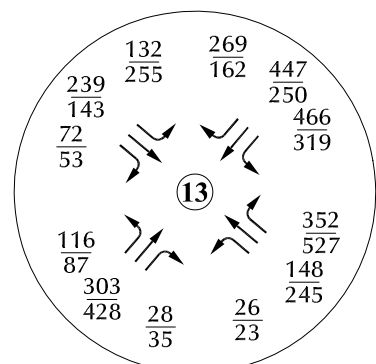
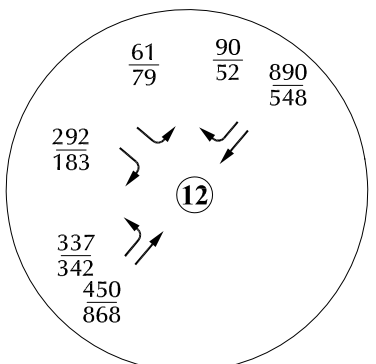
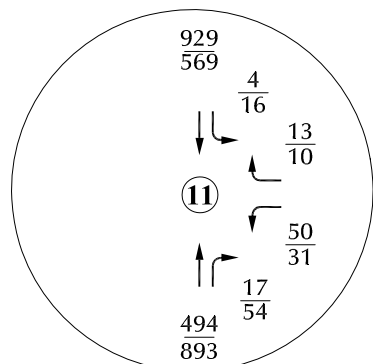
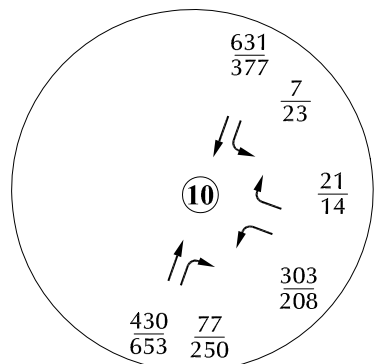
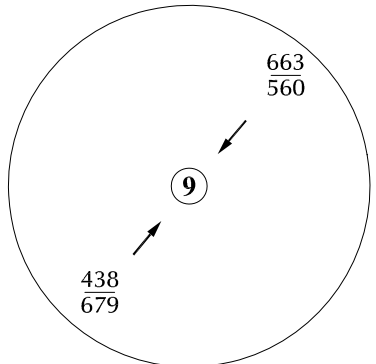

LEGEND:  
 XX/XX = AM Weekday Peak-Hour Traffic (vehicles per hour)  
 XX/XX = PM Weekday Peak-Hour Traffic (vehicles per hour)  
 X,XXX = Annual Average Daily Traffic (vehicles per day)



\* Assumes buildout of Grandview Reserve Phases 1, 2, and 3

Grandview Reserve Phases 2 and 3 (LSC # S234340)

Figure 14a  
 Year 2033 Total  
 Traffic\*

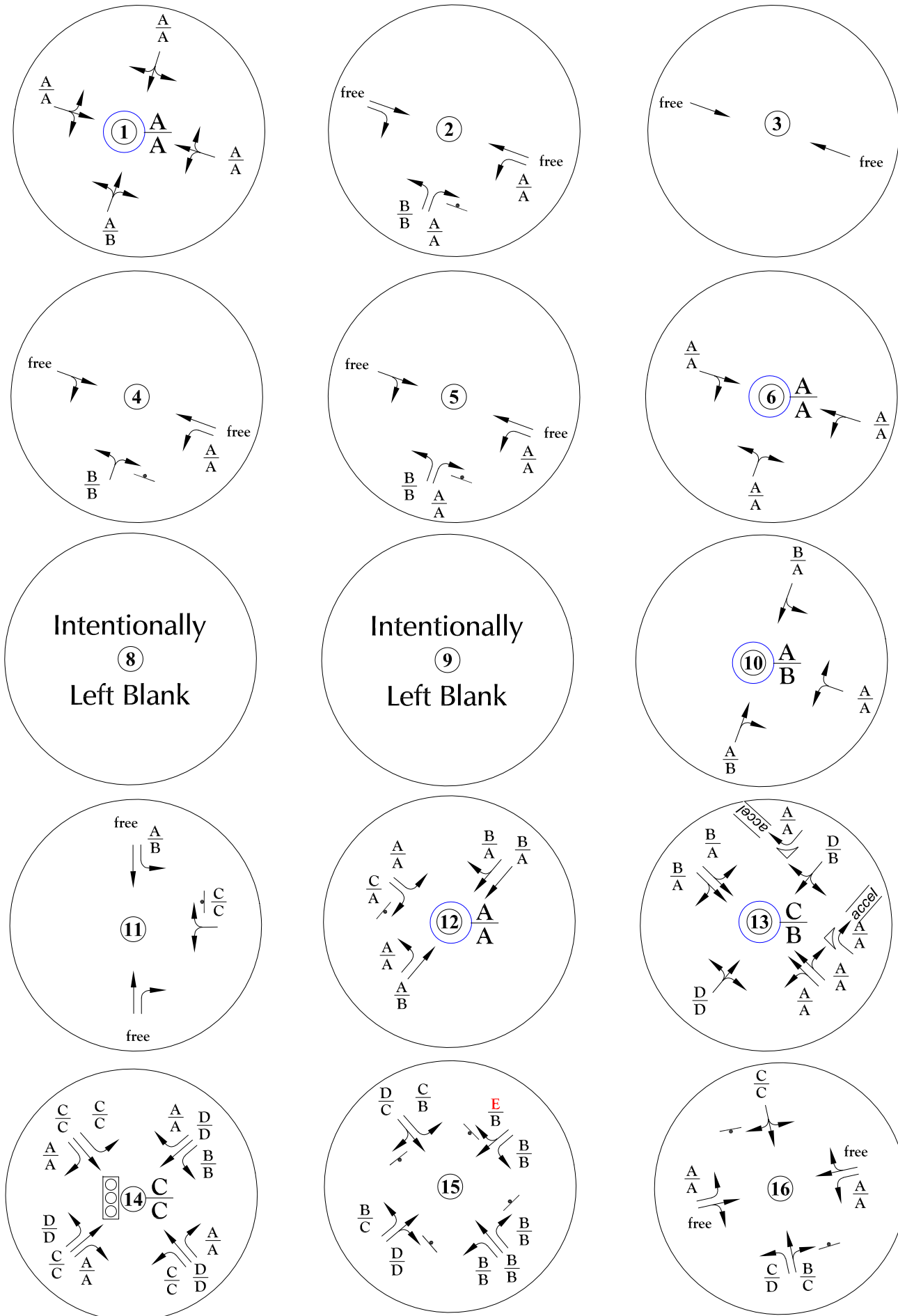
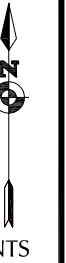

**LEGEND:**  
 Traffic Control Used in the Analysis:  
 ↓ = Stop Sign  
 [ ] = Traffic Signal  
 ○ = Modern Roundabout  
 LOS Analysis Results:  
 A/A = AM Individual Movement Peak-Hour Level of Service  
 B/B = PM Individual Movement Peak-Hour Level of Service  
 C/C = AM Entire Intersection Peak-Hour Level of Service  
 C/C = PM Entire Intersection Peak-Hour Level of Service

Figure 14b  
 Year 2033 Total Lane Geometry,  
 Traffic Control, and Levels of Service\*

\* Assumes buildout of Grandview Reserve Phases 1, 2, and 3



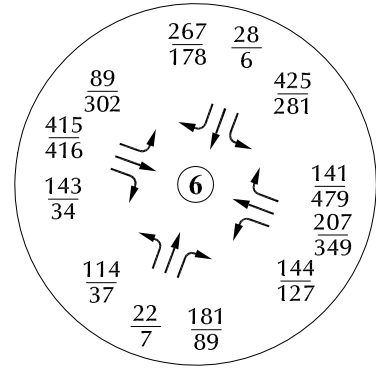
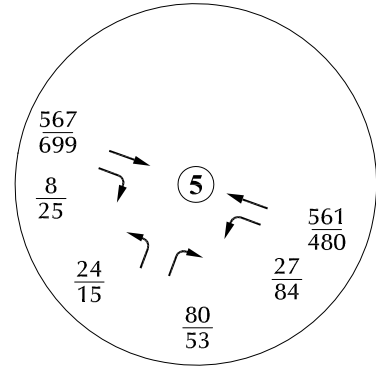
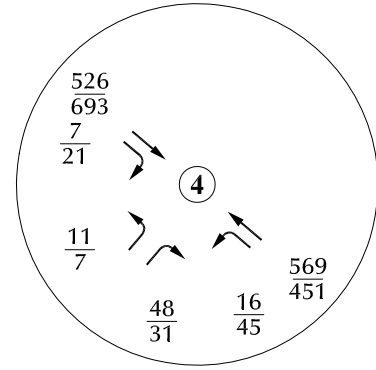
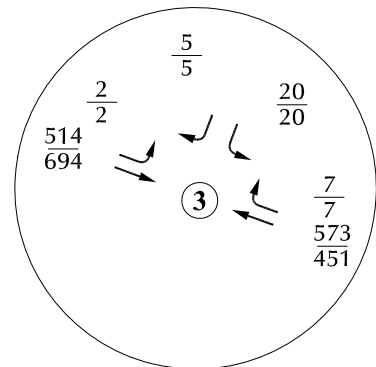
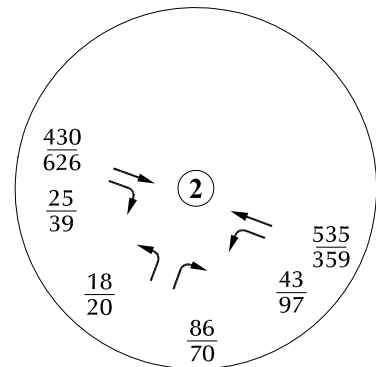
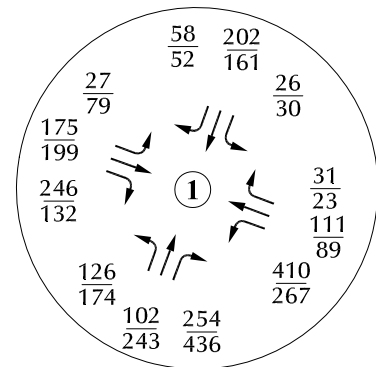

Intentionally  
⑧  
Left Blank

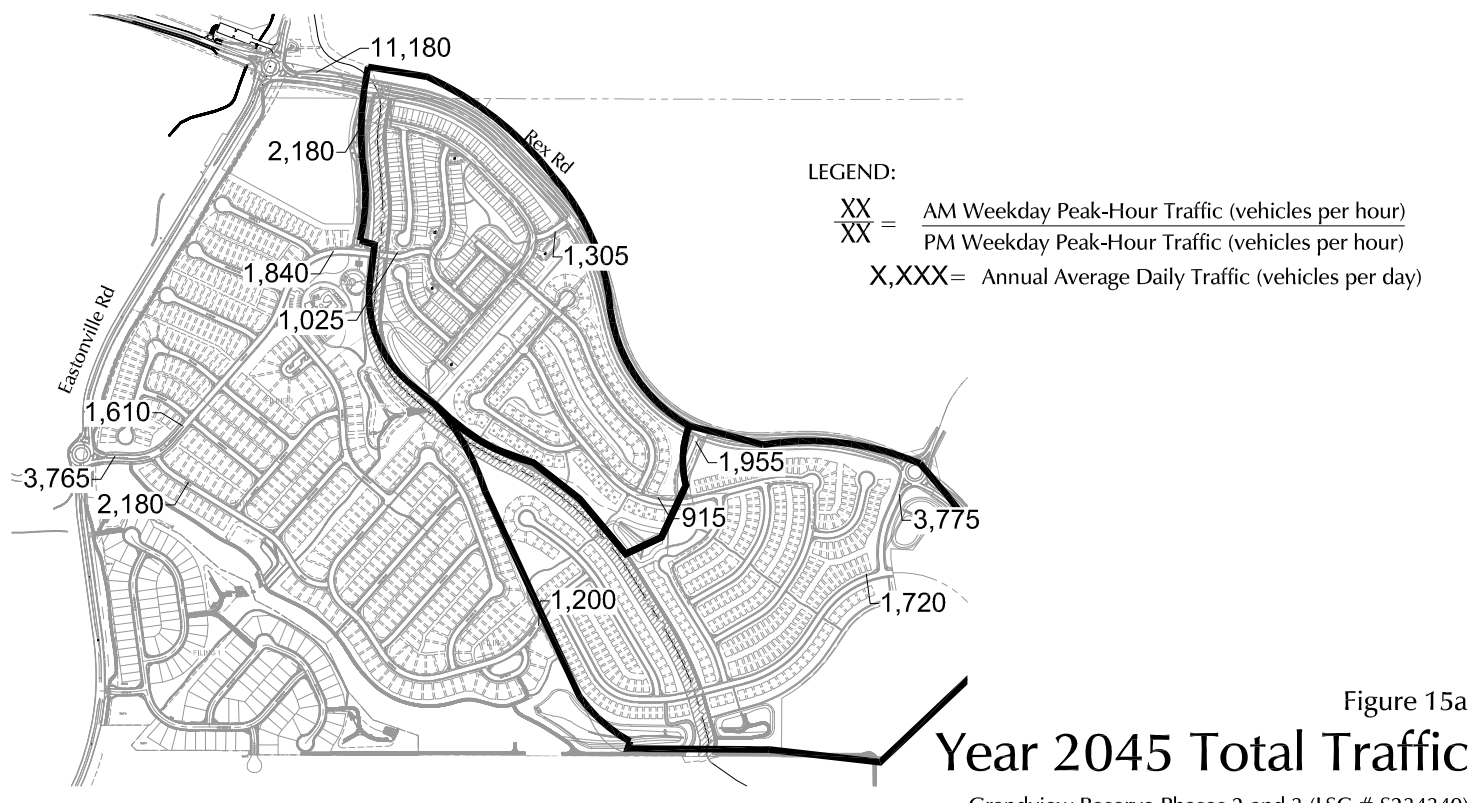
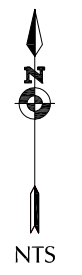
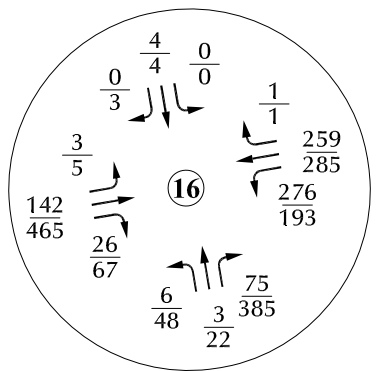
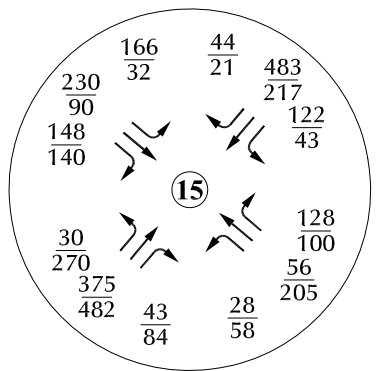
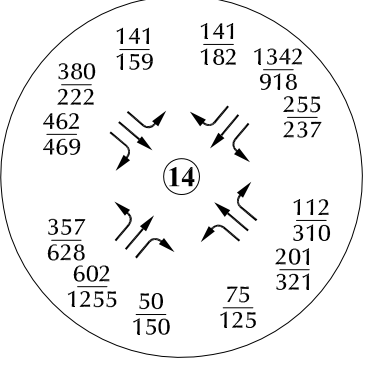
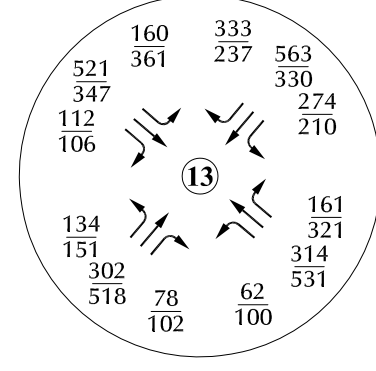
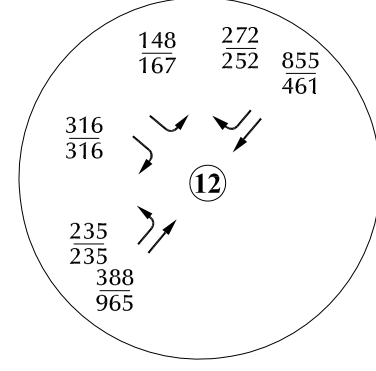
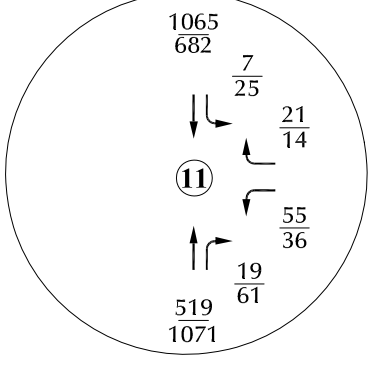
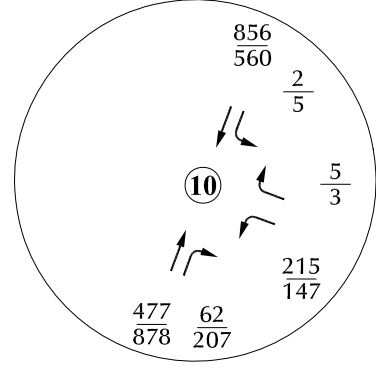
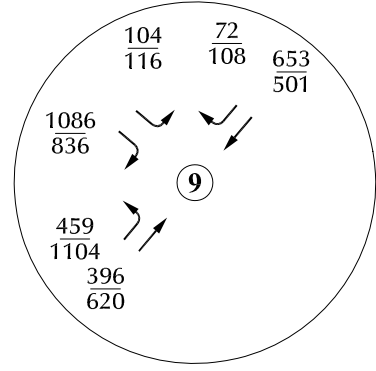
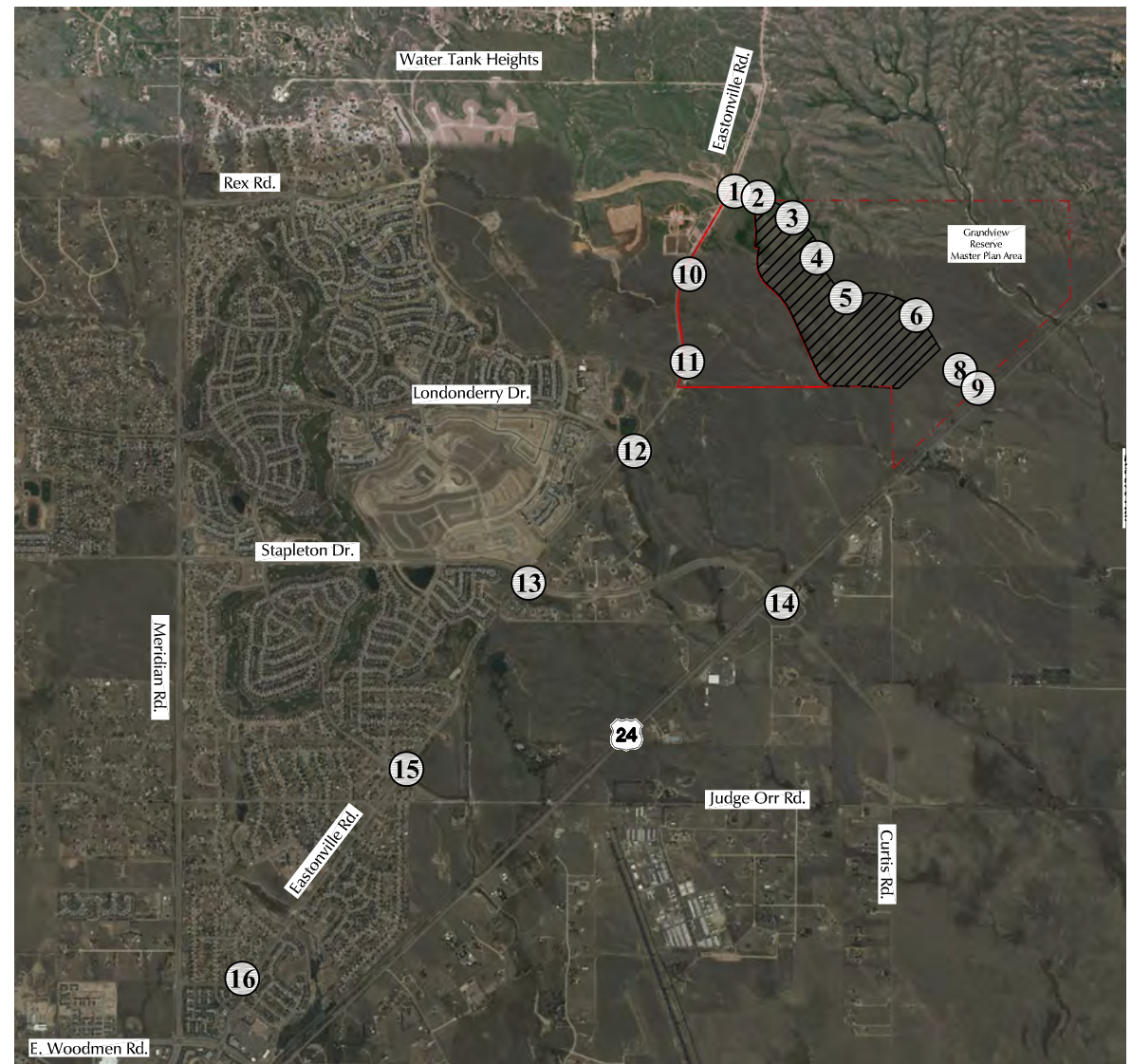
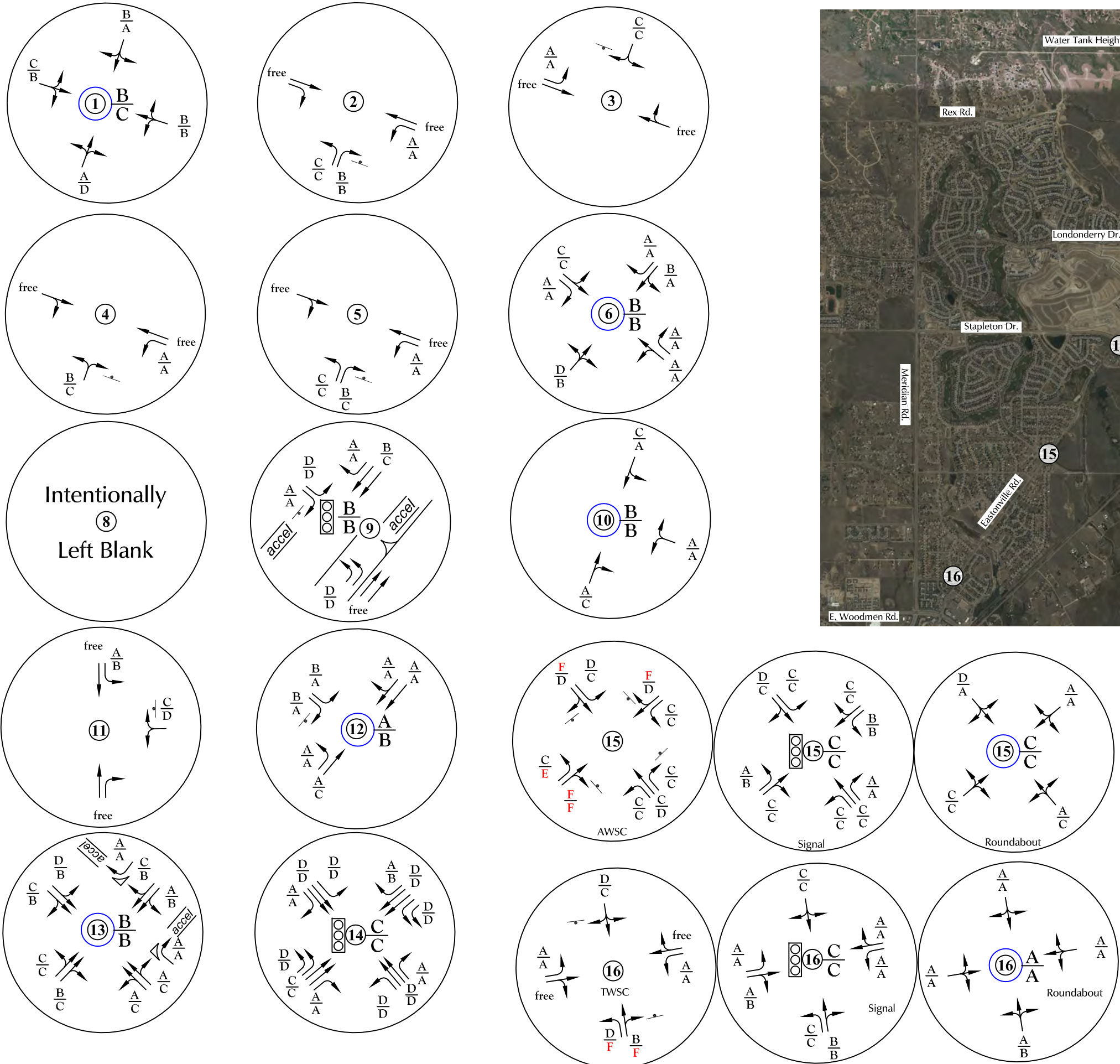

Figure 15a  
 Year 2045 Total Traffic  
 Grandview Reserve Phases 2 and 3 (LSC # S234340)



**LEGEND:**  
 Traffic Control Used in the Analysis:  
 [Stop Sign Symbol] = Stop Sign      [Modern Roundabout Symbol] = Modern Roundabout  
 [Traffic Signal Symbol] = Traffic Signal

LOS Analysis Results:  
 $\frac{A}{B}$  = AM Individual Movement Peak-Hour Level of Service  
 $\frac{A}{A}$  = PM Individual Movement Peak-Hour Level of Service  
 $\frac{C}{C}$  = AM Entire Intersection Peak-Hour Level of Service  
 $\frac{C}{C}$  = PM Entire Intersection Peak-Hour Level of Service

Figure 15b  
 Year 2045  
 Total Lane Geometry,  
 Traffic Control, and Levels  
 of Service



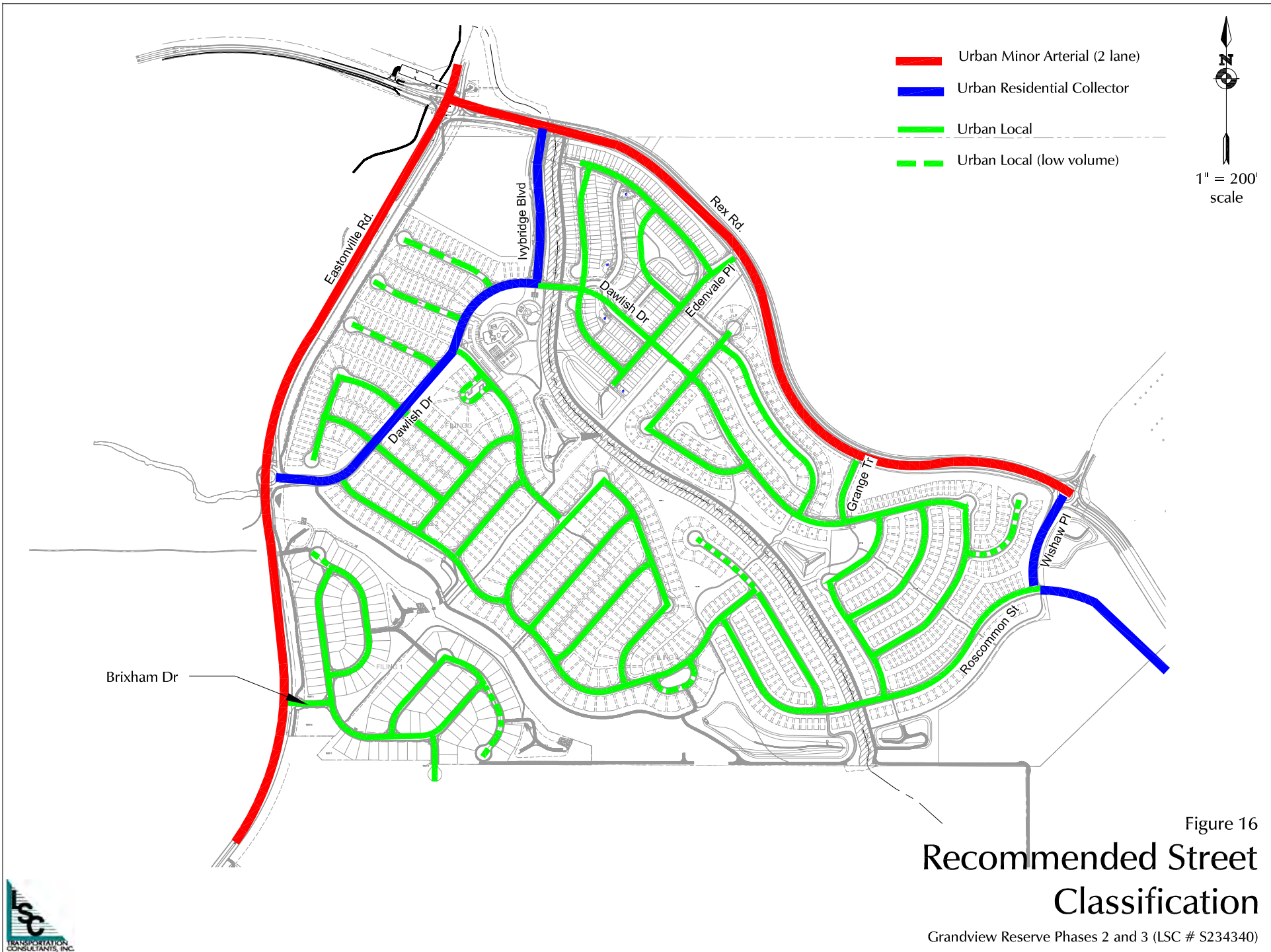

Figure 16  
**Recommended Street  
 Classification**

Grandview Reserve Phases 2 and 3 (LSC # S234340)



# Roundabout Exhibits

---



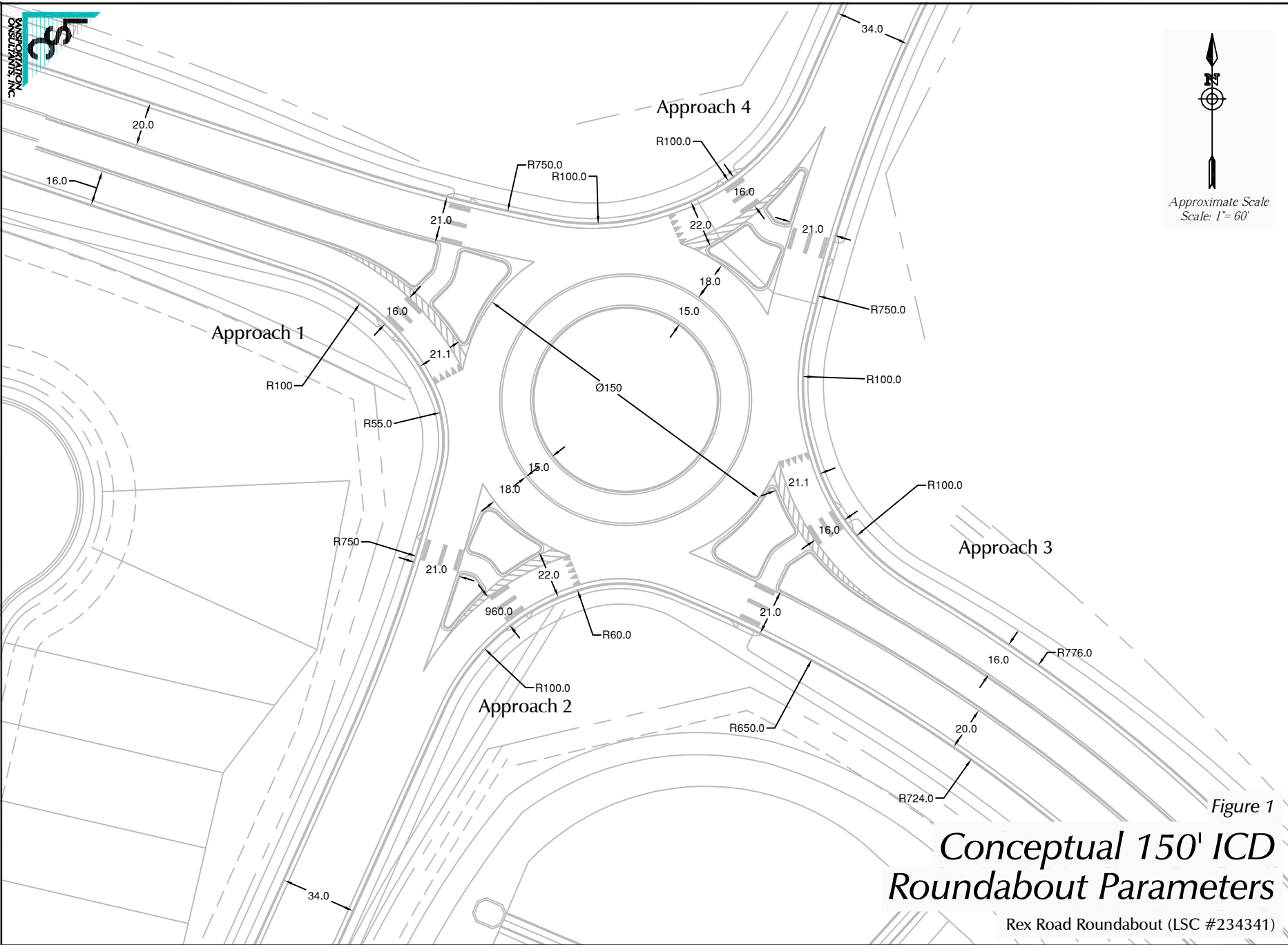
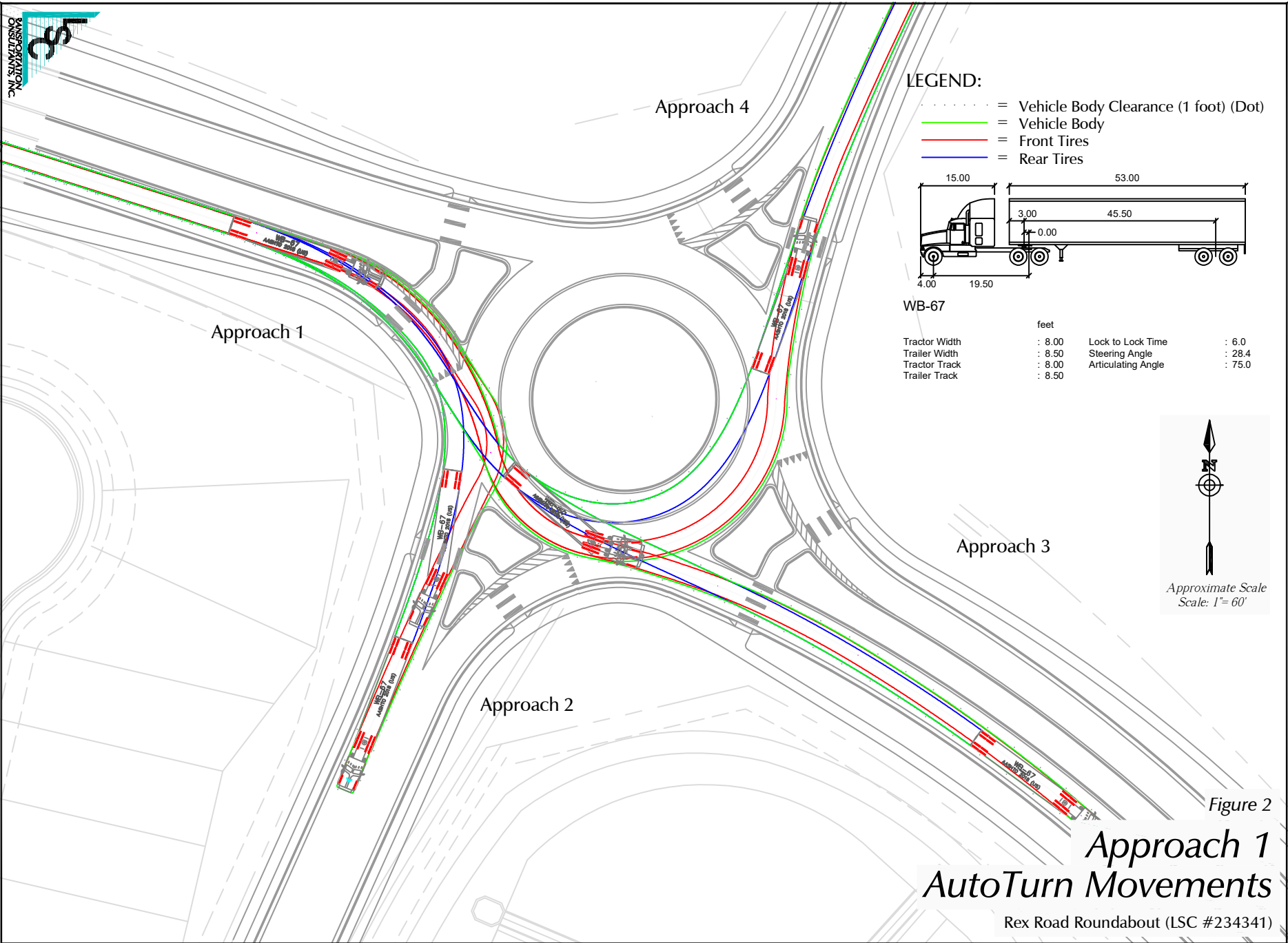

Figure 1

# Conceptual 150' ICD Roundabout Parameters

Rex Road Roundabout (LSC #234341)





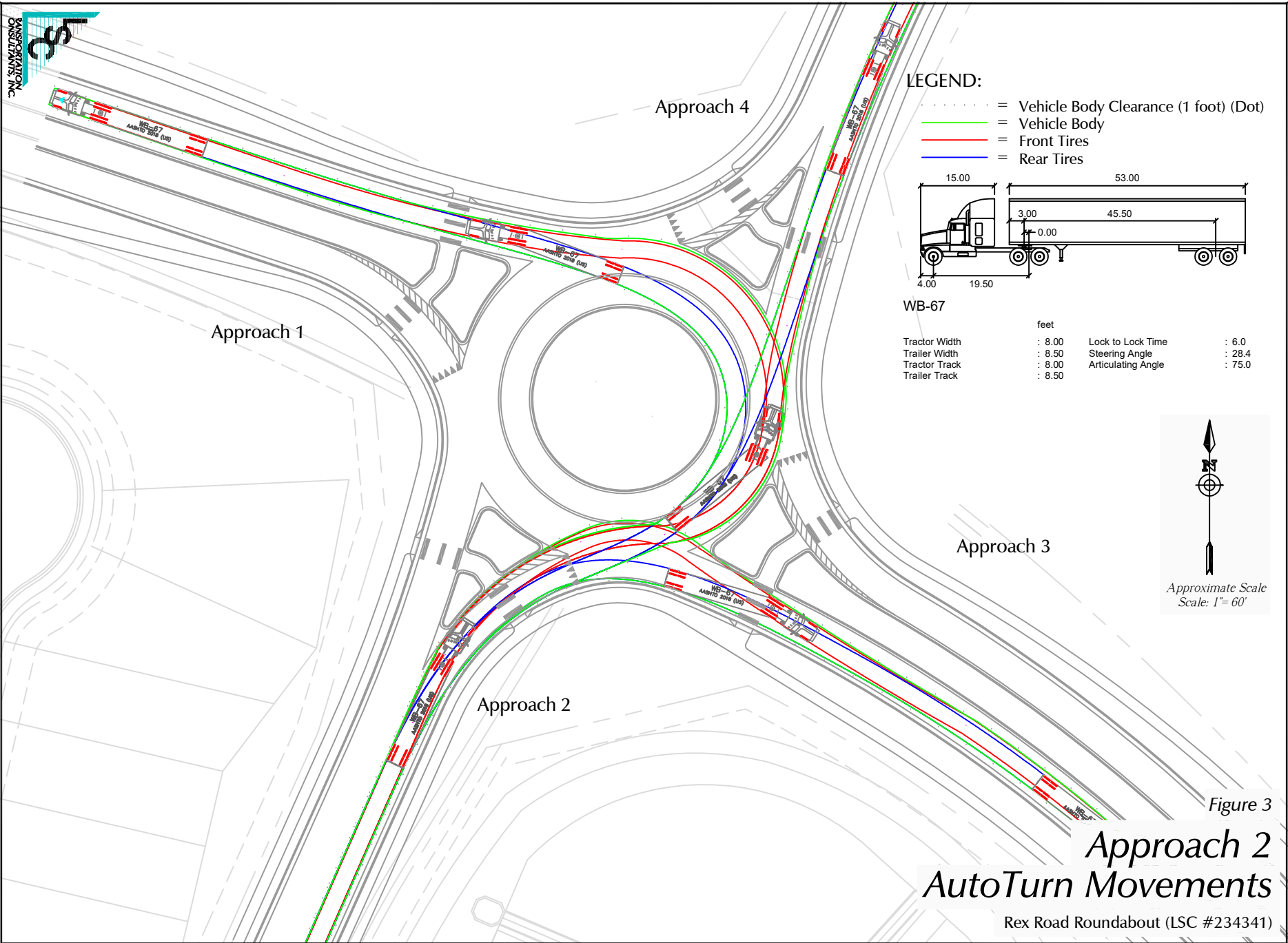

**LEGEND:**

- ..... = Vehicle Body Clearance (1 foot) (Dot)
- = Vehicle Body
- = Front Tires
- = Rear Tires

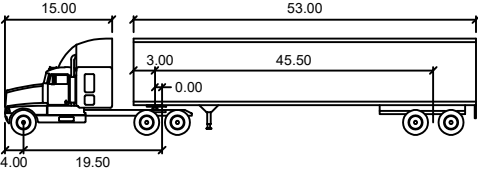

WB-67

	feet		
Tractor Width	: 8.00	Lock to Lock Time	: 6.0
Trailer Width	: 8.50	Steering Angle	: 28.4
Tractor Track	: 8.00	Articulating Angle	: 75.0
Trailer Track	: 8.50		

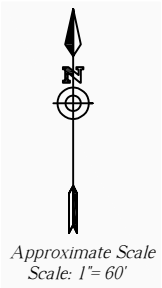

Figure 3

# Approach 2 AutoTurn Movements

Rex Road Roundabout (LSC #234341)

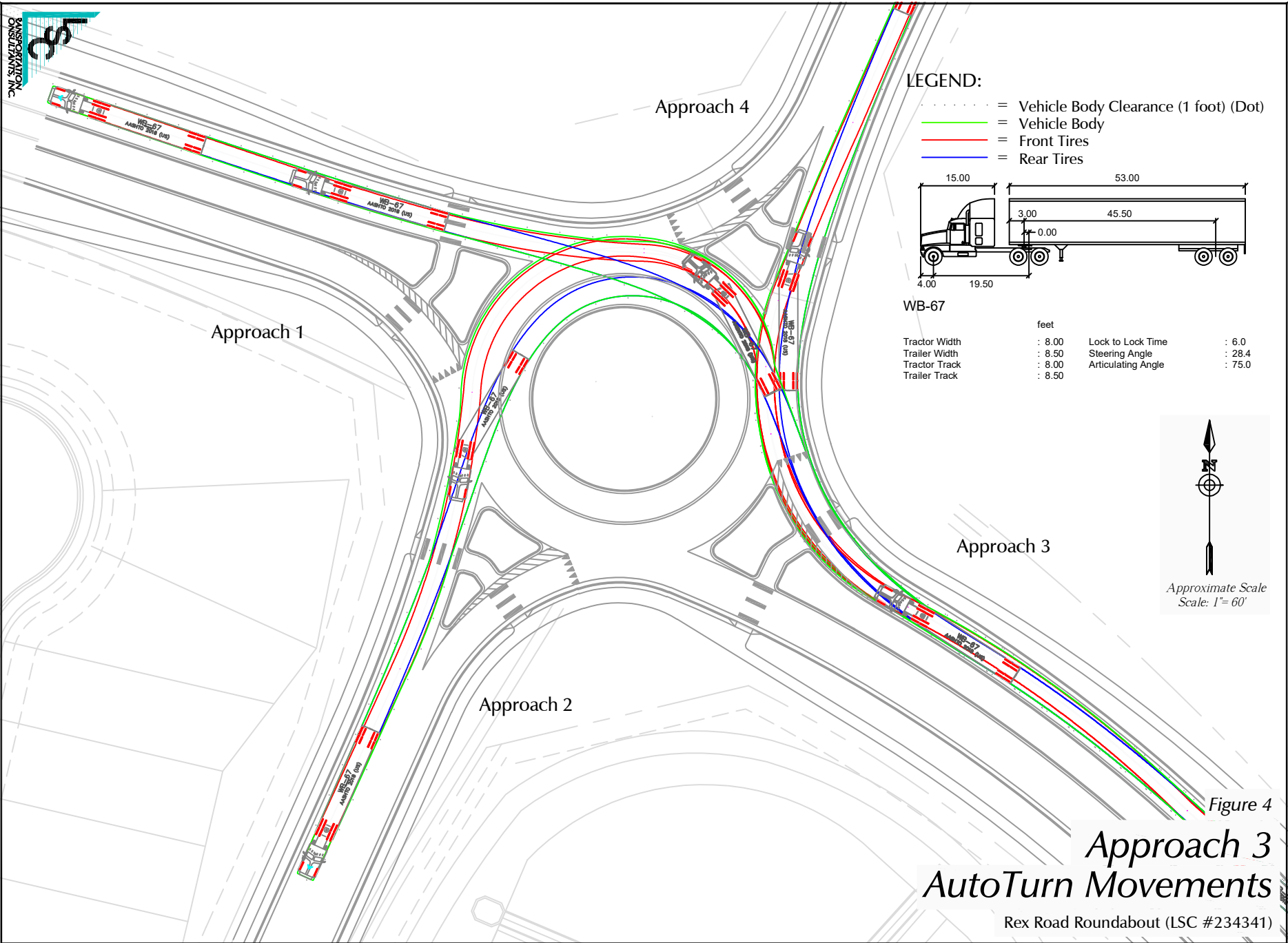
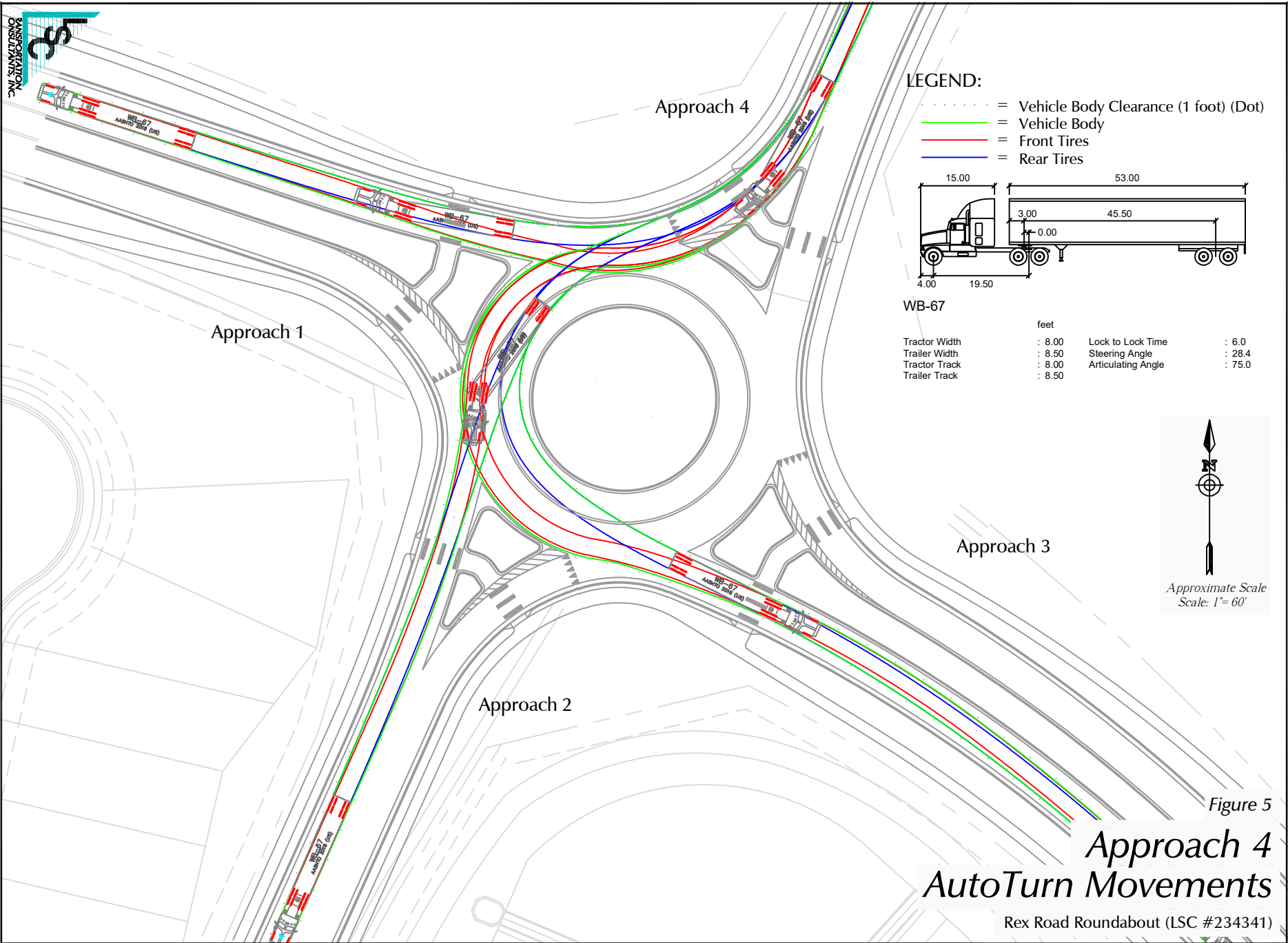

Figure 4  
**Approach 3**  
**AutoTurn Movements**

Rex Road Roundabout (LSC #234341)



**LEGEND:**

- ..... = Vehicle Body Clearance (1 foot) (Dot)
- = Vehicle Body
- = Front Tires
- = Rear Tires

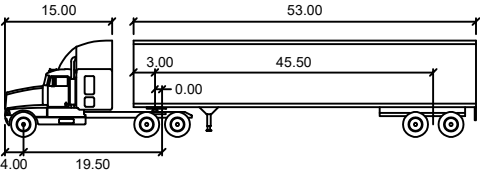

WB-67

	feet		
Tractor Width	: 8.00	Lock to Lock Time	: 6.0
Trailer Width	: 8.50	Steering Angle	: 28.4
Tractor Track	: 8.00	Articulating Angle	: 75.0
Trailer Track	: 8.50		

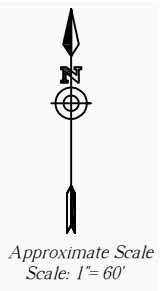

Figure 5  
**Approach 4**  
**AutoTurn Movements**

Rex Road Roundabout (LSC #234341)

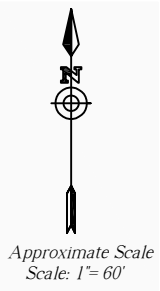
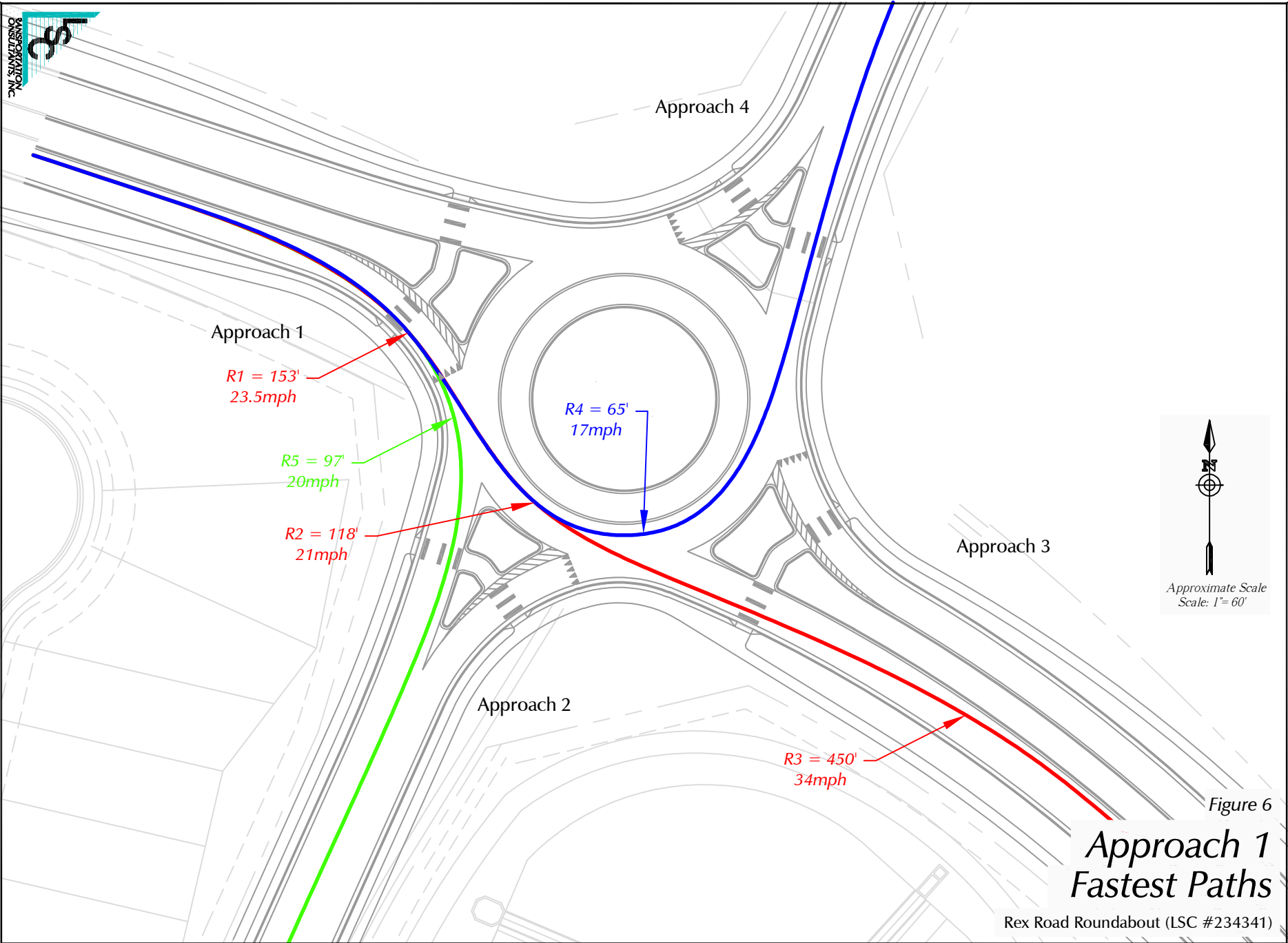

Figure 6  
**Approach 1  
Fastest Paths**

Rex Road Roundabout (LSC #234341)

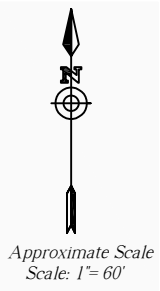
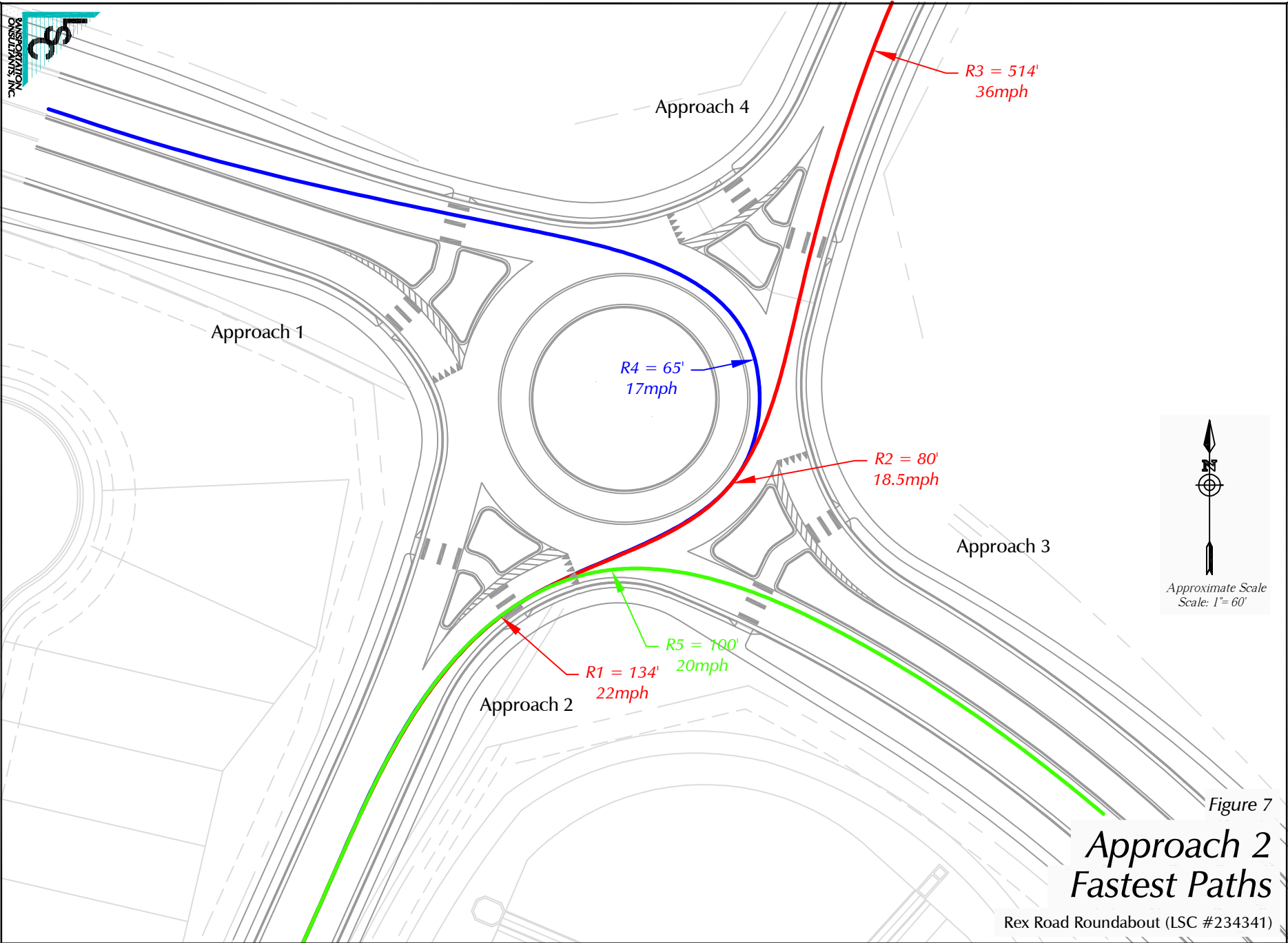

Figure 7  
**Approach 2  
Fastest Paths**

Rex Road Roundabout (LSC #234341)

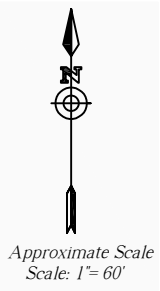
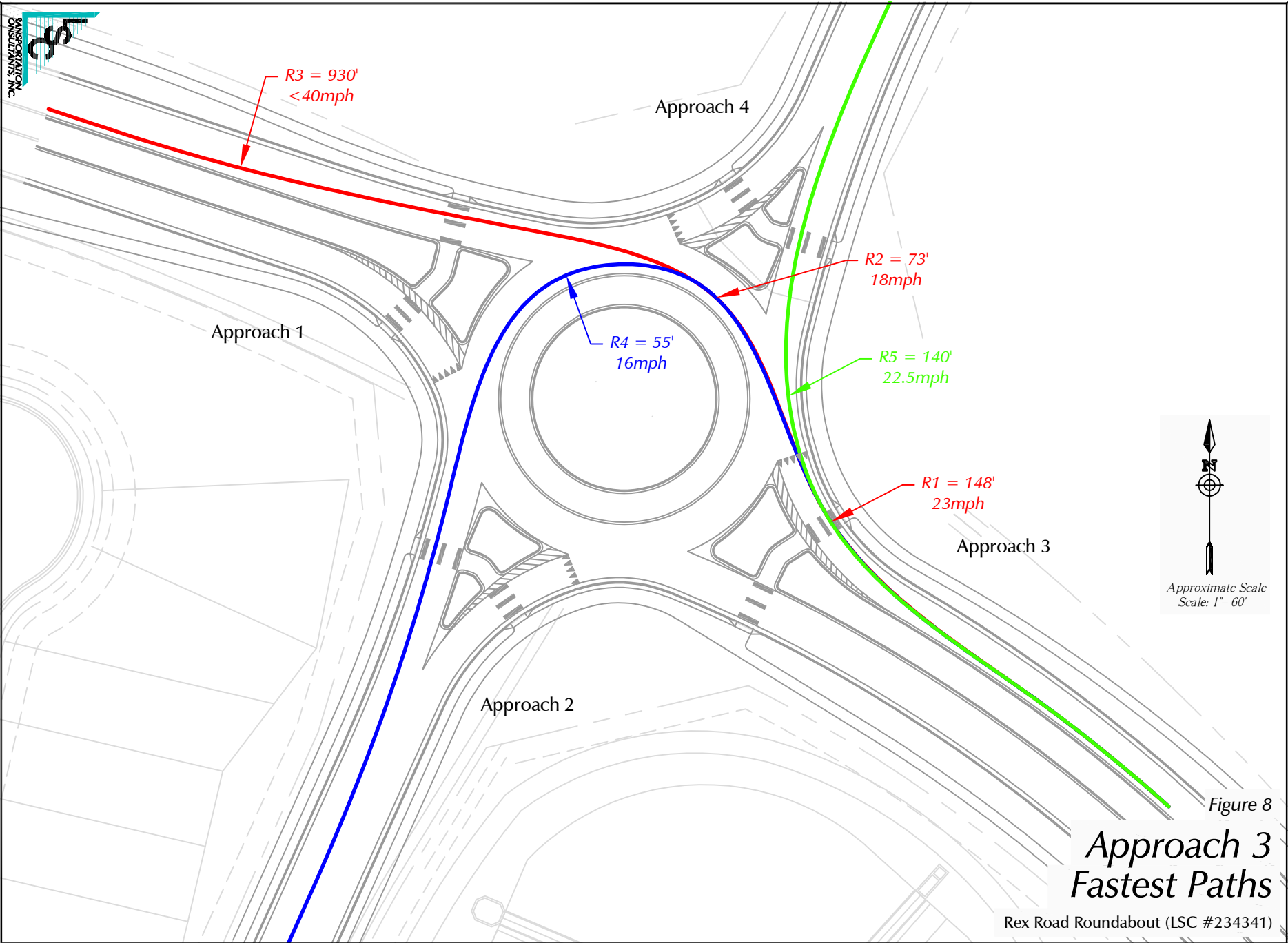

Figure 8  
**Approach 3  
Fastest Paths**

Rex Road Roundabout (LSC #234341)

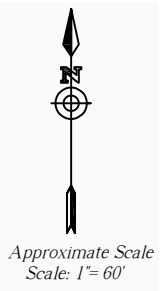
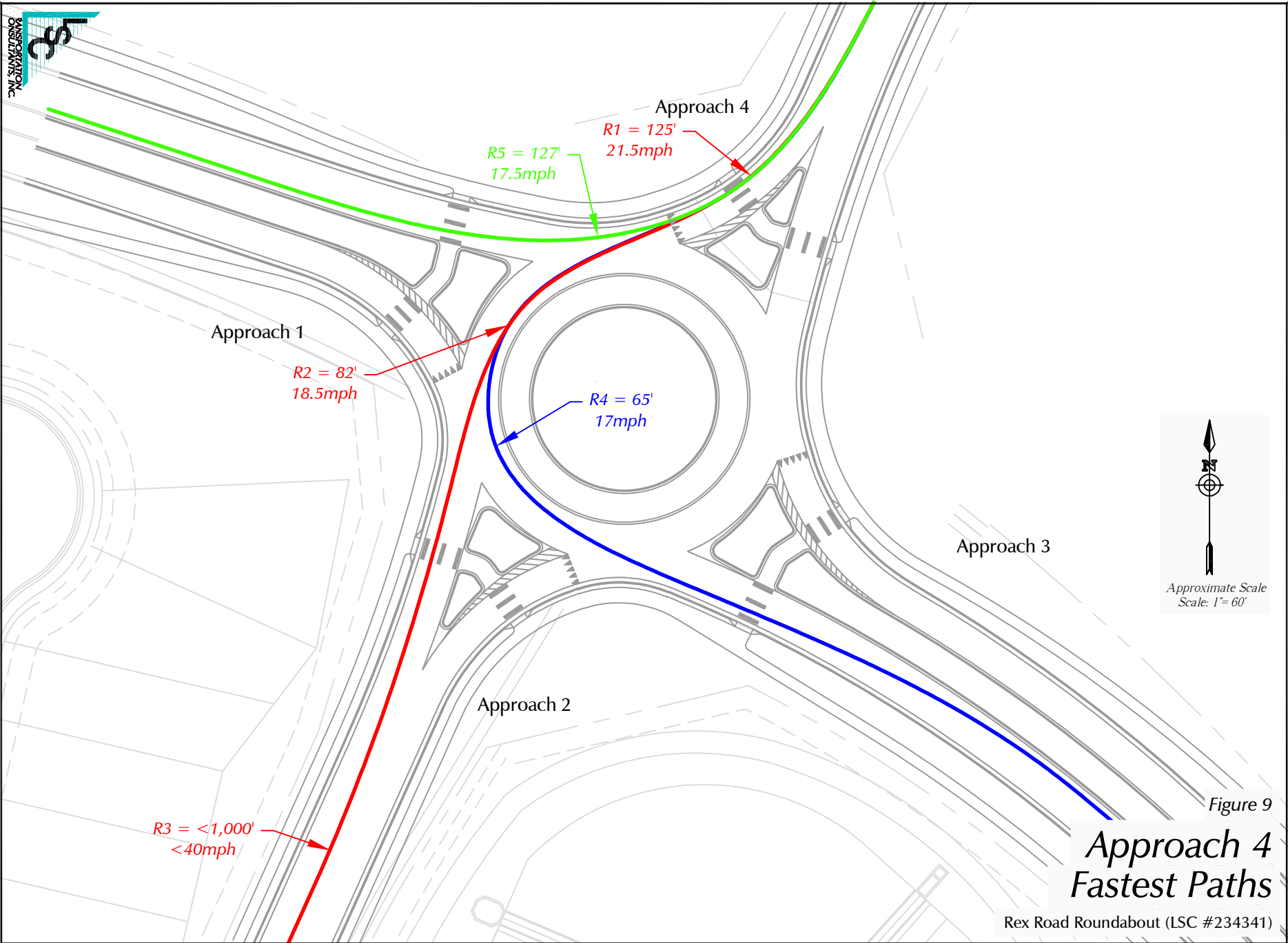

Figure 9  
**Approach 4  
Fastest Paths**

Rex Road Roundabout (LSC #234341)

# Traffic Counts

---





# LSC Transportation Consultants, Inc.

2504 E. Pikes Peak Ave, Suite 304  
 Colorado Springs, CO 80909  
 719-633-2868

File Name : Hwy 24 - Stapleton Dr AM PM

Site Code : S224640

Start Date : 1/10/2023

Page No : 1

### Groups Printed- Unshifted

Start Time	Hwy 24 Southbound					Stapleton Dr Westbound					Hwy 24 Northbound					Stapleton Dr Eastbound					Int. Total
	Right	Thru	Left	Peds	App. Total	Right	Thru	Left	Peds	App. Total	Right	Thru	Left	Peds	App. Total	Right	Thru	Left	Peds	App. Total	
06:30	1	29	1	0	31	0	1	1	0	2	1	7	1	0	9	20	11	1	0	32	74
06:35	0	33	0	0	33	1	4	0	0	5	0	12	0	0	12	11	11	2	0	24	74
06:40	0	35	2	0	37	1	0	0	0	1	0	13	2	0	15	16	8	2	0	26	79
06:45	3	41	3	0	47	1	6	3	0	10	1	22	4	0	27	13	9	2	0	24	108
06:50	3	32	1	0	36	1	3	0	0	4	1	15	7	0	23	14	7	1	0	22	85
06:55	2	22	1	0	25	2	8	0	0	10	0	24	6	0	30	16	13	0	0	29	94
<b>Total</b>	<b>9</b>	<b>192</b>	<b>8</b>	<b>0</b>	<b>209</b>	<b>6</b>	<b>22</b>	<b>4</b>	<b>0</b>	<b>32</b>	<b>3</b>	<b>93</b>	<b>20</b>	<b>0</b>	<b>116</b>	<b>90</b>	<b>59</b>	<b>8</b>	<b>0</b>	<b>157</b>	<b>514</b>
07:00	4	35	3	0	42	2	6	0	0	8	0	29	2	0	31	7	13	1	0	21	102
07:05	4	33	4	0	41	1	10	0	0	11	0	22	4	0	26	7	11	6	0	24	102
07:10	0	33	3	0	36	4	11	1	0	16	0	30	5	0	35	15	12	2	0	29	116
07:15	2	36	2	0	40	4	14	1	0	19	0	29	7	0	36	13	15	3	0	31	126
07:20	4	46	1	0	51	1	6	0	0	7	0	30	4	0	34	11	13	1	0	25	117
07:25	5	51	8	0	64	0	7	0	0	7	0	28	0	0	28	10	7	1	0	18	117
07:30	2	34	2	0	38	0	7	0	0	7	1	16	6	0	23	9	20	2	0	31	99
07:35	6	40	5	0	51	0	9	1	0	10	0	9	2	0	11	12	7	2	0	21	93
07:40	4	31	1	0	36	0	7	2	0	9	0	9	3	0	12	5	9	0	0	14	71
07:45	1	31	1	0	33	2	5	1	0	8	0	13	6	0	19	6	17	2	0	25	85
07:50	3	21	4	0	28	0	5	0	0	5	1	18	1	0	20	10	15	2	0	27	80
07:55	2	15	3	0	20	1	1	0	0	2	0	16	4	0	20	8	5	1	0	14	56
<b>Total</b>	<b>37</b>	<b>406</b>	<b>37</b>	<b>0</b>	<b>480</b>	<b>15</b>	<b>88</b>	<b>6</b>	<b>0</b>	<b>109</b>	<b>2</b>	<b>249</b>	<b>44</b>	<b>0</b>	<b>295</b>	<b>113</b>	<b>144</b>	<b>23</b>	<b>0</b>	<b>280</b>	<b>1164</b>
08:00	3	39	2	0	44	0	6	0	0	6	0	10	5	0	15	4	10	2	0	16	81
08:05	1	30	0	0	31	1	2	1	0	4	2	19	5	0	26	4	6	4	0	14	75
08:10	2	27	2	0	31	2	2	1	0	5	0	13	4	0	17	5	6	0	0	11	64
08:15	4	31	0	0	35	5	1	2	0	8	0	7	5	0	12	8	5	2	0	15	70
08:20	5	22	3	0	30	1	7	0	0	8	0	3	3	0	6	7	4	1	0	12	56
08:25	4	34	1	0	39	0	2	0	0	2	1	14	0	0	15	4	7	5	0	16	72
*** BREAK ***																					
<b>Total</b>	<b>19</b>	<b>183</b>	<b>8</b>	<b>0</b>	<b>210</b>	<b>9</b>	<b>20</b>	<b>4</b>	<b>0</b>	<b>33</b>	<b>3</b>	<b>66</b>	<b>22</b>	<b>0</b>	<b>91</b>	<b>32</b>	<b>38</b>	<b>14</b>	<b>0</b>	<b>84</b>	<b>418</b>
*** BREAK ***																					
16:00	2	26	0	0	28	3	7	1	0	11	0	41	13	0	54	3	3	4	0	10	103
16:05	3	25	0	0	28	4	6	0	0	10	0	46	15	0	61	1	2	5	0	8	107
16:10	3	32	0	0	35	2	8	0	0	10	3	35	15	0	53	6	4	2	0	12	110
16:15	3	36	1	0	40	3	9	1	0	13	4	45	7	0	56	4	1	2	0	7	116
16:20	0	31	3	0	34	1	7	1	0	9	2	46	15	0	63	4	2	1	0	7	113
16:25	1	24	1	0	26	2	11	0	0	13	3	47	8	0	58	5	10	3	0	18	115
16:30	1	23	0	0	24	0	10	2	0	12	1	42	7	0	50	5	3	2	0	10	96
16:35	2	32	1	0	35	1	5	1	0	7	4	34	4	0	42	2	1	1	0	4	88
16:40	5	29	1	0	35	2	13	0	0	15	1	29	7	0	37	4	9	1	0	14	101
16:45	3	31	2	0	36	5	10	3	0	18	2	31	13	0	46	3	2	2	0	7	107
16:50	1	32	1	0	34	2	11	0	0	13	4	39	7	0	50	6	4	2	0	12	109

# LSC Transportation Consultants, Inc.

2504 E. Pikes Peak Ave, Suite 304  
 Colorado Springs, CO 80909  
 719-633-2868

File Name : Hwy 24 - Stapleton Dr AM PM

Site Code : S224640

Start Date : 1/10/2023

Page No : 2

### Groups Printed- Unshifted

Start Time	Hwy 24 Southbound					Stapleton Dr Westbound					Hwy 24 Northbound					Stapleton Dr Eastbound					Int. Total
	Right	Thru	Left	Peds	App. Total	Right	Thru	Left	Peds	App. Total	Right	Thru	Left	Peds	App. Total	Right	Thru	Left	Peds	App. Total	
16:55	5	29	1	0	35	3	15	2	0	20	3	31	15	0	49	2	4	2	0	8	112
<b>Total</b>	29	350	11	0	390	28	112	11	0	151	27	466	126	0	619	45	45	27	0	117	1277
17:00	3	22	0	0	25	0	20	0	0	20	1	37	13	0	51	8	1	0	0	9	105
17:05	2	30	0	0	32	4	6	1	0	11	7	47	14	0	68	2	4	0	0	6	117
17:10	3	45	1	0	49	3	19	1	0	23	1	31	9	0	41	4	1	1	0	6	119
17:15	3	29	1	0	33	1	4	1	0	6	0	46	7	0	53	3	1	1	0	5	97
17:20	3	27	1	0	31	4	11	1	0	16	3	34	8	0	45	3	5	2	0	10	102
17:25	3	21	0	0	24	3	2	0	0	5	0	30	11	0	41	2	4	2	0	8	78
17:30	3	18	0	0	21	5	8	0	0	13	2	43	8	0	53	1	3	0	0	4	91
17:35	3	17	0	0	20	2	6	0	0	8	0	33	14	0	47	2	1	3	0	6	81
17:40	1	18	0	0	19	2	6	2	0	10	1	32	6	0	39	0	1	3	0	4	72
17:45	4	24	1	0	29	2	4	1	0	7	1	51	7	0	59	3	2	1	0	6	101
17:50	1	13	0	0	14	1	6	1	0	8	0	48	13	0	61	2	5	3	0	10	93
17:55	3	18	0	0	21	3	7	0	0	10	1	23	9	0	33	4	7	2	0	13	77
<b>Total</b>	32	282	4	0	318	30	99	8	0	137	17	455	119	0	591	34	35	18	0	87	1133
<b>Grand Total</b>	126	1413	68	0	1607	88	341	33	0	462	52	1329	331	0	1712	314	321	90	0	725	4506
<b>Apprch %</b>	7.8	87.9	4.2	0		19	73.8	7.1	0		3	77.6	19.3	0		43.3	44.3	12.4	0		
<b>Total %</b>	2.8	31.4	1.5	0	35.7	2	7.6	0.7	0	10.3	1.2	29.5	7.3	0	38	7	7.1	2	0	16.1	

# LSC Transportation Consultants, Inc.

2504 E. Pikes Peak Ave, Suite 304  
 Colorado Springs, CO 80909  
 719-633-2868

File Name : Hwy 24 - Stapleton Dr AM PM  
 Site Code : S224640  
 Start Date : 1/10/2023  
 Page No : 3

Start Time	Hwy 24 Southbound					Stapleton Dr Westbound					Hwy 24 Northbound					Stapleton Dr Eastbound					Int. Total
	Right	Thru	Left	Peds	App. Total	Right	Thru	Left	Peds	App. Total	Right	Thru	Left	Peds	App. Total	Right	Thru	Left	Peds	App. Total	
Peak Hour Analysis From 06:30 to 17:55 - Peak 1 of 1																					
Peak Hour for Entire Intersection Begins at 16:15																					
16:15	3	36	1	0	40	3	9	1	0	13	4	45	7	0	56	4	1	2	0	7	116
16:20	0	31	3	0	34	1	7	1	0	9	2	46	15	0	63	4	2	1	0	7	113
16:25	1	24	1	0	26	2	11	0	0	13	3	47	8	0	58	5	10	3	0	18	115
16:30	1	23	0	0	24	0	10	2	0	12	1	42	7	0	50	5	3	2	0	10	96
16:35	2	32	1	0	35	1	5	1	0	7	4	34	4	0	42	2	1	1	0	4	88
16:40	5	29	1	0	35	2	13	0	0	15	1	29	7	0	37	4	9	1	0	14	101
16:45	3	31	2	0	36	5	10	3	0	18	2	31	13	0	46	3	2	2	0	7	107
16:50	1	32	1	0	34	2	11	0	0	13	4	39	7	0	50	6	4	2	0	12	109
16:55	5	29	1	0	35	3	15	2	0	20	3	31	15	0	49	2	4	2	0	8	112
17:00	3	22	0	0	25	0	20	0	0	20	1	37	13	0	51	8	1	0	0	9	105
17:05	2	30	0	0	32	4	6	1	0	11	7	47	14	0	68	2	4	0	0	6	117
17:10	3	45	1	0	49	3	19	1	0	23	1	31	9	0	41	4	1	1	0	6	119
Total Volume	29	364	12	0	405	26	136	12	0	174	33	459	119	0	611	49	42	17	0	108	1298
% App. Total	7.2	89.9	3	0		14.9	78.2	6.9	0		5.4	75.1	19.5	0		45.4	38.9	15.7	0		
PHF	.483	.674	.333	.000	.689	.433	.567	.333	.000	.630	.393	.814	.661	.000	.749	.510	.350	.472	.000	.500	.909

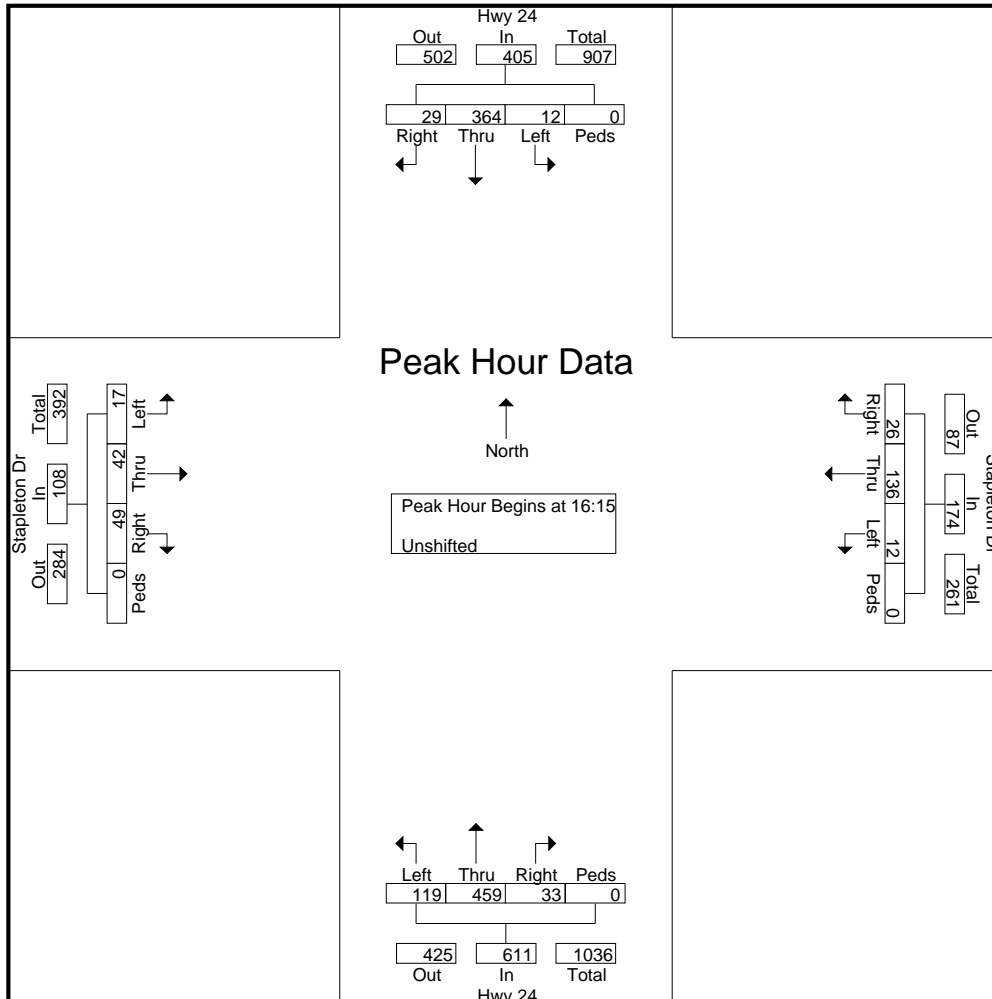

# LSC Transportation Consultants, Inc.

2504 E. Pikes Peak Ave, Suite 304  
Colorado Springs, CO 80909  
719-633-2868

File Name : Eastonville Rd - Stapleton Dr AM  
Site Code : S214870  
Start Date : 10/7/2021  
Page No : 1

### Groups Printed- Unshifted

Start Time	Eastonville Rd Southbound					Stapleton Dr Westbound					Eastonville Rd Northbound					Stapleton Dr Eastbound					Int. Total
	L	T	R	U	App. Total	L	T	R	U	App. Total	L	T	R	U	App. Total	L	T	R	U	App. Total	
06:30 AM	29	8	0	0	37	0	18	8	0	26	2	14	0	0	16	3	32	2	0	37	116
06:45 AM	36	19	2	0	57	0	11	20	0	31	5	18	1	0	24	5	51	8	0	64	176
Total	65	27	2	0	94	0	29	28	0	57	7	32	1	0	40	8	83	10	0	101	292
07:00 AM	31	36	6	0	73	0	16	43	0	59	13	76	2	0	91	2	27	6	0	35	258
07:15 AM	48	67	4	0	119	3	25	34	0	62	33	69	3	0	105	3	36	13	0	52	338
07:30 AM	24	31	2	0	57	3	42	13	0	58	32	24	11	0	67	2	45	15	0	62	244
07:45 AM	15	17	0	0	32	0	20	8	0	28	16	14	1	1	32	0	36	15	0	51	143
Total	118	151	12	0	281	6	103	98	0	207	94	183	17	1	295	7	144	49	0	200	983
08:00 AM	11	14	1	1	27	2	20	11	0	33	8	10	1	0	19	1	24	12	0	37	116
08:15 AM	23	10	0	1	34	1	18	12	0	31	18	9	0	0	27	2	12	11	0	25	117
08:30 AM	12	8	2	0	22	0	18	6	0	24	4	6	2	0	12	3	21	3	0	27	85
Grand Total	229	210	17	2	458	9	188	155	0	352	131	240	21	1	393	21	284	85	0	390	1593
Apprch %	50	45.9	3.7	0.4		2.6	53.4	44	0		33.3	61.1	5.3	0.3		5.4	72.8	21.8	0		
Total %	14.4	13.2	1.1	0.1	28.8	0.6	11.8	9.7	0	22.1	8.2	15.1	1.3	0.1	24.7	1.3	17.8	5.3	0	24.5	

# LSC Transportation Consultants, Inc.

2504 E. Pikes Peak Ave, Suite 304  
 Colorado Springs, CO 80909  
 719-633-2868

File Name : Eastonville Rd - Stapleton Dr AM  
 Site Code : S214870  
 Start Date : 10/7/2021  
 Page No : 3

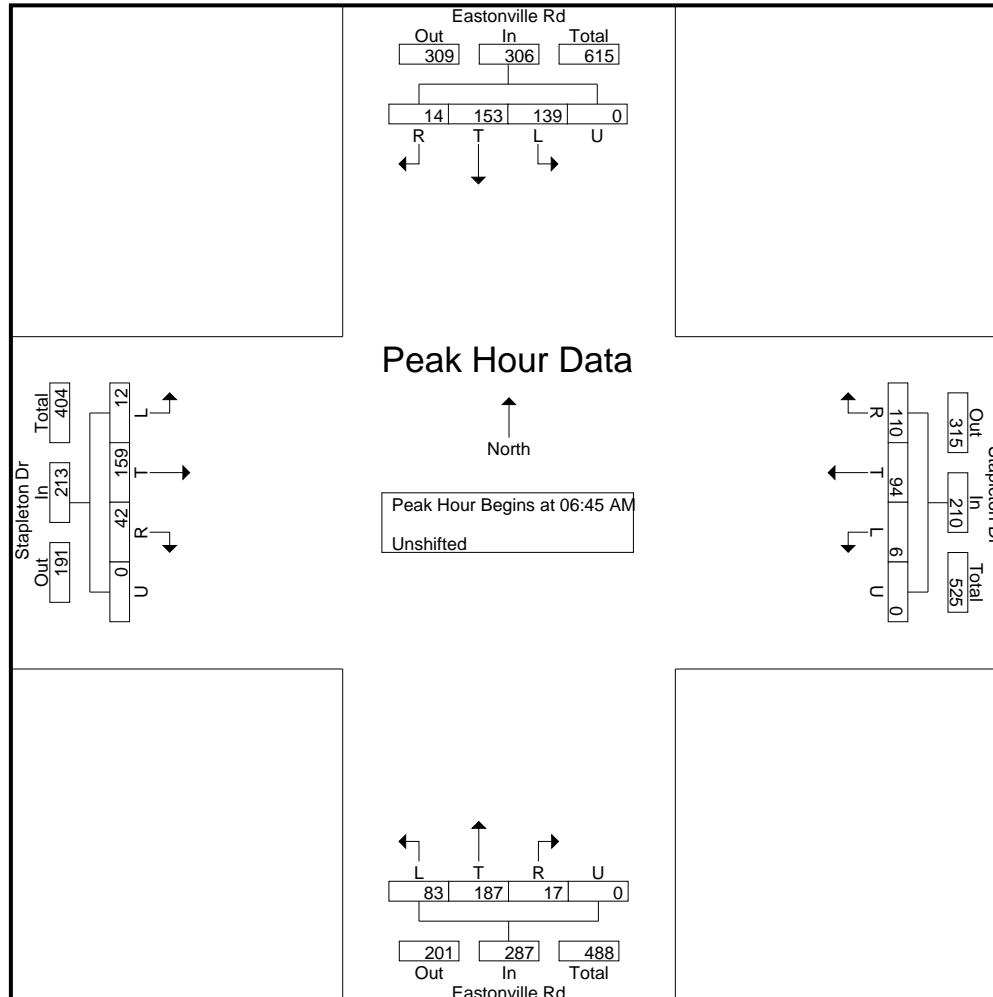

# LSC Transportation Consultants, Inc.

2504 E. Pikes Peak Ave, Suite 304  
 Colorado Springs, CO 80909  
 719-633-2868

File Name : Eastonville Rd - Stapleton Dr PM  
 Site Code : S214870  
 Start Date : 10/7/2021  
 Page No : 1

### Groups Printed- Unshifted

Start Time	Eastonville Rd Southbound					Stapleton Dr Westbound					Eastonville Rd Northbound					Stapleton Dr Eastbound					Int. Total
	L	T	R	U	App. Total	L	T	R	U	App. Total	L	T	R	U	App. Total	L	T	R	U	App. Total	
04:00 PM	9	15	2	0	26	1	42	25	0	68	11	23	3	0	37	1	25	8	0	34	165
04:15 PM	9	20	0	2	31	6	38	27	0	71	6	25	5	0	36	3	23	9	0	35	173
04:30 PM	11	12	0	0	23	1	39	31	0	71	17	40	2	1	60	2	16	8	0	26	180
04:45 PM	21	16	2	0	39	1	34	22	0	57	13	27	2	0	42	5	14	6	0	25	163
Total	50	63	4	2	119	9	153	105	0	267	47	115	12	1	175	11	78	31	0	120	681
05:00 PM	13	27	2	0	42	3	40	18	0	61	5	24	4	0	33	4	18	3	0	25	161
05:15 PM	11	27	2	0	40	2	28	29	0	59	11	25	2	0	38	2	21	3	0	26	163
05:30 PM	14	19	2	0	35	4	30	15	0	49	11	30	2	0	43	0	26	8	0	34	161
05:45 PM	14	15	1	0	30	3	32	13	0	48	10	32	0	0	42	3	26	5	0	34	154
Total	52	88	7	0	147	12	130	75	0	217	37	111	8	0	156	9	91	19	0	119	639
06:00 PM	12	23	5	0	40	2	31	19	0	52	9	22	3	0	34	5	15	1	0	21	147
Grand Total	114	174	16	2	306	23	314	199	0	536	93	248	23	1	365	25	184	51	0	260	1467
Apprch %	37.3	56.9	5.2	0.7		4.3	58.6	37.1	0		25.5	67.9	6.3	0.3		9.6	70.8	19.6	0		
Total %	7.8	11.9	1.1	0.1	20.9	1.6	21.4	13.6	0	36.5	6.3	16.9	1.6	0.1	24.9	1.7	12.5	3.5	0	17.7	

# LSC Transportation Consultants, Inc.

2504 E. Pikes Peak Ave, Suite 304  
 Colorado Springs, CO 80909  
 719-633-2868

File Name : Eastonville Rd - Stapleton Dr PM

Site Code : S214870

Start Date : 10/7/2021

Page No : 3

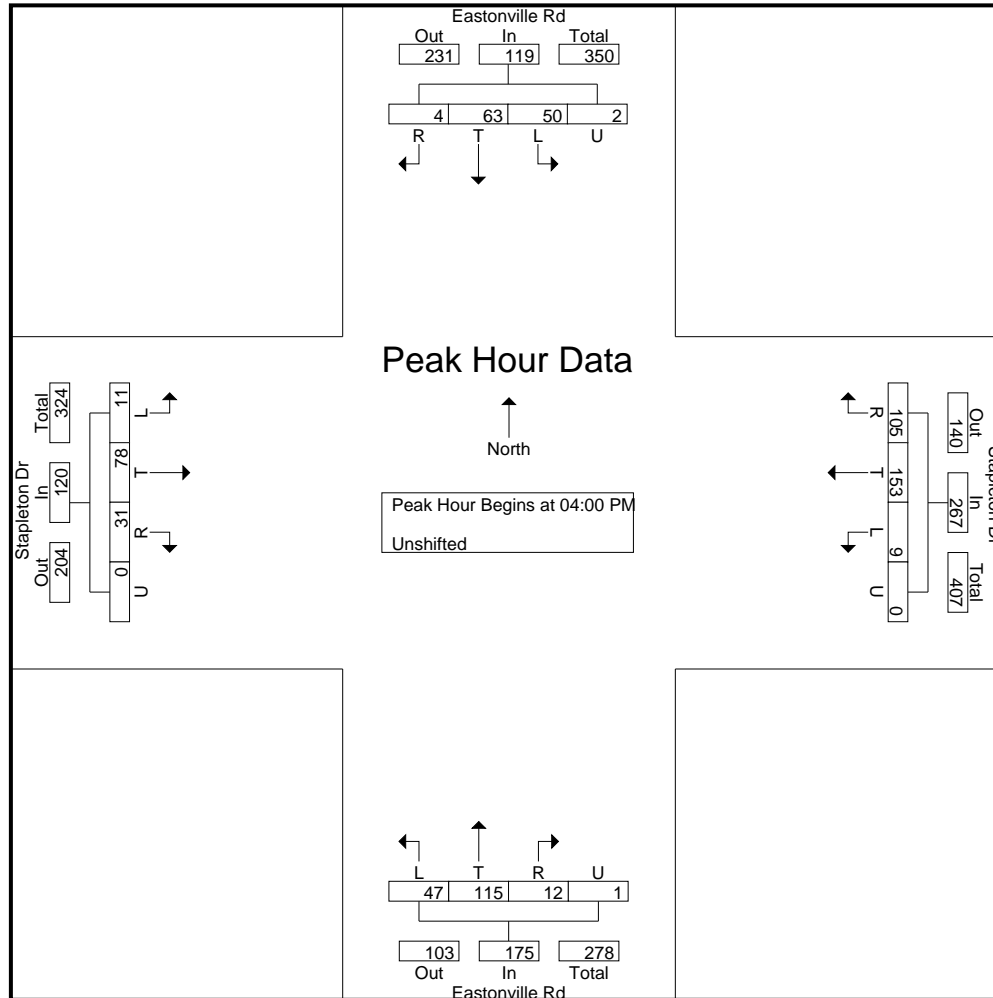

# LSC Transportation Consultants, Inc.

2504 E. Pikes Peak Ave, Suite 304  
 Colorado Springs, CO 80909  
 719-633-2868

File Name : Eastonville Rd -Londonderry Dr AM  
 Site Code : S214250  
 Start Date : 4/15/2021  
 Page No : 1

### Groups Printed- Unshifted

Start Time	Eastonville Rd Southbound					Westbound					Eastonville Rd Northbound					Londonderry Dr Eastbound					Int. Total
	L	T	R	U	App. Total	L	T	R	U	App. Total	L	T	R	U	App. Total	L	T	R	U	App. Total	
07:00 AM	0	2	2	0	4	0	0	0	0	0	44	2	0	0	46	0	0	31	0	31	81
07:15 AM	0	2	3	0	5	0	0	0	0	0	96	1	0	0	97	0	0	74	0	74	176
07:30 AM	0	2	2	0	4	0	0	0	0	0	22	2	0	0	24	0	0	54	0	54	82
07:45 AM	0	3	2	0	5	0	0	0	0	0	28	1	0	0	29	3	0	37	1	41	75
Total	0	9	9	0	18	0	0	0	0	0	190	6	0	0	196	3	0	196	1	200	414
08:00 AM	0	1	5	0	6	0	0	0	0	0	24	1	0	0	25	0	0	18	0	18	49
08:15 AM	0	0	2	0	2	0	0	0	0	0	24	2	0	0	26	2	0	37	1	40	68
08:30 AM	0	1	0	0	1	0	0	0	0	0	13	1	0	0	14	2	0	23	0	25	40
08:45 AM	0	7	2	0	9	0	0	0	0	0	13	5	0	0	18	0	0	12	0	12	39
Total	0	9	9	0	18	0	0	0	0	0	74	9	0	0	83	4	0	90	1	95	196
Grand Total	0	18	18	0	36	0	0	0	0	0	264	15	0	0	279	7	0	286	2	295	610
Apprch %	0	50	50	0		0	0	0	0	0	94.6	5.4	0	0		2.4	0	96.9	0.7		
Total %	0	3	3	0	5.9	0	0	0	0	0	43.3	2.5	0	0	45.7	1.1	0	46.9	0.3	48.4	



# LSC Transportation Consultants, Inc.

2504 E. Pikes Peak Ave, Suite 304  
 Colorado Springs, CO 80909  
 719-633-2868

File Name : Eastonville Rd -Londonderry Dr AM  
 Site Code : S214250  
 Start Date : 4/15/2021  
 Page No : 3

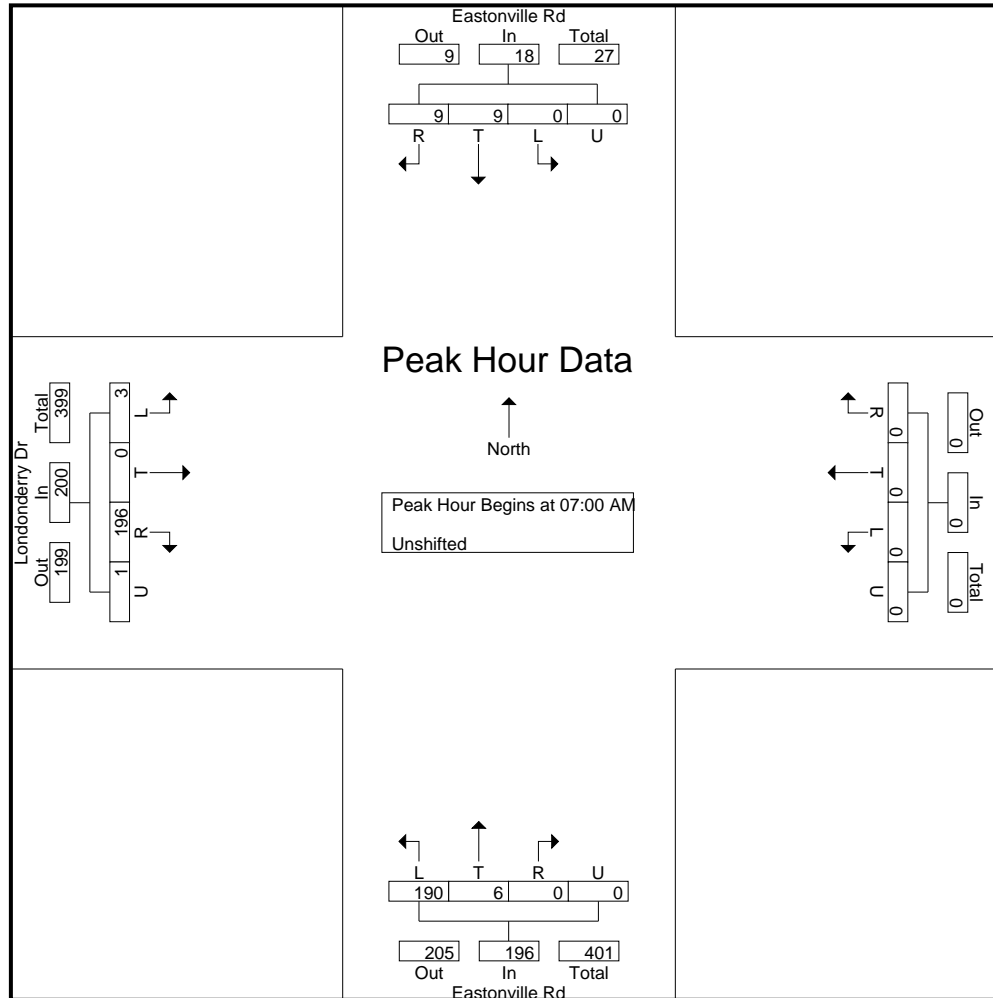

# LSC Transportation Consultants, Inc.

2504 E. Pikes Peak Ave, Suite 304  
 Colorado Springs, CO 80909  
 719-633-2868

File Name : Eastonville Rd -Londonderry Dr PM  
 Site Code : S214250  
 Start Date : 4/15/2021  
 Page No : 1

### Groups Printed- Unshifted

Start Time	Eastonville Rd Southbound					Westbound					Eastonville Rd Northbound					Londonderry Dr Eastbound					Int. Total
	L	T	R	U	App. Total	L	T	R	U	App. Total	L	T	R	U	App. Total	L	T	R	U	App. Total	
04:00 PM	0	2	1	0	3	0	0	0	0	0	47	1	0	0	48	2	0	27	0	29	80
04:15 PM	0	1	0	0	1	0	0	0	0	0	36	3	0	0	39	2	0	19	0	21	61
04:30 PM	0	1	1	0	2	0	0	0	0	0	40	2	0	0	42	0	0	15	0	15	59
04:45 PM	0	1	1	0	2	0	0	0	0	0	36	7	0	0	43	2	0	13	0	15	60
Total	0	5	3	0	8	0	0	0	0	0	159	13	0	0	172	6	0	74	0	80	260
05:00 PM	0	2	2	0	4	0	0	0	0	0	36	1	0	0	37	0	0	12	0	12	53
05:15 PM	0	4	0	0	4	0	0	0	0	0	31	1	0	0	32	1	0	8	0	9	45
05:30 PM	0	1	0	0	1	0	0	0	0	0	35	3	0	1	39	0	0	7	0	7	47
05:45 PM	0	2	0	0	2	0	0	0	0	0	24	2	0	0	26	0	0	15	0	15	43
Total	0	9	2	0	11	0	0	0	0	0	126	7	0	1	134	1	0	42	0	43	188
Grand Total	0	14	5	0	19	0	0	0	0	0	285	20	0	1	306	7	0	116	0	123	448
Apprch %	0	73.7	26.3	0		0	0	0	0		93.1	6.5	0	0.3		5.7	0	94.3	0		
Total %	0	3.1	1.1	0	4.2	0	0	0	0	0	63.6	4.5	0	0.2	68.3	1.6	0	25.9	0	27.5	

# LSC Transportation Consultants, Inc.

2504 E. Pikes Peak Ave, Suite 304  
 Colorado Springs, CO 80909  
 719-633-2868

File Name : Eastonville Rd -Londonderry Dr PM  
 Site Code : S214250  
 Start Date : 4/15/2021  
 Page No : 3

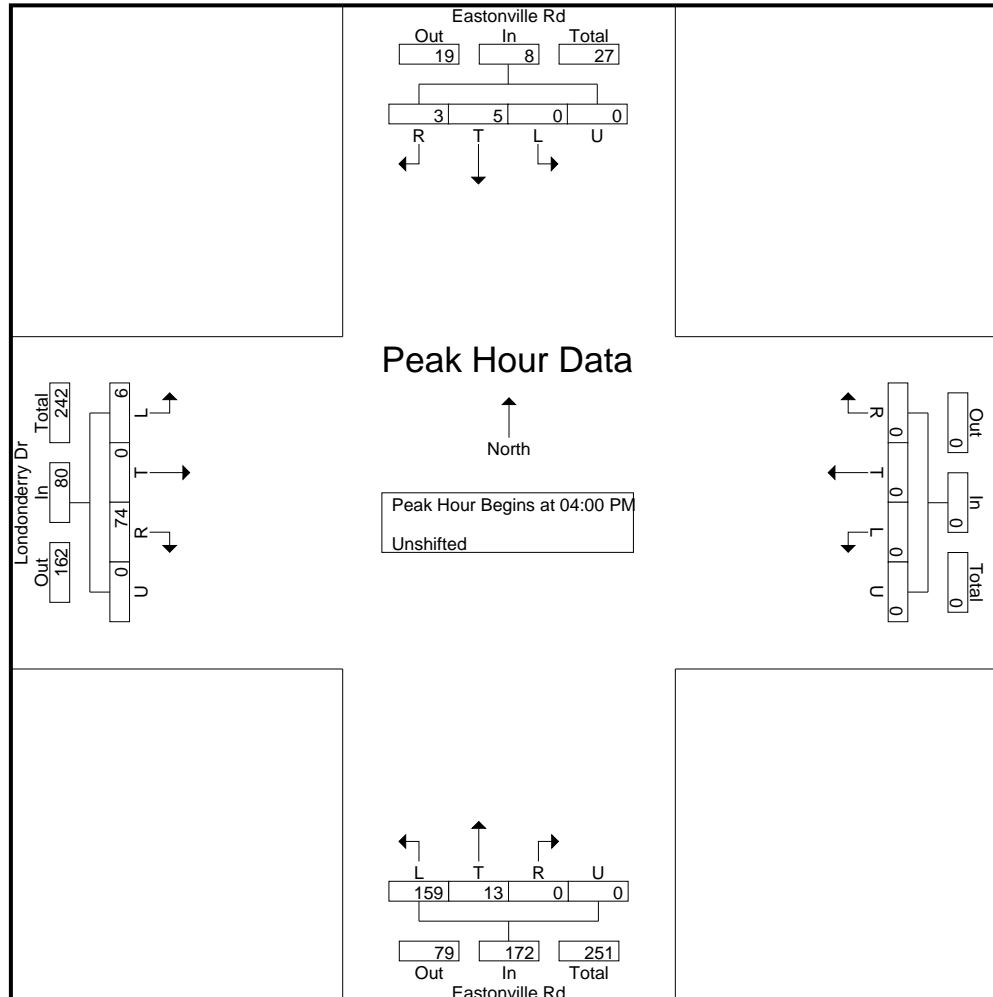

# LSC Transportation Consultants, Inc.

2504 E. Pikes Peak Ave, Suite 304  
 Colorado Springs, CO 80909  
 719-633-2868

File Name : Eastonville Rd - Judge Orr Rd AM

Site Code : S220400

Start Date : 7/7/2022

Page No : 1

## Groups Printed- Unshifted

Start Time	Eastonville Rd Southbound					Judge Orr Rd Westbound					Eastonville Rd Northbound					Meridian Ranch Blvd Eastbound					Int. Total
	Right	Thru	Left	Peds	App. Total	Right	Thru	Left	Peds	App. Total	Right	Thru	Left	Peds	App. Total	Right	Thru	Left	Peds	App. Total	
06:30	1	9	11	0	21	6	7	4	0	17	6	3	2	0	11	12	33	0	0	45	94
06:45	1	12	7	0	20	9	4	2	0	15	7	3	2	0	12	12	29	0	0	41	88
Total	2	21	18	0	41	15	11	6	0	32	13	6	4	0	23	24	62	0	0	86	182
07:00	1	10	14	0	25	4	5	4	0	13	9	2	4	0	15	17	41	0	0	58	111
07:15	0	11	6	0	17	3	3	2	0	8	10	7	4	0	21	22	34	0	0	56	102
07:30	0	10	9	0	19	4	5	4	0	13	1	4	8	0	13	18	28	2	0	48	93
07:45	1	11	11	0	23	1	8	3	0	12	7	7	7	0	21	23	23	0	0	46	102
Total	2	42	40	0	84	12	21	13	0	46	27	20	23	0	70	80	126	2	0	208	408
08:00	0	11	7	0	18	4	8	5	0	17	5	9	8	0	22	14	24	2	0	40	97
08:15	0	10	11	0	21	0	8	3	0	11	4	6	10	0	20	9	27	0	0	36	88
Grand Total	4	84	76	0	164	31	48	27	0	106	49	41	45	0	135	127	239	4	0	370	775
Apprch %	2.4	51.2	46.3	0		29.2	45.3	25.5	0		36.3	30.4	33.3	0		34.3	64.6	1.1	0		
Total %	0.5	10.8	9.8	0	21.2	4	6.2	3.5	0	13.7	6.3	5.3	5.8	0	17.4	16.4	30.8	0.5	0	47.7	

# LSC Transportation Consultants, Inc.

2504 E. Pikes Peak Ave, Suite 304  
 Colorado Springs, CO 80909  
 719-633-2868

File Name : Eastonville Rd - Judge Orr Rd AM

Site Code : S220400

Start Date : 7/7/2022

Page No : 2

Start Time	Eastonville Rd Southbound					Judge Orr Rd Westbound					Eastonville Rd Northbound					Meridian Ranch Blvd Eastbound					Int. Total
	Right	Thru	Left	Peds	App. Total	Right	Thru	Left	Peds	App. Total	Right	Thru	Left	Peds	App. Total	Right	Thru	Left	Peds	App. Total	
Peak Hour Analysis From 6:30:00 AM to 8:15:00 AM - Peak 1 of 1																					
Peak Hour for Entire Intersection Begins at 7:00:00 AM																					
7:00:00 AM	1	10	14	0	25	4	5	4	0	13	9	2	4	0	15	17	41	0	0	58	111
7:15:00 AM	0	11	6	0	17	3	3	2	0	8	10	7	4	0	21	22	34	0	0	56	102
7:30:00 AM	0	10	9	0	19	4	5	4	0	13	1	4	8	0	13	18	28	2	0	48	93
7:45:00 AM	1	11	11	0	23	1	8	3	0	12	7	7	7	0	21	23	23	0	0	46	102
Total Volume	2	42	40	0	84	12	21	13	0	46	27	20	23	0	70	80	126	2	0	208	408
% App. Total	2.4	50	47.6	0		26.1	45.7	28.3	0		38.6	28.6	32.9	0		38.5	60.6	1	0		
PHF	.500	.955	.714	.000	.840	.750	.656	.813	.000	.885	.675	.714	.719	.000	.833	.870	.768	.250	.000	.897	.919

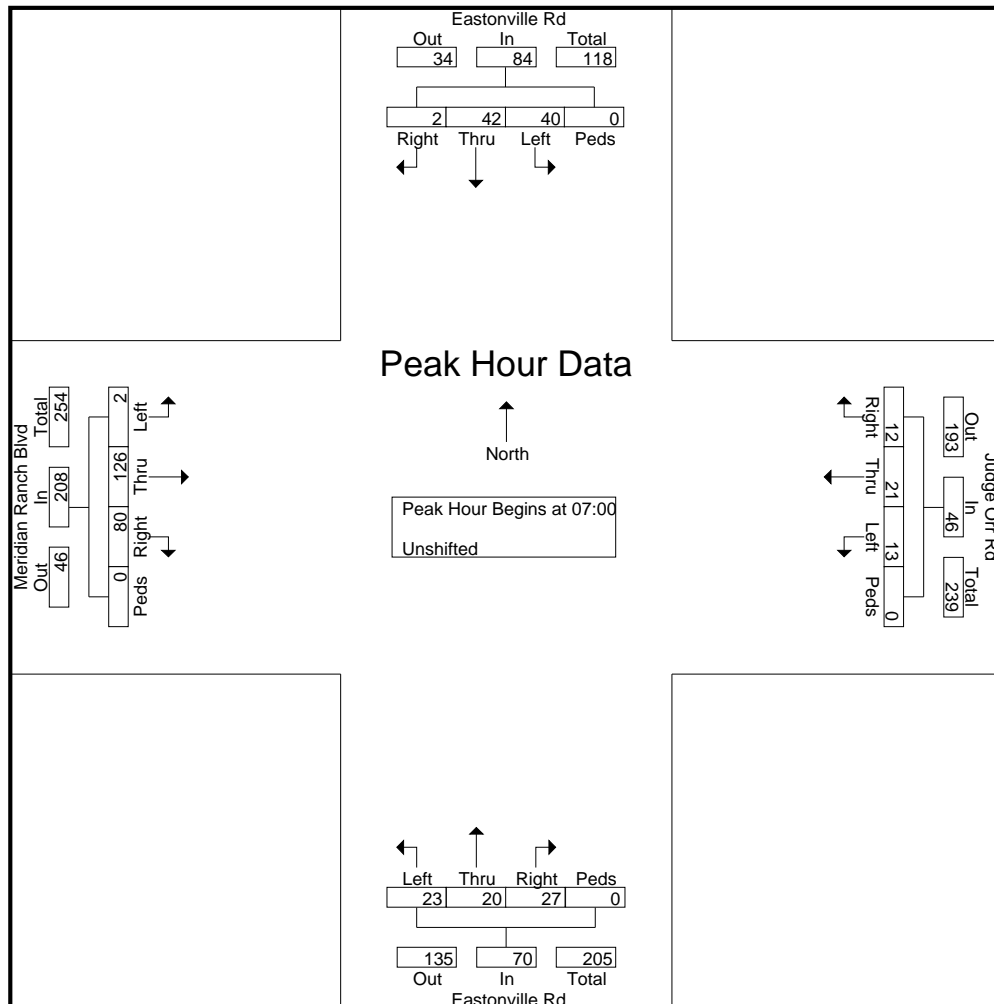

# LSC Transportation Consultants, Inc.

2504 E. Pikes Peak Ave, Suite 304  
 Colorado Springs, CO 80909  
 719-633-2868

File Name : Eastonville Rd - Judge Orr Rd PM

Site Code : S224400

Start Date : 6/22/2022

Page No : 1

### Groups Printed- Unshifted

Start Time	Eastonville Rd Southbound					Judge Orr Rd Westbound					Eastonville Rd Northbound					Meridian Ranch Blvd Eastbound					Int. Total
	Right	Thru	Left	Peds	App. Total	Right	Thru	Left	Peds	App. Total	Right	Thru	Left	Peds	App. Total	Right	Thru	Left	Peds	App. Total	
16:00	0	16	4	0	20	10	31	8	0	49	11	28	31	0	70	21	12	1	0	34	173
16:15	1	13	6	0	20	8	32	8	0	48	13	33	21	0	67	16	14	0	0	30	165
16:30	1	15	2	0	18	15	24	7	0	46	10	46	49	0	105	17	16	0	0	33	202
16:45	0	15	7	0	22	11	31	10	0	52	15	32	43	0	90	30	13	0	0	43	207
Total	2	59	19	0	80	44	118	33	0	195	49	139	144	0	332	84	55	1	0	140	747
17:00	0	11	1	0	12	9	32	8	0	49	14	37	35	0	86	14	18	1	0	33	180
17:15	0	9	5	0	14	10	41	10	0	61	13	41	49	0	103	25	15	2	0	42	220
17:30	0	11	5	0	16	17	26	9	0	52	11	50	44	0	105	20	11	0	1	32	205
17:45	2	13	4	0	19	9	18	7	0	34	11	48	49	0	108	25	15	0	0	40	201
Total	2	44	15	0	61	45	117	34	0	196	49	176	177	0	402	84	59	3	1	147	806
Grand Total	4	103	34	0	141	89	235	67	0	391	98	315	321	0	734	168	114	4	1	287	1553
Apprch %	2.8	73	24.1	0		22.8	60.1	17.1	0		13.4	42.9	43.7	0		58.5	39.7	1.4	0.3		
Total %	0.3	6.6	2.2	0	9.1	5.7	15.1	4.3	0	25.2	6.3	20.3	20.7	0	47.3	10.8	7.3	0.3	0.1	18.5	

# LSC Transportation Consultants, Inc.

2504 E. Pikes Peak Ave, Suite 304  
 Colorado Springs, CO 80909  
 719-633-2868

File Name : Eastonville Rd - Judge Orr Rd PM

Site Code : S224400

Start Date : 6/22/2022

Page No : 2

Start Time	Eastonville Rd Southbound					Judge Orr Rd Westbound					Eastonville Rd Northbound					Meridian Ranch Blvd Eastbound					Int. Total
	Right	Thru	Left	Peds	App. Total	Right	Thru	Left	Peds	App. Total	Right	Thru	Left	Peds	App. Total	Right	Thru	Left	Peds	App. Total	
Peak Hour Analysis From 4:00:00 PM to 5:45:00 PM - Peak 1 of 1																					
Peak Hour for Entire Intersection Begins at 4:45:00 PM																					
4:45:00 PM	0	15	7	0	22	11	31	10	0	52	15	32	43	0	90	30	13	0	0	43	207
5:00:00 PM	0	11	1	0	12	9	32	8	0	49	14	37	35	0	86	14	18	1	0	33	180
5:15:00 PM	0	9	5	0	14	10	41	10	0	61	13	41	49	0	103	25	15	2	0	42	220
5:30:00 PM	0	11	5	0	16	17	26	9	0	52	11	50	44	0	105	20	11	0	1	32	205
Total Volume	0	46	18	0	64	47	130	37	0	214	53	160	171	0	384	89	57	3	1	150	812
% App. Total	0	71.9	28.1	0		22	60.7	17.3	0		13.8	41.7	44.5	0		59.3	38	2	0.7		
PHF	.000	.767	.643	.000	.727	.691	.793	.925	.000	.877	.883	.800	.872	.000	.914	.742	.792	.375	.250	.872	.923

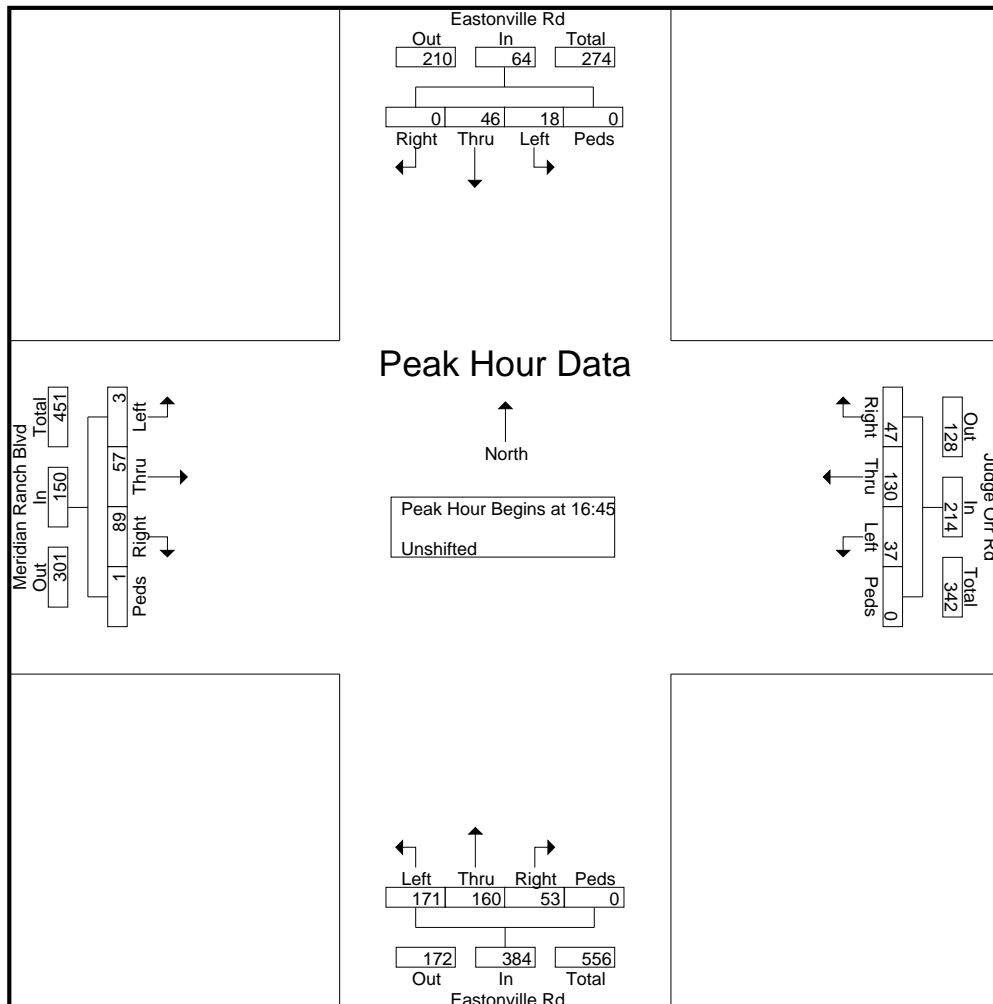

# LSC Transportation Consultants, Inc.

2504 E. Pikes Peak Ave, Suite 304  
 Colorado Springs, CO 80909  
 719-633-2868

File Name : McLaughlin Rd - Eastonville Rd AM 7-18-24

Site Code : S234340

Start Date : 7/18/2024

Page No : 1

### Groups Printed- Unshifted

Start Time	Mc Laughlin Rd Southbound					Eastonville Rd Westbound					Mc Laughlin Rd Northbound					Eastonville Rd Eastbound					Int. Total
	Right	Thru	Left	Peds	App. Total	Right	Thru	Left	Peds	App. Total	Right	Thru	Left	Peds	App. Total	Right	Thru	Left	Peds	App. Total	
06:30	0	0	0	0	0	0	6	12	0	18	2	0	1	0	3	0	2	0	0	2	23
06:35	0	1	0	0	1	0	7	18	0	25	1	0	0	0	1	0	2	0	0	2	29
06:40	0	0	0	0	0	0	11	17	0	28	2	0	1	0	3	1	2	0	0	3	34
06:45	0	1	0	0	1	0	5	14	0	19	1	0	0	0	1	0	2	0	0	2	23
06:50	1	0	0	0	1	0	11	16	0	27	4	0	0	0	4	2	0	0	0	2	34
06:55	0	1	1	0	2	0	8	16	0	24	4	1	0	0	5	4	4	0	0	8	39
<b>Total</b>	<b>1</b>	<b>3</b>	<b>1</b>	<b>0</b>	<b>5</b>	<b>0</b>	<b>48</b>	<b>93</b>	<b>0</b>	<b>141</b>	<b>14</b>	<b>1</b>	<b>2</b>	<b>0</b>	<b>17</b>	<b>7</b>	<b>12</b>	<b>0</b>	<b>0</b>	<b>19</b>	<b>182</b>
07:00	1	0	0	0	1	0	14	12	0	26	5	0	1	0	6	3	2	0	0	5	38
07:05	0	0	0	0	0	0	7	25	0	32	2	0	1	0	3	1	2	0	0	3	38
07:10	0	1	0	0	1	0	11	10	0	21	3	0	0	0	3	1	2	0	0	3	28
07:15	0	0	0	0	0	0	7	19	0	26	2	0	1	0	3	3	4	0	0	7	36
07:20	0	0	0	0	0	0	18	17	0	35	4	1	0	0	5	1	3	0	0	4	44
07:25	0	1	0	0	1	0	12	14	0	26	4	0	0	0	4	0	5	1	0	6	37
07:30	0	0	0	0	0	0	9	9	0	18	6	0	0	0	6	3	6	0	0	9	33
07:35	0	0	0	0	0	0	11	30	0	41	1	0	0	0	1	2	4	0	0	6	48
07:40	0	0	0	0	0	0	12	17	0	29	7	0	1	0	8	3	0	1	0	4	41
07:45	0	1	0	0	1	1	9	17	0	27	2	0	0	0	2	5	3	0	0	8	38
07:50	0	1	0	0	1	0	10	16	0	26	7	0	0	0	7	3	7	0	0	10	44
07:55	0	0	0	0	0	0	7	10	0	17	4	0	0	0	4	2	2	1	0	5	26
<b>Total</b>	<b>1</b>	<b>4</b>	<b>0</b>	<b>0</b>	<b>5</b>	<b>1</b>	<b>127</b>	<b>196</b>	<b>0</b>	<b>324</b>	<b>47</b>	<b>1</b>	<b>4</b>	<b>0</b>	<b>52</b>	<b>27</b>	<b>40</b>	<b>3</b>	<b>0</b>	<b>70</b>	<b>451</b>
08:00	0	0	0	0	0	0	15	21	0	36	5	2	1	0	8	0	2	0	0	2	46
08:05	0	1	0	0	1	0	10	19	0	29	3	0	1	0	4	1	7	0	0	8	42
08:10	0	0	0	0	0	0	8	15	0	23	5	0	1	0	6	0	7	0	0	7	36
08:15	1	0	0	0	1	0	6	10	0	16	2	0	0	0	2	3	3	0	0	6	25
08:20	0	0	0	0	0	0	12	16	0	28	9	0	2	0	11	0	8	0	0	8	47
08:25	0	0	0	0	0	0	8	16	0	24	3	0	0	0	3	1	3	0	0	4	31
<b>Grand Total</b>	<b>3</b>	<b>8</b>	<b>1</b>	<b>0</b>	<b>12</b>	<b>1</b>	<b>234</b>	<b>386</b>	<b>0</b>	<b>621</b>	<b>88</b>	<b>4</b>	<b>11</b>	<b>0</b>	<b>103</b>	<b>39</b>	<b>82</b>	<b>3</b>	<b>0</b>	<b>124</b>	<b>860</b>
<b>Apprch %</b>	<b>25</b>	<b>66.7</b>	<b>8.3</b>	<b>0</b>		<b>0.2</b>	<b>37.7</b>	<b>62.2</b>	<b>0</b>		<b>85.4</b>	<b>3.9</b>	<b>10.7</b>	<b>0</b>		<b>31.5</b>	<b>66.1</b>	<b>2.4</b>	<b>0</b>		
<b>Total %</b>	<b>0.3</b>	<b>0.9</b>	<b>0.1</b>	<b>0</b>	<b>1.4</b>	<b>0.1</b>	<b>27.2</b>	<b>44.9</b>	<b>0</b>	<b>72.2</b>	<b>10.2</b>	<b>0.5</b>	<b>1.3</b>	<b>0</b>	<b>12</b>	<b>4.5</b>	<b>9.5</b>	<b>0.3</b>	<b>0</b>	<b>14.4</b>	



# LSC Transportation Consultants, Inc.

2504 E. Pikes Peak Ave, Suite 304  
 Colorado Springs, CO 80909  
 719-633-2868

File Name : McLaughlin Rd - Eastonville Rd AM 7-18-24

Site Code : S234340

Start Date : 7/18/2024

Page No : 2

Start Time	Mc Laughlin Rd Southbound					Eastonville Rd Westbound					Mc Laughlin Rd Northbound					Eastonville Rd Eastbound					Int. Total
	Right	Thru	Left	Peds	App. Total	Right	Thru	Left	Peds	App. Total	Right	Thru	Left	Peds	App. Total	Right	Thru	Left	Peds	App. Total	
Peak Hour Analysis From 06:30 to 08:25 - Peak 1 of 1																					
Peak Hour for Entire Intersection Begins at 07:15																					
07:15	0	0	0	0	0	0	7	19	0	26	2	0	1	0	3	3	4	0	0	7	36
07:20	0	0	0	0	0	0	18	17	0	35	4	1	0	0	5	1	3	0	0	4	44
07:25	0	1	0	0	1	0	12	14	0	26	4	0	0	0	4	0	5	1	0	6	37
07:30	0	0	0	0	0	0	9	9	0	18	6	0	0	0	6	3	6	0	0	9	33
07:35	0	0	0	0	0	0	11	30	0	41	1	0	0	0	1	2	4	0	0	6	48
07:40	0	0	0	0	0	0	12	17	0	29	7	0	1	0	8	3	0	1	0	4	41
07:45	0	1	0	0	1	1	9	17	0	27	2	0	0	0	2	5	3	0	0	8	38
07:50	0	1	0	0	1	0	10	16	0	26	7	0	0	0	7	3	7	0	0	10	44
07:55	0	0	0	0	0	0	7	10	0	17	4	0	0	0	4	2	2	1	0	5	26
08:00	0	0	0	0	0	0	15	21	0	36	5	2	1	0	8	0	2	0	0	2	46
08:05	0	1	0	0	1	0	10	19	0	29	3	0	1	0	4	1	7	0	0	8	42
08:10	0	0	0	0	0	0	8	15	0	23	5	0	1	0	6	0	7	0	0	7	36
Total Volume	0	4	0	0	4	1	128	204	0	333	50	3	5	0	58	23	50	3	0	76	471
% App. Total	0	100	0	0		0.3	38.4	61.3	0		86.2	5.2	8.6	0		30.3	65.8	3.9	0		
PHF	.000	.333	.000	.000	.333	.083	.593	.567	.000	.677	.595	.125	.417	.000	.604	.383	.595	.250	.000	.633	.818

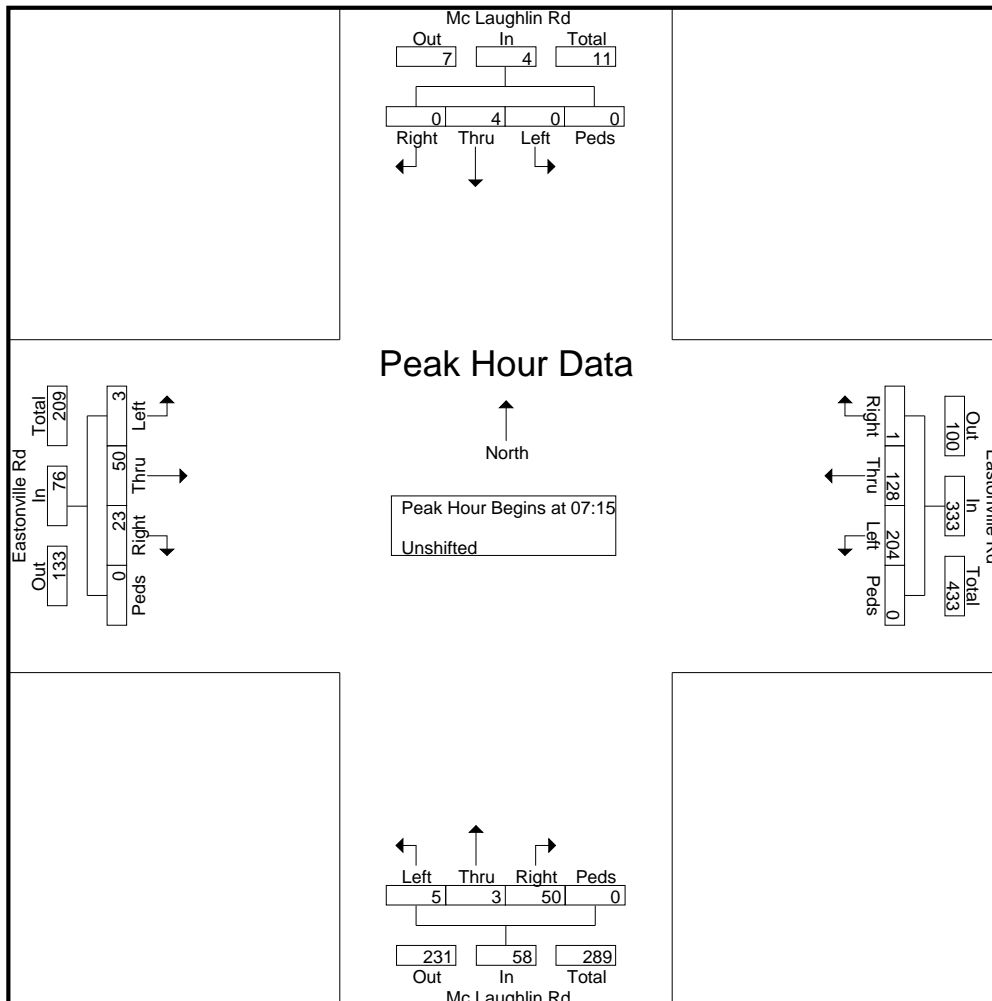

# LSC Transportation Consultants, Inc.

2504 E. Pikes Peak Ave, Suite 304  
 Colorado Springs, CO 80909  
 719-633-2868

File Name : McLaughlin Rd - Eastonville Rd PM 7-18-24

Site Code : S234340

Start Date : 7/17/2024

Page No : 1

### Groups Printed- Unshifted

Start Time	Mc Laughlin Rd Southbound					Eastonville Rd Westbound					Mc Laughlin Rd Northbound					Eastonville Rd Eastbound					Int. Total
	Right	Thru	Left	Peds	App. Total	Right	Thru	Left	Peds	App. Total	Right	Thru	Left	Peds	App. Total	Right	Thru	Left	Peds	App. Total	
16:00	0	0	0	0	0	0	4	15	0	19	15	1	3	0	19	3	13	1	0	17	55
16:05	0	1	0	0	1	0	16	22	0	38	18	0	1	0	19	2	11	0	0	13	71
16:10	0	0	0	0	0	0	14	11	0	25	25	0	1	0	26	6	19	1	0	26	77
16:15	0	0	0	0	0	0	9	13	0	22	20	0	5	0	25	4	20	0	0	24	71
16:20	0	0	0	0	0	0	7	9	0	16	17	2	5	0	24	8	10	0	0	18	58
16:25	1	1	0	0	2	0	6	12	0	18	21	2	2	0	25	6	15	0	0	21	66
16:30	0	0	0	0	0	0	14	14	0	28	32	0	3	0	35	3	18	0	0	21	84
16:35	0	0	0	0	0	0	8	12	0	20	19	1	3	0	23	3	5	0	0	8	51
16:40	0	1	0	0	1	0	6	17	0	23	31	3	2	0	36	7	17	0	0	24	84
16:45	1	1	0	0	2	0	15	8	0	23	25	2	3	0	30	1	21	0	0	22	77
16:50	0	0	0	0	0	0	14	5	0	19	32	1	3	0	36	5	20	0	0	25	80
16:55	1	0	0	0	1	0	9	15	0	24	28	4	1	0	33	6	12	2	0	20	78
<b>Total</b>	<b>3</b>	<b>4</b>	<b>0</b>	<b>0</b>	<b>7</b>	<b>0</b>	<b>122</b>	<b>153</b>	<b>0</b>	<b>275</b>	<b>283</b>	<b>16</b>	<b>32</b>	<b>0</b>	<b>331</b>	<b>54</b>	<b>181</b>	<b>4</b>	<b>0</b>	<b>239</b>	<b>852</b>
17:00	0	1	0	0	1	0	11	16	0	27	23	1	2	0	26	6	15	0	0	21	75
17:05	0	0	0	0	0	0	8	12	0	20	24	3	7	0	34	2	16	1	0	19	73
17:10	0	0	0	0	0	0	8	12	0	20	23	1	9	0	33	7	16	2	0	25	78
17:15	0	0	0	0	0	1	9	11	0	21	24	1	5	0	30	5	14	0	0	19	70
17:20	0	0	0	0	0	0	7	10	0	17	17	1	3	0	21	9	21	0	0	30	68
17:25	1	0	0	0	1	0	11	8	0	19	12	0	6	0	18	5	13	0	0	18	56
17:30	0	0	0	0	0	0	7	10	0	17	23	1	5	0	29	4	17	0	0	21	67
17:35	0	0	0	0	0	0	9	8	0	17	23	0	2	0	25	6	19	0	0	25	67
17:40	0	0	0	0	0	0	7	16	0	23	18	0	1	0	19	4	20	0	0	24	66
17:45	0	1	0	0	1	0	6	15	0	21	32	1	9	0	42	3	13	0	0	16	80
17:50	0	0	0	0	0	0	8	11	0	19	23	1	7	0	31	5	14	0	0	19	69
17:55	0	2	0	0	2	0	10	16	0	26	12	4	4	0	20	3	15	1	0	19	67
<b>Total</b>	<b>1</b>	<b>4</b>	<b>0</b>	<b>0</b>	<b>5</b>	<b>1</b>	<b>101</b>	<b>145</b>	<b>0</b>	<b>247</b>	<b>254</b>	<b>14</b>	<b>60</b>	<b>0</b>	<b>328</b>	<b>59</b>	<b>193</b>	<b>4</b>	<b>0</b>	<b>256</b>	<b>836</b>
<b>Grand Total</b>	<b>4</b>	<b>8</b>	<b>0</b>	<b>0</b>	<b>12</b>	<b>1</b>	<b>223</b>	<b>298</b>	<b>0</b>	<b>522</b>	<b>537</b>	<b>30</b>	<b>92</b>	<b>0</b>	<b>659</b>	<b>113</b>	<b>374</b>	<b>8</b>	<b>0</b>	<b>495</b>	<b>1688</b>
<b>Apprch %</b>	<b>33.3</b>	<b>66.7</b>	<b>0</b>	<b>0</b>		<b>0.2</b>	<b>42.7</b>	<b>57.1</b>	<b>0</b>		<b>81.5</b>	<b>4.6</b>	<b>14</b>	<b>0</b>		<b>22.8</b>	<b>75.6</b>	<b>1.6</b>	<b>0</b>		
<b>Total %</b>	<b>0.2</b>	<b>0.5</b>	<b>0</b>	<b>0</b>	<b>0.7</b>	<b>0.1</b>	<b>13.2</b>	<b>17.7</b>	<b>0</b>	<b>30.9</b>	<b>31.8</b>	<b>1.8</b>	<b>5.5</b>	<b>0</b>	<b>39</b>	<b>6.7</b>	<b>22.2</b>	<b>0.5</b>	<b>0</b>	<b>29.3</b>	

# LSC Transportation Consultants, Inc.

2504 E. Pikes Peak Ave, Suite 304  
 Colorado Springs, CO 80909  
 719-633-2868

File Name : McLaughlin Rd - Eastonville Rd PM 7-18-24

Site Code : S234340

Start Date : 7/17/2024

Page No : 2

Start Time	Mc Laughlin Rd Southbound					Eastonville Rd Westbound					Mc Laughlin Rd Northbound					Eastonville Rd Eastbound					Int. Total
	Right	Thru	Left	Peds	App. Total	Right	Thru	Left	Peds	App. Total	Right	Thru	Left	Peds	App. Total	Right	Thru	Left	Peds	App. Total	
Peak Hour Analysis From 16:00 to 17:55 - Peak 1 of 1																					
Peak Hour for Entire Intersection Begins at 16:25																					
16:25	1	1	0	0	2	0	6	12	0	18	21	2	2	0	25	6	15	0	0	21	66
16:30	0	0	0	0	0	0	14	14	0	28	32	0	3	0	35	3	18	0	0	21	84
16:35	0	0	0	0	0	0	8	12	0	20	19	1	3	0	23	3	5	0	0	8	51
16:40	0	1	0	0	1	0	6	17	0	23	31	3	2	0	36	7	17	0	0	24	84
16:45	1	1	0	0	2	0	15	8	0	23	25	2	3	0	30	1	21	0	0	22	77
16:50	0	0	0	0	0	0	14	5	0	19	32	1	3	0	36	5	20	0	0	25	80
16:55	1	0	0	0	1	0	9	15	0	24	28	4	1	0	33	6	12	2	0	20	78
17:00	0	1	0	0	1	0	11	16	0	27	23	1	2	0	26	6	15	0	0	21	75
17:05	0	0	0	0	0	0	8	12	0	20	24	3	7	0	34	2	16	1	0	19	73
17:10	0	0	0	0	0	0	8	12	0	20	23	1	9	0	33	7	16	2	0	25	78
17:15	0	0	0	0	0	1	9	11	0	21	24	1	5	0	30	5	14	0	0	19	70
17:20	0	0	0	0	0	0	7	10	0	17	17	1	3	0	21	9	21	0	0	30	68
Total Volume	3	4	0	0	7	1	115	144	0	260	299	20	43	0	362	60	190	5	0	255	884
% App. Total	42.9	57.1	0	0		0.4	44.2	55.4	0		82.6	5.5	11.9	0		23.5	74.5	2	0		
PHF	.250	.333	.000	.000	.292	.083	.639	.706	.000	.774	.779	.417	.398	.000	.838	.556	.754	.208	.000	.708	.877

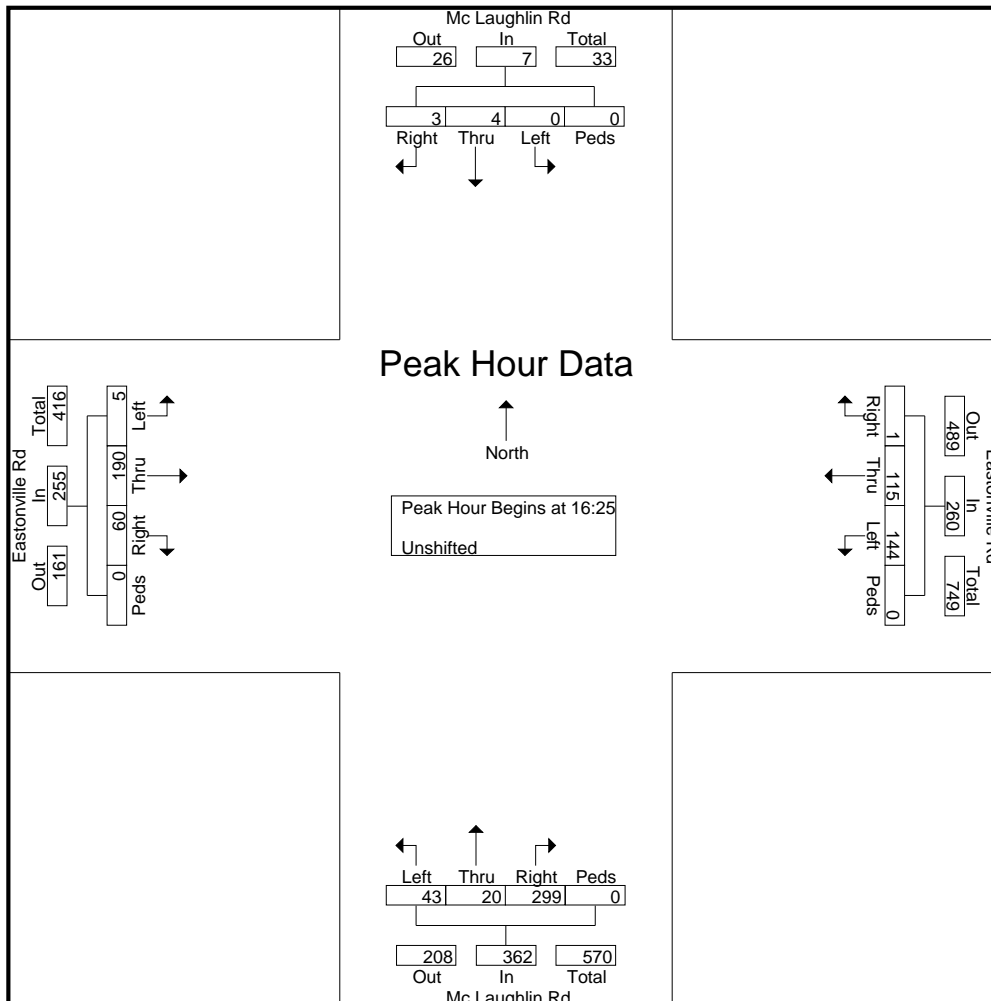

# Level of Service Reports

---



Intersection						
Int Delay, s/veh	9.3					
Movement	EBL	EBR	NBL	NBT	SBT	SBR
Lane Configurations	↶	↷		↶	↷	
Traffic Vol, veh/h	3	297	303	6	9	9
Future Vol, veh/h	3	297	303	6	9	9
Conflicting Peds, #/hr	0	0	0	0	0	0
Sign Control	Stop	Stop	Free	Free	Free	Free
RT Channelized	-	None	-	None	-	None
Storage Length	0	0	-	-	-	-
Veh in Median Storage, #	0	-	-	0	0	-
Grade, %	0	-	-	0	0	-
Peak Hour Factor	67	67	51	51	90	90
Heavy Vehicles, %	2	2	2	2	2	2
Mvmt Flow	4	443	594	12	10	10

Major/Minor	Minor2	Major1		Major2	
Conflicting Flow All	1215	15	20	0	0
Stage 1	15	-	-	-	-
Stage 2	1200	-	-	-	-
Critical Hdwy	6.42	6.22	4.12	-	-
Critical Hdwy Stg 1	5.42	-	-	-	-
Critical Hdwy Stg 2	5.42	-	-	-	-
Follow-up Hdwy	3.518	3.318	2.218	-	-
Pot Cap-1 Maneuver	200	1065	1596	-	-
Stage 1	1008	-	-	-	-
Stage 2	285	-	-	-	-
Platoon blocked, %				-	-
Mov Cap-1 Maneuver	125	1065	1596	-	-
Mov Cap-2 Maneuver	125	-	-	-	-
Stage 1	630	-	-	-	-
Stage 2	285	-	-	-	-

Approach	EB	NB	SB
HCM Control Delay, s	11	8.4	0
HCM LOS	B		

Minor Lane/Major Mvmt	NBL	NBT	EBLn1	EBLn2	SBT	SBR
Capacity (veh/h)	1596	-	125	1065	-	-
HCM Lane V/C Ratio	0.372	-	0.036	0.416	-	-
HCM Control Delay (s)	8.6	0	34.9	10.8	-	-
HCM Lane LOS	A	A	D	B	-	-
HCM 95th %tile Q(veh)	1.8	-	0.1	2.1	-	-

HCM 6th TWSC  
13: Eastonville Rd & Stapleton Dr

Existing Traffic  
AM Peak Hour

Intersection												
Int Delay, s/veh	108.7											
Movement	EBL	EBT	EBR	WBL	WBT	WBR	NBL	NBT	NBR	SBL	SBT	SBR
Lane Configurations		↕			↕	↕		↕			↕	
Traffic Vol, veh/h	12	159	42	6	94	110	83	187	17	139	153	14
Future Vol, veh/h	12	159	42	6	94	110	83	187	17	139	153	14
Conflicting Peds, #/hr	0	0	0	0	0	0	0	0	0	0	0	0
Sign Control	Stop	Stop	Stop	Stop	Stop	Stop	Free	Free	Free	Free	Free	Free
RT Channelized	-	-	None	-	-	None	-	-	None	-	-	None
Storage Length	-	-	-	-	-	250	-	-	-	-	-	-
Veh in Median Storage, #	-	0	-	-	0	-	-	0	-	-	0	-
Grade, %	-	0	-	-	0	-	-	0	-	-	0	-
Peak Hour Factor	87	87	87	85	85	85	68	68	68	64	64	64
Heavy Vehicles, %	2	2	2	2	2	2	2	2	2	2	2	2
Mvmt Flow	14	183	48	7	111	129	122	275	25	217	239	22

Major/Minor	Minor2		Minor1		Major1			Major2				
Conflicting Flow All	1336	1228	250	1332	1227	288	261	0	0	300	0	0
Stage 1	684	684	-	532	532	-	-	-	-	-	-	-
Stage 2	652	544	-	800	695	-	-	-	-	-	-	-
Critical Hdwy	7.12	6.52	6.22	7.12	6.52	6.22	4.12	-	-	4.12	-	-
Critical Hdwy Stg 1	6.12	5.52	-	6.12	5.52	-	-	-	-	-	-	-
Critical Hdwy Stg 2	6.12	5.52	-	6.12	5.52	-	-	-	-	-	-	-
Follow-up Hdwy	3.518	4.018	3.318	3.518	4.018	3.318	2.218	-	-	2.218	-	-
Pot Cap-1 Maneuver	130	~ 178	789	131	178	751	1303	-	-	1261	-	-
Stage 1	439	449	-	531	526	-	-	-	-	-	-	-
Stage 2	457	519	-	379	444	-	-	-	-	-	-	-
Platoon blocked, %								-	-	-	-	-
Mov Cap-1 Maneuver	22	~ 126	789	-	126	751	1303	-	-	1261	-	-
Mov Cap-2 Maneuver	22	~ 126	-	-	126	-	-	-	-	-	-	-
Stage 1	389	358	-	471	467	-	-	-	-	-	-	-
Stage 2	256	460	-	139	354	-	-	-	-	-	-	-

Approach	EB	WB	NB	SB
HCM Control Delay, s	\$ 606.5		2.3	3.8
HCM LOS	F	-		

Minor Lane/Major Mvmt	NBL	NBT	NBR	EBLn1	WBLn1	WBLn2	SBL	SBT	SBR
Capacity (veh/h)	1303	-	-	114	-	751	1261	-	-
HCM Lane V/C Ratio	0.094	-	-	2.148	-	0.172	0.172	-	-
HCM Control Delay (s)	8	0	-	\$ 606.5	-	10.8	8.4	0	-
HCM Lane LOS	A	A	-	F	-	B	A	A	-
HCM 95th %tile Q(veh)	0.3	-	-	20.8	-	0.6	0.6	-	-

Notes  
~: Volume exceeds capacity    \$: Delay exceeds 300s    +: Computation Not Defined    \*: All major volume in platoon

Intersection												
Int Delay, s/veh	14.7											
Movement	EBL	EBT	EBR	WBL	WBT	WBR	NBL	NBT	NBR	SBL	SBT	SBR
Lane Configurations	↘	↗	↗	↘	↗	↗	↘	↗	↗	↘	↗	↗
Traffic Vol, veh/h	23	135	143	6	87	17	49	267	3	35	438	35
Future Vol, veh/h	23	135	143	6	87	17	49	267	3	35	438	35
Conflicting Peds, #/hr	0	0	0	0	0	0	0	0	0	0	0	0
Sign Control	Stop	Stop	Stop	Stop	Stop	Stop	Free	Free	Free	Free	Free	Free
RT Channelized	-	-	None	-	-	None	-	-	None	-	-	None
Storage Length	185	-	325	225	-	225	1000	-	0	785	-	785
Veh in Median Storage, #	-	0	-	-	0	-	-	0	-	-	0	-
Grade, %	-	0	-	-	0	-	-	0	-	-	0	-
Peak Hour Factor	89	89	89	65	65	65	76	76	76	92	92	92
Heavy Vehicles, %	2	2	2	2	2	2	2	2	2	2	2	2
Mvmt Flow	26	152	161	9	134	26	64	351	4	38	476	38

Major/Minor	Minor2		Minor1		Major1		Major2					
Conflicting Flow All	1113	1035	476	1207	1069	351	514	0	0	355	0	0
Stage 1	552	552	-	479	479	-	-	-	-	-	-	-
Stage 2	561	483	-	728	590	-	-	-	-	-	-	-
Critical Hdwy	7.12	6.52	6.22	7.12	6.52	6.22	4.12	-	-	4.12	-	-
Critical Hdwy Stg 1	6.12	5.52	-	6.12	5.52	-	-	-	-	-	-	-
Critical Hdwy Stg 2	6.12	5.52	-	6.12	5.52	-	-	-	-	-	-	-
Follow-up Hdwy	3.518	4.018	3.318	3.518	4.018	3.318	2.218	-	-	2.218	-	-
Pot Cap-1 Maneuver	186	232	589	160	221	692	1052	-	-	1204	-	-
Stage 1	518	515	-	568	555	-	-	-	-	-	-	-
Stage 2	512	553	-	415	495	-	-	-	-	-	-	-
Platoon blocked, %	-	-	-	-	-	-	-	-	-	-	-	-
Mov Cap-1 Maneuver	78	211	589	45	201	692	1052	-	-	1204	-	-
Mov Cap-2 Maneuver	78	211	-	45	201	-	-	-	-	-	-	-
Stage 1	486	499	-	533	521	-	-	-	-	-	-	-
Stage 2	344	519	-	203	479	-	-	-	-	-	-	-

Approach	EB		WB		NB		SB	
HCM Control Delay, s	37.2		49		1.3		0.6	
HCM LOS	E		E					

Minor Lane/Major Mvmt	NBL	NBT	NBR	EBLn1	EBLn2	EBLn3	WBLn1	WBLn2	WBLn3	SBL	SBT	SBR
Capacity (veh/h)	1052	-	-	78	211	589	45	201	692	1204	-	-
HCM Lane V/C Ratio	0.061	-	-	0.331	0.719	0.273	0.205	0.666	0.038	0.032	-	-
HCM Control Delay (s)	8.6	-	-	72.5	56.4	13.4	104.6	52.7	10.4	8.1	-	-
HCM Lane LOS	A	-	-	F	F	B	F	F	B	A	-	-
HCM 95th %tile Q(veh)	0.2	-	-	1.2	4.7	1.1	0.7	4	0.1	0.1	-	-

Intersection	
Intersection Delay, s/veh	14.1
Intersection LOS	B

Movement	EBL	EBT	EBR	WBL	WBT	WBR	NBL	NBT	NBR	SBL	SBT	SBR
Lane Configurations	↵	↵		↵	↵	↵	↵	↵		↵	↵	
Traffic Vol, veh/h	87	140	90	17	34	73	18	176	26	60	164	9
Future Vol, veh/h	87	140	90	17	34	73	18	176	26	60	164	9
Peak Hour Factor	0.87	0.87	0.87	0.97	0.97	0.97	0.82	0.82	0.82	0.87	0.87	0.87
Heavy Vehicles, %	2	2	2	2	2	2	2	2	2	2	2	2
Mvmt Flow	100	161	103	18	35	75	22	215	32	69	189	10
Number of Lanes	1	1	0	1	1	1	1	1	0	1	1	0

Approach	EB	WB	NB	SB
Opposing Approach	WB	EB	SB	NB
Opposing Lanes	3	2	2	2
Conflicting Approach Left	SB	NB	EB	WB
Conflicting Lanes Left	2	2	2	3
Conflicting Approach Right	NB	SB	WB	EB
Conflicting Lanes Right	2	2	3	2
HCM Control Delay	14.6	10.9	15.5	13.5
HCM LOS	B	B	C	B

Lane	NBLn1	NBLn2	EBLn1	EBLn2	WBLn1	WBLn2	WBLn3	SBLn1	SBLn2
Vol Left, %	100%	0%	100%	0%	100%	0%	0%	100%	0%
Vol Thru, %	0%	87%	0%	61%	0%	100%	0%	0%	95%
Vol Right, %	0%	13%	0%	39%	0%	0%	100%	0%	5%
Sign Control	Stop	Stop	Stop	Stop	Stop	Stop	Stop	Stop	Stop
Traffic Vol by Lane	18	202	87	230	17	34	73	60	173
LT Vol	18	0	87	0	17	0	0	60	0
Through Vol	0	176	0	140	0	34	0	0	164
RT Vol	0	26	0	90	0	0	73	0	9
Lane Flow Rate	22	246	100	264	18	35	75	69	199
Geometry Grp	6	6	6	6	6	6	6	6	6
Degree of Util (X)	0.046	0.476	0.207	0.488	0.039	0.074	0.143	0.145	0.388
Departure Headway (Hd)	7.56	6.962	7.44	6.651	8.087	7.576	6.859	7.573	7.029
Convergence, Y/N	Yes	Yes	Yes	Yes	Yes	Yes	Yes	Yes	Yes
Cap	474	517	483	542	443	473	522	474	513
Service Time	5.294	4.696	5.173	4.383	5.831	5.319	4.603	5.307	4.763
HCM Lane V/C Ratio	0.046	0.476	0.207	0.487	0.041	0.074	0.144	0.146	0.388
HCM Control Delay	10.7	15.9	12.1	15.6	11.2	10.9	10.8	11.6	14.2
HCM Lane LOS	B	C	B	C	B	B	B	B	B
HCM 95th-tile Q	0.1	2.5	0.8	2.7	0.1	0.2	0.5	0.5	1.8



Intersection												
Int Delay, s/veh	4.8											
Movement	EBL	EBT	EBR	WBL	WBT	WBR	NBL	NBT	NBR	SBL	SBT	SBR
Lane Configurations	↖	↗		↖	↗		↖	↗			↕	
Traffic Vol, veh/h	3	50	23	204	128	1	5	3	50	0	4	0
Future Vol, veh/h	3	50	23	204	128	1	5	3	50	0	4	0
Conflicting Peds, #/hr	0	0	0	0	0	0	0	0	0	0	0	0
Sign Control	Free	Free	Free	Free	Free	Free	Stop	Stop	Stop	Stop	Stop	Stop
RT Channelized	-	-	None	-	-	None	-	-	None	-	-	None
Storage Length	100	-	-	100	-	-	75	-	-	-	-	-
Veh in Median Storage, #	-	0	-	-	0	-	-	0	-	-	0	-
Grade, %	-	0	-	-	0	-	-	0	-	-	0	-
Peak Hour Factor	78	78	78	95	95	95	78	78	78	78	78	78
Heavy Vehicles, %	2	2	2	2	2	2	2	2	2	2	2	2
Mvmt Flow	4	64	29	215	135	1	6	4	64	0	5	0

Major/Minor	Major1			Major2			Minor1			Minor2		
Conflicting Flow All	136	0	0	93	0	0	655	653	79	687	667	136
Stage 1	-	-	-	-	-	-	87	87	-	566	566	-
Stage 2	-	-	-	-	-	-	568	566	-	121	101	-
Critical Hdwy	4.12	-	-	4.12	-	-	7.12	6.52	6.22	7.12	6.52	6.22
Critical Hdwy Stg 1	-	-	-	-	-	-	6.12	5.52	-	6.12	5.52	-
Critical Hdwy Stg 2	-	-	-	-	-	-	6.12	5.52	-	6.12	5.52	-
Follow-up Hdwy	2.218	-	-	2.218	-	-	3.518	4.018	3.318	3.518	4.018	3.318
Pot Cap-1 Maneuver	1448	-	-	1501	-	-	379	387	981	361	380	913
Stage 1	-	-	-	-	-	-	921	823	-	509	507	-
Stage 2	-	-	-	-	-	-	508	507	-	883	811	-
Platoon blocked, %		-	-		-	-						
Mov Cap-1 Maneuver	1448	-	-	1501	-	-	333	330	981	297	325	913
Mov Cap-2 Maneuver	-	-	-	-	-	-	333	330	-	297	325	-
Stage 1	-	-	-	-	-	-	918	821	-	507	434	-
Stage 2	-	-	-	-	-	-	430	434	-	819	809	-

Approach	EB			WB			NB			SB		
HCM Control Delay, s	0.3			4.8			10			16.3		
HCM LOS							B			C		

Minor Lane/Major Mvmt	NBLn1	NBLn2	EBL	EBT	EBR	WBL	WBT	WBR	SBLn1
Capacity (veh/h)	333	882	1448	-	-	1501	-	-	325
HCM Lane V/C Ratio	0.019	0.077	0.003	-	-	0.143	-	-	0.016
HCM Control Delay (s)	16	9.4	7.5	-	-	7.8	-	-	16.3
HCM Lane LOS	C	A	A	-	-	A	-	-	C
HCM 95th %tile Q(veh)	0.1	0.2	0	-	-	0.5	-	-	0

Intersection						
Int Delay, s/veh	7.7					
Movement	EBL	EBR	NBL	NBT	SBT	SBR
Lane Configurations						
Traffic Vol, veh/h	6	112	218	13	5	3
Future Vol, veh/h	6	112	218	13	5	3
Conflicting Peds, #/hr	0	0	0	0	0	0
Sign Control	Stop	Stop	Free	Free	Free	Free
RT Channelized	-	None	-	None	-	None
Storage Length	0	0	-	-	-	-
Veh in Median Storage, #	0	-	-	0	0	-
Grade, %	0	-	-	0	0	-
Peak Hour Factor	83	83	79	79	78	78
Heavy Vehicles, %	2	2	2	2	2	2
Mvmt Flow	7	135	276	16	6	4

Major/Minor	Minor2	Major1		Major2	
Conflicting Flow All	576	8	10	0	0
Stage 1	8	-	-	-	-
Stage 2	568	-	-	-	-
Critical Hdwy	6.42	6.22	4.12	-	-
Critical Hdwy Stg 1	5.42	-	-	-	-
Critical Hdwy Stg 2	5.42	-	-	-	-
Follow-up Hdwy	3.518	3.318	2.218	-	-
Pot Cap-1 Maneuver	479	1074	1610	-	-
Stage 1	1015	-	-	-	-
Stage 2	567	-	-	-	-
Platoon blocked, %				-	-
Mov Cap-1 Maneuver	396	1074	1610	-	-
Mov Cap-2 Maneuver	396	-	-	-	-
Stage 1	839	-	-	-	-
Stage 2	567	-	-	-	-

Approach	EB	NB	SB
HCM Control Delay, s	9.1	7.3	0
HCM LOS	A		

Minor Lane/Major Mvmt	NBL	NBT	EBLn1	EBLn2	SBT	SBR
Capacity (veh/h)	1610	-	396	1074	-	-
HCM Lane V/C Ratio	0.171	-	0.018	0.126	-	-
HCM Control Delay (s)	7.7	0	14.3	8.8	-	-
HCM Lane LOS	A	A	B	A	-	-
HCM 95th %tile Q(veh)	0.6	-	0.1	0.4	-	-

HCM 6th TWSC  
13: Eastonville Rd & Stapleton Dr

Existing Traffic  
PM Peak Hour

Intersection												
Int Delay, s/veh	9.5											
Movement	EBL	EBT	EBR	WBL	WBT	WBR	NBL	NBT	NBR	SBL	SBT	SBR
Lane Configurations		↕			↕	↕		↕			↕	
Traffic Vol, veh/h	11	78	31	9	153	105	47	115	12	50	63	4
Future Vol, veh/h	11	78	31	9	153	105	47	115	12	50	63	4
Conflicting Peds, #/hr	0	0	0	0	0	0	0	0	0	0	0	0
Sign Control	Stop	Stop	Stop	Stop	Stop	Stop	Free	Free	Free	Free	Free	Free
RT Channelized	-	-	None	-	-	None	-	-	None	-	-	None
Storage Length	-	-	-	-	-	250	-	-	-	-	-	-
Veh in Median Storage, #	-	0	-	-	0	-	-	0	-	-	0	-
Grade, %	-	0	-	-	0	-	-	0	-	-	0	-
Peak Hour Factor	83	83	83	94	94	94	74	74	74	83	83	83
Heavy Vehicles, %	2	2	2	2	2	2	2	2	2	2	2	2
Mvmt Flow	13	94	37	10	163	112	64	155	16	60	76	5

Major/Minor	Minor2		Minor1			Major1			Major2			
Conflicting Flow All	628	498	79	555	492	163	81	0	0	171	0	0
Stage 1	199	199	-	291	291	-	-	-	-	-	-	-
Stage 2	429	299	-	264	201	-	-	-	-	-	-	-
Critical Hdwy	7.12	6.52	6.22	7.12	6.52	6.22	4.12	-	-	4.12	-	-
Critical Hdwy Stg 1	6.12	5.52	-	6.12	5.52	-	-	-	-	-	-	-
Critical Hdwy Stg 2	6.12	5.52	-	6.12	5.52	-	-	-	-	-	-	-
Follow-up Hdwy	3.518	4.018	3.318	3.518	4.018	3.318	2.218	-	-	2.218	-	-
Pot Cap-1 Maneuver	395	474	981	442	478	882	1517	-	-	1406	-	-
Stage 1	803	736	-	717	672	-	-	-	-	-	-	-
Stage 2	604	666	-	741	735	-	-	-	-	-	-	-
Platoon blocked, %								-	-	-	-	-
Mov Cap-1 Maneuver	229	431	981	330	435	882	1517	-	-	1406	-	-
Mov Cap-2 Maneuver	229	431	-	330	435	-	-	-	-	-	-	-
Stage 1	765	703	-	683	640	-	-	-	-	-	-	-
Stage 2	375	635	-	590	702	-	-	-	-	-	-	-

Approach	EB		WB			NB			SB		
HCM Control Delay, s	16.4		15.3			2			3.3		
HCM LOS	C		C								

Minor Lane/Major Mvmt	NBL	NBT	NBR	EBLn1	WBLn1	WBLn2	SBL	SBT	SBR
Capacity (veh/h)	1517	-	-	460	427	882	1406	-	-
HCM Lane V/C Ratio	0.042	-	-	0.314	0.404	0.127	0.043	-	-
HCM Control Delay (s)	7.5	0	-	16.4	19	9.7	7.7	0	-
HCM Lane LOS	A	A	-	C	C	A	A	A	-
HCM 95th %tile Q(veh)	0.1	-	-	1.3	1.9	0.4	0.1	-	-

Intersection												
Int Delay, s/veh	22.5											
Movement	EBL	EBT	EBR	WBL	WBT	WBR	NBL	NBT	NBR	SBL	SBT	SBR
Lane Configurations	↖	↗	↖	↖	↗	↖	↖	↗	↖	↖	↗	↖
Traffic Vol, veh/h	17	42	49	26	136	26	119	459	33	12	364	29
Future Vol, veh/h	17	42	49	26	136	26	119	459	33	12	364	29
Conflicting Peds, #/hr	0	0	0	0	0	0	0	0	0	0	0	0
Sign Control	Stop	Stop	Stop	Stop	Stop	Stop	Free	Free	Free	Free	Free	Free
RT Channelized	-	-	None	-	-	None	-	-	None	-	-	None
Storage Length	185	-	325	225	-	225	1000	-	0	785	-	785
Veh in Median Storage, #	-	0	-	-	0	-	-	0	-	-	0	-
Grade, %	-	0	-	-	0	-	-	0	-	-	0	-
Peak Hour Factor	84	84	84	83	83	83	86	86	86	87	87	87
Heavy Vehicles, %	2	2	2	2	2	2	2	2	2	2	2	2
Mvmt Flow	20	50	58	31	164	31	138	534	38	14	418	33

Major/Minor	Minor2		Minor1		Major1		Major2					
Conflicting Flow All	1373	1294	418	1327	1289	534	451	0	0	572	0	0
Stage 1	446	446	-	810	810	-	-	-	-	-	-	-
Stage 2	927	848	-	517	479	-	-	-	-	-	-	-
Critical Hdwy	7.12	6.52	6.22	7.12	6.52	6.22	4.12	-	-	4.12	-	-
Critical Hdwy Stg 1	6.12	5.52	-	6.12	5.52	-	-	-	-	-	-	-
Critical Hdwy Stg 2	6.12	5.52	-	6.12	5.52	-	-	-	-	-	-	-
Follow-up Hdwy	3.518	4.018	3.318	3.518	4.018	3.318	2.218	-	-	2.218	-	-
Pot Cap-1 Maneuver	123	163	635	132	164	546	1109	-	-	1001	-	-
Stage 1	591	574	-	374	393	-	-	-	-	-	-	-
Stage 2	322	378	-	541	555	-	-	-	-	-	-	-
Platoon blocked, %	-	-	-	-	-	-	-	-	-	-	-	-
Mov Cap-1 Maneuver	-	141	635	78	~ 142	546	1109	-	-	1001	-	-
Mov Cap-2 Maneuver	-	141	-	78	~ 142	-	-	-	-	-	-	-
Stage 1	518	566	-	328	344	-	-	-	-	-	-	-
Stage 2	139	331	-	442	547	-	-	-	-	-	-	-

Approach	EB	WB	NB	SB
HCM Control Delay, s		146.3	1.7	0.3
HCM LOS	-	F		

Minor Lane/Major Mvmt	NBL	NBT	NBR	EBLn1	EBLn2	EBLn3	WBLn1	WBLn2	WBLn3	SBL	SBT	SBR
Capacity (veh/h)	1109	-	-	-	141	635	78	142	546	1001	-	-
HCM Lane V/C Ratio	0.125	-	-	-	0.355	0.092	0.402	1.154	0.057	0.014	-	-
HCM Control Delay (s)	8.7	-	-	-	43.9	11.2	79.2	184.8	12	8.6	-	-
HCM Lane LOS	A	-	-	-	E	B	F	F	B	A	-	-
HCM 95th %tile Q(veh)	0.4	-	-	-	1.5	0.3	1.6	9.3	0.2	0	-	-

Notes  
 ~: Volume exceeds capacity    \$: Delay exceeds 300s    +: Computation Not Defined    \*: All major volume in platoon

Intersection	
Intersection Delay, s/veh	12.2
Intersection LOS	B

Movement	EBL	EBT	EBR	WBL	WBT	WBR	NBL	NBT	NBR	SBL	SBT	SBR
Lane Configurations	↵	↵		↵	↵	↵	↵	↵		↵	↵	
Traffic Vol, veh/h	3	57	89	37	130	47	171	160	53	18	46	0
Future Vol, veh/h	3	57	89	37	130	47	171	160	53	18	46	0
Peak Hour Factor	0.83	0.83	0.83	0.88	0.88	0.88	0.87	0.87	0.87	0.78	0.78	0.78
Heavy Vehicles, %	2	2	2	2	2	2	2	2	2	2	2	2
Mvmt Flow	4	69	107	42	148	53	197	184	61	23	59	0
Number of Lanes	1	1	0	1	1	1	1	1	0	1	1	0

Approach	EB	WB	NB	SB
Opposing Approach	WB	EB	SB	NB
Opposing Lanes	3	2	2	2
Conflicting Approach Left	SB	NB	EB	WB
Conflicting Lanes Left	2	2	2	3
Conflicting Approach Right	NB	SB	WB	EB
Conflicting Lanes Right	2	2	3	2
HCM Control Delay	12.1	11.2	13.1	10.7
HCM LOS	B	B	B	B

Lane	NBLn1	NBLn2	EBLn1	EBLn2	WBLn1	WBLn2	WBLn3	SBLn1	SBLn2
Vol Left, %	100%	0%	100%	0%	100%	0%	0%	100%	0%
Vol Thru, %	0%	75%	0%	39%	0%	100%	0%	0%	100%
Vol Right, %	0%	25%	0%	61%	0%	0%	100%	0%	0%
Sign Control	Stop	Stop	Stop	Stop	Stop	Stop	Stop	Stop	Stop
Traffic Vol by Lane	171	213	3	146	37	130	47	18	46
LT Vol	171	0	3	0	37	0	0	18	0
Through Vol	0	160	0	57	0	130	0	0	46
RT Vol	0	53	0	89	0	0	47	0	0
Lane Flow Rate	197	245	4	176	42	148	53	23	59
Geometry Grp	6	6	6	6	6	6	6	6	6
Degree of Util (X)	0.366	0.409	0.007	0.314	0.084	0.275	0.089	0.048	0.115
Departure Headway (Hd)	6.696	6.018	7.376	6.433	7.21	6.703	5.993	7.538	7.031
Convergence, Y/N	Yes	Yes	Yes	Yes	Yes	Yes	Yes	Yes	Yes
Cap	537	597	484	556	495	533	595	473	507
Service Time	4.449	3.77	5.146	4.202	4.978	4.47	3.76	5.318	4.811
HCM Lane V/C Ratio	0.367	0.41	0.008	0.317	0.085	0.278	0.089	0.049	0.116
HCM Control Delay	13.3	12.9	10.2	12.1	10.6	12	9.4	10.7	10.7
HCM Lane LOS	B	B	B	B	B	B	A	B	B
HCM 95th-tile Q	1.7	2	0	1.3	0.3	1.1	0.3	0.2	0.4

HCM 6th TWSC  
16: McLaughlin Rd & Eastonville Dr

Existing Traffic  
PM Peak Hour

Intersection												
Int Delay, s/veh	7.6											
Movement	EBL	EBT	EBR	WBL	WBT	WBR	NBL	NBT	NBR	SBL	SBT	SBR
Lane Configurations	↖	↗		↖	↗		↖	↗			↕	
Traffic Vol, veh/h	5	190	60	144	155	1	43	20	299	0	4	3
Future Vol, veh/h	5	190	60	144	155	1	43	20	299	0	4	3
Conflicting Peds, #/hr	0	0	0	0	0	0	0	0	0	0	0	0
Sign Control	Free	Free	Free	Free	Free	Free	Stop	Stop	Stop	Stop	Stop	Stop
RT Channelized	-	-	None	-	-	None	-	-	None	-	-	None
Storage Length	100	-	-	100	-	-	75	-	-	-	-	-
Veh in Median Storage, #	-	0	-	-	0	-	-	0	-	-	0	-
Grade, %	-	0	-	-	0	-	-	0	-	-	0	-
Peak Hour Factor	87	87	87	87	87	87	89	89	89	58	58	58
Heavy Vehicles, %	2	2	2	2	2	2	2	2	2	2	2	2
Mvmt Flow	6	218	69	166	178	1	48	22	336	0	7	5

Major/Minor	Major1			Major2			Minor1			Minor2		
Conflicting Flow All	179	0	0	287	0	0	782	776	253	955	810	179
Stage 1	-	-	-	-	-	-	265	265	-	511	511	-
Stage 2	-	-	-	-	-	-	517	511	-	444	299	-
Critical Hdwy	4.12	-	-	4.12	-	-	7.12	6.52	6.22	7.12	6.52	6.22
Critical Hdwy Stg 1	-	-	-	-	-	-	6.12	5.52	-	6.12	5.52	-
Critical Hdwy Stg 2	-	-	-	-	-	-	6.12	5.52	-	6.12	5.52	-
Follow-up Hdwy	2.218	-	-	2.218	-	-	3.518	4.018	3.318	3.518	4.018	3.318
Pot Cap-1 Maneuver	1397	-	-	1275	-	-	312	328	786	238	314	864
Stage 1	-	-	-	-	-	-	740	689	-	545	537	-
Stage 2	-	-	-	-	-	-	541	537	-	593	666	-
Platoon blocked, %	-	-	-	-	-	-	-	-	-	-	-	-
Mov Cap-1 Maneuver	1397	-	-	1275	-	-	273	284	786	115	272	864
Mov Cap-2 Maneuver	-	-	-	-	-	-	273	284	-	115	272	-
Stage 1	-	-	-	-	-	-	737	686	-	543	467	-
Stage 2	-	-	-	-	-	-	461	467	-	327	663	-

Approach	EB	WB	NB	SB
HCM Control Delay, s	0.1	4	15.9	14.7
HCM LOS			C	B

Minor Lane/Major Mvmt	NBLn1	NBLn2	EBL	EBT	EBR	WBL	WBT	WBR	SBLn1
Capacity (veh/h)	273	708	1397	-	-	1275	-	-	385
HCM Lane V/C Ratio	0.177	0.506	0.004	-	-	0.13	-	-	0.031
HCM Control Delay (s)	21	15.2	7.6	-	-	8.2	-	-	14.7
HCM Lane LOS	C	C	A	-	-	A	-	-	B
HCM 95th %tile Q(veh)	0.6	2.9	0	-	-	0.4	-	-	0.1

Intersection				
Intersection Delay, s/veh	3.1			
Intersection LOS	A			
Approach	EB	WB	NB	SB
Entry Lanes	1	1	1	1
Conflicting Circle Lanes	1	1	1	1
Adj Approach Flow, veh/h	73	0	61	25
Demand Flow Rate, veh/h	74	0	62	25
Vehicles Circulating, veh/h	24	64	2	46
Vehicles Exiting, veh/h	47	0	96	18
Ped Vol Crossing Leg, #/h	0	0	0	0
Ped Cap Adj	1.000	1.000	1.000	1.000
Approach Delay, s/veh	3.1	0.0	3.0	2.9
Approach LOS	A	-	A	A
Lane	Left	Left	Left	Left
Designated Moves	LTR	LTR	LTR	LTR
Assumed Moves	LTR	LTR	LTR	LTR
RT Channelized				
Lane Util	1.000	1.000	1.000	1.000
Follow-Up Headway, s	2.609	2.609	2.609	2.609
Critical Headway, s	4.976	4.976	4.976	4.976
Entry Flow, veh/h	74	0	62	25
Cap Entry Lane, veh/h	1346	1293	1377	1317
Entry HV Adj Factor	0.986	1.000	0.979	0.981
Flow Entry, veh/h	73	0	61	25
Cap Entry, veh/h	1328	1293	1348	1292
V/C Ratio	0.055	0.000	0.045	0.019
Control Delay, s/veh	3.1	2.8	3.0	2.9
LOS	A	A	A	A
95th %tile Queue, veh	0	0	0	0

Intersection			
Intersection Delay, s/veh	3.2		
Intersection LOS	A		
Approach	WB	NB	SB
Entry Lanes	1	1	1
Conflicting Circle Lanes	2	2	2
Adj Approach Flow, veh/h	93	68	93
Demand Flow Rate, veh/h	94	70	95
Vehicles Circulating, veh/h	43	6	75
Vehicles Exiting, veh/h	33	164	62
Ped Vol Crossing Leg, #/h	0	0	0
Ped Cap Adj	1.000	1.000	1.000
Approach Delay, s/veh	3.2	3.0	3.3
Approach LOS	A	A	A
Lane	Left	Left	Left
Designated Moves	LR	TR	LT
Assumed Moves	LR	TR	LT
RT Channelized			
Lane Util	1.000	1.000	1.000
Follow-Up Headway, s	2.535	2.535	2.535
Critical Headway, s	4.328	4.328	4.328
Entry Flow, veh/h	94	70	95
Cap Entry Lane, veh/h	1369	1413	1332
Entry HV Adj Factor	0.989	0.974	0.982
Flow Entry, veh/h	93	68	93
Cap Entry, veh/h	1355	1376	1308
V/C Ratio	0.069	0.050	0.071
Control Delay, s/veh	3.2	3.0	3.3
LOS	A	A	A
95th %tile Queue, veh	0	0	0



Intersection						
Int Delay, s/veh	2.5					
Movement	WBL	WBR	NBT	NBR	SBL	SBT
Lane Configurations	Y		↑	↑	↑	↑
Traffic Vol, veh/h	50	13	45	17	4	133
Future Vol, veh/h	50	13	45	17	4	133
Conflicting Peds, #/hr	0	0	0	0	0	0
Sign Control	Stop	Stop	Free	Free	Free	Free
RT Channelized	-	None	-	None	-	None
Storage Length	0	-	-	155	205	-
Veh in Median Storage, #	0	-	0	-	-	0
Grade, %	0	-	0	-	-	0
Peak Hour Factor	85	85	85	85	85	85
Heavy Vehicles, %	2	2	2	2	2	2
Mvmt Flow	59	15	53	20	5	156

Major/Minor	Minor1	Major1	Major2		
Conflicting Flow All	219	53	0	0	73
Stage 1	53	-	-	-	-
Stage 2	166	-	-	-	-
Critical Hdwy	6.42	6.22	-	-	4.12
Critical Hdwy Stg 1	5.42	-	-	-	-
Critical Hdwy Stg 2	5.42	-	-	-	-
Follow-up Hdwy	3.518	3.318	-	-	2.218
Pot Cap-1 Maneuver	769	1014	-	-	1527
Stage 1	970	-	-	-	-
Stage 2	863	-	-	-	-
Platoon blocked, %			-	-	-
Mov Cap-1 Maneuver	767	1014	-	-	1527
Mov Cap-2 Maneuver	758	-	-	-	-
Stage 1	970	-	-	-	-
Stage 2	860	-	-	-	-

Approach	WB	NB	SB
HCM Control Delay, s	10	0	0.2
HCM LOS	B		

Minor Lane/Major Mvmt	NBT	NBRWBLn1	SBL	SBT
Capacity (veh/h)	-	-	800	1527
HCM Lane V/C Ratio	-	-	0.093	0.003
HCM Control Delay (s)	-	-	10	7.4
HCM Lane LOS	-	-	B	A
HCM 95th %tile Q(veh)	-	-	0.3	0

Intersection							
Intersection Delay, s/veh	5.1						
Intersection LOS	A						
Approach	EB		NB		SB		
Entry Lanes	2		2		2		
Conflicting Circle Lanes	2		2		2		
Adj Approach Flow, veh/h	334		451		215		
Demand Flow Rate, veh/h	341		460		219		
Vehicles Circulating, veh/h	200		6		393		
Vehicles Exiting, veh/h	412		535		73		
Ped Vol Crossing Leg, #/h	0		0		0		
Ped Cap Adj	1.000		1.000		1.000		
Approach Delay, s/veh	5.6		5.0		4.8		
Approach LOS	A		A		A		
Lane	Left	Right	Left	Right	Left	Right	
Designated Moves	L	TR	L	TR	LT	TR	
Assumed Moves	L	TR	L	TR	LT	TR	
RT Channelized							
Lane Util	0.018	0.982	0.854	0.146	0.470	0.530	
Follow-Up Headway, s	2.667	2.535	2.667	2.535	2.667	2.535	
Critical Headway, s	4.645	4.328	4.645	4.328	4.645	4.328	
Entry Flow, veh/h	6	335	393	67	103	116	
Cap Entry Lane, veh/h	1123	1198	1342	1413	940	1017	
Entry HV Adj Factor	1.000	0.979	0.980	0.980	0.981	0.983	
Flow Entry, veh/h	6	328	385	66	101	114	
Cap Entry, veh/h	1123	1173	1315	1385	923	999	
V/C Ratio	0.005	0.280	0.293	0.047	0.110	0.114	
Control Delay, s/veh	3.2	5.7	5.3	3.0	4.9	4.6	
LOS	A	A	A	A	A	A	
95th %tile Queue, veh	0	1	1	0	0	0	

Intersection						
Intersection Delay, s/veh	7.3					
Intersection LOS	A					
Approach	EB	WB	NB	SB		
Entry Lanes	1	1	1	1		
Conflicting Circle Lanes	1	1	1	1		
Adj Approach Flow, veh/h	303	343	393	524		
Demand Flow Rate, veh/h	309	350	401	534		
Vehicles Circulating, veh/h	490	405	417	297		
Vehicles Exiting, veh/h	267	413	382	287		
Ped Vol Crossing Leg, #/h	0	0	0	0		
Ped Cap Adj	1.000	1.000	1.000	1.000		
Approach Delay, s/veh	8.8	3.1	9.5	7.6		
Approach LOS	A	A	A	A		
Lane	Left	Left	Bypass	Left	Left	Bypass
Designated Moves	LTR	LT	R	LTR	LT	R
Assumed Moves	LTR	LT	R	LTR	LT	R
RT Channelized			Free			Free
Lane Util	1.000	1.000	1.000	1.000	1.000	
Follow-Up Headway, s	2.609	2.609	2.609	2.609	2.609	
Critical Headway, s	4.976	4.976	171	4.976	4.976	74
Entry Flow, veh/h	309	179	1938	401	460	1938
Cap Entry Lane, veh/h	837	913	0.980	902	1019	0.980
Entry HV Adj Factor	0.980	0.978	168	0.980	0.981	73
Flow Entry, veh/h	303	175	1900	393	451	1900
Cap Entry, veh/h	820	893	0.088	884	1000	0.038
V/C Ratio	0.369	0.196	0.0	0.445	0.451	0.0
Control Delay, s/veh	8.8	6.0	A	9.5	8.8	A
LOS	A	A	0	A	A	0
95th %tile Queue, veh	2	1		2	2	

**Timings**  
**14: US 24 & Stapleton Dr**

**2026 Background Traffic**  
**AM Peak Hour**

	↖	→	↘	↙	←	↖	↙	↑	↗	↘	↓	↙
Lane Group	EBL	EBT	EBR	WBL	WBT	WBR	NBL	NBT	NBR	SBL	SBT	SBR
Lane Configurations	↖	↑	↘	↖	↑	↘	↖	↑	↘	↖	↑	↘
Traffic Volume (vph)	50	211	267	4	103	17	116	280	5	45	470	42
Future Volume (vph)	50	211	267	4	103	17	116	280	5	45	470	42
Turn Type	pm+pt	NA	Free	pm+pt	NA	Free	pm+pt	NA	Perm	pm+pt	NA	Perm
Protected Phases	5	2		1	6		3	8		7	4	
Permitted Phases	2		Free	6		Free	8		8	4		4
Detector Phase	5	2		1	6		3	8	8	7	4	4
Switch Phase												
Minimum Initial (s)	5.0	5.0		5.0	5.0		5.0	5.0	5.0	5.0	15.0	15.0
Minimum Split (s)	10.0	10.0		10.0	10.0		10.0	10.0	10.0	10.0	20.0	20.0
Total Split (s)	12.0	30.0		12.0	30.0		12.0	66.0	66.0	12.0	66.0	66.0
Total Split (%)	10.0%	25.0%		10.0%	25.0%		10.0%	55.0%	55.0%	10.0%	55.0%	55.0%
Yellow Time (s)	3.0	3.0		3.0	3.0		3.0	3.0	3.0	3.0	3.0	3.0
All-Red Time (s)	2.0	2.0		2.0	2.0		2.0	2.0	2.0	2.0	2.0	2.0
Lost Time Adjust (s)	0.0	0.0		0.0	0.0		0.0	0.0	0.0	0.0	0.0	0.0
Total Lost Time (s)	5.0	5.0		5.0	5.0		5.0	5.0	5.0	5.0	5.0	5.0
Lead/Lag	Lead	Lag		Lead	Lag		Lead	Lag	Lag	Lead	Lag	Lag
Lead-Lag Optimize?	Yes	Yes		Yes	Yes		Yes	Yes	Yes	Yes	Yes	Yes
Recall Mode	None	C-Max		None	C-Max		None	Max	Max	None	Max	Max
Act Effct Green (s)	36.1	34.7	120.0	32.1	27.4	120.0	69.2	63.6	63.6	67.5	61.0	61.0
Actuated g/C Ratio	0.30	0.29	1.00	0.27	0.23	1.00	0.58	0.53	0.53	0.56	0.51	0.51
v/c Ratio	0.16	0.44	0.19	0.02	0.28	0.01	0.32	0.33	0.01	0.09	0.54	0.05
Control Delay	23.2	28.9	0.2	29.2	41.8	0.0	12.3	18.0	0.0	10.2	23.0	0.1
Queue Delay	0.0	0.0	0.0	0.0	0.0	0.0	0.0	0.0	0.0	0.0	0.0	0.0
Total Delay	23.2	28.9	0.2	29.2	41.8	0.0	12.3	18.0	0.0	10.2	23.0	0.1
LOS	C	C	A	C	D	A	B	B	A	B	C	A
Approach Delay		13.9			35.6			16.1			20.2	
Approach LOS		B			D			B			C	

**Intersection Summary**  
 Cycle Length: 120  
 Actuated Cycle Length: 120  
 Offset: 0 (0%), Referenced to phase 2:EBTL and 6:WBTL, Start of Green  
 Natural Cycle: 60  
 Control Type: Actuated-Coordinated  
 Maximum v/c Ratio: 0.54  
 Intersection Signal Delay: 18.3    Intersection LOS: B  
 Intersection Capacity Utilization 54.8%                                      ICU Level of Service A  
 Analysis Period (min) 15

**Splits and Phases: 14: US 24 & Stapleton Dr**

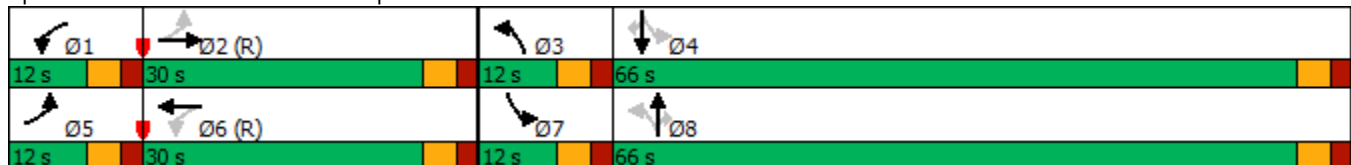

Intersection												
Intersection Delay, s/veh	19.5											
Intersection LOS	C											

Movement	EBL	EBT	EBR	WBL	WBT	WBR	NBL	NBT	NBR	SBL	SBT	SBR
Lane Configurations												
Traffic Vol, veh/h	100	160	101	34	42	85	20	210	36	75	217	14
Future Vol, veh/h	100	160	101	34	42	85	20	210	36	75	217	14
Peak Hour Factor	0.87	0.87	0.87	0.97	0.97	0.97	0.82	0.82	0.82	0.87	0.87	0.87
Heavy Vehicles, %	2	2	2	2	2	2	2	2	2	2	2	2
Mvmt Flow	115	184	116	35	43	88	24	256	44	86	249	16
Number of Lanes	1	1	0	1	1	1	1	1	0	1	1	0

Approach	EB	WB	NB	SB
Opposing Approach	WB	EB	SB	NB
Opposing Lanes	3	2	2	2
Conflicting Approach Left SB		NB	EB	WB
Conflicting Lanes Left	2	2	2	3
Conflicting Approach Right NB		SB	WB	EB
Conflicting Lanes Right	2	2	3	2
HCM Control Delay	20	12.5	23	18.9
HCM LOS	C	B	C	C

Lane	NBLn1	NBLn2	EBLn1	EBLn2	WBLn1	WBLn2	WBLn3	SBLn1	SBLn2
Vol Left, %	100%	0%	100%	0%	100%	0%	0%	100%	0%
Vol Thru, %	0%	85%	0%	61%	0%	100%	0%	0%	94%
Vol Right, %	0%	15%	0%	39%	0%	0%	100%	0%	6%
Sign Control	Stop	Stop	Stop	Stop	Stop	Stop	Stop	Stop	Stop
Traffic Vol by Lane	20	246	100	261	34	42	85	75	231
LT Vol	20	0	100	0	34	0	0	75	0
Through Vol	0	210	0	160	0	42	0	0	217
RT Vol	0	36	0	101	0	0	85	0	14
Lane Flow Rate	24	300	115	300	35	43	88	86	266
Geometry Grp	6	6	6	6	6	6	6	6	6
Degree of Util (X)	0.057	0.648	0.265	0.627	0.089	0.103	0.191	0.2	0.575
Departure Headway (Hd)	8.396	7.781	8.315	7.522	9.191	8.574	7.851	8.352	7.799
Convergence, Y/N	Yes	Yes	Yes	Yes	Yes	Yes	Yes	Yes	Yes
Cap	425	462	431	477	392	416	454	428	459
Service Time	6.182	5.566	6.095	5.302	6.891	6.374	5.65	6.137	5.583
HCM Lane V/C Ratio	0.056	0.649	0.267	0.629	0.089	0.103	0.194	0.201	0.58
HCM Control Delay	11.7	23.9	14.1	22.2	12.8	12.4	12.5	13.2	20.7
HCM Lane LOS	B	C	B	C	B	B	B	B	C
HCM 95th-tile Q	0.2	4.5	1.1	4.2	0.3	0.3	0.7	0.7	3.5

Intersection												
Int Delay, s/veh	4.3											
Movement	EBL	EBT	EBR	WBL	WBT	WBR	NBL	NBT	NBR	SBL	SBT	SBR
Lane Configurations	↖	↗		↖	↗		↖	↗			↕	
Traffic Vol, veh/h	3	70	23	210	176	1	5	3	52	0	4	0
Future Vol, veh/h	3	70	23	210	176	1	5	3	52	0	4	0
Conflicting Peds, #/hr	0	0	0	0	0	0	0	0	0	0	0	0
Sign Control	Free	Free	Free	Free	Free	Free	Stop	Stop	Stop	Stop	Stop	Stop
RT Channelized	-	-	None	-	-	None	-	-	None	-	-	None
Storage Length	100	-	-	100	-	-	75	-	-	-	-	-
Veh in Median Storage, #	-	0	-	-	0	-	-	0	-	-	0	-
Grade, %	-	0	-	-	0	-	-	0	-	-	0	-
Peak Hour Factor	78	78	78	95	95	95	78	78	78	78	78	78
Heavy Vehicles, %	2	2	2	2	2	2	2	2	2	2	2	2
Mvmt Flow	4	90	29	221	185	1	6	4	67	0	5	0

Major/Minor	Major1			Major2			Minor1			Minor2		
Conflicting Flow All	186	0	0	119	0	0	743	741	105	776	755	186
Stage 1	-	-	-	-	-	-	113	113	-	628	628	-
Stage 2	-	-	-	-	-	-	630	628	-	148	127	-
Critical Hdwy	4.12	-	-	4.12	-	-	7.12	6.52	6.22	7.12	6.52	6.22
Critical Hdwy Stg 1	-	-	-	-	-	-	6.12	5.52	-	6.12	5.52	-
Critical Hdwy Stg 2	-	-	-	-	-	-	6.12	5.52	-	6.12	5.52	-
Follow-up Hdwy	2.218	-	-	2.218	-	-	3.518	4.018	3.318	3.518	4.018	3.318
Pot Cap-1 Maneuver	1388	-	-	1469	-	-	331	344	949	315	338	856
Stage 1	-	-	-	-	-	-	892	802	-	471	476	-
Stage 2	-	-	-	-	-	-	470	476	-	855	791	-
Platoon blocked, %	-	-	-	-	-	-	-	-	-	-	-	-
Mov Cap-1 Maneuver	1388	-	-	1469	-	-	288	291	949	256	286	856
Mov Cap-2 Maneuver	-	-	-	-	-	-	288	291	-	256	286	-
Stage 1	-	-	-	-	-	-	889	800	-	470	405	-
Stage 2	-	-	-	-	-	-	394	405	-	789	789	-

Approach	EB			WB			NB			SB		
HCM Control Delay, s	0.2			4.3			10.3			17.8		
HCM LOS							B			C		

Minor Lane/Major Mvmt	NBLn1	NBLn2	EBL	EBT	EBR	WBL	WBT	WBR	SBLn1
Capacity (veh/h)	288	845	1388	-	-	1469	-	-	286
HCM Lane V/C Ratio	0.022	0.083	0.003	-	-	0.15	-	-	0.018
HCM Control Delay (s)	17.8	9.6	7.6	-	-	7.9	-	-	17.8
HCM Lane LOS	C	A	A	-	-	A	-	-	C
HCM 95th %tile Q(veh)	0.1	0.3	0	-	-	0.5	-	-	0.1

Intersection				
Intersection Delay, s/veh	3.3			
Intersection LOS	A			
Approach	EB	WB	NB	SB
Entry Lanes	1	1	1	1
Conflicting Circle Lanes	1	1	1	1
Adj Approach Flow, veh/h	79	0	125	18
Demand Flow Rate, veh/h	80	0	128	18
Vehicles Circulating, veh/h	14	132	4	101
Vehicles Exiting, veh/h	105	0	90	31
Ped Vol Crossing Leg, #/h	0	0	0	0
Ped Cap Adj	1.000	1.000	1.000	1.000
Approach Delay, s/veh	3.1	0.0	3.4	3.1
Approach LOS	A	-	A	A
Lane	Left	Left	Left	Left
Designated Moves	LTR	LTR	LTR	LTR
Assumed Moves	LTR	LTR	LTR	LTR
RT Channelized				
Lane Util	1.000	1.000	1.000	1.000
Follow-Up Headway, s	2.609	2.609	2.609	2.609
Critical Headway, s	4.976	4.976	4.976	4.976
Entry Flow, veh/h	80	0	128	18
Cap Entry Lane, veh/h	1360	1206	1374	1245
Entry HV Adj Factor	0.988	1.000	0.980	0.985
Flow Entry, veh/h	79	0	125	18
Cap Entry, veh/h	1343	1206	1347	1226
V/C Ratio	0.059	0.000	0.093	0.014
Control Delay, s/veh	3.1	3.0	3.4	3.1
LOS	A	A	A	A
95th %tile Queue, veh	0	0	0	0

Intersection			
Intersection Delay, s/veh	3.6		
Intersection LOS	A		
Approach	WB	NB	SB
Entry Lanes	1	1	1
Conflicting Circle Lanes	2	2	2
Adj Approach Flow, veh/h	64	203	93
Demand Flow Rate, veh/h	65	207	94
Vehicles Circulating, veh/h	118	22	53
Vehicles Exiting, veh/h	111	125	130
Ped Vol Crossing Leg, #/h	0	0	0
Ped Cap Adj	1.000	1.000	1.000
Approach Delay, s/veh	3.3	3.8	3.2
Approach LOS	A	A	A
Lane	Left	Left	Left
Designated Moves	LR	TR	LT
Assumed Moves	LR	TR	LT
RT Channelized			
Lane Util	1.000	1.000	1.000
Follow-Up Headway, s	2.535	2.535	2.535
Critical Headway, s	4.328	4.328	4.328
Entry Flow, veh/h	65	207	94
Cap Entry Lane, veh/h	1285	1394	1358
Entry HV Adj Factor	0.985	0.979	0.985
Flow Entry, veh/h	64	203	93
Cap Entry, veh/h	1265	1365	1337
V/C Ratio	0.051	0.149	0.069
Control Delay, s/veh	3.3	3.8	3.2
LOS	A	A	A
95th %tile Queue, veh	0	1	0



Intersection						
Int Delay, s/veh	1.5					
Movement	WBL	WBR	NBT	NBR	SBL	SBT
Lane Configurations	Y		↑	↑	↑	↑
Traffic Vol, veh/h	31	10	158	54	16	86
Future Vol, veh/h	31	10	158	54	16	86
Conflicting Peds, #/hr	0	0	0	0	0	0
Sign Control	Stop	Stop	Free	Free	Free	Free
RT Channelized	-	None	-	None	-	None
Storage Length	0	-	-	155	205	-
Veh in Median Storage, #	0	-	0	-	-	0
Grade, %	0	-	0	-	-	0
Peak Hour Factor	83	83	83	83	83	83
Heavy Vehicles, %	2	2	2	2	2	2
Mvmt Flow	37	12	190	65	19	104

Major/Minor	Minor1	Major1	Major2		
Conflicting Flow All	332	190	0	0	255
Stage 1	190	-	-	-	-
Stage 2	142	-	-	-	-
Critical Hdwy	6.42	6.22	-	-	4.12
Critical Hdwy Stg 1	5.42	-	-	-	-
Critical Hdwy Stg 2	5.42	-	-	-	-
Follow-up Hdwy	3.518	3.318	-	-	2.218
Pot Cap-1 Maneuver	663	852	-	-	1310
Stage 1	842	-	-	-	-
Stage 2	885	-	-	-	-
Platoon blocked, %			-	-	-
Mov Cap-1 Maneuver	653	852	-	-	1310
Mov Cap-2 Maneuver	689	-	-	-	-
Stage 1	842	-	-	-	-
Stage 2	872	-	-	-	-

Approach	WB	NB	SB
HCM Control Delay, s	10.3	0	1.2
HCM LOS	B		

Minor Lane/Major Mvmt	NBT	NBRWBLn1	SBL	SBT
Capacity (veh/h)	-	-	723	1310
HCM Lane V/C Ratio	-	-	0.068	0.015
HCM Control Delay (s)	-	-	10.3	7.8
HCM Lane LOS	-	-	B	A
HCM 95th %tile Q(veh)	-	-	0.2	0

Intersection						
Intersection Delay, s/veh	4.7					
Intersection LOS	A					
Approach	EB		NB		SB	
Entry Lanes	2		2		2	
Conflicting Circle Lanes	2		2		2	
Adj Approach Flow, veh/h	228		632		137	
Demand Flow Rate, veh/h	232		645		140	
Vehicles Circulating, veh/h	131		16		406	
Vehicles Exiting, veh/h	415		347		255	
Ped Vol Crossing Leg, #/h	0		0		0	
Ped Cap Adj	1.000		1.000		1.000	
Approach Delay, s/veh	4.2		4.9		4.4	
Approach LOS	A		A		A	
Lane	Left	Right	Left	Right	Left	Right
Designated Moves	L	TR	L	TR	LT	TR
Assumed Moves	L	TR	L	TR	LT	TR
RT Channelized						
Lane Util	0.069	0.931	0.629	0.371	0.471	0.529
Follow-Up Headway, s	2.667	2.535	2.667	2.535	2.667	2.535
Critical Headway, s	4.645	4.328	4.645	4.328	4.645	4.328
Entry Flow, veh/h	16	216	406	239	66	74
Cap Entry Lane, veh/h	1197	1270	1330	1401	929	1006
Entry HV Adj Factor	1.000	0.981	0.980	0.980	0.979	0.984
Flow Entry, veh/h	16	212	398	234	65	73
Cap Entry, veh/h	1197	1247	1304	1373	909	990
V/C Ratio	0.013	0.170	0.305	0.171	0.071	0.074
Control Delay, s/veh	3.1	4.3	5.5	4.0	4.6	4.3
LOS	A	A	A	A	A	A
95th %tile Queue, veh	0	1	1	1	0	0

Intersection						
Intersection Delay, s/veh	5.3					
Intersection LOS	A					
Approach	EB	WB	NB	SB		
Entry Lanes	1	1	1	1		
Conflicting Circle Lanes	1	1	1	1		
Adj Approach Flow, veh/h	242	484	352	315		
Demand Flow Rate, veh/h	247	493	359	322		
Vehicles Circulating, veh/h	307	397	343	291		
Vehicles Exiting, veh/h	267	305	210	332		
Ped Vol Crossing Leg, #/h	0	0	0	0		
Ped Cap Adj	1.000	1.000	1.000	1.000		
Approach Delay, s/veh	6.0	3.0	7.8	5.6		
Approach LOS	A	A	A	A		
Lane	Left	Left	Bypass	Left	Left	Bypass
Designated Moves	LTR	LT	R	LTR	LT	R
Assumed Moves	LTR	LT	R	LTR	LT	R
RT Channelized			Free			Free
Lane Util	1.000	1.000		1.000	1.000	
Follow-Up Headway, s	2.609	2.609		2.609	2.609	
Critical Headway, s	4.976	4.976	267	4.976	4.976	39
Entry Flow, veh/h	247	226	1938	359	283	1938
Cap Entry Lane, veh/h	1009	920	0.980	973	1026	0.980
Entry HV Adj Factor	0.982	0.982	262	0.980	0.980	38
Flow Entry, veh/h	242	222	1900	352	277	1900
Cap Entry, veh/h	990	904	0.138	953	1005	0.020
V/C Ratio	0.245	0.246	0.0	0.369	0.276	0.0
Control Delay, s/veh	6.0	6.5	A	7.8	6.3	A
LOS	A	A	0	A	A	0
95th %tile Queue, veh	1	1		2	1	

Timings  
14: US 24 & Stapleton Dr

2026 Background Traffic  
PM Peak Hour

Lane Group	EBL	EBT	EBR	WBL	WBT	WBR	NBL	NBT	NBR	SBL	SBT	SBR
Lane Configurations												
Traffic Volume (vph)	29	84	146	5	188	34	262	517	8	10	409	49
Future Volume (vph)	29	84	146	5	188	34	262	517	8	10	409	49
Turn Type	pm+pt	NA	Free	pm+pt	NA	Free	pm+pt	NA	Perm	pm+pt	NA	Perm
Protected Phases	5	2		1	6		3	8		7	4	
Permitted Phases	2		Free	6		Free	8		8	4		4
Detector Phase	5	2		1	6		3	8	8	7	4	4
Switch Phase												
Minimum Initial (s)	5.0	5.0		5.0	5.0		5.0	5.0	5.0	5.0	15.0	15.0
Minimum Split (s)	10.0	10.0		10.0	10.0		10.0	10.0	10.0	10.0	20.0	20.0
Total Split (s)	12.0	30.0		12.0	30.0		12.0	66.0	66.0	12.0	66.0	66.0
Total Split (%)	10.0%	25.0%		10.0%	25.0%		10.0%	55.0%	55.0%	10.0%	55.0%	55.0%
Yellow Time (s)	3.0	3.0		3.0	3.0		3.0	3.0	3.0	3.0	3.0	3.0
All-Red Time (s)	2.0	2.0		2.0	2.0		2.0	2.0	2.0	2.0	2.0	2.0
Lost Time Adjust (s)	0.0	0.0		0.0	0.0		0.0	0.0	0.0	0.0	0.0	0.0
Total Lost Time (s)	5.0	5.0		5.0	5.0		5.0	5.0	5.0	5.0	5.0	5.0
Lead/Lag	Lead	Lag		Lead	Lag		Lead	Lag	Lag	Lead	Lag	Lag
Lead-Lag Optimize?	Yes	Yes		Yes	Yes		Yes	Yes	Yes	Yes	Yes	Yes
Recall Mode	None	C-Max		None	C-Max		None	Max	Max	None	Max	Max
Act Effct Green (s)	36.1	34.7	120.0	33.5	29.8	120.0	72.1	70.7	70.7	66.8	61.0	61.0
Actuated g/C Ratio	0.30	0.29	1.00	0.28	0.25	1.00	0.60	0.59	0.59	0.56	0.51	0.51
v/c Ratio	0.14	0.19	0.11	0.02	0.49	0.03	0.66	0.55	0.01	0.03	0.50	0.07
Control Delay	25.0	28.0	0.1	29.2	44.6	0.0	20.7	18.1	0.0	10.1	22.1	0.1
Queue Delay	0.0	0.0	0.0	0.0	0.0	0.0	0.0	0.0	0.0	0.0	0.0	0.0
Total Delay	25.0	28.0	0.1	29.2	44.6	0.0	20.7	18.1	0.0	10.1	22.1	0.1
LOS	C	C	A	C	D	A	C	B	A	B	C	A
Approach Delay		12.0			37.6			18.8			19.6	
Approach LOS		B			D			B			B	

Intersection Summary

Cycle Length: 120  
 Actuated Cycle Length: 120  
 Offset: 0 (0%), Referenced to phase 2:EBTL and 6:WBTL, Start of Green  
 Natural Cycle: 60  
 Control Type: Actuated-Coordinated  
 Maximum v/c Ratio: 0.66  
 Intersection Signal Delay: 20.5  
 Intersection LOS: C  
 Intersection Capacity Utilization 66.8%  
 ICU Level of Service C  
 Analysis Period (min) 15

Splits and Phases: 14: US 24 & Stapleton Dr

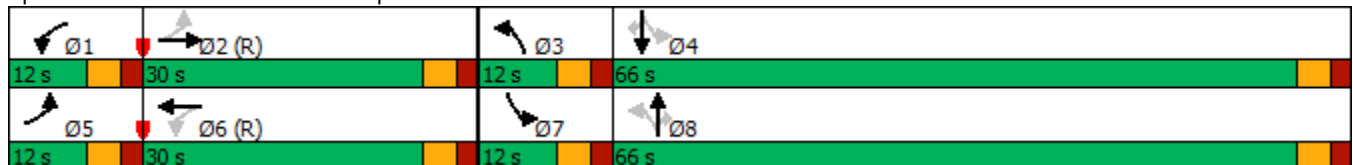

**Intersection**

Intersection Delay, s/veh 15.1  
 Intersection LOS C

Movement	EBL	EBT	EBR	WBL	WBT	WBR	NBL	NBT	NBR	SBL	SBT	SBR
Lane Configurations	↙	↘		↙	↘	↙	↙	↘		↙	↘	
Traffic Vol, veh/h	9	66	96	49	145	58	185	208	73	24	71	4
Future Vol, veh/h	9	66	96	49	145	58	185	208	73	24	71	4
Peak Hour Factor	0.83	0.83	0.83	0.88	0.88	0.88	0.87	0.87	0.87	0.78	0.78	0.78
Heavy Vehicles, %	2	2	2	2	2	2	2	2	2	2	2	2
Mvmt Flow	11	80	116	56	165	66	213	239	84	31	91	5
Number of Lanes	1	1	0	1	1	1	1	1	0	1	1	0

Approach	EB	WB	NB	SB
Opposing Approach	WB	EB	SB	NB
Opposing Lanes	3	2	2	2
Conflicting Approach Left SB		NB	EB	WB
Conflicting Lanes Left	2	2	2	3
Conflicting Approach Right NB		SB	WB	EB
Conflicting Lanes Right	2	2	3	2
HCM Control Delay	14.4	12.7	17.3	12.3
HCM LOS	B	B	C	B

Lane	NBLn1	NBLn2	EBLn1	EBLn2	WBLn1	WBLn2	WBLn3	SBLn1	SBLn2
Vol Left, %	100%	0%	100%	0%	100%	0%	0%	100%	0%
Vol Thru, %	0%	74%	0%	41%	0%	100%	0%	0%	95%
Vol Right, %	0%	26%	0%	59%	0%	0%	100%	0%	5%
Sign Control	Stop	Stop	Stop	Stop	Stop	Stop	Stop	Stop	Stop
Traffic Vol by Lane	185	281	9	162	49	145	58	24	75
LT Vol	185	0	9	0	49	0	0	24	0
Through Vol	0	208	0	66	0	145	0	0	71
RT Vol	0	73	0	96	0	0	58	0	4
Lane Flow Rate	213	323	11	195	56	165	66	31	96
Geometry Grp	6	6	6	6	6	6	6	6	6
Degree of Util (X)	0.43	0.592	0.025	0.393	0.123	0.341	0.123	0.071	0.207
Departure Headway (Hd)	7.288	6.598	8.179	7.241	7.966	7.455	6.741	8.303	7.755
Convergence, Y/N	Yes	Yes	Yes	Yes	Yes	Yes	Yes	Yes	Yes
Cap	495	546	438	498	450	483	532	431	462
Service Time	5.026	4.336	5.923	4.985	5.708	5.198	4.483	6.054	5.505
HCM Lane V/C Ratio	0.43	0.592	0.025	0.392	0.124	0.342	0.124	0.072	0.208
HCM Control Delay	15.4	18.5	11.1	14.6	11.8	14	10.4	11.7	12.5
HCM Lane LOS	C	C	B	B	B	B	B	B	B
HCM 95th-tile Q	2.1	3.8	0.1	1.9	0.4	1.5	0.4	0.2	0.8

Intersection												
Int Delay, s/veh	8.2											
Movement	EBL	EBT	EBR	WBL	WBT	WBR	NBL	NBT	NBR	SBL	SBT	SBR
Lane Configurations	↖	↗		↖	↗		↖	↗			↕	
Traffic Vol, veh/h	5	245	61	148	147	1	43	20	307	0	4	4
Future Vol, veh/h	5	245	61	148	147	1	43	20	307	0	4	4
Conflicting Peds, #/hr	0	0	0	0	0	0	0	0	0	0	0	0
Sign Control	Free	Free	Free	Free	Free	Free	Stop	Stop	Stop	Stop	Stop	Stop
RT Channelized	-	-	None	-	-	None	-	-	None	-	-	None
Storage Length	100	-	-	100	-	-	75	-	-	-	-	-
Veh in Median Storage, #	-	0	-	-	0	-	-	0	-	-	0	-
Grade, %	-	0	-	-	0	-	-	0	-	-	0	-
Peak Hour Factor	87	87	87	87	87	87	89	89	89	58	58	58
Heavy Vehicles, %	2	2	2	2	2	2	2	2	2	2	2	2
Mvmt Flow	6	282	70	170	169	1	48	22	345	0	7	7

Major/Minor	Major1			Major2			Minor1			Minor2		
Conflicting Flow All	170	0	0	352	0	0	846	839	317	1023	874	170
Stage 1	-	-	-	-	-	-	329	329	-	510	510	-
Stage 2	-	-	-	-	-	-	517	510	-	513	364	-
Critical Hdwy	4.12	-	-	4.12	-	-	7.12	6.52	6.22	7.12	6.52	6.22
Critical Hdwy Stg 1	-	-	-	-	-	-	6.12	5.52	-	6.12	5.52	-
Critical Hdwy Stg 2	-	-	-	-	-	-	6.12	5.52	-	6.12	5.52	-
Follow-up Hdwy	2.218	-	-	2.218	-	-	3.518	4.018	3.318	3.518	4.018	3.318
Pot Cap-1 Maneuver	1407	-	-	1207	-	-	282	302	724	214	288	874
Stage 1	-	-	-	-	-	-	684	646	-	546	538	-
Stage 2	-	-	-	-	-	-	541	538	-	544	624	-
Platoon blocked, %	-	-	-	-	-	-	-	-	-	-	-	-
Mov Cap-1 Maneuver	1407	-	-	1207	-	-	244	259	724	93	247	874
Mov Cap-2 Maneuver	-	-	-	-	-	-	244	259	-	93	247	-
Stage 1	-	-	-	-	-	-	681	643	-	544	462	-
Stage 2	-	-	-	-	-	-	454	462	-	274	622	-

Approach	EB			WB			NB			SB		
HCM Control Delay, s	0.1			4.2			18.1			14.7		
HCM LOS							C			B		

Minor Lane/Major Mvmt	NBLn1	NBLn2	EBL	EBT	EBR	WBL	WBT	WBR	SBLn1
Capacity (veh/h)	244	652	1407	-	-	1207	-	-	385
HCM Lane V/C Ratio	0.198	0.564	0.004	-	-	0.141	-	-	0.036
HCM Control Delay (s)	23.4	17.4	7.6	-	-	8.5	-	-	14.7
HCM Lane LOS	C	C	A	-	-	A	-	-	B
HCM 95th %tile Q(veh)	0.7	3.5	0	-	-	0.5	-	-	0.1

Intersection				
Intersection Delay, s/veh	4.4			
Intersection LOS	A			
Approach	EB	WB	NB	SB
Entry Lanes	1	1	1	1
Conflicting Circle Lanes	1	1	1	1
Adj Approach Flow, veh/h	315	46	179	33
Demand Flow Rate, veh/h	321	47	183	34
Vehicles Circulating, veh/h	47	152	20	173
Vehicles Exiting, veh/h	160	51	348	26
Ped Vol Crossing Leg, #/h	0	0	0	0
Ped Cap Adj	1.000	1.000	1.000	1.000
Approach Delay, s/veh	4.9	3.4	3.8	3.4
Approach LOS	A	A	A	A
Lane	Left	Left	Left	Left
Designated Moves	LTR	LTR	LTR	LTR
Assumed Moves	LTR	LTR	LTR	LTR
RT Channelized				
Lane Util	1.000	1.000	1.000	1.000
Follow-Up Headway, s	2.609	2.609	2.609	2.609
Critical Headway, s	4.976	4.976	4.976	4.976
Entry Flow, veh/h	321	47	183	34
Cap Entry Lane, veh/h	1315	1182	1352	1157
Entry HV Adj Factor	0.981	0.988	0.976	0.983
Flow Entry, veh/h	315	46	179	33
Cap Entry, veh/h	1290	1167	1320	1137
V/C Ratio	0.244	0.040	0.135	0.029
Control Delay, s/veh	4.9	3.4	3.8	3.4
LOS	A	A	A	A
95th %tile Queue, veh	1	0	0	0

Intersection						
Int Delay, s/veh	4.4					
Movement	EBT	EBR	WBL	WBT	NBL	NBR
Lane Configurations	↔		↔	↑	↔	↔
Traffic Vol, veh/h	0	45	0	0	43	0
Future Vol, veh/h	0	45	0	0	43	0
Conflicting Peds, #/hr	0	0	0	0	0	0
Sign Control	Free	Free	Free	Free	Stop	Stop
RT Channelized	-	None	-	None	-	None
Storage Length	-	-	155	-	205	0
Veh in Median Storage, #	0	-	-	0	0	-
Grade, %	0	-	-	0	0	-
Peak Hour Factor	92	92	92	92	92	92
Heavy Vehicles, %	2	2	2	2	2	2
Mvmt Flow	0	49	0	0	47	0

Major/Minor	Major1	Major2	Minor1			
Conflicting Flow All	0	0	49	0	26	25
Stage 1	-	-	-	-	25	-
Stage 2	-	-	-	-	1	-
Critical Hdwy	-	-	4.12	-	6.42	6.22
Critical Hdwy Stg 1	-	-	-	-	5.42	-
Critical Hdwy Stg 2	-	-	-	-	5.42	-
Follow-up Hdwy	-	-	2.218	-	3.518	3.318
Pot Cap-1 Maneuver	-	-	1558	-	989	1051
Stage 1	-	-	-	-	998	-
Stage 2	-	-	-	-	1022	-
Platoon blocked, %	-	-	-	-	-	-
Mov Cap-1 Maneuver	-	-	1558	-	989	1051
Mov Cap-2 Maneuver	-	-	-	-	909	-
Stage 1	-	-	-	-	998	-
Stage 2	-	-	-	-	1022	-

Approach	EB	WB	NB
HCM Control Delay, s	0	0	9.2
HCM LOS			A

Minor Lane/Major Mvmt	NBLn1	NBLn2	EBT	EBR	WBL	WBT
Capacity (veh/h)	909	-	-	-	1558	-
HCM Lane V/C Ratio	0.051	-	-	-	-	-
HCM Control Delay (s)	9.2	0	-	-	0	-
HCM Lane LOS	A	A	-	-	A	-
HCM 95th %tile Q(veh)	0.2	-	-	-	0	-



Intersection			
Intersection Delay, s/veh	0.0		
Intersection LOS	-		
Approach	EB	WB	NB
Entry Lanes	1	0	0
Conflicting Circle Lanes	1	1	1
Adj Approach Flow, veh/h	0	0	0
Demand Flow Rate, veh/h	0	0	0
Vehicles Circulating, veh/h	0	0	0
Vehicles Exiting, veh/h	0	0	0
Ped Vol Crossing Leg, #/h	0	0	0
Ped Cap Adj	1.000	1.000	1.000
Approach Delay, s/veh	0.0	0.0	0.0
Approach LOS	-	-	-
Lane	Left	Bypass	
Designated Moves	TR	R	
Assumed Moves	TR	R	
RT Channelized		Yield	
Lane Util	1.000		
Follow-Up Headway, s	2.609		
Critical Headway, s	4.976	0	
Entry Flow, veh/h	0	0	
Cap Entry Lane, veh/h	1380	0.980	
Entry HV Adj Factor	1.000	0	
Flow Entry, veh/h	0	0	
Cap Entry, veh/h	1380	0.000	
V/C Ratio	0.000	0.0	
Control Delay, s/veh	2.6	-	
LOS	A	0	
95th %tile Queue, veh	0		

Intersection			
Intersection Delay, s/veh	5.0		
Intersection LOS	A		
Approach	WB	NB	SB
Entry Lanes	1	1	1
Conflicting Circle Lanes	2	2	2
Adj Approach Flow, veh/h	239	226	344
Demand Flow Rate, veh/h	243	230	351
Vehicles Circulating, veh/h	161	8	220
Vehicles Exiting, veh/h	77	563	184
Ped Vol Crossing Leg, #/h	0	0	0
Ped Cap Adj	1.000	1.000	1.000
Approach Delay, s/veh	4.7	3.9	5.9
Approach LOS	A	A	A
Lane	Left	Left	Left
Designated Moves	LR	TR	LT
Assumed Moves	LR	TR	LT
RT Channelized			
Lane Util	1.000	1.000	1.000
Follow-Up Headway, s	2.535	2.535	2.535
Critical Headway, s	4.328	4.328	4.328
Entry Flow, veh/h	243	230	351
Cap Entry Lane, veh/h	1238	1410	1178
Entry HV Adj Factor	0.984	0.982	0.981
Flow Entry, veh/h	239	226	344
Cap Entry, veh/h	1218	1385	1155
V/C Ratio	0.196	0.163	0.298
Control Delay, s/veh	4.7	3.9	5.9
LOS	A	A	A
95th %tile Queue, veh	1	1	1

Intersection						
Int Delay, s/veh	1.1					
Movement	WBL	WBR	NBT	NBR	SBL	SBT
Lane Configurations	Y		↑	↑	↑	↑
Traffic Vol, veh/h	50	13	195	17	4	504
Future Vol, veh/h	50	13	195	17	4	504
Conflicting Peds, #/hr	0	0	0	0	0	0
Sign Control	Stop	Stop	Free	Free	Free	Free
RT Channelized	-	None	-	None	-	None
Storage Length	0	-	-	155	205	-
Veh in Median Storage, #	0	-	0	-	-	0
Grade, %	0	-	0	-	-	0
Peak Hour Factor	92	92	92	92	92	92
Heavy Vehicles, %	2	2	2	2	2	2
Mvmt Flow	54	14	212	18	4	548

Major/Minor	Minor1	Major1	Major2		
Conflicting Flow All	768	212	0	0	230
Stage 1	212	-	-	-	-
Stage 2	556	-	-	-	-
Critical Hdwy	6.42	6.22	-	-	4.12
Critical Hdwy Stg 1	5.42	-	-	-	-
Critical Hdwy Stg 2	5.42	-	-	-	-
Follow-up Hdwy	3.518	3.318	-	-	2.218
Pot Cap-1 Maneuver	370	828	-	-	1338
Stage 1	823	-	-	-	-
Stage 2	574	-	-	-	-
Platoon blocked, %			-	-	-
Mov Cap-1 Maneuver	369	828	-	-	1338
Mov Cap-2 Maneuver	465	-	-	-	-
Stage 1	823	-	-	-	-
Stage 2	572	-	-	-	-

Approach	WB	NB	SB
HCM Control Delay, s	13.1	0	0.1
HCM LOS	B		

Minor Lane/Major Mvmt	NBT	NBRWBLn1	SBL	SBT
Capacity (veh/h)	-	-	511	1338
HCM Lane V/C Ratio	-	-	0.134	0.003
HCM Control Delay (s)	-	-	13.1	7.7
HCM Lane LOS	-	-	B	A
HCM 95th %tile Q(veh)	-	-	0.5	0

Intersection						
Intersection Delay, s/veh	6.4					
Intersection LOS	A					
Approach	EB		NB		SB	
Entry Lanes	2		2		2	
Conflicting Circle Lanes	2		2		2	
Adj Approach Flow, veh/h	347		566		603	
Demand Flow Rate, veh/h	354		577		615	
Vehicles Circulating, veh/h	557		31		373	
Vehicles Exiting, veh/h	431		880		235	
Ped Vol Crossing Leg, #/h	0		0		0	
Ped Cap Adj	1.000		1.000		1.000	
Approach Delay, s/veh	8.0		4.8		6.9	
Approach LOS	A		A		A	
Lane	Left	Right	Left	Right	Left	Right
Designated Moves	L	TR	L	TR	LT	TR
Assumed Moves	L	TR	L	TR	LT	TR
RT Channelized						
Lane Util	0.088	0.912	0.646	0.354	0.470	0.530
Follow-Up Headway, s	2.667	2.535	2.667	2.535	2.667	2.535
Critical Headway, s	4.645	4.328	4.645	4.328	4.645	4.328
Entry Flow, veh/h	31	323	373	204	289	326
Cap Entry Lane, veh/h	809	884	1312	1383	958	1034
Entry HV Adj Factor	0.968	0.981	0.981	0.980	0.981	0.980
Flow Entry, veh/h	30	317	366	200	283	320
Cap Entry, veh/h	783	868	1287	1356	939	1014
V/C Ratio	0.038	0.365	0.284	0.147	0.302	0.315
Control Delay, s/veh	5.0	8.3	5.3	3.9	7.0	6.8
LOS	A	A	A	A	A	A
95th %tile Queue, veh	0	2	1	1	1	1

Intersection									
Intersection Delay, s/veh 9.5									
Intersection LOS A									
Approach	EB		WB		NB		SB		
Entry Lanes	2		2		1		1		
Conflicting Circle Lanes	2		2		2		2		
Adj Approach Flow, veh/h	395		418		435		863		
Demand Flow Rate, veh/h	403		427		445		880		
Vehicles Circulating, veh/h	770		472		651		322		
Vehicles Exiting, veh/h	293		624		522		343		
Ped Vol Crossing Leg, #/h	0		0		0		0		
Ped Cap Adj	1.000		1.000		1.000		1.000		
Approach Delay, s/veh	8.8		2.3		12.5		11.7		
Approach LOS	A		A		B		B		
Lane	Left	Right	Left	Right	Bypass	Left	Left	Bypass	
Designated Moves	LT	TR	LT	TR	R	LTR	LT	R	
Assumed Moves	LT	TR	LT	TR	R	LTR	LT	R	
RT Channelized					Free			Free	
Lane Util	0.469	0.531	0.472	0.528	1.000		1.000		
Follow-Up Headway, s	2.667	2.535	2.667	2.535	2.535		2.535		
Critical Headway, s	4.645	4.328	4.645	4.328	234	4.328	4.328	139	
Entry Flow, veh/h	189	214	91	102	1938	445	741	1938	
Cap Entry Lane, veh/h	665	738	874	951	0.980	817	1080	0.980	
Entry HV Adj Factor	0.982	0.978	0.975	0.981	229	0.978	0.981	136	
Flow Entry, veh/h	186	209	89	100	1900	435	727	1900	
Cap Entry, veh/h	653	722	853	933	0.121	799	1059	0.072	
V/C Ratio	0.284	0.290	0.104	0.107	0.0	0.545	0.686	0.0	
Control Delay, s/veh	9.1	8.5	5.2	4.9	A	12.5	13.9	A	
LOS	A	A	A	A	0	B	B	0	
95th %tile Queue, veh	1	1	0	0		3	6		

Timings  
14: US 24 & Stapleton Dr

2033 Background Traffic  
AM Peak Hour

Lane Group	EBL	EBT	EBR	WBL	WBT	WBR	NBL	NBT	NBR	SBL	SBT	SBR
Lane Configurations												
Traffic Volume (vph)	73	295	379	4	137	17	165	322	5	45	540	53
Future Volume (vph)	73	295	379	4	137	17	165	322	5	45	540	53
Turn Type	pm+pt	NA	Free	pm+pt	NA	Free	Prot	NA	Perm	pm+pt	NA	Perm
Protected Phases	5	2		1	6		3	8		7	4	
Permitted Phases	2		Free	6		Free			8	4		4
Detector Phase	5	2		1	6		3	8	8	7	4	4
Switch Phase												
Minimum Initial (s)	5.0	10.0		5.0	5.0		15.0	5.0	5.0	5.0	15.0	15.0
Minimum Split (s)	10.0	15.0		10.0	10.0		20.0	10.0	10.0	10.0	20.0	20.0
Total Split (s)	10.0	37.0		10.0	37.0		20.0	63.0	63.0	10.0	53.0	53.0
Total Split (%)	8.3%	30.8%		8.3%	30.8%		16.7%	52.5%	52.5%	8.3%	44.2%	44.2%
Yellow Time (s)	3.0	3.0		3.0	3.0		3.0	3.0	3.0	3.0	3.0	3.0
All-Red Time (s)	2.0	2.0		2.0	2.0		2.0	2.0	2.0	2.0	2.0	2.0
Lost Time Adjust (s)	0.0	0.0		0.0	0.0		0.0	0.0	0.0	0.0	0.0	0.0
Total Lost Time (s)	5.0	5.0		5.0	5.0		5.0	5.0	5.0	5.0	5.0	5.0
Lead/Lag	Lead	Lag		Lead	Lag		Lead	Lag	Lag	Lead	Lag	Lag
Lead-Lag Optimize?	Yes	Yes		Yes	Yes		Yes	Yes	Yes	Yes	Yes	Yes
Recall Mode	None	C-Max		None	C-Max		None	Max	Max	None	Max	Max
Act Effct Green (s)	41.0	40.0	120.0	38.0	34.0	120.0	15.0	60.0	60.0	53.0	48.0	48.0
Actuated g/C Ratio	0.34	0.33	1.00	0.32	0.28	1.00	0.12	0.50	0.50	0.44	0.40	0.40
v/c Ratio	0.21	0.52	0.26	0.01	0.28	0.01	0.42	0.38	0.01	0.10	0.79	0.08
Control Delay	20.5	26.9	0.3	25.8	36.3	0.0	51.8	20.6	0.0	13.3	37.9	0.2
Queue Delay	0.0	0.0	0.0	0.0	0.0	0.0	0.0	0.0	0.0	0.0	0.0	0.0
Total Delay	20.5	26.9	0.3	25.8	36.3	0.0	51.8	20.6	0.0	13.3	37.9	0.2
LOS	C	C	A	C	D	A	D	C	A	B	D	A
Approach Delay		12.8			32.2			30.8			33.0	
Approach LOS		B			C			C			C	

Intersection Summary

Cycle Length: 120  
 Actuated Cycle Length: 120  
 Offset: 0 (0%), Referenced to phase 2:EBTL and 6:WBTL, Start of Green  
 Natural Cycle: 90  
 Control Type: Actuated-Coordinated  
 Maximum v/c Ratio: 0.79  
 Intersection Signal Delay: 25.0  
 Intersection LOS: C  
 Intersection Capacity Utilization 77.3%  
 ICU Level of Service D  
 Analysis Period (min) 15

Splits and Phases: 14: US 24 & Stapleton Dr

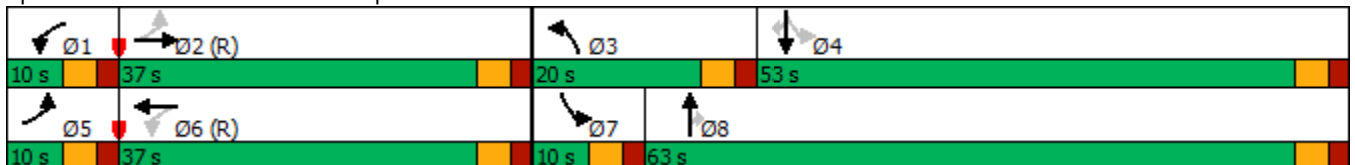

Intersection												
Intersection Delay, s/veh	18.8											
Intersection LOS	C											

Movement	EBL	EBT	EBR	WBL	WBT	WBR	NBL	NBT	NBR	SBL	SBT	SBR
Lane Configurations												
Traffic Vol, veh/h	103	160	101	34	42	87	20	221	36	83	244	17
Future Vol, veh/h	103	160	101	34	42	87	20	221	36	83	244	17
Peak Hour Factor	0.92	0.92	0.92	0.92	0.92	0.92	0.92	0.92	0.92	0.92	0.92	0.92
Heavy Vehicles, %	2	2	2	2	2	2	2	2	2	2	2	2
Mvmt Flow	112	174	110	37	46	95	22	240	39	90	265	18
Number of Lanes	1	1	0	1	1	1	1	1	0	1	1	0

Approach	EB	WB	NB	SB
Opposing Approach	WB	EB	SB	NB
Opposing Lanes	3	2	2	2
Conflicting Approach Left SB		NB	EB	WB
Conflicting Lanes Left	2	2	2	3
Conflicting Approach Right NB		SB	WB	EB
Conflicting Lanes Right	2	2	3	2
HCM Control Delay	18.9	12.5	21.3	19.7
HCM LOS	C	B	C	C

Lane	NBLn1	NBLn2	EBLn1	EBLn2	WBLn1	WBLn2	WBLn3	SBLn1	SBLn2
Vol Left, %	100%	0%	100%	0%	100%	0%	0%	100%	0%
Vol Thru, %	0%	86%	0%	61%	0%	100%	0%	0%	93%
Vol Right, %	0%	14%	0%	39%	0%	0%	100%	0%	7%
Sign Control	Stop	Stop	Stop	Stop	Stop	Stop	Stop	Stop	Stop
Traffic Vol by Lane	20	257	103	261	34	42	87	83	261
LT Vol	20	0	103	0	34	0	0	83	0
Through Vol	0	221	0	160	0	42	0	0	244
RT Vol	0	36	0	101	0	0	87	0	17
Lane Flow Rate	22	279	112	284	37	46	95	90	284
Geometry Grp	6	6	6	6	6	6	6	6	6
Degree of Util (X)	0.051	0.606	0.259	0.594	0.092	0.108	0.204	0.207	0.607
Departure Headway (Hd)	8.427	7.816	8.327	7.534	9.01	8.494	7.771	8.254	7.697
Convergence, Y/N	Yes	Yes	Yes	Yes	Yes	Yes	Yes	Yes	Yes
Cap	423	461	430	477	396	420	459	433	468
Service Time	6.211	5.6	6.106	5.313	6.808	6.291	5.568	6.034	5.477
HCM Lane V/C Ratio	0.052	0.605	0.26	0.595	0.093	0.11	0.207	0.208	0.607
HCM Control Delay	11.7	22	14	20.8	12.7	12.3	12.6	13.2	21.8
HCM Lane LOS	B	C	B	C	B	B	B	B	C
HCM 95th-tile Q	0.2	3.9	1	3.8	0.3	0.4	0.8	0.8	3.9

Intersection												
Int Delay, s/veh	4.3											
Movement	EBL	EBT	EBR	WBL	WBT	WBR	NBL	NBT	NBR	SBL	SBT	SBR
Lane Configurations	↖	↗		↖	↗		↖	↗			↕	
Traffic Vol, veh/h	3	77	23	215	196	1	5	4	54	0	6	0
Future Vol, veh/h	3	77	23	215	196	1	5	4	54	0	6	0
Conflicting Peds, #/hr	0	0	0	0	0	0	0	0	0	0	0	0
Sign Control	Free	Free	Free	Free	Free	Free	Stop	Stop	Stop	Stop	Stop	Stop
RT Channelized	-	-	None	-	-	None	-	-	None	-	-	None
Storage Length	0	-	-	110	-	-	0	-	-	-	-	-
Veh in Median Storage, #	-	0	-	-	0	-	-	0	-	-	0	-
Grade, %	-	0	-	-	0	-	-	0	-	-	0	-
Peak Hour Factor	92	92	92	92	92	92	92	92	92	92	92	92
Heavy Vehicles, %	2	2	2	2	2	2	2	2	2	2	2	2
Mvmt Flow	3	84	25	234	213	1	5	4	59	0	7	0

Major/Minor	Major1			Major2			Minor1			Minor2		
Conflicting Flow All	214	0	0	109	0	0	788	785	97	816	797	214
Stage 1	-	-	-	-	-	-	103	103	-	682	682	-
Stage 2	-	-	-	-	-	-	685	682	-	134	115	-
Critical Hdwy	4.12	-	-	4.12	-	-	7.12	6.52	6.22	7.12	6.52	6.22
Critical Hdwy Stg 1	-	-	-	-	-	-	6.12	5.52	-	6.12	5.52	-
Critical Hdwy Stg 2	-	-	-	-	-	-	6.12	5.52	-	6.12	5.52	-
Follow-up Hdwy	2.218	-	-	2.218	-	-	3.518	4.018	3.318	3.518	4.018	3.318
Pot Cap-1 Maneuver	1356	-	-	1481	-	-	309	325	959	296	319	826
Stage 1	-	-	-	-	-	-	903	810	-	440	450	-
Stage 2	-	-	-	-	-	-	438	450	-	869	800	-
Platoon blocked, %	-	-	-	-	-	-	-	-	-	-	-	-
Mov Cap-1 Maneuver	1356	-	-	1481	-	-	266	273	959	241	268	826
Mov Cap-2 Maneuver	-	-	-	-	-	-	266	273	-	241	268	-
Stage 1	-	-	-	-	-	-	901	808	-	439	379	-
Stage 2	-	-	-	-	-	-	362	379	-	810	798	-

Approach	EB			WB			NB			SB		
HCM Control Delay, s	0.2			4.1			10.5			18.8		
HCM LOS							B			C		

Minor Lane/Major Mvmt	NBLn1	NBLn2	EBL	EBT	EBR	WBL	WBT	WBR	SBLn1
Capacity (veh/h)	266	817	1356	-	-	1481	-	-	268
HCM Lane V/C Ratio	0.02	0.077	0.002	-	-	0.158	-	-	0.024
HCM Control Delay (s)	18.8	9.8	7.7	-	-	7.9	-	-	18.8
HCM Lane LOS	C	A	A	-	-	A	-	-	C
HCM 95th %tile Q(veh)	0.1	0.2	0	-	-	0.6	-	-	0.1



Intersection				
Intersection Delay, s/veh	5.2			
Intersection LOS	A			
Approach	EB	WB	NB	SB
Entry Lanes	1	1	1	1
Conflicting Circle Lanes	1	1	1	1
Adj Approach Flow, veh/h	265	47	415	37
Demand Flow Rate, veh/h	270	47	424	37
Vehicles Circulating, veh/h	49	398	48	392
Vehicles Exiting, veh/h	380	74	271	53
Ped Vol Crossing Leg, #/h	0	0	0	0
Ped Cap Adj	1.000	1.000	1.000	1.000
Approach Delay, s/veh	4.5	4.4	5.7	4.3
Approach LOS	A	A	A	A
Lane	Left	Left	Left	Left
Designated Moves	LTR	LTR	LTR	LTR
Assumed Moves	LTR	LTR	LTR	LTR
RT Channelized				
Lane Util	1.000	1.000	1.000	1.000
Follow-Up Headway, s	2.609	2.609	2.609	2.609
Critical Headway, s	4.976	4.976	4.976	4.976
Entry Flow, veh/h	270	47	424	37
Cap Entry Lane, veh/h	1313	919	1314	925
Entry HV Adj Factor	0.983	0.991	0.979	0.988
Flow Entry, veh/h	265	47	415	37
Cap Entry, veh/h	1290	911	1287	914
V/C Ratio	0.206	0.051	0.323	0.040
Control Delay, s/veh	4.5	4.4	5.7	4.3
LOS	A	A	A	A
95th %tile Queue, veh	1	0	1	0

Intersection						
Int Delay, s/veh	3.5					
Movement	EBT	EBR	WBL	WBT	NBL	NBR
Lane Configurations						
Traffic Vol, veh/h	0	66	0	0	42	0
Future Vol, veh/h	0	66	0	0	42	0
Conflicting Peds, #/hr	0	0	0	0	0	0
Sign Control	Free	Free	Free	Free	Stop	Stop
RT Channelized	-	None	-	None	-	None
Storage Length	-	-	155	-	205	0
Veh in Median Storage, #	0	-	-	0	0	-
Grade, %	0	-	-	0	0	-
Peak Hour Factor	92	92	92	92	92	92
Heavy Vehicles, %	2	2	2	2	2	2
Mvmt Flow	0	72	0	0	46	0

Major/Minor	Major1	Major2	Minor1		
Conflicting Flow All	0	0	72	0	37 36
Stage 1	-	-	-	-	36 -
Stage 2	-	-	-	-	1 -
Critical Hdwy	-	-	4.12	-	6.42 6.22
Critical Hdwy Stg 1	-	-	-	-	5.42 -
Critical Hdwy Stg 2	-	-	-	-	5.42 -
Follow-up Hdwy	-	-	2.218	-	3.518 3.318
Pot Cap-1 Maneuver	-	-	1528	-	975 1037
Stage 1	-	-	-	-	986 -
Stage 2	-	-	-	-	1022 -
Platoon blocked, %	-	-	-	-	-
Mov Cap-1 Maneuver	-	-	1528	-	975 1037
Mov Cap-2 Maneuver	-	-	-	-	898 -
Stage 1	-	-	-	-	986 -
Stage 2	-	-	-	-	1022 -

Approach	EB	WB	NB
HCM Control Delay, s	0	0	9.2
HCM LOS			A

Minor Lane/Major Mvmt	NBLn1	NBLn2	EBT	EBR	WBL	WBT
Capacity (veh/h)	898	-	-	-	1528	-
HCM Lane V/C Ratio	0.051	-	-	-	-	-
HCM Control Delay (s)	9.2	0	-	-	0	-
HCM Lane LOS	A	A	-	-	A	-
HCM 95th %tile Q(veh)	0.2	-	-	-	0	-

Intersection			
Intersection Delay, s/veh	0.0		
Intersection LOS	-		
Approach	EB	WB	NB
Entry Lanes	1	0	0
Conflicting Circle Lanes	1	1	1
Adj Approach Flow, veh/h	0	0	0
Demand Flow Rate, veh/h	0	0	0
Vehicles Circulating, veh/h	0	0	0
Vehicles Exiting, veh/h	0	0	0
Ped Vol Crossing Leg, #/h	0	0	0
Ped Cap Adj	1.000	1.000	1.000
Approach Delay, s/veh	0.0	0.0	0.0
Approach LOS	-	-	-
Lane	Left	Bypass	
Designated Moves	TR	R	
Assumed Moves	TR	R	
RT Channelized		Yield	
Lane Util	1.000		
Follow-Up Headway, s	2.609		
Critical Headway, s	4.976	0	
Entry Flow, veh/h	0	0	
Cap Entry Lane, veh/h	1380	0.980	
Entry HV Adj Factor	1.000	0	
Flow Entry, veh/h	0	0	
Cap Entry, veh/h	1380	0.000	
V/C Ratio	0.000	0.0	
Control Delay, s/veh	2.6	-	
LOS	A	0	
95th %tile Queue, veh	0		

Intersection			
Intersection Delay, s/veh	6.4		
Intersection LOS	A		
Approach	WB	NB	SB
Entry Lanes	1	1	1
Conflicting Circle Lanes	2	2	2
Adj Approach Flow, veh/h	168	641	266
Demand Flow Rate, veh/h	171	654	272
Vehicles Circulating, veh/h	422	25	156
Vehicles Exiting, veh/h	257	402	437
Ped Vol Crossing Leg, #/h	0	0	0
Ped Cap Adj	1.000	1.000	1.000
Approach Delay, s/veh	5.3	7.3	4.9
Approach LOS	A	A	A
Lane	Left	Left	Left
Designated Moves	LR	TR	LT
Assumed Moves	LR	TR	LT
RT Channelized			
Lane Util	1.000	1.000	1.000
Follow-Up Headway, s	2.535	2.535	2.535
Critical Headway, s	4.328	4.328	4.328
Entry Flow, veh/h	171	654	272
Cap Entry Lane, veh/h	992	1390	1244
Entry HV Adj Factor	0.982	0.980	0.979
Flow Entry, veh/h	168	641	266
Cap Entry, veh/h	975	1362	1217
V/C Ratio	0.172	0.470	0.219
Control Delay, s/veh	5.3	7.3	4.9
LOS	A	A	A
95th %tile Queue, veh	1	3	1

Intersection						
Int Delay, s/veh	0.7					
Movement	WBL	WBR	NBT	NBR	SBL	SBT
Lane Configurations	Y		↑	↑	↑	↑
Traffic Vol, veh/h	31	10	580	54	16	347
Future Vol, veh/h	31	10	580	54	16	347
Conflicting Peds, #/hr	0	0	0	0	0	0
Sign Control	Stop	Stop	Free	Free	Free	Free
RT Channelized	-	None	-	None	-	None
Storage Length	0	-	-	155	205	-
Veh in Median Storage, #	0	-	0	-	-	0
Grade, %	0	-	0	-	-	0
Peak Hour Factor	92	92	92	92	92	92
Heavy Vehicles, %	2	2	2	2	2	2
Mvmt Flow	34	11	630	59	17	377

Major/Minor	Minor1	Major1	Major2		
Conflicting Flow All	1041	630	0	0	689
Stage 1	630	-	-	-	-
Stage 2	411	-	-	-	-
Critical Hdwy	6.42	6.22	-	-	4.12
Critical Hdwy Stg 1	5.42	-	-	-	-
Critical Hdwy Stg 2	5.42	-	-	-	-
Follow-up Hdwy	3.518	3.318	-	-	2.218
Pot Cap-1 Maneuver	255	482	-	-	905
Stage 1	531	-	-	-	-
Stage 2	669	-	-	-	-
Platoon blocked, %			-	-	-
Mov Cap-1 Maneuver	250	482	-	-	905
Mov Cap-2 Maneuver	380	-	-	-	-
Stage 1	531	-	-	-	-
Stage 2	656	-	-	-	-

Approach	WB	NB	SB
HCM Control Delay, s	15.1	0	0.4
HCM LOS	C		

Minor Lane/Major Mvmt	NBT	NBRWBLn1	SBL	SBT
Capacity (veh/h)	-	-	401	905
HCM Lane V/C Ratio	-	-	0.111	0.019
HCM Control Delay (s)	-	-	15.1	9.1
HCM Lane LOS	-	-	C	A
HCM 95th %tile Q(veh)	-	-	0.4	0.1

Intersection						
Intersection Delay, s/veh	6.3					
Intersection LOS	A					
Approach	EB		NB		SB	
Entry Lanes	2		2		2	
Conflicting Circle Lanes	2		2		2	
Adj Approach Flow, veh/h	260		1000		412	
Demand Flow Rate, veh/h	265		1020		420	
Vehicles Circulating, veh/h	381		62		379	
Vehicles Exiting, veh/h	418		584		703	
Ped Vol Crossing Leg, #/h	0		0		0	
Ped Cap Adj	1.000		1.000		1.000	
Approach Delay, s/veh	5.2		6.8		5.8	
Approach LOS	A		A		A	
Lane	Left	Right	Left	Right	Left	Right
Designated Moves	L	TR	L	TR	LT	TR
Assumed Moves	L	TR	L	TR	LT	TR
RT Channelized						
Lane Util	0.234	0.766	0.372	0.628	0.469	0.531
Follow-Up Headway, s	2.667	2.535	2.667	2.535	2.667	2.535
Critical Headway, s	4.645	4.328	4.645	4.328	4.645	4.328
Entry Flow, veh/h	62	203	379	641	197	223
Cap Entry Lane, veh/h	951	1027	1275	1347	953	1029
Entry HV Adj Factor	0.984	0.980	0.982	0.980	0.982	0.978
Flow Entry, veh/h	61	199	372	628	193	218
Cap Entry, veh/h	935	1007	1251	1321	935	1006
V/C Ratio	0.065	0.198	0.297	0.476	0.207	0.217
Control Delay, s/veh	4.4	5.4	5.6	7.6	5.9	5.6
LOS	A	A	A	A	A	A
95th %tile Queue, veh	0	1	1	3	1	1

Intersection									
Intersection Delay, s/veh	7.4								
Intersection LOS	A								
Approach	EB		WB			NB		SB	
Entry Lanes	2		2			1		1	
Conflicting Circle Lanes	2		2			2		2	
Adj Approach Flow, veh/h	356		746			533		573	
Demand Flow Rate, veh/h	363		761			544		585	
Vehicles Circulating, veh/h	521		651			568		393	
Vehicles Exiting, veh/h	368		461			316		554	
Ped Vol Crossing Leg, #/h	0		0			0		0	
Ped Cap Adj	1.000		1.000			1.000		1.000	
Approach Delay, s/veh	6.3		2.6			13.9		8.0	
Approach LOS	A		A			B		A	
Lane	Left	Right	Left	Right	Bypass	Left	Left	Bypass	
Designated Moves	LT	TR	LT	TR	R	LTR	LT	R	
Assumed Moves	LT	TR	LT	TR	R	LTR	LT	R	
RT Channelized			Free					Free	
Lane Util	0.471	0.529	0.471	0.529	1.000	1.000	1.000		
Follow-Up Headway, s	2.667	2.535	2.667	2.535	2.535	2.535	2.535		
Critical Headway, s	4.645	4.328	4.645	4.328	464	4.328	4.328	89	
Entry Flow, veh/h	171	192	140	157	1938	544	496	1938	
Cap Entry Lane, veh/h	836	912	742	817	0.980	876	1017	0.980	
Entry HV Adj Factor	0.978	0.982	0.976	0.981	455	0.980	0.981	87	
Flow Entry, veh/h	167	189	137	154	1900	533	486	1900	
Cap Entry, veh/h	818	896	724	801	0.239	859	997	0.046	
V/C Ratio	0.205	0.211	0.189	0.192	0.0	0.621	0.488	0.0	
Control Delay, s/veh	6.6	6.1	7.1	6.5	A	13.9	9.4	A	
LOS	A	A	A	A	1	B	A	0	
95th %tile Queue, veh	1	1	1	1		4	3		

Timings  
14: US 24 & Stapleton Dr

2033 Background Traffic  
PM Peak Hour

	↖	→	↘	↙	←	↖	↙	↑	↘	↘	↓	↙
Lane Group	EBL	EBT	EBR	WBL	WBT	WBR	NBL	NBT	NBR	SBL	SBT	SBR
Lane Configurations	↖	↑	↖	↖	↑	↖	↖	↑	↖	↖	↑	↖
Traffic Volume (vph)	45	139	222	5	280	34	388	594	8	10	469	74
Future Volume (vph)	45	139	222	5	280	34	388	594	8	10	469	74
Turn Type	pm+pt	NA	Free	pm+pt	NA	Free	Prot	NA	Perm	pm+pt	NA	Perm
Protected Phases	5	2		1	6		3	8		7	4	
Permitted Phases	2		Free	6		Free			8	4		4
Detector Phase	5	2		1	6		3	8	8	7	4	4
Switch Phase												
Minimum Initial (s)	5.0	5.0		5.0	5.0		20.0	5.0	5.0	5.0	16.0	16.0
Minimum Split (s)	10.0	10.0		10.0	10.0		25.0	10.0	10.0	10.0	21.0	21.0
Total Split (s)	12.0	34.0		12.0	34.0		33.0	62.0	62.0	12.0	41.0	41.0
Total Split (%)	10.0%	28.3%		10.0%	28.3%		27.5%	51.7%	51.7%	10.0%	34.2%	34.2%
Yellow Time (s)	3.0	3.0		3.0	3.0		3.0	3.0	3.0	3.0	3.0	3.0
All-Red Time (s)	2.0	2.0		2.0	2.0		2.0	2.0	2.0	2.0	2.0	2.0
Lost Time Adjust (s)	0.0	0.0		0.0	0.0		0.0	0.0	0.0	0.0	0.0	0.0
Total Lost Time (s)	5.0	5.0		5.0	5.0		5.0	5.0	5.0	5.0	5.0	5.0
Lead/Lag	Lead	Lag		Lead	Lag		Lead	Lag	Lag	Lead	Lag	Lag
Lead-Lag Optimize?	Yes	Yes		Yes	Yes		Yes	Yes	Yes	Yes	Yes	Yes
Recall Mode	None	C-Max		None	C-Max		None	Max	Max	None	Max	Max
Act Effct Green (s)	40.1	38.7	120.0	36.1	31.4	120.0	21.4	66.7	66.7	48.5	42.6	42.6
Actuated g/C Ratio	0.33	0.32	1.00	0.30	0.26	1.00	0.18	0.56	0.56	0.40	0.36	0.36
v/c Ratio	0.22	0.25	0.15	0.01	0.62	0.02	0.69	0.62	0.01	0.03	0.77	0.12
Control Delay	24.6	27.1	0.2	26.4	46.7	0.0	52.5	22.4	0.0	13.5	41.4	0.4
Queue Delay	0.0	0.0	0.0	0.0	0.0	0.0	0.0	0.0	0.0	0.0	0.0	0.0
Total Delay	24.6	27.1	0.2	26.4	46.7	0.0	52.5	22.4	0.0	13.5	41.4	0.4
LOS	C	C	A	C	D	A	D	C	A	B	D	A
Approach Delay		12.1			41.4			34.0			35.4	
Approach LOS		B			D			C			D	

**Intersection Summary**

Cycle Length: 120  
 Actuated Cycle Length: 120  
 Offset: 0 (0%), Referenced to phase 2:EBTL and 6:WBTL, Start of Green  
 Natural Cycle: 90  
 Control Type: Actuated-Coordinated  
 Maximum v/c Ratio: 0.77  
 Intersection Signal Delay: 31.5  
 Intersection LOS: C  
 Intersection Capacity Utilization 76.9%  
 ICU Level of Service D  
 Analysis Period (min) 15

Splits and Phases: 14: US 24 & Stapleton Dr

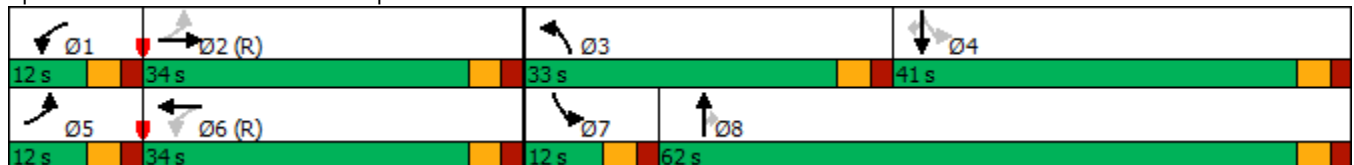



**Intersection**

Intersection Delay, s/veh 15.1  
 Intersection LOS C

Movement	EBL	EBT	EBR	WBL	WBT	WBR	NBL	NBT	NBR	SBL	SBT	SBR
Lane Configurations												
Traffic Vol, veh/h	12	66	96	49	145	64	185	236	73	31	88	7
Future Vol, veh/h	12	66	96	49	145	64	185	236	73	31	88	7
Peak Hour Factor	0.92	0.92	0.92	0.92	0.92	0.92	0.92	0.92	0.92	0.92	0.92	0.92
Heavy Vehicles, %	2	2	2	2	2	2	2	2	2	2	2	2
Mvmt Flow	13	72	104	53	158	70	201	257	79	34	96	8
Number of Lanes	1	1	0	1	1	1	1	1	0	1	1	0

Approach	EB	WB	NB	SB
Opposing Approach	WB	EB	SB	NB
Opposing Lanes	3	2	2	2
Conflicting Approach Left SB		NB	EB	WB
Conflicting Lanes Left	2	2	2	3
Conflicting Approach Right NB		SB	WB	EB
Conflicting Lanes Right	2	2	3	2
HCM Control Delay	13.8	12.5	17.6	12.3
HCM LOS	B	B	C	B

Lane	NBLn1	NBLn2	EBLn1	EBLn2	WBLn1	WBLn2	WBLn3	SBLn1	SBLn2
Vol Left, %	100%	0%	100%	0%	100%	0%	0%	100%	0%
Vol Thru, %	0%	76%	0%	41%	0%	100%	0%	0%	93%
Vol Right, %	0%	24%	0%	59%	0%	0%	100%	0%	7%
Sign Control	Stop	Stop	Stop	Stop	Stop	Stop	Stop	Stop	Stop
Traffic Vol by Lane	185	309	12	162	49	145	64	31	95
LT Vol	185	0	12	0	49	0	0	31	0
Through Vol	0	236	0	66	0	145	0	0	88
RT Vol	0	73	0	96	0	0	64	0	7
Lane Flow Rate	201	336	13	176	53	158	70	34	103
Geometry Grp	6	6	6	6	6	6	6	6	6
Degree of Util (X)	0.406	0.615	0.03	0.355	0.117	0.325	0.13	0.077	0.219
Departure Headway (Hd)	7.265	6.592	8.188	7.25	7.938	7.428	6.713	8.205	7.643
Convergence, Y/N	Yes	Yes	Yes	Yes	Yes	Yes	Yes	Yes	Yes
Cap	499	551	437	497	452	484	534	436	469
Service Time	4.965	4.292	5.938	5	5.688	5.177	4.463	5.96	5.398
HCM Lane V/C Ratio	0.403	0.61	0.03	0.354	0.117	0.326	0.131	0.078	0.22
HCM Control Delay	14.8	19.2	11.2	14	11.7	13.7	10.5	11.6	12.5
HCM Lane LOS	B	C	B	B	B	B	B	B	B
HCM 95th-tile Q	1.9	4.1	0.1	1.6	0.4	1.4	0.4	0.2	0.8

Intersection												
Int Delay, s/veh	7.9											
Movement	EBL	EBT	EBR	WBL	WBT	WBR	NBL	NBT	NBR	SBL	SBT	SBR
Lane Configurations	↖	↗		↖	↗		↖	↗			↕	
Traffic Vol, veh/h	5	267	61	151	161	1	43	20	312	0	4	3
Future Vol, veh/h	5	267	61	151	161	1	43	20	312	0	4	3
Conflicting Peds, #/hr	0	0	0	0	0	0	0	0	0	0	0	0
Sign Control	Free	Free	Free	Free	Free	Free	Stop	Stop	Stop	Stop	Stop	Stop
RT Channelized	-	-	None	-	-	None	-	-	None	-	-	None
Storage Length	0	-	-	110	-	-	0	-	-	-	-	-
Veh in Median Storage, #	-	0	-	-	0	-	-	0	-	-	0	-
Grade, %	-	0	-	-	0	-	-	0	-	-	0	-
Peak Hour Factor	92	92	92	92	92	92	92	92	92	92	92	92
Heavy Vehicles, %	2	2	2	2	2	2	2	2	2	2	2	2
Mvmt Flow	5	290	66	164	175	1	47	22	339	0	4	3

Major/Minor	Major1			Major2			Minor1			Minor2		
Conflicting Flow All	176	0	0	356	0	0	840	837	323	1018	870	176
Stage 1	-	-	-	-	-	-	333	333	-	504	504	-
Stage 2	-	-	-	-	-	-	507	504	-	514	366	-
Critical Hdwy	4.12	-	-	4.12	-	-	7.12	6.52	6.22	7.12	6.52	6.22
Critical Hdwy Stg 1	-	-	-	-	-	-	6.12	5.52	-	6.12	5.52	-
Critical Hdwy Stg 2	-	-	-	-	-	-	6.12	5.52	-	6.12	5.52	-
Follow-up Hdwy	2.218	-	-	2.218	-	-	3.518	4.018	3.318	3.518	4.018	3.318
Pot Cap-1 Maneuver	1400	-	-	1203	-	-	285	303	718	216	290	867
Stage 1	-	-	-	-	-	-	681	644	-	550	541	-
Stage 2	-	-	-	-	-	-	548	541	-	543	623	-
Platoon blocked, %	-	-	-	-	-	-	-	-	-	-	-	-
Mov Cap-1 Maneuver	1400	-	-	1203	-	-	250	261	718	95	250	867
Mov Cap-2 Maneuver	-	-	-	-	-	-	250	261	-	95	250	-
Stage 1	-	-	-	-	-	-	678	641	-	548	467	-
Stage 2	-	-	-	-	-	-	467	467	-	276	621	-

Approach	EB			WB			NB			SB		
HCM Control Delay, s	0.1			4.1			17.9			15.2		
HCM LOS							C			C		

Minor Lane/Major Mvmt	NBLn1	NBLn2	EBL	EBT	EBR	WBL	WBT	WBR	SBLn1
Capacity (veh/h)	250	649	1400	-	-	1203	-	-	360
HCM Lane V/C Ratio	0.187	0.556	0.004	-	-	0.136	-	-	0.021
HCM Control Delay (s)	22.7	17.3	7.6	-	-	8.5	-	-	15.2
HCM Lane LOS	C	C	A	-	-	A	-	-	C
HCM 95th %tile Q(veh)	0.7	3.4	0	-	-	0.5	-	-	0.1

Intersection				
Intersection Delay, s/veh	14.5			
Intersection LOS	B			
Approach	EB	WB	NB	SB
Entry Lanes	1	1	1	1
Conflicting Circle Lanes	1	1	1	1
Adj Approach Flow, veh/h	557	223	441	614
Demand Flow Rate, veh/h	568	228	450	627
Vehicles Circulating, veh/h	624	566	540	123
Vehicles Exiting, veh/h	126	424	652	671
Ped Vol Crossing Leg, #/h	0	0	0	0
Ped Cap Adj	1.000	1.000	1.000	1.000
Approach Delay, s/veh	24.2	8.2	13.3	8.8
Approach LOS	C	A	B	A
Lane	Left	Left	Left	Left
Designated Moves	LTR	LTR	LTR	LTR
Assumed Moves	LTR	LTR	LTR	LTR
RT Channelized				
Lane Util	1.000	1.000	1.000	1.000
Follow-Up Headway, s	2.609	2.609	2.609	2.609
Critical Headway, s	4.976	4.976	4.976	4.976
Entry Flow, veh/h	568	228	450	627
Cap Entry Lane, veh/h	730	775	796	1217
Entry HV Adj Factor	0.981	0.977	0.979	0.979
Flow Entry, veh/h	557	223	441	614
Cap Entry, veh/h	716	757	779	1192
V/C Ratio	0.778	0.294	0.566	0.515
Control Delay, s/veh	24.2	8.2	13.3	8.8
LOS	C	A	B	A
95th %tile Queue, veh	8	1	4	3

Intersection				
Intersection Delay, s/veh	6.5			
Intersection LOS	A			
Approach	EB	WB	NB	SB
Entry Lanes	1	1	1	1
Conflicting Circle Lanes	1	1	1	1
Adj Approach Flow, veh/h	156	615	82	4
Demand Flow Rate, veh/h	160	628	83	4
Vehicles Circulating, veh/h	288	12	132	633
Vehicles Exiting, veh/h	349	203	316	7
Ped Vol Crossing Leg, #/h	0	0	0	0
Ped Cap Adj	1.000	1.000	1.000	1.000
Approach Delay, s/veh	5.0	7.3	3.6	5.1
Approach LOS	A	A	A	A
Lane	Left	Left	Left	Left
Designated Moves	LTR	LTR	LTR	LTR
Assumed Moves	LTR	LTR	LTR	LTR
RT Channelized				
Lane Util	1.000	1.000	1.000	1.000
Follow-Up Headway, s	2.609	2.609	2.609	2.609
Critical Headway, s	4.976	4.976	4.976	4.976
Entry Flow, veh/h	160	628	83	4
Cap Entry Lane, veh/h	1029	1363	1206	724
Entry HV Adj Factor	0.978	0.980	0.987	0.980
Flow Entry, veh/h	156	615	82	4
Cap Entry, veh/h	1006	1335	1191	709
V/C Ratio	0.156	0.461	0.069	0.006
Control Delay, s/veh	5.0	7.3	3.6	5.1
LOS	A	A	A	A
95th %tile Queue, veh	1	2	0	0

Intersection					
Intersection Delay, s/veh	12.6				
Intersection LOS	B				
Approach	EB		WB	NB	SB
Entry Lanes	2		1	1	1
Conflicting Circle Lanes	1		1	1	1
Adj Approach Flow, veh/h	586		298	515	647
Demand Flow Rate, veh/h	597		304	526	660
Vehicles Circulating, veh/h	668		618	582	169
Vehicles Exiting, veh/h	161		490	683	753
Ped Vol Crossing Leg, #/h	0		0	0	0
Ped Cap Adj	1.000		1.000	1.000	1.000
Approach Delay, s/veh	11.5		10.5	18.3	10.1
Approach LOS	B		B	C	B
Lane	Left	Right	Left	Left	Left
Designated Moves	LT	R	LTR	LTR	LTR
Assumed Moves	LT	R	LTR	LTR	LTR
RT Channelized					
Lane Util	0.719	0.281	1.000	1.000	1.000
Follow-Up Headway, s	2.535	2.535	2.609	2.609	2.609
Critical Headway, s	4.544	4.544	4.976	4.976	4.976
Entry Flow, veh/h	429	168	304	526	660
Cap Entry Lane, veh/h	773	773	735	762	1161
Entry HV Adj Factor	0.981	0.982	0.981	0.979	0.980
Flow Entry, veh/h	421	165	298	515	647
Cap Entry, veh/h	759	759	721	746	1138
V/C Ratio	0.555	0.217	0.414	0.690	0.568
Control Delay, s/veh	13.3	7.1	10.5	18.3	10.1
LOS	B	A	B	C	B
95th %tile Queue, veh	3	1	2	6	4

Intersection				
Intersection Delay, s/veh	6.0			
Intersection LOS	A			
Approach	EB	WB	NB	SB
Entry Lanes	1	1	1	1
Conflicting Circle Lanes	1	1	1	1
Adj Approach Flow, veh/h	129	551	133	15
Demand Flow Rate, veh/h	132	562	135	15
Vehicles Circulating, veh/h	375	26	84	582
Vehicles Exiting, veh/h	222	193	423	6
Ped Vol Crossing Leg, #/h	0	0	0	0
Ped Cap Adj	1.000	1.000	1.000	1.000
Approach Delay, s/veh	5.2	6.8	3.8	5.0
Approach LOS	A	A	A	A
Lane	Left	Left	Left	Left
Designated Moves	LTR	LTR	LTR	LTR
Assumed Moves	LTR	LTR	LTR	LTR
RT Channelized				
Lane Util	1.000	1.000	1.000	1.000
Follow-Up Headway, s	2.609	2.609	2.609	2.609
Critical Headway, s	4.976	4.976	4.976	4.976
Entry Flow, veh/h	132	562	135	15
Cap Entry Lane, veh/h	941	1344	1267	762
Entry HV Adj Factor	0.980	0.981	0.985	0.983
Flow Entry, veh/h	129	551	133	15
Cap Entry, veh/h	923	1318	1247	749
V/C Ratio	0.140	0.418	0.107	0.020
Control Delay, s/veh	5.2	6.8	3.8	5.0
LOS	A	A	A	A
95th %tile Queue, veh	0	2	0	0

Timings  
15: Eastonville Rd & Meridian Ranch Blvd/Judge Orr Rd

2045 Background Traffic  
AM Peak Hour

Lane Group	EBL	EBT	WBL	WBT	WBR	NBL	NBT	SBL	SBT	
Lane Configurations										
Traffic Volume (vph)	151	230	28	56	128	30	346	122	431	
Future Volume (vph)	151	230	28	56	128	30	346	122	431	
Turn Type	pm+pt	NA	pm+pt	NA	Perm	pm+pt	NA	pm+pt	NA	
Protected Phases	7	4	3	8		5	2	1	6	
Permitted Phases	4		8		8	2		6		
Detector Phase	7	4	3	8	8	5	2	1	6	
Switch Phase										
Minimum Initial (s)	5.0	5.0	5.0	5.0	5.0	5.0	5.0	5.0	5.0	
Minimum Split (s)	10.0	20.0	10.0	20.0	20.0	10.0	20.0	10.0	20.0	
Total Split (s)	10.0	25.0	10.0	25.0	25.0	15.0	45.0	10.0	40.0	
Total Split (%)	11.1%	27.8%	11.1%	27.8%	27.8%	16.7%	50.0%	11.1%	44.4%	
Yellow Time (s)	3.0	3.0	3.0	3.0	3.0	3.0	3.0	3.0	3.0	
All-Red Time (s)	2.0	2.0	2.0	2.0	2.0	2.0	2.0	2.0	2.0	
Lost Time Adjust (s)	0.0	0.0	0.0	0.0	0.0	0.0	0.0	0.0	0.0	
Total Lost Time (s)	5.0	5.0	5.0	5.0	5.0	5.0	5.0	5.0	5.0	
Lead/Lag	Lead	Lag	Lead	Lag	Lag	Lead	Lag	Lead	Lag	
Lead-Lag Optimize?	Yes	Yes	Yes	Yes	Yes	Yes	Yes	Yes	Yes	
Recall Mode	None	None	None	None	None	None	Min	None	Min	
Act Effct Green (s)	22.9	21.3	16.1	12.4	12.4	27.8	22.8	28.2	26.6	
Actuated g/C Ratio	0.35	0.32	0.25	0.19	0.19	0.42	0.35	0.43	0.41	
v/c Ratio	0.36	0.69	0.11	0.17	0.33	0.10	0.66	0.39	0.67	
Control Delay	22.0	31.5	18.5	26.1	7.4	9.8	23.5	13.7	22.3	
Queue Delay	0.0	0.0	0.0	0.0	0.0	0.0	0.0	0.0	0.0	
Total Delay	22.0	31.5	18.5	26.1	7.4	9.8	23.5	13.7	22.3	
LOS	C	C	B	C	A	A	C	B	C	
Approach Delay		28.8		13.8			22.5		20.5	
Approach LOS		C		B			C		C	

Intersection Summary

Cycle Length: 90  
 Actuated Cycle Length: 65.6  
 Natural Cycle: 65  
 Control Type: Actuated-Uncoordinated  
 Maximum v/c Ratio: 0.69  
 Intersection Signal Delay: 22.7  
 Intersection LOS: C  
 Intersection Capacity Utilization 64.4%  
 ICU Level of Service C  
 Analysis Period (min) 15

Splits and Phases: 15: Eastonville Rd & Meridian Ranch Blvd/Judge Orr Rd

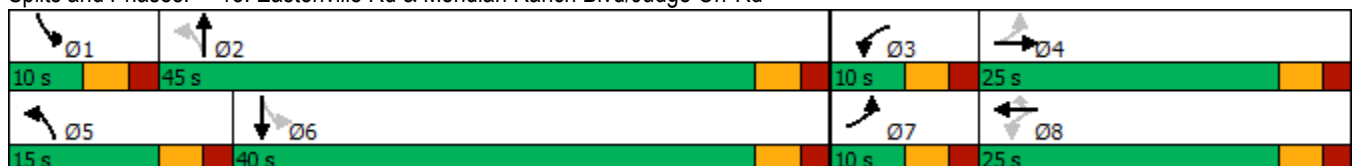

Timings  
16: McLaughlin Rd & Eastonville Rd

2045 Background Traffic  
AM Peak Hour

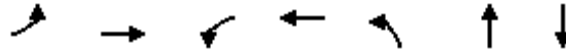

Lane Group	EBL	EBT	WBL	WBT	NBL	NBT	SBT
Lane Configurations	↶	↷	↶	↷	↶	↷	↕
Traffic Volume (vph)	3	120	264	319	6	3	4
Future Volume (vph)	3	120	264	319	6	3	4
Turn Type	pm+pt	NA	pm+pt	NA	Perm	NA	NA
Protected Phases	5	2	1	6		8	4
Permitted Phases	2		6		8		
Detector Phase	5	2	1	6	8	8	4
Switch Phase							
Minimum Initial (s)	5.0	5.0	5.0	5.0	5.0	5.0	5.0
Minimum Split (s)	10.0	20.0	10.0	20.0	20.0	20.0	20.0
Total Split (s)	10.0	45.0	15.0	50.0	30.0	30.0	30.0
Total Split (%)	11.1%	50.0%	16.7%	55.6%	33.3%	33.3%	33.3%
Yellow Time (s)	3.0	3.0	3.0	3.0	3.0	3.0	3.0
All-Red Time (s)	2.0	2.0	2.0	2.0	2.0	2.0	2.0
Lost Time Adjust (s)	0.0	0.0	0.0	0.0	0.0	0.0	0.0
Total Lost Time (s)	5.0	5.0	5.0	5.0	5.0	5.0	5.0
Lead/Lag	Lead	Lag	Lead	Lag			
Lead-Lag Optimize?	Yes	Yes	Yes	Yes			
Recall Mode	None	Max	None	Max	Min	Min	Min
Act Effct Green (s)	45.1	40.1	53.6	51.7	6.5	6.5	6.5
Actuated g/C Ratio	0.64	0.57	0.76	0.74	0.09	0.09	0.09
v/c Ratio	0.00	0.15	0.31	0.25	0.05	0.36	0.02
Control Delay	3.0	7.2	3.4	4.4	30.0	14.0	29.2
Queue Delay	0.0	0.0	0.0	0.0	0.0	0.0	0.0
Total Delay	3.0	7.2	3.4	4.4	30.0	14.0	29.2
LOS	A	A	A	A	C	B	C
Approach Delay		7.2		3.9		15.3	29.3
Approach LOS		A		A		B	C

Intersection Summary

Cycle Length: 90  
 Actuated Cycle Length: 70.1  
 Natural Cycle: 50  
 Control Type: Semi Act-Uncoord  
 Maximum v/c Ratio: 0.36  
 Intersection Signal Delay: 5.7  
 Intersection Capacity Utilization 40.0%  
 Analysis Period (min) 15  
 Intersection LOS: A  
 ICU Level of Service A

Splits and Phases: 16: McLaughlin Rd & Eastonville Rd





Intersection				
Intersection Delay, s/veh	13.5			
Intersection LOS	B			
Approach	EB	WB	NB	SB
Entry Lanes	1	1	1	1
Conflicting Circle Lanes	1	1	1	1
Adj Approach Flow, veh/h	269	382	831	258
Demand Flow Rate, veh/h	275	389	848	263
Vehicles Circulating, veh/h	308	786	171	572
Vehicles Exiting, veh/h	527	233	412	603
Ped Vol Crossing Leg, #/h	0	0	0	0
Ped Cap Adj	1.000	1.000	1.000	1.000
Approach Delay, s/veh	6.4	18.6	14.9	8.9
Approach LOS	A	C	B	A
Lane	Left	Left	Left	Left
Designated Moves	LTR	LTR	LTR	LTR
Assumed Moves	LTR	LTR	LTR	LTR
RT Channelized				
Lane Util	1.000	1.000	1.000	1.000
Follow-Up Headway, s	2.609	2.609	2.609	2.609
Critical Headway, s	4.976	4.976	4.976	4.976
Entry Flow, veh/h	275	389	848	263
Cap Entry Lane, veh/h	1008	619	1159	770
Entry HV Adj Factor	0.979	0.981	0.980	0.981
Flow Entry, veh/h	269	382	831	258
Cap Entry, veh/h	986	607	1136	756
V/C Ratio	0.273	0.628	0.732	0.342
Control Delay, s/veh	6.4	18.6	14.9	8.9
LOS	A	C	B	A
95th %tile Queue, veh	1	4	7	2

Intersection				
Intersection Delay, s/veh	9.1			
Intersection LOS	A			
Approach	EB	WB	NB	SB
Entry Lanes	1	1	1	1
Conflicting Circle Lanes	1	1	1	1
Adj Approach Flow, veh/h	530	472	468	7
Demand Flow Rate, veh/h	540	481	477	7
Vehicles Circulating, veh/h	204	81	468	532
Vehicles Exiting, veh/h	335	864	276	30
Ped Vol Crossing Leg, #/h	0	0	0	0
Ped Cap Adj	1.000	1.000	1.000	1.000
Approach Delay, s/veh	8.7	6.5	12.3	4.6
Approach LOS	A	A	B	A
Lane	Left	Left	Left	Left
Designated Moves	LTR	LTR	LTR	LTR
Assumed Moves	LTR	LTR	LTR	LTR
RT Channelized				
Lane Util	1.000	1.000	1.000	1.000
Follow-Up Headway, s	2.609	2.609	2.609	2.609
Critical Headway, s	4.976	4.976	4.976	4.976
Entry Flow, veh/h	540	481	477	7
Cap Entry Lane, veh/h	1121	1270	856	802
Entry HV Adj Factor	0.981	0.980	0.980	0.989
Flow Entry, veh/h	530	472	468	7
Cap Entry, veh/h	1100	1245	839	793
V/C Ratio	0.482	0.379	0.557	0.009
Control Delay, s/veh	8.7	6.5	12.3	4.6
LOS	A	A	B	A
95th %tile Queue, veh	3	2	4	0

HCM 6th Roundabout  
 15: Eastonville Rd & Meridian Ranch Blvd/Judge Orr Rd

2045 Total Traffic  
 PM Peak Hour

Intersection				
Intersection Delay, s/veh	15.3			
Intersection LOS	C			
Approach	EB	WB	NB	SB
Entry Lanes	1	1	1	1
Conflicting Circle Lanes	1	1	1	1
Adj Approach Flow, veh/h	276	382	879	295
Demand Flow Rate, veh/h	282	389	897	301
Vehicles Circulating, veh/h	341	842	178	572
Vehicles Exiting, veh/h	532	233	445	659
Ped Vol Crossing Leg, #/h	0	0	0	0
Ped Cap Adj	1.000	1.000	1.000	1.000
Approach Delay, s/veh	6.7	21.2	17.3	9.7
Approach LOS	A	C	C	A
Lane	Left	Left	Left	Left
Designated Moves	LTR	LTR	LTR	LTR
Assumed Moves	LTR	LTR	LTR	LTR
RT Channelized				
Lane Util	1.000	1.000	1.000	1.000
Follow-Up Headway, s	2.609	2.609	2.609	2.609
Critical Headway, s	4.976	4.976	4.976	4.976
Entry Flow, veh/h	282	389	897	301
Cap Entry Lane, veh/h	975	585	1151	770
Entry HV Adj Factor	0.979	0.981	0.980	0.981
Flow Entry, veh/h	276	382	879	295
Cap Entry, veh/h	954	574	1128	756
V/C Ratio	0.289	0.665	0.779	0.391
Control Delay, s/veh	6.7	21.2	17.3	9.7
LOS	A	C	C	A
95th %tile Queue, veh	1	5	8	2

Intersection				
Intersection Delay, s/veh	9.9			
Intersection LOS	A			
Approach	EB	WB	NB	SB
Entry Lanes	1	1	1	1
Conflicting Circle Lanes	1	1	1	1
Adj Approach Flow, veh/h	566	504	479	7
Demand Flow Rate, veh/h	577	514	488	7
Vehicles Circulating, veh/h	211	81	505	565
Vehicles Exiting, veh/h	361	912	283	30
Ped Vol Crossing Leg, #/h	0	0	0	0
Ped Cap Adj	1.000	1.000	1.000	1.000
Approach Delay, s/veh	9.4	6.9	13.7	4.8
Approach LOS	A	A	B	A
Lane	Left	Left	Left	Left
Designated Moves	LTR	LTR	LTR	LTR
Assumed Moves	LTR	LTR	LTR	LTR
RT Channelized				
Lane Util	1.000	1.000	1.000	1.000
Follow-Up Headway, s	2.609	2.609	2.609	2.609
Critical Headway, s	4.976	4.976	4.976	4.976
Entry Flow, veh/h	577	514	488	7
Cap Entry Lane, veh/h	1113	1270	824	775
Entry HV Adj Factor	0.981	0.981	0.981	0.989
Flow Entry, veh/h	566	504	479	7
Cap Entry, veh/h	1092	1246	808	767
V/C Ratio	0.519	0.405	0.592	0.009
Control Delay, s/veh	9.4	6.9	13.7	4.8
LOS	A	A	B	A
95th %tile Queue, veh	3	2	4	0

Timings  
15: Eastonville Rd & Meridian Ranch Blvd/Judge Orr Rd

2045 Background Traffic  
PM Peak Hour

Lane Group	EBL	EBT	WBL	WBT	WBR	NBL	NBT	SBL	SBT
Lane Configurations									
Traffic Volume (vph)	26	90	58	205	100	270	436	43	186
Future Volume (vph)	26	90	58	205	100	270	436	43	186
Turn Type	pm+pt	NA	pm+pt	NA	Perm	pm+pt	NA	pm+pt	NA
Protected Phases	7	4	3	8		5	2	1	6
Permitted Phases	4		8		8	2		6	
Detector Phase	7	4	3	8	8	5	2	1	6
Switch Phase									
Minimum Initial (s)	5.0	5.0	5.0	5.0	5.0	5.0	5.0	5.0	5.0
Minimum Split (s)	10.0	20.0	10.0	20.0	20.0	10.0	20.0	10.0	20.0
Total Split (s)	10.0	25.0	10.0	25.0	25.0	15.0	45.0	10.0	40.0
Total Split (%)	11.1%	27.8%	11.1%	27.8%	27.8%	16.7%	50.0%	11.1%	44.4%
Yellow Time (s)	3.0	3.0	3.0	3.0	3.0	3.0	3.0	3.0	3.0
All-Red Time (s)	2.0	2.0	2.0	2.0	2.0	2.0	2.0	2.0	2.0
Lost Time Adjust (s)	0.0	0.0	0.0	0.0	0.0	0.0	0.0	0.0	0.0
Total Lost Time (s)	5.0	5.0	5.0	5.0	5.0	5.0	5.0	5.0	5.0
Lead/Lag	Lead	Lag	Lead	Lag	Lag	Lead	Lag	Lead	Lag
Lead-Lag Optimize?	Yes	Yes	Yes	Yes	Yes	Yes	Yes	Yes	Yes
Recall Mode	None	None	None	None	None	None	Min	None	Min
Act Effct Green (s)	15.7	13.3	16.6	15.1	15.1	35.6	30.7	24.9	19.3
Actuated g/C Ratio	0.24	0.20	0.26	0.23	0.23	0.55	0.47	0.38	0.30
v/c Ratio	0.09	0.61	0.22	0.51	0.23	0.47	0.65	0.13	0.40
Control Delay	19.8	25.9	21.1	29.9	3.8	11.9	20.5	10.1	20.2
Queue Delay	0.0	0.0	0.0	0.0	0.0	0.0	0.0	0.0	0.0
Total Delay	19.8	25.9	21.1	29.9	3.8	11.9	20.5	10.1	20.2
LOS	B	C	C	C	A	B	C	B	C
Approach Delay		25.3		21.3			17.5		18.4
Approach LOS		C		C			B		B

Intersection Summary

Cycle Length: 90  
 Actuated Cycle Length: 64.9  
 Natural Cycle: 65  
 Control Type: Actuated-Uncoordinated  
 Maximum v/c Ratio: 0.65  
 Intersection Signal Delay: 19.7  
 Intersection LOS: B  
 Intersection Capacity Utilization 66.4%  
 ICU Level of Service C  
 Analysis Period (min) 15

Splits and Phases: 15: Eastonville Rd & Meridian Ranch Blvd/Judge Orr Rd

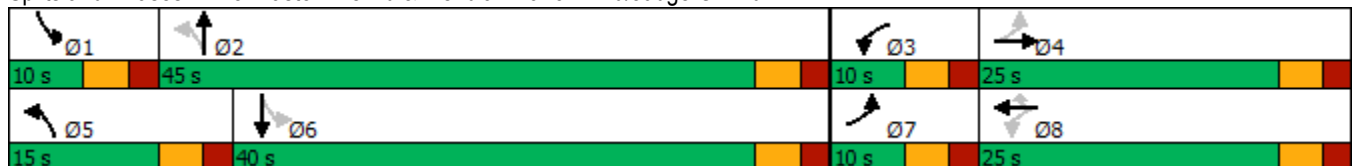

Timings  
16: McLaughlin Rd & Eastonville Rd

2045 Background Traffic  
PM Peak Hour

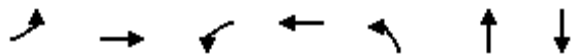

Lane Group	EBL	EBT	WBL	WBT	NBL	NBT	SBT
Lane Configurations	↶	↷	↶	↷	↶	↷	↕
Traffic Volume (vph)	6	430	186	261	48	22	4
Future Volume (vph)	6	430	186	261	48	22	4
Turn Type	pm+pt	NA	pm+pt	NA	Perm	NA	NA
Protected Phases	5	2	1	6		8	4
Permitted Phases	2		6		8		
Detector Phase	5	2	1	6	8	8	4
Switch Phase							
Minimum Initial (s)	5.0	5.0	5.0	5.0	5.0	5.0	5.0
Minimum Split (s)	10.0	20.0	10.0	20.0	20.0	20.0	20.0
Total Split (s)	10.0	45.0	15.0	50.0	30.0	30.0	30.0
Total Split (%)	11.1%	50.0%	16.7%	55.6%	33.3%	33.3%	33.3%
Yellow Time (s)	3.0	3.0	3.0	3.0	3.0	3.0	3.0
All-Red Time (s)	2.0	2.0	2.0	2.0	2.0	2.0	2.0
Lost Time Adjust (s)	0.0	0.0	0.0	0.0	0.0	0.0	0.0
Total Lost Time (s)	5.0	5.0	5.0	5.0	5.0	5.0	5.0
Lead/Lag	Lead	Lag	Lead	Lag			
Lead-Lag Optimize?	Yes	Yes	Yes	Yes			
Recall Mode	None	Max	None	Max	Min	Min	Min
Act Effect Green (s)	45.5	40.4	53.6	51.9	11.5	11.5	11.5
Actuated g/C Ratio	0.61	0.54	0.71	0.69	0.15	0.15	0.15
v/c Ratio	0.01	0.55	0.36	0.22	0.24	0.78	0.03
Control Delay	5.7	15.6	6.5	6.9	29.9	16.1	21.0
Queue Delay	0.0	0.0	0.0	0.0	0.0	0.0	0.0
Total Delay	5.7	15.6	6.5	6.9	29.9	16.1	21.0
LOS	A	B	A	A	C	B	C
Approach Delay		15.4		6.7		17.6	21.0
Approach LOS		B		A		B	C

Intersection Summary

Cycle Length: 90  
 Actuated Cycle Length: 75.2  
 Natural Cycle: 60  
 Control Type: Semi Act-Uncoord  
 Maximum v/c Ratio: 0.78  
 Intersection Signal Delay: 13.4  
 Intersection LOS: B  
 Intersection Capacity Utilization 73.8%  
 ICU Level of Service D  
 Analysis Period (min) 15

Splits and Phases: 16: McLaughlin Rd & Eastonville Rd



HCM 6th Roundabout  
1: Eastonville Rd & Rex Rd

2026 Total Traffic  
AM Peak Hour

Intersection				
Intersection Delay, s/veh	3.8			
Intersection LOS	A			
Approach	EB	WB	NB	SB
Entry Lanes	1	1	1	1
Conflicting Circle Lanes	1	1	1	1
Adj Approach Flow, veh/h	84	183	110	27
Demand Flow Rate, veh/h	85	187	112	27
Vehicles Circulating, veh/h	175	64	15	227
Vehicles Exiting, veh/h	79	63	245	24
Ped Vol Crossing Leg, #/h	0	0	0	0
Ped Cap Adj	1.000	1.000	1.000	1.000
Approach Delay, s/veh	3.8	4.0	3.4	3.6
Approach LOS	A	A	A	A
Lane	Left	Left	Left	Left
Designated Moves	LTR	LTR	LTR	LTR
Assumed Moves	LTR	LTR	LTR	LTR
RT Channelized				
Lane Util	1.000	1.000	1.000	1.000
Follow-Up Headway, s	2.609	2.609	2.609	2.609
Critical Headway, s	4.976	4.976	4.976	4.976
Entry Flow, veh/h	85	187	112	27
Cap Entry Lane, veh/h	1154	1293	1359	1095
Entry HV Adj Factor	0.986	0.981	0.979	0.983
Flow Entry, veh/h	84	183	110	27
Cap Entry, veh/h	1138	1268	1331	1076
V/C Ratio	0.074	0.145	0.082	0.025
Control Delay, s/veh	3.8	4.0	3.4	3.6
LOS	A	A	A	A
95th %tile Queue, veh	0	1	0	0

**Intersection**

Int Delay, s/veh 2.7

Movement	EBT	EBR	WBL	WBT	NBL	NBR
Lane Configurations	↔		↔	↑	↔	↔
Traffic Vol, veh/h	33	19	0	98	57	0
Future Vol, veh/h	33	19	0	98	57	0
Conflicting Peds, #/hr	0	0	0	0	0	0
Sign Control	Free	Free	Free	Free	Stop	Stop
RT Channelized	-	None	-	None	-	None
Storage Length	-	-	155	-	205	0
Veh in Median Storage, #	0	-	-	0	0	-
Grade, %	0	-	-	0	0	-
Peak Hour Factor	85	85	85	85	85	85
Heavy Vehicles, %	2	2	2	2	2	2
Mvmt Flow	39	22	0	115	67	0

**Major/Minor**

	Major1	Major2	Minor1		
Conflicting Flow All	0	0	61	0	165
Stage 1	-	-	-	-	50
Stage 2	-	-	-	-	115
Critical Hdwy	-	-	4.12	-	6.42
Critical Hdwy Stg 1	-	-	-	-	5.42
Critical Hdwy Stg 2	-	-	-	-	5.42
Follow-up Hdwy	-	-	2.218	-	3.518
Pot Cap-1 Maneuver	-	-	1542	-	826
Stage 1	-	-	-	-	972
Stage 2	-	-	-	-	910
Platoon blocked, %	-	-	-	-	-
Mov Cap-1 Maneuver	-	-	1542	-	826
Mov Cap-2 Maneuver	-	-	-	-	803
Stage 1	-	-	-	-	972
Stage 2	-	-	-	-	910

**Approach**

	EB	WB	NB
HCM Control Delay, s	0	0	9.9
HCM LOS			A

**Minor Lane/Major Mvmt**

	NBLn1	NBLn2	EBT	EBR	WBL	WBT
Capacity (veh/h)	803	-	-	-	1542	-
HCM Lane V/C Ratio	0.084	-	-	-	-	-
HCM Control Delay (s)	9.9	0	-	-	0	-
HCM Lane LOS	A	A	-	-	A	-
HCM 95th %tile Q(veh)	0.3	-	-	-	0	-



**Intersection**

Int Delay, s/veh 5.7

Movement	EBT	EBR	WBL	WBT	NBL	NBR
Lane Configurations						
Traffic Vol, veh/h	6	27	0	19	80	0
Future Vol, veh/h	6	27	0	19	80	0
Conflicting Peds, #/hr	0	0	0	0	0	0
Sign Control	Free	Free	Free	Free	Stop	Stop
RT Channelized	-	None	-	None	-	None
Storage Length	-	155	305	-	0	-
Veh in Median Storage, #	0	-	-	0	0	-
Grade, %	0	-	-	0	0	-
Peak Hour Factor	85	85	85	85	85	85
Heavy Vehicles, %	2	2	2	2	2	2
Mvmt Flow	7	32	0	22	94	0

Major/Minor	Major1	Major2	Minor1
Conflicting Flow All	0	0	39
Stage 1	-	-	7
Stage 2	-	-	22
Critical Hdwy	-	4.12	6.42
Critical Hdwy Stg 1	-	-	5.42
Critical Hdwy Stg 2	-	-	5.42
Follow-up Hdwy	-	2.218	3.518
Pot Cap-1 Maneuver	-	1571	986
Stage 1	-	-	1016
Stage 2	-	-	1001
Platoon blocked, %	-	-	-
Mov Cap-1 Maneuver	-	1571	986
Mov Cap-2 Maneuver	-	-	909
Stage 1	-	-	1016
Stage 2	-	-	1001

Approach	EB	WB	NB
HCM Control Delay, s	0	0	9.4
HCM LOS			A

Minor Lane/Major Mvmt	NBLn1	EBT	EBR	WBL	WBT
Capacity (veh/h)	909	-	-	1571	-
HCM Lane V/C Ratio	0.104	-	-	-	-
HCM Control Delay (s)	9.4	-	-	0	-
HCM Lane LOS	A	-	-	A	-
HCM 95th %tile Q(veh)	0.3	-	-	0	-

Intersection						
Int Delay, s/veh	6.6					
Movement	EBT	EBR	WBL	WBT	NBL	NBR
Lane Configurations						
Traffic Vol, veh/h	0	6	0	0	19	0
Future Vol, veh/h	0	6	0	0	19	0
Conflicting Peds, #/hr	0	0	0	0	0	0
Sign Control	Free	Free	Free	Free	Stop	Stop
RT Channelized	-	None	-	None	-	None
Storage Length	-	-	305	-	0	0
Veh in Median Storage, #	0	-	-	0	0	-
Grade, %	0	-	-	0	0	-
Peak Hour Factor	85	85	85	85	85	85
Heavy Vehicles, %	2	2	2	2	2	2
Mvmt Flow	0	7	0	0	22	0

Major/Minor	Major1	Major2	Minor1		
Conflicting Flow All	0	0	7	0	5
Stage 1	-	-	-	-	4
Stage 2	-	-	-	-	1
Critical Hdwy	-	-	4.12	-	6.42
Critical Hdwy Stg 1	-	-	-	-	5.42
Critical Hdwy Stg 2	-	-	-	-	5.42
Follow-up Hdwy	-	-	2.218	-	3.518
Pot Cap-1 Maneuver	-	-	1614	-	1017
Stage 1	-	-	-	-	1019
Stage 2	-	-	-	-	1022
Platoon blocked, %	-	-	-	-	-
Mov Cap-1 Maneuver	-	-	1614	-	1017
Mov Cap-2 Maneuver	-	-	-	-	930
Stage 1	-	-	-	-	1019
Stage 2	-	-	-	-	1022

Approach	EB	WB	NB
HCM Control Delay, s	0	0	9
HCM LOS			A

Minor Lane/Major Mvmt	NBLn1	NBLn2	EBT	EBR	WBL	WBT
Capacity (veh/h)	930	-	-	-	1614	-
HCM Lane V/C Ratio	0.024	-	-	-	-	-
HCM Control Delay (s)	9	0	-	-	0	-
HCM Lane LOS	A	A	-	-	A	-
HCM 95th %tile Q(veh)	0.1	-	-	-	0	-

Intersection			
Intersection Delay, s/veh	3.8		
Intersection LOS	A		
Approach	WB	NB	SB
Entry Lanes	1	1	1
Conflicting Circle Lanes	2	2	2
Adj Approach Flow, veh/h	93	117	239
Demand Flow Rate, veh/h	94	120	244
Vehicles Circulating, veh/h	93	6	75
Vehicles Exiting, veh/h	33	313	112
Ped Vol Crossing Leg, #/h	0	0	0
Ped Cap Adj	1.000	1.000	1.000
Approach Delay, s/veh	3.3	3.3	4.3
Approach LOS	A	A	A
Lane	Left	Left	Left
Designated Moves	LR	TR	LT
Assumed Moves	LR	TR	LT
RT Channelized			
Lane Util	1.000	1.000	1.000
Follow-Up Headway, s	2.535	2.535	2.535
Critical Headway, s	4.328	4.328	4.328
Entry Flow, veh/h	94	120	244
Cap Entry Lane, veh/h	1312	1413	1332
Entry HV Adj Factor	0.989	0.976	0.981
Flow Entry, veh/h	93	117	239
Cap Entry, veh/h	1298	1380	1307
V/C Ratio	0.072	0.085	0.183
Control Delay, s/veh	3.3	3.3	4.3
LOS	A	A	A
95th %tile Queue, veh	0	0	1

Intersection						
Int Delay, s/veh	1.7					
Movement	WBL	WBR	NBT	NBR	SBL	SBT
Lane Configurations	Y		↑	↑	↑	↑
Traffic Vol, veh/h	50	13	86	17	4	257
Future Vol, veh/h	50	13	86	17	4	257
Conflicting Peds, #/hr	0	0	0	0	0	0
Sign Control	Stop	Stop	Free	Free	Free	Free
RT Channelized	-	None	-	None	-	None
Storage Length	0	-	-	155	205	-
Veh in Median Storage, #	0	-	0	-	-	0
Grade, %	0	-	0	-	-	0
Peak Hour Factor	85	85	85	85	85	85
Heavy Vehicles, %	2	2	2	2	2	2
Mvmt Flow	59	15	101	20	5	302

Major/Minor	Minor1	Major1	Major2		
Conflicting Flow All	413	101	0	0	121
Stage 1	101	-	-	-	-
Stage 2	312	-	-	-	-
Critical Hdwy	6.42	6.22	-	-	4.12
Critical Hdwy Stg 1	5.42	-	-	-	-
Critical Hdwy Stg 2	5.42	-	-	-	-
Follow-up Hdwy	3.518	3.318	-	-	2.218
Pot Cap-1 Maneuver	595	954	-	-	1467
Stage 1	923	-	-	-	-
Stage 2	742	-	-	-	-
Platoon blocked, %			-	-	-
Mov Cap-1 Maneuver	593	954	-	-	1467
Mov Cap-2 Maneuver	634	-	-	-	-
Stage 1	923	-	-	-	-
Stage 2	740	-	-	-	-

Approach	WB	NB	SB
HCM Control Delay, s	10.9	0	0.1
HCM LOS	B		

Minor Lane/Major Mvmt	NBT	NBRWBLn1	SBL	SBT
Capacity (veh/h)	-	-	681	1467
HCM Lane V/C Ratio	-	-	0.109	0.003
HCM Control Delay (s)	-	-	10.9	7.5
HCM Lane LOS	-	-	B	A
HCM 95th %tile Q(veh)	-	-	0.4	0

Intersection							
Intersection Delay, s/veh	5.6						
Intersection LOS	A						
Approach	EB		NB		SB		
Entry Lanes	2		2		2		
Conflicting Circle Lanes	2		2		2		
Adj Approach Flow, veh/h	337		497		362		
Demand Flow Rate, veh/h	344		507		370		
Vehicles Circulating, veh/h	341		9		393		
Vehicles Exiting, veh/h	422		676		123		
Ped Vol Crossing Leg, #/h	0		0		0		
Ped Cap Adj	1.000		1.000		1.000		
Approach Delay, s/veh	6.5		4.9		5.6		
Approach LOS	A		A		A		
Lane	Left	Right	Left	Right	Left	Right	
Designated Moves	L	TR	L	TR	LT	TR	
Assumed Moves	L	TR	L	TR	LT	TR	
RT Channelized							
Lane Util	0.026	0.974	0.775	0.225	0.470	0.530	
Follow-Up Headway, s	2.667	2.535	2.667	2.535	2.667	2.535	
Critical Headway, s	4.645	4.328	4.645	4.328	4.645	4.328	
Entry Flow, veh/h	9	335	393	114	174	196	
Cap Entry Lane, veh/h	986	1063	1339	1409	940	1017	
Entry HV Adj Factor	1.000	0.979	0.980	0.980	0.979	0.980	
Flow Entry, veh/h	9	328	385	112	170	192	
Cap Entry, veh/h	986	1041	1311	1382	920	996	
V/C Ratio	0.009	0.315	0.294	0.081	0.185	0.193	
Control Delay, s/veh	3.7	6.6	5.3	3.2	5.7	5.4	
LOS	A	A	A	A	A	A	
95th %tile Queue, veh	0	1	1	0	1	1	

Intersection						
Intersection Delay, s/veh	8.1					
Intersection LOS	A					
Approach	EB	WB	NB	SB		
Entry Lanes	1	1	1	1		
Conflicting Circle Lanes	1	1	1	1		
Adj Approach Flow, veh/h	324	359	404	662		
Demand Flow Rate, veh/h	330	367	412	675		
Vehicles Circulating, veh/h	567	437	485	297		
Vehicles Exiting, veh/h	267	460	412	319		
Ped Vol Crossing Leg, #/h	0	0	0	0		
Ped Cap Adj	1.000	1.000	1.000	1.000		
Approach Delay, s/veh	10.4	3.0	10.9	8.1		
Approach LOS	B	A	B	A		
Lane	Left	Left	Bypass	Left	Left	Bypass
Designated Moves	LTR	LT	R	LTR	LT	R
Assumed Moves	LTR	LT	R	LTR	LT	R
RT Channelized			Free			Free
Lane Util	1.000	1.000		1.000	1.000	
Follow-Up Headway, s	2.609	2.609		2.609	2.609	
Critical Headway, s	4.976	4.976	188	4.976	4.976	138
Entry Flow, veh/h	330	179	1938	412	537	1938
Cap Entry Lane, veh/h	774	884	0.980	841	1019	0.980
Entry HV Adj Factor	0.981	0.978	184	0.980	0.981	135
Flow Entry, veh/h	324	175	1900	404	527	1900
Cap Entry, veh/h	759	864	0.097	825	1000	0.071
V/C Ratio	0.426	0.203	0.0	0.490	0.527	0.0
Control Delay, s/veh	10.4	6.2	A	10.9	10.2	A
LOS	B	A	0	B	B	0
95th %tile Queue, veh	2	1		3	3	

Timings  
14: US 24 & Stapleton Dr

2026 Total Traffic  
AM Peak Hour

	↖	→	↘	↙	←	↖	↙	↑	↗	↘	↓	↙
Lane Group	EBL	EBT	EBR	WBL	WBT	WBR	NBL	NBT	NBR	SBL	SBT	SBR
Lane Configurations	↖	↑	↘	↖	↑	↘	↖	↑	↘	↖	↑	↘
Traffic Volume (vph)	53	224	290	4	107	17	124	280	5	45	470	43
Future Volume (vph)	53	224	290	4	107	17	124	280	5	45	470	43
Turn Type	pm+pt	NA	Free	pm+pt	NA	Free	pm+pt	NA	Perm	pm+pt	NA	Perm
Protected Phases	5	2		1	6		3	8		7	4	
Permitted Phases	2		Free	6		Free	8		8	4		4
Detector Phase	5	2		1	6		3	8	8	7	4	4
Switch Phase												
Minimum Initial (s)	5.0	10.0		5.0	5.0		5.0	5.0	5.0	5.0	15.0	15.0
Minimum Split (s)	10.0	15.0		13.0	10.0		25.0	10.0	10.0	25.0	20.0	20.0
Total Split (s)	12.0	30.0		12.0	30.0		12.0	66.0	66.0	12.0	66.0	66.0
Total Split (%)	10.0%	25.0%		10.0%	25.0%		10.0%	55.0%	55.0%	10.0%	55.0%	55.0%
Yellow Time (s)	3.0	3.0		3.0	3.0		3.0	3.0	3.0	3.0	3.0	3.0
All-Red Time (s)	2.0	2.0		2.0	2.0		2.0	2.0	2.0	2.0	2.0	2.0
Lost Time Adjust (s)	0.0	0.0		0.0	0.0		0.0	0.0	0.0	0.0	0.0	0.0
Total Lost Time (s)	5.0	5.0		5.0	5.0		5.0	5.0	5.0	5.0	5.0	5.0
Lead/Lag	Lead	Lag		Lead	Lag		Lead	Lag	Lag	Lead	Lag	Lag
Lead-Lag Optimize?	Yes	Yes		Yes	Yes		Yes	Yes	Yes	Yes	Yes	Yes
Recall Mode	None	C-Max		None	C-Max		None	Max	Max	None	Max	Max
Act Effct Green (s)	36.1	34.7	120.0	32.1	27.4	120.0	69.2	63.6	63.6	67.5	61.0	61.0
Actuated g/C Ratio	0.30	0.29	1.00	0.27	0.23	1.00	0.58	0.53	0.53	0.56	0.51	0.51
v/c Ratio	0.18	0.47	0.21	0.02	0.30	0.01	0.35	0.33	0.01	0.09	0.54	0.05
Control Delay	23.4	29.5	0.3	29.2	42.0	0.0	12.6	18.0	0.0	10.1	23.0	0.1
Queue Delay	0.0	0.0	0.0	0.0	0.0	0.0	0.0	0.0	0.0	0.0	0.0	0.0
Total Delay	23.4	29.5	0.3	29.2	42.0	0.0	12.6	18.0	0.0	10.1	23.0	0.1
LOS	C	C	A	C	D	A	B	B	A	B	C	A
Approach Delay		14.0			36.0			16.1			20.2	
Approach LOS		B			D			B			C	

**Intersection Summary**

Cycle Length: 120  
 Actuated Cycle Length: 120  
 Offset: 0 (0%), Referenced to phase 2:EBTL and 6:WBTL, Start of Green  
 Natural Cycle: 90  
 Control Type: Actuated-Coordinated  
 Maximum v/c Ratio: 0.54  
 Intersection Signal Delay: 18.3  
 Intersection LOS: B  
 Intersection Capacity Utilization 55.9%  
 ICU Level of Service B  
 Analysis Period (min) 15

Splits and Phases: 14: US 24 & Stapleton Dr

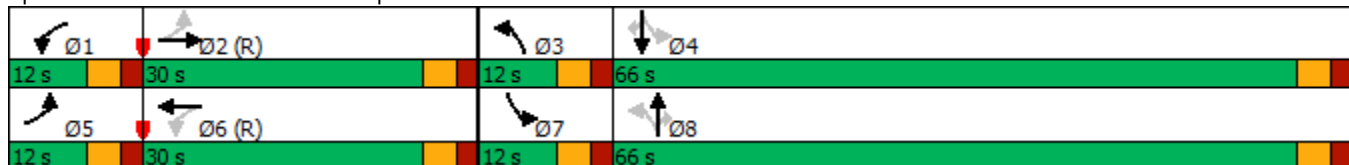

Intersection												
Intersection Delay, s/veh	21.6											
Intersection LOS	C											

Movement	EBL	EBT	EBR	WBL	WBT	WBR	NBL	NBT	NBR	SBL	SBT	SBR
Lane Configurations												
Traffic Vol, veh/h	101	160	101	34	42	85	20	218	36	75	241	16
Future Vol, veh/h	101	160	101	34	42	85	20	218	36	75	241	16
Peak Hour Factor	0.87	0.87	0.87	0.97	0.97	0.97	0.82	0.82	0.82	0.87	0.87	0.87
Heavy Vehicles, %	2	2	2	2	2	2	2	2	2	2	2	2
Mvmt Flow	116	184	116	35	43	88	24	266	44	86	277	18
Number of Lanes	1	1	0	1	1	1	1	1	0	1	1	0

Approach	EB	WB	NB	SB
Opposing Approach	WB	EB	SB	NB
Opposing Lanes	3	2	2	2
Conflicting Approach Left SB		NB	EB	WB
Conflicting Lanes Left	2	2	2	3
Conflicting Approach Right NB		SB	WB	EB
Conflicting Lanes Right	2	2	3	2
HCM Control Delay	21.1	12.9	25.9	22.2
HCM LOS	C	B	D	C

Lane	NBLn1	NBLn2	EBLn1	EBLn2	WBLn1	WBLn2	WBLn3	SBLn1	SBLn2
Vol Left, %	100%	0%	100%	0%	100%	0%	0%	100%	0%
Vol Thru, %	0%	86%	0%	61%	0%	100%	0%	0%	94%
Vol Right, %	0%	14%	0%	39%	0%	0%	100%	0%	6%
Sign Control	Stop	Stop	Stop	Stop	Stop	Stop	Stop	Stop	Stop
Traffic Vol by Lane	20	254	101	261	34	42	85	75	257
LT Vol	20	0	101	0	34	0	0	75	0
Through Vol	0	218	0	160	0	42	0	0	241
RT Vol	0	36	0	101	0	0	85	0	16
Lane Flow Rate	24	310	116	300	35	43	88	86	295
Geometry Grp	6	6	6	6	6	6	6	6	6
Degree of Util (X)	0.059	0.692	0.278	0.643	0.092	0.107	0.199	0.205	0.657
Departure Headway (Hd)	8.661	8.048	8.609	7.848	9.433	8.915	8.19	8.561	8.005
Convergence, Y/N	Yes	Yes	Yes	Yes	Yes	Yes	Yes	Yes	Yes
Cap	415	452	418	462	380	403	439	421	452
Service Time	6.381	5.768	6.343	5.548	7.176	6.658	5.932	6.282	5.726
HCM Lane V/C Ratio	0.058	0.686	0.278	0.649	0.092	0.107	0.2	0.204	0.653
HCM Control Delay	11.9	27	14.6	23.6	13.1	12.7	13	13.5	24.8
HCM Lane LOS	B	D	B	C	B	B	B	B	C
HCM 95th-tile Q	0.2	5.2	1.1	4.4	0.3	0.4	0.7	0.8	4.6



Intersection												
Int Delay, s/veh	4.2											
Movement	EBL	EBT	EBR	WBL	WBT	WBR	NBL	NBT	NBR	SBL	SBT	SBR
Lane Configurations	↖	↗		↖	↗		↖	↗			↕	
Traffic Vol, veh/h	3	76	23	215	195	1	5	3	54	0	4	0
Future Vol, veh/h	3	76	23	215	195	1	5	3	54	0	4	0
Conflicting Peds, #/hr	0	0	0	0	0	0	0	0	0	0	0	0
Sign Control	Free	Free	Free	Free	Free	Free	Stop	Stop	Stop	Stop	Stop	Stop
RT Channelized	-	-	None	-	-	None	-	-	None	-	-	None
Storage Length	100	-	-	100	-	-	75	-	-	-	-	-
Veh in Median Storage, #	-	0	-	-	0	-	-	0	-	-	0	-
Grade, %	-	0	-	-	0	-	-	0	-	-	0	-
Peak Hour Factor	78	78	78	95	95	95	78	78	78	78	78	78
Heavy Vehicles, %	2	2	2	2	2	2	2	2	2	2	2	2
Mvmt Flow	4	97	29	226	205	1	6	4	69	0	5	0

Major/Minor	Major1			Major2			Minor1			Minor2		
Conflicting Flow All	206	0	0	126	0	0	780	778	112	814	792	206
Stage 1	-	-	-	-	-	-	120	120	-	658	658	-
Stage 2	-	-	-	-	-	-	660	658	-	156	134	-
Critical Hdwy	4.12	-	-	4.12	-	-	7.12	6.52	6.22	7.12	6.52	6.22
Critical Hdwy Stg 1	-	-	-	-	-	-	6.12	5.52	-	6.12	5.52	-
Critical Hdwy Stg 2	-	-	-	-	-	-	6.12	5.52	-	6.12	5.52	-
Follow-up Hdwy	2.218	-	-	2.218	-	-	3.518	4.018	3.318	3.518	4.018	3.318
Pot Cap-1 Maneuver	1365	-	-	1460	-	-	313	328	941	297	322	835
Stage 1	-	-	-	-	-	-	884	796	-	453	461	-
Stage 2	-	-	-	-	-	-	452	461	-	846	785	-
Platoon blocked, %	-	-	-	-	-	-	-	-	-	-	-	-
Mov Cap-1 Maneuver	1365	-	-	1460	-	-	271	276	941	239	271	835
Mov Cap-2 Maneuver	-	-	-	-	-	-	271	276	-	239	271	-
Stage 1	-	-	-	-	-	-	881	794	-	452	390	-
Stage 2	-	-	-	-	-	-	377	390	-	778	783	-

Approach	EB			WB			NB			SB		
HCM Control Delay, s	0.2			4.1			10.4			18.5		
HCM LOS							B			C		

Minor Lane/Major Mvmt	NBLn1	NBLn2	EBL	EBT	EBR	WBL	WBT	WBR	SBLn1
Capacity (veh/h)	271	835	1365	-	-	1460	-	-	271
HCM Lane V/C Ratio	0.024	0.088	0.003	-	-	0.155	-	-	0.019
HCM Control Delay (s)	18.6	9.7	7.6	-	-	7.9	-	-	18.5
HCM Lane LOS	C	A	A	-	-	A	-	-	C
HCM 95th %tile Q(veh)	0.1	0.3	0	-	-	0.5	-	-	0.1

Intersection				
Intersection Delay, s/veh	4.1			
Intersection LOS	A			
Approach	EB	WB	NB	SB
Entry Lanes	1	1	1	1
Conflicting Circle Lanes	1	1	1	1
Adj Approach Flow, veh/h	107	118	260	23
Demand Flow Rate, veh/h	109	120	266	23
Vehicles Circulating, veh/h	115	132	38	217
Vehicles Exiting, veh/h	125	172	186	35
Ped Vol Crossing Leg, #/h	0	0	0	0
Ped Cap Adj	1.000	1.000	1.000	1.000
Approach Delay, s/veh	3.7	3.9	4.5	3.5
Approach LOS	A	A	A	A
Lane	Left	Left	Left	Left
Designated Moves	LTR	LTR	LTR	LTR
Assumed Moves	LTR	LTR	LTR	LTR
RT Channelized				
Lane Util	1.000	1.000	1.000	1.000
Follow-Up Headway, s	2.609	2.609	2.609	2.609
Critical Headway, s	4.976	4.976	4.976	4.976
Entry Flow, veh/h	109	120	266	23
Cap Entry Lane, veh/h	1227	1206	1327	1106
Entry HV Adj Factor	0.986	0.980	0.979	0.988
Flow Entry, veh/h	107	118	260	23
Cap Entry, veh/h	1209	1182	1300	1093
V/C Ratio	0.089	0.099	0.200	0.021
Control Delay, s/veh	3.7	3.9	4.5	3.5
LOS	A	A	A	A
95th %tile Queue, veh	0	0	1	0

Intersection						
Int Delay, s/veh	1.5					
Movement	EBT	EBR	WBL	WBT	NBL	NBR
Lane Configurations	↶		↷	↶	↷	↷
Traffic Vol, veh/h	91	53	0	64	36	0
Future Vol, veh/h	91	53	0	64	36	0
Conflicting Peds, #/hr	0	0	0	0	0	0
Sign Control	Free	Free	Free	Free	Stop	Stop
RT Channelized	-	None	-	None	-	None
Storage Length	-	-	155	-	205	0
Veh in Median Storage, #	0	-	-	0	0	-
Grade, %	0	-	-	0	0	-
Peak Hour Factor	83	83	83	83	83	83
Heavy Vehicles, %	2	2	2	2	2	2
Mvmt Flow	110	64	0	77	43	0

Major/Minor	Major1	Major2	Minor1		
Conflicting Flow All	0	0	174	0	219
Stage 1	-	-	-	-	142
Stage 2	-	-	-	-	77
Critical Hdwy	-	-	4.12	-	6.42
Critical Hdwy Stg 1	-	-	-	-	5.42
Critical Hdwy Stg 2	-	-	-	-	5.42
Follow-up Hdwy	-	-	2.218	-	3.518
Pot Cap-1 Maneuver	-	-	1403	-	769
Stage 1	-	-	-	-	885
Stage 2	-	-	-	-	946
Platoon blocked, %	-	-	-	-	-
Mov Cap-1 Maneuver	-	-	1403	-	769
Mov Cap-2 Maneuver	-	-	-	-	766
Stage 1	-	-	-	-	885
Stage 2	-	-	-	-	946

Approach	EB	WB	NB
HCM Control Delay, s	0	0	10
HCM LOS			B

Minor Lane/Major Mvmt	NBLn1	NBLn2	EBT	EBR	WBL	WBT
Capacity (veh/h)	766	-	-	-	1403	-
HCM Lane V/C Ratio	0.057	-	-	-	-	-
HCM Control Delay (s)	10	0	-	-	0	-
HCM Lane LOS	B	A	-	-	A	-
HCM 95th %tile Q(veh)	0.2	-	-	-	0	-

Intersection						
Int Delay, s/veh	3.1					
Movement	EBT	EBR	WBL	WBT	NBL	NBR
Lane Configurations						
Traffic Vol, veh/h	17	74	0	12	52	0
Future Vol, veh/h	17	74	0	12	52	0
Conflicting Peds, #/hr	0	0	0	0	0	0
Sign Control	Free	Free	Free	Free	Stop	Stop
RT Channelized	-	None	-	None	-	None
Storage Length	-	155	305	-	0	-
Veh in Median Storage, #	0	-	-	0	0	-
Grade, %	0	-	-	0	0	-
Peak Hour Factor	83	83	83	83	83	83
Heavy Vehicles, %	2	2	2	2	2	2
Mvmt Flow	20	89	0	14	63	0

Major/Minor	Major1	Major2	Minor1		
Conflicting Flow All	0	0	109	0	34
Stage 1	-	-	-	-	20
Stage 2	-	-	-	-	14
Critical Hdwy	-	-	4.12	-	6.42
Critical Hdwy Stg 1	-	-	-	-	5.42
Critical Hdwy Stg 2	-	-	-	-	5.42
Follow-up Hdwy	-	-	2.218	-	3.518
Pot Cap-1 Maneuver	-	-	1481	-	979
Stage 1	-	-	-	-	1003
Stage 2	-	-	-	-	1009
Platoon blocked, %	-	-	-	-	-
Mov Cap-1 Maneuver	-	-	1481	-	979
Mov Cap-2 Maneuver	-	-	-	-	906
Stage 1	-	-	-	-	1003
Stage 2	-	-	-	-	1009

Approach	EB	WB	NB
HCM Control Delay, s	0	0	9.3
HCM LOS			A

Minor Lane/Major Mvmt	NBLn1	EBT	EBR	WBL	WBT
Capacity (veh/h)	906	-	-	1481	-
HCM Lane V/C Ratio	0.069	-	-	-	-
HCM Control Delay (s)	9.3	-	-	0	-
HCM Lane LOS	A	-	-	A	-
HCM 95th %tile Q(veh)	0.2	-	-	0	-

Intersection						
Int Delay, s/veh	3.6					
Movement	EBT	EBR	WBL	WBT	NBL	NBR
Lane Configurations	↗		↖	↑	↘	↗
Traffic Vol, veh/h	0	17	0	0	12	0
Future Vol, veh/h	0	17	0	0	12	0
Conflicting Peds, #/hr	0	0	0	0	0	0
Sign Control	Free	Free	Free	Free	Stop	Stop
RT Channelized	-	None	-	None	-	None
Storage Length	-	-	305	-	0	0
Veh in Median Storage, #	0	-	-	0	0	-
Grade, %	0	-	-	0	0	-
Peak Hour Factor	83	83	83	83	83	83
Heavy Vehicles, %	2	2	2	2	2	2
Mvmt Flow	0	20	0	0	14	0

Major/Minor	Major1	Major2	Minor1		
Conflicting Flow All	0	0	20	0	11
Stage 1	-	-	-	-	10
Stage 2	-	-	-	-	1
Critical Hdwy	-	-	4.12	-	6.42
Critical Hdwy Stg 1	-	-	-	-	5.42
Critical Hdwy Stg 2	-	-	-	-	5.42
Follow-up Hdwy	-	-	2.218	-	3.518
Pot Cap-1 Maneuver	-	-	1596	-	1009
Stage 1	-	-	-	-	1013
Stage 2	-	-	-	-	1022
Platoon blocked, %	-	-	-	-	-
Mov Cap-1 Maneuver	-	-	1596	-	1009
Mov Cap-2 Maneuver	-	-	-	-	924
Stage 1	-	-	-	-	1013
Stage 2	-	-	-	-	1022

Approach	EB	WB	NB
HCM Control Delay, s	0	0	9
HCM LOS			A

Minor Lane/Major Mvmt	NBLn1	NBLn2	EBT	EBR	WBL	WBT
Capacity (veh/h)	924	-	-	-	1596	-
HCM Lane V/C Ratio	0.016	-	-	-	-	-
HCM Control Delay (s)	9	0	-	-	0	-
HCM Lane LOS	A	A	-	-	A	-
HCM 95th %tile Q(veh)	0	-	-	-	0	-

Intersection			
Intersection Delay, s/veh	4.4		
Intersection LOS	A		
Approach	WB	NB	SB
Entry Lanes	1	1	1
Conflicting Circle Lanes	2	2	2
Adj Approach Flow, veh/h	64	341	189
Demand Flow Rate, veh/h	65	348	192
Vehicles Circulating, veh/h	259	22	53
Vehicles Exiting, veh/h	111	223	271
Ped Vol Crossing Leg, #/h	0	0	0
Ped Cap Adj	1.000	1.000	1.000
Approach Delay, s/veh	3.7	4.8	3.8
Approach LOS	A	A	A
Lane	Left	Left	Left
Designated Moves	LR	TR	LT
Assumed Moves	LR	TR	LT
RT Channelized			
Lane Util	1.000	1.000	1.000
Follow-Up Headway, s	2.535	2.535	2.535
Critical Headway, s	4.328	4.328	4.328
Entry Flow, veh/h	65	348	192
Cap Entry Lane, veh/h	1139	1394	1358
Entry HV Adj Factor	0.985	0.980	0.983
Flow Entry, veh/h	64	341	189
Cap Entry, veh/h	1122	1365	1334
V/C Ratio	0.057	0.250	0.141
Control Delay, s/veh	3.7	4.8	3.8
LOS	A	A	A
95th %tile Queue, veh	0	1	0

Intersection						
Int Delay, s/veh	1.1					
Movement	WBL	WBR	NBT	NBR	SBL	SBT
Lane Configurations	Y		↑	↑	↑	↑
Traffic Vol, veh/h	31	10	274	54	16	166
Future Vol, veh/h	31	10	274	54	16	166
Conflicting Peds, #/hr	0	0	0	0	0	0
Sign Control	Stop	Stop	Free	Free	Free	Free
RT Channelized	-	None	-	None	-	None
Storage Length	0	-	-	155	205	-
Veh in Median Storage, #	0	-	0	-	-	0
Grade, %	0	-	0	-	-	0
Peak Hour Factor	83	83	83	83	83	83
Heavy Vehicles, %	2	2	2	2	2	2
Mvmt Flow	37	12	330	65	19	200

Major/Minor	Minor1	Major1	Major2		
Conflicting Flow All	568	330	0	0	395
Stage 1	330	-	-	-	-
Stage 2	238	-	-	-	-
Critical Hdwy	6.42	6.22	-	-	4.12
Critical Hdwy Stg 1	5.42	-	-	-	-
Critical Hdwy Stg 2	5.42	-	-	-	-
Follow-up Hdwy	3.518	3.318	-	-	2.218
Pot Cap-1 Maneuver	484	712	-	-	1164
Stage 1	728	-	-	-	-
Stage 2	802	-	-	-	-
Platoon blocked, %			-	-	-
Mov Cap-1 Maneuver	476	712	-	-	1164
Mov Cap-2 Maneuver	562	-	-	-	-
Stage 1	728	-	-	-	-
Stage 2	789	-	-	-	-

Approach	WB	NB	SB
HCM Control Delay, s	11.6	0	0.7
HCM LOS	B		

Minor Lane/Major Mvmt	NBT	NBRWBLn1	SBL	SBT
Capacity (veh/h)	-	-	592	1164
HCM Lane V/C Ratio	-	-	0.083	0.017
HCM Control Delay (s)	-	-	11.6	8.1
HCM Lane LOS	-	-	B	A
HCM 95th %tile Q(veh)	-	-	0.3	0.1

Intersection						
Intersection Delay, s/veh	5.1					
Intersection LOS	A					
Approach	EB		NB		SB	
Entry Lanes	2		2		2	
Conflicting Circle Lanes	2		2		2	
Adj Approach Flow, veh/h	237		759		233	
Demand Flow Rate, veh/h	242		774		237	
Vehicles Circulating, veh/h	222		25		406	
Vehicles Exiting, veh/h	421		438		393	
Ped Vol Crossing Leg, #/h	0		0		0	
Ped Cap Adj	1.000		1.000		1.000	
Approach Delay, s/veh	4.6		5.3		4.9	
Approach LOS	A		A		A	
Lane	Left	Right	Left	Right	Left	Right
Designated Moves	L	TR	L	TR	LT	TR
Assumed Moves	L	TR	L	TR	LT	TR
RT Channelized						
Lane Util	0.107	0.893	0.525	0.475	0.468	0.532
Follow-Up Headway, s	2.667	2.535	2.667	2.535	2.667	2.535
Critical Headway, s	4.645	4.328	4.645	4.328	4.645	4.328
Entry Flow, veh/h	26	216	406	368	111	126
Cap Entry Lane, veh/h	1101	1176	1319	1390	929	1006
Entry HV Adj Factor	0.962	0.981	0.980	0.980	0.985	0.979
Flow Entry, veh/h	25	212	398	361	109	123
Cap Entry, veh/h	1058	1154	1293	1363	915	984
V/C Ratio	0.024	0.184	0.308	0.265	0.119	0.125
Control Delay, s/veh	3.6	4.7	5.6	4.9	5.1	4.8
LOS	A	A	A	A	A	A
95th %tile Queue, veh	0	1	1	1	0	0



Intersection						
Intersection Delay, s/veh	5.9					
Intersection LOS	A					
Approach	EB	WB	NB	SB		
Entry Lanes	1	1	1	1		
Conflicting Circle Lanes	1	1	1	1		
Adj Approach Flow, veh/h	298	523	377	397		
Demand Flow Rate, veh/h	305	533	385	404		
Vehicles Circulating, veh/h	352	481	428	291		
Vehicles Exiting, veh/h	267	332	228	416		
Ped Vol Crossing Leg, #/h	0	0	0	0		
Ped Cap Adj	1.000	1.000	1.000	1.000		
Approach Delay, s/veh	7.2	3.1	9.4	5.6		
Approach LOS	A	A	A	A		
Lane	Left	Left	Bypass	Left	Left	Bypass
Designated Moves	LTR	LT	R	LTR	LT	R
Assumed Moves	LTR	LT	R	LTR	LT	R
RT Channelized			Free			Free
Lane Util	1.000	1.000		1.000	1.000	
Follow-Up Headway, s	2.609	2.609		2.609	2.609	
Critical Headway, s	4.976	4.976	307	4.976	4.976	76
Entry Flow, veh/h	305	226	1938	385	328	1938
Cap Entry Lane, veh/h	964	845	0.980	892	1026	0.980
Entry HV Adj Factor	0.979	0.982	301	0.980	0.981	75
Flow Entry, veh/h	298	222	1900	377	322	1900
Cap Entry, veh/h	943	830	0.158	874	1006	0.039
V/C Ratio	0.317	0.268	0.0	0.432	0.320	0.0
Control Delay, s/veh	7.2	7.3	A	9.4	6.8	A
LOS	A	A	1	A	A	0
95th %tile Queue, veh	1	1		2	1	

Timings  
14: US 24 & Stapleton Dr

2026 Total Traffic  
PM Peak Hour

Lane Group	EBL	EBT	EBR	WBL	WBT	WBR	NBL	NBT	NBR	SBL	SBT	SBR
Lane Configurations												
Traffic Volume (vph)	31	92	161	5	200	34	283	517	8	10	409	52
Future Volume (vph)	31	92	161	5	200	34	283	517	8	10	409	52
Turn Type	pm+pt	NA	Free	pm+pt	NA	Free	pm+pt	NA	Perm	pm+pt	NA	Perm
Protected Phases	5	2		1	6		3	8		7	4	
Permitted Phases	2		Free	6		Free	8		8	4		4
Detector Phase	5	2		1	6		3	8	8	7	4	4
Switch Phase												
Minimum Initial (s)	5.0	5.0		5.0	5.0		5.0	5.0	5.0	5.0	15.0	15.0
Minimum Split (s)	10.0	10.0		10.0	10.0		10.0	10.0	10.0	10.0	20.0	20.0
Total Split (s)	12.0	30.0		12.0	30.0		12.0	66.0	66.0	12.0	66.0	66.0
Total Split (%)	10.0%	25.0%		10.0%	25.0%		10.0%	55.0%	55.0%	10.0%	55.0%	55.0%
Yellow Time (s)	3.0	3.0		3.0	3.0		3.0	3.0	3.0	3.0	3.0	3.0
All-Red Time (s)	2.0	2.0		2.0	2.0		2.0	2.0	2.0	2.0	2.0	2.0
Lost Time Adjust (s)	0.0	0.0		0.0	0.0		0.0	0.0	0.0	0.0	0.0	0.0
Total Lost Time (s)	5.0	5.0		5.0	5.0		5.0	5.0	5.0	5.0	5.0	5.0
Lead/Lag	Lead	Lag		Lead	Lag		Lead	Lag	Lag	Lead	Lag	Lag
Lead-Lag Optimize?	Yes	Yes		Yes	Yes		Yes	Yes	Yes	Yes	Yes	Yes
Recall Mode	None	C-Max		None	C-Max		None	Max	Max	None	Max	Max
Act Effct Green (s)	36.1	34.7	120.0	33.5	29.8	120.0	72.1	70.7	70.7	66.8	61.0	61.0
Actuated g/C Ratio	0.30	0.29	1.00	0.28	0.25	1.00	0.60	0.59	0.59	0.56	0.51	0.51
v/c Ratio	0.15	0.20	0.12	0.02	0.52	0.03	0.71	0.55	0.01	0.03	0.50	0.07
Control Delay	25.2	28.2	0.1	29.2	45.4	0.0	23.5	18.1	0.0	10.1	22.1	0.4
Queue Delay	0.0	0.0	0.0	0.0	0.0	0.0	0.0	0.0	0.0	0.0	0.0	0.0
Total Delay	25.2	28.2	0.1	29.2	45.4	0.0	23.5	18.1	0.0	10.1	22.1	0.4
LOS	C	C	A	C	D	A	C	B	A	B	C	A
Approach Delay		12.0			38.6			19.8			19.4	
Approach LOS		B			D			B			B	

Intersection Summary

Cycle Length: 120  
 Actuated Cycle Length: 120  
 Offset: 0 (0%), Referenced to phase 2:EBTL and 6:WBTL, Start of Green  
 Natural Cycle: 60  
 Control Type: Actuated-Coordinated  
 Maximum v/c Ratio: 0.71  
 Intersection Signal Delay: 21.0  
 Intersection LOS: C  
 Intersection Capacity Utilization 68.6%  
 ICU Level of Service C  
 Analysis Period (min) 15

Splits and Phases: 14: US 24 & Stapleton Dr

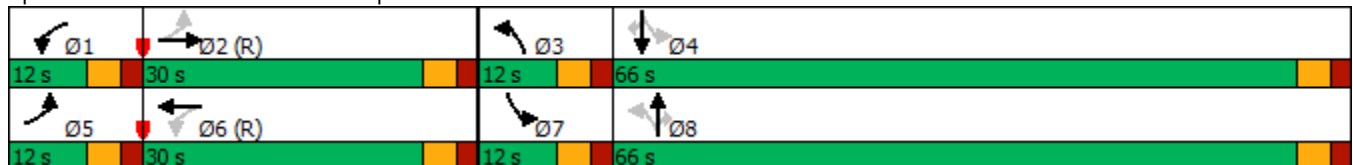

**Intersection**

Intersection Delay, s/veh 16.3

Intersection LOS C

Movement	EBL	EBT	EBR	WBL	WBT	WBR	NBL	NBT	NBR	SBL	SBT	SBR
Lane Configurations												
Traffic Vol, veh/h	10	66	96	49	145	58	185	230	73	24	86	5
Future Vol, veh/h	10	66	96	49	145	58	185	230	73	24	86	5
Peak Hour Factor	0.83	0.83	0.83	0.88	0.88	0.88	0.87	0.87	0.87	0.78	0.78	0.78
Heavy Vehicles, %	2	2	2	2	2	2	2	2	2	2	2	2
Mvmt Flow	12	80	116	56	165	66	213	264	84	31	110	6
Number of Lanes	1	1	0	1	1	1	1	1	0	1	1	0

Approach	EB	WB	NB	SB
Opposing Approach	WB	EB	SB	NB
Opposing Lanes	3	2	2	2
Conflicting Approach Left SB		NB	EB	WB
Conflicting Lanes Left	2	2	2	3
Conflicting Approach Right NB		SB	WB	EB
Conflicting Lanes Right	2	2	3	2
HCM Control Delay	15	13.2	19.2	13.1
HCM LOS	B	B	C	B

Lane	NBLn1	NBLn2	EBLn1	EBLn2	WBLn1	WBLn2	WBLn3	SBLn1	SBLn2
Vol Left, %	100%	0%	100%	0%	100%	0%	0%	100%	0%
Vol Thru, %	0%	76%	0%	41%	0%	100%	0%	0%	95%
Vol Right, %	0%	24%	0%	59%	0%	0%	100%	0%	5%
Sign Control	Stop	Stop	Stop	Stop	Stop	Stop	Stop	Stop	Stop
Traffic Vol by Lane	185	303	10	162	49	145	58	24	91
LT Vol	185	0	10	0	49	0	0	24	0
Through Vol	0	230	0	66	0	145	0	0	86
RT Vol	0	73	0	96	0	0	58	0	5
Lane Flow Rate	213	348	12	195	56	165	66	31	117
Geometry Grp	6	6	6	6	6	6	6	6	6
Degree of Util (X)	0.438	0.651	0.028	0.404	0.126	0.35	0.127	0.072	0.256
Departure Headway (Hd)	7.411	6.734	8.384	7.444	8.166	7.655	6.939	8.434	7.884
Convergence, Y/N	Yes	Yes	Yes	Yes	Yes	Yes	Yes	Yes	Yes
Cap	487	536	427	484	439	470	516	424	455
Service Time	5.156	4.479	6.137	5.196	5.918	5.407	4.691	6.192	5.642
HCM Lane V/C Ratio	0.437	0.649	0.028	0.403	0.128	0.351	0.128	0.073	0.257
HCM Control Delay	15.8	21.2	11.4	15.2	12.1	14.5	10.7	11.8	13.4
HCM Lane LOS	C	C	B	C	B	B	B	B	B
HCM 95th-tile Q	2.2	4.7	0.1	1.9	0.4	1.6	0.4	0.2	1

Intersection												
Int Delay, s/veh	8.4											
Movement	EBL	EBT	EBR	WBL	WBT	WBR	NBL	NBT	NBR	SBL	SBT	SBR
Lane Configurations	↖	↗		↖	↗		↖	↗			↕	
Traffic Vol, veh/h	5	262	61	151	159	1	43	20	311	0	4	4
Future Vol, veh/h	5	262	61	151	159	1	43	20	311	0	4	4
Conflicting Peds, #/hr	0	0	0	0	0	0	0	0	0	0	0	0
Sign Control	Free	Free	Free	Free	Free	Free	Stop	Stop	Stop	Stop	Stop	Stop
RT Channelized	-	-	None	-	-	None	-	-	None	-	-	None
Storage Length	100	-	-	100	-	-	75	-	-	-	-	-
Veh in Median Storage, #	-	0	-	-	0	-	-	0	-	-	0	-
Grade, %	-	0	-	-	0	-	-	0	-	-	0	-
Peak Hour Factor	87	87	87	87	87	87	89	89	89	58	58	58
Heavy Vehicles, %	2	2	2	2	2	2	2	2	2	2	2	2
Mvmt Flow	6	301	70	174	183	1	48	22	349	0	7	7

Major/Minor	Major1			Major2			Minor1			Minor2		
Conflicting Flow All	184	0	0	371	0	0	887	880	336	1066	915	184
Stage 1	-	-	-	-	-	-	348	348	-	532	532	-
Stage 2	-	-	-	-	-	-	539	532	-	534	383	-
Critical Hdwy	4.12	-	-	4.12	-	-	7.12	6.52	6.22	7.12	6.52	6.22
Critical Hdwy Stg 1	-	-	-	-	-	-	6.12	5.52	-	6.12	5.52	-
Critical Hdwy Stg 2	-	-	-	-	-	-	6.12	5.52	-	6.12	5.52	-
Follow-up Hdwy	2.218	-	-	2.218	-	-	3.518	4.018	3.318	3.518	4.018	3.318
Pot Cap-1 Maneuver	1391	-	-	1188	-	-	265	286	706	200	273	858
Stage 1	-	-	-	-	-	-	668	634	-	531	526	-
Stage 2	-	-	-	-	-	-	527	526	-	530	612	-
Platoon blocked, %		-	-		-	-						
Mov Cap-1 Maneuver	1391	-	-	1188	-	-	227	243	706	83	232	858
Mov Cap-2 Maneuver	-	-	-	-	-	-	227	243	-	83	232	-
Stage 1	-	-	-	-	-	-	665	631	-	529	449	-
Stage 2	-	-	-	-	-	-	439	449	-	257	610	-

Approach	EB			WB			NB			SB		
HCM Control Delay, s	0.1			4.2			19.3			15.3		
HCM LOS							C			C		

Minor Lane/Major Mvmt	NBLn1	NBLn2	EBL	EBT	EBR	WBL	WBT	WBR	SBLn1
Capacity (veh/h)	227	633	1391	-	-	1188	-	-	365
HCM Lane V/C Ratio	0.213	0.588	0.004	-	-	0.146	-	-	0.038
HCM Control Delay (s)	25.1	18.5	7.6	-	-	8.5	-	-	15.3
HCM Lane LOS	D	C	A	-	-	A	-	-	C
HCM 95th %tile Q(veh)	0.8	3.8	0	-	-	0.5	-	-	0.1

Intersection				
Intersection Delay, s/veh	7.6			
Intersection LOS	A			
Approach	EB	WB	NB	SB
Entry Lanes	1	1	1	1
Conflicting Circle Lanes	1	1	1	1
Adj Approach Flow, veh/h	365	503	490	52
Demand Flow Rate, veh/h	372	513	500	53
Vehicles Circulating, veh/h	423	152	90	615
Vehicles Exiting, veh/h	245	438	705	50
Ped Vol Crossing Leg, #/h	0	0	0	0
Ped Cap Adj	1.000	1.000	1.000	1.000
Approach Delay, s/veh	9.0	7.6	6.8	5.7
Approach LOS	A	A	A	A
Lane	Left	Left	Left	Left
Designated Moves	LTR	LTR	LTR	LTR
Assumed Moves	LTR	LTR	LTR	LTR
RT Channelized				
Lane Util	1.000	1.000	1.000	1.000
Follow-Up Headway, s	2.609	2.609	2.609	2.609
Critical Headway, s	4.976	4.976	4.976	4.976
Entry Flow, veh/h	372	513	500	53
Cap Entry Lane, veh/h	896	1182	1259	737
Entry HV Adj Factor	0.980	0.980	0.979	0.989
Flow Entry, veh/h	365	503	490	52
Cap Entry, veh/h	879	1158	1233	729
V/C Ratio	0.415	0.434	0.397	0.072
Control Delay, s/veh	9.0	7.6	6.8	5.7
LOS	A	A	A	A
95th %tile Queue, veh	2	2	2	0

Intersection						
Int Delay, s/veh	0.8					
Movement	EBT	EBR	WBL	WBT	NBL	NBR
Lane Configurations	↔		↔	↑	↔	↔
Traffic Vol, veh/h	336	59	0	412	51	0
Future Vol, veh/h	336	59	0	412	51	0
Conflicting Peds, #/hr	0	0	0	0	0	0
Sign Control	Free	Free	Free	Free	Stop	Stop
RT Channelized	-	None	-	None	-	None
Storage Length	-	-	155	-	205	0
Veh in Median Storage, #	0	-	-	0	0	-
Grade, %	0	-	-	0	0	-
Peak Hour Factor	92	92	92	92	92	92
Heavy Vehicles, %	2	2	2	2	2	2
Mvmt Flow	365	64	0	448	55	0

Major/Minor	Major1	Major2	Minor1			
Conflicting Flow All	0	0	429	0	845	397
Stage 1	-	-	-	-	397	-
Stage 2	-	-	-	-	448	-
Critical Hdwy	-	-	4.12	-	6.42	6.22
Critical Hdwy Stg 1	-	-	-	-	5.42	-
Critical Hdwy Stg 2	-	-	-	-	5.42	-
Follow-up Hdwy	-	-	2.218	-	3.518	3.318
Pot Cap-1 Maneuver	-	-	1130	-	333	652
Stage 1	-	-	-	-	679	-
Stage 2	-	-	-	-	644	-
Platoon blocked, %	-	-	-	-	-	-
Mov Cap-1 Maneuver	-	-	1130	-	333	652
Mov Cap-2 Maneuver	-	-	-	-	453	-
Stage 1	-	-	-	-	679	-
Stage 2	-	-	-	-	644	-

Approach	EB	WB	NB
HCM Control Delay, s	0	0	14.1
HCM LOS			B

Minor Lane/Major Mvmt	NBLn1	NBLn2	EBT	EBR	WBL	WBT
Capacity (veh/h)	453	-	-	-	1130	-
HCM Lane V/C Ratio	0.122	-	-	-	-	-
HCM Control Delay (s)	14.1	0	-	-	0	-
HCM Lane LOS	B	A	-	-	A	-
HCM 95th %tile Q(veh)	0.4	-	-	-	0	-

Intersection						
Int Delay, s/veh	0.6					
Movement	EBT	EBR	WBL	WBT	NBL	NBR
Lane Configurations						
Traffic Vol, veh/h	314	22	0	377	35	0
Future Vol, veh/h	314	22	0	377	35	0
Conflicting Peds, #/hr	0	0	0	0	0	0
Sign Control	Free	Free	Free	Free	Stop	Stop
RT Channelized	-	None	-	None	-	None
Storage Length	-	155	305	-	0	-
Veh in Median Storage, #	0	-	-	0	0	-
Grade, %	0	-	-	0	0	-
Peak Hour Factor	92	92	92	92	92	92
Heavy Vehicles, %	2	2	2	2	2	2
Mvmt Flow	341	24	0	410	38	0

Major/Minor	Major1	Major2	Minor1			
Conflicting Flow All	0	0	365	0	751	341
Stage 1	-	-	-	-	341	-
Stage 2	-	-	-	-	410	-
Critical Hdwy	-	-	4.12	-	6.42	6.22
Critical Hdwy Stg 1	-	-	-	-	5.42	-
Critical Hdwy Stg 2	-	-	-	-	5.42	-
Follow-up Hdwy	-	-	2.218	-	3.518	3.318
Pot Cap-1 Maneuver	-	-	1194	-	378	701
Stage 1	-	-	-	-	720	-
Stage 2	-	-	-	-	670	-
Platoon blocked, %	-	-	-	-	-	-
Mov Cap-1 Maneuver	-	-	1194	-	378	701
Mov Cap-2 Maneuver	-	-	-	-	489	-
Stage 1	-	-	-	-	720	-
Stage 2	-	-	-	-	670	-

Approach	EB	WB	NB
HCM Control Delay, s	0	0	13
HCM LOS			B

Minor Lane/Major Mvmt	NBLn1	EBT	EBR	WBL	WBT
Capacity (veh/h)	489	-	-	1194	-
HCM Lane V/C Ratio	0.078	-	-	-	-
HCM Control Delay (s)	13	-	-	0	-
HCM Lane LOS	B	-	-	A	-
HCM 95th %tile Q(veh)	0.3	-	-	0	-

Intersection						
Int Delay, s/veh	1.8					
Movement	EBT	EBR	WBL	WBT	NBL	NBR
Lane Configurations						
Traffic Vol, veh/h	282	33	0	281	96	0
Future Vol, veh/h	282	33	0	281	96	0
Conflicting Peds, #/hr	0	0	0	0	0	0
Sign Control	Free	Free	Free	Free	Stop	Stop
RT Channelized	-	None	-	None	-	None
Storage Length	-	-	305	-	0	0
Veh in Median Storage, #	0	-	-	0	0	-
Grade, %	0	-	-	0	0	-
Peak Hour Factor	92	92	92	92	92	92
Heavy Vehicles, %	2	2	2	2	2	2
Mvmt Flow	307	36	0	305	104	0

Major/Minor	Major1	Major2	Minor1		
Conflicting Flow All	0	0	343	0	630 325
Stage 1	-	-	-	-	325 -
Stage 2	-	-	-	-	305 -
Critical Hdwy	-	-	4.12	-	6.42 6.22
Critical Hdwy Stg 1	-	-	-	-	5.42 -
Critical Hdwy Stg 2	-	-	-	-	5.42 -
Follow-up Hdwy	-	-	2.218	-	3.518 3.318
Pot Cap-1 Maneuver	-	-	1216	-	446 716
Stage 1	-	-	-	-	732 -
Stage 2	-	-	-	-	748 -
Platoon blocked, %	-	-	-	-	-
Mov Cap-1 Maneuver	-	-	1216	-	446 716
Mov Cap-2 Maneuver	-	-	-	-	541 -
Stage 1	-	-	-	-	732 -
Stage 2	-	-	-	-	748 -

Approach	EB	WB	NB
HCM Control Delay, s	0	0	13.2
HCM LOS			B

Minor Lane/Major Mvmt	NBLn1	NBLn2	EBT	EBR	WBL	WBT
Capacity (veh/h)	541	-	-	-	1216	-
HCM Lane V/C Ratio	0.193	-	-	-	-	-
HCM Control Delay (s)	13.2	0	-	-	0	-
HCM Lane LOS	B	A	-	-	A	-
HCM 95th %tile Q(veh)	0.7	-	-	-	0	-



Intersection			
Intersection Delay, s/veh	4.6		
Intersection LOS	A		
Approach	EB	WB	NB
Entry Lanes	1	0	0
Conflicting Circle Lanes	1	1	1
Adj Approach Flow, veh/h	307	0	0
Demand Flow Rate, veh/h	313	0	0
Vehicles Circulating, veh/h	0	311	0
Vehicles Exiting, veh/h	311	0	313
Ped Vol Crossing Leg, #/h	0	0	0
Ped Cap Adj	1.000	1.000	1.000
Approach Delay, s/veh	4.6	0.0	0.0
Approach LOS	A	-	-
Lane	Left	Bypass	
Designated Moves	TR	R	
Assumed Moves	TR	R	
RT Channelized		Yield	
Lane Util	1.000		
Follow-Up Headway, s	2.609		
Critical Headway, s	4.976	0	
Entry Flow, veh/h	313	0	
Cap Entry Lane, veh/h	1380	0.980	
Entry HV Adj Factor	0.981	0	
Flow Entry, veh/h	307	0	
Cap Entry, veh/h	1353	0.000	
V/C Ratio	0.227	0.0	
Control Delay, s/veh	4.6	-	
LOS	A	0	
95th %tile Queue, veh	1		

Intersection

Intersection Delay, s/veh 9.7

Intersection LOS A

Approach	WB	NB	SB
Entry Lanes	1	1	1
Conflicting Circle Lanes	2	2	2
Adj Approach Flow, veh/h	352	551	694
Demand Flow Rate, veh/h	359	562	708
Vehicles Circulating, veh/h	476	8	336
Vehicles Exiting, veh/h	94	1036	499
Ped Vol Crossing Leg, #/h	0	0	0
Ped Cap Adj	1.000	1.000	1.000
Approach Delay, s/veh	8.1	6.3	13.3
Approach LOS	A	A	B

Lane	Left	Left	Left
Designated Moves	LR	TR	LT
Assumed Moves	LR	TR	LT
RT Channelized			
Lane Util	1.000	1.000	1.000
Follow-Up Headway, s	2.535	2.535	2.535
Critical Headway, s	4.328	4.328	4.328
Entry Flow, veh/h	359	562	708
Cap Entry Lane, veh/h	948	1410	1067
Entry HV Adj Factor	0.981	0.980	0.981
Flow Entry, veh/h	352	551	694
Cap Entry, veh/h	929	1382	1047
V/C Ratio	0.379	0.398	0.663
Control Delay, s/veh	8.1	6.3	13.3
LOS	A	A	B
95th %tile Queue, veh	2	2	5

Intersection						
Int Delay, s/veh	0.9					
Movement	WBL	WBR	NBT	NBR	SBL	SBT
Lane Configurations	Y		↑	↑	↑	↑
Traffic Vol, veh/h	50	13	494	17	4	929
Future Vol, veh/h	50	13	494	17	4	929
Conflicting Peds, #/hr	0	0	0	0	0	0
Sign Control	Stop	Stop	Free	Free	Free	Free
RT Channelized	-	None	-	None	-	None
Storage Length	0	-	-	155	205	-
Veh in Median Storage, #	0	-	0	-	-	0
Grade, %	0	-	0	-	-	0
Peak Hour Factor	92	92	92	92	92	92
Heavy Vehicles, %	2	2	2	2	2	2
Mvmt Flow	54	14	537	18	4	1010

Major/Minor	Minor1	Major1	Major2		
Conflicting Flow All	1555	537	0	0	555
Stage 1	537	-	-	-	-
Stage 2	1018	-	-	-	-
Critical Hdwy	6.42	6.22	-	-	4.12
Critical Hdwy Stg 1	5.42	-	-	-	-
Critical Hdwy Stg 2	5.42	-	-	-	-
Follow-up Hdwy	3.518	3.318	-	-	2.218
Pot Cap-1 Maneuver	124	544	-	-	1015
Stage 1	586	-	-	-	-
Stage 2	349	-	-	-	-
Platoon blocked, %			-	-	-
Mov Cap-1 Maneuver	124	544	-	-	1015
Mov Cap-2 Maneuver	251	-	-	-	-
Stage 1	586	-	-	-	-
Stage 2	348	-	-	-	-

Approach	WB	NB	SB
HCM Control Delay, s	21.8	0	0
HCM LOS	C		

Minor Lane/Major Mvmt	NBT	NBRWBLn1	SBL	SBT
Capacity (veh/h)	-	-	282	1015
HCM Lane V/C Ratio	-	-	0.243	0.004
HCM Control Delay (s)	-	-	21.8	8.6
HCM Lane LOS	-	-	C	A
HCM 95th %tile Q(veh)	-	-	0.9	0

Intersection						
Intersection Delay, s/veh	9.5					
Intersection LOS	A					
Approach	EB		NB		SB	
Entry Lanes	2		2		2	
Conflicting Circle Lanes	2		2		2	
Adj Approach Flow, veh/h	383		855		1065	
Demand Flow Rate, veh/h	390		872		1086	
Vehicles Circulating, veh/h	986		67		373	
Vehicles Exiting, veh/h	473		1309		566	
Ped Vol Crossing Leg, #/h	0		0		0	
Ped Cap Adj	1.000		1.000		1.000	
Approach Delay, s/veh	13.9		5.9		10.7	
Approach LOS	B		A		B	
Lane	Left	Right	Left	Right	Left	Right
Designated Moves	L	TR	L	TR	LT	TR
Assumed Moves	L	TR	L	TR	LT	TR
RT Channelized						
Lane Util	0.172	0.828	0.428	0.572	0.470	0.530
Follow-Up Headway, s	2.667	2.535	2.667	2.535	2.667	2.535
Critical Headway, s	4.645	4.328	4.645	4.328	4.645	4.328
Entry Flow, veh/h	67	323	373	499	510	576
Cap Entry Lane, veh/h	545	614	1269	1341	958	1034
Entry HV Adj Factor	0.985	0.981	0.981	0.980	0.981	0.980
Flow Entry, veh/h	66	317	366	489	500	564
Cap Entry, veh/h	537	603	1245	1315	940	1013
V/C Ratio	0.123	0.526	0.294	0.372	0.532	0.557
Control Delay, s/veh	8.3	15.0	5.6	6.2	10.8	10.7
LOS	A	C	A	A	B	B
95th %tile Queue, veh	0	3	1	2	3	4

Intersection									
Intersection Delay, s/veh 19.4									
Intersection LOS C									
Approach	EB		WB		NB		SB		
Entry Lanes	2		2		1		1		
Conflicting Circle Lanes	2		2		2		2		
Adj Approach Flow, veh/h	481		572		485		1285		
Demand Flow Rate, veh/h	491		584		496		1311		
Vehicles Circulating, veh/h	1042		611		928		322		
Vehicles Exiting, veh/h	293		813		605		482		
Ped Vol Crossing Leg, #/h	0		0		0		0		
Ped Cap Adj	1.000		1.000		1.000		1.000		
Approach Delay, s/veh	14.1		1.9		25.9		26.7		
Approach LOS	B		A		D		D		
Lane	Left	Right	Left	Right	Bypass	Left	Left	Bypass	
Designated Moves	LT	TR	LT	TR	R	LTR	LT	R	
Assumed Moves	LT	TR	LT	TR	R	LTR	LT	R	
RT Channelized					Free			Free	
Lane Util	0.470	0.530	0.472	0.528		1.000	1.000		
Follow-Up Headway, s	2.667	2.535	2.667	2.535		2.535	2.535		
Critical Headway, s	4.645	4.328	4.645	4.328	391	4.328	4.328	298	
Entry Flow, veh/h	231	260	91	102	1938	496	1013	1938	
Cap Entry Lane, veh/h	518	586	769	845	0.980	645	1080	0.980	
Entry HV Adj Factor	0.978	0.980	0.975	0.981	383	0.979	0.981	292	
Flow Entry, veh/h	226	255	89	100	1900	485	993	1900	
Cap Entry, veh/h	506	574	750	829	0.202	631	1059	0.154	
V/C Ratio	0.446	0.444	0.118	0.121	0.0	0.769	0.938	0.0	
Control Delay, s/veh	14.9	13.4	6.0	5.5	A	25.9	34.5	A	
LOS	B	B	A	A	1	D	D	1	
95th %tile Queue, veh	2	2	0	0		7	16		

Timings  
14: US 24 & Stapleton Dr

2033 Total Traffic  
AM Peak Hour

Lane Group	EBL	EBT	EBR	WBL	WBT	WBR	NBL	NBT	NBR	SBL	SBT	SBR
Lane Configurations												
Traffic Volume (vph)	101	343	472	4	174	17	238	322	5	45	540	83
Future Volume (vph)	101	343	472	4	174	17	238	322	5	45	540	83
Turn Type	pm+pt	NA	Free	pm+pt	NA	Free	Prot	NA	Perm	pm+pt	NA	Perm
Protected Phases	5	2		1	6		3	8		7	4	
Permitted Phases	2		Free	6		Free			8	4		4
Detector Phase	5	2		1	6		3	8	8	7	4	4
Switch Phase												
Minimum Initial (s)	5.0	10.0		5.0	5.0		15.0	5.0	5.0	5.0	15.0	15.0
Minimum Split (s)	10.0	15.0		10.0	10.0		20.0	10.0	10.0	10.0	20.0	20.0
Total Split (s)	10.0	37.0		10.0	37.0		22.0	63.0	63.0	10.0	51.0	51.0
Total Split (%)	8.3%	30.8%		8.3%	30.8%		18.3%	52.5%	52.5%	8.3%	42.5%	42.5%
Yellow Time (s)	3.0	3.0		3.0	3.0		3.0	3.0	3.0	3.0	3.0	3.0
All-Red Time (s)	2.0	2.0		2.0	2.0		2.0	2.0	2.0	2.0	2.0	2.0
Lost Time Adjust (s)	0.0	0.0		0.0	0.0		0.0	0.0	0.0	0.0	0.0	0.0
Total Lost Time (s)	5.0	5.0		5.0	5.0		5.0	5.0	5.0	5.0	5.0	5.0
Lead/Lag	Lead	Lag		Lead	Lag		Lead	Lag	Lag	Lead	Lag	Lag
Lead-Lag Optimize?	Yes	Yes		Yes	Yes		Yes	Yes	Yes	Yes	Yes	Yes
Recall Mode	None	C-Max		None	C-Max		None	Max	Max	None	Max	Max
Act Effct Green (s)	41.0	40.0	120.0	37.0	32.0	120.0	15.6	60.0	60.0	52.4	47.4	47.4
Actuated g/C Ratio	0.34	0.33	1.00	0.31	0.27	1.00	0.13	0.50	0.50	0.44	0.40	0.40
v/c Ratio	0.33	0.60	0.32	0.02	0.38	0.01	0.58	0.38	0.01	0.10	0.80	0.13
Control Delay	22.3	28.9	0.5	25.8	38.7	0.0	54.8	20.6	0.0	13.4	39.0	0.4
Queue Delay	0.0	0.0	0.0	0.0	0.0	0.0	0.0	0.0	0.0	0.0	0.0	0.0
Total Delay	22.3	28.9	0.5	25.8	38.7	0.0	54.8	20.6	0.0	13.4	39.0	0.4
LOS	C	C	A	C	D	A	D	C	A	B	D	A
Approach Delay		13.6			35.1			34.8			32.5	
Approach LOS		B			D			C			C	

Intersection Summary

Cycle Length: 120  
 Actuated Cycle Length: 120  
 Offset: 0 (0%), Referenced to phase 2:EBTL and 6:WBTL, Start of Green  
 Natural Cycle: 90  
 Control Type: Actuated-Coordinated  
 Maximum v/c Ratio: 0.80  
 Intersection Signal Delay: 25.9  
 Intersection LOS: C  
 Intersection Capacity Utilization 79.8%  
 ICU Level of Service D  
 Analysis Period (min) 15

Splits and Phases: 14: US 24 & Stapleton Dr

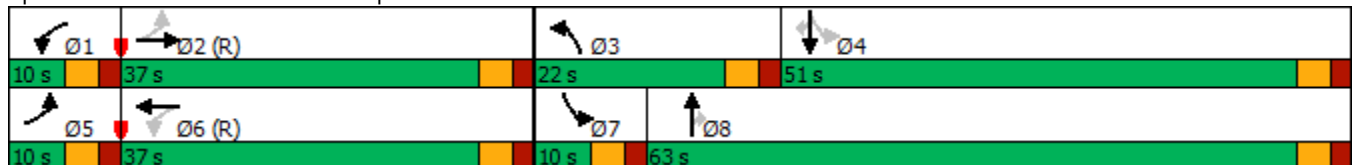

**Intersection**

Intersection Delay, s/veh 27.1

Intersection LOS D

Movement	EBL	EBT	EBR	WBL	WBT	WBR	NBL	NBT	NBR	SBL	SBT	SBR
Lane Configurations												
Traffic Vol, veh/h	118	160	101	34	42	87	20	251	36	83	304	32
Future Vol, veh/h	118	160	101	34	42	87	20	251	36	83	304	32
Peak Hour Factor	0.92	0.92	0.92	0.92	0.92	0.92	0.92	0.92	0.92	0.92	0.92	0.92
Heavy Vehicles, %	2	2	2	2	2	2	2	2	2	2	2	2
Mvmt Flow	128	174	110	37	46	95	22	273	39	90	330	35
Number of Lanes	1	1	0	1	1	1	1	1	0	1	1	0

Approach	EB	WB	NB	SB
Opposing Approach	WB	EB	SB	NB
Opposing Lanes	3	2	2	2
Conflicting Approach Left SB		NB	EB	WB
Conflicting Lanes Left	2	2	2	3
Conflicting Approach Right NB		SB	WB	EB
Conflicting Lanes Right	2	2	3	2
HCM Control Delay	22.3	13.8	29.9	34.6
HCM LOS	C	B	D	D

Lane	NBLn1	NBLn2	EBLn1	EBLn2	WBLn1	WBLn2	WBLn3	SBLn1	SBLn2
Vol Left, %	100%	0%	100%	0%	100%	0%	0%	100%	0%
Vol Thru, %	0%	87%	0%	61%	0%	100%	0%	0%	90%
Vol Right, %	0%	13%	0%	39%	0%	0%	100%	0%	10%
Sign Control	Stop	Stop	Stop	Stop	Stop	Stop	Stop	Stop	Stop
Traffic Vol by Lane	20	287	118	261	34	42	87	83	336
LT Vol	20	0	118	0	34	0	0	83	0
Through Vol	0	251	0	160	0	42	0	0	304
RT Vol	0	36	0	101	0	0	87	0	32
Lane Flow Rate	22	312	128	284	37	46	95	90	365
Geometry Grp	6	6	6	6	6	6	6	6	6
Degree of Util (X)	0.055	0.732	0.322	0.649	0.101	0.119	0.226	0.219	0.828
Departure Headway (Hd)	9.051	8.448	9.032	8.233	9.867	9.347	8.618	8.739	8.159
Convergence, Y/N	Yes	Yes	Yes	Yes	Yes	Yes	Yes	Yes	Yes
Cap	396	427	398	440	363	383	416	410	446
Service Time	6.806	6.202	6.785	5.986	7.637	7.116	6.387	6.492	5.911
HCM Lane V/C Ratio	0.056	0.731	0.322	0.645	0.102	0.12	0.228	0.22	0.818
HCM Control Delay	12.3	31.1	16	25.1	13.8	13.4	13.9	13.9	39.7
HCM Lane LOS	B	D	C	D	B	B	B	B	E
HCM 95th-tile Q	0.2	5.8	1.4	4.5	0.3	0.4	0.9	0.8	7.9

Intersection												
Int Delay, s/veh	4											
Movement	EBL	EBT	EBR	WBL	WBT	WBR	NBL	NBT	NBR	SBL	SBT	SBR
Lane Configurations	↖	↗		↖	↗		↖	↗			↕	
Traffic Vol, veh/h	3	102	23	227	244	1	5	4	60	0	6	0
Future Vol, veh/h	3	102	23	227	244	1	5	4	60	0	6	0
Conflicting Peds, #/hr	0	0	0	0	0	0	0	0	0	0	0	0
Sign Control	Free	Free	Free	Free	Free	Free	Stop	Stop	Stop	Stop	Stop	Stop
RT Channelized	-	-	None	-	-	None	-	-	None	-	-	None
Storage Length	0	-	-	110	-	-	0	-	-	-	-	-
Veh in Median Storage, #	-	0	-	-	0	-	-	0	-	-	0	-
Grade, %	-	0	-	-	0	-	-	0	-	-	0	-
Peak Hour Factor	92	92	92	92	92	92	92	92	92	92	92	92
Heavy Vehicles, %	2	2	2	2	2	2	2	2	2	2	2	2
Mvmt Flow	3	111	25	247	265	1	5	4	65	0	7	0

Major/Minor	Major1		Major2		Minor1		Minor2					
Conflicting Flow All	266	0	0	136	0	0	893	890	124	924	902	266
Stage 1	-	-	-	-	-	-	130	130	-	760	760	-
Stage 2	-	-	-	-	-	-	763	760	-	164	142	-
Critical Hdwy	4.12	-	-	4.12	-	-	7.12	6.52	6.22	7.12	6.52	6.22
Critical Hdwy Stg 1	-	-	-	-	-	-	6.12	5.52	-	6.12	5.52	-
Critical Hdwy Stg 2	-	-	-	-	-	-	6.12	5.52	-	6.12	5.52	-
Follow-up Hdwy	2.218	-	-	2.218	-	-	3.518	4.018	3.318	3.518	4.018	3.318
Pot Cap-1 Maneuver	1298	-	-	1448	-	-	262	282	927	250	277	773
Stage 1	-	-	-	-	-	-	874	789	-	398	414	-
Stage 2	-	-	-	-	-	-	397	414	-	838	779	-
Platoon blocked, %	-	-	-	-	-	-	-	-	-	-	-	-
Mov Cap-1 Maneuver	1298	-	-	1448	-	-	222	233	927	199	229	773
Mov Cap-2 Maneuver	-	-	-	-	-	-	222	233	-	199	229	-
Stage 1	-	-	-	-	-	-	872	787	-	397	343	-
Stage 2	-	-	-	-	-	-	323	343	-	773	777	-

Approach	EB	WB	NB	SB
HCM Control Delay, s	0.2	3.8	10.9	21.2
HCM LOS			B	C

Minor Lane/Major Mvmt	NBLn1	NBLn2	EBL	EBT	EBR	WBL	WBT	WBR	SBLn1
Capacity (veh/h)	222	782	1298	-	-	1448	-	-	229
HCM Lane V/C Ratio	0.024	0.089	0.003	-	-	0.17	-	-	0.028
HCM Control Delay (s)	21.6	10.1	7.8	-	-	8	-	-	21.2
HCM Lane LOS	C	B	A	-	-	A	-	-	C
HCM 95th %tile Q(veh)	0.1	0.3	0	-	-	0.6	-	-	0.1



Intersection				
Intersection Delay, s/veh	8.7			
Intersection LOS	A			
Approach	EB	WB	NB	SB
Entry Lanes	1	1	1	1
Conflicting Circle Lanes	1	1	1	1
Adj Approach Flow, veh/h	333	272	710	52
Demand Flow Rate, veh/h	339	277	725	52
Vehicles Circulating, veh/h	236	398	132	611
Vehicles Exiting, veh/h	427	459	443	64
Ped Vol Crossing Leg, #/h	0	0	0	0
Ped Cap Adj	1.000	1.000	1.000	1.000
Approach Delay, s/veh	6.5	7.2	10.5	5.6
Approach LOS	A	A	B	A
Lane	Left	Left	Left	Left
Designated Moves	LTR	LTR	LTR	LTR
Assumed Moves	LTR	LTR	LTR	LTR
RT Channelized				
Lane Util	1.000	1.000	1.000	1.000
Follow-Up Headway, s	2.609	2.609	2.609	2.609
Critical Headway, s	4.976	4.976	4.976	4.976
Entry Flow, veh/h	339	277	725	52
Cap Entry Lane, veh/h	1085	919	1206	740
Entry HV Adj Factor	0.982	0.981	0.980	0.991
Flow Entry, veh/h	333	272	710	52
Cap Entry, veh/h	1065	902	1181	734
V/C Ratio	0.313	0.301	0.601	0.070
Control Delay, s/veh	6.5	7.2	10.5	5.6
LOS	A	A	B	A
95th %tile Queue, veh	1	1	4	0

**Intersection**

Int Delay, s/veh 0.9

Movement	EBT	EBR	WBL	WBT	NBL	NBR
Lane Configurations	↔		↔	↑	↔	↔
Traffic Vol, veh/h	311	103	0	203	48	0
Future Vol, veh/h	311	103	0	203	48	0
Conflicting Peds, #/hr	0	0	0	0	0	0
Sign Control	Free	Free	Free	Free	Stop	Stop
RT Channelized	-	None	-	None	-	None
Storage Length	-	-	155	-	205	0
Veh in Median Storage, #	0	-	-	0	0	-
Grade, %	0	-	-	0	0	-
Peak Hour Factor	92	92	92	92	92	92
Heavy Vehicles, %	2	2	2	2	2	2
Mvmt Flow	338	112	0	221	52	0

**Major/Minor**

	Major1	Major2	Minor1		
Conflicting Flow All	0	0	450	0	615
Stage 1	-	-	-	-	394
Stage 2	-	-	-	-	221
Critical Hdwy	-	-	4.12	-	6.42
Critical Hdwy Stg 1	-	-	-	-	5.42
Critical Hdwy Stg 2	-	-	-	-	5.42
Follow-up Hdwy	-	-	2.218	-	3.518
Pot Cap-1 Maneuver	-	-	1110	-	455
Stage 1	-	-	-	-	681
Stage 2	-	-	-	-	816
Platoon blocked, %	-	-	-	-	-
Mov Cap-1 Maneuver	-	-	1110	-	455
Mov Cap-2 Maneuver	-	-	-	-	542
Stage 1	-	-	-	-	681
Stage 2	-	-	-	-	816

**Approach**

	EB	WB	NB
HCM Control Delay, s	0	0	12.3
HCM LOS			B

**Minor Lane/Major Mvmt**

	NBLn1	NBLn2	EBT	EBR	WBL	WBT
Capacity (veh/h)	542	-	-	-	1110	-
HCM Lane V/C Ratio	0.096	-	-	-	-	-
HCM Control Delay (s)	12.3	0	-	-	0	-
HCM Lane LOS	B	A	-	-	A	-
HCM 95th %tile Q(veh)	0.3	-	-	-	0	-

Intersection						
Int Delay, s/veh	0.5					
Movement	EBT	EBR	WBL	WBT	NBL	NBR
Lane Configurations						
Traffic Vol, veh/h	250	60	0	180	23	0
Future Vol, veh/h	250	60	0	180	23	0
Conflicting Peds, #/hr	0	0	0	0	0	0
Sign Control	Free	Free	Free	Free	Stop	Stop
RT Channelized	-	None	-	None	-	None
Storage Length	-	155	305	-	0	-
Veh in Median Storage, #	0	-	-	0	0	-
Grade, %	0	-	-	0	0	-
Peak Hour Factor	92	92	92	92	92	92
Heavy Vehicles, %	2	2	2	2	2	2
Mvmt Flow	272	65	0	196	25	0

Major/Minor	Major1	Major2	Minor1			
Conflicting Flow All	0	0	337	0	468	272
Stage 1	-	-	-	-	272	-
Stage 2	-	-	-	-	196	-
Critical Hdwy	-	-	4.12	-	6.42	6.22
Critical Hdwy Stg 1	-	-	-	-	5.42	-
Critical Hdwy Stg 2	-	-	-	-	5.42	-
Follow-up Hdwy	-	-	2.218	-	3.518	3.318
Pot Cap-1 Maneuver	-	-	1222	-	553	767
Stage 1	-	-	-	-	774	-
Stage 2	-	-	-	-	837	-
Platoon blocked, %	-	-	-	-	-	-
Mov Cap-1 Maneuver	-	-	1222	-	553	767
Mov Cap-2 Maneuver	-	-	-	-	618	-
Stage 1	-	-	-	-	774	-
Stage 2	-	-	-	-	837	-

Approach	EB	WB	NB
HCM Control Delay, s	0	0	11.1
HCM LOS			B

Minor Lane/Major Mvmt	NBLn1	EBT	EBR	WBL	WBT
Capacity (veh/h)	618	-	-	1222	-
HCM Lane V/C Ratio	0.04	-	-	-	-
HCM Control Delay (s)	11.1	-	-	0	-
HCM Lane LOS	B	-	-	A	-
HCM 95th %tile Q(veh)	0.1	-	-	0	-

**Intersection**

Int Delay, s/veh 1.6

Movement	EBT	EBR	WBL	WBT	NBL	NBR
Lane Configurations	↔		↔	↑	↔	↔
Traffic Vol, veh/h	145	105	0	117	63	0
Future Vol, veh/h	145	105	0	117	63	0
Conflicting Peds, #/hr	0	0	0	0	0	0
Sign Control	Free	Free	Free	Free	Stop	Stop
RT Channelized	-	None	-	None	-	None
Storage Length	-	-	305	-	0	0
Veh in Median Storage, #	0	-	-	0	0	-
Grade, %	0	-	-	0	0	-
Peak Hour Factor	92	92	92	92	92	92
Heavy Vehicles, %	2	2	2	2	2	2
Mvmt Flow	158	114	0	127	68	0

**Major/Minor**

	Major1	Major2	Minor1		
Conflicting Flow All	0	0	272	0	342
Stage 1	-	-	-	-	215
Stage 2	-	-	-	-	127
Critical Hdwy	-	-	4.12	-	6.42
Critical Hdwy Stg 1	-	-	-	-	5.42
Critical Hdwy Stg 2	-	-	-	-	5.42
Follow-up Hdwy	-	-	2.218	-	3.518
Pot Cap-1 Maneuver	-	-	1291	-	654
Stage 1	-	-	-	-	821
Stage 2	-	-	-	-	899
Platoon blocked, %	-	-	-	-	-
Mov Cap-1 Maneuver	-	-	1291	-	654
Mov Cap-2 Maneuver	-	-	-	-	688
Stage 1	-	-	-	-	821
Stage 2	-	-	-	-	899

**Approach**

	EB	WB	NB
HCM Control Delay, s	0	0	10.8
HCM LOS			B

**Minor Lane/Major Mvmt**

	NBLn1	NBLn2	EBT	EBR	WBL	WBT
Capacity (veh/h)	688	-	-	-	1291	-
HCM Lane V/C Ratio	0.1	-	-	-	-	-
HCM Control Delay (s)	10.8	0	-	-	0	-
HCM Lane LOS	B	A	-	-	A	-
HCM 95th %tile Q(veh)	0.3	-	-	-	0	-

Intersection			
Intersection Delay, s/veh	3.6		
Intersection LOS	A		
Approach	EB	WB	NB
Entry Lanes	1	0	0
Conflicting Circle Lanes	1	1	1
Adj Approach Flow, veh/h	158	0	0
Demand Flow Rate, veh/h	161	0	0
Vehicles Circulating, veh/h	0	130	0
Vehicles Exiting, veh/h	130	0	161
Ped Vol Crossing Leg, #/h	0	0	0
Ped Cap Adj	1.000	1.000	1.000
Approach Delay, s/veh	3.6	0.0	0.0
Approach LOS	A	-	-
Lane	Left	Bypass	
Designated Moves	TR	R	
Assumed Moves	TR	R	
RT Channelized		Yield	
Lane Util	1.000		
Follow-Up Headway, s	2.609		
Critical Headway, s	4.976	0	
Entry Flow, veh/h	161	0	
Cap Entry Lane, veh/h	1380	0.980	
Entry HV Adj Factor	0.981	0	
Flow Entry, veh/h	158	0	
Cap Entry, veh/h	1354	0.000	
V/C Ratio	0.117	0.0	
Control Delay, s/veh	3.6	-	
LOS	A	0	
95th %tile Queue, veh	0		

Intersection			
Intersection Delay, s/veh	10.6		
Intersection LOS	B		
Approach	WB	NB	SB
Entry Lanes	1	1	1
Conflicting Circle Lanes	2	2	2
Adj Approach Flow, veh/h	241	982	435
Demand Flow Rate, veh/h	246	1001	444
Vehicles Circulating, veh/h	724	25	231
Vehicles Exiting, veh/h	302	649	739
Ped Vol Crossing Leg, #/h	0	0	0
Ped Cap Adj	1.000	1.000	1.000
Approach Delay, s/veh	8.6	12.7	7.0
Approach LOS	A	B	A
Lane	Left	Left	Left
Designated Moves	LR	TR	LT
Assumed Moves	LR	TR	LT
RT Channelized			
Lane Util	1.000	1.000	1.000
Follow-Up Headway, s	2.535	2.535	2.535
Critical Headway, s	4.328	4.328	4.328
Entry Flow, veh/h	246	1001	444
Cap Entry Lane, veh/h	767	1390	1167
Entry HV Adj Factor	0.980	0.981	0.979
Flow Entry, veh/h	241	982	435
Cap Entry, veh/h	752	1364	1143
V/C Ratio	0.321	0.720	0.380
Control Delay, s/veh	8.6	12.7	7.0
LOS	A	B	A
95th %tile Queue, veh	1	7	2

Intersection						
Int Delay, s/veh	0.7					
Movement	WBL	WBR	NBT	NBR	SBL	SBT
Lane Configurations	Y		↑	↑	↑	↑
Traffic Vol, veh/h	31	10	893	54	16	569
Future Vol, veh/h	31	10	893	54	16	569
Conflicting Peds, #/hr	0	0	0	0	0	0
Sign Control	Stop	Stop	Free	Free	Free	Free
RT Channelized	-	None	-	None	-	None
Storage Length	0	-	-	155	205	-
Veh in Median Storage, #	0	-	0	-	-	0
Grade, %	0	-	0	-	-	0
Peak Hour Factor	92	92	92	92	92	92
Heavy Vehicles, %	2	2	2	2	2	2
Mvmt Flow	34	11	971	59	17	618

Major/Minor	Minor1	Major1	Major2		
Conflicting Flow All	1623	971	0	0	1030
Stage 1	971	-	-	-	-
Stage 2	652	-	-	-	-
Critical Hdwy	6.42	6.22	-	-	4.12
Critical Hdwy Stg 1	5.42	-	-	-	-
Critical Hdwy Stg 2	5.42	-	-	-	-
Follow-up Hdwy	3.518	3.318	-	-	2.218
Pot Cap-1 Maneuver	113	307	-	-	674
Stage 1	367	-	-	-	-
Stage 2	518	-	-	-	-
Platoon blocked, %			-	-	-
Mov Cap-1 Maneuver	110	307	-	-	674
Mov Cap-2 Maneuver	243	-	-	-	-
Stage 1	367	-	-	-	-
Stage 2	505	-	-	-	-

Approach	WB	NB	SB
HCM Control Delay, s	22	0	0.3
HCM LOS	C		

Minor Lane/Major Mvmt	NBT	NBRWBLn1	SBL	SBT
Capacity (veh/h)	-	-	256	674
HCM Lane V/C Ratio	-	-	0.174	0.026
HCM Control Delay (s)	-	-	22	10.5
HCM Lane LOS	-	-	C	B
HCM 95th %tile Q(veh)	-	-	0.6	0.1

Intersection						
Intersection Delay, s/veh	9.6					
Intersection LOS	A					
Approach	EB		NB		SB	
Entry Lanes	2		2		2	
Conflicting Circle Lanes	2		2		2	
Adj Approach Flow, veh/h	285		1315		653	
Demand Flow Rate, veh/h	291		1341		666	
Vehicles Circulating, veh/h	608		88		379	
Vehicles Exiting, veh/h	437		811		1050	
Ped Vol Crossing Leg, #/h	0		0		0	
Ped Cap Adj	1.000		1.000		1.000	
Approach Delay, s/veh	6.6		11.3		7.2	
Approach LOS	A		B		A	
Lane	Left	Right	Left	Right	Left	Right
Designated Moves	L	TR	L	TR	LT	TR
Assumed Moves	L	TR	L	TR	LT	TR
RT Channelized						
Lane Util	0.302	0.698	0.283	0.717	0.470	0.530
Follow-Up Headway, s	2.667	2.535	2.667	2.535	2.667	2.535
Critical Headway, s	4.645	4.328	4.645	4.328	4.645	4.328
Entry Flow, veh/h	88	203	379	962	313	353
Cap Entry Lane, veh/h	772	847	1245	1318	953	1029
Entry HV Adj Factor	0.977	0.980	0.982	0.980	0.981	0.981
Flow Entry, veh/h	86	199	372	943	307	346
Cap Entry, veh/h	754	830	1222	1292	934	1009
V/C Ratio	0.114	0.240	0.304	0.730	0.329	0.343
Control Delay, s/veh	6.0	6.9	5.8	13.6	7.4	7.1
LOS	A	A	A	B	A	A
95th %tile Queue, veh	0	1	1	7	1	2



Intersection									
Intersection Delay, s/veh 11.9									
Intersection LOS B									
Approach	EB		WB		NB		SB		
Entry Lanes	2		2		1		1		
Conflicting Circle Lanes	2		2		2		2		
Adj Approach Flow, veh/h	490		864		598		795		
Demand Flow Rate, veh/h	500		881		610		811		
Vehicles Circulating, veh/h	656		854		795		393		
Vehicles Exiting, veh/h	368		551		361		757		
Ped Vol Crossing Leg, #/h	0		0		0		0		
Ped Cap Adj	1.000		1.000		1.000		1.000		
Approach Delay, s/veh	8.9		2.8		30.5		9.7		
Approach LOS	A		A		D		A		
Lane	Left	Right	Left	Right	Bypass	Left	Left	Bypass	
Designated Moves	LT	TR	LT	TR	R	LTR	LT	R	
Assumed Moves	L	TR	LT	TR	R	LTR	LT	R	
RT Channelized					Free			Free	
Lane Util	0.566	0.434	0.471	0.529		1.000	1.000		
Follow-Up Headway, s	2.667	2.535	2.667	2.535		2.535	2.535		
Critical Headway, s	4.645	4.328	4.645	4.328	584	4.328	4.328	180	
Entry Flow, veh/h	283	217	140	157	1938	610	631	1938	
Cap Entry Lane, veh/h	738	813	615	687	0.980	722	1017	0.980	
Entry HV Adj Factor	0.979	0.981	0.976	0.981	573	0.980	0.980	176	
Flow Entry, veh/h	277	213	137	154	1900	598	619	1900	
Cap Entry, veh/h	723	798	600	674	0.302	708	997	0.093	
V/C Ratio	0.383	0.267	0.228	0.228	0.0	0.844	0.621	0.0	
Control Delay, s/veh	10.0	7.5	8.9	8.1	A	30.5	12.4	A	
LOS	A	A	A	A	1	D	B	0	
95th %tile Queue, veh	2	1	1	1		10	4		

Timings  
14: US 24 & Stapleton Dr

2033 Total Traffic  
PM Peak Hour

Lane Group	EBL	EBT	EBR	WBL	WBT	WBR	NBL	NBT	NBR	SBL	SBT	SBR
Lane Configurations												
Traffic Volume (vph)	56	163	268	5	313	34	450	594	8	10	469	87
Future Volume (vph)	56	163	268	5	313	34	450	594	8	10	469	87
Turn Type	pm+pt	NA	Free	pm+pt	NA	Free	Prot	NA	Perm	pm+pt	NA	Perm
Protected Phases	5	2		1	6		3	8		7	4	
Permitted Phases	2		Free	6		Free			8	4		4
Detector Phase	5	2		1	6		3	8	8	7	4	4
Switch Phase												
Minimum Initial (s)	5.0	5.0		5.0	5.0		5.0	5.0	5.0	5.0	15.0	15.0
Minimum Split (s)	10.0	10.0		10.0	10.0		10.0	10.0	10.0	10.0	20.0	20.0
Total Split (s)	12.0	34.0		12.0	34.0		33.0	62.0	62.0	12.0	41.0	41.0
Total Split (%)	10.0%	28.3%		10.0%	28.3%		27.5%	51.7%	51.7%	10.0%	34.2%	34.2%
Yellow Time (s)	3.0	3.0		3.0	3.0		3.0	3.0	3.0	3.0	3.0	3.0
All-Red Time (s)	2.0	2.0		2.0	2.0		2.0	2.0	2.0	2.0	2.0	2.0
Lost Time Adjust (s)	0.0	0.0		0.0	0.0		0.0	0.0	0.0	0.0	0.0	0.0
Total Lost Time (s)	5.0	5.0		5.0	5.0		5.0	5.0	5.0	5.0	5.0	5.0
Lead/Lag	Lead	Lag		Lead	Lag		Lead	Lag	Lag	Lead	Lag	Lag
Lead-Lag Optimize?	Yes	Yes		Yes	Yes		Yes	Yes	Yes	Yes	Yes	Yes
Recall Mode	None	C-Max		None	C-Max		None	Max	Max	None	Max	Max
Act Effct Green (s)	40.1	38.7	120.0	36.1	31.4	120.0	22.2	66.7	66.7	47.6	41.8	41.8
Actuated g/C Ratio	0.33	0.32	1.00	0.30	0.26	1.00	0.18	0.56	0.56	0.40	0.35	0.35
v/c Ratio	0.32	0.29	0.18	0.01	0.70	0.02	0.77	0.62	0.01	0.03	0.79	0.15
Control Delay	26.6	27.7	0.2	26.4	49.8	0.0	54.7	22.4	0.0	13.9	43.3	0.9
Queue Delay	0.0	0.0	0.0	0.0	0.0	0.0	0.0	0.0	0.0	0.0	0.0	0.0
Total Delay	26.6	27.7	0.2	26.4	49.8	0.0	54.7	22.4	0.0	13.9	43.3	0.9
LOS	C	C	A	C	D	A	D	C	A	B	D	A
Approach Delay		12.4			44.7			36.0			36.2	
Approach LOS		B			D			D			D	

Intersection Summary

Cycle Length: 120  
 Actuated Cycle Length: 120  
 Offset: 0 (0%), Referenced to phase 2:EBTL and 6:WBTL, Start of Green  
 Natural Cycle: 80  
 Control Type: Actuated-Coordinated  
 Maximum v/c Ratio: 0.79  
 Intersection Signal Delay: 32.6  
 Intersection LOS: C  
 Intersection Capacity Utilization 74.8%  
 ICU Level of Service D  
 Analysis Period (min) 15

Splits and Phases: 14: US 24 & Stapleton Dr

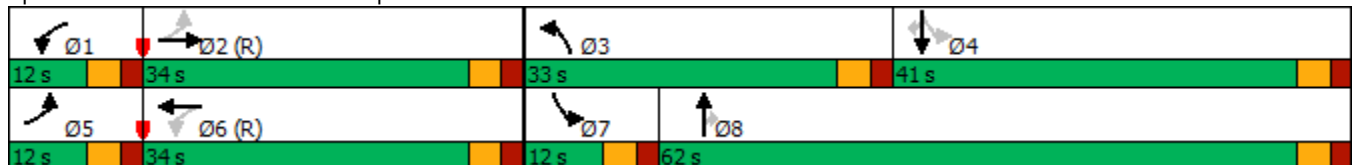

Intersection												
Intersection Delay, s/veh	18.5											
Intersection LOS	C											

Movement	EBL	EBT	EBR	WBL	WBT	WBR	NBL	NBT	NBR	SBL	SBT	SBR
Lane Configurations	↶	↷		↶	↷	↶	↶	↷		↶	↷	
Traffic Vol, veh/h	18	66	96	49	145	64	185	289	73	31	123	13
Future Vol, veh/h	18	66	96	49	145	64	185	289	73	31	123	13
Peak Hour Factor	0.92	0.92	0.92	0.92	0.92	0.92	0.92	0.92	0.92	0.92	0.92	0.92
Heavy Vehicles, %	2	2	2	2	2	2	2	2	2	2	2	2
Mvmt Flow	20	72	104	53	158	70	201	314	79	34	134	14
Number of Lanes	1	1	0	1	1	1	1	1	0	1	1	0

Approach	EB	WB	NB	SB
Opposing Approach	WB	EB	SB	NB
Opposing Lanes	3	2	2	2
Conflicting Approach Left SB		NB	EB	WB
Conflicting Lanes Left	2	2	2	3
Conflicting Approach Right NB		SB	WB	EB
Conflicting Lanes Right	2	2	3	2
HCM Control Delay	14.8	13.4	23.5	14
HCM LOS	B	B	C	B

Lane	NBLn1	NBLn2	EBLn1	EBLn2	WBLn1	WBLn2	WBLn3	SBLn1	SBLn2
Vol Left, %	100%	0%	100%	0%	100%	0%	0%	100%	0%
Vol Thru, %	0%	80%	0%	41%	0%	100%	0%	0%	90%
Vol Right, %	0%	20%	0%	59%	0%	0%	100%	0%	10%
Sign Control	Stop	Stop	Stop	Stop	Stop	Stop	Stop	Stop	Stop
Traffic Vol by Lane	185	362	18	162	49	145	64	31	136
LT Vol	185	0	18	0	49	0	0	31	0
Through Vol	0	289	0	66	0	145	0	0	123
RT Vol	0	73	0	96	0	0	64	0	13
Lane Flow Rate	201	393	20	176	53	158	70	34	148
Geometry Grp	6	6	6	6	6	6	6	6	6
Degree of Util (X)	0.42	0.75	0.047	0.377	0.124	0.345	0.139	0.08	0.326
Departure Headway (Hd)	7.511	6.861	8.647	7.704	8.399	7.887	7.17	8.513	7.934
Convergence, Y/N	Yes	Yes	Yes	Yes	Yes	Yes	Yes	Yes	Yes
Cap	479	527	413	467	426	455	499	420	452
Service Time	5.263	4.613	6.413	5.47	6.162	5.65	4.932	6.282	5.702
HCM Lane V/C Ratio	0.42	0.746	0.048	0.377	0.124	0.347	0.14	0.081	0.327
HCM Control Delay	15.6	27.5	11.8	15.1	12.4	14.8	11.1	12	14.5
HCM Lane LOS	C	D	B	C	B	B	B	B	B
HCM 95th-tile Q	2.1	6.4	0.1	1.7	0.4	1.5	0.5	0.3	1.4

Intersection												
Int Delay, s/veh	8.5											
Movement	EBL	EBT	EBR	WBL	WBT	WBR	NBL	NBT	NBR	SBL	SBT	SBR
Lane Configurations	↖	↗		↖	↗		↖	↗			↕	
Traffic Vol, veh/h	5	309	61	158	189	1	43	20	323	0	4	3
Future Vol, veh/h	5	309	61	158	189	1	43	20	323	0	4	3
Conflicting Peds, #/hr	0	0	0	0	0	0	0	0	0	0	0	0
Sign Control	Free	Free	Free	Free	Free	Free	Stop	Stop	Stop	Stop	Stop	Stop
RT Channelized	-	-	None	-	-	None	-	-	None	-	-	None
Storage Length	0	-	-	110	-	-	0	-	-	-	-	-
Veh in Median Storage, #	-	0	-	-	0	-	-	0	-	-	0	-
Grade, %	-	0	-	-	0	-	-	0	-	-	0	-
Peak Hour Factor	92	92	92	92	92	92	92	92	92	92	92	92
Heavy Vehicles, %	2	2	2	2	2	2	2	2	2	2	2	2
Mvmt Flow	5	336	66	172	205	1	47	22	351	0	4	3

Major/Minor	Major1		Major2		Minor1		Minor2					
Conflicting Flow All	206	0	0	402	0	0	932	929	369	1116	962	206
Stage 1	-	-	-	-	-	-	379	379	-	550	550	-
Stage 2	-	-	-	-	-	-	553	550	-	566	412	-
Critical Hdwy	4.12	-	-	4.12	-	-	7.12	6.52	6.22	7.12	6.52	6.22
Critical Hdwy Stg 1	-	-	-	-	-	-	6.12	5.52	-	6.12	5.52	-
Critical Hdwy Stg 2	-	-	-	-	-	-	6.12	5.52	-	6.12	5.52	-
Follow-up Hdwy	2.218	-	-	2.218	-	-	3.518	4.018	3.318	3.518	4.018	3.318
Pot Cap-1 Maneuver	1365	-	-	1157	-	-	247	268	677	185	256	835
Stage 1	-	-	-	-	-	-	643	615	-	519	516	-
Stage 2	-	-	-	-	-	-	517	516	-	509	594	-
Platoon blocked, %	-	-	-	-	-	-	-	-	-	-	-	-
Mov Cap-1 Maneuver	1365	-	-	1157	-	-	214	227	677	73	217	835
Mov Cap-2 Maneuver	-	-	-	-	-	-	214	227	-	73	217	-
Stage 1	-	-	-	-	-	-	640	613	-	517	439	-
Stage 2	-	-	-	-	-	-	434	439	-	235	592	-

Approach	EB	WB	NB	SB
HCM Control Delay, s	0.1	3.9	20.6	16.6
HCM LOS			C	C

Minor Lane/Major Mvmt	NBLn1	NBLn2	EBL	EBT	EBR	WBL	WBT	WBR	SBLn1
Capacity (veh/h)	214	607	1365	-	-	1157	-	-	318
HCM Lane V/C Ratio	0.218	0.614	0.004	-	-	0.148	-	-	0.024
HCM Control Delay (s)	26.5	19.9	7.6	-	-	8.7	-	-	16.6
HCM Lane LOS	D	C	A	-	-	A	-	-	C
HCM 95th %tile Q(veh)	0.8	4.2	0	-	-	0.5	-	-	0.1

HCM 6th Roundabout  
1: Eastonville Rd & Rex Rd

2045 Total Traffic  
AM Peak Hour

Intersection				
Intersection Delay, s/veh	13.0			
Intersection LOS	B			
Approach	EB	WB	NB	SB
Entry Lanes	1	1	1	1
Conflicting Circle Lanes	1	1	1	1
Adj Approach Flow, veh/h	471	582	507	301
Demand Flow Rate, veh/h	481	594	517	307
Vehicles Circulating, veh/h	686	274	245	696
Vehicles Exiting, veh/h	317	488	922	172
Ped Vol Crossing Leg, #/h	0	0	0	0
Ped Cap Adj	1.000	1.000	1.000	1.000
Approach Delay, s/veh	20.5	10.9	8.9	12.1
Approach LOS	C	B	A	B
Lane	Left	Left	Left	Left
Designated Moves	LTR	LTR	LTR	LTR
Assumed Moves	LTR	LTR	LTR	LTR
RT Channelized				
Lane Util	1.000	1.000	1.000	1.000
Follow-Up Headway, s	2.609	2.609	2.609	2.609
Critical Headway, s	4.976	4.976	4.976	4.976
Entry Flow, veh/h	481	594	517	307
Cap Entry Lane, veh/h	685	1043	1075	679
Entry HV Adj Factor	0.980	0.979	0.980	0.980
Flow Entry, veh/h	471	582	507	301
Cap Entry, veh/h	672	1022	1054	665
V/C Ratio	0.702	0.569	0.481	0.452
Control Delay, s/veh	20.5	10.9	8.9	12.1
LOS	C	B	A	B
95th %tile Queue, veh	6	4	3	2

Intersection						
Int Delay, s/veh	1.5					
Movement	EBT	EBR	WBL	WBT	NBL	NBR
Lane Configurations	↔		↔	↑	↔	↔
Traffic Vol, veh/h	430	25	43	535	18	86
Future Vol, veh/h	430	25	43	535	18	86
Conflicting Peds, #/hr	0	0	0	0	0	0
Sign Control	Free	Free	Free	Free	Stop	Stop
RT Channelized	-	None	-	None	-	None
Storage Length	-	-	155	-	205	0
Veh in Median Storage, #	0	-	-	0	0	-
Grade, %	0	-	-	0	0	-
Peak Hour Factor	92	92	92	92	92	92
Heavy Vehicles, %	2	2	2	2	2	2
Mvmt Flow	467	27	47	582	20	93

Major/Minor	Major1	Major2	Minor1			
Conflicting Flow All	0	0	494	0	1157	481
Stage 1	-	-	-	-	481	-
Stage 2	-	-	-	-	676	-
Critical Hdwy	-	-	4.12	-	6.42	6.22
Critical Hdwy Stg 1	-	-	-	-	5.42	-
Critical Hdwy Stg 2	-	-	-	-	5.42	-
Follow-up Hdwy	-	-	2.218	-	3.518	3.318
Pot Cap-1 Maneuver	-	-	1070	-	217	585
Stage 1	-	-	-	-	622	-
Stage 2	-	-	-	-	505	-
Platoon blocked, %	-	-	-	-	-	-
Mov Cap-1 Maneuver	-	-	1070	-	207	585
Mov Cap-2 Maneuver	-	-	-	-	340	-
Stage 1	-	-	-	-	622	-
Stage 2	-	-	-	-	483	-

Approach	EB	WB	NB
HCM Control Delay, s	0	0.6	13
HCM LOS			B

Minor Lane/Major Mvmt	NBLn1	NBLn2	EBT	EBR	WBL	WBT
Capacity (veh/h)	340	585	-	-	1070	-
HCM Lane V/C Ratio	0.058	0.16	-	-	0.044	-
HCM Control Delay (s)	16.2	12.3	-	-	8.5	-
HCM Lane LOS	C	B	-	-	A	-
HCM 95th %tile Q(veh)	0.2	0.6	-	-	0.1	-

Intersection						
Int Delay, s/veh	0.3					
Movement	EBL	EBT	WBT	WBR	SBL	SBR
Lane Configurations						
Traffic Vol, veh/h	2	514	573	7	20	5
Future Vol, veh/h	2	514	573	7	20	5
Conflicting Peds, #/hr	0	0	0	0	0	0
Sign Control	Free	Free	Free	Free	Stop	Stop
RT Channelized	-	None	-	None	-	None
Storage Length	155	-	-	-	0	-
Veh in Median Storage, #	-	0	0	-	0	-
Grade, %	-	0	0	-	0	-
Peak Hour Factor	92	92	92	92	92	92
Heavy Vehicles, %	2	2	2	2	2	2
Mvmt Flow	2	559	623	8	22	5

Major/Minor	Major1	Major2	Minor2
Conflicting Flow All	631	0	0 1190 627
Stage 1	-	-	- 627 -
Stage 2	-	-	- 563 -
Critical Hdwy	4.12	-	- 6.42 6.22
Critical Hdwy Stg 1	-	-	- 5.42 -
Critical Hdwy Stg 2	-	-	- 5.42 -
Follow-up Hdwy	2.218	-	- 3.518 3.318
Pot Cap-1 Maneuver	951	-	- 207 484
Stage 1	-	-	- 532 -
Stage 2	-	-	- 570 -
Platoon blocked, %		-	- -
Mov Cap-1 Maneuver	951	-	- 207 484
Mov Cap-2 Maneuver	-	-	- 345 -
Stage 1	-	-	- 531 -
Stage 2	-	-	- 570 -

Approach	EB	WB	SB
HCM Control Delay, s	0	0	15.6
HCM LOS			C

Minor Lane/Major Mvmt	EBL	EBT	WBT	WBR	SBLn1
Capacity (veh/h)	951	-	-	-	366
HCM Lane V/C Ratio	0.002	-	-	-	0.074
HCM Control Delay (s)	8.8	-	-	-	15.6
HCM Lane LOS	A	-	-	-	C
HCM 95th %tile Q(veh)	0	-	-	-	0.2

Intersection						
Int Delay, s/veh	0.8					
Movement	EBT	EBR	WBL	WBT	NBL	NBR
Lane Configurations						
Traffic Vol, veh/h	526	7	16	569	11	48
Future Vol, veh/h	526	7	16	569	11	48
Conflicting Peds, #/hr	0	0	0	0	0	0
Sign Control	Free	Free	Free	Free	Stop	Stop
RT Channelized	-	None	-	None	-	None
Storage Length	-	155	305	-	0	-
Veh in Median Storage, #	0	-	-	0	0	-
Grade, %	0	-	-	0	0	-
Peak Hour Factor	95	95	95	95	95	95
Heavy Vehicles, %	2	2	2	2	2	2
Mvmt Flow	554	7	17	599	12	51

Major/Minor	Major1	Major2	Minor1		
Conflicting Flow All	0	0	561	0	1187
Stage 1	-	-	-	-	554
Stage 2	-	-	-	-	633
Critical Hdwy	-	-	4.12	-	6.42
Critical Hdwy Stg 1	-	-	-	-	5.42
Critical Hdwy Stg 2	-	-	-	-	5.42
Follow-up Hdwy	-	-	2.218	-	3.518
Pot Cap-1 Maneuver	-	-	1010	-	208
Stage 1	-	-	-	-	575
Stage 2	-	-	-	-	529
Platoon blocked, %	-	-	-	-	-
Mov Cap-1 Maneuver	-	-	1010	-	204
Mov Cap-2 Maneuver	-	-	-	-	342
Stage 1	-	-	-	-	575
Stage 2	-	-	-	-	520

Approach	EB	WB	NB
HCM Control Delay, s	0	0.2	13.6
HCM LOS			B

Minor Lane/Major Mvmt	NBLn1	EBT	EBR	WBL	WBT
Capacity (veh/h)	482	-	-	1010	-
HCM Lane V/C Ratio	0.129	-	-	0.017	-
HCM Control Delay (s)	13.6	-	-	8.6	-
HCM Lane LOS	B	-	-	A	-
HCM 95th %tile Q(veh)	0.4	-	-	0.1	-



Intersection						
Int Delay, s/veh	1.4					
Movement	EBT	EBR	WBL	WBT	NBL	NBR
Lane Configurations	↔		↔	↑	↔	↔
Traffic Vol, veh/h	567	8	27	561	24	80
Future Vol, veh/h	567	8	27	561	24	80
Conflicting Peds, #/hr	0	0	0	0	0	0
Sign Control	Free	Free	Free	Free	Stop	Stop
RT Channelized	-	None	-	None	-	None
Storage Length	-	-	305	-	0	0
Veh in Median Storage, #	0	-	-	0	0	-
Grade, %	0	-	-	0	0	-
Peak Hour Factor	95	95	95	95	95	95
Heavy Vehicles, %	2	2	2	2	2	2
Mvmt Flow	597	8	28	591	25	84

Major/Minor	Major1	Major2	Minor1		
Conflicting Flow All	0	0	605	0	1248 601
Stage 1	-	-	-	-	601 -
Stage 2	-	-	-	-	647 -
Critical Hdwy	-	-	4.12	-	6.42 6.22
Critical Hdwy Stg 1	-	-	-	-	5.42 -
Critical Hdwy Stg 2	-	-	-	-	5.42 -
Follow-up Hdwy	-	-	2.218	-	3.518 3.318
Pot Cap-1 Maneuver	-	-	973	-	191 500
Stage 1	-	-	-	-	547 -
Stage 2	-	-	-	-	521 -
Platoon blocked, %	-	-	-	-	-
Mov Cap-1 Maneuver	-	-	973	-	185 500
Mov Cap-2 Maneuver	-	-	-	-	324 -
Stage 1	-	-	-	-	547 -
Stage 2	-	-	-	-	506 -

Approach	EB	WB	NB
HCM Control Delay, s	0	0.4	14.5
HCM LOS			B

Minor Lane/Major Mvmt	NBLn1	NBLn2	EBT	EBR	WBL	WBT
Capacity (veh/h)	324	500	-	-	973	-
HCM Lane V/C Ratio	0.078	0.168	-	-	0.029	-
HCM Control Delay (s)	17	13.7	-	-	8.8	-
HCM Lane LOS	C	B	-	-	A	-
HCM 95th %tile Q(veh)	0.3	0.6	-	-	0.1	-

Intersection								
Intersection Delay, s/veh	12.8							
Intersection LOS	B							
Approach	EB		WB		NB		SB	
Entry Lanes	2		2		1		2	
Conflicting Circle Lanes	1		1		1		1	
Adj Approach Flow, veh/h	682		518		334		757	
Demand Flow Rate, veh/h	696		528		340		773	
Vehicles Circulating, veh/h	641		241		998		499	
Vehicles Exiting, veh/h	631		1097		339		270	
Ped Vol Crossing Leg, #/h	0		0		0		0	
Ped Cap Adj	1.000		1.000		1.000		1.000	
Approach Delay, s/veh	15.1		5.9		25.1		10.0	
Approach LOS	C		A		D		A	
Lane	Left	Right	Left	Right	Left	Left	Right	
Designated Moves	LT	R	LT	R	LTR	LT	R	
Assumed Moves	LT	R	LT	R	LTR	LT	R	
RT Channelized								
Lane Util	0.779	0.221	0.714	0.286	1.000	0.629	0.371	
Follow-Up Headway, s	2.535	2.535	2.535	2.535	2.609	2.535	2.535	
Critical Headway, s	4.544	4.544	4.544	4.544	4.976	4.544	4.544	
Entry Flow, veh/h	542	154	377	151	340	486	287	
Cap Entry Lane, veh/h	792	792	1140	1140	499	902	902	
Entry HV Adj Factor	0.980	0.981	0.980	0.980	0.981	0.980	0.979	
Flow Entry, veh/h	531	151	370	148	334	476	281	
Cap Entry, veh/h	777	777	1118	1118	489	884	883	
V/C Ratio	0.684	0.194	0.331	0.132	0.682	0.539	0.318	
Control Delay, s/veh	17.5	6.7	6.5	4.4	25.1	11.4	7.6	
LOS	C	A	A	A	D	B	A	
95th %tile Queue, veh	6	1	1	0	5	3	1	

Timings  
9: US 24 & Rex Rd

2045 Total Traffic  
AM Peak Hour



Lane Group	EBL	EBR	NBL	NBT	SBT	SBR
Lane Configurations	↖	↗	↖↗	↑↑	↑↑	↗
Traffic Volume (vph)	104	1086	459	396	653	72
Future Volume (vph)	104	1086	459	396	653	72
Turn Type	Prot	Free	Prot	NA	NA	Perm
Protected Phases	6!		7	Free!	8	
Permitted Phases		Free				8
Detector Phase	6		7		8	8
Switch Phase						
Minimum Initial (s)	5.0		5.0		5.0	5.0
Minimum Split (s)	20.0		10.0		20.0	20.0
Total Split (s)	23.0		49.0		48.0	48.0
Total Split (%)	19.2%		40.8%		40.0%	40.0%
Yellow Time (s)	3.0		3.0		3.0	3.0
All-Red Time (s)	2.0		2.0		2.0	2.0
Lost Time Adjust (s)	0.0		0.0		0.0	0.0
Total Lost Time (s)	5.0		5.0		5.0	5.0
Lead/Lag			Lead		Lag	Lag
Lead-Lag Optimize?			Yes		Yes	Yes
Recall Mode	Max		None		C-Max	C-Max
Act Effct Green (s)	18.0	120.0	22.5	120.0	64.5	64.5
Actuated g/C Ratio	0.15	1.00	0.19	1.00	0.54	0.54
v/c Ratio	0.41	0.72	0.75	0.11	0.36	0.09
Control Delay	51.5	2.9	53.5	0.1	17.2	3.7
Queue Delay	0.0	0.0	0.0	0.0	0.0	0.0
Total Delay	51.5	2.9	53.5	0.1	17.2	3.7
LOS	D	A	D	A	B	A
Approach Delay	7.1			29.2	15.9	
Approach LOS	A			C	B	

Intersection Summary

Cycle Length: 120  
 Actuated Cycle Length: 120  
 Offset: 50 (42%), Referenced to phase 8:SBT, Start of Green  
 Natural Cycle: 55  
 Control Type: Actuated-Coordinated  
 Maximum v/c Ratio: 0.75  
 Intersection Signal Delay: 16.2  
 Intersection LOS: B  
 Intersection Capacity Utilization 48.6%  
 ICU Level of Service A  
 Analysis Period (min) 15  
 ! Phase conflict between lane groups.

Splits and Phases: 9: US 24 & Rex Rd



Intersection			
Intersection Delay, s/veh	12.4		
Intersection LOS	B		
Approach	WB	NB	SB
Entry Lanes	1	1	1
Conflicting Circle Lanes	2	2	2
Adj Approach Flow, veh/h	231	567	903
Demand Flow Rate, veh/h	236	578	921
Vehicles Circulating, veh/h	512	2	231
Vehicles Exiting, veh/h	68	1150	517
Ped Vol Crossing Leg, #/h	0	0	0
Ped Cap Adj	1.000	1.000	1.000
Approach Delay, s/veh	6.7	6.4	17.7
Approach LOS	A	A	C
Lane	Left	Left	Left
Designated Moves	LR	TR	LT
Assumed Moves	LR	TR	LT
RT Channelized			
Lane Util	1.000	1.000	1.000
Follow-Up Headway, s	2.535	2.535	2.535
Critical Headway, s	4.328	4.328	4.328
Entry Flow, veh/h	236	578	921
Cap Entry Lane, veh/h	919	1418	1167
Entry HV Adj Factor	0.979	0.981	0.980
Flow Entry, veh/h	231	567	903
Cap Entry, veh/h	899	1391	1144
V/C Ratio	0.257	0.408	0.789
Control Delay, s/veh	6.7	6.4	17.7
LOS	A	A	C
95th %tile Queue, veh	1	2	9

Intersection						
Int Delay, s/veh	1.1					
Movement	WBL	WBR	NBT	NBR	SBL	SBT
Lane Configurations	Y		↑	↑	↑	↑
Traffic Vol, veh/h	55	21	519	19	7	1065
Future Vol, veh/h	55	21	519	19	7	1065
Conflicting Peds, #/hr	0	0	0	0	0	0
Sign Control	Stop	Stop	Free	Free	Free	Free
RT Channelized	-	None	-	None	-	None
Storage Length	0	-	-	155	205	-
Veh in Median Storage, #	0	-	0	-	-	0
Grade, %	0	-	0	-	-	0
Peak Hour Factor	95	95	95	95	95	95
Heavy Vehicles, %	2	2	2	2	2	2
Mvmt Flow	58	22	546	20	7	1121

Major/Minor	Minor1	Major1	Major2		
Conflicting Flow All	1681	546	0	0	566
Stage 1	546	-	-	-	-
Stage 2	1135	-	-	-	-
Critical Hdwy	6.42	6.22	-	-	4.12
Critical Hdwy Stg 1	5.42	-	-	-	-
Critical Hdwy Stg 2	5.42	-	-	-	-
Follow-up Hdwy	3.518	3.318	-	-	2.218
Pot Cap-1 Maneuver	104	538	-	-	1006
Stage 1	580	-	-	-	-
Stage 2	307	-	-	-	-
Platoon blocked, %			-	-	-
Mov Cap-1 Maneuver	103	538	-	-	1006
Mov Cap-2 Maneuver	224	-	-	-	-
Stage 1	580	-	-	-	-
Stage 2	305	-	-	-	-

Approach	WB	NB	SB
HCM Control Delay, s	24.1	0	0.1
HCM LOS	C		

Minor Lane/Major Mvmt	NBT	NBRWBLn1	SBL	SBT
Capacity (veh/h)	-	-	267	1006
HCM Lane V/C Ratio	-	-	0.3	0.007
HCM Control Delay (s)	-	-	24.1	8.6
HCM Lane LOS	-	-	C	A
HCM 95th %tile Q(veh)	-	-	1.2	0

Intersection						
Intersection Delay, s/veh	9.4					
Intersection LOS	A					
Approach	EB		NB		SB	
Entry Lanes	2		2		2	
Conflicting Circle Lanes	2		2		2	
Adj Approach Flow, veh/h	489		655		1186	
Demand Flow Rate, veh/h	499		668		1210	
Vehicles Circulating, veh/h	918		159		252	
Vehicles Exiting, veh/h	544		1258		575	
Ped Vol Crossing Leg, #/h	0		0		0	
Ped Cap Adj	1.000		1.000		1.000	
Approach Delay, s/veh	12.9		5.7		10.0	
Approach LOS	B		A		A	
Lane	Left	Right	Left	Right	Left	Right
Designated Moves	L	TR	L	TR	LT	TR
Assumed Moves	L	TR	L	TR	LT	TR
RT Channelized						
Lane Util	0.319	0.681	0.377	0.623	0.470	0.530
Follow-Up Headway, s	2.667	2.535	2.667	2.535	2.667	2.535
Critical Headway, s	4.645	4.328	4.645	4.328	4.645	4.328
Entry Flow, veh/h	159	340	252	416	569	641
Cap Entry Lane, veh/h	580	651	1166	1241	1071	1146
Entry HV Adj Factor	0.981	0.979	0.980	0.980	0.980	0.981
Flow Entry, veh/h	156	333	247	408	557	629
Cap Entry, veh/h	569	637	1143	1216	1049	1124
V/C Ratio	0.274	0.523	0.216	0.335	0.532	0.559
Control Delay, s/veh	10.1	14.3	5.1	6.1	9.9	10.0
LOS	B	B	A	A	A	A
95th %tile Queue, veh	1	3	1	1	3	4

Intersection										
Intersection Delay, s/veh 13.6										
Intersection LOS B										
Approach	EB		WB			NB		SB		
Entry Lanes	2		2			2		2		
Conflicting Circle Lanes	2		2			2		2		
Adj Approach Flow, veh/h	834		565			541		1232		
Demand Flow Rate, veh/h	850		576			552		1257		
Vehicles Circulating, veh/h	965		639			1024		548		
Vehicles Exiting, veh/h	482		937			791		495		
Ped Vol Crossing Leg, #/h	0		0			0		0		
Ped Cap Adj	1.000		1.000			1.000		1.000		
Approach Delay, s/veh	24.1		5.3			15.2		9.6		
Approach LOS	C		A			C		A		
Lane	Left	Right	Left	Right	Bypass	Left	Right	Left	Right	Bypass
Designated Moves	LT	TR	LT	TR	R	LT	TR	L	LTR	R
Assumed Moves	LT	TR	LT	TR	R	LT	TR	L	TR	R
RT Channelized			Free					Free		
Lane Util	0.471	0.529	0.470	0.530		0.469	0.531	0.327	0.673	
Follow-Up Headway, s	2.667	2.535	2.667	2.535		2.667	2.535	2.667	2.535	
Critical Headway, s	4.645	4.328	4.645	4.328	172	4.645	4.328	4.645	4.328	358
Entry Flow, veh/h	400	450	190	214	1938	259	293	294	605	1938
Cap Entry Lane, veh/h	556	625	750	825	0.980	526	595	815	891	0.980
Entry HV Adj Factor	0.980	0.982	0.981	0.982	169	0.981	0.978	0.980	0.980	351
Flow Entry, veh/h	392	442	186	210	1900	254	287	288	593	1900
Cap Entry, veh/h	544	614	735	810	0.089	516	582	799	874	0.185
V/C Ratio	0.720	0.720	0.253	0.259	0.0	0.492	0.493	0.361	0.679	0.0
Control Delay, s/veh	25.4	23.0	7.8	7.3	A	16.0	14.5	8.8	15.8	A
LOS	D	C	A	A	0	C	B	A	C	1
95th %tile Queue, veh	6	6	1	1		3	3	2	5	

Timings  
14: US 24 & Stapleton Dr

2045 Total Traffic  
AM Peak Hour

Lane Group	EBL	EBT	EBR	WBL	WBT	WBR	NBL	NBT	NBR	SBL	SBT	SBR
Lane Configurations												
Traffic Volume (vph)	141	380	462	75	201	112	357	602	50	255	1342	141
Future Volume (vph)	141	380	462	75	201	112	357	602	50	255	1342	141
Turn Type	pm+pt	NA	Free	pm+pt	NA	Free	Prot	NA	Perm	Prot	NA	Perm
Protected Phases	5	2		1	6		3	8		7	4	
Permitted Phases	2		Free	6		Free			8			4
Detector Phase	5	2		1	6		3	8	8	7	4	4
Switch Phase												
Minimum Initial (s)	5.0	10.0		8.0	5.0		20.0	5.0	5.0	20.0	15.0	15.0
Minimum Split (s)	10.0	15.0		13.0	10.0		25.0	10.0	10.0	25.0	20.0	20.0
Total Split (s)	15.0	25.0		15.0	25.0		30.0	60.0	60.0	25.0	50.0	50.0
Total Split (%)	12.0%	20.0%		12.0%	20.0%		24.0%	48.0%	48.0%	20.0%	40.0%	40.0%
Yellow Time (s)	3.0	3.0		3.0	3.0		3.0	3.0	3.0	3.0	3.0	3.0
All-Red Time (s)	2.0	2.0		2.0	2.0		2.0	2.0	2.0	2.0	2.0	2.0
Lost Time Adjust (s)	0.0	0.0		0.0	0.0		0.0	0.0	0.0	0.0	0.0	0.0
Total Lost Time (s)	5.0	5.0		5.0	5.0		5.0	5.0	5.0	5.0	5.0	5.0
Lead/Lag	Lead	Lag		Lead	Lag		Lead	Lag	Lag	Lead	Lag	Lag
Lead-Lag Optimize?	Yes	Yes		Yes	Yes		Yes	Yes	Yes	Yes	Yes	Yes
Recall Mode	None	C-Max		None	C-Max		None	Max	Max	None	Max	Max
Act Effct Green (s)	31.4	23.4	125.0	29.4	20.2	125.0	20.9	55.0	55.0	20.0	54.1	54.1
Actuated g/C Ratio	0.25	0.19	1.00	0.24	0.16	1.00	0.17	0.44	0.44	0.16	0.43	0.43
v/c Ratio	0.49	0.60	0.31	0.33	0.37	0.07	0.66	0.41	0.07	0.49	0.89	0.19
Control Delay	42.2	52.2	0.5	38.3	48.9	0.1	54.5	24.9	0.2	51.3	41.8	4.1
Queue Delay	0.0	0.0	0.0	0.0	0.0	0.0	0.0	0.0	0.0	0.0	0.0	0.0
Total Delay	42.2	52.2	0.5	38.3	48.9	0.1	54.5	24.9	0.2	51.3	41.8	4.1
LOS	D	D	A	D	D	A	D	C	A	D	D	A
Approach Delay		26.5			32.8			34.1			40.1	
Approach LOS		C			C			C			D	

Intersection Summary

Cycle Length: 125  
 Actuated Cycle Length: 125  
 Offset: 64 (51%), Referenced to phase 2:EBTL and 6:WBTL, Start of Green  
 Natural Cycle: 90  
 Control Type: Actuated-Coordinated  
 Maximum v/c Ratio: 0.89  
 Intersection Signal Delay: 34.6  
 Intersection LOS: C  
 Intersection Capacity Utilization 86.5%  
 ICU Level of Service E  
 Analysis Period (min) 15

Splits and Phases: 14: US 24 & Stapleton Dr

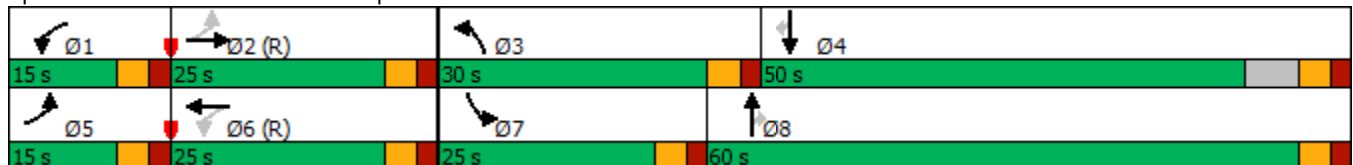



**Intersection**

Intersection Delay, s/veh 44.1  
 Intersection LOS F

Movement	EBL	EBT	EBR	WBL	WBT	WBR	NBL	NBT	NBR	SBL	SBT	SBR
Lane Configurations												
Traffic Vol, veh/h	166	230	148	28	56	128	30	375	43	122	483	44
Future Vol, veh/h	166	230	148	28	56	128	30	375	43	122	483	44
Peak Hour Factor	0.92	0.92	0.92	0.92	0.92	0.92	0.92	0.92	0.92	0.92	0.92	0.92
Heavy Vehicles, %	2	2	2	2	2	2	2	2	2	2	2	2
Mvmt Flow	180	250	161	30	61	139	33	408	47	133	525	48
Number of Lanes	1	1	0	1	1	1	1	1	0	1	1	0

Approach	EB	WB	NB	SB
Opposing Approach	WB	EB	SB	NB
Opposing Lanes	3	2	2	2
Conflicting Approach Left	SB	NB	EB	WB
Conflicting Lanes Left	2	2	2	3
Conflicting Approach Right	NB	SB	WB	EB
Conflicting Lanes Right	2	2	3	2
HCM Control Delay	78.6	20.5	154.2	232.4
HCM LOS	F	C	F	F

Lane	NBLn1	NBLn2	EBLn1	EBLn2	WBLn1	WBLn2	WBLn3	SBLn1	SBLn2
Vol Left, %	100%	0%	100%	0%	100%	0%	0%	100%	0%
Vol Thru, %	0%	90%	0%	61%	0%	100%	0%	0%	92%
Vol Right, %	0%	10%	0%	39%	0%	0%	100%	0%	8%
Sign Control	Stop	Stop	Stop	Stop	Stop	Stop	Stop	Stop	Stop
Traffic Vol by Lane	30	418	166	378	28	56	128	122	527
LT Vol	30	0	166	0	28	0	0	122	0
Through Vol	0	375	0	230	0	56	0	0	483
RT Vol	0	43	0	148	0	0	128	0	44
Lane Flow Rate	33	454	180	411	30	61	139	133	573
Geometry Grp	6	6	6	6	6	6	6	6	6
Degree of Util (X)	0.094	1.244	0.507	1.066	0.096	0.184	0.391	0.376	1.537
Departure Headway (Hd)	11.556	10.955	11.619	10.796	13.274	12.739	11.991	10.978	10.394
Convergence, Y/N	Yes	Yes	Yes	Yes	Yes	Yes	Yes	Yes	Yes
Cap	312	336	312	341	272	284	302	330	355
Service Time	9.256	8.655	9.319	8.496	10.974	10.439	9.691	8.678	8.094
HCM Lane V/C Ratio	0.106	1.351	0.577	1.205	0.11	0.215	0.46	0.403	1.614
HCM Control Delay	15.5	164.2	25.7	101.8	17.4	18.3	22.2	20.1	281.5
HCM Lane LOS	C	F	D	F	C	C	C	C	F
HCM 95th-tile Q	0.3	18.4	2.7	13	0.3	0.7	1.8	1.7	29.9

Intersection												
Int Delay, s/veh	3.8											
Movement	EBL	EBT	EBR	WBL	WBT	WBR	NBL	NBT	NBR	SBL	SBT	SBR
Lane Configurations	↖	↗		↖	↗		↖	↗			↕	
Traffic Vol, veh/h	3	142	26	276	359	1	6	3	75	0	4	0
Future Vol, veh/h	3	142	26	276	359	1	6	3	75	0	4	0
Conflicting Peds, #/hr	0	0	0	0	0	0	0	0	0	0	0	0
Sign Control	Free	Free	Free	Free	Free	Free	Stop	Stop	Stop	Stop	Stop	Stop
RT Channelized	-	-	None	-	-	None	-	-	None	-	-	None
Storage Length	0	-	-	110	-	-	0	-	-	-	-	-
Veh in Median Storage, #	-	0	-	-	0	-	-	0	-	-	0	-
Grade, %	-	0	-	-	0	-	-	0	-	-	0	-
Peak Hour Factor	92	92	92	92	92	92	92	92	92	92	92	92
Heavy Vehicles, %	2	2	2	2	2	2	2	2	2	2	2	2
Mvmt Flow	3	154	28	300	390	1	7	3	82	0	4	0

Major/Minor	Major1		Major2		Minor1			Minor2				
Conflicting Flow All	391	0	0	182	0	0	1167	1165	168	1208	1179	391
Stage 1	-	-	-	-	-	-	174	174	-	991	991	-
Stage 2	-	-	-	-	-	-	993	991	-	217	188	-
Critical Hdwy	4.12	-	-	4.12	-	-	7.12	6.52	6.22	7.12	6.52	6.22
Critical Hdwy Stg 1	-	-	-	-	-	-	6.12	5.52	-	6.12	5.52	-
Critical Hdwy Stg 2	-	-	-	-	-	-	6.12	5.52	-	6.12	5.52	-
Follow-up Hdwy	2.218	-	-	2.218	-	-	3.518	4.018	3.318	3.518	4.018	3.318
Pot Cap-1 Maneuver	1168	-	-	1393	-	-	171	194	876	160	190	658
Stage 1	-	-	-	-	-	-	828	755	-	296	324	-
Stage 2	-	-	-	-	-	-	296	324	-	785	745	-
Platoon blocked, %	-	-	-	-	-	-	-	-	-	-	-	-
Mov Cap-1 Maneuver	1168	-	-	1393	-	-	139	152	876	119	149	658
Mov Cap-2 Maneuver	-	-	-	-	-	-	139	152	-	119	149	-
Stage 1	-	-	-	-	-	-	826	753	-	295	254	-
Stage 2	-	-	-	-	-	-	228	254	-	707	743	-

Approach	EB	WB	NB	SB
HCM Control Delay, s	0.1	3.6	12	29.9
HCM LOS			B	D

Minor Lane/Major Mvmt	NBLn1	NBLn2	EBL	EBT	EBR	WBL	WBT	WBR	SBLn1
Capacity (veh/h)	139	740	1168	-	-	1393	-	-	149
HCM Lane V/C Ratio	0.047	0.115	0.003	-	-	0.215	-	-	0.029
HCM Control Delay (s)	32.2	10.5	8.1	-	-	8.3	-	-	29.9
HCM Lane LOS	D	B	A	-	-	A	-	-	D
HCM 95th %tile Q(veh)	0.1	0.4	0	-	-	0.8	-	-	0.1

HCM 6th Roundabout  
 15: Eastonville Rd & Meridian Ranch Blvd/Judge Orr Rd

2045 Total Traffic  
 AM Peak Hour

Intersection				
Intersection Delay, s/veh	17.4			
Intersection LOS	C			
Approach	EB	WB	NB	SB
Entry Lanes	1	1	1	1
Conflicting Circle Lanes	1	1	1	1
Adj Approach Flow, veh/h	573	223	472	682
Demand Flow Rate, veh/h	584	228	482	696
Vehicles Circulating, veh/h	679	614	556	123
Vehicles Exiting, veh/h	140	424	707	719
Ped Vol Crossing Leg, #/h	0	0	0	0
Ped Cap Adj	1.000	1.000	1.000	1.000
Approach Delay, s/veh	31.7	8.8	15.0	9.8
Approach LOS	D	A	C	A
Lane	Left	Left	Left	Left
Designated Moves	LTR	LTR	LTR	LTR
Assumed Moves	LTR	LTR	LTR	LTR
RT Channelized				
Lane Util	1.000	1.000	1.000	1.000
Follow-Up Headway, s	2.609	2.609	2.609	2.609
Critical Headway, s	4.976	4.976	4.976	4.976
Entry Flow, veh/h	584	228	482	696
Cap Entry Lane, veh/h	690	738	783	1217
Entry HV Adj Factor	0.981	0.977	0.979	0.980
Flow Entry, veh/h	573	223	472	682
Cap Entry, veh/h	678	721	767	1192
V/C Ratio	0.846	0.309	0.616	0.572
Control Delay, s/veh	31.7	8.8	15.0	9.8
LOS	D	A	C	A
95th %tile Queue, veh	10	1	4	4

Intersection				
Intersection Delay, s/veh	7.0			
Intersection LOS	A			
Approach	EB	WB	NB	SB
Entry Lanes	1	1	1	1
Conflicting Circle Lanes	1	1	1	1
Adj Approach Flow, veh/h	179	670	88	4
Demand Flow Rate, veh/h	183	684	90	4
Vehicles Circulating, veh/h	301	12	155	689
Vehicles Exiting, veh/h	392	233	329	7
Ped Vol Crossing Leg, #/h	0	0	0	0
Ped Cap Adj	1.000	1.000	1.000	1.000
Approach Delay, s/veh	5.3	7.9	3.8	5.4
Approach LOS	A	A	A	A
Lane	Left	Left	Left	Left
Designated Moves	LTR	LTR	LTR	LTR
Assumed Moves	LTR	LTR	LTR	LTR
RT Channelized				
Lane Util	1.000	1.000	1.000	1.000
Follow-Up Headway, s	2.609	2.609	2.609	2.609
Critical Headway, s	4.976	4.976	4.976	4.976
Entry Flow, veh/h	183	684	90	4
Cap Entry Lane, veh/h	1015	1363	1178	683
Entry HV Adj Factor	0.978	0.980	0.977	0.980
Flow Entry, veh/h	179	670	88	4
Cap Entry, veh/h	993	1336	1151	670
V/C Ratio	0.180	0.502	0.076	0.006
Control Delay, s/veh	5.3	7.9	3.8	5.4
LOS	A	A	A	A
95th %tile Queue, veh	1	3	0	0

Timings  
15: Eastonville Rd & Meridian Ranch Blvd/Judge Orr Rd

2045 Total Traffic  
AM Peak Hour

Lane Group	EBL	EBT	WBL	WBT	WBR	NBL	NBT	SBL	SBT
Lane Configurations									
Traffic Volume (vph)	166	230	28	56	128	30	375	122	483
Future Volume (vph)	166	230	28	56	128	30	375	122	483
Turn Type	pm+pt	NA	pm+pt	NA	Perm	pm+pt	NA	pm+pt	NA
Protected Phases	7	4	3	8		5	2	1	6
Permitted Phases	4		8		8	2		6	
Detector Phase	7	4	3	8	8	5	2	1	6
Switch Phase									
Minimum Initial (s)	5.0	5.0	5.0	5.0	5.0	5.0	5.0	5.0	5.0
Minimum Split (s)	10.0	20.0	10.0	20.0	20.0	10.0	20.0	10.0	20.0
Total Split (s)	10.0	25.0	10.0	25.0	25.0	15.0	45.0	10.0	40.0
Total Split (%)	11.1%	27.8%	11.1%	27.8%	27.8%	16.7%	50.0%	11.1%	44.4%
Yellow Time (s)	3.0	3.0	3.0	3.0	3.0	3.0	3.0	3.0	3.0
All-Red Time (s)	2.0	2.0	2.0	2.0	2.0	2.0	2.0	2.0	2.0
Lost Time Adjust (s)	0.0	0.0	0.0	0.0	0.0	0.0	0.0	0.0	0.0
Total Lost Time (s)	5.0	5.0	5.0	5.0	5.0	5.0	5.0	5.0	5.0
Lead/Lag	Lead	Lag	Lead	Lag	Lag	Lead	Lag	Lead	Lag
Lead-Lag Optimize?	Yes	Yes	Yes	Yes	Yes	Yes	Yes	Yes	Yes
Recall Mode	None	None	None	None	None	None	Min	None	Min
Act Effct Green (s)	22.9	21.3	16.1	12.5	12.5	31.7	26.8	30.8	28.3
Actuated g/C Ratio	0.33	0.31	0.23	0.18	0.18	0.46	0.39	0.44	0.41
v/c Ratio	0.42	0.74	0.12	0.18	0.34	0.11	0.64	0.39	0.76
Control Delay	25.1	35.3	20.2	28.1	7.6	9.7	22.2	13.3	27.0
Queue Delay	0.0	0.0	0.0	0.0	0.0	0.0	0.0	0.0	0.0
Total Delay	25.1	35.3	20.2	28.1	7.6	9.7	22.2	13.3	27.0
LOS	C	D	C	C	A	A	C	B	C
Approach Delay		32.2		14.7			21.3		24.4
Approach LOS		C		B			C		C

Intersection Summary

Cycle Length: 90  
 Actuated Cycle Length: 69.6  
 Natural Cycle: 75  
 Control Type: Actuated-Uncoordinated  
 Maximum v/c Ratio: 0.76  
 Intersection Signal Delay: 24.9  
 Intersection LOS: C  
 Intersection Capacity Utilization 68.0%  
 ICU Level of Service C  
 Analysis Period (min) 15

Splits and Phases: 15: Eastonville Rd & Meridian Ranch Blvd/Judge Orr Rd

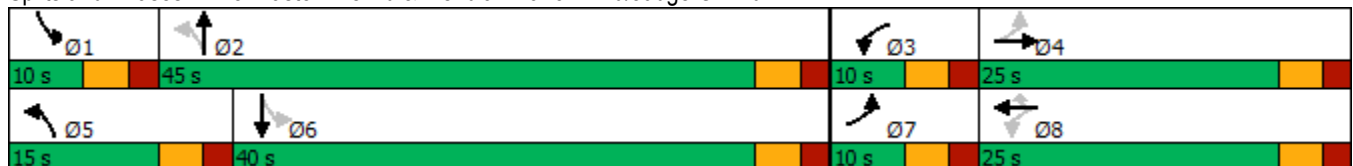

Timings  
16: McLaughlin Rd & Eastonville Rd

2045 Total Traffic  
AM Peak Hour

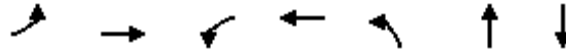

Lane Group	EBL	EBT	WBL	WBT	NBL	NBT	SBT
Lane Configurations	↶	↷	↶	↷	↶	↷	↕
Traffic Volume (vph)	3	142	276	359	6	3	4
Future Volume (vph)	3	142	276	359	6	3	4
Turn Type	pm+pt	NA	pm+pt	NA	Perm	NA	NA
Protected Phases	5	2	1	6		8	4
Permitted Phases	2		6		8		
Detector Phase	5	2	1	6	8	8	4
Switch Phase							
Minimum Initial (s)	5.0	5.0	5.0	5.0	5.0	5.0	5.0
Minimum Split (s)	10.0	20.0	10.0	20.0	20.0	20.0	20.0
Total Split (s)	10.0	45.0	15.0	50.0	30.0	30.0	30.0
Total Split (%)	11.1%	50.0%	16.7%	55.6%	33.3%	33.3%	33.3%
Yellow Time (s)	3.0	3.0	3.0	3.0	3.0	3.0	3.0
All-Red Time (s)	2.0	2.0	2.0	2.0	2.0	2.0	2.0
Lost Time Adjust (s)	0.0	0.0	0.0	0.0	0.0	0.0	0.0
Total Lost Time (s)	5.0	5.0	5.0	5.0	5.0	5.0	5.0
Lead/Lag	Lead	Lag	Lead	Lag			
Lead-Lag Optimize?	Yes	Yes	Yes	Yes			
Recall Mode	None	Max	None	Max	Min	Min	Min
Act Effct Green (s)	45.1	40.1	53.7	51.8	6.5	6.5	6.5
Actuated g/C Ratio	0.64	0.57	0.76	0.74	0.09	0.09	0.09
v/c Ratio	0.00	0.17	0.33	0.28	0.05	0.38	0.02
Control Delay	3.0	7.7	3.5	4.6	30.0	13.9	29.2
Queue Delay	0.0	0.0	0.0	0.0	0.0	0.0	0.0
Total Delay	3.0	7.7	3.5	4.6	30.0	13.9	29.2
LOS	A	A	A	A	C	B	C
Approach Delay		7.6		4.1		15.1	29.3
Approach LOS		A		A		B	C

Intersection Summary

Cycle Length: 90  
 Actuated Cycle Length: 70.3  
 Natural Cycle: 50  
 Control Type: Semi Act-Uncoord  
 Maximum v/c Ratio: 0.38  
 Intersection Signal Delay: 5.9  
 Intersection Capacity Utilization 41.8%  
 Analysis Period (min) 15  
 Intersection LOS: A  
 ICU Level of Service A

Splits and Phases: 16: McLaughlin Rd & Eastonville Rd



HCM 6th Roundabout  
1: Eastonville Rd & Rex Rd

2045 Total Traffic  
PM Peak Hour

Intersection				
Intersection Delay, s/veh	21.6			
Intersection LOS	C			
Approach	EB	WB	NB	SB
Entry Lanes	1	1	1	1
Conflicting Circle Lanes	1	1	1	1
Adj Approach Flow, veh/h	431	399	893	256
Demand Flow Rate, veh/h	440	407	911	261
Vehicles Circulating, veh/h	492	533	331	570
Vehicles Exiting, veh/h	339	709	601	370
Ped Vol Crossing Leg, #/h	0	0	0	0
Ped Cap Adj	1.000	1.000	1.000	1.000
Approach Delay, s/veh	11.8	11.8	34.4	8.9
Approach LOS	B	B	D	A
Lane	Left	Left	Left	Left
Designated Moves	LTR	LTR	LTR	LTR
Assumed Moves	LTR	LTR	LTR	LTR
RT Channelized				
Lane Util	1.000	1.000	1.000	1.000
Follow-Up Headway, s	2.609	2.609	2.609	2.609
Critical Headway, s	4.976	4.976	4.976	4.976
Entry Flow, veh/h	440	407	911	261
Cap Entry Lane, veh/h	835	801	985	772
Entry HV Adj Factor	0.979	0.981	0.980	0.979
Flow Entry, veh/h	431	399	893	256
Cap Entry, veh/h	818	786	965	756
V/C Ratio	0.527	0.508	0.925	0.338
Control Delay, s/veh	11.8	11.8	34.4	8.9
LOS	B	B	D	A
95th %tile Queue, veh	3	3	14	1

Intersection						
Int Delay, s/veh	2					
Movement	EBT	EBR	WBL	WBT	NBL	NBR
Lane Configurations	↔		↔	↑	↔	↔
Traffic Vol, veh/h	626	39	97	359	20	70
Future Vol, veh/h	626	39	97	359	20	70
Conflicting Peds, #/hr	0	0	0	0	0	0
Sign Control	Free	Free	Free	Free	Stop	Stop
RT Channelized	-	None	-	None	-	None
Storage Length	-	-	155	-	205	0
Veh in Median Storage, #	0	-	-	0	0	-
Grade, %	0	-	-	0	0	-
Peak Hour Factor	92	92	92	92	92	92
Heavy Vehicles, %	2	2	2	2	2	2
Mvmt Flow	680	42	105	390	22	76

Major/Minor	Major1	Major2	Minor1		
Conflicting Flow All	0	0	722	0	1301 701
Stage 1	-	-	-	-	701 -
Stage 2	-	-	-	-	600 -
Critical Hdwy	-	-	4.12	-	6.42 6.22
Critical Hdwy Stg 1	-	-	-	-	5.42 -
Critical Hdwy Stg 2	-	-	-	-	5.42 -
Follow-up Hdwy	-	-	2.218	-	3.518 3.318
Pot Cap-1 Maneuver	-	-	880	-	178 439
Stage 1	-	-	-	-	492 -
Stage 2	-	-	-	-	548 -
Platoon blocked, %	-	-	-	-	-
Mov Cap-1 Maneuver	-	-	880	-	157 439
Mov Cap-2 Maneuver	-	-	-	-	294 -
Stage 1	-	-	-	-	492 -
Stage 2	-	-	-	-	483 -

Approach	EB	WB	NB
HCM Control Delay, s	0	2.1	15.6
HCM LOS			C

Minor Lane/Major Mvmt	NBLn1	NBLn2	EBT	EBR	WBL	WBT
Capacity (veh/h)	294	439	-	-	880	-
HCM Lane V/C Ratio	0.074	0.173	-	-	0.12	-
HCM Control Delay (s)	18.2	14.9	-	-	9.6	-
HCM Lane LOS	C	B	-	-	A	-
HCM 95th %tile Q(veh)	0.2	0.6	-	-	0.4	-



Intersection						
Int Delay, s/veh	0.3					
Movement	EBL	EBT	WBT	WBR	SBL	SBR
Lane Configurations						
Traffic Vol, veh/h	2	694	451	7	20	5
Future Vol, veh/h	2	694	451	7	20	5
Conflicting Peds, #/hr	0	0	0	0	0	0
Sign Control	Free	Free	Free	Free	Stop	Stop
RT Channelized	-	None	-	None	-	None
Storage Length	155	-	-	-	0	-
Veh in Median Storage, #	-	0	0	-	0	-
Grade, %	-	0	0	-	0	-
Peak Hour Factor	92	92	92	92	92	92
Heavy Vehicles, %	2	2	2	2	2	2
Mvmt Flow	2	754	490	8	22	5

Major/Minor	Major1	Major2	Minor2
Conflicting Flow All	498	0	0
Stage 1	-	-	-
Stage 2	-	-	-
Critical Hdwy	4.12	-	-
Critical Hdwy Stg 1	-	-	-
Critical Hdwy Stg 2	-	-	-
Follow-up Hdwy	2.218	-	-
Pot Cap-1 Maneuver	1066	-	-
Stage 1	-	-	-
Stage 2	-	-	-
Platoon blocked, %	-	-	-
Mov Cap-1 Maneuver	1066	-	-
Mov Cap-2 Maneuver	-	-	-
Stage 1	-	-	-
Stage 2	-	-	-

Approach	EB	WB	SB
HCM Control Delay, s	0	0	15.9
HCM LOS			C

Minor Lane/Major Mvmt	EBL	EBT	WBT	WBR	SBLn1
Capacity (veh/h)	1066	-	-	-	356
HCM Lane V/C Ratio	0.002	-	-	-	0.076
HCM Control Delay (s)	8.4	-	-	-	15.9
HCM Lane LOS	A	-	-	-	C
HCM 95th %tile Q(veh)	0	-	-	-	0.2

Intersection						
Int Delay, s/veh	0.8					
Movement	EBT	EBR	WBL	WBT	NBL	NBR
Lane Configurations						
Traffic Vol, veh/h	693	21	45	451	7	31
Future Vol, veh/h	693	21	45	451	7	31
Conflicting Peds, #/hr	0	0	0	0	0	0
Sign Control	Free	Free	Free	Free	Stop	Stop
RT Channelized	-	None	-	None	-	None
Storage Length	-	155	305	-	0	-
Veh in Median Storage, #	0	-	-	0	0	-
Grade, %	0	-	-	0	0	-
Peak Hour Factor	95	95	95	95	95	95
Heavy Vehicles, %	2	2	2	2	2	2
Mvmt Flow	729	22	47	475	7	33

Major/Minor	Major1	Major2	Minor1		
Conflicting Flow All	0	0	751	0	1298
Stage 1	-	-	-	-	729
Stage 2	-	-	-	-	569
Critical Hdwy	-	-	4.12	-	6.42
Critical Hdwy Stg 1	-	-	-	-	5.42
Critical Hdwy Stg 2	-	-	-	-	5.42
Follow-up Hdwy	-	-	2.218	-	3.518
Pot Cap-1 Maneuver	-	-	858	-	178
Stage 1	-	-	-	-	477
Stage 2	-	-	-	-	566
Platoon blocked, %	-	-	-	-	-
Mov Cap-1 Maneuver	-	-	858	-	168
Mov Cap-2 Maneuver	-	-	-	-	306
Stage 1	-	-	-	-	477
Stage 2	-	-	-	-	535

Approach	EB	WB	NB
HCM Control Delay, s	0	0.9	15.1
HCM LOS			C

Minor Lane/Major Mvmt	NBLn1	EBT	EBR	WBL	WBT
Capacity (veh/h)	395	-	-	858	-
HCM Lane V/C Ratio	0.101	-	-	0.055	-
HCM Control Delay (s)	15.1	-	-	9.4	-
HCM Lane LOS	C	-	-	A	-
HCM 95th %tile Q(veh)	0.3	-	-	0.2	-

Intersection						
Int Delay, s/veh	1.4					
Movement	EBT	EBR	WBL	WBT	NBL	NBR
Lane Configurations	↔		↔	↑	↔	↔
Traffic Vol, veh/h	699	25	84	480	15	53
Future Vol, veh/h	699	25	84	480	15	53
Conflicting Peds, #/hr	0	0	0	0	0	0
Sign Control	Free	Free	Free	Free	Stop	Stop
RT Channelized	-	None	-	None	-	None
Storage Length	-	-	305	-	0	0
Veh in Median Storage, #	0	-	-	0	0	-
Grade, %	0	-	-	0	0	-
Peak Hour Factor	95	95	95	95	95	95
Heavy Vehicles, %	2	2	2	2	2	2
Mvmt Flow	736	26	88	505	16	56

Major/Minor	Major1	Major2	Minor1		
Conflicting Flow All	0	0	762	0	1430 749
Stage 1	-	-	-	-	749 -
Stage 2	-	-	-	-	681 -
Critical Hdwy	-	-	4.12	-	6.42 6.22
Critical Hdwy Stg 1	-	-	-	-	5.42 -
Critical Hdwy Stg 2	-	-	-	-	5.42 -
Follow-up Hdwy	-	-	2.218	-	3.518 3.318
Pot Cap-1 Maneuver	-	-	850	-	148 412
Stage 1	-	-	-	-	467 -
Stage 2	-	-	-	-	503 -
Platoon blocked, %	-	-	-	-	-
Mov Cap-1 Maneuver	-	-	850	-	133 412
Mov Cap-2 Maneuver	-	-	-	-	270 -
Stage 1	-	-	-	-	467 -
Stage 2	-	-	-	-	451 -

Approach	EB	WB	NB
HCM Control Delay, s	0	1.4	16
HCM LOS			C

Minor Lane/Major Mvmt	NBLn1	NBLn2	EBT	EBR	WBL	WBT
Capacity (veh/h)	270	412	-	-	850	-
HCM Lane V/C Ratio	0.058	0.135	-	-	0.104	-
HCM Control Delay (s)	19.2	15.1	-	-	9.7	-
HCM Lane LOS	C	C	-	-	A	-
HCM 95th %tile Q(veh)	0.2	0.5	-	-	0.3	-

Intersection								
Intersection Delay, s/veh	13.4							
Intersection LOS	B							
Approach	EB		WB		NB		SB	
Entry Lanes	2		2		1		2	
Conflicting Circle Lanes	1		1		1		1	
Adj Approach Flow, veh/h	792		1005		140		489	
Demand Flow Rate, veh/h	808		1025		143		499	
Vehicles Circulating, veh/h	445		371		1073		551	
Vehicles Exiting, veh/h	605		845		180		845	
Ped Vol Crossing Leg, #/h	0		0		0		0	
Ped Cap Adj	1.000		1.000		1.000		1.000	
Approach Delay, s/veh	21.6		9.8		13.0		7.7	
Approach LOS	C		A		B		A	
Lane	Left	Right	Left	Right	Left	Left	Right	
Designated Moves	LT	R	LT	R	LTR	LT	R	
Assumed Moves	LT	R	LT	R	LTR	LT	R	
RT Channelized								
Lane Util	0.954	0.046	0.499	0.501	1.000	0.617	0.383	
Follow-Up Headway, s	2.535	2.535	2.535	2.535	2.609	2.535	2.535	
Critical Headway, s	4.544	4.544	4.544	4.544	4.976	4.544	4.544	
Entry Flow, veh/h	771	37	511	514	143	308	191	
Cap Entry Lane, veh/h	947	947	1013	1013	462	860	860	
Entry HV Adj Factor	0.981	0.973	0.980	0.981	0.978	0.980	0.979	
Flow Entry, veh/h	756	36	501	504	140	302	187	
Cap Entry, veh/h	929	922	993	993	452	843	842	
V/C Ratio	0.814	0.039	0.504	0.507	0.310	0.358	0.222	
Control Delay, s/veh	22.4	4.3	9.8	9.8	13.0	8.4	6.6	
LOS	C	A	A	A	B	A	A	
95th %tile Queue, veh	9	0	3	3	1	2	1	

Timings  
9: US 24 & Rex Rd

2045 Total Traffic  
PM Peak Hour



Lane Group	EBL	EBR	NBL	NBT	SBT	SBR
Lane Configurations	↖	↗	↖↗	↕	↕	↗
Traffic Volume (vph)	116	836	1104	620	501	108
Future Volume (vph)	116	836	1104	620	501	108
Turn Type	Prot	Free	Prot	NA	NA	Perm
Protected Phases	6!		7	Free!	8	
Permitted Phases		Free				8
Detector Phase	6		7		8	8
Switch Phase						
Minimum Initial (s)	5.0		5.0		5.0	5.0
Minimum Split (s)	20.0		10.0		20.0	20.0
Total Split (s)	24.0		52.0		44.0	44.0
Total Split (%)	20.0%		43.3%		36.7%	36.7%
Yellow Time (s)	3.0		3.0		3.0	3.0
All-Red Time (s)	2.0		2.0		2.0	2.0
Lost Time Adjust (s)	0.0		0.0		0.0	0.0
Total Lost Time (s)	5.0		5.0		5.0	5.0
Lead/Lag			Lead		Lag	Lag
Lead-Lag Optimize?			Yes		Yes	Yes
Recall Mode	Max		None		C-Max	C-Max
Act Effct Green (s)	19.0	120.0	44.8	120.0	41.2	41.2
Actuated g/C Ratio	0.16	1.00	0.37	1.00	0.34	0.34
v/c Ratio	0.44	0.56	0.91	0.18	0.43	0.18
Control Delay	51.2	1.4	33.7	0.1	32.3	6.0
Queue Delay	0.0	0.0	0.0	0.0	0.0	0.0
Total Delay	51.2	1.4	33.7	0.1	32.3	6.0
LOS	D	A	C	A	C	A
Approach Delay	7.5			21.8	27.6	
Approach LOS	A			C	C	

Intersection Summary

Cycle Length: 120  
 Actuated Cycle Length: 120  
 Offset: 50 (42%), Referenced to phase 8:SBT, Start of Green  
 Natural Cycle: 70  
 Control Type: Actuated-Coordinated  
 Maximum v/c Ratio: 0.91  
 Intersection Signal Delay: 18.7  
 Intersection LOS: B  
 Intersection Capacity Utilization 63.4%  
 ICU Level of Service B  
 Analysis Period (min) 15

! Phase conflict between lane groups.

Splits and Phases: 9: US 24 & Rex Rd



Intersection			
Intersection Delay, s/veh	13.8		
Intersection LOS	B		
Approach	WB	NB	SB
Entry Lanes	1	1	1
Conflicting Circle Lanes	2	2	2
Adj Approach Flow, veh/h	158	1142	594
Demand Flow Rate, veh/h	161	1164	606
Vehicles Circulating, veh/h	942	5	158
Vehicles Exiting, veh/h	227	759	945
Ped Vol Crossing Leg, #/h	0	0	0
Ped Cap Adj	1.000	1.000	1.000
Approach Delay, s/veh	8.9	17.4	8.2
Approach LOS	A	C	A
Lane	Left	Left	Left
Designated Moves	LR	TR	LT
Assumed Moves	LR	TR	LT
RT Channelized			
Lane Util	1.000	1.000	1.000
Follow-Up Headway, s	2.535	2.535	2.535
Critical Headway, s	4.328	4.328	4.328
Entry Flow, veh/h	161	1164	606
Cap Entry Lane, veh/h	638	1414	1242
Entry HV Adj Factor	0.981	0.981	0.981
Flow Entry, veh/h	158	1142	594
Cap Entry, veh/h	626	1387	1217
V/C Ratio	0.253	0.823	0.488
Control Delay, s/veh	8.9	17.4	8.2
LOS	A	C	A
95th %tile Queue, veh	1	10	3

Intersection						
Int Delay, s/veh	0.9					
Movement	WBL	WBR	NBT	NBR	SBL	SBT
Lane Configurations	Y		↑	↑	↑	↑
Traffic Vol, veh/h	36	14	1071	61	25	682
Future Vol, veh/h	36	14	1071	61	25	682
Conflicting Peds, #/hr	0	0	0	0	0	0
Sign Control	Stop	Stop	Free	Free	Free	Free
RT Channelized	-	None	-	None	-	None
Storage Length	0	-	-	155	205	-
Veh in Median Storage, #	0	-	0	-	-	0
Grade, %	0	-	0	-	-	0
Peak Hour Factor	95	95	95	95	95	95
Heavy Vehicles, %	2	2	2	2	2	2
Mvmt Flow	38	15	1127	64	26	718

Major/Minor	Minor1	Major1	Major2		
Conflicting Flow All	1897	1127	0	0	1191
Stage 1	1127	-	-	-	-
Stage 2	770	-	-	-	-
Critical Hdwy	6.42	6.22	-	-	4.12
Critical Hdwy Stg 1	5.42	-	-	-	-
Critical Hdwy Stg 2	5.42	-	-	-	-
Follow-up Hdwy	3.518	3.318	-	-	2.218
Pot Cap-1 Maneuver	76	249	-	-	586
Stage 1	309	-	-	-	-
Stage 2	457	-	-	-	-
Platoon blocked, %			-	-	-
Mov Cap-1 Maneuver	73	249	-	-	586
Mov Cap-2 Maneuver	197	-	-	-	-
Stage 1	309	-	-	-	-
Stage 2	437	-	-	-	-

Approach	WB	NB	SB
HCM Control Delay, s	27.9	0	0.4
HCM LOS	D		

Minor Lane/Major Mvmt	NBT	NBRWBLn1	SBL	SBT
Capacity (veh/h)	-	-	209	586
HCM Lane V/C Ratio	-	-	0.252	0.045
HCM Control Delay (s)	-	-	27.9	11.4
HCM Lane LOS	-	-	D	B
HCM 95th %tile Q(veh)	-	-	1	0.1

Intersection						
Intersection Delay, s/veh	12.7					
Intersection LOS	B					
Approach	EB		NB		SB	
Entry Lanes	2		2		2	
Conflicting Circle Lanes	2		2		2	
Adj Approach Flow, veh/h	509		1263		750	
Demand Flow Rate, veh/h	520		1288		765	
Vehicles Circulating, veh/h	495		180		252	
Vehicles Exiting, veh/h	522		835		1216	
Ped Vol Crossing Leg, #/h	0		0		0	
Ped Cap Adj	1.000		1.000		1.000	
Approach Delay, s/veh	7.5		18.2		6.8	
Approach LOS	A		C		A	
Lane	Left	Right	Left	Right	Left	Right
Designated Moves	L	TR	L	TR	LT	TR
Assumed Moves	L	TR	L	TR	LT	TR
RT Channelized						
Lane Util	0.346	0.654	0.196	0.804	0.471	0.529
Follow-Up Headway, s	2.667	2.535	2.667	2.535	2.667	2.535
Critical Headway, s	4.645	4.328	4.645	4.328	4.645	4.328
Entry Flow, veh/h	180	340	252	1036	360	405
Cap Entry Lane, veh/h	856	932	1144	1219	1071	1146
Entry HV Adj Factor	0.978	0.979	0.980	0.980	0.980	0.982
Flow Entry, veh/h	176	333	247	1016	353	398
Cap Entry, veh/h	837	913	1121	1195	1049	1125
V/C Ratio	0.210	0.365	0.220	0.850	0.336	0.353
Control Delay, s/veh	6.5	8.0	5.2	21.4	6.8	6.7
LOS	A	A	A	C	A	A
95th %tile Queue, veh	1	2	1	11	1	2



Intersection										
Intersection Delay, s/veh 14.8										
Intersection LOS B										
Approach	EB		WB			NB		SB		
Entry Lanes	2		2			2		2		
Conflicting Circle Lanes	2		2			2		2		
Adj Approach Flow, veh/h	845		985			811		817		
Demand Flow Rate, veh/h	861		1005			827		833		
Vehicles Circulating, veh/h	686		1093			972		822		
Vehicles Exiting, veh/h	715		706			575		931		
Ped Vol Crossing Leg, #/h	0		0			0		0		
Ped Cap Adj	1.000		1.000			1.000		1.000		
Approach Delay, s/veh	13.9		13.8			23.3		8.3		
Approach LOS	B		B			C		A		
Lane	Left	Right	Left	Right	Bypass	Left	Right	Left	Right	Bypass
Designated Moves	LT	TR	LT	TR	R	LT	TR	L	LTR	R
Assumed Moves	LT	TR	LT	TR	R	LT	TR	L	TR	R
RT Channelized			Free					Free		
Lane Util	0.470	0.530	0.470	0.530		0.470	0.530	0.389	0.611	
Follow-Up Headway, s	2.667	2.535	2.667	2.535		2.667	2.535	2.667	2.535	
Critical Headway, s	4.645	4.328	4.645	4.328	345	4.645	4.328	4.645	4.328	254
Entry Flow, veh/h	405	456	310	350	1938	389	438	225	354	1938
Cap Entry Lane, veh/h	718	793	494	561	0.980	552	622	634	706	0.980
Entry HV Adj Factor	0.980	0.982	0.981	0.980	338	0.980	0.981	0.982	0.980	249
Flow Entry, veh/h	397	448	304	343	1900	381	430	221	347	1900
Cap Entry, veh/h	704	778	485	550	0.178	541	610	622	692	0.131
V/C Ratio	0.564	0.575	0.628	0.624	0.0	0.705	0.705	0.355	0.501	0.0
Control Delay, s/veh	14.3	13.6	22.3	19.9	A	24.5	22.3	10.7	12.8	A
LOS	B	B	C	C	1	C	C	B	B	0
95th %tile Queue, veh	4	4	4	4		6	6	2	3	

Timings  
14: US 24 & Stapleton Dr

2045 Total Traffic  
PM Peak Hour

Lane Group	EBL	EBT	EBR	WBL	WBT	WBR	NBL	NBT	NBR	SBL	SBT	SBR
Lane Configurations												
Traffic Volume (vph)	159	222	469	125	321	310	628	1255	150	237	918	182
Future Volume (vph)	159	222	469	125	321	310	628	1255	150	237	918	182
Turn Type	pm+pt	NA	Free	pm+pt	NA	Free	Prot	NA	Perm	Prot	NA	Perm
Protected Phases	5	2		1	6		3	8		7	4	
Permitted Phases	2		Free	6		Free			8			4
Detector Phase	5	2		1	6		3	8	8	7	4	4
Switch Phase												
Minimum Initial (s)	5.0	10.0		4.0	5.0		8.0	5.0	5.0	15.0	15.0	15.0
Minimum Split (s)	10.0	15.0		9.0	10.0		13.0	10.0	10.0	20.0	20.0	20.0
Total Split (s)	12.0	25.0		12.0	25.0		36.0	63.0	63.0	20.0	47.0	47.0
Total Split (%)	10.0%	20.8%		10.0%	20.8%		30.0%	52.5%	52.5%	16.7%	39.2%	39.2%
Yellow Time (s)	3.0	3.0		3.0	3.0		3.0	3.0	3.0	3.0	3.0	3.0
All-Red Time (s)	2.0	2.0		2.0	2.0		2.0	2.0	2.0	2.0	2.0	2.0
Lost Time Adjust (s)	0.0	0.0		0.0	0.0		0.0	0.0	0.0	0.0	0.0	0.0
Total Lost Time (s)	5.0	5.0		5.0	5.0		5.0	5.0	5.0	5.0	5.0	5.0
Lead/Lag	Lead	Lag		Lead	Lag		Lead	Lag	Lag	Lead	Lag	Lag
Lead-Lag Optimize?	Yes	Yes		Yes	Yes		Yes	Yes	Yes	Yes	Yes	Yes
Recall Mode	None	C-Max		None	C-Max		None	Max	Max	None	Max	Max
Act Effct Green (s)	27.0	20.0	120.0	27.0	20.0	120.0	27.5	58.0	58.0	15.0	45.5	45.5
Actuated g/C Ratio	0.22	0.17	1.00	0.22	0.17	1.00	0.23	0.48	0.48	0.12	0.38	0.38
v/c Ratio	0.75	0.40	0.31	0.49	0.57	0.21	0.84	0.77	0.19	0.58	0.70	0.27
Control Delay	50.5	38.4	0.6	43.0	50.4	0.3	54.5	29.4	4.0	43.1	41.2	11.1
Queue Delay	0.0	0.0	0.0	0.0	0.0	0.0	0.0	0.0	0.0	0.0	0.0	0.0
Total Delay	50.5	38.4	0.6	43.0	50.4	0.3	54.5	29.4	4.0	43.1	41.2	11.1
LOS	D	D	A	D	D	A	D	C	A	D	D	B
Approach Delay		19.8			28.7			35.3			37.4	
Approach LOS		B			C			D			D	

Intersection Summary

Cycle Length: 120  
 Actuated Cycle Length: 120  
 Offset: 0 (0%), Referenced to phase 2:EBTL and 6:WBTL, Start of Green  
 Natural Cycle: 80  
 Control Type: Actuated-Coordinated  
 Maximum v/c Ratio: 0.84  
 Intersection Signal Delay: 32.2  
 Intersection LOS: C  
 Intersection Capacity Utilization 81.5%  
 ICU Level of Service D  
 Analysis Period (min) 15

Splits and Phases: 14: US 24 & Stapleton Dr

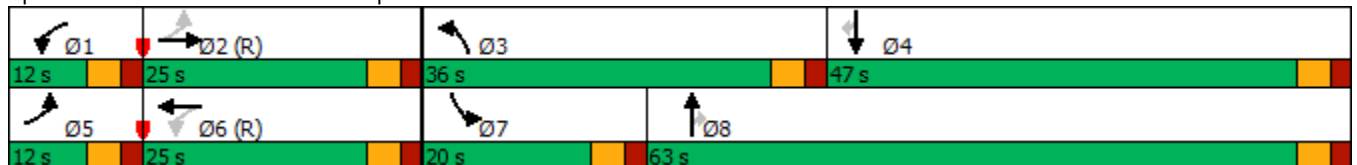

**Intersection**

Intersection Delay, s/veh 106.8  
 Intersection LOS F

Movement	EBL	EBT	EBR	WBL	WBT	WBR	NBL	NBT	NBR	SBL	SBT	SBR
Lane Configurations												
Traffic Vol, veh/h	32	90	140	58	205	100	270	482	84	43	217	21
Future Vol, veh/h	32	90	140	58	205	100	270	482	84	43	217	21
Peak Hour Factor	0.92	0.92	0.92	0.92	0.92	0.92	0.92	0.92	0.92	0.92	0.92	0.92
Heavy Vehicles, %	2	2	2	2	2	2	2	2	2	2	2	2
Mvmt Flow	35	98	152	63	223	109	293	524	91	47	236	23
Number of Lanes	1	1	0	1	1	1	1	1	0	1	1	0

Approach	EB	WB	NB	SB
Opposing Approach	WB	EB	SB	NB
Opposing Lanes	3	2	2	2
Conflicting Approach Left SB		NB	EB	WB
Conflicting Lanes Left	2	2	2	3
Conflicting Approach Right NB		SB	WB	EB
Conflicting Lanes Right	2	2	3	2
HCM Control Delay	28.9	22.5	193.1	31.3
HCM LOS	D	C	F	D

Lane	NBLn1	NBLn2	EBLn1	EBLn2	WBLn1	WBLn2	WBLn3	SBLn1	SBLn2
Vol Left, %	100%	0%	100%	0%	100%	0%	0%	100%	0%
Vol Thru, %	0%	85%	0%	39%	0%	100%	0%	0%	91%
Vol Right, %	0%	15%	0%	61%	0%	0%	100%	0%	9%
Sign Control	Stop	Stop	Stop	Stop	Stop	Stop	Stop	Stop	Stop
Traffic Vol by Lane	270	566	32	230	58	205	100	43	238
LT Vol	270	0	32	0	58	0	0	43	0
Through Vol	0	482	0	90	0	205	0	0	217
RT Vol	0	84	0	140	0	0	100	0	21
Lane Flow Rate	293	615	35	250	63	223	109	47	259
Geometry Grp	6	6	6	6	6	6	6	6	6
Degree of Util (X)	0.774	1.515	0.1	0.656	0.177	0.595	0.269	0.134	0.696
Departure Headway (Hd)	9.49	8.867	11.332	10.357	11.002	10.479	9.748	11.082	10.497
Convergence, Y/N	Yes	Yes	Yes	Yes	Yes	Yes	Yes	Yes	Yes
Cap	384	412	318	353	328	348	371	326	347
Service Time	7.191	6.568	9.032	8.057	8.702	8.179	7.448	8.782	8.197
HCM Lane V/C Ratio	0.763	1.493	0.11	0.708	0.192	0.641	0.294	0.144	0.746
HCM Control Delay	38.1	267	15.3	30.8	16.1	27.5	16	15.5	34.1
HCM Lane LOS	E	F	C	D	C	D	C	C	D
HCM 95th-tile Q	6.4	33.1	0.3	4.4	0.6	3.6	1.1	0.5	5

Intersection												
Int Delay, s/veh	20.6											
Movement	EBL	EBT	EBR	WBL	WBT	WBR	NBL	NBT	NBR	SBL	SBT	SBR
Lane Configurations	↖	↗		↖	↗		↖	↗			↕	
Traffic Vol, veh/h	6	465	67	193	285	1	48	22	385	0	4	3
Future Vol, veh/h	6	465	67	193	285	1	48	22	385	0	4	3
Conflicting Peds, #/hr	0	0	0	0	0	0	0	0	0	0	0	0
Sign Control	Free	Free	Free	Free	Free	Free	Stop	Stop	Stop	Stop	Stop	Stop
RT Channelized	-	-	None	-	-	None	-	-	None	-	-	None
Storage Length	0	-	-	110	-	-	0	-	-	-	-	-
Veh in Median Storage, #	-	0	-	-	0	-	-	0	-	-	0	-
Grade, %	-	0	-	-	0	-	-	0	-	-	0	-
Peak Hour Factor	92	92	92	92	92	92	92	92	92	92	92	92
Heavy Vehicles, %	2	2	2	2	2	2	2	2	2	2	2	2
Mvmt Flow	7	505	73	210	310	1	52	24	418	0	4	3

Major/Minor	Major1			Major2			Minor1			Minor2		
Conflicting Flow All	311	0	0	578	0	0	1290	1287	542	1508	1323	311
Stage 1	-	-	-	-	-	-	556	556	-	731	731	-
Stage 2	-	-	-	-	-	-	734	731	-	777	592	-
Critical Hdwy	4.12	-	-	4.12	-	-	7.12	6.52	6.22	7.12	6.52	6.22
Critical Hdwy Stg 1	-	-	-	-	-	-	6.12	5.52	-	6.12	5.52	-
Critical Hdwy Stg 2	-	-	-	-	-	-	6.12	5.52	-	6.12	5.52	-
Follow-up Hdwy	2.218	-	-	2.218	-	-	3.518	4.018	3.318	3.518	4.018	3.318
Pot Cap-1 Maneuver	1249	-	-	996	-	-	140	164	540	99	156	729
Stage 1	-	-	-	-	-	-	515	513	-	413	427	-
Stage 2	-	-	-	-	-	-	412	427	-	390	494	-
Platoon blocked, %	-	-	-	-	-	-	-	-	-	-	-	-
Mov Cap-1 Maneuver	1249	-	-	996	-	-	113	129	540	16	122	729
Mov Cap-2 Maneuver	-	-	-	-	-	-	113	129	-	16	122	-
Stage 1	-	-	-	-	-	-	512	510	-	411	337	-
Stage 2	-	-	-	-	-	-	320	337	-	83	491	-

Approach	EB			WB			NB			SB		
HCM Control Delay, s	0.1			3.9			62.4			24.7		
HCM LOS							F			C		

Minor Lane/Major Mvmt	NBLn1	NBLn2	EBL	EBT	EBR	WBL	WBT	WBR	SBLn1
Capacity (veh/h)	113	461	1249	-	-	996	-	-	190
HCM Lane V/C Ratio	0.462	0.96	0.005	-	-	0.211	-	-	0.04
HCM Control Delay (s)	61.6	62.5	7.9	-	-	9.6	-	-	24.7
HCM Lane LOS	F	F	A	-	-	A	-	-	C
HCM 95th %tile Q(veh)	2	11.8	0	-	-	0.8	-	-	0.1

HCM 6th Roundabout  
 15: Eastonville Rd & Meridian Ranch Blvd/Judge Orr Rd

2045 Total Traffic  
 PM Peak Hour

Intersection				
Intersection Delay, s/veh	15.3			
Intersection LOS	C			
Approach	EB	WB	NB	SB
Entry Lanes	1	1	1	1
Conflicting Circle Lanes	1	1	1	1
Adj Approach Flow, veh/h	276	382	879	295
Demand Flow Rate, veh/h	282	389	897	301
Vehicles Circulating, veh/h	341	842	178	572
Vehicles Exiting, veh/h	532	233	445	659
Ped Vol Crossing Leg, #/h	0	0	0	0
Ped Cap Adj	1.000	1.000	1.000	1.000
Approach Delay, s/veh	6.7	21.2	17.3	9.7
Approach LOS	A	C	C	A
Lane	Left	Left	Left	Left
Designated Moves	LTR	LTR	LTR	LTR
Assumed Moves	LTR	LTR	LTR	LTR
RT Channelized				
Lane Util	1.000	1.000	1.000	1.000
Follow-Up Headway, s	2.609	2.609	2.609	2.609
Critical Headway, s	4.976	4.976	4.976	4.976
Entry Flow, veh/h	282	389	897	301
Cap Entry Lane, veh/h	975	585	1151	770
Entry HV Adj Factor	0.979	0.981	0.980	0.981
Flow Entry, veh/h	276	382	879	295
Cap Entry, veh/h	954	574	1128	756
V/C Ratio	0.289	0.665	0.779	0.391
Control Delay, s/veh	6.7	21.2	17.3	9.7
LOS	A	C	C	A
95th %tile Queue, veh	1	5	8	2

Intersection				
Intersection Delay, s/veh	9.9			
Intersection LOS	A			
Approach	EB	WB	NB	SB
Entry Lanes	1	1	1	1
Conflicting Circle Lanes	1	1	1	1
Adj Approach Flow, veh/h	566	504	479	7
Demand Flow Rate, veh/h	577	514	488	7
Vehicles Circulating, veh/h	211	81	505	565
Vehicles Exiting, veh/h	361	912	283	30
Ped Vol Crossing Leg, #/h	0	0	0	0
Ped Cap Adj	1.000	1.000	1.000	1.000
Approach Delay, s/veh	9.4	6.9	13.7	4.8
Approach LOS	A	A	B	A
Lane	Left	Left	Left	Left
Designated Moves	LTR	LTR	LTR	LTR
Assumed Moves	LTR	LTR	LTR	LTR
RT Channelized				
Lane Util	1.000	1.000	1.000	1.000
Follow-Up Headway, s	2.609	2.609	2.609	2.609
Critical Headway, s	4.976	4.976	4.976	4.976
Entry Flow, veh/h	577	514	488	7
Cap Entry Lane, veh/h	1113	1270	824	775
Entry HV Adj Factor	0.981	0.981	0.981	0.989
Flow Entry, veh/h	566	504	479	7
Cap Entry, veh/h	1092	1246	808	767
V/C Ratio	0.519	0.405	0.592	0.009
Control Delay, s/veh	9.4	6.9	13.7	4.8
LOS	A	A	B	A
95th %tile Queue, veh	3	2	4	0

Timings  
15: Eastonville Rd & Meridian Ranch Blvd/Judge Orr Rd

2045 Total Traffic  
PM Peak Hour

Lane Group	EBL	EBT	WBL	WBT	WBR	NBL	NBT	SBL	SBT
Lane Configurations									
Traffic Volume (vph)	32	90	58	205	100	270	482	43	217
Future Volume (vph)	32	90	58	205	100	270	482	43	217
Turn Type	pm+pt	NA	pm+pt	NA	Perm	pm+pt	NA	pm+pt	NA
Protected Phases	7	4	3	8		5	2	1	6
Permitted Phases	4		8		8	2		6	
Detector Phase	7	4	3	8	8	5	2	1	6
Switch Phase									
Minimum Initial (s)	5.0	5.0	5.0	5.0	5.0	5.0	5.0	5.0	5.0
Minimum Split (s)	10.0	20.0	10.0	20.0	20.0	10.0	20.0	10.0	20.0
Total Split (s)	10.0	25.0	10.0	25.0	25.0	15.0	45.0	10.0	40.0
Total Split (%)	11.1%	27.8%	11.1%	27.8%	27.8%	16.7%	50.0%	11.1%	44.4%
Yellow Time (s)	3.0	3.0	3.0	3.0	3.0	3.0	3.0	3.0	3.0
All-Red Time (s)	2.0	2.0	2.0	2.0	2.0	2.0	2.0	2.0	2.0
Lost Time Adjust (s)	0.0	0.0	0.0	0.0	0.0	0.0	0.0	0.0	0.0
Total Lost Time (s)	5.0	5.0	5.0	5.0	5.0	5.0	5.0	5.0	5.0
Lead/Lag	Lead	Lag	Lead	Lag	Lag	Lead	Lag	Lead	Lag
Lead-Lag Optimize?	Yes	Yes	Yes	Yes	Yes	Yes	Yes	Yes	Yes
Recall Mode	None	None	None	None	None	None	Min	None	Min
Act Effct Green (s)	16.2	13.7	16.2	13.7	13.7	37.3	32.5	26.6	21.0
Actuated g/C Ratio	0.24	0.20	0.24	0.20	0.20	0.56	0.48	0.40	0.31
v/c Ratio	0.12	0.61	0.23	0.59	0.25	0.48	0.69	0.14	0.45
Control Delay	20.8	26.4	22.1	34.7	4.1	12.2	21.7	10.2	20.8
Queue Delay	0.0	0.0	0.0	0.0	0.0	0.0	0.0	0.0	0.0
Total Delay	20.8	26.4	22.1	34.7	4.1	12.2	21.7	10.2	20.8
LOS	C	C	C	C	A	B	C	B	C
Approach Delay		25.7		24.2			18.6		19.2
Approach LOS		C		C			B		B

Intersection Summary

Cycle Length: 90  
 Actuated Cycle Length: 67.1  
 Natural Cycle: 70  
 Control Type: Actuated-Uncoordinated  
 Maximum v/c Ratio: 0.69  
 Intersection Signal Delay: 21.0  
 Intersection LOS: C  
 Intersection Capacity Utilization 68.8%  
 ICU Level of Service C  
 Analysis Period (min) 15

Splits and Phases: 15: Eastonville Rd & Meridian Ranch Blvd/Judge Orr Rd

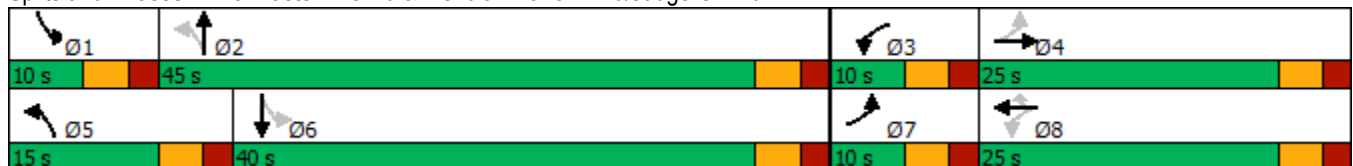

Timings  
16: McLaughlin Rd & Eastonville Rd

2045 Total Traffic  
PM Peak Hour

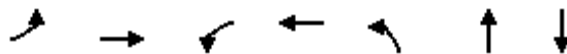

Lane Group	EBL	EBT	WBL	WBT	NBL	NBT	SBT
Lane Configurations	↙	↗	↙	↗	↙	↗	↕
Traffic Volume (vph)	6	465	193	285	48	22	4
Future Volume (vph)	6	465	193	285	48	22	4
Turn Type	pm+pt	NA	pm+pt	NA	Perm	NA	NA
Protected Phases	5	2	1	6		8	4
Permitted Phases	2		6		8		
Detector Phase	5	2	1	6	8	8	4
Switch Phase							
Minimum Initial (s)	5.0	5.0	5.0	5.0	5.0	5.0	5.0
Minimum Split (s)	10.0	20.0	10.0	20.0	20.0	20.0	20.0
Total Split (s)	10.0	45.0	15.0	50.0	30.0	30.0	30.0
Total Split (%)	11.1%	50.0%	16.7%	55.6%	33.3%	33.3%	33.3%
Yellow Time (s)	3.0	3.0	3.0	3.0	3.0	3.0	3.0
All-Red Time (s)	2.0	2.0	2.0	2.0	2.0	2.0	2.0
Lost Time Adjust (s)	0.0	0.0	0.0	0.0	0.0	0.0	0.0
Total Lost Time (s)	5.0	5.0	5.0	5.0	5.0	5.0	5.0
Lead/Lag	Lead	Lag	Lead	Lag			
Lead-Lag Optimize?	Yes	Yes	Yes	Yes			
Recall Mode	None	Max	None	Max	Min	Min	Min
Act Effct Green (s)	45.5	40.5	53.9	52.2	12.8	12.8	12.8
Actuated g/C Ratio	0.59	0.53	0.70	0.68	0.17	0.17	0.17
v/c Ratio	0.01	0.60	0.41	0.25	0.22	0.80	0.02
Control Delay	6.2	17.6	7.6	7.6	28.9	19.4	20.5
Queue Delay	0.0	0.0	0.0	0.0	0.0	0.0	0.0
Total Delay	6.2	17.6	7.6	7.6	28.9	19.4	20.5
LOS	A	B	A	A	C	B	C
Approach Delay		17.5		7.6		20.4	20.5
Approach LOS		B		A		C	C

Intersection Summary

Cycle Length: 90  
 Actuated Cycle Length: 76.8  
 Natural Cycle: 60  
 Control Type: Semi Act-Uncoord  
 Maximum v/c Ratio: 0.80  
 Intersection Signal Delay: 15.2  
 Intersection LOS: B  
 Intersection Capacity Utilization 76.7%  
 ICU Level of Service D  
 Analysis Period (min) 15

Splits and Phases: 16: McLaughlin Rd & Eastonville Rd





# Queuing Reports

---



Intersection: 4: Edenvale PI & Rex Rd

Movement	WB	NB
Directions Served	L	LR
Maximum Queue (ft)	30	62
Average Queue (ft)	5	26
95th Queue (ft)	23	51
Link Distance (ft)		190
Upstream Blk Time (%)		
Queuing Penalty (veh)		
Storage Bay Dist (ft)	305	
Storage Blk Time (%)		
Queuing Penalty (veh)		

Intersection: 5: Grange Tr & Rex Rd

Movement	EB	WB	NB	NB
Directions Served	TR	L	L	R
Maximum Queue (ft)	6	38	59	63
Average Queue (ft)	0	11	18	34
95th Queue (ft)	4	35	47	57
Link Distance (ft)	922		250	250
Upstream Blk Time (%)				
Queuing Penalty (veh)				
Storage Bay Dist (ft)		305		
Storage Blk Time (%)				
Queuing Penalty (veh)				

Network Summary

Network wide Queuing Penalty: 0
---------------------------------

Intersection: 4: Edenvale PI & Rex Rd

Movement	WB	NB
Directions Served	L	LR
Maximum Queue (ft)	48	58
Average Queue (ft)	17	20
95th Queue (ft)	44	47
Link Distance (ft)		190
Upstream Blk Time (%)		
Queuing Penalty (veh)		
Storage Bay Dist (ft)	305	
Storage Blk Time (%)		
Queuing Penalty (veh)		

Intersection: 5: Grange Tr & Rex Rd

Movement	EB	WB	NB	NB
Directions Served	TR	L	L	R
Maximum Queue (ft)	9	76	49	68
Average Queue (ft)	0	29	12	30
95th Queue (ft)	5	62	39	57
Link Distance (ft)	922		250	250
Upstream Blk Time (%)				
Queuing Penalty (veh)				
Storage Bay Dist (ft)		305		
Storage Blk Time (%)				
Queuing Penalty (veh)				

Network Summary

Network wide Queuing Penalty: 0
---------------------------------

# Appendix Table 1



**Appendix Table 1**  
**Area Traffic Impact Studies by LSC**  
**Grandview Reserve Phases 2 and 3**

Study	Date
<b>4-Way Ranch/Waterbury</b>	
4-Way Ranch Updated TIA	January 29, 2009
Waterbury PUD Development Plan Updated TIA	January 10, 2013
Waterbury Filing Nos. 1 and 2 TIA	December 18, 2020
4-Way Ranch Commercial Master Traffic Impact Analysis	December 20, 2022
4-Way Ranch Commercial Phase 1 Traffic Technical Memorandum	November 30, 2023
<b>Meridian Ranch</b>	
Meridian Ranch Sketch Plan TIA	April 11, 2011
Meridian Ranch Filing 11 Updated TIA	November 26, 2013
Stonebridge at Meridian Ranch Filing No. 1 Updated TIA	April 23, 2014
Stonebridge at Meridian Ranch Transportation Memorandum	July 28, 2015
Meridian Ranch Filing 8 Updated TIA	December 23, 2014
Meridian Ranch Filing 9 Updated TIA	May 21, 2015
Meridian Ranch Sketch Plan 2015 Amendment TIA	July 30, 2015
The Vistas at Meridian Ranch TIA	March 24, 2016
Meridian Ranch Estates Filing No. 2 Transportation Memorandum	August 27, 2015
The Vistas at Meridian Ranch Updated Transportation Memorandum	June 20, 2017
Londonderry Drive Pedestrian Operations and Safety Study	February 8, 2017
Stonebridge Filing 3 at Meridian Ranch Updated TIA	March 20, 2017
Meridian Ranch Sketch Plan 2017 Amendment TIA	October 3, 2017
WindingWalk at Meridian Ranch and The Enclave at Stonebridge at Meridian Ranch Updated Traffic Impact Analysis	May 10, 2018
Rolling Hills Ranch at Meridian Ranch PUDSP Traffic Impact Analysis	June 29, 2020
The Estates at Rolling Hills Ranch Filing No. 1 Traffic Impact Analysis	May 13, 2020
Rolling Hills Ranch at Meridian Ranch Filing No. 1 Traffic Impact Analysis	July 14, 2020
The Estates at Rolling Hills Ranch Filing No. 2 Traffic Impact Study	October 8, 2020
Rolling Hills Ranch at Meridian Ranch Filing No. 2 Transportation Memorandum	December 29, 2020
Rolling Hills Ranch at Meridian Ranch Filing No. 3 Transportation Memorandum	June 29, 2021
Meridian Ranch 2021 Sketch Plan Amendment Traffic Impact Study	June 25, 2021
The Sanctuary at Meridian Ranch Transportation Memorandum	May 3, 2022
Rolling Hills Ranch North PUD Transportation Memorandum	October 30, 2023
<b>Grandview Reserve</b>	
Grandview Reserve Updated Master TIA	December 5, 2020
Grandview Reserve Phase 1 TIA	March 8, 2022
<b>Meadowlake Ranch</b>	
Meadowlake Ranch Traffic Impact Analysis	May 29, 2019
<b>Latigo Preserve</b>	
Latigo Preserve Filing No. 10	March 31, 2022
<i>Source: LSC Transportation Consultants, Inc.</i>	
<i>Dec-23</i>	

# MTCP Maps

---



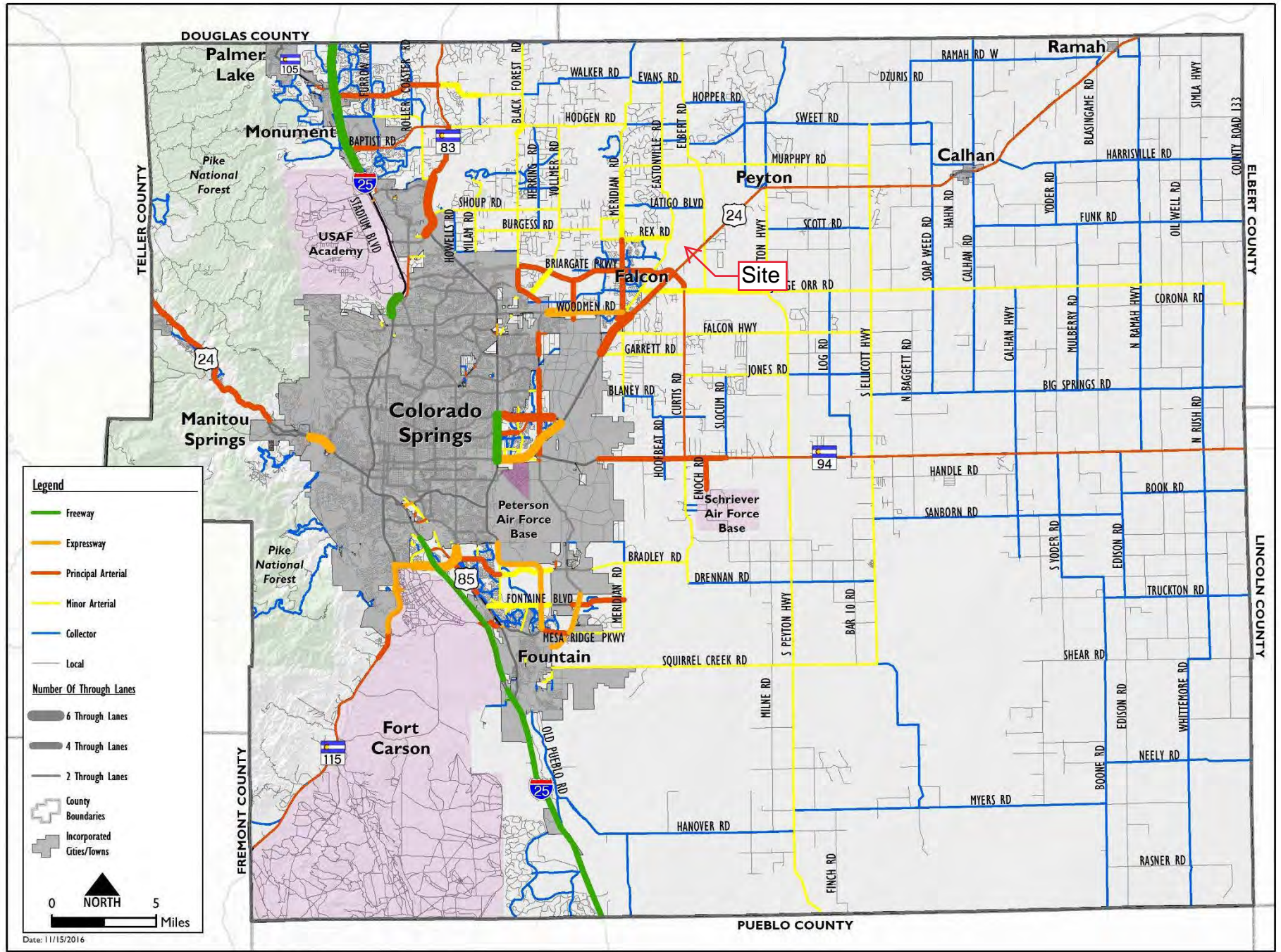

Map 14: 2040 Roadway Plan (Classification and Lanes)

# Map 17: 2060 Corridor Preservation

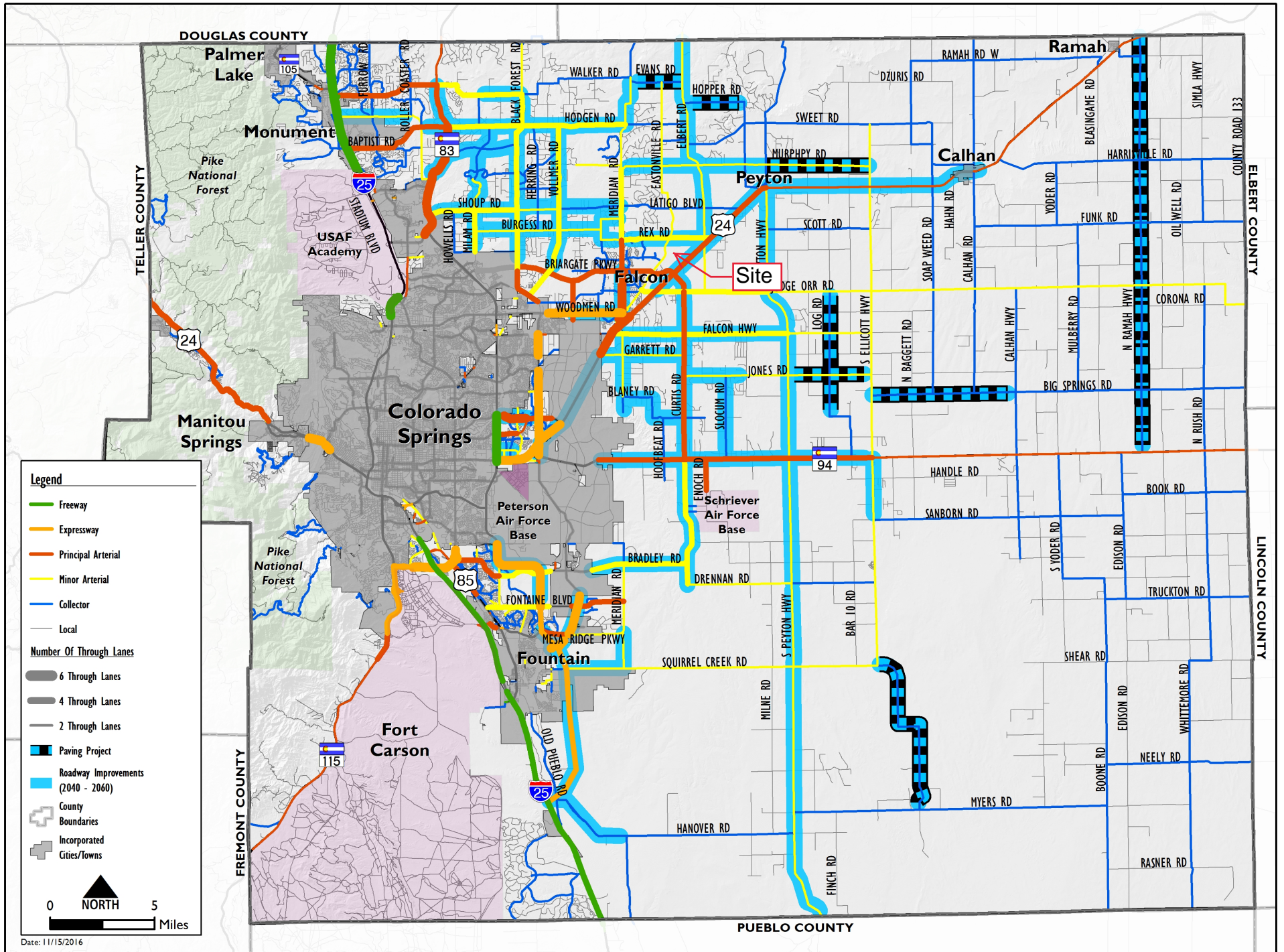

**Legend**

- Freeway
- Expressway
- Principal Arterial
- Minor Arterial
- Collector
- Local

**Number Of Through Lanes**

- 6 Through Lanes
- 4 Through Lanes
- 2 Through Lanes

- Paving Project
- Roadway Improvements (2040 - 2060)
- County Boundaries
- Incorporated Cities/Towns

0 NORTH 5 Miles

Date: 11/15/2016



# Map 15 Bicycle and Pedestrian Network Improvements

---



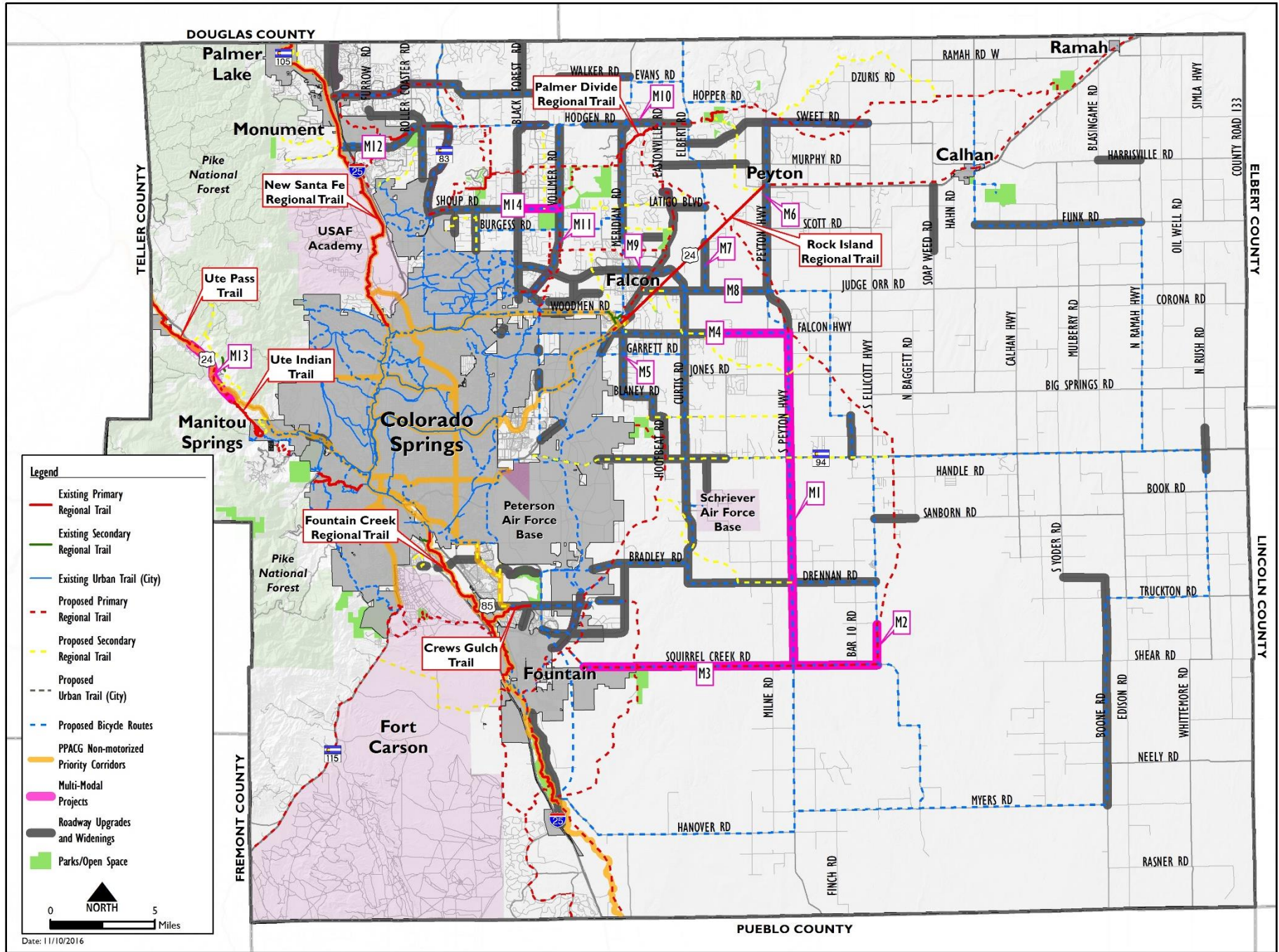

**Map 15: Bicycle and Pedestrian Network and Improvements**

# Rex Road Proposed Cross Section

---



Explain the proposed alternative and compare to the ECM standards (May provide applicable regional or national standards used as basis):

Proposed alternative cross section below:

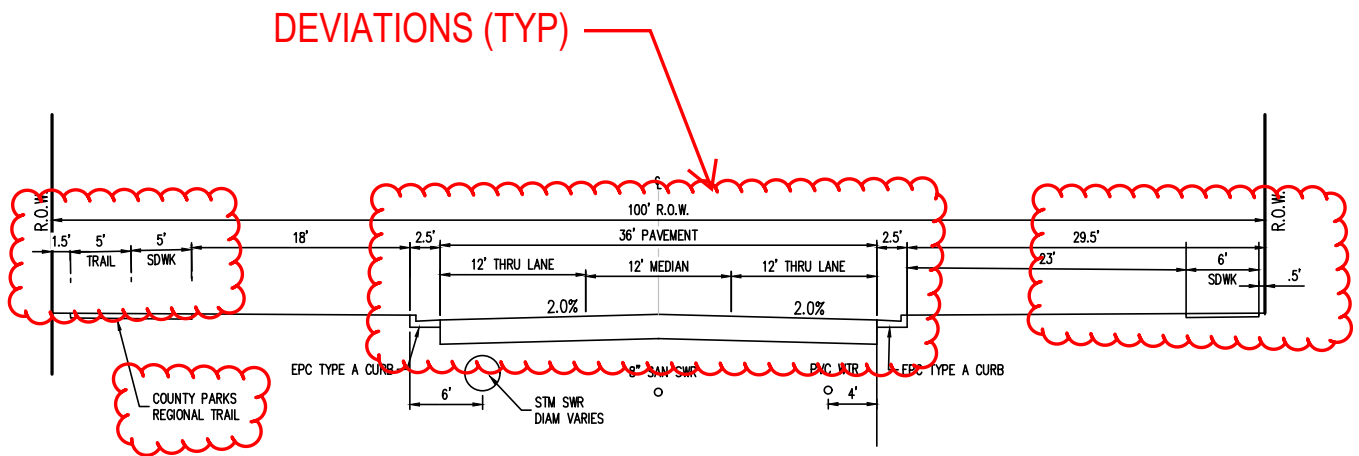

ECM standard:

**Figure 2-13. Typical Urban Minor Arterial Cross Section**

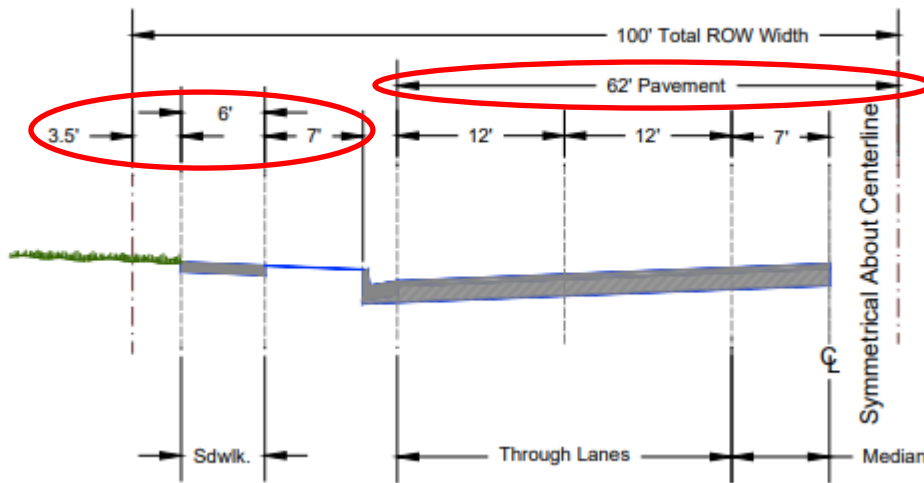

# Crash History

---



AccidentDate	AccidentTime	TotalVehicles	LocationRoadName	NumberInjured	FIP	ReferencePointAtName	AccidentNarrative
2021-01-29	18:25	2	EASTONVILLE	0	Property	STAPLETON DR	Vehicle 1 was westbound on Stapleton Drive at the stop sign of Eastonville Road. Vehicle 2 was southbound on Eastonville Drive approaching the intersection. The intersection has a stop sign for eastbound and westbound traffic on Stapleton Drive. Vehicle 1 proceeded from the stop sign into the intersection. The front end of Vehicle 2 collided with the right side of Vehicle 1 in the
2021-05-07	11:30	2	EASTONVILLE	1	Injury	STAPLETON DR	Vehicle 1 was westbound on Stapleton Dr at Eastonville Rd. Vehicle 2 was southbound on Eastonville Rd at Stapleton Dr. Vehicle 1 failed to yield right of way and proceeded from a stop sign. Vehicle 1 collided its front with the side of vehicle 2. Both vehicles were
2021-11-04	22:40	1	EASTONVILLE	0	Property		Vehicle #1 was traveling northbound on Eastonville road approaching a left turn. Vehicle #1 lost control on the dirt road and rotated counterclockwise before rolling 3/4 time, then coming to rest on its left side off the left side of the roadway facing south.
2021-12-17	10:55	2	EASTONVILLE	0	Property	STAPLETON DR	Vehicle 1 was westbound on Stapleton Dr at Eastonville Rd. Vehicle 2 was northbound on Eastonville Rd at Stapleton Dr. Vehicle 1 failed to stop at a stop sign and entered the intersection. Vehicle 1 collided its front with the side of vehicle 2. Both vehicles were
2022-02-03	13:25	2	EASTONVILLE	0	Property	STAPLETON DR	Vehicle 1 was westbound on Stapleton Dr at Eastonville Rd. Vehicle 2 was northbound on Eastonville Rd at Stapleton Dr. Vehicle 1 failed to stop at a stop sign and entered the intersection in front of vehicle 2. Vehicle 2 collided its front with the side of vehicle 1. Vehicle 2 began to rotate counter clockwise and collided its side with the side of vehicle 1's trailer. Vehicle 2 came to a rest facing
2022-07-15	17:09	2	EASTONVILLE	0	Property	STAPLETON DR	Vehicle 1 was stopped at a controlled stop sign facing southeast on Stapleton Dr. at the intersection of Eastonville Rd. Vehicle 2 was traveling southwest on Eastonville Rd near Stapleton Dr. Vehicle 1 proceeded straight through the intersection. Vehicle 2 struck the
2022-12-05	16:07	2	EASTONVILLE	0	Property	STAPLETON DR	Vehicle #2 was traveling northbound on Eastonville Road in the #1 lane and was stopped at the stop sign at Stapleton Drive and Eastonville Road. Vehicle #1 was traveling northbound on Eastonville in the #1 lane and was stopped at the stop sign behind Vehicle #2 at Stapleton Drive and Eastonville. Vehicle #1 started to advance forward, but Vehicle #2 was still stopped. Vehicle #1 struck it's
2023-03-22	19:10	2	EASTONVILLE	0	Property	STAPLETON DR	Vehicle #1 was traveling east on Stapleton Dr approaching Eastonville Rd. Vehicle #2 was traveling southwest on Eastonville Rd approaching Stapleton Dr. Vehicle #1 failed to stop at the stop sign on Stapleton Dr at Eastonville Rd and failed to yield the right of way to Vehicle #2. Vehicle #1 entered the intersection of Stapleton Dr at Eastonville Rd in front of Vehicle #2, at which point the driver
2023-07-02	13:29	2	EASTONVILLE	0	Property	STAPLETON DR	Vehicle 1 was west bound on Stapleton Drive, stopped at the intersection with Eastonville Road in El Paso County, Colorado. Vehicle 2 was south bound on Eastonville Road, approaching the same intersection. Vehicle 1 entered the intersection to proceed straight. Vehicle 2 swerved to the right and the front right corner of Vehicle 1 hit the front left corner of Vehicle 2, in the intersection. Both

# Additional Attachment

---

Figure 13 from the *Grandview Reserve Phase 1 Updated Traffic Impact Analysis*



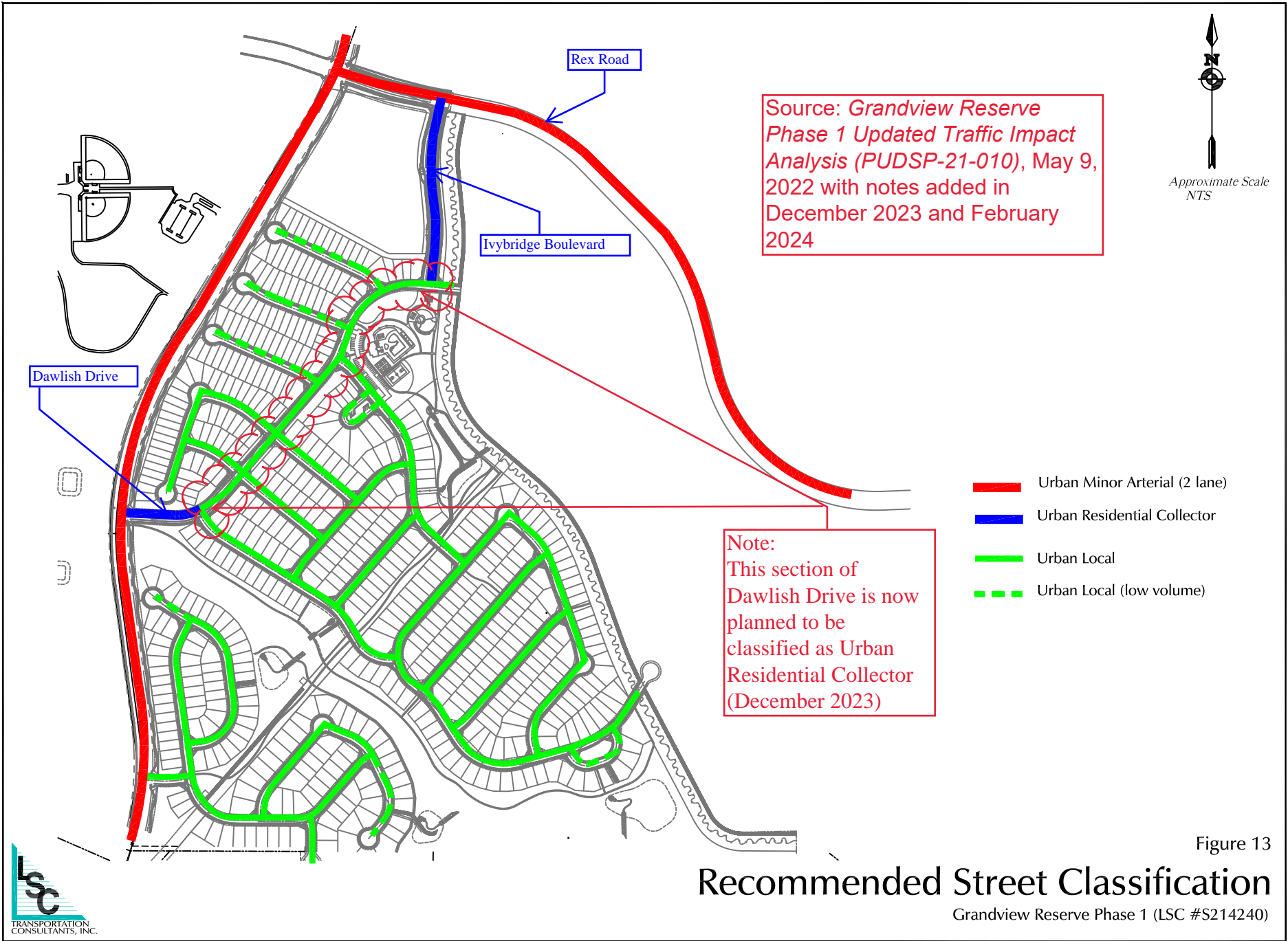



# V3\_TIS.pdf Markup Summary

---

## Engineer (3)

---

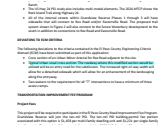

**Subject:** Engineer  
**Page Label:** 21  
**Author:** Bret  
**Date:** 9/10/2024 4:09:27 PM  
**Status:**  
**Color:** ■  
**Layer:**  
**Space:**

ypical Urban Local cross section: The roadway where this modified section would be

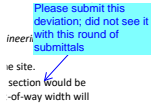

**Subject:** Engineer  
**Page Label:** 21  
**Author:** Bret  
**Date:** 9/10/2024 4:10:05 PM  
**Status:**  
**Color:** ■  
**Layer:**  
**Space:**

Please submit this deviation; did not see it with this round of submittals

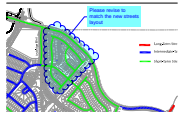

**Subject:** Engineer  
**Page Label:** 31  
**Author:** Bret  
**Date:** 9/10/2024 4:19:34 PM  
**Status:**  
**Color:** ■  
**Layer:**  
**Space:**

Please revise to match the new streets layout