



MILE HIGH FLOOD DISTRICT DETENTION BASIN DESIGN WORKBOOK

MHFD-Detention, Version 4.06 (July 2022)
Mile High Flood District
Denver, Colorado
www.mhfd.org

Purpose: This workbook aids in the estimation of stormwater detention basin sizing and outlet routing based on the modified puls routing method for urban watersheds. Several different BMP types and various outlet configurations can be sized.

Function:

1. Approximates the stage-area-volume relationship for a detention basin based on watershed parameters and basin geometry parameters. Also evaluates existing user-defined basin stage-area relationships.
2. Sizes filtration media orifice, outlet orifices, elliptical slots, weirs, trash racks, and develops stage-discharge relationships. Uses the Modified Puls method to route a series of hydrographs (i.e., 2-, 5-, 10-, 25-, 50-, 100- and 500-year) and calibrates the peak discharge out of the basin to match the pre-development peak discharges for the watershed.

Content: This workbook consists of the following sheets:

Basin Tabulates stage-area-volume relationship estimates based on watershed parameters

Outlet Structure Tabulates a stage-discharge relationship for the user-defined outlet structure (inlet control).

Reference Provides reference equations and figures.

User Tips and Tools Provides instructions and video links to assist in using this workbook. Includes a stage-area calculator.

BMP Zone Images Provides images of typical BMP zone configurations corresponding with Zone pulldown selections.

Acknowledgements: *Spreadsheet Development Team:*
Ken MacKenzie, P.E., Holly Piza, P.E.
Mile High Flood District

Derek N. Rapp, P.E.
Peak Stormwater Engineering, LLC

Dr. James C.Y. Guo, Ph.D., P.E.
Professor, Department of Civil Engineering, University of Colorado at Denver

Comments?
Revisions? Direct all comments regarding this spreadsheet workbook to:
Check for revised versions of this or any other workbook at:

[MHFD E-Mail](#)
[Downloads](#)

DETENTION BASIN STAGE-STORAGE TABLE BUILDER

MHFD-Detention, Version 4.06 (July 2022)

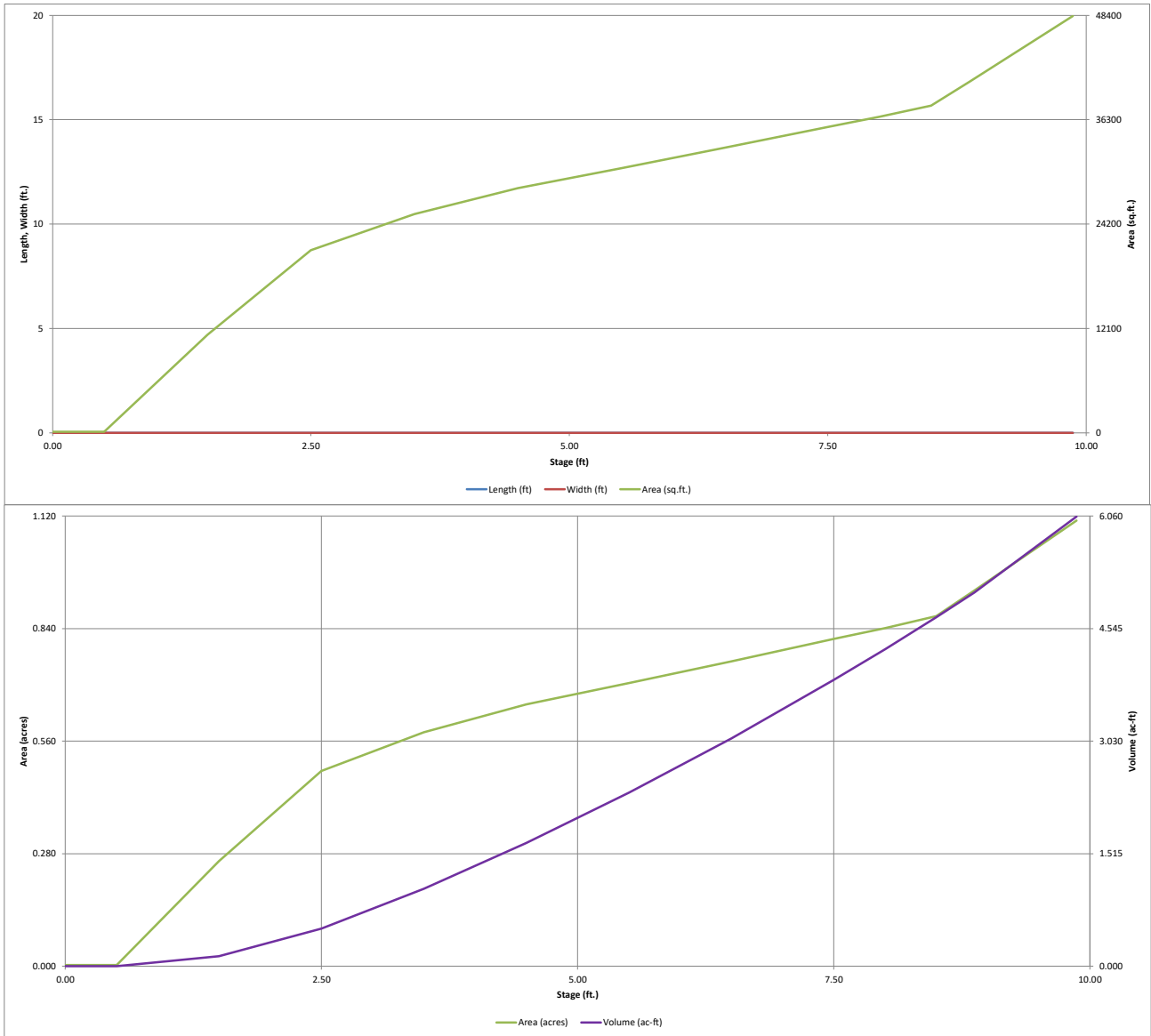

DETENTION BASIN OUTLET STRUCTURE DESIGN

MHFD-Detention, Version 4.06 (July 2022)

Project: Haven Valley
Basin ID: Pond 1

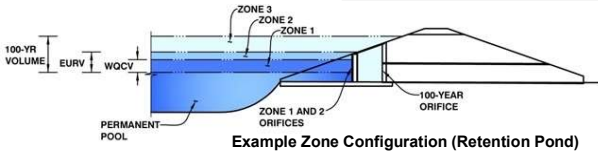

Example Zone Configuration (Retention Pond)

	Estimated Stage (ft)	Estimated Volume (ac-ft)	Outlet Type
Zone 1 (WQCV)	3.08	0.801	Orifice Plate
Zone 2 (EURV)	6.30	2.113	Orifice Plate
Zone 3 (100-year)	8.24	1.550	Weir&Pipe (Restrict)
Total (all zones)		4.464	

User Input: Orifice at Underdrain Outlet (typically used to drain WQCV in a Filtration BMP)

Underdrain Orifice Invert Depth = ft (distance below the filtration media surface)
Underdrain Orifice Diameter = inches

Calculated Parameters for Underdrain
Underdrain Orifice Area = ft²
Underdrain Orifice Centroid = feet

User Input: Orifice Plate with one or more orifices or Elliptical Slot Weir (typically used to drain WQCV and/or EURV in a sedimentation BMP)

Centroid of Lowest Orifice = 0.00 ft (relative to basin bottom at Stage = 0 ft)
Depth at top of Zone using Orifice Plate = 5.89 ft (relative to basin bottom at Stage = 0 ft)
Orifice Plate: Orifice Vertical Spacing = N/A inches
Orifice Plate: Orifice Area per Row = N/A sq. inches

Calculated Parameters for Plate
WQ Orifice Area per Row = N/A ft²
Elliptical Half-Width = N/A feet
Elliptical Slot Centroid = N/A feet
Elliptical Slot Area = N/A ft²

User Input: Stage and Total Area of Each Orifice Row (numbered from lowest to highest)

	Row 1 (required)	Row 2 (optional)	Row 3 (optional)	Row 4 (optional)	Row 5 (optional)	Row 6 (optional)	Row 7 (optional)	Row 8 (optional)
Stage of Orifice Centroid (ft)	0.00	2.00	4.00					
Orifice Area (sq. inches)	4.17	4.17	7.50					
	Row 9 (optional)	Row 10 (optional)	Row 11 (optional)	Row 12 (optional)	Row 13 (optional)	Row 14 (optional)	Row 15 (optional)	Row 16 (optional)
Stage of Orifice Centroid (ft)								
Orifice Area (sq. inches)								

User Input: Vertical Orifice (Circular or Rectangular)

	Not Selected	Not Selected	
Invert of Vertical Orifice =	N/A	N/A	ft (relative to basin bottom at Stage = 0 ft)
Depth at top of Zone using Vertical Orifice =	N/A	N/A	ft (relative to basin bottom at Stage = 0 ft)
Vertical Orifice Diameter =	N/A	N/A	inches

Calculated Parameters for Vertical Orifice
Vertical Orifice Area = N/A ft²
Vertical Orifice Centroid = N/A feet

User Input: Overflow Weir (Dropbox with Flat or Sloped Gate and Outlet Pipe OR Rectangular/Trapezoidal Weir and No Outlet Pipe)

	Zone 3 Weir	Not Selected	
Overflow Weir Front Edge Height, Ho =	6.50	N/A	ft (relative to basin bottom at Stage = 0 ft)
Overflow Weir Front Edge Length =	4.00	N/A	feet
Overflow Weir Gate Slope =	0.00	N/A	H:V
Horiz. Length of Weir Sides =	4.00	N/A	feet
Overflow Gate Type =	Type C Gate	N/A	
Debris Clogging % =	50%	N/A	%

Calculated Parameters for Overflow Weir
Height of Gate Upper Edge, H_u = 6.50 feet
Overflow Weir Slope Length = N/A feet
Gate Open Area / 100-yr Orifice Area = 6.41
Overflow Gate Open Area w/o Debris = 11.14 ft²
Overflow Gate Open Area w/ Debris = 5.57 ft²

User Input: Outlet Pipe w/ Flow Restriction Plate (Circular Orifice, Restrictor Plate, or Rectangular Orifice)

	Zone 3 Restrictor	Not Selected	
Depth to Invert of Outlet Pipe =	0.00	N/A	ft (distance below basin bottom at Stage = 0 ft)
Outlet Pipe Diameter =	24.00	N/A	inches
Restrictor Plate Height Above Pipe Invert =	13.00		inches

Calculated Parameters for Outlet Pipe w/ Flow Restriction Plate
Outlet Orifice Area = 1.74 ft²
Outlet Orifice Centroid = 0.62 feet
Half-Central Angle of Restrictor Plate on Pipe = 1.65 radians

User Input: Emergency Spillway (Rectangular or Trapezoidal)

Spillway Invert Stage = 8.00 ft (relative to basin bottom at Stage = 0 ft)
Spillway Crest Length = 46.00 feet
Spillway End Slopes = 4.00 H:V
Freeboard above Max Water Surface = 1.00 feet

Calculated Parameters for Spillway
Spillway Design Flow Depth = 0.87 feet
Stage at Top of Freeboard = 9.87 feet
Basin Area at Top of Freeboard = 1.11 acres
Basin Volume at Top of Freeboard = 6.05 acre-ft

Routed Hydrograph Results

The user can override the default CUHP hydrographs and runoff volumes by entering new values in the Inflow Hydrographs table (Columns W through AF).

	WQCV	EURV	2 Year	5 Year	10 Year	25 Year	50 Year	100 Year	500 Year
Design Storm Return Period =	N/A	N/A	1.19	1.50	1.75	2.00	2.25	2.52	3.49
One-Hour Rainfall Depth (in) =	0.801	2.914	2.123	2.801	3.345	4.111	4.864	5.798	9.040
CUHP Runoff Volume (acre-ft) =	N/A	N/A	2.123	2.801	3.345	4.111	4.864	5.798	9.040
Inflow Hydrograph Volume (acre-ft) =	N/A	N/A	0.4	0.8	1.1	10.1	19.9	32.7	74.0
CUHP Predevelopment Peak Q (cfs) =	N/A	N/A							
OPTIONAL Override Predevelopment Peak Q (cfs) =	N/A	N/A							
Predevelopment Unit Peak Flow, q (cfs/acre) =	N/A	N/A	0.01	0.02	0.03	0.24	0.47	0.78	1.76
Peak Inflow Q (cfs) =	N/A	N/A	39.4	52.0	61.2	79.9	96.6	119.8	186.8
Peak Outflow Q (cfs) =	0.4	1.0	0.8	1.0	2.2	9.0	18.5	22.7	104.2
Ratio Peak Outflow to Predevelopment Q =	N/A	N/A	N/A	1.2	2.0	0.9	0.9	0.7	1.4
Structure Controlling Flow =	Plate	Plate	Plate	Plate	Overflow Weir 1	Overflow Weir 1	Overflow Weir 1	Outlet Plate 1	Spillway
Max Velocity through Gate 1 (fps) =	N/A	N/A	N/A	N/A	0.1	0.7	1.6	1.9	2.0
Max Velocity through Gate 2 (fps) =	N/A	N/A	N/A	N/A	N/A	N/A	N/A	N/A	N/A
Time to Drain 97% of Inflow Volume (hours) =	39	72	65	72	76	75	73	72	65
Time to Drain 99% of Inflow Volume (hours) =	40	77	68	76	82	81	81	80	78
Maximum Ponding Depth (ft) =	3.08	6.30	5.03	5.95	6.62	6.95	7.27	7.98	8.68
Area at Maximum Ponding Depth (acres) =	0.54	0.75	0.68	0.73	0.77	0.78	0.80	0.84	0.90
Maximum Volume Stored (acre-ft) =	0.805	2.917	2.004	2.659	3.159	3.415	3.661	4.243	4.847

DETENTION BASIN OUTLET STRUCTURE DESIGN

MHFD-Detention, Version 4.06 (July 2022)

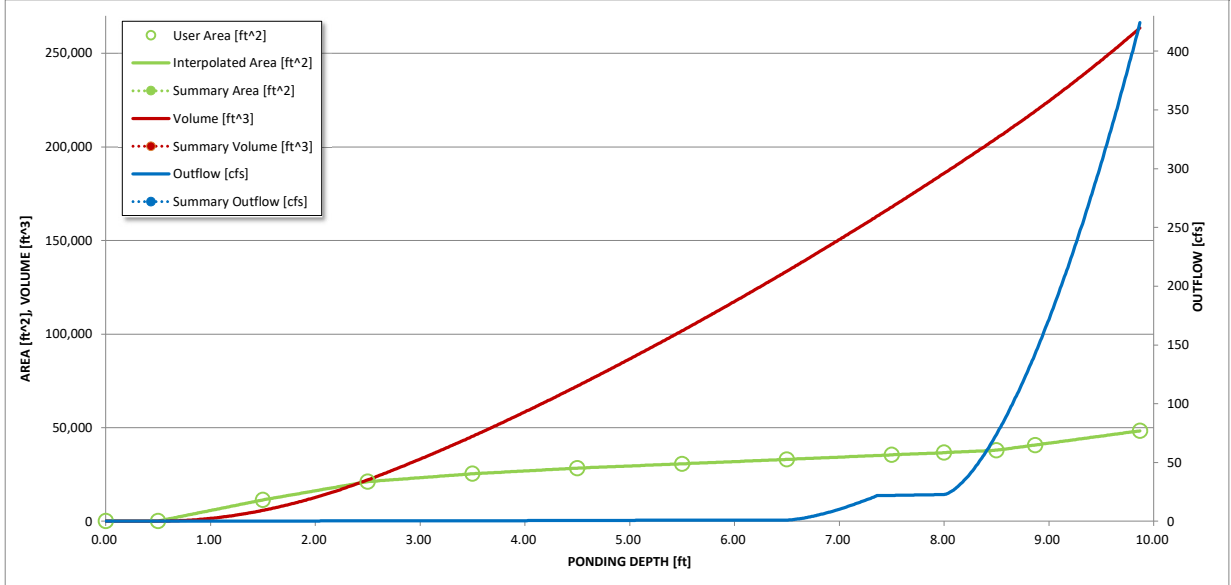
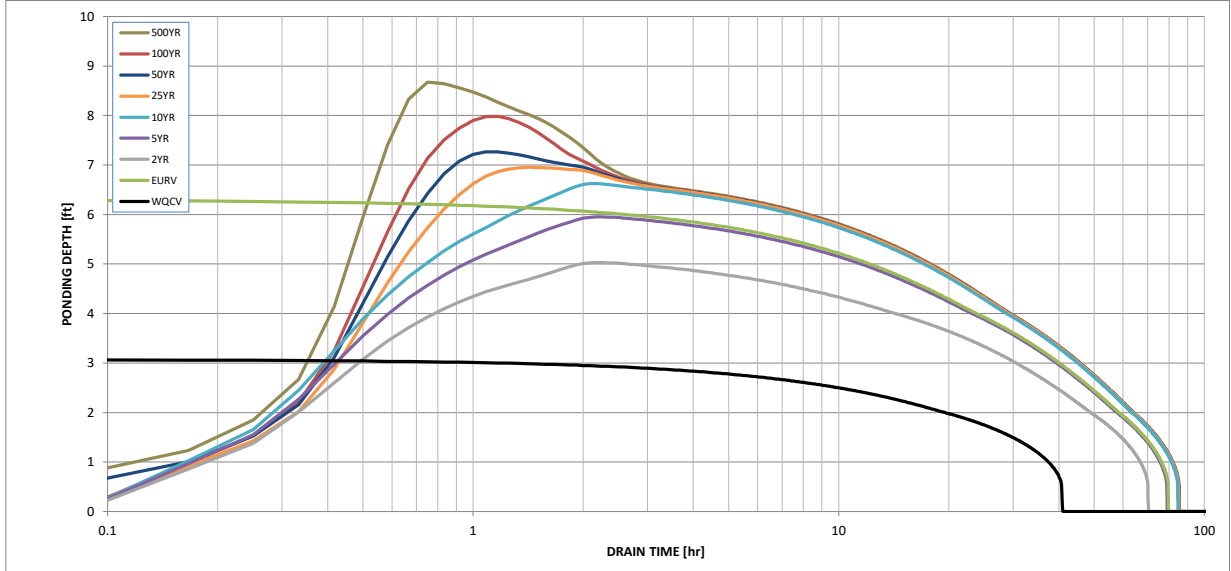
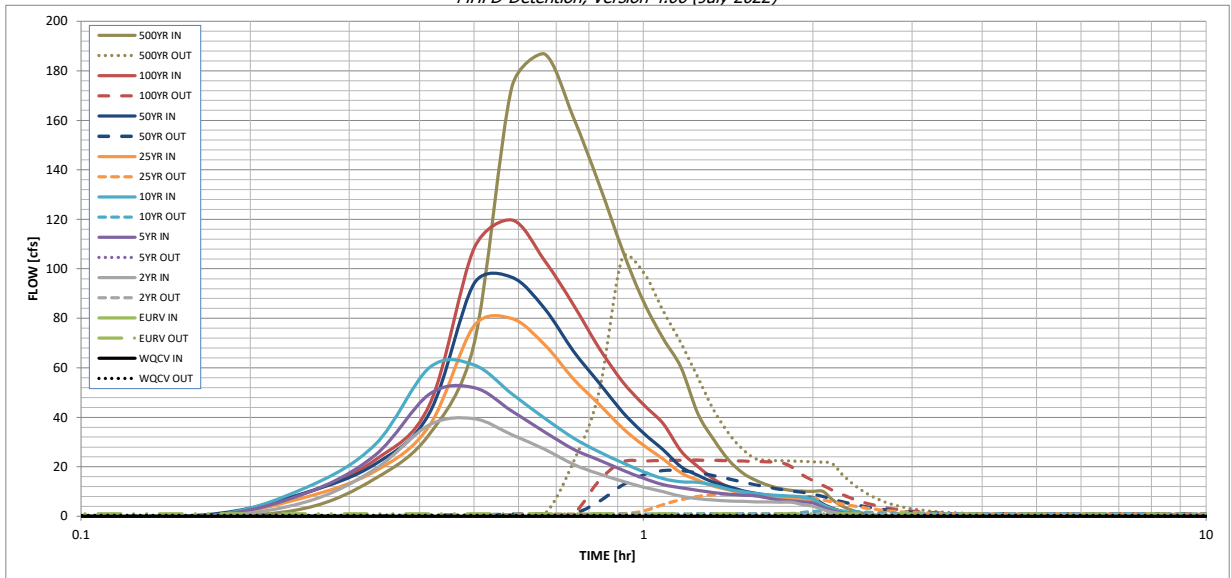

S-A-V-D Chart Axis Override	X-axis	Left Y-Axis	Right Y-Axis
minimum bound			
maximum bound			

DETENTION BASIN OUTLET STRUCTURE DESIGN

Outflow Hydrograph Workbook Filename: _____

Inflow Hydrographs

The user can override the calculated inflow hydrographs from this workbook with inflow hydrographs developed in a separate program.

Time Interval	SOURCE	CUHP	CUHP	CUHP	CUHP	CUHP	CUHP	CUHP	CUHP	CUHP	
	TIME	WQCV [cfs]	EURV [cfs]	2 Year [cfs]	5 Year [cfs]	10 Year [cfs]	25 Year [cfs]	50 Year [cfs]	100 Year [cfs]	500 Year [cfs]	
5.00 min	0:00:00	0.00	0.00	0.00	0.00	0.00	0.00	0.00	0.00	0.00	
	0:05:00	0.00	0.00	0.00	0.00	0.00	0.00	0.00	0.00	0.00	
	0:10:00	0.00	0.00	0.00	0.00	0.00	0.00	0.00	0.64	0.06	3.20
	0:15:00	0.00	0.00	5.66	9.19	11.41	7.68	9.48	9.37	15.23	15.23
	0:20:00	0.00	0.00	19.11	24.72	29.00	18.23	21.11	22.81	33.20	33.20
	0:25:00	0.00	0.00	37.00	49.38	60.10	36.67	41.73	45.18	69.52	69.52
	0:30:00	0.00	0.00	39.40	52.03	61.16	76.89	94.01	108.19	173.19	173.19
	0:35:00	0.00	0.00	32.97	42.49	49.49	79.88	96.63	119.78	186.79	186.79
	0:40:00	0.00	0.00	27.10	34.15	39.65	69.44	84.01	103.39	161.36	161.36
	0:45:00	0.00	0.00	21.04	27.13	31.70	55.59	66.87	85.63	134.48	134.48
	0:50:00	0.00	0.00	17.15	22.76	26.07	45.35	54.02	68.14	107.93	107.93
	0:55:00	0.00	0.00	14.28	18.76	21.73	35.78	42.31	54.61	86.75	86.75
	1:00:00	0.00	0.00	11.78	15.36	18.03	28.72	33.64	45.15	71.94	71.94
	1:05:00	0.00	0.00	9.95	12.80	15.20	23.18	26.91	37.49	60.07	60.07
	1:10:00	0.00	0.00	8.10	11.54	14.02	17.52	19.99	26.37	41.37	41.37
	1:15:00	0.00	0.00	7.10	10.53	13.66	14.62	16.58	20.06	31.05	31.05
	1:20:00	0.00	0.00	6.54	9.58	12.55	12.19	13.76	15.05	22.85	22.85
	1:25:00	0.00	0.00	6.21	8.96	10.97	10.74	12.09	11.87	17.59	17.59
	1:30:00	0.00	0.00	6.02	8.55	9.91	9.22	10.37	10.04	14.57	14.57
	1:35:00	0.00	0.00	5.88	8.31	9.19	8.25	9.28	8.80	12.53	12.53
	1:40:00	0.00	0.00	5.78	7.32	8.72	7.63	8.58	8.01	11.21	11.21
	1:45:00	0.00	0.00	5.73	6.61	8.41	7.21	8.11	7.53	10.42	10.42
	1:50:00	0.00	0.00	5.72	6.15	8.19	6.98	7.85	7.36	10.19	10.19
	1:55:00	0.00	0.00	4.78	5.84	7.78	6.84	7.69	7.28	10.08	10.08
	2:00:00	0.00	0.00	4.11	5.44	6.97	6.77	7.62	7.28	10.08	10.08
	2:05:00	0.00	0.00	2.72	3.60	4.63	4.50	5.05	4.84	6.69	6.69
	2:10:00	0.00	0.00	1.73	2.30	2.98	2.91	3.27	3.13	4.31	4.31
	2:15:00	0.00	0.00	1.10	1.44	1.89	1.85	2.08	1.98	2.72	2.72
	2:20:00	0.00	0.00	0.64	0.87	1.13	1.12	1.25	1.19	1.63	1.63
	2:25:00	0.00	0.00	0.36	0.53	0.67	0.68	0.76	0.72	0.98	0.98
	2:30:00	0.00	0.00	0.16	0.27	0.33	0.35	0.39	0.36	0.49	0.49
	2:35:00	0.00	0.00	0.06	0.10	0.11	0.13	0.14	0.13	0.16	0.16
	2:40:00	0.00	0.00	0.01	0.01	0.01	0.01	0.01	0.00	0.00	0.00
	2:45:00	0.00	0.00	0.00	0.00	0.00	0.00	0.00	0.00	0.00	0.00
	2:50:00	0.00	0.00	0.00	0.00	0.00	0.00	0.00	0.00	0.00	0.00
	2:55:00	0.00	0.00	0.00	0.00	0.00	0.00	0.00	0.00	0.00	0.00
	3:00:00	0.00	0.00	0.00	0.00	0.00	0.00	0.00	0.00	0.00	0.00
	3:05:00	0.00	0.00	0.00	0.00	0.00	0.00	0.00	0.00	0.00	0.00
	3:10:00	0.00	0.00	0.00	0.00	0.00	0.00	0.00	0.00	0.00	0.00
	3:15:00	0.00	0.00	0.00	0.00	0.00	0.00	0.00	0.00	0.00	0.00
	3:20:00	0.00	0.00	0.00	0.00	0.00	0.00	0.00	0.00	0.00	0.00
	3:25:00	0.00	0.00	0.00	0.00	0.00	0.00	0.00	0.00	0.00	0.00
	3:30:00	0.00	0.00	0.00	0.00	0.00	0.00	0.00	0.00	0.00	0.00
	3:35:00	0.00	0.00	0.00	0.00	0.00	0.00	0.00	0.00	0.00	0.00
	3:40:00	0.00	0.00	0.00	0.00	0.00	0.00	0.00	0.00	0.00	0.00
	3:45:00	0.00	0.00	0.00	0.00	0.00	0.00	0.00	0.00	0.00	0.00
	3:50:00	0.00	0.00	0.00	0.00	0.00	0.00	0.00	0.00	0.00	0.00
	3:55:00	0.00	0.00	0.00	0.00	0.00	0.00	0.00	0.00	0.00	0.00
	4:00:00	0.00	0.00	0.00	0.00	0.00	0.00	0.00	0.00	0.00	0.00
	4:05:00	0.00	0.00	0.00	0.00	0.00	0.00	0.00	0.00	0.00	0.00
	4:10:00	0.00	0.00	0.00	0.00	0.00	0.00	0.00	0.00	0.00	0.00
	4:15:00	0.00	0.00	0.00	0.00	0.00	0.00	0.00	0.00	0.00	0.00
	4:20:00	0.00	0.00	0.00	0.00	0.00	0.00	0.00	0.00	0.00	0.00
	4:25:00	0.00	0.00	0.00	0.00	0.00	0.00	0.00	0.00	0.00	0.00
	4:30:00	0.00	0.00	0.00	0.00	0.00	0.00	0.00	0.00	0.00	0.00
	4:35:00	0.00	0.00	0.00	0.00	0.00	0.00	0.00	0.00	0.00	0.00
	4:40:00	0.00	0.00	0.00	0.00	0.00	0.00	0.00	0.00	0.00	0.00
	4:45:00	0.00	0.00	0.00	0.00	0.00	0.00	0.00	0.00	0.00	0.00
	4:50:00	0.00	0.00	0.00	0.00	0.00	0.00	0.00	0.00	0.00	0.00
	4:55:00	0.00	0.00	0.00	0.00	0.00	0.00	0.00	0.00	0.00	0.00
5:00:00	0.00	0.00	0.00	0.00	0.00	0.00	0.00	0.00	0.00	0.00	
5:05:00	0.00	0.00	0.00	0.00	0.00	0.00	0.00	0.00	0.00	0.00	
5:10:00	0.00	0.00	0.00	0.00	0.00	0.00	0.00	0.00	0.00	0.00	
5:15:00	0.00	0.00	0.00	0.00	0.00	0.00	0.00	0.00	0.00	0.00	
5:20:00	0.00	0.00	0.00	0.00	0.00	0.00	0.00	0.00	0.00	0.00	
5:25:00	0.00	0.00	0.00	0.00	0.00	0.00	0.00	0.00	0.00	0.00	
5:30:00	0.00	0.00	0.00	0.00	0.00	0.00	0.00	0.00	0.00	0.00	
5:35:00	0.00	0.00	0.00	0.00	0.00	0.00	0.00	0.00	0.00	0.00	
5:40:00	0.00	0.00	0.00	0.00	0.00	0.00	0.00	0.00	0.00	0.00	
5:45:00	0.00	0.00	0.00	0.00	0.00	0.00	0.00	0.00	0.00	0.00	
5:50:00	0.00	0.00	0.00	0.00	0.00	0.00	0.00	0.00	0.00	0.00	
5:55:00	0.00	0.00	0.00	0.00	0.00	0.00	0.00	0.00	0.00	0.00	
6:00:00	0.00	0.00	0.00	0.00	0.00	0.00	0.00	0.00	0.00	0.00	

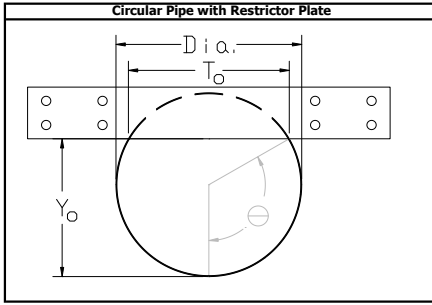

WQ Elliptical Slot Weir (Alternative to WQ Orifice Plate for Large Watersheds)

$$f(y) = \sqrt{2g(h-y)} \left[2 \frac{H}{R} \left(1 - \sqrt{1 - \frac{y^2}{H^2}} \right) + t \right]$$

$$Q_{app} = 0.3015h \left[f(0) + f(0.603h) \right] + 0.1415h \left[f(0.603h) + f(0.886h) \right] + 0.0570h \left[f(0.886h) \right]$$

Orifice Equations

$$Q = C_d A_o \sqrt{2g(h - C_y)}$$

$$A_o = H(2W + t) - \frac{\pi D^2 W}{2} \quad C_y = \frac{H(2W + t) - 2HW}{2W + t - \frac{\pi W}{2}}$$

dy = elementary flow vertical distance [L];
 h = total flow depth [L];
 H = total weir height and semi-major ellipse axis [L];
 t = weir gap thickness [L];
 W = semi-minor ellipse axis [L];
 x = horizontal distance along the ellipse shape [L];
 y = vertical depth measured from the weir crest to the elementary flow strip [L]; and
 y' = vertical distance measured from the water surface to the elementary flow strip [L].

WQCV and EURV Equations

$$WQCV = \frac{A}{12} * \alpha [0.91I^3 - 1.19I^2 + 0.78I]$$

$$EURV = Area * [0.140(IMP)^{1.28} * A\% + 0.113(IMP)^{1.08} * B\% + 0.100(IMP)^{1.08} * C/D\%]$$

Where $WQCV$ is the water quality capture volume (acre-ft), $EURV$ is the excess urban runoff volume (acre-ft), α is a coefficient corresponding to WQCV drain time (1.0 for 40 hours, 0.9 for 24 hours, and 0.8 for 12 hours), A is the contributing watershed area (acres), I is the percentage imperviousness (expressed as a decimal), $A\%$, $B\%$, and $CD\%$ are the percent of each hydraulic soil group (expressed as a decimal).

Approximate Storage Volume Equations

$$V_{Storage,2yr}(ac-ft) = P_1 A [(0.078I^{1.224})A\% + (0.077I^{1.184})B\% + (0.077I^{1.134})CD\%]$$

$$V_{Storage,5yr}(ac-ft) = P_1 A [(0.080I^{1.298})A\% + (0.079I^{1.100})B\% + (0.077I^{1.001} + 0.003I^{0.001})CD\%]$$

$$V_{Storage,10yr}(ac-ft) = P_1 A [(0.081I^{1.251})A\% + (0.077I^{1.056} + 0.005I^{0.056})B\% + (0.069I^{1.467} + 0.011I^{0.167})CD\%]$$

$$V_{Storage,25yr}(ac-ft) = P_1 A [(0.083I^{1.188})A\% + (0.056I^{1.290} + 0.021I^{0.290})B\% + (0.048I^{1.382} + 0.026I^{0.382})CD\%]$$

$$V_{Storage,50yr}(ac-ft) = P_1 A [(0.078I^{1.182} + 0.002I^{0.182})A\% + (0.045I^{1.381} + 0.026I^{0.381})B\% + (0.037I^{1.457} + 0.030I^{0.457})CD\%]$$

$$V_{Storage,100yr}(ac-ft) = P_1 A [(0.067I^{1.225} + 0.009I^{0.225})A\% + (0.034I^{1.371} + 0.031I^{0.371})B\% + (0.028I^{1.389} + 0.033I^{0.389})CD\%]$$

Where $V_{Storage,yr}$ is the estimated storage volume for the given return period (acre-ft), P_1 is the one-hour rainfall depth (in), A is the contributing watershed area (acres), I is the percentage imperviousness (expressed as a decimal), $A\%$, $B\%$, and $CD\%$ are the percent of each hydraulic soil group (expressed as a decimal).

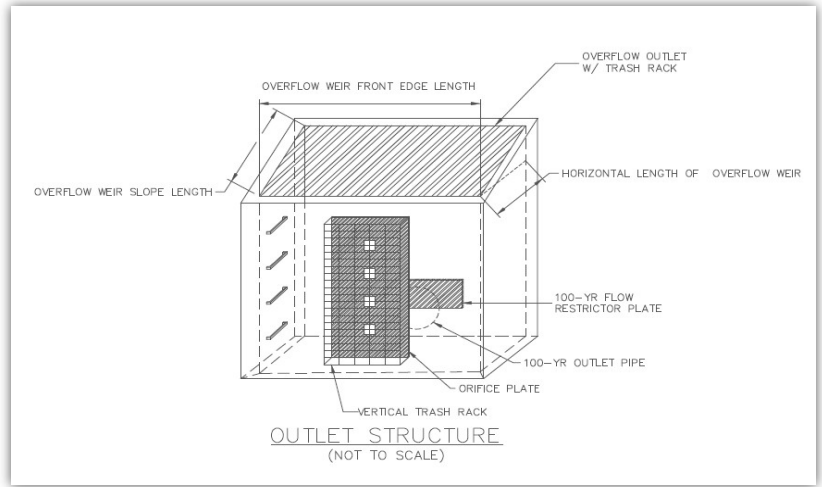

Basin Volume Calculations

Initial Surcharge Volume:

$$ISV = 0.003WQCV \quad L_{ISV} = \sqrt{A_{ISV}}$$

$$A_{ISV} = \frac{ISV}{ISD} \quad W_{ISV} = \sqrt{A_{ISV}}$$

Where ISV is the initial surcharge volume (ft^3), A_{ISV} is ISV surface area (ft^2), ISD is the initial surcharge depth (ft, typically 0.33 to 0.50), and L_{ISV} and W_{ISV} are the length and width of the ISV (ft).

Basin Floor Volume:

$$L_{floor} = L_{ISV} + \frac{H_{floor}}{S_{TC}} + H_{floor}(S_{main}) \quad W_{floor} = W_{ISV} + \frac{H_{floor}}{R_{L,W}(S_{TC})}$$

$$A_{floor} = L_{floor}(W_{floor})$$

$$V_{floor} = \frac{H_{floor}}{3} (A_{ISV} + A_{floor} + \sqrt{A_{ISV}(A_{floor})})$$

Where L_{floor} and W_{floor} (ft) are the length and width of the basin floor section at the point where the top of the basin floor section meets the toe of the basin main section, H_{floor} is the depth of the basin floor section (ft), S_{TC} is the trickle channel slope (ft/ft), S_{main} is the side slope of the basin main section (H:V; e.g., 4 if the horizontal:vertical ratio is 4:1), $R_{L,W}$ is the basin length:width ratio (e.g., 2 if the basin length is twice the basin width), A_{floor} is top area of the basin floor section (ft^2), and V_{floor} is volume of the basin floor section (ft^3).

Main Basin Volume:

$$L_{main} = L_{floor} + 2H_{main}(S_{main}) \quad A_{main} = L_{main}(W_{main})$$

$$W_{main} = W_{floor} + 2H_{main}(S_{main})$$

$$V_{main} = \frac{H_{main}}{3} (A_{main} + A_{floor} + \sqrt{A_{main}(A_{floor})})$$

Where L_{main} and W_{main} (ft) are the length and width of the main basin section at the point at the top of the basin, H_{main} is the depth of the main basin section (ft), A_{main} is top area of the main basin section (ft^2), and V_{main} is volume of the main basin section (ft^3).

Total Basin Volume:

$$V_{total} = ISV + A_{ISV} \cdot D_{TC} + V_{floor} + V_{main}$$

Where V_{total} is the volume of the total basin (ft^3) and D_{TC} is the depth of the trickle channel (ft).

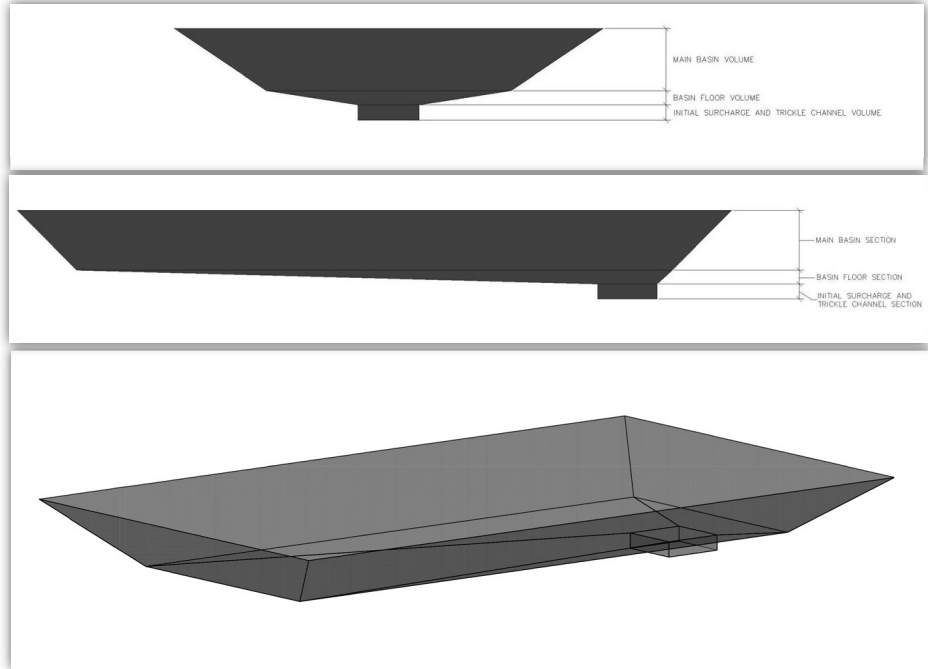

Default Horton's Equation Parameters		
NRCS Hydrologic Group	Infiltration (inches per hour)	Decay Coefficient (1/sec)
A	Initial - f_i , Final - f_f	0.0007
B	4.5	0.0018
C/D	3.0	0.0018

Default Depression Storage	
Impervious (in)	Pervious (in)
0.10	0.35

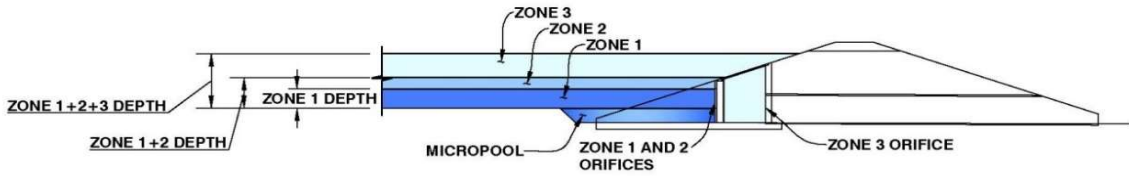

EXTENDED DETENTION BASIN WITH 3 ZONES

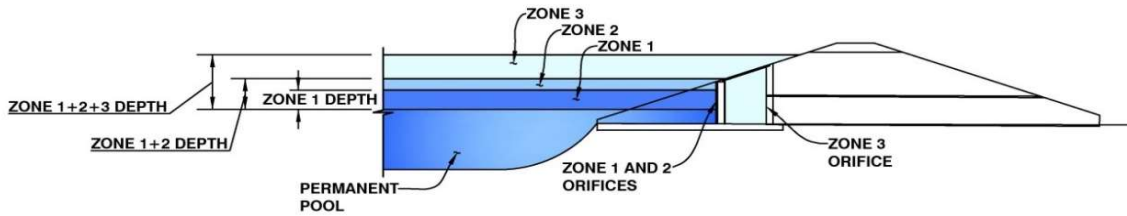

RETENTION POND WITH 3 ZONES

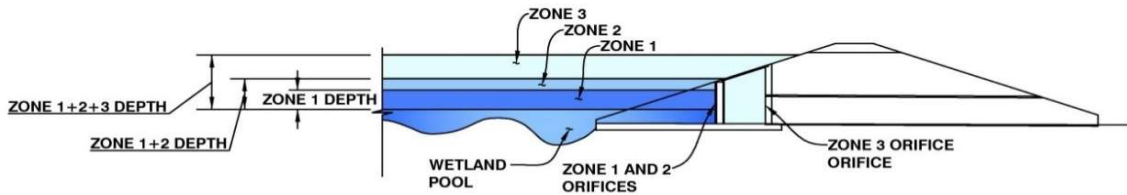

CONSTRUCTED WETLAND POND WITH 3 ZONES

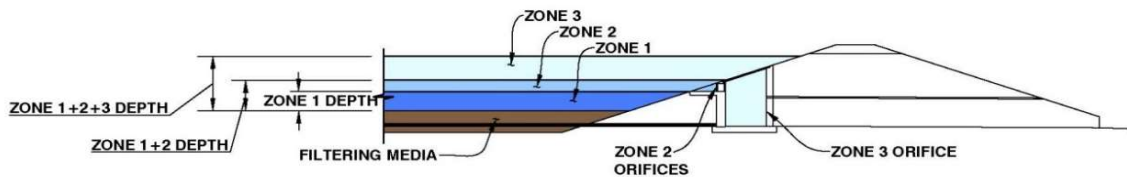

FILTERING BMP WITH 3 ZONES

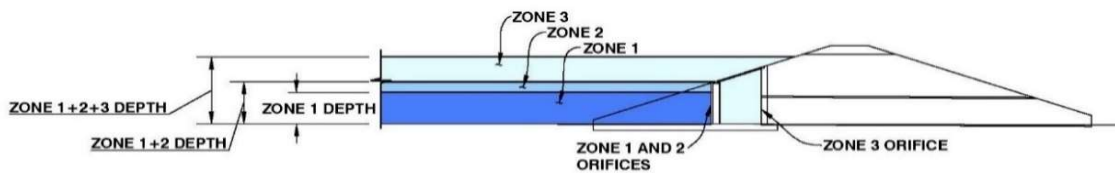

FLOOD CONTROL WITH THREE ZONES

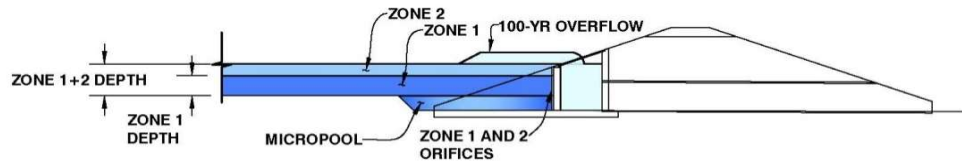

EXTENDED DETENTION BASIN WITH ZONE 1 AND ZONE 2

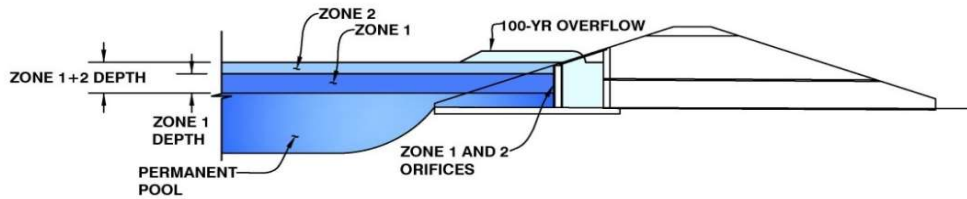

RETENTION POND WITH ZONE 1 AND ZONE 2

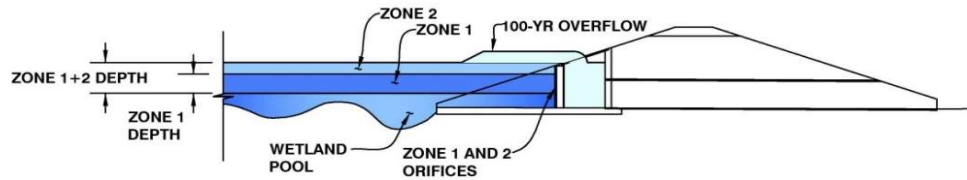

CONSTRUCTED WETLAND POND WITH ZONE 1 AND ZONE 2

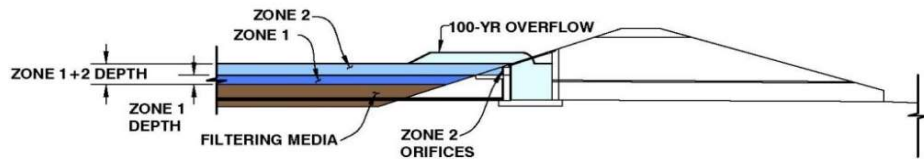

FILTERING BMP ZONE 1 AND ZONE 2

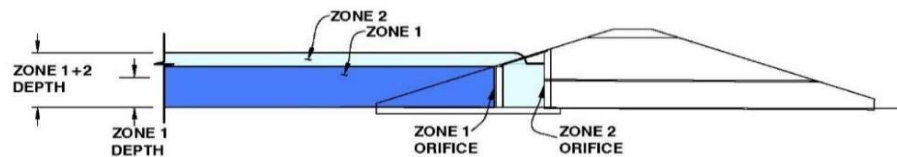

FLOOD CONTROL WITH TWO ZONES

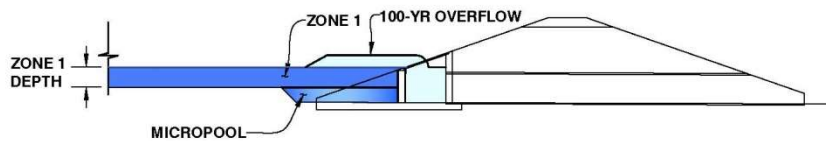

EXTENDED DETENTION BASIN WITH ZONE 1 ONLY

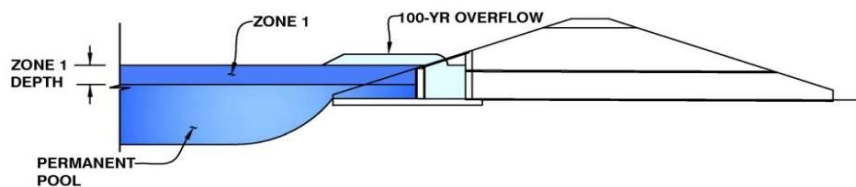

RETENTION POND WITH ZONE 1 ONLY

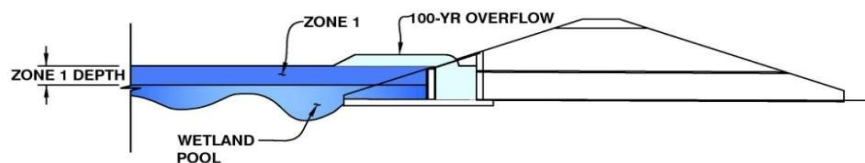

CONSTRUCTED WETLAND POND WITH ZONE 1 ONLY

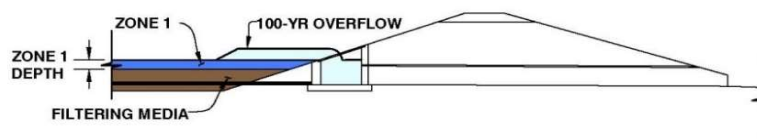

FILTERING BMP WITH ZONE 1 ONLY

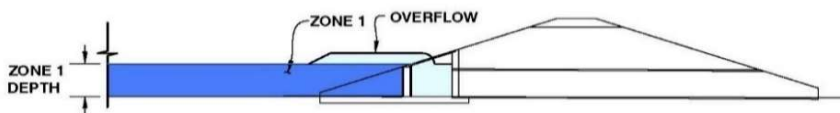

FLOOD CONTROL WITH ONE ZONE

