

# Falcon Marketplace, Lot 4 Discount Tire Falcon, CO

## STORMWATER MANAGEMENT PLAN REPORT

Prepared for (Owner):  
**Halle Properties, LLC**  
**20225 N. Scottsdale Road**  
**Scottsdale, AZ 85255**  
**Contact: Leslie German**  
**(480) 606-6845**

Prepared by:  
**Kimley-Horn and Associates, Inc.**  
**2 North Nevada Avenue, Suite 300**  
**Colorado Springs, Colorado 80903**  
**Contact: Mitchell Hess, P.E.**  
**(719) 453-0180**

Qualified Stormwater Manager / Contractor:  
**Company: TBD**  
**Address:**  
**Contact:**  
**Phone:**

AUGUST 5, 2021

**Kimley»Horn**

PPR-21-012

## TABLE OF CONTENTS

CERTIFICATION .....	4
ENGINEER OF RECORD .....	4
REVIEW ENGINEER .....	4
INTRODUCTION .....	5
INTRODUCTION AND PURPOSE .....	5
PERMIT COVERAGE AND APPLICATIONS .....	5
GENERAL LOCATION.....	5
PROJECT LOCATION .....	5
VICINITY MAP .....	6
SITE DESCRIPTION.....	6
GENERAL PROJECT DESCRIPTION .....	6
VEGETATION .....	7
DRAINAGE CHARACTERISTICS .....	7
IMMEDIATE AND ULTIMATE RECEIVING WATERS .....	7
SITE SOILS.....	7
DEWATERING .....	7
AREAS AND VOLUMES.....	8
TIMING AND PHASING SCHEDULE .....	8
STORMWATER MANAGEMENT PLAN SITE MAP .....	10
SITE MAP MINIMUM REQUIREMENTS .....	10
STORMWATER MANAGEMENT CONTROLS .....	10
QUALIFIED STORMWATER MANAGER.....	10
SITE SPECIFIC POLLUTION SOURCES .....	11
IDENTIFICATION OF POLLUTANT SOURCES .....	11
NON-STORMWATER DISCHARGE COMPONENTS .....	12
CONTROL MEASURES FOR STORMWATER POLLUTION PREVENTION .....	13
OTHER POTENTIAL POLLUTION CONSIDERATIONS.....	15
MATERIALS HANDLING AND SPILL PREVENTION .....	15



VEHICLE TRACKING AND DUST CONTROL .....	16
DEDICATED CONCRETE OR ASPHALT BATCH PLANTS.....	16
WASTE MANAGEMENT AND DISPOSAL.....	16
STABILIZATION AND STORMWATER MANAGEMENT .....	17
TEMPORARY STABILIZATION AND SHORT-TERM STORMWATER MANAGEMENT.....	17
FINAL STABILIZATION AND LONG-TERM STORMWATER MANAGEMENT.....	17
INSPECTION AND MAINTENANCE.....	17
INSPECTION SCHEDULE REQUIREMENTS .....	17
INSPECTION PROCEDURES.....	18
CONTROL MEASURE MAINTENANCE / REPLACEMENT AND FAILED CONTROL MEASURES .....	20
DISPOSITION OF TEMPORARY MEASURES.....	20
PLAN MODIFICATIONS .....	20
REFERENCES .....	22
APPENDIX.....	23
APPENDIX A – GRADING AND EROSION CONTROL PLANS / SITE MAPS	
APPENDIX B – CDPHE STORMWATER PERMIT	
APPENDIX C – FEMA FIRM MAP	
APPENDIX D – SOILS INFORMATION	
APPENDIX E – IDENTIFICATION OF POLLUTANT SOURCES	
APPENDIX F – LAND DISTURBANCE / CONTROL MEASURE / STABILIZATION LOG	
APPENDIX G – CDPHE ENVIRONMENTAL SPILL REPORTING	
APPENDIX H – STORM EVENT LOG	
APPENDIX I – INSPECTION AND SAMPLING REPORTS	
APPENDIX J – SWMP AMENDMENT LOG / CONTROL MEASURE DETAILS	
APPENDIX K – GEOTECHNICAL REPORT	

## CERTIFICATION

### ENGINEER OF RECORD

The Stormwater Management Plan was prepared under my direction and supervision and is correct to the best of my knowledge and belief. Said Plan has been prepared according to the criteria established by the County and State for Stormwater Management Plans



---

Mitchell O. Hess, P.E.  
Registered Professional Engineer  
State of Colorado No. 0053916

### REVIEW ENGINEER

The Stormwater Management Plan was reviewed and found to meet the checklist requirements except where otherwise noted or allowed by an approved deviation request.

---

Review Engineer

## INTRODUCTION

### INTRODUCTION AND PURPOSE

This Stormwater Management Plan (SWMP) is provided to support the approval of the Grading and Erosion Control Plan Construction Drawings through El Paso County (“County”) and the issuance of a CDPS General Permit through Colorado Department of Public Health and Environment (“CDPHE”) for the proposed Discount Tire project located at Lot 4 of Falcon Marketplace, Falcon, Colorado (“Project”). This report, in conjunction with the Construction Drawings in **Appendix A**, provide a site and project understanding along with guidelines for implementation and maintenance of erosion, sediment and stormwater quality control measures prior to and during construction of the Project.

The primary goal of pollution prevention efforts during Project construction is to control sediment and pollutants that originate on the site and prevent them from flowing to surface waters. A successful pollution prevention program also relies upon careful inspection and adjustments during the construction process to enhance its effectiveness. It is the intent of this plan to implement stormwater control measures, also referred to as best management practices (BMP) for enhancing the quality of stormwater discharges associated with the construction activity. Control measures designs are based on the criteria set forth by the General Permit and the Urban Storm Drainage Criteria Manual, Volume 3.

This plan must be implemented before construction begins on the site. It primarily addresses the impact of storm rainfall and runoff on areas of the ground surface disturbed during the construction process. In addition, there are recommendations for controlling other sources of pollution that could accompany the major construction activities. Applicability of this plan shall be terminated when disturbed areas are stabilized, temporary erosion controls are removed, construction activities covered herein have ceased and the permit has been inactivated.

### PERMIT COVERAGE AND APPLICATIONS

The Grading and Erosion Control Plan for this Project shall be approved by El Paso County prior to issuance of construction related permits.

Based upon a Site Disturbance Area of one (1) acre or more, this site requires the issuance of a Colorado Discharge Permit System (CDPS) - Stormwater Discharge Associated with Construction Activities Permit (General Permit) through the Colorado Department of Public Health and Environment (CDPHE). A copy of the CDPS General Permit Application is included in **Appendix B** of this report.

## GENERAL LOCATION

### PROJECT LOCATION

The Project is located in a portion of the southeast quarter of Section 1, Township 13 south, Range 65 west of the 6<sup>th</sup> P.M., County of El Paso, State of Colorado (see Vicinity Map). More specifically, the site is located at Lot 4 within Falcon Marketplace.

The 1.172 acre Site is currently vacant land with recent over-lot grading as part of the Falcon Marketplace Master Development. The proposed Discount Tire store is approximately 7,488SF.

Parcels adjacent to the site include:

- North – Lot 3, Falcon Marketplace
- West – Falcon Market Place (50' ROW), Lot 2 Falcon Marketplace across the street
- South – Unnamed Road (50' ROW), Lot 5 Falcon Marketplace across the street
- East – Meridian Road (ROW varies)

## VICINITY MAP

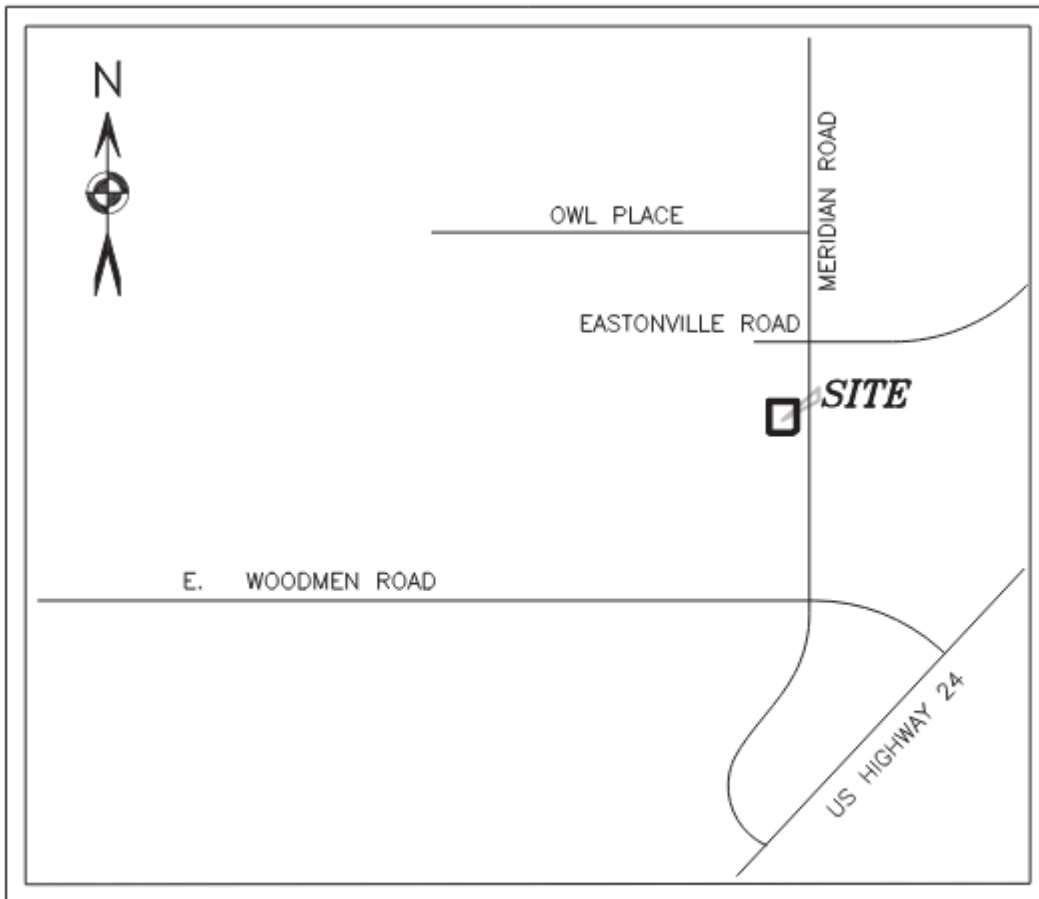

VICINITY MAP  
(NOT TO SCALE)

## SITE DESCRIPTION

### GENERAL PROJECT DESCRIPTION

The Site consists of ±1.172 acres of currently undeveloped land near the northwest corner of E. Woodmen Road and Meridian Road. The limits of construction are ±1.18 acres. The Site is zoned Commercial Regional (CR). The Project will consist of minor grading within the limits of construction and the construction of a Discount Tire store with adjacent landscape and parking areas.

There are no streams that cross the project area.

## VEGETATION

The existing site is currently vacant and due to recent over-lot grading by others, there is little to no vegetation present at the site.

Before the over-lot grading occurred, native grasses on the site had an average approximate groundcover density of 70%. This density was obtained by a site visit and reviewing vegetation densities for areas that had not been over-lot graded within the lot.

## DRAINAGE CHARACTERISTICS

The site generally slopes at about 3% from north to south. A small ditch along Meridian Road separates the ROW flows from onsite flows currently. The site has been over-lot graded as a part of the Falcon Marketplace Master development which includes a regional detention pond to the south of the site that has already been constructed.

The Flood Insurance Rate Maps (FIRM) 08041C0553G effective date December 7, 2018, by FEMA, indicates that the Site is located in Zone X (outside of the 500-year flood plain).

The FIRM is provided in **Appendix C**.

## IMMEDIATE AND ULTIMATE RECEIVING WATERS

Immediate Receiving Waters: Private storm drain inlets located within El Paso County (not within an MS4) that drain to a regional detention pond.

Ultimate Receiving Waters: Black Squirrel Creek.

Stormwater runoff from the site will be collected with a proposed private storm sewer system (refer to the proposed drainage exhibit). The entirety of the proposed storm sewer system is routed to the regional water quality and detention pond (SR4) proposed within the Falcon Marketplace master development. Ultimately, stormwater runoff will discharge from the detention pond via two triple 48" RCP culverts that pass under E. Woodmen Road and on to Pond MN to the south, and into Black Squirrel Creek.

A proposed conditions map is provided in the Appendix.

## SITE SOILS

A review of the Natural Resource Conservation Service (NRCS) Web Soil Survey determined that soils onsite are generally USCS Type A. The K Factor for the onsite soils is 0.10 (on a scale of 0.02 to 0.69), which indicates a low susceptibility of the soil to sheet and rill erosion by water. The Wind Erodibility Groups identified for the onsite soils are Groups 2 and 3 (Highest group is Group 8) which indicates a medium to high susceptibility to wind erosion. The NRSC Soils map is provided in Appendix D.

## DEWATERING

Groundwater dewatering is not anticipated per the Geotechnical Evaluation by CTL Thompson, Inc. dated 2/3/2021. According to the Geotechnical Evaluation, "Groundwater was encountered in three of our exploratory borings at depths between 17 and 19 feet." Groundwater, if closer to the bottom of the drainage system, will also reduce the infiltration/percolation rate. If groundwater is encountered during construction and the site must be dewatered, the operator shall file for appropriate dewatering permits (Permit No.

COG070000) with the CDPHE. The state dewatering permit application and associated information can be found at <https://www.colorado.gov/pacific/cdphe/wq-construction-general-permits>. The permit application will need to be filled out 30 days prior to the anticipated discharge. Refer to the UDFCDs detail and fact sheet for additional dewatering operations information.

## AREAS AND VOLUMES

The total anticipated project disturbance area is approximately 1.18 acres. The estimated earthwork quantities are as follows:

Cut: ±240 cubic yards

Fill: ±1,534 cubic yards

Net: ±1,294 cubic yards FILL

## TIMING AND PHASING SCHEDULE

The operator shall utilize the following general construction practices which are required throughout the project at locations shown on the Grading and Erosion Control Plan or as dictated by construction activities.

- Materials handling and spill prevention
- Waste management and disposal
- Hazardous material storage and containment area
- Vehicle maintenance fueling and storage
- Solid waste containment facility
- Sanitary waste facility
- Street Sweeping (SS) – performed by the Operator

These practices shall remain active and operational throughout the duration of construction and be identified on the Grading and Erosion Control Plan. Due to any phasing required for the Project, it is understood that these control measures may be relocated as needed to facilitate construction operations. The Operator shall locate and identify the original and current location of these control measures on the Grading and Erosion Control Plan, throughout the construction of the Project. An updated copy of the Grading and Erosion Control Plan shall be kept onsite throughout construction of the Project.

General construction sequencing and activities associated with this project are described below. They are presented in the order (or sequence) they are expected to begin, but each activity will not necessarily be completed before the next begins.

The anticipated construction start date is October 2021 and the anticipated construction completion date is July 2022, with final stabilization anticipated October 2022.

---

## INITIAL PHASE

The initial phase shall consist of applying for and receiving the CDPS General Permit as well as construction/installation of temporary control measures to minimize potential for erosion and sediment transfer while mobilizing and preparing the site for construction activities. The operator shall minimize site disturbance by minimizing the extent of grading and clearing to effectively reduce sediment yield. The operator shall complete the anticipated initial phase sequencing as follows:

1. Prepare and submit the State of Colorado, Colorado Department of Public Health and Environment (CDPHE) Colorado Discharge Permit System (CDPS) General Permit. A copy of the permit shall be provided to the owner upon receipt from the CDPHE
2. Prepare and submit the El Paso County ESQCP to the County Department of Public Works. A copy of the permit shall be provided to the owner upon receipt from the County.
3. Install *Vehicle Tracking Control (VTC)* at the proposed northwest parking lot entrance.
4. Install and denote on the plan any of the following areas: trailer, parking, lay down, porta-potty, wheel wash, concrete washout, fuel and material storage containers, solid waste containers, etc.
5. Prepare *Stabilized Staging Area (SSA)*. Contractor to note the actual size and location of this area and shall minimize this area.
6. Install perimeter controls including *Silt Fence (SF)* as shown on the Grading and Erosion Control Plans. Ensure that the limits of construction are defined as necessary and known by all parties which will be responsible for construction on the site.
7. Install *Inlet Protection (IP)* around all inlets as denoted on the Grading and Erosion Control Plans.
8. Upon completion of the initial control measure installation the Operator shall schedule and hold a meeting with the Contractor and Inspector that shall take place prior to the Pre-Construction Meeting.
9. The Operator shall schedule a Pre-Construction Meeting with the County and Owner to confirm control measures installed are adequate prior to proceeding with additional land disturbing activities.
10. Begin clearing and grubbing of the site.
11. Install *Concrete Washout Area (CWA)* prior to construction of concrete improvements.

---

## FINAL PHASE

The final phase shall consist of construction of site improvements, construction of permanent control measures, and final stabilization of the Site. The operator shall complete the anticipated final phase sequencing as follows:

1. Confirm existing control measures from the initial phase which are to be maintained throughout construction, are in working order and compliant with applicable regulations.
2. Repair and/or replace any existing control measures which are deemed inadequate.
3. *Temporarily Seed (TS)*, throughout construction, denuded areas that will be inactive for 14 days or more.
4. Complete installation of utilities and curb and gutters.
5. Permanently stabilize areas to be vegetated as they are brought to final grade.
6. Prepare site for paving.
7. Pave site, including gravel roadways, concrete sidewalk, and paved parking lot.
8. Complete grading and installation of final stabilization over all areas in accordance with the approved landscape plans for the Project.
9. Remove remaining control measures once permanent stabilization has been achieved and accepted by the County Inspector. Repair and stabilize areas disturbed through control measure removal.
10. Notify the owner of intent to file the Notice of Inactivation with CDPHE and receive Owner acceptance to proceed with Stormwater Management Close-out.
11. Proceed with filing the Notice of Inactivation with CDPHE.
12. Provide the Owner with a copy of all stormwater documentation (permits, inspection reports, logs, etc.) upon completion of Project Stormwater Notice of Inactivation.

## STORMWATER MANAGEMENT PLAN SITE MAP

### SITE MAP MINIMUM REQUIREMENTS

The Site Map for this project is included within **Appendix A** of this report and meets the following minimum requirements:

- Construction Site Boundaries
- Flow Arrows Depicting Stormwater Flow Directions
- Identification of Ground Surface Disturbance
- Areas of Storage of Building Materials, Equipment, Soil or Waste
- Location of Dedicated Asphalt or Concrete Batch Plants (As Applicable)
- Location of Structural Control Measures
- Location of Non-Structural Control Measures
- Location of Springs, Streams, Wetlands or other Surface Waters (As Applicable)
- Location of All Stream Crossings Located Within the Construction Site Boundary (As Applicable)

## STORMWATER MANAGEMENT CONTROLS

### QUALIFIED STORMWATER MANAGER

The Qualified Stormwater Manager is the Operator selected for the project. The terms Qualified Stormwater Manager and Operator have been used interchangeably throughout this stormwater management plan and both terms should be interpreted to mean the same thing. The Qualified Stormwater Manager is an individual knowledgeable in the principles and practices of erosion and sediment control and pollution prevention, and with the skills to assess the effectiveness of stormwater controls implemented to meet the requirements of the General Permit. The Qualified Stormwater Manager is responsible for developing, implementing, maintaining and revising the Grading and Erosion Control Plan. The activities and responsibilities of the Qualified Stormwater Manager shall address all aspects of the facility's Grading and Erosion Control Plan. The Qualified Stormwater Manager will be sufficiently qualified for the required duties per the El Paso County ECM Appendix I.5.2.A.

Company: \_\_\_\_\_

Contact: \_\_\_\_\_

Address: \_\_\_\_\_

Phone: \_\_\_\_\_

Email: \_\_\_\_\_

Qualified Stormwater Manager contact info will be given to El Paso County prior to work commencing.



## SITE SPECIFIC POLLUTION SOURCES

Further identification of site-specific pollutants that fall within the categories outlined in the next section may be field noted using the corresponding log included in **Appendix E** of this report. The logs are intended to record site specific pollutants, the date of arrival on the site, the date removed from the site, and the methods of treatment.

## IDENTIFICATION OF POLLUTANT SOURCES

Evaluation of general sediment and non-sediment pollution sources associated with site construction activities, as outlined within the General Permit, consist of the following:

- **Disturbed and Stored Soils** – Earth disturbing activities (grading, excavation, etc.) will be necessary for this project; therefore, the potential exists for disturbed site soils to contribute sediment to stormwater discharges.
- **Vehicle Tracking and Sediment** – Construction traffic will be entering and exiting the Site; therefore, the potential exists for vehicle tracking to contribute sediment to stormwater discharges.
- **Management of Contaminated Soils** – Contaminated soils are not anticipated on this Site. If encountered, the Qualified Stormwater Manager shall take appropriate containment and treatment measures.
- **Loading and Unloading Operations** – Loading and unloading operations will be taking place at the Site; therefore, the potential exists for these operations to introduce sediment and non-sediment pollutants to stormwater discharges.
- **Outdoor Storage of Materials** – Limited outdoor storage of materials is anticipated with construction of this site; however, outdoor storage of chemicals, fertilizers, etc. is not anticipated.
- **Vehicle and Equipment Maintenance and Fueling** – Routine maintenance and fueling of vehicles and equipment is anticipated with this Site; therefore, the potential exists for pollutants associated with these activities to contribute pollutants to stormwater discharges.
- **Significant Dust or Particulate Generating Processes** – Earth disturbing activities (grading, excavation, etc.) will be necessary for this project; therefore, the potential exists for windblown site soils to contribute sediment to stormwater discharges.
- **Routine Maintenance** – Routine maintenance involving fertilizers, pesticides, detergents, fuels, solvents, oils, etc., other than those identified within Vehicle and Equipment Maintenance and Fueling are not anticipated with this project. If encountered, the Qualified Stormwater Manager shall take appropriate containment and treatment measures.
- **Onsite Waste Management** – Waste management consisting of solid waste piles, liquid wastes, dumpsters, etc. are anticipated onsite; therefore, the potential exists for these operations to introduce sediment and non-sediment pollutants to stormwater discharges.
- **Concrete Truck / Equipment Washing** – Concrete truck and equipment washing are not anticipated with this project. If encountered, the Qualified Stormwater Manager shall take appropriate containment and treatment measures.
- **Dedicated Asphalt and Concrete Batch Plants** – Dedicated asphalt and/or concrete batch plants are not anticipated with this project. If encountered, the Qualified Stormwater Manager shall take appropriate containment and treatment measures and document as necessary.
- **Portable Toilets** - Portable toilets will be located a minimum of 10 feet from stormwater inlets and 50 feet from state waters. They will be secured at all four corners to prevent overturning and cleaned on a weekly basis. They will be inspected daily for spills. As decided by the Qualified Stormwater Manager, a spill liner can be added beneath the portable toilets.

- **Non-Industrial Waste Sources** – Non-Industrial waste sources limited to portable sanitary facilities are anticipated with this project.
- **Additional Pollutant Sources** – Additional areas or procedures where potential spills could occur are not anticipated with this project.

Logs for the identification of pollutant sources are included in **Appendix E** for reference and use.

Based on the following, the potential to contribute pollutants to stormwater discharges is not significant for most of the pollutants identified above:

- Relatively Low Frequency of the Activities
- The Ability to Schedule Activities During Dry Weather
- Existing Site Topography
- The Ability to Implement Primary and Secondary Containment for Product Storage
- The Ability to Locate Activities Away from Drainage Ways

Potential pollutant sources noted below shall be mitigated by use of Best Management Practices (BMPs) as noted in the following sections:

- Disturbed and Stored Soils
- Vehicle Tracking and Sediment
- Loading and Unloading Operations
- Outdoor Storage
- Vehicle Equipment and Maintenance Fueling
- Significant Dust or Particulate Generating Processes
- Non-Industrial Waste Sources

## NON-STORMWATER DISCHARGE COMPONENTS

Only specifically authorized non-stormwater discharges are allowed to enter the storm sewer and all authorized non-stormwater discharges shall be eliminated or reduced to the extent practical.

Appropriate control measures shall be used to minimize the discharge of pollutants. Such control measures will be strictly followed to ensure any impacts from non-stormwater discharges are reduced or eliminated. Appropriate control measures are:

- Emergency Fire Fighting Activities
- Uncontaminated ground water or spring water  
If possible, direct uncontaminated ground water or spring water to stabilized points of discharge. If discharged to a disturbed area, assure measures to control erosive velocities and sediment control measures are implemented. Velocity control measures include riprap aprons and other conveyance measures. Sediment control measures might include stone check dams, sediment traps and basins.

If uncontaminated ground water is discharged off-site, a Construction Dewatering Permit will be required. This Permit will not apply if dewatering is not performed or if water is not discharged off-site.

- Landscape Irrigation Return Flows

Volume of water used for irrigation prior to establishment of vegetation shall be controlled to prevent excess runoff and erosion. Temporary sediment control measures shall remain in place until all upstream disturbed areas are stabilized. Sediment loss will be controlled using sediment control measures such as wattles, sediment fence, and vegetative buffers.

## CONTROL MEASURES FOR STORMWATER POLLUTION PREVENTION

There are three general types of control measures that will be utilized for the Project: Erosion Control, Sediment Control, and Site/Material Management control measures. Erosion Control measures are used to limit the amount and extent of erosion. Sediment Control measures are designed to capture eroded sediments prior to their conveyance offsite. Site/Material Management control measures are related to construction access and staging. Several control measures described below may be categorized into more than one of the types described above. Also, these control measures may be categorized into one or more of the following construction phases which pertain to the phase of development in which they may be implemented. Initial Stage control measures shall be installed on existing grades at the outset of construction. Final Stage control measures shall be installed on proposed grades and drainage features after initial site grading. Construction of the identified improvements will take place under two phases of construction anticipated as identified within the construction sequencing included within this report.

Refer to the Grading and Erosion Control Plans for the location and implementation of erosion control measures for the phases of the Project. The following is a brief description of temporary sediment and erosion control measures to be utilized on this Site and the application those control measures are treating.

---

### EROSION CONTROL

Protection of steep slopes is not anticipated on this project. Steep slopes are defined as slopes greater than 3:1 that are higher than 5-feet vertically. Temporary slopes during construction that are greater than 3:1 need to be addressed along with any permanent slopes which are greater than 3:1. The Permittee may need to implement the use of diversion ditches to reroute the storm runoff, terrace the grades to break up the flow of incidental runoff down slopes, compost mulch to protect the exposed soil or other control measure as approved by the inspector. Slopes steeper than 3:1 shall be protected with an erosion control blanket. No un-protected final grades shall be allowed greater than 2:1.

Permanent soil erosion control measures for all slopes, channels, ditches, or any disturbed land area shall be completed within fourteen (14) calendar days after final grading or the final earth disturbances has been completed. When it is not possible to permanently stabilize a disturbed area after an earth disturbance has been completed or where significant earth disturbance activity ceases, temporary soil erosion control measures shall be implemented within fourteen (14) calendar days. All temporary soil erosion control measures shall be maintained until permanent soil erosion measures are implemented.

All disturbed areas shall be stabilized as soon as possible. Seeding and Mulching (SM), to provide protection against rain and wind erosion, shall be performed temporarily, as needed, during the pre-construction, initial, and interim phases and maintained until final stabilization is completed. Site Stabilization will be achieved through use of temporary seeding and mulching (TS) and ultimately permanent landscaping (PS). All disturbed areas which are either final graded or will remain inactive for a period of more than 30 days shall be required to be stabilized within 14 days of the completion of the grading activities.

---

## SEDIMENT CONTROL

Silt Fence (SF) is located downstream of disturbed areas and provides a sediment barrier for runoff. SF is installed to help reduce the amount of sediment in surface runoff that will be exiting/entering the Site. SF will be installed along portions of the limits of construction line located throughout the Site as denoted on the Site Map. The SF will be installed during the initial phases of construction activities and maintained throughout construction. A temporary sediment basin (TSB) is located downstream of all temporary diversion ditches on site to contain and control the release of temporary runoff on site during construction activities. The TSB is to be constructed during the initial phase of construction.

---

## SITE/MATERIAL MANAGEMENT

One construction entrance with Vehicle Tracking Control (VTC) shall be installed at the northwest entrance of the Site in an effort to reduce off-site sediment tracking. The VTC shall be installed during the initial phase of construction activities.

A Concrete Washout Area (CWA) will be installed near the VTC to help isolate concrete truck washout operations upon departure. A CWA is installed when a site anticipates the generation of concrete wash water. CWAs provide an area for the proper collection and disposal of all liquid concrete waste. The CWA will be installed during the initial phase of construction activities. Three basic approaches are available to the Contractor and include an above-grade storage area, excavation of a pit in the ground, and a prefabricated haul-away concrete washout container. All concrete washout areas shall, as a minimum adhere to the following guidelines:

- Maintain a minimum distance of 400 feet from a stream or water body.
- Maintain a minimum distance of 1,000 feet from any wells or drinking water source.
- Shall not be located in a natural draw or drainage swale.
- Shall not be located in areas of highly permeable soils, i.e., gravels and sands.
- The chosen location shall be sited so that if a failure or overtopping occurs, the flow would be directed to a flat or depressed grassy area away from any water sources.
- The use of solvents, cleaners, or hazardous materials when cleaning or removing concrete is strictly prohibited.
- Backflushing shall not be permitted on site.
- Adequate and proper disposal of contents is required once the CWA has reached ½ capacity and at the end of concrete construction activities.

A stabilized staging area (SSA) to provide an area for construction activities and material storage will be located on the north side of the Site. The SSA provides a designated area for staging of construction materials and equipment, placement of job trailer, contractor parking, etc.

Street Sweeping (SS) is necessary for any site that has track out onto adjacent sites or roadways. Paved and impervious surfaces which are adjacent to construction sites must be swept on a weekly basis or as needed during the week when sediment and other materials are tracked or discharged onto them. Either sweeping by hand or use of street sweepers is acceptable. Street sweepers using water while sweeping is preferred in order to minimize dust. Scraped or swept material shall not be deposited in the storm sewer. Materials collected by the inlet protection shall be removed and shall not be deposited in the storm sewer. Street sweeping is the responsibility of the Operator and will not be performed by the City or County to meet the requirements of this Plan.

## OTHER POTENTIAL POLLUTION CONSIDERATIONS

### MATERIALS HANDLING AND SPILL PREVENTION

Any hazardous or potentially hazardous material that is brought onto the construction site shall be handled properly to reduce the potential for stormwater pollution. In an effort to minimize the potential for a spill of petroleum product or hazardous materials to come in contact with stormwater, the following steps shall be implemented:

- Material Safety Data Sheets (MSDS) information shall be kept on site for any and all applicable materials.
- All materials with hazardous properties (such as pesticides, petroleum products, fertilizers, detergents, construction chemicals, acids, paints, paint solvents, additives for soil stabilization, concrete, curing compounds and additives, etc.) shall be stored in a secure location, under cover and in appropriate, tightly sealed containers when not in use.
- The minimum practical quantity of all such materials shall be kept on the job site and scheduled for delivery as close to time of use as practical.
- A spill control and containment kit shall be provided on the construction site and location(s) shown on Site Maps.
- All of the product in a container shall be used before the container is disposed of. All such containers shall be triple rinsed, with water prior to disposal. The rinse water used in these containers shall be disposed of in a manner in compliance with State and Federal regulations and shall not be allowed to mix with stormwater discharges.
- All products shall be stored in and used from the original container with the original product label and used in strict compliance with the instructions on the product label.
- The disposal of excess or used products shall be in strict compliance with instructions on the product label.

Fueling for construction is anticipated to be conducted with a fuel truck that will not be kept permanently onsite. If utilized, temporary onsite fuel tanks for construction vehicles shall meet all state and federal regulations. Tanks shall have approved spill containment with the capacity required by the applicable regulations. From NFPA 30: All tanks shall be provided with secondary containment (i.e. containment external to and separate from primary containment). Secondary containment shall be constructed of materials of sufficient thickness, density and composition so as not to be structurally weakened as a result of contact with the fuel stored and capable of containing discharged fuel for a period of time equal to or longer than the maximum anticipated time sufficient to allow recovery of discharged fuel. Secondary containment may only be required on larger fuel tanks and the qualified stormwater manager should familiarize themselves with and follow local and state requirements.

The tanks shall be in sound condition free of rust or other damage which might compromise containment. Fuel storage areas shall meet all Environmental Protection Agency (EPA), OSHA and other regulatory requirements for signage, fire extinguisher, etc. Hoses, valves, fittings, caps, filler nozzles and associated hardware shall be maintained in proper working condition at all times. The location of fuel tanks shall be shown on the Site Maps and shall be located to minimize exposure to weather and surface water drainage features.

The Operator shall develop and implement a Materials Handling and Spill Prevention Plan (MHSP) in accordance with the EPA and State of Colorado requirements. In the event of an accidental spill, immediate

action shall be undertaken by the Operator to contain and remove the spilled material. All hazardous materials, including contaminated soil, shall be disposed of by the Operator in the manner specified by federal, state and local regulations and by the manufacturer of such products. As soon as possible, the spill shall be reported to the appropriate agencies. As required under the provisions of the Clean Water Act, any spill or discharge entering waters of the United States shall be properly reported. The Operator shall prepare a written record of any spill and associated clean-up activities of petroleum products or hazardous materials in excess of 1 gallon or reportable quantities, whichever is less. A copy of the Spill Report Form is included in **Appendix G** of this report.

Accidental spills shall be handled expeditiously as outlined in CDPHE guidance. Any spills of petroleum products or hazardous materials in excess of Reportable Quantities as defined by EPA or the state or local agency regulations, shall be immediately reported to the Colorado Department of Public Health and Environment spill reporting lines.

- CDPHE Environmental Release and Incident Reporting Line (877) 518-5608.
- National Response Center - (800) 424-8802

## VEHICLE TRACKING AND DUST CONTROL

Vehicle Tracking Control measures (structural and non-structural) shall be implemented in order to control potential sediment discharges from vehicle tracking. Practices shall be implemented for all areas of potential vehicle tracking which include but are not limited to reduced site access and utilization of designated haul routes.

Areas of soil that are denuded of vegetation and have little protection from particles being picked up and carried by wind should be protected with a temporary cover or kept under control with water or other soil adhering products to limit wind transported particles exiting the site perimeter.

## DEDICATED CONCRETE OR ASPHALT BATCH PLANTS

Dedicated concrete or asphalt batch plants are not anticipated with this project. If encountered, the Qualified Stormwater Manager shall take appropriate containment and treatment measures and document as necessary.

## RECEIVING WATERS

No springs, streams, wetlands, or other surface waters, including areas that require maintenance of pre-existing vegetation within 50' of receiving waters exist on or near the project Site.

## WASTE MANAGEMENT AND DISPOSAL

An effective first step towards preventing pollution in stormwater from work sites involves using a common-sense approach to improve the facility's basic housekeeping methods. Poor housekeeping practices result in increased waste and potential for stormwater contamination. Waste disposal bins are to be checked daily for leaks and capacity. All leaks in disposal bins are to be reported to the Qualified Stormwater Manager in order to prevent contamination to the site. Waste disposal bins that are found to be at 98-100% capacity should be emptied before additional waste is added.

No solid materials are allowed to be discharged from the site with stormwater. All solid waste, including disposable materials incidental to the construction activities, must be collected and placed in containers.

Secure covers for the containers shall be provided if required by state and local requirements. The location of solid waste receptacles shall be identified on the SWMP by the Operator.

Concrete waste is anticipated with this project; and therefore, a dedicated concrete washout is required. The Qualified Stormwater Manager shall take appropriate containment and treatment measures and document as necessary

## STABILIZATION AND STORMWATER MANAGEMENT

### TEMPORARY STABILIZATION AND SHORT-TERM STORMWATER MANAGEMENT

The County considers the completion of over-lot grading operations, by definition, to be substantially complete; therefore, all areas that will be dormant for more than 30 days after the completion of the over-lot grading will require temporary seeding within 14 days of establishment. This does not preclude the 7-day requirement for areas fully completed in the future. At a minimum, in ensuring that this requirement is followed, adequate phasing/scheduling will be required.

### FINAL STABILIZATION AND LONG-TERM STORMWATER MANAGEMENT

In the natural condition, the site soil is stabilized by means of native vegetation. The final stabilization technique to be used at this project for stabilizing soils shall be to provide a protective cover of landscaping vegetation, pavement and granular stabilization material. Seeding should be conducted after final grade is achieved and soils are prepared to take advantage of soil moisture and seed germination. The Qualified Stormwater Manager should evaluate the short and long-term forecasts prior to applying permanent seed.

Final site stabilization is achieved when vegetative cover provides permanent stabilization with a density greater than 70 percent of the pre-disturbance levels, or equivalent permanent, physical erosion reduction methods have been employed over the entire area to be stabilized by vegetative cover. This area is exclusive of areas that are covered with rock (crushed granite, gravel, etc.) or landscape mulch, paved or have a building or other permanent structure on them.

The Site will not rely on any control measures that are owned or operated by another entity.

## INSPECTION AND MAINTENANCE

Inspections shall be the responsibility of the Qualified Stormwater Manager throughout the construction process.

### INSPECTION SCHEDULE REQUIREMENTS

Inspection and maintenance of erosion control measures shall comply with the criteria set forth by the General Permit (COR400000), or the following, whichever is more stringent.

The Permittee or Contractor shall make routine checks of all erosion control measures to determine if repairs or sediment removal is necessary. Written inspection records a minimum of once biweekly and within 24 hours after every significant precipitation event (including snowmelt events) or after every significant precipitation event that causes surface erosion. All necessary maintenance and repair shall be



completed immediately. If more frequent inspections are required to ensure that control measures are properly maintained and operated, the inspection schedule shall be modified to meet this need.

When snow cover exists over the entire site for an extended period, inspections are not always feasible. This condition should be documented, including date of snowfall and date of melting conditions to bring awareness of and preparation for areas where melting conditions may pose a risk of surface erosion.

A copy of the SWMP shall be maintained at the site at all times. Any degradation of the control measures described in the SWMP or excessive accumulation of sediments shall be remedied immediately upon discovery. The Contractor shall record all storm events on the Storm Event Log included in **Appendix H**.

## INSPECTION PROCEDURES

The inspection shall include observations of:

- The Construction Site Perimeter and Discharge Points;
- All Disturbed Areas;
- Vehicles and Equipment;
- Areas Used for Material / Waste Storage That are Exposed to Precipitation;
- Other Areas Determined to Have a Significant Potential for Stormwater Pollution;
- Erosion and Sediment Control Measures Identified in the SWMP; and
- Any Other Structural Control Measures That May Require Maintenance.

The inspection must determine if there is evidence of, or the potential for, pollutants entering the drainage system. Control measures should be reviewed to determine if they still meet the design intent and operational criteria in the SWMP and if they continue to adequately control pollutants at the site. Any control measures not operating in accordance with the SWMP must be addressed as soon as possible, immediately in most cases, to minimize the discharge of pollutants and the SWMP must be updated and inspections must be documented.

Examples of specific items to evaluate during site inspections are listed below. This list is not intended to be comprehensive. Ultimately, it is the responsibility of the Contractor to assure the adequacy of site pollutant discharge controls. Actual physical site conditions or contractor practices could make it necessary to install more controls than are shown on the plans. Assessing the need for additional controls and implementing them or adjusting existing controls will be an ongoing requirement until the site achieves final stabilization.

1. Vehicle Tracking Control - Locations where vehicles enter and exit the site shall be inspected for evidence of offsite sediment tracking. Exits shall be maintained as necessary to prevent the release of sediment from vehicles leaving the site. Any sediment deposited on the adjacent roadway shall be removed as necessary throughout the day or at the end of every day and disposed of in an appropriate manner. Sediment shall not be washed into storm sewer systems.
2. Erosion Control Devices - Rolled erosion control products (nets, blankets, turf reinforcement mats) and marginally vegetated areas (areas not meeting required vegetative densities for final stabilization) must be inspected frequently. Riling, rutting and other signs of erosion indicate the erosion control device is not functioning properly and additional erosion control devices are warranted.
3. Sediment Control Devices - Sediment barriers (silt fence, sediment control logs, etc.), traps and basins must be inspected, and they must be cleaned out at such time as their original capacity has been reduced by 50 percent. All material excavated from behind sediment barriers or in traps and basins shall be incorporated into onsite soils or spread out on an upland portion of the site and



stabilized. To minimize the potential for sediment releases from the Project, site perimeter control devices shall be inspected with consideration given to changing up-gradient conditions.

4. Material Storage Areas - Material storage areas should be located to minimize exposure to weather. Inspections shall evaluate disturbed areas and areas used for storing materials that are exposed to rainfall for evidence of, or the potential for, pollutants entering the drainage system or discharging from the site. If necessary, the materials must be covered, or original covers must be repaired or supplemented. Also, protective berms must be constructed, if needed, in order to contain runoff from material storage areas. All state and local regulations pertaining to material storage areas shall be adhered to.
5. Vegetation - Seed/Sod shall be free of weedy species and appropriate for site soils and regional climate. Seeding, sodding, tacking, and mulching shall be completed, in accordance with the requirements outlined within the Project Manual and locations identified within the plans, immediately after topsoil is applied and final grade is reached. Grassed areas shall be inspected to confirm that a healthy stand of grass is maintained. Rip-rap, mulch, gravel, decomposed granite or other equivalent permanent stabilization measures may be employed in lieu of vegetation based on site-specific conditions and Owner approval.
6. Discharge Points - All discharge points must be inspected to determine whether erosion and sediment control measures are effective in preventing discharge of sediment from the site or impacts to receiving waters.

Based on the inspection results, all necessary maintenance and repair shall be completed immediately and in no cases longer than seventy-two (72) hours after identification. The inspection reports must be completed after each inspection. An important aspect of the inspection report is the description of additional measures that need to be taken to enhance plan effectiveness. The inspection report must identify whether the site was in compliance with the SWMP at the time of inspection and specifically identify all incidents of non-compliance.

The Qualified Stormwater Manager shall ensure that, at a minimum, the following is recorded for each inspection and kept onsite for reference:

- a. The inspector's name (must be a Qualified Stormwater Manager),
- b. The date and type of the inspection (regular inspection vs. post-storm inspection),
- c. Weather conditions at the time of the inspection,
- d. Phase of construction at the time of the inspection,
- e. Estimated acreage of disturbance at the time of inspection,
- f. The minimum frequency of inspections chosen,
- g. Location(s) of discharges of sediment or other pollutants from the site,
- h. Location(s) of control measures needing maintenance,
- i. Location(s) and identification of inadequate control measures
- j. Location(s) and identification of additional control measures are needed that were not in place at the time of inspection, and
- k. Any corrective actions taken.

If repairs are needed to any control measures, they shall be completed immediately. After adequate corrective action(s) and maintenance have been taken, or where a report does not identify any incidents requiring corrective action or maintenance, the report shall contain a statement stating the following:

"I verify that, to the best of my knowledge and belief, all corrective action and maintenance items identified during the inspection are complete, and the site is currently in compliance with the permit."

This statement must be signed by a Qualified Stormwater Manager. If it is infeasible to install or repair of control measure immediately after discovering the deficiency, the following information must be documented and kept on record:

1. Describe why it is infeasible to initiate the installation or repair immediately; and
2. Provide a schedule for installing or repairing the control measure and returning it to an effective operating condition as soon as possible.

The use and maintenance of log books, photographs, field notebooks, drawings or maps should also be included in the SWMP records when appropriate. Copies of the Inspection and Sampling Report Forms have been included in **Appendix I** for reference and use.

## CONTROL MEASURE MAINTENANCE / REPLACEMENT AND FAILED CONTROL MEASURES

Site inspection procedures noted above must address maintenance of control measures that are found to no longer function as needed and designed, as well as preventive measures to proactively ensure continued operation.

The Qualified Stormwater Manager shall implement a preventative maintenance program to ensure that control measure breakdowns and failures are handled proactively. Site inspections should uncover any conditions which could result in the discharge of pollutants to storm sewers and surface waters and shall be rectified. For example, sediment shall be removed from silt fences on a regular basis to prevent failure of the control measure. Sediment shall be removed to an appropriate location so that it will not become an additional pollutant source.

The inspection process must also include replacement of control measures when needed or the addition of new control measures in order to adequately manage the pollutant sources at the site.

Any control measure deficiencies, replacement or additional control measures that may be required shall be documented on the Stormwater Management Site Map and on the appropriate Inspection Form. If amendments to the SWMP are required, these amendments shall be documented on the SWMP Amendment Log included in **Appendix J** for reference and use.

## DISPOSITION OF TEMPORARY MEASURES

Most temporary erosion and sediment control measures must be removed within 30 days after final site stabilization is achieved. Trapped sediment and disturbed soil areas resulting from the disposal of temporary measures must be returned to final plan grades and permanently stabilized to prevent further soil erosion.

## PLAN MODIFICATIONS

The SWMP should be viewed as a “living document” that is continuously being reviewed and modified as a part of the overall process of evaluating and managing stormwater quality issues at the site. The Qualified Stormwater Manager shall amend the SWMP when there is a change in design, construction, operation or maintenance of the site which would require the implementation of new or revised BMPs or if the SWMP proves to be ineffective in achieving the general objectives of controlling pollutants in stormwater discharges associated with construction activity or when BMPs are no longer necessary and are removed.

Plan revisions made prior to or following a change(s) onsite, including revisions to sections addressing site conditions and control measures, a notation must be included in the plan that identifies:

- Date of site change,
- The control measure removed or modified,

- The location(s) of those control measures,
- Any changes to the control measure, and
- Initials of the individual who updated the Map.

## REFERENCES

Colorado Discharge Permit System (CDPS) – Stormwater Discharge Associated with Construction Activities Application - Prepared by Water Quality Control Division, Colorado Department of Public Health and Environment; Revised April 2019.

Colorado Discharge Permit System (CDPS) General Permit – Stormwater Discharges Associated with Construction Activity - Prepared by Water Quality Control Division, Colorado Department of Public Health and Environment; signed and issued on May 31, 2007 and administratively continued effective July 1, 2012.

NRCS Web Soil Survey - Website: <http://websoilsurvey.nrcs.usda.gov>, accessed July 30, 2020.

Stormwater Discharges Associated with Construction Activity – Stormwater Management Plan Preparation Guidance - Prepared by Water Quality Control Division, Colorado Department of Public Health and Environment; Revised April 2011.

Urban Storm Drainage Criteria Manual, Volume 3 – Mile High Flood District, Denver, CO.; November 2015.



# APPENDIX A – GRADING AND EROSION CONTROL PLANS / SITE MAPS



# DISCOUNT TIRE

## GRADING AND EROSION CONTROL PLANS

### FALCON MARKETPLACE, LOT 4 - 7585 FALCON MARKET PL

SITUATED IN A PORTION OF THE SOUTHEAST QUARTER OF SECTION 1, TOWNSHIP 13 SOUTH, RANGE 65 WEST  
OF THE 6TH P.M., COUNTY OF EL PASO, STATE OF COLORADO  
PCD FILING NO.: PPR-21-012

#### STANDARD NOTES FOR EL PASO COUNTY GRADING AND EROSION CONTROL PLANS

- STORMWATER DISCHARGES FROM CONSTRUCTION SITES SHALL NOT CAUSE OR THREATEN TO CAUSE POLLUTION, CONTAMINATION, OR DEGRADATION OF STATE WATERS. ALL WORK AND EARTH DISTURBANCE SHALL BE DONE IN A MANNER THAT MINIMIZES POLLUTION OF ANY ON-SITE WATERS, INCLUDING WETLANDS.
- NOTWITHSTANDING ANYTHING DEPICTED IN THESE PLANS IN WORDS OR GRAPHIC REPRESENTATION, ALL DESIGN AND CONSTRUCTION RELATED TO ROADS, STORM DRAINAGE AND EROSION CONTROL SHALL CONFORM TO THE STANDARDS AND REQUIREMENTS OF THE MOST RECENT VERSION OF THE RELEVANT ADOPTED EL PASO COUNTY STANDARDS, INCLUDING THE LAND DEVELOPMENT CODE, THE ENGINEERING CRITERIA MANUAL, THE DRAINAGE CRITERIA MANUAL, AND THE DRAINAGE CRITERIA MANUAL VOLUME 2. ANY DEVIATIONS FROM REGULATIONS AND STANDARDS MUST BE REQUESTED, AND APPROVED IN WRITING.
- A SEPARATE STORMWATER MANAGEMENT PLAN (SWMP) FOR THIS PROJECT SHALL BE COMPLETED AND AN EROSION AND STORMWATER QUALITY CONTROL PERMIT (ESQCP) ISSUED PRIOR TO COMMENCING CONSTRUCTION. MANAGEMENT OF THE SWMP DURING CONSTRUCTION IS THE RESPONSIBILITY OF THE DESIGNATED QUALIFIED STORMWATER MANAGER OR CERTIFIED EROSION CONTROL INSPECTOR. THE SWMP SHALL BE LOCATED ON SITE AT ALL TIMES DURING CONSTRUCTION AND SHALL BE KEPT UP TO DATE WITH WORK PROGRESS IN THE FIELD.
- ONCE THE ESQCP IS APPROVED AND A "NOTICE TO PROCEED" HAS BEEN ISSUED, THE CONTRACTOR MAY INSTALL THE INITIAL STAGE EROSION AND SEDIMENT CONTROL MEASURES AS INDICATED ON THE APPROVED GEC. A PRE-CONSTRUCTION MEETING BETWEEN THE CONTRACTOR, ENGINEER, AND EL PASO COUNTY WILL BE HELD PRIOR TO ANY CONSTRUCTION. IT IS THE RESPONSIBILITY OF THE APPLICANT TO COORDINATE THE MEETING TIME AND PLACE WITH COUNTY STAFF.
- CONTROL MEASURES MUST BE INSTALLED PRIOR TO COMMENCEMENT OF ACTIVITIES THAT COULD CONTRIBUTE POLLUTANTS TO STORMWATER. CONTROL MEASURES FOR ALL SLOPES, CHANNELS, DITCHES AND DISTURBED LAND AREAS SHALL BE INSTALLED IMMEDIATELY UPON COMPLETION OF THE DISTURBANCE.
- ALL TEMPORARY SEDIMENT AND EROSION CONTROL MEASURES SHALL BE MAINTAINED AND REMAIN IN EFFECTIVE OPERATING CONDITION UNTIL PERMANENT SOIL EROSION CONTROL MEASURES ARE IMPLEMENTED AND FINAL STABILIZATION IS ESTABLISHED. ALL PERSONS ENGAGED IN LAND DISTURBANCE ACTIVITIES SHALL ASSESS THE ADEQUACY OF CONTROL MEASURES AT THE SITE AND IDENTIFY IF CHANGES TO THOSE CONTROL MEASURES ARE NEEDED TO ENSURE THE CONTINUED EFFECTIVE PERFORMANCE OF THE CONTROL MEASURES. ALL CHANGES TO TEMPORARY SEDIMENT AND EROSION CONTROL MEASURES MUST BE INCORPORATED INTO THE STORMWATER MANAGEMENT PLAN.
- TEMPORARY STABILIZATION SHALL BE IMPLEMENTED ON DISTURBED AREAS AND STOCKPILES WHERE GROUND DISTURBING CONSTRUCTION ACTIVITY HAS PERMANENTLY CEASED OR TEMPORARILY CEASED FOR LONGER THAN 14 DAYS.
- FINAL STABILIZATION MUST BE IMPLEMENTED AT ALL APPLICABLE CONSTRUCTION SITES. FINAL STABILIZATION IS ACHIEVED WHEN ALL GROUND DISTURBING ACTIVITIES ARE COMPLETE AND ALL DISTURBED AREAS EITHER HAVE A UNIFORM VEGETATIVE COVER WITH INDIVIDUAL PLAN DENSITY OF 70% OF PRE-DISTURBED LEVELS ESTABLISHED OR EQUIVALENT PERMANENT ALTERNATIVE STABILIZATION METHOD IS IMPLEMENTED. ALL TEMPORARY SEDIMENT AND EROSION CONTROL MEASURES SHALL BE REMOVED UPON FINAL STABILIZATION AND BEFORE PERMIT CLOSURE.
- ALL PERMANENT STORMWATER MANAGEMENT FACILITIES SHALL BE INSTALLED AS DESIGNED IN THE APPROVED PLANS. ANY PROPOSED CHANGES THAT EFFECT THE DESIGN OR FUNCTION OF PERMANENT STORMWATER MANAGEMENT STRUCTURES MUST BE APPROVED BY THE ECM ADMINISTRATOR PRIOR TO IMPLEMENTATION.
- EARTH DISTURBANCES SHALL BE CONDUCTED IN SUCH A MANNER SO AS TO EFFECTIVELY MINIMIZE ACCELERATED SOIL EROSION AND RESULTING SEDIMENTATION. ALL DISTURBANCES SHALL BE DESIGNED, CONSTRUCTED, AND COMPLETED SO THAT THE EXPOSED AREA OF ANY DISTURBED LAND SHALL BE LIMITED TO THE SHORTEST PRACTICAL PERIOD OF TIME. PRE-EXISTING VEGETATION SHALL BE PROTECTED AND MAINTAINED WITHIN 50 HORIZONTAL FEET OF A WATERS OF THE STATE UNLESS SHOWN TO BE INFEASIBLE AND SPECIFICALLY REQUESTED AND APPROVED.
- COMPACTION OF SOIL MUST BE PREVENTED IN AREAS DESIGNATED FOR INFILTRATION CONTROL MEASURES OR WHERE FINAL STABILIZATION WILL BE ACHIEVED BY VEGETATIVE COVER. AREAS DESIGNATED FOR INFILTRATION CONTROL MEASURES SHALL ALSO BE PROTECTED FROM SEDIMENTATION DURING CONSTRUCTION UNTIL FINAL STABILIZATION IS ACHIEVED. IF COMPACTION PREVENTION IS NOT FEASIBLE DUE TO SITE CONSTRAINTS, ALL AREAS DESIGNATED FOR INFILTRATION AND VEGETATION CONTROL MEASURES MUST BE LOOSENEED PRIOR TO INSTALLATION OF THE CONTROL MEASURE(S).
- ANY TEMPORARY OR PERMANENT FACILITY DESIGNED AND CONSTRUCTED FOR THE CONVEYANCE OF STORMWATER AROUND, THROUGH, OR FROM THE EARTH DISTURBANCE AREA SHALL BE A STABILIZED CONVEYANCE DESIGNED TO MINIMIZE EROSION AND THE DISCHARGE OF SEDIMENT OFF SITE.
- CONCRETE WASH WATER SHALL BE CONTAINED AND DISPOSED OF IN ACCORDANCE WITH THE SWMP. NO WASH WATER SHALL BE DISCHARGED TO OR ALLOWED TO ENTER STATE WATERS, INCLUDING ANY SURFACE OR SUBSURFACE STORM DRAINAGE SYSTEM OR FACILITIES. CONCRETE WASHOUTS SHALL NOT BE LOCATED IN AN AREA WHERE SHALLOW GROUNDWATER MAY BE PRESENT, OR WITHIN 50 FEET OF A SURFACE WATER BODY, CREEK, OR STREAM.
- DURING DEWATERING OPERATIONS OF UNCONTAMINATED GROUND WATER MAY BE DISCHARGED ON SITE, BUT SHALL NOT LEAVE THE SITE IN THE FORM OF SURFACE RUNOFF UNLESS AN APPROVED STATE DEWATERING PERMIT IS IN PLACE.
- EROSION CONTROL BLANKETING OR OTHER PROTECTIVE COVERING SHALL BE USED ON SLOPES STEEPER THAN 3:1.
- CONTRACTOR SHALL BE RESPONSIBLE FOR THE REMOVAL OF ALL WASTES FROM THE CONSTRUCTION SITE FOR DISPOSAL IN ACCORDANCE WITH LOCAL AND STATE REGULATORY REQUIREMENTS. NO CONSTRUCTION DEBRIS, TREE SLASH, BUILDING MATERIAL WASTES OR UNUSED BUILDING MATERIALS SHALL BE BURIED, DUMPED, OR DISCHARGED AT THE SITE.
- WASTE MATERIALS SHALL NOT BE TEMPORARILY PLACED OR STORED IN THE STREET, ALLEY, OR OTHER PUBLIC WAY, UNLESS IN ACCORDANCE WITH AN APPROVED TRAFFIC CONTROL PLAN. CONTROL MEASURES MAY BE REQUIRED BY EL PASO COUNTY ENGINEERING IF DEMAED NECESSARY, BASED ON SPECIFIC CONDITIONS AND CIRCUMSTANCES.
- TRACKING OF SOILS AND CONSTRUCTION DEBRIS OFF-SITE SHALL BE MINIMIZED. MATERIALS TRACKED OFF-SITE SHALL BE CLEANED UP AND PROPERLY DISPOSED OF IMMEDIATELY.
- THE OWNER/DEVELOPER SHALL BE RESPONSIBLE FOR THE REMOVAL OF ALL CONSTRUCTION DEBRIS, DIRT, TRASH, ROCK, SEDIMENT, SOIL AND SAND THAT MAY ACCUMULATE IN ROADS, STORM DRAINS, AND OTHER DRAINAGE CONVEYANCE SYSTEMS AND STORMWATER APPURTENANCES AS A RESULT OF SITE DEVELOPMENT.
- THE QUANTITY OF MATERIALS STORED ON THE PROJECT SITE SHALL BE LIMITED, AS MUCH AS PRACTICAL, TO THAT QUANTITY REQUIRED TO PERFORM THE WORK IN AN ORDERLY SEQUENCE. ALL MATERIALS STORED ON-SITE SHALL BE STORED IN A NEAT, ORDERLY MANNER, IN THEIR ORIGINAL CONTAINERS, WITH ORIGINAL MANUFACTURER'S LABELS.
- NO CHEMICAL(S) HAVING THE POTENTIAL TO BE RELEASED IN STORMWATER ARE TO BE STORED OR USED ONSITE UNLESS PERMISSION FOR THE USE OF SUCH CHEMICAL(S) IS GRANTED IN WRITING BY THE ECM ADMINISTRATOR. IN GRANTING APPROVAL FOR THE USE OF SUCH CHEMICAL(S), SPECIAL CONDITIONS AND MONITORING MAY BE REQUIRED.
- BULK STORAGE OF ALLOWED PETROLEUM PRODUCTS OR OTHER ALLOWED LIQUID CHEMICALS IN EXCESS OF 55 GALLONS SHALL REQUIRE ADEQUATE SECONDARY CONTAINMENT PROTECTION TO CONTAIN ALL SPILLS ONSITE AND TO PREVENT ANY SPILLED MATERIALS FROM ENTERING STATE WATERS, ANY SURFACE OR SUBSURFACE STORM DRAINAGE SYSTEM OR OTHER FACILITIES.
- NO PERSON SHALL CAUSE THE IMPEDIMENT OF STORMWATER FLOW IN THE CURB AND GUTTER OR DITCH EXCEPT WITH APPROVED SEDIMENT CONTROL MEASURES.
- OWNER/DEVELOPER AND THEIR AGENTS SHALL COMPLY WITH THE "COLORADO WATER QUALITY CONTROL ACT" (TITLE 25, ARTICLE 8, CRS), AND THE "CLEAN WATER ACT" (33 USC 1344), IN ADDITION TO THE REQUIREMENTS OF THE LAND DEVELOPMENT CODE, DCM VOLUME II AND THE ECM APPENDIX I. ALL APPROPRIATE PERMITS MUST BE OBTAINED BY THE CONTRACTOR PRIOR TO CONSTRUCTION (1041, NPDES, FLOODPLAIN, 404, FUGITIVE DUST, ETC.). IN THE EVENT OF CONFLICTS BETWEEN THESE REQUIREMENTS AND OTHER LAWS, RULES, OR REGULATIONS OF OTHER FEDERAL, STATE, LOCAL OR COUNTY AGENCIES, THE MOST RESTRICTIVE LAWS, RULES, OR REGULATIONS SHALL APPLY.
- ALL CONSTRUCTION TRAFFIC MUST ENTER/EXIT THE SITE ONLY AT APPROVED CONSTRUCTION ACCESS POINTS.
- PRIOR TO CONSTRUCTION THE PERMITTEE SHALL VERIFY THE LOCATION OF EXISTING UTILITIES.
- A WATER SOURCE SHALL BE AVAILABLE ON SITE DURING EARTHWORK OPERATIONS AND SHALL BE UTILIZED AS REQUIRED TO MINIMIZE DUST FROM EARTHWORK EQUIPMENT AND WIND.
- THE GEOTECHNICAL EVALUATION FOR THIS SITE HAS BEEN PREPARED BY CTL THOMPSON, INC AND SHALL BE CONSIDERED A PART OF THESE PLANS.
- AT LEAST TEN (10) DAYS PRIOR TO THE ANTICIPATED START OF CONSTRUCTION, FOR PROJECTS THAT WILL DISTURB ONE (1) ACRE OR MORE, THE OWNER OR OPERATOR OF CONSTRUCTION ACTIVITY SHALL SUBMIT A PERMIT APPLICATION FOR STORMWATER DISCHARGE TO THE COLORADO DEPARTMENT OF PUBLIC HEALTH AND ENVIRONMENT, WATER QUALITY DIVISION, THE APPLICATION CONTAINS CERTIFICATION OF COMPLETION OF A STORMWATER MANAGEMENT PLAN (SWMP), OF WHICH THIS GRADING AND EROSION CONTROL PLAN MAY BE A PART. FOR INFORMATION OR APPLICATION MATERIALS CONTACT:

COLORADO DEPARTMENT OF PUBLIC HEALTH AND ENVIRONMENT  
WATER QUALITY CONTROL DIVISION  
WQCD - PERMITS  
4300 CHERRY CREEK DRIVE SOUTH  
DENVER, CO 80246-1530  
ATTN: PERMITS UNIT  
<https://cdphe.colorado.gov/cor400000-stormwater-discharge>

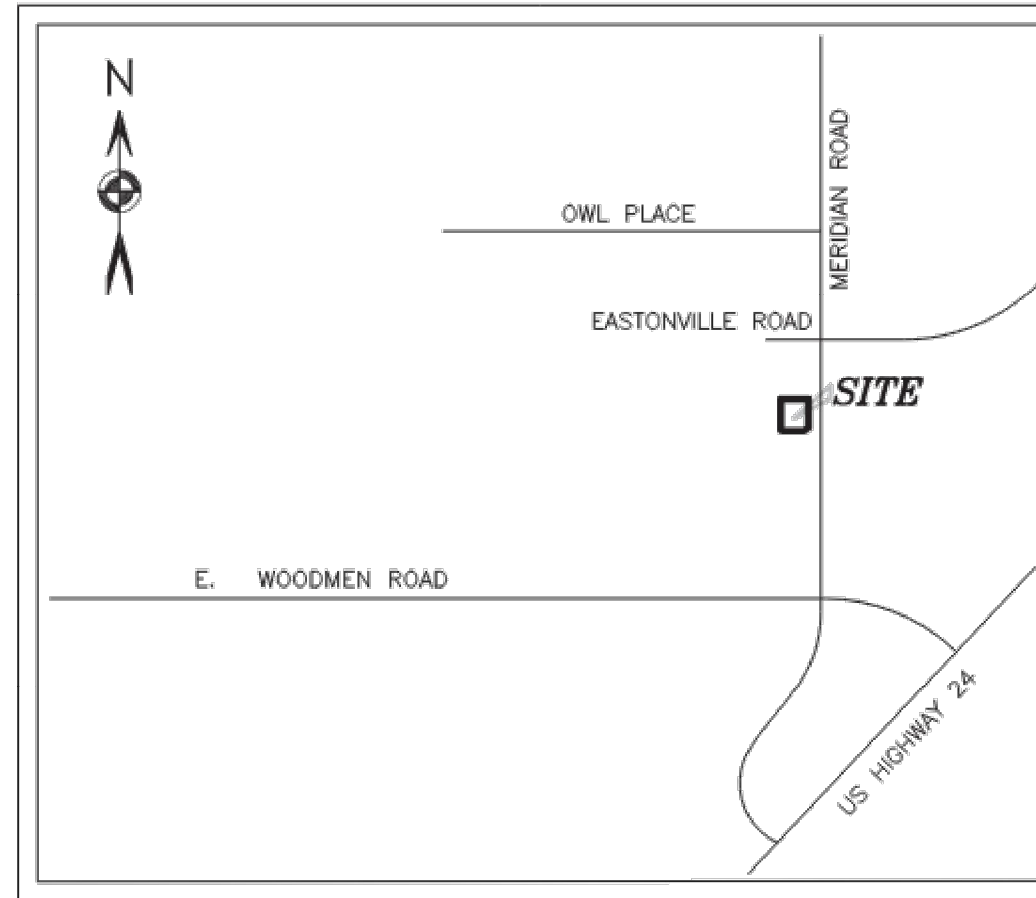

VICINITY MAP  
(NOT TO SCALE)

CONSTRUCTION DOCUMENTS	
SHEET NUMBER	SHEET TITLE
C2.0	COVER SHEET & GENERAL NOTES
C2.1	INITIAL EROSION CONTROL PLAN
C2.2	FINAL EROSION CONTROL PLAN
C2.3	GRADING PLAN
C2.4	EROSION CONTROL DETAILS
C2.5	EROSION CONTROL DETAILS
C2.6	EROSION CONTROL DETAILS
C2.7	EROSION CONTROL DETAILS
C2.8	EROSION CONTROL DETAILS

#### LAND AREA:

51,052 SQ. FT. OR 1.172 ACRES MORE OR LESS

#### BASIS OF BEARING:

BEARINGS ARE BASED UPON A LINE LYING 30° WESTERLY AND PARALLEL OF THE EAST LINE OF SOUTHEAST QUARTER OF SECTION 1, TOWNSHIP 13 SOUTH, RANGE 65 WEST OF THE 6TH P.M. AS SHOWN OF THE PLAT OF FALCON MARKETPLACE, MONUMENTED AT THE NORTH END WITH A #5 REBAR AND YELLOW PLASTIC CAP STAMPED "PLS 31548" AND MONUMENTED AT THE SOUTH END WITH A MAG NAIL AND WASHER STAMPED "PLS 31548", AND IS ASSUMED TO BEAR N 00°29'40" W, A DISTANCE OF 1137.83'.

#### BENCHMARK:

ELEVATIONS ARE BASED UPON THE COLORADO SPRINGS UTILITIES FACILITIES INFORMATION MANAGEMENT SYSTEM (FIMS) MONUMENT BLT167 (ELEVATION = 6873.18 NVGD29)

#### LEGAL DESCRIPTION

PARCEL A, LOT 4, FALCON MARKETPLACE

#### FEMA CLASSIFICATION

THIS SITE IS NOT WITHIN A DESIGNATED F.E.M.A. FLOODPLAIN AS DETERMINED BY FLOOD INSURANCE RATE MAP, COMMUNITY PANEL NUMBER 08041C0553G EFFECTIVE DATE DECEMBER 7, 2018 AND IS LABELED AS A "ZONE "X" AREA, OR AREA OF MINIMAL FLOOD HAZARD.

#### SOIL TYPE

THE SOIL ON SITE IS CLASSIFIED WITH THE USCS AS MOSTLY GRAVELLY SANDY LOAM CLASSIFIED AS HYDROLOGIC SOIL GROUP A.

#### CONTACTS:

**DEVELOPER:**  
HALLE PROPERTIES, LLC.  
20225 N. SCOTTSDALE ROAD  
SCOTTSDALE, AZ 85255  
TEL: (480) 606-6845  
CONTACT: LESLIE GERMAN  
EMAIL: LESLIE.GERMAN@DISCOUNTTIRE.COM

**ARCHITECT:**  
PLUMP ENGINEERING, INC  
914 E. KATELLA AVE.  
ANAHEIM, CA 92805  
TEL: (714) 385-1835  
CONTACT: ERIC KAELEBLE  
EMAIL: EKAELEBLE@PEICA.COM

**ENGINEER:**  
KIMLEY-HORN AND ASSOCIATES, INC.  
2790 N. ACADEMY BOULEVARD, SUITE 311  
COLORADO SPRINGS, CO 80903  
TEL: (719) 453-0180  
CONTACT: MITCHELL HESS, P.E.  
EMAIL: MITCHELL.HESS@KIMLEY-HORN.COM

**SURVEYOR:**  
BARRON LAND SURVEYING  
2790 N. ACADEMY BOULEVARD, SUITE 311  
COLORADO SPRINGS, CO 80917  
TEL: (719) 360-6827  
CONTACT: SPENCER BARRON P.L.S.  
EMAIL: SPENCER@BARRONLAND.COM

**LANDSCAPE ARCHITECT:**  
KIMLEY-HORN AND ASSOCIATES, INC.  
20225 N. SCOTTSDALE ROAD  
SCOTTSDALE, AZ 85255  
TEL: (719) 453-0180  
CONTACT: JEREMY POWELL, P.L.A.  
EMAIL: JEREMY.POWELL@KIMLEY-HORN.COM

**OWNER:**  
HALLE PROPERTIES, LLC.  
20225 N. SCOTTSDALE ROAD  
SCOTTSDALE, AZ 85255  
TEL: (480) 606-6845  
CONTACT: LESLIE GERMAN  
EMAIL: LESLIE.GERMAN@DISCOUNTTIRE.COM

#### OWNER'S SIGNATURE BLOCK

I, THE OWNER/DEVELOPER HAVE READ AND WILL COMPLY WITH THE REQUIREMENTS OF THE GRADING AND EROSION CONTROL PLAN.

NAME \_\_\_\_\_ DATE \_\_\_\_\_

#### ENGINEER'S SIGNATURE BLOCK

THIS GRADING AND EROSION CONTROL PLAN WAS PREPARED UNDER MY DIRECTION AND SUPERVISION AND IS CORRECT TO THE BEST OF MY KNOWLEDGE AND BELIEF. SAID PLAN HAS BEEN PREPARED ACCORDING TO THE CRITERIA ESTABLISHED BY THE COUNTY FOR GRADING AND EROSION CONTROL PLANS. I ACCEPT RESPONSIBILITY FOR ANY LIABILITY CAUSED BY ANY NEGLIGENT ACTS, ERRORS OR OMISSIONS ON MY PART IN PREPARING THIS PLAN.

MITCHELL HESS, PE \_\_\_\_\_ DATE \_\_\_\_\_  
KIMLEY-HORN AND ASSOCIATES, INC.

#### EL PASO COUNTY REVIEW STATEMENT

COUNTY PLAN REVIEW IS PROVIDED ONLY FOR GENERAL CONFORMANCE WITH COUNTY DESIGN CRITERIA. THE COUNTY IS NOT RESPONSIBLE FOR THE ACCURACY AND ADEQUACY OF THE DESIGN, DIMENSION, AND/OR ELEVATIONS WHICH SHALL BE CONFIRMED AT THE JOB SITE. THE COUNTY THROUGH THE APPROVAL OF THIS DOCUMENT ASSUMES NO RESPONSIBILITY FOR COMPLETENESS AND/OR ACCURACY OF THIS DOCUMENT.

FILED IN ACCORDANCE WITH THE REQUIREMENTS OF THE EL PASO COUNTY LAND DEVELOPMENT CODE, DRAINAGE CRITERIA MANUAL VOLUMES 1 AND 2, AND ENGINEERING CRITERIA MANUAL AS AMENDED.

IN ACCORDANCE WITH ECM SECTION 1.12, THESE CONSTRUCTION DOCUMENTS WILL BE VALID FOR A CONSTRUCTION FOR A PERIOD OF 2 YEARS FROM THE DATE SIGNED BY THE EL PASO COUNTY ENGINEER. IF THE CONSTRUCTION HAS NOT STARTED WITHIN THOSE 2 YEARS, THE PLANS WILL NEED TO BE RESUBMITTED FOR APPROVAL, INCLUDING PAYMENT OF REVIEW FEES AT THE PLANNING AND COMMUNITY DEVELOPMENT DIRECTOR'S DISCRETION.

JENNIFER IRVINE, P.E. COUNTY ENGINEER/ ECM ADMINISTRATOR \_\_\_\_\_ DATE \_\_\_\_\_

THIS DRAWING IS AN INSTRUMENT OF SERVICE AND THE PROPERTY OF DISCOUNT TIRE COMPANY AND SHALL REMAIN SUCH. THE USE OF THIS DRAWING SHALL BE RESTRICTED TO THE ORIGINAL SITE FOR WHICH IT WAS PREPARED. PUBLICATION THEREOF IS EXPRESSLY LIMITED TO SUCH.

NO.	REVISION	DATE



PROJECT NAME:  
DISCOUNT TIRE - FALCON, CO

PROJECT ADDRESS:  
7585 FALCON MARKETPLACE

PROJECT NUMBER:  
096010025

DATE:  
08/05/2021

DESIGNED BY:  
JWM

REVIEWED BY:  
MOH

SHEET TITLE:  
COVER SHEET & GENERAL NOTES

SHEET NUMBER:  
C2.0

K:\05\_08\096010025.DTC\_Falcon\_CO\0400\PlanSheet\04\_01.dwg Aug 04, 2021 2:17pm  
This document, together with the concepts and designs presented herein, is intended only for the specific purpose and client for which it was prepared. Reuse of this document, or any part thereof, without written authorization and approval by Kimley-Horn and Associates, Inc. shall be without liability to Kimley-Horn and Associates, Inc.



**LEGEND**

- (LOD) CONSTRUCTION BOUNDARY/LIMITS OF DISTURBANCE (±1.18 AC)
- (CF) CONSTRUCTION FENCE
- (SF) SILT FENCE
- (SP) SOIL STOCKPILE
- (SSA) STABILIZED STAGING AREA
- (VTC) VEHICLE TRACKING CONTROL
- (CWA) CONCRETE WASHOUT
- (IP) INLET PROTECTION
- (SS) STREET SWEEPING
- (TSB) TEMPORARY SEDIMENT BASIN
- EXISTING GRADE SLOPE
- CUT/FILL DEMARCATION
- (DD) DIVERSION DITCH AND CHECK DAM
- (RS) ROCK SOCKS

**EXISTING SOIL TYPE**

BLAKELAND-FLUVAQUENTIC HAPLAQUOLLS: 16% OF SITE  
 COLUMBINE GRAVELLY SANDY LOAM: 86% OF SITE

**GENERAL NOTES:**

1. MASTER DEVELOPER IS CURRENTLY WORKING THROUGH LOMR TO REVISE EXTENTS OF 100-YEAR FLOODPLAIN. SITE IS CURRENTLY NOT WITHIN THE 100-YEAR FLOODPLAIN AND WILL REMAIN OUTSIDE OF THE 100-YEAR FLOODPLAIN AFTER THE LOMR HAS BEEN ACCEPTED BY FEMA.
2. TEMPORARY SEDIMENT BASIN EMERGENCY SPILLWAY TO DIRECT FLOWS WEST TOWARD EXISTING 10' TYPE R INLET IN FALCON MARKET PL.

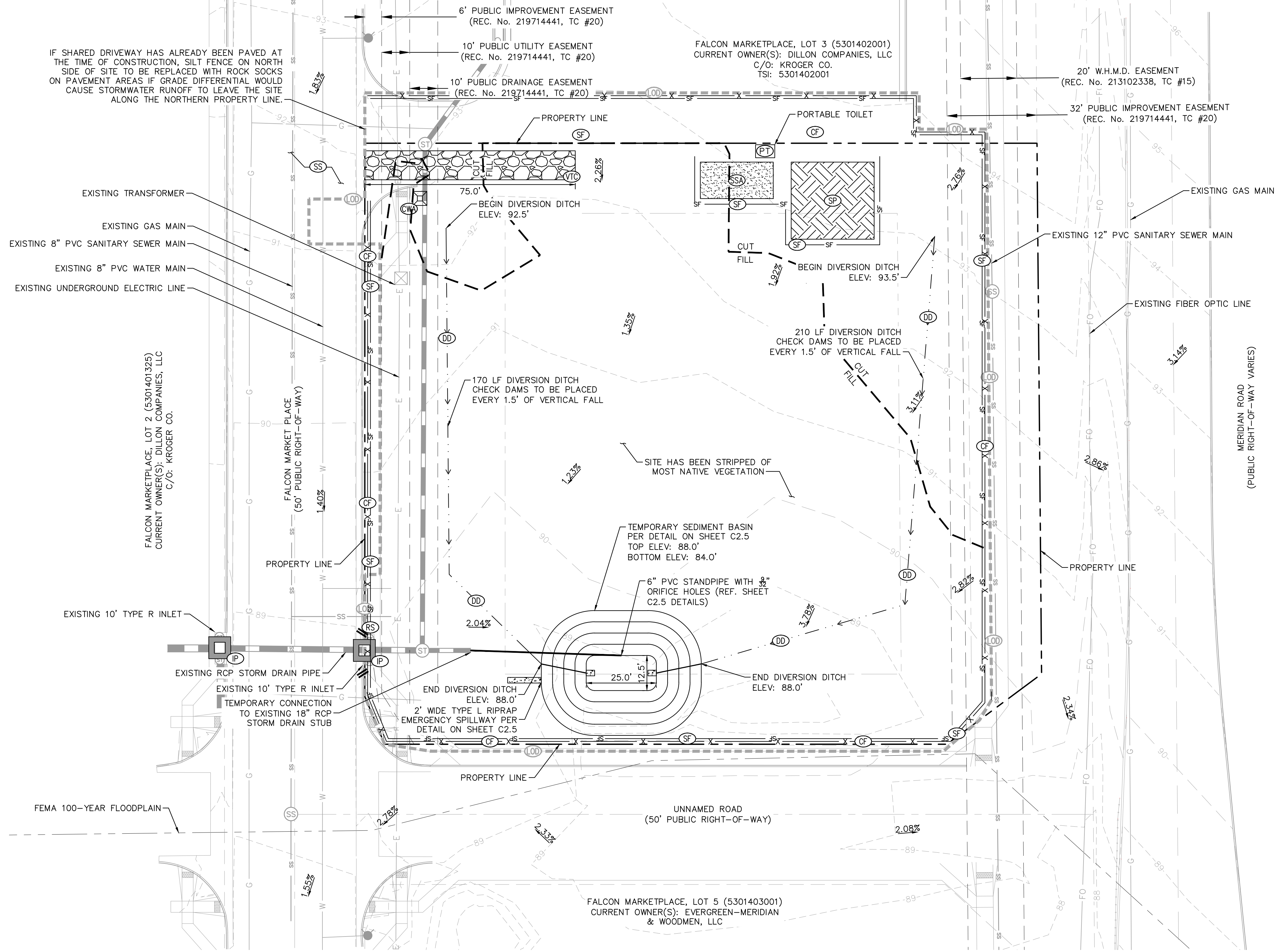
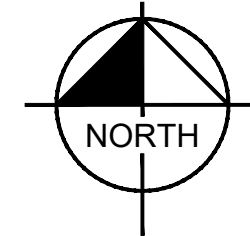
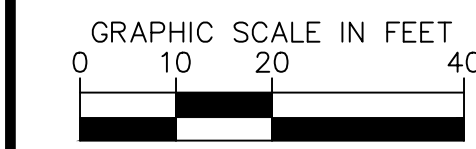

K:\05\_096010025.DWG Falcon CO\05096010025\05096010025.dwg Aug 04, 2021 2:18pm  
 This document, together with the concepts and designs presented herein, as an instrument of service, is intended only for the specific purpose and client for which it was prepared. It is not to be used for any other purpose without the written authorization and adaptation by Kimley-Horn and Associates, Inc. shall be without liability to Kimley-Horn and Associates, Inc.

THIS DRAWING IS AN INSTRUMENT OF SERVICE AND THE PROPERTY OF DISCOUNT TIRE COMPANY AND SHALL REMAIN SUCH. THE USE OF THIS DRAWING SHALL BE RESTRICTED TO THE ORIGINAL SITE FOR WHICH IT WAS PREPARED. PUBLICATION THEREOF IS EXPRESSLY LIMITED TO SUCH.	NO.	REVISION	DATE



**Kimley»Horn**

©2021 2 N. NEVADA AVE., SUITE 300  
 COLORADO SPRINGS, CO 80903 (719) 453-0180

PROJECT NAME:  
DISCOUNT TIRE - FALCON, CO

PROJECT ADDRESS:  
7585 FALCON MARKETPLACE

PROJECT NUMBER:  
096010025

DATE:  
08/05/2021

DESIGNED BY:  
JWM

REVIEWED BY:  
MOH

SHEET TITLE:  
**INITIAL EROSION CONTROL PLAN**

SHEET NUMBER:  
**C2.1**



**LEGEND**

- (LOD) CONSTRUCTION BOUNDARY/LIMITS OF DISTURBANCE (±1.18 AC)
- X- (CF) CONSTRUCTION FENCE
- SF- (SF) SILT FENCE
- [SP] (SP) SOIL STOCKPILE
- [SSA] (SSA) STABILIZED STAGING AREA
- [VTC] (VTC) VEHICLE TRACKING CONTROL
- [SM] (SM) PERMANENT LANDSCAPING/SEEDING. REFER TO APPROVED LANDSCAPE.
- [CWA] (CWA) CONCRETE WASHOUT
- [IP] (IP) INLET PROTECTION
- [SS] (SS) STREET SWEEPING
- X.X% (X.X%) PROPOSED GRADE SLOPE
- - - (CUT/FILL) CUT/FILL DEMARCATION
- [RS] (RS) ROCK SOCKS

**EXISTING SOIL TYPE**

BLAKELAND-FLUVAQUENTIC HAPLAQUOLLS: 16% OF SITE  
 COLUMBINE GRAVELLY SANDY LOAD: 86% OF SITE

**GENERAL NOTES:**

1. MASTER DEVELOPER IS CURRENTLY WORKING THROUGH LOMR TO REVISE EXTENTS OF 100-YEAR FLOODPLAIN.

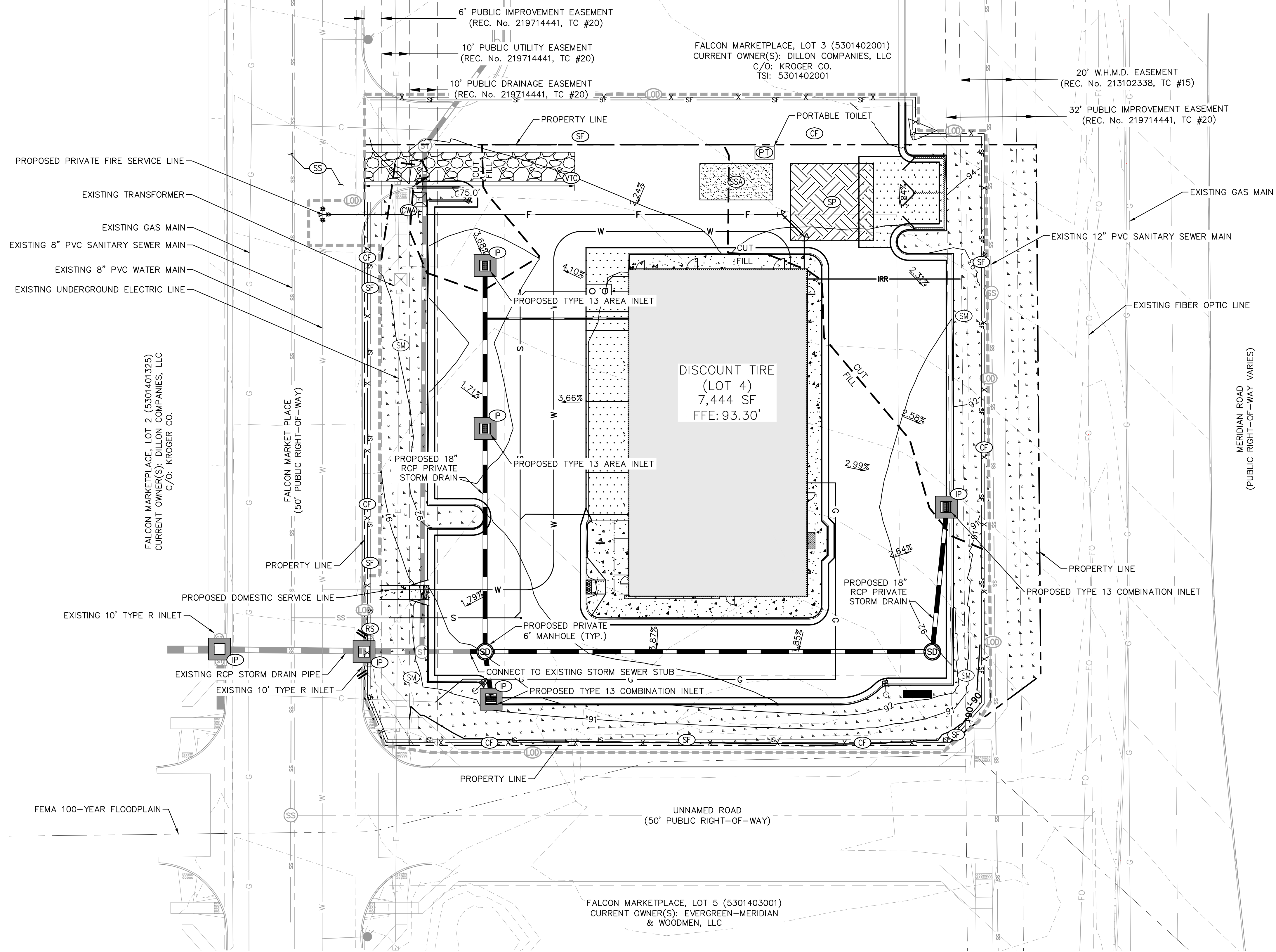
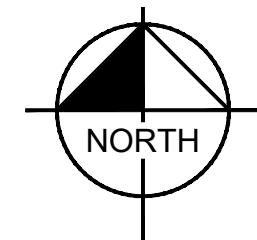

K:\05\_096010025.DWG Falcon CO\05096010025\05096010025.dwg Aug 04, 2021 2:18pm  
 This document, together with the concepts and designs presented herein, is intended only for the specific purpose and client for which it was prepared. Reuse of this document, together with the concepts and designs presented herein, as an instrument of service, is intended only for the specific purpose and client for which it was prepared. Reuse of this document, together with the concepts and designs presented herein, as an instrument of service, is intended only for the specific purpose and client for which it was prepared. Reuse of this document, together with the concepts and designs presented herein, as an instrument of service, is intended only for the specific purpose and client for which it was prepared.

THIS DRAWING IS AN INSTRUMENT OF SERVICE AND THE PROPERTY OF DISCOUNT TIRE COMPANY AND SHALL REMAIN SUCH. THE USE OF THIS DRAWING SHALL BE RESTRICTED TO THE ORIGINAL SITE FOR WHICH IT WAS PREPARED. PUBLICATION THEREOF IS EXPRESSLY LIMITED TO SUCH.

NO.	REVISION	DATE



PROJECT NAME:  
 DISCOUNT TIRE - FALCON, CO

PROJECT ADDRESS:  
 7585 FALCON MARKETPLACE

PROJECT NUMBER:  
 096010025

DATE:  
 08/05/2021

DESIGNED BY:  
 JWM

REVIEWED BY:  
 MOH

SHEET TITLE:  
 FINAL EROSION CONTROL PLAN

SHEET NUMBER:  
 C2.2



**LEGEND**

- PROPERTY LINE
- BUILDING SETBACK LINE
- EASEMENT
- GRADE BREAK
- ADA STALL AREA DELINEATION
- AR ACCESSIBLE ROUTE
- LANDSCAPE
- PROPOSED HEAVY DUTY CONCRETE PAVEMENT
- PROPOSED SIDEWALK CONCRETE PAVEMENT
- 6000 PROPOSED MAJOR CONTOUR
- 6001 PROPOSED MINOR CONTOUR
- 6000 EXISTING MAJOR CONTOUR
- 6001 EXISTING MINOR CONTOUR
- FG FINISHED GRADE
- FFE FINISH FLOOR ELEVATION
- LP LOW POINT
- ME MATCH EXISTING
- FL FLOW LINE
- HP HIGH POINT
- SW SIDEWALK
- TOC TOP/BACK OF CURB

**GENERAL NOTES**

1. ADD 6800 FEET TO ALL PROPOSED CONTOURS AND SPOT GRADES TO OBTAIN ELEVATIONS IN REFERENCE TO NAVD88 DATUM.
2. ALL SPOT GRADE ELEVATIONS ARE CURB FLOWLINE ELEVATIONS UNLESS INDICATED OTHERWISE.
3. ADD 0.5' TO SPOT GRADE ELEVATIONS FOR TOP OF CURB ELEVATIONS, UNLESS OTHERWISE INDICATED.
4. ALL SLOPES ACROSS ADA PARKING SPACES AND ROUTES SHALL BE 2% MAX. IN ALL DIRECTIONS.
5. ALL CROSS SLOPES ACROSS ADA PATH OF TRAVELS SHALL BE 2% MAX AND ALL LONGITUDINAL SLOPES IN NON-RAMP AREAS SHALL BE 5% MAX.
6. REFER TO ARCHITECTURAL PLANS FOR MIN. 5-FT ARCHITECTURAL STOOPS OUTSIDE DOORS. SLOPES ACROSS ARCHITECTURAL STOOPS SHALL BE 2% MAX. IN ALL DIRECTIONS.

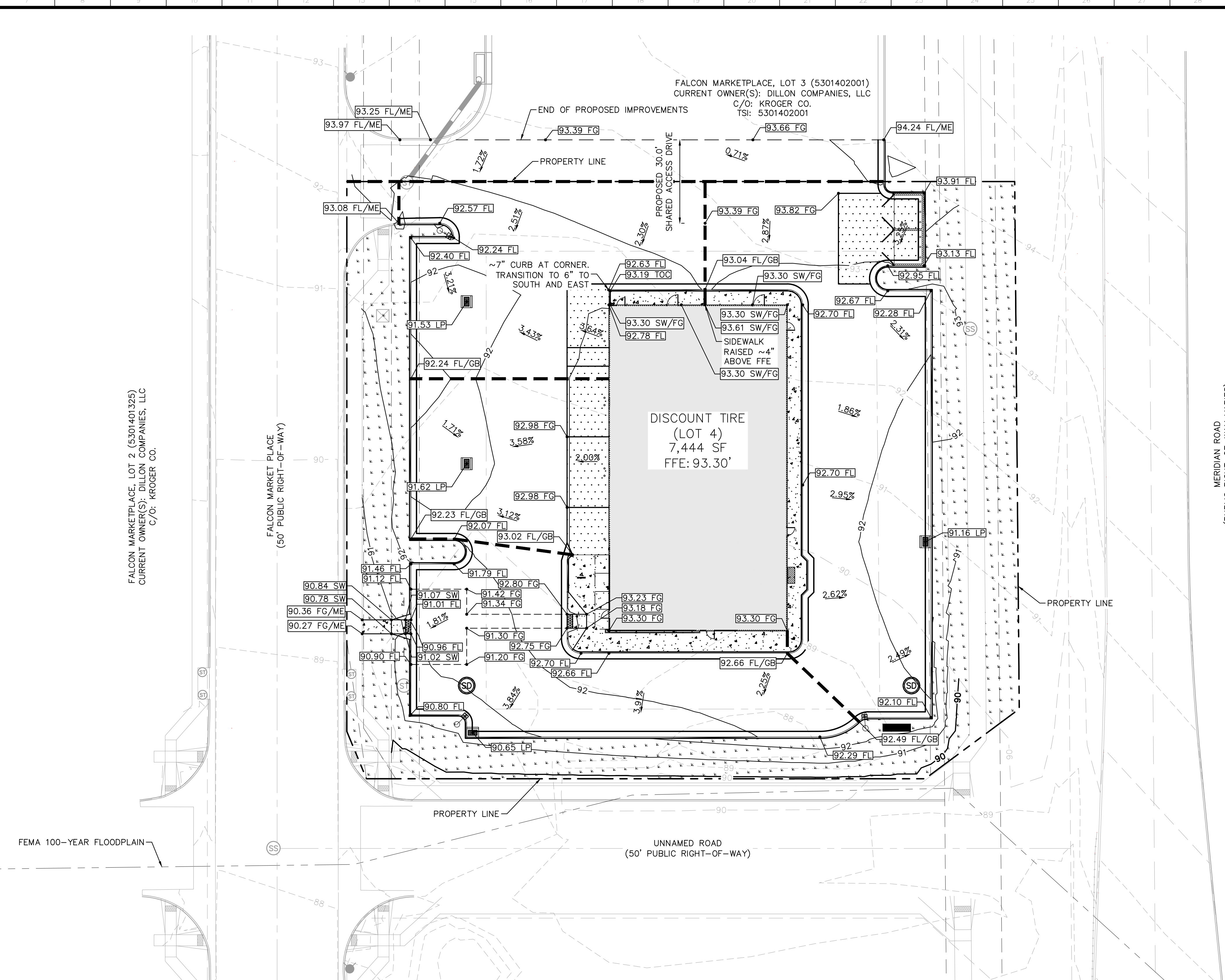
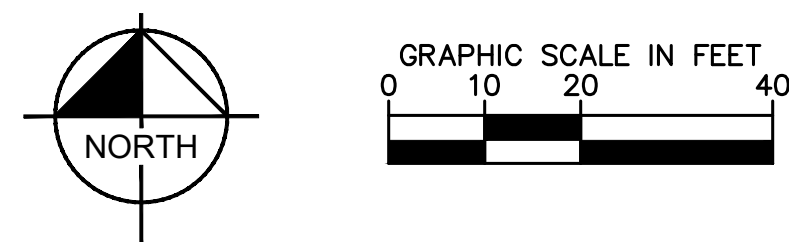

K:\05\_09\09090205.DWG Falcon CO\0509090205\0509090205.dwg Aug 04, 2021 2:18pm  
 This drawing is intended only for the specific purpose and client for which it was prepared. Reuse of this document, together with the concepts and design presented herein, as an instrument of service, is intended only for the specific purpose and client for which it was prepared. Reuse of this document, together with the concepts and design presented herein, as an instrument of service, is intended only for the specific purpose and client for which it was prepared. Reuse of this document, together with the concepts and design presented herein, as an instrument of service, is intended only for the specific purpose and client for which it was prepared.

THIS DRAWING IS AN INSTRUMENT OF SERVICE AND THE PROPERTY OF DISCOUNT TIRE COMPANY AND SHALL REMAIN SUCH. THE USE OF THIS DRAWING SHALL BE RESTRICTED TO THE ORIGINAL SITE FOR WHICH IT WAS PREPARED. PUBLICATION THEREOF IS EXPRESSLY LIMITED TO SUCH.		NO.	REVISION	DATE



PROJECT NAME:  
 DISCOUNT TIRE - FALCON, CO  
 PROJECT ADDRESS:  
 7585 FALCON MARKETPLACE

PROJECT NUMBER:  
 096010025  
 DATE:  
 08/05/2021  
 DESIGNED BY:  
 JWM  
 REVIEWED BY:  
 MOH

SHEET TITLE:  
 GRADING PLAN  
 SHEET NUMBER:  
 C2.3



**SEEDING & MULCHING**

ALL SOIL TESTING, SOILS AMENDMENT AND FERTILIZER DOCUMENTATION, AND SEED LOAD AND BAG TICKETS MUST BE ADDED TO THE CSWMP.

**SOIL PREPARATION**

- IN AREAS TO BE SEED, THE UPPER 6 INCHES OF THE SOIL MUST NOT BE HEAVILY COMPACTED, AND SHOULD BE IN FRIABLE CONDITION. LESS THAN 85% STANDARD PROCTOR DENSITY IS ACCEPTABLE. AREAS OF COMPACTION OR GENERAL CONSTRUCTION ACTIVITY MUST BE SCARIFIED TO A DEPTH OF 6 TO 12 INCHES PRIOR TO SPREADING TOPSOIL TO BREAK UP COMPACTED LAYERS AND PROVIDE A BLENDING ZONE BETWEEN DIFFERENT SOIL LAYERS.
- AREAS TO BE PLANTED SHALL HAVE AT LEAST 4 INCHES OF TOPSOIL SUITABLE TO SUPPORT PLANT GROWTH.
- THE CITY RECOMMENDS THAT EXISTING AND/OR IMPORTED TOPSOIL BE TESTED TO IDENTIFY SOIL DEFICIENCIES AND ANY SOIL AMENDMENTS NECESSARY TO ADDRESS THESE DEFICIENCIES. SOIL AMENDMENTS AND/OR FERTILIZERS SHOULD BE ADDED TO CORRECT TOPSOIL DEFICIENCIES BASED ON SOIL TESTING RESULTS.
- TOPSOIL SHALL BE PROTECTED DURING THE CONSTRUCTION PERIOD TO RETAIN ITS STRUCTURE AVOID COMPACTION, AND TO PREVENT EROSION AND CONTAMINATION. STRIPPED TOPSOIL MUST BE STORED IN AN AREA AWAY FROM MACHINERY AND CONSTRUCTION OPERATIONS, AND CARE MUST BE TAKEN TO PROTECT THE TOPSOIL AS A VALUABLE COMMODITY. TOPSOIL MUST NOT BE STRIPPED DURING UNDESIRABLE WORKING CONDITIONS (E.G. DURING WET WEATHER OR WHEN SOILS ARE SATURATED). TOPSOIL SHALL NOT BE STORED IN SWALES OR IN AREAS WITH POOR DRAINAGE.

**SEEDING**

- ALLOWABLE SEED MIXES ARE INCLUDED IN THE CITY OF COLORADO SPRINGS STORMWATER CONSTRUCTION MANUAL. ALTERNATIVE SEED MIXES ARE ACCEPTABLE IF INCLUDED IN AN APPROVED LANDSCAPING PLAN.
- SEED SHOULD BE DRILL-SEEDED WHENEVER POSSIBLE.
  - SEED DEPTH MUST BE 1/2 TO 3/4 INCHES WHEN DRILL-SEEDED IS USED.
- BROADCAST SEEDING OR HYDRO-SEEDED WITH TACKIFIER MAY BE SUBSTITUTED ON SLOPES STEEPER THAN 3:1 OR ON OTHER AREAS NOT PRACTICAL TO DRILL-SEED.
  - SEEDING RATES MUST BE DOUBLED FOR BROADCAST SEEDING OR INCREASED BY 50% IF USING A BRILLION DRILL OR HYDRO-SEEDED.
  - BROADCAST SEEDING MUST BE LIGHTLY HAND-RAKED INTO THE SOIL.

**MULCHING**

- MULCHING SHOULD BE COMPLETED AS SOON AS PRACTICABLE AFTER SEEDING, HOWEVER PLANTED AREAS MUST BE MULCHED NO LATER THAN 14 DAYS AFTER PLANTING.
- MULCHING REQUIREMENTS INCLUDE:
  - HAY OR STRAW MULCH
    - ONLY CERTIFIED WEED-FREE AND CERTIFIED SEED-FREE MULCH MAY BE USED. MULCH MUST BE APPLIED AT 2 TONS/ACRE AND ADEQUATELY SECURED BY CRIMPING AND/OR TACKIFIER.
    - CRIMPING MUST NOT BE USED ON SLOPES GREATER THAN 3:1 AND MULCH FIBERS MUST BE TUCKED INTO THE SOIL TO A DEPTH OF 3 TO 4 INCHES.
  - TACKIFIER MUST BE USED IN PLACE OF CRIMPING ON SLOPES STEEPER THAN 3:1.
- HYDRAULIC MULCHING
  - HYDRAULIC MULCHING IS AN OPTION ON STEEP SLOPES OR WHERE ACCESS IS LIMITED.
  - IF HYDRO-SEEDED IS USED, MULCHING MUST BE APPLIED AS A SEPARATE, SECOND OPERATION.
  - WOOD CELLULOSE FIBERS MIXED WITH WATER MUST BE APPLIED AT A RATE OF 2,000 TO 2,500 POUNDS/ACRE, AND TACKIFIER MUST BE APPLIED AT A RATE OF 100 POUNDS/ACRE.
- EROSION CONTROL BLANKET
  - EROSION CONTROL BLANKET MAY BE USED IN PLACE OF TRADITIONAL MULCHING METHODS.



	SEEDING & MULCHING	
	APPROVED: <i>[Signature]</i>	
	ISSUED: 10/7/19	REVISION: 8/19/2020
	DRAWING NO. 900-SM	

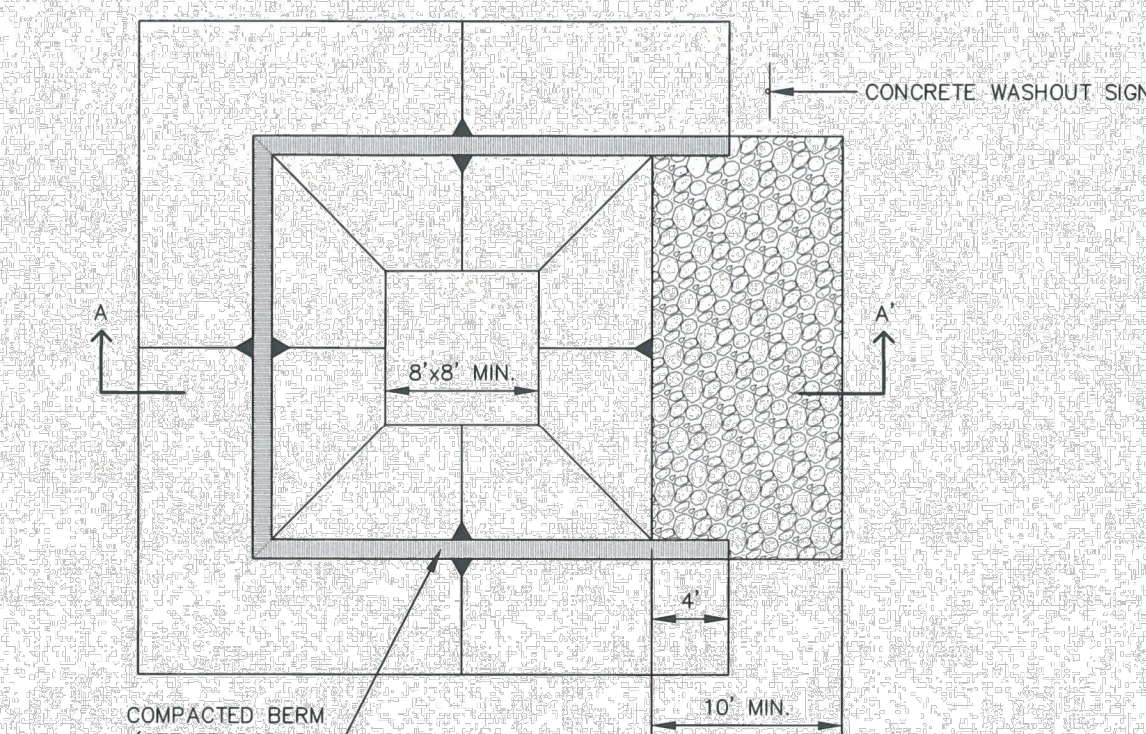

**CONCRETE WASHOUT AREA PLAN**

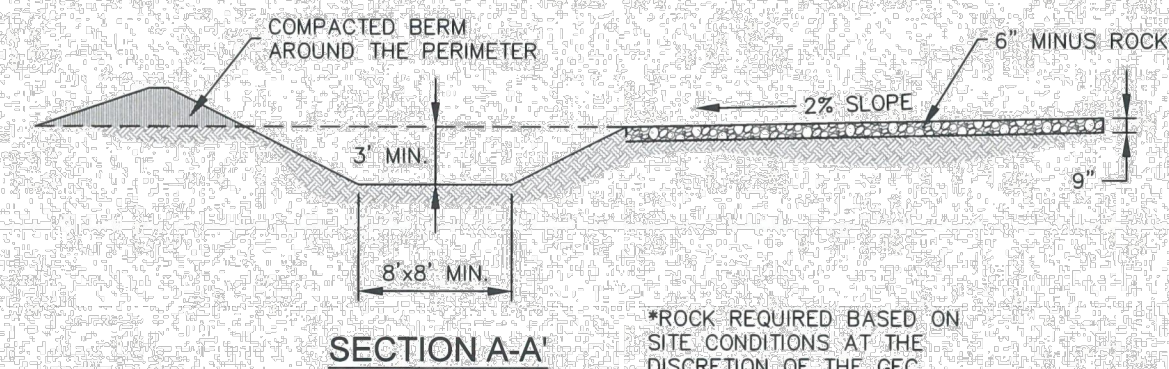

**SECTION A-A'**

\*ROCK REQUIRED BASED ON SITE CONDITIONS AT THE DISCRETION OF THE DEC INSPECTOR



	CONCRETE WASHOUT AREA	
	APPROVED: <i>[Signature]</i>	
	ISSUED: 10/7/19	REVISION: 8/19/2020
	DRAWING NO. 900-CWA-1	

**INSTALLATION NOTES**

- SEE PLAN VIEW FOR:
  - LOCATION OF CONCRETE WASHOUT AREA
  - LOCATE AT LEAST 50' AWAY FROM STATE WATERS MEASURED HORIZONTALLY.
- AN IMPERMEABLE LINER (16 MIL. MINIMUM THICKNESS) IS REQUIRED IF CONCRETE WASH AREA IS LOCATED WITHIN 400' OF STATE WATERS OR 1000' OF WELLS OR DRINKING WATER SOURCES.
- DO NOT LOCATE IN AREAS WHERE SHALLOW GROUNDWATER MAY BE PRESENT.
- THE CONCRETE WASH AREA SHALL BE INSTALLED PRIOR TO CONCRETE PLACEMENT ON SITE.
- CONCRETE WASH AREA SHALL INCLUDE A FLAT SUBSURFACE PIT THAT IS AT LEAST 8' BY 8'.
- BERM SURROUNDING SIDES AND BACK OF CONCRETE WASH AREA SHALL HAVE A MINIMUM HEIGHT OF 2 FEET.
- CONCRETE WASH AREA ENTRANCE SHALL BE SLOPED 2% TOWARDS THE CONCRETE WASH AREA.
- SIGNS SHALL BE PLACED AT THE CONCRETE WASH AREA.
- USE EXCAVATED MATERIAL FOR PERIMETER BERM CONSTRUCTION.

**MAINTENANCE NOTES**

- FREQUENT OBSERVATIONS AND MAINTENANCE ARE NECESSARY TO MAINTAIN CONTROL MEASURES IN EFFECTIVE OPERATING CONDITION. INSPECTIONS AND CORRECTIVE MEASURES SHOULD BE DOCUMENTED THOROUGHLY.
- THE CONCRETE WASH AREA SHALL BE REPAIRED, CLEANED, OR ENLARGED AS NECESSARY TO MAINTAIN CAPACITY FOR CONCRETE WASTE. CONCRETE MATERIALS ACCUMULATED IN THE PIT SHALL BE REMOVED ONCE THE MATERIALS HAVE REACHED A DEPTH OF 3/4 THE HEIGHT OF THE CONCRETE WASH AREA.
- CONCRETE WASHOUT WATER, WASTED PIECES OF CONCRETE, AND ALL OTHER DEBRIS IN THE SUBSURFACE PIT SHALL BE TRANSPORTED FROM THE JOB SITE IN A WATER-TIGHT CONTAINER AND DISPOSED OF PROPERLY.
- THE CONCRETE WASH AREA SHALL REMAIN IN PLACE UNTIL ALL CONCRETE FOR THE PROJECT IS PLACED.
- PERMANENTLY STABILIZE AREA AFTER CONCRETE WASH AREA IS REMOVED.



	CONCRETE WASHOUT AREA	
	APPROVED: <i>[Signature]</i>	
	ISSUED: 10/7/19	REVISION: 8/19/2020
	DRAWING NO. 900-CWA-2	

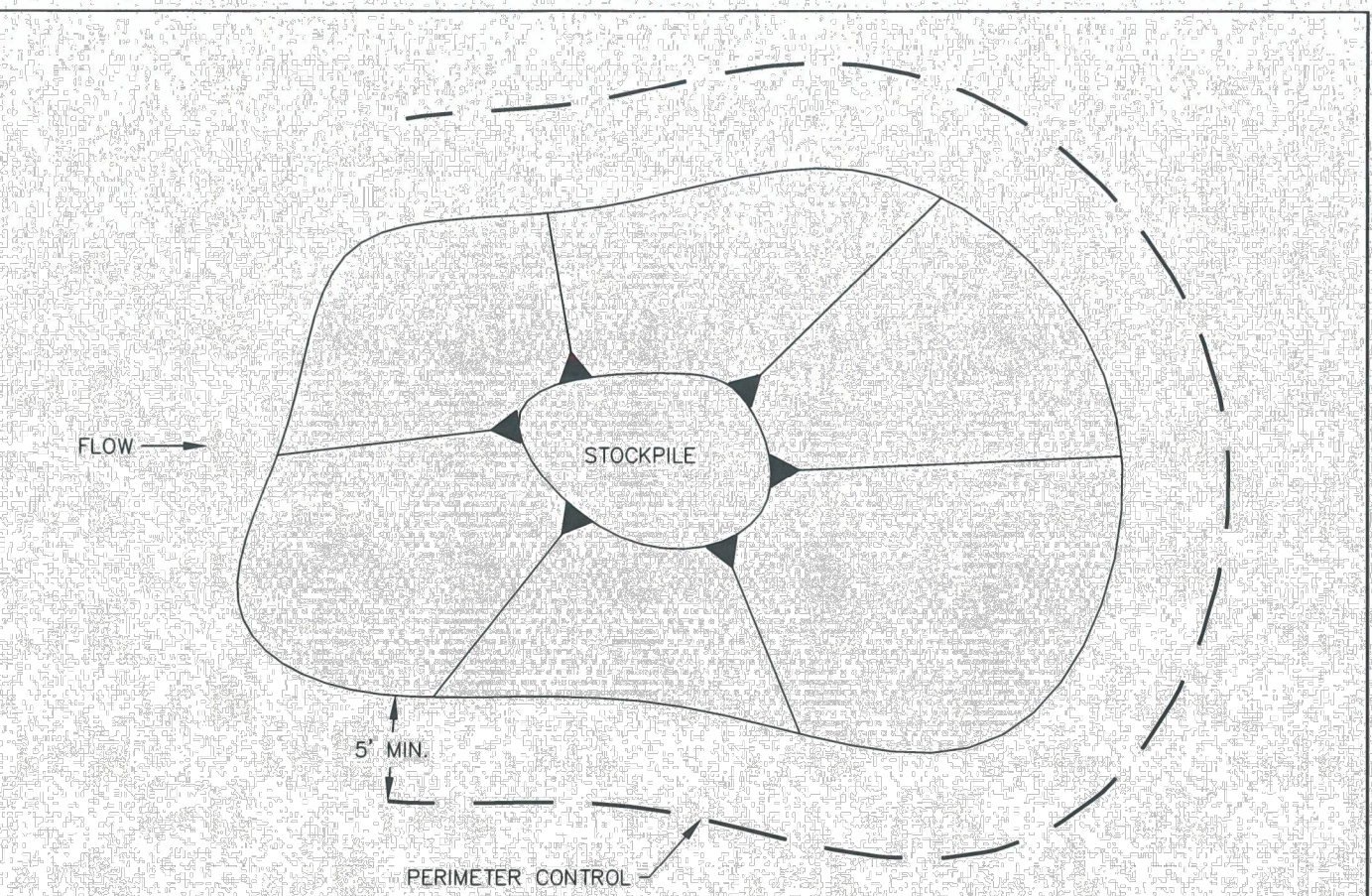

**STOCKPILE PROTECTION PLAN**

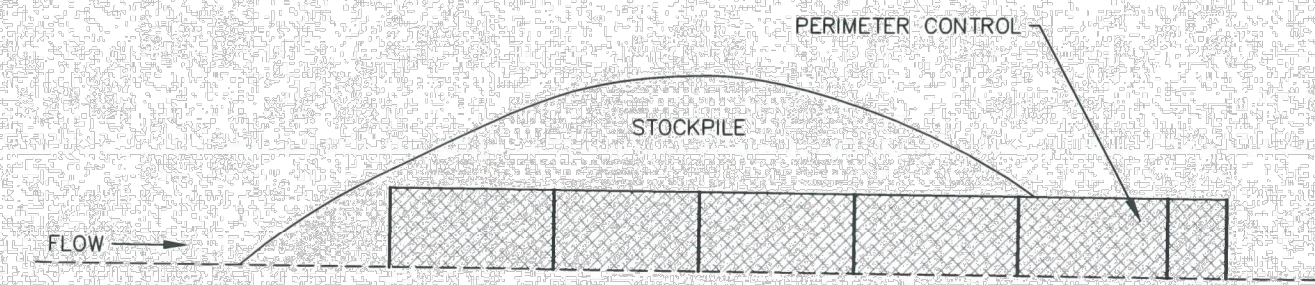

**STOCKPILE PROTECTION ELEVATION**

**INSTALLATION NOTES**

- INSTALL PERIMETER CONTROL AROUND STOCKPILE ON DOWNGRADIENT SIDE. PERIMETER CONTROL MUST BE SUITABLE TO SITE CONDITIONS AND INSTALLED ACCORDING TO THE RELEVANT DETAIL.
- FOR STOCKPILES ON THE INTERIOR PORTION OF A CONSTRUCTION SITE, WHERE OTHER DOWNGRADIENT CONTROLS INCLUDING PERIMETER CONTROL ARE IN PLACE, STOCKPILE PERIMETER CONTROLS MAY NOT BE REQUIRED.

**MAINTENANCE NOTES**

- FREQUENT OBSERVATIONS AND MAINTENANCE ARE NECESSARY TO MAINTAIN CONTROL MEASURES IN EFFECTIVE OPERATING CONDITION. INSPECTIONS AND CORRECTIVE MEASURES SHOULD BE DOCUMENTED THOROUGHLY.
- IF PERIMETER CONTROLS MUST BE MOVED TO ACCESS STOCKPILE, REPLACE PERIMETER CONTROLS BY THE END OF THE WORK DAY.
- ACCUMULATED SEDIMENT MUST BE REMOVED ACCORDING TO PERIMETER CONTROL DETAIL.



	STOCKPILE PROTECTION	
	APPROVED: <i>[Signature]</i>	
	ISSUED: 10/7/19	REVISION: 8/19/2020
	DRAWING NO. 900-SP	

K:\005\_CWA\096010025.DWG Falcon CO\005\096010025.dwg Aug 04, 2021 2:18pm  
This document, together with the concepts and designs presented herein, is an instrument of service, is intended only for the specific purpose and client for which it was prepared. Reuse of this document, together with the concepts and designs presented herein, as an instrument of service, is prohibited without written authorization and adaptation by Kimley-Horn and Associates, Inc. or its affiliates. All rights reserved.

THIS DRAWING IS AN INSTRUMENT OF SERVICE AND THE PROPERTY OF DISCOUNT TIRE COMPANY AND SHALL REMAIN SUCH. THE USE OF THIS DRAWING SHALL BE RESTRICTED TO THE ORIGINAL SITE FOR WHICH IT WAS PREPARED. PUBLICATION THEREOF IS EXPRESSLY LIMITED TO SUCH.

NO.	REVISION	DATE



PROJECT NAME:  
DISCOUNT TIRE - FALCON, CO

PROJECT ADDRESS:  
7585 FALCON MARKETPLACE

PROJECT NUMBER:  
096010025

DATE:  
08/05/2021

DESIGNED BY:  
JWM

REVIEWED BY:  
MOH

SHEET TITLE:  
EROSION CONTROL DETAILS

SHEET NUMBER:  
C2.4



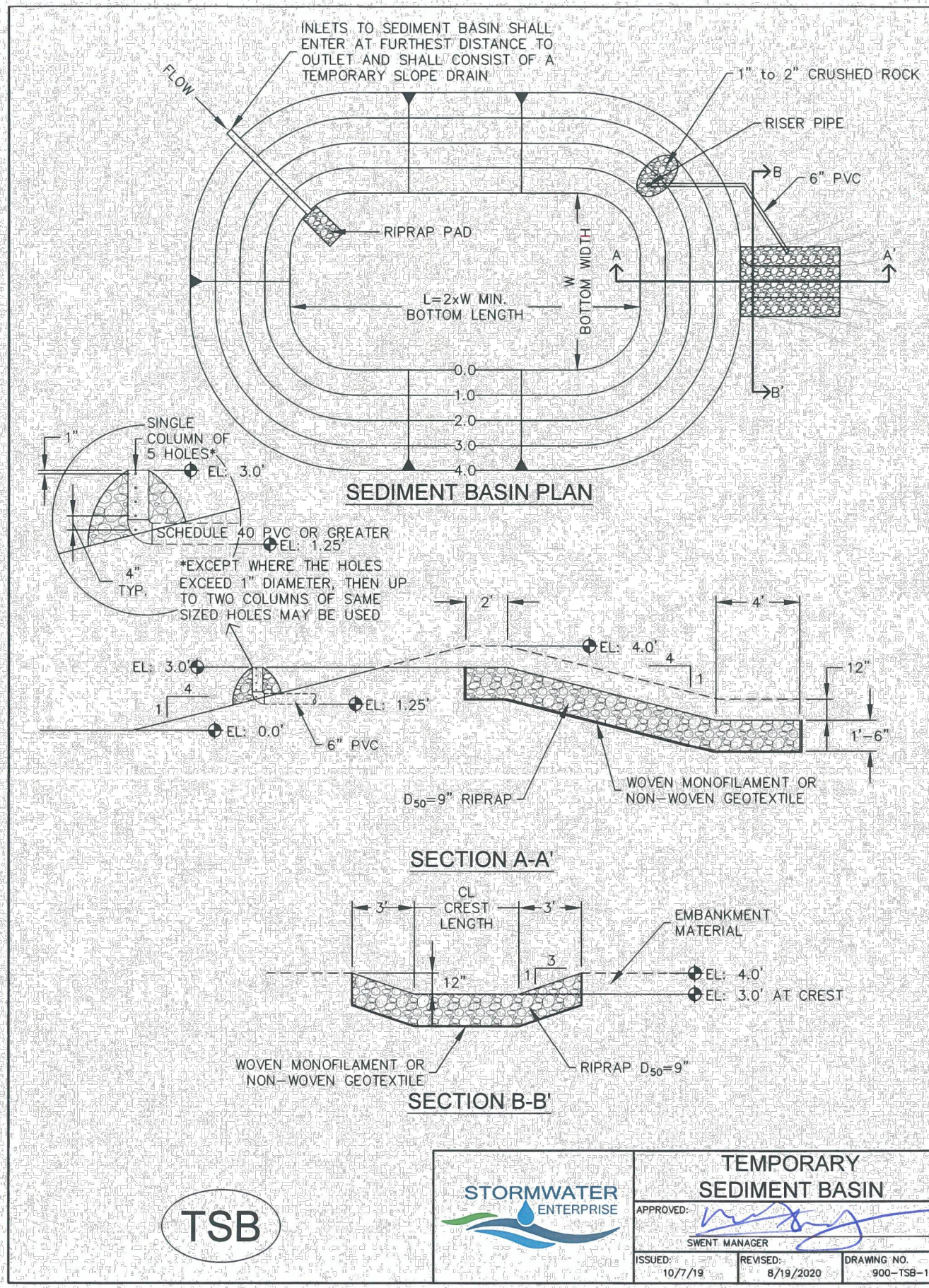
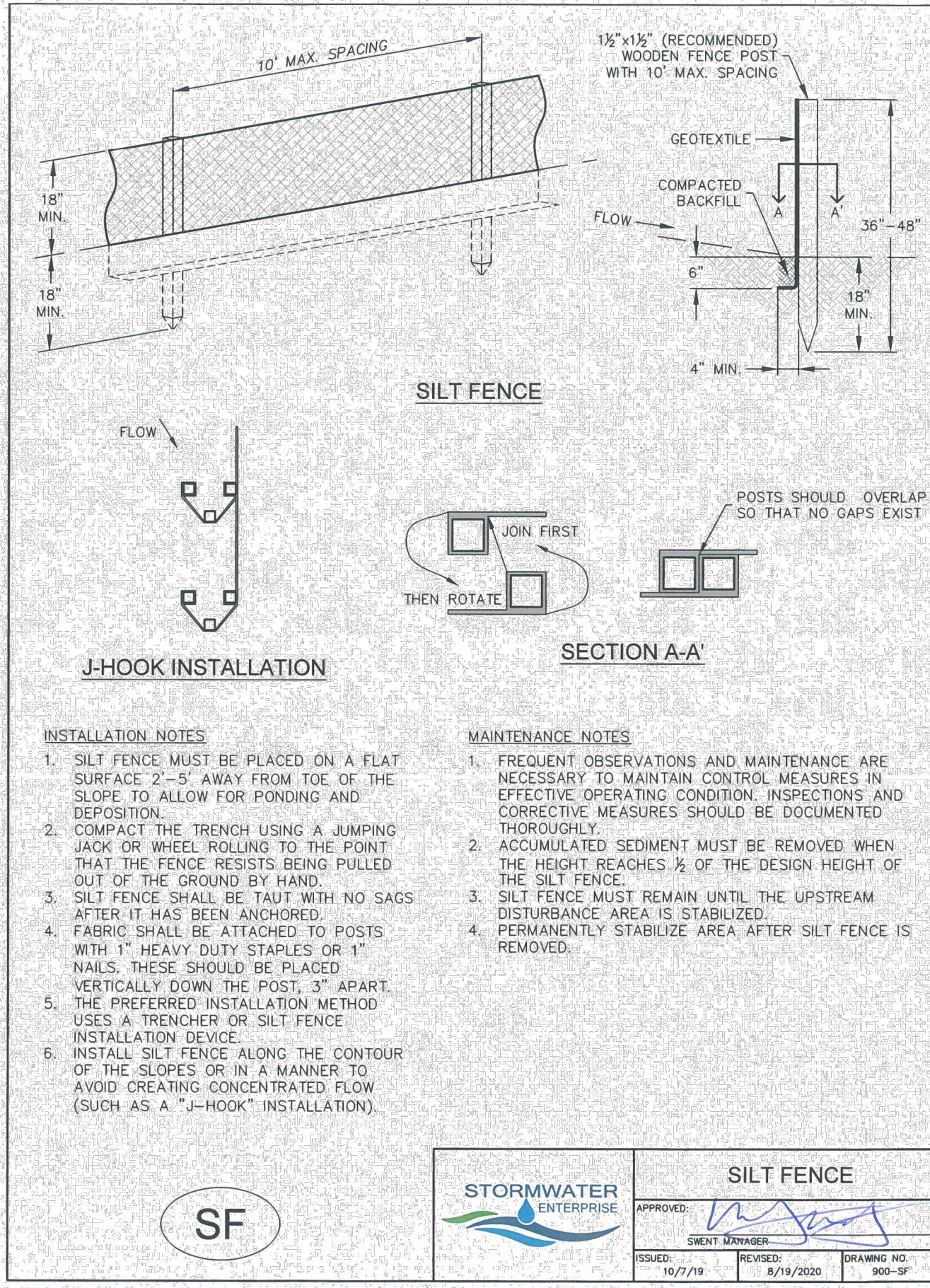

**TABLE SB-1, SIZING INFORMATION FOR STANDARD SEDIMENT BASIN**

UPSTREAM DRAINAGE AREA (ROUNDED TO NEAREST ACRE), (AC)	BASIN BOTTOM W/DTH (W), (FT)	SPILLWAY CREST LENGTH (CL), (FT)	HOLE DIAMETER (HD), (IN)
1	12 1/2	2	3/4
2	21	3	1 1/4
3	28	4	1 3/4
4	33 1/2	6	2 1/4
5	38 1/2	8	2 3/4
6	43	11	3 1/2
7	47 1/2	12	3 3/4
8	51	13	4
9	55	15	4 1/4
10	58 1/2	16	4 3/4
11	61	18	5
12	64	19	5 1/4
13	67 1/2	21	5 3/4
14	70 1/2	21	6
15	73 1/2	22	6 1/4

**INSTALLATION NOTES**

- FOR STANDARD BASIN, BOTTOM DIMENSION MAY BE MODIFIED AS LONG AS BOTTOM AREA IS NOT REDUCED.
- EMBANKMENT MATERIAL SHALL CONSIST OF SOIL FREE OF DEBRIS, ORGANIC MATERIAL, AND ROCKS OR CONCRETE GREATER THAN 3 INCHES, AND SHALL HAVE A MINIMUM OF 15 PERCENT BY WEIGHT PASSING THE No. 200 SIEVE.
- EMBANKMENT MATERIAL SHALL BE COMPACTED TO AT LEAST 95 PERCENT OF MAXIMUM DENSITY IN ACCORDANCE WITH ASTM D-698.
- PIPE SCHEDULE 40 OR GREATER SHALL BE USED.
- THE DETAILS SHOWN ON THESE SHEETS PERTAIN TO STANDARD SEDIMENT BASIN(S) FOR DRAINAGE AREAS LESS THAN 15 ACRES. SEE CONSTRUCTION DRAWINGS FOR EMBANKMENT, STORAGE VOLUME, SPILLWAY, OUTLET, AND OUTLET PROTECTION DETAILS FOR ANY SEDIMENT BASIN(S) THAT HAVE BEEN INDIVIDUALLY DESIGNED FOR DRAINAGE AREAS LARGER THAN 15 ACRES. DESIGN CALCULATIONS MUST BE APPROVED PRIOR TO IMPLEMENTATION.

**MAINTENANCE NOTES**

- FREQUENT OBSERVATIONS AND MAINTENANCE ARE NECESSARY TO MAINTAIN CONTROL MEASURES IN EFFECTIVE OPERATING CONDITION. INSPECTIONS AND CORRECTIVE MEASURES SHOULD BE DOCUMENTED THOROUGHLY.
- SEDIMENT ACCUMULATED IN BASIN SHALL BE REMOVED AS NEEDED TO MAINTAIN CONTROL MEASURE EFFECTIVENESS, TYPICALLY WHEN SEDIMENT DEPTH REACHES ONE FOOT (I.E. TWO FEET BELOW SPILLWAY CREST).
- SEDIMENT BASINS ARE TO REMAIN IN PLACE UNTIL THE UPSTREAM DISTURBED AREA IS PERMANENTLY STABILIZED.
- PERMANENTLY STABILIZE AREA AFTER SEDIMENT BASIN REMOVAL.

**STORMWATER ENTERPRISE**

**TEMPORARY SEDIMENT BASIN**

ISSUED: 10/7/19 REVISION: 8/19/2020 DRAWING NO: 900-108-2

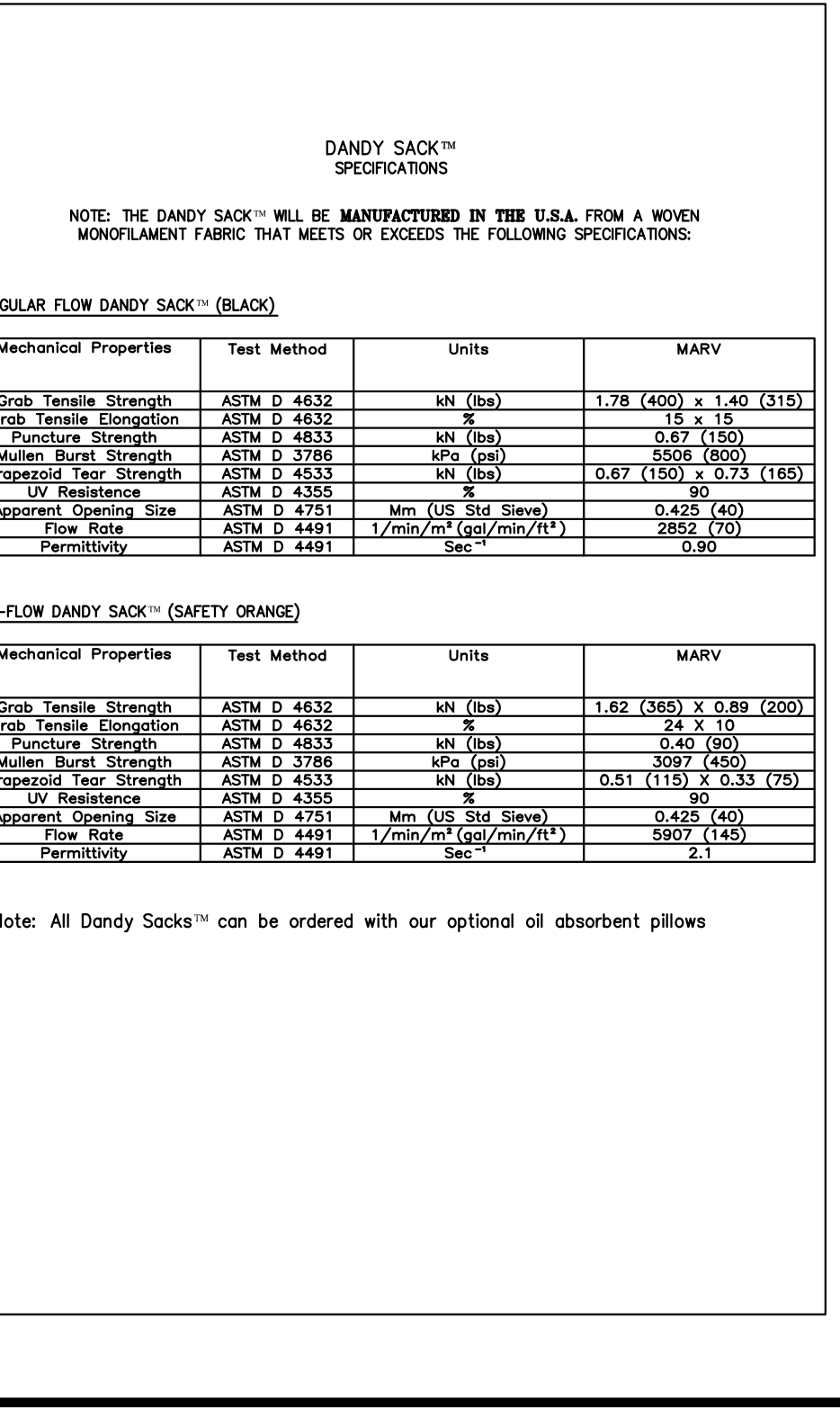
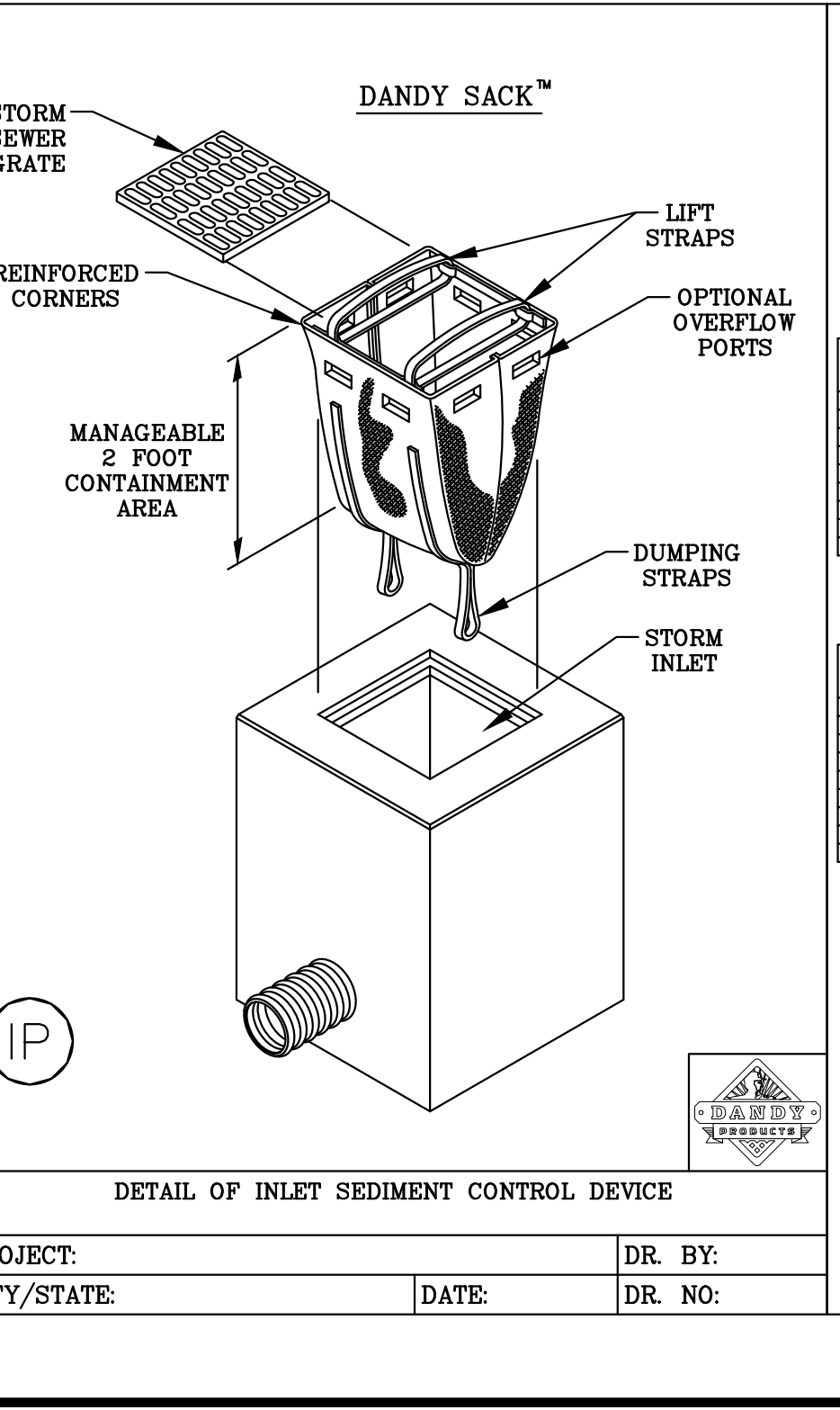
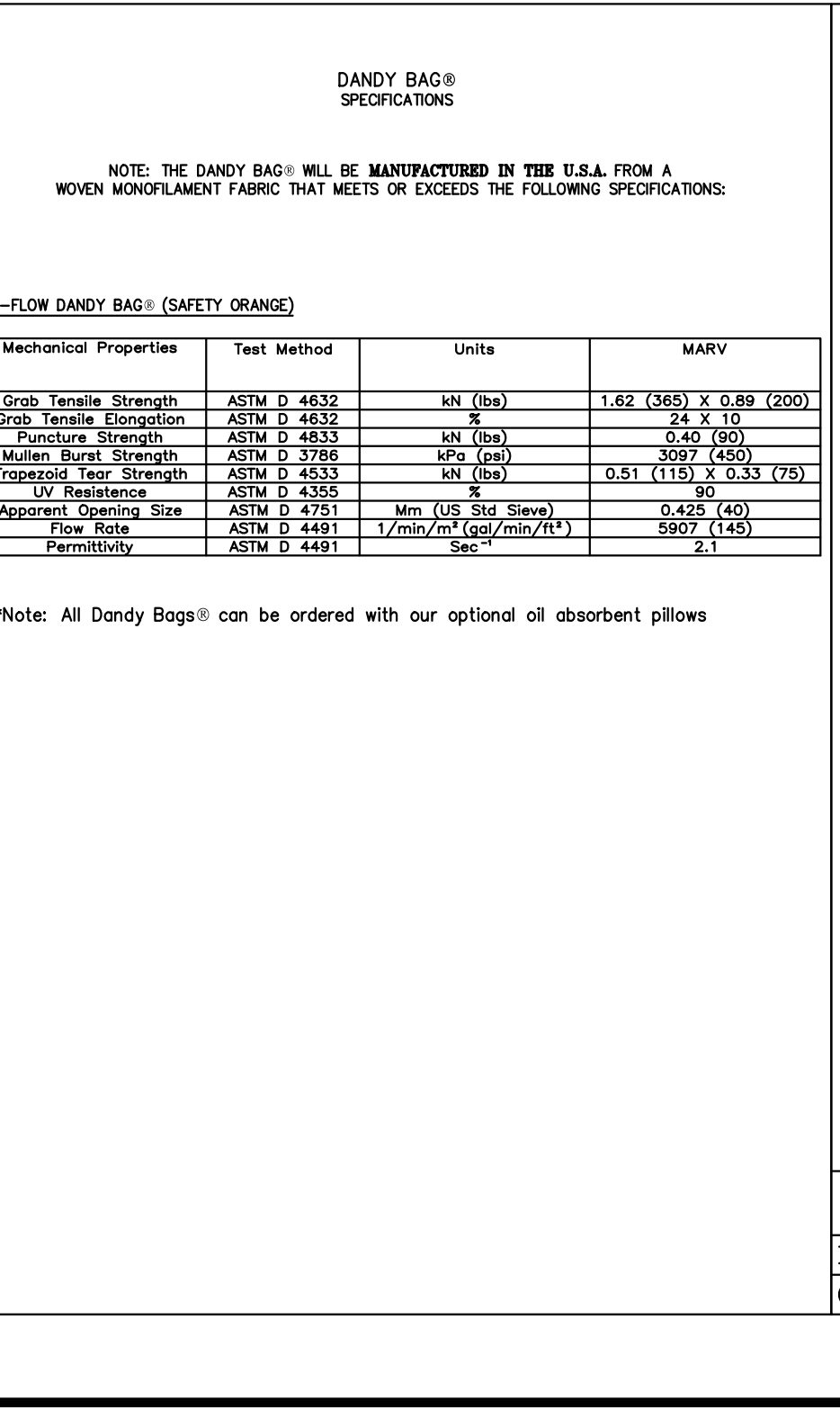
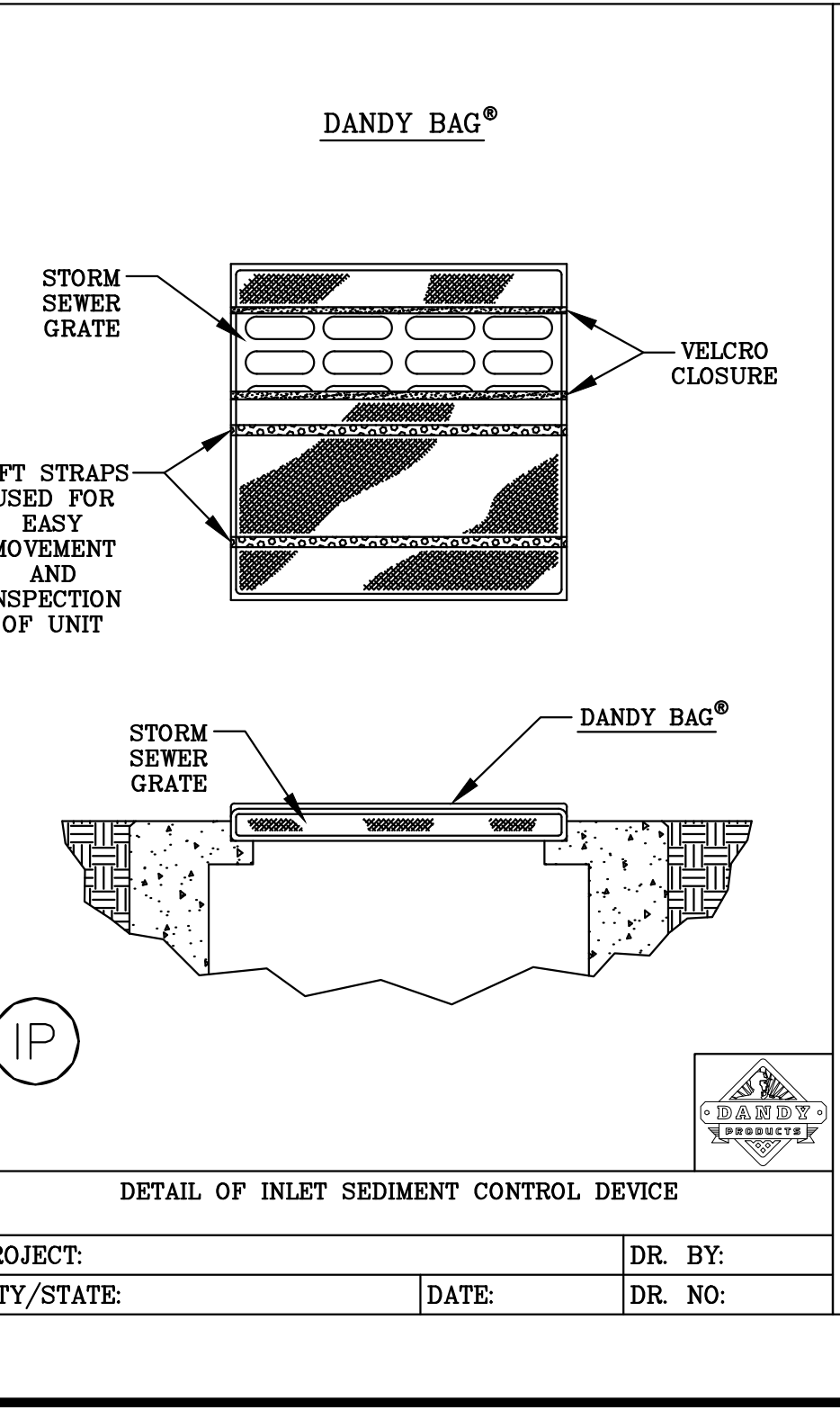
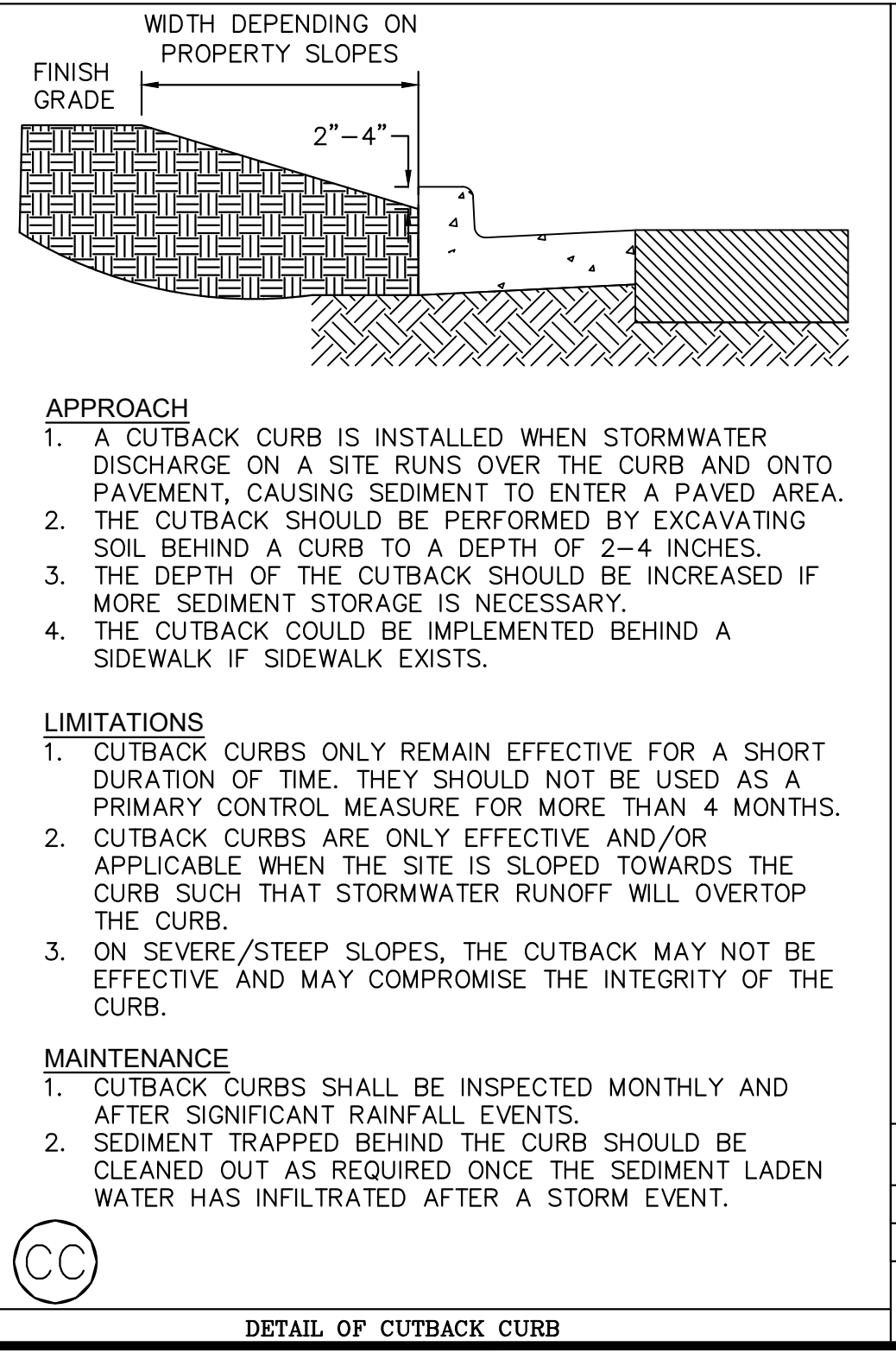
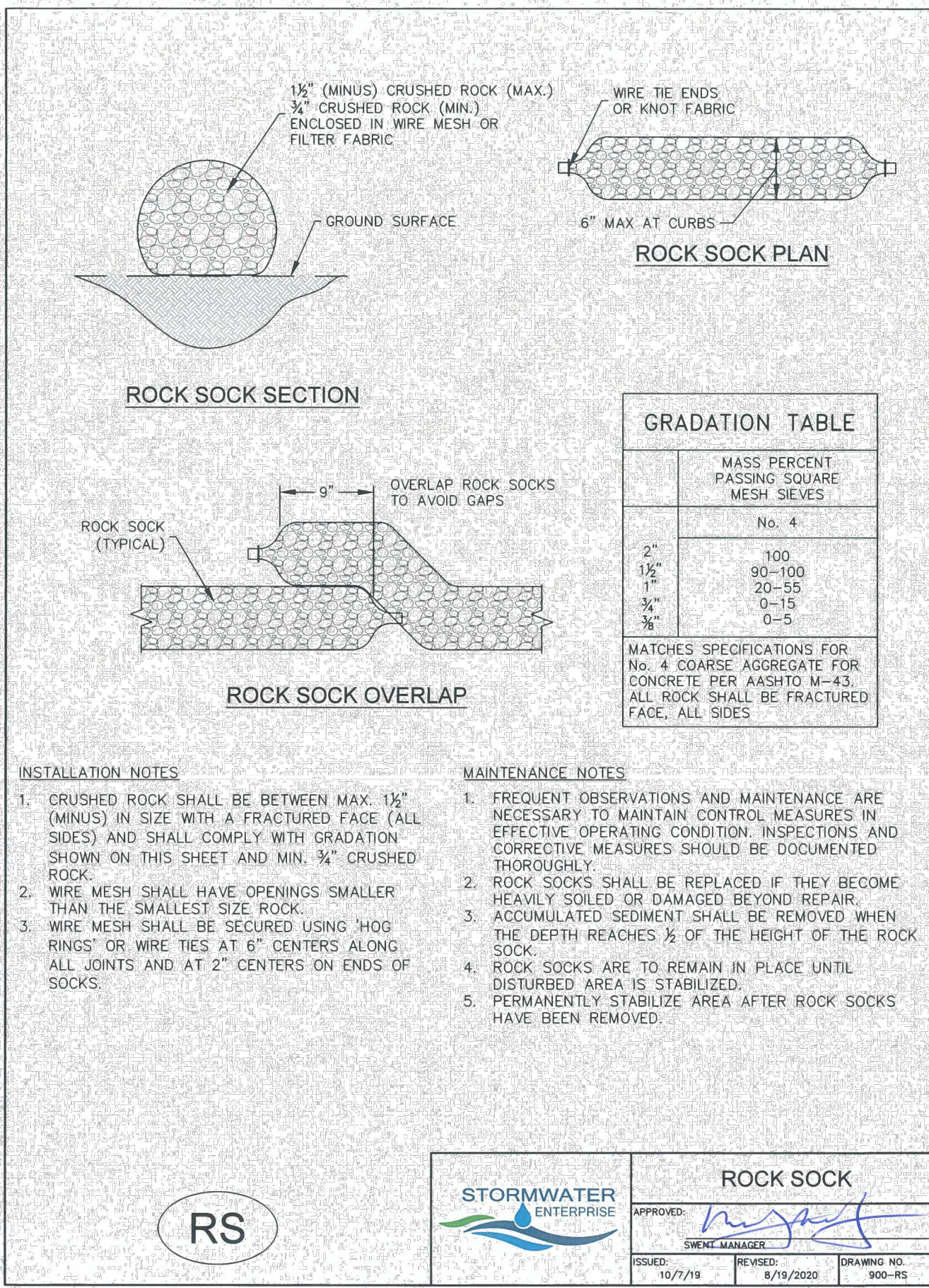

K:\05\_04\09010025.DTC\_Falcon\_00\0400\0400\0400\0400\_01.dwg Aug 04, 2021 2:18pm  
This drawing is an instrument of service, is intended only for the specific purpose and client for which it was prepared. Reuse of this document, together with the concepts and design presented herein, as an instrument of service, or on any other project, without written authorization and adaptation by Kimley-Horn and Associates, Inc. shall be without liability to Kimley-Horn and Associates, Inc.

THIS DRAWING IS AN INSTRUMENT OF SERVICE AND THE PROPERTY OF DISCOUNT TIRE COMPANY AND SHALL REMAIN SUCH. THE USE OF THIS DRAWING SHALL BE RESTRICTED TO THE ORIGINAL SITE FOR WHICH IT WAS PREPARED. PUBLICATION THEREOF IS EXPRESSLY LIMITED TO SUCH.

NO.	REVISION	DATE



PROJECT NAME:  
DISCOUNT TIRE - FALCON, CO

PROJECT ADDRESS:  
7585 FALCON MARKETPLACE

PROJECT NUMBER:  
096010025

DATE:  
08/05/2021

DESIGNED BY:  
JWM

REVIEWED BY:  
MOH

SHEET TITLE:  
EROSION CONTROL DETAILS

SHEET NUMBER:  
C2.5



K:\025\_04\096010025.DWG Falcon CO\0400\096010025.dwg Aug 04, 2021 2:19pm  
 This document, together with the concepts and designs presented herein, is intended only for the specific purpose and client for which it was prepared. Reuse of or improper reliance on this document without written authorization and adaptation by Kimley-Horn and Associates, Inc. shall be without liability to Kimley-Horn and Associates, Inc.

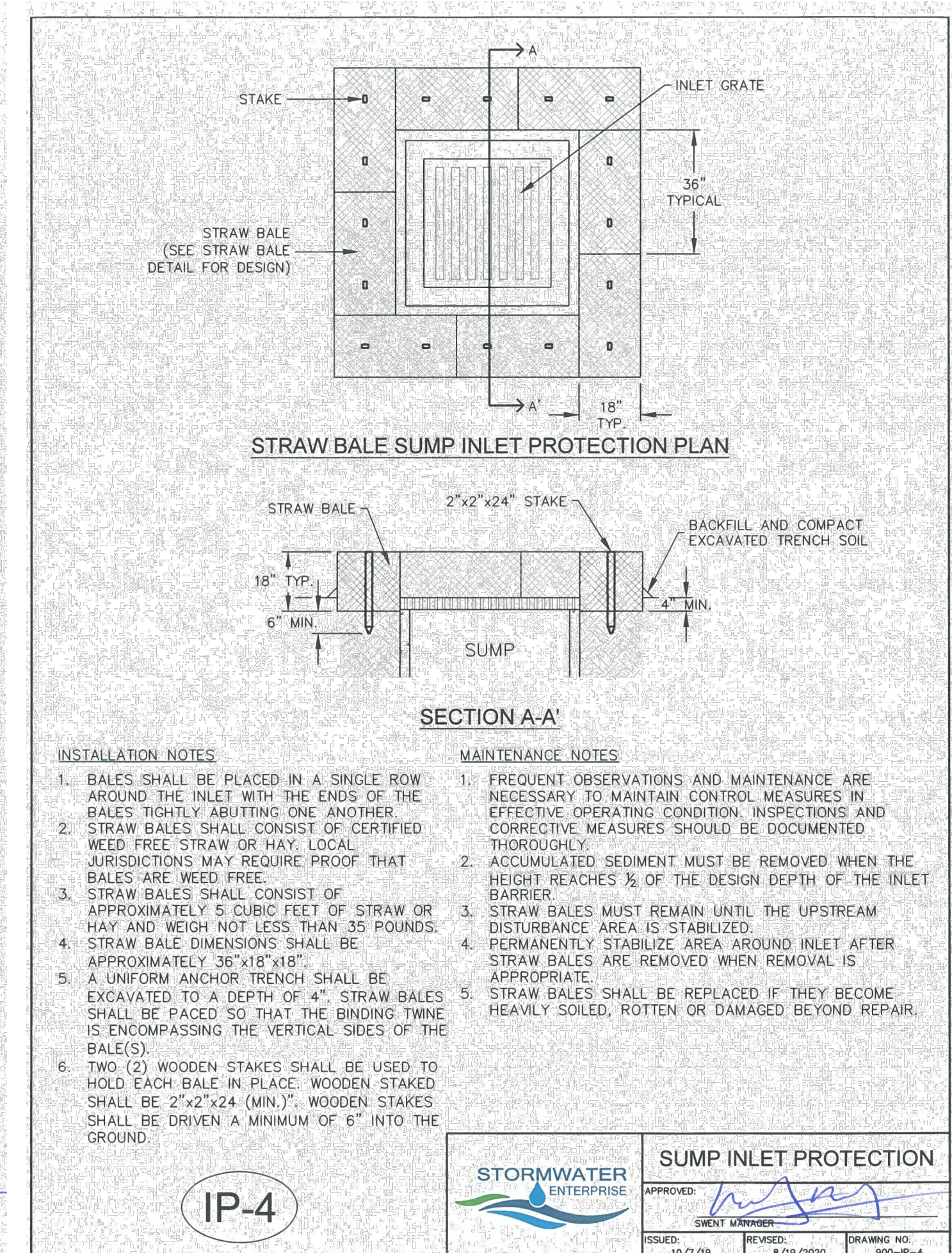
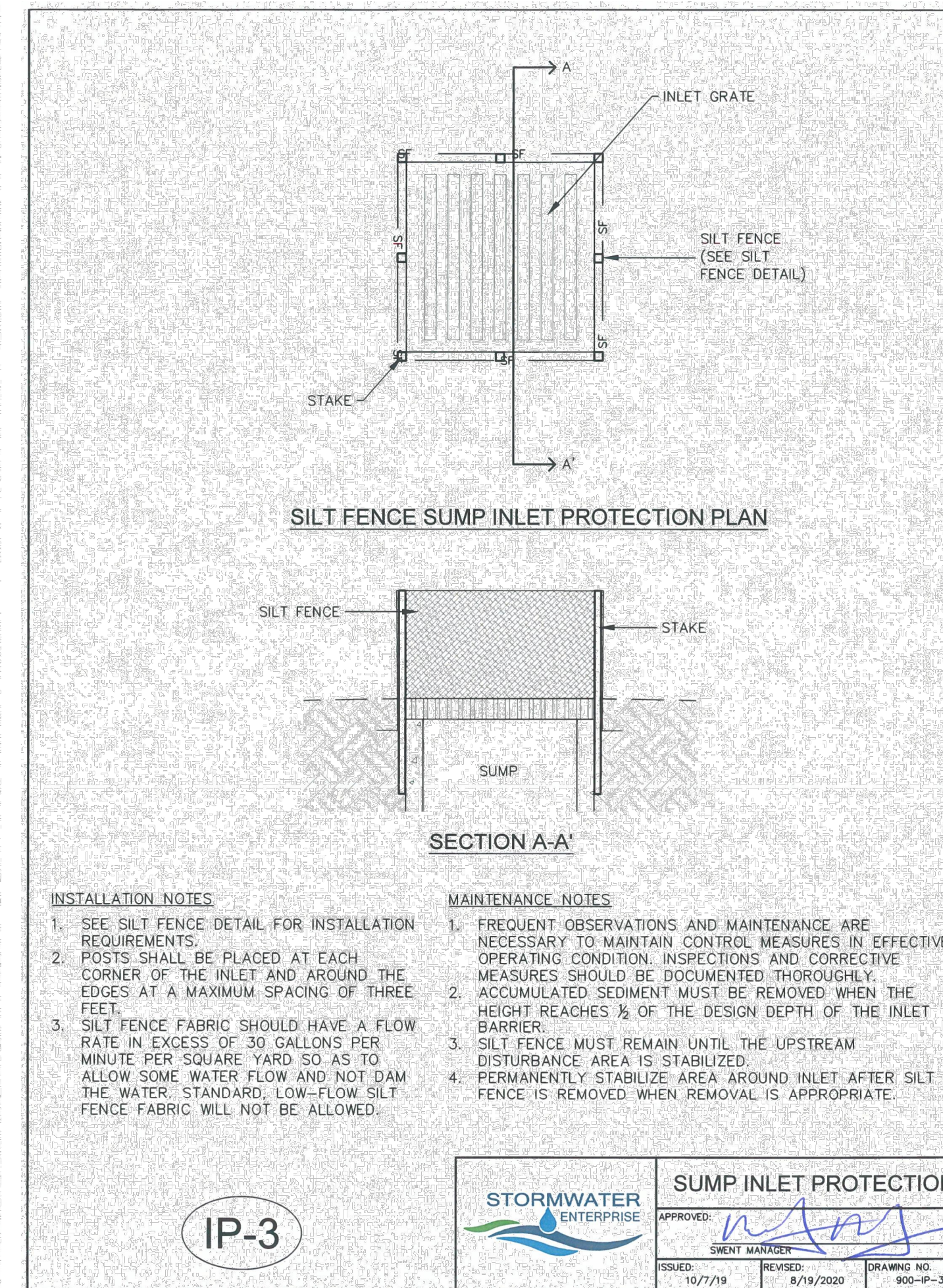
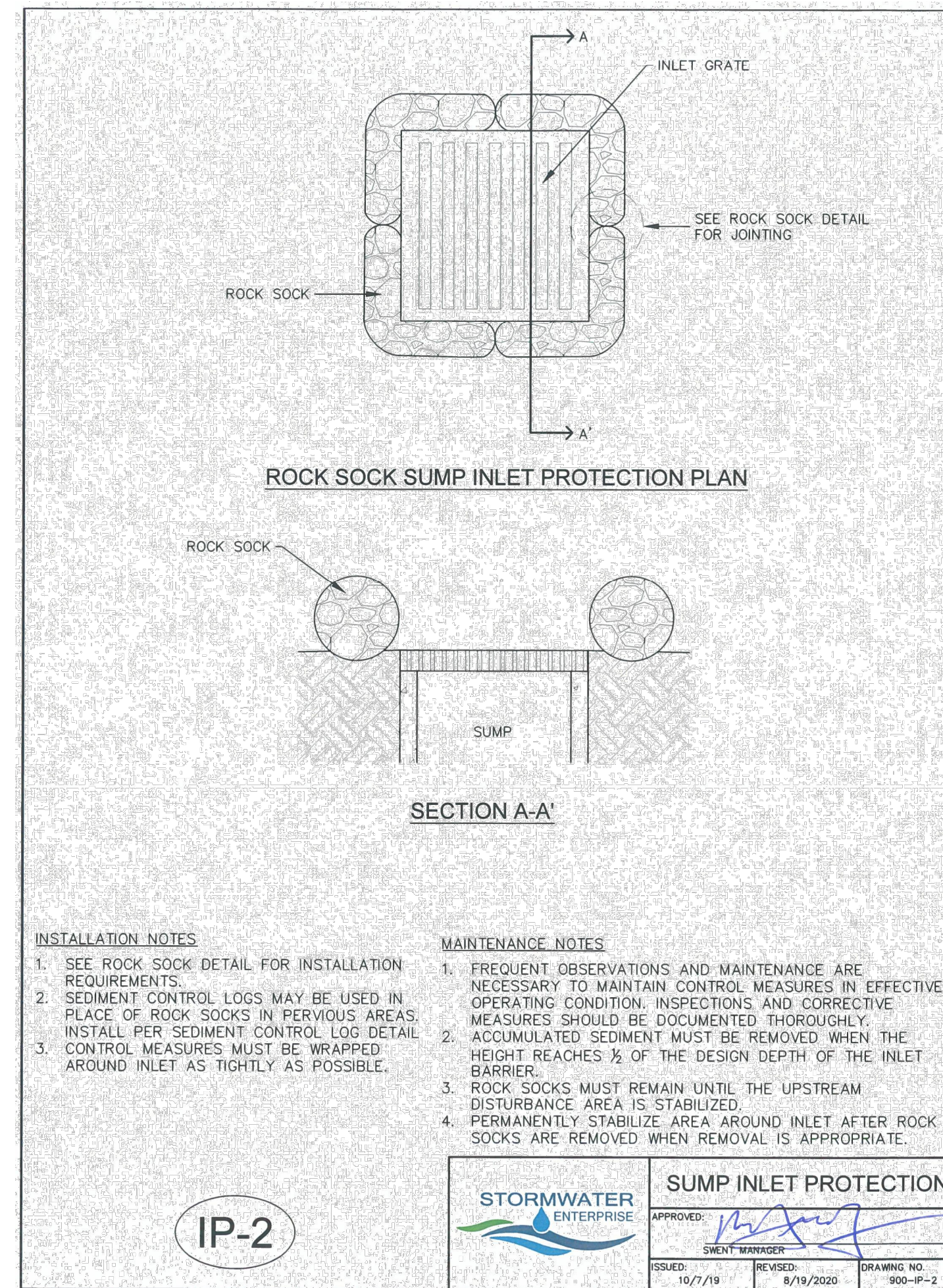
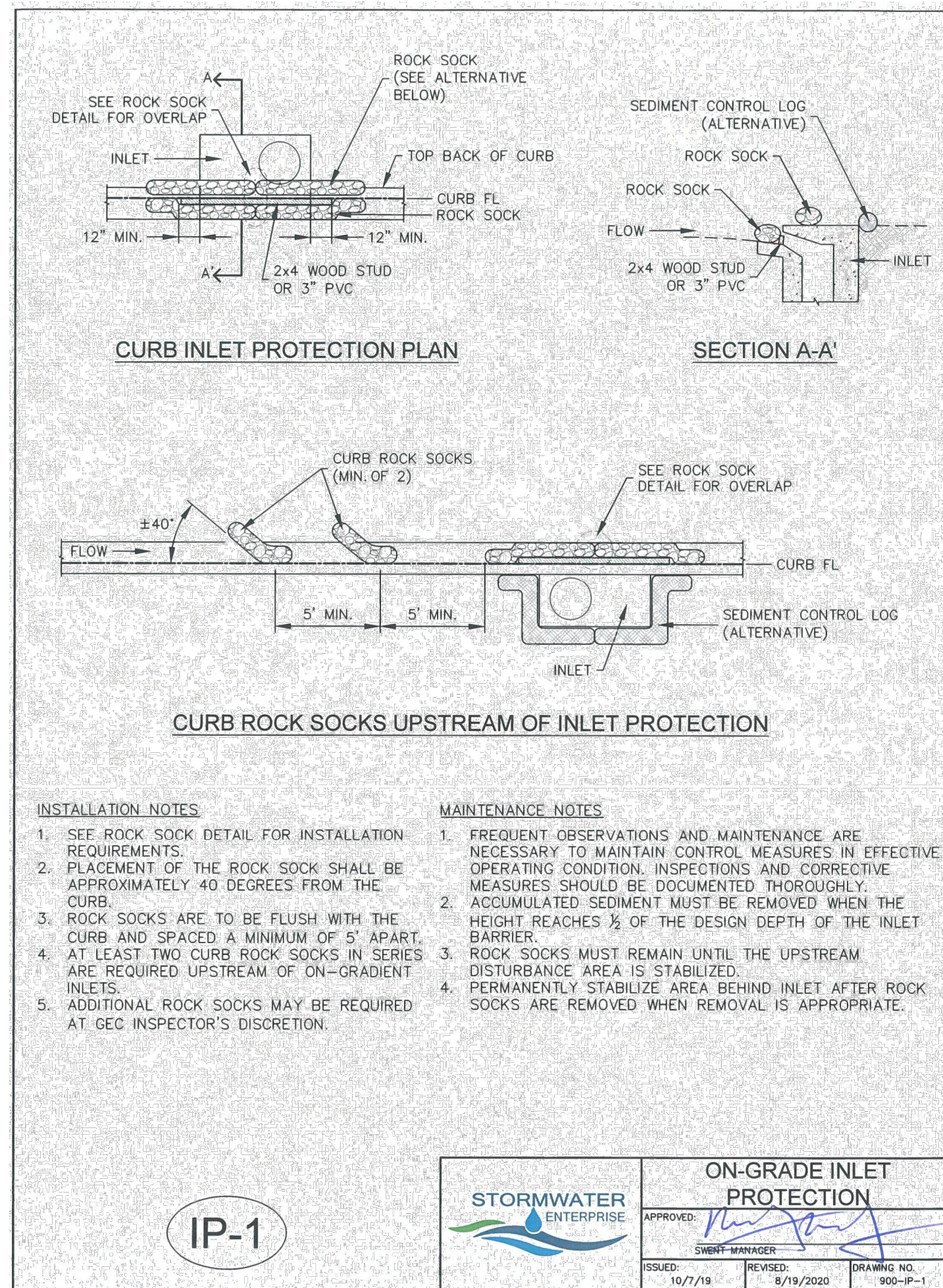

THIS DRAWING IS AN INSTRUMENT OF SERVICE AND THE PROPERTY OF DISCOUNT TIRE COMPANY AND SHALL REMAIN SUCH. THE USE OF THIS DRAWING SHALL BE RESTRICTED TO THE ORIGINAL SITE FOR WHICH IT WAS PREPARED. PUBLICATION THEREOF IS EXPRESSLY LIMITED TO SUCH.

NO.	REVISION	DATE



PROJECT NAME:  
DISCOUNT TIRE - FALCON, CO

PROJECT ADDRESS:  
7585 FALCON MARKETPLACE

PROJECT NUMBER:  
096010025

DATE:  
08/05/2021

DESIGNED BY:  
JWM

REVIEWED BY:  
MOH

SHEET TITLE:  
EROSION CONTROL DETAILS

SHEET NUMBER:  
C2.6



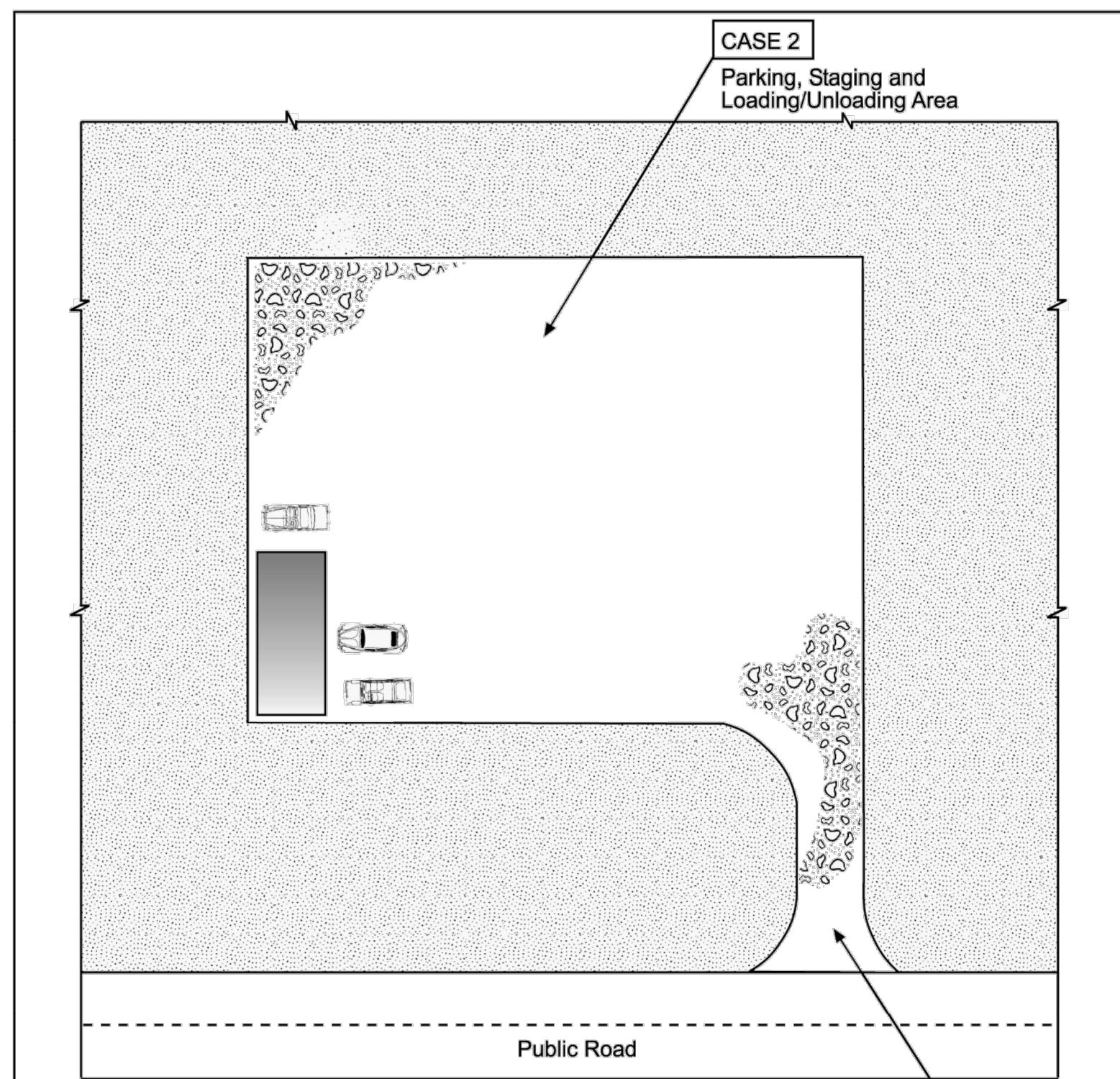
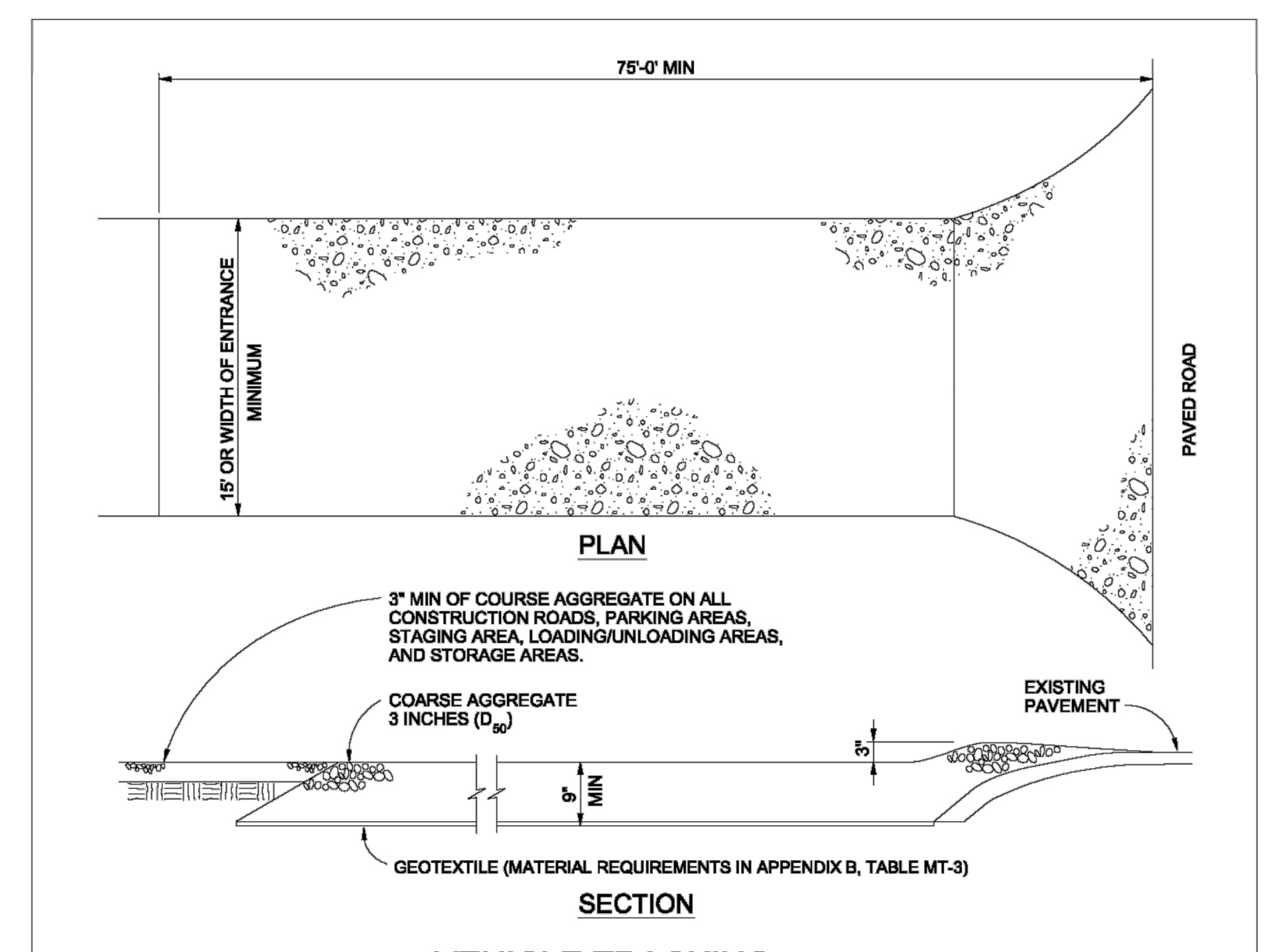

Table VT-1

	Case 1	Case 2
Gravel Thickness	9"	3"
Filter Fabric	YES	NO

City of Colorado Springs Storm Water Quality

Figure VT-1 Vehicle Tracking Application Examples



### VEHICLE TRACKING NOTES

- INSTALLATION REQUIREMENTS**
1. ALL ENTRANCES TO THE CONSTRUCTION SITE ARE TO BE STABILIZED PRIOR TO CONSTRUCTION BEGINNING.
  2. CONSTRUCTION ENTRANCES ARE TO BE BUILT WITH AN APRON TO ALLOW FOR TURNING TRAFFIC, BUT SHOULD NOT BE BUILT OVER EXISTING PAVEMENT EXCEPT FOR A SLIGHT OVERLAP.
  3. AREAS TO BE STABILIZED ARE TO BE PROPERLY GRADED AND COMPACTED PRIOR TO LAYING DOWN GEOTEXTILE AND STONE.
  4. CONSTRUCTION ROADS, PARKING AREAS, LOADING/UNLOADING ZONES, STORAGE AREAS, AND STAGING AREAS ARE TO BE STABILIZED.
  5. CONSTRUCTION ROADS ARE TO BE BUILT TO CONFORM TO SITE GRADES, BUT SHOULD NOT HAVE SIDE SLOPES OR ROAD GRADES THAT ARE EXCESSIVELY STEEP.
- MAINTENANCE REQUIREMENTS**
1. REGULAR INSPECTIONS ARE TO BE MADE OF ALL STABILIZED AREAS, ESPECIALLY AFTER STORM EVENTS.
  2. STONES ARE TO BE REAPPLIED PERIODICALLY AND WHEN REPAIR IS NECESSARY.
  3. SEDIMENT TRACKED ONTO PAVED ROADS IS TO BE REMOVED DAILY BY SHOVELING OR SWEEPING. SEDIMENT IS NOT TO BE WASHED DOWN STORM SEWER DRAINS.
  4. STORM SEWER INLET PROTECTION IS TO BE IN PLACE, INSPECTED, AND CLEANED IF NECESSARY.
  5. OTHER ASSOCIATED SEDIMENT CONTROL MEASURES ARE TO BE INSPECTED TO ENSURE GOOD WORKING CONDITION.

City of Colorado Springs Stormwater Quality

Figure VT-2 Vehicle Tracking Application Examples

### Stabilized Staging Area (SSA) SM-6

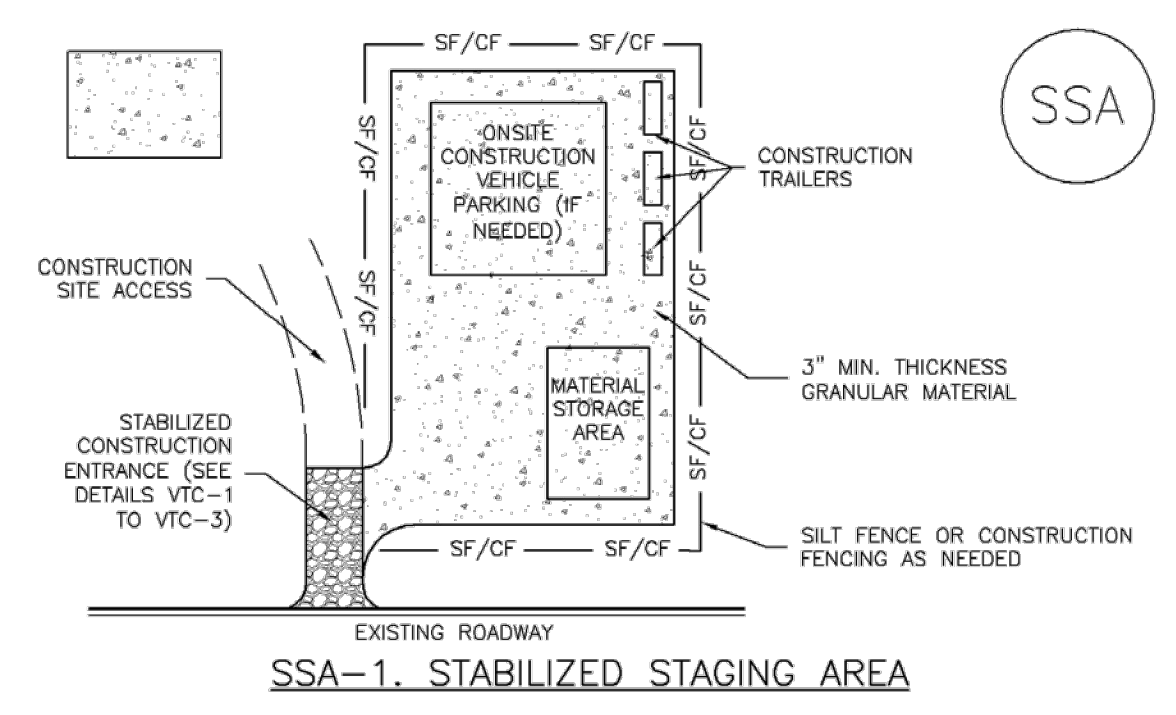

### SSA-1. STABILIZED STAGING AREA

- STABILIZED STAGING AREA INSTALLATION NOTES**
1. SEE PLAN VIEW FOR LOCATION OF STAGING AREA(S). CONTRACTOR MAY ADJUST LOCATION AND SIZE OF STAGING AREA WITH APPROVAL FROM THE LOCAL JURISDICTION.
  2. STABILIZED STAGING AREA SHOULD BE APPROPRIATE FOR THE NEEDS OF THE SITE. OVERSIZING RESULTS IN A LARGER AREA TO STABILIZE FOLLOWING CONSTRUCTION.
  3. STAGING AREA SHALL BE STABILIZED PRIOR TO OTHER OPERATIONS ON THE SITE.
  4. THE STABILIZED STAGING AREA SHALL CONSIST OF A MINIMUM 3" THICK GRANULAR MATERIAL.
  5. UNLESS OTHERWISE SPECIFIED BY LOCAL JURISDICTION, ROCK SHALL CONSIST OF DOT SECT. #703, AASHTO #3 COARSE AGGREGATE OR 6" (MINUS) ROCK.
  6. ADDITIONAL PERIMETER BMPs MAY BE REQUIRED INCLUDING BUT NOT LIMITED TO SILT FENCE AND CONSTRUCTION FENCING.
- STABILIZED STAGING AREA MAINTENANCE NOTES**
1. INSPECT BMPs EACH WORKDAY, AND MAINTAIN THEM IN EFFECTIVE OPERATING CONDITION. MAINTENANCE OF BMPs SHOULD BE PROACTIVE, NOT REACTIVE. INSPECT BMPs AS SOON AS POSSIBLE (AND ALWAYS WITHIN 24 HOURS) FOLLOWING A STORM THAT CAUSES SURFACE EROSION, AND PERFORM NECESSARY MAINTENANCE.
  2. FREQUENT OBSERVATIONS AND MAINTENANCE ARE NECESSARY TO MAINTAIN BMPs IN EFFECTIVE OPERATING CONDITION. INSPECTIONS AND CORRECTIVE MEASURES SHOULD BE DOCUMENTED THOROUGHLY.
  3. WHERE BMPs HAVE FAILED, REPAIR OR REPLACEMENT SHOULD BE INITIATED UPON DISCOVERY OF THE FAILURE.
  4. ROCK SHALL BE REAPPLIED OR REGRADED AS NECESSARY IF RUTTING OCCURS OR UNDERLYING SUBGRADE BECOMES EXPOSED.

November 2010 Urban Drainage and Flood Control District SSA-3

Urban Storm Drainage Criteria Manual Volume 3

### SM-6 Stabilized Staging Area (SSA)

- STABILIZED STAGING AREA MAINTENANCE NOTES**
5. STABILIZED STAGING AREA SHALL BE ENLARGED IF NECESSARY TO CONTAIN PARKING, STORAGE, AND UNLOADING/LOADING OPERATIONS.
  6. THE STABILIZED STAGING AREA SHALL BE REMOVED AT THE END OF CONSTRUCTION. THE GRANULAR MATERIAL SHALL BE REMOVED OR, IF APPROVED BY THE LOCAL JURISDICTION, USED ON SITE, AND THE AREA COVERED WITH TOPSOIL, SEEDED AND MULCHED OR OTHERWISE STABILIZED IN A MANNER APPROVED BY LOCAL JURISDICTION.
- NOTE: MANY MUNICIPALITIES PROHIBIT THE USE OF RECYCLED CONCRETE AS GRANULAR MATERIAL FOR STABILIZED STAGING AREAS DUE TO DIFFICULTIES WITH RE-ESTABLISHMENT OF VEGETATION IN AREAS WHERE RECYCLED CONCRETE WAS PLACED.
- NOTE: MANY JURISDICTIONS HAVE BMP DETAILS THAT VARY FROM UDFCD STANDARD DETAILS. CONSULT WITH LOCAL JURISDICTIONS AS TO WHICH DETAIL SHOULD BE USED WHEN DIFFERENCES ARE NOTED.
- (DETAILS ADAPTED FROM DOUGLAS COUNTY, COLORADO, NOT AVAILABLE IN AUTOCAD)

SSA-4 Urban Drainage and Flood Control District November 2010

Urban Storm Drainage Criteria Manual Volume 3

K:\CDS\_CAD\09090205.DTC\_Falon CO\09090205\09090205\_V01.dwg Aug 04, 2021 2:19pm  
 This drawing is intended only for the specific purpose and client for which it was prepared. Reuse of this document, together with the concepts and designs presented herein, as an instrument of service, is intended only for the specific purpose and client for which it was prepared. Reuse of this document, together with the concepts and designs presented herein, as an instrument of service, is intended only for the specific purpose and client for which it was prepared. Reuse of this document, together with the concepts and designs presented herein, as an instrument of service, is intended only for the specific purpose and client for which it was prepared.

THIS DRAWING IS AN INSTRUMENT OF SERVICE AND THE PROPERTY OF DISCOUNT TIRE COMPANY AND SHALL REMAIN SUCH. THE USE OF THIS DRAWING SHALL BE RESTRICTED TO THE ORIGINAL SITE FOR WHICH IT WAS PREPARED. PUBLICATION THEREOF IS EXPRESSLY LIMITED TO SUCH.

NO.	REVISION	DATE



©2021 2 N. NEVADA AVE., SUITE 300  
 COLORADO SPRINGS, CO 80903 (719) 453-0180

PROJECT NAME:  
 DISCOUNT TIRE - FALCON, CO

PROJECT ADDRESS:  
 7585 FALCON MARKETPLACE

PROJECT NUMBER:  
 096010025

DATE:  
 08/05/2021

DESIGNED BY:  
 JWM

REVIEWED BY:  
 MOH

SHEET TITLE:  
 EROSION CONTROL DETAILS

SHEET NUMBER:  
 C2.7



**Construction Fence (CF)**

**SM-3**

**CONSTRUCTION FENCE MAINTENANCE NOTES**

1. INSPECT BMPs EACH WORKDAY, AND MAINTAIN THEM IN EFFECTIVE OPERATING CONDITION. MAINTENANCE OF BMPs SHOULD BE PROACTIVE, NOT REACTIVE. INSPECT BMPs AS SOON AS POSSIBLE (AND ALWAYS WITHIN 24 HOURS) FOLLOWING A STORM THAT CAUSES SURFACE EROSION, AND PERFORM NECESSARY MAINTENANCE.
2. FREQUENT OBSERVATIONS AND MAINTENANCE ARE NECESSARY TO MAINTAIN BMPs IN EFFECTIVE OPERATING CONDITION. INSPECTIONS AND CORRECTIVE MEASURES SHOULD BE DOCUMENTED THOROUGHLY.
3. WHERE BMPs HAVE FAILED, REPAIR OR REPLACEMENT SHOULD BE INITIATED UPON DISCOVERY OF THE FAILURE.
4. CONSTRUCTION FENCE SHALL BE REPAIRED OR REPLACED WHEN THERE ARE SIGNS OF DAMAGE SUCH AS RIPS OR SNAGS. CONSTRUCTION FENCE IS TO REMAIN IN PLACE UNTIL THE UPSTREAM DISTURBED AREA IS STABILIZED AND APPROVED BY THE LOCAL JURISDICTION.
5. WHEN CONSTRUCTION FENCES ARE REMOVED, ALL DISTURBED AREAS ASSOCIATED WITH THE INSTALLATION, MAINTENANCE, AND/OR REMOVAL OF THE FENCE SHALL BE COVERED WITH TOPSOIL, SEEDED AND MULCHED, OR OTHERWISE STABILIZED AS APPROVED BY LOCAL JURISDICTION.

NOTE: MANY JURISDICTIONS HAVE BMP DETAILS THAT VARY FROM UDFCD STANDARD DETAILS. CONSULT WITH LOCAL JURISDICTIONS AS TO WHICH DETAIL SHOULD BE USED WHEN DIFFERENCES ARE NOTED.

(DETAIL ADAPTED FROM TOWN OF PARKER, COLORADO, NOT AVAILABLE IN AUTOCAD)

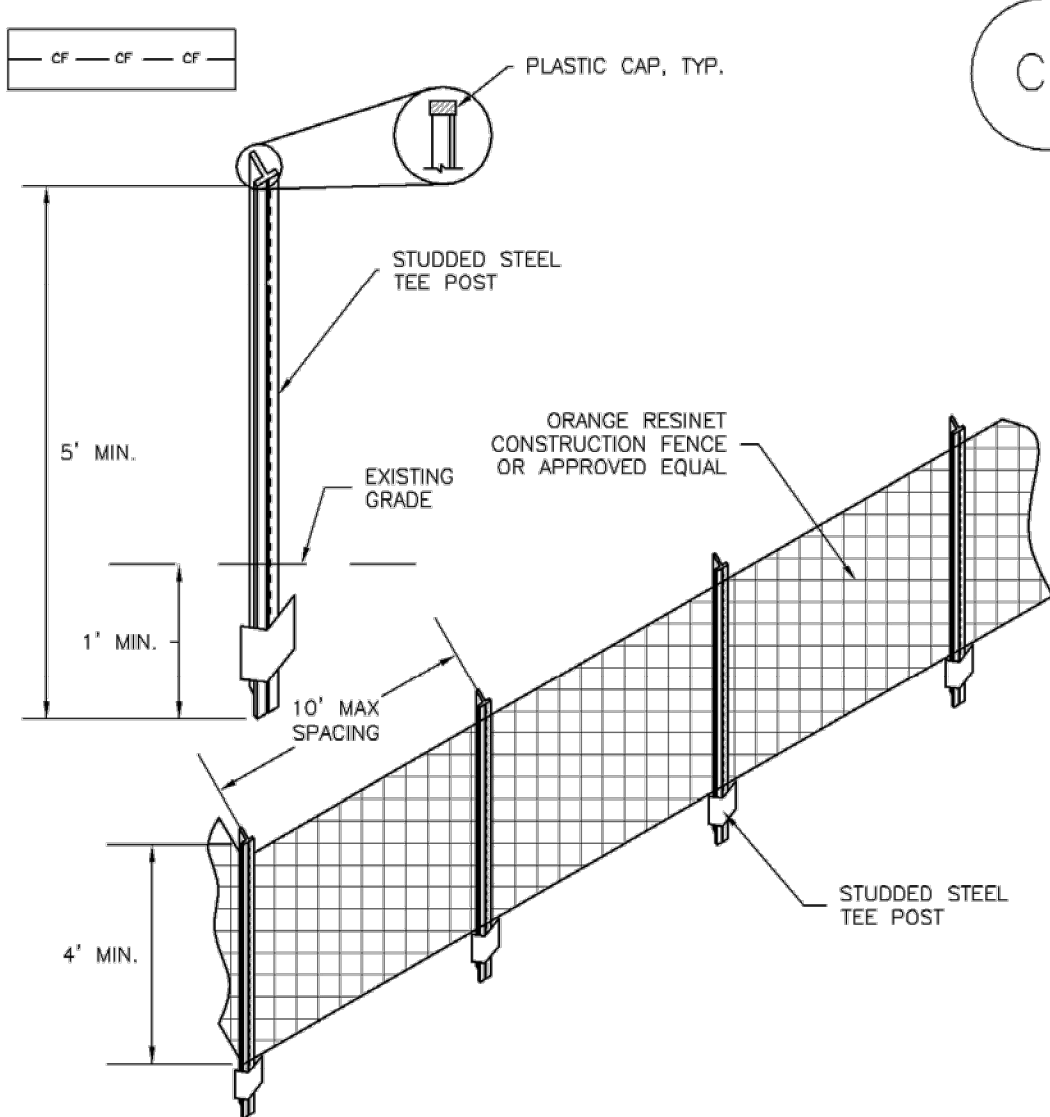

**CF-1. PLASTIC MESH CONSTRUCTION FENCE**

**CONSTRUCTION FENCE INSTALLATION NOTES**

1. SEE PLAN VIEW FOR: -LOCATION OF CONSTRUCTION FENCE.
2. CONSTRUCTION FENCE SHOWN SHALL BE INSTALLED PRIOR TO ANY LAND DISTURBING ACTIVITIES.
3. CONSTRUCTION FENCE SHALL BE COMPOSED OF ORANGE, CONTRACTOR-GRADE MATERIAL THAT IS AT LEAST 4' HIGH. METAL POSTS SHOULD HAVE A PLASTIC CAP FOR SAFETY.
4. STUDDED STEEL TEE POSTS SHALL BE UTILIZED TO SUPPORT THE CONSTRUCTION FENCE. MAXIMUM SPACING FOR STEEL TEE POSTS SHALL BE 10'.
5. CONSTRUCTION FENCE SHALL BE SECURELY FASTENED TO THE TOP, MIDDLE, AND BOTTOM OF EACH POST.

November 2010 Urban Drainage and Flood Control District Urban Storm Drainage Criteria Manual Volume 3 CF-3

**SM-3**

**Construction Fence (CF)**

CF

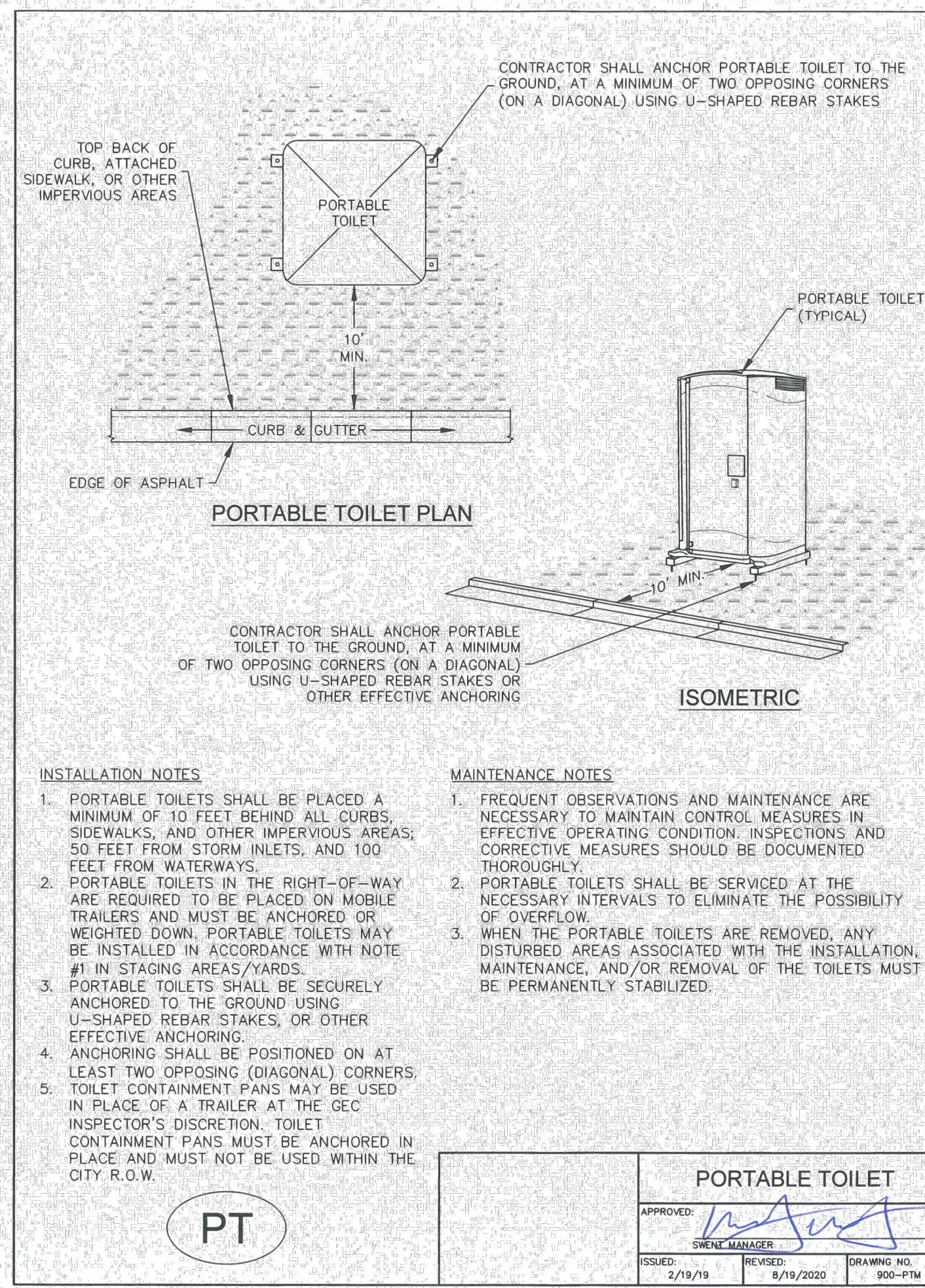

**INSTALLATION NOTES**

1. PORTABLE TOILETS SHALL BE PLACED A MINIMUM OF 10 FEET BEHIND ALL CURBS, SIDEWALKS, AND OTHER IMPERVIOUS AREAS; 50 FEET FROM STORM INLETS, AND 100 FEET FROM WATERWAYS.
2. PORTABLE TOILETS IN THE RIGHT-OF-WAY ARE REQUIRED TO BE PLACED ON MOBILE TRAILERS AND MUST BE ANCHORED OR WEIGHTED DOWN. PORTABLE TOILETS MAY BE INSTALLED IN ACCORDANCE WITH NOTE #1 IN STAGING AREAS/YARDS.
3. PORTABLE TOILETS SHALL BE SECURELY ANCHORED TO THE GROUND USING U-SHAPED REBAR STAKES, OR OTHER EFFECTIVE ANCHORING.
4. ANCHORING SHALL BE POSITIONED ON AT LEAST TWO OPPOSING (DIAGONAL) CORNERS.
5. TOILET CONTAINMENT PANS MAY BE USED IN PLACE OF A TRAILER AT THE GEC INSPECTOR'S DISCRETION. TOILET CONTAINMENT PANS MUST BE ANCHORED IN PLACE AND MUST NOT BE USED WITHIN THE CITY R.O.W.

**MAINTENANCE NOTES**

1. FREQUENT OBSERVATIONS AND MAINTENANCE ARE NECESSARY TO MAINTAIN CONTROL MEASURES IN EFFECTIVE OPERATING CONDITION. INSPECTIONS AND CORRECTIVE MEASURES SHOULD BE DOCUMENTED THOROUGHLY.
2. PORTABLE TOILETS SHALL BE SERVICED AT THE NECESSARY INTERVALS TO ELIMINATE THE POSSIBILITY OF OVERFLOW.
3. WHEN THE PORTABLE TOILETS ARE REMOVED, ANY DISTURBED AREAS ASSOCIATED WITH THE INSTALLATION, MAINTENANCE, AND/OR REMOVAL OF THE TOILETS MUST BE PERMANENTLY STABILIZED.

**PORTABLE TOILET**

APPROVED:	<i>[Signature]</i>
DRAWN BY:	SWEN MANAGER
ISSUED:	2/18/19
REVISED:	6/19/2020
DRAWING NO.:	900-PTM

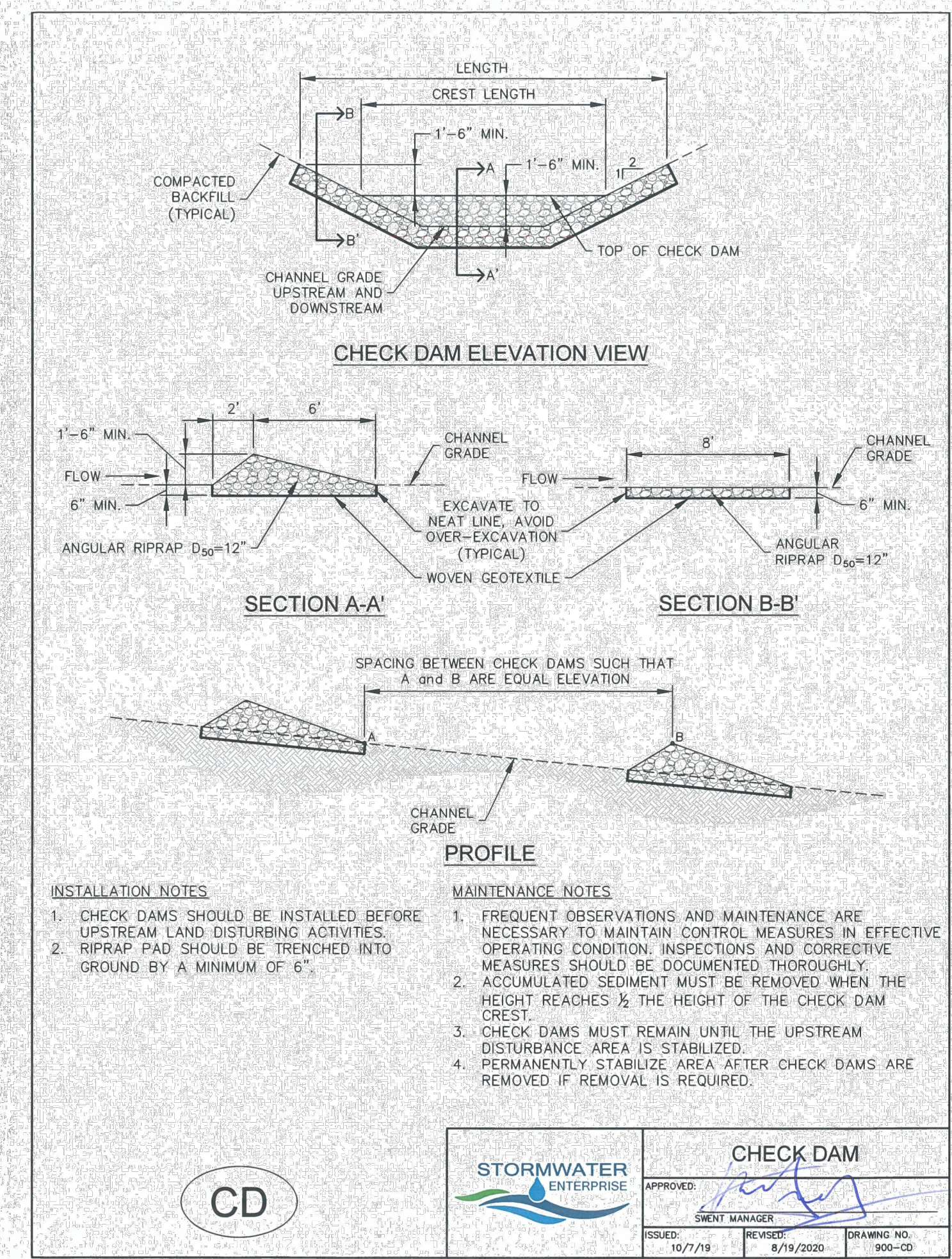

**CHECK DAM ELEVATION VIEW**

**SECTION A-A'**

**SECTION B-B'**

**PROFILE**

**INSTALLATION NOTES**

1. CHECK DAMS SHOULD BE INSTALLED BEFORE UPSTREAM LAND DISTURBING ACTIVITIES.
2. RIPRAP PAD SHOULD BE TRENCHED INTO GROUND BY A MINIMUM OF 6".

**MAINTENANCE NOTES**

1. FREQUENT OBSERVATIONS AND MAINTENANCE ARE NECESSARY TO MAINTAIN CONTROL MEASURES IN EFFECTIVE OPERATING CONDITION. INSPECTIONS AND CORRECTIVE MEASURES SHOULD BE DOCUMENTED THOROUGHLY.
2. ACCUMULATED SEDIMENT MUST BE REMOVED WHEN THE HEIGHT REACHES 1/2 THE HEIGHT OF THE CHECK DAM CREST.
3. CHECK DAMS MUST REMAIN UNTIL THE UPSTREAM DISTURBANCE AREA IS STABILIZED.
4. PERMANENTLY STABILIZE AREA AFTER CHECK DAMS ARE REMOVED IF REMOVAL IS REQUIRED.

CD

**CHECK DAM**

APPROVED:	<i>[Signature]</i>
DRAWN BY:	SWEN MANAGER
ISSUED:	10/7/19
REVISED:	6/19/2020
DRAWING NO.:	900-CD

K:\05\_04\096010025.DTC Falcon CO\CD\05\096010025\05\_04\_2021\_2:19pm This document, together with the concepts and design presented herein, is intended only for the specific purpose and client for which it was prepared. Reuse of this document, together with the concepts and design presented herein, as an instrument of service, is intended only for the specific purpose and client for which it was prepared. Reuse of this document, together with the concepts and design presented herein, as an instrument of service, is intended only for the specific purpose and client for which it was prepared. Reuse of this document, together with the concepts and design presented herein, as an instrument of service, is intended only for the specific purpose and client for which it was prepared.

THIS DRAWING IS AN INSTRUMENT OF SERVICE AND THE PROPERTY OF DISCOUNT TIRE COMPANY AND SHALL REMAIN SUCH. THE USE OF THIS DRAWING SHALL BE RESTRICTED TO THE ORIGINAL SITE FOR WHICH IT WAS PREPARED. PUBLICATION THEREOF IS EXPRESSLY LIMITED TO SUCH.

NO.	REVISION	DATE



PROJECT NAME:  
DISCOUNT TIRE - FALCON, CO

PROJECT ADDRESS:  
7585 FALCON MARKETPLACE

PROJECT NUMBER:  
096010025

DATE:  
08/05/2021

DESIGNED BY:  
JMM

REVIEWED BY:  
MOH

SHEET TITLE:  
EROSION CONTROL DETAILS

SHEET NUMBER:  
C2.8



## APPENDIX B – CDPHE STORMWATER PERMIT





# STATE OF COLORADO

COLORADO DEPARTMENT OF PUBLIC HEALTH AND ENVIRONMENT

Water Quality Control Division

CDPS GENERAL PERMIT  
STORMWATER DISCHARGES ASSOCIATED WITH  
CONSTRUCTION ACTIVITY  
AUTHORIZATION TO DISCHARGE UNDER THE  
COLORADO DISCHARGE PERMIT SYSTEM (CDPS)

In compliance with the provisions of the Colorado Water Quality Control Act, (25-8-101 et seq., CRS, 1973 as amended) and the Federal Water Pollution Control Act, as amended (33 U.S.C. 1251 et seq.; the "Act"), this permit authorizes the discharge of stormwater associated with construction activities (and specific allowable non-stormwater discharges in accordance with Part I.A.1. of the permit) certified under this permit, from those locations specified throughout the State of Colorado to specified waters of the State.

Such discharges shall be in accordance with the conditions of this permit. This permit specifically authorizes the facility listed on the certification to discharge in accordance with permit requirements and conditions set forth in Parts I and II hereof. All discharges authorized herein shall be consistent with the terms and conditions of this permit.

This permit becomes effective on April 1, 2019, and shall expire at midnight March 31, 2024.

Issued and signed this 1st day of November 2018.

COLORADO DEPARTMENT OF PUBLIC HEALTH AND ENVIRONMENT

Ellen Howard Kutzer, Permits Section Manager  
Water Quality Control Division

**Permit History**

Originally signed and issued October 31, 2018; effective April 1, 2019.

## Table of Contents

Part I .....	1
A. COVERAGE UNDER THIS PERMIT.....	1
1. Authorized Discharges .....	1
2. Limitations on Coverage.....	1
3. Permit Certification and Submittal Procedures .....	2
B. EFFLUENT LIMITATIONS .....	6
1. Requirements for Control Measures Used to Meet Effluent Limitations .....	6
2. Discharges to an Impaired Waterbody.....	9
3. General Requirements .....	10
C. STORMWATER MANAGEMENT PLAN (SWMP) REQUIREMENTS .....	11
1. SWMP General Requirements .....	11
2. SWMP Content .....	11
3. SWMP Review and Revisions .....	13
4. SWMP Availability.....	14
D. SITE INSPECTIONS.....	14
1. Person Responsible for Conducting Inspections .....	14
2. Inspection Frequency .....	14
3. Inspection Frequency for Discharges to Outstanding Waters.....	15
4. Reduced Inspection Frequency .....	15
5. Inspection Scope.....	16
E. DEFINITIONS .....	17
F. MONITORING.....	20
G. Oil and Gas Construction .....	21
Part II: Standard Permit Conditions.....	22
A. DUTY TO COMPLY.....	22
B. DUTY TO REAPPLY .....	22
C. NEED TO HALT OR REDUCE ACTIVITY NOT A DEFENSE .....	22
D. DUTY TO MITIGATE .....	22
E. PROPER OPERATION AND MAINTENANCE .....	22
F. PERMIT ACTIONS .....	22
G. PROPERTY RIGHTS .....	22
H. DUTY TO PROVIDE INFORMATION .....	23
I. INSPECTION AND ENTRY .....	23
J. MONITORING AND RECORDS .....	23
K. SIGNATORY REQUIREMENTS .....	24

- 1. Authorization to Sign:..... 24
- 2. Electronic Signatures ..... 25
- 3. Change in Authorization to Sign ..... 25
- L. REPORTING REQUIREMENTS ..... 25
  - 1. Planned Changes..... 25
  - 2. Anticipated Non-Compliance ..... 25
  - 3. Transfer of Ownership or Control ..... 25
  - 4. Monitoring reports..... 26
  - 5. Compliance Schedules ..... 26
  - 6. Twenty-four hour reporting..... 26
  - 7. Other non-compliance ..... 27
  - 8. Other information ..... 27
- M. BYPASS ..... 27
  - 1. Bypass not exceeding limitations ..... 27
  - 2. Notice of bypass ..... 27
  - 3. Prohibition of Bypass..... 27
- N. UPSET..... 28
  - 1. Effect of an upset ..... 28
  - 2. Conditions necessary for demonstration of an Upset ..... 28
  - 3. Burden of Proof ..... 28
- O. RETENTION OF RECORDS..... 28
  - 1. Post-Expiration or Termination Retention ..... 28
  - 2. On-site Retention..... 29
- P. REOPENER CLAUSE..... 29
  - 1. Procedures for modification or revocation ..... 29
  - 2. Water quality protection ..... 29
- Q. SEVERABILITY..... 29
- R. NOTIFICATION REQUIREMENTS ..... 29
  - 1. Notification to Parties ..... 29
- S. RESPONSIBILITIES ..... 30
  - 1. Reduction, Loss, or Failure of Treatment Facility ..... 30
- T. Oil and Hazardous Substance Liability..... 30
- U. Emergency Powers..... 30
- V. Confidentiality ..... 30
- W. Fees..... 30

X. Duration of Permit..... 30

Y. Section 307 Toxics..... 30

## Part I

Note: At the first mention of terminology that has a specific connotation for the purposes of this permit, the terminology is electronically linked to the definitions section of the permit in Part I.E.

**A. COVERAGE UNDER THIS PERMIT****1. Authorized Discharges**

This general permit authorizes [permittee\(s\)](#) to discharge the following to state waters: stormwater associated with [construction activity](#) and specified non-stormwater associated with construction activity. The following types of stormwater and non-stormwater discharges are authorized under this permit:

**a. Allowable Stormwater Discharges**

- i. Stormwater discharges associated with construction activity.
- ii. Stormwater discharges associated with producing earthen materials, such as soils, sand, and gravel dedicated to providing material to a single contiguous site, or within ¼ mile of a construction site (i.e. borrow or fill areas)
- iii. Stormwater discharges associated with [dedicated asphalt, concrete batch plants and masonry mixing stations](#) (Coverage under this permit is not required if alternative coverage has been obtained.)

**b. Allowable Non-Stormwater Discharges**

The following non-stormwater discharges are allowable under this permit if the discharges are identified in the stormwater management plan in accordance with Part I.C. and if they have appropriate [control measures](#) in accordance with Part I.B.1.

- i. Discharges from uncontaminated springs that do not originate from an area of land disturbance.
- ii. Discharges to the ground of concrete washout water associated with the washing of concrete tools and concrete mixer chutes. Discharges of concrete washout water must not leave the site as surface runoff or reach [receiving waters](#) as defined by this permit.
- iii. Discharges of landscape irrigation return flow.

**c. Emergency Fire Fighting**

Discharges resulting from emergency firefighting activities are authorized by this permit.

**2. Limitations on Coverage**

Discharges not authorized by this permit include, but are not limited to, the discharges and activities listed below. Permittees may seek individual or alternate general permit coverage for the discharges, as appropriate and available.

**a. Discharges of Non-Stormwater**

Discharges of non-stormwater, except the authorized non-stormwater discharges listed in Part I.A.1.b., are not eligible for coverage under this permit.

- b. Discharges Currently Covered by another Individual or General Permit
  - c. Discharges Currently Covered by a Water Quality Control Division (division) Low Risk Guidance Document
3. Permit Certification and Submittal Procedures
- a. Duty to apply  
The following activities shall apply for coverage under this permit:
    - i. Construction sites that will disturb one acre or more; or
    - ii. Construction sites that are part of a [common plan of development or sale](#); or
    - iii. Stormwater discharges that are designated by the division as needing a stormwater permit because the discharge:
      - (a) Contributes to a violation of a water quality standard; or
      - (b) is a significant contributor of pollutants to state waters.
  - b. Application Requirements  
To obtain authorization to discharge under this permit, applicants applying for coverage following the effective date of the renewal permit shall meet the following requirements:
    - i. Owners and operators submitting an application for permit coverage will be co-permittees subject to the same benefits, duties, and obligations under this permit.
    - ii. Signature requirements: Both the [owner](#) and [operator](#) (permittee) of the construction site, as defined in Part I.E., must agree to the terms and conditions of the permit and submit a completed application that includes the signature of both the owner and the operator. In cases where the duties of the owner and operator are managed by the owner, both application signatures may be completed by the owner. Both the owner and operator are responsible for ensuring compliance with all terms and conditions of the permit, including implementation of the stormwater management plan.
    - iii. Applicants must use the paper form provided by the division or the electronic form provided on the division's web-based application platform when applying for coverage under this permit.
    - iv. The applicant(s) must develop a stormwater management plan (SWMP) in accordance with the requirements of Part I.C. The applicant(s) must also certify that the SWMP is complete, or will be complete, prior to commencement of any construction activity.

- v. The applicant(s) must submit a complete, accurate, and signed permit application electronically, by mail or hand delivery to the division at least 10 days prior to the commencement of construction activity except that construction activities that are in response to a **public emergency related site** shall apply for coverage no later than 14 days after the commencement of construction activities. The provisions of this part in no way remove a violation of the Colorado Water Quality Control Act if a point source discharge occurs prior to the issuance of a CDPS permit.
  - vi. The application must be signed in accordance with the requirements of Part IA. Applications submitted by mail or hand delivered should be directed to:  
  
Colorado Department of Public Health and Environment  
Water Quality Control Division  
Permits Section, WQCD-PS-B2  
4300 Cherry Creek Drive South  
Denver, CO 80246
  - vii. The applicant(s) must receive written notification that the division granted permit coverage prior to conducting construction activities except for construction activities that are in response to a public emergency related site
- c. Division Review of Permit Application  
Within 10 days of receipt of the application, and following review of the application, the division may:
- i. Issue a certification of coverage;
  - ii. request additional information necessary to evaluate the discharge;
  - iii. delay the authorization to discharge pending further review;
  - iv. notify the applicant that additional terms and conditions are necessary; or
  - v. deny the authorization to discharge under this general permit.
- d. Alternative Permit Coverage
- i. Division Required Alternate Permit Coverage:  
The Division may require an applicant or permittee to apply for an individual permit or an alternative general permit if it determines the discharge does not fall under the scope of this general permit. In this case, the Division will notify the applicant or permittee that an individual permit application is required.
  - ii. Permittee Request for alternate permit coverage:  
A permittee authorized to discharge stormwater under this permit may request to be excluded from coverage under this general permit by applying for an individual permit. In this case, the permittee must submit an individual application, with reasons supporting the request, to the Division at least 180 days prior to any discharge. When an individual permit is issued, the permittee's authorization to discharge under this permit is terminated on the effective date of the individual permit.
- e. Submittal Signature Requirements

Documents required for submittal to the division in accordance with this permit, including applications for permit coverage and other documents as requested by the division, must include signatures by both the owner and the operator, except for instances where the duties of the owner and operator are managed by the owner.

Signatures on all documents submitted to the division as required by this permit must meet the Standard Signatory Requirements in Part II.K. of this permit in accordance with 40 C.F.R. 122.41(k).

i. Signature Certification

Any person(s) signing documents required for submittal to the Division must make the following certification:

"I certify under penalty of law that this document and all attachments were prepared under my direction or supervision in accordance with a system designed to assure that qualified personnel properly gather and evaluate the information submitted. Based on my inquiry of the person or persons who manage the system, or those persons directly responsible for gathering the information, the information submitted is, to the best of my knowledge and belief, true, accurate, and complete. I am aware that there are significant penalties for submitting false information, including the possibility of fine and imprisonment for knowing violations."

f. Compliance Document Signature Requirements

Documents which are required for compliance with the permit, but for which submittal to the division is not required unless specifically requested by the division, must be signed by the individual(s) designated as the Qualified Stormwater Manager, as defined in Part I.E.

i. Any person(s) signing inspection documents required for compliance with the permit must make the following statement:

"I verify that, to the best of my knowledge and belief, all corrective action and maintenance items identified during the inspection are complete, and the site is currently in compliance with the permit."

g. Field Wide Permit Coverage for Oil and Gas Construction

At the discretion of the division, a single permit certification may be issued to a single oil and gas permittee to cover construction activity related discharges from an oil and gas field at multiple locations that are not necessarily contiguous.

h. Permit Coverage without Application

Qualifying Local Program: When a small construction site is within the jurisdiction of a qualifying local program, the owner and operator of the construction activity are authorized to discharge stormwater associated with small construction activity under this general permit without the submittal of an application to the division. Sites covered by a qualifying local program are exempt from the following sections of this general permit:



Part I.A.3.a.; Part I.A.3.b.; Part I.A.3.c.; Part I.A.3.d.; Part I.A.3.g.; Part I.A.3.i.; Part I.A.3.j.; Part I.A.3.k.

Sites covered by a qualifying local program are subject to the following requirements:

- i. **Local Agency Authority:** This permit does not pre-empt or supersede the authority of local agencies to prohibit, restrict, or control discharges of stormwater to storm drain systems or other water courses within their jurisdiction.
  - ii. **Permit Coverage Termination:** When a site under a Qualifying Local Program is finally stabilized, coverage under this permit is automatically terminated.
  - iii. **Compliance with Qualifying Local Program:** Qualifying Local Program requirements that are equivalent to the requirements of this permit are incorporated by reference. Permittees authorized to discharge under this permit, must comply with the equivalent requirements of the Qualifying Local Program that has jurisdiction over the site as a condition of this permit.
  - iv. **Compliance with Remaining Permit Conditions.** Requirements of this permit that are in addition to or more stringent than the requirements of the Qualifying Local Program apply in addition to the requirements of the Qualifying Local Program.
  - v. **Written Authorization of Coverage:** The division or local municipality may require any permittee within the jurisdiction of a Qualifying Local Program covered under this permit to apply for, and obtain written authorization of coverage under this permit. The permittee must be notified in writing that an application for written authorization of coverage is required.
- i. **Permittee Initiated Permit Actions**  
Permittee initiated permit actions, including but not limited to modifications, contact changes, transfers, reassignments, and terminations, shall be conducted following division guidance and using appropriate division-provided forms.
  - j. **Sale of Residence to Homeowner**  
**Residential construction sites only:** The permittee may remove residential lots from permit coverage once the lot meets the following criteria:
    - i. the residential lot has been sold to the homeowner(s) for private residential use;
    - ii. a certificate of occupancy, or equivalent, is maintained on-site and is available during division inspections;
    - iii. the lot is less than one acre of disturbance;
    - iv. all construction activity conducted on the lot by the permittee is complete;
    - v. the permittee is not responsible for final stabilization of the lot; and
    - vi. the SWMP was modified to indicate the lot is no longer part of the construction activity.

If the residential lot meets the criteria listed above then activities occurring on the lot are no longer considered to be construction activities with a duty to apply and maintain permit coverage. Therefore, the permittee is not required to meet the final stabilization requirements and may terminate permit coverage for the lot.

k. Permit Expiration and Continuation of Permit Coverage

Authorization to discharge under this general permit shall expire at midnight on March 31, 2024. While Regulation 61.4 requires a permittee to submit an application for continuing permit coverage 180 days before the permit expires, the division is requiring that permittees desiring continued coverage under this general permit must reapply at least 90 days in advance of this permit expiration. The Division will determine if the permittee may continue to discharge stormwater under the terms of the general permit. An individual permit may be required for any facility not reauthorized to discharge under the reissued general permit.

If this permit is not reissued or replaced prior to the expiration date, it will be administratively continued and remain in force and effect. For permittees that have applied for continued permit coverage, discharges authorized under this permit prior to the expiration date will automatically remain covered by this permit until the earliest of:

- i. An authorization to discharge under a reissued permit, or a replacement of this permit, following the timely and appropriate submittal of a complete application requesting authorization to discharge under the new permit and compliance with the requirements of the new permit; or
- ii. The issuance and effect of a termination issued by the Division; or
- iii. The issuance or denial of an individual permit for the facility's discharges; or
- iv. A formal permit decision by the Division not to reissue this general permit, at which time the Division will identify a reasonable time period for covered dischargers to seek coverage under an alternative general permit or an individual permit. Coverage under this permit will cease when coverage under another permit is granted/authorized; or
- v. The Division has informed the permittee that discharges previously authorized under this permit are no longer covered under this permit.

## B. EFFLUENT LIMITATIONS

### 1. Requirements for Control Measures Used to Meet Effluent Limitations

The permittee must implement control measures to **minimize** the discharge of pollutants from all potential pollutant sources at the site. Control measures must be installed prior to commencement of activities that may contribute pollutants to stormwater discharges. Control measures must be selected, designed, installed and maintained in accordance with good engineering, hydrologic and pollution control practices. Control measures implemented at the site must be designed to prevent pollution or degradation of state waters.

#### a. Stormwater Pollution Prevention

The permittee must implement structural and/or nonstructural control measures that effectively minimize erosion, sediment transport, and the release of other pollutants related to construction activity.

##### i. Control Measures for Erosion and Sediment Control

Control measures for erosion and sediment control may include, but are not limited to, wattles/sediment control logs, silt fences, earthen dikes, drainage swales, sediment traps, subsurface drains, pipe slope drains, inlet protection, outlet protection, gabions, sediment basins, temporary vegetation, permanent vegetation, mulching, geotextiles, sod stabilization, slope roughening, maintaining existing vegetation, protection of trees, and preservation of mature vegetation. Specific non-structural control measures must meet the requirements listed below.

Specific control measures must meet the requirements listed below.

- (a) Vehicle tracking controls shall either be implemented to minimize vehicle tracking of sediment from disturbed areas, or the areas where vehicle tracking occurs shall meet subsection Part I.B.1.a.i(b);
- (b) Stormwater runoff from all disturbed areas and soil storage areas for which permanent or temporary stabilization is not implemented, must flow to at least one control measure to minimize sediment in the discharge. This may be accomplished through filtering, settling, or straining. The control measure must be selected, designed, installed and adequately sized in accordance with good engineering, hydrologic and pollution control practices. The control measure(s) must contain or filter flows in order to prevent the bypass of flows without treatment and must be appropriate for stormwater runoff from disturbed areas and for the expected flow rate, duration, and flow conditions (i.e., sheet or concentrated flow);
- (c) Outlets that withdraw water from or near the surface shall be installed when discharging from basins and impoundments, unless **infeasible**.
- (d) Maintain pre-existing vegetation or equivalent control measures for areas within 50 horizontal feet of receiving waters as defined by this permit, unless **infeasible**.
- (e) Soil compaction must be minimized for areas where infiltration control measures will occur or where **final stabilization** will be achieved through vegetative cover.
- (f) Unless **infeasible**, topsoil shall be preserved for those areas of a site that will utilize vegetative final stabilization.
- (g) Minimize the amount of soil exposed during construction activity, including the disturbance of steep slopes.

ii. Practices for Other Common Pollutants

- (a) Bulk storage, 55 gallons or greater, for petroleum products and other liquid chemicals must have secondary containment, or equivalent protection, in order to contain **spills** and to prevent spilled material from entering state waters.
- (b) Control measures designed for concrete washout waste must be implemented. This includes washout waste discharged to the ground as authorized under this permit and washout waste from concrete trucks and masonry operations contained on site. The permittee must ensure the washing activities do not contribute pollutants to stormwater runoff, or receiving waters in accordance Part I.A.1.b.ii. Discharges that may reach groundwater must flow through soil

that has buffering capacity prior to reaching groundwater, as necessary to meet the effluent limits in this permit, including Part I.B.3.a. The concrete washout location shall not be located in an area where shallow groundwater may be present and would result in buffering capacity not being adequate, such as near natural drainages, springs, or wetlands. This permit authorizes discharges to the ground of concrete washout waste.

iii. Stabilization Requirements

The following requirements must be implemented for each site.

- (a) Temporary stabilization must be implemented for earth disturbing activities on any portion of the site where ground disturbing construction activity has permanently ceased, or temporarily ceased for more than 14 calendar days. Temporary stabilization methods may include, but are not limited to, tarps, soil tackifier, and hydroseed. The permittee may exceed the 14-day schedule when either the function of the specific area of the site requires it to remain disturbed, or, physical characteristics of the terrain and climate prevent stabilization. The SWMP must document the constraints necessitating the alternative schedule, provide the alternate stabilization schedule, and identify all locations where the alternative schedule is applicable on the site map.
- (b) Final stabilization must be implemented for all construction sites. Final stabilization is reached when all ground surface disturbing activities at the construction site are complete; and, for all areas of ground surface disturbing activities, either a uniform vegetative cover with an individual plant density of at least 70 percent of pre-disturbance levels is established, or equivalent permanent alternative stabilization methods are implemented. The division may approve alternative final stabilization criteria for specific operations.
- (c) Final stabilization must be designed and installed as a permanent feature. Final stabilization measures for obtaining a vegetative cover or alternative stabilization methods include, but are not limited to, the following as appropriate:
  - (1) Seed mix selection and application methods;
  - (2) Soil preparation and amendments;
  - (3) Soil stabilization methods (e.g., crimped straw, hydro mulch or rolled erosion control products);
  - (4) Appropriate sediment control measures as needed until final stabilization is achieved;
  - (5) Permanent pavement, hardscape, xeriscape, stabilized driving surfaces;
  - (6) Other alternative stabilization practices as applicable;

(d) The permittee(s) must ensure all temporary control measures are removed from the construction site once final stabilization is achieved, except when the control measure specifications allow the control measure to be left in place (i.e., bio-degradable control measures).

b. Maintenance

The permittee must ensure that all control measures remain in effective operating condition and are protected from activities that would reduce their effectiveness. Control measures must be maintained in accordance with good engineering, hydrologic and pollution control practices. Observations leading to the required maintenance of control measures can be made during a site inspection, or during general observations of site conditions. The necessary repairs or modifications to a [control measure requiring routine maintenance](#), as defined in Part I.E., must be conducted to maintain an effective operating condition. This section is not subject to the requirements in Part I.B.1.c. below.

c. Corrective Actions

The permittee must assess the adequacy of control measures at the site, and the need for changes to those control measures, to ensure continued effective performance. When an [inadequate control measure](#), as defined in Part I.E., is identified (i.e., new or replacement control measures become necessary), the following corrective action requirements apply. The permittee is in noncompliance with the permit until the inadequate control measure is replaced or corrected and returned to effective operating condition in compliance with Part I.B.1. and the general requirements in Part I.B.3. If the inadequate control measure results in noncompliance that meets the conditions of Part II.L., the permittee must also meet the requirements of that section.

i. The permittee must take all necessary steps to minimize or prevent the discharge of pollutants, until a control measure is implemented and made operational and/or an inadequate control measure is replaced or corrected and returned to effective operating condition. If it is infeasible to install or repair of control measure immediately after discovering the deficiency, the following must be documented and kept on record in accordance with the recordkeeping requirements in Part II.

(a) Describe why it is infeasible to initiate the installation or repair immediately; and

(b) Provide a schedule for installing or repairing the control measure and returning it to an effective operating condition as soon as possible.

ii. If applicable, the permittee must remove and properly dispose of any unauthorized release or discharge (e.g., discharge of non-stormwater, spill, or leak not authorized by this permit.) The permittee must also clean up any contaminated surfaces to minimize discharges of the material in subsequent storm events.

2. Discharges to an Impaired Waterbody

a. Total Maximum Daily Load (TMDL)

If the permittee's discharge flows to or could reasonably be expected to flow to any water body for which a TMDL has been approved, and stormwater discharges

associated with construction activity were assigned a pollutant-specific Wasteload Allocation (WLA) under the TMDL, the division may:

- i. ensure the WLA is implemented properly through alternative local requirements, such as by a municipal stormwater permit; or
- ii. notify the permittee of the WLA and amend the permittee's certification to add specific effluent limits and other requirements, as appropriate. The permittee may be required to do the following:
  - (a) under the permittee's SWMP, implement specific control measures based on requirements of the WLA, and evaluate whether the requirements are met through implementation of existing stormwater control measures or if additional control measures are necessary. Document the calculations or other evidence demonstrating that the requirements are expected to be met; and
  - (b) if the evaluation shows that additional or modified control measures are necessary, describe the type and schedule for the control measure additions or modifications.
- iii. Discharge monitoring may also be required. The permittee may maintain coverage under the general permit provided they comply with the applicable requirements outlined above. The division reserves the right to require individual or alternate general permit coverage.

### 3. General Requirements

- a. Discharges authorized by this permit shall not cause, have the reasonable potential to cause, or measurably contribute to an exceedance of any applicable water quality standard, including narrative standards for water quality.
- b. The division may require sampling and testing, on a case-by-case basis, in the event that there is reason to suspect that the SWMP is not adequately minimizing pollutants in stormwater or in order to measure the effectiveness of the control measures in removing pollutants in the effluent. Such monitoring may include Whole Effluent Toxicity testing.
- c. The permittee must comply with the lawful requirements of federal agencies, municipalities, counties, drainage districts and other local agencies including applicable requirements in Municipal Stormwater Management Programs developed to comply with CDPS permits. The permittee must comply with local stormwater management requirements, policies and guidelines including those for erosion and sediment control.
- d. All construction site wastes must be properly managed to prevent potential pollution of state waters. This permit does not authorize on-site waste disposal.
- e. This permit does not relieve the permittee of the reporting requirements in 40 CFR 110, 40 CFR 117 or 40 CFR 302. Any discharge of hazardous material must be handled in accordance with the division's Noncompliance Notification Requirements (see Part II.L. of the permit).

**C. STORMWATER MANAGEMENT PLAN (SWMP) REQUIREMENTS****1. SWMP General Requirements**

- a. A SWMP shall be developed for each construction site covered by this permit. The SWMP must be prepared in accordance with good engineering, hydrologic and pollution control practices.
  - i. For public emergency related sites a SWMP shall be created no later than 14 days after the commencement of construction activities.
- b. The permittee must implement the provisions of the SWMP as written and updated, from commencement of construction activity until final stabilization is complete. The division may review the SWMP.
- c. A copy of the SWMP must be retained onsite or be onsite when construction activities are occurring at the site unless the permittee specifies another location and obtains approval from the division.

**2. SWMP Content**

- a. The SWMP, at a minimum, must include the following elements.
  - i. Qualified Stormwater Manager. The SWMP must list individual(s) by title and name who are designated as the site's qualified stormwater manager(s) responsible for implementing the SWMP in its entirety. This role may be filled by more than one individual.
  - ii. Spill Prevention and Response Plan. The SWMP must have a spill prevention and response plan. The plan may incorporate by reference any part of a Spill Prevention Control and Countermeasure (SPCC) plan under section 311 of the Clean Water Act (CWA) or a Spill Prevention Plan required by a separate CDPS permit. The relevant sections of any referenced plans must be available as part of the SWMP consistent with Part I.C.4.
  - iii. Materials Handling. The SWMP must describe and locate all control measures implemented at the site to minimize impacts from handling **significant materials** that could contribute pollutants to runoff. These handling procedures can include control measures for pollutants and activities such as, exposed storage of building materials, paints and solvents, landscape materials, fertilizers or chemicals, sanitary waste material, trash and equipment maintenance or fueling procedures.
  - iv. Potential Sources of Pollution. The SWMP must list all potential sources of pollution which may reasonably be expected to affect the quality of stormwater discharges associated with construction activity from the site. This shall include, but is not limited to, the following pollutant sources:
    - (a) disturbed and stored soils;
    - (b) vehicle tracking of sediments;
    - (c) management of contaminated soils;
    - (d) loading and unloading operations;

- (e) outdoor storage activities (erodible building materials, fertilizers, chemicals, etc.);
  - (f) vehicle and equipment maintenance and fueling;
  - (g) significant dust or particulate generating processes (e.g., saw cutting material, including dust);
  - (h) routine maintenance activities involving fertilizers, pesticides, herbicides, detergents, fuels, solvents, oils, etc.;
  - (i) on-site waste management practices (waste piles, liquid wastes, dumpsters);
  - (j) concrete truck/equipment washing, including washing of the concrete truck chute and associated fixtures and equipment;
  - (k) dedicated asphalt, concrete batch plants and masonry mixing stations;
  - (l) non-industrial waste sources such as worker trash and portable toilets.
- v. Implementation of Control Measures. The SWMP must include design specifications that contain information on the implementation of the control measure in accordance with good engineering hydrologic and pollution control practices; including as applicable drawings, dimensions, installation information, materials, implementation processes, control measure-specific inspection expectations, and maintenance requirements.

The SWMP must include a documented use agreement between the permittee and the owner or operator of any control measures located outside of the permitted area, that are utilized by the permittee's construction site for compliance with this permit, but not under the direct control of the permittee. The permittee is responsible for ensuring that all control measures located outside of their permitted area, that are being utilized by the permittee's construction site, are properly maintained and in compliance with all terms and conditions of the permit. The SWMP must include all information required of and relevant to any such control measures located outside the permitted area, including location, installation specifications, design specifications and maintenance requirements.

- vi. Site Description. The SWMP must include a site description which includes, at a minimum, the following:
- (a) the nature of the construction activity at the site;
  - (b) the proposed schedule for the sequence for major construction activities and the planned implementation of control measures for each phase. (e.g.: clearing, grading, utilities, vertical, etc.);
  - (c) estimates of the total acreage of the site, and the acreage expected to be disturbed by clearing, excavation, grading, or any other construction activities;
  - (d) a summary of any existing data used in the development of the construction site plans or SWMP that describe the soil or existing potential for soil erosion;



- (e) a description of the percent of existing vegetative ground cover relative to the entire site and the method for determining the percentage;
  - (f) a description of any allowable non-stormwater discharges at the site, including those being discharged under a division low risk discharge guidance policy;
  - (g) a description of areas receiving discharge from the site. Including a description of the immediate source receiving the discharge. If the stormwater discharge is to a municipal separate storm sewer system, the name of the entity owning that system, the location of the storm sewer discharge, and the ultimate receiving water(s); and
  - (h) a description of all stream crossings located within the construction site boundary.
- vii. Site Map. The SWMP must include a site map which includes, at a minimum, the following:
- (a) construction site boundaries;
  - (b) flow arrows that depict stormwater flow directions on-site and runoff direction;
  - (c) all areas of ground disturbance including areas of borrow and fill;
  - (d) areas used for storage of soil;
  - (e) locations of all waste accumulation areas, including areas for liquid, concrete, masonry, and asphalt;
  - (f) locations of dedicated asphalt, concrete batch plants and masonry mixing stations;
  - (g) locations of all structural control measures;
  - (h) locations of all non-structural control measures;
  - (i) locations of springs, streams, wetlands and other state waters, including areas that require pre-existing vegetation be maintained within 50 feet of a receiving water, where determined feasible in accordance with Part I.B.1.a.i.(d).; and
  - (j) locations of all stream crossings located within the construction site boundary.
- viii. Final Stabilization and Long Term Stormwater Management. The SWMP must describe the practices used to achieve final stabilization of all disturbed areas at the site and any planned practices to control pollutants in stormwater discharges that will occur after construction operations are completed. Including but not limited to, detention/retention ponds, rain gardens, stormwater vaults, etc.
- ix. Inspection Reports. The SWMP must include documented inspection reports in accordance with Part ID.

### 3. SWMP Review and Revisions

Permittees must keep a record of SWMP changes made that includes the date and identification of the changes. The SWMP must be amended when the following occurs:

- a. a change in design, construction, operation, or maintenance of the site requiring implementation of new or revised control measures;
- b. the SWMP proves ineffective in controlling pollutants in stormwater runoff in compliance with the permit conditions;
- c. control measures identified in the SWMP are no longer necessary and are removed; and
- d. corrective actions are taken onsite that result in a change to the SWMP.

For SWMP revisions made prior to or following a change(s) onsite, including revisions to sections addressing site conditions and control measures, a notation must be included in the SWMP that identifies the date of the site change, the control measure removed, or modified, the location(s) of those control measures, and any changes to the control measure(s). The permittee must ensure the site changes are reflected in the SWMP. The permittee is noncompliant with the permit until the SWMP revisions have been made.

#### 4. SWMP Availability

A copy of the SWMP must be provided upon request to the division, EPA, and any local agency with authority for approving sediment and erosion plans, grading plans or stormwater management plans within the time frame specified in the request. If the SWMP is required to be submitted to any of these entities, the submission must include a signed certification in accordance with Part I.A.3.e., certifying that the SWMP is complete and compliant with all terms and conditions of the permit.

All SWMPs required under this permit are considered reports that must be available to the public under Section 308(b) of the CWA and Section 61.5(4) of the CDPS regulations. The permittee must make plans available to members of the public upon request. However, the permittee may claim any portion of a SWMP as confidential in accordance with 40 CFR Part 2.

#### D. SITE INSPECTIONS

Site inspections must be conducted in accordance with the following requirements. The required inspection schedules are a minimum frequency and do not affect the permittee's responsibility to implement control measures in effective operating condition as prescribed in the SWMP. Proper maintenance of control measures may require more frequent inspections. Site inspections shall start within 7 calendar days of the commencement of construction activities on site.

##### 1. Person Responsible for Conducting Inspections

The person(s) inspecting the site may be on the permittee's staff or a third party hired to conduct stormwater inspections under the direction of the permittee(s). The permittee is responsible for ensuring that the inspector is a qualified stormwater manager.

##### 2. Inspection Frequency

Permittees must conduct site inspections in accordance with one of the following minimum frequencies, unless the site meets the requirements of Part ID.3

- a. At least one inspection every 7 calendar days. Or
  - b. At least one inspection every 14 calendar days, if post-storm event inspections are conducted within 24 hours after the end of any precipitation or snowmelt event that causes surface erosion. Post-storm inspections may be used to fulfill the 14-day routine inspection requirement.
  - c. When site conditions make the schedule required in this section impractical, the permittee may petition the Division to grant an alternate inspection schedule. The alternative inspection schedule may not be implemented prior to written approval by the division and incorporation into the SWMP.
3. Inspection Frequency for Discharges to Outstanding Waters

Permittees must conduct site inspections at least once every 7 calendar days for sites that discharge to a water body designated as an Outstanding Water by the Water Quality Control Commission.

4. Reduced Inspection Frequency

The permittee may perform site inspections at the following reduced frequencies when one of the following conditions exists:

- a. Post-Storm Inspections at Temporarily Idle Sites  
For permittees choosing to combine 14-day inspections and post-storm-event-inspections, if no construction activities will occur following a storm event, post-storm event inspections must be conducted prior to re-commencing construction activities, but no later than 72 hours following the storm event. The delay of any post-storm event inspection must be documented in the inspection record. Routine inspections must still be conducted at least every 14 calendar days.
- b. Inspections at Completed Sites/Areas  
When the site, or portions of a site are awaiting establishment of a vegetative ground cover and final stabilization, the permittee must conduct a thorough inspection of the stormwater management system at least once every 30 days. Post-storm event inspections are not required under this schedule. This reduced inspection schedule is allowed if all of the following criteria are met:
  - i. all construction activities resulting in ground disturbance are complete;
  - ii. all activities required for final stabilization, in accordance with the SWMP, have been completed, with the exception of the application of seed that has not occurred due to seasonal conditions or the necessity for additional seed application to augment previous efforts; and
  - iii. the SWMP has been amended to locate those areas to be inspected in accordance with the reduced schedule allowed for in this paragraph.
- c. Winter Conditions Inspections Exclusion

Inspections are not required for sites that meet all of the following conditions: construction activities are temporarily halted, snow cover exists over the entire site for an extended period, and melting conditions posing a risk of surface erosion do not exist. This inspection exception is applicable only during the period where melting conditions do not exist, and applies to the routine 7-day, 14-day and monthly inspections, as well as the post-storm-event inspections. When this inspection exclusion is implemented, the following information must be documented in accordance with the requirements in Part II:

- i. dates when snow cover existed;
- ii. date when construction activities ceased; and
- iii. date melting conditions began.

## 5. Inspection Scope

### a. Areas to be Inspected

When conducting a site inspection the following areas, if applicable, must be inspected for evidence of, or the potential for, pollutants leaving the construction site boundaries, entering the stormwater drainage system, or discharging to state waters:

- i. construction site perimeter;
- ii. all disturbed areas;
- iii. designated haul routes;
- iv. material and waste storage areas exposed to precipitation;
- v. locations where stormwater has the potential to discharge offsite; and
- vi. locations where vehicles exit the site.

### b. Inspection Requirements

- i. Visually verify whether all implemented control measures are in effective operational condition and are working as designed in their specifications to minimize pollutant discharges.
- ii. Determine if there are new potential sources of pollutants.
- iii. Assess the adequacy of control measures at the site to identify areas requiring new or modified control measures to minimize pollutant discharges.
- iv. Identify all areas of non-compliance with the permit requirements and, if necessary, implement corrective action in accordance with Part IB.1.c.

### c. Inspection Reports

The permittee must keep a record of all inspections conducted for each permitted site. Inspection reports must identify any incidents of noncompliance with the terms and conditions of this permit. Inspection records must be retained in accordance with Part II.O. and signed in accordance with Part I.A.3.f. At a minimum, the inspection report must include:

- i. the inspection date;

- ii. name(s) and title(s) of personnel conducting the inspection;
- iii. weather conditions at the time of inspection;
- iv. phase of construction at the time of inspection;
- v. estimated acreage of disturbance at the time of inspection
- vi. location(s) of discharges of sediment or other pollutants from the site;
- vii. location(s) of control measures needing maintenance;
- viii. location(s) and identification of inadequate control measures;
- ix. location(s) and identification of additional control measures are needed that were not in place at the time of inspection;
- x. description of the minimum inspection frequency (either in accordance with Part I.D.2., I.D.3. or I.D.4.) utilized when conducting each inspection.
- xi. deviations from the minimum inspection schedule as required in Part I.D.2.;
- xii. after adequate corrective action(s) and maintenance have been taken, or where a report does not identify any incidents requiring corrective action or maintenance, the report shall contain a statement as required in Part I.A.3.f.

#### E. DEFINITIONS

For the purposes of this permit:

- (1) Bypass - the intentional diversion of waste streams from any portion of a treatment facility in accordance with 40 CFR 122.41(m)(1)(i) and Regulation 61.2(12).
- (2) Common Plan of Development or Sale - A contiguous area where multiple separate and distinct construction activities may be taking place at different times on different schedules, but remain related. The Division has determined that "contiguous" means construction activities located in close proximity to each other (within ¼ mile). Construction activities are considered to be "related" if they share the same development plan, builder or contractor, equipment, storage areas, etc. "Common plan of development or sale" includes construction activities that are associated with the construction of field wide oil and gas permits for facilities that are related.
- (3) Construction Activity - Ground surface disturbing and associated activities (land disturbance), which include, but are not limited to, clearing, grading, excavation, demolition, installation of new or improved haul roads and access roads, staging areas, stockpiling of fill materials, and borrow areas. Construction does not include routine maintenance to maintain the original line and grade, hydraulic capacity, or original purpose of the facility. Activities to conduct repairs that are not part of routine maintenance or for replacement are construction activities and are not routine maintenance. Repaving activities where underlying and/or surrounding soil is exposed as part of the repaving operation are considered construction activities. Construction activity is from initial ground breaking to final stabilization regardless of ownership of the construction activities.
- (4) Control Measure - Any best management practice or other method used to prevent or reduce the discharge of pollutants to state waters. Control measures include, but are not limited to, best management practices. Control measures can include other methods such as the installation, operation, and maintenance of structural controls and treatment devices.

- (5) Control Measure Requiring Routine Maintenance - Any control measure that is still operating in accordance with its design and the requirements of this permit, but requires maintenance to prevent a breach of the control measure. See also inadequate control measure.
- (6) Dedicated Asphalt, Concrete Batch Plants and Masonry Mixing Stations - are batch plants or mixing stations located on, or within ¼ mile of, a construction site and that provide materials only to that specific construction site.
- (7) Final Stabilization - The condition reached when all ground surface disturbing activities at the site have been completed, and for all areas of ground surface disturbing activities where a uniform vegetative cover has been established with an individual plant density of at least 70 percent of pre-disturbance levels, or equivalent permanent, physical erosion reduction methods have been employed.
- (8) Good Engineering, Hydrologic and Pollution Control Practices: are methods, procedures, and practices that:
  - a. Are based on basic scientific fact(s).
  - b. Reflect best industry practices and standards.
  - c. Are appropriate for the conditions and pollutant sources.
  - d. Provide appropriate solutions to meet the associated permit requirements, including practice based effluent limits.
- (9) Inadequate Control Measure - Any control measure that is not designed or implemented in accordance with the requirements of the permit and/or any control measure that is not implemented to operate in accordance with its design. See also Control Measure Requiring Routine Maintenance.
- (10) Infeasible - Not technologically possible, or not economically practicable and achievable in light of best industry practices.
- (11) Minimize - reduce or eliminate to the extent achievable using control measures that are technologically available and economically practicable and achievable in light of best industry practice.
- (12) Municipality - A city, town, county, district, association, or other public body created by, or under, State law and having jurisdiction over disposal of sewage, industrial wastes, or other wastes, or a designated and approved management agency under section 208 of CWA (1987).
- (13) Municipal Separate Storm Sewer System (MS4) - A conveyance or system of conveyances (including roads with drainage systems, municipal streets, catch basins, curbs, gutters, ditches, man-made channels, or storm drains):
  - a) owned or operated by a State, city, town, county, district, association, or other public body (created by or pursuant to State law) having jurisdiction over disposal of sewage, industrial wastes, stormwater, or other wastes, including special districts under State law such as a sewer district, flood control district or drainage district, or similar entity, or a designated and approved management agency under section 208 of the CWA that discharges to state waters;
    - i. designed or used for collecting or conveying stormwater;
    - ii. are not a combined sewer; and
    - iii. are not part of a Publicly Owned Treatment Works (POTW). See 5 CCR 1002-61.2(62).
- (14) Municipal Stormwater Management Program - A stormwater program operated by a municipality, typically to meet the requirements of the municipalities MS4 discharge certification.

- (15) Operator - The party that has operational control over day-to-day activities at a project site which are necessary to ensure compliance with the permit. This party is authorized to direct individuals at a site to carry out activities required by the permit. (e.g. the general contractor)
- (16) Owner - The party that has overall control of the activities and that has funded the implementation of the construction plans and specifications. This is the party with ownership of, a long term lease of, or easements on the property on which the construction activity is occurring (e.g., the developer).
- (17) Permittee(s) - The owner and operator named in the discharge certification issued under this permit for the construction site specified in the certification.
- (18) Point Source - Any discernible, confined, and discrete conveyance, including, but not limited to, any pipe, ditch, channel, tunnel, conduit, well, discrete fissure, container, rolling stock, concentrated animal feeding operation, or vessel or other floating craft, from which pollutants are or may be discharged. Point source does not include irrigation return flow. See 5 CCR 102-61.2(75).
- (19) Pollutant - Dredged spoil, dirt, slurry, solid waste, incinerator residue, sewage, sewage sludge, garbage, trash, chemical waste, biological nutrient, biological material, radioactive material, heat, wrecked or discarded equipment, rock, sand, or any industrial, municipal or agricultural waste. See 5 CCR 1002-61.2(76).
- (20) Presentation of credentials - a government issued form of identification, if in person; or (ii) providing name, position and purpose of inspection if request to enter is made via telephone, email or other form of electronic communication. A Permittee's non-response to a request to enter upon presentation of credentials constitutes a denial to such request, and may result in violation of the Permit.
- (21) Process Water - Any water which, during manufacturing or processing, comes into contact with or results from the production of any raw material, intermediate product, finished product, by product or waste product.
- (22) Public Emergency Related Site - a project initiated in response to an unanticipated emergency (e.g., mud slides, earthquake, extreme flooding conditions, disruption in essential public services), for which the related work requires immediate authorization to avoid imminent endangerment to human health or the environment, or to reestablish essential public services.
- (23) Qualified Stormwater Manager - An individual knowledgeable in the principles and practices of erosion and sediment control and pollution prevention, and with the skills to assess conditions at construction sites that could impact stormwater quality and to assess the effectiveness of stormwater controls implemented to meet the requirements of this permit.
- (24) Qualifying Local Program - A municipal program for stormwater discharges associated with small construction activity that was formally approved by the division as a qualifying local program.
- (25) Receiving Water - Any classified or unclassified surface water segment (including tributaries) in the State of Colorado into which stormwater associated with construction activities discharges. This definition includes all water courses, even if they are usually dry, such as borrow ditches, arroyos, and other unnamed waterways.
- (26) Severe Property Damage - substantial physical damage to property, damage to the treatment facilities which causes them to become inoperable, or substantial and permanent loss of natural resources which can reasonably be expected to occur in the absence of a bypass. Severe property damage does not mean economic loss caused by delays in production. See 40 CFR 122.41(m)(1)(ii).



- (27) Significant Materials - Include, but not limited to, raw materials; fuels; materials such as solvents, detergents, and plastic pellets; finished materials such as metallic products; raw materials used in food processing or production; hazardous substances designated under section 101(14) of CERCLA; any chemical the permittee is required to report under section 313 of Title III of the Superfund Amendments and Reauthorization Act (SARA); fertilizers; pesticides; and waste products such as ashes, slag and sludge that have the potential to be released with stormwater discharges.
- (28) Small Construction Activity - The discharge of stormwater from construction activities that result in land disturbance of equal to, or greater than, one acre and less than five acres. Small construction activity also includes the disturbance of less than one acre of total land area that is part of a larger common plan of development or sale, if the larger common plan ultimately disturbs equal to, or greater than, one acre and less than five acres.
- (29) Spill - An unintentional release of solid or liquid material which may pollute state waters.
- (30) State Waters - means any and all surface and subsurface waters which are contained in or flow in or through this state, but does not include waters in sewage systems, waters in treatment works of disposal systems, waters in potable water distribution systems, and all water withdrawn for use until use and treatment have been completed.
- (31) Steep Slopes: where a local government, or industry technical manual (e.g., stormwater BMP manual) has defined what is to be considered a "steep slope", this permit's definition automatically adopts that definition. Where no such definition exists, steep slopes are automatically defined as those that are 3:1 or greater.
- (32) Stormwater - Precipitation runoff, snow melt runoff, and surface runoff and drainage. See 5 CCR 1002-61.2(103).
- (33) Total Maximum Daily Loads (TMDLs) -The sum of the individual wasteload allocations (WLA) for point sources and load allocations (LA) for nonpoint sources and natural background. For the purposes of this permit, a TMDL is a calculation of the maximum amount of a pollutant that a waterbody can receive and still meet water quality standards, and an allocation of that amount to the pollutant's sources. A TMDL includes WLAs, LAs, and must include a margin of safety (MOS), and account for seasonal variations. See section 303(d) of the CWA and 40 C.F.R. 130.2 and 130.7.
- (34) Upset - an exceptional incident in which there is unintentional and temporary noncompliance with permit effluent limitations because of factors beyond the reasonable control of the permittee. An upset does not include noncompliance to the extent caused by operational error, improperly designed treatment facilities, inadequate treatment facilities, lack of preventative maintenance, or careless or improper operation in accordance with 40 CFR 122.41(n) and Regulation 61.2(114).

## F. MONITORING

The division may require sampling and testing, on a case-by-case basis. If the division requires sampling and testing, the division will send a notification to the permittee. Reporting procedures for any monitoring data collected will be included in the notification.

If monitoring is required, the following applies:

1. the thirty (30) day average must be determined by the arithmetic mean of all samples collected during a thirty (30) consecutive-day period; and
2. a grab sample, for monitoring requirements, is a single "dip and take" sample.

**G. Oil and Gas Construction**

Stormwater discharges associated with construction activities directly related to oil and gas exploration, production, processing, and treatment operations or transmission facilities are regulated under the Colorado Discharge Permit System Regulations (5 CCR 1002-61), and require coverage under this permit in accordance with that regulation. However, references in this permit to specific authority under the CWA do not apply to stormwater discharges associated with these oil and gas related construction activities, to the extent that the references are limited by the federal Energy Policy Act of 2005.

**Part II: Standard Permit Conditions**

**A. DUTY TO COMPLY**

The permittee must comply with all conditions of this permit. Any permit noncompliance constitutes a violation of the Water Quality Control Act and is grounds for:

- a. enforcement action;
- b. permit termination, revocation and reissuance, or modification; or
- c. denial of a permit renewal application.

**B. DUTY TO REAPPLY**

If the permittee wishes to continue an activity regulated by this permit after the expiration date of this permit, the permittee must apply for and obtain authorization as required by Part I.A.3.k. of the permit.

**C. NEED TO HALT OR REDUCE ACTIVITY NOT A DEFENSE**

It shall not be a defense for a permittee in an enforcement action that it would have been necessary to halt or reduce the permitted activity in order to maintain compliance with the conditions of this permit.

**D. DUTY TO MITIGATE**

A permittee must take all reasonable steps to minimize or prevent any discharge in violation of this permit which has a reasonable likelihood of adversely affecting human health or the environment.

**E. PROPER OPERATION AND MAINTENANCE**

A permittee must at all times properly operate and maintain all facilities and systems of treatment and control (and related appurtenances) that are installed or used by the permittee to achieve compliance with the conditions of this permit. Proper operation and maintenance also includes adequate laboratory controls and appropriate quality assurance procedures. This provision requires the operation of backup or auxiliary facilities or similar systems which are installed by the permittee only when the operation is necessary to achieve compliance with the conditions of this permit. This requirement can be met by meeting the requirements for Part I.B., I.C., and I.D. above. See also 40 C.F.R. § 122.41(e).

**F. PERMIT ACTIONS**

This permit may be modified, revoked and reissued, or terminated for cause. The permittee request for a permit modification, revocation and reissuance, or termination, or a notification of planned changes or anticipated noncompliance does not stay any permit condition. Any request for modification, revocation, reissuance, or termination under this permit must comply with all terms and conditions of Regulation 61.8(8).

**G. PROPERTY RIGHTS**

In accordance with 40 CFR 122.41(g) and 5 CCR 1002-61, 61.8(9):

1. The issuance of a permit does not convey any property or water rights in either real or personal property, or stream flows or any exclusive privilege.

2. The issuance of a permit does not authorize any injury to person or property or any invasion of personal rights, nor does it authorize the infringement of federal, state, or local laws or regulations.
3. Except for any toxic effluent standard or prohibition imposed under Section 307 of the Federal act or any standard for sewage sludge use or disposal under Section 405(d) of the Federal act, compliance with a permit during its term constitutes compliance, for purposes of enforcement, with Sections 301, 302, 306, 318, 403, and 405(a) and (b) of the Federal act. However, a permit may be modified, revoked and reissued, or terminated during its term for cause as set forth in Section 61.8(8) of the Colorado Discharge Permit System Regulations.

**H. DUTY TO PROVIDE INFORMATION**

The permittee shall furnish to the division, within a reasonable time, any information which the division may request to determine whether cause exists for modifying, revoking and reissuing, or terminating this permit, or to determine compliance with this permit. The permittee shall also furnish to the division, upon request, copies of records required to be kept by this permit in accordance with 40 CFR 122.41(h) and/or Regulation 61.8(3)(q).

**I. INSPECTION AND ENTRY**

The permittee shall allow the division and the authorized representative, upon the presentation of credentials as required by law, to allow for inspections to be conducted in accordance with 40 CFR 122.41(i), Regulation 61.8(3), and Regulation 61.8(4):

1. to enter upon the permittee's premises where a regulated facility or activity is located or in which any records are required to be kept under the terms and conditions of this permit;
2. at reasonable times to have access to and copy any records required to be kept under the terms and conditions of this permit;
3. at reasonable times, inspect any monitoring equipment or monitoring method required in the permit; and
4. to enter upon the permittee's premises in a reasonable manner and at a reasonable time to inspect or investigate, any actual, suspected, or potential source of water pollution, or any violation of the Colorado Water Quality Control Act. The investigation may include: sampling of any discharges, stormwater or process water, taking of photographs, interviewing site staff on alleged violations and other matters related to the permit, and assessing any and all facilities or areas within the site that may affect discharges, the permit, or an alleged violation.

The permittee shall provide access to the division or other authorized representatives upon presentation of proper credentials. A permittee's non-response to a request to enter upon presentation of credentials constitutes a denial of such request, and may result in a violation of the permit.

**J. MONITORING AND RECORDS**

1. Samples and measurements taken for the purpose of monitoring must be representative of the volume and nature of the monitored activity.

2. The permittee must retain records of all monitoring information, including all calibration and maintenance records and all original strip chart recordings for continuous monitoring instrumentation, copies of all reports required by this permit, and records of all data used to complete the application for this permit, for a period of at least three years from the date the permit expires or the date the permittee's authorization is terminated. This period may be extended by request of the division at any time.
3. Records of monitoring information must include:
  - a. The date, exact place, and time of sampling or measurements;
  - b. The individual(s) who performed the sampling or measurements;
  - c. The date(s) analyses were performed
  - d. The individual(s) who performed the analyses;
  - e. The analytical techniques or methods used; and
  - f. The results of such analyses.
4. Monitoring must be conducted according to test procedures approved under 40 CFR Part 136, unless other test procedures have been specified in the permit.

**K. SIGNATORY REQUIREMENTS**

1. Authorization to Sign:

All documents required to be submitted to the division by the permit must be signed in accordance with the following criteria:

- a. For a corporation: By a responsible corporate officer. For the purpose of this subsection, a responsible corporate officer means:
  - i. a president, secretary, treasurer, or vice president of the corporation in charge of a principal business function, or any other person who performs similar policy- or decision-making functions for the corporation, or
  - ii. the manager of one or more manufacturing, production, or operating facilities, provided, the manager is authorized to make management decisions which govern the operation of the regulated facility including having the explicit or implicit duty of making major capital investment recommendations, and initiating and directing other comprehensive measures to assure long term environmental compliance with environmental laws and regulations; the manager can ensure that the necessary systems are established or actions taken to gather complete and accurate information for permit application requirements; and where authority to sign documents has been assigned or delegated to the manager in accordance with corporate procedures.
- b. For a partnership or sole proprietorship: By a general partner or the proprietor, respectively; or
- c. For a municipality, state, federal, or other public agency: By either a principal executive officer or ranking elected official. For purposes of this subsection, a principal executive officer of a federal agency includes
  - i. (i) the chief executive officer of the agency, or

- ii. (ii) a senior executive officer having responsibility for the overall operations of a principal geographic unit of the agency. (e.g., Regional Administrator of EPA)

## 2. Electronic Signatures

For persons signing applications for coverage under this permit electronically, in addition to meeting other applicable requirements stated above, such signatures must meet the same signature, authentication, and identity-proofing standards set forth at 40 CFR § 3.2000(b) for electronic reports (including robust second-factor authentication). Compliance with this requirement can be achieved by submitting the application using the Colorado Environmental Online Service (CEOS) system.

## 3. Change in Authorization to Sign

If an authorization is no longer accurate because a different individual or position has responsibility for the overall operation of the facility, a new authorization must be submitted to the division, prior to the re-authorization, or together with any reports, information, or applications to be signed by an authorized representative.

# L. REPORTING REQUIREMENTS

## 1. Planned Changes

The permittee shall give advance notice to the division, in writing, of any planned physical alterations or additions to the permitted facility in accordance with 40 CFR 122.41(l) and Regulation 61.8(5)(a). Notice is required only when:

- a. The alteration or addition to a permitted facility may meet one of the criteria for determining whether a facility is a new source in 40 CFR 122.29(b); or
- b. The alteration or addition could significantly change the nature or increase the quantity of pollutants discharged. This notification applies to pollutants which are subject neither to effluent limitations in the permit, nor to notification requirements under 40 CFR 122.41(a)(1).

## 2. Anticipated Non-Compliance

The permittee shall give advance notice to the division, in writing, of any planned changes in the permitted facility or activity that may result in noncompliance with permit requirements. The timing of notification requirements differs based on the type of non-compliance as described in subparagraphs 5, 6, 7, and 8 below.

## 3. Transfer of Ownership or Control

The permittee shall notify the division, in writing, ten (10) calendar days in advance of a proposed transfer of the permit. This permit is not transferable to any person except after notice is given to the division.

- a. Where a facility wants to change the name of the permittee, the original permittee (the first owner or operators) must submit a Notice of Termination.
- b. The new owner or operator must submit an application. See also signature requirements in Part II.K, above.
- c. A permit may be automatically transferred to a new permittee if:
  - i. The current permittee notifies the Division in writing 30 calendar days in advance of the proposed transfer date; and
  - ii. The notice includes a written agreement between the existing and new permittee(s) containing a specific date for transfer of permit responsibility, coverage and liability between them; and
  - iii. The division does not notify the existing permittee and the proposed new permittee of its intent to modify, or revoke and reissue the permit.
  - iv. Fee requirements of the Colorado Discharge Permit System Regulations, Section 61.15, have been met.

#### 4. Monitoring reports

Monitoring results must be reported at the intervals specified in this permit per the requirements of 40 CFR 122.41(l)(4).

#### 5. Compliance Schedules

Reports of compliance or noncompliance with, or any progress reports on, interim and final requirements contained in any compliance schedule in the permit, shall be submitted on the date listed in the compliance schedule section. The fourteen (14) calendar day provision in Regulation 61.8(4)(n)(i) has been incorporated into the due date.

#### 6. Twenty-four hour reporting

In addition to the reports required elsewhere in this permit, the permittee shall report the following circumstances orally within twenty-four (24) hours from the time the permittee becomes aware of the circumstances, and shall mail to the division a written report containing the information requested within five (5) working days after becoming aware of the following circumstances:

- a. Circumstances leading to any noncompliance which may endanger health or the environment regardless of the cause of the incident;
- b. Circumstances leading to any unanticipated bypass which exceeds any effluent limitations in the permit;
- c. Circumstances leading to any upset which causes an exceedance of any effluent limitation in the permit;



- d. Daily maximum violations for any of the pollutants limited by Part I of this permit. This includes any toxic pollutant or hazardous substance or any pollutant specifically identified as the method to control any toxic pollutant or hazardous substance.
- e. The division may waive the written report required under subparagraph 6 of this section if the oral report has been received within 24 hours.

#### 7. Other non-compliance

A permittee must report all instances of noncompliance at the time monitoring reports are due. If no monitoring reports are required, these reports are due at least annually in accordance with Regulation 61.8(4)(p). The annual report must contain all instances of non-compliance required under either subparagraph 5 or subparagraph 6 of this subsection.

#### 8. Other information

Where a permittee becomes aware that it failed to submit any relevant facts in a permit application, or submitted incorrect information in a permit application, or in any report to the Permitting Authority, it has a duty to promptly submit such facts or information.

### M. BYPASS

#### 1. Bypass not exceeding limitations

The permittees may allow any bypass to occur which does not cause effluent limitations to be exceeded, but only if it also is for essential maintenance to assure efficient operation. These bypasses are not subject to the provisions of Part II.M.2 of this permit. See 40 CFR 122.41(m)(2).

#### 2. Notice of bypass

- a. Anticipated bypass. If the permittee knows in advance of the need for a bypass, the permittee must submit prior notice, if possible at least ten days before the date of the bypass. See 40 CFR §122.41(m)(3)(i) and/or Regulation 61.9(5)(c).
- b. Unanticipated bypass. The permittee must submit notice of an unanticipated bypass in accordance with Part II.L.6. See 40 CFR §122.41(m)(3)(ii) .

#### 3. Prohibition of Bypass

Bypasses are prohibited and the division may take enforcement action against the permittee for bypass, unless:

- i. the bypass is unavoidable to prevent loss of life, personal injury, or severe property damage;

- ii. There were no feasible alternatives to the bypass, such as the use of auxiliary treatment facilities, retention of untreated wastes, or maintenance during normal periods of equipment downtime. This condition is not satisfied if adequate backup equipment should have been installed in the exercise of reasonable engineering judgment to prevent a bypass which occurred during normal periods of equipment downtime or preventive maintenance; and
- iii. proper notices were submitted to the division.

**N. UPSET**

1. Effect of an upset

An upset constitutes an affirmative defense to an action brought for noncompliance with permit effluent limitations if the requirements of Part II.N.2. of this permit are met. No determination made during administrative review of claims that noncompliance was caused by upset, and before an action for noncompliance, is final administrative action subject to judicial review in accordance with Regulation 61.8(3)(j).

2. Conditions necessary for demonstration of an Upset

A permittee who wishes to establish the affirmative defense of upset shall demonstrate through properly signed contemporaneous operating logs, or other relevant evidence that

- a. an upset occurred and the permittee can identify the specific cause(s) of the upset;
- b. the permitted facility was at the time being properly operated and maintained; and
- c. the permittee submitted proper notice of the upset as required in Part II.L.6. (24-hour notice); and
- d. the permittee complied with any remedial measure necessary to minimize or prevent any discharge or sludge use or disposal in violation of this permit which has a reasonable likelihood of adversely affecting human health or the environment. In addition to the demonstration required above, a permittee who wishes to establish the affirmative defense of upset for a violation of effluent limitations based upon water quality standards shall also demonstrate through monitoring, modeling or other methods that the relevant standards were achieved in the receiving water.

3. Burden of Proof

In any enforcement proceeding, the permittee seeking to establish the occurrence of an upset has the burden of proof.

**O. RETENTION OF RECORDS**

1. Post-Expiration or Termination Retention

Copies of documentation required by this permit, including records of all data used to complete the application for permit coverage to be covered by this permit, must be

retained for at least three years from the date that permit coverage expires or is terminated. This period may be extended by request of EPA at any time.

## 2. On-site Retention

The permittee must retain an electronic version or hardcopy of the SWMP at the construction site from the date of the initiation of construction activities to the date of expiration or inactivation of permit coverage; unless another location, specified by the permittee, is approved by the division.

## P. REOPENER CLAUSE

### 1. Procedures for modification or revocation

Permit modification or revocation of this permit or coverage under this permit will be conducted according to Regulation 61.8(8).

### 2. Water quality protection

If there is evidence indicating that the stormwater discharges authorized by this permit cause, have the reasonable potential to cause or contribute to an excursion above any applicable water quality standard, the permittee may be required to obtain an individual permit, or the permit may be modified to include different limitations and/or requirements.

## Q. SEVERABILITY

The provisions of this permit are severable. If any provisions or the application of any provision of this permit to any circumstances, is held invalid, the application of such provision to other circumstances and the application of the remainder of this permit shall not be affected.

## R. NOTIFICATION REQUIREMENTS

### 1. Notification to Parties

All notification requirements, excluding information submitted using the CEOS portal, shall be directed as follows:

a. Oral Notifications, during normal business hours shall be to:

Clean Water Compliance Section  
Water Quality Control Division  
Telephone: (303) 692-3500

b. Written notification shall be to:

Clean Water Compliance Section  
Water Quality Control Division  
Colorado Department of Public Health and Environment  
WQCD-WQP-B2  
4300 Cherry Creek Drive South  
Denver, CO 80246-1530

**S. RESPONSIBILITIES****1. Reduction, Loss, or Failure of Treatment Facility**

The permittee has the duty to halt or reduce any activity if necessary to maintain compliance with the effluent limitations of the permit. It shall not be a defense for a permittee in an enforcement action that it would be necessary to halt or reduce the permitted activity in order to maintain compliance with the conditions of this permit.

**T. Oil and Hazardous Substance Liability**

Nothing in this permit shall be construed to preclude the institution of any legal action or relieve the permittee from any responsibilities, liabilities, or penalties to which the permittee is or may be subject to under Section 311 (Oil and Hazardous Substance Liability) of the CWA.

**U. Emergency Powers**

Nothing in this permit shall be construed to prevent or limit application of any emergency power of the division.

**V. Confidentiality**

Any information relating to any secret process, method of manufacture or production, or sales or marketing data which has been declared confidential by the permittee, and which may be acquired, ascertained, or discovered, whether in any sampling investigation, emergency investigation, or otherwise, shall not be publicly disclosed by any member, officer, or employee of the Water Quality Control Commission or the division, but shall be kept confidential. Any person seeking to invoke the protection of of this section shall bear the burden of proving its applicability. This section shall never be interpreted as preventing full disclosure of effluent data.

**W. Fees**

The permittee is required to submit payment of an annual fee as set forth in the 2016 amendments to the Water Quality Control Act. Section 25-8-502 (1.1) (b), and the Colorado Discharge Permit System Regulations 5 CCR 1002-61, Section 61.15 as amended. Failure to submit the required fee when due and payable is a violation of the permit and will result in enforcement action pursuant to Section 25-8-601 et. seq., C.R.S.1973 as amended.

**X. Duration of Permit**

The duration of a permit shall be for a fixed term and shall not exceed five (5) years. If the permittee desires to continue to discharge, a permit renewal application shall be submitted at least ninety (90) calendar days before this permit expires. Filing of a timely and complete application shall cause the expired permit to continue in force to the effective date of the new permit. The permit's duration may be extended only through administrative extensions and not through interim modifications. If the permittee anticipates there will be no discharge after the expiration date of this permit, the division should be promptly notified so that it can terminate the permit in accordance with Part I.A.3.i.

**Y. Section 307 Toxics**

If a toxic effluent standard or prohibition, including any applicable schedule of compliance specified, is established by regulation pursuant to Section 307 of the Federal Act for a toxic pollutant which is present in the permittee's discharge and such standard or prohibition is more stringent than any limitation upon such pollutant in the discharge permit, the division

shall institute proceedings to modify or revoke and reissue the permit to conform to the toxic effluent standard or prohibition

## APPENDIX C – FEMA FIRM MAP

# National Flood Hazard Layer FIRMette



104°36'47"W 38°56'57"N



Basemap: USGS National Map: Orthoimagery: Data refreshed October, 2020

## Legend

SEE FIS REPORT FOR DETAILED LEGEND AND INDEX MAP FOR FIRM PANEL LAYOUT

- |                                    |  |  |
|------------------------------------|--|--|
| <b>SPECIAL FLOOD HAZARD AREAS</b>  |  | Without Base Flood Elevation (BFE)<br><i>Zone A, V, A99</i>  |
|                                    |  | With BFE or Depth <i>Zone AE, AO, AH, VE, AR</i>   |
|                                    |  | Regulatory Floodway  |
| <b>OTHER AREAS OF FLOOD HAZARD</b> |  | 0.2% Annual Chance Flood Hazard, Areas of 1% annual chance flood with average depth less than one foot or with drainage areas of less than one square mile <i>Zone X</i> |
|                                    |  | Future Conditions 1% Annual Chance Flood Hazard <i>Zone X</i>  |
|                                    |  | Area with Reduced Flood Risk due to Levee. See Notes. <i>Zone X</i>  |
|                                    |  | Area with Flood Risk due to Levee <i>Zone D</i>  |
| <b>OTHER AREAS</b>                 |  | NO SCREEN Area of Minimal Flood Hazard <i>Zone X</i>   |
|                                    |  | Effective LOMRs  |
| <b>GENERAL STRUCTURES</b>          |  | Area of Undetermined Flood Hazard <i>Zone D</i>  |
|                                    |  | Channel, Culvert, or Storm Sewer   |
|                                    |  | Levee, Dike, or Floodwall  |
| <b>OTHER FEATURES</b>              |  | Cross Sections with 1% Annual Chance Water Surface Elevation   |
|                                    |  | Coastal Transect   |
|                                    |  | Base Flood Elevation Line (BFE)  |
|                                    |  | Limit of Study   |
|                                    |  | Jurisdiction Boundary  |
| <b>MAP PANELS</b>                  |  | Digital Data Available   |
|                                    |  | No Digital Data Available  |
|                                    |  | Unmapped   |
|                                    |  | The pin displayed on the map is an approximate point selected by the user and does not represent an authoritative property location.                                     |



This map complies with FEMA's standards for the use of digital flood maps if it is not void as described below. The basemap shown complies with FEMA's basemap accuracy standards

The flood hazard information is derived directly from the authoritative NFHL web services provided by FEMA. This map was exported on **2/2/2021 at 1:05 PM** and does not reflect changes or amendments subsequent to this date and time. The NFHL and effective information may change or become superseded by new data over time.

This map image is void if the one or more of the following map elements do not appear: basemap imagery, flood zone labels, legend, scale bar, map creation date, community identifiers, FIRM panel number, and FIRM effective date. Map images for unmapped and unmodernized areas cannot be used for regulatory purposes.

## APPENDIX D – SOILS INFORMATION



# Custom Soil Resource Report for El Paso County Area, Colorado



# Preface

---

Soil surveys contain information that affects land use planning in survey areas. They highlight soil limitations that affect various land uses and provide information about the properties of the soils in the survey areas. Soil surveys are designed for many different users, including farmers, ranchers, foresters, agronomists, urban planners, community officials, engineers, developers, builders, and home buyers. Also, conservationists, teachers, students, and specialists in recreation, waste disposal, and pollution control can use the surveys to help them understand, protect, or enhance the environment.

Various land use regulations of Federal, State, and local governments may impose special restrictions on land use or land treatment. Soil surveys identify soil properties that are used in making various land use or land treatment decisions. The information is intended to help the land users identify and reduce the effects of soil limitations on various land uses. The landowner or user is responsible for identifying and complying with existing laws and regulations.

Although soil survey information can be used for general farm, local, and wider area planning, onsite investigation is needed to supplement this information in some cases. Examples include soil quality assessments (<http://www.nrcs.usda.gov/wps/portal/nrcs/main/soils/health/>) and certain conservation and engineering applications. For more detailed information, contact your local USDA Service Center (<https://offices.sc.egov.usda.gov/locator/app?agency=nrcs>) or your NRCS State Soil Scientist ([http://www.nrcs.usda.gov/wps/portal/nrcs/detail/soils/contactus/?cid=nrcs142p2\\_053951](http://www.nrcs.usda.gov/wps/portal/nrcs/detail/soils/contactus/?cid=nrcs142p2_053951)).

Great differences in soil properties can occur within short distances. Some soils are seasonally wet or subject to flooding. Some are too unstable to be used as a foundation for buildings or roads. Clayey or wet soils are poorly suited to use as septic tank absorption fields. A high water table makes a soil poorly suited to basements or underground installations.

The National Cooperative Soil Survey is a joint effort of the United States Department of Agriculture and other Federal agencies, State agencies including the Agricultural Experiment Stations, and local agencies. The Natural Resources Conservation Service (NRCS) has leadership for the Federal part of the National Cooperative Soil Survey.

Information about soils is updated periodically. Updated information is available through the NRCS Web Soil Survey, the site for official soil survey information.

The U.S. Department of Agriculture (USDA) prohibits discrimination in all its programs and activities on the basis of race, color, national origin, age, disability, and where applicable, sex, marital status, familial status, parental status, religion, sexual orientation, genetic information, political beliefs, reprisal, or because all or a part of an individual's income is derived from any public assistance program. (Not all prohibited bases apply to all programs.) Persons with disabilities who require

alternative means for communication of program information (Braille, large print, audiotape, etc.) should contact USDA's TARGET Center at (202) 720-2600 (voice and TDD). To file a complaint of discrimination, write to USDA, Director, Office of Civil Rights, 1400 Independence Avenue, S.W., Washington, D.C. 20250-9410 or call (800) 795-3272 (voice) or (202) 720-6382 (TDD). USDA is an equal opportunity provider and employer.

# Contents

---

<b>Preface</b> .....	2
<b>How Soil Surveys Are Made</b> .....	5
<b>Soil Map</b> .....	8
Soil Map.....	9
Legend.....	10
Map Unit Legend.....	11
Map Unit Descriptions.....	11
El Paso County Area, Colorado.....	13
9—Blakeland-Fluvaquentic Haplaquolls.....	13
19—Columbine gravelly sandy loam, 0 to 3 percent slopes.....	14
<b>Soil Information for All Uses</b> .....	16
Soil Properties and Qualities.....	16
Soil Erosion Factors.....	16
K Factor, Whole Soil.....	16
Wind Erodibility Group.....	19
Soil Qualities and Features.....	22
Hydrologic Soil Group.....	22
<b>References</b> .....	27

# How Soil Surveys Are Made

---

Soil surveys are made to provide information about the soils and miscellaneous areas in a specific area. They include a description of the soils and miscellaneous areas and their location on the landscape and tables that show soil properties and limitations affecting various uses. Soil scientists observed the steepness, length, and shape of the slopes; the general pattern of drainage; the kinds of crops and native plants; and the kinds of bedrock. They observed and described many soil profiles. A soil profile is the sequence of natural layers, or horizons, in a soil. The profile extends from the surface down into the unconsolidated material in which the soil formed or from the surface down to bedrock. The unconsolidated material is devoid of roots and other living organisms and has not been changed by other biological activity.

Currently, soils are mapped according to the boundaries of major land resource areas (MLRAs). MLRAs are geographically associated land resource units that share common characteristics related to physiography, geology, climate, water resources, soils, biological resources, and land uses (USDA, 2006). Soil survey areas typically consist of parts of one or more MLRA.

The soils and miscellaneous areas in a survey area occur in an orderly pattern that is related to the geology, landforms, relief, climate, and natural vegetation of the area. Each kind of soil and miscellaneous area is associated with a particular kind of landform or with a segment of the landform. By observing the soils and miscellaneous areas in the survey area and relating their position to specific segments of the landform, a soil scientist develops a concept, or model, of how they were formed. Thus, during mapping, this model enables the soil scientist to predict with a considerable degree of accuracy the kind of soil or miscellaneous area at a specific location on the landscape.

Commonly, individual soils on the landscape merge into one another as their characteristics gradually change. To construct an accurate soil map, however, soil scientists must determine the boundaries between the soils. They can observe only a limited number of soil profiles. Nevertheless, these observations, supplemented by an understanding of the soil-vegetation-landscape relationship, are sufficient to verify predictions of the kinds of soil in an area and to determine the boundaries.

Soil scientists recorded the characteristics of the soil profiles that they studied. They noted soil color, texture, size and shape of soil aggregates, kind and amount of rock fragments, distribution of plant roots, reaction, and other features that enable them to identify soils. After describing the soils in the survey area and determining their properties, the soil scientists assigned the soils to taxonomic classes (units). Taxonomic classes are concepts. Each taxonomic class has a set of soil characteristics with precisely defined limits. The classes are used as a basis for comparison to classify soils systematically. Soil taxonomy, the system of taxonomic classification used in the United States, is based mainly on the kind and character of soil properties and the arrangement of horizons within the profile. After the soil

## Custom Soil Resource Report

scientists classified and named the soils in the survey area, they compared the individual soils with similar soils in the same taxonomic class in other areas so that they could confirm data and assemble additional data based on experience and research.

The objective of soil mapping is not to delineate pure map unit components; the objective is to separate the landscape into landforms or landform segments that have similar use and management requirements. Each map unit is defined by a unique combination of soil components and/or miscellaneous areas in predictable proportions. Some components may be highly contrasting to the other components of the map unit. The presence of minor components in a map unit in no way diminishes the usefulness or accuracy of the data. The delineation of such landforms and landform segments on the map provides sufficient information for the development of resource plans. If intensive use of small areas is planned, onsite investigation is needed to define and locate the soils and miscellaneous areas.

Soil scientists make many field observations in the process of producing a soil map. The frequency of observation is dependent upon several factors, including scale of mapping, intensity of mapping, design of map units, complexity of the landscape, and experience of the soil scientist. Observations are made to test and refine the soil-landscape model and predictions and to verify the classification of the soils at specific locations. Once the soil-landscape model is refined, a significantly smaller number of measurements of individual soil properties are made and recorded. These measurements may include field measurements, such as those for color, depth to bedrock, and texture, and laboratory measurements, such as those for content of sand, silt, clay, salt, and other components. Properties of each soil typically vary from one point to another across the landscape.

Observations for map unit components are aggregated to develop ranges of characteristics for the components. The aggregated values are presented. Direct measurements do not exist for every property presented for every map unit component. Values for some properties are estimated from combinations of other properties.

While a soil survey is in progress, samples of some of the soils in the area generally are collected for laboratory analyses and for engineering tests. Soil scientists interpret the data from these analyses and tests as well as the field-observed characteristics and the soil properties to determine the expected behavior of the soils under different uses. Interpretations for all of the soils are field tested through observation of the soils in different uses and under different levels of management. Some interpretations are modified to fit local conditions, and some new interpretations are developed to meet local needs. Data are assembled from other sources, such as research information, production records, and field experience of specialists. For example, data on crop yields under defined levels of management are assembled from farm records and from field or plot experiments on the same kinds of soil.

Predictions about soil behavior are based not only on soil properties but also on such variables as climate and biological activity. Soil conditions are predictable over long periods of time, but they are not predictable from year to year. For example, soil scientists can predict with a fairly high degree of accuracy that a given soil will have a high water table within certain depths in most years, but they cannot predict that a high water table will always be at a specific level in the soil on a specific date.

After soil scientists located and identified the significant natural bodies of soil in the survey area, they drew the boundaries of these bodies on aerial photographs and

## Custom Soil Resource Report

identified each as a specific map unit. Aerial photographs show trees, buildings, fields, roads, and rivers, all of which help in locating boundaries accurately.

# Soil Map

---

The soil map section includes the soil map for the defined area of interest, a list of soil map units on the map and extent of each map unit, and cartographic symbols displayed on the map. Also presented are various metadata about data used to produce the map, and a description of each soil map unit.



# Custom Soil Resource Report Soil Map

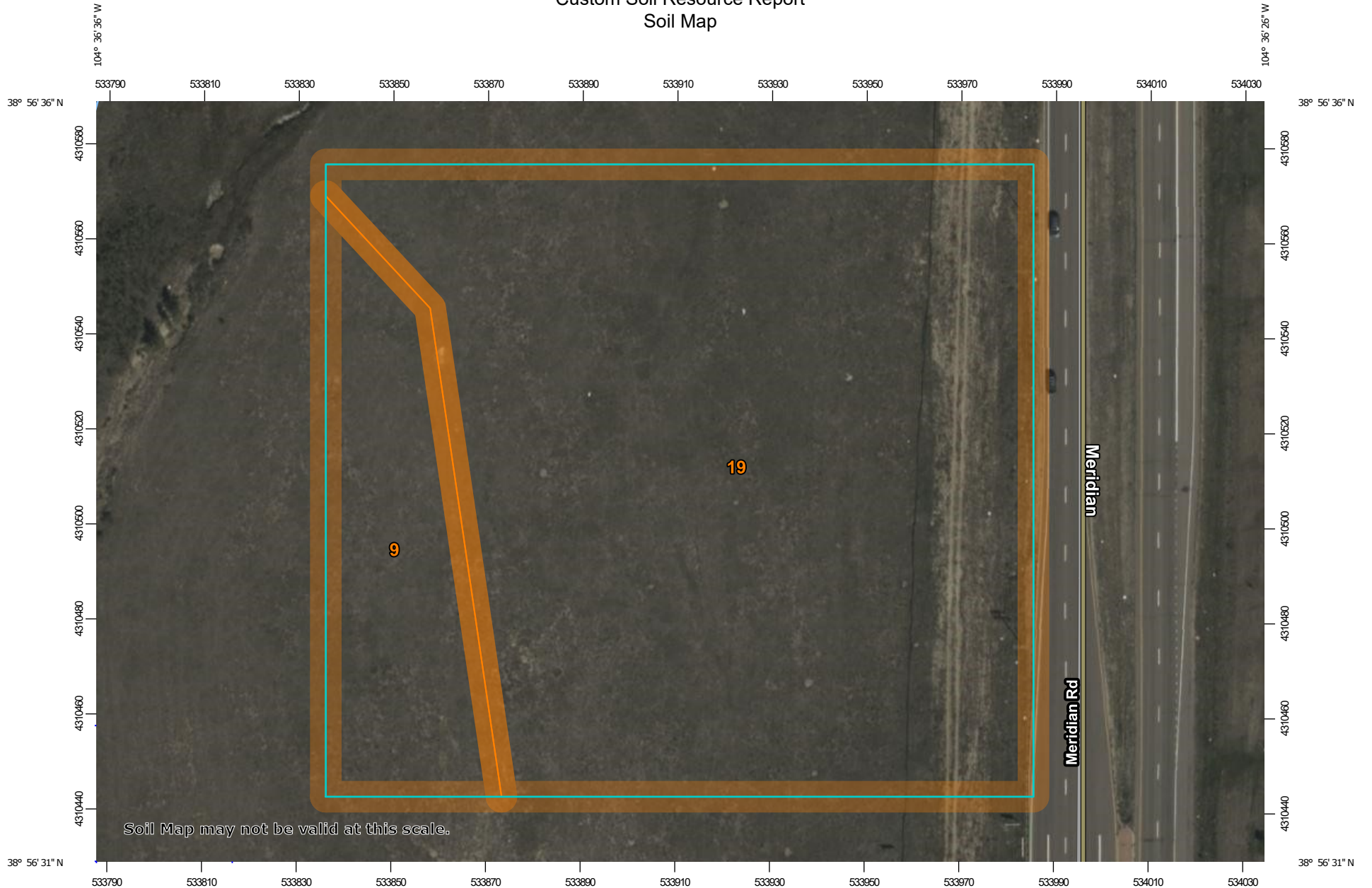

Map Scale: 1:1,130 if printed on A landscape (11" x 8.5") sheet.

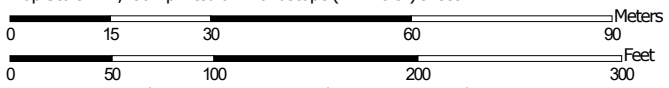

Map projection: Web Mercator Corner coordinates: WGS84 Edge tics: UTM Zone 13N WGS84

### MAP LEGEND

**Area of Interest (AOI)**

 Area of Interest (AOI)

**Soils**

 Soil Map Unit Polygons

 Soil Map Unit Lines

 Soil Map Unit Points

**Special Point Features**

-  Blowout
-  Borrow Pit
-  Clay Spot
-  Closed Depression
-  Gravel Pit
-  Gravelly Spot
-  Landfill
-  Lava Flow
-  Marsh or swamp
-  Mine or Quarry
-  Miscellaneous Water
-  Perennial Water
-  Rock Outcrop
-  Saline Spot
-  Sandy Spot
-  Severely Eroded Spot
-  Sinkhole
-  Slide or Slip
-  Sodic Spot

-  Spoil Area
-  Stony Spot
-  Very Stony Spot
-  Wet Spot
-  Other
-  Special Line Features

**Water Features**

 Streams and Canals

**Transportation**

-  Rails
-  Interstate Highways
-  US Routes
-  Major Roads
-  Local Roads

**Background**

 Aerial Photography

### MAP INFORMATION

The soil surveys that comprise your AOI were mapped at 1:24,000.

Warning: Soil Map may not be valid at this scale.

Enlargement of maps beyond the scale of mapping can cause misunderstanding of the detail of mapping and accuracy of soil line placement. The maps do not show the small areas of contrasting soils that could have been shown at a more detailed scale.

Please rely on the bar scale on each map sheet for map measurements.

Source of Map: Natural Resources Conservation Service  
 Web Soil Survey URL:  
 Coordinate System: Web Mercator (EPSG:3857)

Maps from the Web Soil Survey are based on the Web Mercator projection, which preserves direction and shape but distorts distance and area. A projection that preserves area, such as the Albers equal-area conic projection, should be used if more accurate calculations of distance or area are required.

This product is generated from the USDA-NRCS certified data as of the version date(s) listed below.

Soil Survey Area: El Paso County Area, Colorado  
 Survey Area Data: Version 18, Jun 5, 2020

Soil map units are labeled (as space allows) for map scales 1:50,000 or larger.

Date(s) aerial images were photographed: Sep 11, 2018—Oct 20, 2018

The orthophoto or other base map on which the soil lines were compiled and digitized probably differs from the background imagery displayed on these maps. As a result, some minor shifting of map unit boundaries may be evident.

## Map Unit Legend

Map Unit Symbol	Map Unit Name	Acres in AOI	Percent of AOI
9	Blakeland-Fluvaquentic Haplaquolls	0.8	16.6%
19	Columbine gravelly sandy loam, 0 to 3 percent slopes	4.1	83.4%
<b>Totals for Area of Interest</b>		<b>4.9</b>	<b>100.0%</b>

## Map Unit Descriptions

The map units delineated on the detailed soil maps in a soil survey represent the soils or miscellaneous areas in the survey area. The map unit descriptions, along with the maps, can be used to determine the composition and properties of a unit.

A map unit delineation on a soil map represents an area dominated by one or more major kinds of soil or miscellaneous areas. A map unit is identified and named according to the taxonomic classification of the dominant soils. Within a taxonomic class there are precisely defined limits for the properties of the soils. On the landscape, however, the soils are natural phenomena, and they have the characteristic variability of all natural phenomena. Thus, the range of some observed properties may extend beyond the limits defined for a taxonomic class. Areas of soils of a single taxonomic class rarely, if ever, can be mapped without including areas of other taxonomic classes. Consequently, every map unit is made up of the soils or miscellaneous areas for which it is named and some minor components that belong to taxonomic classes other than those of the major soils.

Most minor soils have properties similar to those of the dominant soil or soils in the map unit, and thus they do not affect use and management. These are called noncontrasting, or similar, components. They may or may not be mentioned in a particular map unit description. Other minor components, however, have properties and behavioral characteristics divergent enough to affect use or to require different management. These are called contrasting, or dissimilar, components. They generally are in small areas and could not be mapped separately because of the scale used. Some small areas of strongly contrasting soils or miscellaneous areas are identified by a special symbol on the maps. If included in the database for a given area, the contrasting minor components are identified in the map unit descriptions along with some characteristics of each. A few areas of minor components may not have been observed, and consequently they are not mentioned in the descriptions, especially where the pattern was so complex that it was impractical to make enough observations to identify all the soils and miscellaneous areas on the landscape.

The presence of minor components in a map unit in no way diminishes the usefulness or accuracy of the data. The objective of mapping is not to delineate pure taxonomic classes but rather to separate the landscape into landforms or landform segments that have similar use and management requirements. The delineation of such segments on the map provides sufficient information for the development of resource plans. If intensive use of small areas is planned, however,

## Custom Soil Resource Report

onsite investigation is needed to define and locate the soils and miscellaneous areas.

An identifying symbol precedes the map unit name in the map unit descriptions. Each description includes general facts about the unit and gives important soil properties and qualities.

Soils that have profiles that are almost alike make up a *soil series*. Except for differences in texture of the surface layer, all the soils of a series have major horizons that are similar in composition, thickness, and arrangement.

Soils of one series can differ in texture of the surface layer, slope, stoniness, salinity, degree of erosion, and other characteristics that affect their use. On the basis of such differences, a soil series is divided into *soil phases*. Most of the areas shown on the detailed soil maps are phases of soil series. The name of a soil phase commonly indicates a feature that affects use or management. For example, Alpha silt loam, 0 to 2 percent slopes, is a phase of the Alpha series.

Some map units are made up of two or more major soils or miscellaneous areas. These map units are complexes, associations, or undifferentiated groups.

A *complex* consists of two or more soils or miscellaneous areas in such an intricate pattern or in such small areas that they cannot be shown separately on the maps. The pattern and proportion of the soils or miscellaneous areas are somewhat similar in all areas. Alpha-Beta complex, 0 to 6 percent slopes, is an example.

An *association* is made up of two or more geographically associated soils or miscellaneous areas that are shown as one unit on the maps. Because of present or anticipated uses of the map units in the survey area, it was not considered practical or necessary to map the soils or miscellaneous areas separately. The pattern and relative proportion of the soils or miscellaneous areas are somewhat similar. Alpha-Beta association, 0 to 2 percent slopes, is an example.

An *undifferentiated group* is made up of two or more soils or miscellaneous areas that could be mapped individually but are mapped as one unit because similar interpretations can be made for use and management. The pattern and proportion of the soils or miscellaneous areas in a mapped area are not uniform. An area can be made up of only one of the major soils or miscellaneous areas, or it can be made up of all of them. Alpha and Beta soils, 0 to 2 percent slopes, is an example.

Some surveys include *miscellaneous areas*. Such areas have little or no soil material and support little or no vegetation. Rock outcrop is an example.

## El Paso County Area, Colorado

### 9—Blakeland-Fluvaquentic Haplaquolls

#### Map Unit Setting

*National map unit symbol:* 36b6  
*Elevation:* 3,500 to 5,800 feet  
*Mean annual precipitation:* 13 to 17 inches  
*Mean annual air temperature:* 46 to 55 degrees F  
*Frost-free period:* 110 to 165 days  
*Farmland classification:* Not prime farmland

#### Map Unit Composition

*Blakeland and similar soils:* 60 percent  
*Fluvaquentic haplaquolls and similar soils:* 38 percent  
*Minor components:* 2 percent  
*Estimates are based on observations, descriptions, and transects of the mapunit.*

#### Description of Blakeland

##### Setting

*Landform:* Hills, flats  
*Landform position (three-dimensional):* Side slope, talf  
*Down-slope shape:* Linear  
*Across-slope shape:* Linear  
*Parent material:* Sandy alluvium derived from arkose and/or eolian deposits derived from arkose

##### Typical profile

*A - 0 to 11 inches:* loamy sand  
*AC - 11 to 27 inches:* loamy sand  
*C - 27 to 60 inches:* sand

##### Properties and qualities

*Slope:* 1 to 9 percent  
*Depth to restrictive feature:* More than 80 inches  
*Drainage class:* Somewhat excessively drained  
*Runoff class:* Low  
*Capacity of the most limiting layer to transmit water (Ksat):* High to very high (5.95 to 19.98 in/hr)  
*Depth to water table:* More than 80 inches  
*Frequency of flooding:* None  
*Frequency of ponding:* None  
*Calcium carbonate, maximum content:* 5 percent  
*Available water capacity:* Low (about 4.5 inches)

##### Interpretive groups

*Land capability classification (irrigated):* 3e  
*Land capability classification (nonirrigated):* 6e  
*Hydrologic Soil Group:* A  
*Ecological site:* R049XB210CO - Sandy Foothill  
*Hydric soil rating:* No

### **Description of Fluvaquentic Haplaquolls**

#### **Setting**

*Landform:* Swales  
*Down-slope shape:* Linear  
*Across-slope shape:* Linear  
*Parent material:* Alluvium

#### **Typical profile**

*H1 - 0 to 12 inches:* variable

#### **Properties and qualities**

*Slope:* 1 to 2 percent  
*Depth to restrictive feature:* More than 80 inches  
*Drainage class:* Poorly drained  
*Runoff class:* Very high  
*Capacity of the most limiting layer to transmit water (Ksat):* Moderately high to high  
(0.20 to 6.00 in/hr)  
*Depth to water table:* About 0 to 24 inches  
*Frequency of flooding:* Occasional  
*Frequency of ponding:* None  
*Maximum salinity:* Nonsaline to slightly saline (0.0 to 4.0 mmhos/cm)

#### **Interpretive groups**

*Land capability classification (irrigated):* 6w  
*Land capability classification (nonirrigated):* 6w  
*Hydrologic Soil Group:* D  
*Hydric soil rating:* Yes

### **Minor Components**

#### **Other soils**

*Percent of map unit:* 1 percent  
*Hydric soil rating:* No

#### **Pleasant**

*Percent of map unit:* 1 percent  
*Landform:* Depressions  
*Hydric soil rating:* Yes

## **19—Columbine gravelly sandy loam, 0 to 3 percent slopes**

### **Map Unit Setting**

*National map unit symbol:* 367p  
*Elevation:* 6,500 to 7,300 feet  
*Mean annual precipitation:* 14 to 16 inches  
*Mean annual air temperature:* 46 to 50 degrees F  
*Frost-free period:* 125 to 145 days  
*Farmland classification:* Not prime farmland

**Map Unit Composition**

*Columbine and similar soils: 97 percent*

*Minor components: 3 percent*

*Estimates are based on observations, descriptions, and transects of the mapunit.*

**Description of Columbine**

**Setting**

*Landform: Fans, flood plains, fan terraces*

*Down-slope shape: Linear*

*Across-slope shape: Linear*

*Parent material: Alluvium*

**Typical profile**

*A - 0 to 14 inches: gravelly sandy loam*

*C - 14 to 60 inches: very gravelly loamy sand*

**Properties and qualities**

*Slope: 0 to 3 percent*

*Depth to restrictive feature: More than 80 inches*

*Drainage class: Well drained*

*Runoff class: Very low*

*Capacity of the most limiting layer to transmit water (Ksat): High to very high (5.95 to 19.98 in/hr)*

*Depth to water table: More than 80 inches*

*Frequency of flooding: None*

*Frequency of ponding: None*

*Available water capacity: Very low (about 2.5 inches)*

**Interpretive groups**

*Land capability classification (irrigated): 4e*

*Land capability classification (nonirrigated): 6e*

*Hydrologic Soil Group: A*

*Ecological site: R049XB215CO - Gravelly Foothill*

*Hydric soil rating: No*

**Minor Components**

**Pleasant**

*Percent of map unit: 1 percent*

*Landform: Depressions*

*Hydric soil rating: Yes*

**Other soils**

*Percent of map unit: 1 percent*

*Hydric soil rating: No*

**Fluvaquentic haplaquolls**

*Percent of map unit: 1 percent*

*Landform: Swales*

*Hydric soil rating: Yes*

# **Soil Information for All Uses**

---

## **Soil Properties and Qualities**

The Soil Properties and Qualities section includes various soil properties and qualities displayed as thematic maps with a summary table for the soil map units in the selected area of interest. A single value or rating for each map unit is generated by aggregating the interpretive ratings of individual map unit components. This aggregation process is defined for each property or quality.

## **Soil Erosion Factors**

Soil Erosion Factors are soil properties and interpretations used in evaluating the soil for potential erosion. Example soil erosion factors can include K factor for the whole soil or on a rock free basis, T factor, wind erodibility group and wind erodibility index.

### **K Factor, Whole Soil**

Erosion factor K indicates the susceptibility of a soil to sheet and rill erosion by water. Factor K is one of six factors used in the Universal Soil Loss Equation (USLE) and the Revised Universal Soil Loss Equation (RUSLE) to predict the average annual rate of soil loss by sheet and rill erosion in tons per acre per year. The estimates are based primarily on percentage of silt, sand, and organic matter and on soil structure and saturated hydraulic conductivity (Ksat). Values of K range from 0.02 to 0.69. Other factors being equal, the higher the value, the more susceptible the soil is to sheet and rill erosion by water.

"Erosion factor Kw (whole soil)" indicates the erodibility of the whole soil. The estimates are modified by the presence of rock fragments.

Factor K does not apply to organic horizons and is not reported for those layers.



# Custom Soil Resource Report Map—K Factor, Whole Soil

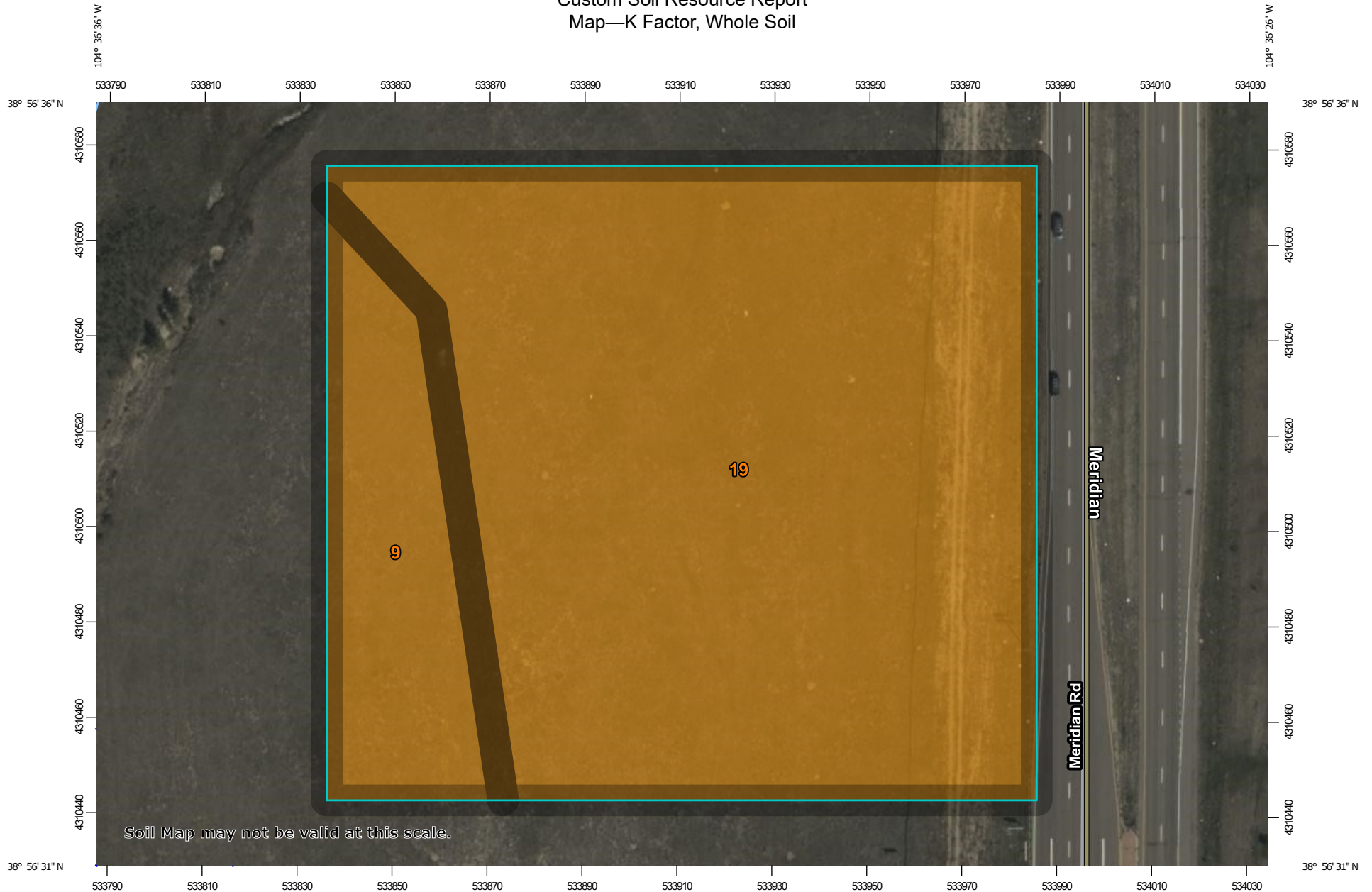

Soil Map may not be valid at this scale.

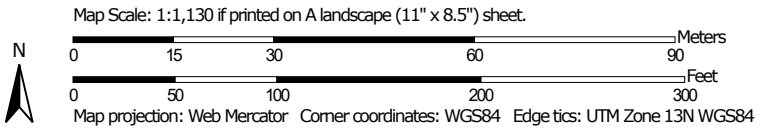















### MAP LEGEND

**Area of Interest (AOI)**







 Area of Interest (AOI)









**Soils**

**Soil Rating Polygons**















-  .02
-  .05
-  .10
-  .15
-  .17
-  .20
-  .24
-  .28
-  .32
-  .37
-  .43
-  .49
-  .55
-  .64
-  Not rated or not available

**Soil Rating Lines**







-  .02
-  .05
-  .10
-  .15
-  .17
-  .20

-  .24
-  .28
-  .32
-  .37
-  .43
-  .49
-  .55
-  .64
-  Not rated or not available

**Soil Rating Points**

-  .02
-  .05
-  .10
-  .15
-  .17
-  .20
-  .24
-  .28
-  .32
-  .37
-  .43
-  .49
-  .55
-  .64
-  Not rated or not available

**Water Features**

-  Streams and Canals
- Transportation**
-  Rails
-  Interstate Highways
-  US Routes
-  Major Roads
-  Local Roads
- Background**
-  Aerial Photography

### MAP INFORMATION

The soil surveys that comprise your AOI were mapped at 1:24,000.

Warning: Soil Map may not be valid at this scale.

Enlargement of maps beyond the scale of mapping can cause misunderstanding of the detail of mapping and accuracy of soil line placement. The maps do not show the small areas of contrasting soils that could have been shown at a more detailed scale.

Please rely on the bar scale on each map sheet for map measurements.

Source of Map: Natural Resources Conservation Service  
 Web Soil Survey URL:  
 Coordinate System: Web Mercator (EPSG:3857)

Maps from the Web Soil Survey are based on the Web Mercator projection, which preserves direction and shape but distorts distance and area. A projection that preserves area, such as the Albers equal-area conic projection, should be used if more accurate calculations of distance or area are required.

This product is generated from the USDA-NRCS certified data as of the version date(s) listed below.

Soil Survey Area: El Paso County Area, Colorado  
 Survey Area Data: Version 18, Jun 5, 2020

Soil map units are labeled (as space allows) for map scales 1:50,000 or larger.

Date(s) aerial images were photographed: Sep 11, 2018—Oct 20, 2018

The orthophoto or other base map on which the soil lines were compiled and digitized probably differs from the background imagery displayed on these maps. As a result, some minor shifting of map unit boundaries may be evident.

**Table—K Factor, Whole Soil**

Map unit symbol	Map unit name	Rating	Acres in AOI	Percent of AOI
9	Blakeland-Fluvaquentic Haplaquolls	.10	0.8	16.6%
19	Columbine gravelly sandy loam, 0 to 3 percent slopes	.10	4.1	83.4%
<b>Totals for Area of Interest</b>			<b>4.9</b>	<b>100.0%</b>

**Rating Options—K Factor, Whole Soil**

*Aggregation Method:* Dominant Condition

*Component Percent Cutoff:* None Specified

*Tie-break Rule:* Higher

*Layer Options (Horizon Aggregation Method):* Surface Layer (Not applicable)

**Wind Erodibility Group**

A wind erodibility group (WEG) consists of soils that have similar properties affecting their susceptibility to wind erosion in cultivated areas. The soils assigned to group 1 are the most susceptible to wind erosion, and those assigned to group 8 are the least susceptible.

# Custom Soil Resource Report Map—Wind Erodibility Group

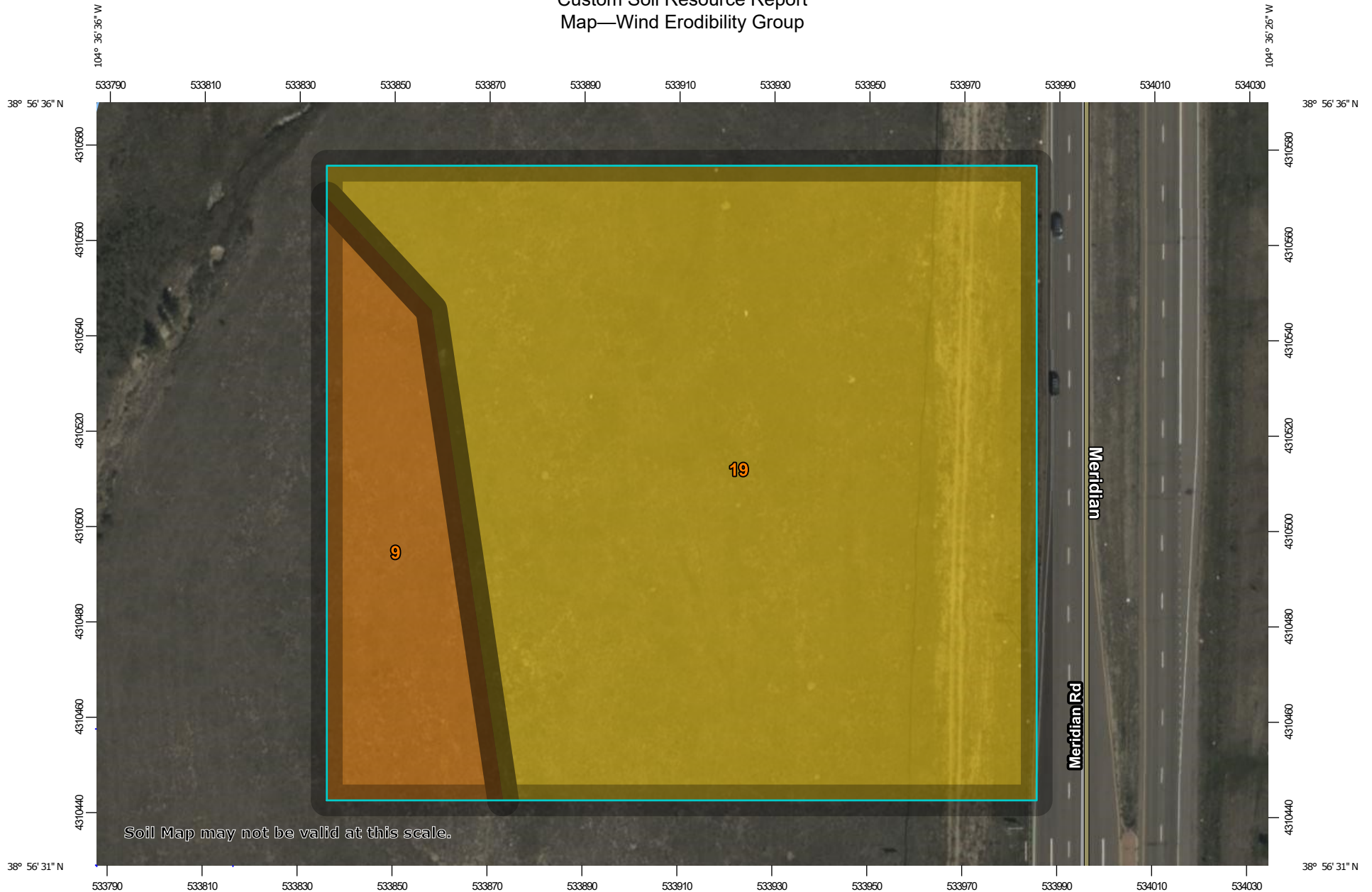

Soil Map may not be valid at this scale.

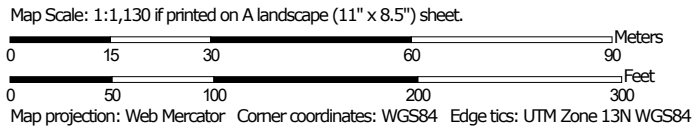











### MAP LEGEND











**Area of Interest (AOI)**  
 Area of Interest (AOI)

**Soils**











**Soil Rating Polygons**

	1
	2
	3
	4
	4L
	5
	6
	7
	8
	Not rated or not available

**Soil Rating Lines**

	1
	2
	3
	4
	4L
	5
	6
	7
	8
	Not rated or not available





**Soil Rating Points**

	1
	2
	3
	4
	4L
	5
	6
	7
	8
	Not rated or not available

**Water Features**

	Streams and Canals
---	--------------------

**Transportation**

	Rails
	Interstate Highways
	US Routes
	Major Roads
	Local Roads

**Background**

	Aerial Photography
---	--------------------

### MAP INFORMATION

The soil surveys that comprise your AOI were mapped at 1:24,000.

Warning: Soil Map may not be valid at this scale.

Enlargement of maps beyond the scale of mapping can cause misunderstanding of the detail of mapping and accuracy of soil line placement. The maps do not show the small areas of contrasting soils that could have been shown at a more detailed scale.

Please rely on the bar scale on each map sheet for map measurements.

Source of Map: Natural Resources Conservation Service  
 Web Soil Survey URL:  
 Coordinate System: Web Mercator (EPSG:3857)

Maps from the Web Soil Survey are based on the Web Mercator projection, which preserves direction and shape but distorts distance and area. A projection that preserves area, such as the Albers equal-area conic projection, should be used if more accurate calculations of distance or area are required.

This product is generated from the USDA-NRCS certified data as of the version date(s) listed below.

Soil Survey Area: El Paso County Area, Colorado  
 Survey Area Data: Version 18, Jun 5, 2020

Soil map units are labeled (as space allows) for map scales 1:50,000 or larger.

Date(s) aerial images were photographed: Sep 11, 2018—Oct 20, 2018

The orthophoto or other base map on which the soil lines were compiled and digitized probably differs from the background imagery displayed on these maps. As a result, some minor shifting of map unit boundaries may be evident.

**Table—Wind Erodibility Group**

Map unit symbol	Map unit name	Rating	Acres in AOI	Percent of AOI
9	Blakeland-Fluvaquentic Haplaquolls	2	0.8	16.6%
19	Columbine gravelly sandy loam, 0 to 3 percent slopes	3	4.1	83.4%
<b>Totals for Area of Interest</b>			<b>4.9</b>	<b>100.0%</b>

**Rating Options—Wind Erodibility Group**

*Aggregation Method:* Dominant Condition  
*Component Percent Cutoff:* None Specified  
*Tie-break Rule:* Lower

**Soil Qualities and Features**

Soil qualities are behavior and performance attributes that are not directly measured, but are inferred from observations of dynamic conditions and from soil properties. Example soil qualities include natural drainage, and frost action. Soil features are attributes that are not directly part of the soil. Example soil features include slope and depth to restrictive layer. These features can greatly impact the use and management of the soil.

**Hydrologic Soil Group**

Hydrologic soil groups are based on estimates of runoff potential. Soils are assigned to one of four groups according to the rate of water infiltration when the soils are not protected by vegetation, are thoroughly wet, and receive precipitation from long-duration storms.

The soils in the United States are assigned to four groups (A, B, C, and D) and three dual classes (A/D, B/D, and C/D). The groups are defined as follows:

Group A. Soils having a high infiltration rate (low runoff potential) when thoroughly wet. These consist mainly of deep, well drained to excessively drained sands or gravelly sands. These soils have a high rate of water transmission.

Group B. Soils having a moderate infiltration rate when thoroughly wet. These consist chiefly of moderately deep or deep, moderately well drained or well drained soils that have moderately fine texture to moderately coarse texture. These soils have a moderate rate of water transmission.

## Custom Soil Resource Report

Group C. Soils having a slow infiltration rate when thoroughly wet. These consist chiefly of soils having a layer that impedes the downward movement of water or soils of moderately fine texture or fine texture. These soils have a slow rate of water transmission.

Group D. Soils having a very slow infiltration rate (high runoff potential) when thoroughly wet. These consist chiefly of clays that have a high shrink-swell potential, soils that have a high water table, soils that have a claypan or clay layer at or near the surface, and soils that are shallow over nearly impervious material. These soils have a very slow rate of water transmission.

If a soil is assigned to a dual hydrologic group (A/D, B/D, or C/D), the first letter is for drained areas and the second is for undrained areas. Only the soils that in their natural condition are in group D are assigned to dual classes.



# Custom Soil Resource Report Map—Hydrologic Soil Group

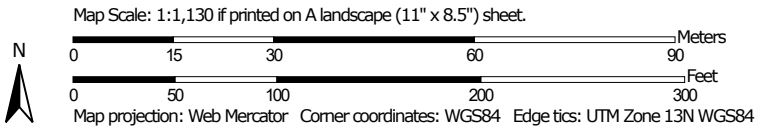
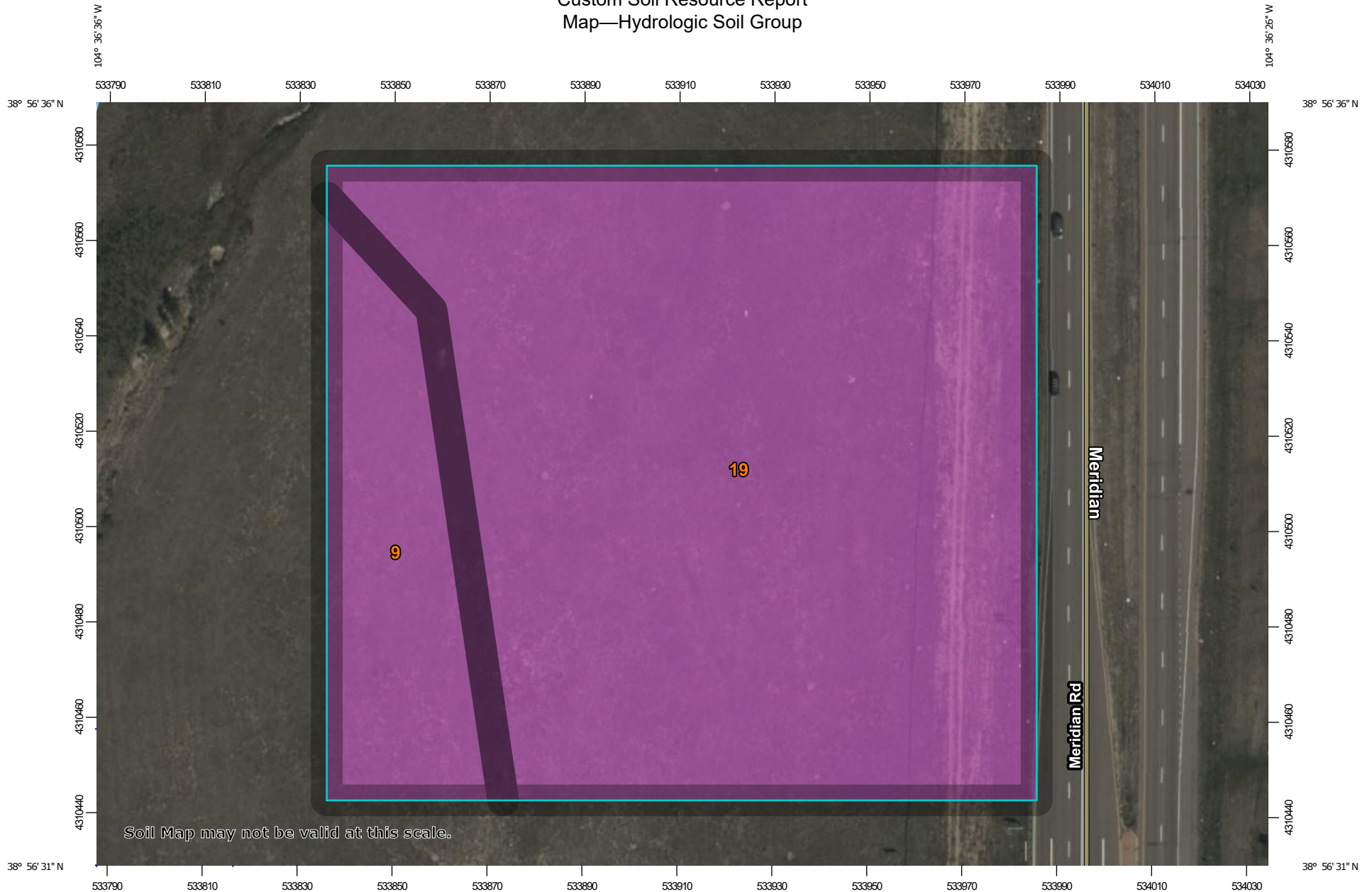



### MAP LEGEND

**Area of Interest (AOI)**









 Area of Interest (AOI)

**Soils**

**Soil Rating Polygons**





-  A
-  A/D
-  B
-  B/D
-  C
-  C/D
-  D
-  Not rated or not available

**Soil Rating Lines**

-  A
-  A/D
-  B
-  B/D
-  C
-  C/D
-  D
-  Not rated or not available

**Soil Rating Points**





-  A
-  A/D
-  B
-  B/D

-  C
-  C/D
-  D
-  Not rated or not available

**Water Features**

 Streams and Canals

**Transportation**

-  Rails
-  Interstate Highways
-  US Routes
-  Major Roads
-  Local Roads

**Background**

 Aerial Photography

### MAP INFORMATION

The soil surveys that comprise your AOI were mapped at 1:24,000.

Warning: Soil Map may not be valid at this scale.

Enlargement of maps beyond the scale of mapping can cause misunderstanding of the detail of mapping and accuracy of soil line placement. The maps do not show the small areas of contrasting soils that could have been shown at a more detailed scale.

Please rely on the bar scale on each map sheet for map measurements.

Source of Map: Natural Resources Conservation Service  
 Web Soil Survey URL:  
 Coordinate System: Web Mercator (EPSG:3857)

Maps from the Web Soil Survey are based on the Web Mercator projection, which preserves direction and shape but distorts distance and area. A projection that preserves area, such as the Albers equal-area conic projection, should be used if more accurate calculations of distance or area are required.

This product is generated from the USDA-NRCS certified data as of the version date(s) listed below.

Soil Survey Area: El Paso County Area, Colorado  
 Survey Area Data: Version 18, Jun 5, 2020

Soil map units are labeled (as space allows) for map scales 1:50,000 or larger.

Date(s) aerial images were photographed: Sep 11, 2018—Oct 20, 2018

The orthophoto or other base map on which the soil lines were compiled and digitized probably differs from the background imagery displayed on these maps. As a result, some minor shifting of map unit boundaries may be evident.

**Table—Hydrologic Soil Group**

Map unit symbol	Map unit name	Rating	Acres in AOI	Percent of AOI
9	Blakeland-Fluvaquentic Haplaquolls	A	0.8	16.6%
19	Columbine gravelly sandy loam, 0 to 3 percent slopes	A	4.1	83.4%
<b>Totals for Area of Interest</b>			<b>4.9</b>	<b>100.0%</b>

**Rating Options—Hydrologic Soil Group**

*Aggregation Method: Dominant Condition*

*Component Percent Cutoff: None Specified*

*Tie-break Rule: Higher*

# References

---

- American Association of State Highway and Transportation Officials (AASHTO). 2004. Standard specifications for transportation materials and methods of sampling and testing. 24th edition.
- American Society for Testing and Materials (ASTM). 2005. Standard classification of soils for engineering purposes. ASTM Standard D2487-00.
- Cowardin, L.M., V. Carter, F.C. Golet, and E.T. LaRoe. 1979. Classification of wetlands and deep-water habitats of the United States. U.S. Fish and Wildlife Service FWS/OBS-79/31.
- Federal Register. July 13, 1994. Changes in hydric soils of the United States.
- Federal Register. September 18, 2002. Hydric soils of the United States.
- Hurt, G.W., and L.M. Vasilas, editors. Version 6.0, 2006. Field indicators of hydric soils in the United States.
- National Research Council. 1995. Wetlands: Characteristics and boundaries.
- Soil Survey Division Staff. 1993. Soil survey manual. Soil Conservation Service. U.S. Department of Agriculture Handbook 18. [http://www.nrcs.usda.gov/wps/portal/nrcs/detail/national/soils/?cid=nrcs142p2\\_054262](http://www.nrcs.usda.gov/wps/portal/nrcs/detail/national/soils/?cid=nrcs142p2_054262)
- Soil Survey Staff. 1999. Soil taxonomy: A basic system of soil classification for making and interpreting soil surveys. 2nd edition. Natural Resources Conservation Service, U.S. Department of Agriculture Handbook 436. [http://www.nrcs.usda.gov/wps/portal/nrcs/detail/national/soils/?cid=nrcs142p2\\_053577](http://www.nrcs.usda.gov/wps/portal/nrcs/detail/national/soils/?cid=nrcs142p2_053577)
- Soil Survey Staff. 2010. Keys to soil taxonomy. 11th edition. U.S. Department of Agriculture, Natural Resources Conservation Service. [http://www.nrcs.usda.gov/wps/portal/nrcs/detail/national/soils/?cid=nrcs142p2\\_053580](http://www.nrcs.usda.gov/wps/portal/nrcs/detail/national/soils/?cid=nrcs142p2_053580)
- Tiner, R.W., Jr. 1985. Wetlands of Delaware. U.S. Fish and Wildlife Service and Delaware Department of Natural Resources and Environmental Control, Wetlands Section.
- United States Army Corps of Engineers, Environmental Laboratory. 1987. Corps of Engineers wetlands delineation manual. Waterways Experiment Station Technical Report Y-87-1.
- United States Department of Agriculture, Natural Resources Conservation Service. National forestry manual. [http://www.nrcs.usda.gov/wps/portal/nrcs/detail/soils/home/?cid=nrcs142p2\\_053374](http://www.nrcs.usda.gov/wps/portal/nrcs/detail/soils/home/?cid=nrcs142p2_053374)
- United States Department of Agriculture, Natural Resources Conservation Service. National range and pasture handbook. <http://www.nrcs.usda.gov/wps/portal/nrcs/detail/national/landuse/rangepasture/?cid=stelprdb1043084>

## Custom Soil Resource Report

United States Department of Agriculture, Natural Resources Conservation Service. National soil survey handbook, title 430-VI. [http://www.nrcs.usda.gov/wps/portal/nrcs/detail/soils/scientists/?cid=nrcs142p2\\_054242](http://www.nrcs.usda.gov/wps/portal/nrcs/detail/soils/scientists/?cid=nrcs142p2_054242)

United States Department of Agriculture, Natural Resources Conservation Service. 2006. Land resource regions and major land resource areas of the United States, the Caribbean, and the Pacific Basin. U.S. Department of Agriculture Handbook 296. [http://www.nrcs.usda.gov/wps/portal/nrcs/detail/national/soils/?cid=nrcs142p2\\_053624](http://www.nrcs.usda.gov/wps/portal/nrcs/detail/national/soils/?cid=nrcs142p2_053624)

United States Department of Agriculture, Soil Conservation Service. 1961. Land capability classification. U.S. Department of Agriculture Handbook 210. [http://www.nrcs.usda.gov/Internet/FSE\\_DOCUMENTS/nrcs142p2\\_052290.pdf](http://www.nrcs.usda.gov/Internet/FSE_DOCUMENTS/nrcs142p2_052290.pdf)

## APPENDIX E – IDENTIFICATION OF POLLUTANT SOURCES















APPENDIX F – LAND DISTURBANCE / CONTROL MEASURE /  
STABILIZATION LOG



APPENDIX G – CDPHE ENVIRONMENTAL SPILL REPORTING



involving a radioactive or infectious material, or there is a release of a marine pollutant.

Spills and incidents that have or may result in a spill along a highway must be reported to the nearest law enforcement agency immediately. The Colorado State Patrol and CDPHE must also be notified as soon as possible. In the event of a spill of hazardous waste at a transfer facility, the transporter must notify CDPHE within 24 hours if the spill exceeds 55 gallons or if there is a fire or explosion.

The National Response Center should be notified as soon as possible after discovery of a release of a hazardous liquid or carbon dioxide from a pipeline system if a person is killed or injured, there is a fire or explosion, there is property damage of \$50,000 or more, or any nearby water body is contaminated.

The National Response Center and the Colorado Public Utilities Commission Gas Pipeline Safety Section must be notified as soon as possible, but not more than two hours after discovery of a release of gas from a natural gas pipeline or liquefied natural gas facility if a person is killed or injured, there is an emergency shutdown of the facility, or there is property damage of \$50,000 or more. The Colorado Public Utilities Commission should also be notified if there is a gas leak from a pipeline, liquefied natural gas system, master meter system or a propane system that results in the evacuation of 50 or more people from an occupied building or the closure of a roadway.

### **Oil and Gas Exploration**

All Class I major events on federal lands, including releases of hazardous substances in excess of the CERCLA reportable quantity and spills of more than 100 barrels of fluid and/or 500 MCF of gas released, must be reported to the Bureau of Land Management (BLM) immediately. Spills of oil, gas, salt water, toxic liquids and waste materials must also be reported to the BLM and the surface management agency.

Spills of exploration and production (E&P) waste on state or private lands in excess of 20 barrels, and spills of any size that impact or threaten to impact waters of the state, an occupied structure, or public byway must be reported to the Colorado Oil and Gas Conservation Commission as soon as practicable, but not more than 24 hours after discovery. Spills of any

size that impact or threaten to impact waters of the state must be reported to CDPHE immediately. Spills that impact or threaten to impact a surface water intake must be reported to the emergency contact for that facility immediately after discovery. Spills of more than five (5) barrels of E&P waste must be reported in writing to the Oil and Gas Conservation Commission within 10 days of discovery.

## **REPORTING NUMBERS**

National Response Center (24-hour)  
**1-800-424-8802**

CDPHE Colorado Environmental Release and Incident Reporting Line (24-hour)  
**1-877-518-5608**

Radiation Incident Reporting Line (24-hour)  
**303-877-9757**

Colorado State Patrol (24-hour)  
**303-239-4501**

Division of Oil and Public Safety  
(business hours)  
**303-318-8547**

Oil and Gas Conservation Commission  
(business hours)  
**303-894-2100**

Colorado Public Utilities Commission Gas Pipeline Safety Section (business hours)  
**303-894-2851**

Local Emergency Planning Committees  
(to obtain list, business hours)  
**720-852-6603**



**Colorado Department  
of Public Health  
and Environment**

# Environmental Spill Reporting

Colorado Department of Public  
Health and Environment  
4300 Cherry Creek Drive South  
Denver, CO 80246-1530

<http://www.cdphe.state.co.us>

January 2009

When a release of a hazardous material or other substance occurs to the environment, there are a number of reporting and notification requirements that must be followed by the company or individual responsible for the release. Most spills are covered by more than one reporting requirement, and **all** requirements must be met. In addition to verbal notification, written reports are generally required. This brochure briefly explains the major requirements. A more detailed description is provided in the "Reporting Environmental Releases in Colorado" Guidance Document, available on the web.

Releases that must be reported to the Colorado Department of Public Health and Environment (CDPHE) may be reported to the Colorado Environmental Release and Incident Reporting Line.

## ENVIRONMENTAL SPILL REPORTING

### CERCLA, EPCRA and RCRA

The Comprehensive Environmental Response, Compensation and Liability Act (CERCLA) and the Emergency Planning and Community Right-to-Know Act (EPCRA) require that a release of a reportable quantity or more of a hazardous substance to the environment be reported immediately to the appropriate authorities when the release is discovered.

Under CERCLA, reportable quantities were established for hazardous substances listed or designated under other environmental statutes. These include:

- all hazardous air pollutants (HAPs) listed under Section 112(b) of the Clean Air Act.
- all toxic pollutants designated under Section 307(a) or Section 311(b)(2)(A) of the Clean Water Act.
- all Resource Conservation and Recovery Act (RCRA) characteristic and listed hazardous wastes.
- any element, compound, or substance designated under Section 102 of CERCLA.

EPCRA established a list of extremely hazardous substances (EHS) that could cause serious irreversible health effects from accidental releases. Many substances appear on both the CERCLA and EPCRA lists. EPCRA extremely hazardous substances that are also CERCLA hazardous substances have the same reportable quantity (RQ) as under CERCLA. EPCRA extremely hazardous substances that are not listed under CERCLA have a reportable quantity that is equal to their threshold planning quantity (TPQ). A list of CERCLA reportable quantities is included in 40 CFR Section 302.4. A list of EPCRA threshold planning quantities is included in 40 CFR Part 355 Appendices A & B.

CERCLA-reportable releases must be reported immediately to the National Response Center (NRC), while EPCRA-reportable releases must be reported immediately to the National Response Center, the State Emergency Response Commission (SERC) and the affected Local Emergency Planning Committee (LEPC). If the release is an EPCRA extremely

hazardous substance, but not a CERCLA hazardous substance, and there is absolutely no potential to affect off-site persons, then only the State Emergency Planning Commission (represented by CDPHE for reporting purposes) and the Local Emergency Planning Committee need to be notified.

In the case of a release of hazardous waste stored in tanks, RCRA-permitted facilities and large quantity generators must also notify CDPHE within 24 hours of any release to the environment that is greater than one (1) pound.

### Radiation Control

Each licensee or registrant must report to the Radiation Incident Reporting Line in the event of lost, stolen or missing licensed or registered radioactive materials or radiation machines, releases of radioactive materials, contamination events, and fires or explosions involving radioactive materials. Releases of radionuclides are reportable under CERCLA.

### Clean Water Act

The Clean Water Act requires the person in charge of a facility or vessel to immediately report to the National Response Center all discharges of oil or designated hazardous substances to water. Oil means oil of any kind or form. Designated hazardous substances are included in the CERCLA list.

The Clean Water Act also requires that facilities with a National Pollutant Discharge Elimination System (NPDES) permit report to the National Response Center within 24 hours of becoming aware of any unanticipated bypasses or upsets that cause an exceedance of the effluent limits in their permit and any violations of their maximum daily discharge limits for pollutants listed in their permit.

A release of any chemical, oil, petroleum product, sewage, etc., which may enter waters of the state of Colorado (which include surface water, ground water and dry gullies and storm sewers leading to surface water) must be reported immediately to CDPHE. Any accidental discharge to the sanitary sewer system must be reported immediately to the local sewer authority and the affected wastewater treatment plant. For additional regarding releases to water, please see "Guidance for Reporting Spills under the Colorado

Water Quality Control Act and Colorado Discharge Permits" at <http://www.cdphe.state.co.us/op/wqcc/Resources/Guidance/spillguidance.pdf>.

### Clean Air Act

Hazardous air pollutants (HAPs) are designated as hazardous substances under CERCLA. If a facility has an air permit but the permit does not allow for or does not specify the release of a substance, or if the facility does not have an air permit, then all releases in excess of the CERCLA / EPCRA reportable quantity for that substance must be reported to the National Response Center and CDPHE. If the facility releases more of a substance than is allowed under its air permit, the facility must also report the release. Discharges of a substance that are within the allowable limits specified in the facility's permit do not need to be reported.

### Regulated Storage Tanks

Owners and operators of regulated storage tank systems must report a release or suspected release of regulated substances to the Division of Oil and Public Safety at the Colorado Department of Labor and Employment within 24 hours. Under this program, the reportable quantity for petroleum releases is 25 gallons or more, or any amount that causes a sheen on nearby surface water. Spills of less than 25 gallons of petroleum must be immediately contained and cleaned up. If cleanup cannot be accomplished within 24 hours, the Division of Oil and Public Safety must be notified immediately.

Spills of hazardous substances from tanks in excess of the CERCLA or EPCRA reportable quantity must be reported immediately to the National Response Center, CDPHE and the local fire authority, and to the Division of Oil and Public Safety within 24 hours.

### Transportation and Pipelines

The person in physical possession of a hazardous material must notify the National Response Center as soon as practical, but not to exceed 12 hours after the incident, if as a direct result of the hazardous material, a person is killed or injured, there is an evacuation of the general public lasting more than an hour, a major transportation artery is shut down for an hour or more, the flight pattern of an aircraft is altered, there is fire, spillage or suspected contamination



## APPENDIX H – STORM EVENT LOG



## APPENDIX I – INSPECTION AND SAMPLING REPORTS

# CONSTRUCTION STORMWATER SITE INSPECTION REPORT

Facility Name		Permittee					
Date of Inspection		Weather Conditions					
Permit Certification #		Disturbed Acreage					
Phase of Construction		Inspector Title					
Inspector Name							
Is the above inspector a qualified stormwater manager? (permittee is responsible for ensuring that the inspector is a qualified stormwater manager)			<table border="1" style="width: 100%; border-collapse: collapse;"> <tr> <td style="width: 50%; text-align: center;">YES</td> <td style="width: 50%; text-align: center;">NO</td> </tr> <tr> <td style="text-align: center;"><input type="checkbox"/></td> <td style="text-align: center;"><input type="checkbox"/></td> </tr> </table>	YES	NO	<input type="checkbox"/>	<input type="checkbox"/>
YES	NO						
<input type="checkbox"/>	<input type="checkbox"/>						

INSPECTION FREQUENCY					
Check the box that describes the minimum inspection frequency utilized when conducting each inspection					
At least one inspection every 7 calendar days	<input type="checkbox"/>				
At least one inspection every 14 calendar days, with post-storm event inspections conducted within 24 hours after the end of any precipitation or snowmelt event that causes surface erosions	<input type="checkbox"/>				
<ul style="list-style-type: none"> <li>• This is this a post-storm event inspection. Event Date: _____</li> </ul>	<input type="checkbox"/>				
Reduced inspection frequency - Include site conditions that warrant reduced inspection frequency	<input type="checkbox"/>				
<ul style="list-style-type: none"> <li>• Post-storm inspections at temporarily idle sites</li> </ul>	<input type="checkbox"/>				
<ul style="list-style-type: none"> <li>• Inspections at completed sites/area</li> </ul>	<input type="checkbox"/>				
<ul style="list-style-type: none"> <li>• Winter conditions exclusion</li> </ul>	<input type="checkbox"/>				
Have there been any deviations from the minimum inspection schedule? If yes, describe below.	<table border="1" style="width: 100%; border-collapse: collapse;"> <tr> <td style="width: 50%; text-align: center;">YES</td> <td style="width: 50%; text-align: center;">NO</td> </tr> <tr> <td style="text-align: center;"><input type="checkbox"/></td> <td style="text-align: center;"><input type="checkbox"/></td> </tr> </table>	YES	NO	<input type="checkbox"/>	<input type="checkbox"/>
YES	NO				
<input type="checkbox"/>	<input type="checkbox"/>				

INSPECTION REQUIREMENTS*
i. Visually verify all implemented control measures are in effective operational condition and are working as designed in the specifications
ii. Determine if there are new potential sources of pollutants
iii. Assess the adequacy of control measures at the site to identify areas requiring new or modified control measures to minimize pollutant discharges
iv. Identify all areas of non-compliance with the permit requirements, and if necessary, implement corrective action
*Use the attached <b>Control Measures Requiring Routine Maintenance</b> and <b>Inadequate Control Measures Requiring Corrective Action</b> forms to document results of this assessment that trigger either maintenance or corrective actions

AREAS TO BE INSPECTED			
Is there evidence of, or the potential for, pollutants leaving the construction site boundaries, entering the stormwater drainage system or discharging to state waters at the following locations?			
	NO	YES	If "YES" describe discharge or potential for discharge below. Document related maintenance, inadequate control measures and corrective actions <b>Inadequate Control Measures Requiring Corrective Action</b> form
Construction site perimeter	<input type="checkbox"/>	<input type="checkbox"/>	
All disturbed areas	<input type="checkbox"/>	<input type="checkbox"/>	
Designated haul routes	<input type="checkbox"/>	<input type="checkbox"/>	
Material and waste storage areas exposed to precipitation	<input type="checkbox"/>	<input type="checkbox"/>	
Locations where stormwater has the potential to discharge offsite	<input type="checkbox"/>	<input type="checkbox"/>	
Locations where vehicles exit the site	<input type="checkbox"/>	<input type="checkbox"/>	
Other: _____	<input type="checkbox"/>	<input type="checkbox"/>	





## REPORTING REQUIREMENTS

The permittee shall report the following circumstances orally within twenty-four (24) hours from the time the permittee becomes aware of the circumstances, and shall mail to the division a written report containing the information requested within five (5) working days after becoming aware of the following circumstances. The division may waive the written report required if the oral report has been received within 24 hours.

<b>All Noncompliance Requiring 24-Hour Notification per Part II.L.6 of the Permit</b>		
<b>a. Endangerment to Health or the Environment</b> Circumstances leading to any noncompliance which may endanger health or the environment regardless of the cause of the incident (See Part II.L.6.a of the Permit) <i>This category would primarily result from the discharge of pollutants in violation of the permit</i>		
<b>b. Numeric Effluent Limit Violations</b> <ul style="list-style-type: none"> <li>o Circumstances leading to any unanticipated bypass which exceeds any effluent limitations (See Part II.L.6.b of the Permit)</li> <li>o Circumstances leading to any upset which causes an exceedance of any effluent limitation (See Part II.L.6.c of the Permit)</li> <li>o Daily maximum violations (See Part II.L.6.d of the Permit)</li> </ul> <i>Numeric effluent limits are very uncommon in certifications under the COR400000 general permit. This category of noncompliance only applies if numeric effluent limits are included in a permit certification.</i>		

Has there been an incident of noncompliance requiring 24-hour notification?	NO	YES	
	<input type="checkbox"/>	<input type="checkbox"/>	If "YES" document below

Date and Time of Incident	Location	Description of Noncompliance	Description of Corrective Action	Date and Time of 24 Hour Oral Notification	Date of 5 Day Written Notification *

\*Attach copy of 5 day written notification to report. Indicate if written notification was waived, including the name of the division personnel who granted waiver.

After adequate corrective action(s) and maintenance have been taken, or where a report does not identify any incidents requiring corrective action or maintenance, the individual(s) designated as the Qualified Stormwater Manager, shall sign and certify the below statement:

“I verify that, to the best of my knowledge and belief, all corrective action and maintenance items identified during the inspection are complete, and the site is currently in compliance with the permit.”

\_\_\_\_\_  
Name of Qualified Stormwater Manager

\_\_\_\_\_  
Title of Qualified Stormwater Manager

\_\_\_\_\_  
Signature of Qualified Stormwater Manager

\_\_\_\_\_  
Date

Notes/Comments



## APPENDIX J – SWMP AMENDMENT LOG / CONTROL MEASURE DETAILS



## Description

Temporary seeding can be used to stabilize disturbed areas that will be inactive for an extended period. Permanent seeding should be used to stabilize areas at final grade that will not be otherwise stabilized. Effective seeding includes preparation of a seedbed, selection of an appropriate seed mixture, proper planting techniques, and protection of the seeded area with mulch, geotextiles, or other appropriate measures.



**Photograph TS/PS -1.** Equipment used to drill seed. Photo courtesy of Douglas County.

## Appropriate Uses

When the soil surface is disturbed and will remain inactive for an extended period (typically 30 days or longer), proactive stabilization measures should be implemented. If the inactive period is short-lived (on the order of two weeks), techniques such as surface roughening may be appropriate. For longer periods of inactivity, temporary seeding and mulching can provide effective erosion control. Permanent seeding should be used on finished areas that have not been otherwise stabilized.

Typically, local governments have their own seed mixes and timelines for seeding. Check jurisdictional requirements for seeding and temporary stabilization.

## Design and Installation

Effective seeding requires proper seedbed preparation, selection of an appropriate seed mixture, use of appropriate seeding equipment to ensure proper coverage and density, and protection with mulch or fabric until plants are established.

The USDCM Volume 2 *Revegetation* Chapter contains detailed seed mix, soil preparations, and seeding and mulching recommendations that may be referenced to supplement this Fact Sheet.

Drill seeding is the preferred seeding method. Hydroseeding is not recommended except in areas where steep slopes prevent use of drill seeding equipment, and even in these instances it is preferable to hand seed and mulch. Some jurisdictions do not allow hydroseeding or hydromulching.

## Seedbed Preparation

Prior to seeding, ensure that areas to be revegetated have soil conditions capable of supporting vegetation. Overlot grading can result in loss of topsoil, resulting in poor quality subsoils at the ground surface that have low nutrient value, little organic matter content, few soil microorganisms, rooting restrictions, and conditions less conducive to infiltration of precipitation. As a result, it is typically necessary to provide stockpiled topsoil, compost, or other

Temporary and Permanent Seeding	
Functions	
Erosion Control	Yes
Sediment Control	No
Site/Material Management	No

## **EC-2      Temporary and Permanent Seeding (TS/PS)**

---

soil amendments and rototill them into the soil to a depth of 6 inches or more.

Topsoil should be salvaged during grading operations for use and spread on areas to be revegetated later. Topsoil should be viewed as an important resource to be utilized for vegetation establishment, due to its water-holding capacity, structure, texture, organic matter content, biological activity, and nutrient content. The rooting depth of most native grasses in the semi-arid Denver metropolitan area is 6 to 18 inches. At a minimum, the upper 6 inches of topsoil should be stripped, stockpiled, and ultimately respread across areas that will be revegetated.

Where topsoil is not available, subsoils should be amended to provide an appropriate plant-growth medium. Organic matter, such as well digested compost, can be added to improve soil characteristics conducive to plant growth. Other treatments can be used to adjust soil pH conditions when needed. Soil testing, which is typically inexpensive, should be completed to determine and optimize the types and amounts of amendments that are required.

If the disturbed ground surface is compacted, rip or rototill the surface prior to placing topsoil. If adding compost to the existing soil surface, rototilling is necessary. Surface roughening will assist in placement of a stable topsoil layer on steeper slopes, and allow infiltration and root penetration to greater depth.

Prior to seeding, the soil surface should be rough and the seedbed should be firm, but neither too loose nor compacted. The upper layer of soil should be in a condition suitable for seeding at the proper depth and conducive to plant growth. Seed-to-soil contact is the key to good germination.

### **Seed Mix for Temporary Vegetation**

To provide temporary vegetative cover on disturbed areas which will not be paved, built upon, or fully landscaped or worked for an extended period (typically 30 days or more), plant an annual grass appropriate for the time of planting and mulch the planted areas. Annual grasses suitable for the Denver metropolitan area are listed in Table TS/PS-1. These are to be considered only as general recommendations when specific design guidance for a particular site is not available. Local governments typically specify seed mixes appropriate for their jurisdiction.

### **Seed Mix for Permanent Revegetation**

To provide vegetative cover on disturbed areas that have reached final grade, a perennial grass mix should be established. Permanent seeding should be performed promptly (typically within 14 days) after reaching final grade. Each site will have different characteristics and a landscape professional or the local jurisdiction should be contacted to determine the most suitable seed mix for a specific site. In lieu of a specific recommendation, one of the perennial grass mixes appropriate for site conditions and growth season listed in Table TS/PS-2 can be used. The pure live seed (PLS) rates of application recommended in these tables are considered to be absolute minimum rates for seed applied using proper drill-seeding equipment.

If desired for wildlife habitat or landscape diversity, shrubs such as rubber rabbitbrush (*Chrysothamnus nauseosus*), fourwing saltbush (*Atriplex canescens*) and skunkbrush sumac (*Rhus trilobata*) could be added to the upland seedmixes at 0.25, 0.5 and 1 pound PLS/acre, respectively. In riparian zones, planting root stock of such species as American plum (*Prunus americana*), woods rose (*Rosa woodsii*), plains cottonwood (*Populus sargentii*), and willow (*Populus spp.*) may be considered. On non-topsoiled upland sites, a legume such as Ladak alfalfa at 1 pound PLS/acre can be included as a source of nitrogen for perennial grasses.

Seeding dates for the highest success probability of perennial species along the Front Range are generally in the spring from April through early May and in the fall after the first of September until the ground freezes. If the area is irrigated, seeding may occur in summer months, as well. See Table TS/PS-3 for appropriate seeding dates.

**Table TS/PS-1. Minimum Drill Seeding Rates for Various Temporary Annual Grasses**

Species <sup>a</sup> (Common name)	Growth Season <sup>b</sup>	Pounds of Pure Live Seed (PLS)/acre <sup>c</sup>	Planting Depth (inches)
1. Oats	Cool	35 - 50	1 - 2
2. Spring wheat	Cool	25 - 35	1 - 2
3. Spring barley	Cool	25 - 35	1 - 2
4. Annual ryegrass	Cool	10 - 15	½
5. Millet	Warm	3 - 15	½ - ¾
6. Sudangrass	Warm	5-10	½ - ¾
7. Sorghum	Warm	5-10	½ - ¾
8. Winter wheat	Cool	20-35	1 - 2
9. Winter barley	Cool	20-35	1 - 2
10. Winter rye	Cool	20-35	1 - 2
11. Triticale	Cool	25-40	1 - 2

<sup>a</sup> Successful seeding of annual grass resulting in adequate plant growth will usually produce enough dead-plant residue to provide protection from wind and water erosion for an additional year. This assumes that the cover is not disturbed or mowed closer than 8 inches.

Hydraulic seeding may be substituted for drilling only where slopes are steeper than 3:1 or where access limitations exist. When hydraulic seeding is used, hydraulic mulching should be applied as a separate operation, when practical, to prevent the seeds from being encapsulated in the mulch.

<sup>b</sup> See Table TS/PS-3 for seeding dates. Irrigation, if consistently applied, may extend the use of cool season species during the summer months.

<sup>c</sup> Seeding rates should be doubled if seed is broadcast, or increased by 50 percent if done using a Brillion Drill or by hydraulic seeding.

# EC-2 Temporary and Permanent Seeding (TS/PS)

**Table TS/PS-2. Minimum Drill Seeding Rates for Perennial Grasses**

Common <sup>a</sup> Name	Botanical Name	Growth Season <sup>b</sup>	Growth Form	Seeds/ Pound	Pounds of PLS/acre
<b>Alakali Soil Seed Mix</b>					
Alkali sacaton	<i>Sporobolus airoides</i>	Cool	Bunch	1,750,000	0.25
Basin wildrye	<i>Elymus cinereus</i>	Cool	Bunch	165,000	2.5
Sodar streambank wheatgrass	<i>Agropyron riparium 'Sodar'</i>	Cool	Sod	170,000	2.5
Jose tall wheatgrass	<i>Agropyron elongatum 'Jose'</i>	Cool	Bunch	79,000	7.0
Arriba western wheatgrass	<i>Agropyron smithii 'Arriba'</i>	Cool	Sod	110,000	5.5
<b>Total</b>					<b>17.75</b>
<b>Fertile Loamy Soil Seed Mix</b>					
Ephriam crested wheatgrass	<i>Agropyron cristatum 'Ephriam'</i>	Cool	Sod	175,000	2.0
Dural hard fescue	<i>Festuca ovina 'duriuscula'</i>	Cool	Bunch	565,000	1.0
Lincoln smooth brome	<i>Bromus inermis leys 'Lincoln'</i>	Cool	Sod	130,000	3.0
Sodar streambank wheatgrass	<i>Agropyron riparium 'Sodar'</i>	Cool	Sod	170,000	2.5
Arriba western wheatgrass	<i>Agropyron smithii 'Arriba'</i>	Cool	Sod	110,000	7.0
<b>Total</b>					<b>15.5</b>
<b>High Water Table Soil Seed Mix</b>					
Meadow foxtail	<i>Alopecurus pratensis</i>	Cool	Sod	900,000	0.5
Redtop	<i>Agrostis alba</i>	Warm	Open sod	5,000,000	0.25
Reed canarygrass	<i>Phalaris arundinacea</i>	Cool	Sod	68,000	0.5
Lincoln smooth brome	<i>Bromus inermis leys 'Lincoln'</i>	Cool	Sod	130,000	3.0
Pathfinder switchgrass	<i>Panicum virgatum 'Pathfinder'</i>	Warm	Sod	389,000	1.0
Alkar tall wheatgrass	<i>Agropyron elongatum 'Alkar'</i>	Cool	Bunch	79,000	5.5
<b>Total</b>					<b>10.75</b>
<b>Transition Turf Seed Mix<sup>c</sup></b>					
Ruebens Canadian bluegrass	<i>Poa compressa 'Ruebens'</i>	Cool	Sod	2,500,000	0.5
Dural hard fescue	<i>Festuca ovina 'duriuscula'</i>	Cool	Bunch	565,000	1.0
Citation perennial ryegrass	<i>Lolium perenne 'Citation'</i>	Cool	Sod	247,000	3.0
Lincoln smooth brome	<i>Bromus inermis leys 'Lincoln'</i>	Cool	Sod	130,000	3.0
<b>Total</b>					<b>7.5</b>

**Table TS/PS-2. Minimum Drill Seeding Rates for Perennial Grasses (cont.)**

Common Name	Botanical Name	Growth Season <sup>b</sup>	Growth Form	Seeds/Pound	Pounds of PLS/acre
<b>Sandy Soil Seed Mix</b>					
Blue grama	<i>Bouteloua gracilis</i>	Warm	Sod-forming bunchgrass	825,000	0.5
Camper little bluestem	<i>Schizachyrium scoparium</i> 'Camper'	Warm	Bunch	240,000	1.0
Prairie sandreed	<i>Calamovilfa longifolia</i>	Warm	Open sod	274,000	1.0
Sand dropseed	<i>Sporobolus cryptandrus</i>	Cool	Bunch	5,298,000	0.25
Vaughn sideoats grama	<i>Bouteloua curtipendula</i> 'Vaughn'	Warm	Sod	191,000	2.0
Arriba western wheatgrass	<i>Agropyron smithii</i> 'Arriba'	Cool	Sod	110,000	5.5
<b>Total</b>					<b>10.25</b>
<b>Heavy Clay, Rocky Foothill Seed Mix</b>					
Ephriam crested wheatgrass <sup>d</sup>	<i>Agropyron cristatum</i> 'Ephriam'	Cool	Sod	175,000	1.5
Oahe Intermediate wheatgrass	<i>Agropyron intermedium</i> 'Oahe'	Cool	Sod	115,000	5.5
Vaughn sideoats grama <sup>e</sup>	<i>Bouteloua curtipendula</i> 'Vaughn'	Warm	Sod	191,000	2.0
Lincoln smooth brome	<i>Bromus inermis</i> leys 'Lincoln'	Cool	Sod	130,000	3.0
Arriba western wheatgrass	<i>Agropyron smithii</i> 'Arriba'	Cool	Sod	110,000	5.5
<b>Total</b>					<b>17.5</b>
<p><sup>a</sup> All of the above seeding mixes and rates are based on drill seeding followed by crimped straw mulch. These rates should be doubled if seed is broadcast and should be increased by 50 percent if the seeding is done using a Brillion Drill or is applied through hydraulic seeding. Hydraulic seeding may be substituted for drilling only where slopes are steeper than 3:1. If hydraulic seeding is used, hydraulic mulching should be done as a separate operation.</p> <p><sup>b</sup> See Table TS/PS-3 for seeding dates.</p> <p><sup>c</sup> If site is to be irrigated, the transition turf seed rates should be doubled.</p> <p><sup>d</sup> Crested wheatgrass should not be used on slopes steeper than 6H to 1V.</p> <p><sup>e</sup> Can substitute 0.5 lbs PLS of blue grama for the 2.0 lbs PLS of Vaughn sideoats grama.</p>					

# EC-2 Temporary and Permanent Seeding (TS/PS)

Table TS/PS-3. Seeding Dates for Annual and Perennial Grasses

Seeding Dates	Annual Grasses (Numbers in table reference species in Table TS/PS-1)		Perennial Grasses	
	Warm	Cool	Warm	Cool
January 1–March 15			✓	✓
March 16–April 30	4	1,2,3	✓	✓
May 1–May 15	4		✓	
May 16–June 30	4,5,6,7			
July 1–July 15	5,6,7			
July 16–August 31				
September 1–September 30		8,9,10,11		
October 1–December 31			✓	✓

## Mulch

Cover seeded areas with mulch or an appropriate rolled erosion control product to promote establishment of vegetation. Anchor mulch by crimping, netting or use of a non-toxic tackifier. See the Mulching BMP Fact Sheet for additional guidance.

## Maintenance and Removal

Monitor and observe seeded areas to identify areas of poor growth or areas that fail to germinate. Reseed and mulch these areas, as needed.

An area that has been permanently seeded should have a good stand of vegetation within one growing season if irrigated and within three growing seasons without irrigation in Colorado. Reseed portions of the site that fail to germinate or remain bare after the first growing season.

Seeded areas may require irrigation, particularly during extended dry periods. Targeted weed control may also be necessary.

Protect seeded areas from construction equipment and vehicle access.



## Description

Rolled Erosion Control Products (RECPs) include a variety of temporary or permanently installed manufactured products designed to control erosion and enhance vegetation establishment and survivability, particularly on slopes and in channels. For applications where natural vegetation alone will provide sufficient permanent erosion protection, temporary products such as netting, open weave textiles and a variety of erosion control blankets (ECBs) made of biodegradable natural materials (e.g., straw, coconut fiber) can be used. For applications where natural vegetation alone will not be sustainable under expected flow conditions, permanent rolled erosion control products such as turf reinforcement mats (TRMs) can be used. In particular, turf reinforcement mats are designed for discharges that exert velocities and shear stresses that exceed the typical limits of mature natural vegetation.



**Photograph RECP-1.** Erosion control blanket protecting the slope from erosion and providing favorable conditions for revegetation.

## Appropriate Uses

RECPs can be used to control erosion in conjunction with revegetation efforts, providing seedbed protection from wind and water erosion. These products are often used on disturbed areas on steep slopes, in areas with highly erosive soils, or as part of drainageway stabilization. In order to select the appropriate RECP for site conditions, it is important to have a general understanding of the general types of these products, their expected longevity, and general characteristics.

The Erosion Control Technology Council (ECTC 2005) characterizes rolled erosion control products according to these categories:

- **Mulch control netting:** A planar woven natural fiber or extruded geosynthetic mesh used as a temporary degradable rolled erosion control product to anchor loose fiber mulches.
- **Open weave textile:** A temporary degradable rolled erosion control product composed of processed natural or polymer yarns woven into a matrix, used to provide erosion control and facilitate vegetation establishment.
- **Erosion control blanket (ECB):** A temporary degradable rolled erosion control product composed of processed natural or polymer fibers which are mechanically, structurally or chemically bound together to form a continuous matrix to provide erosion control and facilitate vegetation establishment. ECBs can be further differentiated into rapidly degrading single-net and double-net types or slowly degrading types.

<b>Rolled Erosion Control Products</b>	
<b>Functions</b>	
Erosion Control	Yes
Sediment Control	No
Site/Material Management	No

## EC-6                      Rolled Erosion Control Products (RECP)

---

- **Turf Reinforcement Mat (TRM):** A rolled erosion control product composed of non-degradable synthetic fibers, filaments, nets, wire mesh, and/or other elements, processed into a permanent, three-dimensional matrix of sufficient thickness. TRMs, which may be supplemented with degradable components, are designed to impart immediate erosion protection, enhance vegetation establishment and provide long-term functionality by permanently reinforcing vegetation during and after maturation. Note: TRMs are typically used in hydraulic applications, such as high flow ditches and channels, steep slopes, stream banks, and shorelines, where erosive forces may exceed the limits of natural, unreinforced vegetation or in areas where limited vegetation establishment is anticipated.

Tables RECP-1 and RECP-2 provide guidelines for selecting rolled erosion control products appropriate to site conditions and desired longevity. Table RECP-1 is for conditions where natural vegetation alone will provide permanent erosion control, whereas Table RECP-2 is for conditions where vegetation alone will not be adequately stable to provide long-term erosion protection due to flow or other conditions.

**Table RECP-1. ECTC Standard Specification for Temporary Rolled Erosion Control Products**  
(Adapted from Erosion Control Technology Council 2005)

Product Description	Slope Applications*		Channel Applications*	Minimum Tensile Strength <sup>1</sup>	Expected Longevity
	Maximum Gradient	C Factor <sup>2,5</sup>			
Mulch Control Nets	5:1 (H:V)	≤0.10 @ 5:1	0.25 lbs/ft <sup>2</sup> (12 Pa)	5 lbs/ft (0.073 kN/m)	Up to 12 months
Netless Rolled Erosion Control Blankets	4:1 (H:V)	≤0.10 @ 4:1	0.5 lbs/ft <sup>2</sup> (24 Pa)	5 lbs/ft (0.073 kN/m)	
Single-net Erosion Control Blankets & Open Weave Textiles	3:1 (H:V)	≤0.15 @ 3:1	1.5 lbs/ft <sup>2</sup> (72 Pa)	50 lbs/ft (0.73 kN/m)	
Double-net Erosion Control Blankets	2:1 (H:V)	≤0.20 @ 2:1	1.75 lbs/ft <sup>2</sup> (84 Pa)	75 lbs/ft (1.09 kN/m)	
Mulch Control Nets	5:1 (H:V)	≤0.10 @ 5:1	0.25 lbs/ft <sup>2</sup> (12 Pa)	25 lbs/ft (0.36 kN/m)	24 months
Erosion Control Blankets & Open Weave Textiles (slowly degrading)	1.5:1 (H:V)	≤0.25 @ 1.5:1	2.00 lbs/ft <sup>2</sup> (96 Pa)	100 lbs/ft (1.45 kN/m)	24 months
Erosion Control Blankets & Open Weave Textiles	1:1 (H:V)	≤0.25 @ 1:1	2.25 lbs/ft <sup>2</sup> (108 Pa)	125 lbs/ft (1.82 kN/m)	36 months

\* C Factor and shear stress for mulch control nettings must be obtained with netting used in conjunction with pre-applied mulch material. (See Section 5.3 of Chapter 7 Construction BMPs for more information on the C Factor.)

<sup>1</sup> Minimum Average Roll Values, Machine direction using ECTC Mod. ASTM D 5035.

<sup>2</sup> C Factor calculated as ratio of soil loss from RECP protected slope (tested at specified or greater gradient, H:V) to ratio of soil loss from unprotected (control) plot in large-scale testing.

<sup>3</sup> Required minimum shear stress RECP (unvegetated) can sustain without physical damage or excess erosion (> 12.7 mm (0.5 in) soil loss) during a 30-minute flow event in large-scale testing.

<sup>4</sup> The permissible shear stress levels established for each performance category are based on historical experience with products characterized by Manning's roughness coefficients in the range of 0.01 - 0.05.

<sup>5</sup> Acceptable large-scale test methods may include ASTM D 6459, or other independent testing deemed acceptable by the engineer.

<sup>6</sup> Per the engineer's discretion. Recommended acceptable large-scale testing protocol may include ASTM D 6460, or other independent testing deemed acceptable by the engineer.

**Table RECP-2. ECTC Standard Specification for Permanent<sup>1</sup> Rolled Erosion Control Products**  
(Adapted from: Erosion Control Technology Council 2005)

Product Type	Slope Applications	Channel Applications	
TRMs with a minimum thickness of 0.25 inches (6.35 mm) per ASTM D 6525 and UV stability of 80% per ASTM D 4355 (500 hours exposure).	Maximum Gradient	Maximum Shear Stress <sup>4,5</sup>	Minimum Tensile Strength <sup>2,3</sup>
	0.5:1 (H:V)	6.0 lbs/ft <sup>2</sup> (288 Pa)	125 lbs/ft (1.82 kN/m)
	0.5:1 (H:V)	8.0 lbs/ft <sup>2</sup> (384 Pa)	150 lbs/ft (2.19 kN/m)
	0.5:1 (H:V)	10.0 lbs/ft <sup>2</sup> (480 Pa)	175 lbs/ft (2.55 kN/m)

<sup>1</sup> For TRMs containing degradable components, all property values must be obtained on the non-degradable portion of the matting alone.

<sup>2</sup> Minimum Average Roll Values, machine direction only for tensile strength determination using [ASTM D 6818](#) (Supersedes Mod. [ASTM D 5035](#) for RECPs)

<sup>3</sup> Field conditions with high loading and/or high survivability requirements may warrant the use of a TRM with a tensile strength of 44 kN/m (3,000 lb/ft) or greater.

<sup>4</sup> Required minimum shear stress TRM (fully vegetated) can sustain without physical damage or excess erosion (> 12.7 mm (0.5 in.) soil loss) during a 30-minute flow event in large scale testing.

<sup>5</sup> Acceptable large-scale testing protocols may include [ASTM D 6460](#), or other independent testing deemed acceptable by the engineer.

## Design and Installation

RECPs should be installed according to manufacturer’s specifications and guidelines. Regardless of the type of product used, it is important to ensure no gaps or voids exist under the material and that all corners of the material are secured using stakes and trenching. Continuous contact between the product and the soil is necessary to avoid failure. Never use metal stakes to secure temporary erosion control products. Often wooden stakes are used to anchor RECPs; however, wood stakes may present installation and maintenance challenges and generally take a long time to biodegrade. Some local jurisdictions have had favorable experiences using biodegradable stakes.

This BMP Fact Sheet provides design details for several commonly used ECB applications, including:

ECB-1 Pipe Outlet to Drainageway

ECB-2 Small Ditch or Drainageway

ECB-3 Outside of Drainageway

Staking patterns are also provided in the design details according to these factors:

- ECB type
- Slope or channel type

For other types of RECPs including TRMs, these design details are intended to serve as general guidelines for design and installation; however, engineers should adhere to manufacturer's installation recommendations.

## **Maintenance and Removal**

Inspection of erosion control blankets and other RECPs includes:

- Check for general signs of erosion, including voids beneath the mat. If voids are apparent, fill the void with suitable soil and replace the erosion control blanket, following the appropriate staking pattern.
- Check for damaged or loose stakes and secure loose portions of the blanket.

Erosion control blankets and other RECPs that are biodegradable typically do not need to be removed after construction. If they must be removed, then an alternate soil stabilization method should be installed promptly following removal.

Turf reinforcement mats, although generally resistant to biodegradation, are typically left in place as a dense vegetated cover grows in through the mat matrix. The turf reinforcement mat provides long-term stability and helps the established vegetation resist erosive forces.

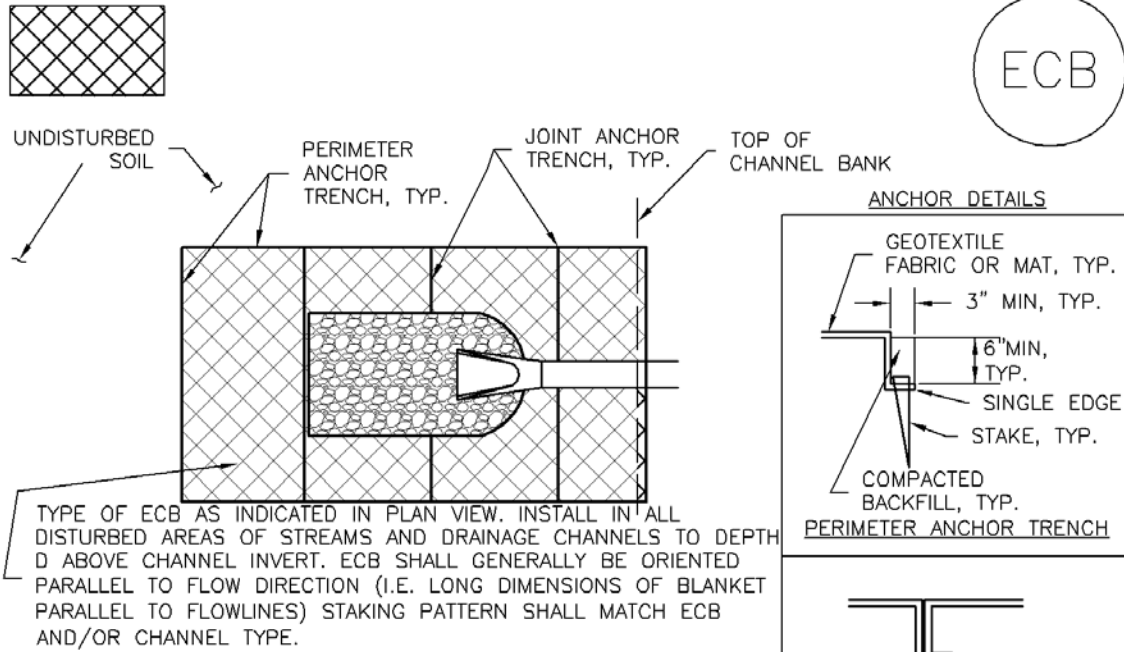

**ECB-1. PIPE OUTLET TO DRAINAGEWAY**

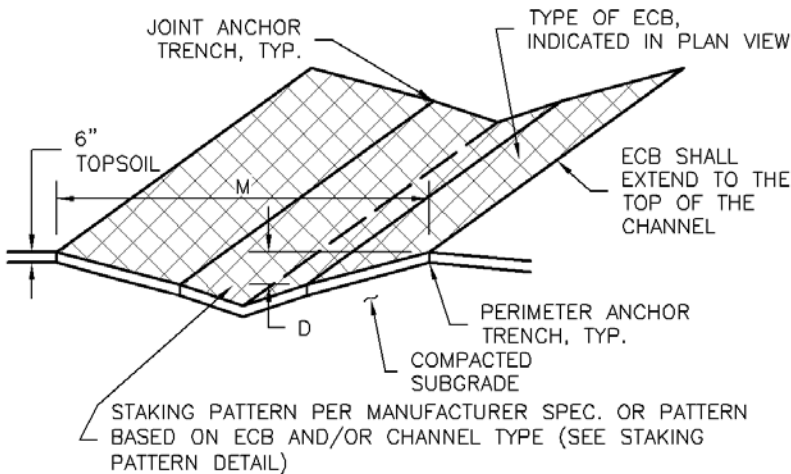

**ECB-2. SMALL DITCH OR DRAINAGEWAY**

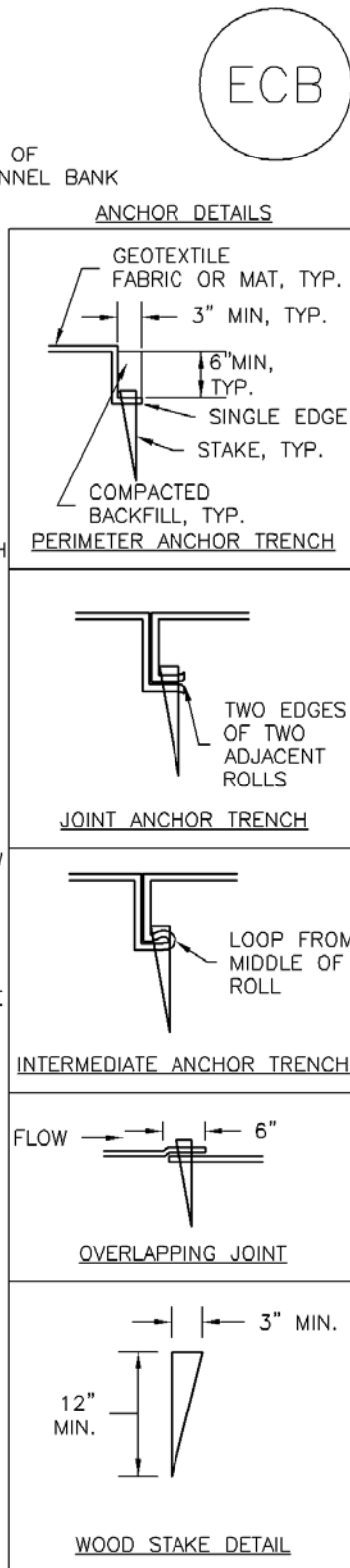

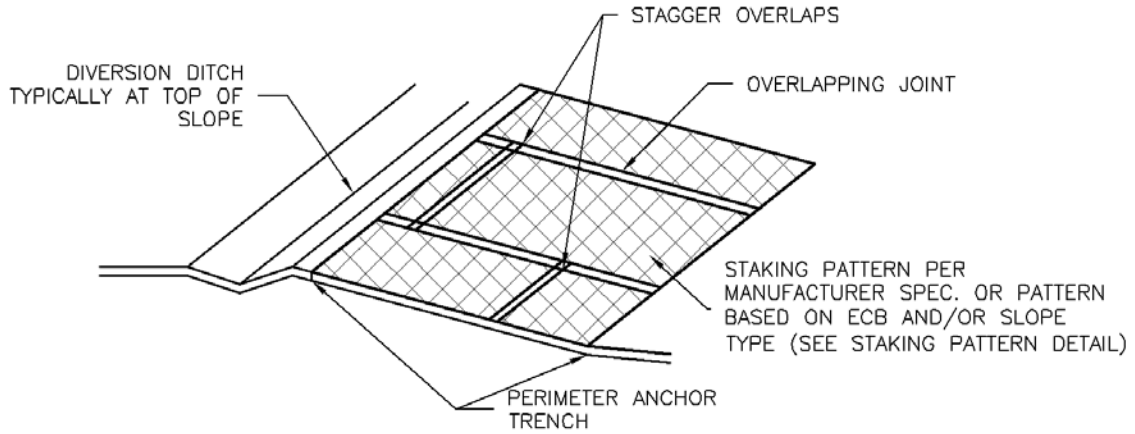

## ECB-3. OUTSIDE OF DRAINAGEWAY

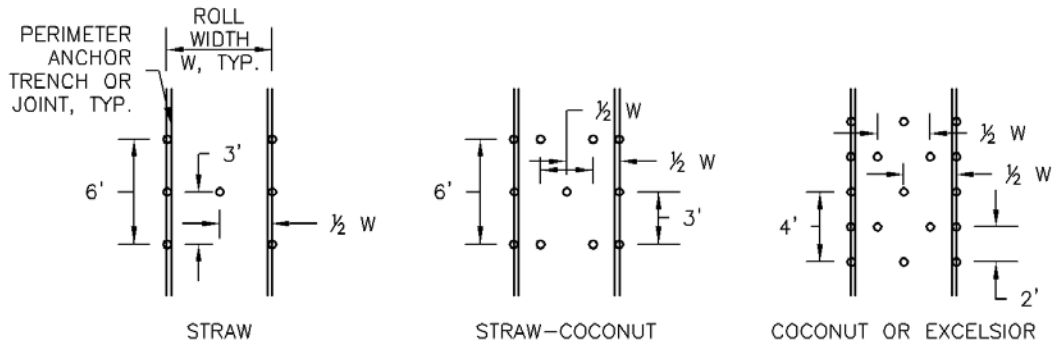

## STAKING PATTERNS BY ECB TYPE

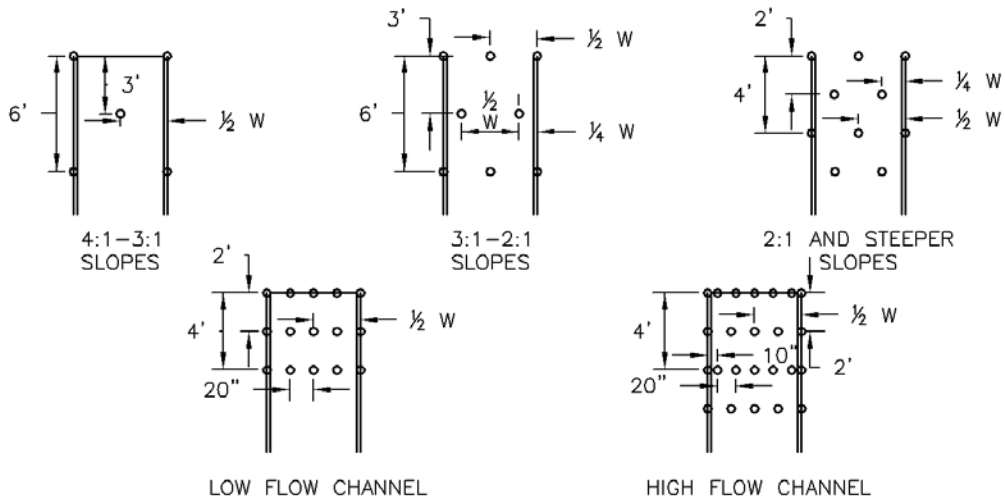

## STAKING PATTERNS BY SLOPE OR CHANNEL TYPE

EROSION CONTROL BLANKET INSTALLATION NOTES

1. SEE PLAN VIEW FOR:
  - LOCATION OF ECB.
  - TYPE OF ECB (STRAW, STRAW-COCONUT, COCONUT, OR EXCELSIOR).
  - AREA, A, IN SQUARE YARDS OF EACH TYPE OF ECB.
2. 100% NATURAL AND BIODEGRADABLE MATERIALS ARE PREFERRED FOR RECPs, ALTHOUGH SOME JURISDICTIONS MAY ALLOW OTHER MATERIALS IN SOME APPLICATIONS.
3. IN AREAS WHERE ECBs ARE SHOWN ON THE PLANS, THE PERMITTEE SHALL PLACE TOPSOIL AND PERFORM FINAL GRADING, SURFACE PREPARATION, AND SEEDING AND MULCHING. SUBGRADE SHALL BE SMOOTH AND MOIST PRIOR TO ECB INSTALLATION AND THE ECB SHALL BE IN FULL CONTACT WITH SUBGRADE. NO GAPS OR VOIDS SHALL EXIST UNDER THE BLANKET.
4. PERIMETER ANCHOR TRENCH SHALL BE USED ALONG THE OUTSIDE PERIMETER OF ALL BLANKET AREAS.
5. JOINT ANCHOR TRENCH SHALL BE USED TO JOIN ROLLS OF ECBs TOGETHER (LONGITUDINALLY AND TRANSVERSELY) FOR ALL ECBs EXCEPT STRAW WHICH MAY USE AN OVERLAPPING JOINT.
6. INTERMEDIATE ANCHOR TRENCH SHALL BE USED AT SPACING OF ONE-HALF ROLL LENGTH FOR COCONUT AND EXCELSIOR ECBs.
7. OVERLAPPING JOINT DETAIL SHALL BE USED TO JOIN ROLLS OF ECBs TOGETHER FOR ECBs ON SLOPES.
8. MATERIAL SPECIFICATIONS OF ECBs SHALL CONFORM TO TABLE ECB-1.
9. ANY AREAS OF SEEDING AND MULCHING DISTURBED IN THE PROCESS OF INSTALLING ECBs SHALL BE RESEEDED AND MULCHED.
10. DETAILS ON DESIGN PLANS FOR MAJOR DRAINAGEWAY STABILIZATION WILL GOVERN IF DIFFERENT FROM THOSE SHOWN HERE.

TABLE ECB-1. ECB MATERIAL SPECIFICATIONS				
TYPE	COCONUT CONTENT	STRAW CONTENT	EXCELSIOR CONTENT	RECOMMENDED NETTING**
STRAW*	-	100%	-	DOUBLE/ NATURAL
STRAW-COCONUT	30% MIN	70% MAX	-	DOUBLE/ NATURAL
COCONUT	100%	-	-	DOUBLE/ NATURAL
EXCELSIOR	-	-	100%	DOUBLE/ NATURAL

\*STRAW ECBs MAY ONLY BE USED OUTSIDE OF STREAMS AND DRAINAGE CHANNEL.  
 \*\*ALTERNATE NETTING MAY BE ACCEPTABLE IN SOME JURISDICTIONS



## EROSION CONTROL BLANKET MAINTENANCE NOTES

1. INSPECT BMPs EACH WORKDAY, AND MAINTAIN THEM IN EFFECTIVE OPERATING CONDITION. MAINTENANCE OF BMPs SHOULD BE PROACTIVE, NOT REACTIVE. INSPECT BMPs AS SOON AS POSSIBLE (AND ALWAYS WITHIN 24 HOURS) FOLLOWING A STORM THAT CAUSES SURFACE EROSION, AND PERFORM NECESSARY MAINTENANCE.
2. FREQUENT OBSERVATIONS AND MAINTENANCE ARE NECESSARY TO MAINTAIN BMPs IN EFFECTIVE OPERATING CONDITION. INSPECTIONS AND CORRECTIVE MEASURES SHOULD BE DOCUMENTED THOROUGHLY.
3. WHERE BMPs HAVE FAILED, REPAIR OR REPLACEMENT SHOULD BE INITIATED UPON DISCOVERY OF THE FAILURE.
4. ECBs SHALL BE LEFT IN PLACE TO EVENTUALLY BIODEGRADE, UNLESS REQUESTED TO BE REMOVED BY THE LOCAL JURISDICTION.
5. ANY ECB PULLED OUT, TORN, OR OTHERWISE DAMAGED SHALL BE REPAIRED OR REINSTALLED. ANY SUBGRADE AREAS BELOW THE GEOTEXTILE THAT HAVE ERODED TO CREATED A VOID UNDER THE BLANKET, OR THAT REMAIN DEVOID OF GRASS SHALL BE REPAIRED, RESEDED AND MULCHED AND THE ECB REINSTALLED.

NOTE: MANY JURISDICTIONS HAVE BMP DETAILS THAT VARY FROM UDFCD STANDARD DETAILS. CONSULT WITH LOCAL JURISDICTIONS AS TO WHICH DETAIL SHOULD BE USED WHEN DIFFERENCES ARE NOTED.

(DETAILS ADAPTED FROM DOUGLAS COUNTY, COLORADO AND TOWN OF PARKER COLORADO, NOT AVAILABLE IN AUTOCAD)

## Description

Earth dikes and drainage swales are temporary storm conveyance channels constructed either to divert runoff around slopes or to convey runoff to additional sediment control BMPs prior to discharge of runoff from a site. Drainage swales may be lined or unlined, but if an unlined swale is used, it must be well compacted and capable of resisting erosive velocities.

## Appropriate Uses

Earth dikes and drainage swales are typically used to control the flow path of runoff at a construction site by diverting runoff around areas prone to erosion, such as steep slopes. Earth dikes and drainage swales may also be constructed as temporary conveyance features. This will direct runoff to additional sediment control treatment BMPs, such as sediment traps or basins.



**Photograph ED/DS-1.** Example of an earth dike used to divert flows at a construction site. Photo courtesy of CDOT.

## Design and Installation

When earth dikes are used to divert water for slope protection, the earth dike typically consists of a horizontal ridge of soil placed perpendicular to the slope and angled slightly to provide drainage along the contour. The dike is used in conjunction with a swale or a small channel upslope of the berm to convey the diverted water. Temporary diversion dikes can be constructed by excavation of a V-shaped trench or ditch and placement of the fill on the downslope side of the cut. There are two types of placement for temporary slope diversion dikes:

- A dike located at the top of a slope to divert upland runoff away from the disturbed area and convey it in a temporary or permanent channel.
- A diversion dike located at the base or mid-slope of a disturbed area to intercept runoff and reduce the effective slope length.

Depending on the project, either an earth dike or drainage swale may be more appropriate. If there is a need for cut on the project, then an excavated drainage swale may be better suited. When the project is primarily fill, then a conveyance constructed using a berm may be the better option.

**All dikes or swales receiving runoff from a disturbed area should direct stormwater to a sediment control BMP such as a sediment trap or basin.**

Earth Dikes and Drainage Swales	
Functions	
Erosion Control	Yes
Sediment Control	Moderate
Site/Material Management	No

# **EC-10      Earth Dikes and Drainage Swales (ED/DS)**

---

**Unlined dikes or swales should only be used for intercepting sheet flow runoff and are not intended for diversion of concentrated flows.**

Details with notes are provided for several design variations, including:

ED-1. Unlined Earth Dike formed by Berm

DS-1. Unlined Excavated Swale

DS-2. Unlined Swale Formed by Cut and Fill

DS-3. ECB-lined Swale

DS-4. Synthetic-lined Swale

DS-5. Riprap-lined Swale

The details also include guidance on permissible velocities for cohesive channels if unlined approaches will be used.

## **Maintenance and Removal**

Inspect earth dikes for stability, compaction, and signs of erosion and repair. Inspect side slopes for erosion and damage to erosion control fabric. Stabilize slopes and repair fabric as necessary. If there is reoccurring extensive damage, consider installing rock check dams or lining the channel with riprap.

If drainage swales are not permanent, remove dikes and fill channels when the upstream area is stabilized. Stabilize the fill or disturbed area immediately following removal by revegetation or other permanent stabilization method approved by the local jurisdiction.

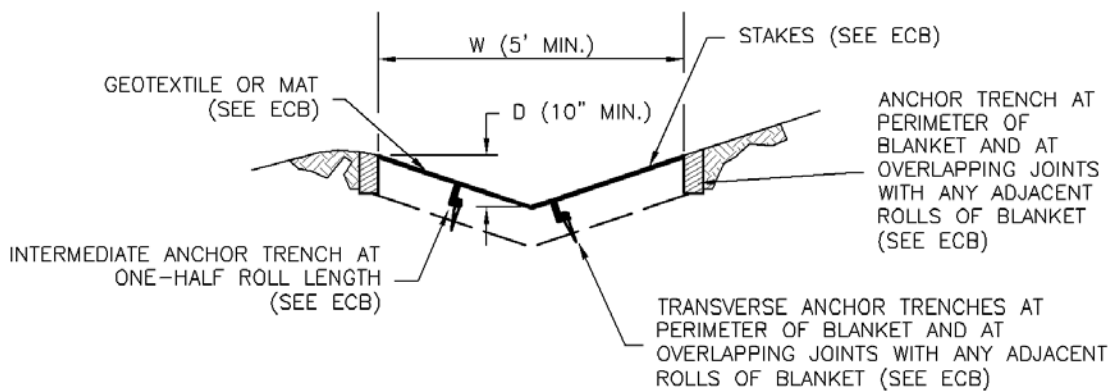
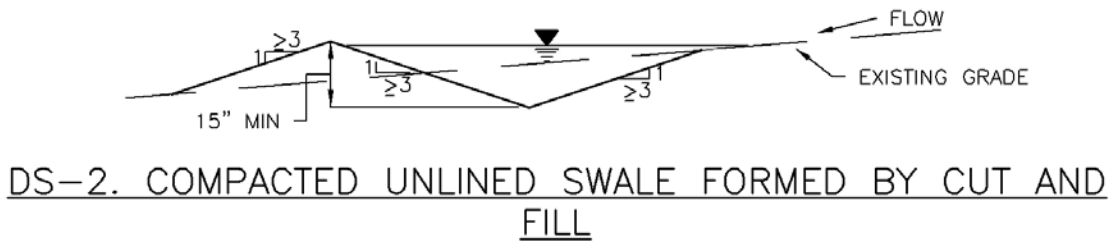
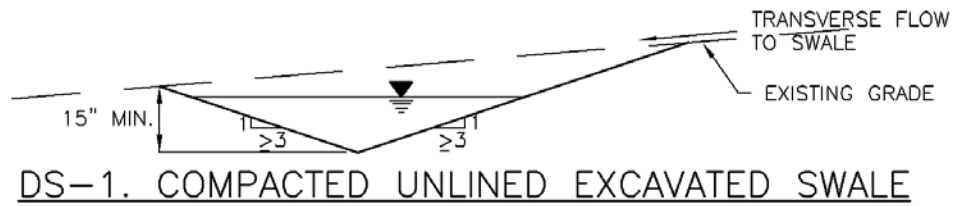
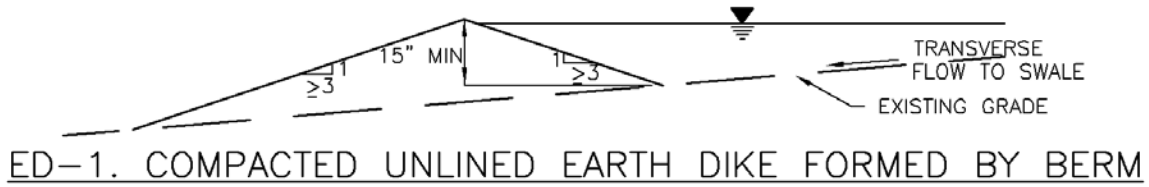
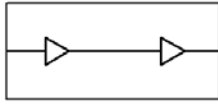

# EC-10 Earth Dikes and Drainage Swales (ED/DS)

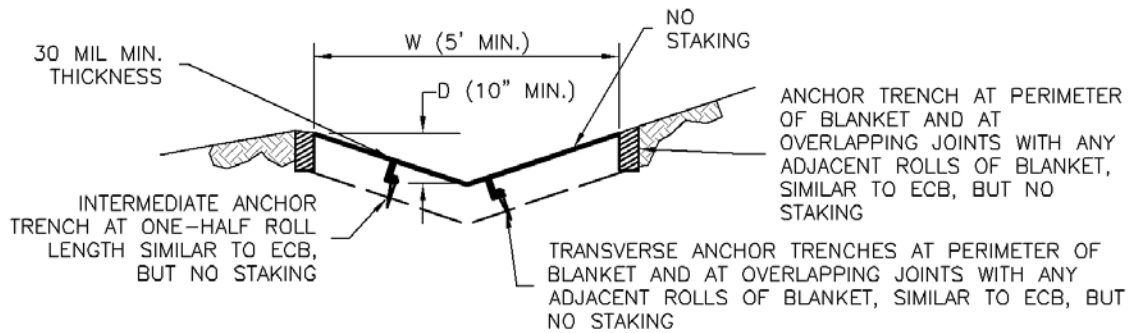

DS-4. SYNTHETIC LINED SWALE

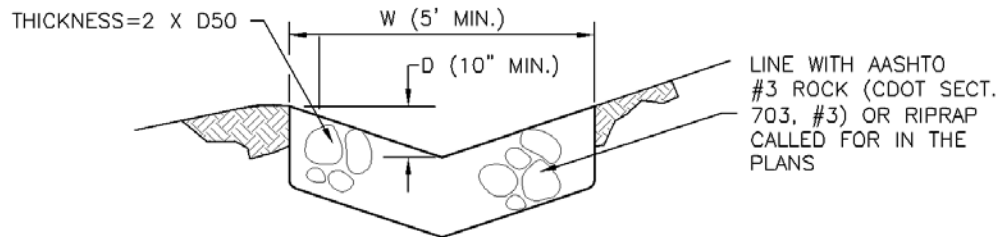

DS-5. RIPRAP LINED SWALE

## EARTH DIKE AND DRAINAGE SWALE INSTALLATION NOTES

1. SEE SITE PLAN FOR:
  - LOCATION OF DIVERSION SWALE
  - TYPE OF SWALE (UNLINED, COMPACTED AND/OR LINED).
  - LENGTH OF EACH SWALE.
  - DEPTH, D, AND WIDTH, W DIMENSIONS.
  - FOR ECB/TRM LINED DITCH, SEE ECB DETAIL.
  - FOR RIPRAP LINED DITCH, SIZE OF RIPRAP, D50.
2. SEE DRAINAGE PLANS FOR DETAILS OF PERMANENT CONVEYANCE FACILITIES AND/OR DIVERSION SWALES EXCEEDING 2-YEAR FLOW RATE OR 10 CFS.
3. EARTH DIKES AND SWALES INDICATED ON SWMP PLAN SHALL BE INSTALLED PRIOR TO LAND-DISTURBING ACTIVITIES IN PROXIMITY.
4. EMBANKMENT IS TO BE COMPACTED TO 90% OF MAXIMUM DENSITY AND WITHIN 2% OF OPTIMUM MOISTURE CONTENT ACCORDING TO ASTM D698.
5. SWALES ARE TO DRAIN TO A SEDIMENT CONTROL BMP.
6. FOR LINED DITCHES, INSTALLATION OF ECB/TRM SHALL CONFORM TO THE REQUIREMENTS OF THE ECB DETAIL.
7. WHEN CONSTRUCTION TRAFFIC MUST CROSS A DIVERSION SWALE, INSTALL A TEMPORARY CULVERT WITH A MINIMUM DIAMETER OF 12 INCHES.

## EARTH DIKE AND DRAINAGE SWALE MAINTENANCE NOTES

1. INSPECT BMPs EACH WORKDAY, AND MAINTAIN THEM IN EFFECTIVE OPERATING CONDITION. MAINTENANCE OF BMPs SHOULD BE PROACTIVE, NOT REACTIVE. INSPECT BMPs AS SOON AS POSSIBLE (AND ALWAYS WITHIN 24 HOURS) FOLLOWING A STORM THAT CAUSES SURFACE EROSION, AND PERFORM NECESSARY MAINTENANCE.
2. FREQUENT OBSERVATIONS AND MAINTENANCE ARE NECESSARY TO MAINTAIN BMPs IN EFFECTIVE OPERATING CONDITION. INSPECTIONS AND CORRECTIVE MEASURES SHOULD BE DOCUMENTED THOROUGHLY.
3. WHERE BMPs HAVE FAILED, REPAIR OR REPLACEMENT SHOULD BE INITIATED UPON DISCOVERY OF THE FAILURE.
4. SWALES SHALL REMAIN IN PLACE UNTIL THE END OF CONSTRUCTION; IF APPROVED BY LOCAL JURISDICTION, SWALES MAY BE LEFT IN PLACE.
5. WHEN A SWALE IS REMOVED, THE DISTURBED AREA SHALL BE COVERED WITH TOPSOIL, SEEDED AND MULCHED OR OTHERWISE STABILIZED IN A MANNER APPROVED BY LOCAL JURISDICTION.

(DETAIL ADAPTED FROM DOUGLAS COUNTY, COLORADO AND THE CITY OF COLORADO SPRINGS, COLORADO, NOT AVAILABLE IN AUTOCAD)

NOTE: MANY JURISDICTIONS HAVE BMP DETAILS THAT VARY FROM UDFCD STANDARD DETAILS. CONSULT WITH LOCAL JURISDICTIONS AS TO WHICH DETAIL SHOULD BE USED WHEN DIFFERENCES ARE NOTED.

## Description

Check dams are temporary grade control structures placed in drainage channels to limit the erosivity of stormwater by reducing flow velocity. Check dams are typically constructed from rock, gravel bags, sand bags, or sometimes, proprietary devices. Reinforced check dams are typically constructed from rock and wire gabion. Although the primary function of check dams is to reduce the velocity of concentrated flows, a secondary benefit is sediment trapping upstream of the structure.



**Photograph CD-1.** Rock check dams in a roadside ditch. Photo courtesy of WWE.

## Appropriate Uses

Use as a grade control for temporary drainage ditches or swales until final soil stabilization measures are established upstream and downstream. Check dams can be used on mild or moderately steep slopes. Check dams may be used under the following conditions:

- As temporary grade control facilities along waterways until final stabilization is established.
- Along permanent swales that need protection prior to installation of a non-erodible lining.
- Along temporary channels, ditches or swales that need protection where construction of a non-erodible lining is not practicable.
- Reinforced check dams should be used in areas subject to high flow velocities.

## Design and Installation

Place check dams at regularly spaced intervals along the drainage swale or ditch. Check dams heights should allow for pools to develop upstream of each check dam, extending to the downstream toe of the check dam immediately upstream.

When rock is used for the check dam, place rock mechanically or by hand. Do not dump rocks into the drainage channel. Where multiple check dams are used, the top of the lower dam should be at the same elevation as the toe of the upper dam.

When reinforced check dams are used, install erosion control fabric under and around the check dam to prevent erosion on the upstream and downstream sides. Each section of the dam should be keyed in to reduce the potential for washout or undermining. A rock apron upstream and downstream of the dam may be necessary to further control erosion.

<b>Check Dams</b>	
<b>Functions</b>	
Erosion Control	Yes
Sediment Control	Moderate
Site/Material Management	No

Design details with notes are provided for the following types of check dams:

- Rock Check Dams (CD-1)
- Reinforced Check Dams (CD-2)

Sediment control logs may also be used as check dams; however, silt fence is not appropriate for use as a check dam. Many jurisdictions also prohibit or discourage use of straw bales for this purpose.

## Maintenance and Removal

Replace missing rocks causing voids in the check dam. If gravel bags or sandbags are used, replace or repair torn or displaced bags.

Remove accumulated sediment, as needed to maintain BMP effectiveness, typically before the sediment depth upstream of the check dam is within ½ of the crest height. Remove accumulated sediment prior to mulching, seeding, or chemical soil stabilization. Removed sediment can be incorporated into the earthwork with approval from the Project Engineer, or disposed of at an alternate location in accordance with the standard specifications.

Check dams constructed in permanent swales should be removed when perennial grasses have become established, or immediately prior to installation of a non-erodible lining. All of the rock and accumulated sediment should be removed, and the area seeded and mulched, or otherwise stabilized.



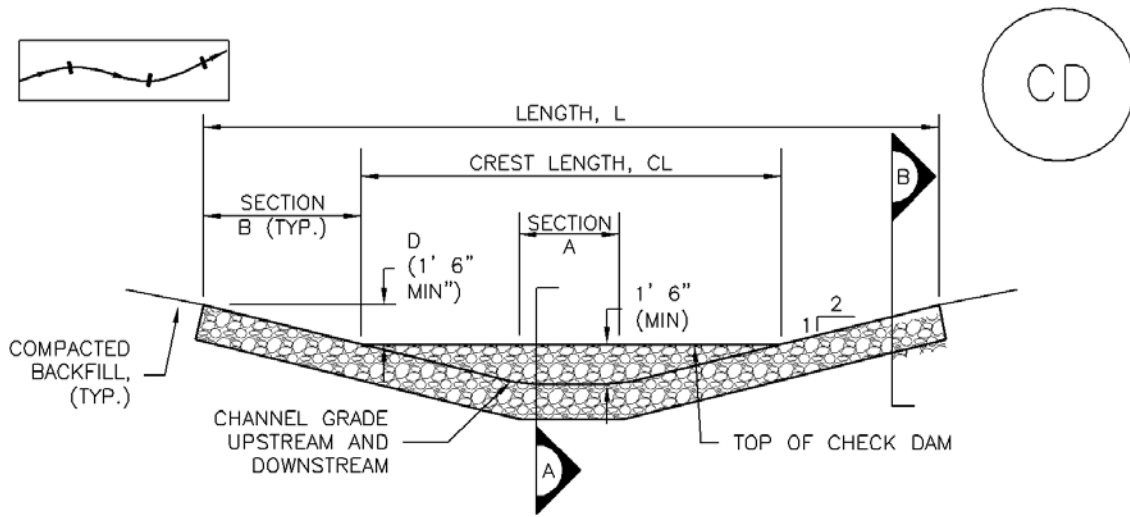

**CHECK DAM ELEVATION VIEW**

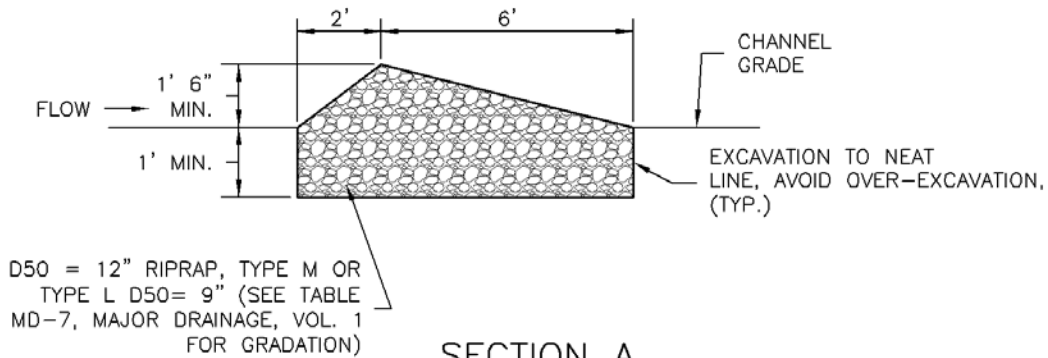

**SECTION A**

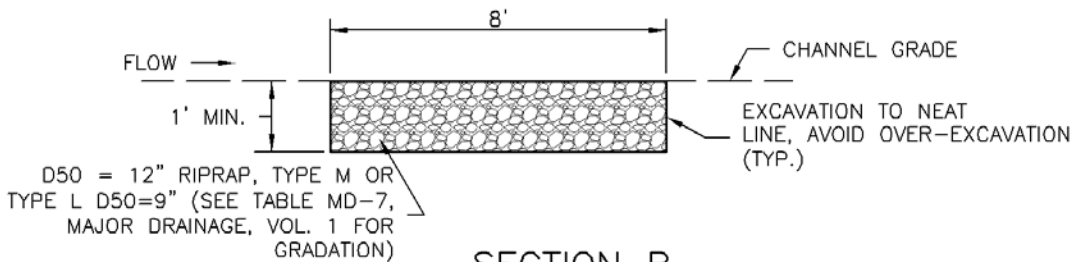

**SECTION B**

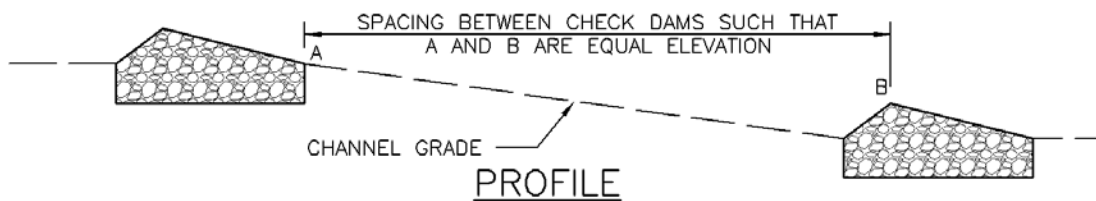

**PROFILE**

**CD-1. CHECK DAM**

CHECK DAM INSTALLATION NOTES

1. SEE PLAN VIEW FOR:
  - LOCATION OF CHECK DAMS.
  - CHECK DAM TYPE (CHECK DAM OR REINFORCED CHECK DAM).
  - LENGTH (L), CREST LENGTH (CL), AND DEPTH (D).
2. CHECK DAMS INDICATED ON INITIAL SWMP SHALL BE INSTALLED AFTER CONSTRUCTION FENCE, BUT PRIOR TO ANY UPSTREAM LAND DISTURBING ACTIVITIES.
3. RIPRAP UTILIZED FOR CHECK DAMS SHOULD BE OF APPROPRIATE SIZE FOR THE APPLICATION. TYPICAL TYPES OF RIPRAP USED FOR CHECK DAMS ARE TYPE M (D50 12") OR TYPE L (D50 9").
4. RIPRAP PAD SHALL BE TRENCHED INTO THE GROUND A MINIMUM OF 1'.
5. THE ENDS OF THE CHECK DAM SHALL BE A MINIMUM OF 1' 6" HIGHER THAN THE CENTER OF THE CHECK DAM.

CHECK DAM MAINTENANCE NOTES

1. INSPECT BMPs EACH WORKDAY, AND MAINTAIN THEM IN EFFECTIVE OPERATING CONDITION. MAINTENANCE OF BMPs SHOULD BE PROACTIVE, NOT REACTIVE. INSPECT BMPs AS SOON AS POSSIBLE (AND ALWAYS WITHIN 24 HOURS) FOLLOWING A STORM THAT CAUSES SURFACE EROSION, AND PERFORM NECESSARY MAINTENANCE.
2. FREQUENT OBSERVATIONS AND MAINTENANCE ARE NECESSARY TO MAINTAIN BMPs IN EFFECTIVE OPERATING CONDITION. INSPECTIONS AND CORRECTIVE MEASURES SHOULD BE DOCUMENTED THOROUGHLY.
3. WHERE BMPs HAVE FAILED, REPAIR OR REPLACEMENT SHOULD BE INITIATED UPON DISCOVERY OF THE FAILURE.
4. SEDIMENT ACCUMULATED UPSTREAM OF THE CHECK DAMS SHALL BE REMOVED WHEN THE SEDIMENT DEPTH IS WITHIN ½ OF THE HEIGHT OF THE CREST.
5. CHECK DAMS ARE TO REMAIN IN PLACE UNTIL THE UPSTREAM DISTURBED AREA IS STABILIZED AND APPROVED BY THE LOCAL JURISDICTION.
6. WHEN CHECK DAMS ARE REMOVED, EXCAVATIONS SHALL BE FILLED WITH SUITABLE COMPACTED BACKFILL. DISTURBED AREA SHALL BE SEEDED AND MULCHED AND COVERED WITH GEOTEXTILE OR OTHERWISE STABILIZED IN A MANNER APPROVED BY THE LOCAL JURISDICTION.

(DETAILS ADAPTED FROM DOUGLAS COUNTY, COLORADO, NOT AVAILABLE IN AUTOCAD)

NOTE: MANY JURISDICTIONS HAVE BMP DETAILS THAT VARY FROM UDFCD STANDARD DETAILS. CONSULT WITH LOCAL JURISDICTIONS AS TO WHICH DETAIL SHOULD BE USED WHEN DIFFERENCES ARE NOTED.

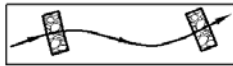

ALTERNATIVE TO STEPS ON BANKS ABOVE CREST:  
DEFORM GABIONS AS NECESSARY TO ALIGN TOP OF GABIONS  
WITH GROUND SURFACE: AVOID GAPS BETWEEN GABIONS

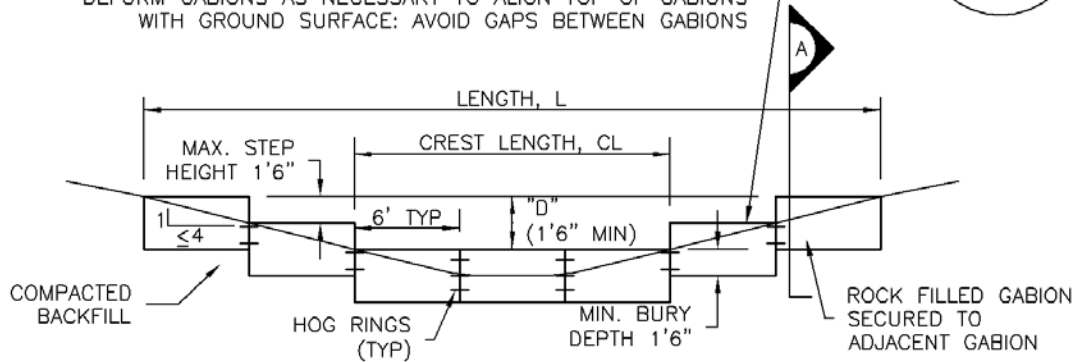

## REINFORCED CHECK DAM ELEVATION VIEW

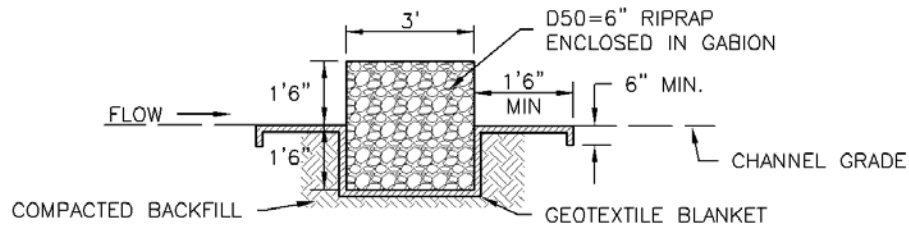

## SECTION A

### REINFORCED CHECK DAM INSTALLATION NOTES

1. SEE PLAN VIEW FOR:
  - LOCATIONS OF CHECK DAMS.
  - CHECK DAM TYPE (CHECK DAM OR REINFORCED CHECK DAM).
  - LENGTH (L), CREST LENGTH (CL), AND DEPTH (D).
2. CHECK DAMS INDICATED ON THE SWMP SHALL BE INSTALLED PRIOR TO AN UPSTREAM LAND-DISTURBING ACTIVITIES.
3. REINFORCED CHECK DAMS, GABIONS SHALL HAVE GALVANIZED TWISTED WIRE NETTING WITH A MAXIMUM OPENING DIMENSION OF  $4\frac{1}{2}$ " AND A MINIMUM WIRE THICKNESS OF 0.10". WIRE "HOG RINGS" AT 4" SPACING OR OTHER APPROVED MEANS SHALL BE USED AT ALL GABION SEAMS AND TO SECURE THE GABION TO THE ADJACENT SECTION.
4. THE CHECK DAM SHALL BE TRENCHED INTO THE GROUND A MINIMUM OF 1' 6".
5. GEOTEXTILE BLANKET SHALL BE PLACED IN THE REINFORCED CHECK DAM TRENCH EXTENDING A MINIMUM OF 1' 6" ON BOTH THE UPSTREAM AND DOWNSTREAM SIDES OF THE REINFORCED CHECK DAM.

## CD-2. REINFORCED CHECK DAM

REINFORCED CHECK DAM MAINTENANCE NOTES

1. INSPECT BMPs EACH WORKDAY, AND MAINTAIN THEM IN EFFECTIVE OPERATING CONDITION. MAINTENANCE OF BMPs SHOULD BE PROACTIVE, NOT REACTIVE. INSPECT BMPs AS SOON AS POSSIBLE (AND ALWAYS WITHIN 24 HOURS) FOLLOWING A STORM THAT CAUSES SURFACE EROSION, AND PERFORM NECESSARY MAINTENANCE.
2. FREQUENT OBSERVATIONS AND MAINTENANCE ARE NECESSARY TO MAINTAIN BMPs IN EFFECTIVE OPERATING CONDITION. INSPECTIONS AND CORRECTIVE MEASURES SHOULD BE DOCUMENTED THOROUGHLY.
3. WHERE BMPs HAVE FAILED, REPAIR OR REPLACEMENT SHOULD BE INITIATED UPON DISCOVERY OF THE FAILURE.
4. SEDIMENT ACCUMULATED UPSTREAM OF REINFORCED CHECK DAMS SHALL BE REMOVED AS NEEDED TO MAINTAIN THE EFFECTIVENESS OF BMP, TYPICALLY WHEN THE UPSTREAM SEDIMENT DEPTH IS WITHIN ½ THE HEIGHT OF THE CREST.
5. REPAIR OR REPLACE REINFORCED CHECK DAMS WHEN THERE ARE SIGNS OF DAMAGE SUCH AS HOLES IN THE GABION OR UNDERCUTTING.
6. REINFORCED CHECK DAMS ARE TO REMAIN IN PLACE UNTIL THE UPSTREAM DISTURBED AREA IS STABILIZED AND APPROVED BY THE LOCAL JURISDICTION.
7. WHEN REINFORCED CHECK DAMS ARE REMOVED, ALL DISTURBED AREAS SHALL BE COVERED WITH TOPSOIL, SEEDED AND MULCHED, AND COVERED WITH A GEOTEXTILE BLANKET, OR OTHERWISE STABILIZED AS APPROVED BY LOCAL JURISDICTION.

(DETAIL ADAPTED FROM DOUGLAS COUNTY, COLORADO AND CITY OF AURORA, COLORADO, NOT AVAILABLE IN AUTOCAD)

NOTE: MANY JURISDICTIONS HAVE BMP DETAILS THAT VARY FROM UDFCD STANDARD DETAILS. CONSULT WITH LOCAL JURISDICTIONS AS TO WHICH DETAIL SHOULD BE USED WHEN DIFFERENCES ARE NOTED.



## Description

Wind erosion and dust control BMPs help to keep soil particles from entering the air as a result of land disturbing construction activities. These BMPs include a variety of practices generally focused on either graded disturbed areas or construction roadways. For graded areas, practices such as seeding and mulching, use of soil binders, site watering, or other practices that provide prompt surface cover should be used. For construction roadways, road watering and stabilized surfaces should be considered.



**Photograph DC-1.** Water truck used for dust suppression. Photo courtesy of Douglas County.

## Appropriate Uses

Dust control measures should be used on any site where dust poses a problem to air quality. Dust control is important to control for the health of construction workers and surrounding waterbodies.

## Design and Installation

The following construction BMPs can be used for dust control:

- An irrigation/sprinkler system can be used to wet the top layer of disturbed soil to help keep dry soil particles from becoming airborne.
- Seeding and mulching can be used to stabilize disturbed surfaces and reduce dust emissions.
- Protecting existing vegetation can help to slow wind velocities across the ground surface, thereby limiting the likelihood of soil particles to become airborne.
- Spray-on soil binders form a bond between soil particles keeping them grounded. Chemical treatments may require additional permitting requirements. Potential impacts to surrounding waterways and habitat must be considered prior to use.
- Placing rock on construction roadways and entrances will help keep dust to a minimum across the construction site.
- Wind fences can be installed on site to reduce wind speeds. Install fences perpendicular to the prevailing wind direction for maximum effectiveness.

## Maintenance and Removal

When using an irrigation/sprinkler control system to aid in dust control, be careful not to overwater. Overwatering will cause construction vehicles to track mud off-site.

<b>Wind Erosion Control/ Dust Control</b>	
<b>Functions</b>	
Erosion Control	Yes
Sediment Control	No
Site/Material Management	Moderate

## Description

Implement construction site good housekeeping practices to prevent pollution associated with solid, liquid and hazardous construction-related materials and wastes. Stormwater Management Plans (SWMPs) should clearly specify BMPs including these good housekeeping practices:

- Provide for waste management.
- Establish proper building material staging areas.
- Designate paint and concrete washout areas.
- Establish proper equipment/vehicle fueling and maintenance practices.
- Control equipment/vehicle washing and allowable non-stormwater discharges.
- Develop a spill prevention and response plan.

**Acknowledgement:** This Fact Sheet is based directly on EPA guidance provided in *Developing Your Stormwater Pollution Prevent Plan (EPA 2007)*.



Photographs GH-1 and GH-2. Proper materials storage and secondary containment for fuel tanks are important good housekeeping practices. Photos courtesy of CDOT and City of Aurora.

## Appropriate Uses

Good housekeeping practices are necessary at all construction sites.

## Design and Installation

The following principles and actions should be addressed in SWMPs:

- **Provide for Waste Management.** Implement management procedures and practices to prevent or reduce the exposure and transport of pollutants in stormwater from solid, liquid and sanitary wastes that will be generated at the site. Practices such as trash disposal, recycling, proper material handling, and cleanup measures can reduce the potential for stormwater runoff to pick up construction site wastes and discharge them to surface waters. Implement a comprehensive set of waste-management practices for hazardous or toxic materials, such as paints, solvents, petroleum products, pesticides, wood preservatives, acids, roofing tar, and other materials. Practices should include storage, handling, inventory, and cleanup procedures, in case of spills. Specific practices that should be considered include:

### Solid or Construction Waste

- Designate trash and bulk waste-collection areas on-site.

Good Housekeeping	
Functions	
Erosion Control	No
Sediment Control	No
Site/Material Management	Yes

- Recycle materials whenever possible (e.g., paper, wood, concrete, oil).
- Segregate and provide proper disposal options for hazardous material wastes.
- Clean up litter and debris from the construction site daily.
- Locate waste-collection areas away from streets, gutters, watercourses, and storm drains. Waste-collection areas (dumpsters, and such) are often best located near construction site entrances to minimize traffic on disturbed soils. Consider secondary containment around waste collection areas to minimize the likelihood of contaminated discharges.
- Empty waste containers before they are full and overflowing.

**Sanitary and Septic Waste**

- Provide convenient, well-maintained, and properly located toilet facilities on-site.
- Locate toilet facilities away from storm drain inlets and waterways to prevent accidental spills and contamination of stormwater.
- Maintain clean restroom facilities and empty portable toilets regularly.
- Where possible, provide secondary containment pans under portable toilets.
- Provide tie-downs or stake-downs for portable toilets.
- Educate employees, subcontractors, and suppliers on locations of facilities.
- Treat or dispose of sanitary and septic waste in accordance with state or local regulations. Do not discharge or bury wastewater at the construction site.
- Inspect facilities for leaks. If found, repair or replace immediately.
- Special care is necessary during maintenance (pump out) to ensure that waste and/or biocide are not spilled on the ground.

**Hazardous Materials and Wastes**

- Develop and implement employee and subcontractor education, as needed, on hazardous and toxic waste handling, storage, disposal, and cleanup.
- Designate hazardous waste-collection areas on-site.
- Place all hazardous and toxic material wastes in secondary containment.



**Photograph GH-3.** Locate portable toilet facilities on level surfaces away from waterways and storm drains. Photo courtesy of WWE.

- Hazardous waste containers should be inspected to ensure that all containers are labeled properly and that no leaks are present.
- **Establish Proper Building Material Handling and Staging Areas.** The SWMP should include comprehensive handling and management procedures for building materials, especially those that are hazardous or toxic. Paints, solvents, pesticides, fuels and oils, other hazardous materials or building materials that have the potential to contaminate stormwater should be stored indoors or under cover whenever possible or in areas with secondary containment. Secondary containment measures prevent a spill from spreading across the site and may include dikes, berms, curbing, or other containment methods. Secondary containment techniques should also ensure the protection of groundwater. Designate staging areas for activities such as fueling vehicles, mixing paints, plaster, mortar, and other potential pollutants. Designated staging areas enable easier monitoring of the use of materials and clean up of spills. Training employees and subcontractors is essential to the success of this pollution prevention principle. Consider the following specific materials handling and staging practices:
  - Train employees and subcontractors in proper handling and storage practices.
  - Clearly designate site areas for staging and storage with signs and on construction drawings. Staging areas should be located in areas central to the construction site. Segment the staging area into sub-areas designated for vehicles, equipment, or stockpiles. Construction entrances and exits should be clearly marked so that delivery vehicles enter/exit through stabilized areas with vehicle tracking controls (See Vehicle Tracking Control Fact Sheet).
  - Provide storage in accordance with Spill Protection, Control and Countermeasures (SPCC) requirements and plans and provide cover and impermeable perimeter control, as necessary, for hazardous materials and contaminated soils that must be stored on site.
  - Ensure that storage containers are regularly inspected for leaks, corrosion, support or foundation failure, or other signs of deterioration and tested for soundness.
  - Reuse and recycle construction materials when possible.
- **Designate Concrete Washout Areas.** Concrete contractors should be encouraged to use the washout facilities at their own plants or dispatch facilities when feasible; however, concrete washout commonly occurs on construction sites. If it is necessary to provide for concrete washout areas on-site, designate specific washout areas and design facilities to handle anticipated washout water. Washout areas should also be provided for paint and stucco operations. Because washout areas can be a source of pollutants from leaks or spills, care must be taken with regard to their placement and proper use. See the Concrete Washout Area Fact Sheet for detailed guidance.

Both self-constructed and prefabricated washout containers can fill up quickly when concrete, paint, and stucco work are occurring on large portions of the site. Be sure to check for evidence that contractors are using the washout areas and not dumping materials onto the ground or into drainage facilities. If the washout areas are not being used regularly, consider posting additional signage, relocating the facilities to more convenient locations, or providing training to workers and contractors.

When concrete, paint, or stucco is part of the construction process, consider these practices which will help prevent contamination of stormwater. Include the locations of these areas and the maintenance and inspection procedures in the SWMP.



- Do not washout concrete trucks or equipment into storm drains, streets, gutters, uncontained areas, or streams. Only use designated washout areas.
- Establish washout areas and advertise their locations with signs. Ensure that signage remains in good repair.
- Provide adequate containment for the amount of wash water that will be used.
- Inspect washout structures daily to detect leaks or tears and to identify when materials need to be removed.
- Dispose of materials properly. The preferred method is to allow the water to evaporate and to recycle the hardened concrete. Full service companies may provide dewatering services and should dispose of wastewater properly. Concrete wash water can be highly polluted. It should not be discharged to any surface water, storm sewer system, or allowed to infiltrate into the ground in the vicinity of waterbodies. Washwater should not be discharged to a sanitary sewer system without first receiving written permission from the system operator.
- **Establish Proper Equipment/Vehicle Fueling and Maintenance Practices.** Create a clearly designated on-site fueling and maintenance area that is clean and dry. The on-site fueling area should have a spill kit, and staff should know how to use it. If possible, conduct vehicle fueling and maintenance activities in a covered area. Consider the following practices to help prevent the discharge of pollutants to stormwater from equipment/vehicle fueling and maintenance. Include the locations of designated fueling and maintenance areas and inspection and maintenance procedures in the SWMP.
  - Train employees and subcontractors in proper fueling procedures (stay with vehicles during fueling, proper use of pumps, emergency shutoff valves, etc.).
  - Inspect on-site vehicles and equipment regularly for leaks, equipment damage, and other service problems.
  - Clearly designate vehicle/equipment service areas away from drainage facilities and watercourses to prevent stormwater run-on and runoff.
  - Use drip pans, drip cloths, or absorbent pads when replacing spent fluids.
  - Collect all spent fluids, store in appropriate labeled containers in the proper storage areas, and recycle fluids whenever possible.
- **Control Equipment/Vehicle Washing and Allowable Non-Stormwater Discharges.** Implement practices to prevent contamination of surface and groundwater from equipment and vehicle wash water. Representative practices include:
  - Educate employees and subcontractors on proper washing procedures.
  - Use off-site washing facilities, when available.
  - Clearly mark the washing areas and inform workers that all washing must occur in this area.
  - Contain wash water and treat it using BMPs. Infiltrate washwater when possible, but maintain separation from drainage paths and waterbodies.

- Use high-pressure water spray at vehicle washing facilities without detergents. Water alone can remove most dirt adequately.
- Do not conduct other activities, such as vehicle repairs, in the wash area.
- Include the location of the washing facilities and the inspection and maintenance procedures in the SWMP.
- **Develop a Spill Prevention and Response Plan.** Spill prevention and response procedures must be identified in the SWMP. Representative procedures include identifying ways to reduce the chance of spills, stop the source of spills, contain and clean up spills, dispose of materials contaminated by spills, and train personnel responsible for spill prevention and response. The plan should also specify material handling procedures and storage requirements and ensure that clear and concise spill cleanup procedures are provided and posted for areas in which spills may potentially occur. When developing a spill prevention plan, include the following:
  - Note the locations of chemical storage areas, storm drains, tributary drainage areas, surface waterbodies on or near the site, and measures to stop spills from leaving the site.
  - Provide proper handling and safety procedures for each type of waste. Keep Material Safety Data Sheets (MSDSs) for chemical used on site with the SWMP.
  - Establish an education program for employees and subcontractors on the potential hazards to humans and the environment from spills and leaks.
  - Specify how to notify appropriate authorities, such as police and fire departments, hospitals, or municipal sewage treatment facilities to request assistance. Emergency procedures and contact numbers should be provided in the SWMP and posted at storage locations.
  - Describe the procedures, equipment and materials for immediate cleanup of spills and proper disposal.
  - Identify personnel responsible for implementing the plan in the event of a spill. Update the spill prevention plan and clean up materials as changes occur to the types of chemicals stored and used at the facility.

**Spill Prevention, Control, and Countermeasure (SPCC) Plan**

Construction sites may be subject to 40 CFR Part 112 regulations that require the preparation and implementation of a SPCC Plan to prevent oil spills from aboveground and underground storage tanks. The facility is subject to this rule if it is a non-transportation-related facility that:

- Has a total storage capacity greater than 1,320 gallons or a completely buried storage capacity greater than 42,000 gallons.
- Could reasonably be expected to discharge oil in quantities that may be harmful to navigable waters of the United States and adjoining shorelines.

Furthermore, if the facility is subject to 40 CFR Part 112, the SWMP should reference the SPCC Plan. To find out more about SPCC Plans, see EPA's website on SPPC at [www.epa.gov/oilspill/spcc.htm](http://www.epa.gov/oilspill/spcc.htm).

**Reporting Oil Spills**

In the event of an oil spill, contact the National Response Center toll free at 1-800-424- 8802 for assistance, or for more details, visit their website: [www.nrc.uscg.mil](http://www.nrc.uscg.mil).

**Maintenance and Removal**

Effective implementation of good housekeeping practices is dependent on clear designation of personnel responsible for supervising and implementing good housekeeping programs, such as site cleanup and disposal of trash and debris, hazardous material management and disposal, vehicle and equipment maintenance, and other practices. Emergency response "drills" may aid in emergency preparedness.

Checklists may be helpful in good housekeeping efforts.

Staging and storage areas require permanent stabilization when the areas are no longer being used for construction-related activities.

Construction-related materials, debris and waste must be removed from the construction site once construction is complete.

**Design Details**

See the following Fact Sheets for related Design Details:

MM-1 Concrete Washout Area

MM-2 Stockpile Management

SM-4 Vehicle Tracking Control

Design details are not necessary for other good housekeeping practices; however, be sure to designate where specific practices will occur on the appropriate construction drawings.

## Description

A silt fence is a woven geotextile fabric attached to wooden posts and trenched into the ground. It is designed as a sediment barrier to intercept sheet flow runoff from disturbed areas.

## Appropriate Uses

A silt fence can be used where runoff is conveyed from a disturbed area as sheet flow. Silt fence is not designed to receive concentrated flow or to be used as a filter fabric. Typical uses include:

- Down slope of a disturbed area to accept sheet flow.
- Along the perimeter of a receiving water such as a stream, pond or wetland.
- At the perimeter of a construction site.



**Photograph SF-1.** Silt fence creates a sediment barrier, forcing sheet flow runoff to evaporate or infiltrate.

## Design and Installation

Silt fence should be installed along the contour of slopes so that it intercepts sheet flow. The maximum recommended tributary drainage area per 100 lineal feet of silt fence, installed along the contour, is approximately 0.25 acres with a disturbed slope length of up to 150 feet and a tributary slope gradient no steeper than 3:1. Longer and steeper slopes require additional measures. This recommendation only applies to silt fence installed along the contour. Silt fence installed for other uses, such as perimeter control, should be installed in a way that will not produce concentrated flows. For example, a "J-hook" installation may be appropriate to force runoff to pond and evaporate or infiltrate in multiple areas rather than concentrate and cause erosive conditions parallel to the silt fence.

See Detail SF-1 for proper silt fence installation, which involves proper trenching, staking, securing the fabric to the stakes, and backfilling the silt fence. Properly installed silt fence should not be easily pulled out by hand and there should be no gaps between the ground and the fabric.

Silt fence must meet the minimum allowable strength requirements, depth of installation requirement, and other specifications in the design details. Improper installation of silt fence is a common reason for silt fence failure; however, when properly installed and used for the appropriate purposes, it can be highly effective.

<b>Silt Fence</b>	
<b>Functions</b>	
Erosion Control	No
Sediment Control	Yes
Site/Material Management	No



## Maintenance and Removal

Inspection of silt fence includes observing the material for tears or holes and checking for slumping fence and undercut areas bypassing flows. Repair of silt fence typically involves replacing the damaged section with a new section. Sediment accumulated behind silt fence should be removed, as needed to maintain BMP effectiveness, typically before it reaches a depth of 6 inches.

Silt fence may be removed when the upstream area has reached final stabilization.



**Photograph SF-2.** When silt fence is not installed along the contour, a "J-hook" installation may be appropriate to ensure that the BMP does not create concentrated flow parallel to the silt fence. Photo courtesy of Tom Gore.

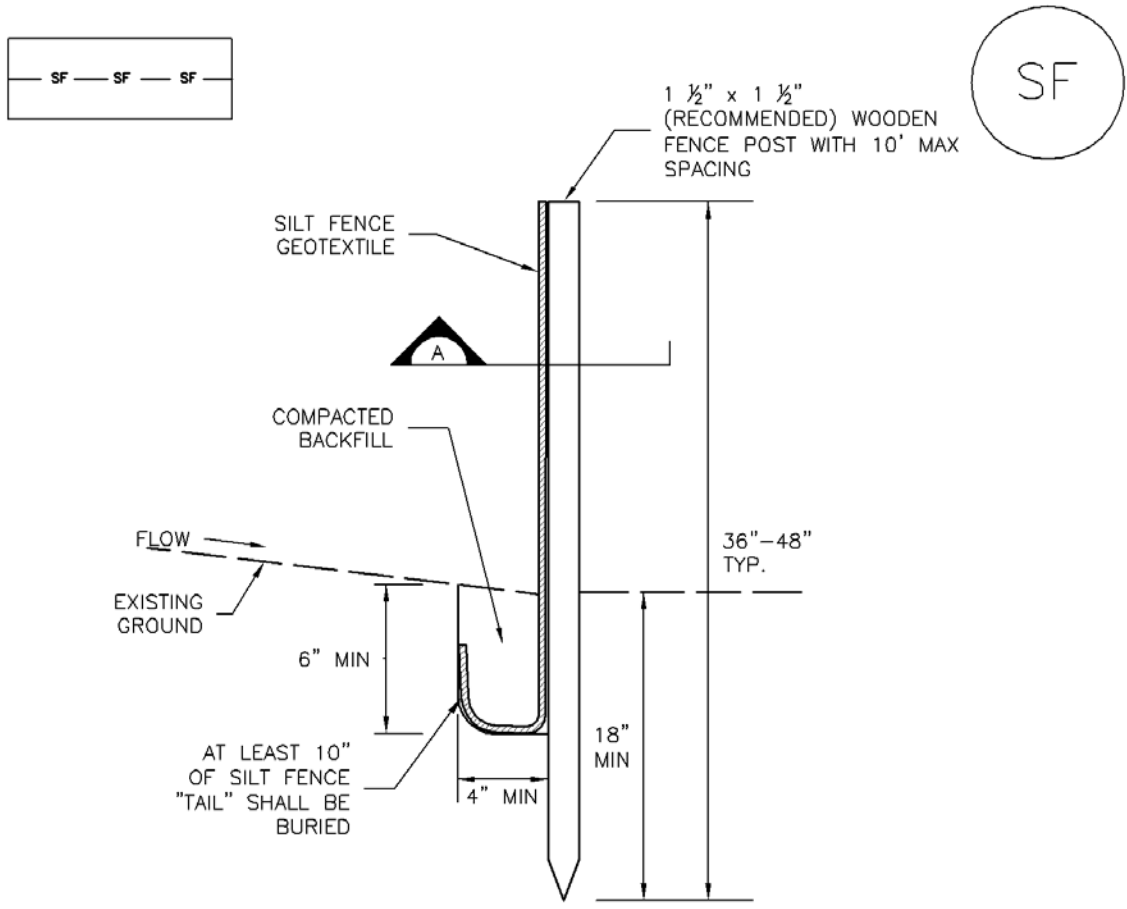

SILT FENCE

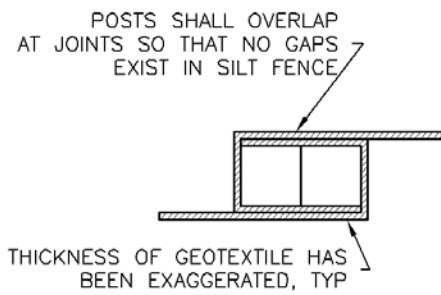
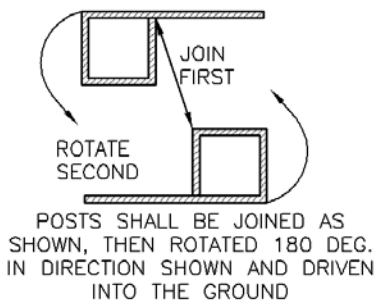

SECTION A

SF-1. SILT FENCE

SILT FENCE INSTALLATION NOTES

1. SILT FENCE MUST BE PLACED AWAY FROM THE TOE OF THE SLOPE TO ALLOW FOR WATER PONDING. SILT FENCE AT THE TOE OF A SLOPE SHOULD BE INSTALLED IN A FLAT LOCATION AT LEAST SEVERAL FEET (2-5 FT) FROM THE TOE OF THE SLOPE TO ALLOW ROOM FOR PONDING AND DEPOSITION.
2. A UNIFORM 6" X 4" ANCHOR TRENCH SHALL BE EXCAVATED USING TRENCHER OR SILT FENCE INSTALLATION DEVICE. NO ROAD GRADERS, BACKHOES, OR SIMILAR EQUIPMENT SHALL BE USED.
3. COMPACT ANCHOR TRENCH BY HAND WITH A "JUMPING JACK" OR BY WHEEL ROLLING. COMPACTION SHALL BE SUCH THAT SILT FENCE RESISTS BEING PULLED OUT OF ANCHOR TRENCH BY HAND.
4. SILT FENCE SHALL BE PULLED TIGHT AS IT IS ANCHORED TO THE STAKES. THERE SHOULD BE NO NOTICEABLE SAG BETWEEN STAKES AFTER IT HAS BEEN ANCHORED TO THE STAKES.
5. SILT FENCE FABRIC SHALL BE ANCHORED TO THE STAKES USING 1" HEAVY DUTY STAPLES OR NAILS WITH 1" HEADS. STAPLES AND NAILS SHOULD BE PLACED 3" ALONG THE FABRIC DOWN THE STAKE.
6. AT THE END OF A RUN OF SILT FENCE ALONG A CONTOUR, THE SILT FENCE SHOULD BE TURNED PERPENDICULAR TO THE CONTOUR TO CREATE A "J-HOOK." THE "J-HOOK" EXTENDING PERPENDICULAR TO THE CONTOUR SHOULD BE OF SUFFICIENT LENGTH TO KEEP RUNOFF FROM FLOWING AROUND THE END OF THE SILT FENCE (TYPICALLY 10' - 20').
7. SILT FENCE SHALL BE INSTALLED PRIOR TO ANY LAND DISTURBING ACTIVITIES.

SILT FENCE MAINTENANCE NOTES

1. INSPECT BMPs EACH WORKDAY, AND MAINTAIN THEM IN EFFECTIVE OPERATING CONDITION. MAINTENANCE OF BMPs SHOULD BE PROACTIVE, NOT REACTIVE. INSPECT BMPs AS SOON AS POSSIBLE (AND ALWAYS WITHIN 24 HOURS) FOLLOWING A STORM THAT CAUSES SURFACE EROSION, AND PERFORM NECESSARY MAINTENANCE.
2. FREQUENT OBSERVATIONS AND MAINTENANCE ARE NECESSARY TO MAINTAIN BMPs IN EFFECTIVE OPERATING CONDITION. INSPECTIONS AND CORRECTIVE MEASURES SHOULD BE DOCUMENTED THOROUGHLY.
3. WHERE BMPs HAVE FAILED, REPAIR OR REPLACEMENT SHOULD BE INITIATED UPON DISCOVERY OF THE FAILURE.
4. SEDIMENT ACCUMULATED UPSTREAM OF THE SILT FENCE SHALL BE REMOVED AS NEEDED TO MAINTAIN THE FUNCTIONALITY OF THE BMP, TYPICALLY WHEN DEPTH OF ACCUMULATED SEDIMENTS IS APPROXIMATELY 6".
5. REPAIR OR REPLACE SILT FENCE WHEN THERE ARE SIGNS OF WEAR, SUCH AS SAGGING, TEARING, OR COLLAPSE.
6. SILT FENCE IS TO REMAIN IN PLACE UNTIL THE UPSTREAM DISTURBED AREA IS STABILIZED AND APPROVED BY THE LOCAL JURISDICTION, OR IS REPLACED BY AN EQUIVALENT PERIMETER SEDIMENT CONTROL BMP.
7. WHEN SILT FENCE IS REMOVED, ALL DISTURBED AREAS SHALL BE COVERED WITH TOPSOIL, SEEDED AND MULCHED OR OTHERWISE STABILIZED AS APPROVED BY LOCAL JURISDICTION.

(DETAIL ADAPTED FROM TOWN OF PARKER, COLORADO AND CITY OF AURORA, NOT AVAILABLE IN AUTOCAD)

NOTE: MANY JURISDICTIONS HAVE BMP DETAILS THAT VARY FROM UDFCD STANDARD DETAILS. CONSULT WITH LOCAL JURISDICTIONS AS TO WHICH DETAIL SHOULD BE USED WHEN DIFFERENCES ARE NOTED.

## Description

A sediment control log is a linear roll made of natural materials such as straw, coconut fiber, or compost. The most common type of sediment control log has straw filling and is often referred to as a "straw wattle." All sediment control logs are used as a sediment barrier to intercept sheet flow runoff from disturbed areas.



## Appropriate Uses

Sediment control logs can be used in the following applications to trap sediment:

- As perimeter control for stockpiles and the site.
- As part of inlet protection designs.
- As check dams in small drainage ditches. (Sediment control logs are not intended for use in channels with high flow velocities.)
- On disturbed slopes to shorten flow lengths (as an erosion control).
- As part of multi-layered perimeter control along a receiving water such as a stream, pond or wetland.



**Photographs SCL-1 and SCL-2.** Sediment control logs used as 1) a perimeter control around a soil stockpile; and, 2) as a "J-hook" perimeter control at the corner of a construction site.

Sediment control logs work well in combination with other layers of erosion and sediment controls.

## Design and Installation

Sediment control logs should be installed along the contour to avoid concentrating flows. The maximum allowable tributary drainage area per 100 lineal feet of sediment control log, installed along the contour, is approximately 0.25 acres with a disturbed slope length of up to 150 feet and a tributary slope gradient no steeper than 3:1. Longer and steeper slopes require additional measures. This recommendation only applies to sediment control logs installed along the contour. When installed for other uses, such as perimeter control, it should be installed in a way that will not produce concentrated flows. For example, a "J-hook" installation may be appropriate to force runoff to pond and evaporate or infiltrate in multiple areas rather than concentrate and cause erosive conditions parallel to the BMP.

Sediment Control Log	
Functions	
Erosion Control	Moderate
Sediment Control	Yes
Site/Material Management	No



Although sediment control logs initially allow runoff to flow through the BMP, they can quickly become a barrier and should be installed as if they are impermeable.

Design details and notes for sediment control logs are provided in the following details. Sediment logs must be properly installed per the detail to prevent undercutting, bypassing and displacement. When installed on slopes, sediment control logs should be installed along the contours (i.e., perpendicular to flow).

Improper installation can lead to poor performance. Be sure that sediment control logs are properly trenched (if lighter than 8 lb/foot), anchored and tightly jointed.

## **Maintenance and Removal**

Be aware that sediment control logs will eventually degrade. Remove accumulated sediment before the depth is one-half the height of the sediment log and repair damage to the sediment log, typically by replacing the damaged section.

Once the upstream area is stabilized, remove and properly dispose of the logs. Areas disturbed beneath the logs may need to be seeded and mulched. Sediment control logs that are biodegradable may occasionally be left in place (e.g., when logs are used in conjunction with erosion control blankets as permanent slope breaks). However, removal of sediment control logs after final stabilization is typically appropriate when used in perimeter control, inlet protection and check dam applications. Compost from compost sediment control logs may be spread over the area and seeded as long as this does not cover newly established vegetation.

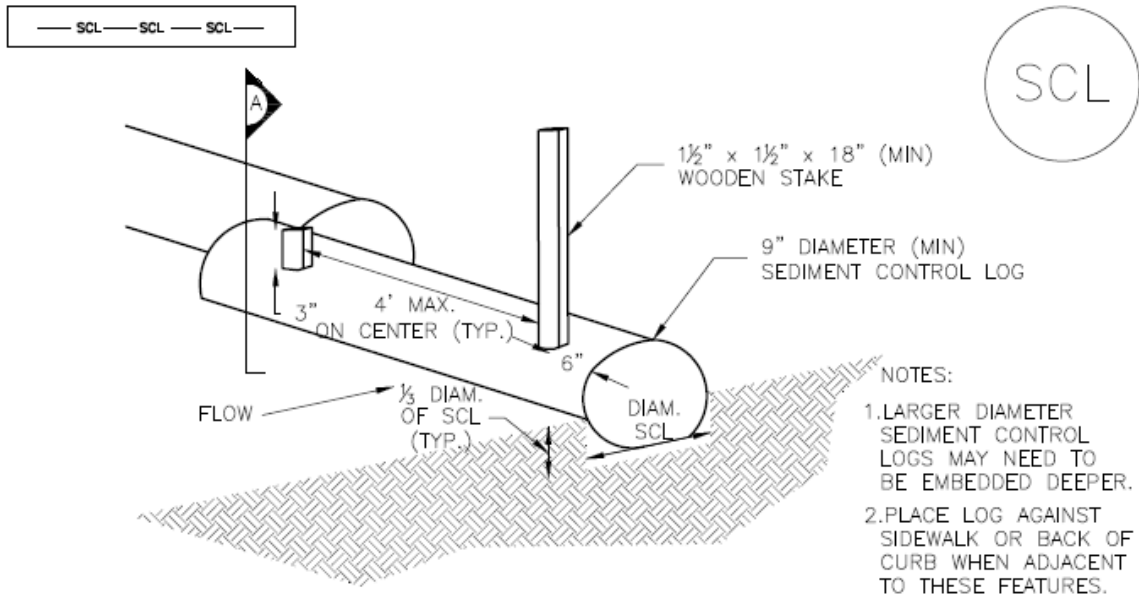

## TRENCHED SEDIMENT CONTROL LOG

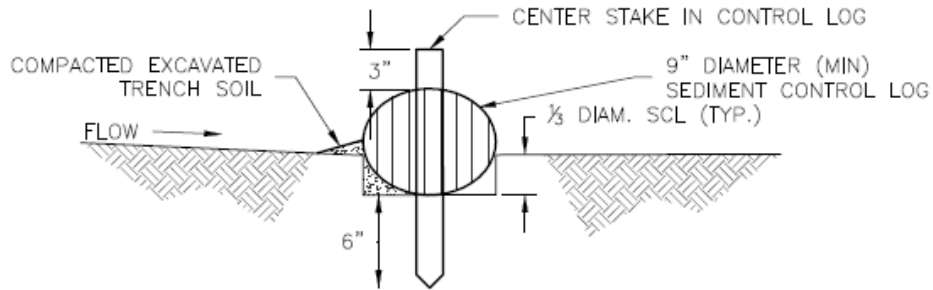

## SECTION A TRENCHED SEDIMENT CONTROL LOG

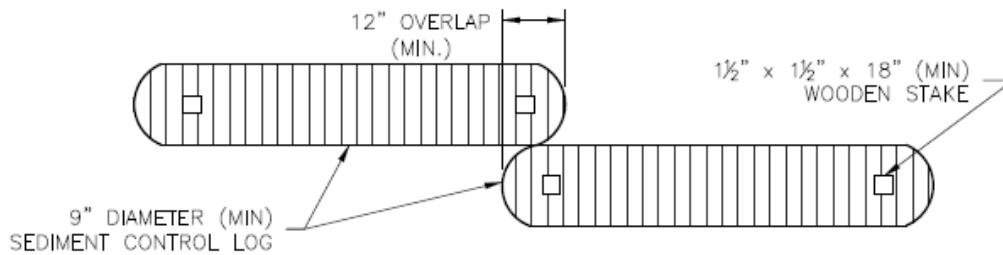

## LOG JOINTS

## SCL-1. TRENCHED SEDIMENT CONTROL LOG

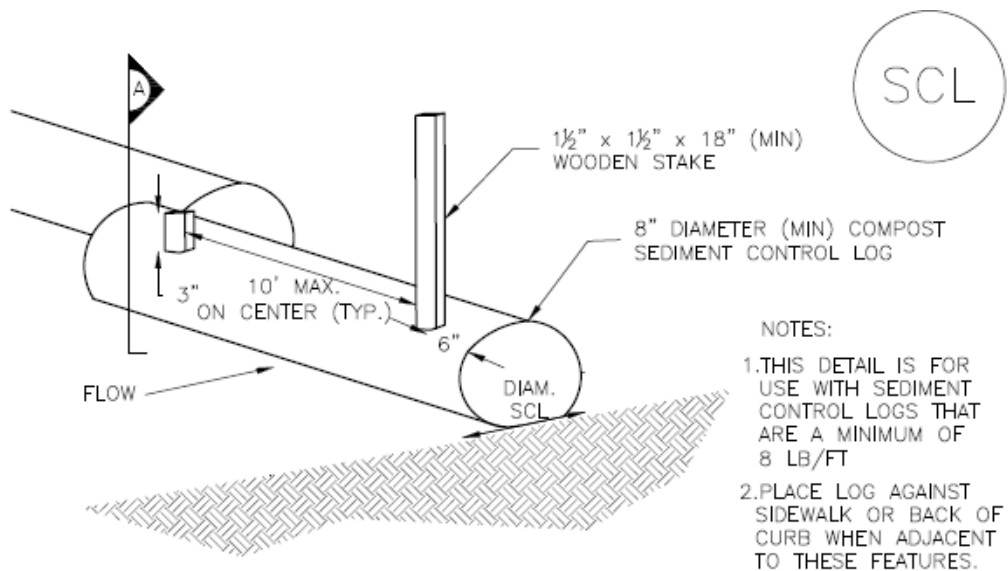

COMPOST SEDIMENT CONTROL LOG (WEIGHTED)

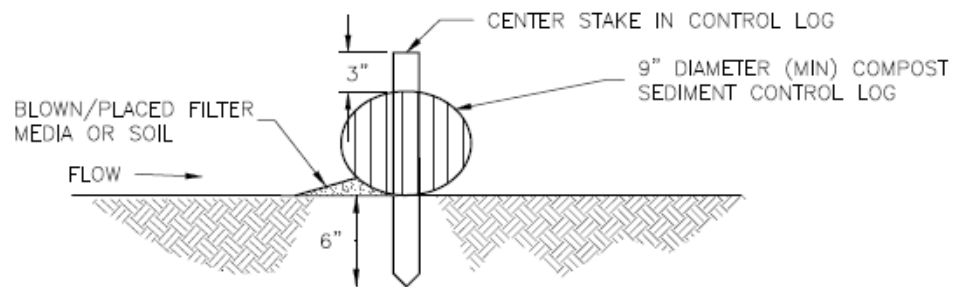

SECTION A  
COMPOST SEDIMENT CONTROL LOG (A)

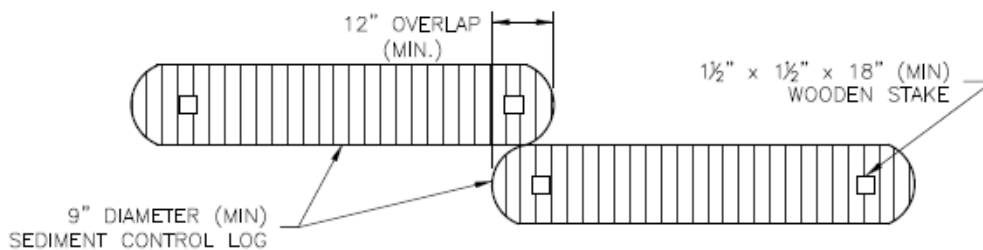

LOG JOINTS

SCL-2. COMPOST SEDIMENT CONTROL LOG (WEIGHTED)

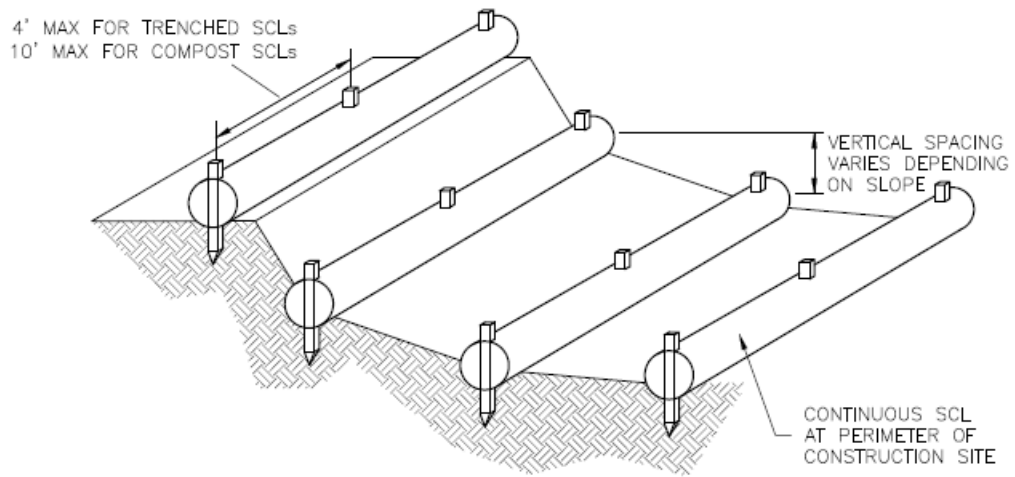

SCL-3. SEDIMENT CONTROL LOGS TO CONTROL SLOPE LENGTH



SEDIMENT CONTROL LOG INSTALLATION NOTES

1. SEE PLAN VIEW FOR LOCATION AND LENGTH OF SEDIMENT CONTROL LOGS.
2. SEDIMENT CONTROL LOGS THAT ACT AS A PERIMETER CONTROL SHALL BE INSTALLED PRIOR TO ANY UPGRADIENT LAND-DISTURBING ACTIVITIES.
3. SEDIMENT CONTROL LOGS SHALL CONSIST OF STRAW, COMPOST, EXCELSIOR OR COCONUT FIBER, AND SHALL BE FREE OF ANY NOXIOUS WEED SEEDS OR DEFECTS INCLUDING RIPS, HOLES AND OBVIOUS WEAR.
4. SEDIMENT CONTROL LOGS MAY BE USED AS SMALL CHECK DAMS IN DITCHES AND SWALES. HOWEVER, THEY SHOULD NOT BE USED IN PERENNIAL STREAMS.
5. IT IS RECOMMENDED THAT SEDIMENT CONTROL LOGS BE TRENCHED INTO THE GROUND TO A DEPTH OF APPROXIMATELY  $\frac{1}{3}$  OF THE DIAMETER OF THE LOG. IF TRENCHING TO THIS DEPTH IS NOT FEASIBLE AND/OR DESIRABLE (SHORT TERM INSTALLATION WITH DESIRE NOT TO DAMAGE LANDSCAPE) A LESSER TRENCHING DEPTH MAY BE ACCEPTABLE WITH MORE ROBUST STAKING. COMPOST LOGS THAT ARE 8 LB/FT DO NOT NEED TO BE TRENCHED.
6. THE UPHILL SIDE OF THE SEDIMENT CONTROL LOG SHALL BE BACKFILLED WITH SOIL OR FILTER MATERIAL THAT IS FREE OF ROCKS AND DEBRIS. THE SOIL SHALL BE TIGHTLY COMPACTED INTO THE SHAPE OF A RIGHT TRIANGLE USING A SHOVEL OR WEIGHTED LAWN ROLLER OR BLOWN IN PLACE.
7. FOLLOW MANUFACTURERS' GUIDANCE FOR STAKING. IF MANUFACTURERS' INSTRUCTIONS DO NOT SPECIFY SPACING, STAKES SHALL BE PLACED ON 4' CENTERS AND EMBEDDED A MINIMUM OF 6" INTO THE GROUND. 3" OF THE STAKE SHALL PROTRUDE FROM THE TOP OF THE LOG. STAKES THAT ARE BROKEN PRIOR TO INSTALLATION SHALL BE REPLACED. COMPOST LOGS SHOULD BE STAKED 10' ON CENTER.

SEDIMENT CONTROL LOG MAINTENANCE NOTES

1. INSPECT BMPs EACH WORKDAY, AND MAINTAIN THEM IN EFFECTIVE OPERATING CONDITION. MAINTENANCE OF BMPs SHOULD BE PROACTIVE, NOT REACTIVE. INSPECT BMPs AS SOON AS POSSIBLE (AND ALWAYS WITHIN 24 HOURS) FOLLOWING A STORM THAT CAUSES SURFACE EROSION, AND PERFORM NECESSARY MAINTENANCE.
2. FREQUENT OBSERVATIONS AND MAINTENANCE ARE NECESSARY TO MAINTAIN BMPs IN EFFECTIVE OPERATING CONDITION. INSPECTIONS AND CORRECTIVE MEASURES SHOULD BE DOCUMENTED THOROUGHLY.
3. WHERE BMPs HAVE FAILED, REPAIR OR REPLACEMENT SHOULD BE INITIATED UPON DISCOVERY OF THE FAILURE.
4. SEDIMENT ACCUMULATED UPSTREAM OF SEDIMENT CONTROL LOG SHALL BE REMOVED AS NEEDED TO MAINTAIN FUNCTIONALITY OF THE BMP, TYPICALLY WHEN DEPTH OF ACCUMULATED SEDIMENTS IS APPROXIMATELY  $\frac{1}{2}$  OF THE HEIGHT OF THE SEDIMENT CONTROL LOG.
5. SEDIMENT CONTROL LOG SHALL BE REMOVED AT THE END OF CONSTRUCTION. COMPOST FROM COMPOST LOGS MAY BE LEFT IN PLACE AS LONG AS BAGS ARE REMOVED AND THE AREA SEEDED. IF DISTURBED AREAS EXIST AFTER REMOVAL, THEY SHALL BE COVERED WITH TOP SOIL, SEEDED AND MULCHED OR OTHERWISE STABILIZED IN A MANNER APPROVED BY THE LOCAL JURISDICTION.

(DETAILS ADAPTED FROM TOWN OF PARKER, COLORADO, JEFFERSON COUNTY, COLORADO, DOUGLAS COUNTY, COLORADO, AND CITY OF AURORA, COLORADO, NOT AVAILABLE IN AUTOCAD)

NOTE: MANY JURISDICTIONS HAVE BMP DETAILS THAT VARY FROM UDFCD STANDARD DETAILS. CONSULT WITH LOCAL JURISDICTIONS AS TO WHICH DETAIL SHOULD BE USED WHEN DIFFERENCES ARE NOTED.

## Description

Inlet protection consists of permeable barriers installed around an inlet to filter runoff and remove sediment prior to entering a storm drain inlet. Inlet protection can be constructed from rock socks, sediment control logs, silt fence, block and rock socks, or other materials approved by the local jurisdiction. Area inlets can also be protected by over-excavating around the inlet to form a sediment trap.



**Photograph IP-1.** Inlet protection for a curb opening inlet.

## Appropriate Uses

Install protection at storm sewer inlets that are operable during construction. Consider the potential for tracked-out sediment or temporary stockpile areas to contribute sediment to inlets when determining which inlets must be protected. This may include inlets in the general proximity of the construction area, not limited to downgradient inlets. Inlet protection is not a stand-alone BMP and should be used in conjunction with other upgradient BMPs.

## Design and Installation

To function effectively, inlet protection measures must be installed to ensure that flows do not bypass the inlet protection and enter the storm drain without treatment. However, designs must also enable the inlet to function without completely blocking flows into the inlet in a manner that causes localized flooding. When selecting the type of inlet protection, consider factors such as type of inlet (e.g., curb or area, sump or on-grade conditions), traffic, anticipated flows, ability to secure the BMP properly, safety and other site-specific conditions. For example, block and rock socks will be better suited to a curb and gutter along a roadway, as opposed to silt fence or sediment control logs, which cannot be properly secured in a curb and gutter setting, but are effective area inlet protection measures.

Several inlet protection designs are provided in the Design Details. Additionally, a variety of proprietary products are available for inlet protection that may be approved for use by local governments. If proprietary products are used, design details and installation procedures from the manufacturer must be followed. Regardless of the type of inlet protection selected, inlet protection is most effective when combined with other BMPs such as curb socks and check dams. Inlet protection is often the last barrier before runoff enters the storm sewer or receiving water.

Design details with notes are provided for these forms of inlet protection:

- IP-1. Block and Rock Sock Inlet Protection for Sump or On-grade Inlets
- IP-2. Curb (Rock) Socks Upstream of Inlet Protection, On-grade Inlets

<b>Inlet Protection (various forms)</b>	
<b>Functions</b>	
Erosion Control	No
Sediment Control	Yes
Site/Material Management	No

IP-3. Rock Sock Inlet Protection for Sump/Area Inlet

IP-4. Silt Fence Inlet Protection for Sump/Area Inlet

IP-5. Over-excavation Inlet Protection

IP-6. Straw Bale Inlet Protection for Sump/Area Inlet

CIP-1. Culvert Inlet Protection

Proprietary inlet protection devices should be installed in accordance with manufacturer specifications.

More information is provided below on selecting inlet protection for sump and on-grade locations.

### **Inlets Located in a Sump**

When applying inlet protection in sump conditions, it is important that the inlet continue to function during larger runoff events. For curb inlets, the maximum height of the protective barrier should be lower than the top of the curb opening to allow overflow into the inlet during larger storms without excessive localized flooding. If the inlet protection height is greater than the curb elevation, particularly if the filter becomes clogged with sediment, runoff will not enter the inlet and may bypass it, possibly causing localized flooding, public safety issues, and downstream erosion and damage from bypassed flows.

Area inlets located in a sump setting can be protected through the use of silt fence, concrete block and rock socks (on paved surfaces), sediment control logs/straw wattles embedded in the adjacent soil and stacked around the area inlet (on pervious surfaces), over-excavation around the inlet, and proprietary products providing equivalent functions.

### **Inlets Located on a Slope**

For curb and gutter inlets on paved sloping streets, block and rock sock inlet protection is recommended in conjunction with curb socks in the gutter leading to the inlet. For inlets located along unpaved roads, also see the Check Dam Fact Sheet.

## **Maintenance and Removal**

Inspect inlet protection frequently. Inspection and maintenance guidance includes:

- Inspect for tears that can result in sediment directly entering the inlet, as well as result in the contents of the BMP (e.g., gravel) washing into the inlet.
- Check for improper installation resulting in untreated flows bypassing the BMP and directly entering the inlet or bypassing to an unprotected downstream inlet. For example, silt fence that has not been properly trenched around the inlet can result in flows under the silt fence and directly into the inlet.
- Look for displaced BMPs that are no longer protecting the inlet. Displacement may occur following larger storm events that wash away or reposition the inlet protection. Traffic or equipment may also crush or displace the BMP.
- Monitor sediment accumulation upgradient of the inlet protection.

- Remove sediment accumulation from the area upstream of the inlet protection, as needed to maintain BMP effectiveness, typically when it reaches no more than half the storage capacity of the inlet protection. For silt fence, remove sediment when it accumulates to a depth of no more than 6 inches. Remove sediment accumulation from the area upstream of the inlet protection as needed to maintain the functionality of the BMP.
- Proprietary inlet protection devices should be inspected and maintained in accordance with manufacturer specifications. If proprietary inlet insert devices are used, sediment should be removed in a timely manner to prevent devices from breaking and spilling sediment into the storm drain.

Inlet protection must be removed and properly disposed of when the drainage area for the inlet has reached final stabilization.

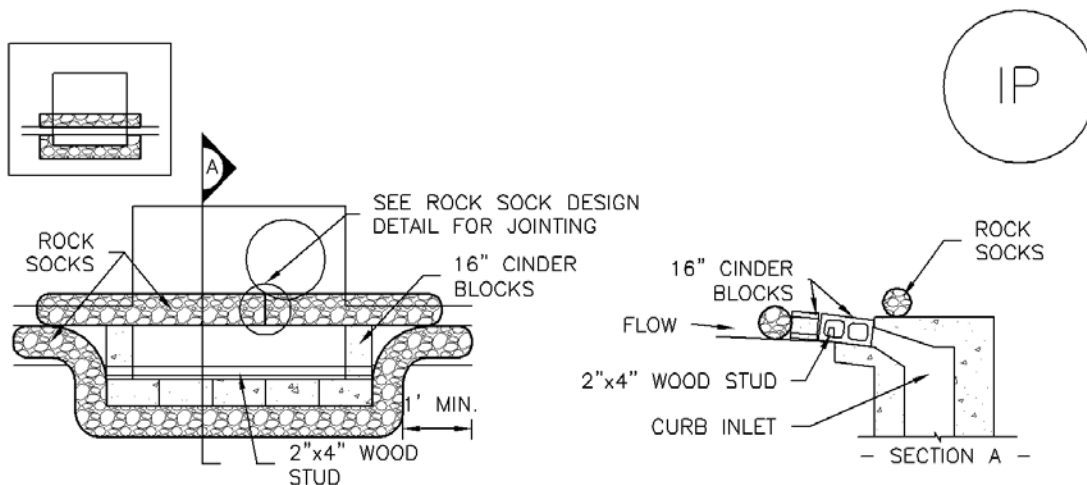

IP-1. BLOCK AND ROCK SOCK SUMP OR ON GRADE INLET PROTECTION

BLOCK AND CURB SOCK INLET PROTECTION INSTALLATION NOTES

1. SEE ROCK SOCK DESIGN DETAIL FOR INSTALLATION REQUIREMENTS.
2. CONCRETE "CINDER" BLOCKS SHALL BE LAID ON THEIR SIDES AROUND THE INLET IN A SINGLE ROW, ABUTTING ONE ANOTHER WITH THE OPEN END FACING AWAY FROM THE CURB.
3. GRAVEL BAGS SHALL BE PLACED AROUND CONCRETE BLOCKS, CLOSELY ABUTTING ONE ANOTHER AND JOINTED TOGETHER IN ACCORDANCE WITH ROCK SOCK DESIGN DETAIL.

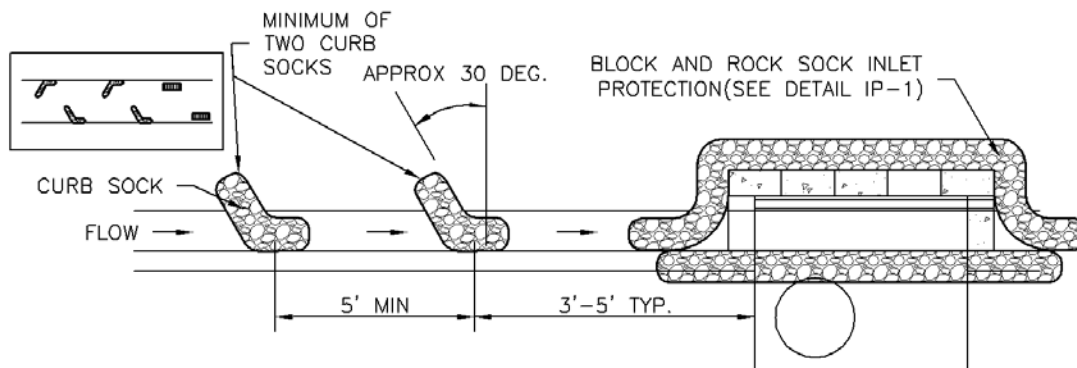

IP-2. CURB ROCK SOCKS UPSTREAM OF INLET PROTECTION

CURB ROCK SOCK INLET PROTECTION INSTALLATION NOTES

1. SEE ROCK SOCK DESIGN DETAIL INSTALLATION REQUIREMENTS.
2. PLACEMENT OF THE SOCK SHALL BE APPROXIMATELY 30 DEGREES FROM PERPENDICULAR IN THE OPPOSITE DIRECTION OF FLOW.
3. SOCKS ARE TO BE FLUSH WITH THE CURB AND SPACED A MINIMUM OF 5 FEET APART.
4. AT LEAST TWO CURB SOCKS IN SERIES ARE REQUIRED UPSTREAM OF ON-GRADE INLETS.



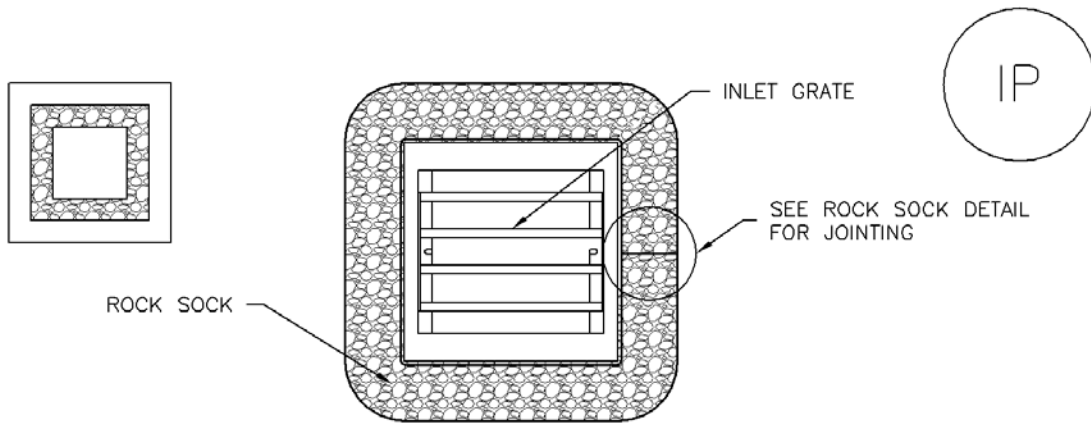

### IP-3. ROCK SOCK SUMP/AREA INLET PROTECTION

ROCK SOCK SUMP/AREA INLET PROTECTION INSTALLATION NOTES

1. SEE ROCK SOCK DESIGN DETAIL FOR INSTALLATION REQUIREMENTS.
2. STRAW WATTLES/SEDIMENT CONTROL LOGS MAY BE USED IN PLACE OF ROCK SOCKS FOR INLETS IN PERVIOUS AREAS. INSTALL PER SEDIMENT CONTROL LOG DETAIL.

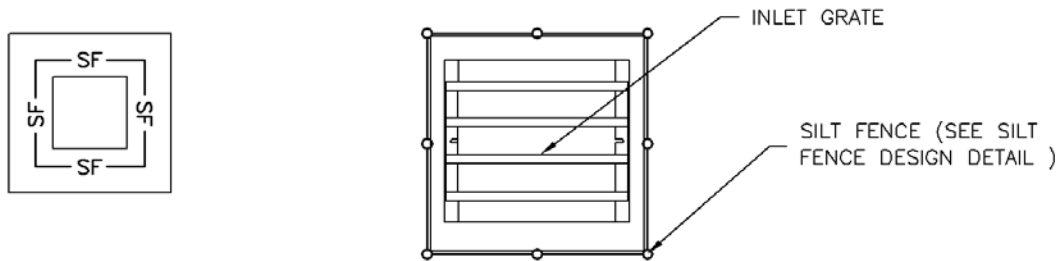

### IP-4. SILT FENCE FOR SUMP INLET PROTECTION

SILT FENCE INLET PROTECTION INSTALLATION NOTES

1. SEE SILT FENCE DESIGN DETAIL FOR INSTALLATION REQUIREMENTS.
2. POSTS SHALL BE PLACED AT EACH CORNER OF THE INLET AND AROUND THE EDGES AT A MAXIMUM SPACING OF 3 FEET.
3. STRAW WATTLES/SEDIMENT CONTROL LOGS MAY BE USED IN PLACE OF SILT FENCE FOR INLETS IN PERVIOUS AREAS. INSTALL PER SEDIMENT CONTROL LOG DETAIL.

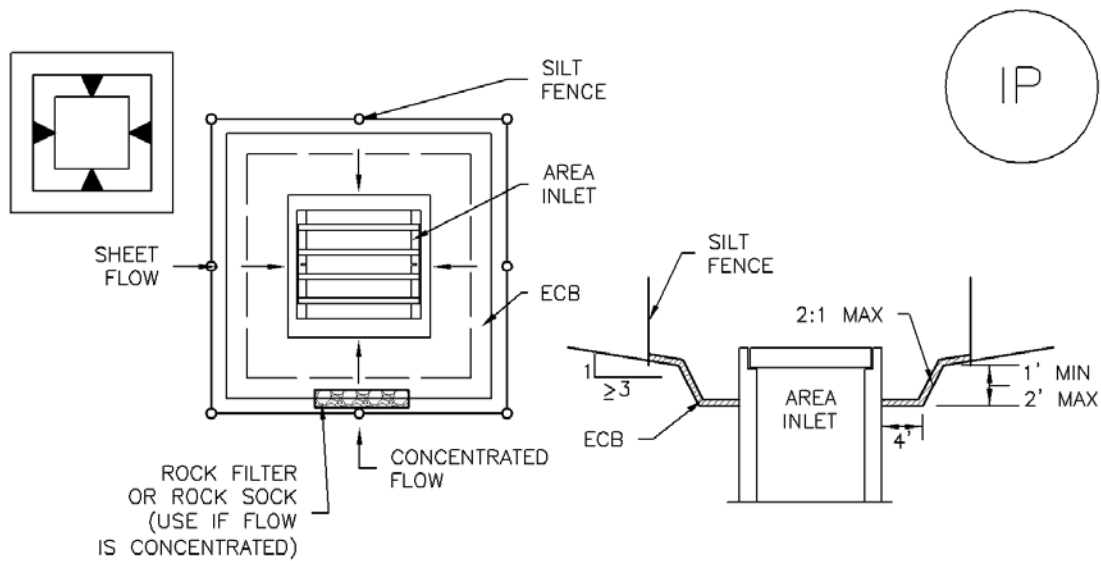

IP-5. OVEREXCAVATION INLET PROTECTION

OVEREXCAVATION INLET PROTECTION INSTALLATION NOTES

1. THIS FORM OF INLET PROTECTION IS PRIMARILY APPLICABLE FOR SITES THAT HAVE NOT YET REACHED FINAL GRADE AND SHOULD BE USED ONLY FOR INLETS WITH A RELATIVELY SMALL CONTRIBUTING DRAINAGE AREA.
2. WHEN USING FOR CONCENTRATED FLOWS, SHAPE BASIN IN 2:1 RATIO WITH LENGTH ORIENTED TOWARDS DIRECTION OF FLOW.
3. SEDIMENT MUST BE PERIODICALLY REMOVED FROM THE OVEREXCAVATED AREA.

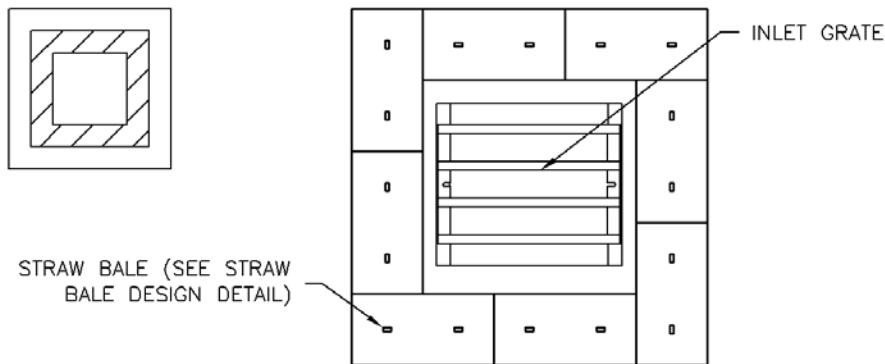

IP-6. STRAW BALE FOR SUMP INLET PROTECTION

STRAW BALE BARRIER INLET PROTECTION INSTALLATION NOTES

1. SEE STRAW BALE DESIGN DETAIL FOR INSTALLATION REQUIREMENTS.
2. BALES SHALL BE PLACED IN A SINGLE ROW AROUND THE INLET WITH ENDS OF BALES TIGHTLY ABUTTING ONE ANOTHER.

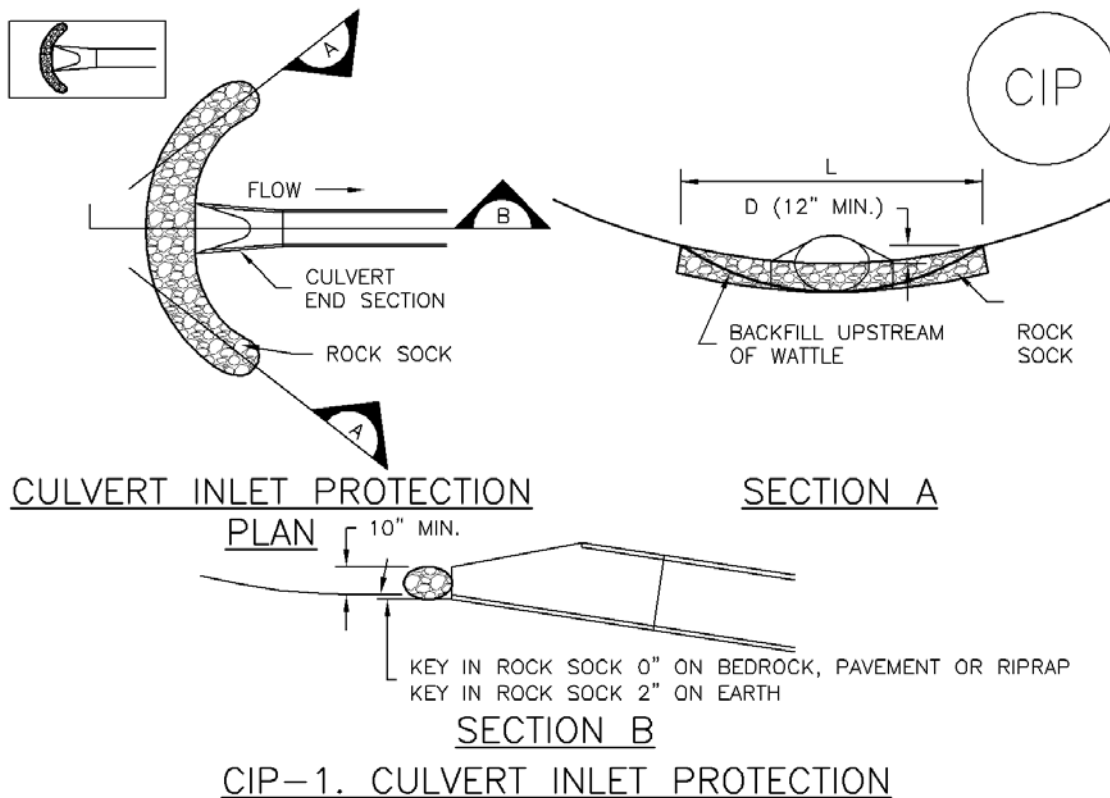

CULVERT INLET PROTECTION INSTALLATION NOTES

1. SEE PLAN VIEW FOR  
-LOCATION OF CULVERT INLET PROTECTION.
2. SEE ROCK SOCK DESIGN DETAIL FOR ROCK GRADATION REQUIREMENTS AND JOINTING DETAIL.

CULVERT INLET PROTECTION MAINTENANCE NOTES

1. INSPECT BMPs EACH WORKDAY, AND MAINTAIN THEM IN EFFECTIVE OPERATING CONDITION. MAINTENANCE OF BMPs SHOULD BE PROACTIVE, NOT REACTIVE. INSPECT BMPs AS SOON AS POSSIBLE (AND ALWAYS WITHIN 24 HOURS) FOLLOWING A STORM THAT CAUSES SURFACE EROSION, AND PERFORM NECESSARY MAINTENANCE.
2. FREQUENT OBSERVATIONS AND MAINTENANCE ARE NECESSARY TO MAINTAIN BMPs IN EFFECTIVE OPERATING CONDITION. INSPECTIONS AND CORRECTIVE MEASURES SHOULD BE DOCUMENTED THOROUGHLY.
3. WHERE BMPs HAVE FAILED, REPAIR OR REPLACEMENT SHOULD BE INITIATED UPON DISCOVERY OF THE FAILURE.
4. SEDIMENT ACCUMULATED UPSTREAM OF THE CULVERT SHALL BE REMOVED WHEN THE SEDIMENT DEPTH IS 1/2 THE HEIGHT OF THE ROCK SOCK.
5. CULVERT INLET PROTECTION SHALL REMAIN IN PLACE UNTIL THE UPSTREAM DISTURBED AREA IS PERMANENTLY STABILIZED AND APPROVED BY THE LOCAL JURISDICTION.

(DETAILS ADAPTED FROM AURORA, COLORADO, NOT AVAILABLE IN AUTOCAD)

**NOTE:** MANY JURISDICTIONS HAVE BMP DETAILS THAT VARY FROM UDFCD STANDARD DETAILS. CONSULT WITH LOCAL JURISDICTIONS AS TO WHICH DETAIL SHOULD BE USED WHEN DIFFERENCES ARE NOTED.

GENERAL INLET PROTECTION INSTALLATION NOTES

1. SEE PLAN VIEW FOR:
  - LOCATION OF INLET PROTECTION.
  - TYPE OF INLET PROTECTION (IP.1, IP.2, IP.3, IP.4, IP.5, IP.6)
2. INLET PROTECTION SHALL BE INSTALLED PROMPTLY AFTER INLET CONSTRUCTION OR PAVING IS COMPLETE (TYPICALLY WITHIN 48 HOURS). IF A RAINFALL/RUNOFF EVENT IS FORECAST, INSTALL INLET PROTECTION PRIOR TO ONSET OF EVENT.
3. MANY JURISDICTIONS HAVE BMP DETAILS THAT VARY FROM UDFCD STANDARD DETAILS. CONSULT WITH LOCAL JURISDICTIONS AS TO WHICH DETAIL SHOULD BE USED WHEN DIFFERENCES ARE NOTED.

INLET PROTECTION MAINTENANCE NOTES

1. INSPECT BMPs EACH WORKDAY, AND MAINTAIN THEM IN EFFECTIVE OPERATING CONDITION. MAINTENANCE OF BMPs SHOULD BE PROACTIVE, NOT REACTIVE. INSPECT BMPs AS SOON AS POSSIBLE (AND ALWAYS WITHIN 24 HOURS) FOLLOWING A STORM THAT CAUSES SURFACE EROSION, AND PERFORM NECESSARY MAINTENANCE.
2. FREQUENT OBSERVATIONS AND MAINTENANCE ARE NECESSARY TO MAINTAIN BMPs IN EFFECTIVE OPERATING CONDITION. INSPECTIONS AND CORRECTIVE MEASURES SHOULD BE DOCUMENTED THOROUGHLY.
3. WHERE BMPs HAVE FAILED, REPAIR OR REPLACEMENT SHOULD BE INITIATED UPON DISCOVERY OF THE FAILURE.
4. SEDIMENT ACCUMULATED UPSTREAM OF INLET PROTECTION SHALL BE REMOVED AS NECESSARY TO MAINTAIN BMP EFFECTIVENESS, TYPICALLY WHEN STORAGE VOLUME REACHES 50% OF CAPACITY, A DEPTH OF 6" WHEN SILT FENCE IS USED, OR ¼ OF THE HEIGHT FOR STRAW BALES.
5. INLET PROTECTION IS TO REMAIN IN PLACE UNTIL THE UPSTREAM DISTURBED AREA IS PERMANENTLY STABILIZED, UNLESS THE LOCAL JURISDICTION APPROVES EARLIER REMOVAL OF INLET PROTECTION IN STREETS.
6. WHEN INLET PROTECTION AT AREA INLETS IS REMOVED, THE DISTURBED AREA SHALL BE COVERED WITH TOP SOIL, SEEDED AND MULCHED, OR OTHERWISE STABILIZED IN A MANNER APPROVED BY THE LOCAL JURISDICTION.

(DETAIL ADAPTED FROM TOWN OF PARKER, COLORADO AND CITY OF AURORA, COLORADO, NOT AVAILABLE IN AUTOCAD)

NOTE: MANY JURISDICTIONS HAVE BMP DETAILS THAT VARY FROM UDFCD STANDARD DETAILS. CONSULT WITH LOCAL JURISDICTIONS AS TO WHICH DETAIL SHOULD BE USED WHEN DIFFERENCES ARE NOTED.

NOTE: THE DETAILS INCLUDED WITH THIS FACT SHEET SHOW COMMONLY USED, CONVENTIONAL METHODS OF INLET PROTECTION IN THE DENVER METROPOLITAN AREA. THERE ARE MANY PROPRIETARY INLET PROTECTION METHODS ON THE MARKET. UDFCD NEITHER ENDORSES NOR DISCOURAGES USE OF PROPRIETARY INLET PROTECTION; HOWEVER, IN THE EVENT PROPRIETARY METHODS ARE USED, THE APPROPRIATE DETAIL FROM THE MANUFACTURER MUST BE INCLUDED IN THE SWMP AND THE BMP MUST BE INSTALLED AND MAINTAINED AS SHOWN IN THE MANUFACTURER'S DETAILS.

NOTE: SOME MUNICIPALITIES DISCOURAGE OR PROHIBIT THE USE OF STRAW BALES FOR INLET PROTECTION. CHECK WITH LOCAL JURISDICTION TO DETERMINE IF STRAW BALE INLET PROTECTION IS ACCEPTABLE.

## Description

A sediment basin is a temporary pond built on a construction site to capture eroded or disturbed soil transported in storm runoff prior to discharge from the site. Sediment basins are designed to capture site runoff and slowly release it to allow time for settling of sediment prior to discharge. Sediment basins are often constructed in locations that will later be modified to serve as post-construction stormwater basins.



**Photograph SB-1.** Sediment basin at the toe of a slope. Photo courtesy of WWE.

## Appropriate Uses

Most large construction sites (typically greater than 2 acres) will require one or more sediment basins for effective management of construction site runoff. On linear construction projects, sediment basins may be impractical; instead, sediment traps or other combinations of BMPs may be more appropriate.

Sediment basins should not be used as stand-alone sediment controls. Erosion and other sediment controls should also be implemented upstream.

When feasible, the sediment basin should be installed in the same location where a permanent post-construction detention pond will be located.

## Design and Installation

The design procedure for a sediment basin includes these steps:

- **Basin Storage Volume:** Provide a storage volume of at least 3,600 cubic feet per acre of drainage area. To the extent practical, undisturbed and/or off-site areas should be diverted around sediment basins to prevent “clean” runoff from mixing with runoff from disturbed areas. For undisturbed areas (both on-site and off-site) that cannot be diverted around the sediment basin, provide a minimum of 500 ft<sup>3</sup>/acre of storage for undeveloped (but stable) off-site areas in addition to the 3,600 ft<sup>3</sup>/acre for disturbed areas. For stable, developed areas that cannot be diverted around the sediment basin, storage volume requirements are summarized in Table SB-1.
- **Basin Geometry:** Design basin with a minimum length-to-width ratio of 2:1 (L:W). If this cannot be achieved because of site space constraints, baffling may be required to extend the effective distance between the inflow point(s) and the outlet to minimize short-circuiting.
- **Dam Embankment:** It is recommended that embankment slopes be 4:1 (H:V) or flatter and no steeper than 3:1 (H:V) in any location.

Sediment Basins	
Functions	
Erosion Control	No
Sediment Control	Yes
Site/Material Management	No



- **Inflow Structure:** For concentrated flow entering the basin, provide energy dissipation at the point of inflow.

**Table SB-1. Additional Volume Requirements for Undisturbed and Developed Tributary Areas Draining through Sediment Basins**

Imperviousness (%)	Additional Storage Volume (ft <sup>3</sup> ) Per Acre of Tributary Area
Undeveloped	500
10	800
20	1230
30	1600
40	2030
50	2470
60	2980
70	3560
80	4360
90	5300
100	6460

- **Outlet Works:** The outlet pipe shall extend through the embankment at a minimum slope of 0.5 percent. Outlet works can be designed using one of the following approaches:
  - **Riser Pipe (Simplified Detail):** Detail SB-1 provides a simplified design for basins treating no more than 15 acres.
  - **Orifice Plate or Riser Pipe:** Follow the design criteria for Full Spectrum Detention outlets in the EDB Fact Sheet provided in Chapter 4 of this manual for sizing of outlet perforations with an emptying time of approximately 72 hours. In lieu of the trash rack, pack uniformly sized 1½ - to 2-inch gravel in front of the plate or surrounding the riser pipe. This gravel will need to be cleaned out frequently during the construction period as sediment accumulates within it. The gravel pack will need to be removed and disposed of following construction to reclaim the basin for use as a permanent detention facility. If the basin will be used as a permanent extended detention basin for the site, a trash rack will need to be installed once contributing drainage areas have been stabilized and the gravel pack and accumulated sediment have been removed.
  - **Floating Skimmer:** If a floating skimmer is used, install it using manufacturer’s recommendations. Illustration SB-1 provides an illustration of a Faircloth Skimmer Floating Outlet™, one of the more commonly used floating skimmer outlets. A skimmer should be designed to release the design volume in no less than 48 hours. The use of a floating skimmer outlet can increase the sediment capture efficiency of a basin significantly. A floating outlet continually decants cleanest water off the surface of the pond and releases cleaner water than would discharge from a perforated riser pipe or plate.

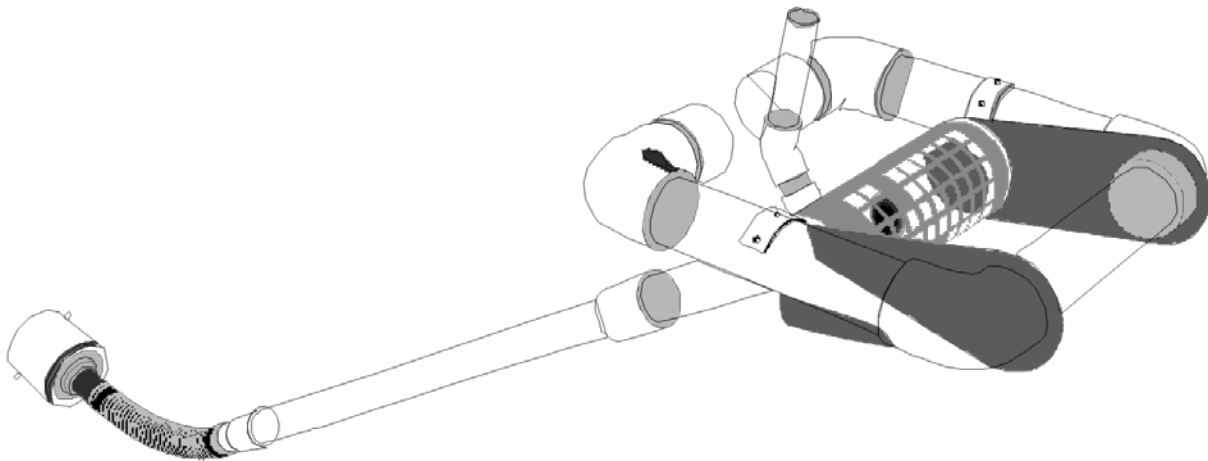

**Illustration SB-1.** Outlet structure for a temporary sediment basin - Faircloth Skimmer Floating Outlet. Illustration courtesy of J. W. Faircloth & Sons, Inc., FairclothSkimmer.com.

- **Outlet Protection and Spillway:** Consider all flow paths for runoff leaving the basin, including protection at the typical point of discharge as well as overtopping.
  - **Outlet Protection:** Outlet protection should be provided where the velocity of flow will exceed the maximum permissible velocity of the material of the waterway into which discharge occurs. This may require the use of a riprap apron at the outlet location and/or other measures to keep the waterway from eroding.
  - **Emergency Spillway:** Provide a stabilized emergency overflow spillway for rainstorms that exceed the capacity of the sediment basin volume and its outlet. Protect basin embankments from erosion and overtopping. If the sediment basin will be converted to a permanent detention basin, design and construct the emergency spillway(s) as required for the permanent facility. If the sediment basin will not become a permanent detention basin, it may be possible to substitute a heavy polyvinyl membrane or properly bedded rock cover to line the spillway and downstream embankment, depending on the height, slope, and width of the embankments.

## Maintenance and Removal

Maintenance activities include the following:

- Dredge sediment from the basin, as needed to maintain BMP effectiveness, typically when the design storage volume is no more than one-third filled with sediment.
- Inspect the sediment basin embankments for stability and seepage.
- Inspect the inlet and outlet of the basin, repair damage, and remove debris. Remove, clean and replace the gravel around the outlet on a regular basis to remove the accumulated sediment within it and keep the outlet functioning.
- Be aware that removal of a sediment basin may require dewatering and associated permit requirements.
- Do not remove a sediment basin until the upstream area has been stabilized with vegetation.

Final disposition of the sediment basin depends on whether the basin will be converted to a permanent post-construction stormwater basin or whether the basin area will be returned to grade. For basins being converted to permanent detention basins, remove accumulated sediment and reconfigure the basin and outlet to meet the requirements of the final design for the detention facility. If the sediment basin is not to be used as a permanent detention facility, fill the excavated area with soil and stabilize with vegetation.

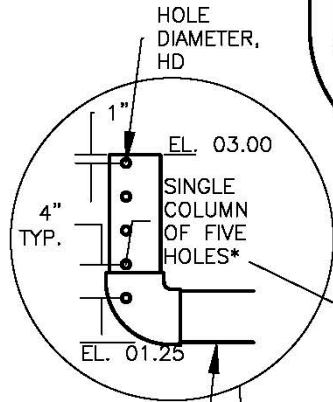
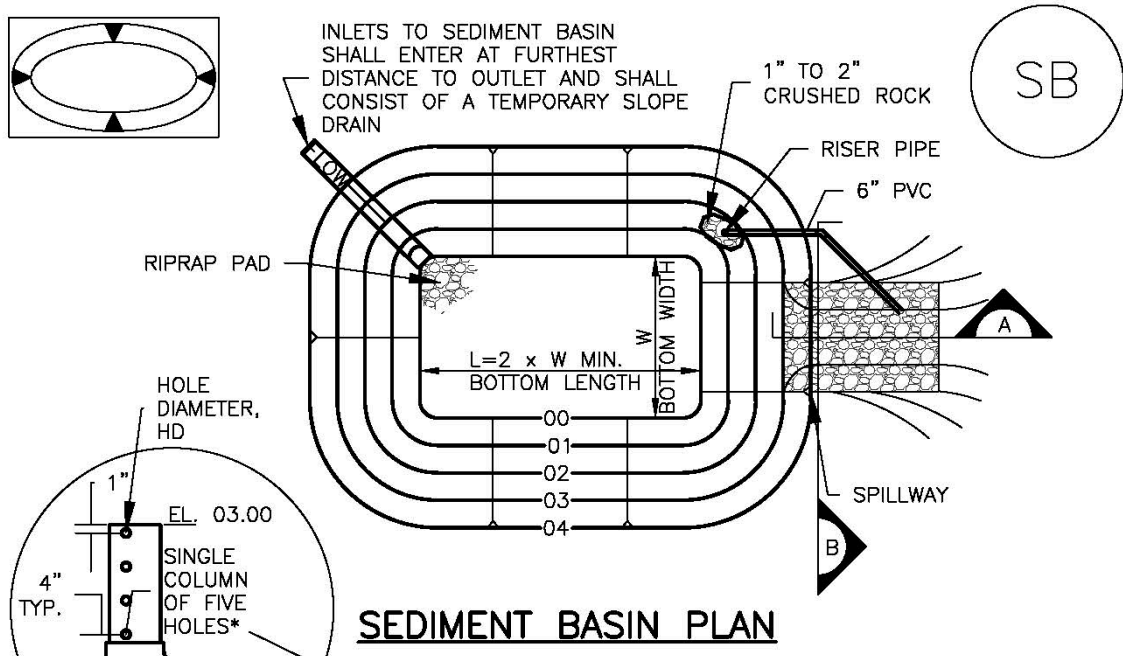

\*EXCEPT WHERE THE HOLES EXCEED 1" DIAMETER, THEN UP TO TWO COLUMNS OF SAME SIZED HOLES MAY BE USED

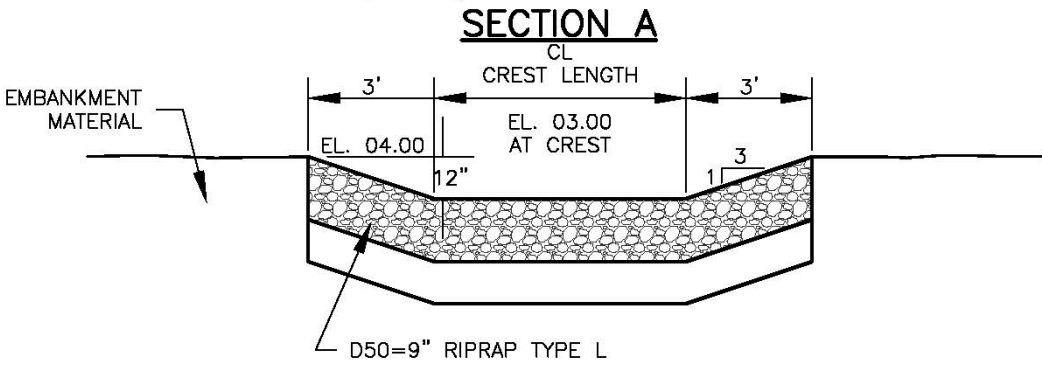
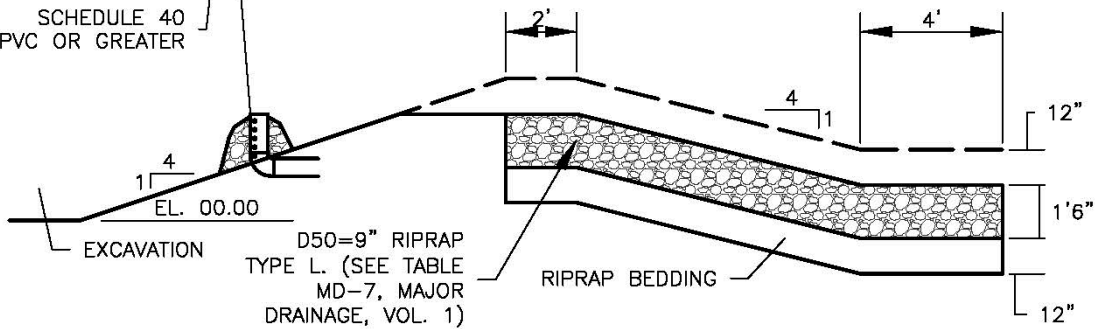

TABLE SB-1. SIZING INFORMATION FOR STANDARD SEDIMENT BASIN			
Upstream Drainage Area (rounded to nearest acre), (ac)	Basin Bottom Width (W), (ft)	Spillway Crest Length (CL), (ft)	Hole Diameter (HD), (in)
1	12 1/2	2	9/32
2	21	3	13/16
3	28	5	1/2
4	33 1/2	6	9/16
5	38 1/2	8	2 1/32
6	43	9	2 1/32
7	47 1/4	11	2 5/32
8	51	12	2 7/32
9	55	13	7/8
10	58 1/4	15	1 5/16
11	61	16	3 1/32
12	64	18	1
13	67 1/2	19	1 1/16
14	70 1/2	21	1 1/8
15	73 1/4	22	1 3/16

SEDIMENT BASIN INSTALLATION NOTES

1. SEE PLAN VIEW FOR:
  - LOCATION OF SEDIMENT BASIN.
  - TYPE OF BASIN (STANDARD BASIN OR NONSTANDARD BASIN).
  - FOR STANDARD BASIN, BOTTOM WIDTH W, CREST LENGTH CL, AND HOLE DIAMETER, HD.
  - FOR NONSTANDARD BASIN, SEE CONSTRUCTION DRAWINGS FOR DESIGN OF BASIN INCLUDING RISER HEIGHT H, NUMBER OF COLUMNS N, HOLE DIAMETER HD AND PIPE DIAMETER D.
2. FOR STANDARD BASIN, BOTTOM DIMENSION MAY BE MODIFIED AS LONG AS BOTTOM AREA IS NOT REDUCED.
3. SEDIMENT BASINS SHALL BE INSTALLED PRIOR TO ANY OTHER LAND-DISTURBING ACTIVITY THAT RELIES ON ON BASINS AS AS A STORMWATER CONTROL.
4. EMBANKMENT MATERIAL SHALL CONSIST OF SOIL FREE OF DEBRIS, ORGANIC MATERIAL, AND ROCKS OR CONCRETE GREATER THAN 3 INCHES AND SHALL HAVE A MINIMUM OF 15 PERCENT BY WEIGHT PASSING THE NO. 200 SIEVE.
5. EMBANKMENT MATERIAL SHALL BE COMPACTED TO AT LEAST 95 PERCENT OF MAXIMUM DENSITY IN ACCORDANCE WITH ASTM D698.
6. PIPE SCH 40 OR GREATER SHALL BE USED.
7. THE DETAILS SHOWN ON THESE SHEETS PERTAIN TO STANDARD SEDIMENT BASIN(S) FOR DRAINAGE AREAS LESS THAN 15 ACRES. SEE CONSTRUCTION DRAWINGS FOR EMBANKMENT, STORAGE VOLUME, SPILLWAY, OUTLET, AND OUTLET PROTECTION DETAILS FOR ANY SEDIMENT BASIN(S) THAT HAVE BEEN INDIVIDUALLY DESIGNED FOR DRAINAGE AREAS LARGER THAN 15 ACRES.



## SEDIMENT BASIN MAINTENANCE NOTES

1. INSPECT BMPs EACH WORKDAY, AND MAINTAIN THEM IN EFFECTIVE OPERATING CONDITION. MAINTENANCE OF BMPs SHOULD BE PROACTIVE, NOT REACTIVE. INSPECT BMPs AS SOON AS POSSIBLE (AND ALWAYS WITHIN 24 HOURS) FOLLOWING A STORM THAT CAUSES SURFACE EROSION, AND PERFORM NECESSARY MAINTENANCE.
2. FREQUENT OBSERVATIONS AND MAINTENANCE ARE NECESSARY TO MAINTAIN BMPs IN EFFECTIVE OPERATING CONDITION. INSPECTIONS AND CORRECTIVE MEASURES SHOULD BE DOCUMENTED THOROUGHLY.
3. WHERE BMPs HAVE FAILED, REPAIR OR REPLACEMENT SHOULD BE INITIATED UPON DISCOVERY OF THE FAILURE.
4. SEDIMENT ACCUMULATED IN BASIN SHALL BE REMOVED AS NEEDED TO MAINTAIN BMP EFFECTIVENESS, TYPICALLY WHEN SEDIMENT DEPTH REACHES ONE FOOT (I.E., TWO FEET BELOW THE SPILLWAY CREST).
5. SEDIMENT BASINS ARE TO REMAIN IN PLACE UNTIL THE UPSTREAM DISTURBED AREA IS STABILIZED AND GRASS COVER IS ACCEPTED BY THE LOCAL JURISDICTION.
6. WHEN SEDIMENT BASINS ARE REMOVED, ALL DISTURBED AREAS SHALL BE COVERED WITH TOPSOIL, SEEDED AND MULCHED OR OTHERWISE STABILIZED AS APPROVED BY LOCAL JURISDICTION.

(DETAILS ADAPTED FROM DOUGLAS COUNTY, COLORADO)

NOTE: MANY JURISDICTIONS HAVE BMP DETAILS THAT VARY FROM UDFCD STANDARD DETAILS. CONSULT WITH LOCAL JURISDICTIONS AS TO WHICH DETAIL SHOULD BE USED WHEN DIFFERENCES ARE NOTED.

## Description

Effective construction site management to minimize erosion and sediment transport includes attention to construction phasing, scheduling, and sequencing of land disturbing activities. On most construction projects, erosion and sediment controls will need to be adjusted as the project progresses and should be documented in the SWMP.

Construction phasing refers to disturbing only part of a site at a time to limit the potential for erosion from dormant parts of a site. Grading activities and construction are completed and soils are effectively stabilized on one part of a site before grading and construction begins on another portion of the site.



**Photograph CP-1.** Construction phasing to avoid disturbing the entire area at one time. Photo courtesy of WWE.

Construction sequencing or scheduling refers to a specified work schedule that coordinates the timing of land disturbing activities and the installation of erosion and sediment control practices.

## Appropriate Uses

All construction projects can benefit from upfront planning to phase and sequence construction activities to minimize the extent and duration of disturbance. Larger projects and linear construction projects may benefit most from construction sequencing or phasing, but even small projects can benefit from construction sequencing that minimizes the duration of disturbance.

Typically, erosion and sediment controls needed at a site will change as a site progresses through the major phases of construction. Erosion and sediment control practices corresponding to each phase of construction must be documented in the SWMP.

## Design and Installation

BMPs appropriate to the major phases of development should be identified on construction drawings. In some cases, it will be necessary to provide several drawings showing construction-phase BMPs placed according to stages of development (e.g., clearing and grading, utility installation, active construction, final stabilization). Some municipalities in the Denver area set maximum sizes for disturbed area associated with phases of a construction project. Additionally, requirements for phased construction drawings vary among local governments within the UDFCD boundary. Some local governments require separate erosion and sediment control drawings for initial BMPs, interim conditions (in active construction), and final stabilization.

Construction Scheduling	
Functions	
Erosion Control	Moderate
Sediment Control	Moderate
Site/Material Management	Yes

Typical construction phasing BMPs include:

- Limit the amount of disturbed area at any given time on a site to the extent practical. For example, a 100-acre subdivision might be constructed in five phases of 20 acres each.
- If there is carryover of stockpiled material from one phase to the next, position carryover material in a location easily accessible for the pending phase that will not require disturbance of stabilized areas to access the stockpile. Particularly with regard to efforts to balance cut and fill at a site, careful planning for location of stockpiles is important.

Typical construction sequencing BMPs include:

- Sequence construction activities to minimize duration of soil disturbance and exposure. For example, when multiple utilities will occupy the same trench, schedule installation so that the trench does not have to be closed and opened multiple times.
- Schedule site stabilization activities (e.g., landscaping, seeding and mulching, installation of erosion control blankets) as soon as feasible following grading.
- Install initial erosion and sediment control practices before construction begins. Promptly install additional BMPs for inlet protection, stabilization, etc., as construction activities are completed.

Table CP-1 provides typical sequencing of construction activities and associated BMPs.

## **Maintenance and Removal**

When the construction schedule is altered, erosion and sediment control measures in the SWMP and construction drawings should be appropriately adjusted to reflect actual "on the ground" conditions at the construction site. Be aware that changes in construction schedules can have significant implications for site stabilization, particularly with regard to establishment of vegetative cover.

**Table CP-1. Typical Phased BMP Installation for Construction Projects**

Project Phase	BMPs
Pre-disturbance, Site Access	<ul style="list-style-type: none"> <li>▪ Install sediment controls downgradient of access point (on paved streets this may consist of inlet protection).</li> <li>▪ Establish vehicle tracking control at entrances to paved streets. Fence as needed.</li> <li>▪ Use construction fencing to define the boundaries of the project and limit access to areas of the site that are not to be disturbed.</li> </ul> <p><b>Note: it may be necessary to protect inlets in the general vicinity of the site, even if not downgradient, if there is a possibility that sediment tracked from the site could contribute to the inlets.</b></p>
Site Clearing and Grubbing	<ul style="list-style-type: none"> <li>▪ Install perimeter controls as needed on downgradient perimeter of site (silt fence, wattles, etc).</li> <li>▪ Limit disturbance to those areas planned for disturbance and protect undisturbed areas within the site (construction fence, flagging, etc).</li> <li>▪ Preserve vegetative buffer at site perimeter.</li> <li>▪ Create stabilized staging area.</li> <li>▪ Locate portable toilets on flat surfaces away from drainage paths. Stake in areas susceptible to high winds.</li> <li>▪ Construct concrete washout area and provide signage.</li> <li>▪ Establish waste disposal areas.</li> <li>▪ Install sediment basins.</li> <li>▪ Create dirt perimeter berms and/or brush barriers during grubbing and clearing.</li> <li>▪ Separate and stockpile topsoil, leave roughened and/or cover.</li> <li>▪ Protect stockpiles with perimeter control BMPs. Stockpiles should be located away from drainage paths and should be accessed from the upgradient side so that perimeter controls can remain in place on the downgradient side. Use erosion control blankets, temporary seeding, and/or mulch for stockpiles that will be inactive for an extended period.</li> <li>▪ Leave disturbed area of site in a roughened condition to limit erosion. Consider temporary revegetation for areas of the site that have been disturbed but that will be inactive for an extended period.</li> <li>▪ Water to minimize dust but not to the point that watering creates runoff.</li> </ul>

Project Phase	BMPs
Utility And Infrastructure Installation	<p><b>In Addition to the Above BMPs:</b></p> <ul style="list-style-type: none"> <li>▪ Close trench as soon as possible (generally at the end of the day).</li> <li>▪ Use rough-cut street control or apply road base for streets that will not be promptly paved.</li> <li>▪ Provide inlet protection as streets are paved and inlets are constructed.</li> <li>▪ Protect and repair BMPs, as necessary.</li> <li>▪ Perform street sweeping as needed.</li> </ul>
Building Construction	<p><b>In Addition to the Above BMPs:</b></p> <ul style="list-style-type: none"> <li>▪ Implement materials management and good housekeeping practices for home building activities.</li> <li>▪ Use perimeter controls for temporary stockpiles from foundation excavations.</li> <li>▪ For lots adjacent to streets, lot-line perimeter controls may be necessary at the back of curb.</li> </ul>
Final Grading	<p><b>In Addition to the Above BMPs:</b></p> <ul style="list-style-type: none"> <li>▪ Remove excess or waste materials.</li> <li>▪ Remove stored materials.</li> </ul>
Final Stabilization	<p><b>In Addition to the Above BMPs:</b></p> <ul style="list-style-type: none"> <li>▪ Seed and mulch/tackify.</li> <li>▪ Seed and install blankets on steep slopes.</li> <li>▪ Remove all temporary BMPs when site has reached final stabilization.</li> </ul>



## Description

A construction fence restricts site access to designated entrances and exits, delineates construction site boundaries, and keeps construction out of sensitive areas such as natural areas to be preserved as open space, wetlands and riparian areas.

## Appropriate Uses

A construction fence can be used to delineate the site perimeter and locations within the site where access is restricted to protect natural resources such as wetlands, waterbodies, trees, and other natural areas of the site that should not be disturbed.



**Photograph CF-1.** A construction fence helps delineate areas where existing vegetation is being protected. Photo courtesy of Douglas County.

If natural resource protection is an objective, then the construction fencing should be used in combination with other perimeter control BMPs such as silt fence, sediment control logs or similar measures.

## Design and Installation

Construction fencing may be chain link or plastic mesh and should be installed following manufacturer’s recommendations. See Detail CF-1 for typical installations.

Do not place construction fencing in areas within work limits of machinery.

## Maintenance and Removal

- Inspect fences for damage; repair or replace as necessary.
- Fencing should be tight and any areas with slumping or fallen posts should be reinstalled.
- Fencing should be removed once construction is complete.

<b>Construction Fence</b>	
<b>Functions</b>	
Erosion Control	No
Sediment Control	No
Site/Material Management	Yes

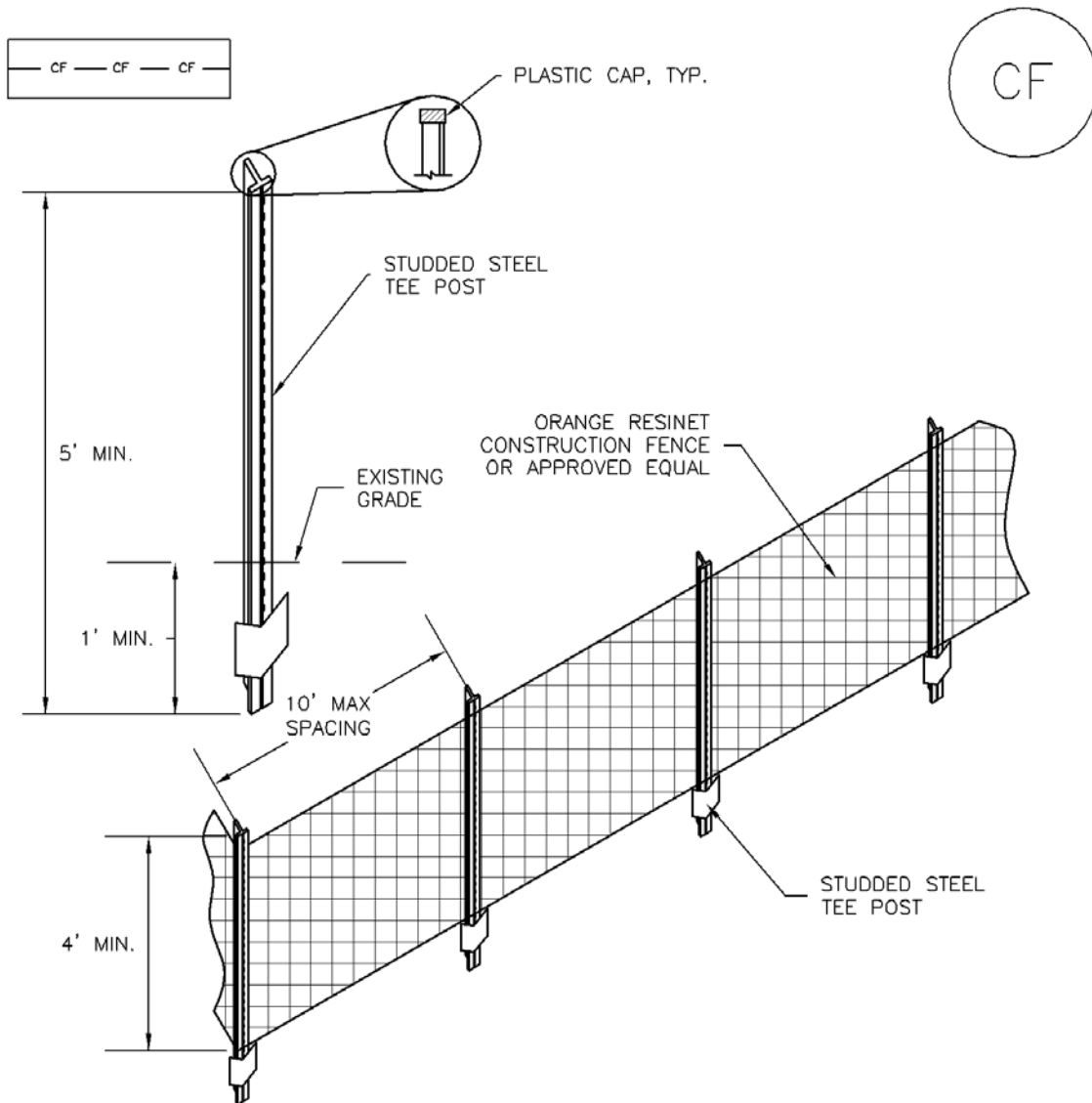

CF-1. PLASTIC MESH CONSTRUCTION FENCE

CONSTRUCTION FENCE INSTALLATION NOTES

1. SEE PLAN VIEW FOR:  
-LOCATION OF CONSTRUCTION FENCE.
2. CONSTRUCTION FENCE SHOWN SHALL BE INSTALLED PRIOR TO ANY LAND DISTURBING ACTIVITIES.
3. CONSTRUCTION FENCE SHALL BE COMPOSED OF ORANGE, CONTRACTOR-GRADE MATERIAL THAT IS AT LEAST 4' HIGH. METAL POSTS SHOULD HAVE A PLASTIC CAP FOR SAFETY.
4. STUDED STEEL TEE POSTS SHALL BE UTILIZED TO SUPPORT THE CONSTRUCTION FENCE. MAXIMUM SPACING FOR STEEL TEE POSTS SHALL BE 10'.
5. CONSTRUCTION FENCE SHALL BE SECURELY FASTENED TO THE TOP, MIDDLE, AND BOTTOM OF EACH POST.

## CONSTRUCTION FENCE MAINTENANCE NOTES

1. INSPECT BMPs EACH WORKDAY, AND MAINTAIN THEM IN EFFECTIVE OPERATING CONDITION. MAINTENANCE OF BMPs SHOULD BE PROACTIVE, NOT REACTIVE. INSPECT BMPs AS SOON AS POSSIBLE (AND ALWAYS WITHIN 24 HOURS) FOLLOWING A STORM THAT CAUSES SURFACE EROSION, AND PERFORM NECESSARY MAINTENANCE.
2. FREQUENT OBSERVATIONS AND MAINTENANCE ARE NECESSARY TO MAINTAIN BMPs IN EFFECTIVE OPERATING CONDITION. INSPECTIONS AND CORRECTIVE MEASURES SHOULD BE DOCUMENTED THOROUGHLY.
3. WHERE BMPs HAVE FAILED, REPAIR OR REPLACEMENT SHOULD BE INITIATED UPON DISCOVERY OF THE FAILURE.
4. CONSTRUCTION FENCE SHALL BE REPAIRED OR REPLACED WHEN THERE ARE SIGNS OF DAMAGE SUCH AS RIPS OR SAGS. CONSTRUCTION FENCE IS TO REMAIN IN PLACE UNTIL THE UPSTREAM DISTURBED AREA IS STABILIZED AND APPROVED BY THE LOCAL JURISDICTION.
5. WHEN CONSTRUCTION FENCES ARE REMOVED, ALL DISTURBED AREAS ASSOCIATED WITH THE INSTALLATION, MAINTENANCE, AND/OR REMOVAL OF THE FENCE SHALL BE COVERED WITH TOPSOIL, SEEDED AND MULCHED, OR OTHERWISE STABILIZED AS APPROVED BY LOCAL JURISDICTION.

NOTE: MANY JURISDICTIONS HAVE BMP DETAILS THAT VARY FROM UDFCD STANDARD DETAILS. CONSULT WITH LOCAL JURISDICTIONS AS TO WHICH DETAIL SHOULD BE USED WHEN DIFFERENCES ARE NOTED.

(DETAIL ADAPTED FROM TOWN OF PARKER, COLORADO, NOT AVAILABLE IN AUTOCAD)

## Description

Vehicle tracking controls provide stabilized construction site access where vehicles exit the site onto paved public roads. An effective vehicle tracking control helps remove sediment (mud or dirt) from vehicles, reducing tracking onto the paved surface.



**Photograph VTC-1.** A vehicle tracking control pad constructed with properly sized rock reduces off-site sediment tracking.

## Appropriate Uses

Implement a stabilized construction entrance or vehicle tracking control where frequent heavy vehicle traffic exits the construction site onto a paved roadway. An effective vehicle tracking control is particularly important during the following conditions:

- Wet weather periods when mud is easily tracked off site.
- During dry weather periods where dust is a concern.
- When poorly drained, clayey soils are present on site.

Although wheel washes are not required in designs of vehicle tracking controls, they may be needed at particularly muddy sites.

## Design and Installation

Construct the vehicle tracking control on a level surface. Where feasible, grade the tracking control towards the construction site to reduce off-site runoff. Place signage, as needed, to direct construction vehicles to the designated exit through the vehicle tracking control. There are several different types of stabilized construction entrances including:

**VTC-1. Aggregate Vehicle Tracking Control.** This is a coarse-aggregate surfaced pad underlain by a geotextile. This is the most common vehicle tracking control, and when properly maintained can be effective at removing sediment from vehicle tires.

**VTC-2. Vehicle Tracking Control with Construction Mat or Turf Reinforcement Mat.** This type of control may be appropriate for site access at very small construction sites with low traffic volume over vegetated areas. Although this application does not typically remove sediment from vehicles, it helps protect existing vegetation and provides a stabilized entrance.

<b>Vehicle Tracking Control</b>	
<b>Functions</b>	
Erosion Control	Moderate
Sediment Control	Yes
Site/Material Management	Yes

**VTC-3. Stabilized Construction Entrance/Exit with Wheel Wash.** This is an aggregate pad, similar to VTC-1, but includes equipment for tire washing. The wheel wash equipment may be as simple as hand-held power washing equipment to more advanced proprietary systems. When a wheel wash is provided, it is important to direct wash water to a sediment trap prior to discharge from the site.

Vehicle tracking controls are sometimes installed in combination with a sediment trap to treat runoff.

## Maintenance and Removal

Inspect the area for degradation and replace aggregate or material used for a stabilized entrance/exit as needed. If the area becomes clogged and ponds water, remove and dispose of excess sediment or replace material with a fresh layer of aggregate as necessary.

With aggregate vehicle tracking controls, ensure rock and debris from this area do not enter the public right-of-way.

Remove sediment that is tracked onto the public right of way daily or more frequently as needed. Excess sediment in the roadway indicates that the stabilized construction entrance needs maintenance.

Ensure that drainage ditches at the entrance/exit area remain clear.

A stabilized entrance should be removed only when there is no longer the potential for vehicle tracking to occur. This is typically after the site has been stabilized.

When wheel wash equipment is used, be sure that the wash water is discharged to a sediment trap prior to discharge. Also inspect channels conveying the water from the wash area to the sediment trap and stabilize areas that may be eroding.

When a construction entrance/exit is removed, excess sediment from the aggregate should be removed and disposed of appropriately. The entrance should be promptly stabilized with a permanent surface following removal, typically by paving.



**Photograph VTC-2.** A vehicle tracking control pad with wheel wash facility. Photo courtesy of Tom Gore.



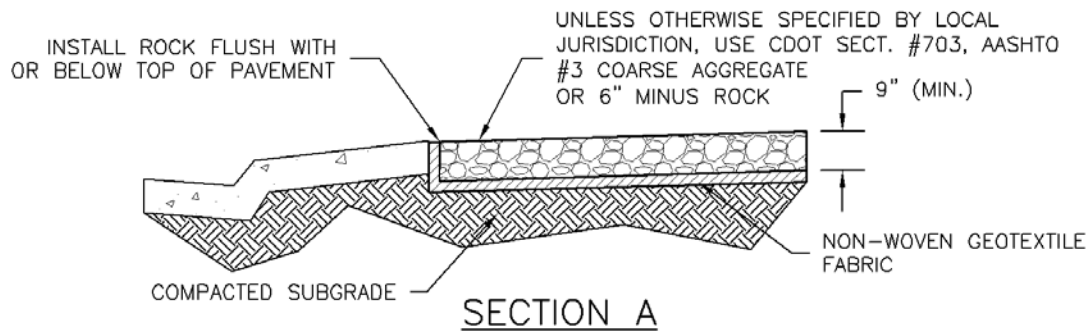
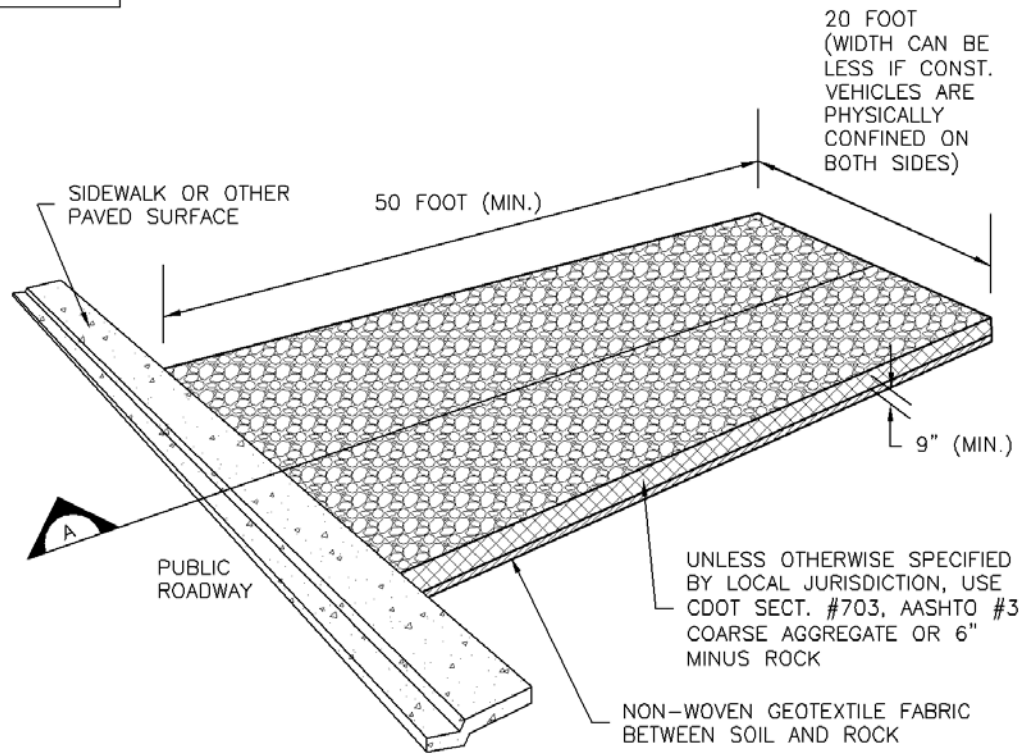
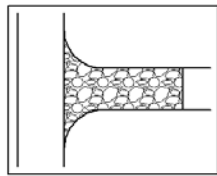

## VTC-1. AGGREGATE VEHICLE TRACKING CONTROL

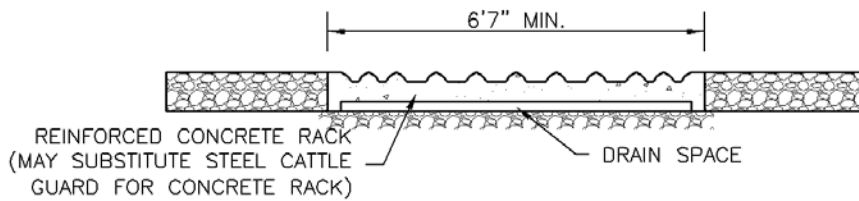
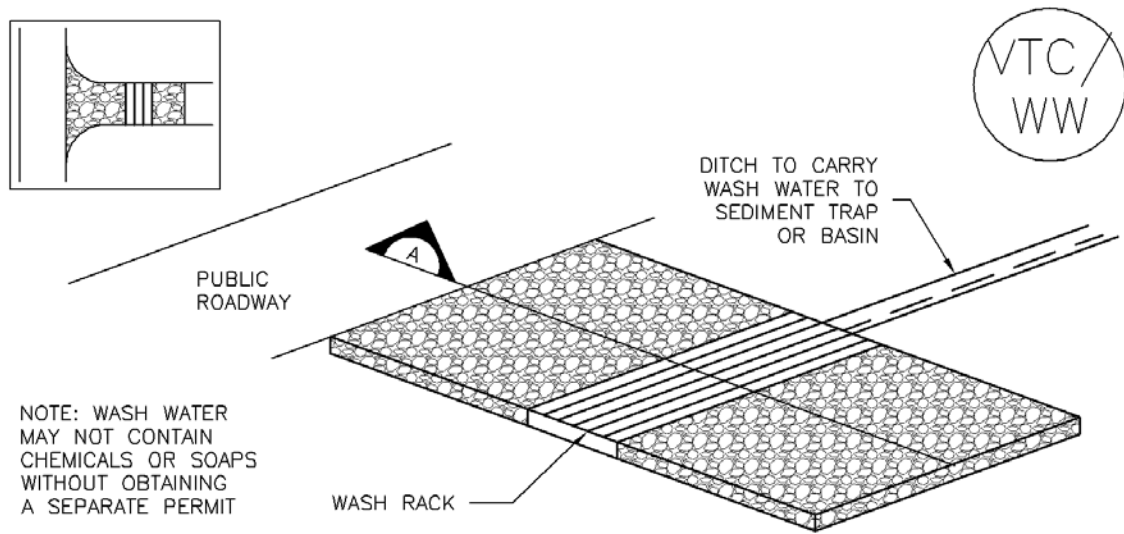

SECTION A

VTC-2. AGGREGATE VEHICLE TRACKING CONTROL WITH WASH RACK

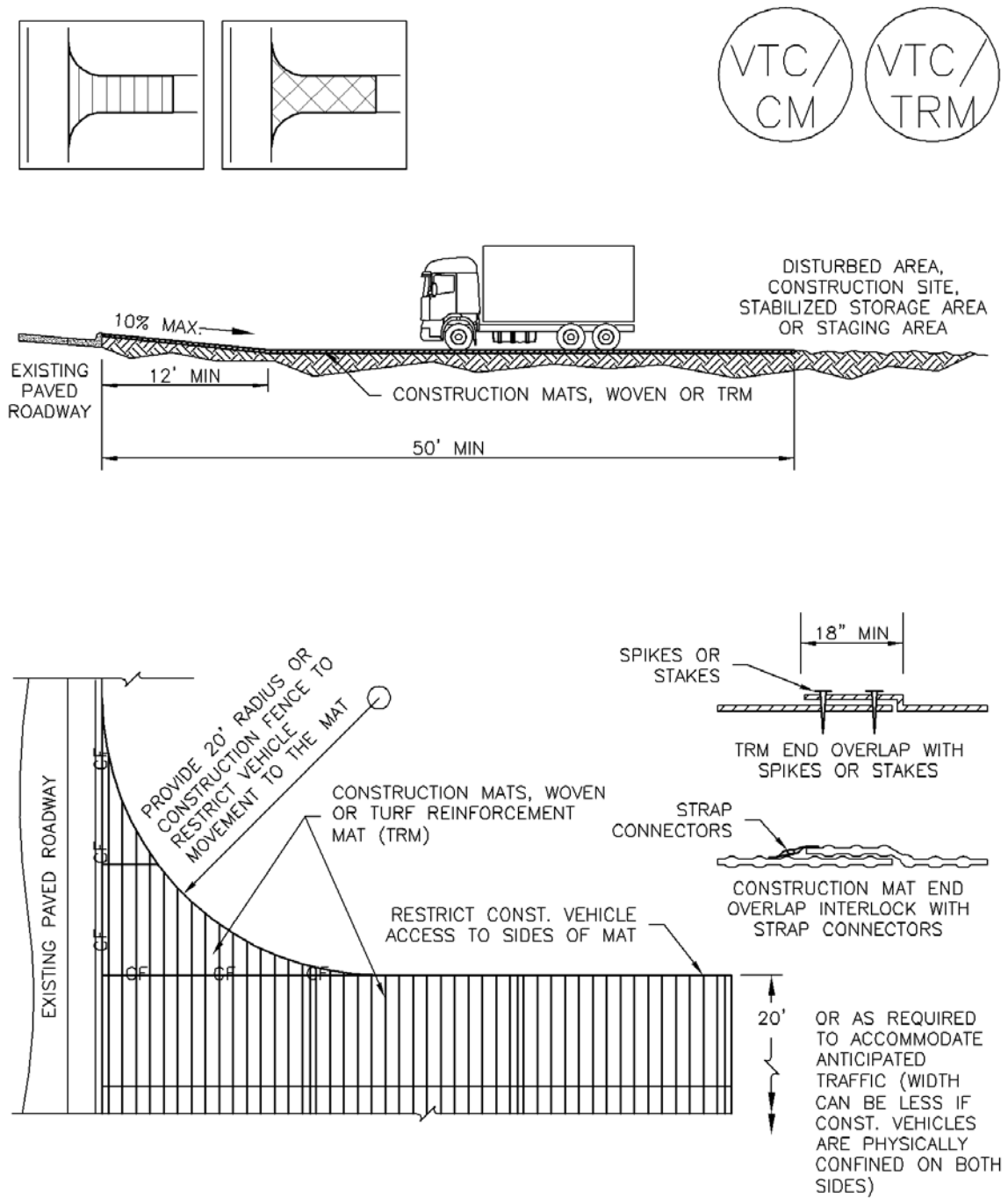

VTC-3. VEHICLE TRACKING CONTROL W/ CONSTRUCTION MAT OR TURF REINFORCEMENT MAT (TRM)

STABILIZED CONSTRUCTION ENTRANCE/EXIT INSTALLATION NOTES

1. SEE PLAN VIEW FOR
  - LOCATION OF CONSTRUCTION ENTRANCE(S)/EXIT(S).
  - TYPE OF CONSTRUCTION ENTRANCE(S)/EXITS(S) (WITH/WITHOUT WHEEL WASH, CONSTRUCTION MAT OR TRM).
2. CONSTRUCTION MAT OR TRM STABILIZED CONSTRUCTION ENTRANCES ARE ONLY TO BE USED ON SHORT DURATION PROJECTS (TYPICALLY RANGING FROM A WEEK TO A MONTH) WHERE THERE WILL BE LIMITED VEHICULAR ACCESS.
3. A STABILIZED CONSTRUCTION ENTRANCE/EXIT SHALL BE LOCATED AT ALL ACCESS POINTS WHERE VEHICLES ACCESS THE CONSTRUCTION SITE FROM PAVED RIGHT-OF-WAYS.
4. STABILIZED CONSTRUCTION ENTRANCE/EXIT SHALL BE INSTALLED PRIOR TO ANY LAND DISTURBING ACTIVITIES.
5. A NON-WOVEN GEOTEXTILE FABRIC SHALL BE PLACED UNDER THE STABILIZED CONSTRUCTION ENTRANCE/EXIT PRIOR TO THE PLACEMENT OF ROCK.
6. UNLESS OTHERWISE SPECIFIED BY LOCAL JURISDICTION, ROCK SHALL CONSIST OF DOT SECT. #703, AASHTO #3 COARSE AGGREGATE OR 6" (MINUS) ROCK.

STABILIZED CONSTRUCTION ENTRANCE/EXIT MAINTENANCE NOTES

1. INSPECT BMPs EACH WORKDAY, AND MAINTAIN THEM IN EFFECTIVE OPERATING CONDITION. MAINTENANCE OF BMPs SHOULD BE PROACTIVE, NOT REACTIVE. INSPECT BMPs AS SOON AS POSSIBLE (AND ALWAYS WITHIN 24 HOURS) FOLLOWING A STORM THAT CAUSES SURFACE EROSION, AND PERFORM NECESSARY MAINTENANCE.
2. FREQUENT OBSERVATIONS AND MAINTENANCE ARE NECESSARY TO MAINTAIN BMPs IN EFFECTIVE OPERATING CONDITION. INSPECTIONS AND CORRECTIVE MEASURES SHOULD BE DOCUMENTED THOROUGHLY.
3. WHERE BMPs HAVE FAILED, REPAIR OR REPLACEMENT SHOULD BE INITIATED UPON DISCOVERY OF THE FAILURE.
4. ROCK SHALL BE REAPPLIED OR REGRADED AS NECESSARY TO THE STABILIZED ENTRANCE/EXIT TO MAINTAIN A CONSISTENT DEPTH.
5. SEDIMENT TRACKED ONTO PAVED ROADS IS TO BE REMOVED THROUGHOUT THE DAY AND AT THE END OF THE DAY BY SHOVELING OR SWEEPING. SEDIMENT MAY NOT BE WASHED DOWN STORM SEWER DRAINS.

NOTE: MANY JURISDICTIONS HAVE BMP DETAILS THAT VARY FROM UDFCD STANDARD DETAILS. CONSULT WITH LOCAL JURISDICTIONS AS TO WHICH DETAIL SHOULD BE USED WHEN DIFFERENCES ARE NOTED.

(DETAILS ADAPTED FROM CITY OF BROOMFIELD, COLORADO, NOT AVAILABLE IN AUTOCAD)

## Description

Street sweeping and vacuuming remove sediment that has been tracked onto roadways to reduce sediment transport into storm drain systems or a surface waterway.

## Appropriate Uses

Use this practice at construction sites where vehicles may track sediment offsite onto paved roadways.

## Design and Installation

Street sweeping or vacuuming should be conducted when there is noticeable sediment accumulation on roadways adjacent to the construction site. Typically, this will be concentrated at the entrance/exit to the construction site. Well-maintained stabilized construction entrances, vehicle tracking controls and tire wash facilities can help reduce the necessary frequency of street sweeping and vacuuming.

On smaller construction sites, street sweeping can be conducted manually using a shovel and broom. Never wash accumulated sediment on roadways into storm drains.

## Maintenance and Removal

- Inspect paved roads around the perimeter of the construction site on a daily basis and more frequently, as needed. Remove accumulated sediment, as needed.
- Following street sweeping, check inlet protection that may have been displaced during street sweeping.
- Inspect area to be swept for materials that may be hazardous prior to beginning sweeping operations.



**Photograph SS-1.** A street sweeper removes sediment and potential pollutants along the curb line at a construction site. Photo courtesy of Tom Gore.

<b>Street Sweeping/ Vacuuming</b>	
<b>Functions</b>	
Erosion Control	No
Sediment Control	Yes
Site/Material Management	Yes



## Description

The BMPs selected for construction dewatering vary depending on site-specific features such as soils, topography, anticipated discharge quantities, and discharge location. Dewatering typically involves pumping water from an inundated area to a BMP, and then downstream to a receiving waterway, sediment basin, or well-vegetated area. Dewatering typically involves use of several BMPs in sequence.



**Photograph DW-1.** A relatively small dewatering operation using straw bales and a dewatering bag.

## Appropriate Uses

Dewatering operations are used when an area of the construction site needs to be dewatered as the result of a large storm event, groundwater, or existing ponding conditions. This can occur during deep excavation, utility trenching, and wetland or pond excavation.



**Photograph DW-2.** Dewatering bags used for a relatively large dewatering operation.

## Design and Installation

Dewatering techniques will vary depending on site conditions. However, all dewatering discharges must be treated to remove sediment before discharging from the construction site. Discharging water into a sediment trap or basin is an acceptable treatment option. Water may also be treated using a dewatering filter bag, and a series of straw bales or sediment logs. If these previous options are not feasible due to space or the ability to passively treat the discharge to remove sediment, then a settling tank or an active treatment system may need to be utilized. Settling tanks are manufactured tanks with a series of baffles to promote settling. Flocculants can also be added to the tank to induce more rapid settling. This is an approach sometimes used on highly urbanized construction sites. Contact the state agency for special requirements prior to using flocculents and land application techniques.

Some commonly used methods to handle the pumped water without surface discharge include land application to vegetated areas through a perforated discharge hose (i.e., the "sprinkler method") or dispersal from a water truck for dust control.

Dewatering Operations	
Functions	
Erosion Control	Moderate
Sediment Control	Yes
Site/Material Management	Yes

Dewatering discharges to non-paved areas must minimize the potential for scour at the discharge point either using a velocity dissipation device or dewatering filter bag.

Design Details are provided for these types of dewatering situations:

DW-1. Dewatering for Pond Already Filled with Water

DW-2 Dewatering Sump for Submersed Pump

DW-3 Sump Discharge Settling Basin

DW-4 Dewatering Filter Bag

## **Maintenance and Removal**

When a sediment basin or trap is used to enable settling of sediment from construction dewatering discharges, inspect the basin for sediment accumulation. Remove sediment prior to the basin or trap reaching half full. Inspect treatment facilities prior to any dewatering activity. If using a sediment control practice such as a sediment trap or basin, complete all maintenance requirements as described in the fact sheets prior to dewatering.

Properly dispose of used dewatering bags, as well as sediment removed from the dewatering BMPs. Depending on the size of the dewatering operation, it may also be necessary to revegetate or otherwise stabilize the area where the dewatering operation was occurring.

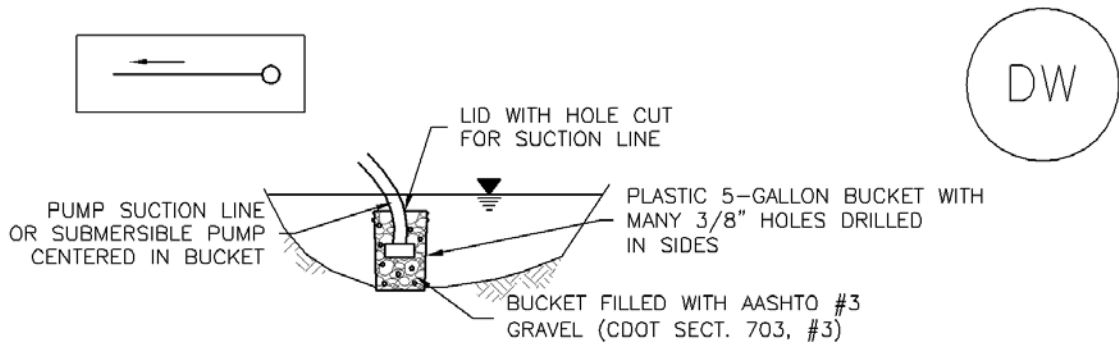

DW-1. DEWATERING POND ALREADY FILLED WITH WATER

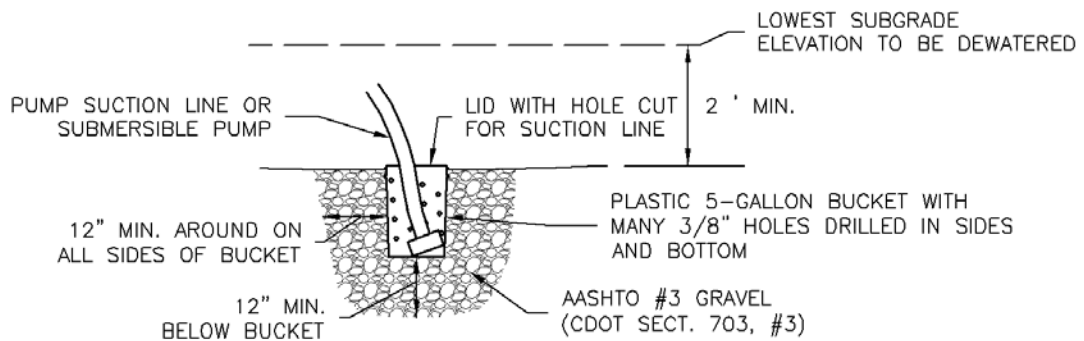

DW-2. DEWATERING SUMP FOR SUBMERSED PUMP

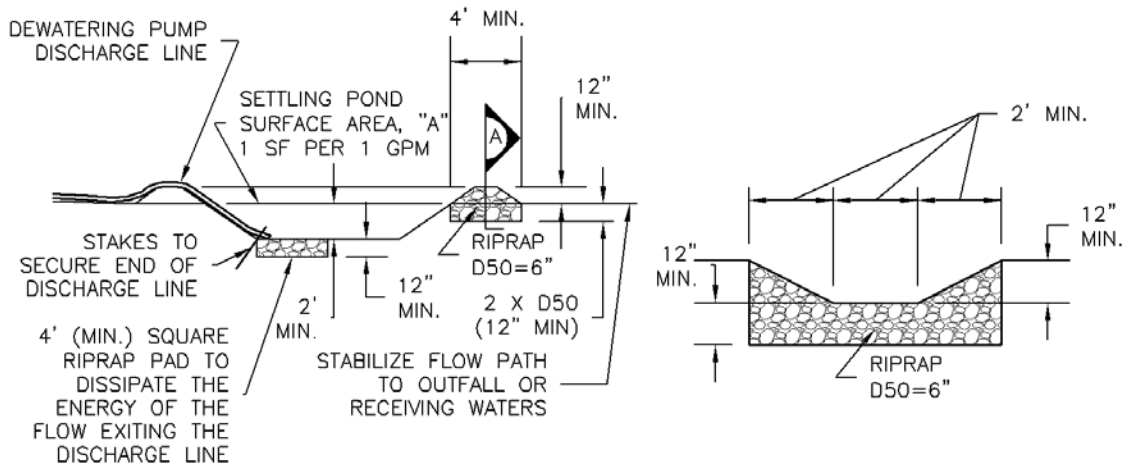

DW-3. SUMP DISCHARGE  
SETTLING BASIN

SETTLING BASIN  
SECTION A

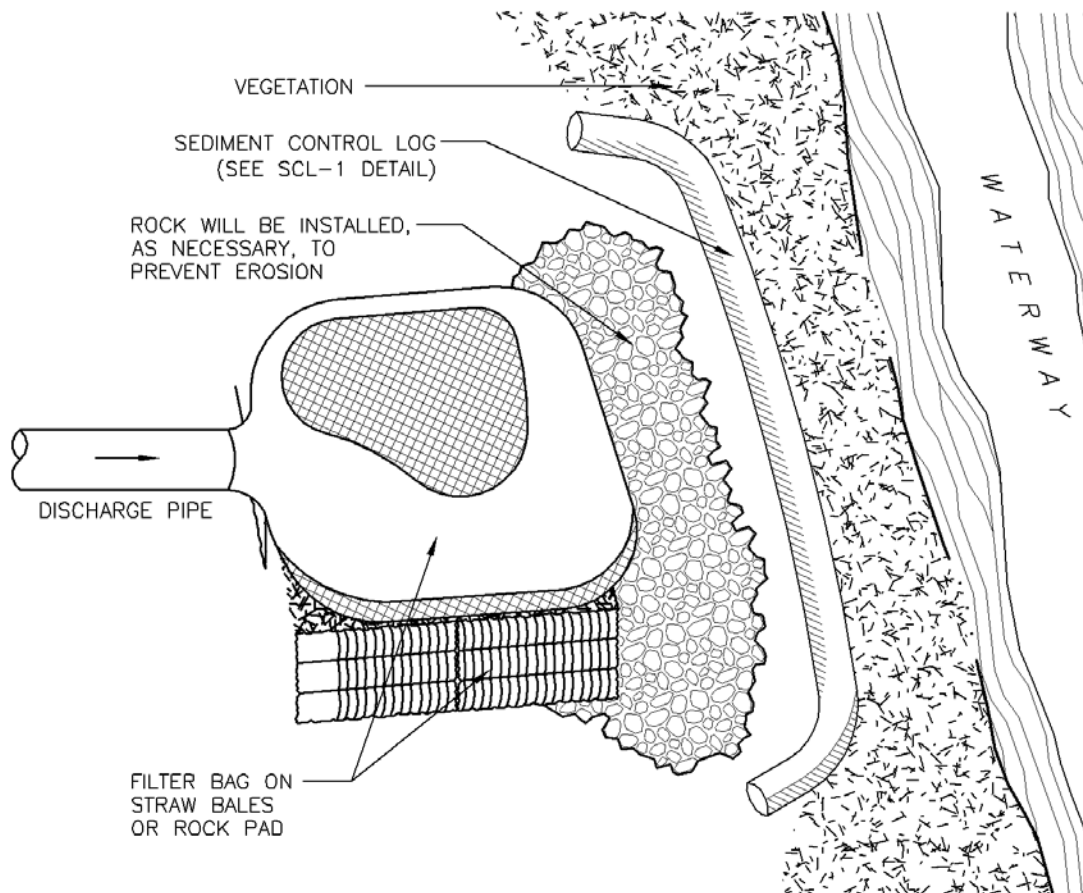

### DW-4. DEWATERING FILTER BAG

#### DEWATERING INSTALLATION NOTES

1. SEE PLAN VIEW FOR;
  - LOCATION OF DEWATERING EQUIPMENT.
  - TYPE OF DEWATERING OPERATION (DW-1 TO DW-4).
  
2. THE OWNER OR CONTRACTOR SHALL OBTAIN A CONSTRUCTION DISCHARGE (DEWATERING) PERMIT FROM THE STATE PRIOR TO ANY DEWATERING OPERATIONS DISCHARGING FROM THE SITE. ALL DEWATERING SHALL BE IN ACCORDANCE WITH THE REQUIREMENTS OF THE PERMIT.
  
3. THE OWNER OR OPERATOR SHALL PROVIDE, OPERATE, AND MAINTAIN DEWATERING SYSTEMS OF SUFFICIENT SIZE AND CAPACITY TO PERMIT EXCAVATION AND SUBSEQUENT CONSTRUCTION IN DRY CONDITIONS AND TO LOWER AND MAINTAIN THE GROUNDWATER LEVEL A MINIMUM OF 2-FEET BELOW THE LOWEST POINT OF EXCAVATION AND CONTINUOUSLY MAINTAIN EXCAVATIONS FREE OF WATER UNTIL BACK-FILLED TO FINAL GRADE.

## DEWATERING INSTALLATION NOTES

4. DEWATERING OPERATIONS SHALL USE ONE OR MORE OF THE DEWATERING SUMPS SHOWN ABOVE, WELL POINTS, OR OTHER MEANS APPROVED BY THE LOCAL JURISDICTION TO REDUCE THE PUMPING OF SEDIMENT, AND SHALL PROVIDE A TEMPORARY SEDIMENT BASIN OR FILTRATION BMP TO REDUCE SEDIMENT TO ALLOWABLE LEVELS PRIOR TO RELEASE OFF SITE OR TO A RECEIVING WATER. A SEDIMENT BASIN MAY BE USED IN LIEU OF SUMP DISCHARGE SETTLING BASIN SHOWN ABOVE IF A 4-FOOT-SQUARE RIPRAP PAD IS PLACED AT THE DISCHARGE POINT AND THE DISCHARGE END OF THE LINE IS STAKED IN PLACE TO PREVENT MOVEMENT OF THE LINE.

## DEWATERING MAINTENANCE NOTES

1. INSPECT BMPs EACH WORKDAY, AND MAINTAIN THEM IN EFFECTIVE OPERATING CONDITION. MAINTENANCE OF BMPs SHOULD BE PROACTIVE, NOT REACTIVE. INSPECT BMPs AS SOON AS POSSIBLE (AND ALWAYS WITHIN 24 HOURS) FOLLOWING A STORM THAT CAUSES SURFACE EROSION, AND PERFORM NECESSARY MAINTENANCE.

2. FREQUENT OBSERVATIONS AND MAINTENANCE ARE NECESSARY TO MAINTAIN BMPs IN EFFECTIVE OPERATING CONDITION. INSPECTIONS AND CORRECTIVE MEASURES SHOULD BE DOCUMENTED THOROUGHLY.

3. WHERE BMPs HAVE FAILED, REPAIR OR REPLACEMENT SHOULD BE INITIATED UPON DISCOVERY OF THE FAILURE.

4. DEWATERING BMPs ARE REQUIRED IN ADDITION TO ALL OTHER PERMIT REQUIREMENTS.

5. TEMPORARY SETTLING BASINS SHALL BE REMOVED WHEN NO LONGER NEEDED FOR DEWATERING OPERATIONS. ANY DISTURBED AREA SHALL BE COVERED WITH TOPSOIL, SEEDED AND MULCHED OR OTHERWISE STABILIZED IN A MANNER APPROVED BY THE LOCAL JURISDICTION.

NOTE: MANY JURISDICTIONS HAVE BMP DETAILS THAT VARY FROM UDFCD STANDARD DETAILS. CONSULT WITH LOCAL JURISDICTIONS AS TO WHICH DETAIL SHOULD BE USED WHEN DIFFERENCES ARE NOTED.

(DETAILS ADAPTED FROM DOUGLAS COUNTY, COLORADO, NOT AVAILABLE IN AUTOCAD)



## Description

Where an actively flowing watercourse must be crossed regularly by construction vehicles, a temporary crossing should be provided. Three primary methods are available:

- Culvert crossing
- Stream ford
- Temporary bridge

Culvert crossings and fords are the most commonly used methods. Due to the expense associated with a temporary bridge, these are used primarily on long-term projects.



**Photograph TSC-1.** A temporary stream crossing using culverts. Photo courtesy of Tom Gore.

## Appropriate Uses

Construction vehicles shall be kept out of waterways to the maximum extent practicable. Use a temporary stream crossing when it is absolutely necessary to cross a stream on a construction site. Construct a temporary crossing even if the stream or drainageway is typically dry. Multiple stream crossings should be avoided to minimize environmental impacts.

A permit is required for placement of fill in a waterway under Section 404 of the Clean Water Act. The local office of the U.S. Army Corps of Engineers (USACE) should be contacted concerning the requirements for obtaining a 404 permit. In addition, a permit from the U.S. Fish and Wildlife Service (USFWS) may be needed if endangered species are of concern in the work area. Typically, the USFWS issues are addressed by a 404 permit, if one is required. The municipality of jurisdiction should also be consulted, and can provide assistance. Other permits to be obtained may include a floodplain development permit from the local jurisdiction.

## Design and Installation

Design details are provided for these types of stream crossings:

TSC-1. Culvert Crossing

TSC-2. Ford Crossing

TSC-3. Flume Crossing

Temporary Stream Crossing	
Functions	
Erosion Control	Yes
Sediment Control	Yes
Site/Material Management	No

A culvert crossing should be sized appropriately with consideration for the duration of construction and seasonal variation of flows. The sizing methodology provided in the Temporary Diversion Methods Fact Sheet is also appropriate for determining the design flow for temporary stream crossings. Culvert sizing must account for the headwater and tailwater controls to properly size the culvert. For additional discussion on design of box culverts and pipes, see the *Major Drainage* chapter in Volume 1. The designer also needs to confirm that the riprap selected is appropriate for the conditions in the channel being crossed.

When a ford must be used, namely when a culvert is not practical or the best solution, the ford should be lined with at least a 12-inch thick layer of Type VL ( $D_{50} = 6$  inches) or Type L ( $D_{50} = 9$  inches) riprap with void spaces filled with 1-1/2 inch diameter rock. Ford crossings are recommended primarily for crossings of ephemeral (i.e. intermittently, briefly flowing) streams.

For a temporary bridge crossing, consult with a structural and/or geotechnical engineer for temporary bridge design or consider pre-fabricated alternatives.

## **Maintenance and Removal**

Inspect stream for bank erosion and in-stream degradation. If bank erosion is occurring, stabilize banks using erosion control practices such as erosion control blankets. If in-stream degradation is occurring, armor the culvert outlet(s) with riprap to dissipate energy. If sediment is accumulating upstream of the crossing, remove excess sediment as needed to maintain the functionality of the crossing.

Remove the temporary crossing when it is no longer needed for construction. Take care to minimize the amount of sediment lost into the stream upon removal. Once the crossing has been removed, stabilize the stream banks with seed and erosion control blankets.

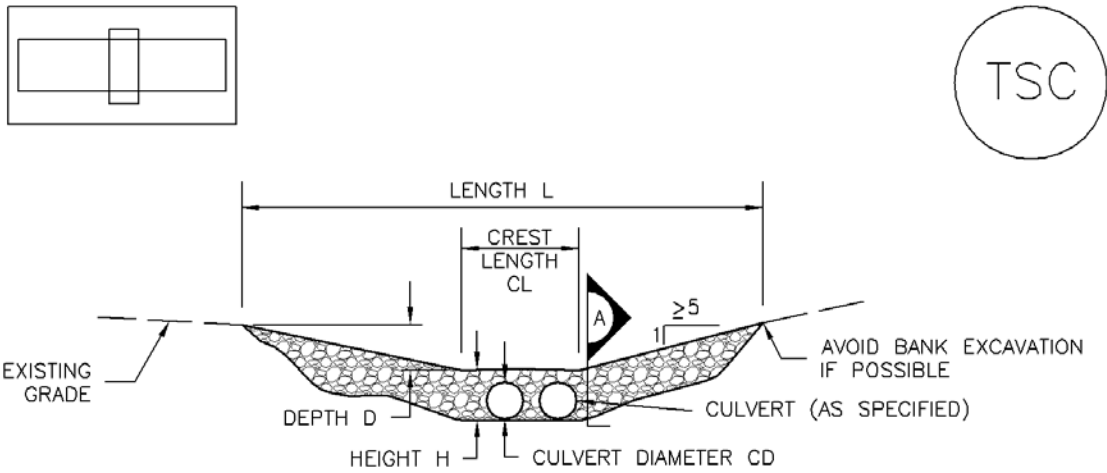

CULVERT CROSSING SECTION

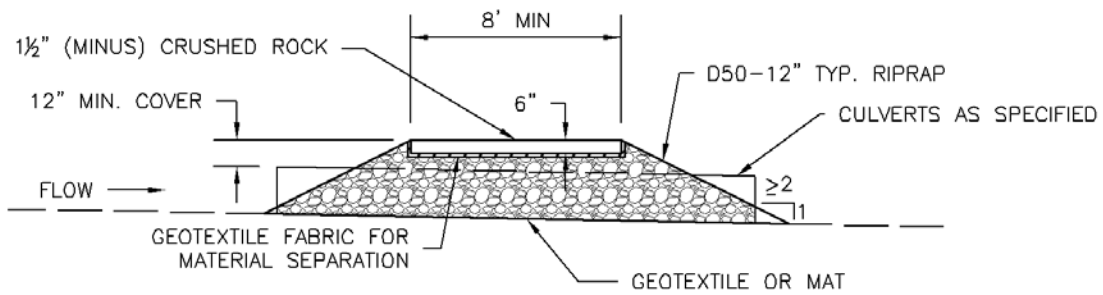

SECTION A

TSC-1. CULVERT CROSSING

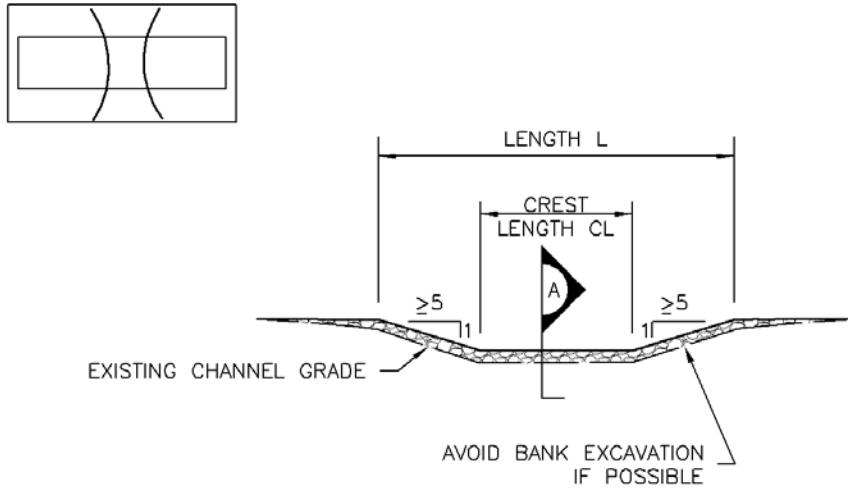

FORD CROSSING SECTION

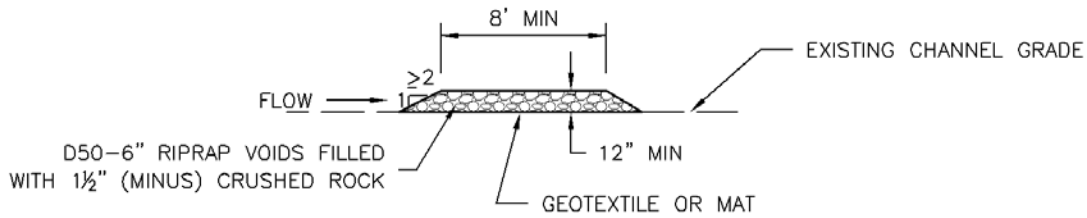

SECTION A

TSC-2. FORD CROSSING

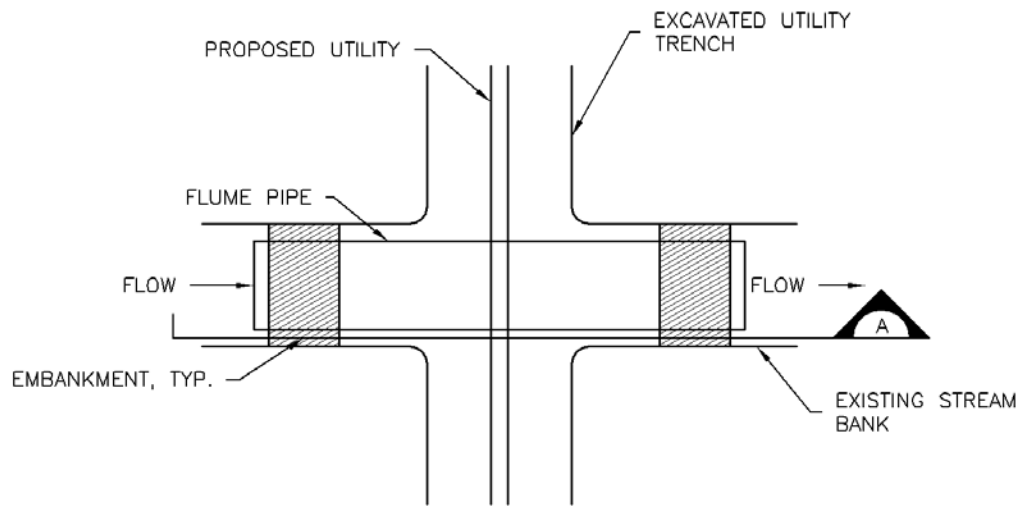
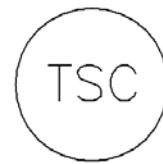

FLUME CROSSING PLAN

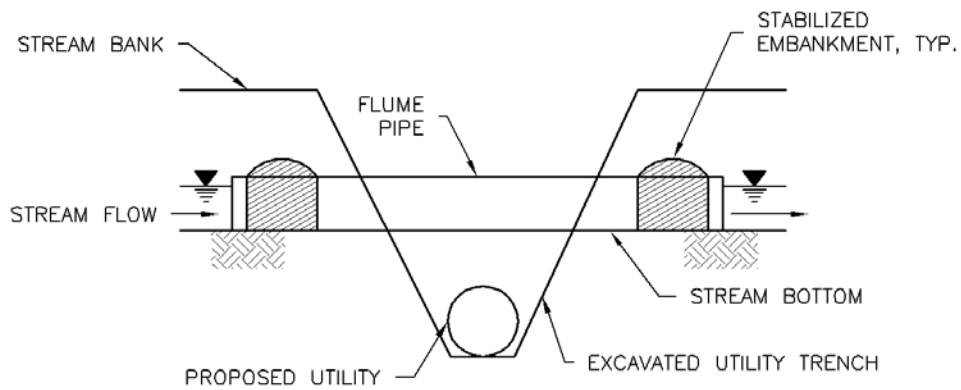

SECTION A

## TSC-3. FLUME CROSSING



TEMPORARY STREAM CROSSING INSTALLATION NOTES

1. SEE PLAN VIEW FOR:
  - LOCATIONS OF TEMPORARY STREAM CROSSINGS.
  - STREAM CROSSING TYPE (FORD, CULVERT, OR FLUME).
  - FOR FORD CROSSING: LENGTH (L), CREST LENGTH (CL), AND DEPTH (D).
  - FOR CULVERT CROSSING: LENGTH (L), CREST LENGTH (CL), CROSSING HEIGHT (H), DEPTH (D), CULVERT DIAMETER (CD), AND NUMBER, TYPE AND CLASS OR GAUGE OF CULVERTS.
2. TEMPORARY STREAM CROSSING DIMENSIONS, D50, AND NUMBER OF CULVERTS INDICATED (FOR CULVERT CROSSING) SHALL BE CONSIDERED MINIMUM DIMENSIONS; ENGINEER MAY ELECT TO INSTALL LARGER FACILITIES. ANY DAMAGE TO STREAM CROSSING OR EXISTING STREAM CHANNEL DURING BASEFLOW OR FLOOD EVENTS SHALL BE PROMPTLY REPAIRED.
3. SEE MAJOR DRAINAGE CHAPTER FOR RIPRAP GRADATIONS.
4. WHERE FAILURE OF A STREAM CROSSING CAN RESULT IN SIGNIFICANT DAMAGE OR HARM IT MUST BE DESIGNED BY A STRUCTURAL ENGINEER.

TEMPORARY STREAM CROSSING MAINTENANCE NOTES

1. INSPECT BMPs EACH WORKDAY, AND MAINTAIN THEM IN EFFECTIVE OPERATING CONDITION. MAINTENANCE OF BMPs SHOULD BE PROACTIVE, NOT REACTIVE. INSPECT BMPs AS SOON AS POSSIBLE (AND ALWAYS WITHIN 24 HOURS) FOLLOWING A STORM THAT CAUSES SURFACE EROSION, AND PERFORM NECESSARY MAINTENANCE.
2. FREQUENT OBSERVATIONS AND MAINTENANCE ARE NECESSARY TO MAINTAIN BMPs IN EFFECTIVE OPERATING CONDITION. INSPECTIONS AND CORRECTIVE MEASURES SHOULD BE DOCUMENTED THOROUGHLY.
3. WHERE BMPs HAVE FAILED, REPAIR OR REPLACEMENT SHOULD BE INITIATED UPON DISCOVERY OF THE FAILURE.
4. REMOVE SEDIMENT ACCUMULATED UPSTREAM OF CROSSING AS NEEDED TO MAINTAIN THE FUNCTIONALITY OF THE CROSSING.
5. STREAM CROSSINGS ARE TO REMAIN IN PLACE UNTIL NO LONGER NEEDED AND SHALL BE REMOVED PRIOR TO THE END OF CONSTRUCTION.
6. WHEN STREAM CROSSINGS ARE REMOVED, THE DISTURBED AREA SHALL BE COVERED WITH TOPSOIL, SEEDED AND MULCHED AND COVERED WITH GEOTEXTILE OR OTHERWISE STABILIZED IN A MANNER APPROVED BY THE LOCAL JURISDICTION.

NOTE: MANY JURISDICTIONS HAVE BMP DETAILS THAT VARY FROM UDFCD STANDARD DETAILS. CONSULT WITH LOCAL JURISDICTIONS AS TO WHICH DETAIL SHOULD BE USED WHEN DIFFERENCES ARE NOTED.

(DETAIL ADAPTED FROM DOUGLAS COUNTY, COLORADO AND CITY OF AURORA, COLORADO (Vg. DSWC), NOT AVAILABLE IN AUTOCAD)

## Description

Outlet protection helps to reduce erosion immediately downstream of a pipe, culvert, slope drain, rundown or other conveyance with concentrated, high-velocity flows. Typical outlet protection consists of riprap or rock aprons at the conveyance outlet.



**Photograph TOP-1.** Riprap outlet protection.

## Appropriate Uses

Outlet protection should be used when a conveyance discharges onto a disturbed area where there is potential for accelerated erosion due to concentrated flow. Outlet protection should be provided where the velocity at the culvert outlet exceeds the maximum permissible velocity of the material in the receiving channel.

**Note:** This Fact Sheet and detail are for temporary outlet protection, outlets that are intended to be used for less than 2 years. For permanent, long-term outlet protection, see the *Major Drainage* chapter of Volume 1.

## Design and Installation

Design outlet protection to handle runoff from the largest drainage area that may be contributing runoff during construction (the drainage area may change as a result of grading). Key in rock, around the entire perimeter of the apron, to a minimum depth of 6 inches for stability. Extend riprap to the height of the culvert or the normal flow depth of the downstream channel, whichever is less. Additional erosion control measures such as vegetative lining, turf reinforcement mat and/or other channel lining methods may be required downstream of the outlet protection if the channel is susceptible to erosion. See Design Detail OP-1 for additional information.

## Maintenance and Removal

Inspect apron for damage and displaced rocks. If rocks are missing or significantly displaced, repair or replace as necessary. If rocks are continuously missing or displaced, consider increasing the size of the riprap or deeper keying of the perimeter.

Remove sediment accumulated at the outlet before the outlet protection becomes buried and ineffective. When sediment accumulation is noted, check that upgradient BMPs, including inlet protection, are in effective operating condition.

Outlet protection may be removed once the pipe is no longer draining an upstream area, or once the downstream area has been sufficiently stabilized. If the drainage pipe is permanent, outlet protection can be left in place; however, permanent outlet protection should be designed and constructed in accordance with the requirements of the *Major Drainage* chapter of Volume 2.

Outlet Protection	
Functions	
Erosion Control	Yes
Sediment Control	Moderate
Site/Material Management	No

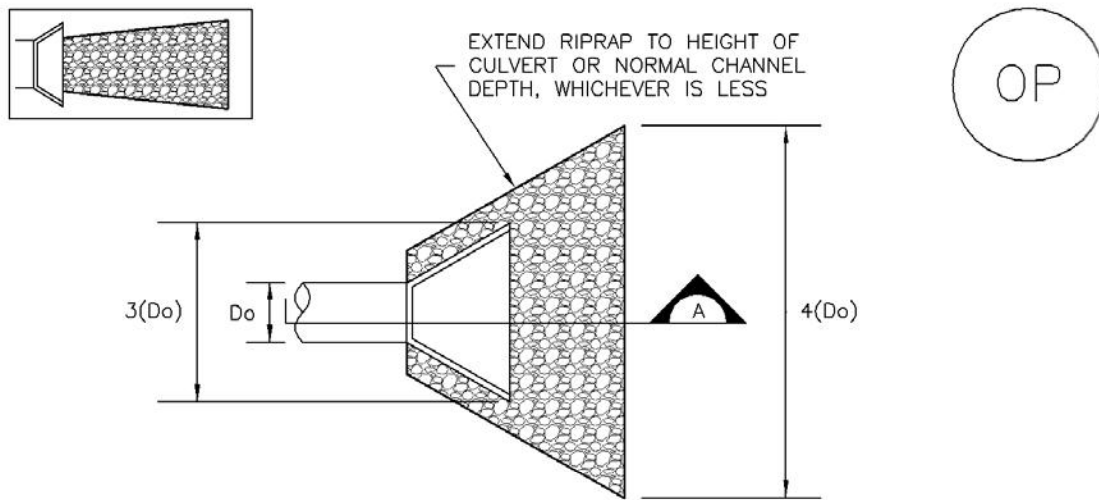

TEMPORARY OUTLET PROTECTION PLAN

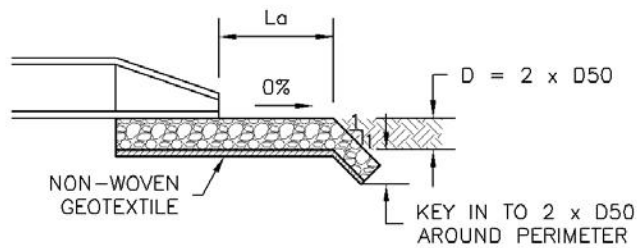

SECTION A

TABLE OP-1. TEMPORARY OUTLET PROTECTION SIZING TABLE			
PIPE DIAMETER, D <sub>o</sub> (INCHES)	DISCHARGE, Q (CFS)	APRON LENGTH, L <sub>a</sub> (FT)	RIPRAP D50 DIAMETER MIN (INCHES)
8	2.5	5	4
	5	10	6
12	5	10	4
	10	13	6
18	10	10	6
	20	16	9
	30	23	12
24	40	26	16
	30	16	9
	40	26	9
	50	26	12
	60	30	16

OP-1. TEMPORARY OUTLET PROTECTION

## TEMPORARY OUTLET PROTECTION INSTALLATION NOTES

1. SEE PLAN VIEW FOR
  - LOCATION OF OUTLET PROTECTION.
  - DIMENSIONS OF OUTLET PROTECTION.
2. DETAIL IS INTENDED FOR PIPES WITH SLOPE  $\leq$  10%. ADDITIONAL EVALUATION OF RIPRAP SIZING AND OUTLET PROTECTION DIMENSIONS REQUIRED FOR STEEPER SLOPES.
3. TEMPORARY OUTLET PROTECTION INFORMATION IS FOR OUTLETS INTENDED TO BE UTILIZED LESS THAN 2 YEARS.

## TEMPORARY OUTLET PROTECTION INSPECTION AND MAINTENANCE NOTES

1. INSPECT BMPs EACH WORKDAY, AND MAINTAIN THEM IN EFFECTIVE OPERATING CONDITION. MAINTENANCE OF BMPs SHOULD BE PROACTIVE, NOT REACTIVE. INSPECT BMPs AS SOON AS POSSIBLE (AND ALWAYS WITHIN 24 HOURS) FOLLOWING A STORM THAT CAUSES SURFACE EROSION, AND PERFORM NECESSARY MAINTENANCE.
2. FREQUENT OBSERVATIONS AND MAINTENANCE ARE NECESSARY TO MAINTAIN BMPs IN EFFECTIVE OPERATING CONDITION. INSPECTIONS AND CORRECTIVE MEASURES SHOULD BE DOCUMENTED THOROUGHLY.
3. WHERE BMPs HAVE FAILED, REPAIR OR REPLACEMENT SHOULD BE INITIATED UPON DISCOVERY OF THE FAILURE.

NOTE: MANY JURISDICTIONS HAVE BMP DETAILS THAT VARY FROM UDFCD STANDARD DETAILS. CONSULT WITH LOCAL JURISDICTIONS AS TO WHICH DETAIL SHOULD BE USED WHEN DIFFERENCES ARE NOTED.

(DETAILS ADAPTED FROM AURORA, COLORADO AND PREVIOUS VERSION OF VOLUME 3, NOT AVAILABLE IN AUTOCAD)

**> DANDY BAG® <**

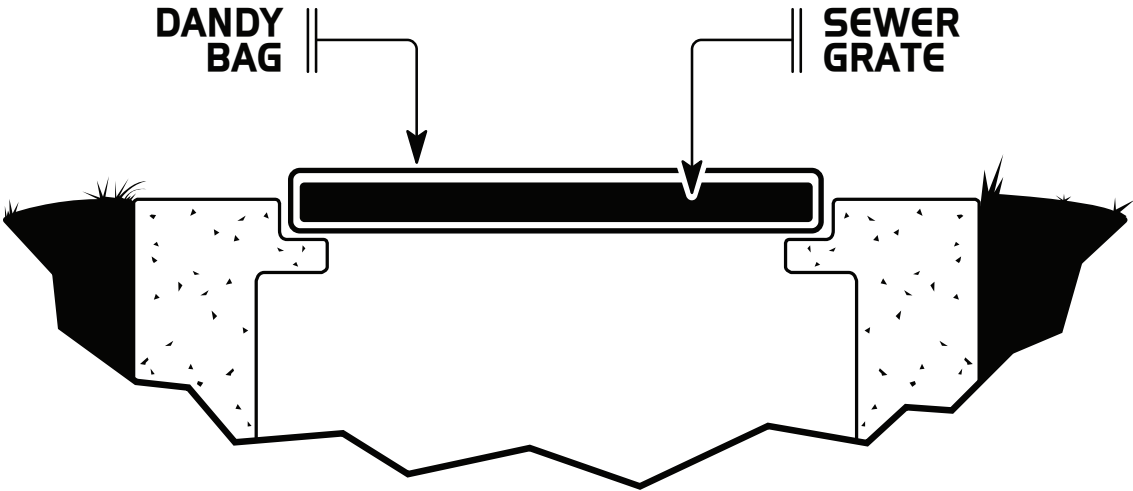
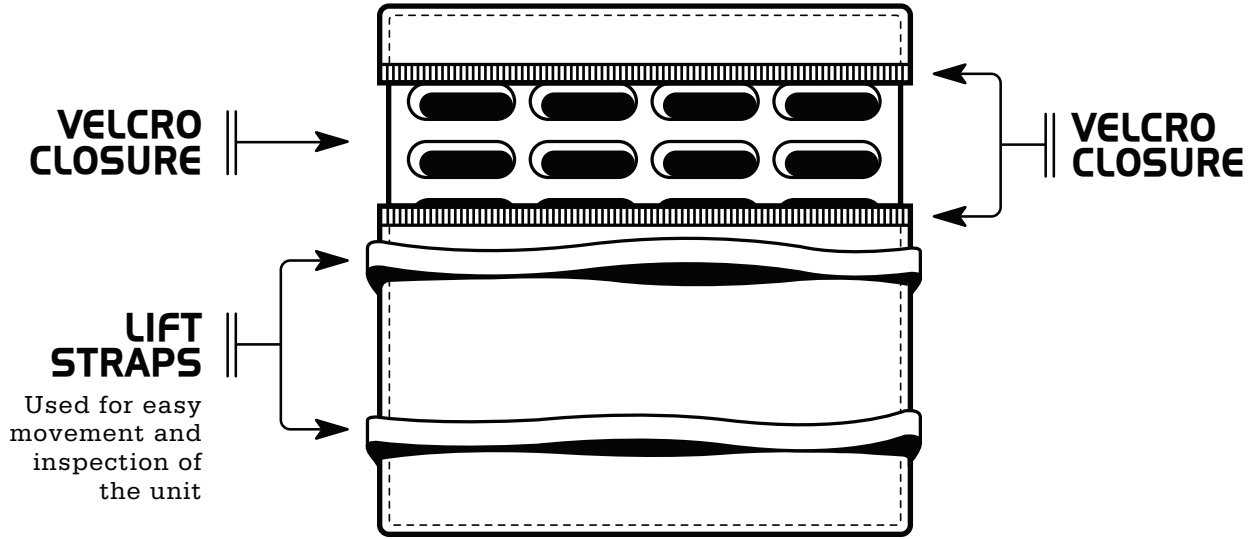



# DANDY BAG®

## INLET PROTECTION SYSTEM GUIDE SPECIFICATION

PRODUCT:

DANDY BAG®

MANUFACTURER:

Dandy Products Inc.  
P.O. Box 1980  
Westerville, Ohio 43086  
Phone: 800-591-2284  
Fax: 740-881-2791  
E mail [dlc@dandyproducts.com](mailto:dlc@dandyproducts.com)  
Web [www.dandyproducts.com](http://www.dandyproducts.com)

### 1.0 Description:

1.1 Work covered under this item consists of installing a Dandy Bag® inlet protection system. The purpose is to keep silt, sediment and construction debris out of the storm water system.

### 2.0 Material:

2.1 The Dandy Bag® inlet protection unit shall be a **sewn in the U.S.A.** geotextile fabric unit fitted to the individual grate(s) and completely enclosing the grate(s).

2.2 The Dandy Bag® shall have lifting devices to allow manual inspection of the storm water system.

2.3 The Dandy Bag® unit shall utilize an orange monofilament fabric manufactured in the U.S.A. with the following characteristics:

PROPERTY	TEST METHOD	UNITS	TEST RESULTS
Grab Tensile Strength	ASTM D 4632	lbs	450 X 300
Elongation	ASTM D 4632	%	40% X 25%
Puncture Strength	ASTM D 4833	lbs	130
Mullen Burst Strength	ASTM D 3786	psi	600
Trapezoid Tear Strength	ASTM D 4533	lbs	165 x 150
% Open Area (POA)	COE - 22125-86	%	28
Apparent Opening Size	ASTM D 4751	US Std Sieve	30
Permittivity	ASTM D 4491	sec <sup>1</sup>	3.5
Permeability	ASTM 4491	cm/sec	0.25
Water Flow Rate	ASTM 4491	gal/min/ft <sup>2</sup>	250
Ultraviolet Resistance	ASTM D 4355	%	70
Color			Orange <sup>1</sup>

<sup>1</sup>The color orange is a trademark of Dandy Products, Inc.

The property values listed above are effective October 2010 and are subject to change without notice.

**3.0 Installation:**

- 3.1 Place the empty Dandy Bag® over the grate as the grate stands on end.
- 3.2 *For oil and sediment model; to install or replace absorbent, place absorbent pillow in pouch, on the bottom (below-grade side) of the unit.*
- 3.3 Tuck the enclosure flap inside to completely enclose the grate.
- 3.4 Holding the lifting devices, insert the grate into the inlet being careful not to damage the Dandy Bag® unit.

**4.0 Maintenance:**

- 4.1 The contractor shall remove all accumulated sediment and debris from surface and vicinity of unit after each rain event or as directed by engineer/inspector. Dispose of unit no longer in use at an appropriate recycling or solid waste facility.
- 4.2 *For oil and sediment model; remove and replace absorbent when near saturation.*

**5.0 Method of Measurement:**

- 5.1 The quantity to be paid is for the actual number of Dandy Bag® inlet protection units installed

**6.0 Basis of Payment:**

- 6.1 The unit price shall include labor, equipment, and materials necessary to complete the work and maintain the Dandy Bag® inlet protection units.
- 6.2 Payment for the completed work will be made at the contract prices for:

<u>ITEM</u>	<u>UNIT</u>	<u>DESCRIPTION</u>
Dandy Bag®	EA	Inlet Protection Unit (# _____ Inlet)

**DANDY SACK™**

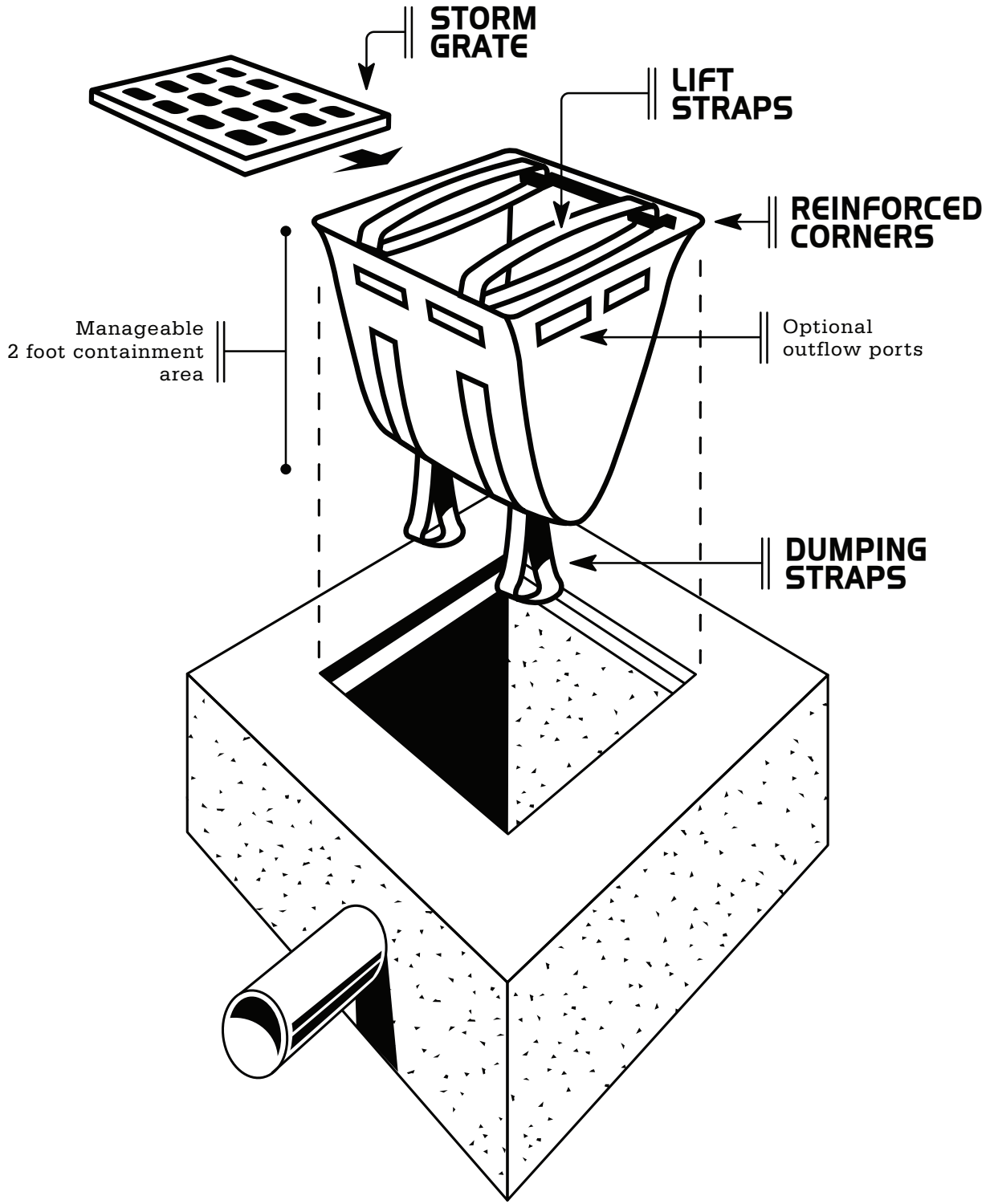

# DANDY SACK®

## INLET PROTECTION SYSTEM GUIDE SPECIFICATION

PRODUCT:

DANDY SACK®

MANUFACTURER:

Dandy Products Inc.  
P.O. Box 1980  
Westerville, Ohio 43086  
Phone: 800-591-2284  
Fax: 740-881-2791  
E mail [dlc@dandyproducts.com](mailto:dlc@dandyproducts.com)  
Web [www.dandyproducts.com](http://www.dandyproducts.com)

### 1.0 Description:

1.1 Work covered under this item consists of installing a Dandy Sack® inlet protection system. The purpose is to keep silt, sediment and construction debris out of the storm water system.

### 2.0 Material:

2.1 The Dandy Sack® inlet protection unit shall be a **sewn in the U.S.A.** geotextile fabric unit.

2.2 The Dandy Sack® shall have lifting straps to allow removal of the unit and manual inspection of the storm water system.

2.3 The Dandy Sack® unit shall utilize an orange monofilament fabric that is manufactured in the U.S.A. with the following characteristics:

PROPERTY	TEST METHOD	UNITS	TEST RESULTS
Grab Tensile Strength	ASTM D 4632	lbs	450 x 300
Grab Tensile Elongation	ASTM D 4632	%	40 x 25
Puncture Strength	ASTM D 4833	lbs	130
Mullen Burst Strength	ASTM D 3786	psi	600
Trapezoid Tear Strength	ASTM D 4533	lbs	165 x 150
% Open Area (POA)	COE - 22125-86	%	28
Apparent Opening Size	ASTM D 4751	US Std Sieve	30
Permittivity	ASTM D 4491	sec <sup>1</sup>	3.5
Permeability	ASTM 4491	cm/sec	0.25
Water Flow Rate	ASTM 4491	gal/min/ft <sup>2</sup>	250
Ultraviolet Resistance	ASTM D 4355	%	70
Color			Orange <sup>1</sup>

<sup>1</sup>The color orange is a trademark of Dandy Products, Inc.

The property values listed above are effective October 2010 and are subject to change without notice.

**3.0 Installation:**

- 3.1 Remove the grate from the catch basin.
- 3.2 *For Oil and Sediment Model; to install or replace absorbent, place absorbent pillow in unit, on the bottom (below-grade side) of the unit.*
- 3.3 Stand the grate on end. Move the top lifting straps out of the way and place the grate into the Dandy Sack® unit so that the grate is below the top straps and above the lower straps. The grate should be cradled between the upper and lower straps.
- 3.4 Holding the lifting devices, insert the grate into the inlet, being careful that the grate remains in place and being careful not to damage the Dandy Sack® unit.

**4.0 Maintenance:**

- 4.1 Remove all accumulated sediment and debris from vicinity of unit after each storm event.
- 4.2 After each storm event and at regular intervals, look into the Dandy Sack® unit. If the unit is more than 1/3 full of accumulated sediment, the unit must be emptied.
- 4.3 To empty the unit, using the lifting straps lift the unit out of the inlet and remove the grate. Transport the unit to an appropriate location for removal of the contents. Holding the dumping straps on the outside at the bottom of the unit, turn the unit upside down, emptying the contents. Reinstall unit as above.
- 4.4 *For Oil and Sediment Model; remove and replace absorbent when near saturation.*
- 4.5 Dispose of unit and/or absorbent in accord with applicable Federal, state and local environmental laws and regulations.

**5.0 Method of Measurement:**

- 5.1 The quantity to be paid is for the actual number of Dandy Sack® inlet protection units installed

**6.0 Basis of Payment:**

- 6.1 The unit price shall include labor, equipment, and materials necessary to complete the work and maintain the Dandy Sack® inlet protection units.
- 6.2 Payment for the completed work will be made at the contract prices for:

<u>ITEM</u>	<u>UNIT</u>	<u>DESCRIPTION</u>
Dandy Sack®	EA	Inlet Protection



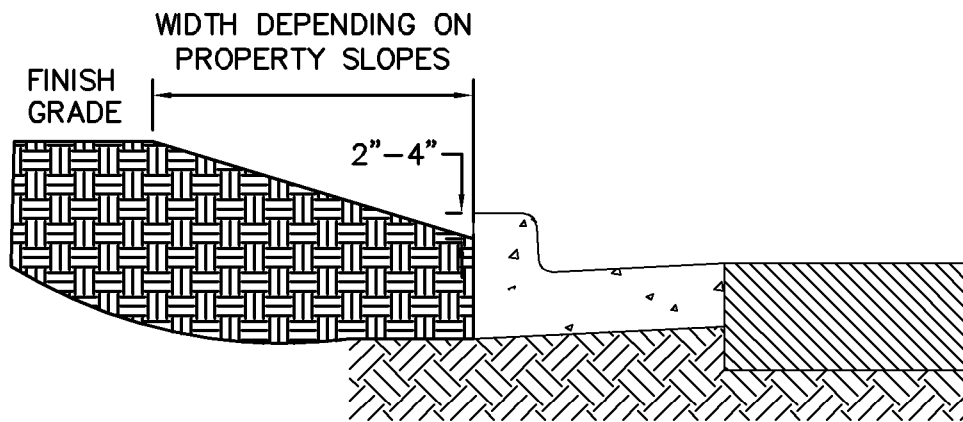

#### APPROACH

1. A CUTBACK CURB IS INSTALLED WHEN STORMWATER DISCHARGE ON A SITE RUNS OVER THE CURB AND ONTO PAVEMENT, CAUSING SEDIMENT TO ENTER A PAVED AREA.
2. THE CUTBACK SHOULD BE PERFORMED BY EXCAVATING SOIL BEHIND A CURB TO A DEPTH OF 2-4 INCHES.
3. THE DEPTH OF THE CUTBACK SHOULD BE INCREASED IF MORE SEDIMENT STORAGE IS NECESSARY.
4. THE CUTBACK COULD BE IMPLEMENTED BEHIND A SIDEWALK IF SIDEWALK EXISTS.

#### LIMITATIONS

1. CUTBACK CURBS ONLY REMAIN EFFECTIVE FOR A SHORT DURATION OF TIME. THEY SHOULD NOT BE USED AS A PRIMARY CONTROL MEASURE FOR MORE THAN 4 MONTHS.
2. CUTBACK CURBS ARE ONLY EFFECTIVE AND/OR APPLICABLE WHEN THE SITE IS SLOPED TOWARDS THE CURB SUCH THAT STORMWATER RUNOFF WILL OVERTOP THE CURB.
3. ON SEVERE/STEEP SLOPES, THE CUTBACK MAY NOT BE EFFECTIVE AND MAY COMPROMISE THE INTEGRITY OF THE CURB.

#### MAINTENANCE

1. CUTBACK CURBS SHALL BE INSPECTED MONTHLY AND AFTER SIGNIFICANT RAINFALL EVENTS.
2. SEDIMENT TRAPPED BEHIND THE CURB SHOULD BE CLEANED OUT AS REQUIRED ONCE THE SEDIMENT LADEN WATER HAS INFILTRATED AFTER A STORM EVENT.

**DETAIL OF CUTBACK CURB**

## APPENDIX K – GEOTECHNICAL REPORT



February 3, 2021  
Project No. 1720204827.0002

Wood Environment & Infrastructure Solutions, Inc.  
4600 East Washington Street, Suite 600  
Phoenix, Arizona 85034  
T: (602) 733-6000  
F: (602) 733-6100  
[www.woodplc.com](http://www.woodplc.com)

Halle Properties, LLC  
20225 North Scottsdale Road  
Scottsdale, Arizona 85255

Attn: Ms. Leslie German

**Re: Letter of Transmittal  
Discount Tire Site  
COS 12371 – Lot 4 E. Woodmen & Meridian Rd.  
Falcon, Colorado**

Dear Ms. German:

Wood Environment & Infrastructure Solutions, Inc. (Wood) representatives have completed the Geotechnical Evaluation for the proposed Discount Tire store to be located at Lot 4 East Woodmen & Meridian Road, Falcon, Colorado. This work was performed in general accordance with our Proposal for Geotechnical Evaluation dated February 3, 2021 and numbered 1720204827.0002. The Geotechnical Investigation prepared for the above site as requested by Wood and Halle Properties, LLC is attached.

This report has been prepared for the development of the project described and is for the sole use of the Reinalt-Thomas Corporation, a Michigan Corporation, Halle Properties, LLC, an Arizona limited liability company, and their subsidiaries, affiliates, and successors.

We are committed to providing quality engineering services combined with client satisfaction in order to achieve a continuing relationship with our clients. We appreciate the opportunity to provide these services for you.

If you have any questions regarding any of the other engineering and testing services Wood provides, please do not hesitate to contact us.

Respectfully Submitted,

**Wood Environment & Infrastructure Solutions, Inc.**

Reviewed by:

**David.Klann**  
Digitally signed by David.Klann  
DN: cn=David.Klann  
Date: 2021.02.03 15:58:53  
-07'00'

 Date:  
2021.02.03  
16:01:44 -07'00'

David Klann  
Project Manager

Mark Hartig  
Arizona Operations Manager

Attachments: Discussion of Geotechnical Issues  
Geotechnical Investigation

G:\Geotechnical\2020 Projects\01\_Discount Tire\17-2020-4827 - DT - COS 12371 - Lot 4 E. Woodmen & Meridian Rd. (Falcon, CO)\0002 Geotechnical\Letter of Transmittal - Geo - COS 12371.docx





February 3, 2021  
Project No. 1720204827.0002

Wood Environment & Infrastructure Solutions, Inc.  
4600 East Washington Street, Suite 600  
Phoenix, Arizona 85034  
T: (602) 733-6000  
F: (602) 733-6100  
[www.woodplc.com](http://www.woodplc.com)

Proposed Discount Tire Store  
COS 12371 – Lot 4 E. Woodmen & Meridian Rd.  
Falcon, Colorado

## **RE: Discussion of Geotechnical Issues**

The purpose of this information is to provide a brief discussion of the key geotechnical issues associated with the development of this site as proposed by Halle Properties, LLC. The issues discussed here shall not be construed as all inclusive, and each reader shall make his or her own assessment of the important issues related to this site by reading in its entirety the Geotechnical Investigation prepared for this project by CTL Thompson, Inc. dated February 3, 2021 and numbered CS19362-125. Wood assumes no responsibility for the decisions or inferences made by any person who relies on the information here without reading the referenced Geotechnical Investigation.

### **Existing Fill**

Existing fill was encountered in 4 of the 5 borings located within the proposed building pad ranging in depth from 2 to 4 feet below existing grade and was encountered in the parking lot borings to depths of 3 and 5 feet below existing grade. Records of the fill placement was not provided prior to this evaluation. The existing fill material should be removed in its entirety within the building pad and 5-foot overbuild zone and replaced with new engineered fill. The existing fill may be reused as new engineered fill provided it is free of organics and other deleterious material.

In pavement areas, the existing fill may be left in place provided it is thoroughly evaluated by a geotechnical engineer or their representative including observing a passing proofroll. Any soft or yielding areas should be excavated and backfilled with new fill soil or crushed rock and compacted in accordance with the attached report.

### **Site Preparation**

General site preparation in new construction areas (building pad and pavement areas) should consist of removing topsoil, organic laden material, vegetation, old fill (as noted above), and/or other deleterious material.

Following stripping, the exposed subgrade soils should be scarified, moisture conditioned, and compacted in accordance with the attached report. Scarification may terminate where hard sandstone is encountered. Following subgrade approval, backfill operations may begin provided observations and testing is performed in accordance with the attached report.

### **Foundations and Interior Slabs**

The building may be supported using a shallow continuous or spread footing system founded on approved native soil or new fill material. The footing excavation bottoms should be evaluated by a



geotechnical engineer or their representative for suitability of the bearing conditions prior to placement of rebar and concrete. Footings may be designed with a net allowable bearing pressure of 3,000 pounds per square foot. Continuous and spread footings should have minimum widths of 16 and 24 inches, respectively. Exterior footings and footings in unheated areas should be founded at a minimum depth of 30 inches below finished site grades.

Floor slabs may be founded on newly placed engineered fill. See attached report for additional details regarding a vapor retarder.

### **Pavement and Exterior Slabs**

The materials used and pavement subgrade preparation should be in accordance with the City of Colorado Springs "Standard Specifications" and the Pikes Peak Region Asphalt Paving Specifications.

Light and Heavy-duty flexible pavement sections should consist of 3 inches of asphaltic concrete (AC) over 6 inches of aggregate base (AB) and 4 inches of AC over 6 inches of AB, respectively.

The rigid pavement section for truck drive lanes, dumpster pads and aprons should consist of 8 inches of Portland cement concrete over a prepared subgrade.

Respectfully submitted,

**Wood Environment & Infrastructure Solutions, Inc.**

**David.Klann**

Digitally signed by David.Klann  
DN: cn=David.Klann  
Date: 2021.02.03 15:59:11  
-07'00'

Dave Klann  
Project Manager

Reviewed by:



Date:  
2021.02.03  
16:55:48 -07'00'

Mark Hartig  
Arizona Operations Manager





**GEOTECHNICAL INVESTIGATION  
FALCON DISCOUNT TIRE  
LOT 4 FALCON MARKETPLACE  
NORTHWEST OF MERIDIAN ROAD  
AND WOODMEN ROAD  
EL PASO COUNTY, COLORADO**

Prepared for:

WOOD PLC  
4600 East Washington Street, Suite 600  
Phoenix, AZ 85036

Attention: Mr. Dave Klann

Project No. CS19362-125

February 3, 2021

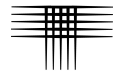

## TABLE OF CONTENTS

SCOPE .....	1
SUMMARY OF CONCLUSIONS .....	1
PROPOSED CONSTRUCTION.....	2
SITE CONDITIONS .....	2
SUBSURFACE INVESTIGATION.....	3
SUBSURFACE CONDITIONS.....	4
Seismicity.....	5
SITE DEVELOPMENT.....	5
Excavation.....	5
Fill Placement.....	6
Utilities.....	7
FOUNDATIONS.....	7
SLAB-ON-GRADE FLOORS .....	8
PAVEMENTS.....	10
CONCRETE.....	11
SURFACE DRAINAGE .....	12
CONSTRUCTION OBSERVATIONS.....	13
GEOTECHNICAL RISK .....	13
LIMITATIONS .....	13
FIG. 1 – LOCATION OF EXPLORATORY BORINGS	
FIG. 2 – SUMMARY LOGS OF EXPLORATORY BORINGS	
FIG. 3 – SWELL CONSOLIDATION TEST RESULTS	
FIGS 4 THROUGH 6 – GRADATION TEST RESULTS	
TABLE 1 – SUMMARY OF LABORATORY TESTING	

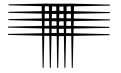

## SCOPE

This report presents the results of our Geotechnical Investigation for a proposed Discount Tire shop to be constructed on Lot 4 of the Falcon Marketplace commercial development located northwest of the intersection of Meridian Road and Woodmen Road in El Paso County, Colorado. The purpose of our investigation was to evaluate subsurface conditions at the site in order to develop geotechnical design criteria for the proposed tire shop building and site improvements. This report summarizes the results of our field and laboratory investigations, and presents our design and construction recommendations for foundations, floor systems, and pavement section alternatives, as well as other details influenced by subsurface conditions. We believe the investigation was completed in accordance with our proposal (CTL|T Proposal No. CS-20-0186) dated December 23, 2020. Evaluation of the property for the possible presence of potentially hazardous materials (environmental site assessment) was performed by CTL|T under a separate cover.

The report was prepared based on conditions disclosed by our exploratory borings, results of laboratory tests, engineering analyses, and our experience. The design criteria presented in the report were based on our understanding of the planned construction. The following section summarizes the report. More detailed descriptions of subsurface conditions, as well as our design and construction recommendations, are presented in the report.

## SUMMARY OF CONCLUSIONS

1. Subsurface conditions encountered in four of our exploratory borings drilled at the site consist of one to five feet of silty to clayey sand fill material underlain by natural sand soils or sandstone bedrock. In one of our borings, natural silty sand was encountered at the surface and underlain by sandstone bedrock. The sandstone bedrock extends to the 20-foot boring termination depths in four of our borings. The sandstone was interbedded with claystone below 20 feet in boring TH-2 which extended to a depth of 30 feet.

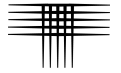

2. At the time of drilling, groundwater was encountered in three of our exploratory borings at depths between 17 and 19 feet. Groundwater elevations will vary with seasonal precipitation and landscaping irrigation.
3. We believe the proposed Discount Tire building can be supported on a spread footing foundation system bearing on densely compacted fill or sandstone bedrock.
4. We judge the risk of poor slab-on-grade performance to be low for slabs constructed on densely compacted fill.
5. The parking lots can be paved with 3 inches of asphalt concrete over 6 inches of aggregate base course. Pavement recommendations are included in the report.
6. Overall surface drainage should provide for the rapid removal of runoff away from the proposed building and off of the pavement areas.

## **PROPOSED CONSTRUCTION**

We understand the proposed Discount Tire building will be an 8,192 square-foot, single-story, structure with a slab-on-grade floor. No below grade levels are planned. Exterior improvements will include areas of concrete flatwork, asphalt paved parking and drive aisles, and underground utilities. We understand the building will be masonry and steel framing with steel joists and decking for the roof. Structural loading is expected to light to moderate considering the type of construction. Detailed grading plans and finish floor elevations were not available at the time of this report. Based on the gently sloping topography of the site and the adjacent rough grades of the access road to the west, we expect maximum cuts and fills will be less than 3 feet.

## **SITE CONDITIONS**

The project site is located at Lot 4 of the Falcon Marketplace, northwest of the intersection of Meridian Road and Woodmen Road within the community of Falcon, El Paso County, Colorado. The general vicinity of the property is presented in Figure 1.

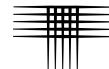

At the time of our investigation, the Falcon Marketplace was undergoing site grading and utility installation. Roadways were rough graded and curb and gutter installation was in process. Lot 4 lies in the northeastern portion of the development adjacent to Meridian Road and about 300 feet south of the intersection of Meridian Road and Eastonville Road. The site is 1.17-acres in size and is bordered to the east by Meridian Road, to the west by the proposed Falcon Market Place road which is rough graded, and to the north and south by rough graded undeveloped land. The site exhibits a gently sloping ground surface descending at an approximate gradient of 2 to 3 percent to the south. Vegetation has been removed as a result of grading activity with the exception of a sparse cover of grasses and weeds near the center of the site.

## **SUBSURFACE INVESTIGATION**

Subsurface conditions at the site were investigated by drilling five exploratory borings and two shallow subgrade test holes on January 8, 2021 at the approximate locations shown on Fig. 1. The boring locations were selected by the client. The holes were advanced to depths of 20 to 30 feet using a 4-inch diameter, continuous-flight auger, and a truck-mounted drill rig. The subgrade borings were drilled to a depth of 5 feet.

Samples of the soils were obtained at 5-foot intervals using a 2.5-inch diameter (O.D.) modified California barrel sampler driven by blows from a 140-pound hammer falling 30 inches. A representative of CTL | Thompson, Inc. was present during drilling to observe drilling operations, log the subsurface conditions encountered in the borings, and obtain samples for laboratory tests.

Samples were returned to our laboratory where they were examined by the geotechnical engineer for this project, and laboratory tests were assigned. Laboratory tests included dry density, moisture content, swell-consolidation, Atterberg limits, gradation analysis, and water-soluble sulfate content. Graphical logs of the condi-



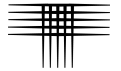

tions found in our exploratory borings, the results of field penetration resistance tests, and some laboratory data are shown in Figure 2. Swell-consolidation and gradation test results are presented in Figs 2 through 5. Laboratory test data are summarized in Table 1.

## **SUBSURFACE CONDITIONS**

Subsurface conditions found within four of our five borings consisted of a layer of surficial fill underlain by natural sand and/or sandstone bedrock. The fill is about 1 to 5 feet in thickness. We expect the fill consists of onsite material resulting from site grading and development that has occurred within the overall Falcon Marketplace development. The fill consists of clayey sand and is suitable for reuse as site grading fill. If records associated with fill placement such as density tests and observation reports are available, we request they be provided to our office. Otherwise the fill is considered undocumented and will require reworking within the building area prior to placement of new fill or structural loading. Natural clayey and silty sand was encountered at the surface in one of our borings and below fill in another boring.

A sample of the natural clay sand contained 23 percent silt and clay-sized particles (passing the No. 200 sieve) and exhibited measured swell of 1.6 percent.

Sandstone bedrock was encountered below fill or natural soils in each of our exploratory borings. Sandstone was the predominant bedrock type. The sandstone was interbedded with claystone below 20 feet in boring TH-2. Field penetration resistance test results indicated the bedrock was hard to very hard. Our experience indicates the sandstone bedrock exhibits low to negligible swell potential. The claystone was encountered at a depth below that which would affect the overlying improvements.

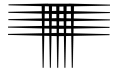

At the time of drilling, groundwater was encountered in two of our exploratory borings at depths of 17 and 19 feet below the existing ground surface. Groundwater elevations will vary with seasonal precipitation and landscaping irrigation.

### **Seismicity**

The soil is not expected to respond unusually to seismic activity. According to the 2015 International Building Code (IBC), we judge the site classifies as Site Class C.

## **SITE DEVELOPMENT**

The site is generally underlain by granular soils and sandstone bedrock that will provide adequate support for the proposed improvements provided the recommendations set forth herein are followed. The most significant geotechnical constraint is the presence of existing fill and shallow bedrock. The following sections discuss our earthwork recommendations for this project.

### **Excavation**

We believe the soils and near surface bedrock can be excavated with conventional, heavy-duty excavation equipment. Excavation and trenching into layers of very hard sandstone bedrock may require more aggressive excavation techniques, such as rock buckets, to speed up the excavation process. Based on our investigation and Occupational Safety and Health Administration (OSHA) standards, we believe a majority of the on-site surficial soils classify as Type C soil and the bedrock will classify as a Type A soil. Type C soil requires a maximum excavation slope inclination of 1.5:1 (horizontal to vertical), and Type A soil requires a maximum excavation slope inclination of 3/4:1 (horizontal to vertical) for dry conditions. Excavation slopes specified by OSHA are dependent upon the types of soil and groundwater conditions encountered. The contractor's "competent person" should identify the soils encountered in the excavations and refer to OSHA standards to determine appropriate

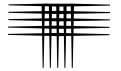

slopes. Stockpiles of soils and equipment should not be placed within a horizontal distance equal to one-half the excavation depth, from the edge of the excavation.

### **Fill Placement**

A grading plan was not available at the time of this report. Based on the existing topography and the need to match grades at the adjacent rough graded street and drives, we expect cuts and fills of about 4 feet or less will be necessary to achieve site grades.

Prior to placement of new fill or structural loading, the existing undocumented fill should be removed within the building area to natural soils or bedrock and replaced as compacted fill. The granular soils and excavated sandstone bedrock at this site are suitable to reuse as fill material provided vegetation, topsoil, debris and other deleterious materials are substantially removed. Excavated sandstone bedrock is also suitable to reuse as fill, however some of the sandstone may excavate in large pieces. Particles greater than 3-inches in size should be broken down to smaller sizes or should be omitted from the fill. If encountered during site grading, claystone bedrock should be evaluated prior to incorporation into fill material.

If imported fill is necessary, it should ideally consist of granular material with 100 percent passing the 2-inch sieve and 10 to 30 percent passing the No. 200 sieve. The import soil should exhibit low plasticity with a Liquid Limit less than 30 and a Plasticity Index less than 10. Import soils similar to the on-site materials may be suitable. A sample of the import material should be submitted to our office for testing before stockpiling at the site.

Before fill placement, vegetation, topsoil, and other deleterious material should be removed. Areas to receive fill should be scarified to a depth of at least 8 inches, moisture conditioned to near optimum moisture content and densely compacted. Scarification may terminate where hard sandstone is encountered.

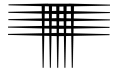

Fill consisting of the onsite granular soils and excavated sandstone bedrock should be moisture conditioned to within 2 percent of optimum moisture content and compacted in thin lifts to at least 95 percent of maximum modified Proctor dry density (ASTM D 1557).

### **Utilities**

Utility trench backfill and fills placed outside the building footprint should be moisture conditioned to within 2 percent of the optimum moisture content and compacted as stated above. The placement and compaction of backfill should be observed and tested by a representative of our firm during construction.

## **FOUNDATIONS**

We anticipate the proposed Discount Tire shop will include moderate structural loads and existing fill, natural sand or sandstone may be encountered at or near the foundation elevations. Existing fill should be removed and reworked as described in the SITE DEVELOPMENT section. A shallow spread footing foundation system is appropriate for this site. We recommend spread footing foundations be designed and constructed in accordance with the criteria presented below.

1. Footings can be constructed on new dense fill, natural sand, or sandstone. Materials loosened during the excavation process should be removed or moisture conditioned and compacted prior to the placement of concrete.
2. Building footings may be designed for a maximum allowable soil pressure of 3,000 psf.
3. We recommend footings beneath continuous foundation walls be at least 16 inches wide. Footings beneath isolated column pads should be at least 24 inches square. Larger footing sizes may be required to accommodate the anticipated structural loads.
4. We estimate total settlement of foundations to be approximately 1-inch. Differential movements should be on the order of  $\frac{1}{2}$  of the total settlement. These estimates are based on the anticipated loading conditions,

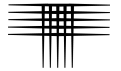

the available soil boring information, and our experience with similar soils.

5. Foundations subject to lateral loading may be designed using a coefficient of base friction of 0.40.
6. Foundations should be designed to span an unsupported distance of at least 8 feet.
7. Exterior footings must be protected from frost action per local building codes. Normally, 30 inches of frost cover is typical for this area.
8. A representative of our firm should observe the completed foundation excavation to confirm the exposed conditions are similar to those encountered in our exploratory borings. The placement and compaction of below-footing fill and footing subgrade preparation should be observed and tested by a representative of our firm during construction.
9. Excessive wetting of foundation soils during and after construction can cause heave or softening and settlement of foundation soils and result in footing and slab movements. Proper surface drainage around the structures is critical to control wetting.

## **SLAB-ON-GRADE FLOORS**

We expect a conventional slab-on-grade floor is the preferred floor system for the proposed tire shop building. We anticipate grading fill consisting of the reworked onsite fill and natural clayey sand and sandstone will be underlie the finished floor elevation. We performed swell-consolidation testing at approximate overburden pressures (the weight of the soils and bedrock above the samples) of the natural soils and the measured swell value was low. Our experience indicates the reworked grading fill and excavated sandstone placed as fill will exhibit low swell potential. We judge the risk of poor slab performance due to heave is low for this building if the slab is constructed on the onsite materials.

We recommend the following precautions for slab-on-grade construction at this site. The following precautions can help reduce, but not eliminate damage or distress due to slab movement.



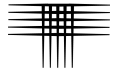

1. New fill placed below the floor slabs should consist of the on-site sand, excavated sandstone, or an approved, import material. The placement and compaction of the below-slab fill should be observed and tested by a representative of our office during construction and should be controlled per the Fill Placement section of this report.
2. We recommend slab-on-grade floors be separated from exterior walls and interior bearing members with joints that allow for independent vertical movements of the slab relative to the foundation. Provision of a 2-inch-thick slip joint in slab-bearing partitions can reduce the risk of cracking of drywall resulting from slab movements. If the “float” is provided at the top of the partitions, the connection between interior, slab-supported partitions and exterior, foundation-supported walls should be detailed to allow differential movement. These architectural connections are critical to help reduce cosmetic damage should foundations and floor slabs move relative to each other. We have seen instances where these architectural connections were not designed and constructed properly and resulted in moderate cosmetic damage, even though the movement experienced was well within the anticipated range. The architect should pay special attention to these issues and detail the connections accordingly. Masonry block partitions (load bearing or not) should be constructed on their own independent foundations and not a thickened floor slab.
3. While, in our opinion, there is no need from a geotechnical standpoint for a vapor retarder at this site, the 2015 International Building Code (IBC) requires a vapor retarder be placed between a base course layer or the subgrade soils and a concrete slab-on-grade floor, unless the designer of the floor waives this requirement. The merits of installing a vapor retarder below the floor slab depend on the sensitivity of floor coverings and building use to moisture. A properly installed vapor retarder (10 mil minimum) is more beneficial below concrete slab-on-grade floors where floor coverings, painted floor surfaces or products stored on the floor will be sensitive to moisture. The vapor retarder is most effective when concrete is placed directly on top of it, rather than placing a sand or gravel leveling course between the vapor retarder and the floor slab. We do not recommend a sand or gravel leveling course be placed between the vapor retarder and the floor slab as this layer will provide a permeable zone through which a point water source can move beneath the entire floor slab. The placement of concrete on the vapor retarder may increase the risk of shrinkage cracking and curling. Use of concrete with reduced shrinkage characteristics including minimized water content, maximized coarse aggregate content, and reasonably low slump will reduce the risk of shrinkage cracking and curling. Considerations and recommendations for the installation of vapor retarders below concrete slabs are outlined in Section 3.2.3 of the 2006

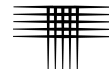

report of the American Concrete Institute (ACI) Committee 302, "Guide for Concrete Floor and Slab Construction (ACI 302.R-96)".

4. Underslab plumbing should be avoided as much as possible. If underslab plumbing is necessary, service lines should be pressure tested for leaks during construction. Any utility line that penetrates a slab should be isolated from the slab with a joint to allow for free vertical movement.
5. Slab-supported mechanical systems should have flexible connections to allow for vertical movement without rupturing supply lines.
6. Frequent control joints should be provided in the slabs to reduce the effects of curling and help reduce shrinkage cracking. Our experience indicates a joint spacing of not greater than 30 times the slab thickness is effective in this area.
7. Exterior flatwork and sidewalks should be separated from the structure. These slabs should be designed to function as independent units. Movement of these slabs should not be transmitted directly to the foundation of the building.

## **PAVEMENTS**

Pavement subgrade soils across the site will likely consist predominantly of very clayey sand and silty, clayey sand that generally classify as A-2-6 soils, respectively. Based on our laboratory testing a Hveem stabilometer ("R") value of 40 assigned to the subgrade materials for design purposes.

Specific traffic loadings for the project were not available at the time of preparation of this report. Equivalent 18-kip single axle load applications (ESAL's) of 21,900 and 73,000 for 20-year design lives were assumed for standard duty pavements (i.e. automobile traffic and parking areas) and heavy duty pavements. In our opinion, the parking areas can be paved with 3 inches of asphalt concrete over 6 inches of aggregate base course. Driveway entrances can be paved with 4 inches of asphalt concrete over 6 inches of aggregate base course.

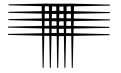

We recommend a concrete pad be provided at dumpster locations. The pad should be at least 8 inches thick and long enough to support the entire length of the trash truck and dumpster. The concrete pad should extend at least 5 feet outside of the anticipated truck dimensions. Joints between concrete and asphalt pavements should be sealed with a flexible compound.

Our design considers pavement construction will be completed in accordance with the City of Colorado Springs “Standard Specifications” and the Pikes Peak Region Asphalt Paving Specifications. The specifications contain requirements for the pavement materials (asphalt, base course, and concrete) as well as the construction practices used (compaction, materials sampling, and proof-rolling). Of particular importance are those recommendations directed toward subgrade and base course compaction and proof-rolling. During proof-rolling, particular attention should be directed toward the areas of confined backfill compaction. Soft or loose subgrade or areas that pump excessively should be stabilized prior to pavement construction. A representative of our office should be present at the site during placement of fill and construction of pavements to perform density testing.

## **CONCRETE**

Concrete in contact with soils can be subject to sulfate attack. We measured the water-soluble sulfate concentration in one sample from the site at less than 0.1 percent. Sulfate concentrations of less than 0.1 percent indicate Class 0 exposure to sulfate attack for concrete in contact with the subsoils, according to ACI 201.2R-01, as published in the 2008 American Concrete Institute (ACI) *Manual of Concrete Practice*. For this level of sulfate concentration, the ACI indicates Type I cement can be used for concrete in contact with the subsoils. Superficial damage may occur to the exposed surfaces of highly permeable concrete, even though sulfate levels are relatively low. To control this risk and to resist freeze-thaw deterioration, the water-to-cementitious material ratio should not exceed 0.50 for concrete in contact with soils

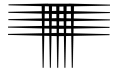

that are likely to stay moist due to surface drainage or high water tables. Concrete subjected to freeze-thaw cycles should be air entrained.

## **SURFACE DRAINAGE**

Performance of the foundation system, floor slabs, pavements, and concrete flatwork to be constructed at this site will be influenced by the moisture conditions existing within the near-surface soils. Overall surface drainage patterns must be planned to provide for the rapid removal of storm runoff. Water should not be allowed to pond adjacent to foundations or over pavements or concrete flatwork. We recommend the following precautions be observed during construction and maintained at all times after the building is completed.

1. Excessive wetting or drying of the open foundation excavation should be avoided.
2. Foundation wall backfill should be graded to provide for the rapid removal of runoff. We recommend a slope equivalent to at least 6 inches in the first 10 feet. In flatwork areas adjacent to the structure, the slope may be reduced to comply with ADA requirements.
3. Backfill around foundations should be moistened and compacted according to criteria presented in Fill Placement.
4. Roof downspouts and drains should discharge well away from the building. Downspout extensions and/or splash blocks should be provided to help reduce infiltration into the backfill adjacent to the structure.
5. Landscaping concepts should concentrate on use of plantings that require little or no supplemental irrigation after the vegetation is established. Irrigated sod, if it is included in the landscaping plan, should not be located within 6 feet of the foundation walls. Irrigation should be limited to the minimum amount sufficient to maintain vegetation. Application of more water will increase likelihood of slab and foundation movements.
6. Backfill around foundations should be moistened and compacted according to criteria presented in Fill Placement.

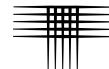

## **CONSTRUCTION OBSERVATIONS**

We recommend that CTL | Thompson, Inc. provide construction observation services to allow us the opportunity to confirm subsurface conditions are consistent with those found during this investigation. If others perform these observations, they must accept responsibility to judge whether the recommendations in this report remain appropriate.

## **GEOTECHNICAL RISK**

The concept of risk is an important aspect with any geotechnical evaluation primarily because the methods used to develop geotechnical recommendations do not comprise an exact science. We never have complete knowledge of subsurface conditions. Our analysis must be tempered with engineering judgment and experience. Therefore, the recommendations presented in any geotechnical evaluation should not be considered risk-free. Our recommendations represent our judgment of those measures that are necessary to increase the chances that the structures will perform satisfactorily. It is critical that all recommendations in this report are followed during construction. The owner must assume responsibility for maintaining the structure and use appropriate practices regarding drainage.

## **LIMITATIONS**

This report has been prepared for the exclusive use of Wood PLC for the purpose of providing geotechnical design and construction criteria for the proposed project. The information, conclusions, and recommendations presented herein are based upon consideration of many factors including, but not limited to, the type of structure proposed, the geologic setting, and the subsurface conditions encountered. The conclusions and recommendations contained in the report are not valid for use by others. Standards of practice continuously evolve in the area of geotechnical engineering. The recommendations provided are appropriate for about three years. If





the project is not constructed within about three years, we should be contacted to determine if we should update this report.

Our borings were spaced to obtain a reasonably accurate picture of foundation conditions below the proposed building area. Locations were limited by the existing structure. The data are representative of conditions encountered only at the exact boring locations. Variations in the subsurface conditions not indicated by our borings are possible. Representatives of our firm should periodically visit the site during construction to perform observation and testing services.

We believe this investigation was conducted in a manner consistent with that level of skill and care normally used by geotechnical engineers practicing in this area at this time. No warranty, express or implied, is made.

If we can be of further service in discussing the contents of this report or in the analysis of the influence of the subsoil conditions on design of the building, please call.

CTL | THOMPSON, INC

  
Jeffrey M. Jones, P.E.  
Associate Engineer

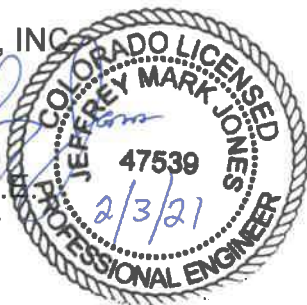

Reviewed by:

  
William C. Hoffmann, Jr., P.E., FACEC  
Senior Engineering Consultant

JMJ:WCH:cw  
(2 copies)

Via e-mail: [David.klann@woodplc.com](mailto:David.klann@woodplc.com)

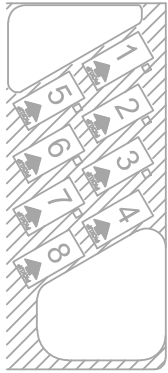

FALCON MARKETPLACE  
LOT 2

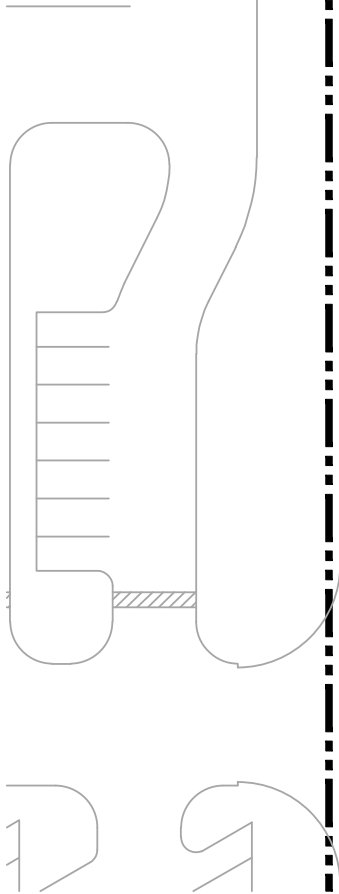

FALCON MARKET PLACE

PROPERTY LINE

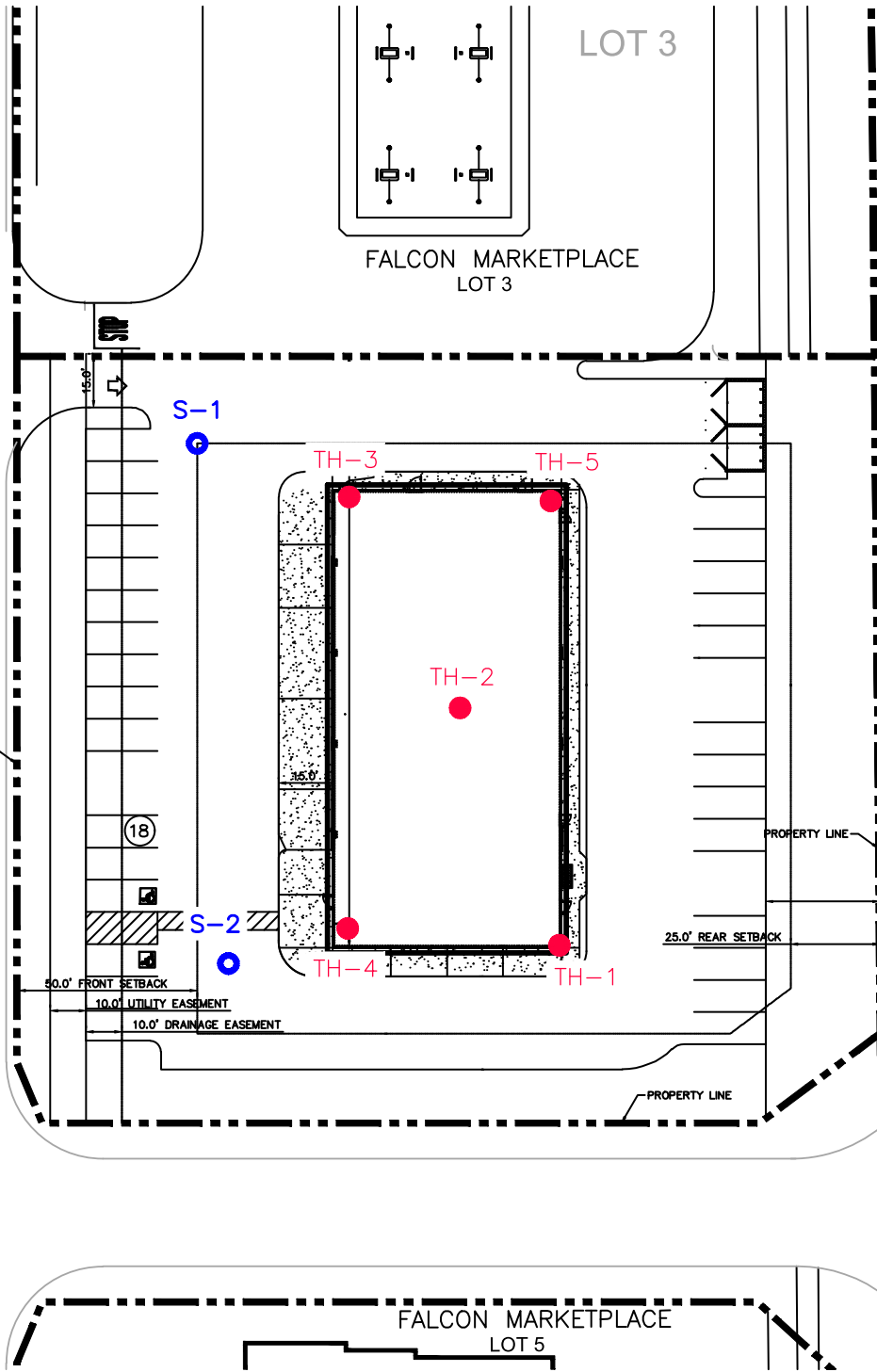

LOT 3

FALCON MARKETPLACE  
LOT 3

FALCON MARKETPLACE  
LOT 5

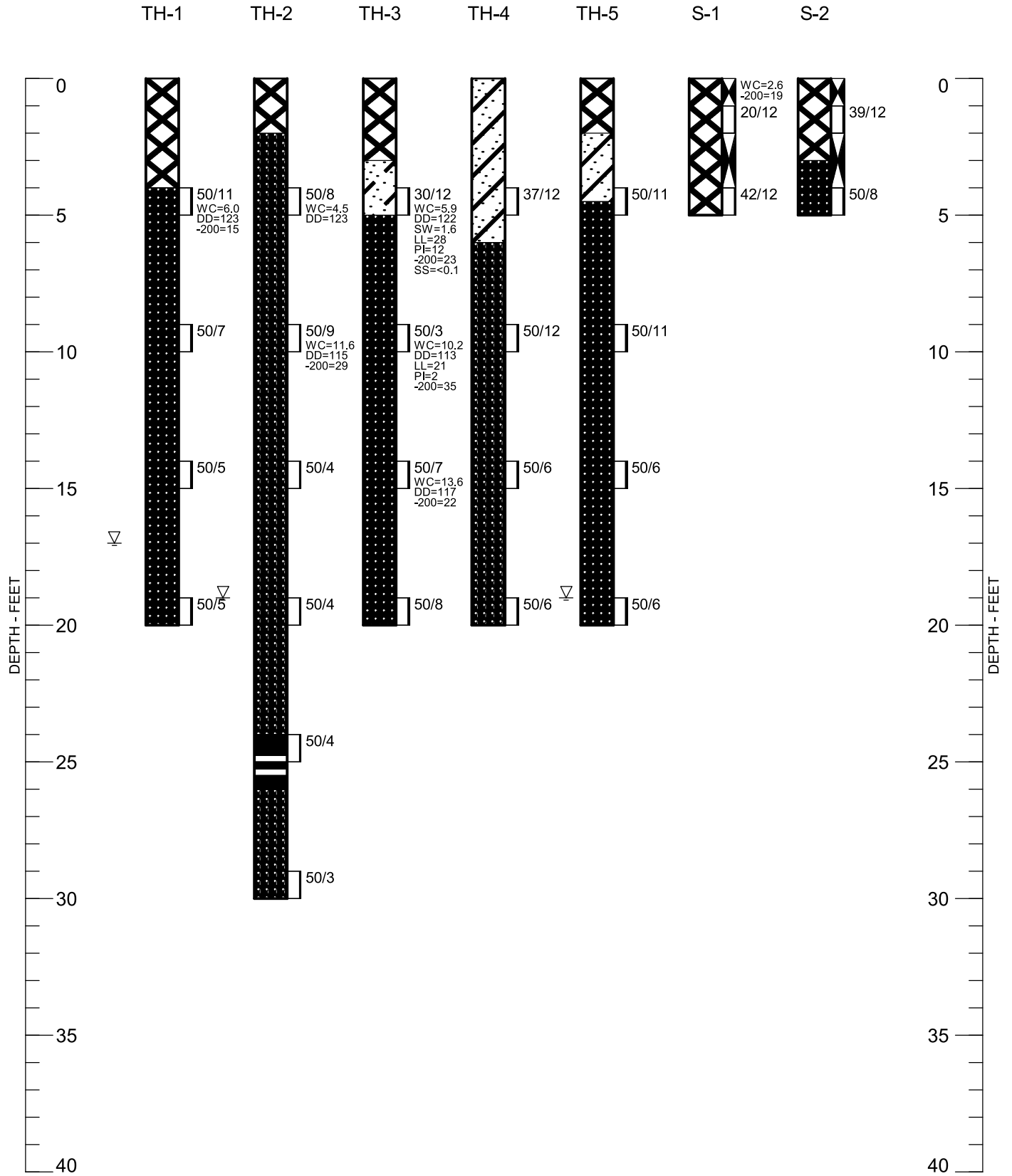

**SUMMARY LOGS OF EXPLORATORY BORINGS**

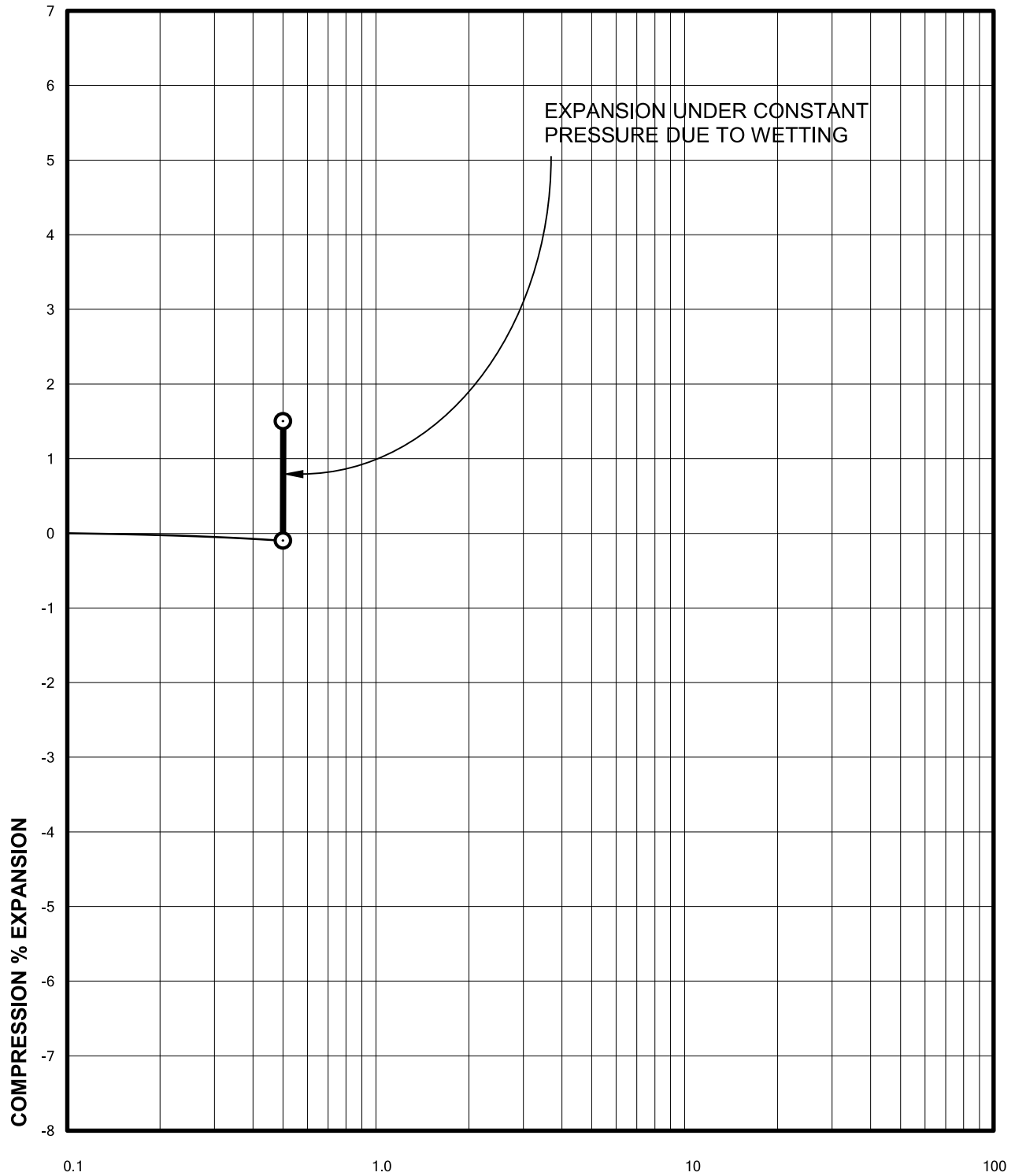

**APPLIED PRESSURE - KSF**  
Sample of SANDSTONE, CLAYEY  
From TH-3 AT 4 FEET

DRY UNIT WEIGHT= 122 PCF  
MOISTURE CONTENT= 5.9 %

## Swell Consolidation Test Results

FIG. 3

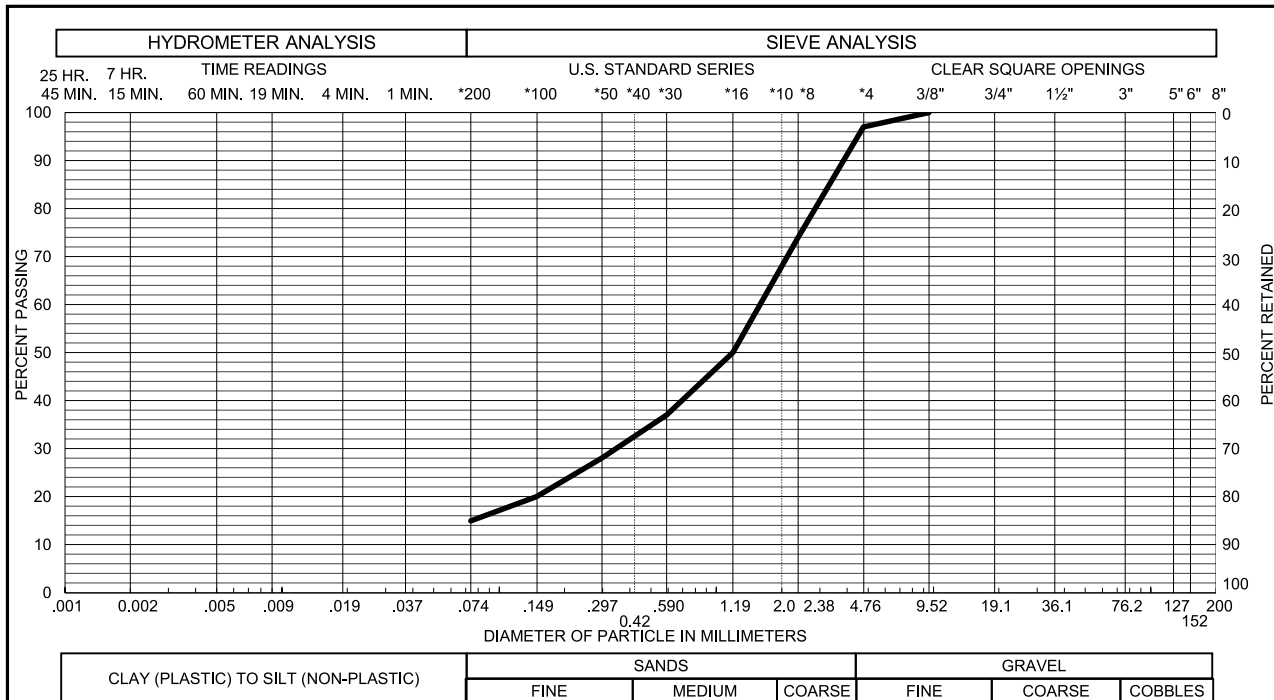
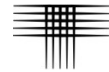

Sample of SANDSTONE, SILTY GRAVEL 3 % SAND 82 %  
 From TH - 1 AT 4 FEET SILT & CLAY 15 % LIQUID LIMIT \_\_\_\_\_  
 PLASTICITY INDEX \_\_\_\_\_

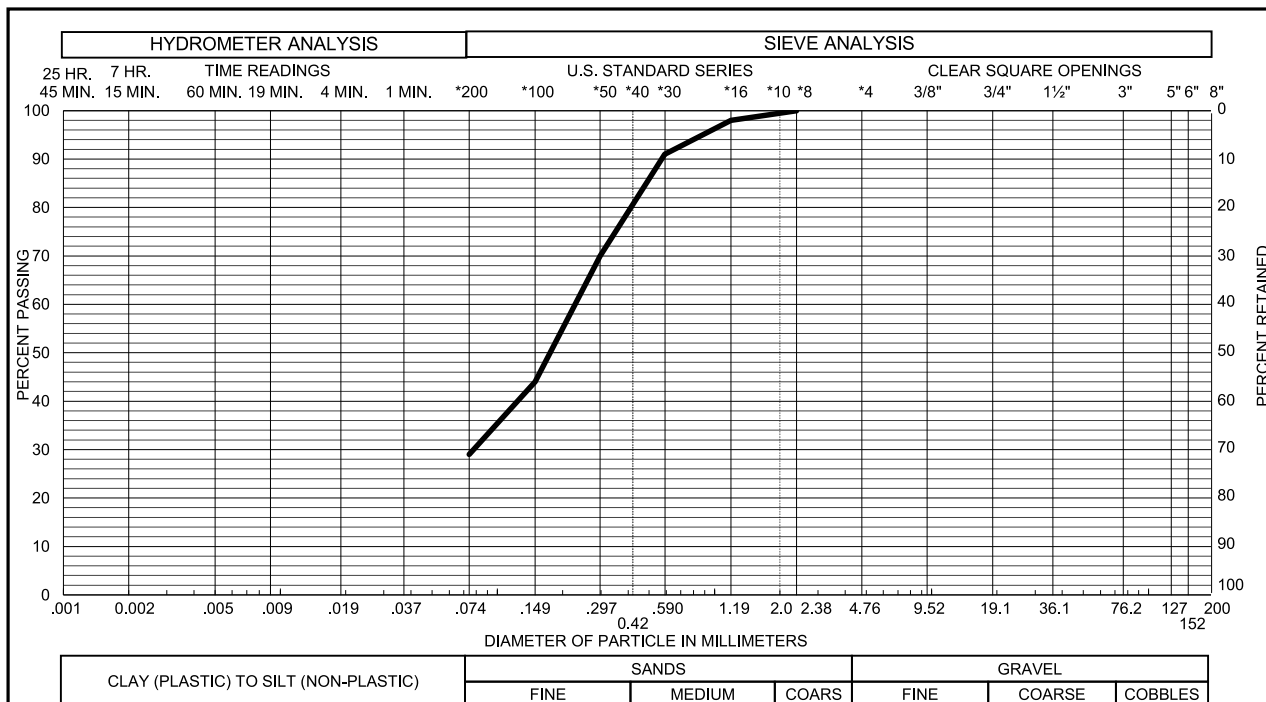

Sample of SANDSTONE, SILTY GRAVEL 0 % SAND 71 %  
 From TH - 2 AT 9 FEET SILT & CLAY 29 % LIQUID LIMIT \_\_\_\_\_  
 PLASTICITY INDEX \_\_\_\_\_

## Gradation Test Results

FIG. 4

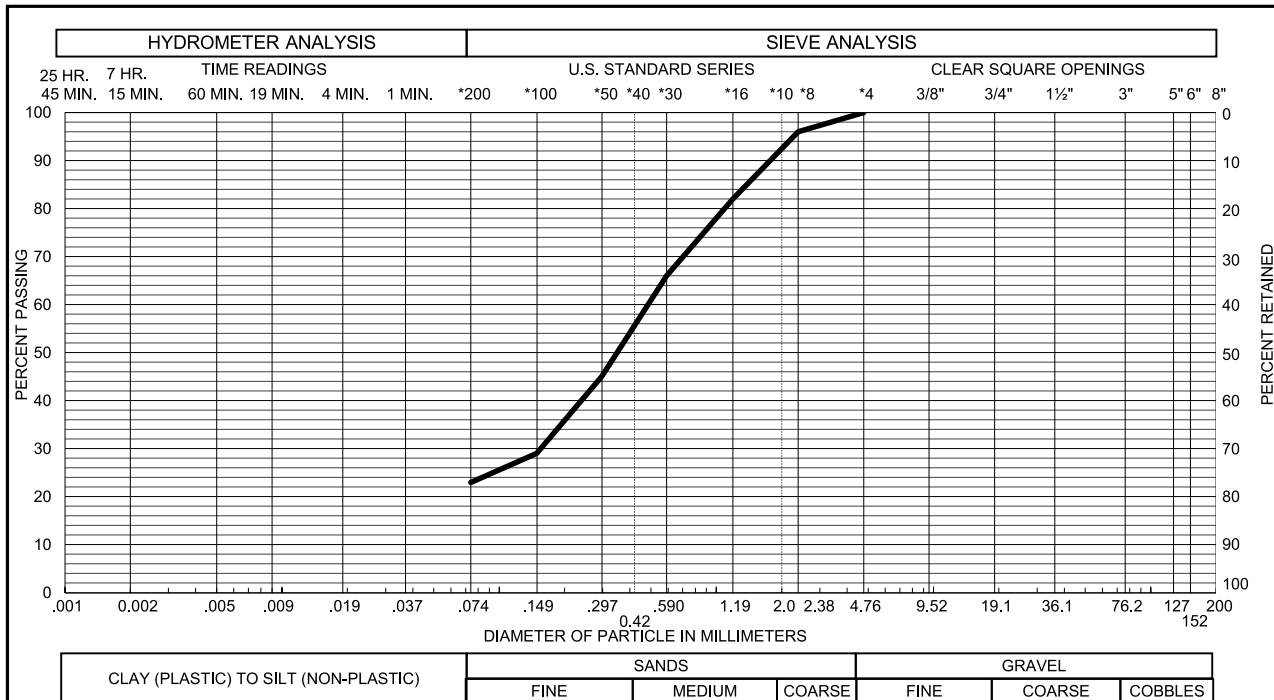
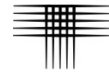

Sample of SAND, CLAYEY (SC) GRAVEL 0 % SAND 77 %  
 From TH - 3 AT 4 FEET SILT & CLAY 23 % LIQUID LIMIT 28  
 PLASTICITY INDEX 12

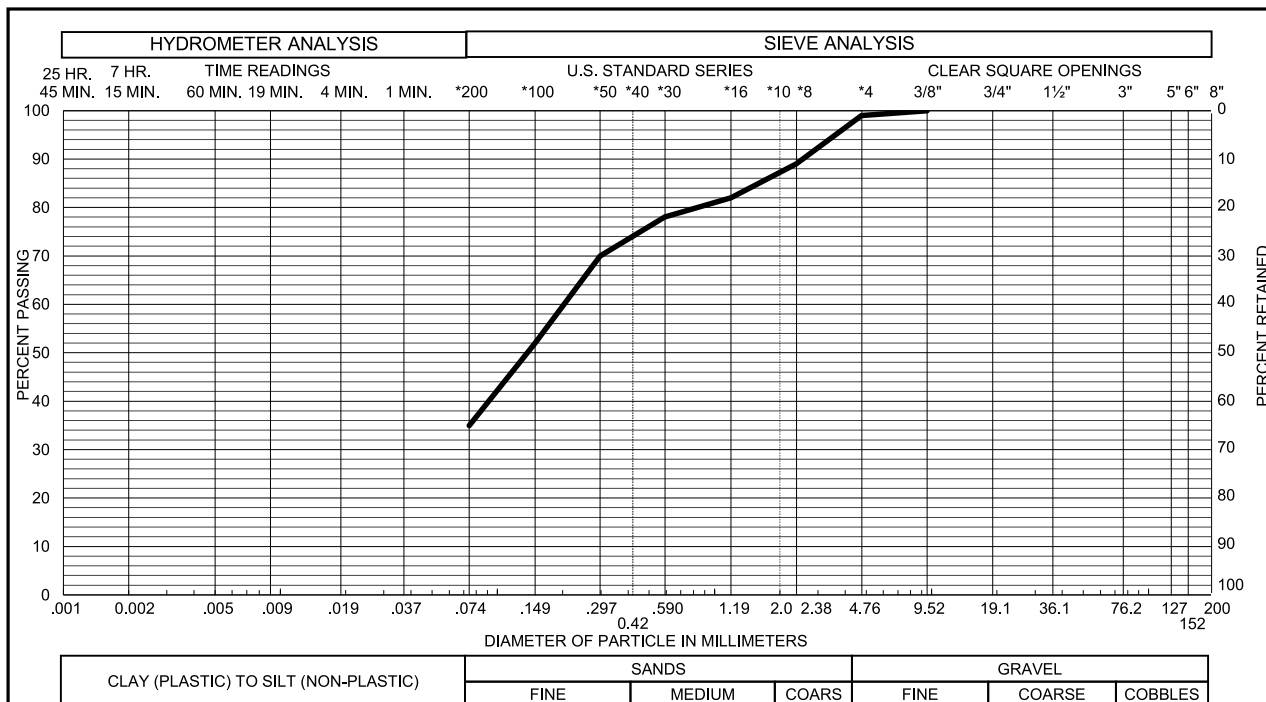

Sample of SANDSTONE, SILTY GRAVEL 1 % SAND 64 %  
 From TH - 3 AT 9 FEET SILT & CLAY 35 % LIQUID LIMIT 21  
 PLASTICITY INDEX 2

## Gradation Test Results

FIG. 5



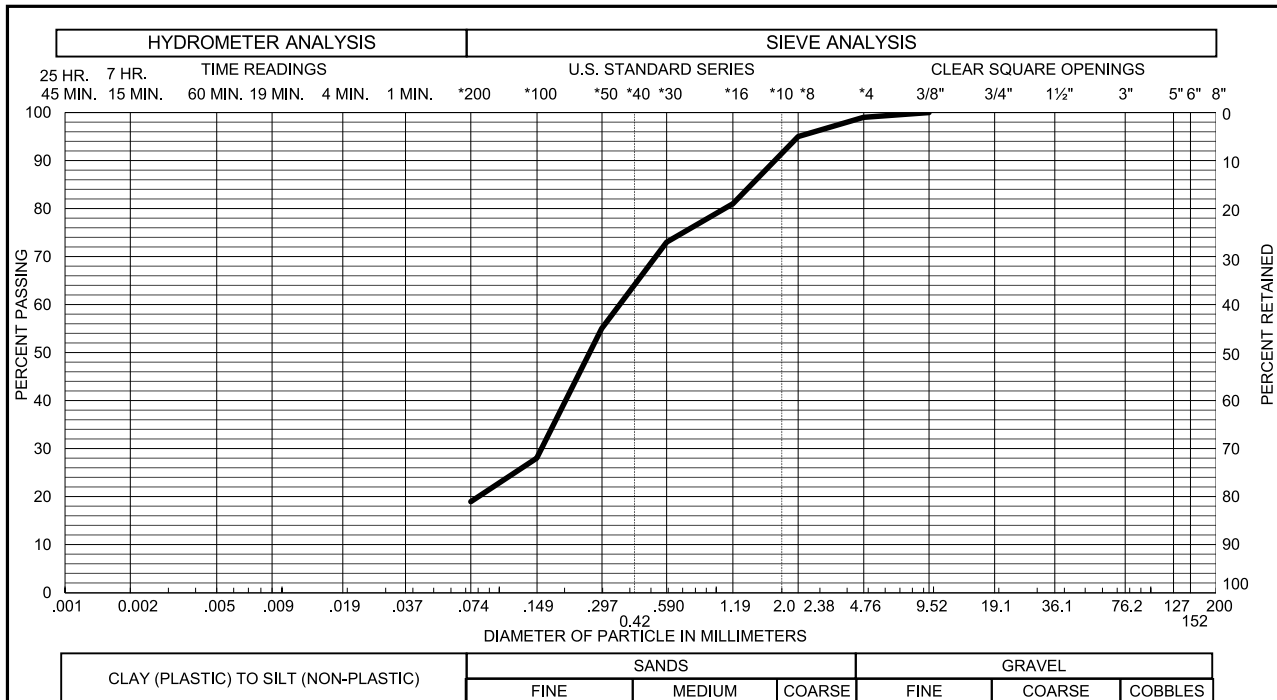
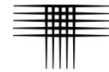

Sample of SAND, SILTY (SM) GRAVEL 1 % SAND 80 %  
 From S - 1 AT 0-4 FEET SILT & CLAY 19 % LIQUID LIMIT \_\_\_\_\_  
 PLASTICITY INDEX \_\_\_\_\_

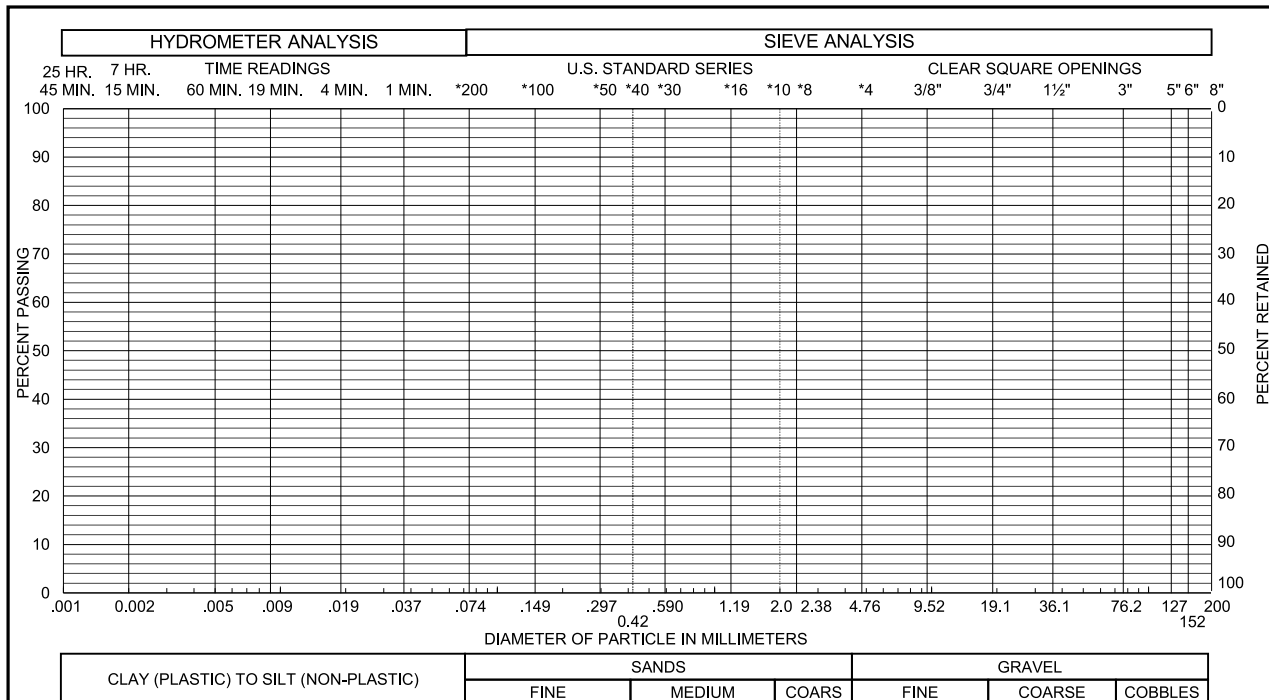

Sample of \_\_\_\_\_ GRAVEL \_\_\_\_\_ % SAND \_\_\_\_\_ %  
 From \_\_\_\_\_ SILT & CLAY \_\_\_\_\_ % LIQUID LIMIT \_\_\_\_\_  
 PLASTICITY INDEX \_\_\_\_\_

## Gradation Test Results

FIG. 6

**TABLE I**  
**SUMMARY OF LABORATORY TEST RESULTS**

BORING	DEPTH (ft)	MOISTURE CONTENT (%)	DRY DENSITY (pcf)	SWELL TEST DATA		ATTERBERG LIMITS		SOLUBLE SULFATE CONTENT (%)	PASSING NO. 200 SIEVE (%)	
				SWELL (%)	APPLIED PRESSURE (psf)	LIQUID LIMIT	PLASTICITY INDEX			
TH-1	4	6.0	123						15	SANDSTONE
TH-2	4	4.5	123							SAND, CLAYE
TH-2	9	11.6	115						29	SANDSTONE
TH-3	4	5.9	122	1.6	500	28	12	<0.1	23	SANDSTONE
TH-3	9	10.2	113			21	2		35	SANDSTONE
TH-3	14	13.6	117						22	SANDSTONE
S-1	0-4	2.6							19	SAND, SILTY

WOOD PLC  
FALCON DISCOUNT TIRE  
CTLJT PROJECT NO. CS19362-125