



LSC TRANSPORTATION CONSULTANTS, INC.
2504 East Pikes Peak Avenue, Suite 304
Colorado Springs, CO 80909
(719) 633-2868
FAX (719) 633-5430
E-mail: lsc@lscctrans.com
Website: <http://www.lscctrans.com>

Sterling Ranch East
Rezoning & Preliminary Plan
SP-22-004, P-22-012, P-22-013
Traffic Impact Study
(LSC #S224510)
February 10, 2023

Traffic Engineer's Statement

This traffic report and supporting information were prepared under my responsible charge and they comport with the standard of care. So far as is consistent with the standard of care, said report was prepared in general conformance with the criteria established by the County for traffic reports.

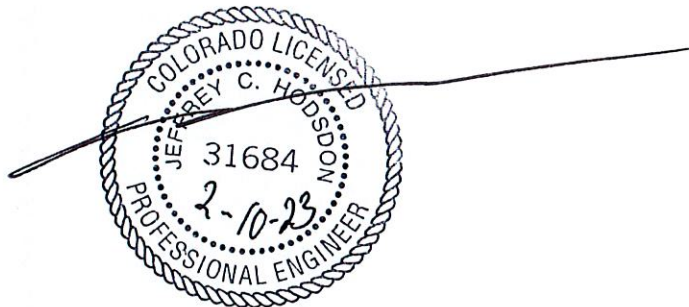

Developer's Statement

I, the Developer, have read and will comply with all commitments made on my behalf within this report.

A handwritten signature in blue ink, appearing to be 'J. P.', written over a horizontal line.

A handwritten date '2/15/2023' in blue ink, written over a horizontal line.

Sterling Ranch East Rezoning & Preliminary Plan Traffic Impact Study

Prepared for:
Loren J. Moreland
Vice President/ Project Manager
Classic SRJ
2138 Flying Horse Club Drive
Colorado Springs, CO 80921

FEBRUARY 10, 2023

LSC Transportation Consultants
Prepared by: Kirstin D. Ferrin, P.E.
Reviewed by: Jeffrey C. Hodsdon, P.E.

LSC #S224510
SP-22-004, P-22-012, P-22-013



CONTENTS

REPORT CONTENTS 1

RECENT TRAFFIC REPORTS 2

STUDY AREA 2

 Land Use..... 2

 Pedestrian Plan 2

 Proposed Access Points..... 3

 Briargate Access Points 3

 School Site – Possible Access Points..... 4

 For Reference: Other nearby Briargate access points (shown on the Sketch Plan)..... 4

 Sight Distance Analysis..... 4

REPORT SCENARIOS 5

 Short-Term Scenario 5

 Long-Term Scenario 5

EXISTING ROAD AND TRAFFIC CONDITIONS..... 5

 Existing Traffic Volumes 6

 Existing Levels of Service 7

 Burgess/Vollmer..... 7

 Safety and Accident Analysis..... 7

BASELINE CONDITIONS 8

 Short-Term Scenario Baseline Conditions 8

 Long-Term Scenario Baseline Conditions 8

TRIP GENERATION..... 8

TRIP DISTRIBUTION AND ASSIGNMENT..... 9

TOTAL TRAFFIC..... 10

 Short-Term Total Traffic..... 10

 2042 Total Traffic 10

LEVEL OF SERVICE ANALYSIS 10

 Intersection #1: Vollmer/Burgess..... 11

 Intersection #4: Vollmer/Briargate 11

 Intersection #5: Sterling Ranch/Briargate 11

 Intersection #8: Oak Park/Sterling Ranch..... 11

Intersection #12: Vollmer/Marksheffel	12
Intersection #13: Sterling Ranch/Marksheffel.....	12
Sterling Ranch Road Site Access Points (Intersection #303-#308).....	13
Briargate Parkway Site Access Points (Intersection #102-#103).....	13
SIGNAL WARRANT THRESHOLD ANALYSIS – AM AND PM PEAK HOURS	13
ROADWAY FUNCTIONAL CLASSIFICATIONS AND LANEAGE.....	14
AREA MTCP 2040 ROADWAY IMPROVEMENT PROJECTS.....	14
CONCLUSIONS AND RECOMMENDATIONS	14
Trip Generation	14
Level of Service	15
Recommended Improvements.....	16
TRANSPORTATION IMPROVEMENT FEE PROGRAM AND CREDIT AGREEMENTS.....	16
Enclosures:	17
Tables 2-6	
Figures 1-17	
Appendix Table 1	
2008 TIS TAZ Map	
MTCP Maps	
Traffic Count Reports	
Level of Service Reports	
Crash History	



LSC TRANSPORTATION CONSULTANTS, INC.
2504 East Pikes Peak Avenue, Suite 304
Colorado Springs, CO 80909
(719) 633-2868
FAX (719) 633-5430
E-mail: lsc@lsctrans.com
Website: <http://www.lsctrans.com>

February 10, 2023

Loren J. Moreland
Vice President/ Project Manager
Classic SRJ
2138 Flying Horse Club Drive
Colorado Springs, CO 80921

RE: Sterling Ranch East -
Rezoning & Preliminary Plan
Traffic Impact Study
El Paso County, Colorado
SP-22-004, P-22-012, P-22-013
LSC #S224510

Dear Mr. Moreland:

LSC Transportation Consultants, Inc. has prepared this Traffic Impact Study for the proposed Sterling Ranch East (SRE) Rezones and Preliminary Plan. As shown in Figure 1, the site is located east of Vollmer Road near Lochwinnoch Lane between the future extensions of Marksheffel Road and Stapleton Drive in El Paso County, Colorado.

REPORT CONTENTS

The preparation of this report included the following:

- A list of previous Sterling Ranch traffic reports and the context of this project;
- A summary of the proposed land use and access plan;
- The existing roadway and traffic conditions in the site's vicinity including the roadway widths, surface conditions, lane geometries, traffic controls, and posted speed limits;
- Existing traffic volume data;
- Estimates of projected short-term long-term baseline traffic volumes;
- The projected average weekday and peak-hour vehicle trips to be generated by the proposed future development within the preliminary plan area;
- The assignment of the projected preliminary-plan site-generated traffic volumes to the area roadways;
- The projected short-term and long-term total traffic volumes on the area roadways;

- The projected levels of service at the key intersections within the study area;
- A list of deviation requests
- Findings and recommendations for study area roadways and intersections, including number of lanes, auxiliary turn lanes, intersection traffic control, etc.; and
- The recommended street classifications

RECENT TRAFFIC REPORTS

LSC prepared a previous master traffic impact study (TIS) for the entire Sterling Ranch development dated June 5, 2008. **This master study was updated October 21, 2022, December 22, 2022, and February 10, 2023 (current version).** Since 2008, LSC and SM Rocha, LLC have completed multiple studies for individual filings and phases within Sterling Ranch. Appendix Table 1 includes a list of other traffic studies within Sterling Ranch and in the vicinity of area of study completed within the past five years (that LSC is aware of) is attached for reference.

El Paso County is currently studying the Briargate Stapleton Corridor as part of a Pikes Peak Rural Transportation Authority (PPRTA) study. A draft version of the Briargate-Stapleton Corridor Study by Wilson & Company was published December 9, 2021.

STUDY AREA

Figure 1 shows the location of the Sterling Ranch East Phase 1 Preliminary Plan Area relative to the overall Sterling Ranch Sketch Plan Area. As shown in Figure 1, the site is located generally in the middle of the Sketch Plan Area adjacent to the future extension of Sterling Ranch Road.

Land Use

Figure 2 shows the proposed Sterling Ranch East Phase 1 Preliminary Plan. The trip-generation table (Table 2) also lists the land uses and quantities of dwelling units, estimated non-residential building square footage, etc. The site is planned to be developed with 761 lots for single-family homes. Two future tracts are also included in the Preliminary Plan. Tract M, located southwest of the future intersection of Briargate/Sterling Ranch, is planned to be developed with a K-8 school and Tract T, located on the south end of the Preliminary Plan area, is planned to be developed with an elementary school. This land use is consistent with the land use assumed in the October 21, 2022 (and December 22, 2022) Master TIS reports.

Pedestrian Plan

Figure 2 also shows the location of all planned trails and sidewalks in the vicinity of the site. There are no proposed regional trails within the boundary of this Preliminary Plan. Multiple community trails are included for circulation and recreational use through the Sterling Ranch Phase 1 Preliminary Plan, including a 15-foot combined trail and maintenance road along the

east side of Sand Creek area. This is shown in Figure 2. A 5-foot trail along the south boundary will provide connectivity from the eastern portion of Sterling Ranch to the Regional Trail on the west side of Sand Creek and the community parks, trails, and open space within Sterling Ranch.

A detached sidewalk will be provided along the west side of Sterling Ranch Road. The multi-use paved shoulder on Sterling Ranch Road will accommodate bicycles.

Proposed Access Points

Figure 3 shows the roadway connections that are planned to be constructed in the short term. As shown in Figure 3, in the short term Briargate Parkway is planned to be constructed to its final cross section between Vollmer Road and Sterling Ranch Road, Marksheffel Road is planned to be completed between Vollmer Road and Woodmen Road, and Sterling Ranch Road is planned to be constructed from Marksheffel Road to the northmost access point within the Sterling Ranch East Phase 1 Preliminary Plan area.

Figure 2 shows the access plan for the SRE Phase 1 Preliminary Plan. The access plan for this Preliminary plan is consistent with the access plan shown in the February 10, 2023 LSC Sketch Plan Master TIS.

Briargate Access Points

The Briargate Parkway-Stapleton Road Corridor Study Appendix D: Access Control Plan shows the access locations and intersection access restrictions along Briargate Parkway between Black Forest Road and Meridian Road. The currently proposed plan has several access points that are not included in the access control plan.

- The access control plan shows a right-in/right-out access point north and south of Briargate Parkway between Wheatland Drive and Sterling Ranch Road. The currently proposed Preliminary Plan shows two offset three-quarter movement (left-in/right-in/right-out only) access points. A deviation request is being submitted with this application for the north-side access. The south-side access is not part of these Sterling Ranch East applications. However, it has been shown in case the school district needs it for access and/or adequate school circulation. The access request would be reviewed at the time of development of the future school.
- The access control plan shows the intersection of Briargate Parkway/Sterling Ranch Road as a three-leg intersection. The currently proposed Preliminary Plan includes a north leg at this future full-movement signal-controlled intersection.

School Site – Possible Access Points

This TIS report shows potential/possible access points with the intent of addressing the school site traffic in general. However, no information or plans are available for the school site and a separate site-specific TIS will be required to be approved prior to school site development. Figures in this report show estimates of possible school-traffic turning movements at intersection numbers 103, 307, and 8. These are intended to represent approximate volumes for one possible access scenario for purposes of loading the LSC estimate of school-site trips to the adjacent streets. Design details such as the actual access plan for the school, sight distance, levels of service, queuing, auxiliary turn lanes, and other design elements will likely be included in a site-specific study for the school site.

For Reference: Other nearby Briargate access points (shown on the Sketch Plan)

- The access control plan shows a right-in/right-out access to the south side of Briargate Parkway at Wheatland Drive between Vollmer Road and Sterling Ranch Road. The currently proposed Sketch Plan Amendment shows a three-quarter movement access for the south leg and a right-in/right-out access on the north leg. A deviation request for this access point has been submitted and approved.
- The currently proposed Sketch Plan Amendment shows a right-in/right-out access to the north side of Briargate Parkway about 1,230 feet east of Sterling Ranch Road that is not shown on the access control plan.
- The access control plan shows a right-in/right-out access to the south side of Briargate Parkway just west of Banning Lewis Parkway. The currently proposed Sketch Plan Amendment shows a right-in/right-out access to the north side of Briargate and a three-quarter movement access to the south side of Briargate at approximately the same location (1,085 feet west of Banning Lewis Parkway).
- The access control plan shows the intersection of Briargate/Banning Lewis as a three-leg intersection. The currently proposed Sketch Plan includes a north leg at this future full-movement signal-controlled intersection.

Sight Distance Analysis

Figures 4a through 4b show sight-distance analysis at the proposed intersections to Sterling Ranch Road. Based on a design speed of 40 miles per hour (mph) and the criteria contained in Table 2-21 of the *Engineering Criteria Manual (ECM)*, the required intersection sight distance at the future intersections is 445 feet.

Figure 4c shows sight-distance analysis at the proposed three-quarter movement intersections to Briargate Parkway. Based on a design speed of 50 miles per hour (mph) and the criteria contained in Table 2-21 of the *Engineering Criteria Manual (ECM)*, the required intersection sight distance at the future intersections is 555 feet.

As shown in these figures, that intersection sight distance can be met at all of the proposed site-access points.

REPORT SCENARIOS

Short-Term Scenario

The short-term scenario includes the roadway segments to be added in the short term only as shown in Figure 3. This scenario includes the SRE Phase 1 Rezone and Preliminary Plan area (“the site”) as well as traffic to be generated in the short term by buildout of Homestead at Sterling Ranch, Branding Iron at Sterling Ranch, Sterling Ranch Filings 2-4, Copper Chase at Sterling Ranch, Homestead North at Sterling Ranch Filings 1-3, the Retreat at TimberRidge Filings 1-3, the planned FourSquare at Sterling Ranch East development, and the planned Villages at Sterling Ranch East development. Trips projected from these other short-term developments outside of the SRE Phase 1 Preliminary Plan/Rezone boundary are included as short-term “background traffic” in this report.

Long-Term Scenario

The long-term scenario is essentially the same as the 2042 Long-Term scenario contained in the LSC February 10, 2023 Master TIS with additional detail added for this application – including the analysis of minor intersections and street segments that are part of the Preliminary Plan. The study area of this report is more focused than the Sketch Plan.

EXISTING ROAD AND TRAFFIC CONDITIONS

The adjacent streets are shown in Figure 1 and are described below. Copies of the *2016 El Paso County Major Transportation Corridors Plan (MTCP)*, *2040 Roadway Plan*, and *2016 MTCP 2060 Corridor Preservation Plan* with the site location identified on them have been attached to this report.

Vollmer Road is currently a five-lane urban street within the City of Colorado Springs limits between Black Forest Road and Cowpoke Road; and a two-lane, rural, paved roadway north of Cowpoke Road extending to north of Hodgen Road. In the southbound direction, Vollmer Road has a posted speed limit of 45 mph. South of Cowpoke Road, Vollmer Road has a 40-mph posted speed limit. The *2040 El Paso County Major Transportation Corridors Plan (MTCP)* and the prior Sterling Ranch master traffic study show Vollmer Road as a four-lane Urban Minor Arterial in the vicinity of the site. Note: The new *Connect COS* City of Colorado Springs transportation plan shows Vollmer as a Principal Arterial.

Marksheffel Road is a Principal Arterial extending north from the City of Fountain to Woodmen Road. Marksheffel Road is planned to ultimately be widened to six lanes and extended north

and west from Woodmen Road to connect to Research Parkway at Black Forest Road. Marksheffel Road is shown as a four-lane Principal Arterial through the site on the El Paso County *MTCP*. The City of Colorado Springs intends to take ownership and maintenance of Marksheffel Road when it is constructed from Vollmer to the east and south to where it will connect to the segment constructed north of Woodmen Road in the City.

The section of Marksheffel Road adjacent to Sterling Ranch is planned to be constructed on 107 feet of right-of-way to the City's required cross section(s) and criteria. The section of Marksheffel Road between Sterling Ranch Road and Vollmer Road will be constructed in the very short-term future and the section of Marksheffel Road southeast of Sterling Ranch Road (to connect to the segment recently constructed) will be completed in the short term and will open the connection to Woodmen Road. Marksheffel will be constructed as a four-lane roadway to the previously agreed upon cross section.

Briargate Parkway is a six-lane, Principal Arterial that extends east from I-25 to Grand Lawn Circle (about one-half mile east of Powers Boulevard). Briargate Parkway is planned ultimately to extend to Towner Drive. The segment of Briargate Parkway between Vollmer Road and Sterling Ranch Road is planned to be constructed in the short term with this Preliminary Plan.

Sterling Ranch Road is a planned Non-Residential Collector shown extending through the Sterling Ranch development between Marksheffel Road and the north end of the Sketch Plan area (Arroya Road). The segment south of Briargate Parkway will be constructed in the short term with this Preliminary Plan.

Tahiti Drive is a gravel road which extends for about 750 feet north from Vollmer Road. The intersection of Vollmer/Tahiti is located just south of the future location of the intersection of Vollmer/Marksheffel. This intersection is planned to be closed with the construction of Marksheffel Road between Vollmer Road and Sterling Ranch Road. Access for the existing home using this access will be relocated north to Loch Fyne Lane.

Existing Traffic Volumes

Figures 5a and 5b show the existing average weekday and peak-hour traffic volumes at the key study-area intersections. The peak-hour traffic volumes shown are based on manual turning-movement counts by LSC Transportation Consultants and All Traffic Data Services. The date of each count is shown in Figure 5b. The average weekday traffic volumes shown in Figure 5a are estimates by LSC, based on the manual peak-hour traffic-count data. The traffic count sheets are attached.

Existing Levels of Service

Level of service (LOS) is a quantitative measure of the level of congestion or delay at an intersection. Level of service is indicated on a scale from “A” to “F.” LOS A represents control delay of less than 10 seconds for unsignalized intersections. LOS F represents control delay of more than 50 seconds for unsignalized intersections. Table 1 shows the level of service delay ranges.

Table 1: Intersection Levels of Service Delay Ranges

Level of Service	Signalized Intersections	Unsignalized Intersections
	Average Control Delay (seconds per vehicle)	Average Control Delay (seconds per vehicle) ⁽¹⁾
A	10.0 sec or less	10.0 sec or less
B	10.1-20.0 sec	10.1-15.0 sec
C	20.1-35.0 sec	15.1-25.0 sec
D	35.1-55.0 sec	25.1-35.0 sec
E	55.1-80.0 sec	35.1-50.0 sec
F	80.1 sec or more	50.1 sec or more

(1) For unsignalized intersections, if V/C ratio is greater than 1.0 the level of service is LOS F, regardless of the projected average control delay per vehicle.

The intersection of Burgess/Vollmer has been analyzed based on the unsignalized-intersection analysis procedures from the *Highway Capacity Manual, 6th Edition* by the Transportation Research Board.

Burgess/Vollmer

The stop-sign-controlled intersection of Burgess/Vollmer is currently operating at LOS E for the eastbound approach and LOS F for the westbound approach during the afternoon peak hour.

Safety and Accident Analysis

The Colorado State Patrol (CSP) provided LSC with crash history data for Vollmer Road between Tahiti Drive and Burgess Road from September 2019 through September 2022. During the reported time period, there were twelve reported crashes. Of the twelve reports, ten were single-vehicle non-intersection-related crashes on Vollmer Road. One crash involved a southbound vehicle that turned right onto Poco Road and crashed into several cars parked on Poco Road partially in the lane. The only intersection-related crash occurred in June 2022. A vehicle heading northbound on Vollmer Road was slowing to turn left at Lochwinnoch Road and the vehicle behind them attempted to pass on the left side. The crash history data has been attached.

BASELINE CONDITIONS

Baseline traffic is the traffic estimated to be on the adjacent roadways and at adjacent intersections without the proposed development's trip generation of site-generated traffic volumes. Baseline traffic (for a specified horizon year) includes the through traffic and the traffic generated by nearby developments (existing and planned, including traffic generated by existing and planned developments within the greater Sterling Ranch overall development) but assumes zero traffic generated by land uses within the site (the SRE Phase 1 rezone/preliminary plan boundary area).

Short-Term Scenario Baseline Conditions

Please refer to the description of the short-term scenario above. Figures 6a and 6b show the projected volumes for the short-term baseline scenario.

Figure 6c shows the lane geometry, traffic control, and level of service at the key area intersections, based on the short-term scenario baseline volumes.

Long-Term Scenario Baseline Conditions

Figure 7a shows the projected 2042 baseline daily traffic volumes on key street segments at the key area intersections and Figure 7b shows the projected 2042 peak-hour baseline traffic volumes at the key area intersections. These volumes assume buildout of the area street network, including the completion of Marksheffel Road between Vollmer Road and Black Forest Road, Briargate Parkway between Meridian Road and Black Forest Road, and Sterling Ranch Road between Marksheffel Road and Briargate Parkway.

The 2042 baseline traffic volumes are estimates by LSC, based on the traffic projections in the LSC February 10, 2023 Master TIS report. The 2042 baseline daily traffic volumes assume buildout of the land uses within the Sterling Ranch Master Plan that are not included in the Sterling Ranch East Phase 1 Preliminary Plan area.

Figure 7b shows the lane geometry, traffic control, and level of service at the key area intersections, based on the 2042 baseline volumes.

TRIP GENERATION

The site-generated vehicle trips were estimated using the nationally-published trip-generation rates from *Trip Generation, 11th Edition, 2021* by the Institute of Transportation Engineers (ITE). Table 2 shows the trip-generation estimates.

The residential portion of the Sterling Ranch East Phase 1 Preliminary Plan is projected to generate about 7,176 new external vehicle trips on the average weekday, with about half entering and half exiting the site during a 24-hour period. During the morning peak hour, which generally occurs for one hour between 6:30 and 8:30 a.m., about 19 vehicles would enter and 394 vehicles would exit the site. During the afternoon peak hour, which generally occurs for one hour between 4:15 and 6:15 p.m., about 451 vehicles would enter and 265 vehicles would exit the site.

The future school sites within Sterling Ranch East Phase 1 Preliminary Plan are projected to generate about 3,774 new external vehicle trips on the average weekday, with about half entering and half exiting the site during a 24-hour period. During the morning peak hour, which generally occurs for one hour between 6:30 and 8:30 a.m., about 660 vehicles would enter and 563 vehicles would exit the site. During the afternoon peak hour, which generally occurs for one hour between 4:15 and 6:15 p.m., about 124 vehicles would enter and 143 vehicles would exit the site. As shown in the October 22, 2022, and subsequent Master TIS reports, about 60 percent of these trips are projected to be internal to the Sterling Ranch Sketch Plan area.

TRIP DISTRIBUTION AND ASSIGNMENT

The directional distribution of the site-generated traffic volumes on the street and roadway system serving the site is an important factor in determining the site's traffic impacts. The distribution estimates for short-term and long-term residential related traffic are shown in Figures 8 and 9, respectively. The short-term directional-distribution estimate assumes the short-term roadway network shown in Figure 3 only and the long-term directional-distribution estimate assumes buildout of the roadway network. Figure 10 shows the long-term directional-distribution estimate for the school related traffic. The directional-distribution estimates are based, in part, on the estimates contained in the sketch plan TIS report. Factors include: the location of the site with respect to the Colorado Springs metropolitan area, the planned access system for the site, the street and roadway system serving the site, and the land uses proposed for the site.

When the distribution percentages (from Figures 8, 9, and 10) are applied to the new, external trip-generation estimates (from Table 2), the resulting site-generated traffic volumes can be determined. Figures 11a and 11b show the short-term residential site-generated traffic volumes. These volumes assume only the street network shown in Figure 3. Figures 12a and 12b show the long-term residential site-generated traffic volumes assuming buildout of the area roadway network. Figure 13a and 13b show the long-term school-related site-generated traffic volumes. These volumes include internal trips between the residential land uses within SRE Phase 1 Preliminary Plan and the two future school sites.

TOTAL TRAFFIC

Short-Term Total Traffic

Figure 14a shows the projected short-term total daily traffic volumes on key street segments and Figure 14b shows the projected short-term total peak-hour traffic volumes at the key study-area intersections. These volumes are the sum of the short-term baseline traffic volumes (from Figures 6a and 6b) and the short-term residential-related site-generated traffic volumes (from Figures 11a and 11b). The short-term analysis assumes only the street network shown in Figure 3 has been constructed and assumes the future school sites (Tracts T and M) within the SRE Phase 1 Preliminary Plan have not yet been developed.

Figure 14c shows the level of service analysis results for the key area intersections based on the projected short-term total volumes. The figure also shows the general intersection lane geometry and intersection traffic control used in the analysis.

2042 Total Traffic

Figure 15a shows the projected 2042 total daily traffic volumes on key street segments and Figure 15b shows the projected 2042 total peak-hour traffic volumes at the key study-area intersections. These volumes are the sum of the 2042 baseline traffic volumes (from Figures 7a and 7b), the long-term residential-related site-generated traffic volumes (from Figures 12a and 12b) and the long-term school-related site-generated traffic volumes (from Figures 13a and 13b).

Figure 14c shows the level of service analysis results for the key area intersections based on the projected 2042 total volumes. The figure also shows the general intersection lane geometry and intersection traffic control used in the analysis.

LEVEL OF SERVICE ANALYSIS

The key area future signalized intersections have been analyzed to determine the projected intersection levels of service for short-term and 2042 baseline and total traffic scenarios for the morning and afternoon peak-hour periods using Synchro. The key area future stop-sign-controlled and modern-roundabout-controlled intersections have been analyzed based on the unsignalized-intersection analysis procedures from the *Highway Capacity Manual 6th Edition*. Figures 6c, 7c, 14c and 15c show the level of service analysis results. The level of service reports are attached.

Intersection #1: Vollmer/Burgess

The stop-sign-controlled intersection of Burgess/Vollmer is currently operating at LOS E for the eastbound approach and LOS F for the westbound approach during the afternoon peak hour. The intersection currently has one-lane approaches in all directions. Based on existing traffic volumes shown in Figure 5 and the criteria contained in the *El Paso County Engineering Criteria Manual (ECM)*, multiple auxiliary turn lanes would be required to meet the *ECM* standard. LSC recommends this intersection be reconstructed as a modern one-lane roundabout. As a modern roundabout, it is projected to operate at LOS C or better for all approaches during the peak hours based on the projected short-term and 2042 total traffic volumes.

Intersection #4: Vollmer/Briargate

The section of Briargate Parkway between Vollmer Road and Sterling Ranch Road is planned to be constructed to its final cross section in the short term. The intersection of Briargate/ Vollmer could operate at a satisfactory level of service (LOS C or better) in the short term as a stop-sign-controlled intersection.

By 2042, it was assumed Briargate Parkway would be extended west to Black Forest Road and East to Towner Avenue and that the intersection of Vollmer/Briargate will be converted to traffic-signal control. The intersection of Vollmer/Briargate is projected to operate at an overall LOS C during the peak hours as a signalized intersection, based on the projected 2042 total traffic volumes shown in Figure 15b and the lane geometry shown in Figure 15c.

Intersection #5: Sterling Ranch/Briargate

The section of Briargate Parkway between Vollmer Road and Sterling Ranch Road is planned to be constructed to its final cross section in the short term. The intersection of Briargate/Sterling Ranch could operate at a satisfactory level of service (LOS C or better) in the short term as a stop-sign-controlled intersection.

By 2042, it was assumed Briargate Parkway would be extended west to Black Forest Road and East to Towner Avenue and that the intersection of Briargate/Sterling Ranch will be converted to traffic-signal control. The intersection of Sterling Ranch/Briargate is projected to operate at an overall LOS C during the peak hours as a signalized intersection, based on the projected 2042 total traffic volumes shown in Figure 15b and the lane geometry shown in Figure 15c.

Intersection #8: Oak Park/Sterling Ranch

The intersection of Oak Park Place/Sterling Ranch Road is projected to operate at LOS B or better for all movements as a stop-sign-controlled intersection, based on the projected short-term total traffic volumes shown in Figure 14b and the lane geometry shown in Figure 14c.

By 2042, it was assumed the future K-8 School planned for the parcel southwest of Briargate/Sterling Ranch would be constructed and that an **exit-only** access would be constructed aligning with the Oak Park/Sterling Ranch intersection. Based on the 2042 total traffic volumes shown in Figure 15b and the lane geometry shown in Figure 15c, the eastbound and westbound left-turn movements are projected to operate at LOS E during the morning peak hour and LOS C during the afternoon peak hour. Alternate traffic control may be needed to achieve a satisfactory level of service at this intersection. Further analysis of this intersection should be conducted when the number of students, site layout, and proposed access plan are determined.

Intersection #12: Vollmer/Marksheffel

Marksheffel Road is planned to be constructed between Vollmer Road and Sterling Ranch Road in the short-term future. The intersection of Marksheffel/Vollmer is initially planned to be stop-sign controlled. Based on the projected short-term total traffic volumes which assume buildout of the residential portion of SRE Phase 1 Preliminary Plan, the westbound left-turn movement is projected to operate at LOS E during the morning peak hour and LOS F during the afternoon peak hour. If this intersection is converted to traffic-signal control prior to buildout, it is projected to operate at an overall LOS A during the peak hours.

By 2042, it was assumed that Marksheffel Road would be constructed west to Briargate Parkway and that the intersection of Vollmer/Marksheffel will be converted to traffic-signal control. The intersection of Vollmer/Marksheffel is projected to operate at an overall LOS C or better during the peak hours as a signalized intersection, based on the projected 2042 total traffic volumes shown in Figure 15b and the lane geometry shown in Figure 15c.

Intersection #13: Sterling Ranch/Marksheffel

Marksheffel Road is planned to be constructed between Vollmer Road and Sterling Ranch Road in the short-term future. The intersection of Marksheffel/Sterling Ranch is initially planned to be stop-sign controlled. Based on the projected short-term total traffic volumes which assume buildout of the residential portion of SRE Phase 1 Preliminary Plan, the southbound left-turn movement is projected to operate at LOS F during both the morning and afternoon peak hours. If this intersection is converted to traffic-signal control prior to buildout, it is projected to operate at an overall LOS A during the peak hours.

The intersection of Sterling Ranch/Marksheffel is projected to operate at an overall LOS C or better during the peak hours as a signalized intersection, based on the projected 2042 total traffic volumes shown in Figure 15b and the lane geometry shown in Figure 15c.

Sterling Ranch Road Site Access Points (Intersection #303-#308)

The intersections of Lubbock Trail/Sterling Ranch Road (#303), Bellflower Drive/Sterling Ranch Road (#304), Lake Tahoe Drive/Sterling Ranch Road (#305), Newport Beach Place/Sterling Ranch Road (#306), Idaho Falls Drive/Sterling Ranch Road (#308) and Vancouver Street/Sterling Ranch Road (#309) are projected to operate at a satisfactory level of service (LOS C or better) during the peak hours as stop-sign-controlled intersections, based on the projected short-term and 2042 total traffic volumes

Briargate Parkway Site Access Points (Intersection #102-#103)

The intersection of Boulder City Place/Briargate Parkway and the future K-8 school access to Briargate Parkway are projected to operate at LOS B or better for all movements as three-quarter movement (left-in/right-in/right-out only) stop-sign-controlled intersections, based on the projected short-term and 2042 total traffic volumes.

SIGNAL WARRANT THRESHOLD ANALYSIS – AM AND PM PEAK HOURS

The intersections of Marksheffel/Vollmer and Marksheffel/Sterling Ranch were analyzed to determine if the thresholds for Four-Hour and/or Eight-Hour Vehicular-Volume Traffic-Signal Warrant thresholds would be reached or exceeded, based on the projected short-term peak-hour traffic volumes only. In order for an Eight-Hour Vehicular Volume Traffic Signal Warrant to be satisfied, the volume threshold would need to be met for six additional hours of the day and in order for a Four-Hour Vehicular Volume Traffic Signal Warrant to be satisfied, the volume threshold would need to be met for two additional hours of the day. For example, the four-hour warrant would be satisfied with the volume thresholds met for one hour in the morning, two hours (instead of the one-hour peak) during the afternoon peak period, and an hour during the mid-afternoon.

This “cursory”/planning-level analysis has been provided at the Preliminary Plan level to identify intersections which may need to be signalized in the short-term future. Detailed analysis of all applicable signal warrants should be evaluated with Filing submitted. The satisfaction of warrants does not indicate that a signal must be installed. The decision to require a signal to be installed rests with the County.

Table 3 shows the results of the analysis for the intersection of Marksheffel/Vollmer and Table 4 shows the results of the analysis for the intersection of Marksheffel/Sterling Ranch. As shown in Tables 3 and 4, the projected short-term morning and afternoon peak-hour traffic volumes at both intersections are projected to meet the thresholds for both Four-Hour and Eight-Hour Vehicular Volume Traffic Signal Warrants. This analysis indicates that traffic signal warrant(s) may be met at both of these intersections prior to buildout of SRE Phase 1 Preliminary Plan. Detailed analysis should be provided with each future filing within the Preliminary Plan. Escrow towards these improvements may also need to be provided with each filing.

ROADWAY FUNCTIONAL CLASSIFICATIONS AND LANEAGE

Figure 16 shows the recommended functional classifications and number of through lanes for the streets in the study area.

ARTERIAL CORRIDOR SIGNAL-PROGRESSION ANALYSIS

No additional full-movement intersections to an arterial corridor with the potential to become signalized are shown on this preliminary plan. Therefore, an arterial signal-progression analysis has not been included.

DEVIATION REQUEST

A deviation request for the proposed three-quarter-movement access Boulder City Drive to Briargate Parkway has been prepared by JR Engineering and is included with this submittal.

AREA MTCP 2040 ROADWAY IMPROVEMENT PROJECTS

The *El Paso County 2016 Major Transportation Corridors Plan Update* identified the following 2040 roadway improvement projects within the study area:

- C13: Vollmer Road from Marksheffel Road to Stapleton Drive as a Rural 4-Lane Minor Arterial;
- N5: Stapleton Drive [Briargate Parkway] from Towner Road to Black Forest Road as a 4-Lane Urban Principal Arterial;
- N12: Marksheffel Road from Woodman Road to Research Parkway as a 4-Lane Urban Principal Arterial; and
- M11: Vollmer Road Bicycle & Primary Regional Trail from Marksheffel Road to Shoup Road.

CONCLUSIONS AND RECOMMENDATIONS

Trip Generation

- The residential portion of the Sterling Ranch East Phase 1 Preliminary Plan is projected to generate about 7,176 new external vehicle trips on the average weekday, with about half entering and half exiting the site during a 24-hour period. During the morning peak hour, which generally occurs for one hour between 6:30 and 8:30 a.m., about 19 vehicles would enter and 394 vehicles would exit the site. During the afternoon peak hour, which generally occurs for one hour between 4:15 and 6:15 p.m., about 451 vehicles would enter and 265 vehicles would exit the site.
- The future school sites within Sterling Ranch East Phase 1 Preliminary Plan are projected to generate about 3,774 new external vehicle trips on the average weekday, with about half entering and half exiting the site during a 24-hour period. During the morning peak hour, which generally occurs for one hour between 6:30 and 8:30 a.m., about

660 vehicles would enter and 563 vehicles would exit the site. During the afternoon peak hour, which generally occurs for one hour between 4:15 and 6:15 p.m., about 124 vehicles would enter and 143 vehicles would exit the site. As shown in the October 22, 2022, and subsequent Master TIS reports, about 60 percent of these trips are projected to be internal to the Sterling Ranch Sketch Plan area.

Level of Service

- The stop-sign-controlled intersection of Burgess/Vollmer is currently operating at LOS E for the eastbound approach and LOS F for the westbound approach during the afternoon peak hour. The intersection currently has one-lane approaches in all directions. Based on existing traffic volumes shown in Figure 5 and the criteria contained in the El Paso County *Engineering Criteria Manual (ECM)*, multiple auxiliary turn lanes would be required to meet the *ECM* standard. LSC recommends this intersection be reconstructed as a modern one-lane roundabout. As a modern roundabout, it is projected to operate at LOS C or better for all approaches during the peak hours based on the projected short-term and 2042 total traffic volumes.
- The intersections of Briargate/Vollmer and Briargate/Sterling Ranch are projected to operate at a satisfactory level of service as stop-sign-controlled intersections in the short-term future. By 2042, these intersections will likely need to be converted to traffic-signal control. As signalized intersections, all movements are projected to operate at LOS D or better during the peak hours based on the projected 2042 total traffic volumes.
- Some of the movements at the intersections of Marksheffel/Vollmer and Marksheffel/Sterling Ranch Road are projected to operate at LOS E or LOS F during the peak hours if they remain stop-sign controlled in the short-term future. Once signalized, all movements at these intersections are projected to operate at LOS D or better, based on the projected short-term and 2042 total traffic volumes.
- All of the site-access points to Sterling Ranch Road except the intersection of Sterling Ranch/Oak Park Place are projected to operate at a satisfactory level of service (LOS D or better) during the peak hours as stop-sign-controlled intersections, based on the projected short-term and 2042 total traffic volumes.
- The intersection of Oak Park Place/Sterling Ranch Road is projected to operate at LOS B or better for all movements as a stop-sign-controlled intersection, based on the projected short-term total traffic volumes shown in Figure 14b and the lane geometry shown in Figure 14c. By 2042, it was assumed the future K-8 School planned for the parcel southwest of Briargate/Sterling Ranch would be constructed and that an **exit-only** access would be constructed aligning with the Oak Park/Sterling Ranch intersection. Based on the 2042 total traffic volumes shown in Figure 15b and the lane geometry shown in Figure 15c, the eastbound and westbound left-turn movements are projected to operate at LOS E during the morning peak hour and LOS C during the afternoon peak hour. Alternate traffic control may be needed to achieve a satisfactory

level of service at this intersection. Further analysis of this intersection should be conducted when number of students, site layout, and proposed access plan are determined.

- The intersection of Boulder City Place/Briargate Parkway and the future K-8 school access to Briargate Parkway are projected to operate at LOS B or better for all movements as three-quarter movement (left-in/right-in/right-out only) stop-sign-controlled intersections based on the projected short-term and 2042 total traffic volumes.

Recommended Improvements

- Table 5 shows detailed **intersection** improvements needed with SRE Phase 1 Preliminary Plan at the site-access points and the intersection of Briargate/Sterling Ranch. The recommended improvements are based on the short-term and 2042 total traffic volumes shown in Figures 14b and 15b and the criteria contained in the El Paso County *Engineering Criteria Manual (ECM)*.
- Table 6 shows a list of the **roadway segment** improvements in the vicinity of the site. Please see Figure 17 for a map of the key street segment locations. These recommendations are consistent with the LSC Sketch Plan TIS report.

TRANSPORTATION IMPROVEMENT FEE PROGRAM AND CREDIT AGREEMENTS

The applicant will be required to participate in the Countywide Transportation Improvement Fee Program. These projects will annex into the 5 mil PID, which has a per-lot upfront building permit fee of \$2,527 per dwelling unit. The total building permit fee amount for the 761 lots within SRE Phase 1 Preliminary Plan would be \$1,923,047. Note: This is based on the current rate, which is subject to change. El Paso County updates this rate periodically.

A road fee credit agreement and development agreement and Subdivision Improvements Agreement will be required to address developer's road fee credits for construction of Vollmer Road. Additional credit agreements will be needed with each phase of construction to account for reimbursement of costs for the additional lanes and major intersection improvements.

* * * * *

Please contact me if you have any questions regarding this report.

Sincerely,

LSC TRANSPORTATION CONSULTANTS, INC.

By Jeffrey C. Hodsdon, P.E.
Principal

JCH/KDF:jas

Enclosures: Tables 2-6
Figures 1-17
Appendix Table 1
2008 TIS TAZ Map
MTCP Maps
Traffic Count Reports
Level of Service Reports
Crash History

Tables 2-6



**Table 2
Sterling Ranch East Rezoning & Preliminary Plan
Trip Generation**

Sketch Plan TAZ	Filing	Location	ITE Code	ITE Land Use	Quantity	Unit	Trip Generation Rates ⁽¹⁾				Total Trip Generated					
							Daily	AM Peak Hour		PM Peak Hour		Daily	AM Peak Hour		PM Peak Hour	
								In	Out	In	Out		In	Out	In	Out
Residential Land Uses (Short-Term)																
18	1	North of Briargate Parkway	210	Single-Family Detached Housing	42	DU ⁽²⁾	9.43	0.18	0.52	0.59	0.35	396	8	22	25	15
22 & 26	1	South of Briargate Parkway	210	Single-Family Detached Housing	294	DU	9.43	0.18	0.52	0.59	0.35	2,772	54	152	174	102
17, 23, 24 & 38	2	Southeast of Sterling Ranch Road	210	Single-Family Detached Housing	187	DU	9.43	0.18	0.52	0.59	0.35	1,763	34	97	111	65
37	3	North of Briargate Parkway	210	Single-Family Detached Housing	238	DU	9.43	0.18	0.52	0.59	0.35	2,244	43	123	141	83
Residential Total						761	DU	Total Residential Land Uses				7,176	139	394	451	265
Non-Residential Land Uses (Future Phases)																
102	Future	Tract F	520	Elementary School	600	Students	2.27	0.40	0.34	0.07	0.09	1,362	240	204	44	52
103		Tract M	520	Elementary School	600	Students	2.27	0.40	0.34	0.07	0.09	1,362	240	204	44	52
			522	Middle School/Junior High	500	Students	2.10	0.36	0.31	0.07	0.08	1,050	181	154	36	39
Total Non-Residential Land Uses								Total Non-Residential Land Uses				3,774	660	563	124	143
Grand Total											10,950	799	957	575	407	

Notes:

(1) Source: "Trip Generation, 11th Edition, 2021" by the Institute of Transportation Engineers (ITE)

(2) DU = Dwelling Unit

Table 3
Traffic Signal Warrant Analysis
 Marksheffel Road/Vollmer Road

Warrant Analysis ⁽¹⁾																				
Hour	Short-Term Background Traffic ⁽²⁾						SRE Filing 1 Generated Traffic		Short-Term Total Traffic		Warrant 1: Eight Hour Vehicular Volume Evaluation				Warrant 2: Four Hour Vehicular Volume Evaluation					
	Major ⁽³⁾		Minor ⁽⁴⁾		Major		Minor		Major		Minor		Warrant Threshold Met?		Background		Short-Term Total			
	Marksheffel		Vollmer		Marksheffel		Vollmer		Marksheffel		Vollmer		Condition A		Condition B		Warrant Threshold Minor		Warrant Threshold Met? WB	
	Major		Minor		Major		Minor		Major		Minor		Condition A		Condition B		Minimum		WB	
	Marksheffel		Vollmer		Marksheffel		Vollmer		Major		Minor		Condition A		Condition B		Minimum		WB	
Short-Term Total Traffic⁽⁵⁾																				
12-1 AM	53	3	0	0	53	3	600	150	900	75	No	No	No	No	Low Volume	No	Low Volume	No		
1-2 AM	26	3	0	0	26	3	600	150	900	75	No	No	No	No	Low Volume	No	Low Volume	No		
2-3 AM	19	0	0	0	19	0	600	150	900	75	No	No	No	No	Low Volume	No	Low Volume	No		
3-4 AM	28	3	0	0	28	3	600	150	900	75	No	No	No	No	Low Volume	No	Low Volume	No		
4-5 AM	43	14	0	1	43	15	600	150	900	75	No	No	No	No	Low Volume	No	Low Volume	No		
5-6 AM	117	34	0	2	117	36	600	150	900	75	No	No	No	No	Low Volume	No	Low Volume	No		
6-7 AM	347	101	2	5	349	106	600	150	900	75	No	No	No	No	Low Volume	No	Low Volume	No		
7-8 AM	833	174	3	8	836	182	600	150	900	75	Yes	No	Yes	No	192	No	191	No		
8-9 AM	931	147	3	7	934	154	600	150	900	75	No	Yes	Yes	Yes	167	No	167	No		
9-10 AM	805	92	3	4	808	96	600	150	900	75	No	No	No	No	199	No	198	No		
10-11 AM	935	92	4	4	939	96	600	150	900	75	No	Yes	No	Yes	166	No	165	No		
11-12 PM	1055	87	5	4	1060	91	600	150	900	75	No	Yes	No	Yes	134	No	132	No		
12-1 PM	999	51	0	0	999	51	600	150	900	75	No	No	No	No	150	No	150	No		
1-2 PM	758	73	15	3	773	76	600	150	900	75	No	No	No	No	221	No	214	No		
2-3 PM	871	77	5	4	876	81	600	150	900	75	No	No	No	No	182	No	181	No		
3-4 PM	927	74	6	4	933	78	600	150	900	75	No	No	No	Yes	168	No	167	No		
4-5 PM	962	93	7	4	969	97	600	150	900	75	No	Yes	No	Yes	160	No	158	No		
5-6 PM	807	92	9	5	816	97	600	150	900	75	No	No	No	No	198	No	196	No		
6-7 PM	553	73	9	5	562	78	600	150	900	75	No	No	No	No	314	No	309	No		
7-8 PM	348	53	7	4	355	57	600	150	900	75	No	No	No	No	Low Volume	No	Low Volume	No		
8-9 PM	282	38	5	3	287	41	600	150	900	75	No	No	No	No	Low Volume	No	Low Volume	No		
9-10 PM	180	30	5	2	185	32	600	150	900	75	No	No	No	No	Low Volume	No	Low Volume	No		
10-11 PM	101	14	4	2	105	16	600	150	900	75	No	No	No	No	Low Volume	No	Low Volume	No		
11-12 AM	55	9	2	1	57	10	600	150	900	75	No	No	No	No	Low Volume	No	Low Volume	No		
Numbers of Hours the Warrant Thresholds Are Met											1	4	2	5						
Warrant Met?											No		No							

Notes:
 (1) Thresholds are based on 2 or more lanes on the major approach and 1 lane on the minor approach
 (2) Source: Sterling Ranch East Phase 1 Rezoning and Preliminary Plan Traffic Impact Study, November 14, 2022
 (3) The major street traffic includes all movements (left, through, and right)
 (4) The minor street traffic includes only the left turns from the minor street
 (5) Off peak hour traffic volumes are based on the projected peak hour traffic volumes, 72-hour machine counts conducted on Vollmer Road in November 2020 and vehicle time-of-day distribution data for single-family residential published by the Institute of Transportation Engineers
 Source: LSC Transportation Consultants, Inc.

Table 4
Traffic Signal Warrant Analysis
Marksheffel Road/Sterling Ranch Road

Warrant Analysis ⁽¹⁾																		
Warrant 1: Eight Hour Vehicular Volume Evaluation														Warrant 2: Four Hour Vehicular Volume Evaluation				
Hour	Short-Term Background Traffic ⁽²⁾		SRE Filing 1 Generated Traffic		Short-Term Total Traffic		Warrant Thresholds				Warrant Threshold Met?				Background		Short-Term Total	
	Major ⁽³⁾ Marksheffel	Minor ⁽⁴⁾ Sterling Ranch	Major Marksheffel	Minor Sterling Ranch	Major Marksheffel	Minor Sterling Ranch	Condition A		Condition B		Conditio n A	Conditio n B	Conditio n A	Conditio n B	Warrant Threshold Minor Minimum	Warrant Threshold Met? WB	Warrant Threshold Minor Minimum	Warrant Threshold Met? WB
							Major	Minor	Major	Minor								
															Minimum	WB	Minimum	WB
														Minimum	WB	Minimum	WB	
Short-Term Total Traffic⁽⁵⁾																		
12-1 AM	47	7	3	52	50	59	600	150	900	75	No	No	No	No	Low Volume	No	Low Volume	No
1-2 AM	20	7	3	21	23	28	600	150	900	75	No	No	No	No	Low Volume	No	Low Volume	No
2-3 AM	19	0	0	21	19	21	600	150	900	75	No	No	No	No	Low Volume	No	Low Volume	No
3-4 AM	21	7	3	21	24	28	600	150	900	75	No	No	No	No	Low Volume	No	Low Volume	No
4-5 AM	31	26	13	31	44	57	600	150	900	75	No	No	No	No	Low Volume	No	Low Volume	No
5-6 AM	64	65	33	52	97	117	600	150	900	75	No	No	No	No	Low Volume	No	Low Volume	No
6-7 AM	193	192	98	166	291	358	600	150	900	75	No	No	No	No	Low Volume	No	Low Volume	No
7-8 AM	414	332	170	332	584	664	600	150	900	75	No	No	No	No	383	No	298	Yes
8-9 AM	469	280	143	384	612	664	600	150	900	75	No	No	Yes	No	356	No	285	Yes
9-10 AM	406	176	90	332	496	508	600	150	900	75	No	No	No	No	387	No	342	Yes
10-11 AM	503	176	90	436	593	612	600	150	900	75	No	No	No	No	339	No	294	Yes
11-12 PM	616	166	85	560	701	726	600	150	900	75	Yes	No	Yes	No	284	No	250	Yes
12-1 PM	928	114	176	358	1104	472	600	150	900	75	No	Yes	Yes	Yes	168	No	119	Yes
1-2 PM	415	164	253	119	668	283	600	150	900	75	No	No	Yes	No	383	No	263	Yes
2-3 PM	483	172	265	139	748	311	600	150	900	75	No	No	Yes	No	349	No	226	Yes
3-4 PM	552	166	257	168	809	334	600	150	900	75	No	No	Yes	No	314	No	198	Yes
4-5 PM	636	208	321	208	957	416	600	150	900	75	Yes	No	Yes	Yes	276	No	161	Yes
5-6 PM	589	205	317	204	906	409	600	150	900	75	No	No	Yes	Yes	296	No	174	Yes
6-7 PM	460	164	253	170	713	334	600	150	900	75	No	No	Yes	No	360	No	244	Yes
7-8 PM	318	119	184	123	502	242	600	150	900	75	No	No	No	No	Low Volume	No	339	No
8-9 PM	307	86	133	125	440	211	600	150	900	75	No	No	No	No	Low Volume	No	370	No
9-10 PM	214	67	103	89	317	156	600	150	900	75	No	No	No	No	Low Volume	No	Low Volume	No
10-11 PM	107	31	47	44	154	75	600	150	900	75	No	No	No	No	Low Volume	No	Low Volume	No
11-12 AM	63	19	30	26	93	45	600	150	900	75	No	No	No	No	Low Volume	No	Low Volume	No
Numbers of Hours the Warrant Thresholds Are Met											2	1	9	3		0		12
Warrant Met?											No		Yes			No		Yes

Notes:

- Thresholds are based on 2 or more lanes on the major approach and 1 lane on the minor approach
- Source: *Sterling Ranch East Phase 1 Rezoning and Preliminary Plan Traffic Impact Study*, November 14, 2022
- The major street traffic includes all movements (left, through, and right)
- The minor street traffic includes only the left turns from the minor street
- Off peak hour traffic volumes are based on the projected peak hour traffic volumes, 72-hour machine counts conducted on Vollmer Road in November 2020 and vehicle time-of-day distribution data for single-family residential published by the Institute of Transportation Engineers

Source: LSC Transportation Consultants, Inc. Nov-22

**Table 5
Sterling Ranch East Rezoning & Preliminary Plan
Intersection Improvements**

Item #	Improvement	Trigger	Timing	Responsibility
1) Burgess Road/Vollmer Road				
1	Reconstruct as a modern one-lane roundabout	When the LOS degrades below LOS F	Existing deficiency	This intersection may be eligible intersection under the fee impact program
12) Marksheffel Road/Vollmer Road				
2	Signalization of the intersection	Once warrants are met. The decision on timing of traffic signal installation rests with El Paso County Public Works.	Anticipated by buildout of Sterling Ranch East Phase 1 Preliminary Plan	This intersection may be eligible intersection under the fee impact program
14) Marksheffel Road/Sterling Ranch Road				
3	Signalization of the intersection	Once warrants are met. The decision on timing of traffic signal installation rests with El Paso County Public Works.	Anticipated by buildout of Sterling Ranch East Phase 1 Preliminary Plan	SRMD#3
102) Briargate Parkway/Boulder City Drive				
4	Construct an eastbound left-turn lane on Briargate Parkway approaching Boulder City Drive. The lane should be 285' long plus a 200' taper.	eastbound left-turn volume > 10 vph	With Sterling Ranch East Phase 1 Preliminary Plan or Foursquare at Sterling Ranch	Sterling Ranch
5	Construct a westbound right-turn deceleration lane on Briargate Parkway approaching Boulder City Drive. The lane should be 235' long plus a 200' taper.	westbound right-turn volume > 25 vph	Long Term	Sterling Ranch
103) Briargate Parkway/Future School 3/4 Movement Access				
6	Construct a westbound left-turn lane on Briargate Parkway approaching the school access. The lane should be 285' long plus a 200' taper.	westbound left-turn volume > 10 vph	Long Term With development of the K-8 School Parcel (Tract M)	Sterling Ranch
7	Construct an eastbound right-turn deceleration lane on Briargate Parkway approaching the school access. The lane should be 235' long plus a 200' taper.	eastbound right-turn volume > 25 vph	Long Term With development of the K-8 School Parcel (Tract M)	Sterling Ranch
5) Briargate Parkway/Sterling Ranch Road				
8	Construct an eastbound left-turn lane on Briargate Parkway approaching Sterling Ranch Road. The lane should be 435' long plus a 200' taper.	eastbound left-turn volume > 10 vph	With Sterling Ranch East Phase 1 Preliminary Plan or Foursquare at Sterling Ranch	Sterling Ranch
9	Construct an eastbound right-turn deceleration lane on Briargate Parkway approaching Sterling Ranch Road. The lane should be 235' long plus a 200' taper.	eastbound right-turn volume > 25 vph	Long Term With development of the K-8 School Parcel (Tract M)	Sterling Ranch
10	Construct a northbound to eastbound right-turn acceleration lane on Briargate Parkway at Sterling Ranch Road. The lane should be 580' long plus a 180' taper.	northbound right-turn volume > 50 vph	Long Term With development of the K-8 School Parcel (Tract M)	Sterling Ranch
11	Construct a westbound left-turn lane on Briargate Parkway approaching Sterling Ranch Road. The lane should be 285' long plus a 200' taper.	westbound left-turn volume > 10 vph	Long Term	Sterling Ranch
12	Construct an eastbound right-turn deceleration lane on Briargate Parkway approaching Sterling Ranch Road. The lane should be 235' long plus a 200' taper.	eastbound right-turn volume > 25 vph	Long Term	Sterling Ranch
13	Construct a southbound to westbound right-turn acceleration lane on Briargate Parkway at Sterling Ranch Road. The lane should be 580' long plus a 180' taper.	southbound right-turn volume > 50 vph	With Sterling Ranch East Phase 1 Preliminary Plan	Sterling Ranch
303) Sterling Ranch Road/Lubbock Trail				
14	Construct an northeastbound right-turn deceleration lane on Sterling Ranch Road approaching Lubbock Trail. The lane should be 155' long plus a 160' taper	northeastbound right-turn volume > 50 vph	Long Term With development of the Elementary School Parcel (Tract F)	Sterling Ranch
15	Construct a southwestbound left-turn lane on Sterling Ranch Road approaching Lubbock Trail. The lane should be 305' long plus a 200' taper.	southwestbound-turn volume > 25 vph	Long Term With development of the Elementary School Parcel (Tract F)	Sterling Ranch
304) Sterling Ranch Road/Westmont Drive				
16	Construct an northeastbound left-turn deceleration lane on Sterling Ranch Road approaching Westmont Drive. The lane should be 205' long plus a 160' taper	northeastbound left-turn volume > 25 vph	With Sterling Ranch East Phase 1 Preliminary Plan	Sterling Ranch
17	Construct a southwestbound left-turn lane on Sterling Ranch Road approaching Westmont Drive. The lane should be 205' long plus a 200' taper.	southwestbound-turn volume > 25 vph	Long Term (Needed with construction of a northeastbound left-turn lane)	Sterling Ranch
305) Sterling Ranch Road/Lake Tahoe Drive				
18	Construct an northeastbound left-turn deceleration lane on Sterling Ranch Road approaching Lake Tahoe Drive. The lane should be 225' long plus a 160' taper	northeastbound left-turn volume > 25 vph	With Sterling Ranch East Phase 1 Preliminary Plan	Sterling Ranch
19	Construct a southwestbound left-turn lane on Sterling Ranch Road approaching Lake Tahoe Drive. The lane should be 205' long plus a 200' taper.	southwestbound-turn volume > 25 vph	Not Required (Needed with construction of a northeastbound left-turn lane)	Sterling Ranch
20	Construct an northeastbound right-turn deceleration lane on Sterling Ranch Road approaching Lake Tahoe Drive. The lane should be 155' long plus a 160' taper	northeastbound right-turn volume > 50 vph	Long Term	Sterling Ranch
306) Sterling Ranch Road/Newport Beach Drive				
21	Construct a northeastbound left-turn lane on Sterling Ranch Road approaching Newport Beach Drive. The lane should be 205' long plus a 200' taper.	northeastbound left-turn volume > 25 vph	With Sterling Ranch East Phase 1 Preliminary Plan	Sterling Ranch
308) Sterling Ranch Road/Idaho Falls Drive				
22	Construct a northeastbound left-turn lane on Sterling Ranch Road approaching Idaho Falls Drive. The lane should be 240' long plus a 200' taper.	northeastbound left-turn volume > 25 vph	With Sterling Ranch East Phase 1 Preliminary Plan	Sterling Ranch
309) Sterling Ranch Road/Vancouver Street				
23	Construct a northeastbound left-turn lane on Sterling Ranch Road approaching Vancouver Street. The lane should be 265' long plus a 200' taper.	northeastbound left-turn volume > 25 vph	With Sterling Ranch East Phase 1 Preliminary Plan	Sterling Ranch
Notes:				
Source: LSC Transportation Consultants, Inc. (February 2023)				

Table 6

(Page 1 of 2)

Sterling Ranch East Rexoning & Preliminary Plan

Roadway Segment Improvements

Segment ID ⁽¹⁾ (See Figure 12 for map)	Improvement Description	Timing	Design ADT (vpd)	Projected 2042 ADT (vpd)	Responsibility
V1 northbound	Per the City of Colorado Springs, an outside paved shoulder will need to be added along the east side of Vollmer Road from Dry Needle Place up to the south end of segment V2 improvements.	With Sterling Ranch Filing No. 4 but potentially complete concurrently with the construction of the right-turn lane at Pioneer Landscape Center access for the Sterling Ranch Recycling Facility (PCD No. PPR2241)	5,500 (Directional northbound)	16,275	Sterling Ranch
V1 southbound			10,000 (Directional southbound)		
V1	Improve Vollmer Road between Dry Needle Place and the Sterling Ranch south boundary to a standard 4-Lane Urban Minor Arterial Cross Section (add a second northbound through lane and painted center median). ⁽²⁾	The need driven by anticipated traffic from each development impacting this section of Vollmer Road.	20,000		Sterling Ranch, if necessary, prior to construction by others.
V2	Improve Vollmer Road between the Sterling Ranch south boundary to Lochwinnoch Lane/Sterling property boundary to a standard 4-Lane Urban Minor Arterial Cross Section. ⁽²⁾	Short-Term Future (With Sterling Ranch Fil No. 2 Or Sterling Ranch Phase 2)	20,000 (Note: Existing Capacity 8,000 ⁽³⁾)	17,475	Sterling Ranch
V3	Short Term: Improve Vollmer Road from Lochwinnoch Lane to Sterling Ranch boundary (northeast of Glider Loop) to provide 36' of pavement (existing pavement 1 approx. 23.38') and stripe for one through lane plus a 6' paved, striped outside shoulder in each direction. ⁽²⁾	Short-Term Future (With Homestead North)	11,000 (Note: Existing Capacity 8,000)	17,380	Sterling Ranch
	Long Term: Improve Vollmer Road from Lochwinnoch Lane to Sterling Ranch boundary (northeast of Glider Loop) to a standard 4-Lane Urban Minor Arterial Cross Section. ⁽²⁾	Long-Term Future	20,000		Sterling Ranch with potential County assistance with ROW acquisition - pursuant to the recent development agreement between Sterling Ranch and EPC.
V4	Improve Vollmer Road from Sterling Ranch boundary (northeast of Glider Loop) to Briargate Parkway to a standard 4-Lane Urban Minor Arterial Cross Section. ⁽²⁾	Short-Term Future— May 2024 Updated 10/15/2022 - Sections V4, V5, V6 to be constructed by May 2024 (prior note: With Homestead North Filing 1)	20,000	16,445	Sterling Ranch
V5	Improve Vollmer Road from Briargate Parkway to Jane Kirkham Drive to a standard 4-Lane Urban Minor Arterial Cross Section. ⁽²⁾	Short-Term Future— May 2024 Updated 10/15/2022 - Sections V4, V5, V6 to be constructed by May 2024 (prior note: prior note: With Homestead North Filing 1)	20,000	11,690	Sterling Ranch
V6	Improve Vollmer Road from Jane Kirkham Drive to Sam Bass Drive to a standard 4-Lane Urban Minor Arterial Cross Section. ⁽²⁾	Short-Term Future— May 2024 Updated 10/15/2022 - Sections V4, V5, V6 to be constructed by May 2024 (prior note: prior note: With Homestead North Filing 2)	20,000	11,425	Sterling Ranch
V7	Improve Vollmer Road between Sam Bass Drive and Poco Road to a 4-lane Urban Minor Arterial but with necessary lane transitions, redirect tapers, etc. south of Poco to adequately transition between the 4-Lane Urban Minor Arterial Cross Section and the 2-Lane Rural Arterial Cross Section north of Poco Road.	Short-Term Future – May 2024 Updated 10/15/2022 - Sections V4, V5, V6 to be constructed by May 2024 (prior note: With Homestead North Filing 3)	20,000	10,030	Sterling Ranch
V8	Improve Vollmer Road from Poco Road to Shoup Road to a Rural 2-Lane Arterial Cross Section. ⁽²⁾	Long-Term Future	10,000	11,790	El Paso County Project ID U-12

Part 1/2 of this table (see Part 2 on next page)

Notes:

(1) See Figure 10

(2) Adequate transition/redirect tapers would be needed between the various cross sections on Vollmer Road. Based on the criteria contained in Table 2-29 of the *El Paso Engineering Criteria Manual*, an appropriate taper ratio for a roadway with a design speed of 40 miles per hour is 20:1

(3) Source: Table 20 *Road Impact Fee Study Updated* November 16, 2016

Source: LSC Transportation Consultants, Inc. (February 10, 2023)

Table 6
(Page 2 of 2)

Sterling Ranch East Rezoning & Preliminary Plan
Roadway Segment Improvements

Segment ID ⁽¹⁾ (See Figure 12 for map)	Improvement Description	Timing	Design ADT (vpd)	Projected 2042 ADT (vpd)	Responsibility
SR1	Construct Sterling Ranch Road as an Urban Non-Residential Collector from Marksheffel Road to Dines Boulevard.	Short Term - with Sterling Ranch Fil No. 2	20,000	14,840	Sterling Ranch
SR2	Construct Sterling Ranch Road as an Urban Non-Residential Collector from Dines Boulevard to Briargate Parkway.	Short-Term	20,000	10,275	Sterling Ranch
SR3	Construct Sterling Ranch Road as an Urban Collector from Briargate Parkway to Vancouver Street.	Short Term	10,000	9,300	Sterling Ranch
SR4	Construct Sterling Ranch Road from Vancouver Street north to Arroya (or ultimate north terminus).	Long-Term Future	10,000	4,260	Sterling Ranch
M1	Construct Marksheffel Road as an Urban Principal Arterial to City of Colorado Springs standards in 107' of right-of-way between Vollmer Road and Sterling Ranch Road.	Updated 10/15/2022: to be completed by the end of 2022 (prior note: With Sterling Ranch Fil No. 2)	40,000	23,370	Sterling Ranch
M2	Construct Marksheffel Road as an Urban Principal Arterial to City of Colorado Springs standards in 107' of right-of-way between Sterling Ranch Road and the south boundary of the Sterling Ranch Master Plan Area. 10/16/2022 NOTE: With the completion of M2 in 2023, the connection between Vollmer and Woodmen Road (via M3) will be completed.	Short Term Updated 10/15/2022: to be completed in 2023 (prior note: With Sterling Ranch Phase 2)	40,000	29,600	Sterling Ranch
M3	Construct Marksheffel Road between the south boundary of the Sterling Ranch Master Plan Area and Woodmen Road. (Note this segment is located within the City of Colorado Springs). 10/16/2022 NOTE: With the completion of M2 in 2023, the connection between Vollmer and Woodmen Road (via M3) will be completed.	Updated 10/15/2022: Completed (by Others)	40,000	24,525	Others (Completed)
M4	Construct Marksheffel Road between Black Forest Road and Vollmer Road.	Long-Term Future	40,000	27,910	Others
B1	Construct the south half section of Briargate Pkwy (4-Lane Principal Arterial) between Vollmer Road and Wheatland Drive [now full section by 2023] .	Short-Term Future Updated 10/15/2022: Full section to be completed in 2023 with Homestead at Sterling Ranch Filing No. 1 (prior note: With Homestead at Sterling Ranch Fil 2)	20,000	24,745	Sterling Ranch
	Construct the north half section of Briargate Pkwy (4-Lane Principal Arterial) between Vollmer Road and Wheatland Drive [now full section by 2023] .	Short-Term Future Updated 10/15/2022: Full section to be completed in 2023 with Homestead at Sterling Ranch Filing No. 1 (prior note: Long-Term Future)	40,000		Sterling Ranch
B2	Construct Briargate Pkwy (full section) as a 4-Lane Principal Arterial between Wheatland Dr and Sterling Ranch Road.	Short-Term Future Updated 10/15/2022: Full section to be completed in 2023 or Spring 2024 (prior note: Long-Term Future)	40,000	26,375	Sterling Ranch
B3	Construct Briargate Pkwy as a 4-Lane Principal Arterial between Sterling Ranch Road and Banning Lewis Parkway.	Intermediate Term	40,000	22,365	Sterling Ranch
B4	Construct Stapleton Road as a 4-Lane Principal Arterial between Banning Lewis Parkway and Meridian Road (including upgrade of existing rural two-lane segment between Towner and Meridian).	Long-Term Future	40,000	17,945	Others
B5	Construct Briargate Pkwy as a 4-Lane Principal Arterial between Black Forest Road and Vollmer Road.	Long-Term Future	40,000	24,340	Others; PPRTA A List Project
BL1	Construct Banning Lewis Parkway as a 4-Lane Principal Arterial between the south Sterling Ranch boundary and Briargate Pkwy.	Long-Term Future	40,000	20,320	Financial assurances for half-section, Sterling Ranch half-section or full-section w/ cost recovery
BL2	Construct Banning Lewis Parkway as a 4-Lane Principal Arterial between Woodmen Road and the south Sterling Ranch boundary. (Note this segment will be located within the City of Colorado Springs)	Long-Term Future	40,000	28,480	Others
W1	Widen Woodmen Road from 4-lane to 6-lane section from Powers Boulevard to US 24.	Long-Term Future	72,000	66,690	PPRTA A-List Project; City of Colorado Springs ConnectCOS Index No.476
B1	Widen Black Forest Road between Woodmen Road to just north of Research Road to two northbound and southbound through lanes.	Black Forest Widening Project	40,000	28,420	City of Colorado Springs
B2	Widen Black Forest Road from just north of Research Road to Briargate Parkway.	Long-Term Future	40,000	25,145	Others/City of Colorado Springs
B3	Widen Black Forest Rd from Briargate Pkwy to Old Ranch Rd as a 4-lane Principal Arterial with bike and pedestrian facilities.	Long-Term Future	40,000	19,135	PPRTA B List Project ConnectCOS Index No. 479

Part 2/2 of this table

Notes:

(1) See Figure 10

(2) Adequate transition/redirect tapers would be needed between the various cross sections on Vollmer Road. Based on the criteria contained in Table 2-29 of the *El Paso Engineering Criteria Manual*, an appropriate taper ratio for a roadway with a design speed of 40 miles per hour is 20:1

(3) Source: Table 20 *Road Impact Fee Study Updated* November 16, 2016

Source: LSC Transportation Consultants, Inc. (February 10, 2023)

Figures 1-17





Not to scale

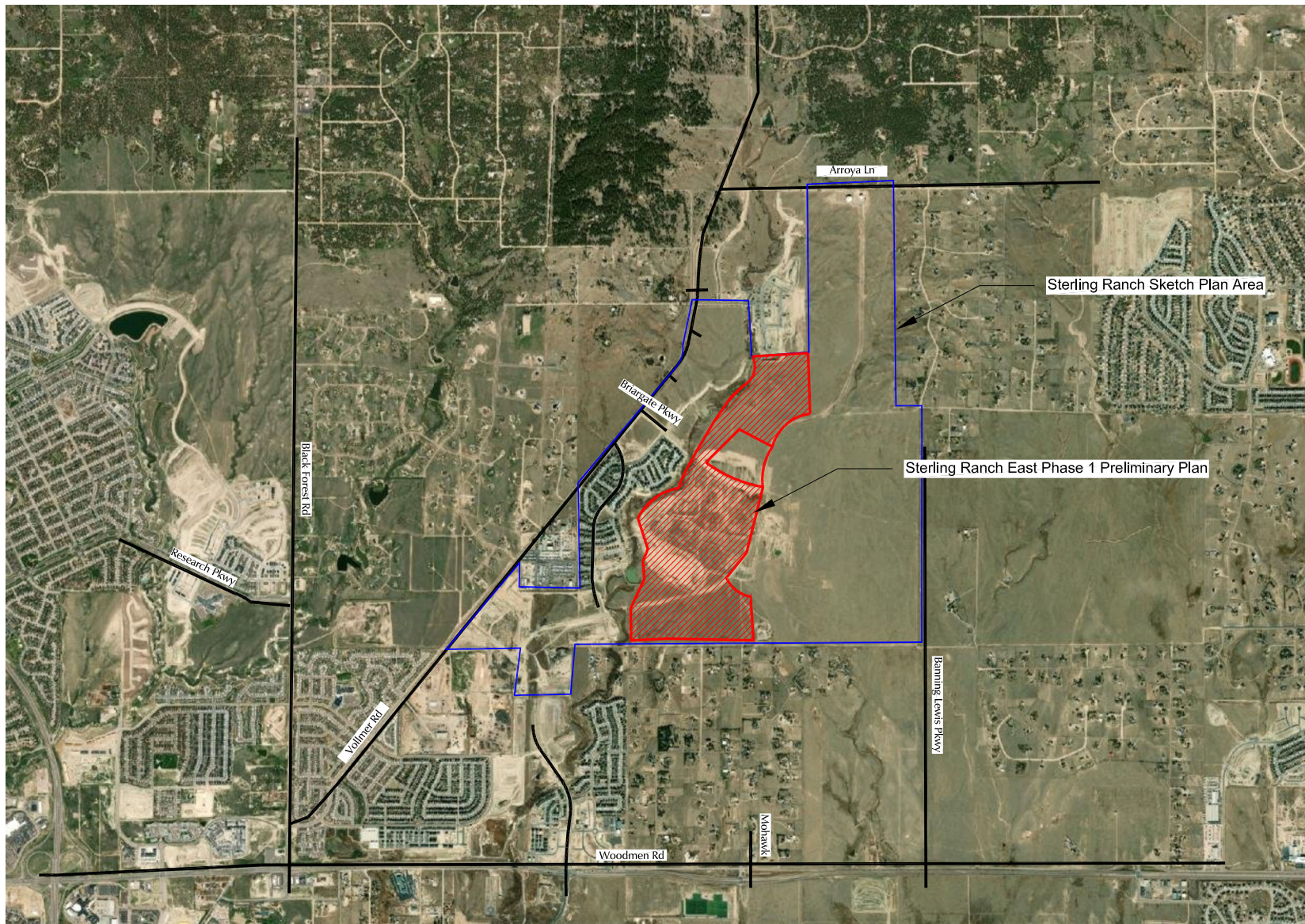

Figure 1

Vicinity Map

Sterling Ranch East Rezoning and Preliminary Plan (LSC# S224440)





Approximate
Scale:
1"=1,000'

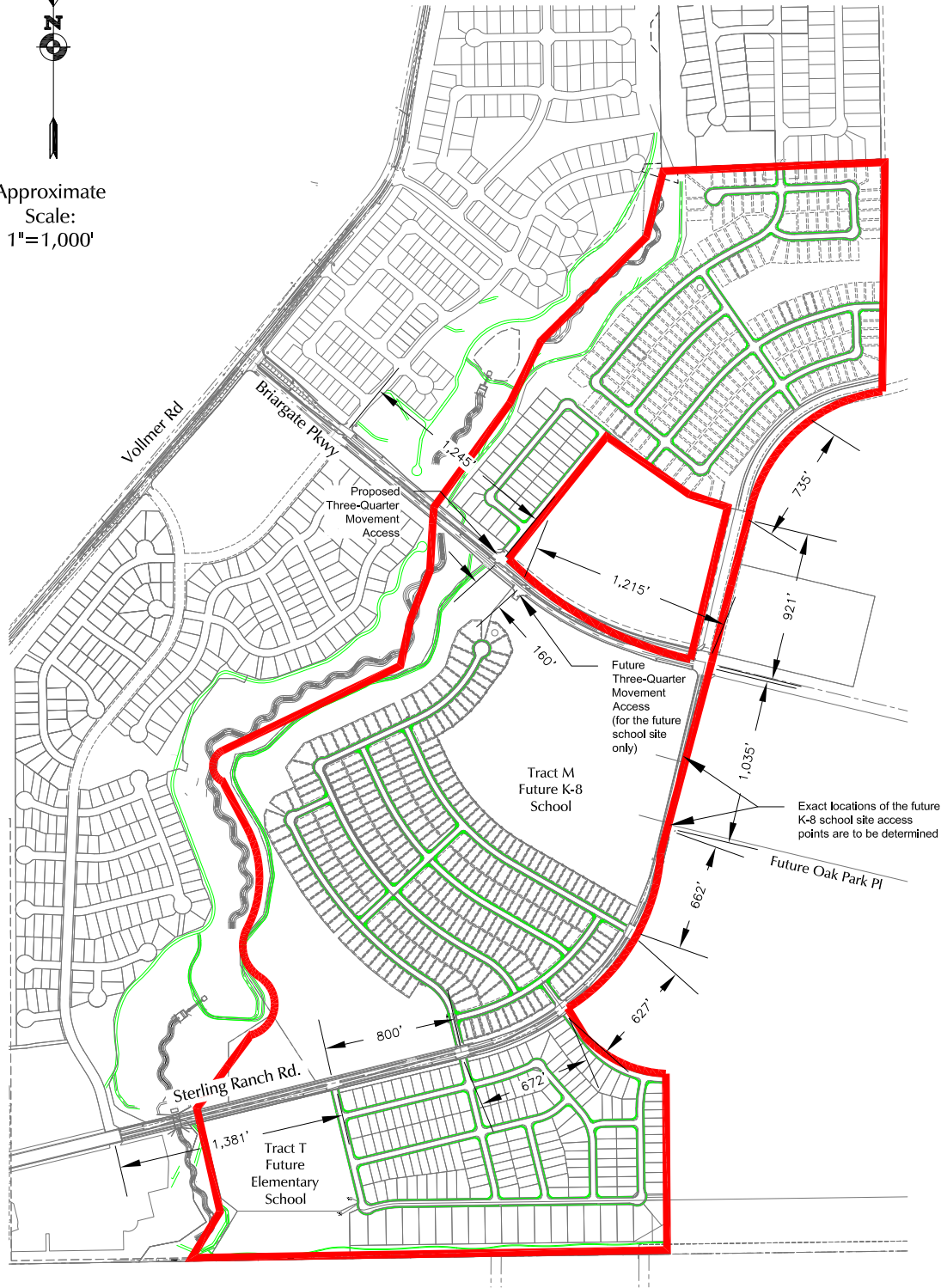

LEGEND:

- Trail & Sidewalks
- X,XXX' - Centerline Spacing of Intersections

Figure 2
Site Plan





Not to scale

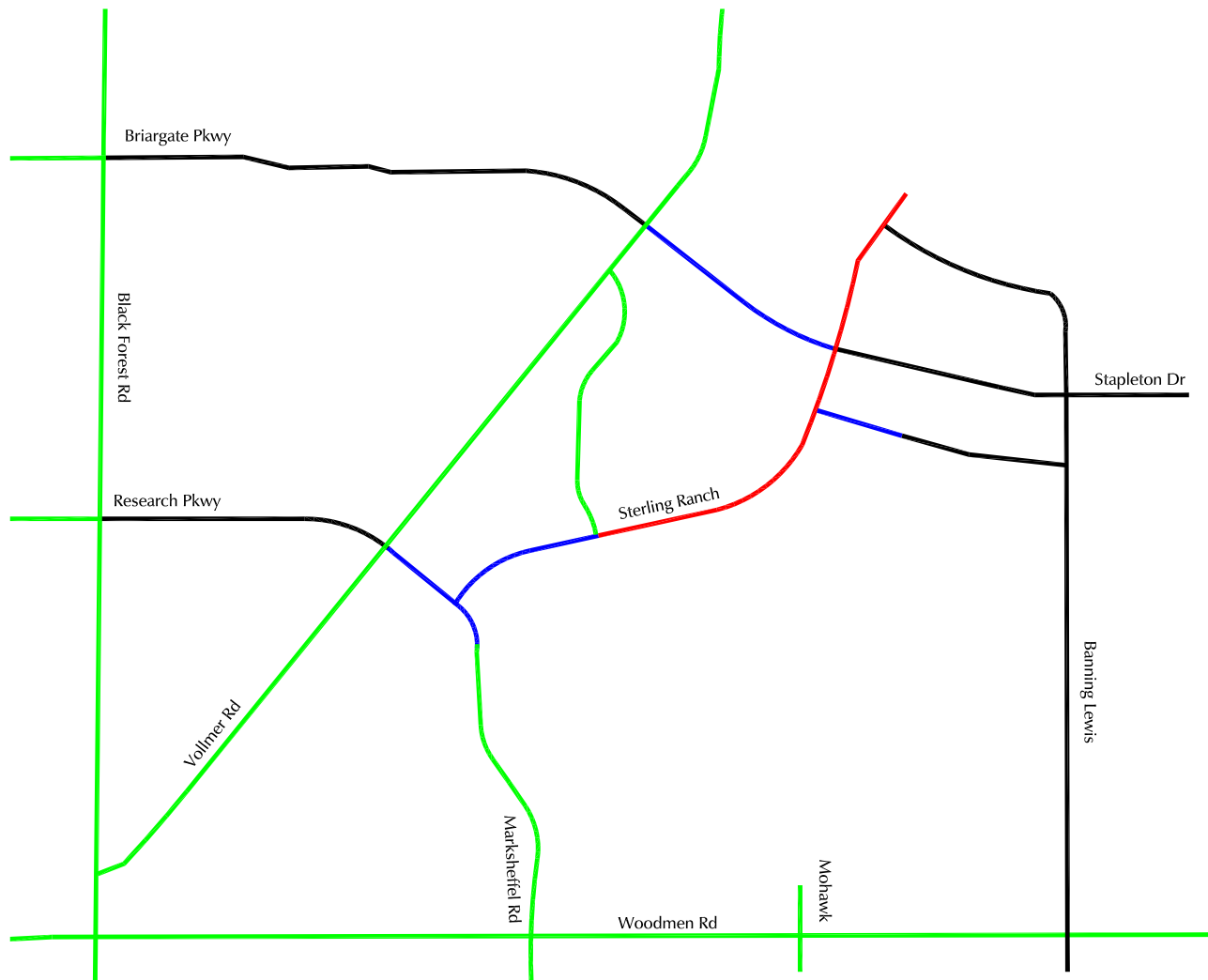

- Roadway connection planned with Sterling Ranch East Preliminary Plan 1
- Roadway connection planned to be completed by 2023
- Existing Roadway
- Future Roadway



Short-Term Roadway Connections

Figure 3

Sterling Ranch East Rezoning and Preliminary Plan (LSC# S224440)

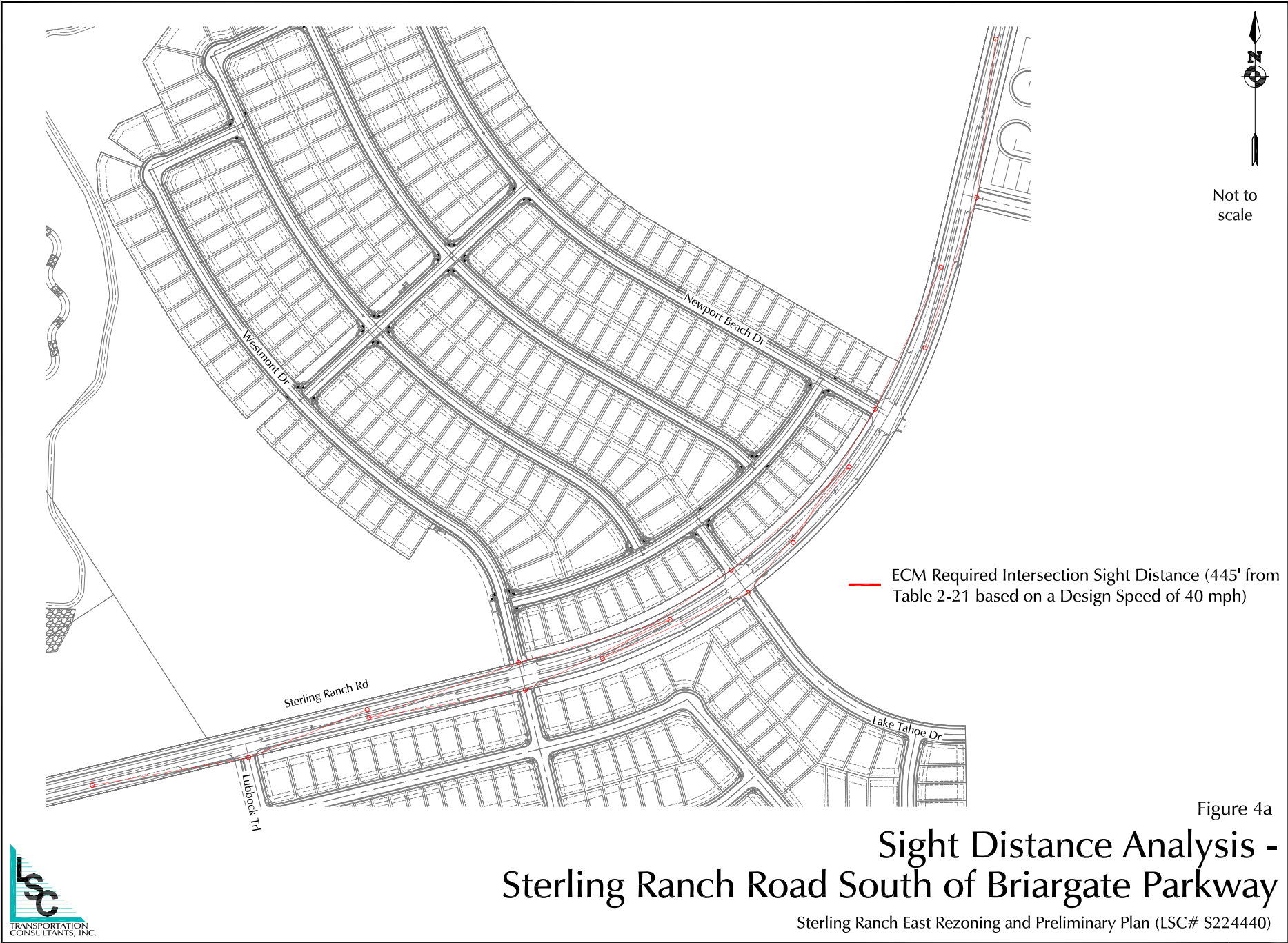

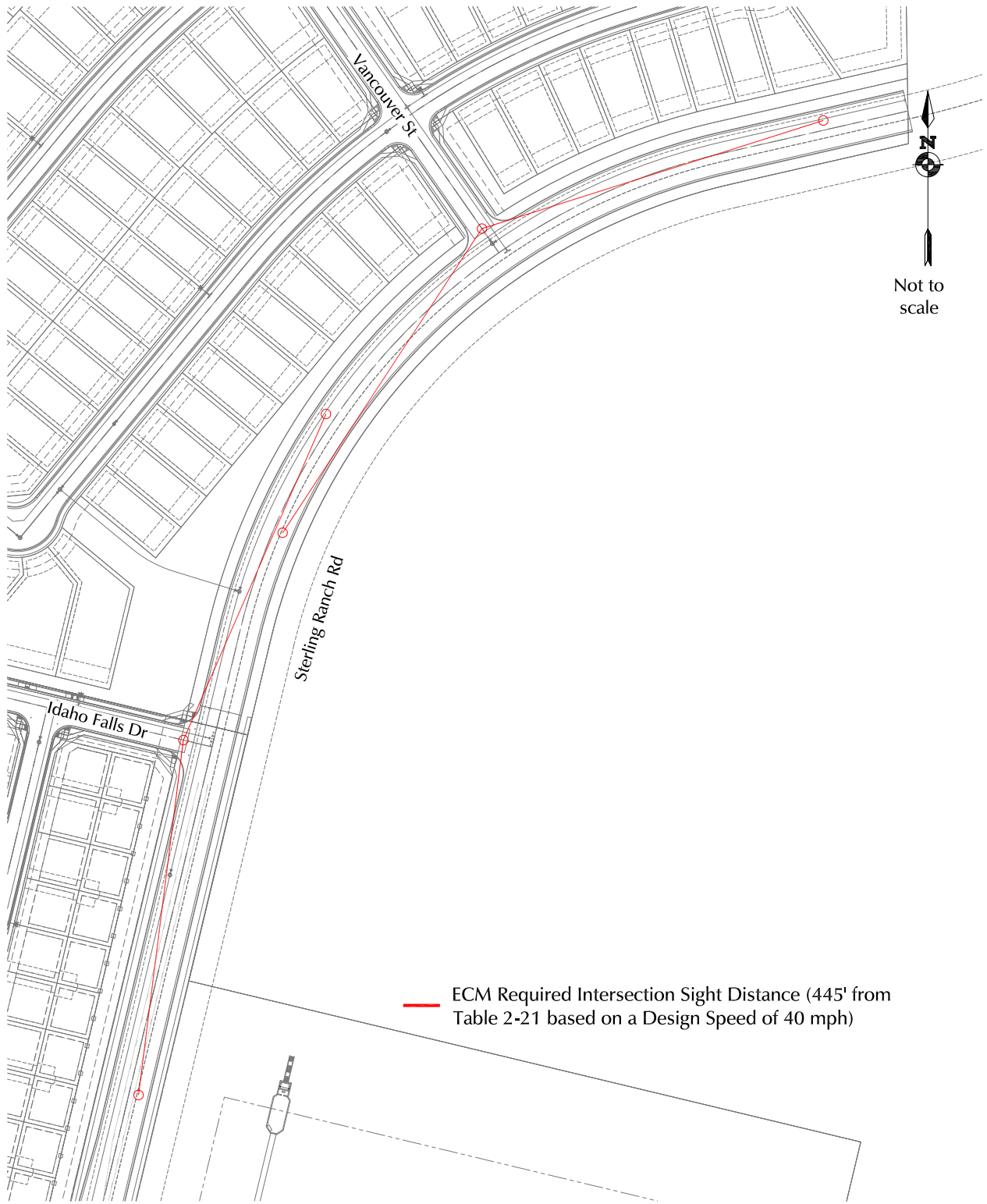
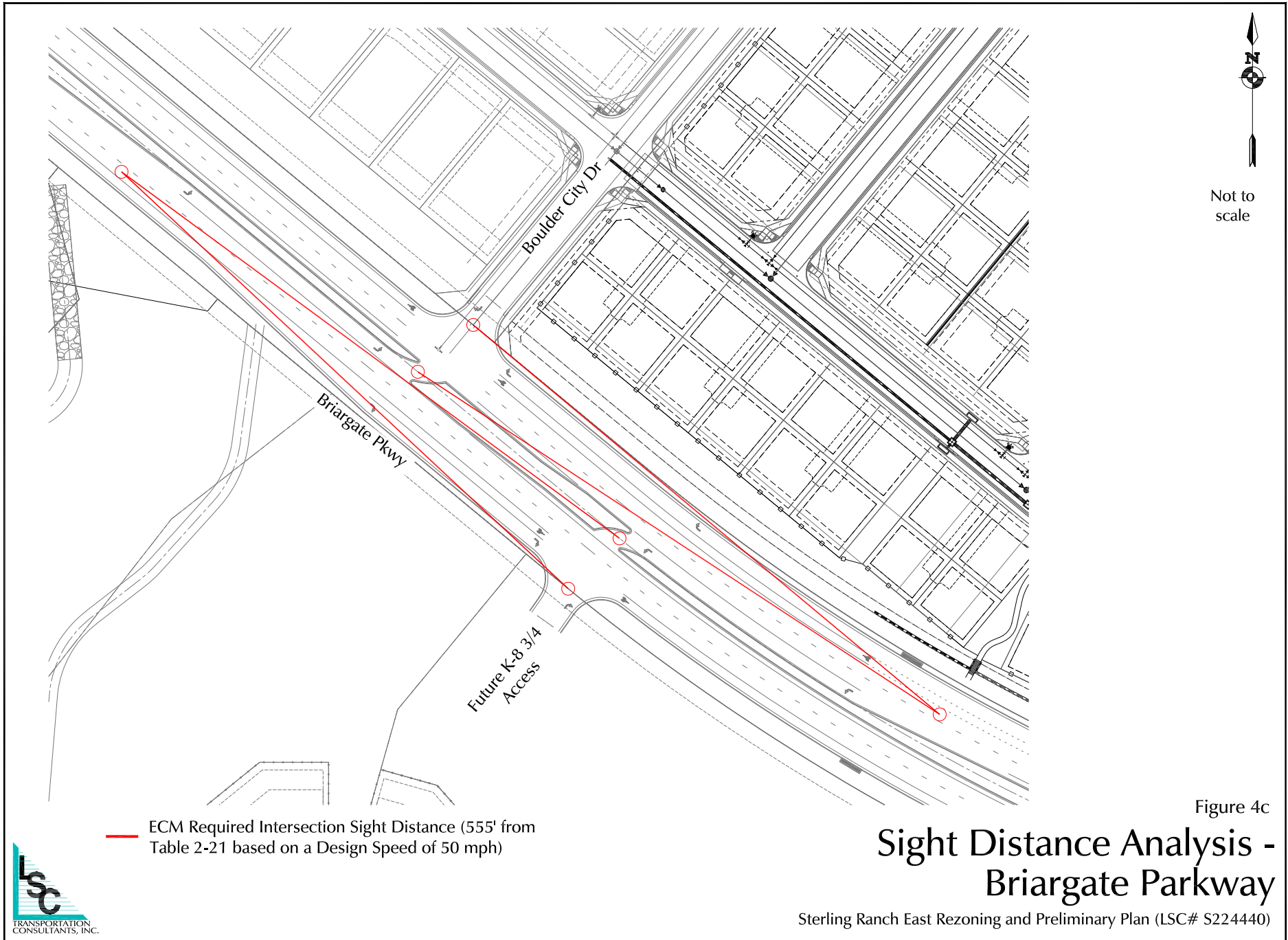

Figure 4b

Sight Distance Analysis - Sterling Ranch Road North of Briargate Parkway

Sterling Ranch East Rezoning and Preliminary Plan (LSC# S224440)







Not to scale

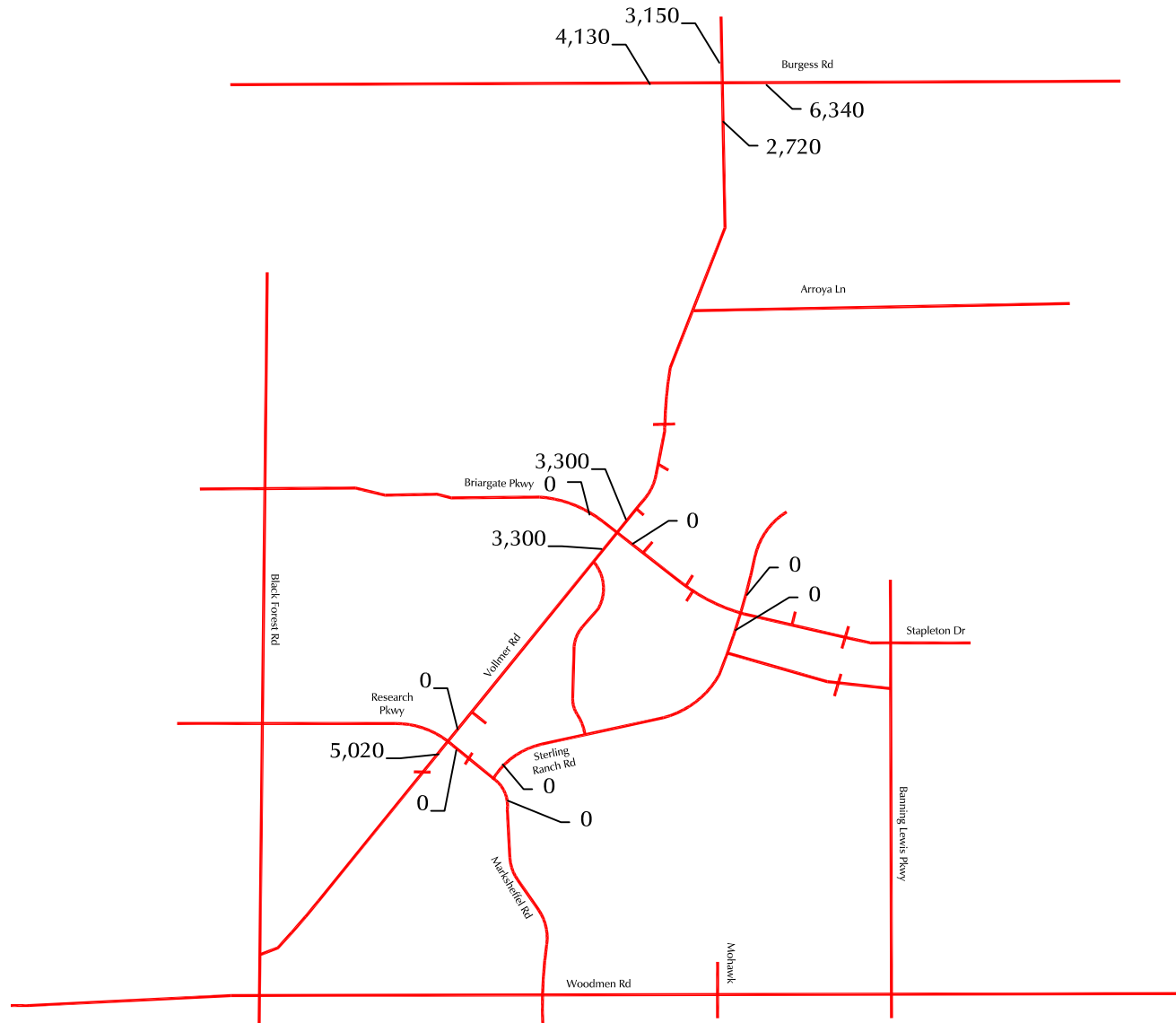

LEGEND:

XXX = Average Weekday Traffic (vehicles per day)(AWT) Estimates by LSC

Figure 5a Existing Average Weekday Traffic

Sterling Ranch East Rezoning and Preliminary Plan (LSC# S224440)

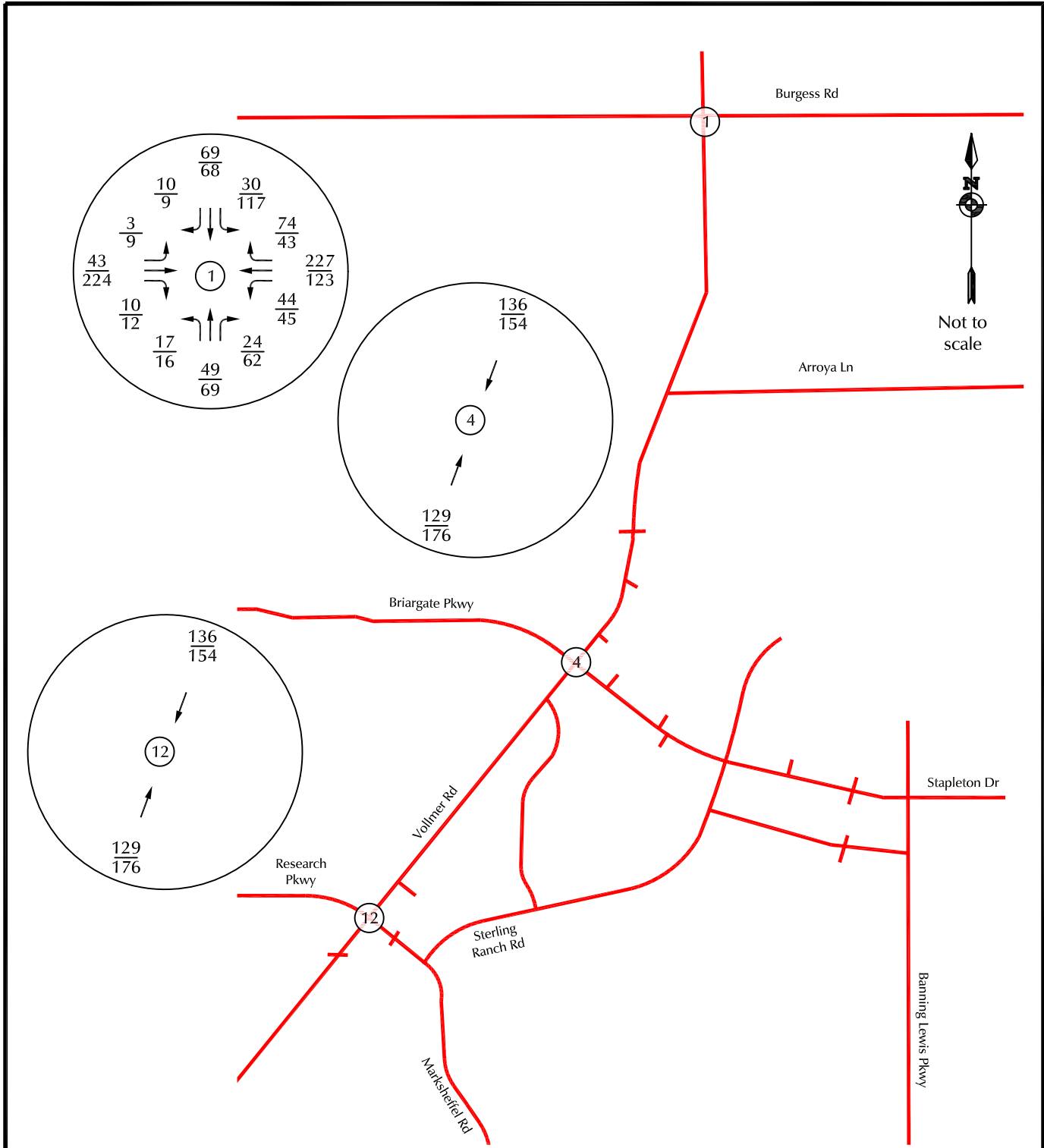

LEGEND: $\frac{XX}{XX} = \frac{\text{AM Peak-Hour Traffic (veh/hr)}}{\text{PM Peak-Hour Traffic (veh/hr)}}$

Figure 5b
Existing Traffic



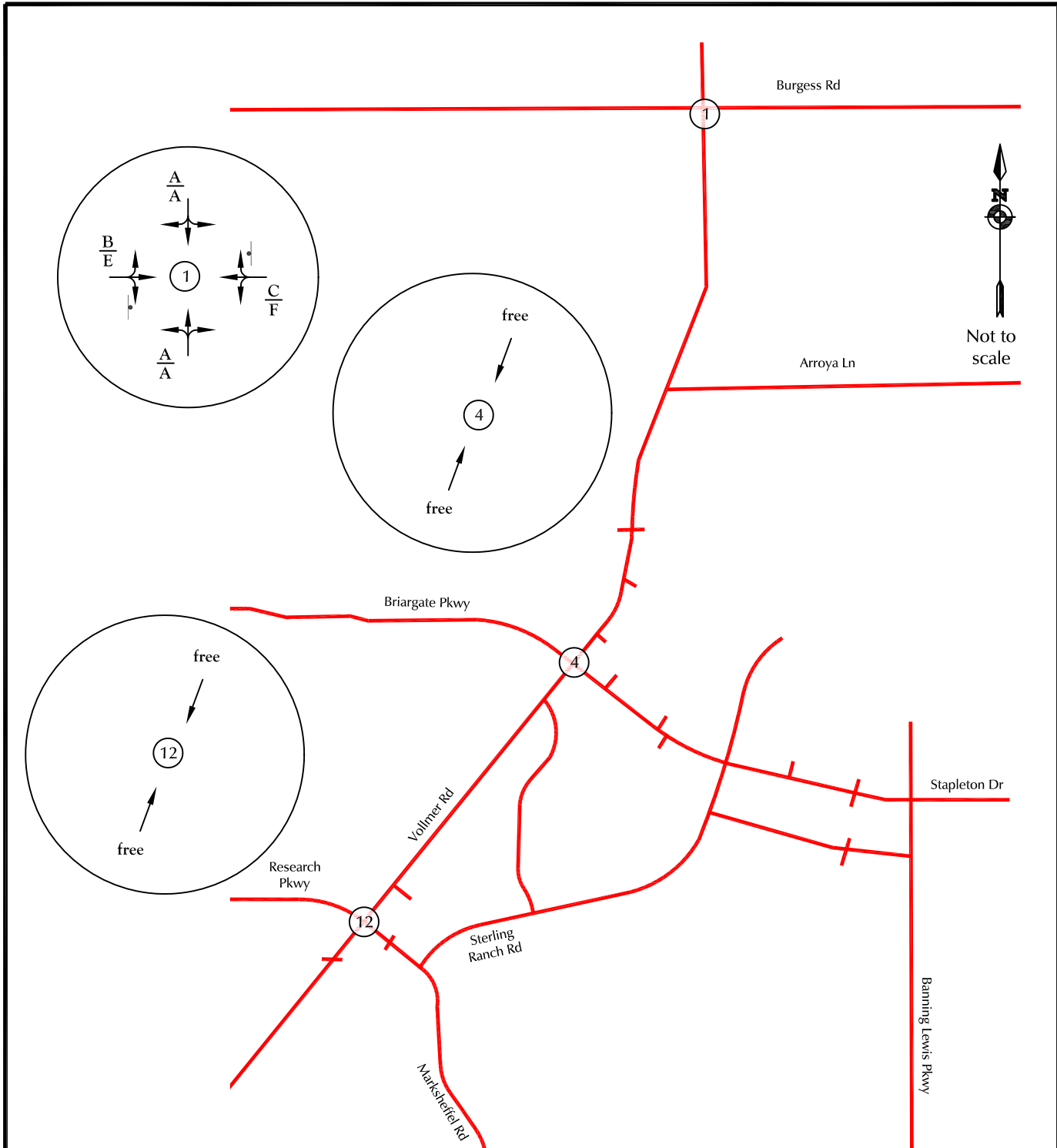

LEGEND:

$\frac{A}{B}$ = $\frac{\text{AM Individual Movement Peak-Hour Level of Service}}{\text{PM Individual Movement Peak-Hour Level of Service}}$

⊥ = Stop Sign

Figure 5c

Existing Lane Geometry, Traffic Control, and Level of Service

Sterling Ranch East Rezoning and Preliminary Plan (LSC# S224440)



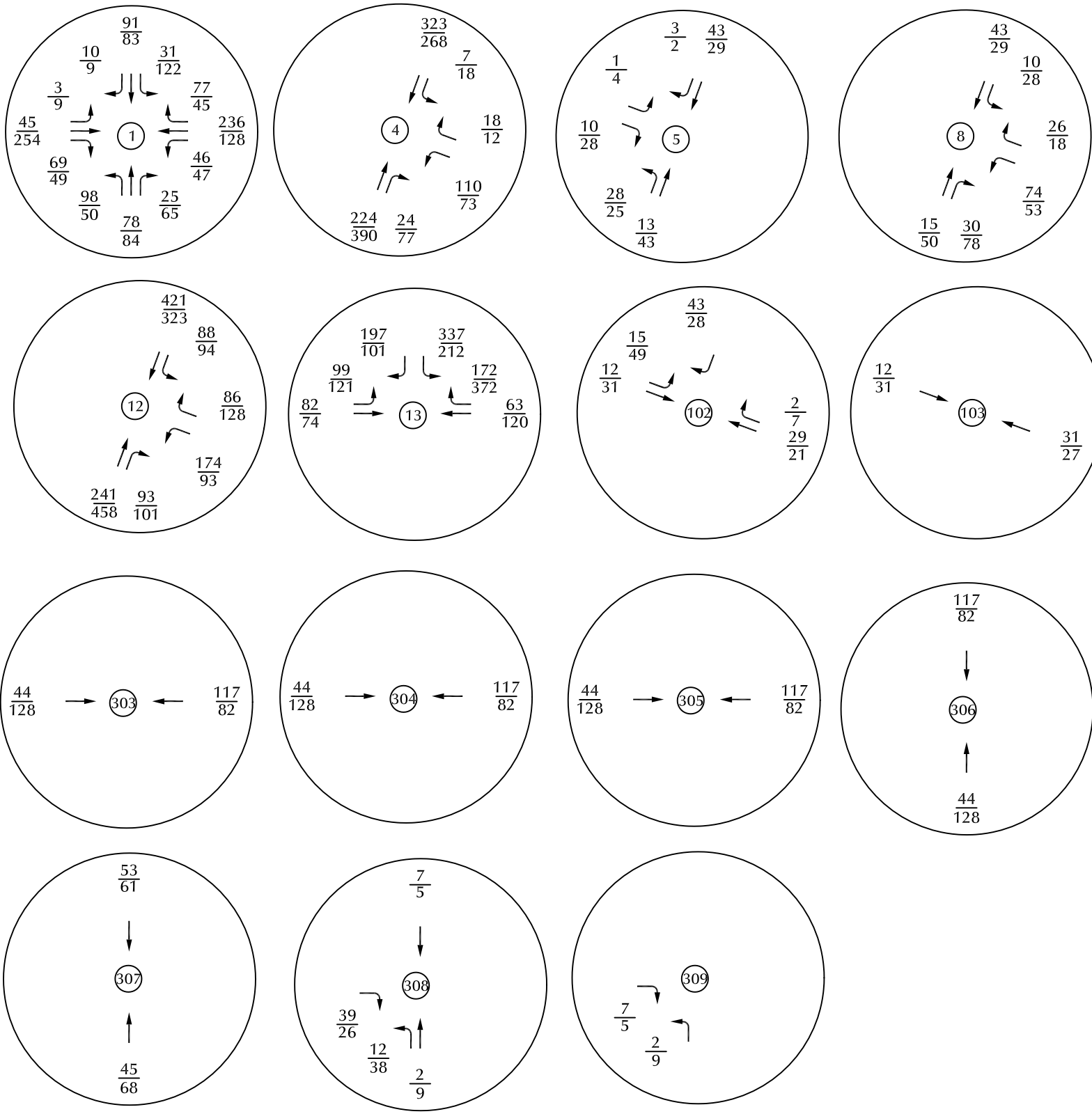

LEGEND: $\frac{XX}{XX} = \frac{\text{AM Peak-Hour Traffic (veh/hr)}}{\text{PM Peak-Hour Traffic (veh/hr)}}$

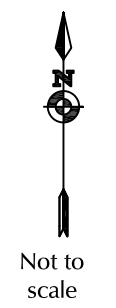
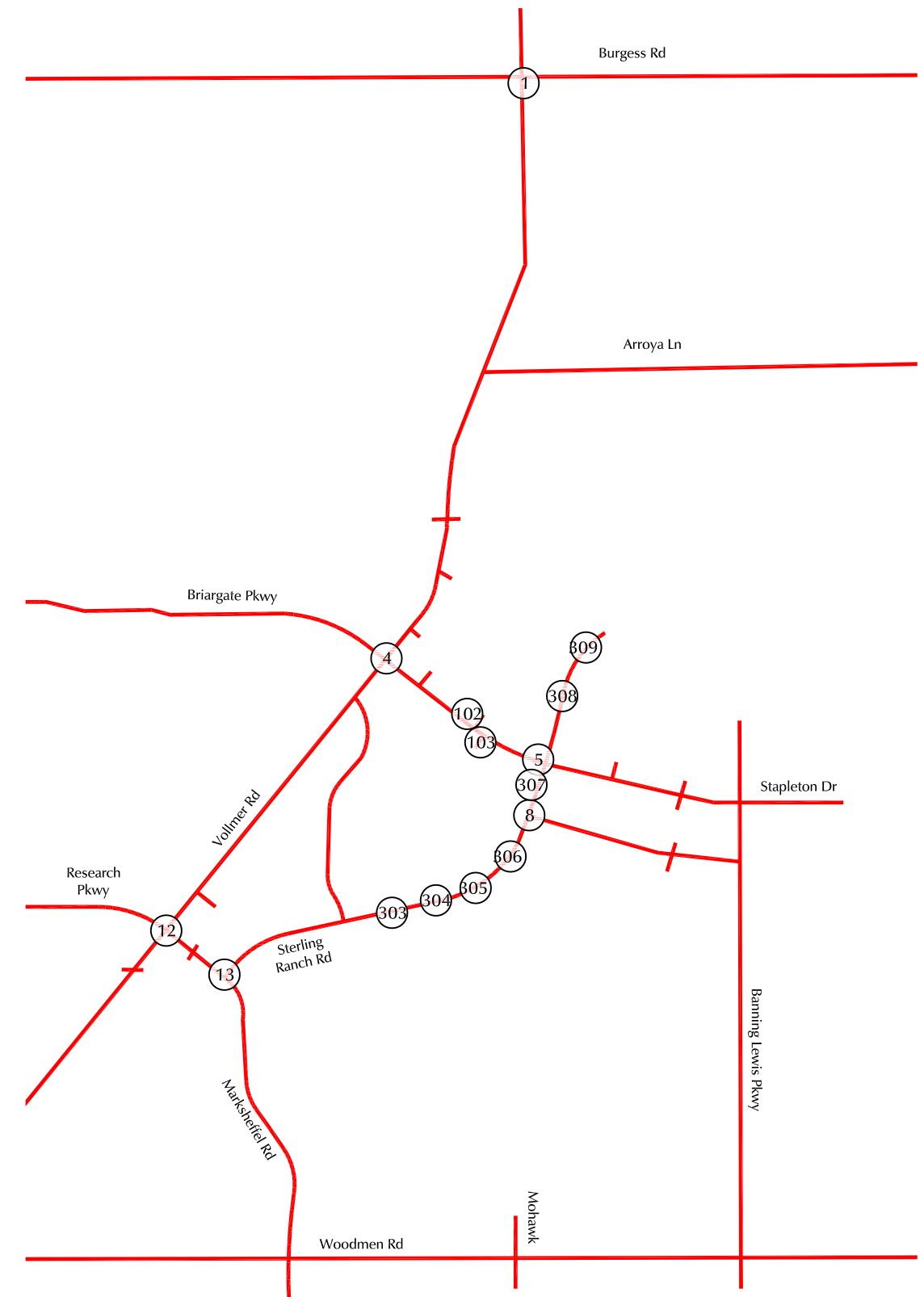
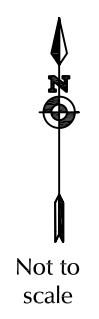
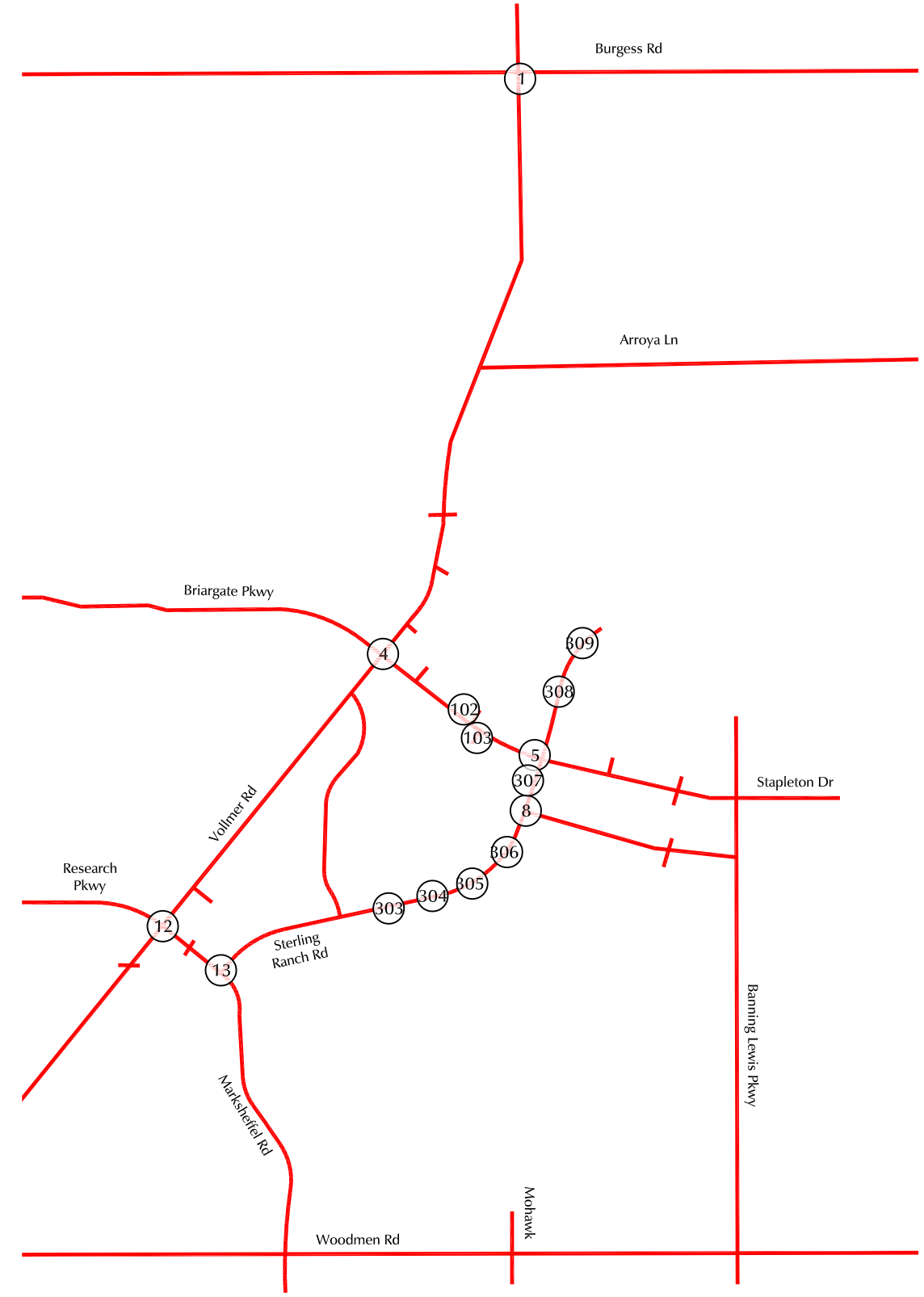
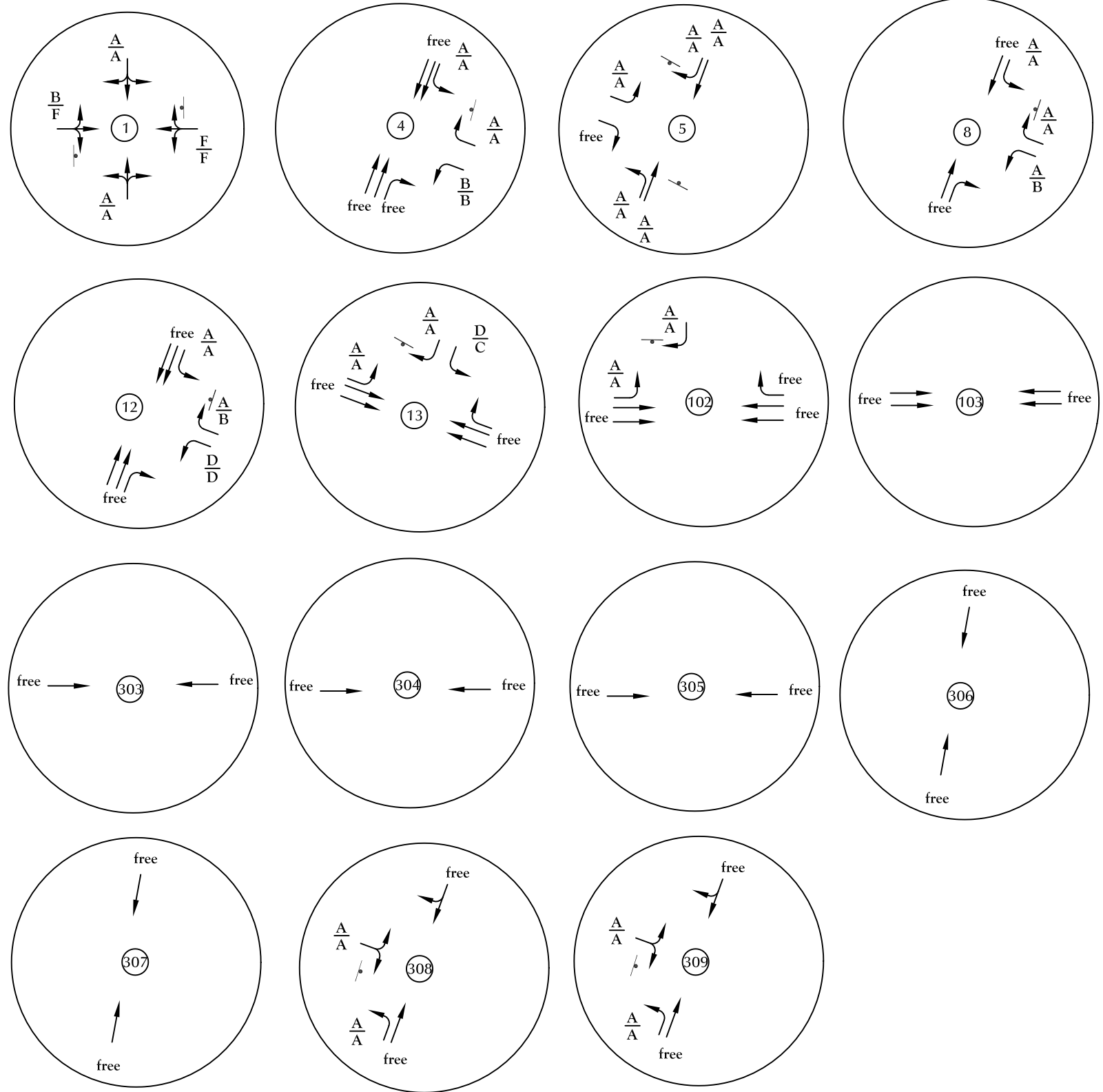

Figure 6b
Short-Term Background Traffic
 Sterling Ranch East Rezoning and Preliminary Plan (LSC# S224440)





LEGEND:

- $\frac{A}{A}$ = AM Individual Movement Peak-Hour Level of Service
- $\frac{B}{B}$ = PM Individual Movement Peak-Hour Level of Service
- $\frac{C}{C}$ = AM Entire Intersection Peak-Hour Level of Service
- $\frac{D}{D}$ = PM Entire Intersection Peak-Hour Level of Service

- ⊥ = Stop Sign
- ⊙ = Traffic Signal



Figure 6c
Short-Term Lane Geometry,
Traffic Control, and Level of Service

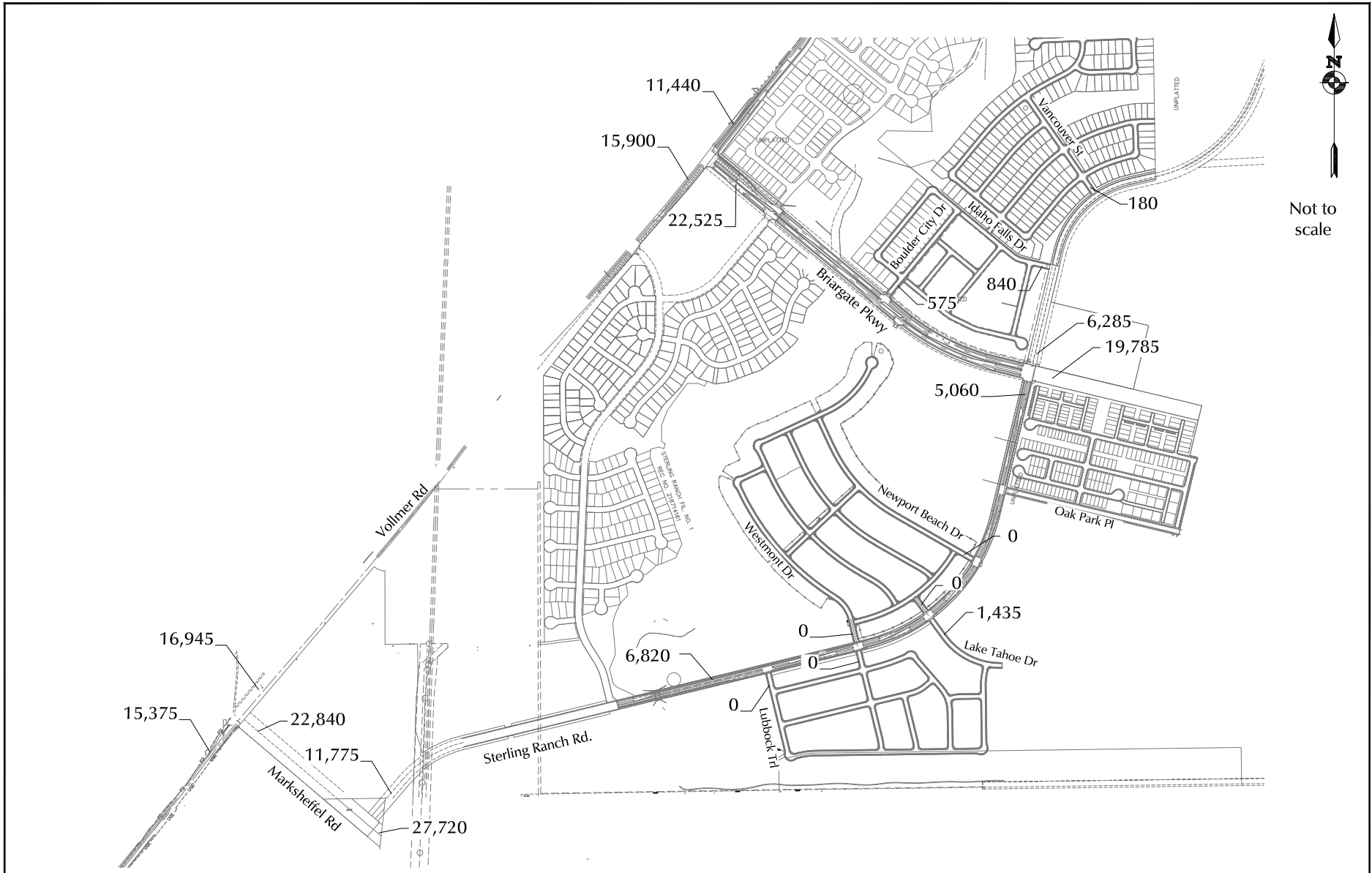

Not to scale

LEGEND: **XXX** = Average Weekday Traffic (vehicles per day)(AWT)

2042 Background Average Weekday Traffic

Figure 7a

Sterling Ranch East Rezoning and Preliminary Plan (LSC# S224440)



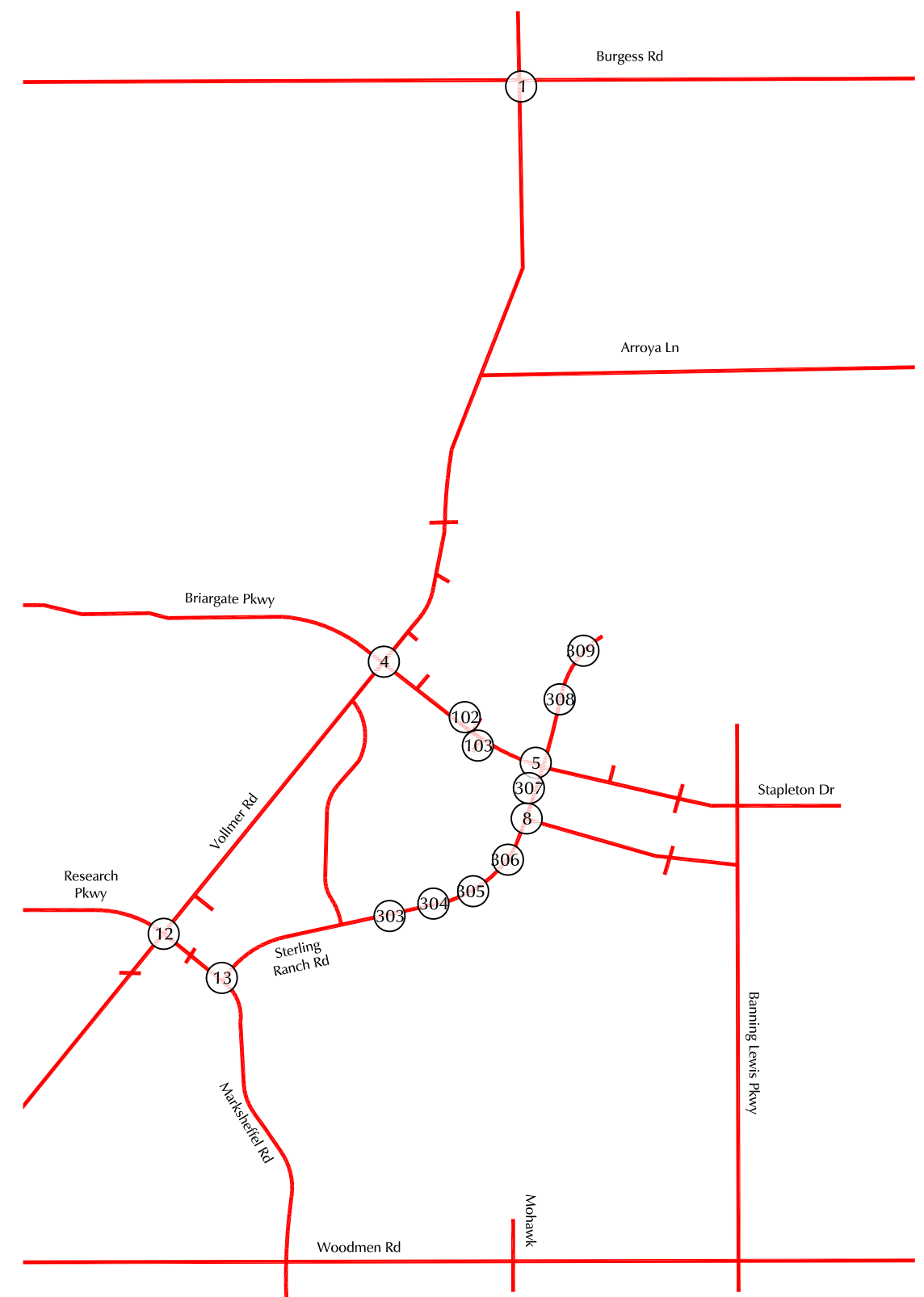
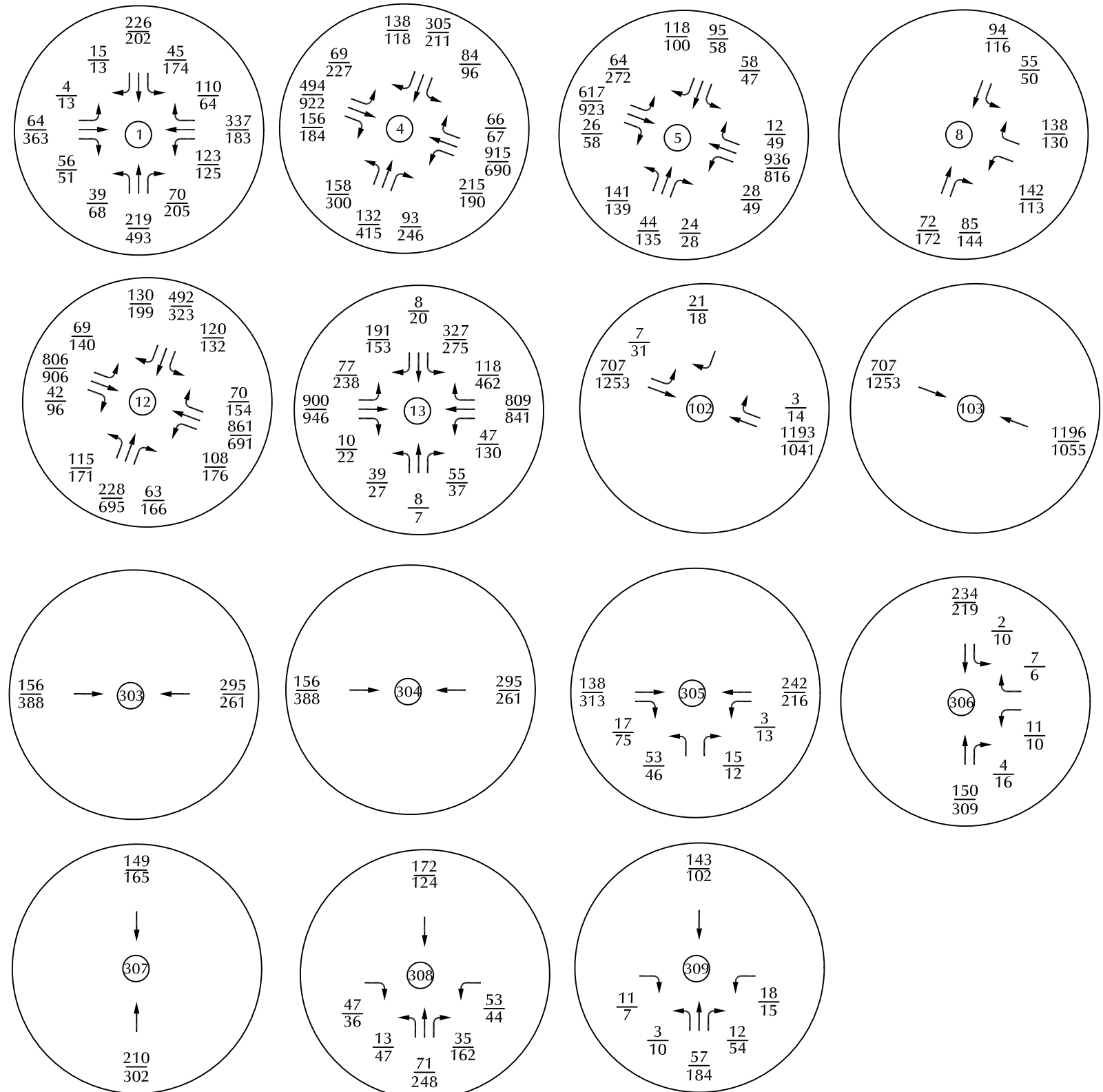

LEGEND: $\frac{XX}{XX}$ = AM Peak-Hour Traffic (veh/hr)
 $\frac{XX}{XX}$ = PM Peak-Hour Traffic (veh/hr)



Figure 7b
2042 Background Traffic

Sterling Ranch East Rezoning and Preliminary Plan (LSC# S224440)

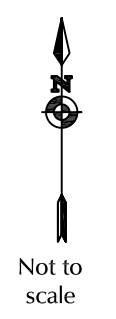
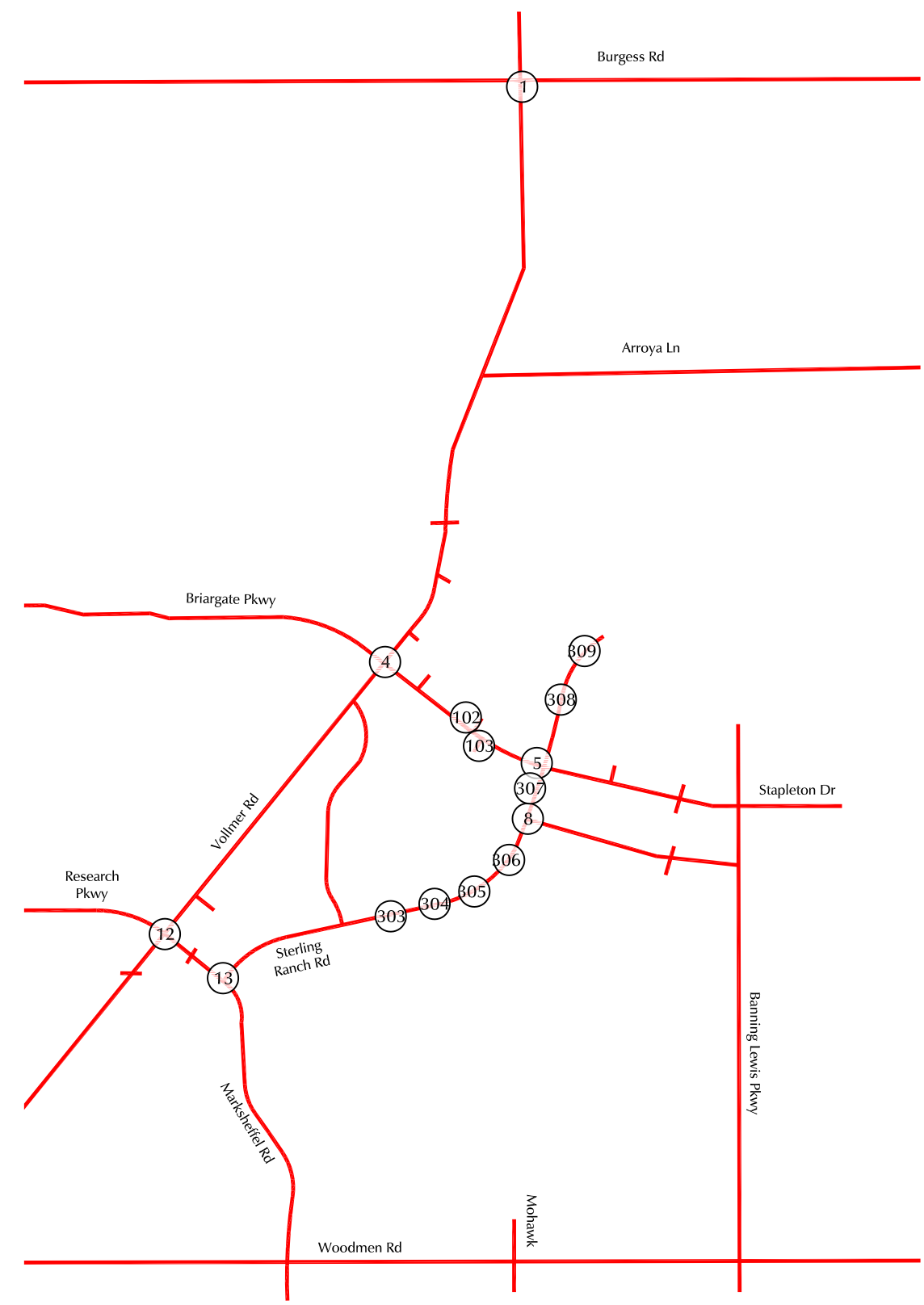
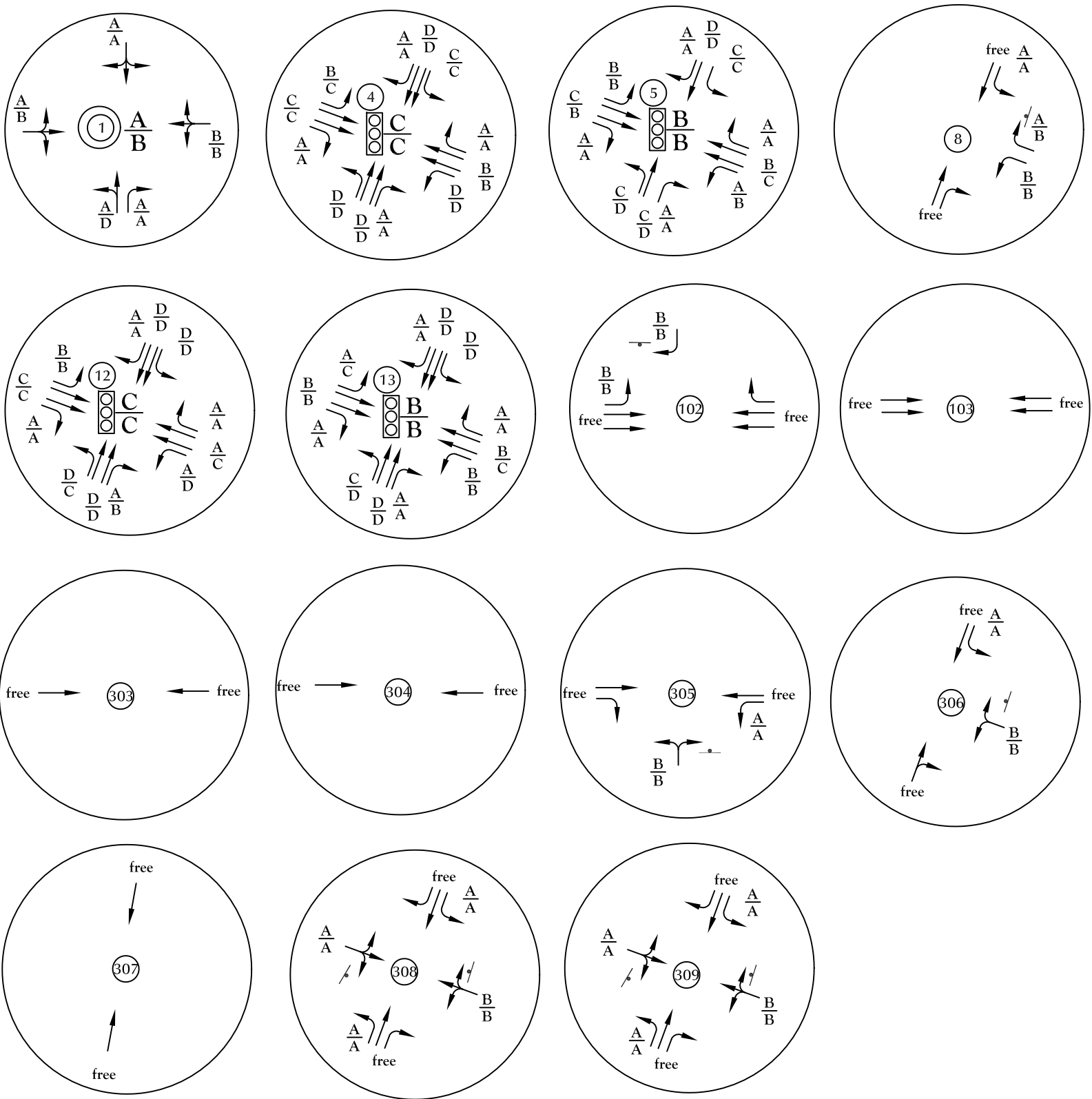

LEGEND:

$\frac{A}{B}$ = AM Individual Movement Peak-Hour Level of Service
 PM Individual Movement Peak-Hour Level of Service
 $\frac{C}{D}$ = AM Entire Intersection Peak-Hour Level of Service
 PM Entire Intersection Peak-Hour Level of Service

T = Stop Sign
 = Traffic Signal



Figure 7c
 2042 Background Lane Geometry,
 Traffic Control, and Level of Service



Not to scale

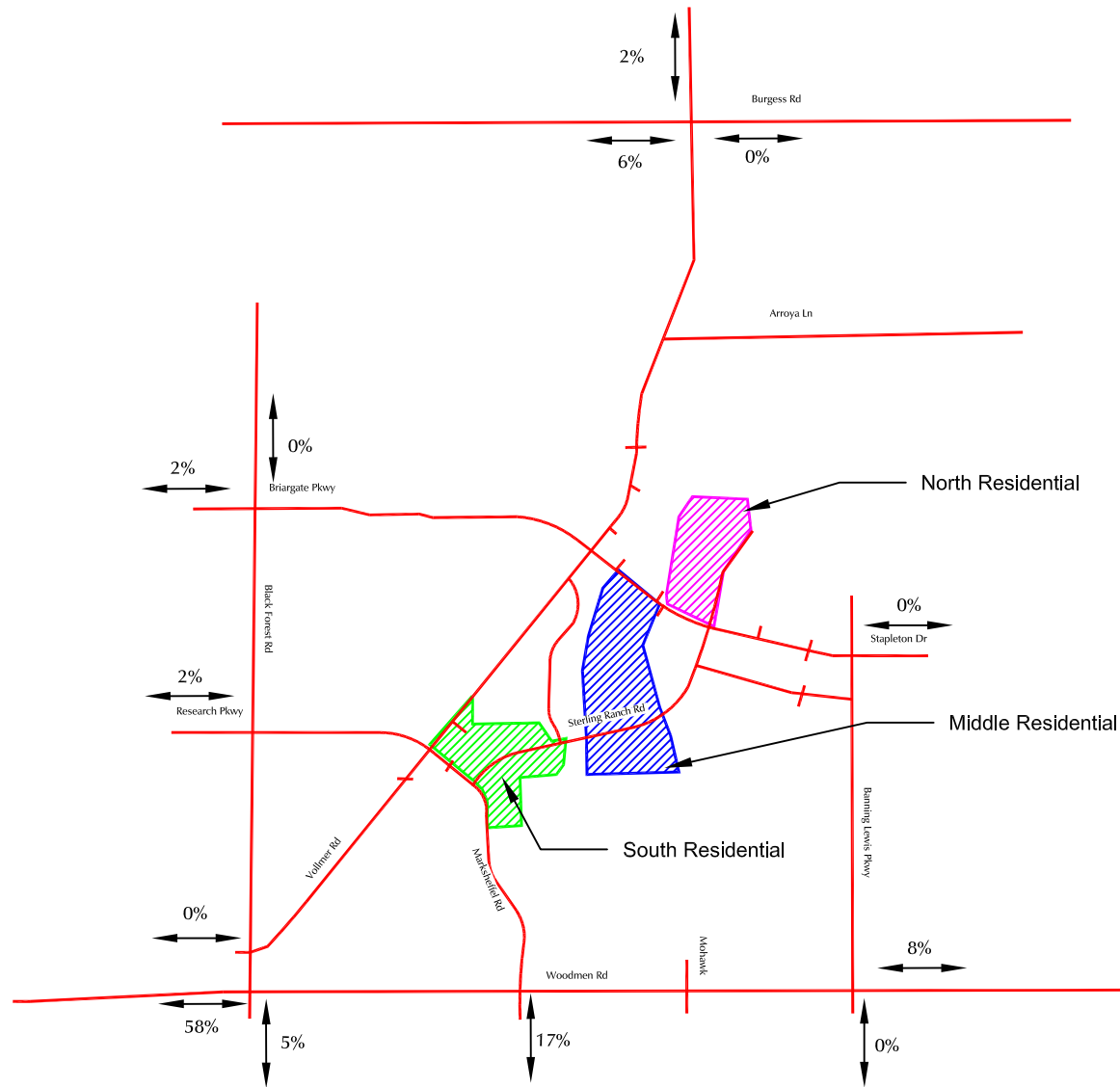

North Residential

Middle Residential

South Residential

LEGEND: XX% = Percent of Residential Trips

Short-Term Directional Distribution of Residential-Generated Traffic

Figure 8

Sterling Ranch East Rezoning and Preliminary Plan (LSC# S224440)





Not to scale

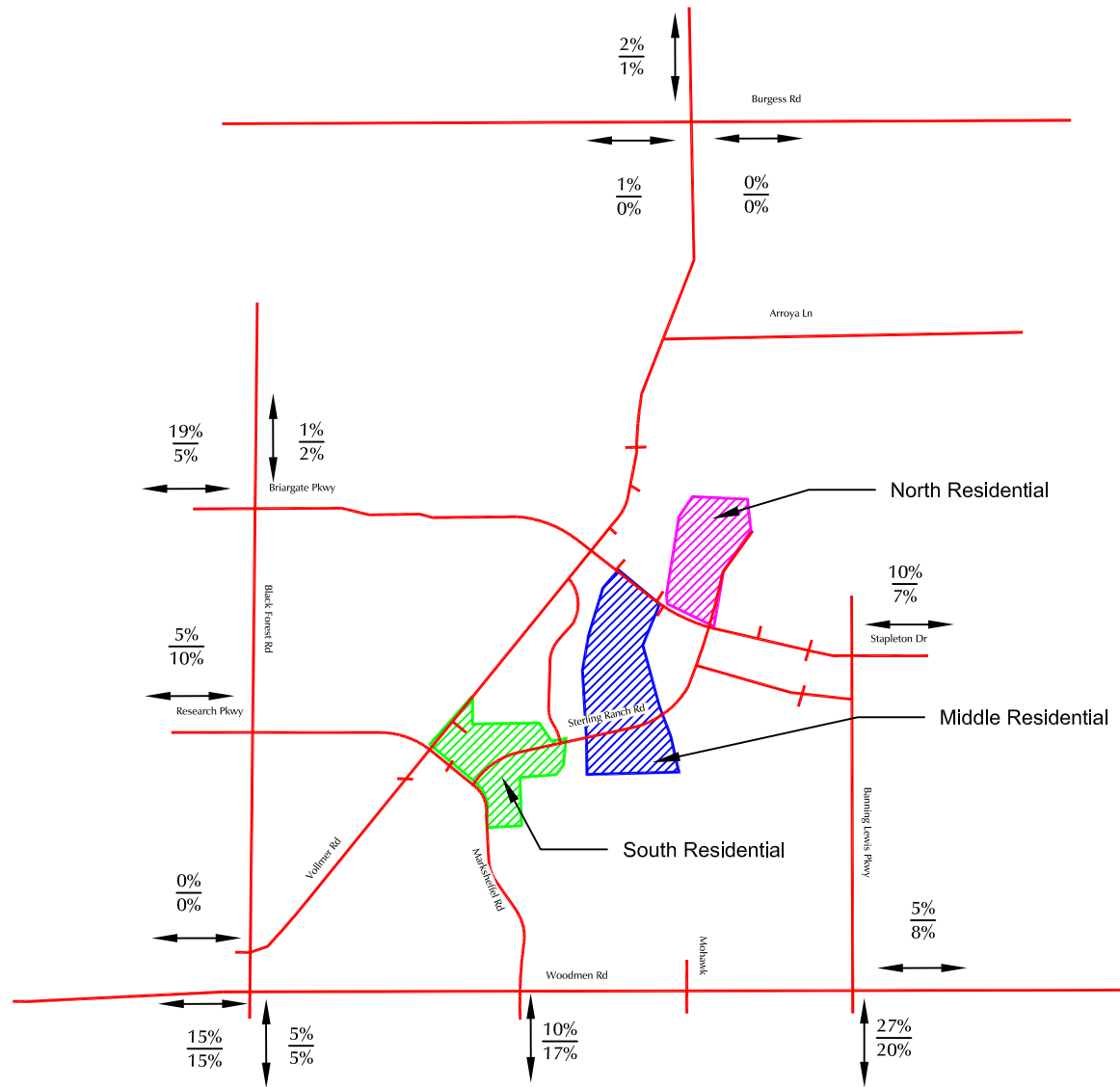

LEGEND:

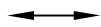

$\frac{XX\%}{XX\%} = \frac{\text{Percent of North-Residential Trips}}{\text{Percent of Middle-Residential Trips}}$

Buildout Long-Term Directional Distribution of Residential-Generated Traffic

Figure 9

Sterling Ranch East Rezoning and Preliminary Plan (LSC# S224440)





Not to scale

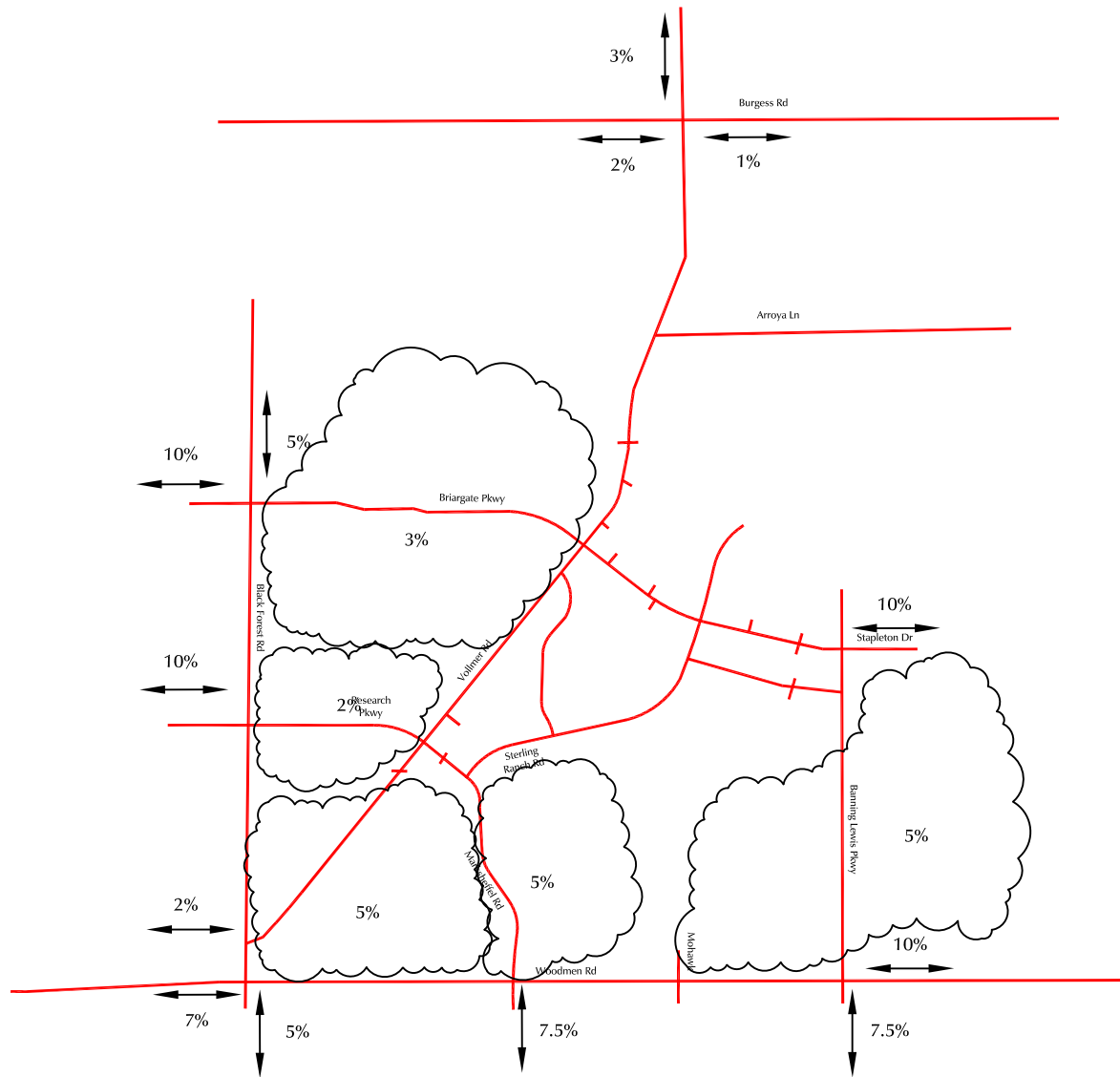

*External to Sterling Ranch

LEGEND: XX% = Percent of Non-Residential Trips

Buildout Long-Term Directional Distribution of School-Generated Traffic*

Figure 10

Sterling Ranch East Rezoning and Preliminary Plan (LSC# S224440)



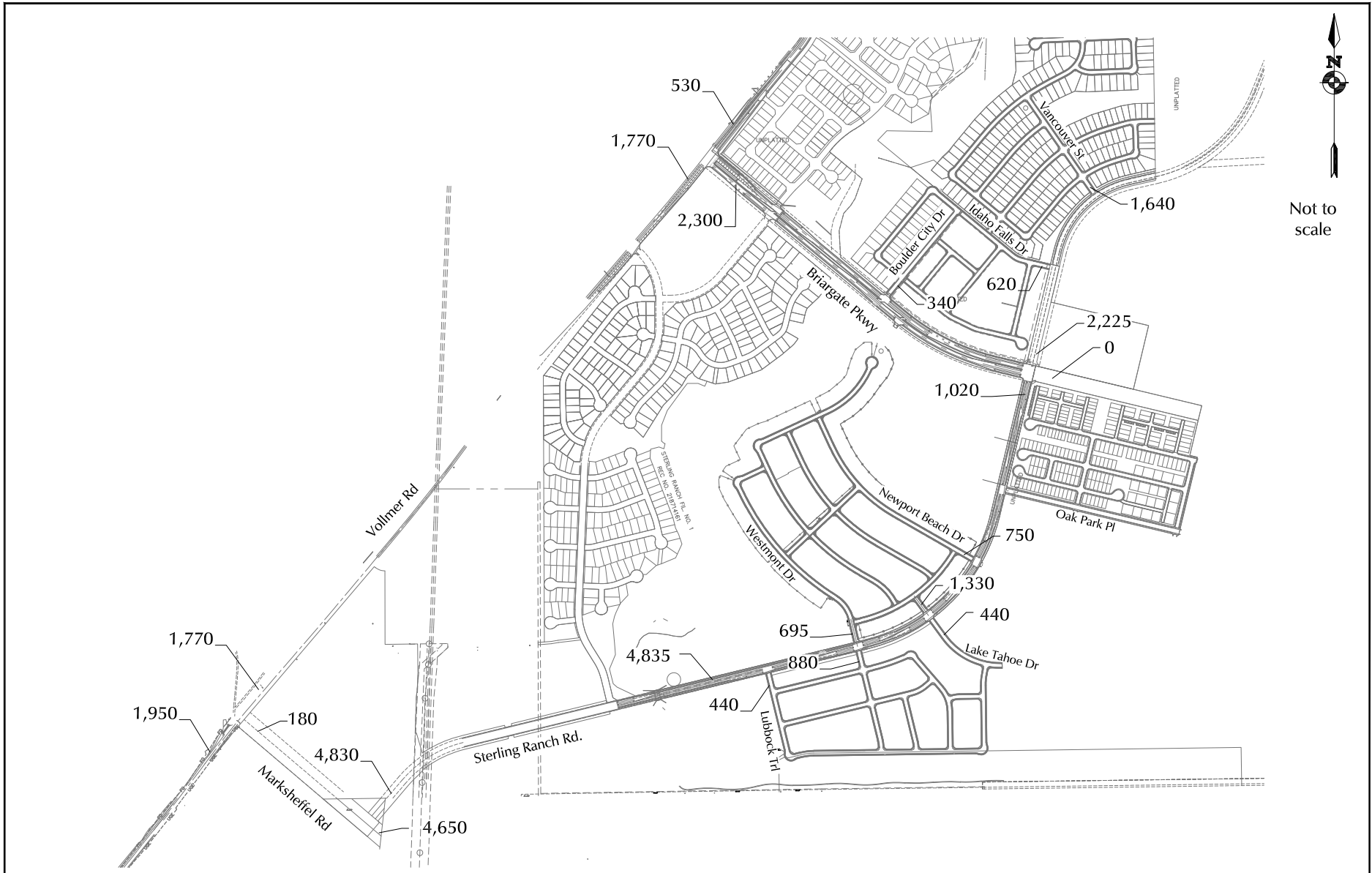

LEGEND: XXX = Average Weekday Traffic (vehicles per day)(AWT)

Figure 11a

Short-Term Site Generated Average Weekday Traffic

Sterling Ranch East Rezoning and Preliminary Plan (LSC# S224440)



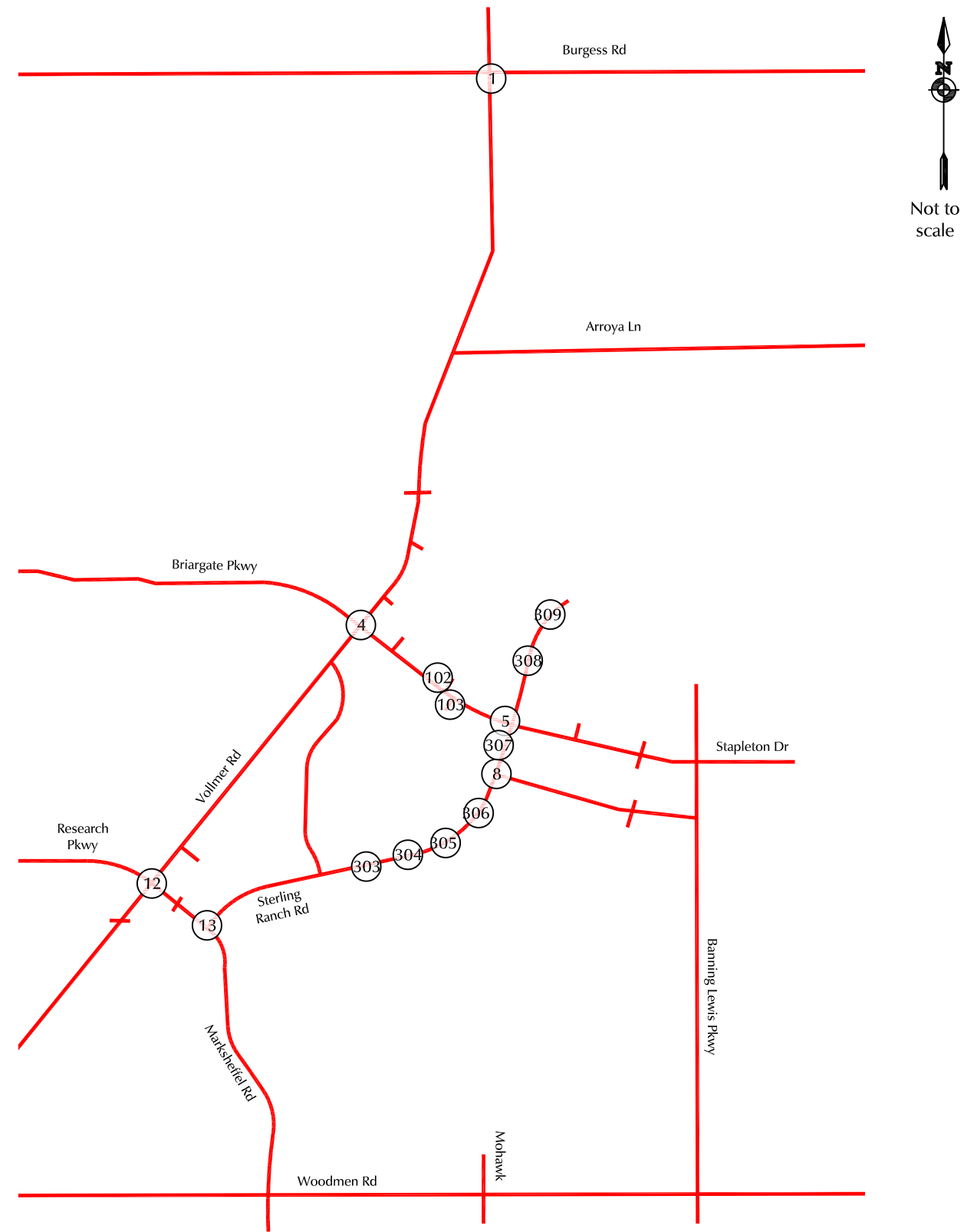
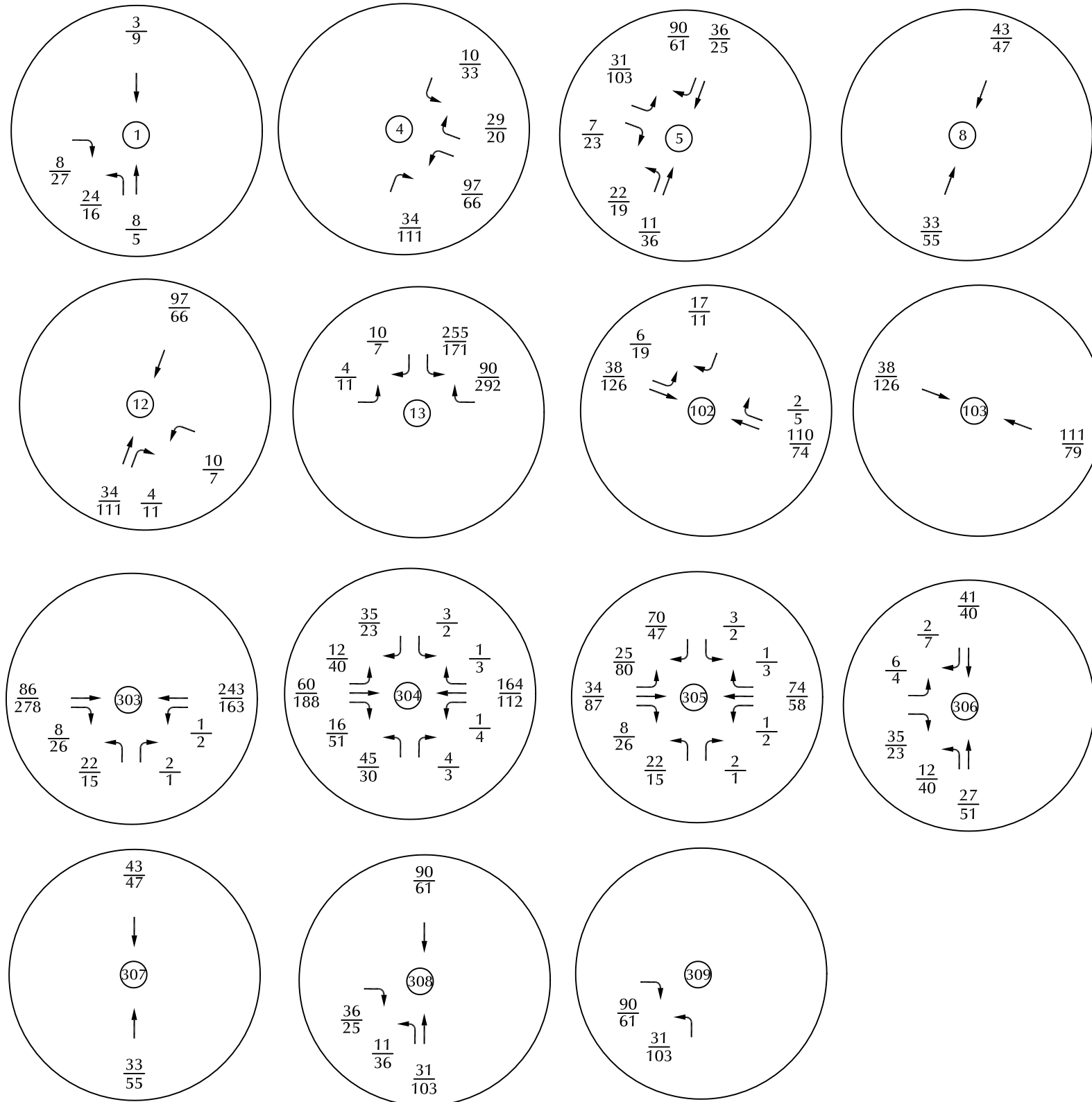

LEGEND: $\frac{XX}{XX} = \frac{\text{AM Peak-Hour Traffic (veh/hr)}}{\text{PM Peak-Hour Traffic (veh/hr)}}$



Figure 11b
Short-Term Site-Generated Traffic

Sterling Ranch East Rezoning and Preliminary Plan (LSC# S224440)

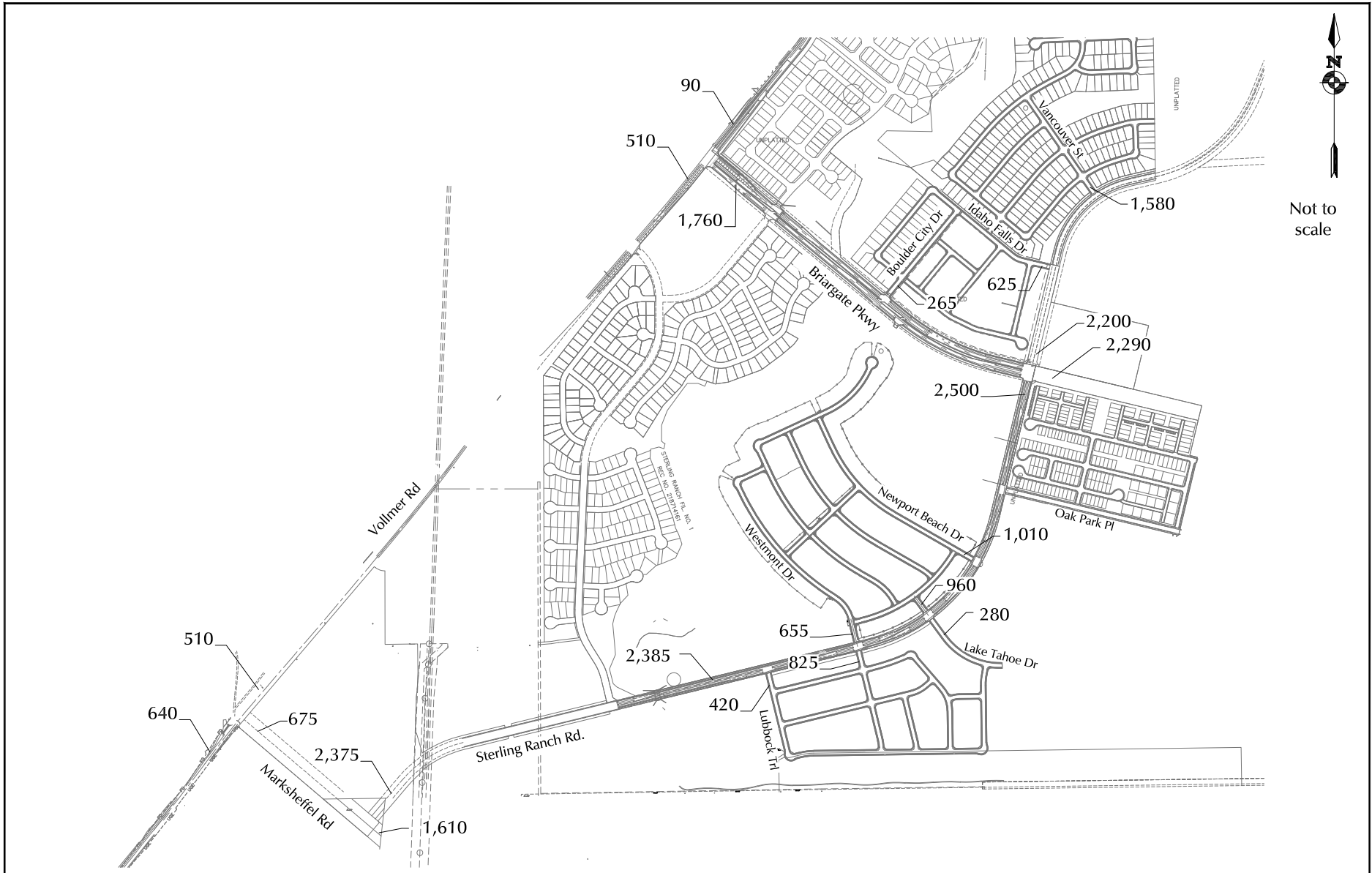

LEGEND: **XXX** = Average Weekday Traffic (vehicles per day)(AWT)

Long-Term Residential-Generated Average Weekday Traffic

Figure 12a

Sterling Ranch East Rezoning and Preliminary Plan (LSC# S224440)



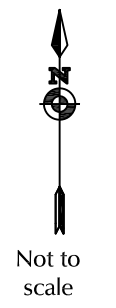
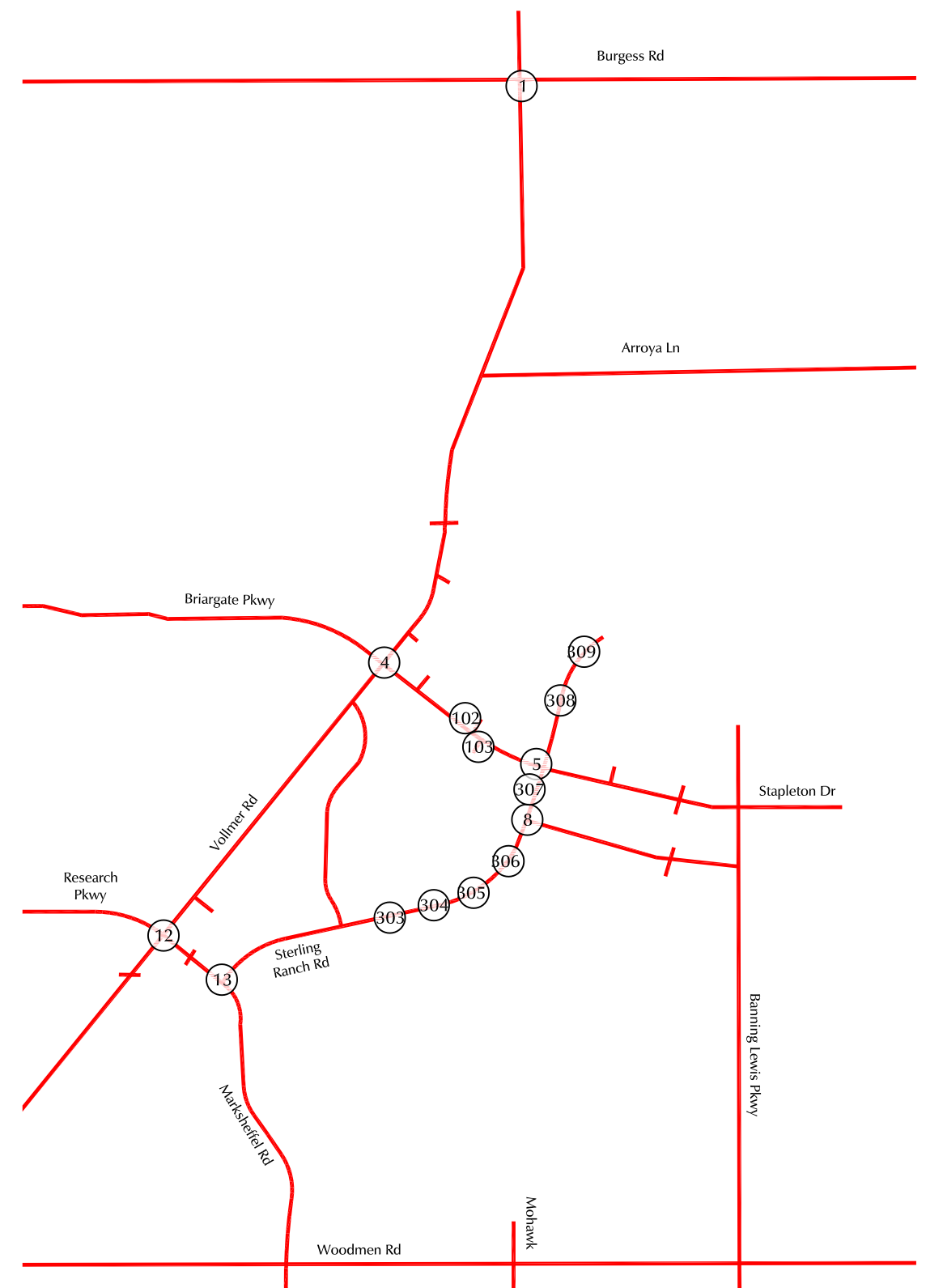
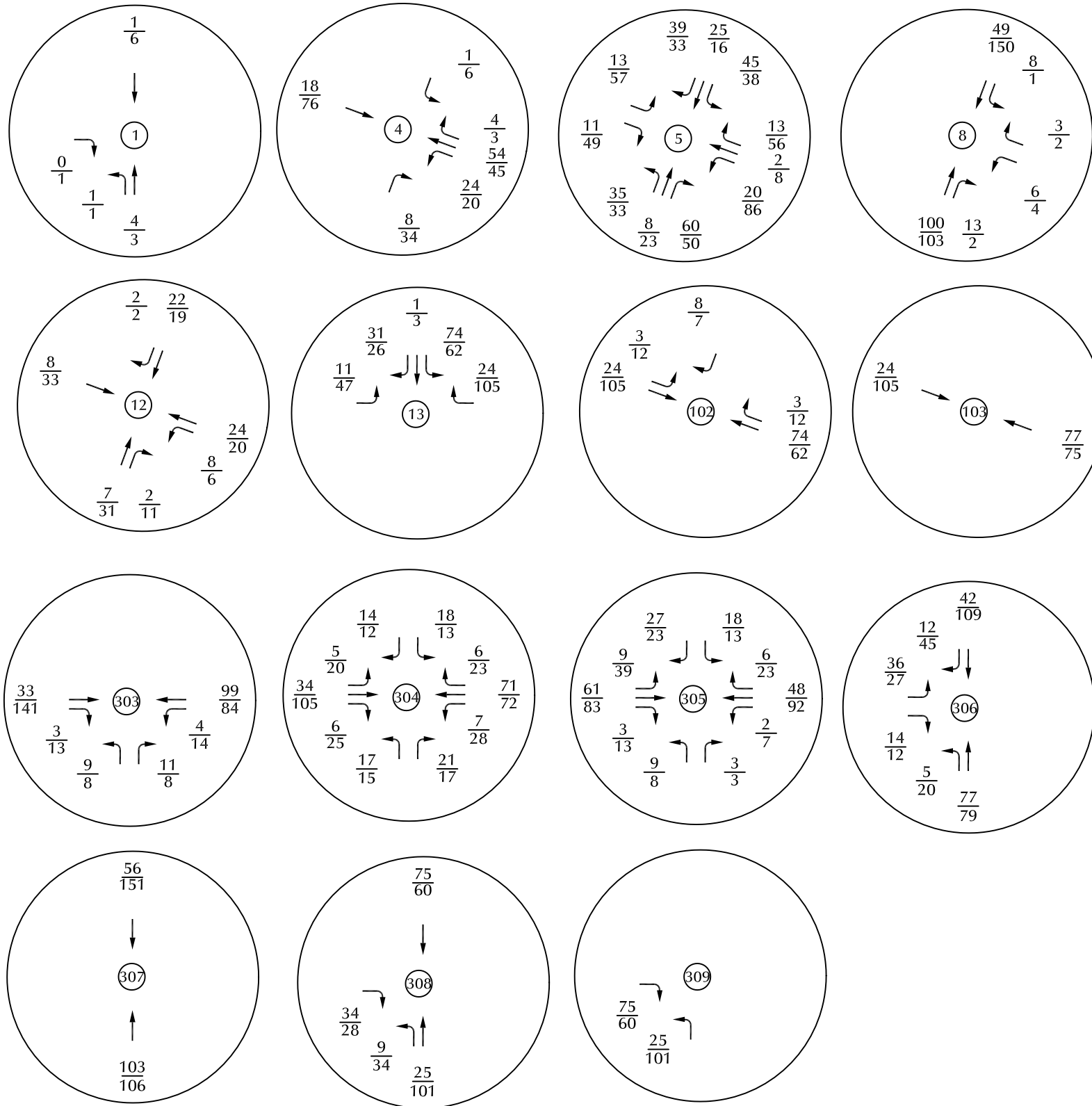

LEGEND: $\frac{XX}{XX} = \frac{\text{AM Peak-Hour Traffic (veh/hr)}}{\text{PM Peak-Hour Traffic (veh/hr)}}$



Figure 12b
Long-Term Residential-Generated Traffic

Sterling Ranch East Rezoning and Preliminary Plan (LSC# S224440)

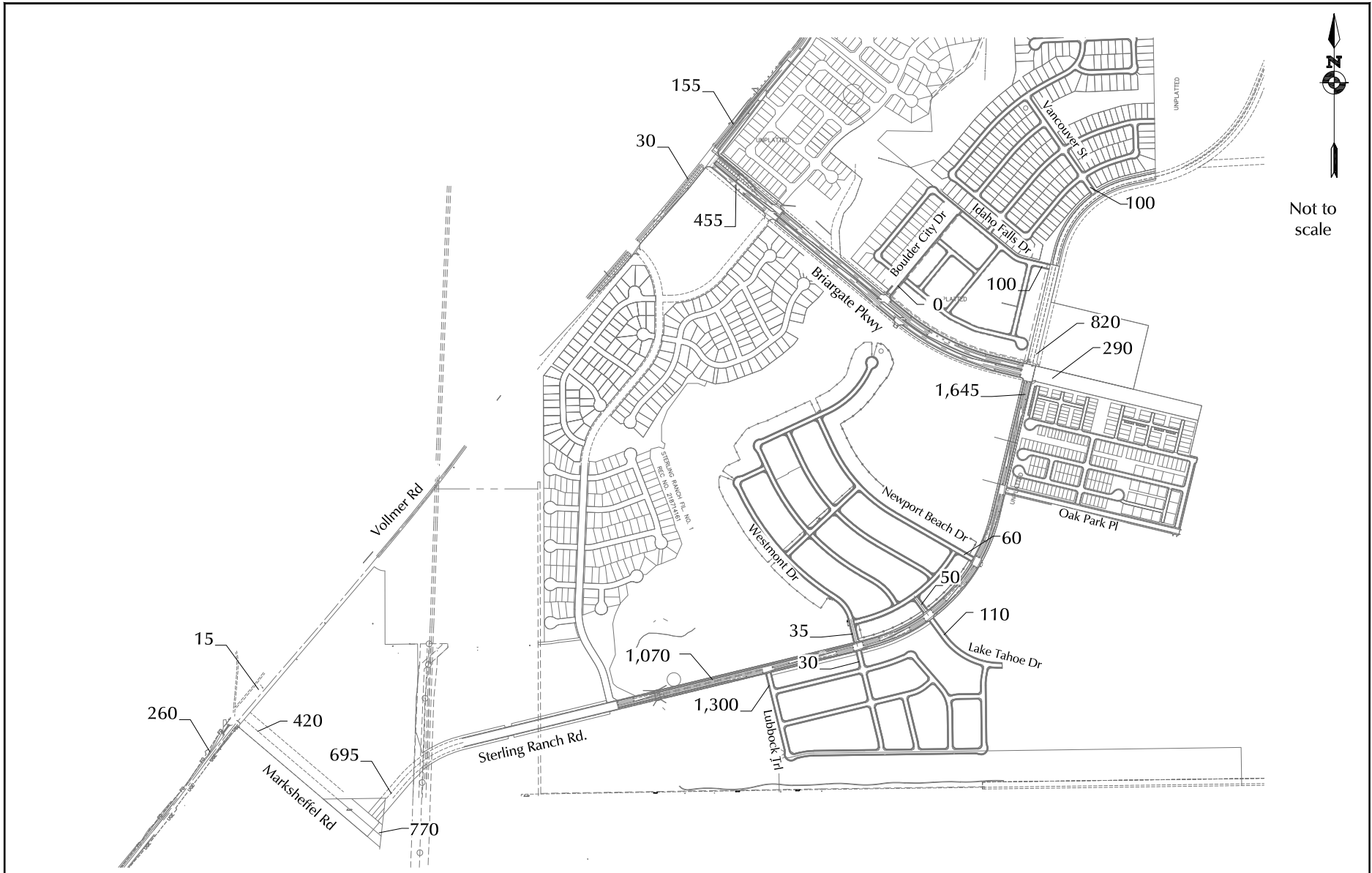

LEGEND: **XXX** = Average Weekday Traffic (vehicles per day)(AWT)

Figure 13a

Long-Term School-Generated Average Weekday Traffic

Sterling Ranch East Rezoning and Preliminary Plan (LSC# S224440)



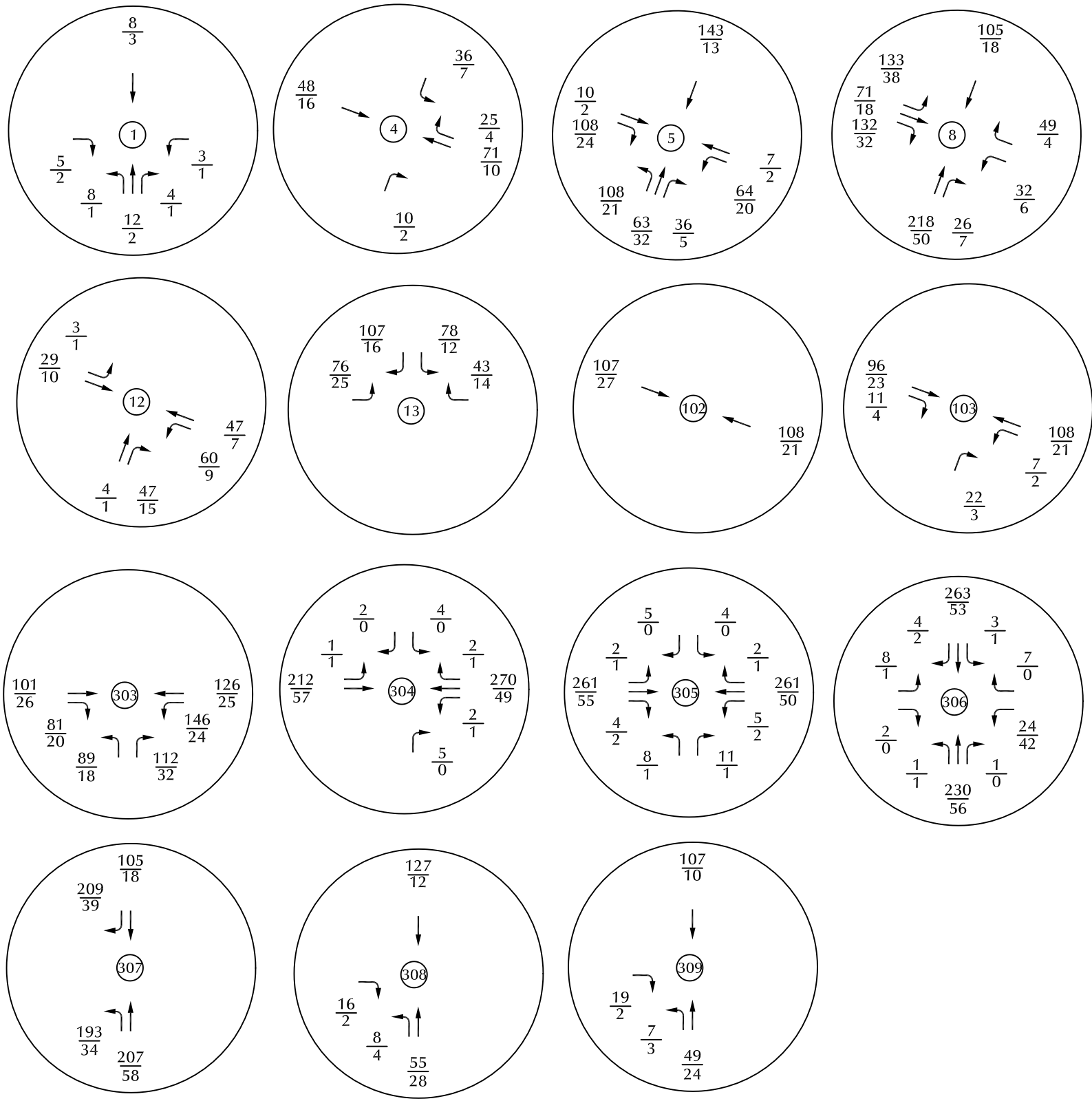

LEGEND: $\frac{XX}{XX}$ = AM Peak-Hour Traffic (veh/hr)
 $\frac{XX}{XX}$ = PM Peak-Hour Traffic (veh/hr)

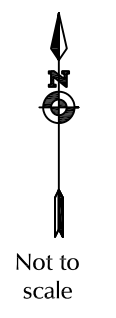
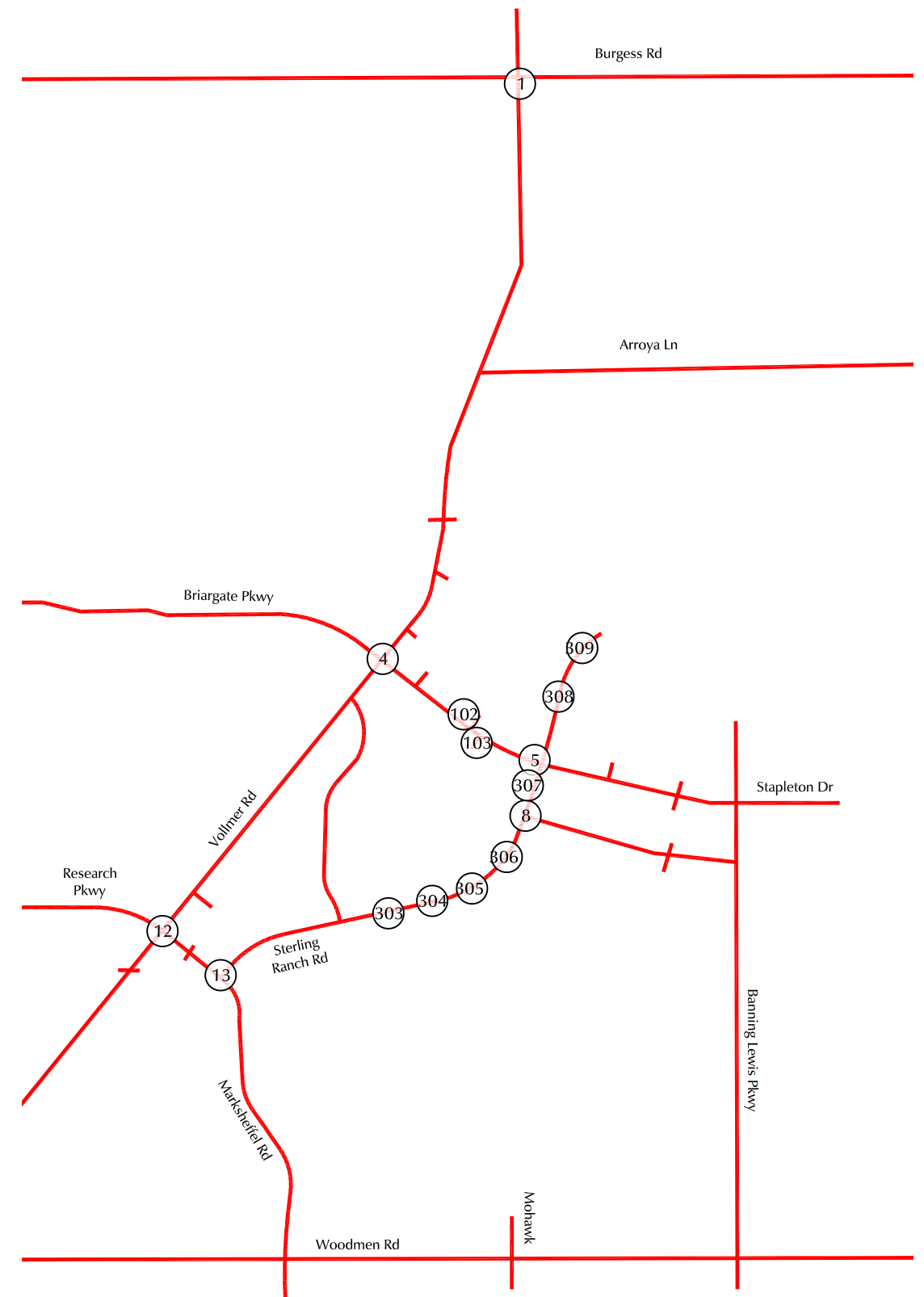
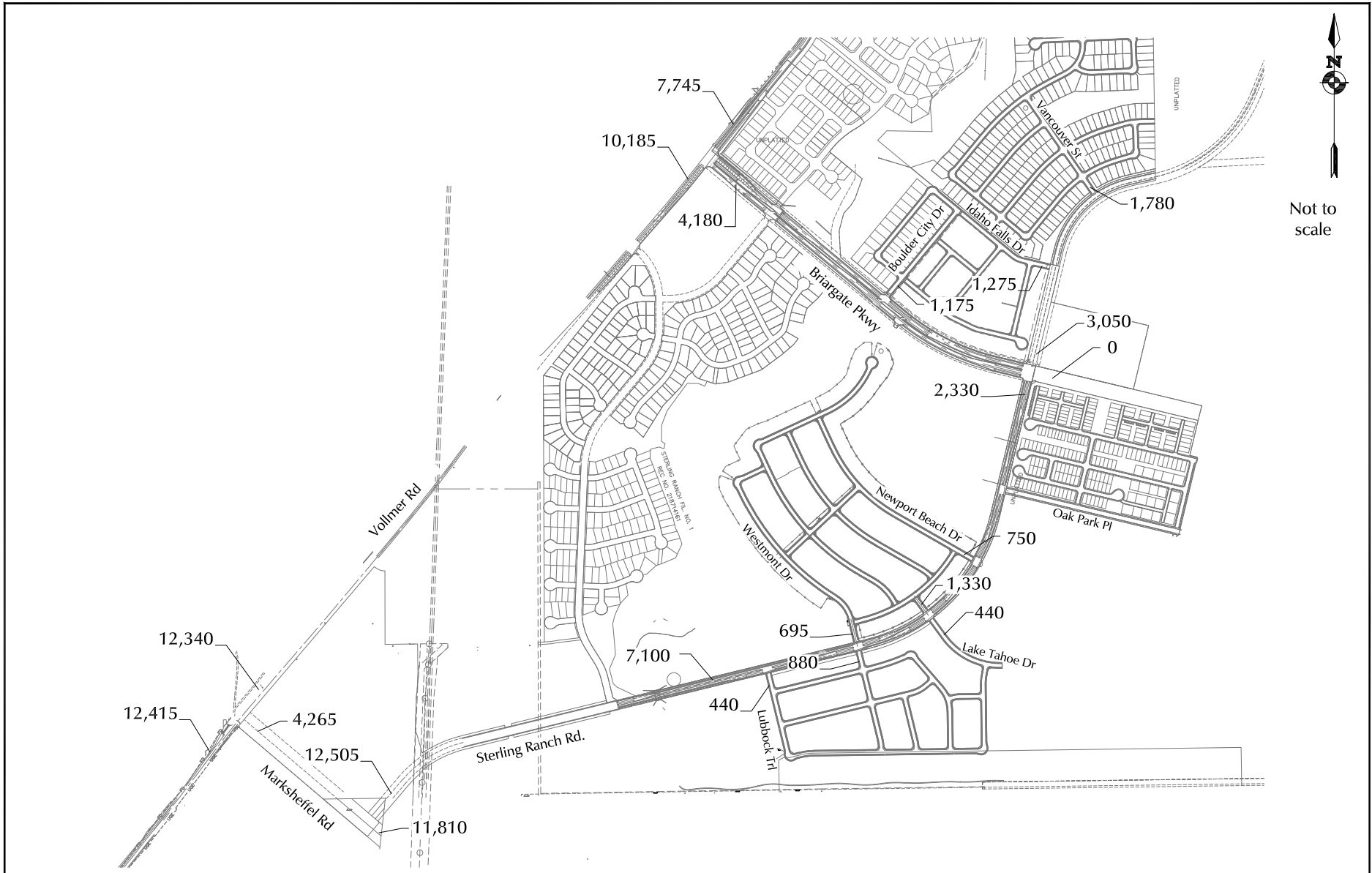

Figure 13b
Long-Term School-Generated Traffic

Sterling Ranch East Rezoning and Preliminary Plan (LSC# S224440)



LEGEND: XXX = Average Weekday Traffic (vehicles per day)(AWT)

Short-Term Total Average Weekday Traffic

Sterling Ranch East Rezoning and Preliminary Plan (LSC# S224440)



Figure 14a

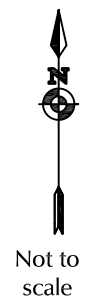
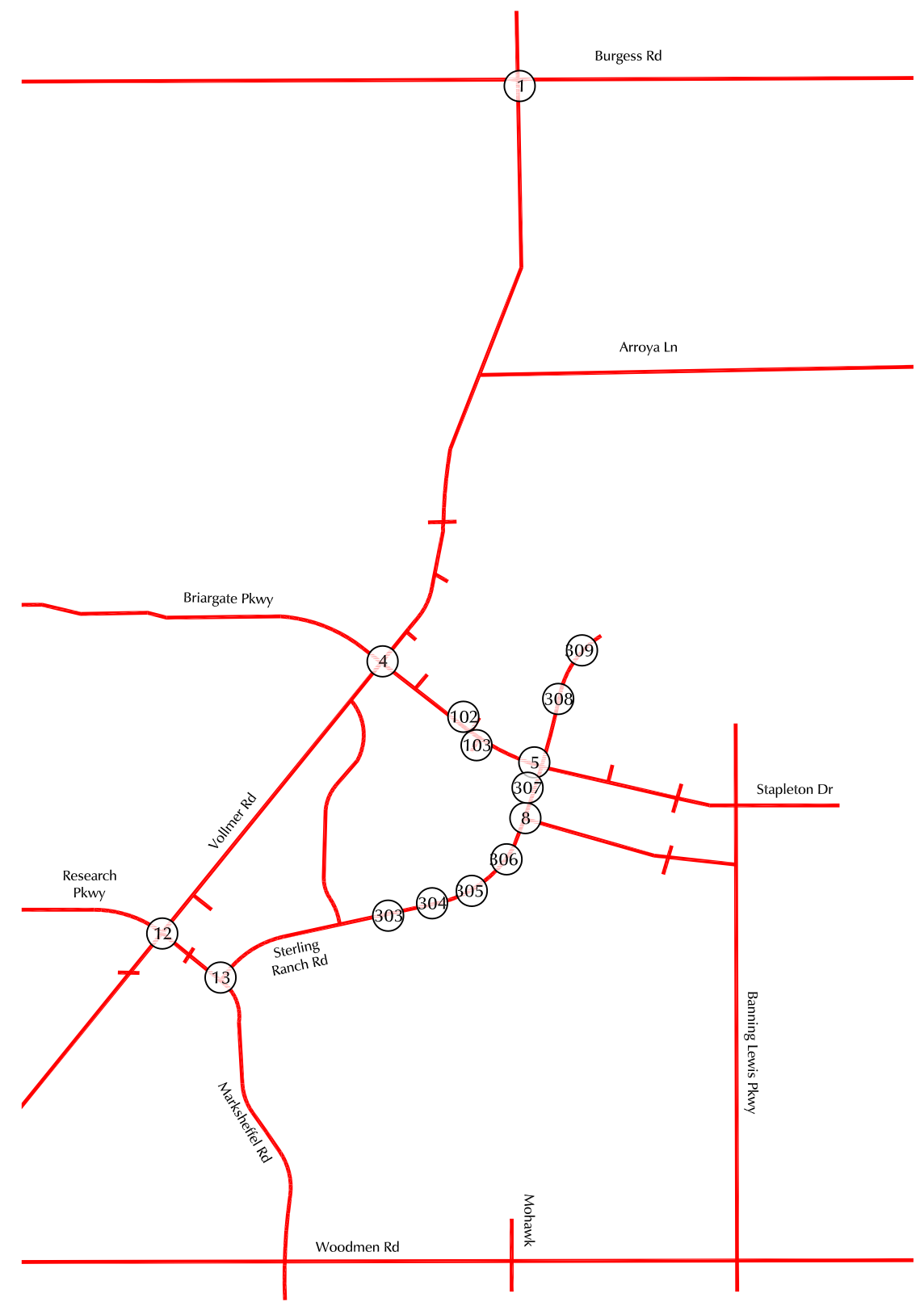
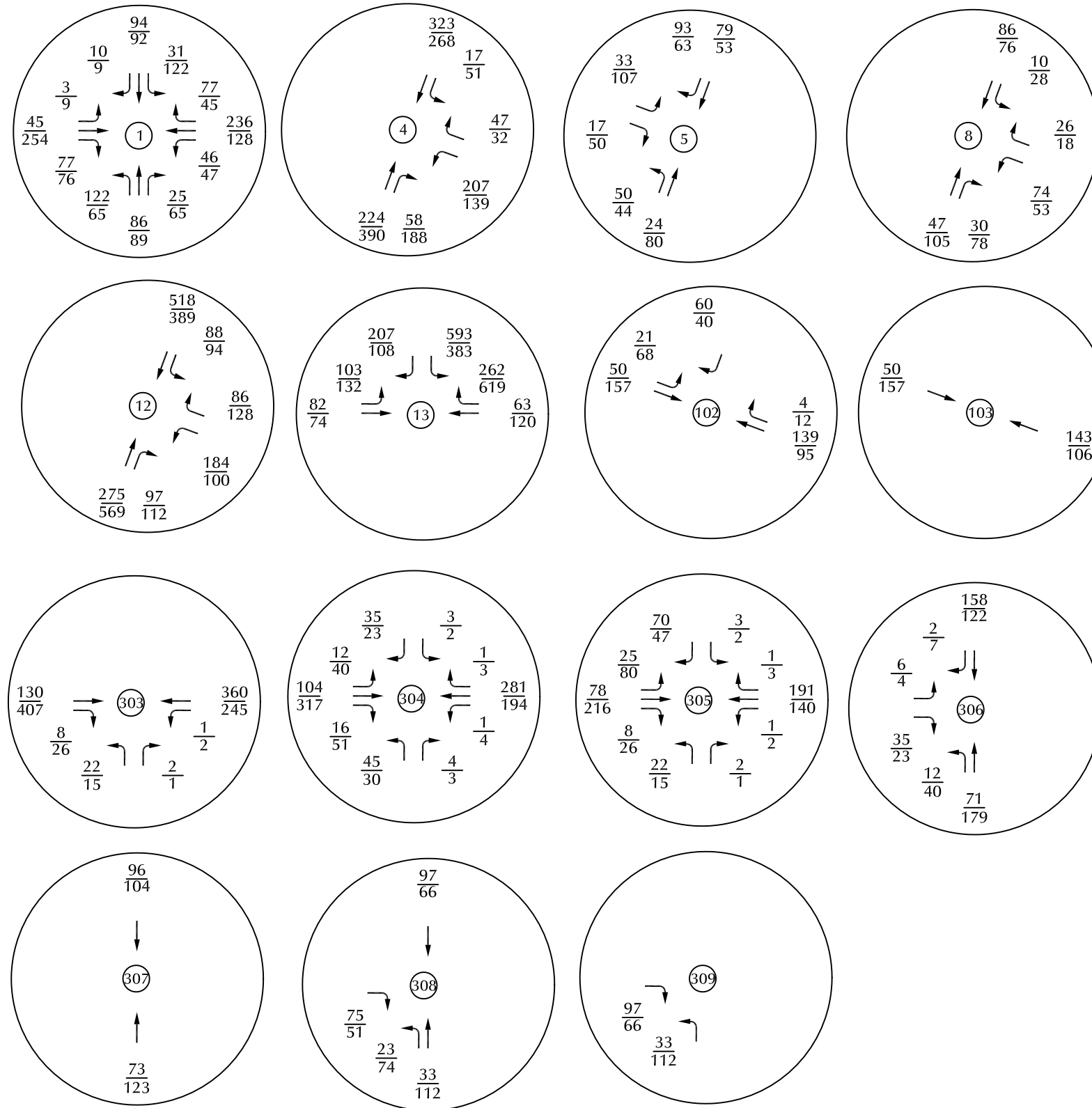

LEGEND: $\frac{XX}{XX} = \frac{\text{AM Peak-Hour Traffic (veh/hr)}}{\text{PM Peak-Hour Traffic (veh/hr)}}$



Figure 14b
Short-Term Total Traffic

Sterling Ranch East Rezoning and Preliminary Plan (LSC# S224440)

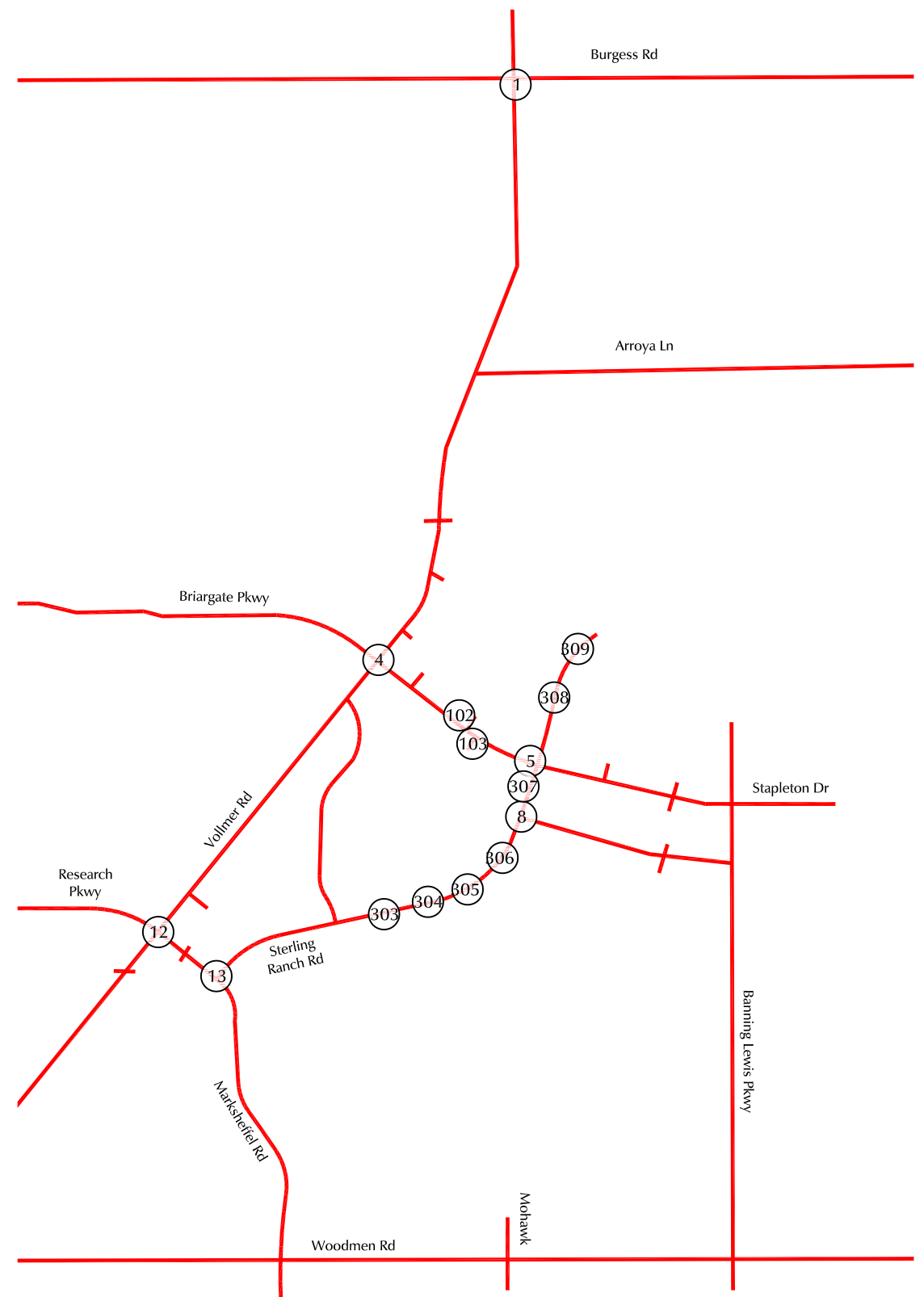
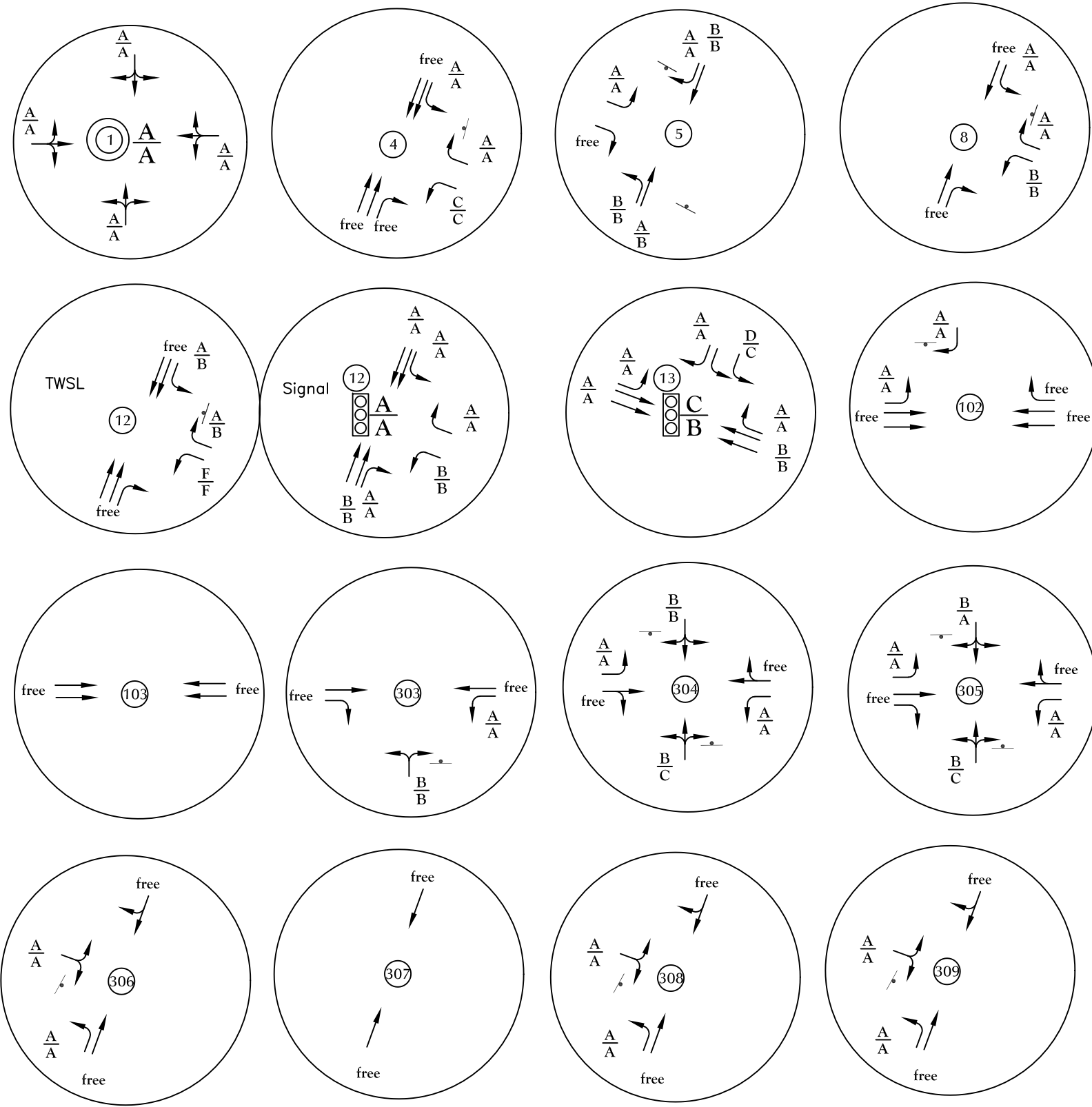

LEGEND:

$\frac{A}{B}$ = AM Individual Movement Peak-Hour Level of Service
 PM Individual Movement Peak-Hour Level of Service
 $\frac{C}{D}$ = AM Entire Intersection Peak-Hour Level of Service
 PM Entire Intersection Peak-Hour Level of Service

| = Stop Sign
 = Traffic Signal
 = Roundabout

Figure 14c
**Short-Term Total Lane Geometry,
 Traffic Control, and Level of Service**



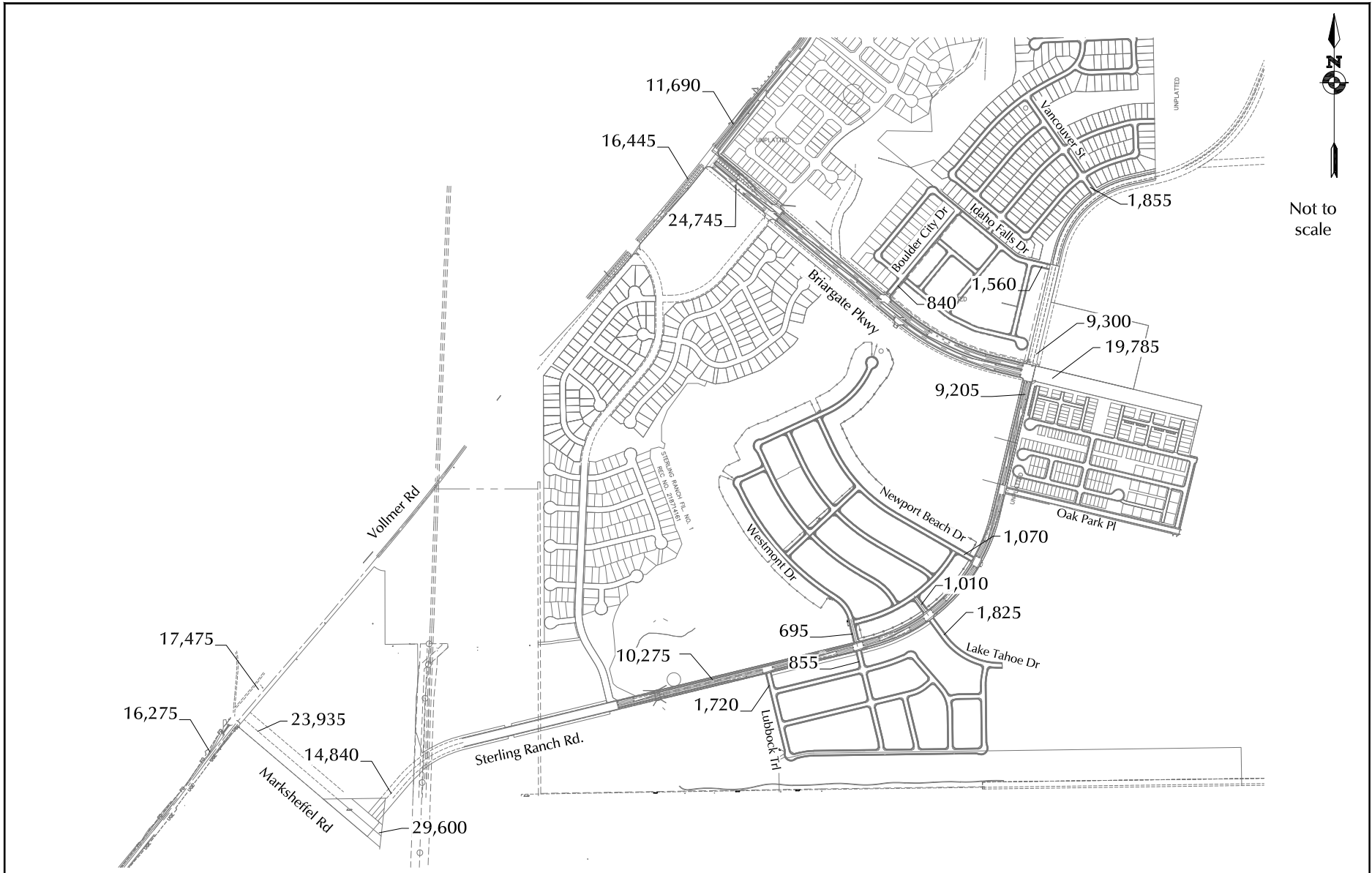

Not to scale



LEGEND:

XXX = Average Weekday Traffic (vehicles per day)(AWT)

Figure 15a
2042 Total Average Weekday Traffic
 Sterling Ranch East Rezoning and Preliminary Plan (LSC# S224440)

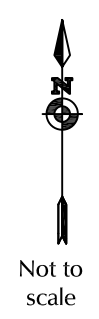
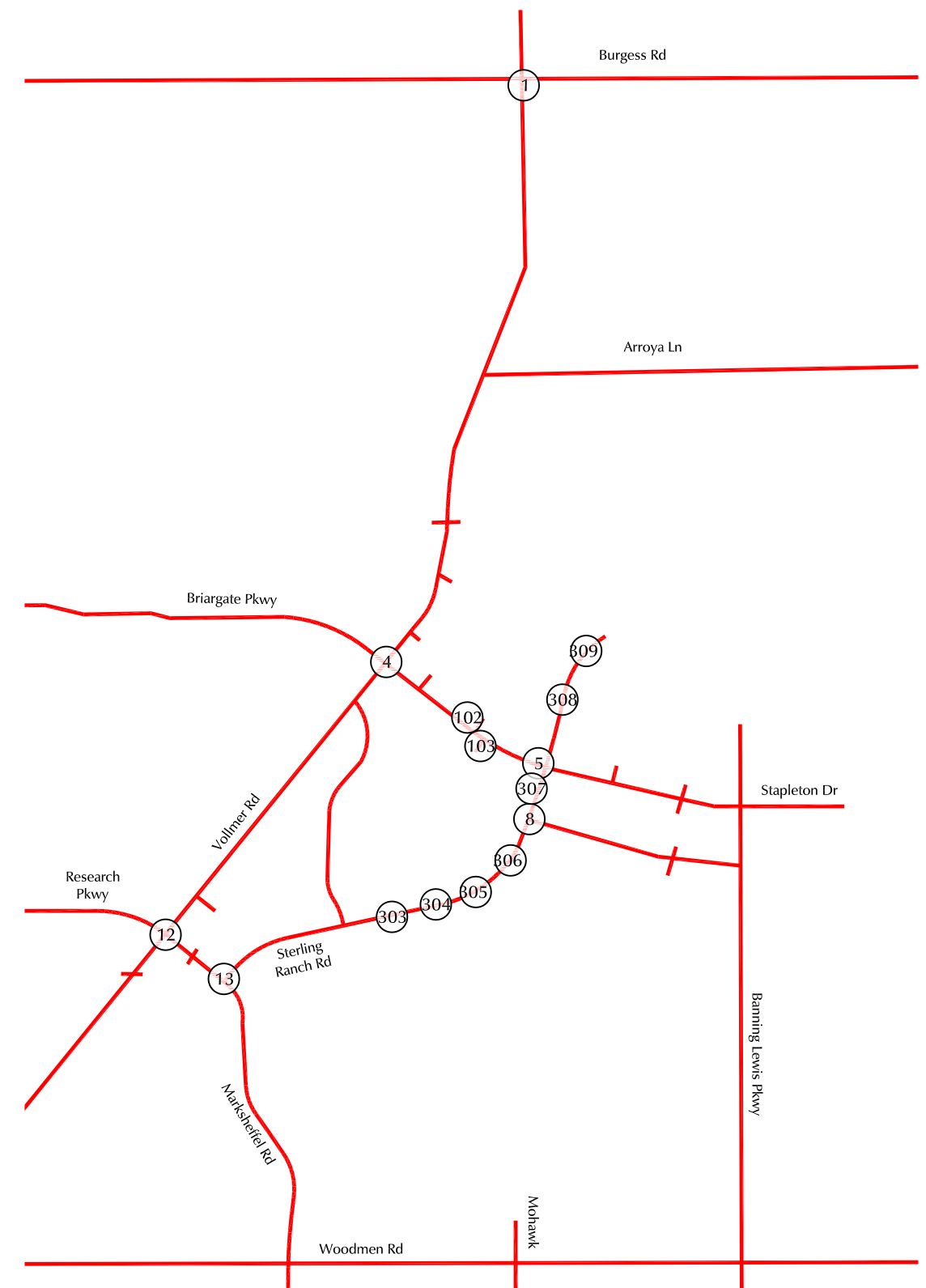
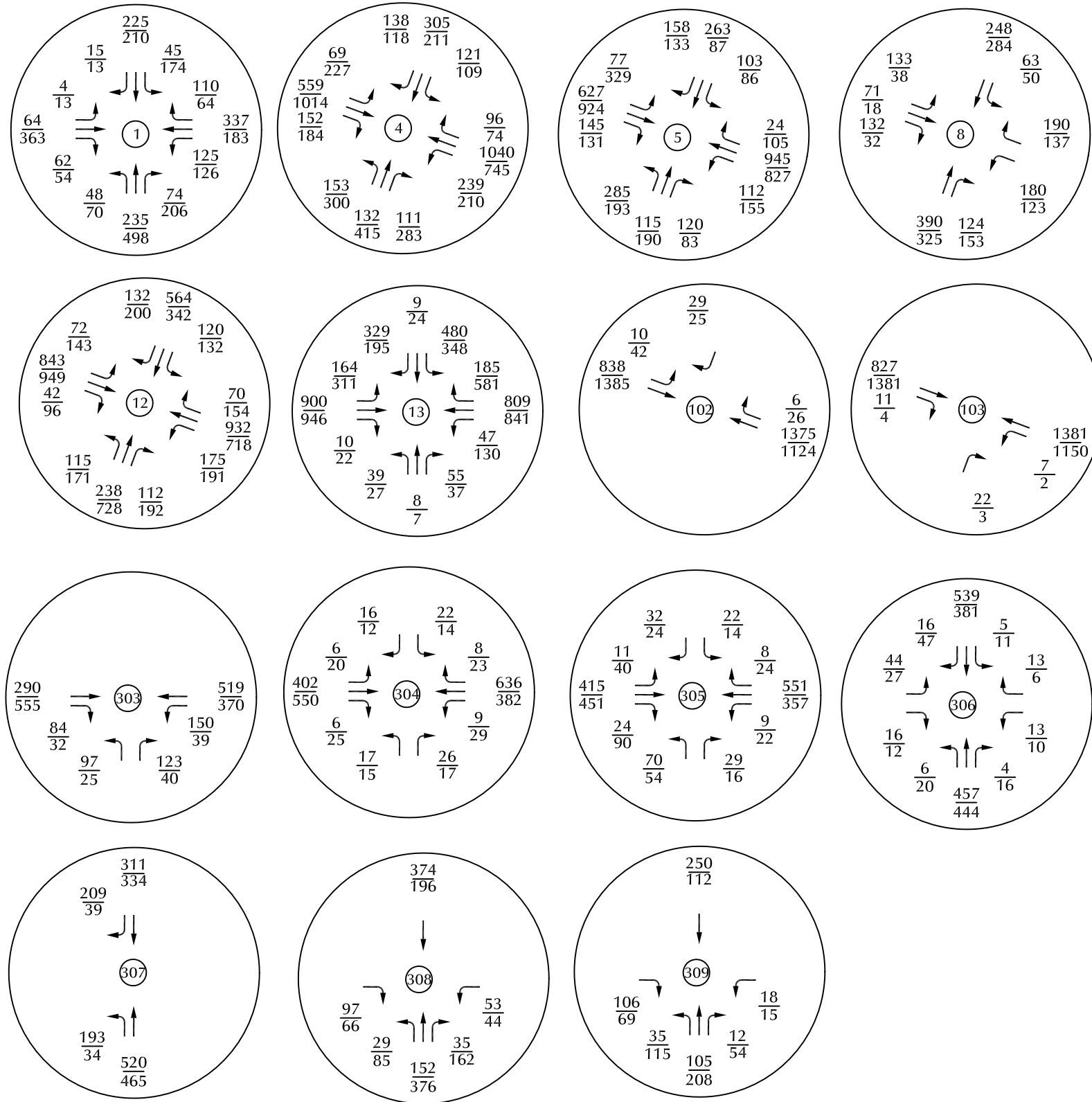

LEGEND: $\frac{XX}{XX} = \frac{\text{AM Peak-Hour Traffic (veh/hr)}}{\text{PM Peak-Hour Traffic (veh/hr)}}$



Figure 15b
2042 Total Traffic

Sterling Ranch East Rezoning and Preliminary Plan (LSC# S224440)

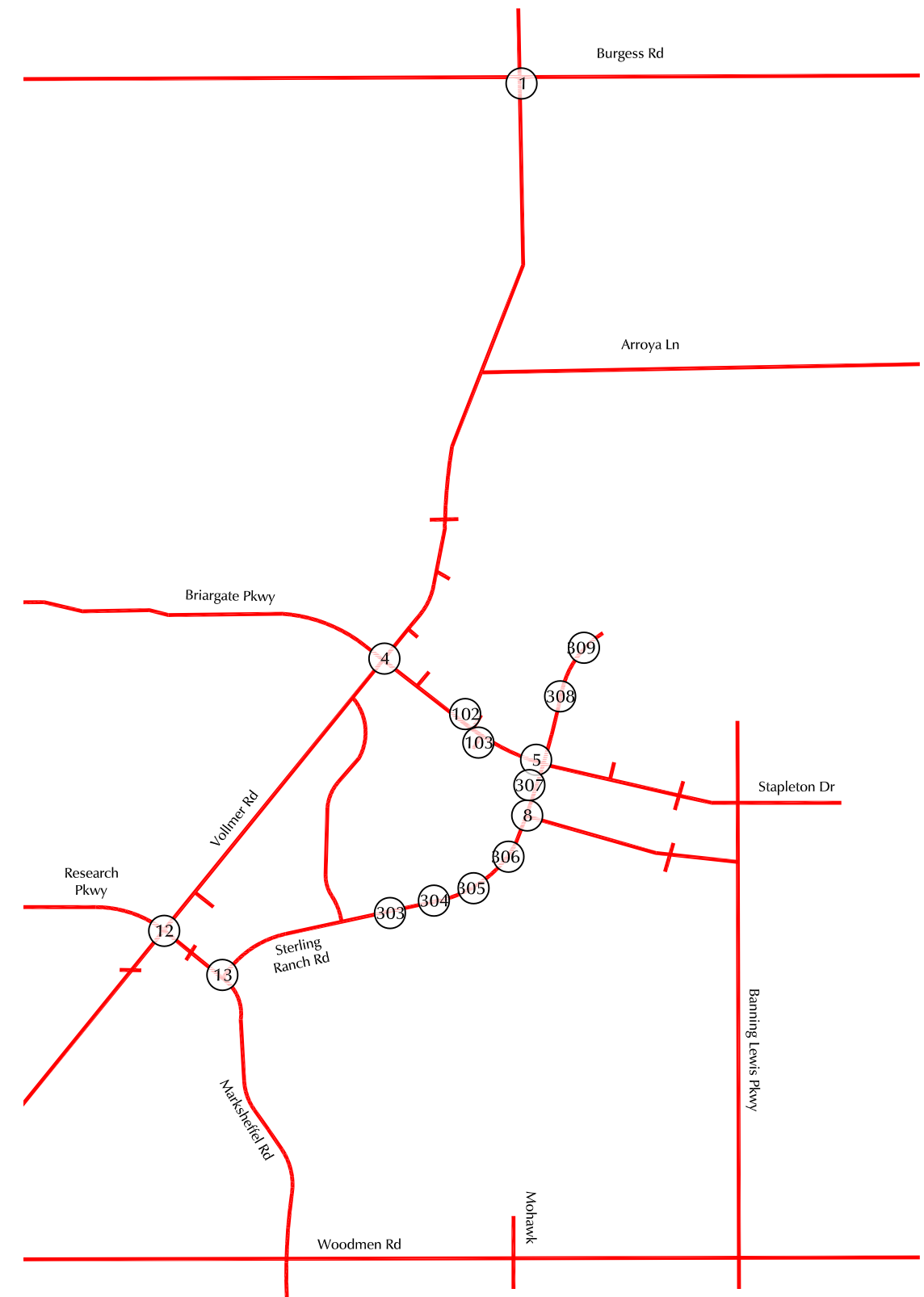
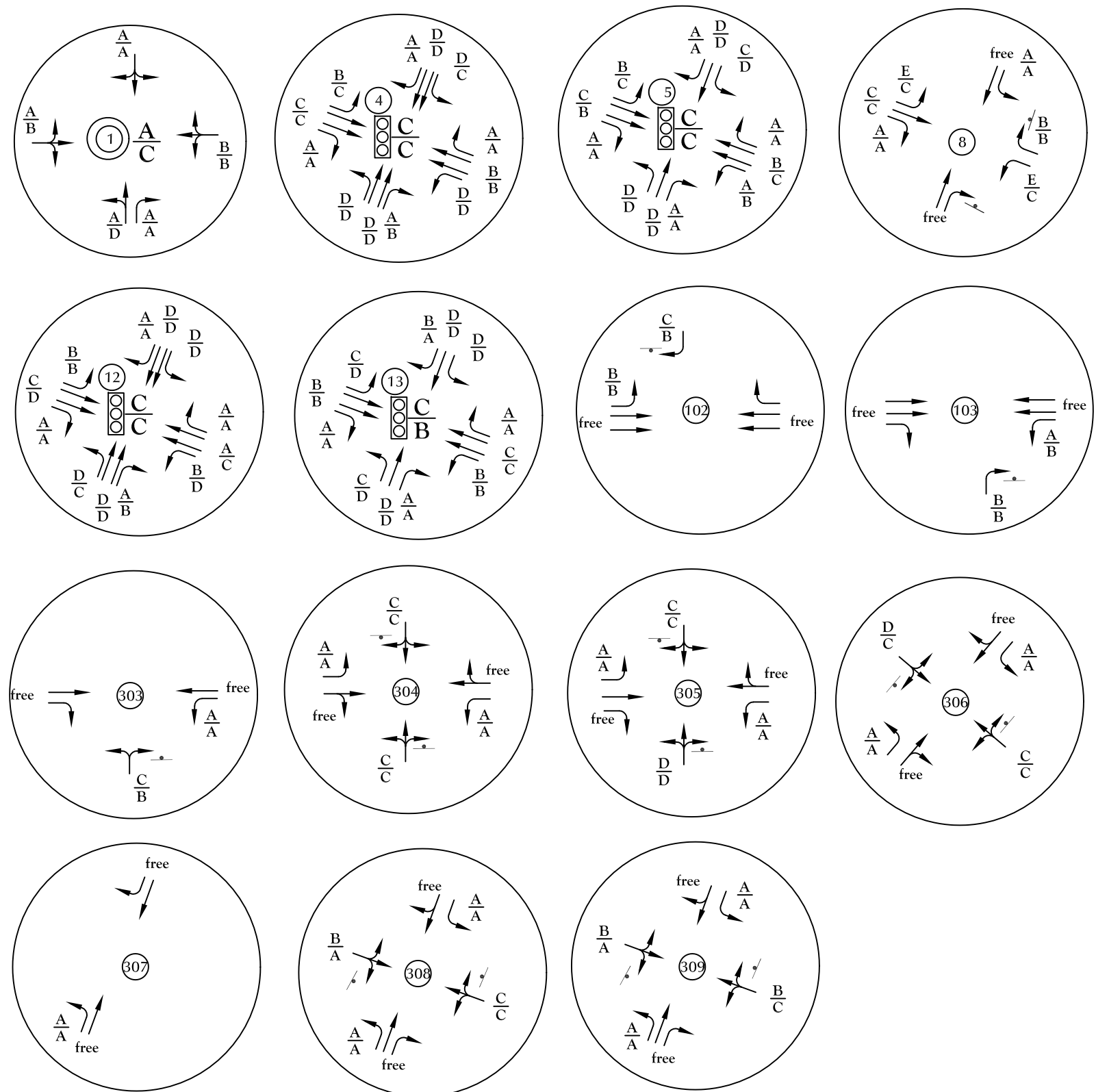

LEGEND:

$\frac{A}{B}$ = AM Individual Movement Peak-Hour Level of Service
 PM Individual Movement Peak-Hour Level of Service
 $\frac{C}{D}$ = AM Entire Intersection Peak-Hour Level of Service
 PM Entire Intersection Peak-Hour Level of Service

T = Stop Sign
 = Traffic Signal

= Roundabout



Figure 15c
 2042 Total Lane Geometry,
 Traffic Control, and Level of Service

Sterling Ranch East Rezoning and Preliminary Plan (LSC# S224440)

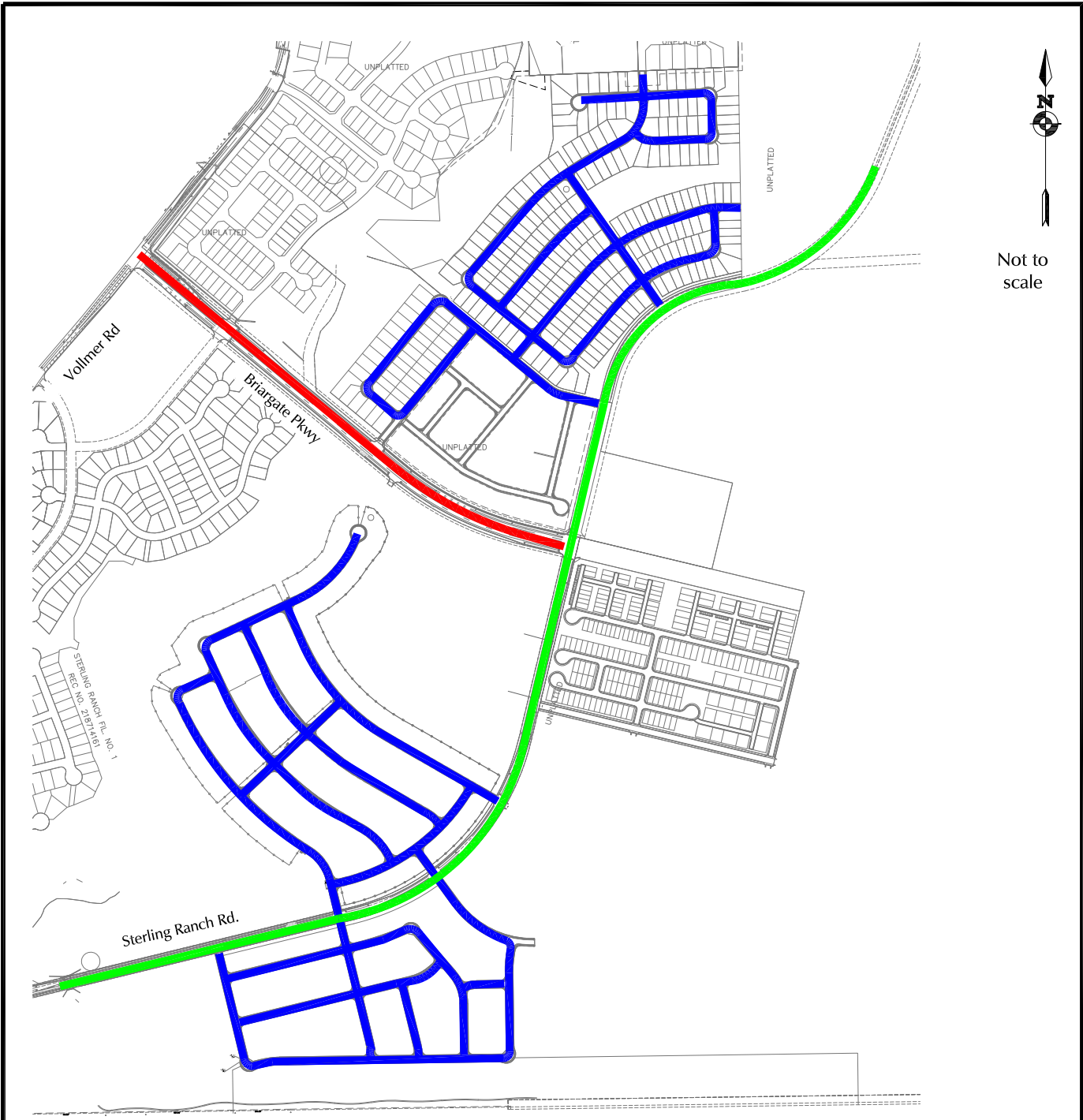

Not to scale

LEGEND:

- 4-Lane Urban Principal Arterial

— Urban Local
- Urban Non-Residential Collector

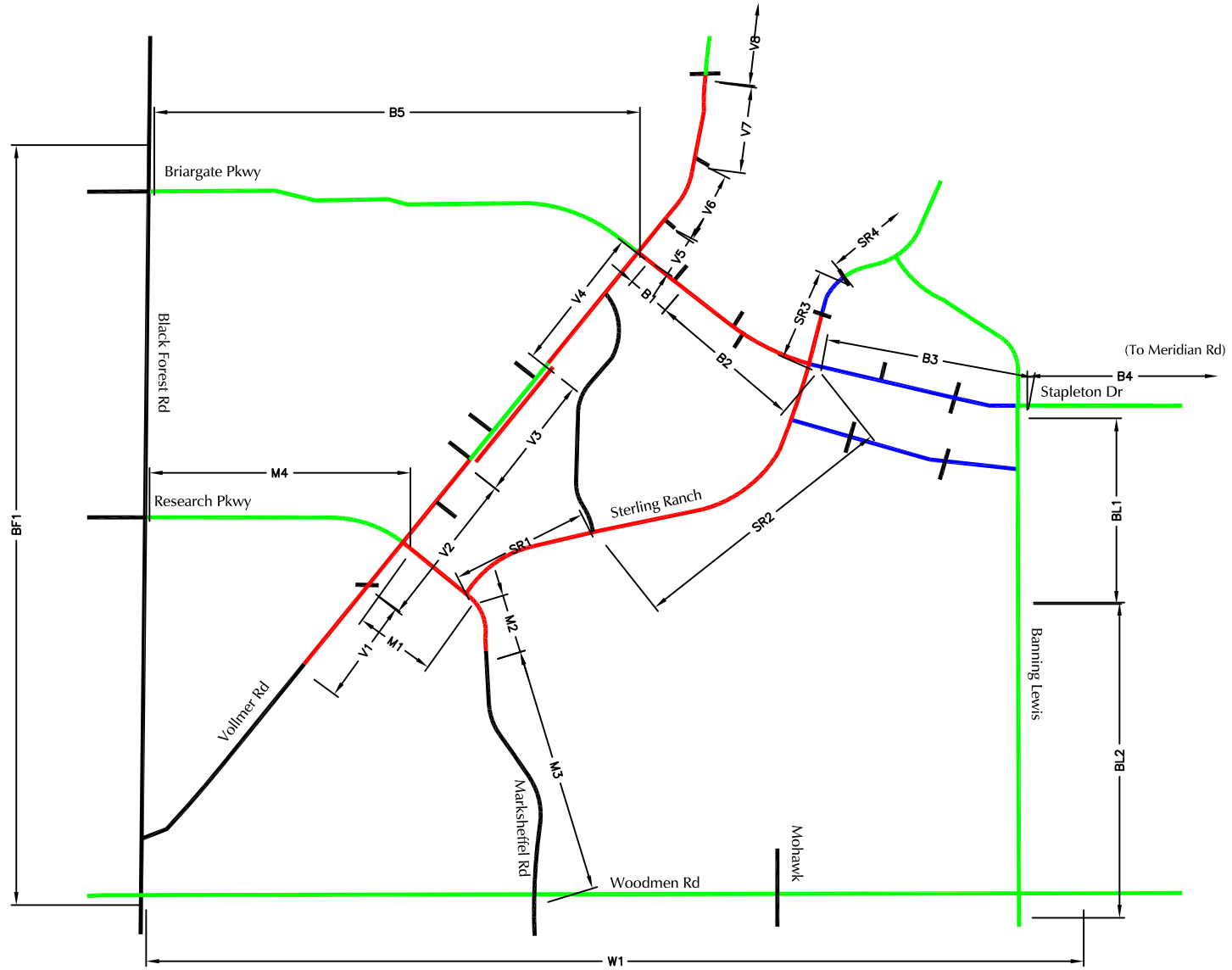

Figure 16
Roadway Classifications

Sterling Ranch East Rezoning and Preliminary Plan (LSC# S224440)



Not to scale



V1, B4, SR3, etc - Segment Identifier*

- Short-Term
- Intermediate-Term
- Long-Term

*See Table 4 for recommended roadway segment improvements for each segment.

Roadway Improvement Segments*

Sterling Ranch East Rezoning and Preliminary Plan (LSC# S224440)



Figure 17

Appendix Table 1



**Appendix Table 1
Area Traffic Impact Studies
Sterling Ranch East - Rezoning & Preliminary Plan**

Study	PCD File No⁽¹⁾	Consultant	Date
Sterling Ranch Reports			
Sterling Ranch Updated Traffic Impact Analysis	SKP07007	LSC Transportation Consultants, Inc	June 5, 2008
Sterling Ranch Phase 1 Traffic Impact Study	P151	LSC Transportation Consultants, Inc	March 16, 2015
Sterling Ranch Phases 1-3 Transportation Memorandum	SP1415	LSC Transportation Consultants, Inc	October 2, 2017
Branding Iron at Sterling Ranch Filing No. 1 and Homestead at Sterling Ranch Filing No. 1 Transportation	SF1724 SF1725	LSC Transportation Consultants, Inc	December 19, 2017
Sterling Ranch Filing No. 2 Transportation Memorandum	SF1820	LSC Transportation Consultants, Inc	April 3, 2018
Sterling Ranch Phase 2 Preliminary Plan Traffic Impact Study	SP203	LSC Transportation Consultants, Inc	December 20, 2018
Homestead at Sterling Ranch Filing No. 2 Transportation Memorandum	SF194	LSC Transportation Consultants, Inc	March 3, 2020
Branding Iron at Sterling Ranch Filing No. 2 Transportation Memorandum	SF1918	LSC Transportation Consultants, Inc	May 6, 2020
Sterling Ranch Filing No. 2 and Phase 2 Traffic Impact Study	SF2015 SP191	LSC Transportation Consultants, Inc	June 23, 2021
Sterling Ranch Filing No. 3 Transportation Memorandum	SF2132	LSC Transportation Consultants, Inc	April 19, 2022
Copper Chase at Sterling Ranch Transportation Memorandum	PUDSP222	LSC Transportation Consultants, Inc	December 14, 2021
Homestead North Phase 1 Updated Transportation Memorandum	SP208	LSC Transportation Consultants, Inc	January 11, 2022
Homestead North Filing No. 1 Traffic Technical Memorandum	SF2213	LSC Transportation Consultants, Inc	February 2, 2022
Homestead North Filing No. 2 Traffic Technical Memorandum	SF2218	LSC Transportation Consultants, Inc	April 15, 2022
Homestead North Filing 3 Traffic Impact Study	SF2229	LSC Transportation Consultants, Inc	June 17, 2022
Foursquare at Sterling Ranch East Preliminary Plan/Traffic Generation Analysis	PUDSP227	LSC Transportation Consultants, Inc	November 22, 2022
The Villages at Sterling Ranch East Preliminary Plan/Traffic Generation Analysis	PUDSP226	LSC Transportation Consultants, Inc	December 9, 2022
Sterling Ranch Sketch Plan Amendment Master Traffic Impact Study	SKP224	LSC Transportation Consultants, Inc	February 10, 2023
Retreat at TimberRidge Reports			
The Retreat at TimberRidge Traffic Impact Analysis	PUD173	LSC Transportation Consultants, Inc	January 25, 2018
The Retreat at TimberRidge Preliminary Plan Traffic Technical Memorandum	SP182	LSC Transportation Consultants, Inc	June 29, 2018
The Retreat at TimberRidge Filing No. 1 Traffic Technical Memorandum	SF199	LSC Transportation Consultants, Inc	April 3, 2020
The Retreat at TimberRidge Filing No. 2 Updated Traffic Technical Memorandum	SF2121	LSC Transportation Consultants, Inc	October 4, 2021
The Retreat at TimberRidge Filing No. 3 Traffic Technical Memorandum		LSC Transportation Consultants, Inc	July 1, 2022
Other Area Reports			
Wolf Ranch School Site Traffic Impact Study	OAR1720	Matrix Design Group, Inc.	5-May-17
The Ranch Sketch Plan Traffic Impact Analysis	SKP186	LSC Transportation Consultants, Inc	July 9, 2019
Lodge III Traffic Impact Study	OAR	LSC Transportation Consultants, Inc	December 13, 2019
Continental 613 Traffic Impact Study	OAR2177	LSC Transportation Consultants, Inc	July 16, 2021
Solace at Black Forest Traffic Impact and Access Analysis	OAR2134	LSC Transportation Consultants, Inc	August 13, 2021
Traffic Impact Study Addendum for Percheron	OAR2173	SM Rocha, LLC	October, 2021
Woodmen East Commercial Center Traffic Impact Analysis	OAR2191	LSC Transportation Consultants, Inc	December 8, 2021
Traffic Impact Study for Jaynes Property	SKP225	SM Rocha, LLC	January, 2023
Traffic Impact Study for Rhetoric Site	P2216	SM Rocha, LLC	June, 2022
Briargate-Stapleton Corridor Study (DRAFT)	briargate-stapleton.com	Wilson & Company	December 9, 2021
Notes:			
(1) Follow the links listed below to obtain the most recent version of each listed study. To obtain a copy of the version of each study used in preparing this report please contact LSC Transportation Consultants, Inc.			
Source: LSC Transportation Consultants, Inc.			

2008 TIS TAZ Map



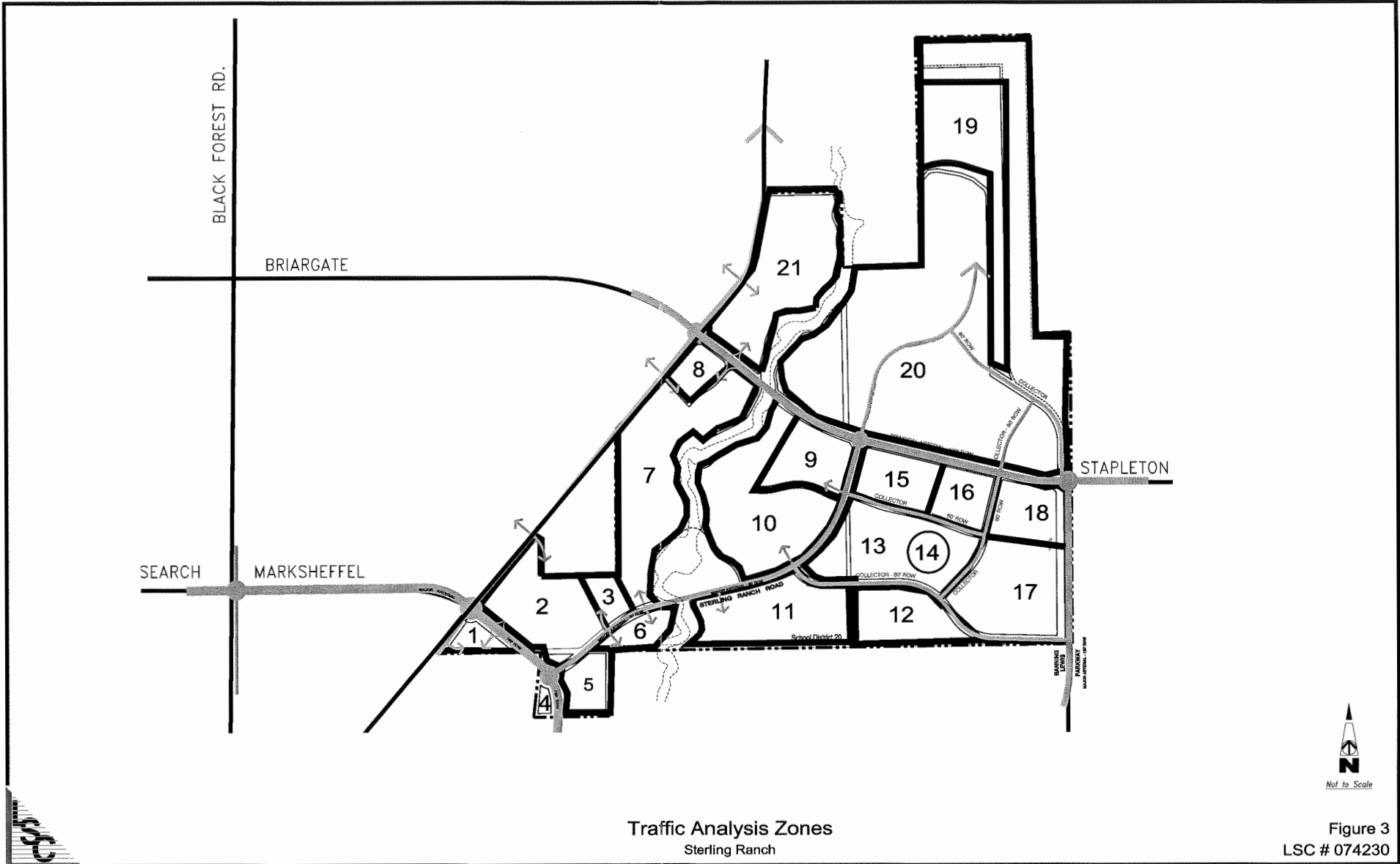

Traffic Analysis Zones
Sterling Ranch

Figure 3
LSC # 074230

MTCP Maps



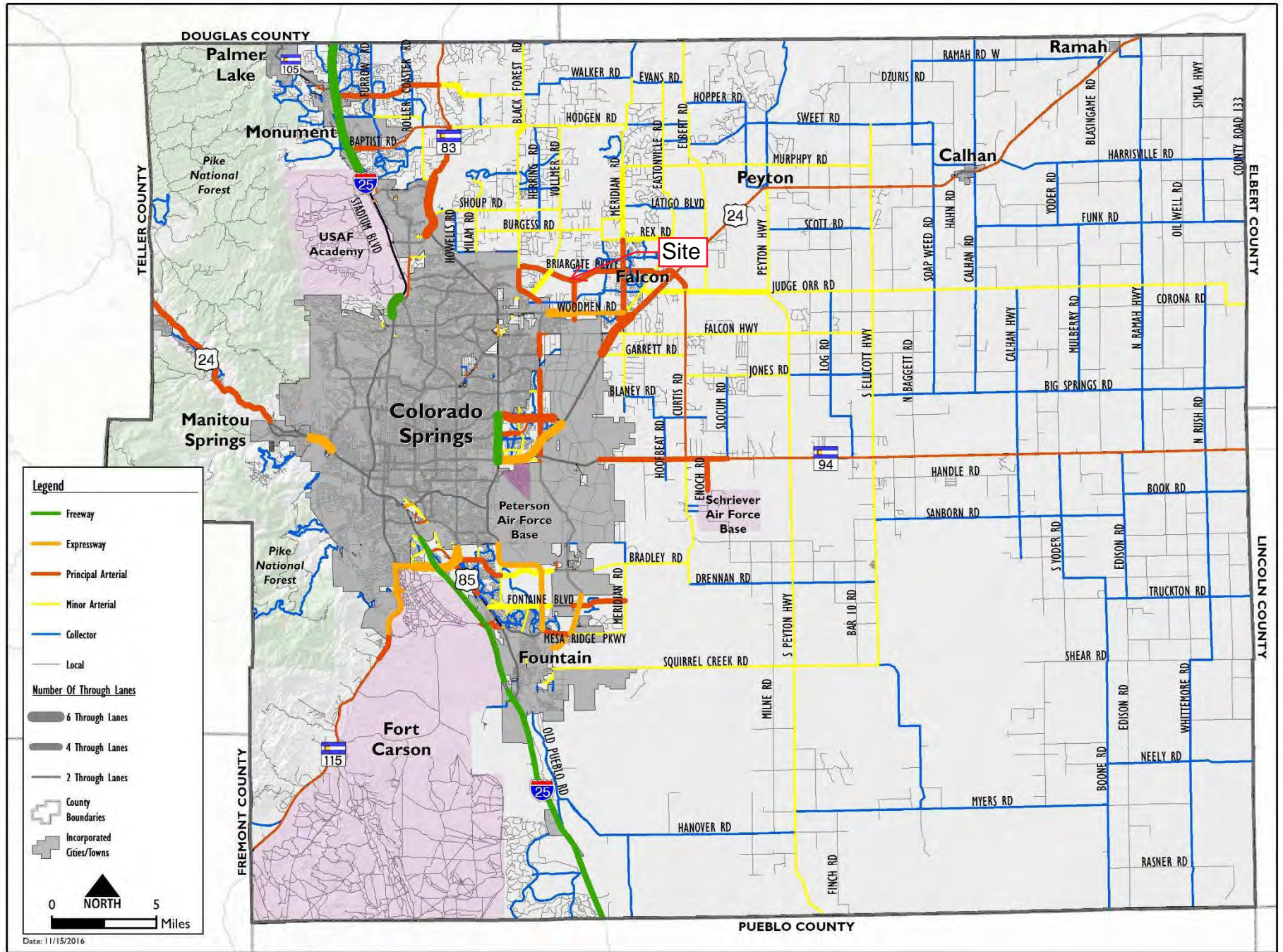

Map 14: 2040 Roadway Plan (Classification and Lanes)

Map 17: 2060 Corridor Preservation

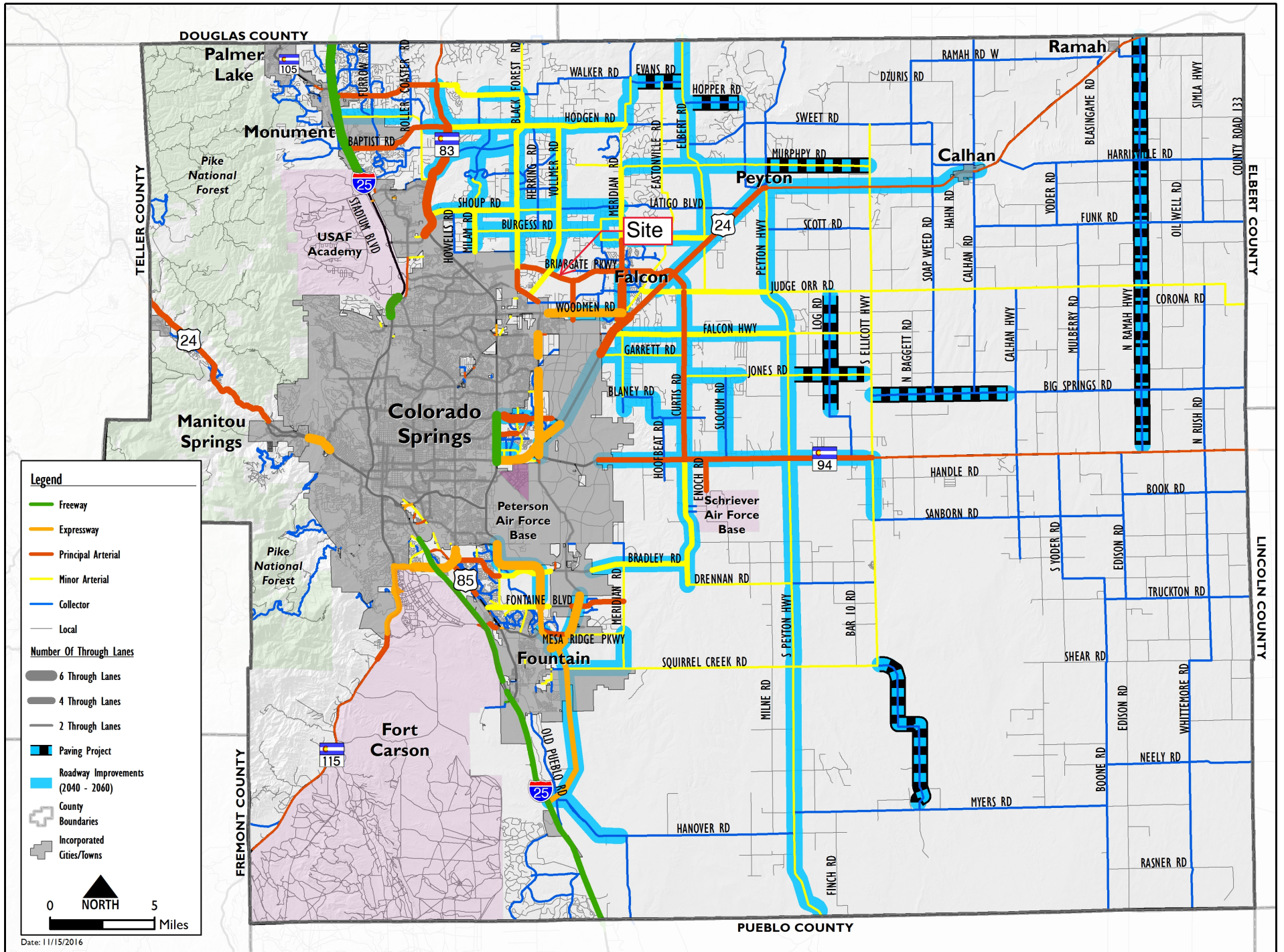

DOUGLAS COUNTY

Palmer Lake

Monument

Pike National Forest

USAF Academy

Manitou Springs

Colorado Springs

Peterson Air Force Base

Schriever Air Force Base

Fountain

Fort Carson

Ramah

Calhan

Peyton

Site

Falcon

TELLER COUNTY

ELBERT COUNTY

LINCOLN COUNTY

FREMONT COUNTY

PUEBLO COUNTY

Palmer Lake

Monument

Pike National Forest

USAF Academy

Manitou Springs

Colorado Springs

Peterson Air Force Base

Schriever Air Force Base

Fountain

Fort Carson

Ramah

Calhan

Peyton

Site

Falcon

TELLER COUNTY

ELBERT COUNTY

LINCOLN COUNTY

FREMONT COUNTY

PUEBLO COUNTY

Traffic Counts



LSC Transportation Consultants, Inc.

2504 E. Pikes Peak Ave, Suite 304
 Colorado Springs, CO 80909
 719-633-2868

File Name : Vollmer Rd - Burgess Rd AM

Site Code : S224440

Start Date : 7/28/2022

Page No : 1

Groups Printed- Unshifted

Start Time	Vollmer Rd Southbound					Burgess Rd Westbound					Vollmer Rd Northbound					Burgess Rd Eastbound					Int. Total
	Right	Thru	Left	Peds	App. Total	Right	Thru	Left	Peds	App. Total	Right	Thru	Left	Peds	App. Total	Right	Thru	Left	Peds	App. Total	
06:30	0	15	5	0	20	19	47	10	0	76	4	5	1	0	10	0	6	0	0	6	112
06:45	1	15	4	0	20	17	35	13	0	65	5	5	1	0	11	3	6	1	0	10	106
Total	1	30	9	0	40	36	82	23	0	141	9	10	2	0	21	3	12	1	0	16	218
07:00	2	20	9	0	31	15	51	14	0	80	6	9	1	0	16	2	10	0	0	12	139
07:15	2	14	8	0	24	21	57	12	0	90	4	11	5	0	20	1	8	0	0	9	143
07:30	2	17	7	0	26	19	58	12	0	89	4	19	5	0	28	3	13	1	0	17	160
07:45	3	16	10	0	29	17	51	8	0	76	9	11	3	0	23	0	8	2	0	10	138
Total	9	67	34	0	110	72	217	46	0	335	23	50	14	0	87	6	39	3	0	48	580
08:00	3	22	5	0	30	17	61	12	0	90	7	8	4	0	19	6	14	0	0	20	159
08:15	2	16	6	0	24	7	36	15	0	58	13	16	3	0	32	3	9	1	0	13	127
Grand Total	15	135	54	0	204	132	396	96	0	624	52	84	23	0	159	18	74	5	0	97	1084
Apprch %	7.4	66.2	26.5	0		21.2	63.5	15.4	0		32.7	52.8	14.5	0		18.6	76.3	5.2	0		
Total %	1.4	12.5	5	0	18.8	12.2	36.5	8.9	0	57.6	4.8	7.7	2.1	0	14.7	1.7	6.8	0.5	0	8.9	

LSC Transportation Consultants, Inc.

2504 E. Pikes Peak Ave, Suite 304
 Colorado Springs, CO 80909
 719-633-2868

File Name : Vollmer Rd - Burgess Rd AM

Site Code : S224440

Start Date : 7/28/2022

Page No : 2

Start Time	Vollmer Rd Southbound					Burgess Rd Westbound					Vollmer Rd Northbound					Burgess Rd Eastbound					Int. Total
	Right	Thru	Left	Peds	App. Total	Right	Thru	Left	Peds	App. Total	Right	Thru	Left	Peds	App. Total	Right	Thru	Left	Peds	App. Total	
Peak Hour Analysis From 6:30:00 AM to 8:15:00 AM - Peak 1 of 1																					
Peak Hour for Entire Intersection Begins at 7:15:00 AM																					
7:15:00 AM	2	14	8	0	24	21	57	12	0	90	4	11	5	0	20	1	8	0	0	9	143
7:30:00 AM	2	17	7	0	26	19	58	12	0	89	4	19	5	0	28	3	13	1	0	17	160
7:45:00 AM	3	16	10	0	29	17	51	8	0	76	9	11	3	0	23	0	8	2	0	10	138
8:00:00 AM	3	22	5	0	30	17	61	12	0	90	7	8	4	0	19	6	14	0	0	20	159
Total Volume	10	69	30	0	109	74	227	44	0	345	24	49	17	0	90	10	43	3	0	56	600
% App. Total	9.2	63.3	27.5	0		21.4	65.8	12.8	0		26.7	54.4	18.9	0		17.9	76.8	5.4	0		
PHF	.833	.784	.750	.000	.908	.881	.930	.917	.000	.958	.667	.645	.850	.000	.804	.417	.768	.375	.000	.700	.938

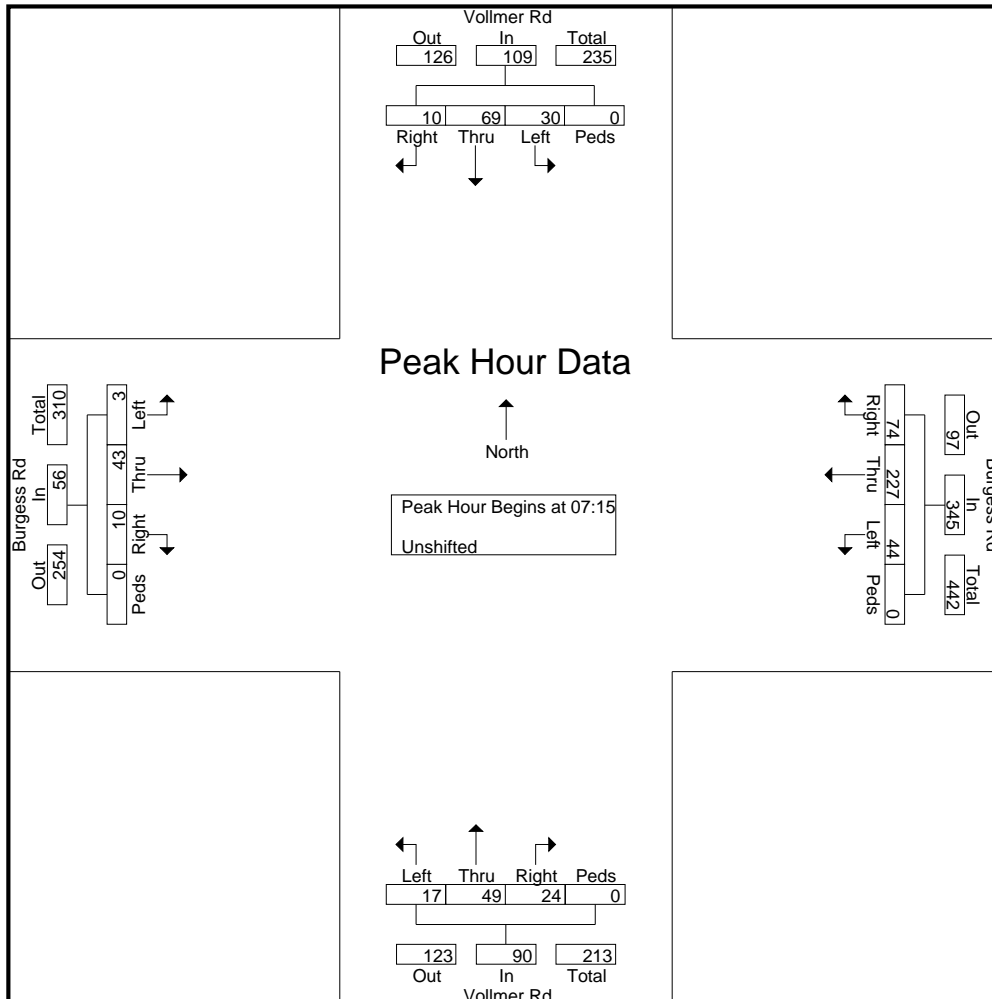

LSC Transportation Consultants, Inc.

2504 E. Pikes Peak Ave, Suite 304
 Colorado Springs, CO 80909
 719-633-2868

File Name : Vollmer Rd - Burgess Rd PM

Site Code : S224440

Start Date : 7/27/2022

Page No : 1

Groups Printed- Unshifted

Start Time	Vollmer Rd Southbound					Burgess Rd Westbound					Vollmer Rd Northbound					Burgess Rd Eastbound					Int. Total
	Right	Thru	Left	Peds	App. Total	Right	Thru	Left	Peds	App. Total	Right	Thru	Left	Peds	App. Total	Right	Thru	Left	Peds	App. Total	
16:00	2	19	22	0	43	7	21	7	0	35	9	17	6	0	32	3	37	3	0	43	153
16:15	5	13	29	0	47	6	23	11	0	40	18	11	8	0	37	4	37	5	0	46	170
16:30	2	19	31	0	52	10	30	9	0	49	12	19	4	0	35	5	46	3	0	54	190
16:45	1	8	20	0	29	8	33	17	0	58	16	14	5	0	35	1	65	0	0	66	188
Total	10	59	102	0	171	31	107	44	0	182	55	61	23	0	139	13	185	11	0	209	701
17:00	5	16	28	0	49	14	29	9	0	52	16	18	3	0	37	1	56	3	0	60	198
17:15	1	25	38	0	64	11	31	10	0	52	18	18	4	0	40	5	77	3	0	85	241
17:30	1	10	30	0	41	11	21	19	0	51	13	23	4	0	40	5	46	1	0	52	184
17:45	6	14	19	0	39	11	23	5	0	39	14	16	1	0	31	6	43	6	0	55	164
Total	13	65	115	0	193	47	104	43	0	194	61	75	12	0	148	17	222	13	0	252	787
Grand Total	23	124	217	0	364	78	211	87	0	376	116	136	35	0	287	30	407	24	0	461	1488
Apprch %	6.3	34.1	59.6	0		20.7	56.1	23.1	0		40.4	47.4	12.2	0		6.5	88.3	5.2	0		
Total %	1.5	8.3	14.6	0	24.5	5.2	14.2	5.8	0	25.3	7.8	9.1	2.4	0	19.3	2	27.4	1.6	0	31	

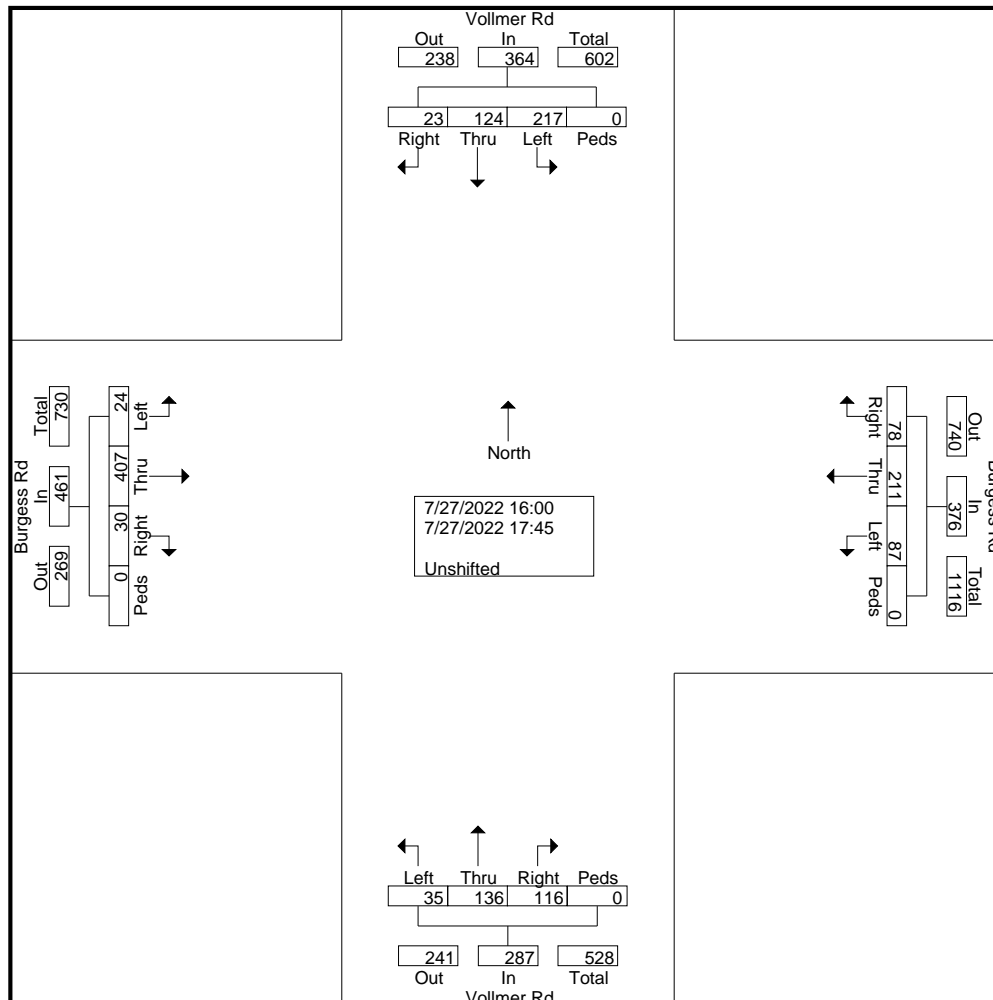

LSC Transportation Consultants, Inc.

2504 E. Pikes Peak Ave, Suite 304
 Colorado Springs, CO 80909
 719-633-2868

File Name : Vollmer Rd - Burgess Rd PM

Site Code : S224440

Start Date : 7/27/2022

Page No : 2

Start Time	Vollmer Rd Southbound					Burgess Rd Westbound					Vollmer Rd Northbound					Burgess Rd Eastbound					Int. Total
	Right	Thru	Left	Peds	App. Total	Right	Thru	Left	Peds	App. Total	Right	Thru	Left	Peds	App. Total	Right	Thru	Left	Peds	App. Total	
Peak Hour Analysis From 4:00:00 PM to 5:45:00 PM - Peak 1 of 1																					
Peak Hour for Entire Intersection Begins at 4:30:00 PM																					
4:30:00 PM	2	19	31	0	52	10	30	9	0	49	12	19	4	0	35	5	46	3	0	54	190
4:45:00 PM	1	8	20	0	29	8	33	17	0	58	16	14	5	0	35	1	65	0	0	66	188
5:00:00 PM	5	16	28	0	49	14	29	9	0	52	16	18	3	0	37	1	56	3	0	60	198
5:15:00 PM	1	25	38	0	64	11	31	10	0	52	18	18	4	0	40	5	77	3	0	85	241
Total Volume	9	68	117	0	194	43	123	45	0	211	62	69	16	0	147	12	244	9	0	265	817
% App. Total	4.6	35.1	60.3	0		20.4	58.3	21.3	0		42.2	46.9	10.9	0		4.5	92.1	3.4	0		
PHF	.450	.680	.770	.000	.758	.768	.932	.662	.000	.909	.861	.908	.800	.000	.919	.600	.792	.750	.000	.779	.848

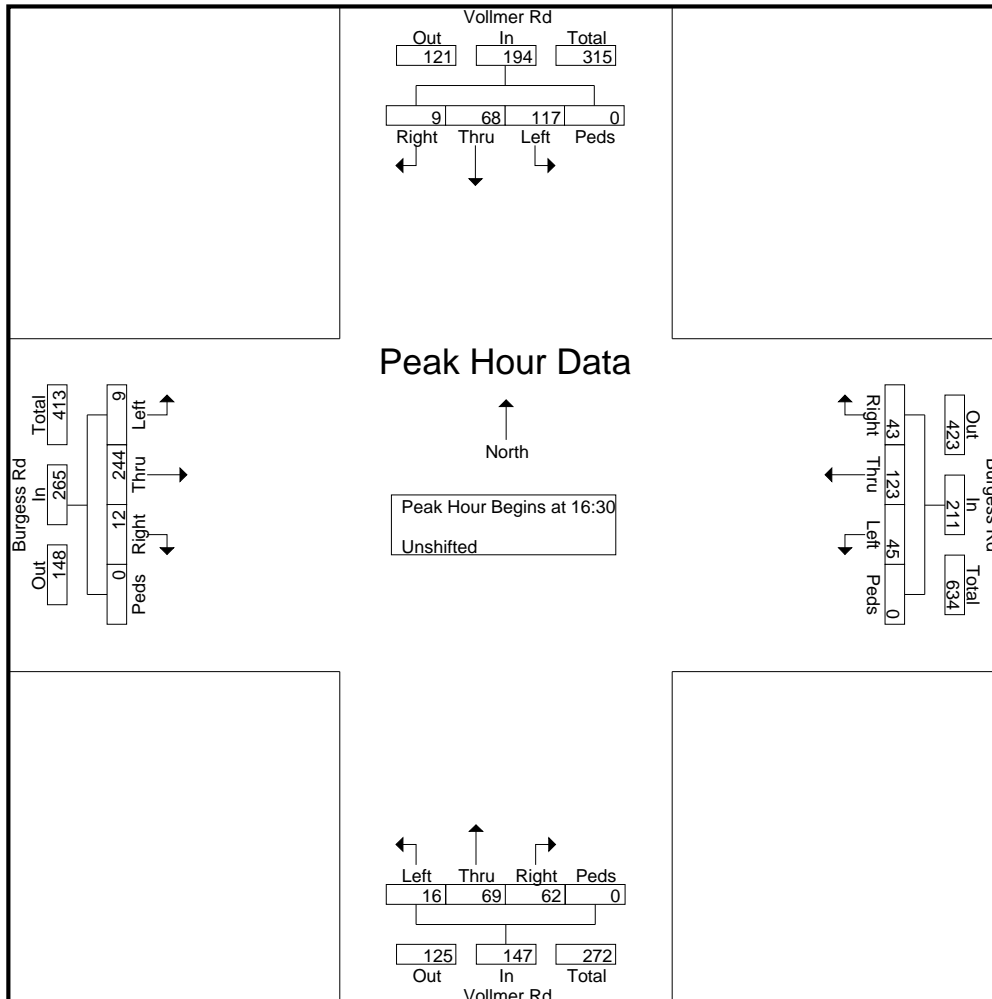



ALL TRAFFIC DATA SERVICES

(303) 216-2439

www.alltrafficdata.net

Location: 5 Vollmer Road & Dines Blvd AM

Date: Thursday, March 24, 2022

Peak Hour: 07:15 AM - 08:15 AM

Peak 15-Minutes: 07:45 AM - 08:00 AM

Peak Hour - All Vehicles

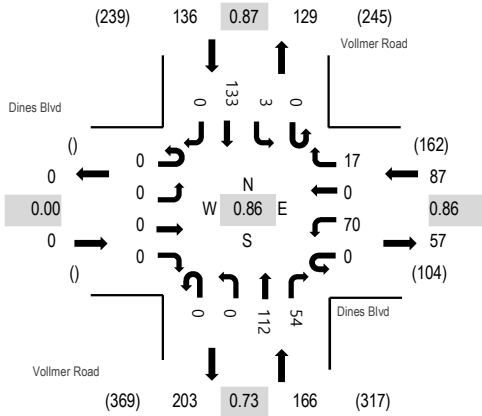

Peak Hour - Pedestrians/Bicycles on Crosswalk

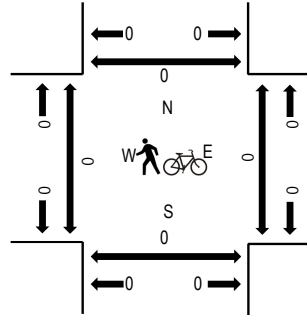

Note: Total study counts contained in parentheses.

Traffic Counts

Interval Start Time	Dines Blvd Eastbound				Dines Blvd Westbound				Vollmer Road Northbound				Vollmer Road Southbound				Total	Rolling Hour	Pedestrian Crossings			
	U-Turn	Left	Thru	Right	U-Turn	Left	Thru	Right	U-Turn	Left	Thru	Right	U-Turn	Left	Thru	Right			West	East	South	North
7:00 AM	0	0	0	0	0	11	0	1	0	0	25	14	0	2	16	0	69	370	0	0	0	0
7:15 AM	0	0	0	0	0	15	0	3	0	0	22	13	0	1	29	0	83	389	0	0	0	0
7:30 AM	0	0	0	0	0	21	0	5	0	0	27	13	0	0	39	0	105	381	0	0	0	0
7:45 AM	0	0	0	0	0	11	0	6	0	0	38	21	0	1	36	0	113	375	0	0	0	0
8:00 AM	0	0	0	0	0	23	0	3	0	0	25	7	0	1	29	0	88	348	0	0	0	0
8:15 AM	0	0	0	0	0	18	0	2	0	0	23	8	0	0	24	0	75		0	0	0	0
8:30 AM	0	0	0	0	0	23	0	1	1	0	28	13	1	2	30	0	99		0	0	0	0
8:45 AM	0	0	0	0	0	15	0	4	0	0	31	8	0	0	28	0	86		0	0	0	0
Count Total	0	0	0	0	0	137	0	25	1	0	219	97	1	7	231	0	718		0	0	0	0
Peak Hour	0	0	0	0	0	70	0	17	0	0	112	54	0	3	133	0	389		0	0	0	0



ALL TRAFFIC DATA SERVICES

(303) 216-2439

www.alltrafficdata.net

Location: 6 Vollmer Road & Poco Road AM

Date: Thursday, March 24, 2022

Peak Hour: 07:15 AM - 08:15 AM

Peak 15-Minutes: 07:45 AM - 08:00 AM

Peak Hour - All Vehicles

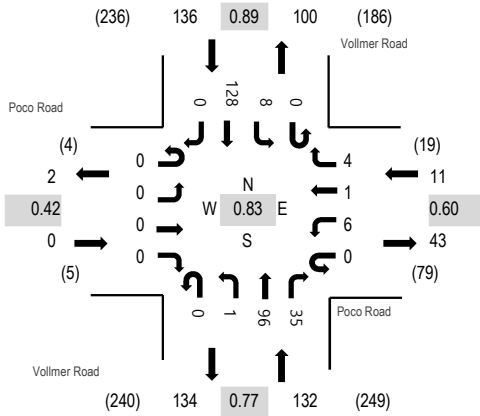

Peak Hour - Pedestrians/Bicycles on Crosswalk

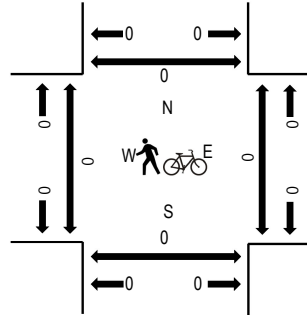

Note: Total study counts contained in parentheses.

Traffic Counts

Interval Start Time	Poco Road Eastbound				Poco Road Westbound				Vollmer Road Northbound				Vollmer Road Southbound				Total	Rolling Hour	Pedestrian Crossings			
	U-Turn	Left	Thru	Right	U-Turn	Left	Thru	Right	U-Turn	Left	Thru	Right	U-Turn	Left	Thru	Right			West	East	South	North
7:00 AM	0	0	0	0	0	0	0	0	0	0	10	15	0	1	20	0	46	264	0	0	0	0
7:15 AM	0	0	0	0	0	1	0	2	0	0	18	8	0	2	27	0	58	279	0	0	0	0
7:30 AM	0	0	0	0	0	1	0	2	0	1	26	8	0	2	36	0	76	273	0	0	0	0
7:45 AM	0	0	0	0	0	4	0	0	0	0	34	9	0	4	33	0	84	265	0	0	0	0
8:00 AM	0	0	0	0	0	0	1	0	0	0	18	10	0	0	32	0	61	245	0	0	0	0
8:15 AM	0	0	0	0	0	1	0	1	0	0	24	3	0	0	23	0	52		0	0	0	0
8:30 AM	0	0	0	2	0	3	0	2	0	1	24	6	0	1	29	0	68		0	0	0	0
8:45 AM	0	2	0	1	0	1	0	0	0	1	23	10	0	0	26	0	64		0	0	0	0
Count Total	0	2	0	3	0	11	1	7	0	3	177	69	0	10	226	0	509		0	0	0	0
Peak Hour	0	0	0	0	0	6	1	4	0	1	96	35	0	8	128	0	279		0	0	0	0

Location: 5 Vollmer Road & Dines Blvd PM

Date: Thursday, March 24, 2022

Peak Hour: 04:00 PM - 05:00 PM

Peak 15-Minutes: 04:00 PM - 04:15 PM

Peak Hour - All Vehicles

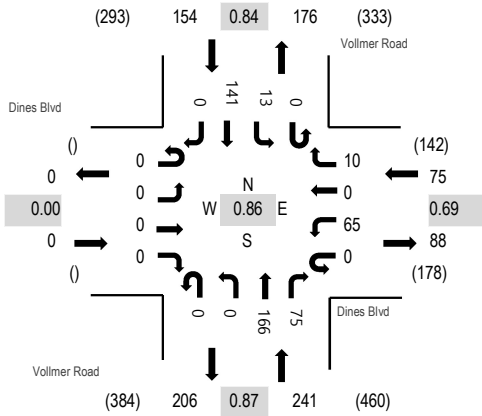

Peak Hour - Pedestrians/Bicycles on Crosswalk

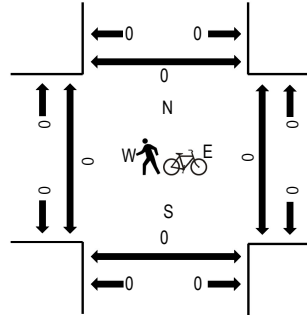

Note: Total study counts contained in parentheses.

Traffic Counts

Interval Start Time	Dines Blvd Eastbound				Dines Blvd Westbound				Vollmer Road Northbound				Vollmer Road Southbound				Total	Rolling Hour	Pedestrian Crossings			
	U-Turn	Left	Thru	Right	U-Turn	Left	Thru	Right	U-Turn	Left	Thru	Right	U-Turn	Left	Thru	Right			West	East	South	North
4:00 PM	0	0	0	0	0	24	0	3	0	0	46	18	0	2	44	0	137	470	0	0	0	0
4:15 PM	0	0	0	0	0	13	0	5	0	0	36	25	0	5	37	0	121	441	0	0	0	0
4:30 PM	0	0	0	0	0	12	0	2	0	0	35	11	0	3	30	0	93	436	0	0	0	0
4:45 PM	0	0	0	0	0	16	0	0	0	0	49	21	0	3	30	0	119	452	0	0	0	0
5:00 PM	0	0	0	0	0	14	0	5	0	0	42	18	0	2	27	0	108	425	0	0	0	0
5:15 PM	0	0	0	0	0	17	0	3	0	0	39	17	0	4	36	0	116		0	0	0	0
5:30 PM	0	0	0	0	0	12	0	1	0	0	36	21	0	8	31	0	109		0	0	0	0
5:45 PM	0	0	0	0	0	14	0	1	0	0	30	16	0	4	27	0	92		0	0	0	0
Count Total	0	0	0	0	0	122	0	20	0	0	313	147	0	31	262	0	895		0	0	0	0
Peak Hour	0	0	0	0	0	65	0	10	0	0	166	75	0	13	141	0	470		0	0	0	0

Location: 6 Vollmer Road & Poco Road PM

Date: Thursday, March 24, 2022

Peak Hour: 04:00 PM - 05:00 PM

Peak 15-Minutes: 04:15 PM - 04:30 PM

Peak Hour - All Vehicles

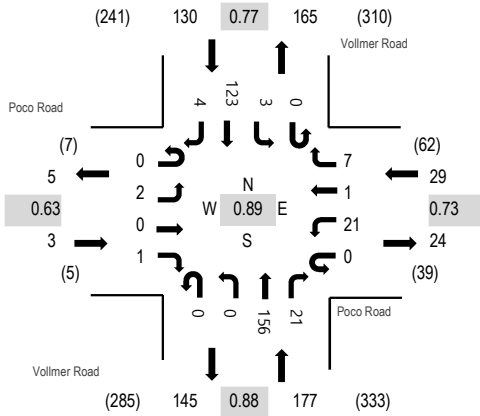

Peak Hour - Pedestrians/Bicycles on Crosswalk

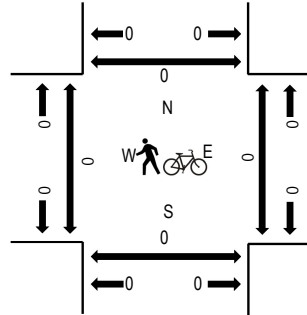

Note: Total study counts contained in parentheses.

Traffic Counts

Interval Start Time	Poco Road Eastbound				Poco Road Westbound				Vollmer Road Northbound				Vollmer Road Southbound				Total	Rolling Hour	Pedestrian Crossings			
	U-Turn	Left	Thru	Right	U-Turn	Left	Thru	Right	U-Turn	Left	Thru	Right	U-Turn	Left	Thru	Right			West	East	South	North
4:00 PM	0	0	0	0	0	8	1	4	0	0	41	4	0	1	29	2	90	339	0	0	0	0
4:15 PM	0	1	0	0	0	4	0	2	0	0	40	6	0	1	39	2	95	325	0	0	0	0
4:30 PM	0	0	0	0	0	2	0	0	0	0	32	3	0	1	28	0	66	313	0	0	0	0
4:45 PM	0	1	0	1	0	7	0	1	0	0	43	8	0	0	27	0	88	321	0	0	0	0
5:00 PM	0	0	0	2	0	6	0	1	0	0	44	3	0	0	20	0	76	302	0	0	0	0
5:15 PM	0	0	0	0	0	12	0	0	0	0	37	4	0	0	29	1	83		0	0	0	0
5:30 PM	0	0	0	0	0	6	0	2	0	0	33	3	0	1	29	0	74		0	0	0	0
5:45 PM	0	0	0	0	0	5	0	1	0	1	27	4	0	0	31	0	69		0	0	0	0
Count Total	0	2	0	3	0	50	1	11	0	1	297	35	0	4	232	5	641		0	0	0	0
Peak Hour	0	2	0	1	0	21	1	7	0	0	156	21	0	3	123	4	339		0	0	0	0

Levels of Service



Levels of Service

NOTE: *Regarding Yellow and All-Red Clearance Interval Splits shown in these LOS Reports: The all-red clearance intervals are typical of this region and are acceptable for this planning level analysis. These may not reflect the splits used at the design or operational level for implementation in the field. Regarding Yellow Clearance splits shown in these reports, please note, higher-speed approaches will likely require longer yellow times per MUTCD and EPC standards, and the splits shown herein are not intended to reflect the splits that should be used at the design or operational level for implementation in the field. However, the splits shown are acceptable for this planning level analysis, as even if the splits herein were calculated and the analysis were run with 4.0, 4.5, 5.5 sec of yellow etc., the LOS would not be significantly different from those reported here.*

HCM 6th TWSC
1: Vollmer Rd & Burgess Rd

Existing Traffic
AM Peak Hour

Intersection												
Int Delay, s/veh	12.4											
Movement	EBL	EBT	EBR	WBL	WBT	WBR	NBL	NBT	NBR	SBL	SBT	SBR
Lane Configurations		↕			↕			↕			↕	
Traffic Vol, veh/h	3	43	10	44	227	74	17	49	24	30	69	10
Future Vol, veh/h	3	43	10	44	227	74	17	49	24	30	69	10
Conflicting Peds, #/hr	0	0	0	0	0	0	0	0	0	0	0	0
Sign Control	Stop	Stop	Stop	Stop	Stop	Stop	Free	Free	Free	Free	Free	Free
RT Channelized	-	-	None	-	-	None	-	-	Free	-	-	None
Storage Length	-	-	-	-	-	-	-	-	-	-	-	-
Veh in Median Storage, #	-	0	-	-	0	-	-	0	-	-	0	-
Grade, %	-	0	-	-	0	-	-	0	-	-	0	-
Peak Hour Factor	78	78	78	87	87	87	80	80	80	83	83	83
Heavy Vehicles, %	2	2	2	2	2	2	2	2	2	2	2	2
Mvmt Flow	4	55	13	51	261	85	21	61	30	36	83	12

Major/Minor	Minor2		Minor1		Major1		Major2					
Conflicting Flow All	437	264	89	298	270	61	95	0	-	61	0	0
Stage 1	161	161	-	103	103	-	-	-	-	-	-	-
Stage 2	276	103	-	195	167	-	-	-	-	-	-	-
Critical Hdwy	7.12	6.52	6.22	7.12	6.52	6.22	4.12	-	-	4.12	-	-
Critical Hdwy Stg 1	6.12	5.52	-	6.12	5.52	-	-	-	-	-	-	-
Critical Hdwy Stg 2	6.12	5.52	-	6.12	5.52	-	-	-	-	-	-	-
Follow-up Hdwy	3.518	4.018	3.318	3.518	4.018	3.318	2.218	-	-	2.218	-	-
Pot Cap-1 Maneuver	530	641	969	654	636	1004	1499	-	0	1542	-	-
Stage 1	841	765	-	903	810	-	-	-	0	-	-	-
Stage 2	730	810	-	807	760	-	-	-	0	-	-	-
Platoon blocked, %								-			-	-
Mov Cap-1 Maneuver	314	615	969	583	611	1004	1499	-	-	1542	-	-
Mov Cap-2 Maneuver	314	615	-	583	611	-	-	-	-	-	-	-
Stage 1	828	746	-	889	798	-	-	-	-	-	-	-
Stage 2	443	798	-	719	741	-	-	-	-	-	-	-

Approach	EB		WB		NB		SB	
HCM Control Delay, s	11.5		18.2		1.9		2	
HCM LOS	B		C					

Minor Lane/Major Mvmt	NBL	NBT	EBLn1	WBLn1	SBL	SBT	SBR
Capacity (veh/h)	1499	-	624	663	1542	-	-
HCM Lane V/C Ratio	0.014	-	0.115	0.598	0.023	-	-
HCM Control Delay (s)	7.4	0	11.5	18.2	7.4	0	-
HCM Lane LOS	A	A	B	C	A	A	-
HCM 95th %tile Q(veh)	0	-	0.4	4	0.1	-	-

HCM 6th TWSC
1: Vollmer Rd & Burgess Rd

Existing Traffic
PM Peak Hour

Intersection												
Int Delay, s/veh	31.1											
Movement	EBL	EBT	EBR	WBL	WBT	WBR	NBL	NBT	NBR	SBL	SBT	SBR
Lane Configurations		↕			↕			↕			↕	
Traffic Vol, veh/h	9	244	12	45	123	43	16	69	62	117	68	9
Future Vol, veh/h	9	244	12	45	123	43	16	69	62	117	68	9
Conflicting Peds, #/hr	0	0	0	0	0	0	0	0	0	0	0	0
Sign Control	Stop	Stop	Stop	Stop	Stop	Stop	Free	Free	Free	Free	Free	Free
RT Channelized	-	-	None	-	-	None	-	-	Free	-	-	None
Storage Length	-	-	-	-	-	-	-	-	-	-	-	-
Veh in Median Storage, #	-	0	-	-	0	-	-	0	-	-	0	-
Grade, %	-	0	-	-	0	-	-	0	-	-	0	-
Peak Hour Factor	78	78	78	87	87	87	92	92	92	76	76	76
Heavy Vehicles, %	2	2	2	2	2	2	2	2	2	2	2	2
Mvmt Flow	12	313	15	52	141	49	17	75	67	154	89	12

Major/Minor	Minor2		Minor1		Major1		Major2					
Conflicting Flow All	607	512	95	676	518	75	101	0	-	75	0	0
Stage 1	403	403	-	109	109	-	-	-	-	-	-	-
Stage 2	204	109	-	567	409	-	-	-	-	-	-	-
Critical Hdwy	7.12	6.52	6.22	7.12	6.52	6.22	4.12	-	-	4.12	-	-
Critical Hdwy Stg 1	6.12	5.52	-	6.12	5.52	-	-	-	-	-	-	-
Critical Hdwy Stg 2	6.12	5.52	-	6.12	5.52	-	-	-	-	-	-	-
Follow-up Hdwy	3.518	4.018	3.318	3.518	4.018	3.318	2.218	-	-	2.218	-	-
Pot Cap-1 Maneuver	408	465	962	367	462	986	1491	-	0	1524	-	-
Stage 1	624	600	-	896	805	-	-	-	0	-	-	-
Stage 2	798	805	-	508	596	-	-	-	0	-	-	-
Platoon blocked, %								-			-	-
Mov Cap-1 Maneuver	259	410	962	125	407	986	1491	-	-	1524	-	-
Mov Cap-2 Maneuver	259	410	-	125	407	-	-	-	-	-	-	-
Stage 1	617	536	-	885	795	-	-	-	-	-	-	-
Stage 2	616	795	-	186	532	-	-	-	-	-	-	-

Approach	EB		WB		NB		SB	
HCM Control Delay, s	43.2		53.3		1.4		4.6	
HCM LOS	E		F					

Minor Lane/Major Mvmt	NBL	NBT	EBLn1	WBLn1	SBL	SBT	SBR
Capacity (veh/h)	1491	-	413	299	1524	-	-
HCM Lane V/C Ratio	0.012	-	0.823	0.811	0.101	-	-
HCM Control Delay (s)	7.4	0	43.2	53.3	7.6	0	-
HCM Lane LOS	A	A	E	F	A	A	-
HCM 95th %tile Q(veh)	0	-	7.6	6.6	0.3	-	-

Intersection												
Int Delay, s/veh	30.5											
Movement	EBL	EBT	EBR	WBL	WBT	WBR	NBL	NBT	NBR	SBL	SBT	SBR
Lane Configurations		↕			↕			↕			↕	
Traffic Vol, veh/h	3	45	69	46	236	77	98	78	25	31	91	10
Future Vol, veh/h	3	45	69	46	236	77	98	78	25	31	91	10
Conflicting Peds, #/hr	0	0	0	0	0	0	0	0	0	0	0	0
Sign Control	Stop	Stop	Stop	Stop	Stop	Stop	Free	Free	Free	Free	Free	Free
RT Channelized	-	-	None	-	-	None	-	-	None	-	-	None
Storage Length	-	-	-	-	-	-	-	-	-	-	-	-
Veh in Median Storage, #	-	0	-	-	0	-	-	0	-	-	0	-
Grade, %	-	0	-	-	0	-	-	0	-	-	0	-
Peak Hour Factor	85	85	85	85	85	85	85	85	85	85	85	85
Heavy Vehicles, %	2	2	2	2	2	2	2	2	2	2	2	2
Mvmt Flow	4	53	81	54	278	91	115	92	29	36	107	12

Major/Minor	Minor2		Minor1		Major1		Major2					
Conflicting Flow All	706	536	113	589	528	107	119	0	0	121	0	0
Stage 1	185	185	-	337	337	-	-	-	-	-	-	-
Stage 2	521	351	-	252	191	-	-	-	-	-	-	-
Critical Hdwy	7.12	6.52	6.22	7.12	6.52	6.22	4.12	-	-	4.12	-	-
Critical Hdwy Stg 1	6.12	5.52	-	6.12	5.52	-	-	-	-	-	-	-
Critical Hdwy Stg 2	6.12	5.52	-	6.12	5.52	-	-	-	-	-	-	-
Follow-up Hdwy	3.518	4.018	3.318	3.518	4.018	3.318	2.218	-	-	2.218	-	-
Pot Cap-1 Maneuver	351	451	940	420	456	947	1469	-	-	1467	-	-
Stage 1	817	747	-	677	641	-	-	-	-	-	-	-
Stage 2	539	632	-	752	742	-	-	-	-	-	-	-
Platoon blocked, %								-	-	-	-	-
Mov Cap-1 Maneuver	133	402	940	317	407	947	1469	-	-	1467	-	-
Mov Cap-2 Maneuver	133	402	-	317	407	-	-	-	-	-	-	-
Stage 1	748	728	-	620	587	-	-	-	-	-	-	-
Stage 2	235	579	-	621	723	-	-	-	-	-	-	-

Approach	EB	WB	NB	SB
HCM Control Delay, s	13.5	61.5	3.7	1.8
HCM LOS	B	F		

Minor Lane/Major Mvmt	NBL	NBT	NBR	EBLn1WBLn1	SBL	SBT	SBR
Capacity (veh/h)	1469	-	-	563	445	1467	-
HCM Lane V/C Ratio	0.078	-	-	0.244	0.949	0.025	-
HCM Control Delay (s)	7.7	0	-	13.5	61.5	7.5	0
HCM Lane LOS	A	A	-	B	F	A	A
HCM 95th %tile Q(veh)	0.3	-	-	1	11.2	0.1	-

Intersection						
Int Delay, s/veh	2.3					
Movement	WBL	WBR	NBT	NBR	SBL	SBT
Lane Configurations	↘	↗	↑↑	↗	↘	↑↑
Traffic Vol, veh/h	110	18	224	24	7	323
Future Vol, veh/h	110	18	224	24	7	323
Conflicting Peds, #/hr	0	0	0	0	0	0
Sign Control	Stop	Stop	Free	Free	Free	Free
RT Channelized	-	None	-	None	-	None
Storage Length	485	-	-	235	385	-
Veh in Median Storage, #	0	-	0	-	-	0
Grade, %	0	-	0	-	-	0
Peak Hour Factor	85	85	85	85	85	85
Heavy Vehicles, %	2	2	2	2	2	2
Mvmt Flow	129	21	264	28	8	380

Major/Minor	Minor1	Major1	Major2		
Conflicting Flow All	470	132	0	0	292
Stage 1	264	-	-	-	-
Stage 2	206	-	-	-	-
Critical Hdwy	6.84	6.94	-	-	4.14
Critical Hdwy Stg 1	5.84	-	-	-	-
Critical Hdwy Stg 2	5.84	-	-	-	-
Follow-up Hdwy	3.52	3.32	-	-	2.22
Pot Cap-1 Maneuver	522	893	-	-	1267
Stage 1	756	-	-	-	-
Stage 2	808	-	-	-	-
Platoon blocked, %			-	-	-
Mov Cap-1 Maneuver	519	893	-	-	1267
Mov Cap-2 Maneuver	592	-	-	-	-
Stage 1	756	-	-	-	-
Stage 2	803	-	-	-	-

Approach	WB	NB	SB
HCM Control Delay, s	12.3	0	0.2
HCM LOS	B		

Minor Lane/Major Mvmt	NBT	NBR	WBLn1	WBLn2	SBL	SBT
Capacity (veh/h)	-	-	592	893	1267	-
HCM Lane V/C Ratio	-	-	0.219	0.024	0.006	-
HCM Control Delay (s)	-	-	12.8	9.1	7.9	-
HCM Lane LOS	-	-	B	A	A	-
HCM 95th %tile Q(veh)	-	-	0.8	0.1	0	-

Intersection												
Int Delay, s/veh	8.1											
Movement	EBL	EBT	EBR	WBL	WBT	WBR	NBL	NBT	NBR	SBL	SBT	SBR
Lane Configurations	↘	↑↑	↗	↘	↑↑	↗	↘	↑	↗	↘	↑	↗
Traffic Vol, veh/h	1	0	10	0	0	0	28	13	0	0	43	3
Future Vol, veh/h	1	0	10	0	0	0	28	13	0	0	43	3
Conflicting Peds, #/hr	0	0	0	0	0	0	0	0	0	0	0	0
Sign Control	Free	Free	Free	Free	Free	Free	Stop	Stop	Stop	Stop	Stop	Stop
RT Channelized	-	-	None	-	-	None	-	-	None	-	-	None
Storage Length	535	-	0	310	-	0	410	-	155	235	-	155
Veh in Median Storage, #	-	0	-	-	0	-	-	0	-	-	0	-
Grade, %	-	0	-	-	0	-	-	0	-	-	0	-
Peak Hour Factor	85	85	85	85	85	85	85	85	85	85	85	85
Heavy Vehicles, %	2	2	2	2	2	2	2	2	2	2	2	2
Mvmt Flow	1	0	12	0	0	0	33	15	0	0	51	4

Major/Minor	Major1		Major2			Minor1			Minor2			
Conflicting Flow All	1	0	0	12	0	0	28	3	0	11	15	1
Stage 1	-	-	-	-	-	-	2	2	-	1	1	-
Stage 2	-	-	-	-	-	-	26	1	-	10	14	-
Critical Hdwy	4.14	-	-	4.14	-	-	7.54	6.54	6.94	7.54	6.54	6.94
Critical Hdwy Stg 1	-	-	-	-	-	-	6.54	5.54	-	6.54	5.54	-
Critical Hdwy Stg 2	-	-	-	-	-	-	6.54	5.54	-	6.54	5.54	-
Follow-up Hdwy	2.22	-	-	2.22	-	-	3.52	4.02	3.32	3.52	4.02	3.32
Pot Cap-1 Maneuver	1620	-	-	1605	-	-	978	892	-	1005	879	1083
Stage 1	-	-	-	-	-	-	1020	894	-	1021	895	-
Stage 2	-	-	-	-	-	-	988	895	-	1009	883	-
Platoon blocked, %	-	-	-	-	-	-	-	-	-	-	-	-
Mov Cap-1 Maneuver	1620	-	-	1605	-	-	931	891	-	-	878	1083
Mov Cap-2 Maneuver	-	-	-	-	-	-	931	891	-	-	878	-
Stage 1	-	-	-	-	-	-	1019	893	-	1020	895	-
Stage 2	-	-	-	-	-	-	929	895	-	991	882	-

Approach	EB	WB	NB	SB
HCM Control Delay, s	0.7	0	9	9.3
HCM LOS			A	A

Minor Lane/Major Mvmt	NBLn1	NBLn2	NBLn3	EBL	EBT	EBR	WBL	WBT	WBR	SBLn1	SBLn2	SBLn3
Capacity (veh/h)	931	891	-	1620	-	-	1605	-	-	-	-	878 1083
HCM Lane V/C Ratio	0.035	0.017	-	0.001	-	-	-	-	-	-	-	0.058 0.003
HCM Control Delay (s)	9	9.1	0	7.2	-	-	0	-	-	0	9.4	8.3
HCM Lane LOS	A	A	A	A	-	-	A	-	-	A	A	A
HCM 95th %tile Q(veh)	0.1	0.1	-	0	-	-	0	-	-	-	0.2	0

Intersection						
Int Delay, s/veh	5.1					
Movement	WBL	WBR	NBT	NBR	SBL	SBT
Lane Configurations	↘	↗	↑	↗	↘	↑
Traffic Vol, veh/h	74	26	15	30	10	43
Future Vol, veh/h	74	26	15	30	10	43
Conflicting Peds, #/hr	0	0	0	0	0	0
Sign Control	Stop	Stop	Free	Free	Free	Free
RT Channelized	-	None	-	None	-	None
Storage Length	0	0	-	205	205	-
Veh in Median Storage, #	0	-	0	-	-	0
Grade, %	0	-	0	-	-	0
Peak Hour Factor	85	85	85	85	85	85
Heavy Vehicles, %	2	2	2	2	2	2
Mvmt Flow	87	31	18	35	12	51

Major/Minor	Minor1	Major1	Major2		
Conflicting Flow All	93	18	0	0	53
Stage 1	18	-	-	-	-
Stage 2	75	-	-	-	-
Critical Hdwy	6.42	6.22	-	-	4.12
Critical Hdwy Stg 1	5.42	-	-	-	-
Critical Hdwy Stg 2	5.42	-	-	-	-
Follow-up Hdwy	3.518	3.318	-	-	2.218
Pot Cap-1 Maneuver	907	1061	-	-	1553
Stage 1	1005	-	-	-	-
Stage 2	948	-	-	-	-
Platoon blocked, %			-	-	-
Mov Cap-1 Maneuver	900	1061	-	-	1553
Mov Cap-2 Maneuver	848	-	-	-	-
Stage 1	1005	-	-	-	-
Stage 2	940	-	-	-	-

Approach	WB	NB	SB
HCM Control Delay, s	9.4	0	1.4
HCM LOS	A		

Minor Lane/Major Mvmt	NBT	NBR	WBLn1	WBLn2	SBL	SBT
Capacity (veh/h)	-	-	848	1061	1553	-
HCM Lane V/C Ratio	-	-	0.103	0.029	0.008	-
HCM Control Delay (s)	-	-	9.7	8.5	7.3	-
HCM Lane LOS	-	-	A	A	A	-
HCM 95th %tile Q(veh)	-	-	0.3	0.1	0	-

Intersection						
Int Delay, s/veh	6.8					
Movement	WBL	WBR	NBT	NBR	SBL	SBT
Lane Configurations						
Traffic Vol, veh/h	174	86	241	93	88	421
Future Vol, veh/h	174	86	241	93	88	421
Conflicting Peds, #/hr	0	0	0	0	0	0
Sign Control	Stop	Stop	Free	Free	Free	Free
RT Channelized	-	None	-	None	-	None
Storage Length	300	-	-	155	300	-
Veh in Median Storage, #	0	-	0	-	-	0
Grade, %	0	-	0	-	-	0
Peak Hour Factor	85	85	85	85	85	85
Heavy Vehicles, %	2	2	2	2	2	2
Mvmt Flow	205	101	284	109	104	495

Major/Minor	Minor1	Major1	Major2			
Conflicting Flow All	740	142	0	0	393	0
Stage 1	284	-	-	-	-	-
Stage 2	456	-	-	-	-	-
Critical Hdwy	6.84	6.94	-	-	4.14	-
Critical Hdwy Stg 1	5.84	-	-	-	-	-
Critical Hdwy Stg 2	5.84	-	-	-	-	-
Follow-up Hdwy	3.52	3.32	-	-	2.22	-
Pot Cap-1 Maneuver	352	880	-	-	1162	-
Stage 1	739	-	-	-	-	-
Stage 2	605	-	-	-	-	-
Platoon blocked, %			-	-	-	-
Mov Cap-1 Maneuver	320	880	-	-	1162	-
Mov Cap-2 Maneuver	320	-	-	-	-	-
Stage 1	739	-	-	-	-	-
Stage 2	551	-	-	-	-	-

Approach	WB	NB	SB
HCM Control Delay, s	26.1	0	1.5
HCM LOS	D		

Minor Lane/Major Mvmt	NBT	NBR	WBLn1	WBLn2	SBL	SBT
Capacity (veh/h)	-	-	320	880	1162	-
HCM Lane V/C Ratio	-	-	0.64	0.115	0.089	-
HCM Control Delay (s)	-	-	34.2	9.6	8.4	-
HCM Lane LOS	-	-	D	A	A	-
HCM 95th %tile Q(veh)	-	-	4.1	0.4	0.3	-

Intersection						
Int Delay, s/veh	11.8					
Movement	EBL	EBT	WBT	WBR	SBL	SBR
Lane Configurations	↘	↑↑	↑↑	↗	↘	↗
Traffic Vol, veh/h	99	82	63	172	337	197
Future Vol, veh/h	99	82	63	172	337	197
Conflicting Peds, #/hr	0	0	0	0	0	0
Sign Control	Free	Free	Free	Free	Stop	Stop
RT Channelized	-	None	-	None	-	None
Storage Length	300	-	-	205	155	0
Veh in Median Storage, #	-	0	0	-	0	-
Grade, %	-	0	0	-	0	-
Peak Hour Factor	85	85	85	85	85	85
Heavy Vehicles, %	2	2	2	2	2	2
Mvmt Flow	116	96	74	202	396	232

Major/Minor	Major1	Major2	Minor2		
Conflicting Flow All	276	0	-	0	354 37
Stage 1	-	-	-	-	74 -
Stage 2	-	-	-	-	280 -
Critical Hdwy	4.14	-	-	-	6.84 6.94
Critical Hdwy Stg 1	-	-	-	-	5.84 -
Critical Hdwy Stg 2	-	-	-	-	5.84 -
Follow-up Hdwy	2.22	-	-	-	3.52 3.32
Pot Cap-1 Maneuver	1284	-	-	-	618 1027
Stage 1	-	-	-	-	940 -
Stage 2	-	-	-	-	742 -
Platoon blocked, %		-	-	-	
Mov Cap-1 Maneuver	1284	-	-	-	562 1027
Mov Cap-2 Maneuver	-	-	-	-	562 -
Stage 1	-	-	-	-	855 -
Stage 2	-	-	-	-	742 -

Approach	EB	WB	SB
HCM Control Delay, s	4.4	0	19.5
HCM LOS			C

Minor Lane/Major Mvmt	EBL	EBT	WBT	WBR	SBLn1	SBLn2
Capacity (veh/h)	1284	-	-	-	562	1027
HCM Lane V/C Ratio	0.091	-	-	-	0.705	0.226
HCM Control Delay (s)	8.1	-	-	-	25.3	9.5
HCM Lane LOS	A	-	-	-	D	A
HCM 95th %tile Q(veh)	0.3	-	-	-	5.6	0.9

Intersection						
Int Delay, s/veh	4.8					
Movement	EBL	EBT	WBT	WBR	SBL	SBR
Lane Configurations	↘	↑↑	↑↑	↗		↗
Traffic Vol, veh/h	15	12	29	2	0	43
Future Vol, veh/h	15	12	29	2	0	43
Conflicting Peds, #/hr	0	0	0	0	0	0
Sign Control	Free	Free	Free	Free	Stop	Stop
RT Channelized	-	None	-	None	-	None
Storage Length	285	-	-	235	-	0
Veh in Median Storage, #	-	0	0	-	0	-
Grade, %	-	0	0	-	0	-
Peak Hour Factor	85	85	85	85	85	85
Heavy Vehicles, %	2	2	2	2	2	2
Mvmt Flow	18	14	34	2	0	51

Major/Minor	Major1	Major2	Minor2		
Conflicting Flow All	36	0	-	0	- 17
Stage 1	-	-	-	-	-
Stage 2	-	-	-	-	-
Critical Hdwy	4.14	-	-	-	- 6.94
Critical Hdwy Stg 1	-	-	-	-	-
Critical Hdwy Stg 2	-	-	-	-	-
Follow-up Hdwy	2.22	-	-	-	- 3.32
Pot Cap-1 Maneuver	1573	-	-	-	0 1058
Stage 1	-	-	-	-	0 -
Stage 2	-	-	-	-	0 -
Platoon blocked, %		-	-	-	
Mov Cap-1 Maneuver	1573	-	-	-	- 1058
Mov Cap-2 Maneuver	-	-	-	-	-
Stage 1	-	-	-	-	-
Stage 2	-	-	-	-	-

Approach	EB	WB	SB
HCM Control Delay, s	4.1	0	8.6
HCM LOS			A

Minor Lane/Major Mvmt	EBL	EBT	WBT	WBR	SBLn1
Capacity (veh/h)	1573	-	-	-	1058
HCM Lane V/C Ratio	0.011	-	-	-	0.048
HCM Control Delay (s)	7.3	-	-	-	8.6
HCM Lane LOS	A	-	-	-	A
HCM 95th %tile Q(veh)	0	-	-	-	0.1

Intersection						
Int Delay, s/veh	7					
Movement	EBL	EBR	NBL	NBT	SBT	SBR
Lane Configurations						
Traffic Vol, veh/h	0	39	12	2	7	0
Future Vol, veh/h	0	39	12	2	7	0
Conflicting Peds, #/hr	0	0	0	0	0	0
Sign Control	Stop	Stop	Free	Free	Free	Free
RT Channelized	-	None	-	None	-	None
Storage Length	0	-	200	-	-	-
Veh in Median Storage, #	0	-	-	0	0	-
Grade, %	0	-	-	0	0	-
Peak Hour Factor	85	85	85	85	85	85
Heavy Vehicles, %	2	2	2	2	2	2
Mvmt Flow	0	46	14	2	8	0

Major/Minor	Minor2	Major1		Major2	
Conflicting Flow All	38	8	8	0	0
Stage 1	8	-	-	-	-
Stage 2	30	-	-	-	-
Critical Hdwy	6.42	6.22	4.12	-	-
Critical Hdwy Stg 1	5.42	-	-	-	-
Critical Hdwy Stg 2	5.42	-	-	-	-
Follow-up Hdwy	3.518	3.318	2.218	-	-
Pot Cap-1 Maneuver	974	1074	1612	-	-
Stage 1	1015	-	-	-	-
Stage 2	993	-	-	-	-
Platoon blocked, %				-	-
Mov Cap-1 Maneuver	965	1074	1612	-	-
Mov Cap-2 Maneuver	965	-	-	-	-
Stage 1	1006	-	-	-	-
Stage 2	993	-	-	-	-

Approach	EB	NB	SB
HCM Control Delay, s	8.5	6.2	0
HCM LOS	A		

Minor Lane/Major Mvmt	NBL	NBT	EBLn1	SBT	SBR
Capacity (veh/h)	1612	-	1074	-	-
HCM Lane V/C Ratio	0.009	-	0.043	-	-
HCM Control Delay (s)	7.3	-	8.5	-	-
HCM Lane LOS	A	-	A	-	-
HCM 95th %tile Q(veh)	0	-	0.1	-	-

Intersection						
Int Delay, s/veh	7.3					
Movement	EBL	EBR	NBL	NBT	SBT	SBR
Lane Configurations						
Traffic Vol, veh/h	0	7	2	0	0	0
Future Vol, veh/h	0	7	2	0	0	0
Conflicting Peds, #/hr	0	0	0	0	0	0
Sign Control	Stop	Stop	Free	Free	Free	Free
RT Channelized	-	None	-	None	-	None
Storage Length	0	-	200	-	-	-
Veh in Median Storage, #	0	-	-	0	0	-
Grade, %	0	-	-	0	0	-
Peak Hour Factor	85	85	85	85	85	85
Heavy Vehicles, %	2	2	2	2	2	2
Mvmt Flow	0	8	2	0	0	0

Major/Minor	Minor2	Major1		Major2	
Conflicting Flow All	5	1	1	0	0
Stage 1	1	-	-	-	-
Stage 2	4	-	-	-	-
Critical Hdwy	6.42	6.22	4.12	-	-
Critical Hdwy Stg 1	5.42	-	-	-	-
Critical Hdwy Stg 2	5.42	-	-	-	-
Follow-up Hdwy	3.518	3.318	2.218	-	-
Pot Cap-1 Maneuver	1017	1084	1622	-	-
Stage 1	1022	-	-	-	-
Stage 2	1019	-	-	-	-
Platoon blocked, %				-	-
Mov Cap-1 Maneuver	1016	1084	1622	-	-
Mov Cap-2 Maneuver	1016	-	-	-	-
Stage 1	1021	-	-	-	-
Stage 2	1019	-	-	-	-

Approach	EB	NB	SB
HCM Control Delay, s	8.3	7.2	0
HCM LOS	A		

Minor Lane/Major Mvmt	NBL	NBT	EBLn1	SBT	SBR
Capacity (veh/h)	1622	-	1084	-	-
HCM Lane V/C Ratio	0.001	-	0.008	-	-
HCM Control Delay (s)	7.2	-	8.3	-	-
HCM Lane LOS	A	-	A	-	-
HCM 95th %tile Q(veh)	0	-	0	-	-

Intersection												
Int Delay, s/veh	152											
Movement	EBL	EBT	EBR	WBL	WBT	WBR	NBL	NBT	NBR	SBL	SBT	SBR
Lane Configurations		↕			↕			↕			↕	
Traffic Vol, veh/h	9	254	49	47	128	45	50	84	65	122	83	9
Future Vol, veh/h	9	254	49	47	128	45	50	84	65	122	83	9
Conflicting Peds, #/hr	0	0	0	0	0	0	0	0	0	0	0	0
Sign Control	Stop	Stop	Stop	Stop	Stop	Stop	Free	Free	Free	Free	Free	Free
RT Channelized	-	-	None	-	-	None	-	-	None	-	-	None
Storage Length	-	-	-	-	-	-	-	-	-	-	-	-
Veh in Median Storage, #	-	0	-	-	0	-	-	0	-	-	0	-
Grade, %	-	0	-	-	0	-	-	0	-	-	0	-
Peak Hour Factor	85	85	85	85	85	85	85	85	85	85	85	85
Heavy Vehicles, %	2	2	2	2	2	2	2	2	2	2	2	2
Mvmt Flow	11	299	58	55	151	53	59	99	76	144	98	11

Major/Minor	Minor2		Minor1		Major1		Major2					
Conflicting Flow All	749	685	104	825	652	137	109	0	0	175	0	0
Stage 1	392	392	-	255	255	-	-	-	-	-	-	-
Stage 2	357	293	-	570	397	-	-	-	-	-	-	-
Critical Hdwy	7.12	6.52	6.22	7.12	6.52	6.22	4.12	-	-	4.12	-	-
Critical Hdwy Stg 1	6.12	5.52	-	6.12	5.52	-	-	-	-	-	-	-
Critical Hdwy Stg 2	6.12	5.52	-	6.12	5.52	-	-	-	-	-	-	-
Follow-up Hdwy	3.518	4.018	3.318	3.518	4.018	3.318	2.218	-	-	2.218	-	-
Pot Cap-1 Maneuver	328	371	951	292	387	911	1481	-	-	1401	-	-
Stage 1	633	606	-	749	696	-	-	-	-	-	-	-
Stage 2	661	670	-	506	603	-	-	-	-	-	-	-
Platoon blocked, %								-	-	-	-	-
Mov Cap-1 Maneuver	177	316	951	~39	329	911	1481	-	-	1401	-	-
Mov Cap-2 Maneuver	177	316	-	~39	329	-	-	-	-	-	-	-
Stage 1	605	540	-	715	665	-	-	-	-	-	-	-
Stage 2	460	640	-	189	537	-	-	-	-	-	-	-

Approach	EB	WB	NB	SB
HCM Control Delay, s	103	\$ 500.8	1.9	4.5
HCM LOS	F	F		

Minor Lane/Major Mvmt	NBL	NBT	NBR	EBLn1WBLn1	SBL	SBT	SBR
Capacity (veh/h)	1481	-	-	344	134	1401	-
HCM Lane V/C Ratio	0.04	-	-	1.067	1.932	0.102	-
HCM Control Delay (s)	7.5	0	-	103	\$ 500.8	7.9	0
HCM Lane LOS	A	A	-	F	F	A	A
HCM 95th %tile Q(veh)	0.1	-	-	13.3	20.4	0.3	-

Notes
 ~: Volume exceeds capacity \$: Delay exceeds 300s +: Computation Not Defined *: All major volume in platoon

Intersection						
Int Delay, s/veh	1.5					
Movement	WBL	WBR	NBT	NBR	SBL	SBT
Lane Configurations	↘	↗	↑↑	↗	↘	↑↑
Traffic Vol, veh/h	73	12	390	77	18	268
Future Vol, veh/h	73	12	390	77	18	268
Conflicting Peds, #/hr	0	0	0	0	0	0
Sign Control	Stop	Stop	Free	Free	Free	Free
RT Channelized	-	None	-	None	-	None
Storage Length	485	-	-	235	385	-
Veh in Median Storage, #	0	-	0	-	-	0
Grade, %	0	-	0	-	-	0
Peak Hour Factor	85	85	85	85	85	85
Heavy Vehicles, %	2	2	2	2	2	2
Mvmt Flow	86	14	459	91	21	315

Major/Minor	Minor1	Major1	Major2			
Conflicting Flow All	659	230	0	0	550	0
Stage 1	459	-	-	-	-	-
Stage 2	200	-	-	-	-	-
Critical Hdwy	6.84	6.94	-	-	4.14	-
Critical Hdwy Stg 1	5.84	-	-	-	-	-
Critical Hdwy Stg 2	5.84	-	-	-	-	-
Follow-up Hdwy	3.52	3.32	-	-	2.22	-
Pot Cap-1 Maneuver	397	772	-	-	1016	-
Stage 1	603	-	-	-	-	-
Stage 2	814	-	-	-	-	-
Platoon blocked, %			-	-		-
Mov Cap-1 Maneuver	389	772	-	-	1016	-
Mov Cap-2 Maneuver	483	-	-	-	-	-
Stage 1	603	-	-	-	-	-
Stage 2	797	-	-	-	-	-

Approach	WB	NB	SB
HCM Control Delay, s	13.5	0	0.5
HCM LOS	B		

Minor Lane/Major Mvmt	NBT	NBRWBLn1	WBLn2	SBL	SBT
Capacity (veh/h)	-	-	483	772	1016
HCM Lane V/C Ratio	-	-	0.178	0.018	0.021
HCM Control Delay (s)	-	-	14.1	9.8	8.6
HCM Lane LOS	-	-	B	A	A
HCM 95th %tile Q(veh)	-	-	0.6	0.1	0.1

Intersection												
Int Delay, s/veh	7.1											
Movement	EBL	EBT	EBR	WBL	WBT	WBR	NBL	NBT	NBR	SBL	SBT	SBR
Lane Configurations	↘	↑↑	↗	↘	↑↑	↗	↘	↑	↗	↘	↑	↗
Traffic Vol, veh/h	4	0	28	0	0	0	25	43	0	0	29	2
Future Vol, veh/h	4	0	28	0	0	0	25	43	0	0	29	2
Conflicting Peds, #/hr	0	0	0	0	0	0	0	0	0	0	0	0
Sign Control	Free	Free	Free	Free	Free	Free	Stop	Stop	Stop	Stop	Stop	Stop
RT Channelized	-	-	None	-	-	None	-	-	None	-	-	None
Storage Length	535	-	0	310	-	0	410	-	155	235	-	155
Veh in Median Storage, #	-	0	-	-	0	-	-	0	-	-	0	-
Grade, %	-	0	-	-	0	-	-	0	-	-	0	-
Peak Hour Factor	85	85	85	85	85	85	85	85	85	85	85	85
Heavy Vehicles, %	2	2	2	2	2	2	2	2	2	2	2	2
Mvmt Flow	5	0	33	0	0	0	29	51	0	0	34	2

Major/Minor	Major1			Major2			Minor1			Minor2		
Conflicting Flow All	1	0	0	33	0	0	28	11	0	37	44	1
Stage 1	-	-	-	-	-	-	10	10	-	1	1	-
Stage 2	-	-	-	-	-	-	18	1	-	36	43	-
Critical Hdwy	4.14	-	-	4.14	-	-	7.54	6.54	6.94	7.54	6.54	6.94
Critical Hdwy Stg 1	-	-	-	-	-	-	6.54	5.54	-	6.54	5.54	-
Critical Hdwy Stg 2	-	-	-	-	-	-	6.54	5.54	-	6.54	5.54	-
Follow-up Hdwy	2.22	-	-	2.22	-	-	3.52	4.02	3.32	3.52	4.02	3.32
Pot Cap-1 Maneuver	1620	-	-	1577	-	-	978	883	-	964	847	1083
Stage 1	-	-	-	-	-	-	1009	887	-	1021	895	-
Stage 2	-	-	-	-	-	-	999	895	-	975	858	-
Platoon blocked, %	-	-	-	-	-	-	-	-	-	-	-	-
Mov Cap-1 Maneuver	1620	-	-	1577	-	-	944	880	-	-	844	1083
Mov Cap-2 Maneuver	-	-	-	-	-	-	944	880	-	-	844	-
Stage 1	-	-	-	-	-	-	1006	884	-	1018	895	-
Stage 2	-	-	-	-	-	-	959	895	-	916	855	-

Approach	EB	WB	NB	SB
HCM Control Delay, s	0.9	0	9.2	9.3
HCM LOS			A	A

Minor Lane/Major Mvmt	NBLn1	NBLn2	NBLn3	EBL	EBT	EBR	WBL	WBT	WBR	SBLn1	SBLn2	SBLn3
Capacity (veh/h)	944	880	-	1620	-	-	1577	-	-	-	844	1083
HCM Lane V/C Ratio	0.031	0.057	-	0.003	-	-	-	-	-	-	0.04	0.002
HCM Control Delay (s)	8.9	9.3	0	7.2	-	-	0	-	-	0	9.4	8.3
HCM Lane LOS	A	A	A	A	-	-	A	-	-	A	A	A
HCM 95th %tile Q(veh)	0.1	0.2	-	0	-	-	0	-	-	-	0.1	0

Intersection						
Int Delay, s/veh	3.5					
Movement	WBL	WBR	NBT	NBR	SBL	SBT
Lane Configurations	↘	↗	↑	↗	↘	↑
Traffic Vol, veh/h	53	18	50	78	28	29
Future Vol, veh/h	53	18	50	78	28	29
Conflicting Peds, #/hr	0	0	0	0	0	0
Sign Control	Stop	Stop	Free	Free	Free	Free
RT Channelized	-	None	-	None	-	None
Storage Length	0	0	-	205	205	-
Veh in Median Storage, #	0	-	0	-	-	0
Grade, %	0	-	0	-	-	0
Peak Hour Factor	85	85	85	85	85	85
Heavy Vehicles, %	2	2	2	2	2	2
Mvmt Flow	62	21	59	92	33	34

Major/Minor	Minor1	Major1	Major2		
Conflicting Flow All	159	59	0	0	151
Stage 1	59	-	-	-	-
Stage 2	100	-	-	-	-
Critical Hdwy	6.42	6.22	-	-	4.12
Critical Hdwy Stg 1	5.42	-	-	-	-
Critical Hdwy Stg 2	5.42	-	-	-	-
Follow-up Hdwy	3.518	3.318	-	-	2.218
Pot Cap-1 Maneuver	832	1007	-	-	1430
Stage 1	964	-	-	-	-
Stage 2	924	-	-	-	-
Platoon blocked, %			-	-	-
Mov Cap-1 Maneuver	813	1007	-	-	1430
Mov Cap-2 Maneuver	794	-	-	-	-
Stage 1	964	-	-	-	-
Stage 2	903	-	-	-	-

Approach	WB	NB	SB
HCM Control Delay, s	9.6	0	3.7
HCM LOS	A		

Minor Lane/Major Mvmt	NBT	NBRWBLn1	WBLn2	SBL	SBT
Capacity (veh/h)	-	-	794	1007	1430
HCM Lane V/C Ratio	-	-	0.079	0.021	0.023
HCM Control Delay (s)	-	-	9.9	8.7	7.6
HCM Lane LOS	-	-	A	A	A
HCM 95th %tile Q(veh)	-	-	0.3	0.1	0.1

Intersection						
Int Delay, s/veh	4.6					
Movement	WBL	WBR	NBT	NBR	SBL	SBT
Lane Configurations	↘	↗	↑↑	↗	↘	↑↑
Traffic Vol, veh/h	93	128	458	101	94	323
Future Vol, veh/h	93	128	458	101	94	323
Conflicting Peds, #/hr	0	0	0	0	0	0
Sign Control	Stop	Stop	Free	Free	Free	Free
RT Channelized	-	None	-	None	-	None
Storage Length	300	-	-	155	300	-
Veh in Median Storage, #	0	-	0	-	-	0
Grade, %	0	-	0	-	-	0
Peak Hour Factor	85	85	85	85	85	85
Heavy Vehicles, %	2	2	2	2	2	2
Mvmt Flow	109	151	539	119	111	380

Major/Minor	Minor1	Major1	Major2		
Conflicting Flow All	951	270	0	0	658
Stage 1	539	-	-	-	-
Stage 2	412	-	-	-	-
Critical Hdwy	6.84	6.94	-	-	4.14
Critical Hdwy Stg 1	5.84	-	-	-	-
Critical Hdwy Stg 2	5.84	-	-	-	-
Follow-up Hdwy	3.52	3.32	-	-	2.22
Pot Cap-1 Maneuver	258	728	-	-	926
Stage 1	549	-	-	-	-
Stage 2	637	-	-	-	-
Platoon blocked, %			-	-	-
Mov Cap-1 Maneuver	227	728	-	-	926
Mov Cap-2 Maneuver	227	-	-	-	-
Stage 1	549	-	-	-	-
Stage 2	561	-	-	-	-

Approach	WB	NB	SB
HCM Control Delay, s	21.1	0	2.1
HCM LOS	C		

Minor Lane/Major Mvmt	NBT	NBRWBLn1	WBLn2	SBL	SBT
Capacity (veh/h)	-	-	227	728	926
HCM Lane V/C Ratio	-	-	0.482	0.207	0.119
HCM Control Delay (s)	-	-	34.8	11.2	9.4
HCM Lane LOS	-	-	D	B	A
HCM 95th %tile Q(veh)	-	-	2.4	0.8	0.4

Intersection						
Int Delay, s/veh	7.1					
Movement	EBL	EBT	WBT	WBR	SBL	SBR
Lane Configurations	↘	↑↑	↑↑	↗	↘	↗
Traffic Vol, veh/h	121	74	120	327	212	101
Future Vol, veh/h	121	74	120	327	212	101
Conflicting Peds, #/hr	0	0	0	0	0	0
Sign Control	Free	Free	Free	Free	Stop	Stop
RT Channelized	-	None	-	None	-	None
Storage Length	300	-	-	205	155	0
Veh in Median Storage, #	-	0	0	-	0	-
Grade, %	-	0	0	-	0	-
Peak Hour Factor	85	85	85	85	85	85
Heavy Vehicles, %	2	2	2	2	2	2
Mvmt Flow	142	87	141	385	249	119

Major/Minor	Major1	Major2	Minor2		
Conflicting Flow All	526	0	-	0	469 71
Stage 1	-	-	-	-	141 -
Stage 2	-	-	-	-	328 -
Critical Hdwy	4.14	-	-	-	6.84 6.94
Critical Hdwy Stg 1	-	-	-	-	5.84 -
Critical Hdwy Stg 2	-	-	-	-	5.84 -
Follow-up Hdwy	2.22	-	-	-	3.52 3.32
Pot Cap-1 Maneuver	1037	-	-	-	523 977
Stage 1	-	-	-	-	871 -
Stage 2	-	-	-	-	702 -
Platoon blocked, %		-	-	-	
Mov Cap-1 Maneuver	1037	-	-	-	451 977
Mov Cap-2 Maneuver	-	-	-	-	451 -
Stage 1	-	-	-	-	752 -
Stage 2	-	-	-	-	702 -

Approach	EB	WB	SB
HCM Control Delay, s	5.6	0	18.1
HCM LOS			C

Minor Lane/Major Mvmt	EBL	EBT	WBT	WBR	SBLn1	SBLn2
Capacity (veh/h)	1037	-	-	-	451	977
HCM Lane V/C Ratio	0.137	-	-	-	0.553	0.122
HCM Control Delay (s)	9	-	-	-	22.4	9.2
HCM Lane LOS	A	-	-	-	C	A
HCM 95th %tile Q(veh)	0.5	-	-	-	3.3	0.4

Intersection						
Int Delay, s/veh	4.4					
Movement	EBL	EBT	WBT	WBR	SBL	SBR
Lane Configurations	↘	↑↑	↑↑	↗		↗
Traffic Vol, veh/h	49	31	21	7	0	29
Future Vol, veh/h	49	31	21	7	0	29
Conflicting Peds, #/hr	0	0	0	0	0	0
Sign Control	Free	Free	Free	Free	Stop	Stop
RT Channelized	-	None	-	None	-	None
Storage Length	285	-	-	235	-	0
Veh in Median Storage, #	-	0	0	-	0	-
Grade, %	-	0	0	-	0	-
Peak Hour Factor	85	85	85	85	85	85
Heavy Vehicles, %	2	2	2	2	2	2
Mvmt Flow	58	36	25	8	0	34

Major/Minor	Major1	Major2	Minor2		
Conflicting Flow All	33	0	-	0	- 13
Stage 1	-	-	-	-	-
Stage 2	-	-	-	-	-
Critical Hdwy	4.14	-	-	-	- 6.94
Critical Hdwy Stg 1	-	-	-	-	-
Critical Hdwy Stg 2	-	-	-	-	-
Follow-up Hdwy	2.22	-	-	-	- 3.32
Pot Cap-1 Maneuver	1577	-	-	-	0 1064
Stage 1	-	-	-	-	0 -
Stage 2	-	-	-	-	0 -
Platoon blocked, %		-	-	-	
Mov Cap-1 Maneuver	1577	-	-	-	- 1064
Mov Cap-2 Maneuver	-	-	-	-	-
Stage 1	-	-	-	-	-
Stage 2	-	-	-	-	-

Approach	EB	WB	SB
HCM Control Delay, s	4.5	0	8.5
HCM LOS			A

Minor Lane/Major Mvmt	EBL	EBT	WBT	WBR	SBLn1
Capacity (veh/h)	1577	-	-	-	1064
HCM Lane V/C Ratio	0.037	-	-	-	0.032
HCM Control Delay (s)	7.4	-	-	-	8.5
HCM Lane LOS	A	-	-	-	A
HCM 95th %tile Q(veh)	0.1	-	-	-	0.1

Intersection						
Int Delay, s/veh	6.4					
Movement	EBL	EBR	NBL	NBT	SBT	SBR
Lane Configurations	↔		↔	↑	↔	
Traffic Vol, veh/h	0	26	38	9	5	0
Future Vol, veh/h	0	26	38	9	5	0
Conflicting Peds, #/hr	0	0	0	0	0	0
Sign Control	Stop	Stop	Free	Free	Free	Free
RT Channelized	-	None	-	None	-	None
Storage Length	0	-	200	-	-	-
Veh in Median Storage, #	0	-	-	0	0	-
Grade, %	0	-	-	0	0	-
Peak Hour Factor	85	85	85	85	85	85
Heavy Vehicles, %	2	2	2	2	2	2
Mvmt Flow	0	31	45	11	6	0

Major/Minor	Minor2	Major1	Major2			
Conflicting Flow All	107	6	6	0	-	0
Stage 1	6	-	-	-	-	-
Stage 2	101	-	-	-	-	-
Critical Hdwy	6.42	6.22	4.12	-	-	-
Critical Hdwy Stg 1	5.42	-	-	-	-	-
Critical Hdwy Stg 2	5.42	-	-	-	-	-
Follow-up Hdwy	3.518	3.318	2.218	-	-	-
Pot Cap-1 Maneuver	891	1077	1615	-	-	-
Stage 1	1017	-	-	-	-	-
Stage 2	923	-	-	-	-	-
Platoon blocked, %				-	-	-
Mov Cap-1 Maneuver	866	1077	1615	-	-	-
Mov Cap-2 Maneuver	866	-	-	-	-	-
Stage 1	989	-	-	-	-	-
Stage 2	923	-	-	-	-	-

Approach	EB	NB	SB
HCM Control Delay, s	8.4	5.9	0
HCM LOS	A		

Minor Lane/Major Mvmt	NBL	NBT	EBLn1	SBT	SBR
Capacity (veh/h)	1615	-	1077	-	-
HCM Lane V/C Ratio	0.028	-	0.028	-	-
HCM Control Delay (s)	7.3	-	8.4	-	-
HCM Lane LOS	A	-	A	-	-
HCM 95th %tile Q(veh)	0.1	-	0.1	-	-

Intersection						
Int Delay, s/veh	7.1					
Movement	EBL	EBR	NBL	NBT	SBT	SBR
Lane Configurations						
Traffic Vol, veh/h	0	5	9	0	0	0
Future Vol, veh/h	0	5	9	0	0	0
Conflicting Peds, #/hr	0	0	0	0	0	0
Sign Control	Stop	Stop	Free	Free	Free	Free
RT Channelized	-	None	-	None	-	None
Storage Length	0	-	200	-	-	-
Veh in Median Storage, #	0	-	-	0	0	-
Grade, %	0	-	-	0	0	-
Peak Hour Factor	85	85	85	85	85	85
Heavy Vehicles, %	2	2	2	2	2	2
Mvmt Flow	0	6	11	0	0	0

Major/Minor	Minor2	Major1		Major2	
Conflicting Flow All	23	1	1	0	0
Stage 1	1	-	-	-	-
Stage 2	22	-	-	-	-
Critical Hdwy	6.42	6.22	4.12	-	-
Critical Hdwy Stg 1	5.42	-	-	-	-
Critical Hdwy Stg 2	5.42	-	-	-	-
Follow-up Hdwy	3.518	3.318	2.218	-	-
Pot Cap-1 Maneuver	993	1084	1622	-	-
Stage 1	1022	-	-	-	-
Stage 2	1001	-	-	-	-
Platoon blocked, %				-	-
Mov Cap-1 Maneuver	986	1084	1622	-	-
Mov Cap-2 Maneuver	986	-	-	-	-
Stage 1	1015	-	-	-	-
Stage 2	1001	-	-	-	-

Approach	EB	NB	SB
HCM Control Delay, s	8.3	7.2	0
HCM LOS	A		

Minor Lane/Major Mvmt	NBL	NBT	EBLn1	SBT	SBR
Capacity (veh/h)	1622	-	1084	-	-
HCM Lane V/C Ratio	0.007	-	0.005	-	-
HCM Control Delay (s)	7.2	-	8.3	-	-
HCM Lane LOS	A	-	A	-	-
HCM 95th %tile Q(veh)	0	-	0	-	-

HCM 6th Roundabout
1: Vollmer Rd & Burgess Rd

Short-Term Total Traffic
AM Peak Hour

Intersection				
Intersection Delay, s/veh	6.3			
Intersection LOS	A			
Approach	EB	WB	NB	SB
Entry Lanes	1	1	1	1
Conflicting Circle Lanes	1	1	1	1
Adj Approach Flow, veh/h	148	423	274	159
Demand Flow Rate, veh/h	151	432	280	162
Vehicles Circulating, veh/h	205	254	95	486
Vehicles Exiting, veh/h	443	121	261	200
Ped Vol Crossing Leg, #/h	0	0	0	0
Ped Cap Adj	1.000	1.000	1.000	1.000
Approach Delay, s/veh	4.5	7.8	4.9	6.4
Approach LOS	A	A	A	A
Lane	Left	Left	Left	Left
Designated Moves	LTR	LTR	LTR	LTR
Assumed Moves	LTR	LTR	LTR	LTR
RT Channelized				
Lane Util	1.000	1.000	1.000	1.000
Follow-Up Headway, s	2.609	2.609	2.609	2.609
Critical Headway, s	4.976	4.976	4.976	4.976
Entry Flow, veh/h	151	432	280	162
Cap Entry Lane, veh/h	1120	1065	1252	841
Entry HV Adj Factor	0.980	0.980	0.979	0.980
Flow Entry, veh/h	148	423	274	159
Cap Entry, veh/h	1097	1044	1225	824
V/C Ratio	0.135	0.406	0.224	0.193
Control Delay, s/veh	4.5	7.8	4.9	6.4
LOS	A	A	A	A
95th %tile Queue, veh	0	2	1	1

Intersection						
Int Delay, s/veh	4.4					
Movement	WBL	WBR	NBT	NBR	SBL	SBT
Lane Configurations	↘	↗	↑↑	↗	↘	↑↑
Traffic Vol, veh/h	207	47	224	58	17	323
Future Vol, veh/h	207	47	224	58	17	323
Conflicting Peds, #/hr	0	0	0	0	0	0
Sign Control	Stop	Stop	Free	Free	Free	Free
RT Channelized	-	None	-	None	-	None
Storage Length	485	-	-	235	385	-
Veh in Median Storage, #	0	-	0	-	-	0
Grade, %	0	-	0	-	-	0
Peak Hour Factor	85	85	85	85	85	85
Heavy Vehicles, %	2	2	2	2	2	2
Mvmt Flow	244	55	264	68	20	380

Major/Minor	Minor1	Major1	Major2			
Conflicting Flow All	494	132	0	0	332	0
Stage 1	264	-	-	-	-	-
Stage 2	230	-	-	-	-	-
Critical Hdwy	6.84	6.94	-	-	4.14	-
Critical Hdwy Stg 1	5.84	-	-	-	-	-
Critical Hdwy Stg 2	5.84	-	-	-	-	-
Follow-up Hdwy	3.52	3.32	-	-	2.22	-
Pot Cap-1 Maneuver	504	893	-	-	1224	-
Stage 1	756	-	-	-	-	-
Stage 2	786	-	-	-	-	-
Platoon blocked, %			-	-	-	-
Mov Cap-1 Maneuver	496	893	-	-	1224	-
Mov Cap-2 Maneuver	575	-	-	-	-	-
Stage 1	756	-	-	-	-	-
Stage 2	773	-	-	-	-	-

Approach	WB	NB	SB
HCM Control Delay, s	14.6	0	0.4
HCM LOS	B		

Minor Lane/Major Mvmt	NBT	NBR	WBLn1	WBLn2	SBL	SBT
Capacity (veh/h)	-	-	575	893	1224	-
HCM Lane V/C Ratio	-	-	0.424	0.062	0.016	-
HCM Control Delay (s)	-	-	15.8	9.3	8	-
HCM Lane LOS	-	-	C	A	A	-
HCM 95th %tile Q(veh)	-	-	2.1	0.2	0.1	-

Intersection												
Int Delay, s/veh	8.9											
Movement	EBL	EBT	EBR	WBL	WBT	WBR	NBL	NBT	NBR	SBL	SBT	SBR
Lane Configurations	↘	↑↑	↗	↘	↑↑	↗	↘	↑	↗	↘	↑	↗
Traffic Vol, veh/h	33	0	17	0	0	0	50	24	0	0	79	93
Future Vol, veh/h	33	0	17	0	0	0	50	24	0	0	79	93
Conflicting Peds, #/hr	0	0	0	0	0	0	0	0	0	0	0	0
Sign Control	Free	Free	Free	Free	Free	Free	Stop	Stop	Stop	Stop	Stop	Stop
RT Channelized	-	-	None	-	-	None	-	-	None	-	-	None
Storage Length	535	-	0	310	-	0	410	-	155	235	-	155
Veh in Median Storage, #	-	0	-	-	0	-	-	0	-	-	0	-
Grade, %	-	0	-	-	0	-	-	0	-	-	0	-
Peak Hour Factor	85	85	85	85	85	85	85	85	85	85	85	85
Heavy Vehicles, %	2	2	2	2	2	2	2	2	2	2	2	2
Mvmt Flow	39	0	20	0	0	0	59	28	0	0	93	109

Major/Minor	Major1			Major2			Minor1			Minor2		
Conflicting Flow All	1	0	0	20	0	0	125	79	0	93	99	1
Stage 1	-	-	-	-	-	-	78	78	-	1	1	-
Stage 2	-	-	-	-	-	-	47	1	-	92	98	-
Critical Hdwy	4.14	-	-	4.14	-	-	7.54	6.54	6.94	7.54	6.54	6.94
Critical Hdwy Stg 1	-	-	-	-	-	-	6.54	5.54	-	6.54	5.54	-
Critical Hdwy Stg 2	-	-	-	-	-	-	6.54	5.54	-	6.54	5.54	-
Follow-up Hdwy	2.22	-	-	2.22	-	-	3.52	4.02	3.32	3.52	4.02	3.32
Pot Cap-1 Maneuver	1620	-	-	1595	-	-	836	811	-	881	790	1083
Stage 1	-	-	-	-	-	-	922	829	-	1021	895	-
Stage 2	-	-	-	-	-	-	961	895	-	905	813	-
Platoon blocked, %	-	-	-	-	-	-	-	-	-	-	-	-
Mov Cap-1 Maneuver	1620	-	-	1595	-	-	670	792	-	-	771	1083
Mov Cap-2 Maneuver	-	-	-	-	-	-	670	792	-	-	771	-
Stage 1	-	-	-	-	-	-	900	809	-	996	895	-
Stage 2	-	-	-	-	-	-	774	895	-	852	793	-

Approach	EB			WB			NB			SB		
HCM Control Delay, s	4.8			0			10.5			9.4		
HCM LOS							B			A		

Minor Lane/Major Mvmt	NBLn1	NBLn2	NBLn3	EBL	EBT	EBR	WBL	WBT	WBR	SBLn1	SBLn2	SBLn3
Capacity (veh/h)	670	792	-	1620	-	-	1595	-	-	-	-	771 1083
HCM Lane V/C Ratio	0.088	0.036	-	0.024	-	-	-	-	-	-	-	0.121 0.101
HCM Control Delay (s)	10.9	9.7	0	7.3	-	-	0	-	-	0	10.3	8.7
HCM Lane LOS	B	A	A	A	-	-	A	-	-	A	B	A
HCM 95th %tile Q(veh)	0.3	0.1	-	0.1	-	-	0	-	-	-	0.4	0.3

Intersection						
Int Delay, s/veh	3.8					
Movement	WBL	WBR	NBT	NBR	SBL	SBT
Lane Configurations	↘	↗	↑	↗	↘	↑
Traffic Vol, veh/h	74	26	47	30	10	86
Future Vol, veh/h	74	26	47	30	10	86
Conflicting Peds, #/hr	0	0	0	0	0	0
Sign Control	Stop	Stop	Free	Free	Free	Free
RT Channelized	-	None	-	None	-	None
Storage Length	0	0	-	205	205	-
Veh in Median Storage, #	0	-	0	-	-	0
Grade, %	0	-	0	-	-	0
Peak Hour Factor	85	85	85	85	85	85
Heavy Vehicles, %	2	2	2	2	2	2
Mvmt Flow	87	31	55	35	12	101

Major/Minor	Minor1	Major1	Major2		
Conflicting Flow All	180	55	0	0	90
Stage 1	55	-	-	-	-
Stage 2	125	-	-	-	-
Critical Hdwy	6.42	6.22	-	-	4.12
Critical Hdwy Stg 1	5.42	-	-	-	-
Critical Hdwy Stg 2	5.42	-	-	-	-
Follow-up Hdwy	3.518	3.318	-	-	2.218
Pot Cap-1 Maneuver	810	1012	-	-	1505
Stage 1	968	-	-	-	-
Stage 2	901	-	-	-	-
Platoon blocked, %			-	-	-
Mov Cap-1 Maneuver	804	1012	-	-	1505
Mov Cap-2 Maneuver	787	-	-	-	-
Stage 1	968	-	-	-	-
Stage 2	894	-	-	-	-

Approach	WB	NB	SB
HCM Control Delay, s	9.7	0	0.8
HCM LOS	A		

Minor Lane/Major Mvmt	NBT	NBR	WBLn1	WBLn2	SBL	SBT
Capacity (veh/h)	-	-	787	1012	1505	-
HCM Lane V/C Ratio	-	-	0.111	0.03	0.008	-
HCM Control Delay (s)	-	-	10.1	8.7	7.4	-
HCM Lane LOS	-	-	B	A	A	-
HCM 95th %tile Q(veh)	-	-	0.4	0.1	0	-

Intersection						
Int Delay, s/veh	9					
Movement	WBL	WBR	NBT	NBR	SBL	SBT
Lane Configurations	↘	↗	↑↑	↗	↘	↑↑
Traffic Vol, veh/h	184	86	275	97	88	518
Future Vol, veh/h	184	86	275	97	88	518
Conflicting Peds, #/hr	0	0	0	0	0	0
Sign Control	Stop	Stop	Free	Free	Free	Free
RT Channelized	-	None	-	None	-	None
Storage Length	300	-	-	155	300	-
Veh in Median Storage, #	0	-	0	-	-	0
Grade, %	0	-	0	-	-	0
Peak Hour Factor	85	85	85	85	85	85
Heavy Vehicles, %	2	2	2	2	2	2
Mvmt Flow	216	101	324	114	104	609















Major/Minor	Minor1	Major1	Major2		
Conflicting Flow All	837	162	0	0	438
Stage 1	324	-	-	-	-
Stage 2	513	-	-	-	-
Critical Hdwy	6.84	6.94	-	-	4.14
Critical Hdwy Stg 1	5.84	-	-	-	-
Critical Hdwy Stg 2	5.84	-	-	-	-
Follow-up Hdwy	3.52	3.32	-	-	2.22
Pot Cap-1 Maneuver	305	854	-	-	1118
Stage 1	705	-	-	-	-
Stage 2	566	-	-	-	-
Platoon blocked, %			-	-	-
Mov Cap-1 Maneuver	277	854	-	-	1118
Mov Cap-2 Maneuver	277	-	-	-	-
Stage 1	705	-	-	-	-
Stage 2	513	-	-	-	-

Approach	WB	NB	SB
HCM Control Delay, s	38.8	0	1.2
HCM LOS	E		

Minor Lane/Major Mvmt	NBT	NBRWBLn1	WBLn2	SBL	SBT
Capacity (veh/h)	-	-	277	854	1118
HCM Lane V/C Ratio	-	-	0.781	0.118	0.093
HCM Control Delay (s)	-	-	52.4	9.8	8.5
HCM Lane LOS	-	-	F	A	A
HCM 95th %tile Q(veh)	-	-	6	0.4	0.3

Timings
12: Vollmer Rd & Marksheffel Rd

Short-Term Total Traffic
AM Peak Hour

						
Lane Group	WBL	WBR	NBT	NBR	SBL	SBT
Lane Configurations			 			 
Traffic Volume (vph)	184	86	275	97	88	518
Future Volume (vph)	184	86	275	97	88	518
Turn Type	Prot	Prot	NA	Perm	pm+pt	NA
Protected Phases	5	5	8		7	4
Permitted Phases				8	4	
Detector Phase	5	5	8	8	7	4
Switch Phase						
Minimum Initial (s)	5.0	5.0	10.0	10.0	5.0	10.0
Minimum Split (s)	10.0	10.0	23.0	23.0	10.0	23.0
Total Split (s)	30.0	30.0	48.0	48.0	12.0	60.0
Total Split (%)	33.3%	33.3%	53.3%	53.3%	13.3%	66.7%
Yellow Time (s)	3.0	3.0	3.0	3.0	3.0	3.0
All-Red Time (s)	2.0	2.0	2.0	2.0	2.0	2.0
Lost Time Adjust (s)	0.0	0.0	0.0	0.0	0.0	0.0
Total Lost Time (s)	5.0	5.0	5.0	5.0	5.0	5.0
Lead/Lag			Lag	Lag	Lead	
Lead-Lag Optimize?			Yes	Yes	Yes	
Recall Mode	None	None	None	None	None	None
Act Effect Green (s)	11.4	11.4	15.5	15.5	21.3	23.8
Actuated g/C Ratio	0.29	0.29	0.40	0.40	0.55	0.61
v/c Ratio	0.42	0.19	0.23	0.16	0.17	0.28
Control Delay	16.8	4.9	13.7	4.6	6.5	6.3
Queue Delay	0.0	0.0	0.0	0.0	0.0	0.0
Total Delay	16.8	4.9	13.7	4.6	6.5	6.3
LOS	B	A	B	A	A	A
Approach Delay	13.0		11.4			6.3
Approach LOS	B		B			A

Intersection Summary

Cycle Length: 90	
Actuated Cycle Length: 38.7	
Natural Cycle: 45	
Control Type: Actuated-Uncoordinated	
Maximum v/c Ratio: 0.42	
Intersection Signal Delay: 9.3	Intersection LOS: A
Intersection Capacity Utilization 35.9%	ICU Level of Service A
Analysis Period (min) 15	

Splits and Phases: 12: Vollmer Rd & Marksheffel Rd

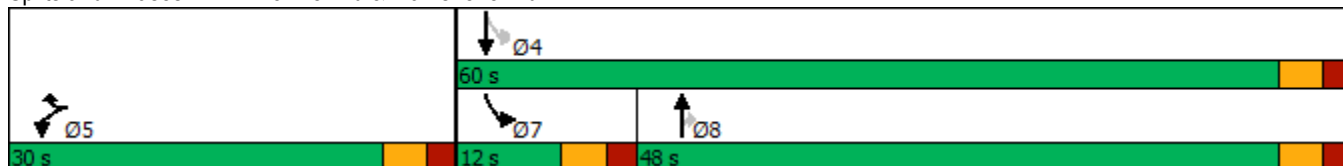

Intersection						
Int Delay, s/veh	75.4					
Movement	EBL	EBT	WBT	WBR	SBL	SBR
Lane Configurations	↘	↑↑	↑↑	↗	↘	↗
Traffic Vol, veh/h	103	82	63	262	593	207
Future Vol, veh/h	103	82	63	262	593	207
Conflicting Peds, #/hr	0	0	0	0	0	0
Sign Control	Free	Free	Free	Free	Stop	Stop
RT Channelized	-	None	-	None	-	None
Storage Length	300	-	-	205	155	0
Veh in Median Storage, #	-	0	0	-	0	-
Grade, %	-	0	0	-	0	-
Peak Hour Factor	85	85	85	85	85	85
Heavy Vehicles, %	2	2	2	2	2	2
Mvmt Flow	121	96	74	308	698	244

Major/Minor	Major1	Major2	Minor2		
Conflicting Flow All	382	0	-	0	364 37
Stage 1	-	-	-	-	74 -
Stage 2	-	-	-	-	290 -
Critical Hdwy	4.14	-	-	-	6.84 6.94
Critical Hdwy Stg 1	-	-	-	-	5.84 -
Critical Hdwy Stg 2	-	-	-	-	5.84 -
Follow-up Hdwy	2.22	-	-	-	3.52 3.32
Pot Cap-1 Maneuver	1173	-	-	-	~ 609 1027
Stage 1	-	-	-	-	940 -
Stage 2	-	-	-	-	734 -
Platoon blocked, %		-	-	-	
Mov Cap-1 Maneuver	1173	-	-	-	~ 546 1027
Mov Cap-2 Maneuver	-	-	-	-	~ 546 -
Stage 1	-	-	-	-	843 -
Stage 2	-	-	-	-	734 -

Approach	EB	WB	SB
HCM Control Delay, s	4.7	0	122.4
HCM LOS			F

Minor Lane/Major Mvmt	EBL	EBT	WBT	WBR	SBLn1	SBLn2
Capacity (veh/h)	1173	-	-	-	546	1027
HCM Lane V/C Ratio	0.103	-	-	-	1.278	0.237
HCM Control Delay (s)	8.4	-	-	-	161.8	9.6
HCM Lane LOS	A	-	-	-	F	A
HCM 95th %tile Q(veh)	0.3	-	-	-	28.2	0.9

Notes
 ~: Volume exceeds capacity \$: Delay exceeds 300s +: Computation Not Defined *: All major volume in platoon

Timings
13: Marksheffel Rd & Sterling Ranch Rd

Short-Term Total Traffic
AM Peak Hour



Lane Group	EBL	EBT	WBT	WBR	SBL	SBR
Lane Configurations	↖	↑↑	↑↑	↗	↖↗	↗
Traffic Volume (vph)	103	82	63	262	593	207
Future Volume (vph)	103	82	63	262	593	207
Turn Type	pm+pt	NA	NA	Perm	Prot	Perm
Protected Phases	5	2	6		7	
Permitted Phases	2			6		4
Detector Phase	5	2	6	6	7	4
Switch Phase						
Minimum Initial (s)	5.0	15.0	15.0	15.0	20.0	10.0
Minimum Split (s)	10.0	20.0	20.0	20.0	25.0	20.0
Total Split (s)	12.0	60.0	48.0	48.0	30.0	30.0
Total Split (%)	13.3%	66.7%	53.3%	53.3%	33.3%	33.3%
Yellow Time (s)	3.0	3.0	3.0	3.0	3.0	3.0
All-Red Time (s)	2.0	2.0	2.0	2.0	2.0	2.0
Lost Time Adjust (s)	0.0	0.0	0.0	0.0	0.0	0.0
Total Lost Time (s)	5.0	5.0	5.0	5.0	5.0	5.0
Lead/Lag	Lead		Lag	Lag		
Lead-Lag Optimize?	Yes		Yes	Yes		
Recall Mode	None	C-Max	C-Max	C-Max	None	None
Act Effct Green (s)	57.1	57.1	45.1	45.1	22.9	22.9
Actuated g/C Ratio	0.63	0.63	0.50	0.50	0.25	0.25
v/c Ratio	0.15	0.04	0.04	0.33	0.80	0.42
Control Delay	7.4	6.7	12.3	2.7	39.0	5.9
Queue Delay	0.0	0.0	0.0	0.0	0.0	0.0
Total Delay	7.4	6.7	12.3	2.7	39.0	5.9
LOS	A	A	B	A	D	A
Approach Delay		7.1	4.5		30.5	
Approach LOS		A	A		C	

Intersection Summary

Cycle Length: 90
 Actuated Cycle Length: 90
 Offset: 0 (0%), Referenced to phase 2:EBTL and 6:WBT, Start of Green
 Natural Cycle: 55
 Control Type: Actuated-Coordinated
 Maximum v/c Ratio: 0.80
 Intersection Signal Delay: 20.7
 Intersection LOS: C
 Intersection Capacity Utilization 37.8%
 ICU Level of Service A
 Analysis Period (min) 15

Splits and Phases: 13: Marksheffel Rd & Sterling Ranch Rd

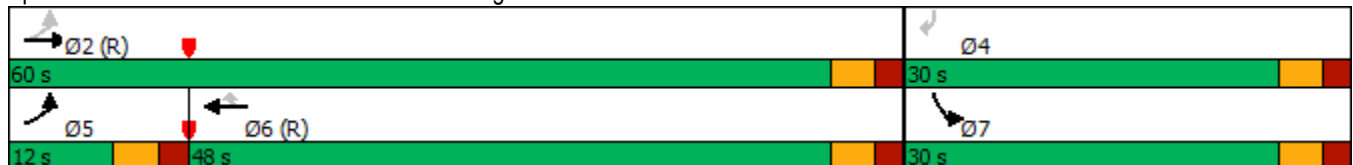

Intersection						
Int Delay, s/veh	2.5					
Movement	EBL	EBT	WBT	WBR	SBL	SBR
Lane Configurations	↘	↑↑	↑↑	↗		↗
Traffic Vol, veh/h	21	50	139	4	0	60
Future Vol, veh/h	21	50	139	4	0	60
Conflicting Peds, #/hr	0	0	0	0	0	0
Sign Control	Free	Free	Free	Free	Stop	Stop
RT Channelized	-	None	-	None	-	None
Storage Length	285	-	-	235	-	0
Veh in Median Storage, #	-	0	0	-	0	-
Grade, %	-	0	0	-	0	-
Peak Hour Factor	85	85	85	85	85	85
Heavy Vehicles, %	2	2	2	2	2	2
Mvmt Flow	25	59	164	5	0	71

Major/Minor	Major1	Major2	Minor2		
Conflicting Flow All	169	0	-	0	- 82
Stage 1	-	-	-	-	-
Stage 2	-	-	-	-	-
Critical Hdwy	4.14	-	-	-	- 6.94
Critical Hdwy Stg 1	-	-	-	-	-
Critical Hdwy Stg 2	-	-	-	-	-
Follow-up Hdwy	2.22	-	-	-	- 3.32
Pot Cap-1 Maneuver	1406	-	-	-	0 961
Stage 1	-	-	-	-	0 -
Stage 2	-	-	-	-	0 -
Platoon blocked, %		-	-	-	
Mov Cap-1 Maneuver	1406	-	-	-	- 961
Mov Cap-2 Maneuver	-	-	-	-	-
Stage 1	-	-	-	-	-
Stage 2	-	-	-	-	-

Approach	EB	WB	SB
HCM Control Delay, s	2.2	0	9
HCM LOS			A

Minor Lane/Major Mvmt	EBL	EBT	WBT	WBR	SBLn1
Capacity (veh/h)	1406	-	-	-	961
HCM Lane V/C Ratio	0.018	-	-	-	0.073
HCM Control Delay (s)	7.6	-	-	-	9
HCM Lane LOS	A	-	-	-	A
HCM 95th %tile Q(veh)	0.1	-	-	-	0.2

Intersection						
Int Delay, s/veh	0.5					
Movement	EBT	EBR	WBL	WBT	NBL	NBR
Lane Configurations	↑	↗	↖	↑	↘	↙
Traffic Vol, veh/h	130	8	1	360	22	2
Future Vol, veh/h	130	8	1	360	22	2
Conflicting Peds, #/hr	0	0	0	0	0	0
Sign Control	Free	Free	Free	Free	Stop	Stop
RT Channelized	-	None	-	None	-	None
Storage Length	-	155	205	-	0	-
Veh in Median Storage, #	0	-	-	0	0	-
Grade, %	0	-	-	0	0	-
Peak Hour Factor	85	85	85	85	85	85
Heavy Vehicles, %	2	2	2	2	2	2
Mvmt Flow	153	9	1	424	26	2

Major/Minor	Major1	Major2	Minor1			
Conflicting Flow All	0	0	162	0	579	153
Stage 1	-	-	-	-	153	-
Stage 2	-	-	-	-	426	-
Critical Hdwy	-	-	4.12	-	6.42	6.22
Critical Hdwy Stg 1	-	-	-	-	5.42	-
Critical Hdwy Stg 2	-	-	-	-	5.42	-
Follow-up Hdwy	-	-	2.218	-	3.518	3.318
Pot Cap-1 Maneuver	-	-	1417	-	477	893
Stage 1	-	-	-	-	875	-
Stage 2	-	-	-	-	659	-
Platoon blocked, %	-	-	-	-	-	-
Mov Cap-1 Maneuver	-	-	1417	-	477	893
Mov Cap-2 Maneuver	-	-	-	-	549	-
Stage 1	-	-	-	-	875	-
Stage 2	-	-	-	-	658	-

Approach	EB	WB	NB
HCM Control Delay, s	0	0	11.7
HCM LOS			B

Minor Lane/Major Mvmt	NBLn1	EBT	EBR	WBL	WBT
Capacity (veh/h)	567	-	-	1417	-
HCM Lane V/C Ratio	0.05	-	-	0.001	-
HCM Control Delay (s)	11.7	-	-	7.5	-
HCM Lane LOS	B	-	-	A	-
HCM 95th %tile Q(veh)	0.2	-	-	0	-

Intersection												
Int Delay, s/veh	2.4											
Movement	EBL	EBT	EBR	WBL	WBT	WBR	NBL	NBT	NBR	SBL	SBT	SBR
Lane Configurations	↖	↗		↖	↗			↕			↕	
Traffic Vol, veh/h	12	104	16	1	281	1	45	0	4	3	0	35
Future Vol, veh/h	12	104	16	1	281	1	45	0	4	3	0	35
Conflicting Peds, #/hr	0	0	0	0	0	0	0	0	0	0	0	0
Sign Control	Free	Free	Free	Free	Free	Free	Stop	Stop	Stop	Stop	Stop	Stop
RT Channelized	-	-	None	-	-	None	-	-	None	-	-	None
Storage Length	205	-	-	205	-	-	-	-	-	-	-	-
Veh in Median Storage, #	-	0	-	-	0	-	-	0	-	-	0	-
Grade, %	-	0	-	-	0	-	-	0	-	-	0	-
Peak Hour Factor	85	85	85	85	85	85	85	85	85	85	85	85
Heavy Vehicles, %	2	2	2	2	2	2	2	2	2	2	2	2
Mvmt Flow	14	122	19	1	331	1	53	0	5	4	0	41

Major/Minor	Major1			Major2			Minor1			Minor2		
Conflicting Flow All	332	0	0	141	0	0	514	494	132	496	503	332
Stage 1	-	-	-	-	-	-	160	160	-	334	334	-
Stage 2	-	-	-	-	-	-	354	334	-	162	169	-
Critical Hdwy	4.12	-	-	4.12	-	-	7.12	6.52	6.22	7.12	6.52	6.22
Critical Hdwy Stg 1	-	-	-	-	-	-	6.12	5.52	-	6.12	5.52	-
Critical Hdwy Stg 2	-	-	-	-	-	-	6.12	5.52	-	6.12	5.52	-
Follow-up Hdwy	2.218	-	-	2.218	-	-	3.518	4.018	3.318	3.518	4.018	3.318
Pot Cap-1 Maneuver	1227	-	-	1442	-	-	471	476	917	484	471	710
Stage 1	-	-	-	-	-	-	842	766	-	680	643	-
Stage 2	-	-	-	-	-	-	663	643	-	840	759	-
Platoon blocked, %		-	-	-	-	-						
Mov Cap-1 Maneuver	1227	-	-	1442	-	-	439	470	917	477	465	710
Mov Cap-2 Maneuver	-	-	-	-	-	-	439	470	-	477	465	-
Stage 1	-	-	-	-	-	-	833	758	-	673	642	-
Stage 2	-	-	-	-	-	-	624	642	-	826	751	-

Approach	EB	WB	NB	SB
HCM Control Delay, s	0.7	0	14	10.6
HCM LOS			B	B

Minor Lane/Major Mvmt	NBLn1	EBL	EBT	EBR	WBL	WBT	WBR	SBLn1
Capacity (veh/h)	459	1227	-	-	1442	-	-	684
HCM Lane V/C Ratio	0.126	0.012	-	-	0.001	-	-	0.065
HCM Control Delay (s)	14	8	-	-	7.5	-	-	10.6
HCM Lane LOS	B	A	-	-	A	-	-	B
HCM 95th %tile Q(veh)	0.4	0	-	-	0	-	-	0.2

Intersection												
Int Delay, s/veh	3.1											
Movement	EBL	EBT	EBR	WBL	WBT	WBR	NBL	NBT	NBR	SBL	SBT	SBR
Lane Configurations	↙	↑	↗	↙	↗			↕			↕	
Traffic Vol, veh/h	25	78	8	1	191	1	22	0	2	3	0	70
Future Vol, veh/h	25	78	8	1	191	1	22	0	2	3	0	70
Conflicting Peds, #/hr	0	0	0	0	0	0	0	0	0	0	0	0
Sign Control	Free	Free	Free	Free	Free	Free	Stop	Stop	Stop	Stop	Stop	Stop
RT Channelized	-	-	None	-	-	None	-	-	None	-	-	None
Storage Length	305	-	255	305	-	-	-	-	-	-	-	-
Veh in Median Storage, #	-	0	-	-	0	-	-	0	-	-	0	-
Grade, %	-	0	-	-	0	-	-	0	-	-	0	-
Peak Hour Factor	85	85	85	85	85	85	85	85	85	85	85	85
Heavy Vehicles, %	2	2	2	2	2	2	2	2	2	2	2	2
Mvmt Flow	29	92	9	1	225	1	26	0	2	4	0	82

Major/Minor	Major1			Major2			Minor1			Minor2		
Conflicting Flow All	226	0	0	101	0	0	419	378	92	384	387	226
Stage 1	-	-	-	-	-	-	150	150	-	228	228	-
Stage 2	-	-	-	-	-	-	269	228	-	156	159	-
Critical Hdwy	4.12	-	-	4.12	-	-	7.12	6.52	6.22	7.12	6.52	6.22
Critical Hdwy Stg 1	-	-	-	-	-	-	6.12	5.52	-	6.12	5.52	-
Critical Hdwy Stg 2	-	-	-	-	-	-	6.12	5.52	-	6.12	5.52	-
Follow-up Hdwy	2.218	-	-	2.218	-	-	3.518	4.018	3.318	3.518	4.018	3.318
Pot Cap-1 Maneuver	1342	-	-	1491	-	-	544	554	965	574	547	813
Stage 1	-	-	-	-	-	-	853	773	-	775	715	-
Stage 2	-	-	-	-	-	-	737	715	-	846	766	-
Platoon blocked, %	-	-	-	-	-	-	-	-	-	-	-	-
Mov Cap-1 Maneuver	1342	-	-	1491	-	-	480	541	965	563	534	813
Mov Cap-2 Maneuver	-	-	-	-	-	-	480	541	-	563	534	-
Stage 1	-	-	-	-	-	-	834	756	-	758	714	-
Stage 2	-	-	-	-	-	-	662	714	-	826	749	-

Approach	EB	WB	NB	SB
HCM Control Delay, s	1.7	0	12.6	10.1
HCM LOS			B	B

Minor Lane/Major Mvmt	NBLn1	EBL	EBT	EBR	WBL	WBT	WBR	SBLn1
Capacity (veh/h)	501	1342	-	-	1491	-	-	798
HCM Lane V/C Ratio	0.056	0.022	-	-	0.001	-	-	0.108
HCM Control Delay (s)	12.6	7.7	-	-	7.4	-	-	10.1
HCM Lane LOS	B	A	-	-	A	-	-	B
HCM 95th %tile Q(veh)	0.2	0.1	-	-	0	-	-	0.4

Intersection						
Int Delay, s/veh	1.7					
Movement	EBL	EBR	NBL	NBT	SBT	SBR
Lane Configurations	Y		Y	↑	↑	
Traffic Vol, veh/h	6	35	12	71	158	2
Future Vol, veh/h	6	35	12	71	158	2
Conflicting Peds, #/hr	0	0	0	0	0	0
Sign Control	Stop	Stop	Free	Free	Free	Free
RT Channelized	-	None	-	None	-	None
Storage Length	0	-	205	-	-	-
Veh in Median Storage, #	0	-	-	0	0	-
Grade, %	0	-	-	0	0	-
Peak Hour Factor	85	85	85	85	85	85
Heavy Vehicles, %	2	2	2	2	2	2
Mvmt Flow	7	41	14	84	186	2

Major/Minor	Minor2	Major1	Major2			
Conflicting Flow All	299	187	188	0	-	0
Stage 1	187	-	-	-	-	-
Stage 2	112	-	-	-	-	-
Critical Hdwy	6.42	6.22	4.12	-	-	-
Critical Hdwy Stg 1	5.42	-	-	-	-	-
Critical Hdwy Stg 2	5.42	-	-	-	-	-
Follow-up Hdwy	3.518	3.318	2.218	-	-	-
Pot Cap-1 Maneuver	692	855	1386	-	-	-
Stage 1	845	-	-	-	-	-
Stage 2	913	-	-	-	-	-
Platoon blocked, %				-	-	-
Mov Cap-1 Maneuver	685	855	1386	-	-	-
Mov Cap-2 Maneuver	709	-	-	-	-	-
Stage 1	837	-	-	-	-	-
Stage 2	913	-	-	-	-	-

Approach	EB	NB	SB
HCM Control Delay, s	9.6	1.1	0
HCM LOS	A		

Minor Lane/Major Mvmt	NBL	NBT	EBLn1	SBT	SBR
Capacity (veh/h)	1386	-	830	-	-
HCM Lane V/C Ratio	0.01	-	0.058	-	-
HCM Control Delay (s)	7.6	-	9.6	-	-
HCM Lane LOS	A	-	A	-	-
HCM 95th %tile Q(veh)	0	-	0.2	-	-

Intersection						
Int Delay, s/veh	3.8					
Movement	EBL	EBR	NBL	NBT	SBT	SBR
Lane Configurations	Y		Y	↑	↑	
Traffic Vol, veh/h	0	75	23	33	97	0
Future Vol, veh/h	0	75	23	33	97	0
Conflicting Peds, #/hr	0	0	0	0	0	0
Sign Control	Stop	Stop	Free	Free	Free	Free
RT Channelized	-	None	-	None	-	None
Storage Length	0	-	200	-	-	-
Veh in Median Storage, #	0	-	-	0	0	-
Grade, %	0	-	-	0	0	-
Peak Hour Factor	85	85	85	85	85	85
Heavy Vehicles, %	2	2	2	2	2	2
Mvmt Flow	0	88	27	39	114	0

Major/Minor	Minor2	Major1	Major2			
Conflicting Flow All	207	114	114	0	-	0
Stage 1	114	-	-	-	-	-
Stage 2	93	-	-	-	-	-
Critical Hdwy	6.42	6.22	4.12	-	-	-
Critical Hdwy Stg 1	5.42	-	-	-	-	-
Critical Hdwy Stg 2	5.42	-	-	-	-	-
Follow-up Hdwy	3.518	3.318	2.218	-	-	-
Pot Cap-1 Maneuver	781	939	1475	-	-	-
Stage 1	911	-	-	-	-	-
Stage 2	931	-	-	-	-	-
Platoon blocked, %				-	-	-
Mov Cap-1 Maneuver	767	939	1475	-	-	-
Mov Cap-2 Maneuver	767	-	-	-	-	-
Stage 1	895	-	-	-	-	-
Stage 2	931	-	-	-	-	-

Approach	EB	NB	SB
HCM Control Delay, s	9.2	3.1	0
HCM LOS	A		

Minor Lane/Major Mvmt	NBL	NBT	EBLn1	SBT	SBR
Capacity (veh/h)	1475	-	939	-	-
HCM Lane V/C Ratio	0.018	-	0.094	-	-
HCM Control Delay (s)	7.5	-	9.2	-	-
HCM Lane LOS	A	-	A	-	-
HCM 95th %tile Q(veh)	0.1	-	0.3	-	-

Intersection						
Int Delay, s/veh	8.3					
Movement	EBL	EBR	NBL	NBT	SBT	SBR
Lane Configurations	Y		Y	↑	↑	
Traffic Vol, veh/h	0	97	33	0	0	0
Future Vol, veh/h	0	97	33	0	0	0
Conflicting Peds, #/hr	0	0	0	0	0	0
Sign Control	Stop	Stop	Free	Free	Free	Free
RT Channelized	-	None	-	None	-	None
Storage Length	0	-	200	-	-	-
Veh in Median Storage, #	0	-	-	0	0	-
Grade, %	0	-	-	0	0	-
Peak Hour Factor	85	85	85	85	85	85
Heavy Vehicles, %	2	2	2	2	2	2
Mvmt Flow	0	114	39	0	0	0

Major/Minor	Minor2	Major1	Major2			
Conflicting Flow All	79	1	1	0	-	0
Stage 1	1	-	-	-	-	-
Stage 2	78	-	-	-	-	-
Critical Hdwy	6.42	6.22	4.12	-	-	-
Critical Hdwy Stg 1	5.42	-	-	-	-	-
Critical Hdwy Stg 2	5.42	-	-	-	-	-
Follow-up Hdwy	3.518	3.318	2.218	-	-	-
Pot Cap-1 Maneuver	924	1084	1622	-	-	-
Stage 1	1022	-	-	-	-	-
Stage 2	945	-	-	-	-	-
Platoon blocked, %				-	-	-
Mov Cap-1 Maneuver	902	1084	1622	-	-	-
Mov Cap-2 Maneuver	902	-	-	-	-	-
Stage 1	997	-	-	-	-	-
Stage 2	945	-	-	-	-	-

Approach	EB	NB	SB
HCM Control Delay, s	8.7	7.3	0
HCM LOS	A		

Minor Lane/Major Mvmt	NBL	NBT	EBLn1	SBT	SBR
Capacity (veh/h)	1622	-	1084	-	-
HCM Lane V/C Ratio	0.024	-	0.105	-	-
HCM Control Delay (s)	7.3	-	8.7	-	-
HCM Lane LOS	A	-	A	-	-
HCM 95th %tile Q(veh)	0.1	-	0.4	-	-

HCM 6th Roundabout
1: Vollmer Rd & Burgess Rd

Short-Term Total Traffic
PM Peak Hour

Intersection				
Intersection Delay, s/veh	7.0			
Intersection LOS	A			
Approach	EB	WB	NB	SB
Entry Lanes	1	1	1	1
Conflicting Circle Lanes	1	1	1	1
Adj Approach Flow, veh/h	399	259	257	263
Demand Flow Rate, veh/h	407	264	263	268
Vehicles Circulating, veh/h	313	196	463	288
Vehicles Exiting, veh/h	243	530	257	172
Ped Vol Crossing Leg, #/h	0	0	0	0
Ped Cap Adj	1.000	1.000	1.000	1.000
Approach Delay, s/veh	8.2	5.4	7.7	6.1
Approach LOS	A	A	A	A
Lane	Left	Left	Left	Left
Designated Moves	LTR	LTR	LTR	LTR
Assumed Moves	LTR	LTR	LTR	LTR
RT Channelized				
Lane Util	1.000	1.000	1.000	1.000
Follow-Up Headway, s	2.609	2.609	2.609	2.609
Critical Headway, s	4.976	4.976	4.976	4.976
Entry Flow, veh/h	407	264	263	268
Cap Entry Lane, veh/h	1003	1130	861	1029
Entry HV Adj Factor	0.980	0.981	0.977	0.981
Flow Entry, veh/h	399	259	257	263
Cap Entry, veh/h	983	1108	841	1009
V/C Ratio	0.406	0.234	0.306	0.261
Control Delay, s/veh	8.2	5.4	7.7	6.1
LOS	A	A	A	A
95th %tile Queue, veh	2	1	1	1

Intersection						
Int Delay, s/veh	3.1					
Movement	WBL	WBR	NBT	NBR	SBL	SBT
Lane Configurations	↘	↗	↕↕	↗	↘	↕↕
Traffic Vol, veh/h	139	32	390	188	51	268
Future Vol, veh/h	139	32	390	188	51	268
Conflicting Peds, #/hr	0	0	0	0	0	0
Sign Control	Stop	Stop	Free	Free	Free	Free
RT Channelized	-	None	-	None	-	None
Storage Length	485	-	-	235	385	-
Veh in Median Storage, #	0	-	0	-	-	0
Grade, %	0	-	0	-	-	0
Peak Hour Factor	85	85	85	85	85	85
Heavy Vehicles, %	2	2	2	2	2	2
Mvmt Flow	164	38	459	221	60	315

Major/Minor	Minor1	Major1	Major2		
Conflicting Flow All	737	230	0	0	680
Stage 1	459	-	-	-	-
Stage 2	278	-	-	-	-
Critical Hdwy	6.84	6.94	-	-	4.14
Critical Hdwy Stg 1	5.84	-	-	-	-
Critical Hdwy Stg 2	5.84	-	-	-	-
Follow-up Hdwy	3.52	3.32	-	-	2.22
Pot Cap-1 Maneuver	354	772	-	-	908
Stage 1	603	-	-	-	-
Stage 2	744	-	-	-	-
Platoon blocked, %			-	-	-
Mov Cap-1 Maneuver	331	772	-	-	908
Mov Cap-2 Maneuver	444	-	-	-	-
Stage 1	603	-	-	-	-
Stage 2	695	-	-	-	-

Approach	WB	NB	SB
HCM Control Delay, s	16.3	0	1.5
HCM LOS	C		

Minor Lane/Major Mvmt	NBT	NBR	WBLn1	WBLn2	SBL	SBT
Capacity (veh/h)	-	-	444	772	908	-
HCM Lane V/C Ratio	-	-	0.368	0.049	0.066	-
HCM Control Delay (s)	-	-	17.8	9.9	9.2	-
HCM Lane LOS	-	-	C	A	A	-
HCM 95th %tile Q(veh)	-	-	1.7	0.2	0.2	-

HCM 6th TWSC
5: Sterling Ranch Rd & Briargate Pkwy

Short-Term Total Traffic
PM Peak Hour

Intersection												
Int Delay, s/veh	8.8											
Movement	EBL	EBT	EBR	WBL	WBT	WBR	NBL	NBT	NBR	SBL	SBT	SBR
Lane Configurations	↘	↑↑	↗	↘	↑↑	↗	↘	↑	↗	↘	↑	↗
Traffic Vol, veh/h	107	0	50	0	0	0	44	80	0	0	53	63
Future Vol, veh/h	107	0	50	0	0	0	44	80	0	0	53	63
Conflicting Peds, #/hr	0	0	0	0	0	0	0	0	0	0	0	0
Sign Control	Free	Free	Free	Free	Free	Free	Stop	Stop	Stop	Stop	Stop	Stop
RT Channelized	-	-	None	-	-	None	-	-	None	-	-	None
Storage Length	535	-	0	310	-	0	410	-	155	235	-	155
Veh in Median Storage, #	-	0	-	-	0	-	-	0	-	-	0	-
Grade, %	-	0	-	-	0	-	-	0	-	-	0	-
Peak Hour Factor	85	85	85	85	85	85	85	85	85	85	85	85
Heavy Vehicles, %	2	2	2	2	2	2	2	2	2	2	2	2
Mvmt Flow	126	0	59	0	0	0	52	94	0	0	62	74

Major/Minor	Major1			Major2			Minor1			Minor2		
Conflicting Flow All	1	0	0	59	0	0	284	253	0	300	312	1
Stage 1	-	-	-	-	-	-	252	252	-	1	1	-
Stage 2	-	-	-	-	-	-	32	1	-	299	311	-
Critical Hdwy	4.14	-	-	4.14	-	-	7.54	6.54	6.94	7.54	6.54	6.94
Critical Hdwy Stg 1	-	-	-	-	-	-	6.54	5.54	-	6.54	5.54	-
Critical Hdwy Stg 2	-	-	-	-	-	-	6.54	5.54	-	6.54	5.54	-
Follow-up Hdwy	2.22	-	-	2.22	-	-	3.52	4.02	3.32	3.52	4.02	3.32
Pot Cap-1 Maneuver	1620	-	-	1543	-	-	646	649	-	630	602	1083
Stage 1	-	-	-	-	-	-	730	697	-	1021	895	-
Stage 2	-	-	-	-	-	-	980	895	-	685	657	-
Platoon blocked, %	-	-	-	-	-	-	-	-	-	-	-	-
Mov Cap-1 Maneuver	1620	-	-	1543	-	-	518	598	-	-	555	1083
Mov Cap-2 Maneuver	-	-	-	-	-	-	518	598	-	-	555	-
Stage 1	-	-	-	-	-	-	673	643	-	941	895	-
Stage 2	-	-	-	-	-	-	849	895	-	539	606	-

Approach	EB			WB			NB			SB		
HCM Control Delay, s	5			0			12.3			10.3		
HCM LOS	B			B			B			B		

Minor Lane/Major Mvmt	NBLn1	NBLn2	NBLn3	EBL	EBT	EBR	WBL	WBT	WBR	SBLn1	SBLn2	SBLn3
Capacity (veh/h)	518	598	-	1620	-	-	1543	-	-	-	555	1083
HCM Lane V/C Ratio	0.1	0.157	-	0.078	-	-	-	-	-	-	0.112	0.068
HCM Control Delay (s)	12.7	12.1	0	7.4	-	-	0	-	-	0	12.3	8.6
HCM Lane LOS	B	B	A	A	-	-	A	-	-	A	B	A
HCM 95th %tile Q(veh)	0.3	0.6	-	0.3	-	-	0	-	-	-	0.4	0.2

Intersection						
Int Delay, s/veh	2.6					
Movement	WBL	WBR	NBT	NBR	SBL	SBT
Lane Configurations	↘	↗	↑	↗	↘	↑
Traffic Vol, veh/h	53	18	105	78	28	76
Future Vol, veh/h	53	18	105	78	28	76
Conflicting Peds, #/hr	0	0	0	0	0	0
Sign Control	Stop	Stop	Free	Free	Free	Free
RT Channelized	-	None	-	None	-	None
Storage Length	0	0	-	205	205	-
Veh in Median Storage, #	0	-	0	-	-	0
Grade, %	0	-	0	-	-	0
Peak Hour Factor	85	85	85	85	85	85
Heavy Vehicles, %	2	2	2	2	2	2
Mvmt Flow	62	21	124	92	33	89

Major/Minor	Minor1	Major1	Major2		
Conflicting Flow All	279	124	0	0	216
Stage 1	124	-	-	-	-
Stage 2	155	-	-	-	-
Critical Hdwy	6.42	6.22	-	-	4.12
Critical Hdwy Stg 1	5.42	-	-	-	-
Critical Hdwy Stg 2	5.42	-	-	-	-
Follow-up Hdwy	3.518	3.318	-	-	2.218
Pot Cap-1 Maneuver	711	927	-	-	1354
Stage 1	902	-	-	-	-
Stage 2	873	-	-	-	-
Platoon blocked, %			-	-	-
Mov Cap-1 Maneuver	694	927	-	-	1354
Mov Cap-2 Maneuver	715	-	-	-	-
Stage 1	902	-	-	-	-
Stage 2	852	-	-	-	-

Approach	WB	NB	SB
HCM Control Delay, s	10.1	0	2.1
HCM LOS	B		

Minor Lane/Major Mvmt	NBT	NBR	WBLn1	WBLn2	SBL	SBT
Capacity (veh/h)	-	-	715	927	1354	-
HCM Lane V/C Ratio	-	-	0.087	0.023	0.024	-
HCM Control Delay (s)	-	-	10.5	9	7.7	-
HCM Lane LOS	-	-	B	A	A	-
HCM 95th %tile Q(veh)	-	-	0.3	0.1	0.1	-

Intersection						
Int Delay, s/veh	6.2					
Movement	WBL	WBR	NBT	NBR	SBL	SBT
Lane Configurations	↘	↗	↑↑	↗	↘	↑↑
Traffic Vol, veh/h	100	128	569	112	94	389
Future Vol, veh/h	100	128	569	112	94	389
Conflicting Peds, #/hr	0	0	0	0	0	0
Sign Control	Stop	Stop	Free	Free	Free	Free
RT Channelized	-	None	-	None	-	None
Storage Length	300	-	-	155	300	-
Veh in Median Storage, #	0	-	0	-	-	0
Grade, %	0	-	0	-	-	0
Peak Hour Factor	85	85	85	85	85	85
Heavy Vehicles, %	2	2	2	2	2	2
Mvmt Flow	118	151	669	132	111	458

Major/Minor	Minor1	Major1	Major2		
Conflicting Flow All	1120	335	0	0	801
Stage 1	669	-	-	-	-
Stage 2	451	-	-	-	-
Critical Hdwy	6.84	6.94	-	-	4.14
Critical Hdwy Stg 1	5.84	-	-	-	-
Critical Hdwy Stg 2	5.84	-	-	-	-
Follow-up Hdwy	3.52	3.32	-	-	2.22
Pot Cap-1 Maneuver	200	661	-	-	818
Stage 1	471	-	-	-	-
Stage 2	609	-	-	-	-
Platoon blocked, %			-	-	-
Mov Cap-1 Maneuver	173	661	-	-	818
Mov Cap-2 Maneuver	173	-	-	-	-
Stage 1	471	-	-	-	-
Stage 2	526	-	-	-	-

Approach	WB	NB	SB
HCM Control Delay, s	33.6	0	2
HCM LOS	D		

Minor Lane/Major Mvmt	NBT	NBR	WBLn1	WBLn2	SBL	SBT
Capacity (veh/h)	-	-	173	661	818	-
HCM Lane V/C Ratio	-	-	0.68	0.228	0.135	-
HCM Control Delay (s)	-	-	61.3	12	10.1	-
HCM Lane LOS	-	-	F	B	B	-
HCM 95th %tile Q(veh)	-	-	4	0.9	0.5	-

Timings
12: Vollmer Rd & Marksheffel Rd

Short-Term Total Traffic
PM Peak Hour

Lane Group	WBL	WBR	NBT	NBR	SBL	SBT
Lane Configurations						
Traffic Volume (vph)	100	128	569	112	94	389
Future Volume (vph)	100	128	569	112	94	389
Turn Type	Prot	Prot	NA	Perm	pm+pt	NA
Protected Phases	1	1	8		7	4
Permitted Phases				8	4	
Detector Phase	1	1	8	8	7	4
Switch Phase						
Minimum Initial (s)	5.0	5.0	10.0	10.0	5.0	10.0
Minimum Split (s)	10.0	10.0	23.0	23.0	10.0	23.0
Total Split (s)	30.0	30.0	48.0	48.0	12.0	60.0
Total Split (%)	33.3%	33.3%	53.3%	53.3%	13.3%	66.7%
Yellow Time (s)	3.0	3.0	3.0	3.0	3.0	3.0
All-Red Time (s)	2.0	2.0	2.0	2.0	2.0	2.0
Lost Time Adjust (s)	0.0	0.0	0.0	0.0	0.0	0.0
Total Lost Time (s)	5.0	5.0	5.0	5.0	5.0	5.0
Lead/Lag			Lag	Lag	Lead	
Lead-Lag Optimize?			Yes	Yes	Yes	
Recall Mode	None	None	None	None	None	None
Act Effct Green (s)	9.8	9.8	20.4	20.4	25.9	28.7
Actuated g/C Ratio	0.23	0.23	0.48	0.48	0.61	0.68
v/c Ratio	0.29	0.31	0.39	0.16	0.20	0.19
Control Delay	20.0	6.3	12.2	3.3	5.2	4.4
Queue Delay	0.0	0.0	0.0	0.0	0.0	0.0
Total Delay	20.0	6.3	12.2	3.3	5.2	4.4
LOS	B	A	B	A	A	A
Approach Delay	12.3		10.8			4.6
Approach LOS	B		B			A

Intersection Summary

Cycle Length: 90	
Actuated Cycle Length: 42.2	
Natural Cycle: 45	
Control Type: Actuated-Uncoordinated	
Maximum v/c Ratio: 0.39	
Intersection Signal Delay: 8.9	Intersection LOS: A
Intersection Capacity Utilization 39.0%	ICU Level of Service A
Analysis Period (min) 15	

Splits and Phases: 12: Vollmer Rd & Marksheffel Rd

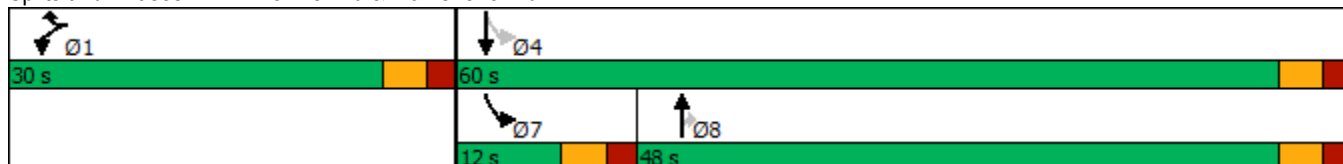

Intersection						
Int Delay, s/veh	31.7					
Movement	EBL	EBT	WBT	WBR	SBL	SBR
Lane Configurations	↘	↑↑	↑↑	↗	↘	↗
Traffic Vol, veh/h	132	74	120	619	383	108
Future Vol, veh/h	132	74	120	619	383	108
Conflicting Peds, #/hr	0	0	0	0	0	0
Sign Control	Free	Free	Free	Free	Stop	Stop
RT Channelized	-	None	-	None	-	None
Storage Length	300	-	-	205	155	0
Veh in Median Storage, #	-	0	0	-	0	-
Grade, %	-	0	0	-	0	-
Peak Hour Factor	85	85	85	85	85	85
Heavy Vehicles, %	2	2	2	2	2	2
Mvmt Flow	155	87	141	728	451	127

Major/Minor	Major1	Major2	Minor2		
Conflicting Flow All	869	0	-	0	495 71
Stage 1	-	-	-	-	141 -
Stage 2	-	-	-	-	354 -
Critical Hdwy	4.14	-	-	-	6.84 6.94
Critical Hdwy Stg 1	-	-	-	-	5.84 -
Critical Hdwy Stg 2	-	-	-	-	5.84 -
Follow-up Hdwy	2.22	-	-	-	3.52 3.32
Pot Cap-1 Maneuver	771	-	-	-	504 977
Stage 1	-	-	-	-	871 -
Stage 2	-	-	-	-	681 -
Platoon blocked, %		-	-	-	
Mov Cap-1 Maneuver	771	-	-	-	~ 403 977
Mov Cap-2 Maneuver	-	-	-	-	~ 403 -
Stage 1	-	-	-	-	696 -
Stage 2	-	-	-	-	681 -

Approach	EB	WB	SB
HCM Control Delay, s	6.9	0	89.9
HCM LOS			F

Minor Lane/Major Mvmt	EBL	EBT	WBT	WBR	SBLn1	SBLn2
Capacity (veh/h)	771	-	-	-	403	977
HCM Lane V/C Ratio	0.201	-	-	-	1.118	0.13
HCM Control Delay (s)	10.8	-	-	-	112.6	9.2
HCM Lane LOS	B	-	-	-	F	A
HCM 95th %tile Q(veh)	0.7	-	-	-	16.3	0.4

Notes
 ~: Volume exceeds capacity \$: Delay exceeds 300s +: Computation Not Defined *: All major volume in platoon

Timings
13: Marksheffel Rd & Sterling Ranch Rd

Short-Term Total Traffic
PM Peak Hour



Lane Group	EBL	EBT	WBT	WBR	SBL	SBR
Lane Configurations	↖	↕↕	↕↕	↗	↖↗	↗
Traffic Volume (vph)	132	74	120	619	383	108
Future Volume (vph)	132	74	120	619	383	108
Turn Type	pm+pt	NA	NA	Perm	Prot	Perm
Protected Phases	5	2	6		7	
Permitted Phases	2			6		4
Detector Phase	5	2	6	6	7	4
Switch Phase						
Minimum Initial (s)	5.0	15.0	15.0	15.0	20.0	10.0
Minimum Split (s)	10.0	20.0	20.0	20.0	25.0	20.0
Total Split (s)	12.0	60.0	48.0	48.0	30.0	30.0
Total Split (%)	13.3%	66.7%	53.3%	53.3%	33.3%	33.3%
Yellow Time (s)	3.0	3.0	3.0	3.0	3.0	3.0
All-Red Time (s)	2.0	2.0	2.0	2.0	2.0	2.0
Lost Time Adjust (s)	0.0	0.0	0.0	0.0	0.0	0.0
Total Lost Time (s)	5.0	5.0	5.0	5.0	5.0	5.0
Lead/Lag	Lead		Lag	Lag		
Lead-Lag Optimize?	Yes		Yes	Yes		
Recall Mode	None	C-Max	C-Max	C-Max	None	None
Act Effct Green (s)	59.7	59.7	46.3	46.3	20.3	20.3
Actuated g/C Ratio	0.66	0.66	0.51	0.51	0.23	0.23
v/c Ratio	0.19	0.04	0.08	0.62	0.58	0.28
Control Delay	6.3	5.4	11.7	3.8	34.5	7.1
Queue Delay	0.0	0.0	0.0	0.0	0.0	0.0
Total Delay	6.3	5.4	11.7	3.8	34.5	7.1
LOS	A	A	B	A	C	A
Approach Delay		6.0	5.1		28.5	
Approach LOS		A	A		C	

Intersection Summary

Cycle Length: 90
 Actuated Cycle Length: 90
 Offset: 0 (0%), Referenced to phase 2:EBTL and 6:WBT, Start of Green
 Natural Cycle: 60
 Control Type: Actuated-Coordinated
 Maximum v/c Ratio: 0.62
 Intersection Signal Delay: 13.2
 Intersection LOS: B
 Intersection Capacity Utilization 54.0%
 ICU Level of Service A
 Analysis Period (min) 15

Splits and Phases: 13: Marksheffel Rd & Sterling Ranch Rd

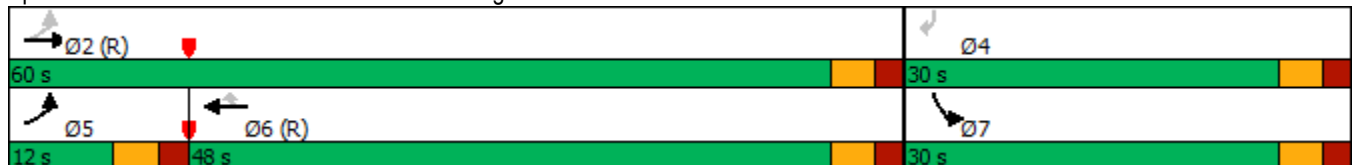

Intersection						
Int Delay, s/veh	2.3					
Movement	EBL	EBT	WBT	WBR	SBL	SBR
Lane Configurations	↘	↑↑	↑↑	↗		↗
Traffic Vol, veh/h	68	157	95	12	0	40
Future Vol, veh/h	68	157	95	12	0	40
Conflicting Peds, #/hr	0	0	0	0	0	0
Sign Control	Free	Free	Free	Free	Stop	Stop
RT Channelized	-	None	-	None	-	None
Storage Length	285	-	-	235	-	0
Veh in Median Storage, #	-	0	0	-	0	-
Grade, %	-	0	0	-	0	-
Peak Hour Factor	85	85	85	85	85	85
Heavy Vehicles, %	2	2	2	2	2	2
Mvmt Flow	80	185	112	14	0	47

Major/Minor	Major1	Major2	Minor2		
Conflicting Flow All	126	0	-	0	- 56
Stage 1	-	-	-	-	-
Stage 2	-	-	-	-	-
Critical Hdwy	4.14	-	-	-	- 6.94
Critical Hdwy Stg 1	-	-	-	-	-
Critical Hdwy Stg 2	-	-	-	-	-
Follow-up Hdwy	2.22	-	-	-	- 3.32
Pot Cap-1 Maneuver	1458	-	-	-	0 999
Stage 1	-	-	-	-	0 -
Stage 2	-	-	-	-	0 -
Platoon blocked, %		-	-	-	
Mov Cap-1 Maneuver	1458	-	-	-	- 999
Mov Cap-2 Maneuver	-	-	-	-	-
Stage 1	-	-	-	-	-
Stage 2	-	-	-	-	-

Approach	EB	WB	SB
HCM Control Delay, s	2.3	0	8.8
HCM LOS			A

Minor Lane/Major Mvmt	EBL	EBT	WBT	WBR	SBLn1
Capacity (veh/h)	1458	-	-	-	999
HCM Lane V/C Ratio	0.055	-	-	-	0.047
HCM Control Delay (s)	7.6	-	-	-	8.8
HCM Lane LOS	A	-	-	-	A
HCM 95th %tile Q(veh)	0.2	-	-	-	0.1

Intersection						
Int Delay, s/veh	0.3					
Movement	EBT	EBR	WBL	WBT	NBL	NBR
Lane Configurations	↑	↗	↖	↑	↘	↙
Traffic Vol, veh/h	407	26	2	245	15	1
Future Vol, veh/h	407	26	2	245	15	1
Conflicting Peds, #/hr	0	0	0	0	0	0
Sign Control	Free	Free	Free	Free	Stop	Stop
RT Channelized	-	None	-	None	-	None
Storage Length	-	155	205	-	0	-
Veh in Median Storage, #	0	-	-	0	0	-
Grade, %	0	-	-	0	0	-
Peak Hour Factor	85	85	85	85	85	85
Heavy Vehicles, %	2	2	2	2	2	2
Mvmt Flow	479	31	2	288	18	1

Major/Minor	Major1	Major2	Minor1		
Conflicting Flow All	0	0	510	0	771 479
Stage 1	-	-	-	-	479 -
Stage 2	-	-	-	-	292 -
Critical Hdwy	-	-	4.12	-	6.42 6.22
Critical Hdwy Stg 1	-	-	-	-	5.42 -
Critical Hdwy Stg 2	-	-	-	-	5.42 -
Follow-up Hdwy	-	-	2.218	-	3.518 3.318
Pot Cap-1 Maneuver	-	-	1055	-	368 587
Stage 1	-	-	-	-	623 -
Stage 2	-	-	-	-	758 -
Platoon blocked, %	-	-	-	-	-
Mov Cap-1 Maneuver	-	-	1055	-	367 587
Mov Cap-2 Maneuver	-	-	-	-	476 -
Stage 1	-	-	-	-	623 -
Stage 2	-	-	-	-	756 -

Approach	EB	WB	NB
HCM Control Delay, s	0	0.1	12.8
HCM LOS			B

Minor Lane/Major Mvmt	NBLn1	EBT	EBR	WBL	WBT
Capacity (veh/h)	482	-	-	1055	-
HCM Lane V/C Ratio	0.039	-	-	0.002	-
HCM Control Delay (s)	12.8	-	-	8.4	-
HCM Lane LOS	B	-	-	A	-
HCM 95th %tile Q(veh)	0.1	-	-	0	-

Intersection												
Int Delay, s/veh	1.8											
Movement	EBL	EBT	EBR	WBL	WBT	WBR	NBL	NBT	NBR	SBL	SBT	SBR
Lane Configurations	↖	↗		↖	↗			↕			↕	
Traffic Vol, veh/h	40	317	51	4	194	3	30	0	3	2	0	23
Future Vol, veh/h	40	317	51	4	194	3	30	0	3	2	0	23
Conflicting Peds, #/hr	0	0	0	0	0	0	0	0	0	0	0	0
Sign Control	Free	Free	Free	Free	Free	Free	Stop	Stop	Stop	Stop	Stop	Stop
RT Channelized	-	-	None	-	-	None	-	-	None	-	-	None
Storage Length	205	-	-	205	-	-	-	-	-	-	-	-
Veh in Median Storage, #	-	0	-	-	0	-	-	0	-	-	0	-
Grade, %	-	0	-	-	0	-	-	0	-	-	0	-
Peak Hour Factor	85	85	85	85	85	85	85	85	85	85	85	85
Heavy Vehicles, %	2	2	2	2	2	2	2	2	2	2	2	2
Mvmt Flow	47	373	60	5	228	4	35	0	4	2	0	27

Major/Minor	Major1			Major2			Minor1			Minor2		
Conflicting Flow All	232	0	0	433	0	0	751	739	403	739	767	230
Stage 1	-	-	-	-	-	-	497	497	-	240	240	-
Stage 2	-	-	-	-	-	-	254	242	-	499	527	-
Critical Hdwy	4.12	-	-	4.12	-	-	7.12	6.52	6.22	7.12	6.52	6.22
Critical Hdwy Stg 1	-	-	-	-	-	-	6.12	5.52	-	6.12	5.52	-
Critical Hdwy Stg 2	-	-	-	-	-	-	6.12	5.52	-	6.12	5.52	-
Follow-up Hdwy	2.218	-	-	2.218	-	-	3.518	4.018	3.318	3.518	4.018	3.318
Pot Cap-1 Maneuver	1336	-	-	1127	-	-	327	345	647	333	332	809
Stage 1	-	-	-	-	-	-	555	545	-	763	707	-
Stage 2	-	-	-	-	-	-	750	705	-	554	528	-
Platoon blocked, %	-	-	-	-	-	-	-	-	-	-	-	-
Mov Cap-1 Maneuver	1336	-	-	1127	-	-	306	332	647	321	319	809
Mov Cap-2 Maneuver	-	-	-	-	-	-	306	332	-	321	319	-
Stage 1	-	-	-	-	-	-	536	526	-	736	704	-
Stage 2	-	-	-	-	-	-	722	702	-	532	510	-

Approach	EB			WB			NB			SB		
HCM Control Delay, s	0.8			0.2			17.8			10.2		
HCM LOS							C			B		

Minor Lane/Major Mvmt	NBLn1	EBL	EBT	EBR	WBL	WBT	WBR	SBLn1
Capacity (veh/h)	321	1336	-	-	1127	-	-	721
HCM Lane V/C Ratio	0.121	0.035	-	-	0.004	-	-	0.041
HCM Control Delay (s)	17.8	7.8	-	-	8.2	-	-	10.2
HCM Lane LOS	C	A	-	-	A	-	-	B
HCM 95th %tile Q(veh)	0.4	0.1	-	-	0	-	-	0.1

Intersection												
Int Delay, s/veh	2.5											
Movement	EBL	EBT	EBR	WBL	WBT	WBR	NBL	NBT	NBR	SBL	SBT	SBR
Lane Configurations	↙	↑	↗	↙	↗			↕			↕	
Traffic Vol, veh/h	80	216	26	2	140	3	15	0	1	2	0	47
Future Vol, veh/h	80	216	26	2	140	3	15	0	1	2	0	47
Conflicting Peds, #/hr	0	0	0	0	0	0	0	0	0	0	0	0
Sign Control	Free	Free	Free	Free	Free	Free	Stop	Stop	Stop	Stop	Stop	Stop
RT Channelized	-	-	None	-	-	None	-	-	None	-	-	None
Storage Length	305	-	255	305	-	-	-	-	-	-	-	-
Veh in Median Storage, #	-	0	-	-	0	-	-	0	-	-	0	-
Grade, %	-	0	-	-	0	-	-	0	-	-	0	-
Peak Hour Factor	85	85	85	85	85	85	85	85	85	85	85	85
Heavy Vehicles, %	2	2	2	2	2	2	2	2	2	2	2	2
Mvmt Flow	94	254	31	2	165	4	18	0	1	2	0	55

Major/Minor	Major1			Major2			Minor1			Minor2		
Conflicting Flow All	169	0	0	285	0	0	641	615	254	629	644	167
Stage 1	-	-	-	-	-	-	442	442	-	171	171	-
Stage 2	-	-	-	-	-	-	199	173	-	458	473	-
Critical Hdwy	4.12	-	-	4.12	-	-	7.12	6.52	6.22	7.12	6.52	6.22
Critical Hdwy Stg 1	-	-	-	-	-	-	6.12	5.52	-	6.12	5.52	-
Critical Hdwy Stg 2	-	-	-	-	-	-	6.12	5.52	-	6.12	5.52	-
Follow-up Hdwy	2.218	-	-	2.218	-	-	3.518	4.018	3.318	3.518	4.018	3.318
Pot Cap-1 Maneuver	1409	-	-	1277	-	-	388	407	785	395	391	877
Stage 1	-	-	-	-	-	-	594	576	-	831	757	-
Stage 2	-	-	-	-	-	-	803	756	-	583	558	-
Platoon blocked, %	-	-	-	-	-	-	-	-	-	-	-	-
Mov Cap-1 Maneuver	1409	-	-	1277	-	-	345	379	785	374	364	877
Mov Cap-2 Maneuver	-	-	-	-	-	-	345	379	-	374	364	-
Stage 1	-	-	-	-	-	-	554	537	-	775	755	-
Stage 2	-	-	-	-	-	-	751	754	-	543	521	-

Approach	EB			WB			NB			SB		
HCM Control Delay, s	1.9			0.1			15.6			9.7		
HCM LOS							C			A		

Minor Lane/Major Mvmt	NBLn1	EBL	EBT	EBR	WBL	WBT	WBR	SBLn1
Capacity (veh/h)	358	1409	-	-	1277	-	-	831
HCM Lane V/C Ratio	0.053	0.067	-	-	0.002	-	-	0.069
HCM Control Delay (s)	15.6	7.7	-	-	7.8	-	-	9.7
HCM Lane LOS	C	A	-	-	A	-	-	A
HCM 95th %tile Q(veh)	0.2	0.2	-	-	0	-	-	0.2

Intersection						
Int Delay, s/veh	1.5					
Movement	EBL	EBR	NBL	NBT	SBT	SBR
Lane Configurations	↔		↔	↑	↑	
Traffic Vol, veh/h	4	23	40	179	122	7
Future Vol, veh/h	4	23	40	179	122	7
Conflicting Peds, #/hr	0	0	0	0	0	0
Sign Control	Stop	Stop	Free	Free	Free	Free
RT Channelized	-	None	-	None	-	None
Storage Length	0	-	205	-	-	-
Veh in Median Storage, #	0	-	-	0	0	-
Grade, %	0	-	-	0	0	-
Peak Hour Factor	85	85	85	85	85	85
Heavy Vehicles, %	2	2	2	2	2	2
Mvmt Flow	5	27	47	211	144	8

Major/Minor	Minor2	Major1	Major2			
Conflicting Flow All	453	148	152	0	-	0
Stage 1	148	-	-	-	-	-
Stage 2	305	-	-	-	-	-
Critical Hdwy	6.42	6.22	4.12	-	-	-
Critical Hdwy Stg 1	5.42	-	-	-	-	-
Critical Hdwy Stg 2	5.42	-	-	-	-	-
Follow-up Hdwy	3.518	3.318	2.218	-	-	-
Pot Cap-1 Maneuver	565	899	1429	-	-	-
Stage 1	880	-	-	-	-	-
Stage 2	748	-	-	-	-	-
Platoon blocked, %				-	-	-
Mov Cap-1 Maneuver	546	899	1429	-	-	-
Mov Cap-2 Maneuver	609	-	-	-	-	-
Stage 1	851	-	-	-	-	-
Stage 2	748	-	-	-	-	-

Approach	EB	NB	SB
HCM Control Delay, s	9.5	1.4	0
HCM LOS	A		

Minor Lane/Major Mvmt	NBL	NBT	EBLn1	SBT	SBR
Capacity (veh/h)	1429	-	840	-	-
HCM Lane V/C Ratio	0.033	-	0.038	-	-
HCM Control Delay (s)	7.6	-	9.5	-	-
HCM Lane LOS	A	-	A	-	-
HCM 95th %tile Q(veh)	0.1	-	0.1	-	-

Intersection						
Int Delay, s/veh	3.3					
Movement	EBL	EBR	NBL	NBT	SBT	SBR
Lane Configurations	Y		Y	↑	↑	
Traffic Vol, veh/h	0	51	74	112	66	0
Future Vol, veh/h	0	51	74	112	66	0
Conflicting Peds, #/hr	0	0	0	0	0	0
Sign Control	Stop	Stop	Free	Free	Free	Free
RT Channelized	-	None	-	None	-	None
Storage Length	0	-	200	-	-	-
Veh in Median Storage, #	0	-	-	0	0	-
Grade, %	0	-	-	0	0	-
Peak Hour Factor	85	85	85	85	85	85
Heavy Vehicles, %	2	2	2	2	2	2
Mvmt Flow	0	60	87	132	78	0

Major/Minor	Minor2	Major1		Major2	
Conflicting Flow All	384	78	78	0	0
Stage 1	78	-	-	-	-
Stage 2	306	-	-	-	-
Critical Hdwy	6.42	6.22	4.12	-	-
Critical Hdwy Stg 1	5.42	-	-	-	-
Critical Hdwy Stg 2	5.42	-	-	-	-
Follow-up Hdwy	3.518	3.318	2.218	-	-
Pot Cap-1 Maneuver	619	983	1520	-	-
Stage 1	945	-	-	-	-
Stage 2	747	-	-	-	-
Platoon blocked, %				-	-
Mov Cap-1 Maneuver	584	983	1520	-	-
Mov Cap-2 Maneuver	584	-	-	-	-
Stage 1	891	-	-	-	-
Stage 2	747	-	-	-	-

Approach	EB	NB	SB
HCM Control Delay, s	8.9	3	0
HCM LOS	A		

Minor Lane/Major Mvmt	NBL	NBT	EBLn1	SBT	SBR
Capacity (veh/h)	1520	-	983	-	-
HCM Lane V/C Ratio	0.057	-	0.061	-	-
HCM Control Delay (s)	7.5	-	8.9	-	-
HCM Lane LOS	A	-	A	-	-
HCM 95th %tile Q(veh)	0.2	-	0.2	-	-

Intersection						
Int Delay, s/veh	7.8					
Movement	EBL	EBR	NBL	NBT	SBT	SBR
Lane Configurations						
Traffic Vol, veh/h	0	66	112	0	0	0
Future Vol, veh/h	0	66	112	0	0	0
Conflicting Peds, #/hr	0	0	0	0	0	0
Sign Control	Stop	Stop	Free	Free	Free	Free
RT Channelized	-	None	-	None	-	None
Storage Length	0	-	200	-	-	-
Veh in Median Storage, #	0	-	-	0	0	-
Grade, %	0	-	-	0	0	-
Peak Hour Factor	85	85	85	85	85	85
Heavy Vehicles, %	2	2	2	2	2	2
Mvmt Flow	0	78	132	0	0	0

Major/Minor	Minor2	Major1		Major2	
Conflicting Flow All	265	1	1	0	0
Stage 1	1	-	-	-	-
Stage 2	264	-	-	-	-
Critical Hdwy	6.42	6.22	4.12	-	-
Critical Hdwy Stg 1	5.42	-	-	-	-
Critical Hdwy Stg 2	5.42	-	-	-	-
Follow-up Hdwy	3.518	3.318	2.218	-	-
Pot Cap-1 Maneuver	724	1084	1622	-	-
Stage 1	1022	-	-	-	-
Stage 2	780	-	-	-	-
Platoon blocked, %				-	-
Mov Cap-1 Maneuver	665	1084	1622	-	-
Mov Cap-2 Maneuver	665	-	-	-	-
Stage 1	939	-	-	-	-
Stage 2	780	-	-	-	-

Approach	EB	NB	SB
HCM Control Delay, s	8.6	7.4	0
HCM LOS	A		

Minor Lane/Major Mvmt	NBL	NBT	EBLn1	SBT	SBR
Capacity (veh/h)	1622	-	1084	-	-
HCM Lane V/C Ratio	0.081	-	0.072	-	-
HCM Control Delay (s)	7.4	-	8.6	-	-
HCM Lane LOS	A	-	A	-	-
HCM 95th %tile Q(veh)	0.3	-	0.2	-	-

Intersection					
Intersection Delay, s/veh	8.6				
Intersection LOS	A				
Approach	EB	WB	NB	SB	
Entry Lanes	1	1	1	1	
Conflicting Circle Lanes	1	1	1	1	
Adj Approach Flow, veh/h	130	600	346	301	
Demand Flow Rate, veh/h	132	612	353	307	
Vehicles Circulating, veh/h	423	282	120	536	
Vehicles Exiting, veh/h	420	116	435	358	
Ped Vol Crossing Leg, #/h	0	0	0	0	
Ped Cap Adj	1.000	1.000	1.000	1.000	
Approach Delay, s/veh	5.5	11.5	4.0	9.4	
Approach LOS	A	B	A	A	
Lane	Left	Left	Left	Bypass	Left
Designated Moves	LTR	LTR	LT	R	LTR
Assumed Moves	LTR	LTR	LT	R	LTR
RT Channelized				Free	
Lane Util	1.000	1.000	1.000		1.000
Follow-Up Headway, s	2.609	2.609	2.609		2.609
Critical Headway, s	4.976	4.976	4.976	75	4.976
Entry Flow, veh/h	132	612	278	1938	307
Cap Entry Lane, veh/h	896	1035	1221	0.980	799
Entry HV Adj Factor	0.982	0.980	0.980	74	0.981
Flow Entry, veh/h	130	600	272	1900	301
Cap Entry, veh/h	880	1015	1196	0.039	784
V/C Ratio	0.147	0.591	0.228	0.0	0.384
Control Delay, s/veh	5.5	11.5	5.0	A	9.4
LOS	A	B	A	0	A
95th %tile Queue, veh	1	4	1		2

Timings
4: Vollmer Rd & Briargate Pkwy

2042 Background Traffic
AM Peak Hour

Lane Group	EBL	EBT	EBR	WBL	WBT	WBR	NBL	NBT	NBR	SBL	SBT	SBR
Lane Configurations												
Traffic Volume (vph)	69	494	56	215	915	66	158	132	93	84	305	138
Future Volume (vph)	69	494	56	215	915	66	158	132	93	84	305	138
Turn Type	pm+pt	NA	Perm	Prot	NA	Perm	pm+pt	NA	Perm	pm+pt	NA	Perm
Protected Phases	5	2		1	6		3	8		7	4	
Permitted Phases	2		2			6	8		8	4		4
Detector Phase	5	2	2	1	6	6	3	8	8	7	4	4
Switch Phase												
Minimum Initial (s)	5.0	15.0	15.0	15.0	15.0	15.0	5.0	5.0	5.0	5.0	5.0	5.0
Minimum Split (s)	10.0	20.0	20.0	20.0	20.0	20.0	10.0	10.0	10.0	10.0	10.0	10.0
Total Split (s)	12.0	57.0	57.0	20.0	65.0	65.0	17.0	28.0	28.0	15.0	26.0	26.0
Total Split (%)	10.0%	47.5%	47.5%	16.7%	54.2%	54.2%	14.2%	23.3%	23.3%	12.5%	21.7%	21.7%
Yellow Time (s)	3.0	3.0	3.0	3.0	3.0	3.0	3.0	3.0	3.0	3.0	3.0	3.0
All-Red Time (s)	2.0	2.0	2.0	2.0	2.0	2.0	2.0	2.0	2.0	2.0	2.0	2.0
Lost Time Adjust (s)	0.0	0.0	0.0	0.0	0.0	0.0	0.0	0.0	0.0	0.0	0.0	0.0
Total Lost Time (s)	5.0	5.0	5.0	5.0	5.0	5.0	5.0	5.0	5.0	5.0	5.0	5.0
Lead/Lag	Lead	Lag	Lag	Lead	Lag	Lag	Lead	Lag	Lag	Lead	Lag	Lag
Lead-Lag Optimize?	Yes	Yes	Yes	Yes	Yes	Yes	Yes	Yes	Yes	Yes	Yes	Yes
Recall Mode	None	Max	Max	None	Max	Max	None	None	None	None	None	None
Act Effct Green (s)	58.7	52.1	52.1	15.0	62.7	62.7	30.3	20.8	20.8	24.8	15.9	15.9
Actuated g/C Ratio	0.51	0.46	0.46	0.13	0.55	0.55	0.26	0.18	0.18	0.22	0.14	0.14
v/c Ratio	0.23	0.31	0.07	0.50	0.50	0.08	0.61	0.21	0.24	0.28	0.65	0.41
Control Delay	11.7	21.0	0.2	51.3	18.4	1.0	42.7	41.9	2.4	33.3	53.3	9.5
Queue Delay	0.0	0.0	0.0	0.0	0.0	0.0	0.0	0.0	0.0	0.0	0.0	0.0
Total Delay	11.7	21.0	0.2	51.3	18.4	1.0	42.7	41.9	2.4	33.3	53.3	9.5
LOS	B	C	A	D	B	A	D	D	A	C	D	A
Approach Delay		18.0			23.4			32.5			38.6	
Approach LOS		B			C			C			D	

Intersection Summary

Cycle Length: 120
 Actuated Cycle Length: 114.4
 Natural Cycle: 60
 Control Type: Actuated-Uncoordinated
 Maximum v/c Ratio: 0.65
 Intersection Signal Delay: 26.4
 Intersection LOS: C
 Intersection Capacity Utilization 63.3%
 ICU Level of Service B
 Analysis Period (min) 15

Splits and Phases: 4: Vollmer Rd & Briargate Pkwy



Timings

5: Sterling Ranch Rd & Briargate Pkwy

2042 Background Traffic
AM Peak Hour

Lane Group	EBL	EBT	EBR	WBL	WBT	WBR	NBL	NBT	NBR	SBL	SBT	SBR
Lane Configurations												
Traffic Volume (vph)	64	617	26	28	936	12	141	44	24	58	95	118
Future Volume (vph)	64	617	26	28	936	12	141	44	24	58	95	118
Turn Type	pm+pt	NA	Perm	pm+pt	NA	Perm	pm+pt	NA	Free	pm+pt	NA	Free
Protected Phases	5	2		1	6		3	8		7	4	
Permitted Phases	2		2	6		6	8		Free	4		Free
Detector Phase	5	2	2	1	6	6	3	8		7	4	
Switch Phase												
Minimum Initial (s)	5.0	5.0	5.0	5.0	5.0	5.0	5.0	20.0		5.0	20.0	
Minimum Split (s)	10.0	10.0	10.0	10.0	10.0	10.0	10.0	25.0		10.0	25.0	
Total Split (s)	12.0	56.0	56.0	12.0	56.0	56.0	20.0	32.0		20.0	32.0	
Total Split (%)	10.0%	46.7%	46.7%	10.0%	46.7%	46.7%	16.7%	26.7%		16.7%	26.7%	
Yellow Time (s)	3.0	3.0	3.0	3.0	3.0	3.0	3.0	3.0		3.0	3.0	
All-Red Time (s)	2.0	2.0	2.0	2.0	2.0	2.0	2.0	2.0		2.0	2.0	
Lost Time Adjust (s)	0.0	0.0	0.0	0.0	0.0	0.0	0.0	0.0		0.0	0.0	
Total Lost Time (s)	5.0	5.0	5.0	5.0	5.0	5.0	5.0	5.0		5.0	5.0	
Lead/Lag	Lead	Lag	Lag	Lead	Lag	Lag	Lead	Lag		Lead	Lag	
Lead-Lag Optimize?	Yes	Yes	Yes	Yes	Yes	Yes	Yes	Yes		Yes	Yes	
Recall Mode	None	C-Max	C-Max	None	C-Max	C-Max	None	Max		None	Max	
Act Effct Green (s)	60.1	55.9	55.9	58.7	53.4	53.4	46.3	36.0	120.0	38.2	30.1	120.0
Actuated g/C Ratio	0.50	0.47	0.47	0.49	0.44	0.44	0.39	0.30	1.00	0.32	0.25	1.00
v/c Ratio	0.29	0.39	0.03	0.08	0.63	0.02	0.30	0.08	0.02	0.13	0.21	0.08
Control Delay	17.6	22.7	0.1	4.4	16.3	0.0	26.2	33.2	0.0	24.3	38.1	0.1
Queue Delay	0.0	0.0	0.0	0.0	0.0	0.0	0.0	0.0	0.0	0.0	0.0	0.0
Total Delay	17.6	22.7	0.1	4.4	16.3	0.0	26.2	33.2	0.0	24.3	38.1	0.1
LOS	B	C	A	A	B	A	C	C	A	C	D	A
Approach Delay		21.4			15.8			24.7			18.6	
Approach LOS		C			B			C			B	

Intersection Summary

Cycle Length: 120
 Actuated Cycle Length: 120
 Offset: 63 (53%), Referenced to phase 2:EBTL and 6:WBTL, Start of Green
 Natural Cycle: 70
 Control Type: Actuated-Coordinated
 Maximum v/c Ratio: 0.63
 Intersection Signal Delay: 18.8 Intersection LOS: B
 Intersection Capacity Utilization 59.2% ICU Level of Service B
 Analysis Period (min) 15

Splits and Phases: 5: Sterling Ranch Rd & Briargate Pkwy

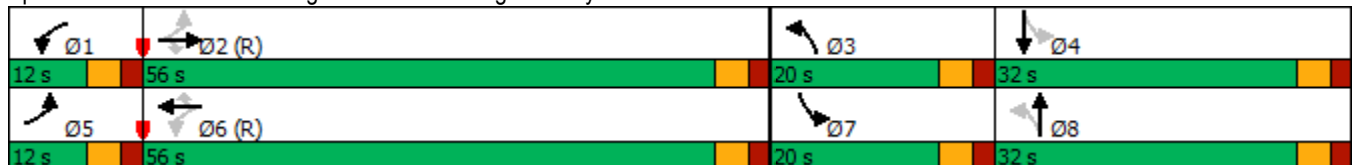

Intersection						
Int Delay, s/veh	5.7					
Movement	WBL	WBR	NBT	NBR	SBL	SBT
Lane Configurations	↘	↗	↑	↗	↘	↑
Traffic Vol, veh/h	142	138	72	85	55	94
Future Vol, veh/h	142	138	72	85	55	94
Conflicting Peds, #/hr	0	0	0	0	0	0
Sign Control	Stop	Stop	Free	Free	Free	Free
RT Channelized	-	None	-	None	-	None
Storage Length	0	0	-	205	205	-
Veh in Median Storage, #	0	-	0	-	-	0
Grade, %	0	-	0	-	-	0
Peak Hour Factor	95	95	95	95	95	95
Heavy Vehicles, %	2	2	2	2	2	2
Mvmt Flow	149	145	76	89	58	99

Major/Minor	Minor1	Major1	Major2		
Conflicting Flow All	291	76	0	0	165
Stage 1	76	-	-	-	-
Stage 2	215	-	-	-	-
Critical Hdwy	6.42	6.22	-	-	4.12
Critical Hdwy Stg 1	5.42	-	-	-	-
Critical Hdwy Stg 2	5.42	-	-	-	-
Follow-up Hdwy	3.518	3.318	-	-	2.218
Pot Cap-1 Maneuver	700	985	-	-	1413
Stage 1	947	-	-	-	-
Stage 2	821	-	-	-	-
Platoon blocked, %			-	-	-
Mov Cap-1 Maneuver	671	985	-	-	1413
Mov Cap-2 Maneuver	687	-	-	-	-
Stage 1	947	-	-	-	-
Stage 2	787	-	-	-	-

Approach	WB	NB	SB
HCM Control Delay, s	10.5	0	2.8
HCM LOS	B		

Minor Lane/Major Mvmt	NBT	NBRWBLn1	WBLn2	SBL	SBT
Capacity (veh/h)	-	-	687	985	1413
HCM Lane V/C Ratio	-	-	0.218	0.147	0.041
HCM Control Delay (s)	-	-	11.7	9.3	7.7
HCM Lane LOS	-	-	B	A	A
HCM 95th %tile Q(veh)	-	-	0.8	0.5	0.1

Timings
12: Vollmer Rd & Marksheffel Rd

2042 Background Traffic
AM Peak Hour

Lane Group	EBL	EBT	EBR	WBL	WBT	WBR	NBL	NBT	NBR	SBL	SBT	SBR
Lane Configurations												
Traffic Volume (vph)	69	806	42	108	861	70	115	228	63	120	492	130
Future Volume (vph)	69	806	42	108	861	70	115	228	63	120	492	130
Turn Type	pm+pt	NA	Perm	pm+pt	NA	Perm	pm+pt	NA	Perm	pm+pt	NA	Perm
Protected Phases	5	2		1	6		3	8		7	4	
Permitted Phases	2		2	6		6	8		8	4		4
Detector Phase	5	2	2	1	6	6	3	8	8	7	4	4
Switch Phase												
Minimum Initial (s)	5.0	5.0	5.0	5.0	5.0	5.0	5.0	10.0	10.0	5.0	10.0	10.0
Minimum Split (s)	10.0	23.0	23.0	10.0	23.0	23.0	10.0	23.0	23.0	10.0	23.0	23.0
Total Split (s)	12.0	66.0	66.0	12.0	66.0	66.0	12.0	30.0	30.0	12.0	30.0	30.0
Total Split (%)	10.0%	55.0%	55.0%	10.0%	55.0%	55.0%	10.0%	25.0%	25.0%	10.0%	25.0%	25.0%
Yellow Time (s)	3.0	3.0	3.0	3.0	3.0	3.0	3.0	3.0	3.0	3.0	3.0	3.0
All-Red Time (s)	2.0	2.0	2.0	2.0	2.0	2.0	2.0	2.0	2.0	2.0	2.0	2.0
Lost Time Adjust (s)	0.0	0.0	0.0	0.0	0.0	0.0	0.0	0.0	0.0	0.0	0.0	0.0
Total Lost Time (s)	5.0	5.0	5.0	5.0	5.0	5.0	5.0	5.0	5.0	5.0	5.0	5.0
Lead/Lag	Lead	Lag	Lag	Lead	Lag	Lag	Lead	Lag	Lag	Lead	Lag	Lag
Lead-Lag Optimize?	Yes	Yes	Yes	Yes	Yes	Yes	Yes	Yes	Yes	Yes	Yes	Yes
Recall Mode	None	C-Max	C-Max	None	C-Max	C-Max	None	Max	Max	None	Max	Max
Act Effct Green (s)	67.8	61.1	61.1	69.0	63.4	63.4	32.0	25.0	25.0	32.0	25.0	25.0
Actuated g/C Ratio	0.56	0.51	0.51	0.58	0.53	0.53	0.27	0.21	0.21	0.27	0.21	0.21
v/c Ratio	0.22	0.47	0.05	0.33	0.48	0.08	0.62	0.33	0.16	0.40	0.70	0.31
Control Delay	11.4	20.1	0.1	7.9	8.5	0.2	46.7	41.8	2.4	36.0	50.0	8.5
Queue Delay	0.0	0.0	0.0	0.0	0.0	0.0	0.0	0.0	0.0	0.0	0.0	0.0
Total Delay	11.4	20.1	0.1	7.9	8.5	0.2	46.7	41.8	2.4	36.0	50.0	8.5
LOS	B	C	A	A	A	A	D	D	A	D	D	A
Approach Delay		18.5			7.8			37.1			40.5	
Approach LOS		B			A			D			D	

Intersection Summary

Cycle Length: 120
 Actuated Cycle Length: 120
 Offset: 0 (0%), Referenced to phase 2:EBTL and 6:WBTL, Start of Green
 Natural Cycle: 70
 Control Type: Actuated-Coordinated
 Maximum v/c Ratio: 0.70
 Intersection Signal Delay: 22.6
 Intersection LOS: C
 Intersection Capacity Utilization 64.9%
 ICU Level of Service C
 Analysis Period (min) 15

Splits and Phases: 12: Vollmer Rd & Marksheffel Rd

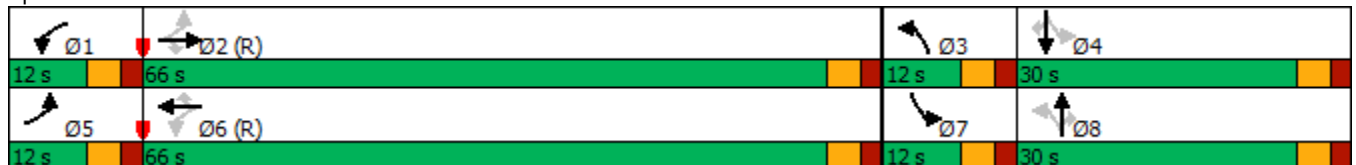

Timings
13: Sterling Ranch Rd & Marksheffel Rd

2042 Background Traffic
AM Peak Hour

Lane Group	EBL	EBT	EBR	WBL	WBT	WBR	NBL	NBT	NBR	SBL	SBT	SBR
Lane Configurations												
Traffic Volume (vph)	77	900	10	47	809	118	39	8	55	327	8	191
Future Volume (vph)	77	900	10	47	809	118	39	8	55	327	8	191
Turn Type	pm+pt	NA	Perm	pm+pt	NA	Perm	pm+pt	NA	Perm	Prot	NA	Perm
Protected Phases	5	2		1	6		3	8		7	4	
Permitted Phases	2		2	6		6	8		8			4
Detector Phase	5	2	2	1	6	6	3	8	8	7	4	4
Switch Phase												
Minimum Initial (s)	5.0	15.0	15.0	5.0	15.0	15.0	5.0	10.0	10.0	20.0	10.0	10.0
Minimum Split (s)	10.0	20.0	20.0	10.0	20.0	20.0	10.0	15.0	15.0	25.0	20.0	20.0
Total Split (s)	12.0	51.0	51.0	12.0	51.0	51.0	12.0	25.0	25.0	32.0	45.0	45.0
Total Split (%)	10.0%	42.5%	42.5%	10.0%	42.5%	42.5%	10.0%	20.8%	20.8%	26.7%	37.5%	37.5%
Yellow Time (s)	3.0	3.0	3.0	3.0	3.0	3.0	3.0	3.0	3.0	3.0	3.0	3.0
All-Red Time (s)	2.0	2.0	2.0	2.0	2.0	2.0	2.0	2.0	2.0	2.0	2.0	2.0
Lost Time Adjust (s)	0.0	0.0	0.0	0.0	0.0	0.0	0.0	0.0	0.0	0.0	0.0	0.0
Total Lost Time (s)	5.0	5.0	5.0	5.0	5.0	5.0	5.0	5.0	5.0	5.0	5.0	5.0
Lead/Lag	Lead	Lag	Lag	Lead	Lag	Lag	Lead	Lag	Lag	Lead	Lag	Lag
Lead-Lag Optimize?	Yes	Yes	Yes	Yes	Yes	Yes	Yes	Yes	Yes	Yes	Yes	Yes
Recall Mode	None	C-Max	C-Max	None	C-Max	C-Max	None	None	None	None	None	None
Act Effct Green (s)	74.4	68.0	68.0	72.8	67.2	67.2	14.6	10.0	10.0	20.4	22.8	22.8
Actuated g/C Ratio	0.62	0.57	0.57	0.61	0.56	0.56	0.12	0.08	0.08	0.17	0.19	0.19
v/c Ratio	0.21	0.47	0.01	0.14	0.43	0.13	0.21	0.05	0.21	0.59	0.02	0.43
Control Delay	9.0	13.7	0.0	10.2	17.9	1.5	34.7	51.6	1.8	50.6	39.0	8.6
Queue Delay	0.0	0.0	0.0	0.0	0.0	0.0	0.0	0.0	0.0	0.0	0.0	0.0
Total Delay	9.0	13.7	0.0	10.2	17.9	1.5	34.7	51.6	1.8	50.6	39.0	8.6
LOS	A	B	A	B	B	A	C	D	A	D	D	A
Approach Delay		13.1			15.6			18.1			35.2	
Approach LOS		B			B			B			D	

Intersection Summary

Cycle Length: 120
 Actuated Cycle Length: 120
 Offset: 0 (0%), Referenced to phase 2:EBTL and 6:WBTL, Start of Green
 Natural Cycle: 75
 Control Type: Actuated-Coordinated
 Maximum v/c Ratio: 0.59
 Intersection Signal Delay: 18.7
 Intersection LOS: B
 Intersection Capacity Utilization 57.5%
 ICU Level of Service B
 Analysis Period (min) 15

Splits and Phases: 13: Sterling Ranch Rd & Marksheffel Rd

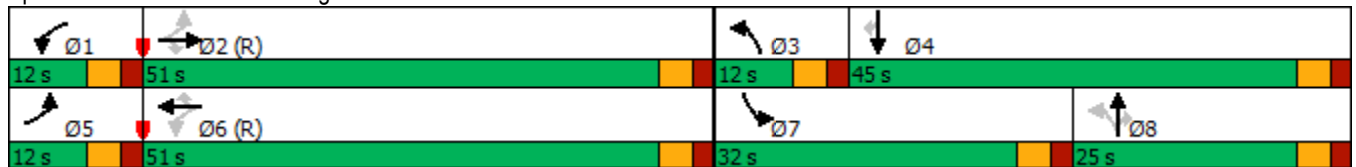

Intersection						
Int Delay, s/veh	0.2					
Movement	EBL	EBT	WBT	WBR	SBL	SBR
Lane Configurations	↘	↑↑	↑↑	↗		↗
Traffic Vol, veh/h	7	707	1193	3	0	21
Future Vol, veh/h	7	707	1193	3	0	21
Conflicting Peds, #/hr	0	0	0	0	0	0
Sign Control	Free	Free	Free	Free	Stop	Stop
RT Channelized	-	None	-	None	-	None
Storage Length	285	-	-	235	-	0
Veh in Median Storage, #	-	0	0	-	0	-
Grade, %	-	0	0	-	0	-
Peak Hour Factor	95	95	95	95	95	95
Heavy Vehicles, %	2	2	2	2	2	2
Mvmt Flow	7	744	1256	3	0	22

Major/Minor	Major1	Major2	Minor2
Conflicting Flow All	1259	0	0
Stage 1	-	-	-
Stage 2	-	-	-
Critical Hdwy	4.14	-	-
Critical Hdwy Stg 1	-	-	-
Critical Hdwy Stg 2	-	-	-
Follow-up Hdwy	2.22	-	-
Pot Cap-1 Maneuver	548	-	0
Stage 1	-	-	0
Stage 2	-	-	0
Platoon blocked, %	-	-	-
Mov Cap-1 Maneuver	548	-	-
Mov Cap-2 Maneuver	-	-	-
Stage 1	-	-	-
Stage 2	-	-	-

Approach	EB	WB	SB
HCM Control Delay, s	0.1	0	13.9
HCM LOS			B

Minor Lane/Major Mvmt	EBL	EBT	WBT	WBR	SBLn1
Capacity (veh/h)	548	-	-	-	426
HCM Lane V/C Ratio	0.013	-	-	-	0.052
HCM Control Delay (s)	11.7	-	-	-	13.9
HCM Lane LOS	B	-	-	-	B
HCM 95th %tile Q(veh)	0	-	-	-	0.2

Intersection						
Int Delay, s/veh	1.6					
Movement	EBT	EBR	WBL	WBT	NBL	NBR
Lane Configurations	↑	↗	↖	↑	↘	↙
Traffic Vol, veh/h	138	17	3	242	53	15
Future Vol, veh/h	138	17	3	242	53	15
Conflicting Peds, #/hr	0	0	0	0	0	0
Sign Control	Free	Free	Free	Free	Stop	Stop
RT Channelized	-	None	-	None	-	None
Storage Length	-	255	305	-	0	-
Veh in Median Storage, #	0	-	-	0	0	-
Grade, %	0	-	-	0	0	-
Peak Hour Factor	95	95	95	95	95	95
Heavy Vehicles, %	2	2	2	2	2	2
Mvmt Flow	145	18	3	255	56	16

Major/Minor	Major1	Major2	Minor1			
Conflicting Flow All	0	0	163	0	406	145
Stage 1	-	-	-	-	145	-
Stage 2	-	-	-	-	261	-
Critical Hdwy	-	-	4.12	-	6.42	6.22
Critical Hdwy Stg 1	-	-	-	-	5.42	-
Critical Hdwy Stg 2	-	-	-	-	5.42	-
Follow-up Hdwy	-	-	2.218	-	3.518	3.318
Pot Cap-1 Maneuver	-	-	1416	-	601	902
Stage 1	-	-	-	-	882	-
Stage 2	-	-	-	-	783	-
Platoon blocked, %	-	-	-	-	-	-
Mov Cap-1 Maneuver	-	-	1416	-	600	902
Mov Cap-2 Maneuver	-	-	-	-	648	-
Stage 1	-	-	-	-	882	-
Stage 2	-	-	-	-	781	-

Approach	EB	WB	NB
HCM Control Delay, s	0	0.1	10.8
HCM LOS			B

Minor Lane/Major Mvmt	NBLn1	EBT	EBR	WBL	WBT
Capacity (veh/h)	691	-	-	1416	-
HCM Lane V/C Ratio	0.104	-	-	0.002	-
HCM Control Delay (s)	10.8	-	-	7.5	-
HCM Lane LOS	B	-	-	A	-
HCM 95th %tile Q(veh)	0.3	-	-	0	-

Intersection						
Int Delay, s/veh	0.5					
Movement	WBL	WBR	NBT	NBR	SBL	SBT
Lane Configurations						
Traffic Vol, veh/h	11	7	150	4	2	234
Future Vol, veh/h	11	7	150	4	2	234
Conflicting Peds, #/hr	0	0	0	0	0	0
Sign Control	Stop	Stop	Free	Free	Free	Free
RT Channelized	-	None	-	None	-	None
Storage Length	0	-	-	-	205	-
Veh in Median Storage, #	0	-	0	-	-	0
Grade, %	0	-	0	-	-	0
Peak Hour Factor	95	95	95	95	95	95
Heavy Vehicles, %	2	2	2	2	2	2
Mvmt Flow	12	7	158	4	2	246

Major/Minor	Minor1	Major1	Major2		
Conflicting Flow All	410	160	0	0	162
Stage 1	160	-	-	-	-
Stage 2	250	-	-	-	-
Critical Hdwy	6.42	6.22	-	-	4.12
Critical Hdwy Stg 1	5.42	-	-	-	-
Critical Hdwy Stg 2	5.42	-	-	-	-
Follow-up Hdwy	3.518	3.318	-	-	2.218
Pot Cap-1 Maneuver	598	885	-	-	1417
Stage 1	869	-	-	-	-
Stage 2	792	-	-	-	-
Platoon blocked, %			-	-	-
Mov Cap-1 Maneuver	597	885	-	-	1417
Mov Cap-2 Maneuver	648	-	-	-	-
Stage 1	869	-	-	-	-
Stage 2	791	-	-	-	-

Approach	WB	NB	SB
HCM Control Delay, s	10.1	0	0.1
HCM LOS	B		

Minor Lane/Major Mvmt	NBT	NBRWBLn1	SBL	SBT
Capacity (veh/h)	-	-	723	1417
HCM Lane V/C Ratio	-	-	0.026	0.001
HCM Control Delay (s)	-	-	10.1	7.5
HCM Lane LOS	-	-	B	A
HCM 95th %tile Q(veh)	-	-	0.1	0

Intersection												
Int Delay, s/veh	2.9											
Movement	EBL	EBT	EBR	WBL	WBT	WBR	NBL	NBT	NBR	SBL	SBT	SBR
Lane Configurations		↕			↕		↗	↑	↖	↗	↖	↖
Traffic Vol, veh/h	0	0	47	53	0	0	13	72	35	0	172	0
Future Vol, veh/h	0	0	47	53	0	0	13	72	35	0	172	0
Conflicting Peds, #/hr	0	0	0	0	0	0	0	0	0	0	0	0
Sign Control	Stop	Stop	Stop	Stop	Stop	Stop	Free	Free	Free	Free	Free	Free
RT Channelized	-	-	None	-	-	None	-	-	None	-	-	None
Storage Length	-	-	-	-	-	-	200	-	200	200	-	-
Veh in Median Storage, #	-	0	-	-	0	-	-	0	-	-	0	-
Grade, %	-	0	-	-	0	-	-	0	-	-	0	-
Peak Hour Factor	95	95	95	95	95	95	95	95	95	95	95	95
Heavy Vehicles, %	2	2	2	2	2	2	2	2	2	2	2	2
Mvmt Flow	0	0	49	56	0	0	14	76	37	0	181	0

Major/Minor	Minor2		Minor1		Major1		Major2					
Conflicting Flow All	304	322	181	310	285	76	181	0	0	113	0	0
Stage 1	181	181	-	104	104	-	-	-	-	-	-	-
Stage 2	123	141	-	206	181	-	-	-	-	-	-	-
Critical Hdwy	7.12	6.52	6.22	7.12	6.52	6.22	4.12	-	-	4.12	-	-
Critical Hdwy Stg 1	6.12	5.52	-	6.12	5.52	-	-	-	-	-	-	-
Critical Hdwy Stg 2	6.12	5.52	-	6.12	5.52	-	-	-	-	-	-	-
Follow-up Hdwy	3.518	4.018	3.318	3.518	4.018	3.318	2.218	-	-	2.218	-	-
Pot Cap-1 Maneuver	648	595	862	642	624	985	1394	-	-	1476	-	-
Stage 1	821	750	-	902	809	-	-	-	-	-	-	-
Stage 2	881	780	-	796	750	-	-	-	-	-	-	-
Platoon blocked, %								-	-	-	-	-
Mov Cap-1 Maneuver	643	589	862	600	618	985	1394	-	-	1476	-	-
Mov Cap-2 Maneuver	643	589	-	600	618	-	-	-	-	-	-	-
Stage 1	813	750	-	893	801	-	-	-	-	-	-	-
Stage 2	872	772	-	750	750	-	-	-	-	-	-	-

Approach	EB	WB	NB	SB
HCM Control Delay, s	9.4	11.6	0.8	0
HCM LOS	A	B		

Minor Lane/Major Mvmt	NBL	NBT	NBR	EBLn1	WBLn1	SBL	SBT	SBR
Capacity (veh/h)	1394	-	-	862	600	1476	-	-
HCM Lane V/C Ratio	0.01	-	-	0.057	0.093	-	-	-
HCM Control Delay (s)	7.6	-	-	9.4	11.6	0	-	-
HCM Lane LOS	A	-	-	A	B	A	-	-
HCM 95th %tile Q(veh)	0	-	-	0.2	0.3	0	-	-

Intersection												
Int Delay, s/veh	1.2											
Movement	EBL	EBT	EBR	WBL	WBT	WBR	NBL	NBT	NBR	SBL	SBT	SBR
Lane Configurations		↕			↕		↗	↖	↗	↖	↖	↗
Traffic Vol, veh/h	0	0	11	18	0	0	3	57	12	0	143	0
Future Vol, veh/h	0	0	11	18	0	0	3	57	12	0	143	0
Conflicting Peds, #/hr	0	0	0	0	0	0	0	0	0	0	0	0
Sign Control	Stop	Stop	Stop	Stop	Stop	Stop	Free	Free	Free	Free	Free	Free
RT Channelized	-	-	None	-	-	None	-	-	None	-	-	None
Storage Length	-	-	-	-	-	-	200	-	200	200	-	-
Veh in Median Storage, #	-	0	-	-	0	-	-	0	-	-	0	-
Grade, %	-	0	-	-	0	-	-	0	-	-	0	-
Peak Hour Factor	95	95	95	95	95	95	95	95	95	95	95	95
Heavy Vehicles, %	2	2	2	2	2	2	2	2	2	2	2	2
Mvmt Flow	0	0	12	19	0	0	3	60	13	0	151	0

Major/Minor	Minor2		Minor1			Major1		Major2				
Conflicting Flow All	224	230	151	223	217	60	151	0	0	73	0	0
Stage 1	151	151	-	66	66	-	-	-	-	-	-	-
Stage 2	73	79	-	157	151	-	-	-	-	-	-	-
Critical Hdwy	7.12	6.52	6.22	7.12	6.52	6.22	4.12	-	-	4.12	-	-
Critical Hdwy Stg 1	6.12	5.52	-	6.12	5.52	-	-	-	-	-	-	-
Critical Hdwy Stg 2	6.12	5.52	-	6.12	5.52	-	-	-	-	-	-	-
Follow-up Hdwy	3.518	4.018	3.318	3.518	4.018	3.318	2.218	-	-	2.218	-	-
Pot Cap-1 Maneuver	732	670	895	733	681	1005	1430	-	-	1527	-	-
Stage 1	851	772	-	945	840	-	-	-	-	-	-	-
Stage 2	937	829	-	845	772	-	-	-	-	-	-	-
Platoon blocked, %								-	-	-	-	-
Mov Cap-1 Maneuver	731	669	895	722	680	1005	1430	-	-	1527	-	-
Mov Cap-2 Maneuver	731	669	-	722	680	-	-	-	-	-	-	-
Stage 1	849	772	-	943	838	-	-	-	-	-	-	-
Stage 2	935	827	-	834	772	-	-	-	-	-	-	-

Approach	EB		WB			NB		SB		
HCM Control Delay, s	9.1		10.1			0.3		0		
HCM LOS	A		B							

Minor Lane/Major Mvmt	NBL	NBT	NBR	EBLn1	WBLn1	SBL	SBT	SBR
Capacity (veh/h)	1430	-	-	895	722	1527	-	-
HCM Lane V/C Ratio	0.002	-	-	0.013	0.026	-	-	-
HCM Control Delay (s)	7.5	-	-	9.1	10.1	0	-	-
HCM Lane LOS	A	-	-	A	B	A	-	-
HCM 95th %tile Q(veh)	0	-	-	0	0.1	0	-	-

Intersection					
Intersection Delay, s/veh	14.6				
Intersection LOS	B				
Approach	EB	WB	NB	SB	
Entry Lanes	1	1	1	1	
Conflicting Circle Lanes	1	1	1	1	
Adj Approach Flow, veh/h	450	392	807	410	
Demand Flow Rate, veh/h	459	400	822	418	
Vehicles Circulating, veh/h	539	616	591	405	
Vehicles Exiting, veh/h	284	577	407	611	
Ped Vol Crossing Leg, #/h	0	0	0	0	
Ped Cap Adj	1.000	1.000	1.000	1.000	
Approach Delay, s/veh	13.6	13.5	18.3	9.7	
Approach LOS	B	B	C	A	
Lane	Left	Left	Left	Bypass	Left
Designated Moves	LTR	LTR	LT	R	LTR
Assumed Moves	LTR	LTR	LT	R	LTR
RT Channelized				Free	
Lane Util	1.000	1.000	1.000		1.000
Follow-Up Headway, s	2.609	2.609	2.609		2.609
Critical Headway, s	4.976	4.976	4.976	220	4.976
Entry Flow, veh/h	459	400	602	1938	418
Cap Entry Lane, veh/h	796	736	755	0.980	913
Entry HV Adj Factor	0.981	0.980	0.981	216	0.980
Flow Entry, veh/h	450	392	591	1900	410
Cap Entry, veh/h	781	722	741	0.114	895
V/C Ratio	0.576	0.543	0.797	0.0	0.458
Control Delay, s/veh	13.6	13.5	25.1	A	9.7
LOS	B	B	D	0	A
95th %tile Queue, veh	4	3	8		2

Timings
4: Vollmer Rd & Briargate Pkwy

2042 Background Traffic
PM Peak Hour

Lane Group	EBL	EBT	EBR	WBL	WBT	WBR	NBL	NBT	NBR	SBL	SBT	SBR
Lane Configurations												
Traffic Volume (vph)	227	922	184	190	690	67	300	415	246	96	211	118
Future Volume (vph)	227	922	184	190	690	67	300	415	246	96	211	118
Turn Type	pm+pt	NA	Perm	Prot	NA	Perm	pm+pt	NA	Perm	pm+pt	NA	Perm
Protected Phases	5	2		1	6		3	8		7	4	
Permitted Phases	2		2			6	8		8	4		4
Detector Phase	5	2	2	1	6	6	3	8	8	7	4	4
Switch Phase												
Minimum Initial (s)	5.0	15.0	15.0	15.0	15.0	15.0	5.0	5.0	5.0	5.0	5.0	5.0
Minimum Split (s)	10.0	20.0	20.0	20.0	20.0	20.0	10.0	10.0	10.0	10.0	10.0	10.0
Total Split (s)	12.0	50.0	50.0	20.0	58.0	58.0	24.0	28.0	28.0	22.0	26.0	26.0
Total Split (%)	10.0%	41.7%	41.7%	16.7%	48.3%	48.3%	20.0%	23.3%	23.3%	18.3%	21.7%	21.7%
Yellow Time (s)	3.0	3.0	3.0	3.0	3.0	3.0	3.0	3.0	3.0	3.0	3.0	3.0
All-Red Time (s)	2.0	2.0	2.0	2.0	2.0	2.0	2.0	2.0	2.0	2.0	2.0	2.0
Lost Time Adjust (s)	0.0	-2.0	0.0	0.0	-2.0	0.0	0.0	0.0	0.0	0.0	0.0	0.0
Total Lost Time (s)	5.0	3.0	5.0	5.0	3.0	5.0	5.0	5.0	5.0	5.0	5.0	5.0
Lead/Lag	Lead	Lag	Lag	Lead	Lag	Lag	Lead	Lag	Lag	Lead	Lag	Lag
Lead-Lag Optimize?	Yes	Yes	Yes	Yes	Yes	Yes	Yes	Yes	Yes	Yes	Yes	Yes
Recall Mode	None	Max	Max	None	Max	Max	None	None	None	None	None	None
Act Effct Green (s)	52.1	47.1	45.1	15.0	55.1	53.1	35.8	20.7	20.7	22.7	12.7	12.7
Actuated g/C Ratio	0.47	0.42	0.41	0.14	0.50	0.48	0.32	0.19	0.19	0.20	0.11	0.11
v/c Ratio	0.65	0.63	0.26	0.43	0.41	0.09	0.79	0.64	0.51	0.38	0.55	0.39
Control Delay	24.6	27.9	4.2	48.1	19.1	1.3	46.4	46.7	8.8	31.6	51.6	7.1
Queue Delay	0.0	0.0	0.0	0.0	0.0	0.0	0.0	0.0	0.0	0.0	0.0	0.0
Total Delay	24.6	27.9	4.2	48.1	19.1	1.3	46.4	46.7	8.8	31.6	51.6	7.1
LOS	C	C	A	D	B	A	D	D	A	C	D	A
Approach Delay		24.0			23.7			36.8			34.7	
Approach LOS		C			C			D			C	

Intersection Summary

Cycle Length: 120
 Actuated Cycle Length: 110.9
 Natural Cycle: 70
 Control Type: Actuated-Uncoordinated
 Maximum v/c Ratio: 0.79
 Intersection Signal Delay: 28.5
 Intersection LOS: C
 Intersection Capacity Utilization 76.3%
 ICU Level of Service D
 Analysis Period (min) 15

Splits and Phases: 4: Vollmer Rd & Briargate Pkwy

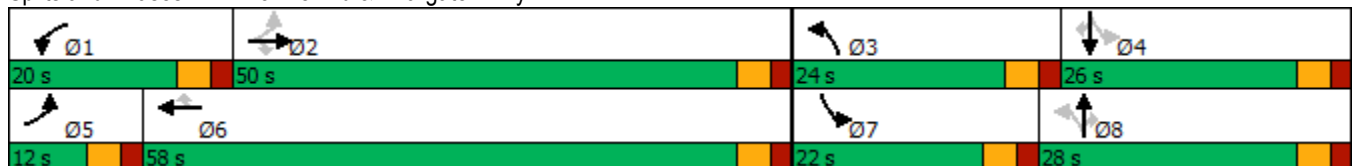

Timings
5: Sterling Ranch Rd & Briargate Pkwy

2042 Background Traffic
PM Peak Hour

Lane Group	EBL	EBT	EBR	WBL	WBT	WBR	NBL	NBT	NBR	SBL	SBT	SBR
Lane Configurations												
Traffic Volume (vph)	272	923	58	49	816	49	139	135	28	47	58	100
Future Volume (vph)	272	923	58	49	816	49	139	135	28	47	58	100
Turn Type	pm+pt	NA	Perm	pm+pt	NA	Perm	pm+pt	NA	Free	pm+pt	NA	Free
Protected Phases	5	2		1	6		3	8		7	4	
Permitted Phases	2		2	6		6	8		Free	4		Free
Detector Phase	5	2	2	1	6	6	3	8		7	4	
Switch Phase												
Minimum Initial (s)	5.0	5.0	5.0	5.0	5.0	5.0	5.0	20.0		5.0	20.0	
Minimum Split (s)	10.0	23.0	23.0	10.0	23.0	23.0	10.0	25.0		10.0	25.0	
Total Split (s)	22.0	68.0	68.0	12.0	58.0	58.0	15.0	30.0		10.0	25.0	
Total Split (%)	18.3%	56.7%	56.7%	10.0%	48.3%	48.3%	12.5%	25.0%		8.3%	20.8%	
Yellow Time (s)	3.0	3.0	3.0	3.0	3.0	3.0	3.0	3.0		3.0	3.0	
All-Red Time (s)	2.0	2.0	2.0	2.0	2.0	2.0	2.0	2.0		2.0	2.0	
Lost Time Adjust (s)	-2.0	-2.0	0.0	0.0	-2.0	0.0	0.0	0.0		0.0	0.0	
Total Lost Time (s)	3.0	3.0	5.0	5.0	3.0	5.0	5.0	5.0		5.0	5.0	
Lead/Lag	Lead	Lag	Lag	Lead	Lag	Lag	Lead	Lag		Lead	Lag	
Lead-Lag Optimize?	Yes	Yes	Yes	Yes	Yes	Yes	Yes	Yes		Yes	Yes	
Recall Mode	None	C-Max	C-Max	None	C-Max	C-Max	None	None		None	None	
Act Effct Green (s)	80.0	70.6	68.6	66.2	61.7	59.7	32.0	24.0	120.0	21.0	20.0	120.0
Actuated g/C Ratio	0.67	0.59	0.57	0.55	0.51	0.50	0.27	0.20	1.00	0.18	0.17	1.00
v/c Ratio	0.63	0.47	0.06	0.16	0.47	0.06	0.42	0.38	0.02	0.21	0.20	0.07
Control Delay	15.3	16.4	0.4	10.6	21.5	2.0	38.1	44.6	0.0	33.7	45.0	0.1
Queue Delay	0.0	0.0	0.0	0.0	0.0	0.0	0.0	0.0	0.0	0.0	0.0	0.0
Total Delay	15.3	16.4	0.4	10.6	21.5	2.0	38.1	44.6	0.0	33.7	45.0	0.1
LOS	B	B	A	B	C	A	D	D	A	C	D	A
Approach Delay		15.4			19.9			37.5			20.5	
Approach LOS		B			B			D			C	

Intersection Summary

Cycle Length: 120

Actuated Cycle Length: 120

Offset: 0 (0%), Referenced to phase 2:EBTL and 6:WBTL, Start of Green

Natural Cycle: 70

Control Type: Actuated-Coordinated

Maximum v/c Ratio: 0.63

Intersection Signal Delay: 19.8

Intersection LOS: B

Intersection Capacity Utilization 77.0%

ICU Level of Service D

Analysis Period (min) 15

Splits and Phases: 5: Sterling Ranch Rd & Briargate Pkwy

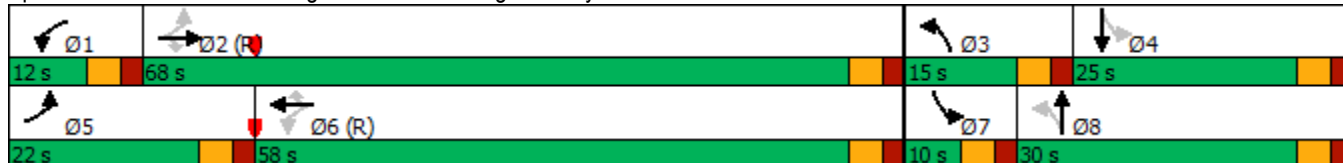

Intersection						
Int Delay, s/veh	4.2					
Movement	WBL	WBR	NBT	NBR	SBL	SBT
Lane Configurations	↘	↗	↑	↗	↘	↑
Traffic Vol, veh/h	113	130	172	144	50	116
Future Vol, veh/h	113	130	172	144	50	116
Conflicting Peds, #/hr	0	0	0	0	0	0
Sign Control	Stop	Stop	Free	Free	Free	Free
RT Channelized	-	None	-	None	-	None
Storage Length	0	0	-	205	205	-
Veh in Median Storage, #	0	-	0	-	-	0
Grade, %	0	-	0	-	-	0
Peak Hour Factor	95	95	95	95	95	95
Heavy Vehicles, %	2	2	2	2	2	2
Mvmt Flow	119	137	181	152	53	122

Major/Minor	Minor1	Major1	Major2			
Conflicting Flow All	409	181	0	0	333	0
Stage 1	181	-	-	-	-	-
Stage 2	228	-	-	-	-	-
Critical Hdwy	6.42	6.22	-	-	4.12	-
Critical Hdwy Stg 1	5.42	-	-	-	-	-
Critical Hdwy Stg 2	5.42	-	-	-	-	-
Follow-up Hdwy	3.518	3.318	-	-	2.218	-
Pot Cap-1 Maneuver	599	862	-	-	1226	-
Stage 1	850	-	-	-	-	-
Stage 2	810	-	-	-	-	-
Platoon blocked, %			-	-		-
Mov Cap-1 Maneuver	573	862	-	-	1226	-
Mov Cap-2 Maneuver	630	-	-	-	-	-
Stage 1	850	-	-	-	-	-
Stage 2	775	-	-	-	-	-

Approach	WB	NB	SB
HCM Control Delay, s	10.9	0	2.4
HCM LOS	B		

Minor Lane/Major Mvmt	NBT	NBR	WBLn1	WBLn2	SBL	SBT
Capacity (veh/h)	-	-	630	862	1226	-
HCM Lane V/C Ratio	-	-	0.189	0.159	0.043	-
HCM Control Delay (s)	-	-	12	10	8.1	-
HCM Lane LOS	-	-	B	B	A	-
HCM 95th %tile Q(veh)	-	-	0.7	0.6	0.1	-

Timings
12: Vollmer Rd & Marksheffel Rd

2042 Background Traffic
PM Peak Hour

Lane Group	EBL	EBT	EBR	WBL	WBT	WBR	NBL	NBT	NBR	SBL	SBT	SBR
Lane Configurations												
Traffic Volume (vph)	140	906	96	176	691	154	171	695	166	132	323	199
Future Volume (vph)	140	906	96	176	691	154	171	695	166	132	323	199
Turn Type	pm+pt	NA	Perm	pm+pt	NA	Perm	pm+pt	NA	Perm	pm+pt	NA	Perm
Protected Phases	5	2		1	6		3	8		7	4	
Permitted Phases	2		2	6		6	8		8	4		4
Detector Phase	5	2	2	1	6	6	3	8	8	7	4	4
Switch Phase												
Minimum Initial (s)	5.0	5.0	5.0	5.0	5.0	5.0	5.0	10.0	10.0	5.0	10.0	10.0
Minimum Split (s)	10.0	23.0	23.0	10.0	23.0	23.0	10.0	23.0	23.0	10.0	23.0	23.0
Total Split (s)	20.0	50.0	50.0	19.0	49.0	49.0	15.0	36.0	36.0	15.0	36.0	36.0
Total Split (%)	16.7%	41.7%	41.7%	15.8%	40.8%	40.8%	12.5%	30.0%	30.0%	12.5%	30.0%	30.0%
Yellow Time (s)	3.0	3.0	3.0	3.0	3.0	3.0	3.0	3.0	3.0	3.0	3.0	3.0
All-Red Time (s)	2.0	2.0	2.0	2.0	2.0	2.0	2.0	2.0	2.0	2.0	2.0	2.0
Lost Time Adjust (s)	0.0	0.0	0.0	0.0	0.0	0.0	0.0	0.0	0.0	0.0	0.0	0.0
Total Lost Time (s)	5.0	5.0	5.0	5.0	5.0	5.0	5.0	5.0	5.0	5.0	5.0	5.0
Lead/Lag	Lead	Lag	Lag	Lead	Lag	Lag	Lead	Lag	Lag	Lead	Lag	Lag
Lead-Lag Optimize?	Yes	Yes	Yes	Yes	Yes	Yes	Yes	Yes	Yes	Yes	Yes	Yes
Recall Mode	None	C-Max	C-Max	None	C-Max	C-Max	None	Max	Max	None	Max	Max
Act Effct Green (s)	57.9	47.3	47.3	60.1	48.4	48.4	41.2	31.4	31.4	40.8	31.2	31.2
Actuated g/C Ratio	0.48	0.39	0.39	0.50	0.40	0.40	0.34	0.26	0.26	0.34	0.26	0.26
v/c Ratio	0.42	0.68	0.15	0.65	0.51	0.22	0.49	0.79	0.34	0.66	0.37	0.37
Control Delay	18.3	33.6	4.5	44.6	21.9	5.0	31.0	48.6	12.6	40.5	37.8	6.7
Queue Delay	0.0	0.0	0.0	0.0	0.0	0.0	0.0	0.0	0.0	0.0	0.0	0.0
Total Delay	18.3	33.6	4.5	44.6	21.9	5.0	31.0	48.6	12.6	40.5	37.8	6.7
LOS	B	C	A	D	C	A	C	D	B	D	D	A
Approach Delay		29.3			23.2			39.9			28.9	
Approach LOS		C			C			D			C	

Intersection Summary

Cycle Length: 120
 Actuated Cycle Length: 120
 Offset: 0 (0%), Referenced to phase 2:EBTL and 6:WBTL, Start of Green
 Natural Cycle: 70
 Control Type: Actuated-Coordinated
 Maximum v/c Ratio: 0.79
 Intersection Signal Delay: 30.5
 Intersection LOS: C
 Intersection Capacity Utilization 78.0%
 ICU Level of Service D
 Analysis Period (min) 15

Splits and Phases: 12: Vollmer Rd & Marksheffel Rd

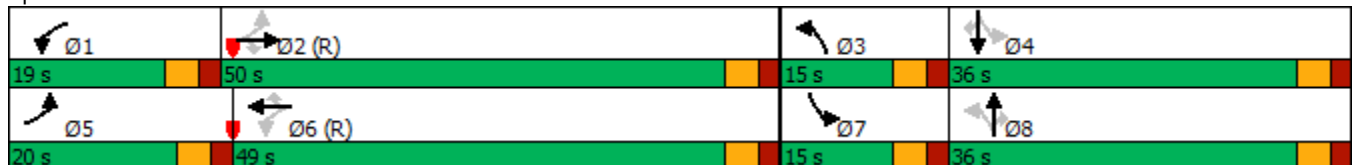

Timings
13: Sterling Ranch Rd & Marksheffel Rd

2042 Background Traffic
PM Peak Hour

Lane Group	EBL	EBT	EBR	WBL	WBT	WBR	NBL	NBT	NBR	SBL	SBT	SBR
Lane Configurations												
Traffic Volume (vph)	238	946	22	130	841	462	27	7	37	275	20	153
Future Volume (vph)	238	946	22	130	841	462	27	7	37	275	20	153
Turn Type	pm+pt	NA	Perm	pm+pt	NA	Perm	pm+pt	NA	Perm	Prot	NA	Perm
Protected Phases	5	2		1	6		3	8		7	4	
Permitted Phases	2		2	6		6	8		8			4
Detector Phase	5	2	2	1	6	6	3	8	8	7	4	4
Switch Phase												
Minimum Initial (s)	5.0	15.0	15.0	5.0	15.0	15.0	5.0	10.0	10.0	20.0	10.0	10.0
Minimum Split (s)	10.0	20.0	20.0	10.0	20.0	20.0	10.0	15.0	15.0	25.0	20.0	20.0
Total Split (s)	20.0	68.0	68.0	12.0	60.0	60.0	10.0	15.0	15.0	25.0	30.0	30.0
Total Split (%)	16.7%	56.7%	56.7%	10.0%	50.0%	50.0%	8.3%	12.5%	12.5%	20.8%	25.0%	25.0%
Yellow Time (s)	3.0	3.0	3.0	3.0	3.0	3.0	3.0	3.0	3.0	3.0	3.0	3.0
All-Red Time (s)	2.0	2.0	2.0	2.0	2.0	2.0	2.0	2.0	2.0	2.0	2.0	2.0
Lost Time Adjust (s)	0.0	0.0	0.0	0.0	0.0	0.0	0.0	0.0	0.0	0.0	0.0	0.0
Total Lost Time (s)	5.0	5.0	5.0	5.0	5.0	5.0	5.0	5.0	5.0	5.0	5.0	5.0
Lead/Lag	Lead	Lag	Lag	Lead	Lag	Lag	Lead	Lag	Lag	Lead	Lag	Lag
Lead-Lag Optimize?	Yes	Yes	Yes	Yes	Yes	Yes	Yes	Yes	Yes	Yes	Yes	Yes
Recall Mode	None	C-Max	C-Max	None	C-Max	C-Max	None	None	None	None	None	None
Act Effct Green (s)	79.7	69.1	69.1	71.0	64.0	64.0	11.0	10.0	10.0	20.0	23.0	23.0
Actuated g/C Ratio	0.66	0.58	0.58	0.59	0.53	0.53	0.09	0.08	0.08	0.17	0.19	0.19
v/c Ratio	0.61	0.49	0.02	0.41	0.47	0.45	0.20	0.05	0.12	0.51	0.06	0.37
Control Delay	28.7	10.1	0.0	12.7	20.1	3.2	37.7	51.4	0.8	49.0	39.0	8.6
Queue Delay	0.0	0.0	0.0	0.0	0.0	0.0	0.0	0.0	0.0	0.0	0.0	0.0
Total Delay	28.7	10.1	0.0	12.7	20.1	3.2	37.7	51.4	0.8	49.0	39.0	8.6
LOS	C	B	A	B	C	A	D	D	A	D	D	A
Approach Delay		13.6			14.0			19.6			34.7	
Approach LOS		B			B			B			C	

Intersection Summary

Cycle Length: 120
 Actuated Cycle Length: 120
 Offset: 0 (0%), Referenced to phase 2:EBTL and 6:WBTL, Start of Green
 Natural Cycle: 80
 Control Type: Actuated-Coordinated
 Maximum v/c Ratio: 0.61
 Intersection Signal Delay: 16.9
 Intersection LOS: B
 Intersection Capacity Utilization 63.4%
 ICU Level of Service B
 Analysis Period (min) 15

Splits and Phases: 13: Sterling Ranch Rd & Marksheffel Rd

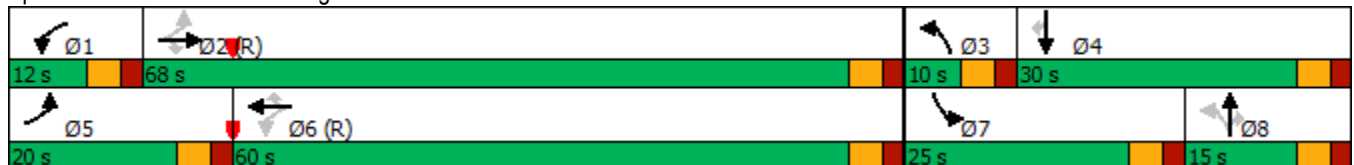

Intersection						
Int Delay, s/veh	0.3					
Movement	EBL	EBT	WBT	WBR	SBL	SBR
Lane Configurations	↘	↑↑	↑↑	↗		↗
Traffic Vol, veh/h	31	1253	1041	14	0	18
Future Vol, veh/h	31	1253	1041	14	0	18
Conflicting Peds, #/hr	0	0	0	0	0	0
Sign Control	Free	Free	Free	Free	Stop	Stop
RT Channelized	-	None	-	None	-	None
Storage Length	285	-	-	235	-	0
Veh in Median Storage, #	-	0	0	-	0	-
Grade, %	-	0	0	-	0	-
Peak Hour Factor	95	95	95	95	95	95
Heavy Vehicles, %	2	2	2	2	2	2
Mvmt Flow	33	1319	1096	15	0	19

Major/Minor	Major1	Major2	Minor2		
Conflicting Flow All	1111	0	-	0	- 548
Stage 1	-	-	-	-	-
Stage 2	-	-	-	-	-
Critical Hdwy	4.14	-	-	-	- 6.94
Critical Hdwy Stg 1	-	-	-	-	-
Critical Hdwy Stg 2	-	-	-	-	-
Follow-up Hdwy	2.22	-	-	-	- 3.32
Pot Cap-1 Maneuver	624	-	-	-	0 480
Stage 1	-	-	-	-	0 -
Stage 2	-	-	-	-	0 -
Platoon blocked, %		-	-	-	
Mov Cap-1 Maneuver	624	-	-	-	- 480
Mov Cap-2 Maneuver	-	-	-	-	-
Stage 1	-	-	-	-	-
Stage 2	-	-	-	-	-

Approach	EB	WB	SB
HCM Control Delay, s	0.3	0	12.8
HCM LOS			B

Minor Lane/Major Mvmt	EBL	EBT	WBT	WBR	SBLn1
Capacity (veh/h)	624	-	-	-	480
HCM Lane V/C Ratio	0.052	-	-	-	0.039
HCM Control Delay (s)	11.1	-	-	-	12.8
HCM Lane LOS	B	-	-	-	B
HCM 95th %tile Q(veh)	0.2	-	-	-	0.1

Intersection						
Int Delay, s/veh	1.2					
Movement	EBT	EBR	WBL	WBT	NBL	NBR
Lane Configurations	↑	↗	↘	↑	↘	↗
Traffic Vol, veh/h	313	75	13	216	46	12
Future Vol, veh/h	313	75	13	216	46	12
Conflicting Peds, #/hr	0	0	0	0	0	0
Sign Control	Free	Free	Free	Free	Stop	Stop
RT Channelized	-	None	-	None	-	None
Storage Length	-	255	305	-	0	-
Veh in Median Storage, #	0	-	-	0	0	-
Grade, %	0	-	-	0	0	-
Peak Hour Factor	95	95	95	95	95	95
Heavy Vehicles, %	2	2	2	2	2	2
Mvmt Flow	329	79	14	227	48	13

Major/Minor	Major1	Major2	Minor1			
Conflicting Flow All	0	0	408	0	584	329
Stage 1	-	-	-	-	329	-
Stage 2	-	-	-	-	255	-
Critical Hdwy	-	-	4.12	-	6.42	6.22
Critical Hdwy Stg 1	-	-	-	-	5.42	-
Critical Hdwy Stg 2	-	-	-	-	5.42	-
Follow-up Hdwy	-	-	2.218	-	3.518	3.318
Pot Cap-1 Maneuver	-	-	1151	-	474	712
Stage 1	-	-	-	-	729	-
Stage 2	-	-	-	-	788	-
Platoon blocked, %	-	-	-	-	-	-
Mov Cap-1 Maneuver	-	-	1151	-	468	712
Mov Cap-2 Maneuver	-	-	-	-	557	-
Stage 1	-	-	-	-	729	-
Stage 2	-	-	-	-	779	-

Approach	EB	WB	NB
HCM Control Delay, s	0	0.5	11.9
HCM LOS			B

Minor Lane/Major Mvmt	NBLn1	EBT	EBR	WBL	WBT
Capacity (veh/h)	583	-	-	1151	-
HCM Lane V/C Ratio	0.105	-	-	0.012	-
HCM Control Delay (s)	11.9	-	-	8.2	-
HCM Lane LOS	B	-	-	A	-
HCM 95th %tile Q(veh)	0.3	-	-	0	-

Intersection						
Int Delay, s/veh	0.4					
Movement	WBL	WBR	NBT	NBR	SBL	SBT
Lane Configurations	↔		↔		↔	↔
Traffic Vol, veh/h	10	6	309	16	10	219
Future Vol, veh/h	10	6	309	16	10	219
Conflicting Peds, #/hr	0	0	0	0	0	0
Sign Control	Stop	Stop	Free	Free	Free	Free
RT Channelized	-	None	-	None	-	None
Storage Length	0	-	-	-	205	-
Veh in Median Storage, #	0	-	0	-	-	0
Grade, %	0	-	0	-	-	0
Peak Hour Factor	95	95	95	95	95	95
Heavy Vehicles, %	2	2	2	2	2	2
Mvmt Flow	11	6	325	17	11	231

Major/Minor	Minor1	Major1	Major2		
Conflicting Flow All	587	334	0	0	342
Stage 1	334	-	-	-	-
Stage 2	253	-	-	-	-
Critical Hdwy	6.42	6.22	-	-	4.12
Critical Hdwy Stg 1	5.42	-	-	-	-
Critical Hdwy Stg 2	5.42	-	-	-	-
Follow-up Hdwy	3.518	3.318	-	-	2.218
Pot Cap-1 Maneuver	472	708	-	-	1217
Stage 1	725	-	-	-	-
Stage 2	789	-	-	-	-
Platoon blocked, %			-	-	-
Mov Cap-1 Maneuver	468	708	-	-	1217
Mov Cap-2 Maneuver	556	-	-	-	-
Stage 1	725	-	-	-	-
Stage 2	782	-	-	-	-

Approach	WB	NB	SB
HCM Control Delay, s	11.1	0	0.3
HCM LOS	B		

Minor Lane/Major Mvmt	NBT	NBRWBLn1	SBL	SBT
Capacity (veh/h)	-	-	605	1217
HCM Lane V/C Ratio	-	-	0.028	0.009
HCM Control Delay (s)	-	-	11.1	8
HCM Lane LOS	-	-	B	A
HCM 95th %tile Q(veh)	-	-	0.1	0

Intersection												
Int Delay, s/veh	2											
Movement	EBL	EBT	EBR	WBL	WBT	WBR	NBL	NBT	NBR	SBL	SBT	SBR
Lane Configurations		↕			↕		↗	↖	↗	↖	↖	↗
Traffic Vol, veh/h	0	0	36	44	0	0	47	248	162	0	125	0
Future Vol, veh/h	0	0	36	44	0	0	47	248	162	0	125	0
Conflicting Peds, #/hr	0	0	0	0	0	0	0	0	0	0	0	0
Sign Control	Stop	Stop	Stop	Stop	Stop	Stop	Free	Free	Free	Free	Free	Free
RT Channelized	-	-	None	-	-	None	-	-	None	-	-	None
Storage Length	-	-	-	-	-	-	200	-	200	200	-	-
Veh in Median Storage, #	-	0	-	-	0	-	-	0	-	-	0	-
Grade, %	-	0	-	-	0	-	-	0	-	-	0	-
Peak Hour Factor	95	95	95	95	95	95	95	95	95	95	95	95
Heavy Vehicles, %	2	2	2	2	2	2	2	2	2	2	2	2
Mvmt Flow	0	0	38	46	0	0	49	261	171	0	132	0

Major/Minor	Minor2		Minor1		Major1			Major2				
Conflicting Flow All	577	662	132	510	491	261	132	0	0	432	0	0
Stage 1	132	132	-	359	359	-	-	-	-	-	-	-
Stage 2	445	530	-	151	132	-	-	-	-	-	-	-
Critical Hdwy	7.12	6.52	6.22	7.12	6.52	6.22	4.12	-	-	4.12	-	-
Critical Hdwy Stg 1	6.12	5.52	-	6.12	5.52	-	-	-	-	-	-	-
Critical Hdwy Stg 2	6.12	5.52	-	6.12	5.52	-	-	-	-	-	-	-
Follow-up Hdwy	3.518	4.018	3.318	3.518	4.018	3.318	2.218	-	-	2.218	-	-
Pot Cap-1 Maneuver	428	382	917	474	478	778	1453	-	-	1128	-	-
Stage 1	871	787	-	659	627	-	-	-	-	-	-	-
Stage 2	592	527	-	851	787	-	-	-	-	-	-	-
Platoon blocked, %								-	-	-	-	-
Mov Cap-1 Maneuver	417	369	917	443	462	778	1453	-	-	1128	-	-
Mov Cap-2 Maneuver	417	369	-	443	462	-	-	-	-	-	-	-
Stage 1	841	787	-	637	606	-	-	-	-	-	-	-
Stage 2	572	509	-	816	787	-	-	-	-	-	-	-

Approach	EB	WB	NB	SB
HCM Control Delay, s	9.1	14.1	0.8	0
HCM LOS	A	B		

Minor Lane/Major Mvmt	NBL	NBT	NBR	EBLn1	WBLn1	SBL	SBT	SBR
Capacity (veh/h)	1453	-	-	917	443	1128	-	-
HCM Lane V/C Ratio	0.034	-	-	0.041	0.105	-	-	-
HCM Control Delay (s)	7.6	-	-	9.1	14.1	0	-	-
HCM Lane LOS	A	-	-	A	B	A	-	-
HCM 95th %tile Q(veh)	0.1	-	-	0.1	0.3	0	-	-

Intersection												
Int Delay, s/veh	0.8											
Movement	EBL	EBT	EBR	WBL	WBT	WBR	NBL	NBT	NBR	SBL	SBT	SBR
Lane Configurations		↕			↕		↗	↑	↖	↗	↖	↖
Traffic Vol, veh/h	0	0	7	15	0	0	10	184	54	0	102	0
Future Vol, veh/h	0	0	7	15	0	0	10	184	54	0	102	0
Conflicting Peds, #/hr	0	0	0	0	0	0	0	0	0	0	0	0
Sign Control	Stop	Stop	Stop	Stop	Stop	Stop	Free	Free	Free	Free	Free	Free
RT Channelized	-	-	None	-	-	None	-	-	None	-	-	None
Storage Length	-	-	-	-	-	-	200	-	200	200	-	-
Veh in Median Storage, #	-	0	-	-	0	-	-	0	-	-	0	-
Grade, %	-	0	-	-	0	-	-	0	-	-	0	-
Peak Hour Factor	95	95	95	95	95	95	95	95	95	95	95	95
Heavy Vehicles, %	2	2	2	2	2	2	2	2	2	2	2	2
Mvmt Flow	0	0	7	16	0	0	11	194	57	0	107	0

Major/Minor	Minor2		Minor1		Major1		Major2					
Conflicting Flow All	352	380	107	327	323	194	107	0	0	251	0	0
Stage 1	107	107	-	216	216	-	-	-	-	-	-	-
Stage 2	245	273	-	111	107	-	-	-	-	-	-	-
Critical Hdwy	7.12	6.52	6.22	7.12	6.52	6.22	4.12	-	-	4.12	-	-
Critical Hdwy Stg 1	6.12	5.52	-	6.12	5.52	-	-	-	-	-	-	-
Critical Hdwy Stg 2	6.12	5.52	-	6.12	5.52	-	-	-	-	-	-	-
Follow-up Hdwy	3.518	4.018	3.318	3.518	4.018	3.318	2.218	-	-	2.218	-	-
Pot Cap-1 Maneuver	603	552	947	626	595	847	1484	-	-	1314	-	-
Stage 1	898	807	-	786	724	-	-	-	-	-	-	-
Stage 2	759	684	-	894	807	-	-	-	-	-	-	-
Platoon blocked, %								-	-	-	-	-
Mov Cap-1 Maneuver	599	548	947	618	591	847	1484	-	-	1314	-	-
Mov Cap-2 Maneuver	599	548	-	618	591	-	-	-	-	-	-	-
Stage 1	892	807	-	780	719	-	-	-	-	-	-	-
Stage 2	753	679	-	887	807	-	-	-	-	-	-	-

Approach	EB	WB	NB	SB
HCM Control Delay, s	8.8	11	0.3	0
HCM LOS	A	B		

Minor Lane/Major Mvmt	NBL	NBT	NBR	EBLn1	WBLn1	SBL	SBT	SBR
Capacity (veh/h)	1484	-	-	947	618	1314	-	-
HCM Lane V/C Ratio	0.007	-	-	0.008	0.026	-	-	-
HCM Control Delay (s)	7.4	-	-	8.8	11	0	-	-
HCM Lane LOS	A	-	-	A	B	A	-	-
HCM 95th %tile Q(veh)	0	-	-	0	0.1	0	-	-

Intersection					
Intersection Delay, s/veh	8.9				
Intersection LOS	A				
Approach	EB	WB	NB	SB	
Entry Lanes	1	1	1	1	
Conflicting Circle Lanes	1	1	1	1	
Adj Approach Flow, veh/h	136	604	376	310	
Demand Flow Rate, veh/h	138	616	384	316	
Vehicles Circulating, veh/h	436	308	120	550	
Vehicles Exiting, veh/h	430	116	454	374	
Ped Vol Crossing Leg, #/h	0	0	0	0	
Ped Cap Adj	1.000	1.000	1.000	1.000	
Approach Delay, s/veh	5.7	12.3	4.2	9.8	
Approach LOS	A	B	A	A	
Lane	Left	Left	Left	Bypass	Left
Designated Moves	LTR	LTR	LT	R	LTR
Assumed Moves	LTR	LTR	LT	R	LTR
RT Channelized				Free	
Lane Util	1.000	1.000	1.000		1.000
Follow-Up Headway, s	2.609	2.609	2.609		2.609
Critical Headway, s	4.976	4.976	4.976	80	4.976
Entry Flow, veh/h	138	616	304	1938	316
Cap Entry Lane, veh/h	885	1008	1221	0.980	787
Entry HV Adj Factor	0.983	0.980	0.980	78	0.981
Flow Entry, veh/h	136	604	298	1900	310
Cap Entry, veh/h	870	988	1197	0.041	773
V/C Ratio	0.156	0.611	0.249	0.0	0.401
Control Delay, s/veh	5.7	12.3	5.2	A	9.8
LOS	A	B	A	0	A
95th %tile Queue, veh	1	4	1		2

Timings
4: Vollmer Rd & Briargate Pkwy

2042 Total Traffic
AM Peak Hour

Lane Group	EBL	EBT	EBR	WBL	WBT	WBR	NBL	NBT	NBR	SBL	SBT	SBR
Lane Configurations												
Traffic Volume (vph)	69	559	152	239	1040	96	158	132	111	121	305	138
Future Volume (vph)	69	559	152	239	1040	96	158	132	111	121	305	138
Turn Type	pm+pt	NA	Perm	Prot	NA	Perm	pm+pt	NA	Perm	pm+pt	NA	Perm
Protected Phases	5	2		1	6		3	8		7	4	
Permitted Phases	2		2			6	8		8	4		4
Detector Phase	5	2	2	1	6	6	3	8	8	7	4	4
Switch Phase												
Minimum Initial (s)	5.0	15.0	15.0	15.0	15.0	15.0	5.0	5.0	5.0	5.0	5.0	5.0
Minimum Split (s)	10.0	20.0	20.0	20.0	20.0	20.0	10.0	10.0	10.0	10.0	10.0	10.0
Total Split (s)	12.0	57.0	57.0	20.0	65.0	65.0	17.0	28.0	28.0	15.0	26.0	26.0
Total Split (%)	10.0%	47.5%	47.5%	16.7%	54.2%	54.2%	14.2%	23.3%	23.3%	12.5%	21.7%	21.7%
Yellow Time (s)	3.0	3.0	3.0	3.0	3.0	3.0	3.0	3.0	3.0	3.0	3.0	3.0
All-Red Time (s)	2.0	2.0	2.0	2.0	2.0	2.0	2.0	2.0	2.0	2.0	2.0	2.0
Lost Time Adjust (s)	0.0	0.0	0.0	0.0	0.0	0.0	0.0	0.0	0.0	0.0	0.0	0.0
Total Lost Time (s)	5.0	5.0	5.0	5.0	5.0	5.0	5.0	5.0	5.0	5.0	5.0	5.0
Lead/Lag	Lead	Lag	Lag	Lead	Lag	Lag	Lead	Lag	Lag	Lead	Lag	Lag
Lead-Lag Optimize?	Yes	Yes	Yes	Yes	Yes	Yes	Yes	Yes	Yes	Yes	Yes	Yes
Recall Mode	None	Max	Max	None	Max	Max	None	None	None	None	None	None
Act Effct Green (s)	58.7	52.1	52.1	15.0	62.7	62.7	29.1	17.7	17.7	25.4	15.9	15.9
Actuated g/C Ratio	0.51	0.46	0.46	0.13	0.55	0.55	0.25	0.15	0.15	0.22	0.14	0.14
v/c Ratio	0.26	0.35	0.20	0.56	0.56	0.11	0.61	0.25	0.31	0.40	0.65	0.41
Control Delay	12.3	21.6	3.7	52.7	19.7	2.8	42.6	43.3	4.8	35.7	53.3	9.5
Queue Delay	0.0	0.0	0.0	0.0	0.0	0.0	0.0	0.0	0.0	0.0	0.0	0.0
Total Delay	12.3	21.6	3.7	52.7	19.7	2.8	42.6	43.3	4.8	35.7	53.3	9.5
LOS	B	C	A	D	B	A	D	D	A	D	D	A
Approach Delay		17.2			24.2			32.3			38.8	
Approach LOS		B			C			C			D	

Intersection Summary

Cycle Length: 120
 Actuated Cycle Length: 114.4
 Natural Cycle: 60
 Control Type: Actuated-Uncoordinated
 Maximum v/c Ratio: 0.65
 Intersection Signal Delay: 26.2
 Intersection LOS: C
 Intersection Capacity Utilization 66.8%
 ICU Level of Service C
 Analysis Period (min) 15

Splits and Phases: 4: Vollmer Rd & Briargate Pkwy

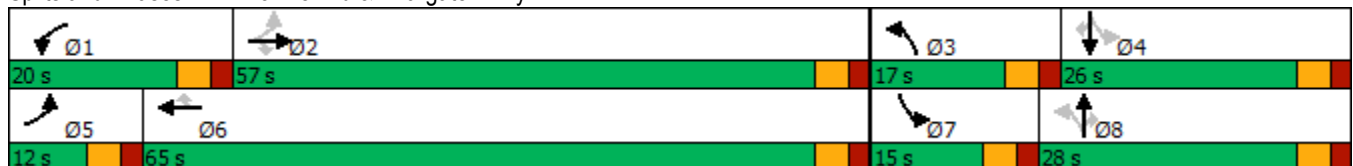

Timings
5: Sterling Ranch Rd & Briargate Pkwy

2042 Total Traffic
AM Peak Hour

Lane Group	EBL	EBT	EBR	WBL	WBT	WBR	NBL	NBT	NBR	SBL	SBT	SBR
Lane Configurations												
Traffic Volume (vph)	77	627	145	112	945	24	285	115	120	103	263	158
Future Volume (vph)	77	627	145	112	945	24	285	115	120	103	263	158
Turn Type	pm+pt	NA	Perm	pm+pt	NA	Perm	pm+pt	NA	Free	pm+pt	NA	Free
Protected Phases	5	2		1	6		3	8		7	4	
Permitted Phases	2		2	6		6	8		Free	4		Free
Detector Phase	5	2	2	1	6	6	3	8		7	4	
Switch Phase												
Minimum Initial (s)	5.0	5.0	5.0	5.0	5.0	5.0	5.0	20.0		5.0	20.0	
Minimum Split (s)	10.0	10.0	10.0	10.0	10.0	10.0	10.0	25.0		10.0	25.0	
Total Split (s)	12.0	56.0	56.0	12.0	56.0	56.0	20.0	32.0		20.0	32.0	
Total Split (%)	10.0%	46.7%	46.7%	10.0%	46.7%	46.7%	16.7%	26.7%		16.7%	26.7%	
Yellow Time (s)	3.0	3.0	3.0	3.0	3.0	3.0	3.0	3.0		3.0	3.0	
All-Red Time (s)	2.0	2.0	2.0	2.0	2.0	2.0	2.0	2.0		2.0	2.0	
Lost Time Adjust (s)	0.0	0.0	0.0	0.0	0.0	0.0	0.0	0.0		0.0	0.0	
Total Lost Time (s)	5.0	5.0	5.0	5.0	5.0	5.0	5.0	5.0		5.0	5.0	
Lead/Lag	Lead	Lag	Lag	Lead	Lag	Lag	Lead	Lag		Lead	Lag	
Lead-Lag Optimize?	Yes	Yes	Yes	Yes	Yes	Yes	Yes	Yes		Yes	Yes	
Recall Mode	None	C-Max	C-Max	None	C-Max	C-Max	None	Max		None	Max	
Act Effct Green (s)	57.8	51.0	51.0	59.0	53.4	53.4	45.9	31.7	120.0	37.3	27.0	120.0
Actuated g/C Ratio	0.48	0.42	0.42	0.49	0.44	0.44	0.38	0.26	1.00	0.31	0.22	1.00
v/c Ratio	0.35	0.44	0.20	0.34	0.63	0.03	0.85	0.25	0.08	0.25	0.66	0.10
Control Delay	18.6	25.5	4.0	9.6	18.6	0.8	50.5	37.3	0.1	25.7	51.0	0.1
Queue Delay	0.0	0.0	0.0	0.0	0.0	0.0	0.0	0.0	0.0	0.0	0.0	0.0
Total Delay	18.6	25.5	4.0	9.6	18.6	0.8	50.5	37.3	0.1	25.7	51.0	0.1
LOS	B	C	A	A	B	A	D	D	A	C	D	A
Approach Delay		21.2			17.3			36.0			30.7	
Approach LOS		C			B			D			C	

Intersection Summary

Cycle Length: 120
 Actuated Cycle Length: 120
 Offset: 63 (53%), Referenced to phase 2:EBTL and 6:WBTL, Start of Green
 Natural Cycle: 70
 Control Type: Actuated-Coordinated
 Maximum v/c Ratio: 0.85
 Intersection Signal Delay: 24.0
 Intersection LOS: C
 Intersection Capacity Utilization 79.5%
 ICU Level of Service D
 Analysis Period (min) 15

Splits and Phases: 5: Sterling Ranch Rd & Briargate Pkwy

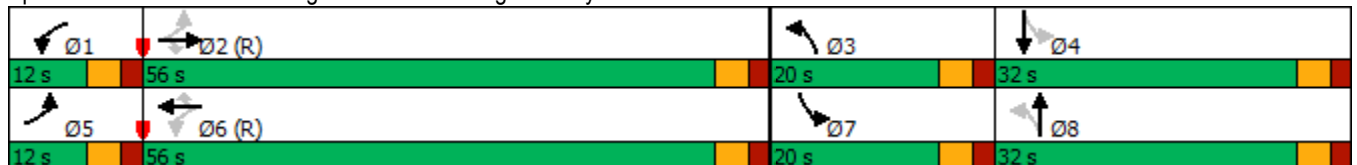

HCM 6th TWSC
 8: Sterling Ranch Rd & School Access/Oak Park Pl

2042 Total Traffic
 AM Peak Hour

Intersection												
Int Delay, s/veh	11.5											
Movement	EBL	EBT	EBR	WBL	WBT	WBR	NBL	NBT	NBR	SBL	SBT	SBR
Lane Configurations	↘	↑	↗	↘		↗		↑	↗	↘	↑	
Traffic Vol, veh/h	133	71	132	180	0	190	0	390	124	63	248	0
Future Vol, veh/h	133	71	132	180	0	190	0	390	124	63	248	0
Conflicting Peds, #/hr	0	0	0	0	0	0	0	0	0	0	0	0
Sign Control	Stop	Stop	Stop	Stop	Stop	Stop	Free	Free	Free	Free	Free	Free
RT Channelized	-	-	None	-	-	None	-	-	None	-	-	None
Storage Length	0	-	0	0	-	0	-	-	205	205	-	-
Veh in Median Storage, #	-	0	-	-	0	-	-	0	-	-	0	-
Grade, %	-	0	-	-	0	-	-	0	-	-	0	-
Peak Hour Factor	95	95	95	95	95	95	95	95	95	95	95	95
Heavy Vehicles, %	2	2	2	2	2	2	2	2	2	2	2	2
Mvmt Flow	140	75	139	189	0	200	0	411	131	66	261	0

Major/Minor	Minor2		Minor1		Major1			Major2				
Conflicting Flow All	970	935	261	911	-	411	-	0	0	542	0	0
Stage 1	393	393	-	411	-	-	-	-	-	-	-	-
Stage 2	577	542	-	500	-	-	-	-	-	-	-	-
Critical Hdwy	7.12	6.52	6.22	7.12	-	6.22	-	-	-	4.12	-	-
Critical Hdwy Stg 1	6.12	5.52	-	6.12	-	-	-	-	-	-	-	-
Critical Hdwy Stg 2	6.12	5.52	-	6.12	-	-	-	-	-	-	-	-
Follow-up Hdwy	3.518	4.018	3.318	3.518	-	3.318	-	-	-	2.218	-	-
Pot Cap-1 Maneuver	229	258	894	255	0	641	0	-	-	1027	-	0
Stage 1	694	632	-	618	0	-	0	-	-	-	-	0
Stage 2	502	520	-	592	0	-	0	-	-	-	-	0
Platoon blocked, %	1	1	1	1				-	-	-	-	
Mov Cap-1 Maneuver	150	241	894	~ 171	-	641	-	-	-	1027	-	-
Mov Cap-2 Maneuver	232	341	-	298	-	-	-	-	-	-	-	-
Stage 1	694	592	-	618	-	-	-	-	-	-	-	-
Stage 2	345	520	-	409	-	-	-	-	-	-	-	-

Approach	EB		WB		NB			SB		
HCM Control Delay, s	24.2		24.2		0			1.8		
HCM LOS	C		C							

Minor Lane/Major Mvmt	NBT	NBR	EBLn1	EBLn2	EBLn3	WBLn1	WBLn2	SBL	SBT
Capacity (veh/h)	-	-	232	341	894	298	641	1027	-
HCM Lane V/C Ratio	-	-	0.603	0.219	0.155	0.636	0.312	0.065	-
HCM Control Delay (s)	-	-	41.6	18.5	9.8	36	13.1	8.7	-
HCM Lane LOS	-	-	E	C	A	E	B	A	-
HCM 95th %tile Q(veh)	-	-	3.5	0.8	0.5	4	1.3	0.2	-

Notes
 ~: Volume exceeds capacity \$: Delay exceeds 300s +: Computation Not Defined *: All major volume in platoon

Timings
12: Vollmer Rd & Marksheffel Rd

2042 Total Traffic
AM Peak Hour

	↖	→	↘	↙	←	↖	↙	↑	↘	↘	↓	↙
Lane Group	EBL	EBT	EBR	WBL	WBT	WBR	NBL	NBT	NBR	SBL	SBT	SBR
Lane Configurations	↘	↗↗	↘	↘	↗↗	↘	↘	↗↗	↘	↘	↗↗	↘
Traffic Volume (vph)	72	843	42	175	932	70	115	238	112	120	514	132
Future Volume (vph)	72	843	42	175	932	70	115	238	112	120	514	132
Turn Type	pm+pt	NA	Perm	pm+pt	NA	Perm	pm+pt	NA	Perm	pm+pt	NA	Perm
Protected Phases	5	2		1	6		3	8		7	4	
Permitted Phases	2		2	6		6	8		8	4		4
Detector Phase	5	2	2	1	6	6	3	8	8	7	4	4
Switch Phase												
Minimum Initial (s)	5.0	5.0	5.0	5.0	5.0	5.0	5.0	10.0	10.0	5.0	10.0	10.0
Minimum Split (s)	10.0	23.0	23.0	10.0	23.0	23.0	10.0	23.0	23.0	10.0	23.0	23.0
Total Split (s)	12.0	66.0	66.0	12.0	66.0	66.0	12.0	30.0	30.0	12.0	30.0	30.0
Total Split (%)	10.0%	55.0%	55.0%	10.0%	55.0%	55.0%	10.0%	25.0%	25.0%	10.0%	25.0%	25.0%
Yellow Time (s)	3.0	3.0	3.0	3.0	3.0	3.0	3.0	3.0	3.0	3.0	3.0	3.0
All-Red Time (s)	2.0	2.0	2.0	2.0	2.0	2.0	2.0	2.0	2.0	2.0	2.0	2.0
Lost Time Adjust (s)	0.0	0.0	0.0	0.0	0.0	0.0	0.0	0.0	0.0	0.0	0.0	0.0
Total Lost Time (s)	5.0	5.0	5.0	5.0	5.0	5.0	5.0	5.0	5.0	5.0	5.0	5.0
Lead/Lag	Lead	Lag	Lag	Lead	Lag	Lag	Lead	Lag	Lag	Lead	Lag	Lag
Lead-Lag Optimize?	Yes	Yes	Yes	Yes	Yes	Yes	Yes	Yes	Yes	Yes	Yes	Yes
Recall Mode	None	C-Max	C-Max	None	C-Max	C-Max	None	Max	Max	None	Max	Max
Act Effct Green (s)	67.7	61.0	61.0	69.0	63.4	63.4	32.0	25.0	25.0	32.0	25.0	25.0
Actuated g/C Ratio	0.56	0.51	0.51	0.58	0.53	0.53	0.27	0.21	0.21	0.27	0.21	0.21
v/c Ratio	0.25	0.49	0.05	0.56	0.52	0.08	0.64	0.34	0.28	0.41	0.73	0.32
Control Delay	11.9	20.5	0.1	18.0	9.9	0.2	48.9	42.0	8.8	36.2	51.2	9.6
Queue Delay	0.0	0.0	0.0	0.0	0.0	0.0	0.0	0.0	0.0	0.0	0.0	0.0
Total Delay	11.9	20.5	0.1	18.0	9.9	0.2	48.9	42.0	8.8	36.2	51.2	9.6
LOS	B	C	A	B	A	A	D	D	A	D	D	A
Approach Delay		19.0			10.6			35.7			41.7	
Approach LOS		B			B			D			D	

Intersection Summary	
Cycle Length:	120
Actuated Cycle Length:	120
Offset:	0 (0%), Referenced to phase 2:EBTL and 6:WBTL, Start of Green
Natural Cycle:	70
Control Type:	Actuated-Coordinated
Maximum v/c Ratio:	0.73
Intersection Signal Delay:	23.5
Intersection LOS:	C
Intersection Capacity Utilization:	70.2%
ICU Level of Service:	C
Analysis Period (min):	15

Splits and Phases: 12: Vollmer Rd & Marksheffel Rd



Timings
13: Sterling Ranch Rd & Marksheffel Rd

2042 Total Traffic
AM Peak Hour

Lane Group	EBL	EBT	EBR	WBL	WBT	WBR	NBL	NBT	NBR	SBL	SBT	SBR
Lane Configurations												
Traffic Volume (vph)	164	900	10	47	809	185	39	8	55	480	9	329
Future Volume (vph)	164	900	10	47	809	185	39	8	55	480	9	329
Turn Type	pm+pt	NA	Perm	pm+pt	NA	Perm	pm+pt	NA	Perm	Prot	NA	Perm
Protected Phases	5	2		1	6		3	8		7	4	
Permitted Phases	2		2	6		6	8		8			4
Detector Phase	5	2	2	1	6	6	3	8	8	7	4	4
Switch Phase												
Minimum Initial (s)	5.0	15.0	15.0	5.0	15.0	15.0	5.0	10.0	10.0	20.0	10.0	10.0
Minimum Split (s)	10.0	20.0	20.0	10.0	20.0	20.0	10.0	15.0	15.0	25.0	20.0	20.0
Total Split (s)	12.0	51.0	51.0	12.0	51.0	51.0	12.0	25.0	25.0	32.0	45.0	45.0
Total Split (%)	10.0%	42.5%	42.5%	10.0%	42.5%	42.5%	10.0%	20.8%	20.8%	26.7%	37.5%	37.5%
Yellow Time (s)	3.0	3.0	3.0	3.0	3.0	3.0	3.0	3.0	3.0	3.0	3.0	3.0
All-Red Time (s)	2.0	2.0	2.0	2.0	2.0	2.0	2.0	2.0	2.0	2.0	2.0	2.0
Lost Time Adjust (s)	0.0	0.0	0.0	0.0	0.0	0.0	0.0	0.0	0.0	0.0	0.0	0.0
Total Lost Time (s)	5.0	5.0	5.0	5.0	5.0	5.0	5.0	5.0	5.0	5.0	5.0	5.0
Lead/Lag	Lead	Lag	Lag	Lead	Lag	Lag	Lead	Lag	Lag	Lead	Lag	Lag
Lead-Lag Optimize?	Yes	Yes	Yes	Yes	Yes	Yes	Yes	Yes	Yes	Yes	Yes	Yes
Recall Mode	None	C-Max	C-Max	None	C-Max	C-Max	None	None	None	None	None	None
Act Effct Green (s)	74.5	65.1	65.1	65.7	58.8	58.8	14.6	10.0	10.0	23.1	25.5	25.5
Actuated g/C Ratio	0.62	0.54	0.54	0.55	0.49	0.49	0.12	0.08	0.08	0.19	0.21	0.21
v/c Ratio	0.45	0.49	0.01	0.15	0.49	0.22	0.21	0.05	0.21	0.77	0.02	0.63
Control Delay	21.9	15.6	0.0	12.3	23.6	3.7	32.6	51.6	1.8	54.0	35.2	15.7
Queue Delay	0.0	0.0	0.0	0.0	0.0	0.0	0.0	0.0	0.0	0.0	0.0	0.0
Total Delay	21.9	15.6	0.0	12.3	23.6	3.7	32.6	51.6	1.8	54.0	35.2	15.7
LOS	C	B	A	B	C	A	C	D	A	D	D	B
Approach Delay		16.4			19.5			17.3			38.4	
Approach LOS		B			B			B			D	

Intersection Summary

Cycle Length: 120
 Actuated Cycle Length: 120
 Offset: 0 (0%), Referenced to phase 2:EBTL and 6:WBTL, Start of Green
 Natural Cycle: 75
 Control Type: Actuated-Coordinated
 Maximum v/c Ratio: 0.77
 Intersection Signal Delay: 23.4
 Intersection LOS: C
 Intersection Capacity Utilization 64.3%
 ICU Level of Service C
 Analysis Period (min) 15

Splits and Phases: 13: Sterling Ranch Rd & Marksheffel Rd

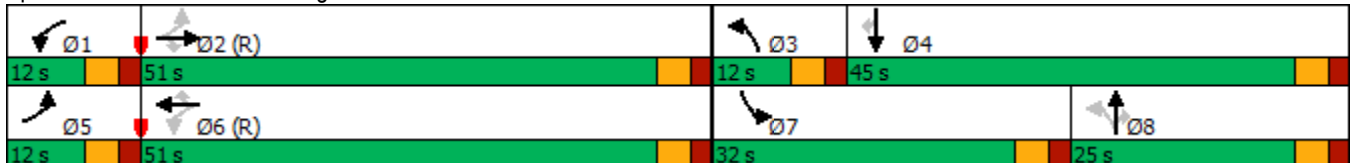

Intersection						
Int Delay, s/veh	0.3					
Movement	EBL	EBT	WBT	WBR	SBL	SBR
Lane Configurations	↘	↑↑	↑↑	↗		↗
Traffic Vol, veh/h	10	838	1375	6	0	29
Future Vol, veh/h	10	838	1375	6	0	29
Conflicting Peds, #/hr	0	0	0	0	0	0
Sign Control	Free	Free	Free	Free	Stop	Stop
RT Channelized	-	None	-	None	-	None
Storage Length	285	-	-	235	-	0
Veh in Median Storage, #	-	0	0	-	0	-
Grade, %	-	0	0	-	0	-
Peak Hour Factor	95	95	95	95	95	95
Heavy Vehicles, %	2	2	2	2	2	2
Mvmt Flow	11	882	1447	6	0	31

Major/Minor	Major1	Major2	Minor2
Conflicting Flow All	1453	0	0
Stage 1	-	-	-
Stage 2	-	-	-
Critical Hdwy	4.14	-	-
Critical Hdwy Stg 1	-	-	-
Critical Hdwy Stg 2	-	-	-
Follow-up Hdwy	2.22	-	-
Pot Cap-1 Maneuver	462	-	0
Stage 1	-	-	0
Stage 2	-	-	0
Platoon blocked, %	-	-	-
Mov Cap-1 Maneuver	462	-	-
Mov Cap-2 Maneuver	-	-	-
Stage 1	-	-	-
Stage 2	-	-	-

Approach	EB	WB	SB
HCM Control Delay, s	0.2	0	15.7
HCM LOS			C

Minor Lane/Major Mvmt	EBL	EBT	WBT	WBR	SBLn1
Capacity (veh/h)	462	-	-	-	368
HCM Lane V/C Ratio	0.023	-	-	-	0.083
HCM Control Delay (s)	13	-	-	-	15.7
HCM Lane LOS	B	-	-	-	C
HCM 95th %tile Q(veh)	0.1	-	-	-	0.3

Intersection						
Int Delay, s/veh	0.1					
Movement	EBT	EBR	WBL	WBT	NBL	NBR
Lane Configurations	↑↑	↑	↑	↑↑		↑
Traffic Vol, veh/h	827	11	7	1381	0	22
Future Vol, veh/h	827	11	7	1381	0	22
Conflicting Peds, #/hr	0	0	0	0	0	0
Sign Control	Free	Free	Free	Free	Stop	Stop
RT Channelized	-	None	-	None	-	None
Storage Length	-	235	285	-	-	0
Veh in Median Storage, #	0	-	-	0	0	-
Grade, %	0	-	-	0	0	-
Peak Hour Factor	95	95	95	95	95	95
Heavy Vehicles, %	2	2	2	2	2	2
Mvmt Flow	871	12	7	1454	0	23

Major/Minor	Major1	Major2	Minor1	Minor2	Minor3
Conflicting Flow All	0	0	883	0	436
Stage 1	-	-	-	-	-
Stage 2	-	-	-	-	-
Critical Hdwy	-	-	4.14	-	6.94
Critical Hdwy Stg 1	-	-	-	-	-
Critical Hdwy Stg 2	-	-	-	-	-
Follow-up Hdwy	-	-	2.22	-	3.32
Pot Cap-1 Maneuver	-	-	762	-	568
Stage 1	-	-	-	0	-
Stage 2	-	-	-	0	-
Platoon blocked, %	-	-	-	-	-
Mov Cap-1 Maneuver	-	-	762	-	568
Mov Cap-2 Maneuver	-	-	-	-	-
Stage 1	-	-	-	-	-
Stage 2	-	-	-	-	-

Approach	EB	WB	NB
HCM Control Delay, s	0	0	11.6
HCM LOS			B

Minor Lane/Major Mvmt	NBLn1	EBT	EBR	WBL	WBT
Capacity (veh/h)	568	-	-	762	-
HCM Lane V/C Ratio	0.041	-	-	0.01	-
HCM Control Delay (s)	11.6	-	-	9.8	-
HCM Lane LOS	B	-	-	A	-
HCM 95th %tile Q(veh)	0.1	-	-	0	-

Intersection						
Int Delay, s/veh	4.9					
Movement	EBT	EBR	WBL	WBT	NBL	NBR
Lane Configurations	↑	↗	↖	↑	↘	↙
Traffic Vol, veh/h	290	84	150	519	97	123
Future Vol, veh/h	290	84	150	519	97	123
Conflicting Peds, #/hr	0	0	0	0	0	0
Sign Control	Free	Free	Free	Free	Stop	Stop
RT Channelized	-	None	-	None	-	None
Storage Length	-	155	205	-	0	-
Veh in Median Storage, #	0	-	-	0	0	-
Grade, %	0	-	-	0	0	-
Peak Hour Factor	95	95	95	95	95	95
Heavy Vehicles, %	2	2	2	2	2	2
Mvmt Flow	305	88	158	546	102	129

Major/Minor	Major1	Major2	Minor1		
Conflicting Flow All	0	0	393	0	1167 305
Stage 1	-	-	-	-	305 -
Stage 2	-	-	-	-	862 -
Critical Hdwy	-	-	4.12	-	6.42 6.22
Critical Hdwy Stg 1	-	-	-	-	5.42 -
Critical Hdwy Stg 2	-	-	-	-	5.42 -
Follow-up Hdwy	-	-	2.218	-	3.518 3.318
Pot Cap-1 Maneuver	-	-	1166	-	214 735
Stage 1	-	-	-	-	748 -
Stage 2	-	-	-	-	414 -
Platoon blocked, %	-	-	-	-	-
Mov Cap-1 Maneuver	-	-	1166	-	185 735
Mov Cap-2 Maneuver	-	-	-	-	290 -
Stage 1	-	-	-	-	748 -
Stage 2	-	-	-	-	358 -

Approach	EB	WB	NB
HCM Control Delay, s	0	1.9	22.1
HCM LOS			C

Minor Lane/Major Mvmt	NBLn1	EBT	EBR	WBL	WBT
Capacity (veh/h)	438	-	-	1166	-
HCM Lane V/C Ratio	0.529	-	-	0.135	-
HCM Control Delay (s)	22.1	-	-	8.6	-
HCM Lane LOS	C	-	-	A	-
HCM 95th %tile Q(veh)	3	-	-	0.5	-

Intersection												
Int Delay, s/veh	1.6											
Movement	EBL	EBT	EBR	WBL	WBT	WBR	NBL	NBT	NBR	SBL	SBT	SBR
Lane Configurations	↖	↗		↖	↗			↕			↕	
Traffic Vol, veh/h	6	402	6	9	636	8	17	0	26	22	0	16
Future Vol, veh/h	6	402	6	9	636	8	17	0	26	22	0	16
Conflicting Peds, #/hr	0	0	0	0	0	0	0	0	0	0	0	0
Sign Control	Free	Free	Free	Free	Free	Free	Stop	Stop	Stop	Stop	Stop	Stop
RT Channelized	-	-	None	-	-	None	-	-	None	-	-	None
Storage Length	205	-	-	205	-	-	-	-	-	-	-	-
Veh in Median Storage, #	-	0	-	-	0	-	-	0	-	-	0	-
Grade, %	-	0	-	-	0	-	-	0	-	-	0	-
Peak Hour Factor	95	95	95	95	95	95	95	95	95	95	95	95
Heavy Vehicles, %	2	2	2	2	2	2	2	2	2	2	2	2
Mvmt Flow	6	423	6	9	669	8	18	0	27	23	0	17

Major/Minor	Major1			Major2			Minor1			Minor2		
Conflicting Flow All	677	0	0	429	0	0	1138	1133	426	1143	1132	673
Stage 1	-	-	-	-	-	-	438	438	-	691	691	-
Stage 2	-	-	-	-	-	-	700	695	-	452	441	-
Critical Hdwy	4.12	-	-	4.12	-	-	7.12	6.52	6.22	7.12	6.52	6.22
Critical Hdwy Stg 1	-	-	-	-	-	-	6.12	5.52	-	6.12	5.52	-
Critical Hdwy Stg 2	-	-	-	-	-	-	6.12	5.52	-	6.12	5.52	-
Follow-up Hdwy	2.218	-	-	2.218	-	-	3.518	4.018	3.318	3.518	4.018	3.318
Pot Cap-1 Maneuver	915	-	-	1130	-	-	179	203	628	177	203	455
Stage 1	-	-	-	-	-	-	597	579	-	435	446	-
Stage 2	-	-	-	-	-	-	430	444	-	587	577	-
Platoon blocked, %		-	-	-	-	-						
Mov Cap-1 Maneuver	915	-	-	1130	-	-	170	200	628	167	200	455
Mov Cap-2 Maneuver	-	-	-	-	-	-	170	200	-	167	200	-
Stage 1	-	-	-	-	-	-	593	575	-	432	442	-
Stage 2	-	-	-	-	-	-	411	440	-	558	573	-

Approach	EB			WB			NB			SB		
HCM Control Delay, s	0.1			0.1			18.9			24.1		
HCM LOS							C			C		

Minor Lane/Major Mvmt	NBLn1	EBL	EBT	EBR	WBL	WBT	WBR	SBLn1
Capacity (veh/h)	304	915	-	-	1130	-	-	228
HCM Lane V/C Ratio	0.149	0.007	-	-	0.008	-	-	0.175
HCM Control Delay (s)	18.9	9	-	-	8.2	-	-	24.1
HCM Lane LOS	C	A	-	-	A	-	-	C
HCM 95th %tile Q(veh)	0.5	0	-	-	0	-	-	0.6

Intersection												
Int Delay, s/veh	3.9											
Movement	EBL	EBT	EBR	WBL	WBT	WBR	NBL	NBT	NBR	SBL	SBT	SBR
Lane Configurations	↙	↑	↗	↙	↗			↕			↕	
Traffic Vol, veh/h	11	415	24	9	551	8	70	0	29	22	0	32
Future Vol, veh/h	11	415	24	9	551	8	70	0	29	22	0	32
Conflicting Peds, #/hr	0	0	0	0	0	0	0	0	0	0	0	0
Sign Control	Free	Free	Free	Free	Free	Free	Stop	Stop	Stop	Stop	Stop	Stop
RT Channelized	-	-	None	-	-	None	-	-	None	-	-	None
Storage Length	305	-	255	305	-	-	-	-	-	-	-	-
Veh in Median Storage, #	-	0	-	-	0	-	-	0	-	-	0	-
Grade, %	-	0	-	-	0	-	-	0	-	-	0	-
Peak Hour Factor	95	95	95	95	95	95	95	95	95	95	95	95
Heavy Vehicles, %	2	2	2	2	2	2	2	2	2	2	2	2
Mvmt Flow	12	437	25	9	580	8	74	0	31	23	0	34

Major/Minor	Major1			Major2			Minor1			Minor2		
Conflicting Flow All	588	0	0	462	0	0	1080	1067	437	1091	1088	584
Stage 1	-	-	-	-	-	-	461	461	-	602	602	-
Stage 2	-	-	-	-	-	-	619	606	-	489	486	-
Critical Hdwy	4.12	-	-	4.12	-	-	7.12	6.52	6.22	7.12	6.52	6.22
Critical Hdwy Stg 1	-	-	-	-	-	-	6.12	5.52	-	6.12	5.52	-
Critical Hdwy Stg 2	-	-	-	-	-	-	6.12	5.52	-	6.12	5.52	-
Follow-up Hdwy	2.218	-	-	2.218	-	-	3.518	4.018	3.318	3.518	4.018	3.318
Pot Cap-1 Maneuver	987	-	-	1099	-	-	196	222	620	192	216	512
Stage 1	-	-	-	-	-	-	581	565	-	486	489	-
Stage 2	-	-	-	-	-	-	476	487	-	561	551	-
Platoon blocked, %		-	-	-	-	-						
Mov Cap-1 Maneuver	987	-	-	1099	-	-	180	218	620	180	212	512
Mov Cap-2 Maneuver	-	-	-	-	-	-	180	218	-	180	212	-
Stage 1	-	-	-	-	-	-	574	558	-	480	485	-
Stage 2	-	-	-	-	-	-	441	483	-	527	544	-

Approach	EB			WB			NB			SB		
HCM Control Delay, s	0.2			0.1			33.6			20.3		
HCM LOS							D			C		

Minor Lane/Major Mvmt	NBLn1	EBL	EBT	EBR	WBL	WBT	WBR	SBLn1
Capacity (veh/h)	227	987	-	-	1099	-	-	292
HCM Lane V/C Ratio	0.459	0.012	-	-	0.009	-	-	0.195
HCM Control Delay (s)	33.6	8.7	-	-	8.3	-	-	20.3
HCM Lane LOS	D	A	-	-	A	-	-	C
HCM 95th %tile Q(veh)	2.2	0	-	-	0	-	-	0.7

Intersection												
Int Delay, s/veh	2											
Movement	EBL	EBT	EBR	WBL	WBT	WBR	NBL	NBT	NBR	SBL	SBT	SBR
Lane Configurations		↕			↕		↕	↕		↕	↕	
Traffic Vol, veh/h	44	0	16	13	0	13	6	457	4	5	539	16
Future Vol, veh/h	44	0	16	13	0	13	6	457	4	5	539	16
Conflicting Peds, #/hr	0	0	0	0	0	0	0	0	0	0	0	0
Sign Control	Stop	Stop	Stop	Stop	Stop	Stop	Free	Free	Free	Free	Free	Free
RT Channelized	-	-	None	-	-	None	-	-	None	-	-	None
Storage Length	-	-	-	-	-	-	205	-	-	205	-	-
Veh in Median Storage, #	-	0	-	-	0	-	-	0	-	-	0	-
Grade, %	-	0	-	-	0	-	-	0	-	-	0	-
Peak Hour Factor	95	95	95	95	95	95	95	95	95	95	95	95
Heavy Vehicles, %	2	2	2	2	2	2	2	2	2	2	2	2
Mvmt Flow	46	0	17	14	0	14	6	481	4	5	567	17

Major/Minor	Minor2		Minor1		Major1		Major2					
Conflicting Flow All	1088	1083	576	1089	1089	483	584	0	0	485	0	0
Stage 1	586	586	-	495	495	-	-	-	-	-	-	-
Stage 2	502	497	-	594	594	-	-	-	-	-	-	-
Critical Hdwy	7.12	6.52	6.22	7.12	6.52	6.22	4.12	-	-	4.12	-	-
Critical Hdwy Stg 1	6.12	5.52	-	6.12	5.52	-	-	-	-	-	-	-
Critical Hdwy Stg 2	6.12	5.52	-	6.12	5.52	-	-	-	-	-	-	-
Follow-up Hdwy	3.518	4.018	3.318	3.518	4.018	3.318	2.218	-	-	2.218	-	-
Pot Cap-1 Maneuver	193	217	517	193	215	584	991	-	-	1078	-	-
Stage 1	496	497	-	556	546	-	-	-	-	-	-	-
Stage 2	552	545	-	491	493	-	-	-	-	-	-	-
Platoon blocked, %								-	-	-	-	-
Mov Cap-1 Maneuver	187	215	517	185	213	584	991	-	-	1078	-	-
Mov Cap-2 Maneuver	187	215	-	185	213	-	-	-	-	-	-	-
Stage 1	493	495	-	553	543	-	-	-	-	-	-	-
Stage 2	536	542	-	473	491	-	-	-	-	-	-	-

Approach	EB		WB		NB		SB	
HCM Control Delay, s	27.1		19.2		0.1		0.1	
HCM LOS	D		C					

Minor Lane/Major Mvmt	NBL	NBT	NBR	EBLn1	WBLn1	SBL	SBT	SBR
Capacity (veh/h)	991	-	-	225	281	1078	-	-
HCM Lane V/C Ratio	0.006	-	-	0.281	0.097	0.005	-	-
HCM Control Delay (s)	8.7	-	-	27.1	19.2	8.4	-	-
HCM Lane LOS	A	-	-	D	C	A	-	-
HCM 95th %tile Q(veh)	0	-	-	1.1	0.3	0	-	-

Intersection						
Int Delay, s/veh	1.5					
Movement	EBL	EBR	NBL	NBT	SBT	SBR
Lane Configurations		↗	↘	↑	↑	↗
Traffic Vol, veh/h	0	0	193	520	311	209
Future Vol, veh/h	0	0	193	520	311	209
Conflicting Peds, #/hr	0	0	0	0	0	0
Sign Control	Stop	Stop	Free	Free	Free	Free
RT Channelized	-	None	-	None	-	None
Storage Length	-	0	150	-	-	150
Veh in Median Storage, #	0	-	-	0	0	-
Grade, %	0	-	-	0	0	-
Peak Hour Factor	95	95	95	95	95	95
Heavy Vehicles, %	2	2	2	2	2	2
Mvmt Flow	0	0	203	547	327	220

Major/Minor	Minor2	Major1	Major2			
Conflicting Flow All	-	327	547	0	-	0
Stage 1	-	-	-	-	-	-
Stage 2	-	-	-	-	-	-
Critical Hdwy	-	6.22	4.12	-	-	-
Critical Hdwy Stg 1	-	-	-	-	-	-
Critical Hdwy Stg 2	-	-	-	-	-	-
Follow-up Hdwy	-	3.318	2.218	-	-	-
Pot Cap-1 Maneuver	0	*847	1002	-	-	-
Stage 1	0	-	-	-	-	-
Stage 2	0	-	-	-	-	-
Platoon blocked, %		1	1	-	-	-
Mov Cap-1 Maneuver	-	*847	1002	-	-	-
Mov Cap-2 Maneuver	-	-	-	-	-	-
Stage 1	-	-	-	-	-	-
Stage 2	-	-	-	-	-	-

Approach	EB	NB	SB
HCM Control Delay, s	0	2.6	0
HCM LOS	A		

Minor Lane/Major Mvmt	NBL	NBT	EBLn1	SBT	SBR
Capacity (veh/h)	1002	-	-	-	-
HCM Lane V/C Ratio	0.203	-	-	-	-
HCM Control Delay (s)	9.5	-	0	-	-
HCM Lane LOS	A	-	A	-	-
HCM 95th %tile Q(veh)	0.8	-	-	-	-

Notes
 ~: Volume exceeds capacity \$: Delay exceeds 300s +: Computation Not Defined *: All major volume in platoon

Intersection												
Int Delay, s/veh	3.2											
Movement	EBL	EBT	EBR	WBL	WBT	WBR	NBL	NBT	NBR	SBL	SBT	SBR
Lane Configurations		↕			↕		↗	↑	↖	↗	↖	↖
Traffic Vol, veh/h	0	0	97	53	0	0	29	152	35	0	374	0
Future Vol, veh/h	0	0	97	53	0	0	29	152	35	0	374	0
Conflicting Peds, #/hr	0	0	0	0	0	0	0	0	0	0	0	0
Sign Control	Stop	Stop	Stop	Stop	Stop	Stop	Free	Free	Free	Free	Free	Free
RT Channelized	-	-	None	-	-	None	-	-	None	-	-	None
Storage Length	-	-	-	-	-	-	200	-	200	200	-	-
Veh in Median Storage, #	-	0	-	-	0	-	-	0	-	-	0	-
Grade, %	-	0	-	-	0	-	-	0	-	-	0	-
Peak Hour Factor	95	95	95	95	95	95	95	95	95	95	95	95
Heavy Vehicles, %	2	2	2	2	2	2	2	2	2	2	2	2
Mvmt Flow	0	0	102	56	0	0	31	160	37	0	394	0

Major/Minor	Minor2		Minor1		Major1		Major2					
Conflicting Flow All	635	653	394	667	616	160	394	0	0	197	0	0
Stage 1	394	394	-	222	222	-	-	-	-	-	-	-
Stage 2	241	259	-	445	394	-	-	-	-	-	-	-
Critical Hdwy	7.12	6.52	6.22	7.12	6.52	6.22	4.12	-	-	4.12	-	-
Critical Hdwy Stg 1	6.12	5.52	-	6.12	5.52	-	-	-	-	-	-	-
Critical Hdwy Stg 2	6.12	5.52	-	6.12	5.52	-	-	-	-	-	-	-
Follow-up Hdwy	3.518	4.018	3.318	3.518	4.018	3.318	2.218	-	-	2.218	-	-
Pot Cap-1 Maneuver	391	387	655	372	406	885	1165	-	-	1376	-	-
Stage 1	631	605	-	780	720	-	-	-	-	-	-	-
Stage 2	762	694	-	592	605	-	-	-	-	-	-	-
Platoon blocked, %								-	-	-	-	-
Mov Cap-1 Maneuver	383	377	655	308	395	885	1165	-	-	1376	-	-
Mov Cap-2 Maneuver	383	377	-	308	395	-	-	-	-	-	-	-
Stage 1	614	605	-	759	701	-	-	-	-	-	-	-
Stage 2	742	675	-	500	605	-	-	-	-	-	-	-

Approach	EB	WB	NB	SB
HCM Control Delay, s	11.5	19.3	1.1	0
HCM LOS	B	C		

Minor Lane/Major Mvmt	NBL	NBT	NBR	EBLn1	WBLn1	SBL	SBT	SBR
Capacity (veh/h)	1165	-	-	655	308	1376	-	-
HCM Lane V/C Ratio	0.026	-	-	0.156	0.181	-	-	-
HCM Control Delay (s)	8.2	-	-	11.5	19.3	0	-	-
HCM Lane LOS	A	-	-	B	C	A	-	-
HCM 95th %tile Q(veh)	0.1	-	-	0.6	0.7	0	-	-

Intersection												
Int Delay, s/veh	3.1											
Movement	EBL	EBT	EBR	WBL	WBT	WBR	NBL	NBT	NBR	SBL	SBT	SBR
Lane Configurations		↕			↕		↗	↑	↖	↗	↖	↖
Traffic Vol, veh/h	0	0	106	18	0	0	35	105	12	0	250	0
Future Vol, veh/h	0	0	106	18	0	0	35	105	12	0	250	0
Conflicting Peds, #/hr	0	0	0	0	0	0	0	0	0	0	0	0
Sign Control	Stop	Stop	Stop	Stop	Stop	Stop	Free	Free	Free	Free	Free	Free
RT Channelized	-	-	None	-	-	None	-	-	None	-	-	None
Storage Length	-	-	-	-	-	-	200	-	200	200	-	-
Veh in Median Storage, #	-	0	-	-	0	-	-	0	-	-	0	-
Grade, %	-	0	-	-	0	-	-	0	-	-	0	-
Peak Hour Factor	95	95	95	95	95	95	95	95	95	95	95	95
Heavy Vehicles, %	2	2	2	2	2	2	2	2	2	2	2	2
Mvmt Flow	0	0	112	19	0	0	37	111	13	0	263	0

Major/Minor	Minor2		Minor1		Major1			Major2				
Conflicting Flow All	455	461	263	504	448	111	263	0	0	124	0	0
Stage 1	263	263	-	185	185	-	-	-	-	-	-	-
Stage 2	192	198	-	319	263	-	-	-	-	-	-	-
Critical Hdwy	7.12	6.52	6.22	7.12	6.52	6.22	4.12	-	-	4.12	-	-
Critical Hdwy Stg 1	6.12	5.52	-	6.12	5.52	-	-	-	-	-	-	-
Critical Hdwy Stg 2	6.12	5.52	-	6.12	5.52	-	-	-	-	-	-	-
Follow-up Hdwy	3.518	4.018	3.318	3.518	4.018	3.318	2.218	-	-	2.218	-	-
Pot Cap-1 Maneuver	515	497	776	478	506	942	1301	-	-	1463	-	-
Stage 1	742	691	-	817	747	-	-	-	-	-	-	-
Stage 2	810	737	-	693	691	-	-	-	-	-	-	-
Platoon blocked, %								-	-	-	-	-
Mov Cap-1 Maneuver	504	483	776	401	492	942	1301	-	-	1463	-	-
Mov Cap-2 Maneuver	504	483	-	401	492	-	-	-	-	-	-	-
Stage 1	721	691	-	794	726	-	-	-	-	-	-	-
Stage 2	787	716	-	593	691	-	-	-	-	-	-	-

Approach	EB	WB	NB	SB
HCM Control Delay, s	10.4	14.4	1.8	0
HCM LOS	B	B		

Minor Lane/Major Mvmt	NBL	NBT	NBR	EBLn1	WBLn1	SBL	SBT	SBR
Capacity (veh/h)	1301	-	-	776	401	1463	-	-
HCM Lane V/C Ratio	0.028	-	-	0.144	0.047	-	-	-
HCM Control Delay (s)	7.8	-	-	10.4	14.4	0	-	-
HCM Lane LOS	A	-	-	B	B	A	-	-
HCM 95th %tile Q(veh)	0.1	-	-	0.5	0.1	0	-	-

Intersection					
Intersection Delay, s/veh	15.0				
Intersection LOS	C				
Approach	EB	WB	NB	SB	
Entry Lanes	1	1	1	1	
Conflicting Circle Lanes	1	1	1	1	
Adj Approach Flow, veh/h	453	393	815	418	
Demand Flow Rate, veh/h	462	401	830	426	
Vehicles Circulating, veh/h	548	623	591	408	
Vehicles Exiting, veh/h	286	577	419	616	
Ped Vol Crossing Leg, #/h	0	0	0	0	
Ped Cap Adj	1.000	1.000	1.000	1.000	
Approach Delay, s/veh	13.9	13.7	19.0	9.9	
Approach LOS	B	B	C	A	
Lane	Left	Left	Left	Bypass	Left
Designated Moves	LTR	LTR	LT	R	LTR
Assumed Moves	LTR	LTR	LT	R	LTR
RT Channelized				Free	
Lane Util	1.000	1.000	1.000		1.000
Follow-Up Headway, s	2.609	2.609	2.609		2.609
Critical Headway, s	4.976	4.976	4.976	221	4.976
Entry Flow, veh/h	462	401	609	1938	426
Cap Entry Lane, veh/h	789	731	755	0.980	910
Entry HV Adj Factor	0.981	0.980	0.981	217	0.980
Flow Entry, veh/h	453	393	598	1900	418
Cap Entry, veh/h	774	717	741	0.114	892
V/C Ratio	0.586	0.549	0.806	0.0	0.468
Control Delay, s/veh	13.9	13.7	25.8	A	9.9
LOS	B	B	D	0	A
95th %tile Queue, veh	4	3	8		3

Timings
4: Vollmer Rd & Briargate Pkwy

2042 Total Traffic
PM Peak Hour

Lane Group	EBL	EBT	EBR	WBL	WBT	WBR	NBL	NBT	NBR	SBL	SBT	SBR
Lane Configurations												
Traffic Volume (vph)	227	1014	184	210	745	74	300	415	283	109	211	118
Future Volume (vph)	227	1014	184	210	745	74	300	415	283	109	211	118
Turn Type	pm+pt	NA	Perm	Prot	NA	Perm	pm+pt	NA	Perm	pm+pt	NA	Perm
Protected Phases	5	2		1	6		3	8		7	4	
Permitted Phases	2		2			6	8		8	4		4
Detector Phase	5	2	2	1	6	6	3	8	8	7	4	4
Switch Phase												
Minimum Initial (s)	5.0	15.0	15.0	15.0	15.0	15.0	8.0	5.0	5.0	5.0	5.0	5.0
Minimum Split (s)	10.0	20.0	20.0	20.0	20.0	20.0	13.0	10.0	10.0	10.0	10.0	10.0
Total Split (s)	12.0	53.0	53.0	20.0	61.0	61.0	22.0	28.0	28.0	19.0	25.0	25.0
Total Split (%)	10.0%	44.2%	44.2%	16.7%	50.8%	50.8%	18.3%	23.3%	23.3%	15.8%	20.8%	20.8%
Yellow Time (s)	3.0	3.0	3.0	3.0	3.0	3.0	3.0	3.0	3.0	3.0	3.0	3.0
All-Red Time (s)	2.0	2.0	2.0	2.0	2.0	2.0	2.0	2.0	2.0	2.0	2.0	2.0
Lost Time Adjust (s)	0.0	-2.0	0.0	0.0	-2.0	0.0	0.0	0.0	0.0	0.0	0.0	0.0
Total Lost Time (s)	5.0	3.0	5.0	5.0	3.0	5.0	5.0	5.0	5.0	5.0	5.0	5.0
Lead/Lag	Lead	Lag	Lag	Lead	Lag	Lag	Lead	Lag	Lag	Lead	Lag	Lag
Lead-Lag Optimize?	Yes	Yes	Yes	Yes	Yes	Yes	Yes	Yes	Yes	Yes	Yes	Yes
Recall Mode	None	Max	Max	None	Max	Max	None	None	None	None	None	None
Act Effct Green (s)	55.1	50.1	48.1	15.0	58.1	56.1	35.6	20.3	20.3	25.3	14.5	14.5
Actuated g/C Ratio	0.48	0.44	0.42	0.13	0.51	0.49	0.31	0.18	0.18	0.22	0.13	0.13
v/c Ratio	0.68	0.67	0.25	0.49	0.44	0.09	0.83	0.67	0.59	0.43	0.50	0.37
Control Delay	26.6	28.8	4.7	51.1	19.3	1.6	52.7	50.0	12.0	33.9	50.1	6.5
Queue Delay	0.0	0.0	0.0	0.0	0.0	0.0	0.0	0.0	0.0	0.0	0.0	0.0
Total Delay	26.6	28.8	4.7	51.1	19.3	1.6	52.7	50.0	12.0	33.9	50.1	6.5
LOS	C	C	A	D	B	A	D	D	B	C	D	A
Approach Delay		25.2			24.5			39.9			34.3	
Approach LOS		C			C			D			C	

Intersection Summary

Cycle Length: 120
 Actuated Cycle Length: 114.3
 Natural Cycle: 75
 Control Type: Actuated-Uncoordinated
 Maximum v/c Ratio: 0.83
 Intersection Signal Delay: 29.8
 Intersection LOS: C
 Intersection Capacity Utilization 78.8%
 ICU Level of Service D
 Analysis Period (min) 15

Splits and Phases: 4: Vollmer Rd & Briargate Pkwy



Timings
5: Sterling Ranch Rd & Briargate Pkwy

2042 Total Traffic
PM Peak Hour

Lane Group	EBL	EBT	EBR	WBL	WBT	WBR	NBL	NBT	NBR	SBL	SBT	SBR
Lane Configurations												
Traffic Volume (vph)	329	924	131	155	827	105	193	190	83	86	87	133
Future Volume (vph)	329	924	131	155	827	105	193	190	83	86	87	133
Turn Type	pm+pt	NA	Perm	pm+pt	NA	Perm	pm+pt	NA	Free	pm+pt	NA	Free
Protected Phases	5	2		1	6		3	8		7	4	
Permitted Phases	2		2	6		6	8		Free	4		Free
Detector Phase	5	2	2	1	6	6	3	8		7	4	
Switch Phase												
Minimum Initial (s)	5.0	5.0	5.0	5.0	5.0	5.0	5.0	20.0		5.0	20.0	
Minimum Split (s)	10.0	23.0	23.0	10.0	23.0	23.0	10.0	25.0		10.0	25.0	
Total Split (s)	22.0	68.0	68.0	12.0	58.0	58.0	15.0	30.0		10.0	25.0	
Total Split (%)	18.3%	56.7%	56.7%	10.0%	48.3%	48.3%	12.5%	25.0%		8.3%	20.8%	
Yellow Time (s)	3.0	3.0	3.0	3.0	3.0	3.0	3.0	3.0		3.0	3.0	
All-Red Time (s)	2.0	2.0	2.0	2.0	2.0	2.0	2.0	2.0		2.0	2.0	
Lost Time Adjust (s)	-2.0	-2.0	0.0	0.0	-2.0	0.0	0.0	0.0		0.0	0.0	
Total Lost Time (s)	3.0	3.0	5.0	5.0	3.0	5.0	5.0	5.0		5.0	5.0	
Lead/Lag	Lead	Lag	Lag	Lead	Lag	Lag	Lead	Lag		Lead	Lag	
Lead-Lag Optimize?	Yes	Yes	Yes	Yes	Yes	Yes	Yes	Yes		Yes	Yes	
Recall Mode	None	C-Max	C-Max	None	C-Max	C-Max	None	None		None	None	
Act Effct Green (s)	77.0	65.0	63.0	61.8	56.8	54.8	35.0	25.0	120.0	25.0	20.0	120.0
Actuated g/C Ratio	0.64	0.54	0.52	0.52	0.47	0.46	0.29	0.21	1.00	0.21	0.17	1.00
v/c Ratio	0.77	0.51	0.15	0.54	0.52	0.14	0.57	0.52	0.05	0.36	0.30	0.09
Control Delay	24.6	18.6	2.8	19.4	24.0	5.3	41.3	47.6	0.1	38.3	46.8	0.1
Queue Delay	0.0	0.0	0.0	0.0	0.0	0.0	0.0	0.0	0.0	0.0	0.0	0.0
Total Delay	24.6	18.6	2.8	19.4	24.0	5.3	41.3	47.6	0.1	38.3	46.8	0.1
LOS	C	B	A	B	C	A	D	D	A	D	D	A
Approach Delay		18.5			21.6			36.6			24.2	
Approach LOS		B			C			D			C	

Intersection Summary

Cycle Length: 120
 Actuated Cycle Length: 120
 Offset: 0 (0%), Referenced to phase 2:EBTL and 6:WBTL, Start of Green
 Natural Cycle: 75
 Control Type: Actuated-Coordinated
 Maximum v/c Ratio: 0.77
 Intersection Signal Delay: 22.7
 Intersection LOS: C
 Intersection Capacity Utilization 83.4%
 ICU Level of Service E
 Analysis Period (min) 15

Splits and Phases: 5: Sterling Ranch Rd & Briargate Pkwy

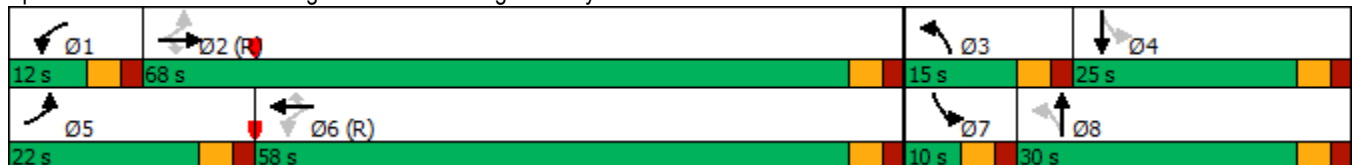

Intersection												
Int Delay, s/veh	4.7											
Movement	EBL	EBT	EBR	WBL	WBT	WBR	NBL	NBT	NBR	SBL	SBT	SBR
Lane Configurations	↖	↗	↖	↖		↖		↗	↖	↖	↗	
Traffic Vol, veh/h	38	18	32	123	0	137	0	325	153	50	284	0
Future Vol, veh/h	38	18	32	123	0	137	0	325	153	50	284	0
Conflicting Peds, #/hr	0	0	0	0	0	0	0	0	0	0	0	0
Sign Control	Stop	Stop	Stop	Stop	Stop	Stop	Free	Free	Free	Free	Free	Free
RT Channelized	-	-	None	-	-	None	-	-	None	-	-	None
Storage Length	0	-	0	0	-	0	-	-	205	205	-	-
Veh in Median Storage, #	-	0	-	-	0	-	-	0	-	-	0	-
Grade, %	-	0	-	-	0	-	-	0	-	-	0	-
Peak Hour Factor	95	95	95	95	95	95	95	95	95	95	95	95
Heavy Vehicles, %	2	2	2	2	2	2	2	2	2	2	2	2
Mvmt Flow	40	19	34	129	0	144	0	342	161	53	299	0

Major/Minor	Minor2		Minor1		Major1			Major2				
Conflicting Flow All	900	908	299	774	-	342	-	0	0	503	0	0
Stage 1	405	405	-	342	-	-	-	-	-	-	-	-
Stage 2	495	503	-	432	-	-	-	-	-	-	-	-
Critical Hdwy	7.12	6.52	6.22	7.12	-	6.22	-	-	-	4.12	-	-
Critical Hdwy Stg 1	6.12	5.52	-	6.12	-	-	-	-	-	-	-	-
Critical Hdwy Stg 2	6.12	5.52	-	6.12	-	-	-	-	-	-	-	-
Follow-up Hdwy	3.518	4.018	3.318	3.518	-	3.318	-	-	-	2.218	-	-
Pot Cap-1 Maneuver	262	269	865	333	0	701	0	-	-	1061	-	0
Stage 1	695	628	-	673	0	-	0	-	-	-	-	0
Stage 2	556	541	-	667	0	-	0	-	-	-	-	0
Platoon blocked, %	1	1	1	1				-	-	-		
Mov Cap-1 Maneuver	200	255	865	295	-	701	-	-	-	1061	-	-
Mov Cap-2 Maneuver	307	359	-	421	-	-	-	-	-	-	-	-
Stage 1	695	597	-	673	-	-	-	-	-	-	-	-
Stage 2	442	541	-	590	-	-	-	-	-	-	-	-

Approach	EB		WB		NB			SB		
HCM Control Delay, s	14.6		14.2		0			1.3		
HCM LOS	B		B							

Minor Lane/Major Mvmt	NBT	NBR	EBLn1	EBLn2	EBLn3	WBLn1	WBLn2	SBL	SBT
Capacity (veh/h)	-	-	307	359	865	421	701	1061	-
HCM Lane V/C Ratio	-	-	0.13	0.053	0.039	0.308	0.206	0.05	-
HCM Control Delay (s)	-	-	18.5	15.6	9.3	17.3	11.5	8.6	-
HCM Lane LOS	-	-	C	C	A	C	B	A	-
HCM 95th %tile Q(veh)	-	-	0.4	0.2	0.1	1.3	0.8	0.2	-

Timings
12: Vollmer Rd & Marksheffel Rd

2042 Total Traffic
PM Peak Hour

Lane Group	EBL	EBT	EBR	WBL	WBT	WBR	NBL	NBT	NBR	SBL	SBT	SBR
Lane Configurations												
Traffic Volume (vph)	143	949	96	191	718	154	171	728	192	132	342	200
Future Volume (vph)	143	949	96	191	718	154	171	728	192	132	342	200
Turn Type	pm+pt	NA	Perm	pm+pt	NA	Perm	pm+pt	NA	Perm	pm+pt	NA	Perm
Protected Phases	5	2		1	6		3	8		7	4	
Permitted Phases	2		2	6		6	8		8	4		4
Detector Phase	5	2	2	1	6	6	3	8	8	7	4	4
Switch Phase												
Minimum Initial (s)	5.0	5.0	5.0	5.0	5.0	5.0	5.0	10.0	10.0	5.0	10.0	10.0
Minimum Split (s)	10.0	23.0	23.0	10.0	23.0	23.0	10.0	23.0	23.0	10.0	23.0	23.0
Total Split (s)	20.0	50.0	50.0	19.0	49.0	49.0	15.0	36.0	36.0	15.0	36.0	36.0
Total Split (%)	16.7%	41.7%	41.7%	15.8%	40.8%	40.8%	12.5%	30.0%	30.0%	12.5%	30.0%	30.0%
Yellow Time (s)	3.0	3.0	3.0	3.0	3.0	3.0	3.0	3.0	3.0	3.0	3.0	3.0
All-Red Time (s)	2.0	2.0	2.0	2.0	2.0	2.0	2.0	2.0	2.0	2.0	2.0	2.0
Lost Time Adjust (s)	0.0	0.0	0.0	0.0	0.0	0.0	0.0	0.0	0.0	0.0	0.0	0.0
Total Lost Time (s)	5.0	5.0	5.0	5.0	5.0	5.0	5.0	5.0	5.0	5.0	5.0	5.0
Lead/Lag	Lead	Lag	Lag	Lead	Lag	Lag	Lead	Lag	Lag	Lead	Lag	Lag
Lead-Lag Optimize?	Yes	Yes	Yes	Yes	Yes	Yes	Yes	Yes	Yes	Yes	Yes	Yes
Recall Mode	None	C-Max	C-Max	None	C-Max	C-Max	None	Max	Max	None	Max	Max
Act Effct Green (s)	57.5	46.7	46.7	60.5	48.2	48.2	41.2	31.4	31.4	40.8	31.2	31.2
Actuated g/C Ratio	0.48	0.39	0.39	0.50	0.40	0.40	0.34	0.26	0.26	0.34	0.26	0.26
v/c Ratio	0.44	0.73	0.15	0.73	0.53	0.23	0.50	0.83	0.39	0.68	0.39	0.37
Control Delay	18.8	35.3	4.5	53.1	22.5	5.5	31.4	50.7	13.7	43.5	38.2	6.7
Queue Delay	0.0	0.0	0.0	0.0	0.0	0.0	0.0	0.0	0.0	0.0	0.0	0.0
Total Delay	18.8	35.3	4.5	53.1	22.5	5.5	31.4	50.7	13.7	43.5	38.2	6.7
LOS	B	D	A	D	C	A	C	D	B	D	D	A
Approach Delay		30.8			25.6			41.2			29.9	
Approach LOS		C			C			D			C	

Intersection Summary

Cycle Length: 120
 Actuated Cycle Length: 120
 Offset: 0 (0%), Referenced to phase 2:EBTL and 6:WBTL, Start of Green
 Natural Cycle: 70
 Control Type: Actuated-Coordinated
 Maximum v/c Ratio: 0.83
 Intersection Signal Delay: 32.1
 Intersection LOS: C
 Intersection Capacity Utilization 80.9%
 ICU Level of Service D
 Analysis Period (min) 15

Splits and Phases: 12: Vollmer Rd & Marksheffel Rd

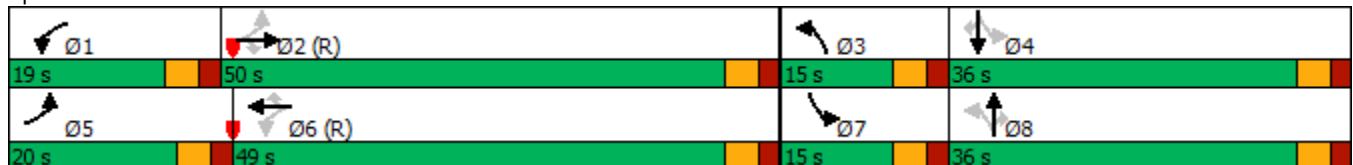

Timings
13: Sterling Ranch Rd & Marksheffel Rd

2042 Total Traffic
PM Peak Hour

Lane Group	EBL	EBT	EBR	WBL	WBT	WBR	NBL	NBT	NBR	SBL	SBT	SBR
Lane Configurations												
Traffic Volume (vph)	311	946	22	130	841	581	27	7	37	348	24	195
Future Volume (vph)	311	946	22	130	841	581	27	7	37	348	24	195
Turn Type	pm+pt	NA	Perm	pm+pt	NA	Perm	pm+pt	NA	Perm	Prot	NA	Perm
Protected Phases	5	2		1	6		3	8		7	4	
Permitted Phases	2		2	6		6	8		8			4
Detector Phase	5	2	2	1	6	6	3	8	8	7	4	4
Switch Phase												
Minimum Initial (s)	5.0	15.0	15.0	5.0	15.0	15.0	5.0	10.0	10.0	20.0	10.0	10.0
Minimum Split (s)	10.0	20.0	20.0	10.0	20.0	20.0	10.0	15.0	15.0	25.0	20.0	20.0
Total Split (s)	20.0	68.0	68.0	12.0	60.0	60.0	10.0	15.0	15.0	25.0	30.0	30.0
Total Split (%)	16.7%	56.7%	56.7%	10.0%	50.0%	50.0%	8.3%	12.5%	12.5%	20.8%	25.0%	25.0%
Yellow Time (s)	3.0	3.0	3.0	3.0	3.0	3.0	3.0	3.0	3.0	3.0	3.0	3.0
All-Red Time (s)	2.0	2.0	2.0	2.0	2.0	2.0	2.0	2.0	2.0	2.0	2.0	2.0
Lost Time Adjust (s)	0.0	0.0	0.0	0.0	0.0	0.0	0.0	0.0	0.0	0.0	0.0	0.0
Total Lost Time (s)	5.0	5.0	5.0	5.0	5.0	5.0	5.0	5.0	5.0	5.0	5.0	5.0
Lead/Lag	Lead	Lag	Lag	Lead	Lag	Lag	Lead	Lag	Lag	Lead	Lag	Lag
Lead-Lag Optimize?	Yes	Yes	Yes	Yes	Yes	Yes	Yes	Yes	Yes	Yes	Yes	Yes
Recall Mode	None	C-Max	C-Max	None	C-Max	C-Max	None	None	None	None	None	None
Act Effct Green (s)	80.7	69.1	69.1	69.5	62.6	62.6	11.0	10.0	10.0	20.0	23.0	23.0
Actuated g/C Ratio	0.67	0.58	0.58	0.58	0.52	0.52	0.09	0.08	0.08	0.17	0.19	0.19
v/c Ratio	0.76	0.49	0.02	0.41	0.48	0.55	0.20	0.05	0.12	0.64	0.07	0.44
Control Delay	40.4	10.5	0.0	12.9	20.9	3.6	37.8	51.4	0.8	52.4	39.2	8.5
Queue Delay	0.0	0.0	0.0	0.0	0.0	0.0	0.0	0.0	0.0	0.0	0.0	0.0
Total Delay	40.4	10.5	0.0	12.9	20.9	3.6	37.8	51.4	0.8	52.4	39.2	8.5
LOS	D	B	A	B	C	A	D	D	A	D	D	A
Approach Delay		17.6			13.8			19.6			36.8	
Approach LOS		B			B			B			D	

Intersection Summary

Cycle Length: 120
 Actuated Cycle Length: 120
 Offset: 0 (0%), Referenced to phase 2:EBTL and 6:WBTL, Start of Green
 Natural Cycle: 90
 Control Type: Actuated-Coordinated
 Maximum v/c Ratio: 0.76
 Intersection Signal Delay: 19.1
 Intersection LOS: B
 Intersection Capacity Utilization 74.0%
 ICU Level of Service D
 Analysis Period (min) 15

Splits and Phases: 13: Sterling Ranch Rd & Marksheffel Rd



Intersection						
Int Delay, s/veh	0.3					
Movement	EBL	EBT	WBT	WBR	SBL	SBR
Lane Configurations	↘	↑↑	↑↑	↗		↗
Traffic Vol, veh/h	42	1385	1124	26	0	25
Future Vol, veh/h	42	1385	1124	26	0	25
Conflicting Peds, #/hr	0	0	0	0	0	0
Sign Control	Free	Free	Free	Free	Stop	Stop
RT Channelized	-	None	-	None	-	None
Storage Length	285	-	-	235	-	0
Veh in Median Storage, #	-	0	0	-	0	-
Grade, %	-	0	0	-	0	-
Peak Hour Factor	95	95	95	95	95	95
Heavy Vehicles, %	2	2	2	2	2	2
Mvmt Flow	44	1458	1183	27	0	26

Major/Minor	Major1	Major2	Minor2
Conflicting Flow All	1210	0	0
Stage 1	-	-	-
Stage 2	-	-	-
Critical Hdwy	4.14	-	6.94
Critical Hdwy Stg 1	-	-	-
Critical Hdwy Stg 2	-	-	-
Follow-up Hdwy	2.22	-	3.32
Pot Cap-1 Maneuver	572	-	0
Stage 1	-	-	0
Stage 2	-	-	0
Platoon blocked, %	-	-	-
Mov Cap-1 Maneuver	572	-	449
Mov Cap-2 Maneuver	-	-	-
Stage 1	-	-	-
Stage 2	-	-	-

Approach	EB	WB	SB
HCM Control Delay, s	0.3	0	13.5
HCM LOS			B

Minor Lane/Major Mvmt	EBL	EBT	WBT	WBR	SBLn1
Capacity (veh/h)	572	-	-	-	449
HCM Lane V/C Ratio	0.077	-	-	-	0.059
HCM Control Delay (s)	11.8	-	-	-	13.5
HCM Lane LOS	B	-	-	-	B
HCM 95th %tile Q(veh)	0.2	-	-	-	0.2

Intersection						
Int Delay, s/veh	0					
Movement	EBT	EBR	WBL	WBT	NBL	NBR
Lane Configurations	↑↑	↑	↓	↑↑		↑
Traffic Vol, veh/h	1381	4	2	1150	0	3
Future Vol, veh/h	1381	4	2	1150	0	3
Conflicting Peds, #/hr	0	0	0	0	0	0
Sign Control	Free	Free	Free	Free	Stop	Stop
RT Channelized	-	None	-	None	-	None
Storage Length	-	235	285	-	-	0
Veh in Median Storage, #	0	-	-	0	0	-
Grade, %	0	-	-	0	0	-
Peak Hour Factor	95	95	95	95	95	95
Heavy Vehicles, %	2	2	2	2	2	2
Mvmt Flow	1454	4	2	1211	0	3

Major/Minor	Major1	Major2	Minor1		
Conflicting Flow All	0	0	1458	0	- 727
Stage 1	-	-	-	-	-
Stage 2	-	-	-	-	-
Critical Hdwy	-	-	4.14	-	- 6.94
Critical Hdwy Stg 1	-	-	-	-	-
Critical Hdwy Stg 2	-	-	-	-	-
Follow-up Hdwy	-	-	2.22	-	- 3.32
Pot Cap-1 Maneuver	-	-	460	-	0 366
Stage 1	-	-	-	-	0 -
Stage 2	-	-	-	-	0 -
Platoon blocked, %	-	-	-	-	-
Mov Cap-1 Maneuver	-	-	460	-	- 366
Mov Cap-2 Maneuver	-	-	-	-	-
Stage 1	-	-	-	-	-
Stage 2	-	-	-	-	-

Approach	EB	WB	NB
HCM Control Delay, s	0	0	14.9
HCM LOS			B

Minor Lane/Major Mvmt	NBLn1	EBT	EBR	WBL	WBT
Capacity (veh/h)	366	-	-	460	-
HCM Lane V/C Ratio	0.009	-	-	0.005	-
HCM Control Delay (s)	14.9	-	-	12.9	-
HCM Lane LOS	B	-	-	B	-
HCM 95th %tile Q(veh)	0	-	-	0	-

Intersection						
Int Delay, s/veh	1.2					
Movement	EBT	EBR	WBL	WBT	NBL	NBR
Lane Configurations	↑	↗	↖	↑	↘	↙
Traffic Vol, veh/h	555	32	39	370	25	40
Future Vol, veh/h	555	32	39	370	25	40
Conflicting Peds, #/hr	0	0	0	0	0	0
Sign Control	Free	Free	Free	Free	Stop	Stop
RT Channelized	-	None	-	None	-	None
Storage Length	-	155	205	-	0	-
Veh in Median Storage, #	0	-	-	0	0	-
Grade, %	0	-	-	0	0	-
Peak Hour Factor	95	95	95	95	95	95
Heavy Vehicles, %	2	2	2	2	2	2
Mvmt Flow	584	34	41	389	26	42

Major/Minor	Major1	Major2	Minor1		
Conflicting Flow All	0	0	618	0	1055 584
Stage 1	-	-	-	-	584 -
Stage 2	-	-	-	-	471 -
Critical Hdwy	-	-	4.12	-	6.42 6.22
Critical Hdwy Stg 1	-	-	-	-	5.42 -
Critical Hdwy Stg 2	-	-	-	-	5.42 -
Follow-up Hdwy	-	-	2.218	-	3.518 3.318
Pot Cap-1 Maneuver	-	-	962	-	250 512
Stage 1	-	-	-	-	557 -
Stage 2	-	-	-	-	628 -
Platoon blocked, %	-	-	-	-	-
Mov Cap-1 Maneuver	-	-	962	-	239 512
Mov Cap-2 Maneuver	-	-	-	-	373 -
Stage 1	-	-	-	-	557 -
Stage 2	-	-	-	-	601 -

Approach	EB	WB	NB
HCM Control Delay, s	0	0.8	14.5
HCM LOS			B

Minor Lane/Major Mvmt	NBLn1	EBT	EBR	WBL	WBT
Capacity (veh/h)	448	-	-	962	-
HCM Lane V/C Ratio	0.153	-	-	0.043	-
HCM Control Delay (s)	14.5	-	-	8.9	-
HCM Lane LOS	B	-	-	A	-
HCM 95th %tile Q(veh)	0.5	-	-	0.1	-

Intersection												
Int Delay, s/veh	1.5											
Movement	EBL	EBT	EBR	WBL	WBT	WBR	NBL	NBT	NBR	SBL	SBT	SBR
Lane Configurations	↶	↷		↶	↷			↕			↕	
Traffic Vol, veh/h	20	550	25	29	382	23	15	0	17	14	0	12
Future Vol, veh/h	20	550	25	29	382	23	15	0	17	14	0	12
Conflicting Peds, #/hr	0	0	0	0	0	0	0	0	0	0	0	0
Sign Control	Free	Free	Free	Free	Free	Free	Stop	Stop	Stop	Stop	Stop	Stop
RT Channelized	-	-	None	-	-	None	-	-	None	-	-	None
Storage Length	205	-	-	205	-	-	-	-	-	-	-	-
Veh in Median Storage, #	-	0	-	-	0	-	-	0	-	-	0	-
Grade, %	-	0	-	-	0	-	-	0	-	-	0	-
Peak Hour Factor	95	95	95	95	95	95	95	95	95	95	95	95
Heavy Vehicles, %	2	2	2	2	2	2	2	2	2	2	2	2
Mvmt Flow	21	579	26	31	402	24	16	0	18	15	0	13

Major/Minor	Major1		Major2		Minor1		Minor2					
Conflicting Flow All	426	0	0	605	0	0	1117	1122	592	1119	1123	414
Stage 1	-	-	-	-	-	-	634	634	-	476	476	-
Stage 2	-	-	-	-	-	-	483	488	-	643	647	-
Critical Hdwy	4.12	-	-	4.12	-	-	7.12	6.52	6.22	7.12	6.52	6.22
Critical Hdwy Stg 1	-	-	-	-	-	-	6.12	5.52	-	6.12	5.52	-
Critical Hdwy Stg 2	-	-	-	-	-	-	6.12	5.52	-	6.12	5.52	-
Follow-up Hdwy	2.218	-	-	2.218	-	-	3.518	4.018	3.318	3.518	4.018	3.318
Pot Cap-1 Maneuver	1133	-	-	973	-	-	185	206	506	184	206	638
Stage 1	-	-	-	-	-	-	467	473	-	570	557	-
Stage 2	-	-	-	-	-	-	565	550	-	462	467	-
Platoon blocked, %		-	-	-	-	-						
Mov Cap-1 Maneuver	1133	-	-	973	-	-	174	196	506	171	196	638
Mov Cap-2 Maneuver	-	-	-	-	-	-	174	196	-	171	196	-
Stage 1	-	-	-	-	-	-	458	464	-	559	539	-
Stage 2	-	-	-	-	-	-	536	532	-	437	458	-

Approach	EB		WB		NB		SB	
HCM Control Delay, s	0.3		0.6		20.4		20.6	
HCM LOS					C		C	

Minor Lane/Major Mvmt	NBLn1	EBL	EBT	EBR	WBL	WBT	WBR	SBLn1
Capacity (veh/h)	267	1133	-	-	973	-	-	258
HCM Lane V/C Ratio	0.126	0.019	-	-	0.031	-	-	0.106
HCM Control Delay (s)	20.4	8.2	-	-	8.8	-	-	20.6
HCM Lane LOS	C	A	-	-	A	-	-	C
HCM 95th %tile Q(veh)	0.4	0.1	-	-	0.1	-	-	0.4

Intersection												
Int Delay, s/veh	2.8											
Movement	EBL	EBT	EBR	WBL	WBT	WBR	NBL	NBT	NBR	SBL	SBT	SBR
Lane Configurations	↙	↑	↗	↙	↗			↕			↕	
Traffic Vol, veh/h	40	451	90	22	357	24	54	0	16	14	0	24
Future Vol, veh/h	40	451	90	22	357	24	54	0	16	14	0	24
Conflicting Peds, #/hr	0	0	0	0	0	0	0	0	0	0	0	0
Sign Control	Free	Free	Free	Free	Free	Free	Stop	Stop	Stop	Stop	Stop	Stop
RT Channelized	-	-	None	-	-	None	-	-	None	-	-	None
Storage Length	305	-	255	305	-	-	-	-	-	-	-	-
Veh in Median Storage, #	-	0	-	-	0	-	-	0	-	-	0	-
Grade, %	-	0	-	-	0	-	-	0	-	-	0	-
Peak Hour Factor	95	95	95	95	95	95	95	95	95	95	95	95
Heavy Vehicles, %	2	2	2	2	2	2	2	2	2	2	2	2
Mvmt Flow	42	475	95	23	376	25	57	0	17	15	0	25

Major/Minor	Major1			Major2			Minor1			Minor2		
Conflicting Flow All	401	0	0	570	0	0	1006	1006	475	1050	1089	389
Stage 1	-	-	-	-	-	-	559	559	-	435	435	-
Stage 2	-	-	-	-	-	-	447	447	-	615	654	-
Critical Hdwy	4.12	-	-	4.12	-	-	7.12	6.52	6.22	7.12	6.52	6.22
Critical Hdwy Stg 1	-	-	-	-	-	-	6.12	5.52	-	6.12	5.52	-
Critical Hdwy Stg 2	-	-	-	-	-	-	6.12	5.52	-	6.12	5.52	-
Follow-up Hdwy	2.218	-	-	2.218	-	-	3.518	4.018	3.318	3.518	4.018	3.318
Pot Cap-1 Maneuver	1158	-	-	1002	-	-	220	241	590	205	215	659
Stage 1	-	-	-	-	-	-	513	511	-	600	580	-
Stage 2	-	-	-	-	-	-	591	573	-	479	463	-
Platoon blocked, %		-	-	-	-	-						
Mov Cap-1 Maneuver	1158	-	-	1002	-	-	202	227	590	190	203	659
Mov Cap-2 Maneuver	-	-	-	-	-	-	202	227	-	190	203	-
Stage 1	-	-	-	-	-	-	495	493	-	578	567	-
Stage 2	-	-	-	-	-	-	555	560	-	448	446	-

Approach	EB			WB			NB			SB		
HCM Control Delay, s	0.6			0.5			26.8			16.8		
HCM LOS							D			C		

Minor Lane/Major Mvmt	NBLn1	EBL	EBT	EBR	WBL	WBT	WBR	SBLn1
Capacity (veh/h)	238	1158	-	-	1002	-	-	345
HCM Lane V/C Ratio	0.31	0.036	-	-	0.023	-	-	0.116
HCM Control Delay (s)	26.8	8.2	-	-	8.7	-	-	16.8
HCM Lane LOS	D	A	-	-	A	-	-	C
HCM 95th %tile Q(veh)	1.3	0.1	-	-	0.1	-	-	0.4

Intersection												
Int Delay, s/veh	1.3											
Movement	EBL	EBT	EBR	WBL	WBT	WBR	NBL	NBT	NBR	SBL	SBT	SBR
Lane Configurations		↕			↕		↕	↕		↕	↕	
Traffic Vol, veh/h	27	0	12	10	0	6	20	444	16	11	381	47
Future Vol, veh/h	27	0	12	10	0	6	20	444	16	11	381	47
Conflicting Peds, #/hr	0	0	0	0	0	0	0	0	0	0	0	0
Sign Control	Stop	Stop	Stop	Stop	Stop	Stop	Free	Free	Free	Free	Free	Free
RT Channelized	-	-	None	-	-	None	-	-	None	-	-	None
Storage Length	-	-	-	-	-	-	205	-	-	205	-	-
Veh in Median Storage, #	-	0	-	-	0	-	-	0	-	-	0	-
Grade, %	-	0	-	-	0	-	-	0	-	-	0	-
Peak Hour Factor	95	95	95	95	95	95	95	95	95	95	95	95
Heavy Vehicles, %	2	2	2	2	2	2	2	2	2	2	2	2
Mvmt Flow	28	0	13	11	0	6	21	467	17	12	401	49

Major/Minor	Minor2		Minor1		Major1			Major2				
Conflicting Flow All	971	976	426	974	992	476	450	0	0	484	0	0
Stage 1	450	450	-	518	518	-	-	-	-	-	-	-
Stage 2	521	526	-	456	474	-	-	-	-	-	-	-
Critical Hdwy	7.12	6.52	6.22	7.12	6.52	6.22	4.12	-	-	4.12	-	-
Critical Hdwy Stg 1	6.12	5.52	-	6.12	5.52	-	-	-	-	-	-	-
Critical Hdwy Stg 2	6.12	5.52	-	6.12	5.52	-	-	-	-	-	-	-
Follow-up Hdwy	3.518	4.018	3.318	3.518	4.018	3.318	2.218	-	-	2.218	-	-
Pot Cap-1 Maneuver	232	251	628	231	246	589	1110	-	-	1079	-	-
Stage 1	589	572	-	541	533	-	-	-	-	-	-	-
Stage 2	539	529	-	584	558	-	-	-	-	-	-	-
Platoon blocked, %								-	-	-	-	-
Mov Cap-1 Maneuver	224	243	628	221	239	589	1110	-	-	1079	-	-
Mov Cap-2 Maneuver	224	243	-	221	239	-	-	-	-	-	-	-
Stage 1	578	566	-	531	523	-	-	-	-	-	-	-
Stage 2	523	519	-	566	552	-	-	-	-	-	-	-

Approach	EB		WB		NB		SB	
HCM Control Delay, s	20.1		18.2		0.3		0.2	
HCM LOS	C		C					

Minor Lane/Major Mvmt	NBL	NBT	NBR	EBLn1	WBLn1	SBL	SBT	SBR
Capacity (veh/h)	1110	-	-	279	289	1079	-	-
HCM Lane V/C Ratio	0.019	-	-	0.147	0.058	0.011	-	-
HCM Control Delay (s)	8.3	-	-	20.1	18.2	8.4	-	-
HCM Lane LOS	A	-	-	C	C	A	-	-
HCM 95th %tile Q(veh)	0.1	-	-	0.5	0.2	0	-	-

Intersection						
Int Delay, s/veh	0.3					
Movement	EBL	EBR	NBL	NBT	SBT	SBR
Lane Configurations		↗	↘	↑	↑	↗
Traffic Vol, veh/h	0	0	34	465	334	39
Future Vol, veh/h	0	0	34	465	334	39
Conflicting Peds, #/hr	0	0	0	0	0	0
Sign Control	Stop	Stop	Free	Free	Free	Free
RT Channelized	-	None	-	None	-	None
Storage Length	-	0	150	-	-	150
Veh in Median Storage, #	0	-	-	0	0	-
Grade, %	0	-	-	0	0	-
Peak Hour Factor	95	95	95	95	95	95
Heavy Vehicles, %	2	2	2	2	2	2
Mvmt Flow	0	0	36	489	352	41

Major/Minor	Minor2	Major1	Major2			
Conflicting Flow All	-	352	393	0	-	0
Stage 1	-	-	-	-	-	-
Stage 2	-	-	-	-	-	-
Critical Hdwy	-	6.22	4.12	-	-	-
Critical Hdwy Stg 1	-	-	-	-	-	-
Critical Hdwy Stg 2	-	-	-	-	-	-
Follow-up Hdwy	-	3.318	2.218	-	-	-
Pot Cap-1 Maneuver	0	692	1166	-	-	-
Stage 1	0	-	-	-	-	-
Stage 2	0	-	-	-	-	-
Platoon blocked, %				-	-	-
Mov Cap-1 Maneuver	-	692	1166	-	-	-
Mov Cap-2 Maneuver	-	-	-	-	-	-
Stage 1	-	-	-	-	-	-
Stage 2	-	-	-	-	-	-

Approach	EB	NB	SB
HCM Control Delay, s	0	0.6	0
HCM LOS	A		

Minor Lane/Major Mvmt	NBL	NBT	EBLn1	SBT	SBR
Capacity (veh/h)	1166	-	-	-	-
HCM Lane V/C Ratio	0.031	-	-	-	-
HCM Control Delay (s)	8.2	-	0	-	-
HCM Lane LOS	A	-	A	-	-
HCM 95th %tile Q(veh)	0.1	-	-	-	-

Intersection												
Int Delay, s/veh	2.5											
Movement	EBL	EBT	EBR	WBL	WBT	WBR	NBL	NBT	NBR	SBL	SBT	SBR
Lane Configurations		↕			↕		↗	↑	↖	↖	↗	
Traffic Vol, veh/h	0	0	66	44	0	0	85	376	162	0	196	0
Future Vol, veh/h	0	0	66	44	0	0	85	376	162	0	196	0
Conflicting Peds, #/hr	0	0	0	0	0	0	0	0	0	0	0	0
Sign Control	Stop	Stop	Stop	Stop	Stop	Stop	Free	Free	Free	Free	Free	Free
RT Channelized	-	-	None	-	-	None	-	-	None	-	-	None
Storage Length	-	-	-	-	-	-	200	-	200	200	-	-
Veh in Median Storage, #	-	0	-	-	0	-	-	0	-	-	0	-
Grade, %	-	0	-	-	0	-	-	0	-	-	0	-
Peak Hour Factor	95	95	95	95	95	95	95	95	95	95	95	95
Heavy Vehicles, %	2	2	2	2	2	2	2	2	2	2	2	2
Mvmt Flow	0	0	69	46	0	0	89	396	171	0	206	0

Major/Minor	Minor2		Minor1		Major1			Major2				
Conflicting Flow All	866	951	206	815	780	396	206	0	0	567	0	0
Stage 1	206	206	-	574	574	-	-	-	-	-	-	-
Stage 2	660	745	-	241	206	-	-	-	-	-	-	-
Critical Hdwy	7.12	6.52	6.22	7.12	6.52	6.22	4.12	-	-	4.12	-	-
Critical Hdwy Stg 1	6.12	5.52	-	6.12	5.52	-	-	-	-	-	-	-
Critical Hdwy Stg 2	6.12	5.52	-	6.12	5.52	-	-	-	-	-	-	-
Follow-up Hdwy	3.518	4.018	3.318	3.518	4.018	3.318	2.218	-	-	2.218	-	-
Pot Cap-1 Maneuver	274	260	835	296	327	653	1365	-	-	1005	-	-
Stage 1	796	731	-	504	503	-	-	-	-	-	-	-
Stage 2	452	421	-	762	731	-	-	-	-	-	-	-
Platoon blocked, %								-	-	-	-	-
Mov Cap-1 Maneuver	260	243	835	258	306	653	1365	-	-	1005	-	-
Mov Cap-2 Maneuver	260	243	-	258	306	-	-	-	-	-	-	-
Stage 1	744	731	-	471	470	-	-	-	-	-	-	-
Stage 2	423	394	-	699	731	-	-	-	-	-	-	-

Approach	EB	WB	NB	SB
HCM Control Delay, s	9.7	22	1.1	0
HCM LOS	A	C		

Minor Lane/Major Mvmt	NBL	NBT	NBR	EBLn1	WBLn1	SBL	SBT	SBR
Capacity (veh/h)	1365	-	-	835	258	1005	-	-
HCM Lane V/C Ratio	0.066	-	-	0.083	0.18	-	-	-
HCM Control Delay (s)	7.8	-	-	9.7	22	0	-	-
HCM Lane LOS	A	-	-	A	C	A	-	-
HCM 95th %tile Q(veh)	0.2	-	-	0.3	0.6	0	-	-

Intersection												
Int Delay, s/veh	3											
Movement	EBL	EBT	EBR	WBL	WBT	WBR	NBL	NBT	NBR	SBL	SBT	SBR
Lane Configurations		↕			↕		↗	↖	↗	↖	↗	↖
Traffic Vol, veh/h	0	0	69	15	0	0	115	208	54	0	112	0
Future Vol, veh/h	0	0	69	15	0	0	115	208	54	0	112	0
Conflicting Peds, #/hr	0	0	0	0	0	0	0	0	0	0	0	0
Sign Control	Stop	Stop	Stop	Stop	Stop	Stop	Free	Free	Free	Free	Free	Free
RT Channelized	-	-	None	-	-	None	-	-	None	-	-	None
Storage Length	-	-	-	-	-	-	200	-	200	200	-	-
Veh in Median Storage, #	-	0	-	-	0	-	-	0	-	-	0	-
Grade, %	-	0	-	-	0	-	-	0	-	-	0	-
Peak Hour Factor	95	95	95	95	95	95	95	95	95	95	95	95
Heavy Vehicles, %	2	2	2	2	2	2	2	2	2	2	2	2
Mvmt Flow	0	0	73	16	0	0	121	219	57	0	118	0

Major/Minor	Minor2		Minor1		Major1		Major2					
Conflicting Flow All	608	636	118	616	579	219	118	0	0	276	0	0
Stage 1	118	118	-	461	461	-	-	-	-	-	-	-
Stage 2	490	518	-	155	118	-	-	-	-	-	-	-
Critical Hdwy	7.12	6.52	6.22	7.12	6.52	6.22	4.12	-	-	4.12	-	-
Critical Hdwy Stg 1	6.12	5.52	-	6.12	5.52	-	-	-	-	-	-	-
Critical Hdwy Stg 2	6.12	5.52	-	6.12	5.52	-	-	-	-	-	-	-
Follow-up Hdwy	3.518	4.018	3.318	3.518	4.018	3.318	2.218	-	-	2.218	-	-
Pot Cap-1 Maneuver	408	395	934	403	426	821	1470	-	-	1287	-	-
Stage 1	887	798	-	581	565	-	-	-	-	-	-	-
Stage 2	560	533	-	847	798	-	-	-	-	-	-	-
Platoon blocked, %								-	-	-	-	-
Mov Cap-1 Maneuver	382	363	934	348	391	821	1470	-	-	1287	-	-
Mov Cap-2 Maneuver	382	363	-	348	391	-	-	-	-	-	-	-
Stage 1	814	798	-	533	519	-	-	-	-	-	-	-
Stage 2	514	489	-	781	798	-	-	-	-	-	-	-

Approach	EB	WB	NB	SB
HCM Control Delay, s	9.2	15.8	2.3	0
HCM LOS	A	C		

Minor Lane/Major Mvmt	NBL	NBT	NBR	EBLn1	WBLn1	SBL	SBT	SBR
Capacity (veh/h)	1470	-	-	934	348	1287	-	-
HCM Lane V/C Ratio	0.082	-	-	0.078	0.045	-	-	-
HCM Control Delay (s)	7.7	-	-	9.2	15.8	0	-	-
HCM Lane LOS	A	-	-	A	C	A	-	-
HCM 95th %tile Q(veh)	0.3	-	-	0.3	0.1	0	-	-

Crash History



AccidentDate	TotalVehicles	ReferencePointName	ReferencePointAtName	AccidentNarrative
2019-09-29	1	VOLLMER RD	GLIDER LP	Vehicle # 1 was traveling northbound Vollmer Road .8 miles north of Glider Loop. Vehicle # 1's right side tires dropped off the right side of the roadway as it entered a sharp left curve. Vehicle #1 lost control on the roadway for approximately 131' before it traveled approximately 100' off the right side of the roadway. Vehicle # 1 collided its rear with a barbed-wire fence. Vehicle # 1 was moved prior to investigation.
2019-10-01	1	VOLLMER RD	S POCO RD	Vehicle #1 was northbound on Vollmer Road in a left hand curve. Vehicle #1 ran off the right side of the road for 107.3'. Vehicle over corrected, reentered the roadway, spinning counter clockwise. Vehicle #1 was out of control for 98.5'. Vehicle #1 ran off the left side of the road for 99.8', rolling 1 1/2 times. Vehicle #1 came to rest on its top facing west.
2019-11-14	1	VOLLMER RD	GLIDER PL	Vehicle 1 was southbound on Vollmer Road south of Burgess Road. Vehicle 1 was travelling in excessive speed, when it failed to negotiate a right hand bend in the roadway. Vehicle left heavy left side tire skids marks for 115.8 feet in the northbound lane, afterwhich it traveled for 59.4 across the southbound lane. Vehicle 1 ran off the right side of the road for 130.9 feet where it began to overturn, airborne for 20.7 feet, colliding with the ground, traveled another 25.9 feet and rolled another 52.2 feet where it came to final rest facing east on its right side 23.9 feet from the west road edge.
2020-04-23	1	VOLLMER RD	WILDFLOWER RD	Vehicle #1 was traveling south on Vollmer Rd approaching Wildflower Rd. Vehicle #1 failed to navigate the slight left curve in the roadway at which point it ran off the right side of the road. Vehicle #1 crashed through the fence on the right side of the road, traveled southwest into the yard of 8455 Wildflower Rd, rolled, crashed into a well, and came to rest on its wheels facing south.
2020-05-26	1	VOLLMER	WILD FLOWER	Vehicle #1 was southbound on Vollmer. Driver of vehicle #1 lost control and went off the right side of the road and overturned. Vehicle #1 was moved prior to investigation.
2020-07-25	1	VOLLMER RD	POCO RD	Vehicle 1 was traveling in an easterly direction on Vollmer Road approaching a left curve. Vehicle 1 drove on the wrong side of the road to avoid a deceased raccoon in the middle of its lane. Vehicle 1 returned to its lane while navigating the curve. Vehicle 1's right tires dropped off the right edge of the road. Driver 1 pulled the wheel to the left causing Vehicle 1 to spin out of control. Driver 1 overcorrected to the right and the vehicle rolled 3/4 times off the right side of the road. Vehicle 1 came to final rest on top of a fence facing south on its right side.
2021-03-24	1	VOLLMER RD	POCO RD	Vehicle #1 was southbound on Vollmer Road just south of Poco Road. Vehicle #1 lost control on the icy covered roadway and slid off of the west edge of the roadway for approximately 50 feet while rotating 1/4 times clockwise. Vehicle #1 then collided with a barbed wire fence approximately 15 feet west of the road edge and overturned 1/4 times onto it's left. Vehicle #1 came to final rest on its left side, approximately 15 feet west of the road edge facing west.
2021-09-13	3	VOLLMER RD	POCO RD	Vehicle #1 was traveling southbound on Vollmer Road. Vehicle #2 was parked on Poco Road, facing east, just west of the intersection of Vollmer Rd. and Poco Rd. Vehicle #2 was partially in the lane and partially on what would be a shoulder, as the entire road is dirt. Vehicle #3 was parked likewise, behind vehicle #2. Vehicle #1 made a right hand turn, to travel westbound on Poco Rd. The left front of vehicle #1 crashed into the left front of vehicle #2. Vehicle #2, being on dirt, slid backwards into the front of vehicle #3. Both vehicles #2 and #3 were unoccupied. Vehicle #1 pulled through and pulled over further down Poco Road to a safe location.
2021-11-11	1	VOLLMER RD	POCO RD	Vehicle #1 was travelling northbound on Vollmer Rd approaching Poco Rd. Vehicle #1 failed to negotiate a curve to the left and travelled off the right side of the road. Vehicle #1 overcorrected to the left, travelled across both lanes of traffic, and drove off the left side of the road. Vehicle #1 rotated counter-clockwise and hit a trip point in the soft dirt. Vehicle #1 rolled 1 and 3/4 times, coming to rest on its left side facing southwest approximately 30 feet off the road. The driver of the vehicle was ejected out of the passenger window during the rollover and came to rest in the field approximately 50 feet northwest of the vehicle.
2022-04-07	1	VOLLMER RD	WILDFLOWER RD	Vehicle 1 was traveling southbound on Vollmer Rd approaching the intersection of Wildflower Rd. Vehicle 1 failed to negotiate a curve and drove off the right side of the roadway at the intersection of Wildflower Rd. Vehicle 1 drove approximately 19 feet off of the right side of the roadway impacting an embankment and came to final rest 85 feet south of Wildflower Rd on the southwest side of the intersection facing south.
2022-06-19	2	VOLLMER RD	LOCHWINNOCH LN	VEHICLE 1 WAS NORTHBOUND ON VOLLMER ROAD. VEHICLE 2 WAS NORTHBOUND ON VOLLMER ROAD, IN FRONT OF VEHICLE 1. VEHICLE 2 BEGAN TO SLOW TO MAKE A LEFT TURN ONTO LOCHWINNOCH ROAD. VEHICLE 1 ATTEMPTED TO PASS VEHICLE 2 ON THE LEFT SIDE IN A MARKED NO PASSING ZONE. VEHICLE 2 BEGAN TO MAKE THE LEFT TURN WHERE VEHICLE 2 WAS STRUCK IN THE FRONT DRIVERS SIDE, BY THE FRONT PASSENGER SIDE OF VEHICLE 1. THE COLLISION OCCURRED WITHIN THE SOUTHBOUND LANE OF VOLLMER ROAD. VEHICLE 1 THEN ROTATED 1/2 TIME CLOCKWISE ACROSS THE NORTHBOUND LANE. VEHICLE 1 THEN DROVE OFF THE NORTHBOUND SIDE OF THE ROAD AND OVERTURNED 1/2 TIME, COMING TO FINAL REST ON ITS ROOF FACING SOUTH. VEHICLE 2 CAME TO A CONTROLLED FINAL REST ON LOCHWINNOCH LN.
2022-07-03	1	VOLLMER RD	POCO RD	Motorcycle was traveling on Vollmer Rd headed northbound. Motorcycle traveled off the right side of the road. Motorcycle lost control and rolled multiple times, the rider was ejected. Motorcycle came to rest on the left side. Rider came to rest on his back.