

Haven School

Traffic Impact Study

Haven School

El Paso County, Colorado

August 25, 2023

Prepared By:



Sustainable Traffic Solutions, Inc.

<http://www.sustainabletrafficsolutions.com/>

Joseph L. Henderson, PE, PTOE

303.589.6875

joe@sustainabletrafficsolutions.com

Joseph L. Henderson's electronic or digital seal and signature is effective only as to that version of this document as originally published by Joseph L. Henderson. Joseph L. Henderson is not responsible for any subsequent modification, corruption, or unauthorized use of this document. To verify the validity or applicability of the seal and signature, contact Joseph L. Henderson.



2880 International Circle, Suite 110
 Colorado Springs, CO 80910
 Phone 719-520-6300
 Fax 719-520-6695
 www.elpasoco.com

**EL PASO COUNTY PLANNING AND
 COMMUNITY DEVELOPMENT
 DEPARTMENT**

TRAFFIC IMPACT STUDY

Revised: January 2022

Traffic Impact Study Report

The purpose of the traffic impact study is to provide detailed recommendations for the preparation of plans for all necessary transportation facility improvements and adequate access to those facilities for proposed development. The facilities include roadways and their structures, as well as extrinsic structures that support the use of the transportation facility. El Paso County standards and technical criteria shall be used to plan, design, construct, choose materials, locate, repair, maintain, reconstruct, and use roadways and other transportation facilities and the associated extrinsic structures. The Traffic Impact Study shall be prepared by a qualified professional engineer and shall be tailored to the stage of development application and the stage of subdivision-related construction.

The report preparer shall verify type and level of TIS/memorandum required in accordance with ECM Section B.1.

		Applicant	PCD
Please confirm each item below has been included by placing a check mark in the "Applicant" column. See right for an example. The "PCD" column is for office use only.		✓	Office use only
1	Signature Page (ECM B.8)	X	
2	Table of contents, pages numbered	X	
3	Existing/background conditions narrative to include at a minimum:	X	
	Vicinity map showing the subdivision in relation to section lines and existing or proposed arterial or collector roadways.	X	
	Label all roads discussed in the report	X	
	Graphically indicate all intersections evaluated	X	
	Accurately depict the site location and boundaries	X	
	Study Area – Provide calculations showing that the study area includes all affected intersections, address ECM B.2.3 requirements	X	
	Background traffic	X	
	Clearly explain how background traffic was derived	X	
	List other traffic studies in the area of study within the past five years identified by County staff or that the applicant is aware of. State whether the current study is consistent with those studies and explain any discrepancies.	N/A	
	Excerpts from studies of those developments are included in the appendices.	N/A	
	Sketch diagrams of all existing intersections evaluated in the study showing widths of all approach lanes and lengths of auxiliary lanes and tapers.	X	
	Description, classification, and link ADT of major roads in the study area (collector classification and higher).	X	
	Specify MTCP functional and corridor preservation classifications	X	
	Description of intersections evaluated in the study including existing controls	X	
	Do existing road segments meet cross section standards for designated classifications?	X	
	Traffic Count Data	X	
	24 Hour Counts for ADT for major road segments	X	
	Peak-hour counts for all intersections evaluated in the study	X	
4	Proposed development and trip generation narrative shall include at a minimum:	X	
	Site Plan	X	
	Land Use – Type and extent correspond with associated application documents	X	



2880 International Circle, Suite 110
 Colorado Springs, CO 80910
 Phone 719-520-6300
 Fax 719-520-6695
 www.elpasoco.com

**EL PASO COUNTY PLANNING AND
 COMMUNITY DEVELOPMENT
 DEPARTMENT**

TRAFFIC IMPACT STUDY

Revised: January 2022

	Discussion of applicable ITE land use type(s) (including ITE code(s)) and comparison between the proposed use(s) and the codified use	X	
	Total traffic generated by the proposed development using ITE trip generation; provide footnotes on the methods used (equation/chart/interpolation)	X	
	Adjustments to trip generation including pass-by trips and internal trip capture	N/A	
	Trip distribution assumptions and map	X	
	Specify expected year of completion (build-out) and intermediate years if phasing is proposed	X	
	On-site road classification figure including ADT numbers	N/A	
	On-site Traffic control recommendations (particularly stop controls at intersections)	N/A	
	Evaluation of intersection spacing along all interior roads, and new intersections on adjacent or off-site roads, and confirmation that the spacing meet criteria	N/A	
	List ECM criteria for stacking, storage, and taper for every affected auxiliary lane and access and state whether this access can be met. If it cannot be met, state the required modifications so that it can be met.	X	
	State what the sight distance is for every affected access and whether it can be met. If it cannot be met, state the required modifications so that it can be met.	X	
5	Evaluation and Mitigation of Impacts shall include a minimum:	X	
	Short-term, intermediate and long-term analysis horizon years are clearly stated and years are labeled on the corresponding figures.	X	
	Capacity analysis of major road segments. Results presented in a figure or table showing short-term and long-term ADTs against maximum allowable ADT	X	
	Capacity analysis of all existing intersections evaluated in the study and all proposed access locations onto existing public roads	X	
	For capacity analysis of signalized intersections, provide discussion of the following parameters:	X	
	Cycle length	X	
	Provisions for left turns ~ permissive/protected; lead/lag	X	
	Free right turns	X	
	Identification of any sub-standard LOS situations and discussion of recommendations for mitigation.	X	
	Evaluation of safety-based warrants for turn lanes at unsignalized intersections (speed change lanes).	X	
	Weaving analysis if applicable	N/A	
	Summary table of necessary turn lane improvements including design speed, taper rates and taper lengths, storage lengths, deceleration or acceleration lengths, and the resulting full-width lane lengths.	X	
	Signal warrant analysis; estimated projected need if not currently warranted	N/A	
	Graphical depiction of improvements required to meet level-of-service standards	N/A	
	Trigger points for the construction of all required future improvements including but not limited to turn lanes, signals, widenings, and openings or closings of accesses. ("Trigger points" are the conditions that, when met, will call for the construction of said improvements.)	X	
	Summary of accident history within the study area.	N/A	
	Accident history data presented in tabular form by location and including annual vehicle use volume and accident rate calculations	N/A	
	Discussion of pedestrian/bicyclist needs and provisions.	N/A	



2880 International Circle, Suite 110
 Colorado Springs, CO 80910
 Phone 719-520-6300
 Fax 719-520-6695
 www.elpasoco.com

**EL PASO COUNTY PLANNING AND
 COMMUNITY DEVELOPMENT
 DEPARTMENT**

TRAFFIC IMPACT STUDY

Revised: January 2022

	School and pedestrian routing plans	N/A	
	School traffic analysis per North Carolina DOT MSTA https://connect.ncdot.gov/municipalities/School/pages/default.aspx	N/A	
	Master-planned trails	N/A	
	Project Traffic modeling and figures	X	
	Short Term Background Plus Project Traffic lanes, intersection control and LOS modeling and figures for all affected intersection movements	X	
	Long Term Background Plus Project Traffic lanes, intersection control and LOS modeling and figures for all affected intersection movements	X	
	Assess and summarize all project impacts (roadways, intersections, pedestrians, bicycles, etc.)	X	
	Describe proposed mitigation measures	X	
	Specifically address all deviations requested (separate form(s) required)	X	
	Address any special studies that apply (access management plan, neighborhood impact evaluation, sight distance evaluation, traffic speed study, etc.)	N/A	
6	Recommendations and Report Conclusions shall include a minimum of:	X	
	Narrative recommendations and conclusions	X	
	For final plats, state definitively what improvements the developer will be constructing with the project.	N/A	
	State whether or not any improvements affected by the project are reimbursable under the current Major Transportation Corridors Plan (MTCP) and Road Fee program.	N/A	
	State whether the MTCP or other approved corridor study calls for the construction of improvements in the immediate area.	N/A	
	State what the current applicable Road Impact Fees are and what option the developer will be selecting for payment. If the site is in a special district, so state and summarize the applicable fees.	N/A	
	Provide a description of how transportation improvements will be financed (responsibility) and a Recommended Improvements Summary Table per ECM section B.6.1.D.	N/A	
	List of References.	X	
7	A minimum of the following appendices:	X	
	Complete modeling for all existing and proposed development horizons	X	
	Modeled signal cycle timing matches narrative and is within DPW allowances and signal coordination requirements, if applicable	N/A	
	Modeled lanes match improvements table and CDs	X	

Table of Contents

	Page
1.0 Introduction	1
2.0 Project Description.....	2
2.1 Study Area.....	2
2.2 Study Assumptions.....	2
3.0 Traffic Count Data	3
3.1 Level of Service Analysis.....	3
4.0 Site Generated Traffic	4
4.1 Trip Generation.....	4
5.0 2025 Traffic Conditions.....	4
6.0 Year 2045 Traffic Conditions	5
7.0 Auxiliary Lanes at the Haven School Site Access.....	5
8.0 Intersection Sight Distance	5
9.0 Conclusions and Recommendations.....	6

Table of Contents (Continued)

List of Appendices

Appendix A	Project Correspondence
Appendix B	PPACG Traffic Volume Projections
Appendix C	Traffic Count Data
Appendix D	VISTRO Analysis Results

List of Tables

Table 1	– Estimated Daily Volumes for Key Links in the Study Area
Table 2	– Intersection Operational Summary
Table 3	– Trip Generation Estimate
Table 4	– Auxiliary Lane Analysis

List of Figures

Figure 1	– Vicinity Map
Figure 2	– Site Plan
Figure 3	– Laneage and Traffic Control – Existing
Figure 4	– Year 2023 Traffic Volumes – Morning Peak Hour
Figure 5	– Year 2023 Traffic Volumes – After School Peak Hour
Figure 6	– Trip Distribution
Figure 7	– Trip Assignment – Morning Peak Hour
Figure 8	– Trip Assignment – After School Peak Hour
Figure 9	– Year 2025 Background Traffic Volumes – Morning Peak Hour
Figure 10	– Year 2025 Background Traffic Volumes – After School Peak Hour
Figure 11	– Year 2025 Total Traffic Volumes – Morning Peak Hour
Figure 12	– Year 2025 Total Traffic Volumes – After School Peak Hour
Figure 13	– Laneage and Traffic Control – Year 2025 Traffic Volume Scenarios
Figure 14	– Year 2045 Background Traffic Volumes – Morning Peak Hour
Figure 15	– Year 2045 Background Traffic Volumes – After School Peak Hour
Figure 16	– Year 2045 Total Traffic Volumes – Morning Peak Hour
Figure 17	– Year 2045 Total Traffic Volumes – After School Peak Hour
Figure 18	– Laneage and Traffic Control – Year 2045 Traffic Volume Scenarios
Figure 19	– Intersection Sight Distance

Haven School

Traffic Impact Study

1.0 Introduction

The Haven School is a tuition-free public program serving kindergarten through 12th grade homeschool students in the Colorado Springs area. It is located at 5484 Burgess Road in El Paso County. The property has two buildings that are used for the school and a single family dwelling unit that is not occupied. A vicinity map is contained in Figure 1 that shows the location of the site on the north side of Burgess Road. Figure 2 shows an aerial photo that was obtained from the El Paso County website. The buildings and their proximity to Burgess Road can be seen in the figure. Information about the Haven School can be found at <https://www.havenclassical.com/>.

Haven School provides science, arts, and nature courses in the classical tradition. Kindergarten through 6th grade students come to the school one day per week on Monday through Thursday, and 7th through 12th grade students come to the school twice each week on Tuesdays and Thursdays. The school has a capacity of 40 kindergarten through 6th grade students, and 70 7th through 12th grade students. Haven School is open a total of thirty weeks during the school year. The school day begins after the morning peak hour and ends before the evening peak hour. The drop off times are 8:45 a.m. and 9:00 a.m., and the pick up times are 3:00 p.m. and 3:15 p.m. The times are staggered to separate the elementary and secondary grades.

A meeting was held with the County staff on June 27, 2023 to discuss the assumptions that will be used in the traffic study. Meeting notes and the traffic study assumptions discussed at the meeting are contained in Appendix A.

This study has been prepared in conformance with the El Paso County criteria for traffic impact studies¹.

County report review is provided only for general conformance with County standards and design criteria. The County is not responsible for the accuracy and adequacy of the data, analysis, or conclusions. The County through the approval of this document assumes no responsibility for completeness and/or accuracy of this document.

¹ [El Paso County Engineering Criteria Manual, Appendix B](#), May 16, 2021.

2.0 Project Description

2.1 Study Area

The study area includes the site access on Burgess Road plus the intersections of Burgess Road / Milam Road and Burgess Road / Black Forest Road. Burgess Road / Milam Road is a four-legged intersection with side street stop control. The west leg of the intersection is a private road. Burgess Road / Black Forest Road is a four-legged, signalized intersection. Burgess Road, Milam Road, and Black Forest Road are two-lane minor arterial roadways. The speed limit on Burgess Road near the site is 45 MPH. Refer to Figure 3 for the laneage and traffic control at the study area intersections.

2.2 Study Assumptions

The following assumptions were utilized for this study.

Short-Term Study Horizon. The short-term horizon is assumed to be the Year 2025. The school should be at capacity by that time.

Long-Term Study Horizon. Year 2045 will be the long-term horizon because it is 20 years following the year when the school is expected to reach capacity.

Growth in Background Traffic. The following annual growth rates were calculated based on Year 2045 projected volumes that were provided by the Pikes Peak Area Council of Governments (PPACG) (see Appendix B).

- Burgess Road between Milam Road and Black Forest Road – 5%
- Milam Road north of Burgess Road – 4%
- Milam Road south of Burgess Road – 2%
- Black Forest Road north of Burgess Road – 3%
- Black Forest Road south of Burgess Road – 5%
- Burgess Road east of Black Forest Road – 2%

Saturation Flow Rate. The saturation flow rate was assumed to be 1,900 passenger cars / hour / lane.

Future Roadway Improvements. No capacity improvements are planned on Burgess Road.

Peak Hour Factor (PHF). For the existing and the short-term planning horizons, the PHF was based on the data collected for the traffic study. A PHF of 0.5 was assumed for the turning movements at the site access. In the long-term horizon, the PHF was assumed to be 0.92 unless the existing PHF is higher than 0.92. In that case, the existing PHF was used in the analysis of the long-term volumes.

Truck Percentage. Vehicle classification data were collected on Burgess Road near the site for 24-hours and the data are summarized in the following table. It shows

that an average of 7% trucks passed by the site. Therefore, 7% were assumed for all movements except for the site access. Refer to Section 3.0 for a discussion of the traffic data collection. A truck percentage of 2% was assumed for all movements associated with the site access.

Direction	Traffic		% Trucks
	Total	Trucks	
Eastbound	2,404	133	6%
Westbound	2,287	204	9%
Total	4,691	337	7%

3.0 Traffic Count Data

Traffic count data were collected for the project on Wednesday July 19, 2023 by All Traffic Data. The peak hour counts were collected during the drop off and pick up times for the school. The Year 2023 peak hour volumes are summarized in Figures 4 and 5. Existing and future daily volumes are summarized in Table 1. The traffic count data are contained in Appendix C.

The Year 2045 projected volumes found in Table 1 were compared against Table B-1 from Appendix B of the El Paso County Engineering Criteria Manual (ECM). All of the roadways are two-lane minor arterials which have a threshold of 10,000 ADT for a four-lane section. Therefore, the threshold for a two-lane section would be 5,000 ADT. The traffic volumes on all of the roadways are expected to exceed 10,000 ADT by the Year 2045 which would suggest that these roadways need to be widened to four lanes. However, the intersection capacity analysis suggests that the two-lane sections will be adequate to accommodate the Year 2045 traffic volumes.

3.1 Level of Service Analysis

To evaluate the performance of the intersections within the study area, the level of service (LOS) was calculated using PTV VISTRO software. This software package utilizes criteria described in the Highway Capacity Manual². LOS is a measure used to describe operational conditions at an intersection. LOS categories ranging from A to F are assigned based on the predicted delay in seconds per vehicle for the intersection as a whole, as well as for individual turning movements. LOS A indicates very good operations, and LOS F indicates poor, congested operations. In rural areas, LOS C is considered the minimum intersection operation.

The following table summarizes the analysis of the Year 2023 conditions. It shows that both of the intersections are currently operating at LOS C, or better. The level of service for intersections with side-street stop-control is determined by the movement

² Highway Capacity Manual, 7th Edition. National Academy of Sciences, Engineering, and Medicine. 2022.

with the highest delay value. The detailed analysis results are summarized in Table 2 and the VISTRO analysis results are contained in Appendix D.

Year 2023 Traffic Conditions

Intersection	Control	Total	
		Morning	After School
1 - Burgess Road / Milam Road	Side-Street Stop	C	B
2 - Burgess Road / Black Forest Road	Signalized	A	A

4.0 Site Generated Traffic

4.1 Trip Generation

In order to determine the traffic impacts associated with the Haven School, the trip generation was estimated using rates that are contained in Trip Generation, 11th Edition³. The trip generation estimate is contained in Table 3.

The peak hour trips that are expected to be generated by the Haven School are assumed to be distributed based on the assumption that is contained in Figure 6. It is based on the proximity of the school to residences in the area. The peak hour trip assignment is contained in Figures 7 and 8. The trip assignment is based on the trip generation for Tuesday and Thursday because the volumes are expected to be higher than on Monday, Wednesday, and Friday. Considering that the school is open 30 weeks per year, these volumes would only be observed on 60 days per year.

5.0 2025 Traffic Conditions

The Haven School is expected to be at capacity by the Year 2025. Background traffic volumes were developed by inflating the Year 2023 volumes by the growth rates discussed in Section 2.2. The background traffic volume scenarios are contained in Figures 9 and 10. Total traffic volume scenarios were developed by adding the trip assignment to the background traffic volume scenarios (see Figures 11 and 12).

The results of the analysis are summarized in the following table. It shows that all of the intersections are expected to be operating at LOS C, or better. Figure 13 contains the laneage and traffic control assumed in the analysis of the total traffic volume scenarios. The detailed analysis results are summarized in Table 2 and the VISTRO analysis results are contained in Appendix D.

³ Trip Generation, 11th Edition. Institute of Transportation Engineers. September 2021.

Year 2025 Traffic Conditions

Intersection	Control	Background		Total	
		Morning	After School	Morning	After School
1 - Burgess Road / Milam Road	Side-Street Stop	C	B	C	B
2 - Burgess Road / Black Forest Road	Signalized	A	A	A	A
3 - Burgess Road / Haven School Access	Side-Street Stop	---		B	B

6.0 Year 2045 Traffic Conditions

The Year 2045 background and total traffic volume scenarios were determined as discussed in Section 5.0. The background traffic volume scenarios are contained in Figures 14 and 15, and the total traffic volume scenarios are contained in Figures 16 and 17.

The results of the analysis are summarized in the following table. Figure 18 contains the laneage and traffic control assumed in the analysis of the total traffic volume scenarios. It shows that all of the intersections are expected to operate at LOS C, or better, with the exception of the site access for the Haven School. That intersection is expected to operate at LOS D during the morning peak hour. The intersection of Burgess Road / Haven Road is assumed to be signalized by the Year 2045. The detailed analysis results are summarized in Table 2 and the VISTRO analysis results are contained in Appendix D.

Year 2045 Traffic Conditions

Intersection	Control	Background		Total	
		Morning	After School	Morning	After School
1 - Burgess Road / Milam Road	Signalized	B	A	B	A
2 - Burgess Road / Black Forest Road	Signalized	A	A	A	A
3 - Burgess Road / Haven School Access	Side-Street Stop	---		D	C

7.0 Auxiliary Lanes at the Haven School Site Access

Burgess Road is classified as a minor arterial by El Paso County. The County has requirements for auxiliary lanes in Section 2.3.7D of the ECM. The criteria are summarized in Table 4 which shows that an eastbound left turn deceleration lane is warranted by the inbound traffic during the morning peak hour. Table 4 also includes the length of the lane.

8.0 Intersection Sight Distance

The intersection sight distance was estimated at the site access for the Haven School using methodology that is contained in Section 9.5 of A Policy on the Geometric Design of Highways and Streets, 7th Edition⁴. Figure 19 shows that adequate intersection sight distance exists at the site access. The intersection sight

⁴ A Policy on the Geometric Design of Highways and Streets, 7th Edition. American Association of State Highway and Transportation Officials. 2018.

distance was only verified for the passenger vehicle because trucks are not expected to use the access.

9.0 Conclusions and Recommendations

STS has drawn the following conclusions based on the analysis performed for this project.

Intersection Operation. The existing intersections that were analyzed in this study are currently operating at LOS C, or better. In the Year 2045, all of the intersections are expected to continue to operate at LOS C, or better, with the exception of the school access. That intersection is expected to operate at LOS D during the morning peak hour.

Auxiliary Lanes at the Site Access. An eastbound left turn deceleration lane is warranted based on the Tuesday and Thursday peak hour trip generation. Considering that the school is open 30 weeks per year, these volumes would only be observed on 60 days per year. Since the decel lane is only warranted during the morning peak hour and the morning drop off lasts less than one hour, this lane would only be warranted for a few minutes per day on Tuesday and Thursday.

Intersection Sight Distance. There is adequate intersection sight distance for passenger vehicles based on the 45 MPH speed limit.

Recommendation. STS recommends that El Paso County wave the requirement for the eastbound left turn decel lane. As noted above, this lane would only be warranted for a few minutes on Tuesday and Thursday mornings on 60 days per year. Considering the small percentage of the year that the lane would be warranted, constructing this lane would be an excessive requirement.

Tables

Table 1 – Estimated Daily Volumes for Key Links in the Study Area

Table 2 – Intersection Operational Summary

Table 3 – Trip Generation Estimate

Table 4 – Auxiliary Lane Analysis

Table 1. Estimated Daily Volumes for Key Links in the Study Area

Link	Year 2023 Existing Traffic ¹	Year 2025 Background Traffic	Haven School	Year 2025 Total Traffic	Year 2045 Background Traffic	Year 2045 Total Traffic
Burgess Road east of High Meadows Drive	4,691	5,200	140	5,340	14,430	14,570
Burgess Road west of Black Forest Road	4,610	5,110	60	5,170	14,250	14,310
Milam Road north of Burgess Road	4,660	5,010	20	5,030	10,370	10,390
Milam Road south of Burgess Road	7,920	8,250	120	8,370	12,280	12,400
Black Forest Road north of Burgess Road	4,660	4,940	0	4,940	8,890	8,890
Black Forest Road south of Burgess Road	4,850	5,380	40	5,420	15,230	15,270
Burgess Road east of Black Forest Road	4,990	5,200	20	5,220	7,830	7,850

1. The Year 2022 volumes highlighted in yellow were collected in the field. The other existing volumes were estimated using the peak hour to daily ratio for the evening peak hour.

Table 2. Intersection Operational Summary

Signalized Intersections ¹	Year 2023 Volumes				Year 2025 Background Volumes				Year 2025 Total Volumes				Year 2045 Background Volumes				Year 2045 Total Volumes			
	Morning		After School		Morning		After School		Morning		After School		Morning		After School		Morning		After School	
	Delay	LOS	Delay	LOS	Delay	LOS	Delay	LOS	Delay	LOS	Delay	LOS	Delay	LOS	Delay	LOS	Delay	LOS	Delay	LOS
1 - Burgess Road / Milam Road	---				---				---				13.5	B	7.9	A	14.8	B	8.1	A
2 - Burgess Road / Black Forest Road	6.0	A	5.9	A	6.1	A	6.0	A	6.2	A	6.0	A	7.0	A	8.1	A	7.1	A	8.2	A
Stop-Controlled Intersections ²	Year 2023 Volumes				Year 2025 Background Volumes				Year 2025 Total Volumes				Year 2045 Background Volumes				Year 2045 Total Volumes			
	Morning		After School		Morning		After School		Morning		After School		Morning		After School		Morning		After School	
	Delay	LOS	Delay	LOS	Delay	LOS	Delay	LOS	Delay	LOS	Delay	LOS	Delay	LOS	Delay	LOS	Delay	LOS	Delay	LOS
1 - Burgess Road / Milam Road	16.2	C	13.1	B	18.4	C	13.8	B	20.3	C	14.4	B	---				---			
	WBLT				WBLT		WBLT		WBLT		WBLT									
3 - Burgess Road / Haven School Access	---				---				13.1	B	12.3	B	---				27.5	D	24.7	C
									SBLT		SBLT						SBLT		SBLT	

Notes

1. The level of service for signalized intersections is based on the delay for the entire intersection.
2. The level of service for intersections with side-street stop-control is determined by the movement with the highest delay value.

Table 3. Trip Generation Estimate

Land Use	ITE Code ¹	Size	Unit	Trips											
				Average Weekday				Morning Peak Hour of Generator				Afternoon Peak Hour of Generator			
				Rate	Total	In	Out	Rate	Total	In	Out	Rate	Total	In	Out
Monday & Wednesday															
Private School (K-8)	530	10	Students	4.11	42	21	21	1.01	10	6	4	0.60	6	3	3
Tuesday & Thursday															
Private School (K-12)	532	80	Students	2.48	198	99	99	0.80	64	40	24	0.53	42	18	25

Notes

1. The trip generation rates were obtained from Trip Generation, 11th Edition (Institute of Transportation Engineers, 2021).

Table 4. Auxiliary Lane Analysis

Movement	Threshold	Haven School		Lane Length ¹			
		Morning	Evening	Bay Taper	Decel	Storage	Total ⁵
EB Left Turn Decel	25 VPH	28	13	200	235	50	285
WB Right Turn Decel	50 VPH	12	6	---			
SB to WB Right Turn Accel	50 VPH	17	17	---			

XX Threshold Exceeded

Notes

1. The length of the decel lanes is based on a 50 MPH design speed for the 45 MPH speed limit.

Figures

Figure 1 – Vicinity Map

Figure 2 – Site Plan

Figure 3 – Laneage and Traffic Control – Existing

Figure 4 – Year 2023 Traffic Volumes – Morning Peak Hour

Figure 5 – Year 2023 Traffic Volumes – After School Peak Hour

Figure 6 – Trip Distribution

Figure 7 – Trip Assignment – Morning Peak Hour

Figure 8 – Trip Assignment – After School Peak Hour

Figure 9 – Year 2025 Background Traffic Volumes – Morning Peak Hour

Figure 10 – Year 2025 Background Traffic Volumes – After School Peak Hour

Figure 11 – Year 2025 Total Traffic Volumes – Morning Peak Hour

Figure 12 – Year 2025 Total Traffic Volumes – After School Peak Hour

Figure 13 – Laneage and Traffic Control – Year 2025 Traffic Volume Scenarios

Figure 14 – Year 2045 Background Traffic Volumes – Morning Peak Hour

Figure 15 – Year 2045 Background Traffic Volumes – After School Peak Hour

Figure 16 – Year 2045 Total Traffic Volumes – Morning Peak Hour

Figure 17 – Year 2045 Total Traffic Volumes – After School Peak Hour

Figure 18 – Laneage and Traffic Control – Year 2045 Traffic Volume Scenarios

Figure 19 – Intersection Sight Distance

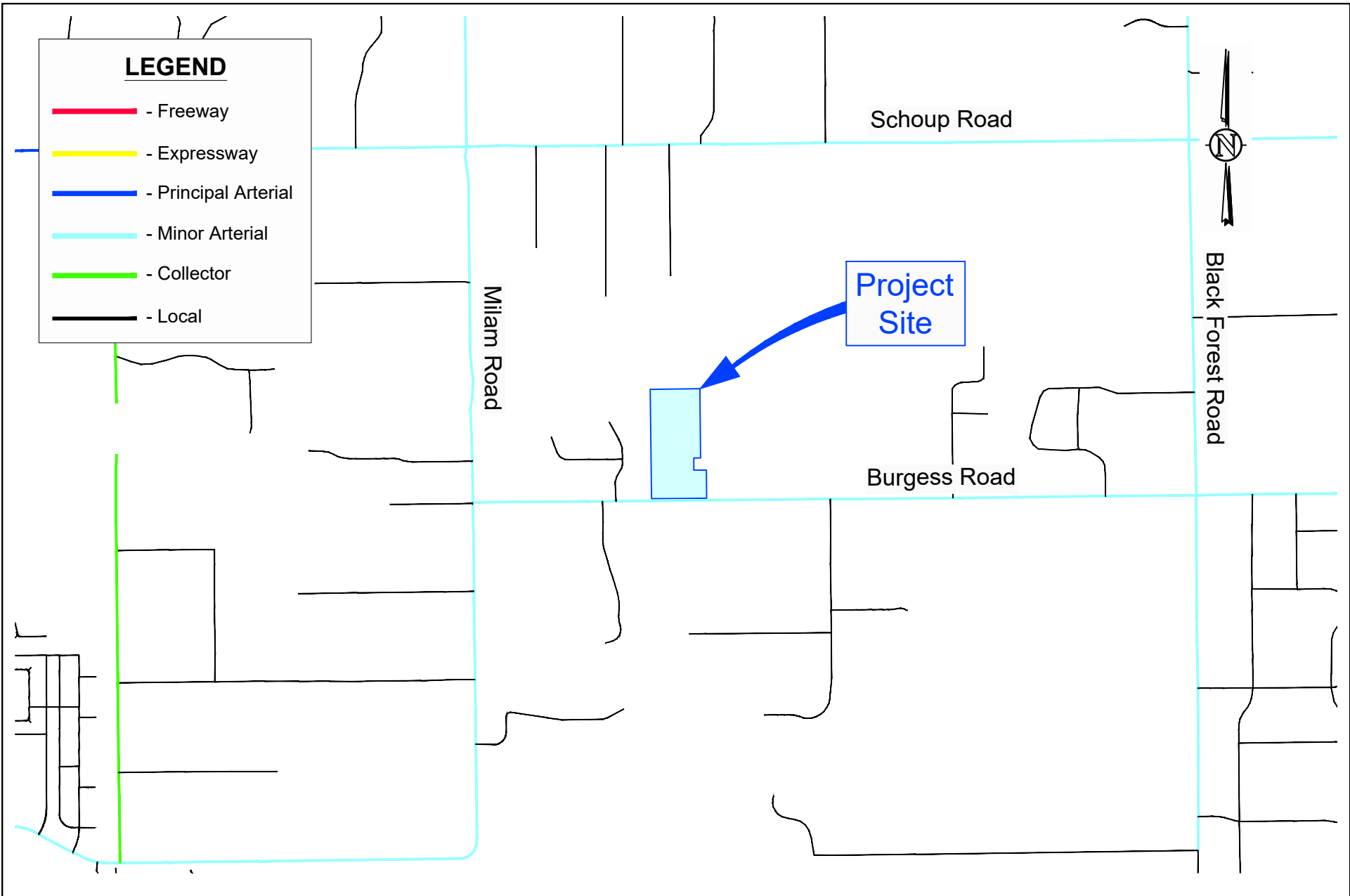

Haven School Traffic Impact Study
VICINITY MAP

Scale	1" = 2,000'	Date	August 25, 2023	Drawn by	JLH	Job #	Haven School	Figure	1
-------	-------------	------	-----------------	----------	-----	-------	--------------	--------	---



Haven School Traffic Impact Study
SITE PLAN

Scale	NTS	Date	August 25, 2023	Drawn by	JLH	Job #	Haven School	Figure	2
-------	-----	------	-----------------	----------	-----	-------	--------------	--------	---

Figure 3 – Laneage and Traffic Control – Existing

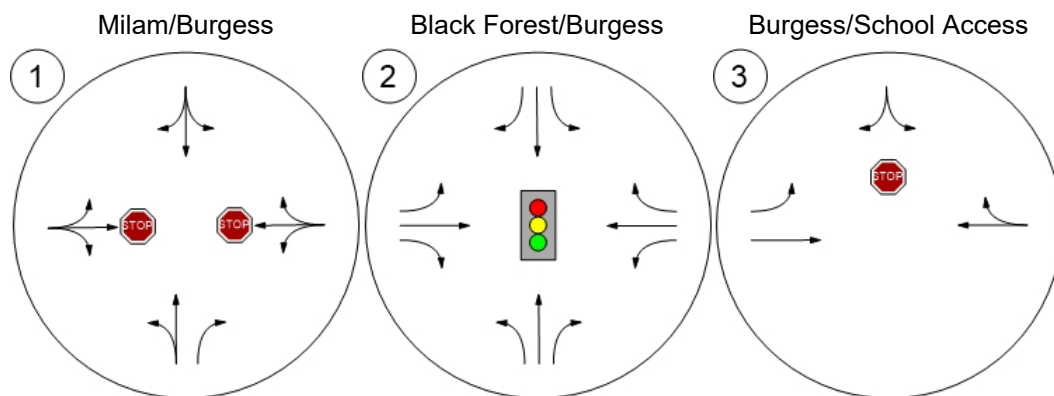

Figure 4 – Year 2023 Traffic Volumes – Morning Peak Hour



Milam/Burgess

Black Forest/Burgess

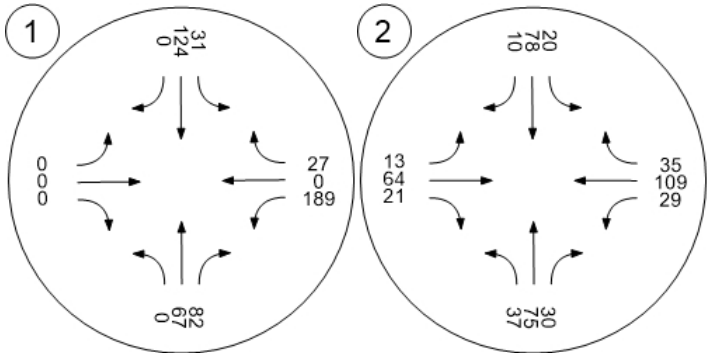
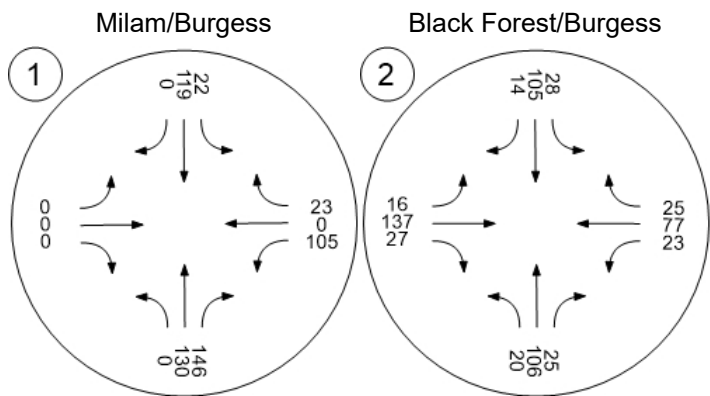
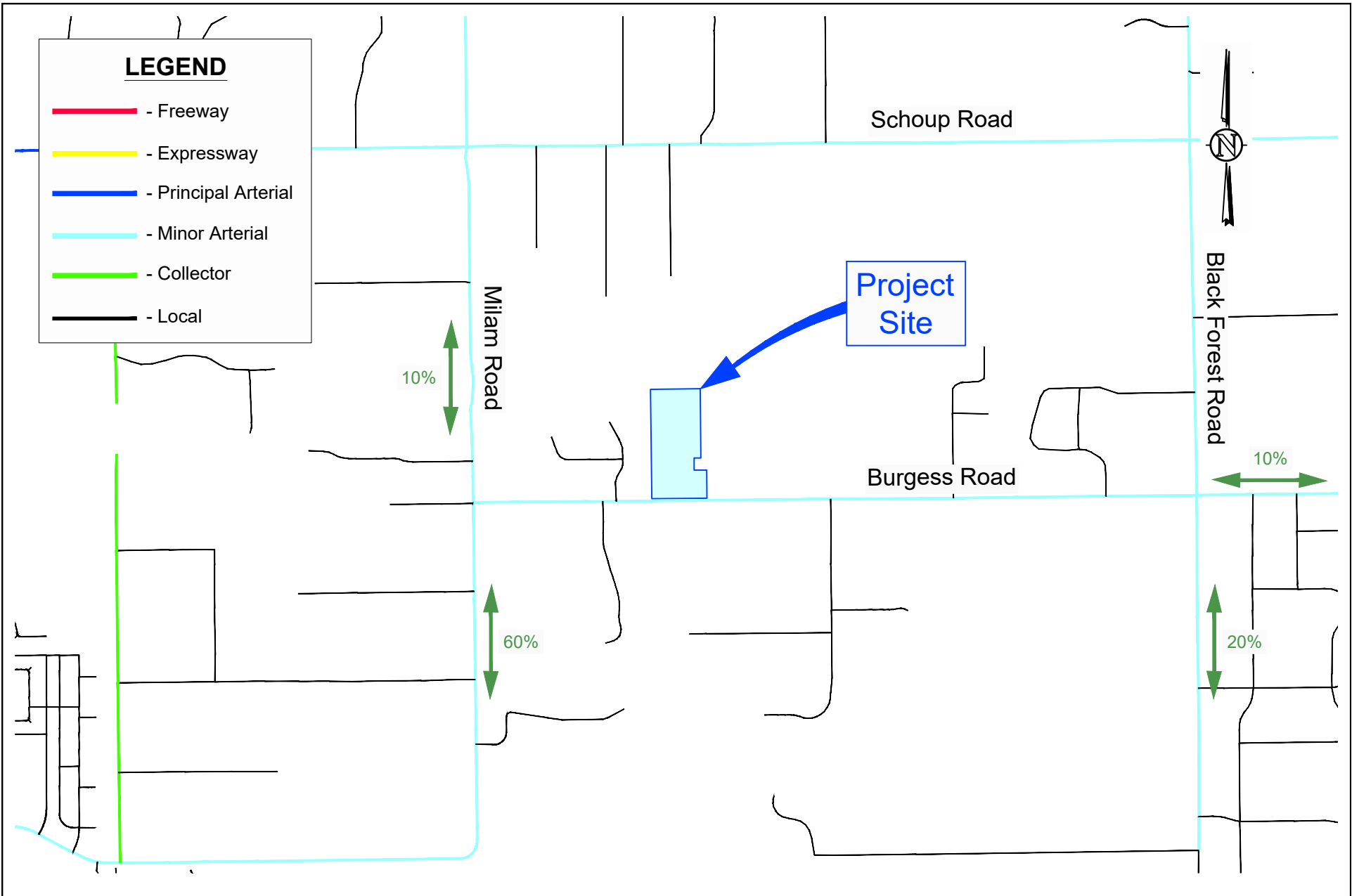

Figure 5 – Year 2023 Traffic Volumes – After School Peak Hour





Haven School Traffic Impact Study
TRIP DISTRIBUTION



Scale	1" = 2,000'	Date	August 25, 2023	Drawn by	JLH	Job #	Haven School	Figure	6
-------	-------------	------	-----------------	----------	-----	-------	--------------	--------	---

Figure 7 – Trip Assignment – Morning Peak Hour

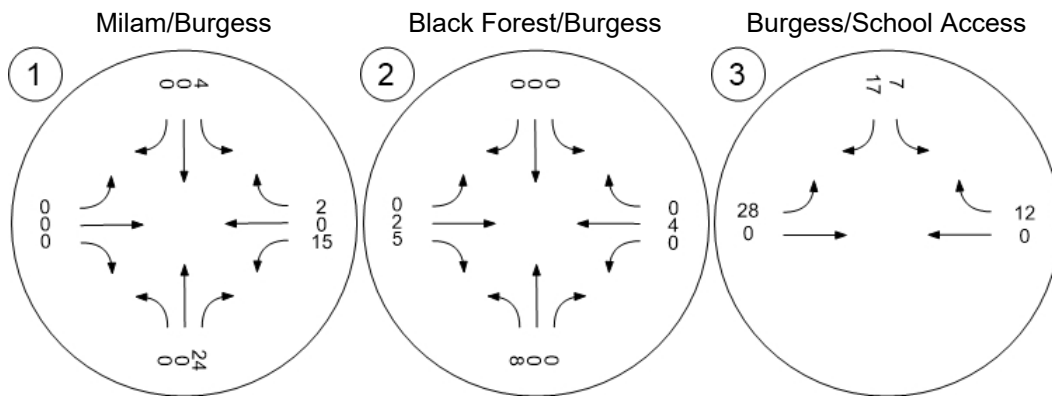

Figure 8 – Trip Assignment – After School Peak Hour

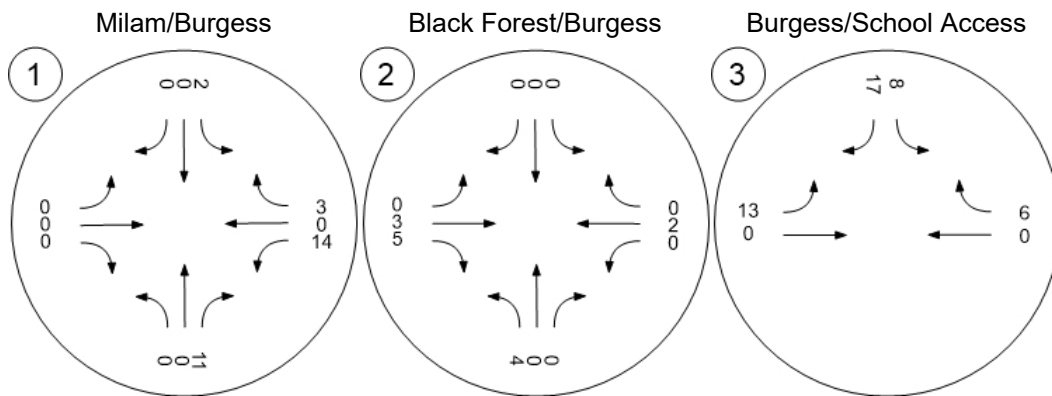

Figure 9 – Year 2025 Background Traffic Volumes – Morning Peak Hour



Milam/Burgess

Black Forest/Burgess

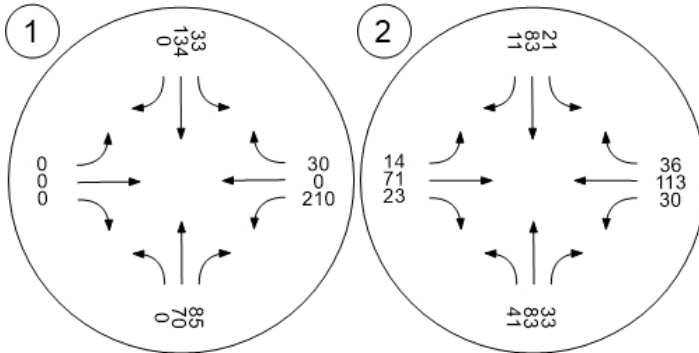

Figure 11 – Year 2025 Total Traffic Volumes – Morning Peak Hour

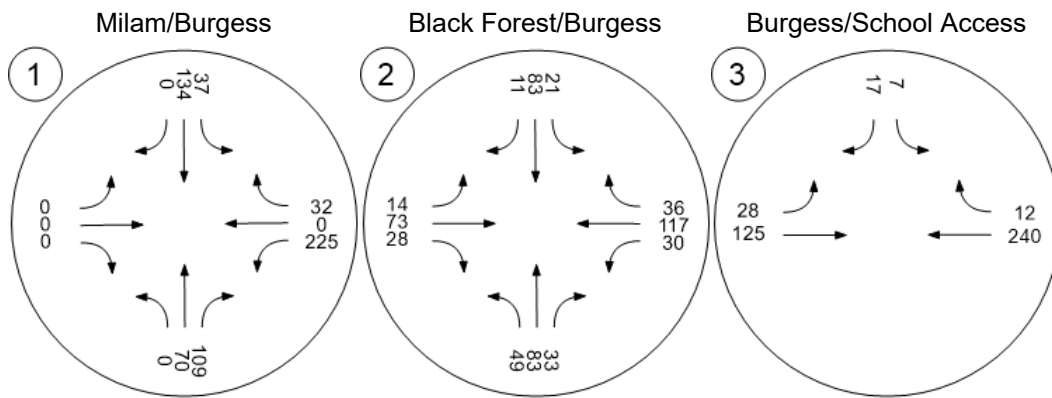

Figure 12 – Year 2025 Total Traffic Volumes – After School Peak Hour

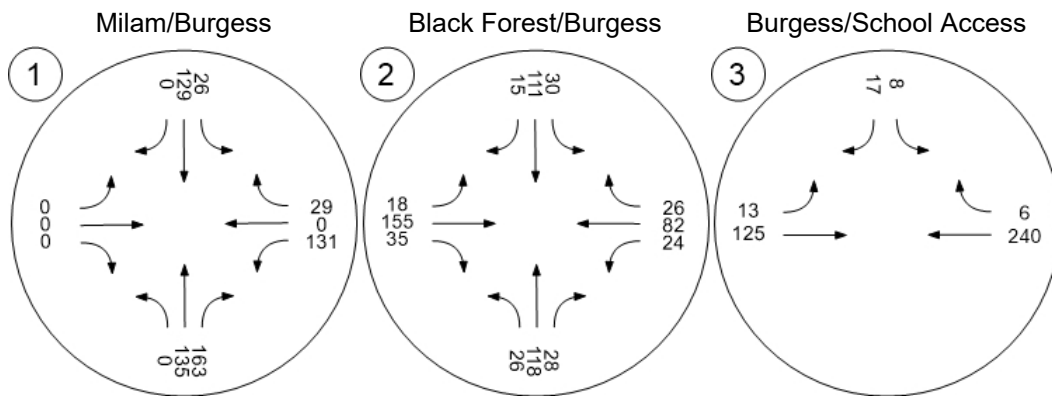

Figure 13 – Laneage and Traffic Control – Year 2025 Traffic Volume Scenarios

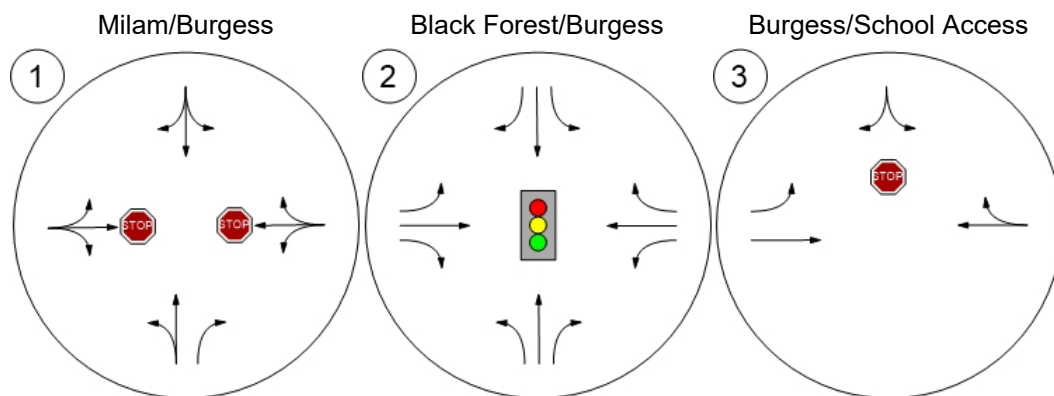

Figure 14 – Year 2045 Background Traffic Volumes – Morning Peak Hour

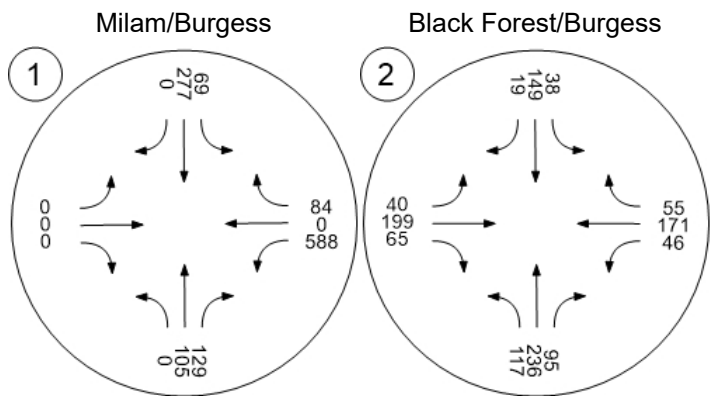

Figure 16 – Year 2045 Total Traffic Volumes – Morning Peak Hour

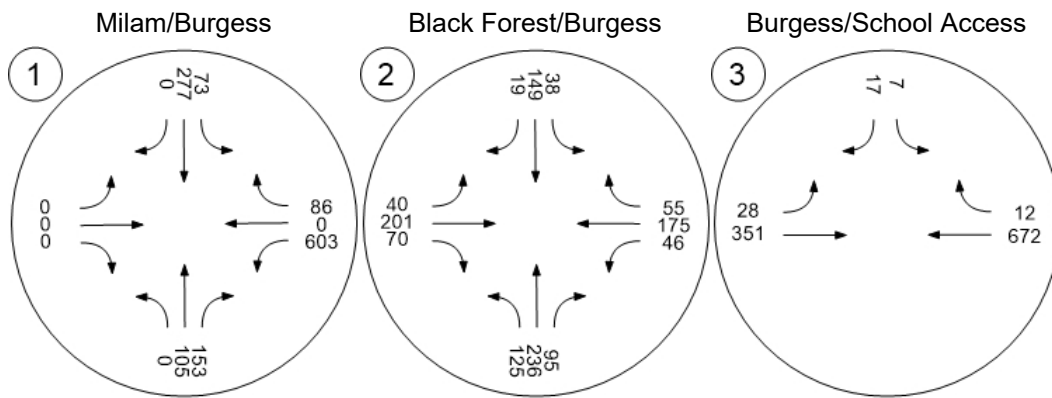

Figure 17 – Year 2045 Total Traffic Volumes – After School Peak Hour



© 2023 Maxar
 © 2023 Microsoft Corporation
 © CNE S (2023) Distribution Airbus DS
 Microsoft product screen shot reprinted with permission from Microsoft Corporation.

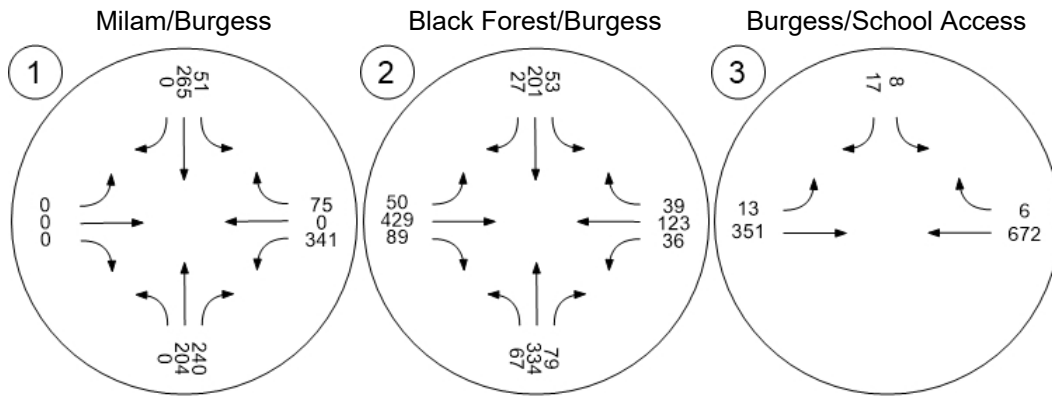
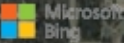
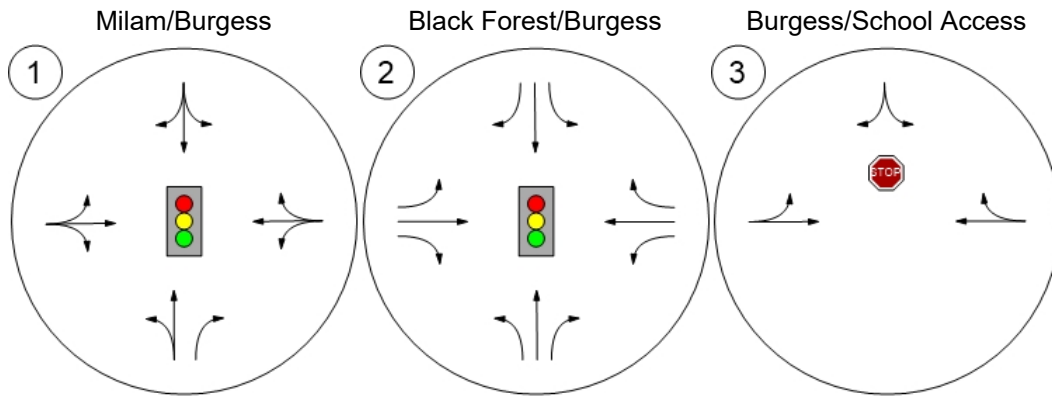
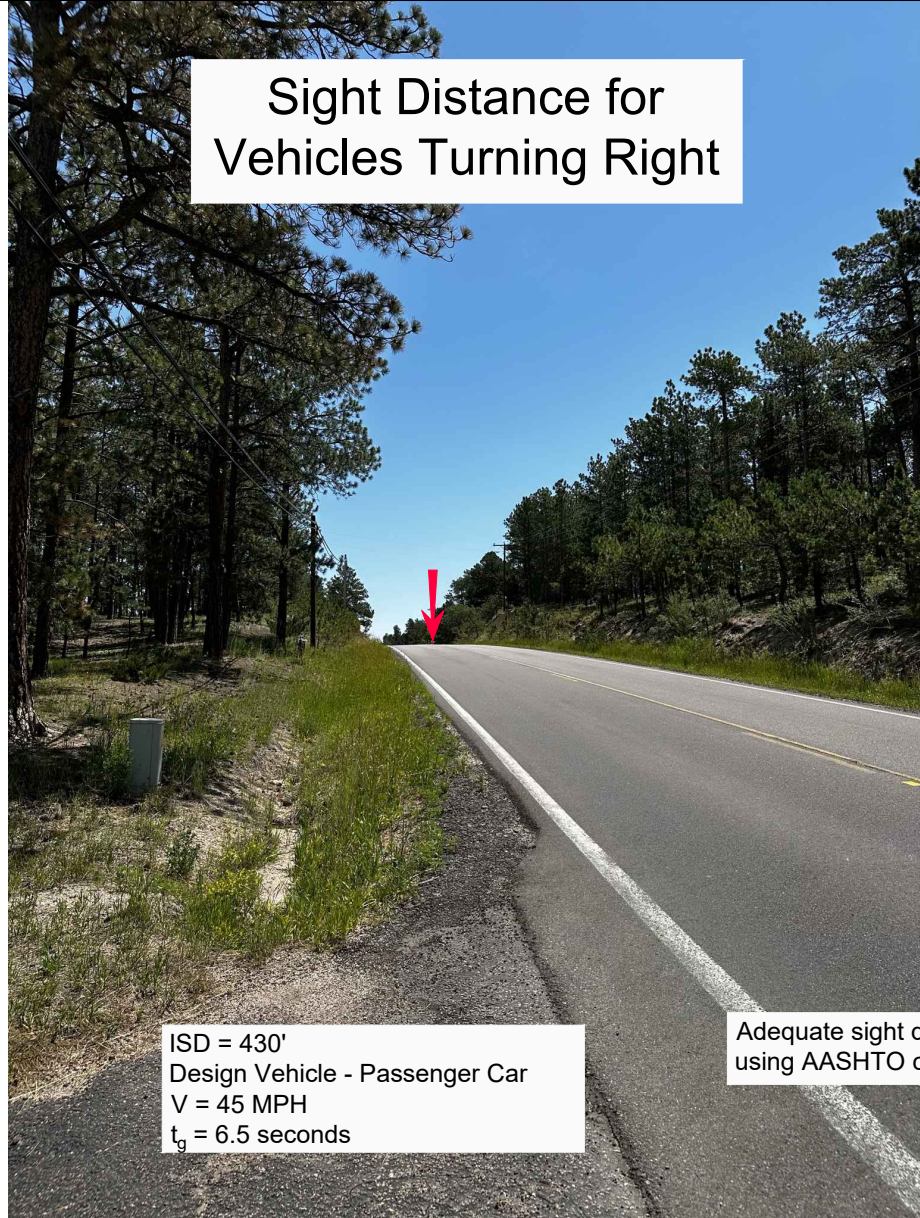

Figure 18 – Laneage and Traffic Control – Year 2045 Traffic Volume Scenarios



Sight Distance for Vehicles Turning Right



ISD = 430'
Design Vehicle - Passenger Car
V = 45 MPH
 $t_g = 6.5$ seconds

Adequate sight distance is available using AASHTO criteria.

Sight Distance for Vehicles Turning Left

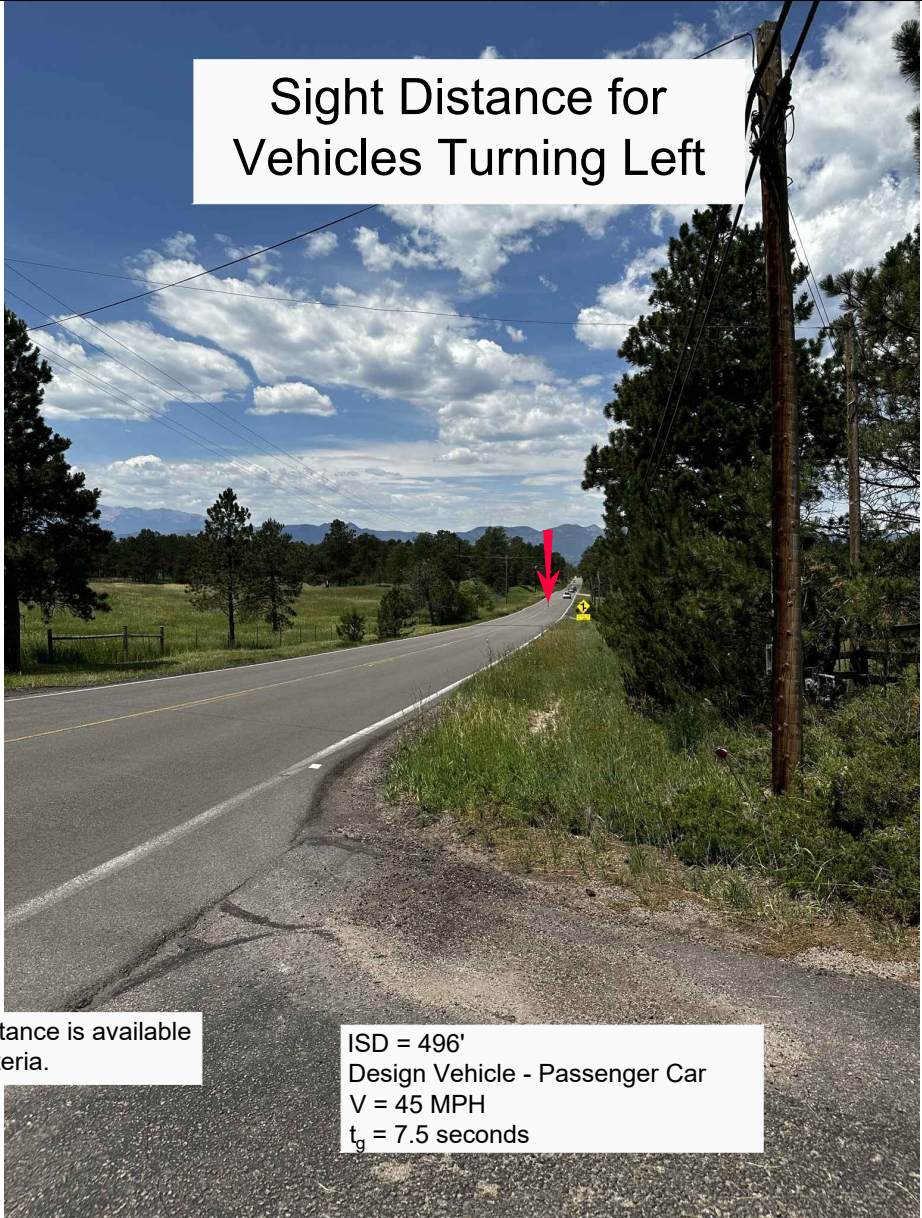

ISD = 496'
Design Vehicle - Passenger Car
V = 45 MPH
 $t_g = 7.5$ seconds



Haven School Traffic Impact Study INTERSECTION SIGHT DISTANCE

Scale	NTS	Date	August 25, 2023	Drawn by	JLH	Job #	Haven School	Figure	19
-------	-----	------	-----------------	----------	-----	-------	--------------	--------	----

Appendix A

Project Correspondence

Haven School

Traffic Impact Study

1.0 Introduction

The Haven School is a tuition-free public program serving kindergarten through 12th grade homeschool students in the Colorado Springs area. It is located at 5484 Burgess Road in El Paso County. The property has two buildings that are used for the school and a single family dwelling unit that is not occupied. A vicinity map is contained in Figure 1 that shows the location of the site on the north side of Burgess Road. Figure 2 shows an aerial photo that was obtained from the El Paso County website. The buildings and their proximity to Burgess Road can be seen in the figure.

Haven School provides science, arts, and nature courses in the classical tradition. Kindergarten through 6th grade students come to the school one day per week on Monday through Thursday, and 7th through 12th grade students come to the school twice each week on Tuesdays and Thursdays. The school has a capacity of 40 kindergarten through 6th grade students, and 70 7th through 12th grade students. Haven School is open a total of thirty weeks during the school year.

A meeting was held with the County staff on June 27, 2023 to discuss the assumptions that will be used in the traffic study. Meeting minutes can be found in Appendix A.

This study has been prepared in conformance with the El Paso County criteria for traffic impact studies¹.

2.0 Project Description

2.1 Study Area

The study area includes the site access. It is a T-intersection with side-street stop control.

2.2 Study Assumptions

The following assumptions were utilized for this study.

Short-Term Study Horizon. The short-term horizon is assumed to be the Year 2025. The school should be at capacity by that time.

Long-Term Study Horizon. Year 2043 will be the long-term horizon because it is 20 years following the completion of the development.

Growth in Background Traffic. xxxxxxxx

¹ [El Paso County Engineering Criteria Manual, Appendix B](#). May 16, 2021.

Saturation Flow Rate. The saturation flow rate was assumed to be 1,900 passenger cars / hour / lane.

Future Roadway Improvements. xxxxxxxx

Peak Hour Factor (PHF). For the existing and the short-term planning horizons, the PHF was based on the data collected for the traffic study. At new approaches, the PHF was assumed to be 0.85 for all movements in all of the planning horizons. In the long-term horizon, the PHF was assumed to be 0.92 unless the existing PHF is higher than 0.92. In that case, the existing PHF was used in the analysis of the long-term volumes.

Truck Percentage. A truck percentage of 2% was assumed for all movements.

3.0 Site Generated Traffic

3.1 Trip Generation

In order to estimate the traffic impacts associated with the Haven School, the trip generation was estimated using rates contained in the Institute of Transportation Engineers Trip Generation manual² (see Table 3). The trip generation estimate was based on the following assumptions.

- **K – 6th Grade Students.** These students attend the school on one day between Monday and Thursday. The school has a capacity of 40 K through 6th grade students, so 10 students were assumed to attend on each day.
- **7th – 12th Grade Students.** These students attend the school on Tuesday and Thursday. The school has a capacity of 70 7th through 12th grade students.

3.2 Trip Distribution and Assignment

The trip distribution for the development is contained in Figure 6. It was based on population density near the school. The peak hour assignments are contained in Figures 7 and 8.

² Trip Generation, 11th Edition. Institute of Transportation Engineers. September 2021.

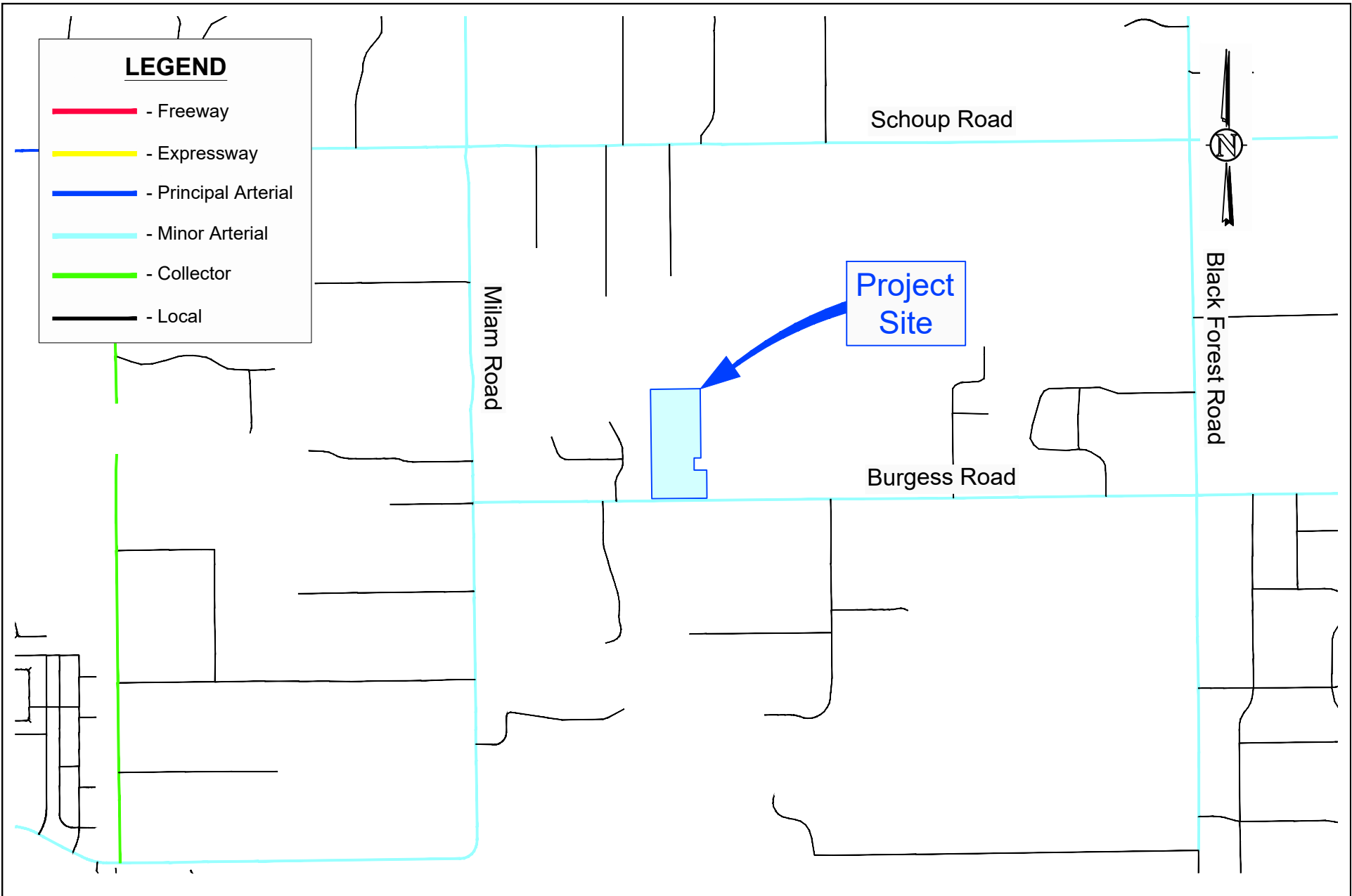

Haven School Traffic Impact Study
VICINITY MAP

Scale	1" = 2,000'	Date	June 27, 2023	Drawn by	JLH	Job #	Haven School	Figure	1
-------	-------------	------	---------------	----------	-----	-------	--------------	--------	---



Haven School Traffic Impact Study
SITE PLAN

Scale	NTS	Date	June 27, 2023	Drawn by	JLH	Job #	Haven School	Figure	2
-------	-----	------	---------------	----------	-----	-------	--------------	--------	---

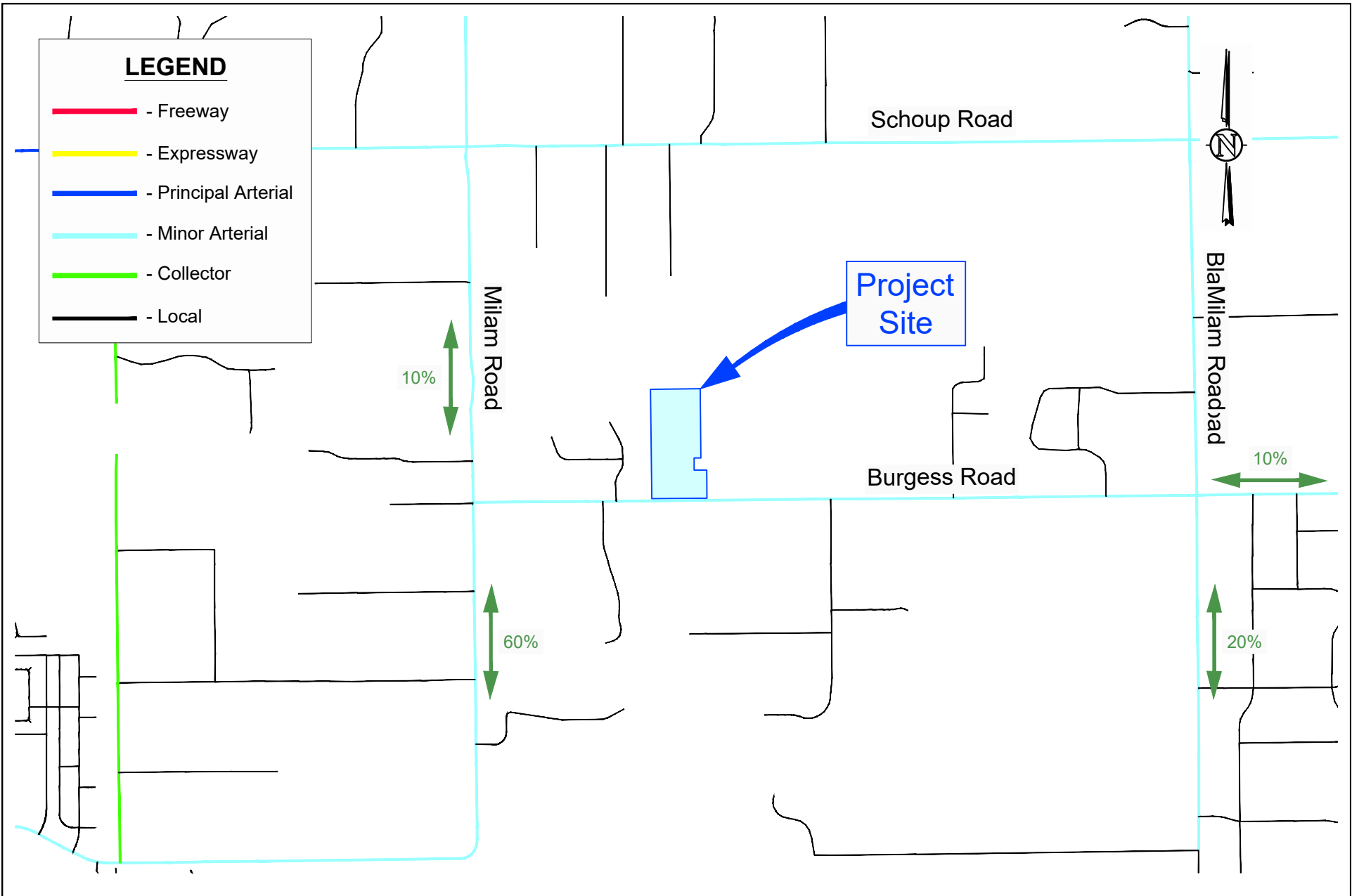

Haven School Traffic Impact Study
TRIP DISTRIBUTION

Scale	1" = 2,000'	Date	June 27, 2023	Drawn by	JLH	Job #	Haven School	Figure	6
-------	-------------	------	---------------	----------	-----	-------	--------------	--------	---

Table 3. Trip Generation Estimate

Land Use	ITE Code ¹	Size	Unit	Trips											
				Average Weekday				Morning Peak Hour of Generator				Afternoon Peak Hour of Generator			
				Rate	Total	In	Out	Rate	Total	In	Out	Rate	Total	In	Out
Monday & Wednesday															
Private School (K-8)	530	10	Students	4.11	42	21	21	1.01	10	6	4	0.60	6	3	3
Tuesday & Thursday															
Private School (K-12)	532	80	Students	2.48	198	99	99	0.80	64	40	24	0.53	42	18	25

Notes

1. The trip generation rates were obtained from Trip Generation, 11th Edition (Institute of Transportation Engineers, 2021).

Haven School Meeting with Jeff Rice

June 27, 2023

- Use 0.5 PHF for school
- No improvements are planned on Burgess Road
- Significant impacts for signalized intersection
- Count Milman and Black Forest Road
- Sight distance study is required
- Does the road cross section fit the ADT?

Appendix B

PPACG Traffic Volume Projections



Joe Henderson <thetrafficczar@gmail.com>

Projected Volumes in El Paso County

5 messages

Joe Henderson <joe@sustainabletrafficsolutions.com>

Wed, Aug 23, 2023 at 1:54 PM

To: dmiller@ppacg.org, jobrien@ppacg.org, jbechtel@ppacg.org, jliosatos@ppacg.org

I'm working on a traffic impact study in El Paso County and I need to develop annual growth rates for the roadways in the study area. Does PPACG publish traffic count data and the projected volumes? I've looked your website and can't find them.

--

Joseph L. Henderson, PE, PTOE

Principal

Sustainable Traffic Solutions, Inc.

823 West 124th Drive

Westminster, CO 80234

303.589.6875

joe@sustainabletrafficsolutions.com

sustainabletrafficsolutions.com

Licensed in CO, WY, and IA



William Mast <wmast@ppacg.org>

Wed, Aug 23, 2023 at 2:33 PM

To: "joe@sustainabletrafficsolutions.com" <joe@sustainabletrafficsolutions.com>

Hi Joseph,

We do not publish the model outputs, but can share them. Where is your study area and which forecast years are you interested in?

William Mast, GISP

GIS Admin & Modeling Lead

Pikes Peak Area Council of Governments

(719) 471-7080 ext. 109



**Pikes Peak Area
Council of Governments**

Communities Working Together

[Quoted text hidden]

Joe Henderson <joe@sustainabletrafficsolutions.com>
To: William Mast <wmast@ppacg.org>

Wed, Aug 23, 2023 at 2:52 PM

William,

The roads in my project at Burgess Road, Milam Road, and Black Forest Road. The long-term horizon year in my study is 2045.

Does that give you enough information?

Joe
[Quoted text hidden]

William Mast <wmast@ppacg.org>
To: Joe Henderson <joe@sustainabletrafficsolutions.com>

Wed, Aug 23, 2023 at 8:56 PM

The attached png displays the 2045 directional volumes for Burgess Rd, Milam to Black Forest.

[Quoted text hidden]
[Quoted text hidden]

[Quoted text hidden]
[Quoted text hidden]
[Quoted text hidden]
[Quoted text hidden]



--

Joseph L. Henderson, PE, PTOE

Principal

Sustainable Traffic Solutions, Inc.

823 West 124th Drive

Westminster, CO 80234

303.589.6875

joe@sustainabletrafficsolutions.com

sustainabletrafficsolutions.com

Licensed in CO, WY, and IA

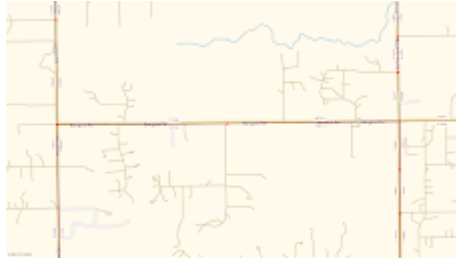
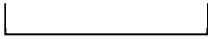

Burgess Rd Tot Volume 2045.png
343K

Joe Henderson <joe@sustainabletrafficsolutions.com>
To: William Mast <wmast@ppacg.org>

Wed, Aug 23, 2023 at 8:58 PM

Thanks. That's exactly what I needed.

[Quoted text hidden]

[Quoted text hidden]

[Quoted text hidden]



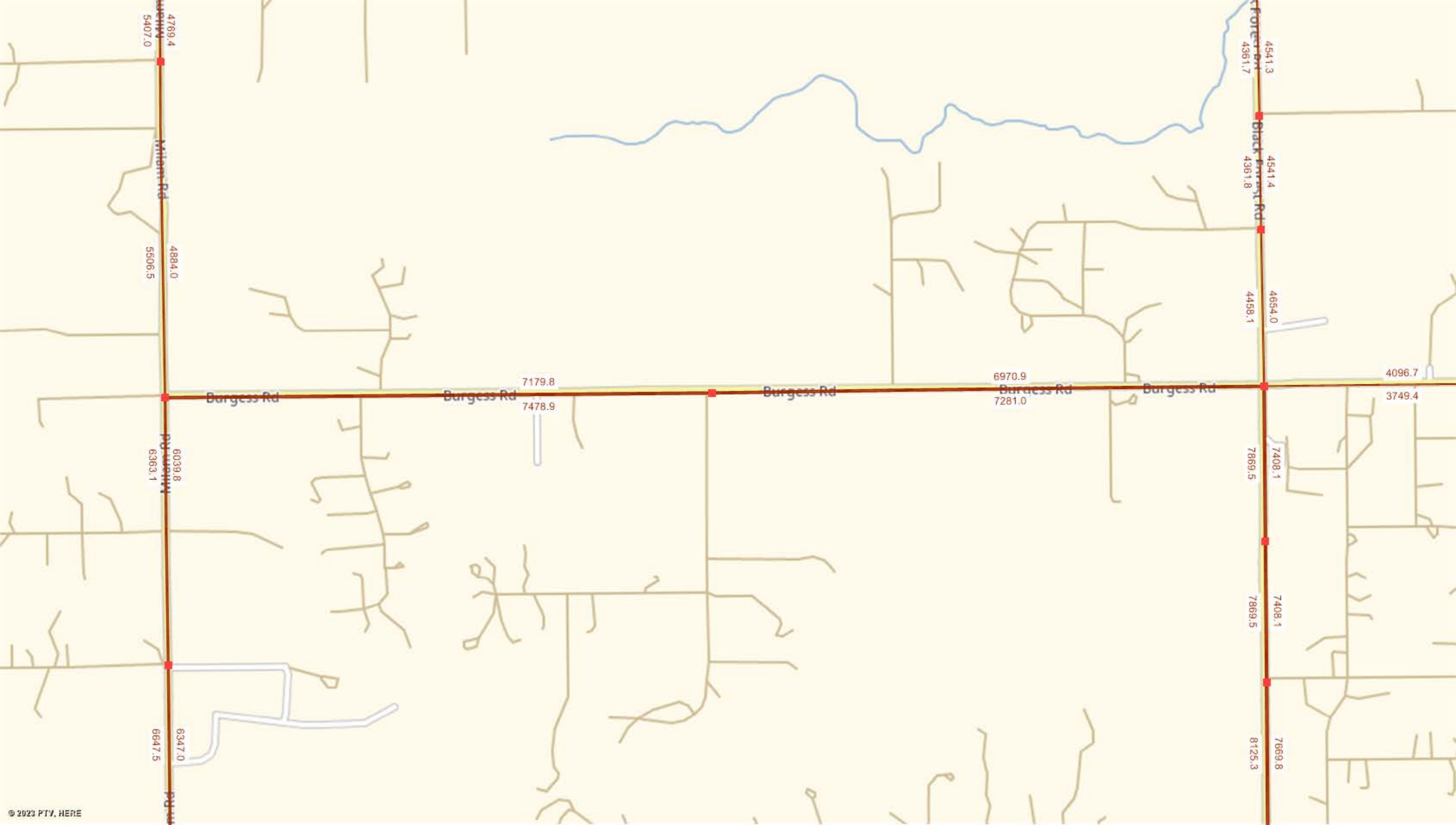

Appendix C

Traffic Count Data

Location: 1 MILAM ROAD & BURGESS ROAD AM

Date: Wednesday, July 19, 2023

Peak Hour: 08:30 AM - 09:30 AM

Peak 15-Minutes: 09:00 AM - 09:15 AM

Peak Hour - Motorized Vehicles

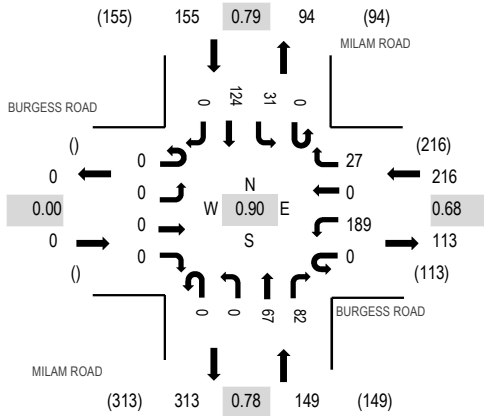

Peak Hour - Bicycles

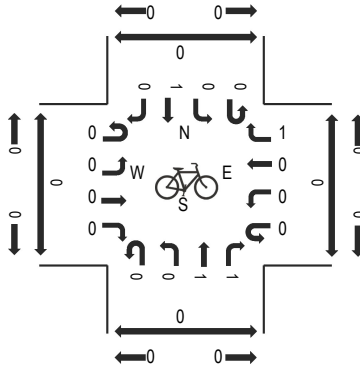

Peak Hour - Pedestrians

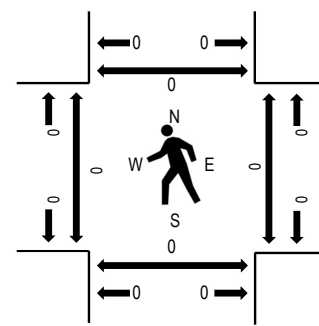

Note: Total study counts contained in parentheses.

Traffic Counts - Motorized Vehicles

Interval Start Time	BURGESS ROAD Eastbound				BURGESS ROAD Westbound				MILAM ROAD Northbound				MILAM ROAD Southbound				Total	Rolling Hour	Pedestrian Crossings			
	U-Turn	Left	Thru	Right	U-Turn	Left	Thru	Right	U-Turn	Left	Thru	Right	U-Turn	Left	Thru	Right			West	East	South	North
8:30 AM	0	0	0	0	0	49	0	5	0	0	18	18	0	3	24	0	117	520	0	0	0	0
8:45 AM	0	0	0	0	0	34	0	3	0	0	15	24	0	10	39	0	125		0	0	0	0
9:00 AM	0	0	0	0	0	66	0	13	0	0	13	13	0	9	30	0	144		0	0	0	0
9:15 AM	0	0	0	0	0	40	0	6	0	0	21	27	0	9	31	0	134		0	0	0	0
Count Total	0	0	0	0	0	189	0	27	0	0	67	82	0	31	124	0	520		0	0	0	0
Peak Hour	0	0	0	0	0	189	0	27	0	0	67	82	0	31	124	0	520		0	0	0	0

Location: 2 BLACK FOREST ROAD & BURGESS ROAD AM

Date: Wednesday, July 19, 2023

Peak Hour: 08:30 AM - 09:30 AM

Peak 15-Minutes: 09:15 AM - 09:30 AM

Peak Hour - Motorized Vehicles

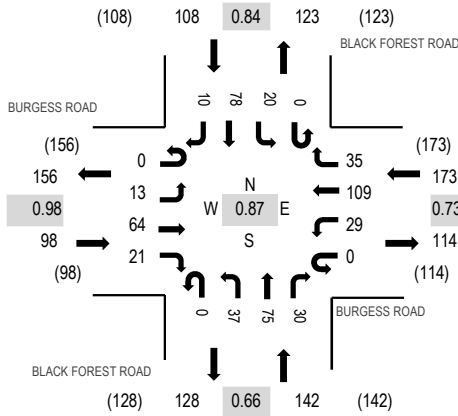

Peak Hour - Bicycles

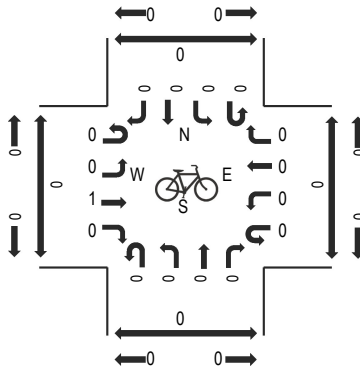

Peak Hour - Pedestrians

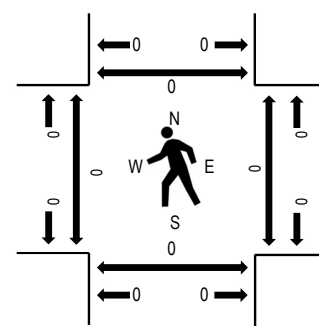

Note: Total study counts contained in parentheses.

Traffic Counts - Motorized Vehicles

Interval Start Time	BURGESS ROAD Eastbound				BURGESS ROAD Westbound				BLACK FOREST ROAD Northbound				BLACK FOREST ROAD Southbound				Total	Rolling Hour	Pedestrian Crossings			
	U-Turn	Left	Thru	Right	U-Turn	Left	Thru	Right	U-Turn	Left	Thru	Right	U-Turn	Left	Thru	Right			West	East	South	North
	8:30 AM	0	3	14	6	0	9	40	10	0	3	17	3	0	3	20			4	132	521	0
8:45 AM	0	5	13	7	0	5	22	11	0	9	22	3	0	4	20	3	124		0	0	0	0
9:00 AM	0	4	18	3	0	8	22	7	0	12	9	10	0	5	17	0	115		0	0	0	0
9:15 AM	0	1	19	5	0	7	25	7	0	13	27	14	0	8	21	3	150		0	0	0	0
Count Total	0	13	64	21	0	29	109	35	0	37	75	30	0	20	78	10	521		0	0	0	0
Peak Hour	0	13	64	21	0	29	109	35	0	37	75	30	0	20	78	10	521		0	0	0	0

Location: 1 MILAM ROAD & BURGESS ROAD PM

Date: Wednesday, July 19, 2023

Peak Hour: 02:45 PM - 03:45 PM

Peak 15-Minutes: 03:30 PM - 03:45 PM

Peak Hour - Motorized Vehicles

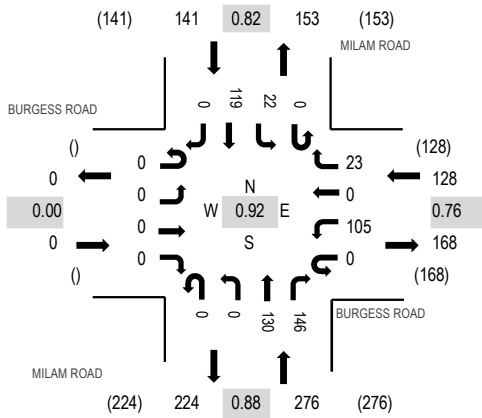

Peak Hour - Bicycles

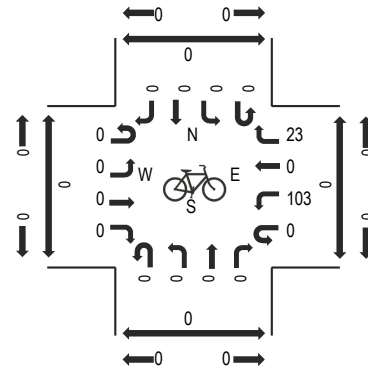

Peak Hour - Pedestrians

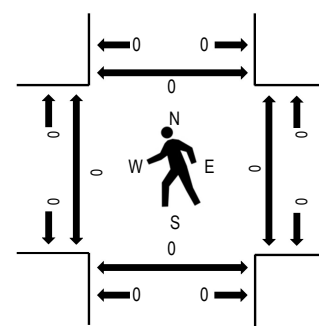

Note: Total study counts contained in parentheses.

Traffic Counts - Motorized Vehicles

Interval Start Time	BURGESS ROAD Eastbound				BURGESS ROAD Westbound				MILAM ROAD Northbound				MILAM ROAD Southbound				Total	Rolling Hour	Pedestrian Crossings			
	U-Turn	Left	Thru	Right	U-Turn	Left	Thru	Right	U-Turn	Left	Thru	Right	U-Turn	Left	Thru	Right			West	East	South	North
2:45 PM	0	0	0	0	0	22	0	4	0	0	28	26	0	6	37	0	123	545	0	0	0	0
3:00 PM	0	0	0	0	0	25	0	5	0	0	38	32	0	6	33	0	139		0	0	0	0
3:15 PM	0	0	0	0	0	22	0	8	0	0	35	43	0	3	24	0	135		0	0	0	0
3:30 PM	0	0	0	0	0	36	0	6	0	0	29	45	0	7	25	0	148		0	0	0	0
Count Total	0	0	0	0	0	105	0	23	0	0	130	146	0	22	119	0	545		0	0	0	0
Peak Hour	0	0	0	0	0	105	0	23	0	0	130	146	0	22	119	0	545		0	0	0	0

Location: 2 BLACK FOREST ROAD & BURGESS ROAD PM

Date: Wednesday, July 19, 2023

Peak Hour: 02:45 PM - 03:45 PM

Peak 15-Minutes: 03:15 PM - 03:30 PM

Peak Hour - Motorized Vehicles

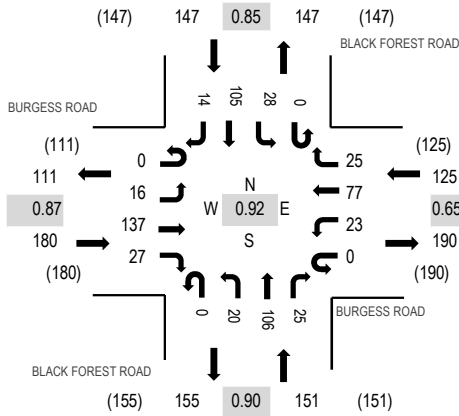

Peak Hour - Bicycles

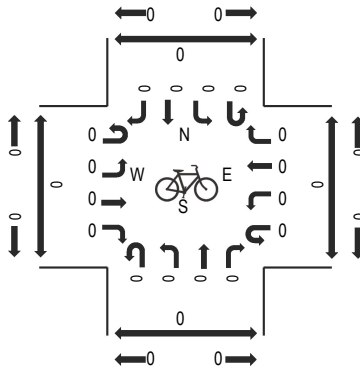

Peak Hour - Pedestrians

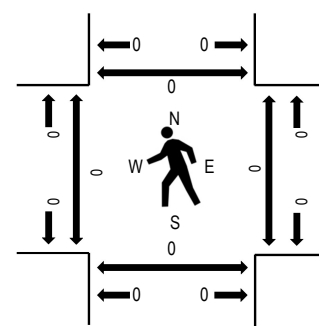

Note: Total study counts contained in parentheses.

Traffic Counts - Motorized Vehicles

Interval Start Time	BURGESS ROAD Eastbound				BURGESS ROAD Westbound				BLACK FOREST ROAD Northbound				BLACK FOREST ROAD Southbound				Total	Rolling Hour	Pedestrian Crossings			
	U-Turn	Left	Thru	Right	U-Turn	Left	Thru	Right	U-Turn	Left	Thru	Right	U-Turn	Left	Thru	Right			West	East	South	North
2:45 PM	0	3	37	6	0	5	11	9	0	2	22	8	0	7	28	4	142	603	0	0	0	0
3:00 PM	0	4	29	4	0	6	14	3	0	7	27	8	0	9	30	4	145		0	0	0	0
3:15 PM	0	3	37	12	0	8	29	11	0	3	31	3	0	4	19	3	163		0	0	0	0
3:30 PM	0	6	34	5	0	4	23	2	0	8	26	6	0	8	28	3	153		0	0	0	0
Count Total	0	16	137	27	0	23	77	25	0	20	106	25	0	28	105	14	603		0	0	0	0
Peak Hour	0	16	137	27	0	23	77	25	0	20	106	25	0	28	105	14	603		0	0	0	0

Vehicle Volume Report - Hourly

Site Description: BURGESS RD E.O. HIGH MEADOWS DR
 Site Number: 3
 Start Date: 7/19/2023
 End Date: 7/19/2023

Time	Monday			Tuesday			Wednesday			Thursday			Friday			Saturday			Sunday			3 Day Avg		5 Day Avg		7 Day Avg	
	7/24/23			7/25/23			7/19/23			7/20/23			7/21/23			7/22/23			7/23/23			Tue-Thu		Mon-Fri		Mon-Sun	
	EB	WB	Total	EB	WB	Total	EB	WB	Total	EB	WB	Total	EB	WB	Total	EB	WB	Total	EB	WB	Total	EB	WB	EB	WB	EB	WB
12:00 AM	-	-	-	-	-	-	10	5	15	-	-	-	-	-	-	-	-	-	-	-	-	-	-	-	-	-	
1:00 AM	-	-	-	-	-	-	4	1	5	-	-	-	-	-	-	-	-	-	-	-	-	-	-	-	-	-	
2:00 AM	-	-	-	-	-	-	1	1	2	-	-	-	-	-	-	-	-	-	-	-	-	-	-	-	-	-	
3:00 AM	-	-	-	-	-	-	3	0	3	-	-	-	-	-	-	-	-	-	-	-	-	-	-	-	-	-	
4:00 AM	-	-	-	-	-	-	3	16	19	-	-	-	-	-	-	-	-	-	-	-	-	-	-	-	-	-	
5:00 AM	-	-	-	-	-	-	5	39	44	-	-	-	-	-	-	-	-	-	-	-	-	-	-	-	-	-	
6:00 AM	-	-	-	-	-	-	33	139	172	-	-	-	-	-	-	-	-	-	-	-	-	-	-	-	-	-	
7:00 AM	-	-	-	-	-	-	65	234	299	-	-	-	-	-	-	-	-	-	-	-	-	-	-	-	-	-	
8:00 AM	-	-	-	-	-	-	108	239	347	-	-	-	-	-	-	-	-	-	-	-	-	-	-	-	-	-	
9:00 AM	-	-	-	-	-	-	123	204	327	-	-	-	-	-	-	-	-	-	-	-	-	-	-	-	-	-	
10:00 AM	-	-	-	-	-	-	130	157	287	-	-	-	-	-	-	-	-	-	-	-	-	-	-	-	-	-	
11:00 AM	-	-	-	-	-	-	148	161	309	-	-	-	-	-	-	-	-	-	-	-	-	-	-	-	-	-	
12:00 PM	-	-	-	-	-	-	145	162	307	-	-	-	-	-	-	-	-	-	-	-	-	-	-	-	-	-	
1:00 PM	-	-	-	-	-	-	149	145	294	-	-	-	-	-	-	-	-	-	-	-	-	-	-	-	-	-	
2:00 PM	-	-	-	-	-	-	188	110	298	-	-	-	-	-	-	-	-	-	-	-	-	-	-	-	-	-	
3:00 PM	-	-	-	-	-	-	190	154	344	-	-	-	-	-	-	-	-	-	-	-	-	-	-	-	-	-	
4:00 PM	-	-	-	-	-	-	261	112	373	-	-	-	-	-	-	-	-	-	-	-	-	-	-	-	-	-	
5:00 PM	-	-	-	-	-	-	265	138	403	-	-	-	-	-	-	-	-	-	-	-	-	-	-	-	-	-	
6:00 PM	-	-	-	-	-	-	199	107	306	-	-	-	-	-	-	-	-	-	-	-	-	-	-	-	-	-	
7:00 PM	-	-	-	-	-	-	121	67	188	-	-	-	-	-	-	-	-	-	-	-	-	-	-	-	-	-	
8:00 PM	-	-	-	-	-	-	99	41	140	-	-	-	-	-	-	-	-	-	-	-	-	-	-	-	-	-	
9:00 PM	-	-	-	-	-	-	101	33	134	-	-	-	-	-	-	-	-	-	-	-	-	-	-	-	-	-	
10:00 PM	-	-	-	-	-	-	38	17	55	-	-	-	-	-	-	-	-	-	-	-	-	-	-	-	-	-	
11:00 PM	-	-	-	-	-	-	15	5	20	-	-	-	-	-	-	-	-	-	-	-	-	-	-	-	-	-	
6:00 AM - 9:00 AM	-	-	-	-	-	-	206	612	818	-	-	-	-	-	-	-	-	-	-	-	-	-	-	-	-	-	
3:00 PM - 6:00 PM	-	-	-	-	-	-	716	404	1120	-	-	-	-	-	-	-	-	-	-	-	-	-	-	-	-	-	
6:00 AM - 7:00 PM	-	-	-	-	-	-	2004	2062	4066	-	-	-	-	-	-	-	-	-	-	-	-	-	-	-	-	-	
12:00 AM - 12:00 AM	-	-	-	-	-	-	2404	2287	4691	-	-	-	-	-	-	-	-	-	-	-	-	-	-	-	-	-	
Percent	-	-	-	-	-	-	51.2%	48.8%	100.0%	-	-	-	-	-	-	-	-	-	-	-	-	-	-	-	-	-	
AM Peak	-	-	-	-	-	-	8:00 AM	9:00 AM	-	-	-	-	-	-	-	-	-	-	-	-	-	-	-	-	-	-	
PM Peak	-	-	-	-	-	-	5:00 PM	6:00 PM	-	-	-	-	-	-	-	-	-	-	-	-	-	-	-	-	-	-	

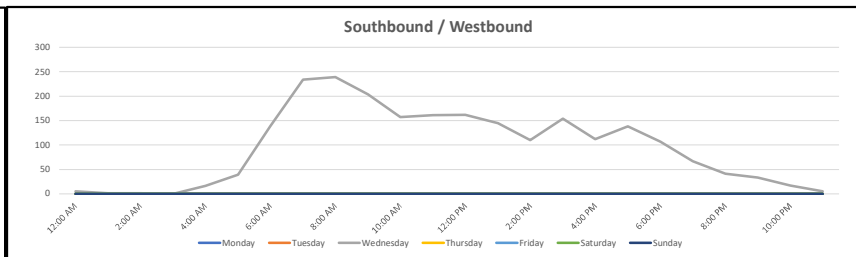
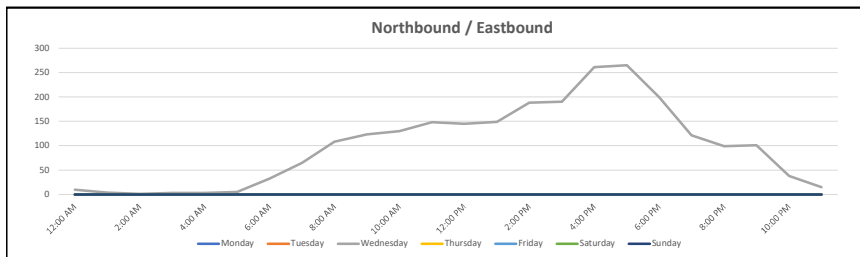

Vehicle Classification Report - Hourly

Site Description: BURGESS RD E.O. HIGH MEADOWS DR
Site Number: 3
Start Date: 7/19/2023
End Date: 7/19/2023

FHWA Vehicle Classification	
Class 1 - Motorcycles	Class 8 - Four or Fewer Axle Single-Trailer Trucks
Class 2 - Passenger Cars	Class 9 - Five-Axle Single-Trailer Trucks
Class 3 - Other Two-Axle, Four-Tire Single Unit Vehicles	Class 10 - Six or More Axle Single-Trailer Trucks
Class 4 - Buses	Class 11 - Five or fewer Axle Multi-Trailer Trucks
Class 5 - Two-Axle, Six-Tire, Single-Unit Trucks	Class 12 - Six-Axle Multi-Trailer Trucks
Class 6 - Three-Axle Single-Unit Trucks	Class 13 - Seven or More Axle Multi-Trailer Trucks
Class 7 - Four or More Axle Single-Unit Trucks	

FHWA Vehicle Classification - Total Study														
	Total	1	2	3	4	5	6	7	8	9	10	11	12	13
Eastbound	2404	10	1606	655	1	122	6	0	3	1	0	0	0	0
<i>Percent</i>	<i>100.0%</i>	<i>0.4%</i>	<i>66.8%</i>	<i>27.2%</i>	<i>0.0%</i>	<i>5.1%</i>	<i>0.2%</i>	<i>0.0%</i>	<i>0.1%</i>	<i>0.0%</i>	<i>0.0%</i>	<i>0.0%</i>	<i>0.0%</i>	<i>0.0%</i>
Westbound	2287	11	1452	620	1	186	11	0	2	3	0	0	1	0
<i>Percent</i>	<i>100.0%</i>	<i>0.5%</i>	<i>63.5%</i>	<i>27.1%</i>	<i>0.0%</i>	<i>8.1%</i>	<i>0.5%</i>	<i>0.0%</i>	<i>0.1%</i>	<i>0.1%</i>	<i>0.0%</i>	<i>0.0%</i>	<i>0.0%</i>	<i>0.0%</i>
Total	4691	21	3058	1275	2	308	17	0	5	4	0	0	1	0
<i>Percent</i>	<i>100.0%</i>	<i>0.4%</i>	<i>65.2%</i>	<i>27.2%</i>	<i>0.0%</i>	<i>6.6%</i>	<i>0.4%</i>	<i>0.0%</i>	<i>0.1%</i>	<i>0.1%</i>	<i>0.0%</i>	<i>0.0%</i>	<i>0.0%</i>	<i>0.0%</i>

Site Description: BURGESS RD E.O. HIGH MEADOWS DR
 Site Number: 3
 Start Date: 7/19/2023
 End Date: 7/19/2023

Vehicle Classification Report (Eastbound - 07/19/2023)

Wednesday	Total	Eastbound												
		Classes												
7/19/23		1	2	3	4	5	6	7	8	9	10	11	12	13
12:00 AM	10	0	5	5	0	0	0	0	0	0	0	0	0	0
1:00 AM	4	0	3	1	0	0	0	0	0	0	0	0	0	0
2:00 AM	1	0	1	0	0	0	0	0	0	0	0	0	0	0
3:00 AM	3	0	2	1	0	0	0	0	0	0	0	0	0	0
4:00 AM	3	1	2	0	0	0	0	0	0	0	0	0	0	0
5:00 AM	5	0	4	1	0	0	0	0	0	0	0	0	0	0
6:00 AM	33	0	26	4	0	3	0	0	0	0	0	0	0	0
7:00 AM	65	0	47	13	0	5	0	0	0	0	0	0	0	0
8:00 AM	108	1	70	34	0	3	0	0	0	0	0	0	0	0
9:00 AM	123	0	77	38	0	7	1	0	0	0	0	0	0	0
10:00 AM	130	1	88	31	0	8	1	0	1	0	0	0	0	0
11:00 AM	148	1	97	40	0	9	0	0	0	1	0	0	0	0
12:00 PM	145	0	90	43	0	11	1	0	0	0	0	0	0	0
1:00 PM	149	0	98	45	0	6	0	0	0	0	0	0	0	0
2:00 PM	188	0	120	56	0	9	2	0	1	0	0	0	0	0
3:00 PM	190	1	127	45	0	16	1	0	0	0	0	0	0	0
4:00 PM	261	1	176	70	1	13	0	0	0	0	0	0	0	0
5:00 PM	265	0	170	82	0	13	0	0	0	0	0	0	0	0
6:00 PM	199	2	121	67	0	8	0	0	1	0	0	0	0	0
7:00 PM	121	1	83	32	0	5	0	0	0	0	0	0	0	0
8:00 PM	99	0	70	26	0	3	0	0	0	0	0	0	0	0
9:00 PM	101	1	85	13	0	2	0	0	0	0	0	0	0	0
10:00 PM	38	0	34	3	0	1	0	0	0	0	0	0	0	0
11:00 PM	15	0	10	5	0	0	0	0	0	0	0	0	0	0
6:00 AM - 9:00 AM	206	1	143	51	0	11	0	0	0	0	0	0	0	0
3:00 PM - 6:00 PM	716	2	473	197	1	42	1	0	0	0	0	0	0	0
6:00 AM - 7:00 PM	2004	7	1307	568	1	111	6	0	3	1	0	0	0	0
12:00 AM - 12:00 AM	2404	10	1606	655	1	122	6	0	3	1	0	0	0	0
Percent	100%	0.4%	66.8%	27.2%	0.0%	5.1%	0.2%	0.0%	0.1%	0.0%	0.0%	0.0%	0.0%	0.0%

Site Description: BURGESS RD E.O. HIGH MEADOWS DR
 Site Number: 3
 Start Date: 7/19/2023
 End Date: 7/19/2023

Vehicle Classification Report (Westbound - 07/19/2023)

Wednesday	Total	Westbound															
		Classes															
		1	2	3	4	5	6	7	8	9	10	11	12	13			
7/19/23																	
12:00 AM	5	0	3	1	0	1	0	0	0	0	0	0	0	0	0	0	0
1:00 AM	1	0	1	0	0	0	0	0	0	0	0	0	0	0	0	0	0
2:00 AM	1	0	1	0	0	0	0	0	0	0	0	0	0	0	0	0	0
3:00 AM	0	0	0	0	0	0	0	0	0	0	0	0	0	0	0	0	0
4:00 AM	16	0	12	4	0	0	0	0	0	0	0	0	0	0	0	0	0
5:00 AM	39	0	29	6	0	4	0	0	0	0	0	0	0	0	0	0	0
6:00 AM	139	1	92	34	0	11	1	0	0	0	0	0	0	0	0	0	0
7:00 AM	234	0	164	50	0	19	1	0	0	0	0	0	0	0	0	0	0
8:00 AM	239	1	174	51	1	12	0	0	0	0	0	0	0	0	0	0	0
9:00 AM	204	2	143	40	0	18	0	0	0	0	0	0	0	1	0	0	0
10:00 AM	157	1	116	33	0	5	2	0	0	0	0	0	0	0	0	0	0
11:00 AM	161	0	124	27	0	8	0	0	0	2	0	0	0	0	0	0	0
12:00 PM	162	2	103	49	0	6	1	0	1	0	0	0	0	0	0	0	0
1:00 PM	145	1	103	34	0	6	0	0	0	1	0	0	0	0	0	0	0
2:00 PM	110	0	74	24	0	12	0	0	0	0	0	0	0	0	0	0	0
3:00 PM	154	0	117	27	0	7	3	0	0	0	0	0	0	0	0	0	0
4:00 PM	112	1	80	24	0	5	2	0	0	0	0	0	0	0	0	0	0
5:00 PM	138	0	58	59	0	21	0	0	0	0	0	0	0	0	0	0	0
6:00 PM	107	0	14	67	0	25	1	0	0	0	0	0	0	0	0	0	0
7:00 PM	67	1	10	40	0	15	0	0	1	0	0	0	0	0	0	0	0
8:00 PM	41	0	7	28	0	6	0	0	0	0	0	0	0	0	0	0	0
9:00 PM	33	1	15	13	0	4	0	0	0	0	0	0	0	0	0	0	0
10:00 PM	17	0	9	8	0	0	0	0	0	0	0	0	0	0	0	0	0
11:00 PM	5	0	3	1	0	1	0	0	0	0	0	0	0	0	0	0	0
6:00 AM - 9:00 AM	612	2	430	135	1	42	2	0	0	0	0	0	0	0	0	0	0
3:00 PM - 6:00 PM	404	1	255	110	0	33	5	0	0	0	0	0	0	0	0	0	0
6:00 AM - 7:00 PM	2062	9	1362	519	1	155	11	0	1	3	0	0	1	0	1	0	0
12:00 AM - 12:00 AM	2287	11	1452	620	1	186	11	0	2	3	0	0	0	1	1	0	0
Percent	0%	-	-	-	-	-	-	-	-	-	-	-	-	-	-	-	-

Appendix D

VISTRO Analysis Results

Year 2023 Traffic Volumes

Haven School TIS

Vistro File: C:\...\AM.vistro
Report File: C:\...\2023 AM.pdf

Scenario 1 2023 AM
8/24/2023

Intersection Analysis Summary

ID	Intersection Name	Control Type	Method	Worst Mvmt	V/C	Delay (s/veh)	LOS
1	Milam/Burgess	Two-way stop	HCM 7th Edition	WB Left	0.453	16.2	C
2	Black Forest/Burgess	Signalized	HCM 7th Edition	NB Left	0.141	6.0	A

V/C, Delay, LOS: For two-way stop, these values are taken from the movement with the worst (highest) delay value. For all other control types, they are taken for the whole intersection.

Intersection Level Of Service Report
Intersection 1: Milam/Burgess

Control Type: Two-way stop
 Analysis Method: HCM 7th Edition
 Analysis Period: 15 minutes

Delay (sec / veh): 16.2
 Level Of Service: C
 Volume to Capacity (v/c): 0.453

Intersection Setup

Name	Milam Road			Milam Road			Private Road			Burgess Road		
Approach	Northbound			Southbound			Eastbound			Westbound		
Lane Configuration	↔↔			↑			↑			↑		
Turning Movement	Left	Thru	Right	Left	Thru	Right	Left	Thru	Right	Left	Thru	Right
Lane Width [ft]	12.00	12.00	12.00	12.00	12.00	12.00	12.00	12.00	12.00	12.00	12.00	12.00
No. of Lanes in Entry Pocket	0	0	1	0	0	0	0	0	0	0	0	0
Entry Pocket Length [ft]	100.00	100.00	100.00	100.00	100.00	100.00	100.00	100.00	100.00	100.00	100.00	100.00
No. of Lanes in Exit Pocket	0	0	0	0	0	0	0	0	0	0	0	0
Exit Pocket Length [ft]	0.00	0.00	0.00	0.00	0.00	0.00	0.00	0.00	0.00	0.00	0.00	0.00
Speed [mph]	30.00			30.00			30.00			30.00		
Grade [%]	0.00			0.00			0.00			0.00		
Crosswalk	No			No			No			No		

Volumes

Name	Milam Road			Milam Road			Private Road			Burgess Road		
Base Volume Input [veh/h]	0	67	82	31	124	0	0	0	0	189	0	27
Base Volume Adjustment Factor	1.0000	1.0000	1.0000	1.0000	1.0000	1.0000	1.0000	1.0000	1.0000	1.0000	1.0000	1.0000
Heavy Vehicles Percentage [%]	2.00	2.00	2.00	2.00	2.00	2.00	2.00	2.00	2.00	2.00	2.00	2.00
Growth Factor	1.0000	1.0000	1.0000	1.0000	1.0000	1.0000	1.0000	1.0000	1.0000	1.0000	1.0000	1.0000
In-Process Volume [veh/h]	0	0	0	0	0	0	0	0	0	0	0	0
Site-Generated Trips [veh/h]	0	0	0	0	0	0	0	0	0	0	0	0
Diverted Trips [veh/h]	0	0	0	0	0	0	0	0	0	0	0	0
Pass-by Trips [veh/h]	0	0	0	0	0	0	0	0	0	0	0	0
Existing Site Adjustment Volume [veh/h]	0	0	0	0	0	0	0	0	0	0	0	0
Other Volume [veh/h]	0	0	0	0	0	0	0	0	0	0	0	0
Total Hourly Volume [veh/h]	0	67	82	31	124	0	0	0	0	189	0	27
Peak Hour Factor	0.7800	0.7800	0.7800	0.7900	0.7900	0.7900	0.8500	0.8500	0.8500	0.6800	0.6800	0.6800
Other Adjustment Factor	1.0000	1.0000	1.0000	1.0000	1.0000	1.0000	1.0000	1.0000	1.0000	1.0000	1.0000	1.0000
Total 15-Minute Volume [veh/h]	0	21	26	10	39	0	0	0	0	69	0	10
Total Analysis Volume [veh/h]	0	86	105	39	157	0	0	0	0	278	0	40
Pedestrian Volume [ped/h]	0			0			0			0		

Intersection Settings

Priority Scheme	Free	Free	Stop	Stop
Flared Lane			No	No
Storage Area [veh]	0	0	0	0
Two-Stage Gap Acceptance			No	No
Number of Storage Spaces in Median	0	0	0	0

Movement, Approach, & Intersection Results

V/C, Movement V/C Ratio	0.00	0.00	0.00	0.03	0.00	0.00	0.00	0.00	0.00	0.45	0.00	0.04
d_M, Delay for Movement [s/veh]	7.53	0.00	0.00	7.43	0.00	0.00	11.83	11.22	9.05	16.19	16.55	14.03
Movement LOS	A	A	A	A	A	A	B	B	A	C	C	B
95th-Percentile Queue Length [veh/ln]	0.00	0.00	0.00	0.07	0.07	0.07	0.00	0.00	0.00	2.74	2.74	2.74
95th-Percentile Queue Length [ft/ln]	0.00	0.00	0.00	1.66	1.66	1.66	0.00	0.00	0.00	68.57	68.57	68.57
d_A, Approach Delay [s/veh]	0.00			1.48			10.70			15.92		
Approach LOS	A			A			B			C		
d_I, Intersection Delay [s/veh]	7.59											
Intersection LOS	C											

**Intersection Level Of Service Report
Intersection 2: Black Forest/Burgess**

Control Type:	Signalized	Delay (sec / veh):	6.0
Analysis Method:	HCM 7th Edition	Level Of Service:	A
Analysis Period:	15 minutes	Volume to Capacity (v/c):	0.141

Intersection Setup

Name	Black Forest Road			Black Forest Road			Burgess Road			Burgess Road		
Approach	Northbound			Southbound			Eastbound			Westbound		
Lane Configuration	↵↵↵			↵↵↵			↵↵↵			↵↵↵		
Turning Movement	Left	Thru	Right	Left	Thru	Right	Left	Thru	Right	Left	Thru	Right
Lane Width [ft]	12.00	12.00	12.00	12.00	12.00	12.00	12.00	12.00	12.00	12.00	12.00	12.00
No. of Lanes in Entry Pocket	1	0	1	1	0	1	1	0	1	1	0	1
Entry Pocket Length [ft]	100.00	100.00	100.00	100.00	100.00	100.00	100.00	100.00	200.00	100.00	100.00	200.00
No. of Lanes in Exit Pocket	0	0	0	0	0	0	0	0	0	0	0	0
Exit Pocket Length [ft]	0.00	0.00	0.00	0.00	0.00	0.00	0.00	0.00	0.00	0.00	0.00	0.00
Speed [mph]	30.00			30.00			30.00			30.00		
Grade [%]	0.00			0.00			0.00			0.00		
Curb Present	No			No			No			No		
Crosswalk	No			No			No			No		

Volumes

Name	Black Forest Road			Black Forest Road			Burgess Road			Burgess Road		
Base Volume Input [veh/h]	37	75	30	20	78	10	13	64	21	29	109	35
Base Volume Adjustment Factor	1.0000	1.0000	1.0000	1.0000	1.0000	1.0000	1.0000	1.0000	1.0000	1.0000	1.0000	1.0000
Heavy Vehicles Percentage [%]	2.00	2.00	2.00	2.00	2.00	2.00	2.00	2.00	2.00	2.00	2.00	2.00
Proportion of CAVs [%]	0.00											
Growth Factor	1.0000	1.0000	1.0000	1.0000	1.0000	1.0000	1.0000	1.0000	1.0000	1.0000	1.0000	1.0000
In-Process Volume [veh/h]	0	0	0	0	0	0	0	0	0	0	0	0
Site-Generated Trips [veh/h]	0	0	0	0	0	0	0	0	0	0	0	0
Diverted Trips [veh/h]	0	0	0	0	0	0	0	0	0	0	0	0
Pass-by Trips [veh/h]	0	0	0	0	0	0	0	0	0	0	0	0
Existing Site Adjustment Volume [veh/h]	0	0	0	0	0	0	0	0	0	0	0	0
Other Volume [veh/h]	0	0	0	0	0	0	0	0	0	0	0	0
Right Turn on Red Volume [veh/h]	0	0	15	0	0	5	0	0	11	0	0	18
Total Hourly Volume [veh/h]	37	75	15	20	78	5	13	64	10	29	109	17
Peak Hour Factor	0.6600	0.6600	0.6600	0.8400	0.8400	0.8400	0.9800	0.9800	0.9800	0.7300	0.7300	0.7300
Other Adjustment Factor	1.0000	1.0000	1.0000	1.0000	1.0000	1.0000	1.0000	1.0000	1.0000	1.0000	1.0000	1.0000
Total 15-Minute Volume [veh/h]	14	28	6	6	23	1	3	16	3	10	37	6
Total Analysis Volume [veh/h]	56	114	23	24	93	6	13	65	10	40	149	23
Presence of On-Street Parking	No		No	No		No	No		No	No		No
On-Street Parking Maneuver Rate [/h]	0	0	0	0	0	0	0	0	0	0	0	0
Local Bus Stopping Rate [/h]	0	0	0	0	0	0	0	0	0	0	0	0
v_do, Outbound Pedestrian Volume crossing	0			0			0			0		
v_di, Inbound Pedestrian Volume crossing m	0			0			0			0		
v_co, Outbound Pedestrian Volume crossing	0			0			0			0		
v_ci, Inbound Pedestrian Volume crossing mi	0			0			0			0		
v_ab, Corner Pedestrian Volume [ped/h]	0			0			0			0		
Bicycle Volume [bicycles/h]	0			0			0			0		

Intersection Settings

Located in CBD	No
Signal Coordination Group	-
Cycle Length [s]	90
Active Pattern	Free Running
Coordination Type	<i>Free Running</i>
Actuation Type	<i>Fully actuated</i>
Offset [s]	0.0
Offset Reference	Lead Green - Beginning of First Green
Permissive Mode	SingleBand
Lost time [s]	0.00

Phasing & Timing

Control Type	Permiss	Permiss	Permiss	Permiss	Permiss	Permiss	Permiss	Permiss	Permiss	Permiss	Permiss	Permiss
Signal Group	0	2	0	0	6	0	0	4	0	0	8	0
Auxiliary Signal Groups												
Lead / Lag	-	-	-	-	-	-	-	-	-	-	-	-
Minimum Green [s]	0	10	0	0	10	0	0	10	0	0	10	0
Maximum Green [s]	0	40	0	0	40	0	0	40	0	0	40	0
Amber [s]	0.0	3.0	0.0	0.0	3.0	0.0	0.0	3.0	0.0	0.0	3.0	0.0
All red [s]	0.0	1.0	0.0	0.0	1.0	0.0	0.0	1.0	0.0	0.0	1.0	0.0
Split [s]	0	14	0	0	14	0	0	14	0	0	14	0
Vehicle Extension [s]	0.0	3.0	0.0	0.0	3.0	0.0	0.0	3.0	0.0	0.0	3.0	0.0
Walk [s]	0	5	0	0	5	0	0	5	0	0	5	0
Pedestrian Clearance [s]	0	10	0	0	10	0	0	10	0	0	10	0
Delayed Vehicle Green [s]	0.0	0.0	0.0	0.0	0.0	0.0	0.0	0.0	0.0	0.0	0.0	0.0
Rest In Walk		No			No			No			No	
I1, Start-Up Lost Time [s]	0.0	2.0	0.0	0.0	2.0	0.0	0.0	2.0	0.0	0.0	2.0	0.0
I2, Clearance Lost Time [s]	0.0	2.0	0.0	0.0	2.0	0.0	0.0	2.0	0.0	0.0	2.0	0.0
Minimum Recall		No			No			No			No	
Maximum Recall		No			No			No			No	
Pedestrian Recall		No			No			No			No	
Detector Location [ft]	0.0	0.0	0.0	0.0	0.0	0.0	0.0	0.0	0.0	0.0	0.0	0.0
Detector Length [ft]	0.0	40.0	0.0	0.0	40.0	0.0	0.0	40.0	0.0	0.0	40.0	0.0
I, Upstream Filtering Factor	1.00	1.00	1.00	1.00	1.00	1.00	1.00	1.00	1.00	1.00	1.00	1.00

Exclusive Pedestrian Phase

Pedestrian Signal Group	0
Pedestrian Walk [s]	0
Pedestrian Clearance [s]	0

Lane Group Calculations

Lane Group	L	C	R	L	C	R	L	C	R	L	C	R
C, Cycle Length [s]	23	23	23	23	23	23	23	23	23	23	23	23
L, Total Lost Time per Cycle [s]	4.00	4.00	4.00	4.00	4.00	4.00	4.00	4.00	4.00	4.00	4.00	4.00
l1_p, Permitted Start-Up Lost Time [s]	2.00	0.00	0.00	2.00	0.00	0.00	2.00	0.00	0.00	2.00	0.00	0.00
l2, Clearance Lost Time [s]	2.00	2.00	2.00	2.00	2.00	2.00	2.00	2.00	2.00	2.00	2.00	2.00
g_i, Effective Green Time [s]	7	7	7	7	7	7	7	7	7	7	7	7
g / C, Green / Cycle	0.32	0.32	0.32	0.32	0.32	0.32	0.33	0.33	0.33	0.33	0.33	0.33
(v / s)_i Volume / Saturation Flow Rate	0.04	0.06	0.01	0.02	0.05	0.00	0.01	0.03	0.01	0.03	0.08	0.01
s, saturation flow rate [veh/h]	1296	1870	1589	1252	1870	1589	1213	1870	1589	1324	1870	1589
c, Capacity [veh/h]	582	594	505	562	594	505	555	621	528	623	621	528
d1, Uniform Delay [s]	7.52	5.66	5.39	7.50	5.59	5.34	7.43	5.28	5.13	6.94	5.53	5.17
k, delay calibration	0.11	0.11	0.11	0.11	0.11	0.11	0.11	0.11	0.11	0.11	0.11	0.11
l, Upstream Filtering Factor	1.00	1.00	1.00	1.00	1.00	1.00	1.00	1.00	1.00	1.00	1.00	1.00
d2, Incremental Delay [s]	0.07	0.16	0.04	0.03	0.12	0.01	0.02	0.07	0.01	0.04	0.20	0.03
d3, Initial Queue Delay [s]	0.00	0.00	0.00	0.00	0.00	0.00	0.00	0.00	0.00	0.00	0.00	0.00
Rp, platoon ratio	1.00	1.00	1.00	1.00	1.00	1.00	1.00	1.00	1.00	1.00	1.00	1.00
PF, progression factor	1.00	1.00	1.00	1.00	1.00	1.00	1.00	1.00	1.00	1.00	1.00	1.00

Lane Group Results

X, volume / capacity	0.10	0.19	0.05	0.04	0.16	0.01	0.02	0.10	0.02	0.06	0.24	0.04
d, Delay for Lane Group [s/veh]	7.59	5.82	5.43	7.53	5.71	5.34	7.45	5.35	5.14	6.99	5.73	5.20
Lane Group LOS	A	A	A	A	A	A	A	A	A	A	A	A
Critical Lane Group	No	Yes	No	No	No	No	No	No	No	No	Yes	No
50th-Percentile Queue Length [veh/ln]	0.14	0.20	0.04	0.06	0.16	0.01	0.03	0.10	0.02	0.09	0.25	0.04
50th-Percentile Queue Length [ft/ln]	3.40	4.94	0.96	1.45	3.97	0.25	0.78	2.55	0.39	2.21	6.22	0.90
95th-Percentile Queue Length [veh/ln]	0.24	0.36	0.07	0.10	0.29	0.02	0.06	0.18	0.03	0.16	0.45	0.06
95th-Percentile Queue Length [ft/ln]	6.11	8.90	1.72	2.62	7.14	0.44	1.41	4.58	0.69	3.97	11.19	1.61

Movement, Approach, & Intersection Results

d_M, Delay for Movement [s/veh]	7.59	5.82	5.43	7.53	5.71	5.34	7.45	5.35	5.14	6.99	5.73	5.20
Movement LOS	A	A	A	A	A	A	A	A	A	A	A	A
d_A, Approach Delay [s/veh]	6.28			6.05			5.64			5.91		
Approach LOS	A			A			A			A		
d_I, Intersection Delay [s/veh]	6.02											
Intersection LOS	A											
Intersection V/C	0.141											

Other Modes

g_Walk,mi, Effective Walk Time [s]	0.0			0.0			0.0			0.0		
M_corner, Corner Circulation Area [ft ² /ped]	0.00			0.00			0.00			0.00		
M_CW, Crosswalk Circulation Area [ft ² /ped]	0.00			0.00			0.00			0.00		
d_p, Pedestrian Delay [s]	0.00			0.00			0.00			0.00		
I_p,int, Pedestrian LOS Score for Intersectio	0.000			0.000			0.000			0.000		
Crosswalk LOS	F			F			F			F		
s_b, Saturation Flow Rate of the bicycle lane	2000			2000			2000			2000		
c_b, Capacity of the bicycle lane [bicycles/h]	3534			3534			3534			3534		
d_b, Bicycle Delay [s]	6.66			6.66			6.66			6.66		
I_b,int, Bicycle LOS Score for Intersection	1.903			1.771			1.723			1.939		
Bicycle LOS	A			A			A			A		

Sequence

Ring 1	-	2	-	4	-	-	-	-	-	-	-	-	-	-	-	-
Ring 2	-	6	-	8	-	-	-	-	-	-	-	-	-	-	-	-
Ring 3	-	-	-	-	-	-	-	-	-	-	-	-	-	-	-	-
Ring 4	-	-	-	-	-	-	-	-	-	-	-	-	-	-	-	-



Haven School TIS

Vistro File: C:\...\pm.vistro
Report File: C:\...\2023 PM.pdf

Scenario 1 2023 PM
8/24/2023

Intersection Analysis Summary

ID	Intersection Name	Control Type	Method	Worst Mvmt	V/C	Delay (s/veh)	LOS
1	Milam/Burgess	Two-way stop	HCM 7th Edition	WB Left	0.232	13.1	B
2	Black Forest/Burgess	Signalized	HCM 7th Edition	SB Left	0.150	5.9	A

V/C, Delay, LOS: For two-way stop, these values are taken from the movement with the worst (highest) delay value. For all other control types, they are taken for the whole intersection.

Intersection Level Of Service Report
Intersection 1: Milam/Burgess

Control Type: Two-way stop
Analysis Method: HCM 7th Edition
Analysis Period: 15 minutes

Delay (sec / veh): 13.1
Level Of Service: B
Volume to Capacity (v/c): 0.232

Intersection Setup

Name	Milam Road			Milam Road			Private Road			Burgess Road		
Approach	Northbound			Southbound			Eastbound			Westbound		
Lane Configuration	← →			↑			↑			↑		
Turning Movement	Left	Thru	Right	Left	Thru	Right	Left	Thru	Right	Left	Thru	Right
Lane Width [ft]	12.00	12.00	12.00	12.00	12.00	12.00	12.00	12.00	12.00	12.00	12.00	12.00
No. of Lanes in Entry Pocket	0	0	1	0	0	0	0	0	0	0	0	0
Entry Pocket Length [ft]	100.00	100.00	100.00	100.00	100.00	100.00	100.00	100.00	100.00	100.00	100.00	100.00
No. of Lanes in Exit Pocket	0	0	0	0	0	0	0	0	0	0	0	0
Exit Pocket Length [ft]	0.00	0.00	0.00	0.00	0.00	0.00	0.00	0.00	0.00	0.00	0.00	0.00
Speed [mph]	30.00			30.00			30.00			30.00		
Grade [%]	0.00			0.00			0.00			0.00		
Crosswalk	No			No			No			No		

Volumes

Name	Milam Road			Milam Road			Private Road			Burgess Road		
Base Volume Input [veh/h]	0	130	146	22	119	0	0	0	0	105	0	23
Base Volume Adjustment Factor	1.0000	1.0000	1.0000	1.0000	1.0000	1.0000	1.0000	1.0000	1.0000	1.0000	1.0000	1.0000
Heavy Vehicles Percentage [%]	2.00	2.00	2.00	2.00	2.00	2.00	2.00	2.00	2.00	2.00	2.00	2.00
Growth Factor	1.0000	1.0000	1.0000	1.0000	1.0000	1.0000	1.0000	1.0000	1.0000	1.0000	1.0000	1.0000
In-Process Volume [veh/h]	0	0	0	0	0	0	0	0	0	0	0	0
Site-Generated Trips [veh/h]	0	0	0	0	0	0	0	0	0	0	0	0
Diverted Trips [veh/h]	0	0	0	0	0	0	0	0	0	0	0	0
Pass-by Trips [veh/h]	0	0	0	0	0	0	0	0	0	0	0	0
Existing Site Adjustment Volume [veh/h]	0	0	0	0	0	0	0	0	0	0	0	0
Other Volume [veh/h]	0	0	0	0	0	0	0	0	0	0	0	0
Total Hourly Volume [veh/h]	0	130	146	22	119	0	0	0	0	105	0	23
Peak Hour Factor	0.8800	0.8800	0.8800	0.8200	0.8200	0.8200	0.8500	0.8500	0.8500	0.7600	0.7600	0.7600
Other Adjustment Factor	1.0000	1.0000	1.0000	1.0000	1.0000	1.0000	1.0000	1.0000	1.0000	1.0000	1.0000	1.0000
Total 15-Minute Volume [veh/h]	0	37	41	7	36	0	0	0	0	35	0	8
Total Analysis Volume [veh/h]	0	148	166	27	145	0	0	0	0	138	0	30
Pedestrian Volume [ped/h]	0			0			0			0		

Intersection Settings

Priority Scheme	Free	Free	Stop	Stop
Flared Lane			No	No
Storage Area [veh]	0	0	0	0
Two-Stage Gap Acceptance			No	No
Number of Storage Spaces in Median	0	0	0	0

Movement, Approach, & Intersection Results

V/C, Movement V/C Ratio	0.00	0.00	0.00	0.02	0.00	0.00	0.00	0.00	0.00	0.23	0.00	0.03
d_M, Delay for Movement [s/veh]	7.50	0.00	0.00	7.54	0.00	0.00	12.27	11.38	8.99	13.09	13.42	11.05
Movement LOS	A	A	A	A	A	A	B	B	A	B	B	B
95th-Percentile Queue Length [veh/ln]	0.00	0.00	0.00	0.05	0.05	0.05	0.00	0.00	0.00	1.06	1.06	1.06
95th-Percentile Queue Length [ft/ln]	0.00	0.00	0.00	1.14	1.14	1.14	0.00	0.00	0.00	26.60	26.60	26.60
d_A, Approach Delay [s/veh]	0.00			1.18			10.88			12.73		
Approach LOS	A			A			B			B		
d_I, Intersection Delay [s/veh]	3.58											
Intersection LOS	B											

**Intersection Level Of Service Report
Intersection 2: Black Forest/Burgess**

Control Type:	Signalized	Delay (sec / veh):	5.9
Analysis Method:	HCM 7th Edition	Level Of Service:	A
Analysis Period:	15 minutes	Volume to Capacity (v/c):	0.150

Intersection Setup

Name	Black Forest Road			Black Forest Road			Burgess Road			Burgess Road		
Approach	Northbound			Southbound			Eastbound			Westbound		
Lane Configuration	↵↵↵			↵↵↵			↵↵↵			↵↵↵		
Turning Movement	Left	Thru	Right	Left	Thru	Right	Left	Thru	Right	Left	Thru	Right
Lane Width [ft]	12.00	12.00	12.00	12.00	12.00	12.00	12.00	12.00	12.00	12.00	12.00	12.00
No. of Lanes in Entry Pocket	1	0	1	1	0	1	1	0	1	1	0	1
Entry Pocket Length [ft]	100.00	100.00	100.00	100.00	100.00	100.00	100.00	100.00	200.00	100.00	100.00	200.00
No. of Lanes in Exit Pocket	0	0	0	0	0	0	0	0	0	0	0	0
Exit Pocket Length [ft]	0.00	0.00	0.00	0.00	0.00	0.00	0.00	0.00	0.00	0.00	0.00	0.00
Speed [mph]	30.00			30.00			30.00			30.00		
Grade [%]	0.00			0.00			0.00			0.00		
Curb Present	No			No			No			No		
Crosswalk	No			No			No			No		

Volumes

Name	Black Forest Road			Black Forest Road			Burgess Road			Burgess Road		
Base Volume Input [veh/h]	20	106	25	28	105	14	16	137	27	23	77	25
Base Volume Adjustment Factor	1.0000	1.0000	1.0000	1.0000	1.0000	1.0000	1.0000	1.0000	1.0000	1.0000	1.0000	1.0000
Heavy Vehicles Percentage [%]	2.00	2.00	2.00	2.00	2.00	2.00	2.00	2.00	2.00	2.00	2.00	2.00
Proportion of CAVs [%]	0.00											
Growth Factor	1.0000	1.0000	1.0000	1.0000	1.0000	1.0000	1.0000	1.0000	1.0000	1.0000	1.0000	1.0000
In-Process Volume [veh/h]	0	0	0	0	0	0	0	0	0	0	0	0
Site-Generated Trips [veh/h]	0	0	0	0	0	0	0	0	0	0	0	0
Diverted Trips [veh/h]	0	0	0	0	0	0	0	0	0	0	0	0
Pass-by Trips [veh/h]	0	0	0	0	0	0	0	0	0	0	0	0
Existing Site Adjustment Volume [veh/h]	0	0	0	0	0	0	0	0	0	0	0	0
Other Volume [veh/h]	0	0	0	0	0	0	0	0	0	0	0	0
Right Turn on Red Volume [veh/h]	0	0	13	0	0	7	0	0	14	0	0	13
Total Hourly Volume [veh/h]	20	106	12	28	105	7	16	137	13	23	77	12
Peak Hour Factor	0.9000	0.9000	0.9000	0.8500	0.8500	0.8500	0.8700	0.8700	0.8700	0.6540	0.6540	0.6540
Other Adjustment Factor	1.0000	1.0000	1.0000	1.0000	1.0000	1.0000	1.0000	1.0000	1.0000	1.0000	1.0000	1.0000
Total 15-Minute Volume [veh/h]	6	29	3	8	31	2	5	39	4	9	29	5
Total Analysis Volume [veh/h]	22	118	13	33	124	8	18	157	15	35	118	18
Presence of On-Street Parking	No		No	No		No	No		No	No		No
On-Street Parking Maneuver Rate [/h]	0	0	0	0	0	0	0	0	0	0	0	0
Local Bus Stopping Rate [/h]	0	0	0	0	0	0	0	0	0	0	0	0
v_do, Outbound Pedestrian Volume crossing	0			0			0			0		
v_di, Inbound Pedestrian Volume crossing m	0			0			0			0		
v_co, Outbound Pedestrian Volume crossing	0			0			0			0		
v_ci, Inbound Pedestrian Volume crossing mi	0			0			0			0		
v_ab, Corner Pedestrian Volume [ped/h]	0			0			0			0		
Bicycle Volume [bicycles/h]	0			0			0			0		

Intersection Settings

Located in CBD	No
Signal Coordination Group	-
Cycle Length [s]	90
Active Pattern	Free Running
Coordination Type	<i>Free Running</i>
Actuation Type	<i>Fully actuated</i>
Offset [s]	0.0
Offset Reference	Lead Green - Beginning of First Green
Permissive Mode	SingleBand
Lost time [s]	0.00

Phasing & Timing

Control Type	Permiss	Permiss	Permiss	Permiss	Permiss	Permiss	Permiss	Permiss	Permiss	Permiss	Permiss	Permiss
Signal Group	0	2	0	0	6	0	0	4	0	0	8	0
Auxiliary Signal Groups												
Lead / Lag	-	-	-	-	-	-	-	-	-	-	-	-
Minimum Green [s]	0	10	0	0	10	0	0	10	0	0	10	0
Maximum Green [s]	0	40	0	0	40	0	0	40	0	0	40	0
Amber [s]	0.0	3.0	0.0	0.0	3.0	0.0	0.0	3.0	0.0	0.0	3.0	0.0
All red [s]	0.0	1.0	0.0	0.0	1.0	0.0	0.0	1.0	0.0	0.0	1.0	0.0
Split [s]	0	14	0	0	14	0	0	14	0	0	14	0
Vehicle Extension [s]	0.0	3.0	0.0	0.0	3.0	0.0	0.0	3.0	0.0	0.0	3.0	0.0
Walk [s]	0	5	0	0	5	0	0	5	0	0	5	0
Pedestrian Clearance [s]	0	10	0	0	10	0	0	10	0	0	10	0
Delayed Vehicle Green [s]	0.0	0.0	0.0	0.0	0.0	0.0	0.0	0.0	0.0	0.0	0.0	0.0
Rest In Walk		No			No			No			No	
I1, Start-Up Lost Time [s]	0.0	2.0	0.0	0.0	2.0	0.0	0.0	2.0	0.0	0.0	2.0	0.0
I2, Clearance Lost Time [s]	0.0	2.0	0.0	0.0	2.0	0.0	0.0	2.0	0.0	0.0	2.0	0.0
Minimum Recall		No			No			No			No	
Maximum Recall		No			No			No			No	
Pedestrian Recall		No			No			No			No	
Detector Location [ft]	0.0	0.0	0.0	0.0	0.0	0.0	0.0	0.0	0.0	0.0	0.0	0.0
Detector Length [ft]	0.0	40.0	0.0	0.0	40.0	0.0	0.0	40.0	0.0	0.0	40.0	0.0
I, Upstream Filtering Factor	1.00	1.00	1.00	1.00	1.00	1.00	1.00	1.00	1.00	1.00	1.00	1.00

Exclusive Pedestrian Phase

Pedestrian Signal Group	0
Pedestrian Walk [s]	0
Pedestrian Clearance [s]	0

Lane Group Calculations

Lane Group	L	C	R	L	C	R	L	C	R	L	C	R
C, Cycle Length [s]	21	21	21	21	21	21	21	21	21	21	21	21
L, Total Lost Time per Cycle [s]	4.00	4.00	4.00	4.00	4.00	4.00	4.00	4.00	4.00	4.00	4.00	4.00
l1_p, Permitted Start-Up Lost Time [s]	2.00	0.00	0.00	2.00	0.00	0.00	2.00	0.00	0.00	2.00	0.00	0.00
l2, Clearance Lost Time [s]	2.00	2.00	2.00	2.00	2.00	2.00	2.00	2.00	2.00	2.00	2.00	2.00
g_i, Effective Green Time [s]	6	6	6	6	6	6	7	7	7	7	7	7
g / C, Green / Cycle	0.30	0.30	0.30	0.30	0.30	0.30	0.32	0.32	0.32	0.32	0.32	0.32
(v / s)_i Volume / Saturation Flow Rate	0.02	0.06	0.01	0.03	0.07	0.01	0.01	0.08	0.01	0.03	0.06	0.01
s, saturation flow rate [veh/h]	1258	1870	1589	1259	1870	1589	1253	1870	1589	1213	1870	1589
c, Capacity [veh/h]	546	561	477	550	561	477	581	606	515	553	606	515
d1, Uniform Delay [s]	7.54	5.57	5.26	7.56	5.59	5.24	7.02	5.31	4.91	7.42	5.19	4.92
k, delay calibration	0.11	0.11	0.11	0.11	0.11	0.11	0.11	0.11	0.11	0.11	0.11	0.11
l, Upstream Filtering Factor	1.00	1.00	1.00	1.00	1.00	1.00	1.00	1.00	1.00	1.00	1.00	1.00
d2, Incremental Delay [s]	0.03	0.18	0.02	0.05	0.20	0.01	0.02	0.22	0.02	0.05	0.16	0.03
d3, Initial Queue Delay [s]	0.00	0.00	0.00	0.00	0.00	0.00	0.00	0.00	0.00	0.00	0.00	0.00
Rp, platoon ratio	1.00	1.00	1.00	1.00	1.00	1.00	1.00	1.00	1.00	1.00	1.00	1.00
PF, progression factor	1.00	1.00	1.00	1.00	1.00	1.00	1.00	1.00	1.00	1.00	1.00	1.00

Lane Group Results

X, volume / capacity	0.04	0.21	0.03	0.06	0.22	0.02	0.03	0.26	0.03	0.06	0.19	0.03
d, Delay for Lane Group [s/veh]	7.57	5.75	5.28	7.61	5.78	5.26	7.04	5.53	4.93	7.47	5.34	4.94
Lane Group LOS	A	A	A	A	A	A	A	A	A	A	A	A
Critical Lane Group	No	No	No	No	Yes	No	No	Yes	No	No	No	No
50th-Percentile Queue Length [veh/ln]	0.05	0.18	0.02	0.08	0.19	0.01	0.04	0.22	0.02	0.08	0.16	0.02
50th-Percentile Queue Length [ft/ln]	1.25	4.60	0.48	1.88	4.86	0.29	0.94	5.61	0.49	1.95	4.08	0.59
95th-Percentile Queue Length [veh/ln]	0.09	0.33	0.03	0.14	0.35	0.02	0.07	0.40	0.04	0.14	0.29	0.04
95th-Percentile Queue Length [ft/ln]	2.25	8.29	0.86	3.38	8.75	0.53	1.69	10.10	0.89	3.51	7.35	1.07

Movement, Approach, & Intersection Results

d_M, Delay for Movement [s/veh]	7.57	5.75	5.28	7.61	5.78	5.26	7.04	5.53	4.93	7.47	5.34	4.94
Movement LOS	A	A	A	A	A	A	A	A	A	A	A	A
d_A, Approach Delay [s/veh]	5.97			6.12			5.63			5.74		
Approach LOS	A			A			A			A		
d_I, Intersection Delay [s/veh]	5.85											
Intersection LOS	A											
Intersection V/C	0.150											

Other Modes

g_Walk,mi, Effective Walk Time [s]	0.0			0.0			0.0			0.0		
M_corner, Corner Circulation Area [ft ² /ped]	0.00			0.00			0.00			0.00		
M_CW, Crosswalk Circulation Area [ft ² /ped]	0.00			0.00			0.00			0.00		
d_p, Pedestrian Delay [s]	0.00			0.00			0.00			0.00		
I_p,int, Pedestrian LOS Score for Intersectio	0.000			0.000			0.000			0.000		
Crosswalk LOS	F			F			F			F		
s_b, Saturation Flow Rate of the bicycle lane	2000			2000			2000			2000		
c_b, Capacity of the bicycle lane [bicycles/h]	3786			3786			3786			3786		
d_b, Bicycle Delay [s]	8.42			8.42			8.42			8.42		
I_b,int, Bicycle LOS Score for Intersection	1.834			1.843			1.896			1.863		
Bicycle LOS	A			A			A			A		

Sequence

Ring 1	-	2	-	4	-	-	-	-	-	-	-	-	-	-	-	-
Ring 2	-	6	-	8	-	-	-	-	-	-	-	-	-	-	-	-
Ring 3	-	-	-	-	-	-	-	-	-	-	-	-	-	-	-	-
Ring 4	-	-	-	-	-	-	-	-	-	-	-	-	-	-	-	-



Year 2025 Traffic Volume Scenarios

Haven School TIS

Vistro File: C:\...\AM.vistro

Scenario 2 2025 Back AM

Report File: C:\...\2025 Back AM.pdf

8/24/2023

Intersection Analysis Summary

ID	Intersection Name	Control Type	Method	Worst Mvmt	V/C	Delay (s/veh)	LOS
1	Milam/Burgess	Two-way stop	HCM 7th Edition	WB Left	0.522	18.4	C
2	Black Forest/Burgess	Signalized	HCM 7th Edition	NB Left	0.150	6.1	A

V/C, Delay, LOS: For two-way stop, these values are taken from the movement with the worst (highest) delay value. For all other control types, they are taken for the whole intersection.

Intersection Level Of Service Report
Intersection 1: Milam/Burgess

Control Type: Two-way stop
Analysis Method: HCM 7th Edition
Analysis Period: 15 minutes

Delay (sec / veh): 18.4
Level Of Service: C
Volume to Capacity (v/c): 0.522

Intersection Setup

Name	Milam Road			Milam Road			Private Road			Burgess Road		
Approach	Northbound			Southbound			Eastbound			Westbound		
Lane Configuration	↔↔			↑			↑			↑		
Turning Movement	Left	Thru	Right	Left	Thru	Right	Left	Thru	Right	Left	Thru	Right
Lane Width [ft]	12.00	12.00	12.00	12.00	12.00	12.00	12.00	12.00	12.00	12.00	12.00	12.00
No. of Lanes in Entry Pocket	0	0	1	0	0	0	0	0	0	0	0	0
Entry Pocket Length [ft]	100.00	100.00	100.00	100.00	100.00	100.00	100.00	100.00	100.00	100.00	100.00	100.00
No. of Lanes in Exit Pocket	0	0	0	0	0	0	0	0	0	0	0	0
Exit Pocket Length [ft]	0.00	0.00	0.00	0.00	0.00	0.00	0.00	0.00	0.00	0.00	0.00	0.00
Speed [mph]	30.00			30.00			30.00			30.00		
Grade [%]	0.00			0.00			0.00			0.00		
Crosswalk	No			No			No			No		

Volumes

Name	Milam Road			Milam Road			Private Road			Burgess Road		
Base Volume Input [veh/h]	0	67	82	31	124	0	0	0	0	189	0	27
Base Volume Adjustment Factor	1.0000	1.0000	1.0000	1.0000	1.0000	1.0000	1.0000	1.0000	1.0000	1.0000	1.0000	1.0000
Heavy Vehicles Percentage [%]	2.00	2.00	2.00	2.00	2.00	2.00	2.00	2.00	2.00	2.00	2.00	2.00
Growth Factor	1.0400	1.0400	1.0400	1.0800	1.0800	1.0800	1.0000	1.0000	1.0000	1.1100	1.1100	1.1100
In-Process Volume [veh/h]	0	0	0	0	0	0	0	0	0	0	0	0
Site-Generated Trips [veh/h]	0	0	0	0	0	0	0	0	0	0	0	0
Diverted Trips [veh/h]	0	0	0	0	0	0	0	0	0	0	0	0
Pass-by Trips [veh/h]	0	0	0	0	0	0	0	0	0	0	0	0
Existing Site Adjustment Volume [veh/h]	0	0	0	0	0	0	0	0	0	0	0	0
Other Volume [veh/h]	0	0	0	0	0	0	0	0	0	0	0	0
Total Hourly Volume [veh/h]	0	70	85	33	134	0	0	0	0	210	0	30
Peak Hour Factor	0.7800	0.7800	0.7800	0.7900	0.7900	0.7900	0.8500	0.8500	0.8500	0.6800	0.6800	0.6800
Other Adjustment Factor	1.0000	1.0000	1.0000	1.0000	1.0000	1.0000	1.0000	1.0000	1.0000	1.0000	1.0000	1.0000
Total 15-Minute Volume [veh/h]	0	22	27	10	42	0	0	0	0	77	0	11
Total Analysis Volume [veh/h]	0	90	109	42	170	0	0	0	0	309	0	44
Pedestrian Volume [ped/h]	0			0			0			0		

Intersection Settings

Priority Scheme	Free	Free	Stop	Stop
Flared Lane			No	No
Storage Area [veh]	0	0	0	0
Two-Stage Gap Acceptance			No	No
Number of Storage Spaces in Median	0	0	0	0

Movement, Approach, & Intersection Results

V/C, Movement V/C Ratio	0.00	0.00	0.00	0.03	0.00	0.00	0.00	0.00	0.00	0.52	0.00	0.05
d_M, Delay for Movement [s/veh]	7.56	0.00	0.00	7.44	0.00	0.00	12.16	11.42	9.12	18.42	18.76	16.06
Movement LOS	A	A	A	A	A	A	B	B	A	C	C	C
95th-Percentile Queue Length [veh/ln]	0.00	0.00	0.00	0.07	0.07	0.07	0.00	0.00	0.00	3.56	3.56	3.56
95th-Percentile Queue Length [ft/ln]	0.00	0.00	0.00	1.79	1.79	1.79	0.00	0.00	0.00	89.12	89.12	89.12
d_A, Approach Delay [s/veh]	0.00			1.47			10.90			18.13		
Approach LOS	A			A			B			C		
d_I, Intersection Delay [s/veh]	8.79											
Intersection LOS	C											

**Intersection Level Of Service Report
Intersection 2: Black Forest/Burgess**

Control Type:	Signalized	Delay (sec / veh):	6.1
Analysis Method:	HCM 7th Edition	Level Of Service:	A
Analysis Period:	15 minutes	Volume to Capacity (v/c):	0.150

Intersection Setup

Name	Black Forest Road			Black Forest Road			Burgess Road			Burgess Road		
Approach	Northbound			Southbound			Eastbound			Westbound		
Lane Configuration	↵↵↵			↵↵↵			↵↵↵			↵↵↵		
Turning Movement	Left	Thru	Right	Left	Thru	Right	Left	Thru	Right	Left	Thru	Right
Lane Width [ft]	12.00	12.00	12.00	12.00	12.00	12.00	12.00	12.00	12.00	12.00	12.00	12.00
No. of Lanes in Entry Pocket	1	0	1	1	0	1	1	0	1	1	0	1
Entry Pocket Length [ft]	100.00	100.00	100.00	100.00	100.00	100.00	100.00	100.00	200.00	100.00	100.00	200.00
No. of Lanes in Exit Pocket	0	0	0	0	0	0	0	0	0	0	0	0
Exit Pocket Length [ft]	0.00	0.00	0.00	0.00	0.00	0.00	0.00	0.00	0.00	0.00	0.00	0.00
Speed [mph]	30.00			30.00			30.00			30.00		
Grade [%]	0.00			0.00			0.00			0.00		
Curb Present	No			No			No			No		
Crosswalk	No			No			No			No		

Volumes

Name	Black Forest Road			Black Forest Road			Burgess Road			Burgess Road		
Base Volume Input [veh/h]	37	75	30	20	78	10	13	64	21	29	109	35
Base Volume Adjustment Factor	1.0000	1.0000	1.0000	1.0000	1.0000	1.0000	1.0000	1.0000	1.0000	1.0000	1.0000	1.0000
Heavy Vehicles Percentage [%]	2.00	2.00	2.00	2.00	2.00	2.00	2.00	2.00	2.00	2.00	2.00	2.00
Proportion of CAVs [%]	0.00											
Growth Factor	1.1100	1.1100	1.1100	1.0600	1.0600	1.0600	1.1100	1.1100	1.1100	1.0400	1.0400	1.0400
In-Process Volume [veh/h]	0	0	0	0	0	0	0	0	0	0	0	0
Site-Generated Trips [veh/h]	0	0	0	0	0	0	0	0	0	0	0	0
Diverted Trips [veh/h]	0	0	0	0	0	0	0	0	0	0	0	0
Pass-by Trips [veh/h]	0	0	0	0	0	0	0	0	0	0	0	0
Existing Site Adjustment Volume [veh/h]	0	0	0	0	0	0	0	0	0	0	0	0
Other Volume [veh/h]	0	0	0	0	0	0	0	0	0	0	0	0
Right Turn on Red Volume [veh/h]	0	0	17	0	0	6	0	0	12	0	0	18
Total Hourly Volume [veh/h]	41	83	16	21	83	5	14	71	11	30	113	18
Peak Hour Factor	0.6600	0.6600	0.6600	0.8400	0.8400	0.8400	0.9800	0.9800	0.9800	0.7300	0.7300	0.7300
Other Adjustment Factor	1.0000	1.0000	1.0000	1.0000	1.0000	1.0000	1.0000	1.0000	1.0000	1.0000	1.0000	1.0000
Total 15-Minute Volume [veh/h]	16	31	6	6	25	1	4	18	3	10	39	6
Total Analysis Volume [veh/h]	62	126	24	25	99	6	14	72	11	41	155	25
Presence of On-Street Parking	No		No	No		No	No		No	No		No
On-Street Parking Maneuver Rate [/h]	0	0	0	0	0	0	0	0	0	0	0	0
Local Bus Stopping Rate [/h]	0	0	0	0	0	0	0	0	0	0	0	0
v_do, Outbound Pedestrian Volume crossing	0			0			0			0		
v_di, Inbound Pedestrian Volume crossing m	0			0			0			0		
v_co, Outbound Pedestrian Volume crossing	0			0			0			0		
v_ci, Inbound Pedestrian Volume crossing mi	0			0			0			0		
v_ab, Corner Pedestrian Volume [ped/h]	0			0			0			0		
Bicycle Volume [bicycles/h]	0			0			0			0		

Intersection Settings

Located in CBD	No
Signal Coordination Group	-
Cycle Length [s]	90
Active Pattern	Free Running
Coordination Type	<i>Free Running</i>
Actuation Type	<i>Fully actuated</i>
Offset [s]	0.0
Offset Reference	Lead Green - Beginning of First Green
Permissive Mode	SingleBand
Lost time [s]	0.00

Phasing & Timing

Control Type	Permiss	Permiss	Permiss	Permiss	Permiss	Permiss	Permiss	Permiss	Permiss	Permiss	Permiss	Permiss
Signal Group	0	2	0	0	6	0	0	4	0	0	8	0
Auxiliary Signal Groups												
Lead / Lag	-	-	-	-	-	-	-	-	-	-	-	-
Minimum Green [s]	0	10	0	0	10	0	0	10	0	0	10	0
Maximum Green [s]	0	40	0	0	40	0	0	40	0	0	40	0
Amber [s]	0.0	3.0	0.0	0.0	3.0	0.0	0.0	3.0	0.0	0.0	3.0	0.0
All red [s]	0.0	1.0	0.0	0.0	1.0	0.0	0.0	1.0	0.0	0.0	1.0	0.0
Split [s]	0	14	0	0	14	0	0	14	0	0	14	0
Vehicle Extension [s]	0.0	3.0	0.0	0.0	3.0	0.0	0.0	3.0	0.0	0.0	3.0	0.0
Walk [s]	0	5	0	0	5	0	0	5	0	0	5	0
Pedestrian Clearance [s]	0	10	0	0	10	0	0	10	0	0	10	0
Delayed Vehicle Green [s]	0.0	0.0	0.0	0.0	0.0	0.0	0.0	0.0	0.0	0.0	0.0	0.0
Rest In Walk		No			No			No			No	
I1, Start-Up Lost Time [s]	0.0	2.0	0.0	0.0	2.0	0.0	0.0	2.0	0.0	0.0	2.0	0.0
I2, Clearance Lost Time [s]	0.0	2.0	0.0	0.0	2.0	0.0	0.0	2.0	0.0	0.0	2.0	0.0
Minimum Recall		No			No			No			No	
Maximum Recall		No			No			No			No	
Pedestrian Recall		No			No			No			No	
Detector Location [ft]	0.0	0.0	0.0	0.0	0.0	0.0	0.0	0.0	0.0	0.0	0.0	0.0
Detector Length [ft]	0.0	40.0	0.0	0.0	40.0	0.0	0.0	40.0	0.0	0.0	40.0	0.0
I, Upstream Filtering Factor	1.00	1.00	1.00	1.00	1.00	1.00	1.00	1.00	1.00	1.00	1.00	1.00

Exclusive Pedestrian Phase

Pedestrian Signal Group	0
Pedestrian Walk [s]	0
Pedestrian Clearance [s]	0

Lane Group Calculations

Lane Group	L	C	R	L	C	R	L	C	R	L	C	R
C, Cycle Length [s]	23	23	23	23	23	23	23	23	23	23	23	23
L, Total Lost Time per Cycle [s]	4.00	4.00	4.00	4.00	4.00	4.00	4.00	4.00	4.00	4.00	4.00	4.00
l1_p, Permitted Start-Up Lost Time [s]	2.00	0.00	0.00	2.00	0.00	0.00	2.00	0.00	0.00	2.00	0.00	0.00
l2, Clearance Lost Time [s]	2.00	2.00	2.00	2.00	2.00	2.00	2.00	2.00	2.00	2.00	2.00	2.00
g_i, Effective Green Time [s]	8	8	8	8	8	8	8	8	8	8	8	8
g / C, Green / Cycle	0.33	0.33	0.33	0.33	0.33	0.33	0.33	0.33	0.33	0.33	0.33	0.33
(v / s)_i Volume / Saturation Flow Rate	0.05	0.07	0.02	0.02	0.05	0.00	0.01	0.04	0.01	0.03	0.08	0.02
s, saturation flow rate [veh/h]	1289	1870	1589	1237	1870	1589	1204	1870	1589	1315	1870	1589
c, Capacity [veh/h]	583	611	519	558	611	519	544	622	528	611	622	528
d1, Uniform Delay [s]	7.61	5.70	5.40	7.60	5.62	5.34	7.66	5.44	5.26	7.16	5.70	5.31
k, delay calibration	0.11	0.11	0.11	0.11	0.11	0.11	0.11	0.11	0.11	0.11	0.11	0.11
l, Upstream Filtering Factor	1.00	1.00	1.00	1.00	1.00	1.00	1.00	1.00	1.00	1.00	1.00	1.00
d2, Incremental Delay [s]	0.08	0.17	0.04	0.03	0.12	0.01	0.02	0.08	0.02	0.05	0.21	0.04
d3, Initial Queue Delay [s]	0.00	0.00	0.00	0.00	0.00	0.00	0.00	0.00	0.00	0.00	0.00	0.00
Rp, platoon ratio	1.00	1.00	1.00	1.00	1.00	1.00	1.00	1.00	1.00	1.00	1.00	1.00
PF, progression factor	1.00	1.00	1.00	1.00	1.00	1.00	1.00	1.00	1.00	1.00	1.00	1.00

Lane Group Results

X, volume / capacity	0.11	0.21	0.05	0.04	0.16	0.01	0.03	0.12	0.02	0.07	0.25	0.05
d, Delay for Lane Group [s/veh]	7.69	5.87	5.44	7.63	5.74	5.35	7.68	5.52	5.28	7.20	5.91	5.35
Lane Group LOS	A	A	A	A	A	A	A	A	A	A	A	A
Critical Lane Group	No	Yes	No	No	No	No	No	No	No	No	Yes	No
50th-Percentile Queue Length [veh/ln]	0.16	0.23	0.04	0.06	0.18	0.01	0.04	0.12	0.02	0.10	0.28	0.04
50th-Percentile Queue Length [ft/ln]	3.92	5.70	1.03	1.58	4.39	0.25	0.89	3.05	0.46	2.42	6.99	1.05
95th-Percentile Queue Length [veh/ln]	0.28	0.41	0.07	0.11	0.32	0.02	0.06	0.22	0.03	0.17	0.50	0.08
95th-Percentile Queue Length [ft/ln]	7.06	10.27	1.86	2.85	7.91	0.46	1.61	5.49	0.82	4.35	12.58	1.89

Movement, Approach, & Intersection Results

d_M, Delay for Movement [s/veh]	7.69	5.87	5.44	7.63	5.74	5.35	7.68	5.52	5.28	7.20	5.91	5.35
Movement LOS	A	A	A	A	A	A	A	A	A	A	A	A
d_A, Approach Delay [s/veh]	6.35			6.09			5.80			6.08		
Approach LOS	A			A			A			A		
d_I, Intersection Delay [s/veh]	6.13											
Intersection LOS	A											
Intersection V/C	0.150											

Other Modes

g_Walk,mi, Effective Walk Time [s]	0.0			0.0			0.0			0.0		
M_corner, Corner Circulation Area [ft ² /ped]	0.00			0.00			0.00			0.00		
M_CW, Crosswalk Circulation Area [ft ² /ped]	0.00			0.00			0.00			0.00		
d_p, Pedestrian Delay [s]	0.00			0.00			0.00			0.00		
I_p,int, Pedestrian LOS Score for Intersectio	0.000			0.000			0.000			0.000		
Crosswalk LOS	F			F			F			F		
s_b, Saturation Flow Rate of the bicycle lane	2000			2000			2000			2000		
c_b, Capacity of the bicycle lane [bicycles/h]	3436			3436			3436			3436		
d_b, Bicycle Delay [s]	6.00			6.00			6.00			6.00		
I_b,int, Bicycle LOS Score for Intersection	1.937			1.784			1.739			1.954		
Bicycle LOS	A			A			A			A		

Sequence

Ring 1	-	2	-	4	-	-	-	-	-	-	-	-	-	-	-	-
Ring 2	-	6	-	8	-	-	-	-	-	-	-	-	-	-	-	-
Ring 3	-	-	-	-	-	-	-	-	-	-	-	-	-	-	-	-
Ring 4	-	-	-	-	-	-	-	-	-	-	-	-	-	-	-	-



Haven School TIS

Vistro File: C:\...\pm.vistro

Scenario 2 2025 Back PM

Report File: C:\...\2025 Back PM.pdf

8/24/2023

Intersection Analysis Summary

ID	Intersection Name	Control Type	Method	Worst Mvmt	V/C	Delay (s/veh)	LOS
1	Milam/Burgess	Two-way stop	HCM 7th Edition	WB Left	0.268	13.8	B
2	Black Forest/Burgess	Signalized	HCM 7th Edition	SB Left	0.164	6.0	A

V/C, Delay, LOS: For two-way stop, these values are taken from the movement with the worst (highest) delay value. For all other control types, they are taken for the whole intersection.

Intersection Level Of Service Report
Intersection 1: Milam/Burgess

Control Type: Two-way stop
 Analysis Method: HCM 7th Edition
 Analysis Period: 15 minutes

Delay (sec / veh): 13.8
 Level Of Service: B
 Volume to Capacity (v/c): 0.268

Intersection Setup

Name	Milam Road			Milam Road			Private Road			Burgess Road		
Approach	Northbound			Southbound			Eastbound			Westbound		
Lane Configuration	↔↔			↑			↑			↑		
Turning Movement	Left	Thru	Right	Left	Thru	Right	Left	Thru	Right	Left	Thru	Right
Lane Width [ft]	12.00	12.00	12.00	12.00	12.00	12.00	12.00	12.00	12.00	12.00	12.00	12.00
No. of Lanes in Entry Pocket	0	0	1	0	0	0	0	0	0	0	0	0
Entry Pocket Length [ft]	100.00	100.00	100.00	100.00	100.00	100.00	100.00	100.00	100.00	100.00	100.00	100.00
No. of Lanes in Exit Pocket	0	0	0	0	0	0	0	0	0	0	0	0
Exit Pocket Length [ft]	0.00	0.00	0.00	0.00	0.00	0.00	0.00	0.00	0.00	0.00	0.00	0.00
Speed [mph]	30.00			30.00			30.00			30.00		
Grade [%]	0.00			0.00			0.00			0.00		
Crosswalk	No			No			No			No		

Volumes

Name	Milam Road			Milam Road			Private Road			Burgess Road		
Base Volume Input [veh/h]	0	130	146	22	119	0	0	0	0	105	0	23
Base Volume Adjustment Factor	1.0000	1.0000	1.0000	1.0000	1.0000	1.0000	1.0000	1.0000	1.0000	1.0000	1.0000	1.0000
Heavy Vehicles Percentage [%]	2.00	2.00	2.00	2.00	2.00	2.00	2.00	2.00	2.00	2.00	2.00	2.00
Growth Factor	1.0400	1.0400	1.0400	1.0800	1.0800	1.0800	1.0000	1.0000	1.0000	1.1100	1.1100	1.1100
In-Process Volume [veh/h]	0	0	0	0	0	0	0	0	0	0	0	0
Site-Generated Trips [veh/h]	0	0	0	0	0	0	0	0	0	0	0	0
Diverted Trips [veh/h]	0	0	0	0	0	0	0	0	0	0	0	0
Pass-by Trips [veh/h]	0	0	0	0	0	0	0	0	0	0	0	0
Existing Site Adjustment Volume [veh/h]	0	0	0	0	0	0	0	0	0	0	0	0
Other Volume [veh/h]	0	0	0	0	0	0	0	0	0	0	0	0
Total Hourly Volume [veh/h]	0	135	152	24	129	0	0	0	0	117	0	26
Peak Hour Factor	0.8800	0.8800	0.8800	0.8200	0.8200	0.8200	0.8500	0.8500	0.8500	0.7600	0.7600	0.7600
Other Adjustment Factor	1.0000	1.0000	1.0000	1.0000	1.0000	1.0000	1.0000	1.0000	1.0000	1.0000	1.0000	1.0000
Total 15-Minute Volume [veh/h]	0	38	43	7	39	0	0	0	0	38	0	9
Total Analysis Volume [veh/h]	0	153	173	29	157	0	0	0	0	154	0	34
Pedestrian Volume [ped/h]	0			0			0			0		

Intersection Settings

Priority Scheme	Free	Free	Stop	Stop
Flared Lane			No	No
Storage Area [veh]	0	0	0	0
Two-Stage Gap Acceptance			No	No
Number of Storage Spaces in Median	0	0	0	0

Movement, Approach, & Intersection Results

V/C, Movement V/C Ratio	0.00	0.00	0.00	0.02	0.00	0.00	0.00	0.00	0.00	0.27	0.00	0.04
d_M, Delay for Movement [s/veh]	7.53	0.00	0.00	7.55	0.00	0.00	12.62	11.56	9.05	13.82	14.12	11.59
Movement LOS	A	A	A	A	A	A	B	B	A	B	B	B
95th-Percentile Queue Length [veh/ln]	0.00	0.00	0.00	0.05	0.05	0.05	0.00	0.00	0.00	1.29	1.29	1.29
95th-Percentile Queue Length [ft/ln]	0.00	0.00	0.00	1.23	1.23	1.23	0.00	0.00	0.00	32.25	32.25	32.25
d_A, Approach Delay [s/veh]	0.00			1.18			11.08			13.41		
Approach LOS	A			A			B			B		
d_I, Intersection Delay [s/veh]	3.92											
Intersection LOS	B											

**Intersection Level Of Service Report
Intersection 2: Black Forest/Burgess**

Control Type:	Signalized	Delay (sec / veh):	6.0
Analysis Method:	HCM 7th Edition	Level Of Service:	A
Analysis Period:	15 minutes	Volume to Capacity (v/c):	0.164

Intersection Setup

Name	Black Forest Road			Black Forest Road			Burgess Road			Burgess Road		
Approach	Northbound			Southbound			Eastbound			Westbound		
Lane Configuration	↵↵↵			↵↵↵			↵↵↵			↵↵↵		
Turning Movement	Left	Thru	Right	Left	Thru	Right	Left	Thru	Right	Left	Thru	Right
Lane Width [ft]	12.00	12.00	12.00	12.00	12.00	12.00	12.00	12.00	12.00	12.00	12.00	12.00
No. of Lanes in Entry Pocket	1	0	1	1	0	1	1	0	1	1	0	1
Entry Pocket Length [ft]	100.00	100.00	100.00	100.00	100.00	100.00	100.00	100.00	200.00	100.00	100.00	200.00
No. of Lanes in Exit Pocket	0	0	0	0	0	0	0	0	0	0	0	0
Exit Pocket Length [ft]	0.00	0.00	0.00	0.00	0.00	0.00	0.00	0.00	0.00	0.00	0.00	0.00
Speed [mph]	30.00			30.00			30.00			30.00		
Grade [%]	0.00			0.00			0.00			0.00		
Curb Present	No			No			No			No		
Crosswalk	No			No			No			No		

Volumes

Name	Black Forest Road			Black Forest Road			Burgess Road			Burgess Road		
Base Volume Input [veh/h]	20	106	25	28	105	14	16	137	27	23	77	25
Base Volume Adjustment Factor	1.0000	1.0000	1.0000	1.0000	1.0000	1.0000	1.0000	1.0000	1.0000	1.0000	1.0000	1.0000
Heavy Vehicles Percentage [%]	2.00	2.00	2.00	2.00	2.00	2.00	2.00	2.00	2.00	2.00	2.00	2.00
Proportion of CAVs [%]	0.00											
Growth Factor	1.1100	1.1100	1.1100	1.0600	1.0600	1.0600	1.1100	1.1100	1.1100	1.0400	1.0400	1.0400
In-Process Volume [veh/h]	0	0	0	0	0	0	0	0	0	0	0	0
Site-Generated Trips [veh/h]	0	0	0	0	0	0	0	0	0	0	0	0
Diverted Trips [veh/h]	0	0	0	0	0	0	0	0	0	0	0	0
Pass-by Trips [veh/h]	0	0	0	0	0	0	0	0	0	0	0	0
Existing Site Adjustment Volume [veh/h]	0	0	0	0	0	0	0	0	0	0	0	0
Other Volume [veh/h]	0	0	0	0	0	0	0	0	0	0	0	0
Right Turn on Red Volume [veh/h]	0	0	14	0	0	8	0	0	15	0	0	13
Total Hourly Volume [veh/h]	22	118	14	30	111	7	18	152	15	24	80	13
Peak Hour Factor	0.9000	0.9000	0.9000	0.8500	0.8500	0.8500	0.8700	0.8700	0.8700	0.6540	0.6540	0.6540
Other Adjustment Factor	1.0000	1.0000	1.0000	1.0000	1.0000	1.0000	1.0000	1.0000	1.0000	1.0000	1.0000	1.0000
Total 15-Minute Volume [veh/h]	6	33	4	9	33	2	5	44	4	9	31	5
Total Analysis Volume [veh/h]	24	131	16	35	131	8	21	175	17	37	122	20
Presence of On-Street Parking	No		No	No		No	No		No	No		No
On-Street Parking Maneuver Rate [/h]	0	0	0	0	0	0	0	0	0	0	0	0
Local Bus Stopping Rate [/h]	0	0	0	0	0	0	0	0	0	0	0	0
v_do, Outbound Pedestrian Volume crossing	0			0			0			0		
v_di, Inbound Pedestrian Volume crossing m	0			0			0			0		
v_co, Outbound Pedestrian Volume crossing	0			0			0			0		
v_ci, Inbound Pedestrian Volume crossing mi	0			0			0			0		
v_ab, Corner Pedestrian Volume [ped/h]	0			0			0			0		
Bicycle Volume [bicycles/h]	0			0			0			0		

Intersection Settings

Located in CBD	No
Signal Coordination Group	-
Cycle Length [s]	90
Active Pattern	Free Running
Coordination Type	<i>Free Running</i>
Actuation Type	<i>Fully actuated</i>
Offset [s]	0.0
Offset Reference	Lead Green - Beginning of First Green
Permissive Mode	SingleBand
Lost time [s]	0.00

Phasing & Timing

Control Type	Permiss	Permiss	Permiss	Permiss	Permiss	Permiss	Permiss	Permiss	Permiss	Permiss	Permiss	Permiss
Signal Group	0	2	0	0	6	0	0	4	0	0	8	0
Auxiliary Signal Groups												
Lead / Lag	-	-	-	-	-	-	-	-	-	-	-	-
Minimum Green [s]	0	10	0	0	10	0	0	10	0	0	10	0
Maximum Green [s]	0	40	0	0	40	0	0	40	0	0	40	0
Amber [s]	0.0	3.0	0.0	0.0	3.0	0.0	0.0	3.0	0.0	0.0	3.0	0.0
All red [s]	0.0	1.0	0.0	0.0	1.0	0.0	0.0	1.0	0.0	0.0	1.0	0.0
Split [s]	0	14	0	0	14	0	0	14	0	0	14	0
Vehicle Extension [s]	0.0	3.0	0.0	0.0	3.0	0.0	0.0	3.0	0.0	0.0	3.0	0.0
Walk [s]	0	5	0	0	5	0	0	5	0	0	5	0
Pedestrian Clearance [s]	0	10	0	0	10	0	0	10	0	0	10	0
Delayed Vehicle Green [s]	0.0	0.0	0.0	0.0	0.0	0.0	0.0	0.0	0.0	0.0	0.0	0.0
Rest In Walk		No			No			No			No	
I1, Start-Up Lost Time [s]	0.0	2.0	0.0	0.0	2.0	0.0	0.0	2.0	0.0	0.0	2.0	0.0
I2, Clearance Lost Time [s]	0.0	2.0	0.0	0.0	2.0	0.0	0.0	2.0	0.0	0.0	2.0	0.0
Minimum Recall		No			No			No			No	
Maximum Recall		No			No			No			No	
Pedestrian Recall		No			No			No			No	
Detector Location [ft]	0.0	0.0	0.0	0.0	0.0	0.0	0.0	0.0	0.0	0.0	0.0	0.0
Detector Length [ft]	0.0	40.0	0.0	0.0	40.0	0.0	0.0	40.0	0.0	0.0	40.0	0.0
I, Upstream Filtering Factor	1.00	1.00	1.00	1.00	1.00	1.00	1.00	1.00	1.00	1.00	1.00	1.00

Exclusive Pedestrian Phase

Pedestrian Signal Group	0
Pedestrian Walk [s]	0
Pedestrian Clearance [s]	0

Lane Group Calculations

Lane Group	L	C	R	L	C	R	L	C	R	L	C	R
C, Cycle Length [s]	22	22	22	22	22	22	22	22	22	22	22	22
L, Total Lost Time per Cycle [s]	4.00	4.00	4.00	4.00	4.00	4.00	4.00	4.00	4.00	4.00	4.00	4.00
l1_p, Permitted Start-Up Lost Time [s]	2.00	0.00	0.00	2.00	0.00	0.00	2.00	0.00	0.00	2.00	0.00	0.00
l2, Clearance Lost Time [s]	2.00	2.00	2.00	2.00	2.00	2.00	2.00	2.00	2.00	2.00	2.00	2.00
g_i, Effective Green Time [s]	7	7	7	7	7	7	7	7	7	7	7	7
g / C, Green / Cycle	0.30	0.30	0.30	0.30	0.30	0.30	0.33	0.33	0.33	0.33	0.33	0.33
(v / s)_i Volume / Saturation Flow Rate	0.02	0.07	0.01	0.03	0.07	0.01	0.02	0.09	0.01	0.03	0.07	0.01
s, saturation flow rate [veh/h]	1250	1870	1589	1241	1870	1589	1246	1870	1589	1191	1870	1589
c, Capacity [veh/h]	536	567	482	534	567	482	583	628	534	544	628	534
d1, Uniform Delay [s]	7.81	5.78	5.43	7.88	5.78	5.41	7.08	5.39	4.94	7.60	5.23	4.95
k, delay calibration	0.11	0.11	0.11	0.11	0.11	0.11	0.11	0.11	0.11	0.11	0.11	0.11
l, Upstream Filtering Factor	1.00	1.00	1.00	1.00	1.00	1.00	1.00	1.00	1.00	1.00	1.00	1.00
d2, Incremental Delay [s]	0.03	0.21	0.03	0.05	0.21	0.01	0.02	0.24	0.02	0.05	0.15	0.03
d3, Initial Queue Delay [s]	0.00	0.00	0.00	0.00	0.00	0.00	0.00	0.00	0.00	0.00	0.00	0.00
Rp, platoon ratio	1.00	1.00	1.00	1.00	1.00	1.00	1.00	1.00	1.00	1.00	1.00	1.00
PF, progression factor	1.00	1.00	1.00	1.00	1.00	1.00	1.00	1.00	1.00	1.00	1.00	1.00

Lane Group Results

X, volume / capacity	0.04	0.23	0.03	0.07	0.23	0.02	0.04	0.28	0.03	0.07	0.19	0.04
d, Delay for Lane Group [s/veh]	7.84	5.99	5.46	7.93	5.99	5.42	7.11	5.63	4.96	7.66	5.38	4.98
Lane Group LOS	A	A	A	A	A	A	A	A	A	A	A	A
Critical Lane Group	No	Yes	No	No	No	No	No	Yes	No	No	No	No
50th-Percentile Queue Length [veh/ln]	0.06	0.23	0.03	0.09	0.23	0.01	0.05	0.27	0.02	0.09	0.18	0.03
50th-Percentile Queue Length [ft/ln]	1.48	5.69	0.65	2.18	5.69	0.32	1.16	6.75	0.60	2.22	4.51	0.70
95th-Percentile Queue Length [veh/ln]	0.11	0.41	0.05	0.16	0.41	0.02	0.08	0.49	0.04	0.16	0.32	0.05
95th-Percentile Queue Length [ft/ln]	2.66	10.24	1.17	3.93	10.24	0.58	2.08	12.15	1.07	3.99	8.12	1.27

Movement, Approach, & Intersection Results

d_M, Delay for Movement [s/veh]	7.84	5.99	5.46	7.93	5.99	5.42	7.11	5.63	4.96	7.66	5.38	4.98
Movement LOS	A	A	A	A	A	A	A	A	A	A	A	A
d_A, Approach Delay [s/veh]	6.20			6.35			5.72			5.80		
Approach LOS	A			A			A			A		
d_I, Intersection Delay [s/veh]	6.00											
Intersection LOS	A											
Intersection V/C	0.164											

Other Modes

g_Walk,mi, Effective Walk Time [s]	0.0			0.0			0.0			0.0		
M_corner, Corner Circulation Area [ft ² /ped]	0.00			0.00			0.00			0.00		
M_CW, Crosswalk Circulation Area [ft ² /ped]	0.00			0.00			0.00			0.00		
d_p, Pedestrian Delay [s]	0.00			0.00			0.00			0.00		
I_p,int, Pedestrian LOS Score for Intersectio	0.000			0.000			0.000			0.000		
Crosswalk LOS	F			F			F			F		
s_b, Saturation Flow Rate of the bicycle lane	2000			2000			2000			2000		
c_b, Capacity of the bicycle lane [bicycles/h]	3635			3635			3635			3635		
d_b, Bicycle Delay [s]	7.35			7.35			7.35			7.35		
I_b,int, Bicycle LOS Score for Intersection	1.865			1.860			1.936			1.876		
Bicycle LOS	A			A			A			A		

Sequence

Ring 1	-	2	-	4	-	-	-	-	-	-	-	-	-	-	-	-	-
Ring 2	-	6	-	8	-	-	-	-	-	-	-	-	-	-	-	-	-
Ring 3	-	-	-	-	-	-	-	-	-	-	-	-	-	-	-	-	-
Ring 4	-	-	-	-	-	-	-	-	-	-	-	-	-	-	-	-	-



Haven School TIS

Vistro File: C:\...\AM.vistro

Scenario 3 2025 Total AM

Report File: C:\...\2025 Total AM.pdf

8/24/2023

Intersection Analysis Summary

ID	Intersection Name	Control Type	Method	Worst Mvmt	V/C	Delay (s/veh)	LOS
1	Milam/Burgess	Two-way stop	HCM 7th Edition	WB Left	0.570	20.3	C
2	Black Forest/Burgess	Signalized	HCM 7th Edition	EB Left	0.153	6.2	A
3	Burgess/School Access	Two-way stop	HCM 7th Edition	SB Left	0.030	13.1	B

V/C, Delay, LOS: For two-way stop, these values are taken from the movement with the worst (highest) delay value. For all other control types, they are taken for the whole intersection.

Intersection Level Of Service Report
Intersection 1: Milam/Burgess

Control Type: Two-way stop
Analysis Method: HCM 7th Edition
Analysis Period: 15 minutes

Delay (sec / veh): 20.3
Level Of Service: C
Volume to Capacity (v/c): 0.570

Intersection Setup

Name	Milam Road			Milam Road			Private Road			Burgess Road		
Approach	Northbound			Southbound			Eastbound			Westbound		
Lane Configuration	↔↔			↑			↑			↑		
Turning Movement	Left	Thru	Right	Left	Thru	Right	Left	Thru	Right	Left	Thru	Right
Lane Width [ft]	12.00	12.00	12.00	12.00	12.00	12.00	12.00	12.00	12.00	12.00	12.00	12.00
No. of Lanes in Entry Pocket	0	0	1	0	0	0	0	0	0	0	0	0
Entry Pocket Length [ft]	100.00	100.00	100.00	100.00	100.00	100.00	100.00	100.00	100.00	100.00	100.00	100.00
No. of Lanes in Exit Pocket	0	0	0	0	0	0	0	0	0	0	0	0
Exit Pocket Length [ft]	0.00	0.00	0.00	0.00	0.00	0.00	0.00	0.00	0.00	0.00	0.00	0.00
Speed [mph]	30.00			30.00			30.00			30.00		
Grade [%]	0.00			0.00			0.00			0.00		
Crosswalk	No			No			No			No		

Volumes

Name	Milam Road			Milam Road			Private Road			Burgess Road		
Base Volume Input [veh/h]	0	67	82	31	124	0	0	0	0	189	0	27
Base Volume Adjustment Factor	1.0000	1.0000	1.0000	1.0000	1.0000	1.0000	1.0000	1.0000	1.0000	1.0000	1.0000	1.0000
Heavy Vehicles Percentage [%]	2.00	2.00	2.00	2.00	2.00	2.00	2.00	2.00	2.00	2.00	2.00	2.00
Growth Factor	1.0400	1.0400	1.0400	1.0800	1.0800	1.0800	1.0000	1.0000	1.0000	1.1100	1.1100	1.1100
In-Process Volume [veh/h]	0	0	0	0	0	0	0	0	0	0	0	0
Site-Generated Trips [veh/h]	0	0	24	4	0	0	0	0	0	15	0	2
Diverted Trips [veh/h]	0	0	0	0	0	0	0	0	0	0	0	0
Pass-by Trips [veh/h]	0	0	0	0	0	0	0	0	0	0	0	0
Existing Site Adjustment Volume [veh/h]	0	0	0	0	0	0	0	0	0	0	0	0
Other Volume [veh/h]	0	0	0	0	0	0	0	0	0	0	0	0
Total Hourly Volume [veh/h]	0	70	109	37	134	0	0	0	0	225	0	32
Peak Hour Factor	0.7800	0.7800	0.7800	0.7900	0.7900	0.7900	0.8500	0.8500	0.8500	0.6800	0.6800	0.6800
Other Adjustment Factor	1.0000	1.0000	1.0000	1.0000	1.0000	1.0000	1.0000	1.0000	1.0000	1.0000	1.0000	1.0000
Total 15-Minute Volume [veh/h]	0	22	35	12	42	0	0	0	0	83	0	12
Total Analysis Volume [veh/h]	0	90	140	47	170	0	0	0	0	331	0	47
Pedestrian Volume [ped/h]	0			0			0			0		

Intersection Settings

Priority Scheme	Free	Free	Stop	Stop
Flared Lane			No	No
Storage Area [veh]	0	0	0	0
Two-Stage Gap Acceptance			No	No
Number of Storage Spaces in Median	0	0	0	0

Movement, Approach, & Intersection Results

V/C, Movement V/C Ratio	0.00	0.00	0.00	0.03	0.00	0.00	0.00	0.00	0.00	0.57	0.00	0.05
d_M, Delay for Movement [s/veh]	7.56	0.00	0.00	7.45	0.00	0.00	12.52	11.53	9.12	20.30	20.62	17.81
Movement LOS	A	A	A	A	A	A	B	B	A	C	C	C
95th-Percentile Queue Length [veh/ln]	0.00	0.00	0.00	0.08	0.08	0.08	0.00	0.00	0.00	4.25	4.25	4.25
95th-Percentile Queue Length [ft/ln]	0.00	0.00	0.00	2.01	2.01	2.01	0.00	0.00	0.00	106.29	106.29	106.29
d_A, Approach Delay [s/veh]	0.00			1.61			11.05			19.99		
Approach LOS	A			A			B			C		
d_I, Intersection Delay [s/veh]	9.58											
Intersection LOS	C											

**Intersection Level Of Service Report
Intersection 2: Black Forest/Burgess**

Control Type:	Signalized	Delay (sec / veh):	6.2
Analysis Method:	HCM 7th Edition	Level Of Service:	A
Analysis Period:	15 minutes	Volume to Capacity (v/c):	0.153

Intersection Setup

Name	Black Forest Road			Black Forest Road			Burgess Road			Burgess Road		
Approach	Northbound			Southbound			Eastbound			Westbound		
Lane Configuration	↵↵↵			↵↵↵			↵↵↵			↵↵↵		
Turning Movement	Left	Thru	Right	Left	Thru	Right	Left	Thru	Right	Left	Thru	Right
Lane Width [ft]	12.00	12.00	12.00	12.00	12.00	12.00	12.00	12.00	12.00	12.00	12.00	12.00
No. of Lanes in Entry Pocket	1	0	1	1	0	1	1	0	1	1	0	1
Entry Pocket Length [ft]	100.00	100.00	100.00	100.00	100.00	100.00	100.00	100.00	200.00	100.00	100.00	200.00
No. of Lanes in Exit Pocket	0	0	0	0	0	0	0	0	0	0	0	0
Exit Pocket Length [ft]	0.00	0.00	0.00	0.00	0.00	0.00	0.00	0.00	0.00	0.00	0.00	0.00
Speed [mph]	30.00			30.00			30.00			30.00		
Grade [%]	0.00			0.00			0.00			0.00		
Curb Present	No			No			No			No		
Crosswalk	No			No			No			No		

Volumes

Name	Black Forest Road			Black Forest Road			Burgess Road			Burgess Road		
Base Volume Input [veh/h]	37	75	30	20	78	10	13	64	21	29	109	35
Base Volume Adjustment Factor	1.0000	1.0000	1.0000	1.0000	1.0000	1.0000	1.0000	1.0000	1.0000	1.0000	1.0000	1.0000
Heavy Vehicles Percentage [%]	2.00	2.00	2.00	2.00	2.00	2.00	2.00	2.00	2.00	2.00	2.00	2.00
Proportion of CAVs [%]	0.00											
Growth Factor	1.1100	1.1100	1.1100	1.0600	1.0600	1.0600	1.1100	1.1100	1.1100	1.0400	1.0400	1.0400
In-Process Volume [veh/h]	0	0	0	0	0	0	0	0	0	0	0	0
Site-Generated Trips [veh/h]	8	0	0	0	0	0	0	2	5	0	4	0
Diverted Trips [veh/h]	0	0	0	0	0	0	0	0	0	0	0	0
Pass-by Trips [veh/h]	0	0	0	0	0	0	0	0	0	0	0	0
Existing Site Adjustment Volume [veh/h]	0	0	0	0	0	0	0	0	0	0	0	0
Other Volume [veh/h]	0	0	0	0	0	0	0	0	0	0	0	0
Right Turn on Red Volume [veh/h]	0	0	17	0	0	6	0	0	14	0	0	18
Total Hourly Volume [veh/h]	49	83	16	21	83	5	14	73	14	30	117	18
Peak Hour Factor	0.6600	0.6600	0.6600	0.8400	0.8400	0.8400	0.9800	0.9800	0.9800	0.7300	0.7300	0.7300
Other Adjustment Factor	1.0000	1.0000	1.0000	1.0000	1.0000	1.0000	1.0000	1.0000	1.0000	1.0000	1.0000	1.0000
Total 15-Minute Volume [veh/h]	19	31	6	6	25	1	4	19	4	10	40	6
Total Analysis Volume [veh/h]	74	126	24	25	99	6	14	74	14	41	160	25
Presence of On-Street Parking	No		No	No		No	No		No	No		No
On-Street Parking Maneuver Rate [/h]	0	0	0	0	0	0	0	0	0	0	0	0
Local Bus Stopping Rate [/h]	0	0	0	0	0	0	0	0	0	0	0	0
v_do, Outbound Pedestrian Volume crossing	0			0			0			0		
v_di, Inbound Pedestrian Volume crossing m	0			0			0			0		
v_co, Outbound Pedestrian Volume crossing	0			0			0			0		
v_ci, Inbound Pedestrian Volume crossing mi	0			0			0			0		
v_ab, Corner Pedestrian Volume [ped/h]	0			0			0			0		
Bicycle Volume [bicycles/h]	0			0			0			0		

Intersection Settings

Located in CBD	No
Signal Coordination Group	-
Cycle Length [s]	90
Active Pattern	Free Running
Coordination Type	<i>Free Running</i>
Actuation Type	<i>Fully actuated</i>
Offset [s]	0.0
Offset Reference	Lead Green - Beginning of First Green
Permissive Mode	SingleBand
Lost time [s]	0.00

Phasing & Timing

Control Type	Permiss	Permiss	Permiss	Permiss	Permiss	Permiss	Permiss	Permiss	Permiss	Permiss	Permiss	Permiss
Signal Group	0	2	0	0	6	0	0	4	0	0	8	0
Auxiliary Signal Groups												
Lead / Lag	-	-	-	-	-	-	-	-	-	-	-	-
Minimum Green [s]	0	10	0	0	10	0	0	10	0	0	10	0
Maximum Green [s]	0	40	0	0	40	0	0	40	0	0	40	0
Amber [s]	0.0	3.0	0.0	0.0	3.0	0.0	0.0	3.0	0.0	0.0	3.0	0.0
All red [s]	0.0	1.0	0.0	0.0	1.0	0.0	0.0	1.0	0.0	0.0	1.0	0.0
Split [s]	0	14	0	0	14	0	0	14	0	0	14	0
Vehicle Extension [s]	0.0	3.0	0.0	0.0	3.0	0.0	0.0	3.0	0.0	0.0	3.0	0.0
Walk [s]	0	5	0	0	5	0	0	5	0	0	5	0
Pedestrian Clearance [s]	0	10	0	0	10	0	0	10	0	0	10	0
Delayed Vehicle Green [s]	0.0	0.0	0.0	0.0	0.0	0.0	0.0	0.0	0.0	0.0	0.0	0.0
Rest In Walk		No			No			No			No	
I1, Start-Up Lost Time [s]	0.0	2.0	0.0	0.0	2.0	0.0	0.0	2.0	0.0	0.0	2.0	0.0
I2, Clearance Lost Time [s]	0.0	2.0	0.0	0.0	2.0	0.0	0.0	2.0	0.0	0.0	2.0	0.0
Minimum Recall		No			No			No			No	
Maximum Recall		No			No			No			No	
Pedestrian Recall		No			No			No			No	
Detector Location [ft]	0.0	0.0	0.0	0.0	0.0	0.0	0.0	0.0	0.0	0.0	0.0	0.0
Detector Length [ft]	0.0	40.0	0.0	0.0	40.0	0.0	0.0	40.0	0.0	0.0	40.0	0.0
I, Upstream Filtering Factor	1.00	1.00	1.00	1.00	1.00	1.00	1.00	1.00	1.00	1.00	1.00	1.00

Exclusive Pedestrian Phase

Pedestrian Signal Group	0
Pedestrian Walk [s]	0
Pedestrian Clearance [s]	0

Lane Group Calculations

Lane Group	L	C	R	L	C	R	L	C	R	L	C	R
C, Cycle Length [s]	24	24	24	24	24	24	24	24	24	24	24	24
L, Total Lost Time per Cycle [s]	4.00	4.00	4.00	4.00	4.00	4.00	4.00	4.00	4.00	4.00	4.00	4.00
l1_p, Permitted Start-Up Lost Time [s]	2.00	0.00	0.00	2.00	0.00	0.00	2.00	0.00	0.00	2.00	0.00	0.00
l2, Clearance Lost Time [s]	2.00	2.00	2.00	2.00	2.00	2.00	2.00	2.00	2.00	2.00	2.00	2.00
g_i, Effective Green Time [s]	8	8	8	8	8	8	8	8	8	8	8	8
g / C, Green / Cycle	0.33	0.33	0.33	0.33	0.33	0.33	0.33	0.33	0.33	0.33	0.33	0.33
(v / s)_i Volume / Saturation Flow Rate	0.06	0.07	0.02	0.02	0.05	0.00	0.01	0.04	0.01	0.03	0.09	0.02
s, saturation flow rate [veh/h]	1289	1870	1589	1237	1870	1589	1198	1870	1589	1309	1870	1589
c, Capacity [veh/h]	586	620	527	561	620	527	537	622	529	605	622	529
d1, Uniform Delay [s]	7.68	5.70	5.40	7.60	5.62	5.34	7.79	5.52	5.35	7.26	5.80	5.39
k, delay calibration	0.11	0.11	0.11	0.11	0.11	0.11	0.11	0.11	0.11	0.11	0.11	0.11
l, Upstream Filtering Factor	1.00	1.00	1.00	1.00	1.00	1.00	1.00	1.00	1.00	1.00	1.00	1.00
d2, Incremental Delay [s]	0.10	0.16	0.04	0.03	0.12	0.01	0.02	0.08	0.02	0.05	0.22	0.04
d3, Initial Queue Delay [s]	0.00	0.00	0.00	0.00	0.00	0.00	0.00	0.00	0.00	0.00	0.00	0.00
Rp, platoon ratio	1.00	1.00	1.00	1.00	1.00	1.00	1.00	1.00	1.00	1.00	1.00	1.00
PF, progression factor	1.00	1.00	1.00	1.00	1.00	1.00	1.00	1.00	1.00	1.00	1.00	1.00

Lane Group Results

X, volume / capacity	0.13	0.20	0.05	0.04	0.16	0.01	0.03	0.12	0.03	0.07	0.26	0.05
d, Delay for Lane Group [s/veh]	7.77	5.86	5.44	7.63	5.74	5.35	7.81	5.60	5.37	7.31	6.01	5.42
Lane Group LOS	A	A	A	A	A	A	A	A	A	A	A	A
Critical Lane Group	No	Yes	No	No	No	No	No	No	No	No	Yes	No
50th-Percentile Queue Length [veh/ln]	0.19	0.23	0.04	0.06	0.18	0.01	0.04	0.13	0.02	0.10	0.30	0.04
50th-Percentile Queue Length [ft/ln]	4.80	5.80	1.05	1.61	4.47	0.26	0.93	3.27	0.61	2.50	7.52	1.09
95th-Percentile Queue Length [veh/ln]	0.35	0.42	0.08	0.12	0.32	0.02	0.07	0.24	0.04	0.18	0.54	0.08
95th-Percentile Queue Length [ft/ln]	8.65	10.45	1.89	2.89	8.05	0.47	1.67	5.88	1.09	4.50	13.54	1.96

Movement, Approach, & Intersection Results

d_M, Delay for Movement [s/veh]	7.77	5.86	5.44	7.63	5.74	5.35	7.81	5.60	5.37	7.31	6.01	5.42
Movement LOS	A	A	A	A	A	A	A	A	A	A	A	A
d_A, Approach Delay [s/veh]	6.45			6.08			5.88			6.18		
Approach LOS	A			A			A			A		
d_I, Intersection Delay [s/veh]	6.21											
Intersection LOS	A											
Intersection V/C	0.153											

Other Modes

g_Walk,mi, Effective Walk Time [s]	0.0			0.0			0.0			0.0		
M_corner, Corner Circulation Area [ft ² /ped]	0.00			0.00			0.00			0.00		
M_CW, Crosswalk Circulation Area [ft ² /ped]	0.00			0.00			0.00			0.00		
d_p, Pedestrian Delay [s]	0.00			0.00			0.00			0.00		
I_p,int, Pedestrian LOS Score for Intersectio	0.000			0.000			0.000			0.000		
Crosswalk LOS	F			F			F			F		
s_b, Saturation Flow Rate of the bicycle lane	2000			2000			2000			2000		
c_b, Capacity of the bicycle lane [bicycles/h]	3384			3384			3384			3384		
d_b, Bicycle Delay [s]	5.66			5.66			5.66			5.66		
I_b,int, Bicycle LOS Score for Intersection	1.957			1.784			1.751			1.962		
Bicycle LOS	A			A			A			A		

Sequence

Ring 1	-	2	-	4	-	-	-	-	-	-	-	-	-	-	-	-
Ring 2	-	6	-	8	-	-	-	-	-	-	-	-	-	-	-	-
Ring 3	-	-	-	-	-	-	-	-	-	-	-	-	-	-	-	-
Ring 4	-	-	-	-	-	-	-	-	-	-	-	-	-	-	-	-



**Intersection Level Of Service Report
Intersection 3: Burgess/School Access**

Control Type:	Two-way stop	Delay (sec / veh):	13.1
Analysis Method:	HCM 7th Edition	Level Of Service:	B
Analysis Period:	15 minutes	Volume to Capacity (v/c):	0.030

Intersection Setup

Name	Haven School Access		Burgess Road		Burgess Road	
Approach	Southbound		Eastbound		Westbound	
Lane Configuration						
Turning Movement	Left	Right	Left	Thru	Thru	Right
Lane Width [ft]	12.00	12.00	12.00	12.00	12.00	12.00
No. of Lanes in Entry Pocket	0	0	1	0	0	0
Entry Pocket Length [ft]	100.00	100.00	100.00	100.00	100.00	100.00
No. of Lanes in Exit Pocket	0	0	0	0	0	0
Exit Pocket Length [ft]	0.00	0.00	0.00	0.00	0.00	0.00
Speed [mph]	30.00		30.00		30.00	
Grade [%]	0.00		0.00		0.00	
Crosswalk	No		No		No	

Volumes

Name	Haven School Access		Burgess Road		Burgess Road	
Base Volume Input [veh/h]	0	0	0	113	216	0
Base Volume Adjustment Factor	1.0000	1.0000	1.0000	1.0000	1.0000	1.0000
Heavy Vehicles Percentage [%]	2.00	2.00	2.00	2.00	2.00	2.00
Growth Factor	1.0000	1.0000	1.0000	1.1100	1.1100	1.0000
In-Process Volume [veh/h]	0	0	0	0	0	0
Site-Generated Trips [veh/h]	7	17	28	0	0	12
Diverted Trips [veh/h]	0	0	0	0	0	0
Pass-by Trips [veh/h]	0	0	0	0	0	0
Existing Site Adjustment Volume [veh/h]	0	0	0	0	0	0
Other Volume [veh/h]	0	0	0	0	0	0
Total Hourly Volume [veh/h]	7	17	28	125	240	12
Peak Hour Factor	0.5000	0.5000	0.5000	0.8500	0.8500	0.5000
Other Adjustment Factor	1.0000	1.0000	1.0000	1.0000	1.0000	1.0000
Total 15-Minute Volume [veh/h]	4	9	14	37	71	6
Total Analysis Volume [veh/h]	14	34	56	147	282	24
Pedestrian Volume [ped/h]	0		0		0	

Intersection Settings

Priority Scheme	Stop	Free	Free
Flared Lane	No		
Storage Area [veh]	0	0	0
Two-Stage Gap Acceptance	No		
Number of Storage Spaces in Median	0	0	0

Movement, Approach, & Intersection Results

V/C, Movement V/C Ratio	0.03	0.05	0.04	0.00	0.00	0.00
d_M, Delay for Movement [s/veh]	13.09	10.29	8.00	0.00	0.00	0.00
Movement LOS	B	B	A	A	A	A
95th-Percentile Queue Length [veh/ln]	0.24	0.24	0.14	0.00	0.00	0.00
95th-Percentile Queue Length [ft/ln]	6.09	6.09	3.50	0.00	0.00	0.00
d_A, Approach Delay [s/veh]	11.11		2.21		0.00	
Approach LOS	B		A		A	
d_I, Intersection Delay [s/veh]	1.76					
Intersection LOS	B					

Haven School TIS

Vistro File: C:\...\pm.vistro

Scenario 3 2025 Total PM

Report File: C:\...\2025 Total PM.pdf

8/24/2023

Intersection Analysis Summary

ID	Intersection Name	Control Type	Method	Worst Mvmt	V/C	Delay (s/veh)	LOS
1	Milam/Burgess	Two-way stop	HCM 7th Edition	WB Left	0.302	14.4	B
2	Black Forest/Burgess	Signalized	HCM 7th Edition	SB Left	0.165	6.0	A
3	Burgess/School Access	Two-way stop	HCM 7th Edition	SB Left	0.030	12.3	B

V/C, Delay, LOS: For two-way stop, these values are taken from the movement with the worst (highest) delay value. For all other control types, they are taken for the whole intersection.

Intersection Level Of Service Report
Intersection 1: Milam/Burgess

Control Type: Two-way stop
Analysis Method: HCM 7th Edition
Analysis Period: 15 minutes

Delay (sec / veh): 14.4
Level Of Service: B
Volume to Capacity (v/c): 0.302

Intersection Setup

Name	Milam Road			Milam Road			Private Road			Burgess Road		
Approach	Northbound			Southbound			Eastbound			Westbound		
Lane Configuration	↔↔			↑			↑			↑		
Turning Movement	Left	Thru	Right	Left	Thru	Right	Left	Thru	Right	Left	Thru	Right
Lane Width [ft]	12.00	12.00	12.00	12.00	12.00	12.00	12.00	12.00	12.00	12.00	12.00	12.00
No. of Lanes in Entry Pocket	0	0	1	0	0	0	0	0	0	0	0	0
Entry Pocket Length [ft]	100.00	100.00	100.00	100.00	100.00	100.00	100.00	100.00	100.00	100.00	100.00	100.00
No. of Lanes in Exit Pocket	0	0	0	0	0	0	0	0	0	0	0	0
Exit Pocket Length [ft]	0.00	0.00	0.00	0.00	0.00	0.00	0.00	0.00	0.00	0.00	0.00	0.00
Speed [mph]	30.00			30.00			30.00			30.00		
Grade [%]	0.00			0.00			0.00			0.00		
Crosswalk	No			No			No			No		

Volumes

Name	Milam Road			Milam Road			Private Road			Burgess Road		
Base Volume Input [veh/h]	0	130	146	22	119	0	0	0	0	105	0	23
Base Volume Adjustment Factor	1.0000	1.0000	1.0000	1.0000	1.0000	1.0000	1.0000	1.0000	1.0000	1.0000	1.0000	1.0000
Heavy Vehicles Percentage [%]	2.00	2.00	2.00	2.00	2.00	2.00	2.00	2.00	2.00	2.00	2.00	2.00
Growth Factor	1.0400	1.0400	1.0400	1.0800	1.0800	1.0800	1.0000	1.0000	1.0000	1.1100	1.1100	1.1100
In-Process Volume [veh/h]	0	0	0	0	0	0	0	0	0	0	0	0
Site-Generated Trips [veh/h]	0	0	11	2	0	0	0	0	0	14	0	3
Diverted Trips [veh/h]	0	0	0	0	0	0	0	0	0	0	0	0
Pass-by Trips [veh/h]	0	0	0	0	0	0	0	0	0	0	0	0
Existing Site Adjustment Volume [veh/h]	0	0	0	0	0	0	0	0	0	0	0	0
Other Volume [veh/h]	0	0	0	0	0	0	0	0	0	0	0	0
Total Hourly Volume [veh/h]	0	135	163	26	129	0	0	0	0	131	0	29
Peak Hour Factor	0.8800	0.8800	0.8800	0.8200	0.8200	0.8200	0.8500	0.8500	0.8500	0.7600	0.7600	0.7600
Other Adjustment Factor	1.0000	1.0000	1.0000	1.0000	1.0000	1.0000	1.0000	1.0000	1.0000	1.0000	1.0000	1.0000
Total 15-Minute Volume [veh/h]	0	38	46	8	39	0	0	0	0	43	0	10
Total Analysis Volume [veh/h]	0	153	185	32	157	0	0	0	0	172	0	38
Pedestrian Volume [ped/h]	0			0			0			0		

Intersection Settings

Priority Scheme	Free	Free	Stop	Stop
Flared Lane			No	No
Storage Area [veh]	0	0	0	0
Two-Stage Gap Acceptance			No	No
Number of Storage Spaces in Median	0	0	0	0

Movement, Approach, & Intersection Results

V/C, Movement V/C Ratio	0.00	0.00	0.00	0.02	0.00	0.00	0.00	0.00	0.00	0.30	0.00	0.04
d_M, Delay for Movement [s/veh]	7.53	0.00	0.00	7.56	0.00	0.00	12.83	11.63	9.05	14.41	14.71	12.11
Movement LOS	A	A	A	A	A	A	B	B	A	B	B	B
95th-Percentile Queue Length [veh/ln]	0.00	0.00	0.00	0.05	0.05	0.05	0.00	0.00	0.00	1.53	1.53	1.53
95th-Percentile Queue Length [ft/ln]	0.00	0.00	0.00	1.36	1.36	1.36	0.00	0.00	0.00	38.32	38.32	38.32
d_A, Approach Delay [s/veh]	0.00			1.28			11.17			14.00		
Approach LOS	A			A			B			B		
d_I, Intersection Delay [s/veh]	4.32											
Intersection LOS	B											

Intersection Level Of Service Report
Intersection 2: Black Forest/Burgess

Control Type:	Signalized	Delay (sec / veh):	6.0
Analysis Method:	HCM 7th Edition	Level Of Service:	A
Analysis Period:	15 minutes	Volume to Capacity (v/c):	0.165

Intersection Setup

Name	Black Forest Road			Black Forest Road			Burgess Road			Burgess Road		
Approach	Northbound			Southbound			Eastbound			Westbound		
Lane Configuration												
Turning Movement	Left	Thru	Right	Left	Thru	Right	Left	Thru	Right	Left	Thru	Right
Lane Width [ft]	12.00	12.00	12.00	12.00	12.00	12.00	12.00	12.00	12.00	12.00	12.00	12.00
No. of Lanes in Entry Pocket	1	0	1	1	0	1	1	0	1	1	0	1
Entry Pocket Length [ft]	100.00	100.00	100.00	100.00	100.00	100.00	100.00	100.00	200.00	100.00	100.00	200.00
No. of Lanes in Exit Pocket	0	0	0	0	0	0	0	0	0	0	0	0
Exit Pocket Length [ft]	0.00	0.00	0.00	0.00	0.00	0.00	0.00	0.00	0.00	0.00	0.00	0.00
Speed [mph]	30.00			30.00			30.00			30.00		
Grade [%]	0.00			0.00			0.00			0.00		
Curb Present	No			No			No			No		
Crosswalk	No			No			No			No		

Volumes

Name	Black Forest Road			Black Forest Road			Burgess Road			Burgess Road		
Base Volume Input [veh/h]	20	106	25	28	105	14	16	137	27	23	77	25
Base Volume Adjustment Factor	1.0000	1.0000	1.0000	1.0000	1.0000	1.0000	1.0000	1.0000	1.0000	1.0000	1.0000	1.0000
Heavy Vehicles Percentage [%]	2.00	2.00	2.00	2.00	2.00	2.00	2.00	2.00	2.00	2.00	2.00	2.00
Proportion of CAVs [%]	0.00											
Growth Factor	1.1100	1.1100	1.1100	1.0600	1.0600	1.0600	1.1100	1.1100	1.1100	1.0400	1.0400	1.0400
In-Process Volume [veh/h]	0	0	0	0	0	0	0	0	0	0	0	0
Site-Generated Trips [veh/h]	4	0	0	0	0	0	0	3	5	0	2	0
Diverted Trips [veh/h]	0	0	0	0	0	0	0	0	0	0	0	0
Pass-by Trips [veh/h]	0	0	0	0	0	0	0	0	0	0	0	0
Existing Site Adjustment Volume [veh/h]	0	0	0	0	0	0	0	0	0	0	0	0
Other Volume [veh/h]	0	0	0	0	0	0	0	0	0	0	0	0
Right Turn on Red Volume [veh/h]	0	0	14	0	0	8	0	0	18	0	0	13
Total Hourly Volume [veh/h]	26	118	14	30	111	7	18	155	17	24	82	13
Peak Hour Factor	0.9000	0.9000	0.9000	0.8500	0.8500	0.8500	0.8700	0.8700	0.8700	0.6540	0.6540	0.6540
Other Adjustment Factor	1.0000	1.0000	1.0000	1.0000	1.0000	1.0000	1.0000	1.0000	1.0000	1.0000	1.0000	1.0000
Total 15-Minute Volume [veh/h]	7	33	4	9	33	2	5	45	5	9	31	5
Total Analysis Volume [veh/h]	29	131	16	35	131	8	21	178	20	37	125	20
Presence of On-Street Parking	No		No	No		No	No		No	No		No
On-Street Parking Maneuver Rate [/h]	0	0	0	0	0	0	0	0	0	0	0	0
Local Bus Stopping Rate [/h]	0	0	0	0	0	0	0	0	0	0	0	0
v_do, Outbound Pedestrian Volume crossing	0			0			0			0		
v_di, Inbound Pedestrian Volume crossing m	0			0			0			0		
v_co, Outbound Pedestrian Volume crossing	0			0			0			0		
v_ci, Inbound Pedestrian Volume crossing mi	0			0			0			0		
v_ab, Corner Pedestrian Volume [ped/h]	0			0			0			0		
Bicycle Volume [bicycles/h]	0			0			0			0		

Intersection Settings

Located in CBD	No
Signal Coordination Group	-
Cycle Length [s]	90
Active Pattern	Free Running
Coordination Type	<i>Free Running</i>
Actuation Type	<i>Fully actuated</i>
Offset [s]	0.0
Offset Reference	Lead Green - Beginning of First Green
Permissive Mode	SingleBand
Lost time [s]	0.00

Phasing & Timing

Control Type	Permiss	Permiss	Permiss	Permiss	Permiss	Permiss	Permiss	Permiss	Permiss	Permiss	Permiss	Permiss
Signal Group	0	2	0	0	6	0	0	4	0	0	8	0
Auxiliary Signal Groups												
Lead / Lag	-	-	-	-	-	-	-	-	-	-	-	-
Minimum Green [s]	0	10	0	0	10	0	0	10	0	0	10	0
Maximum Green [s]	0	40	0	0	40	0	0	40	0	0	40	0
Amber [s]	0.0	3.0	0.0	0.0	3.0	0.0	0.0	3.0	0.0	0.0	3.0	0.0
All red [s]	0.0	1.0	0.0	0.0	1.0	0.0	0.0	1.0	0.0	0.0	1.0	0.0
Split [s]	0	14	0	0	14	0	0	14	0	0	14	0
Vehicle Extension [s]	0.0	3.0	0.0	0.0	3.0	0.0	0.0	3.0	0.0	0.0	3.0	0.0
Walk [s]	0	5	0	0	5	0	0	5	0	0	5	0
Pedestrian Clearance [s]	0	10	0	0	10	0	0	10	0	0	10	0
Delayed Vehicle Green [s]	0.0	0.0	0.0	0.0	0.0	0.0	0.0	0.0	0.0	0.0	0.0	0.0
Rest In Walk		No			No			No			No	
I1, Start-Up Lost Time [s]	0.0	2.0	0.0	0.0	2.0	0.0	0.0	2.0	0.0	0.0	2.0	0.0
I2, Clearance Lost Time [s]	0.0	2.0	0.0	0.0	2.0	0.0	0.0	2.0	0.0	0.0	2.0	0.0
Minimum Recall		No			No			No			No	
Maximum Recall		No			No			No			No	
Pedestrian Recall		No			No			No			No	
Detector Location [ft]	0.0	0.0	0.0	0.0	0.0	0.0	0.0	0.0	0.0	0.0	0.0	0.0
Detector Length [ft]	0.0	40.0	0.0	0.0	40.0	0.0	0.0	40.0	0.0	0.0	40.0	0.0
I, Upstream Filtering Factor	1.00	1.00	1.00	1.00	1.00	1.00	1.00	1.00	1.00	1.00	1.00	1.00

Exclusive Pedestrian Phase

Pedestrian Signal Group	0
Pedestrian Walk [s]	0
Pedestrian Clearance [s]	0

Lane Group Calculations

Lane Group	L	C	R	L	C	R	L	C	R	L	C	R
C, Cycle Length [s]	22	22	22	22	22	22	22	22	22	22	22	22
L, Total Lost Time per Cycle [s]	4.00	4.00	4.00	4.00	4.00	4.00	4.00	4.00	4.00	4.00	4.00	4.00
l1_p, Permitted Start-Up Lost Time [s]	2.00	0.00	0.00	2.00	0.00	0.00	2.00	0.00	0.00	2.00	0.00	0.00
l2, Clearance Lost Time [s]	2.00	2.00	2.00	2.00	2.00	2.00	2.00	2.00	2.00	2.00	2.00	2.00
g_i, Effective Green Time [s]	7	7	7	7	7	7	7	7	7	7	7	7
g / C, Green / Cycle	0.30	0.30	0.30	0.30	0.30	0.30	0.34	0.34	0.34	0.34	0.34	0.34
(v / s)_i Volume / Saturation Flow Rate	0.02	0.07	0.01	0.03	0.07	0.01	0.02	0.10	0.01	0.03	0.07	0.01
s, saturation flow rate [veh/h]	1250	1870	1589	1241	1870	1589	1243	1870	1589	1184	1870	1589
c, Capacity [veh/h]	534	568	482	533	568	482	582	633	538	543	633	538
d1, Uniform Delay [s]	7.88	5.83	5.47	7.92	5.83	5.45	7.11	5.40	4.95	7.63	5.24	4.95
k, delay calibration	0.11	0.11	0.11	0.11	0.11	0.11	0.11	0.11	0.11	0.11	0.11	0.11
l, Upstream Filtering Factor	1.00	1.00	1.00	1.00	1.00	1.00	1.00	1.00	1.00	1.00	1.00	1.00
d2, Incremental Delay [s]	0.04	0.21	0.03	0.05	0.21	0.01	0.03	0.24	0.03	0.05	0.15	0.03
d3, Initial Queue Delay [s]	0.00	0.00	0.00	0.00	0.00	0.00	0.00	0.00	0.00	0.00	0.00	0.00
Rp, platoon ratio	1.00	1.00	1.00	1.00	1.00	1.00	1.00	1.00	1.00	1.00	1.00	1.00
PF, progression factor	1.00	1.00	1.00	1.00	1.00	1.00	1.00	1.00	1.00	1.00	1.00	1.00

Lane Group Results

X, volume / capacity	0.05	0.23	0.03	0.07	0.23	0.02	0.04	0.28	0.04	0.07	0.20	0.04
d, Delay for Lane Group [s/veh]	7.93	6.03	5.50	7.98	6.03	5.46	7.13	5.64	4.98	7.69	5.39	4.98
Lane Group LOS	A	A	A	A	A	A	A	A	A	A	A	A
Critical Lane Group	No	Yes	No	No	No	No	No	Yes	No	No	No	No
50th-Percentile Queue Length [veh/ln]	0.07	0.23	0.03	0.09	0.23	0.01	0.05	0.28	0.03	0.09	0.19	0.03
50th-Percentile Queue Length [ft/ln]	1.83	5.81	0.67	2.22	5.81	0.33	1.17	6.97	0.71	2.25	4.69	0.71
95th-Percentile Queue Length [veh/ln]	0.13	0.42	0.05	0.16	0.42	0.02	0.08	0.50	0.05	0.16	0.34	0.05
95th-Percentile Queue Length [ft/ln]	3.29	10.46	1.20	3.99	10.46	0.60	2.11	12.55	1.28	4.04	8.44	1.28

Movement, Approach, & Intersection Results

d_M, Delay for Movement [s/veh]	7.93	6.03	5.50	7.98	6.03	5.46	7.13	5.64	4.98	7.69	5.39	4.98
Movement LOS	A	A	A	A	A	A	A	A	A	A	A	A
d_A, Approach Delay [s/veh]	6.30			6.40			5.73			5.81		
Approach LOS	A			A			A			A		
d_I, Intersection Delay [s/veh]	6.04											
Intersection LOS	A											
Intersection V/C	0.165											

Other Modes

g_Walk,mi, Effective Walk Time [s]	0.0			0.0			0.0			0.0		
M_corner, Corner Circulation Area [ft ² /ped]	0.00			0.00			0.00			0.00		
M_CW, Crosswalk Circulation Area [ft ² /ped]	0.00			0.00			0.00			0.00		
d_p, Pedestrian Delay [s]	0.00			0.00			0.00			0.00		
I_p,int, Pedestrian LOS Score for Intersectio	0.000			0.000			0.000			0.000		
Crosswalk LOS	F			F			F			F		
s_b, Saturation Flow Rate of the bicycle lane	2000			2000			2000			2000		
c_b, Capacity of the bicycle lane [bicycles/h]	3603			3603			3603			3603		
d_b, Bicycle Delay [s]	7.13			7.13			7.13			7.13		
I_b,int, Bicycle LOS Score for Intersection	1.873			1.860			1.951			1.881		
Bicycle LOS	A			A			A			A		

Sequence

Ring 1	-	2	-	4	-	-	-	-	-	-	-	-	-	-	-	-
Ring 2	-	6	-	8	-	-	-	-	-	-	-	-	-	-	-	-
Ring 3	-	-	-	-	-	-	-	-	-	-	-	-	-	-	-	-
Ring 4	-	-	-	-	-	-	-	-	-	-	-	-	-	-	-	-



Intersection Level Of Service Report
Intersection 3: Burgess/School Access

Control Type:	Two-way stop	Delay (sec / veh):	12.3
Analysis Method:	HCM 7th Edition	Level Of Service:	B
Analysis Period:	15 minutes	Volume to Capacity (v/c):	0.030

Intersection Setup

Name	Haven School Access		Burgess Road		Burgess Road	
Approach	Southbound		Eastbound		Westbound	
Lane Configuration	↔		↖		↗	
Turning Movement	Left	Right	Left	Thru	Thru	Right
Lane Width [ft]	12.00	12.00	12.00	12.00	12.00	12.00
No. of Lanes in Entry Pocket	0	0	1	0	0	0
Entry Pocket Length [ft]	100.00	100.00	100.00	100.00	100.00	100.00
No. of Lanes in Exit Pocket	0	0	0	0	0	0
Exit Pocket Length [ft]	0.00	0.00	0.00	0.00	0.00	0.00
Speed [mph]	30.00		30.00		30.00	
Grade [%]	0.00		0.00		0.00	
Crosswalk	No		No		No	

Volumes

Name	Haven School Access		Burgess Road		Burgess Road	
Base Volume Input [veh/h]	0	0	0	113	216	0
Base Volume Adjustment Factor	1.0000	1.0000	1.0000	1.0000	1.0000	1.0000
Heavy Vehicles Percentage [%]	2.00	2.00	2.00	2.00	2.00	2.00
Growth Factor	1.0000	1.0000	1.0000	1.1100	1.1100	1.0000
In-Process Volume [veh/h]	0	0	0	0	0	0
Site-Generated Trips [veh/h]	8	17	13	0	0	6
Diverted Trips [veh/h]	0	0	0	0	0	0
Pass-by Trips [veh/h]	0	0	0	0	0	0
Existing Site Adjustment Volume [veh/h]	0	0	0	0	0	0
Other Volume [veh/h]	0	0	0	0	0	0
Total Hourly Volume [veh/h]	8	17	13	125	240	6
Peak Hour Factor	0.5000	0.5000	0.5000	0.8500	0.8500	0.5000
Other Adjustment Factor	1.0000	1.0000	1.0000	1.0000	1.0000	1.0000
Total 15-Minute Volume [veh/h]	4	9	7	37	71	3
Total Analysis Volume [veh/h]	16	34	26	147	282	12
Pedestrian Volume [ped/h]	0		0		0	

Intersection Settings

Priority Scheme	Stop	Free	Free
Flared Lane	No		
Storage Area [veh]	0	0	0
Two-Stage Gap Acceptance	No		
Number of Storage Spaces in Median	0	0	0

Movement, Approach, & Intersection Results

V/C, Movement V/C Ratio	0.03	0.05	0.02	0.00	0.00	0.00
d_M, Delay for Movement [s/veh]	12.26	10.24	7.90	0.00	0.00	0.00
Movement LOS	B	B	A	A	A	A
95th-Percentile Queue Length [veh/ln]	0.24	0.24	0.06	0.00	0.00	0.00
95th-Percentile Queue Length [ft/ln]	6.11	6.11	1.57	0.00	0.00	0.00
d_A, Approach Delay [s/veh]	10.88		1.19		0.00	
Approach LOS	B		A		A	
d_I, Intersection Delay [s/veh]	1.45					
Intersection LOS	B					

Year 2045 Traffic Volume Scenarios

Haven School TIS

Vistro File: C:\...\AM.vistro

Scenario 4 2045 Back AM

Report File: C:\...\2045 Back AM.pdf

8/24/2023

Intersection Analysis Summary

ID	Intersection Name	Control Type	Method	Worst Mvmt	V/C	Delay (s/veh)	LOS
1	Milam/Burgess	Signalized	HCM 7th Edition	SB Thru	0.727	13.5	B
2	Black Forest/Burgess	Signalized	HCM 7th Edition	WB Left	0.246	7.0	A

V/C, Delay, LOS: For two-way stop, these values are taken from the movement with the worst (highest) delay value. For all other control types, they are taken for the whole intersection.

Intersection Level Of Service Report
Intersection 1: Milam/Burgess

Control Type:	Signalized	Delay (sec / veh):	13.5
Analysis Method:	HCM 7th Edition	Level Of Service:	B
Analysis Period:	15 minutes	Volume to Capacity (v/c):	0.727

Intersection Setup

Name	Milam Road			Milam Road			Private Road			Burgess Road		
Approach	Northbound			Southbound			Eastbound			Westbound		
Lane Configuration												
Turning Movement	Left	Thru	Right	Left	Thru	Right	Left	Thru	Right	Left	Thru	Right
Lane Width [ft]	12.00	12.00	12.00	12.00	12.00	12.00	12.00	12.00	12.00	12.00	12.00	12.00
No. of Lanes in Entry Pocket	0	0	1	0	0	0	0	0	0	0	0	0
Entry Pocket Length [ft]	100.00	100.00	100.00	100.00	100.00	100.00	100.00	100.00	100.00	100.00	100.00	100.00
No. of Lanes in Exit Pocket	0	0	0	0	0	0	0	0	0	0	0	0
Exit Pocket Length [ft]	0.00	0.00	0.00	0.00	0.00	0.00	0.00	0.00	0.00	0.00	0.00	0.00
Speed [mph]	30.00			30.00			30.00			30.00		
Grade [%]	0.00			0.00			0.00			0.00		
Curb Present	No			No			No			No		
Crosswalk	No			No			No			No		

Volumes

Name	Milam Road			Milam Road			Private Road			Burgess Road		
Base Volume Input [veh/h]	0	67	82	31	124	0	0	0	0	189	0	27
Base Volume Adjustment Factor	1.0000	1.0000	1.0000	1.0000	1.0000	1.0000	1.0000	1.0000	1.0000	1.0000	1.0000	1.0000
Heavy Vehicles Percentage [%]	2.00	2.00	2.00	2.00	2.00	2.00	2.00	2.00	2.00	2.00	2.00	2.00
Proportion of CAVs [%]	0.00											
Growth Factor	1.5700	1.5700	1.5700	2.2300	2.2300	2.2300	1.0000	1.0000	1.0000	3.1100	3.1100	3.1100
In-Process Volume [veh/h]	0	0	0	0	0	0	0	0	0	0	0	0
Site-Generated Trips [veh/h]	0	0	0	0	0	0	0	0	0	0	0	0
Diverted Trips [veh/h]	0	0	0	0	0	0	0	0	0	0	0	0
Pass-by Trips [veh/h]	0	0	0	0	0	0	0	0	0	0	0	0
Existing Site Adjustment Volume [veh/h]	0	0	0	0	0	0	0	0	0	0	0	0
Other Volume [veh/h]	0	0	0	0	0	0	0	0	0	0	0	0
Right Turn on Red Volume [veh/h]	0	0	0	0	0	0	0	0	0	0	0	0
Total Hourly Volume [veh/h]	0	105	129	69	277	0	0	0	0	588	0	84
Peak Hour Factor	0.9200	0.9200	0.9200	0.9200	0.9200	0.9200	0.9200	0.9200	0.9200	0.9200	0.9200	0.9200
Other Adjustment Factor	1.0000	1.0000	1.0000	1.0000	1.0000	1.0000	1.0000	1.0000	1.0000	1.0000	1.0000	1.0000
Total 15-Minute Volume [veh/h]	0	29	35	19	75	0	0	0	0	160	0	23
Total Analysis Volume [veh/h]	0	114	140	75	301	0	0	0	0	639	0	91
Presence of On-Street Parking	No		No	No		No	No		No	No		No
On-Street Parking Maneuver Rate [/h]	0	0	0	0	0	0	0	0	0	0	0	0
Local Bus Stopping Rate [/h]	0	0	0	0	0	0	0	0	0	0	0	0
v_do, Outbound Pedestrian Volume crossing	0			0			0			0		
v_di, Inbound Pedestrian Volume crossing m	0			0			0			0		
v_co, Outbound Pedestrian Volume crossing	0			0			0			0		
v_ci, Inbound Pedestrian Volume crossing mi	0			0			0			0		
v_ab, Corner Pedestrian Volume [ped/h]	0			0			0			0		
Bicycle Volume [bicycles/h]	0			0			0			0		

Intersection Settings

Located in CBD	No
Signal Coordination Group	-
Cycle Length [s]	90
Active Pattern	Free Running
Coordination Type	<i>Free Running</i>
Actuation Type	<i>Fully actuated</i>
Offset [s]	0.0
Offset Reference	Lead Green - Beginning of First Green
Permissive Mode	SingleBand
Lost time [s]	0.00

Phasing & Timing

Control Type	Permiss	Permiss	Permiss	Permiss	Permiss	Permiss	Permiss	Permiss	Permiss	Permiss	Permiss	Permiss
Signal Group	0	2	0	0	6	0	0	4	0	0	8	0
Auxiliary Signal Groups												
Lead / Lag	-	-	-	-	-	-	-	-	-	-	-	-
Minimum Green [s]	0	10	0	0	10	0	0	10	0	0	10	0
Maximum Green [s]	0	40	0	0	40	0	0	40	0	0	40	0
Amber [s]	0.0	3.0	0.0	0.0	3.0	0.0	0.0	3.0	0.0	0.0	3.0	0.0
All red [s]	0.0	1.0	0.0	0.0	1.0	0.0	0.0	1.0	0.0	0.0	1.0	0.0
Split [s]	0	14	0	0	14	0	0	14	0	0	14	0
Vehicle Extension [s]	0.0	3.0	0.0	0.0	3.0	0.0	0.0	3.0	0.0	0.0	3.0	0.0
Walk [s]	0	5	0	0	5	0	0	5	0	0	5	0
Pedestrian Clearance [s]	0	10	0	0	10	0	0	10	0	0	10	0
Delayed Vehicle Green [s]	0.0	0.0	0.0	0.0	0.0	0.0	0.0	0.0	0.0	0.0	0.0	0.0
Rest In Walk		No			No			No			No	
I1, Start-Up Lost Time [s]	0.0	2.0	0.0	0.0	2.0	0.0	0.0	2.0	0.0	0.0	2.0	0.0
I2, Clearance Lost Time [s]	0.0	2.0	0.0	0.0	2.0	0.0	0.0	2.0	0.0	0.0	2.0	0.0
Minimum Recall		No			No			No			No	
Maximum Recall		No			No			No			No	
Pedestrian Recall		No			No			No			No	
Detector Location [ft]	0.0	0.0	0.0	0.0	0.0	0.0	0.0	0.0	0.0	0.0	0.0	0.0
Detector Length [ft]	0.0	40.0	0.0	0.0	40.0	0.0	0.0	40.0	0.0	0.0	40.0	0.0
I, Upstream Filtering Factor	1.00	1.00	1.00	1.00	1.00	1.00	1.00	1.00	1.00	1.00	1.00	1.00

Exclusive Pedestrian Phase

Pedestrian Signal Group	0
Pedestrian Walk [s]	0
Pedestrian Clearance [s]	0

Lane Group Calculations

Lane Group	C	R	C	C	C
C, Cycle Length [s]	48	48	48	48	48
L, Total Lost Time per Cycle [s]	4.00	4.00	4.00	4.00	4.00
l1_p, Permitted Start-Up Lost Time [s]	2.00	0.00	2.00	2.00	2.00
l2, Clearance Lost Time [s]	2.00	2.00	2.00	2.00	2.00
g_i, Effective Green Time [s]	13	13	13	26	26
g / C, Green / Cycle	0.28	0.28	0.28	0.55	0.55
(v / s)_i Volume / Saturation Flow Rate	0.06	0.09	0.23	0.00	0.50
s, saturation flow rate [veh/h]	1774	1589	1651	1857	1461
c, Capacity [veh/h]	574	447	555	1100	947
d1, Uniform Delay [s]	13.19	13.59	15.95	0.00	9.41
k, delay calibration	0.11	0.11	0.11	0.11	0.16
l, Upstream Filtering Factor	1.00	1.00	1.00	1.00	1.00
d2, Incremental Delay [s]	0.17	0.40	1.46	0.00	2.05
d3, Initial Queue Delay [s]	0.00	0.00	0.00	0.00	0.00
Rp, platoon ratio	1.00	1.00	1.00	1.00	1.00
PF, progression factor	1.00	1.00	1.00	1.00	1.00

Lane Group Results

X, volume / capacity	0.20	0.31	0.68	0.00	0.77
d, Delay for Lane Group [s/veh]	13.36	13.98	17.41	0.00	11.46
Lane Group LOS	B	B	B	A	B
Critical Lane Group	No	No	Yes	No	Yes
50th-Percentile Queue Length [veh/ln]	0.84	1.07	3.47	0.00	4.92
50th-Percentile Queue Length [ft/ln]	20.90	26.81	86.77	0.00	123.03
95th-Percentile Queue Length [veh/ln]	1.50	1.93	6.25	0.00	8.56
95th-Percentile Queue Length [ft/ln]	37.62	48.26	156.19	0.00	213.99

Movement, Approach, & Intersection Results

d_M, Delay for Movement [s/veh]	13.36	13.36	13.98	17.41	17.41	17.41	0.00	0.00	0.00	11.46	11.46	11.46
Movement LOS	B	B	B	B	B	B	A	A	A	B	B	B
d_A, Approach Delay [s/veh]	13.70			17.41			0.00			11.46		
Approach LOS	B			B			A			B		
d_I, Intersection Delay [s/veh]	13.52											
Intersection LOS	B											
Intersection V/C	0.727											

Other Modes

g_Walk,mi, Effective Walk Time [s]	0.0			0.0			0.0			0.0		
M_corner, Corner Circulation Area [ft ² /ped]	0.00			0.00			0.00			0.00		
M_CW, Crosswalk Circulation Area [ft ² /ped]	0.00			0.00			0.00			0.00		
d_p, Pedestrian Delay [s]	0.00			0.00			0.00			0.00		
I_p,int, Pedestrian LOS Score for Intersectio	0.000			0.000			0.000			0.000		
Crosswalk LOS	F			F			F			F		
s_b, Saturation Flow Rate of the bicycle lane	2000			2000			2000			2000		
c_b, Capacity of the bicycle lane [bicycles/h]	1672			1672			1672			1672		
d_b, Bicycle Delay [s]	0.64			0.64			0.64			0.64		
I_b,int, Bicycle LOS Score for Intersection	1.979			2.180			1.560			2.764		
Bicycle LOS	A			B			A			C		

Sequence

Ring 1	-	2	-	4	-	-	-	-	-	-	-	-	-	-	-	-
Ring 2	-	6	-	8	-	-	-	-	-	-	-	-	-	-	-	-
Ring 3	-	-	-	-	-	-	-	-	-	-	-	-	-	-	-	-
Ring 4	-	-	-	-	-	-	-	-	-	-	-	-	-	-	-	-



**Intersection Level Of Service Report
Intersection 2: Black Forest/Burgess**

Control Type:	Signalized	Delay (sec / veh):	7.0
Analysis Method:	HCM 7th Edition	Level Of Service:	A
Analysis Period:	15 minutes	Volume to Capacity (v/c):	0.246

Intersection Setup

Name	Black Forest Road			Black Forest Road			Burgess Road			Burgess Road		
Approach	Northbound			Southbound			Eastbound			Westbound		
Lane Configuration	↵↵↵			↵↵↵			↵↵↵			↵↵↵		
Turning Movement	Left	Thru	Right	Left	Thru	Right	Left	Thru	Right	Left	Thru	Right
Lane Width [ft]	12.00	12.00	12.00	12.00	12.00	12.00	12.00	12.00	12.00	12.00	12.00	12.00
No. of Lanes in Entry Pocket	1	0	1	1	0	1	1	0	1	1	0	1
Entry Pocket Length [ft]	100.00	100.00	100.00	100.00	100.00	100.00	100.00	100.00	200.00	100.00	100.00	200.00
No. of Lanes in Exit Pocket	0	0	0	0	0	0	0	0	0	0	0	0
Exit Pocket Length [ft]	0.00	0.00	0.00	0.00	0.00	0.00	0.00	0.00	0.00	0.00	0.00	0.00
Speed [mph]	30.00			30.00			30.00			30.00		
Grade [%]	0.00			0.00			0.00			0.00		
Curb Present	No			No			No			No		
Crosswalk	No			No			No			No		

Volumes

Name	Black Forest Road			Black Forest Road			Burgess Road			Burgess Road		
Base Volume Input [veh/h]	37	75	30	20	78	10	13	64	21	29	109	35
Base Volume Adjustment Factor	1.0000	1.0000	1.0000	1.0000	1.0000	1.0000	1.0000	1.0000	1.0000	1.0000	1.0000	1.0000
Heavy Vehicles Percentage [%]	2.00	2.00	2.00	2.00	2.00	2.00	2.00	2.00	2.00	2.00	2.00	2.00
Proportion of CAVs [%]	0.00											
Growth Factor	3.1500	3.1500	3.1500	1.9100	1.9100	1.9100	3.1100	3.1100	3.1100	1.5700	1.5700	1.5700
In-Process Volume [veh/h]	0	0	0	0	0	0	0	0	0	0	0	0
Site-Generated Trips [veh/h]	0	0	0	0	0	0	0	0	0	0	0	0
Diverted Trips [veh/h]	0	0	0	0	0	0	0	0	0	0	0	0
Pass-by Trips [veh/h]	0	0	0	0	0	0	0	0	0	0	0	0
Existing Site Adjustment Volume [veh/h]	0	0	0	0	0	0	0	0	0	0	0	0
Other Volume [veh/h]	0	0	0	0	0	0	0	0	0	0	0	0
Right Turn on Red Volume [veh/h]	0	0	48	0	0	10	0	0	33	0	0	28
Total Hourly Volume [veh/h]	117	236	47	38	149	9	40	199	32	46	171	27
Peak Hour Factor	0.9200	0.9200	0.9200	0.9200	0.9200	0.9200	0.9800	0.9800	0.9800	0.9200	0.9200	0.9200
Other Adjustment Factor	1.0000	1.0000	1.0000	1.0000	1.0000	1.0000	1.0000	1.0000	1.0000	1.0000	1.0000	1.0000
Total 15-Minute Volume [veh/h]	32	64	13	10	40	2	10	51	8	13	46	7
Total Analysis Volume [veh/h]	127	257	51	41	162	10	41	203	33	50	186	29
Presence of On-Street Parking	No		No	No		No	No		No	No		No
On-Street Parking Maneuver Rate [/h]	0	0	0	0	0	0	0	0	0	0	0	0
Local Bus Stopping Rate [/h]	0	0	0	0	0	0	0	0	0	0	0	0
v_do, Outbound Pedestrian Volume crossing	0			0			0			0		
v_di, Inbound Pedestrian Volume crossing m	0			0			0			0		
v_co, Outbound Pedestrian Volume crossing	0			0			0			0		
v_ci, Inbound Pedestrian Volume crossing mi	0			0			0			0		
v_ab, Corner Pedestrian Volume [ped/h]	0			0			0			0		
Bicycle Volume [bicycles/h]	0			0			0			0		

Intersection Settings

Located in CBD	No
Signal Coordination Group	-
Cycle Length [s]	90
Active Pattern	Free Running
Coordination Type	<i>Free Running</i>
Actuation Type	<i>Fully actuated</i>
Offset [s]	0.0
Offset Reference	Lead Green - Beginning of First Green
Permissive Mode	SingleBand
Lost time [s]	0.00

Phasing & Timing

Control Type	Permiss	Permiss	Permiss	Permiss	Permiss	Permiss	Permiss	Permiss	Permiss	Permiss	Permiss	Permiss
Signal Group	0	2	0	0	6	0	0	4	0	0	8	0
Auxiliary Signal Groups												
Lead / Lag	-	-	-	-	-	-	-	-	-	-	-	-
Minimum Green [s]	0	10	0	0	10	0	0	10	0	0	10	0
Maximum Green [s]	0	40	0	0	40	0	0	40	0	0	40	0
Amber [s]	0.0	3.0	0.0	0.0	3.0	0.0	0.0	3.0	0.0	0.0	3.0	0.0
All red [s]	0.0	1.0	0.0	0.0	1.0	0.0	0.0	1.0	0.0	0.0	1.0	0.0
Split [s]	0	14	0	0	14	0	0	14	0	0	14	0
Vehicle Extension [s]	0.0	3.0	0.0	0.0	3.0	0.0	0.0	3.0	0.0	0.0	3.0	0.0
Walk [s]	0	5	0	0	5	0	0	5	0	0	5	0
Pedestrian Clearance [s]	0	10	0	0	10	0	0	10	0	0	10	0
Delayed Vehicle Green [s]	0.0	0.0	0.0	0.0	0.0	0.0	0.0	0.0	0.0	0.0	0.0	0.0
Rest In Walk		No			No			No			No	
I1, Start-Up Lost Time [s]	0.0	2.0	0.0	0.0	2.0	0.0	0.0	2.0	0.0	0.0	2.0	0.0
I2, Clearance Lost Time [s]	0.0	2.0	0.0	0.0	2.0	0.0	0.0	2.0	0.0	0.0	2.0	0.0
Minimum Recall		No			No			No			No	
Maximum Recall		No			No			No			No	
Pedestrian Recall		No			No			No			No	
Detector Location [ft]	0.0	0.0	0.0	0.0	0.0	0.0	0.0	0.0	0.0	0.0	0.0	0.0
Detector Length [ft]	0.0	40.0	0.0	0.0	40.0	0.0	0.0	40.0	0.0	0.0	40.0	0.0
I, Upstream Filtering Factor	1.00	1.00	1.00	1.00	1.00	1.00	1.00	1.00	1.00	1.00	1.00	1.00

Exclusive Pedestrian Phase

Pedestrian Signal Group	0
Pedestrian Walk [s]	0
Pedestrian Clearance [s]	0

Lane Group Calculations

Lane Group	L	C	R	L	C	R	L	C	R	L	C	R
C, Cycle Length [s]	26	26	26	26	26	26	26	26	26	26	26	26
L, Total Lost Time per Cycle [s]	4.00	4.00	4.00	4.00	4.00	4.00	4.00	4.00	4.00	4.00	4.00	4.00
l1_p, Permitted Start-Up Lost Time [s]	2.00	0.00	0.00	2.00	0.00	0.00	2.00	0.00	0.00	2.00	0.00	0.00
l2, Clearance Lost Time [s]	2.00	2.00	2.00	2.00	2.00	2.00	2.00	2.00	2.00	2.00	2.00	2.00
g_i, Effective Green Time [s]	10	10	10	10	10	10	9	9	9	9	9	9
g / C, Green / Cycle	0.37	0.37	0.37	0.37	0.37	0.37	0.33	0.33	0.33	0.33	0.33	0.33
(v / s)_i Volume / Saturation Flow Rate	0.10	0.14	0.03	0.04	0.09	0.01	0.04	0.11	0.02	0.04	0.10	0.02
s, saturation flow rate [veh/h]	1213	1870	1589	1071	1870	1589	1166	1870	1589	1144	1870	1589
c, Capacity [veh/h]	562	683	581	482	683	581	500	624	531	487	624	531
d1, Uniform Delay [s]	8.58	6.21	5.53	8.90	5.86	5.39	8.89	6.62	6.03	9.14	6.55	6.01
k, delay calibration	0.11	0.11	0.11	0.11	0.11	0.11	0.11	0.11	0.11	0.11	0.11	0.11
l, Upstream Filtering Factor	1.00	1.00	1.00	1.00	1.00	1.00	1.00	1.00	1.00	1.00	1.00	1.00
d2, Incremental Delay [s]	0.20	0.34	0.06	0.07	0.18	0.01	0.07	0.30	0.05	0.09	0.26	0.04
d3, Initial Queue Delay [s]	0.00	0.00	0.00	0.00	0.00	0.00	0.00	0.00	0.00	0.00	0.00	0.00
Rp, platoon ratio	1.00	1.00	1.00	1.00	1.00	1.00	1.00	1.00	1.00	1.00	1.00	1.00
PF, progression factor	1.00	1.00	1.00	1.00	1.00	1.00	1.00	1.00	1.00	1.00	1.00	1.00

Lane Group Results

X, volume / capacity	0.23	0.38	0.09	0.09	0.24	0.02	0.08	0.33	0.06	0.10	0.30	0.05
d, Delay for Lane Group [s/veh]	8.78	6.55	5.60	8.98	6.04	5.40	8.96	6.92	6.07	9.23	6.82	6.05
Lane Group LOS	A	A	A	A	A	A	A	A	A	A	A	A
Critical Lane Group	No	Yes	No	No	No	No	No	Yes	No	No	No	No
50th-Percentile Queue Length [veh/ln]	0.42	0.60	0.10	0.14	0.35	0.02	0.14	0.51	0.08	0.17	0.46	0.07
50th-Percentile Queue Length [ft/ln]	10.39	14.89	2.61	3.47	8.73	0.50	3.46	12.80	1.88	4.35	11.58	1.65
95th-Percentile Queue Length [veh/ln]	0.75	1.07	0.19	0.25	0.63	0.04	0.25	0.92	0.14	0.31	0.83	0.12
95th-Percentile Queue Length [ft/ln]	18.70	26.80	4.69	6.25	15.72	0.89	6.23	23.05	3.39	7.82	20.84	2.97

Movement, Approach, & Intersection Results

d_M, Delay for Movement [s/veh]	8.78	6.55	5.60	8.98	6.04	5.40	8.96	6.92	6.07	9.23	6.82	6.05
Movement LOS	A	A	A	A	A	A	A	A	A	A	A	A
d_A, Approach Delay [s/veh]	7.09			6.58			7.12			7.19		
Approach LOS	A			A			A			A		
d_I, Intersection Delay [s/veh]	7.03											
Intersection LOS	A											
Intersection V/C	0.246											

Other Modes

g_Walk,mi, Effective Walk Time [s]	0.0			0.0			0.0			0.0		
M_corner, Corner Circulation Area [ft ² /ped]	0.00			0.00			0.00			0.00		
M_CW, Crosswalk Circulation Area [ft ² /ped]	0.00			0.00			0.00			0.00		
d_p, Pedestrian Delay [s]	0.00			0.00			0.00			0.00		
I_p,int, Pedestrian LOS Score for Intersectio	0.000			0.000			0.000			0.000		
Crosswalk LOS	F			F			F			F		
s_b, Saturation Flow Rate of the bicycle lane	2000			2000			2000			2000		
c_b, Capacity of the bicycle lane [bicycles/h]	3025			3025			3025			3025		
d_b, Bicycle Delay [s]	3.47			3.47			3.47			3.47		
I_b,int, Bicycle LOS Score for Intersection	2.357			1.928			2.071			2.043		
Bicycle LOS	B			A			B			B		

Sequence

Ring 1	-	2	-	4	-	-	-	-	-	-	-	-	-	-	-	-
Ring 2	-	6	-	8	-	-	-	-	-	-	-	-	-	-	-	-
Ring 3	-	-	-	-	-	-	-	-	-	-	-	-	-	-	-	-
Ring 4	-	-	-	-	-	-	-	-	-	-	-	-	-	-	-	-



Haven School TIS

Vistro File: C:\...\pm.vistro

Scenario 4 2045 Back PM

Report File: C:\...\2045 Back PM.pdf

8/24/2023

Intersection Analysis Summary

ID	Intersection Name	Control Type	Method	Worst Mvmt	V/C	Delay (s/veh)	LOS
1	Milam/Burgess	Signalized	HCM 7th Edition	WB Left	0.497	7.9	A
2	Black Forest/Burgess	Signalized	HCM 7th Edition	WB Left	0.442	8.1	A

V/C, Delay, LOS: For two-way stop, these values are taken from the movement with the worst (highest) delay value. For all other control types, they are taken for the whole intersection.

Intersection Level Of Service Report
Intersection 1: Milam/Burgess

Control Type:	Signalized	Delay (sec / veh):	7.9
Analysis Method:	HCM 7th Edition	Level Of Service:	A
Analysis Period:	15 minutes	Volume to Capacity (v/c):	0.497

Intersection Setup

Name	Milam Road			Milam Road			Private Road			Burgess Road		
Approach	Northbound			Southbound			Eastbound			Westbound		
Lane Configuration												
Turning Movement	Left	Thru	Right	Left	Thru	Right	Left	Thru	Right	Left	Thru	Right
Lane Width [ft]	12.00	12.00	12.00	12.00	12.00	12.00	12.00	12.00	12.00	12.00	12.00	12.00
No. of Lanes in Entry Pocket	0	0	1	0	0	0	0	0	0	0	0	0
Entry Pocket Length [ft]	100.00	100.00	100.00	100.00	100.00	100.00	100.00	100.00	100.00	100.00	100.00	100.00
No. of Lanes in Exit Pocket	0	0	0	0	0	0	0	0	0	0	0	0
Exit Pocket Length [ft]	0.00	0.00	0.00	0.00	0.00	0.00	0.00	0.00	0.00	0.00	0.00	0.00
Speed [mph]	30.00			30.00			30.00			30.00		
Grade [%]	0.00			0.00			0.00			0.00		
Curb Present	No			No			No			No		
Crosswalk	No			No			No			No		

Volumes

Name	Milam Road			Milam Road			Private Road			Burgess Road		
Base Volume Input [veh/h]	0	130	146	22	119	0	0	0	0	105	0	23
Base Volume Adjustment Factor	1.0000	1.0000	1.0000	1.0000	1.0000	1.0000	1.0000	1.0000	1.0000	1.0000	1.0000	1.0000
Heavy Vehicles Percentage [%]	2.00	2.00	2.00	2.00	2.00	2.00	2.00	2.00	2.00	2.00	2.00	2.00
Proportion of CAVs [%]	0.00											
Growth Factor	1.5700	1.5700	1.5700	2.2300	2.2300	2.2300	1.0000	1.0000	1.0000	3.1100	3.1100	3.1100
In-Process Volume [veh/h]	0	0	0	0	0	0	0	0	0	0	0	0
Site-Generated Trips [veh/h]	0	0	0	0	0	0	0	0	0	0	0	0
Diverted Trips [veh/h]	0	0	0	0	0	0	0	0	0	0	0	0
Pass-by Trips [veh/h]	0	0	0	0	0	0	0	0	0	0	0	0
Existing Site Adjustment Volume [veh/h]	0	0	0	0	0	0	0	0	0	0	0	0
Other Volume [veh/h]	0	0	0	0	0	0	0	0	0	0	0	0
Right Turn on Red Volume [veh/h]	0	0	0	0	0	0	0	0	0	0	0	0
Total Hourly Volume [veh/h]	0	204	229	49	265	0	0	0	0	327	0	72
Peak Hour Factor	0.9200	0.9200	0.9200	0.9200	0.9200	0.9200	0.9200	0.9200	0.9200	0.9200	0.9200	0.9200
Other Adjustment Factor	1.0000	1.0000	1.0000	1.0000	1.0000	1.0000	1.0000	1.0000	1.0000	1.0000	1.0000	1.0000
Total 15-Minute Volume [veh/h]	0	55	62	13	72	0	0	0	0	89	0	20
Total Analysis Volume [veh/h]	0	222	249	53	288	0	0	0	0	355	0	78
Presence of On-Street Parking	No		No	No		No	No		No	No		No
On-Street Parking Maneuver Rate [/h]	0	0	0	0	0	0	0	0	0	0	0	0
Local Bus Stopping Rate [/h]	0	0	0	0	0	0	0	0	0	0	0	0
v_do, Outbound Pedestrian Volume crossing	0			0			0			0		
v_di, Inbound Pedestrian Volume crossing m	0			0			0			0		
v_co, Outbound Pedestrian Volume crossing	0			0			0			0		
v_ci, Inbound Pedestrian Volume crossing mi	0			0			0			0		
v_ab, Corner Pedestrian Volume [ped/h]	0			0			0			0		
Bicycle Volume [bicycles/h]	0			0			0			0		

Intersection Settings

Located in CBD	No
Signal Coordination Group	-
Cycle Length [s]	90
Active Pattern	Free Running
Coordination Type	<i>Free Running</i>
Actuation Type	<i>Fully actuated</i>
Offset [s]	0.0
Offset Reference	Lead Green - Beginning of First Green
Permissive Mode	SingleBand
Lost time [s]	0.00

Phasing & Timing

Control Type	Permiss	Permiss	Permiss	Permiss	Permiss	Permiss	Permiss	Permiss	Permiss	Permiss	Permiss	Permiss
Signal Group	0	2	0	0	6	0	0	4	0	0	8	0
Auxiliary Signal Groups												
Lead / Lag	-	-	-	-	-	-	-	-	-	-	-	-
Minimum Green [s]	0	10	0	0	10	0	0	10	0	0	10	0
Maximum Green [s]	0	40	0	0	40	0	0	40	0	0	40	0
Amber [s]	0.0	3.0	0.0	0.0	3.0	0.0	0.0	3.0	0.0	0.0	3.0	0.0
All red [s]	0.0	1.0	0.0	0.0	1.0	0.0	0.0	1.0	0.0	0.0	1.0	0.0
Split [s]	0	14	0	0	14	0	0	14	0	0	14	0
Vehicle Extension [s]	0.0	3.0	0.0	0.0	3.0	0.0	0.0	3.0	0.0	0.0	3.0	0.0
Walk [s]	0	5	0	0	5	0	0	5	0	0	5	0
Pedestrian Clearance [s]	0	10	0	0	10	0	0	10	0	0	10	0
Delayed Vehicle Green [s]	0.0	0.0	0.0	0.0	0.0	0.0	0.0	0.0	0.0	0.0	0.0	0.0
Rest In Walk		No			No			No			No	
I1, Start-Up Lost Time [s]	0.0	2.0	0.0	0.0	2.0	0.0	0.0	2.0	0.0	0.0	2.0	0.0
I2, Clearance Lost Time [s]	0.0	2.0	0.0	0.0	2.0	0.0	0.0	2.0	0.0	0.0	2.0	0.0
Minimum Recall		No			No			No			No	
Maximum Recall		No			No			No			No	
Pedestrian Recall		No			No			No			No	
Detector Location [ft]	0.0	0.0	0.0	0.0	0.0	0.0	0.0	0.0	0.0	0.0	0.0	0.0
Detector Length [ft]	0.0	40.0	0.0	0.0	40.0	0.0	0.0	40.0	0.0	0.0	40.0	0.0
I, Upstream Filtering Factor	1.00	1.00	1.00	1.00	1.00	1.00	1.00	1.00	1.00	1.00	1.00	1.00

Exclusive Pedestrian Phase

Pedestrian Signal Group	0
Pedestrian Walk [s]	0
Pedestrian Clearance [s]	0

Lane Group Calculations

Lane Group	C	R	C	C	C
C, Cycle Length [s]	28	28	28	28	28
L, Total Lost Time per Cycle [s]	4.00	4.00	4.00	4.00	4.00
l1_p, Permitted Start-Up Lost Time [s]	2.00	0.00	2.00	2.00	2.00
l2, Clearance Lost Time [s]	2.00	2.00	2.00	2.00	2.00
g_i, Effective Green Time [s]	10	10	10	10	10
g / C, Green / Cycle	0.35	0.35	0.35	0.37	0.37
(v / s)_i Volume / Saturation Flow Rate	0.12	0.16	0.21	0.00	0.29
s, saturation flow rate [veh/h]	1870	1589	1629	1796	1504
c, Capacity [veh/h]	774	550	711	794	790
d1, Uniform Delay [s]	6.86	7.17	7.42	0.00	7.66
k, delay calibration	0.11	0.11	0.11	0.11	0.11
l, Upstream Filtering Factor	1.00	1.00	1.00	1.00	1.00
d2, Incremental Delay [s]	0.20	0.58	0.50	0.00	0.60
d3, Initial Queue Delay [s]	0.00	0.00	0.00	0.00	0.00
Rp, platoon ratio	1.00	1.00	1.00	1.00	1.00
PF, progression factor	1.00	1.00	1.00	1.00	1.00

Lane Group Results

X, volume / capacity	0.29	0.45	0.48	0.00	0.55
d, Delay for Lane Group [s/veh]	7.06	7.75	7.92	0.00	8.26
Lane Group LOS	A	A	A	A	A
Critical Lane Group	No	No	Yes	No	Yes
50th-Percentile Queue Length [veh/ln]	0.60	0.75	1.03	0.00	1.33
50th-Percentile Queue Length [ft/ln]	15.09	18.64	25.67	0.00	33.14
95th-Percentile Queue Length [veh/ln]	1.09	1.34	1.85	0.00	2.39
95th-Percentile Queue Length [ft/ln]	27.16	33.56	46.21	0.00	59.64

Movement, Approach, & Intersection Results

d_M, Delay for Movement [s/veh]	7.06	7.06	7.75	7.92	7.92	7.92	0.00	0.00	0.00	8.26	8.26	8.26
Movement LOS	A	A	A	A	A	A	A	A	A	A	A	A
d_A, Approach Delay [s/veh]	7.43			7.92			0.00			8.26		
Approach LOS	A			A			A			A		
d_I, Intersection Delay [s/veh]	7.85											
Intersection LOS	A											
Intersection V/C	0.497											

Other Modes

g_Walk,mi, Effective Walk Time [s]	0.0			0.0			0.0			0.0		
M_corner, Corner Circulation Area [ft ² /ped]	0.00			0.00			0.00			0.00		
M_CW, Crosswalk Circulation Area [ft ² /ped]	0.00			0.00			0.00			0.00		
d_p, Pedestrian Delay [s]	0.00			0.00			0.00			0.00		
I_p,int, Pedestrian LOS Score for Intersectio	0.000			0.000			0.000			0.000		
Crosswalk LOS	F			F			F			F		
s_b, Saturation Flow Rate of the bicycle lane	2000			2000			2000			2000		
c_b, Capacity of the bicycle lane [bicycles/h]	2842			2842			2842			2842		
d_b, Bicycle Delay [s]	2.49			2.49			2.49			2.49		
I_b,int, Bicycle LOS Score for Intersection	2.337			2.122			1.560			2.274		
Bicycle LOS	B			B			A			B		

Sequence

Ring 1	-	2	-	4	-	-	-	-	-	-	-	-	-	-	-	-
Ring 2	-	6	-	8	-	-	-	-	-	-	-	-	-	-	-	-
Ring 3	-	-	-	-	-	-	-	-	-	-	-	-	-	-	-	-
Ring 4	-	-	-	-	-	-	-	-	-	-	-	-	-	-	-	-



**Intersection Level Of Service Report
Intersection 2: Black Forest/Burgess**

Control Type:	Signalized	Delay (sec / veh):	8.1
Analysis Method:	HCM 7th Edition	Level Of Service:	A
Analysis Period:	15 minutes	Volume to Capacity (v/c):	0.442

Intersection Setup

Name	Black Forest Road			Black Forest Road			Burgess Road			Burgess Road		
Approach	Northbound			Southbound			Eastbound			Westbound		
Lane Configuration	↵↵↵			↵↵↵			↵↵↵			↵↵↵		
Turning Movement	Left	Thru	Right	Left	Thru	Right	Left	Thru	Right	Left	Thru	Right
Lane Width [ft]	12.00	12.00	12.00	12.00	12.00	12.00	12.00	12.00	12.00	12.00	12.00	12.00
No. of Lanes in Entry Pocket	1	0	1	1	0	1	1	0	1	1	0	1
Entry Pocket Length [ft]	100.00	100.00	100.00	100.00	100.00	100.00	100.00	100.00	200.00	100.00	100.00	200.00
No. of Lanes in Exit Pocket	0	0	0	0	0	0	0	0	0	0	0	0
Exit Pocket Length [ft]	0.00	0.00	0.00	0.00	0.00	0.00	0.00	0.00	0.00	0.00	0.00	0.00
Speed [mph]	30.00			30.00			30.00			30.00		
Grade [%]	0.00			0.00			0.00			0.00		
Curb Present	No			No			No			No		
Crosswalk	No			No			No			No		

Volumes

Name	Black Forest Road			Black Forest Road			Burgess Road			Burgess Road		
Base Volume Input [veh/h]	20	106	25	28	105	14	16	137	27	23	77	25
Base Volume Adjustment Factor	1.0000	1.0000	1.0000	1.0000	1.0000	1.0000	1.0000	1.0000	1.0000	1.0000	1.0000	1.0000
Heavy Vehicles Percentage [%]	2.00	2.00	2.00	2.00	2.00	2.00	2.00	2.00	2.00	2.00	2.00	2.00
Proportion of CAVs [%]	0.00											
Growth Factor	3.1500	3.1500	3.1500	1.9100	1.9100	1.9100	3.1100	3.1100	3.1100	1.5700	1.5700	1.5700
In-Process Volume [veh/h]	0	0	0	0	0	0	0	0	0	0	0	0
Site-Generated Trips [veh/h]	0	0	0	0	0	0	0	0	0	0	0	0
Diverted Trips [veh/h]	0	0	0	0	0	0	0	0	0	0	0	0
Pass-by Trips [veh/h]	0	0	0	0	0	0	0	0	0	0	0	0
Existing Site Adjustment Volume [veh/h]	0	0	0	0	0	0	0	0	0	0	0	0
Other Volume [veh/h]	0	0	0	0	0	0	0	0	0	0	0	0
Right Turn on Red Volume [veh/h]	0	0	40	0	0	14	0	0	42	0	0	20
Total Hourly Volume [veh/h]	63	334	39	53	201	13	50	426	42	36	121	19
Peak Hour Factor	0.9200	0.9200	0.9200	0.9200	0.9200	0.9200	0.9200	0.9200	0.9200	0.9200	0.9200	0.9200
Other Adjustment Factor	1.0000	1.0000	1.0000	1.0000	1.0000	1.0000	1.0000	1.0000	1.0000	1.0000	1.0000	1.0000
Total 15-Minute Volume [veh/h]	17	91	11	14	55	4	14	116	11	10	33	5
Total Analysis Volume [veh/h]	68	363	42	58	218	14	54	463	46	39	132	21
Presence of On-Street Parking	No		No	No		No	No		No	No		No
On-Street Parking Maneuver Rate [/h]	0	0	0	0	0	0	0	0	0	0	0	0
Local Bus Stopping Rate [/h]	0	0	0	0	0	0	0	0	0	0	0	0
v_do, Outbound Pedestrian Volume crossing	0			0			0			0		
v_di, Inbound Pedestrian Volume crossing m	0			0			0			0		
v_co, Outbound Pedestrian Volume crossing	0			0			0			0		
v_ci, Inbound Pedestrian Volume crossing mi	0			0			0			0		
v_ab, Corner Pedestrian Volume [ped/h]	0			0			0			0		
Bicycle Volume [bicycles/h]	0			0			0			0		

Intersection Settings

Located in CBD	No
Signal Coordination Group	-
Cycle Length [s]	90
Active Pattern	Free Running
Coordination Type	<i>Free Running</i>
Actuation Type	<i>Fully actuated</i>
Offset [s]	0.0
Offset Reference	Lead Green - Beginning of First Green
Permissive Mode	SingleBand
Lost time [s]	0.00

Phasing & Timing

Control Type	Permiss	Permiss	Permiss	Permiss	Permiss	Permiss	Permiss	Permiss	Permiss	Permiss	Permiss	Permiss
Signal Group	0	2	0	0	6	0	0	4	0	0	8	0
Auxiliary Signal Groups												
Lead / Lag	-	-	-	-	-	-	-	-	-	-	-	-
Minimum Green [s]	0	10	0	0	10	0	0	10	0	0	10	0
Maximum Green [s]	0	40	0	0	40	0	0	40	0	0	40	0
Amber [s]	0.0	3.0	0.0	0.0	3.0	0.0	0.0	3.0	0.0	0.0	3.0	0.0
All red [s]	0.0	1.0	0.0	0.0	1.0	0.0	0.0	1.0	0.0	0.0	1.0	0.0
Split [s]	0	14	0	0	14	0	0	14	0	0	14	0
Vehicle Extension [s]	0.0	3.0	0.0	0.0	3.0	0.0	0.0	3.0	0.0	0.0	3.0	0.0
Walk [s]	0	5	0	0	5	0	0	5	0	0	5	0
Pedestrian Clearance [s]	0	10	0	0	10	0	0	10	0	0	10	0
Delayed Vehicle Green [s]	0.0	0.0	0.0	0.0	0.0	0.0	0.0	0.0	0.0	0.0	0.0	0.0
Rest In Walk		No			No			No			No	
I1, Start-Up Lost Time [s]	0.0	2.0	0.0	0.0	2.0	0.0	0.0	2.0	0.0	0.0	2.0	0.0
I2, Clearance Lost Time [s]	0.0	2.0	0.0	0.0	2.0	0.0	0.0	2.0	0.0	0.0	2.0	0.0
Minimum Recall		No			No			No			No	
Maximum Recall		No			No			No			No	
Pedestrian Recall		No			No			No			No	
Detector Location [ft]	0.0	0.0	0.0	0.0	0.0	0.0	0.0	0.0	0.0	0.0	0.0	0.0
Detector Length [ft]	0.0	40.0	0.0	0.0	40.0	0.0	0.0	40.0	0.0	0.0	40.0	0.0
I, Upstream Filtering Factor	1.00	1.00	1.00	1.00	1.00	1.00	1.00	1.00	1.00	1.00	1.00	1.00

Exclusive Pedestrian Phase

Pedestrian Signal Group	0
Pedestrian Walk [s]	0
Pedestrian Clearance [s]	0

Lane Group Calculations

Lane Group	L	C	R	L	C	R	L	C	R	L	C	R
C, Cycle Length [s]	28	28	28	28	28	28	28	28	28	28	28	28
L, Total Lost Time per Cycle [s]	4.00	4.00	4.00	4.00	4.00	4.00	4.00	4.00	4.00	4.00	4.00	4.00
l1_p, Permitted Start-Up Lost Time [s]	2.00	0.00	0.00	2.00	0.00	0.00	2.00	0.00	0.00	2.00	0.00	0.00
l2, Clearance Lost Time [s]	2.00	2.00	2.00	2.00	2.00	2.00	2.00	2.00	2.00	2.00	2.00	2.00
g_i, Effective Green Time [s]	10	10	10	10	10	10	10	10	10	10	10	10
g / C, Green / Cycle	0.35	0.35	0.35	0.35	0.35	0.35	0.36	0.36	0.36	0.36	0.36	0.36
(v / s)_i Volume / Saturation Flow Rate	0.06	0.19	0.03	0.06	0.12	0.01	0.04	0.25	0.03	0.04	0.07	0.01
s, saturation flow rate [veh/h]	1148	1870	1589	980	1870	1589	1234	1870	1589	890	1870	1589
c, Capacity [veh/h]	486	662	563	381	662	563	566	676	575	334	676	575
d1, Uniform Delay [s]	9.56	7.29	6.03	11.38	6.65	5.92	8.24	7.62	5.91	12.26	6.17	5.81
k, delay calibration	0.11	0.11	0.11	0.11	0.11	0.11	0.11	0.11	0.11	0.11	0.11	0.11
l, Upstream Filtering Factor	1.00	1.00	1.00	1.00	1.00	1.00	1.00	1.00	1.00	1.00	1.00	1.00
d2, Incremental Delay [s]	0.13	0.71	0.06	0.18	0.29	0.02	0.07	1.24	0.06	0.15	0.14	0.03
d3, Initial Queue Delay [s]	0.00	0.00	0.00	0.00	0.00	0.00	0.00	0.00	0.00	0.00	0.00	0.00
Rp, platoon ratio	1.00	1.00	1.00	1.00	1.00	1.00	1.00	1.00	1.00	1.00	1.00	1.00
PF, progression factor	1.00	1.00	1.00	1.00	1.00	1.00	1.00	1.00	1.00	1.00	1.00	1.00

Lane Group Results

X, volume / capacity	0.14	0.55	0.07	0.15	0.33	0.02	0.10	0.68	0.08	0.12	0.20	0.04
d, Delay for Lane Group [s/veh]	9.69	8.00	6.09	11.56	6.93	5.94	8.31	8.86	5.97	12.41	6.31	5.84
Lane Group LOS	A	A	A	B	A	A	A	A	A	B	A	A
Critical Lane Group	No	Yes	No	No	No	No	No	Yes	No	No	No	No
50th-Percentile Queue Length [veh/ln]	0.26	1.10	0.10	0.26	0.58	0.03	0.18	1.53	0.11	0.19	0.32	0.05
50th-Percentile Queue Length [ft/ln]	6.49	27.47	2.54	6.52	14.59	0.83	4.46	38.13	2.72	4.69	8.11	1.22
95th-Percentile Queue Length [veh/ln]	0.47	1.98	0.18	0.47	1.05	0.06	0.32	2.75	0.20	0.34	0.58	0.09
95th-Percentile Queue Length [ft/ln]	11.69	49.45	4.57	11.74	26.26	1.49	8.03	68.63	4.90	8.43	14.60	2.20

Movement, Approach, & Intersection Results

d_M, Delay for Movement [s/veh]	9.69	8.00	6.09	11.56	6.93	5.94	8.31	8.86	5.97	12.41	6.31	5.84
Movement LOS	A	A	A	B	A	A	A	A	A	B	A	A
d_A, Approach Delay [s/veh]	8.07			7.81			8.57			7.50		
Approach LOS	A			A			A			A		
d_I, Intersection Delay [s/veh]	8.14											
Intersection LOS	A											
Intersection V/C	0.442											

Other Modes

g_Walk,mi, Effective Walk Time [s]	0.0			0.0			0.0			0.0		
M_corner, Corner Circulation Area [ft ² /ped]	0.00			0.00			0.00			0.00		
M_CW, Crosswalk Circulation Area [ft ² /ped]	0.00			0.00			0.00			0.00		
d_p, Pedestrian Delay [s]	0.00			0.00			0.00			0.00		
I_p,int, Pedestrian LOS Score for Intersectio	0.000			0.000			0.000			0.000		
Crosswalk LOS	F			F			F			F		
s_b, Saturation Flow Rate of the bicycle lane	2000			2000			2000			2000		
c_b, Capacity of the bicycle lane [bicycles/h]	2850			2850			2850			2850		
d_b, Bicycle Delay [s]	2.54			2.54			2.54			2.54		
I_b,int, Bicycle LOS Score for Intersection	2.406			2.061			2.558			1.909		
Bicycle LOS	B			B			B			A		

Sequence

Ring 1	-	2	-	4	-	-	-	-	-	-	-	-	-	-	-	-
Ring 2	-	6	-	8	-	-	-	-	-	-	-	-	-	-	-	-
Ring 3	-	-	-	-	-	-	-	-	-	-	-	-	-	-	-	-
Ring 4	-	-	-	-	-	-	-	-	-	-	-	-	-	-	-	-



Haven School TIS

Vistro File: C:\...\AM.vistro

Scenario 5 2045 Total AM

Report File: C:\...\2045 Total AM.pdf

8/24/2023

Intersection Analysis Summary

ID	Intersection Name	Control Type	Method	Worst Mvmt	V/C	Delay (s/veh)	LOS
1	Milam/Burgess	Signalized	HCM 7th Edition	SB Thru	0.746	14.8	B
2	Black Forest/Burgess	Signalized	HCM 7th Edition	WB Left	0.247	7.1	A
3	Burgess/School Access	Two-way stop	HCM 7th Edition	SB Left	0.078	27.5	D

V/C, Delay, LOS: For two-way stop, these values are taken from the movement with the worst (highest) delay value. For all other control types, they are taken for the whole intersection.

Intersection Level Of Service Report
Intersection 1: Milam/Burgess

Control Type:	Signalized	Delay (sec / veh):	14.8
Analysis Method:	HCM 7th Edition	Level Of Service:	B
Analysis Period:	15 minutes	Volume to Capacity (v/c):	0.746

Intersection Setup

Name	Milam Road			Milam Road			Private Road			Burgess Road		
Approach	Northbound			Southbound			Eastbound			Westbound		
Lane Configuration												
Turning Movement	Left	Thru	Right	Left	Thru	Right	Left	Thru	Right	Left	Thru	Right
Lane Width [ft]	12.00	12.00	12.00	12.00	12.00	12.00	12.00	12.00	12.00	12.00	12.00	12.00
No. of Lanes in Entry Pocket	0	0	1	0	0	0	0	0	0	0	0	0
Entry Pocket Length [ft]	100.00	100.00	100.00	100.00	100.00	100.00	100.00	100.00	100.00	100.00	100.00	100.00
No. of Lanes in Exit Pocket	0	0	0	0	0	0	0	0	0	0	0	0
Exit Pocket Length [ft]	0.00	0.00	0.00	0.00	0.00	0.00	0.00	0.00	0.00	0.00	0.00	0.00
Speed [mph]	30.00			30.00			30.00			30.00		
Grade [%]	0.00			0.00			0.00			0.00		
Curb Present	No			No			No			No		
Crosswalk	No			No			No			No		

Volumes

Name	Milam Road			Milam Road			Private Road			Burgess Road		
Base Volume Input [veh/h]	0	67	82	31	124	0	0	0	0	189	0	27
Base Volume Adjustment Factor	1.0000	1.0000	1.0000	1.0000	1.0000	1.0000	1.0000	1.0000	1.0000	1.0000	1.0000	1.0000
Heavy Vehicles Percentage [%]	2.00	2.00	2.00	2.00	2.00	2.00	2.00	2.00	2.00	2.00	2.00	2.00
Proportion of CAVs [%]	0.00											
Growth Factor	1.5700	1.5700	1.5700	2.2300	2.2300	2.2300	1.0000	1.0000	1.0000	3.1100	3.1100	3.1100
In-Process Volume [veh/h]	0	0	0	0	0	0	0	0	0	0	0	0
Site-Generated Trips [veh/h]	0	0	24	4	0	0	0	0	0	15	0	2
Diverted Trips [veh/h]	0	0	0	0	0	0	0	0	0	0	0	0
Pass-by Trips [veh/h]	0	0	0	0	0	0	0	0	0	0	0	0
Existing Site Adjustment Volume [veh/h]	0	0	0	0	0	0	0	0	0	0	0	0
Other Volume [veh/h]	0	0	0	0	0	0	0	0	0	0	0	0
Right Turn on Red Volume [veh/h]	0	0	0	0	0	0	0	0	0	0	0	0
Total Hourly Volume [veh/h]	0	105	153	73	277	0	0	0	0	603	0	86
Peak Hour Factor	0.9200	0.9200	0.9200	0.9200	0.9200	0.9200	0.9200	0.9200	0.9200	0.9200	0.9200	0.9200
Other Adjustment Factor	1.0000	1.0000	1.0000	1.0000	1.0000	1.0000	1.0000	1.0000	1.0000	1.0000	1.0000	1.0000
Total 15-Minute Volume [veh/h]	0	29	42	20	75	0	0	0	0	164	0	23
Total Analysis Volume [veh/h]	0	114	166	79	301	0	0	0	0	655	0	93
Presence of On-Street Parking	No		No	No		No	No		No	No		No
On-Street Parking Maneuver Rate [/h]	0	0	0	0	0	0	0	0	0	0	0	0
Local Bus Stopping Rate [/h]	0	0	0	0	0	0	0	0	0	0	0	0
v_do, Outbound Pedestrian Volume crossing	0			0			0			0		
v_di, Inbound Pedestrian Volume crossing m	0			0			0			0		
v_co, Outbound Pedestrian Volume crossing	0			0			0			0		
v_ci, Inbound Pedestrian Volume crossing mi	0			0			0			0		
v_ab, Corner Pedestrian Volume [ped/h]	0			0			0			0		
Bicycle Volume [bicycles/h]	0			0			0			0		

Intersection Settings

Located in CBD	No
Signal Coordination Group	-
Cycle Length [s]	90
Active Pattern	Free Running
Coordination Type	<i>Free Running</i>
Actuation Type	<i>Fully actuated</i>
Offset [s]	0.0
Offset Reference	Lead Green - Beginning of First Green
Permissive Mode	SingleBand
Lost time [s]	0.00

Phasing & Timing

Control Type	Permiss	Permiss	Permiss	Permiss	Permiss	Permiss	Permiss	Permiss	Permiss	Permiss	Permiss	Permiss
Signal Group	0	2	0	0	6	0	0	4	0	0	8	0
Auxiliary Signal Groups												
Lead / Lag	-	-	-	-	-	-	-	-	-	-	-	-
Minimum Green [s]	0	10	0	0	10	0	0	10	0	0	10	0
Maximum Green [s]	0	40	0	0	40	0	0	40	0	0	40	0
Amber [s]	0.0	3.0	0.0	0.0	3.0	0.0	0.0	3.0	0.0	0.0	3.0	0.0
All red [s]	0.0	1.0	0.0	0.0	1.0	0.0	0.0	1.0	0.0	0.0	1.0	0.0
Split [s]	0	14	0	0	14	0	0	14	0	0	14	0
Vehicle Extension [s]	0.0	3.0	0.0	0.0	3.0	0.0	0.0	3.0	0.0	0.0	3.0	0.0
Walk [s]	0	5	0	0	5	0	0	5	0	0	5	0
Pedestrian Clearance [s]	0	10	0	0	10	0	0	10	0	0	10	0
Delayed Vehicle Green [s]	0.0	0.0	0.0	0.0	0.0	0.0	0.0	0.0	0.0	0.0	0.0	0.0
Rest In Walk		No			No			No			No	
I1, Start-Up Lost Time [s]	0.0	2.0	0.0	0.0	2.0	0.0	0.0	2.0	0.0	0.0	2.0	0.0
I2, Clearance Lost Time [s]	0.0	2.0	0.0	0.0	2.0	0.0	0.0	2.0	0.0	0.0	2.0	0.0
Minimum Recall		No			No			No			No	
Maximum Recall		No			No			No			No	
Pedestrian Recall		No			No			No			No	
Detector Location [ft]	0.0	0.0	0.0	0.0	0.0	0.0	0.0	0.0	0.0	0.0	0.0	0.0
Detector Length [ft]	0.0	40.0	0.0	0.0	40.0	0.0	0.0	40.0	0.0	0.0	40.0	0.0
I, Upstream Filtering Factor	1.00	1.00	1.00	1.00	1.00	1.00	1.00	1.00	1.00	1.00	1.00	1.00

Exclusive Pedestrian Phase

Pedestrian Signal Group	0
Pedestrian Walk [s]	0
Pedestrian Clearance [s]	0

Lane Group Calculations

Lane Group	C	R	C	C	C
C, Cycle Length [s]	51	51	51	51	51
L, Total Lost Time per Cycle [s]	4.00	4.00	4.00	4.00	4.00
l1_p, Permitted Start-Up Lost Time [s]	2.00	0.00	2.00	2.00	2.00
l2, Clearance Lost Time [s]	2.00	2.00	2.00	2.00	2.00
g_i, Effective Green Time [s]	15	15	15	29	29
g / C, Green / Cycle	0.28	0.28	0.28	0.56	0.56
(v / s)_i Volume / Saturation Flow Rate	0.06	0.10	0.23	0.00	0.51
s, saturation flow rate [veh/h]	1786	1589	1628	1860	1459
c, Capacity [veh/h]	577	451	547	1111	949
d1, Uniform Delay [s]	13.97	14.65	17.03	0.00	9.96
k, delay calibration	0.11	0.11	0.11	0.11	0.21
l, Upstream Filtering Factor	1.00	1.00	1.00	1.00	1.00
d2, Incremental Delay [s]	0.17	0.50	1.60	0.00	2.83
d3, Initial Queue Delay [s]	0.00	0.00	0.00	0.00	0.00
Rp, platoon ratio	1.00	1.00	1.00	1.00	1.00
PF, progression factor	1.00	1.00	1.00	1.00	1.00

Lane Group Results

X, volume / capacity	0.20	0.37	0.69	0.00	0.79
d, Delay for Lane Group [s/veh]	14.14	15.15	18.62	0.00	12.79
Lane Group LOS	B	B	B	A	B
Critical Lane Group	No	No	Yes	No	Yes
50th-Percentile Queue Length [veh/ln]	0.91	1.41	3.85	0.00	5.80
50th-Percentile Queue Length [ft/ln]	22.74	35.27	96.26	0.00	145.06
95th-Percentile Queue Length [veh/ln]	1.64	2.54	6.93	0.00	9.75
95th-Percentile Queue Length [ft/ln]	40.93	63.49	173.27	0.00	243.83

Movement, Approach, & Intersection Results

d_M, Delay for Movement [s/veh]	14.14	14.14	15.15	18.62	18.62	18.62	0.00	0.00	0.00	12.79	12.79	12.79
Movement LOS	B	B	B	B	B	B	A	A	A	B	B	B
d_A, Approach Delay [s/veh]	14.74			18.62			0.00			12.79		
Approach LOS	B			B			A			B		
d_I, Intersection Delay [s/veh]	14.75											
Intersection LOS	B											
Intersection V/C	0.746											

Other Modes

g_Walk,mi, Effective Walk Time [s]	0.0			0.0			0.0			0.0		
M_corner, Corner Circulation Area [ft ² /ped]	0.00			0.00			0.00			0.00		
M_CW, Crosswalk Circulation Area [ft ² /ped]	0.00			0.00			0.00			0.00		
d_p, Pedestrian Delay [s]	0.00			0.00			0.00			0.00		
I_p,int, Pedestrian LOS Score for Intersectio	0.000			0.000			0.000			0.000		
Crosswalk LOS	F			F			F			F		
s_b, Saturation Flow Rate of the bicycle lane	2000			2000			2000			2000		
c_b, Capacity of the bicycle lane [bicycles/h]	1566			1566			1566			1566		
d_b, Bicycle Delay [s]	1.20			1.20			1.20			1.20		
I_b,int, Bicycle LOS Score for Intersection	2.022			2.187			1.560			2.794		
Bicycle LOS	B			B			A			C		

Sequence

Ring 1	-	2	-	4	-	-	-	-	-	-	-	-	-	-	-	-
Ring 2	-	6	-	8	-	-	-	-	-	-	-	-	-	-	-	-
Ring 3	-	-	-	-	-	-	-	-	-	-	-	-	-	-	-	-
Ring 4	-	-	-	-	-	-	-	-	-	-	-	-	-	-	-	-



**Intersection Level Of Service Report
Intersection 2: Black Forest/Burgess**

Control Type:	Signalized	Delay (sec / veh):	7.1
Analysis Method:	HCM 7th Edition	Level Of Service:	A
Analysis Period:	15 minutes	Volume to Capacity (v/c):	0.247

Intersection Setup

Name	Black Forest Road			Black Forest Road			Burgess Road			Burgess Road		
Approach	Northbound			Southbound			Eastbound			Westbound		
Lane Configuration	↵↵↵			↵↵↵			↵↵↵			↵↵↵		
Turning Movement	Left	Thru	Right	Left	Thru	Right	Left	Thru	Right	Left	Thru	Right
Lane Width [ft]	12.00	12.00	12.00	12.00	12.00	12.00	12.00	12.00	12.00	12.00	12.00	12.00
No. of Lanes in Entry Pocket	1	0	1	1	0	1	1	0	1	1	0	1
Entry Pocket Length [ft]	100.00	100.00	100.00	100.00	100.00	100.00	100.00	100.00	200.00	100.00	100.00	200.00
No. of Lanes in Exit Pocket	0	0	0	0	0	0	0	0	0	0	0	0
Exit Pocket Length [ft]	0.00	0.00	0.00	0.00	0.00	0.00	0.00	0.00	0.00	0.00	0.00	0.00
Speed [mph]	30.00			30.00			30.00			30.00		
Grade [%]	0.00			0.00			0.00			0.00		
Curb Present	No			No			No			No		
Crosswalk	No			No			No			No		

Volumes

Name	Black Forest Road			Black Forest Road			Burgess Road			Burgess Road		
Base Volume Input [veh/h]	37	75	30	20	78	10	13	64	21	29	109	35
Base Volume Adjustment Factor	1.0000	1.0000	1.0000	1.0000	1.0000	1.0000	1.0000	1.0000	1.0000	1.0000	1.0000	1.0000
Heavy Vehicles Percentage [%]	2.00	2.00	2.00	2.00	2.00	2.00	2.00	2.00	2.00	2.00	2.00	2.00
Proportion of CAVs [%]	0.00											
Growth Factor	3.1500	3.1500	3.1500	1.9100	1.9100	1.9100	3.1100	3.1100	3.1100	1.5700	1.5700	1.5700
In-Process Volume [veh/h]	0	0	0	0	0	0	0	0	0	0	0	0
Site-Generated Trips [veh/h]	8	0	0	0	0	0	0	2	5	0	4	0
Diverted Trips [veh/h]	0	0	0	0	0	0	0	0	0	0	0	0
Pass-by Trips [veh/h]	0	0	0	0	0	0	0	0	0	0	0	0
Existing Site Adjustment Volume [veh/h]	0	0	0	0	0	0	0	0	0	0	0	0
Other Volume [veh/h]	0	0	0	0	0	0	0	0	0	0	0	0
Right Turn on Red Volume [veh/h]	0	0	48	0	0	10	0	0	35	0	0	28
Total Hourly Volume [veh/h]	125	236	47	38	149	9	40	201	35	46	175	27
Peak Hour Factor	0.9200	0.9200	0.9200	0.9200	0.9200	0.9200	0.9800	0.9800	0.9800	0.9200	0.9200	0.9200
Other Adjustment Factor	1.0000	1.0000	1.0000	1.0000	1.0000	1.0000	1.0000	1.0000	1.0000	1.0000	1.0000	1.0000
Total 15-Minute Volume [veh/h]	34	64	13	10	40	2	10	51	9	13	48	7
Total Analysis Volume [veh/h]	136	257	51	41	162	10	41	205	36	50	190	29
Presence of On-Street Parking	No		No	No		No	No		No	No		No
On-Street Parking Maneuver Rate [/h]	0	0	0	0	0	0	0	0	0	0	0	0
Local Bus Stopping Rate [/h]	0	0	0	0	0	0	0	0	0	0	0	0
v_do, Outbound Pedestrian Volume crossing	0			0			0			0		
v_di, Inbound Pedestrian Volume crossing m	0			0			0			0		
v_co, Outbound Pedestrian Volume crossing	0			0			0			0		
v_ci, Inbound Pedestrian Volume crossing mi	0			0			0			0		
v_ab, Corner Pedestrian Volume [ped/h]	0			0			0			0		
Bicycle Volume [bicycles/h]	0			0			0			0		

Intersection Settings

Located in CBD	No
Signal Coordination Group	-
Cycle Length [s]	90
Active Pattern	Free Running
Coordination Type	<i>Free Running</i>
Actuation Type	<i>Fully actuated</i>
Offset [s]	0.0
Offset Reference	Lead Green - Beginning of First Green
Permissive Mode	SingleBand
Lost time [s]	0.00

Phasing & Timing

Control Type	Permiss	Permiss	Permiss	Permiss	Permiss	Permiss	Permiss	Permiss	Permiss	Permiss	Permiss	Permiss
Signal Group	0	2	0	0	6	0	0	4	0	0	8	0
Auxiliary Signal Groups												
Lead / Lag	-	-	-	-	-	-	-	-	-	-	-	-
Minimum Green [s]	0	10	0	0	10	0	0	10	0	0	10	0
Maximum Green [s]	0	40	0	0	40	0	0	40	0	0	40	0
Amber [s]	0.0	3.0	0.0	0.0	3.0	0.0	0.0	3.0	0.0	0.0	3.0	0.0
All red [s]	0.0	1.0	0.0	0.0	1.0	0.0	0.0	1.0	0.0	0.0	1.0	0.0
Split [s]	0	14	0	0	14	0	0	14	0	0	14	0
Vehicle Extension [s]	0.0	3.0	0.0	0.0	3.0	0.0	0.0	3.0	0.0	0.0	3.0	0.0
Walk [s]	0	5	0	0	5	0	0	5	0	0	5	0
Pedestrian Clearance [s]	0	10	0	0	10	0	0	10	0	0	10	0
Delayed Vehicle Green [s]	0.0	0.0	0.0	0.0	0.0	0.0	0.0	0.0	0.0	0.0	0.0	0.0
Rest In Walk		No			No			No			No	
I1, Start-Up Lost Time [s]	0.0	2.0	0.0	0.0	2.0	0.0	0.0	2.0	0.0	0.0	2.0	0.0
I2, Clearance Lost Time [s]	0.0	2.0	0.0	0.0	2.0	0.0	0.0	2.0	0.0	0.0	2.0	0.0
Minimum Recall		No			No			No			No	
Maximum Recall		No			No			No			No	
Pedestrian Recall		No			No			No			No	
Detector Location [ft]	0.0	0.0	0.0	0.0	0.0	0.0	0.0	0.0	0.0	0.0	0.0	0.0
Detector Length [ft]	0.0	40.0	0.0	0.0	40.0	0.0	0.0	40.0	0.0	0.0	40.0	0.0
I, Upstream Filtering Factor	1.00	1.00	1.00	1.00	1.00	1.00	1.00	1.00	1.00	1.00	1.00	1.00

Exclusive Pedestrian Phase

Pedestrian Signal Group	0
Pedestrian Walk [s]	0
Pedestrian Clearance [s]	0

Lane Group Calculations

Lane Group	L	C	R	L	C	R	L	C	R	L	C	R
C, Cycle Length [s]	27	27	27	27	27	27	27	27	27	27	27	27
L, Total Lost Time per Cycle [s]	4.00	4.00	4.00	4.00	4.00	4.00	4.00	4.00	4.00	4.00	4.00	4.00
l1_p, Permitted Start-Up Lost Time [s]	2.00	0.00	0.00	2.00	0.00	0.00	2.00	0.00	0.00	2.00	0.00	0.00
l2, Clearance Lost Time [s]	2.00	2.00	2.00	2.00	2.00	2.00	2.00	2.00	2.00	2.00	2.00	2.00
g_i, Effective Green Time [s]	10	10	10	10	10	10	9	9	9	9	9	9
g / C, Green / Cycle	0.37	0.37	0.37	0.37	0.37	0.37	0.33	0.33	0.33	0.33	0.33	0.33
(v / s)_i Volume / Saturation Flow Rate	0.11	0.14	0.03	0.04	0.09	0.01	0.04	0.11	0.02	0.04	0.10	0.02
s, saturation flow rate [veh/h]	1213	1870	1589	1071	1870	1589	1162	1870	1589	1139	1870	1589
c, Capacity [veh/h]	561	683	581	482	683	581	498	626	532	486	626	532
d1, Uniform Delay [s]	8.67	6.23	5.55	8.93	5.88	5.41	8.93	6.63	6.04	9.16	6.57	6.01
k, delay calibration	0.11	0.11	0.11	0.11	0.11	0.11	0.11	0.11	0.11	0.11	0.11	0.11
l, Upstream Filtering Factor	1.00	1.00	1.00	1.00	1.00	1.00	1.00	1.00	1.00	1.00	1.00	1.00
d2, Incremental Delay [s]	0.22	0.34	0.06	0.08	0.18	0.01	0.07	0.30	0.05	0.09	0.27	0.04
d3, Initial Queue Delay [s]	0.00	0.00	0.00	0.00	0.00	0.00	0.00	0.00	0.00	0.00	0.00	0.00
Rp, platoon ratio	1.00	1.00	1.00	1.00	1.00	1.00	1.00	1.00	1.00	1.00	1.00	1.00
PF, progression factor	1.00	1.00	1.00	1.00	1.00	1.00	1.00	1.00	1.00	1.00	1.00	1.00

Lane Group Results

X, volume / capacity	0.24	0.38	0.09	0.09	0.24	0.02	0.08	0.33	0.07	0.10	0.30	0.05
d, Delay for Lane Group [s/veh]	8.89	6.57	5.62	9.00	6.06	5.42	9.00	6.93	6.09	9.25	6.84	6.05
Lane Group LOS	A	A	A	A	A	A	A	A	A	A	A	A
Critical Lane Group	No	Yes	No	No	No	No	No	Yes	No	No	No	No
50th-Percentile Queue Length [veh/ln]	0.45	0.60	0.10	0.14	0.35	0.02	0.14	0.52	0.08	0.17	0.48	0.07
50th-Percentile Queue Length [ft/ln]	11.29	15.00	2.62	3.49	8.80	0.50	3.49	12.99	2.06	4.37	11.90	1.65
95th-Percentile Queue Length [veh/ln]	0.81	1.08	0.19	0.25	0.63	0.04	0.25	0.94	0.15	0.31	0.86	0.12
95th-Percentile Queue Length [ft/ln]	20.32	27.00	4.72	6.28	15.84	0.90	6.28	23.38	3.71	7.86	21.42	2.98

Movement, Approach, & Intersection Results

d_M, Delay for Movement [s/veh]	8.89	6.57	5.62	9.00	6.06	5.42	9.00	6.93	6.09	9.25	6.84	6.05
Movement LOS	A	A	A	A	A	A	A	A	A	A	A	A
d_A, Approach Delay [s/veh]	7.17			6.60			7.12			7.20		
Approach LOS	A			A			A			A		
d_I, Intersection Delay [s/veh]	7.07											
Intersection LOS	A											
Intersection V/C	0.247											

Other Modes

g_Walk,mi, Effective Walk Time [s]	0.0			0.0			0.0			0.0		
M_corner, Corner Circulation Area [ft ² /ped]	0.00			0.00			0.00			0.00		
M_CW, Crosswalk Circulation Area [ft ² /ped]	0.00			0.00			0.00			0.00		
d_p, Pedestrian Delay [s]	0.00			0.00			0.00			0.00		
I_p,int, Pedestrian LOS Score for Intersectio	0.000			0.000			0.000			0.000		
Crosswalk LOS	F			F			F			F		
s_b, Saturation Flow Rate of the bicycle lane	2000			2000			2000			2000		
c_b, Capacity of the bicycle lane [bicycles/h]	3015			3015			3015			3015		
d_b, Bicycle Delay [s]	3.42			3.42			3.42			3.42		
I_b,int, Bicycle LOS Score for Intersection	2.371			1.928			2.083			2.050		
Bicycle LOS	B			A			B			B		

Sequence



Ring 1	-	2	-	4	-	-	-	-	-	-	-	-	-	-	-	-
Ring 2	-	6	-	8	-	-	-	-	-	-	-	-	-	-	-	-
Ring 3	-	-	-	-	-	-	-	-	-	-	-	-	-	-	-	-
Ring 4	-	-	-	-	-	-	-	-	-	-	-	-	-	-	-	-



Intersection Level Of Service Report
Intersection 3: Burgess/School Access

Control Type:	Two-way stop	Delay (sec / veh):	27.5
Analysis Method:	HCM 7th Edition	Level Of Service:	D
Analysis Period:	15 minutes	Volume to Capacity (v/c):	0.078

Intersection Setup

Name	Haven School Access		Burgess Road		Burgess Road	
Approach	Southbound		Eastbound		Westbound	
Lane Configuration						
Turning Movement	Left	Right	Left	Thru	Thru	Right
Lane Width [ft]	12.00	12.00	12.00	12.00	12.00	12.00
No. of Lanes in Entry Pocket	0	0	0	0	0	0
Entry Pocket Length [ft]	100.00	100.00	100.00	100.00	100.00	100.00
No. of Lanes in Exit Pocket	0	0	0	0	0	0
Exit Pocket Length [ft]	0.00	0.00	0.00	0.00	0.00	0.00
Speed [mph]	30.00		30.00		30.00	
Grade [%]	0.00		0.00		0.00	
Crosswalk	No		No		No	

Volumes

Name	Haven School Access		Burgess Road		Burgess Road	
Base Volume Input [veh/h]	0	0	0	113	216	0
Base Volume Adjustment Factor	1.0000	1.0000	1.0000	1.0000	1.0000	1.0000
Heavy Vehicles Percentage [%]	2.00	2.00	2.00	2.00	2.00	2.00
Growth Factor	1.0000	1.0000	1.0000	3.1100	3.1100	1.0000
In-Process Volume [veh/h]	0	0	0	0	0	0
Site-Generated Trips [veh/h]	7	17	28	0	0	12
Diverted Trips [veh/h]	0	0	0	0	0	0
Pass-by Trips [veh/h]	0	0	0	0	0	0
Existing Site Adjustment Volume [veh/h]	0	0	0	0	0	0
Other Volume [veh/h]	0	0	0	0	0	0
Total Hourly Volume [veh/h]	7	17	28	351	672	12
Peak Hour Factor	0.5000	0.5000	0.5000	0.9200	0.9200	0.5000
Other Adjustment Factor	1.0000	1.0000	1.0000	1.0000	1.0000	1.0000
Total 15-Minute Volume [veh/h]	4	9	14	95	183	6
Total Analysis Volume [veh/h]	14	34	56	382	730	24
Pedestrian Volume [ped/h]	0		0		0	



Intersection Settings

Priority Scheme	Stop	Free	Free
Flared Lane	No		
Storage Area [veh]	0	0	0
Two-Stage Gap Acceptance	No		
Number of Storage Spaces in Median	0	0	0

Movement, Approach, & Intersection Results

V/C, Movement V/C Ratio	0.08	0.08	0.07	0.00	0.01	0.00
d_M, Delay for Movement [s/veh]	27.47	15.94	9.27	0.00	0.00	0.00
Movement LOS	D	C	A	A	A	A
95th-Percentile Queue Length [veh/ln]	0.56	0.56	0.10	0.10	0.00	0.00
95th-Percentile Queue Length [ft/ln]	14.07	14.07	2.41	2.41	0.00	0.00
d_A, Approach Delay [s/veh]	19.30		1.19		0.00	
Approach LOS	C		A		A	
d_I, Intersection Delay [s/veh]	1.17					
Intersection LOS	D					

Haven School TIS

Vistro File: C:\...\pm.vistro

Scenario 5 2045 Total PM

Report File: C:\...\2045 Total PM.pdf

8/24/2023

Intersection Analysis Summary

ID	Intersection Name	Control Type	Method	Worst Mvmt	V/C	Delay (s/veh)	LOS
1	Milam/Burgess	Signalized	HCM 7th Edition	SB Thru	0.517	8.1	A
2	Black Forest/Burgess	Signalized	HCM 7th Edition	WB Left	0.443	8.2	A
3	Burgess/School Access	Two-way stop	HCM 7th Edition	SB Left	0.078	24.7	C

V/C, Delay, LOS: For two-way stop, these values are taken from the movement with the worst (highest) delay value. For all other control types, they are taken for the whole intersection.

Intersection Level Of Service Report
Intersection 1: Milam/Burgess

Control Type:	Signalized	Delay (sec / veh):	8.1
Analysis Method:	HCM 7th Edition	Level Of Service:	A
Analysis Period:	15 minutes	Volume to Capacity (v/c):	0.517

Intersection Setup

Name	Milam Road			Milam Road			Private Road			Burgess Road		
Approach	Northbound			Southbound			Eastbound			Westbound		
Lane Configuration												
Turning Movement	Left	Thru	Right	Left	Thru	Right	Left	Thru	Right	Left	Thru	Right
Lane Width [ft]	12.00	12.00	12.00	12.00	12.00	12.00	12.00	12.00	12.00	12.00	12.00	12.00
No. of Lanes in Entry Pocket	0	0	1	0	0	0	0	0	0	0	0	0
Entry Pocket Length [ft]	100.00	100.00	100.00	100.00	100.00	100.00	100.00	100.00	100.00	100.00	100.00	100.00
No. of Lanes in Exit Pocket	0	0	0	0	0	0	0	0	0	0	0	0
Exit Pocket Length [ft]	0.00	0.00	0.00	0.00	0.00	0.00	0.00	0.00	0.00	0.00	0.00	0.00
Speed [mph]	30.00			30.00			30.00			30.00		
Grade [%]	0.00			0.00			0.00			0.00		
Curb Present	No			No			No			No		
Crosswalk	No			No			No			No		

Volumes

Name	Milam Road			Milam Road			Private Road			Burgess Road		
Base Volume Input [veh/h]	0	130	146	22	119	0	0	0	0	105	0	23
Base Volume Adjustment Factor	1.0000	1.0000	1.0000	1.0000	1.0000	1.0000	1.0000	1.0000	1.0000	1.0000	1.0000	1.0000
Heavy Vehicles Percentage [%]	2.00	2.00	2.00	2.00	2.00	2.00	2.00	2.00	2.00	2.00	2.00	2.00
Proportion of CAVs [%]	0.00											
Growth Factor	1.5700	1.5700	1.5700	2.2300	2.2300	2.2300	1.0000	1.0000	1.0000	3.1100	3.1100	3.1100
In-Process Volume [veh/h]	0	0	0	0	0	0	0	0	0	0	0	0
Site-Generated Trips [veh/h]	0	0	11	2	0	0	0	0	0	14	0	3
Diverted Trips [veh/h]	0	0	0	0	0	0	0	0	0	0	0	0
Pass-by Trips [veh/h]	0	0	0	0	0	0	0	0	0	0	0	0
Existing Site Adjustment Volume [veh/h]	0	0	0	0	0	0	0	0	0	0	0	0
Other Volume [veh/h]	0	0	0	0	0	0	0	0	0	0	0	0
Right Turn on Red Volume [veh/h]	0	0	0	0	0	0	0	0	0	0	0	0
Total Hourly Volume [veh/h]	0	204	240	51	265	0	0	0	0	341	0	75
Peak Hour Factor	0.9200	0.9200	0.9200	0.9200	0.9200	0.9200	0.9200	0.9200	0.9200	0.9200	0.9200	0.9200
Other Adjustment Factor	1.0000	1.0000	1.0000	1.0000	1.0000	1.0000	1.0000	1.0000	1.0000	1.0000	1.0000	1.0000
Total 15-Minute Volume [veh/h]	0	55	65	14	72	0	0	0	0	93	0	20
Total Analysis Volume [veh/h]	0	222	261	55	288	0	0	0	0	371	0	82
Presence of On-Street Parking	No		No	No		No	No		No	No		No
On-Street Parking Maneuver Rate [/h]	0	0	0	0	0	0	0	0	0	0	0	0
Local Bus Stopping Rate [/h]	0	0	0	0	0	0	0	0	0	0	0	0
v_do, Outbound Pedestrian Volume crossing	0			0			0			0		
v_di, Inbound Pedestrian Volume crossing m	0			0			0			0		
v_co, Outbound Pedestrian Volume crossing	0			0			0			0		
v_ci, Inbound Pedestrian Volume crossing mi	0			0			0			0		
v_ab, Corner Pedestrian Volume [ped/h]	0			0			0			0		
Bicycle Volume [bicycles/h]	0			0			0			0		

Intersection Settings

Located in CBD	No
Signal Coordination Group	-
Cycle Length [s]	90
Active Pattern	Free Running
Coordination Type	<i>Free Running</i>
Actuation Type	<i>Fully actuated</i>
Offset [s]	0.0
Offset Reference	Lead Green - Beginning of First Green
Permissive Mode	SingleBand
Lost time [s]	0.00

Phasing & Timing

Control Type	Permiss	Permiss	Permiss	Permiss	Permiss	Permiss	Permiss	Permiss	Permiss	Permiss	Permiss	Permiss
Signal Group	0	2	0	0	6	0	0	4	0	0	8	0
Auxiliary Signal Groups												
Lead / Lag	-	-	-	-	-	-	-	-	-	-	-	-
Minimum Green [s]	0	10	0	0	10	0	0	10	0	0	10	0
Maximum Green [s]	0	40	0	0	40	0	0	40	0	0	40	0
Amber [s]	0.0	3.0	0.0	0.0	3.0	0.0	0.0	3.0	0.0	0.0	3.0	0.0
All red [s]	0.0	1.0	0.0	0.0	1.0	0.0	0.0	1.0	0.0	0.0	1.0	0.0
Split [s]	0	14	0	0	14	0	0	14	0	0	14	0
Vehicle Extension [s]	0.0	3.0	0.0	0.0	3.0	0.0	0.0	3.0	0.0	0.0	3.0	0.0
Walk [s]	0	5	0	0	5	0	0	5	0	0	5	0
Pedestrian Clearance [s]	0	10	0	0	10	0	0	10	0	0	10	0
Delayed Vehicle Green [s]	0.0	0.0	0.0	0.0	0.0	0.0	0.0	0.0	0.0	0.0	0.0	0.0
Rest In Walk		No			No			No			No	
I1, Start-Up Lost Time [s]	0.0	2.0	0.0	0.0	2.0	0.0	0.0	2.0	0.0	0.0	2.0	0.0
I2, Clearance Lost Time [s]	0.0	2.0	0.0	0.0	2.0	0.0	0.0	2.0	0.0	0.0	2.0	0.0
Minimum Recall		No			No			No			No	
Maximum Recall		No			No			No			No	
Pedestrian Recall		No			No			No			No	
Detector Location [ft]	0.0	0.0	0.0	0.0	0.0	0.0	0.0	0.0	0.0	0.0	0.0	0.0
Detector Length [ft]	0.0	40.0	0.0	0.0	40.0	0.0	0.0	40.0	0.0	0.0	40.0	0.0
I, Upstream Filtering Factor	1.00	1.00	1.00	1.00	1.00	1.00	1.00	1.00	1.00	1.00	1.00	1.00

Exclusive Pedestrian Phase

Pedestrian Signal Group	0
Pedestrian Walk [s]	0
Pedestrian Clearance [s]	0

Lane Group Calculations

Lane Group	C	R	C	C	C
C, Cycle Length [s]	29	29	29	29	29
L, Total Lost Time per Cycle [s]	4.00	4.00	4.00	4.00	4.00
l1_p, Permitted Start-Up Lost Time [s]	2.00	0.00	2.00	2.00	2.00
l2, Clearance Lost Time [s]	2.00	2.00	2.00	2.00	2.00
g_i, Effective Green Time [s]	10	10	10	11	11
g / C, Green / Cycle	0.34	0.34	0.34	0.38	0.38
(v / s)_i Volume / Saturation Flow Rate	0.12	0.16	0.22	0.00	0.30
s, saturation flow rate [veh/h]	1870	1589	1591	1812	1503
c, Capacity [veh/h]	760	540	685	819	803
d1, Uniform Delay [s]	7.15	7.53	7.78	0.00	7.66
k, delay calibration	0.11	0.11	0.11	0.11	0.11
l, Upstream Filtering Factor	1.00	1.00	1.00	1.00	1.00
d2, Incremental Delay [s]	0.21	0.67	0.57	0.00	0.62
d3, Initial Queue Delay [s]	0.00	0.00	0.00	0.00	0.00
Rp, platoon ratio	1.00	1.00	1.00	1.00	1.00
PF, progression factor	1.00	1.00	1.00	1.00	1.00

Lane Group Results

X, volume / capacity	0.29	0.48	0.50	0.00	0.56
d, Delay for Lane Group [s/veh]	7.36	8.21	8.35	0.00	8.28
Lane Group LOS	A	A	A	A	A
Critical Lane Group	No	No	Yes	No	Yes
50th-Percentile Queue Length [veh/ln]	0.65	0.85	1.11	0.00	1.42
50th-Percentile Queue Length [ft/ln]	16.19	21.21	27.84	0.00	35.44
95th-Percentile Queue Length [veh/ln]	1.17	1.53	2.00	0.00	2.55
95th-Percentile Queue Length [ft/ln]	29.14	38.17	50.11	0.00	63.80

Movement, Approach, & Intersection Results

d_M, Delay for Movement [s/veh]	7.36	7.36	8.21	8.35	8.35	8.35	0.00	0.00	0.00	8.28	8.28	8.28
Movement LOS	A	A	A	A	A	A	A	A	A	A	A	A
d_A, Approach Delay [s/veh]	7.82			8.35			0.00			8.28		
Approach LOS	A			A			A			A		
d_I, Intersection Delay [s/veh]	8.13											
Intersection LOS	A											
Intersection V/C	0.517											

Other Modes

g_Walk,mi, Effective Walk Time [s]	0.0			0.0			0.0			0.0		
M_corner, Corner Circulation Area [ft ² /ped]	0.00			0.00			0.00			0.00		
M_CW, Crosswalk Circulation Area [ft ² /ped]	0.00			0.00			0.00			0.00		
d_p, Pedestrian Delay [s]	0.00			0.00			0.00			0.00		
I_p,int, Pedestrian LOS Score for Intersectio	0.000			0.000			0.000			0.000		
Crosswalk LOS	F			F			F			F		
s_b, Saturation Flow Rate of the bicycle lane	2000			2000			2000			2000		
c_b, Capacity of the bicycle lane [bicycles/h]	2778			2778			2778			2778		
d_b, Bicycle Delay [s]	2.18			2.18			2.18			2.18		
I_b,int, Bicycle LOS Score for Intersection	2.357			2.126			1.560			2.307		
Bicycle LOS	B			B			A			B		

Sequence

Ring 1	-	2	-	4	-	-	-	-	-	-	-	-	-	-	-	-
Ring 2	-	6	-	8	-	-	-	-	-	-	-	-	-	-	-	-
Ring 3	-	-	-	-	-	-	-	-	-	-	-	-	-	-	-	-
Ring 4	-	-	-	-	-	-	-	-	-	-	-	-	-	-	-	-



**Intersection Level Of Service Report
Intersection 2: Black Forest/Burgess**

Control Type:	Signalized	Delay (sec / veh):	8.2
Analysis Method:	HCM 7th Edition	Level Of Service:	A
Analysis Period:	15 minutes	Volume to Capacity (v/c):	0.443

Intersection Setup

Name	Black Forest Road			Black Forest Road			Burgess Road			Burgess Road		
Approach	Northbound			Southbound			Eastbound			Westbound		
Lane Configuration	↵↵↵			↵↵↵			↵↵↵			↵↵↵		
Turning Movement	Left	Thru	Right	Left	Thru	Right	Left	Thru	Right	Left	Thru	Right
Lane Width [ft]	12.00	12.00	12.00	12.00	12.00	12.00	12.00	12.00	12.00	12.00	12.00	12.00
No. of Lanes in Entry Pocket	1	0	1	1	0	1	1	0	1	1	0	1
Entry Pocket Length [ft]	100.00	100.00	100.00	100.00	100.00	100.00	100.00	100.00	200.00	100.00	100.00	200.00
No. of Lanes in Exit Pocket	0	0	0	0	0	0	0	0	0	0	0	0
Exit Pocket Length [ft]	0.00	0.00	0.00	0.00	0.00	0.00	0.00	0.00	0.00	0.00	0.00	0.00
Speed [mph]	30.00			30.00			30.00			30.00		
Grade [%]	0.00			0.00			0.00			0.00		
Curb Present	No			No			No			No		
Crosswalk	No			No			No			No		

Volumes

Name	Black Forest Road			Black Forest Road			Burgess Road			Burgess Road		
Base Volume Input [veh/h]	20	106	25	28	105	14	16	137	27	23	77	25
Base Volume Adjustment Factor	1.0000	1.0000	1.0000	1.0000	1.0000	1.0000	1.0000	1.0000	1.0000	1.0000	1.0000	1.0000
Heavy Vehicles Percentage [%]	2.00	2.00	2.00	2.00	2.00	2.00	2.00	2.00	2.00	2.00	2.00	2.00
Proportion of CAVs [%]	0.00											
Growth Factor	3.1500	3.1500	3.1500	1.9100	1.9100	1.9100	3.1100	3.1100	3.1100	1.5700	1.5700	1.5700
In-Process Volume [veh/h]	0	0	0	0	0	0	0	0	0	0	0	0
Site-Generated Trips [veh/h]	4	0	0	0	0	0	0	3	5	0	2	0
Diverted Trips [veh/h]	0	0	0	0	0	0	0	0	0	0	0	0
Pass-by Trips [veh/h]	0	0	0	0	0	0	0	0	0	0	0	0
Existing Site Adjustment Volume [veh/h]	0	0	0	0	0	0	0	0	0	0	0	0
Other Volume [veh/h]	0	0	0	0	0	0	0	0	0	0	0	0
Right Turn on Red Volume [veh/h]	0	0	40	0	0	14	0	0	45	0	0	20
Total Hourly Volume [veh/h]	67	334	39	53	201	13	50	429	44	36	123	19
Peak Hour Factor	0.9200	0.9200	0.9200	0.9200	0.9200	0.9200	0.9200	0.9200	0.9200	0.9200	0.9200	0.9200
Other Adjustment Factor	1.0000	1.0000	1.0000	1.0000	1.0000	1.0000	1.0000	1.0000	1.0000	1.0000	1.0000	1.0000
Total 15-Minute Volume [veh/h]	18	91	11	14	55	4	14	117	12	10	33	5
Total Analysis Volume [veh/h]	73	363	42	58	218	14	54	466	48	39	134	21
Presence of On-Street Parking	No		No	No		No	No		No	No		No
On-Street Parking Maneuver Rate [/h]	0	0	0	0	0	0	0	0	0	0	0	0
Local Bus Stopping Rate [/h]	0	0	0	0	0	0	0	0	0	0	0	0
v_do, Outbound Pedestrian Volume crossing	0			0			0			0		
v_di, Inbound Pedestrian Volume crossing m	0			0			0			0		
v_co, Outbound Pedestrian Volume crossing	0			0			0			0		
v_ci, Inbound Pedestrian Volume crossing mi	0			0			0			0		
v_ab, Corner Pedestrian Volume [ped/h]	0			0			0			0		
Bicycle Volume [bicycles/h]	0			0			0			0		

Intersection Settings

Located in CBD	No
Signal Coordination Group	-
Cycle Length [s]	90
Active Pattern	Free Running
Coordination Type	<i>Free Running</i>
Actuation Type	<i>Fully actuated</i>
Offset [s]	0.0
Offset Reference	Lead Green - Beginning of First Green
Permissive Mode	SingleBand
Lost time [s]	0.00

Phasing & Timing

Control Type	Permiss	Permiss	Permiss	Permiss	Permiss	Permiss	Permiss	Permiss	Permiss	Permiss	Permiss	Permiss
Signal Group	0	2	0	0	6	0	0	4	0	0	8	0
Auxiliary Signal Groups												
Lead / Lag	-	-	-	-	-	-	-	-	-	-	-	-
Minimum Green [s]	0	10	0	0	10	0	0	10	0	0	10	0
Maximum Green [s]	0	40	0	0	40	0	0	40	0	0	40	0
Amber [s]	0.0	3.0	0.0	0.0	3.0	0.0	0.0	3.0	0.0	0.0	3.0	0.0
All red [s]	0.0	1.0	0.0	0.0	1.0	0.0	0.0	1.0	0.0	0.0	1.0	0.0
Split [s]	0	14	0	0	14	0	0	14	0	0	14	0
Vehicle Extension [s]	0.0	3.0	0.0	0.0	3.0	0.0	0.0	3.0	0.0	0.0	3.0	0.0
Walk [s]	0	5	0	0	5	0	0	5	0	0	5	0
Pedestrian Clearance [s]	0	10	0	0	10	0	0	10	0	0	10	0
Delayed Vehicle Green [s]	0.0	0.0	0.0	0.0	0.0	0.0	0.0	0.0	0.0	0.0	0.0	0.0
Rest In Walk		No			No			No			No	
I1, Start-Up Lost Time [s]	0.0	2.0	0.0	0.0	2.0	0.0	0.0	2.0	0.0	0.0	2.0	0.0
I2, Clearance Lost Time [s]	0.0	2.0	0.0	0.0	2.0	0.0	0.0	2.0	0.0	0.0	2.0	0.0
Minimum Recall		No			No			No			No	
Maximum Recall		No			No			No			No	
Pedestrian Recall		No			No			No			No	
Detector Location [ft]	0.0	0.0	0.0	0.0	0.0	0.0	0.0	0.0	0.0	0.0	0.0	0.0
Detector Length [ft]	0.0	40.0	0.0	0.0	40.0	0.0	0.0	40.0	0.0	0.0	40.0	0.0
I, Upstream Filtering Factor	1.00	1.00	1.00	1.00	1.00	1.00	1.00	1.00	1.00	1.00	1.00	1.00

Exclusive Pedestrian Phase

Pedestrian Signal Group	0
Pedestrian Walk [s]	0
Pedestrian Clearance [s]	0

Lane Group Calculations

Lane Group	L	C	R	L	C	R	L	C	R	L	C	R
C, Cycle Length [s]	28	28	28	28	28	28	28	28	28	28	28	28
L, Total Lost Time per Cycle [s]	4.00	4.00	4.00	4.00	4.00	4.00	4.00	4.00	4.00	4.00	4.00	4.00
l1_p, Permitted Start-Up Lost Time [s]	2.00	0.00	0.00	2.00	0.00	0.00	2.00	0.00	0.00	2.00	0.00	0.00
l2, Clearance Lost Time [s]	2.00	2.00	2.00	2.00	2.00	2.00	2.00	2.00	2.00	2.00	2.00	2.00
g_i, Effective Green Time [s]	10	10	10	10	10	10	10	10	10	10	10	10
g / C, Green / Cycle	0.35	0.35	0.35	0.35	0.35	0.35	0.36	0.36	0.36	0.36	0.36	0.36
(v / s)_i Volume / Saturation Flow Rate	0.06	0.19	0.03	0.06	0.12	0.01	0.04	0.25	0.03	0.04	0.07	0.01
s, saturation flow rate [veh/h]	1148	1870	1589	980	1870	1589	1232	1870	1589	886	1870	1589
c, Capacity [veh/h]	485	662	563	380	662	563	566	680	578	333	680	578
d1, Uniform Delay [s]	9.65	7.33	6.07	11.43	6.69	5.96	8.25	7.64	5.91	12.31	6.18	5.81
k, delay calibration	0.11	0.11	0.11	0.11	0.11	0.11	0.11	0.11	0.11	0.11	0.11	0.11
l, Upstream Filtering Factor	1.00	1.00	1.00	1.00	1.00	1.00	1.00	1.00	1.00	1.00	1.00	1.00
d2, Incremental Delay [s]	0.14	0.71	0.06	0.18	0.29	0.02	0.07	1.24	0.06	0.16	0.14	0.03
d3, Initial Queue Delay [s]	0.00	0.00	0.00	0.00	0.00	0.00	0.00	0.00	0.00	0.00	0.00	0.00
Rp, platoon ratio	1.00	1.00	1.00	1.00	1.00	1.00	1.00	1.00	1.00	1.00	1.00	1.00
PF, progression factor	1.00	1.00	1.00	1.00	1.00	1.00	1.00	1.00	1.00	1.00	1.00	1.00

Lane Group Results

X, volume / capacity	0.15	0.55	0.07	0.15	0.33	0.02	0.10	0.69	0.08	0.12	0.20	0.04
d, Delay for Lane Group [s/veh]	9.79	8.04	6.12	11.62	6.97	5.98	8.33	8.88	5.98	12.46	6.32	5.84
Lane Group LOS	A	A	A	B	A	A	A	A	A	B	A	A
Critical Lane Group	No	Yes	No	No	No	No	No	Yes	No	No	No	No
50th-Percentile Queue Length [veh/ln]	0.28	1.11	0.10	0.26	0.59	0.03	0.18	1.54	0.11	0.19	0.33	0.05
50th-Percentile Queue Length [ft/ln]	7.07	27.78	2.57	6.58	14.76	0.84	4.49	38.62	2.86	4.72	8.29	1.23
95th-Percentile Queue Length [veh/ln]	0.51	2.00	0.18	0.47	1.06	0.06	0.32	2.78	0.21	0.34	0.60	0.09
95th-Percentile Queue Length [ft/ln]	12.72	50.01	4.62	11.84	26.56	1.51	8.08	69.52	5.15	8.49	14.91	2.21

Movement, Approach, & Intersection Results

d_M, Delay for Movement [s/veh]	9.79	8.04	6.12	11.62	6.97	5.98	8.33	8.88	5.98	12.46	6.32	5.84
Movement LOS	A	A	A	B	A	A	A	A	A	B	A	A
d_A, Approach Delay [s/veh]	8.14			7.85			8.58			7.50		
Approach LOS	A			A			A			A		
d_I, Intersection Delay [s/veh]	8.17											
Intersection LOS	A											
Intersection V/C	0.443											

Other Modes

g_Walk,mi, Effective Walk Time [s]	0.0			0.0			0.0			0.0		
M_corner, Corner Circulation Area [ft ² /ped]	0.00			0.00			0.00			0.00		
M_CW, Crosswalk Circulation Area [ft ² /ped]	0.00			0.00			0.00			0.00		
d_p, Pedestrian Delay [s]	0.00			0.00			0.00			0.00		
I_p,int, Pedestrian LOS Score for Intersectio	0.000			0.000			0.000			0.000		
Crosswalk LOS	F			F			F			F		
s_b, Saturation Flow Rate of the bicycle lane	2000			2000			2000			2000		
c_b, Capacity of the bicycle lane [bicycles/h]	2836			2836			2836			2836		
d_b, Bicycle Delay [s]	2.46			2.46			2.46			2.46		
I_b,int, Bicycle LOS Score for Intersection	2.414			2.061			2.571			1.913		
Bicycle LOS	B			B			B			A		

Sequence

Ring 1	-	2	-	4	-	-	-	-	-	-	-	-	-	-	-	-
Ring 2	-	6	-	8	-	-	-	-	-	-	-	-	-	-	-	-
Ring 3	-	-	-	-	-	-	-	-	-	-	-	-	-	-	-	-
Ring 4	-	-	-	-	-	-	-	-	-	-	-	-	-	-	-	-



Intersection Level Of Service Report
Intersection 3: Burgess/School Access

Control Type:	Two-way stop	Delay (sec / veh):	24.7
Analysis Method:	HCM 7th Edition	Level Of Service:	C
Analysis Period:	15 minutes	Volume to Capacity (v/c):	0.078

Intersection Setup

Name	Haven School Access		Burgess Road		Burgess Road	
Approach	Southbound		Eastbound		Westbound	
Lane Configuration	↔		↕		↔	
Turning Movement	Left	Right	Left	Thru	Thru	Right
Lane Width [ft]	12.00	12.00	12.00	12.00	12.00	12.00
No. of Lanes in Entry Pocket	0	0	0	0	0	0
Entry Pocket Length [ft]	100.00	100.00	100.00	100.00	100.00	100.00
No. of Lanes in Exit Pocket	0	0	0	0	0	0
Exit Pocket Length [ft]	0.00	0.00	0.00	0.00	0.00	0.00
Speed [mph]	30.00		30.00		30.00	
Grade [%]	0.00		0.00		0.00	
Crosswalk	No		No		No	

Volumes

Name	Haven School Access		Burgess Road		Burgess Road	
Base Volume Input [veh/h]	0	0	0	113	216	0
Base Volume Adjustment Factor	1.0000	1.0000	1.0000	1.0000	1.0000	1.0000
Heavy Vehicles Percentage [%]	2.00	2.00	2.00	2.00	2.00	2.00
Growth Factor	1.0000	1.0000	1.0000	3.1100	3.1100	1.0000
In-Process Volume [veh/h]	0	0	0	0	0	0
Site-Generated Trips [veh/h]	8	17	13	0	0	6
Diverted Trips [veh/h]	0	0	0	0	0	0
Pass-by Trips [veh/h]	0	0	0	0	0	0
Existing Site Adjustment Volume [veh/h]	0	0	0	0	0	0
Other Volume [veh/h]	0	0	0	0	0	0
Total Hourly Volume [veh/h]	8	17	13	351	672	6
Peak Hour Factor	0.5000	0.5000	0.5000	0.9200	0.9200	0.5000
Other Adjustment Factor	1.0000	1.0000	1.0000	1.0000	1.0000	1.0000
Total 15-Minute Volume [veh/h]	4	9	7	95	183	3
Total Analysis Volume [veh/h]	16	34	26	382	730	12
Pedestrian Volume [ped/h]	0		0		0	

Intersection Settings

Priority Scheme	Stop	Free	Free
Flared Lane	No		
Storage Area [veh]	0	0	0
Two-Stage Gap Acceptance	No		
Number of Storage Spaces in Median	0	0	0

Movement, Approach, & Intersection Results

V/C, Movement V/C Ratio	0.08	0.08	0.03	0.00	0.01	0.00
d_M, Delay for Movement [s/veh]	24.72	15.75	9.19	0.00	0.00	0.00
Movement LOS	C	C	A	A	A	A
95th-Percentile Queue Length [veh/ln]	0.56	0.56	0.04	0.04	0.00	0.00
95th-Percentile Queue Length [ft/ln]	13.96	13.96	1.10	1.10	0.00	0.00
d_A, Approach Delay [s/veh]	18.62		0.59		0.00	
Approach LOS	C		A		A	
d_I, Intersection Delay [s/veh]	0.97					
Intersection LOS	C					