

# DRAINAGE LETTER

for

**Lot 12 - Rolling Thunder Business Park  
10707 Maltese Pt.  
Peyton, Colorado**

**SK Project No. 24-105**

**April 11, 2024**

**Prepared for:  
WT Holdings, LLC.**

William Tibbitt  
30 E. Uintah St.  
Colorado Springs, CO 80903  
Phone: 719-492-0084  
Email: BTibbit@wdconstruct.com

**Prepared by:**

SK Design Group, Inc.  
333 Perry Street #209  
Castle Rock, CO 80104  
Email: [amahobian@skdg.com](mailto:amahobian@skdg.com), [eprskalo@skdg.com](mailto:eprskalo@skdg.com)

EA243

PPR2414

Project number has  
been updated. -  
SKDG



**TABLE OF CONTENTS**

<b><u>DESCRIPTION</u></b>	<b><u>PAGE</u></b>
ENGINEER’S STATEMENT .....	1
DEVELOPER’S STATEMENT .....	1
EL PASO COUNTY .....	1
LOCATION AND DESCRIPTION .....	2
FLOODPLAIN STATEMENT .....	2
DESCRIPTION OF RUNOFF .....	2
RATIONAL METHOD & INFILTRATION CALCULATION SUMMARY .....	4
FEES .....	5
FOUR STEP PROCESS.....	6
SUMMARY .....	6
REFERENCES.....	7

**APPENDIX**

- A – VICINITY MAP
- B – SOIL MAP
- C – NOAA ATLAS 14 RAINFALL DATA
- D – FEMA FIRMETTE
- E – CALCULATIONS
- F – EXISTING AND PROPOSED DRAINAGE MAPS
- G – REFERENCE DOCUMENTS



**1. Engineer's Statement:**

The attached drainage maps and letter were prepared under my direction and supervision and are correct to the best of my knowledge and belief. Said drainage letter has been prepared according to the criteria established by the County for drainage letters and said report is in conformity with the master plan of the drainage basin. I accept responsibility for any liability caused by any negligent acts, errors or omissions on my part in preparing this report.

\_\_\_\_\_  
Name PE number

PE name and number have been added. -SKDG

(Seal)

**2. Developer's Statement:**

I, \_\_\_\_\_ the owner/developer have read and will comply with all of the requirements specified in this drainage letter and plan.

\_\_\_\_\_  
Business Name

By: \_\_\_\_\_

Title: \_\_\_\_\_

Address: \_\_\_\_\_

**3. El Paso County:**

El Paso County:  
Filed in accordance with the requirements of the Drainage Criteria Manual, Volumes 1 and 2, El Paso County Engineering Criteria Manual and Land Development Code as amended.  
\_\_\_\_\_  
Joshua Palmer, P.E. Date  
County Engineer / ECM Administrator  
Conditions:

Code, Drainage Criteria ed.

\_\_\_\_\_  
ate

Signature block has been updated. -SKDG

**4. Location and Description:**

Lot 12 of Rolling Thunder Business Park is located northwest of the intersection of Rolling Thunder Way and Firehouse View, and south of Maltese Point. The property is located in a portion of the NE ¼ of Section 11, Township 13 South, Range 65 West of the 6<sup>th</sup> P.M. in El Paso County, Colorado. The lot area is 1.17 acres. This project is proposing to construct a commercial building on the site. A Vicinity Map showing the Site location is included in Appendix A.

**5. Floodplain Statement:**

This development is not within the limits of a designated floodplain or flood hazard area, per C0535G dated December 7, 2018. The site is designated as Zone X, which is minimal flood hazard. The FEMA FIRMap is included in Appendix D.

**6.**

EDARP project number has been added. -SKDG

Add the EDARP Project number the Drainage Report was approved under (SF07019).

**a. Existing Conditions:**

This Site was platted as Lot 12 of the Rolling Thunder Business Park in 2008. Rolling Thunder Business Park Preliminary/Final Drainage Report (hereafter referred to as the Rolling Thunder FDR), dated September 2008, was approved by El Paso County on 10-16-08. Lot 12 was rough graded with runoff generally directed south and east, to Tank water quality pond, which was constructed and designed as a part of the Rolling Thunder FDR. Tank pond was recently cleaned/maintained by the metro district and appears to be in good working order, operating as originally intended. There is an existing combined landscape, utility, and drainage easement at the south of the property, this was intended to service the future development of the site and allow for runoff to be directed to Tank water quality pond in the developed condition. Access to this easement has since been blocked by grading, landscaping, paving and fencing on Lot 13. Due to the Lot 13 development, the Lot 12 Site is not draining as originally intended with the Rolling Thunder FDR. Currently, a majority of the Site runoff, as well as the runoff from the western half of the building on Lot 13 are routed overland to the curb and gutter of Rolling Thunder Way, bypassing the Tank water quality pond. This existing condition has existed since 2008.

**b. Proposed Conditions**

Per the original Rolling Thunder FDR, the entire Lot 12 Site was intended to be treated for water quality at Tank water quality pond. However, due to the development of Lot 13 blocking access to Tank pond, this Site has been sub-divided into 3 basins. Photos of the existing condition of the Site and the Lot 13 approved plan are included in Appendix G. An infiltration basin has been designed to treat the WQCV that would have been treated at Tank pond. This infiltration basin ensures the water quality needs of the proposed development are met. In order to follow the original plan laid out in the Rolling Thunder

FDR, with all runoff being treated at Tank pond, the entire grading of the site would have had to been reversed due to Lot 13 blocking the drainage easement and access to Tank pond. The northern area of the Site drains to Tank pond, as intended with the Rolling Thunder FDR. The entire Site is within Basin D-12 of the Rolling Thunder FDR, which assumed a percent impervious of 85% and consisted of the entire Lot 12 area, approximately 0.91 acres per the Rolling Thunder FDR. The area of the Site discharging to Tank pond is 0.24 acres and the percent impervious of that area is 63.4%. Since only a

Q5 and Q100 rates are now shown in basin headers. -SKDG

the Site is able to discharge into Tank pond, and the impervious percentage of less than what was assumed with the Rolling Thunder FDR, Tank pond has capacity to accept and treat runoff from the Site

**(0.24 acres)**

Please include the Q5 and Q100 rates in the basin discussion.

Basin A consists of the northern landscape area of Lot 12, roughly 75% of the roof area of the proposed building, and a small area in the northeast corner of the site. Runoff for Basin A is conveyed via overland flow, as well as roof drains and a concrete channel to the north. Runoff discharges into the existing curb and gutter of Maltese Point and is then conveyed east to an existing curb cut and channel that routes runoff to Tank water quality pond, which was intended to service the entire area of Lot 12.

**Basin B (0.53 acres)**

Basin B consists of the parking lot and southern roof drainage areas. Basin B is treated for water quality on-site at the proposed infiltration basin. Full infiltration of the required WQCV is achieved with a sand filter basin, utilizing the hydrological properties of the existing Type A soils on the site (see Appendix B). Calculations for the proposed infiltration basin are included in Appendix E. Runoff beyond the WQCV overtops the infiltration basin and flows overland to the existing curb and gutter of Rolling Thunder Way, following the existing drainage pattern of the Site.

**Basin C (0.18 acres)**

Basin C generally consists of landscape areas adjacent to Fire House View and Rolling Thunder Way, as well as the area where the adjacent building on Lot 13 is discharging runoff onto the Lot 12 site. Runoff from the landscape areas adjacent to the existing roadways is routed overland to existing curb and gutter, where it is captured at the existing inlet in Rolling Thunder Way. Runoff from the adjacent building and a portion of the area in the southwest corner of the Site is captured and conveyed by a grass-lined drainage channel. This development is proposing a sidewalk chase and concrete pan at the southwest corner of the Site which allows runoff to reach the curb

Can this basin be reasonably routed to the proposed infiltration basin?

Given the constraints of the site, as much of the developed area as is reasonably possible is being routed to the infiltration basin and/or the existing water quality pond. -SKDG

Rolling Thunder Way and maintain the existing drainage patterns of the bypasses water quality treatment and makes up 19% of the total . A significant portion of the runoff associated with this basin is not

being treated for water quality due to the existing conditions imposed on the Site by the existing Lot 13 development.

**Off-Site Basin (0.13 acres)**

There is only one off-site basin associated with this development. The building on the adjacent Lot 13 of the Rolling Thunder Business Park discharges runoff directly onto the Lot 12 Site via the roof drains/downspouts on the west side of the building. These downspouts will be shortened, and all runoff from the existing building currently being discharged onto the Lot 12 Site will be picked up by a grass lined swale and conveyed south to the curb and gutter of Rolling Thunder Way, maintaining the existing drainage pattern in this area.

**7. Rational Method & Infiltration Calculation Summary:**

**Table 1: Existing Conditions Rational Method Summary**

Rational Method Summary - Existing					
Basin ID	Area (acres)	Percent Impervious (%)	Q <sub>5</sub> (cfs)	Q <sub>10</sub> (cfs)	Q <sub>100</sub> (cfs)
EX-1	0.95	2.0	0.11	0.24	0.87
EX-2 (OS-1)	0.13	90.0	0.12	0.14	0.27
<b>Existing Basin Total</b>	<b>1.08</b>	<b>0.0</b>	<b>0.22</b>	<b>0.38</b>	<b>1.14</b>

**Table 2: Proposed Conditions Rational Method Summary**

Rational Method Summary - Proposed					
Basin ID	Area (acres)	Percent Impervious (%)	Q <sub>5</sub> (cfs)	Q <sub>10</sub> (cfs)	Q <sub>100</sub> (cfs)
Basin A-1	0.21	66.7	0.15	0.19	0.37
Basin A-2	0.03	36.1	0.01	0.02	0.04
<b>Basin A Total</b>	<b>0.24</b>	<b>63.4</b>	<b>0.16</b>	<b>0.20</b>	<b>0.41</b>
Basin B-1	0.48	85.5	0.44	0.55	1.02
Basin B-2	0.05	90.0	0.04	0.06	0.10
<b>Basin B Total</b>	<b>0.53</b>	<b>85.9</b>	<b>0.49</b>	<b>0.61</b>	<b>1.13</b>
Basin C-1	0.11	20.5	0.04	0.05	0.15
Basin C-2	0.08	17.9	0.03	0.04	0.11
<b>Basin C Total</b>	<b>0.18</b>	<b>19.4</b>	<b>0.06</b>	<b>0.09</b>	<b>0.25</b>
Basin EX-2 (OS-1)	0.13	90.0	0.12	0.14	0.27

Please add some text documenting how the calculations were completed for the infiltration basin. The sand filter basin spreadsheet it appears, is used for WQCV calculation and general geometry, but the actual design infiltration basin is not really an SFB per the plans. Discuss why that is used, clarify the actual constructed infiltration basin won't be an SFB, and discuss additional calculations used to create the table on the next page and in the appendix. We generally want some narrative describing the approach to calculations, what was used etc.

Text has been added documenting how the calculations were completed for the infiltration basin and better explaining the thought process behind the design of the basin. -SKDG

**Table 3: WQCV and Infiltration Rate Summary**

WQCV and Infiltration Rate Summary	
Infiltration Basin	
WQCV (cf)	568
<sup>1</sup> WQCV Depth (ft)	0.55
<sup>2</sup> 12-hr Infiltration Rate (in/hr)	0.7
<sup>1</sup> Refer to WSEL calculations in the appendices of this letter	
<sup>2</sup> Conservative estimate of infiltration rate based on soil type	

Table has been updated. Updated constant infiltration rate shown in table 3 is used and table 4 is for calculation of infiltration time. - SKDG

Please report infiltration rate in in/hr.

**Table 4: Infiltration Rate and Drain Time Calculation**

Infiltration Rate and Drain Time Calculation				
Stage (ft)	Area (sf)	Volume (cf)	Time (hr)	Rate (cfs)
0	875	0	0.00	0
0.5	1204	520	8.57	0.0169
0.55	1245	581	9.43	0.0171
0.9	1486	1059	15.43	0.0191

**8. Fees:**

The Site is within the Sand Creek Drainage Basin. It was previously platted, and drainage fees were previously paid with the Rolling Thunder Business Park Development. The Rolling Thunder FDR showing the original fee calculations are included in the Rolling Thunder Business Park development assumed a percent impervious area encompassing Lot 12 (Basin D-12 in the Rolling Thunder FDR). Since the site was previously platted, fees are calculated using the increase in impervious developed area associated with this project is 0.95 acres. A summary of the impervious area is shown below.

Total Developed Area: 0.95 acres  
 Landscaped Area: 0.274 acres 29%  
 Impervious Area: 71%

Infiltration testing was performed, infiltration rates of the native soils were not sufficient to meet the requirements for full infiltration as anticipated. Design has been updated to include amending the soils as recommended by the Geotech and is detailed in the updated report. -SKDG

Due to the impervious area not being increased when compared to the original plat and fees calculated with the overall development, there are no drainage fees associated with the proposed development of Lot 12.

For sites where full infiltration for WQ is proposed, an on-site infiltration test using double-ring infiltrometer is required. Infiltration tests should be performed or supervised by a licensed professional engineer and conducted at a minimum depth equal to the bottom of the PCM. Underdrains are required if infiltration tests show rates slower than 2 times that required to drain the WQCV over 12 hours. General guidelines for infiltration testing can be found here: <https://coloradosprings.gov/document/policyclarification-infiltrationvs.percolationtesting-signed.pdf>

## 9. Four Step Process

### a. Step 1: Employ Runoff Reduction Practices

Directly connected impervious areas are minimized to the extent possible, with runoff from the sidewalk, east of the proposed building, and runoff from the existing building on the adjacent lot being conveyed via grass swale. Runoff is concentrated along the curb and gutter of the proposed parking lot and then released into the proposed infiltration basin within the proposed development.

### b. Step 2: Stabilize Drainageways

The development of this project does not create drainageways and does not anticipate having any negative effects on existing downstream drainageways.

### c. Step 3: Provide Water Quality Capture Volume

The limit of disturbance for the proposed construction is 0.95 acres. Only water quality is required and necessary. An infiltration basin is proposed to capture the WQCV for Basin B due to Lot 13 blocking drainage to Tank water quality pond. Basin A WQCV will be captured by the existing Tank water quality pond.

### d. Step 4: Consider Need for Industrial and Commercial BMPs

This submittal provides a final grading and erosion control plan with BMPs in place. The proposed project will use silt fence, a vehicle tracking control pad, concrete washout area, stabilized staging area, erosion control blankets and rock socks, reseeding and landscaping to mitigate the potential for erosion across the site. The proposed BMPs are fully adequate for this development.

## 10. Summary

The proposed development of Lot 12 Rolling Thunder Business Park shall not adversely affect adjacent or downstream properties and is consistent with the Rolling Thunder FDR. The proposed improvements will overcome the hardship caused by the development of adjacent Lot 13 that blocked the previously planned drainage easement and path to the existing Tank water quality pond, by adding an infiltration basin on the Site. All drainage facilities outlined in this document and depicted in the drawings are susceptible to modifications based on final design and development of construction documents. This letter has been prepared in accordance with the El Paso Land Development Code, Drainage Criteria Manual Volumes 1 and 2, and the Engineering Criteria Manual, as amended.





## 11. References

- a. Drainage Criteria Manual County of El Paso, Colorado, Volume 1 and Volume 2, Version: October 31, 2018 (current).
- b. Engineering Criteria Manual County of El Paso, Colorado, Adopted: December 23, 2004, Revised: December 13, 2016.
- c. Urban Storm Drainage Criteria Manual: Volume 3, Stormwater Best Management Practices, Mile High Flood District (MHFD), latest version.
- d. Rolling Thunder Business Park Preliminary/Final Drainage Report, Springs Engineering, September, 2008.
- e. Rolling Thunder – Lot 13 Civil Plot Plan, Sheet 1 of 8, Springs Engineering, Date: 2-17-09.
- f. Geotechnical and Pavement Design Report – 10707 Maltese Point Peyton, Colorado, by Entech Engineering, Inc., Date: March 25, 2024.

S K D E S I G N G R O U P , I N C .

C I V I L E N G I N E E R S S I N C E 1 9 8 9



## APPENDIX A – VICINITY MAP

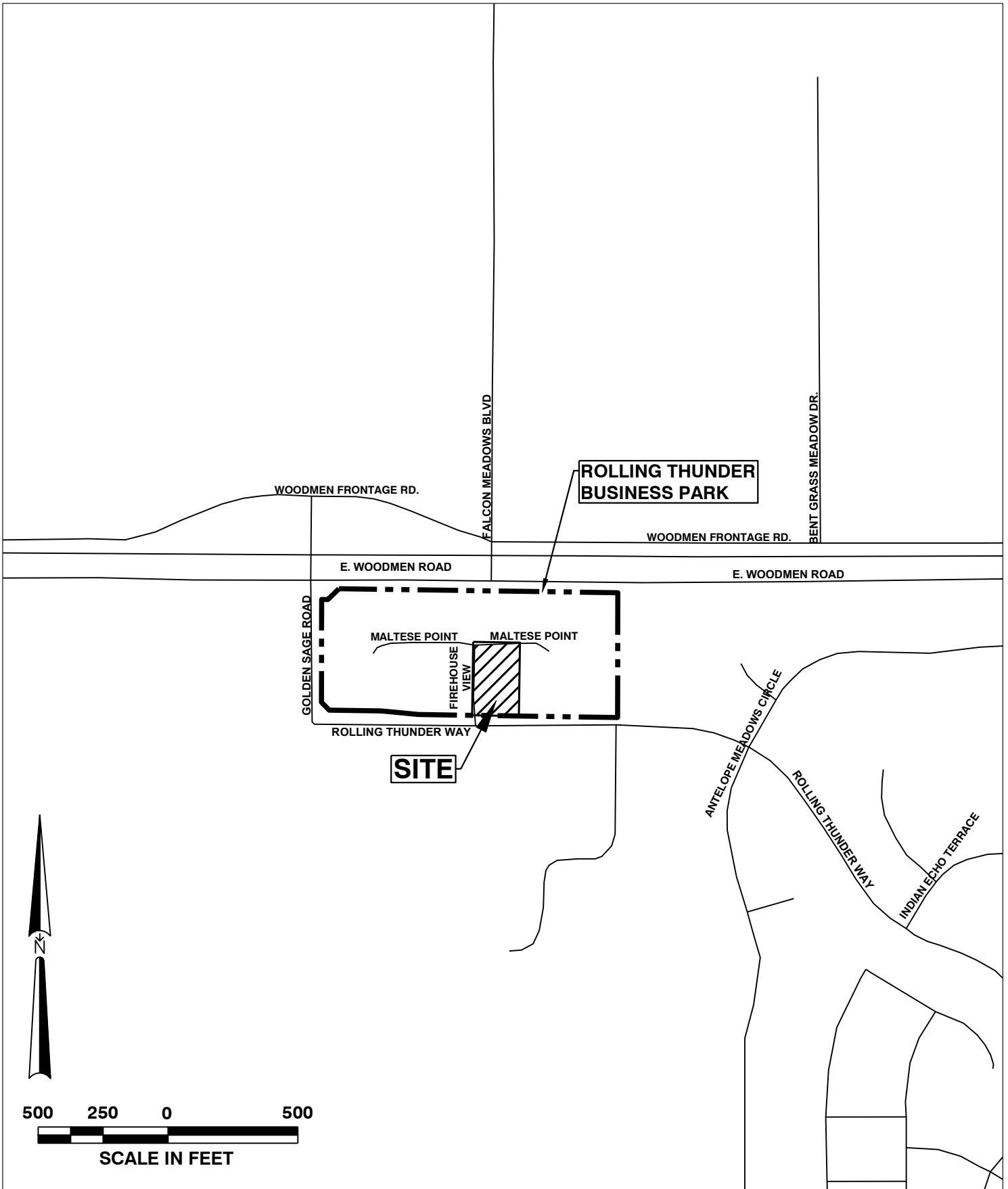

333 Perry St.,  
 Suite 209  
 Castle Rock, Colorado 80104  
 Tel: 913-451-1818  
 Fax: 913-451-7599

**VICINITY MAP**

**ROLLING THUNDER BUSINESS PARK - LOT 12**  
**10701 MALTESE PT, EL PASO COUNTY,**  
**PEYTON, CO**

**EXHIBIT**

APRIL, 2024

S K D E S I G N G R O U P , I N C .

C I V I L E N G I N E E R S S I N C E 1 9 8 9



## APPENDIX B – SOIL MAP

Hydrologic Soil Group—El Paso County Area, Colorado

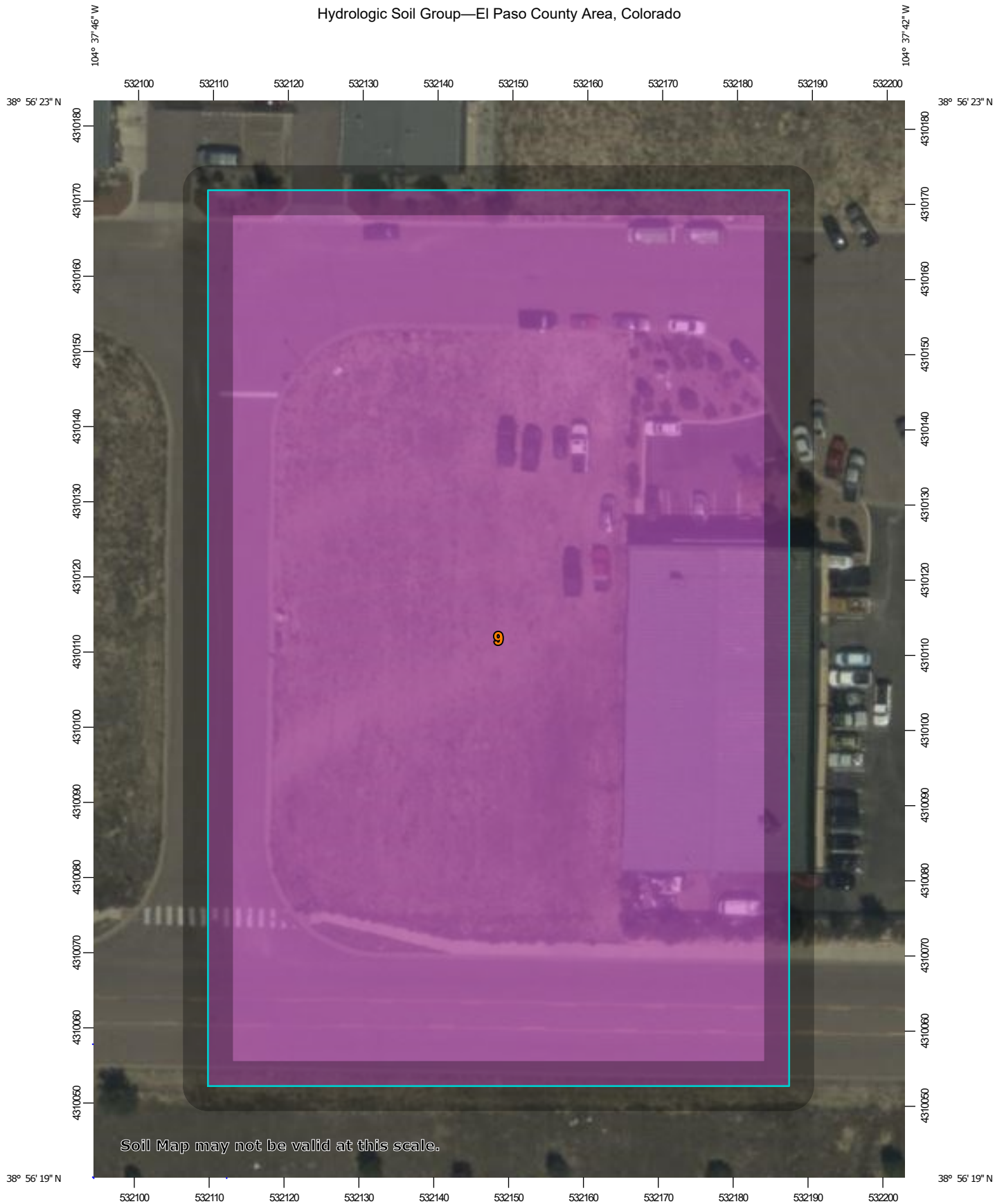

Map Scale: 1:699 if printed on A portrait (8.5" x 11") sheet.



Map projection: Web Mercator Corner coordinates: WGS84 Edge tics: UTM Zone 13N WGS84



### MAP LEGEND

**Area of Interest (AOI)**









 Area of Interest (AOI)

**Soils**

**Soil Rating Polygons**





-  A
-  A/D
-  B
-  B/D
-  C
-  C/D
-  D
-  Not rated or not available

**Soil Rating Lines**

-  A
-  A/D
-  B
-  B/D
-  C
-  C/D
-  D
-  Not rated or not available

**Soil Rating Points**





-  A
-  A/D
-  B
-  B/D

-  C
-  C/D
-  D
-  Not rated or not available

**Water Features**

 Streams and Canals

**Transportation**

-  Rails
-  Interstate Highways
-  US Routes
-  Major Roads
-  Local Roads

**Background**

 Aerial Photography

### MAP INFORMATION

The soil surveys that comprise your AOI were mapped at 1:24,000.

**Warning:** Soil Map may not be valid at this scale.

Enlargement of maps beyond the scale of mapping can cause misunderstanding of the detail of mapping and accuracy of soil line placement. The maps do not show the small areas of contrasting soils that could have been shown at a more detailed scale.

Please rely on the bar scale on each map sheet for map measurements.

Source of Map: Natural Resources Conservation Service  
 Web Soil Survey URL:  
 Coordinate System: Web Mercator (EPSG:3857)

Maps from the Web Soil Survey are based on the Web Mercator projection, which preserves direction and shape but distorts distance and area. A projection that preserves area, such as the Albers equal-area conic projection, should be used if more accurate calculations of distance or area are required.

This product is generated from the USDA-NRCS certified data as of the version date(s) listed below.

Soil Survey Area: El Paso County Area, Colorado  
 Survey Area Data: Version 21, Aug 24, 2023

Soil map units are labeled (as space allows) for map scales 1:50,000 or larger.

Date(s) aerial images were photographed: Sep 11, 2018—Oct 20, 2018

The orthophoto or other base map on which the soil lines were compiled and digitized probably differs from the background imagery displayed on these maps. As a result, some minor shifting of map unit boundaries may be evident.

## Hydrologic Soil Group

Map unit symbol	Map unit name	Rating	Acres in AOI	Percent of AOI
9	Blakeland-Fluvaquentic Haplaquolls	A	2.3	100.0%
<b>Totals for Area of Interest</b>			<b>2.3</b>	<b>100.0%</b>

### Description

Hydrologic soil groups are based on estimates of runoff potential. Soils are assigned to one of four groups according to the rate of water infiltration when the soils are not protected by vegetation, are thoroughly wet, and receive precipitation from long-duration storms.

The soils in the United States are assigned to four groups (A, B, C, and D) and three dual classes (A/D, B/D, and C/D). The groups are defined as follows:

Group A. Soils having a high infiltration rate (low runoff potential) when thoroughly wet. These consist mainly of deep, well drained to excessively drained sands or gravelly sands. These soils have a high rate of water transmission.

Group B. Soils having a moderate infiltration rate when thoroughly wet. These consist chiefly of moderately deep or deep, moderately well drained or well drained soils that have moderately fine texture to moderately coarse texture. These soils have a moderate rate of water transmission.

Group C. Soils having a slow infiltration rate when thoroughly wet. These consist chiefly of soils having a layer that impedes the downward movement of water or soils of moderately fine texture or fine texture. These soils have a slow rate of water transmission.

Group D. Soils having a very slow infiltration rate (high runoff potential) when thoroughly wet. These consist chiefly of clays that have a high shrink-swell potential, soils that have a high water table, soils that have a claypan or clay layer at or near the surface, and soils that are shallow over nearly impervious material. These soils have a very slow rate of water transmission.

If a soil is assigned to a dual hydrologic group (A/D, B/D, or C/D), the first letter is for drained areas and the second is for undrained areas. Only the soils that in their natural condition are in group D are assigned to dual classes.

### Rating Options

*Aggregation Method:* Dominant Condition

*Component Percent Cutoff:* None Specified

*Tie-break Rule:* Higher



S K D E S I G N G R O U P , I N C .

C I V I L E N G I N E E R S S I N C E 1 9 8 9



## APPENDIX C – NOAA ATLAS 14 RAINFALL DATA



**POINT PRECIPITATION FREQUENCY ESTIMATES**

Sanja Perica, Deborah Martin, Sandra Pavlovic, Ishani Roy, Michael St. Laurent, Carl Trypaluk, Dale Unruh, Michael Yekta, Geoffery Bonnin

NOAA, National Weather Service, Silver Spring, Maryland

[PF\\_tabular](#) | [PF\\_graphical](#) | [Maps\\_&\\_aerials](#)

**PF tabular**

PDS-based point precipitation frequency estimates with 90% confidence intervals (in inches) <sup>1</sup>										
Duration	Average recurrence interval (years)									
	1	2	5	10	25	50	100	200	500	1000
5-min	0.237 (0.193-0.294)	0.289 (0.235-0.358)	0.379 (0.307-0.470)	0.458 (0.369-0.571)	0.574 (0.449-0.748)	0.669 (0.510-0.882)	0.769 (0.565-1.04)	0.876 (0.616-1.21)	1.02 (0.691-1.46)	1.14 (0.748-1.64)
10-min	0.348 (0.283-0.430)	0.423 (0.344-0.524)	0.555 (0.450-0.689)	0.671 (0.540-0.836)	0.841 (0.658-1.10)	0.980 (0.746-1.29)	1.13 (0.827-1.52)	1.28 (0.901-1.78)	1.50 (1.01-2.14)	1.67 (1.10-2.41)
15-min	0.424 (0.345-0.525)	0.516 (0.420-0.640)	0.676 (0.548-0.840)	0.818 (0.659-1.02)	1.02 (0.802-1.34)	1.20 (0.910-1.58)	1.37 (1.01-1.85)	1.56 (1.10-2.17)	1.83 (1.23-2.60)	2.04 (1.34-2.93)
30-min	0.615 (0.500-0.761)	0.748 (0.608-0.926)	0.978 (0.793-1.22)	1.18 (0.952-1.47)	1.48 (1.16-1.93)	1.72 (1.31-2.27)	1.98 (1.45-2.67)	2.25 (1.58-3.12)	2.63 (1.78-3.75)	2.94 (1.92-4.22)
60-min	0.795 (0.647-0.984)	0.949 (0.772-1.18)	1.23 (0.994-1.52)	1.48 (1.19-1.85)	1.87 (1.47-2.45)	2.20 (1.68-2.91)	2.55 (1.88-3.46)	2.93 (2.07-4.08)	3.48 (2.35-4.97)	3.92 (2.57-5.64)
2-hr	0.975 (0.800-1.20)	1.15 (0.942-1.41)	1.48 (1.20-1.82)	1.78 (1.45-2.21)	2.26 (1.80-2.96)	2.67 (2.06-3.52)	3.12 (2.32-4.21)	3.62 (2.57-5.01)	4.33 (2.95-6.15)	4.91 (3.24-7.02)
3-hr	1.07 (0.884-1.31)	1.25 (1.03-1.53)	1.58 (1.30-1.94)	1.92 (1.56-2.36)	2.44 (1.96-3.20)	2.91 (2.26-3.84)	3.43 (2.56-4.62)	4.00 (2.87-5.54)	4.84 (3.33-6.88)	5.54 (3.67-7.88)
6-hr	1.24 (1.03-1.51)	1.43 (1.19-1.74)	1.80 (1.49-2.20)	2.18 (1.79-2.66)	2.79 (2.26-3.65)	3.34 (2.62-4.39)	3.96 (2.99-5.32)	4.65 (3.36-6.41)	5.68 (3.93-8.02)	6.53 (4.36-9.23)
12-hr	1.43 (1.20-1.72)	1.65 (1.38-1.99)	2.09 (1.74-2.53)	2.52 (2.09-3.06)	3.22 (2.63-4.16)	3.84 (3.03-4.99)	4.52 (3.44-6.02)	5.29 (3.85-7.22)	6.41 (4.47-8.98)	7.34 (4.95-10.3)
24-hr	1.64 (1.39-1.96)	1.93 (1.62-2.30)	2.45 (2.06-2.94)	2.95 (2.46-3.55)	3.72 (3.04-4.73)	4.38 (3.48-5.63)	5.11 (3.91-6.72)	5.90 (4.32-7.97)	7.05 (4.95-9.78)	7.99 (5.43-11.1)
2-day	1.90 (1.62-2.25)	2.25 (1.91-2.66)	2.87 (2.43-3.41)	3.43 (2.89-4.10)	4.27 (3.50-5.35)	4.97 (3.97-6.30)	5.72 (4.40-7.44)	6.54 (4.81-8.73)	7.68 (5.43-10.6)	8.61 (5.90-11.9)
3-day	2.09 (1.79-2.46)	2.47 (2.11-2.91)	3.13 (2.66-3.70)	3.73 (3.15-4.43)	4.61 (3.80-5.75)	5.35 (4.29-6.74)	6.13 (4.74-7.93)	6.98 (5.16-9.27)	8.16 (5.80-11.2)	9.12 (6.28-12.6)
4-day	2.25 (1.93-2.65)	2.64 (2.26-3.11)	3.33 (2.84-3.93)	3.95 (3.35-4.68)	4.87 (4.02-6.04)	5.63 (4.52-7.07)	6.44 (4.99-8.30)	7.31 (5.43-9.69)	8.54 (6.08-11.6)	9.52 (6.58-13.1)
7-day	2.67 (2.30-3.11)	3.08 (2.66-3.60)	3.81 (3.28-4.47)	4.47 (3.82-5.26)	5.45 (4.53-6.71)	6.26 (5.07-7.81)	7.13 (5.56-9.12)	8.06 (6.02-10.6)	9.36 (6.72-12.7)	10.4 (7.25-14.3)
10-day	3.03 (2.63-3.52)	3.48 (3.02-4.05)	4.27 (3.69-4.98)	4.98 (4.27-5.83)	6.01 (5.02-7.36)	6.87 (5.58-8.52)	7.78 (6.09-9.90)	8.75 (6.56-11.5)	10.1 (7.28-13.6)	11.2 (7.82-15.3)
20-day	4.06 (3.55-4.68)	4.67 (4.08-5.38)	5.69 (4.95-6.58)	6.57 (5.68-7.64)	7.82 (6.55-9.44)	8.82 (7.20-10.8)	9.84 (7.76-12.4)	10.9 (8.23-14.1)	12.4 (8.96-16.5)	13.5 (9.52-18.3)
30-day	4.90 (4.30-5.62)	5.64 (4.95-6.48)	6.87 (6.00-7.91)	7.89 (6.86-9.12)	9.30 (7.80-11.1)	10.4 (8.52-12.6)	11.5 (9.10-14.4)	12.6 (9.56-16.2)	14.1 (10.3-18.7)	15.3 (10.8-20.6)
45-day	5.94 (5.24-6.78)	6.84 (6.04-7.82)	8.30 (7.29-9.51)	9.49 (8.28-10.9)	11.1 (9.32-13.1)	12.3 (10.1-14.8)	13.5 (10.7-16.7)	14.6 (11.1-18.7)	16.2 (11.8-21.3)	17.3 (12.3-23.2)
60-day	6.82 (6.04-7.75)	7.84 (6.94-8.93)	9.48 (8.35-10.8)	10.8 (9.45-12.4)	12.5 (10.5-14.7)	13.8 (11.4-16.5)	15.0 (11.9-18.5)	16.2 (12.4-20.6)	17.7 (13.0-23.2)	18.8 (13.5-25.2)

<sup>1</sup> Precipitation frequency (PF) estimates in this table are based on frequency analysis of partial duration series (PDS). Numbers in parenthesis are PF estimates at lower and upper bounds of the 90% confidence interval. The probability that precipitation frequency estimates (for a given duration and average recurrence interval) will be greater than the upper bound (or less than the lower bound) is 5%. Estimates at upper bounds are not checked against probable maximum precipitation (PMP) estimates and may be higher than currently valid PMP values. Please refer to NOAA Atlas 14 document for more information.

[Back to Top](#)

**PF graphical**

# PDS-based depth-duration-frequency (DDF) curves

Latitude: 38.9394°, Longitude: -104.6292°

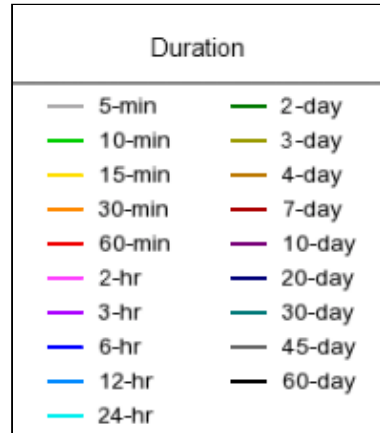
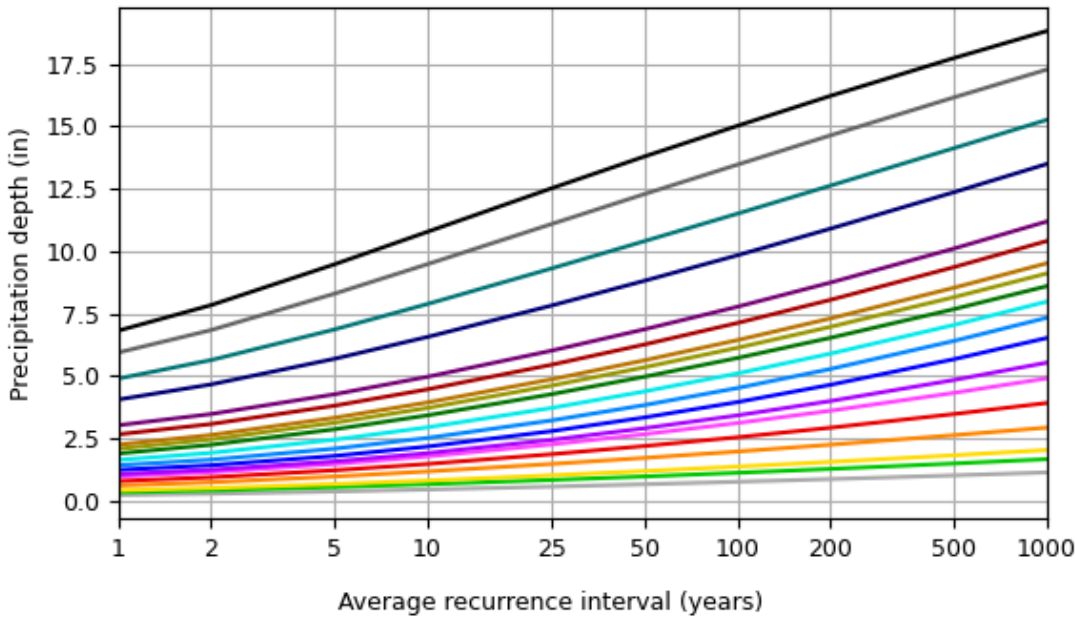
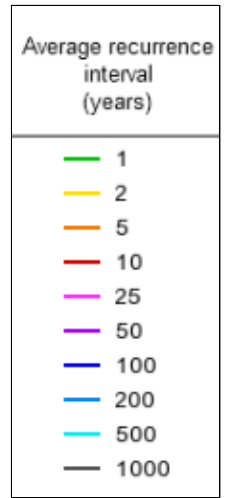
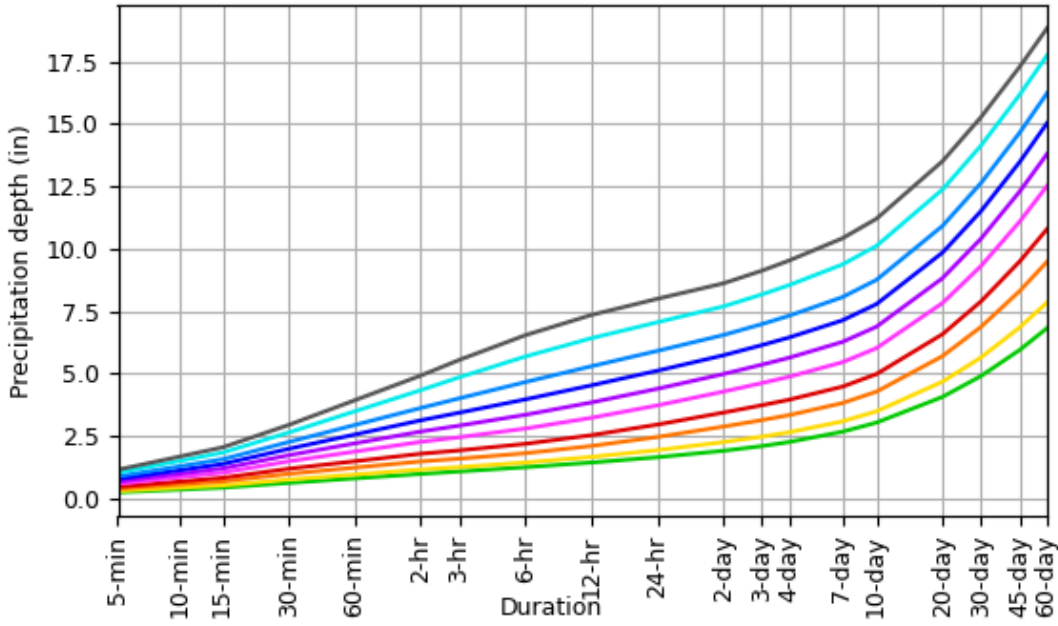

[Back to Top](#)

## Maps & aerials

Small scale terrain

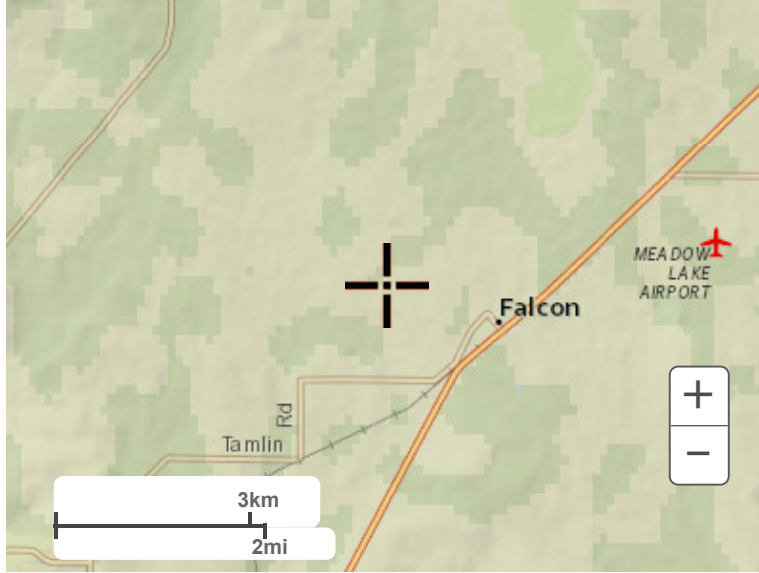

Large scale terrain



Large scale map

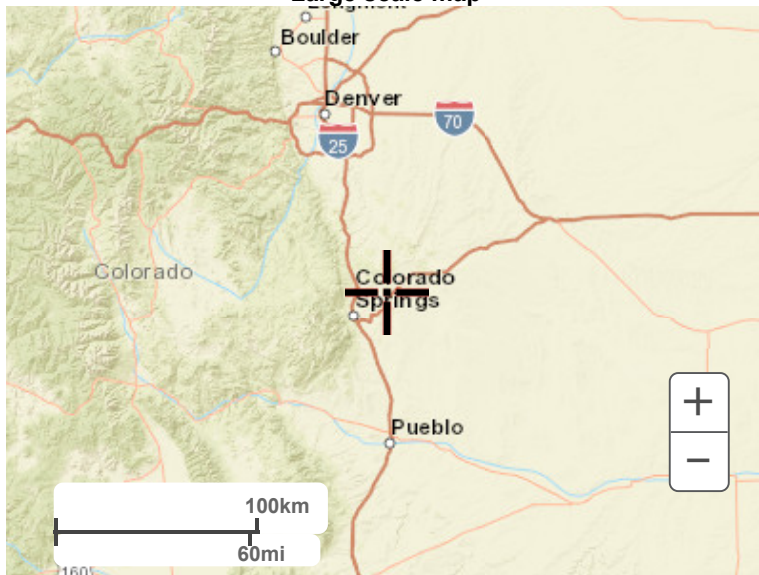

Large scale aerial



[Back to Top](#)

---

[US Department of Commerce](#)  
[National Oceanic and Atmospheric Administration](#)  
[National Weather Service](#)  
[National Water Center](#)  
1325 East West Highway  
Silver Spring, MD 20910  
Questions?: [HDSC.Questions@noaa.gov](mailto:HDSC.Questions@noaa.gov)

[Disclaimer](#)

S K D E S I G N G R O U P , I N C .

C I V I L E N G I N E E R S S I N C E 1 9 8 9



## APPENDIX D – FEMA FIRMETTE

# National Flood Hazard Layer FIRMMette



104°38'4"W 38°56'36"N

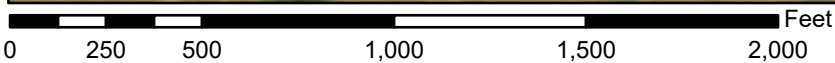

1:6,000

104°37'26"W 38°56'8"N

Basemap Imagery Source: USGS National Map 2023

## Legend

SEE FIS REPORT FOR DETAILED LEGEND AND INDEX MAP FOR FIRM PANEL LAYOUT

- |                                    |  |  |
|------------------------------------|--|--|
| <b>SPECIAL FLOOD HAZARD AREAS</b>  |  | Without Base Flood Elevation (BFE)<br><i>Zone A, V, A99</i>  |
|                                    |  | With BFE or Depth <i>Zone AE, AO, AH, VE, AR</i>   |
|                                    |  | Regulatory Floodway  |
| <b>OTHER AREAS OF FLOOD HAZARD</b> |  | 0.2% Annual Chance Flood Hazard, Areas of 1% annual chance flood with average depth less than one foot or with drainage areas of less than one square mile <i>Zone X</i> |
|                                    |  | Future Conditions 1% Annual Chance Flood Hazard <i>Zone X</i>  |
|                                    |  | Area with Reduced Flood Risk due to Levee. See Notes. <i>Zone X</i>  |
|                                    |  | Area with Flood Risk due to Levee <i>Zone D</i>  |
| <b>OTHER AREAS</b>                 |  | NO SCREEN Area of Minimal Flood Hazard <i>Zone X</i>   |
|                                    |  | Effective LOMRs  |
|                                    |  | Area of Undetermined Flood Hazard <i>Zone D</i>  |
| <b>GENERAL STRUCTURES</b>          |  | Channel, Culvert, or Storm Sewer   |
|                                    |  | Levee, Dike, or Floodwall  |
| <b>OTHER FEATURES</b>              |  | 20.2 Cross Sections with 1% Annual Chance Water Surface Elevation  |
|                                    |  | 17.5 Water Surface Elevation   |
|                                    |  | Coastal Transect   |
|                                    |  | Base Flood Elevation Line (BFE)  |
|                                    |  | Limit of Study   |
|                                    |  | Jurisdiction Boundary  |
|                                    |  | Coastal Transect Baseline  |
|                                    |  | Profile Baseline   |
|                                    |  | Hydrographic Feature   |
| <b>MAP PANELS</b>                  |  | Digital Data Available   |
|                                    |  | No Digital Data Available  |
|                                    |  | Unmapped   |



The pin displayed on the map is an approximate point selected by the user and does not represent an authoritative property location.

This map complies with FEMA's standards for the use of digital flood maps if it is not void as described below. The basemap shown complies with FEMA's basemap accuracy standards

The flood hazard information is derived directly from the authoritative NFHL web services provided by FEMA. This map was exported on 3/27/2024 at 6:53 PM and does not reflect changes or amendments subsequent to this date and time. The NFHL and effective information may change or become superseded by new data over time.

This map image is void if the one or more of the following map elements do not appear: basemap imagery, flood zone labels, legend, scale bar, map creation date, community identifiers, FIRM panel number, and FIRM effective date. Map images for unmapped and unmodernized areas cannot be used for regulatory purposes.



## APPENDIX E – CALCULATIONS

Provide analysis for eastern swale and under sidewalk drain.

Sections have been added for the eastern swale, sidewalk drain, and Pond A overflow.  
-SKDG





**Comp C and i%**

**Project: Rolling Thunder Business Park, Lot 12**

**Location: Peyton, CO**

**Date: 2024-03-29**

**Calculated By: EP**

**Checked By: AM**

From Table 6-6 of the El Paso County DCM: Volume 1 Update				
Land Use or Surface Characteristics	Percent Impervious (%)	Runoff Coefficients (HSG A&B)		
		5-YR	10-YR	100-YR
Historic Flow Analysis	2	0.09	0.17	0.36
Drives and Walks	100	0.90	0.92	0.96
Roofs	90	0.73	0.75	0.81
Lawns	0	0.08	0.15	0.35

Basin ID	Areas				Total Area (acres)	Comp i% Percent Imperviousness (%)	Comp C		
	Historic Flow Analysis (sf)	Drives and Walks (sf)	Roofs (sf)	Lawns (sf)			C <sub>5</sub>	C <sub>10</sub>	C <sub>100</sub>
EX-1	41368	0	0	0	0.950	2.0	0.09	0.17	0.36
EX-2 (OS-1)	0	0	5613	0	0.129	90.0	0.73	0.75	0.81
Basin A-1	0	104	6750	2405	0.213	66.7	0.56	0.60	0.69
Basin A-2	0	414	0	733	0.026	36.1	0.38	0.43	0.57
Basin B-1	0	17862	0	3034	0.480	85.5	0.78	0.81	0.87
Basin B-2	0	0	2201	0	0.051	90.0	0.73	0.75	0.81
Basin C-1	0	956	0	3716	0.107	20.5	0.25	0.31	0.47
Basin C-2	0	593	0	2712	0.076	17.9	0.23	0.29	0.46
<b>Basin A Total</b>	0	518	6750	3138	0.239	63.4	0.54	0.58	0.68
<b>Basin B Total</b>	0	17862	2201	3034	0.530	85.9	0.78	0.80	0.87
<b>Basin C Total</b>	0	1549	0	6428	0.183	19.4	0.24	0.30	0.47
<b>Site Total</b>	0	19929	8951	12600	0.952	67.5	0.61	0.65	0.74



**Standard Form SF-1. Time of Concentration**  
**Project: Rolling Thunder Business Park, Lot 12**  
**Location: Peyton, CO**  
**Date: 2024-03-29**  
**Calculated By: EP**  
**Checked By: AM**

Sub-Basin			Initial/Overland Time (T <sub>i</sub> )			Travel Time (T <sub>t</sub> )					T <sub>c</sub> Check (Urbanized Basin)		Final T <sub>c</sub>	Notes
Basin ID	<sup>5</sup> C <sub>s</sub>	Area (ac)	Length (ft)	Slope (ft/ft)	<sup>1</sup> T <sub>i</sub> (min)	Length (ft)	Slope (%)	<sup>3</sup> C <sub>v</sub>	<sup>2</sup> V (ft/s)	T <sub>t</sub> (min)	Total Length (ft)	<sup>4</sup> T <sub>c</sub> (min)	T <sub>c</sub> (min)	
EX-1	0.09	0.95	65	0.004	19.9	170	0.02	10	1.4	2.0	235	11.3	11.3	
EX-2 (OS-1)	0.73	0.13	40	0.05	2.5	185	0.02	10	1.4	2.2	225	11.3	11.3	
Basin A-1	0.56	0.21	60	0.02	6.0	100	0.005	20	1.4	1.2	160	10.9	7.2	
Basin A-2	0.38	0.03	25	0.02	5.2	60	0.02	20	2.8	0.4	85	10.5	5.6	
Basin B-1	0.78	0.46	45	0.03	2.7	240	0.005	20	1.4	2.8	285	11.6	5.5	
Basin B-2	0.73	0.05	60	0.02	4.1	75	0.03	20	3.5	0.4	135	10.8	10.8	
Basin C-1	0.25	0.12	15	0.05	3.5	450	0.01	20	2.0	3.8	465	12.6	7.3	
Basin C-2	0.23	0.09	15	0.08	3.1	180	0.01	20	2.0	1.5	195	11.1	11.1	

<sup>1</sup> Drainage Criteria Manual, Volume 1 Update, El Paso County, Eq. 6-8

<sup>2</sup> Drainage Criteria Manual, Volume 1 Update, El Paso County, Eq. 6-9

<sup>3</sup> Drainage Criteria Manual, Volume 1 Update, El Paso County, Table 6-7

<sup>4</sup> Drainage Criteria Manual, Volume 1 Update, El Paso County, Eq. 6-7

<sup>5</sup> Drainage Criteria Manual, Volume 1 Update, El Paso County, Table 6-6



**Standard Form SF-2. Storm Drainage System Design (Rational Method Procedure)**

**Project: Rolling Thunder Business Park, Lot 12**

**Location: Peyton, CO**

**Date: 2024-03-29**

**Calculated By: EP**

**Checked By: AM**

**Design Storm: 5 -YR**

Point Precipitation Frequency Estimates, 1-hr Duration							
NOAA Atlas 14, Volume 8, Version 2							
Average Recurrence Interval (years)	1	2	5	10	25	50	100
Point Based Precipitation Frequency (inches)	0.80	0.95	1.23	1.48	1.87	2.20	2.55

Design Point	Area Designation	Area (A) (ac)	Runoff Coeff. (C)	Direct Runoff				Total Runoff				Street		Pipe			Travel Time		Notes
				T <sub>c</sub> (min)	Total CA	I <sub>1</sub> (in/hr)	Q (cfs)	T <sub>c</sub> (min)	Total CA	I <sub>1</sub> (in/hr)	Q (cfs)	Slope (%)	Street Flow	Design Flow (cfs)	Slope (%)	Pipe Size (in)	Length (ft)	Velocity (ft/second)	
	EX-1	0.95	0.09	11.3	0.09	1.23	<b>0.11</b>												
	EX-2 (OS-1)	0.13	0.73	11.3	0.69	1.23	<b>0.12</b>												
	Basin A-1	0.21	0.56	7.2	0.12	1.23	<b>0.15</b>												
	Basin A-2	0.03	0.38	5.6	0.01	1.23	<b>0.01</b>												
	Basin B-1	0.46	0.78	5.5	0.36	1.23	<b>0.44</b>												
	Basin B-2	0.05	0.73	10.8	0.04	1.23	<b>0.04</b>												
	Basin C-1	0.12	0.25	7.3	0.03	1.23	<b>0.04</b>												
	Basin C-2	0.09	0.23	11.1	0.02	1.23	<b>0.03</b>												

<sup>1</sup> Drainage Criteria Manual, Volume 1 Update, El Paso County, Table 6-6



**Standard Form SF-2. Storm Drainage System Design (Rational Method Procedure)**

**Project: Rolling Thunder Business Park, Lot 12**

**Location: Peyton, CO**

**Date: 2024-03-29**

**Calculated By: EP**

**Checked By: AM**

**Design Storm: 10 -YR**

Point Precipitation Frequency Estimates, 1-hr Duration							
NOAA Atlas 14, Volume 8, Version 2							
Average Recurrence Interval (years)	1	2	5	10	25	50	100
Point Based Precipitation Frequency (inches)	0.80	0.95	1.23	1.48	1.87	2.20	2.55

Design Point	Area Designation	Area (A) (ac)	Runoff Coeff. (C)	Direct Runoff				Total Runoff				Street		Pipe			Travel Time		Notes
				T <sub>c</sub> (min)	Total CA	I <sub>t</sub> (in/hr)	Q (cfs)	T <sub>c</sub> (min)	Total CA	I <sub>t</sub> (in/hr)	Q (cfs)	Slope (%)	Street Flow	Design Flow (cfs)	Slope (%)	Pipe Size (in)	Length (ft)	Velocity (ft/sec)	
	EX-1	0.95	0.17	11.3	0.16	1.48	<b>0.24</b>												
	EX-2 (OS-1)	0.13	0.75	11.3	0.10	1.48	<b>0.14</b>												
	Basin A-1	0.21	0.60	7.2	0.13	1.48	<b>0.19</b>												
	Basin A-2	0.03	0.43	5.6	0.01	1.48	<b>0.02</b>												
	Basin B-1	0.46	0.81	5.5	0.37	1.48	<b>0.55</b>												
	Basin B-2	0.05	0.75	10.8	0.04	1.48	<b>0.06</b>												
	Basin C-1	0.12	0.31	7.3	0.04	1.48	<b>0.05</b>												
	Basin C-2	0.09	0.29	11.1	0.03	1.48	<b>0.04</b>												

<sup>1</sup> Drainage Criteria Manual, Volume 1 Update, El Paso County, Table 6-6



**Standard Form SF-2. Storm Drainage System Design (Rational Method Procedure)**

**Project: Rolling Thunder Business Park, Lot 12**

**Location: Peyton, CO**

**Date: 2024-03-29**

**Calculated By: EP**

**Checked By: AM**

**Design Storm: 100 -YR**

Point Precipitation Frequency Estimates, 1-hr Duration							
NOAA Atlas 14, Volume 8, Version 2							
Average Recurrence Interval (years)							
1	2	5	10	25	50	100	
0.80	0.95	1.23	1.48	1.87	2.20	2.55	

Design Point	Direct Runoff						Total Runoff				Street		Pipe			Travel Time			Notes	
	Area Designation	Area (A) (ac)	Runoff Coeff. (C)	T <sub>r</sub> (min)	Total CA	I (in/hr)	Q (cfs)	T <sub>r</sub> (min)	Total CA	I (in/hr)	Q (cfs)	Slope (%)	Street Flow	Design Flow (cfs)	Slope (%)	Pipe Size (in)	Length (ft)	Velocity (ft/sec)		T <sub>t</sub> (min)
EX-1		0.95	0.36	11.3	0.34	2.55	0.87													
EX-2 (OS-1)		0.13	0.81	11.3	0.11	2.55	0.27													
Basin A-1		0.21	0.69	7.2	0.15	2.55	0.37													
Basin A-2		0.03	0.57	5.6	0.02	2.55	0.04													
Basin B-1		0.46	0.87	5.5	0.40	2.55	1.02													
Basin B-2		0.05	0.81	10.8	0.04	2.55	0.10													
Basin C-1		0.12	0.47	7.3	0.06	2.55	0.15													
Basin C-2		0.09	0.46	11.1	0.04	2.55	0.11													

<sup>1</sup> Drainage Criteria Manual, Volume 1 Update, El Paso County, Table 6-6

## Design Procedure Form: Sand Filter (SF)

UD-BMP (Version 3.07, March 2018)

Sheet 1 of 2

**Designer:** EP  
**Company:** SK Design Group  
**Date:** April 11, 2024  
**Project:** Roling Thunder Business Park, Lot 12  
**Location:** Peyton, CO

<p>1. Basin Storage Volume</p> <p>A) Effective Imperviousness of Tributary Area, <math>I_a</math> (100% if all paved and roofed areas upstream of sand filter)</p> <p>B) Tributary Area's Imperviousness Ratio (<math>i = I_a/100</math>)</p> <p>C) Water Quality Capture Volume (WQCV) Based on 12-hour Drain Time <math>WQCV = 0.8 * (0.91 * i^3 - 1.19 * i^2 + 0.78 * i)</math></p> <p>D) Contributing Watershed Area (including sand filter area)</p> <p>E) Water Quality Capture Volume (WQCV) Design Volume <math>V_{WQCV} = WQCV / 12 * Area</math></p> <p>F) For Watersheds Outside of the Denver Region, Depth of Average Runoff Producing Storm</p> <p>G) For Watersheds Outside of the Denver Region, Water Quality Capture Volume (WQCV) Design Volume</p> <p>H) User Input of Water Quality Capture Volume (WQCV) Design Volume (Only if a different WQCV Design Volume is desired)</p>	<p><math>I_a = </math> <input type="text" value="85.9"/> %</p> <p><math>i = </math> <input type="text" value="0.859"/></p> <p>WQCV = <input type="text" value="0.29"/> watershed inches</p> <p>Area = <input type="text" value="23,097"/> sq ft</p> <p><math>V_{WQCV} = </math> <input type="text" value="568"/> cu ft</p> <p><math>d_e = </math> <input type="text"/> in</p> <p><math>V_{WQCV OTHER} = </math> <input type="text"/> cu ft</p> <p><math>V_{WQCV USER} = </math> <input type="text"/> cu ft</p>
<p>2. Basin Geometry</p> <p>A) WQCV Depth</p> <p>B) Sand Filter Side Slopes (Horizontal distance per unit vertical, 4:1 or flatter preferred). Use "0" if sand filter has vertical walls.</p> <p>C) Minimum Filter Area (Flat Surface Area)</p> <p>D) Actual Filter Area</p> <p>E) Volume Provided</p>	<p><math>D_{WQCV} = </math> <input type="text" value="0.9"/> ft</p> <p><math>Z = </math> <input type="text" value="3.00"/> ft / ft <b>DIFFICULT TO MAINTAIN, INCREASE WHERE POSSIBLE</b></p> <p><math>A_{Min} = </math> <input type="text" value="248"/> sq ft</p> <p><math>A_{Actual} = </math> <input type="text" value="875"/> sq ft</p> <p><math>V_T = </math> <input type="text" value="1180"/> cu ft</p>
<p>3. Filter Material</p>	<p>Choose One</p> <p><input type="radio"/> 18" CDOT Class B or C Filter Material</p> <p><input checked="" type="radio"/> Other (Explain):</p> <p style="border: 1px solid black; padding: 2px;">Native Soil - Blakeland-Fluvaquentic Soil NRCS Hydrologic Soil Group Rating A</p>
<p>4. Underdrain System</p> <p>A) Are underdrains provided?</p> <p>B) Underdrain system orifice diameter for 12 hour drain time</p> <p style="margin-left: 20px;">i) Distance From Lowest Elevation of the Storage Volume to the Center of the Orifice</p> <p style="margin-left: 20px;">ii) Volume to Drain in 12 Hours</p> <p style="margin-left: 20px;">iii) Orifice Diameter, 3/8" Minimum</p>	<p>Choose One</p> <p><input type="radio"/> YES</p> <p><input checked="" type="radio"/> NO</p> <p><math>y = </math> <input type="text" value="N/A"/> ft</p> <p><math>Vol_{12} = </math> <input type="text" value="N/A"/> cu ft</p> <p><math>D_o = </math> <input type="text" value="N/A"/> in</p>

See comments on GEC, provide riprap sizing for erosion protection at concentrated flow points within the infiltration basin.

Riprap has been added at inflow and outflow locations, sizing is called out in the GEC plan and sections are included with WSEL's. -SKDG

Design Procedure Form: Sand Filter (SF)

Sheet 2 of 2

Designer: EP  
Company: SK Design Group  
Date: April 11, 2024  
Project: Rolling Thunder Business Park, Lot 12  
Location: Peyton, CO

5. Impermeable Geomembrane Liner and Geotextile Separator Fabric

A) Is an impermeable liner provided due to proximity of structures or groundwater contamination?

Choose One

YES  NO

6. Inlet / Outlet Works

A) Describe the type of energy dissipation at inlet points and means of conveying flows in excess of the WQCV through the outlet

N/A

---

---

---

Notes: Sheet flow discharge overland and into existing curb and gutter. No energy dissipation is required.  
Full infiltration of detained volumes is achieved and there is no conveyance of flows in excess of WQCV through an outlet.

---

---

# DETENTION BASIN STAGE-STORAGE TABLE BUILDER

MHFD-Detention, Version 4.06 (July 2022)

Project: **Rolling Thunder Business Park, Lot 12 - Infiltration Basin**

Basin ID: \_\_\_\_\_

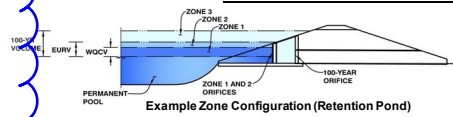

### Watershed Information

Selected BMP Type =	SF
Watershed Area =	0.53 acres
Watershed Length =	230 ft
Watershed Length to Centroid =	125 ft
Watershed Slope =	0.005 ft/ft
Watershed Imperviousness =	85.90% percent
Percentage Hydrologic Soil Group A =	100.0% percent
Percentage Hydrologic Soil Group B =	0.0% percent
Percentage Hydrologic Soil Groups C/D =	0.0% percent
Target WQCV Drain Time =	12.0 hours
Location for 1-hr Rainfall Depths =	User Input

Selected inputs above including 1-hour rainfall depth to generate runoff hydrographs using the Colorado Urban Hydrograph Procedure.

### Optional User Overrides

Volume (WQCV) =	0.013 acre-feet
Volume (EURV) =	0.061 acre-feet
100-yr Runoff Depth (P1 = 0.95 in.) =	0.032 acre-feet
50-yr Runoff Depth (P1 = 1.23 in.) =	0.043 acre-feet
25-yr Runoff Depth (P1 = 1.48 in.) =	0.053 acre-feet
10-yr Runoff Depth (P1 = 1.87 in.) =	0.069 acre-feet
5-yr Runoff Depth (P1 = 2.20 in.) =	0.083 acre-feet
2-yr Runoff Depth (P1 = 2.55 in.) =	0.099 acre-feet
1-yr Runoff Depth (P1 = 3.14 in.) =	0.125 acre-feet
Approximate 2-yr Detention Volume =	0.032 acre-feet
Approximate 5-yr Detention Volume =	0.043 acre-feet
Approximate 10-yr Detention Volume =	0.053 acre-feet
Approximate 25-yr Detention Volume =	0.069 acre-feet
Approximate 50-yr Detention Volume =	0.078 acre-feet
Approximate 100-yr Detention Volume =	0.087 acre-feet

### Define Zones and Basin Geometry

Select Zone 1 Storage Volume (Required) =		acre-feet
Select Zone 2 Storage Volume (Optional) =		acre-feet
Select Zone 3 Storage Volume (Optional) =		acre-feet
Total Detention Basin Volume =		acre-feet
Initial Surcharge Volume (ISV) =	N/A	ft <sup>3</sup>
Initial Surcharge Depth (ISD) =	N/A	ft
Total Available Detention Depth (H <sub>total</sub> ) =	user	ft
Depth of Trickle Channel (H <sub>TC</sub> ) =	N/A	ft
Slope of Trickle Channel (S <sub>TC</sub> ) =	N/A	ft/ft
Slopes of Main Basin Sides (S <sub>Main</sub> ) =	user	H:V
Basin Length-to-Width Ratio (R <sub>L/W</sub> ) =	user	

Initial Surcharge Area (A <sub>ISV</sub> ) =	user	ft <sup>2</sup>
Surcharge Volume Length (L <sub>ISV</sub> ) =	user	ft
Surcharge Volume Width (W <sub>ISV</sub> ) =	user	ft
Depth of Basin Floor (H <sub>FLOOR</sub> ) =	user	ft
Length of Basin Floor (L <sub>FLOOR</sub> ) =	user	ft
Width of Basin Floor (W <sub>FLOOR</sub> ) =	user	ft
Area of Basin Floor (A <sub>FLOOR</sub> ) =	user	ft <sup>2</sup>
Volume of Basin Floor (V <sub>FLOOR</sub> ) =	user	ft <sup>3</sup>
Depth of Main Basin (H <sub>MAN</sub> ) =	user	ft
Length of Main Basin (L <sub>MAN</sub> ) =	user	ft
Width of Main Basin (W <sub>MAN</sub> ) =	user	ft
Area of Main Basin (A <sub>MAN</sub> ) =	user	ft <sup>2</sup>
Volume of Main Basin (V <sub>MAN</sub> ) =	user	ft <sup>3</sup>
Calculated Total Basin Volume (V <sub>total</sub> ) =	user	acre-feet

Stage - Storage Description	Depth Increment =	ft	Optional Override Stage (ft)	Length (ft)	Width (ft)	Area (ft <sup>2</sup> )	Optional Override Area (ft <sup>2</sup> )	Area (acre)	Volume (ft <sup>3</sup> )	Volume (ac-ft)
	ft									
<b>Media Surface</b>	--		0.00	--	--	--	875	0.020		
	--		0.50	--	--	--		0.028	520	0.012
<b>WQCV = 6896.55</b>	--		0.55	--	--	--	1,245	0.029	581	0.013
	--		0.90	--	--	--	1,486	0.034	1,059	0.024
	--			--	--	--				
	--			--	--	--				
	--			--	--	--				

This worksheet is really only for determining full spectrum performance of an EDB, it would not be needed for this project.

Worksheet has been removed from the drainage letter. -SKDG



# DETENTION BASIN STAGE-STORAGE TABLE BUILDER

*MHFD-Detention, Version 4.06 (July 2022)*

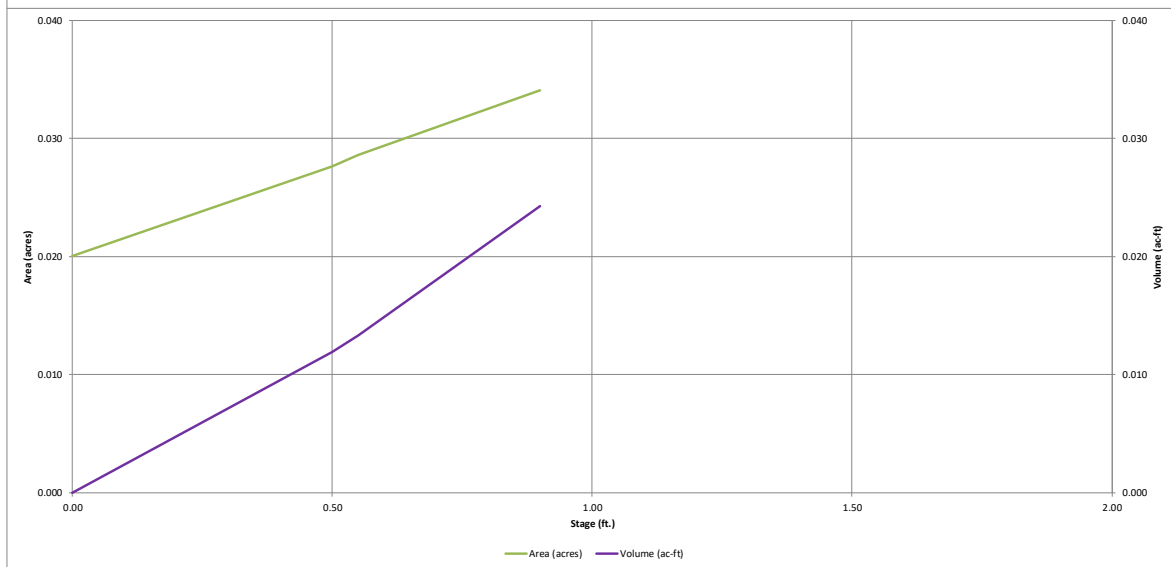
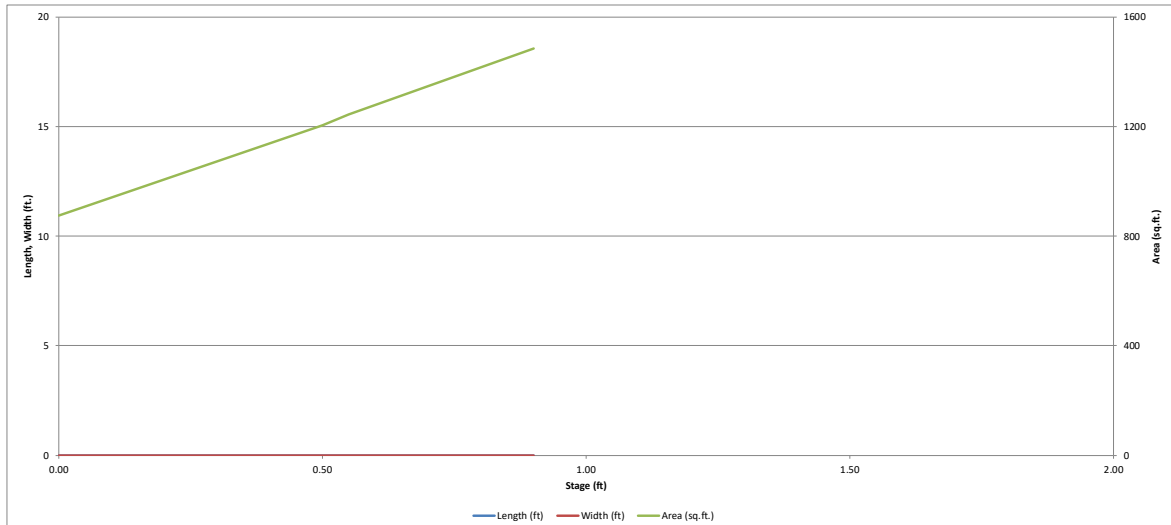



**WQCV & Drain Time Calculation**

**Project: Rolling Thunder Business Park, Lot 12**

**Location: Peyton, CO**

**Date: 2024-03-29**

**Calculated By: EP**

**Checked By: AM**

Calculations have been updated. -SKDG

WQCV and Infiltration Rate Summary	
	Infiltration Rate (in/hr)
WQCV (cf)	568
<sup>1</sup> WQCV Depth (ft)	0.55
<sup>2</sup> 12-hr Infiltration Rate (in/hr)	0.7
<sup>1</sup> Refer to WSEL calculations in the appendices of this letter	
<sup>2</sup> Conservative estimate of infiltration rate based on soil type	

Rate in CFS has been removed and infiltration rate has been updated per new amended soil design. -SKDG

infiltration rate should be in in/hr.

Please provide equation used. Are you calculating time or rate?

Infiltration Rate and Drain Time Calculation				
Stage (ft)	Area (sf)	Volume (cf)	Time (hr)	Rate (cfs)
0	875	0	0.00	0
0.5	1204	520	8.57	0.0169
0.55	1245	581	9.43	0.0171
0.9	1486	1059	15.43	0.0191

We would want to clearly see the infiltration rate required to drain WQCV over 12 hours. See previous comment on infiltration testing.

Calculation showing this rate and the new rate have been added. -SKDG















Appendix F has been  
relocated. -SKDG

Please move these to  
the end of the report

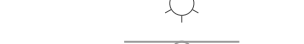
## APPENDIX F – EXISTING AND PROPOSED DRAINAGE MAPS

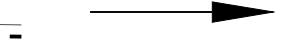
**EXISTING DRAINAGE MAP LEGEND :**

-  EXISTING CONTOURS
-  PROPERTY LINE
-  ROADWAY CENTERLINE
-  EXISTING WATER LINE
-  EXISTING SANITARY SEWER
-  EXISTING FIRE HYDRANT
-  EXISTING WATER VALVE
-  EXISTING SANITARY MANHOLE
-  EXISTING STREET LIGHT
-  EXISTING SIGN
-  EXISTING DRAINAGE FLOW ARROW
-  EXISTING DRAINAGE BASIN BOUNDARY
-  EXISTING OVERLAND/CHANNELIZED FLOW PATH

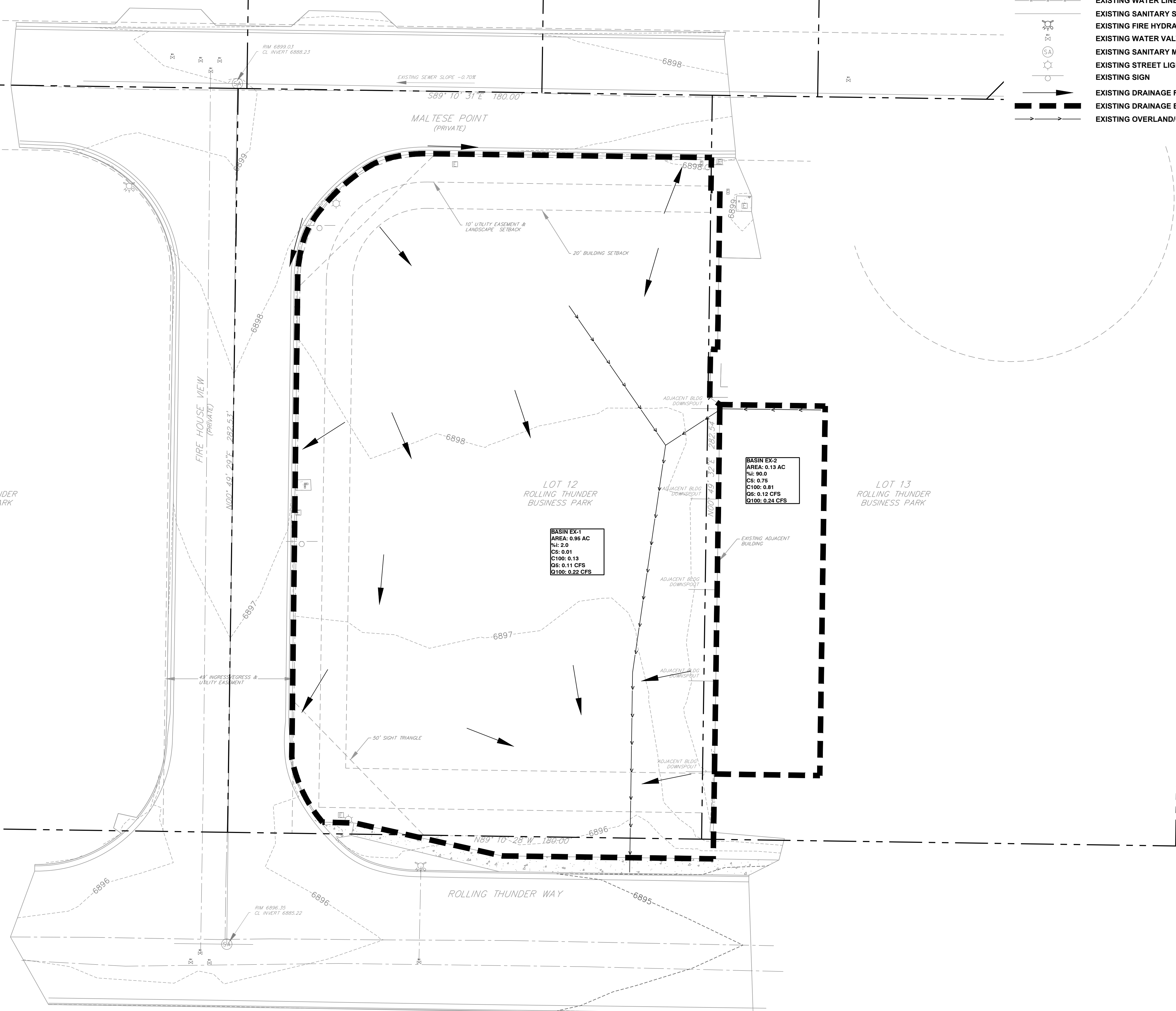

NO.	DATE	REVISIONS

**ROLLING THUNDER BUSINESS PARK - LOT 12**  
 10707 MALTESE PT. PEYTON, CO

  
**SK Design Group, Inc.**  
 333 Perry St.  
 Suite 209  
 Castle Rock, Colorado 80104  
 Phone: 913-451-1818  
 Fax: 913-451-7599

SK JOB NUMBER: 24-105	DESIGNED: AM	CHECKED: SM	APPROVED:
DATE: 02-22-2024	DETAILED: EP		

**EXISTING DRAINAGE MAP**

**SHEET 1 OF 2**

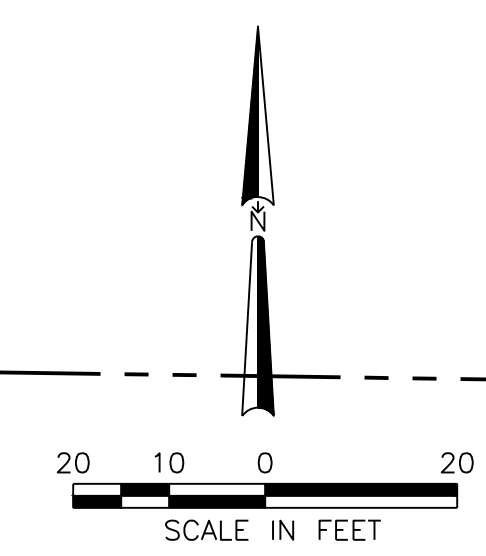

**PROPOSED DRAINAGE MAP LEGEND :**

- EXISTING CONTOURS
- PROPOSED CONTOURS
- PROPERTY LINE
- ROADWAY CENTERLINE
- EXISTING WATER LINE
- EXISTING SANITARY SEWER
- EXISTING FIRE HYDRANT
- EXISTING WATER VALVE
- EXISTING SANITARY MANHOLE
- EXISTING STREET LIGHT
- EXISTING SIGN
- PROPOSED EPC TYPE A CURB
- PROPOSED EPC TYPE B CURB
- PROPOSED SPILL CURB & LEVEL SPREADER
- PROPOSED RETAINING WALL (MAX HEIGHT 1.5')
- DRAINAGE CHANNEL FLOW LINE
- PROPOSED DOWNSPOUT & PVC STORM DRAIN
- PROPOSED CONCRETE DRAINAGE CHANNEL
- PROPOSED SIDEWALK CHASE
- PROPOSED CONCRETE CURB STOP
- PROPOSED REINFORCED CONCRETE
- PROPOSED DRAINAGE FLOW ARROW
- PROPOSED DRAINAGE BASIN BOUNDARY
- PROPOSED OVERLAND/CHANNELIZED FLOW PATH

**REVISIONS**

ROLLING THUNDER BUSINESS  
PARK - LOT 12  
10707 MALTESE PT. PEYTON, CO

**SK**  
SK Design Group, Inc.  
333 Perry St.  
Suite 209  
Castle Rock, Colorado 80104  
Phone: 913-451-1818  
Fax: 913-451-7599

SK JOB NUMBER: 24-105	DESIGNED: AM	CHECKED: SM	APPROVED:
DATE: 02-22-2024	DESIGNED: AM	CHECKED: SM	APPROVED:
	DESIGNED: AM	CHECKED: SM	APPROVED:
	DESIGNED: AM	CHECKED: SM	APPROVED:

**PROPOSED  
DRAINAGE  
MAP**

**SHEET  
2 OF 2**

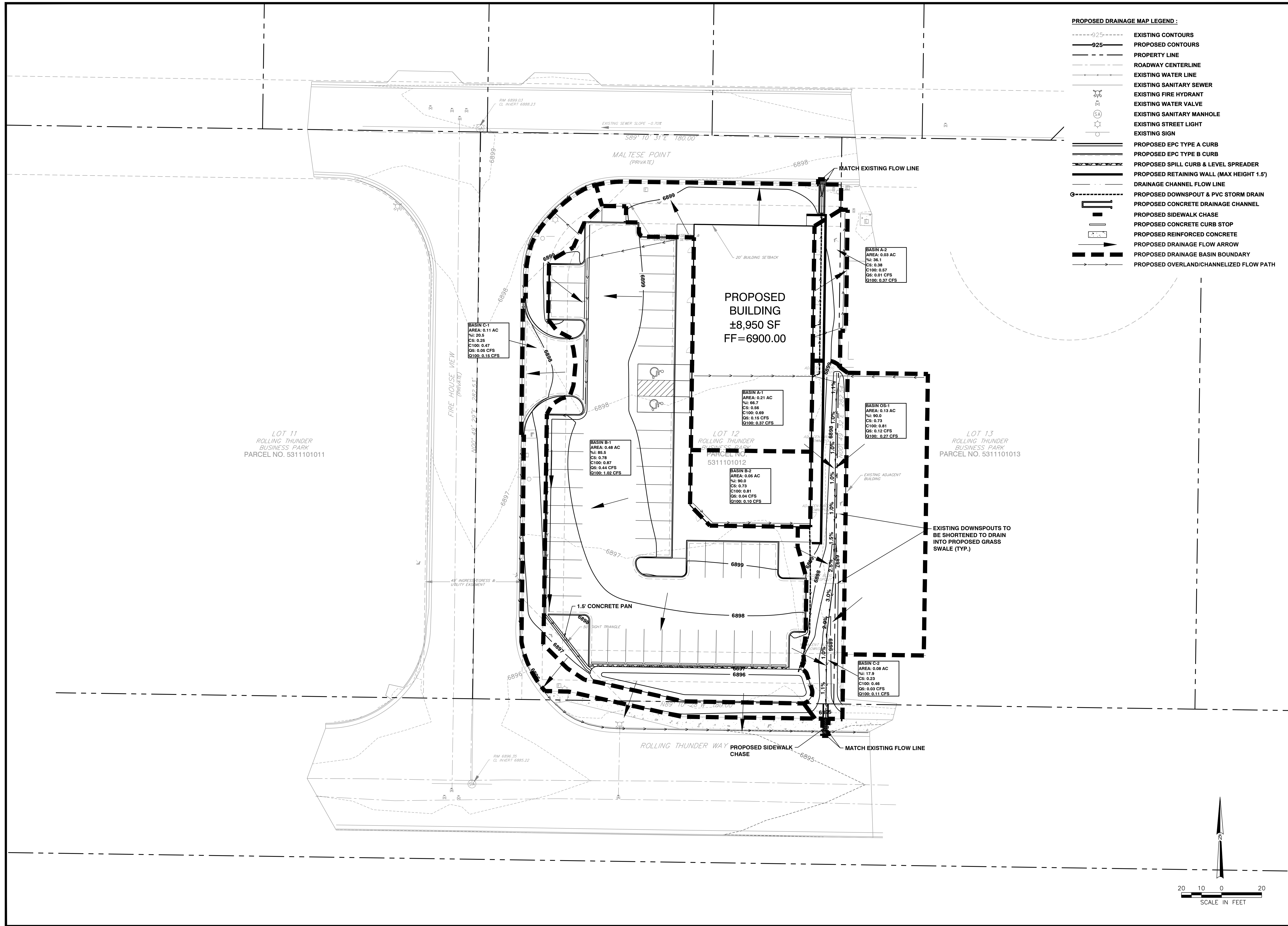

S K D E S I G N G R O U P , I N C .

C I V I L E N G I N E E R S S I N C E 1 9 8 9



## **APPENDIX G – REFERENCE DOCUMENTS**



ROLLING THUNDER  
BUSINESS PARK  
PRELIMINARY/FINAL  
DRAINAGE REPORT  
EL PASO COUNTY, COLORADO

September 2008

PREPARED FOR:

**Foursome Development LLC**

31 N. Tejon Street, Suite 500  
Colorado Springs, CO 80903

PREPARED BY:

*Springs Engineering*

31 N. Tejon Street, Suite 315  
Colorado Springs, CO 80903  
719.227.7388

PROJECT NO. 06-0041

- Basin D-11 (5.33 acres) consists of the area to the east of the proposed site. This area is undeveloped. Flows continue on their existing path, through a shallow, wide bottom natural swale to the twin existing 48-inch culverts under Rolling Thunder Way. This flow combines with the onsite flow from the east portion of the site at Design Point 10. Flows generated by this basin are 8.2 cfs and 19.4 cfs for the 5 and 100-year storms. Offsite flows are released into this basin by an existing 48-inch rcp under Woodmen Road.
- Basin D-12 (1.58 acres) contains the area south of Maltese Point, situated between Firehouse View and the existing tank site. This basin will sheetflow to the south and east where it will be directed to the tank water quality pond. This flow is then released from the pond outlet structure and combines with flows at Design Point 10. This basin generates 7.3 cfs for the 5-year event and 13.6 cfs for the 100-year event.

### Design Points

- DP-14 ( $Q_5=7.3$ ,  $Q_{100}=13.6$ ,  $A=1.58$  acres) consists of Basin D-7a. A 5-foot curb cut will be placed at the low point in the west end cul-de-sac. These flows will be directed through a proposed swale to the southwest pond.
- DP-1 ( $Q_5=20.7$ ,  $Q_{100}=38.9$ ,  $A=4.72$  acres) combines the released flows from the Southwest Pond and the Firehouse Pond in Basins D-7, D-7a and D-8. This flow enters the existing storm sewer system under Rolling Thunder Way between Golden Sage and Firehouse View. Individual storm systems are discussed in the following section.
- DP-2 ( $Q_5=7.6$ ,  $Q_{100}=14.3$ ,  $A=1.98$  acres) combines flow from Basins D-2 and D-3. It is located at the intersection of Rolling Thunder Way and Golden Sage. An existing sump inlet is located at this location to intercept the street flow.
- DP-3 ( $Q_5=3.2$ ,  $Q_{100}=6.1$ ,  $A=0.70$  acres) consists of Basin D-1. An existing at-grade inlet intercepts this flow. The inlet flow combines with the flow from DP-2 and is released into an existing swale which conveys the runoff to the west and an existing drainage channel.
- DP-4 ( $Q_5=1.0$ ,  $Q_{100}=2.5$ ) consists of the released flow from the inlet located at DP-3. This flow is released into an existing drainage swale and releases into an existing drainage channel west of the proposed site.
- DP-5 ( $Q_5=3.1$ ,  $Q_{100}=5.8$ ,  $A=0.74$  acres) consists of Basin D-4. This is the street flow from this basin and is released on the curb return of Rolling Thunder Way.
- DP-6 ( $Q_5=5.4$ ,  $Q_{100}=10.2$ ,  $A=1.48$  acres) contains Basin D-5. A sump inlet on the north side of Rolling Thunder Way intercepts this flow. The inlet connects to an existing 48-inch rcp under the roadway.
- DP-7 ( $Q_5=5.2$ ,  $Q_{100}=9.7$ ,  $A=1.25$  acres) contains Basin D-6. A sump inlet on the south side of Rolling Thunder Way intercepts the street flow from this basin. This flow is also released into the existing 48-inch rcp under the roadway, along with the flow from DP-6. Individual storm sewers are discussed in the following section.



- DP-8 ( $Q_5=16.5$ ,  $Q_{100}=31.0$ ,  $A=4.94$  acres) contains Basin D-9. This flow is conveyed as street flow along Maltese Point to a low point in the east cul-de-sac. At this location a curb cut will be installed to release the flow. A drainage swale will then convey the flow to the Tank Pond, a water quality pond on the water tank site. Swales and channels are discussed in a later section.
- DP-9 ( $Q_5=27.3$ ,  $Q_{100}=51.2$ ,  $A=8.67$  acres) consists of Basins D-10 and D-12 and DP-8. This flow is released directly into the proposed Tank water quality pond at the southeast corner of the site. These flows will be released over a 40-hour drain time. Refer to water quality pond design in Appendix F. These flows will be released into a proposed storm system which will convey flows to the east towards the existing culverts at DP-10.
- DP-10 ( $Q_5=133.7$ ,  $Q_{100}=254.6$ ,  $A=14.00$  acres) combines Basin D-11 with the flow from DP-10. This design point is located at the set of existing twin 48-inch rcp's. The flow entering these structures is the flow from Basin D-11 along with the released flow from the Tank Pond. Flows released from these structures will continue to the south and follow existing drainage patterns. The existing structures were designed in the MDDP and FDR for Falcon Highlands Filing No. 1. Based on the MDDP/PDR/FDR this design point also combines 200 cfs from an offsite basin north of Woodmen Road. Flow from Basin D-11 and the tank pond will have already passed as the flow from the offsite basin reaches the existing culverts under Rolling Thunder Way. The analysis of these structures, refer to Appendix D and Appendix E, shows the structures still function as designed in the approved FDR for Falcon Highlands Filing No. 1. The existing structures (culverts and channel) were designed for the offsite flow of 200 cfs in the MDDP/PDR/FDR for Falcon Highlands Filing No. 1. The current analysis on both was performed with the overall flow of 254 cfs, even though the 200 cfs is the maximum major flow through these structures (offsite flow reaches structures after flow from D-11 and Tank Pond have already passed).
- DP-11 ( $Q_5=141.9$ ,  $Q_{100}=270.1$ ,  $A=16.73$  acres) combines the flow from DP-10 with the intercepted flow from the existing inlets at DP-6 and DP-7. This is the flow released at the end of the existing culverts under Rolling Thunder Way. A discussion of this storm system is included under the heading "Storm Systems". The analysis of these existing structures is included in Appendix D.
- DP-12 ( $Q_5=11.3$ ,  $Q_{100}=21.7$ ,  $A=2.68$  acres) combines the intercepted inlet flows from DP-2 and DP-3 the flow-by associated with DP-4. This flow is released into a minor swale which conveys the flow towards the existing drainage channel west of the site. The swale was designed as part of the FDR for Golden Sage/Rolling Thunder Way. This temporary swale was not reanalyzed as there was no change to the release flow in the storm system. There is an analysis of the storm system located in Appendix D.
- DP-13 ( $Q_5=32.2$ ,  $Q_{100}=61.1$ ,  $A=5.82$  acres) combines flow from DP-12 with DP-5 and DP-1. This is the flow from the site which enters the existing drainage channel west of the site. There was no previous analysis of this channel, so there are no flows or recommendations for this facility. An analysis was performed on the channel based on the flows being released into the channel. The channel is more than adequate to handle the flows from the proposed site. See Appendix E for channel analysis.

The third pond has been designed as a porous landscape detention facility (PLD). Calculations for the pond volumes, 2-year water quality release and major storm release rates have been included in the appendix. Two of the water quality capture ponds (WQCP) will be extended detention basins with a 40-hour drain time. The outlet will be a structure with orifice holes, which will extend the emptying time of the pond to allow for pollutants to settle out prior to being released from the pond. The third pond will be a porous landscape detention area which will drain through a sand filter bottom and a 3-inch perforated pvc pipe along the bottom of the facility. The Southwest pond is required to hold a volume of 0.17 ac-ft and the second pond (Tank Pond) located at the southeast corner of the site near the water tanks is required to hold a volume of 0.33 ac-ft. The Firehouse Pond is required to hold a volume of 1,312 cubic feet. The outlet will consist of a 3" perforated pvc underdrain and sand bottom for exfiltration. The PLD provides filtering absorption and biological uptake of constituents in storm water.

***Downstream Facilities***

The downstream facilities analyzed for this report are the existing channel which runs alongside the west property line of the site and the existing channel downstream of the twin 48-inch rcp's to the east and south of the site. Calculations on these channels have been included in Appendix E. This site is located within the Sand Creek DBPS, however, there are no facilities in the vicinity of the area which were analyzed in this report. The existing channels, which continue south to Dublin Avenue, do not start any analysis until well over a mile past the proposed site. The analysis of the existing channels show that they are more than adequate to handle the developed flows. There are no negative impacts to downstream structures or facilities.

***DRAINAGE FEES, COST ESTIMATE & MAINTENANCE***

***Maintenance***

The streets and major improvements within this site will be maintained by the Rolling Thunder Business Park Property Owners Association (POA) for ownership and maintenance. This includes the roads, drainage facilities, and water quality ponds. The Falcon Highlands Metropolitan District will own and operate water and wastewater systems. The remaining utilities (gas, phone, electric, cable, etc) will be owned and maintained by their respective companies. Easements will be issued to ensure each entity is able to access and maintain their facilities.

***Drainage Fees***

The proposed development falls within the Sand Creek Drainage Basin. The entire development occupies approximately 12.42 acres. Fees will be based on 11.13 acres for the business park. This area was determined by removing the existing tank site. Right-of-way adjacent to the site is 3.48 acres. Based on an 85% impervious area for the site, the area which the fees will be based on is 9.46 acres for the business park and 2.96 acres for the right-of-way.

Since the development is commercial and roadway, the actual imperviousness of the area was calculated for use in calculating drainage and bridge fees. Drainage fees in the Sand Creek basin are \$15,000 and bridge fees \$1,982.

	<u>Acres</u>	<u>Acreage for fees</u>	<u>Impervious Acres</u>
Rolling Thunder Bus. Park	12.42	11.13	9.46

Right-of-Way (Rolling Thunder & Golden Sage)

3.48

2.96

The calculated fees due will be as follows:

Drainage Fees:	<b>Business Park</b>	<b>\$141,900</b>
	Right-of-Way	44,400
	<b>Total Drainage Fee</b>	<b>\$186,300</b>
Bridge Fees:	Business Park	\$18,750
	Right-of-Way	5,867
	<b>Total Bridge Fee</b>	<b>\$24,617</b>

The developer of Rolling Thunder Business Park has credits within the Sand Creek Basin, as generated from the Constitution LID. Drainage credits are \$182,375 and bridge credits are \$433,789.

**Proposed Facilities Estimate**

ITEM	UNITS	UNIT COST	QUANTITY	ITEM COST
<b>DRAINAGE</b>				
24" RCP	LF	\$ 50.00	228	\$ 11,400
30" RCP	LF	\$ 55.00	254	\$ 13,970
36" RCP	LF	\$ 65.00	8	\$ 520
WATER QUALITY PONDS	EA	\$ 3,000.00	3	\$ 9,000
5' STORM MANHOLE	EA	\$ 2,800.00	3	\$ 8,400
3' x 3' CONCRETE BOX	EA	\$ 4,500.00	2	\$ 9,000
TYPE C INLET	EA	\$ 4,000.00	1	\$ 4,000
RIPRAP	CY	\$ 45.00	22	\$ 990
<b>SUBTOTAL DRAINAGE</b>				<b>\$ 74,680</b>
<b>GRADING AND EROSION CONTROL</b>				
CLEARING AND GRUBBING	AC	\$ 800.00	13	\$ 10,400
EARTHWORK	CY	\$ 3.50	500	\$ 46,550
CURB BACKFILL	LF	\$ 2.50	1,325	\$ 3,313
MISC SEEDING AND MULCH	AC	\$ 3,500.00	2	\$ 7,000
HAY BALE CHECKS	EA	\$ 10.00	190	\$ 1,900
VEHICLE TRACKING CONTROL	EA	\$ 1,500.00	1	\$ 1,500
SILT FENCING	LF	\$ 5.00	3166	\$ 15,830
<b>SUBTOTAL GRADING &amp; EROSION CONTROL</b>				<b>\$ 86,493</b>
<b>SUBTOTAL DRAINAGE &amp; GRADING/EROSION CONTROL</b>				<b>\$ 161,173</b>
ENGINEERING (10%)				\$ 16,117
CONTINGENCY (25%)				\$ 40,293
<b>TOTAL</b>				<b>\$ 217,583</b>

WOODMEN ROAD

GOLDEN SAGE

FALCON HIGHLANDS  
PLING NO. 1

ROLLING GAP

THUNDER WAY



BASIN  
Os | O100  
AREA

DESIGN POINT	Q (5)	Q (100)
DP-14	7.3	13.6
DP-1	20.7	38.9
DP-2	7.6	14.3
DP-3	3.2	6.1
DP-4	1.0	2.5
DP-5	3.1	5.8
DP-6	5.4	10.2
DP-7	5.2	9.7
DP-8	16.5	31.0
DP-9	27.3	51.2
DP-10	133.7	254.6
DP-11	141.9	270.1
DP-12	11.3	21.7
DP-13	32.2	61.1

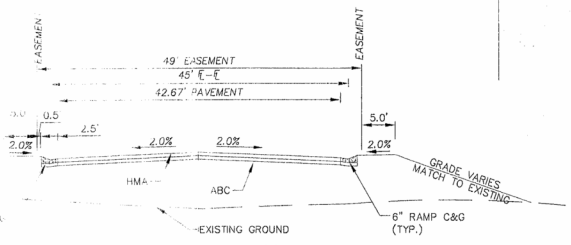

**TYPICAL SECTION**  
**(NON RESIDENTIAL COLLECTOR - MODIFIED)**  
**PRIVATE ROAD**  
SCALE: N.T.S.

REVISIONS:		
NO.	DESCRIPTION	DATE

ENGINEER:  
DESIGNED BY: CMS DATE: 10/03/06  
DRAWN BY: CMS DATE: 10/03/06  
CHECKED BY: \_\_\_\_\_ DATE: \_\_\_\_\_  
48 HOURS BEFORE YOU DIG,  
CALL UTILITY LOCATORS  
1-800-922-1987  
CITY OF COLORADO SPRINGS DEPT. OF UTILITIES  
GAS, ELECTRIC, WATER AND WASTEWATER

**SE Springs Engineering**  
31 N. TEJON, SUITE 315  
COLORADO SPRINGS, CO 80903  
P: (719) 227-7388  
F: (719) 227-7392  
PROJECT: ROLLING THUNDER BUSINESS PARK  
SHEET TITLE: PROPOSED DRAINAGE PLAN  
FROM: N/A TO: N/A  
JOB NO. 08-0041 SHEET 1 OF 1



LOT 8  
PUD

**DOWNSPOUTS  
EXTEND ~6'  
BEYOND LOT 13  
PROPERTY LINE  
AND DISCHARGE  
WITHIN LOT 12  
PROPERTY, NOT  
SHOWN ON LOT 13  
APPROVED PLANS**

**ACCESS TO DRAINAGE  
EASEMENT TO ALLOW LOT  
12 TO DRAIN TO TANK POND  
FOR WQ TREATMENT  
BLOCKED BY EXISTING LOT  
13 LANDSCAPING**

EL PASO COUNTY CONSTRUCTION PLANS STANDARD NOTES

SETBACKS  
FRONT 20  
SIDE 0  
REAR 25

BUILDING AREA: 11,200 S.F. PHASE 1  
2,448 S.F. PHASE 2

BUILDING(S) COLOR SCHEME: OPTON B

PARKING REQUIRED: REPAIR GARAGE  
1 SPACE PER PLUS 3 SPACES  
5 BAYS  
5 EMPLOYEES 20 REQUIRED

PARKING PROVIDED: 20 PROVIDED  
1 BICYCLE SPACE

HANDICAP: 1 SPACE REQUIRED/1 SPACE

LOT COVERAGE:  
EX. PAVEMENT 24.0%  
NEW PAVEMENT 22.7%  
BUILDING PHASE 1 22.0%  
BUILDING PHASE 2 4.8%  
TOTAL 76.5%

**DEVELOPMENT SCHEDULE**

GRADING - MARCH 2009  
UTILITY INSTALLATION - APRIL 2009  
CONSTRUCTION - APRIL AND 2009  
FINAL GRADING - JUNE 2009

APPROVED FOR THE CITY OF EL PASO  
NOTES: 1. 2. 3. 4. 5. 6. 7. 8. 9. 10. 11. 12. 13. 14. 15. 16. 17. 18. 19. 20. 21. 22. 23. 24. 25. 26. 27. 28. 29. 30. 31. 32. 33. 34. 35. 36. 37. 38. 39. 40. 41. 42. 43. 44. 45. 46. 47. 48. 49. 50. 51. 52. 53. 54. 55. 56. 57. 58. 59. 60. 61. 62. 63. 64. 65. 66. 67. 68. 69. 70. 71. 72. 73. 74. 75. 76. 77. 78. 79. 80. 81. 82. 83. 84. 85. 86. 87. 88. 89. 90. 91. 92. 93. 94. 95. 96. 97. 98. 99. 100.

EL PASO COUNTY DEVELOPMENT SERVICES

Division of Public Works - Engineering  
upon compliance with all applicable codes on the recorded plan.

An access permit must be granted by the Development Services Engineering Division prior to the establishment of any driveway onto a County Road.

Division of Public Works - Engineering  
not permitted without the approval of the Development Services Engineering Division.

ANY APPROVAL GIVEN BY EL PASO COUNTY IS NOT VALID UNLESS THE COUNTY ENGINEER HAS REVIEWED AND APPROVED THE PLAN IN ACCORDANCE WITH FEDERAL, STATE AND LOCAL LAWS AND/OR REGULATIONS.

REVIEWED FOR GENERAL COMPLIANCE WITH EL PASO COUNTY ENGINEERING CRITERIA  
BY: *Angela Hernandez*  
DATE: 6-24-09

16. 6" OPAQUE CHAIN WITH VINYL SLATS TO BE INSTALLED FROM TO C/O. LANDSCAPE TO BE BETWEEN FENCE AND ROLLING THUNDER WAY.

**SHEET INDEX**

1. PLOT PLAN
2. GRADING & EROSION CONTROL
3. MASTER UTILITY PLAN
4. LANDSCAPING PLAN
5. LANDSCAPING DETAILS
6. BODY SHOP BUILDING ELEVATION
7. ACCESSORY BUILDING ELEVATION
8. PHOTOMETRIC PLAN

- NOTE:**
- ALL RADI EDGE OF ASPHALT
  - ALL DIMENSIONS IN PARKING AREA TO EDGE OF ASPHALT

**EL PASO COUNTY CONSTRUCTION PLANS STANDARD NOTES**

1. ALL DRAINAGE AND ROADWAY CONSTRUCTION SHALL MEET THE STANDARDS AND SPECIFICATIONS OF THE CITY OF COLORADO SPRINGS/EL PASO COUNTY DRAINAGE CRITERIA MANUAL, VOLUMES 1 AND 2, AND THE EL PASO COUNTY ENGINEERING CRITERIA MANUAL.
2. CONTRACTOR SHALL BE RESPONSIBLE FOR THE NOTIFICATION AND FIELD NOTIFICATION OF ALL EXISTING UTILITIES, WHETHER SHOWN ON THE PLANS OR NOT, BEFORE BEGINNING CONSTRUCTION. LOCATION OF EXISTING UTILITIES SHALL BE VERIFIED BY THE CONTRACTOR PRIOR TO CONSTRUCTION. CALL 811 TO CONTACT THE UTILITY NOTIFICATION CENTER OF COLORADO (UNCC).
3. CONTRACTOR SHALL KEEP A COPY OF THESE APPROVED PLANS, THE GRADING AND EROSION CONTROL PLAN, THE STORMWATER MANAGEMENT PLAN (SWMP), THE SOILS AND GEOTECHNICAL REPORT, AND THE APPROPRIATE DESIGN AND CONSTRUCTION STANDARDS AND SPECIFICATIONS AT THE JOB SITE AT ALL TIMES, INCLUDING THE FOLLOWING:
  - a. EL PASO COUNTY ENGINEERING CRITERIA MANUAL (ECM)
  - b. CITY OF COLORADO SPRINGS/EL PASO COUNTY DRAINAGE CRITERIA MANUAL, VOLUMES 1 AND 2
  - c. COLORADO DEPARTMENT OF TRANSPORTATION (CDOT) STANDARD SPECIFICATIONS FOR ROAD AND BRIDGE CONSTRUCTION 6.00T M & S STANDARDS
4. NOTWITHSTANDING ANYTHING DEPICTED IN THESE PLANS IN WORDS OR GRAPHIC REPRESENTATION, ALL DESIGN AND CONSTRUCTION RELATED TO ROADS, STORM DRAINAGE AND EROSION CONTROL SHALL CONFORM TO THE STANDARDS AND REQUIREMENTS OF THE MOST RECENT VERSION OF THE RELEVANT ADOPTED EL PASO COUNTY STANDARDS, INCLUDING THE LAND DEVELOPMENT CODE, THE ENGINEERING CRITERIA MANUAL, THE DRAINAGE CRITERIA MANUAL, AND THE DRAINAGE CRITERIA MANUAL VOLUME 2. ANY DEVIATIONS FROM REGULATORY STANDARDS MUST BE REQUESTED, AND APPROVED, IN WRITING. ANY MODIFICATIONS NECESSARY TO MEET CRITERIA AFTER-THE-FACT WILL BE ENTIRELY THE DEVELOPER'S RESPONSIBILITY TO RECTIFY.
5. IT IS THE DESIGN ENGINEER'S RESPONSIBILITY TO ACCURATELY SHOW EXISTING CONDITIONS, BOTH ONSITE AND OFFSITE, ON THE CONSTRUCTION PLANS. ANY MODIFICATIONS NECESSARY DUE TO CONFLICTS, OMISSIONS, OR CHANGED CONDITIONS WILL BE ENTIRELY THE DEVELOPER'S RESPONSIBILITY TO RECTIFY.
6. CONTRACTOR SHALL SCHEDULE A PRE-CONSTRUCTION MEETING WITH EL PASO COUNTY DEVELOPMENT SERVICES DEPARTMENT (DSD) INSPECTIONS, PRIOR TO STARTING CONSTRUCTION.
7. IT IS THE CONTRACTOR'S RESPONSIBILITY TO UNDERSTAND THE REQUIREMENTS OF ALL JURISDICTIONAL AGENCIES AND TO OBTAIN ALL REQUIRED PERMITS, INCLUDING BUT NOT LIMITED TO EL PASO COUNTY EROSION AND STORMWATER QUALITY CONTROL PERMIT (ESQCP), REGIONAL BUILDING FLOORPLAN DEVELOPMENT PERMIT, U.S. ARMY CORPS OF ENGINEERS-ISSUED 401 AND/OR 404 PERMITS, AND COUNTY AND STATE FUGITIVE DUST PERMITS.
8. CONTRACTOR SHALL NOT DEVIATE FROM THE PLANS WITHOUT FIRST OBTAINING WRITTEN APPROVAL FROM THE DESIGN ENGINEER AND DSD. CONTRACTOR SHALL NOTIFY THE DESIGN ENGINEER IMMEDIATELY UPON DISCOVERY OF ANY ERRORS OR INCONSISTENCIES.
9. ALL STORM DRAIN PIPE SHALL BE CLASS III RCP UNLESS OTHERWISE NOTED AND APPROVED BY DSD.
10. CONTRACTOR SHALL COORDINATE GEOTECHNICAL TESTING PER EGM STANDARDS. PAVEMENT DESIGN SHALL BE APPROVED BY EL PASO COUNTY DSD PRIOR TO PLACEMENT OF CURB AND GUTTER AND PAVEMENT.
11. ALL CONSTRUCTION TRAFFIC MUST ENTER/EXIT THE SITE AT APPROVED CONSTRUCTION ACCESS POINTS.
12. SIGHT VISIBILITY TRIANGLES AS IDENTIFIED IN THE PLANS SHALL BE PROVIDED AT ALL INTERSECTIONS. OBSTRUCTIONS GREATER THAN 18 INCHES ABOVE FLOWLINE ARE NOT ALLOWED WITHIN SIGHT TRIANGLES.
13. SIGNING AND STRIPING SHALL COMPLY WITH EL PASO COUNTY DOT AND MUTCD CRITERIA. (IF APPLICABLE, ADDITIONAL SIGNING AND STRIPING NOTES WILL BE PROVIDED.)
14. CONTRACTOR SHALL OBTAIN ANY PERMITS REQUIRED BY EL PASO COUNTY DOT, INCLUDING WORK WITHIN THE RIGHT-OF-WAY AND SPECIAL TRANSPORTATION PERMITS.
15. THE LIMITS OF CONSTRUCTION SHALL REMAIN WITHIN THE PROPERTY LINE UNLESS OTHERWISE NOTED. THE OWNER/DEVELOPER SHALL OBTAIN WRITTEN PERMISSION AND EASEMENTS, WHERE REQUIRED, FROM ADJOINING PROPERTY OWNER(S) PRIOR TO ANY OFF-SITE DISTURBANCE, GRADING, OR CONSTRUCTION.

REVISIONS:		
NO.	DESCRIPTION	DATE

ENGINEER: \_\_\_\_\_  
DESIGNED BY: TWR DATE: 2-17-09  
DRAWN BY: TWR DATE: 2-17-09  
CHECKED BY: WDC DATE: 2-17-09

48 HOURS BEFORE YOU DIG,  
CALL UTILITY LOCATORS  
1-800-922-1987  
CITY OF COLORADO SPRINGS DEPT. OF UTILITIES  
GAS, ELECTRIC, WATER AND WASTEWATER

**SE Springs Engineering**  
31 N. TEJON, SUITE 315  
COLORADO SPRINGS, CO 80903  
P: (719) 227-7269  
F: (719) 227-7392

PROJECT ROLLING THUNDER - LOT 13  
SHEET TITLE CIVIL PLOT PLAN  
FROM n/a TO n/a  
JOB NO. 083-08-026 SHEET 1 OF 8

RECEIVED  
FEB 18 2009  
EPC DEVELOPMENT SERVICES



**ENTECH**  
ENGINEERING, INC.

505 ELKTON DRIVE  
COLORADO SPRINGS, CO 80907  
PHONE (719) 531-5599

**GEOTECHNICAL AND PAVEMENT DESIGN REPORT**

**10707 MALTESE POINT  
PEYTON**

Report has been amended to include relevant soil information only.  
-SKDG

Please do not include the entire pavement report here. Only include what is needed for the soils samples.

Prepared for:

**WD Construction**  
**Cucharras Street, Suite 100**  
**Colorado Springs, CO 80905**

Attn: Bill Tibbit

March 25, 2024

Respectfully Submitted,

ENTECH ENGINEERING, INC.

Stuart Wood  
Geologist

Reviewed by:

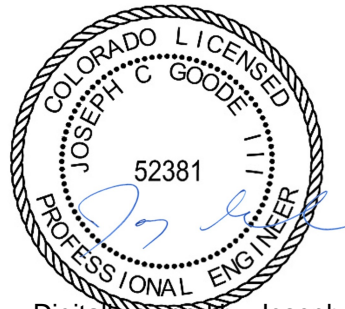

Digitally signed by Joseph C Goode III  
Date: 03/25/24

Joseph C. Goode III, P.E.  
Sr. Engineer

SW:JCG/

Entech Job No. 240324

**Table of Contents**

**1 Introduction ..... 1**

**2 Project and Site Description..... 1**

**3 Subsurface Explorations and Laboratory Testing ..... 1**

    3.1 Subsurface Exploration Program ..... 1

    3.2 Geotechnical Index and Engineering Property Testing ..... 2

**4 Subsurface Conditions ..... 2**

    4.1 Soil and Bedrock ..... 3

    4.2 Groundwater ..... 3

**5 Geotechnical Evaluation and Recommendations ..... 3**

    5.1 Shallow Foundations ..... 4

    5.2 On-Grade Floor Slabs ..... 5

    5.3 Detention Pond..... 5

    5.4 Seismic Site Classification..... 5

    5.5 Surface and Subsurface Drainage..... 6

**6 Pavement Design Recommendations ..... 6**

    6.1 Pavement Subgrade Conditions ..... 6

    6.2 Swell Mitigation ..... 7

    6.3 Traffic Loading..... 7

    6.4 Pavement Designs ..... 7

**7 Construction Recommendations ..... 8**

    7.1 Earthwork Recommendations for Structures ..... 8

        7.1.1 Subgrade Preparation ..... 8

        7.1.2 Shallow Groundwater ..... 8

        7.1.3 Granular Fill..... 9

        7.1.4 Fill Placement and Compaction ..... 9

    7.2 Pavements ..... 9

        7.2.1 Pavement Subgrade Preparation ..... 10

        7.2.2 Aggregate Base Course ..... 10

    7.3 Excavation Potential ..... 10

    7.4 Excavation Stability ..... 10

    7.5 Utility Trench Backfill ..... 10

    7.6 General Backfill ..... 11

    7.7 Concrete Degradation Due to Sulfate Attack ..... 11

    7.8 Winter Construction ..... 12

    7.9 Foundation Excavation and Construction Observation ..... 12

**8 Closure..... 12**

**Figures**

*Figure 1: Vicinity Map*

*Figure 2: Site and Exploration Plan*

*Figure 3: Exterior Perimeter Drain Detail*

**List of Appendices**

*Appendix A: Test Boring Logs*

*Appendix B: Laboratory Test Results*

*Appendix C: Pavement Design Calculations*



## **1 Introduction**

Entech Engineering Inc. (Entech) completed this geotechnical and pavement design report for a new building and associated site improvements located at 10707 Maltese Point in Peyton, Colorado. This report describes the subsurface exploration program conducted at the site and provides recommendations for foundation design, pavement design sections, and construction considerations. Our services were completed for WD Construction in accordance with our geotechnical and pavement design service agreement dated February 9, 2024. The contents of this report, including the geotechnical evaluation and recommendations, are subject to the limitations and assumptions presented in Section 8.

## **2 Project and Site Description**

We understand that the project will consist of the construction of a new 8,950 square foot metal frame structure and associated site improvements to be located at 10707 Maltese Point in Peyton, Colorado. The location of the project site is shown on the Vicinity Map (Figure 1). Site improvements include an access lane and passenger vehicle parking lot to be paved with asphalt.

At the time of drilling, the property was a large flat vacant lot. Vegetation consists of sparse native grass and weeds. Building loads are expected to be light to moderate. The property is surrounded by large vacant to commercial lots. We understand that a detention pond will be located at the south side of the property.

## **3 Subsurface Explorations and Laboratory Testing**

### **3.1 Subsurface Exploration Program**

Subsurface conditions at the project site were explored by five test borings, designated TB-1 through TB-5, drilled on March 6, 2024 at the approximate locations shown on the Site and Exploration Plan (Figure 2). Three of the borings were drilled within the footprint of the proposed building. Two additional borings were drilled in the parking lot and access drive to provide pavement design recommendations. The borings in the building footprints were drilled to depths of 20 feet below the existing ground surface (bgs), the borings drilled in the parking and drive areas were drilled to depths of 10 feet bgs. The drilling was performed using a truck-mounted, continuous flight auger drill rig supplied and operated by Entech. Descriptive boring logs providing

the lithologies of the subsurface conditions encountered during drilling are presented in Appendix A. Groundwater levels were measured in each of the open boreholes at the conclusion of drilling.

Soil and bedrock samples were obtained from the borings utilizing the Standard Penetration Test (ASTM D1586) using a split-barrel California sampler. Results of the Standard Penetration Test (SPT) are included on the boring logs in terms of N-values expressed in blows per foot (bpf). Soil and bedrock samples recovered from the borings were visually classified and recorded on the boring logs. The soil and bedrock classifications were later verified utilizing laboratory testing and grouped by soil type. The soil and bedrock type numbers are included on the boring logs. It should be understood that the soil and bedrock descriptions shown on the boring logs may vary between boring locations and sample depths. It should also be noted that the lines of stratigraphic separation shown on the boring logs represent approximate boundaries between soil and bedrock types and the actual stratigraphic transitions may be more gradual or variable with location.

### **3.2 Geotechnical Index and Engineering Property Testing**

Water content testing (ASTM D2216) was performed on the samples recovered from the borings and the results are shown on the boring logs. Grain-Size Analysis (ASTM D422) and Atterberg Limits testing (ASTM D4318) were performed on selected samples to assist in classifying the materials encountered in the borings. One-dimensional swell or collapse testing (ASTM D4546) was performed to evaluate the expansive characteristics and collapse potential of the soil. Soluble sulfate testing was performed on select soil samples to evaluate the potential for below-grade degradation of concrete due to sulfate attack.

For pavement design, a Modified Proctor (ASTM D1557) and California Bearing Ratio (CBR) test (ASTM D1883) were completed on a bulk sample from the roadway subgrade. The Laboratory Testing Results are presented in Appendix B and summarized in Table B-1.

## **4 Subsurface Conditions**

Two primary soil types and two bedrock types were encountered in the test borings drilled for the subsurface exploration program. Each soil and bedrock type was classified in accordance with the Unified Soil Classification System (USCS) and the American Association of State Highway and Transportation Officials (AASHTO) soil classification system using the laboratory testing results and the observations made during drilling.

#### **4.1 Soil and Bedrock**

Subsurface conditions for the proposed project site consisted of native loose to medium dense silty sand to sand with silt (Soil Type 1) encountered in all the test borings from the existing ground surface and extended to depths of 7 to 13 feet bgs. Hard sandy clay (Soil Type 2) was encountered below the Soil Type 1 sands in three of the test borings at 7 to 9 feet and extended to depths of 12 to 14 feet or to the termination of the boring at 10 feet. Sandstone bedrock, or very dense clayey sand when classified as a soil (Soil Type 3), was encountered in borings TB-1, TB-2, and TB-3 at depths ranging from 13 to 18 feet and extended to the termination of the borings (20 feet). Claystone bedrock, or hard sandy clay when classified as a soil (Soil Type 4) was encountered overlying the sandstone bedrock in TB-2 and TB-3 beginning at 12 to 14 feet and extended to 16 to 18 feet. The AASHTO soil classifications of the subgrade Soil Type 1 was A-1-b, and A-4.

Swell or collapse testing on samples of the site clayey soils resulted in a volume change of 0.5%. The results indicate a low expansion potential. One dimensional swell or collapse testing on the claystone bedrock resulted in a volume change of 1.2% indicating a low to moderate expansion potential.

#### **4.2 Groundwater**

Depth to groundwater was measured in each of the borings at the conclusion of drilling. Groundwater was encountered in TB-1 at 5 feet and in TB-2 at 9 feet during, or subsequent to, drilling. It should be noted that groundwater levels could change due to seasonal variations, changes in land runoff characteristics, and future development of nearby areas.

### **5 Geotechnical Evaluation and Recommendations**

*The following discussion is based on the subsurface conditions encountered in the borings drilled in the planned lot for construction. If subsurface conditions different from those described herein are encountered during construction, or if the project elements change from those described, Entech Engineering, Inc. should be notified so that the evaluation and recommendations presented can be reviewed and revised if necessary.*

As discussed in Section 2, we understand that the site will be developed with the construction of a new large metal building. The proposed building is expected to have a shallow foundation and slab on grade floors.

## 5.1 Shallow Foundations

Upon completion of proper subgrade preparation as described in Section 7.1.1, the proposed structure may be supported with a shallow spread footing foundation placed on dense and unyielding granular soils. The suitability of subgrades should be field determined.

Refer to Exhibit 1 for the recommended allowable bearing capacity value. Groundwater was encountered in borings TB-1 and TB-2 at 5 and 9 feet bgs, respectively. We recommend keeping all foundation components a minimum of 3 feet above the groundwater table if possible. Groundwater, if encountered near foundation grade, will likely create unstable subgrade conditions, and stabilization with shot rock and/or geogrid may be required as discussed in Section 7.1.2.

Shallow foundations shall not be placed on loose granular soil, cohesive soil, uncontrolled fill, or bedrock. Refer to Sections 7.1.1 for further discussion. Actual bearing capacities and the need for overexcavation will be verified at the time of the open excavation observation (Section 7.9).

For design, continuous spread footings are recommended to have a minimum width of 16 inches, and individual column footings for main support beams should have minimum plan dimensions of 24 inches on each side in order to avoid punching failure into the supporting subgrade soils. Exterior footings should extend a minimum of 30 inches below the adjacent exterior site grade for frost protection.

Foundation walls should be designed to resist lateral pressures generated by the soils used for backfill. Recommended active equivalent fluid density parameters for the on-site granular soils are provided in Exhibit 1. Clay soils (more than 50% passing the No. 200 sieve) are not recommended for backfill against the walls unless properly moisture conditioned. It should be noted that the equivalent design parameters apply to level backfill conditions. If sloping backfill conditions exist, pressures will increase substantially depending on the conditions adjacent to the walls. Surcharge loading should also be considered in wall designs. Equivalent fluid pressures for sloping conditions should be determined on an individual basis.

**Exhibit 1: Foundation Design Parameters**

Design Parameter	Value
<b>Allowable Bearing Capacity <sup>1</sup></b>	
Recompacted site sands or granular fill	2,000 psf
<b>Lateral Earth Pressure Equivalent Fluid Density <sup>2</sup></b>	
Active Conditions - Granular Backfill	40 pcf

pcf = pounds per cubic foot; psf = pounds per square foot

Notes:

1. Assumes a minimum embedment of 30 inches for frost protection.
2. Assumes level backfill conditions.

**5.2 On-Grade Floor Slabs**

On-grade floor slabs for the planned structure should be supported on moisture-conditioned, compacted, site granular soils, or imported granular fill prepared in accordance with Section 7.1.1. Any loose soils or uncontrolled fill encountered will require removal according to Section 7.1.1.

Grade-supported floor slabs should be separated from other building structural components and utility penetrations to allow for possible future vertical movement. Interior partition walls should be constructed in such a manner so as not to transfer slab movement into the overlying floor(s) and/or roof members, should slab movement occur. Control joints in grade-supported slabs are recommended at 10- to 15-foot perpendicular spacings to control cracking. If slab movement cannot be tolerated, a structural floor system should be used.

**5.3 Detention Pond**

We understand that a detention pond will be located on the south side of the project site. Based on boring TB-5 we anticipate silty sands to a depth of 9 feet overlying clayey sand. We recommend that detention pond slopes be constructed at 3H:1V (horizontal to vertical).

**5.4 Seismic Site Classification**

Based on the subsurface conditions encountered at the site, and in accordance with Section 1613 of the 2021 *International Building Code* (IBC), the site meets the conditions of Site Class D.

## 5.5 Surface and Subsurface Drainage

Positive surface drainage is recommended around the building's perimeter to minimize infiltration of surface water into the supporting foundation soils. A minimum ground surface slope of 5% in the first 10 feet adjacent to exterior foundation walls is recommended for unpaved areas. For paved areas and other impervious surfaces, a minimum slope of 2% is adequate. All roof drains and gutter downspouts should be extended to discharge well beyond the building's foundation backfill zone or be connected to a storm sewer system.

To help minimize infiltration of water into the foundation zone, vegetative plantings placed close to foundation walls should be limited to those species having low watering requirements and irrigated grass should not be located within 5 feet of the foundation. Similarly, sprinklers are not recommended to discharge water within 5 feet of foundations. Irrigation near foundations should be limited to the minimum amount sufficient to maintain vegetation. Application of more irrigation water than necessary can increase the potential for slab and foundation movement.

Perimeter drains are recommended for usable space below grade (areas where the interior slab or bottom of the crawl space is below the exterior grade). A typical perimeter drain detail is shown in Figure 3.

## 6 Pavement Design Recommendations

Pavement design recommendations were made based on guidance from the *Pavement Design Criteria for El Paso County*. We understand that the access lane and passenger vehicle parking lot will be paved with asphalt.

### 6.1 Pavement Subgrade Conditions

Two test borings (TB-4 and TB-5) were drilled to depths of approximately 10 feet in the parking lot and access road areas. The soils at the roadway subgrade depth consisted of silty sand. Soil Type 1 was used to evaluate the subgrade support characteristics of pavement based on laboratory testing. The Type 1 subgrade soils classified as A-1-b, and A-4 using the AASHTO classification system.

California Bearing Ratio (CBR) testing was performed on a representative bulk sample of the silty sand (Soil Type 1) from TB-4 to determine the support characteristics of the subgrade soils for

the roadway sections. The results of the CBR testing are presented in Appendix B and summarized in Exhibit 1.

**Exhibit 2: Pavement Subgrade Laboratory Summary**

Design Parameter	Value
Soil Type	1 – Silty Sand
CBR at 95%	42.18
Design CBR	10
Liquid Limit	NV
Plasticity Index	NP
Percent Passing 200	23.8
AASHTO Classification	A-1-b
Group Index	0
Unified Soils Classification	SM

**6.2 Swell Mitigation**

El Paso County criteria requires mitigation of expansive soils for roadway subgrade that have a swell of 2% or greater with a 150 pound per square foot surcharge. Based on the swell testing, mitigation for expansive soils is not required for this site.

**6.3 Traffic Loading**

Traffic data is not available for the private parking lot and access road. Based on the Colorado Asphalt Pavement Association (CAPA), *Guideline for Design and Construction of Asphalt Parking Lots in Colorado* (2006), an 18-kip equivalent single axle loading (ESAL) of 100,000 is appropriate for moderate traffic levels which includes passenger cars and light trucks.

**6.4 Pavement Designs**

The pavement sections were determined utilizing the *El Paso County Pavement Design Criteria*, design ESAL, and the CBR testing. Design parameters used in the pavement analysis for the parking and access drives are presented in Exhibit 3.

**Exhibit 3: Pavement Design Parameters**

Design Parameter	Value
Reliability	75%
Standard Deviation	0.44
Serviceability Loss ( $\Delta$ psi)	2.0
Design CBR	10
Resilient Modulus	15,000 psi
Structural Coefficients	
Hot Bituminous Pavement	0.44
Aggregate Basecourse	0.11

The recommended pavement section is presented in Exhibit 4. Any additional grading may result in subgrade soils with different support characteristics. The following pavement sections should be re-evaluated if additional grading is performed.

**Exhibit 4: Recommended Pavement Sections**

Pavement Area	Design ESAL	Alternative
Access Drive and Parking Areas	100,000	1. 4.0 inches HMA over 4.0 inches ABC

ABC = Aggregate Base Course; ESAL = equivalent single axle loads; HMA = Hot Mix Asphalt

**7 Construction Recommendations**

**7.1 Earthwork Recommendations for Structures**

**7.1.1 Subgrade Preparation**

Foundations and on-grade floor slabs may be placed on dense and unyielding granular soil. The final subgrade should then be scarified 12 inches, moisture conditioned to +/- 2% of the optimum moisture, and recompactd in place (refer to Section 7.1.3). Refer to Section 7.1.2 for shallow groundwater recommendations. All soil beneath the foundation and slabs should be free of organics, debris, and cobbles larger than 3 inches in diameter. Uncontrolled fill or loose soil will require removal to suitable, dense underlying soils and recompactd in place or replaced with granular fill (Section 7.1.3 and 7.1.4).

**7.1.2 Shallow Groundwater**

Shallow groundwater was encountered in the test borings at depths of 5 to 9 feet. We recommend keeping foundation elements a minimum of 3 feet above groundwater. If groundwater is encountered during subgrade preparation, we recommend overexcavating loose, wet soils to a



depth of 12 inches below the base of foundation elements, pushing 2- to 4-inch shot rock into the subgrade for stabilization, as required, followed by a layer of Tensor BX1200 geogrid (or equivalent). We then recommend placing compacted granular fill in accordance with Section 7.1.3 and 7.1.4. After placement of backfill, the subgrade should be proof rolled and evaluated to ensure that subgrade is not pumping. Based on the groundwater conditions encountered at the time of excavation, dewatering methods may be required, which could include diversion ditches, pumping, or capillary drains. Entech should observe the overexcavated subgrade to verify existing conditions and provide additional recommendations if required.

### **7.1.3 Granular Fill**

Granular fill placed beneath foundation components and floor slabs shall consist of non-expansive, granular soil, free of organic matter, unsuitable materials, debris, and cobbles larger than 3 inches in diameter. Entech should approve any site or imported granular material to be used within the foundation area.

### **7.1.4 Fill Placement and Compaction**

Granular fill placed within the foundation area should be compacted to a minimum of 95% of its maximum Modified Proctor Dry Density (ASTM D1557) at +/-2% of optimum moisture content. Fill material should be placed in horizontal lifts such that each finished lift has a compacted thickness of 6 inches or less. Mechanical methods can be used for placement and compaction of fill; however, heavy equipment should be kept at a distance from foundation walls and below slab infrastructure to avoid overstressing. No water flooding techniques of any type should be used for compaction or placement of foundation or floor slab fill material.

Fill placement and compaction beneath and around foundations should be observed and tested by Entech during construction. Density tests should be performed frequently to verify compaction with the first density test performed at the overexcavated subgrade elevation and with additional testing once each 12 to 18 inches of granular fill has been placed.

## **7.2 Pavements**

Pavement design recommendations provided herein are contingent on good construction practices, and poor construction techniques may result in poor performance. Our analyses assumed that this project will be constructed according to the *El Paso County Pavement Design Criteria*.

### **7.2.1 Pavement Subgrade Preparation**

Proper subgrade preparation is required for adequate pavement performance. Paving areas should be cleared of all deleterious materials including but not limited to existing pavements, utility poles, and fence poles. Surface vegetation should be removed by stripping, with the depth to be field determined.

We recommend that paving areas be moisture conditioned to a depth of 18 inches. After overexcavating 12 inches of the pavement subgrade, the final subgrade surface for pavement areas should be scarified an additional 8 inches, moisture conditioned to within 0 to +3% of its optimum moisture, and recompact in place to 95% of its maximum Standard Proctor Dry Density ASTM D698. The overexcavated material can then be placed in 6-inch lifts to the same specifications as described above. The compacted surface below pavements should be proof-rolled with a fully loaded, tandem-axle, 10-yard dump truck or equivalent. Any areas that are delineated to be soft, loose, or yielding during proof-rolling should be removed and reconditioned or replaced.

### **7.2.2 Aggregate Base Course**

Aggregate Base Course (ABC) materials shall conform to the *El Paso County Standard Specification Manual*, Section D-6. ABC materials should be compacted to a minimum of 95% of its maximum Modified Proctor Dry Density (ASTM D1557) at +/-2% of optimum moisture content.

### **7.3 Excavation Potential**

Excavation of the site soils should be feasible with rubber-tired equipment.

### **7.4 Excavation Stability**

Excavation sidewalls must be properly sloped, benched, and/or otherwise supported in order to maintain stable conditions. All excavation openings and work completed therein shall conform to OSHA Standards as put forward in CFR 29, Part 1926.650-652, (Subpart P).

### **7.5 Utility Trench Backfill**

Trench backfill placement should be performed in accordance with El Paso County specifications. All excavation and excavation shoring/bracing should be performed in accordance with OSHA guidelines.

Fill placement and compaction in utility trenches should be observed and tested by Entech during construction. Fill should be placed in horizontal lifts having a compacted thickness of 6 inches or less and at a water content conducive to adequate compaction, within +/-2% of optimum water content. No water flooding techniques of any type should be used for compaction or placement of utility trench fill.

## **7.6 General Backfill**

Any areas to receive general grading fill should have all topsoil, organic material, and debris removed. Fill must be properly benched into existing slopes in order to be adequately compacted. The fill-receiving surface should be scarified to a depth of 12 inches, moisture conditioned to +/-2% of the optimum water content, and compacted to a minimum of 95% of the ASTM D1557 maximum dry density or the ASTM D698 maximum dry density for cohesive soils before the addition of new fill. Fill should be placed in thin lifts not to exceed 6 inches in thickness after compaction while maintaining at least 95% of the ASTM D1557 or ASTM D698 maximum dry density. Fill material should be free of vegetation and other unsuitable material and should not contain cobbles or fragments larger than 3 inches. Topsoil and strippings should be segregated from all other fill sources on the site. Fill placement and compaction beneath and around foundations, in utility trenches, or beneath roadways or other structural features of the project should be observed and tested by Entech during construction.

## **7.7 Concrete Degradation Due to Sulfate Attack**

Sulfate solubility testing was conducted on several samples recovered from the test borings to evaluate the potential for sulfate attack on concrete placed below surface grade. The test results indicated 0.00 to less than 0.01% soluble sulfate (by weight). The test results indicate the sulfate component of the in-place soils presents a negligible exposure threat to concrete placed below the site grade.

Type IL or Type II cement is recommended for all concrete on this site. Care should be taken to prevent the accumulation or ponding of water in the foundation excavation prior to the placement of concrete. If standing water is present in the foundation excavation, it should be removed by ditching to sumps and pumping the water away from the foundation area prior to concrete placement.

## **7.8 Winter Construction**

In the event construction of the planned facility occurs during winter, foundations and subgrades should be protected from freezing conditions. Concrete should not be placed on frozen soil, and once concrete has been placed, it should not be allowed to freeze. Similarly, once exposed, the foundation subgrade should not be allowed to freeze. This may require covering the concrete with insulated blankets and adding heat to prohibit freezing. During site grading and subgrade preparation, care should be taken to eliminate the burial of snow, ice, or frozen material within the planned construction area.

## **7.9 Foundation Excavation and Construction Observation**

Subgrade preparation for building foundations should be observed by Entech prior to construction of the footings and floor slabs in order to verify that (1) no anomalies are present, (2) materials similar to those described in this report have been encountered or placed, and (3) no soft spots, expansive or organic soil, or debris are present in the foundation area prior to concrete placement or backfilling. Entech should make final recommendations for overexcavation, if required, and foundation drainage at the time of excavation observation, if necessary.

In addition, Entech should observe and document the placement and compaction of utility bedding and trench backfill.

## **8 Closure**

The subsurface investigation, geotechnical evaluation, and recommendations presented in this report are intended for use by WD Construction with application to the planned new metal building and associated site improvements located at 10707 Maltese Point in Peyton, Colorado. In conducting the subsurface exploration program, laboratory testing, engineering evaluation, and reporting, Entech Engineering, Inc. endeavored to work in accordance with generally accepted professional geotechnical and geologic practices and principles consistent with the level of care and skill ordinarily exercised by members of the geotechnical profession currently practicing in the same locality and under similar conditions. No other warranty, expressed or implied, is made. During final design and/or construction, if conditions are encountered that appear different from those described in this report, Entech Engineering, Inc. requests to be notified so that the evaluation and recommendations presented herein can be reviewed and modified as appropriate.



If there are any questions regarding the information provided herein, or if Entech Engineering, Inc. can be of further assistance, please do not hesitate to contact us.

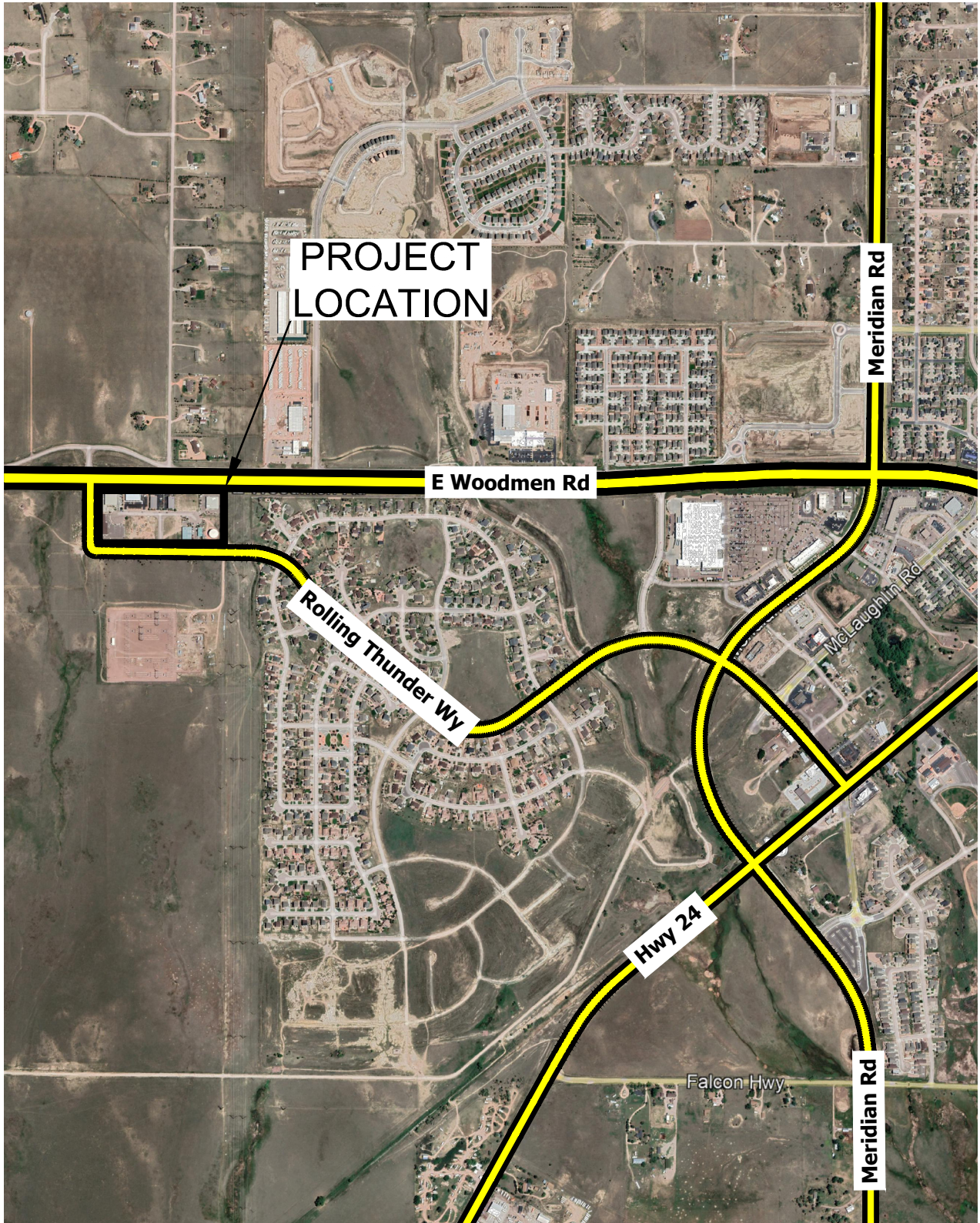

**VICINITY MAP**  
10707 MALTESE POINT  
WD CONSTRUCTION

JOB NO.  
240324

**FIG. 1**

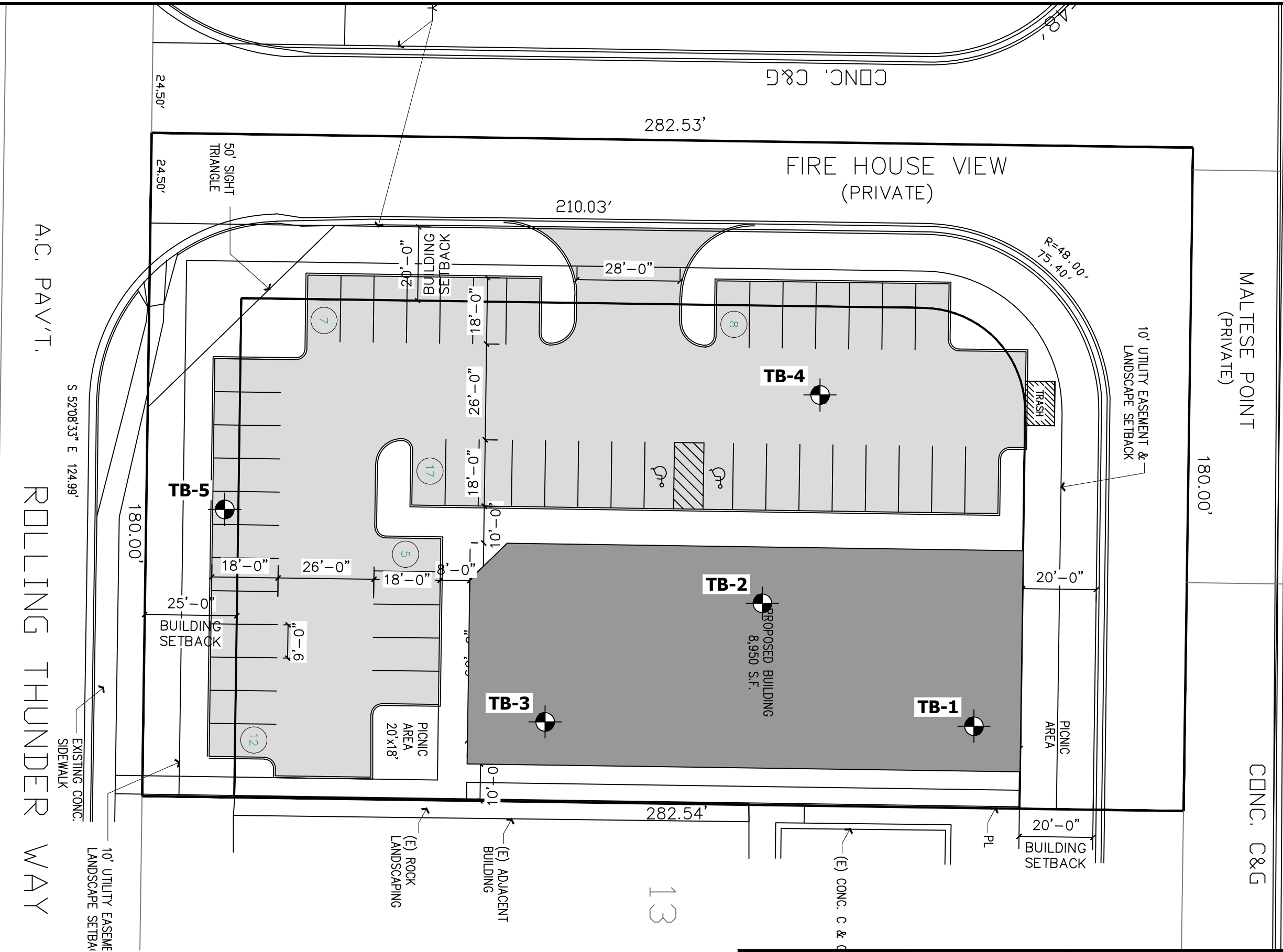

R.D.W. VARIES CONC. S/W

A.C. PAV'T. ROLLING THUNDER WAY

S 52°08'33" E 124.99'

EXISTING CONC. SIDEWALK

10' UTILITY EASEMENT LANDSCAPE SETBACK

MALTESE POINT (PRIVATE)

180.00'

CONC. C&G

TB- APPROXIMATE TEST BORING LOCATION AND NUMBER

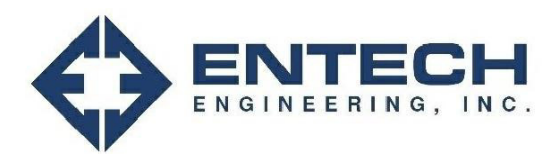

**SITE AND EXPLORATION PLAN**  
10707 MALTESE POINT  
WD CONSTRUCTION

JOB NO. 240324  
**FIG. 2**

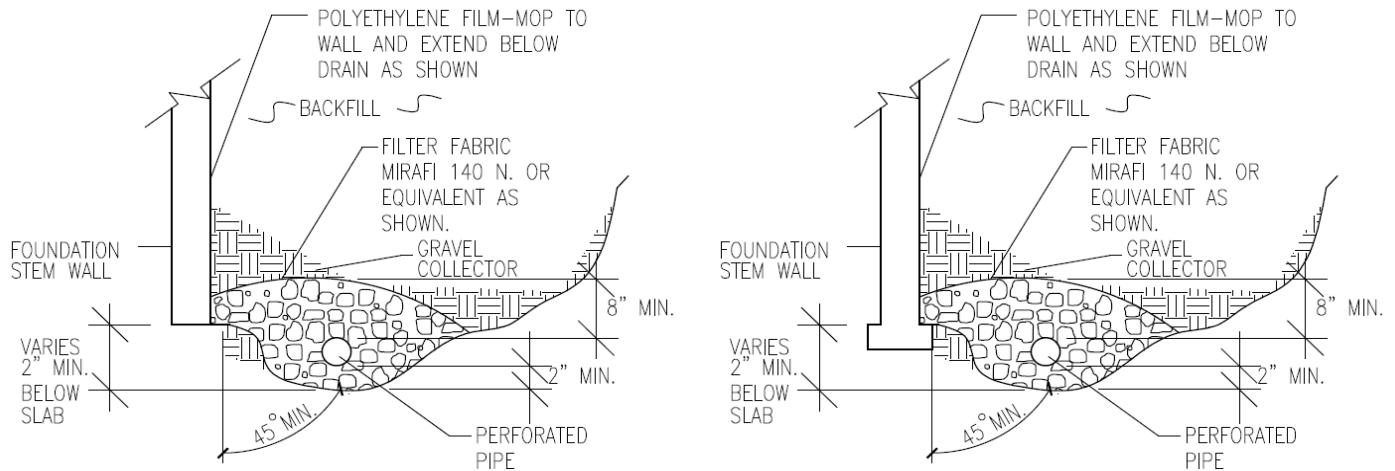

NOTES:

-GRAVEL SIZE IS RELATED TO DIAMETER OF PIPE PERFORATIONS-85% GRAVEL GREATER THAN 2x PERFORATION DIAMETER.

-PIPE DIAMETER DEPENDS UPON EXPECTED SEEPAGE. 4-INCH DIAMETER IS MOST OFTEN USED.

-ALL PIPE SHALL BE PERFORATED PLASTIC. THE DISCHARGE PORTION OF THE PIPE SHOULD BE NON-PERFORATED PIPE.

-FLEXIBLE PIPE MAY BE USED UP TO 8 FEET IN DEPTH, IF SUCH PIPE IS DESIGNED TO WITHSTAND THE PRESSURES. RIGID PLASTIC PIPE WOULD OTHERWISE BE REQUIRED.

-MINIMUM GRADE FOR DRAIN PIPE TO BE 1% OR 3 INCHES OF FALL IN 25 FEET.

-DRAIN TO BE PROVIDED WITH A FREE GRAVITY OUTFALL, IF POSSIBLE. A SUMP AND PUMP MAY BE USED IF GRAVITY OUTFALL IS NOT AVAILABLE.



**PERIMETER DRAIN DETAIL**

10707 MALTESE POINT  
WD CONSTRUCTION

JOB NO.  
240324

**FIG. 3**





## **APPENDIX A: Test Boring Logs**

**TABLE A-1**  
**DEPTH TO GROUNDWATER & BEDROCK**

TEST BORING	DEPTH TO GROUNDWATER (ft.)	DEPTH TO BEDROCK (ft.)
1	5	13
2	9	14
3	>20	12
4	>10	>10
5	>10	>10

TEST BORING 1  
 DATE DRILLED 3/6/2024

TEST BORING 2  
 DATE DRILLED 3/6/2024

REMARKS

REMARKS

WATER @ 5', 3/6/24

WATER @ 9', 3/6/24

SAND, SILTY to WITH SILT, TAN to BROWN, MEDIUM DENSE, DRY to WET

SAND, SILTY, BROWN, LOOSE to MEDIUM DENSE, MOIST

SANDSTONE, VERY WEAK, GRAY, HIGHLY WEATHERED (SAND, CLAYEY, VERY DENSE, MOIST)

CLAY, SANDY, BROWN, HARD, MOIST

CLAYSTONE, VERY WEAK, GRAY, MODERATELY WEATHERED (CLAY, SANDY, HARD, MOIST)

SANDSTONE, VERY WEAK, GRAY, COMPLETELY WEATHERED (SAND, CLAYEY, VERY DENSE, MOIST)

Depth (ft)	Symbol	Samples	Blows per foot	Watercontent %	Soil Type
5			16	2.6	1
5			11	13.1	1
10			29	13.6	1
15			50	9.9	3
15			11"		
20			50	11.3	3
20			9"		

Depth (ft)	Symbol	Samples	Blows per foot	Watercontent %	Soil Type
5			5	8.1	1
5			17	7.6	1
10			40	9.0	2
15			50	11.9	4
15			10"		
20			50	10.4	3
20			8"		



**TEST BORING LOGS**

10707 MALTESE POINT  
 WD CONSTRUCTION

JOB NO.  
 240324

**FIG. A-1**

TEST BORING 3  
 DATE DRILLED 3/6/2024

TEST BORING 4  
 DATE DRILLED 3/6/2024

REMARKS

REMARKS

DRY TO 20', 3/6/24

DRY TO 10', 3/6/24

Depth (ft)	Symbol	Samples	Blows per foot	Watercontent %	Soil Type
0 - 18"	TOPSOIL				
18" - 5'	SAND, SILTY to SLIGHTLY SILTY, LIGHT BROWN, LOOSE to MEDIUM DENSE, MOIST		9	4.6	1
5' - 10'	CLAY, SANDY, BROWN, HARD, MOIST		28	8.2	1
10' - 15'	CLAYSTONE, VERY WEAK, GRAY, MODERATELY WEATHERED (CLAY, SANDY, HARD, MOIST)		39	9.2	2
15' - 20'	SANDSTONE, VERY WEAK, GRAY, COMPLETELY WEATHERED (SAND, CLAYEY, VERY DENSE, MOIST)		50	12.6	4
20' - 27'			10"		
27' - 30'			50	11.1	3
30' - 37'			7"		

Depth (ft)	Symbol	Samples	Blows per foot	Watercontent %	Soil Type
0 - 12"	TOPSOIL				
12" - 5'	SAND, SILTY, DARK BROWN to BROWN, LOOSE to MEDIUM DENSE, MOIST		7	11.7	1
5' - 10'			7	7.0	1
10' - 15'			22	10.9	1
15' - 20'					
20' - 27'					



**TEST BORING LOGS**

10707 MALTESE POINT  
 WD CONSTRUCTION

JOB NO.  
 240324

**FIG. A-2**

TEST BORING 5  
 DATE DRILLED 3/6/2024

REMARKS

DRY TO 10', 3/6/24

SAND, SILTY, TAN to BROWN,  
 MEDIUM DENSE to DENSE, DRY  
 to MOIST

CLAY, SANDY, GRAY, HARD,  
 MOIST

Depth (ft)	Symbol	Samples	Blows per foot	Watercontent %	Soil Type
0 - 5	(Dotted pattern)		15	2.6	1
5 - 10	(Dotted pattern)		33	6.8	1
10 - 11	(Hatched pattern)		44	9.2	2
11 - 15	(Dotted pattern)				
15 - 20	(Dotted pattern)				
20 - 25	(Dotted pattern)				



TEST BORING LOGS

10707 MALTESE POINT  
 WD CONSTRUCTION

JOB NO.  
 240324

FIG. A-3



## **APPENDIX B: Laboratory Test Results**

**TABLE B-1  
SUMMARY OF LABORATORY TEST RESULTS**

SOIL TYPE	TEST BORING NO.	DEPTH (FT)	WATER (%)	DRY DENSITY (PCF)	PASSING NO. 200 SIEVE (%)	LIQUID LIMIT	PLASTIC LIMIT	PLASTIC INDEX	SULFATE (WT %)	AASHTO CLASS.	SWELL/ CONSOL (%)	USCS	SOIL DESCRIPTION
1, CBR	4	0-3			23.8	NV	NP	NP	<0.01	A-1-b		SM	SAND, SILTY
1	1	2-3			7.2	NV	NP	NP	0.00			SW-SM	SAND, WITH SILT
1	4	1-2			36.8	NV	NP	NP	0.00	A-4		SM	SAND, SILTY
1	5	1-2			3.8	NV	NP	NP		A-1-b		SW	SAND, SLIGHTLY SILTY
2	2	10	13.8	118.8	51.3	26	17	9	<0.01		0.5	CL	CLAY, SANDY
3	1	15			27.9	29	20	9	<0.01			SC	SANDSTONE (SAND, CLAYEY)
4	3	15	13.1	113.4	52.7	36	24	12	0.00		1.2	CL	CLAYSTONE (CLAY, SANDY)

TEST BORING 4  
 DEPTH (FT) 0-3

SOIL DESCRIPTION SAND, SILTY  
 SOIL TYPE 1, CBR

**Sieve Analysis  
 Grain Size Distribution**

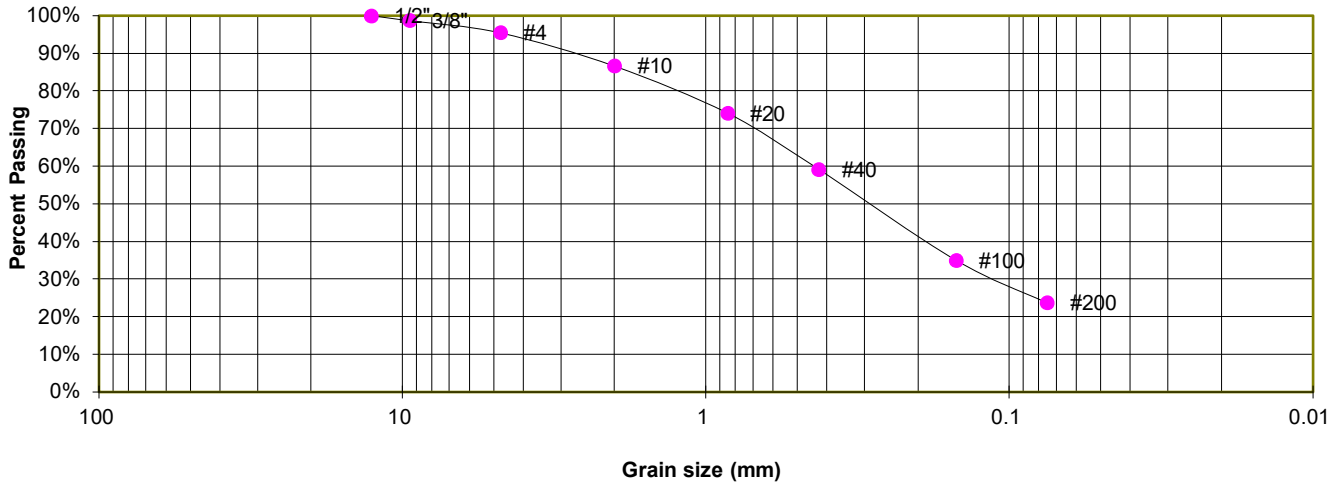

**GRAIN SIZE ANALYSIS**

U.S. Sieve #	Percent Finer
3"	
1 1/2"	
3/4"	
1/2"	100.0%
3/8"	98.7%
4	95.5%
10	86.7%
20	74.1%
40	59.2%
100	35.0%
200	23.8%

**ATTERBERG LIMITS**

Plastic Limit	NP
Liquid Limit	NV
Plastic Index	NP

**SOIL CLASSIFICATION**

USCS CLASSIFICATION: SM  
 AASHTO CLASSIFICATION: A-1-b  
 AASHTO GROUP INDEX: 0



**LABORATORY TEST RESULTS**

10707 MALTESE POINT  
 WD CONSTRUCTION

JOB NO.  
 240324

**FIG. B-1**



TEST BORING 1  
 DEPTH (FT) 2-3

SOIL DESCRIPTION SAND, WITH SILT  
 SOIL TYPE 1

**Sieve Analysis  
 Grain Size Distribution**

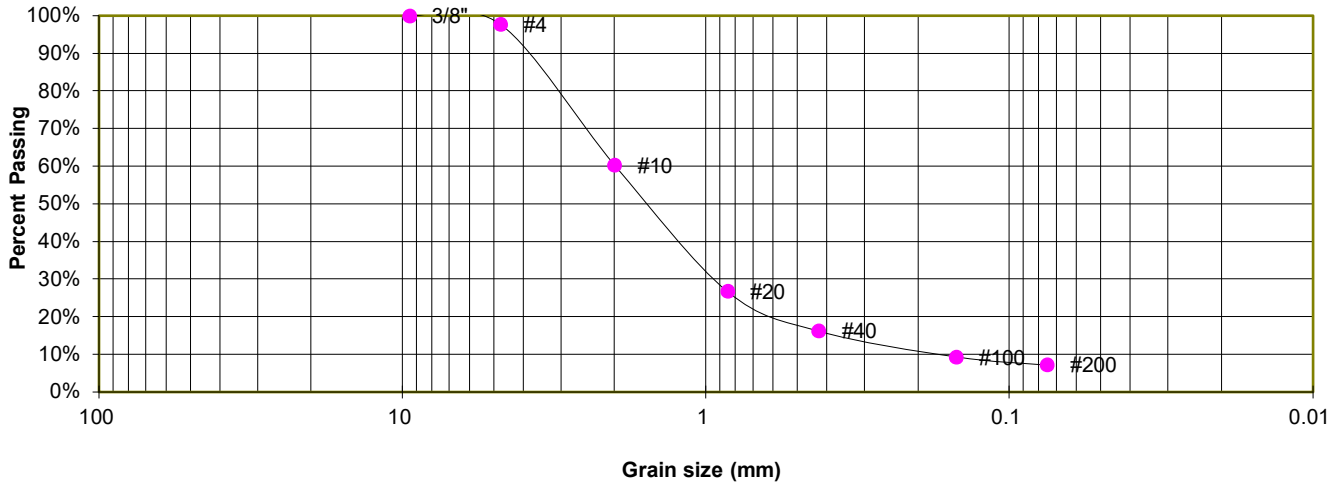

**GRAIN SIZE ANALYSIS**

U.S. Sieve #	Percent Finer
3"	
1 1/2"	
3/4"	
1/2"	
3/8"	100.0%
4	97.7%
10	60.3%
20	26.8%
40	16.2%
100	9.3%
200	7.2%

**ATTERBERG LIMITS**

Plastic Limit	NP
Liquid Limit	NV
Plastic Index	NP

**SOIL CLASSIFICATION**

USCS CLASSIFICATION: SW-SM



**LABORATORY TEST RESULTS**

10707 MALTESE POINT  
 WD CONSTRUCTION

JOB NO.  
 240324

**FIG. B-2**

TEST BORING 4  
 DEPTH (FT) 1-2

SOIL DESCRIPTION SAND, SILTY  
 SOIL TYPE 1

**Sieve Analysis  
 Grain Size Distribution**

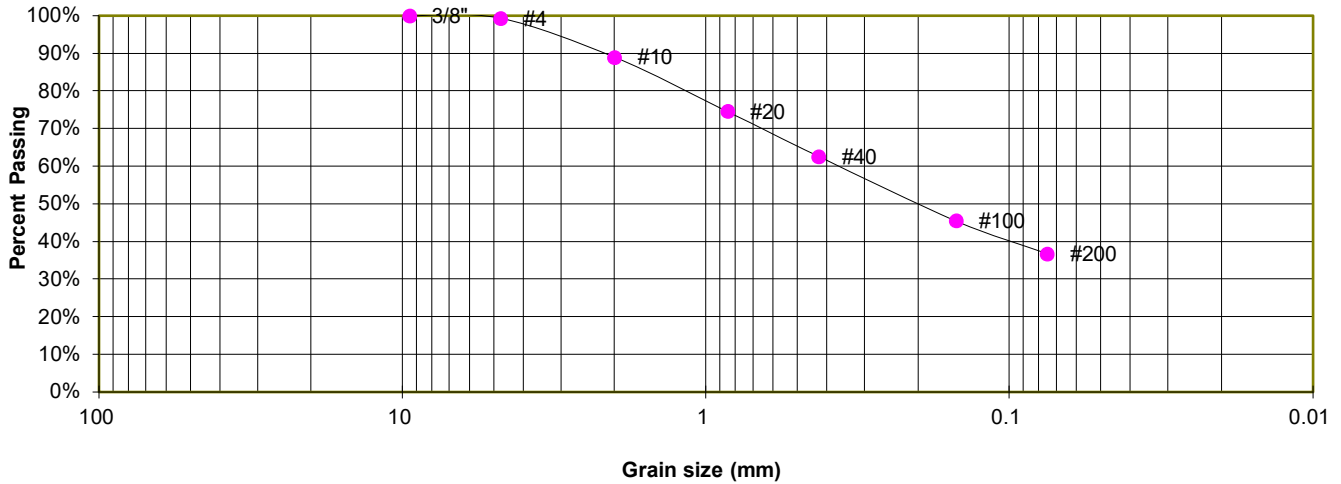

**GRAIN SIZE ANALYSIS**

U.S. Sieve #	Percent Finer
3"	
1 1/2"	
3/4"	
1/2"	
3/8"	100.0%
4	99.3%
10	89.0%
20	74.6%
40	62.6%
100	45.5%
200	36.8%

**ATTERBERG LIMITS**

Plastic Limit	NP
Liquid Limit	NV
Plastic Index	NP

**SOIL CLASSIFICATION**

USCS CLASSIFICATION: SM  
 AASHTO CLASSIFICATION: A-4  
 AASHTO GROUP INDEX: 0



**LABORATORY TEST RESULTS**

10707 MALTESE POINT  
 WD CONSTRUCTION

JOB NO.  
 240324

**FIG. B-3**

TEST BORING 5  
 DEPTH (FT) 1-2

SOIL DESCRIPTION SAND, SLIGHTLY SILTY  
 SOIL TYPE 1

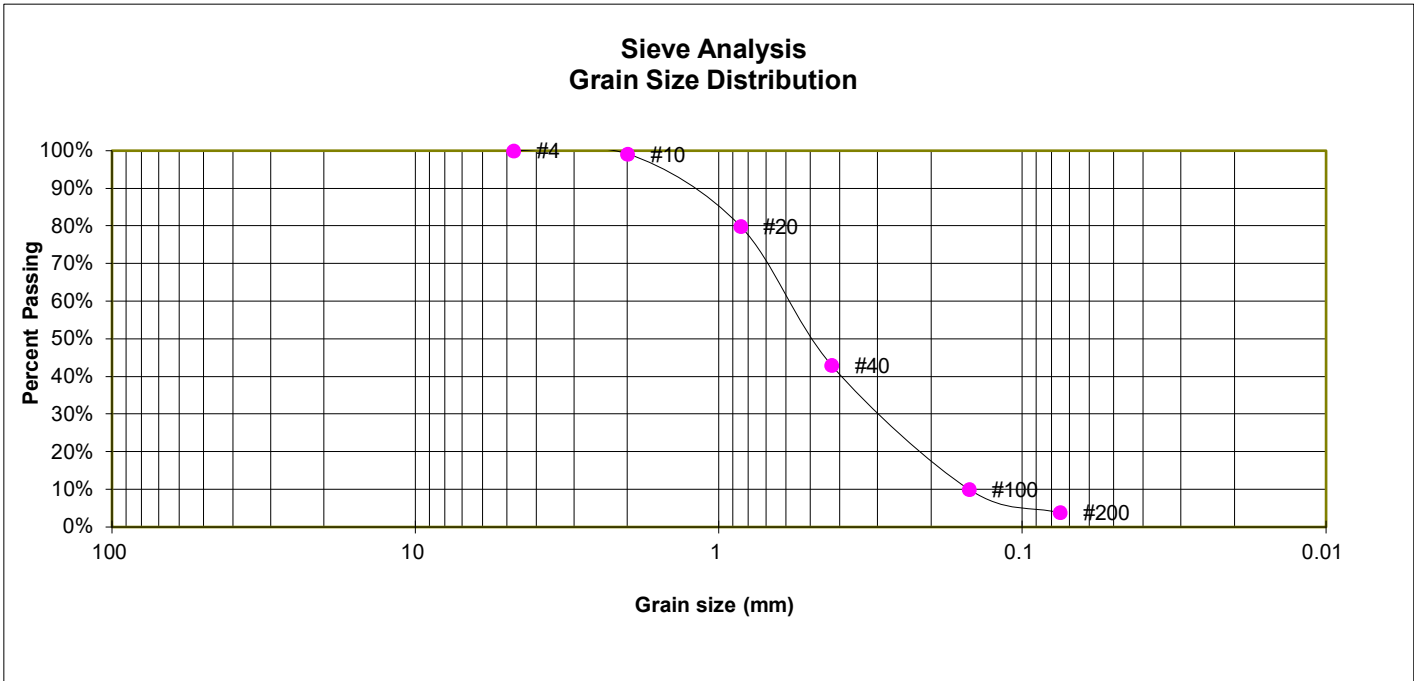

**GRAIN SIZE ANALYSIS**

U.S. Sieve #	Percent Finer
3"	
1 1/2"	
3/4"	
1/2"	
3/8"	
4	100.0%
10	99.2%
20	79.9%
40	43.0%
100	10.0%
200	3.8%

**ATTERBERG LIMITS**

Plastic Limit	NP
Liquid Limit	NV
Plastic Index	NP

**SOIL CLASSIFICATION**

USCS CLASSIFICATION: SW  
 AASHTO CLASSIFICATION: A-1-b  
 AASHTO GROUP INDEX: 0



**LABORATORY TEST RESULTS**

10707 MALTESE POINT  
 WD CONSTRUCTION

JOB NO.  
 240324

**FIG. B-4**

TEST BORING 2  
 DEPTH (FT) 10

SOIL DESCRIPTION CLAY, SANDY  
 SOIL TYPE 2

**Sieve Analysis  
 Grain Size Distribution**

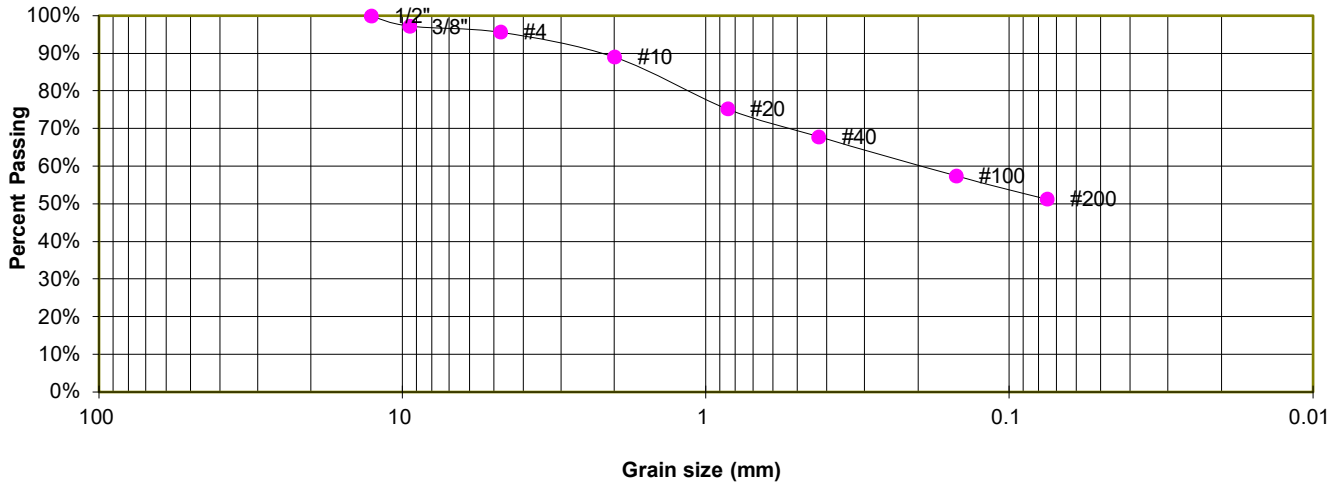

**GRAIN SIZE ANALYSIS**

U.S. Sieve #	Percent Finer
3"	
1 1/2"	
3/4"	
1/2"	100.0%
3/8"	97.3%
4	95.7%
10	89.0%
20	75.3%
40	67.8%
100	57.5%
200	51.3%

**ATTERBERG LIMITS**

Plastic Limit	17
Liquid Limit	26
Plastic Index	9

**SOIL CLASSIFICATION**

USCS CLASSIFICATION: CL



**LABORATORY TEST RESULTS**

10707 MALTESE POINT  
 WD CONSTRUCTION

JOB NO.  
 240324

**FIG. B-5**

TEST BORING 1  
 DEPTH (FT) 15

SOIL DESCRIPTION SANDSTONE (SAND, CLAYEY)  
 SOIL TYPE 3

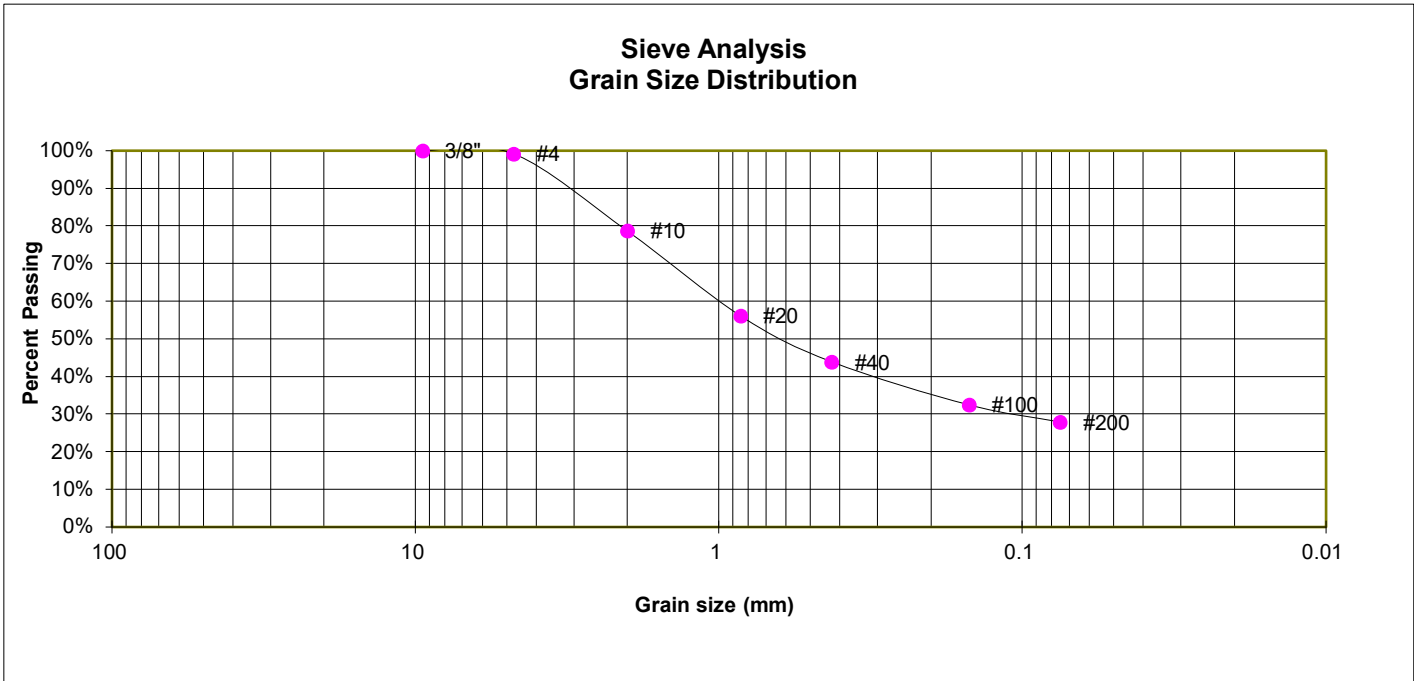

**GRAIN SIZE ANALYSIS**

U.S. Sieve #	Percent Finer
3"	
1 1/2"	
3/4"	
1/2"	
3/8"	100.0%
4	99.2%
10	78.7%
20	56.2%
40	43.9%
100	32.5%
200	27.9%

**ATTERBERG LIMITS**

Plastic Limit	20
Liquid Limit	29
Plastic Index	9

**SOIL CLASSIFICATION**

USCS CLASSIFICATION: SC



**LABORATORY TEST RESULTS**

10707 MALTESE POINT  
 WD CONSTRUCTION

JOB NO.  
 240324

**FIG. B-6**

TEST BORING 3  
 DEPTH (FT) 15

SOIL DESCRIPTION CLAYSTONE (CLAY, SANDY)  
 SOIL TYPE 4

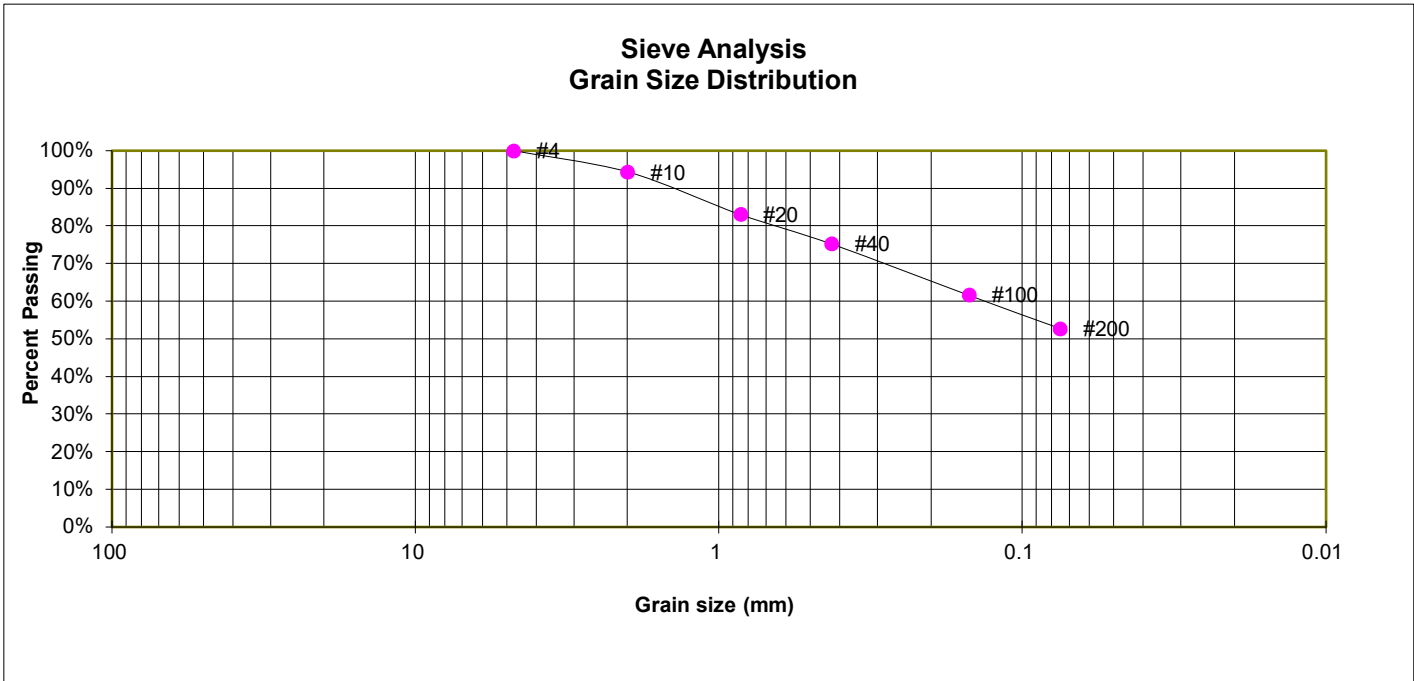

**GRAIN SIZE ANALYSIS**

U.S. Sieve #	Percent Finer
3"	
1 1/2"	
3/4"	
1/2"	
3/8"	
4	100.0%
10	94.4%
20	83.1%
40	75.2%
100	61.7%
200	52.7%

**ATTERBERG LIMITS**

Plastic Limit	24
Liquid Limit	36
Plastic Index	12

**SOIL CLASSIFICATION**

USCS CLASSIFICATION: CL



**LABORATORY TEST RESULTS**

10707 MALTESE POINT  
 WD CONSTRUCTION

JOB NO.  
 240324

**FIG. B-7**

TEST BORING 2  
DEPTH (FT) 10

SOIL DESCRIPTION CLAY, SANDY  
SOIL TYPE 2



**SWELL/COLLAPSE TEST RESULTS**

NATURAL UNIT DRY WEIGHT (PCF): 119  
NATURAL MOISTURE CONTENT: 13.8%  
SWELL/COLLAPSE (%): 0.5%



**SWELL TEST RESULTS**

10707 MALTESE POINT  
WD CONSTRUCTION

JOB NO.  
240324

**FIG. B-8**

TEST BORING 3  
DEPTH (FT) 15

SOIL DESCRIPTION CLAYSTONE (CLAY, SANDY)  
SOIL TYPE 4

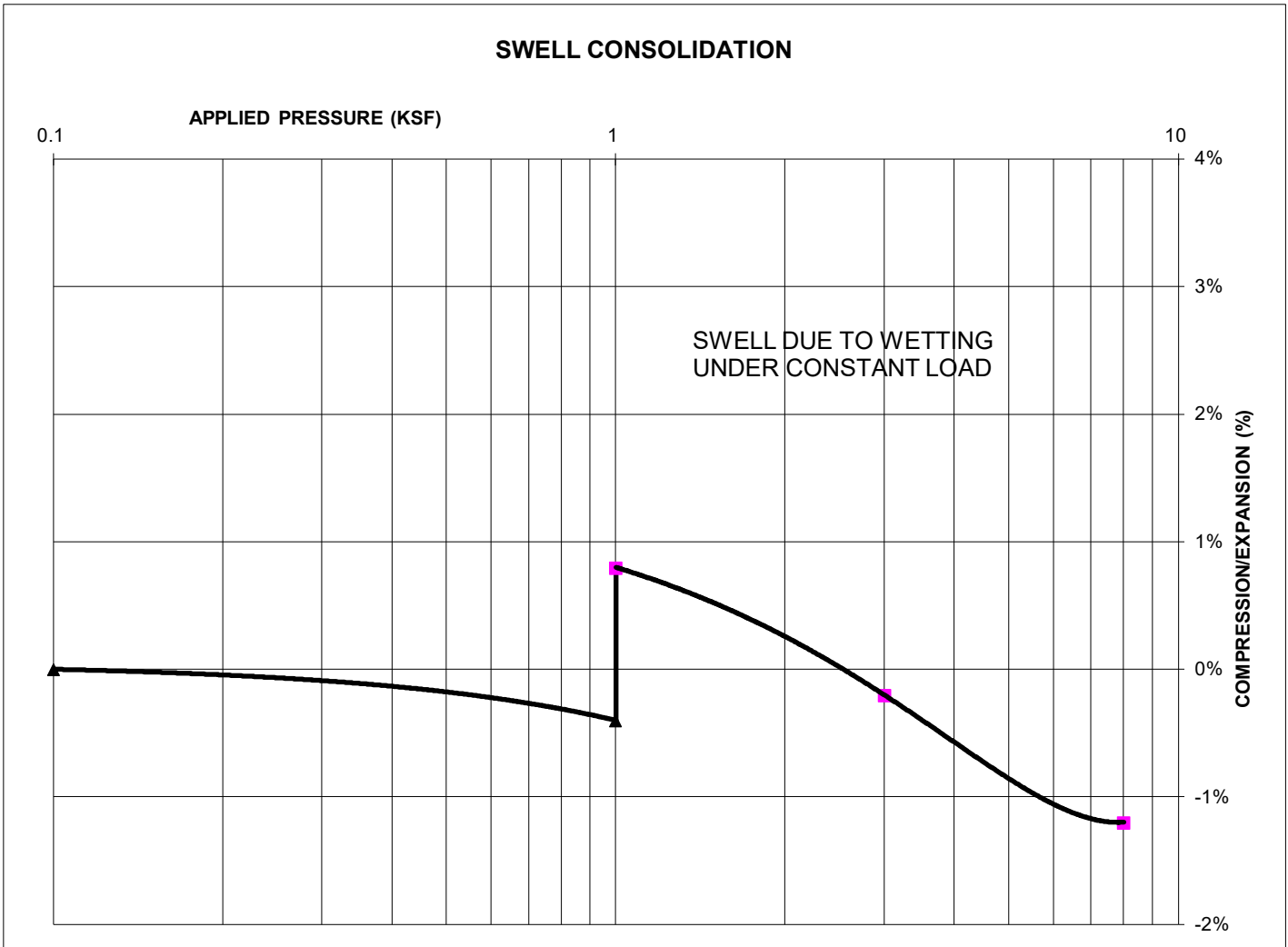

**SWELL/COLLAPSE TEST RESULTS**

NATURAL UNIT DRY WEIGHT (PCF): 113  
NATURAL MOISTURE CONTENT: 13.1%  
SWELL/COLLAPSE (%): 1.2%



**SWELL TEST RESULTS**

10707 MALTESE POINT  
WD CONSTRUCTION

JOB NO.  
240324

**FIG. B-9**



SAMPLE LOCATION TB-4 @ 0-3'

SOIL DESCRIPTION SAND, SILTY, BROWN  
SOIL TYPE 1

**PROCTOR DATA**

IDENTIFICATION: SM  
PROCTOR TEST #: 1  
TEST BY: DK  
TEST DESIGNATION: ASTM-1557-A  
MAXIMUM DRY DENSITY (PCF): 124.9  
OPTIMUM MOISTURE: 8.6

**Compaction Curve**

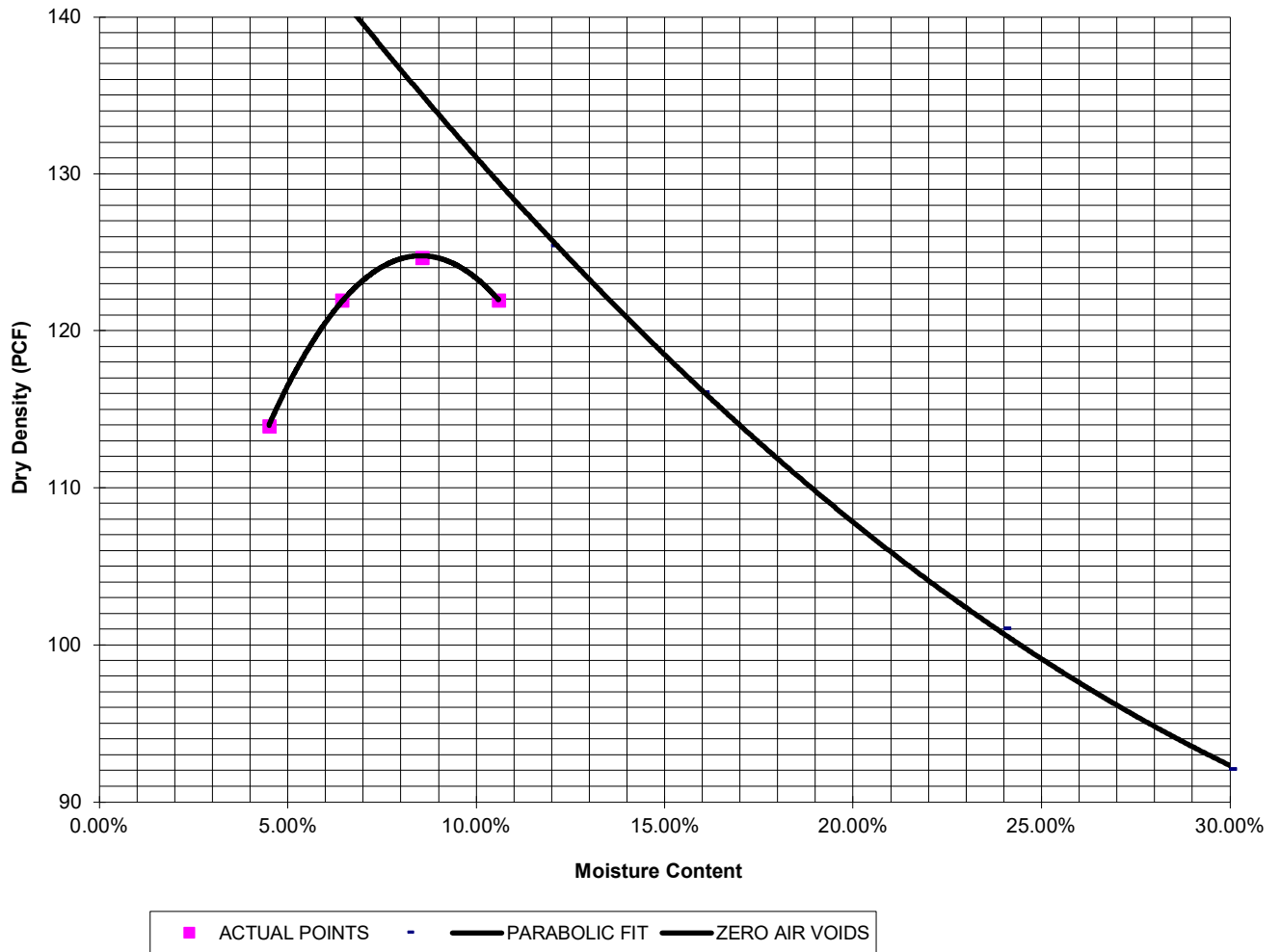

**LABORATORY TEST RESULTS**

10707 MALTESE POINT  
WD CONSTRUCTION

JOB NO.  
240324

**FIG. B-10**

SAMPLE LOCATION TB-4 @ 0-3'  
DEPTH (FT) 0

SOIL DESCRIPTION SAND, SILTY, BROWN  
SOIL TYPE 1

**CBR TEST LOAD DATA**

Piston Diameter (cm): 4.958  
Piston Area (in<sup>2</sup>): 2.993

Penetration Depth (inches)	10 BLOWS Mold # 1		25 BLOWS Mold # 2		56 BLOWS Mold # 3	
	Load (lbs)	Stress (psi)	Load (lbs)	Stress (psi)	Load (lbs)	Stress (psi)
0.000	0	0.00	0	0.00	0	0.00
0.025	199	66.50	422	141.02	590	197.16
0.050	274	91.56	668	223.22	1213	405.35
0.075	335	111.95	829	277.03	1711	571.76
0.100	393	131.33	1055	352.55	2425	810.36
0.125	465	155.39	1264	422.39	2868	958.39
0.150	530	177.11	1429	477.53	3238	1082.04
0.175	585	195.49	1578	527.32	3529	1179.28
0.200	628	209.86	1688	564.08	3799	1269.50
0.300	775	258.98	2121	708.77	4618	1543.19
0.400	884	295.40	2332	779.28	4738	1583.29
0.500	1015	339.18	2694	900.25	5114	1708.93

**MOISTURE AND DENSITY DATA**

	Mold # 1	Mold # 2	Mold # 3
Can #	399	400	41
Wt. Can	8.39	8.36	8.31
Wt. Can+Wet	301.02	322.9	292.73
Wt. Can+Dry	266.35	288.51	263.96
Wt. H2O	34.67	34.39	28.77
Wt. Dry Soil	257.96	280.15	255.65
Moisture Content	13.44%	12.28%	11.25%
Wet Density (PCF)	121.6	128.1	133.3
Dry Density (PCF)	112.0	117.9	122.7
% Compaction	90%	94%	98%
CBR	13.13	35.25	81.04

**PROCTOR DATA**

Maximum Dry Density (pcf) 124.9  
Optimum Moisture 8.6  
90% of Max. Dry Density (pcf) 112.4  
95% of Max. Dry Density (pcf) 118.7

CBR at 90% of Max. Density = 14.74 ~ R VALUE 45  
CBR at 95% of Max. Density = 42.18 ~ R VALUE 75



**LABORATORY TEST RESULTS**

10707 MALTESE POINT  
WD CONSTRUCTION

JOB NO.  
240324

**FIG. B-11**

SAMPLE LOCATION TB-4 @ 0-3'  
DEPTH (FT) 0

SOIL DESCRIPTION SAND, SILTY, BROWN  
SOIL TYPE 0

Stress VS Penetration

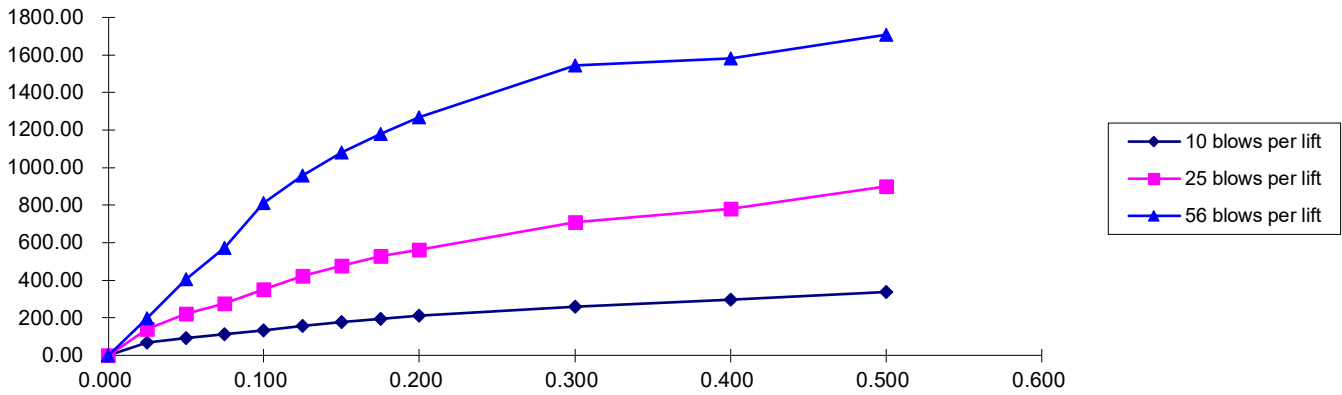

Bearing Ratio VS Dry Density

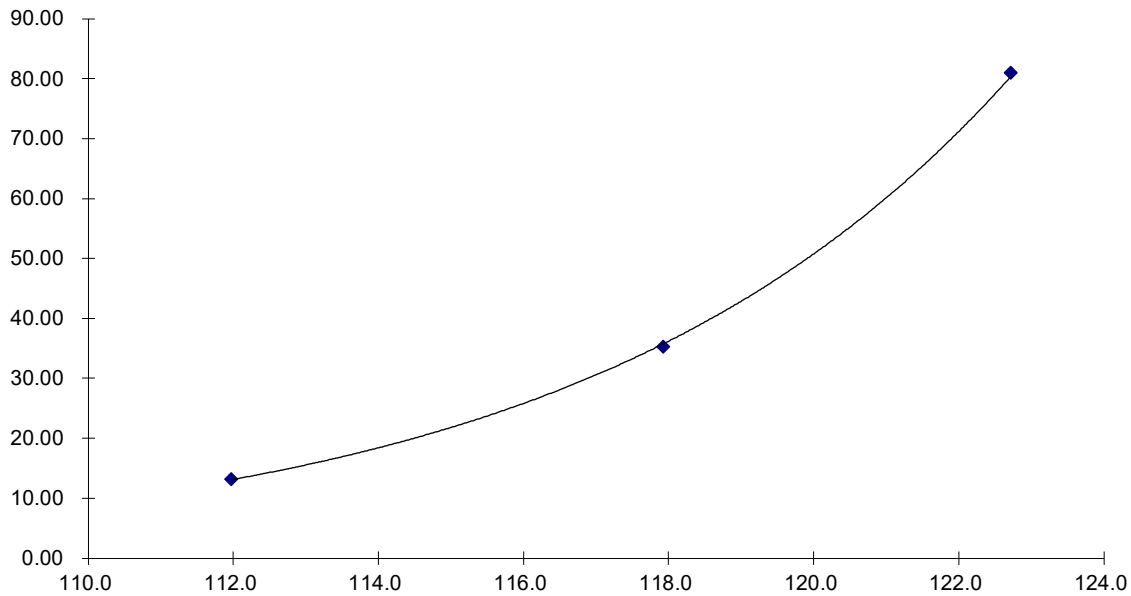

LABORATORY TEST RESULTS

10707 MALTESE POINT  
WD CONSTRUCTION

JOB NO.  
240324

FIG. B-12



## **APPENDIX C: Pavement Design Calculations**

## FLEXIBLE PAVEMENT DESIGN

### PROJECT DATA

Project Location WD Construction 10707 Maltese Point Parking Lot and Access Drive

Job Number: 240324

### DESIGN DATA

Equivalent (18-kip) Single Axle Load Applications (ESAL):	ESAL ( $W_{18}$ ) =	100,000
Design CBR	CBR =	10
Standard Deviation	$S_o$ =	0.44
Loss in Serviceability	$\Delta\psi$ =	2.0
Reliability	Reliability =	75
Reliability (z-statistic)	$Z_R$ =	-0.67
Soil Resilient Modulus	$M_R$ =	15,000 psi

Required Structural Number (SN): ➔ SN = 1.61

### DESIGN EQUATIONS

#### Resilient Modulus

If using CBR:

$$M_R = (\text{CBR}) \times 1,500$$

If using R-Value:

$$M_R = 10^{[(S_1 + 18.72) / 6.24]} \text{ where: } S_1 = [(R\text{-value} - 5) / 11.29] + 3$$

#### Required Structural Number

$$\log_{10} W_{18} = Z_R \cdot S_o + 9.36 \cdot \log_{10} \{(\text{SN}+1) - 0.20 + \frac{\log_{10} \left[ \frac{\Delta \text{PSI}}{4.2 - 1.5} \right]}{0.40 + \frac{1094}{(\text{SN}+1)^{5.19}}} + 2.32 \cdot \log_{10} M_R - 8.07$$

#### Pavement Section Thickness

$$\text{SN}^* = C_1 D_1 + C_2 D_2 \quad \text{where: } C_1 = \text{Strength Coefficient - HMA}$$

$C_2$  = Strength Coefficient - ABC

$D_1$  = Depth of HMA (inches)

$D_2$  = Depth of ABC (inches)

### RECOMMENED THICKNESSES

Layer	Material	Coefficient	Thickness ( $D^*_i$ )	$\text{SN}^*_i$	SN
1	HMA	$C_1 = 0.44$	4.0 inches	1.760	-
2	ABC	$C_2 = 0.11$	4.0 inches	0.440	
				$\text{SN}^* = 2.200$	1.61

Pavement SN > Required SN, Design is Acceptable