

LSC TRANSPORTATION CONSULTANTS, INC.
 2504 East Pikes Peak Avenue, Suite 304
 Colorado Springs, CO 80909
 (719) 633-2868
 FAX (719) 633-5430
 E-mail: lsc@lscstrans.com
 Website: <http://www.lscstrans.com>

Homestead North Filing No. 3
 Traffic Impact Study
 PCD File No.: P-22-015 & SF-22-29
 (LSC #S224250)
 February 7, 2023

Traffic Engineer's Statement

This traffic report and supporting information were prepared under my responsible charge and they comport with the standard of care. So far as is consistent with the standard of care, said report was prepared in general conformance with the criteria established by the County for traffic reports.

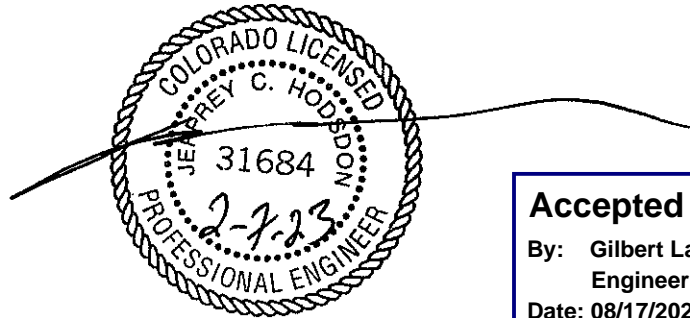

<p>Accepted for File</p> <p>By: Gilbert LaForce, P.E. Engineering Manager</p> <p>Date: 08/17/2023 8:47:16 AM</p> <p>El Paso County Department of Public Works</p>	
---	--

Developer's Statement

I, the Developer, have read and will comply with all commitments made on my behalf within this report.

[Handwritten Signature]

2/13/2023
 Date

Homestead North Filing 3

Traffic Impact Study

Mr. Jim Morley
SR Land, LLC
20 Boulder Crescent, 1st Floor
Colorado Springs, CO 80903

FEBRUARY 7, 2023

LSC Transportation Consultants
Prepared by: Kirstin D. Ferrin, P.E.
Reviewed by: Jeffrey C. Hodsdon, P.E.

LSC #S224250

PCD File No.: P-22-015 & SF-22-29



CONTENTS

REPORT CONTENTS 1

RECENT TRAFFIC REPORTS 2

STUDY AREA 3

 Study-Area Land Use 3

 Sketch Plan 3

 Study-Area Access Plan 3

CURRENTLY PROPOSED LAND USE AND ACCESS 3

 Land Use and Vehicle Access 3

 Sight Distance Analysis 4

 Pedestrian and Bicycle Access 4

EXISTING ROAD AND TRAFFIC CONDITIONS 4

 Study-Area Roadways and Streets 4

 Existing Traffic Volumes 5

 Existing Level of Service 5

BACKGROUND (BASELINE) CONDITIONS (SHORT- AND LONG-TERM FUTURE) 6

TRIP GENERATION 7

TRIP DISTRIBUTION AND ASSIGNMENT 8

TOTAL TRAFFIC 8

 Short-Term Total Traffic Volumes 8

 2042 Total Traffic Volumes 8

LEVEL OF SERVICE ANALYSIS 8

 Briargate Parkway/Vollmer Road 9

 Briargate Parkway/Wheatland Drive 9

 Vollmer Road/Sam Bass Drive 9

 Vollmer Road/Poco Road 9

SUBDIVISION STREET CLASSIFICATIONS 10

AREA MTCP 2040 ROADWAY IMPROVEMENT PROJECTS 10

AUXILIARY TURN LANES 10

TRANSPORTATION IMPROVEMENT FEE PROGRAM 11

CONCLUSIONS AND RECOMMENDATIONS 11

 Trip Generation 11

 Level of Service 11

 Recommended Improvements 12

Enclosures: 12

Tables 1 and 3

Figures 1-13

Approved Deviation Form

TAZ Map

MTCP Maps

Traffic Count Reports

Level of Service Reports



LSC TRANSPORTATION CONSULTANTS, INC.
2504 East Pikes Peak Avenue, Suite 304
Colorado Springs, CO 80909
(719) 633-2868
FAX (719) 633-5430
E-mail: lsc@lsctrans.com
Website: <http://www.lsctrans.com>

February 7, 2023

Mr. Jim Morley
SR Land, LLC
20 Boulder Crescent, 1st Floor
Colorado Springs, CO 80903

RE: Homestead North Filing 3
Traffic Impact Study
El Paso County, Colorado
PCD File No.: P-22-015 & SF-22-29
LSC #S224250

Dear Mr. Morley:

LSC Transportation Consultants, Inc. has prepared this updated Traffic Impact Study for Homestead North Filing 3 Preliminary Plan and Final Plat. As shown in Figure 1, Homestead North is located east of Vollmer Road and north of the future extension of Briargate Parkway in El Paso County, Colorado. Homestead North is part of the Sterling Ranch Master Plan area.

REPORT CONTENTS

The preparation of this report included the following:

- A list of previous Sterling Ranch traffic reports and traffic reports completed by LSC Transportation Consultants, Inc. for other area developments;
- A summary of the proposed land use and access plan;
- The existing roadway and traffic conditions in the site's vicinity, including the roadway widths, surface conditions, lane geometries, traffic controls, and posted speed limits;
- Existing (2022) traffic-volume data;
- Estimates of projected short-term and long-term traffic volumes;
- The projected average weekday and peak-hour vehicle trips to be generated by the proposed development;
- The assignment of the projected site-generated traffic volumes to the area roadways;
- The projected short-term and long-term total traffic volumes on the area roadways;
- The projected levels of service at the key intersections in the vicinity of the site;
- The recommended street classifications for the internal streets within the proposed development;
- The project's obligation to the County roadway improvement fee program; and
- Recommended roadway improvements.

RECENT TRAFFIC REPORTS

LSC prepared a traffic impact study (TIS) for the entire Sterling Ranch development dated June 5, 2008. A LSC update to the 2008 master study was recently submitted in support of the current Sketch Plan Amendment (SKP224). The overall Sterling Ranch improvements table has been recently updated and portions of this updated table (relevant to this application) are presented in an updated improvements table in this report. The items in this table have been based on the updated table that were included in the updated Master TIS.

LSC also prepared a traffic impact analysis for the first phase of the Sterling Ranch development, dated March 16, 2015; a memorandum for Phases 1-3, dated October 2, 2017; and a traffic impact analysis for the Sterling Ranch Phase 2 Preliminary Plan, dated December 20, 2018. The following site-specific, final plat traffic reports have also been prepared:

- *Branding Iron at Sterling Ranch Filing No. 1 and Homestead at Sterling Ranch Filing No. 1*, dated December 19, 2017
- *Sterling Ranch Filing No. 2*, dated April 3, 2018
- *Sterling Ranch Phase 2*, dated December 20, 2018
- *Homestead at Sterling Ranch Filing No. 2*, dated March 3, 2020
- *Branding Iron at Sterling Ranch Filing No. 2*, dated March 31, 2020 (revised May 6, 2020)
- *Sterling Ranch Filing No. 2 and Sterling Ranch Phase 2*, dated June 23, 2021.
- *Sterling Ranch Filing No. 3 Transportation Memorandum*, dated April 19, 2022
- *Copper Chase at Sterling Ranch*, dated December 14, 2021.
- *Homestead North Phase 1 Updated Traffic Study*, dated January 11, 2022
- *Homestead North Filing No. 1 Traffic Technical Memorandum*, dated February 2, 2022
- *Homestead North Filing No. 2 Traffic Technical Memorandum*, dated April 15, 2022

LSC prepared a TIS for the Retreat at TimberRidge, located just north of the Homestead North development, dated January 25, 2018. LSC also prepared transportation memoranda for the Retreat at TimberRidge Preliminary Plan, dated June 29th, 2018, and the Retreat at TimberRidge Filing No. 1, dated April 3, 2020.

A traffic impact study for Jaynes Property (SKP225) prepared by SM Rocha LLC, dated January 19, 2023 is currently under review by El Paso County. As the Jaynes Property TIS was submitted after the initial Homestead North Filing 3 TIS dated June 17, 2022 this report does not account for traffic from the Jaynes Property. Please refer the Jaynes Property TIS and other documents on EDARP for additional improvements needed at the intersection of Vollmer/Sam Bass with the addition of the proposed west leg to serve the Jaynes property. Also please note that the recently submitted Sterling Ranch Master TIS update incorporated the proposed land use and access for the Jaynes property.

STUDY AREA

Study-Area Land Use

Sketch Plan

Figure 2 shows the location of the currently-proposed Homestead North development. These parcels were included as part of traffic analysis zone (TAZ) 21 in the 2008 master traffic impact report. Table 1 shows the land uses assumed for TAZ 21 in the 2008 report and the land uses assumed in this report. A copy of the TAZ map from the 2008 report has been attached. As shown in Table 1, the 2008 report assumed the study area would be developed with 327 single-family homes. This same area is now planned to be developed with about 224 single-family homes. This includes 73 single-family homes in the approved Filing No. 1, 74 single-family homes in Filing No. 2 which is currently under review, and 77 homes in the currently-proposed in Filing No. 3. The currently proposed land use for Homestead North Filing 3 is consistent with the land use assumed in the *Homestead North Phase 1 Updated Traffic Study*, dated January 11, 2022.

Study-Area Access Plan

The access plan for the current study area is generally consistent with the access plan shown in the master traffic report. The following summarizes the changes:

- The Sterling Ranch access to Briargate Parkway just east of Vollmer Road (Wheatland Drive) was previously shown as a right-in/right-out-only intersection in the Sketch Plan. The south leg is now proposed as a three-quarter-movement (left-in/right-in/right-out-only) access. A deviation request for this access point was submitted and approved as part of PUD 09-005 (DEV 1410). A copy of the approved deviation has been attached. The north leg that will serve Homestead North Phase 1 is still proposed to be restricted to right-in/right-out only.
- An additional right-in-only access (Jane Kirkham Drive) is planned from northbound Vollmer Road between Briargate Parkway and the first full-movement site access. The access was part of the Filing 1 application and prior LSC TIS report.

These changes to the plan will result in some localized shifts in intersection turning movements shown in the master traffic study long-term traffic projections, but nothing significant requiring an update to the master study.

CURRENTLY PROPOSED LAND USE AND ACCESS

Land Use and Vehicle Access

Homestead North Fil 3 is planned to include 77 lots for single-family homes. Filing 3 will have access to Vollmer Road and Briargate Parkway via the Homestead North Phase 1 street system to the access points approved as part of the Homestead North Filing 1. These access points

include a full-movement site access (Sam Bass Drive) to Vollmer Road about 1,410 feet north of Briargate Parkway and 1,370 feet south of Poco Road and an additional right-in-only access (Jane Kirkham Drive) to Vollmer Road 704 feet north of Briargate Parkway and about 704 feet south of Sam Bass Drive.

An access is also planned to Briargate Parkway 750 feet east of Vollmer Road aligning with Wheatland Drive. In the short term, full-movement access will be allowed at this intersection, as only a half section of Briargate Parkway is planned to be constructed between Vollmer Road and Wheatland Drive. Once Briargate Parkway is widened to the full Principal Arterial cross-section **and** the roadway is extended east of Wheatland, the north leg serving Homestead North will be restricted to right-in/right-out only and the south leg will be restricted to three-quarter movements (left-in/right-in/right-out only).

The plan shows an “internal” full-movement access to Poco Road about 675 feet east of Vollmer Road as part of the currently proposed Homestead North Filing 3.

Sight Distance Analysis

Figure 3 shows a sight-distance analysis at the future access to Poco Road. Based on a design speed of 25 miles per hour (mph) and the criteria contained in Table 2-21 of the *El Paso County Engineering Criteria Manual (ECM)*, the required intersection sight distance at the future intersection is 280 feet. Based on the criteria contained in Table 2-17 of the *ECM*, the required stopping sight distance approaching this intersection is 155 feet. As shown in Figure 3, the future intersection analyzed will meet the criteria.

Pedestrian and Bicycle Access

There are no existing schools within two miles of the site. However, there are planned future school sites within the Sterling Ranch Master Plan area south of Briargate Parkway. There are planned sidewalks along the subdivision streets, Vollmer Road, adjacent to the site, and Briargate Parkway. School crossings will be needed at the intersection of Briargate Parkway/Vollmer Road. School crossings should not be allowed at the intersection of Briargate Parkway/Wheatland Drive.

EXISTING ROAD AND TRAFFIC CONDITIONS

Study-Area Roadways and Streets

The adjacent streets are shown in Figure 1 and are described below. Copies of the *2016 El Paso County Major Transportation Corridors Plan (MTCP)*, *2040 Roadway Plan*, and *2016 MTCP 2060 Corridor Preservation Plan* with the site location identified on each of them have been attached to this report.

Vollmer Road is currently a five-lane urban street within the City of Colorado Springs limits between Black Forest Road and Cowpoke Road; and a two-lane, rural, paved roadway north of Cowpoke Road extending to north of Hodgen Road. In the southbound direction, Vollmer Road has a posted speed limit of 45 miles per hour (mph). South of Cowpoke Road, Vollmer Road has a 40-mph posted speed limit. The *2040 El Paso County Major Transportation Corridors Plan (MTCP)* and the Sterling Ranch master traffic study show Vollmer Road as a four-lane Urban Minor Arterial adjacent to the site. Vollmer Road is planned to transition to a 2-lane Rural Minor Arterial north of Poco Road.

Marksheffel Road is a Principal Arterial extending north from the City of Fountain to Woodmen Road. Marksheffel Road is planned to ultimately be widened to six lanes and extended north and west from Woodmen Road to connect to Research Parkway at Black Forest Road. Marksheffel Road is shown as a six-lane Principal Arterial through the Sterling Ranch Master Plan area on the El Paso County *MTCP*.

Briargate Parkway is a six-lane, Principal Arterial that extends east from I-25 to Grand Lawn Circle (about one-half mile east of Powers Boulevard). Briargate Parkway/Stapleton Road is planned ultimately to extend to Towner Drive. The section of Briargate Parkway between Vollmer Road and Sterling Ranch Road is planned to be constructed in the short term.

Poco Road is an existing gravel road which extends east for about three-quarters of a mile from Lochwinnoch Lane to Vollmer Road. Poco Road has recently been constructed east of Vollmer Road as an Urban Local Road to serve the Retreat at TimberRidge Filing No. 1 (PCD-SF-19-009).

Existing Traffic Volumes

Figure 4 shows the existing (2022) peak-hour traffic volumes at the intersection of Poco/Vollmer. The traffic volumes were based on traffic counts conducted by LSC in May 2022. At the time the traffic counts were conducted only a few homes within the Retreat at TimberRidge were occupied. However, heavy construction activity was observed on the east leg of this intersection. The counts include all vehicles using the intersection, so construction vehicles are included in the counts. The traffic count sheets are attached.

Existing Level of Service

Level of service (LOS) is a quantitative measure of the level of congestion or delay at an intersection. Level of service is indicated on a scale from "A" to "F." LOS A represents control delay of less than 10 seconds for unsignalized intersections. LOS F represents control delay of more than 50 seconds for unsignalized intersections. Table 2 shows the level of service delay ranges.

Table 2: Intersection Levels of Service Delay Ranges

Level of Service	Signalized Intersections	Unsignalized Intersections
	Average Control Delay (seconds per vehicle)	Average Control Delay (seconds per vehicle) ⁽¹⁾
A	10.0 sec or less	10.0 sec or less
B	10.1-20.0 sec	10.1-15.0 sec
C	20.1-35.0 sec	15.1-25.0 sec
D	35.1-55.0 sec	25.1-35.0 sec
E	55.1-80.0 sec	35.1-50.0 sec
F	80.1 sec or more	50.1 sec or more

(1) For unsignalized intersections, if V/C ratio is greater than 1.0 the level of service is LOS F, regardless of the projected average control delay per vehicle.

The intersection of POCO/Vollmer has been analyzed to determine the existing intersection levels of service. The analysis was based on the unsignalized intersection analysis procedures from the *Highway Capacity Manual, 6th Edition*. Figure 4 shows the level of service analysis results. The level of service reports are attached.

All movements at the intersection of POCO/Vollmer are currently operating at LOS B or better during the peak hours.

BACKGROUND (BASELINE) CONDITIONS (SHORT- AND LONG-TERM FUTURE)

Background traffic is the traffic estimated to be on the adjacent roadways and at adjacent intersections without the proposed development’s trip generation of site-generated traffic volumes. Background traffic includes the through traffic and the traffic generated by nearby developments but assumes zero traffic generated by Homestead North Phase 1.

Figure 5 shows the projected short-term background traffic volumes at the key area intersections. The short-term background volumes assume a half section of Briargate Parkway has been constructed between Vollmer Road and Wheatland Drive and that full-movement access is permitted at the intersection of Briargate/Wheatland. This condition will likely remain until Briargate is extended east to Sterling Ranch Road. Briargate Parkway is planned to be constructed to its full cross section by late 2023. Once Briargate has been fully constructed and connected to Sterling Ranch Road, this intersection will be restricted to right-in/right-out for the north leg and three-quarter movement (left-in/right-in/right-out) for the south leg. The short-term background traffic includes the existing traffic volumes (from Figure 3 with the traffic on the east leg of the intersection of Vollmer/Poco removed as most of it was observed to be construction related) plus increases in through traffic due to regional growth, plus traffic estimated to be generated by buildout of the Homestead at Sterling Ranch Filing 2, Branding Iron at Sterling Ranch Filing 2, Sterling Ranch Filing No. 2, Sterling Ranch Phase 2, the Retreat at

TimberRidge Filing Nos. 1 and 2 to be located generally northeast of the intersection of Vollmer Road and Poco Road, and Homestead North Filings 1 and 2.

Figure 6 shows the projected 2042 background traffic volumes at the key area intersections. 2042 background traffic-volume estimates were based on 2040 volume projections in the *El Paso County Major Transportation Corridors Plan (MTCP)* and previous work completed in the area by LSC, including the previous reports for Sterling Ranch land-use applications, and the *Retreat at TimberRidge Updated Traffic Impact Analysis* by LSC (dated January 25, 2018). The 2042 background traffic volumes assume buildout of the Sterling Ranch development, including Homestead North Filings 1 and 2, and buildout of the Retreat at TimberRidge. The 2042 background traffic assumes Briargate Parkway/Stapleton Road has been constructed between Black Forest Road and Towner Avenue and that the intersection of Briargate/Wheatland is restricted to a three-quarter movement (left-in/right-in/right-out only) for the south leg and right-in/right-out only for the north leg. Note that the 2042 background volumes shown in this report were estimated prior to the submittal of the Jaynes Property (SKP225) TIS and associated traffic projections. A few additional notes: 1) This project and TIS has been in the review process prior to that submittal, 2) This improvements table for this project reflects full improvements to Vollmer Road along the Homestead North frontage, and 3) the traffic impact study for that project is under review. Also please note that the recently submitted Sterling Ranch Master TIS update (by LSC) incorporated the proposed land use and access for the Jaynes property. Please refer to the study prepared by SM Rocha LLC., dated January 19, 2023, and other documents on EDARP for details.

TRIP GENERATION

The site-generated vehicle trips were estimated using the nationally published trip-generation rates from *Trip Generation, 11th Edition, 2021* by the Institute of Transportation Engineers (ITE). Table 1 shows the trip-generation estimates.

Homestead North Filing 3 is projected to generate about 726 new external vehicle trips on the average weekday, with about half entering and half exiting the site during a 24-hour period. During the morning peak hour, which generally occurs for one hour between 6:30 and 8:30 a.m., about 14 vehicles would enter and 40 vehicles would exit the site. During the afternoon peak hour, which generally occurs for one hour between 4:15 and 6:15 p.m., about 46 vehicles would enter and 27 vehicles would exit the site. The land use shown in Table 1 is consistent with estimate shown for "Future Homestead North Phases" in the *Homestead North Phase 1 Updated Traffic Study*, dated January 11, 2022, however, the trip-generation estimate is slightly lower, as the Phase 1 TIS estimate was based on the 10th edition trip-generation rates.

TRIP DISTRIBUTION AND ASSIGNMENT

The directional distribution of the site-generated traffic volumes on the street and roadway system serving the site is one of the most important factors in determining the site's traffic impacts. The specific short-term and long-term distribution estimates are shown in Figure 7. The directional-distribution estimates are based on the following factors: the location of the site with respect to the Colorado Springs metropolitan area, the planned access system for the site, the street and roadway system serving the site, the land uses proposed for the site, and the distribution of existing traffic volumes. The short-term distribution estimate assumes only the short section of Briargate Parkway between Vollmer Road and Wheatland Drive has been constructed in the vicinity of the site (**note:** This condition will exist until Briargate Parkway is extended east to Sterling Ranch Road by late 2023. At that point, additional portions of the roadway network will become available for trip distribution) and the long-term distribution estimate assumes full buildout of the future roadway network in the vicinity of the site.

When the distribution percentages (from Figure 7 and discussed in the preceding paragraph) are applied to the trip-generation estimates (from Table 1), the resulting site-generated traffic volumes can be determined. Figures 8 and 9 show the short-term and 2042 site-generated traffic volume estimate for Homestead Filing 3, respectively.

TOTAL TRAFFIC

Short-Term Total Traffic Volumes

Figure 10 shows the projected short-term total traffic volumes at the intersection of Briargate/Vollmer and the site-access points. The short-term total traffic volumes are the sum of the short-term background traffic volumes (from Figure 5) and the short-term site-generated traffic volumes (from Figure 8).

2042 Total Traffic Volumes

Figure 11 shows the projected 2042 total traffic volumes at the intersection of Briargate/Vollmer and the site-access points. The 2042 total traffic volumes are the sum of the 2042 background traffic volumes (from Figure 6) and the long-term site-generated traffic volumes (from Figure 9).

LEVEL OF SERVICE ANALYSIS

The intersection of Briargate/Vollmer and the site-access points have been analyzed to determine the projected intersection levels of service for short-term, 2042 background, and total traffic scenarios for the morning and afternoon peak-hour periods. The short-term analysis of the intersection of Briargate/Vollmer and the short-term and 2042 analysis of the site-access points were based on the unsignalized intersection analysis procedures from the *Highway Capacity Manual, 6th Edition*. The intersection of Briargate/Vollmer was analyzed as a signalized

intersection using Synchro for the 2042 analysis. Figures 5, 6, 10, and 11 show the level of service analysis results. The level of service reports are attached.

Briargate Parkway/Vollmer Road

The intersection of Briargate/Vollmer is projected to operate at a satisfactory level of service (LOS C or better) as a stop-sign-controlled intersection, based on the short-term total traffic scenario. By 2042, it was assumed that Briargate Road would be extended east to Black Forest Road and west to connect to its current terminus. It was also assumed that the intersection of Briargate/Vollmer would be signal-controlled by 2042. This intersection is projected to operate at an overall satisfactory level of service (LOS D or better) as a signalized intersection.

Briargate Parkway/Wheatland Drive

The intersection of Briargate/Wheatland is projected to operate at a LOS B or better for all movements as an interim full-movement stop-sign-controlled intersection, based on the short-term total-traffic scenario.

By 2042, it was assumed that the south leg of the intersection of Briargate/Wheatland would be restricted to three-quarter movement (left-in/right-in/right-out only) and the north leg would be restricted to right-in/right-out only. These restrictions are likely to occur prior to 2042, as Briargate Parkway is extended to the east of Wheatland. Based on the 2042 total traffic volumes and lane geometry shown in Figure 11, all movements at this intersection are projected to operate at LOS D or better during the peak hours.

Vollmer Road/Sam Bass Drive

The intersection of Vollmer Road/Sam Bass Drive is projected to operate at LOS C or better for all movements during the peak hours as a stop-sign-controlled intersection, based on the projected short-term and 2042 total traffic volumes.

Note: Please refer to the background traffic section for notes regarding the Jaynes Property (SKP225). Please refer the traffic impact study prepared by SM Rocha LLC. dated January 19, 2023 and associated and/or revised documents on EDARP for potential improvements that may be needed with the addition of a west leg to serve that development.

Vollmer Road/Poco Road

The intersection of Vollmer Road/Poco Road is projected to operate at LOS D or better for all movements during the peak hours as a stop-sign-controlled intersection, based on the projected short-term and 2042 total traffic volumes.

SUBDIVISION STREET CLASSIFICATIONS

Figure 12 shows the recommended street classifications for the Filing No. 3 streets and established classifications of other streets/roads in the vicinity of the site.

AREA MTCP 2040 ROADWAY IMPROVEMENT PROJECTS

The *El Paso County 2016 Major Transportation Corridors Plan Update* identified the following 2040 roadway improvement projects within the study area:

- C13: Vollmer Road, from Marksheffel Road to Stapleton Drive [Briargate Parkway], as a Rural 4-Lane Minor Arterial. The *Retreat at TimberRidge Preliminary Plan Transportation Memorandum* by LSC Transportation Consultants, Inc. dated June 29th, 2018, recommends Vollmer Road be upgraded to a 4-lane **Urban** Minor Arterial from Marksheffel Road to Poco Road. LSC recommends a transition section between the 4-Lane Minor Arterial section south of Poco Road and the 2-lane **Rural** Arterial section north of Poco Road be constructed between Sam Bass Drive and Poco Road. This could be accomplished by having the second northbound through lane transition to a “trap” right-turn lane at Poco Road. The second southbound through lane could be added either by providing a southbound acceleration lane at Poco Road or having Vollmer Road flare out just south of Poco Road.
- N5: Stapleton Drive [Briargate Parkway], from Towner Road to Black Forest Road, as a 4-Lane Urban Principal Arterial.
- N12: Marksheffel Road, from Woodman Road to Research Parkway, as a 4-Lane Urban Principal Arterial.
- M11: Vollmer Road Bicycle & Primary Regional Trail, from Marksheffel Road to Shoup Road.

AUXILIARY TURN LANES

- Based on the projected short-term background traffic volumes and the criteria contained in the *El Paso County Engineering Criteria Manual (ECM)*, a northbound right-turn deceleration lane is projected to be warranted on Vollmer Road approaching Sam Bass Drive. This lane, which was required with Homestead North Filing 2, should be 155 feet long plus a 160-foot taper.
- Based on the projected short-term total traffic volumes and the criteria contained in the *El Paso County Engineering Criteria Manual (ECM)*, a northbound right-turn deceleration lane is projected to be warranted on Vollmer Road approaching Poco Road with Homestead North Filing 3. This lane should be 155 feet long plus a 160-foot taper.
- Based on the projected short-term and 2042 total traffic volumes and the criteria contained in the *El Paso County Engineering Criteria Manual (ECM)*, southbound left-turn lanes are **not** projected to be warranted on Vollmer Road approaching Poco Road and Sam Bass Drive. Vollmer Road is planned to be improved to a Minor Arterial cross section

south of Poco Road. As left-turn lanes are included in the standard cross section for a Minor Arterial, LSC recommends a southbound left-turn lane approaching Sam Bass Drive be included in the design for the Vollmer Road improvements adjacent to the site. The recommended length for this lane is 205 feet plus a 160-foot taper. A left-turn lane is not needed on Vollmer approaching Poco Road as Vollmer is planned to remain a Rural Minor Arterial north of Poco Road.

- Based on the projected 2042 total traffic volumes and the criteria contained in the *El Paso County Engineering Criteria Manual (ECM)*, a westbound right-turn deceleration lane is projected to be warranted on Briargate Parkway approaching Wheatland Drive. This lane should be 235 feet long plus a 200-foot taper.

TRANSPORTATION IMPROVEMENT FEE PROGRAM

The applicant will be required to participate in the Countywide Transportation Improvement Fee Program. These projects will annex into the 10 mil PID, which has a per-lot upfront building permit fee of \$1,221 per dwelling unit. The total building permit fee amount for the 77 lots within Homestead Filing 3 would be \$94,017.

CONCLUSIONS AND RECOMMENDATIONS

Trip Generation

Homestead North Filing 3 is projected to generate about 727 new external vehicle trips on the average weekday, with about half entering and half exiting the site during a 24-hour period. During the morning peak hour, which generally occurs for one hour between 6:30 and 8:30 a.m., about 14 vehicles would enter and 43 vehicles would exit the site. During the afternoon peak hour, which generally occurs for one hour between 4:15 and 6:15 p.m., about 48 vehicles would enter and 28 vehicles would exit the site.

Level of Service

- In the short term, the intersection of Briargate/Vollmer is projected to operate at a satisfactory level of service as a stop-sign-controlled "T" intersection. By 2042, it was assumed that Briargate Road/Stapleton Road would be extended west to Black Forest Road and east to connect to its current terminus. It was also assumed that the intersection of Briargate/Vollmer would be signal controlled by 2042. This intersection is projected to operate at an overall satisfactory level of service (LOS D or better) as a signalized intersection.
- The proposed site-access points to Vollmer Road and Briargate Parkway are projected to operate at a satisfactory level of service as stop-sign-controlled intersections, based on the short-term and 2042 total traffic volumes and lane geometry shown in Figures 10 and 11.

Recommended Improvements

- A list of roadway segment improvements in the vicinity of the site is presented in Table 3. The location of each roadway segment is identified in Figure 13. **Note:** This table is a simplified version of Table 4 from the draft Sterling Ranch Sketch Plan Amendment TIS currently in process by LSC. The roadway segment improvements most relevant to this application have been included in this table. For the complete list of all Sterling Ranch roadway improvements, please refer to Table 4 in the sketch plan report, which is anticipated to be submitted in the very-near-term future.
- Please refer to the Auxiliary Turn Lanes section above for auxiliary turn-lane recommendations. Figures 10 and 11 also show turn lanes as part of the intersection laneage graphics.

* * * * *

Please contact me if you have any questions regarding this report.

Respectfully Submitted,

LSC TRANSPORTATION CONSULTANTS, INC.

By Jeffrey C. Hodsdon, P.E.
Principal

JCH/KDF:jas

Enclosures: **Tables 1 and 3**
Figures 1-13
Approved Deviation Form
TAZ Map
MTCP Maps
Traffic Count Reports
Level of Service Reports

Tables 1 and 3



**Table 1
Trip Generation Estimate
Homestead North Filing 3**

Filing	Land Use Code	Land Use Description	Trip Generation Units	Trip Generation Rates ⁽¹⁾				Total External Trips Generated						
				Average Weekday Traffic	Morning Peak Hour In	Morning Peak Hour Out	Evening Peak Hour In	Evening Peak Hour Out	Average Weekday Traffic	Morning Peak Hour In	Morning Peak Hour Out	Evening Peak Hour In	Evening Peak Hour Out	
Trip Generation Estimate for the Currently Proposed Homestead North Filing 3														
3	210	Single-Family Detached Housing	77 DU ⁽²⁾	9.43	0.18	0.52	0.59	0.35	726	14	40	46	27	
Trip Generation Estimate for Previous Homestead North Filings														
1	210	Single-Family Detached Housing	73 DU	9.43	0.18	0.52	0.59	0.35	688	13	38	43	25	
2	210	Single-Family Detached Housing	74 DU	9.43	0.18	0.52	0.59	0.35	698	13	38	44	26	
		Total Filings 1-3	224 DU						2,112	40	116	133	78	
Trip Generation Estimate from the <i>Homestead North Phase 1 Updated Traffic Study</i>, dated January 11, 2022⁽³⁾														
Phase 1	210	Single-Family Detached Housing	147 DU	9.44	0.19	0.56	0.62	0.37	1,388	27	82	92	54	
Future	210	Single-Family Detached Housing	77 DU	9.44	0.19	0.56	0.62	0.37	727	14	43	48	28	
			224 DU						2,115	41	125	140	82	
		Change (decrease) in trip generation estimate	77 DU						-3	-1	-9	-7	-4	

Notes:

(1) Source: "Trip Generation, 11th Edition, 2021" by the Institute of Transportation Engineers (ITE)

(2) DU = dwelling unit

(3) The trip generation estimate was based on the trip generation rates from the "Trip Generation, 10th Edition, 2017" by the Institute of Transportation Engineers (ITE)

Table 3
(page 1 of 2)
Homestead North Filing No. 3
Roadway Segment Improvements

Segment ID ⁽¹⁾ (See Figure 10 for map)	Improvement Description	Timing	Design ADT (vpd)	Projected 2042 ADT (vpd)	Responsibility
V3	Short Term: Improve Vollmer Road from Lochwinnoch Lane to Sterling Ranch boundary (northeast of Glider Loop) to provide 36' of pavement (existing pavement 1 approx. 23.38') and stripe for one through lane and plus a 6' paved, striped outside shoulder in each direction ⁽²⁾	Short-Term Future (With Homestead North)	11,000 (Note: Existing Capacity 8,000)	15,040	Sterling Ranch
	Long Term: Improve Vollmer Road from Lochwinnoch Lane to Sterling Ranch boundary (northeast of Glider Loop) to a standard 4-Lane Urban Minor Arterial Cross Section ⁽²⁾	Long-Term Future	20,000		By others - pursuant to the recent development agreement between Sterling Ranch and EPC.
V4	Improve Vollmer Road from Sterling Ranch boundary (northeast of Glider Loop) to Briargate Parkway to a standard 4-Lane Urban Minor Arterial Cross Section ⁽²⁾	Short-Term Future— May 2024 Updated 11/28/2022 - Sections V4, V5, V6 & V7 to be constructed by May 2024 (prior note: With Homestead North Filing 1)	20,000	14,495	Sterling Ranch
V5	Improve Vollmer Road from Briargate Parkway to Jane Kirkham Drive to a standard 4-Lane Urban Minor Arterial Cross Section ⁽²⁾	Short-Term Future— May 2024 Updated 11/28/2022 - Sections V4, V5, V6 & V7 to be constructed by May 2024 (prior note: prior note: With Homestead North Filing 1)	20,000	11,690	Sterling Ranch
V6	Improve Vollmer Road from Jane Kirkham Drive to Sam Bass Drive to a standard 4-Lane Urban Minor Arterial Cross Section ⁽²⁾	Short-Term Future— May 2024 Updated 11/28/2022 - Sections V4, V5, V6 & V7 to be constructed by May 2024 (prior note: prior note: With Homestead North Filing 2)	20,000	11,425	Sterling Ranch
V7	Improve Vollmer Road between Sam Bass Drive and Poco Road to a 4-lane Urban Minor Arterial but with necessary lane transitions, redirect tapers, etc. south of Poco to adequately transition between the 4-Lane Urban Minor Arterial Cross Section and the 2-Lane Rural Arterial Cross Section north of Poco Road.	Short-Term Future – May 2024 Updated 11/28/2022 - Sections V4, V5, V6 & V7 to be constructed by May 2024 (prior note: With Homestead North Filing 3)	20,000	9,920	Sterling Ranch
V8	Improve Vollmer Road from Poco Road to Shoup Road to a Rural 2-Lane Arterial Cross Section ⁽²⁾	Long-Term Future	10,000	8,760	El Paso County Project ID U-12

Part 1/2 of this table (see Part 2 on next page)

Notes:

(1) See Figure 10

(2) Adequate transition/redirect tapers would be needed between the various cross sections on Vollmer Road. Based on the criteria contained in Table 2-29 of the *El Paso Engineering Criteria Manual* an appropriate taper ratio for a roadway with a design speed of 40 mile per hour is 20:1

(3) Source: Table 20 *Road Impact Fee Study Updated* November 16, 2016

Source: LSC Transportation Consultants, Inc. (November 28, 2022)

Table 3

(page 2 of 2)

Homestead North Filing, No. 3

Roadway Segment Improvements

Segment ID ⁽¹⁾ (See Figure 10 for map)	Improvement Description	Timing	Design ADT (vpd)	Projected 2042 ADT (vpd)	Responsibility
B1	Construct the south half section of Briargate Pkwy (4-Lane Principal Arterial) between Vollmer Road and Wheatland Drive [now full section by 2023]	Short-Term Future Updated 10/15/2022: Full section to be completed in 2023 with Homestead at Sterling Ranch Filing No. 1 (prior note: With Homestead at Sterling Ranch Fil 2)	20,000	24,685	Sterling Ranch
	Construct the north half section of Briargate Pkwy (4-Lane Principal Arterial) between Vollmer Road and Wheatland Drive [now full section by 2023]	Short-Term Future Updated 10/15/2022: Full section to be completed in 2023 with Homestead at Sterling Ranch Filing No. 1 (prior note: Long-Term Future)	40,000		Sterling Ranch

Part 2/2 of this table

Notes:

(1) See Figure 10

(2) Adequate transition/redirect tapers would be needed between the various cross sections on Vollmer Road. Based on the criteria contained in Table 2-29 of the *El Paso Engineering Criteria Manual* an appropriate taper ratio for a roadway with a design speed of 40 mile per hour is 20:1

(3) Source: Table 20 *Road Impact Fee Study Updated November 16, 2016*

Source: LSC Transportation Consultants, Inc. (November 28, 2022)

Note: This table is a simplified version of Table 4 from the Sterling Ranch Sketch Plan Amendment TIS (LSC, October 2022). The roadway segment improvements most relevant to this application have been included in this table. For the complete list of all Sterling Ranch roadway improvements, please refer to Table 4 in the sketch plan report.

Figures 1-13





Approximate Scale
Scale: 1" = 3,000'

Retreat at TimberRidge Development

Homestead North Filing 3 (currently proposing)

Homestead North Filing 2 (currently under review)

Homestead North Filing 1 (approved)

Baker Rd.

Huntsman Rd.

Wildflower Rd.

Poco Rd.

Arroya Ln.

Tomahawk Trl.

Briargate Pkwy.
(future)

Vollmer Rd.

Marksheffel Rd
(future)

Figure 1
Vicinity Map



Homestead North Filing 3 (LSC #S224250)



Approximate Scale
NTS

Figure 2
Site Plan

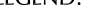
LEGEND:

-  = ECM Required Intersection Sight Distance (280' based on a design speed of 25mph from Table 2-21)
-  = ECM Required Stopping Sight Distance (travel path) (155' based on a design speed of 25mph from Table 2-17)



Approximate Scale
NTS

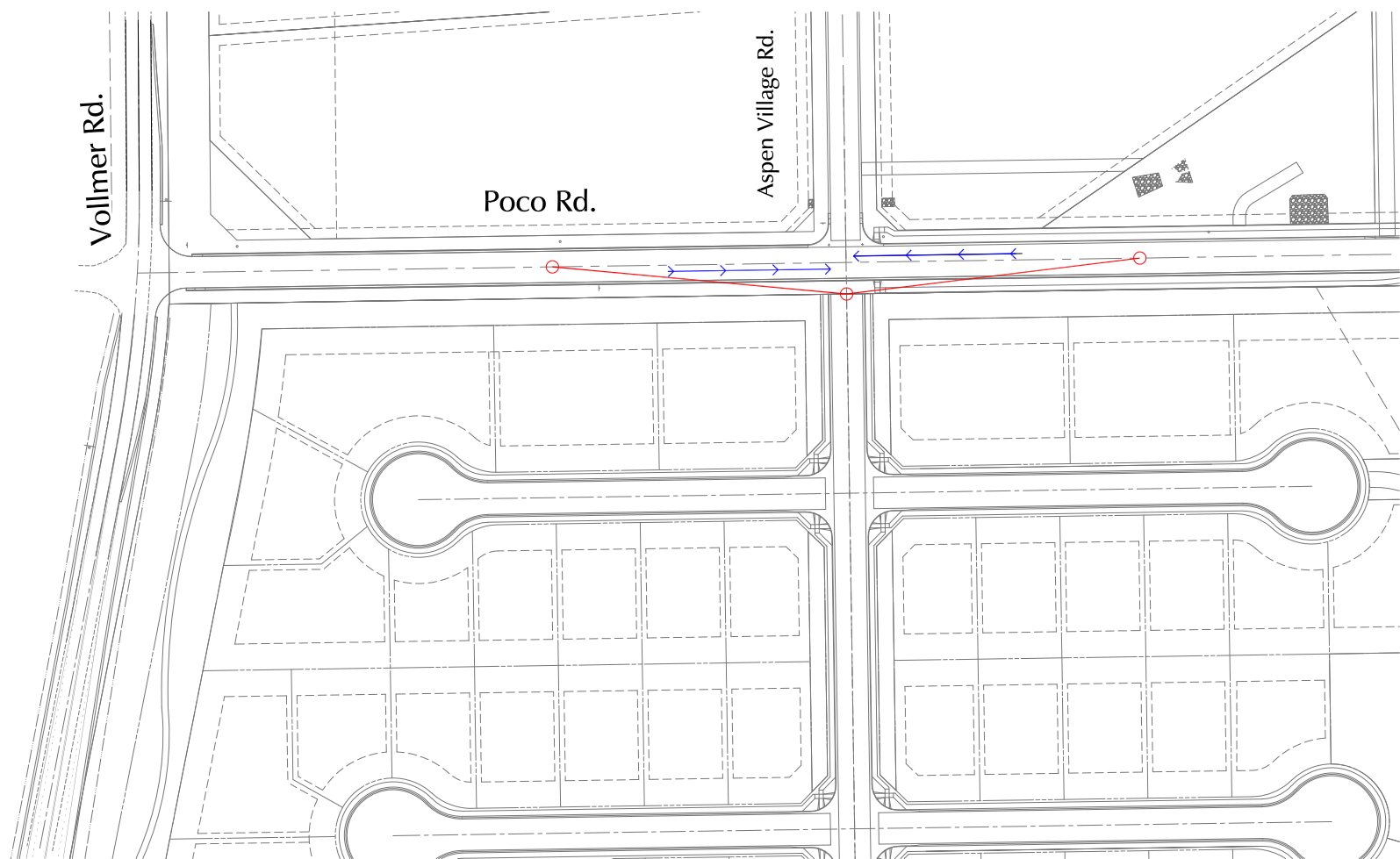
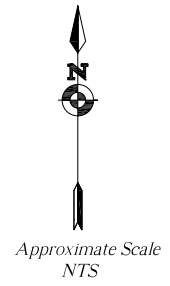
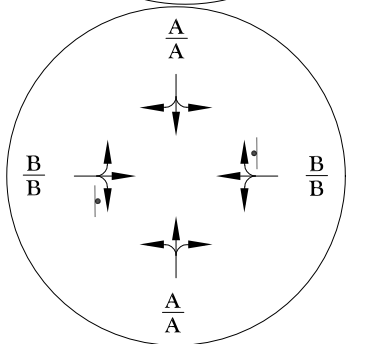
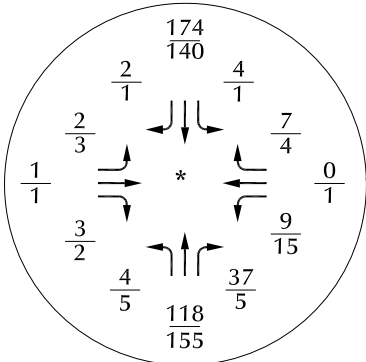

Figure 3

Sight Distance Analysis

Homestead North Filing 3 (LSC #S224250)





LEGEND:

$\frac{XX}{XX}$ = AM Weekday Peak-Hour Traffic (vehicles per hour) / PM Weekday Peak-Hour Traffic (vehicles per hour) Based on counts by LSC May 2022

XXX = Average Weekday Traffic (vehicles per day) Estimate by LSC



*Note: Traffic on the east leg is primarily construction related traffic

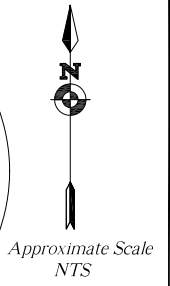
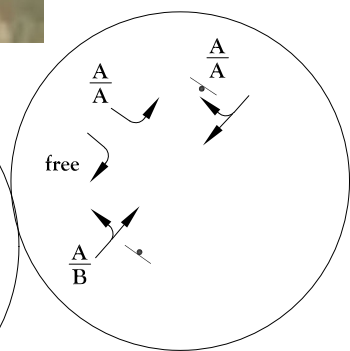
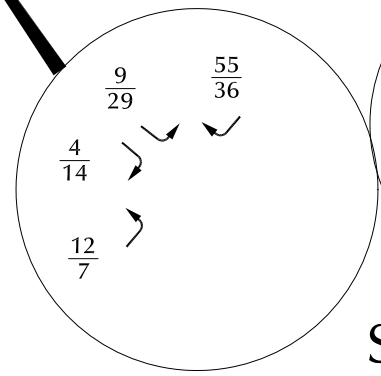
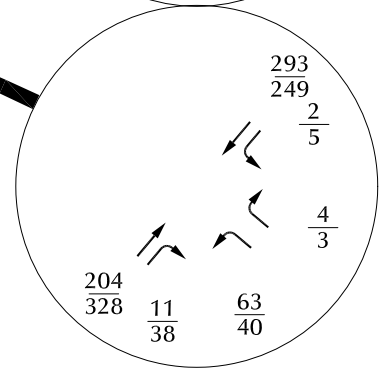
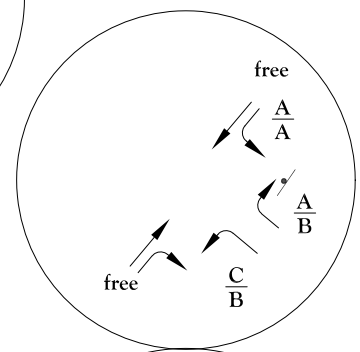
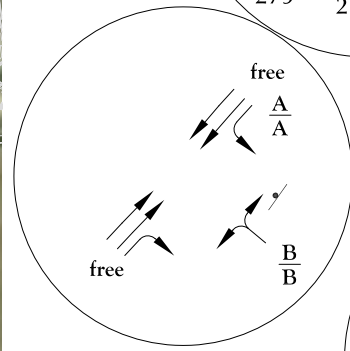
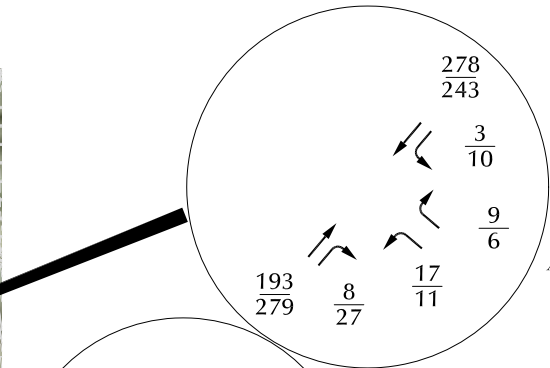
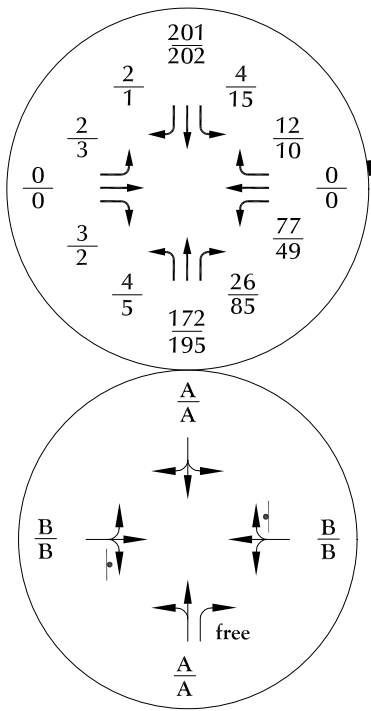
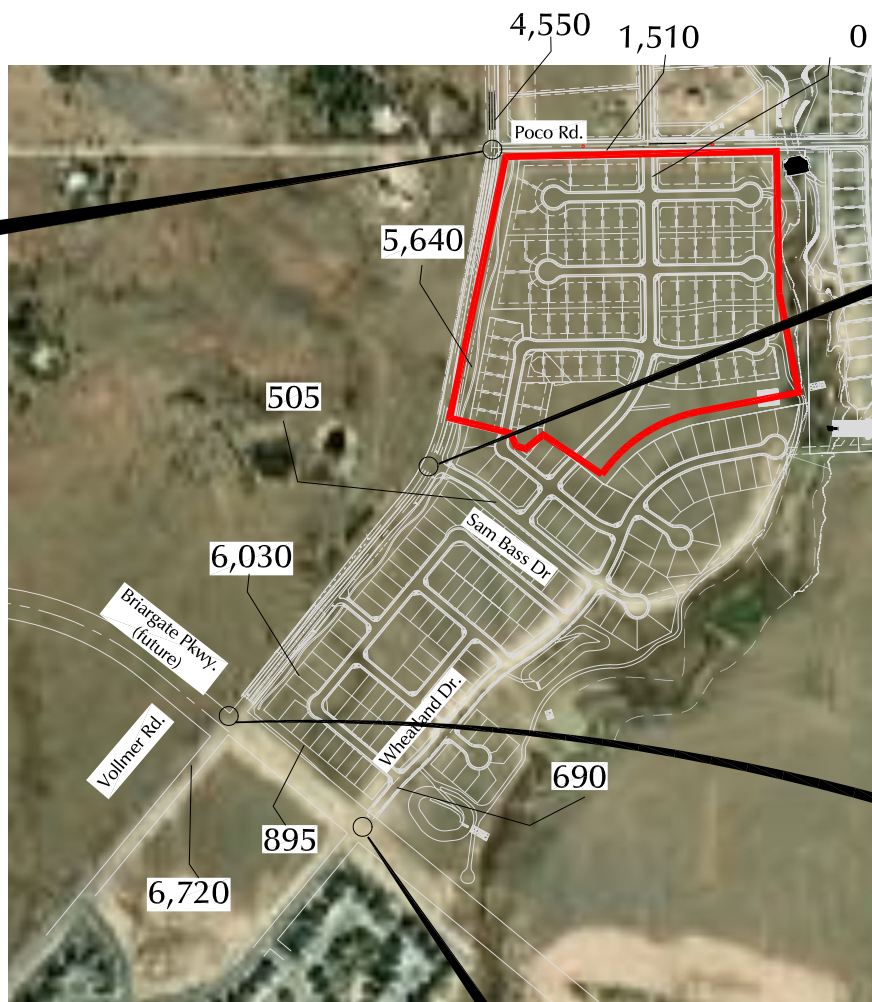

Figure 4
Existing Traffic
 Homestead North Filing 3 (LSC #S224250)



LEGEND:

 = Stop Sign
  = Traffic Signal

$\frac{XX}{XX}$ = AM Weekday Peak-Hour Traffic (vehicles per hour)
 PM Weekday Peak-Hour Traffic (vehicles per hour)

XXX = Average Weekday Traffic (vehicles per day)

$\frac{A}{B}$ = AM Individual Movement Peak-Hour Level of Service
 PM Individual Movement Peak-Hour Level of Service

$\frac{C}{D}$ = AM Entire Intersection Peak-Hour Level of Service
 PM Entire Intersection Peak-Hour Level of Service



Figure 5
Short-Term Background Traffic
 Homestead North Filing 3 (LSC #S224250)

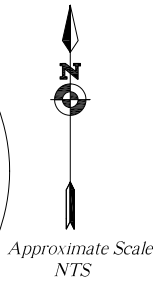
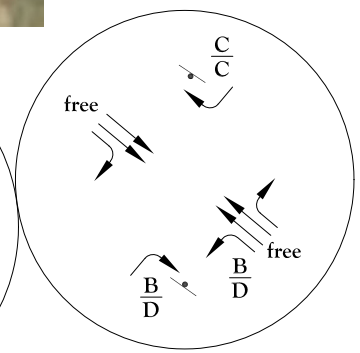
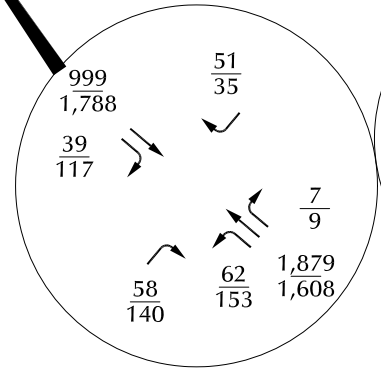
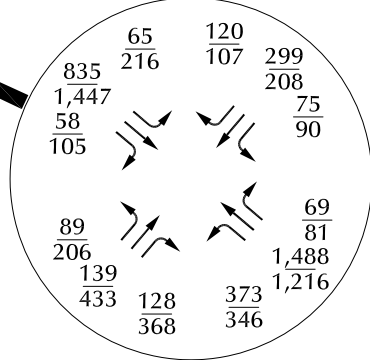
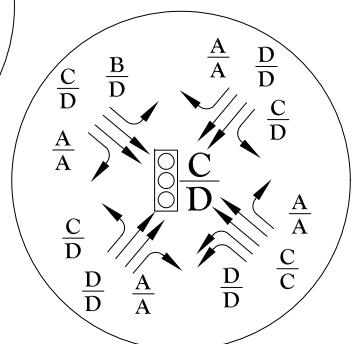
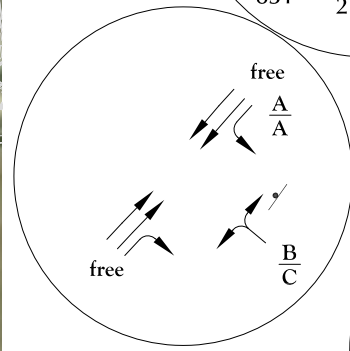
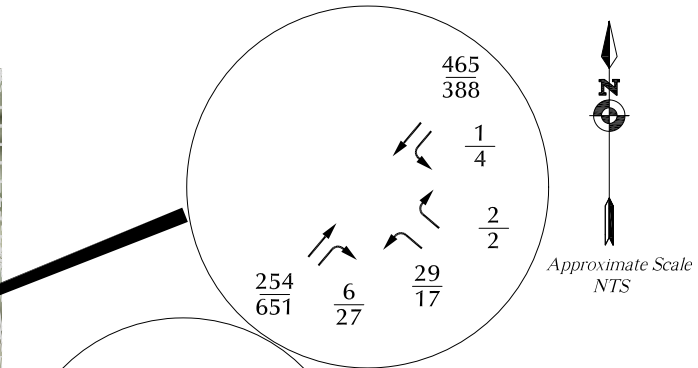
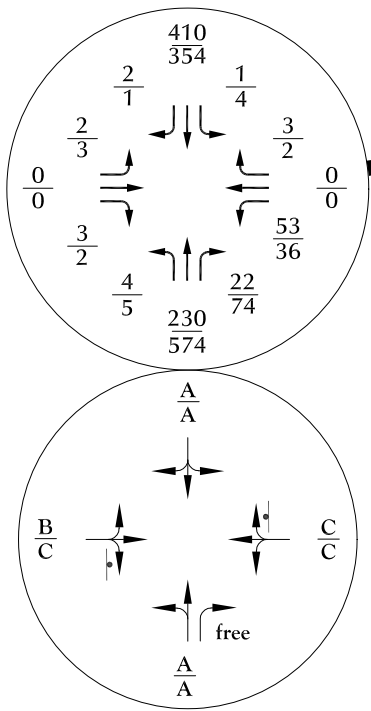

LEGEND:

= Stop Sign
 = Traffic Signal

$\frac{XX}{XX}$ = AM Weekday Peak-Hour Traffic (vehicles per hour)
 PM Weekday Peak-Hour Traffic (vehicles per hour)

XXX = Average Weekday Traffic (vehicles per day)

$\frac{A}{B}$ = AM Individual Movement Peak-Hour Level of Service
 PM Individual Movement Peak-Hour Level of Service

$\frac{C}{D}$ = AM Entire Intersection Peak-Hour Level of Service
 PM Entire Intersection Peak-Hour Level of Service



Figure 6
2042 Background Traffic
 Homestead North Filing 3 (LSC #S224250)



Approximate Scale
Scale: 1" = 3,000'

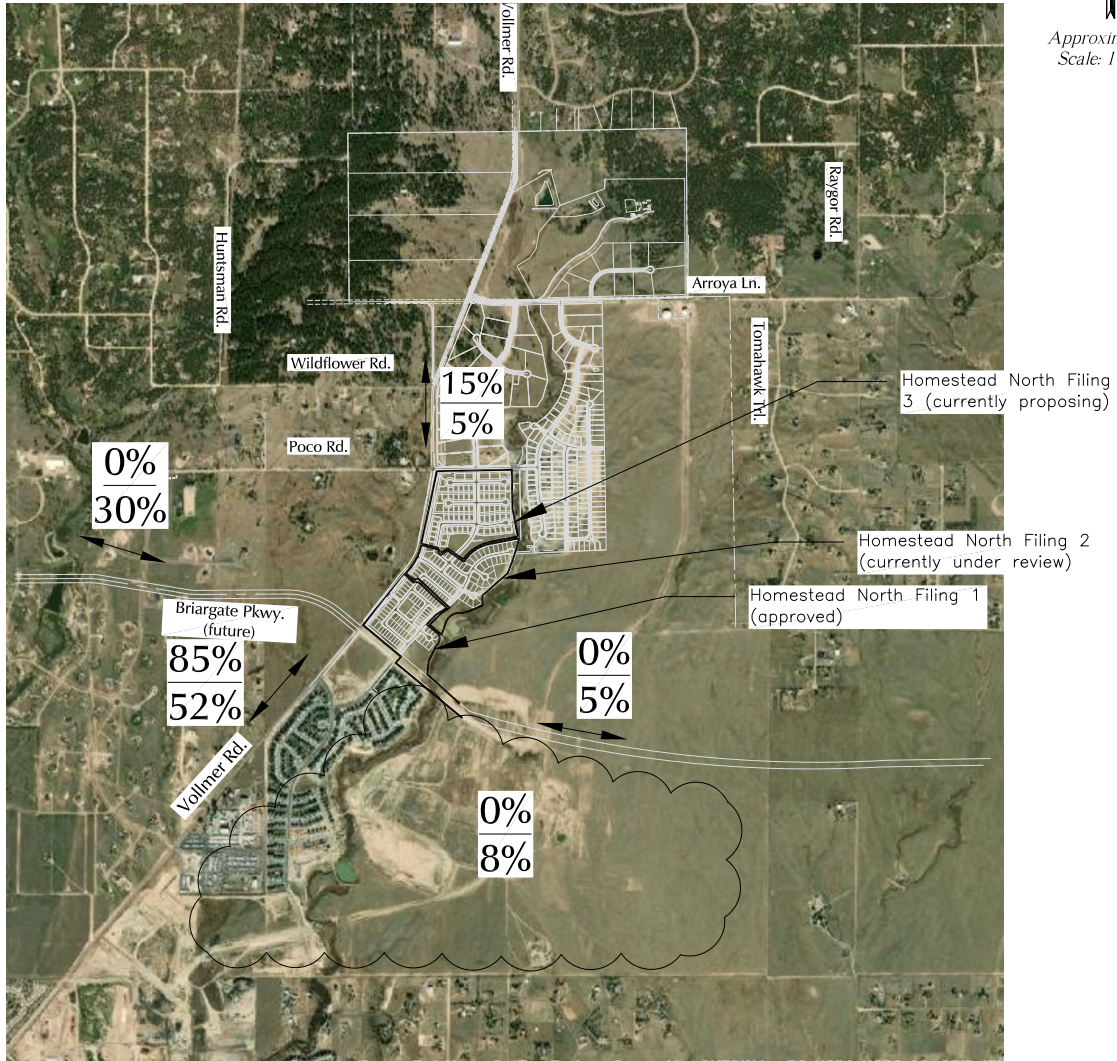

LEGEND:

$\frac{XX\%}{XX\%}$ = $\frac{\text{Short-Term Percent Directional Distribution}}{\text{Long-Term Percent Directional Distribution}}$

Figure 7

Directional Distribution of Site-Generated Traffic

Homestead North Filing 3 (LSC #S224250)



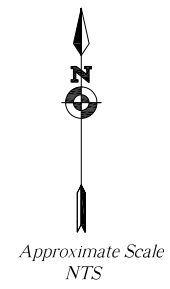
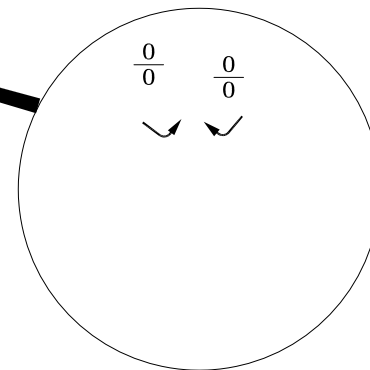
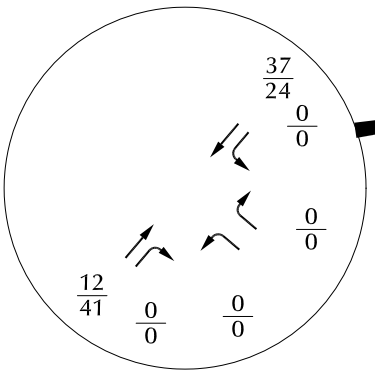
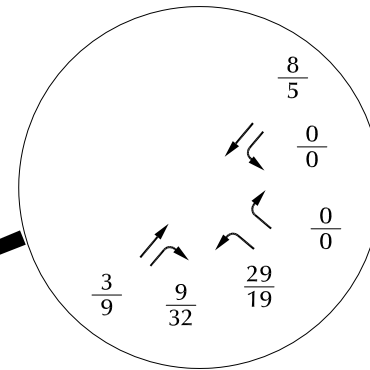
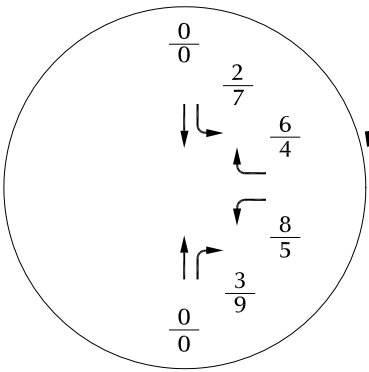
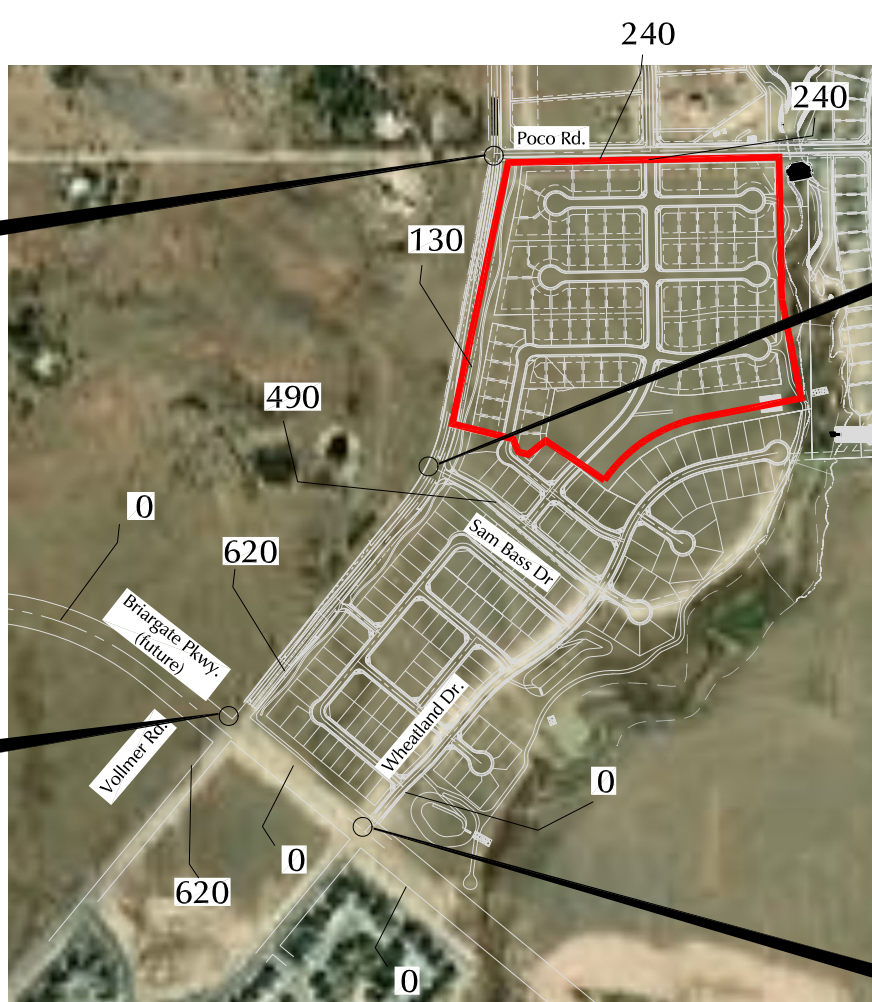

LEGEND:
 $\frac{XX}{XX}$ = AM Weekday Peak-Hour Traffic (vehicles per hour)
 $\frac{XX}{XX}$ = PM Weekday Peak-Hour Traffic (vehicles per hour)
 XXX = Average Weekday Traffic (vehicles per day)



Figure 8
 Short-Term Site-Generated Traffic

Homestead North Filing 3 (LSC #S224250)

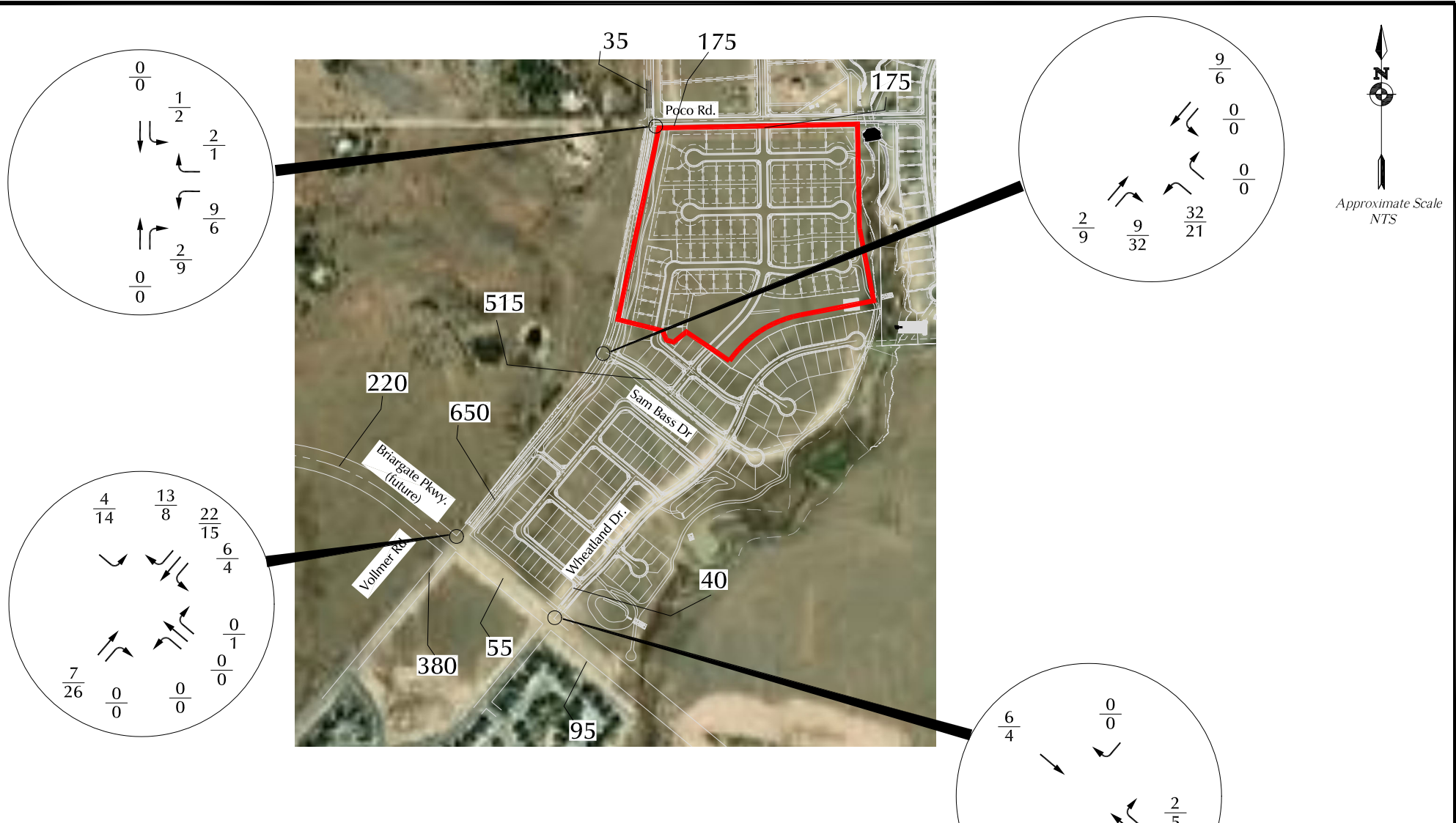

LEGEND:

- $\frac{XX}{XX}$ = AM Weekday Peak-Hour Traffic (vehicles per hour)
- $\frac{XX}{XX}$ = PM Weekday Peak-Hour Traffic (vehicles per hour)
- XXX = Average Weekday Traffic (vehicles per day)

Figure 9
Long-Term Site-Generated Traffic
 Homestead North Filing 3 (LSC #S224250)

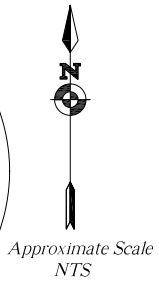
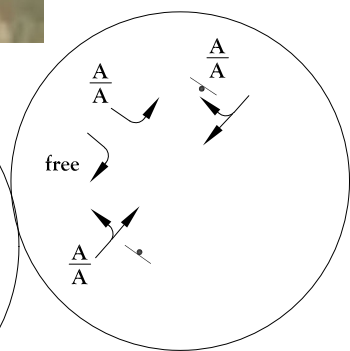
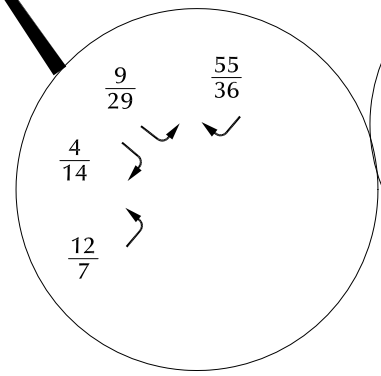
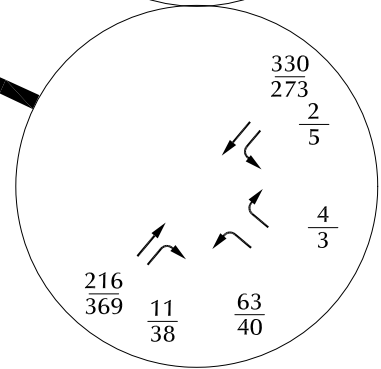
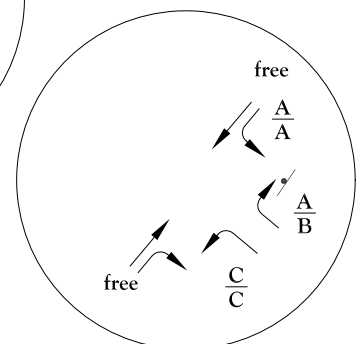
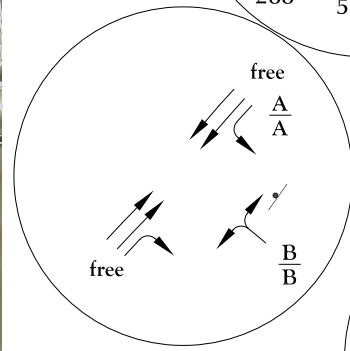
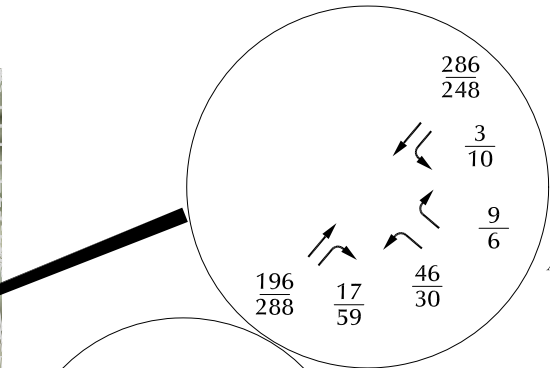
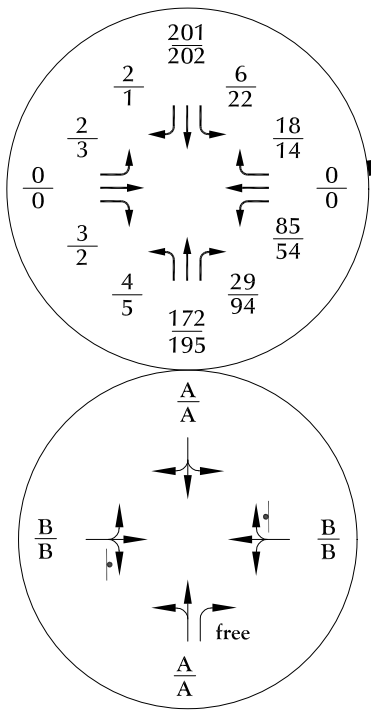
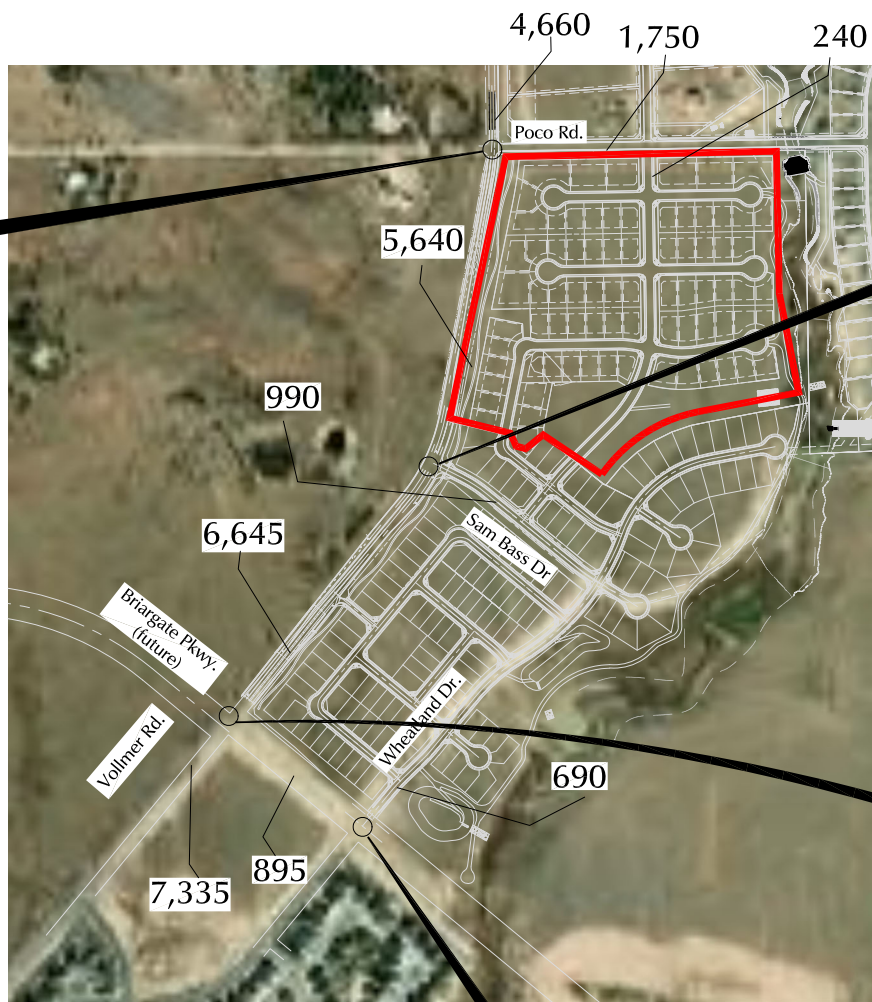

LEGEND:

= Stop Sign = Traffic Signal
 $\frac{XX}{XX}$ = AM Weekday Peak-Hour Traffic (vehicles per hour)
 $\frac{XX}{XX}$ = PM Weekday Peak-Hour Traffic (vehicles per hour)
 XXX = Average Weekday Traffic (vehicles per day)
 $\frac{A}{B}$ = AM Individual Movement Peak-Hour Level of Service
 $\frac{A}{B}$ = PM Individual Movement Peak-Hour Level of Service
 $\frac{C}{D}$ = AM Entire Intersection Peak-Hour Level of Service
 $\frac{C}{D}$ = PM Entire Intersection Peak-Hour Level of Service



Figure 10
Short-Term Total Traffic
 Homestead North Filing 3 (LSC #S224250)

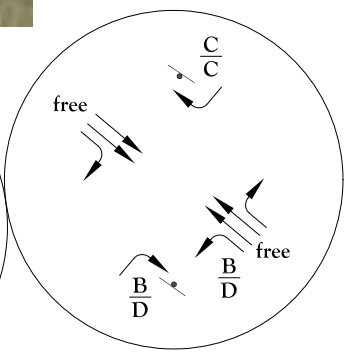
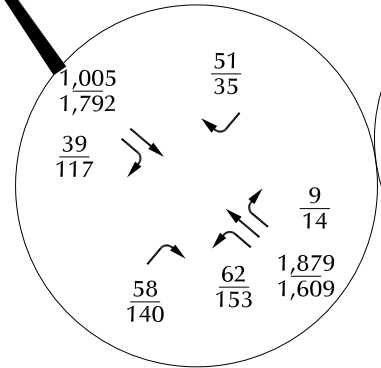
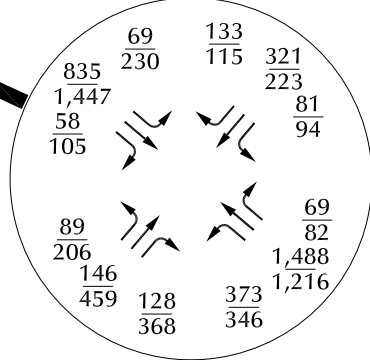
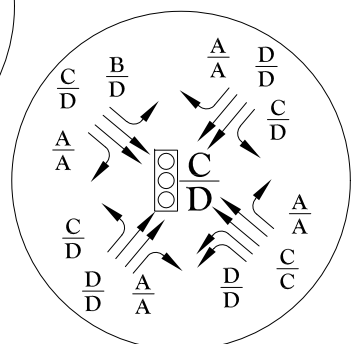
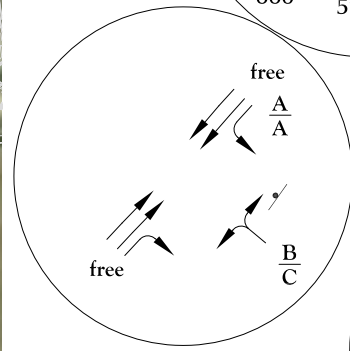
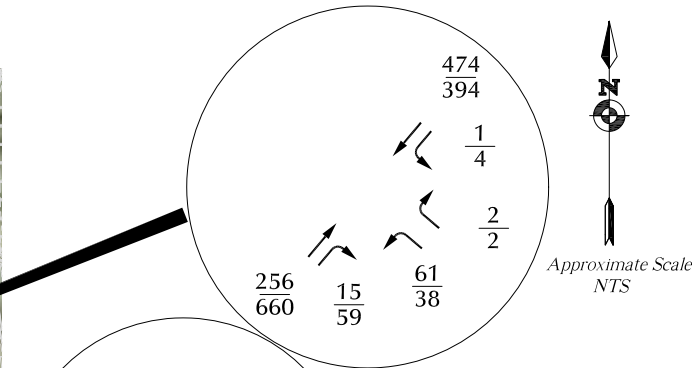
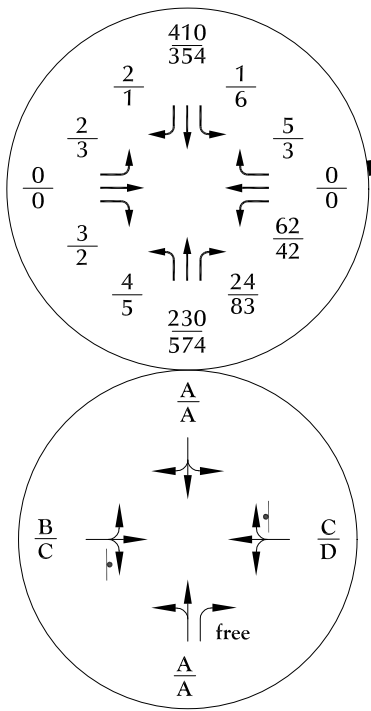

LEGEND:

= Stop Sign
 = Traffic Signal

$\frac{XX}{XX}$ = AM Weekday Peak-Hour Traffic (vehicles per hour)
 PM Weekday Peak-Hour Traffic (vehicles per hour)

XXX = Average Weekday Traffic (vehicles per day)

$\frac{A}{B}$ = AM Individual Movement Peak-Hour Level of Service
 PM Individual Movement Peak-Hour Level of Service

$\frac{C}{D}$ = AM Entire Intersection Peak-Hour Level of Service
 PM Entire Intersection Peak-Hour Level of Service



Figure 11
2042 Total Traffic
 Homestead North Filing 3 (LSC #S224250)

LEGEND:

- = Urban Principal Arterial
- = Urban Minor Arterial (4 lanes)
- - - = Rural Minor Arterial (2 lanes)
- = Urban Local
- - - = Urban Local (low volume)



Approximate Scale
NTS

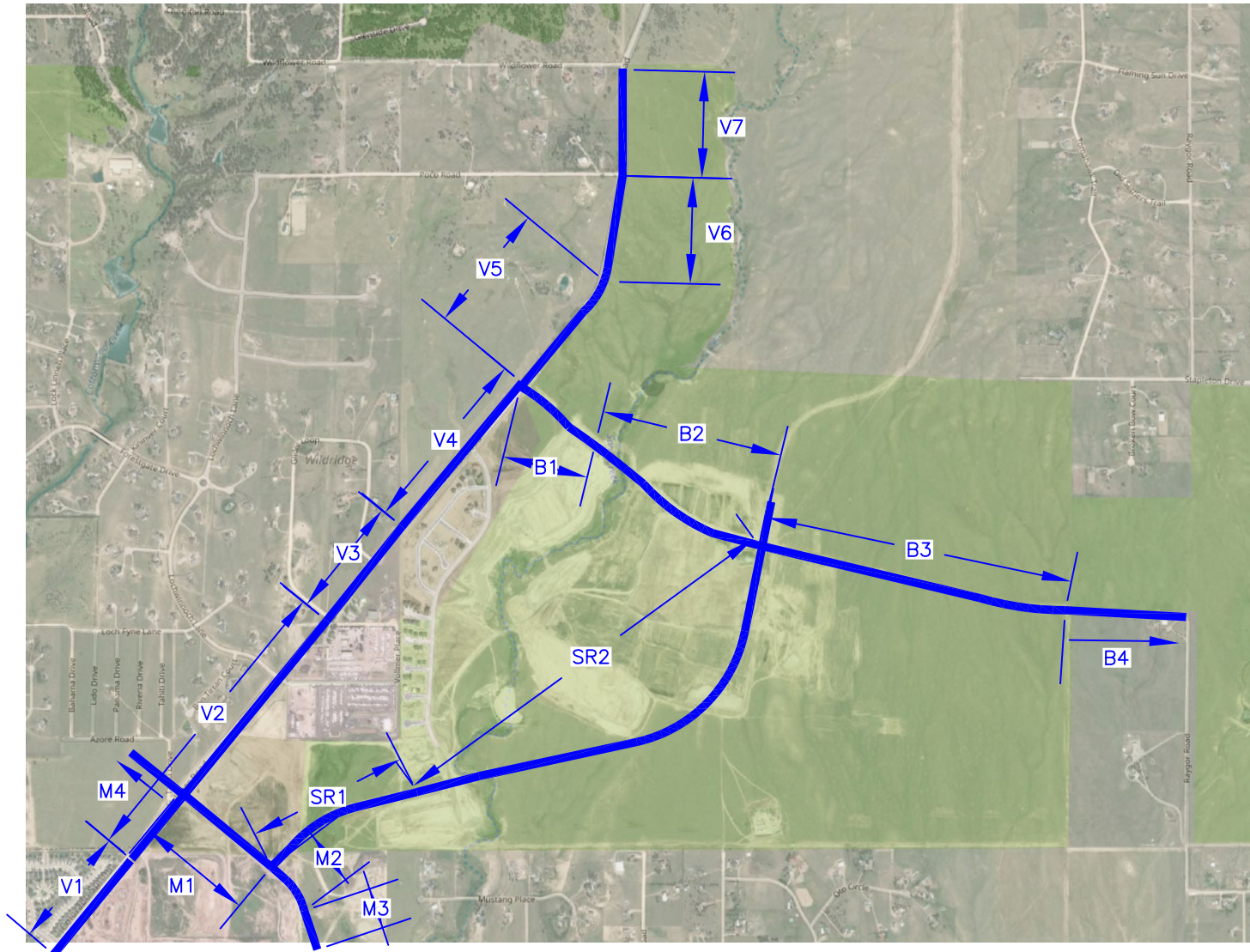

Approximate Scale
Scale: NTS

Figure 13

Roadway Improvement Segments*

*See Table 3 for recommended roadway segment improvements for each segment.

Homestead North Filing 3 (LSC #S224250)



Approved Deviation Form





Development Services Department
 2880 International Circle
 Colorado Springs, Colorado 80910

Phone: 719.520.6300
 Fax: 719.520.6695
 Website www.elpasoco.com

**DEVIATION REVIEW
 AND DECISION FORM**

Procedure # R-FM-051-07
 Issue Date: 12/31/07
 Revision Issued: 00/00/00

DSD FILE NO.:

P	U	D	0	9	0	0	5
---	---	---	---	---	---	---	---

General Property Information:

Address of Subject Property (Street Number/Name): 8715 Vollmer Road
 Tax Schedule ID(s) #: 5233000006

Legal Description of Property: E2, E2SW4, SW4SW4; that part of E2NW4 LY SELY of CO Road W/MR Section 33-12-65

Subdivision or Project Name: Sterling Ranch Phases 1-3

Section of ECM from Which Deviation is Sought: 2.3.2 & 2.2.5.B.1 Principal Arterial Access Spacing

Specific Criteria from Which a Deviation is Sought: One-half-mile access spacing on Principal Arterials

Proposed Nature and Extent of Deviation: Allow a three-quarter movement site access (south side) to future Stapleton Drive about 750 feet east of Vollmer Road.

Applicant Information:

Applicant: Morley-Bentley Investments, LLC - Jim Morley Email Address: jmorley3870@aol.com
 Applicant is: Owner Consultant Contractor
 Mailing Address: 20 Boulder Crescent, 1st Floor, Colorado Springs State: CO
 Telephone Number: 719-471-1742 Fax Number: _____

Engineer Information:

Engineer: Jeffrey C. Hodsdon, P.E., PTOE Email Address: Jeff@LSCTrans.com
 Company Name: LSC Transportation Consultants, Inc.
 Mailing Address: 516 North Tejon Street, Colorado Springs State: CO Postal Code: 80903
 Registration Number: 31684 State of Registration: CO
 Telephone Number: 719-633-2868 Fax Number: 719-633-5430

Explanation of Request (Attached diagrams, figures and other documentation to clarify request):

Section of ECM from Which Deviation is Sought: 2.3.2 & 2.2.5.B.1 Principal Arterial Access Spacing

Specific Criteria from Which a Deviation is Sought: One-half-mile access spacing on Principal Arterials

Proposed Nature and Extent of Deviation: Allow a three-quarter movement site access (south side) to Stapleton Drive about 750 feet east of Vollmer Road.

Reason for the Requested Deviation: See attached "Sterling Ranch Phases 1-3 Stapleton Drive Deviation Request Memorandum" dated July 2, 2014 by LSC.

Comparison of Proposed Deviation to ECM Standard: ECM Standard: One-half-mile access spacing on Principal Arterials. The proposed deviation would allow a three-quarter movement access on Stapleton Drive 750 feet east of Vollmer Road. The access is not proposed to be full-movement. The access spacing allowed is one-half-mile spacing. The requested access as a three-quarter movement access would allow eastbound right-in and right-out turning movements and westbound left-in turning movements.

Applicable Regional or National Standards used as Basis: Not applicable

Application Consideration:

CHECK IF APPLICATION MEETS CRITERIA FOR CONSIDERATION

JUSTIFICATION

The ECM standard is inapplicable to a particular situation.

Topography, right-of-way, or other geographical conditions or impediments impose an undue hardship on the applicant, and an equivalent alternative that can accomplish the same design objective is available and does not compromise public safety or accessibility.

See attached "Sterling Ranch Phases 1-3 Stapleton Drive Deviation Request Memorandum" dated July 2, 2014 by LSC.

A change to a standard is required to address a specific design or construction problem, and if not modified, the standard will impose an undue hardship on the applicant with little or no material benefit to the public.

If at least one of the criteria listed above is not met, this application for deviation cannot be considered.

Criteria for Approval:

PLEASE EXPLAIN HOW EACH OF THE FOLLOWING CRITERIA HAVE BEEN SATISFIED BY THIS REQUEST

The request for a deviation is not based exclusively on financial considerations.

See attached "Sterling Ranch Phases 1-3 Stapleton Drive Deviation Request Memorandum" dated July 2, 2014 by LSC

The deviation will achieve the intended result with a comparable or superior design and quality of improvement.

See attached "Sterling Ranch Phases 1-3 Stapleton Drive Deviation Request Memorandum" dated July 2, 2014 by LSC

The deviation will not adversely affect safety or operations.

See attached "Sterling Ranch Phases 1-3 Stapleton Drive Deviation Request Memorandum" dated July 2, 2014 by LSC

The deviation will not adversely affect maintenance and its associated cost.

See attached "Sterling Ranch Phases 1-3 Stapleton Drive Deviation Request Memorandum" dated July 2, 2014 by LSC

The deviation will not adversely affect aesthetic appearance.

See attached "Sterling Ranch Phases 1-3 Stapleton Drive Deviation Request Memorandum" dated July 2, 2014 by LSC

Owner, Applicant and Engineer Declaration:

To the best of my knowledge, the information on this application and all additional or supplemental documentation is true, factual and complete. I am fully aware that any misrepresentation of any information on this application may be grounds for denial. I have familiarized myself with the rules, regulations and procedures with respect to preparing and filing this application. I also understand that an incorrect submittal will be cause to have the project removed from the agenda of the Planning Commission, Board of County Commissioners and/or Board of Adjustment or delay review, and that any approval of this application is based on the representations made in the application and may be revoked on any breach of representation or condition(s) of approval.

El Paso County Procedures Manual

Procedure # R-FM-051-07

Issue Date: 12/31/07

Revision Issued: 00/00/00

DSD File No. _____

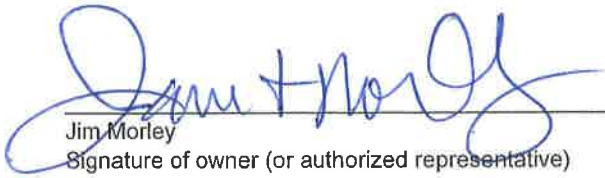
Jim Morley
Signature of owner (or authorized representative)

7/23/14
Date

Signature of applicant (if different from owner)

Date

Jeffrey C. Hodsdon, P.E., PTOE
Signature of Engineer

7/2/14
Date

Engineer's Seal



Review and Recommendation
APPROVED by the ECM Administrator

Date 7-29-14

This request has been determined to have met the criteria for approval. A deviation from Section _____ of ECM is hereby granted based on the justification provided. Comments:

____ Additional comments or information are attached.

DENIED by the ECM Administrator

Date _____

This request has been determined not to have met criteria for approval. A deviation from Section _____ of ECM is hereby denied. Comments:

____ Additional comments or information are attached.

TAZ Map



Source: Sterling Ranch Updated
Traffic Impact Analysis June 5, 2008

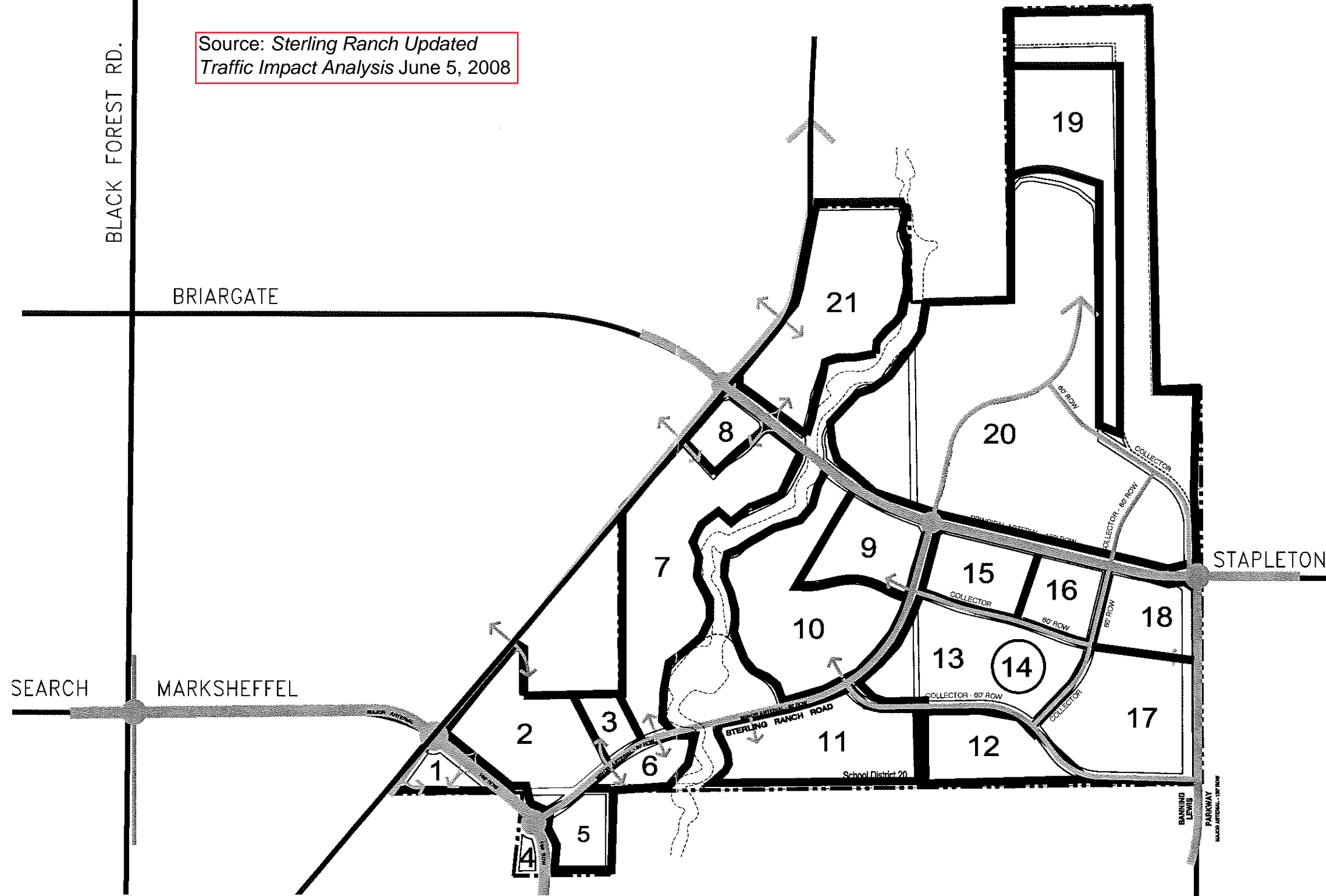

Traffic Analysis Zones
Sterling Ranch



Not to Scale

Figure 3
LSC # 074230



TRANSPORTATION
CONSULTANTS, INC.

MTCP Maps



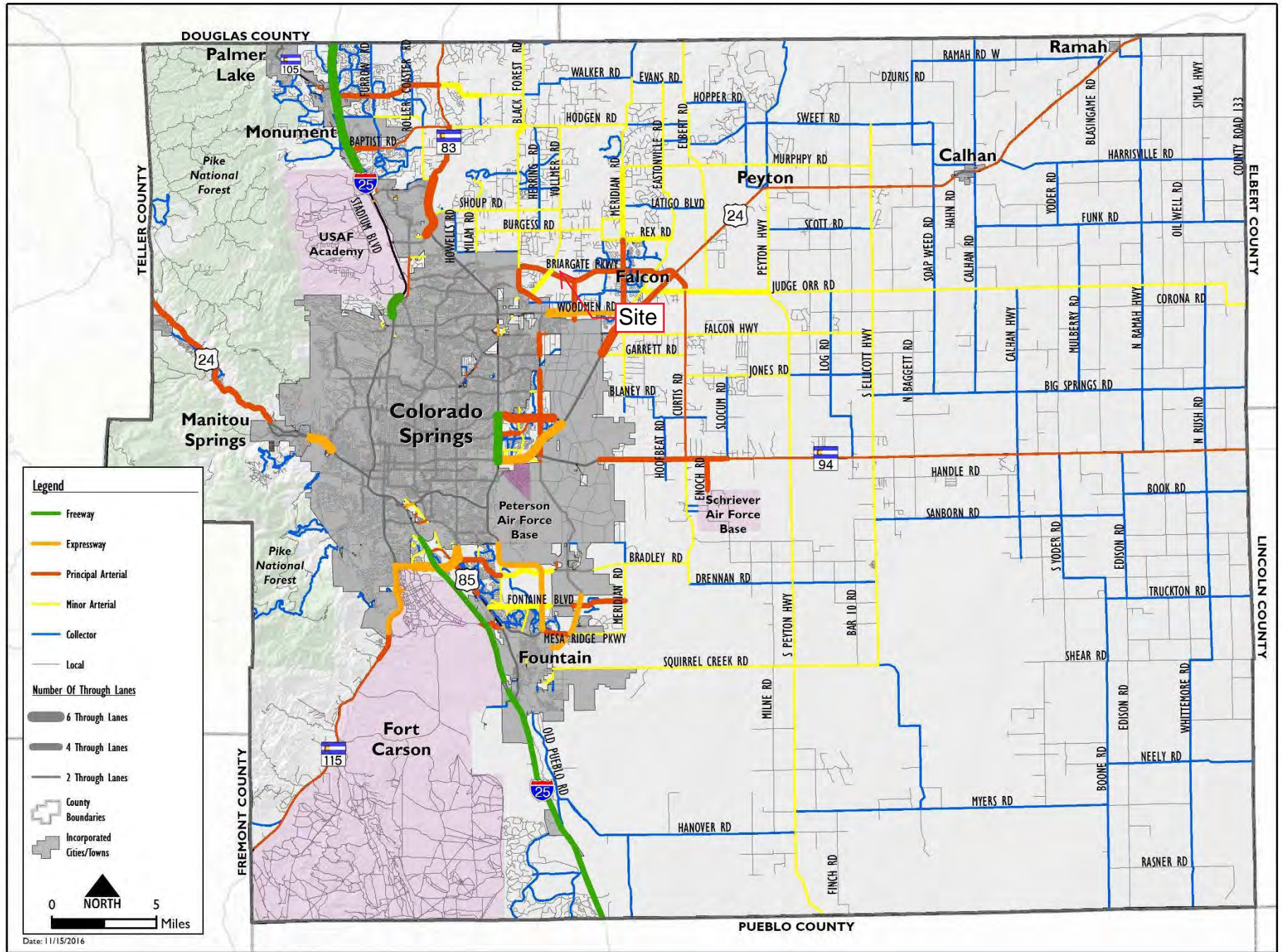

Map 14: 2040 Roadway Plan (Classification and Lanes)

Map 17: 2060 Corridor Preservation

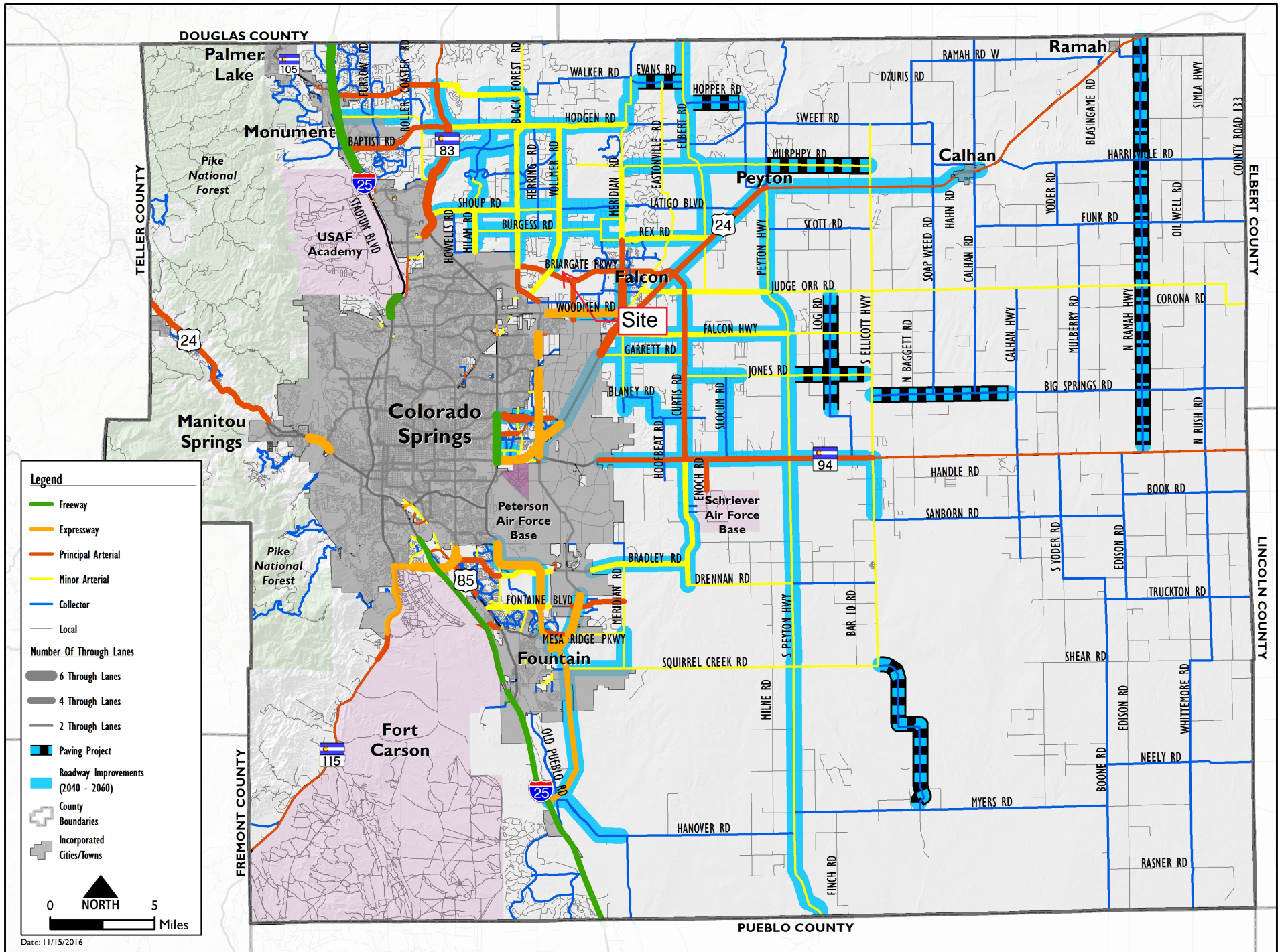

Traffic Counts



LSC Transportation Consultants, Inc.

2504 E. Pikes Peak Ave, Suite 304
 Colorado Springs, CO 80909
 719-633-2868

File Name : Vollmer rd - POCO rd Am
 Site Code : S224250
 Start Date : 5/11/2022
 Page No : 1

Groups Printed- Unshifted

Start Time	Vollmer Rd Southbound					Poco Rd Westbound					Vollmer Rd Northbound					Poco Rd Eastbound					Int. Total
	Right	Thru	Left	Peds	App. Total	Right	Thru	Left	Peds	App. Total	Right	Thru	Left	Peds	App. Total	Right	Thru	Left	Peds	App. Total	
06:30	0	38	0	0	38	0	0	1	0	1	6	20	0	0	26	1	0	1	0	2	67
06:45	0	34	0	0	34	0	0	0	0	0	12	16	0	0	28	0	0	0	0	0	62
Total	0	72	0	0	72	0	0	1	0	1	18	36	0	0	54	1	0	1	0	2	129
07:00	1	28	1	0	30	0	0	2	0	2	8	15	0	0	23	0	0	1	0	1	56
07:15	0	38	0	0	38	0	0	3	0	3	2	24	3	0	29	0	1	1	0	2	72
07:30	2	64	1	0	67	3	0	3	0	6	8	19	0	0	27	3	0	0	0	3	103
07:45	0	41	2	0	43	0	0	2	0	2	13	39	0	0	52	0	0	0	0	0	97
Total	3	171	4	0	178	3	0	10	0	13	31	97	3	0	131	3	1	2	0	6	328
08:00	0	31	1	0	32	4	0	1	0	5	14	36	1	0	51	0	0	1	0	1	89
08:15	0	20	0	0	20	2	0	7	0	9	7	24	2	0	33	0	0	0	0	0	62
Grand Total	3	294	5	0	302	9	0	19	0	28	70	193	6	0	269	4	1	4	0	9	608
Apprch %	1	97.4	1.7	0		32.1	0	67.9	0		26	71.7	2.2	0		44.4	11.1	44.4	0		
Total %	0.5	48.4	0.8	0	49.7	1.5	0	3.1	0	4.6	11.5	31.7	1	0	44.2	0.7	0.2	0.7	0	1.5	

LSC Transportation Consultants, Inc.

2504 E. Pikes Peak Ave, Suite 304
 Colorado Springs, CO 80909
 719-633-2868

File Name : Vollmer rd - POCO rd Am

Site Code : S224250

Start Date : 5/11/2022

Page No : 2

Start Time	Vollmer Rd Southbound					Poco Rd Westbound					Vollmer Rd Northbound					Poco Rd Eastbound					Int. Total
	Right	Thru	Left	Peds	App. Total	Right	Thru	Left	Peds	App. Total	Right	Thru	Left	Peds	App. Total	Right	Thru	Left	Peds	App. Total	
Peak Hour Analysis From 6:30:00 AM to 8:15:00 AM - Peak 1 of 1																					
Peak Hour for Entire Intersection Begins at 7:15:00 AM																					
7:15:00 AM	0	38	0	0	38	0	0	3	0	3	2	24	3	0	29	0	1	1	0	2	72
7:30:00 AM	2	64	1	0	67	3	0	3	0	6	8	19	0	0	27	3	0	0	0	3	103
7:45:00 AM	0	41	2	0	43	0	0	2	0	2	13	39	0	0	52	0	0	0	0	0	97
8:00:00 AM	0	31	1	0	32	4	0	1	0	5	14	36	1	0	51	0	0	1	0	1	89
Total Volume	2	174	4	0	180	7	0	9	0	16	37	118	4	0	159	3	1	2	0	6	361
% App. Total	1.1	96.7	2.2	0		43.8	0	56.2	0		23.3	74.2	2.5	0		50	16.7	33.3	0		
PHF	.250	.680	.500	.000	.672	.438	.000	.750	.000	.667	.661	.756	.333	.000	.764	.250	.250	.500	.000	.500	.876

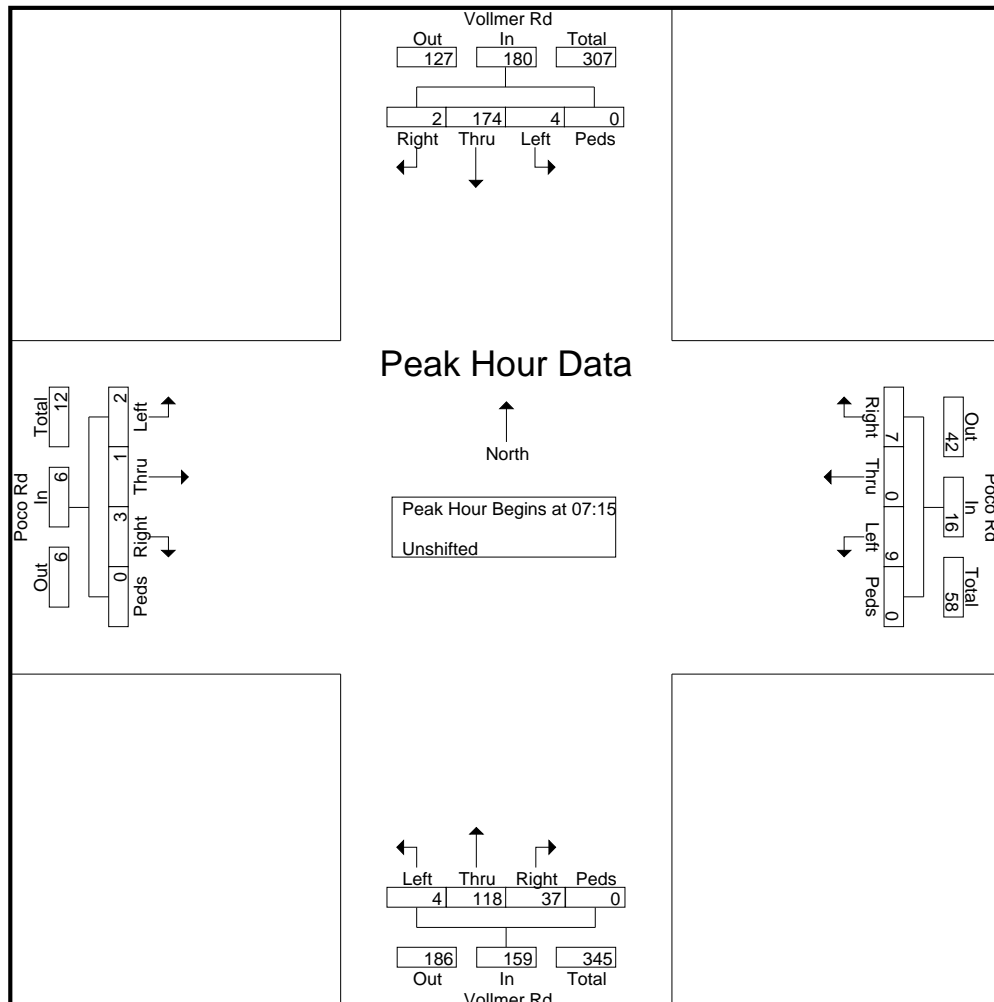

LSC Transportation Consultants, Inc.

2504 E. Pikes Peak Ave, Suite 304
 Colorado Springs, CO 80909
 719-633-2868

File Name : Vollmer Rd - POCO Rd PM Construction

Site Code : S224250

Start Date : 5/11/2022

Page No : 1

Start Time	Vollmer Rd					Poco Rd					Vollmer Rd					Poco Rd					Int. Total
	Southbound					Westbound					Northbound					Eastbound					
	Right	Thru	Left	Peds	App. Total	Right	Thru	Left	Peds	App. Total	Right	Thru	Left	Peds	App. Total	Right	Thru	Left	Peds	App. Total	
16:00	1	35	6	0	42	0	0	6	0	6	1	32	0	0	33	1	1	1	0	3	84
16:15	1	29	0	0	30	0	0	2	0	2	1	43	0	0	44	0	0	0	0	0	76
16:30	0	40	0	0	40	4	0	5	0	9	0	41	3	0	44	0	1	1	0	2	95
16:45	0	36	0	0	36	0	1	6	0	7	2	30	0	0	32	0	0	1	0	1	76
Total	2	140	6	0	148	4	1	19	0	24	4	146	3	0	153	1	2	3	0	6	331
17:00	0	33	1	0	34	0	0	1	0	1	1	45	0	0	46	0	0	0	0	0	81
17:15	1	31	0	0	32	0	0	3	0	3	2	39	2	0	43	2	0	1	0	3	81
17:30	0	37	0	0	37	0	0	6	0	6	2	37	0	0	39	1	0	0	0	1	83
17:45	0	34	0	0	34	0	0	1	0	1	1	35	1	0	37	0	0	0	0	0	72
Total	1	135	1	0	137	0	0	11	0	11	6	156	3	0	165	3	0	1	0	4	317
Grand Total	3	275	7	0	285	4	1	30	0	35	10	302	6	0	318	4	2	4	0	10	648
Apprch %	1.1	96.5	2.5	0		11.4	2.9	85.7	0		3.1	95	1.9	0		40	20	40	0		
Total %	0.5	42.4	1.1	0	44	0.6	0.2	4.6	0	5.4	1.5	46.6	0.9	0	49.1	0.6	0.3	0.6	0	1.5	

LSC Transportation Consultants, Inc.

2504 E. Pikes Peak Ave, Suite 304
 Colorado Springs, CO 80909
 719-633-2868

File Name : vollmer rd - poco rd pm
 Site Code : S22425
 Start Date : 5/11/2022
 Page No : 2

Start Time	Poco Rd Southbound					Vollmer Rd Westbound					Poco Rd Northbound					Vollmer Rd Eastbound					Int. Total
	Right	Thru	Left	Peds	App. Total	Right	Thru	Left	Peds	App. Total	Right	Thru	Left	Peds	App. Total	Right	Thru	Left	Peds	App. Total	
Peak Hour Analysis From 4:00:00 PM to 5:45:00 PM - Peak 1 of 1																					
Peak Hour for Entire Intersection Begins at 4:30:00 PM																					
4:30:00 PM	0	40	0	0	40	4	0	5	0	9	0	41	3	0	44	0	1	1	0	2	95
4:45:00 PM	0	36	0	0	36	0	1	6	0	7	2	30	0	0	32	0	0	1	0	1	76
5:00:00 PM	0	33	1	0	34	0	0	1	0	1	1	45	0	0	46	0	0	0	0	0	81
5:15:00 PM	1	31	0	0	32	0	0	3	0	3	2	39	2	0	43	2	0	1	0	3	81
Total Volume	1	140	1	0	142	4	1	15	0	20	5	155	5	0	165	2	1	3	0	6	333
% App. Total	0.7	98.6	0.7	0		20	5	75	0		3	93.9	3	0		33.3	16.7	50	0		
PHF	.250	.875	.250	.000	.888	.250	.250	.625	.000	.556	.625	.861	.417	.000	.897	.250	.250	.750	.000	.500	.876

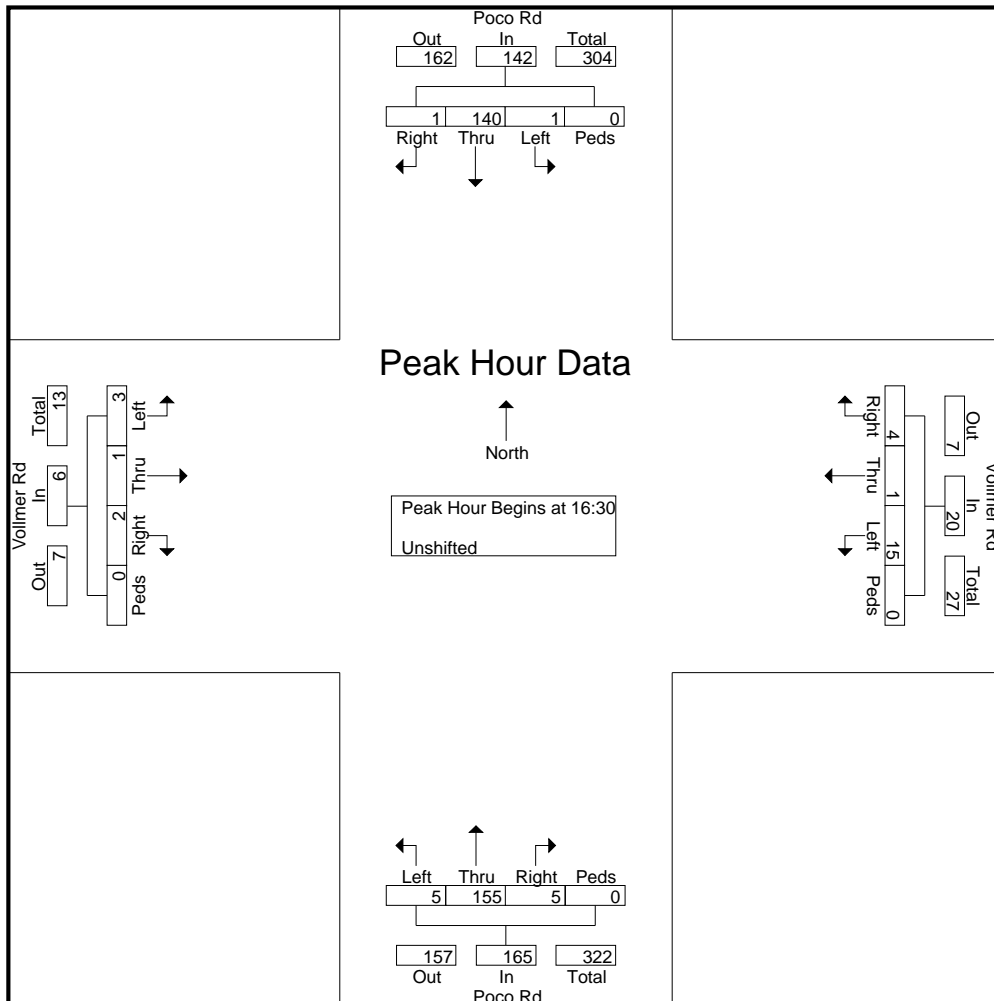

Levels of Service



Intersection												
Int Delay, s/veh	1											
Movement	EBL	EBT	EBR	WBL	WBT	WBR	NBL	NBT	NBR	SBL	SBT	SBR
Lane Configurations		↕			↕			↕			↕	
Traffic Vol, veh/h	2	1	3	9	0	7	4	118	37	4	174	2
Future Vol, veh/h	2	1	3	9	0	7	4	118	37	4	174	2
Conflicting Peds, #/hr	0	0	0	0	0	0	0	0	0	0	0	0
Sign Control	Stop	Stop	Stop	Stop	Stop	Stop	Free	Free	Free	Free	Free	Free
RT Channelized	-	-	None	-	-	None	-	-	None	-	-	None
Storage Length	-	-	-	-	-	-	-	-	-	-	-	-
Veh in Median Storage, #	-	0	-	-	0	-	-	0	-	-	0	-
Grade, %	-	0	-	-	0	-	-	0	-	-	0	-
Peak Hour Factor	50	50	50	67	67	67	87	87	87	67	67	67
Heavy Vehicles, %	2	2	2	2	2	2	2	2	2	2	2	2
Mvmt Flow	4	2	6	13	0	10	5	136	43	6	260	3

Major/Minor	Minor2		Minor1		Major1		Major2					
Conflicting Flow All	447	463	262	446	443	158	263	0	0	179	0	0
Stage 1	274	274	-	168	168	-	-	-	-	-	-	-
Stage 2	173	189	-	278	275	-	-	-	-	-	-	-
Critical Hdwy	7.12	6.52	6.22	7.12	6.52	6.22	4.12	-	-	4.12	-	-
Critical Hdwy Stg 1	6.12	5.52	-	6.12	5.52	-	-	-	-	-	-	-
Critical Hdwy Stg 2	6.12	5.52	-	6.12	5.52	-	-	-	-	-	-	-
Follow-up Hdwy	3.518	4.018	3.318	3.518	4.018	3.318	2.218	-	-	2.218	-	-
Pot Cap-1 Maneuver	522	496	777	523	509	887	1301	-	-	1397	-	-
Stage 1	732	683	-	834	759	-	-	-	-	-	-	-
Stage 2	829	744	-	728	683	-	-	-	-	-	-	-
Platoon blocked, %								-	-	-	-	-
Mov Cap-1 Maneuver	512	492	777	514	504	887	1301	-	-	1397	-	-
Mov Cap-2 Maneuver	512	492	-	514	504	-	-	-	-	-	-	-
Stage 1	729	680	-	831	756	-	-	-	-	-	-	-
Stage 2	816	741	-	717	680	-	-	-	-	-	-	-

Approach	EB	WB	NB	SB
HCM Control Delay, s	11	10.9	0.2	0.2
HCM LOS	B	B		

Minor Lane/Major Mvmt	NBL	NBT	NBR	EBLn1	WBLn1	SBL	SBT	SBR
Capacity (veh/h)	1301	-	-	612	630	1397	-	-
HCM Lane V/C Ratio	0.004	-	-	0.02	0.038	0.004	-	-
HCM Control Delay (s)	7.8	0	-	11	10.9	7.6	0	-
HCM Lane LOS	A	A	-	B	B	A	A	-
HCM 95th %tile Q(veh)	0	-	-	0.1	0.1	0	-	-

Intersection												
Int Delay, s/veh	1.3											
Movement	EBL	EBT	EBR	WBL	WBT	WBR	NBL	NBT	NBR	SBL	SBT	SBR
Lane Configurations		↕			↕			↕			↕	
Traffic Vol, veh/h	3	1	2	15	1	4	5	155	5	1	140	1
Future Vol, veh/h	3	1	2	15	1	4	5	155	5	1	140	1
Conflicting Peds, #/hr	0	0	0	0	0	0	0	0	0	0	0	0
Sign Control	Stop	Stop	Stop	Stop	Stop	Stop	Free	Free	Free	Free	Free	Free
RT Channelized	-	-	None	-	-	None	-	-	None	-	-	None
Storage Length	-	-	-	-	-	-	-	-	-	-	-	-
Veh in Median Storage, #	-	0	-	-	0	-	-	0	-	-	0	-
Grade, %	-	0	-	-	0	-	-	0	-	-	0	-
Peak Hour Factor	78	78	78	56	56	56	87	87	87	89	89	89
Heavy Vehicles, %	2	2	2	2	2	2	2	2	2	2	2	2
Mvmt Flow	4	1	3	27	2	7	6	178	6	1	157	1

Major/Minor	Minor2		Minor1		Major1		Major2					
Conflicting Flow All	358	356	158	355	353	181	158	0	0	184	0	0
Stage 1	160	160	-	193	193	-	-	-	-	-	-	-
Stage 2	198	196	-	162	160	-	-	-	-	-	-	-
Critical Hdwy	7.12	6.52	6.22	7.12	6.52	6.22	4.12	-	-	4.12	-	-
Critical Hdwy Stg 1	6.12	5.52	-	6.12	5.52	-	-	-	-	-	-	-
Critical Hdwy Stg 2	6.12	5.52	-	6.12	5.52	-	-	-	-	-	-	-
Follow-up Hdwy	3.518	4.018	3.318	3.518	4.018	3.318	2.218	-	-	2.218	-	-
Pot Cap-1 Maneuver	597	570	887	600	572	862	1422	-	-	1391	-	-
Stage 1	842	766	-	809	741	-	-	-	-	-	-	-
Stage 2	804	739	-	840	766	-	-	-	-	-	-	-
Platoon blocked, %								-	-	-	-	-
Mov Cap-1 Maneuver	588	567	887	595	569	862	1422	-	-	1391	-	-
Mov Cap-2 Maneuver	588	567	-	595	569	-	-	-	-	-	-	-
Stage 1	838	765	-	805	737	-	-	-	-	-	-	-
Stage 2	791	735	-	835	765	-	-	-	-	-	-	-

Approach	EB	WB	NB	SB
HCM Control Delay, s	10.5	11	0.2	0.1
HCM LOS	B	B		

Minor Lane/Major Mvmt	NBL	NBT	NBR	EBLn1	WBLn1	SBL	SBT	SBR
Capacity (veh/h)	1422	-	-	658	633	1391	-	-
HCM Lane V/C Ratio	0.004	-	-	0.012	0.056	0.001	-	-
HCM Control Delay (s)	7.5	0	-	10.5	11	7.6	0	-
HCM Lane LOS	A	A	-	B	B	A	A	-
HCM 95th %tile Q(veh)	0	-	-	0	0.2	0	-	-

Intersection												
Int Delay, s/veh	7.9											
Movement	EBL	EBT	EBR	WBL	WBT	WBR	NBL	NBT	NBR	SBL	SBT	SBR
Lane Configurations	↖	↗			↖			↔			↔	
Traffic Vol, veh/h	9	0	4	0	0	0	12	0	0	0	0	55
Future Vol, veh/h	9	0	4	0	0	0	12	0	0	0	0	55
Conflicting Peds, #/hr	0	0	0	0	0	0	0	0	0	0	0	0
Sign Control	Free	Free	Free	Free	Free	Free	Stop	Stop	Stop	Stop	Stop	Stop
RT Channelized	-	-	None	-	-	None	-	-	None	-	-	None
Storage Length	100	-	-	-	-	-	-	-	-	-	-	-
Veh in Median Storage, #	-	0	-	-	0	-	-	0	-	-	0	-
Grade, %	-	0	-	-	0	-	-	0	-	-	0	-
Peak Hour Factor	85	85	85	85	85	85	85	85	85	85	85	85
Heavy Vehicles, %	2	2	2	2	2	2	2	2	2	2	2	2
Mvmt Flow	11	0	5	0	0	0	14	0	0	0	0	65

Major/Minor	Major1			Major2			Minor1			Minor2		
Conflicting Flow All	1	0	0	5	0	0	59	26	3	26	28	1
Stage 1	-	-	-	-	-	-	25	25	-	1	1	-
Stage 2	-	-	-	-	-	-	34	1	-	25	27	-
Critical Hdwy	4.12	-	-	4.12	-	-	7.12	6.52	6.22	7.12	6.52	6.22
Critical Hdwy Stg 1	-	-	-	-	-	-	6.12	5.52	-	6.12	5.52	-
Critical Hdwy Stg 2	-	-	-	-	-	-	6.12	5.52	-	6.12	5.52	-
Follow-up Hdwy	2.218	-	-	2.218	-	-	3.518	4.018	3.318	3.518	4.018	3.318
Pot Cap-1 Maneuver	1622	-	-	1616	-	0	937	867	1081	984	865	1084
Stage 1	-	-	-	-	-	0	993	874	-	1022	895	-
Stage 2	-	-	-	-	-	0	982	895	-	993	873	-
Platoon blocked, %	-	-	-	-	-	-	-	-	-	-	-	-
Mov Cap-1 Maneuver	1622	-	-	1616	-	-	876	861	1081	979	859	1084
Mov Cap-2 Maneuver	-	-	-	-	-	-	876	861	-	979	859	-
Stage 1	-	-	-	-	-	-	986	868	-	1015	895	-
Stage 2	-	-	-	-	-	-	923	895	-	986	867	-

Approach	EB			WB			NB			SB		
HCM Control Delay, s	5			0			9.2			8.5		
HCM LOS							A			A		

Minor Lane/Major Mvmt	NBLn1	EBL	EBT	EBR	WBL	WBT	SBLn1
Capacity (veh/h)	876	1622	-	-	1616	-	1084
HCM Lane V/C Ratio	0.016	0.007	-	-	-	-	0.06
HCM Control Delay (s)	9.2	7.2	-	-	0	-	8.5
HCM Lane LOS	A	A	-	-	A	-	A
HCM 95th %tile Q(veh)	0	0	-	-	0	-	0.2

Intersection						
Int Delay, s/veh	1.6					
Movement	WBL	WBR	NBT	NBR	SBL	SBT
Lane Configurations	↘	↗	↑	↗	↘	↑
Traffic Vol, veh/h	63	4	204	11	2	293
Future Vol, veh/h	63	4	204	11	2	293
Conflicting Peds, #/hr	0	0	0	0	0	0
Sign Control	Stop	Stop	Free	Free	Free	Free
RT Channelized	-	None	-	None	-	None
Storage Length	-	235	-	235	385	-
Veh in Median Storage, #	0	-	0	-	-	0
Grade, %	0	-	0	-	-	0
Peak Hour Factor	85	85	87	85	85	69
Heavy Vehicles, %	2	2	2	2	2	2
Mvmt Flow	74	5	234	13	2	425

Major/Minor	Minor1	Major1	Major2		
Conflicting Flow All	663	234	0	0	247
Stage 1	234	-	-	-	-
Stage 2	429	-	-	-	-
Critical Hdwy	6.42	6.22	-	-	4.12
Critical Hdwy Stg 1	5.42	-	-	-	-
Critical Hdwy Stg 2	5.42	-	-	-	-
Follow-up Hdwy	3.518	3.318	-	-	2.218
Pot Cap-1 Maneuver	426	805	-	-	1319
Stage 1	805	-	-	-	-
Stage 2	657	-	-	-	-
Platoon blocked, %			-	-	-
Mov Cap-1 Maneuver	425	805	-	-	1319
Mov Cap-2 Maneuver	425	-	-	-	-
Stage 1	805	-	-	-	-
Stage 2	656	-	-	-	-

Approach	WB	NB	SB
HCM Control Delay, s	15	0	0
HCM LOS	C		

Minor Lane/Major Mvmt	NBT	NBR	WBLn1	WBLn2	SBL	SBT
Capacity (veh/h)	-	-	425	805	1319	-
HCM Lane V/C Ratio	-	-	0.174	0.006	0.002	-
HCM Control Delay (s)	-	-	15.3	9.5	7.7	-
HCM Lane LOS	-	-	C	A	A	-
HCM 95th %tile Q(veh)	-	-	0.6	0	0	-

Intersection						
Int Delay, s/veh	0.6					
Movement	WBL	WBR	NBT	NBR	SBL	SBT
Lane Configurations	Y ^Y		↑↑	↑	↑	↑↑
Traffic Vol, veh/h	17	9	193	8	3	278
Future Vol, veh/h	17	9	193	8	3	278
Conflicting Peds, #/hr	0	0	0	0	0	0
Sign Control	Stop	Stop	Free	Free	Free	Free
RT Channelized	-	None	-	None	-	None
Storage Length	0	-	-	155	205	-
Veh in Median Storage, #	0	-	0	-	-	0
Grade, %	0	-	0	-	-	0
Peak Hour Factor	85	85	87	87	85	67
Heavy Vehicles, %	2	2	2	2	2	2
Mvmt Flow	20	11	222	9	4	415

Major/Minor	Minor1	Major1	Major2		
Conflicting Flow All	438	111	0	0	231
Stage 1	222	-	-	-	-
Stage 2	216	-	-	-	-
Critical Hdwy	6.84	6.94	-	-	4.14
Critical Hdwy Stg 1	5.84	-	-	-	-
Critical Hdwy Stg 2	5.84	-	-	-	-
Follow-up Hdwy	3.52	3.32	-	-	2.22
Pot Cap-1 Maneuver	547	921	-	-	1334
Stage 1	794	-	-	-	-
Stage 2	799	-	-	-	-
Platoon blocked, %			-	-	-
Mov Cap-1 Maneuver	545	921	-	-	1334
Mov Cap-2 Maneuver	545	-	-	-	-
Stage 1	794	-	-	-	-
Stage 2	797	-	-	-	-

Approach	WB	NB	SB
HCM Control Delay, s	11	0	0.1
HCM LOS	B		

Minor Lane/Major Mvmt	NBT	NBRWBLn1	SBL	SBT
Capacity (veh/h)	-	-	635	1334
HCM Lane V/C Ratio	-	-	0.048	0.003
HCM Control Delay (s)	-	-	11	7.7
HCM Lane LOS	-	-	B	A
HCM 95th %tile Q(veh)	-	-	0.2	0

Intersection												
Int Delay, s/veh	2.6											
Movement	EBL	EBT	EBR	WBL	WBT	WBR	NBL	NBT	NBR	SBL	SBT	SBR
Lane Configurations		↕			↕			↕	↕		↕	
Traffic Vol, veh/h	2	0	3	77	0	12	4	172	26	4	201	2
Future Vol, veh/h	2	0	3	77	0	12	4	172	26	4	201	2
Conflicting Peds, #/hr	0	0	0	0	0	0	0	0	0	0	0	0
Sign Control	Stop	Stop	Stop	Stop	Stop	Stop	Free	Free	Free	Free	Free	Free
RT Channelized	-	-	None	-	-	None	-	-	None	-	-	None
Storage Length	-	-	-	-	-	-	-	-	-	-	-	-
Veh in Median Storage, #	-	0	-	-	0	-	-	0	-	-	0	-
Grade, %	-	0	-	-	0	-	-	0	-	-	0	-
Peak Hour Factor	50	50	50	85	85	85	87	87	87	67	67	67
Heavy Vehicles, %	2	2	2	2	2	2	2	2	2	2	2	2
Mvmt Flow	4	0	6	91	0	14	5	198	30	6	300	3

Major/Minor	Minor2		Minor1		Major1		Major2					
Conflicting Flow All	544	552	302	525	523	198	303	0	0	228	0	0
Stage 1	314	314	-	208	208	-	-	-	-	-	-	-
Stage 2	230	238	-	317	315	-	-	-	-	-	-	-
Critical Hdwy	7.12	6.52	6.22	7.12	6.52	6.22	4.12	-	-	4.12	-	-
Critical Hdwy Stg 1	6.12	5.52	-	6.12	5.52	-	-	-	-	-	-	-
Critical Hdwy Stg 2	6.12	5.52	-	6.12	5.52	-	-	-	-	-	-	-
Follow-up Hdwy	3.518	4.018	3.318	3.518	4.018	3.318	2.218	-	-	2.218	-	-
Pot Cap-1 Maneuver	450	442	738	463	459	843	1258	-	-	1340	-	-
Stage 1	697	656	-	794	730	-	-	-	-	-	-	-
Stage 2	773	708	-	694	656	-	-	-	-	-	-	-
Platoon blocked, %								-	-	-	-	-
Mov Cap-1 Maneuver	439	438	738	456	454	843	1258	-	-	1340	-	-
Mov Cap-2 Maneuver	439	438	-	456	454	-	-	-	-	-	-	-
Stage 1	694	653	-	790	726	-	-	-	-	-	-	-
Stage 2	756	704	-	685	653	-	-	-	-	-	-	-

Approach	EB		WB		NB		SB	
HCM Control Delay, s	11.3		14.4		0.2		0.1	
HCM LOS	B		B					

Minor Lane/Major Mvmt	NBL	NBT	NBR	EBLn1	WBLn1	SBL	SBT	SBR
Capacity (veh/h)	1258	-	-	580	486	1340	-	-
HCM Lane V/C Ratio	0.004	-	-	0.017	0.215	0.004	-	-
HCM Control Delay (s)	7.9	0	-	11.3	14.4	7.7	0	-
HCM Lane LOS	A	A	-	B	B	A	A	-
HCM 95th %tile Q(veh)	0	-	-	0.1	0.8	0	-	-

Intersection												
Int Delay, s/veh	6.7											
Movement	EBL	EBT	EBR	WBL	WBT	WBR	NBL	NBT	NBR	SBL	SBT	SBR
Lane Configurations	↖	↗			↖			↔			↔	
Traffic Vol, veh/h	29	0	14	0	0	0	7	0	0	0	0	36
Future Vol, veh/h	29	0	14	0	0	0	7	0	0	0	0	36
Conflicting Peds, #/hr	0	0	0	0	0	0	0	0	0	0	0	0
Sign Control	Free	Free	Free	Free	Free	Free	Stop	Stop	Stop	Stop	Stop	Stop
RT Channelized	-	-	None	-	-	None	-	-	None	-	-	None
Storage Length	100	-	-	-	-	-	-	-	-	-	-	-
Veh in Median Storage, #	-	0	-	-	0	-	-	0	-	-	0	-
Grade, %	-	0	-	-	0	-	-	0	-	-	0	-
Peak Hour Factor	85	85	85	85	85	85	85	85	85	85	85	85
Heavy Vehicles, %	2	2	2	2	2	2	2	2	2	2	2	2
Mvmt Flow	34	0	16	0	0	0	8	0	0	0	0	42

Major/Minor	Major1			Major2			Minor1			Minor2		
Conflicting Flow All	1	0	0	16	0	0	98	77	8	77	85	1
Stage 1	-	-	-	-	-	-	76	76	-	1	1	-
Stage 2	-	-	-	-	-	-	22	1	-	76	84	-
Critical Hdwy	4.12	-	-	4.12	-	-	7.12	6.52	6.22	7.12	6.52	6.22
Critical Hdwy Stg 1	-	-	-	-	-	-	6.12	5.52	-	6.12	5.52	-
Critical Hdwy Stg 2	-	-	-	-	-	-	6.12	5.52	-	6.12	5.52	-
Follow-up Hdwy	2.218	-	-	2.218	-	-	3.518	4.018	3.318	3.518	4.018	3.318
Pot Cap-1 Maneuver	1622	-	-	1602	-	0	884	813	1074	912	805	1084
Stage 1	-	-	-	-	-	0	933	832	-	1022	895	-
Stage 2	-	-	-	-	-	0	996	895	-	933	825	-
Platoon blocked, %	-	-	-	-	-	-	-	-	-	-	-	-
Mov Cap-1 Maneuver	1622	-	-	1602	-	-	836	796	1074	897	788	1084
Mov Cap-2 Maneuver	-	-	-	-	-	-	836	796	-	897	788	-
Stage 1	-	-	-	-	-	-	913	815	-	1001	895	-
Stage 2	-	-	-	-	-	-	957	895	-	913	808	-

Approach	EB			WB			NB			SB		
HCM Control Delay, s	4.9			0			9.3			8.5		
HCM LOS							A			A		

Minor Lane/Major Mvmt	NBLn1	EBL	EBT	EBR	WBL	WBT	SBLn1
Capacity (veh/h)	836	1622	-	-	1602	-	1084
HCM Lane V/C Ratio	0.01	0.021	-	-	-	-	0.039
HCM Control Delay (s)	9.3	7.3	-	-	0	-	8.5
HCM Lane LOS	A	A	-	-	A	-	A
HCM 95th %tile Q(veh)	0	0.1	-	-	0	-	0.1

Intersection						
Int Delay, s/veh	1					
Movement	WBL	WBR	NBT	NBR	SBL	SBT
Lane Configurations	↘	↗	↑	↗	↘	↑
Traffic Vol, veh/h	40	3	328	38	5	249
Future Vol, veh/h	40	3	328	38	5	249
Conflicting Peds, #/hr	0	0	0	0	0	0
Sign Control	Stop	Stop	Free	Free	Free	Free
RT Channelized	-	None	-	None	-	None
Storage Length	-	235	-	235	385	-
Veh in Median Storage, #	0	-	0	-	-	0
Grade, %	0	-	0	-	-	0
Peak Hour Factor	85	85	87	85	85	89
Heavy Vehicles, %	2	2	2	2	2	2
Mvmt Flow	47	4	377	45	6	280

Major/Minor	Minor1	Major1	Major2		
Conflicting Flow All	669	377	0	0	422
Stage 1	377	-	-	-	-
Stage 2	292	-	-	-	-
Critical Hdwy	6.42	6.22	-	-	4.12
Critical Hdwy Stg 1	5.42	-	-	-	-
Critical Hdwy Stg 2	5.42	-	-	-	-
Follow-up Hdwy	3.518	3.318	-	-	2.218
Pot Cap-1 Maneuver	423	670	-	-	1137
Stage 1	694	-	-	-	-
Stage 2	758	-	-	-	-
Platoon blocked, %			-	-	-
Mov Cap-1 Maneuver	421	670	-	-	1137
Mov Cap-2 Maneuver	421	-	-	-	-
Stage 1	694	-	-	-	-
Stage 2	754	-	-	-	-

Approach	WB	NB	SB
HCM Control Delay, s	14.3	0	0.2
HCM LOS	B		

Minor Lane/Major Mvmt	NBT	NBRWBLn1	WBLn2	SBL	SBT
Capacity (veh/h)	-	-	421	670	1137
HCM Lane V/C Ratio	-	-	0.112	0.005	0.005
HCM Control Delay (s)	-	-	14.6	10.4	8.2
HCM Lane LOS	-	-	B	B	A
HCM 95th %tile Q(veh)	-	-	0.4	0	0

Intersection						
Int Delay, s/veh	0.5					
Movement	WBL	WBR	NBT	NBR	SBL	SBT
Lane Configurations	↘↗		↑↑	↗	↘	↑↑
Traffic Vol, veh/h	11	6	279	27	10	243
Future Vol, veh/h	11	6	279	27	10	243
Conflicting Peds, #/hr	0	0	0	0	0	0
Sign Control	Stop	Stop	Free	Free	Free	Free
RT Channelized	-	None	-	None	-	None
Storage Length	0	-	-	155	205	-
Veh in Median Storage, #	0	-	0	-	-	0
Grade, %	0	-	0	-	-	0
Peak Hour Factor	85	85	87	87	89	89
Heavy Vehicles, %	2	2	2	2	2	2
Mvmt Flow	13	7	321	31	11	273

Major/Minor	Minor1	Major1	Major2			
Conflicting Flow All	480	161	0	0	352	0
Stage 1	321	-	-	-	-	-
Stage 2	159	-	-	-	-	-
Critical Hdwy	6.84	6.94	-	-	4.14	-
Critical Hdwy Stg 1	5.84	-	-	-	-	-
Critical Hdwy Stg 2	5.84	-	-	-	-	-
Follow-up Hdwy	3.52	3.32	-	-	2.22	-
Pot Cap-1 Maneuver	515	855	-	-	1203	-
Stage 1	708	-	-	-	-	-
Stage 2	853	-	-	-	-	-
Platoon blocked, %			-	-	-	-
Mov Cap-1 Maneuver	510	855	-	-	1203	-
Mov Cap-2 Maneuver	510	-	-	-	-	-
Stage 1	708	-	-	-	-	-
Stage 2	845	-	-	-	-	-

Approach	WB	NB	SB
HCM Control Delay, s	11.3	0	0.3
HCM LOS	B		

Minor Lane/Major Mvmt	NBT	NBRWBLn1	SBL	SBT
Capacity (veh/h)	-	-	595	1203
HCM Lane V/C Ratio	-	-	0.034	0.009
HCM Control Delay (s)	-	-	11.3	8
HCM Lane LOS	-	-	B	A
HCM 95th %tile Q(veh)	-	-	0.1	0

Intersection												
Int Delay, s/veh	1.8											
Movement	EBL	EBT	EBR	WBL	WBT	WBR	NBL	NBT	NBR	SBL	SBT	SBR
Lane Configurations		↕			↕			↕	↕		↕	
Traffic Vol, veh/h	3	0	2	49	0	10	5	195	85	15	202	1
Future Vol, veh/h	3	0	2	49	0	10	5	195	85	15	202	1
Conflicting Peds, #/hr	0	0	0	0	0	0	0	0	0	0	0	0
Sign Control	Stop	Stop	Stop	Stop	Stop	Stop	Free	Free	Free	Free	Free	Free
RT Channelized	-	-	None	-	-	None	-	-	None	-	-	None
Storage Length	-	-	-	-	-	-	-	-	-	-	-	-
Veh in Median Storage, #	-	0	-	-	0	-	-	0	-	-	0	-
Grade, %	-	0	-	-	0	-	-	0	-	-	0	-
Peak Hour Factor	78	78	78	85	85	85	87	87	87	89	89	89
Heavy Vehicles, %	2	2	2	2	2	2	2	2	2	2	2	2
Mvmt Flow	4	0	3	58	0	12	6	224	98	17	227	1

Major/Minor	Minor2		Minor1		Major1		Major2					
Conflicting Flow All	553	596	228	499	498	224	228	0	0	322	0	0
Stage 1	262	262	-	236	236	-	-	-	-	-	-	-
Stage 2	291	334	-	263	262	-	-	-	-	-	-	-
Critical Hdwy	7.12	6.52	6.22	7.12	6.52	6.22	4.12	-	-	4.12	-	-
Critical Hdwy Stg 1	6.12	5.52	-	6.12	5.52	-	-	-	-	-	-	-
Critical Hdwy Stg 2	6.12	5.52	-	6.12	5.52	-	-	-	-	-	-	-
Follow-up Hdwy	3.518	4.018	3.318	3.518	4.018	3.318	2.218	-	-	2.218	-	-
Pot Cap-1 Maneuver	444	417	811	482	474	815	1340	-	-	1238	-	-
Stage 1	743	691	-	767	710	-	-	-	-	-	-	-
Stage 2	717	643	-	742	691	-	-	-	-	-	-	-
Platoon blocked, %								-	-	-	-	-
Mov Cap-1 Maneuver	430	408	811	472	464	815	1340	-	-	1238	-	-
Mov Cap-2 Maneuver	430	408	-	472	464	-	-	-	-	-	-	-
Stage 1	739	680	-	762	706	-	-	-	-	-	-	-
Stage 2	702	639	-	728	680	-	-	-	-	-	-	-

Approach	EB		WB		NB		SB	
HCM Control Delay, s	11.9		13.2		0.1		0.5	
HCM LOS	B		B					

Minor Lane/Major Mvmt	NBL	NBT	NBR	EBLn1	WBLn1	SBL	SBT	SBR
Capacity (veh/h)	1340	-	-	530	508	1238	-	-
HCM Lane V/C Ratio	0.004	-	-	0.012	0.137	0.014	-	-
HCM Control Delay (s)	7.7	0	-	11.9	13.2	7.9	0	-
HCM Lane LOS	A	A	-	B	B	A	A	-
HCM 95th %tile Q(veh)	0	-	-	0	0.5	0	-	-

Intersection												
Int Delay, s/veh	7.9											
Movement	EBL	EBT	EBR	WBL	WBT	WBR	NBL	NBT	NBR	SBL	SBT	SBR
Lane Configurations	↖	↗			↖			↕			↕	
Traffic Vol, veh/h	9	0	4	0	0	0	12	0	0	0	0	55
Future Vol, veh/h	9	0	4	0	0	0	12	0	0	0	0	55
Conflicting Peds, #/hr	0	0	0	0	0	0	0	0	0	0	0	0
Sign Control	Free	Free	Free	Free	Free	Free	Stop	Stop	Stop	Stop	Stop	Stop
RT Channelized	-	-	None	-	-	None	-	-	None	-	-	None
Storage Length	100	-	-	-	-	-	-	-	-	-	-	-
Veh in Median Storage, #	-	0	-	-	0	-	-	0	-	-	0	-
Grade, %	-	0	-	-	0	-	-	0	-	-	0	-
Peak Hour Factor	85	85	85	85	85	85	85	85	85	85	85	85
Heavy Vehicles, %	2	2	2	2	2	2	2	2	2	2	2	2
Mvmt Flow	11	0	5	0	0	0	14	0	0	0	0	65

Major/Minor	Major1			Major2			Minor1			Minor2		
Conflicting Flow All	1	0	0	5	0	0	59	26	3	26	28	1
Stage 1	-	-	-	-	-	-	25	25	-	1	1	-
Stage 2	-	-	-	-	-	-	34	1	-	25	27	-
Critical Hdwy	4.12	-	-	4.12	-	-	7.12	6.52	6.22	7.12	6.52	6.22
Critical Hdwy Stg 1	-	-	-	-	-	-	6.12	5.52	-	6.12	5.52	-
Critical Hdwy Stg 2	-	-	-	-	-	-	6.12	5.52	-	6.12	5.52	-
Follow-up Hdwy	2.218	-	-	2.218	-	-	3.518	4.018	3.318	3.518	4.018	3.318
Pot Cap-1 Maneuver	1622	-	-	1616	-	0	937	867	1081	984	865	1084
Stage 1	-	-	-	-	-	0	993	874	-	1022	895	-
Stage 2	-	-	-	-	-	0	982	895	-	993	873	-
Platoon blocked, %	-	-	-	-	-	-	-	-	-	-	-	-
Mov Cap-1 Maneuver	1622	-	-	1616	-	-	876	861	1081	979	859	1084
Mov Cap-2 Maneuver	-	-	-	-	-	-	876	861	-	979	859	-
Stage 1	-	-	-	-	-	-	986	868	-	1015	895	-
Stage 2	-	-	-	-	-	-	923	895	-	986	867	-

Approach	EB			WB			NB			SB		
HCM Control Delay, s	5			0			9.2			8.5		
HCM LOS							A			A		

Minor Lane/Major Mvmt	NBLn1	EBL	EBT	EBR	WBL	WBT	SBLn1
Capacity (veh/h)	876	1622	-	-	1616	-	1084
HCM Lane V/C Ratio	0.016	0.007	-	-	-	-	0.06
HCM Control Delay (s)	9.2	7.2	-	-	0	-	8.5
HCM Lane LOS	A	A	-	-	A	-	A
HCM 95th %tile Q(veh)	0	0	-	-	0	-	0.2

Intersection						
Int Delay, s/veh	1.5					
Movement	WBL	WBR	NBT	NBR	SBL	SBT
Lane Configurations	↘	↗	↑	↗	↘	↑
Traffic Vol, veh/h	63	4	216	11	2	330
Future Vol, veh/h	63	4	216	11	2	330
Conflicting Peds, #/hr	0	0	0	0	0	0
Sign Control	Stop	Stop	Free	Free	Free	Free
RT Channelized	-	None	-	None	-	None
Storage Length	-	235	-	235	385	-
Veh in Median Storage, #	0	-	0	-	-	0
Grade, %	0	-	0	-	-	0
Peak Hour Factor	85	85	87	85	85	69
Heavy Vehicles, %	2	2	2	2	2	2
Mvmt Flow	74	5	248	13	2	478

Major/Minor	Minor1	Major1	Major2		
Conflicting Flow All	730	248	0	0	261
Stage 1	248	-	-	-	-
Stage 2	482	-	-	-	-
Critical Hdwy	6.42	6.22	-	-	4.12
Critical Hdwy Stg 1	5.42	-	-	-	-
Critical Hdwy Stg 2	5.42	-	-	-	-
Follow-up Hdwy	3.518	3.318	-	-	2.218
Pot Cap-1 Maneuver	389	791	-	-	1303
Stage 1	793	-	-	-	-
Stage 2	621	-	-	-	-
Platoon blocked, %			-	-	-
Mov Cap-1 Maneuver	388	791	-	-	1303
Mov Cap-2 Maneuver	388	-	-	-	-
Stage 1	793	-	-	-	-
Stage 2	620	-	-	-	-

Approach	WB	NB	SB
HCM Control Delay, s	16.1	0	0
HCM LOS	C		

Minor Lane/Major Mvmt	NBT	NBR	WBLn1	WBLn2	SBL	SBT
Capacity (veh/h)	-	-	388	791	1303	-
HCM Lane V/C Ratio	-	-	0.191	0.006	0.002	-
HCM Control Delay (s)	-	-	16.5	9.6	7.8	-
HCM Lane LOS	-	-	C	A	A	-
HCM 95th %tile Q(veh)	-	-	0.7	0	0	-

Intersection						
Int Delay, s/veh	1.1					
Movement	WBL	WBR	NBT	NBR	SBL	SBT
Lane Configurations	↘↙		↑↑	↗	↘	↑↑
Traffic Vol, veh/h	46	9	196	17	3	286
Future Vol, veh/h	46	9	196	17	3	286
Conflicting Peds, #/hr	0	0	0	0	0	0
Sign Control	Stop	Stop	Free	Free	Free	Free
RT Channelized	-	None	-	None	-	None
Storage Length	0	-	-	155	205	-
Veh in Median Storage, #	0	-	0	-	-	0
Grade, %	0	-	0	-	-	0
Peak Hour Factor	85	85	87	87	85	67
Heavy Vehicles, %	2	2	2	2	2	2
Mvmt Flow	54	11	225	20	4	427

Major/Minor	Minor1	Major1	Major2		
Conflicting Flow All	447	113	0	0	245
Stage 1	225	-	-	-	-
Stage 2	222	-	-	-	-
Critical Hdwy	6.84	6.94	-	-	4.14
Critical Hdwy Stg 1	5.84	-	-	-	-
Critical Hdwy Stg 2	5.84	-	-	-	-
Follow-up Hdwy	3.52	3.32	-	-	2.22
Pot Cap-1 Maneuver	540	918	-	-	1318
Stage 1	791	-	-	-	-
Stage 2	794	-	-	-	-
Platoon blocked, %			-	-	-
Mov Cap-1 Maneuver	538	918	-	-	1318
Mov Cap-2 Maneuver	538	-	-	-	-
Stage 1	791	-	-	-	-
Stage 2	792	-	-	-	-

Approach	WB	NB	SB
HCM Control Delay, s	12	0	0.1
HCM LOS	B		

Minor Lane/Major Mvmt	NBT	NBRWBLn1	SBL	SBT
Capacity (veh/h)	-	-	577	1318
HCM Lane V/C Ratio	-	-	0.112	0.003
HCM Control Delay (s)	-	-	12	7.7
HCM Lane LOS	-	-	B	A
HCM 95th %tile Q(veh)	-	-	0.4	0

Intersection												
Int Delay, s/veh	3											
Movement	EBL	EBT	EBR	WBL	WBT	WBR	NBL	NBT	NBR	SBL	SBT	SBR
Lane Configurations		↕			↕			↕	↕		↕	
Traffic Vol, veh/h	2	0	3	85	0	18	4	172	29	6	201	2
Future Vol, veh/h	2	0	3	85	0	18	4	172	29	6	201	2
Conflicting Peds, #/hr	0	0	0	0	0	0	0	0	0	0	0	0
Sign Control	Stop	Stop	Stop	Stop	Stop	Stop	Free	Free	Free	Free	Free	Free
RT Channelized	-	-	None	-	-	None	-	-	None	-	-	None
Storage Length	-	-	-	-	-	-	-	-	-	-	-	-
Veh in Median Storage, #	-	0	-	-	0	-	-	0	-	-	0	-
Grade, %	-	0	-	-	0	-	-	0	-	-	0	-
Peak Hour Factor	50	50	50	85	85	85	87	87	87	67	67	67
Heavy Vehicles, %	2	2	2	2	2	2	2	2	2	2	2	2
Mvmt Flow	4	0	6	100	0	21	5	198	33	9	300	3

Major/Minor	Minor2		Minor1		Major1		Major2					
Conflicting Flow All	555	561	302	531	529	198	303	0	0	231	0	0
Stage 1	320	320	-	208	208	-	-	-	-	-	-	-
Stage 2	235	241	-	323	321	-	-	-	-	-	-	-
Critical Hdwy	7.12	6.52	6.22	7.12	6.52	6.22	4.12	-	-	4.12	-	-
Critical Hdwy Stg 1	6.12	5.52	-	6.12	5.52	-	-	-	-	-	-	-
Critical Hdwy Stg 2	6.12	5.52	-	6.12	5.52	-	-	-	-	-	-	-
Follow-up Hdwy	3.518	4.018	3.318	3.518	4.018	3.318	2.218	-	-	2.218	-	-
Pot Cap-1 Maneuver	442	436	738	459	455	843	1258	-	-	1337	-	-
Stage 1	692	652	-	794	730	-	-	-	-	-	-	-
Stage 2	768	706	-	689	652	-	-	-	-	-	-	-
Platoon blocked, %								-	-	-	-	-
Mov Cap-1 Maneuver	427	430	738	451	449	843	1258	-	-	1337	-	-
Mov Cap-2 Maneuver	427	430	-	451	449	-	-	-	-	-	-	-
Stage 1	689	647	-	790	726	-	-	-	-	-	-	-
Stage 2	745	702	-	678	647	-	-	-	-	-	-	-

Approach	EB		WB		NB		SB	
HCM Control Delay, s	11.4		14.7		0.2		0.2	
HCM LOS	B		B					

Minor Lane/Major Mvmt	NBL	NBT	NBR	EBLn1	WBLn1	SBL	SBT	SBR
Capacity (veh/h)	1258	-	-	572	491	1337	-	-
HCM Lane V/C Ratio	0.004	-	-	0.017	0.247	0.007	-	-
HCM Control Delay (s)	7.9	0	-	11.4	14.7	7.7	0	-
HCM Lane LOS	A	A	-	B	B	A	A	-
HCM 95th %tile Q(veh)	0	-	-	0.1	1	0	-	-

Intersection												
Int Delay, s/veh	6.7											
Movement	EBL	EBT	EBR	WBL	WBT	WBR	NBL	NBT	NBR	SBL	SBT	SBR
Lane Configurations	↖	↗			↖			↔			↔	
Traffic Vol, veh/h	29	0	14	0	0	0	7	0	0	0	0	36
Future Vol, veh/h	29	0	14	0	0	0	7	0	0	0	0	36
Conflicting Peds, #/hr	0	0	0	0	0	0	0	0	0	0	0	0
Sign Control	Free	Free	Free	Free	Free	Free	Stop	Stop	Stop	Stop	Stop	Stop
RT Channelized	-	-	None	-	-	None	-	-	None	-	-	None
Storage Length	100	-	-	-	-	-	-	-	-	-	-	-
Veh in Median Storage, #	-	0	-	-	0	-	-	0	-	-	0	-
Grade, %	-	0	-	-	0	-	-	0	-	-	0	-
Peak Hour Factor	85	85	85	85	85	85	85	85	85	85	85	85
Heavy Vehicles, %	2	2	2	2	2	2	2	2	2	2	2	2
Mvmt Flow	34	0	16	0	0	0	8	0	0	0	0	42

Major/Minor	Major1			Major2			Minor1			Minor2		
Conflicting Flow All	1	0	0	16	0	0	98	77	8	77	85	1
Stage 1	-	-	-	-	-	-	76	76	-	1	1	-
Stage 2	-	-	-	-	-	-	22	1	-	76	84	-
Critical Hdwy	4.12	-	-	4.12	-	-	7.12	6.52	6.22	7.12	6.52	6.22
Critical Hdwy Stg 1	-	-	-	-	-	-	6.12	5.52	-	6.12	5.52	-
Critical Hdwy Stg 2	-	-	-	-	-	-	6.12	5.52	-	6.12	5.52	-
Follow-up Hdwy	2.218	-	-	2.218	-	-	3.518	4.018	3.318	3.518	4.018	3.318
Pot Cap-1 Maneuver	1622	-	-	1602	-	0	884	813	1074	912	805	1084
Stage 1	-	-	-	-	-	0	933	832	-	1022	895	-
Stage 2	-	-	-	-	-	0	996	895	-	933	825	-
Platoon blocked, %	-	-	-	-	-	-	-	-	-	-	-	-
Mov Cap-1 Maneuver	1622	-	-	1602	-	-	836	796	1074	897	788	1084
Mov Cap-2 Maneuver	-	-	-	-	-	-	836	796	-	897	788	-
Stage 1	-	-	-	-	-	-	913	815	-	1001	895	-
Stage 2	-	-	-	-	-	-	957	895	-	913	808	-

Approach	EB	WB	NB	SB
HCM Control Delay, s	4.9	0	9.3	8.5
HCM LOS			A	A

Minor Lane/Major Mvmt	NBLn1	EBL	EBT	EBR	WBL	WBT	SBLn1
Capacity (veh/h)	836	1622	-	-	1602	-	1084
HCM Lane V/C Ratio	0.01	0.021	-	-	-	-	0.039
HCM Control Delay (s)	9.3	7.3	-	-	0	-	8.5
HCM Lane LOS	A	A	-	-	A	-	A
HCM 95th %tile Q(veh)	0	0.1	-	-	0	-	0.1

Intersection						
Int Delay, s/veh	1					
Movement	WBL	WBR	NBT	NBR	SBL	SBT
Lane Configurations	↘	↗	↑	↗	↘	↑
Traffic Vol, veh/h	40	3	369	38	5	273
Future Vol, veh/h	40	3	369	38	5	273
Conflicting Peds, #/hr	0	0	0	0	0	0
Sign Control	Stop	Stop	Free	Free	Free	Free
RT Channelized	-	None	-	None	-	None
Storage Length	-	235	-	235	385	-
Veh in Median Storage, #	0	-	0	-	-	0
Grade, %	0	-	0	-	-	0
Peak Hour Factor	85	85	87	85	85	89
Heavy Vehicles, %	2	2	2	2	2	2
Mvmt Flow	47	4	424	45	6	307

Major/Minor	Minor1	Major1	Major2		
Conflicting Flow All	743	424	0	0	469
Stage 1	424	-	-	-	-
Stage 2	319	-	-	-	-
Critical Hdwy	6.42	6.22	-	-	4.12
Critical Hdwy Stg 1	5.42	-	-	-	-
Critical Hdwy Stg 2	5.42	-	-	-	-
Follow-up Hdwy	3.518	3.318	-	-	2.218
Pot Cap-1 Maneuver	383	630	-	-	1093
Stage 1	660	-	-	-	-
Stage 2	737	-	-	-	-
Platoon blocked, %			-	-	-
Mov Cap-1 Maneuver	381	630	-	-	1093
Mov Cap-2 Maneuver	381	-	-	-	-
Stage 1	660	-	-	-	-
Stage 2	733	-	-	-	-

Approach	WB	NB	SB
HCM Control Delay, s	15.4	0	0.2
HCM LOS	C		

Minor Lane/Major Mvmt	NBT	NBR	WBLn1	WBLn2	SBL	SBT
Capacity (veh/h)	-	-	381	630	1093	-
HCM Lane V/C Ratio	-	-	0.124	0.006	0.005	-
HCM Control Delay (s)	-	-	15.8	10.7	8.3	-
HCM Lane LOS	-	-	C	B	A	-
HCM 95th %tile Q(veh)	-	-	0.4	0	0	-

Intersection						
Int Delay, s/veh	0.8					
Movement	WBL	WBR	NBT	NBR	SBL	SBT
Lane Configurations	Y		↑↑	↑	↑	↑↑
Traffic Vol, veh/h	30	6	288	59	10	248
Future Vol, veh/h	30	6	288	59	10	248
Conflicting Peds, #/hr	0	0	0	0	0	0
Sign Control	Stop	Stop	Free	Free	Free	Free
RT Channelized	-	None	-	None	-	None
Storage Length	0	-	-	155	205	-
Veh in Median Storage, #	0	-	0	-	-	0
Grade, %	0	-	0	-	-	0
Peak Hour Factor	85	85	87	87	89	89
Heavy Vehicles, %	2	2	2	2	2	2
Mvmt Flow	35	7	331	68	11	279

Major/Minor	Minor1	Major1	Major2		
Conflicting Flow All	493	166	0	0	399
Stage 1	331	-	-	-	-
Stage 2	162	-	-	-	-
Critical Hdwy	6.84	6.94	-	-	4.14
Critical Hdwy Stg 1	5.84	-	-	-	-
Critical Hdwy Stg 2	5.84	-	-	-	-
Follow-up Hdwy	3.52	3.32	-	-	2.22
Pot Cap-1 Maneuver	505	849	-	-	1156
Stage 1	700	-	-	-	-
Stage 2	850	-	-	-	-
Platoon blocked, %			-	-	-
Mov Cap-1 Maneuver	500	849	-	-	1156
Mov Cap-2 Maneuver	500	-	-	-	-
Stage 1	700	-	-	-	-
Stage 2	842	-	-	-	-

Approach	WB	NB	SB
HCM Control Delay, s	12.3	0	0.3
HCM LOS	B		

Minor Lane/Major Mvmt	NBT	NBRWBLn1	SBL	SBT
Capacity (veh/h)	-	-	537	1156
HCM Lane V/C Ratio	-	-	0.079	0.01
HCM Control Delay (s)	-	-	12.3	8.1
HCM Lane LOS	-	-	B	A
HCM 95th %tile Q(veh)	-	-	0.3	0

Intersection												
Int Delay, s/veh	2.1											
Movement	EBL	EBT	EBR	WBL	WBT	WBR	NBL	NBT	NBR	SBL	SBT	SBR
Lane Configurations		↕			↕			↕	↕		↕	
Traffic Vol, veh/h	3	0	2	54	0	14	5	195	94	22	202	1
Future Vol, veh/h	3	0	2	54	0	14	5	195	94	22	202	1
Conflicting Peds, #/hr	0	0	0	0	0	0	0	0	0	0	0	0
Sign Control	Stop	Stop	Stop	Stop	Stop	Stop	Free	Free	Free	Free	Free	Free
RT Channelized	-	-	None	-	-	None	-	-	None	-	-	None
Storage Length	-	-	-	-	-	-	-	-	-	-	-	-
Veh in Median Storage, #	-	0	-	-	0	-	-	0	-	-	0	-
Grade, %	-	0	-	-	0	-	-	0	-	-	0	-
Peak Hour Factor	78	78	78	85	85	85	87	87	87	89	89	89
Heavy Vehicles, %	2	2	2	2	2	2	2	2	2	2	2	2
Mvmt Flow	4	0	3	64	0	16	6	224	108	25	227	1

Major/Minor	Minor2		Minor1		Major1		Major2					
Conflicting Flow All	576	622	228	515	514	224	228	0	0	332	0	0
Stage 1	278	278	-	236	236	-	-	-	-	-	-	-
Stage 2	298	344	-	279	278	-	-	-	-	-	-	-
Critical Hdwy	7.12	6.52	6.22	7.12	6.52	6.22	4.12	-	-	4.12	-	-
Critical Hdwy Stg 1	6.12	5.52	-	6.12	5.52	-	-	-	-	-	-	-
Critical Hdwy Stg 2	6.12	5.52	-	6.12	5.52	-	-	-	-	-	-	-
Follow-up Hdwy	3.518	4.018	3.318	3.518	4.018	3.318	2.218	-	-	2.218	-	-
Pot Cap-1 Maneuver	428	403	811	470	464	815	1340	-	-	1227	-	-
Stage 1	728	680	-	767	710	-	-	-	-	-	-	-
Stage 2	711	637	-	728	680	-	-	-	-	-	-	-
Platoon blocked, %								-	-	-	-	-
Mov Cap-1 Maneuver	410	391	811	458	451	815	1340	-	-	1227	-	-
Mov Cap-2 Maneuver	410	391	-	458	451	-	-	-	-	-	-	-
Stage 1	724	664	-	762	706	-	-	-	-	-	-	-
Stage 2	692	633	-	709	664	-	-	-	-	-	-	-

Approach	EB		WB		NB		SB	
HCM Control Delay, s	12.1		13.5		0.1		0.8	
HCM LOS	B		B					

Minor Lane/Major Mvmt	NBL	NBT	NBR	EBLn1	WBLn1	SBL	SBT	SBR
Capacity (veh/h)	1340	-	-	511	503	1227	-	-
HCM Lane V/C Ratio	0.004	-	-	0.013	0.159	0.02	-	-
HCM Control Delay (s)	7.7	0	-	12.1	13.5	8	0	-
HCM Lane LOS	A	A	-	B	B	A	A	-
HCM 95th %tile Q(veh)	0	-	-	0	0.6	0.1	-	-

Intersection												
Int Delay, s/veh	0.9											
Movement	EBL	EBT	EBR	WBL	WBT	WBR	NBL	NBT	NBR	SBL	SBT	SBR
Lane Configurations		↑↑	↑	↑	↑↑	↑			↑			↑
Traffic Vol, veh/h	0	999	39	62	1879	7	0	0	58	0	0	51
Future Vol, veh/h	0	999	39	62	1879	7	0	0	58	0	0	51
Conflicting Peds, #/hr	0	0	0	0	0	0	0	0	0	0	0	0
Sign Control	Free	Free	Free	Free	Free	Free	Stop	Stop	Stop	Stop	Stop	Stop
RT Channelized	-	-	None	-	-	None	-	-	None	-	-	None
Storage Length	-	-	205	100	-	205	-	-	0	-	-	0
Veh in Median Storage, #	-	0	-	-	0	-	-	0	-	-	0	-
Grade, %	-	0	-	-	0	-	-	0	-	-	0	-
Peak Hour Factor	95	95	95	95	95	95	95	95	95	95	95	95
Heavy Vehicles, %	2	2	2	2	2	2	2	2	2	2	2	2
Mvmt Flow	0	1052	41	65	1978	7	0	0	61	0	0	54

Major/Minor	Major1			Major2			Minor1			Minor2		
Conflicting Flow All	-	0	0	1093	0	0	-	-	526	-	-	989
Stage 1	-	-	-	-	-	-	-	-	-	-	-	-
Stage 2	-	-	-	-	-	-	-	-	-	-	-	-
Critical Hdwy	-	-	-	4.14	-	-	-	-	6.94	-	-	6.94
Critical Hdwy Stg 1	-	-	-	-	-	-	-	-	-	-	-	-
Critical Hdwy Stg 2	-	-	-	-	-	-	-	-	-	-	-	-
Follow-up Hdwy	-	-	-	2.22	-	-	-	-	3.32	-	-	3.32
Pot Cap-1 Maneuver	0	-	-	634	-	-	0	0	496	0	0	246
Stage 1	0	-	-	-	-	-	0	0	-	0	0	-
Stage 2	0	-	-	-	-	-	0	0	-	0	0	-
Platoon blocked, %	-	-	-	-	-	-	-	-	-	-	-	-
Mov Cap-1 Maneuver	-	-	-	634	-	-	-	-	496	-	-	246
Mov Cap-2 Maneuver	-	-	-	-	-	-	-	-	-	-	-	-
Stage 1	-	-	-	-	-	-	-	-	-	-	-	-
Stage 2	-	-	-	-	-	-	-	-	-	-	-	-

Approach	EB			WB			NB			SB		
HCM Control Delay, s	0			0.4			13.3			23.7		
HCM LOS							B			C		

Minor Lane/Major Mvmt	NBLn1	EBT	EBR	WBL	WBT	WBR	SBLn1
Capacity (veh/h)	496	-	-	634	-	-	246
HCM Lane V/C Ratio	0.123	-	-	0.103	-	-	0.218
HCM Control Delay (s)	13.3	-	-	11.3	-	-	23.7
HCM Lane LOS	B	-	-	B	-	-	C
HCM 95th %tile Q(veh)	0.4	-	-	0.3	-	-	0.8

Timings
8: Vollmer Rd & Briargate Pkwy

2042 Background Traffic
AM Peak Hour

Lane Group	EBL	EBT	EBR	WBL	WBT	WBR	NBL	NBT	NBR	SBL	SBT	SBR
Lane Configurations												
Traffic Volume (vph)	65	835	58	373	1488	69	89	139	128	75	299	120
Future Volume (vph)	65	835	58	373	1488	69	89	139	128	75	299	120
Turn Type	pm+pt	NA	Perm	Prot	NA	Perm	pm+pt	NA	Perm	pm+pt	NA	Perm
Protected Phases	5	2		1	6		3	8		7	4	
Permitted Phases	2		2			6	8		8	4		4
Detector Phase	5	2	2	1	6	6	3	8	8	7	4	4
Switch Phase												
Minimum Initial (s)	5.0	5.0	5.0	5.0	5.0	5.0	5.0	5.0	5.0	5.0	5.0	5.0
Minimum Split (s)	10.0	10.0	10.0	10.0	10.0	10.0	10.0	10.0	10.0	10.0	10.0	10.0
Total Split (s)	10.0	53.0	53.0	22.0	65.0	65.0	15.0	30.0	30.0	15.0	30.0	30.0
Total Split (%)	8.3%	44.2%	44.2%	18.3%	54.2%	54.2%	12.5%	25.0%	25.0%	12.5%	25.0%	25.0%
Yellow Time (s)	3.0	3.0	3.0	3.0	3.0	3.0	3.0	3.0	3.0	3.0	3.0	3.0
All-Red Time (s)	2.0	2.0	2.0	2.0	2.0	2.0	2.0	2.0	2.0	2.0	2.0	2.0
Lost Time Adjust (s)	0.0	0.0	0.0	0.0	0.0	0.0	0.0	0.0	0.0	0.0	0.0	0.0
Total Lost Time (s)	5.0	5.0	5.0	5.0	5.0	5.0	5.0	5.0	5.0	5.0	5.0	5.0
Lead/Lag	Lead	Lag	Lag	Lead	Lag	Lag	Lead	Lag	Lag	Lead	Lag	Lag
Lead-Lag Optimize?	Yes	Yes	Yes	Yes	Yes	Yes	Yes	Yes	Yes	Yes	Yes	Yes
Recall Mode	None	None	None	None	None	None	None	None	None	None	None	None
Act Effct Green (s)	44.6	39.2	39.2	16.1	53.5	53.5	22.0	15.2	15.2	21.7	15.0	15.0
Actuated g/C Ratio	0.46	0.40	0.40	0.17	0.55	0.55	0.23	0.16	0.16	0.22	0.15	0.15
v/c Ratio	0.40	0.61	0.08	0.69	0.80	0.08	0.35	0.26	0.36	0.24	0.57	0.34
Control Delay	18.1	25.5	0.2	48.9	23.8	1.1	33.4	41.5	7.7	31.5	45.7	6.2
Queue Delay	0.0	0.0	0.0	0.0	0.0	0.0	0.0	0.0	0.0	0.0	0.0	0.0
Total Delay	18.1	25.5	0.2	48.9	23.8	1.1	33.4	41.5	7.7	31.5	45.7	6.2
LOS	B	C	A	D	C	A	C	D	A	C	D	A
Approach Delay		23.5			27.8			27.3			33.9	
Approach LOS		C			C			C			C	

Intersection Summary

Cycle Length: 120
 Actuated Cycle Length: 97
 Natural Cycle: 70
 Control Type: Actuated-Uncoordinated
 Maximum v/c Ratio: 0.80
 Intersection Signal Delay: 27.5
 Intersection LOS: C
 Intersection Capacity Utilization 75.2%
 ICU Level of Service D
 Analysis Period (min) 15

Splits and Phases: 8: Vollmer Rd & Briargate Pkwy



Intersection						
Int Delay, s/veh	0.5					
Movement	WBL	WBR	NBT	NBR	SBL	SBT
Lane Configurations	Y		↑↑	↑	↑	↑↑
Traffic Vol, veh/h	29	2	254	6	1	465
Future Vol, veh/h	29	2	254	6	1	465
Conflicting Peds, #/hr	0	0	0	0	0	0
Sign Control	Stop	Stop	Free	Free	Free	Free
RT Channelized	-	None	-	None	-	None
Storage Length	0	-	-	155	205	-
Veh in Median Storage, #	0	-	0	-	-	0
Grade, %	0	-	0	-	-	0
Peak Hour Factor	95	95	95	95	95	95
Heavy Vehicles, %	2	2	2	2	2	2
Mvmt Flow	31	2	267	6	1	489

Major/Minor	Minor1	Major1	Major2		
Conflicting Flow All	514	134	0	0	273
Stage 1	267	-	-	-	-
Stage 2	247	-	-	-	-
Critical Hdwy	6.84	6.94	-	-	4.14
Critical Hdwy Stg 1	5.84	-	-	-	-
Critical Hdwy Stg 2	5.84	-	-	-	-
Follow-up Hdwy	3.52	3.32	-	-	2.22
Pot Cap-1 Maneuver	490	890	-	-	1287
Stage 1	754	-	-	-	-
Stage 2	771	-	-	-	-
Platoon blocked, %			-	-	-
Mov Cap-1 Maneuver	490	890	-	-	1287
Mov Cap-2 Maneuver	490	-	-	-	-
Stage 1	754	-	-	-	-
Stage 2	770	-	-	-	-

Approach	WB	NB	SB
HCM Control Delay, s	12.6	0	0
HCM LOS	B		

Minor Lane/Major Mvmt	NBT	NBRWBLn1	SBL	SBT
Capacity (veh/h)	-	-	505	1287
HCM Lane V/C Ratio	-	-	0.065	0.001
HCM Control Delay (s)	-	-	12.6	7.8
HCM Lane LOS	-	-	B	A
HCM 95th %tile Q(veh)	-	-	0.2	0

Intersection												
Int Delay, s/veh	1.4											
Movement	EBL	EBT	EBR	WBL	WBT	WBR	NBL	NBT	NBR	SBL	SBT	SBR
Lane Configurations		↕			↕			↕	↕		↕	
Traffic Vol, veh/h	2	0	3	53	0	3	4	230	22	1	410	2
Future Vol, veh/h	2	0	3	53	0	3	4	230	22	1	410	2
Conflicting Peds, #/hr	0	0	0	0	0	0	0	0	0	0	0	0
Sign Control	Stop	Stop	Stop	Stop	Stop	Stop	Free	Free	Free	Free	Free	Free
RT Channelized	-	-	None	-	-	None	-	-	None	-	-	None
Storage Length	-	-	-	-	-	-	-	-	-	-	-	-
Veh in Median Storage, #	-	0	-	-	0	-	-	0	-	-	0	-
Grade, %	-	0	-	-	0	-	-	0	-	-	0	-
Peak Hour Factor	95	95	95	95	95	95	95	95	95	95	95	95
Heavy Vehicles, %	2	2	2	2	2	2	2	2	2	2	2	2
Mvmt Flow	2	0	3	56	0	3	4	242	23	1	432	2

Major/Minor	Minor2		Minor1		Major1		Major2					
Conflicting Flow All	698	708	433	687	686	242	434	0	0	265	0	0
Stage 1	435	435	-	250	250	-	-	-	-	-	-	-
Stage 2	263	273	-	437	436	-	-	-	-	-	-	-
Critical Hdwy	7.12	6.52	6.22	7.12	6.52	6.22	4.12	-	-	4.12	-	-
Critical Hdwy Stg 1	6.12	5.52	-	6.12	5.52	-	-	-	-	-	-	-
Critical Hdwy Stg 2	6.12	5.52	-	6.12	5.52	-	-	-	-	-	-	-
Follow-up Hdwy	3.518	4.018	3.318	3.518	4.018	3.318	2.218	-	-	2.218	-	-
Pot Cap-1 Maneuver	355	360	623	361	370	797	1126	-	-	1299	-	-
Stage 1	600	580	-	754	700	-	-	-	-	-	-	-
Stage 2	742	684	-	598	580	-	-	-	-	-	-	-
Platoon blocked, %								-	-	-	-	-
Mov Cap-1 Maneuver	352	358	623	358	368	797	1126	-	-	1299	-	-
Mov Cap-2 Maneuver	352	358	-	358	368	-	-	-	-	-	-	-
Stage 1	598	579	-	751	697	-	-	-	-	-	-	-
Stage 2	736	681	-	594	579	-	-	-	-	-	-	-

Approach	EB	WB	NB	SB
HCM Control Delay, s	12.6	16.6	0.1	0
HCM LOS	B	C		

Minor Lane/Major Mvmt	NBL	NBT	NBR	EBLn1	WBLn1	SBL	SBT	SBR
Capacity (veh/h)	1126	-	-	476	369	1299	-	-
HCM Lane V/C Ratio	0.004	-	-	0.011	0.16	0.001	-	-
HCM Control Delay (s)	8.2	0	-	12.6	16.6	7.8	0	-
HCM Lane LOS	A	A	-	B	C	A	A	-
HCM 95th %tile Q(veh)	0	-	-	0	0.6	0	-	-

Intersection												
Int Delay, s/veh	2.8											
Movement	EBL	EBT	EBR	WBL	WBT	WBR	NBL	NBT	NBR	SBL	SBT	SBR
Lane Configurations		↑↑	↑	↑	↑↑	↑			↑			↑
Traffic Vol, veh/h	0	1788	117	153	1608	9	0	0	140	0	0	35
Future Vol, veh/h	0	1788	117	153	1608	9	0	0	140	0	0	35
Conflicting Peds, #/hr	0	0	0	0	0	0	0	0	0	0	0	0
Sign Control	Free	Free	Free	Free	Free	Free	Stop	Stop	Stop	Stop	Stop	Stop
RT Channelized	-	-	None	-	-	None	-	-	None	-	-	None
Storage Length	-	-	205	100	-	205	-	-	0	-	-	0
Veh in Median Storage, #	-	0	-	-	0	-	-	0	-	-	0	-
Grade, %	-	0	-	-	0	-	-	0	-	-	0	-
Peak Hour Factor	95	95	95	95	95	95	95	95	95	95	95	95
Heavy Vehicles, %	2	2	2	2	2	2	2	2	2	2	2	2
Mvmt Flow	0	1882	123	161	1693	9	0	0	147	0	0	37

Major/Minor	Major1			Major2			Minor1			Minor2		
Conflicting Flow All	-	0	0	2005	0	0	-	-	941	-	-	847
Stage 1	-	-	-	-	-	-	-	-	-	-	-	-
Stage 2	-	-	-	-	-	-	-	-	-	-	-	-
Critical Hdwy	-	-	-	4.14	-	-	-	-	6.94	-	-	6.94
Critical Hdwy Stg 1	-	-	-	-	-	-	-	-	-	-	-	-
Critical Hdwy Stg 2	-	-	-	-	-	-	-	-	-	-	-	-
Follow-up Hdwy	-	-	-	2.22	-	-	-	-	3.32	-	-	3.32
Pot Cap-1 Maneuver	0	-	-	282	-	-	0	0	264	0	0	305
Stage 1	0	-	-	-	-	-	0	0	-	0	0	-
Stage 2	0	-	-	-	-	-	0	0	-	0	0	-
Platoon blocked, %	-	-	-	-	-	-	-	-	-	-	-	-
Mov Cap-1 Maneuver	-	-	-	282	-	-	-	-	264	-	-	305
Mov Cap-2 Maneuver	-	-	-	-	-	-	-	-	-	-	-	-
Stage 1	-	-	-	-	-	-	-	-	-	-	-	-
Stage 2	-	-	-	-	-	-	-	-	-	-	-	-

Approach	EB			WB			NB			SB		
HCM Control Delay, s	0			2.9			34.6			18.4		
HCM LOS							D			C		

Minor Lane/Major Mvmt	NBLn1	EBT	EBR	WBL	WBT	WBR	SBLn1
Capacity (veh/h)	264	-	-	282	-	-	305
HCM Lane V/C Ratio	0.558	-	-	0.571	-	-	0.121
HCM Control Delay (s)	34.6	-	-	33.5	-	-	18.4
HCM Lane LOS	D	-	-	D	-	-	C
HCM 95th %tile Q(veh)	3.1	-	-	3.3	-	-	0.4

Timings
8: Vollmer Rd & Briargate Pkwy

2042 Background Traffic
PM Peak Hour

Lane Group	EBL	EBT	EBR	WBL	WBT	WBR	NBL	NBT	NBR	SBL	SBT	SBR
Lane Configurations												
Traffic Volume (vph)	216	1447	105	346	1216	81	206	433	368	90	208	107
Future Volume (vph)	216	1447	105	346	1216	81	206	433	368	90	208	107
Turn Type	pm+pt	NA	Perm	Prot	NA	Perm	pm+pt	NA	Perm	pm+pt	NA	Perm
Protected Phases	5	2		1	6		3	8		7	4	
Permitted Phases	2		2			6	8		8	4		4
Detector Phase	5	2	2	1	6	6	3	8	8	7	4	4
Switch Phase												
Minimum Initial (s)	5.0	5.0	5.0	5.0	5.0	5.0	5.0	5.0	5.0	5.0	5.0	5.0
Minimum Split (s)	10.0	10.0	10.0	10.0	10.0	10.0	10.0	10.0	10.0	10.0	10.0	10.0
Total Split (s)	20.0	44.0	44.0	35.0	59.0	59.0	21.0	28.0	28.0	13.0	20.0	20.0
Total Split (%)	16.7%	36.7%	36.7%	29.2%	49.2%	49.2%	17.5%	23.3%	23.3%	10.8%	16.7%	16.7%
Yellow Time (s)	3.0	3.0	3.0	3.0	3.0	3.0	3.0	3.0	3.0	3.0	3.0	3.0
All-Red Time (s)	2.0	2.0	2.0	2.0	2.0	2.0	2.0	2.0	2.0	2.0	2.0	2.0
Lost Time Adjust (s)	0.0	0.0	0.0	0.0	0.0	0.0	0.0	0.0	0.0	0.0	0.0	0.0
Total Lost Time (s)	5.0	5.0	5.0	5.0	5.0	5.0	5.0	5.0	5.0	5.0	5.0	5.0
Lead/Lag	Lead	Lag	Lag	Lead	Lag	Lag	Lead	Lag	Lag	Lead	Lag	Lag
Lead-Lag Optimize?	Yes	Yes	Yes	Yes	Yes	Yes	Yes	Yes	Yes	Yes	Yes	Yes
Recall Mode	None	Max	Max	None	Max	Max	None	None	None	None	None	None
Act Effct Green (s)	63.7	50.1	50.1	17.6	54.1	54.1	32.7	20.1	20.1	20.9	13.2	13.2
Actuated g/C Ratio	0.55	0.43	0.43	0.15	0.47	0.47	0.28	0.17	0.17	0.18	0.11	0.11
v/c Ratio	0.79	0.96	0.14	0.70	0.77	0.10	0.65	0.72	0.65	0.46	0.54	0.32
Control Delay	46.2	48.8	0.4	54.1	30.3	0.2	43.8	52.5	9.9	40.0	54.2	2.3
Queue Delay	0.0	0.0	0.0	0.0	0.0	0.0	0.0	0.0	0.0	0.0	0.0	0.0
Total Delay	46.2	48.8	0.4	54.1	30.3	0.2	43.8	52.5	9.9	40.0	54.2	2.3
LOS	D	D	A	D	C	A	D	D	A	D	D	A
Approach Delay		45.5			33.9			34.9			37.3	
Approach LOS		D			C			C			D	

Intersection Summary

Cycle Length: 120
 Actuated Cycle Length: 115.6
 Natural Cycle: 90
 Control Type: Actuated-Uncoordinated
 Maximum v/c Ratio: 0.96
 Intersection Signal Delay: 38.6
 Intersection LOS: D
 Intersection Capacity Utilization 83.7%
 ICU Level of Service E
 Analysis Period (min) 15

Splits and Phases: 8: Vollmer Rd & Briargate Pkwy



Intersection						
Int Delay, s/veh	0.4					
Movement	WBL	WBR	NBT	NBR	SBL	SBT
Lane Configurations	Y ^Y		↑↑	↑	↑	↑↑
Traffic Vol, veh/h	17	2	651	27	4	388
Future Vol, veh/h	17	2	651	27	4	388
Conflicting Peds, #/hr	0	0	0	0	0	0
Sign Control	Stop	Stop	Free	Free	Free	Free
RT Channelized	-	None	-	None	-	None
Storage Length	0	-	-	155	205	-
Veh in Median Storage, #	0	-	0	-	-	0
Grade, %	0	-	0	-	-	0
Peak Hour Factor	95	95	95	95	95	95
Heavy Vehicles, %	2	2	2	2	2	2
Mvmt Flow	18	2	685	28	4	408

Major/Minor	Minor1	Major1	Major2		
Conflicting Flow All	897	343	0	0	713
Stage 1	685	-	-	-	-
Stage 2	212	-	-	-	-
Critical Hdwy	6.84	6.94	-	-	4.14
Critical Hdwy Stg 1	5.84	-	-	-	-
Critical Hdwy Stg 2	5.84	-	-	-	-
Follow-up Hdwy	3.52	3.32	-	-	2.22
Pot Cap-1 Maneuver	279	653	-	-	883
Stage 1	462	-	-	-	-
Stage 2	803	-	-	-	-
Platoon blocked, %			-	-	-
Mov Cap-1 Maneuver	278	653	-	-	883
Mov Cap-2 Maneuver	278	-	-	-	-
Stage 1	462	-	-	-	-
Stage 2	799	-	-	-	-

Approach	WB	NB	SB
HCM Control Delay, s	18	0	0.1
HCM LOS	C		

Minor Lane/Major Mvmt	NBT	NBRWBLn1	SBL	SBT
Capacity (veh/h)	-	-	296	883
HCM Lane V/C Ratio	-	-	0.068	0.005
HCM Control Delay (s)	-	-	18	9.1
HCM Lane LOS	-	-	C	A
HCM 95th %tile Q(veh)	-	-	0.2	0

Intersection												
Int Delay, s/veh	1.1											
Movement	EBL	EBT	EBR	WBL	WBT	WBR	NBL	NBT	NBR	SBL	SBT	SBR
Lane Configurations		↕			↕			↕	↕		↕	
Traffic Vol, veh/h	3	0	2	36	0	2	5	574	74	4	354	1
Future Vol, veh/h	3	0	2	36	0	2	5	574	74	4	354	1
Conflicting Peds, #/hr	0	0	0	0	0	0	0	0	0	0	0	0
Sign Control	Stop	Stop	Stop	Stop	Stop	Stop	Free	Free	Free	Free	Free	Free
RT Channelized	-	-	None	-	-	None	-	-	None	-	-	None
Storage Length	-	-	-	-	-	-	-	-	-	-	-	-
Veh in Median Storage, #	-	0	-	-	0	-	-	0	-	-	0	-
Grade, %	-	0	-	-	0	-	-	0	-	-	0	-
Peak Hour Factor	95	95	95	95	95	95	95	95	95	95	95	95
Heavy Vehicles, %	2	2	2	2	2	2	2	2	2	2	2	2
Mvmt Flow	3	0	2	38	0	2	5	604	78	4	373	1

Major/Minor	Minor2		Minor1		Major1		Major2					
Conflicting Flow All	1036	1074	374	997	996	604	374	0	0	682	0	0
Stage 1	382	382	-	614	614	-	-	-	-	-	-	-
Stage 2	654	692	-	383	382	-	-	-	-	-	-	-
Critical Hdwy	7.12	6.52	6.22	7.12	6.52	6.22	4.12	-	-	4.12	-	-
Critical Hdwy Stg 1	6.12	5.52	-	6.12	5.52	-	-	-	-	-	-	-
Critical Hdwy Stg 2	6.12	5.52	-	6.12	5.52	-	-	-	-	-	-	-
Follow-up Hdwy	3.518	4.018	3.318	3.518	4.018	3.318	2.218	-	-	2.218	-	-
Pot Cap-1 Maneuver	210	220	672	223	244	498	1184	-	-	911	-	-
Stage 1	640	613	-	479	483	-	-	-	-	-	-	-
Stage 2	456	445	-	640	613	-	-	-	-	-	-	-
Platoon blocked, %								-	-	-	-	-
Mov Cap-1 Maneuver	207	217	672	220	241	498	1184	-	-	911	-	-
Mov Cap-2 Maneuver	207	217	-	220	241	-	-	-	-	-	-	-
Stage 1	636	609	-	476	480	-	-	-	-	-	-	-
Stage 2	451	442	-	634	609	-	-	-	-	-	-	-

Approach	EB		WB		NB		SB	
HCM Control Delay, s	17.8		24.2		0.1		0.1	
HCM LOS	C		C					

Minor Lane/Major Mvmt	NBL	NBT	NBR	EBLn1	WBLn1	SBL	SBT	SBR
Capacity (veh/h)	1184	-	-	286	227	911	-	-
HCM Lane V/C Ratio	0.004	-	-	0.018	0.176	0.005	-	-
HCM Control Delay (s)	8.1	0	-	17.8	24.2	9	0	-
HCM Lane LOS	A	A	-	C	C	A	A	-
HCM 95th %tile Q(veh)	0	-	-	0.1	0.6	0	-	-

Intersection												
Int Delay, s/veh	0.9											
Movement	EBL	EBT	EBR	WBL	WBT	WBR	NBL	NBT	NBR	SBL	SBT	SBR
Lane Configurations		↑↑	↑	↑	↑↑	↑			↑			↑
Traffic Vol, veh/h	0	1005	39	62	1879	9	0	0	58	0	0	51
Future Vol, veh/h	0	1005	39	62	1879	9	0	0	58	0	0	51
Conflicting Peds, #/hr	0	0	0	0	0	0	0	0	0	0	0	0
Sign Control	Free	Free	Free	Free	Free	Free	Stop	Stop	Stop	Stop	Stop	Stop
RT Channelized	-	-	None	-	-	None	-	-	None	-	-	None
Storage Length	-	-	205	100	-	205	-	-	0	-	-	0
Veh in Median Storage, #	-	0	-	-	0	-	-	0	-	-	0	-
Grade, %	-	0	-	-	0	-	-	0	-	-	0	-
Peak Hour Factor	95	95	95	95	95	95	95	95	95	95	95	95
Heavy Vehicles, %	2	2	2	2	2	2	2	2	2	2	2	2
Mvmt Flow	0	1058	41	65	1978	9	0	0	61	0	0	54

Major/Minor	Major1			Major2			Minor1			Minor2		
Conflicting Flow All	-	0	0	1099	0	0	-	-	529	-	-	989
Stage 1	-	-	-	-	-	-	-	-	-	-	-	-
Stage 2	-	-	-	-	-	-	-	-	-	-	-	-
Critical Hdwy	-	-	-	4.14	-	-	-	-	6.94	-	-	6.94
Critical Hdwy Stg 1	-	-	-	-	-	-	-	-	-	-	-	-
Critical Hdwy Stg 2	-	-	-	-	-	-	-	-	-	-	-	-
Follow-up Hdwy	-	-	-	2.22	-	-	-	-	3.32	-	-	3.32
Pot Cap-1 Maneuver	0	-	-	631	-	-	0	0	494	0	0	246
Stage 1	0	-	-	-	-	-	0	0	-	0	0	-
Stage 2	0	-	-	-	-	-	0	0	-	0	0	-
Platoon blocked, %	-	-	-	-	-	-	-	-	-	-	-	-
Mov Cap-1 Maneuver	-	-	-	631	-	-	-	-	494	-	-	246
Mov Cap-2 Maneuver	-	-	-	-	-	-	-	-	-	-	-	-
Stage 1	-	-	-	-	-	-	-	-	-	-	-	-
Stage 2	-	-	-	-	-	-	-	-	-	-	-	-

Approach	EB			WB			NB			SB		
HCM Control Delay, s	0			0.4			13.3			23.7		
HCM LOS							B			C		

Minor Lane/Major Mvmt	NBLn1	EBT	EBR	WBL	WBT	WBR	SBLn1
Capacity (veh/h)	494	-	-	631	-	-	246
HCM Lane V/C Ratio	0.124	-	-	0.103	-	-	0.218
HCM Control Delay (s)	13.3	-	-	11.4	-	-	23.7
HCM Lane LOS	B	-	-	B	-	-	C
HCM 95th %tile Q(veh)	0.4	-	-	0.3	-	-	0.8

Timings
8: Vollmer Rd & Briargate Pkwy

2042 Total Traffic
AM Peak Hour

Lane Group	EBL	EBT	EBR	WBL	WBT	WBR	NBL	NBT	NBR	SBL	SBT	SBR
Lane Configurations												
Traffic Volume (vph)	69	835	58	373	1488	69	89	146	128	81	321	133
Future Volume (vph)	69	835	58	373	1488	69	89	146	128	81	321	133
Turn Type	pm+pt	NA	Perm	Prot	NA	Perm	pm+pt	NA	Perm	pm+pt	NA	Perm
Protected Phases	5	2		1	6		3	8		7	4	
Permitted Phases	2		2			6	8		8	4		4
Detector Phase	5	2	2	1	6	6	3	8	8	7	4	4
Switch Phase												
Minimum Initial (s)	5.0	5.0	5.0	5.0	5.0	5.0	5.0	5.0	5.0	5.0	5.0	5.0
Minimum Split (s)	10.0	10.0	10.0	10.0	10.0	10.0	10.0	10.0	10.0	10.0	10.0	10.0
Total Split (s)	10.0	53.0	53.0	22.0	65.0	65.0	15.0	30.0	30.0	15.0	30.0	30.0
Total Split (%)	8.3%	44.2%	44.2%	18.3%	54.2%	54.2%	12.5%	25.0%	25.0%	12.5%	25.0%	25.0%
Yellow Time (s)	3.0	3.0	3.0	3.0	3.0	3.0	3.0	3.0	3.0	3.0	3.0	3.0
All-Red Time (s)	2.0	2.0	2.0	2.0	2.0	2.0	2.0	2.0	2.0	2.0	2.0	2.0
Lost Time Adjust (s)	0.0	0.0	0.0	0.0	0.0	0.0	0.0	0.0	0.0	0.0	0.0	0.0
Total Lost Time (s)	5.0	5.0	5.0	5.0	5.0	5.0	5.0	5.0	5.0	5.0	5.0	5.0
Lead/Lag	Lead	Lag	Lag	Lead	Lag	Lag	Lead	Lag	Lag	Lead	Lag	Lag
Lead-Lag Optimize?	Yes	Yes	Yes	Yes	Yes	Yes	Yes	Yes	Yes	Yes	Yes	Yes
Recall Mode	None	None	None	None	None	None	None	None	None	None	None	None
Act Effct Green (s)	44.8	39.4	39.4	16.1	53.7	53.7	22.9	16.0	16.0	22.7	16.0	16.0
Actuated g/C Ratio	0.46	0.40	0.40	0.16	0.55	0.55	0.23	0.16	0.16	0.23	0.16	0.16
v/c Ratio	0.43	0.62	0.08	0.70	0.81	0.08	0.35	0.27	0.35	0.26	0.59	0.36
Control Delay	20.0	26.1	0.2	49.9	24.6	1.2	33.3	41.2	7.4	31.4	45.6	8.1
Queue Delay	0.0	0.0	0.0	0.0	0.0	0.0	0.0	0.0	0.0	0.0	0.0	0.0
Total Delay	20.0	26.1	0.2	49.9	24.6	1.2	33.3	41.2	7.4	31.4	45.6	8.1
LOS	B	C	A	D	C	A	C	D	A	C	D	A
Approach Delay		24.1			28.6			27.3			34.1	
Approach LOS		C			C			C			C	

Intersection Summary

Cycle Length: 120
 Actuated Cycle Length: 98.2
 Natural Cycle: 70
 Control Type: Actuated-Uncoordinated
 Maximum v/c Ratio: 0.81
 Intersection Signal Delay: 28.1
 Intersection LOS: C
 Intersection Capacity Utilization 75.8%
 ICU Level of Service D
 Analysis Period (min) 15

Splits and Phases: 8: Vollmer Rd & Briargate Pkwy



Intersection						
Int Delay, s/veh	1.1					
Movement	WBL	WBR	NBT	NBR	SBL	SBT
Lane Configurations	Y		↑↑	↑	↑	↑↑
Traffic Vol, veh/h	61	2	256	15	1	474
Future Vol, veh/h	61	2	256	15	1	474
Conflicting Peds, #/hr	0	0	0	0	0	0
Sign Control	Stop	Stop	Free	Free	Free	Free
RT Channelized	-	None	-	None	-	None
Storage Length	0	-	-	155	205	-
Veh in Median Storage, #	0	-	0	-	-	0
Grade, %	0	-	0	-	-	0
Peak Hour Factor	95	95	95	95	95	95
Heavy Vehicles, %	2	2	2	2	2	2
Mvmt Flow	64	2	269	16	1	499

Major/Minor	Minor1	Major1	Major2		
Conflicting Flow All	521	135	0	0	285
Stage 1	269	-	-	-	-
Stage 2	252	-	-	-	-
Critical Hdwy	6.84	6.94	-	-	4.14
Critical Hdwy Stg 1	5.84	-	-	-	-
Critical Hdwy Stg 2	5.84	-	-	-	-
Follow-up Hdwy	3.52	3.32	-	-	2.22
Pot Cap-1 Maneuver	485	889	-	-	1274
Stage 1	752	-	-	-	-
Stage 2	767	-	-	-	-
Platoon blocked, %			-	-	-
Mov Cap-1 Maneuver	485	889	-	-	1274
Mov Cap-2 Maneuver	485	-	-	-	-
Stage 1	752	-	-	-	-
Stage 2	766	-	-	-	-

Approach	WB	NB	SB
HCM Control Delay, s	13.5	0	0
HCM LOS	B		

Minor Lane/Major Mvmt	NBT	NBRWBLn1	SBL	SBT
Capacity (veh/h)	-	-	492	1274
HCM Lane V/C Ratio	-	-	0.135	0.001
HCM Control Delay (s)	-	-	13.5	7.8
HCM Lane LOS	-	-	B	A
HCM 95th %tile Q(veh)	-	-	0.5	0

Intersection												
Int Delay, s/veh	1.6											
Movement	EBL	EBT	EBR	WBL	WBT	WBR	NBL	NBT	NBR	SBL	SBT	SBR
Lane Configurations		↕			↕			↕	↕		↕	
Traffic Vol, veh/h	2	0	3	62	0	5	4	230	24	1	410	2
Future Vol, veh/h	2	0	3	62	0	5	4	230	24	1	410	2
Conflicting Peds, #/hr	0	0	0	0	0	0	0	0	0	0	0	0
Sign Control	Stop	Stop	Stop	Stop	Stop	Stop	Free	Free	Free	Free	Free	Free
RT Channelized	-	-	None	-	-	None	-	-	None	-	-	None
Storage Length	-	-	-	-	-	-	-	-	-	-	-	-
Veh in Median Storage, #	-	0	-	-	0	-	-	0	-	-	0	-
Grade, %	-	0	-	-	0	-	-	0	-	-	0	-
Peak Hour Factor	95	95	95	95	95	95	95	95	95	95	95	95
Heavy Vehicles, %	2	2	2	2	2	2	2	2	2	2	2	2
Mvmt Flow	2	0	3	65	0	5	4	242	25	1	432	2

Major/Minor	Minor2		Minor1		Major1		Major2					
Conflicting Flow All	700	710	433	687	686	242	434	0	0	267	0	0
Stage 1	435	435	-	250	250	-	-	-	-	-	-	-
Stage 2	265	275	-	437	436	-	-	-	-	-	-	-
Critical Hdwy	7.12	6.52	6.22	7.12	6.52	6.22	4.12	-	-	4.12	-	-
Critical Hdwy Stg 1	6.12	5.52	-	6.12	5.52	-	-	-	-	-	-	-
Critical Hdwy Stg 2	6.12	5.52	-	6.12	5.52	-	-	-	-	-	-	-
Follow-up Hdwy	3.518	4.018	3.318	3.518	4.018	3.318	2.218	-	-	2.218	-	-
Pot Cap-1 Maneuver	354	359	623	361	370	797	1126	-	-	1297	-	-
Stage 1	600	580	-	754	700	-	-	-	-	-	-	-
Stage 2	740	683	-	598	580	-	-	-	-	-	-	-
Platoon blocked, %								-	-	-	-	-
Mov Cap-1 Maneuver	350	357	623	358	368	797	1126	-	-	1297	-	-
Mov Cap-2 Maneuver	350	357	-	358	368	-	-	-	-	-	-	-
Stage 1	598	579	-	751	697	-	-	-	-	-	-	-
Stage 2	732	680	-	594	579	-	-	-	-	-	-	-

Approach	EB	WB	NB	SB
HCM Control Delay, s	12.7	16.9	0.1	0
HCM LOS	B	C		

Minor Lane/Major Mvmt	NBL	NBT	NBR	EBLn1	WBLn1	SBL	SBT	SBR
Capacity (veh/h)	1126	-	-	475	373	1297	-	-
HCM Lane V/C Ratio	0.004	-	-	0.011	0.189	0.001	-	-
HCM Control Delay (s)	8.2	0	-	12.7	16.9	7.8	0	-
HCM Lane LOS	A	A	-	B	C	A	A	-
HCM 95th %tile Q(veh)	0	-	-	0	0.7	0	-	-

Intersection												
Int Delay, s/veh	2.8											
Movement	EBL	EBT	EBR	WBL	WBT	WBR	NBL	NBT	NBR	SBL	SBT	SBR
Lane Configurations		↑↑	↑	↑	↑↑	↑			↑			↑
Traffic Vol, veh/h	0	1792	117	153	1609	14	0	0	140	0	0	35
Future Vol, veh/h	0	1792	117	153	1609	14	0	0	140	0	0	35
Conflicting Peds, #/hr	0	0	0	0	0	0	0	0	0	0	0	0
Sign Control	Free	Free	Free	Free	Free	Free	Stop	Stop	Stop	Stop	Stop	Stop
RT Channelized	-	-	None	-	-	None	-	-	None	-	-	None
Storage Length	-	-	205	100	-	205	-	-	0	-	-	0
Veh in Median Storage, #	-	0	-	-	0	-	-	0	-	-	0	-
Grade, %	-	0	-	-	0	-	-	0	-	-	0	-
Peak Hour Factor	95	95	95	95	95	95	95	95	95	95	95	95
Heavy Vehicles, %	2	2	2	2	2	2	2	2	2	2	2	2
Mvmt Flow	0	1886	123	161	1694	15	0	0	147	0	0	37

Major/Minor	Major1			Major2			Minor1			Minor2		
Conflicting Flow All	-	0	0	2009	0	0	-	-	943	-	-	847
Stage 1	-	-	-	-	-	-	-	-	-	-	-	-
Stage 2	-	-	-	-	-	-	-	-	-	-	-	-
Critical Hdwy	-	-	-	4.14	-	-	-	-	6.94	-	-	6.94
Critical Hdwy Stg 1	-	-	-	-	-	-	-	-	-	-	-	-
Critical Hdwy Stg 2	-	-	-	-	-	-	-	-	-	-	-	-
Follow-up Hdwy	-	-	-	2.22	-	-	-	-	3.32	-	-	3.32
Pot Cap-1 Maneuver	0	-	-	281	-	-	0	0	264	0	0	305
Stage 1	0	-	-	-	-	-	0	0	-	0	0	-
Stage 2	0	-	-	-	-	-	0	0	-	0	0	-
Platoon blocked, %	-	-	-	-	-	-	-	-	-	-	-	-
Mov Cap-1 Maneuver	-	-	-	281	-	-	-	-	264	-	-	305
Mov Cap-2 Maneuver	-	-	-	-	-	-	-	-	-	-	-	-
Stage 1	-	-	-	-	-	-	-	-	-	-	-	-
Stage 2	-	-	-	-	-	-	-	-	-	-	-	-

Approach	EB			WB			NB			SB		
HCM Control Delay, s	0			2.9			34.6			18.4		
HCM LOS							D			C		

Minor Lane/Major Mvmt	NBLn1	EBT	EBR	WBL	WBT	WBR	SBLn1
Capacity (veh/h)	264	-	-	281	-	-	305
HCM Lane V/C Ratio	0.558	-	-	0.573	-	-	0.121
HCM Control Delay (s)	34.6	-	-	33.7	-	-	18.4
HCM Lane LOS	D	-	-	D	-	-	C
HCM 95th %tile Q(veh)	3.1	-	-	3.3	-	-	0.4

Timings
8: Vollmer Rd & Briargate Pkwy

2042 Total Traffic
PM Peak Hour

Lane Group	EBL	EBT	EBR	WBL	WBT	WBR	NBL	NBT	NBR	SBL	SBT	SBR
Lane Configurations												
Traffic Volume (vph)	230	1447	105	346	1216	82	206	459	368	94	223	115
Future Volume (vph)	230	1447	105	346	1216	82	206	459	368	94	223	115
Turn Type	pm+pt	NA	Perm	Prot	NA	Perm	pm+pt	NA	Perm	pm+pt	NA	Perm
Protected Phases	5	2		1	6		3	8		7	4	
Permitted Phases	2		2			6	8		8	4		4
Detector Phase	5	2	2	1	6	6	3	8	8	7	4	4
Switch Phase												
Minimum Initial (s)	5.0	5.0	5.0	5.0	5.0	5.0	5.0	5.0	5.0	5.0	5.0	5.0
Minimum Split (s)	10.0	10.0	10.0	10.0	10.0	10.0	10.0	10.0	10.0	10.0	10.0	10.0
Total Split (s)	20.0	44.0	44.0	35.0	59.0	59.0	21.0	28.0	28.0	13.0	20.0	20.0
Total Split (%)	16.7%	36.7%	36.7%	29.2%	49.2%	49.2%	17.5%	23.3%	23.3%	10.8%	16.7%	16.7%
Yellow Time (s)	3.0	3.0	3.0	3.0	3.0	3.0	3.0	3.0	3.0	3.0	3.0	3.0
All-Red Time (s)	2.0	2.0	2.0	2.0	2.0	2.0	2.0	2.0	2.0	2.0	2.0	2.0
Lost Time Adjust (s)	0.0	0.0	0.0	0.0	0.0	0.0	0.0	0.0	0.0	0.0	0.0	0.0
Total Lost Time (s)	5.0	5.0	5.0	5.0	5.0	5.0	5.0	5.0	5.0	5.0	5.0	5.0
Lead/Lag	Lead	Lag	Lag	Lead	Lag	Lag	Lead	Lag	Lag	Lead	Lag	Lag
Lead-Lag Optimize?	Yes	Yes	Yes	Yes	Yes	Yes	Yes	Yes	Yes	Yes	Yes	Yes
Recall Mode	None	Max	Max	None	Max	Max	None	None	None	None	None	None
Act Effct Green (s)	64.8	50.6	50.6	17.7	54.1	54.1	33.4	20.8	20.8	21.7	13.9	13.9
Actuated g/C Ratio	0.55	0.43	0.43	0.15	0.46	0.46	0.29	0.18	0.18	0.19	0.12	0.12
v/c Ratio	0.84	0.96	0.14	0.70	0.78	0.11	0.66	0.74	0.65	0.50	0.56	0.33
Control Delay	53.2	49.5	0.4	54.8	31.3	0.3	44.2	53.5	9.7	41.7	54.5	2.4
Queue Delay	0.0	0.0	0.0	0.0	0.0	0.0	0.0	0.0	0.0	0.0	0.0	0.0
Total Delay	53.2	49.5	0.4	54.8	31.3	0.3	44.2	53.5	9.7	41.7	54.5	2.4
LOS	D	D	A	D	C	A	D	D	A	D	D	A
Approach Delay		47.0			34.7			35.8			37.9	
Approach LOS		D			C			D			D	

Intersection Summary

Cycle Length: 120
 Actuated Cycle Length: 116.9
 Natural Cycle: 90
 Control Type: Actuated-Uncoordinated
 Maximum v/c Ratio: 0.96
 Intersection Signal Delay: 39.6
 Intersection Capacity Utilization 84.4%
 Analysis Period (min) 15
 Intersection LOS: D
 ICU Level of Service E

Splits and Phases: 8: Vollmer Rd & Briargate Pkwy



Intersection						
Int Delay, s/veh	0.7					
Movement	WBL	WBR	NBT	NBR	SBL	SBT
Lane Configurations	Y		↑↑	↑	↑	↑↑
Traffic Vol, veh/h	38	2	660	59	4	394
Future Vol, veh/h	38	2	660	59	4	394
Conflicting Peds, #/hr	0	0	0	0	0	0
Sign Control	Stop	Stop	Free	Free	Free	Free
RT Channelized	-	None	-	None	-	None
Storage Length	0	-	-	155	205	-
Veh in Median Storage, #	0	-	0	-	-	0
Grade, %	0	-	0	-	-	0
Peak Hour Factor	95	95	95	95	95	95
Heavy Vehicles, %	2	2	2	2	2	2
Mvmt Flow	40	2	695	62	4	415

Major/Minor	Minor1	Major1	Major2		
Conflicting Flow All	911	348	0	0	757
Stage 1	695	-	-	-	-
Stage 2	216	-	-	-	-
Critical Hdwy	6.84	6.94	-	-	4.14
Critical Hdwy Stg 1	5.84	-	-	-	-
Critical Hdwy Stg 2	5.84	-	-	-	-
Follow-up Hdwy	3.52	3.32	-	-	2.22
Pot Cap-1 Maneuver	274	648	-	-	850
Stage 1	456	-	-	-	-
Stage 2	799	-	-	-	-
Platoon blocked, %			-	-	-
Mov Cap-1 Maneuver	273	648	-	-	850
Mov Cap-2 Maneuver	273	-	-	-	-
Stage 1	456	-	-	-	-
Stage 2	795	-	-	-	-

Approach	WB	NB	SB
HCM Control Delay, s	20.1	0	0.1
HCM LOS	C		

Minor Lane/Major Mvmt	NBT	NBRWBLn1	SBL	SBT
Capacity (veh/h)	-	-	281	850
HCM Lane V/C Ratio	-	-	0.15	0.005
HCM Control Delay (s)	-	-	20.1	9.3
HCM Lane LOS	-	-	C	A
HCM 95th %tile Q(veh)	-	-	0.5	0

Intersection												
Int Delay, s/veh	1.2											
Movement	EBL	EBT	EBR	WBL	WBT	WBR	NBL	NBT	NBR	SBL	SBT	SBR
Lane Configurations		↕			↕			↕	↕		↕	
Traffic Vol, veh/h	3	0	2	42	0	3	5	574	83	6	354	1
Future Vol, veh/h	3	0	2	42	0	3	5	574	83	6	354	1
Conflicting Peds, #/hr	0	0	0	0	0	0	0	0	0	0	0	0
Sign Control	Stop	Stop	Stop	Stop	Stop	Stop	Free	Free	Free	Free	Free	Free
RT Channelized	-	-	None	-	-	None	-	-	None	-	-	None
Storage Length	-	-	-	-	-	-	-	-	-	-	-	-
Veh in Median Storage, #	-	0	-	-	0	-	-	0	-	-	0	-
Grade, %	-	0	-	-	0	-	-	0	-	-	0	-
Peak Hour Factor	95	95	95	95	95	95	95	95	95	95	95	95
Heavy Vehicles, %	2	2	2	2	2	2	2	2	2	2	2	2
Mvmt Flow	3	0	2	44	0	3	5	604	87	6	373	1

Major/Minor	Minor2		Minor1		Major1		Major2					
Conflicting Flow All	1045	1087	374	1001	1000	604	374	0	0	691	0	0
Stage 1	386	386	-	614	614	-	-	-	-	-	-	-
Stage 2	659	701	-	387	386	-	-	-	-	-	-	-
Critical Hdwy	7.12	6.52	6.22	7.12	6.52	6.22	4.12	-	-	4.12	-	-
Critical Hdwy Stg 1	6.12	5.52	-	6.12	5.52	-	-	-	-	-	-	-
Critical Hdwy Stg 2	6.12	5.52	-	6.12	5.52	-	-	-	-	-	-	-
Follow-up Hdwy	3.518	4.018	3.318	3.518	4.018	3.318	2.218	-	-	2.218	-	-
Pot Cap-1 Maneuver	207	216	672	222	243	498	1184	-	-	904	-	-
Stage 1	637	610	-	479	483	-	-	-	-	-	-	-
Stage 2	453	441	-	637	610	-	-	-	-	-	-	-
Platoon blocked, %								-	-	-	-	-
Mov Cap-1 Maneuver	203	213	672	219	239	498	1184	-	-	904	-	-
Mov Cap-2 Maneuver	203	213	-	219	239	-	-	-	-	-	-	-
Stage 1	633	605	-	476	480	-	-	-	-	-	-	-
Stage 2	447	438	-	630	605	-	-	-	-	-	-	-

Approach	EB		WB		NB		SB	
HCM Control Delay, s	18		25		0.1		0.1	
HCM LOS	C		D					

Minor Lane/Major Mvmt	NBL	NBT	NBR	EBLn1	WBLn1	SBL	SBT	SBR
Capacity (veh/h)	1184	-	-	282	227	904	-	-
HCM Lane V/C Ratio	0.004	-	-	0.019	0.209	0.007	-	-
HCM Control Delay (s)	8.1	0	-	18	25	9	0	-
HCM Lane LOS	A	A	-	C	D	A	A	-
HCM 95th %tile Q(veh)	0	-	-	0.1	0.8	0	-	-