



**STORMWATER MANAGEMENT PLAN  
FOR  
SADDLEHORN RANCH  
FILING NO. 5**

**Prepared For (Applicant):**

**ROI Property Group, LLC**  
2495 Rigdon Street  
Napa, CA 94558  
(707) 365-6891

**Prepared By:**

**JR Engineering, LLC**  
5475 Tech Center Drive, Suite 235  
Colorado Springs, Colorado 80919  
(719) 593-2593

**Qualified Stormwater Manager:**

KCI  
P.O. Box 930  
Strasburg, CO 80136  
(303) 809-7253  
Contact: Glenn Kunkel

**Contractor:**

KCI  
P.O. Box 930  
Strasburg, CO 80136  
(303) 809-7253  
Contact: Glenn Kunkel

**September, 2022**

El Paso County PCD File No.:  
SF-XX-XXX

EGP226

COMMENT ADDRESSED

ENGINEER OF RECORD:

The Stormwater Management Plan was prepared under my direction and supervision and is correct to the best of my knowledge and belief. Said Plan has been prepared according to the criteria established by the County and State for Stormwater Management Plans.



Bryan T. Law, P.E.

Registered Professional Engineer

State of Colorado No. 25043

For and on behalf of JR Engineering, LLC.



9/14/22

Date



## TABLE OF CONTENTS

1. Applicant / Contact Information .....	1
2. Site Description and Location .....	1
3. Proposed Sequence of Major Activities .....	2
4. BMPs for Stormwater Pollution Prevention .....	3
5. Final Stabilization and Long-Term Stormwater Management.....	5
6. Inspection and Maintenance.....	6

### Appendices

- A. Vicinity Map
- B. Soils Map
- C. GEC Plans and Details
- D. SWMP Report and GEC Plan Checklists
- E. Inspection Report Template

**1. Applicant / Contact Information**

**Owner/Developer:**

ROI Property Group, LLC  
Attn: Brady Williams  
2495 Rigdon Street  
Napa, CA 94558  
(717) 365-6891

**Engineer:**

JR Engineering, LLC  
5475 Tech Center Drive, Suite 235  
Colorado Springs, CO 80919  
Attn: Bryan Law (303) 267-6254  
[blaw@jrengineering.com](mailto:blaw@jrengineering.com)

**Qualified Stormwater  
Manager (QSM):**

KCI  
P.O. Box 930  
Strasburg, CO 80136  
Attn: Glenn Kunkel (303) 809-7253  
[kci@tds.net](mailto:kci@tds.net)

**Contractor:**

KCI  
P.O. Box 930  
Strasburg, CO 80136  
Attn: Glenn Kunkel (303) 809-7253  
[kci@tds.net](mailto:kci@tds.net)

**2. Site Description and Location**

The site is located in Section 3 and 10, Township 13 South, Range 65 West of the Sixth Principal Meridian, in the County of El Paso, State of Colorado. The site is bounded by Saddlehorn Filing 4 to the north, the Haegler Ranch to the east, and an unimproved driveway to the west, undeveloped land owned by 7120 Sudie to the south, and undeveloped land owned by Brent Houser Enterprises LLC to the east. A vicinity map is included in Appendix A.

ACREAGE  
UPDATED TO  
126.73

ESQCP states 127ac,  
please confirm

The site is currently undeveloped grassland and encompasses approximately 175 acres. The development of the proposed site will include implementation of BMPs, site grading, utility and storm installation, roadway paving, associated residential site development, and removal of temporary BMPs. Refer to the GEC plans in Appendix C for the phasing of BMPs.

UPDATED TO  
126.73 ACRES

**Site details:**

- a. Estimated area to undergo disturbance: 33 acres (Platted Acreage = 175 acres)

- b. Estimated 100-year runoff coefficients:
  - i. Historic:  $C = 0.13$
  - ii. Developed:  $C = 0.25$
- c. Soil erosion potential and potential impacts upon discharge: Site soils include Blakeland loamy sand, Columbine gravelly sandy loam, and Truckton loamy sand. The soils are classified as Hydrologic Soils Group A (low runoff potential). Refer to Appendix B for a soils map. Eroded soil may adversely impact downstream drainageways. BMPs will be installed and maintained to mitigate adverse impacts due to soil erosion.
- d. Existing vegetation: Native meadow grasses (approximately 70% coverage), determined using a combination of visual field verification and aerial inspection.
- e. Location and description of potential pollution sources: Potential sources of pollution include: onsite vehicle fueling, portable toilets, temporary stock pile, and concrete washout area. The locations of these sources are shown in the GEC plans in Appendix C or will be determined by the contractor.
- f. Spill prevention and pollution controls for dedicated batch plants: Not applicable for this site since there will be no dedicated batch plants.
- g. Location and description of anticipated non-stormwater components of discharge: There will be a concrete washout area (CWA) where the cleaning of concrete trucks could produce a non-stormwater discharge. Proper installation and maintenance of the CWA will not allow runoff from this area. Another potential source of non-stormwater discharge could be the irrigation of permanent seeding (PS). Irrigation will be kept at a rate so as to not create runoff.
- h. Ultimate receiving waters: Surface drainage from this site will follow historic drainage patterns, flowing southerly and westerly into Haegler Ranch Main Stem 6 (MS-06). The Haegler Ranch Drainage Basin is a tributary to Black Squirrel Creek, which flows into the Arkansas River.
- i. Streams located within project area: Main Stem (MS-06) within the Haegler Ranch Drainage Basin.

### **3. Proposed Sequence of Major Activities**

The project will follow standard construction sequences for construction, i.e., clearing and grubbing, over excavation, overlot grading, utility installation, and street paving. The contractor will be responsible for implementing and maintaining the erosion and sediment control measures described in this document and the accompanying design drawings. The contractor may designate these tasks to certain subcontractors as they see fit, but the ultimate responsibility for implementing these controls and their proposed function at each phase of the project remains with the contractor. The order of major activities will be as follows:

1. Install VTC and other perimeter soil erosion control measures.
2. Clear and rough grade for improvements.
3. Excavate and install improvements including underground piping and drainage structures.
4. Fine grading.
5. Install paving.

6. Install landscaping.
7. Clean up and final stabilization.

#### **4. BMPs for Stormwater Pollution Prevention**

See GEC plans in Appendix C for BMP locations and detail sheets.

- a. Erosion and Sediment Controls
  - i. Structural BMPs:
    1. Sediment basins (SBs) to collect runoff before it enters receiving waters
    2. Silt fence (SF) along downstream limits of disturbed areas to filter sediment from runoff
    3. Stabilized staging area (SSA) near site entrance to consolidate construction equipment in a stabilized location
    4. Construction marker (CM) to identify limits of construction (LOC)
    5. Vehicle tracking control (VTC) at site entrance to prevent sediment from leaving the site via vehicle tires
    6. Temporary stock pile (TSP) to consolidate materials such as topsoil in a controlled area bounded by silt fence
    7. Erosion control blanket (ECB) placed on any slopes of 3:1 or greater, including the sides of sediment basins
    8. Inlet protection (IP) around culvert entrances
    9. Outlet protection (OP) at culvert outlets
    10. Diversion ditch (DD) to convey runoff to sediment basins
    11. Concrete washout area (CWA) to allow a controlled area for concrete trucks to be washed
    12. Reinforced rock berm (RRB) in Drainageway MS-0 6 to slow and filter sediment from runoff.
    13. Rock Sock (RS) to reduce sediment loading caused by stormwater runoff.
  - ii. Non-structural BMPs:
    1. Mulching (MU) to stabilize soils and promote seed growth
    2. Permanent seeding (PS) to stabilize disturbed areas
- b. Materials Handling and Spill Prevention
  - i. General Materials Handling Practices:
    1. Potential pollutants shall be stored and used in a manner consistent with the manufacturer's instructions in a secure location. To the extent practical, material storage areas should not be located near storm drain inlets and should be equipped with covers, roofs, or secondary containment as required to prevent storm water from contacting stored materials. Chemicals that are not compatible shall be stored in segregated areas so that spilled materials cannot combine and react.
    2. Disposal of materials shall be in accordance with the manufacturer's instructions and applicable local, state, and federal regulations.

3. Materials no longer required for construction shall be removed from the site as soon as possible.

4. Adequate garbage, construction waste, and sanitary waste handling and disposal facilities shall be provided as necessary to keep the site clear of obstruction and BMPs clear and functional.

ii. Specific Materials Handling Practices

1. All pollutants, including waste materials and demolition debris, that occur onsite during construction shall be handled in a way that does not contaminate storm water.

2. All chemicals including liquid products, petroleum products, water treatment chemicals, and wastes stored onsite shall be covered and protected from vandalism.

3. Maintenance, fueling, and repair of all equipment and vehicles involving oil changes, hydraulic system drain down, degreasing operations, fuel tank drain down and removal, and other activities which may result in the accidental release of contaminants, shall be conducted under cover during wet weather and on an impervious surface to prevent release of contaminants onto the ground. Materials spilled during maintenance operations shall be cleaned up immediately and properly disposed of.

4. Wheel wash water shall be settled and discharged onsite by infiltration.

5. Application of agricultural chemicals, including fertilizers and pesticides, shall be conducted in a manner and at application rates that will not result in loss of chemical to storm water runoff. Follow manufacturer's recommendations for application rates and procedures.

6. pH-modifying sources shall be managed to prevent contamination of runoff and storm water collected onsite. The most common sources of pH-modifying materials are bulk cement, cement kiln dust (CKD), fly ash, new concrete washing and curing waters, waste streams generated from concrete grinding and sawing, exposed aggregate processes, and concrete pumping and mixer washout waters.

iii. Spill Prevention and Response Procedures

1. The primary objective in responding to a spill is to quickly contain the material(s) and prevent or minimize their migration into storm water runoff and conveyance systems. If the release has impacted onsite storm water, it is critical to contain the released materials onsite and prevent their release into receiving waters.

2. Spill Response Procedures:

a. Notify site superintendent immediately when a spill, or the threat of a spill, is observed. The superintendent shall assess the situation and determine the appropriate response.

b. If spills represent an imminent threat of escaping onsite facilities and entering the receiving waters, site personnel

shall respond immediately to contain the release and notify the superintendent after the situation has stabilized.

c. The site superintendent, or his/her designee, shall be responsible for completing a spill reporting form and for reporting the spill to the appropriate agency.

d. Spill response equipment shall be inspected and maintained as necessary to replace any materials used in spill response activities.

3. Spill kits shall be on-hand at all fueling sites. Spill kit location(s) shall be reported to the SWMP administrator.

4. Absorbent materials shall be on-hand at all fueling areas for use in containing inadvertent spills. Containers shall be on-hand at all fueling sites for disposal of used absorbents.

5. Recommended components of spill kits include the following:

a. Oil absorbent pads (one bale)

b. Oil absorbent booms (40 feet)

c. 55-gallon drums (2)

d. 9-mil plastic bags (10)

e. Personal protective equipment including gloves and goggles

6. Concrete wash water: unless confined in a pre-defined, bermed containment area, the cleaning of concrete truck delivery chutes is prohibited at the job site.

7. Notification procedures:

a. In the event of an accident or spill, the SWMP administrator shall be notified.

b. Depending on the nature of the spill material involved, the Colorado Department of Public Health and Environment (24-hour spill reporting line: 887-518-5608), downstream water users, or other agencies may also need to be notified.

c. Any spill of oil which 1) violates water quality standards, 2) produces a “sheen” on a surface water, or 3) causes a sludge or emulsion, or any hazardous substance release, or hazardous waste release which exceeds the reportable quantity, must be reported immediately by telephone to the National Response Center Hotline at (800) 424-8802.

## **5. Final Stabilization and Long-Term Stormwater Management**

a. Permanent seeding will be provided to achieve long-term stabilization of the site.

b. Seed Mix: Pawnee Buttes Seed Inc. – “Low Grow native Mix” or approved equal.

c. Seeding Application Rate: Drill seed 0.25” to 0.5” into the soil. In small areas not accessible to a drill, hand broadcast at double the rate and rake 0.25” to 0.5” into the soil. Apply seed at the following rates:

i. Dryland: 20-25 lbs/acre

ii. Irrigated: 40 lbs/acre

d. Soil stabilization Practices:



- i. Mulching Application: Apply 1-1/2 tons of certified weed free hay per acre mechanically crimped into the soil in combination with an organic mulch tackifier. On slopes and ditches requiring a blanket, the blanket shall be placed in lieu of mulch and mulch tackifier.
- e. Soil Conditioning and Fertilization Requirements:
  - i. Soil conditioner, organic amendment shall be applied to all seeded areas at 3 CY / 1000 SF.
  - ii. Fertilizer shall consist of 90% fungal biomass (mycelium) and 10% potassium-magnesia with a grade of 6-1-3 or approved equal. Fertilizer shall be applied as recommended by seed supplier.
- f. Final stabilization is reached when all soil-disturbing activities at the site have been completed, and uniform vegetative cover has been established with an individual plan density of at least 70 percent of pre-disturbance levels, or equivalent permanent, physical erosion reduction methods have been employed.
- g. Two extended detention basins will be added to detain stormwater following storm events which will serve as flood-control as well as facilitate pollutant removal.
- h. This project does not rely on control measures owned or operated by another entity.

**CORRECTED**

**6. Inspection and Maintenance**

**QSM**

- a. Inspection Schedules:
  - i. The ~~contractor~~ shall inspect BMPs once every 14 days at a minimum, and immediately (within 24 hours) after any precipitation or snowmelt event that causes surface erosion (i.e. that results in storm water running across the ground), to ensure that BMPs are maintained in effective operating condition.
- b. Inspection Procedures:
  - i. Site Inspection / Observation Items:
    1. Construction site perimeter and discharge points
    2. All disturbed areas
    3. Areas used for material / waste storage that are exposed to precipitation
    4. Other areas having a significant potential for storm water pollution, such as demolition areas or concrete washout areas, or locations where vehicles enter or leave the site
    5. Erosion and sediment control measures identified in the SWMP
    6. Any other structural BMPs that may require maintenance, such as secondary containment around fuel tanks, or the conditions of spill response kits.
  - ii. Inspection Requirements:
    1. Determine if there is any evidence of, or potential for, pollutants entering the receiving waters.
    2. Review BMPs to determine if they still meet design and operational criteria in the SWMP, and if they continue to

- adequately control pollutants at the site.
3. Upgrade and/or revise any BMPs not operating in accordance with the SWMP and update the SWMP to reflect any revisions.
- iii. BMP Maintenance / Replacement and Failed BMPs:
1. The contractor shall remove sediment that has been collected by perimeter controls, such as silt fence and inlet protection, on a regular basis to prevent failure of BMPs, and remove potential of sediment from being discharged from the site in the event of BMP failure.
  2. Removed sediment must be moved to an appropriate location where it will not become an additional pollutant source, and should never be placed in ditches or streams.
  3. The contractor shall update the GEC as required with any new BMPs added during the construction period.
  4. The contractor shall address BMPs that have failed or have the potential to fail without maintenance or modifications, as soon as possible, immediately in most cases, to prevent discharge of pollutants.
- iv. Record Keeping and Documenting Inspections:
1. The contractor shall maintain records of all inspection reports, including signed inspection logs, at the project site.
  2. The permittee shall document inspection results and maintain a record of the results for a period of 3 years following expiration or inactivation of permit coverage.
  3. Site inspection records shall include the following:
    - a. Inspection date  and signature 
    - b. Name and title of personnel making the inspection
    - c. Location of discharges of sediment or other pollutants from the site
    - d. Location(s) of BMPs in need of maintenance
    - e. Location(s) of BMPs that failed to operate as designed or proved inadequate for a particular location
    - f. Location(s) where additional BMPs are needed that were not in place at the time of inspection
    - g. Deviations from the minimum inspection schedule

ADDED

COMMENT ADDED

SWMP Checklist Item 21. Add text stating that the SWMP should be viewed as a "living document" that is continuously being reviewed and modified as a part of the overall process of evaluating and managing SW quality issues at the site. The QSM shall amend the SWMP when there is a change in design, construction, O&M of the site which would require the implementation of new or revised BMPs or if the SWMP proves to be ineffective in achieving the general objectives of controlling pollutants in SW discharges associated with construction activity or when BMPs are no longer necessary and are removed.



## **APPENDIX A – VICINITY MAP**

---

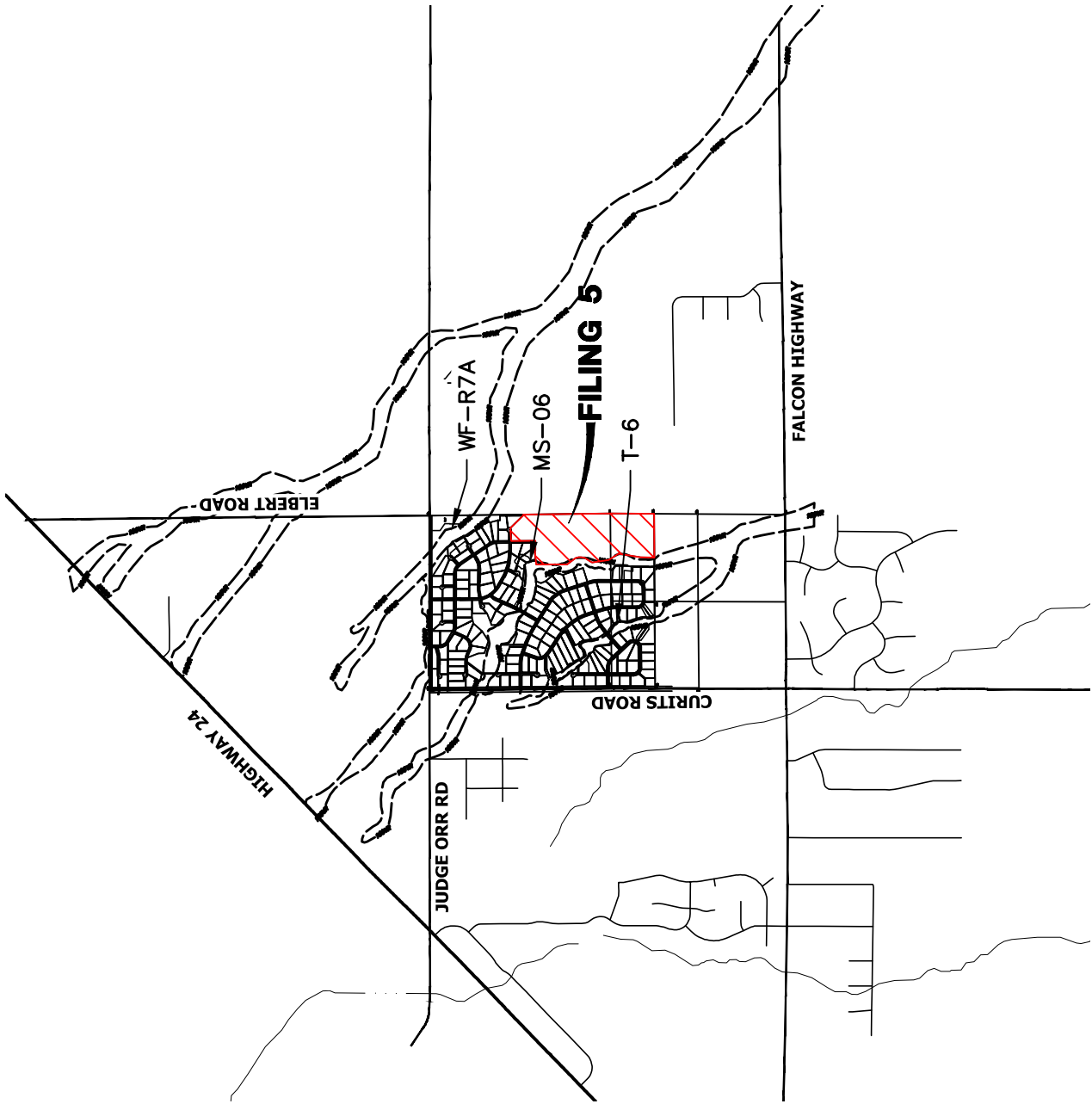

VICINITY MAP  
 SADDLEHORN RANCH  
 25142.07  
 08/29/21  
 SHEET 1 OF 1



**J.R. ENGINEERING**  
 A Westrian Company

Centennial 303-740-9888 • Colorado Springs 719-583-2536  
 Fort Collins 970-491-9888 • www.jrengineering.com

## **APPENDIX B – SOILS MAP**

---

Hydrologic Soil Group—El Paso County Area, Colorado

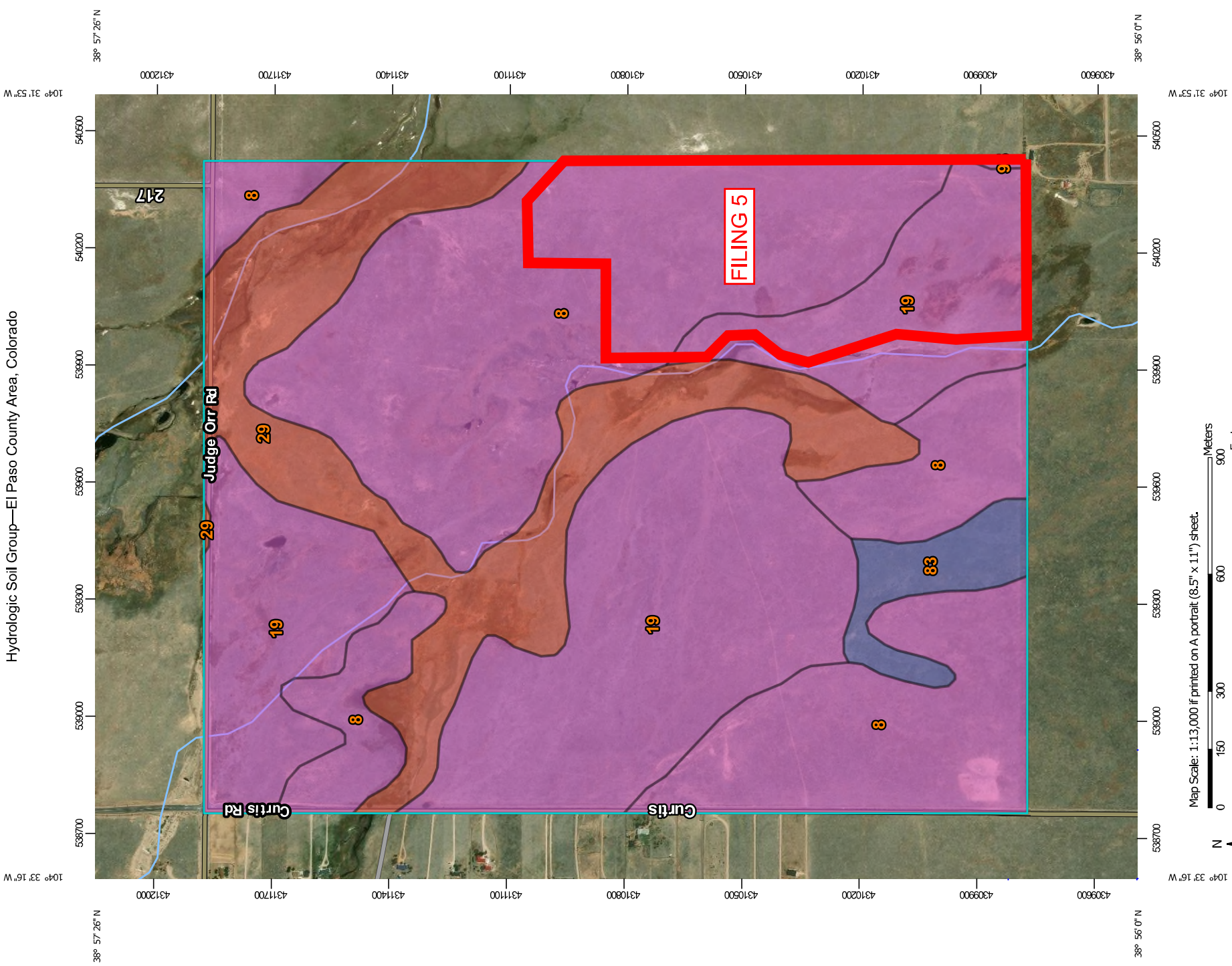

38° 57' 26" N

104° 33' 16" W

538700 538800 538900 539000 539100 539200 539300 539400 539500 539600 540200 540800

38° 57' 26" N

104° 31' 53" W

4312000 4311700 4311400 4311100 4310800 4310500 4310200 4309900 4309600

38° 56' 01" N

104° 33' 16" W

538700 538800 538900 539000 539100 539200 539300 539400 539500 539600 540200 540800

38° 56' 01" N

104° 31' 53" W

Curtis Rd

Curtis

Judge Orr Rd

217

FILING 5

8

29

19

8

8

19

8

83

8

19

8



Natural Resources  
Conservation Service

Web Soil Survey  
National Cooperative Soil Survey

### MAP LEGEND

**Area of Interest (AOI)**









 Area of Interest (AOI)

**Soils**

**Soil Rating Polygons**





-  A
-  A/D
-  B
-  B/D
-  C
-  C/D
-  D
-  Not rated or not available

**Soil Rating Lines**

-  A
-  A/D
-  B
-  B/D
-  C
-  C/D
-  D
-  Not rated or not available

**Soil Rating Points**



-  A
-  A/D
-  B
-  B/D

-  C
-  C/D
-  D
-  Not rated or not available

**Water Features**

 Streams and Canals

**Transportation**

-  Rails
-  Interstate Highways
-  US Routes
-  Major Roads
-  Local Roads

**Background**

 Aerial Photography

### MAP INFORMATION

The soil surveys that comprise your AOI were mapped at 1:24,000.

Please rely on the bar scale on each map sheet for map measurements.

Source of Map: Natural Resources Conservation Service  
 Web Soil Survey URL:  
 Coordinate System: Web Mercator (EPSG:3857)

Maps from the Web Soil Survey are based on the Web Mercator projection, which preserves direction and shape but distorts distance and area. A projection that preserves area, such as the Albers equal-area conic projection, should be used if more accurate calculations of distance or area are required.

This product is generated from the USDA-NRCS certified data as of the version date(s) listed below.

Soil Survey Area: El Paso County Area, Colorado  
 Survey Area Data: Version 16, Sep 10, 2018

Soil map units are labeled (as space allows) for map scales 1:50,000 or larger.

Date(s) aerial images were photographed: May 22, 2016—Aug 17, 2017

The orthophoto or other base map on which the soil lines were compiled and digitized probably differs from the background imagery displayed on these maps. As a result, some minor shifting of map unit boundaries may be evident.

## Hydrologic Soil Group

Map unit symbol	Map unit name	Rating	Acres in AOI	Percent of AOI
8	Blakeland loamy sand, 1 to 9 percent slopes	A	388.3	44.6%
19	Columbine gravelly sandy loam, 0 to 3 percent slopes	A	307.3	35.3%
29	Fluvaquentic Haplaquolls, nearly level	D	150.0	17.2%
83	Stapleton sandy loam, 3 to 8 percent slopes	B	24.6	2.8%
95	Truckton loamy sand, 1 to 9 percent slopes	A	0.6	0.1%
<b>Totals for Area of Interest</b>			<b>870.8</b>	<b>100.0%</b>

## Description

Hydrologic soil groups are based on estimates of runoff potential. Soils are assigned to one of four groups according to the rate of water infiltration when the soils are not protected by vegetation, are thoroughly wet, and receive precipitation from long-duration storms.

The soils in the United States are assigned to four groups (A, B, C, and D) and three dual classes (A/D, B/D, and C/D). The groups are defined as follows:

Group A. Soils having a high infiltration rate (low runoff potential) when thoroughly wet. These consist mainly of deep, well drained to excessively drained sands or gravelly sands. These soils have a high rate of water transmission.

Group B. Soils having a moderate infiltration rate when thoroughly wet. These consist chiefly of moderately deep or deep, moderately well drained or well drained soils that have moderately fine texture to moderately coarse texture. These soils have a moderate rate of water transmission.

Group C. Soils having a slow infiltration rate when thoroughly wet. These consist chiefly of soils having a layer that impedes the downward movement of water or soils of moderately fine texture or fine texture. These soils have a slow rate of water transmission.

Group D. Soils having a very slow infiltration rate (high runoff potential) when thoroughly wet. These consist chiefly of clays that have a high shrink-swell potential, soils that have a high water table, soils that have a claypan or clay layer at or near the surface, and soils that are shallow over nearly impervious material. These soils have a very slow rate of water transmission.

If a soil is assigned to a dual hydrologic group (A/D, B/D, or C/D), the first letter is for drained areas and the second is for undrained areas. Only the soils that in their natural condition are in group D are assigned to dual classes.

## Rating Options

*Aggregation Method:* Dominant Condition

*Component Percent Cutoff:* None Specified

*Tie-break Rule:* Higher

## **APPENDIX C – GEC PLANS AND DETAILS**

---



# SADDLEHORN RANCH - FILING 5

LOCATED IN SECTIONS 3 AND 10

TOWNSHIP 13 SOUTH, RANGE 64 WEST OF THE 6TH P.M.,

EL PASO COUNTY, STATE OF COLORADO

## PRE-DEVELOPMENT GRADING AND EROSION CONTROL PLANS



Know what's below.  
Call before you dig.

UNTIL SUCH TIME AS  
APPROVED BY THE  
APPROPRIATE REVIEWING  
AGENCIES, THESE PLANS  
ARE NOT TO BE USED FOR  
CONSTRUCTION PURPOSES  
WITHOUT THE WRITTEN  
AUTHORIZATION.

PREPARED FOR  
RO PROPERTY GROUP, LLC  
2495 RIGDON STREET  
NAPA, CALIFORNIA  
94957-3807  
BRADY WILLIAMS

**JR ENGINEERING**  
A National Company  
Central 303-742-5338 • Colorado Stamp: 74-269-2538  
For Color: 970-691-9988 • www.jrengineering.com

### ABBREVIATIONS

AC	ACRE	INT	INTERSECTION
AD	ALGEBRAIC DIFFERENCE	INV	INVERT
AH	AHEAD	IRR	IRRIGATION
ARCH	ARCHITECT	KB	KICK (THRUST) BLOCK
ASCE	AMERICAN SOCIETY OF CIVIL ENGINEERS	LB	LOAD
AVE	AVENUE	LE	LANDSCAPE EASEMENT
ASSEMBLY	ASSEMBLY	LF	LINEAR FOOT
BB	BOX BASE	LMR	LETTER OF MAP REVISION
BK	BACK	LP	LOW POINT
BNDY	BOUNDARY	LS	LUMP SUM
BOP	BOTTOM OF PIPE	LT	LEFT
BOV	BLOW OFF VALVE	MAX	MAXIMUM
BPV	BUTTERFLY VALVE	M/D	MOISTURE DENSITY
BLVD	BULEVARD	M/DP	MASTER DEVELOPMENT DRAINAGE PLAN
BW	BOTTOM OF WALL	MH	MANHOLE
CBG	CURB & GUTTER	MIN	MINIMUM
CATV	CABLE TELEVISION	MS	MOUNTABLE SIDEWALK
CB	CATCH BASIN	N	NORTH
CBC	CONCRETE BOX CULVERT	NRP	NON-REINFORCED CONCRETE PIPE
CDOT	COLORADO DEPARTMENT OF TRANSPORTATION	ODP	OFFICIAL DEVELOPMENT PLAN
CDS	CUL-DE-SAC	OHE	OVERHEAD ELECTRIC
CF	CUBIC FOOT	OHU	OVERHEAD UTILITY
CCS	CUBIC FEET PER SECOND	PC	POINT OF CURVATURE
CP	COMPLETE IN PLACE	PCC	POINT OF COMPOUND CURVATURE
CL	CENTER LINE	PCR	POINT OF CURB RETURN
CLMR	CONDITIONAL LETTER OF MAP REVISION	PDP	PRELIMINARY DEVELOPMENT PLAN
CLR	CLEAR	PE	PLANNING ENGINEER
CMP	CORRUGATED METAL PIPE	PI	POINT OF INTERSECTION
CO	CLEAN OUT	PKWY	PARKWAY
CCDS	CITY OF COLORADO SPRINGS CONCRETE	PL	PROPOSED
CONC	CONCRETE	PR	POINT OF REVERSE CURVATURE
CP	CORRUGATED STEEL PIPE	PT	POINT OF TANGENCY
CSU	COLORADO SPRINGS UTILITIES	PV	PLUG VALVE
CT	COURT	PVC	POLYVINYL CHLORIDE
CTB	CONCRETE THRUST REDUCER BLOCK	R	RADIUS
CY	CUBIC YARD	RCBC	REINFORCED CONCRETE BOX CULVERT
DBPS	DRAINAGE BASIN PLANNING STUDY	RCR	REINFORCED CONCRETE PIPE ROAD
DE	DRAINAGE EASEMENT	RD	ROAD
DA	DIAMETER	ROW	RIGHT OF WAY
DIP	DUCTILE IRON PIPE	RT	RIGHT
DR	DRIVE	S	SOUTH
DRC	DESIGN REVIEW COMMITTEE	STE	STEEL
DU	DWELLING UNITS	SSN	SANITARY SEWER
DY	DAY	SF	SQUARE FOOT
E	EAST	ST	STREET
EA	EACH	STA	STATION
EGL	ENERGY GRADE LINE	STM	STORM SEWER
EL	ELEVATION	SY	SQUARE YARD
ELEC	ELECTRIC	SY-IN	SQUARE YARD INCH
EDA	EDGE OF ASPHALT	TB	THRUST BLOCK
EPC	EL PASO COUNTY	TBC	TOP BACK OF CURB
ERCP	ELLIPTICAL RCP	TBOW	TOP BACK OF WALK
ESMT	EASEMENT	TEW	TELEPHONE
EST	ESTIMATE	TON	TON
EX	EXISTING	TOA	TOP OF ASPHALT
FDP	FINAL DEVELOPMENT PLAN	TOT	TOP OF TIE
FR	FINAL DRAINAGE REPORT	TOC	TOP OF CURB OR CONCRETE
FES	FLARED END SECTION	TOF	TOP OF FOUNDATION
FF	FINISHED FLOOR ELEVATION	TOP	TOP OF PIPE
FG	FINISHED GRADE	TW	TOP OF WALL
FH	FIRE HYDRANT	TYP	TYPICAL
FL	FLOWLINE	UDFCD	URBAN DRAINAGE AND FLOOD CONTROL DISTRICT
FL	FILING	UE	UTILITY EASEMENT
GB	GRADE BREAK	UGE	UTILITY & DRAINAGE EASEMENT
GE	GAS EASEMENT	UGE	UNDERGROUND ELECTRIC
GIS	GEOGRAPHIC INFORMATION SYSTEM	VCP	VIRRIDED CLAY PIPE
GL	GAS LINE	VPC	VERTICAL POINT OF CURVATURE
GPS	GLOBAL POSITIONING SYSTEM	VPI	VERTICAL POINT OF INTERSECTION
GV	GATE VALVE	VPT	VERTICAL POINT OF TANGENCY
HBP	HOT BITUMINOUS PAVEMENT HANDPAV	VTC	VEHICLE TRACKING CONTROL
HDC	HIGH DEFLECTION COUPLING	W	WEST
HDP	HIGH DENSITY POLYETHYLENE	WM	WATER MAIN
HGL	HYDRAULIC GRADE LINE	WRD	WATER RESOURCES DEPARTMENT
HMA	HOT MIX ASPHALT	WS	WATER SURFACE
HOA	HOME OWNERS ASSOCIATION	WSE	WATER SURFACE ELEVATION
HP	HIGH POINT	WR	WATER
HR	HOUR	WR	WATER
I	INLET	YR	YEAR
E	IRRIGATION EASEMENT		

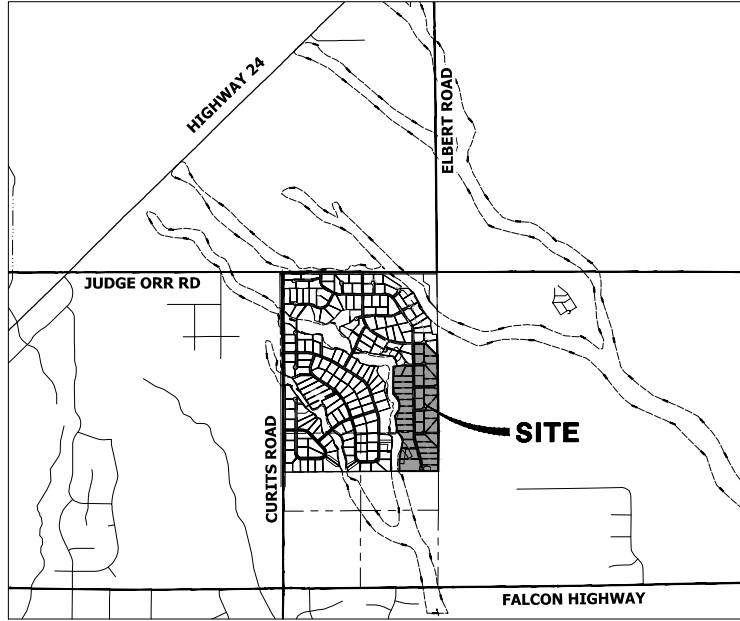

### VICINITY MAP

SCALE: 1" = 2000'

### SHEET INDEX

1	COVER SHEET
2	LEGEND & NOTES
3	TYPICAL SECTIONS
4	OVERALL SITE MAP
4.1	EARLY GRADING IMPROVEMENTS
5	GRADING & EROSION CONTROL PLANS
6-8	GRADING & EROSION CONTROL DETAILS

### CONTACTS:

OWNER	GORILLA CAPITAL CO SADDLEHORN RANCH, LLC 1342 HIGH STREET EUGENE, OR 97401 P-541-393-9043
DEVELOPER	RO PROPERTY GROUP, LLC 2495 RIGDON STREET NAPA, CALIFORNIA 94558 P-707-633-9700
ENGINEER/SURVEYOR	JR ENGINEERING, LLC ATTN: BRYAN LAW 5475 TECH CENTER DRIVE, SUITE 235 COLORADO SPRINGS, CO 80919 P-(303) 267-6254
FIRE PROTECTION DISTRICT	FALCON FIRE PROTECTION 12072 ROYAL COUNTY DOWN ROAD FALCON, CO 80833 P-(719) 495-4050
DISTRICT	SADDLEHORN RANCH METRO DISTRICT

### BENCHMARK

THE VERTICAL DATUM IS BASED OFF AN OPUS SOLUTION RAN ON CONTROL POINT #100 (NO. 4 REBAR) AND IS ADJUSTED TO NVD 1929, ELEVATION 6754.61.

### BAISIS OF BEARING

THE WEST LINE OF SECTION 3, T3S, R64W, 6TH PM., MONUMENTED BY A 3-1/4" ALUMINUM CAP STAMPED "PLS 17490" IN A RANGE BOX AT THE NORTHWEST CORNER OF SECTION 3 AND A NO. 8 REBAR IN A RANGE BOX AT THE SOUTHWEST CORNER OF SECTION 3, BEARING N00°32'28"W, AS REFERENCED TO COLORADO STATE PLANE CENTRAL ZONE.

### EL PASO COUNTY STATEMENT

COUNTY PLAN REVIEW IS PROVIDED ONLY FOR GENERAL CONFORMANCE WITH COUNTY DESIGN CRITERIA. THE COUNTY IS NOT RESPONSIBLE FOR THE ACCURACY AND ADEQUACY OF THE DESIGN, DIMENSIONS, AND/OR ELEVATIONS WHICH SHALL BE CONFIRMED AT THE JOB SITE. THE COUNTY THROUGH THE APPROVAL OF THIS DOCUMENT ASSUMES NO RESPONSIBILITY FOR COMPLETENESS AND/OR ACCURACY OF THIS DOCUMENT.

FILED IN ACCORDANCE WITH THE REQUIREMENTS OF THE EL PASO COUNTY LAND DEVELOPMENT CODE, DRAINAGE CRITERIA MANUAL, VOLUMES 1 AND 2, AND ENGINEERING CRITERIA MANUAL AS AMENDED.

IN ACCORDANCE WITH ECM SECTION 1.12, THESE CONSTRUCTION DOCUMENTS WILL BE VALID FOR CONSTRUCTION FOR A PERIOD OF 2 YEARS FROM THE DATE SIGNED BY THE EL PASO COUNTY ENGINEER. IF CONSTRUCTION HAS NOT STARTED WITHIN THOSE 2 YEARS, THE PLANS WILL NEED TO BE RESUBMITTED FOR APPROVAL, INCLUDING PAYMENT OF REVIEW FEES AT THE PLANNING AND COMMUNITY DEVELOPMENT DIRECTORS DISCRETION.

JOSHUA PALMER, P.E. DATE \_\_\_\_\_  
COUNTY ENGINEER/ECM ADMINISTRATOR

### ENGINEER'S STATEMENT

THIS GRADING AND EROSION CONTROL PLAN WAS PREPARED UNDER MY DIRECTION AND SUPERVISION AND IS CORRECT TO THE BEST OF MY KNOWLEDGE AND BELIEF. SAID PLAN HAS BEEN PREPARED ACCORDING TO THE CRITERIA ESTABLISHED BY THE COUNTY FOR GRADING AND EROSION CONTROL PLANS. I ACCEPT RESPONSIBILITY FOR ANY LIABILITY CAUSED BY ANY NEGLIGENT ACTS, ERRORS OR OMISSIONS ON MY PART IN PREPARING THIS PLANS.

BRYAN T. LAW, P.E. DATE 9/2/22  
COLORADO P.E. 25043  
FOR AND ON BEHALF OF JR ENGINEERING, LLC

BY	DATE	H-SCALE	V-SCALE	N/A	DATE	DESIGNED BY	DRAWN BY	CHECKED BY
					9/2/2022	SWW	SWW	

SADDLEHORN RANCH - FILING 5  
COVER SHEET  
SHEET 1 OF 8  
JOB NO. 25142.07

THE LOCATIONS OF EXISTING ABOVE GROUND AND UNDERGROUND UTILITIES ARE SHOWN IN AN APPROXIMATE WAY ONLY. THE CONTRACTOR SHALL DETERMINE THE EXACT LOCATION OF ALL EXISTING UTILITIES BEFORE COMMENCING WORK. THE CONTRACTOR SHALL BE FULLY RESPONSIBLE FOR ANY AND ALL DAMAGES WHICH MIGHT BE CAUSED BY HIS FAILURE TO EXACTLY LOCATE AND PRESERVE ANY AND ALL ABOVE GROUND AND UNDERGROUND UTILITIES.

### OWNER/DEVELOPER STATEMENT

I, THE OWNER/DEVELOPER HAVE READ AND WILL COMPLY WITH THE REQUIREMENTS OF THE GRADING AND EROSION CONTROL PLAN.

JOHN HELMICK DATE 9/9/22  
GORILLA CAPITAL CO SADDLEHORN RANCH, LLC  
1342 HIGH STREET  
EUGENE, OR 97401

PCD FILE NO. EGPXXX

**GRADING AND EROSION CONTROL STANDARD NOTES**

- CONSTRUCTION MAY NOT COMMENCE UNTIL A CONSTRUCTION PERMIT IS OBTAINED FROM PLANNING AND COMMUNITY DEVELOPMENT AND A PRECONSTRUCTION CONFERENCE IS HELD WITH PLANNING AND COMMUNITY DEVELOPMENT INSPECTIONS.
- STORMWATER DISCHARGES FROM CONSTRUCTION SITES SHALL NOT CAUSE OR THREATEN TO CAUSE POLLUTION, CONTAMINATION, OR DEGRADATION OF STATE WATERS. ALL WORK AND EARTH DISTURBANCE SHALL BE DONE IN A MANNER THAT MINIMIZES POLLUTION OF ANY ON-SITE OR OFF-SITE WATERS, INCLUDING WETLANDS.
- NOTWITHSTANDING ANYTHING DEPICTED IN THESE PLANS IN WORDS OR GRAPHIC REPRESENTATION, ALL DESIGN AND CONSTRUCTION RELATED TO ROADS, STORM DRAINAGE AND EROSION CONTROL SHALL CONFORM TO THE STANDARDS AND REQUIREMENTS OF THE MOST RECENT VERSION OF THE RELEVANT ADOPTED EL PASO COUNTY STANDARDS, INCLUDING THE LAND DEVELOPMENT CODE, THE ENGINEERING CRITERIA MANUAL, THE DRAINAGE CRITERIA MANUAL, AND THE DRAINAGE CRITERIA MANUAL VOLUME 2. ANY DEVIATIONS FROM REGULATIONS AND STANDARDS MUST BE REQUESTED, AND APPROVED, IN WRITING.
- A SEPARATE STORMWATER MANAGEMENT PLAN (SWMP) FOR THIS PROJECT SHALL BE COMPLETED AND AN EROSION AND STORMWATER QUALITY CONTROL PERMIT (ESQCP) ISSUED PRIOR TO COMMENCING CONSTRUCTION. MANAGEMENT OF THE SWMP DURING CONSTRUCTION IS THE RESPONSIBILITY OF THE DESIGNATED QUALIFIED STORMWATER MANAGER OR CERTIFIED EROSION CONTROL INSPECTOR. THE SWMP SHALL BE LOCATED ON SITE AT ALL TIMES DURING CONSTRUCTION AND SHALL BE KEPT UP TO DATE WITH WORK PROGRESS AND CHANGES IN THE FIELD.
- ONCE THE ESQCP IS APPROVED AND A NOTICE TO PROCEED HAS BEEN ISSUED, THE CONTRACTOR MAY INSTALL THE INITIAL STAGE EROSION AND SEDIMENT CONTROL MEASURES AS INDICATED ON THE APPROVED GEC. A PRECONSTRUCTION MEETING BETWEEN THE CONTRACTOR, ENGINEER, AND EL PASO COUNTY WILL BE HELD PRIOR TO ANY CONSTRUCTION. IT IS THE RESPONSIBILITY OF THE APPLICANT TO COORDINATE THE MEETING AND PLACE WITH COUNTY STAFF.
- CONTROL MEASURES MUST BE INSTALLED PRIOR TO COMMENCEMENT OF ACTIVITIES THAT COULD CONTRIBUTE POLLUTANTS TO STORMWATER. CONTROL MEASURES FOR ALL SLOPES, CHANNELS, DITCHES, AND DISTURBED LAND AREAS SHALL BE INSTALLED IMMEDIATELY UPON COMPLETION OF THE DISTURBANCE.
- ALL TEMPORARY SEDIMENT AND EROSION CONTROL MEASURES SHALL BE MAINTAINED AND REMAIN IN EFFECTIVE OPERATING CONDITION UNTIL PERMANENT SOIL EROSION CONTROL MEASURES ARE IMPLEMENTED AND FINAL STABILIZATION IS ESTABLISHED. ALL PERSONS ENGAGED IN LAND DISTURBANCE ACTIVITIES SHALL ASSESS THE ADEQUACY OF CONTROL MEASURES AT THE SITE AND IDENTIFY IF CHANGES TO THOSE CONTROL MEASURES ARE NEEDED TO ENSURE THE CONTINUED EFFECTIVE PERFORMANCE OF THE CONTROL MEASURES. ALL CHANGES TO TEMPORARY SEDIMENT AND EROSION CONTROL MEASURES MUST BE INCORPORATED INTO THE STORMWATER MANAGEMENT PLAN.
- TEMPORARY STABILIZATION SHALL BE IMPLEMENTED ON DISTURBED AREAS AND STOCKPILES WHERE GROUND DISTURBING CONSTRUCTION ACTIVITY HAS PERMANENTLY CEASED OR TEMPORARILY CEASED FOR LONGER THAN 14 DAYS.
- FINAL STABILIZATION MUST BE IMPLEMENTED AT ALL APPLICABLE CONSTRUCTION SITES. FINAL STABILIZATION IS ACHIEVED WHEN ALL GROUND DISTURBING ACTIVITIES ARE COMPLETE AND ALL DISTURBED AREAS EITHER HAVE A UNIFORM VEGETATIVE COVER WITH INDIVIDUAL PLANT DENSITY OF 70 PERCENT OF PRE-DISTURBANCE LEVELS ESTABLISHED OR EQUIVALENT PERMANENT ALTERNATIVE STABILIZATION METHOD IS IMPLEMENTED. ALL TEMPORARY SEDIMENT AND EROSION CONTROL MEASURES SHALL BE REMOVED UPON FINAL STABILIZATION AND BEFORE PERMIT CLOSURE.
- ALL PERMANENT STORMWATER MANAGEMENT FACILITIES SHALL BE INSTALLED AS DESIGNED IN THE APPROVED PLANS. ANY PROPOSED CHANGES THAT AFFECT THE DESIGN OR FUNCTION OF PERMANENT STORMWATER MANAGEMENT STRUCTURES MUST BE APPROVED BY THE EDM ADMINISTRATOR PRIOR TO IMPLEMENTATION.
- EARTH DISTURBANCES SHALL BE CONDUCTED IN SUCH A MANNER SO AS TO EFFECTIVELY MINIMIZE ACCELERATED SOIL EROSION AND RESULTING SEDIMENTATION. ALL DISTURBANCES SHALL BE DESIGNED, CONSTRUCTED, AND COMPLETED SO THAT THE EXPOSED AREA OF ANY DISTURBED LAND SHALL BE LIMITED TO THE SHORTEST PRACTICAL PERIOD OF TIME. PRE-EXISTING VEGETATION SHALL BE PROTECTED AND MAINTAINED WITHIN 50 HORIZONTAL FEET OF A WATERS OF THE STATE UNLESS SHOWN TO BE INFEASIBLE AND SPECIFICALLY REQUESTED AND APPROVED.
- COMPACTION OF SOIL MUST BE PREVENTED IN AREAS DESIGNATED FOR INFILTRATION CONTROL MEASURES OR WHERE FINAL STABILIZATION WILL BE ACHIEVED BY VEGETATIVE COVER. AREAS DESIGNATED FOR INFILTRATION CONTROL MEASURES SHALL ALSO BE PROTECTED FROM SEDIMENTATION DURING CONSTRUCTION UNTIL FINAL STABILIZATION IS ACHIEVED. IF COMPACTION PREVENTION IS NOT FEASIBLE DUE TO SITE CONSTRAINTS, ALL AREAS DESIGNATED FOR INFILTRATION AND VEGETATION CONTROL MEASURES MUST BE LOOSENEED PRIOR TO INSTALLATION OF THE CONTROL MEASURE(S).
- ANY TEMPORARY OR PERMANENT FACILITY DESIGNED AND CONSTRUCTED FOR THE CONVEYANCE OF STORMWATER AROUND, THROUGH, OR FROM THE EARTH DISTURBANCE AREA SHALL BE A STABILIZED CONVEYANCE DESIGNED TO MINIMIZE EROSION AND THE DISCHARGE OF SEDIMENT OFF SITE.
- CONCRETE WASH WATER SHALL BE CONTAINED AND DISPOSED OF IN ACCORDANCE WITH THE SWMP. NO WASH WATER SHALL BE DISCHARGED OR ALLOWED TO ENTER STATE WATERS INCLUDING ANY SUBSURFACE STORM DRAINAGE SYSTEM OR FACILITIES. CONCRETE WASHWATS SHALL NOT BE LOCATED IN AN AREA WHERE SHALLOW GROUNDWATER MAY BE PRESENT, OR WITHIN 50 FEET OF A SURFACE WATER BODY, CREEK OR STREAM.
- DURING DEWATERING OPERATIONS OF UNCONTAMINATED GROUND WATER MAY BE DISCHARGED ON SITE, BUT SHALL NOT LEAVE THE SITE IN THE FORM OF SURFACE RUNOFF UNLESS AN APPROVED STATE DEWATERING PERMIT IS IN PLACE.
- EROSION CONTROL BLANKETING OR OTHER PROTECTIVE COVERING SHALL BE USED ON SLOPES STEEPER THAN 3:1.
- CONTRACTOR SHALL BE RESPONSIBLE FOR THE REMOVAL OF ALL WASTES FROM THE CONSTRUCTION SITE FOR DISPOSAL IN ACCORDANCE WITH LOCAL AND STATE REGULATORY REQUIREMENTS. NO CONSTRUCTION DEBRIS, TREE SLASH, BUILDING MATERIAL, WASTES OR UNUSED BUILDING MATERIALS SHALL BE BURIED, DUMPED, OR DISCHARGED AT THE SITE.
- WASTE MATERIALS SHALL NOT BE TEMPORARILY PLACED OR STORED IN THE STREET, ALLEY, OR OTHER PUBLIC WAY. UNLESS IN ACCORDANCE WITH AN APPROVED TRAFFIC CONTROL PLAN, CONTROL MEASURES MAY BE REQUIRED BY EL PASO COUNTY ENGINEERING IF DEEMED NECESSARY, BASED ON SPECIFIC CONDITIONS AND CIRCUMSTANCES.
- TRACKING OF SOILS AND CONSTRUCTION DEBRIS OFF-SITE SHALL BE MINIMIZED. MATERIALS TRACKED OFF-SITE SHALL BE CLEANED UP AND PROPERLY DISPOSED OF IMMEDIATELY.
- THE OWNER/DEVELOPER SHALL BE RESPONSIBLE FOR THE REMOVAL OF ALL CONSTRUCTION DEBRIS, DIRT, TRASH, ROCK, SEDIMENT, SOIL, AND SAND THAT MAY ACCUMULATE IN ROADS, STORM DRAINS AND OTHER DRAINAGE CONVEYANCE SYSTEMS AND STORMWATER APPURTENANCES AS A RESULT OF SITE DEVELOPMENT.
- THE QUANTITY OF MATERIALS STORED ON THE PROJECT SITE SHALL BE LIMITED, AS MUCH AS PRACTICAL, TO THAT QUANTITY REQUIRED TO PERFORM THE WORK IN AN ORDERLY SEQUENCE. ALL MATERIALS STORED ON-SITE SHALL BE STORED IN A NEAT, ORDERLY MANNER, IN THEIR ORIGINAL CONTAINERS, WITH ORIGINAL MANUFACTURER'S LABELS.
- NO CHEMICAL(S) HAVING THE POTENTIAL TO BE RELEASED IN STORMWATER ARE TO BE STORED OR USED ON-SITE UNLESS PERMISSION FOR THE USE OF SUCH CHEMICAL(S) IS GRANTED IN WRITING BY THE EDM ADMINISTRATOR. IN GRANTING APPROVAL FOR THE USE OF SUCH CHEMICAL(S), SPECIAL CONDITIONS AND MONITORING MAY BE REQUIRED.
- BULK STORAGE OF ALLOWED PETROLEUM PRODUCTS OR OTHER ALLOWED LIQUID CHEMICALS IN EXCESS OF 55 GALLONS SHALL REQUIRE ADEQUATE SECONDARY CONTAINMENT PROTECTION TO CONTAIN ALL SPILLS ON-SITE AND TO PREVENT ANY SPILLED MATERIALS FROM ENTERING STATE WATERS, ANY SURFACE OR SUBSURFACE STORM DRAINAGE SYSTEM OR OTHER FACILITIES.
- NO PERSON SHALL CAUSE THE IMPEDIMENT OF STORMWATER FLOW IN THE CURB AND GUTTER OR DITCH EXCEPT WITH APPROVED SEDIMENT CONTROL MEASURES.
- OWNER/DEVELOPER AND THEIR AGENTS SHALL COMPLY WITH THE COLORADO WATER QUALITY CONTROL ACT (TITLE 25, ARTICLE 8, CRS), AND THE CLEAN WATER ACT (33 USC 1344), IN ADDITION TO THE REQUIREMENTS OF THE LAND DEVELOPMENT CODE (DOM VOLUME 8) AND THE EDM APPENDIX 1. ALL APPROPRIATE PERMITS MUST BE OBTAINED BY THE CONTRACTOR PRIOR TO CONSTRUCTION (1041, NPDES, FLOODPLAIN, 404, FUGITIVE DUST, ETC.). IN THE EVENT OF CONFLICTS BETWEEN THESE REQUIREMENTS AND OTHER LAWS, RULES, OR REGULATIONS OF OTHER FEDERAL, STATE, LOCAL, OR COUNTY AGENCIES, THE MOST RESTRICTIVE LAWS, RULES, OR REGULATIONS SHALL APPLY.
- ALL CONSTRUCTION TRAFFIC MUST ENTER/EXIT THE SITE ONLY AT APPROVED CONSTRUCTION ACCESS POINTS.
- PRIOR TO CONSTRUCTION THE PERMITTEE SHALL VERIFY THE LOCATION OF EXISTING UTILITIES.
- A WATER SOURCE SHALL BE AVAILABLE ON SITE DURING EARTHWORK OPERATIONS AND SHALL BE UTILIZED AS REQUIRED TO MINIMIZE DUST FROM EARTHWORK EQUIPMENT AND WIND.
- THE SOILS REPORT FOR THIS SITE HAS BEEN PREPARED BY ENTECH ENGINEERING, INC. ON APRIL 29, 2019 AND SHALL BE CONSIDERED A PART OF THESE PLANS. THIS REPORT CAN BE FOUND IN PGD FILE NO: SF-21-033.
- AT LEAST TEN (10) DAYS PRIOR TO THE ANTICIPATED START OF CONSTRUCTION, FOR PROJECTS THAT WILL DISTURB ONE (1) ACRE OR MORE, THE OWNER OR OPERATOR OF CONSTRUCTION ACTIVITY SHALL SUBMIT A PERMIT APPLICATION FOR STORMWATER DISCHARGE TO THE COLORADO DEPARTMENT OF PUBLIC HEALTH AND ENVIRONMENT, WATER QUALITY DIVISION. THE APPLICATION CONTAINS CERTIFICATION OF COMPLETION OF A STORMWATER MANAGEMENT PLAN (SWMP), OF WHICH THIS GRADING AND EROSION CONTROL PLAN MAY BE A PART. FOR INFORMATION OR APPLICATION MATERIALS CONTACT:

COLORADO DEPARTMENT OF PUBLIC HEALTH AND ENVIRONMENT  
 WATER QUALITY CONTROL DIVISION  
 WQCD - PERMITS  
 4300 CHERRY CREEK DRIVE SOUTH  
 DENVER, CO 80246-1530  
 ATTN: PERMITS UNIT

**LAYER LINETYPE LEGEND**

	EXISTING	PROPOSED
PHASE LINE	---	---
MATCH LINE	---	---
SECTION LINE	---	---
BOUNDARY LINE	---	---
PROPERTY LINE	---	---
EASEMENT LINE	---	---
RIGHT OF WAY	---	---
R.O.W. A LINE	---	---
CENTERLINE	---	---
CITY LIMITS	---	---
WIRE FENCE	---	---
CHAIN LINK FENCE	---	---
WOOD FENCE	---	---
MASONRY FENCE	---	---
QUADRIL	---	---
CONC. BARRIER	---	---
CABLE TV	---	---
ELECTRIC	---	---
FIBER OPTIC	---	---
GAS MAIN	---	---
IRRIGATION MAIN	---	---
OIL/PETRO. MAIN	---	---
OVERHEAD UTILITY	---	---
SANITARY SEWER	---	---
STORM DRAIN	---	---
TELEPHONE	---	---
WATER MAIN	---	---
RAW WATER LINE	---	---
SWALE/WATERWAY FLOWLINE	---	---
DIVERSION DITCH	---	---
DIVERSION CHANNEL	---	---
MAJOR DRAINAGE BASIN	---	---
MINOR DRAINAGE BASIN	---	---
TOP OF SLOPE	---	---
EDGE OF SLOPE	---	---
EDGE OF WATER	---	---
INDEX CONTOUR	---	---
INTERMEDIATE CONTOUR	---	---
DEPRESSION CONT. (INDEX)	---	---
DEPRESSION CONT. (INTER)	---	---
TOP OF CUTS	---	---
EDGE OF FILLS	---	---
CUT AND FILL LINE	---	---
SILT FENCE	---	---
100 YEAR FLOODPLAIN	---	---
500 YEAR FLOODPLAIN	---	---
FLOODWAY	---	---
BASE FLOOD ELEVATION	---	---
EDGE OF WETLANDS	---	---
STONE WALL	---	---
STORMWATER FLOW ARROWS	---	---

**UTILITIES LEGEND**

	EXISTING	PROPOSED
STORM SEWER	---	---
MANHOLE	---	---
STORM INLET	---	---
AREA INLET - SQUARE	---	---
AREA INLET - ROUND	---	---
FLARED END SECTION	---	---
RIPRAP	---	---
SANITARY SEWER	---	---
LINE MARKER	---	---
SERVICE MARKER	---	---
CLEAN-OUT	---	---
MANHOLE W/ DIRECTIONAL FLOW ARROW	---	---
WATER LINE	---	---
LINE MARKER	---	---
SERVICE MARKER	---	---
FIRE HYDRANT	---	---
FIRE CONNECTION	---	---
MANHOLE	---	---
BEND	---	---
BLOW-OFF VALVE	---	---
WELL	---	---
METER	---	---
VALVE	---	---
REDUCER	---	---
THRUST BLOCK	---	---
CROSS	---	---
PLUG W/ THRUST BLOCK	---	---
TEE	---	---
REVERSE ANCHOR	---	---
ANODE	---	---
AIR & VACUUM VALVE ASSEMBLY	---	---
TRANSMISSION BLOW-OFF ASSEMBLY	---	---
GAS LINE	---	---
MARKER	---	---
SERVICE MARKER	---	---
METER	---	---
VALVE	---	---
PLUG	---	---
TEE	---	---
DRY UTILITIES	---	---
CABLE TV MARKER	---	---
CABLE TELEVISION PEDESTAL	---	---
ELECTRIC MARKER	---	---
ELECTRIC SERVICE MARKER	---	---
ELECTRICAL PEDESTAL	---	---
ELECTRICAL METER	---	---
ELECTRICAL MANHOLE	---	---
FIBER-OPTIC MARKER	---	---
IRRIGATION PEDESTAL	---	---
TELEPHONE MARKER	---	---
TELEPHONE PEDESTAL	---	---
TELEPHONE MANHOLE	---	---
UTILITY POLE	---	---
GUY ANCHOR	---	---
GUY POLE	---	---

UNIL SUCH TIME AS THE APPLICANT HAS OBTAINED THE NECESSARY APPROPRIATE REVIEWING AGENCIES' APPROVALS FOR THE PURPOSES OF THIS PERMIT.

PREPARED FOR  
 RO PROPERTY GROUP, LLC  
 2495 RIGDON STREET  
 NAPA, CALIFORNIA  
 94558-1607  
 CONTACT: BRADY WILLIAMS

**JR ENGINEERING**  
 A National Company  
 Central 303-740-5338 • Colorado Springs 719-599-2533  
 Fort Collins 970-699-8888 • www.jrengineering.com

NO.	REVISION	DATE

SADDLEHORRN RANCH -  
 FILING 5  
 LEGEND & NOTES

**ENGINEER'S STATEMENT**  
 PREPARED UNDER MY DIRECT SUPERVISION AND ON BEHALF OF JR ENGINEERING  
 9/2/22  
 BRYAN T. LAW, P.E.  
 COLORADO P.E. 25043  
 FOR AND ON BEHALF OF JR ENGINEERING, LLC



H-SCALE	N/A	V-SCALE	N/A	DATE	DESIGNED BY	DRAWN BY	CHECKED BY
				9/2/2022			

SHEET 2 OF 8  
 JOB NO. 25142.07

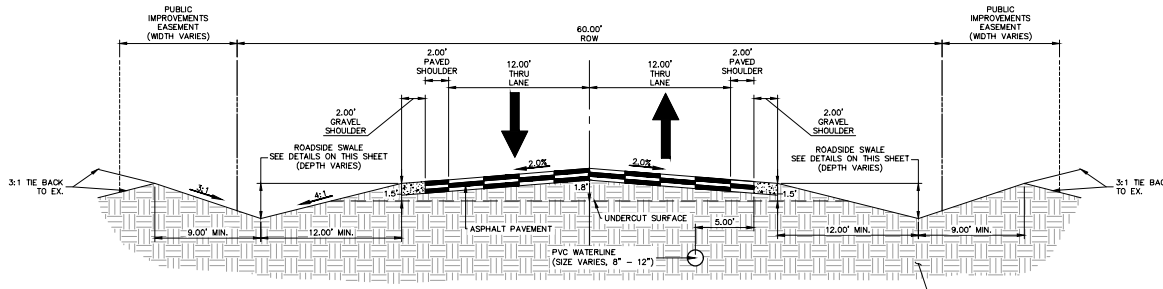

NOTE: SUBGRADE UNDERCUT GRADING ONLY IS PERMITTED WITH THIS PREDEVELOPMENT CONSTRUCTION PLANS. ASPHALT AND BASE COURSE SHALL NOT BE CONSTRUCTED WITH THIS PREDEVELOPMENT GRADING

**TYPICAL RURAL LOCAL**  
 POSTED SPEED LIMIT = 30 MPH, DESIGN SPEED LIMIT = 30 MPH  
 SCALE: 1" = 5'

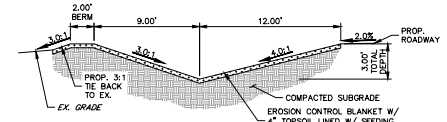

**SWALE SECTION B-B**  
 SCALE: 1" = 5'

SWALE SEED MIX:  
 EROSION CONTROL BLANKET WITH PANNEE BUTTES SEED INC. - "LOW GROW NATIVE MIX"  
 - IDAHO FESCUE  
 - SANDBERG BLUEGRASS  
 - ROCKY MOUNTAIN FESCUE  
 - BIG BLUEGRASS

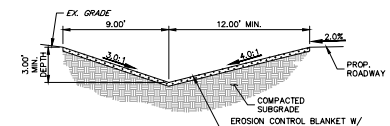

**SWALE SECTION A-A**  
 SCALE: 1" = 5'

SWALE SEED MIX:  
 EROSION CONTROL BLANKET WITH PANNEE BUTTES SEED INC. - "LOW GROW NATIVE MIX"  
 - IDAHO FESCUE  
 - SANDBERG BLUEGRASS  
 - ROCKY MOUNTAIN FESCUE  
 - BIG BLUEGRASS

**ROADSIDE SWALE NOTES**

- SWALE SECTION A-A PROVIDES MINIMUM SWALE DIMENSIONS. IN AREAS WHERE 3:1 TIE BACK TO EXISTING DOES NOT PROVIDE MINIMUM SWALE DEPTH, SWALE TO BE CUT DEEPER SUCH THAT 3' DEPTH IS PROVIDED RELATIVE TO EXISTING GRADE.
- SWALE SECTION B-B TO BE USED IN FILL AREAS OF ROADWAY WHERE CUTTING SWALE DEEPER TO ACHIEVE 3:0' DEPTH RELATIVE TO EXISTING GRADE CAN NOT BE ACHIEVED DUE TO DOWN STREAM GRADE REQUIREMENTS. 2.0' BERM MUST BE PROVIDED TO MITIGATE FUTURE EROSION.

**EARLY GRADING NOTES**

- NO PAVEMENT SHOWN IN THE ABOVE ROAD SECTION SHALL BE PROPOSED WITH ANY EARLY GRADING IMPROVEMENTS.
- ALL PROPOSED TEMPORARY CULVERTS SHALL BE 18" CMP. TEMPORARY CULVERT LOCATIONS CAN BE FOUND ON SHEET 4.1.
- ALL TEMPORARY SWALE CONNECTIONS SHALL MATCH FUTURE CULVERT GRASSES. TEMPORARY SWALE CONNECTION LOCATIONS CAN BE FOUND ON SHEET 4.1.
- ALL INITIAL BMPs SHALL BE INSTALLED PRIOR TO ANY GRADING ONSITE.
- ALL CHECK DAMS AND INLET/OUTLET PROTECTIONS SHALL BE INSTALLED AND MAINTAINED UNTIL 70% VEGETATION HAS BEEN ACHIEVED AND REMOVAL IS APPROVED BY EPC.
- NO GRADING IMPROVEMENTS SHALL BE PERFORMED WITHIN THE CURBED ROAD ROW AS PART OF THE EARLY GRADING IMPROVEMENTS FOR THIS SITE.

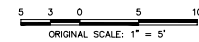

**ENGINEER'S STATEMENT**

PREPARED UNDER MY DIRECT SUPERVISION AND ON BEHALF OF JR ENGINEERING  
 [Signature]  
 BRYAN T. CAW, P.E.  
 COLORADO P.E. 25043  
 FOR AND ON BEHALF OF JR ENGINEERING, LLC



9/2/22  
 DATE

UNTIL SUCH TIME AS THE APPROVED BY THE APPROPRIATE REVIEWING AGENCIES THEIR USE ONLY FOR THE PURPOSES INDICATED IN THE WRITTEN AUTHORIZATION.	
PREPARED FOR	RO PROPERTY GROUP, LLC 2495 RIGDON STREET NAPA, CALIFORNIA 94949-3600 BRADY WILLIAMS
FOR	JR ENGINEERING A Naiman Company Central 303-742-8338 • Colorado Springs 719-599-2938 For Color 970-691-9988 • www.jrengineering.com
H-SCALE	1" = 5'
V-SCALE	N/A
DATE	9/2/2022
DESIGNED BY	SWW
DRAWN BY	SWW
CHECKED BY	
NO. REVISION	
BY	
DATE	
SADDLEHORN RANCH - FILING 5	
TYPICAL SECTIONS	
SHEET	3 OF 8
JOB NO.	25142.07

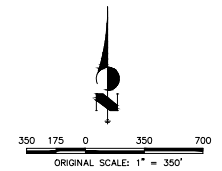
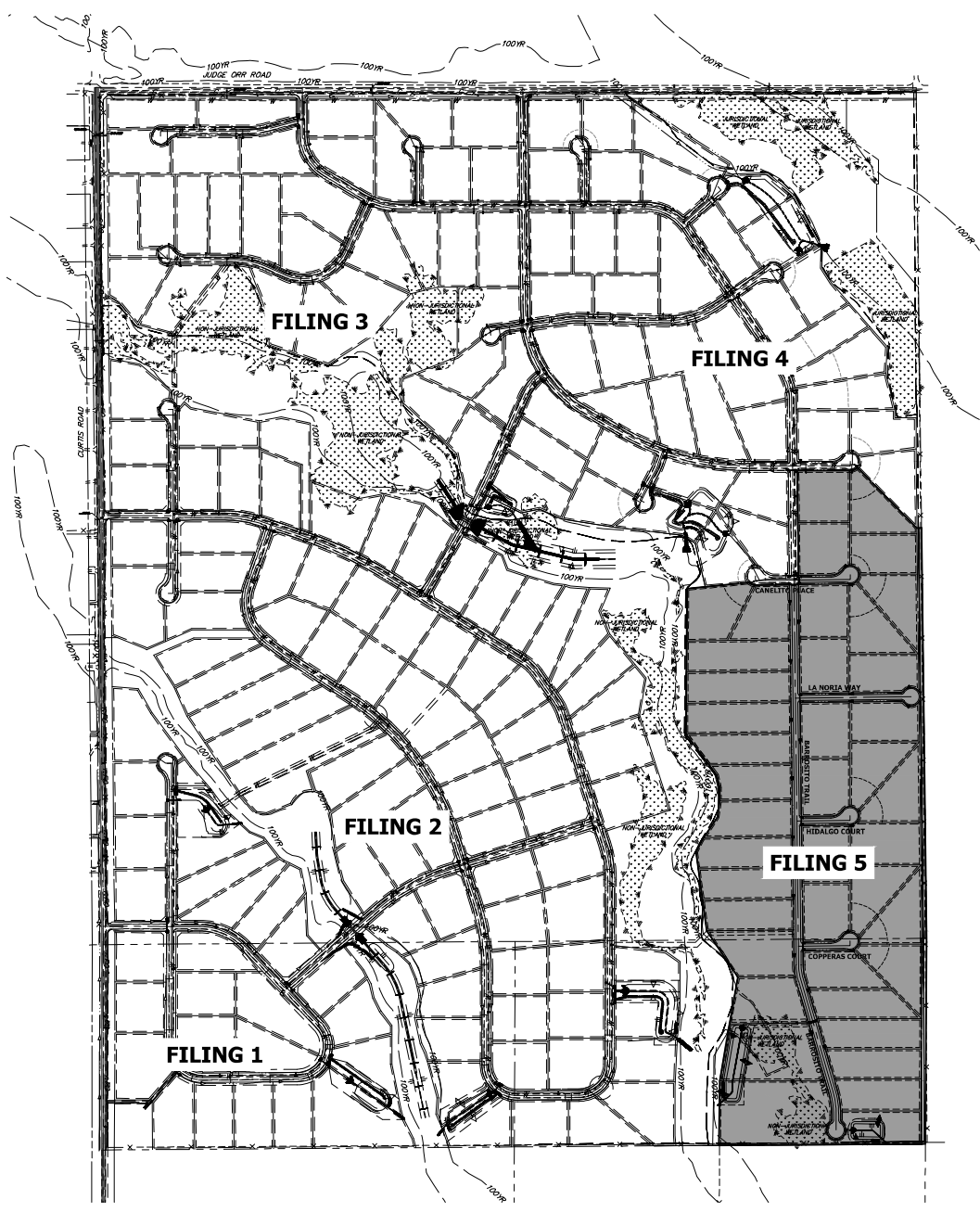

UNTIL SUCH TIME AS APPROVED BY THE APPROPRIATE REVIEWING AGENCIES, THEIR USE IS FOR THE PURPOSES ONLY AND NOT FOR ANY OTHER PURPOSES WITHOUT THE WRITTEN AUTHORIZATION.	
PREPARED FOR <b>RO PROPERTY GROUP, LLC</b> 2495 RIGDON STREET NAPA, CALIFORNIA 94957-1600 BRAD J. WILLIAMS	1" = 350' N/A 9/2/2022 GVT GVT
<b>JR ENGINEERING</b> A Valenti Company Central 303-742-8388 • Colorado Springs 719-599-2538 Fort Collins 970-691-8988 • www.jrengineering.com	BY DATE NO. REVISION H-SCALE 1" = 350' V-SCALE N/A DATE 9/2/2022 DESIGNED BY GVT DRAWN BY GVT CHECKED BY
<b>OWNER/DEVELOPER STATEMENT</b> I, THE OWNER/DEVELOPER HAVE READ AND WILL COMPLY WITH THE REQUIREMENTS OF THE GRADING AND EROSION CONTROL PLAN. JOHN HELMICK 9/9/22 GORILLA CAPITAL CO SADDLEHORN RANCH, LLC 1342 HIGH STREET EUGENE, OR 97401	SADDLEHORN RANCH - FILING 5 OVERALL SITE MAP
<b>ENGINEER'S STATEMENT</b> THIS GRADING AND EROSION CONTROL PLAN WAS PREPARED UNDER MY DIRECTION AND SUPERVISION AND IS CORRECT TO THE BEST OF MY KNOWLEDGE AND BELIEF. SAID PLAN HAS BEEN PREPARED ACCORDING TO THE CRITERIA ESTABLISHED BY THE COUNTY FOR GRADING AND EROSION CONTROL PLANS. I ACCEPT RESPONSIBILITY FOR ANY LIABILITY CAUSED BY ANY NEGLIGENT ACTS, ERRORS OR OMISSIONS ON MY PART IN PREPARING THIS PLANS. BRYAN T. LAW, P.E. 9/2/22 COLORADO P.E. 25043 FOR AND ON BEHALF OF JR ENGINEERING, LLC	SHEET 4 OF 8 JOB NO. 25142.07



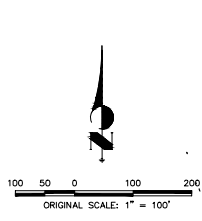
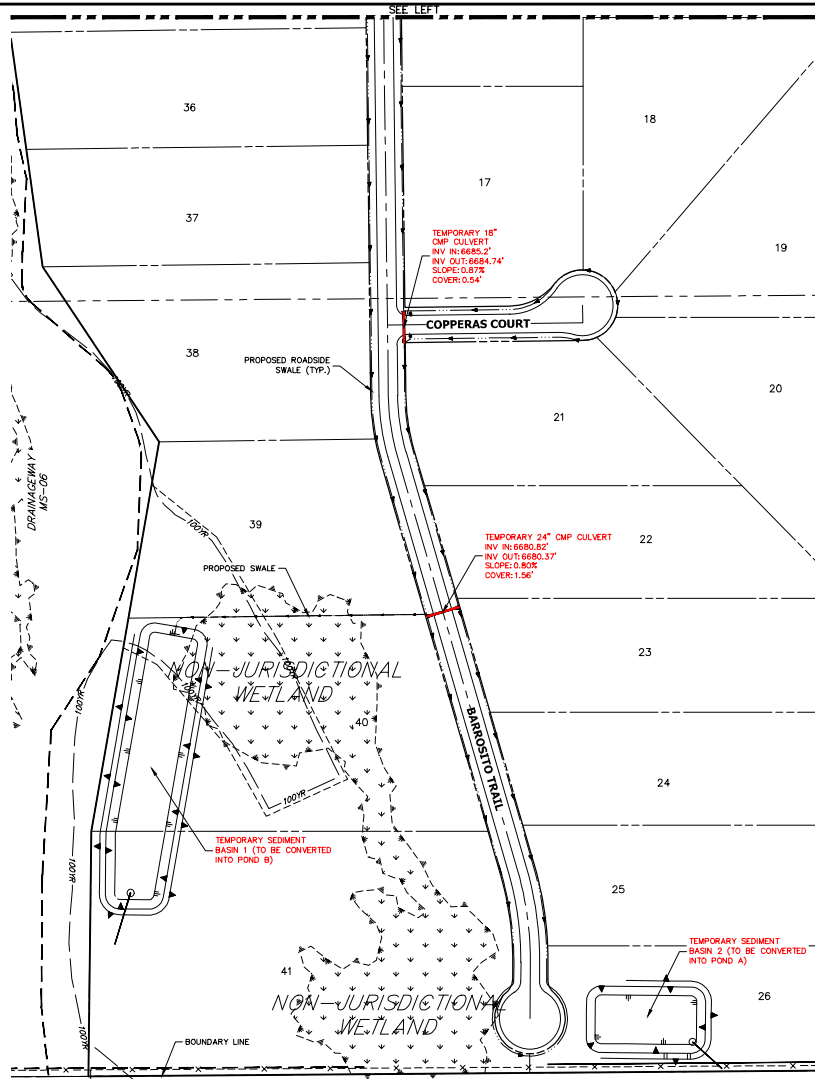
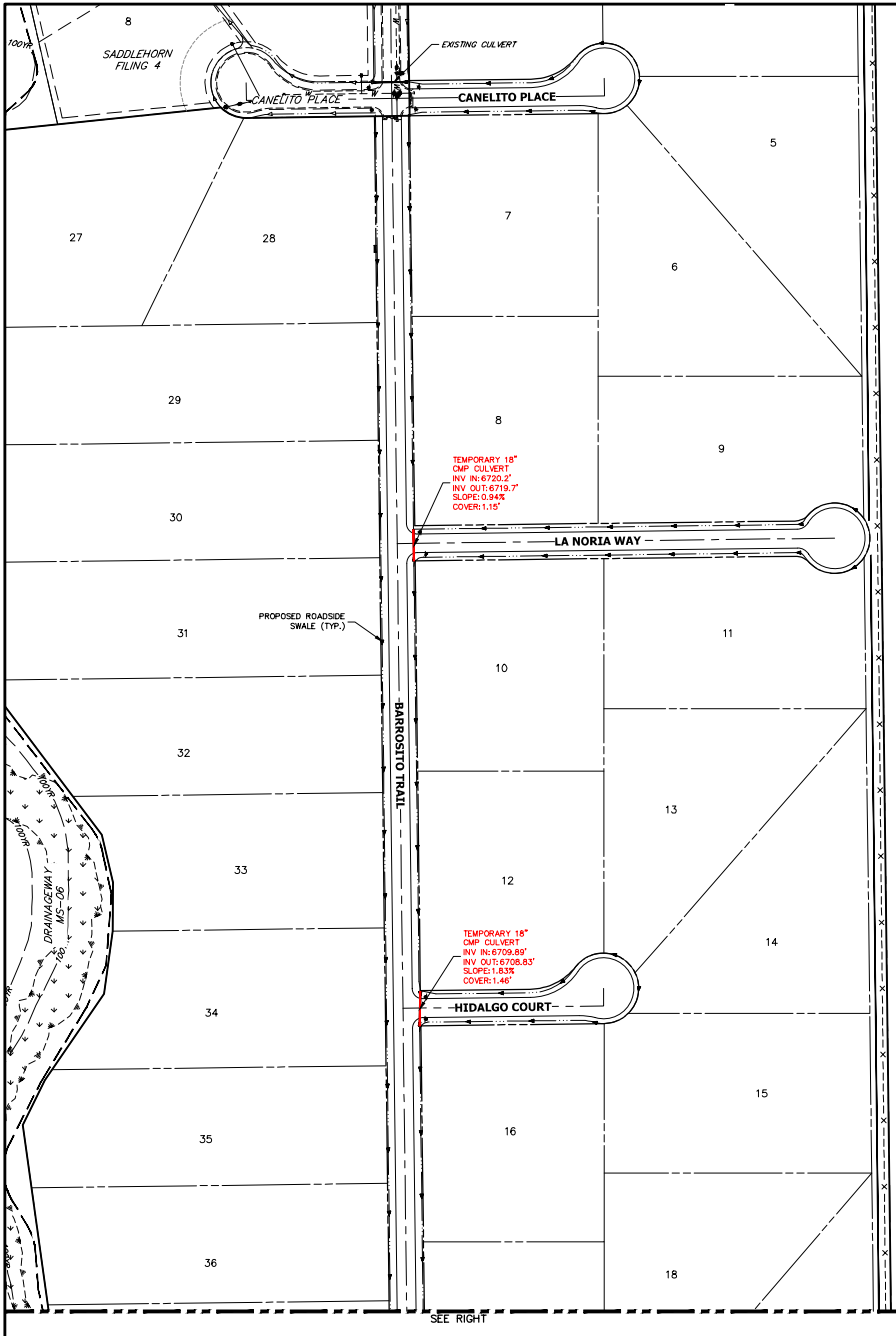

**LEGEND**  
 EARLY GRADING TEMPORARY IMPROVEMENTS

**OWNER/DEVELOPER STATEMENT**  
 I, THE OWNER/DEVELOPER HAVE READ AND WILL COMPLY WITH THE REQUIREMENTS OF THE GRADING AND EROSION CONTROL PLAN.  
 \_\_\_\_\_  
 JOHN HELMICK  
 GORILLA CAPITAL CO SADDLEHORN RANCH, LLC  
 1342 HIGH STREET  
 EUGENE, OR 97401

9/9/22  
 DATE

**ENGINEER'S STATEMENT**  
 THIS GRADING AND EROSION CONTROL PLAN WAS PREPARED UNDER MY DIRECTION AND SUPERVISION AND IS CORRECT TO THE BEST OF MY KNOWLEDGE AND BELIEF. SAID PLAN HAS BEEN PREPARED ACCORDING TO THE CRITERIA ESTABLISHED BY THE COUNTY FOR GRADING AND EROSION CONTROL PLANS. I ACCEPT RESPONSIBILITY FOR ANY LIABILITY CAUSED BY ANY NEGLIGENT ACTS, ERRORS OR OMISSIONS ON MY PART IN PREPARING THIS PLANS.  
 \_\_\_\_\_  
 BRYAN T. LAW, P.E.  
 COLORADO P.E. 25043  
 FOR AND ON BEHALF OF JR ENGINEERING, LLC



9/2/22  
 DATE

**811**  
 Know what's below.  
 Call before you dig.

PREPARED FOR <b>RO PROPERTY GROUP, LLC</b> 2495 RIGDON STREET NAPA, CALIFORNIA (707) 251-1111 BRADY WILLIAMS	
UNTIL SUCH TIME AS APPROVED BY THE APPROPRIATE REVIEWING AGENCIES, THIS PLAN IS FOR THE PURPOSES OF OBTAINING PERMITS ONLY AND DOES NOT CONSTITUTE AN AUTHORIZATION.	
<b>JR ENGINEERING</b> A Napa Company Central 330-740-8388 • Colorado Springs 719-599-2538 For Calif. 916-891-8988 • www.jrengineering.com	
BY	DATE
NO. REVISION	
H-SCALE 1"=100'	N/A
V-SCALE	DATE
DESIGNED BY	WKN
DRAWN BY	WKN
CHECKED BY	
SADDLEHORN RANCH - FILING 5 EARLY GRADING IMPROVEMENTS	
SHEET	4.1 OF 8
JOB NO.	25142.07

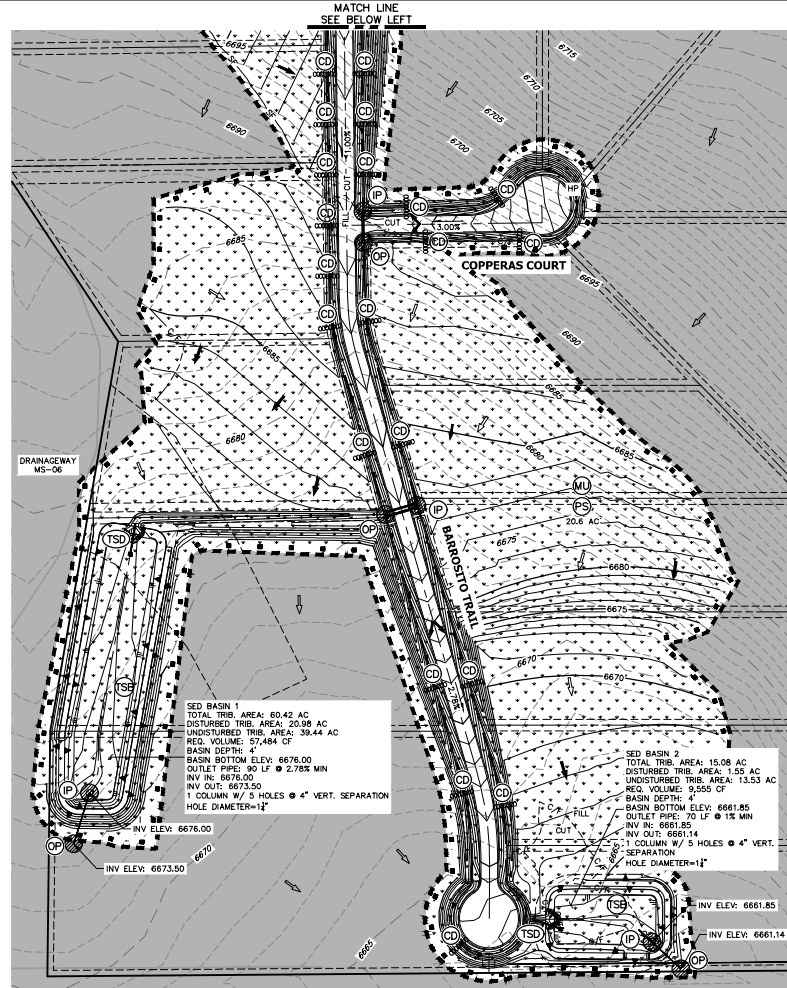
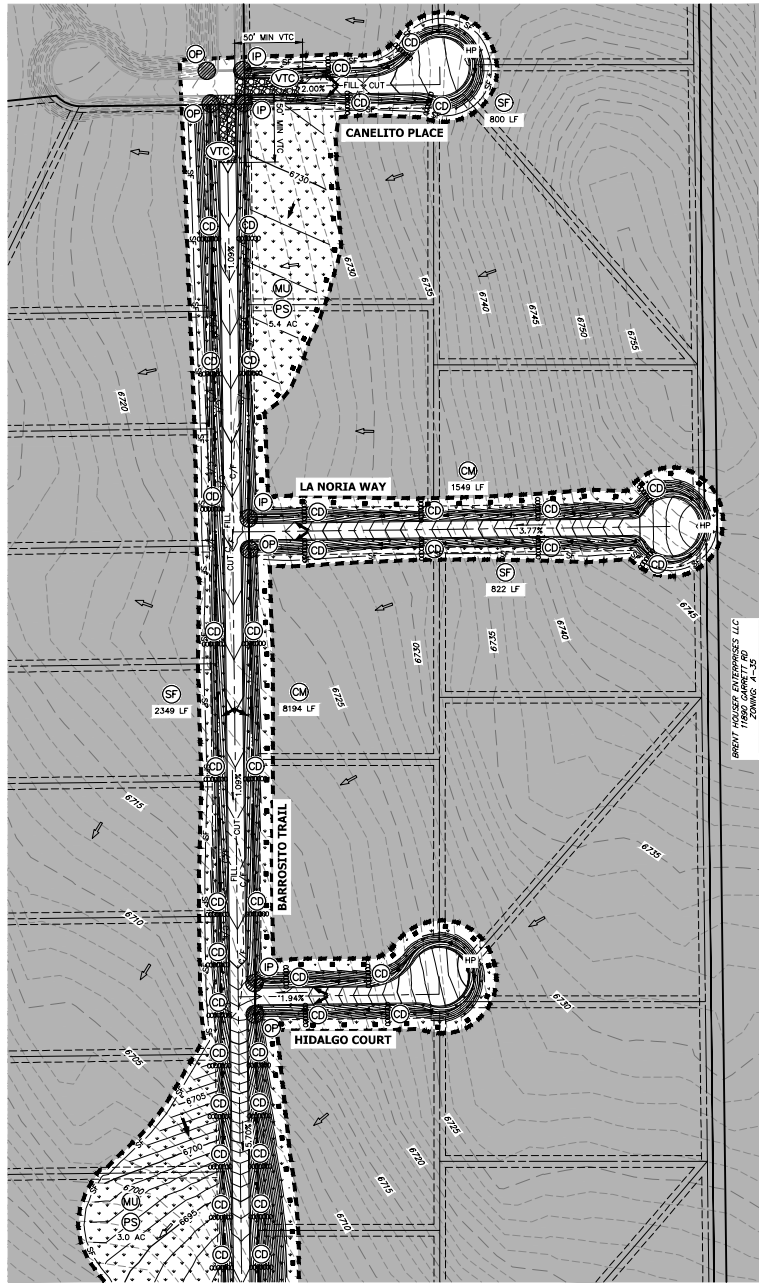

**NOTES**

- REFER TO THE STORMWATER MANAGEMENT PLAN (SWMP) FOR A DETAILED DESCRIPTION OF THE MAINTENANCE PROGRAMS FOR EROSION CONTROL FACILITIES.
- SEE SHEET 3 FOR SWALE TYPICAL CROSS SECTIONS THAT INCLUDES SWALE LINING DETAIL.
- ALL DISTURBED AREAS NOT TO BE PAVED SHALL BE PERMANENTLY SEEDED PER THE PANNING BUTTES SEED INC. "LOW GROW" NATIVE MIX OR APPROVED EQUAL. SEE SHEET 3 FOR SEED MIX DETAILS: 12.7 TOTAL ACRES OF SEEDING ESTIMATED.
- PUE = PUBLIC IMPROVEMENTS EASEMENT
- EXISTING VEGETATION CONSISTS OF NATIVE MEADOW GRASSES (APPROX. 70% COVERAGE) DETERMINED THROUGH A COMBINATION OF FIELD VERIFICATION AND AERIAL INSPECTION.
- NO BATCH PLANTS WILL BE UTILIZED ON SITE.
- DETENTION POND DETAILS ARE PROVIDED IN THE CONSTRUCTION DRAWINGS.

**EARTHWORK SUMMARY TABLE**

NET CUT (CY)	64,395
NET FILL (CY)	94,796
NET IMPORT (CY)	30,602
*1 ROAD CUT	
*10% COMPACTION	

**BMP PHASING**

- INITIAL**
- 1) INSTALL VTC
  - 2) INSTALL CWA
  - 3) ESTABLISH SSA
  - 4) INSTALL CONSTRUCTION MARKERS
  - 5) INSTALL SILT FENCE
  - 6) INSTALL SEDIMENT BASINS
  - 7) INSTALL DIVERSION DITCHES
- INTERIM**
- 1) LOCATE/INSTALL TEMPORARY STOCKPILE
  - 2) MAINTAIN ALL BMPs
  - 3) INSTALL RRBS
  - 4) INSTALL INLET AND OUTLET PROTECTION
  - 5) INSTALL EROSION CONTROL BLANKETS
- FINAL**
- 1) INSTALL MULCH AND PERMANENT SEEDING IN ALL DISTURBED AREAS
  - 2) REMOVE SILT FENCE AFTER STABILIZED, INLET & OUTLET PROTECTION, RRBS, EROSION CONTROL BLANKETS, VTC, CWA, CONSTRUCTION MARKERS, SEDIMENT BASINS, DIVERSION DITCHES, SSA, AND TEMPORARY STOCKPILES

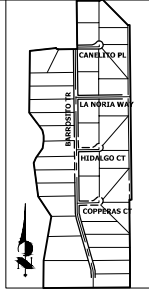
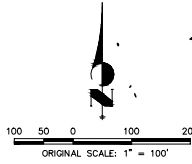

**LEGEND**

TEMPORARY SEDIMENT BASIN	(Symbol)	TOE	(Symbol)
SILT FENCE	(Symbol)	SF	(Symbol)
STABILIZED STAGING AREA	(Symbol)	SSA	(Symbol)
CONSTRUCTION MARKER	(Symbol)	CM	(Symbol)
VEHICLE TRACKING CONTROL	(Symbol)	VTC	(Symbol)
TEMPORARY STOCK PILE	(Symbol)	TSP	(Symbol)
EROSION CONTROL BLANKET	(Symbol)	ECB	(Symbol)
INLET PROTECTION	(Symbol)	IP	(Symbol)
OUTLET PROTECTION	(Symbol)	OP	(Symbol)
DIVERSION DITCH AND DIKE, TEMPORARY	(Symbol)	DD	(Symbol)
CUT AND FILL LINE	(Symbol)	C/F	(Symbol)
LIMITS OF CONSTRUCTION/DISTURBANCE	(Symbol)	LOC	(Symbol)
CONCRETE WASHOUT AREA	(Symbol)	CWA	(Symbol)
MULCHING & PERMANENT SEEDING	(Symbol)	ML	(Symbol)
TEMPORARY SLOPE DRAIN	(Symbol)	TSD	(Symbol)
REINFORCED ROCK BERM	(Symbol)	RRB	(Symbol)
CHECK DAM	(Symbol)	CD	(Symbol)
ROCK SOCK	(Symbol)	RS	(Symbol)
EXISTING DRAINAGE ARROW	(Symbol)	(Symbol)	(Symbol)
PROPOSED DRAINAGE ARROW	(Symbol)	(Symbol)	(Symbol)

**OWNER/DEVELOPER STATEMENT**

I, THE OWNER/DEVELOPER HAVE READ AND WILL COMPLY WITH THE REQUIREMENTS OF THE GRADING AND EROSION CONTROL PLAN.

*John Helwick*  
 JOHN HELWICK  
 GORILLA CAPITAL CO SADDLEHORN RANCH, LLC  
 1342 HIGH STREET  
 EUGENE, OR 97401  
 9/9/22  
 DATE

**ENGINEER'S STATEMENT**

THIS GRADING AND EROSION CONTROL PLAN WAS PREPARED UNDER MY DIRECTION AND SUPERVISION AND IS CORRECT TO THE BEST OF MY KNOWLEDGE AND BELIEF. SAID PLAN HAS BEEN PREPARED ACCORDING TO THE CRITERIA ESTABLISHED BY THE COUNTY FOR GRADING AND EROSION CONTROL PLANS. I ACCEPT RESPONSIBILITY FOR ANY LIABILITY CAUSED BY ANY NEGLIGENT ACTS, ERRORS OR OMISSIONS ON MY PART IN PREPARING THIS PLANS.

*Bryan T. Law, P.E.*  
 BRYAN T. LAW, P.E.  
 COLORADO P.E. 25043  
 FOR AND ON BEHALF OF JR ENGINEERING, LLC  
 9/2/22  
 DATE



PREPARED FOR <b>ROI PROPERTY GROUP, LLC</b> 2495 RIGDON STREET NAPA, CALIFORNIA 94950-1000 BRADY WILLIAMS AUTHORIZATION	H-SCALE 1"=100' V-SCALE N/A DATE 9/2/2022 DESIGNED BY SWW DRAWN BY SWW CHECKED BY
	NO. REVISION BY DATE
<b>JR ENGINEERING</b> A NAPA COMPANY General 330-740-8388 • Colorado State: 760-599-2938 For Color: 970-691-9988 • www.jrengineering.com	SADDLEHORN RANCH - FILING 5 GRADING & EROSION CONTROL PLANS SHEET 5 OF 8 JOB NO. 25142.07





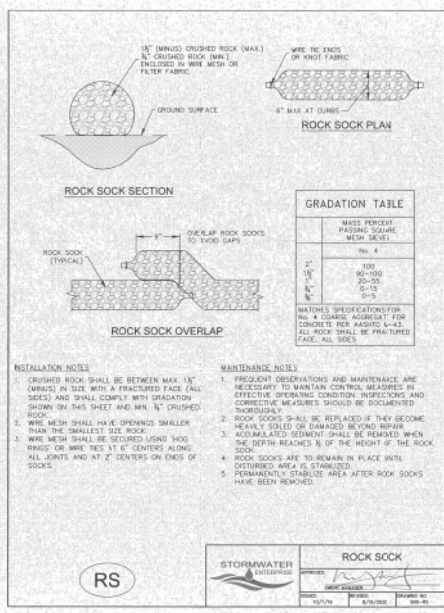
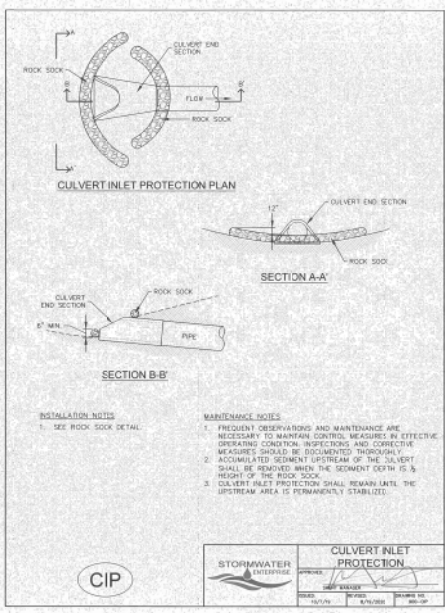
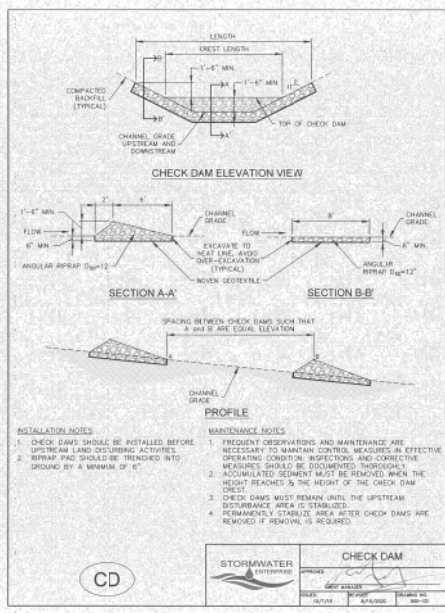
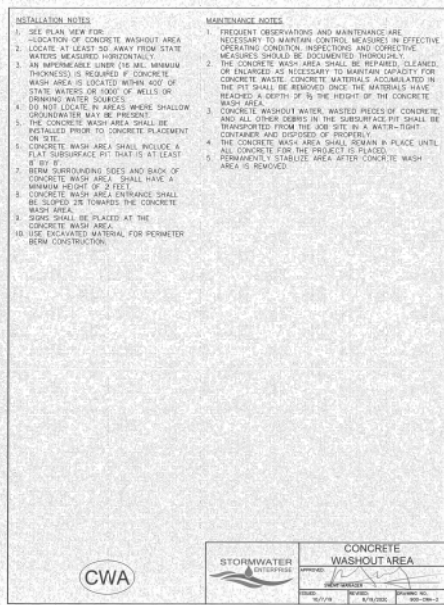
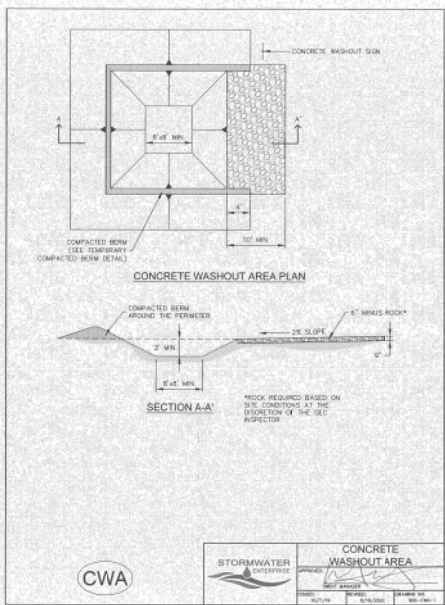
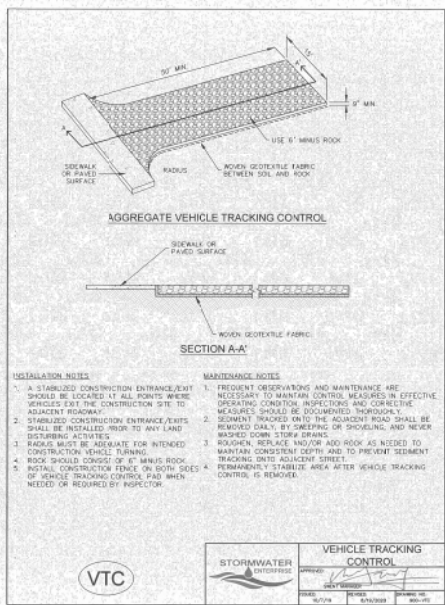

**811**  
Know what's below.  
Call before you dig.

**ENGINEER'S STATEMENT**

THIS GRADING AND EROSION CONTROL PLAN WAS PREPARED UNDER MY DIRECTION AND SUPERVISION AND IS CORRECT TO THE BEST OF MY KNOWLEDGE AND BELIEF. SAID PLAN HAS BEEN PREPARED ACCORDING TO THE CRITERIA ESTABLISHED BY THE COUNTY FOR GRADING AND EROSION CONTROL PLANS. I ACCEPT RESPONSIBILITY FOR ANY LIABILITY CAUSED BY ANY NEGLIGENT ACTS, ERRORS OR OMISSIONS ON MY PART IN PREPARING THIS PLANS.

9/2/22  
DATE

BRYAN T. LAW, P.E.  
COLORADO P.E. 25043  
FOR AND ON BEHALF OF JR ENGINEERING, LLC

**REGISTERED PROFESSIONAL ENGINEER**  
85048  
EXPIRES 12/31/2024

PREPARED FOR: **RO PROPERTY GROUP, LLC**  
2495 RIGDON STREET  
NAPA, CALIFORNIA  
94558  
BY: **JR ENGINEERING**  
A Williams Company  
Central 330-740-5538 • Colorado Springs 761-569-2538  
For Color 970-691-9966 • www.jrengineering.com

NO. REVISION: N/A  
H-SCALE: N/A  
V-SCALE: N/A  
DATE: 9/2/2022  
DESIGNED BY: SWW  
DRAWN BY: SWW  
CHECKED BY:

SADDLEHORN RANCH - FILING 5  
GRADING & EROSION CONTROL DETAILS

SHEET 7 OF 8  
JOB NO. 25142.07





## Description

Concrete waste management involves designating and properly managing a specific area of the construction site as a concrete washout area. A concrete washout area can be created using one of several approaches designed to receive wash water from washing of tools and concrete mixer chutes, liquid concrete waste from dump trucks, mobile batch mixers, or pump trucks. Three basic approaches are available: excavation of a pit in the ground, use of an above ground storage area, or use of prefabricated haul-away concrete washout containers.

Surface discharges of concrete washout water from construction sites are prohibited.

## Appropriate Uses

Concrete washout areas must be designated on all sites that will generate concrete wash water or liquid concrete waste from onsite concrete mixing or concrete delivery.

Because pH is a pollutant of concern for washout activities, when unlined pits are used for concrete washout, the soil must have adequate buffering capacity to result in protection of state groundwater standards; otherwise, a liner/containerment must be used. The following management practices are recommended to prevent an impact from unlined pits to groundwater:

- The use of the washout site should be temporary (less than 1 year), and
- The washout site should be not be located in an area where shallow groundwater may be present, such as near natural drainages, springs, or wetlands.

## Design and Installation

Concrete washout activities must be conducted in a manner that does not contribute pollutants to surface waters or stormwater runoff. Concrete washout areas may be lined or unlined excavated pits in the ground, commercially manufactured prefabricated washout containers, or aboveground holding areas constructed of berms, sandbags or straw bales with a plastic liner.

Although unlined washout areas may be used, lined pits may be required to protect groundwater under certain conditions.

**Do not locate an unlined washout area within 400 feet of any natural drainage pathway or waterbody or within 1,000 feet of any wells or drinking water sources.** Even for lined concrete washouts, it is advisable to locate the facility away from waterbodies and drainage paths. If site constraints make these



**Photograph CWA-1.** Example of concrete washout area. Note gravel tracking pad for access and sign.

Concrete Washout Area	
<b>Functions</b>	
Erosion Control	No
Sediment Control	No
Site/Material Management	Yes

# MM-1 Concrete Washout Area (CWA)

---

setbacks infeasible or if highly permeable soils exist in the area, then the pit must be installed with an impermeable liner (16 mil minimum thickness) or surface storage alternatives using prefabricated concrete washout devices or a lined aboveground storage area should be used.

Design details with notes are provided in Detail CWA-1 for pits and CWA-2 for aboveground storage areas. Pre-fabricated concrete washout container information can be obtained from vendors.

## Maintenance and Removal

A key consideration for concrete washout areas is to ensure that adequate signage is in place identifying the location of the washout area. Part of inspecting and maintaining washout areas is ensuring that adequate signage is provided and in good repair and that the washout area is being used, as opposed to washout in non-designated areas of the site.

Remove concrete waste in the washout area, as needed to maintain BMP function (typically when filled to about two-thirds of its capacity). Collect concrete waste and deliver offsite to a designated disposal location.

Upon termination of use of the washout site, accumulated solid waste, including concrete waste and any contaminated soils, must be removed from the site to prevent on-site disposal of solid waste. If the wash water is allowed to evaporate and the concrete hardens, it may be recycled.



**Photograph CWA-2.** Prefabricated concrete washout. Photo courtesy of CDOT.



**Photograph CWA-3.** Earthen concrete washout. Photo courtesy of CDOT.

# Concrete Washout Area (CWA)

MM-1

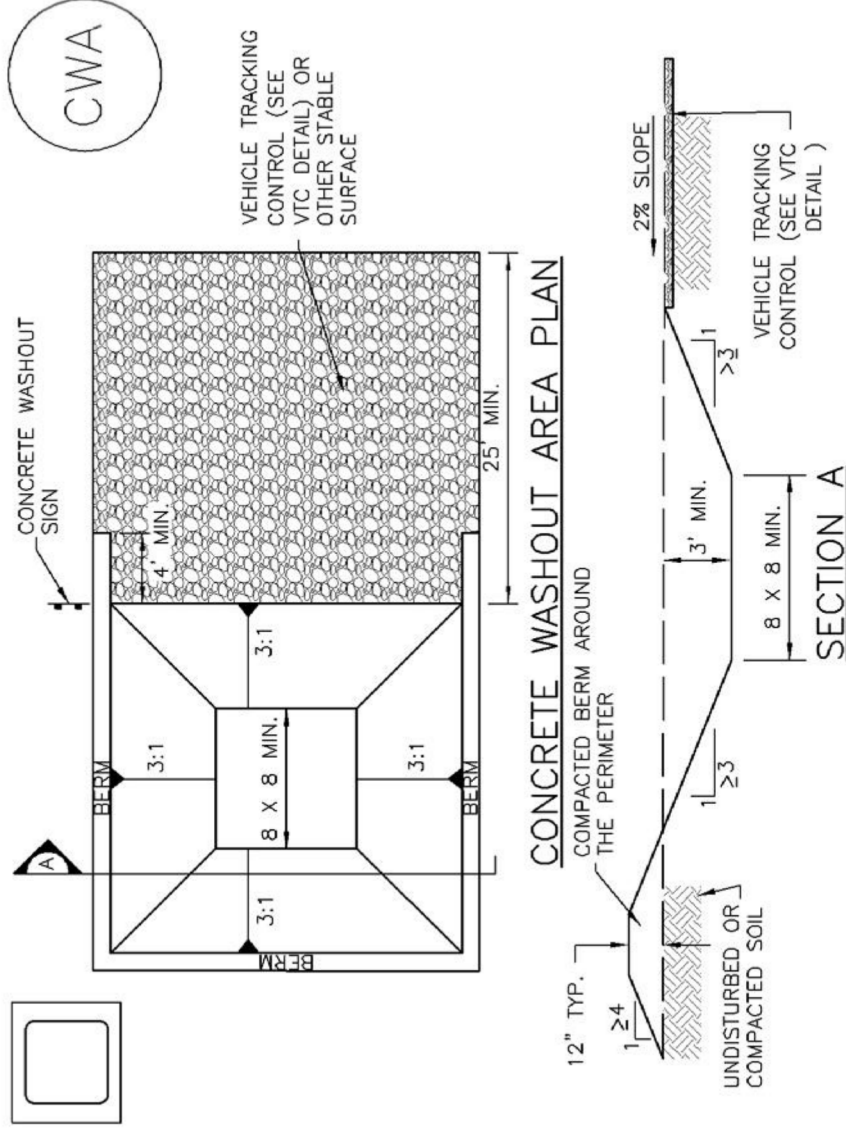

## CWA-1. CONCRETE WASHOUT AREA

### CWA INSTALLATION NOTES

1. SEE PLAN VIEW FOR:  
-CWA INSTALLATION LOCATION.
2. DO NOT LOCATE AN UNLINED CWA WITHIN 400' OF ANY NATURAL DRAINAGE PATHWAY OR WATERBODY, DO NOT LOCATE WITHIN 1,000' OF ANY WELLS OR DRINKING WATER SOURCES. IF SITE CONSTRAINTS MAKE THIS INFEASIBLE, OR IF HIGHLY PERMEABLE SOILS EXIST ON SITE, THE CWA MUST BE INSTALLED WITH AN IMPERMEABLE LINER (16 MIL MIN. THICKNESS) OR SURFACE STORAGE ALTERNATIVES USING PREFABRICATED CONCRETE WASHOUT DEVICES OR A LINED ABOVE GROUND STORAGE ARE SHOULD BE USED.
3. THE CWA SHALL BE INSTALLED PRIOR TO CONCRETE PLACEMENT ON SITE.
4. CWA SHALL INCLUDE A FLAT SUBSURFACE PIT THAT IS AT LEAST 8' BY 8' SLOPES LEADING OUT OF THE SUBSURFACE PIT SHALL BE 3:1 OR FLATTER. THE PIT SHALL BE AT LEAST 3' DEEP.
5. BERM SURROUNDING SIDES AND BACK OF THE CWA SHALL HAVE MINIMUM HEIGHT OF 1'.
6. VEHICLE TRACKING PAD SHALL BE SLOPED 2% TOWARDS THE CWA.
7. SIGNS SHALL BE PLACED AT THE CONSTRUCTION ENTRANCE, AT THE CWA, AND ELSEWHERE AS NECESSARY TO CLEARLY INDICATE THE LOCATION OF THE CWA TO OPERATORS OF CONCRETE TRUCKS AND PUMP RIGS.
8. USE EXCAVATED MATERIAL FOR PERIMETER BERM CONSTRUCTION.

**CWA MAINTENANCE NOTES**

1. INSPECT BMPs EACH WORKDAY, AND MAINTAIN THEM IN EFFECTIVE OPERATING CONDITION. MAINTENANCE OF BMPs SHOULD BE PROACTIVE, NOT REACTIVE. INSPECT BMPs AS SOON AS POSSIBLE (AND ALWAYS WITHIN 24 HOURS) FOLLOWING A STORM THAT CAUSES SURFACE EROSION, AND PERFORM NECESSARY MAINTENANCE.
2. FREQUENT OBSERVATIONS AND MAINTENANCE ARE NECESSARY TO MAINTAIN BMPs IN EFFECTIVE OPERATING CONDITION. INSPECTIONS AND CORRECTIVE MEASURES SHOULD BE DOCUMENTED THOROUGHLY.
3. WHERE BMPs HAVE FAILED, REPAIR OR REPLACEMENT SHOULD BE INITIATED UPON DISCOVERY OF THE FAILURE.
4. THE CWA SHALL BE REPAIRED, CLEANED, OR ENLARGED AS NECESSARY TO MAINTAIN CAPACITY FOR CONCRETE WASTE. CONCRETE MATERIALS, ACCUMULATED IN PIT, SHALL BE REMOVED ONCE THE MATERIALS HAVE REACHED A DEPTH OF 2'.
5. CONCRETE WASHOUT WATER, WASTED PIECES OF CONCRETE AND ALL OTHER DEBRIS IN THE SUBSURFACE PIT SHALL BE TRANSPORTED FROM THE JOB SITE IN A WATER-TIGHT CONTAINER AND DISPOSED OF PROPERLY.
6. THE CWA SHALL REMAIN IN PLACE UNTIL ALL CONCRETE FOR THE PROJECT IS PLACED.
7. WHEN THE CWA IS REMOVED, COVER THE DISTURBED AREA WITH TOP SOIL, SEED AND MULCH OR OTHERWISE STABILIZED IN A MANNER APPROVED BY THE LOCAL JURISDICTION.

(DETAIL ADAPTED FROM DOUGLAS COUNTY, COLORADO AND THE CITY OF PARKER, COLORADO, NOT AVAILABLE IN AUTOCAD).

NOTE: MANY JURISDICTIONS HAVE BMP DETAILS THAT VARY FROM UDFCD STANDARD DETAILS. CONSULT WITH LOCAL JURISDICTIONS AS TO WHICH DETAIL SHOULD BE USED WHEN DIFFERENCES ARE NOTED.



# Erosion Control Blankets

## What it is

Erosion control blankets are geotextiles or filter fabrics that are used to stabilize soils, steep slopes and drainage channels.

### TYPES OF EROSION CONTROL BLANKETS

- WOVEN OR BONDED SYNTHETIC MATERIALS SUCH AS POLYPROPYLENE, POLYESTER, POLYETHYLENE, NYLON, POLYVINYL CHLORIDE, GLASS AND VARIOUS MIXTURES OF THESE.
- MULCH MATTING MADE FROM JUTE OR OTHER WOOD FIBER THAT HAS BEEN FORMED INTO SHEETS.
- NETTING MADE FROM JUTE OR OTHER WOOD FIBER, PLASTIC, PAPER, OR COTTON USED TO HOLD MULCH AND MATTING TO THE GROUND.
- BLANKETS OF WOVEN STRAW MULCH WITH A SYNTHETIC LAYER OR NET.



## When and Where to use it

- In temporary and permanent swales.
- To protect recently seeded slopes.
- In drainageway channels.

## When and Where NOT to use it

- In swales with slopes greater than 5 percent or with stormwater velocities > 8 feet per second.

## Installation and Maintenance Requirements

Installation requirements are provided in Figures ECB-1 and ECB-2.

Maintenance requirements include regular inspections to determine if fabric is damaged or has come loose, and appropriate repairs or replacement of damaged materials.

Shallow Slope

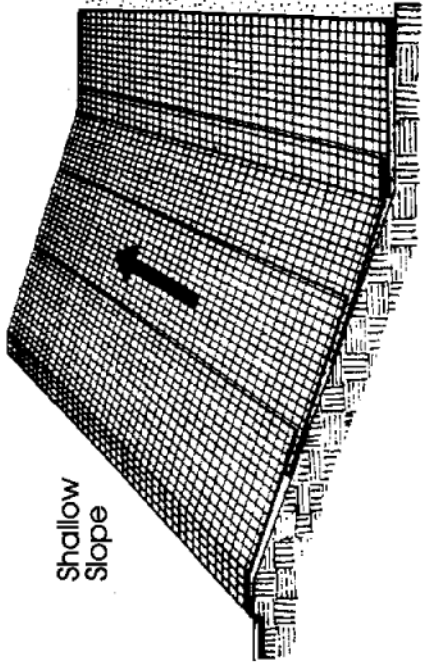

On shallow slopes, strips of netting may be applied across the slope.

Where there is a berm at the top of the slope, bring the netting over the berm and anchor it behind the berm.



Steep Slope

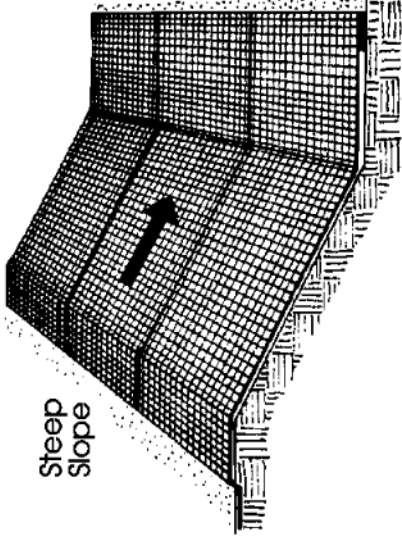

On steep slopes, apply strips of netting parallel to the direction of flow and anchor securely.

Bring netting down to a level area before terminating the installation. Turn the end under 6" and staple at 12" intervals.

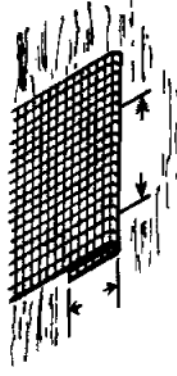

Ditch

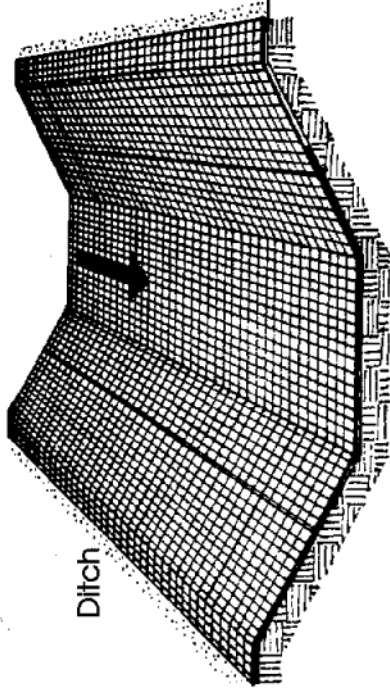

In ditches, apply netting of parallel to the direction of flow. Use check slots every 15 feet. Do not join strips in the center of the ditch.

From: Virginia Soil and Water Conservation Commission, 1985

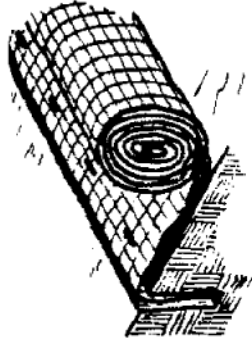

**Anchor Slot:** Bury the up-channel end of the net in a 6" deep trench. Tamp the soil firmly. Staple at 12" intervals across the net.

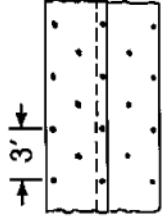
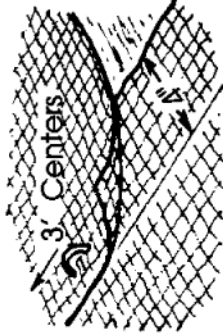

**Overlap:** Overlap edges of the strips at least 4". Staple every 3 feet down the center of the strip.

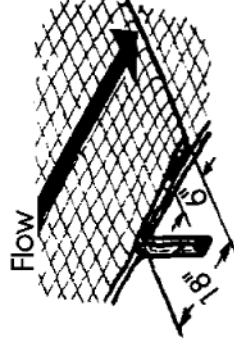

**Joining Strips:** Insert the new roll of net in a trench, as with the Anchor Slot. Overlap the up-channel end of the previous roll 18" and turn the end under 6". Staple the end of the previous roll just below the anchor slot and at the end at 12" intervals.

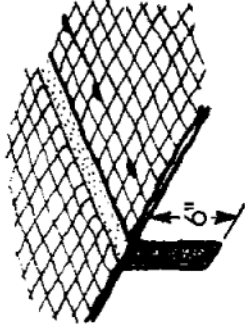

**Check Slots:** On erodible soils or steep slopes, check slots should be made every 15 feet. Insert a fold of the net into a 6" trench and tamp firmly. Staple at 12" intervals across the net. Lay the net smoothly on the surface of the soil - do not stretch the net, and do not allow wrinkles.

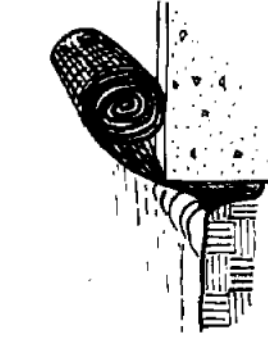

**Anchoring Ends At Structures:** Place the end of the net in a 6" slot on the up-channel side of the structure. Fill the trench and tamp firmly. Roll the net up the channel. Place staples at 12" intervals along the anchor end of the net.

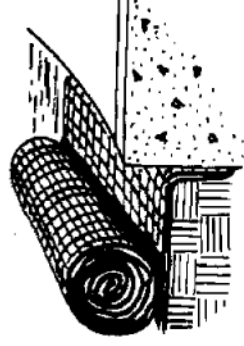

From: Virginia Soil and Water Conservation Commission, 1985



# Inlet Protection

## What it is

Inlet protection is a sediment control barrier formed around a storm drain inlet. A number of alternative inlet protection designs are available, including:

- Silt Fence Inlet Protection.
- Straw Bale Barrier Inlet Protection.
- Block and Gravel Bag Inlet Protection.
- Curb Socks Inlet Protection.



## When and Where to use it

Application of inlet protection differs by design.

- Filter fabric and straw bale inlet protection are used for area inlets (not located within streets).
- Block and gravel bag curb inlet protection is used for street inlets in sumps.
- Curb sock protection is used for street inlets in sumps or on continuous grade.

## When and Where NOT to use it

- Filter fabric and straw bale inlet protection cannot be used for drain inlets that are paved because these designs require excavation and/or staking of materials.
- Block and gravel bag inlet protection is not recommended for continuous grade inlets due to concerns about damage from bypassed flow.

## Construction Detail and Maintenance Requirements

Figures IP-1 through IP-4 provide a construction detail and maintenance requirements for each inlet protection design alternative.



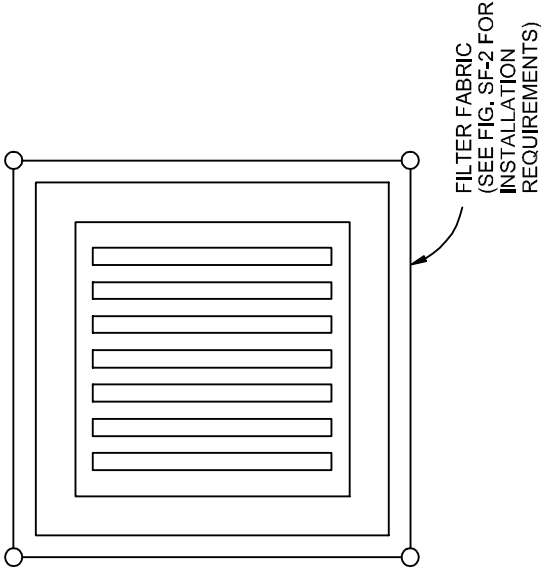

## FILTER FABRIC INLET PROTECTION

NTS

### FILTER FABRIC INLET PROTECTION NOTES

#### INSTALLATION REQUIREMENTS

1. INLET PROTECTION SHALL BE INSTALLED IMMEDIATELY AFTER CONSTRUCTION OF INLET.
2. SEE SILT FENCE FIGURE SF-2 FOR INSTALLATION REQUIREMENTS.
3. POSTS ARE TO BE PLACED AT EACH CORNER OF THE INLET AND AROUND THE EDGES AT A MAXIMUM SPACING OF 3 FEET.

#### MAINTENANCE REQUIREMENTS

1. CONTRACTOR SHALL INSPECT INLET PROTECTION IMMEDIATELY AFTER EACH RAINFALL, AT LEAST DAILY DURING PROLONGED RAINFALL, AND WEEKLY DURING PERIODS NO RAINFALL.
2. DAMAGED, COLLAPSED, UNENTRENCHED OR INEFFECTIVE INLET PROTECTION SHALL BE PROMPTLY REPAIRED OR REPLACED.
3. SEDIMENT SHALL BE REMOVED FROM BEHIND FILTER FABRIC WHEN IT ACCUMULATES TO HALF THE EXPOSED GEOTEXTILE HEIGHT.
4. FILTER FABRIC PROTECTION SHALL BE REMOVED WHEN ADEQUATE VEGETATIVE COVER IS ATTAINED IN THE DRAINAGE AREA AS APPROVED BY THE CITY.

City of Colorado Springs  
Stormwater Quality

Figure IP-1  
Filter Fabric Inlet Protection  
Construction Detail and Maintenance  
Requirements

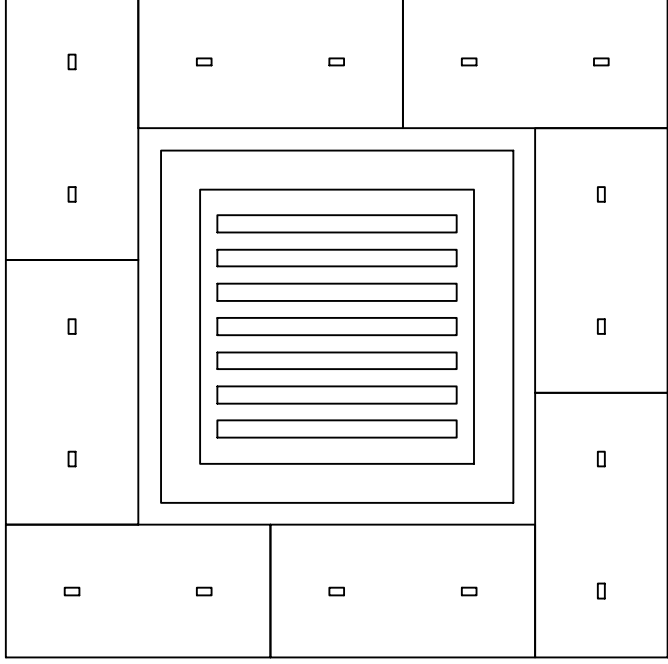

STRAW BALE  
(SEE FIG. SBB-2  
FOR INSTALLATION  
REQUIREMENTS)

## STRAW BALE INLET PROTECTION

NTS

### STRAW BALE INLET PROTECTION NOTES

#### INSTALLATION REQUIREMENTS

1. INLET PROTECTION SHALL BE INSTALLED IMMEDIATELY AFTER CONSTRUCTION OF INLET.
2. BALES ARE TO BE PLACED IN A SINGLE ROW AROUND THE INLET WITH THE END OF THE BALES TIGHTLY ABUTTING ONE ANOTHER.
3. SEE STRAW BALE BARRIER FIGURE SBB-2 FOR INSTALLATION REQUIREMENTS.

#### MAINTENANCE REQUIREMENTS

1. CONTRACTOR SHALL INSPECT STRAW BALE INLET PROTECTION IMMEDIATELY AFTER EACH RAINFALL, AT LEAST DAILY DURING PROLONGED RAINFALL, AND WEEKLY DURING PERIODS NO RAINFALL.
2. DAMAGED OR INEFFECTIVE INLET PROTECTION SHALL PROMPTLY BE REPAIRED. REPLACING BALES IF NECESSARY, AND UNENTRENCHED BALES NEED TO BE REPAIRED WITH COMPACTED BACKFILL MATERIAL.
3. SEDIMENT SHALL BE REMOVED FROM BEHIND STRAW BALES WHEN IT ACCUMULATES TO APPROXIMATELY 1/3 THE HEIGHT OF THE BARRIER.
4. INLET PROTECTION SHALL BE REMOVED WHEN ADEQUATE VEGETATIVE COVER IS ATTAINED WITHIN THE DRAINAGE AREA AS APPROVED BY THE CITY.

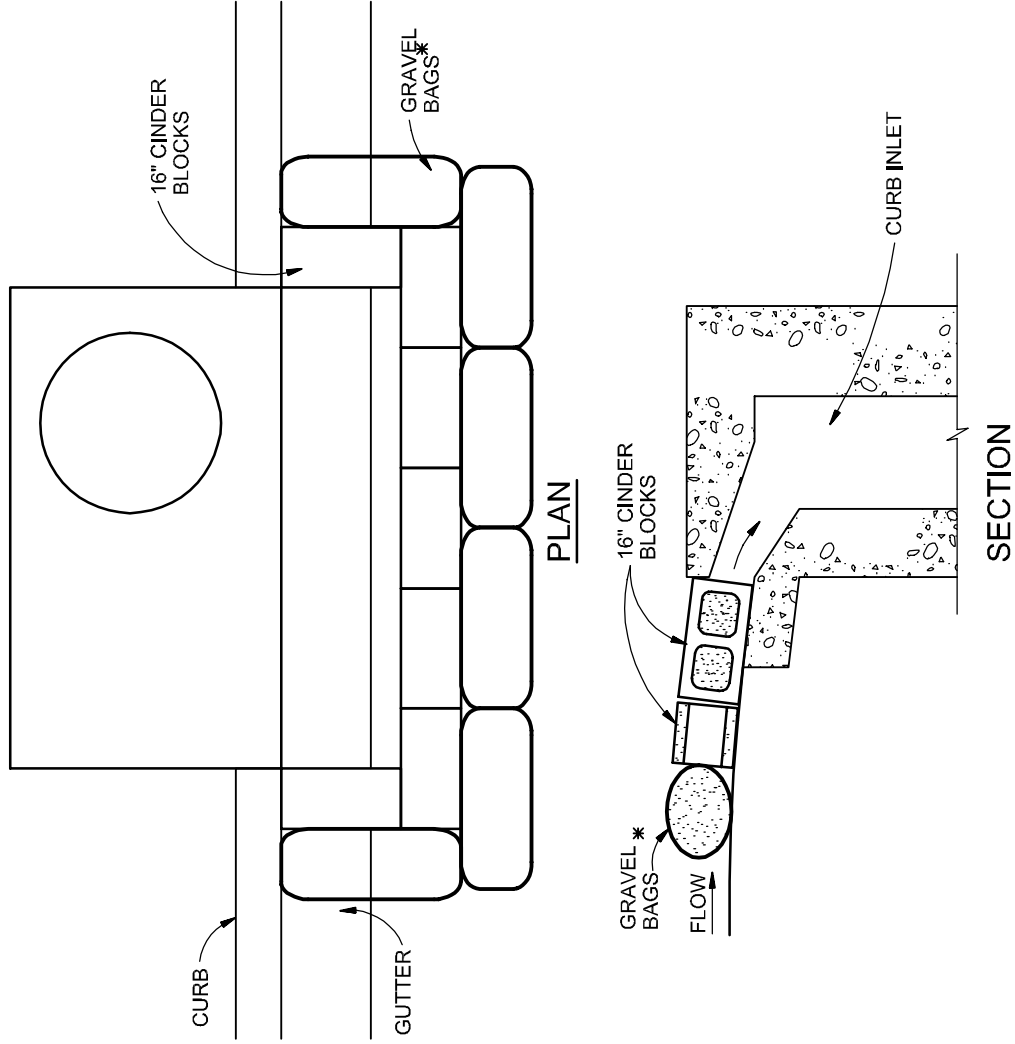

**BLOCK AND GRAVEL BAG\*CURB INLET PROTECTION**  
NTS

**BLOCK AND GRAVEL BAG\*CURB INLET PROTECTION NOTES**

**INSTALLATION REQUIREMENTS**

1. INLET PROTECTION SHALL BE INSTALLED IMMEDIATELY AFTER CONSTRUCTION OF INLET.
2. CONCRETE BLOCKS ARE TO BE LAID AROUND THE INLET IN A SINGLE ROW ON THEIR SIDES, ABUTTING ONE ANOTHER WITH THE OPEN ENDS OF THE BLOCK FACING OUTWARD.
3. GRAVEL BAGS ARE TO BE PLACED AROUND THE CONCRETE BLOCKS CLOSELY ABUTTING ONE ANOTHER SO THERE ARE NO GAPS.
4. GRAVEL BAGS ARE TO CONTAIN WASHED SAND OR GRAVEL APPROXIMATELY 3/4 INCH IN DIAMETER.
5. BAGS ARE TO BE MADE OF 1/4" INCH WIRE MESH (USED WITH GRAVEL ONLY) OR GEOTEXTILE.

\* AN ALTERNATE 3/4" TO 1" GRAVEL FILTER OVER A WIRE SCREEN MAY BE USED IN PLACE OF GRAVEL BAGS. THE WIRE MESH SHALL EXTEND ABOVE THE TOP OF THE CONCRETE BLOCKS AND THE GRAVEL PLACED OVER THE WIRE SCREEN TO THE TOP OF THE CONCRETE BLOCKS.

**MAINTENANCE REQUIREMENTS**

1. CONTRACTOR SHALL INSPECT INLET PROTECTION IMMEDIATELY AFTER EACH RAINFALL, AT LEAST DAILY DURING PROLONGED RAINFALL, AND WEEKLY DURING PERIODS NO RAINFALL.
2. DAMAGED OR INEFFECTIVE INLET PROTECTION SHALL PROMPTLY BE REPAIRED OR REPLACED.
3. SEDIMENT SHALL BE REMOVED WHEN SEDIMENT HAS ACCUMULATED TO APPROXIMATELY 1/2 THE DESIGN DEPTH OF THE TRAP.
4. INLET PROTECTION SHALL BE REMOVED WHEN ADEQUATE VEGETATIVE COVER IS ATTAINED WITHIN THE DRAINAGE AREA AS APPROVED BY THE CITY.

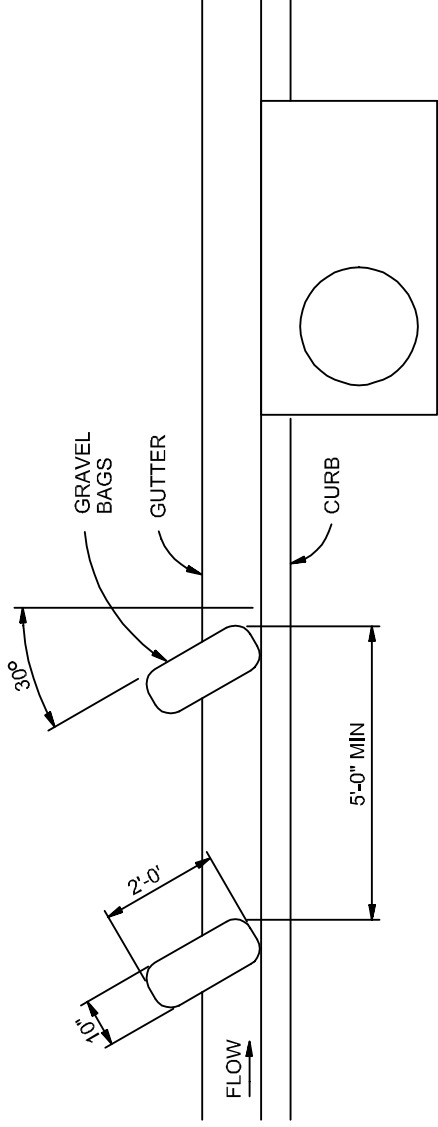

## CURB SOCK INLET PROTECTION

NTS

### CURB SOCK INLET PROTECTION NOTES

#### INSTALLATION REQUIREMENTS

1. INLET PROTECTION SHALL BE INSTALLED IMMEDIATELY AFTER CONSTRUCTION OF INLET.
2. SOCK IS TO BE MADE OF 1/4 INCH WIRE MESH (USED WITH GRAVEL ONLY) OR GEOTEXTILE.
3. WASHED SAND OR GRAVEL 3/4 INCH TO 4 INCHES IN DIAMETER IS PLACED INSIDE THE SOCK.
4. PLACEMENT OF THE SOCK IS TO BE 30 DEGREES FROM PERPENDICULAR IN THE OPPOSITE DIRECTION OF FLOW.
5. SOCKS ARE TO BE FLUSH WITH THE CURB AND SPACED AT A MINIMUM 5 FEET APART.
6. AT LEAST 2 CURB SOCKS IN SERIES IS REQUIRED.

#### MAINTENANCE REQUIREMENTS

1. CONTRACTOR SHALL INSPECT INLET PROTECTION IMMEDIATELY AFTER EACH RAINFALL, AT LEAST DAILY DURING PROLONGED RAINFALL AND WEEKLY DURING PERIODS NO RAINFALL.
2. DAMAGED OR INEFFECTIVE INLET PROTECTION SHALL PROMPTLY BE REPAIRED OR REPLACED.
3. SEDIMENT SHALL BE REMOVED FROM BEHIND THE SOCK WHEN GUTTER WIDTH IS FILLED.
4. INLET PROTECTION SHALL BE REMOVED WHEN ADEQUATE VEGETATIVE COVER IS ATTAINED WITHIN THE DRAINAGE AREA AS APPROVED BY THE CITY.

# Mulching

## What it is

Mulching is used to temporarily stabilize soils by securely applying materials such as grass, hay, woodchips or wood fibers to the soil's surface. Mulching protects the soil from raindrop impact and reduces the velocity of overland runoff. Mulch also aids in the growth of temporary seeding by holding seeds and topsoil in place, retaining moisture, and insulating against extreme temperatures.

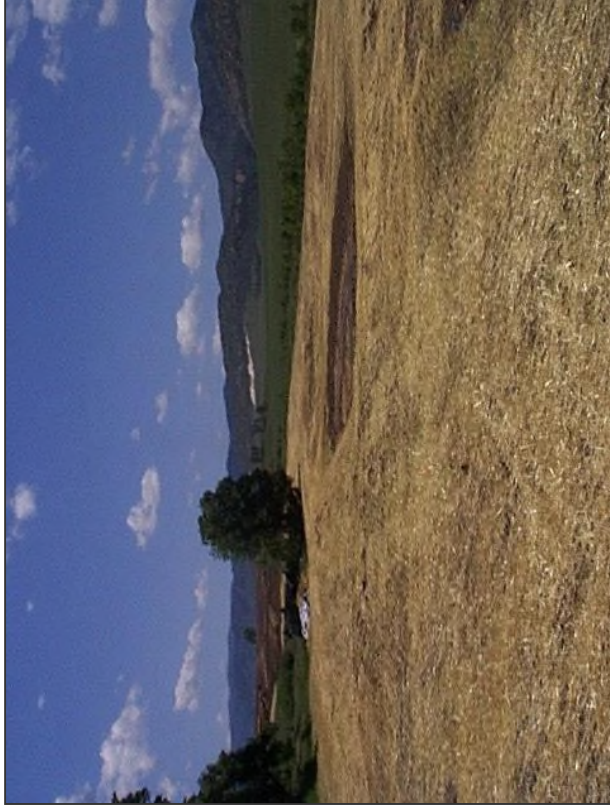

## When and Where to use it

- All disturbed areas and stockpiles shall be mulched within 21 days after final grade is reached.
- Disturbed areas and stockpiles which are not at final grade but will remain dormant for longer than 30 days shall also be mulched within 21 days after interim grading.
- An area that is going to remain in an interim state for more than 60 days shall also be seeded.
- Mulching is always to be used when applying temporary or permanent seeding.
- Mulching is often used when temporary seeding cannot be used due to the season or climate.

## When and Where NOT to use it

- In areas that will involve paving, building, or utility construction within 21 days after final grade is reached.

## Application Techniques and Maintenance Requirements

Figure MU-1 provides application techniques and maintenance requirements for mulching.

## MULCHING NOTES

### INSTALLATION REQUIREMENTS

1. ALL DISTURBED AREAS MUST BE MULCHED WITHIN 21 DAYS AFTER FINAL GRADE AND SEEDED AREAS ARE TO BE MULCHED WITHIN 24 HOURS AFTER SEEDING.
2. MATERIAL USED FOR MULCH CAN BE CERTIFIED CLEAN, WEED- AND SEED-FREE LONG STEMMED FIELD OR MARSH HAY, OR STRAW OF OATS, BARLEY, WHEAT, RYE, OR TRITICALE CERTIFIED BY THE COLORADO DEPARTMENT OF AGRICULTURE WEED FREE FORAGE CERTIFICATION PROGRAM.
3. HYDRAULIC MULCHING MATERIAL SHALL CONSIST OF VIRGIN WOOD FIBER MANUFACTURED FROM CLEAN WHOLE WOOD CHIPS. WOOD CHIPS CANNOT CONTAIN ANY GROWTH OR GERMINATION INHIBITORS OR BE PRODUCED FROM RECYCLED MATERIAL. GRAVEL CAN ALSO BE USED.
4. MULCH IS TO BE APPLIED EVENLY AT A RATE OF 2 TONS PER ACRE.
5. MULCH IS TO BE ANCHORED EITHER BY CRIMPING (TUCKING MULCH FIBERS 4 INCHES INTO THE SOIL), USING NETTING (USED ON SMALL AREAS WITH STEEP SLOPES), OR WITH A TACKIFIER.
6. HYDRAULIC MULCHING AND TACKIFIERS ARE NOT TO BE USED IN THE PRESENCE OF FREE SURFACE WATER.

### MAINTENANCE REQUIREMENTS

1. REGULAR INSPECTIONS ARE TO BE MADE OF ALL MULCHED AREAS.
2. MULCH IS TO BE REPLACED IMMEDIATELY IN THOSE AREAS IT HAS BEEN REMOVED, AND IF NECESSARY THE AREA SHOULD BE RESEDED.



## Description

Outlet protection helps to reduce erosion immediately downstream of a pipe, culvert, slope drain, rundown or other conveyance with concentrated, high-velocity flows. Typical outlet protection consists of riprap or rock aprons at the conveyance outlet.

## Appropriate Uses

Outlet protection should be used when a conveyance discharges onto a disturbed area where there is potential for accelerated erosion due to concentrated flow. Outlet protection should be provided where the velocity at the culvert outlet exceeds the maximum permissible velocity of the material in the receiving channel.

**Note:** This Fact Sheet and detail are for temporary outlet protection, outlets that are intended to be used for less than 2 years. For permanent, long-term outlet protection, see the *Major Drainage* chapter of Volume 1.

## Design and Installation

Design outlet protection to handle runoff from the largest drainage area that may be contributing runoff during construction (the drainage area may change as a result of grading). Key in rock, around the entire perimeter of the apron, to a minimum depth of 6 inches for stability. Extend riprap to the height of the culvert or the normal flow depth of the downstream channel, whichever is less. Additional erosion control measures such as vegetative lining, turf reinforcement mat and/or other channel lining methods may be required downstream of the outlet protection if the channel is susceptible to erosion. See Design Detail OP-1 for additional information.

## Maintenance and Removal

Inspect apron for damage and displaced rocks. If rocks are missing or significantly displaced, repair or replace as necessary. If rocks are continuously missing or displaced, consider increasing the size of the riprap or deeper keying of the perimeter.

Remove sediment accumulated at the outlet before the outlet protection becomes buried and ineffective. When sediment accumulation is noted, check that upgradient BMPs, including inlet protection, are in effective operating condition.

Outlet protection may be removed once the pipe is no longer draining an upstream area, or once the downstream area has been sufficiently stabilized. If the drainage pipe is permanent, outlet protection can be left in place; however, permanent outlet protection should be designed and constructed in accordance with the requirements of the *Major Drainage* chapter of Volume 2.



**Photograph TOP-1.** Riprap outlet protection.

Outlet protection should be provided where the velocity at the culvert outlet exceeds the maximum permissible velocity of the material in the receiving channel.

Outlet Protection	
<b>Functions</b>	
Erosion Control	Yes
Sediment Control	Moderate
Site/Material Management	No

# EC-8 Temporary Outlet Protection (TOP)

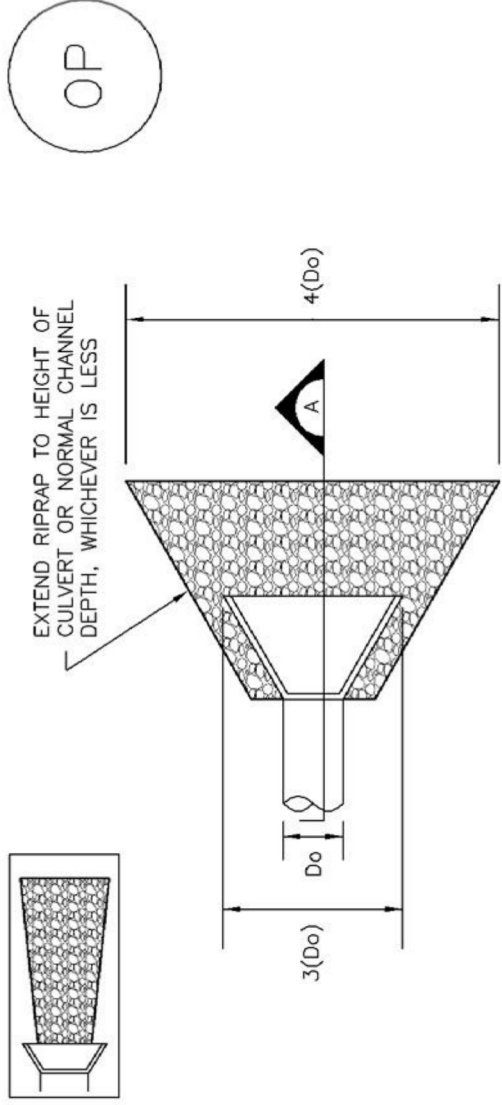

TEMPORARY OUTLET PROTECTION PLAN

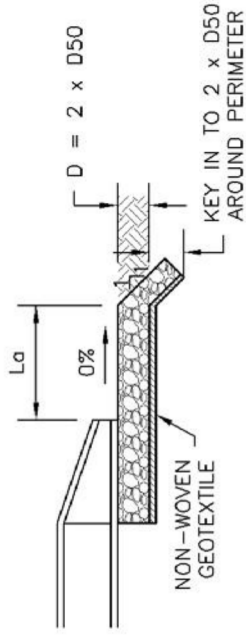

SECTION A

TABLE OP-1. TEMPORARY OUTLET PROTECTION SIZING TABLE

PIPE DIAMETER, $D_o$ (INCHES)	DISCHARGE, $Q$ (CFS)	APRON LENGTH, $L_a$ (FT)	RIPRAP $D_{50}$ DIAMETER MIN (INCHES)
8	2.5	5	4
	5	10	6
12	5	10	4
	10	13	6
18	10	10	6
	20	16	9
	30	23	12
	40	26	16
24	30	16	9
	40	26	9
	50	26	12
	60	30	16

OP-1. TEMPORARY OUTLET PROTECTION

## TEMPORARY OUTLET PROTECTION INSTALLATION NOTES

1. SEE PLAN VIEW FOR  
-LOCATION OF OUTLET PROTECTION.  
-DIMENSIONS OF OUTLET PROTECTION.
2. DETAIL IS INTENDED FOR PIPES WITH SLOPE  $\leq$  10%. ADDITIONAL EVALUATION OF RIPRAP SIZING AND OUTLET PROTECTION DIMENSIONS REQUIRED FOR STEEPER SLOPES.
3. TEMPORARY OUTLET PROTECTION INFORMATION IS FOR OUTLETS INTENDED TO BE UTILIZED LESS THAN 2 YEARS.

## TEMPORARY OUTLET PROTECTION INSPECTION AND MAINTENANCE NOTES

1. INSPECT BMPs EACH WORKDAY, AND MAINTAIN THEM IN EFFECTIVE OPERATING CONDITION. MAINTENANCE OF BMPs SHOULD BE PROACTIVE, NOT REACTIVE. INSPECT BMPs AS SOON AS POSSIBLE (AND ALWAYS WITHIN 24 HOURS) FOLLOWING A STORM THAT CAUSES SURFACE EROSION, AND PERFORM NECESSARY MAINTENANCE.
2. FREQUENT OBSERVATIONS AND MAINTENANCE ARE NECESSARY TO MAINTAIN BMPs IN EFFECTIVE OPERATING CONDITION. INSPECTIONS AND CORRECTIVE MEASURES SHOULD BE DOCUMENTED THOROUGHLY.
3. WHERE BMPs HAVE FAILED, REPAIR OR REPLACEMENT SHOULD BE INITIATED UPON DISCOVERY OF THE FAILURE.

NOTE: MANY JURISDICTIONS HAVE BMP DETAILS THAT VARY FROM UDFCD STANDARD DETAILS. CONSULT WITH LOCAL JURISDICTIONS AS TO WHICH DETAIL SHOULD BE USED WHEN DIFFERENCES ARE NOTED.

(DETAILS ADAPTED FROM AURORA, COLORADO AND PREVIOUS VERSION OF VOLUME 3, NOT AVAILABLE IN AUTOCAD)

## Description

Temporary seeding can be used to stabilize disturbed areas that will be inactive for an extended period. Permanent seeding should be used to stabilize areas at final grade that will not be otherwise stabilized. Effective seeding includes preparation of a seedbed, selection of an appropriate seed mixture, proper planting techniques, and protection of the seeded area with mulch, geotextiles, or other appropriate measures.

## Appropriate Uses

When the soil surface is disturbed and will remain inactive for an extended period (typically 30 days or longer),

proactive stabilization measures should be implemented. If the inactive period is short-lived (on the order of two weeks), techniques such as surface roughening may be appropriate. For longer periods of inactivity, temporary seeding and mulching can provide effective erosion control. Permanent seeding should be used on finished areas that have not been otherwise stabilized.

Typically, local governments have their own seed mixes and timelines for seeding. Check jurisdictional requirements for seeding and temporary stabilization.

## Design and Installation

Effective seeding requires proper seedbed preparation, selection of an appropriate seed mixture, use of appropriate seeding equipment to ensure proper coverage and density, and protection with mulch or fabric until plants are established.

The USDCM Volume 2 *Revegetation* Chapter contains detailed seed mix, soil preparations, and seeding and mulching recommendations that may be referenced to supplement this Fact Sheet.

Drill seeding is the preferred seeding method. Hydroseeding is not recommended except in areas where steep slopes prevent use of drill seeding equipment, and even in these instances it is preferable to hand seed and mulch. Some jurisdictions do not allow hydroseeding or hydromulching.

## Seedbed Preparation

Prior to seeding, ensure that areas to be revegetated have soil conditions capable of supporting vegetation. Overlot grading can result in loss of topsoil, resulting in poor quality subsoils at the ground surface that have low nutrient value, little organic matter content, few soil microorganisms, rooting restrictions, and conditions less conducive to infiltration of precipitation. As a result, it is typically necessary to provide stockpiled topsoil, compost, or other



**Photograph TS/PS -1.** Equipment used to drill seed. Photo courtesy of Douglas County.

Temporary and Permanent Seeding	
Functions	
Erosion Control	Yes
Sediment Control	No
Site/Material Management	No

## **EC-2 Temporary and Permanent Seeding (TS/PS)**

---

soil amendments and rototill them into the soil to a depth of 6 inches or more.

Topsoil should be salvaged during grading operations for use and spread on areas to be revegetated later. Topsoil should be viewed as an important resource to be utilized for vegetation establishment, due to its water-holding capacity, structure, texture, organic matter content, biological activity, and nutrient content. The rooting depth of most native grasses in the semi-arid Denver metropolitan area is 6 to 18 inches. At a minimum, the upper 6 inches of topsoil should be stripped, stockpiled, and ultimately respread across areas that will be revegetated.

Where topsoil is not available, subsoils should be amended to provide an appropriate plant-growth medium. Organic matter, such as well digested compost, can be added to improve soil characteristics conducive to plant growth. Other treatments can be used to adjust soil pH conditions when needed. Soil testing, which is typically inexpensive, should be completed to determine and optimize the types and amounts of amendments that are required.

If the disturbed ground surface is compacted, rip or rototill the surface prior to placing topsoil. If adding compost to the existing soil surface, rototilling is necessary. Surface roughening will assist in placement of a stable topsoil layer on steeper slopes, and allow infiltration and root penetration to greater depth.

Prior to seeding, the soil surface should be rough and the seedbed should be firm, but neither too loose nor compacted. The upper layer of soil should be in a condition suitable for seeding at the proper depth and conducive to plant growth. Seed-to-soil contact is the key to good germination.

### **Seed Mix for Temporary Vegetation**

To provide temporary vegetative cover on disturbed areas which will not be paved, built upon, or fully landscaped or worked for an extended period (typically 30 days or more), plant an annual grass appropriate for the time of planting and mulch the planted areas. Annual grasses suitable for the Denver metropolitan area are listed in Table TS/PS-1. These are to be considered only as general recommendations when specific design guidance for a particular site is not available. Local governments typically specify seed mixes appropriate for their jurisdiction.

### **Seed Mix for Permanent Revegetation**

To provide vegetative cover on disturbed areas that have reached final grade, a perennial grass mix should be established. Permanent seeding should be performed promptly (typically within 14 days) after reaching final grade. Each site will have different characteristics and a landscape professional or the local jurisdiction should be contacted to determine the most suitable seed mix for a specific site. In lieu of a specific recommendation, one of the perennial grass mixes appropriate for site conditions and growth season listed in Table TS/PS-2 can be used. The pure live seed (PLS) rates of application recommended in these tables are considered to be absolute minimum rates for seed applied using proper drill-seeding equipment.

If desired for wildlife habitat or landscape diversity, shrubs such as rubber rabbitbrush (*Chrysothamnus nauseosus*), fourwing saltbush (*Atriplex canescens*) and skunkbrush sumac (*Rhus trilobata*) could be added to the upland seedmixes at 0.25, 0.5 and 1 pound PLS/acre, respectively. In riparian zones, planting root stock of such species as American plum (*Prunus americana*), woods rose (*Rosa woodsii*), plains cottonwood (*Populus sargentii*), and willow (*Populus spp.*) may be considered. On non-topsoiled upland sites, a legume such as Ladak alfalfa at 1 pound PLS/acre can be included as a source of nitrogen for perennial grasses.

# Temporary and Permanent Seeding (TS/PS) EC-2

Seeding dates for the highest success probability of perennial species along the Front Range are generally in the spring from April through early May and in the fall after the first of September until the ground freezes. If the area is irrigated, seeding may occur in summer months, as well. See Table TS/PS-3 for appropriate seeding dates.

**Table TS/PS-1. Minimum Drill Seeding Rates for Various Temporary Annual Grasses**

Species <sup>a</sup> (Common name)	Growth Season <sup>b</sup>	Pounds of Pure Live Seed (PLS)/acre <sup>c</sup>	Planting Depth (inches)
1. Oats	Cool	35 - 50	1 - 2
2. Spring wheat	Cool	25 - 35	1 - 2
3. Spring barley	Cool	25 - 35	1 - 2
4. Annual ryegrass	Cool	10 - 15	½
5. Millet	Warm	3 - 15	½ - ¾
6. Sudangrass	Warm	5-10	½ - ¾
7. Sorghum	Warm	5-10	½ - ¾
8. Winter wheat	Cool	20-35	1 - 2
9. Winter barley	Cool	20-35	1 - 2
10. Winter rye	Cool	20-35	1 - 2
11. Triticale	Cool	25-40	1 - 2

<sup>a</sup> Successful seeding of annual grass resulting in adequate plant growth will usually produce enough dead-plant residue to provide protection from wind and water erosion for an additional year. This assumes that the cover is not disturbed or mowed closer than 8 inches.

Hydraulic seeding may be substituted for drilling only where slopes are steeper than 3:1 or where access limitations exist. When hydraulic seeding is used, hydraulic mulching should be applied as a separate operation, when practical, to prevent the seeds from being encapsulated in the mulch.

<sup>b</sup> See Table TS/PS-3 for seeding dates. Irrigation, if consistently applied, may extend the use of cool season species during the summer months.

<sup>c</sup> Seeding rates should be doubled if seed is broadcast, or increased by 50 percent if done using a Brillion Drill or by hydraulic seeding.



# EC-2 Temporary and Permanent Seeding (TS/PS)

Table TS/PS-2. Minimum Drill Seeding Rates for Perennial Grasses

Common <sup>a</sup> Name	Botanical Name	Growth Season <sup>b</sup>	Growth Form	Seeds/ Pound	Pounds of PLS/acre
<b>Alkali Soil Seed Mix</b>					
Alkali sacaton	<i>Sporobolus airoides</i>	Cool	Bunch	1,750,000	0.25
Basin wildrye	<i>Elymus cinereus</i>	Cool	Bunch	165,000	2.5
Sodar streambank wheatgrass	<i>Agropyron riparium 'Sodar'</i>	Cool	Sod	170,000	2.5
Jose tall wheatgrass	<i>Agropyron elongatum 'Jose'</i>	Cool	Bunch	79,000	7.0
Arriba western wheatgrass	<i>Agropyron smithii 'Arriba'</i>	Cool	Sod	110,000	5.5
<b>Total</b>					<b>17.75</b>
<b>Fertile Loamy Soil Seed Mix</b>					
Ephriam crested wheatgrass	<i>Agropyron cristatum 'Ephriam'</i>	Cool	Sod	175,000	2.0
Dural hard fescue	<i>Festuca ovina 'duriuscula'</i>	Cool	Bunch	565,000	1.0
Lincoln smooth brome	<i>Bromus inermis leysii 'Lincoln'</i>	Cool	Sod	130,000	3.0
Sodar streambank wheatgrass	<i>Agropyron riparium 'Sodar'</i>	Cool	Sod	170,000	2.5
Arriba western wheatgrass	<i>Agropyron smithii 'Arriba'</i>	Cool	Sod	110,000	7.0
<b>Total</b>					<b>15.5</b>
<b>High Water Table Soil Seed Mix</b>					
Meadow foxtail	<i>Alopecurus pratensis</i>	Cool	Sod	900,000	0.5
Redtop	<i>Agrostis alba</i>	Warm	Open sod	5,000,000	0.25
Reed canarygrass	<i>Phalaris arundinacea</i>	Cool	Sod	68,000	0.5
Lincoln smooth brome	<i>Bromus inermis leysii 'Lincoln'</i>	Cool	Sod	130,000	3.0
Pathfinder switchgrass	<i>Panicum virgatum 'Pathfinder'</i>	Warm	Sod	389,000	1.0
Alkar tall wheatgrass	<i>Agropyron elongatum 'Alkar'</i>	Cool	Bunch	79,000	5.5
<b>Total</b>					<b>10.75</b>
<b>Transition Turf Seed Mix<sup>c</sup></b>					
Ruebens Canadian bluegrass	<i>Poa compressa 'Ruebens'</i>	Cool	Sod	2,500,000	0.5
Dural hard fescue	<i>Festuca ovina 'duriuscula'</i>	Cool	Bunch	565,000	1.0
Citation perennial ryegrass	<i>Lolium perenne 'Citation'</i>	Cool	Sod	247,000	3.0
Lincoln smooth brome	<i>Bromus inermis leysii 'Lincoln'</i>	Cool	Sod	130,000	3.0
<b>Total</b>					<b>7.5</b>

# Temporary and Permanent Seeding (TS/PS)      EC-2

**Table TS/PS-2. Minimum Drill Seeding Rates for Perennial Grasses (cont.)**

Common Name	Botanical Name	Growth Season <sup>b</sup>	Growth Form	Seeds/Pound	Pounds of PLS/acre
<b>Sandy Soil Seed Mix</b>					
Blue grama	<i>Bouteloua gracilis</i>	Warm	Sod-forming bunchgrass	825,000	0.5
Camper little bluestem	<i>Schizachyrium scoparium</i> 'Camper'	Warm	Bunch	240,000	1.0
Prairie sandreed	<i>Calamovilfa longifolia</i>	Warm	Open sod	274,000	1.0
Sand dropseed	<i>Sporobolus cryptandrus</i>	Cool	Bunch	5,298,000	0.25
Vaughn sideoats grama	<i>Bouteloua curtipendula</i> 'Vaughn'	Warm	Sod	191,000	2.0
Arriba western wheatgrass	<i>Agropyron smithii</i> 'Arriba'	Cool	Sod	110,000	5.5
<b>Total</b>					<b>10.25</b>
<b>Heavy Clay, Rocky Foothill Seed Mix</b>					
Ephriam crested wheatgrass <sup>d</sup>	<i>Agropyron cristatum</i> 'Ephriam'	Cool	Sod	175,000	1.5
Oahe Intermediate wheatgrass	<i>Agropyron intermedium</i> 'Oahe'	Cool	Sod	115,000	5.5
Vaughn sideoats grama <sup>e</sup>	<i>Bouteloua curtipendula</i> 'Vaughn'	Warm	Sod	191,000	2.0
Lincoln smooth brome	<i>Bromus inermis</i> <i>leysii</i> 'Lincoln'	Cool	Sod	130,000	3.0
Arriba western wheatgrass	<i>Agropyron smithii</i> 'Arriba'	Cool	Sod	110,000	5.5
<b>Total</b>					<b>17.5</b>

<sup>a</sup> All of the above seeding mixes and rates are based on drill seeding followed by crimped straw mulch. These rates should be doubled if seed is broadcast and should be increased by 50 percent if the seeding is done using a Brillion Drill or is applied through hydraulic seeding. Hydraulic seeding may be substituted for drilling only where slopes are steeper than 3:1. If hydraulic seeding is used, hydraulic mulching should be done as a separate operation.

<sup>b</sup> See Table TS/PS-3 for seeding dates.

<sup>c</sup> If site is to be irrigated, the transition turf seed rates should be doubled.

<sup>d</sup> Crested wheatgrass should not be used on slopes steeper than 6H to 1V.

<sup>e</sup> Can substitute 0.5 lbs PLS of blue grama for the 2.0 lbs PLS of Vaughn sideoats grama.

# EC-2 Temporary and Permanent Seeding (TS/PS)

Table TS/PS-3. Seeding Dates for Annual and Perennial Grasses

Seeding Dates	Annual Grasses (Numbers in table reference species in Table TS/PS-1)		Perennial Grasses	
	Warm	Cool	Warm	Cool
January 1–March 15			✓	✓
March 16–April 30	4	1,2,3	✓	✓
May 1–May 15	4		✓	
May 16–June 30	4,5,6,7			
July 1–July 15	5,6,7			
July 16–August 31				
September 1–September 30		8,9,10,11		
October 1–December 31			✓	✓

## Mulch

Cover seeded areas with mulch or an appropriate rolled erosion control product to promote establishment of vegetation. Anchor mulch by crimping, netting or use of a non-toxic tackifier. See the Mulching BMP Fact Sheet for additional guidance.

## Maintenance and Removal

Monitor and observe seeded areas to identify areas of poor growth or areas that fail to germinate. Reseed and mulch these areas, as needed.

An area that has been permanently seeded should have a good stand of vegetation within one growing season if irrigated and within three growing seasons without irrigation in Colorado. Reseed portions of the site that fail to germinate or remain bare after the first growing season.

Seeded areas may require irrigation, particularly during extended dry periods. Targeted weed control may also be necessary.

Protect seeded areas from construction equipment and vehicle access.

R1	Sheet Revisions
R2	5/15 GESC MANUAL UPDATES
R3	3/11 GESC MANUAL UPDATES

NOTE: SCALES FOR 22"x34" SHEETS, ADJUST ACCORDINGLY FOR 11"x17" SHEETS.	
DVD	SHOW AREAS
DVD	GESC MANUAL UPDATES
DVD	GESC MANUAL UPDATES



UTLITIES DEPARTMENT  
Stormwater Engineering Division  
GESC

GRADING, EROSION, AND SEDIMENT CONTROL  
GESC PLAN

STANDARD NOTES AND DETAILS  
GESC PLAN

SHEET 7 OF 14

**REINFORCED CHECK DAM**

- REINFORCED CHECK DAM MAINTENANCE NOTES**
1. THE GESC MANAGER SHALL INSPECT CHECK DAMS WEEKLY, DURING AND AFTER ANY STORM EVENT AND MAKE REPAIRS OR CLEAN OUT AS NECESSARY.
  2. SEDIMENT ACCUMULATED UPSTREAM OF CHECK DAMS SHALL BE REMOVED WHEN THE SEDIMENT DEPTH UPSTREAM OF CHECK DAM IS WITHIN 1/2 OF THE HEIGHT OF THE CREST.
  3. CHECK DAMS ARE TO REMAIN IN PLACE UNTIL THE UPSTREAM DISTURBED AREA IS STABILIZED AND GRASS COVER IS APPROVED BY THE TOWN.
  4. WHEN CHECK DAMS ARE REMOVED, EXCAVATIONS SHALL BE FILLED WITH SUITABLE COMPACTED BACK FILL. ANY DISTURBED AREA SHALL BE DRILL SEEDED AND CRIMP MULCHED AND COVERED WITH EROSION CONTROL BLANKET OR OTHERWISE STABILIZED IN A MANNER APPROVED BY THE TOWN.
- REINFORCED CHECK DAM INSTALLATION NOTES**
1. SEE PLAN VIEW FOR:
    - LOCATIONS OF CHECK DAMS.
    - CHECK DAM TYPE (CHECK DAM OR REINFORCED CHECK DAM).
    - LENGTH, "L", CREST LENGTH, "CL", AND DEPTH, "D".
  2. CHECK DAMS INDICATED ON INITIAL GESC PLAN SHALL BE INSTALLED AFTER CONSTRUCTION FENCE, BUT PRIOR TO ANY UPSTREAM LAND-DISTURBING ACTIVITIES.
  3. REINFORCED CHECK DAMS, GABIONS SHALL HAVE GALVANIZED TWISTED WIRE NETTING WITH A MAXIMUM OPENING DIMENSION OF 4-1/2" AND A MINIMUM WIRE THICKNESS OF 0.10" WIRE RINGS AT 4" SPACING OR OTHER APPROVED MEANS SHALL BE USED AT ALL GABION SEAMS AND TO SECURE THE GABION TO THE ADJACENT GABION.
  4. RIPRAP UTILIZED FOR CHECK DAMS SHALL HAVE A  $D_{50}$  MEDIAN STONE SIZE OF 6".
  5. THE CHECK DAM SHALL BE TRENCHED INTO THE GROUND A MINIMUM OF 1'-6".
  6. EROSION BLANKET SHALL BE PLACED IN THE REINFORCED CHECK DAM TRENCH EXTENDING A MINIMUM OF 1'-6" ON BOTH THE UPSTREAM AND DOWNSTREAM SIDES OF THE REINFORCED CHECK DAM.

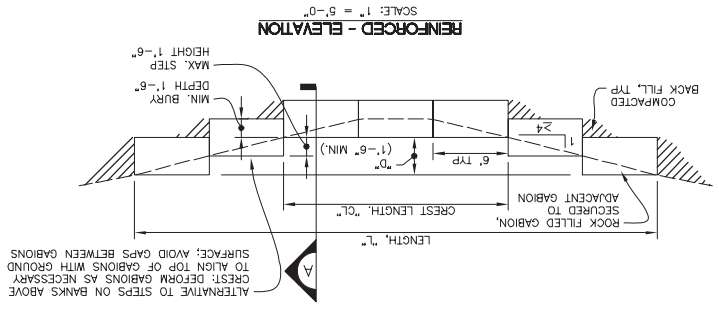
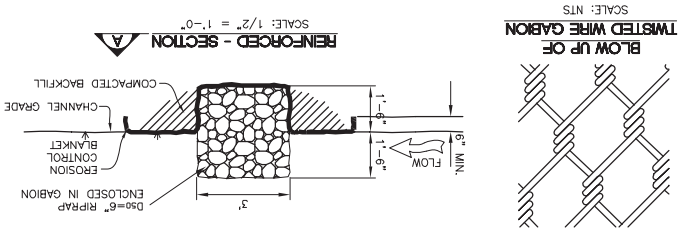

**REINFORCED ROCK BERM**

- REINFORCED ROCK BERM MAINTENANCE NOTES**
1. THE GESC MANAGER SHALL INSPECT REINFORCED ROCK BERMS WEEKLY, DURING AND AFTER ANY STORM EVENT AND MAKE REPAIRS OR CLEAN OUT AS NECESSARY.
  2. REMOVE WHEN THE SEDIMENT DEPTH UPSTREAM OF REINFORCED ROCK BERM SHALL BE INCHES OF THE CREST.
  3. REINFORCED ROCK BERMS ARE TO REMAIN IN PLACE UNTIL THE UPSTREAM DISTURBED AREA IS STABILIZED AND GRASS COVER IS APPROVED.
  4. WHEN REINFORCED ROCK BERMS ARE REMOVED, ANY DISTURBED AREA SHALL BE DRILL SEEDED AND CRIMP MULCHED OR OTHERWISE STABILIZED IN A MANNER APPROVED BY THE TOWN.
- REINFORCED ROCK BERM INSTALLATION NOTES**
1. SEE PLAN VIEW FOR:
    - LOCATIONS OF REINFORCED ROCK BERMS.
    - LENGTH, "L", AND DEPTH, "D" DIMENSIONS.
  2. REINFORCED ROCK BERM SECTION APPLIES TO CULVERT INLET FILTER AND INLET PROTECTION.
  3. CRUSHED ROCK SHALL BE FACTURED FACE (ALL SIDES) AND SHALL COMPLY WITH GRADATION SHOWN ON SHEET 14 (1-1/2" MINUS). RECYCLED CONCRETE MEETING THIS GRADATION MAY BE USED.
  4. WIRE SHALL BE FABRICATED TO 10 GAUGE WITH TWISTED INTO A MESH WITH A MAXIMUM OPENING OF 1.0 INCH (COMMONLY TERMED "CHICKEN WIRE"). ROLL WIDTH SHALL BE 48-INCHES.
  5. WIRE MESH SHALL BE SECURED USING "HOG RINGS" OR WIRE TIES AT 6-INCH CENTERS ALONG ALL JOINTS AND AT 2-INCH CENTERS ON ENDS OF BERM.
  6. FOR CONCENTRATED FLOW AREAS THE ENDS OF THE REINFORCED ROCK BERM SHALL BE 12" HIGHER THAN THE CENTER OF THE BERM.

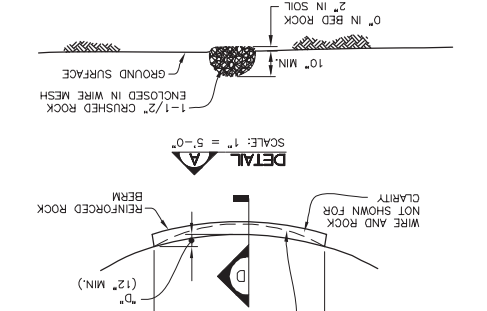
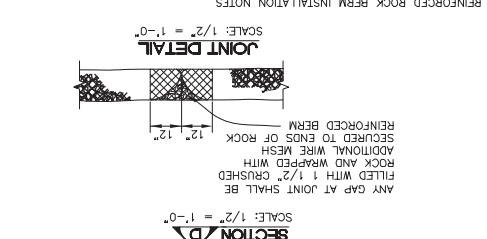

**RFB FOR CULVERT PROTECTION**

- RFB FOR CULVERT PROTECTION MAINTENANCE NOTES**
1. THE GESC MANAGER SHALL INSPECT CULVERT INLET FILTER WEEKLY, DURING AND AFTER ANY STORM EVENT AND MAKE REPAIRS OR CLEAN OUT AS NECESSARY.
  2. SEDIMENT ACCUMULATED UPSTREAM OF CULVERT INLET FILTER SHALL BE REMOVED WHEN THE SEDIMENT DEPTH UPSTREAM OF FILTER IS 1/2 THE HEIGHT OF THE REINFORCED ROCK BERM.
  3. RFB FOR CULVERT PROTECTION ARE TO REMAIN IN PLACE UNTIL THE UPSTREAM DISTURBED AREA IS STABILIZED AND GRASS COVER IS APPROVED BY THE TOWN.
  4. WHEN CULVERT INLET FILTERS ARE REMOVED, ANY DISTURBED AREA SHALL BE DRILL SEEDED AND CRIMP MULCHED OR OTHERWISE STABILIZED IN A MANNER APPROVED BY THE TOWN.
- RFB FOR CULVERT PROTECTION INSTALLATION NOTES**
1. SEE PLAN VIEW FOR:
    - LENGTH, "L", AND DEPTH, "D",
  2. CRUSHED ROCK SHALL BE FACTURED FACE (ALL SIDES) AND SHALL COMPLY WITH GRADATION SHOWN ON SHEET 14 (1-1/2" MINUS). RECYCLED CONCRETE MEETING THIS GRADATION MAY BE USED.
  3. WIRE MESH SHALL BE FABRICATED TO 10 GAUGE WIRE TWISTED INTO A MESH WITH A MAXIMUM OPENING OF 1.0 INCH (COMMONLY TERMED "CHICKEN WIRE").
  4. WIRE MESH SHALL BE SECURED USING "HOG RINGS" OR WIRE TIES AT 6-INCH CENTERS ON ENDS OF BERM.
  5. THE ENDS OF THE REINFORCED ROCK BERM SHALL BE 12" HIGHER THAN THE CENTER OF THE BERM.

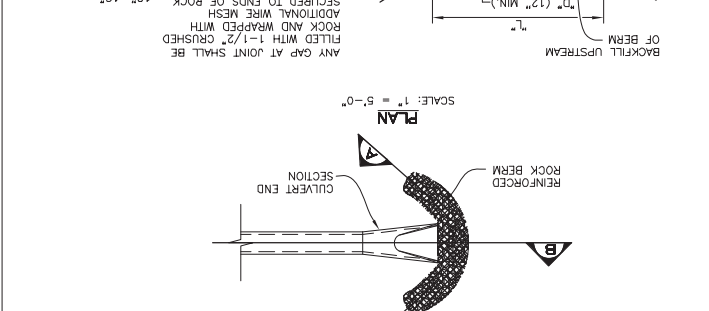
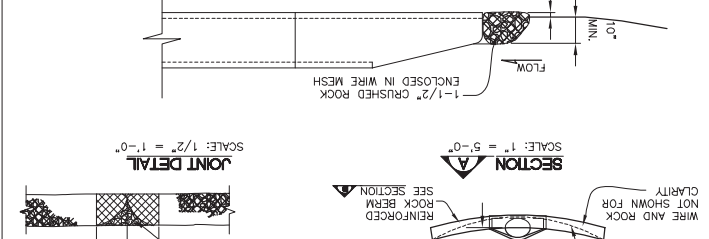

# Sediment Basin

## What it is

A temporary sediment basin detains sediment-laden runoff long enough to allow much of the sediment to settle out. Sediment basins are constructed by excavation and/or by placing an earthen embankment across a low area or drainage swale. Basins can be designed to maintain a permanent pool or to drain completely dry through a controlled outlet structure.



## When and Where to use it

- Required in disturbed areas draining more than one acre.
- Where there is sufficient space and appropriate topography.
- In areas that allow access for maintenance and sediment removal.
- Positioned so that it captures sediment from the entire upstream disturbed area.
- Where a permanent detention basin is planned for the site.

## When and Where NOT to use it

- Sediment basins are not to be installed in active streams.



This low area will provide for some removal of sediment; however, it lacks a designed outlet structure.

## Construction Detail and Maintenance Requirements

Figure SB-1 provides a construction detail and maintenance requirements for a sediment basin.

BASIN GEOMETRY:  
 $\frac{\text{LENGTH (L)}}{\text{WIDTH (W)}} \geq 2$

REQUIRED VOLUME TO CREST  
 OF EMERGENCY SPILLWAY  
 = 1800 CUBIC FEET PER  
 ACRE OF DRAINAGE AREA

8" (OR LARGER) PVC PERFORATED  
 RISER PIPE, PERFORATIONS VERTICALLY  
 SPACED 4" APART AND SIZED TO DRAIN  
 VOLUME BELOW EMERGENCY SPILLWAY  
 IN 40 HOURS (SEE FIGURE SB-2  
 FOR PERFORATION SIZING)

100 YR (OR LARGER)  
 EMERGENCY SPILLWAY CREST (BEYOND)  
 (SHALL BE DESIGNED SO THAT EMBANKMENT  
 FAILURE SHALL NOT OCCUR IN 100 YR EVENT)

BASIN  
 EMBANKMENT

3 OR  
 FLATTER

3 OR  
 FLATTER

RIPRAP  
 APRON

8" (OR LARGER) PVC OUTLET PIPE  
 0.5% MIN SLOPE

8" (OR LARGER)  
 PVC 90° ELBOW

## SEDIMENT BASIN

NTS

## SEDIMENT BASIN NOTES

### INSTALLATION REQUIREMENTS

1. SEDIMENT BASINS SHALL BE INSTALLED BEFORE ANY CLEARING AND/OR GRADING IS UNDERTAKEN.
2. THE AREA UNDER WHICH THE EMBANKMENT IS TO BE INSTALLED SHALL BE CLEARED, GRUBBED, AND STRIPPED OF ALL VEGETATION AND ROOT MAT.
3. THE OUTLET OF THE BASIN SHALL BE DESIGNED TO DRAIN ITS VOLUME IN 40 HOURS.
4. THE OUTLET IS TO BE LOCATED AT THE FURTHEST DISTANCE FROM THE INLET OF THE BASIN. BAFFLES MAY BE NEEDED TO INCREASE THE FLOW LENGTH AND SETTLING TIME.
5. EMBANKMENT MATERIAL SHALL CONSIST OF SOIL WITH A MINIMUM OF 15% PASSING A #200 SIEVE. EXCAVATED SOIL CAN BE USED IF IT MEETS THIS REQUIREMENT.
6. EMBANKMENT IS TO BE COMPACTED TO AT LEAST 90% OF MAXIMUM DENSITY AND WITHIN 2% OF OPTIMUM MOISTURE CONTENT ACCORDING TO ASTM D 698.
7. WHEN A BASIN IS INSTALLED NEAR A RESIDENTIAL AREA, FOR SAFETY REASONS, A SIGN SHALL BE POSTED AND THE AREA SECURED WITH A FENCE.

### MAINTENANCE REQUIREMENTS

1. CONTRACTOR SHALL INSPECT SEDIMENT BASINS AFTER EACH RAINFALL, AT LEAST DAILY DURING PROLONGED RAINFALL, AND WEEKLY DURING PERIODS NO RAINFALL.
2. SEDIMENT BASINS SHALL BE CLEANED OUT BEFORE SEDIMENT HAS FILLED HALF THE VOLUME OF THE BASIN.
3. SEDIMENT BASINS SHALL REMAIN OPERATIONAL AND PROPERLY MAINTAINED UNTIL THE SITE AREA IS PERMANENTLY STABILIZED WITH ADEQUATE VEGETATIVE COVER AND/OR OTHER PERMANENT STRUCTURE AS APPROVED BY THE CITY.

City of Colorado Springs  
 Stormwater Quality

Figure SB-1  
 Sediment Basin  
 Construction Detail and Maintenance  
 Requirements



Required Area per Row (in<sup>2</sup>)

	Depth at Outlet (ft)								
	1.0	1.5	2.0	2.5	3.0	3.5	4.0	4.5	
2	15.04	7.71	5.10	3.76	2.95	2.41	2.02	1.73	
1	7.52	3.86	2.55	1.88	1.48	1.21	1.01	0.87	
0.6	4.51	2.31	1.53	1.13	0.89	0.72	0.61	0.52	
0.4	3.01	1.54	1.02	0.75	0.59	0.48	0.40	0.35	
0.2	1.50	0.77	0.51	0.38	0.30	0.24	0.20	0.17	
0.1	0.75	0.39	0.26	0.19	0.15	0.12	0.10	0.09	
0.06	0.45	0.23	0.15	0.11	0.09	0.07	0.06	0.05	
0.04	0.30	0.15	0.10	0.08	0.06	0.05	0.04	0.03	
0.02	0.15	0.08	0.05	0.04	0.03	0.02	0.02	0.02	
0.01	0.08	0.04	0.03	0.02	0.01	0.01	0.01	0.01	

**TABLE SB-1**

Circular Perforation Sizing

Hole Diameter (in)	Hole Diameter (in)	Area per Row (in <sup>2</sup> )		
		n = 1	n = 2	n = 3
1/4	0.250	0.05	0.10	0.15
5/16	0.313	0.08	0.15	0.23
3/8	0.375	0.11	0.22	0.33
7/16	0.438	0.15	0.30	0.45
1/2	0.500	0.20	0.39	0.59
9/16	0.563	0.25	0.50	0.75
5/8	0.625	0.31	0.61	0.92
11/16	0.688	0.37	0.74	1.11
3/4	0.750	0.44	0.88	1.33
7/8	0.875	0.60	1.20	1.80
1	1.000	0.79	1.57	2.36
1 1/8	1.125	0.99	1.99	2.98
1 1/4	1.250	1.23	2.45	3.68
1 3/8	1.375	1.48	2.97	4.45
1 1/2	1.500	1.77	3.53	5.30
1 5/8	1.625	2.07	4.15	6.22
1 3/4	1.750	2.41	4.81	7.22
1 7/8	1.875	2.76	5.52	8.28
2	2.000	3.14	6.28	9.42
n = Number of columns of perforations				
Minimum steel plate thickness		1/4"	5/16"	3/8"

**TABLE SB-2**

# Silt Fence

## What it is

A silt fence is a temporary sediment barrier constructed of filter fabric stretched across supporting posts. The bottom edge of the fabric is entrenched and covered with backfill.



## When and Where to use it

- On the down gradient perimeters of a construction site.
- On a contour to control overland sheet flow.
- At the top or toe of a steep slope.
- As a form of inlet protection (see inlet protection factsheet).

Figure SF-1 depicts five cases where the use of silt fence is appropriate.

## When and Where NOT to use it

- In areas of concentrated flows such as in ditches, swales or channels that drain areas greater than 1.0 acre.
- At the top of a slope or at high points which do not receive any drainage flows.



This photo reveals a silt fence that has become unentrenched because it was not securely installed.



This photo illustrates what will happen to a silt fence if it is installed in an area of concentrated flow.

## Construction Detail and Maintenance Requirements

Figure SF-2 provides a construction detail and maintenance requirements for a silt fence.

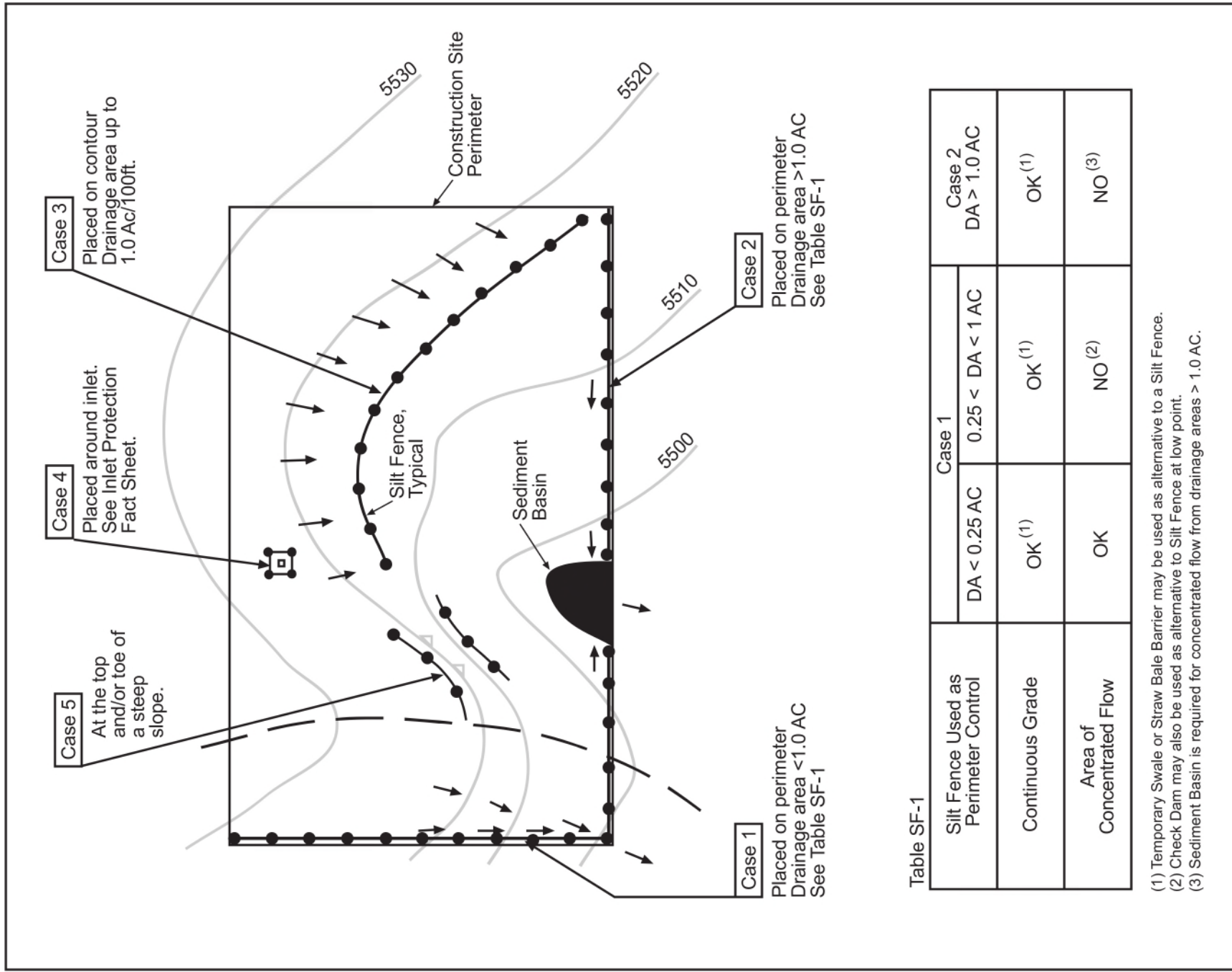

Table SF-1

Silt Fence Used as Perimeter Control	Case 1		Case 2
	DA < 0.25 AC	0.25 < DA < 1 AC	DA > 1.0 AC
Continuous Grade	OK <sup>(1)</sup>	OK <sup>(1)</sup>	OK <sup>(1)</sup>
Area of Concentrated Flow	OK	NO <sup>(2)</sup>	NO <sup>(3)</sup>

(1) Temporary Swale or Straw Bale Barrier may be used as alternative to a Silt Fence.

(2) Check Dam may also be used as alternative to Silt Fence at low point.

(3) Sediment Basin is required for concentrated flow from drainage areas > 1.0 AC.

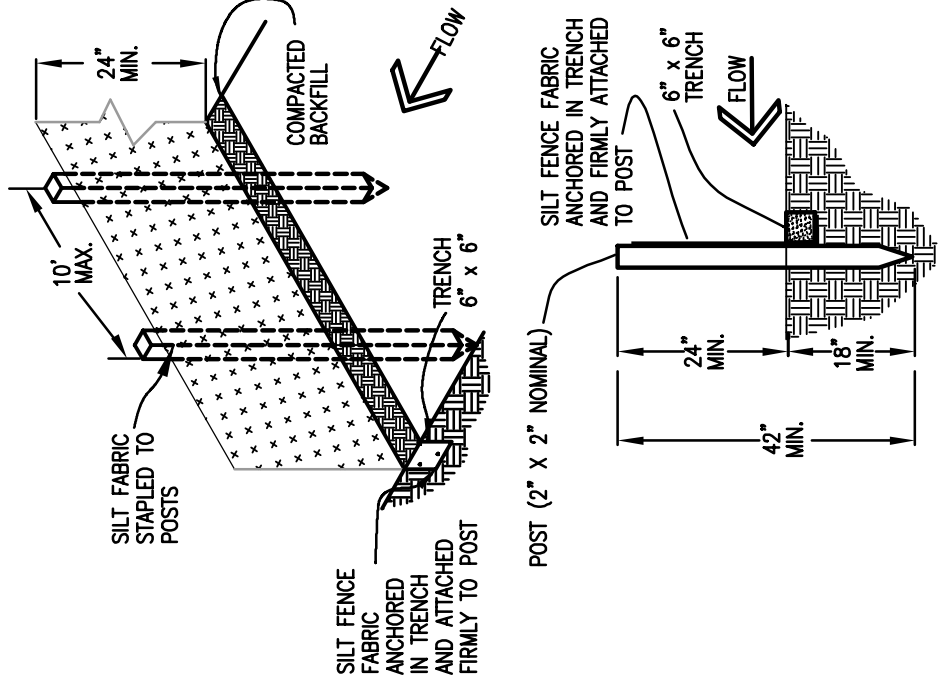

SILT FENCE

**SILT FENCE NOTES**

**INSTALLATION REQUIREMENTS**

1. SILT FENCES SHALL BE INSTALLED PRIOR TO ANY LAND DISTURBING ACTIVITIES.
2. WHEN JOINTS ARE NECESSARY, SILT FENCE GEOTEXTILE SHALL BE SPLICED TOGETHER ONLY AT SUPPORT POST AND SECURELY SEALED.
3. METAL POSTS SHALL BE "STUDDED TEE" OR "U" TYPE WITH MINIMUM WEIGHT OF 1.33 POUNDS PER LINEAR FOOT. WOOD POSTS SHALL HAVE A MINIMUM DIAMETER OR CROSS SECTION DIMENSION OF 2 INCHES.
4. THE FILTER MATERIAL SHALL BE FASTENED SECURELY TO METAL OR WOOD POSTS USING WIRE TIES, OR TO WOOD POSTS WITH 3/4" LONG #9 HEAVY-DUTY STAPLES. THE SILT FENCE GEOTEXTILE SHALL NOT BE STAPLED TO EXISTING TREES.
5. WHILE NOT REQUIRED, WIRE MESH FENCE MAY BE USED TO SUPPORT THE GEOTEXTILE. WIRE FENCE SHALL BE FASTENED SECURELY TO THE UPSLOPE SIDE OF THE POSTS USING HEAVY-DUTY WIRE STAPLES AT LEAST 3/4" LONG, TIE WIRES OR HOG RINGS. THE WIRE SHALL EXTEND INTO THE TRENCH A MINIMUM OF 6" AND SHALL NOT EXTEND MORE THAN 3' ABOVE THE ORIGINAL GROUND SURFACE.

6. ALONG THE TOE OF FILLS, INSTALL THE SILT FENCE ALONG A LEVEL CONTOUR AND PROVIDE AN AREA BEHIND THE FENCE FOR RUNOFF TO POND AND SEDIMENT TO SETTLE. A MINIMUM DISTANCE OF 5 FEET FROM THE TOE OF THE FILL IS RECOMMENDED.
7. THE HEIGHT OF THE SILT FENCE FROM THE GROUND SURFACE SHALL BE MINIMUM OF 24 INCHES AND SHALL NOT EXCEED 36 INCHES; HIGHER FENCES MAY INPOUND VOLUMES OF WATER SUFFICIENT TO CAUSE FAILURE OF THE STRUCTURE.

**MAINTENANCE REQUIREMENTS**

1. CONTRACTOR SHALL INSPECT SILT FENCES IMMEDIATELY AFTER EACH RAINFALL, AT LEAST DAILY DURING PROLONGED RAINFALL, AND WEEKLY DURING PERIODS OF NO RAINFALL. DAMAGED, COLLAPSED, UNENTRENCHED OR INEFFECTIVE SILT FENCES SHALL BE PROMPTLY REPAIRED OR REPLACED.
2. SEDIMENT SHALL BE REMOVED FROM BEHIND SILT FENCE WHEN IT ACCUMULATES TO HALF THE EXPOSED GEOTEXTILE HEIGHT.
3. SILT FENCES SHALL BE REMOVED WHEN ADEQUATE VEGETATIVE COVER IS ATTAINED AS APPROVED BY THE CITY.

# Top View of Silt Fence Posts Detail

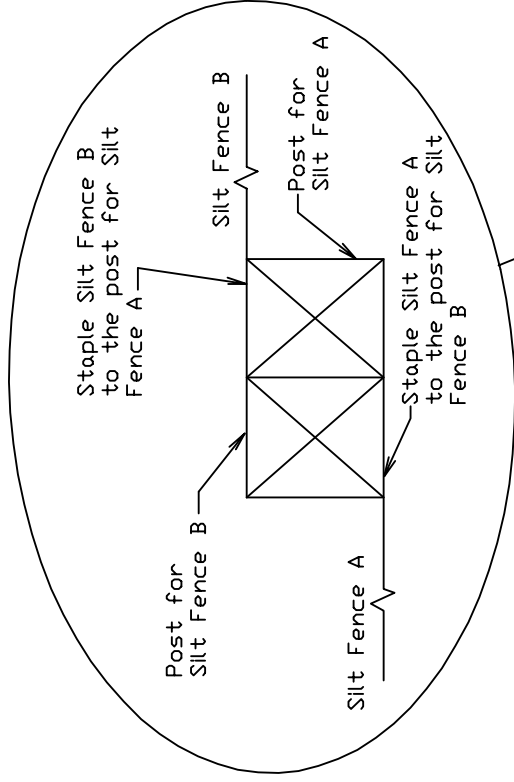

Refer to "Top View of Silt Fence Posts Detail"

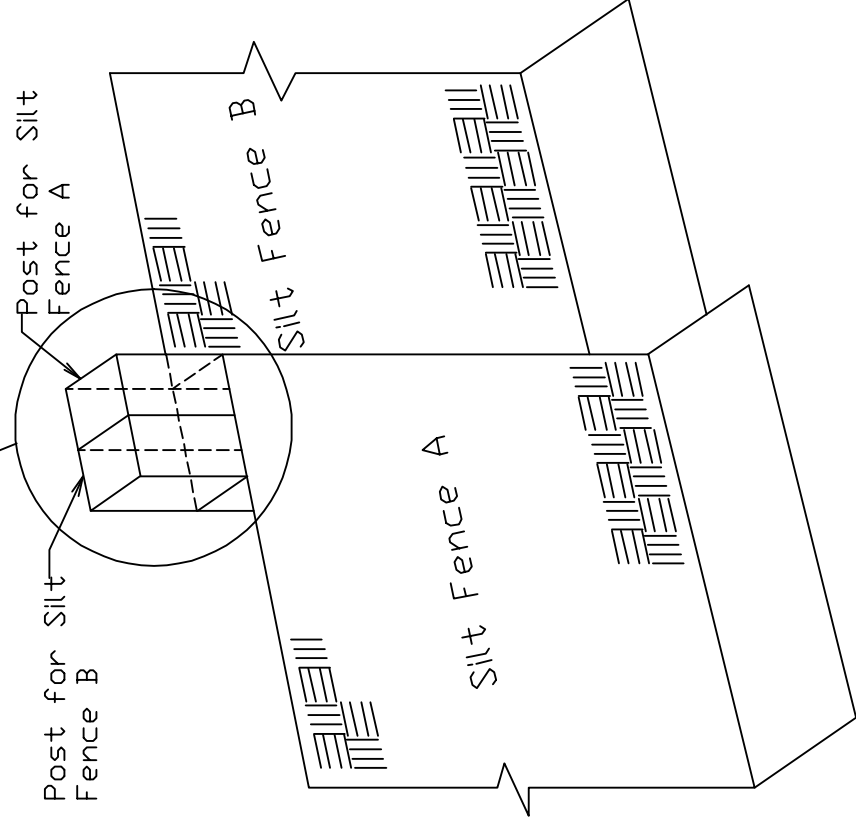



## Description

A stabilized staging area is a clearly designated area where construction equipment and vehicles, stockpiles, waste bins, and other construction-related materials are stored. The contractor office trailer may also be located in this area. Depending on the size of the construction site, more than one staging area may be necessary.

## Appropriate Uses

Most construction sites will require a staging area, which should be clearly designated in SWMP drawings. The layout of the staging area may vary depending on the type of construction activity. Staging areas located in roadways due to space constraints require special measures to avoid materials being washed into storm inlets.

## Design and Installation

Stabilized staging areas should be completed prior to other construction activities beginning on the site. Major components of a stabilized staging area include:

- Appropriate space to contain storage and provide for loading/unloading operations, as well as parking if necessary.
- A stabilized surface, either paved or covered, with 3-inch diameter aggregate or larger.
- Perimeter controls such as silt fence, sediment control logs, or other measures.
- Construction fencing to prevent unauthorized access to construction materials.
- Provisions for Good Housekeeping practices related to materials storage and disposal, as described in the Good Housekeeping BMP Fact Sheet.
- A stabilized construction entrance/exit, as described in the Vehicle Tracking Control BMP Fact Sheet, to accommodate traffic associated with material delivery and waste disposal vehicles.

Over-sizing the stabilized staging area may result in disturbance of existing vegetation in excess of that required for the project. This increases costs, as well as requirements for long-term stabilization following the construction period. When designing the stabilized staging area, minimize the area of disturbance to the extent practical.



**Photograph SSA-1.** Example of a staging area with a gravel surface to prevent mud tracking and reduce runoff. Photo courtesy of Douglas County.

Stabilized Staging Area	
<b>Functions</b>	
Erosion Control	Yes
Sediment Control	Moderate
Site/Material	Yes



**Minimizing Long-Term Stabilization Requirements**

- Utilize off-site parking and restrict vehicle access to the site.
- Use construction mats in lieu of rock when staging is provided in an area that will not be disturbed otherwise.
- Consider use of a bermed contained area for materials and equipment that do not require a stabilized surface.
- Consider phasing of staging areas to avoid disturbance in an area that will not be otherwise disturbed.

See Detail SSA-1 for a typical stabilized staging area and SSA-2 for a stabilized staging area when materials staging in roadways is required.

**Maintenance and Removal**

Maintenance of stabilized staging areas includes maintaining a stable surface cover of gravel, repairing perimeter controls, and following good housekeeping practices.

When construction is complete, debris, unused stockpiles and materials should be recycled or properly disposed. In some cases, this will require disposal of contaminated soil from equipment leaks in an appropriate landfill. Staging areas should then be permanently stabilized with vegetation or other surface cover planned for the development.

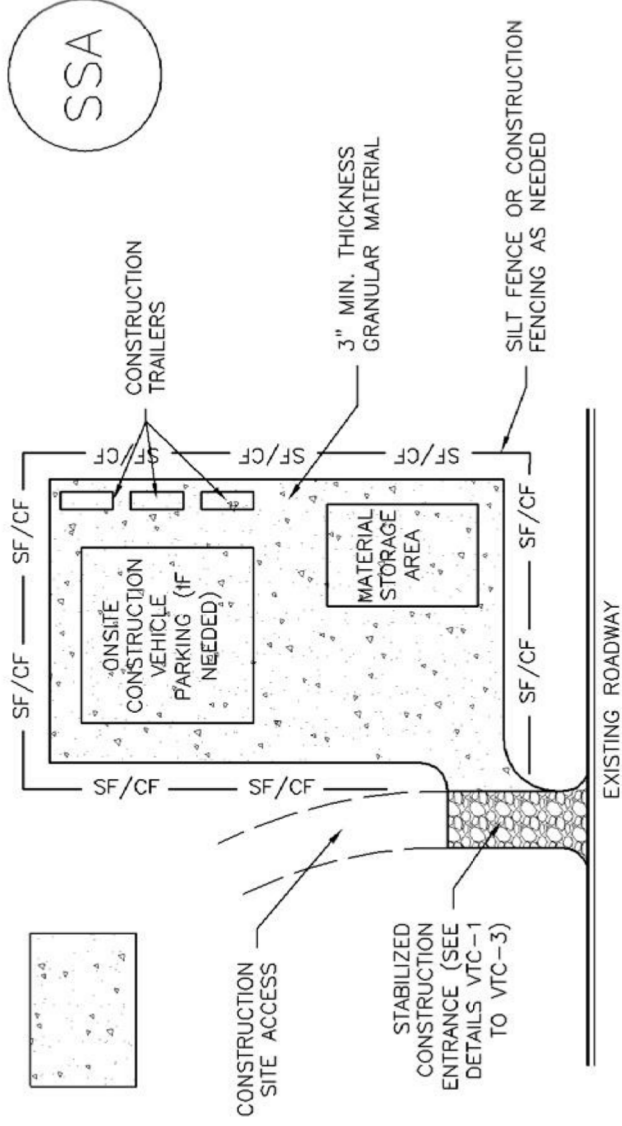

## SSA-1. STABILIZED STAGING AREA

### STABILIZED STAGING AREA INSTALLATION NOTES

1. SEE PLAN VIEW FOR  
-LOCATION OF STAGING AREA(S).  
-CONTRACTOR MAY ADJUST LOCATION AND SIZE OF STAGING AREA WITH APPROVAL FROM THE LOCAL JURISDICTION.
2. STABILIZED STAGING AREA SHOULD BE APPROPRIATE FOR THE NEEDS OF THE SITE. OVERSIZING RESULTS IN A LARGER AREA TO STABILIZE FOLLOWING CONSTRUCTION.
3. STAGING AREA SHALL BE STABILIZED PRIOR TO OTHER OPERATIONS ON THE SITE.
4. THE STABILIZED STAGING AREA SHALL CONSIST OF A MINIMUM 3" THICK GRANULAR MATERIAL.
5. UNLESS OTHERWISE SPECIFIED BY LOCAL JURISDICTION, ROCK SHALL CONSIST OF DOT SECT. #703, AASHTO #3 COARSE AGGREGATE OR 6" (MINUS) ROCK.
6. ADDITIONAL PERIMETER BMPs MAY BE REQUIRED INCLUDING BUT NOT LIMITED TO SILT FENCE AND CONSTRUCTION FENCING.

### STABILIZED STAGING AREA MAINTENANCE NOTES

1. INSPECT BMPs EACH WORKDAY, AND MAINTAIN THEM IN EFFECTIVE OPERATING CONDITION. MAINTENANCE OF BMPs SHOULD BE PROACTIVE, NOT REACTIVE. INSPECT BMPs AS SOON AS POSSIBLE (AND ALWAYS WITHIN 24 HOURS) FOLLOWING A STORM THAT CAUSES SURFACE EROSION, AND PERFORM NECESSARY MAINTENANCE.
2. FREQUENT OBSERVATIONS AND MAINTENANCE ARE NECESSARY TO MAINTAIN BMPs IN EFFECTIVE OPERATING CONDITION. INSPECTIONS AND CORRECTIVE MEASURES SHOULD BE DOCUMENTED THOROUGHLY.
3. WHERE BMPs HAVE FAILED, REPAIR OR REPLACEMENT SHOULD BE INITIATED UPON DISCOVERY OF THE FAILURE.
4. ROCK SHALL BE REAPPLIED OR REGRADED AS NECESSARY IF RUTTING OCCURS OR UNDERLYING SUBGRADE BECOMES EXPOSED.

**STABILIZED STAGING AREA MAINTENANCE NOTES**

5. STABILIZED STAGING AREA SHALL BE ENLARGED IF NECESSARY TO CONTAIN PARKING, STORAGE, AND UNLOADING/LOADING OPERATIONS.
6. THE STABILIZED STAGING AREA SHALL BE REMOVED AT THE END OF CONSTRUCTION. THE GRANULAR MATERIAL SHALL BE REMOVED OR, IF APPROVED BY THE LOCAL JURISDICTION, USED ON SITE, AND THE AREA COVERED WITH TOPSOIL, SEEDED AND MULCHED OR OTHERWISE STABILIZED IN A MANNER APPROVED BY LOCAL JURISDICTION.

**NOTE:** MANY MUNICIPALITIES PROHIBIT THE USE OF RECYCLED CONCRETE AS GRANULAR MATERIAL FOR STABILIZED STAGING AREAS DUE TO DIFFICULTIES WITH RE-ESTABLISHMENT OF VEGETATION IN AREAS WHERE RECYCLED CONCRETE WAS PLACED.

**NOTE:** MANY JURISDICTIONS HAVE BMP DETAILS THAT VARY FROM UDFCD STANDARD DETAILS. CONSULT WITH LOCAL JURISDICTIONS AS TO WHICH DETAIL SHOULD BE USED WHEN DIFFERENCES ARE NOTED.

(DETAILS ADAPTED FROM DOUGLAS COUNTY, COLORADO, NOT AVAILABLE IN AUTOCAD)

# Slope Drain

---

## **What it is**

Slope drains are either flexible or rigid pipes that convey concentrated runoff from the top of a slope to a stable discharge point at the bottom of the slope. Slope drains can be either temporary or permanent depending on the method of installation and material used.

## **When and Where to use it**

- At the top of cut-and-fill slopes to convey stormwater down the slope.
- Before a slope has been stabilized or before permanent drainage structures are ready for use.
- In combination with other BMPs that have been used to concentrate flows, including temporary swales.

## **When and Where NOT to use it**

Slope drains should not be used for drainage areas larger than 5 acres.

## **Construction Detail and Maintenance Requirements**

Figure SD-1 provides a construction detail and maintenance requirements for a slope drain.

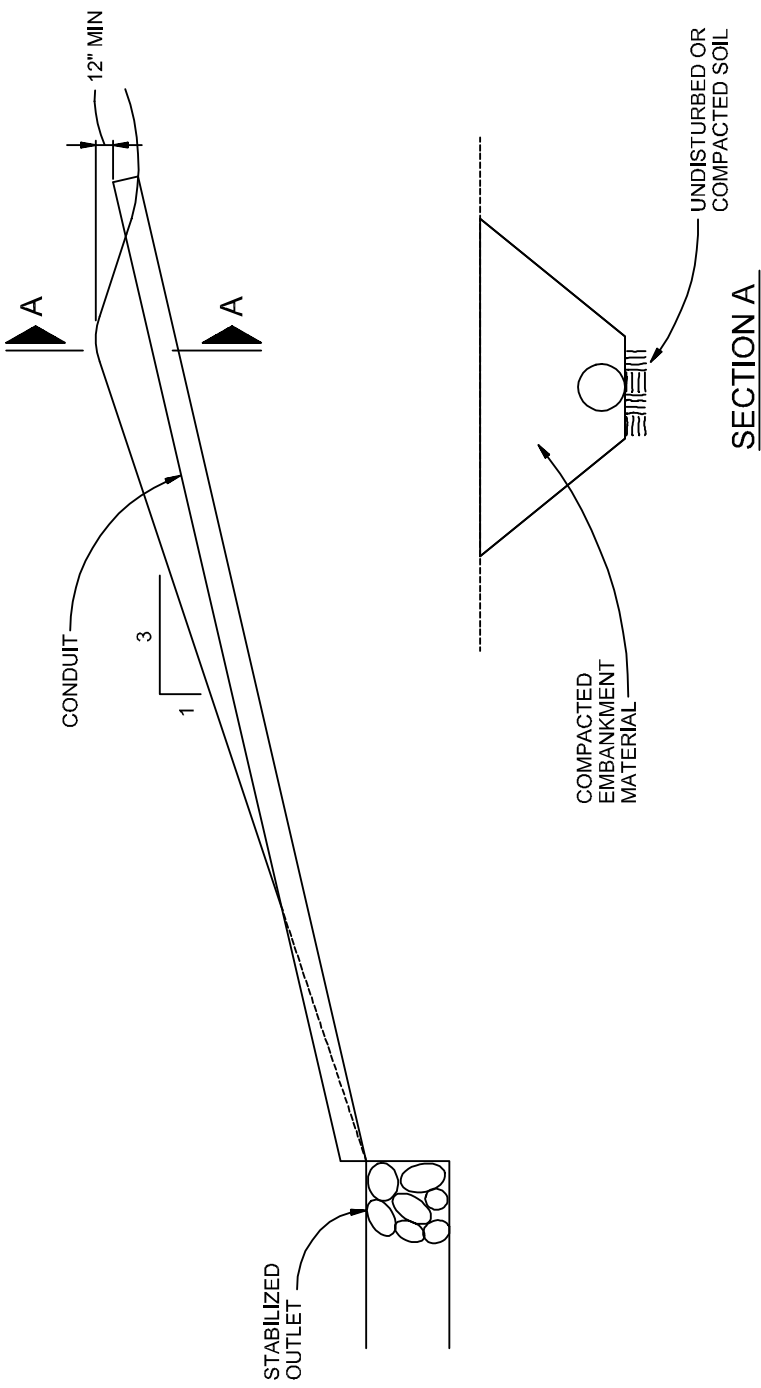

## SLOPE DRAIN

NTS

### SLOPE DRAIN NOTES

#### INSTALLATION REQUIREMENTS

1. THE SLOPE DRAIN IS TO BE DESIGNED TO CONVEY THE PEAK RUNOFF FOR THE 2-YEAR STORM.
2. PIPE MATERIAL MAY INCLUDE CORRUGATED METAL, OR RIGID OR FLEXIBLE PLASTIC.
3. EMBANKMENT MATERIAL SHALL CONSIST OF SOIL WITH A MINIMUM OF 15% PASSING A #200 SIEVE. EXCAVATED SOIL CAN BE USED IF IT MEETS THIS REQUIREMENT.
4. EMBANKMENT IS TO BE COMPACTED TO AT LEAST 90% OF MAXIMUM DENSITY AND WITHIN 2% OF OPTIMUM MOISTURE CONTENT ACCORDING TO ASTM D 698.
5. SLOPE DRAIN SECTIONS ARE TO BE SECURELY FASTENED TOGETHER AND HAVE WATERTIGHT FITTINGS.
6. THE OUTLET IS TO BE STABILIZED AND, UNLESS THE DRAIN DISCHARGES DIRECTLY TO A SEDIMENT BASIN, A TEMPORARY SURFACE IS TO BE PROVIDED TO CONVEY FLOWS DOWN STREAM.
7. IMMEDIATELY STABILIZE ALL AREAS DISTURBED BY INSTALLATION OR REMOVAL OF THE PIPE SLOPE DRAIN.

#### MAINTENANCE REQUIREMENTS

1. INLET AND OUTLET POINTS ARE TO BE CHECKED REGULARLY, AND AFTER HEAVY STORMS FOR CLOGGING AND OVERCHARGING. ANY BREAKS IN THE PIPE ARE TO BE PROMPTLY REPAIRED, AND CLOGS REMOVED AS NEEDED.
2. WATER IS NOT TO BYPASS OR UNDERCUT THE INLET OR PIPE. IF THESE PROBLEMS DO EXIST, THE HEADWALL NEEDS TO BE REINFORCED WITH COMPACT EARTH OR SANDBAGS.
3. THE OUTLET POINT IS TO BE FREE OF EROSION, AND, IF NECESSARY, ADDITIONAL OUTLET PROTECTION SHOULD BE INSTALLED.
4. CONSTRUCTION TRAFFIC IS NOT TO CROSS THE SLOPE DRAIN AND MATERIALS ARE NOT TO BE PLACED ON IT.
5. THE SLOPE DRAIN IS TO REMAIN IN PLACE UNTIL THE SLOPE HAS BEEN COMPLETELY STABILIZED OR UP TO 30 DAYS AFTER PERMANENT SLOPE STABILIZATION.

## Description

Stockpile management includes measures to minimize erosion and sediment transport from soil stockpiles.

## Appropriate Uses

Stockpile management should be used when soils or other erodible materials are stored at the construction site. Special attention should be given to stockpiles in close proximity to natural or manmade storm systems.

## Design and Installation

Locate stockpiles away from all drainage system components including storm sewer inlets. Where practical, choose stockpile locations that that will remain undisturbed for the longest period of time as the phases of construction progress. Place sediment control BMPs around the perimeter of the stockpile, such as sediment control logs, rock socks, silt fence, straw bales and sand bags. See Detail SP-1 for guidance on proper establishment of perimeter controls around a stockpile. For stockpiles in active use, provide a stabilized designated access point on the upgradient side of the stockpile.



**Photograph SP-1.** A topsoil stockpile that has been partially revegetated and is protected by silt fence perimeter control.

Stabilize the stockpile surface with surface roughening, temporary seeding and mulching, erosion control blankets, or soil binders. Soils stockpiled for an extended period (typically for more than 60 days) should be seeded and mulched with a temporary grass cover once the stockpile is placed (typically within 14 days). Use of mulch only or a soil binder is acceptable if the stockpile will be in place for a more limited time period (typically 30-60 days). Timeframes for stabilization of stockpiles noted in this fact sheet are "typical" guidelines. Check permit requirements for specific federal, state, and/or local requirements that may be more prescriptive.

Stockpiles should not be placed in streets or paved areas unless no other practical alternative exists. See the Stabilized Staging Area Fact Sheet for guidance when staging in roadways is unavoidable due to space or right-of-way constraints. For paved areas, rock socks must be used for perimeter control and all inlets with the potential to receive sediment from the stockpile (even from vehicle tracking) must be protected.

## Maintenance and Removal

Inspect perimeter controls and inlet protection in accordance with their respective BMP Fact Sheets. Where seeding, mulch and/or soil binders are used, reseeding or reapplication of soil binder may be necessary.

When temporary removal of a perimeter BMP is necessary to access a stockpile, ensure BMPs are reinstalled in accordance with their respective design detail section.

Stockpile Management	
<b>Functions</b>	
Erosion Control	Yes
Sediment Control	Yes
Site/Material Management	Yes

When the stockpile is no longer needed, properly dispose of excess materials and revegetate or otherwise stabilize the ground surface where the stockpile was located.



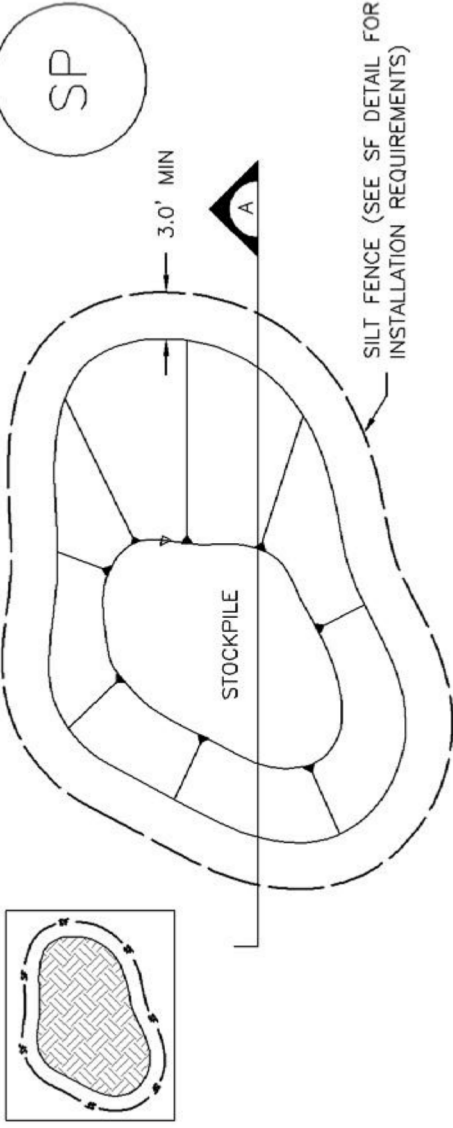

## STOCKPILE PROTECTION PLAN

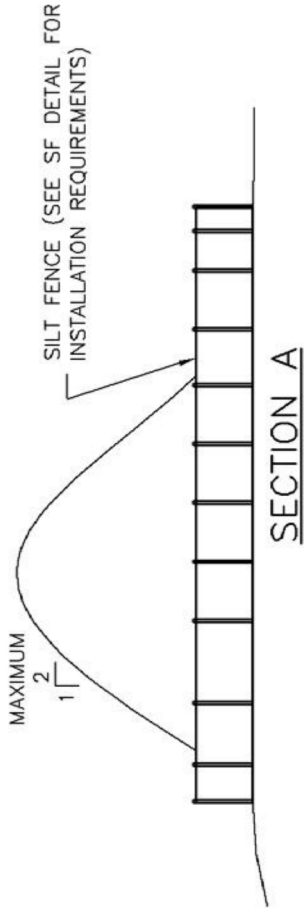

## SP-1. STOCKPILE PROTECTION

### STOCKPILE PROTECTION INSTALLATION NOTES

1. SEE PLAN VIEW FOR:
  - LOCATION OF STOCKPILES.
  - TYPE OF STOCKPILE PROTECTION.
2. INSTALL PERIMETER CONTROLS IN ACCORDANCE WITH THEIR RESPECTIVE DESIGN DETAILS. SILT FENCE IS SHOWN IN THE STOCKPILE PROTECTION DETAILS; HOWEVER, OTHER TYPES OF PERIMETER CONTROLS INCLUDING SEDIMENT CONTROL LOGS OR ROCK SOCKS MAY BE SUITABLE IN SOME CIRCUMSTANCES. CONSIDERATIONS FOR DETERMINING THE APPROPRIATE TYPE OF PERIMETER CONTROL FOR A STOCKPILE INCLUDE WHETHER THE STOCKPILE IS LOCATED ON A PERVIOUS OR IMPVIOUS SURFACE, THE RELATIVE HEIGHTS OF THE PERIMETER CONTROL AND STOCKPILE, THE ABILITY OF THE PERIMETER CONTROL TO CONTAIN THE STOCKPILE WITHOUT FAILING IN THE EVENT THAT MATERIAL FROM THE STOCKPILE SHIFTS OR SLUMPS AGAINST THE PERIMETER, AND OTHER FACTORS.
3. STABILIZE THE STOCKPILE SURFACE WITH SURFACE ROUGHENING, TEMPORARY SEEDING AND MULCHING, EROSION CONTROL BLANKETS, OR SOIL BINDERS. SOILS STOCKPILED FOR AN EXTENDED PERIOD (TYPICALLY FOR MORE THAN 60 DAYS) SHOULD BE SEEDED AND MULCHED WITH A TEMPORARY GRASS COVER ONCE THE STOCKPILE IS PLACED (TYPICALLY WITHIN 14 DAYS). USE OF MULCH ONLY OR A SOIL BINDER IS ACCEPTABLE IF THE STOCKPILE WILL BE IN PLACE FOR A MORE LIMITED TIME PERIOD (TYPICALLY 30-60 DAYS).
4. FOR TEMPORARY STOCKPILES ON THE INTERIOR PORTION OF A CONSTRUCTION SITE, WHERE OTHER DOWNGRADIENT CONTROLS, INCLUDING PERIMETER CONTROL, ARE IN PLACE, STOCKPILE PERIMETER CONTROLS MAY NOT BE REQUIRED.

STOCKPILE PROTECTION MAINTENANCE NOTES

1. INSPECT BMPs EACH WORKDAY, AND MAINTAIN THEM IN EFFECTIVE OPERATING CONDITION. MAINTENANCE OF BMPs SHOULD BE PROACTIVE, NOT REACTIVE. INSPECT BMPs AS SOON AS POSSIBLE (AND ALWAYS WITHIN 24 HOURS) FOLLOWING A STORM THAT CAUSES SURFACE EROSION, AND PERFORM NECESSARY MAINTENANCE.
2. FREQUENT OBSERVATIONS AND MAINTENANCE ARE NECESSARY TO MAINTAIN BMPs IN EFFECTIVE OPERATING CONDITION. INSPECTIONS AND CORRECTIVE MEASURES SHOULD BE DOCUMENTED THOROUGHLY.
3. WHERE BMPs HAVE FAILED, REPAIR OR REPLACEMENT SHOULD BE INITIATED UPON DISCOVERY OF THE FAILURE.

STOCKPILE PROTECTION MAINTENANCE NOTES

4. IF PERIMETER PROTECTION MUST BE MOVED TO ACCESS SOIL STOCKPILE, REPLACE PERIMETER CONTROLS BY THE END OF THE WORKDAY.
5. STOCKPILE PERIMETER CONTROLS CAN BE REMOVED ONCE ALL THE MATERIAL FROM THE STOCKPILE HAS BEEN USED.

(DETAILS ADAPTED FROM PARKER, COLORADO, NOT AVAILABLE IN AUTOCAD)

NOTE: MANY JURISDICTIONS HAVE BMP DETAILS THAT VARY FROM UDFCD STANDARD DETAILS. CONSULT WITH LOCAL JURISDICTIONS AS TO WHICH DETAIL SHOULD BE USED WHEN DIFFERENCES ARE NOTED.

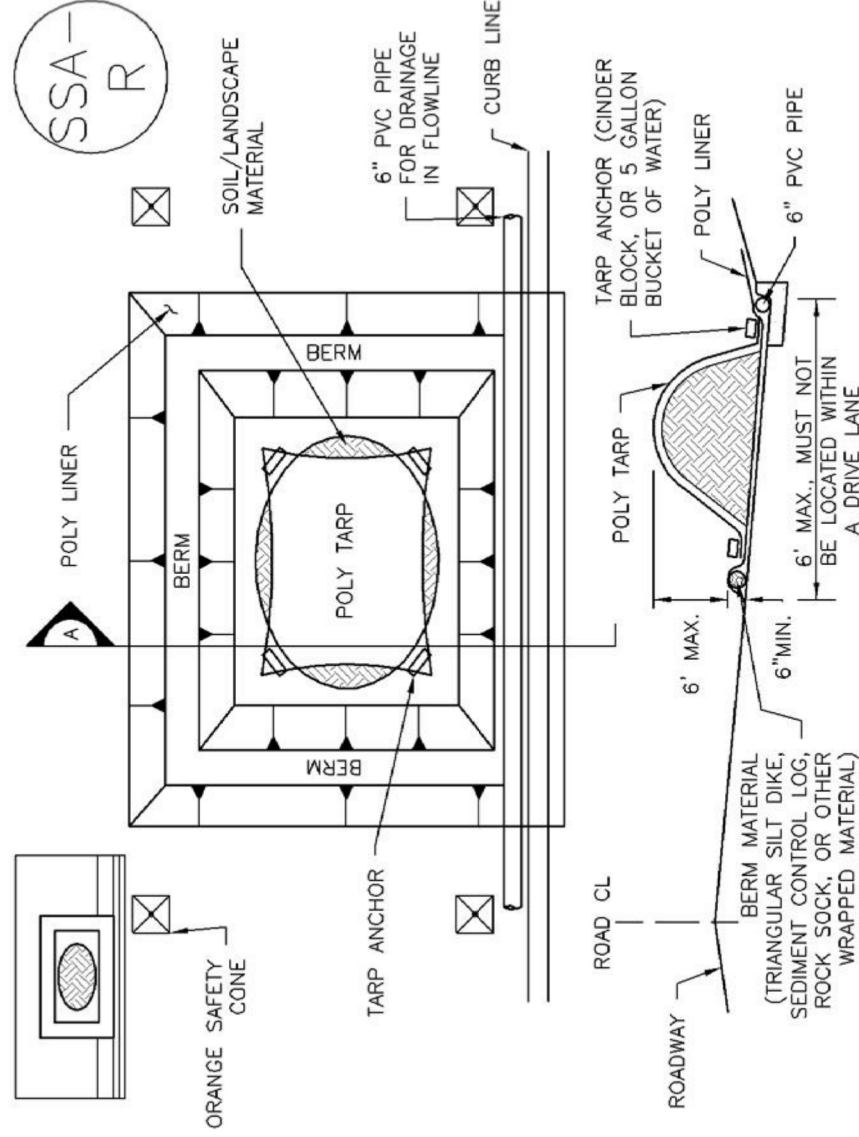

## SP-2. MATERIALS STAGING IN ROADWAY

### MATERIALS STAGING IN ROADWAYS INSTALLATION NOTES

1. SEE PLAN VIEW FOR
  - LOCATION OF MATERIAL STAGING AREA(S).
  - CONTRACTOR MAY ADJUST LOCATION AND SIZE OF STAGING AREA WITH APPROVAL FROM THE LOCAL JURISDICTION.
2. FEATURE MUST BE INSTALLED PRIOR TO EXCAVATION, EARTHWORK OR DELIVERY OF MATERIALS.
3. MATERIALS MUST BE STATIONED ON THE POLY LINER. ANY INCIDENTAL MATERIALS DEPOSITED ON PAVED SECTION OR ALONG CURB LINE MUST BE CLEANED UP PROMPTLY.
4. POLY LINER AND TARP COVER SHOULD BE OF SIGNIFICANT THICKNESS TO PREVENT DAMAGE OR LOSS OF INTEGRITY.
5. SAND BAGS MAY BE SUBSTITUTED TO ANCHOR THE COVER TARP OR PROVIDE BERMING UNDER THE BASE LINER.
6. FEATURE IS NOT INTENDED FOR USE WITH WET MATERIAL THAT WILL BE DRAINING AND/OR SPREADING OUT ON THE POLY LINER OR FOR DEMOLITION MATERIALS.
7. THIS FEATURE CAN BE USED FOR:
  - UTILITY REPAIRS.
  - WHEN OTHER STAGING LOCATIONS AND OPTIONS ARE LIMITED.
  - OTHER LIMITED APPLICATION AND SHORT DURATION STAGING.

**MATERIALS STAGING IN ROADWAY MAINTENANCE NOTES**

1. INSPECT BMPs EACH WORKDAY, AND MAINTAIN THEM IN EFFECTIVE OPERATING CONDITION. MAINTENANCE OF BMPs SHOULD BE PROACTIVE, NOT REACTIVE. INSPECT BMPs AS SOON AS POSSIBLE (AND ALWAYS WITHIN 24 HOURS) FOLLOWING A STORM THAT CAUSES SURFACE EROSION, AND PERFORM NECESSARY MAINTENANCE.
2. FREQUENT OBSERVATIONS AND MAINTENANCE ARE NECESSARY TO MAINTAIN BMPs IN EFFECTIVE OPERATING CONDITION. INSPECTIONS AND CORRECTIVE MEASURES SHOULD BE DOCUMENTED THOROUGHLY.
3. WHERE BMPs HAVE FAILED, REPAIR OR REPLACEMENT SHOULD BE INITIATED UPON DISCOVERY OF THE FAILURE.
4. INSPECT PVC PIPE ALONG CURB LINE FOR CLOGGING AND DEBRIS. REMOVE OBSTRUCTIONS PROMPTLY.
5. CLEAN MATERIAL FROM PAVED SURFACES BY SWEEPING OR VACUUMING.

**NOTE:** MANY JURISDICTIONS HAVE BMP DETAILS THAT VARY FROM UDFCD STANDARD DETAILS. CONSULT WITH LOCAL JURISDICTIONS AS TO WHICH DETAIL SHOULD BE USED WHEN DIFFERENCES ARE NOTED.

(DETAILS ADAPTED FROM AURORA, COLORADO)

# Temporary Swale

---

## What it is

A temporary swale is an earth channel used to convey runoff. A temporary swale can be excavated or formed upslope from an earthen berm, and may be lined or unlined.

## When and Where to use it

- At the top of a slope to divert upland runoff away from the slope face.
- At the bottom of a slope to convey sediment-laden runoff to a sediment-trapping device such as a sediment basin.
- Along the perimeter of the construction site to keep runoff from leaving the site.

Figure TSW-1 illustrates cases where temporary swales are most effective.

## When and Where NOT to use it

- Where longitudinal slope exceeds 10 percent (lining is required where longitudinal slope exceeds 2 percent).
- In areas where concentrated flow will overtop the swale transversely.

## Construction Detail and Maintenance Requirements

Figure TSW-2 provides a construction detail and maintenance requirements for a temporary swale. Figure TSW-3 provides a construction detail and maintenance requirements for swale linings.



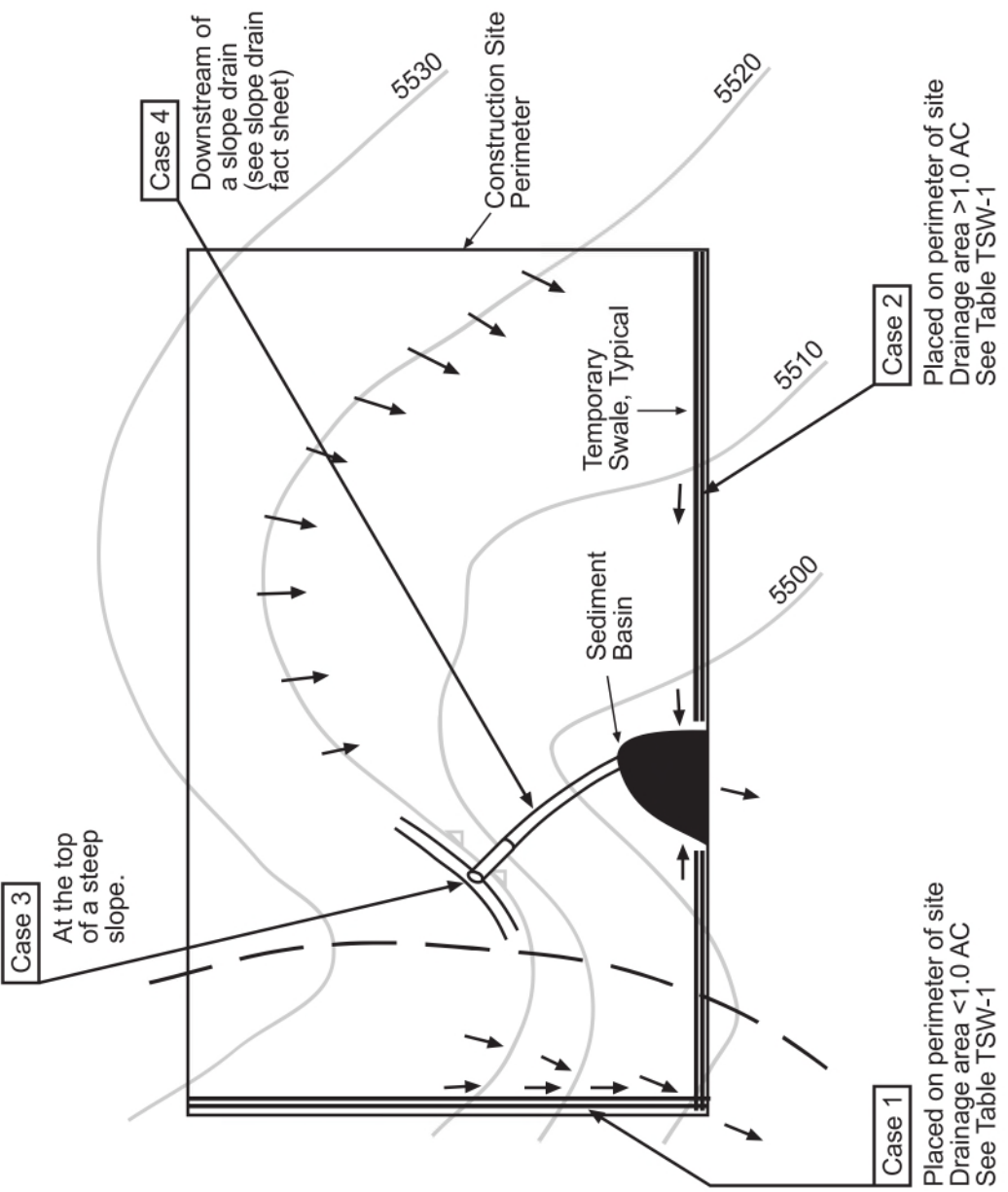

Table TSW-1

Temporary Swale Used as Perimeter Control	Case 1 DA < 1.0 AC	Case 2 DA > 1.0 AC
Continuous Grade	OK <sup>(1)</sup>	OK <sup>(1)</sup>
Area of Concentrated Flow	NO <sup>(3)</sup>	NO <sup>(2)</sup>

(1) Silt Fence or Straw Bale Barrier may be used as alternative to a Temporary Swale.  
 (2) With Temporary Swales Sediment Basin is required for concentrated flow from drainage areas > 1.0 AC.  
 (3) Check Dam is required at concentrated flow for drainage areas > 1.0 acres.



CONVEYANCE  
SIZED FOR 2 YEAR  
FLOW OR GREATER

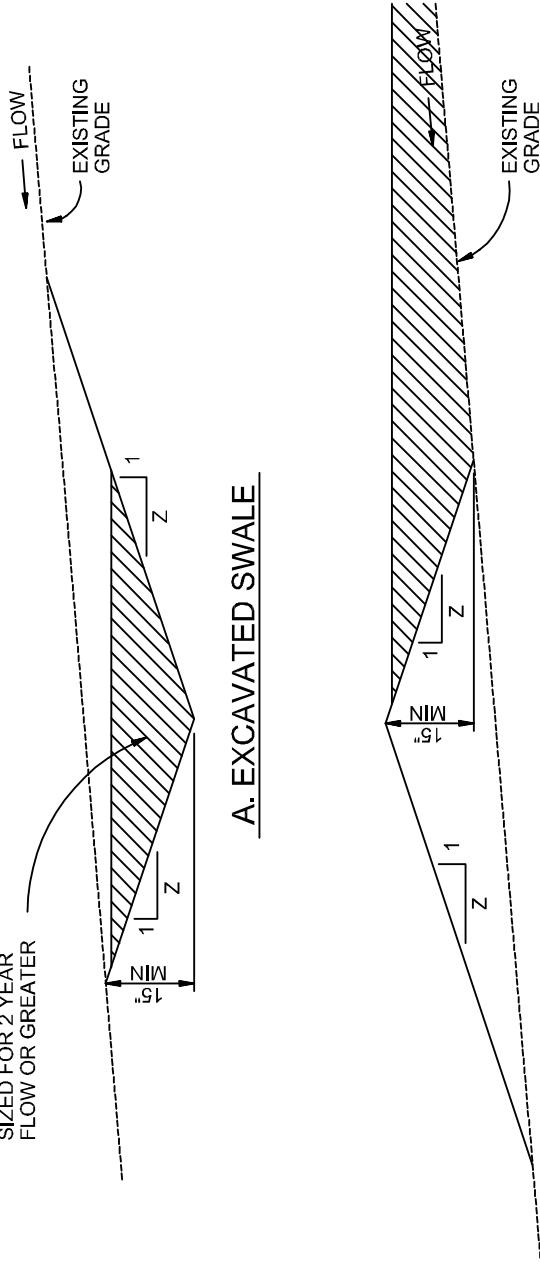

A. EXCAVATED SWALE

B. SWALE FORMED BY BERM

C. SWALE FORMED BY CUT AND FILL

TEMPORARY SWALE

NTS

TEMPORARY SWALE NOTES

INSTALLATION REQUIREMENTS

1. TEMPORARY SWALES SHALL BE INSTALLED PRIOR TO ANY LAND DISTURBING ACTIVITIES.
2. THE AREA UNDER WHICH THE EMBANKMENT IS TO BE INSTALLED SHALL BE CLEARED, GRUBBED, AND STRIPPED OF ALL VEGETATION AND ROOT MAT.
3. EMBANKMENT MATERIAL SHALL CONSIST OF SOIL WITH A MINIMUM OF 15% PASSING A #200 SIEVE. EXCAVATED SOIL CAN BE USED IF IT MEETS THIS REQUIREMENT.
4. EMBANKMENT IS TO BE COMPACTED TO AT LEAST 90% OF MAXIMUM DENSITY AND WITHIN 2% OF OPTIMUM MOISTURE CONTENT ACCORDING TO ASTM D 698.
5. SWALES WITH SLOPE > 2% SHALL BE LINED, SEE FIGURE TSW-3.
6. SWALES ARE TO DRAIN INTO A SEDIMENT BASIN OR OTHER STABILIZED OUTLET.
7. Z SHALL BE 3 OR GREATER.

MAINTENANCE REQUIREMENTS

1. CONTRACTOR SHALL INSPECT SWALES AFTER EACH RAINFALL, AT LEAST DAILY DURING PROLONGED RAINFALL, AND WEEKLY DURING PERIODS OF NO RAINFALL.
2. SWALES SHALL BE ROUTINELY CLEARED OF ANY DEBRIS OR ACCUMULATION OF SEDIMENT.
3. ERODED SLOPES OR DAMAGED LININGS SHALL IMMEDIATELY BE REPAIRED.
4. TEMPORARY SWALES SHALL REMAIN OPERATIONAL AND PROPERLY MAINTAINED UNTIL THE SITE AREA IS PERMANENTLY STABILIZED WITH ADEQUATE VEGETATIVE COVER AND/OR OTHER PERMANENT STRUCTURE AS APPROVED BY THE CITY.

City of Colorado Springs  
Stormwater Quality

Figure TSW-2  
Temporary Swale  
Construction Detail and Maintenance  
Requirements

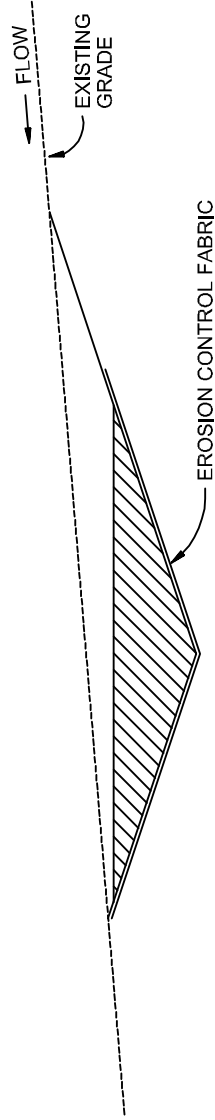

**A. EROSION CONTROL FABRIC**

2% < SLOPE < 5% AND VELOCITY ≤ 8 FPS

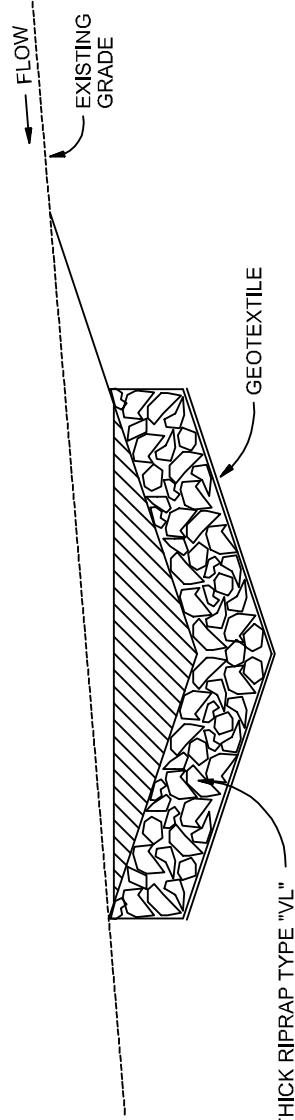

12" THICK RIPRAP TYPE "VI"

**B. RIPRAP**

SLOPE > 5% OR VELOCITY > 8 FPS

**SWALE LINING**

NTS

**SWALE LINING NOTES**

**INSTALLATION REQUIREMENTS**

1. REFER TO THE EROSION CONTROL BLANKETS FACTSHEET FOR PROPER INSTALLATION OF EROSION CONTROL FABRIC LINING.
2. SWALES WITH EASILY ERODIBLE SOILS AND SLOPES LESS THAN 2% SHALL BE LINED WITH EROSION CONTROL FABRIC.
3. VELOCITIES FOR EROSION CONTROL FABRICS SHALL NOT EXCEED 8 FPS. SWALES WITH VELOCITIES GREATER THAN 8 FPS SHALL BE LINED WITH RIP RAP.

**MAINTENANCE REQUIREMENTS**

1. CONTRACTOR SHALL INSPECT SWALE LININGS AFTER EACH RAINFALL, AT LEAST DAILY DURING PROLONGED RAINFALL AND WEEKLY DURING PERIODS OF NO RAINFALL.
2. DAMAGED LININGS SHALL IMMEDIATELY BE REPAIRED.
3. REFER TO THE EROSION CONTROL BLANKETS FACTSHEET FOR PROPER MAINTENANCE.
4. DISPLACED RIPRAP OR COARSE AGGREGATE IS TO BE REPLACED AS SOON AS POSSIBLE.
5. SWALE LININGS ARE TO REMAIN IN PLACE AND BE PROPERLY MAINTAINED UNTIL THE TEMPORARY SWALE IS REMOVED.

# Vehicle Tracking

## What it is

Vehicle tracking refers to the stabilization of construction entrances, roads, parking areas, and staging areas to prevent the tracking of sediment from the construction site.



## When and Where to use it

- All points where vehicles exit the construction site onto a public road.
- Construction entrance/exit should be located at permanent access locations if at all possible.
- Construction roads and parking areas.
- Loading and unloading areas.
- Storage and staging areas.
- Where trailers are parked.
- Any construction area that receives high vehicular traffic.

## When and Where NOT to use it

- The vehicle tracking area should not be located in areas that are wet or where soils erode easily.



This picture shows an unstabilized entrance where dirt is being tracked onto a public road.

## Construction Details and Maintenance Requirements

Figure VT-1 and VT-2 provide construction details and maintenance requirements for vehicle tracking.

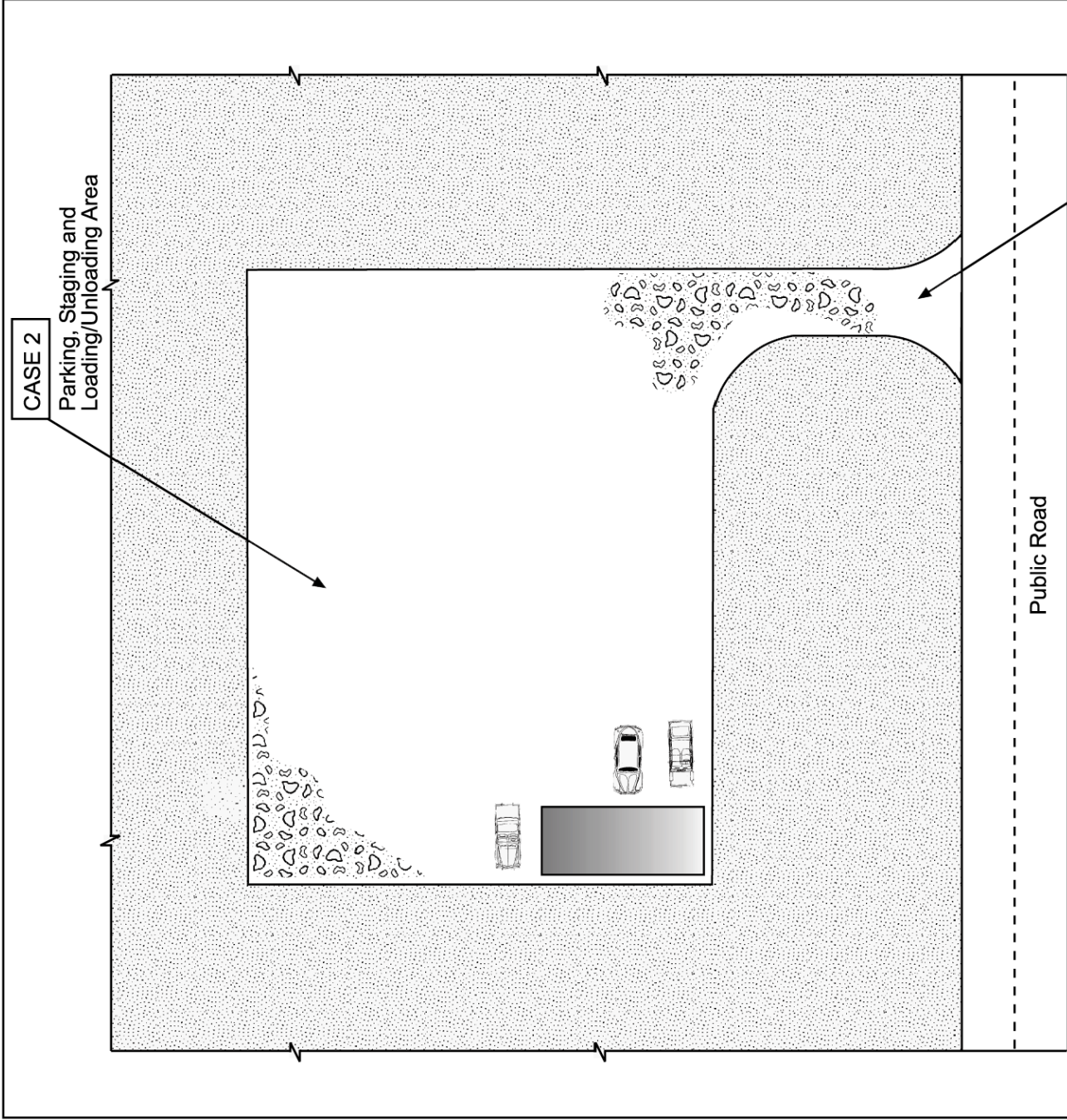
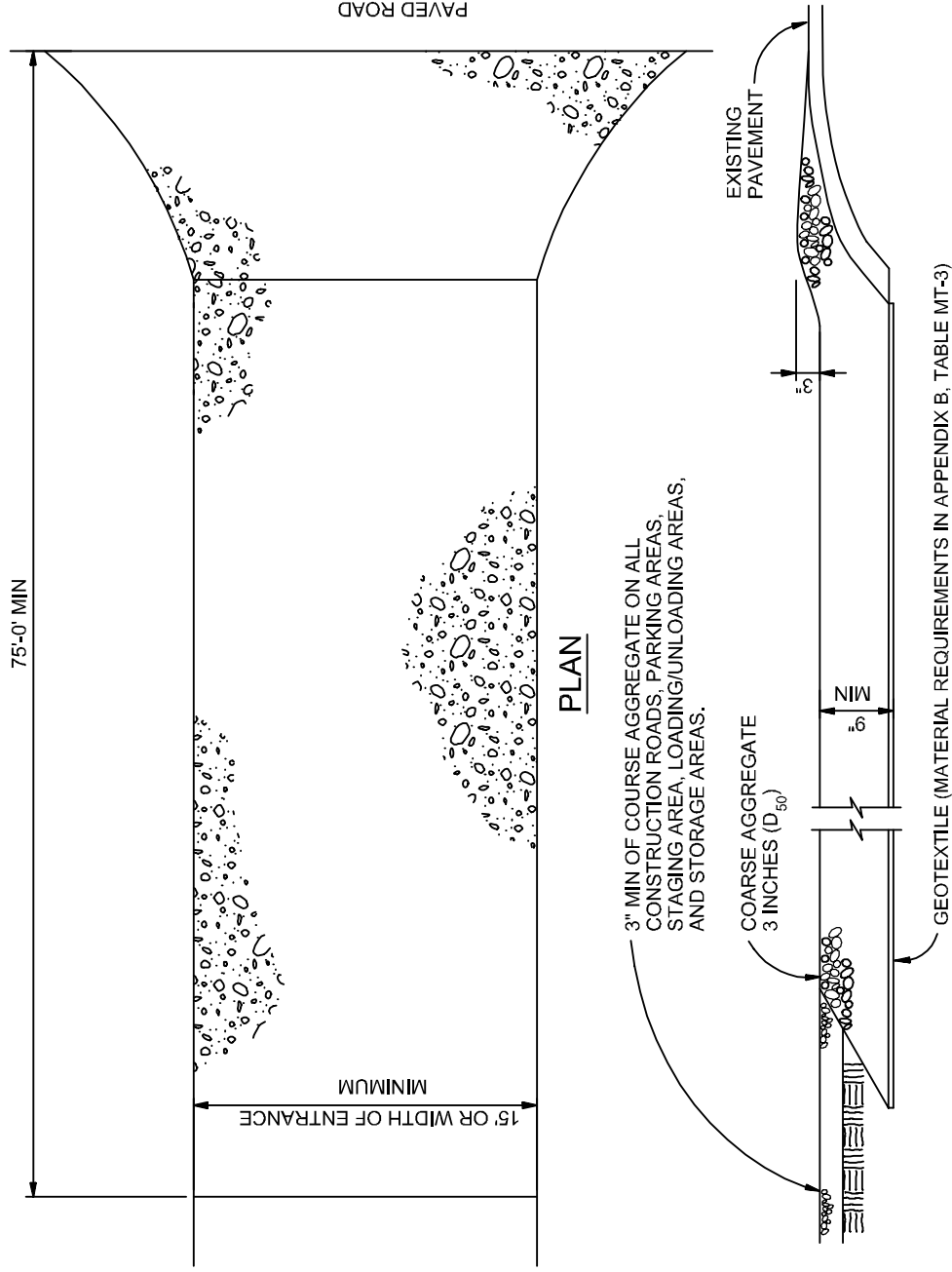

Table VT-1

	Case 1	Case 2
Gravel Thickness	9"	3"
Filter Fabric	YES	NO



## VEHICLE TRACKING

NTS

### VEHICLE TRACKING NOTES

#### INSTALLATION REQUIREMENTS

1. ALL ENTRANCES TO THE CONSTRUCTION SITE ARE TO BE STABILIZED PRIOR TO CONSTRUCTION BEGINNING.
2. CONSTRUCTION ENTRANCES ARE TO BE BUILT WITH AN APRON TO ALLOW FOR TURNING TRAFFIC, BUT SHOULD NOT BE BUILT OVER EXISTING PAVEMENT EXCEPT FOR A SLIGHT OVERLAP.
3. AREAS TO BE STABILIZED ARE TO BE PROPERLY GRADED AND COMPACTED PRIOR TO LAYING DOWN GEOTEXTILE AND STONE.
4. CONSTRUCTION ROADS, PARKING AREAS, LOADING/UNLOADING ZONES, STORAGE AREAS, AND STAGING AREAS ARE TO BE STABILIZED.
5. CONSTRUCTION ROADS ARE TO BE BUILT TO CONFORM TO SITE GRADES, BUT SHOULD NOT HAVE SIDE SLOPES OR ROAD GRADES THAT ARE EXCESSIVELY STEEP.

#### MAINTENANCE REQUIREMENTS

1. REGULAR INSPECTIONS ARE TO BE MADE OF ALL STABILIZED AREAS, ESPECIALLY AFTER STORM EVENTS.
2. STONES ARE TO BE REAPPLIED PERIODICALLY AND WHEN REPAIR IS NECESSARY.
3. SEDIMENT TRACKED ONTO PAVED ROADS IS TO BE REMOVED DAILY BY SHOVELING OR SWEEPING. SEDIMENT IS NOT TO BE WASHED DOWN STORM SEWER DRAINS.
4. STORM SEWER INLET PROTECTION IS TO BE IN PLACE, INSPECTED, AND CLEANED IF NECESSARY.
5. OTHER ASSOCIATED SEDIMENT CONTROL MEASURES ARE TO BE INSPECTED TO ENSURE GOOD WORKING CONDITION.

City of Colorado Springs  
Stormwater Quality

Figure VT-2  
Vehicle Tracking

Application Examples

**APPENDIX D – SWMP REPORT AND GEC PLAN CHECKLISTS**

---





3275 Akers Drive  
 Colorado Springs, CO 80922  
 Phone 719-520-6460  
 Fax 719-520-6879  
 www.elpasoco.com

## EL PASO COUNTY STORMWATER MANAGEMENT PLAN CHECKLIST

EPC Project Number: EGP-XX-XXX

Revised: October, 2021

<b>1. STORMWATER MANAGEMENT PLAN</b> (in the "Applicant" column specify the page number for each item)		Applicant	EPC
1	Applicant (owner/designated operator), SWMP Preparer, Qualified Stormwater Manager, and Contractor Information. (On cover/title sheet)	Y	
2	Table of Contents	Y	
3	Site description and location to include: vicinity map with nearest street/crossroads description	Y	
4	Narrative description of construction activities proposed (e.g., may include clearing and grubbing, temporary stabilization, road grading, utility / storm installation, final grading, final stabilization, and removal of temporary control measures)	Y	
5	Phasing plan – may require separate drawings indicating initial, interim, and final site phases for larger projects. Provide "living maps" that can be revised in the field as conditions dictate	Y	
6	Proposed sequence for major activities: Provide a construction schedule of anticipated starting and completion dates for each stage of land-disturbing activity depicting conservation measures anticipated, including the expected date on which the final stabilization will be completed	Y	
7	Estimates of the total site area and area to undergo disturbance; current area of disturbance must be updated on the SWMP as changes occur	Y	
8	Soil erosion potential and impacts on discharge that includes a summary of the data used to determine soil erosion potential	Y	
9	A description of existing vegetation at the site and percent ground cover and method used to determine ground cover	Y	
10	Location and description of all potential pollution sources including but not limited to: disturbed and stored soils; vehicle tracking; management of contaminated soils; loading and unloading operations; outdoor storage of materials; vehicle and equipment maintenance and fueling; significant dust generating process; routine maintenance activities involving fertilizers, pesticides, herbicides, detergents, fuels, solvents, oils, etc.; on-site waste management; concrete truck/equipment washing; dedicated asphalt, concrete batch plants and masonry mixing stations; non-industrial waste such as trash and portable toilets	Y	
11	Material handling to include spill prevention and response plan and procedures	Y	
12	Spill prevention and pollution controls for dedicated batch plants	Y	
13	Other SW pollutant control measures to include waste disposal and off-site soil tracking	Y	
14	Location and description of any anticipated allowable non-stormwater discharge (ground water, springs, irrigation, discharge covered by CDPHE Low Risk Guidance, etc.)	Y	
15	Name(s) of ultimate receiving waters; size, type and location of stormwater outfall or storm sewer system discharge	Y	
16	Description of all stream crossings located within the project area or statement that no streams cross the project area	Y	



3275 Akers Drive  
 Colorado Springs, CO 80922  
 Phone 719-520-6460  
 Fax 719-520-6879  
 www.elpasoco.com

## EL PASO COUNTY STORMWATER MANAGEMENT PLAN CHECKLIST

EPC Project Number: EGP-XX-XXX

Revised: October 2021

		Applicant	EPC
17	SWMP Map to include:		
17a	construction site boundaries	Y	
17b	flow arrows to depict stormwater flow directions	Y	
17c	all areas of disturbance	Y	
17d	areas of cut and fill	Y	
17e	areas used for storage of building materials, soils (stockpiles) or wastes	Y	
17f	location of any dedicated asphalt / concrete batch plants	Y	
17g	location of all structural control measures	Y	
17h	location of all non-structural control measures	Y	
17i	springs, streams, wetlands and other surface waters, including areas that require maintenance of pre-existing vegetation within 50 feet of a receiving water	Y	
18	Narrative description of all structural control measures to be used. Modifications to EPC standard control measures must meet or exceed County-approved details	Y	
19	Description of all non-structural control measures to be used including seeding, mulching, protection of existing vegetation, site watering, sod placement, etc.	Y	
20	Technical drawing details for all control measure installation and maintenance; custom or other jurisdiction's details used must meet or exceed EPC standards	Y	
21	Procedure describing how the SWMP is to be revised	Y	
22	Description of Final Stabilization and Long-term Stormwater Quality (describe nonstructural and structural measures to control SW pollutants after construction operations have been completed, including detention, water quality control measure etc.)	Y	
23	Specification that final vegetative cover density is to be 70% of pre-disturbed levels	Y	
24	Outline of permit holder inspection procedures to install, maintain, and effectively operate control measures to manage erosion and sediment	Y	
25	Record keeping procedures identified to include signature on inspection logs and location of SWMP records on-site	Y	
26	If this project relies on control measures owned or operated by another entity, a documented agreement must be included in the SWMP that identifies location, installation and design specifications, and maintenance requirements and responsibility of the control measure(s)	Y	
	<b>Please note: all items above must be addressed. If not applicable, explain why, simply identifying "not applicable" will not satisfy CDPHE requirement of explanation.</b>		
<b>2. ADDITIONAL REPORTS/PERMITS/DOCUMENTS</b>			
a	Grading and Erosion Control Plan (signed)	Y	
b	Erosion and Stormwater Quality Control Permit (ESQCP) (signed)	Y	



3275 Akers Drive  
 Colorado Springs, CO 80922  
 Phone 719-520-6460  
 Fax 719-520-6879  
 www.elpasoco.com

## EL PASO COUNTY STORMWATER MANAGEMENT PLAN CHECKLIST

EPC Project Number: EGP-XX-XXX

Revised: October 2021

<b>3. APPLICANT COMMENTS</b>		Applicant	EPC
a			
b			
c			
<b>4. CHECKLIST REVIEW CERTIFICATIONS</b>			
<p>Applicant:            The Stormwater Management Plan was prepared under my direction and supervision and is correct to the best of my knowledge and belief. Said Plan has been prepared according to the criteria established by the County and State for Stormwater Management Plans.</p>			
a	<p>Engineer of Record and/or            Qualified Stormwater Manager Signature _____ Date _____</p>		
b	<p>Review Engineer:            The Stormwater Management Plan was reviewed and found to meet the checklist requirements except where otherwise noted or allowed by an approved deviation request.</p> <p>Review Engineer _____ Date _____</p>		

**SWMP Content Checklist - Stormwater Discharges Associated with Construction Activity (COR4000000)**

**PART I.C.2.a...**

	Yes	No
i) <b>Qualified Stormwater Manager</b> - Does the SWMP list individual(s) by title and name who are designated as the site's qualified stormwater manager(s) responsible for implementing the SWMP in its entirety?	✓	
ii) <b>Spill Prevention and Response Plan</b> - Does the SWMP have a spill prevention and response plan?	✓	
iii) <b>Materials Handling</b> - Does the SWMP describe and locate all control measures implemented at the site to minimize impacts from handling significant materials that could contribute pollutants to runoff	✓	
iv) <b>Potential Sources of Pollution</b> - Does the SWMP list all potential sources of pollution which may reasonably be expected to affect the quality of stormwater discharges associated with construction activity from the site. This shall include, but is not limited to, the following pollutant sources:	✓	
a) disturbed and stored soils	✓	
b) vehicle tracking of sediments	✓	
c) management of contaminated soils	✓	
d) loading and unloading operations	✓	
e) outdoor storage activities (erodible building materials, fertilizers, chemicals, etc.)	✓	
f) vehicle and equipment maintenance and fueling	✓	
g) significant dust or particulate generating processes (e.g., saw cutting material, including dust)	✓	
h) routine maintenance activities involving fertilizers, pesticides, herbicides, detergents, fuels, solvents, oils, etc.	✓	
i) on-site waste management practices (waste piles, liquid wastes, dumpsters)	✓	
j) concrete truck/equipment washing, including washing of the concrete truck chute and associated fixtures and equipment	✓	
k) dedicated asphalt, concrete batch plants and masonry mixing stations	✓	
l) non-industrial waste sources such as worker trash and portable toilets	✓	
vi) <b>Implementation of Control Measures</b> - Does the SWMP include design specifications that contain information on the implementation of the control measure in accordance with good engineering hydrologic and pollution control practices; including as applicable drawings, dimensions, installation information, materials, implementation processes, control measure-specific inspection expectations, and maintenance requirements.	✓	
<b>Notes:</b>		

**SWMP Content Checklist - Stormwater Discharges Associated with Construction Activity (COR4000000)**

	Yes	No
vi) <b>Site Description</b> - Does the SWMP include a site description which includes, at a minimum, the following:		
a) the nature of the construction activity at the site		
b) the proposed schedule for the sequence for major construction activities and the planned implementation of control measures for each phase. (e.g.: clearing, grading, utilities, vertical, etc.)		
c) estimates of the total acreage of the site, and the acreage expected to be disturbed by clearing, excavation, grading, or any other construction activities		
d) a summary of any existing data used in the development of the construction site plans or SWMP that describe the soil or existing potential for soil erosion		
e) a description of the percent of existing vegetative ground cover relative to the entire site and the method for determining the percentage		
f) a description of any allowable non-stormwater discharges at the site, including those being discharged under a division low risk discharge guidance policy		
g) a description of areas receiving discharge from the site. Including a description of the immediate source receiving the discharge. If the stormwater discharge is to a municipal separate storm sewer system, the name of the entity owning that system, the location of the storm sewer discharge, and the ultimate receiving water(s)		
h) a description of all stream crossings located within the construction site boundary		
<b>Notes:</b>		

**SWMP Content Checklist - Stormwater Discharges Associated with Construction Activity (COR4000000)**

	Yes	No
vii) <b>Site Map</b> - Does the SWMP include a site map which includes, at a minimum, the following:	✓	
a) construction site boundaries	✓	
b) flow arrows that depict stormwater flow directions on-site and runoff direction	✓	
c) all areas of ground disturbance including areas of borrow and fill	✓	
d) areas used for storage of soil	✓	
e) locations of all waste accumulation areas, including areas for liquid, concrete, masonry, and asphalt	✓	
f) locations of dedicated asphalt, concrete batch plants and masonry mixing stations	✓	
g) locations of all structural control measures	✓	
h) locations of all non-structural control measures	✓	
i) locations of springs, streams, wetlands and other state waters, including areas that require pre-existing vegetation be maintained within 50 feet of a receiving water, where determined feasible in accordance with Part I.B. 1.a.i.(d)	✓	
j) locations of all stream crossings located within the construction site boundary	✓	
viii) <b>Final Stabilization and Long Term Stormwater Management</b> - Does the SWMP describe the practices used to achieve final stabilization of all disturbed areas at the site and any planned practices to control pollutants in stormwater discharges that will occur after construction operations are completed. Including but not limited to, detention/retention ponds, rain gardens, stormwater vaults, etc	✓	

**Notes:**



**SWMP Content Checklist - Stormwater Discharges Associated with Construction Activity (COR4000000)**

	Yes	No
ix) <b>Inspection Reports</b> - Does the SWMP include documented inspection reports in accordance with Part I.D. of the permit?		✓
a) Is the inspector a qualified stormwater manager?	✓	
b) Do the inspection records meet the minimum required inspection frequency identified on the inspection reports? <ul style="list-style-type: none"> <li>• What minimum inspection frequency is being implemented at the site?</li> <li>• Is a reduced inspection frequency being implemented?</li> </ul>	✓	
c) Were the following areas inspected for evidence of, or the potential for, pollutants leaving the construction site boundaries, entering the stormwater drainage system, or discharging to state waters: <ol style="list-style-type: none"> <li>1) Construction site perimeter</li> <li>2) All disturbed areas</li> <li>3) Designated haul routes</li> <li>4) Material and waste storage areas exposed to precipitation</li> <li>5) Locations where stormwater has the potential to discharge offsite</li> <li>6) Locations where vehicles exit the site</li> </ol>	✓	
d) Do the inspection records include the following requirements: <ol style="list-style-type: none"> <li>1) Visually verify whether all implemented control measures are in effective operational condition and are working as designed in their specifications to minimize pollutant discharges</li> <li>2) Determine if there are new potential sources of pollutants</li> <li>3) Assess the adequacy of control measures at the site to identify areas requiring new or modified control measures to minimize pollutant discharges</li> <li>4) Identify all areas of non-compliance with the permit requirements and, if necessary, implement corrective action as described below</li> </ol>	✓	
e) Do the inspection reports include, at a minimum, the following items: <ol style="list-style-type: none"> <li>1) The inspection date</li> <li>2) Name(s) and title(s) of personnel conducting the inspection</li> <li>3) Weather conditions at the time of inspection</li> <li>4) Phase of construction at the time of inspection</li> <li>5) Estimated acreage of disturbance at the time of inspection</li> <li>6) Location(s) of discharges of sediment or other pollutants from the site</li> <li>7) Location(s) of control measures requiring routine maintenance (see Section VI)</li> <li>8) Location(s) and identification of inadequate control measures and requiring corrective actions (see Section VII)</li> <li>9) Location(s) and identification of additional control measures are needed that were not in place at the time of inspection</li> <li>10) Description of the minimum inspection frequency and any deviations from the minimum inspection schedule</li> <li>11) After adequate corrective action(s) and maintenance have been taken, or where a report does not identify any incidents requiring corrective action or maintenance, the report shall contain the following statement:                      "I verify that, to the best of my knowledge and belief, all corrective action and maintenance items identified during the inspection are complete, and the site is currently in compliance with the permit."</li> </ol>	✓	



**SWMP Content Checklist - Stormwater Discharges Associated with Construction Activity (COR4000000)**

**Notes:**

A large, empty rectangular box with a thin black border, intended for handwritten notes. It occupies the majority of the page's width and height.



3275 Akers Drive  
 Colorado Springs, CO 80922  
 Phone 719-520-6460  
 Fax 719-520-6879  
 www.elpasoco.com

## EL PASO COUNTY GRADING AND EROSION CONTROL PLAN CHECKLIST

EPC Project Number: EGP-XX-XXX

Revised: October 2021

1. GRADING AND EROSION CONTROL PLAN (complete form using Y, N, N/A in the "Applicant" column)		Applicant	EPC
a	Vicinity map	Y	
b	Adjacent city/town/jurisdictional boundaries, subdivision names, and property parcel numbers labeled	Y	
c	North arrow and acceptable scale (1"=20' to 1"=100')	Y	
d	Legend for all symbols used in the plan	Y	
e	Existing and proposed property lines. Proposed subdivision boundary for subdivision projects	Y	
f	All existing structures	Y	
g	All existing utilities	Y	
h	Construction site boundaries	Y	
i	Existing vegetation (notes are acceptable in cases where there is no notable vegetation, only grasses/weeds, or site has already been stripped)	Y	
j	FEMA 100-yr floodplain	Y	
k	Existing and proposed water courses including springs, streams, wetlands, detention ponds, stormwater quality structures, roadside ditches, irrigation ditches and other water surfaces. Show maintenance of pre-existing vegetation within 50 feet of a receiving water	Y	
l	Existing and proposed contours 2 feet or less (except for hillside)	Y	
m	Limits of disturbance delineating all anticipated areas of soil disturbance	Y	
n	Identify and protect areas outside of the construction site boundary with existing fencing, construction fencing or other methods as appropriate	Y	
o	Off-site grading clearly shown and called out	N/A	
p	Areas of cut and fill identified	Y	
q	Conclusions from soils/geotechnical report and geologic hazards report incorporated in grading design (slopes, embankments, materials, mitigation, etc.)	Y	
r	Proposed slopes steeper than 3:1 with top and toe of slope delineated. Erosion control blanketing or other protective covering required	Y	
s	Stormwater flow direction arrows	Y	
t	Location of any dedicated asphalt / concrete batch plants	N/A	
u	Areas used for staging, storage of building materials, soils (stockpiles) or wastes. The use of construction office trailers requires PCD permitting	Y	
v	All proposed temporary construction control measures, structural and non-structural. Temporary construction control measures shall be identified by phase of implementation to include "initial," "interim," and "final" or shown on separate phased maps identifying each phase	Y	
w	Vehicle tracking provided at all construction entrances/exits. Construction fencing, barricades, and/or signage provided at access points not to be used for construction	Y	
x	Temporary sediment ponds provided for disturbed drainage areas greater than 1 acre	Y	



3275 Akers Drive  
 Colorado Springs, CO 80922  
 Phone 719-520-6460  
 Fax 719-520-6879  
 www.elpasoco.com

## EL PASO COUNTY GRADING AND EROSION CONTROL PLAN CHECKLIST

EPC Project Number: EGP-XX-XXX

Revised: October 2021

		Applicant	EPC
y	Dewatering operations to include locations of diversion, pump and discharge(s) as anticipated at time of design	N/A	
z	All proposed temporary construction control measure details. Custom or other jurisdiction's details used must meet or exceed EPC standards	Y	
aa	Any off-site stormwater control measure proposed for use by the project and not under the direct control or ownership of the Owner or Operator	N/A	
bb	Existing and proposed permanent storm water management facilities, including areas proposed for stormwater infiltration or subsurface detention	Y	
cc	Existing and proposed easements (permanent and construction) including required off-site easements	Y	
dd	Retaining walls shall not be located in County ROW unless approved via license agreement. A building permit from Regional Building Department is required for walls greater than or equal to 4 feet in height, series of walls, or walls supporting a surcharge and must be design by P.E.	N/A	
ee	Plan certified by a Colorado Registered P.E., with EPC standard signature blocks for Engineer, Owner and EPC	Y	
ff	Engineer's Statement (for standalone GEC Plan): This Grading and Erosion Control Plan was prepared under my direction and supervision and is correct to the best of my knowledge and belief. Said Plan has been prepared according to the criteria established by the County for Grading and Erosion Control Plans. I accept responsibility for any liability caused by any negligent acts, errors or omissions on my part in preparing this plan.  Engineer of Record Signature _____ Date _____	Y	
gg	Engineer's Statement (for GEC Plan within Construction Drawing set): These detailed plans and specifications were prepared under my direction and supervision. Said plans and specifications have been prepared according to the criteria established by the County for detailed roadway, drainage, grading and erosion control plans and specifications, and said plans and specifications are in conformity with applicable master drainage plans and master transportation plans. Said plans and specifications meet the purposes for which the particular roadway and drainage facilities are designed and are correct to the best of my knowledge and belief. I accept responsibility for any liability caused by any negligent acts, errors or omissions on my part in preparation of these detailed plans and specifications.  Engineer of Record Signature _____ Date _____	N/A	
hh	Owner's Statement (for standalone GEC Plan): I, the owner/developer have read and will comply with the requirements of the Grading and Erosion Control Plan.  Owner Signature _____ Date _____	Y	
ii	Owner's Statement (for GEC Plan within Construction Drawing set): I, the owner/developer have read and will comply with the requirements of the grading and erosion control plan and all of the requirements specified in these detailed plans and specifications.  Owner Signature _____ Date _____	N/A	



3275 Akers Drive  
 Colorado Springs, CO 80922  
 Phone 719-520-6460  
 Fax 719-520-6879  
 www.elpasoco.com

## EL PASO COUNTY GRADING AND EROSION CONTROL PLAN CHECKLIST

EPC Project Number: EGP-XX-XXX

Revised: October 2021

	Applicant	EPC
<p>El Paso County:            County plan review is provided only for general conformance with County Design Criteria. The County is not responsible for the accuracy and adequacy of the design, dimensions, and/or elevations which shall be confirmed at the job site. The County through the approval of this document assumes no responsibility for completeness and/ or accuracy of this document.</p> <p>Filed in accordance with the requirements of the El Paso County Land Development Code, Drainage Criteria Manual Volumes 1 and 2, and Engineering Criteria Manual, as amended.</p> <p>In accordance with ECM Section 1.12, these construction documents will be valid for construction for a period of 2 years from the date signed by the El Paso County Engineer. If construction has not started within those 2 years, the plans will need to be resubmitted for approval, including payment of review fees at the Planning and Community Development Director's discretion.</p> <p>County Engineer/ECM Administrator _____ Date _____</p>	Y	
<b>2. ADDITIONAL REPORTS/PERMITS/DOCUMENTS</b>		
a	Soils report / geotechnical investigation as appropriate for grading/utilities/drainage/road construction.	Y
b	Use Agreement/easement between the Owner or Operator and other third party for use of all off-site grading or stormwater control measures, used by the owner or operator but not under their direct control or ownership.	N/A
c	Floodplain Development Permit	N/A
d	USACE 404/wetlands permit/mitigation plan	N/A
e	FEMA CLOMR	N/A
f	State Engineer's permit/Notice Of Intent to Construct	
g	Stormwater Management Plan (SWMP)	N
h	Financial Assurance Estimate (FAE) (signed)	N
i	Erosion and Stormwater Quality Control Permit (ESQCP) (signed)	Y
j	Pre-Development Site Grading Acknowledgement & Right of Access Form (signed)	N
k	Conditions of Approval met?	N



3275 Akers Drive  
 Colorado Springs, CO 80922  
 Phone 719-520-6460  
 Fax 719-520-6879  
 www.elpasoco.com

## EL PASO COUNTY GRADING AND EROSION CONTROL PLAN CHECKLIST

EPC Project Number: EGP-XX-XXX

Revised: October 2021		Applicant	EPC
<b>3. STANDARD NOTES FOR EL PASO COUNTY GRADING AND EROSION CONTROL PLANS</b>			
1	Stormwater discharges from construction sites shall not cause or threaten to cause pollution, contamination, or degradation of State Waters. All work and earth disturbance shall be done in a manner that minimizes pollution of any on-site or off-site waters, including wetlands.	Y	
2	Notwithstanding anything depicted in these plans in words or graphic representation, all design and construction related to roads, storm drainage and erosion control shall conform to the standards and requirements of the most recent version of the relevant adopted El Paso County standards, including the Land Development Code, the Engineering Criteria Manual, the Drainage Criteria Manual, and the Drainage Criteria Manual Volume 2. Any deviations from regulations and standards must be requested, and approved, in writing.	Y	
3	A separate Stormwater Management Plan (SMWP) for this project shall be completed and an Erosion and Stormwater Quality Control Permit (ESQCP) issued prior to commencing construction. Management of the SWMP during construction is the responsibility of the designated Qualified Stormwater Manager or Certified Erosion Control Inspector. The SWMP shall be located on-site at all times during construction and shall be kept up to date with work progress and changes in the field.	Y	
4	Once the ESQCP is approved and a "Notice to Proceed" has been issued, the contractor may install the initial stage erosion and sediment control measures as indicated on the approved GEC. A Preconstruction Meeting between the contractor, engineer, and El Paso County will be held prior to any construction. It is the responsibility of the applicant to coordinate the meeting time and place with County staff.	Y	
5	Control measures must be installed prior to commencement of activities that could contribute pollutants to stormwater. Control measures for all slopes, channels, ditches, and disturbed land areas shall be installed immediately upon completion of the disturbance.	Y	
6	All temporary sediment and erosion control measures shall be maintained and remain in effective operating condition until permanent soil erosion control measures are implemented and final stabilization is established. All persons engaged in land disturbance activities shall assess the adequacy of control measures at the site and identify if changes to those control measures are needed to ensure the continued effective performance of the control measures. All changes to temporary sediment and erosion control measures must be incorporated into the Stormwater Management Plan.	Y	
7	Temporary stabilization shall be implemented on disturbed areas and stockpiles where ground disturbing construction activity has permanently ceased or temporarily ceased for longer than 14 days.	Y	
8	Final stabilization must be implemented at all applicable construction sites. Final stabilization is achieved when all ground disturbing activities are complete and all disturbed areas either have a uniform vegetative cover with individual plant density of 70 percent of pre-disturbance levels established or equivalent permanent alternative stabilization method is implemented. All temporary sediment and erosion control measures shall be removed upon final stabilization and before permit closure.	Y	
9	All permanent stormwater management facilities shall be installed as designed in the approved plans. Any proposed changes that effect the design or function of permanent stormwater management structures must be approved by the ECM Administrator prior to implementation.	Y	





3275 Akers Drive  
 Colorado Springs, CO 80922  
 Phone 719-520-6460  
 Fax 719-520-6879  
 www.elpasoco.com

## EL PASO COUNTY GRADING AND EROSION CONTROL PLAN CHECKLIST

EPC Project Number: EGP-XX-XXX

Revised: October 2021

		Applicant	EPC
10	Earth disturbances shall be conducted in such a manner so as to effectively minimize accelerated soil erosion and resulting sedimentation. All disturbances shall be designed, constructed, and completed so that the exposed area of any disturbed land shall be limited to the shortest practical period of time. Pre-existing vegetation shall be protected and maintained within 50 horizontal feet of a waters of the state unless shown to be infeasible and specifically requested and approved.	Y	
11	Compaction of soil must be prevented in areas designated for infiltration control measures or where final stabilization will be achieved by vegetative cover. Areas designated for infiltration control measures shall also be protected from sedimentation during construction until final stabilization is achieved. If compaction prevention is not feasible due to site constraints, all areas designated for infiltration and vegetation control measures must be loosened prior to installation of the control measure(s).	Y	
12	Any temporary or permanent facility designed and constructed for the conveyance of stormwater around, through, or from the earth disturbance area shall be a stabilized conveyance designed to minimize erosion and the discharge of sediment off-site.	Y	
13	Concrete wash water shall be contained and disposed of in accordance with the SWMP. No wash water shall be discharged to or allowed to enter State Waters, including any surface or subsurface storm drainage system or facilities. Concrete washouts shall not be located in an area where shallow groundwater may be present, or within 50 feet of a surface water body, creek or stream.	Y	
14	During dewatering operations, uncontaminated groundwater may be discharged on-site, but shall not leave the site in the form of surface runoff unless an approved State dewatering permit is in place.	Y	
15	Erosion control blanketing or other protective covering shall be used on slopes steeper than 3:1.	Y	
16	Contractor shall be responsible for the removal of all wastes from the construction site for disposal in accordance with local and State regulatory requirements. No construction debris, tree slash, building material wastes or unused building materials shall be buried, dumped, or discharged at the site.	Y	
17	Waste materials shall not be temporarily placed or stored in the street, alley, or other public way, unless in accordance with an approved Traffic Control Plan. Control measures may be required by El Paso County Engineering if deemed necessary, based on specific conditions and circumstances.	Y	
18	Tracking of soils and construction debris off-site shall be minimized. Materials tracked off-site shall be cleaned up and properly disposed of immediately.	Y	
19	The owner/developer shall be responsible for the removal of all construction debris, dirt, trash, rock, sediment, soil, and sand that may accumulate in roads, storm drains and other drainage conveyance systems and stormwater appurtenances as a result of site development.	Y	
20	The quantity of materials stored on the project site shall be limited, as much as practical, to that quantity required to perform the work in an orderly sequence. All materials stored on-site shall be stored in a neat, orderly manner, in their original containers, with original manufacturer's labels.	Y	
21	No chemical(s) having the potential to be released in stormwater are to be stored or used on-site unless permission for the use of such chemical(s) is granted in writing by the ECM Administrator. In granting approval for the use of such chemical(s), special conditions and monitoring may be required.	Y	
22	Bulk storage of allowed petroleum products or other allowed liquid chemicals in excess of 55 gallons shall require adequate secondary containment protection to contain all spills on-site and to prevent any spilled materials from entering State Waters, any surface or subsurface storm drainage system or other facilities.	Y	



3275 Akers Drive  
 Colorado Springs, CO 80922  
 Phone 719-520-6460  
 Fax 719-520-6879  
 www.elpasoco.com

## EL PASO COUNTY GRADING AND EROSION CONTROL PLAN CHECKLIST

EPC Project Number: EGP-XX-XXX

Revised: October 2021

		Applicant	EPC
23	No person shall cause the impediment of stormwater flow in the curb and gutter or ditch except with approved sediment control measures.	Y	
24	Owner/developer and their agents shall comply with the "Colorado Water Quality Control Act" (Title 25, Article 8, CRS), and the "Clean Water Act" (33 USC 1344), in addition to the requirements of the Land Development Code, DCM Volume II and the ECM Appendix I. All appropriate permits must be obtained by the contractor prior to construction (1041, NPDES, Floodplain, 404, fugitive dust, etc.). In the event of conflicts between these requirements and other laws, rules, or regulations of other Federal, State, local, or County agencies, the most restrictive laws, rules, or regulations shall apply.	Y	
25	All construction traffic must enter/exit the site only at approved construction access points.	Y	
26	Prior to construction the permittee shall verify the location of existing utilities.	Y	
27	A water source shall be available on-site during earthwork operations and shall be utilized as required to minimize dust from earthwork equipment and wind.	Y	
28	The soils report for this site has been prepared by <b>[Company Name, Date of Report]</b> and shall be considered a part of these plans.	Y	
29	At least ten (10) days prior to the anticipated start of construction, for projects that will disturb one (1) acre or more, the owner or operator of construction activity shall submit a permit application for stormwater discharge to the Colorado Department of Public Health and Environment, Water Quality Division. The application contains certification of completion of a stormwater management plan (SWMP), of which this Grading and Erosion Control Plan may be a part. For information or application materials contact:  Colorado Department of Public Health and Environment Water Quality Control Division WQCD – Permits 4300 Cherry Creek Drive South Denver, CO 80246-1530 Attn: Permits Unit	Y	
<b>4. APPLICANT COMMENTS</b>			
a			
b			
c			





## **APPENDIX E – INSPECTION REPORT TEMPLATE**

---

# CONSTRUCTION STORMWATER SITE INSPECTION REPORT

Facility Name	Permittee		
Date of Inspection	Weather Conditions		
Permit Certification #	Disturbed Acreage		
Phase of Construction	Inspector Title		
Inspector Name			
Is the above inspector a qualified stormwater manager? (permittee is responsible for ensuring that the inspector is a qualified stormwater manager)			
	YES	NO	
	<input type="checkbox"/>	<input type="checkbox"/>	<input type="checkbox"/>

## INSPECTION FREQUENCY

Check the box that describes the minimum inspection frequency utilized when conducting each inspection

At least one inspection every 7 calendar days	<input type="checkbox"/>				
At least one inspection every 14 calendar days, with post-storm event inspections conducted within 24 hours after the end of any precipitation or snowmelt event that causes surface erosions	<input type="checkbox"/>				
<ul style="list-style-type: none"> <li>• This is this a post-storm event inspection. Event Date: _____</li> </ul>	<input type="checkbox"/>				
Reduced inspection frequency - Include site conditions that warrant reduced inspection frequency	<input type="checkbox"/>				
• Post-storm inspections at temporarily idle sites	<input type="checkbox"/>				
• Inspections at completed sites/area	<input type="checkbox"/>				
• Winter conditions exclusion	<input type="checkbox"/>				
Have there been any deviations from the minimum inspection schedule? If yes, describe below.	<table border="0" style="width: 100%;"> <tr> <td style="text-align: center;">YES</td> <td style="text-align: center;">NO</td> </tr> <tr> <td style="text-align: center;"><input type="checkbox"/></td> <td style="text-align: center;"><input type="checkbox"/></td> </tr> </table>	YES	NO	<input type="checkbox"/>	<input type="checkbox"/>
YES	NO				
<input type="checkbox"/>	<input type="checkbox"/>				

## INSPECTION REQUIREMENTS\*

- i. Visually verify all implemented control measures are in effective operational condition and are working as designed in the specifications
  - ii. Determine if there are new potential sources of pollutants
  - iii. Assess the adequacy of control measures at the site to identify areas requiring new or modified control measures to minimize pollutant discharges
  - iv. Identify all areas of non-compliance with the permit requirements, and if necessary, implement corrective action
- \*Use the attached **Control Measures Requiring Routine Maintenance** and **Inadequate Control Measures Requiring Corrective Action** forms to document results of this assessment that trigger either maintenance or corrective actions

## AREAS TO BE INSPECTED

Is there evidence of, or the potential for, pollutants leaving the construction site boundaries, entering the stormwater drainage system or discharging to state waters at the following locations?

	NO	YES
Construction site perimeter	<input type="checkbox"/>	<input type="checkbox"/>
All disturbed areas	<input type="checkbox"/>	<input type="checkbox"/>
Designated haul routes	<input type="checkbox"/>	<input type="checkbox"/>
Material and waste storage areas exposed to precipitation	<input type="checkbox"/>	<input type="checkbox"/>
Locations where stormwater has the potential to discharge offsite	<input type="checkbox"/>	<input type="checkbox"/>
Locations where vehicles exit the site	<input type="checkbox"/>	<input type="checkbox"/>
Other: _____	<input type="checkbox"/>	<input type="checkbox"/>

If "YES" describe discharge or potential for discharge below.  
Document related maintenance, inadequate control measures and corrective actions **Inadequate Control Measures Requiring Corrective Action** form





## REPORTING REQUIREMENTS

The permittee shall report the following circumstances orally within twenty-four (24) hours from the time the permittee becomes aware of the circumstances, and shall mail to the division a written report containing the information requested within five (5) working days after becoming aware of the following circumstances. The division may waive the written report required if the oral report has been received within 24 hours.

<b>All Noncompliance Requiring 24-Hour Notification per Part II.L.6 of the Permit</b>		
<b>a. Endangerment to Health or the Environment</b> Circumstances leading to any noncompliance which may endanger health or the environment regardless of the cause of the incident (See Part II.L.6.a of the Permit) <i>This category would primarily result from the discharge of pollutants in violation of the permit</i>		
<b>b. Numeric Effluent Limit Violations</b> <ul style="list-style-type: none"> <li>○ Circumstances leading to any unanticipated bypass which exceeds any effluent limitations (See Part II.L.6.b of the Permit)</li> <li>○ Circumstances leading to any upset which causes an exceedance of any effluent limitation (See Part II.L.6.c of the Permit)</li> <li>○ Daily maximum violations (See Part II.L.6.d of the Permit)</li> </ul> <i>Numeric effluent limits are very uncommon in certifications under the COR400000 general permit. This category of noncompliance only applies if numeric effluent limits are included in a permit certification.</i>		

Has there been an incident of noncompliance requiring 24-hour notification?	NO	YES	
	<input type="checkbox"/>	<input type="checkbox"/>	If "YES" document below

Date and Time of Incident	Location	Description of Noncompliance	Description of Corrective Action	Date and Time of 24 Hour Oral Notification	Date of 5 Day Written Notification *

\*Attach copy of 5 day written notification to report. Indicate if written notification was waived, including the name of the division personnel who granted waiver.

