



TRAFFIC IMPACT STUDY

OWL PLACE STORAGE TRAFFIC IMPACT STUDY
El Paso County, Colorado

PREPARED FOR:
Meridian Storage, LLC

PREPARED BY:
Max Rusch, PE, PTOE

Galloway & Company, Inc.
5500 Greenwood Plaza Boulevard, Suite 200
Greenwood Village, CO 80111

DATE:
July 10, 2023

PCD File No. CS224



Accepted for File
By: Gilbert LaForce, P.E.
Date: 07/19/2023 1:55:35 PM
El Paso County Department of Public Works



Owl Place Storage
El Paso County, CO

Traffic Engineer's Statement

The attached traffic report and supporting information were prepared under my responsible charge and they comport with the standard of care. So far as is consistent with the standard of care, said report was prepared in general conformance with the criteria established by the County for traffic reports.

Maxwell Rusch
Max Rusch, P.E. PTOE #55895

7/10/2023
Date

Developer's Statement

I, the Developer, have read and will comply with all commitments made on my behalf within this report.


Mike Texer
Meridian Storage, LLC
11750 Owl Place Peyton,
CO 80831

7/11/23
Date

TABLE OF CONTENTS

| | |
|---|----|
| Executive Summary | 6 |
| Site Location and Study Area | 6 |
| Conclusions and Recommendations | 6 |
| Conclusions | 6 |
| Recommendations | 7 |
| I. Introduction | 8 |
| Overview | 8 |
| Site Location and Study Area | 8 |
| Site Description and Access | 9 |
| Figure 1-1 Site Location | 10 |
| Figure 1-2 Site Plan | 11 |
| Figure 1-3 Zoning | 12 |
| II. Background Information | 13 |
| Study Area | 13 |
| Study Assumptions | 13 |
| Study Methodology | 13 |
| Existing Roadway Network | 13 |
| Figure 2-1 Existing Lane Use and Traffic Control | 15 |
| III. Analysis of Existing Conditions | 16 |
| Traffic Volumes | 16 |
| Existing Operational Analysis | 16 |
| Existing Intersection Queues | 17 |
| Figure 3-1 Existing 2022 Volumes | 18 |
| Figure 3-2 Existing 2022 Levels of Service | 19 |
| Table 3-1 Existing 2022 Levels of Service | 20 |
| Table 3-2 Existing 2022 Queues | 21 |
| IV. Analysis of Background 2024 & 2040 Conditions | 22 |
| Methodology | 22 |
| Roadway Improvements | 22 |
| Regional Growth | 22 |
| Pipeline Developments | 22 |
| Background 2024 & 2040 Traffic Forecasts | 23 |
| Background 2024 & 2040 Levels of Service | 23 |

| | |
|---|----|
| Background 2024 & 2040 Intersection Queues | 24 |
| Background 2024 & 2040 Recommended Mitigation | 25 |
| Figure 4-1 Background Lane Use and Traffic Control | 26 |
| Figure 4-2 Owl PI Rerouted Trips | 27 |
| Figure 4-3 Background 2024 Growth..... | 28 |
| Figure 4-4 Background 2040 Growth..... | 29 |
| Figure 4-5 Pipeline Locations | 30 |
| Figure 4-6 Owl Place Commercial Pipeline Trip Distribution | 31 |
| Figure 4-7 Falcon Marketplace Pipeline Trip Distribution (2024) | 32 |
| Figure 4-8 Falcon Marketplace Pipeline Trip Distribution (2040) | 33 |
| Figure 4-9 Falcon Meadows at Bent Grass Pipeline Trip Distribution | 34 |
| Figure 4-10 Background 2024 Forecasts | 35 |
| Figure 4-11 Background 2040 Forecasts | 36 |
| Figure 4-12 Background 2024 Level of Service..... | 37 |
| Figure 4-13 Background 2040 Level of Service..... | 38 |
| Table 4-1 Background 2024 & 2040 Levels of Service..... | 39 |
| Table 4-2 Background 2024 & 2040 Queues | 40 |
| V. Site Analysis | 41 |
| Overview | 41 |
| Proposed Site Access | 41 |
| Trip Generation | 41 |
| Figure 5-1 Proposed Development (Warehouse) Site Trips..... | 42 |
| Figure 5-2 Maximum Trip Generator (Shopping Plaza) Site Trips | 43 |
| Table 5-1 Site Trip Generation..... | 45 |
| VI. Analysis of Total 2024 & 2040 Conditions (Proposed Development) | 46 |
| Total 2024 & 2040 Traffic Forecasts..... | 46 |
| Total 2024 & 2040 Levels of Service | 46 |
| Total 2024 & 2040 Intersection Queues | 47 |
| Total 2024 & 2040 Recommended Mitigation..... | 47 |
| Figure 6-1 Total 2024 Forecasts..... | 48 |
| Figure 6-2 Total 2040 Forecasts..... | 49 |
| Figure 6-3 Total 2024 LOS | 50 |
| Figure 6-4 Total 2040 LOS | 51 |
| Table 6-1 Total 2024 & 2040 Levels of Service | 52 |
| Table 6-2 Total 2024 & 2040 Queues..... | 53 |

| | |
|--|----|
| VII. Analysis of Total 2024 & 2040 Conditions (Maximum Trip Generator) | 54 |
| Total 2024 & 2040 Traffic Forecasts | 54 |
| Total 2024 & 2040 Levels of Service | 54 |
| Total 2024 & 2040 Intersection Queues | 55 |
| Total 2024 & 2040 Recommended Mitigation..... | 55 |
| Figure 7-1 Total 2024 Forecasts (Max Trip Generator)..... | 57 |
| Figure 7-2 Total 2040 Forecasts (Max Trip Generator)..... | 58 |
| Figure 7-3 Total 2024 LOS (Max Trip Generator)..... | 59 |
| Figure 7-4 Total 2040 LOS (Max Trip Generator)..... | 60 |
| Table 7-1 Total 2024 & 2040 Levels of Service (Max Trip Generator) | 61 |
| Table 7-2 Total 2024 & 2040 Queues (Max Trip Generator)..... | 62 |
| VIII. Pedestrian and Bicycle Connectivity | 63 |
| IX. Conclusions and Recommendations | 63 |
| Conclusions..... | 63 |
| Recommendations | 64 |

Appendices:

- A. Full Sized Site Plan
- B. LOS Descriptions
- C. Traffic Counts
- D. Existing Synchro Outputs
- E. Pipeline TIS Excerpts
- F. Background 2024 & 2040 (without site development) Synchro Outputs
- G. Total 2024 & 2040 (with site development) Synchro Outputs

Executive Summary

This traffic impact study (TIS) analyzes the impact that the proposed Owl Place Storage development in El Paso County, CO will have on traffic operations at the intersections proximate to the site and determines whether any additional improvements are needed to accommodate the development through the study area. The effects of the several other nearby pipeline developments, as well as background growth, were incorporated into the future analysis.

Site Location and Study Area

The Applicant, Meridian Storage, proposes to develop the site with 158 self-storage units as well as 96 RV/Boat storage spaces. Since the site will be rezoned, El Paso County has requested that the maximum trip generating land use allowed on the rezoned area be analyzed as well. As such, this study will analyze a scenario in which a 133,294 SF shopping plaza has been developed, although it should be noted that the developer has no intention of developing this higher trip generating option.

The site is bound by Eastonville Rd to the south, Meridian Road to the east, and property lines to the north and west, as detailed in Figure 1-1. The study area for the project includes the following intersections that may see impacts to traffic operations as a result of the proposed development:

- Woodman Rd & Meridian Rd
- Meridian Rd & Eastonville Rd
- Meridian Rd & Owl Pl
- Meridian Rd & Bent Grass Meadows Dr
- Bent Grass Meadows Dr & Meridian Park Dr

Conclusions and Recommendations

Conclusions

Based on the results of this traffic impact study, the following may be concluded:

- Under existing conditions, the signalized intersections operate at LOS D or better. The intersection of Meridian Rd & Eastonville Rd was modeled as a three-legged stop-control intersection and is shown to fail during both peak time periods. Several of the thru queues will block adjacent turn lanes.
- In the background 2024 scenario, all intersections operate at LOS D or better. Queueing remains similar to the existing scenario, however, many of the queues at Meridian Rd & Eastonville Rd are shown to exceed their respective storage lengths.
- In the background 2040 scenario, Woodmen Rd & Meridian Rd will operate at LOS F in the PM peak and Meridian Rd & Eastonville Rd will operate at LOS E in the AM peak. The remaining intersections will operate acceptably. The forecasted ADTs along Meridian Rd will exceed the El Paso County Roadway ADT Threshold Capacity. Many of the queues will exceed their respective storage lengths by 2040.
- The proposed warehouse development will generate 3 weekday AM and 4 weekday PM peak hour vehicle trips as well as 46 weekday daily trips.

- The total scenarios in which the warehouse has been built will have very similar operations to the background scenarios. As such, it is not the responsibility of the developer to mitigate the failing traffic operations since these are problems expected to occur regardless of whether the site is developed.
- As requested by El Paso County, the maximum trip generator allowed on a site zoned as Commercial Service was analyzed. This was found to be a 133,294 SF shopping plaza. In this scenario, the shopping plaza would generate 471 weekday AM and 1,141 weekday PM peak hour vehicle trips as well as 11,671 weekday daily trips.
- The total 2024 scenario where the maximum trip generator was assumed instead of the proposed warehouse shows an increase in intersection delay. The intersection of Woodmen Rd & Meridian Rd will fail in the PM peak hour and the intersection of Meridian Rd & Eastonville Rd will operate at LOS E. The ADT along the southern portion of Meridian Rd is forecasted to exceed the El Paso County Roadway ADT Threshold Capacity while the northern portion of Meridian Rd will remain under capacity.
- In the total 2040 scenario for which the maximum trip generator is assumed, the Intersection of Woodmen Rd & Meridian Rd will fail in the PM peak, and the intersection of Meridian Rd & Eastonville Rd will fail during both the AM and PM peaks. The ADT along Meridian Rd will exceed capacity as well. The analysis for the maximum trip generator is a requirement of El Paso County. The developer has no intention of building a shopping center, and therefore, no roadway improvements are needed to mitigate the failing operations reported in this scenario.
- Traffic operations are reported to be almost identical between the background scenario and the total scenario in which the proposed warehouse development has been constructed. There are no intersection or individual movements found to operate acceptably in the background scenario and then unacceptable in the total warehouse scenario. It is the responsibility of El Paso County, not the developer, to provide mitigation solutions to achieve acceptable traffic operations through the year 2040.
- Road Impact Fees will be due by the Applicant at the last land use approval consistent with the use and Impact Fee schedule.

Recommendations

- It is recommended that the proposed development be designed as shown in the site plan.
- It is recommended that El Paso County implement the mitigation recommendations detailed in Section IV of this report in order to achieve acceptable traffic operations through the study area.

I. Introduction

Overview

This Traffic Impact Study (TIS) was conducted in support of Meridian Storage proposed Owl Place Storage development in El Paso County, Colorado. This study evaluates an existing conditions scenario, year 2024 background and total scenarios, and year 2040 background and total scenarios. By analyzing and comparing the background and total future scenarios, this study will be able to assess the impact that the site will have on traffic operations through the immediate roadway network. In addition, El Paso County has requested that the maximum trip generator allowed on a site zoned as Commercial Service be analyzed. As such, this study will analyze a scenario in which the maximum trip generator has been constructed in place of the proposed storage use.

Site Location and Study Area

The property that comprises the application area is located on El Paso County Parcel Numbers 5301001001, 5301001002, and 5301001014. Upon completion, the site will be bounded by Eastonville Rd to the south, Meridian Road to the east, and property lines to the north and west. The site is currently zoned as Residential Rural (RR-5) and is mostly vacant with only several residential homes on site. The site is in the process of being rezoned to Commercial Service (CS). Access to the southern side of the proposed development will be provided via one full movement access along Owl Place. In addition, Meridian Park Dr will be extended to the south, providing access to the northern side of the development. The southern parcel is shown to have two access points via Owl Pl, however, there are no immediate plans to develop this parcel.

The Applicant proposes to develop the site with 158 self-storage units as well as 96 RV/Boat storage spaces. A reduction of the Applicant's proposed conceptual site plan is provided in Figure 1-2. A full-size copy of the plan is provided in Appendix A.

Tasks undertaken in the course of this study included the following:

1. The Applicant's proposed development plans and other background data were reviewed.
2. A virtual field reconnaissance of existing roadway and intersection geometries, traffic controls, and speed limits was conducted.
3. Turning movement counts that were taken on Wednesday, June 1, 2022 for the Owl Place Commercial traffic study were used in this study.
4. Using Synchro 11, the Level of Service (LOS) for each intersection was reported based on the methodology prescribed by the Highway Capacity Guidelines 6th Edition. Synchro was also used to conduct a queuing analysis and signal progression analysis for each scenario.
5. The AM and PM peak hour background 2024 and background 2040 traffic volumes were forecasted by using the existing volumes, a background growth rate, and the trips expected to be generated from the identified pipeline developments.
6. The LOS for the background scenarios was reported by incorporating the forecasted background volumes.

7. The site trip generation was calculated utilizing the Institute of Transportation Engineers (ITE) Trip Generation 11th Ed.
8. The total 2024 and 2040 traffic forecasts were calculated by adding the background volume forecasts and the projected site trips.
9. The LOS was reported for the total scenarios by incorporating the forecasted total future volumes.
10. The trip generation for the maximum trip generating scenario was calculated utilizing the Institute of Transportation Engineers (ITE) Trip Generation 11th Ed.
11. The total 2024 and 2040 traffic forecasts were calculated by adding the background volume forecasts and the projected maximum use site.
12. The LOS was reported for the maximum use scenarios by incorporating the forecasted total future volumes.

Sources of data for this analysis included the Highway Capacity Guidelines (HCM) 6th, ITE 11th Ed, El Paso County, and the files/library of Galloway.

Site Description and Access

Site Conditions

The topography proximate to and surrounding the site is generally classified as “level”.

Hazardous Conditions

Based on the field reconnaissance in the vicinity of the subject site, no hazardous features or constraints were identified.

Proposed Site Access

The site will have one full movement access on Owl Pl. Meridian Park Dr will be extended to the south, where it will provide a second access to the proposed site.

Existing Zoning

The site is currently zoned as Residential Rural and is being rezoned to Commercial Service. The existing zoning is shown in Figure 1-3.





Nearby Uses

The properties surrounding the subject site are primarily residential, however, the existing land use immediate north of the site and the proposed land uses immediately south of the site are commercial. The parcel number 5301001015 will be rezoned to commercial use as well.



FIGURE 1-1
Site Location

Meridian Storage
 El Paso County, CO

-  MOVEMENT
-  SIGNALIZED INTERSECTION
-  STOP SIGN
-  YIELD SIGN



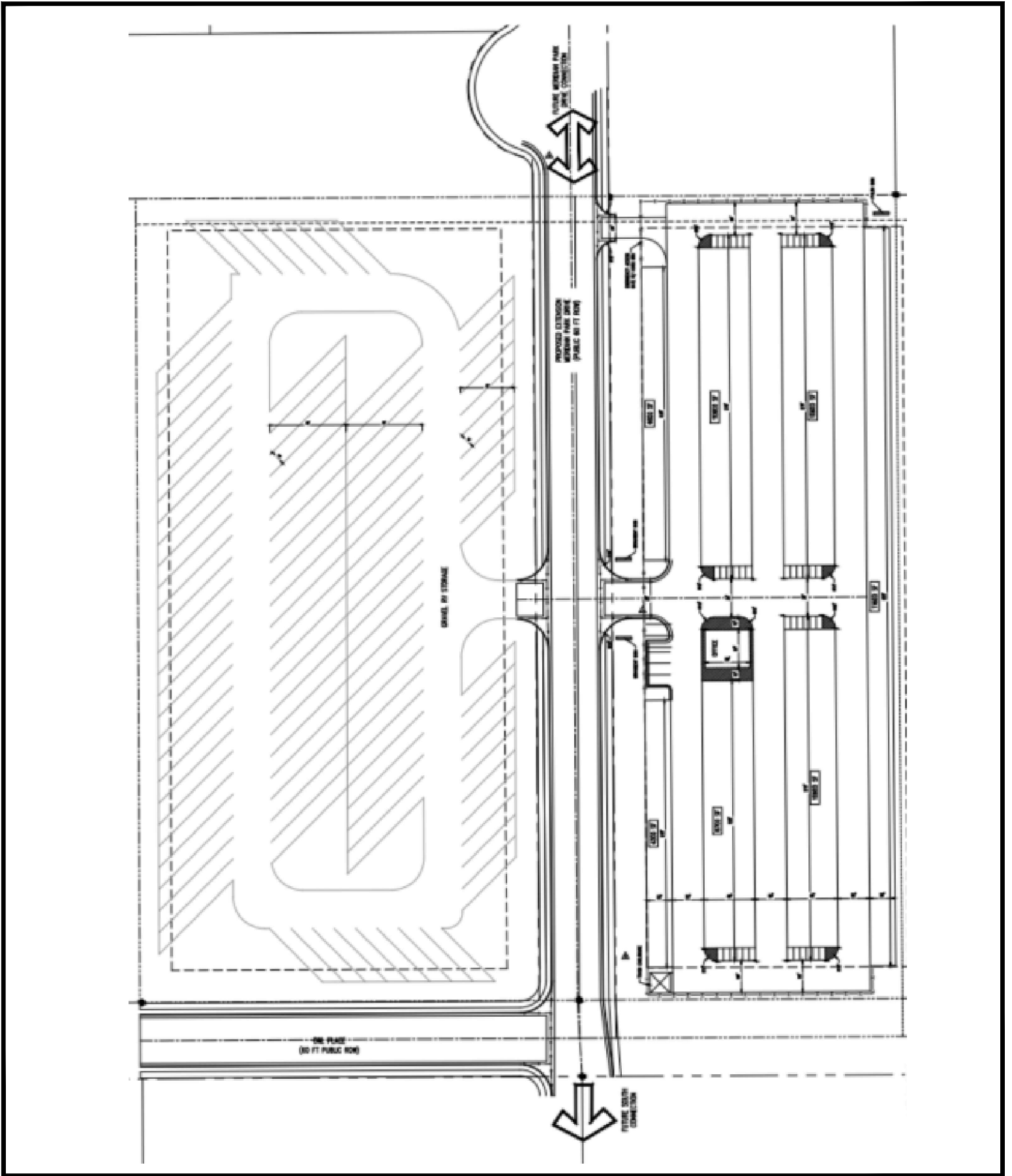


FIGURE 1-2
Site Plan

Meridian Storage
El Paso County, CO



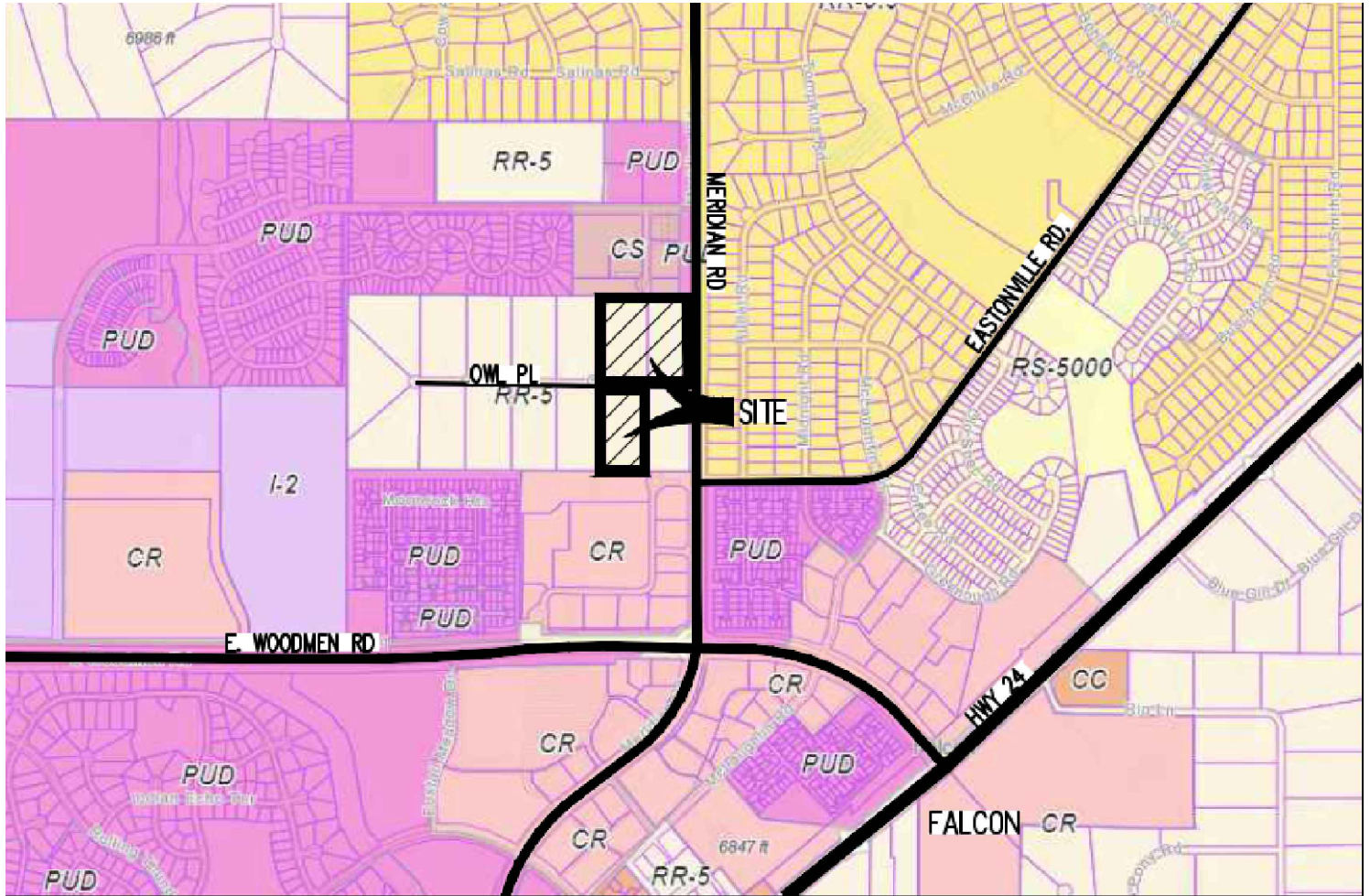






FIGURE 1-3
Zoning Map

Meridian Storage
El Paso County, CO

-  MOVEMENT
-  SIGNALIZED INTERSECTION
-  STOP SIGN
-  YIELD SIGN



II. Background Information

Study Area

The study area was determined by a review of intersections that would experience a significant portion of turning movement volumes generated by the site. The study area for the project includes the following intersections that may see impacts to traffic operations as a result of the proposed development:

Study Intersections

- Woodman Rd & Meridian Rd
- Meridian Rd & Eastonville Rd
- Meridian Rd & Owl PI
- Meridian Rd & Bent Grass Meadows Dr
- Bent Grass Meadows Dr & Meridian Park Dr

Study Assumptions

For purposes of this analysis only, it is assumed that the proposed development will be completed by 2024. It is assumed that the nearby pipeline developments of Falcon Meadows at Bent Grass, Owl Place Commercial, and Falcon Marketplace will be built and operating by year 2024. A background growth rate of 2% year was applied to the existing turning movement counts.

Study Methodology

Synchro software version 11 was used to evaluate levels of service at each of the study intersections during the weekday AM and PM peak hours. Synchro is a macroscopic model used for optimizing traffic signal timing and performing capacity analyses. The software can model existing traffic signal timings or optimize splits, offsets, and cycle lengths for individual intersections, an arterial, or a complete network. Synchro allows the user to evaluate the effects of changing intersection geometrics, traffic demands, traffic control, and/or traffic signal settings as well as optimize traffic signal timings.

The levels of service reported for the signalized and unsignalized intersections analyzed were taken from the Highway Capacity Manual (HCM) 6th reports, generated by Synchro 11. Level of service descriptions are included in Appendix B.

Existing Roadway Network

Figure 2-1 depicts existing lane use and traffic controls in the vicinity of the subject site. The following provides a description of each of the roadways within the study network.

Woodmen Rd

Woodmen Rd is a four-lane, east/west, divided highway with a posted speed limit of 45 mph through the study area. It provides access to US-24 east of the site and to CO-21 west of the site.

Meridian Rd

Meridian Rd is a four-lane, north/south, divided highway with a posted speed limit of 55 mph through the study area. It provides access to many of the nearby residential developments, as well as several commercial uses.

Bent Grass Meadows Dr

Bent Grass Meadows Dr is an east/west local road with a posted speed limit of 35 mph and provides access to the newly constructed housing development Falcon Meadows at Bent Grass.

Meridian Park Dr

Meridian Park Dr is a two lane, north/south local road. It currently dead ends just north of the proposed development. Upon completion of the development, Meridian Park Dr will be extended to the south and will provide site access.

Owl PI

Owl PI is a two-lane, east/west, local road that provides access to several single-family homes. Owl PI currently intersects Meridian Rd in a stop-controlled intersection. There are plans to close access to Meridian Rd in the future. When this access is closed, an extension will be constructed between Owl PI and Eastonville Rd, allowing Owl PI residents to access Eastonville Rd and then access Meridian Rd from there. The trips on and off Owl PI have been rerouted along this extension to Eastonville Rd in the future scenarios.

Eastonville Rd

Eastonville Rd is a two-lane, east/west road. It intersects with Meridian Rd in a four-leg, signalized intersection. At the time of the traffic counts in June 2022, the intersection of Eastonville Rd & Meridian Rd was a three-legged stop-controlled intersection, as the west leg had not been built. The existing conditions analysis in this study assumes that the west leg of Eastonville Rd has not yet been constructed to match the geometry at the time of the counts. All future analysis in this study assume that the west leg has been built and that Eastonville Rd intersects Meridian Rd in a signalized intersection.

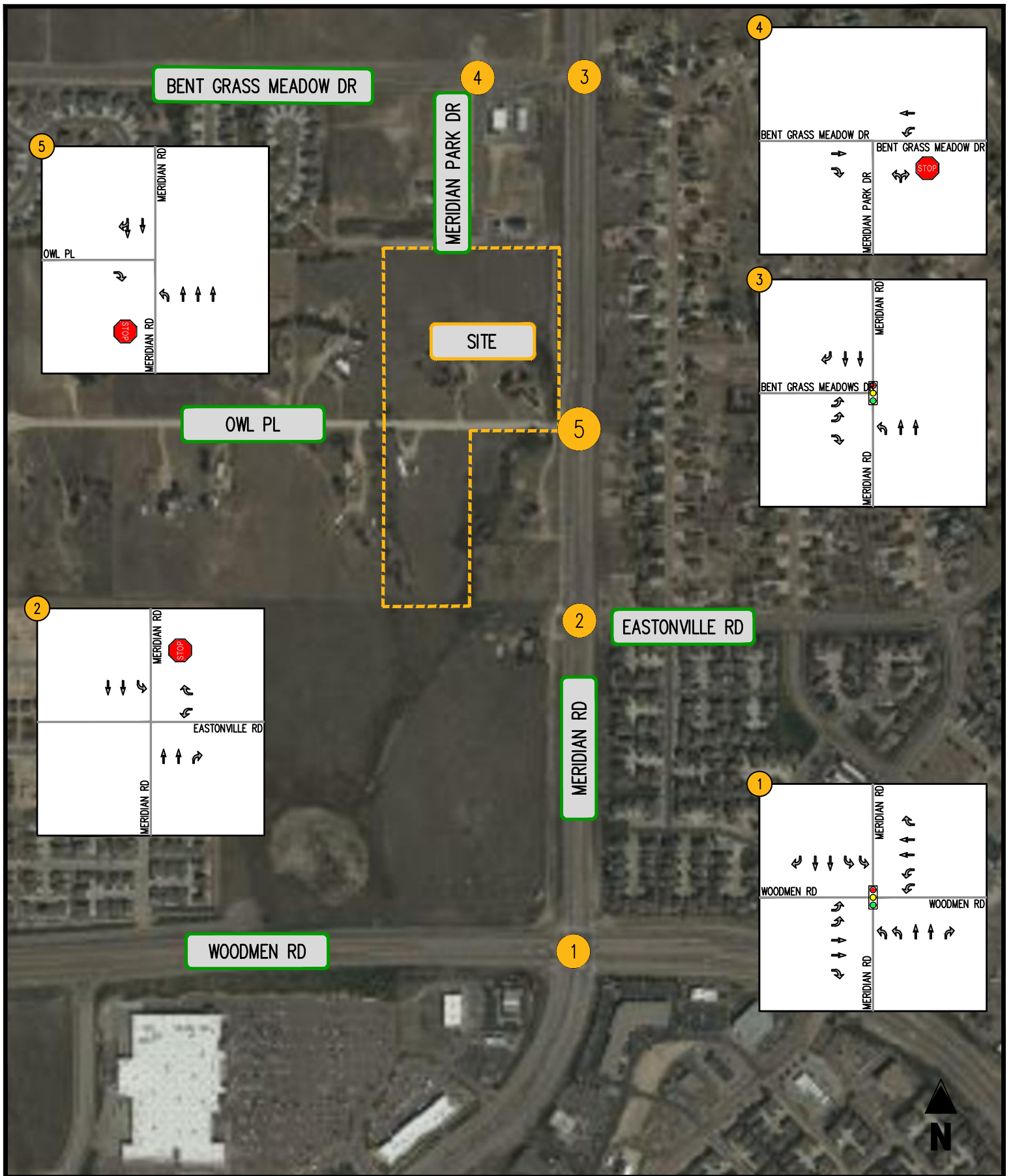






FIGURE 2-1
Existing Lane Use and Traffic Control

Meridian Storage
 El Paso County, CO

-  MOVEMENT
-  SIGNALIZED INTERSECTION
-  STOP SIGN
-  YIELD SIGN



III. Analysis of Existing Conditions

Traffic Volumes

The Owl Place Commercial traffic study, conducted by SM Rocha LLC in September 2022 studied four of the same intersections as this traffic study. The turning movement counts collected on Wednesday, June 1, 2022, for the SM Rocha study were used as the existing volumes in this study for all intersections except for Bent Grass Meadows Dr & Meridian Park Dr. The traffic counts taken for the Bent Grass East Commercial Filing No. 3 TIS conducted by LSC Transportation Consultants, Inc. in May 2021 were used for the volumes at Bent Grass Meadows Dr & Meridian Park Dr. At the time of the counts for the Bent Grass study, there was an access to the 7-Eleven along Bent Grass Meadows Dr. At the time of this study, the access has been closed and vehicles will have to access the 7-Eleven from Meridian Park Dr. As such, the trips that had been using the access along Bent Grass Meadows Dr were rerouted onto Meridian Park Dr for the existing conditions analysis in this study.

The volumes were balanced along Meridian Rd by increasing the thru movements to balance with the highest intersection. The eastbound and westbound thru volumes along Bent Grass Meadows Dr at the intersection of Bent Grass Meadows Dr & Meridian Park Dr were balanced with the intersection of Meridian Rd & Bent Grass Meadows Dr. The raw traffic counts are provided in Appendix C. The existing traffic volumes are presented in Figure 3-1.

Existing Operational Analysis

Capacity/level of service (LOS) analyses were conducted at the study intersections based on the existing lane use and traffic controls shown in Figure 2-1, and existing traffic volumes shown in Figure 3-1. Per the El Paso County Transportation Impact Study Guidelines, the peak hour factors (PHF) were calculated or set to 0.85, whichever was higher. The signal timings for the two signals in the study area were incorporated into the Synchro models. Using the Time Space Diagram analysis in Synchro, a progression analysis was conducted along Meridian Rd. A detailed results report is presented in Appendix D and is summarized in Table 3-1 and in Figure 3-2. The Synchro printouts are included in Appendix D.

The signalized intersection of Woodmen Rd & Meridian Rd operates at LOS D during both the AM and PM peak hours. The signalized intersection of Bent Grass Meadows Dr & Meridian Rd operates at LOS A during both time periods, as does the stop-controlled intersection of Bent Grass Meadows Dr & Meridian Park Dr. The stop-controlled intersection of Meridian Rd & Owl PI operates at LOS C or better. The stop-controlled intersection of Meridian Rd & Eastonville Rd operates at LOS F during both the AM and PM peak hours due to the westbound left turn movement. It should be noted that this intersection is modeled as a three-legged stop-controlled intersection to match the configuration from when the counts were taken. It has recently been improved to a four-legged signalized intersection, which negates the LOS F found in this analysis. As such, there are no operational concerns in the existing conditions scenario.

The El Paso County Roadway ADT Threshold Capacities were reviewed for a 4-lane principal arterial to ensure that Meridian Rd is operating under capacity in the existing conditions, and is reported in Table 3-1. Based on the ADT counts taken in September 2022 from the Owl Place Commercial study, it was found that the ADT along Meridian both immediately south of Bent Grass Meadows and immediately north of Woodman Rd were under capacity.

The signal progression analysis along Meridian Rd was conducted using the Synchro time space diagrams and the results are reported in Table 3-1 with the Synchro printouts included in Appendix D. It was found that with a 120 second cycle length, the NB bandwidth is 22 seconds in the AM and 32

seconds in the PM between the signals of Woodmen Rd & Meridian Rd while the SB bandwidth is 30 seconds in the AM and 37 seconds in the PM. Since the intersection of Meridian Rd & Woodmen Rd is a major intersection that must provide a large proportion of the available green time to movements other than the NB and SB thru movements, it would be difficult to expand the bandwidth along Meridian Rd.

Existing Intersection Queues

The 95% queue lengths were reported for each movement within the study area using the Synchro queuing reports. The results are summarized in Table 3-2. The movements highlighted in yellow indicate that the queue exceeds its respective storage length or extends past the adjacent storage, possible blocking vehicles trying to enter an adjacent turn lane. Queues highlighted in orange exceed capacity indicate that the movement exceeds capacity, and the queues highlighted in red exceed capacity and extend past the adjacent storage or their own storage. Generally, the queueing is minor in the existing conditions, however, several queues were identified as having the potential to affect traffic operations. The NBT queue at Woodmen Rd & Meridian Rd extends 338 feet in the PM peak hour, while the adjacent NBR storage is only 330'. Although this indicates that the thru movement may block the right turn storage by 8', it is unlikely to affect operations since the queue length only barely exceeds the adjacent storage length. The westbound left turn queue at Meridian Rd & Eastonville Rd was reported to extend 165' in the AM and 92.5' in the PM with an available storage length of 120'. Since this movement is over capacity and Synchro becomes unreliable once capacity is exceeded, it is possible that the queue extends further than reported. This queue is no longer a problem, however, since this intersection has recently been signalized and has a different geometric layout. The SBT queue at Meridian Rd & Bent Grass Meadows Dr extends 386' in the AM peak hour, while the adjacent SBR storage is only 350'. Although the thru movement may periodically extend past the adjacent right turn storage, it is unlikely to cause operations problems since it does not exceed the storage length by much more than a car length.

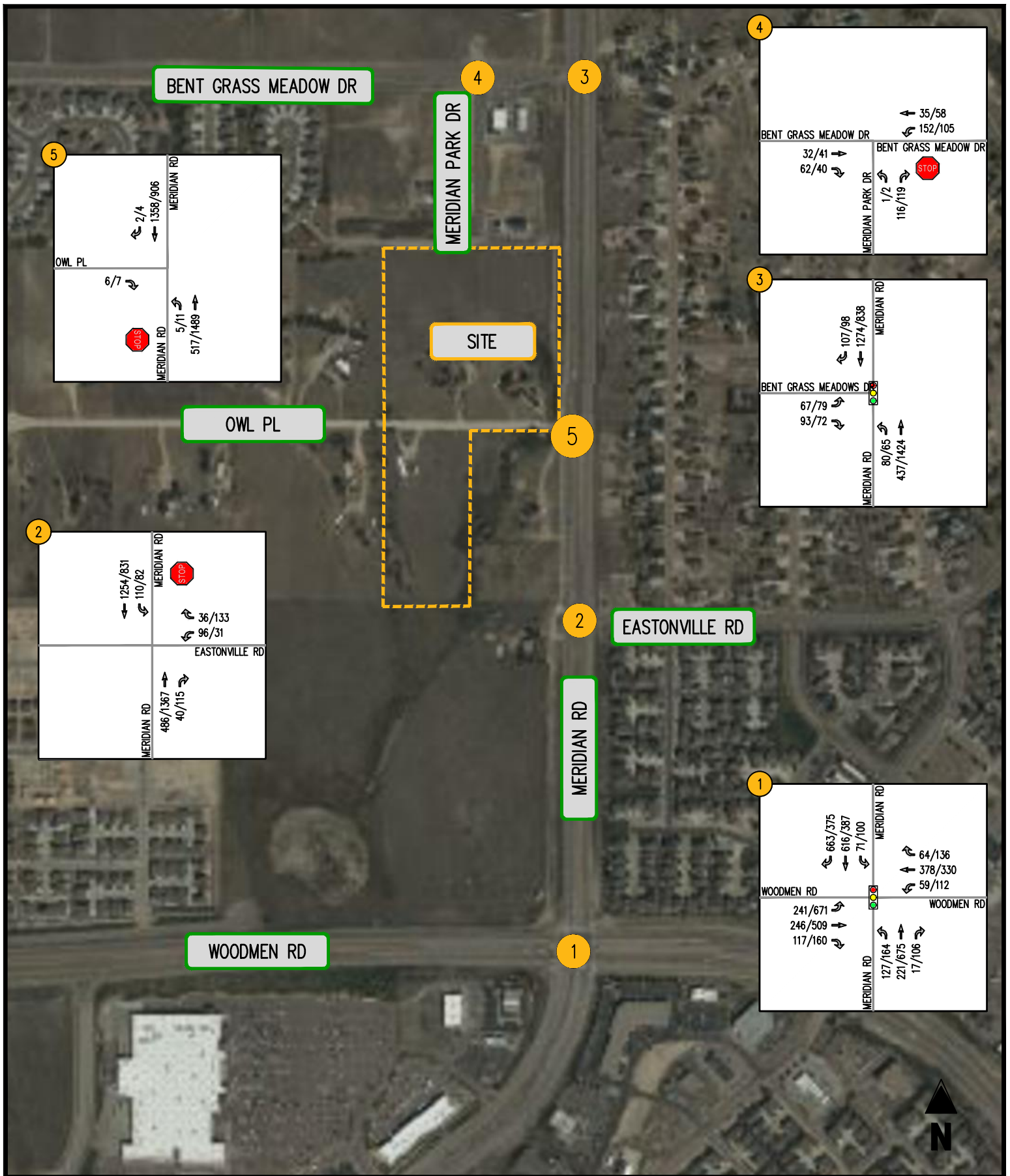


FIGURE 3-1
Existing 2023 Volumes

0000/0000 (AM PEAK HOUR/PM PEAK HOUR)

Meridian Storage
El Paso County, CO

- MOVEMENT
- SIGNALIZED INTERSECTION
- STOP SIGN
- YIELD SIGN



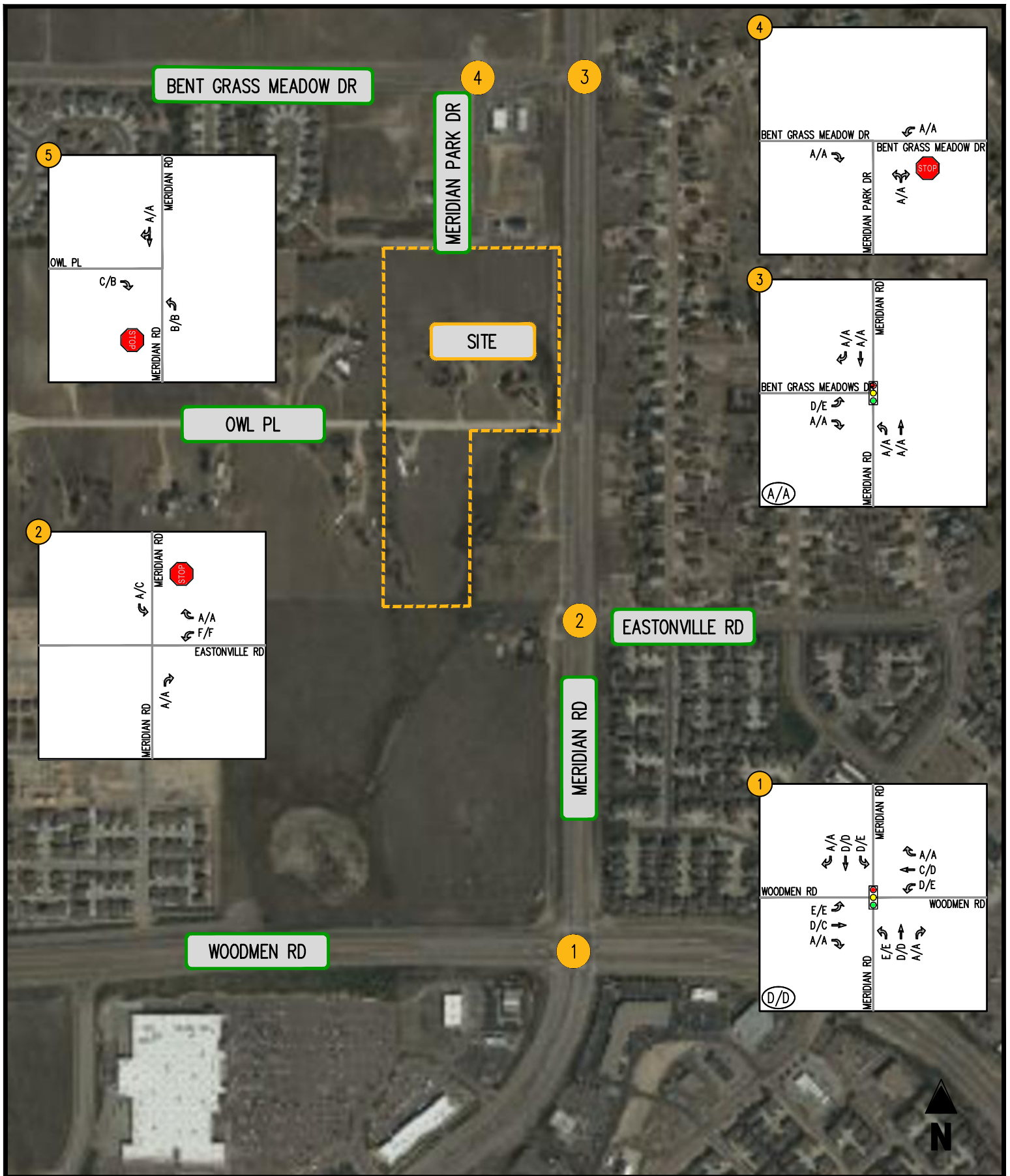


FIGURE 3-2
Existing 2023 Level of Service

Meridian Storage
 El Paso County, CO

(A/A) INTERSECTION LOS
 0000/0000 (AM PEAK HOUR/PM PEAK HOUR)

- ← MOVEMENT
- 🚦 SIGNALIZED INTERSECTION
- 🛑 STOP SIGN
- 🚧 YIELD SIGN



Table 3-1
Meridian Storage
Existing Intersection Level of Service Summary (1) (2)

| Intersection | Operating Condition | Street Name | Approach/ Movement | Existing 2023 | |
|--|---------------------|---------------------------------------|--------------------|----------------------|---------------------|
| | | | | AM Peak Hour | PM Peak Hour |
| 1 Woodmen Rd/Meridian Rd | SIGNAL | Woodmen Road | EBL | E (57.3) | E (57.6) |
| | | | EBT | D (38.6) | C (24.5) |
| | | | EBR | A (0.0) | A (0.0) |
| | | Woodmen Road | WBL | D (37.3) | E (60.1) |
| | | | WBT | C (28.8) | D (39.6) |
| | | | WBR | A (0.0) | A (0.0) |
| | | Meridian Road | NBL | E (60.5) | E (64.5) |
| | | | NBT | D (50.1) | D (52.1) |
| | | | NBR | A (0.0) | A (0.0) |
| | | Meridian Road | SBL | D (43.0) | E (61.0) |
| SBT | D (50.0) | | D (42.9) | | |
| SBR | A (0.0) | | A (0.0) | | |
| Overall | | | | D (45.5) | D (47.2) |
| 2 Meridian Rd/Eastonville Rd | STOP | Eastonville Road | WBL | F [186.2] | F [409.6] |
| | | | WBR | A [0.0] | A [0.0] |
| | | Meridian Rd | NBT | A [0.0] | A [0.0] |
| | | | NBR | A [0.0] | A [0.0] |
| | | Meridian Rd | SBL | A [9.3] | C [17.4] |
| 3 Meridian Rd/Bent Grass Meadows Dr | SIGNAL | Bent Grass Meadows Drive | EBL | D (55.0) | E (56.1) |
| | | | EBR | A (0.0) | A (0.0) |
| | | Meridian Road | NBL | A (8.2) | A (4.8) |
| | | | NBT | A (2.5) | A (4.4) |
| | | Meridian Road | SBT | A (9.9) | A (7.5) |
| | | | SBR | A (5.9) | A (5.9) |
| Overall | | | | A (9.4) | A (7.8) |
| 4 Bent Grass Meadows Dr/Meridian Park Dr | STOP | Bent Grass Meadows Drive | EBR | A [0.0] | A [0.0] |
| | | | WBL | A [7.8] | A [7.6] |
| | | Meridian Park Drive | NBLR | A [9.1] | A [9.1] |
| 5 Meridain Rd & Owl Pl | STOP | Owl Pl | EBR | C [16.2] | B [12.5] |
| | | Meridian Road | NBL | B [14.0] | B [10.7] |
| | | Meridian Road | SBTR | A [0.0] | A [0.0] |
| Street Name | | | | Existing 2023 | |
| | | | | ADT | ADT Capacity |
| El Paso County Roadway ADT Threshold Capacity Principal Arterial (4-Lane) | | Meridian Rd (S.O. Bent Grass Meadows) | | 24,989 | 40,000 |
| | | Meridian Rd (N.O. Woodman Rd) | | 24,416 | 40,000 |
| Meridian Rd Signal Progression Arterial Band (Seconds Per Cycle) | | | NB | AM | PM |
| | | | SB | 22 | 32 |
| | | | | 30 | 37 |

Notes (1) Numbers in brackets [] represent delay at unsignalized intersections in seconds per vehicle.
(2) Numbers in parenthesis () represent delay at signalized intersections in seconds per vehicle.

Table 3-2
 Meridian Storage
 Existing Intersection Queueing Summary (1)

| Intersection | Operating Condition | Street Name | Approach/ Movement | Available Storage | Existing 2023 | |
|--|---------------------|--------------------------|--------------------|-------------------|---------------|--------------|
| | | | | | AM Peak Hour | PM Peak Hour |
| 1 Woodmen Rd/Meridian Rd | SIGNAL | Woodmen Road | EBL | 500 | 141 | 347 |
| | | | EBT | - | 130 | 240 |
| | | | EBR | 630 | 0 | 0 |
| | | Woodmen Road | WBL | 350 | 44 | 77 |
| | | | WBT | - | 197 | 193 |
| | | | WBR | 250 | 0 | 0 |
| | | Meridian Road | NBL | 440 | 84 | 106 |
| | | | NBT | - | 129 | 338 |
| | | | NBR | 330 | 0 | 0 |
| | | | SBL | 490 | 34 | 67 |
| Meridian Road | SBT | - | 225 | 188 | | |
| | SBR | 450 | 6 | 0 | | |
| 2 Meridian Rd/Eastonville Rd | STOP | Eastonville Road | WBL | 120 | 165 | 92.5 |
| | | | WBR | - | 0 | 0 |
| | | Meridian Rd | NBR | 400 | 0 | 0 |
| | | | SBL | 375 | 10 | 22.5 |
| 3 Meridian Rd/Bent Grass Meadows Dr | SIGNAL | Bent Grass Meadows Drive | EBL | 150 | 48 | 55 |
| | | | EBR | - | 47 | 19 |
| | | Meridian Road | NBL | 700 | 25 | 6 |
| | | | NBT | - | 10 | 249 |
| | | Meridian Road | SBT | - | 386 | 201 |
| | | | SBR | 350 | 20 | 20 |
| 4 Bent Grass Meadows Dr/Meridian Park Dr | STOP | Bent Grass Meadows Drive | EBR | 150 | 0 | 0 |
| | | Bent Grass Meadows Drive | WBL | 100 | 10 | 7.5 |
| | | Meridian Park Drive | NBLR | - | 12.5 | 12.5 |
| 5 Meridain Rd & Owl PI | STOP | Owl PI | EBR | - | 2.5 | 2.5 |
| | | Meridian Road | NBL | 270 | 0 | 2.5 |
| | | Meridian Road | SBTR | - | 0 | 0 |

Notes: (1) Queue length is based on the 95th percentile queue as reported by Synchro, Version 11.

IV. Analysis of Background 2024 & 2040 Conditions

Methodology

The background scenarios analyze traffic operations assuming that the site has not been developed but that traffic volumes have increased due to background growth.

Roadway Improvements

The background scenarios model the intersection of Meridian Rd & Eastonville Rd as a four-legged signalized intersection. It is assumed that the connection between Owl PI and Meridian Rd has been closed. The proposed development (Owl Place Commercial) on the southwest corner of Meridian Rd & Owl PI will provide access between Owl PI and Eastonville Rd. Upon completion, vehicles that would have previously accessed Meridian Rd from Owl PI will travel south to Eastonville Rd to do so. Figure 4-1 shows the assumed lane use and traffic control for the background scenarios. Figure 4-2 shows the rerouted trips from Owl PI, and the impact in terms of vph that this will have on the turning movements through the study area.

Regional Growth

A 2% annual growth rate was applied to the existing traffic volumes. The resulting increases in background traffic volumes within the study area are reflected in Figure 4-3 for the background 2024 scenario and in Figure 4-4 for the background 2040 scenario.

Pipeline Developments

Three nearby pipeline developments were identified and analyzed to determine their volume contributions through the study area. An accompanying TIS for each development was provided. For purposes of this study, it is assumed that two of the pipeline developments will be completed by 2024 and the third will have phase 1 completed by 2024 and will be fully built by 2040. Figure 4-5 shows the location of the pipeline developments in respect to the proposed site.

The Owl Place Commercial development will be located on the southwest corner of Meridian Rd & Owl PI. The Owl Place Commercial Traffic Impact Study conducted by SM Rocha, LLC in September 2022 was referenced to determine the trip generation and distribution from the development. The development will consist of a fast-food restaurant, a coffee/donut shop, a gas station with convenience store, and a car wash. When this development is constructed, access between Owl PI and Meridian Rd will be restricted. The trip generation figures from the Owl Place Commercial study distributes the trips with the assumption that the connection between Owl PI and Meridian Rd is still open. Since this study assumes that it will not be open, the trips have been rerouted to access Meridian Rd via Eastonville Rd. Vehicles will use the access road on the west side of the site to reach Eastonville Rd where they will be able to access Meridian Rd. Figure 4-6 details the trip distribution of the development through the study area.

The Falcon Marketplace Development is located on the northwest corner of Woodmen Rd & Meridian Rd. The Falcon Marketplace Development Traffic Impact Study conducted by LSC Transportation Consultants, INC in September 2018 was referenced to determine the trip generation and distribution. The table below shows the land uses that were analyzed in the LSC traffic study:

| ITE Code | Land Use | Size |
|-----------------|--|-------------|
| 866 | Pet Supply Superstore | 15 KSF |
| 850 | Supermarket | 123 KSF |
| 944 | Gasoline/Service Station | 18 VFP |
| 934 | Fast-Food Restaurant with Drive-Through Window | 2.5 KSF |
| 820 | Shopping Center | 5 KSF |
| 848 | Tire Store | 7.72 KSF |
| 934 | Fast-Food Restaurant with Drive-Through Window | 3.5 KSF |
| 934 | Fast-Food Restaurant with Drive-Through Window | 2.5 KSF |
| 610 | Clinic | 7.8 KSF |
| 820 | Shopping Center | 8 KSF |
| 937 | Coffee/Donut Shop With Drive-Through Window | 1.3 KSF |

The Falcon Marketplace Development will be constructed in two phases, with the first phase expected to be completed by 2024 and the second phase expected to be completed by 2040. Figure 4-7 shows the trip distribution for phase 1 of the development and Figure 4-8 shows phase 2 of the development.

The third identified pipeline is the Falcon Meadows at Bent Grass Development. This development was studied in the Falcon Meadows at Bent Grass (Filing Numbers 1-4) conducted by LSC Transportation Consultants, INC. Each filing was conducted for a section of the development, with the most recent Filing 4, conducted in October 2022. Filing 4 was referenced in this study, as it includes trip generation from the entire pipeline development. Falcon Meadows at Bent Grass will be located west of Bent Grass Meadows Dr, to the northwest of the proposed development. Falcon Meadows at Bent Grass is a large development that will consist of residential housing, a shopping center, a marketplace, and a school. Figure 4-9 shows the trip distribution for Falcon Meadows at Bent Grass.

The relevant pages from the pipeline development TIS's are included in Appendix E.

Background 2024 & 2040 Traffic Forecasts

The background 2024 traffic forecast, shown in Figure 4-10, was calculated by taking the existing volumes from Figure 3-1, incorporating the redistributed movements from Owl PI (Figure 4-2), adding the background 2024 growth (Figure 4-3), and the pipeline trip distributions (Figures 4-6, 4-7, and 4-9).

The background 2040 traffic forecast, shown in Figure 4-11, was calculated by taking the existing volumes from Figure 3-1, incorporating the redistributed movements from Owl PI (Figure 4-2), adding the background 2040 growth (Figure 4-4), and the pipeline trip distributions (Figures 4-6, 4-8, and 4-9).

Background 2024 & 2040 Levels of Service

Capacity analyses of the background scenarios are provided in Appendix F. The background 2024 forecasted levels of service are shown in Table 4-1 and depicted graphically in Figure 4-12. The background 2040 forecasted levels of service are shown in Table 4-1 and depicted graphically in Figure 4-13. The Synchro models were updated with the future background volumes. Per the El Paso County Transportation Impact Study Guidelines, the peak hour factors (PHF) were calculated or set to 0.95, whichever was higher. The signal timings for Meridian Rd & Eastonville Rd were provided by the County and incorporated into the Synchro models, while the splits for the other two signals were optimized. The cycle lengths and offsets remain the same as in the existing scenario. Using the Time Space Diagram analysis in Synchro, a

progression analysis was conducted along Meridian Rd. A detailed results report is presented in Appendix F and is summarized in Table 4-1. The Synchro printouts are included in Appendix F.

The signalized intersection of Woodmen Rd & Meridian Rd operates at LOS D during both peak hours in the background 2024 scenario but will operate at LOS F in the background 2040 scenario. Many of the movements are reported to exceed capacity by the 2040 PM peak, with the EBL exceeding capacity the most severely. There will be 993 eastbound left turns and only dual left turn lanes. In order for this movement to operate acceptably, triple left turn lanes would likely be necessary. The signal at Meridian Rd & Eastonville Rd operates at LOS D or better in 2024 and operates at LOS E in the background 2040 AM peak hour. The southbound thru movement and the northbound left turn movement exceed capacity in this scenario, contributing to the high overall delay. The signalized intersection of Meridian Rd & Bent Grass Meadows Dr operates at LOS B during all background scenarios, with no operational concerns. The stop-controlled intersection of Bent Grass Meadows Dr & Meridian Park Dr operates at LOS B or better during all background scenarios as well.

The El Paso County Roadway ADT Threshold Capacities were reviewed for a 4-lane principal arterial to ensure that Meridian Rd is operating under capacity in the background scenarios. The results are reported in Table 4-1. The ADT counts that were taken in September 2022 were grown for the background scenarios by the same proportion that the turning movements onto and off of each of the links increased between the existing and background scenarios. It was reported that Meridian Rd will operate below the capacity threshold in the background 2024 scenario and over capacity in the background 2040 scenario. Meridian Rd exceeding capacity in the background 2040 scenario is the primary reason for the poor operations at the signalized intersections through the study area. Widening Meridian Rd to 6-lanes would likely be necessary for the signals to operate acceptably in 2040.

The signal progression analysis along Meridian Rd was conducted using the Synchro time space diagrams and the results are reported in Table 4-1 with the Synchro printouts included in Appendix F. In the background 2025 scenario with a 120 second cycle length, the NB bandwidth is 0 seconds in the AM and 31 seconds in the PM between the signals of Woodmen Rd & Meridian Rd while the SB bandwidth is 1 seconds in the AM and 0 seconds in the PM. It was found for the background 2040 scenario that with a 120 second cycle length, the NB bandwidth is 0 seconds in the AM and 39 seconds in the PM between the signals of Woodmen Rd & Meridian Rd while the SB bandwidth is 1 seconds in the AM and 0 seconds in the PM. This poor progression is to be expected due to unacceptable delays at the signalized intersections and the fact that Meridian Rd will exceed capacity by 2040. It is expected that if Meridian Rd were to be widened to 6-lanes, progression could be improved between signals. Another option to be considered is increasing the cycle length to provide a longer green time along Meridian Rd.

Background 2024 & 2040 Intersection Queues

The 95% queue lengths were reported for each movement within the study area using the Synchro queuing reports. The results are summarized in Table 4-2. The movements highlighted in yellow indicate that the queue exceeds its respective storage length or extends past the adjacent storage, possible blocking vehicles trying to enter an adjacent turn lane. Queues highlighted in orange exceed capacity indicate that the movement exceeds capacity, and, the queues highlighted in red exceed capacity and extend past the adjacent storage or their own storage.

As can be seen in Table 4-1, many of the queues at the intersection of Meridian Rd & Eastonville Rd will exceed their respective storage lengths. The eastbound queues at Meridian Rd & Eastonville Rd will extend 177' in the background 2024 scenario and 254' in the background 2040 scenario. There is a roundabout located approximately 150' west of the signal along Eastonville Rd, meaning that in the future queues will likely extend into the roundabout. It should be noted that the Owl Place Commercial traffic study by SM Rocha, LLC reported that the queue from this signal would extend into the roundabout. Given the roundabouts close proximity to a major signal, it will be difficult to prevent queuing into the roundabout. One solution could be to run the signal on a half cycle of 60 seconds, however, that will hurt progression along Meridian Rd.

In the background 2024 scenario, the NBT queue at Woodmen Rd & Meridian Rd extends 442' in the PM peak hour, while the adjacent NBR storage is only 330'. This could potentially block vehicles trying to enter the NBR turn lane. The SBT queue at Meridian Rd & Bent Grass Meadows Dr extends 617' in the AM peak hour, while the adjacent SBR storage is only 350'. Since this movement is under capacity, even though it may block the SBR storage, it will likely clear each cycle.

The queues in the background 2040 scenario have increased, with many of the PM queues at Woodmen Rd & Meridian Rd expected to exceed their respective storage lengths or the adjacent storage lengths. As previously discussed, this intersection will exceed capacity in the 2040 scenario. Implementing the recommended mitigation measures, discussed in the section below, will help the queuing at this intersection. The SBT queue at Meridian Rd & Bent Grass Meadows Dr extends 951' in the AM peak hour and 491' in the PM peak hour, while the adjacent SBR storage is only 350'. Since this movement is under capacity, even though it may block the SBR storage, it will likely clear each cycle.

Background 2024 & 2040 Recommended Mitigation

The following measures are recommended to help achieve acceptable traffic operations through the background 2040 scenario.

- Improve Meridian Rd to a 6-lane highway through the entire study area
(It should be noted that the El Paso County Major Transportation Corridors Plan (MTCP) shows this section of Meridian Rd to remain a 4-lane highway in the 2040 plan)
- Install triple left turn lanes for the EBL at Meridian Rd & Woodman Rd
- Install dual left turn lanes for the NBL movement at Meridian Rd & Eastonville Rd
(This will require modifications for the westbound approach to the roundabout, as it is currently a 1-lane approach)
- Ensure that the storage lengths at Meridian Rd & Eastonville Rd are long enough to accommodate their forecasted queues.

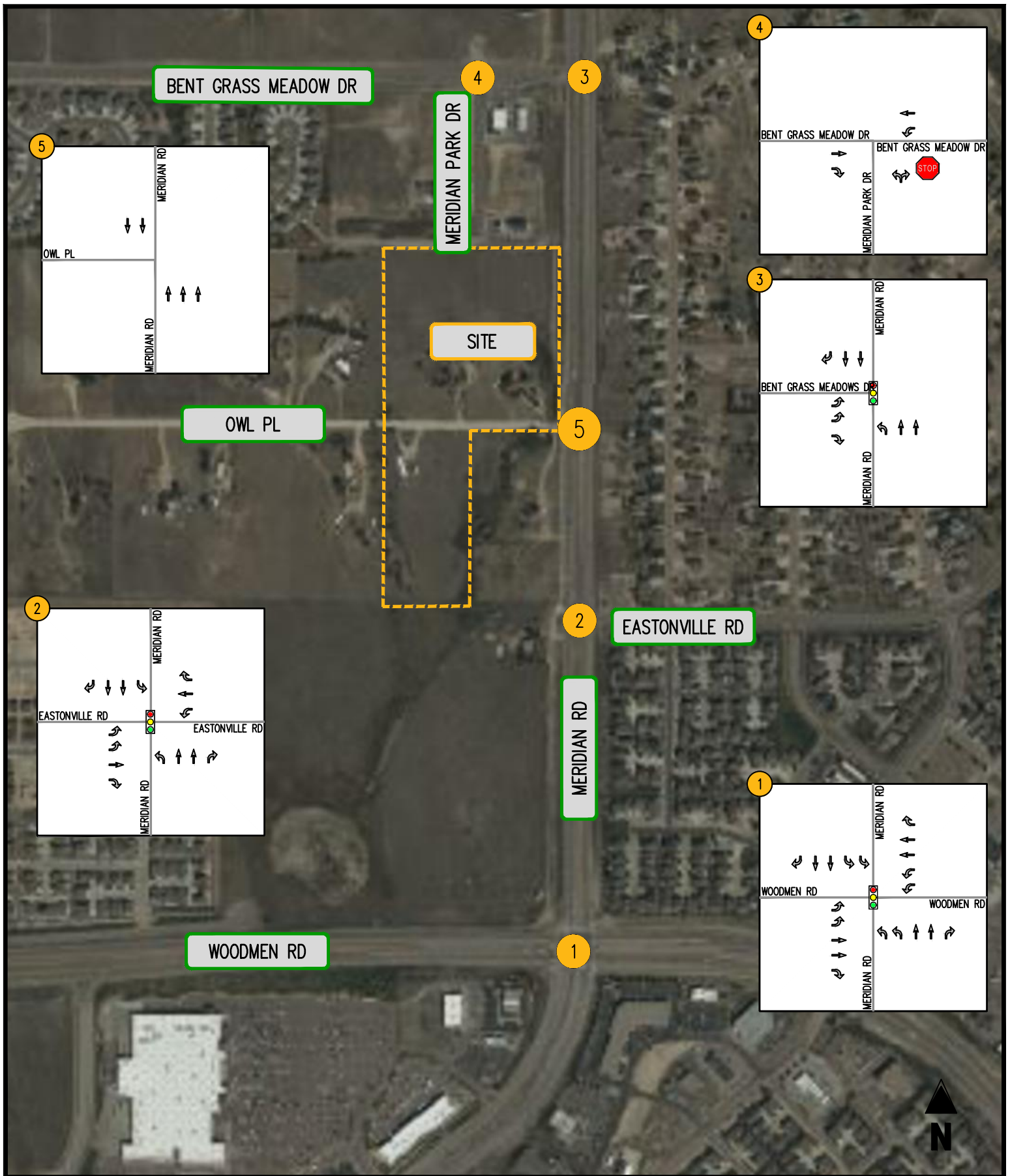






FIGURE 4-1
Background Lane Use and Traffic Control

Meridian Storage
 El Paso County, CO

-  MOVEMENT
-  SIGNALIZED INTERSECTION
-  STOP SIGN
-  YIELD SIGN



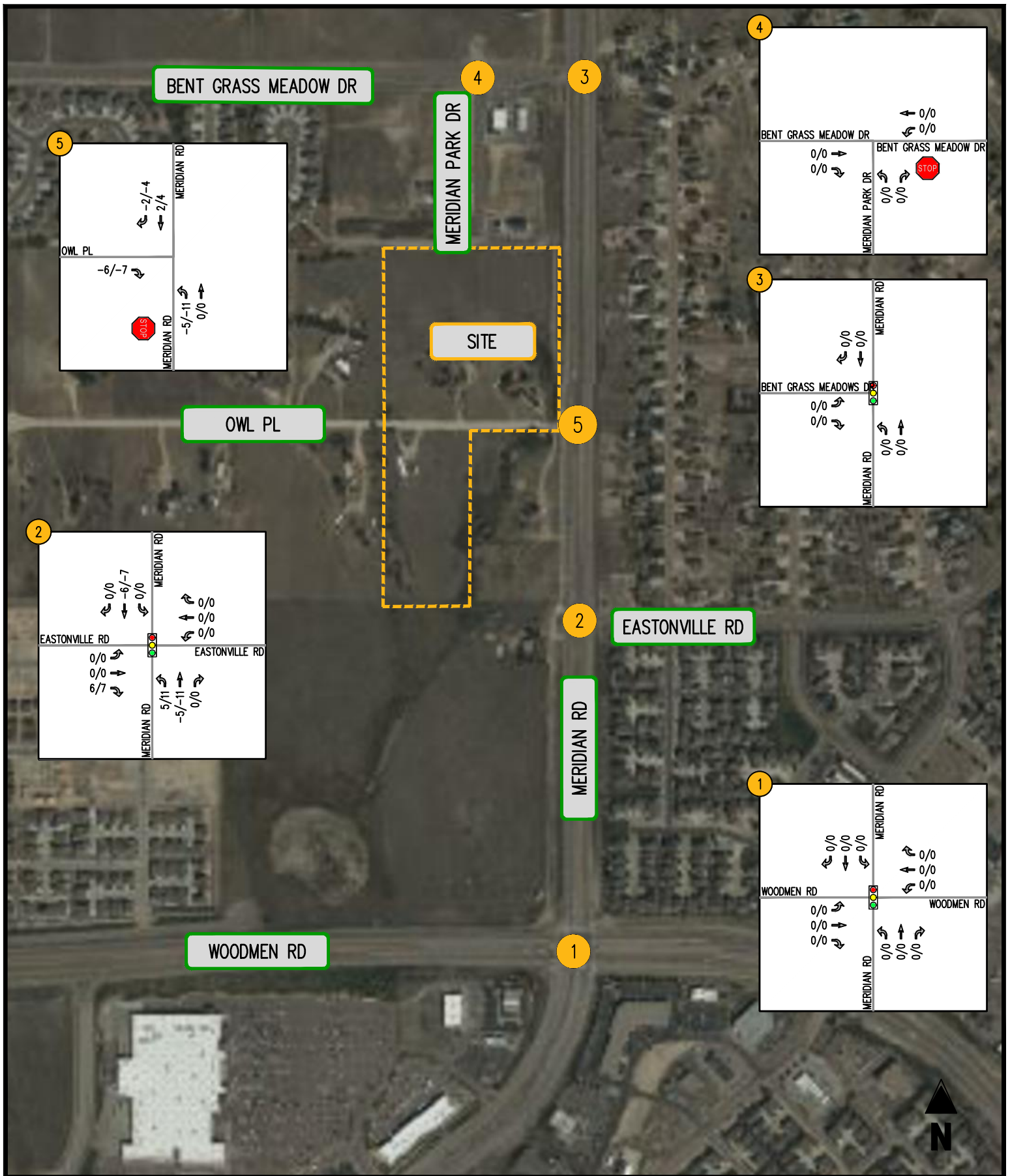


FIGURE 4-2
Owl Pl Rerouted Trips

Meridian Storage
 El Paso County, CO

0000/0000 (AM PEAK HOUR/PM PEAK HOUR)

- MOVEMENT
- SIGNALIZED INTERSECTION
- STOP SIGN
- YIELD SIGN



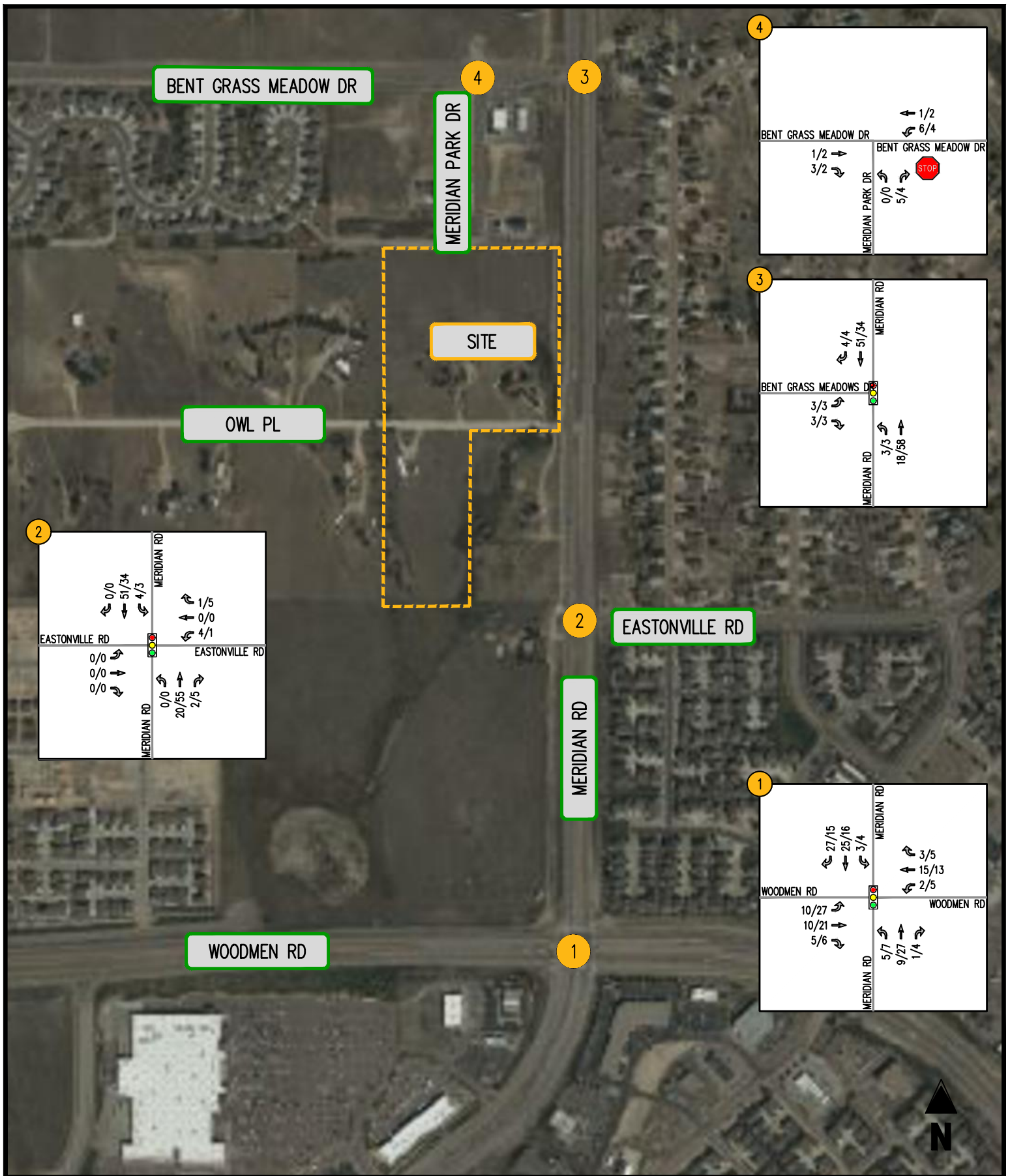


FIGURE 4-3
Background 2024 Growth

0000/0000 (AM PEAK HOUR/PM PEAK HOUR)

Meridian Storage
 El Paso County, CO

- ← MOVEMENT
- SIGNALIZED INTERSECTION
- STOP SIGN
- YIELD SIGN



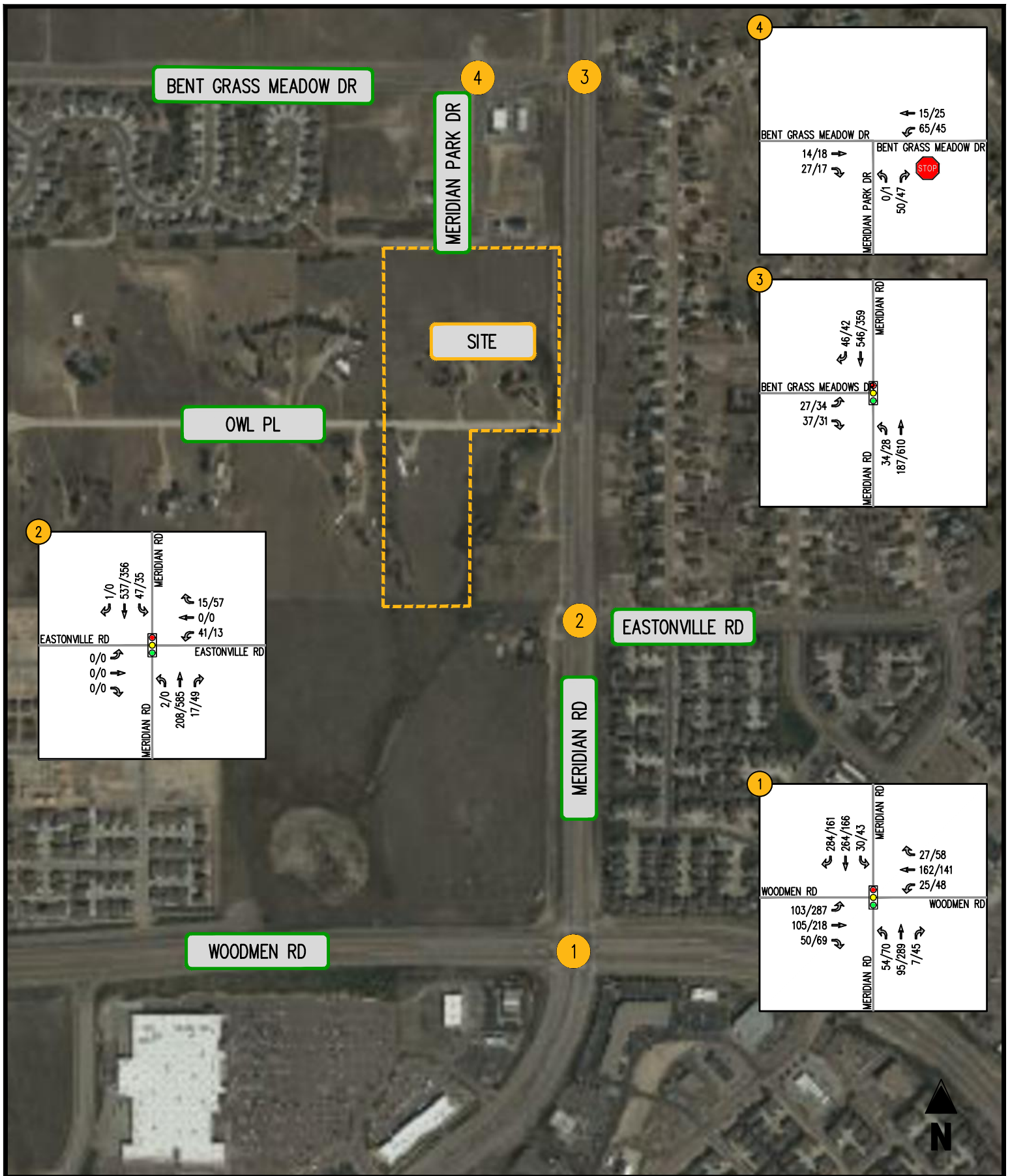


FIGURE 4-4
Background 2040 Growth

0000/0000 (AM PEAK HOUR/PM PEAK HOUR)

Meridian Storage
 El Paso County, CO

← MOVEMENT

SIGNALIZED INTERSECTION

STOP SIGN

YIELD SIGN



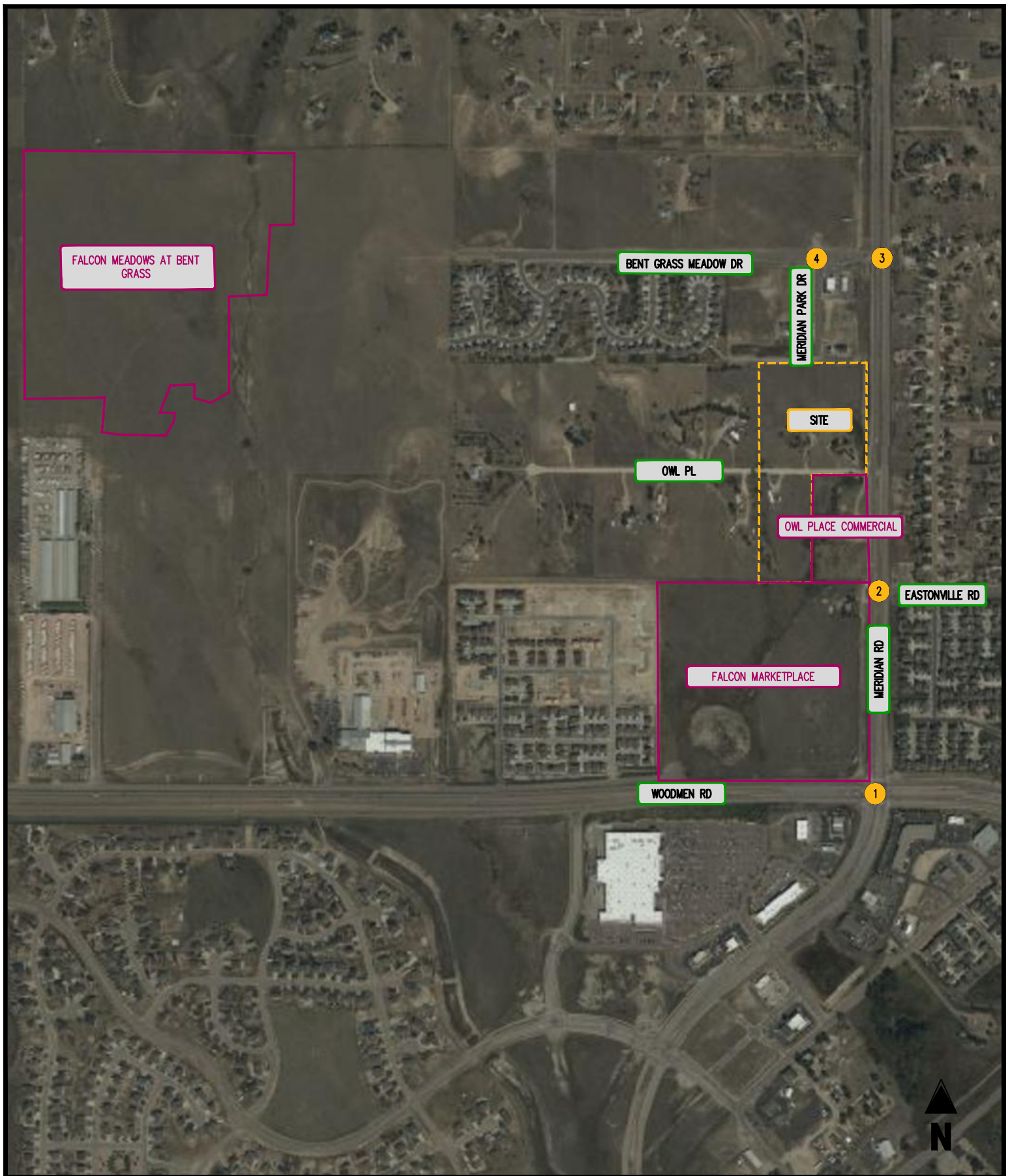






FIGURE 4-5
Pipeline Locations

Meridian Storage
 El Paso County, CO

-  MOVEMENT
-  SIGNALIZED INTERSECTION
-  STOP SIGN
-  YIELD SIGN



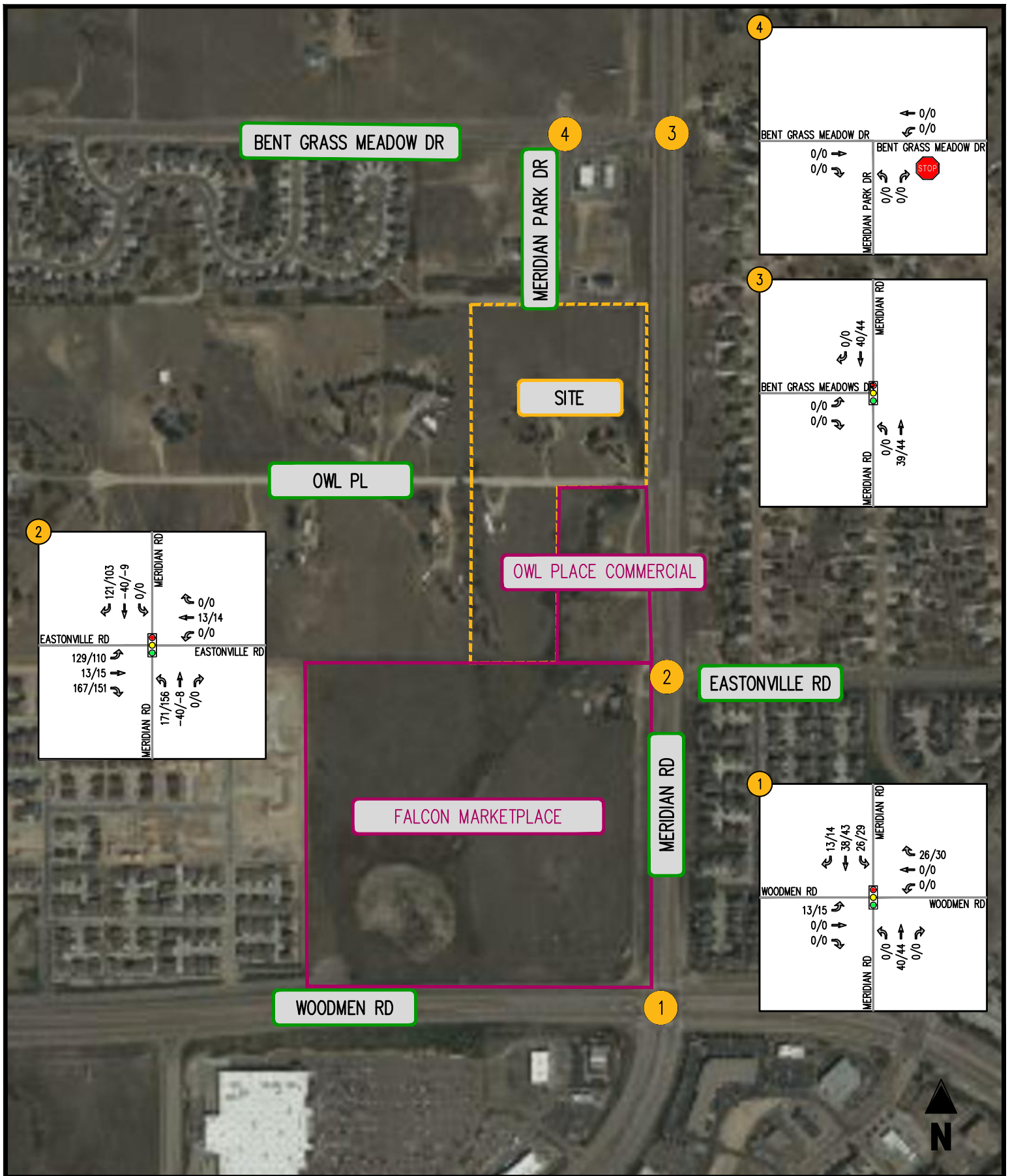


FIGURE 4-6
Pipeline Site Trips: Owl Place Commercial

Meridian Storage
 El Paso County, CO

0000/0000 (AM PEAK HOUR/PM PEAK HOUR)

- ← MOVEMENT
- 🚦 SIGNALIZED INTERSECTION
- 🛑 STOP SIGN
- 🚧 YIELD SIGN



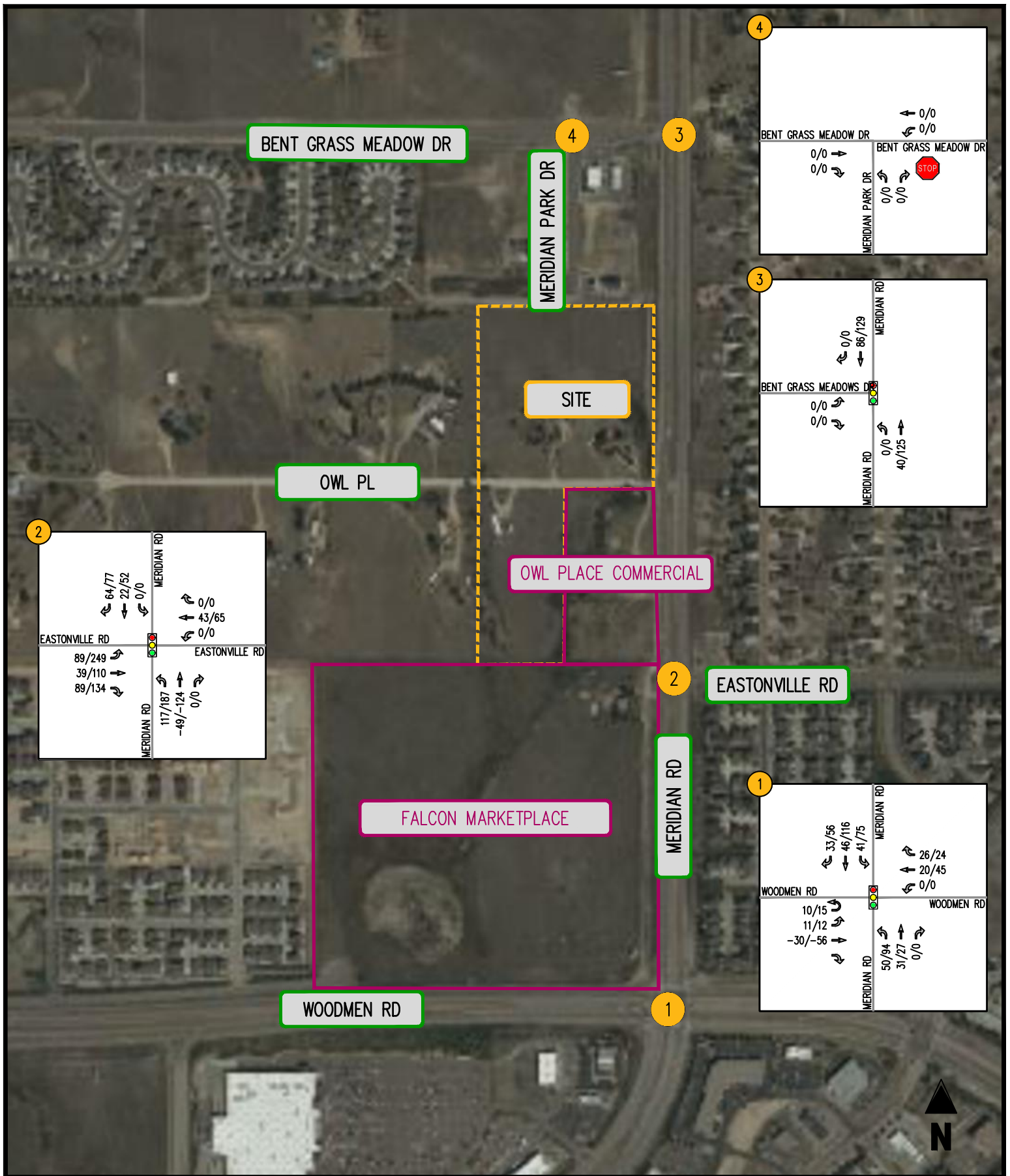


FIGURE 4-7
Pipeline Site Trips: Falcon Marketplace 2024

Meridian Storage
 El Paso County, CO

0000/0000 (AM PEAK HOUR/PM PEAK HOUR)

- ← MOVEMENT
- 🚦 SIGNALIZED INTERSECTION
- 🛑 STOP SIGN
- 🚧 YIELD SIGN



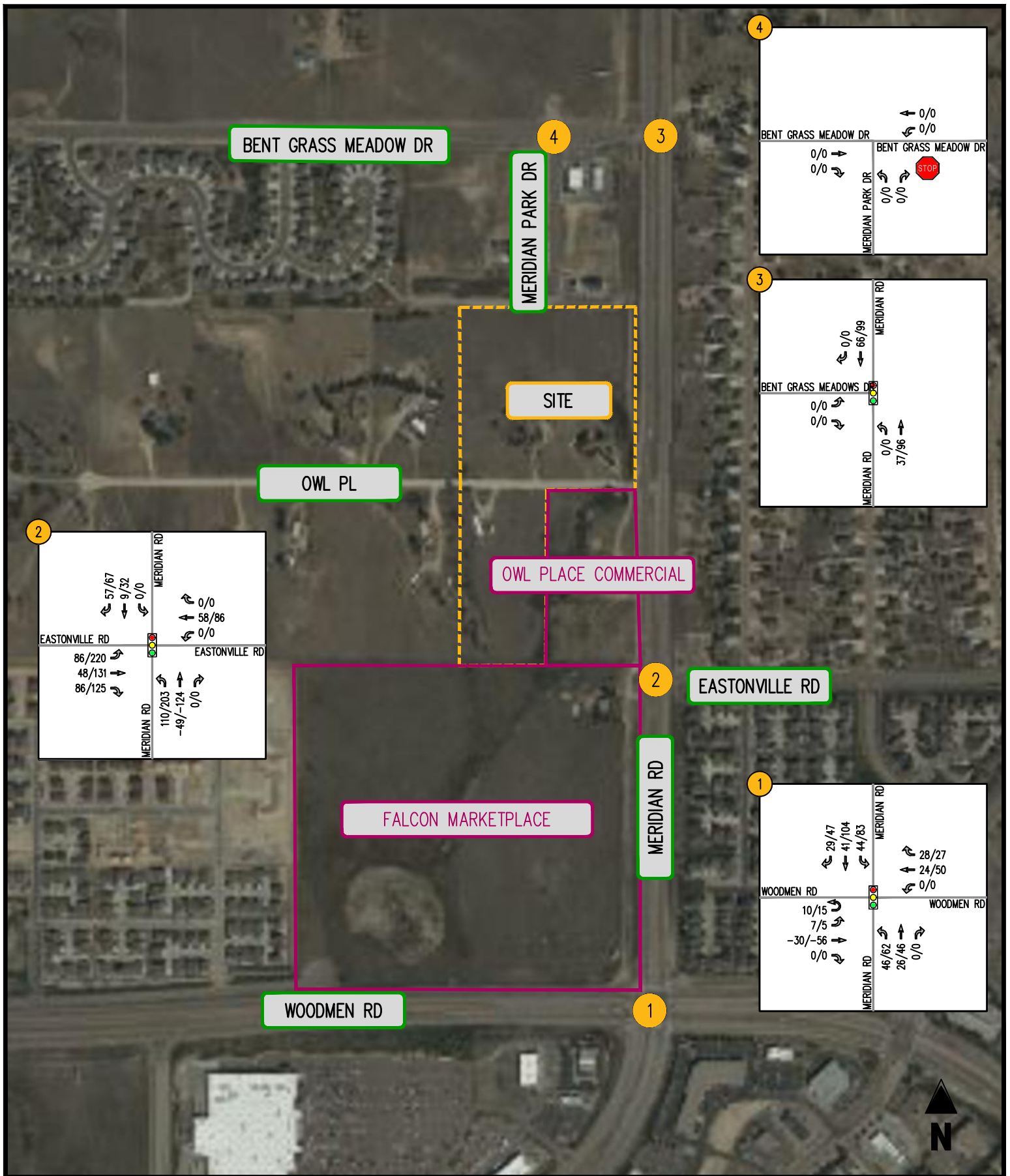


FIGURE 4-8
Pipeline Site Trips: Falcon Marketplace 2040

Meridian Storage
 El Paso County, CO

0000/0000 (AM PEAK HOUR/PM PEAK HOUR)

- MOVEMENT
- SIGNALIZED INTERSECTION
- STOP SIGN
- YIELD SIGN



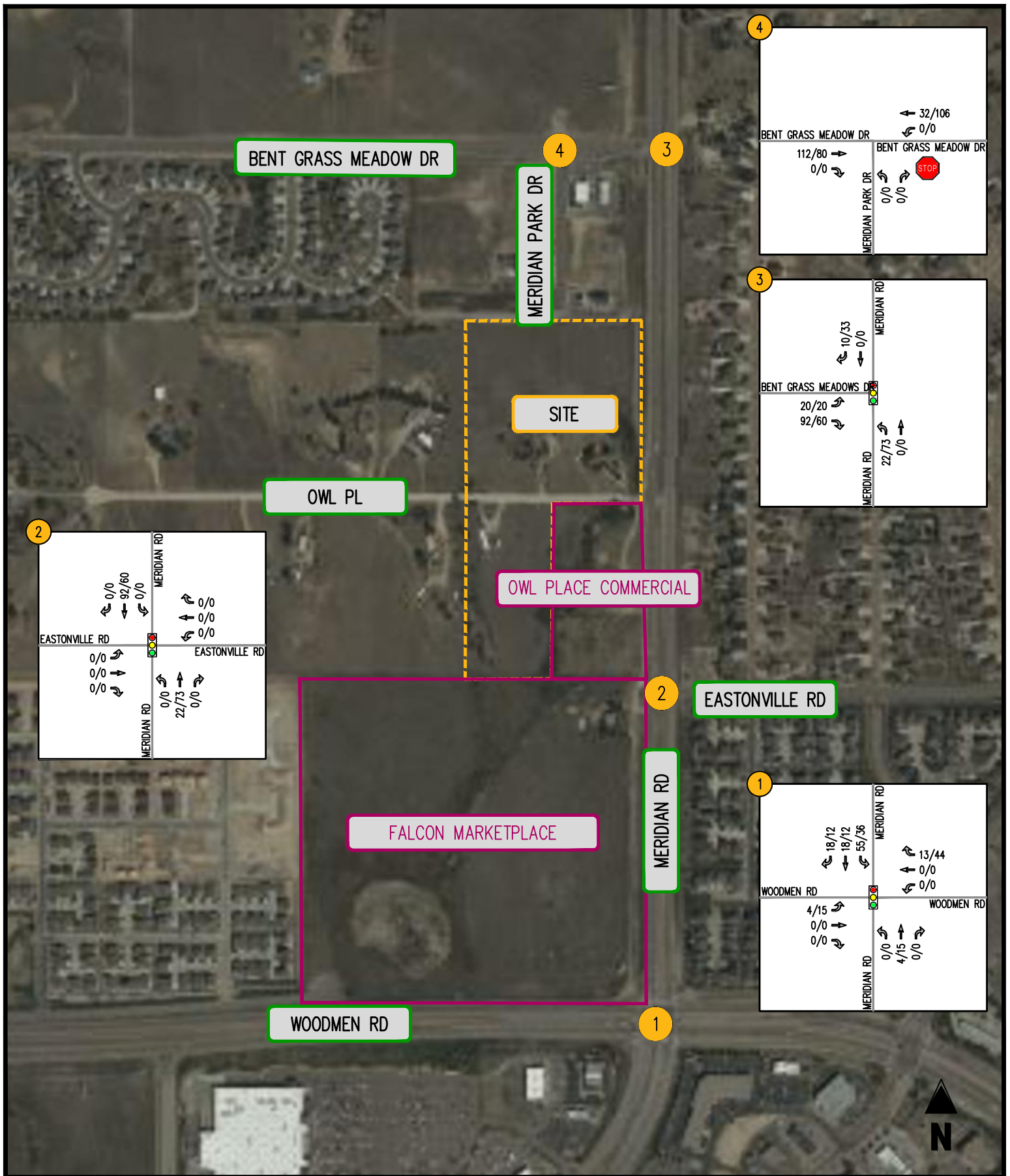


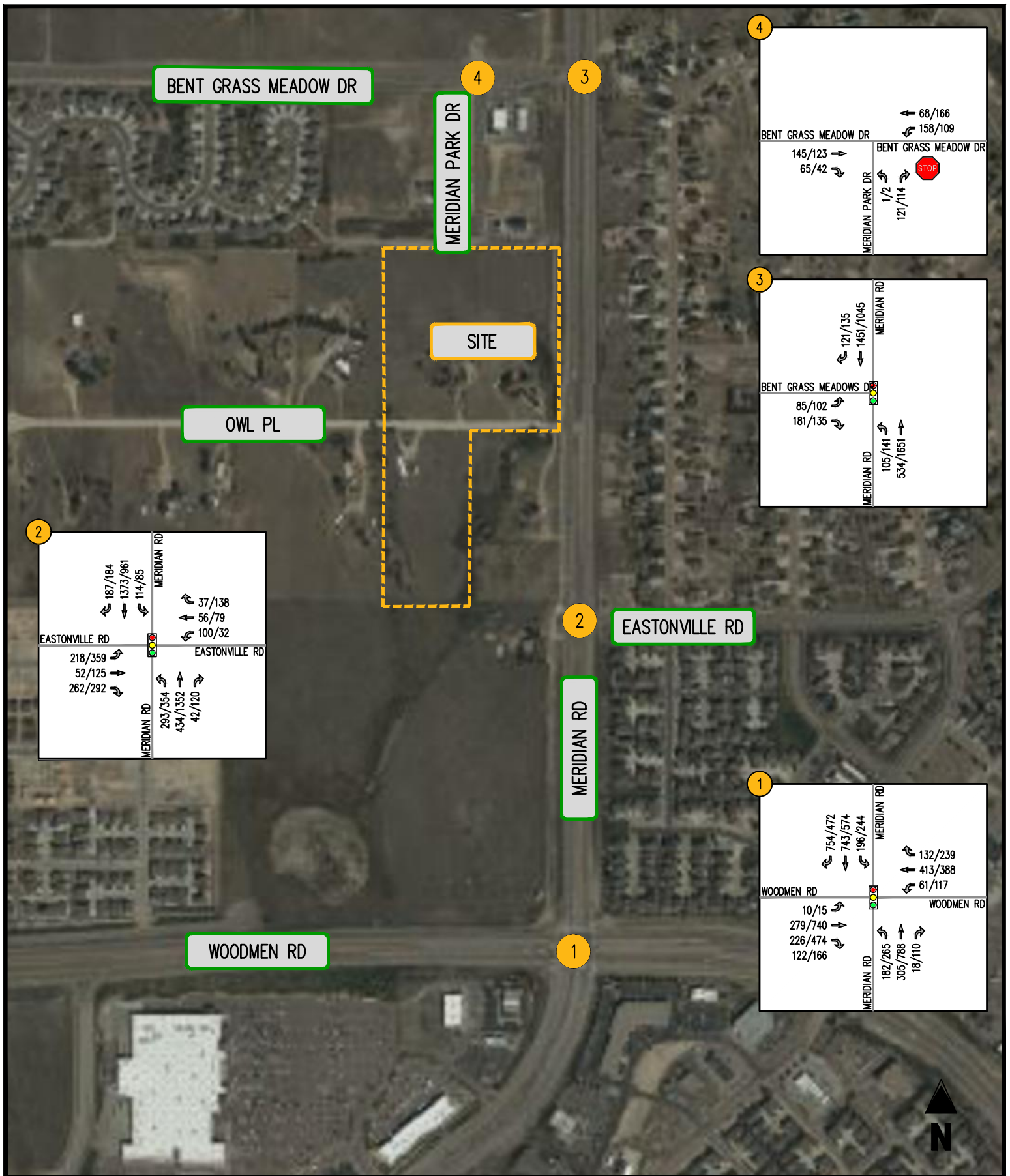
FIGURE 4-9
Pipeline Site Trips: Bent Grass Filing 4

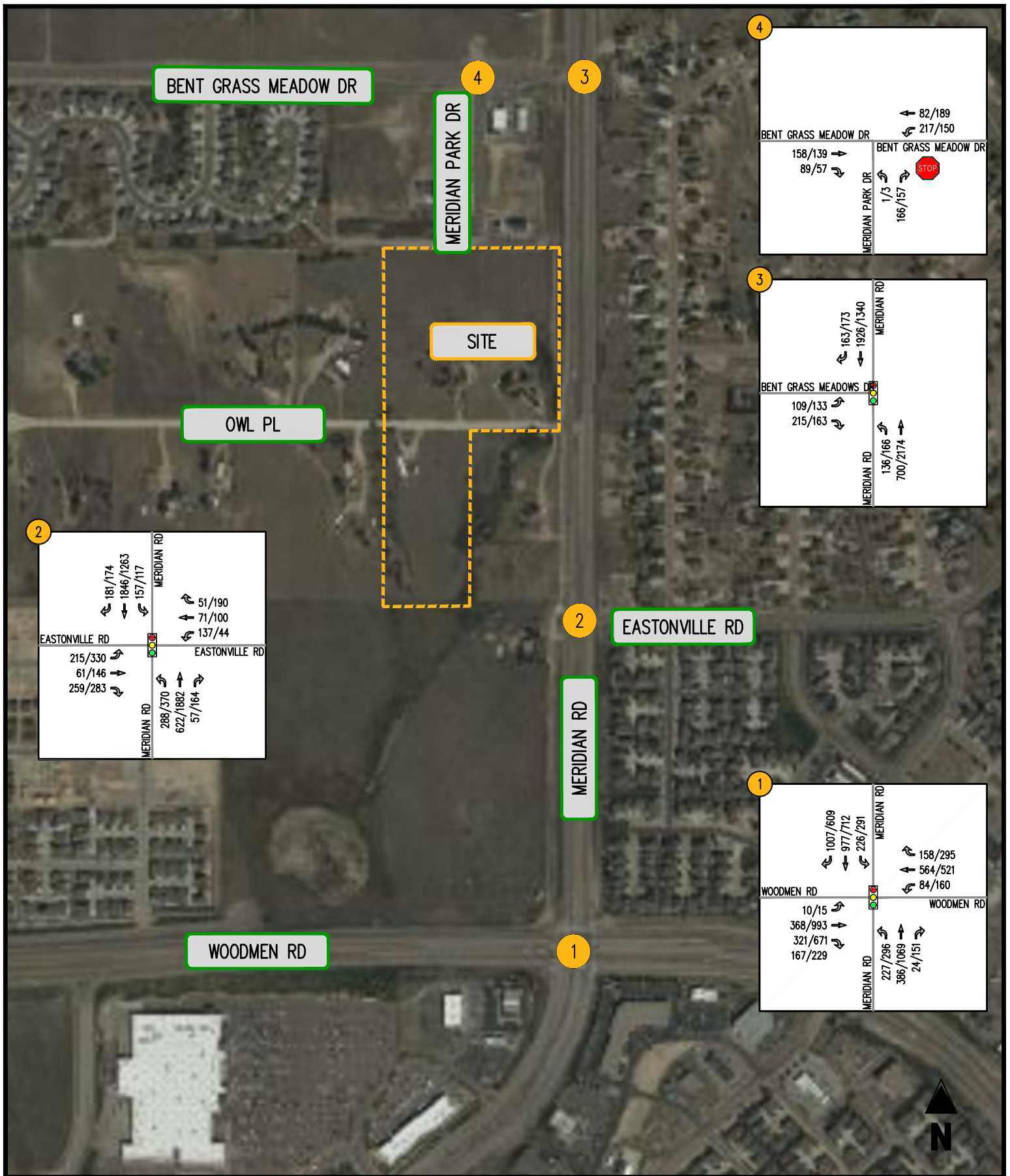
Meridian Storage
 El Paso County, CO

0000/0000 (AM PEAK HOUR/PM PEAK HOUR)

- MOVEMENT
- SIGNALIZED INTERSECTION
- STOP SIGN
- YIELD SIGN







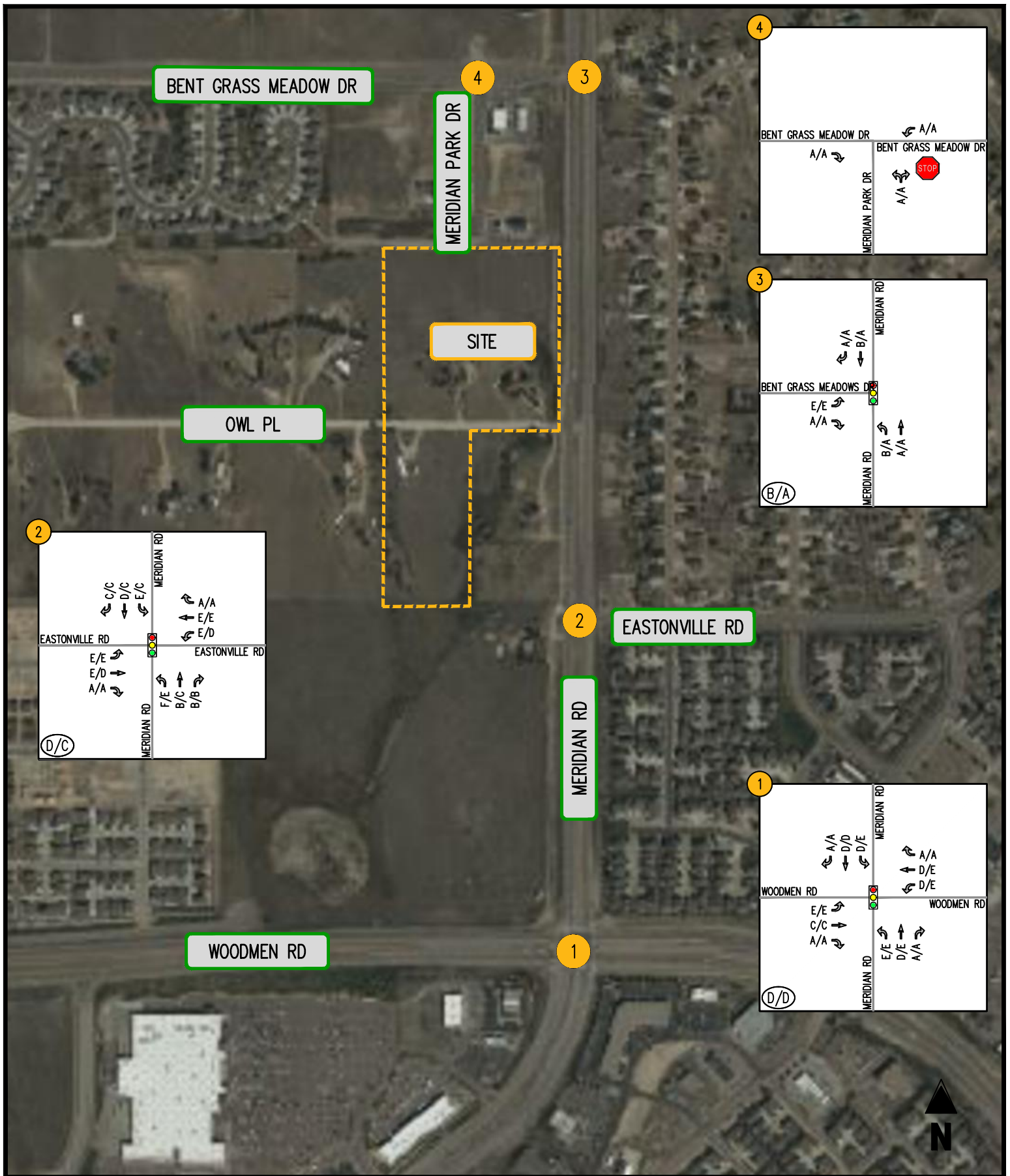


FIGURE 4-12
Background 2024 Levels of Service

Meridian Storage
El Paso County, CO

(A/A) INTERSECTION LOS
0000/0000 (AM PEAK HOUR/PM PEAK HOUR)

- MOVEMENT
- SIGNALIZED INTERSECTION
- STOP SIGN
- YIELD SIGN



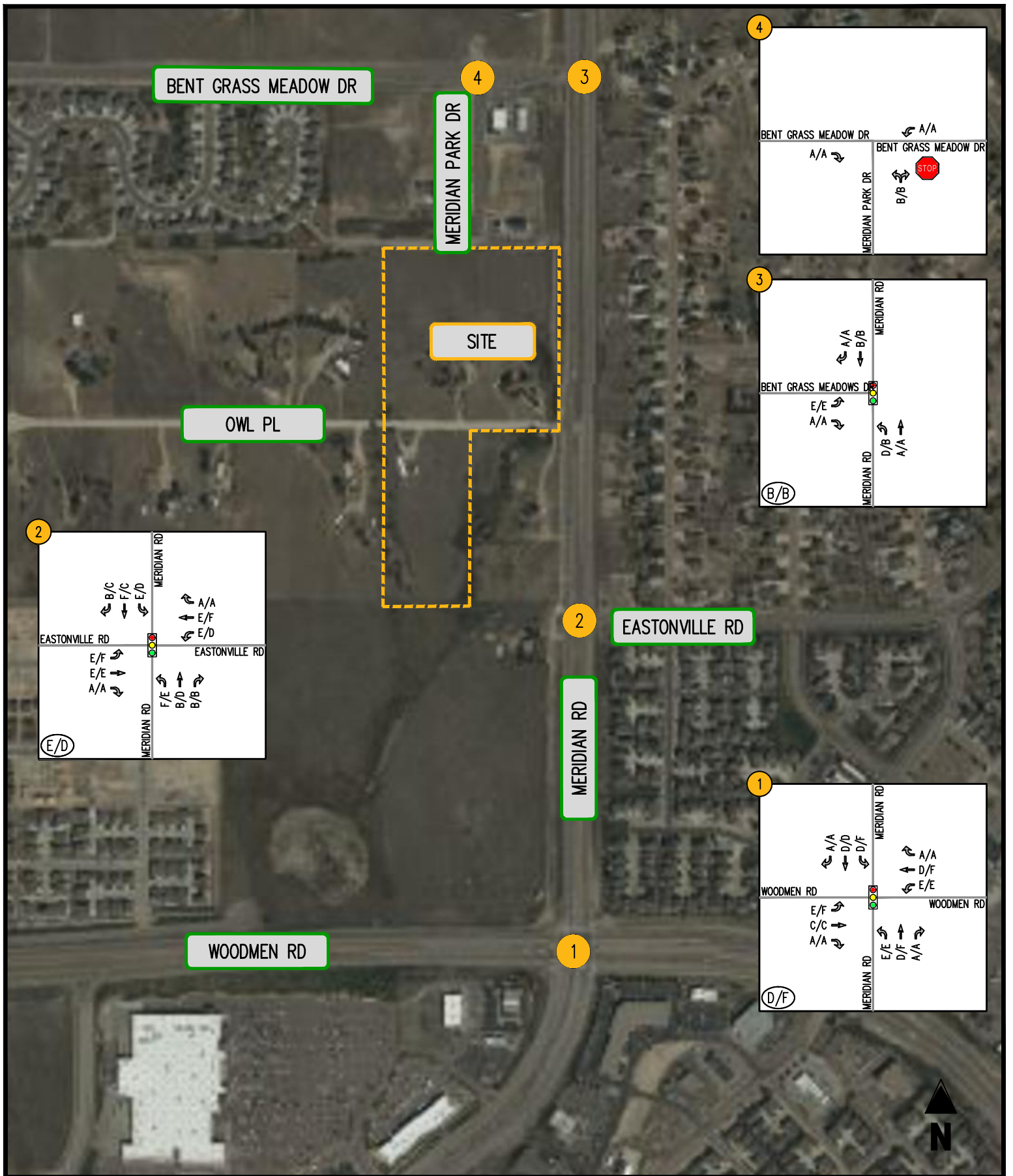


FIGURE 4-13
Background 2040 Levels of Service

Meridian Storage
 El Paso County, CO

(A/A) INTERSECTION LOS
 0000/0000 (AM PEAK HOUR/PM PEAK HOUR)

- ← MOVEMENT
- 🚦 SIGNALIZED INTERSECTION
- 🛑 STOP SIGN
- 🚧 YIELD SIGN



Table 4-1
 Meridian Storage
 Background Intersection Level of Service Summary (1) (2)

| Intersection | Operating Condition | Street Name | Approach/Movement | Existing 2023 | | Background 2024 | | Background 2040 | |
|--|---------------------|---------------------------------------|-------------------|----------------|----------------|-----------------|-----------------|-----------------|-----------------|
| | | | | AM Peak Hour | PM Peak Hour | AM Peak Hour | PM Peak Hour | AM Peak Hour | PM Peak Hour |
| 1 Woodmen Rd/Meridian Rd | SIGNAL | Woodmen Road | EBL | E (57.3) | E (57.6) | E (61.5) | E (60.7) | E (66.9) | F (159.1) |
| | | | EBT | D (38.6) | C (24.5) | C (33.1) | C (29.8) | C (35.0) | C (34.8) |
| | | | EBR | A (0.0) | A (0.0) | A (0.0) | A (0.0) | A (0.0) | A (0.0) |
| | | Woodmen Road | WBL | D (37.3) | E (60.1) | D (48.4) | E (60.6) | E (55.8) | E (60.1) |
| | | | WBT | C (28.8) | D (39.6) | D (36.2) | E (55.2) | D (53.4) | F (82.3) |
| | | | WBR | A (0.0) | A (0.0) | A (0.0) | A (0.0) | A (0.0) | A (0.0) |
| | | Meridian Road | NBL | E (60.5) | E (64.5) | E (60.3) | E (65.5) | E (69.3) | E (72.4) |
| | | | NBT | D (50.1) | D (52.1) | D (52.6) | E (58.6) | D (51.9) | F (138.9) |
| | | | NBR | A (0.0) | A (0.0) | A (0.0) | A (0.0) | A (0.0) | A (0.0) |
| | | Meridian Road | SBL | D (43.0) | E (61.0) | D (39.0) | E (73.9) | D (35.4) | F (145.3) |
| | | | SBT | D (50.0) | D (42.9) | D (49.6) | D (44.2) | D (54.0) | D (53.5) |
| | | | SBR | A (0.0) | A (0.0) | A (0.0) | A (0.0) | A (0.0) | A (0.0) |
| | | Overall | | | | D (45.5) | D (47.2) | D (47.4) | D (54.1) |
| 2 Meridian Rd/Eastonville Rd | STOP | Eastonville Road | WBL | F [186.2] | F [409.6] | N/A | N/A | N/A | N/A |
| | | | WBR | A [0.0] | A [0.0] | N/A | N/A | N/A | N/A |
| | | | NBT | A [0.0] | A [0.0] | N/A | N/A | N/A | N/A |
| | | Meridian Rd | NBR | A [0.0] | A [0.0] | N/A | N/A | N/A | N/A |
| | | | SBL | A [9.3] | C [17.4] | N/A | N/A | N/A | N/A |
| 2 Meridian Rd/Eastonville Rd 4-Legged Signalized | SIGNAL | Eastonville Road | EBL | N/A | N/A | E (57.9) | E (65.6) | E (56.0) | F (80.8) |
| | | | EBT | N/A | N/A | E (57.0) | D (54.5) | E (57.4) | E (76.7) |
| | | | EBR | N/A | N/A | A (0.0) | A (0.0) | A (0.0) | A (0.0) |
| | | Eastonville Road | WBL | N/A | N/A | E (55.2) | D (50.7) | E (71.1) | D (50.9) |
| | | | WBT | N/A | N/A | E (56.9) | E (60.7) | E (61.2) | F (82.0) |
| | | | WBR | N/A | N/A | A (0.0) | A (0.0) | A (0.0) | A (0.0) |
| | | Meridian Road | NBL | N/A | N/A | F (81.1) | E (62.5) | F (159.7) | E (63.3) |
| | | | NBT | N/A | N/A | B (14.4) | C (24.1) | B (16.9) | D (43.3) |
| | | | NBR | N/A | N/A | B (12.5) | B (13.5) | B (14.0) | B (13.3) |
| | | Meridian Road | SBL | N/A | N/A | E (67.4) | C (22.6) | E (65.0) | D (50.1) |
| | | | SBT | N/A | N/A | D (47.7) | C (27.6) | F (81.7) | C (34.1) |
| | | | SBR | N/A | N/A | C (22.5) | C (21.3) | C (21.8) | C (21.4) |
| | | Overall | | | | N/A | N/A | D (46.0) | C (34.5) |
| 3 Meridian Rd/Bent Grass Meadows Dr | SIGNAL | Bent Grass Meadows Drive | EBL | D (55.0) | E (56.1) | E (55.5) | E (56.2) | E (56.0) | E (57.2) |
| | | | EBR | A (0.0) | A (0.0) | A (0.0) | A (0.0) | A (0.0) | A (0.0) |
| | | Meridian Road | NBL | A (8.2) | A (4.8) | B (13.4) | A (6.7) | D (42.3) | B (12.2) |
| | | | NBT | A (2.5) | A (4.4) | A (2.7) | A (5.2) | A (3.0) | A (8.5) |
| | | Meridian Road | SBT | A (9.9) | A (7.5) | B (11.5) | A (8.6) | B (15.9) | B (10.4) |
| | | | SBR | A (5.9) | A (5.9) | A (6.2) | A (6.3) | A (6.5) | A (6.7) |
| Overall | | | | A (9.4) | A (7.8) | B (11.0) | A (8.4) | B (15.0) | B (10.9) |
| 4 Bent Grass Meadows Dr/Meridian Park Dr | STOP | Bent Grass Meadows Drive | EBR | A [0.0] | A [0.0] | A [0.0] | A [0.0] | A [0.0] | A [0.0] |
| | | | WBL | A [7.8] | A [7.6] | A [8.2] | A [7.9] | A [8.3] | A [8.0] |
| | | Meridian Park Drive | NBLR | A [9.1] | A [9.1] | A [10.0] | A [9.8] | B [10.2] | B [10.1] |
| 5 Meridain Rd & Owl Pl | STOP | Owl Pl | EBR | C [16.2] | B [12.5] | N/A | N/A | N/A | N/A |
| | | Meridian Road | NBL | B [14.0] | B [10.7] | N/A | N/A | N/A | N/A |
| | | Meridian Road | SBTR | A [0.0] | A [0.0] | N/A | N/A | N/A | N/A |
| Street Name | | | | Existing 2023 | | Background 2024 | | Background 2040 | |
| | | | | ADT | ADT Capacity | ADT | LOS | AM | PM |
| El Paso County Roadway ADT Threshold Capacity Principal Arterial (4-Lane) | | Meridian Rd (S.O. Bent Grass Meadows) | | 24,989 | 40,000 | 30,958 | 40,000 | 40,030 | 40,000 |
| | | Meridian Rd (N.O. Woodman Rd) | | 24,416 | 40,000 | 32,405 | 40,000 | 41,728 | 40,000 |
| Meridian Rd Signal Progression Arterial Band (Seconds Per Cycle) | | | | NB | PM | AM | PM | AM | PM |
| | | | | SB | | 22 | 32 | 0 | 31 |
| | | | | 30 | 37 | 1 | 0 | 1 | 0 |

Notes (1) Numbers in brackets [] represent delay at unsignalized intersections in seconds per vehicle.
 (2) Numbers in parenthesis () represent delay at signalized intersections in seconds per vehicle.

Table 4-2
Meridian Storage
Background Intersection Queueing Summary (1)

| Intersection | Operating Condition | Street Name | Approach/ Movement | Available Storage | Existing 2023 | | Background 2024 | | Background 2040 | |
|---|---------------------|--------------------------|--------------------|-------------------|---------------|--------------|-----------------|--------------|-----------------|--------------|
| | | | | | AM Peak Hour | PM Peak Hour | AM Peak Hour | PM Peak Hour | AM Peak Hour | PM Peak Hour |
| 1 Woodmen Rd/Meridian Rd | SIGNAL | Woodmen Road | EBL | 500 | 141 | 347 | 170 | 436 | 236 | 662 |
| | | | EBT | - | 130 | 240 | 112 | 215 | 152 | 315 |
| | | | EBR | 630 | 0 | 0 | 0 | 0 | 0 | 0 |
| | | Woodmen Road | WBL | 350 | 44 | 77 | 49 | 81 | 62 | 102 |
| | | | WBT | - | 197 | 193 | 221 | 237 | 300 | 341 |
| | | | WBR | 250 | 0 | 0 | 0 | 86 | 0 | 142 |
| | | Meridian Road | NBL | 440 | 84 | 106 | 111 | 156 | 157 | 203 |
| | | | NBT | - | 129 | 338 | 167 | 442 | 203 | 688 |
| | | | NBR | 330 | 0 | 0 | 0 | 0 | 0 | 0 |
| | | Meridian Road | SBL | 490 | 34 | 67 | 85 | 160 | 90 | 173 |
| | | | SBT | - | 225 | 188 | 345 | 310 | 423 | 352 |
| | | | SBR | 450 | 6 | 0 | 29 | 0 | 61 | 0 |
| 2 Meridian Rd/Eastonville Rd | STOP | Eastonville Road | WBL | 120 | 165 | 92.5 | N/A | N/A | N/A | N/A |
| | | | WBR | - | 0 | 0 | N/A | N/A | N/A | N/A |
| | | Meridian Rd | NBR | 400 | 0 | 0 | N/A | N/A | N/A | N/A |
| | | | SBL | 375 | 10 | 22.5 | N/A | N/A | N/A | N/A |
| 2 Meridian Rd/Eastonville Rd 4-Legged Signalized | SIGNAL | Eastonville Road | EBL | 145 | N/A | N/A | 147 | 177 | 144 | 174 |
| | | | EBT | - | N/A | N/A | 86 | 167 | 96 | 254 |
| | | | EBR | 115 | N/A | N/A | 138 | 104 | 133 | 167 |
| | | Eastonville Road | WBL | 120 | N/A | N/A | 136 | 46 | 225 | 64 |
| | | | WBT | - | N/A | N/A | 91 | 111 | 116 | 179 |
| | | | WBR | 100 | N/A | N/A | 0 | 30 | 0 | 29 |
| | | Meridian Road | NBL | 490 | N/A | N/A | 420 | 396 | 431 | 234 |
| | | | NBT | - | N/A | N/A | 135 | 600 | 184 | 175 |
| | | | NBR | 400 | N/A | N/A | 5 | 5 | 10 | 3 |
| | | Meridian Road | SBL | 375 | N/A | N/A | 137 | 67 | 127 | 128 |
| | | | SBT | - | N/A | N/A | 800 | 509 | 1066 | 643 |
| | | | SBR | 320 | N/A | N/A | 28 | 110 | 13 | 75 |
| 3 Meridian Rd/Bent Grass Meadows Dr | SIGNAL | Bent Grass Meadows Drive | EBL | 150 | 48 | 55 | 59 | 71 | 70 | 85 |
| | | | EBR | - | 47 | 19 | 87 | 54 | 198 | 66 |
| | | Meridian Road | NBL | 700 | 25 | 6 | 80 | 26 | 175 | 40 |
| | | | NBT | - | 10 | 249 | 112 | 167 | 155 | 139 |
| | | Meridian Road | SBT | - | 386 | 201 | 617 | 291 | 951 | 491 |
| | | | SBR | 350 | 20 | 20 | 27 | 24 | 27 | 32 |
| 4 Bent Grass Meadows Dr/Meridian Park Dr | STOP | Bent Grass Meadows Drive | EBR | 150 | 0 | 0 | 0 | 0 | 0 | 0 |
| | | | WBL | 100 | 10 | 7.5 | 12.5 | 7.5 | 15 | 10 |
| | | Meridian Park Drive | NBLR | - | 12.5 | 12.5 | 15 | 12.5 | 20 | 17.5 |
| 5 Meridain Rd & Owl Pl | STOP | Owl Pl | EBR | - | 2.5 | 2.5 | N/A | N/A | N/A | N/A |
| | | Meridian Road | NBL | 270 | 0 | 2.5 | N/A | N/A | N/A | N/A |
| | | Meridian Road | SBTR | - | 0 | 0 | N/A | N/A | N/A | N/A |

Note: (1) Queue length is based on the 95th percentile queue as reported by Synchro, Version 11.

V. Site Analysis

Overview

The Applicant proposes to construct a development consisting of 158 self-storage units and 96 RV/Boat storage spaces. Since the site is currently zoned as Residential Rural and is being rezoned to Commercial Service, El Paso County has requested that this study also analyze the highest trip generating development that would be allowed on the proposed zoning. It was determined that a shopping plaza would be the highest realistic trip generator. Typically, this type of development is allowed to occupy 20% of a site's square footage. Since the site is 15.3 acres, it would allow for a 133,294 SF shopping plaza.

Proposed Site Access

Upon completion, the proposed site will have two full movement accesses. One access will be located along Owl Pl. Meridian Park Dr will be extended to the south, where it will provide a second access to the site. The site plan shows two access points to the southern parcel, however, this parcel is not expected to be developed with this project. The self-storage will be entirely contained by the northern two parcels. A detailed site plan has been included in Appendix A.

Trip Generation

Trip generation estimates for the weekday AM and PM peak hours, as well as the weekday average daily traffic (ADT), were derived from the standard Institute of Transportation Engineers (ITE) Trip Generation Manual rates/equations, as published in the 11th edition.

Site Trips

The site trips for both the proposed development (Mini-Warehouse) and the maximum trip generator (Shopping Plaza) are shown in Table 5-1. As shown in Table 5-1, the proposed development will generate 3 vph in the AM peak hour, 4 vph in the PM peak hour, and 46 daily weekday trips. The maximum trip generator will generate 471 vph in the AM peak hour, 1,141 vph in the PM peak hour, and 11,671 daily weekday trips.

Site Trip Distributions

The distribution of the generated trips was based on an examination of existing traffic counts as well as the development's location relative to nearby population centers and major roads. The following trip distribution was used for the site generated trips:

- To/from the north on Meridian Rd: 20%
- To/from the south on Meridian Rd: 20%
- To/from the east on Woodman Rd: 15%
- To/from the west on Woodman Rd: 45%

The site trips were distributed through the study area based on the distribution above. The trip distribution for the proposed warehouse is shown in Figure 5-1. The trip distribution for the maximum trip generator (shopping plaza) is shown in Figure 5-2. While the site trips will use Meridian Park Dr to enter and exit the site, since the number of site trips are so low, Meridian Park Dr will remain classified as a local road.

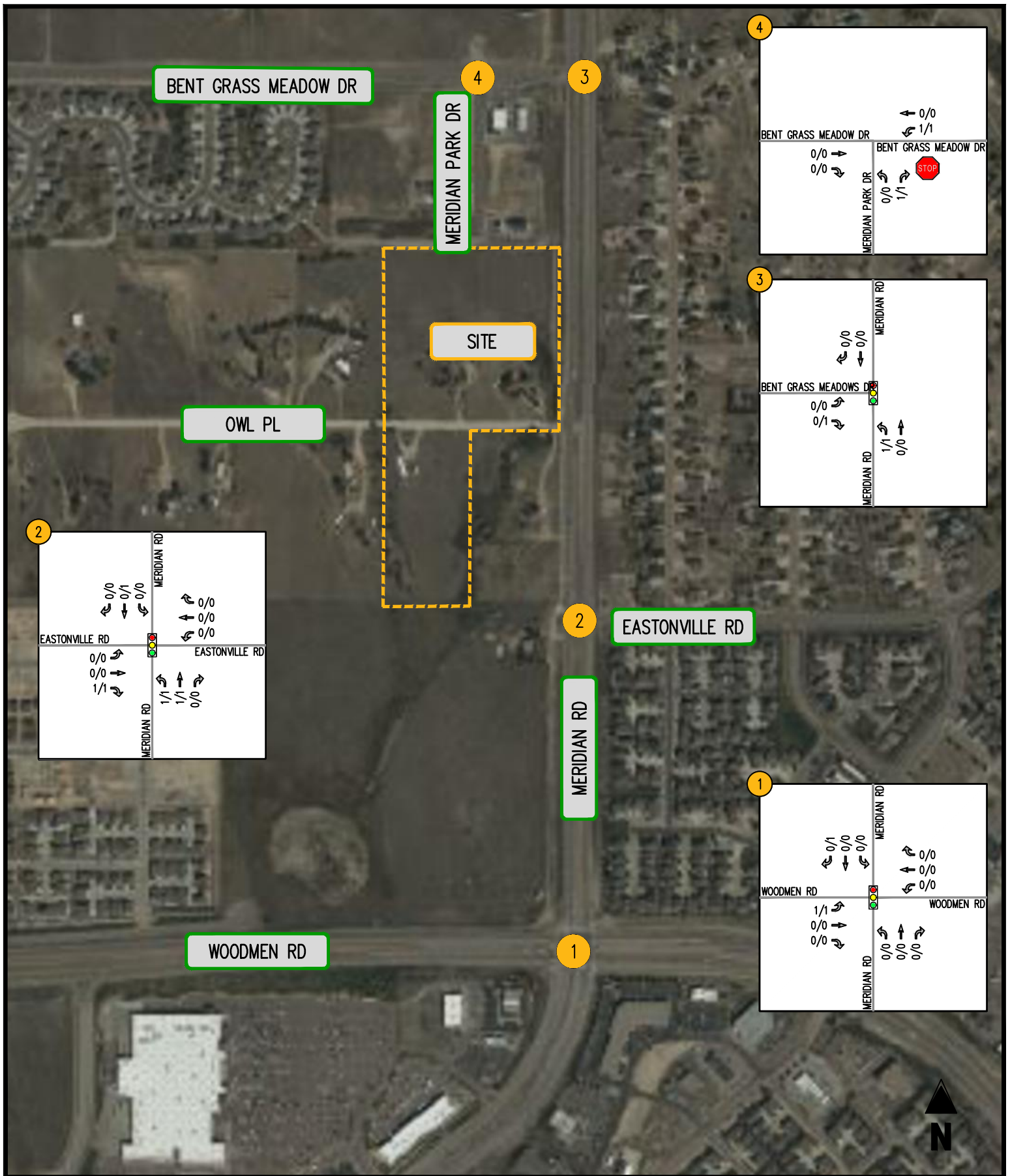


FIGURE 5-1
Site Trips Warehouse

Meridian Storage
 El Paso County, CO

0000/0000 (AM PEAK HOUR/PM PEAK HOUR)

- MOVEMENT
- SIGNALIZED INTERSECTION
- STOP SIGN
- YIELD SIGN



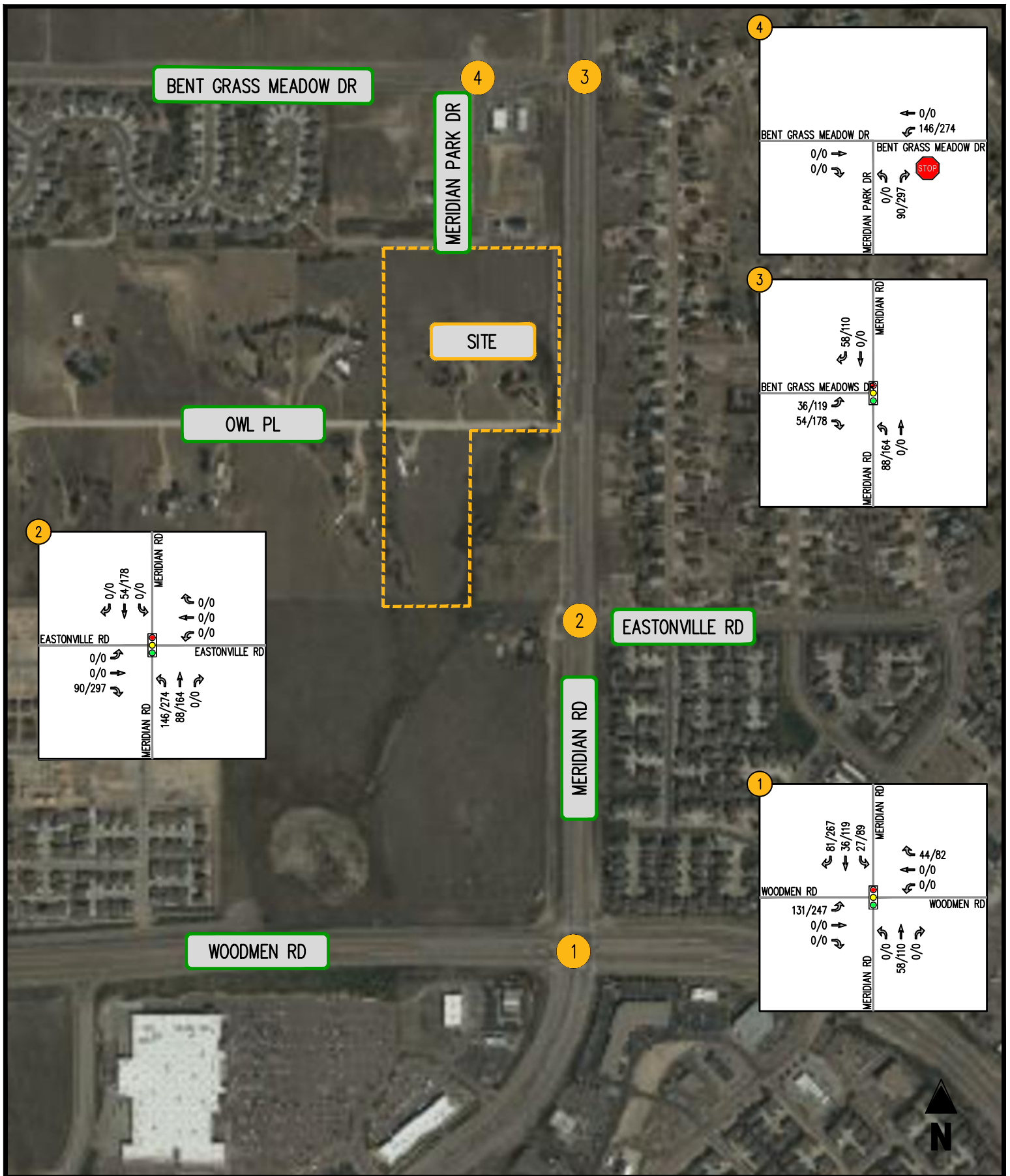


FIGURE 5-2
Site Trips Shopping Center

Meridian Storage
El Paso County, CO

0000/0000 (AM PEAK HOUR/PM PEAK HOUR)

← MOVEMENT

🚦 SIGNALIZED INTERSECTION

🛑 STOP SIGN

🚧 YIELD SIGN



Table 5-1

Meridian Storage
 Site Trip Generation

| Land Use | Use Code | Amount | Units | AM Peak Hour | | | PM Peak Hour | | | Average Daily Trips |
|--|------------|----------------|--------------|--------------|------------|------------|--------------|------------|--------------|---------------------|
| | | | | In | Out | Total | In | Out | Total | |
| Proposed Development (Mini-Warehouse) | 151 | 254 | Units | 2 | 1 | 3 | 2 | 2 | 4 | 46 |
| Maximum Trip Generator (Shopping Plaza 40-150K) | 821 | 133,294 | SF | 292 | 179 | 471 | 548 | 593 | 1,141 | 11,671 |

Note(s):
 (1) Trip generation based on the Institute of Transportation Engineers' Trip Generation Manual, 11th Edition

VI. Analysis of Total 2024 & 2040 Conditions (Proposed Development)

Total 2024 & 2040 Traffic Forecasts

The 2024 total traffic forecasts, shown in Figure 6-1, were developed by combining the background 2024 forecasts (Figure 4-10) and the proposed development site trip assignments (Figure 5-1). The 2040 total traffic forecasts, shown in Figure 6-2, were developed by combining the background 2040 forecasts (Figure 4-11) and the proposed development site trip assignments (Figure 5-1).

Total 2024 & 2040 Levels of Service

Capacity analyses of the total scenarios are provided in Appendix G. The total 2024 forecasted levels of service are shown in Table 6-1 and depicted graphically in Figure 6-3. The total 2040 forecasted levels of service are shown in Table 6-1 and depicted graphically in Figure 6-4. The Synchro models were updated with the total volumes. Per the El Paso County Transportation Impact Study Guidelines, the peak hour factors (PHF) were calculated or set to 0.95, whichever was higher. The signal splits were optimized, and the cycle lengths and offsets were kept the same as in the existing conditions. Using the Time Space Diagram analysis in Synchro, a progression analysis was conducted along Meridian Rd. A detailed results report is presented in Appendix G and is summarized in Table 6-1. The Synchro printouts are included in Appendix G.

Since the proposed development will only generate three vehicles in the AM peak hour and four vehicles in the PM peak hour, the traffic operations remain almost identical to the background scenarios. The signalized intersection of Woodmen Rd & Meridian Rd operates at LOS D during both peak hours in the 2024 total scenarios and at LOS F in the 2040 PM peak total scenario, as it does in the background scenarios. Many of the movements are reported to exceed capacity by the 2040 PM peak, with the EBL exceeding capacity the most severely. There will be 994 eastbound left turns served by dual left turn lanes. In order for this movement to operate acceptably, triple left turn lanes would likely be necessary. The signal at Meridian Rd & Eastonville Rd operates at LOS D or better in 2024 and operates at LOS E in the total 2040 AM peak hour. The signalized intersection of Meridian Rd & Bent Grass Meadows Dr operates at LOS B or better during the total scenarios, as does the stop-controlled intersection of Bent Grass Meadows Dr & Meridian Park Dr. It should be noted that all of these results are consistent with the results reported in the background scenarios. There are no intersections in the study area that operate acceptably in the background scenario and unacceptably in the total scenarios. As such, it is the responsibility of the county to provide roadway improvements to mitigate the failing traffic operations.

The El Paso County Roadway ADT Threshold Capacities were reviewed for a 4-lane principal arterial to ensure that Meridian Rd is operating under capacity in the total scenarios, in which the proposed development has been constructed. The results are reported in Table 6-1. The 46 daily trips that will be generated by the proposed development were distributed through the network and were added to the background ADT forecasts. Consistent with the background scenarios, it was reported that Meridian Rd will operate below the capacity threshold in the total 2024 scenario and over capacity in the total 2040 scenario. As discussed in the background scenario, Meridian Rd will likely need to be widened to 6-lanes by 2040 in order to achieve acceptable operations at the signals along the highway.

The signal progression analysis along Meridian Rd was conducted using the Synchro time space diagrams and the results are reported in Table 6-1 with the Synchro printouts included in Appendix G. The cycle length was held at 120 seconds for all three signals. In the total 2025 scenario, the NB

bandwidth between the signalized intersection of Woodmen Rd & Meridian Rd is 0 seconds in the AM and 32 seconds in the PM while the SB bandwidth is 1 seconds in the AM and 0 seconds in the PM. It was found for the total 2040 scenario that the NB bandwidth is 0 seconds in the AM and 39 seconds in the PM between the signals of Woodmen Rd & Meridian Rd while the SB bandwidth is 1 seconds in the AM and 0 seconds in the PM. This poor progression is to be expected due to unacceptable delays at the signalized intersections and the fact that Meridian Rd will exceed capacity by 2040. It is expected that if Meridian Rd were to be widened to 6-lanes, progression could be improved between signals.

Total 2024 & 2040 Intersection Queues

The 95% queue lengths were reported for each movement within the study area using the Synchro queuing reports. The results are summarized in Table 6-2. The movements highlighted in yellow indicate that the queue exceeds its respective storage length or extends past the adjacent storage, possibly blocking vehicles trying to enter an adjacent turn lane. Queues highlighted in orange exceed capacity indicate that the movement exceeds capacity, and the queues highlighted in red exceed capacity and extend past the adjacent storage or their own storage.

As can be seen in table, the total queues are very similar to the background queues, with the same movements anticipated to exceed their respective storage lengths. Many of the queues at the intersection of Meridian Rd & Eastonville Rd will exceed their respective storage lengths.

In the total 2024 scenario, the NBT queue at Woodmen Rd & Meridian Rd extends 455' in the PM peak hour, while the adjacent NBR storage is only 330'. This could potentially block vehicles trying to enter the NBR turn lane. The SBT queue at Meridian Rd & Bent Grass Meadows Dr extends 604' in the AM peak hour, while the adjacent SBR storage is only 350'. Since this movement is under capacity, even though it may block the SBR storage, it will likely clear each cycle.

The queues in the total 2040 scenario have increased, with many of the PM queues at Woodmen Rd & Meridian Rd expected to exceed their respective storage lengths or the adjacent storage lengths. As previously discussed, this intersection will exceed capacity in the 2040 scenario. The SBT queue at Meridian Rd & Bent Grass Meadows Dr extends 975' in the AM peak hour and 495' in the PM peak hour, while the adjacent SBR storage is only 350'. Since this movement is under capacity, even though it may block the SBR storage, it will likely clear each cycle.

Total 2024 & 2040 Recommended Mitigation

There is no intersection or movement reported to operate acceptably in the background scenarios and unacceptable during the total scenarios. This is to be expected as the proposed development only generates 3 AM peak hour trips and 4 PM peak hour trips. As such, it is the responsibility of the El Paso County rather than the developer to provide mitigation solutions. Refer to the "Recommended Mitigation" part of Section IV for the list of recommended measures to ensure acceptable traffic operations through year 2040.

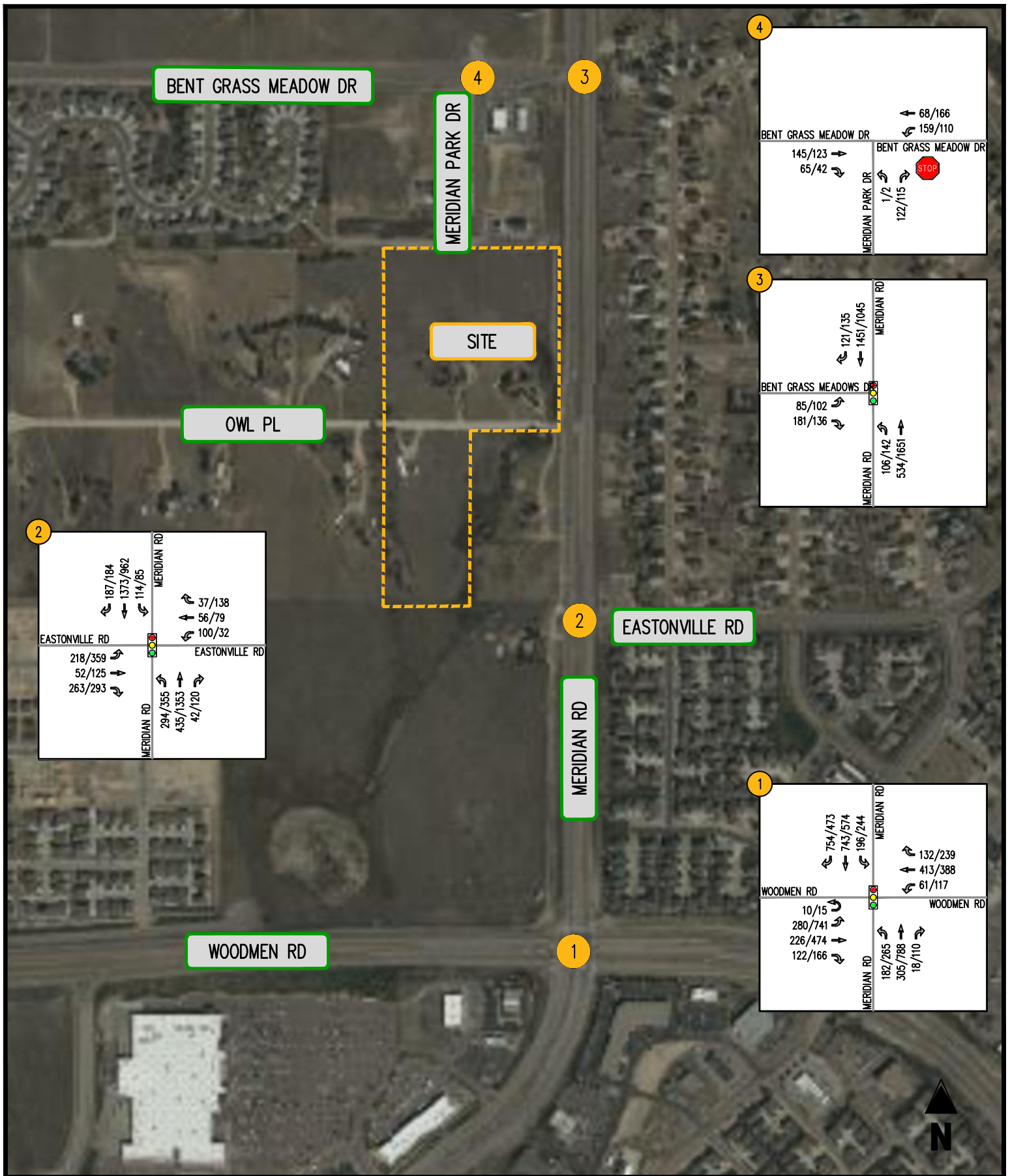


FIGURE 6-1
Total Future 2024 Forecasts Warehouse

Meridian Storage
 El Paso County, CO

0000/0000 (AM PEAK HOUR/PM PEAK HOUR)

- ← MOVEMENT
- 🚦 SIGNALIZED INTERSECTION
- 🛑 STOP SIGN
- 🚧 YIELD SIGN



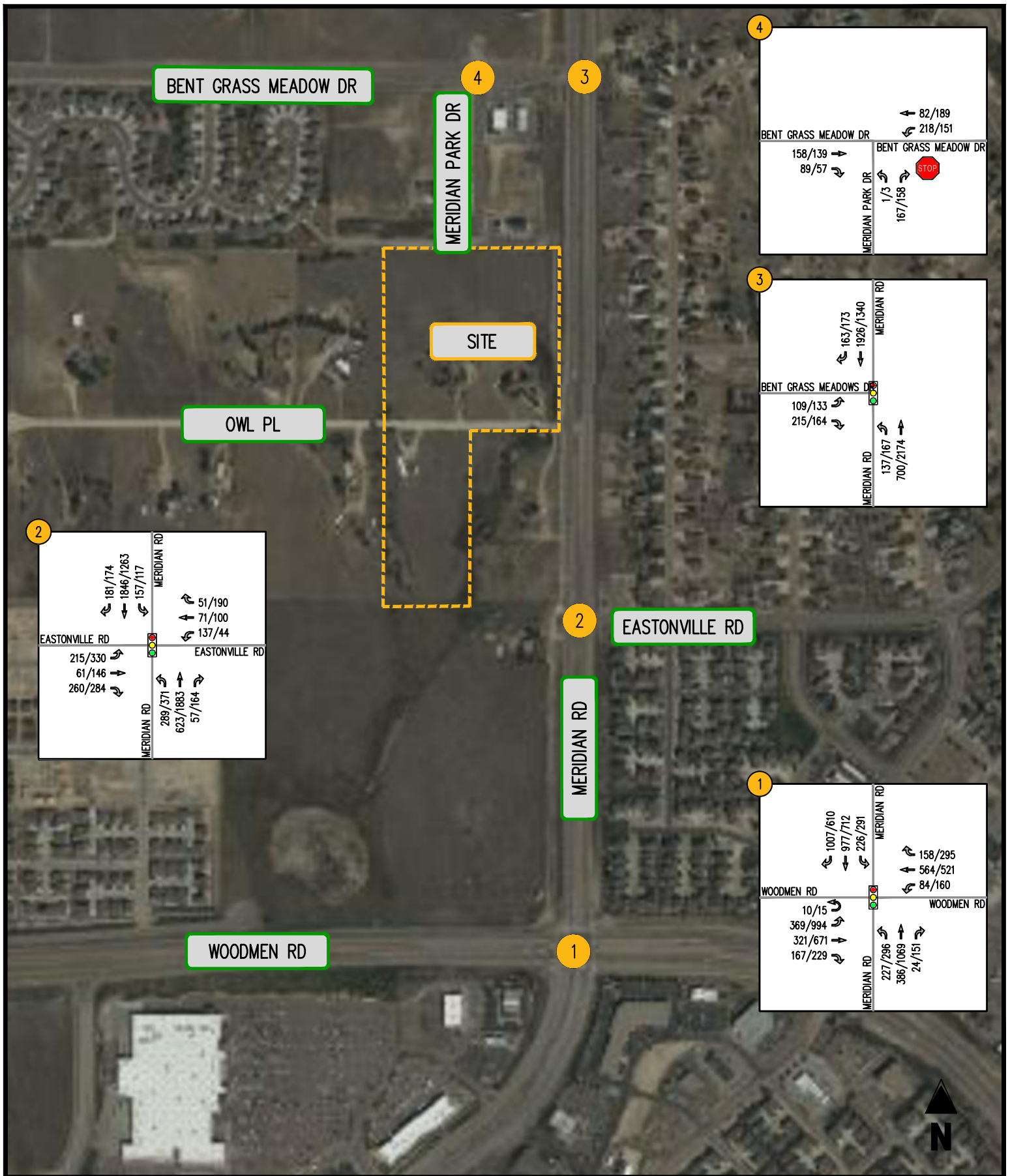


FIGURE 6-2
Total Future 2040 Forecasts Warehouse

Meridian Storage
 El Paso County, CO

0000/0000 (AM PEAK HOUR/PM PEAK HOUR)

- MOVEMENT
- SIGNALIZED INTERSECTION
- STOP SIGN
- YIELD SIGN



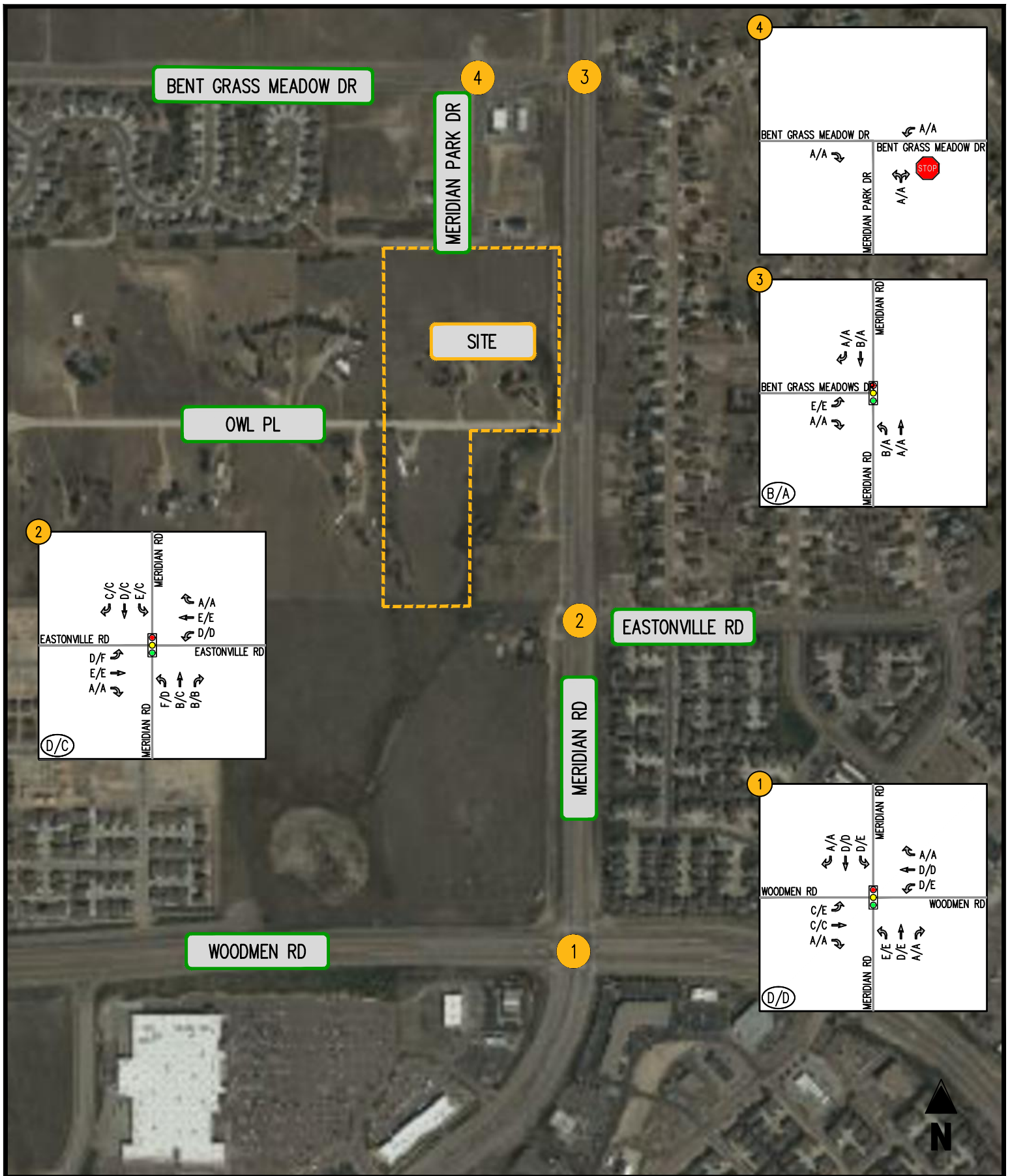


FIGURE 6-3
Total Future 2024 Levels of Service Warehouse

Meridian Storage
 El Paso County, CO

(A/A) INTERSECTION LOS
 0000/0000 (AM PEAK HOUR/PM PEAK HOUR)

- ← MOVEMENT
- 🚦 SIGNALIZED INTERSECTION
- 🛑 STOP SIGN
- 🚧 YIELD SIGN



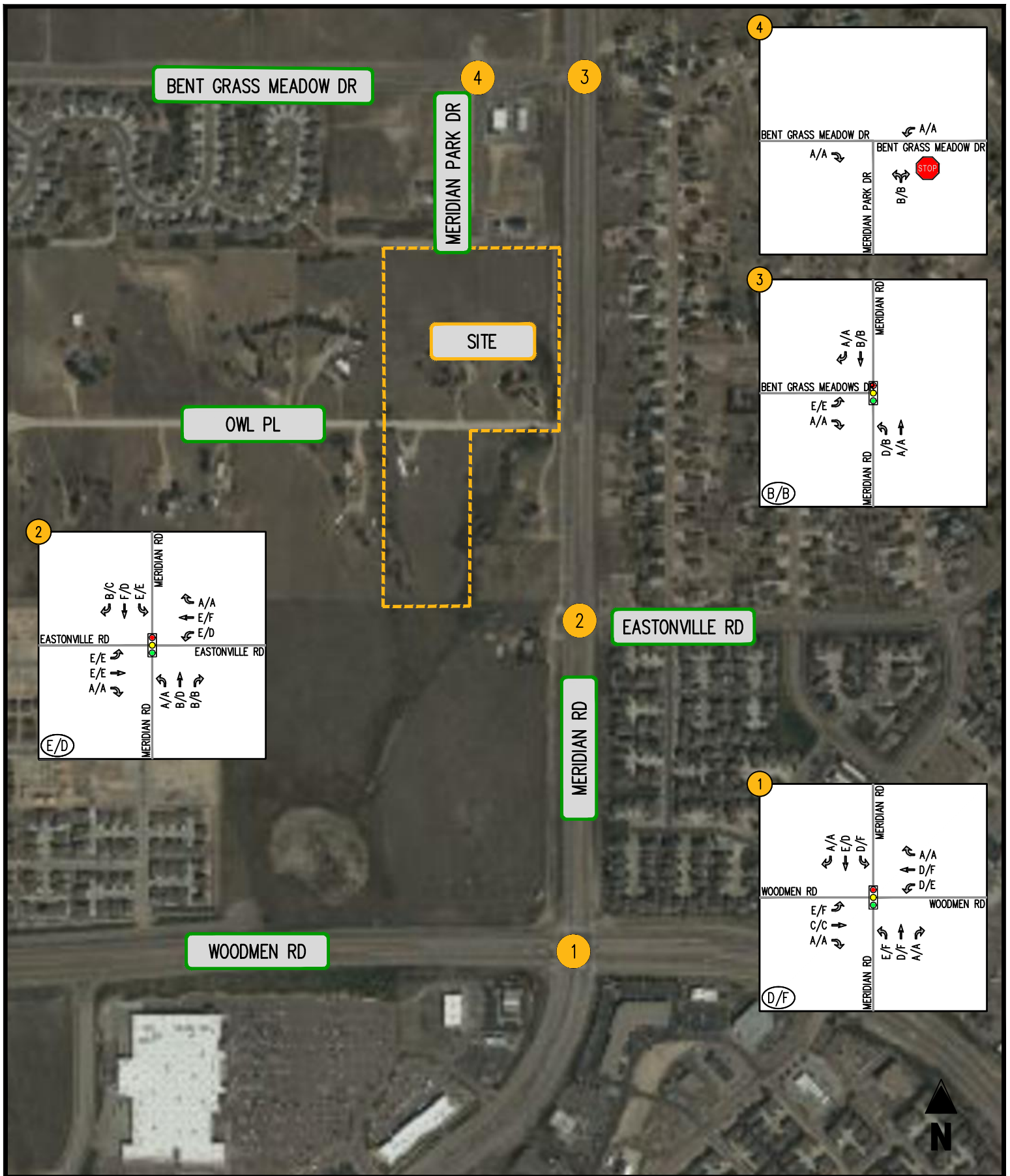


FIGURE 6-4
Total Future 2040 Levels of Service Warehouse

Meridian Storage
 El Paso County, CO

(A/A) INTERSECTION LOS
 0000/0000 (AM PEAK HOUR/PM PEAK HOUR)

- ← MOVEMENT
- 🚦 SIGNALIZED INTERSECTION
- 🛑 STOP SIGN
- 🚧 YIELD SIGN



Table 6-1
 Meridian Storage
 Total Intersection Level of Service Summary (1) (2)

| Intersection | Operating Condition | Street Name | Approach/Movement | Background 2024 | | Background 2040 | | Total Future 2024 Warehouse | | Total Future 2040 Warehouse | | |
|--|---------------------|---|-------------------|---------------------------------------|-----------------|------------------------|-----------------|------------------------------------|-----------------|------------------------------------|-----------------|------------------|
| | | | | AM Peak Hour | PM Peak Hour | AM Peak Hour | PM Peak Hour | AM Peak Hour | PM Peak Hour | AM Peak Hour | PM Peak Hour | |
| 1 Woodmen Rd/Meridian Rd | SIGNAL | Woodmen Road | EBL | E (61.5) | E (60.7) | E (66.9) | F (159.1) | C (31.6) | E (60.7) | E (67.0) | F (142.0) | |
| | | | EBT | C (33.1) | C (29.8) | C (35.0) | C (34.8) | C (32.3) | C (29.5) | C (34.1) | C (34.8) | |
| | | | EBR | A (0.0) | A (0.0) | A (0.0) | A (0.0) | A (0.0) | A (0.0) | A (0.0) | A (0.0) | |
| | | Woodmen Road | WBL | D (48.4) | E (60.6) | E (55.8) | E (60.1) | D (49.3) | E (60.6) | D (47.3) | E (60.1) | |
| | | | WBT | D (36.2) | E (55.2) | D (53.4) | F (82.3) | D (36.2) | D (54.1) | D (39.4) | F (97.3) | |
| | | | WBR | A (0.0) | A (0.0) | A (0.0) | A (0.0) | A (0.0) | A (0.0) | A (0.0) | A (0.0) | |
| | | Meridian Road | NBL | E (60.3) | E (65.5) | E (69.3) | E (72.4) | E (62.0) | E (67.9) | E (69.3) | F (88.5) | |
| | | | NBT | D (52.6) | E (58.6) | D (51.9) | F (138.9) | D (52.6) | E (61.7) | D (51.9) | F (138.9) | |
| | | | NBR | A (0.0) | A (0.0) | A (0.0) | A (0.0) | A (0.0) | A (0.0) | A (0.0) | A (0.0) | |
| | | Meridian Road | SBL | D (39.0) | E (73.9) | D (35.4) | F (145.3) | D (39.0) | E (73.9) | D (35.8) | F (145.3) | |
| | | | SBT | D (49.6) | D (44.2) | D (54.0) | D (53.5) | D (49.6) | D (44.7) | E (56.8) | D (50.2) | |
| | | | SBR | A (0.0) | A (0.0) | A (0.0) | A (0.0) | A (0.0) | A (0.0) | A (0.0) | A (0.0) | |
| | | Overall | | | D (47.4) | D (54.1) | D (53.0) | F (102.7) | D (47.5) | D (54.9) | D (51.1) | F (101.3) |
| 2 Meridian Rd/Eastonville Rd 4-Legged Signalized | SIGNAL | Eastonville Road | EBL | E (57.9) | E (65.6) | E (56.0) | F (80.8) | D (54.5) | F (94.9) | E (56.0) | E (67.7) | |
| | | | EBT | E (57.0) | D (54.5) | E (57.4) | E (76.7) | E (55.2) | E (56.4) | E (57.4) | E (66.7) | |
| | | | EBR | A (0.0) | A (0.0) | A (0.0) | A (0.0) | A (0.0) | A (0.0) | A (0.0) | A (0.0) | |
| | | Eastonville Road | WBL | E (55.2) | D (50.7) | E (71.1) | D (50.9) | D (53.8) | D (50.9) | E (71.1) | D (50.7) | |
| | | | WBT | E (56.9) | E (60.7) | E (61.2) | F (82.0) | E (56.9) | E (60.7) | E (61.2) | F (82.0) | |
| | | | WBR | A (0.0) | A (0.0) | A (0.0) | A (0.0) | A (0.0) | A (0.0) | A (0.0) | A (0.0) | |
| | | Meridian Road | NBL | F (81.1) | E (62.5) | F (159.7) | E (63.3) | F (107.6) | D (45.7) | F (161.1) | E (63.3) | |
| | | | NBT | B (14.4) | C (24.1) | B (16.9) | D (43.3) | B (14.9) | C (22.1) | B (16.9) | D (44.2) | |
| | | | NBR | B (12.5) | B (13.5) | B (14.0) | B (13.3) | B (13.0) | B (12.5) | B (14.0) | B (13.4) | |
| | | Meridian Road | SBL | E (67.4) | C (22.6) | E (65.0) | D (50.1) | E (67.4) | C (21.0) | E (66.7) | E (65.6) | |
| | | | SBT | D (47.7) | C (27.6) | F (81.7) | C (34.1) | D (44.1) | C (26.6) | F (81.7) | D (36.8) | |
| | | | SBR | C (22.5) | C (21.3) | B (17.8) | C (21.4) | C (21.9) | C (20.5) | B (17.8) | C (22.5) | |
| | | Overall | | | D (46.0) | C (34.5) | E (69.1) | D (45.3) | D (46.9) | C (34.8) | E (69.3) | D (45.6) |
| 3 Meridian Rd/Bent Grass Meadows Dr | SIGNAL | Bent Grass Meadows Drive | EBL | E (55.5) | E (56.2) | E (56.0) | E (57.2) | E (55.5) | E (56.2) | E (56.0) | E (57.2) | |
| | | | EBR | A (0.0) | A (0.0) | A (0.0) | A (0.0) | A (0.0) | A (0.0) | A (0.0) | A (0.0) | |
| | | | NBL | B (13.4) | A (6.7) | D (42.3) | B (12.2) | B (13.5) | A (6.7) | D (41.0) | B (12.3) | |
| | | Meridian Road | NBT | A (2.7) | A (5.2) | A (3.0) | A (8.5) | A (2.7) | A (5.2) | A (3.0) | A (8.5) | |
| | | | SBT | B (11.5) | A (8.6) | B (15.9) | B (10.4) | B (11.6) | A (8.6) | B (15.9) | B (10.4) | |
| | | Meridian Road | SBR | A (6.2) | A (6.3) | A (6.5) | A (6.7) | A (6.2) | A (6.3) | A (6.5) | A (6.8) | |
| | | | Overall | | | B (11.0) | A (8.4) | B (15.0) | B (10.9) | B (11.0) | A (8.4) | B (15.0) |
| 4 Bent Grass Meadows Dr/Meridian Park Dr | STOP | Bent Grass Meadows Drive Bent Grass Meadows Drive Meridian Park Drive | EBR | A [0.0] | A [0.0] | A [0.0] | A [0.0] | A [0.0] | A [0.0] | A [0.0] | A [0.0] | |
| | | | WBL | A [8.2] | A [7.9] | A [8.3] | A [8.0] | A [8.2] | A [7.9] | A [8.3] | A [8.0] | |
| | | | NBLR | A [10.0] | A [9.8] | B [10.2] | B [10.1] | A [10.0] | A [9.8] | B [10.2] | B [10.1] | |
| | | | | | | | | | | | | |
| Street Name | | | | Background 2024 | | Background 2040 | | Total Future 2024 Warehouse | | Total Future 2040 Warehouse | | |
| | | | | ADT | LOS | AM | PM | ADT | LOS | AM | PM | |
| El Paso County Roadway ADT Threshold Capacity Principal Arterial (4-Lane) | | | | Meridian Rd (S.O. Bent Grass Meadows) | 30,958 | 40,000 | 40,030 | 40,000 | 30,978 | 40,000 | 40,051 | 40,000 |
| | | | | Meridian Rd (N.O. Woodman Rd) | 32,405 | 40,000 | 41,728 | 40,000 | 32,447 | 40,000 | 41,759 | 40,000 |
| Meridian Rd Signal Progression Arterial Band (Seconds Per Cycle) | | | | AM | PM | AM | PM | AM | PM | AM | PM | |
| | | | | NB | 0 | 31 | 0 | 39 | 0 | 32 | 0 | 39 |
| | | | | SB | 1 | 0 | 1 | 0 | 1 | 0 | 1 | 0 |

Notes (1) Numbers in brackets [] represent delay at unsignalized intersections in seconds per vehicle.
 (2) Numbers in parenthesis () represent delay at signalized intersections in seconds per vehicle.

Table 6-2
Meridian Storage
Total Future Intersection Queueing Summary (1)

| Intersection | Operating Condition | Street Name | Approach/ Movement | Available Storage | Background 2024 | | Background 2040 | | Total Future 2024 Warehouse | | Total Future 2040 Warehouse | |
|---|---------------------|--------------------------|--------------------|-------------------|-----------------|--------------|-----------------|--------------|-----------------------------|--------------|-----------------------------|--------------|
| | | | | | AM Peak Hour | PM Peak Hour | AM Peak Hour | PM Peak Hour | AM Peak Hour | PM Peak Hour | AM Peak Hour | PM Peak Hour |
| 1 Woodmen Rd/Meridian Rd | SIGNAL | Woodmen Road | EBL | 500 | 170 | 436 | 236 | 662 | 170 | 437 | 236 | 651 |
| | | | EBT | - | 112 | 215 | 152 | 315 | 111 | 212 | 150 | 315 |
| | | | EBR | 630 | 0 | 0 | 0 | 0 | 0 | 0 | 0 | 0 |
| | | Woodmen Road | WBL | 350 | 49 | 81 | 62 | 102 | 49 | 81 | 62 | 102 |
| | | | WBT | - | 221 | 237 | 300 | 341 | 218 | 224 | 297 | 354 |
| | | | WBR | 250 | 0 | 86 | 0 | 142 | 0 | 85 | 0 | 143 |
| | | Meridian Road | NBL | 440 | 111 | 156 | 157 | 203 | 113 | 172 | 157 | 215 |
| | | | NBT | - | 167 | 442 | 203 | 688 | 167 | 455 | 203 | 688 |
| | | | NBR | 330 | 0 | 0 | 0 | 0 | 0 | 0 | 0 | 0 |
| | | Meridian Road | SBL | 490 | 85 | 160 | 90 | 173 | 87 | 147 | 90 | 164 |
| | | | SBT | - | 345 | 310 | 423 | 352 | 347 | 314 | 424 | 340 |
| | | | SBR | 450 | 29 | 0 | 61 | 0 | 22 | 0 | 61 | 0 |
| 2 Meridian Rd/Eastonville Rd | STOP | Eastonville Road | WBL | 120 | N/A | N/A | N/A | N/A | N/A | N/A | N/A | N/A |
| | | | WBR | - | N/A | N/A | N/A | N/A | N/A | N/A | N/A | N/A |
| | | Meridian Rd | NBR | 400 | N/A | N/A | N/A | N/A | N/A | N/A | N/A | N/A |
| | | | SBL | 375 | N/A | N/A | N/A | N/A | N/A | N/A | N/A | N/A |
| 2 Meridian Rd/Eastonville Rd 4-Legged Signalized | SIGNAL | Eastonville Road | EBL | 145 | 147 | 177 | 144 | 174 | 141 | 177 | 144 | 207 |
| | | | EBT | - | 86 | 167 | 96 | 254 | 86 | 160 | 96 | 241 |
| | | | EBR | 115 | 138 | 104 | 133 | 167 | 160 | 62 | 139 | 139 |
| | | Eastonville Road | WBL | 120 | 136 | 46 | 225 | 64 | 146 | 46 | 225 | 64 |
| | | | WBT | - | 91 | 111 | 116 | 179 | 91 | 109 | 116 | 179 |
| | | | WBR | 100 | 0 | 30 | 0 | 29 | 0 | 0 | 0 | 29 |
| | | Meridian Road | NBL | 490 | 420 | 396 | 431 | 234 | 447 | 284 | 431 | 239 |
| | | | NBT | - | 135 | 600 | 184 | 175 | 135 | 408 | 183 | 185 |
| | | | NBR | 400 | 5 | 5 | 10 | 3 | 6 | 3 | 10 | 4 |
| | | Meridian Road | SBL | 375 | 137 | 67 | 127 | 128 | 135 | 92 | 132 | 140 |
| | | | SBT | - | 800 | 509 | 1066 | 643 | 774 | 560 | 1058 | 649 |
| | | | SBR | 320 | 28 | 110 | 13 | 75 | 31 | 98 | 12 | 80 |
| 3 Meridian Rd/Bent Grass Meadows Dr | SIGNAL | Bent Grass Meadows Drive | EBL | 150 | 59 | 71 | 70 | 85 | 58 | 71 | 69 | 85 |
| | | | EBR | - | 87 | 54 | 198 | 66 | 97 | 54 | 171 | 67 |
| | | Meridian Road | NBL | 700 | 80 | 26 | 175 | 40 | 83 | 25 | 176 | 43 |
| | | | NBT | - | 112 | 167 | 155 | 139 | 113 | 160 | 155 | 137 |
| | | Meridian Road | SBT | - | 617 | 291 | 951 | 491 | 604 | 291 | 975 | 495 |
| | | | SBR | 350 | 27 | 24 | 27 | 32 | 26 | 25 | 29 | 32 |
| 4 Bent Grass Meadows Dr/Meridian Park Dr | STOP | Bent Grass Meadows Drive | EBR | 150 | 0 | 0 | 0 | 0 | 0 | 0 | 0 | 0 |
| | | | WBL | 100 | 12.5 | 7.5 | 15 | 10 | 12.5 | 7.5 | 15 | 10 |
| | | Meridian Park Drive | NBLR | - | 15 | 12.5 | 20 | 17.5 | 15 | 12.5 | 20 | 17.5 |
| 5 Meridain Rd & Owl Pl | STOP | Owl Pl | EBR | - | N/A | N/A | N/A | N/A | N/A | N/A | N/A | N/A |
| | | Meridian Road | NBL | 270 | N/A | N/A | N/A | N/A | N/A | N/A | N/A | N/A |
| | | Meridian Road | SBTR | - | N/A | N/A | N/A | N/A | N/A | N/A | N/A | N/A |

Notes: (1) Queue length is based on the 95th percentile queue as reported by Synchro, Version 11.

VII. Analysis of Total 2024 & 2040 Conditions (Maximum Trip Generator)

Since the site is being rezoned to Commercial Service, El Paso County has requested that in addition to analyzing the study area with the proposed warehouse development, the study area be analyzed with the highest allowed trip generating land use. It was determined that out of the land uses allowed on an area zoned as Commercial Service, a shopping plaza would generate the most trips. It was assumed that 20% of the site would be occupied by the building, meaning that the shopping plaza would be 133,294 SF.

The developer has no intention of constructing a shopping plaza on the site, and the following analysis is required by El Paso County since the site is being rezoned.

Total 2024 & 2040 Traffic Forecasts

The 2024 total traffic forecasts, shown in Figure 7-1, were developed by combining the background 2024 forecasts (Figure 4-10) and the proposed development site trip assignments (Figure 5-2). The 2040 total traffic forecasts, shown in Figure 7-2, were developed by combining the background 2040 forecasts (Figure 4-11) and the proposed development site trip assignments (Figure 5-2).

Total 2024 & 2040 Levels of Service

Capacity analyses of the total scenarios are provided in Appendix G. The total 2024 forecasted levels of service are shown in Table 7-1 and depicted graphically in Figure 7-3. The total 2040 forecasted levels of service are shown in Table 7-1 and depicted graphically in Figure 7-4. The Synchro models were updated with the total volumes. Per the El Paso County Transportation Impact Study Guidelines, the peak hour factors (PHF) were calculated or set to 0.95, whichever was higher. The signal splits were optimized, and the cycle lengths and offsets were kept the same as in the existing conditions. Using the Time Space Diagram analysis in Synchro, a progression analysis was conducted along Meridian Rd. A detailed results report is presented in Appendix G and is summarized in Table 7-1. The Synchro printouts are included in Appendix G.

As can be seen in the table, if a shopping center were to be built instead of the proposed storage facility, the delays through the study area would generally increase. The signalized intersection of Woodmen Rd & Meridian Rd operates at LOS D in the AM peak and LOF F in the PM peak for both the total 2024 and total 2040 scenarios. Many of the movements are reported to exceed capacity by the 2040 PM peak, with the EBL exceeding capacity the most severely. There will be 1240 eastbound left turns served by dual left turn lanes. At a minimum, triple left turns would be needed to accommodate this movement. The signal at Meridian Rd & Eastonville Rd operates at LOS E or better in 2024 and operates at LOS F during both total 2040 peak periods. The intersections of Meridian Rd & Bent Grass Meadows Dr and Bent Grass Meadows Dr & Meridian Park Dr will operate at LOS C or better with no operational concerns.

The El Paso County Roadway ADT Threshold Capacities were reviewed for a 4-lane principal arterial to ensure that Meridian Rd is operating under capacity in the total scenarios in which the proposed development has been constructed. The results are reported in Table 7-1. The 11,671 daily trips that will be generated by the proposed development were distributed through the network and were added to the background ADT forecasts. The southern portion of Meridian Rd, just north of Woodman Rd will exceed capacity in 2024 while the northern part, just south of Bent Grass Meadows will remain under capacity. All

of Meridian Rd through the study area will exceed capacity by 2040. Meridian Rd would need to be widened to 6-lanes by 2040 in order to achieve acceptable operations at the signals along the highway.

The signal progression analysis along Meridian Rd was conducted using the Synchro time space diagrams and the results are reported in Table 7-1 with the Synchro printouts included in Appendix G. The cycle length remains at 120 seconds for all three signals. In the total 2025 scenario, the NB bandwidth between the signalized intersection of Woodmen Rd & Meridian Rd is 0 seconds in the AM and 28 seconds in the PM while the SB bandwidth is 2 seconds in the AM and 0 seconds in the PM. It was found for the total 2040 scenario that the NB bandwidth is 0 seconds in the AM and 38 seconds in the PM between the signals of Woodmen Rd & Meridian Rd while the SB bandwidth is 2 seconds in the AM and 0 seconds in the PM. This poor progression is to be expected due to much of the study area operating over capacity. It is expected that if Meridian Rd were to be widened to 6-lanes, progression could be improved between signals.

Total 2024 & 2040 Intersection Queues

The 95% queue lengths were reported for each movement within the study area using the Synchro queuing reports. The results are summarized in Table 7-2. The movements highlighted in yellow indicate that the queue exceeds its respective storage length or extends past the adjacent storage, possible blocking vehicles trying to enter an adjacent turn lane. Queues highlighted in orange exceed capacity indicate that the movement exceeds capacity, and the queues highlighted in red exceed capacity and extend past the adjacent storage or their own storage.

As can be seen in the table, the queue lengths have increased when compared to the lengths reported in the storage facility scenarios. Much of the queueing problem identified in the table is a result of intersection and roadway capacity being exceeded. In order to achieve acceptable queue lengths, the capacity deficiencies throughout the study area will need to be addressed. As such, it is advised that the "Recommended Mitigation" section below be referenced as a solution to achieving acceptable queue lengths. In addition, the storage lengths at Meridian Rd & Eastonville Rd should be reviewed since they are likely too short even if acceptable intersection operations are achieved.

Total 2024 & 2040 Recommended Mitigation

The following measures are recommended to help achieve acceptable traffic operations through the total 2040 scenario. It should be noted that this is for a hypothetical scenario in which the lot is developed to the maximum extent. The developer has no intention of developing the lot with a shopping center.

- Improve Meridian Rd to a 6-lane highway through the entire study area
- Meridian Rd will need 4 NBT lanes through the intersection of Meridian Rd & Woodman Rd. The outside thru lane can turn into the right turn only lane at Meridian Rd & Eastonville Rd
(It should be noted that the El Paso County Major Transportation Corridors Plan (MTCP) shows this section of Meridian Rd to remain a 4-lane highway in the 2040 plan)
- Improve Woodman Rd to a 6-lane highway through the study area
- Install triple left turn lanes for the EBL at Meridian Rd & Woodman Rd
- Install dual left turn lanes for the NBL movement at Meridian Rd & Eastonville Rd
(This will require modifications for the westbound approach to the roundabout, as it is currently a 1-lane approach)

Owl Place Storage
El Paso County, CO

- Ensure that the storage lengths at Meridian Rd & Eastonville Rd are long enough to accommodate their forecasted queues.
- Install dual left turn lanes for the NBL movement at Meridian Rd & Bent Grass Meadows

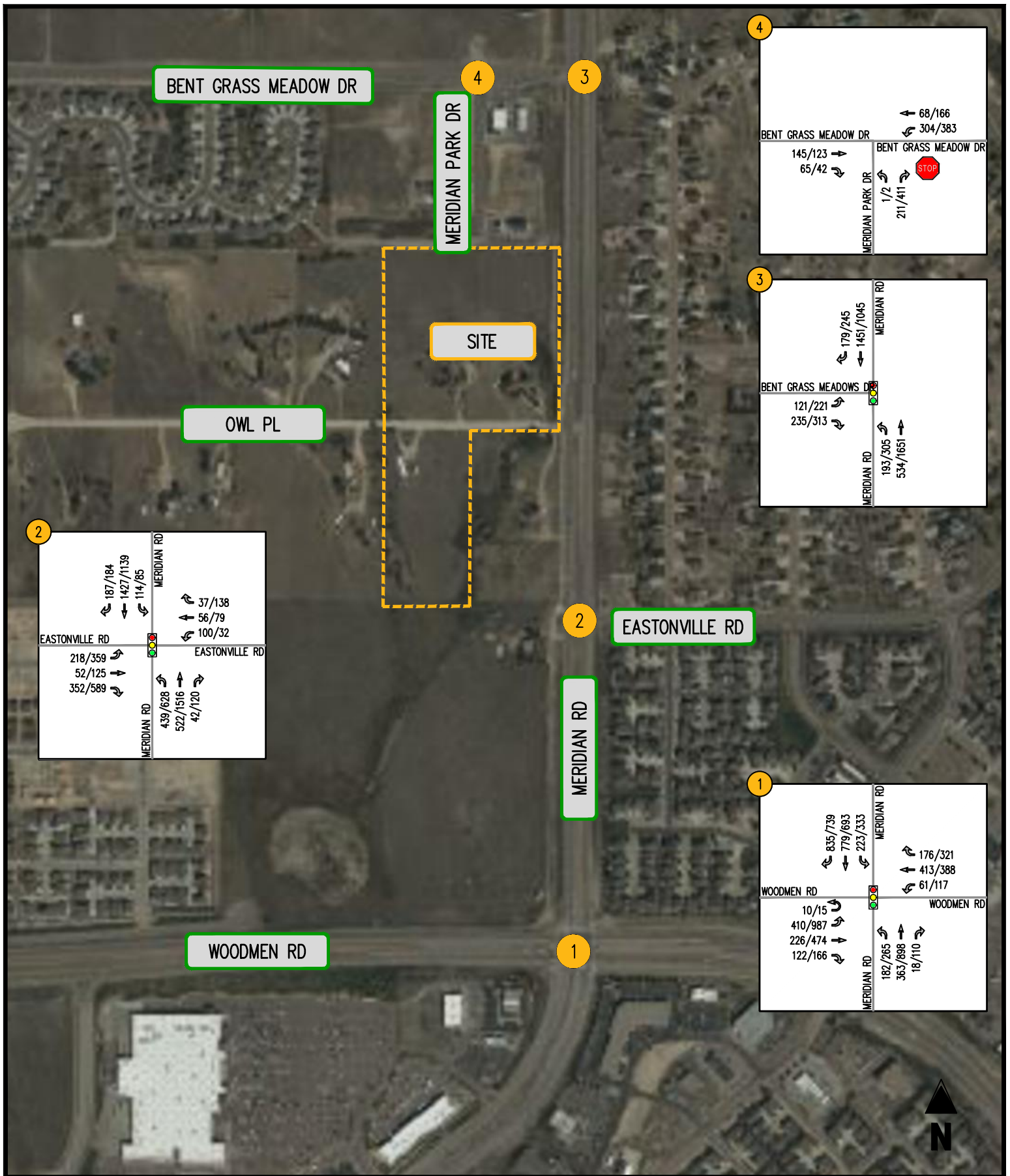






FIGURE 7-1
Total Future 2024 Forecasts Shopping Center

Meridian Storage
 El Paso County, CO

0000/0000 (AM PEAK HOUR/PM PEAK HOUR)

-  MOVEMENT
-  SIGNALIZED INTERSECTION
-  STOP SIGN
-  YIELD SIGN



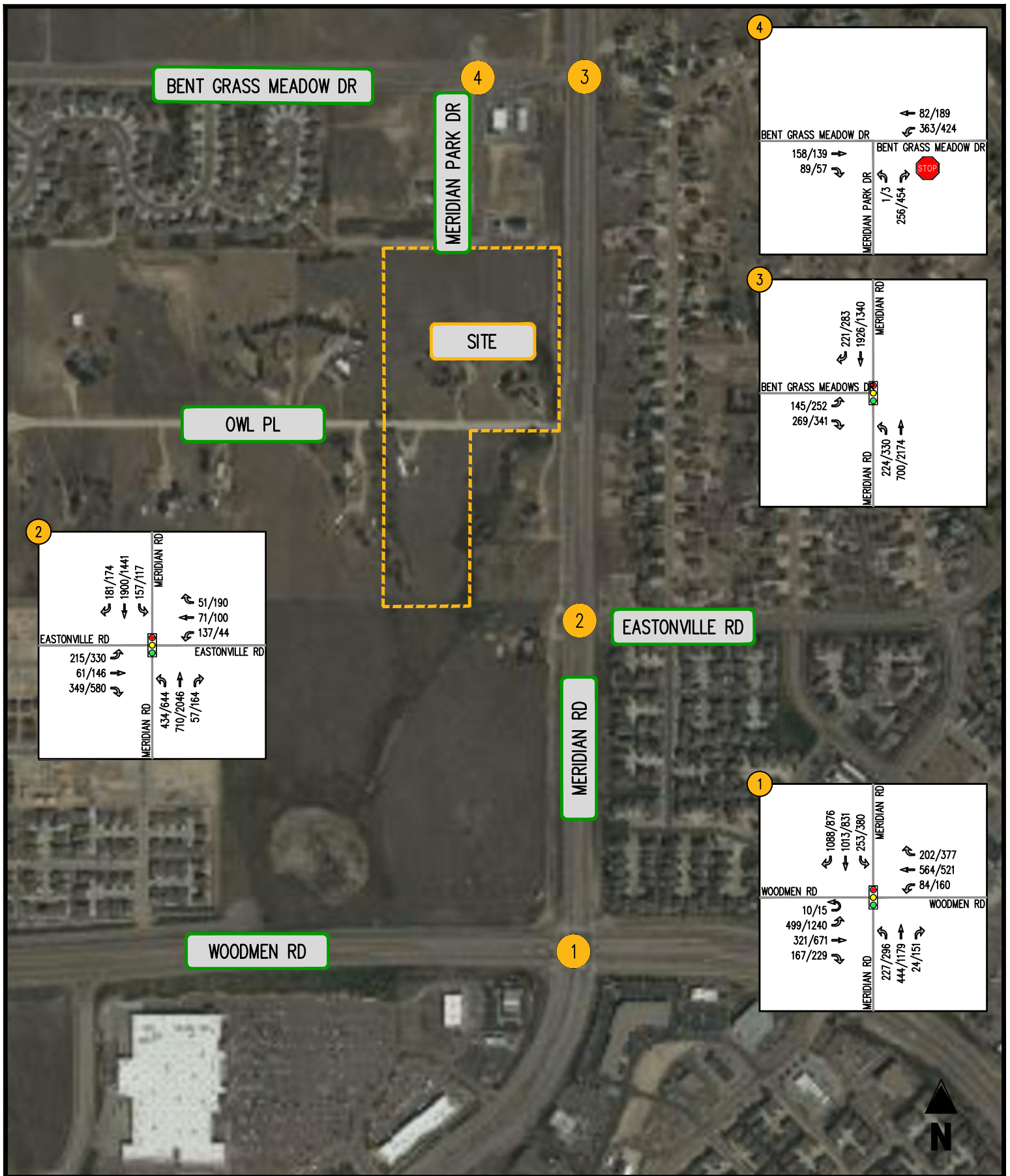


FIGURE 7-2
Total Future 2040 Forecasts Shopping Center

Meridian Storage
 El Paso County, CO

0000/0000 (AM PEAK HOUR/PM PEAK HOUR)

- MOVEMENT
- SIGNALIZED INTERSECTION
- STOP SIGN
- YIELD SIGN



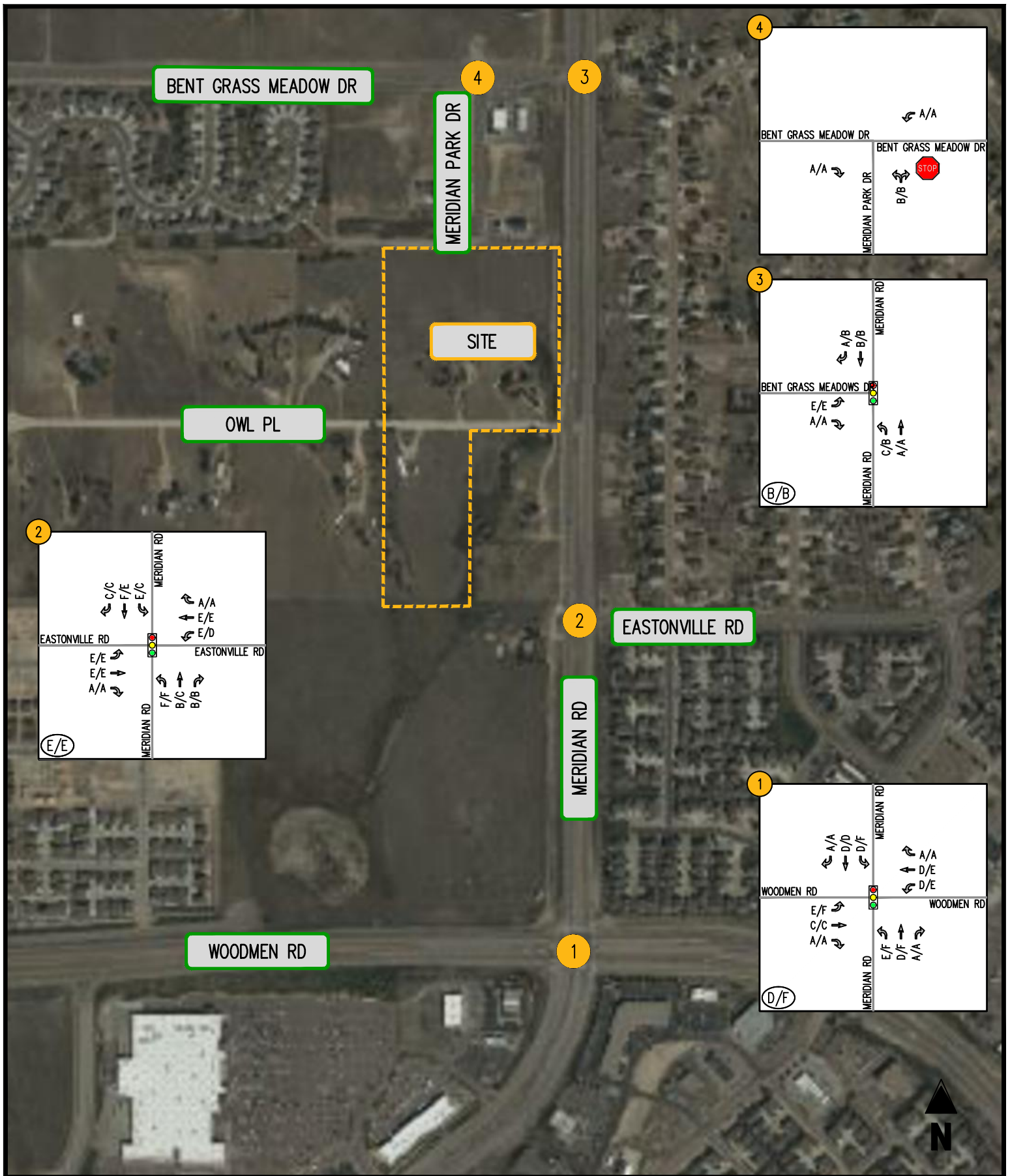


FIGURE 7-3
Total Future 2024 Levels of Service Shopping Center

Meridian Storage
 El Paso County, CO

(A/A) INTERSECTION LOS
 0000/0000 (AM PEAK HOUR/PM PEAK HOUR)

- ← MOVEMENT
- 🚦 SIGNALIZED INTERSECTION
- 🛑 STOP SIGN
- 🚧 YIELD SIGN



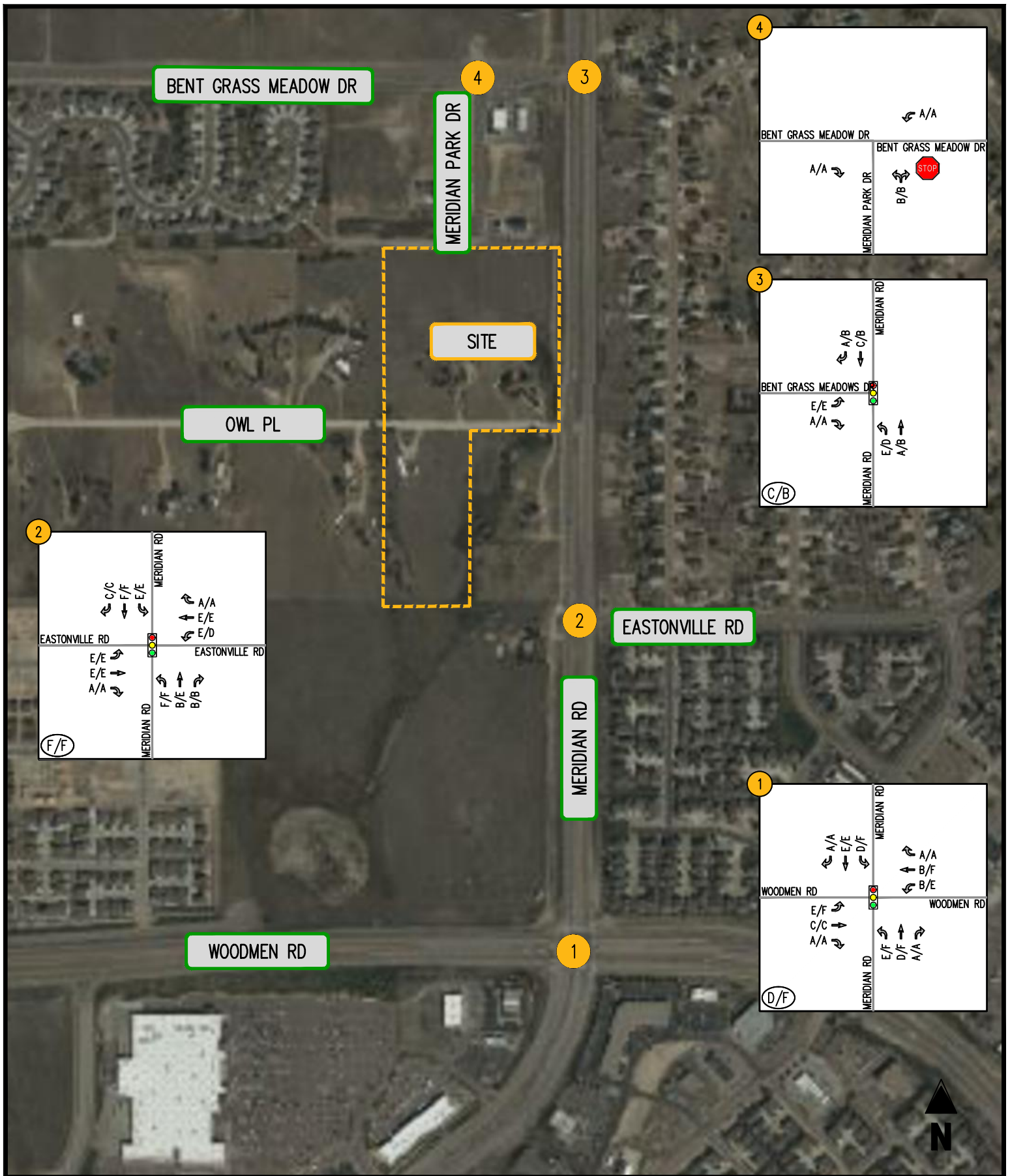


FIGURE 7-4
Total Future 2040 Levels of Service Shopping Center

Meridian Storage
 El Paso County, CO

(A/A) INTERSECTION LOS
 0000/0000 (AM PEAK HOUR/PM PEAK HOUR)

- ← MOVEMENT
- 🚦 SIGNALIZED INTERSECTION
- 🛑 STOP SIGN
- 🚧 YIELD SIGN



Table 7-1
Meridian Storage
Total Intersection Level of Service Summary (1) (2)

| Intersection | Operating Condition | Street Name | Approach/Movement | Background 2024 | | Background 2040 | | Total Future 2024 Shopping Center | | Total Future 2040 Shopping Center | |
|--|---------------------|---------------------------------------|-------------------|------------------------|-----------------|------------------------|-----------------|---|-----------------|---|------------------|
| | | | | AM Peak Hour | PM Peak Hour | AM Peak Hour | PM Peak Hour | AM Peak Hour | PM Peak Hour | AM Peak Hour | PM Peak Hour |
| 1 Woodmen Rd/Meridian Rd | SIGNAL | Woodmen Road | EBL | E (61.5) | E (60.7) | E (66.9) | F (159.1) | E (62.5) | F (91.3) | E (67.0) | F (269.4) |
| | | | EBT | C (33.1) | C (29.8) | C (35.0) | C (34.8) | C (30.8) | C (28.9) | C (33.3) | C (34.8) |
| | | | EBR | A (0.0) | A (0.0) | A (0.0) | A (0.0) | A (0.0) | A (0.0) | A (0.0) | A (0.0) |
| | | Woodmen Road | WBL | D (48.4) | E (60.6) | E (55.8) | E (60.1) | D (52.0) | E (60.6) | B (16.2) | E (60.1) |
| | | | WBT | D (36.2) | E (55.2) | D (53.4) | F (82.3) | D (42.2) | E (72.7) | B (10.9) | F (97.3) |
| | | | WBR | A (0.0) | A (0.0) | A (0.0) | A (0.0) | A (0.0) | A (0.0) | A (0.0) | A (0.0) |
| | | Meridian Road | NBL | E (60.3) | E (65.5) | E (69.3) | E (72.4) | E (64.0) | F (86.7) | E (79.9) | F (88.5) |
| | | | NBT | D (52.6) | E (58.6) | D (51.9) | F (138.9) | D (52.7) | F (123.3) | D (51.1) | F (210.0) |
| | | | NBR | A (0.0) | A (0.0) | A (0.0) | A (0.0) | A (0.0) | A (0.0) | A (0.0) | A (0.0) |
| | | Meridian Road | SBL | D (39.0) | E (73.9) | D (35.4) | F (145.3) | D (40.1) | F (120.4) | D (38.2) | F (221.3) |
| | | | SBT | D (49.6) | D (44.2) | D (54.0) | D (53.5) | D (51.5) | D (51.4) | E (61.8) | E (71.2) |
| | | | SBR | A (0.0) | A (0.0) | A (0.0) | A (0.0) | A (0.0) | A (0.0) | A (0.0) | A (0.0) |
| | | Overall | | | D (47.4) | D (54.1) | D (53.0) | F (102.7) | D (50.1) | F (83.7) | D (48.4) |
| 2 Meridian Rd/Eastonville Rd <i>4-Legged Signalized</i> | SIGNAL | Eastonville Road | EBL | E (57.9) | E (65.6) | E (56.0) | F (80.8) | E (57.9) | E (77.2) | E (56.0) | E (66.0) |
| | | | EBT | E (57.0) | D (54.5) | E (57.4) | E (76.7) | E (57.0) | E (55.1) | E (57.4) | E (61.5) |
| | | | EBR | A (0.0) | A (0.0) | A (0.0) | A (0.0) | A (0.0) | A (0.0) | A (0.0) | A (0.0) |
| | | Eastonville Road | WBL | E (55.2) | D (50.7) | E (71.1) | D (50.9) | E (55.2) | D (50.8) | E (71.1) | D (50.4) |
| | | | WBT | E (56.9) | E (60.7) | E (61.2) | F (82.0) | E (56.9) | E (60.7) | E (61.2) | E (65.7) |
| | | | WBR | A (0.0) | A (0.0) | A (0.0) | A (0.0) | A (0.0) | A (0.0) | A (0.0) | A (0.0) |
| | | Meridian Road | NBL | F (81.1) | E (62.5) | F (159.7) | E (63.3) | F (164.3) | F (202.0) | F (206.9) | F (252.2) |
| | | | NBT | B (14.4) | C (24.1) | B (16.9) | D (43.3) | B (15.0) | C (27.6) | B (15.0) | E (72.6) |
| | | | NBR | B (12.5) | B (13.5) | B (14.0) | B (13.3) | B (12.5) | B (13.2) | B (14.0) | B (13.5) |
| | | Meridian Road | SBL | E (67.4) | C (22.6) | E (65.0) | D (50.1) | E (67.4) | C (30.2) | E (66.7) | E (69.6) |
| | | | SBT | D (47.7) | C (27.6) | F (81.7) | C (34.1) | F (84.2) | E (75.6) | F (151.2) | F (96.3) |
| | | | SBR | C (22.5) | C (21.3) | B (17.8) | C (21.4) | C (25.4) | C (31.1) | C (21.6) | C (26.9) |
| | | Overall | | | D (46.0) | C (34.5) | E (69.1) | D (45.3) | E (75.2) | E (71.7) | F (110.7) |
| 3 Meridian Rd/Bent Grass Meadows Dr | SIGNAL | Bent Grass Meadows Drive | EBL | E (55.5) | E (56.2) | E (56.0) | E (57.2) | E (57.3) | E (57.3) | E (58.1) | E (57.5) |
| | | | EBR | A (0.0) | A (0.0) | A (0.0) | A (0.0) | A (0.0) | A (0.0) | A (0.0) | A (0.0) |
| | | | NBL | B (13.4) | A (6.7) | D (42.3) | B (12.2) | C (30.6) | B (20.0) | E (73.3) | D (47.3) |
| | | Meridian Road | NBT | A (2.7) | A (5.2) | A (3.0) | A (8.5) | A (2.8) | A (6.8) | A (3.0) | B (11.2) |
| | | | SBT | B (11.5) | A (8.6) | B (15.9) | B (10.4) | B (12.7) | B (13.1) | C (23.5) | B (19.8) |
| | | | SBR | A (6.2) | A (6.3) | A (6.5) | A (6.7) | A (7.2) | B (10.8) | A (9.5) | B (14.2) |
| Overall | | | B (11.0) | A (8.4) | B (15.0) | B (10.9) | B (13.8) | B (13.7) | C (23.1) | B (19.4) | |
| 4 Bent Grass Meadows Dr/Meridian Park Dr | STOP | Bent Grass Meadows Drive | EBR | A [0.0] | A [0.0] | A [0.0] | A [0.0] | A [0.0] | A [0.0] | A [0.0] | A [0.0] |
| | | | WBL | A [8.2] | A [7.9] | A [8.3] | A [8.0] | A [8.7] | A [8.9] | A [8.9] | A [8.9] |
| | | | NBLR | A [10.0] | A [9.8] | B [10.2] | B [10.1] | B [10.9] | B [14.1] | B [11.0] | B [14.2] |
| Street Name | | | | Background 2024 | | Background 2040 | | Total Future 2024 Shopping Plaza | | Total Future 2040 Shopping Plaza | |
| | | | | ADT | LOS | AM | PM | ADT | LOS | ADT | LOS |
| El Paso County Roadway ADT Threshold Capacity | | Meridian Rd (S.O. Bent Grass Meadows) | | 30,958 | 40,000 | 40,030 | 40,000 | 34,520 | 40,000 | 43,593 | 40,000 |
| | | Meridian Rd (N.O. Woodman Rd) | | 32,405 | 40,000 | 41,728 | 40,000 | 41,916 | 40,000 | 51,238 | 40,000 |
| Meridian Rd Signal Progression | | | NB | AM | PM | AM | PM | AM | PM | AM | PM |
| | | | SB | 0 | 31 | 0 | 39 | 0 | 28 | 0 | 38 |
| Arterial Band (Seconds Per Cycle) | | | NB | 1 | 0 | 1 | 0 | 2 | 0 | 2 | 0 |
| | | | SB | 1 | 0 | 1 | 0 | 2 | 0 | 2 | 0 |

Notes (1) Numbers in brackets [] represent delay at unsignalized intersections in seconds per vehicle.
(2) Numbers in parenthesis () represent delay at signalized intersections in seconds per vehicle.

Table 7-2
Meridian Storage
Total Future Intersection Queueing Summary (1)

| Intersection | Operating Condition | Street Name | Approach/ Movement | Available Storage | Background 2024 | | Background 2040 | | Total Future 2024 Shopping Center | | Total Future 2040 Shopping Center | |
|---|---------------------|--------------------------|--------------------|-------------------|-----------------|--------------|-----------------|--------------|-----------------------------------|--------------|-----------------------------------|--------------|
| | | | | | AM Peak Hour | PM Peak Hour | AM Peak Hour | PM Peak Hour | AM Peak Hour | PM Peak Hour | AM Peak Hour | PM Peak Hour |
| 1 Woodmen Rd/Meridian Rd | SIGNAL | Woodmen Road | EBL | 500 | 170 | 436 | 236 | 662 | 226 | 597 | 313 | 869 |
| | | | EBT | - | 112 | 215 | 152 | 315 | 104 | 204 | 148 | 315 |
| | | | EBR | 630 | 0 | 0 | 0 | 0 | 0 | 0 | 0 | 0 |
| | | Woodmen Road | WBL | 350 | 49 | 81 | 62 | 102 | 48 | 79 | 62 | 102 |
| | | | WBT | - | 221 | 237 | 300 | 341 | 221 | 250 | 334 | 354 |
| | | | WBR | 250 | 0 | 86 | 0 | 142 | 12 | 207 | 33 | 299 |
| | | Meridian Road | NBL | 440 | 111 | 156 | 157 | 203 | 115 | 195 | 169 | 215 |
| | | | NBT | - | 167 | 442 | 203 | 688 | 193 | 583 | 228 | 801 |
| | | | NBR | 330 | 0 | 0 | 0 | 0 | 0 | 0 | 0 | 0 |
| | | Meridian Road | SBL | 490 | 85 | 160 | 90 | 173 | 92 | 142 | 88 | 160 |
| | | | SBT | - | 345 | 310 | 423 | 352 | 325 | 274 | 368 | 304 |
| SBR | 450 | 29 | 0 | 61 | 0 | 61 | 45 | 82 | 44 | | | |
| 2 Meridian Rd/Eastonville Rd | STOP | Eastonville Road | WBL | 120 | N/A | N/A | N/A | N/A | N/A | N/A | N/A | N/A |
| | | | WBR | - | N/A | N/A | N/A | N/A | N/A | N/A | N/A | N/A |
| | | Meridian Rd | NBR | 400 | N/A | N/A | N/A | N/A | N/A | N/A | N/A | N/A |
| | | | SBL | 375 | N/A | N/A | N/A | N/A | N/A | N/A | N/A | N/A |
| 2 Meridian Rd/Eastonville Rd 4-Legged Signalized | SIGNAL | Eastonville Road | EBL | 145 | 147 | 177 | 144 | 174 | 147 | 176 | 145 | 165 |
| | | | EBT | - | 86 | 167 | 96 | 254 | 86 | 160 | 96 | 188 |
| | | | EBR | 115 | 138 | 104 | 133 | 167 | 219 | 409 | 267 | 532 |
| | | Eastonville Road | WBL | 120 | 136 | 46 | 225 | 64 | 138 | 48 | 225 | 61 |
| | | | WBT | - | 91 | 111 | 116 | 179 | 90 | 113 | 116 | 138 |
| | | | WBR | 100 | 0 | 30 | 0 | 29 | 0 | 0 | 0 | 28 |
| | | Meridian Road | NBL | 490 | 420 | 396 | 431 | 234 | 630 | 527 | 620 | 399 |
| | | | NBT | - | 135 | 600 | 184 | 175 | 147 | 364 | 193 | 309 |
| | | | NBR | 400 | 5 | 5 | 10 | 3 | 3 | 0 | 4 | 2 |
| | | Meridian Road | SBL | 375 | 137 | 67 | 127 | 128 | 143 | 88 | 128 | 95 |
| | | | SBT | - | 800 | 509 | 1066 | 643 | 831 | 716 | 1048 | 917 |
| SBR | 320 | 28 | 110 | 13 | 75 | 27 | 116 | 14 | 47 | | | |
| 3 Meridian Rd/Bent Grass Meadows Dr | SIGNAL | Bent Grass Meadows Drive | EBL | 150 | 59 | 71 | 70 | 85 | 76 | 126 | 87 | 142 |
| | | | EBR | - | 87 | 54 | 198 | 66 | 90 | 86 | 204 | 97 |
| | | Meridian Road | NBL | 700 | 80 | 26 | 175 | 40 | 167 | 150 | 314 | 181 |
| | | | NBT | - | 112 | 167 | 155 | 139 | 108 | 143 | 154 | 120 |
| | | Meridian Road | SBT | - | 617 | 291 | 951 | 491 | 610 | 457 | 1025 | 627 |
| | | | SBR | 350 | 27 | 24 | 27 | 32 | 35 | 50 | 40 | 50 |
| 4 Bent Grass Meadows Dr/Meridian Park Dr | STOP | Bent Grass Meadows Drive | EBR | 150 | 0 | 0 | 0 | 0 | 0 | 0 | 0 | 0 |
| | | | WBL | 100 | 12.5 | 7.5 | 15 | 10 | 22.5 | 30 | 30 | 35 |
| | | Meridian Park Drive | NBLR | - | 15 | 12.5 | 20 | 17.5 | 25 | 67.5 | 32.5 | 87.5 |
| 5 Meridain Rd & Owl Pl | STOP | Owl Pl | EBR | - | N/A | N/A | N/A | N/A | N/A | N/A | N/A | N/A |
| | | Meridian Road | NBL | 270 | N/A | N/A | N/A | N/A | N/A | N/A | N/A | N/A |
| | | Meridian Road | SBTR | - | N/A | N/A | N/A | N/A | N/A | N/A | N/A | N/A |

Notes: (1) Queue length is based on the 95th percentile queue as reported by Synchro, Version 11.

VIII. Pedestrian and Bicycle Connectivity

The El Paso County Major Transportation Corridor Plan (MTCP) was referenced to determine whether the proposed development would affect any of the existing pedestrian or bike routes in the area and whether there are any planned pedestrian or bike routes through the study area. The study area in general does not see much pedestrian activity, and there are no marked bike lanes on any of the study roads.

The MTCP has marked Meridian Rd as a proposed bicycle route. There is also a proposed secondary regional trail that will run north/south to the west of the study area but will not intersect any of the roadway segments within the study area. Since the proposed development will generate four trips in the peak hour, it will not affect operations along Meridian Rd and therefore will not have an impact on bicycle safety along Meridian Rd.

Given the location of the proposed site and the nature of its use, it is not expected to generate pedestrian trips. In addition, there are no existing or proposed pedestrian or bicycle routes traveling through the proposed site. The developer will provide sidewalks along Meridian Park Dr, as shown in the site plan. Since the site is not expected to impact pedestrian and bicycle operations in the study area, the developer is not required to provide additional pedestrian facilities outside of what is shown in the site plan.

IX. Conclusions and Recommendations

Conclusions

Based on the results of this traffic impact study, the following may be concluded:

- Under existing conditions, the signalized intersections operate at LOS D or better. The intersection of Meridian Rd & Eastonville Rd was modeled as a three-legged stop-control intersection and is shown to fail during both peak time periods. Several of the thru queues will block adjacent turn lanes.
- In the background 2024 scenario, all intersections operate at LOS D or better. Queueing remains similar to the existing scenario, however, many of the queues at Meridian Rd & Eastonville Rd are shown to exceed their respective storage lengths.
- In the background 2040 scenario, Woodmen Rd & Meridian Rd will operate at LOS F in the PM peak and Meridian Rd & Eastonville Rd will operate at LOS E in the AM peak. The remaining intersections will operate acceptably. The forecasted ADTs along Meridian Rd will exceed the El Paso County Roadway ADT Threshold Capacity. Many of the queues will exceed their respective storage lengths by 2040.
- The proposed warehouse development will generate 3 weekday AM and 4 weekday PM peak hour vehicle trips as well as 46 weekday daily trips.
- The total scenarios in which the warehouse has been built will have very similar operations to the background scenarios. As such, it is not the responsibility of the developer to mitigate the failing traffic operations since these are problems expected to occur regardless of whether the site is developed.

- As requested by El Paso County, the maximum trip generator allowed on a site zoned as Commercial Service was analyzed. This was found to be a 133,294 SF shopping plaza. In this scenario, the shopping plaza would generate 471 weekday AM and 1,141 weekday PM peak hour vehicle trips as well as 11,671 weekday daily trips.
- The total 2024 scenario where the maximum trip generator was assumed instead of the proposed warehouse shows an increase in intersection delay. The intersection of Woodmen Rd & Meridian Rd will fail in the PM peak hour and the intersection of Meridian Rd & Eastonville Rd will operate at LOS E. The ADT along the southern portion of Meridian Rd is forecasted to exceed the El Paso County Roadway ADT Threshold Capacity while the northern portion of Meridian Rd will remain under capacity.
- In the total 2040 scenario for which the maximum trip generator is assumed, the Intersection of Woodmen Rd & Meridian Rd will fail in the PM peak, and the intersection of Meridian Rd & Eastonville Rd will fail during both the AM and PM peaks. The ADT along Meridian Rd will exceed capacity as well. The analysis for the maximum trip generator is a requirement of El Paso County. The developer has no intention of building a shopping center, and therefore, no roadway improvements are needed to mitigate the failing operations reported in this scenario.
- Traffic operations are reported to be almost identical between the background scenario and the total scenario in which the proposed warehouse development has been constructed. There are no intersection or individual movements found to operate acceptably in the background scenario and then unacceptable in the total warehouse scenario. It is the responsibility of El Paso County, not the developer, to provide mitigation solutions to achieve acceptable traffic operations through the year 2040.
- Road Impact Fees will be due by the Applicant at the last land use approval consistent with the use and Impact Fee schedule.

Recommendations

- It is recommended that the proposed development be designed as shown in the site plan.
- It is recommended that El Paso County implement the mitigation recommendations detailed in Section IV of this report in order to achieve acceptable traffic operations through the study area.

APPENDIX A – Full Sized Site Plan

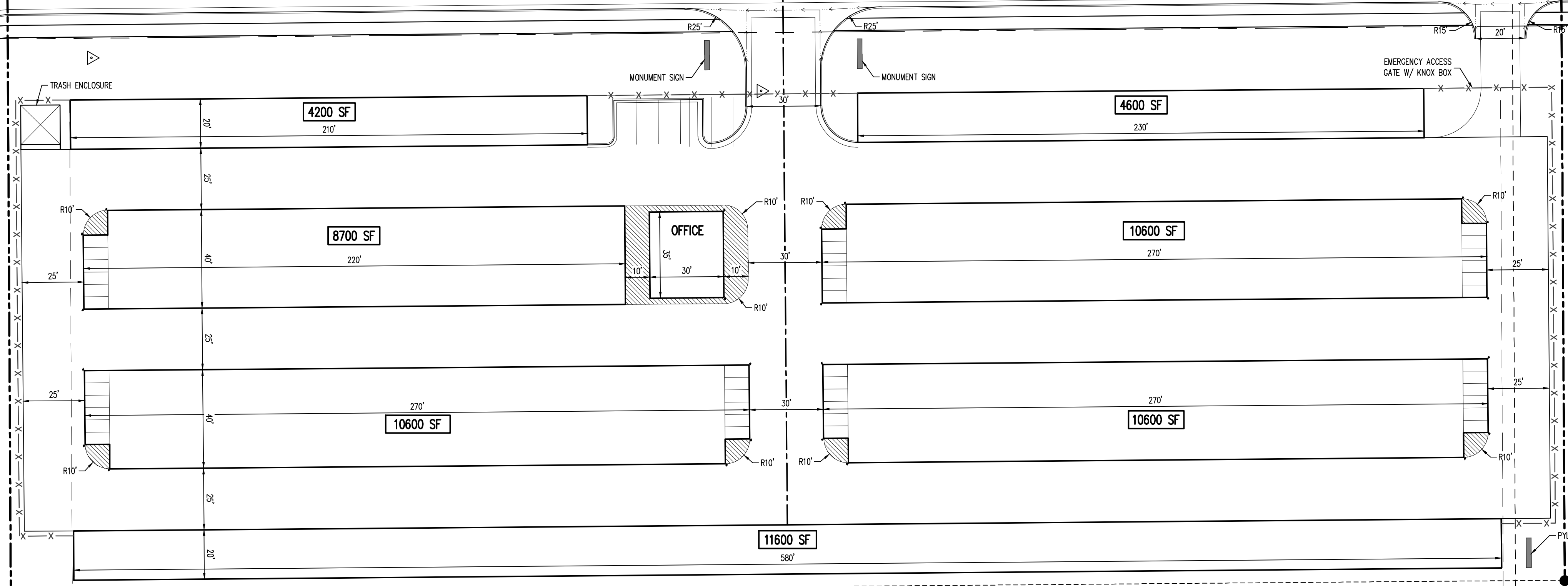
OWL PLACE
(60 FT PUBLIC ROW)

GRAVEL RV STORAGE

PROPOSED EXTENSION
MERIDIAN PARK DRIVE
(PUBLIC 60 FT ROW)

FUTURE MERIDIAN PARK
DRIVE CONNECTION

FUTURE SOUTH
CONNECTION



CLOSE OWL PLACE
INTERSECTION

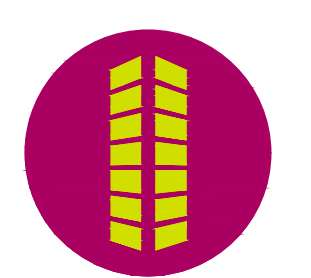
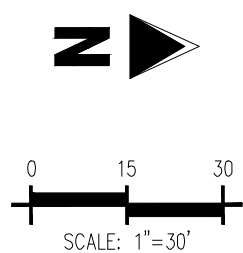
OWL PLACE STORAGE

LOT 1 & 2 CONCEPTUAL SITE PLAN

MERIDIAN STORAGE, LLC

This information is copyrighted by Galloway & Company, Inc. All rights reserved.

01.11.2023



APPENDIX B – LOS Descriptions

Level of Service for Signalized Intersections

Level of service for signalized intersections is defined in terms of delay, which is a measure of driver discomfort and frustration, fuel consumption, and lost travel time. Specifically, level-of-service (LOS) criteria are stated in terms of the average stopped delay per vehicle for a 15-min analysis period. The criteria are given in Exhibit 16-2. Delay may be measured in the field or estimated using procedures presented later in this chapter. Delay is a complex measure and is dependent on a number of variables, including the quality of progression, the cycle length, the green ratio, and the v/c ratio for the lane group in question.

LOS A describes operations with very low delay, up to 10 sec per vehicle. This level of service occurs when progression is extremely favorable and most vehicles arrive during the green phase. Most vehicles do not stop at all. Short cycle lengths may also contribute to low delay.

LOS B describes operations with delay greater than 10 and up to 20 sec per vehicle. This level generally occurs with good progression, short cycle lengths, or both. More vehicles stop than with LOS A, causing higher levels of average delay.

Exhibit 16-2. Level-of-Service Criteria for Signalized Intersections

| LEVEL OF SERVICE | STOPPED DELAY PER VEHICLE (SEC) |
|------------------|---------------------------------|
| A | ≤ 10.0 |
| B | > 10.0 and ≤ 20.0 |
| C | > 20.0 and ≤ 35.0 |
| D | > 35.0 and ≤ 55.0 |
| E | > 55.0 and ≤ 80.0 |
| F | > 80.0 |

LOS C describes operations with delay greater than 20 and up to 35 sec per vehicle. These higher delays may result from fair progression, longer cycle lengths, or both. Individual cycle failures may begin to appear at this level. The number of vehicles stopping is significant at this level, though many still pass through the intersection without stopping.

LOS D describes operations with delay greater than 35 and up to 55 sec per vehicle. At level D, the influence of congestion becomes more noticeable. Longer delays may result from some combination of unfavorable progression, long cycle lengths, or high v/c ratios. Many vehicles stop, and the proportion of vehicles not stopping declines. Individual cycle failures are noticeable.

LOS E describes operations with delay greater than 55 and up to 80 sec per vehicle. This level is considered by many agencies to be the limit of acceptable delay. These high delay values generally indicate poor progression, long cycle lengths, and high v/c ratios. Individual cycle failures are frequent occurrences.

LOS F describes operations with delay in excess of 80 sec per vehicle. This level, considered to be unacceptable to most drivers, often occurs with oversaturation, that is, when arrival flow rates exceed the capacity of the intersection. It may also occur at high v/c ratios below 1.0 with many individual cycle failures. Poor progression and long cycle lengths may also be major contributing causes to such delay levels.

Source: [Highway Capacity Manual, 2000](#). Transportation Research Board, National Research Council

Level of Service Criteria for Stop Sign Controlled Intersections

The level of service criteria are given in Table 17-2. As used here, control delay is defined as the total elapsed time from the time a vehicle stops at the end of the queue until the vehicle departs from the stop line; this time includes the time required for the vehicle to travel from the last-in-queue position to the first-in-queue position, including deceleration of vehicles from free-flow speed to the speed of vehicles in queue.

The average total delay for any particular minor movement is a function of the service rate or capacity of the approach and the degree of saturation. . . .

Table 17-2. Level of Service Criteria for TWSC Intersections

| LEVEL OF SERVICE | AVERAGE CONTROL DELAY (sec/veh) |
|------------------|------------------------------------|
| A | ≤ 10 |
| B | > 10 and ≤ 15 |
| C | > 15 and ≤ 25 |
| D | > 25 and ≤ 35 |
| E | > 35 and ≤ 50 |
| F | > 50 |

Average total delay less than 10 sec/veh is defined as Level of Service (LOS) A. Follow-up times of less than 5 sec have been measured when there is no conflicting traffic for a minor street movement, so control delays of less than 10 sec/veh are appropriate for low flow conditions. To remain consistent with the AWSC intersection analysis procedure described later in this chapter, a total delay of 50 sec/veh is assumed as the break point between LOS E and F.

The proposed level of service criteria for TWSC intersections are somewhat different from the criteria used in Chapter 16 for signalized intersections. The primary reason for this difference is that drivers expect different levels of performance from different kinds of transportation facilities. The expectation is that a signalized intersection is designed to carry higher traffic volumes than an unsignalized intersection. Additionally, several driver behavior considerations combine to make delays at signalized intersections less onerous than at unsignalized intersections. For example, drivers at signalized intersections are able to relax during the red interval, where drivers on the minor approaches to unsignalized intersections must remain attentive to the task of identifying acceptable gaps and vehicle conflicts. Also, there is often much more variability in the amount of delay experienced by individual drivers at unsignalized than signalized intersections. For these reasons, it is considered that the total delay threshold for any given level of service is less for an unsignalized intersection than for a signalized intersection. . . .

LOS F exists when there are insufficient gaps of suitable size to allow a side street demand to cross safely through a major street traffic stream. This level of service is generally evident from extremely long total delays experienced by side street traffic and by queueing on the minor approaches. The method, however, is based on a constant critical gap size - that is, the critical gap remains constant, no matter how long the side street motorist waits. LOS F may also appear in the form of side street vehicles' selecting smaller-than-usual gaps. In such cases, safety may be a problem and some disruption to the major traffic stream may result. It is important to note that LOS F may not always result in long queues but may result in adjustments to normal gap acceptance behavior. The latter is more difficult to observe on the field than queueing, which is more obvious.

Source: Highway Capacity Manual, 2000. Transportation Research Board, National Research Council

APPENDIX C – Traffic Counts

Location: 1 MERIDIAN ROAD & EAST WOODMEN ROAD AM

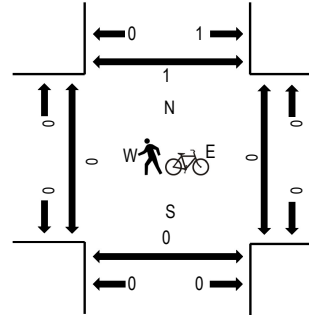
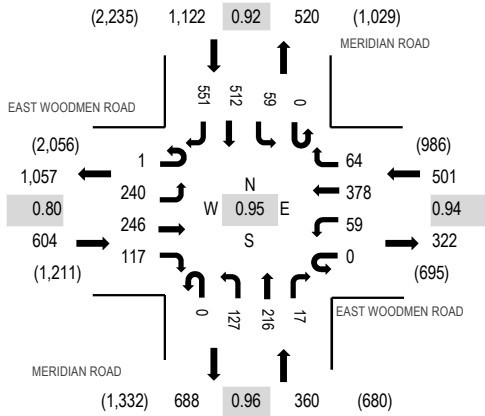
Date: Wednesday, June 1, 2022

Peak Hour: 07:15 AM - 08:15 AM

Peak 15-Minutes: 07:15 AM - 07:30 AM

Peak Hour - All Vehicles

Peak Hour - Pedestrians/Bicycles on Crosswalk



Note: Total study counts contained in parentheses.

Traffic Counts

| Interval Start Time | EAST WOODMEN ROAD Eastbound | | | | EAST WOODMEN ROAD Westbound | | | | MERIDIAN ROAD Northbound | | | | MERIDIAN ROAD Southbound | | | | Total | Rolling Hour | Pedestrian Crossings | | | |
|------------------------|--------------------------------|------|------|-------|--------------------------------|------|------|-------|-----------------------------|------|------|-------|-----------------------------|------|-------|-------|-------|-----------------|----------------------|------|-------|-------|
| | U-Turn | Left | Thru | Right | U-Turn | Left | Thru | Right | U-Turn | Left | Thru | Right | U-Turn | Left | Thru | Right | | | West | East | South | North |
| 7:00 AM | 0 | 41 | 45 | 41 | 0 | 9 | 112 | 15 | 0 | 26 | 47 | 7 | 0 | 9 | 165 | 127 | 644 | 2,584 | 0 | 0 | 0 | 0 |
| 7:15 AM | 0 | 45 | 61 | 32 | 0 | 16 | 104 | 19 | 0 | 40 | 52 | 1 | 0 | 8 | 144 | 156 | 678 | 2,587 | 0 | 0 | 0 | 0 |
| 7:30 AM | 0 | 55 | 64 | 26 | 0 | 8 | 113 | 17 | 0 | 32 | 52 | 6 | 0 | 13 | 150 | 142 | 678 | 2,550 | 0 | 0 | 0 | 0 |
| 7:45 AM | 0 | 72 | 72 | 30 | 0 | 20 | 78 | 10 | 0 | 28 | 51 | 4 | 0 | 19 | 105 | 95 | 584 | 2,509 | 0 | 0 | 0 | 1 |
| 8:00 AM | 1 | 68 | 49 | 29 | 0 | 15 | 83 | 18 | 0 | 27 | 61 | 6 | 0 | 19 | 113 | 158 | 647 | 2,528 | 0 | 0 | 0 | 0 |
| 8:15 AM | 0 | 60 | 60 | 13 | 0 | 9 | 101 | 17 | 2 | 20 | 56 | 6 | 0 | 25 | 120 | 152 | 641 | | 0 | 0 | 0 | 0 |
| 8:30 AM | 0 | 71 | 67 | 14 | 0 | 15 | 73 | 19 | 0 | 27 | 47 | 7 | 0 | 17 | 123 | 157 | 637 | | 0 | 0 | 0 | 0 |
| 8:45 AM | 0 | 78 | 94 | 23 | 0 | 25 | 69 | 21 | 2 | 27 | 36 | 10 | 1 | 26 | 83 | 108 | 603 | | 0 | 0 | 0 | 0 |
| Count Total | 1 | 490 | 512 | 208 | 0 | 117 | 733 | 136 | 4 | 227 | 402 | 47 | 1 | 136 | 1,003 | 1,095 | 5,112 | | 0 | 0 | 0 | 1 |
| Peak Hour | 1 | 240 | 246 | 117 | 0 | 59 | 378 | 64 | 0 | 127 | 216 | 17 | 0 | 59 | 512 | 551 | 2,587 | | 0 | 0 | 0 | 1 |

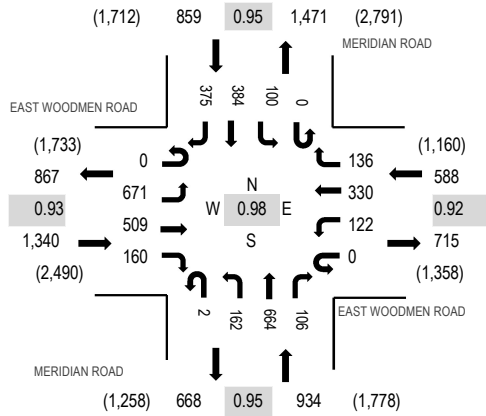
Location: 1 MERIDIAN ROAD & EAST WOODMEN ROAD PM

Date: Wednesday, June 1, 2022

Peak Hour: 04:45 PM - 05:45 PM

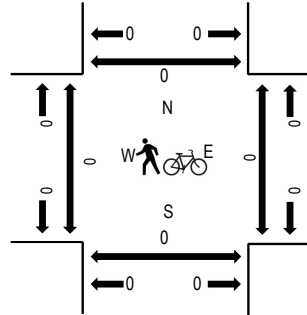
Peak 15-Minutes: 05:30 PM - 05:45 PM

Peak Hour - All Vehicles



Note: Total study counts contained in parentheses.

Peak Hour - Pedestrians/Bicycles on Crosswalk



Traffic Counts

| Interval Start Time | EAST WOODMEN ROAD Eastbound | | | | EAST WOODMEN ROAD Westbound | | | | MERIDIAN ROAD Northbound | | | | MERIDIAN ROAD Southbound | | | | Total | Rolling Hour | Pedestrian Crossings | | | |
|------------------------|--------------------------------|-------|------|-------|--------------------------------|------|------|-------|-----------------------------|------|-------|-------|-----------------------------|------|------|-------|-------|-----------------|----------------------|------|-------|-------|
| | U-Turn | Left | Thru | Right | U-Turn | Left | Thru | Right | U-Turn | Left | Thru | Right | U-Turn | Left | Thru | Right | | | West | East | South | North |
| 4:00 PM | 0 | 108 | 100 | 28 | 0 | 21 | 80 | 36 | 0 | 40 | 132 | 23 | 0 | 22 | 100 | 107 | 797 | 3,490 | 0 | 0 | 0 | 0 |
| 4:15 PM | 0 | 142 | 136 | 41 | 1 | 31 | 75 | 33 | 2 | 31 | 141 | 22 | 0 | 24 | 85 | 104 | 868 | 3,609 | 0 | 0 | 0 | 0 |
| 4:30 PM | 0 | 160 | 129 | 25 | 0 | 25 | 82 | 32 | 3 | 32 | 190 | 21 | 0 | 17 | 91 | 100 | 907 | 3,678 | 0 | 0 | 0 | 0 |
| 4:45 PM | 0 | 166 | 113 | 48 | 0 | 26 | 75 | 35 | 1 | 45 | 158 | 32 | 0 | 23 | 100 | 96 | 918 | 3,721 | 0 | 0 | 0 | 0 |
| 5:00 PM | 0 | 147 | 137 | 43 | 0 | 35 | 82 | 29 | 0 | 44 | 171 | 21 | 0 | 31 | 90 | 86 | 916 | 3,650 | 0 | 0 | 0 | 0 |
| 5:15 PM | 0 | 180 | 119 | 27 | 0 | 31 | 89 | 45 | 0 | 30 | 164 | 27 | 0 | 21 | 110 | 94 | 937 | | 0 | 0 | 0 | 0 |
| 5:30 PM | 0 | 178 | 140 | 42 | 0 | 30 | 84 | 27 | 1 | 43 | 171 | 26 | 0 | 25 | 84 | 99 | 950 | | 0 | 0 | 0 | 0 |
| 5:45 PM | 0 | 154 | 101 | 26 | 1 | 24 | 94 | 37 | 0 | 30 | 155 | 22 | 0 | 24 | 88 | 91 | 847 | | 0 | 0 | 0 | 0 |
| Count Total | 0 | 1,235 | 975 | 280 | 2 | 223 | 661 | 274 | 7 | 295 | 1,282 | 194 | 0 | 187 | 748 | 777 | 7,140 | | 0 | 0 | 0 | 0 |
| Peak Hour | 0 | 671 | 509 | 160 | 0 | 122 | 330 | 136 | 2 | 162 | 664 | 106 | 0 | 100 | 384 | 375 | 3,721 | | 0 | 0 | 0 | 0 |



ALL TRAFFIC DATA SERVICES

(303) 216-2439

www.alltrafficdata.net

Location: 2 MERIDIAN ROAD & EASTONVILLE ROAD AM

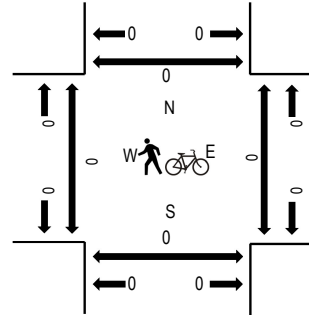
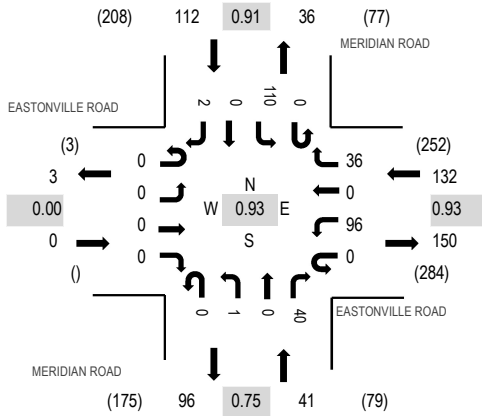
Date: Wednesday, June 1, 2022

Peak Hour: 07:45 AM - 08:45 AM

Peak 15-Minutes: 08:00 AM - 08:15 AM

Peak Hour - All Vehicles

Peak Hour - Pedestrians/Bicycles on Crosswalk



Note: Total study counts contained in parentheses.

Traffic Counts

| Interval Start Time | EASTONVILLE ROAD Eastbound | | | | EASTONVILLE ROAD Westbound | | | | MERIDIAN ROAD Northbound | | | | MERIDIAN ROAD Southbound | | | | Total | Rolling Hour | Pedestrian Crossings | | | |
|------------------------|-------------------------------|------|------|-------|-------------------------------|------|------|-------|-----------------------------|------|------|-------|-----------------------------|------|------|-------|-------|-----------------|----------------------|------|-------|-------|
| | U-Turn | Left | Thru | Right | U-Turn | Left | Thru | Right | U-Turn | Left | Thru | Right | U-Turn | Left | Thru | Right | | | West | East | South | North |
| 7:00 AM | 0 | 0 | 0 | 0 | 0 | 14 | 0 | 12 | 0 | 0 | 0 | 8 | 0 | 21 | 0 | 0 | 55 | 254 | 0 | 0 | 0 | 0 |
| 7:15 AM | 0 | 0 | 0 | 0 | 0 | 17 | 0 | 11 | 0 | 0 | 0 | 9 | 0 | 24 | 0 | 0 | 61 | 276 | 0 | 0 | 0 | 0 |
| 7:30 AM | 0 | 0 | 0 | 0 | 0 | 19 | 0 | 9 | 0 | 0 | 0 | 12 | 0 | 29 | 0 | 0 | 69 | 283 | 0 | 0 | 0 | 0 |
| 7:45 AM | 0 | 0 | 0 | 0 | 0 | 21 | 0 | 7 | 0 | 0 | 0 | 9 | 0 | 31 | 0 | 1 | 69 | 285 | 0 | 0 | 0 | 0 |
| 8:00 AM | 0 | 0 | 0 | 0 | 0 | 23 | 0 | 10 | 0 | 1 | 0 | 14 | 0 | 29 | 0 | 0 | 77 | 285 | 0 | 0 | 0 | 0 |
| 8:15 AM | 0 | 0 | 0 | 0 | 0 | 27 | 0 | 8 | 0 | 0 | 0 | 7 | 0 | 26 | 0 | 0 | 68 | | 0 | 0 | 0 | 0 |
| 8:30 AM | 0 | 0 | 0 | 0 | 0 | 25 | 0 | 11 | 0 | 0 | 0 | 10 | 0 | 24 | 0 | 1 | 71 | | 0 | 0 | 0 | 0 |
| 8:45 AM | 0 | 0 | 0 | 0 | 0 | 29 | 0 | 9 | 0 | 0 | 0 | 9 | 0 | 22 | 0 | 0 | 69 | | 0 | 0 | 0 | 0 |
| Count Total | 0 | 0 | 0 | 0 | 0 | 175 | 0 | 77 | 0 | 1 | 0 | 78 | 0 | 206 | 0 | 2 | 539 | | 0 | 0 | 0 | 0 |
| Peak Hour | 0 | 0 | 0 | 0 | 0 | 96 | 0 | 36 | 0 | 1 | 0 | 40 | 0 | 110 | 0 | 2 | 285 | | 0 | 0 | 0 | 0 |



ALL TRAFFIC DATA SERVICES

(303) 216-2439

www.alltrafficdata.net

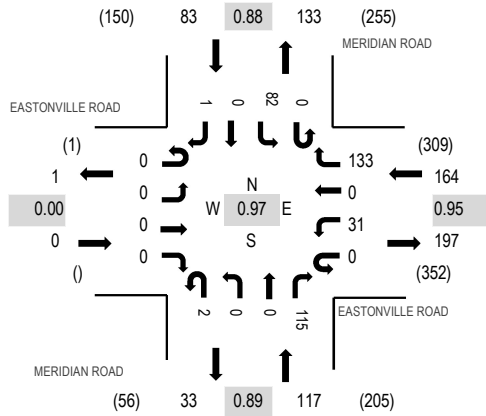
Location: 2 MERIDIAN ROAD & EASTONVILLE ROAD PM

Date: Wednesday, June 1, 2022

Peak Hour: 05:00 PM - 06:00 PM

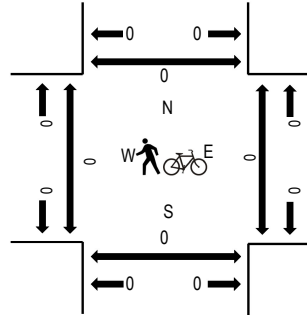
Peak 15-Minutes: 05:15 PM - 05:30 PM

Peak Hour - All Vehicles



Note: Total study counts contained in parentheses.

Peak Hour - Pedestrians/Bicycles on Crosswalk



Traffic Counts

| Interval Start Time | EASTONVILLE ROAD Eastbound | | | | EASTONVILLE ROAD Westbound | | | | MERIDIAN ROAD Northbound | | | | MERIDIAN ROAD Southbound | | | | Total | Rolling Hour | Pedestrian Crossings | | | |
|------------------------|-------------------------------|------|------|-------|-------------------------------|------|------|-------|-----------------------------|------|------|-------|-----------------------------|------|------|-------|-------|-----------------|----------------------|------|-------|-------|
| | U-Turn | Left | Thru | Right | U-Turn | Left | Thru | Right | U-Turn | Left | Thru | Right | U-Turn | Left | Thru | Right | | | West | East | South | North |
| 4:00 PM | 0 | 0 | 0 | 0 | 0 | 4 | 0 | 23 | 0 | 0 | 0 | 12 | 0 | 14 | 0 | 0 | 53 | 300 | 0 | 0 | 0 | 0 |
| 4:15 PM | 0 | 0 | 0 | 0 | 0 | 7 | 0 | 27 | 0 | 0 | 0 | 23 | 0 | 13 | 0 | 0 | 70 | 336 | 0 | 0 | 0 | 0 |
| 4:30 PM | 0 | 0 | 0 | 0 | 0 | 9 | 0 | 39 | 0 | 0 | 0 | 25 | 0 | 16 | 0 | 0 | 89 | 360 | 0 | 0 | 0 | 0 |
| 4:45 PM | 0 | 0 | 0 | 0 | 0 | 3 | 0 | 33 | 0 | 0 | 0 | 28 | 0 | 24 | 0 | 0 | 88 | 359 | 0 | 0 | 0 | 0 |
| 5:00 PM | 0 | 0 | 0 | 0 | 0 | 7 | 0 | 36 | 0 | 0 | 0 | 23 | 0 | 23 | 0 | 0 | 89 | 364 | 0 | 0 | 0 | 0 |
| 5:15 PM | 0 | 0 | 0 | 0 | 0 | 5 | 0 | 31 | 2 | 0 | 0 | 31 | 0 | 24 | 0 | 1 | 94 | | 0 | 0 | 0 | 0 |
| 5:30 PM | 0 | 0 | 0 | 0 | 0 | 9 | 0 | 34 | 0 | 0 | 0 | 30 | 0 | 15 | 0 | 0 | 88 | | 0 | 0 | 0 | 0 |
| 5:45 PM | 0 | 0 | 0 | 0 | 0 | 10 | 0 | 32 | 0 | 0 | 0 | 31 | 0 | 20 | 0 | 0 | 93 | | 0 | 0 | 0 | 0 |
| Count Total | 0 | 0 | 0 | 0 | 0 | 54 | 0 | 255 | 2 | 0 | 0 | 203 | 0 | 149 | 0 | 1 | 664 | | 0 | 0 | 0 | 0 |
| Peak Hour | 0 | 0 | 0 | 0 | 0 | 31 | 0 | 133 | 2 | 0 | 0 | 115 | 0 | 82 | 0 | 1 | 364 | | 0 | 0 | 0 | 0 |



ALL TRAFFIC DATA SERVICES

(303) 216-2439

www.alltrafficdata.net

Location: 3 MERIDIAN ROAD & OWL PLACE AM

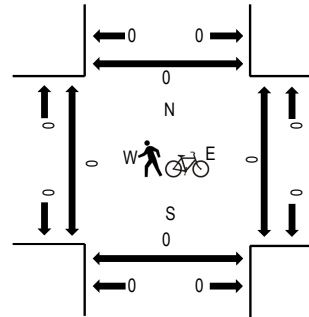
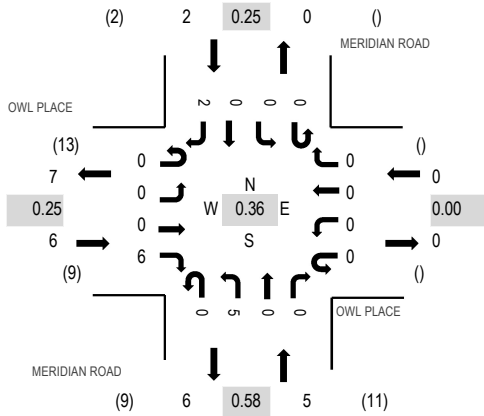
Date: Wednesday, June 1, 2022

Peak Hour: 07:00 AM - 08:00 AM

Peak 15-Minutes: 07:00 AM - 07:15 AM

Peak Hour - All Vehicles

Peak Hour - Pedestrians/Bicycles on Crosswalk



Note: Total study counts contained in parentheses.

Traffic Counts

| Interval Start Time | OWL PLACE Eastbound | | | | OWL PLACE Westbound | | | | MERIDIAN ROAD Northbound | | | | MERIDIAN ROAD Southbound | | | | Total | Rolling Hour | Pedestrian Crossings | | | | | | |
|------------------------|------------------------|------|------|-------|------------------------|------|------|-------|-----------------------------|------|------|-------|-----------------------------|------|------|-------|-------|-----------------|----------------------|------|-------|-------|---|---|---|
| | U-Turn | Left | Thru | Right | U-Turn | Left | Thru | Right | U-Turn | Left | Thru | Right | U-Turn | Left | Thru | Right | | | West | East | South | North | | | |
| 7:00 AM | 0 | 0 | 0 | 6 | 0 | 0 | 0 | 0 | 0 | 0 | 1 | 0 | 0 | 0 | 0 | 0 | 0 | 0 | 2 | 9 | 13 | 0 | 0 | 0 | 0 |
| 7:15 AM | 0 | 0 | 0 | 0 | 0 | 0 | 0 | 0 | 0 | 0 | 1 | 0 | 0 | 0 | 0 | 0 | 0 | 0 | 0 | 1 | 7 | 0 | 0 | 0 | 0 |
| 7:30 AM | 0 | 0 | 0 | 0 | 0 | 0 | 0 | 0 | 0 | 0 | 1 | 0 | 0 | 0 | 0 | 0 | 0 | 0 | 0 | 1 | 8 | 0 | 0 | 0 | 0 |
| 7:45 AM | 0 | 0 | 0 | 0 | 0 | 0 | 0 | 0 | 0 | 0 | 2 | 0 | 0 | 0 | 0 | 0 | 0 | 0 | 0 | 2 | 8 | 0 | 0 | 0 | 0 |
| 8:00 AM | 0 | 0 | 0 | 0 | 0 | 0 | 0 | 0 | 0 | 0 | 3 | 0 | 0 | 0 | 0 | 0 | 0 | 0 | 0 | 3 | 9 | 0 | 0 | 0 | 0 |
| 8:15 AM | 0 | 0 | 0 | 2 | 0 | 0 | 0 | 0 | 0 | 0 | 0 | 0 | 0 | 0 | 0 | 0 | 0 | 0 | 0 | 2 | | 0 | 0 | 0 | 0 |
| 8:30 AM | 0 | 0 | 0 | 1 | 0 | 0 | 0 | 0 | 0 | 0 | 0 | 0 | 0 | 0 | 0 | 0 | 0 | 0 | 0 | 1 | | 0 | 0 | 0 | 0 |
| 8:45 AM | 0 | 0 | 0 | 0 | 0 | 0 | 0 | 0 | 0 | 0 | 3 | 0 | 0 | 0 | 0 | 0 | 0 | 0 | 0 | 3 | | 0 | 0 | 0 | 0 |
| Count Total | 0 | 0 | 0 | 9 | 0 | 0 | 0 | 0 | 0 | 0 | 11 | 0 | 0 | 0 | 0 | 0 | 0 | 0 | 2 | 22 | | 0 | 0 | 0 | 0 |
| Peak Hour | 0 | 0 | 0 | 6 | 0 | 0 | 0 | 0 | 0 | 0 | 5 | 0 | 0 | 0 | 0 | 0 | 0 | 0 | 2 | 13 | | 0 | 0 | 0 | 0 |

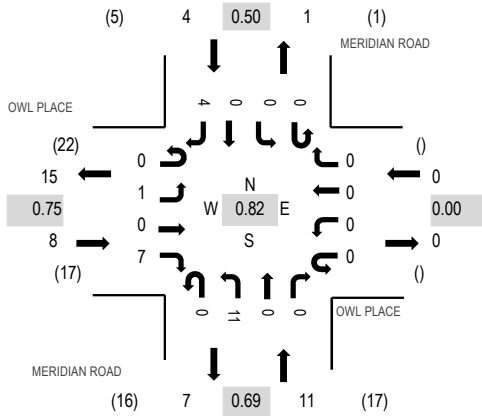
Location: 3 MERIDIAN ROAD & OWL PLACE PM

Date: Wednesday, June 1, 2022

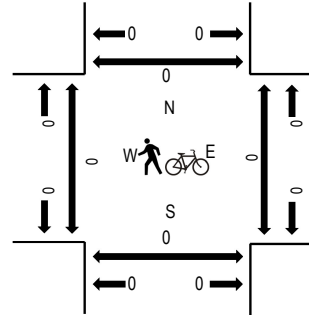
Peak Hour: 04:00 PM - 05:00 PM

Peak 15-Minutes: 04:00 PM - 04:15 PM

Peak Hour - All Vehicles



Peak Hour - Pedestrians/Bicycles on Crosswalk



Note: Total study counts contained in parentheses.

Traffic Counts

| Interval Start Time | OWL PLACE Eastbound | | | | OWL PLACE Westbound | | | | MERIDIAN ROAD Northbound | | | | MERIDIAN ROAD Southbound | | | | Total | Rolling Hour | Pedestrian Crossings | | | |
|------------------------|------------------------|------|------|-------|------------------------|------|------|-------|-----------------------------|------|------|-------|-----------------------------|------|------|-------|-------|-----------------|----------------------|------|-------|-------|
| | U-Turn | Left | Thru | Right | U-Turn | Left | Thru | Right | U-Turn | Left | Thru | Right | U-Turn | Left | Thru | Right | | | West | East | South | North |
| 4:00 PM | 0 | 0 | 0 | 2 | 0 | 0 | 0 | 0 | 0 | 3 | 0 | 0 | 0 | 0 | 0 | 2 | 7 | 23 | 0 | 0 | 0 | 0 |
| 4:15 PM | 0 | 1 | 0 | 2 | 0 | 0 | 0 | 0 | 0 | 2 | 0 | 0 | 0 | 0 | 0 | 1 | 6 | 21 | 0 | 0 | 0 | 0 |
| 4:30 PM | 0 | 0 | 0 | 2 | 0 | 0 | 0 | 0 | 0 | 4 | 0 | 0 | 0 | 0 | 0 | 0 | 6 | 18 | 0 | 0 | 0 | 0 |
| 4:45 PM | 0 | 0 | 0 | 1 | 0 | 0 | 0 | 0 | 0 | 2 | 0 | 0 | 0 | 0 | 0 | 1 | 4 | 15 | 0 | 0 | 0 | 0 |
| 5:00 PM | 0 | 0 | 0 | 3 | 0 | 0 | 0 | 0 | 0 | 2 | 0 | 0 | 0 | 0 | 0 | 0 | 5 | 16 | 0 | 0 | 0 | 0 |
| 5:15 PM | 0 | 0 | 0 | 3 | 0 | 0 | 0 | 0 | 0 | 0 | 0 | 0 | 0 | 0 | 0 | 0 | 3 | | 0 | 0 | 0 | 0 |
| 5:30 PM | 0 | 0 | 0 | 1 | 0 | 0 | 0 | 0 | 0 | 2 | 0 | 0 | 0 | 0 | 0 | 0 | 3 | | 0 | 0 | 0 | 0 |
| 5:45 PM | 0 | 0 | 0 | 2 | 0 | 0 | 0 | 0 | 0 | 2 | 0 | 0 | 0 | 0 | 0 | 1 | 5 | | 0 | 0 | 0 | 0 |
| Count Total | 0 | 1 | 0 | 16 | 0 | 0 | 0 | 0 | 0 | 17 | 0 | 0 | 0 | 0 | 0 | 5 | 39 | | 0 | 0 | 0 | 0 |
| Peak Hour | 0 | 1 | 0 | 7 | 0 | 0 | 0 | 0 | 0 | 11 | 0 | 0 | 0 | 0 | 0 | 4 | 23 | | 0 | 0 | 0 | 0 |

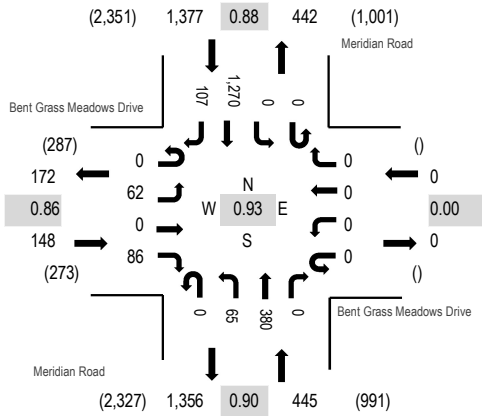
Location: 1 Meridian Road & Bent Grass Meadows Drive AM

Date: Tuesday, March 29, 2022

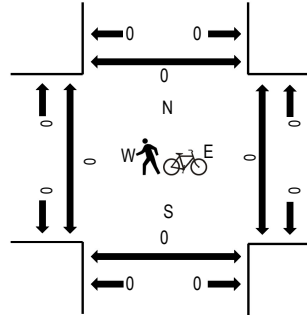
Peak Hour: 07:00 AM - 08:00 AM

Peak 15-Minutes: 07:15 AM - 07:30 AM

Peak Hour - All Vehicles



Peak Hour - Pedestrians/Bicycles on Crosswalk



Note: Total study counts contained in parentheses.

Traffic Counts

| Interval Start Time | Bent Grass Meadows Drive Eastbound | | | | Bent Grass Meadows Drive Westbound | | | | Meridian Road Northbound | | | Meridian Road Southbound | | | | Total | Rolling Hour | Pedestrian Crossings | | | | |
|------------------------|---------------------------------------|------|------|-------|---------------------------------------|------|------|-------|-----------------------------|------|------|-----------------------------|--------|------|-------|-------|-----------------|----------------------|------|------|-------|-------|
| | U-Turn | Left | Thru | Right | U-Turn | Left | Thru | Right | U-Turn | Left | Thru | Right | U-Turn | Left | Thru | | | Right | West | East | South | North |
| 7:00 AM | 0 | 17 | 0 | 18 | 0 | 0 | 0 | 0 | 0 | 19 | 63 | 0 | 0 | 0 | 341 | 36 | 494 | 1,970 | 0 | 0 | 0 | 0 |
| 7:15 AM | 0 | 14 | 0 | 29 | 0 | 0 | 0 | 0 | 0 | 17 | 79 | 0 | 0 | 0 | 366 | 26 | 531 | 1,912 | 0 | 0 | 0 | 0 |
| 7:30 AM | 0 | 13 | 0 | 24 | 0 | 0 | 0 | 0 | 0 | 16 | 97 | 0 | 0 | 0 | 307 | 21 | 478 | 1,794 | 0 | 0 | 0 | 0 |
| 7:45 AM | 0 | 18 | 0 | 15 | 0 | 0 | 0 | 0 | 0 | 13 | 141 | 0 | 0 | 0 | 256 | 24 | 467 | 1,718 | 0 | 0 | 0 | 0 |
| 8:00 AM | 0 | 12 | 0 | 15 | 0 | 0 | 0 | 0 | 0 | 12 | 111 | 0 | 0 | 0 | 259 | 27 | 436 | 1,645 | 0 | 0 | 0 | 0 |
| 8:15 AM | 0 | 16 | 0 | 15 | 0 | 0 | 0 | 0 | 0 | 16 | 138 | 0 | 0 | 0 | 210 | 18 | 413 | | 0 | 0 | 0 | 0 |
| 8:30 AM | 0 | 18 | 0 | 21 | 0 | 0 | 0 | 0 | 1 | 9 | 115 | 0 | 0 | 0 | 229 | 9 | 402 | | 0 | 0 | 0 | 0 |
| 8:45 AM | 0 | 13 | 0 | 15 | 0 | 0 | 0 | 0 | 1 | 7 | 136 | 0 | 0 | 0 | 205 | 17 | 394 | | 0 | 0 | 0 | 0 |
| Count Total | 0 | 121 | 0 | 152 | 0 | 0 | 0 | 0 | 2 | 109 | 880 | 0 | 0 | 0 | 2,173 | 178 | 3,615 | | 0 | 0 | 0 | 0 |
| Peak Hour | 0 | 62 | 0 | 86 | 0 | 0 | 0 | 0 | 0 | 65 | 380 | 0 | 0 | 0 | 1,270 | 107 | 1,970 | | 0 | 0 | 0 | 0 |

Location: 1 Meridian Road & Bent Grass Meadows Drive PM

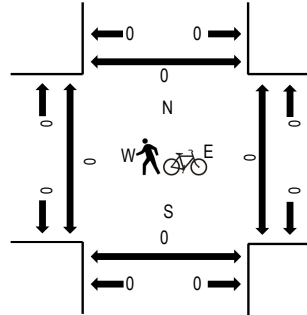
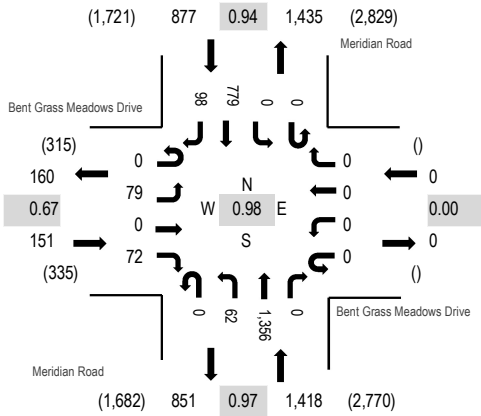
Date: Tuesday, March 29, 2022

Peak Hour: 04:30 PM - 05:30 PM

Peak 15-Minutes: 04:30 PM - 04:45 PM

Peak Hour - All Vehicles

Peak Hour - Pedestrians/Bicycles on Crosswalk



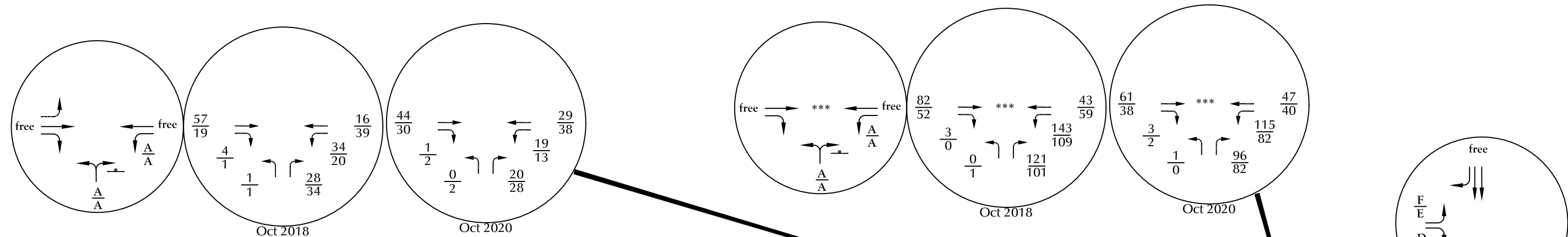
Note: Total study counts contained in parentheses.

Traffic Counts

| Interval Start Time | Bent Grass Meadows Drive Eastbound | | | | Bent Grass Meadows Drive Westbound | | | | Meridian Road Northbound | | | Meridian Road Southbound | | | | Total | Rolling Hour | Pedestrian Crossings | | | | |
|------------------------|------------------------------------|------|------|-------|------------------------------------|------|------|-------|--------------------------|------|-------|--------------------------|--------|------|-------|-------|--------------|----------------------|------|------|-------|-------|
| | U-Turn | Left | Thru | Right | U-Turn | Left | Thru | Right | U-Turn | Left | Thru | Right | U-Turn | Left | Thru | | | Right | West | East | South | North |
| 4:00 PM | 0 | 19 | 0 | 21 | 0 | 0 | 0 | 0 | 0 | 17 | 324 | 0 | 0 | 0 | 196 | 22 | 599 | 2,398 | 0 | 0 | 0 | 0 |
| 4:15 PM | 0 | 21 | 0 | 23 | 0 | 0 | 0 | 0 | 0 | 13 | 308 | 0 | 0 | 0 | 171 | 31 | 567 | 2,417 | 0 | 0 | 0 | 0 |
| 4:30 PM | 0 | 20 | 0 | 19 | 0 | 0 | 0 | 0 | 0 | 15 | 336 | 0 | 0 | 0 | 208 | 25 | 623 | 2,446 | 0 | 0 | 0 | 0 |
| 4:45 PM | 0 | 19 | 0 | 17 | 0 | 0 | 0 | 0 | 0 | 17 | 348 | 0 | 0 | 0 | 182 | 26 | 609 | 2,446 | 0 | 0 | 0 | 0 |
| 5:00 PM | 0 | 20 | 0 | 23 | 0 | 0 | 0 | 0 | 0 | 13 | 342 | 0 | 0 | 0 | 198 | 22 | 618 | 2,428 | 0 | 0 | 0 | 0 |
| 5:15 PM | 0 | 20 | 0 | 13 | 0 | 0 | 0 | 0 | 0 | 17 | 330 | 0 | 0 | 0 | 191 | 25 | 596 | | 0 | 0 | 0 | 0 |
| 5:30 PM | 0 | 47 | 0 | 19 | 0 | 0 | 0 | 0 | 0 | 12 | 317 | 0 | 0 | 0 | 203 | 25 | 623 | | 0 | 0 | 0 | 0 |
| 5:45 PM | 0 | 17 | 0 | 17 | 0 | 0 | 0 | 0 | 0 | 20 | 341 | 0 | 0 | 0 | 181 | 15 | 591 | | 0 | 0 | 0 | 0 |
| Count Total | 0 | 183 | 0 | 152 | 0 | 0 | 0 | 0 | 0 | 124 | 2,646 | 0 | 0 | 0 | 1,530 | 191 | 4,826 | | 0 | 0 | 0 | 0 |
| Peak Hour | 0 | 79 | 0 | 72 | 0 | 0 | 0 | 0 | 0 | 62 | 1,356 | 0 | 0 | 0 | 779 | 98 | 2,446 | | 0 | 0 | 0 | 0 |

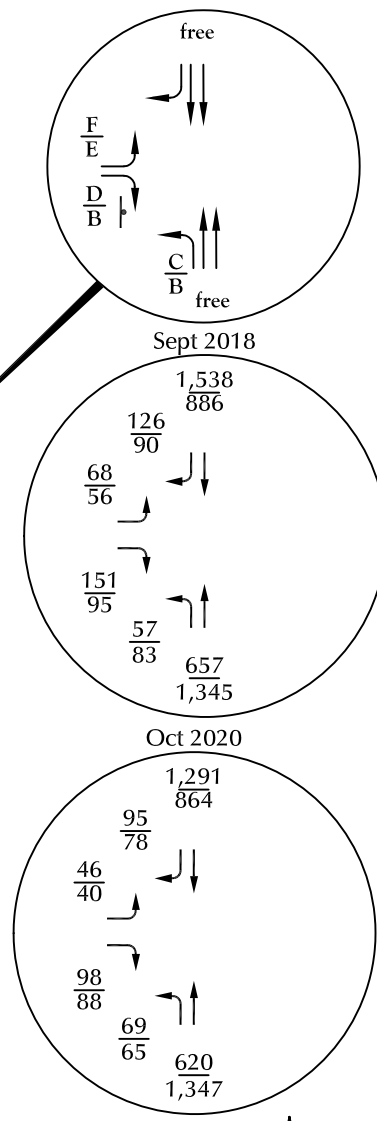
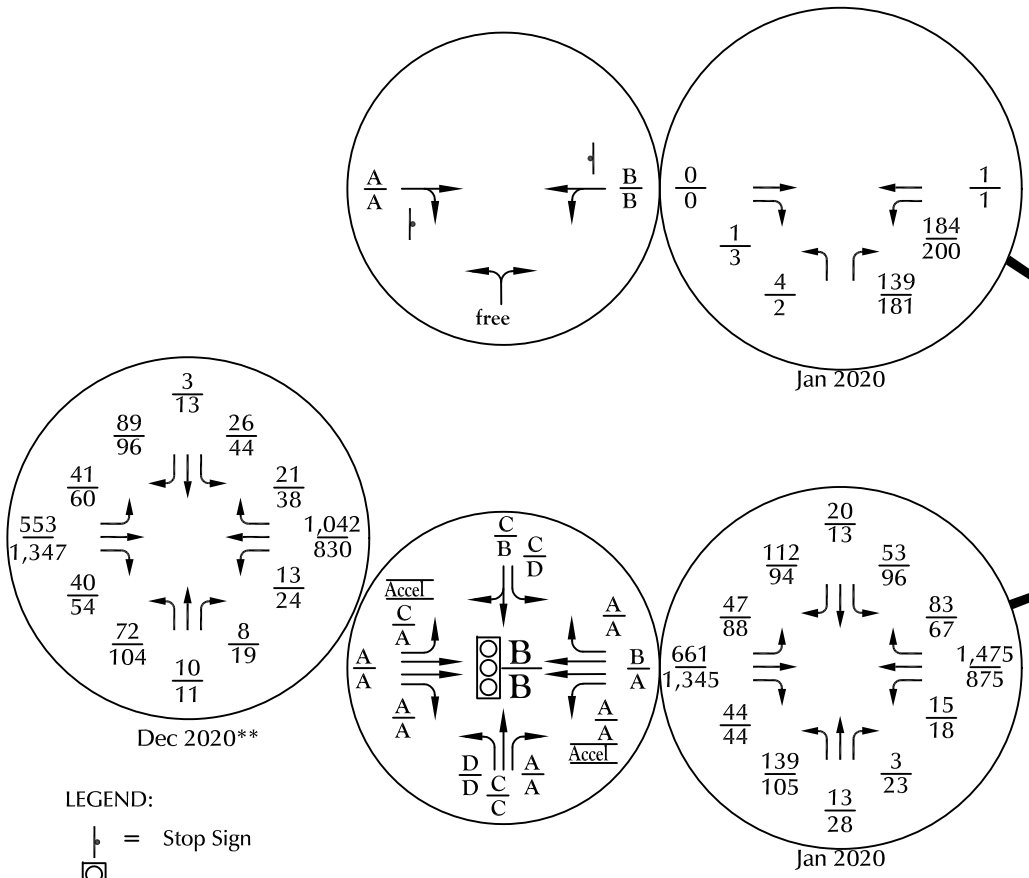
Date Start: 29-Mar-22
Site Code: 3
Station ID: 3
MERIDIAN RD S.O. BENT GRASS MEADOWS DR

| Start Time | 29-Mar-22 Tue | NB | SB | Total |
|-------------|---------------|------------|------------|-------|
| 12:00 AM | | 50 | 15 | 65 |
| 01:00 | | 19 | 11 | 30 |
| 02:00 | | 12 | 18 | 30 |
| 03:00 | | 11 | 45 | 56 |
| 04:00 | | 24 | 138 | 162 |
| 05:00 | | 58 | 358 | 416 |
| 06:00 | | 211 | 1018 | 1229 |
| 07:00 | | 447 | 1364 | 1811 |
| 08:00 | | 547 | 967 | 1514 |
| 09:00 | | 512 | 805 | 1317 |
| 10:00 | | 562 | 757 | 1319 |
| 11:00 | | 656 | 745 | 1401 |
| 12:00 PM | | 774 | 756 | 1530 |
| 01:00 | | 798 | 723 | 1521 |
| 02:00 | | 836 | 808 | 1644 |
| 03:00 | | 1115 | 796 | 1911 |
| 04:00 | | 1379 | 846 | 2225 |
| 05:00 | | 1400 | 836 | 2236 |
| 06:00 | | 1001 | 670 | 1671 |
| 07:00 | | 782 | 438 | 1220 |
| 08:00 | | 521 | 287 | 808 |
| 09:00 | | 332 | 164 | 496 |
| 10:00 | | 184 | 75 | 259 |
| 11:00 | | 77 | 41 | 118 |
| Total | | 12308 | 12681 | 24989 |
| Percent | | 49.3% | 50.7% | |
| AM Peak | - | 11:00 | 07:00 | - |
| Vol. | - | 656 | 1364 | - |
| PM Peak | - | 17:00 | 16:00 | - |
| Vol. | - | 1400 | 846 | - |
| Grand Total | | 12308 | 12681 | 24989 |
| Percent | | 49.3% | 50.7% | |
| ADT | | ADT 24,989 | ADT 24,989 | |

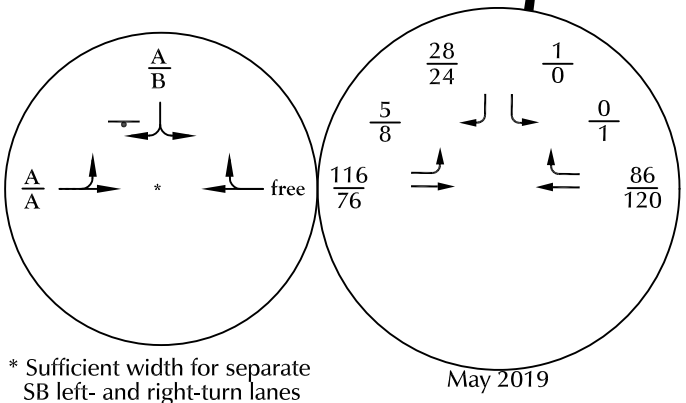


**This traffic count was conducted following the completion of Bent Grass Meadows Drive between the Woodmen frontage road and Meridian Ranch. All other counts were conducted prior to this connection being made.

***This access was closed after the traffic counts were conducted.



- LEGEND:
- = Stop Sign
 - = Traffic Signal
 - $\frac{XX}{XX}$ = AM Weekday Peak-Hour Traffic (vehicles per hour)
PM Weekday Peak-Hour Traffic (vehicles per hour)
 - $\frac{A}{B}$ = AM Individual Movement Peak-Hour Level of Service
PM Individual Movement Peak-Hour Level of Service
 - $\frac{C}{C}$ = AM Entire Intersection Peak-Hour Level of Service
PM Entire Intersection Peak-Hour Level of Service
 - X,XXX = Average Daily Traffic (vehicles per day)



* Sufficient width for separate SB left- and right-turn lanes

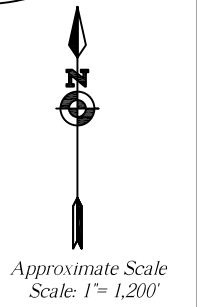


Figure 5
Existing Traffic, Lane Geometry, Traffic Control and Level of Service
 Bent Grass East Commercial Filing 3 (LSC #204660)



APPENDIX D – Existing Synchro Outputs

Timings
1: MERIDIAN ROAD & WOODMAN ROAD

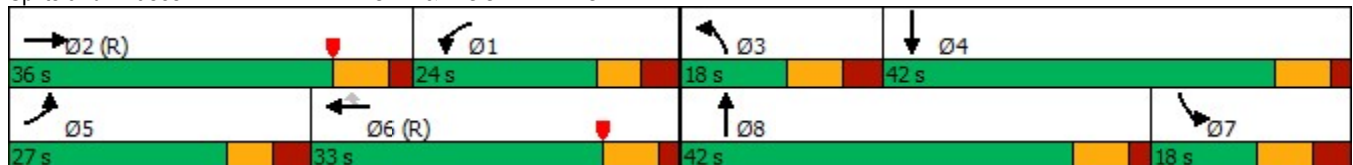
Existing AM
03/30/2023

| Lane Group | EBL | EBT | EBR | WBL | WBT | WBR | NBL | NBT | NBR | SBL | SBT | SBR |
|----------------------|-------|-------|-------|-------|-------|-------|-------|-------|-------|-------|-------|-------|
| Lane Configurations | | | | | | | | | | | | |
| Traffic Volume (vph) | 241 | 246 | 117 | 59 | 378 | 64 | 127 | 221 | 17 | 71 | 616 | 663 |
| Future Volume (vph) | 241 | 246 | 117 | 59 | 378 | 64 | 127 | 221 | 17 | 71 | 616 | 663 |
| Turn Type | Prot | NA | Free | Prot | NA | Perm | Prot | NA | Free | Prot | NA | Free |
| Protected Phases | 5 | 2 | | 1 | 6 | | 3 | 8 | | 7 | 4 | |
| Permitted Phases | | | Free | | | 6 | | | Free | | | Free |
| Detector Phase | 5 | 2 | | 1 | 6 | 6 | 3 | 8 | | 7 | 4 | |
| Switch Phase | | | | | | | | | | | | |
| Minimum Initial (s) | 5.0 | 15.0 | | 5.0 | 15.0 | 15.0 | 5.0 | 15.0 | | 5.0 | 15.0 | |
| Minimum Split (s) | 13.5 | 22.0 | | 13.5 | 22.0 | 22.0 | 13.5 | 22.0 | | 13.5 | 22.0 | |
| Total Split (s) | 27.0 | 36.0 | | 24.0 | 33.0 | 33.0 | 18.0 | 42.0 | | 18.0 | 42.0 | |
| Total Split (%) | 22.5% | 30.0% | | 20.0% | 27.5% | 27.5% | 15.0% | 35.0% | | 15.0% | 35.0% | |
| Yellow Time (s) | 4.0 | 5.0 | | 4.0 | 5.0 | 5.0 | 5.0 | 5.0 | | 5.0 | 5.0 | |
| All-Red Time (s) | 3.5 | 2.0 | | 3.5 | 2.0 | 2.0 | 3.5 | 2.0 | | 3.5 | 2.0 | |
| Lost Time Adjust (s) | 0.0 | 0.0 | | 0.0 | 0.0 | 0.0 | 0.0 | 0.0 | | 0.0 | 0.0 | |
| Total Lost Time (s) | 7.5 | 7.0 | | 7.5 | 7.0 | 7.0 | 8.5 | 7.0 | | 8.5 | 7.0 | |
| Lead/Lag | Lead | Lead | | Lag | Lag | Lag | Lead | Lead | | Lag | Lag | |
| Lead-Lag Optimize? | Yes | Yes | | Yes | Yes | Yes | Yes | Yes | | Yes | Yes | |
| Recall Mode | None | C-Max | | None | C-Max | C-Max | None | None | | None | None | |
| Act Effct Green (s) | 15.2 | 40.7 | 120.0 | 14.3 | 37.3 | 37.3 | 8.9 | 19.9 | 120.0 | 20.6 | 28.7 | 120.0 |
| Actuated g/C Ratio | 0.13 | 0.34 | 1.00 | 0.12 | 0.31 | 0.31 | 0.07 | 0.17 | 1.00 | 0.17 | 0.24 | 1.00 |
| v/c Ratio | 0.66 | 0.24 | 0.09 | 0.15 | 0.37 | 0.10 | 0.52 | 0.39 | 0.01 | 0.13 | 0.79 | 0.46 |
| Control Delay | 57.1 | 32.5 | 0.1 | 46.8 | 35.3 | 0.3 | 61.0 | 49.0 | 0.0 | 42.5 | 47.3 | 1.2 |
| Queue Delay | 0.0 | 0.0 | 0.0 | 0.0 | 0.0 | 0.0 | 0.0 | 0.0 | 0.0 | 0.0 | 0.0 | 0.0 |
| Total Delay | 57.1 | 32.5 | 0.1 | 46.8 | 35.3 | 0.3 | 61.0 | 49.0 | 0.0 | 42.5 | 47.3 | 1.2 |
| LOS | E | C | A | D | D | A | E | D | A | D | D | A |
| Approach Delay | | 36.0 | | | 32.2 | | | 50.8 | | | 24.4 | |
| Approach LOS | | D | | | C | | | D | | | C | |

Intersection Summary

Cycle Length: 120
 Actuated Cycle Length: 120
 Offset: 30 (25%), Referenced to phase 2:EBT and 6:WBT, Start of Yellow
 Natural Cycle: 75
 Control Type: Actuated-Coordinated
 Maximum v/c Ratio: 0.79
 Intersection Signal Delay: 31.7
 Intersection Capacity Utilization 65.6%
 Analysis Period (min) 15
 Intersection LOS: C
 ICU Level of Service C

Splits and Phases: 1: MERIDIAN ROAD & WOODMAN ROAD



Queues
1: MERIDIAN ROAD & WOODMAN ROAD

Existing AM
03/30/2023



| Lane Group | EBL | EBT | EBR | WBL | WBT | WBR | NBL | NBT | NBR | SBL | SBT | SBR |
|-------------------------|------|------|------|------|------|------|------|------|------|------|------|------|
| Lane Group Flow (vph) | 284 | 289 | 138 | 63 | 402 | 68 | 132 | 230 | 18 | 77 | 670 | 721 |
| v/c Ratio | 0.66 | 0.24 | 0.09 | 0.15 | 0.37 | 0.10 | 0.52 | 0.39 | 0.01 | 0.13 | 0.79 | 0.46 |
| Control Delay | 57.1 | 32.5 | 0.1 | 46.8 | 35.3 | 0.3 | 61.0 | 49.0 | 0.0 | 42.5 | 47.3 | 1.2 |
| Queue Delay | 0.0 | 0.0 | 0.0 | 0.0 | 0.0 | 0.0 | 0.0 | 0.0 | 0.0 | 0.0 | 0.0 | 0.0 |
| Total Delay | 57.1 | 32.5 | 0.1 | 46.8 | 35.3 | 0.3 | 61.0 | 49.0 | 0.0 | 42.5 | 47.3 | 1.2 |
| Queue Length 50th (ft) | 109 | 90 | 0 | 22 | 128 | 0 | 51 | 88 | 0 | 19 | 182 | 2 |
| Queue Length 95th (ft) | 141 | 130 | 0 | 44 | 197 | 0 | 84 | 129 | 0 | m34 | 225 | 6 |
| Internal Link Dist (ft) | | 1165 | | | 1100 | | | 344 | | | 1171 | |
| Turn Bay Length (ft) | 500 | | 630 | 350 | | 250 | 440 | | 330 | 490 | | 450 |
| Base Capacity (vph) | 557 | 1201 | 1583 | 472 | 1099 | 670 | 271 | 1047 | 1583 | 609 | 1032 | 1583 |
| Starvation Cap Reductn | 0 | 0 | 0 | 0 | 0 | 0 | 0 | 0 | 0 | 0 | 0 | 0 |
| Spillback Cap Reductn | 0 | 0 | 0 | 0 | 0 | 0 | 0 | 0 | 0 | 0 | 0 | 0 |
| Storage Cap Reductn | 0 | 0 | 0 | 0 | 0 | 0 | 0 | 0 | 0 | 0 | 0 | 0 |
| Reduced v/c Ratio | 0.51 | 0.24 | 0.09 | 0.13 | 0.37 | 0.10 | 0.49 | 0.22 | 0.01 | 0.13 | 0.65 | 0.46 |

Intersection Summary

m Volume for 95th percentile queue is metered by upstream signal.

HCM 6th Signalized Intersection Summary
1: MERIDIAN ROAD & WOODMAN ROAD

Existing AM
03/30/2023



| Movement | EBL | EBT | EBR | WBL | WBT | WBR | NBL | NBT | NBR | SBL | SBT | SBR |
|------------------------------|------|------|------|-------|------|-------|------|------|------|------|------|------|
| Lane Configurations | ↔↔ | ↑↑ | ↗ | ↔↔ | ↑↑ | ↗ | ↔↔ | ↑↑ | ↗ | ↔↔ | ↑↑ | ↗ |
| Traffic Volume (veh/h) | 241 | 246 | 117 | 59 | 378 | 64 | 127 | 221 | 17 | 71 | 616 | 663 |
| Future Volume (veh/h) | 241 | 246 | 117 | 59 | 378 | 64 | 127 | 221 | 17 | 71 | 616 | 663 |
| Initial Q (Qb), veh | 0 | 0 | 0 | 0 | 0 | 0 | 0 | 0 | 0 | 0 | 0 | 0 |
| Ped-Bike Adj(A_pbT) | 1.00 | | 1.00 | 1.00 | | 1.00 | 1.00 | | 1.00 | 1.00 | | 1.00 |
| Parking Bus, Adj | 1.00 | 1.00 | 1.00 | 1.00 | 1.00 | 1.00 | 1.00 | 1.00 | 1.00 | 1.00 | 1.00 | 1.00 |
| Work Zone On Approach | | No | | | No | | | No | | | No | |
| Adj Sat Flow, veh/h/ln | 1870 | 1870 | 1870 | 1870 | 1870 | 1870 | 1870 | 1870 | 1870 | 1870 | 1870 | 1870 |
| Adj Flow Rate, veh/h | 284 | 289 | 0 | 63 | 402 | 0 | 132 | 230 | 0 | 77 | 670 | 0 |
| Peak Hour Factor | 0.85 | 0.85 | 0.85 | 0.94 | 0.94 | 0.94 | 0.96 | 0.96 | 0.96 | 0.92 | 0.92 | 0.92 |
| Percent Heavy Veh, % | 2 | 2 | 2 | 2 | 2 | 2 | 2 | 2 | 2 | 2 | 2 | 2 |
| Cap, veh/h | 352 | 859 | | 758 | 1261 | | 188 | 444 | | 567 | 790 | |
| Arrive On Green | 0.10 | 0.24 | 0.00 | 0.22 | 0.35 | 0.00 | 0.05 | 0.13 | 0.00 | 0.16 | 0.22 | 0.00 |
| Sat Flow, veh/h | 3456 | 3554 | 1585 | 3456 | 3554 | 1585 | 3456 | 3554 | 1585 | 3456 | 3554 | 1585 |
| Grp Volume(v), veh/h | 284 | 289 | 0 | 63 | 402 | 0 | 132 | 230 | 0 | 77 | 670 | 0 |
| Grp Sat Flow(s),veh/h/ln | 1728 | 1777 | 1585 | 1728 | 1777 | 1585 | 1728 | 1777 | 1585 | 1728 | 1777 | 1585 |
| Q Serve(g_s), s | 9.7 | 8.1 | 0.0 | 1.7 | 9.9 | 0.0 | 4.5 | 7.3 | 0.0 | 2.3 | 21.7 | 0.0 |
| Cycle Q Clear(g_c), s | 9.7 | 8.1 | 0.0 | 1.7 | 9.9 | 0.0 | 4.5 | 7.3 | 0.0 | 2.3 | 21.7 | 0.0 |
| Prop In Lane | 1.00 | | 1.00 | 1.00 | | 1.00 | 1.00 | | 1.00 | 1.00 | | 1.00 |
| Lane Grp Cap(c), veh/h | 352 | 859 | | 758 | 1261 | | 188 | 444 | | 567 | 790 | |
| V/C Ratio(X) | 0.81 | 0.34 | | 0.08 | 0.32 | | 0.70 | 0.52 | | 0.14 | 0.85 | |
| Avail Cap(c_a), veh/h | 562 | 859 | | 758 | 1261 | | 274 | 1036 | | 567 | 1036 | |
| HCM Platoon Ratio | 1.00 | 1.00 | 1.00 | 1.00 | 1.00 | 1.00 | 1.00 | 1.00 | 1.00 | 1.00 | 1.00 | 1.00 |
| Upstream Filter(I) | 1.00 | 1.00 | 0.00 | 1.00 | 1.00 | 0.00 | 1.00 | 1.00 | 0.00 | 1.00 | 1.00 | 0.00 |
| Uniform Delay (d), s/veh | 52.7 | 37.6 | 0.0 | 37.2 | 28.1 | 0.0 | 55.8 | 49.1 | 0.0 | 42.9 | 44.7 | 0.0 |
| Incr Delay (d2), s/veh | 4.6 | 1.1 | 0.0 | 0.0 | 0.7 | 0.0 | 4.7 | 0.9 | 0.0 | 0.1 | 5.3 | 0.0 |
| Initial Q Delay(d3),s/veh | 0.0 | 0.0 | 0.0 | 0.0 | 0.0 | 0.0 | 0.0 | 0.0 | 0.0 | 0.0 | 0.0 | 0.0 |
| %ile BackOfQ(50%),veh/ln | 4.3 | 3.5 | 0.0 | 0.7 | 4.2 | 0.0 | 2.1 | 3.3 | 0.0 | 0.9 | 9.6 | 0.0 |
| Unsig. Movement Delay, s/veh | | | | | | | | | | | | |
| LnGrp Delay(d),s/veh | 57.3 | 38.6 | 0.0 | 37.3 | 28.8 | 0.0 | 60.5 | 50.1 | 0.0 | 43.0 | 50.0 | 0.0 |
| LnGrp LOS | E | D | | D | C | | E | D | | D | D | |
| Approach Vol, veh/h | | 573 | A | | 465 | A | | 362 | A | | 747 | A |
| Approach Delay, s/veh | | 47.9 | | | 30.0 | | | 53.9 | | | 49.3 | |
| Approach LOS | | D | | | C | | | D | | | D | |
| Timer - Assigned Phs | 1 | 2 | 3 | 4 | 5 | 6 | 7 | 8 | | | | |
| Phs Duration (G+Y+Rc), s | 33.8 | 36.0 | 15.0 | 35.2 | 19.7 | 50.1 | 28.2 | 22.0 | | | | |
| Change Period (Y+Rc), s | 7.5 | 7.0 | 8.5 | * 8.5 | 7.5 | * 7.5 | 8.5 | 7.0 | | | | |
| Max Green Setting (Gmax), s | 16.5 | 29.0 | 9.5 | * 35 | 19.5 | * 26 | 9.5 | 35.0 | | | | |
| Max Q Clear Time (g_c+I1), s | 3.7 | 10.1 | 6.5 | 23.7 | 11.7 | 11.9 | 4.3 | 9.3 | | | | |
| Green Ext Time (p_c), s | 0.1 | 1.5 | 0.1 | 3.0 | 0.6 | 2.0 | 0.1 | 1.4 | | | | |

Intersection Summary

| | |
|--------------------|------|
| HCM 6th Ctrl Delay | 45.5 |
| HCM 6th LOS | D |

Notes

- User approved pedestrian interval to be less than phase max green.
- * HCM 6th computational engine requires equal clearance times for the phases crossing the barrier.
- Unsignalized Delay for [NBR, EBR, WBR, SBR] is excluded from calculations of the approach delay and intersection delay.

| Intersection | | | | | | |
|--------------------------|------|------|------|------|------|------|
| Int Delay, s/veh | 9.2 | | | | | |
| Movement | WBL | WBR | NBT | NBR | SBL | SBT |
| Lane Configurations | ↘ | ↗ | ↑↑ | ↗ | ↘ | ↑↑ |
| Traffic Vol, veh/h | 96 | 36 | 486 | 40 | 110 | 1254 |
| Future Vol, veh/h | 96 | 36 | 486 | 40 | 110 | 1254 |
| Conflicting Peds, #/hr | 0 | 0 | 0 | 0 | 0 | 0 |
| Sign Control | Stop | Stop | Free | Free | Free | Free |
| RT Channelized | - | Free | - | None | - | None |
| Storage Length | 120 | 0 | - | 400 | 375 | - |
| Veh in Median Storage, # | 0 | - | 0 | - | - | 0 |
| Grade, % | 0 | - | 0 | - | - | 0 |
| Peak Hour Factor | 93 | 93 | 85 | 85 | 91 | 91 |
| Heavy Vehicles, % | 2 | 2 | 2 | 2 | 2 | 2 |
| Mvmt Flow | 103 | 39 | 572 | 47 | 121 | 1378 |

| Major/Minor | Minor1 | Major1 | Major2 | | |
|----------------------|--------|--------|--------|---|------|
| Conflicting Flow All | 1503 | - | 0 | 0 | 619 |
| Stage 1 | 572 | - | - | - | - |
| Stage 2 | 931 | - | - | - | - |
| Critical Hdwy | 6.84 | - | - | - | 4.14 |
| Critical Hdwy Stg 1 | 5.84 | - | - | - | - |
| Critical Hdwy Stg 2 | 5.84 | - | - | - | - |
| Follow-up Hdwy | 3.52 | - | - | - | 2.22 |
| Pot Cap-1 Maneuver | 112 | 0 | - | - | 957 |
| Stage 1 | 528 | 0 | - | - | - |
| Stage 2 | 344 | 0 | - | - | - |
| Platoon blocked, % | | | | | |
| Mov Cap-1 Maneuver | ~ 98 | - | - | - | 957 |
| Mov Cap-2 Maneuver | ~ 98 | - | - | - | - |
| Stage 1 | 528 | - | - | - | - |
| Stage 2 | 301 | - | - | - | - |

| Approach | WB | NB | SB |
|----------------------|-------|----|-----|
| HCM Control Delay, s | 186.2 | 0 | 0.8 |
| HCM LOS | F | | |

| Minor Lane/Major Mvmt | NBT | NBRWBLn1WBLn2 | SBL | SBT |
|-----------------------|-----|---------------|-------|-------|
| Capacity (veh/h) | - | - | 98 | 957 |
| HCM Lane V/C Ratio | - | - | 1.053 | 0.126 |
| HCM Control Delay (s) | - | - | 186.2 | 0 |
| HCM Lane LOS | - | - | F | A |
| HCM 95th %tile Q(veh) | - | - | 6.6 | 0.4 |

Notes
 ~: Volume exceeds capacity \$: Delay exceeds 300s +: Computation Not Defined *: All major volume in platoon

Timings
3: MERIDIAN ROAD & BENT GRASS MEADOWS DRIVE

Existing AM
03/30/2023

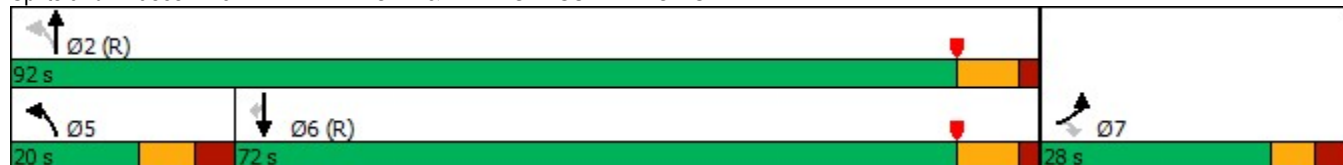


| Lane Group | EBL | EBR | NBL | NBT | SBT | SBR |
|----------------------|-------|-------|-------|-------|-------|-------|
| Lane Configurations | ↖↗ | ↗ | ↖ | ↑↑ | ↑↑ | ↗ |
| Traffic Volume (vph) | 62 | 86 | 80 | 437 | 1274 | 107 |
| Future Volume (vph) | 62 | 86 | 80 | 437 | 1274 | 107 |
| Turn Type | Prot | Perm | pm+pt | NA | NA | Perm |
| Protected Phases | 7 | | 5 | 2 | 6 | |
| Permitted Phases | | 7 | 2 | | | 6 |
| Detector Phase | 7 | 7 | 5 | 2 | 6 | 6 |
| Switch Phase | | | | | | |
| Minimum Initial (s) | 8.0 | 8.0 | 5.0 | 15.0 | 15.0 | 15.0 |
| Minimum Split (s) | 25.5 | 25.5 | 13.5 | 25.5 | 25.5 | 25.5 |
| Total Split (s) | 28.0 | 28.0 | 20.0 | 92.0 | 72.0 | 72.0 |
| Total Split (%) | 23.3% | 23.3% | 16.7% | 76.7% | 60.0% | 60.0% |
| Yellow Time (s) | 4.0 | 4.0 | 5.0 | 5.5 | 5.5 | 5.5 |
| All-Red Time (s) | 3.5 | 3.5 | 3.5 | 2.0 | 2.0 | 2.0 |
| Lost Time Adjust (s) | 0.0 | 0.0 | 0.0 | 0.0 | 0.0 | 0.0 |
| Total Lost Time (s) | 7.5 | 7.5 | 8.5 | 7.5 | 7.5 | 7.5 |
| Lead/Lag | | | Lead | | Lag | Lag |
| Lead-Lag Optimize? | | | Yes | | Yes | Yes |
| Recall Mode | None | None | None | C-Max | C-Max | C-Max |
| Act Effct Green (s) | 8.7 | 8.7 | 95.3 | 96.3 | 80.8 | 80.8 |
| Actuated g/C Ratio | 0.07 | 0.07 | 0.79 | 0.80 | 0.67 | 0.67 |
| v/c Ratio | 0.29 | 0.48 | 0.33 | 0.17 | 0.61 | 0.11 |
| Control Delay | 55.4 | 18.2 | 11.2 | 0.9 | 12.4 | 1.6 |
| Queue Delay | 0.0 | 0.0 | 0.0 | 0.0 | 0.0 | 0.0 |
| Total Delay | 55.4 | 18.2 | 11.2 | 0.9 | 12.4 | 1.6 |
| LOS | E | B | B | A | B | A |
| Approach Delay | 33.8 | | | 2.5 | 11.6 | |
| Approach LOS | C | | | A | B | |

Intersection Summary

Cycle Length: 120
 Actuated Cycle Length: 120
 Offset: 5 (4%), Referenced to phase 2:NBTL and 6:SBT, Start of Yellow
 Natural Cycle: 80
 Control Type: Actuated-Coordinated
 Maximum v/c Ratio: 0.61
 Intersection Signal Delay: 11.0
 Intersection Capacity Utilization 65.9%
 Analysis Period (min) 15
 Intersection LOS: B
 ICU Level of Service C

Splits and Phases: 3: MERIDIAN ROAD & BENT GRASS MEADOWS DRIVE



3: MERIDIAN ROAD & BENT GRASS MEADOWS DRIVE

03/30/2023

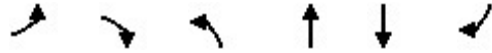


| Lane Group | EBL | EBR | NBL | NBT | SBT | SBR |
|-------------------------|------|------|------|------|------|------|
| Lane Group Flow (vph) | 72 | 100 | 89 | 486 | 1448 | 122 |
| v/c Ratio | 0.29 | 0.48 | 0.33 | 0.17 | 0.61 | 0.11 |
| Control Delay | 55.4 | 18.2 | 11.2 | 0.9 | 12.4 | 1.6 |
| Queue Delay | 0.0 | 0.0 | 0.0 | 0.0 | 0.0 | 0.0 |
| Total Delay | 55.4 | 18.2 | 11.2 | 0.9 | 12.4 | 1.6 |
| Queue Length 50th (ft) | 27 | 0 | 7 | 6 | 288 | 0 |
| Queue Length 95th (ft) | 48 | 47 | 25 | 10 | 386 | 20 |
| Internal Link Dist (ft) | 310 | | | 750 | 1921 | |
| Turn Bay Length (ft) | 150 | | 700 | | | 350 |
| Base Capacity (vph) | 586 | 353 | 328 | 2838 | 2384 | 1106 |
| Starvation Cap Reductn | 0 | 0 | 0 | 0 | 0 | 0 |
| Spillback Cap Reductn | 0 | 0 | 0 | 0 | 0 | 0 |
| Storage Cap Reductn | 0 | 0 | 0 | 0 | 0 | 0 |
| Reduced v/c Ratio | 0.12 | 0.28 | 0.27 | 0.17 | 0.61 | 0.11 |

Intersection Summary

HCM 6th Signalized Intersection Summary
 3: MERIDIAN ROAD & BENT GRASS MEADOWS DRIVE

Existing AM
 03/30/2023



| Movement | EBL | EBR | NBL | NBT | SBT | SBR |
|--|------|-------|------|------|------|------|
| Lane Configurations | ↖↗ | ↗ | ↖ | ↑↑ | ↑↑ | ↗ |
| Traffic Volume (veh/h) | 62 | 86 | 80 | 437 | 1274 | 107 |
| Future Volume (veh/h) | 62 | 86 | 80 | 437 | 1274 | 107 |
| Initial Q (Qb), veh | 0 | 0 | 0 | 0 | 0 | 0 |
| Ped-Bike Adj(A_pbT) | 1.00 | 1.00 | 1.00 | | | 1.00 |
| Parking Bus, Adj | 1.00 | 1.00 | 1.00 | 1.00 | 1.00 | 1.00 |
| Work Zone On Approach | No | | | No | No | |
| Adj Sat Flow, veh/h/ln | 1870 | 1870 | 1870 | 1870 | 1870 | 1870 |
| Adj Flow Rate, veh/h | 72 | 0 | 89 | 486 | 1448 | 122 |
| Peak Hour Factor | 0.86 | 0.86 | 0.90 | 0.90 | 0.88 | 0.88 |
| Percent Heavy Veh, % | 2 | 2 | 2 | 2 | 2 | 2 |
| Cap, veh/h | 209 | | 294 | 2894 | 2502 | 1116 |
| Arrive On Green | 0.06 | 0.00 | 0.04 | 0.81 | 0.70 | 0.70 |
| Sat Flow, veh/h | 3456 | 1585 | 1781 | 3647 | 3647 | 1585 |
| Grp Volume(v), veh/h | 72 | 0 | 89 | 486 | 1448 | 122 |
| Grp Sat Flow(s),veh/h/ln | 1728 | 1585 | 1781 | 1777 | 1777 | 1585 |
| Q Serve(g_s), s | 2.4 | 0.0 | 1.5 | 3.5 | 24.4 | 3.0 |
| Cycle Q Clear(g_c), s | 2.4 | 0.0 | 1.5 | 3.5 | 24.4 | 3.0 |
| Prop In Lane | 1.00 | 1.00 | 1.00 | | | 1.00 |
| Lane Grp Cap(c), veh/h | 209 | | 294 | 2894 | 2502 | 1116 |
| V/C Ratio(X) | 0.34 | | 0.30 | 0.17 | 0.58 | 0.11 |
| Avail Cap(c_a), veh/h | 590 | | 394 | 2894 | 2502 | 1116 |
| HCM Platoon Ratio | 1.00 | 1.00 | 1.00 | 1.00 | 1.00 | 1.00 |
| Upstream Filter(I) | 1.00 | 0.00 | 1.00 | 1.00 | 1.00 | 1.00 |
| Uniform Delay (d), s/veh | 54.1 | 0.0 | 7.6 | 2.4 | 8.9 | 5.7 |
| Incr Delay (d2), s/veh | 1.0 | 0.0 | 0.6 | 0.1 | 1.0 | 0.2 |
| Initial Q Delay(d3),s/veh | 0.0 | 0.0 | 0.0 | 0.0 | 0.0 | 0.0 |
| %ile BackOfQ(50%),veh/ln | 1.1 | 0.0 | 0.5 | 0.7 | 7.5 | 5.3 |
| Unsig. Movement Delay, s/veh | | | | | | |
| LnGrp Delay(d),s/veh | 55.0 | 0.0 | 8.2 | 2.5 | 9.9 | 5.9 |
| LnGrp LOS | E | | A | A | A | A |
| Approach Vol, veh/h | 72 | A | | 575 | 1570 | |
| Approach Delay, s/veh | 55.0 | | | 3.4 | 9.5 | |
| Approach LOS | E | | | A | A | |
| Timer - Assigned Phs | | 2 | | 4 | 5 | 6 |
| Phs Duration (G+Y+Rc), s | | 105.2 | | 14.8 | 13.2 | 92.0 |
| Change Period (Y+Rc), s | | 7.5 | | 7.5 | 8.5 | 7.5 |
| Max Green Setting (Gmax), s | | 84.5 | | 20.5 | 11.5 | 64.5 |
| Max Q Clear Time (g_c+I1), s | | 5.5 | | 4.4 | 3.5 | 26.4 |
| Green Ext Time (p_c), s | | 3.0 | | 0.1 | 0.1 | 13.3 |
| Intersection Summary | | | | | | |
| HCM 6th Ctrl Delay | | | 9.4 | | | |
| HCM 6th LOS | | | A | | | |
| Notes | | | | | | |
| Unsignalized Delay for [EBR] is excluded from calculations of the approach delay and intersection delay. | | | | | | |

| Intersection | | | | | | |
|--------------------------|------|------|------|------|------|------|
| Int Delay, s/veh | 5.6 | | | | | |
| Movement | EBT | EBR | WBL | WBT | NBL | NBR |
| Lane Configurations | ↑ | ↗ | ↖ | ↑ | ↘ | ↙ |
| Traffic Vol, veh/h | 32 | 62 | 152 | 35 | 1 | 116 |
| Future Vol, veh/h | 32 | 62 | 152 | 35 | 1 | 116 |
| Conflicting Peds, #/hr | 0 | 0 | 0 | 0 | 0 | 0 |
| Sign Control | Free | Free | Free | Free | Stop | Stop |
| RT Channelized | - | None | - | None | - | None |
| Storage Length | - | 150 | 100 | - | 0 | - |
| Veh in Median Storage, # | 0 | - | - | 0 | 0 | - |
| Grade, % | 0 | - | - | 0 | 0 | - |
| Peak Hour Factor | 85 | 85 | 85 | 85 | 85 | 85 |
| Heavy Vehicles, % | 2 | 2 | 2 | 2 | 2 | 2 |
| Mvmt Flow | 38 | 73 | 179 | 41 | 1 | 136 |

| Major/Minor | Major1 | Major2 | Minor1 | | |
|----------------------|--------|--------|--------|---|-------------|
| Conflicting Flow All | 0 | 0 | 111 | 0 | 437 38 |
| Stage 1 | - | - | - | - | 38 - |
| Stage 2 | - | - | - | - | 399 - |
| Critical Hdwy | - | - | 4.12 | - | 6.42 6.22 |
| Critical Hdwy Stg 1 | - | - | - | - | 5.42 - |
| Critical Hdwy Stg 2 | - | - | - | - | 5.42 - |
| Follow-up Hdwy | - | - | 2.218 | - | 3.518 3.318 |
| Pot Cap-1 Maneuver | - | - | 1479 | - | 577 1034 |
| Stage 1 | - | - | - | - | 984 - |
| Stage 2 | - | - | - | - | 678 - |
| Platoon blocked, % | - | - | - | - | - |
| Mov Cap-1 Maneuver | - | - | 1479 | - | 507 1034 |
| Mov Cap-2 Maneuver | - | - | - | - | 507 - |
| Stage 1 | - | - | - | - | 984 - |
| Stage 2 | - | - | - | - | 596 - |

| Approach | EB | WB | NB |
|----------------------|----|-----|-----|
| HCM Control Delay, s | 0 | 6.3 | 9.1 |
| HCM LOS | | | A |

| Minor Lane/Major Mvmt | NBLn1 | EBT | EBR | WBL | WBT |
|-----------------------|-------|-----|-----|-------|-----|
| Capacity (veh/h) | 1025 | - | - | 1479 | - |
| HCM Lane V/C Ratio | 0.134 | - | - | 0.121 | - |
| HCM Control Delay (s) | 9.1 | - | - | 7.8 | - |
| HCM Lane LOS | A | - | - | A | - |
| HCM 95th %tile Q(veh) | 0.5 | - | - | 0.4 | - |

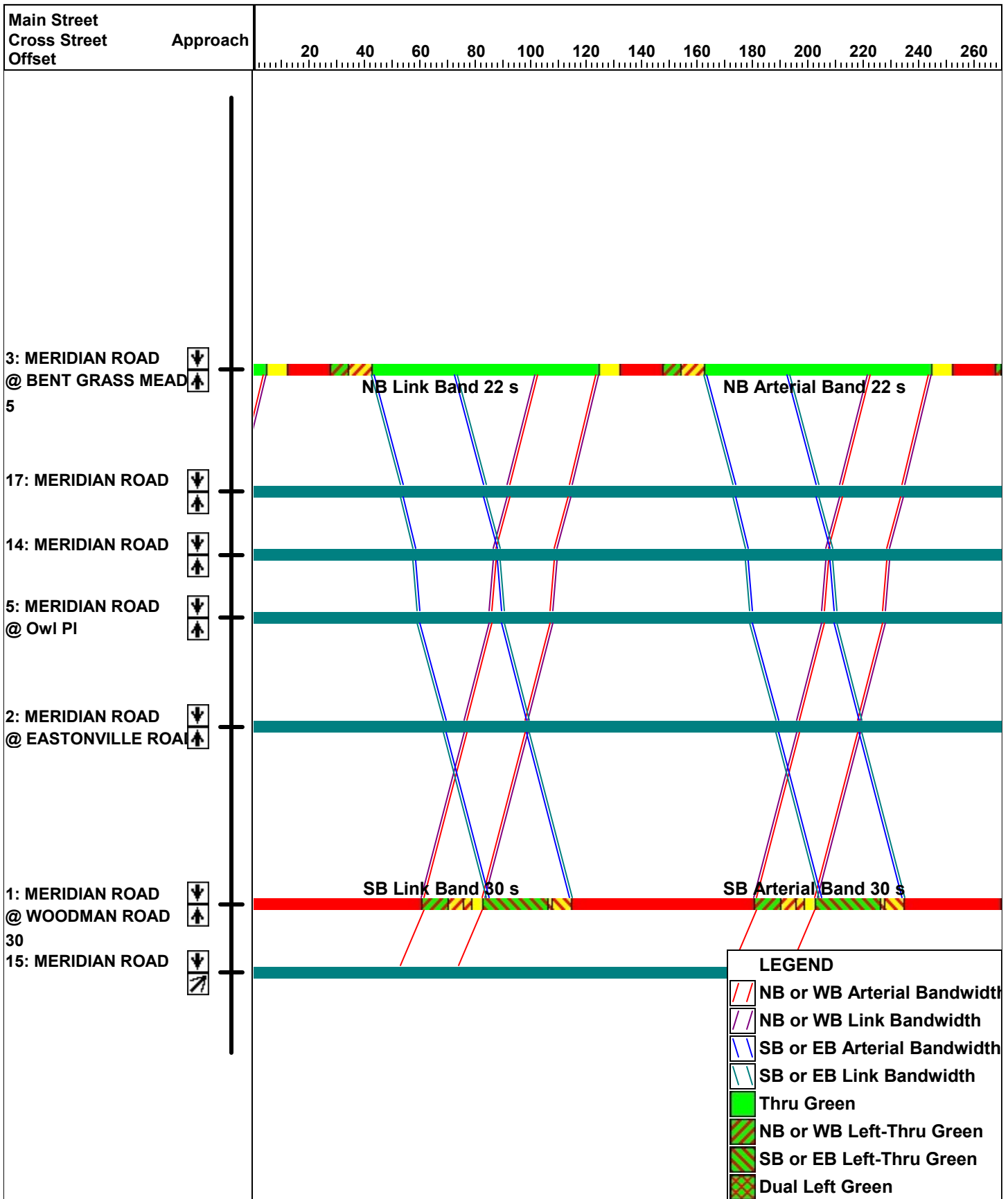
| Intersection | | | | | | |
|--------------------------|------|------|------|------|------|------|
| Int Delay, s/veh | 0.1 | | | | | |
| Movement | EBL | EBR | NBL | NBT | SBT | SBR |
| Lane Configurations | | ↗ | ↘ | ↑↑↑ | ↑↑ | |
| Traffic Vol, veh/h | 0 | 6 | 5 | 517 | 1358 | 2 |
| Future Vol, veh/h | 0 | 6 | 5 | 517 | 1358 | 2 |
| Conflicting Peds, #/hr | 0 | 0 | 0 | 0 | 0 | 0 |
| Sign Control | Stop | Stop | Free | Free | Free | Free |
| RT Channelized | - | None | - | None | - | None |
| Storage Length | - | 0 | 270 | - | - | - |
| Veh in Median Storage, # | 0 | - | - | 0 | 0 | - |
| Grade, % | 0 | - | - | 0 | 0 | - |
| Peak Hour Factor | 85 | 85 | 85 | 85 | 85 | 85 |
| Heavy Vehicles, % | 2 | 2 | 2 | 2 | 2 | 2 |
| Mvmt Flow | 0 | 7 | 6 | 608 | 1598 | 2 |

| Major/Minor | Minor2 | Major1 | Major2 | | |
|----------------------|--------|--------|--------|---|---|
| Conflicting Flow All | - | 800 | 1600 | 0 | 0 |
| Stage 1 | - | - | - | - | - |
| Stage 2 | - | - | - | - | - |
| Critical Hdwy | - | 6.94 | 4.14 | - | - |
| Critical Hdwy Stg 1 | - | - | - | - | - |
| Critical Hdwy Stg 2 | - | - | - | - | - |
| Follow-up Hdwy | - | 3.32 | 2.22 | - | - |
| Pot Cap-1 Maneuver | 0 | 328 | 405 | - | - |
| Stage 1 | 0 | - | - | - | - |
| Stage 2 | 0 | - | - | - | - |
| Platoon blocked, % | | | | - | - |
| Mov Cap-1 Maneuver | - | 328 | 405 | - | - |
| Mov Cap-2 Maneuver | - | - | - | - | - |
| Stage 1 | - | - | - | - | - |
| Stage 2 | - | - | - | - | - |

| Approach | EB | NB | SB |
|----------------------|------|-----|----|
| HCM Control Delay, s | 16.2 | 0.1 | 0 |
| HCM LOS | C | | |

| Minor Lane/Major Mvmt | NBL | NBT | EBLn1 | SBT | SBR |
|-----------------------|-------|-----|-------|-----|-----|
| Capacity (veh/h) | 405 | - | 328 | - | - |
| HCM Lane V/C Ratio | 0.015 | - | 0.022 | - | - |
| HCM Control Delay (s) | 14 | - | 16.2 | - | - |
| HCM Lane LOS | B | - | C | - | - |
| HCM 95th %tile Q(veh) | 0 | - | 0.1 | - | - |

Existing AM Signal Progression



Timings
1: MERIDIAN ROAD & WOODMAN ROAD

Existing PM
03/30/2023

| Lane Group | EBL | EBT | EBR | WBL | WBT | WBR | NBL | NBT | NBR | SBL | SBT | SBR |
|----------------------|-------|-------|-------|-------|-------|-------|-------|-------|-------|-------|-------|-------|
| Lane Configurations | | | | | | | | | | | | |
| Traffic Volume (vph) | 671 | 509 | 160 | 112 | 330 | 136 | 164 | 675 | 106 | 100 | 387 | 375 |
| Future Volume (vph) | 671 | 509 | 160 | 112 | 330 | 136 | 164 | 675 | 106 | 100 | 387 | 375 |
| Turn Type | Prot | NA | Free | Prot | NA | Perm | Prot | NA | Free | Prot | NA | Free |
| Protected Phases | 5 | 2 | | 1 | 6 | | 3 | 8 | | 7 | 4 | |
| Permitted Phases | | | Free | | | 6 | | | Free | | | Free |
| Detector Phase | 5 | 2 | | 1 | 6 | 6 | 3 | 8 | | 7 | 4 | |
| Switch Phase | | | | | | | | | | | | |
| Minimum Initial (s) | 5.0 | 15.0 | | 5.0 | 15.0 | 15.0 | 5.0 | 15.0 | | 5.0 | 15.0 | |
| Minimum Split (s) | 13.5 | 22.0 | | 13.5 | 22.0 | 22.0 | 13.5 | 22.0 | | 13.5 | 22.0 | |
| Total Split (s) | 38.0 | 37.0 | | 26.0 | 25.0 | 25.0 | 18.0 | 39.0 | | 18.0 | 39.0 | |
| Total Split (%) | 31.7% | 30.8% | | 21.7% | 20.8% | 20.8% | 15.0% | 32.5% | | 15.0% | 32.5% | |
| Yellow Time (s) | 4.0 | 5.0 | | 4.0 | 5.0 | 5.0 | 5.0 | 5.0 | | 5.0 | 5.0 | |
| All-Red Time (s) | 3.5 | 2.0 | | 3.5 | 2.0 | 2.0 | 3.5 | 2.0 | | 3.5 | 2.0 | |
| Lost Time Adjust (s) | 0.0 | 0.0 | | 0.0 | 0.0 | 0.0 | 0.0 | 0.0 | | 0.0 | 0.0 | |
| Total Lost Time (s) | 7.5 | 7.0 | | 7.5 | 7.0 | 7.0 | 8.5 | 7.0 | | 8.5 | 7.0 | |
| Lead/Lag | Lead | Lag | | Lead | Lag | Lag | Lead | Lag | | Lead | Lag | |
| Lead-Lag Optimize? | Yes | Yes | | Yes | Yes | Yes | Yes | Yes | | Yes | Yes | |
| Recall Mode | None | C-Max | | None | C-Max | C-Max | None | None | | None | None | |
| Act Effct Green (s) | 28.7 | 42.6 | 120.0 | 9.6 | 23.6 | 23.6 | 9.2 | 29.2 | 120.0 | 8.5 | 28.5 | 120.0 |
| Actuated g/C Ratio | 0.24 | 0.36 | 1.00 | 0.08 | 0.20 | 0.20 | 0.08 | 0.24 | 1.00 | 0.07 | 0.24 | 1.00 |
| v/c Ratio | 0.88 | 0.44 | 0.11 | 0.44 | 0.52 | 0.29 | 0.66 | 0.83 | 0.07 | 0.43 | 0.48 | 0.25 |
| Control Delay | 57.0 | 32.1 | 0.1 | 57.4 | 47.9 | 1.4 | 66.2 | 51.7 | 0.1 | 67.9 | 34.3 | 0.4 |
| Queue Delay | 0.0 | 0.0 | 0.0 | 0.0 | 0.0 | 0.0 | 0.0 | 0.0 | 0.0 | 0.0 | 0.0 | 0.0 |
| Total Delay | 57.0 | 32.1 | 0.1 | 57.4 | 47.9 | 1.4 | 66.2 | 51.7 | 0.1 | 67.9 | 34.3 | 0.4 |
| LOS | E | C | A | E | D | A | E | D | A | E | C | A |
| Approach Delay | | 40.7 | | | 38.8 | | | 48.4 | | | 23.4 | |
| Approach LOS | | D | | | D | | | D | | | C | |

Intersection Summary

Cycle Length: 120

Actuated Cycle Length: 120

Offset: 100 (83%), Referenced to phase 2:EBT and 6:WBT, Start of Yellow

Natural Cycle: 90

Control Type: Actuated-Coordinated

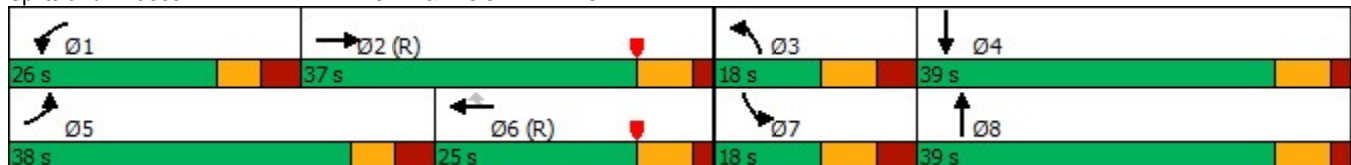
Maximum v/c Ratio: 0.88

Intersection Signal Delay: 38.4 Intersection LOS: D

Intersection Capacity Utilization 79.1% ICU Level of Service D

Analysis Period (min) 15

Splits and Phases: 1: MERIDIAN ROAD & WOODMAN ROAD



Queues
1: MERIDIAN ROAD & WOODMAN ROAD

Existing PM
03/30/2023



| Lane Group | EBL | EBT | EBR | WBL | WBT | WBR | NBL | NBT | NBR | SBL | SBT | SBR |
|-------------------------|------|------|------|------|------|------|------|------|------|------|------|------|
| Lane Group Flow (vph) | 722 | 547 | 172 | 122 | 359 | 148 | 173 | 711 | 112 | 105 | 407 | 395 |
| v/c Ratio | 0.88 | 0.44 | 0.11 | 0.44 | 0.52 | 0.29 | 0.66 | 0.83 | 0.07 | 0.43 | 0.48 | 0.25 |
| Control Delay | 57.0 | 32.1 | 0.1 | 57.4 | 47.9 | 1.4 | 66.2 | 51.7 | 0.1 | 67.9 | 34.3 | 0.4 |
| Queue Delay | 0.0 | 0.0 | 0.0 | 0.0 | 0.0 | 0.0 | 0.0 | 0.0 | 0.0 | 0.0 | 0.0 | 0.0 |
| Total Delay | 57.0 | 32.1 | 0.1 | 57.4 | 47.9 | 1.4 | 66.2 | 51.7 | 0.1 | 67.9 | 34.3 | 0.4 |
| Queue Length 50th (ft) | 273 | 173 | 0 | 47 | 137 | 0 | 68 | 271 | 0 | 34 | 141 | 0 |
| Queue Length 95th (ft) | 347 | 240 | 0 | 77 | 193 | 0 | 106 | 338 | 0 | 67 | 188 | 0 |
| Internal Link Dist (ft) | | 1165 | | | 1100 | | | 344 | | | 1171 | |
| Turn Bay Length (ft) | 500 | | 630 | 350 | | 250 | 440 | | 330 | 490 | | 450 |
| Base Capacity (vph) | 872 | 1257 | 1583 | 529 | 694 | 511 | 271 | 943 | 1583 | 271 | 943 | 1583 |
| Starvation Cap Reductn | 0 | 0 | 0 | 0 | 0 | 0 | 0 | 0 | 0 | 0 | 0 | 0 |
| Spillback Cap Reductn | 0 | 0 | 0 | 0 | 0 | 0 | 0 | 0 | 0 | 0 | 0 | 0 |
| Storage Cap Reductn | 0 | 0 | 0 | 0 | 0 | 0 | 0 | 0 | 0 | 0 | 0 | 0 |
| Reduced v/c Ratio | 0.83 | 0.44 | 0.11 | 0.23 | 0.52 | 0.29 | 0.64 | 0.75 | 0.07 | 0.39 | 0.43 | 0.25 |

Intersection Summary

HCM 6th Signalized Intersection Summary
1: MERIDIAN ROAD & WOODMAN ROAD

Existing PM
03/30/2023



| Movement | EBL | EBT | EBR | WBL | WBT | WBR | NBL | NBT | NBR | SBL | SBT | SBR |
|------------------------------|------|------|------|------|------|------|------|------|------|------|------|------|
| Lane Configurations | ↔↔ | ↑↑ | ↗ | ↔↔ | ↑↑ | ↗ | ↔↔ | ↑↑ | ↗ | ↔↔ | ↑↑ | ↗ |
| Traffic Volume (veh/h) | 671 | 509 | 160 | 112 | 330 | 136 | 164 | 675 | 106 | 100 | 387 | 375 |
| Future Volume (veh/h) | 671 | 509 | 160 | 112 | 330 | 136 | 164 | 675 | 106 | 100 | 387 | 375 |
| Initial Q (Qb), veh | 0 | 0 | 0 | 0 | 0 | 0 | 0 | 0 | 0 | 0 | 0 | 0 |
| Ped-Bike Adj(A_pbT) | 1.00 | | 1.00 | 1.00 | | 1.00 | 1.00 | | 1.00 | 1.00 | | 1.00 |
| Parking Bus, Adj | 1.00 | 1.00 | 1.00 | 1.00 | 1.00 | 1.00 | 1.00 | 1.00 | 1.00 | 1.00 | 1.00 | 1.00 |
| Work Zone On Approach | | No | | | No | | | No | | | No | |
| Adj Sat Flow, veh/h/ln | 1870 | 1870 | 1870 | 1870 | 1870 | 1870 | 1870 | 1870 | 1870 | 1870 | 1870 | 1870 |
| Adj Flow Rate, veh/h | 722 | 547 | 0 | 122 | 359 | 0 | 173 | 711 | 0 | 105 | 407 | 0 |
| Peak Hour Factor | 0.93 | 0.93 | 0.93 | 0.92 | 0.92 | 0.92 | 0.95 | 0.95 | 0.95 | 0.95 | 0.95 | 0.95 |
| Percent Heavy Veh, % | 2 | 2 | 2 | 2 | 2 | 2 | 2 | 2 | 2 | 2 | 2 | 2 |
| Cap, veh/h | 794 | 1496 | | 181 | 866 | | 229 | 820 | | 158 | 747 | |
| Arrive On Green | 0.23 | 0.42 | 0.00 | 0.05 | 0.24 | 0.00 | 0.07 | 0.23 | 0.00 | 0.05 | 0.21 | 0.00 |
| Sat Flow, veh/h | 3456 | 3554 | 1585 | 3456 | 3554 | 1585 | 3456 | 3554 | 1585 | 3456 | 3554 | 1585 |
| Grp Volume(v), veh/h | 722 | 547 | 0 | 122 | 359 | 0 | 173 | 711 | 0 | 105 | 407 | 0 |
| Grp Sat Flow(s),veh/h/ln | 1728 | 1777 | 1585 | 1728 | 1777 | 1585 | 1728 | 1777 | 1585 | 1728 | 1777 | 1585 |
| Q Serve(g_s), s | 24.4 | 12.6 | 0.0 | 4.2 | 10.2 | 0.0 | 5.9 | 23.1 | 0.0 | 3.6 | 12.3 | 0.0 |
| Cycle Q Clear(g_c), s | 24.4 | 12.6 | 0.0 | 4.2 | 10.2 | 0.0 | 5.9 | 23.1 | 0.0 | 3.6 | 12.3 | 0.0 |
| Prop In Lane | 1.00 | | 1.00 | 1.00 | | 1.00 | 1.00 | | 1.00 | 1.00 | | 1.00 |
| Lane Grp Cap(c), veh/h | 794 | 1496 | | 181 | 866 | | 229 | 820 | | 158 | 747 | |
| V/C Ratio(X) | 0.91 | 0.37 | | 0.67 | 0.41 | | 0.75 | 0.87 | | 0.66 | 0.54 | |
| Avail Cap(c_a), veh/h | 878 | 1496 | | 533 | 866 | | 274 | 948 | | 274 | 948 | |
| HCM Platoon Ratio | 1.00 | 1.00 | 1.00 | 1.00 | 1.00 | 1.00 | 1.00 | 1.00 | 1.00 | 1.00 | 1.00 | 1.00 |
| Upstream Filter(I) | 1.00 | 1.00 | 0.00 | 1.00 | 1.00 | 0.00 | 1.00 | 1.00 | 0.00 | 1.00 | 1.00 | 0.00 |
| Uniform Delay (d), s/veh | 45.0 | 23.8 | 0.0 | 55.8 | 38.2 | 0.0 | 55.1 | 44.4 | 0.0 | 56.3 | 42.3 | 0.0 |
| Incr Delay (d2), s/veh | 12.6 | 0.7 | 0.0 | 4.3 | 1.5 | 0.0 | 9.4 | 7.7 | 0.0 | 4.7 | 0.6 | 0.0 |
| Initial Q Delay(d3),s/veh | 0.0 | 0.0 | 0.0 | 0.0 | 0.0 | 0.0 | 0.0 | 0.0 | 0.0 | 0.0 | 0.0 | 0.0 |
| %ile BackOfQ(50%),veh/ln | 11.5 | 5.2 | 0.0 | 1.9 | 4.5 | 0.0 | 2.9 | 10.9 | 0.0 | 1.6 | 5.2 | 0.0 |
| Unsig. Movement Delay, s/veh | | | | | | | | | | | | |
| LnGrp Delay(d),s/veh | 57.6 | 24.5 | 0.0 | 60.1 | 39.6 | 0.0 | 64.5 | 52.1 | 0.0 | 61.0 | 42.9 | 0.0 |
| LnGrp LOS | E | C | | E | D | | E | D | | E | D | |
| Approach Vol, veh/h | | 1269 | A | | 481 | A | | 884 | A | | 512 | A |
| Approach Delay, s/veh | | 43.3 | | | 44.8 | | | 54.5 | | | 46.6 | |
| Approach LOS | | D | | | D | | | D | | | D | |
| Timer - Assigned Phs | 1 | 2 | 3 | 4 | 5 | 6 | 7 | 8 | | | | |
| Phs Duration (G+Y+Rc), s | 13.8 | 57.5 | 16.5 | 32.2 | 35.1 | 36.2 | 14.0 | 34.7 | | | | |
| Change Period (Y+Rc), s | 7.5 | 7.0 | 8.5 | 7.0 | 7.5 | 7.0 | 8.5 | 7.0 | | | | |
| Max Green Setting (Gmax), s | 18.5 | 30.0 | 9.5 | 32.0 | 30.5 | 18.0 | 9.5 | 32.0 | | | | |
| Max Q Clear Time (g_c+I1), s | 6.2 | 14.6 | 7.9 | 14.3 | 26.4 | 12.2 | 5.6 | 25.1 | | | | |
| Green Ext Time (p_c), s | 0.2 | 2.9 | 0.1 | 2.1 | 1.2 | 1.0 | 0.1 | 2.6 | | | | |

Intersection Summary

| | |
|--------------------|------|
| HCM 6th Ctrl Delay | 47.2 |
| HCM 6th LOS | D |

Notes

User approved pedestrian interval to be less than phase max green.
Unsignalized Delay for [NBR, EBR, WBR, SBR] is excluded from calculations of the approach delay and intersection delay.

| Intersection | | | | | | |
|--------------------------|------|------|------|------|------|------|
| Int Delay, s/veh | 5.5 | | | | | |
| Movement | WBL | WBR | NBT | NBR | SBL | SBT |
| Lane Configurations | ↘ | ↗ | ↑↑ | ↗ | ↘ | ↑↑ |
| Traffic Vol, veh/h | 31 | 133 | 1367 | 115 | 82 | 831 |
| Future Vol, veh/h | 31 | 133 | 1367 | 115 | 82 | 831 |
| Conflicting Peds, #/hr | 0 | 0 | 0 | 0 | 0 | 0 |
| Sign Control | Stop | Stop | Free | Free | Free | Free |
| RT Channelized | - | Free | - | None | - | None |
| Storage Length | 120 | 0 | - | 400 | 375 | - |
| Veh in Median Storage, # | 0 | - | 0 | - | - | 0 |
| Grade, % | 0 | - | 0 | - | - | 0 |
| Peak Hour Factor | 95 | 95 | 89 | 89 | 88 | 88 |
| Heavy Vehicles, % | 2 | 2 | 2 | 2 | 2 | 2 |
| Mvmt Flow | 33 | 140 | 1536 | 129 | 93 | 944 |

| Major/Minor | Minor1 | Major1 | Major2 | | |
|----------------------|--------|--------|--------|---|------|
| Conflicting Flow All | 2194 | - | 0 | 0 | 1665 |
| Stage 1 | 1536 | - | - | - | - |
| Stage 2 | 658 | - | - | - | - |
| Critical Hdwy | 6.84 | - | - | - | 4.14 |
| Critical Hdwy Stg 1 | 5.84 | - | - | - | - |
| Critical Hdwy Stg 2 | 5.84 | - | - | - | - |
| Follow-up Hdwy | 3.52 | - | - | - | 2.22 |
| Pot Cap-1 Maneuver | 38 | 0 | - | - | 382 |
| Stage 1 | 164 | 0 | - | - | - |
| Stage 2 | 477 | 0 | - | - | - |
| Platoon blocked, % | | | | | |
| Mov Cap-1 Maneuver | ~ 29 | - | - | - | 382 |
| Mov Cap-2 Maneuver | ~ 29 | - | - | - | - |
| Stage 1 | 164 | - | - | - | - |
| Stage 2 | 361 | - | - | - | - |

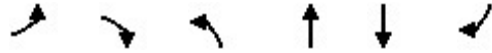
| Approach | WB | NB | SB |
|----------------------|----------|----|-----|
| HCM Control Delay, s | \$ 409.6 | 0 | 1.6 |
| HCM LOS | F | | |

| Minor Lane/Major Mvmt | NBT | NBR | WBLn1 | WBLn2 | SBL | SBT |
|-----------------------|-----|-----|----------|-------|-------|-----|
| Capacity (veh/h) | - | - | 29 | - | 382 | - |
| HCM Lane V/C Ratio | - | - | 1.125 | - | 0.244 | - |
| HCM Control Delay (s) | - | - | \$ 409.6 | 0 | 17.4 | - |
| HCM Lane LOS | - | - | F | A | C | - |
| HCM 95th %tile Q(veh) | - | - | 3.7 | - | 0.9 | - |

Notes
 ~: Volume exceeds capacity \$: Delay exceeds 300s +: Computation Not Defined *: All major volume in platoon

Timings
 3: MERIDIAN ROAD & BENT GRASS MEADOWS DRIVE

Existing PM
 03/30/2023

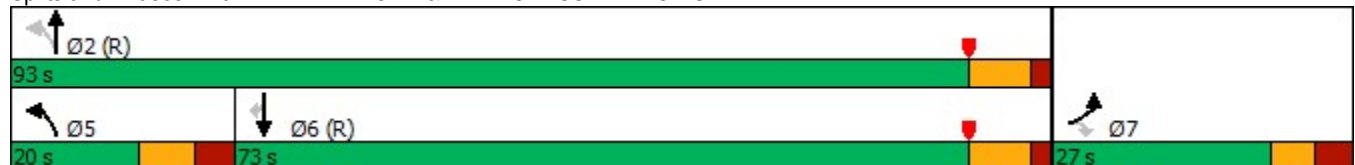


| Lane Group | EBL | EBR | NBL | NBT | SBT | SBR |
|----------------------|-------|-------|-------|-------|-------|-------|
| Lane Configurations | ↖↗ | ↗ | ↖ | ↑↑ | ↑↑ | ↗ |
| Traffic Volume (vph) | 79 | 72 | 65 | 1424 | 838 | 98 |
| Future Volume (vph) | 79 | 72 | 65 | 1424 | 838 | 98 |
| Turn Type | Prot | Perm | pm+pt | NA | NA | Perm |
| Protected Phases | 7 | | 5 | 2 | 6 | |
| Permitted Phases | | 7 | 2 | | | 6 |
| Detector Phase | 7 | 7 | 5 | 2 | 6 | 6 |
| Switch Phase | | | | | | |
| Minimum Initial (s) | 8.0 | 8.0 | 5.0 | 15.0 | 15.0 | 15.0 |
| Minimum Split (s) | 25.5 | 25.5 | 13.5 | 25.5 | 25.5 | 25.5 |
| Total Split (s) | 27.0 | 27.0 | 20.0 | 93.0 | 73.0 | 73.0 |
| Total Split (%) | 22.5% | 22.5% | 16.7% | 77.5% | 60.8% | 60.8% |
| Yellow Time (s) | 4.0 | 4.0 | 5.0 | 5.5 | 5.5 | 5.5 |
| All-Red Time (s) | 3.5 | 3.5 | 3.5 | 2.0 | 2.0 | 2.0 |
| Lost Time Adjust (s) | 0.0 | 0.0 | 0.0 | 0.0 | 0.0 | 0.0 |
| Total Lost Time (s) | 7.5 | 7.5 | 8.5 | 7.5 | 7.5 | 7.5 |
| Lead/Lag | | | Lead | | Lag | Lag |
| Lead-Lag Optimize? | | | Yes | | Yes | Yes |
| Recall Mode | None | None | None | C-Max | C-Max | C-Max |
| Act Effct Green (s) | 9.7 | 9.7 | 94.3 | 95.3 | 83.1 | 83.1 |
| Actuated g/C Ratio | 0.08 | 0.08 | 0.79 | 0.79 | 0.69 | 0.69 |
| v/c Ratio | 0.43 | 0.47 | 0.15 | 0.53 | 0.36 | 0.09 |
| Control Delay | 57.0 | 16.8 | 1.7 | 4.2 | 8.9 | 1.7 |
| Queue Delay | 0.0 | 0.0 | 0.0 | 0.0 | 0.0 | 0.0 |
| Total Delay | 57.0 | 16.8 | 1.7 | 4.2 | 8.9 | 1.7 |
| LOS | E | B | A | A | A | A |
| Approach Delay | 37.9 | | | 4.1 | 8.1 | |
| Approach LOS | D | | | A | A | |

Intersection Summary

Cycle Length: 120
 Actuated Cycle Length: 120
 Offset: 27 (23%), Referenced to phase 2:NBTL and 6:SBT, Start of Yellow
 Natural Cycle: 65
 Control Type: Actuated-Coordinated
 Maximum v/c Ratio: 0.53
 Intersection Signal Delay: 8.2
 Intersection Capacity Utilization 58.5%
 Analysis Period (min) 15
 Intersection LOS: A
 ICU Level of Service B

Splits and Phases: 3: MERIDIAN ROAD & BENT GRASS MEADOWS DRIVE



3: MERIDIAN ROAD & BENT GRASS MEADOWS DRIVE

03/30/2023



| Lane Group | EBL | EBR | NBL | NBT | SBT | SBR |
|-------------------------|------|------|------|------|------|------|
| Lane Group Flow (vph) | 118 | 107 | 68 | 1499 | 891 | 104 |
| v/c Ratio | 0.43 | 0.47 | 0.15 | 0.53 | 0.36 | 0.09 |
| Control Delay | 57.0 | 16.8 | 1.7 | 4.2 | 8.9 | 1.7 |
| Queue Delay | 0.0 | 0.0 | 0.0 | 0.0 | 0.0 | 0.0 |
| Total Delay | 57.0 | 16.8 | 1.7 | 4.2 | 8.9 | 1.7 |
| Queue Length 50th (ft) | 45 | 0 | 2 | 203 | 145 | 0 |
| Queue Length 95th (ft) | 55 | 19 | m6 | 249 | 201 | 20 |
| Internal Link Dist (ft) | 310 | | | 750 | 1921 | |
| Turn Bay Length (ft) | 150 | | 700 | | | 350 |
| Base Capacity (vph) | 557 | 346 | 512 | 2810 | 2450 | 1127 |
| Starvation Cap Reductn | 0 | 0 | 0 | 0 | 0 | 0 |
| Spillback Cap Reductn | 0 | 0 | 0 | 0 | 0 | 0 |
| Storage Cap Reductn | 0 | 0 | 0 | 0 | 0 | 0 |
| Reduced v/c Ratio | 0.21 | 0.31 | 0.13 | 0.53 | 0.36 | 0.09 |

Intersection Summary

m Volume for 95th percentile queue is metered by upstream signal.

HCM 6th Signalized Intersection Summary
 3: MERIDIAN ROAD & BENT GRASS MEADOWS DRIVE

Existing PM
 03/30/2023



| Movement | EBL | EBR | NBL | NBT | SBT | SBR |
|------------------------------|------|-------|------|------|------|------|
| Lane Configurations | ↖↗ | ↗ | ↖ | ↑↑ | ↑↑ | ↗ |
| Traffic Volume (veh/h) | 79 | 72 | 65 | 1424 | 838 | 98 |
| Future Volume (veh/h) | 79 | 72 | 65 | 1424 | 838 | 98 |
| Initial Q (Qb), veh | 0 | 0 | 0 | 0 | 0 | 0 |
| Ped-Bike Adj(A_pbT) | 1.00 | 1.00 | 1.00 | | | 1.00 |
| Parking Bus, Adj | 1.00 | 1.00 | 1.00 | 1.00 | 1.00 | 1.00 |
| Work Zone On Approach | No | | | No | No | |
| Adj Sat Flow, veh/h/ln | 1870 | 1870 | 1870 | 1870 | 1870 | 1870 |
| Adj Flow Rate, veh/h | 118 | 0 | 68 | 1499 | 891 | 104 |
| Peak Hour Factor | 0.67 | 0.67 | 0.95 | 0.95 | 0.94 | 0.94 |
| Percent Heavy Veh, % | 2 | 2 | 2 | 2 | 2 | 2 |
| Cap, veh/h | 226 | | 467 | 2877 | 2493 | 1112 |
| Arrive On Green | 0.07 | 0.00 | 0.04 | 0.81 | 0.70 | 0.70 |
| Sat Flow, veh/h | 3456 | 1585 | 1781 | 3647 | 3647 | 1585 |
| Grp Volume(v), veh/h | 118 | 0 | 68 | 1499 | 891 | 104 |
| Grp Sat Flow(s),veh/h/ln | 1728 | 1585 | 1781 | 1777 | 1777 | 1585 |
| Q Serve(g_s), s | 4.0 | 0.0 | 1.2 | 16.7 | 12.0 | 2.5 |
| Cycle Q Clear(g_c), s | 4.0 | 0.0 | 1.2 | 16.7 | 12.0 | 2.5 |
| Prop In Lane | 1.00 | 1.00 | 1.00 | | | 1.00 |
| Lane Grp Cap(c), veh/h | 226 | | 467 | 2877 | 2493 | 1112 |
| V/C Ratio(X) | 0.52 | | 0.15 | 0.52 | 0.36 | 0.09 |
| Avail Cap(c_a), veh/h | 562 | | 571 | 2877 | 2493 | 1112 |
| HCM Platoon Ratio | 1.00 | 1.00 | 1.00 | 1.00 | 1.00 | 1.00 |
| Upstream Filter(I) | 1.00 | 0.00 | 1.00 | 1.00 | 1.00 | 1.00 |
| Uniform Delay (d), s/veh | 54.3 | 0.0 | 4.7 | 3.8 | 7.1 | 5.7 |
| Incr Delay (d2), s/veh | 1.9 | 0.0 | 0.1 | 0.7 | 0.4 | 0.2 |
| Initial Q Delay(d3),s/veh | 0.0 | 0.0 | 0.0 | 0.0 | 0.0 | 0.0 |
| %ile BackOfQ(50%),veh/ln | 1.8 | 0.0 | 0.3 | 3.3 | 3.7 | 4.6 |
| Unsig. Movement Delay, s/veh | | | | | | |
| LnGrp Delay(d),s/veh | 56.1 | 0.0 | 4.8 | 4.4 | 7.5 | 5.9 |
| LnGrp LOS | E | | A | A | A | A |
| Approach Vol, veh/h | 118 | A | | 1567 | 995 | |
| Approach Delay, s/veh | 56.1 | | | 4.5 | 7.4 | |
| Approach LOS | E | | | A | A | |
| Timer - Assigned Phs | | 2 | | 4 | 5 | 6 |
| Phs Duration (G+Y+Rc), s | | 104.7 | | 15.3 | 13.0 | 91.7 |
| Change Period (Y+Rc), s | | 7.5 | | 7.5 | 8.5 | 7.5 |
| Max Green Setting (Gmax), s | | 85.5 | | 19.5 | 11.5 | 65.5 |
| Max Q Clear Time (g_c+I1), s | | 18.7 | | 6.0 | 3.2 | 14.0 |
| Green Ext Time (p_c), s | | 14.8 | | 0.3 | 0.1 | 6.7 |

Intersection Summary

| | |
|--------------------|-----|
| HCM 6th Ctrl Delay | 7.8 |
| HCM 6th LOS | A |

Notes

Unsignalized Delay for [EBR] is excluded from calculations of the approach delay and intersection delay.

| Intersection | | | | | | |
|--------------------------|------|------|------|------|------|------|
| Int Delay, s/veh | 5.1 | | | | | |
| Movement | EBT | EBR | WBL | WBT | NBL | NBR |
| Lane Configurations | ↑ | ↗ | ↖ | ↑ | ↘ | ↙ |
| Traffic Vol, veh/h | 41 | 40 | 105 | 58 | 2 | 110 |
| Future Vol, veh/h | 41 | 40 | 105 | 58 | 2 | 110 |
| Conflicting Peds, #/hr | 0 | 0 | 0 | 0 | 0 | 0 |
| Sign Control | Free | Free | Free | Free | Stop | Stop |
| RT Channelized | - | None | - | None | - | None |
| Storage Length | - | 150 | 100 | - | 0 | - |
| Veh in Median Storage, # | 0 | - | - | 0 | 0 | - |
| Grade, % | 0 | - | - | 0 | 0 | - |
| Peak Hour Factor | 85 | 85 | 85 | 85 | 85 | 85 |
| Heavy Vehicles, % | 2 | 2 | 2 | 2 | 2 | 2 |
| Mvmt Flow | 48 | 47 | 124 | 68 | 2 | 129 |

| Major/Minor | Major1 | Major2 | Minor1 | | |
|----------------------|--------|--------|--------|---|-------------|
| Conflicting Flow All | 0 | 0 | 95 | 0 | 364 48 |
| Stage 1 | - | - | - | - | 48 - |
| Stage 2 | - | - | - | - | 316 - |
| Critical Hdwy | - | - | 4.12 | - | 6.42 6.22 |
| Critical Hdwy Stg 1 | - | - | - | - | 5.42 - |
| Critical Hdwy Stg 2 | - | - | - | - | 5.42 - |
| Follow-up Hdwy | - | - | 2.218 | - | 3.518 3.318 |
| Pot Cap-1 Maneuver | - | - | 1499 | - | 635 1021 |
| Stage 1 | - | - | - | - | 974 - |
| Stage 2 | - | - | - | - | 739 - |
| Platoon blocked, % | - | - | - | - | - |
| Mov Cap-1 Maneuver | - | - | 1499 | - | 582 1021 |
| Mov Cap-2 Maneuver | - | - | - | - | 582 - |
| Stage 1 | - | - | - | - | 974 - |
| Stage 2 | - | - | - | - | 678 - |

| Approach | EB | WB | NB |
|----------------------|----|-----|-----|
| HCM Control Delay, s | 0 | 4.9 | 9.1 |
| HCM LOS | | | A |

| Minor Lane/Major Mvmt | NBLn1 | EBT | EBR | WBL | WBT |
|-----------------------|-------|-----|-----|-------|-----|
| Capacity (veh/h) | 1007 | - | - | 1499 | - |
| HCM Lane V/C Ratio | 0.131 | - | - | 0.082 | - |
| HCM Control Delay (s) | 9.1 | - | - | 7.6 | - |
| HCM Lane LOS | A | - | - | A | - |
| HCM 95th %tile Q(veh) | 0.5 | - | - | 0.3 | - |

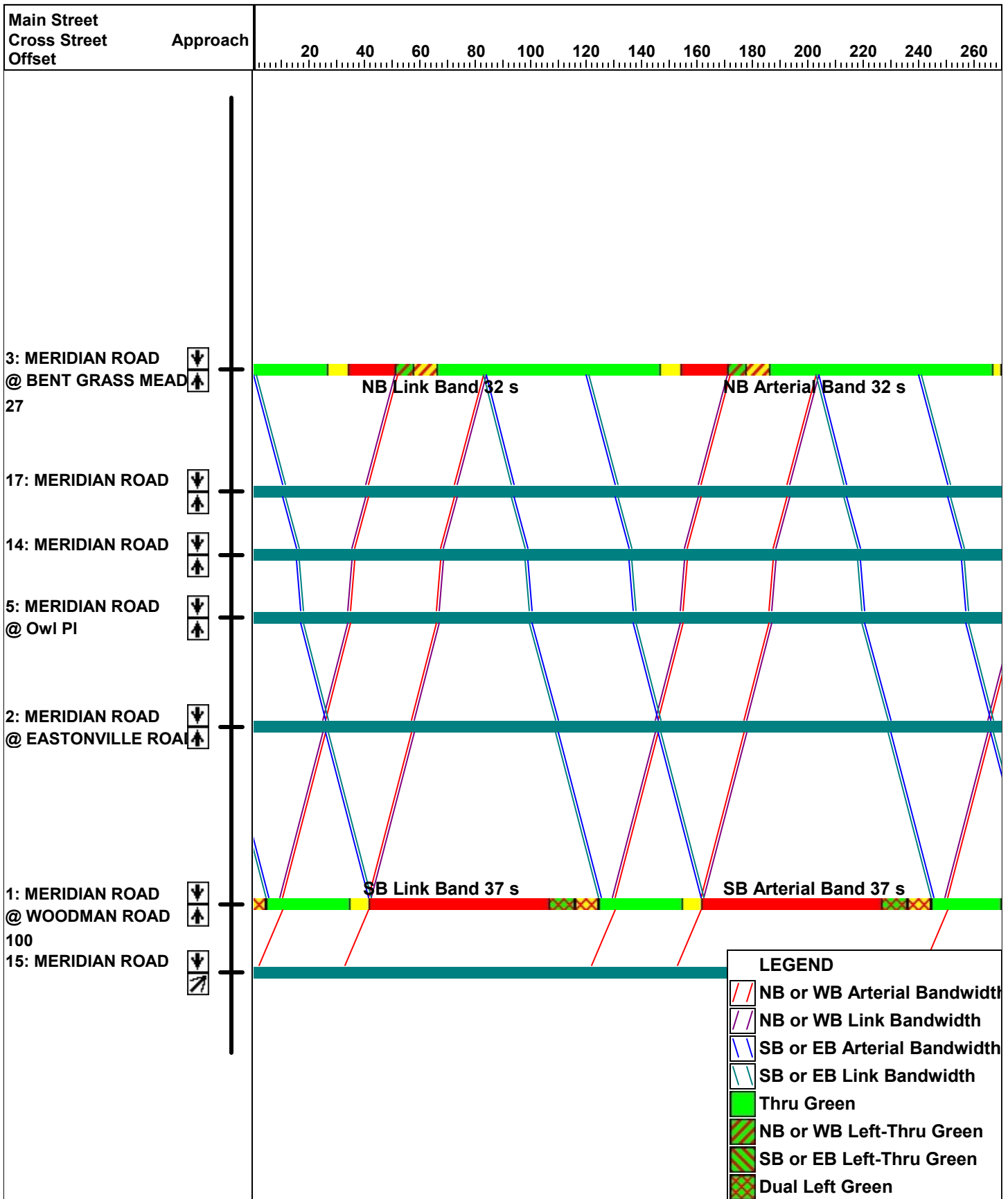
| Intersection | | | | | | |
|--------------------------|------|------|------|------|------|------|
| Int Delay, s/veh | 0.1 | | | | | |
| Movement | EBL | EBR | NBL | NBT | SBT | SBR |
| Lane Configurations | | ↗ | ↘ | ↑↑↑ | ↑↑ | |
| Traffic Vol, veh/h | 0 | 7 | 11 | 1489 | 906 | 4 |
| Future Vol, veh/h | 0 | 7 | 11 | 1489 | 906 | 4 |
| Conflicting Peds, #/hr | 0 | 0 | 0 | 0 | 0 | 0 |
| Sign Control | Stop | Stop | Free | Free | Free | Free |
| RT Channelized | - | None | - | None | - | None |
| Storage Length | - | 0 | 270 | - | - | - |
| Veh in Median Storage, # | 0 | - | - | 0 | 0 | - |
| Grade, % | 0 | - | - | 0 | 0 | - |
| Peak Hour Factor | 85 | 85 | 85 | 85 | 85 | 85 |
| Heavy Vehicles, % | 2 | 2 | 2 | 2 | 2 | 2 |
| Mvmt Flow | 0 | 8 | 13 | 1752 | 1066 | 5 |

| Major/Minor | Minor2 | Major1 | Major2 | | | |
|----------------------|--------|--------|--------|---|---|---|
| Conflicting Flow All | - | 536 | 1071 | 0 | - | 0 |
| Stage 1 | - | - | - | - | - | - |
| Stage 2 | - | - | - | - | - | - |
| Critical Hdwy | - | 6.94 | 4.14 | - | - | - |
| Critical Hdwy Stg 1 | - | - | - | - | - | - |
| Critical Hdwy Stg 2 | - | - | - | - | - | - |
| Follow-up Hdwy | - | 3.32 | 2.22 | - | - | - |
| Pot Cap-1 Maneuver | 0 | 489 | 647 | - | - | - |
| Stage 1 | 0 | - | - | - | - | - |
| Stage 2 | 0 | - | - | - | - | - |
| Platoon blocked, % | | | | - | - | - |
| Mov Cap-1 Maneuver | - | 489 | 647 | - | - | - |
| Mov Cap-2 Maneuver | - | - | - | - | - | - |
| Stage 1 | - | - | - | - | - | - |
| Stage 2 | - | - | - | - | - | - |

| Approach | EB | NB | SB |
|----------------------|------|-----|----|
| HCM Control Delay, s | 12.5 | 0.1 | 0 |
| HCM LOS | B | | |

| Minor Lane/Major Mvmt | NBL | NBT | EBLn1 | SBT | SBR |
|-----------------------|------|-----|-------|-----|-----|
| Capacity (veh/h) | 647 | - | 489 | - | - |
| HCM Lane V/C Ratio | 0.02 | - | 0.017 | - | - |
| HCM Control Delay (s) | 10.7 | - | 12.5 | - | - |
| HCM Lane LOS | B | - | B | - | - |
| HCM 95th %tile Q(veh) | 0.1 | - | 0.1 | - | - |

Existing PM Signal Progression



APPENDIX E – Pipeline TIS Excerpts

TRAFFIC IMPACT STUDY

For

**Owl Place Commercial
El Paso County, Colorado
PCD File No. CR221**

June 2022
Revised:
September 2022

Prepared for:

First Cup
106 S Kyrene Road, Suite 2
Chandler, AZ 85226

Prepared by:



SM ROCHA, LLC
TRAFFIC AND TRANSPORTATION CONSULTANTS

8703 Yates Drive, Suite 210
Westminster, Colorado 80031
(303) 458-9798

6 South Tejon Street, Suite 515
Colorado Springs, Colorado 80903
(719) 203-6639

Project Engineer:
Stephen Simon, EIT

Engineer in Responsible Charge:
Fred Lantz, PE



22-051673

Traffic Engineer's Statement

The attached traffic report and supporting information were prepared under my responsible charge and they comport with the standard of care. So far as is consistent with the standard of care, said report was prepared in general conformance with the criteria established by the County for traffic reports.

Fred Lantz, P.E. #23410

Date

Developer's Statement

I, the Developer, have read and will comply with all commitments made on my behalf within this report.

*Brian Zurek
First Cup
106 S Kyrene Road, Suite 2
Chandler, AZ 85226*

Date

Table of Contents

| | |
|---|-----------|
| I. Introduction | 1 |
| Project Overview..... | 1 |
| Study Area | 1 |
| Site Description..... | 1 |
| Existing and Committed Surface Transportation Network..... | 5 |
| II. Existing Traffic Conditions | 7 |
| Peak Hour Intersection Levels of Service – Existing Traffic..... | 9 |
| Existing Traffic Analysis Results | 9 |
| III. Future Traffic Conditions Without Proposed Development..... | 11 |
| Peak Hour Intersection Levels of Service – Background Traffic | 14 |
| Background Traffic Analysis Results – Year 2024 | 14 |
| Background Traffic Analysis Results – Year 2040 | 15 |
| IV. Proposed Project Traffic | 16 |
| Trip Generation..... | 16 |
| Adjustments to Trip Generation Rates | 17 |
| Trip Distribution..... | 18 |
| Trip Assignment..... | 19 |
| V. Future Traffic Conditions With Proposed Developments | 21 |
| VI. Project Impacts | 24 |
| Peak Hour Intersection Levels of Service – Total Traffic | 24 |
| Total Traffic Analysis Results Upon Development Build-Out | 25 |
| Auxiliary Lane Analysis | 26 |
| Queue Length Analysis..... | 26 |
| Pedestrian Circulation & Safety Analysis | 27 |
| Transportation Demand Management Plan | 27 |
| Recommended Improvements | 28 |
| VII. Conclusion | 29 |

List of Figures

Figure 1 – Location.....3
Figure 2 – Conceptual Site Plan.....4
Figure 3 – Existing Traffic Volumes & Intersection Geometry8
Figure 4 – Background Traffic Volumes & Intersection Geometry – Year 2024.....12
Figure 5 – Background Traffic Volumes & Intersection Geometry – Year 2040.....13
Figure 6 – Distribution and Site-Generated Assignment.....20
Figure 7 – Total Traffic Volumes & Intersection Geometry – Year 2024.....22
Figure 8 – Total Traffic Volumes & Intersection Geometry – Year 2040.....23

List of Tables

Table 1 – Intersection Capacity Analysis Summary – Existing Traffic9
Table 2 – Intersection Capacity Analysis Summary – Background Traffic – Year 202414
Table 3 – Intersection Capacity Analysis Summary – Background Traffic – Year 204015
Table 4 – Trip Generation Rates16
Table 5 – Trip Generation Summary17
Table 6 – Trip Generation Summary with Pass-By Trip Reductions.....18
Table 7 – Intersection Capacity Analysis Summary – Total Traffic – Year 202424
Table 8 – Intersection Capacity Analysis Summary – Total Traffic – Year 204024
Table 9 – Recommended Improvements Summary28

Appendices

APPENDIX A TRAFFIC COUNT DATA
 SIGNAL TIMING INFORMATION
APPENDIX B LEVEL OF SERVICE DEFINITIONS
APPENDIX C CAPACITY WORKSHEETS

I. Introduction

Project Overview

This traffic impact study is provided as a planning document and addresses the capacity, geometric, and control requirements associated with the development entitled Owl Place Commercial.

This traffic impact study has been revised to address County review comments made to the June 2022 version of the traffic impact study regarding inclusion of additional analyses and recommendations with corresponding revisions to figures and tables pursuant to the latest conceptual site plan.

This proposed commercial development consists of various potential uses including a gas station convenience store, coffee/donut shop with drive-through window, automated car wash, and quick-serve restaurants. The development is located at the southwest corner of the intersection of Meridian Road with Owl Place in El Paso County, Colorado.

Study Area

The study area to be examined in this analysis encompasses Meridian Road between the intersections of Bent Grass Meadows Drive and E Woodmen Road.

Figure 1 illustrates location of the site and study intersections.

Site Description

Land for the development is currently occupied by a single-family dwelling unit and is surrounded by a mix of residential, commercial, and open space land uses.

The proposed development is conceptual and no specific land uses have been determined. However, for purposes of this analysis, there is assumed to be construction for an approximate 5,300 square foot gas station convenience store supporting up to 12 vehicle fueling positions, an approximate 2,000 square foot coffee/donut shop with drive-through window, a 4,170 square foot automated car wash with one wash tunnel, and an approximate 3,420 square foot high-turnover quick-serve restaurant.

Proposed access to the development is provided at the following locations: one full-movement access onto Owl Place (referred to as Access A), and one full-movement access onto Eastonville Road as an extension of Falcon Market Place (referred to as Access B). For analysis purposes and given the conceptual nature of proposed land uses, proposed accesses are considered to be internal to the overall development area and are not specifically analyzed. Access operations are generally considered to be comparable to or better than that of the closest major intersection.

For purposes of this study, it is anticipated that development construction would be completed by end of Year 2024. General site and access locations are shown on Figure 1.

A conceptual site plan, as prepared by Baseline Engineering Corporation, is shown on Figure 2. This plan is provided for illustrative purposes only.



OWL PLACE COMMERCIAL
Traffic Impact Study

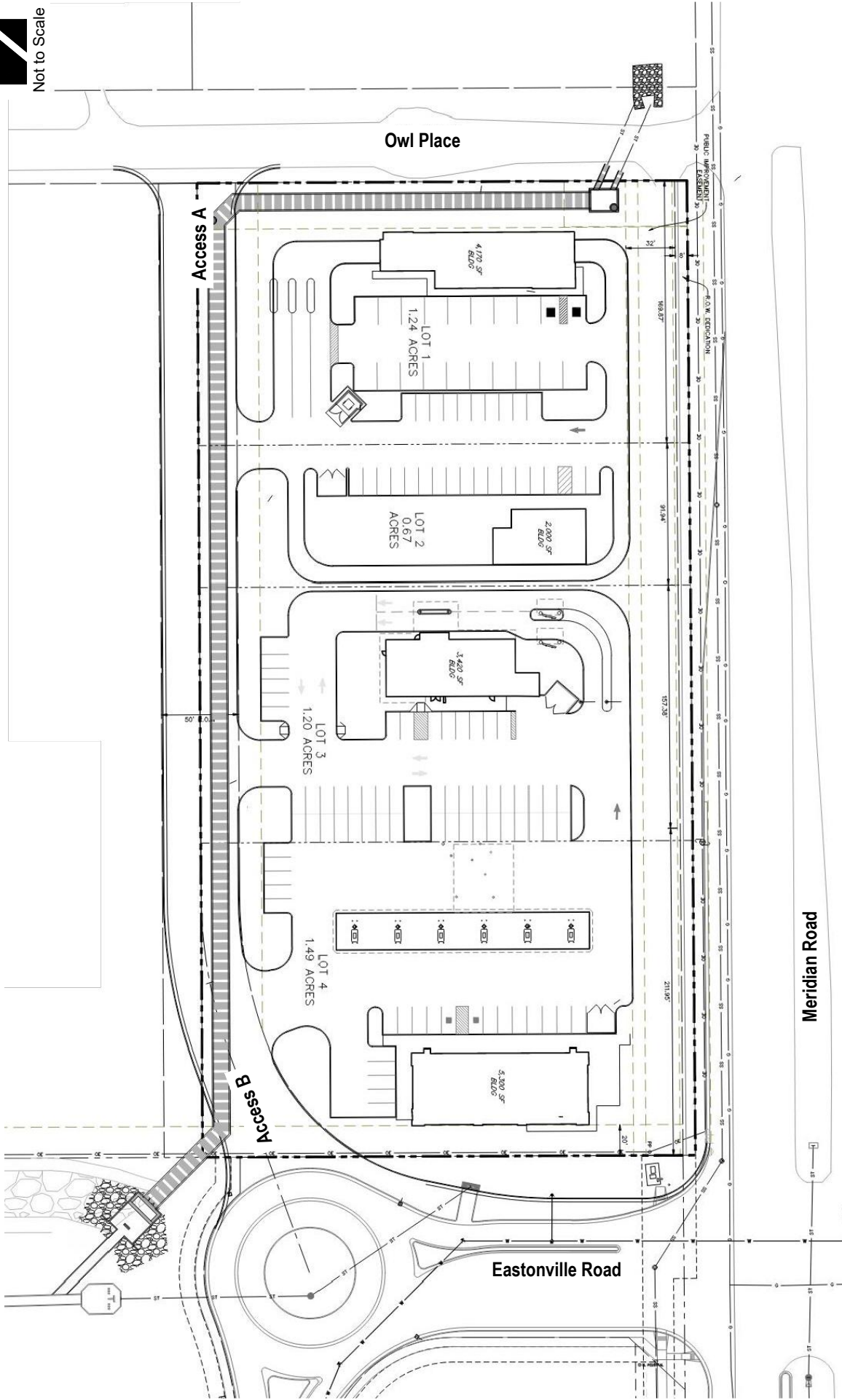
Figure 1
SITE LOCATION

SM ROCHA, LLC
Traffic and Transportation Consultants





Not to Scale



Existing and Committed Surface Transportation Network

Within the study area, Meridian Road is the primary roadway that will accommodate traffic to and from the proposed development. The secondary roadways include E Woodmen Road, Eastonville Road, Owl Place, and Bent Grass Meadows Drive. A brief description of each roadway, based on the County's 2040 Major Transportation Corridors Plan (MTCP)¹ and Engineering Criteria Manual (ECM)², is provided below:

Meridian Road is a north-south principal arterial roadway having four through lanes (two lanes in each direction) with exclusive turn lanes at the intersections within the study area. Meridian Road provides a posted speed limit of 55 MPH.

E Woodmen Road is an east-west principal arterial roadway having four through lanes (two lanes in each direction) with exclusive turn lanes at the intersection within the study area. E Woodmen Road provides a posted speed limit of 55 MPH.

Eastonville Road is an east-west arterial roadway having two through lanes (one lane in each direction) with a combination of shared and exclusive turn lanes at the intersection within the study area. Eastonville Road provides a posted speed limit of 35 MPH.

Owl Place is an east-west unpaved roadway having two through lanes (one lane in each direction) with shared turn lanes at the intersection within the study area. Owl Place is unclassified in County's MTCP. However, per Standard Drawing 2-10 of County ECM and the roadway's estimated ROW width, Owl Place is assumed to be classified as a local roadway and provides a posted speed limit of 30 MPH.

Bent Grass Meadows Drive is an east-west collector roadway having two through lanes (one lanes in each direction) with exclusive turn lanes at the intersections within the study area. Bent Grass Meadows Drive provides a posted speed limit of 35 MPH.

The study intersections of Meridian Road with E Woodmen Road, Eastonville Road, and Bent Grass Meadows Drive are signalized. All other study intersections operate under a stop-controlled condition. A stop-controlled intersection is defined as a roadway intersection where vehicle rights-of-way are controlled by one or more "STOP" signs.

¹ El Paso County 2016 Major Transportation Corridors Plan Update, Felsburg Holt & Ullevig, December 2016.

² El Paso County Engineering Criteria Manual, El Paso County, December 2016.

It is however noted that signal installation at Eastonville Road and Meridian Road is a recent occurrence with associated extension of Eastonville Road west of Meridian Road. Due to the ongoing development within the area, the newly constructed west leg of the study intersection was observed to experience low volumes associated with construction traffic only. Therefore, for analysis purposes, the study intersection was assumed to not currently operate at its anticipated capacity and was considered as a three-leg stop-controlled intersection for existing conditions only.

In reference to the County's MTCP, E Woodmen Road is planned to become a six-lane, expressway by Year 2040. The remaining study area roadways appear to be built to their ultimate cross-sections excluding potential improvements required due to the proposed development.

II. Existing Traffic Conditions

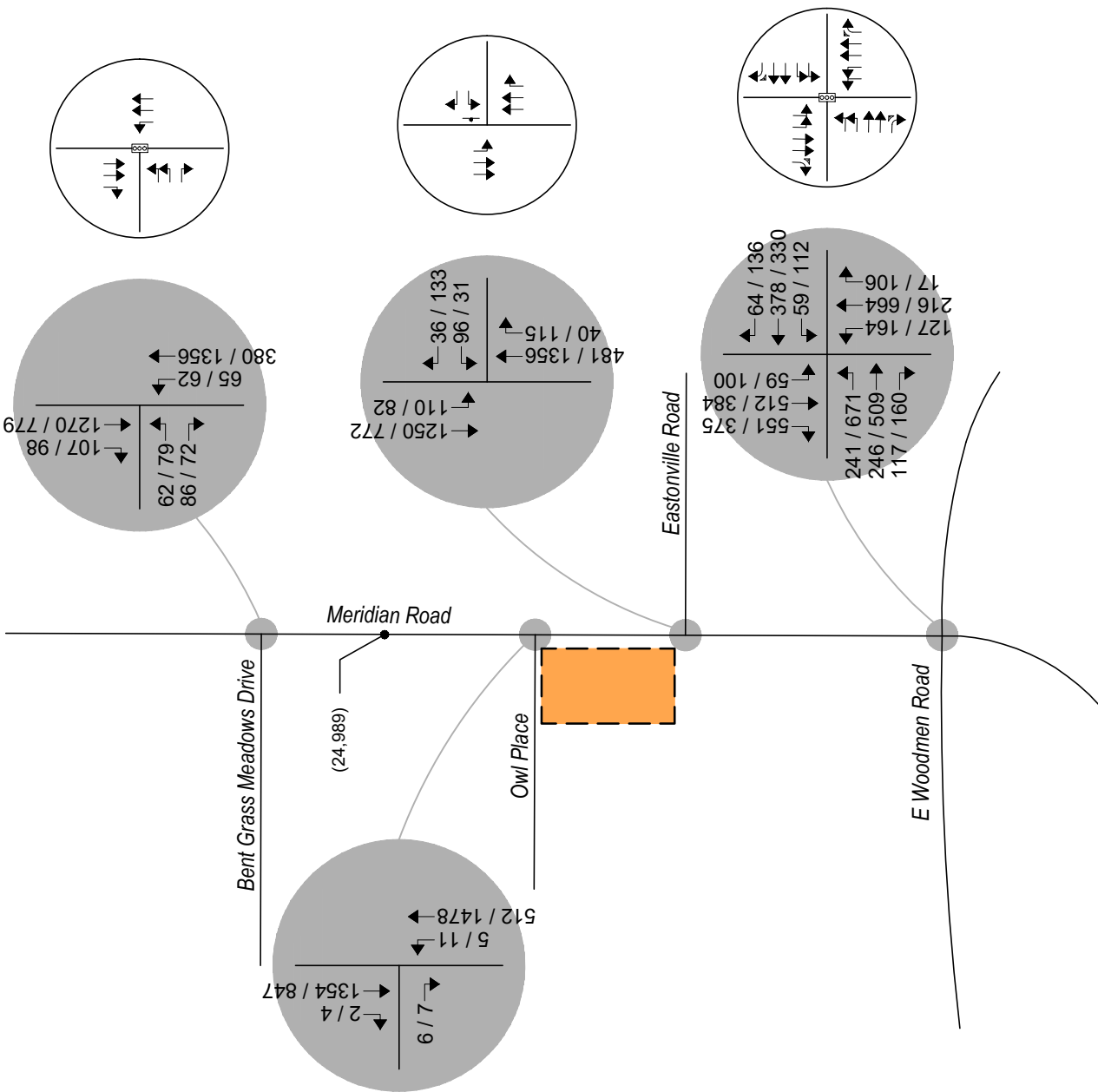
Morning (AM) and afternoon (PM) peak hour traffic counts were collected at the intersections of Meridian Road with E Woodmen Road, Eastonville Road, and Owl Place. Counts were collected on June 1, 2022, with AM peak hour counts being collected during the period of 7:00 a.m. to 9:00 a.m. and PM peak hour counts being collected during the period of 4:00 p.m. to 6:00 p.m.

Peak hour traffic counts and 24-hour traffic volumes shown for Meridian Road and the intersection of Meridian Road with Bent Grass Meadows Drive were obtained from a previous traffic study³. Referenced counts were collected on March 29, 2022.

Newly collected and referenced counts representing existing traffic volumes, as well as existing intersection geometries, are shown on Figure 3.

Existing signal timing parameters for the intersections of Meridian Road with E Woodmen Road and Bent Grass Meadows Drive were obtained from County Staff and used throughout this study to the best extent possible in order to remain consistent with existing signal coordination plans. City signal timing information received is included for reference in Appendix A.

³ Bent Grass Dunkin' Donuts, SM ROCHA, LLC, April 2022.



LEGEND

- Study Intersection
- Study Intersection Lane Geometry
- Development Site

Figure 3
EXISTING TRAFFIC
Volumes & Intersection Geometry
AM / PM Peak Hour
(ADT) : Average Daily Traffic

Peak Hour Intersection Levels of Service – Existing Traffic

The Signalized and Unsignalized Intersection Analysis techniques, as published in the Highway Capacity Manual (HCM), 6th Edition, by the Transportation Research Board and as incorporated into the SYNCHRO computer program, were used to analyze the study intersections for existing and future traffic conditions. These nationally accepted techniques allow for the determination of intersection level of service (LOS) based on the congestion and delay of each traffic movement.

Level of service is a method of measurement used by transportation professionals to quantify a driver's perception of travel conditions that include travel time, number of stops, and total amount of stopped delay experienced on a roadway network. The HCM categorizes level of service into a range from "A" which indicates little, if any, vehicle delay, to "F" which indicates a level of operation considered unacceptable to most drivers. These levels of service grades with brief descriptions of the operating condition, for unsignalized and signalized intersections, are included for reference in Appendix B and have been used throughout this study.

The level of service analyses results for existing conditions are summarized in Table 1.

Intersection capacity worksheets developed for this study are provided in Appendix C.

Table 1 – Intersection Capacity Analysis Summary – Existing Traffic

| INTERSECTION LANE GROUPS | LEVEL OF SERVICE | |
|---|------------------|--------------|
| | AM PEAK HOUR | PM PEAK HOUR |
| Meridian Road / E Woodmen Road (Signalized) | C (30.5) | D (37.8) |
| Meridian Road / Bent Grass Meadows Drive (Signalized) | A (9.9) | A (7.6) |
| Meridian Road / Eastonville Road (Stop-Controlled) | | |
| Westbound Left | B | F |
| Westbound Right | A | B |
| Southbound Left | A | B |
| Meridian Road / Owl Place (Stop-Controlled) | | |
| Eastbound Right | B | A |
| Northbound Left | A | A |

Key: Signalized Intersection: Level of Service (Control Delay in sec/veh)
Stop-Controlled Intersection: Level of Service

Existing Traffic Analysis Results

Under existing conditions, operational analysis shows that the signalized intersection of Meridian Road with E Woodmen Road has overall operations at LOS C during the morning peak traffic hour and LOS D during the afternoon peak traffic hour.

The signalized intersection of Meridian Road with Bent Grass Meadows Drive has overall operations at LOS A during both the morning and afternoon peak traffic hours.

The unsignalized intersection of Meridian Road with Eastonville Road has turning movement operations at or better than LOS B during either peak traffic hour. Exceptions would include the westbound left turning movement which operates at LOS F during the PM peak traffic hour. The LOS F operation is attributed to the high through traffic volumes along Meridian Road and the stop-controlled nature of the intersection. However, as previously discussed, given the recent signalization of the study intersection, actual operations are expected to be better than shown.

The unsignalized intersection of Meridian Road with Owl Place has turning movement operations at or better than LOS B during the morning peak traffic hour and LOS A during the afternoon peak traffic hour.

It is to be noted that it is not uncommon for unsignalized movements to or from an arterial roadway, in urban areas, to operate with noticeable delays during peak traffic hours.

III. Future Traffic Conditions Without Proposed Development

Background traffic is the traffic projected to be on area roadways without consideration of the proposed development. Background traffic includes traffic generated by development of vacant parcels in the area.

To account for projected increases in background traffic for Years 2024 and 2040, a compounded annual growth rate was determined using population growth estimates provided by the Pikes Peak Area Council of Governments' (PPACG) 2045 Long Range Transportation Plan⁴ which anticipates a 20-year growth rate of less than two percent. Therefore, in order to provide for a conservative analysis, a growth rate of two percent was applied to existing traffic volumes.

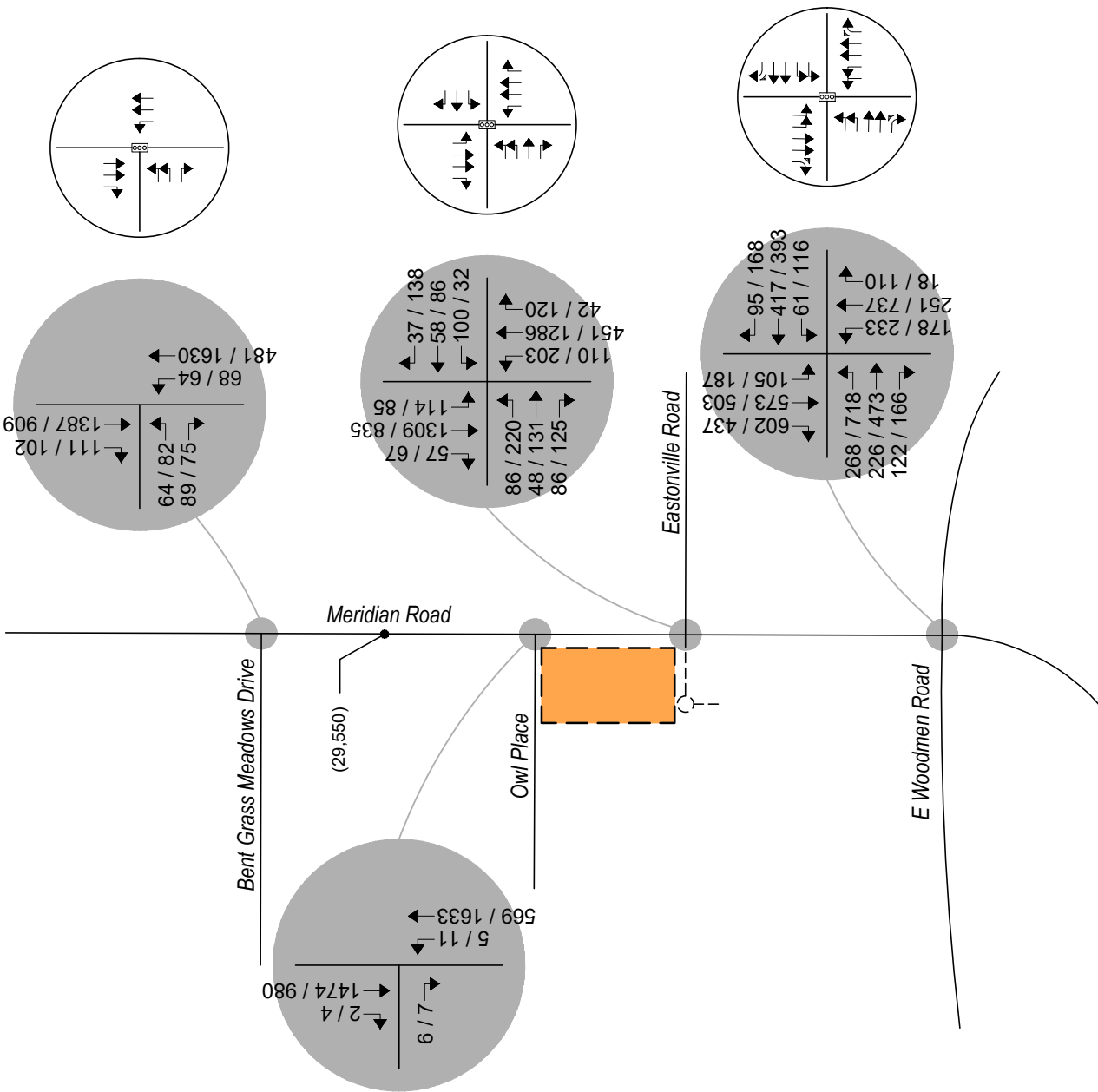
To account for projected traffic from adjacent developments not yet built, trip generations from the previously prepared Falcon Marketplace Traffic Impact Analysis⁵, provided by the County's Electronic Development Application Review Program (EDARP), were added to background traffic volumes.

Pursuant to the proposed and committed area roadway improvements discussed in Section I, Year 2024 and Year 2040 background traffic conditions assume the completion of the Eastonville Road extension west of Meridian Road and the improvement of the intersection including signalization. Year 2040 also assumes signal timing parameters for the Meridian Road intersections with optimized intersection splits in effort to better long-term intersection performance.

Projected background traffic volumes and intersection geometry for Years 2024 and 2040 are shown on Figure 4 and Figure 5, respectively.

⁴ Moving Forward 2045: Pikes Peak Area Regional Transportation Plan, PPACG, January 2020.

⁵ Falcon Marketplace Traffic Impact Analysis, LSC Transportation Consultants Inc., September 2018.



LEGEND

- Study Intersection Volumes
- Study Intersection Lane Geometry
- Development Site

Figure 4
BACKGROUND TRAFFIC - YEAR 2024
Volumes & Intersection Geometry
AM / PM Peak Hour
(ADT) : Average Daily Traffic

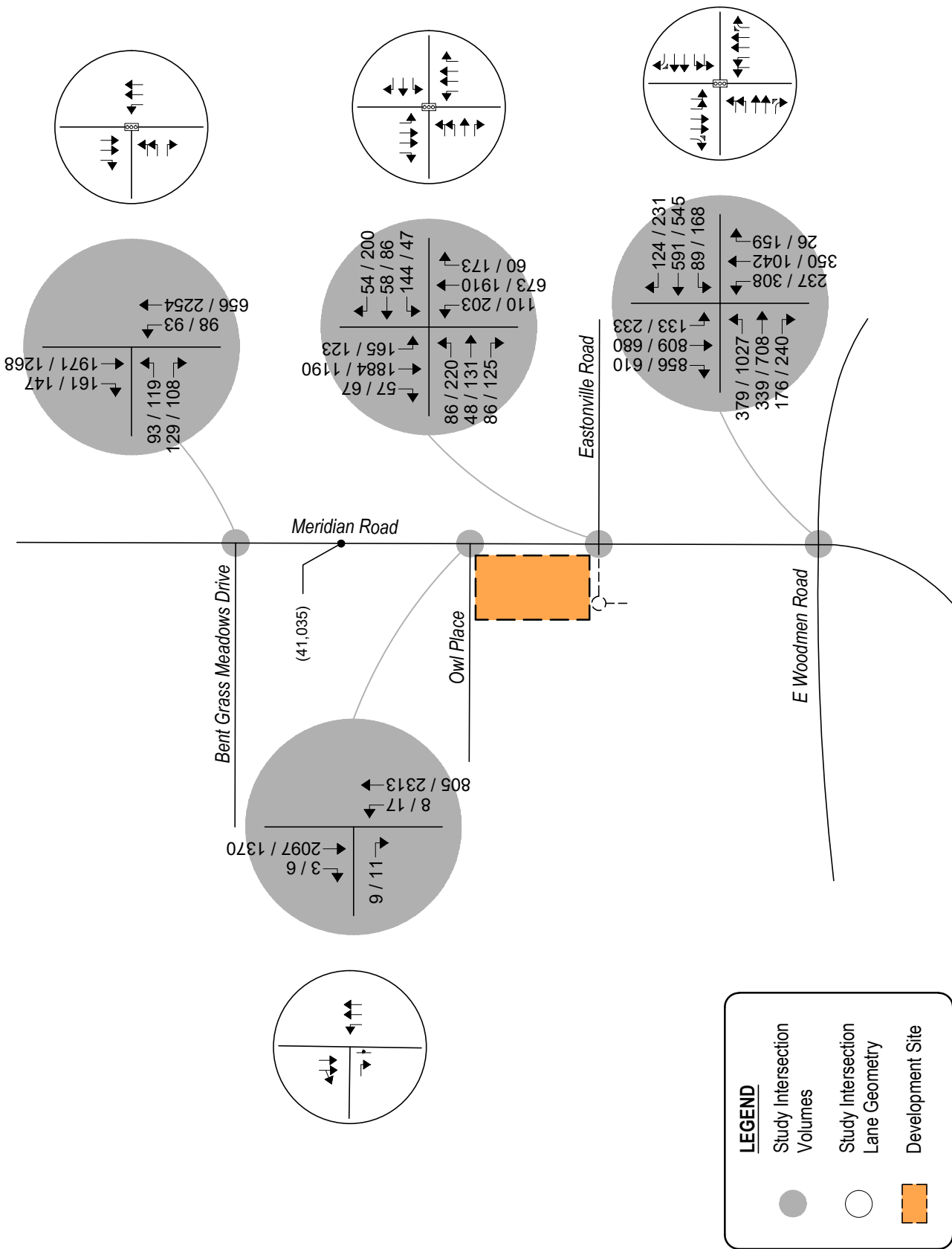


Figure 5
BACKGROUND TRAFFIC - YEAR 2040
Volumes & Intersection Geometry
AM / PM Peak Hour
(ADT) : Average Daily Traffic

Peak Hour Intersection Levels of Service – Background Traffic

As with existing traffic conditions, the operations of study intersections were analyzed under background conditions, without the proposed development, using the SYNCHRO computer program.

Background traffic level of service analysis results for Year 2024 are listed in Table 2. Year 2040 operational results are summarized in Table 3.

Definitions of levels of service are given in Appendix B. Intersection capacity worksheets are provided in Appendix C.

Table 2 – Intersection Capacity Analysis Summary – Background Traffic – Year 2024

| INTERSECTION LANE GROUPS | LEVEL OF SERVICE | |
|---|------------------|--------------|
| | AM PEAK HOUR | PM PEAK HOUR |
| Meridian Road / E Woodmen Road (Signalized) | C (31.6) | D (45.1) |
| Meridian Road / Bent Grass Meadows Drive (Signalized) | B (10.2) | A (5.9) |
| Meridian Road / Eastonville Road (Signalized) | D (35.3) | C (23.2) |
| Meridian Road / Owl Place (Stop-Controlled) | | |
| Eastbound Right | B | B |
| Northbound Left | B | A |

Key: Signalized Intersection: Level of Service (Control Delay in sec/veh)
Stop-Controlled Intersection: Level of Service

Background Traffic Analysis Results – Year 2024

Year 2024 background traffic analysis indicates that the signalized intersection of Meridian Road with E Woodmen Road has overall operations at LOS C during the AM peak traffic hour and LOS D during the PM peak traffic hour.

The signalized intersection of Meridian Road with Bent Grass Meadows Drive has overall operations at LOS B during the AM peak traffic hour and LOS A during the PM peak traffic hour.

The signalized intersection of Meridian Road with Eastonville Road has overall operations at LOS D during the AM peak traffic hour and LOS C during the PM peak traffic hour.

The unsignalized intersection of Meridian Road with Owl Place operates at or better than LOS B during both AM and PM peak traffic periods.

Table 3 – Intersection Capacity Analysis Summary – Background Traffic – Year 2040

| INTERSECTION LANE GROUPS | LEVEL OF SERVICE | |
|---|------------------|--------------|
| | AM PEAK HOUR | PM PEAK HOUR |
| Meridian Road / E Woodmen Road (Signalized) | D (39.0) | F (86.8) |
| Meridian Road / Bent Grass Meadows Drive (Signalized) | B (19.6) | B (11.9) |
| Meridian Road / Eastonville Road (Signalized) | D (38.6) | C (30.6) |
| Meridian Road / Owl Place (Stop-Controlled) | | |
| Eastbound Right | C | B |
| Northbound Left | C | A |

Key: Signalized Intersection: Level of Service (Control Delay in sec/veh)
 Stop-Controlled Intersection: Level of Service

Background Traffic Analysis Results – Year 2040

By Year 2040 and without the proposed development, the study intersection of Meridian Road with E Woodmen Road experiences LOS D operations during the AM peak traffic hour and LOS F during the PM peak traffic hour. The LOS F operation is primarily attributed to the high eastbound, northbound and southbound left turning volumes. In order to provide mitigation to the poor overall operation and increase available intersection capacity, potential improvements may include the widening of E Woodmen Road to six-lanes, pursuant to its future classification as an expressway, as well as further optimization of traffic signal timings to accommodate future regional demand. It is noted that long-term operations may be better than shown given the potential for future planned roadway connections to the west along E Woodmen Road to influence vehicle routes. As example, planned construction of future Banning Lewis Parkway within the City of Colorado Springs along E Woodmen Road will provide an additional major north-south arterial roadway which may reduce some of the volumes projected to utilize Meridian Road for north-south travel. It is recommended that County Staff continues to monitor the study intersection in order to determine what mitigation may be most applicable and when implementation of said improvements becomes necessary.

The study intersection of Meridian Road with Bent Grass Meadows Drive experiences LOS B operations during both the AM and PM peak traffic hours.

The study intersection of Meridian Road with Eastonville Road experiences LOS D operations during the AM peak traffic hour and LOS C operations during the PM peak traffic hour.

The study intersection of Meridian Road with Owl Place experiences LOS C operations during the AM peak traffic hour and LOS B or better operations during the PM peak traffic hour.

It is not recommended that access onto Meridian Road from Owl Place be more limited than that already existing. Limited access will interfere with the existing and proposed developments' ability to equally distribute traffic within the site and out to available roadways, thus impacting existing and future traffic in the surrounding area and potentially cause the adjacent roadway network to be used in a manner not intended or cause additional delay that could impact emergency response times.

IV. Proposed Project Traffic

Trip Generation

Standard traffic generation characteristics compiled by the Institute of Transportation Engineers (ITE) in their report entitled Trip Generation Manual, 11th Edition, were applied to the proposed land use in order to estimate average daily traffic (ADT), AM Peak Hour, and PM Peak Hour vehicle trips. A vehicle trip is defined as a one-way vehicle movement from a point of origin to a point of destination.

The ITE land use codes 934 (Fast-Food Restaurant with Drive-Through Window), 937 (Coffee/Donut Shop with Drive-Through Window), 945 (Convenience Store/Gas Station), and 948 (Automated Car Wash) were used for estimating trip generation because of their conservative rates and best fit to the anticipated land use descriptions.

As actual land uses, densities or site plans within the Owl Place Commercial development area become defined over time, it is expected that traffic generation characteristics considered within this study will need to be updated by more specific traffic analyses or studies to help assess if transportation improvements are needed to mitigate potential traffic impacts.

Trip generation rates used in this study are presented in Table 4.

Table 4 – Trip Generation Rates

| ITE CODE | LAND USE | UNIT | TRIP GENERATION RATES | | | | | | |
|-------------|-------------------------------|------|-----------------------|--------------|-------|-------|--------------|-------|-------|
| | | | 24 HOUR | AM PEAK HOUR | | | PM PEAK HOUR | | |
| | | | | ENTER | EXIT | TOTAL | ENTER | EXIT | TOTAL |
| 934 | Fast-Food Restaurant w/DTW | KSF | 467.48 | 22.75 | 21.86 | 44.61 | 17.18 | 15.85 | 33.03 |
| 937 | Coffee/Donut Shop w/DTW | KSF | 533.57 | 43.80 | 42.08 | 85.88 | 19.50 | 19.50 | 38.99 |
| 945 | Convenience Store/Gas Station | KSF | 700.43 | 28.26 | 28.26 | 56.52 | 27.26 | 27.26 | 54.52 |
| 948 | Automated Car Wash | CWT | 775.00 | * | * | * | 38.75 | 38.75 | 77.50 |

Key: KSF = Thousand Square Feet Gross Floor Area. CWT = Car Wash Tunnels.

* = ITE does not report significant AM peak hour generation due to the nature of the business (ie, operating hours typically open after AM peak).

Note: All data and calculations above are subject to being rounded to nearest value.

Table 5 illustrates projected ADT, AM Peak Hour, and PM Peak Hour traffic volumes likely generated by the proposed development upon build-out.

Table 5 – Trip Generation Summary

| ITE CODE | LAND USE | SIZE | TOTAL TRIPS GENERATED | | | | | | |
|------------------------|-------------------------------|---------|-----------------------|--------------|------------|------------|--------------|------------|------------|
| | | | 24 HOUR | AM PEAK HOUR | | | PM PEAK HOUR | | |
| | | | | ENTER | EXIT | TOTAL | ENTER | EXIT | TOTAL |
| 934 | Fast-Food Restaurant w/DTW | 3.4 KSF | 1,599 | 78 | 75 | 153 | 59 | 54 | 113 |
| 937 | Coffee/Donut Shop w/DTW | 2.0 KSF | 1,067 | 88 | 84 | 172 | 39 | 39 | 78 |
| 945 | Convenience Store/Gas Station | 5.3 KSF | 3,712 | 150 | 150 | 300 | 144 | 144 | 289 |
| 948 | Automated Car Wash | 1 CWT | 775 | * | * | * | 39 | 39 | 78 |
| <i>Proposed Total:</i> | | | <i>7,153</i> | <i>315</i> | <i>309</i> | <i>624</i> | <i>281</i> | <i>276</i> | <i>557</i> |

Key: KSF = Thousand Square Feet Gross Floor Area. CWT = Car Wash Tunnels.

* = ITE does not report significant AM peak hour generation due to the nature of the business (ie, operating hours typically open after AM peak).

Note: All data and calculations above are subject to being rounded to nearest value.

Upon build-out, Table 5 illustrates that the proposed development has the potential to generate approximately 7,153 daily vehicle trips with 624 of those occurring during the morning peak hour and 557 during the afternoon peak hour.

Adjustments to Trip Generation Rates

A development of this type is likely to attract pass-by trips from the adjacent roadway system. ITE defines a pass-by trip as an intermediate stop on the way from an origin to a primary trip destination without a route diversion. Due to this behavior, pass-by trips are not considered as “new” traffic generated by the development since the trips are already present on the roadway network enroute to their primary destination.

Pass-by trips are especially common to fast-food restaurant, coffee/donut shop, and gas station land uses given the convenience provided by these businesses on the way to another primary destination such as a place of work or home. As example, published ITE pass-by and diverted link trip data indicates an average trip generation reduction rate of 49 percent during the AM peak traffic hour and 50 percent during the PM peak traffic hour as typical to fast-food restaurants with drive-through window.

It is also considered likely that a mixed-use development of this type will attract trips from within area land uses as well as from the adjacent Falcon Marketplace development. However, due to the conceptual nature of proposed land uses, specific internal capture rates can only be assumed. Therefore, no trip reduction was taken in this analysis. This assumption provides for a conservative analysis.

Upon consideration of the proposed land use, reductions were applied pursuant to ITE average data to the proposed land use in order to account for the high probability of pass-by trip generation. ITE average pass-by trip percentages used are presented in Table 6.

Table 6 illustrates projected ADT, AM Peak Hour, and PM Peak Hour traffic volumes likely generated by the proposed development upon build-out with reductions applied due to pass-by trips. Average daily (24-Hour) pass-by trip percentages were estimated as the average between the AM and PM peak hour rates indicated by ITE.

Table 6 – Trip Generation Summary with Pass-By Trip Reductions

| ITE CODE | LAND USE | SIZE | TOTAL NEW TRIPS GENERATED | | | | | | |
|--------------------------------|-------------------------------|---------|---------------------------|--------------|------|-------|--------------|------|-------|
| | | | 24 HOUR | AM PEAK HOUR | | | PM PEAK HOUR | | |
| | | | | ENTER | EXIT | TOTAL | ENTER | EXIT | TOTAL |
| <i>Pass-By Trip Reduction:</i> | | | 50% | 49% | 49% | 49% | 50% | 50% | 50% |
| 934 | Fast-Food Restaurant w/DTW | 3.4 KSF | 807 | 40 | 38 | 78 | 29 | 27 | 56 |
| <i>Pass-By Trip Reduction:</i> | | | 60% | 60% | 60% | 60% | 60% | 60% | 60% |
| 937 | Coffee/Donut Shop w/DTW | 2.0 KSF | 427 | 35 | 34 | 69 | 16 | 16 | 31 |
| <i>Pass-By Trip Reduction:</i> | | | 59% | 62% | 62% | 62% | 56% | 56% | 56% |
| 945 | Convenience Store/Gas Station | 5.3 KSF | 1,522 | 57 | 57 | 114 | 64 | 64 | 127 |
| <i>Pass-By Trip Reduction:</i> | | | 0% | 0% | 0% | 0% | 0% | 0% | 0% |
| 948 | Automated Car Wash | 1.0 CWT | 775 | * | * | * | 39 | 39 | 78 |
| <i>Proposed Total:</i> | | | 3,531 | 132 | 129 | 260 | 147 | 145 | 292 |

Key: KSF = Thousand Square Feet Gross Floor Area. CWT = Car Wash Tunnels.

* = ITE does not report significant AM peak hour generation due to the nature of the business (ie, operating hours typically open after AM peak).

Note: All data and calculations above are subject to being rounded to nearest value.

Upon build-out and with consideration for pass-by trip reductions, Table 6 illustrates that the proposed development has the potential to generate approximately 3,531 new daily trips with 260 of those occurring during the morning peak hour and 292 during the afternoon peak hour.

Trip Distribution

The overall directional distribution of site-generated traffic was determined based on the location of development site within the County, proposed and existing area land uses, allowed turning movements, available roadway network, assumptions made for previous studies within the area, and in reference to distribution patterns of existing traffic count data.

Additional pass-by trip distribution is assumed to include vehicle routes heading north-south along Meridian Road. Distribution percentages utilized for pass-by trips are anticipated to be 50 percent from the north and south.

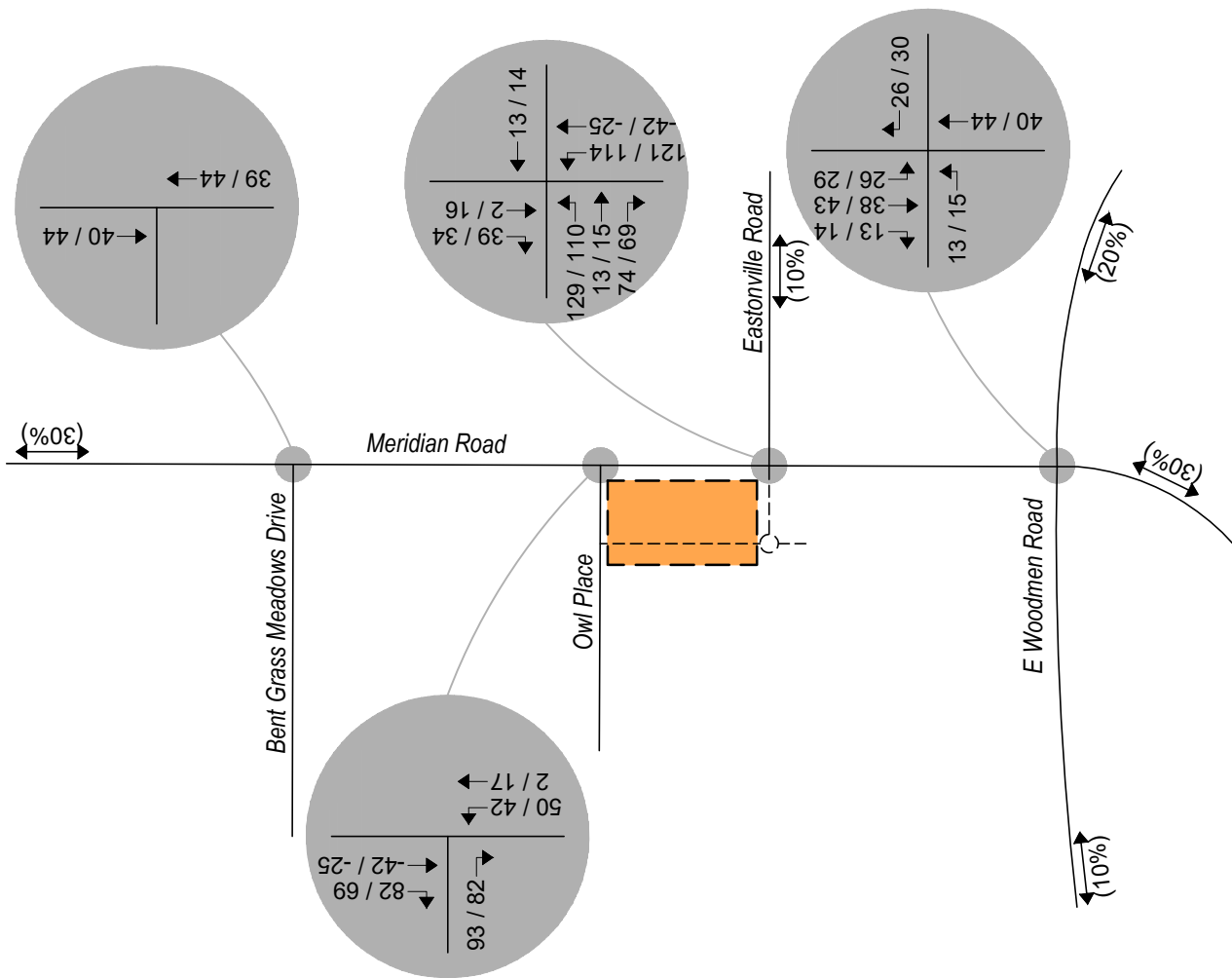
Overall trip distribution patterns for the development are shown on Figure 6.

Trip Assignment

Trip assignment is how generated and distributed vehicle trips are expected to be loaded onto the available roadway network.

Applying trip distribution patterns to site-generated traffic provides the overall site-generated trip assignments shown on Figure 6.

It is to be noted that the overall site-generated trip assignments shown on Figure 6 represent the combination of both primary trip generation and pass-by trips. Due to the application of pass-by trips, some negative site-generated trips are shown at the study intersections. These negative trips are the result of redistributing existing through volumes along Meridian Road to site-generated ingress volumes.



LEGEND

- Study Intersection
- Volumes
- Development Site

Figure 6
SITE DEVELOPMENT DISTRIBUTION
(%) : Overall
SITE-GENERATED
AM / PM Peak Hour

OWL PLACE COMMERCIAL
Traffic Impact Study



SM ROCHA, LLC
Traffic and Transportation Consultants

Falcon Marketplace

Updated Traffic Impact Analysis

Prepared for:

Hummel Investments, LLC
8117 Preston Road, Suite 120
Dallas, TX 75225
(214) 416-9820

Prepared by:

LSC Transportation Consultants, Inc.
545 East Pikes Peak Avenue
Colorado Springs, CO 80903
(719) 633-2868

LSC #164350

October 23, 2017
Revised September 5, 2018

TABLE OF CONTENTS

| Chapter | Title | Page |
|---------|---|------|
| | EXECUTIVE SUMMARY | 1 |
| | Traffic Report | 1 |
| | Material Change to the Right-in Design and Benefits of New Design | 1 |
| | Summary of Traffic Operations Analysis and Comparison | 2 |
| | Right-In-Only Access/Roundabout | 3 |
| | Meridian/Eastonville Intersection | 3 |
| | Meridian/Woodmen Intersection | 3 |
| 1 | INTRODUCTION | 4 |
| | Report Contents | 7 |
| 2 | SITE LAND USE AND ACCESS/CIRCULATION PLAN | 8 |
| | Site Context | 8 |
| | Land Use | 8 |
| | Access and Circulation | 8 |
| | Intersection/Access Sight Distance Analysis | 8 |
| | Truck Turning Analysis | 9 |
| 3 | EXISTING ROADWAY AND TRAFFIC CONDITIONS | 13 |
| | Area Roadways | 13 |
| | Existing Traffic Conditions | 14 |
| | Accident/Crash History | 14 |
| | Existing Levels of Service | 16 |
| 4 | PROJECTED FUTURE BACKGROUND TRAFFIC CONDITIONS | 17 |
| | Short-Term Background Traffic | 17 |
| | 2040 Background Traffic | 22 |
| 5 | TRIP GENERATION, DISTRIBUTION, AND TRAFFIC VOLUME ESTIMATES | 27 |
| | Trip Generation | 27 |
| | Trip Distribution and Assignment | 29 |
| | Short-Term Total Traffic | 35 |
| | 2040 Total Traffic | 40 |
| 6 | TRAFFIC OPERATIONS ANALYSIS | 49 |
| | Projected Levels of Service | 49 |
| | Intersection Levels of Service | 49 |
| | Woodmen/Meridian | 52 |
| | Meridian/Eastonville | 52 |
| | Meridian/Right-In/Right-Out-Only Site Access | 52 |
| | Woodmen Frontage Road Intersections | 53 |
| | Roundabout Level of Service | 53 |

| | |
|---|----|
| Internal Public Road Intersections | 53 |
| Weaving Section Level of Service | 53 |
| Vehicle Queuing Analysis | 58 |
| Roundabout Queuing Analysis | 58 |
| Roundabout Design Vehicle and Fastest Path Analysis | 60 |
| Traffic Signal Warrant Analysis | 60 |
| | |
| 7 COMPARISON OF ANALYSIS SCENARIOS | 62 |
| Meridian/Eastonville Intersection Operations | 62 |
| Meridian/Woodmen Intersection Operations | 63 |
| Woodmen Road Operations | 63 |
| Woodmen Frontage Road Access | 64 |
| | |
| 8 RECOMMENDED IMPROVEMENTS | 65 |
| | |
| 9 SUMMARY AND CONCLUSIONS | 80 |
| Woodmen Right-In-Only Access with Roundabout | 80 |
| Trip Generation | 80 |
| Projected Levels of Service | 80 |
| Comparison of Analysis Scenarios | 81 |
| Recommended Improvements | 81 |

APPENDICES:

- Summary of Crash/Accident History
- Internal Trip Calculations
- Southwest Roundabout Analysis Exhibits
- Rodel Analysis Reports
- Traffic Count Reports
- Intersection Level of Service Reports
- Weaving Level of Service Reports
- Queuing Level of Service Reports

LIST OF TABULATIONS

| Table | Title | Page |
|-------|---|------|
| 1 | Intersection Levels of Service Delay Ranges | 16 |
| 2 | Trip Generation Estimate | 28 |
| 3 | Short-Term Total Traffic Level of Service E Movements | 50 |
| 4 | 2040 Projected Total Traffic Level of Service E and F Movements | 51 |
| 5 | Weaving Traffic Volumes | 55 |
| 6 | Projected Queue Lengths | 59 |
| 7a | Roadway Improvements Without Proposed Right-In Access to Woodmen Road | 66 |
| 7b | Roadway Improvements with Proposed Right-In Access to Woodmen Road | 67 |

LIST OF ILLUSTRATIONS

| Figure | Title | Page |
|--------|--|------|
| 1 | Vicinity Map | 6 |
| 2 | Woodmen Road Intersection/Access Spacing | 10 |
| 3 | Meridian Road Intersection/Access Spacing | 11 |
| 4 | Sight Distance for Meridian Road | 12 |
| 5 | Existing Traffic, Lane Geometry, Traffic Control and Levels of Service | 15 |
| 6a | Short-Term Background Traffic Without Proposed Right-In Access | 18 |
| 6b | Short-Term Background Lane Geometry, Traffic Control and Levels of Service Without Proposed Right-In Access | 19 |
| 7a | Short-Term Background Traffic With Proposed Right-In Access | 20 |
| 7b | Short-Term Background Lane Geometry, Traffic Control and Levels of Service With Proposed Right-In Access | 21 |
| 8a | Year 2040 Background Traffic Without Proposed Right-In Access | 23 |
| 8b | Year 2040 Background Lane Geometry, Traffic Control and Levels of Service Without Proposed Right-In Access | 24 |
| 9a | Year 2040 Background Traffic With Proposed Right-In Access | 25 |
| 9b | Year 2040 Background Lane Geometry Traffic Control and Levels of Service With Proposed Right-In Access | 26 |
| 10 | Directional Distribution of Site-Generated Traffic | 30 |
| 11 | Short-Term Assignment of Site-Generated Traffic Without Proposed Right-In Access | 31 |
| 12 | Short-Term Assignment of Site-Generated Traffic With Proposed Right-In Access | 32 |
| 13 | Long-Term Assignment of Site-Generated Traffic Without Proposed Right-In Access | 33 |
| 14 | Long-Term Assignment of Site-Generated Traffic With Proposed Right-In Access | 34 |
| 15a | Short-Term Total Traffic Without Proposed Right-in Access | 36 |
| 15b | Short-Term Total Lane Geometry, Traffic Control and Levels of Service Without Proposed Right-In Access | 37 |
| 16a | Short-Term Total Traffic With Proposed Right-In Access | 37 |
| 16b | Short-Term Total Lane Geometry, Traffic Control and Levels of Service With Proposed Right-In Access | 38 |
| 17a | Year 2040 Total Traffic Without Proposed Right-In Access | 41 |
| 17b | Year 2040 Total Traffic Without Proposed Right-In Access | 42 |
| 17c | Year 2040 Total Lane Geometry, Traffic Control and Levels of Service Without Proposed Right-In Access | 43 |
| 17d | Year 2040 Total Lane Geometry, Traffic Control and Levels of Service Without Proposed Right-In Access | 44 |
| 18a | Year 2040 Total Traffic With Proposed Right-In Access | 45 |
| 18b | Year 2040 Total Traffic With Proposed Right-In Access | 46 |
| 18c | Year 2040 Total Lane Geometry, Traffic Control and Levels of Service With Proposed Right-In Access | 47 |

| | | |
|-----|--|----|
| 18d | Year 2040 Total Lane Geometry, Traffic Control and levels of Service With Proposed Right-In Access | 48 |
| 19 | Weaving and Non-Weaving Movements | 56 |
| 20 | Traffic Signal Warrant Analysis | 61 |
| 21a | Recommended Improvement Locations Without Right-In Access to Woodmen (East Area) | 68 |
| 21b | Recommended Improvement Locations Without Right-In Access to Woodmen (West Area) | 69 |
| 22a | Recommended Improvement Locations With Right-In Access to Woodmen (East Area) | 70 |
| 22b | Recommended Improvement Locations With Right-In Access to Woodmen (West Area) | 71 |
| 23 | Accel/Decel Distances for Meridian Road North of Woodmen Road | 74 |
| 24 | Existing & ECM-Prescribed Accel/Decel Lane Lengths for Woodmen Road | 75 |
| 25 | Woodmen Road Acceleration, Deceleration and Stacking Lengths | 76 |
| 26 | Woodmen Road Acceleration/Deceleration Lane Signing & Striping | 77 |
| 27 | Short-Term Meridian Road South of Woodmen Road NB Left-Turn Deceleration Lane, Taper and Stacking Lengths | 78 |
| 28 | Potential Future Long-Term Meridian Road South of Woodmen Road NB Left-Turn Deceleration Lane, Taper and Stacking Lengths | 79 |

Executive Summary

TRAFFIC REPORT

- This updated traffic report has been prepared to address staff comments.
- This report presents analysis of the proposed right-in-only access to Woodmen Road combined with a proposed roundabout intersection with the Woodmen Frontage Road in the southwest corner of the site.
- The report also includes, for comparison purposes, analysis assuming no right-in-only access.
- This report contains short- and long-term traffic projections for Falcon Marketplace, other area properties, and study area roadways and intersections. Traffic analysis has been performed based on the projected volumes.
- Based on the analysis, detailed findings and study area roadway improvements have been presented for both “**with**” and “**without**” the proposed **right-in access** (and accompanying roundabout) scenarios.
- The overall report recommendation is to approve the proposed right-in-only access from Woodmen Road and accompanying roundabout. **Analysis results indicate significantly improved area traffic circulation and benefits to operations at the study area intersections.**

MATERIAL CHANGE TO THE RIGHT-IN DESIGN AND BENEFITS OF NEW DESIGN

- The inclusion of a roundabout into the design of the right-in access **will provide for public access to the westbound frontage road**—a significant change to the previous design. This enhancement will not only **provide better access** for these nearby residential and non-residential developments, but will also offer **superior access for emergency response vehicles** thereby reducing their response times to all properties on the north side of Woodmen between Meridian and Golden Sage—a significant and meaningful change.
- The new design for the right-in with a roundabout **allows for direct public access to the Woodmen Frontage Road** for passenger vehicles, trucks, and buses, as well as fire and emergency response vehicles as requested by the Falcon Fire Protection District. This accommodation will significantly improve the access to the Courtyards residential development, Mountain View Electric Association (MVEA), Falcon School District 49 (and other properties), which currently have poor access.
- Due to its configuration, the previously requested right-in-only access would have essentially served only the proposed Falcon Marketplace development as there was no public access from the right-in to the Woodmen Frontage Road. Additionally, the new configuration includes changing the required internal roadway (required by the 2008 BOCC-approved rezoning of the

site), which extends from Eastonville to the Woodmen Frontage Road, from a private access easement drive to a public right-of-way.

- The previously requested right-in-only was configured to direct traffic from westbound Woodmen northward into the site only, with no "direct" access for westbound travel to the neighboring residential and non-residential properties along the Woodmen Frontage Road west of the proposed Falcon Marketplace development. In the previous design, access for westbound travel along the Woodmen Frontage Road would have required a circuitous route into Falcon Marketplace in order to reverse direction.
- With this new design of the right-in combined with a roundabout, residents, employees, and other motorists traveling to the properties along the frontage road from westbound Woodmen or northbound Meridian (many traveling from eastbound US Highway 24) would have a **new direct connection to the east end of the Woodmen Frontage Road** and will no longer need to do either of the following to access their destination:
 - travel west for over a mile along Woodmen Road to the Golden Sage/Woodmen intersection, make a 180-degree turn and travel back to the east along the Woodmen Frontage Road, or alternatively,
 - travel north to the Eastonville/Meridian intersection, turn left and travel through the proposed Falcon Marketplace development, a route of over one-half mile including a traffic signal.
- The proposed right-in-only with the roundabout would also **benefit operations at the Woodmen/Golden Sage and Woodmen Frontage Road/Golden Sage** intersection by reducing existing and future traffic turning movements from these closely spaced intersections.
- This site is within the commercial “node” of Falcon as defined in the Falcon/Peyton Small Area Master Plan and an access from Woodmen Road at the proposed location is reasonable for a regional commercial development as allowed by the Commercial Regional zoning approved for the site in 2008. Furthermore, additional access points to Woodmen were contemplated by the BOCC-approved resolution adopting the Woodmen Road Access Management Plan.

SUMMARY OF TRAFFIC OPERATIONS ANALYSIS AND COMPARISON

- The three key intersections within this study are (a) the southwest roundabout at the proposed right-in-only access from Woodmen, (b) the meridian/Eastonville intersection, and (3) the Meridian/Woodmen intersection.
- The comparison between the two analysis scenarios (**with** and **without** the proposed right-in-only access from Woodmen) with respect to operations at the Meridian/Eastonville intersection shows significantly better operations with the proposed Woodmen access/roundabout. In addition to the intersection analysis, the right-in-only access would significantly reduce overall travel times and emergency response times for those traveling to destinations along the frontage road and Falcon Marketplace.

Right-In-Only Access/Roundabout

- The continuous lane along westbound Woodmen Road between Meridian and the access is projected to operate at weaving LOS C during the morning peak hour and LOS B during the afternoon peak hour.
- Multiple methods of analysis indicate level of service A for all roundabout approaches during the peak hours **based on 2040 volumes**.
- The southwest roundabout will see **minimal queuing** for traffic exiting Woodmen Road and entering the roundabout. A maximum queue during the peak hour of about 100-120 feet is projected and even this maximum queue will clear quickly as the queue will be more of a **“rolling” queue**.
- The proposed Woodmen access will have **little effect** on the operation of Woodmen Road as the turning movements will be right-turn in-only from westbound Woodmen Road with a continuous acceleration/deceleration lane between Meridian and the point of right-turn entry into the site.
- The roundabout has been designed to accommodate large tractor-trailer trucks/semis.

Meridian/Eastonville Intersection

- The northbound left turn at this intersection is projected to operate at **LOS F** during the afternoon peak hour **without the right-in-only access off Woodmen. However, it will operate at LOS D** during the afternoon peak hour with the right-in-only access off of Woodmen with the roundabout.
- The northbound left-turn queue would be **significantly longer without the Woodmen-access scenario. Without the right-in-only access off of Woodmen** the projected maximum queue will fill the dual left-turn lanes (457-foot queue within the lanes) and will **overspill** into the adjacent northbound through lane during the peak analysis interval unless the lanes are lengthened. Any significant lengthening would reduce the storage length of the southbound left turn lane for the Woodmen/Meridian intersection to the south as this northbound left turn lane is "back-to-back" with the southbound left turn lane at the Woodmen/Meridian intersection. There is a shared transition taper for both lanes and any lengthening would require either shortening the shared taper and/or shortening of that southbound left turn lane at Woodmen/Meridian (likely both).

Meridian/Woodmen Intersection

- The addition of the proposed right-in-only access off of Woodmen will provide motorists approaching from the south the option to utilize the existing dual left-turn lanes to go westbound on Woodmen to enter the project site. This allows motorists to adjust to the path of least congestion and will benefit the overall intersection. Providing this option will reduce the quantity of northbound through traffic. This will be especially helpful during the afternoon peak hour. Although the overall intersection delays shown in the table are comparable, the

analysis shows failure of the northbound through movement (with two northbound through lanes) **without** the right-in-only access off of Woodmen. A comparison with **three** northbound through lanes on this intersection approach has also been included in this report as required by staff. Analysis results with an additional northbound through lane indicate improvement to LOS D for this approach. However, the implementation of three through lanes at this one intersection in advance of an overall project to convert Meridian Road from a four to six-lane arterial would involve significant cost for improvements at this intersection and to the north to create three-northbound “receiving” lanes and a merge lane back to two northbound through lanes. Moreover, from an operational standpoint, although a third through lane would add capacity at the intersection, this would introduce a potentially confusing and awkward “lane-add” followed by a lane reduction/merge just downstream to the north.

- Without the requested right-in-only from Woodmen, the northbound through movement is projected to operate at **LOS F** during the 2040 afternoon peak hour (LOS D when analyzing assuming three northbound through lanes as explained in the previous paragraph).

Introduction

LSC Transportation Consultants, Inc. has prepared this updated traffic impact analysis for the 36-acre Falcon Marketplace to be located west of Meridian Road and north of Woodmen Road in the Falcon area of El Paso County, Colorado. The site is planned to be developed for a mixture of commercial and medical office land uses. Figure 1 shows the site location. Access is proposed to Meridian Road and the Woodmen Road Frontage Road. The previous report date was August 7, 2017.

The report has been updated to include analysis of a right-in-only access from Woodmen Road combined with a roundabout intersection with the Woodmen Frontage Road in the southwest corner of the site. This new right-in-only access with the proposed roundabout intersection connecting to the Woodmen Frontage Road would significantly improve access not only to the site, but also to the properties to the west along the Woodmen Frontage Road. This new provision for public access from westbound Woodmen Road to the westbound Woodmen Frontage Road is a **significant change** from the previously proposed right-in-only access configuration, which essentially only served the proposed Falcon Marketplace.

The salient points of the significant change are:

- Allows direct public access to east end of the frontage road.
- Provides badly needed access for emergency response vehicles.
- Takes traffic off of the Golden Sage intersection by providing access from the east.
- Addition of roundabout keeps traffic moving at a steady flow.
- Reduces potential backup on the frontage road.



Approximate Scale
Scale: 1" = 1,200'

Figure 1
**Vicinity
Map**

Falcon Marketplace (LSC #164350)

REPORT CONTENTS

The report contains the following:

- The proposed site land uses and circulation plan for the site.
- The proposed plan to allow for a public street connection through the site between the current terminus of the Woodmen Frontage Road and Meridian Road.
- The existing and planned roadways in the study area including the number of lanes, classifications, posted speed limits, lane geometries, traffic controls, etc.
- Traffic volumes for the Meridian/Woodmen and Meridian/Eastonville intersections plus added traffic count data for the intersection of Woodmen Road and Golden Sage Road.
- The projected future peak-hour traffic volumes for the access points, internal intersections and the intersections adjacent to the site, the intersection of Golden Sage/Woodmen and along the Woodmen Frontage Road with and without the proposed right-in-only access from Woodmen Road.
- The resulting traffic impacts. The traffic impacts have been quantified by determining the future levels of service at the access points, internal intersections and adjacent intersections with and without the proposed right-in-only access from Woodmen Road.
- Recommended improvements.

Site Land Use and Access/Circulation Plan

SITE CONTEXT

The site is located within the downtown Falcon commercial/service area. This site is part of the Falcon “commercial node.” Several shopping centers exist south and southeast of this site on the south side of Woodmen Road. The Safeway shopping center is located to the east, and the Bent Grass Commercial Center is directly north of the site and the Owl Lane area.

LAND USE

The 36-acre site is located north of Woodmen Road and west of Meridian Road. The site is planned to contain a large grocery store anchor with associated gas station. The peripheral development lots are planned to include a pet supply store, in-line retail buildings, three free-standing fast-food restaurants, a coffee shop with drive-through, and an urgent/primary care clinic.

ACCESS AND CIRCULATION

Full-movement site access is proposed from Meridian Road aligning with Eastonville Road and via a connection to the current terminus of the Woodmen Frontage Road. A right-in/right-out access to Meridian Road is also proposed between Eastonville and Woodmen. In addition to the connection to the current terminus of the Woodmen Frontage Road, a right-in-only access from westbound Woodmen Road is also proposed in the southwest corner of the site.

Figures 2 and 3 show the access/intersection spacing for Woodmen Road and Meridian Road, respectively.

The site plan also shows a street stub to the property to the north to allow for a planned future connection to Bent Grass Meadows Drive. The access points and the proposed public street connection through the site is also shown on the site plan.

INTERSECTION/ACCESS SIGHT DISTANCE ANALYSIS

Figure 4 shows the sight distance analysis for the Meridian Road access points. There are currently no posted speed limit signs for southbound traffic on the approach to Eastonville Road and the speed limit to the north is 55 miles per hour (mph). This analysis assumes (following development of the site) a future posted speed limit of 45 mph (design speed of 50 mph) for southbound Meridian in the vicinity of and adjacent to the site. This is based on the *Meridian Road North Corridor Plan* dated December 2009.

Sight distance analysis for the internal intersections within the Preliminary Plan is included with the deviation request for Falcon Market Place.

Truck Turning Analysis

Truck turning analysis using AutoTurn for the internal intersections within the Preliminary Plan is included with the deviation request for Falcon Market Place. The truck turning analysis for the roundabout proposed for the southwest corner of the site is included in this report as it is directly associated with the driveway permit application.






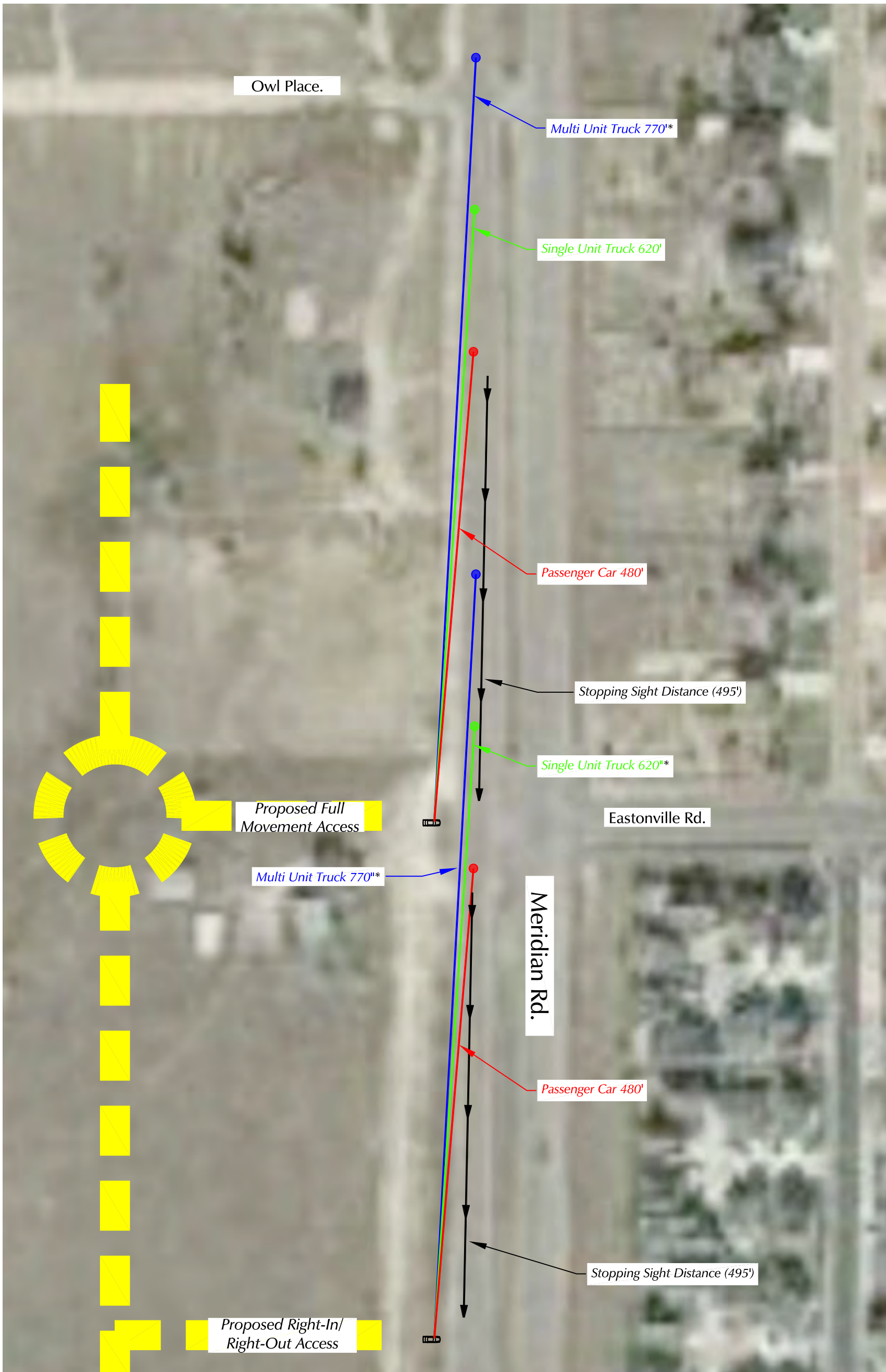
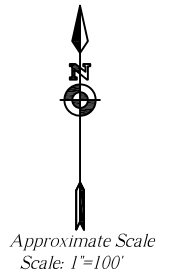

 Approximate Scale
 Scale: 1"=60'

Figure 3
Meridian Road Intersection/Access Spacing
 Falcon Marketplace (LSC #164350)



LEGEND:

- = Required intersection sight distance for passenger cars
- = Required intersection sight distance for single-unit trucks
- = Required intersection sight distance for multi-unit trucks
- ↕ = Required stopping sight distance

Based on an anticipated post-development speed limit of 45mph (50 mph design speed)



Figure 4
Sight Distance for Meridian Road

Falcon Marketplace (LSC #164350)

Existing Roadway and Traffic Conditions

AREA ROADWAYS

The roadways in the study area are shown on Figure 1 and are described below.

- **US Highway (US) 24** is generally a two-lane State Highway extending east/west across Colorado connecting the Buena Vista, Colorado Springs, and Limon areas. US 24 is planned to be widened to four lanes through the Falcon area. US 24 is classified as an Expressway by the Colorado Department of Transportation (CDOT) and the *El Paso County Major Transportation Corridors Plan (MTCP)*. The posted speed limit on US 24 in the vicinity of Woodmen Road is 50 mph.
- **Woodmen Road** is shown on the *El Paso County 2040 Major Transportation Corridors Plan* and the *Preserved Corridor Network Plan* as a four-lane Expressway adjacent to and in the vicinity of the site. The posted speed limit on Woodmen Road adjacent to the site is 45 mph. The posted speed limit on Woodmen Road just west of the site is 55 mph.
- **Woodmen Frontage Road** is a paved two-lane frontage road along the north side of Woodmen Road. The Woodmen Frontage Road extends west from this site to its current terminus west of Golden Sage Road. The posted speed limit on the Woodmen Frontage Road is 30 mph.
- **Meridian Road** is shown on the MTCP as a four-lane Principal Arterial adjacent to the site. Meridian Road is currently four lanes plus some auxiliary turn lanes at intersections north of Rolling Thunder. There is a center median adjacent to the site. There are no speed limit signs specifically for the section of Meridian adjacent to the site. However, the posted limit on the section to the north is 55 mph. Meridian Road south of Rolling Thunder is not currently open and the road does not connect to US Highway 24. However, Meridian Road is planned to be opened south from Rolling Thunder to a new intersection with US 24 and extended south to Falcon Highway in the near future.
- **Eastonville Road** is a two-lane roadway extending northeast from Meridian Road to past Hodgen Road. It is shown as a two-lane Minor Arterial on the MTCP. The intersection of Meridian Road and Eastonville Road is currently stop-sign controlled.

EXISTING TRAFFIC CONDITIONS

Figure 5 shows the morning and afternoon peak-hour traffic volumes at the intersections of Woodmen Road/Meridian Road, Woodmen Road/Golden Sage Road, and Eastonville Road/Meridian Road based on counts conducted by LSC in September 2015, February 2016, March 2017, and June 2017. The traffic count reports are attached. The traffic volumes at Woodmen/Meridian have been adjusted to balance with more recent counts to the west and north.

ACCIDENT/CRASH HISTORY

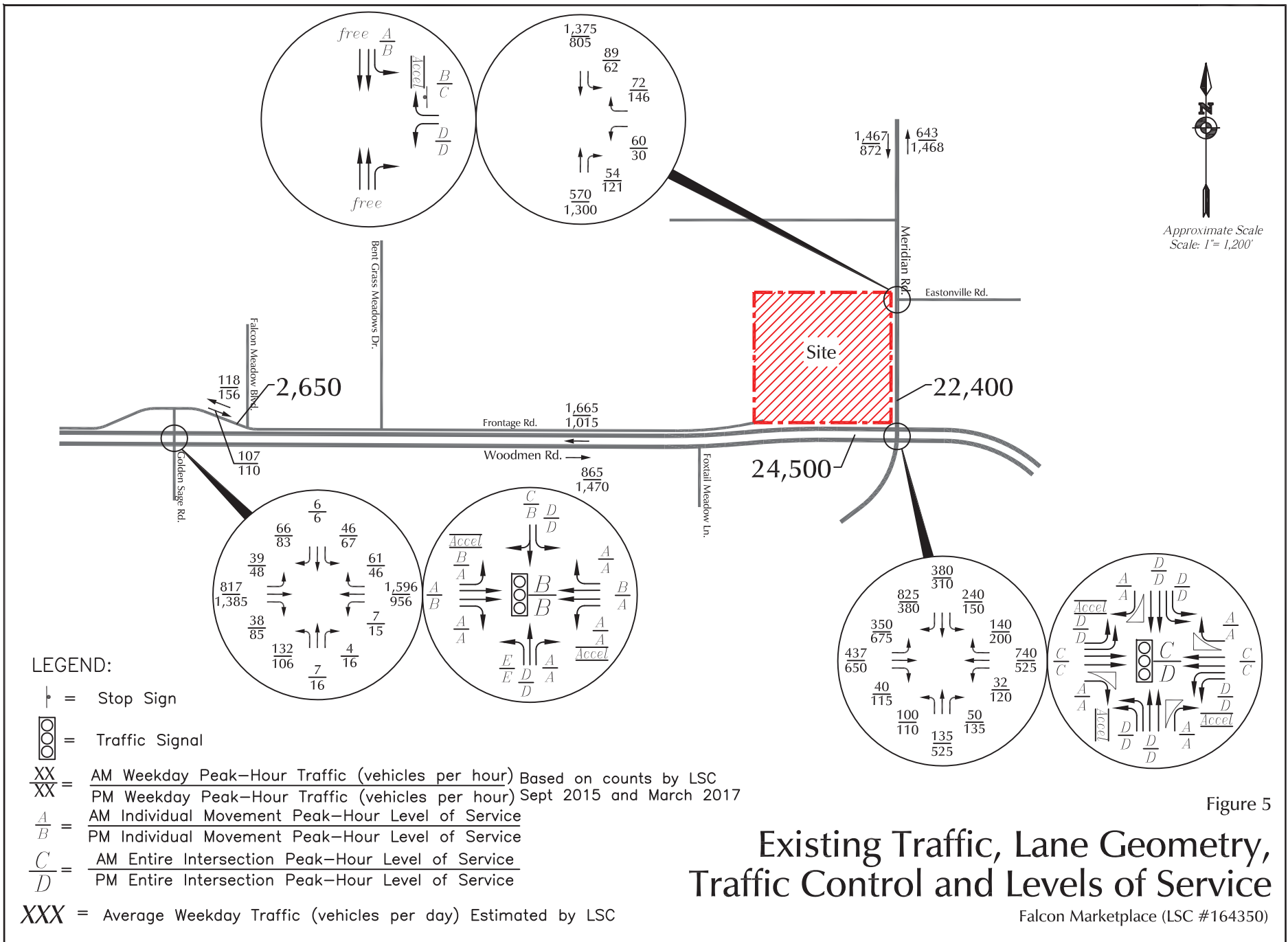
Traffic accident/crash data at study area intersections are attached. These have been provided by the Colorado State Patrol. The data show crashes by calendar year for 2014, 2015, and 2016 as well as year-to-date crashes for 2017.

There were seven reported crashes at the Woodmen/Golden Sage intersection in 2016. Five of the seven crashes in 2016 were non-intersection related. The remaining two crashes were rear-end crashes involving eastbound vehicles. The first crash resulted in property damage only and the second crash resulted in two injuries. There have also been seven crashes in 2017 (from January 1 to July 26). Of these crashes, two were non-intersection related. One involved an eastbound left-turning vehicle hitting a westbound through vehicle. This crash resulted in a fatality. The remaining four crashes were rear-end crashes (two involving westbound vehicles and two involving eastbound vehicles). These rear-end crashes all resulted in property damage only.

There were six reported crashes at the Woodmen/Meridian intersection in 2016. One of the crashes was non-intersection related. This was the only crash at this intersection in 2016 and 2017 that resulted in an injury. Three of the 2016 crashes were rear-end crashes (two involved vehicles in the westbound through lanes and one involved vehicles in the southbound to westbound acceleration lane). One 2016 crash involved a westbound vehicle that failed to stop for the red light and hit a northbound vehicle. The final 2016 crash involved a single vehicle traveling the wrong direction in the westbound acceleration lane hitting the pedestrian island in the northwest corner of the intersection. Based on the data provided, there has been one reported accident in 2017 (from January 1 to July 26). This crash was a rear-end accident involving vehicles in the eastbound left-turn lanes.

There were two reported crashes at the Eastonville/Meridian intersection in 2016. In the first crash, two vehicles were attempting to turn left from Eastonville Road onto Meridian Road. The first vehicle attempted a two-stage left turn, stopping in the median on Meridian Road, and was rear-ended by the second vehicle. This crash resulted in property damage only. The second crash involved an eastbound left-turn vehicle and a bicycle in the northbound shoulder. This crash resulted in an injury. There has been one crash at this intersection recorded in 2017 (from January 1 to July 26). This injury crash involved a southbound left-turning vehicle turning in front of a northbound through vehicle.

The estimated three-year crash/accident rate at Woodmen/Meridian is 0.46. This is based on an estimated average of 33,500 entering vehicles per day and 17 total intersection-related crashes in three years. **This is a relatively low accident rate.** For comparison, the Powers and Barnes intersection, which is one of the City of Colorado Springs' high accident locations, had a 2016 accident rate of about 2.25.



EXISTING LEVELS OF SERVICE

Level of service (LOS) is a quantitative measure of the level of congestion or delay at an intersection. Level of service is indicated on a scale from “A” to “F.” LOS A represents control delay of less than 10 seconds for unsignalized and signalized intersections. LOS F represents control delay of more than 50 seconds for unsignalized intersections and more than 80 seconds for signalized intersections. For reference, Table 1 shows the level of service delay ranges.

| Table 1 Intersection Levels of Service Delay Ranges | | | |
|--|--|--------------------------|--|
| Level of Service | Signalized Intersections | | Unsignalized Intersections |
| | Average Control Delay (seconds per vehicle) | V/C⁽¹⁾ | Average Control Delay (seconds per vehicle)⁽²⁾ |
| A | 10.0 sec or less | less than 0.60 | 10.0 sec or less |
| B | 10.1-20.0 sec | 0.60-0.69 | 10.1-15.0 sec |
| C | 20.1-35.0 sec | 0.70-0.79 | 15.1-25.0 sec |
| D | 35.1-55.0 sec | 0.80-0.89 | 25.1-35.0 sec |
| E | 55.1-80.0 sec | 0.90-0.99 | 35.1-50.0 sec |
| F | 80.1 sec or more | 1.00 and greater | 50.1 sec or more |

(1) Source: *Transportation Research Circular 212*
 (2) For unsignalized intersections if V/C ratio is greater than 1.0 the level of service is LOS F regardless of the projected average control delay per vehicle.

The intersections of Woodmen Road/Meridian Road and Woodmen Road/Golden Sage Road were analyzed to determine the existing levels of service using Synchro. The intersection of Eastonville Road/Meridian Road was analyzed based on the unsignalized method of analysis procedures found in the *Highway Capacity Manual, 6th Edition* by the Transportation Research Board. As shown on Figure 5, these intersections are operating at acceptable levels of service during peak periods. **The detailed level of service analysis reports are attached.**

Projected Future Background Traffic Conditions

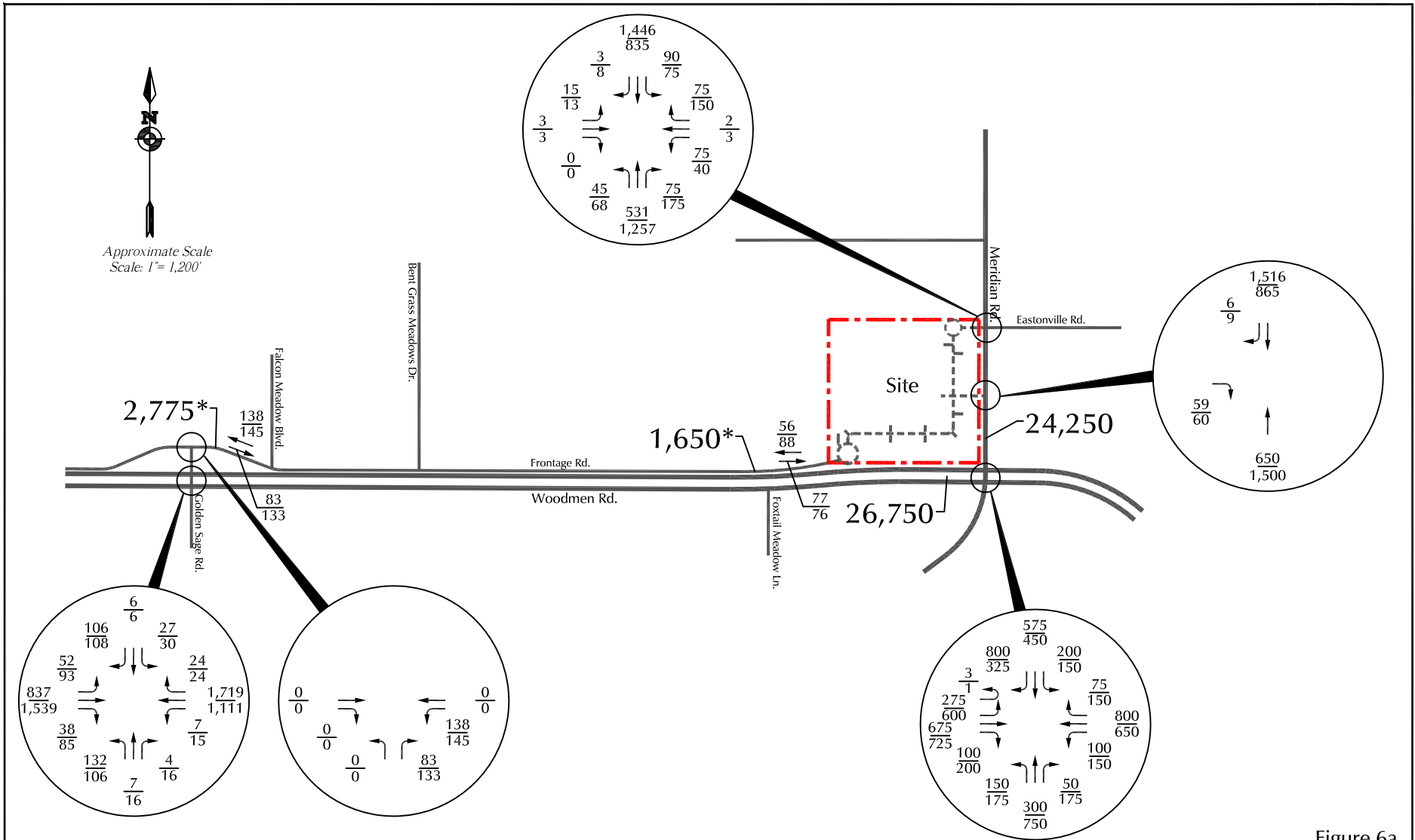
Baseline or “background” traffic is the traffic estimated to be on the adjacent roadways and at adjacent intersections without the proposed development’s trip generation and resulting added traffic volumes (site traffic is presented in the following chapter). New baseline/background traffic is the difference between future background traffic and existing traffic.

The background traffic analysis hypothetically assumes the site street connections and access points to be in place (but without site traffic). Background traffic includes the through traffic and the traffic generated by nearby developments, but hypothetically assumes zero traffic generated by the site for analysis purposes.

SHORT-TERM BACKGROUND TRAFFIC

Background traffic is the traffic estimated to be on the adjacent roadways and at adjacent intersections without the proposed development’s trip generation and resulting site-generated traffic volumes. However, the site street connections and access points were assumed to be in place. Background traffic includes the through traffic and the traffic generated by nearby developments, but hypothetically assumes zero traffic generated by the site for analysis purposes. Figure 6a and 7a show the background traffic volumes traveling through the site and in the vicinity of the site for the short term. The short-term background traffic volumes were based on some growth in existing traffic volumes shown in Figure 5, with some adjustments to the existing traffic patterns due to the planned Meridian Road project to the south, the proposed vehicular connection through the site (between the end of the Woodmen Frontage Road and Eastonville Road) via access easement(s) and internal commercial drives, and the new west leg of the intersection of Meridian Road and Eastonville Road. The volumes shown in Figure 6a assume no access to Woodmen Road and the volumes shown in Figure 7a assume the proposed right-in-only access from Woodmen Road. The short-term background traffic volumes assume some additional traffic due to buildout of the Woodmen Courtyards development just west of the site.

Figures 6b and 7b show the lane geometry, traffic control, and level of service at the key intersections based on the short-term background volumes.



*Frontage Road Traffic Volumes

Figure 6a

Short-Term Background Traffic Without Proposed Right-In Access

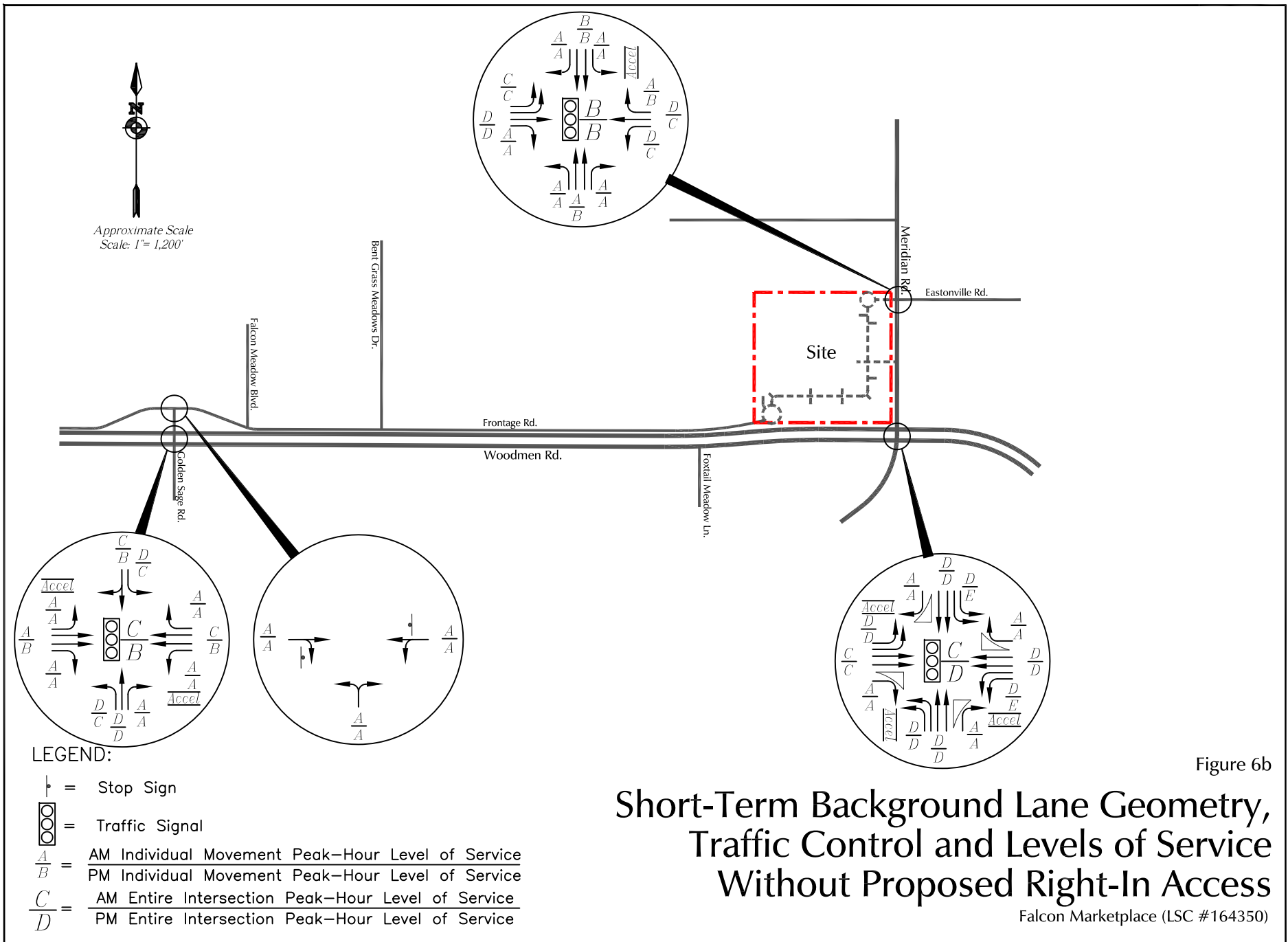
Falcon Marketplce (LSC #164350)

LEGEND:

$\frac{XX}{XX}$ = AM Weekday Peak-Hour Traffic (vehicles per hour)

$\frac{XX}{XX}$ = PM Weekday Peak-Hour Traffic (vehicles per hour)

XXX = Average Weekday Traffic (vehicles per day) Estimated by LSC



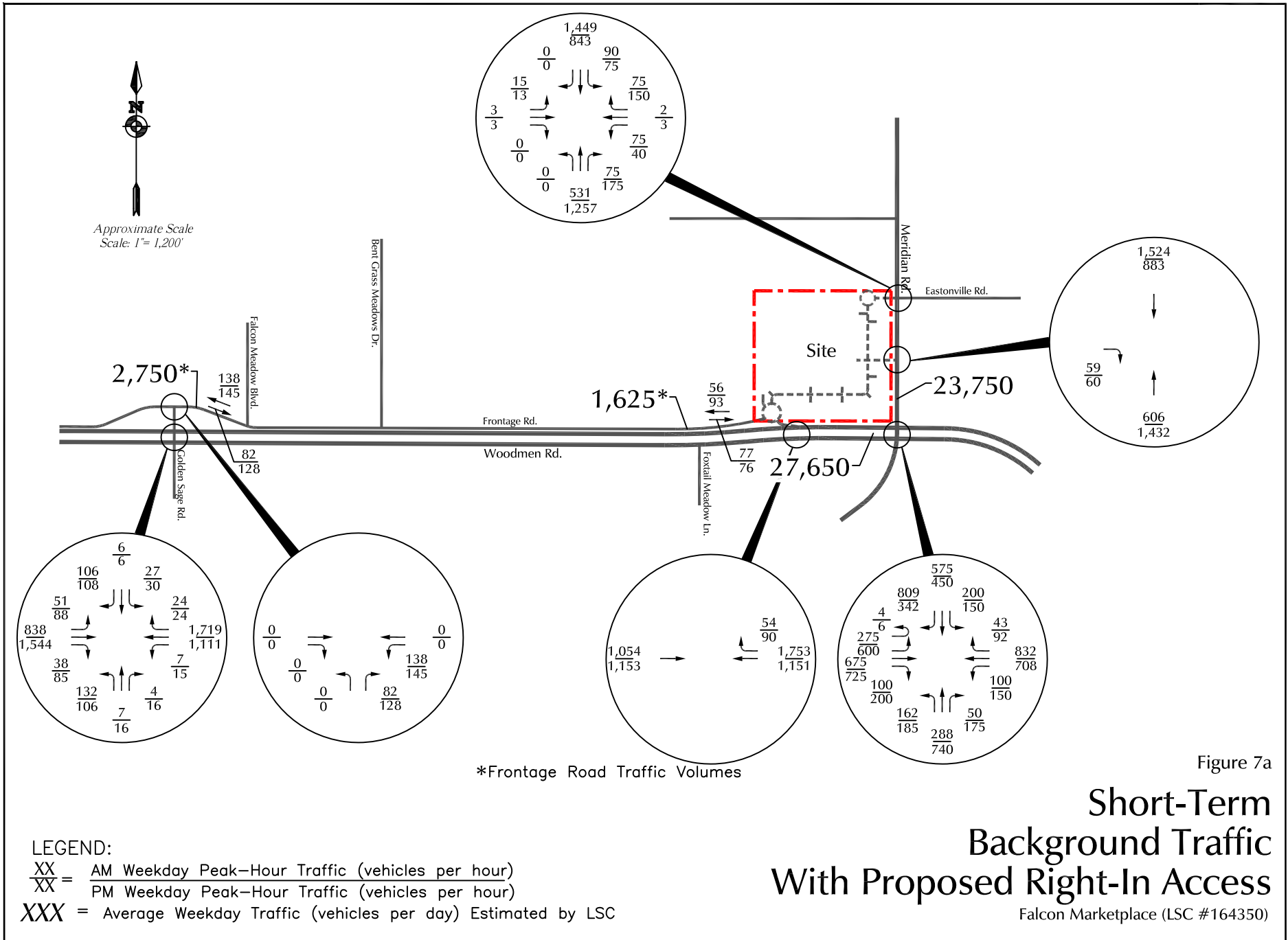
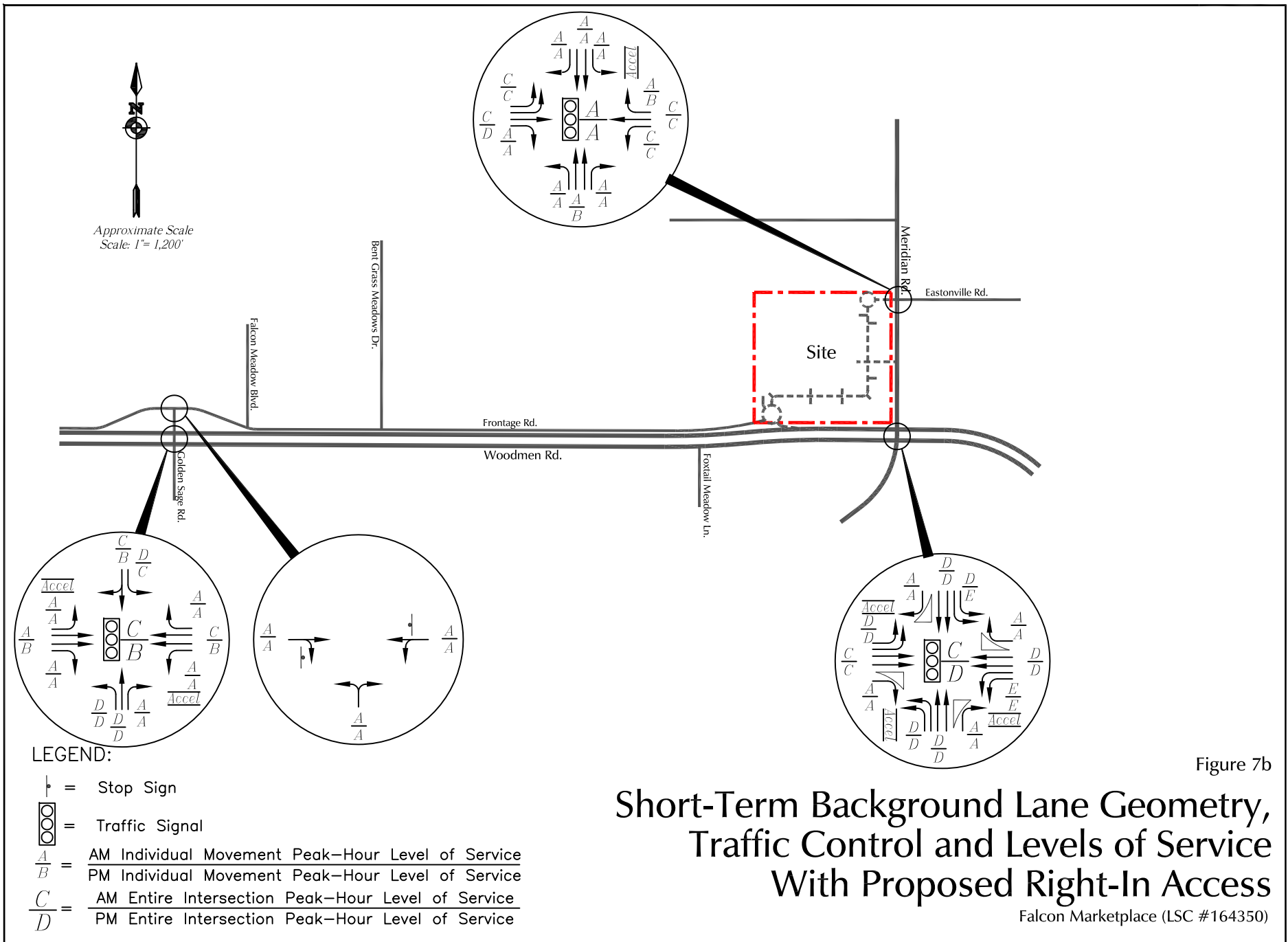


Figure 7a

Short-Term Background Traffic With Proposed Right-In Access

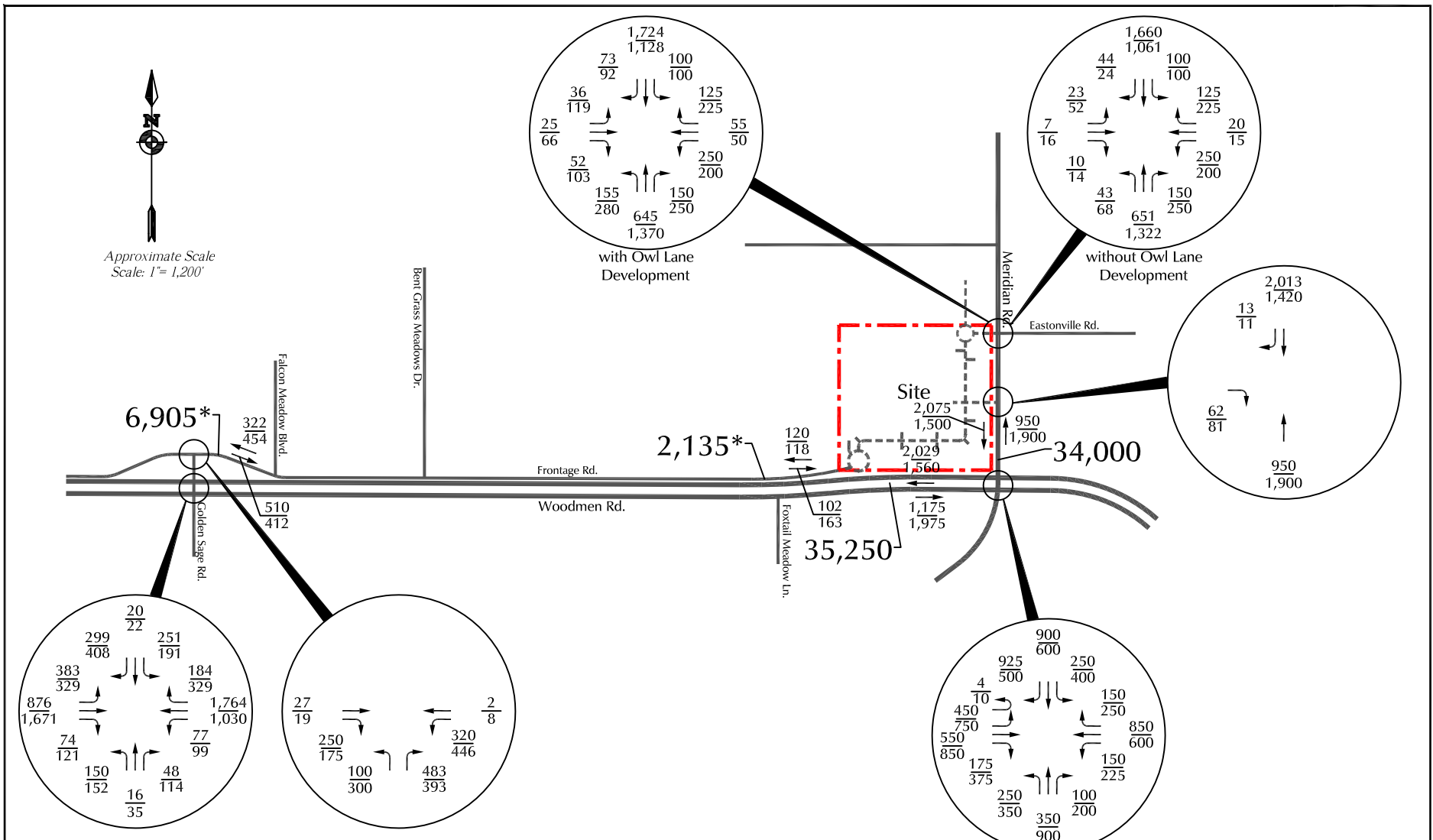
Falcon Marketplace (LSC #164350)



2040 BACKGROUND TRAFFIC

Figures 8a and 9a show the background traffic volumes for the year 2040. The volumes shown in Figure 8a assume no access from Woodmen Road and the volumes shown in Figure 9a assume the proposed right-in-only access. The 2040 background traffic volume estimates were based on the *El Paso County Major Transportation Corridors Plan (MTCP) 2040* and previous work completed in the area by LSC, including the Bent Grass Subdivision PUD/Preliminary Plan Updated Traffic Impact Study and the previous studies for this site, other area traffic studies, and traffic count data. The 2040 background traffic includes buildout of the Bent Grass subdivision, the Latigo site northeast of Bent Grass Meadows Drive/Woodmen Frontage Road (assuming the current I-2 industrial zoning -- although previous reports have been prepared contemplating rezoning to commercial/shopping center land uses), and potential Owl Lane redevelopment for commercial land uses with the planned north/south street connection between Eastonville and Bent Grass Meadows Drive. Increases in through traffic are also included. The 2040 background traffic estimates also take into account the Stapleton Drive extension to the west to the Briargate Parkway/Black Forest Road intersection.

Figures 8b and 9b show the lane geometry, traffic control, and level of service at the key intersections based on the 2040 background volumes.



*Frontage Road Traffic Volumes

LEGEND:

- $\frac{XX}{XX}$ = AM Weekday Peak-Hour Traffic (vehicles per hour)
- $\frac{XX}{XX}$ = PM Weekday Peak-Hour Traffic (vehicles per hour)
- XXX = Average Weekday Traffic (vehicles per day) Estimated by LSC

Figure 8a
Year 2040
Background Traffic
Without Proposed Right-In Access
Falcon Marketplace (LSC #164350)

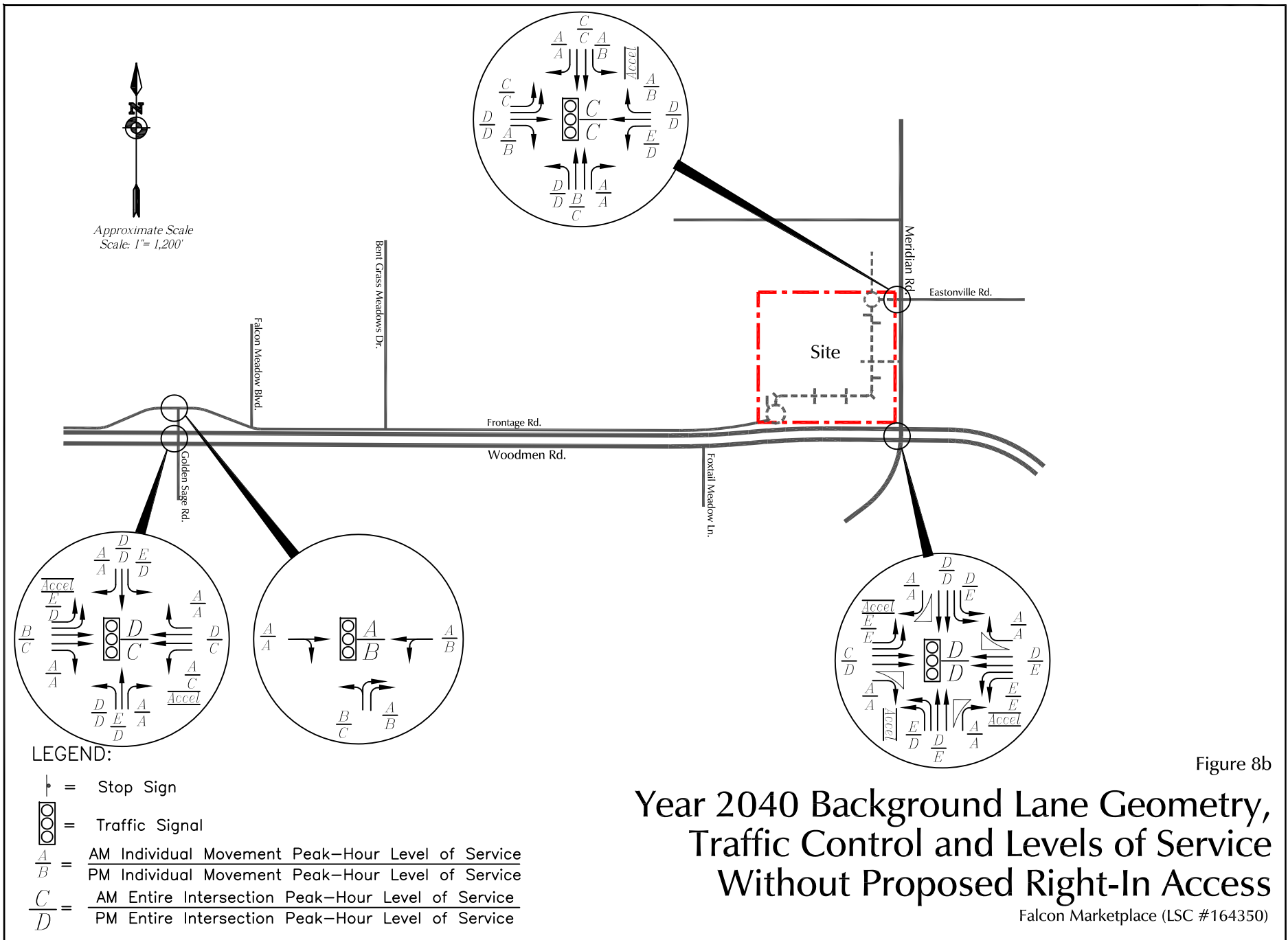
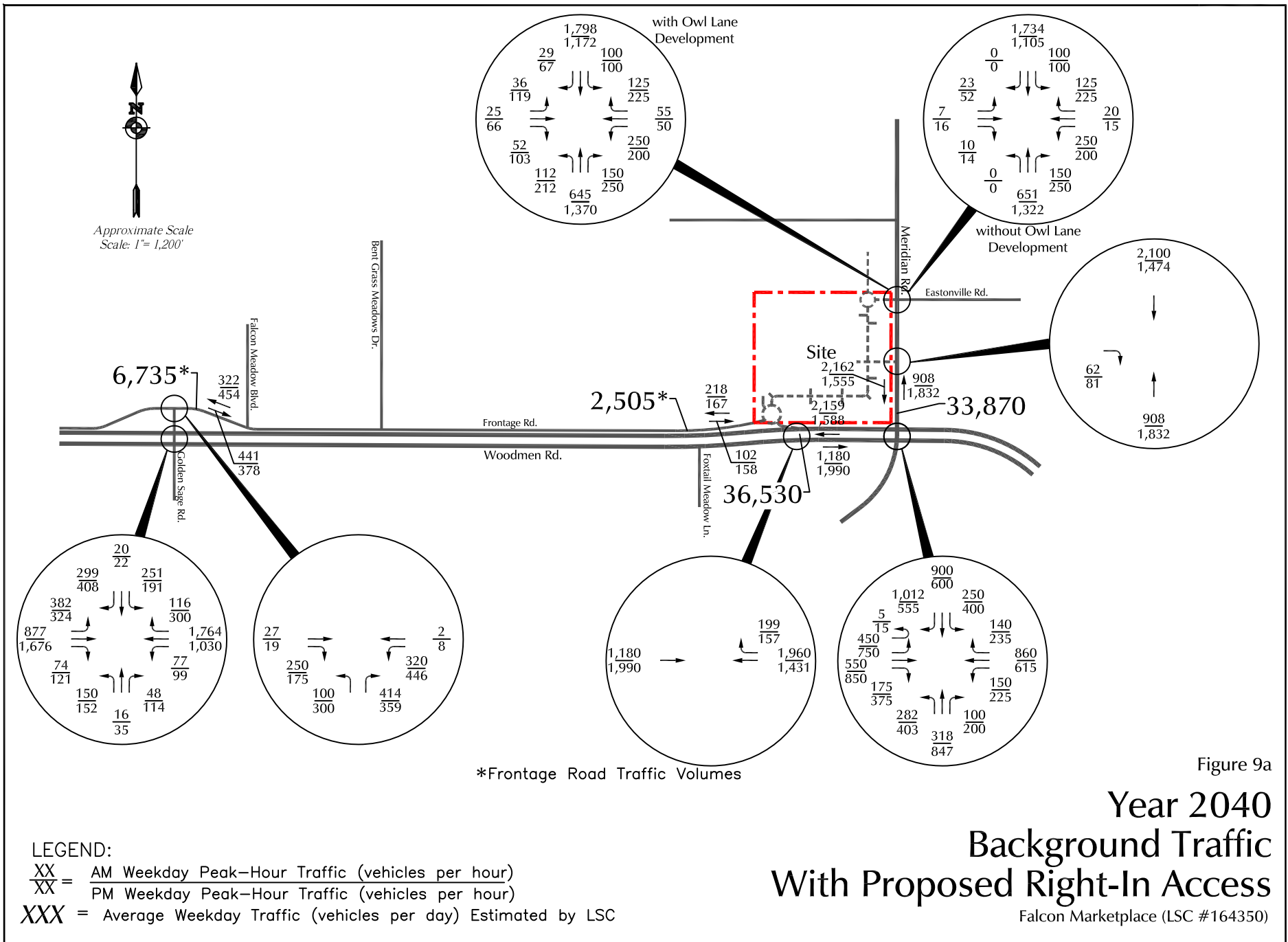
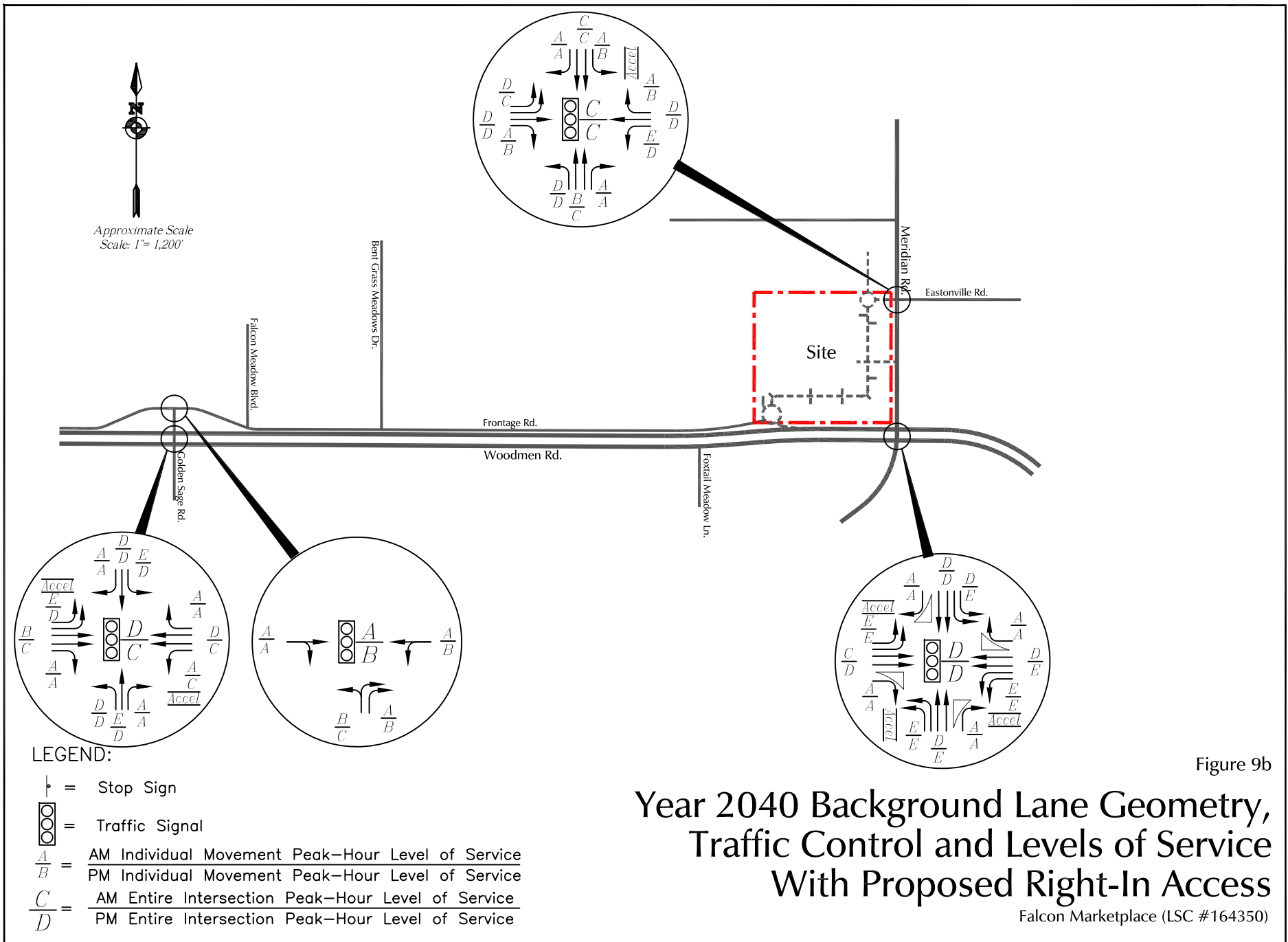


Figure 8b





Trip Generation, Distribution, and Traffic Volume Estimates

TRIP GENERATION

Estimates of the traffic volumes expected to be generated by the existing and proposed land uses within the study area were made using the nationally published trip generation rates found in *Trip Generation, 9th Edition, 2012* by the Institute of Transportation Engineers (ITE). Table 2 shows the trip generation estimates.

The total number of vehicle-trips generated by the land uses has been reduced to account for the internal vehicle-trips made within the site between land uses, without use of the external streets surrounding the site. Table 2 shows the number of internal trips assumed for each land use. The internal trip reduction is an estimate by LSC based on National Highway Cooperative Highway Research Program (NCHRP) Report 684 *Enhancing Internal Trip Capture Estimation for Mixed-Use Developments*. The results of the spreadsheet model are attached.

The total number of external new impact vehicle-trips generated by the retail land uses has been reduced to take into account the “pass-by” and “diverted link” phenomena. A pass-by trip is made by a motorist who would already be on the adjacent roadways regardless of the proposed development, but who stops in at the site while passing by. The motorist would then continue on his or her way to a final destination in the original direction. The pass-by percentages shown on Table 2 are from the *Trip Generation Handbook - An ITE Proposed Recommended Practice, 3rd Edition, 2014* by ITE. A diverted link trip is one made by a motorist who would already be traveling on a nearby (but not adjacent) roadway regardless of this development who now uses another roadway to access the site before continuing on his or her way to a final destination in the original direction. Diverted link trips are included in the distribution percentages.

The site is projected to generate about 9,558 new external vehicle-trips on the average weekday, with about half entering and half exiting the site during a 24-hour period.

Figure 8a

**Table 2
Trip Generation Estimate
Falcon Marketplace**

| Lot | Land Use Code | Land Use Description | Trip Generation Units | Trip Generation Rates ⁽¹⁾ | | | | Total Trips Generated | | | | Internal Trips ⁽⁷⁾ | | | | Total External Trips Generated | | | | Pass-By Trips ⁽²⁾ | New External Trips Generated Average New Weekday Traffic | | | | |
|--|---------------|---|-----------------------|--------------------------------------|----------------------|-----------------------|------------------------|-------------------------|-------------------------|----------------------|-----------------------|-------------------------------|-------------------------|-------------------------|----------------------|--------------------------------|------------------------|-------------------------|---------------|------------------------------|---|------------|------------|-----|--------------|
| | | | | Average Weekday Traffic | Morning Peak Hour In | Morning Peak Hour Out | Afternoon Peak Hour In | Afternoon Peak Hour Out | Average Weekday Traffic | Morning Peak Hour In | Morning Peak Hour Out | Afternoon Peak Hour In | Afternoon Peak Hour Out | Average Weekday Traffic | Morning Peak Hour In | Morning Peak Hour Out | Afternoon Peak Hour In | Afternoon Peak Hour Out | | | | | | | |
| Trip Generation Estimate Based on the Currently Proposed Plan | | | | | | | | | | | | | | | | | | | | | | | | | |
| 1 | 866 | Pet Supply Superstore ⁽³⁾ | 15 KSF ⁽⁴⁾ | 38.24 | 0.53 | 0.33 | 1.69 | 1.69 | 574 | 8 | 5 | 25 | 25 | 54 | 1 | 2 | 3 | 2 | 520 | 7 | 3 | 22 | 23 | 10% | 468 |
| 2 | 850 | Supermarket | 123 KSF | 78.26 | 2.11 | 1.29 | 3.76 | 3.62 | 9,626 | 259 | 159 | 463 | 445 | 909 | 17 | 26 | 48 | 37 | 8,717 | 242 | 133 | 415 | 408 | 36% | 5,579 |
| 3 | 944 | Gasoline/Service Station | 18 VFP ⁽⁵⁾ | 168.56 | 6.20 | 5.96 | 6.94 | 6.94 | 3,034 | 112 | 107 | 125 | 125 | 286 | 5 | 8 | 15 | 12 | 2,748 | 107 | 99 | 110 | 113 | 56% | 1,209 |
| 4 | 934 | Fast-Food Restaurant with Drive-Through Window ⁽⁶⁾ | 2.5 KSF | 496.12 | 0.42 | 0.39 | 16.98 | 15.67 | 1,240 | 1 | 1 | 42 | 39 | 380 | 0 | 0 | 12 | 17 | 860 | 1 | 1 | 30 | 22 | 50% | 430 |
| 5 | 820 | Shopping Center | 5 KSF | 55.14 | 0.77 | 0.47 | 2.36 | 2.51 | 276 | 4 | 2 | 12 | 13 | 26 | 1 | 0 | 1 | 1 | 250 | 3 | 2 | 11 | 12 | 34% | 165 |
| 6 | 848 | Tire Store | 7.72 KSF | 24.87 | 1.82 | 1.07 | 1.78 | 2.37 | 192 | 14 | 8 | 14 | 18 | 18 | 0 | 1 | 1 | 1 | 174 | 14 | 7 | 13 | 17 | 28% | 125 |
| 7 | 934 | Fast-Food Restaurant with Drive-Through Window | 3.5 KSF | 496.12 | 23.16 | 22.26 | 16.98 | 15.67 | 1,736 | 81 | 78 | 59 | 55 | 532 | 26 | 12 | 17 | 24 | 1,204 | 55 | 66 | 42 | 31 | 50% | 602 |
| 8 | 934 | Fast-Food Restaurant with Drive-Through Window ⁽⁶⁾ | 2.5 KSF | 496.12 | 0.42 | 0.39 | 16.98 | 15.67 | 1,240 | 1 | 1 | 42 | 39 | 380 | 0 | 0 | 12 | 17 | 860 | 1 | 1 | 30 | 22 | 50% | 430 |
| 9 | 610 | Clinic | 7.8 KSF | 31.45 | 2.19 | 2.19 | 2.12 | 3.06 | 245 | 17 | 17 | 17 | 24 | 40 | 3 | 16 | 10 | 5 | 205 | 14 | 1 | 7 | 19 | 0% | 205 |
| 10 | 820 | Shopping Center | 8 KSF | 55.14 | 0.77 | 0.47 | 2.36 | 2.51 | 441 | 6 | 4 | 19 | 20 | 42 | 1 | 1 | 2 | 2 | 399 | 5 | 3 | 17 | 18 | 34% | 263 |
| 11 | 937 | Coffee/Donut Shop With Drive-Through Window | 1.3 KSF | 818.58 | 51.30 | 49.28 | 21.40 | 21.40 | 1,064 | 67 | 64 | 28 | 28 | 326 | 21 | 10 | 9 | 12 | 738 | 46 | 54 | 19 | 16 | 89% | 81 |
| | | | | | | | | | 19,669 | 570 | 446 | 846 | 831 | 2,993 | 75 | 76 | 130 | 130 | 16,676 | 495 | 370 | 716 | 701 | | 9,558 |

Notes:

- (1) Source: "Trip Generation, 9th Edition, 2012" by the Institute of Transportation Engineers (ITE)
- (2) Source: "Trip Generation Handbook - An ITE Proposed Recommended Practice" 3rd Edition, 2014
- (3) Daily and morning peak-hour trip generation rates for Pet Supply Superstore are estimates by LSC
- (4) KSF = 1,000 square feet of floor space
- (5) VFP = vehicle fueling position
- (6) The AM peak-hour trip generation rates have been reduced by LSC as the proposed fast-food restaurant does not serve breakfast
- (6) See attached NCHRP 684 Internal Trip Capture Estimate Tool Sheets

Source: LSC Transportation Consultants, Inc.

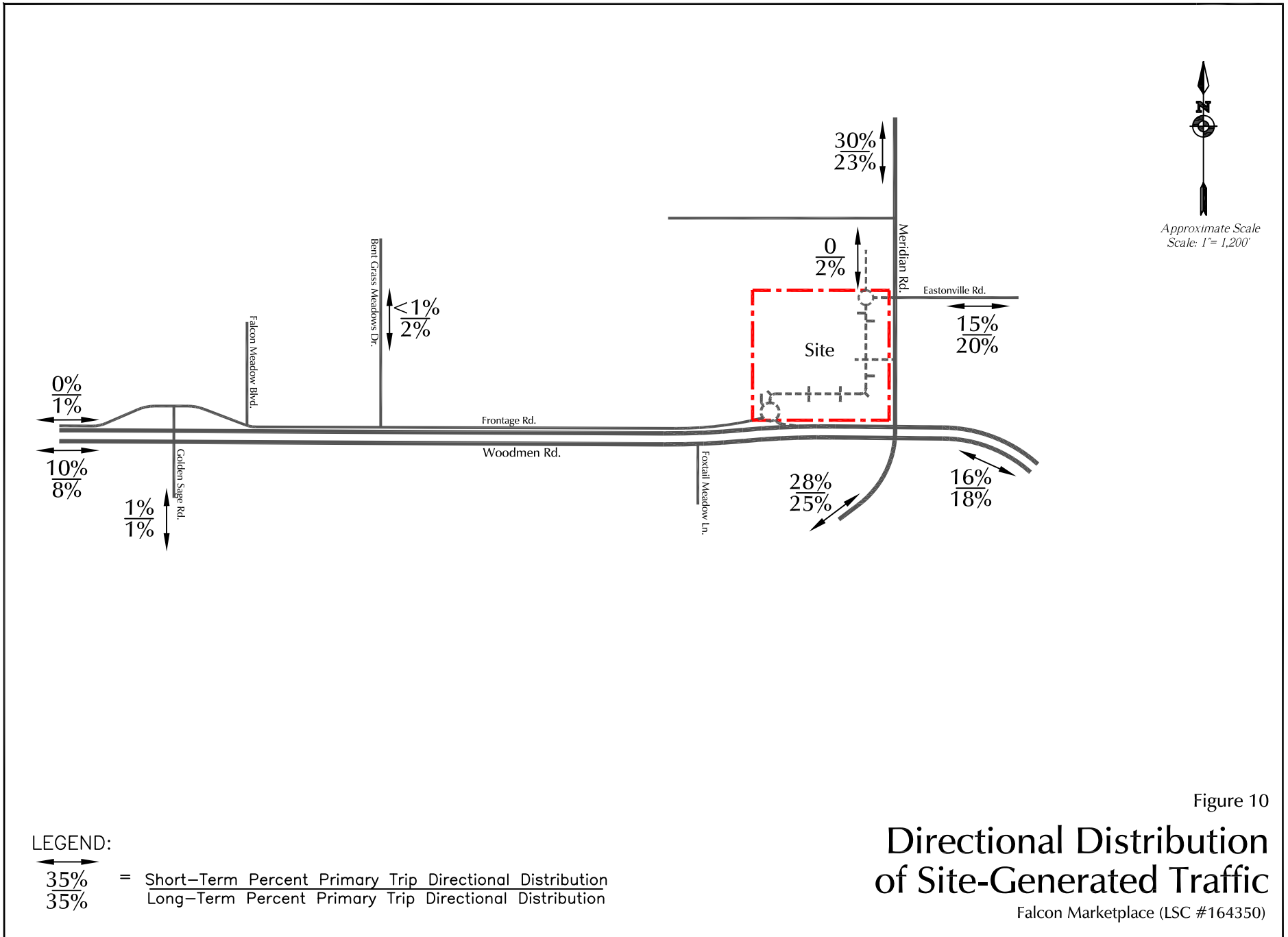
During the morning peak hour, which generally occurs for one hour between 6:30 and 8:30 a.m., about 495 vehicles would enter and 370 vehicles would exit the site.

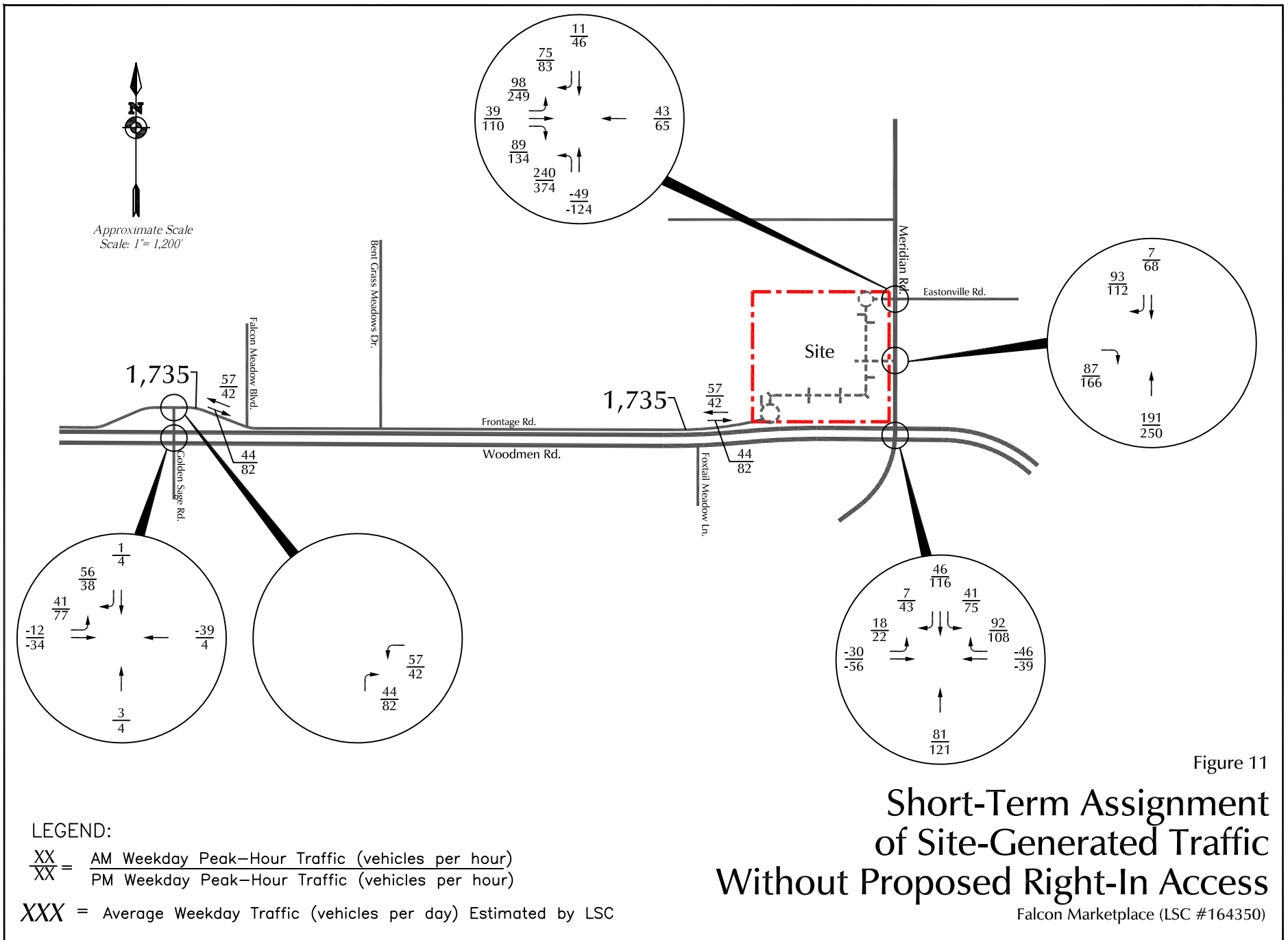
During the afternoon peak hour, which generally occurs for one hour between 4:15 and 6:15 p.m., about 716 vehicles would enter and 701 vehicles would exit the site.

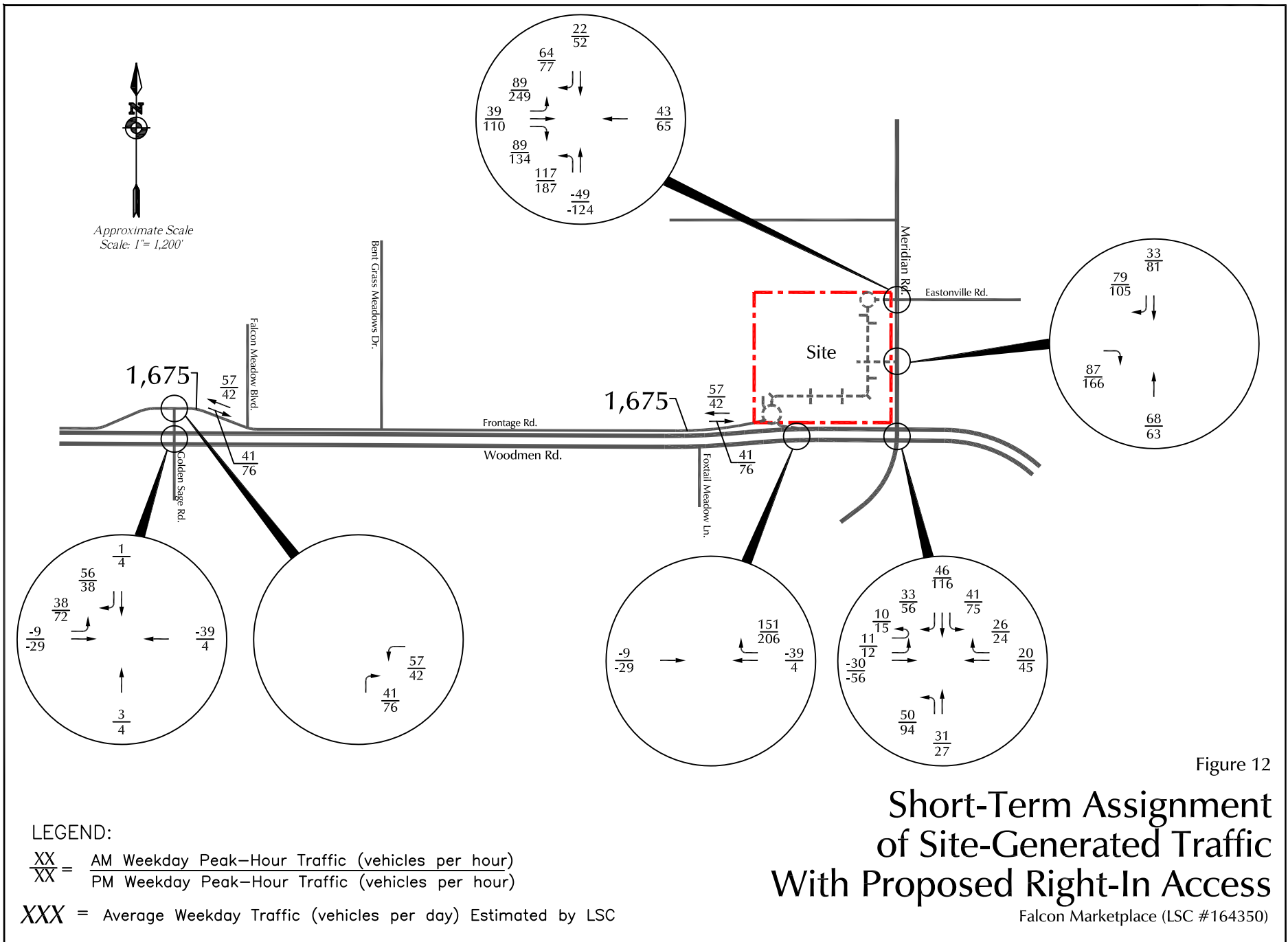
TRIP DISTRIBUTION AND ASSIGNMENT

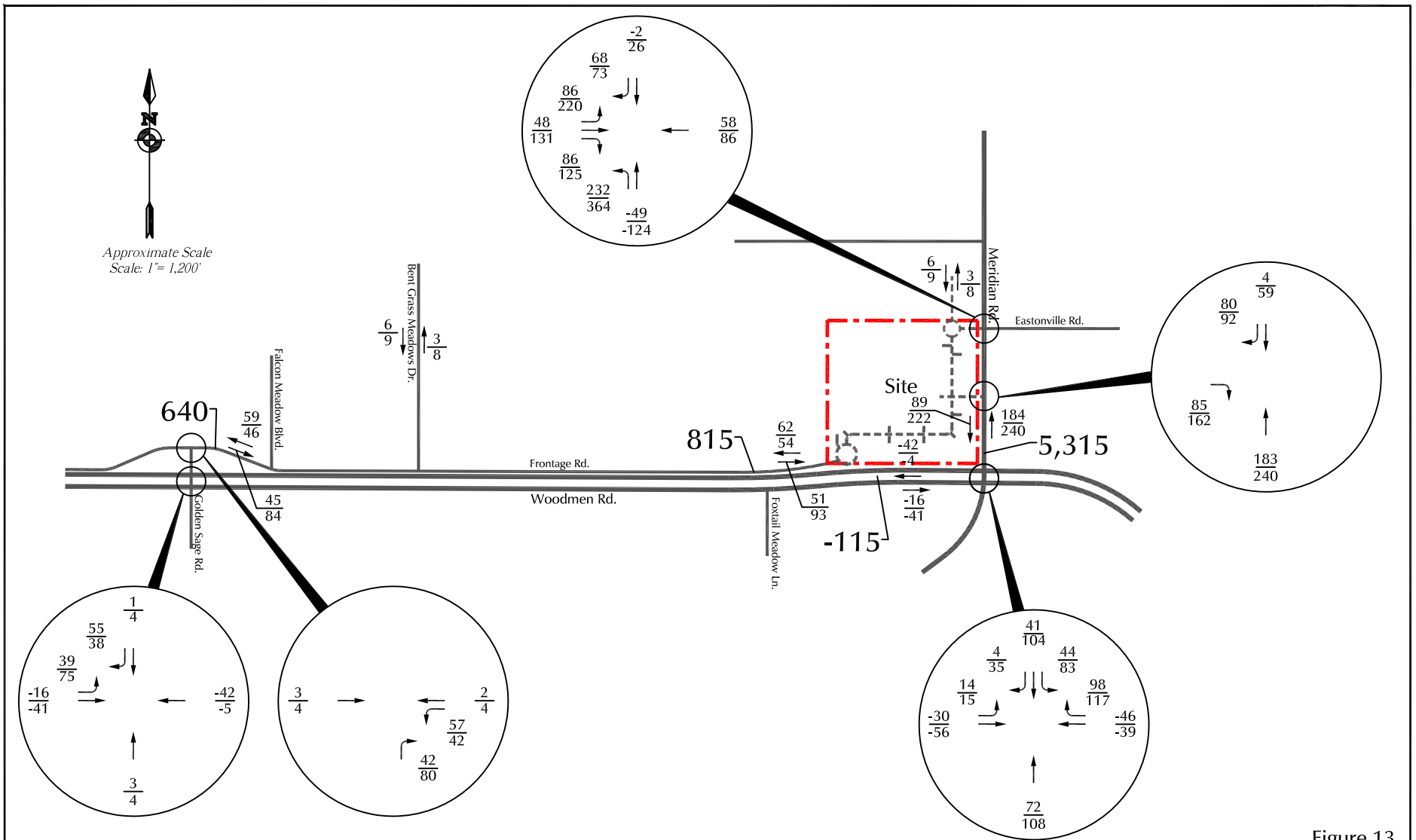
The estimated directional distribution of the site-generated traffic volumes on the adjacent roadways is an important factor in determining the site's traffic impacts. Figure 10 shows the directional distribution estimates for the primary site-generated traffic. The estimates have been based on the following factors: the site's location with respect to the Falcon area's residential, employment, and commercial areas; the balance of the northeast Colorado Springs metropolitan area and the rural areas of the county to the east; the site's proposed land uses; the site's proposed access and circulation system; and the roadway system serving the site. The short-term distribution estimate assumes the existing street network plus the Meridian Road project, and the long-term estimate assumes the future Stapleton extension to the west and additional east-west potential connections west of US 24 through Banning Lewis Ranch such as Dublin Boulevard. The pass-by trips and diverted trips were assigned based in large part on the magnitude and direction of the existing and projected background traffic volumes on the adjacent roadways.

When the distribution percentages (from Figure 10) were applied to the trip generation estimates (from Table 2), the site-generated traffic volumes on the area roadways were determined. Figures 11 and 12 show the short-term site-generated traffic volumes without and with the proposed right-in-only access from Woodmen Road, respectively. Figures 13 and 14 show the long-term site-generated traffic volumes with no access to Woodmen Road and with the proposed right-in-only access from Woodmen Road, respectively.







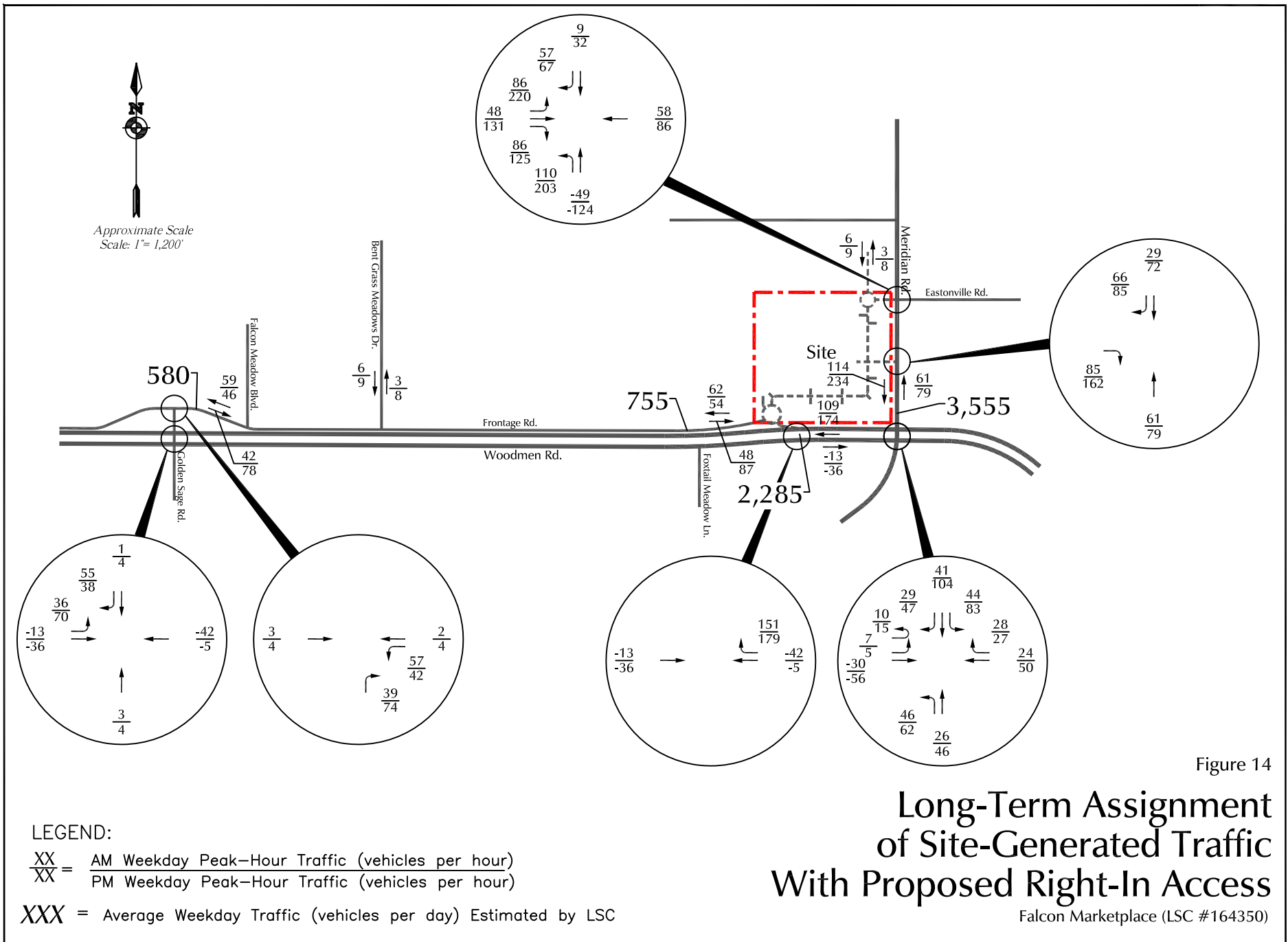


LEGEND:

$\frac{XX}{XX}$ = $\frac{\text{AM Weekday Peak-Hour Traffic (vehicles per hour)}}{\text{PM Weekday Peak-Hour Traffic (vehicles per hour)}}$

XXX = Average Weekday Traffic (vehicles per day) Estimated by LSC

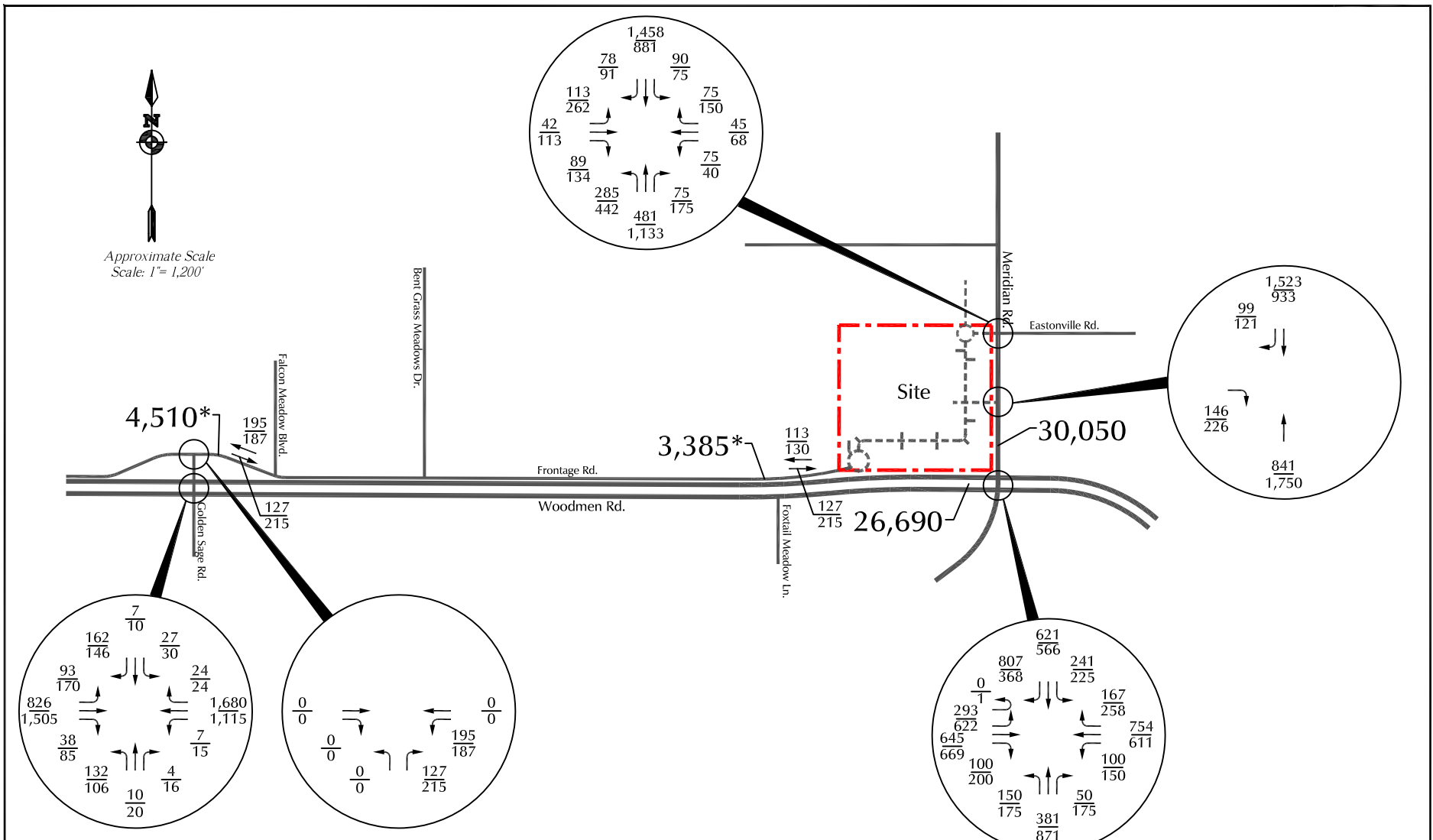
Figure 13
**Long-Term Assignment
of Site-Generated Traffic
Without Proposed Right-In Access**
Falcon Marketplce (LSC #164350)



SHORT-TERM TOTAL TRAFFIC

Figures 15a and 16a show the short-term total traffic volumes at the access points and key intersections adjacent to the site with no access to Woodmen Road and with the proposed right-in-only access from Woodmen Road, respectively. The volumes are the sum of the short-term background traffic volumes from Figures 6a and 7a, plus the short-term site-generated traffic volumes from Figures 11 and 12. The volumes shown in Figures 15a and 16a represent the short-term impacts of the development.

Figures 15b and 16b show the lane geometry, traffic control, and level of service at the key intersections based on the short-term total volumes.



*Frontage Road Traffic Volumes

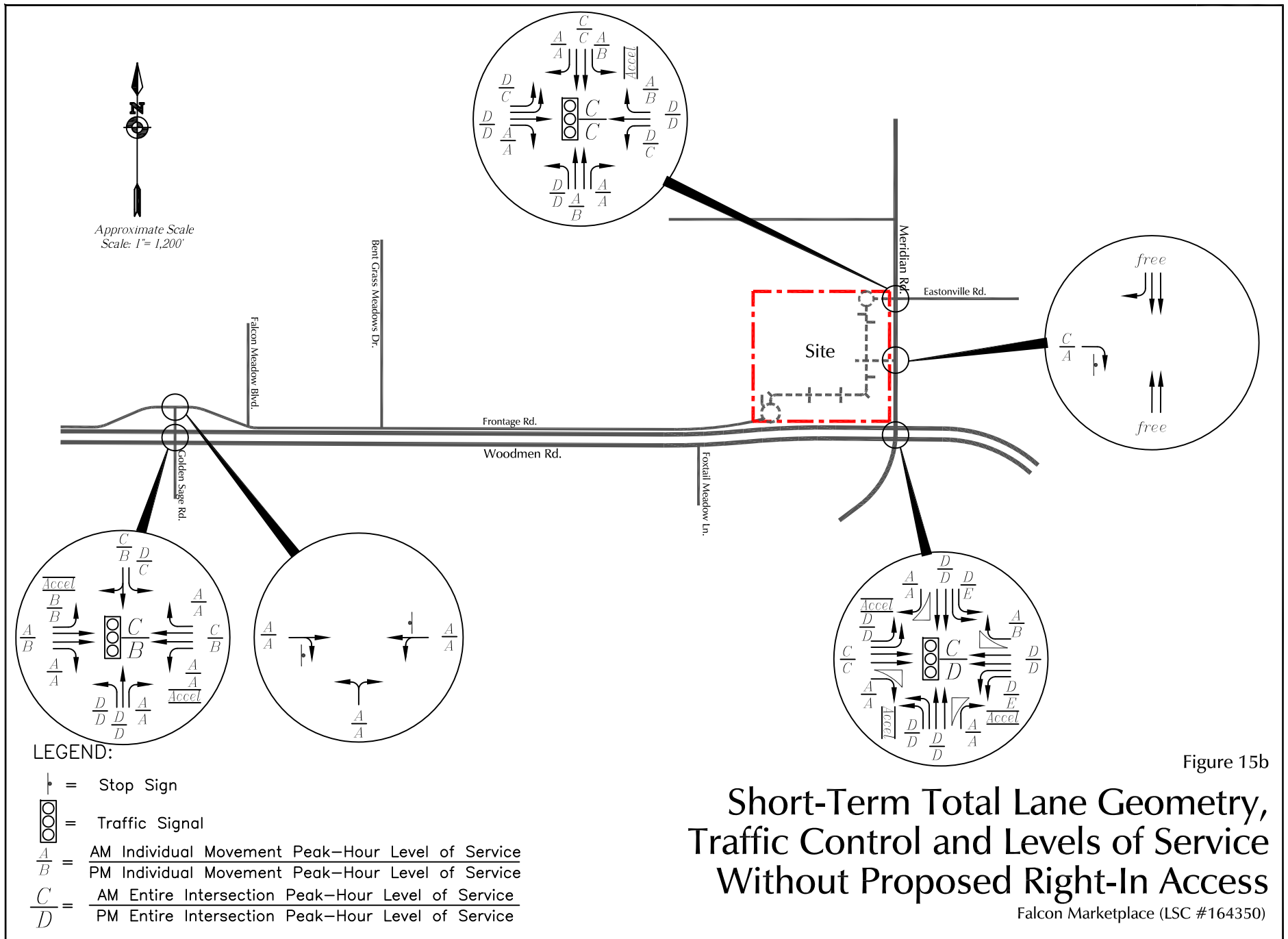
LEGEND:

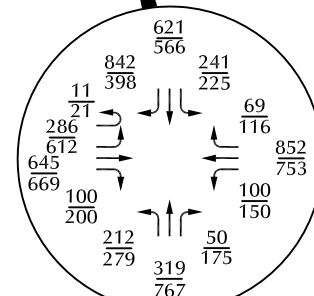
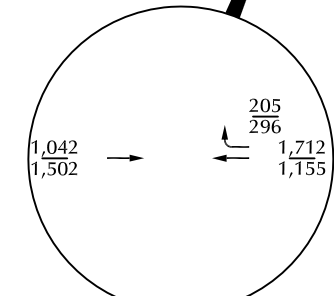
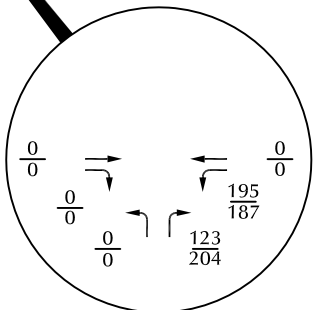
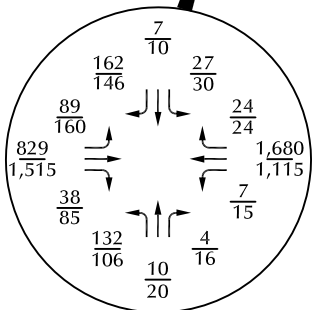
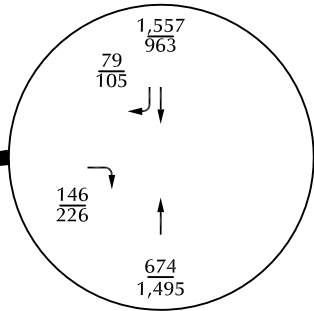
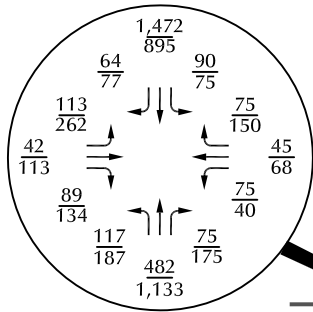
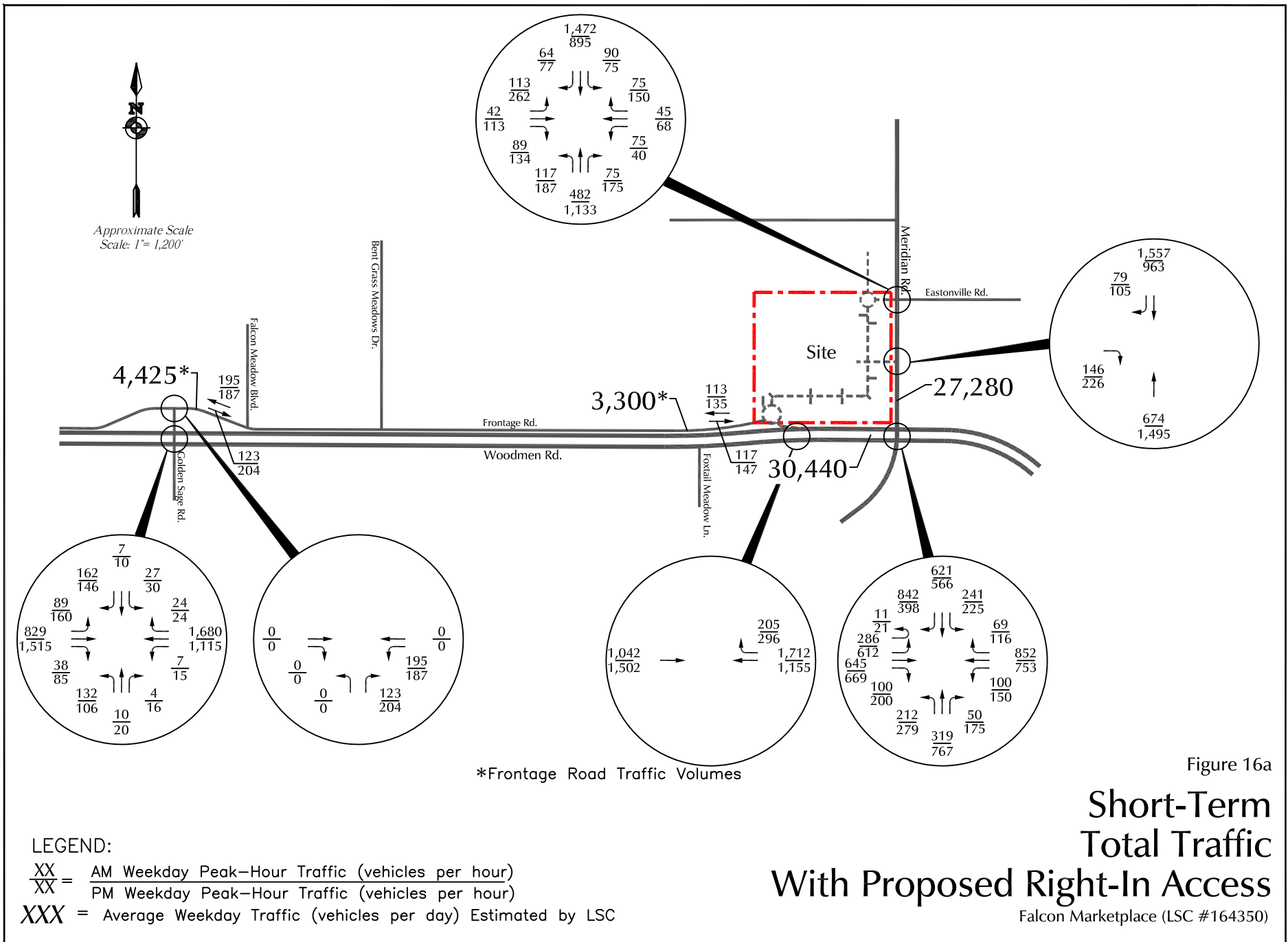
$\frac{XX}{XX}$ = AM Weekday Peak-Hour Traffic (vehicles per hour)

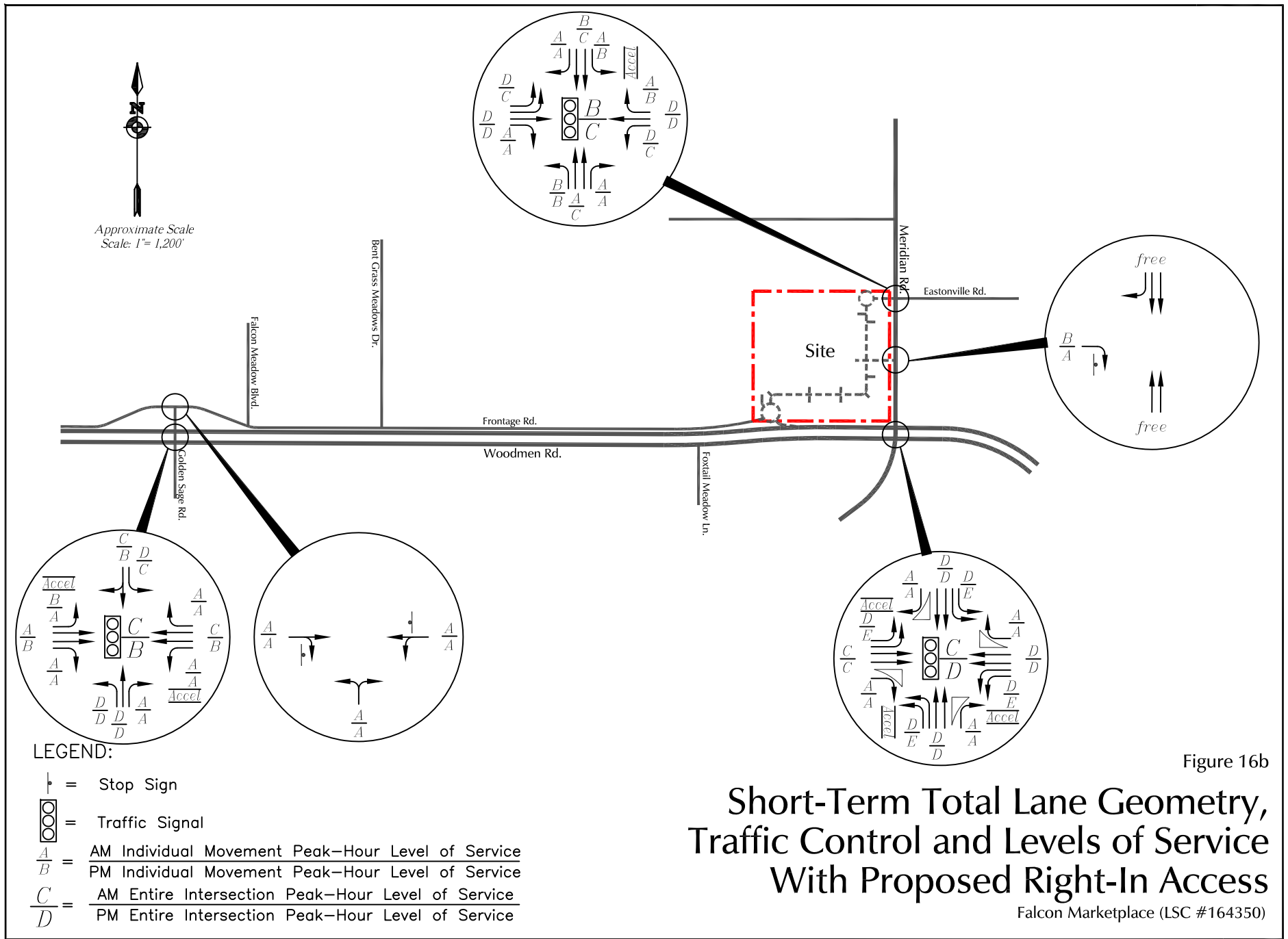
$\frac{XX}{XX}$ = PM Weekday Peak-Hour Traffic (vehicles per hour)

XXX = Average Weekday Traffic (vehicles per day) Estimated by LSC

Figure 15a
**Short-Term
Total Traffic
Without Proposed Right-In Access**
Falcon Marketplce (LSC #164350)



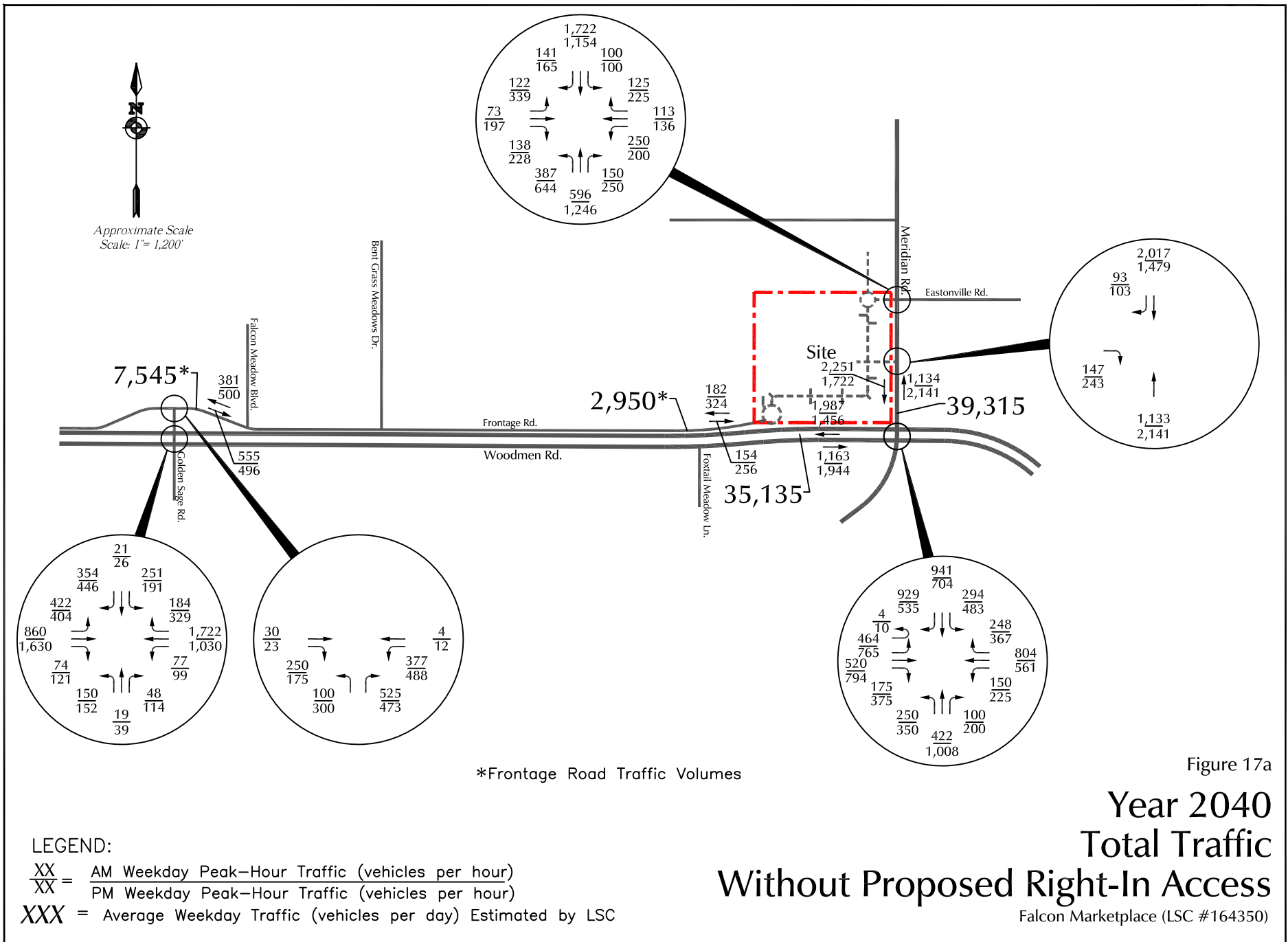




2040 TOTAL TRAFFIC

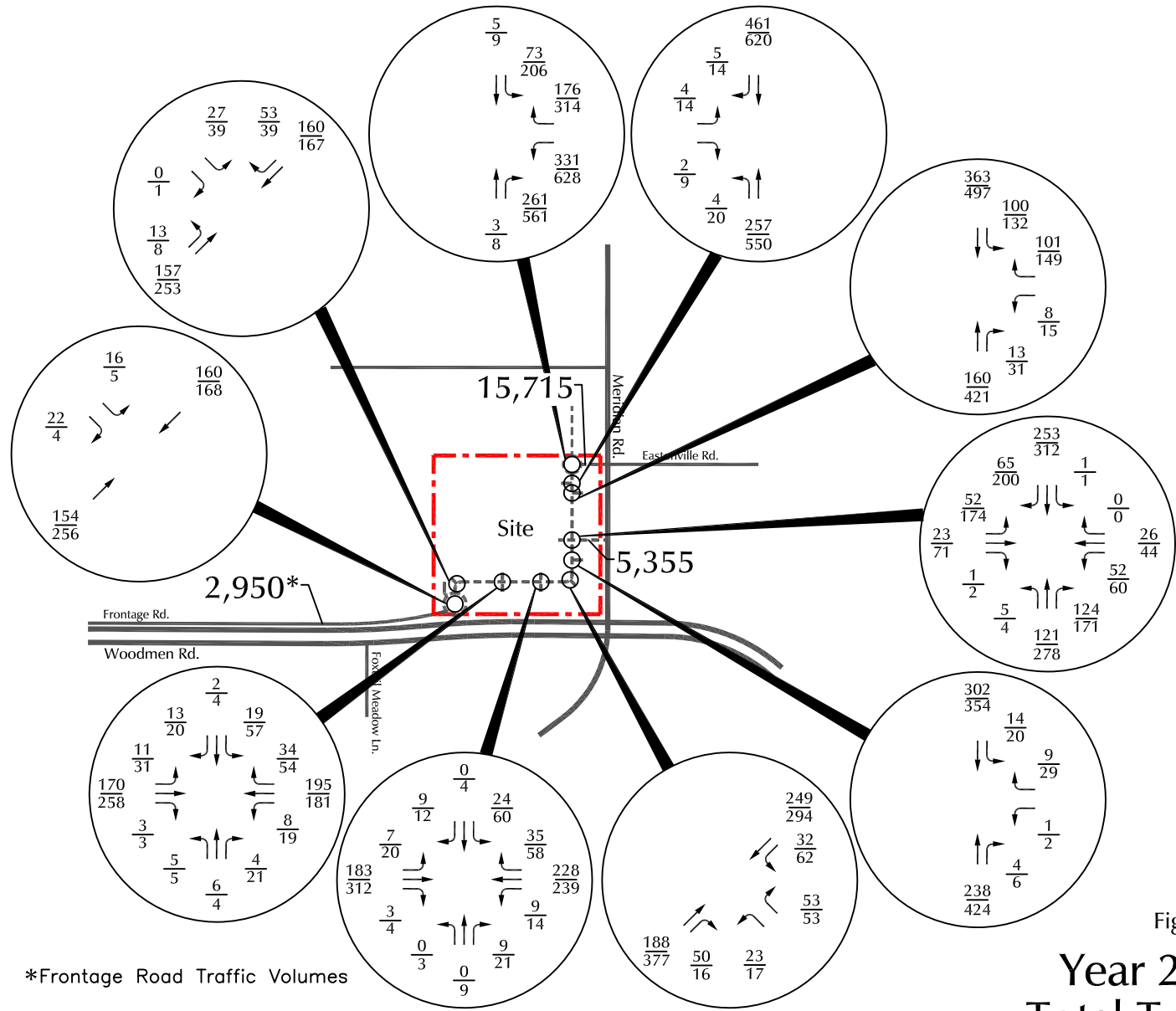
Figures 17a and 18a show the 2040 total traffic volumes at the site access points and key intersections adjacent to the site with no access to Woodmen Road and with the proposed right-in-only access from Woodmen Road, respectively. The volumes are the sum of the 2040 background traffic volumes from Figures 8a and 9a, plus the long-term site-generated traffic volumes from Figures 13 and 14. Figures 17b and 18b show the 2040 total traffic volumes at all of the proposed access points to the public internal road, which extends from the terminus of the Woodmen Frontage Road to Eastonville Road.

Figures 17c and 18c show the lane geometry, traffic control, and level of service at the site access points and key intersections adjacent to the site based on the 2040 total volumes. Figures 17d and 18d show the lane geometry, traffic control, and level of service at the site access points and key intersections adjacent to the site based on the 2040 total volumes. Figures 17d and 18d show the lane geometry, traffic control, and level of service at all of the proposed access points to the public internal road, which extends from the terminus of the Woodmen Frontage Road to Eastonville Road.





Approximate Scale
Scale: 1" = 1,200'

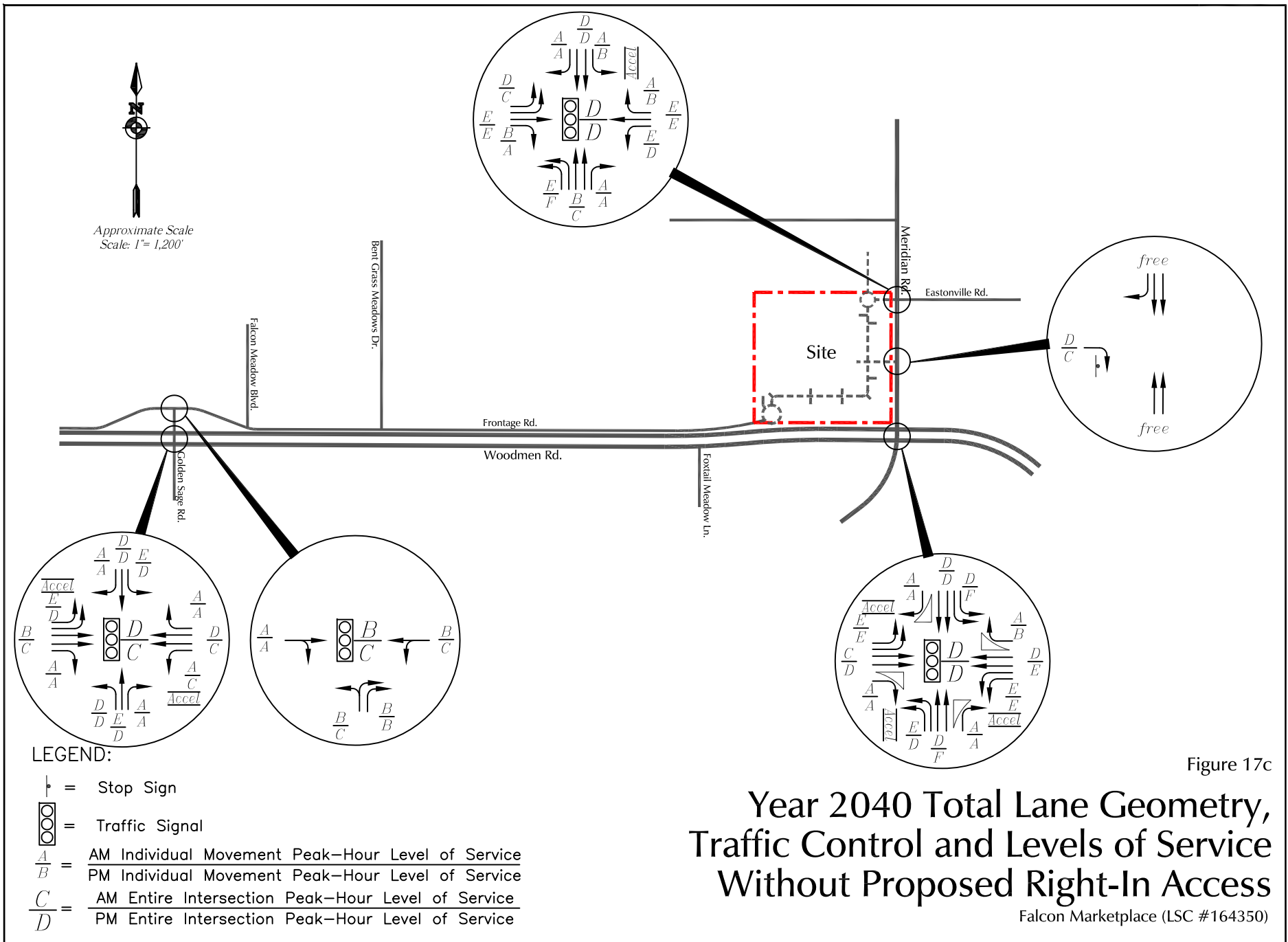


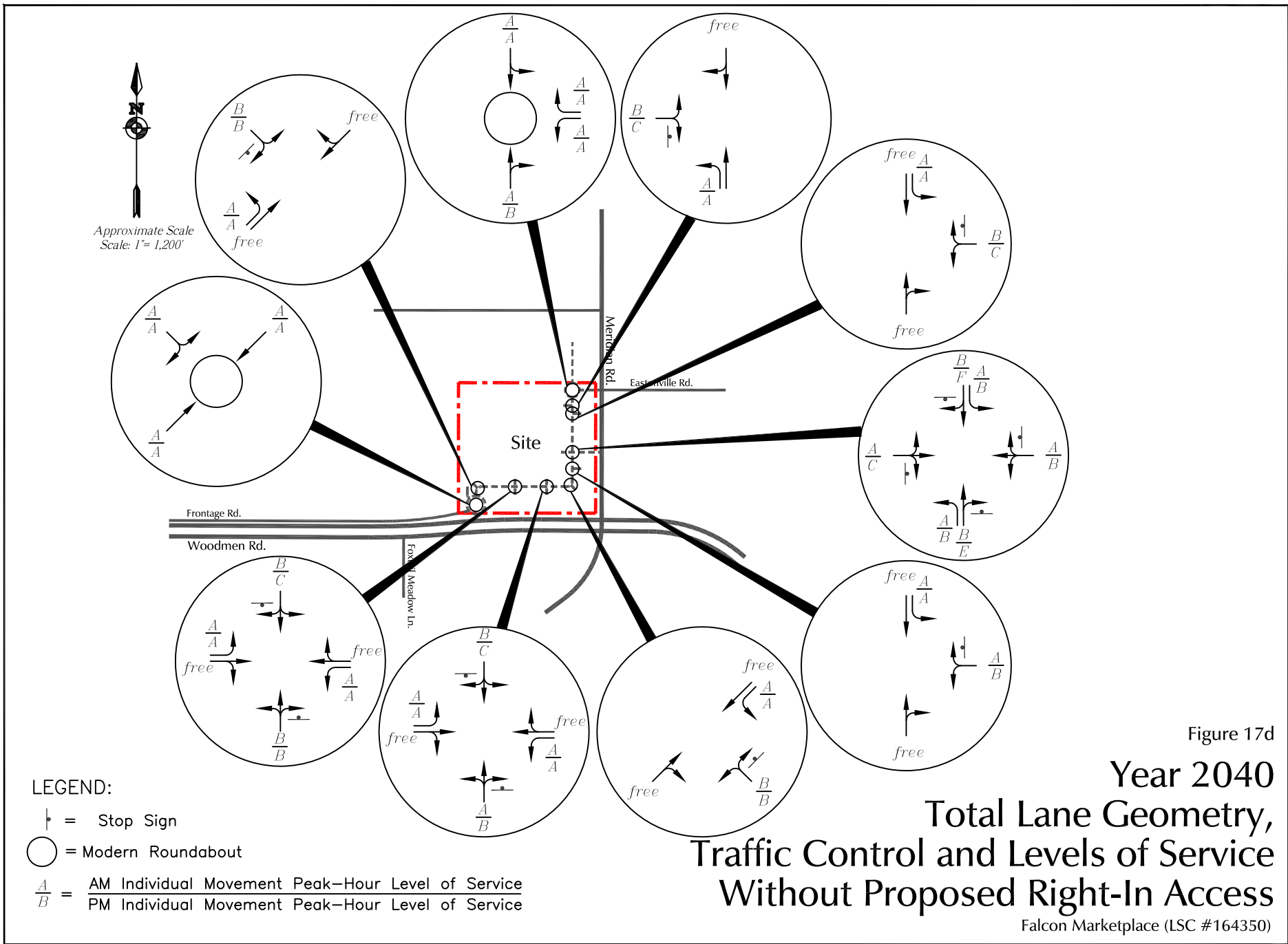
*Frontage Road Traffic Volumes

LEGEND:

- $\frac{XX}{XX}$ = AM Weekday Peak-Hour Traffic (vehicles per hour)
- $\frac{XX}{XX}$ = PM Weekday Peak-Hour Traffic (vehicles per hour)
- XXX = Average Weekday Traffic (vehicles per day) Estimated by LSC

Figure 17b
**Year 2040
 Total Traffic
 Without Proposed Right-In Access**
 Falcon Marketplace (LSC #164350)





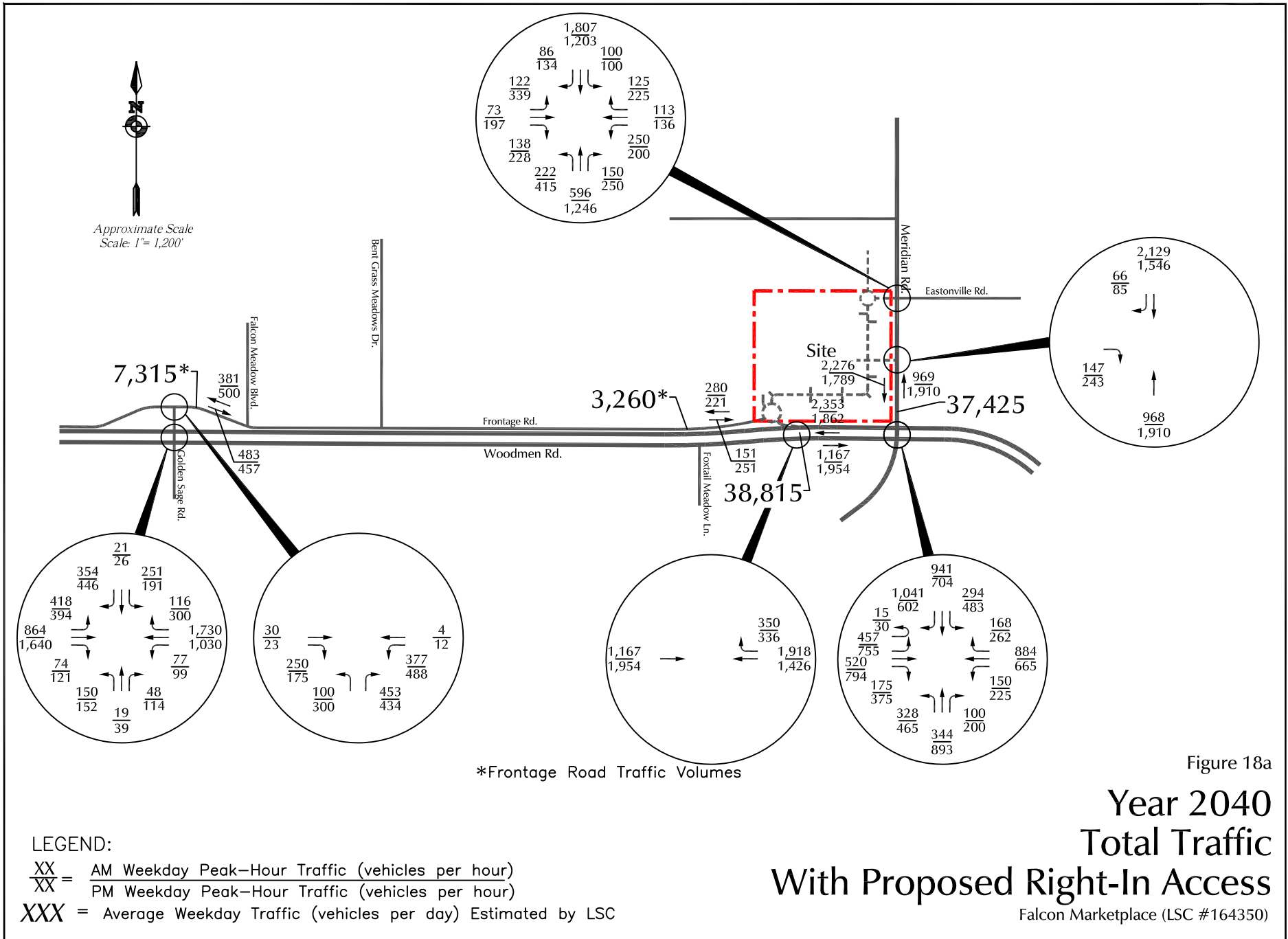
Approximate Scale
Scale: 1" = 1,200'

LEGEND:

- ⊥ = Stop Sign
- = Modern Roundabout

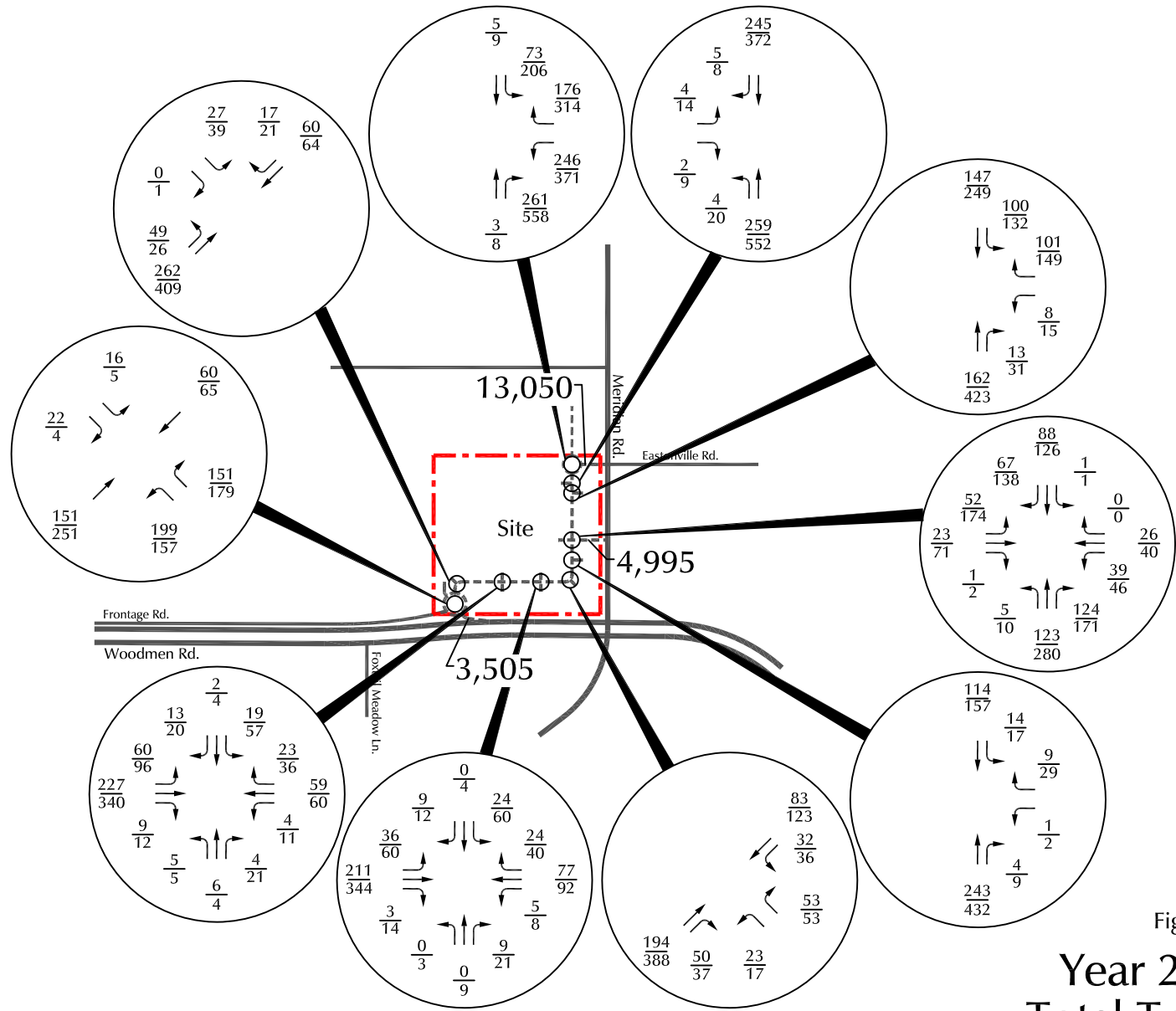
$\frac{A}{A}$ = AM Individual Movement Peak-Hour Level of Service
 $\frac{B}{B}$ = PM Individual Movement Peak-Hour Level of Service

Figure 17d
Year 2040
Total Lane Geometry,
Traffic Control and Levels of Service
Without Proposed Right-In Access
 Falcon Marketplace (LSC #164350)





Approximate Scale
Scale: 1" = 1,200'



LEGEND:

$\frac{XX}{XX}$ = AM Weekday Peak-Hour Traffic (vehicles per hour)

$\frac{XX}{XX}$ = PM Weekday Peak-Hour Traffic (vehicles per hour)

XXX = Average Weekday Traffic (vehicles per day) Estimated by LSC

Figure 18b
**Year 2040
Total Traffic
With Proposed Right-In Access**

Falcon MarketPlace (LSC #164350)

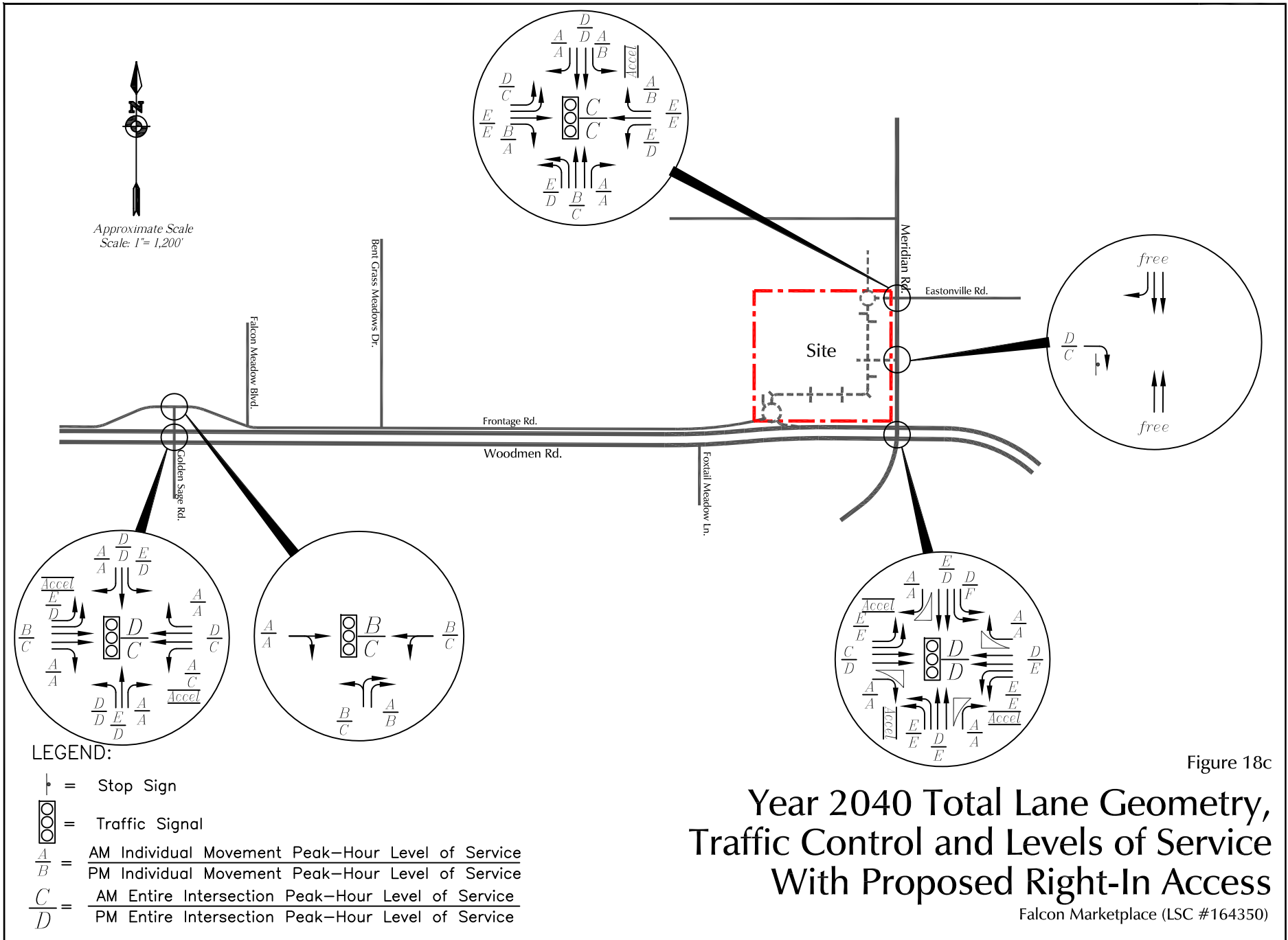
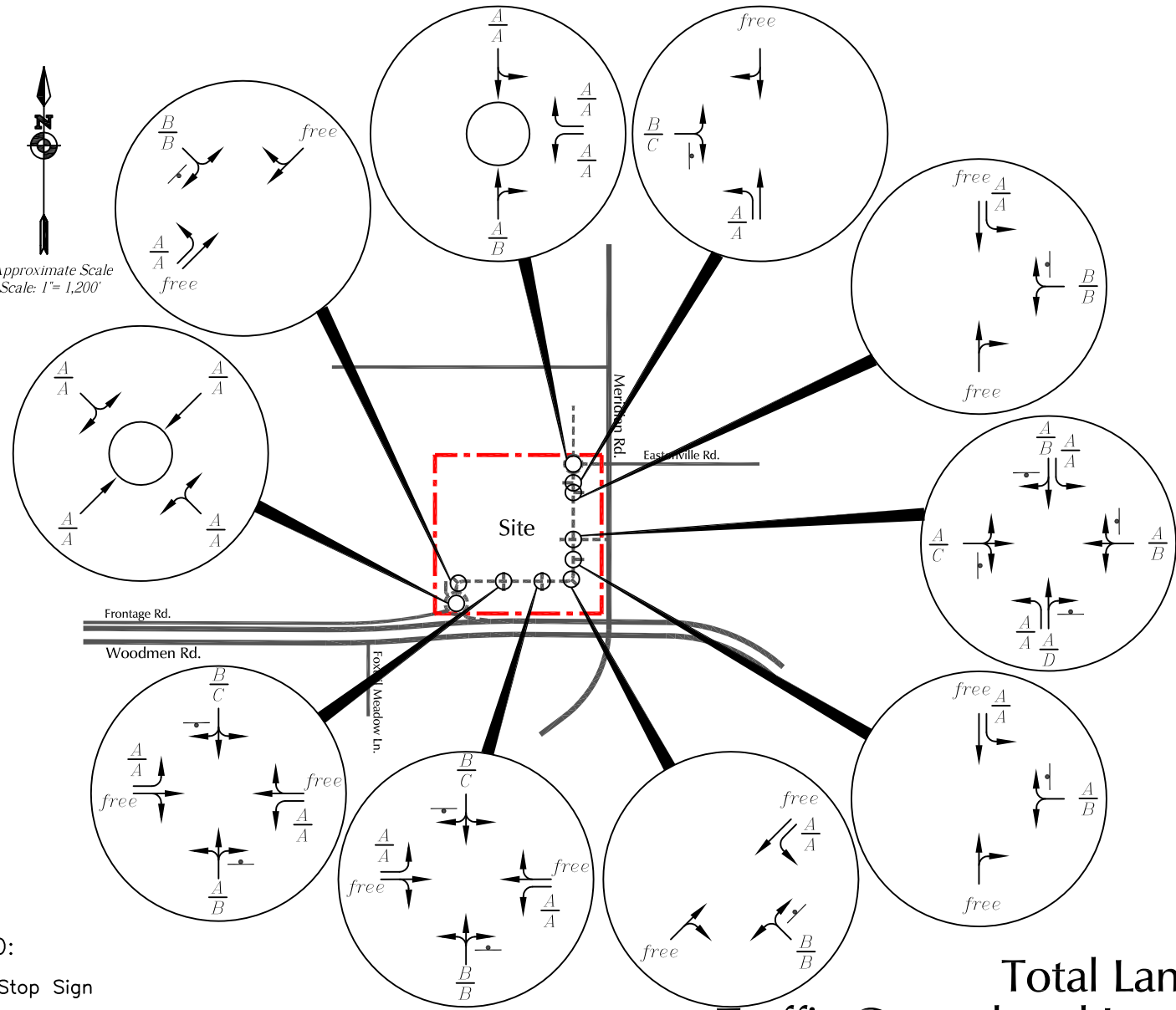


Figure 18c

Approximate Scale
Scale: 1" = 1,200'



LEGEND:

- = Stop Sign
- = Modern Roundabout
- $\frac{A}{A}$ = AM Individual Movement Peak-Hour Level of Service
- $\frac{B}{B}$ = PM Individual Movement Peak-Hour Level of Service

Figure 18d
Year 2040
Total Lane Geometry,
Traffic Control and Levels of Service
With Proposed Right-In Access

Falcon Marketplace (LSC #164350)



LSC TRANSPORTATION CONSULTANTS, INC.
2504 East Pikes Peak Avenue, Suite 304
Colorado Springs, CO 80909
(719) 633-2868
FAX (719) 633-5430
E-mail: lsc@lsctrans.com
Website: <http://www.lsctrans.com>

Falcon Meadows at Bent Grass Filing No. 4
Transportation Memorandum
(LSC #S214333)
October 7, 2022

Traffic Engineer's Statement

This traffic report and supporting information were prepared under my responsible charge and they comport with the standard of care. So far as is consistent with the standard of care, said report was prepared in general conformance with the criteria established by the County for traffic reports.



Developer's Statement

I, the Developer, have read and will comply with all commitments made on my behalf within this report.

Date

Falcon Meadows at Bent Grass

Filing No. 4

Transportation Memorandum

Prepared for:
Mr. Jim Byers
VP of Community Development
Challenger Homes
8605 Explorer Dr, Suite 250
Colorado Springs, CO 80920

OCTOBER 7, 2022

LSC Transportation Consultants
Prepared by: Kirstin D. Ferrin, P.E.
Reviewed by: Jeffrey C. Hodsdon, P.E.

LSC #S214333



CONTENTS

| | |
|--|---|
| LAND USE AND ACCESS | 1 |
| Land Use..... | 1 |
| Access | 1 |
| Sight Distance..... | 2 |
| Pedestrian Routes to Schools..... | 2 |
| EXISTING TRAFFIC CONDITIONS | 2 |
| TRIP GENERATION..... | 3 |
| PROJECTED SHORT-TERM ADDITIONAL TRAFFIC..... | 3 |
| SHORT-TERM TOTAL TRAFFIC | 3 |
| 2040 TOTAL TRAFFIC..... | 3 |
| REQUIRED IMPROVEMENTS..... | 4 |
| ROADWAY CLASSIFICATIONS | 6 |
| ROAD IMPROVEMENT FEE PROGRAM | 6 |
| Enclosures:..... | 6 |

Tables 1-2

Figures 1-7

Pages from the *Falcon Meadows at Bent Grass Updated Traffic Impact Study*
December 11, 2020 (with updates noted)

Traffic Counts

Falcon Marketplace TIS Report Addendum



LSC TRANSPORTATION CONSULTANTS, INC.
2504 East Pikes Peak Avenue, Suite 304
Colorado Springs, CO 80909
(719) 633-2868
FAX (719) 633-5430
E-mail: lsc@lsctrans.com
Website: <http://www.lsctrans.com>

October 7, 2022

Mr. Jim Byers
VP of Community Development
Challenger Homes
8605 Explorer Dr, Suite 250
Colorado Springs, CO 80920

RE: Falcon Meadows at Bent Grass Filing No. 4
El Paso County, CO
Updated Transportation Memorandum
LSC #S214333

Dear Mr. Byers,

LSC Transportation Consultants, Inc. has prepared this updated Transportation Memorandum for Falcon Meadows at Bent Grass Filing No. 4. The location of the site is shown in Figure 1. This report is intended as a site-specific, final-plat traffic report for the currently-proposed Filing 4.

LSC recently completed a traffic impact study (TIS) for the Falcon Meadows at Bent Grass PUD (PUDSP-20-005). This report was dated December 11, 2020. The land use and access currently proposed for Filing No. 4 is consistent with the land use and trip generation estimated and evaluated in that report.

Memos were also prepared for Filing 1 (dated September 28, 2021), Filing 2 (dated March 18, 2022), and Filing 3 (dated April 7, 2022).

LAND USE AND ACCESS

Land Use

Filing No. 4 is planned to include a total of 39 lots for single-family homes. The location of the lots to be included as part of currently-proposed Filing No. 4 was included in traffic-analysis zone (TAZ) 1 in the PUD TIS.

Access

Two full-movement access points (Rowena Way and Henzilee Place) to the recently-completed section of Bent Grass Meadows Drive were approved as part of Falcon Meadows at Bent Grass

Filing No. 2. An additional access point (Lemon Grass Road) is proposed to be constructed as part of Filing No. 4. Please refer to the attached site-plan exhibit. Figure 2 shows the location of the access points.

Sight Distance

Figure 3 shows a sight-distance analysis at the proposed Falcon Meadows at Bent Grass access points to Bent Grass Meadows Drive. Based on a design speed of 40 miles per hour (mph) on Bent Grass Meadows Drive and the criteria contained in Table 2-21 of the *Engineering Criteria Manual (ECM)*, the required intersection sight distance at the proposed site-access points is 445 feet. The required stopping sight distance from *ECM* Table 2-17 is also shown in the figure. The required intersection sight distance and stopping sight distance can be met at both intersections if the areas between the sight-distance lines and the curb line have low-level landscaping and are kept free of other obstructions (such as monument signs and parking areas) that would restrict the drivers' line of sight. Landscaping should be low — about 18 inches or lower in height — to the east of the passenger-vehicle lines of sight shown. Please refer to *ECM* Sections 2.3.6.G.1 and 2.

Pedestrian Routes to Schools

- Woodmen and Meridian are shown as proposed bike routes on the *Major Transportation Corridors Plan (MTCP)* Non-Motorized Plan. Also shown is a proposed secondary regional trail west of the site.
- Bent Grass Meadows Drive is sufficiently wide for bicycles with the paved shoulder.
- There are developing pedestrian connections along the north side of the Woodmen North Frontage Road, Bent Grass Meadows Drive, and Meridian Park Drive. Other area sections of sidewalk/trail connections are being added as development occurs.
- Sidewalks have been added along Bent Grass Meadows Drive with the connection south to the frontage road, adjacent to the School District 49 headquarters.
- The subdivision streets will all have sidewalks to connect to the sidewalk along Bent Grass Meadows Drive.

EXISTING TRAFFIC CONDITIONS

Figure 4 shows the existing morning and afternoon peak-hour traffic volumes at the intersections of Woodmen Road/Golden Sage Road and Meridian Road/Bent Grass Meadows Drive. The counts at the intersection of Woodmen Road/Golden Sage Road were counted in January 2020 and again in December 2020. The January 2020 counts were conducted prior to the completion of Bent Grass Meadows Drive between the Woodmen frontage road and Meridian Road, but before the restrictions due to the COVID-19 pandemic were put in place. Figure 4 shows the results of both the October 2018 counts and the October 2020 counts, as the more current counts were likely impacted by the COVID-19 pandemic. The traffic-count reports are attached.

TRIP GENERATION

The site-generated vehicle trips were estimated using the nationally-published trip-generation rates from *Trip Generation, 11th Edition, 2021* by the Institute of Transportation Engineers (ITE). Table 1 shows the trip-generation estimates for Falcon Meadows at Bent Grass Filing No. 4.

Falcon Meadows at Bent Grass Filing No. 4 is expected to generate about 368 vehicle trips on the average weekday, with about half entering and half exiting the site during a 24-hour period. During the morning peak hour, which generally occurs for one hour between 6:30 a.m. and 8:30 a.m., about 7 vehicles would enter and 22 vehicles would exit the site. During the afternoon peak hour, which generally occurs for one hour between 4:15 p.m. and 6:15 p.m., about 24 vehicles would enter and 14 vehicles would exit the site.

PROJECTED SHORT-TERM ADDITIONAL TRAFFIC

Figure 5 shows the projected additional traffic volumes at the intersections of Woodmen/Golden Sage and Meridian/Bent Grass Meadows due to Falcon Meadows at Bent Grass Filing No. 4. These volumes were calculated by applying the external trip-distribution percentages shown in Figure 7 of the PUD TIS to the trip generation shown in Table 1. Trips with destinations and/or origins within the area bound by Woodmen Road on the south and Meridian Road on the east have been assigned separately, based on the location of the future commercial and school uses within the study area.

Figure 5 also shows the projected additional traffic volumes at the intersections of Woodmen/Golden Sage and Meridian/Bent Grass Meadows due to Bent Grass Residential Filing 2 taken from the TIS dated January 24, 2020 (PCD File No. SF-1914), due to Falcon Meadows at Bent Grass Filing No. 1 taken from the September 2021 memorandum (PCD File NO. SF-2034), due to Falcon Meadows at Bent Grass Filing No. 2 taken from the March 2022 memorandum (PCD File NO. SF-2134), and due to Falcon Meadows at Bent Grass Filing No. 3 taken from the April 2022 memorandum (PCD File NO. SF-2216).

SHORT-TERM TOTAL TRAFFIC

Figure 6 shows the projected short-term total traffic volumes at the intersections of Woodmen/Golden Sage and Meridian/Bent Grass Meadows. The volumes are the sum of the January 2020 traffic volumes (from Figure 4) plus the additional short-term traffic volumes (from Figure 5). Please refer to the PUD TIS for short-term total traffic volumes at the other area intersections and the short-term level of service analysis.

2040 TOTAL TRAFFIC

Please refer to the PUD TIS for the 2040-total traffic volumes and level of service analysis.

REQUIRED IMPROVEMENTS

Based on the projected short-term total traffic volumes from the PUD TIS, the classification of Bent Grass Meadows Drive as an Urban Non-Residential Collector, and the criteria contained in the *ECM*, right-turn deceleration lanes are **not** projected to be warranted on Bent Grass Meadows Drive approaching any of the Falcon Meadows at Bent Grass access points (Rowena Way, Henzlee Place, and Lemon Grass Road).

Based on the projected short-term total traffic volumes from the PUD TIS, the classification of Bent Grass Meadows Drive as an Urban Non-Residential Collector, and the criteria contained in the *ECM*, northeast-bound left-turn lanes are projected to be warranted on Bent Grass Meadows Drive approaching all of the Falcon Meadows at Bent Grass access points (Rowena Way, Henzlee Place, and Lemon Grass Road). Bent Grass Meadows Drive has been constructed with a center two-way, left-turn lane that will meet these criteria.

Please see a copy of Table 4 Roadway System Improvements from the PUD TIS with annotations added in September 2021 (as part of the Filing 1 memo), March 2022 (as part of the Filing 2 memo), April 2022 (as part of the Filing 3 memo) and June 2022 (for this memo) indicating the status of each improvement.

Regarding Improvement F, note that Bent Grass Meadows Drive has been completed between the Woodmen frontage road and Meridian Road since completion of the PUD TIS. The approved Filing 1 in Falcon Meadows at Bent Grass required construction, paving, and associated repairs to Bent Grass Meadows Drive south of the site, as deemed appropriate by the PCD Director and the County Engineer, including design and construction of an eastbound left-turn lane on Woodmen Frontage Road at Bent Grass Meadows Drive, if warranted, to meet the minimum standards of a Non-Residential Collector in accordance with the *Engineering Criteria Manual*. These road improvements may be eligible for cost recovery from adjacent developers.

Meeting were held with El Paso County PCD staff and City Traffic Engineering on March 14, 2022 and March 29, 2022 to discuss items G,H, I, and J in this table. The intersection is under city ownership/jurisdiction, however the ownership of the intersection of Golden Sage/N. Frontage Road is not clear. The city will be researching the ownership and the availability of potential additional ROW (if possible) to accommodate potential future alternative intersection options for the intersection of Golden Sage/N. Frontage Road and the approach legs to the south, east and west. It was determined that item H would not be needed at this time. Item I would likely be needed in the short term; however, it was agreed that Falcon Meadows at Bent Grass would only be required to provide escrow towards this improvement for future construction once ownership and the availability of potential additional ROW is determined.

As of the week of **June 20, 2022**, and a conversation with City Traffic staff, there are no updates to the above meeting notes. City staff indicated they would like the County to collect the escrow from this and all future Falcon Meadows at Bent Grass filings and then give the money to the City

to go towards future improvements at Golden Sage/Woodmen and Golden Sage/North Frontage Road.

Regarding Improvement G, protected/permitted phasing has been added to the intersection of Golden Sage/Woodmen. This improvement is complete.

Regarding Improvement H, the *Falcon Marketplace TIS Report Addendum* by LSC dated July 21, 2020 (PCD File No. SP-17-001/CDR-16-007) identified the trigger for the need to lengthen the current eastbound single left-turn deceleration lane on Woodmen Road approaching Golden Sage Road as when the eastbound left-turn volume is greater than 200 vehicles per hour (vph) during the afternoon peak hour. As shown in Figure 6, following buildout of Bent Grass Residential Filing No. 1 and Falcon Meadows at Bent Grass Filings Nos. 1, 2, 3 and 4, the projected volume for this movement is 222 vph during the afternoon peak hour. However, it should be noted that our understanding is that control over the intersection of Golden Sage/Woodmen has been transferred to the City of Colorado Springs as part of the Banning Lewis Ranch North Annexation (CPC A 19-00022). The outcome of a meeting with the city was that item H would not be needed at this time.

Regarding Improvement I, the *Falcon Marketplace TIS Report Addendum* by LSC dated July 21, 2020 (PCD File No. SP-17-001/CDR-16-007) identified the trigger for the need to for an exclusive southbound right-turn deceleration lane on Golden Sage Road approaching Woodmen Road as when the southbound left-turn volume is greater than 167 to 192 vph during the morning peak hour. As shown in Figure 6, following buildout of Bent Grass Residential Filing No. 1 and Falcon Meadows at Bent Grass Filings Nos. 1, 2, 3 and 4, the projected volume for this movement is 225 vph during the morning peak hour. This exceeds the estimated trigger identified that would require the construction of an exclusive southbound right-turn deceleration lane. However, recent analysis suggests that the existing laneage will accommodate Filing 4 traffic. Also note that control over the intersection of Golden Sage/Woodmen has transferred to the City of Colorado Springs as part of the Banning Lewis Ranch North Annexation (CPC A 19-00022). The outcome of meetings with the city was that escrow would be collected for improvement I for future construction once right-of-way and ownership issues are resolved.

Table 2 shows the percentage of the projected 2040 total traffic due to Falcon Meadows at Bent Grass Filing No 4 for Improvements H, I, and J. These percentages could be used to determine the pro-rata share of the cost of intersection improvements. However, it should be noted that control over the intersection of Golden Sage/Woodmen has been transferred to the City of Colorado Springs as part of the Banning Lewis Ranch North Annexation (CPC A 19-00022). Per the paragraph above, additional research is underway which will be helpful in determining a solution for Golden Sage/N. Frontage Road.

ROADWAY CLASSIFICATIONS

Figure 7 shows the recommended internal street classifications.

ROAD IMPROVEMENT FEE PROGRAM

Applicable fees will need to be paid to the Woodmen Road District pursuant to the agreement between El Paso County and the Woodmen Road District.

* * * * *

Please contact me if you have any questions regarding this report.

Respectfully Submitted,

LSC TRANSPORTATION CONSULTANTS, INC.

By: Jeffrey C. Hodsdon, P.E.
Principal

JCH/KDF:jas

Enclosures: Tables 1-2
Figures 1-7
Pages from the *Falcon Meadows at Bent Grass Updated Traffic Impact Study*
December 11, 2020 (with updates noted)
Traffic Counts
Falcon Marketplace TIS Report Addendum

Tables 1-2



**Table 1
Trip Generation Estimate
Falcon Meadows at Bent Grass Filing No. 4**

| Land Use Code | Land Use Description | Trip Generation Units | Trip Generation Rates ⁽¹⁾ | | | | Total Trips Generated | | | | | |
|---------------|--------------------------------|-----------------------|--------------------------------------|-------------------|------|---------------------|-----------------------|-------------------------|-------------------|-----|---------------------|-----|
| | | | Average Weekday Traffic | Morning Peak Hour | | Afternoon Peak Hour | | Average Weekday Traffic | Morning Peak Hour | | Afternoon Peak Hour | |
| | | | | In | Out | In | Out | | In | Out | In | Out |
| 210 | Single-Family Detached Housing | 39 DU ⁽²⁾ | 9.44 | 0.19 | 0.56 | 0.62 | 0.37 | 368 | 7 | 22 | 24 | 14 |

Notes:
(1) Source: "Trip Generation, 11th Edition, 2017" by the Institute of Transportation Engineers (ITE)
(2) DU = dwelling unit

Source: LSC Transportation Consultants, Inc. Jun-22

Table 2
Prorata Share Contribution Calculations⁽¹⁾
Falcon Meadows at Bent Grass Filing No. 4

| Item | Improvement Description and Estimated Cost | | AM | PM | AM + PM | |
|------|---|------------|---|----------|---------|-------|
| H | Lengthening of the current eastbound single left-turn deceleration lane on Woodmen approaching Golden Sage Road | | Site-Generated Traffic ⁽²⁾ (vehicles per hour) | 4 | 12 | 16 |
| | | | 2040 Total Traffic ⁽²⁾ (vehicles per hour) | 319 | 447 | 766 |
| | | | % | 1.25% | 2.68% | 2.09% |
| | Estimated Improvement Cost: | \$ 200,000 | Estimated Fair-Share Portion for this project based on calculated AM + PM percentage: | \$ 4,178 | | |
| I | Southbound exclusive right-turn lane on Golden Sage Road approaching Woodmen Road | | Site-Generated Traffic ⁽³⁾ (vehicles per hour) | 11 | 7 | 18 |
| | | | 2040 Total Traffic ⁽³⁾ (vehicles per hour) | 392 | 391 | 783 |
| | | | % | 2.81% | 1.79% | 2.30% |
| | Estimated Improvement Cost: | \$ 100,000 | Estimated Fair-Share Portion for this project based on calculated AM + PM percentage: | \$ 2,299 | | |
| J | Signalization of Golden Sage Road/Woodmen Frontage Road or reconstruction as a modern roundabout; Future additional laneage may be necessary at this intersection to accommodate vehicle queues and for traffic operations. | | Site-Generated Traffic ⁽⁴⁾ (vehicles per hour) | 15 | 19 | 34 |
| | | | 2040 Total Traffic ⁽⁴⁾ (vehicles per hour) | 979 | 1183 | 2162 |
| | | | % | 1.53% | 1.61% | 1.57% |
| | Estimated Improvement Cost: | \$ 350,000 | Estimated Fair-Share Portion for this project based on calculated AM + PM percentage: | \$ 5,504 | | |

Notes:

(1) The improvements and fair shares are to be verified with an updated traffic impact analysis or memorandum as appropriate with each final plat in the Falcon Meadows at Bent Grass development. An escrow agreement, including a financial assurance estimate for the intersection improvements, as approved by the Planning and Community Development Department Director and the County Attorney's Office shall be completed and escrow deposited with each final plat for the respective improvements within the County's jurisdiction. It should be noted that our understanding is that control over the intersection of Golden Sage/Woodmen is being transferred to the City of Colorado Springs as part of the Banning Lewis Ranch North Annexation (CPC A 19-00022).

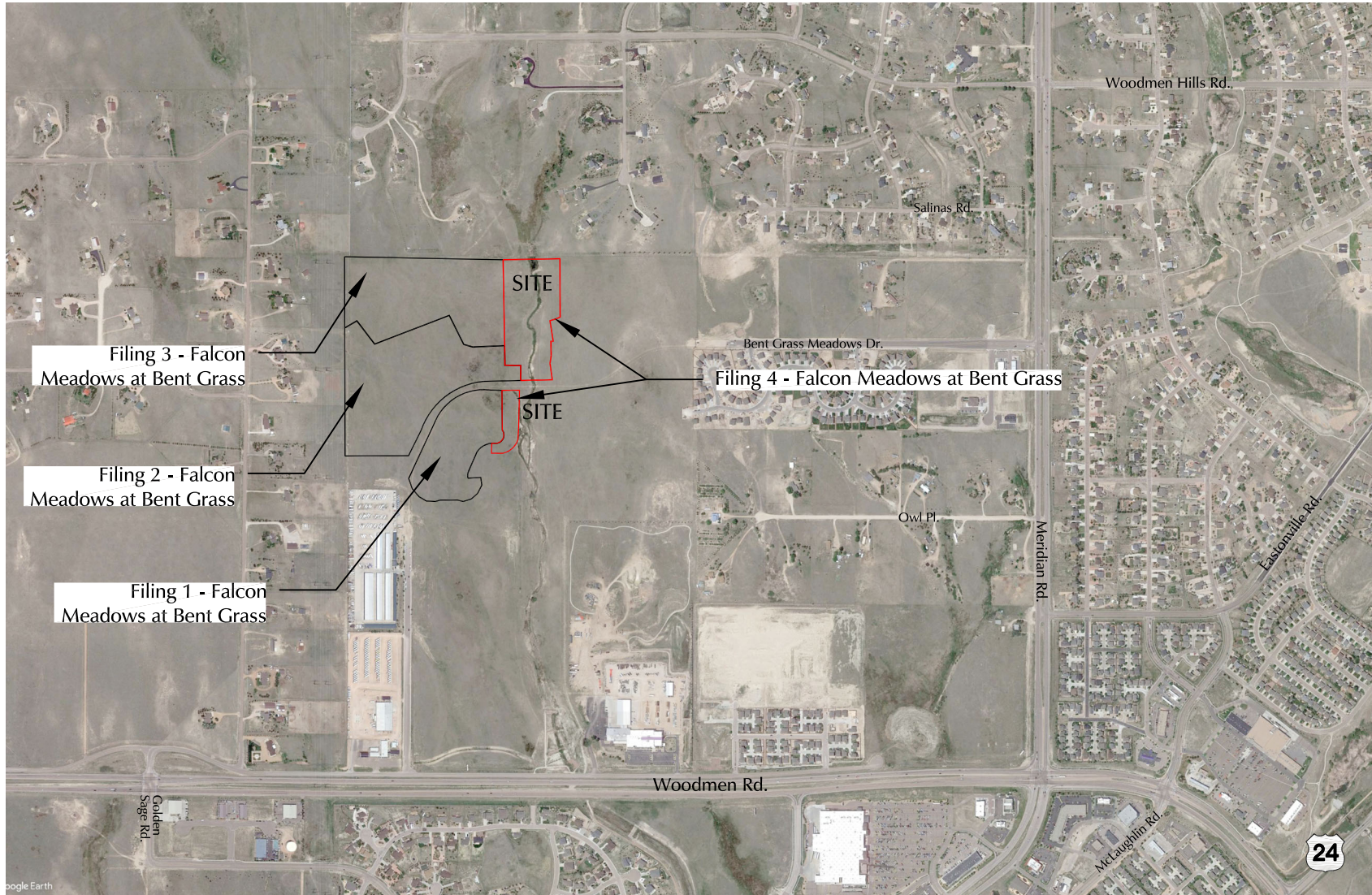
(2) Eastbound left-turn volume at the intersection of Woodmen/Golden Sage

(3) Southbound right-turn volume at the intersection of Woodmen/Golden Sage

(4) Sum of all traffic volumes at the intersection of Golden Sage/Woodmen frontage road

Figures 1-7






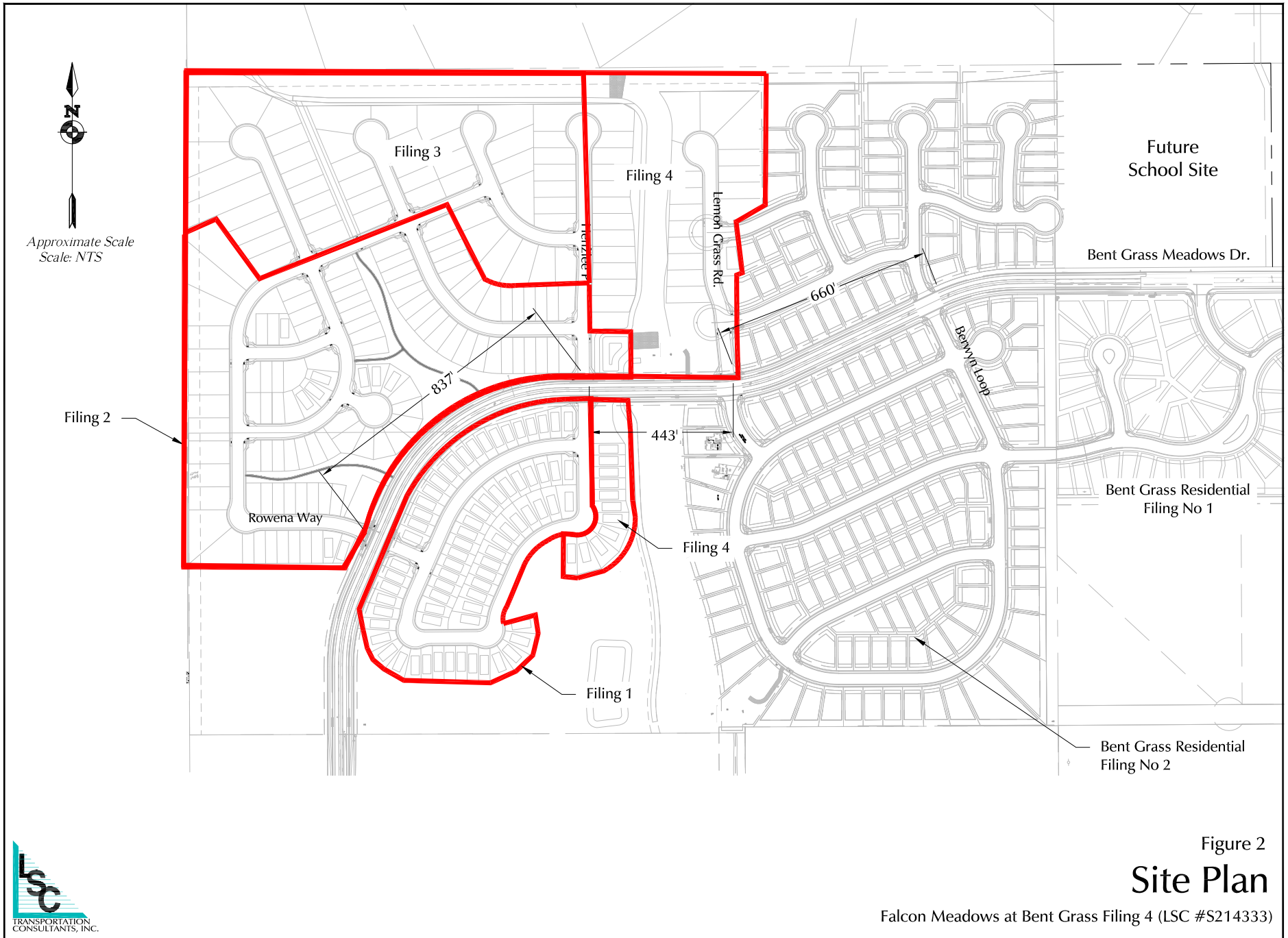

 Approximate Scale
 Scale: 1" = 1,200'

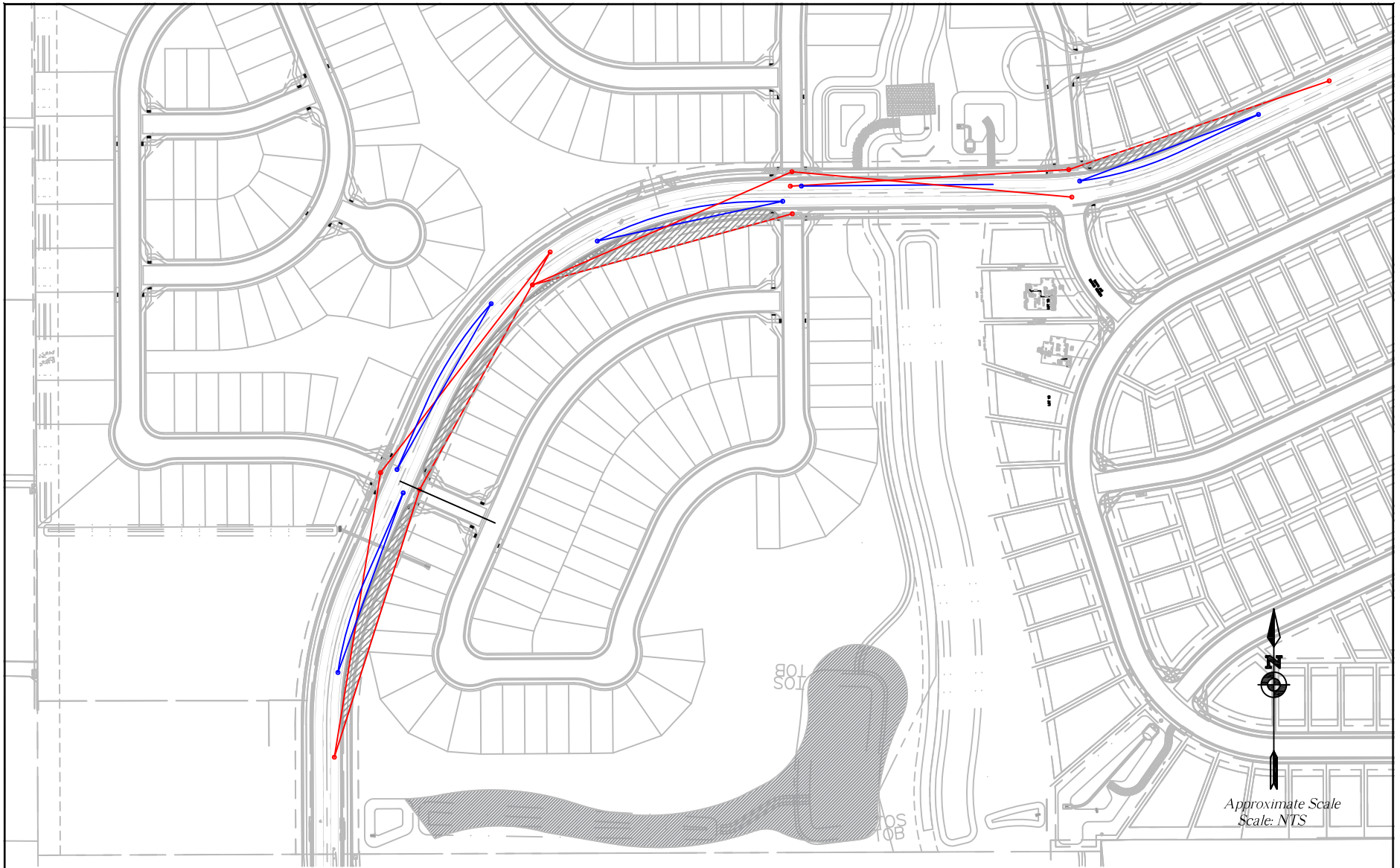
Figure 1

Vicinity Map

Falcon Meadows at Bent Grass Filing 4 (LSC #S214333)







LEGEND:

- = ECM Required Intersection Sight Distance (445' based on design speed of 40mph from Table 2-21)
- ←←← = ECM Required Stopping Sight Distance Travel Path (305' based on design speed of 40mph from Table 2-17)
- = Stopping Sight Distance Sight Line
- = Area must be kept clear of obstructions to intersection distance line of sight.

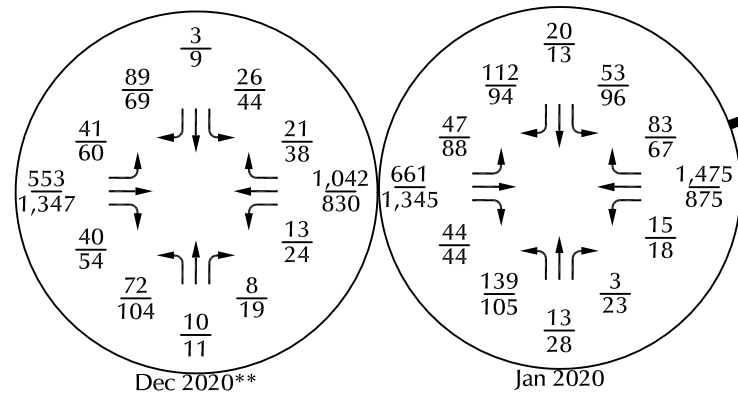
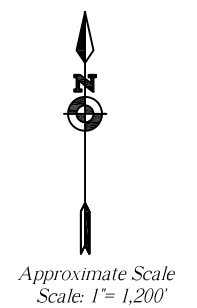
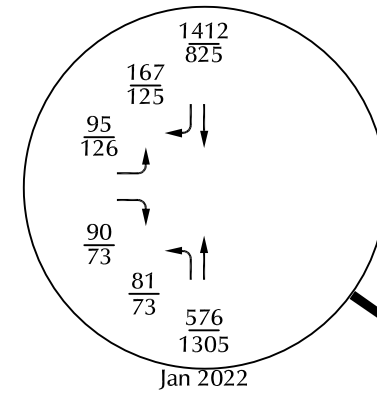


Figure 3
Sight Distance

Falcon Meadows at Bent Grass Filing 4 (LSC #S214333)

*Approximate Scale
Scale: NTS*

**The January 2020 counts were conducted prior to the completion of Bent Grass Meadows Drive between the Woodmen frontage road and Meridian Ranch, but before impacts of the COVID-19 pandemic. The December 2020 counts were conducted following the completion of Bent Grass Meadows Drive between the Woodmen frontage road and Meridian Ranch, but during the COVID-19 pandemic.



LEGEND:

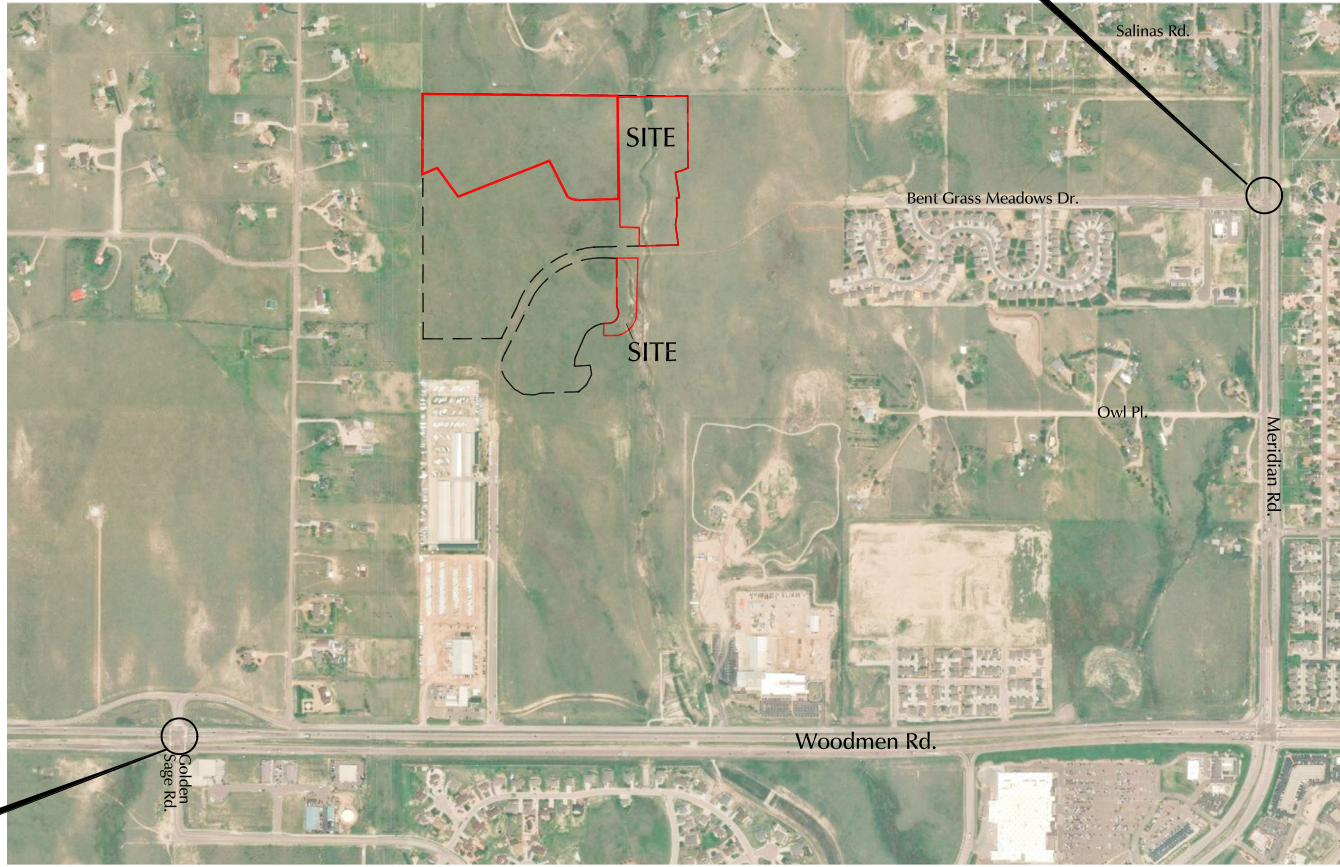
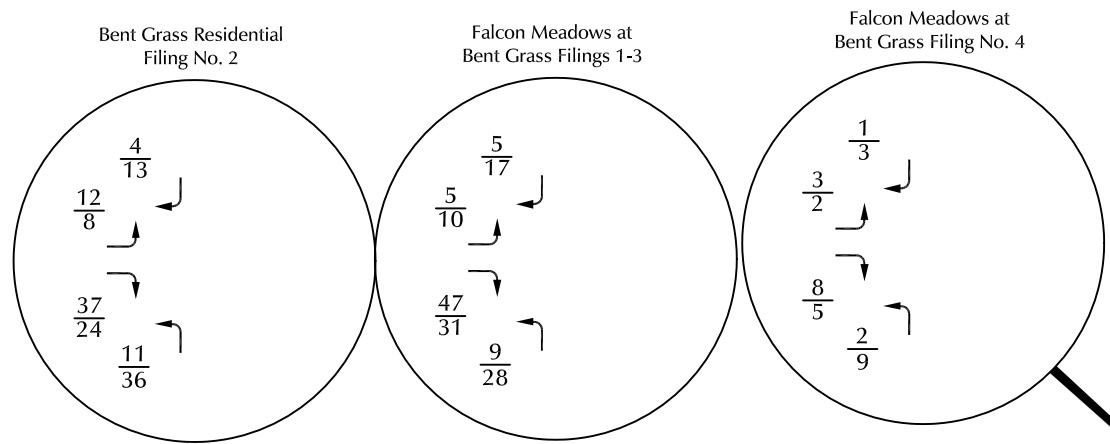
$\frac{XX}{XX}$ = AM Weekday Peak-Hour Traffic (vehicles per hour)
 $\frac{XX}{XX}$ = PM Weekday Peak-Hour Traffic (vehicles per hour)

X,XXX= Average Daily Traffic (vehicles per day)

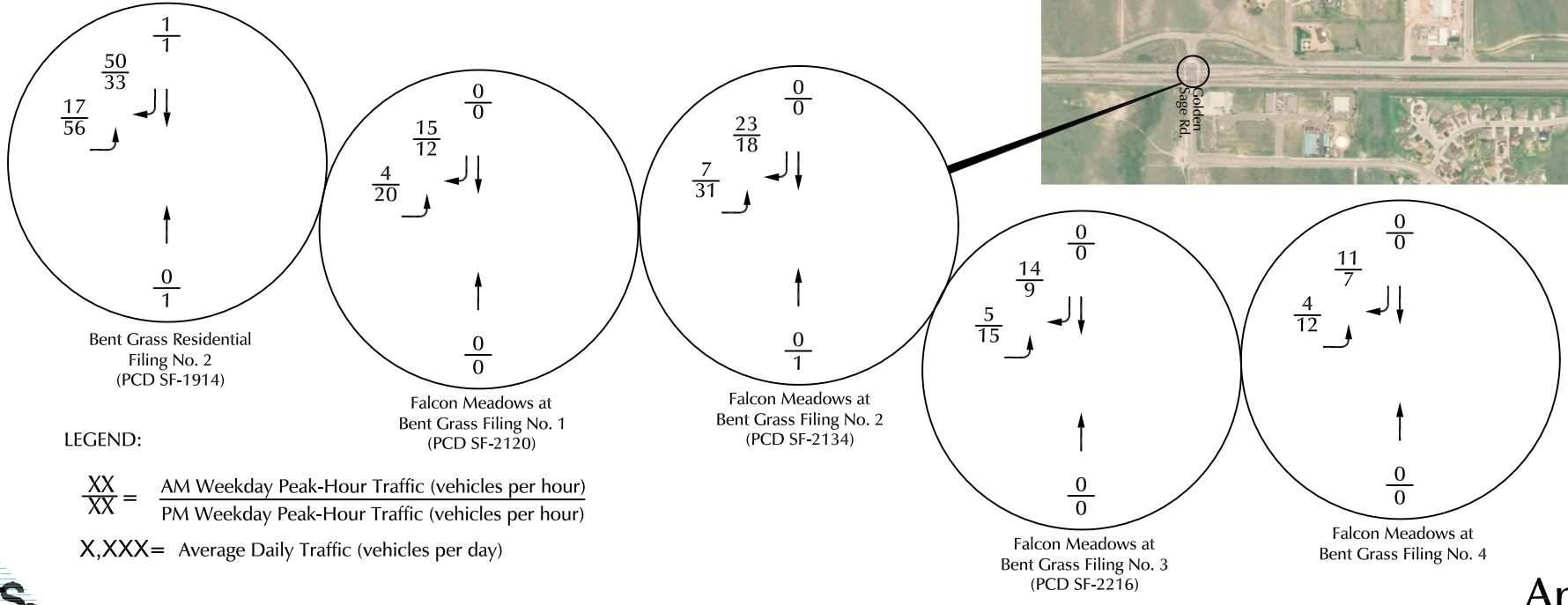


Figure 4
Existing Traffic

Falcon Meadows at Bent Grass Filing 4 (LSC #S214333)



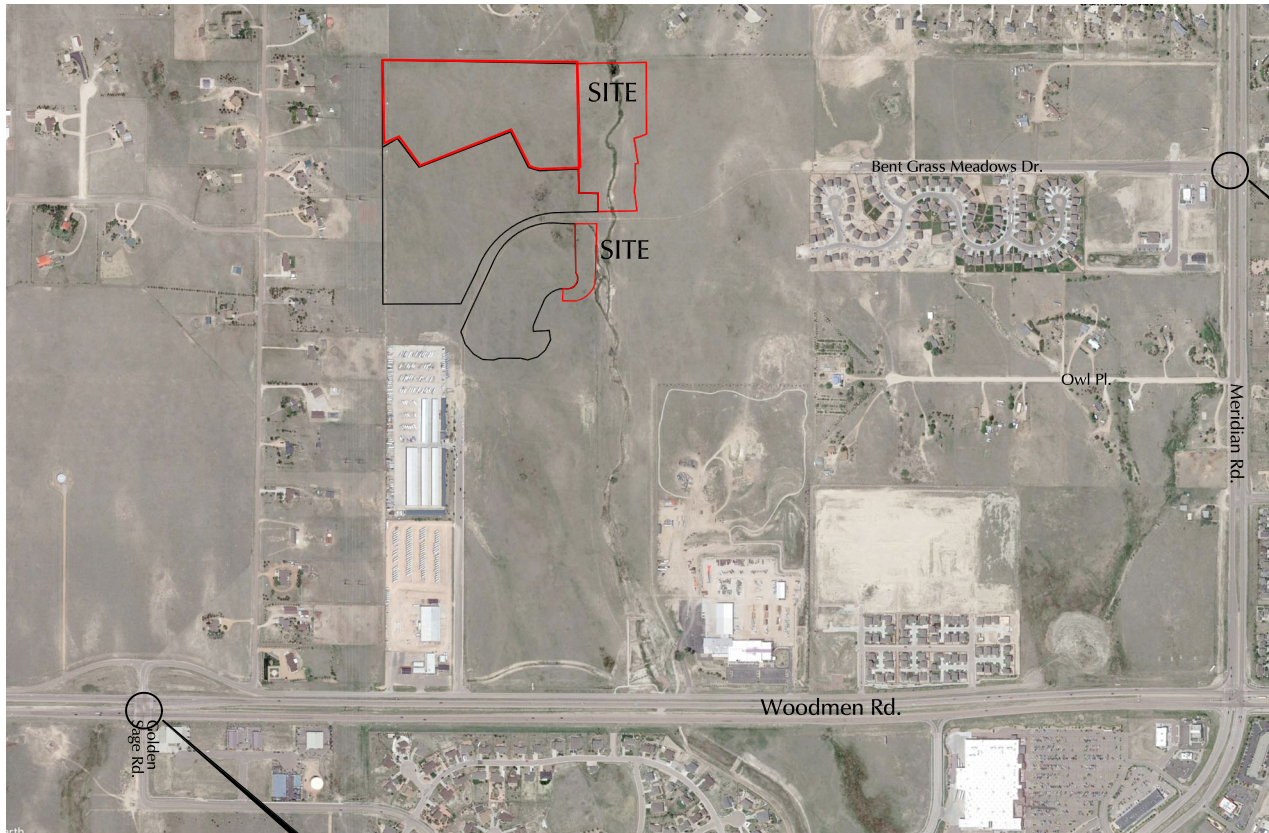
Approximate Scale
Scale: 1" = 1,200'



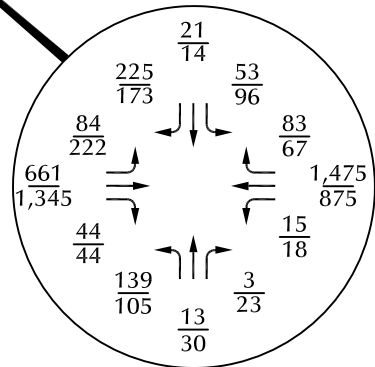
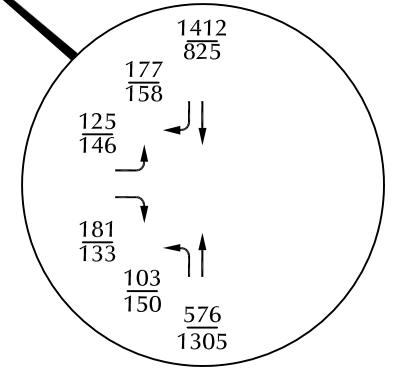
LEGEND:
 $\frac{XX}{XX}$ = AM Weekday Peak-Hour Traffic (vehicles per hour)
 $\frac{XX}{XX}$ = PM Weekday Peak-Hour Traffic (vehicles per hour)
 X,XXX= Average Daily Traffic (vehicles per day)



Figure 5
Anticipated Additional Short-Term Traffic Volumes
 Falcon Meadows at Bent Grass Filing 4 (LSC #S214333)



Approximate Scale
NTS



*The short-term total traffic volumes are the sum of the January 2020 volumes from Figure 4 plus the anticipated additional short-term traffic volumes from Figure 5.



LEGEND:

$\frac{XX}{XX} =$ AM Weekday Peak-Hour Traffic (vehicles per hour)
PM Weekday Peak-Hour Traffic (vehicles per hour)

Figure 6
Short-Term Total* Traffic
Falcon Meadows at Bent Grass Filing 4 (LSC #S214333)

APPENDIX F - Background 2024 & 2040 Synchro Outputs

Timings
1: MERIDIAN ROAD & WOODMAN ROAD

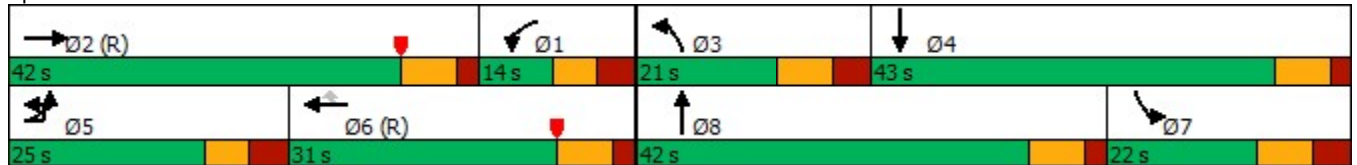
Background 2024 AM
04/10/2023

| Lane Group | EBL | EBT | EBR | WBL | WBT | WBR | NBL | NBT | NBR | SBL | SBT | SBR |
|----------------------|-------|-------|-------|-------|-------|-------|-------|-------|-------|-------|-------|-------|
| Lane Configurations | | | | | | | | | | | | |
| Traffic Volume (vph) | 279 | 226 | 122 | 61 | 413 | 132 | 182 | 305 | 18 | 196 | 743 | 754 |
| Future Volume (vph) | 279 | 226 | 122 | 61 | 413 | 132 | 182 | 305 | 18 | 196 | 743 | 754 |
| Turn Type | Prot | NA | Free | Prot | NA | Perm | Prot | NA | Free | Prot | NA | Free |
| Protected Phases | 5 | 2 | | 1 | 6 | | 3 | 8 | | 7 | 4 | |
| Permitted Phases | | | Free | | | 6 | | | Free | | | Free |
| Detector Phase | 5 | 2 | | 1 | 6 | 6 | 3 | 8 | | 7 | 4 | |
| Switch Phase | | | | | | | | | | | | |
| Minimum Initial (s) | 5.0 | 15.0 | | 5.0 | 15.0 | 15.0 | 5.0 | 15.0 | | 5.0 | 15.0 | |
| Minimum Split (s) | 13.5 | 22.0 | | 13.5 | 22.0 | 22.0 | 13.5 | 22.0 | | 13.5 | 22.0 | |
| Total Split (s) | 25.0 | 42.0 | | 14.0 | 31.0 | 31.0 | 21.0 | 42.0 | | 22.0 | 43.0 | |
| Total Split (%) | 20.8% | 35.0% | | 11.7% | 25.8% | 25.8% | 17.5% | 35.0% | | 18.3% | 35.8% | |
| Yellow Time (s) | 4.0 | 5.0 | | 4.0 | 5.0 | 5.0 | 5.0 | 5.0 | | 5.0 | 5.0 | |
| All-Red Time (s) | 3.5 | 2.0 | | 3.5 | 2.0 | 2.0 | 3.5 | 2.0 | | 3.5 | 2.0 | |
| Lost Time Adjust (s) | 0.0 | 0.0 | | 0.0 | 0.0 | 0.0 | 0.0 | 0.0 | | 0.0 | 0.0 | |
| Total Lost Time (s) | 7.5 | 7.0 | | 7.5 | 7.0 | 7.0 | 8.5 | 7.0 | | 8.5 | 7.0 | |
| Lead/Lag | Lead | Lead | | Lag | Lag | Lag | Lead | Lead | | Lag | Lag | |
| Lead-Lag Optimize? | Yes | Yes | | Yes | Yes | Yes | Yes | Yes | | Yes | Yes | |
| Recall Mode | None | C-Max | | None | C-Max | C-Max | None | None | | None | None | |
| Act Effct Green (s) | 16.0 | 42.3 | 120.0 | 6.3 | 30.0 | 30.0 | 11.2 | 16.9 | 120.0 | 27.2 | 32.8 | 120.0 |
| Actuated g/C Ratio | 0.13 | 0.35 | 1.00 | 0.05 | 0.25 | 0.25 | 0.09 | 0.14 | 1.00 | 0.23 | 0.27 | 1.00 |
| v/c Ratio | 0.74 | 0.21 | 0.09 | 0.36 | 0.50 | 0.24 | 0.59 | 0.64 | 0.01 | 0.27 | 0.84 | 0.52 |
| Control Delay | 60.4 | 30.1 | 0.1 | 60.6 | 42.4 | 0.9 | 59.9 | 54.7 | 0.0 | 33.4 | 41.1 | 2.4 |
| Queue Delay | 0.0 | 0.0 | 0.0 | 0.0 | 0.0 | 0.0 | 0.0 | 0.0 | 0.0 | 0.0 | 0.0 | 0.0 |
| Total Delay | 60.4 | 30.1 | 0.1 | 60.6 | 42.4 | 0.9 | 59.9 | 54.7 | 0.0 | 33.4 | 41.1 | 2.4 |
| LOS | E | C | A | E | D | A | E | D | A | C | D | A |
| Approach Delay | | 38.1 | | | 35.3 | | | 54.6 | | | 23.0 | |
| Approach LOS | | D | | | D | | | D | | | C | |

Intersection Summary

Cycle Length: 120
 Actuated Cycle Length: 120
 Offset: 30 (25%), Referenced to phase 2:EBT and 6:WBT, Start of Yellow
 Natural Cycle: 80
 Control Type: Actuated-Coordinated
 Maximum v/c Ratio: 0.84
 Intersection Signal Delay: 32.5
 Intersection LOS: C
 Intersection Capacity Utilization 71.5%
 ICU Level of Service C
 Analysis Period (min) 15

Splits and Phases: 1: MERIDIAN ROAD & WOODMAN ROAD



Queues
1: MERIDIAN ROAD & WOODMAN ROAD

Background 2024 AM
04/10/2023



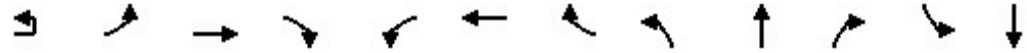
| Lane Group | EBL | EBT | EBR | WBL | WBT | WBR | NBL | NBT | NBR | SBL | SBT | SBR |
|-------------------------|------|------|------|------|------|------|------|------|------|------|------|------|
| Lane Group Flow (vph) | 340 | 266 | 144 | 65 | 439 | 140 | 190 | 318 | 19 | 213 | 808 | 820 |
| v/c Ratio | 0.74 | 0.21 | 0.09 | 0.36 | 0.50 | 0.24 | 0.59 | 0.64 | 0.01 | 0.27 | 0.84 | 0.52 |
| Control Delay | 60.4 | 30.1 | 0.1 | 60.6 | 42.4 | 0.9 | 59.9 | 54.7 | 0.0 | 33.4 | 41.1 | 2.4 |
| Queue Delay | 0.0 | 0.0 | 0.0 | 0.0 | 0.0 | 0.0 | 0.0 | 0.0 | 0.0 | 0.0 | 0.0 | 0.0 |
| Total Delay | 60.4 | 30.1 | 0.1 | 60.6 | 42.4 | 0.9 | 59.9 | 54.7 | 0.0 | 33.4 | 41.1 | 2.4 |
| Queue Length 50th (ft) | 130 | 80 | 0 | 25 | 158 | 0 | 73 | 125 | 0 | 80 | 338 | 13 |
| Queue Length 95th (ft) | 170 | 112 | 0 | 49 | 221 | 0 | 111 | 167 | 0 | m85 | m345 | m29 |
| Internal Link Dist (ft) | | 1165 | | | 1100 | | | 342 | | | | 860 |
| Turn Bay Length (ft) | 500 | | 630 | 350 | | 250 | 440 | | 330 | 490 | | 450 |
| Base Capacity (vph) | 500 | 1246 | 1583 | 185 | 883 | 589 | 357 | 1032 | 1583 | 776 | 1061 | 1583 |
| Starvation Cap Reductn | 0 | 0 | 0 | 0 | 0 | 0 | 0 | 0 | 0 | 0 | 0 | 0 |
| Spillback Cap Reductn | 0 | 0 | 0 | 0 | 0 | 0 | 0 | 0 | 0 | 0 | 0 | 0 |
| Storage Cap Reductn | 0 | 0 | 0 | 0 | 0 | 0 | 0 | 0 | 0 | 0 | 0 | 0 |
| Reduced v/c Ratio | 0.68 | 0.21 | 0.09 | 0.35 | 0.50 | 0.24 | 0.53 | 0.31 | 0.01 | 0.27 | 0.76 | 0.52 |

Intersection Summary

m Volume for 95th percentile queue is metered by upstream signal.

HCM 6th Signalized Intersection Summary
1: MERIDIAN ROAD & WOODMAN ROAD

Background 2024 AM
04/10/2023



| Movement | EBU | EBL | EBT | EBR | WBL | WBT | WBR | NBL | NBT | NBR | SBL | SBT |
|------------------------------|------|------|------|-------|------|-------|------|------|------|------|------|------|
| Lane Configurations | | ↔↔ | ↕↕ | ↔ | ↔↔ | ↕↕ | ↔↔ | ↔ | ↔↔ | ↔ | ↔↔ | ↕↕ |
| Traffic Volume (veh/h) | 10 | 279 | 226 | 122 | 61 | 413 | 132 | 182 | 305 | 18 | 196 | 743 |
| Future Volume (veh/h) | 10 | 279 | 226 | 122 | 61 | 413 | 132 | 182 | 305 | 18 | 196 | 743 |
| Initial Q (Qb), veh | | 0 | 0 | 0 | 0 | 0 | 0 | 0 | 0 | 0 | 0 | 0 |
| Ped-Bike Adj(A_pbT) | | 1.00 | | 1.00 | 1.00 | | 1.00 | 1.00 | | 1.00 | 1.00 | |
| Parking Bus, Adj | | 1.00 | 1.00 | 1.00 | 1.00 | 1.00 | 1.00 | 1.00 | 1.00 | 1.00 | 1.00 | 1.00 |
| Work Zone On Approach | | | No | | | No | | | No | | | No |
| Adj Sat Flow, veh/h/ln | | 1870 | 1870 | 1870 | 1870 | 1870 | 1870 | 1870 | 1870 | 1870 | 1870 | 1870 |
| Adj Flow Rate, veh/h | | 328 | 266 | 0 | 65 | 439 | 0 | 190 | 318 | 0 | 213 | 808 |
| Peak Hour Factor | | 0.85 | 0.85 | 0.85 | 0.94 | 0.94 | 0.94 | 0.96 | 0.96 | 0.96 | 0.92 | 0.92 |
| Percent Heavy Veh, % | | 2 | 2 | 2 | 2 | 2 | 2 | 2 | 2 | 2 | 2 | 2 |
| Cap, veh/h | | 392 | 1036 | | 388 | 1018 | | 250 | 444 | | 764 | 928 |
| Arrive On Green | | 0.11 | 0.29 | 0.00 | 0.11 | 0.29 | 0.00 | 0.07 | 0.13 | 0.00 | 0.22 | 0.26 |
| Sat Flow, veh/h | | 3456 | 3554 | 1585 | 3456 | 3554 | 1585 | 3456 | 3554 | 1585 | 3456 | 3554 |
| Grp Volume(v), veh/h | | 328 | 266 | 0 | 65 | 439 | 0 | 190 | 318 | 0 | 213 | 808 |
| Grp Sat Flow(s),veh/h/ln | | 1728 | 1777 | 1585 | 1728 | 1777 | 1585 | 1728 | 1777 | 1585 | 1728 | 1777 |
| Q Serve(g_s), s | | 11.2 | 6.9 | 0.0 | 2.0 | 12.1 | 0.0 | 6.5 | 10.3 | 0.0 | 6.1 | 26.1 |
| Cycle Q Clear(g_c), s | | 11.2 | 6.9 | 0.0 | 2.0 | 12.1 | 0.0 | 6.5 | 10.3 | 0.0 | 6.1 | 26.1 |
| Prop In Lane | | 1.00 | | 1.00 | 1.00 | | 1.00 | 1.00 | | 1.00 | 1.00 | |
| Lane Grp Cap(c), veh/h | | 392 | 1036 | | 388 | 1018 | | 250 | 444 | | 764 | 928 |
| V/C Ratio(X) | | 0.84 | 0.26 | | 0.17 | 0.43 | | 0.76 | 0.72 | | 0.28 | 0.87 |
| Avail Cap(c_a), veh/h | | 504 | 1036 | | 388 | 1018 | | 360 | 1036 | | 764 | 1066 |
| HCM Platoon Ratio | | 1.00 | 1.00 | 1.00 | 1.00 | 1.00 | 1.00 | 1.00 | 1.00 | 1.00 | 1.00 | 1.00 |
| Upstream Filter(I) | | 1.00 | 1.00 | 0.00 | 1.00 | 1.00 | 0.00 | 1.00 | 1.00 | 0.00 | 1.00 | 1.00 |
| Uniform Delay (d), s/veh | | 52.1 | 32.5 | 0.0 | 48.2 | 34.9 | 0.0 | 54.6 | 50.5 | 0.0 | 38.8 | 42.4 |
| Incr Delay (d2), s/veh | | 9.4 | 0.6 | 0.0 | 0.2 | 1.3 | 0.0 | 5.7 | 2.2 | 0.0 | 0.2 | 7.2 |
| Initial Q Delay(d3),s/veh | | 0.0 | 0.0 | 0.0 | 0.0 | 0.0 | 0.0 | 0.0 | 0.0 | 0.0 | 0.0 | 0.0 |
| %ile BackOfQ(50%),veh/ln | | 5.2 | 3.0 | 0.0 | 0.9 | 5.3 | 0.0 | 3.0 | 4.7 | 0.0 | 2.6 | 12.2 |
| Unsig. Movement Delay, s/veh | | | | | | | | | | | | |
| LnGrp Delay(d),s/veh | | 61.5 | 33.1 | 0.0 | 48.4 | 36.2 | 0.0 | 60.3 | 52.6 | 0.0 | 39.0 | 49.6 |
| LnGrp LOS | | E | C | | D | D | | E | D | | D | D |
| Approach Vol, veh/h | | | 594 | A | | 504 | A | | 508 | A | | 1021 |
| Approach Delay, s/veh | | | 48.8 | | | 37.8 | | | 55.5 | | | 47.4 |
| Approach LOS | | | D | | | D | | | E | | | D |
| Timer - Assigned Phs | 1 | 2 | 3 | 4 | 5 | 6 | 7 | 8 | | | | |
| Phs Duration (G+Y+Rc), s | 21.0 | 42.0 | 17.2 | 39.8 | 21.1 | 41.9 | 35.0 | 22.0 | | | | |
| Change Period (Y+Rc), s | 7.5 | 7.0 | 8.5 | * 8.5 | 7.5 | * 7.5 | 8.5 | 7.0 | | | | |
| Max Green Setting (Gmax), s | 6.5 | 35.0 | 12.5 | * 36 | 17.5 | * 24 | 13.5 | 35.0 | | | | |
| Max Q Clear Time (g_c+I1), s | 4.0 | 8.9 | 8.5 | 28.1 | 13.2 | 14.1 | 8.1 | 12.3 | | | | |
| Green Ext Time (p_c), s | 0.0 | 1.5 | 0.2 | 3.3 | 0.5 | 1.8 | 0.3 | 1.9 | | | | |

Intersection Summary

| | |
|--------------------|------|
| HCM 6th Ctrl Delay | 47.4 |
| HCM 6th LOS | D |

Notes

- User approved pedestrian interval to be less than phase max green.
- User approved ignoring U-Turning movement.
- * HCM 6th computational engine requires equal clearance times for the phases crossing the barrier.

| | |
|---|------|
| Movement | SBR |
| Lane Configurations | |
| Traffic Volume (veh/h) | 754 |
| Future Volume (veh/h) | 754 |
| Initial Q (Qb), veh | 0 |
| Ped-Bike Adj(A_pbT) | 1.00 |
| Parking Bus, Adj | 1.00 |
| Work Zone On Approach | |
| Adj Sat Flow, veh/h/ln | 1870 |
| Adj Flow Rate, veh/h | 0 |
| Peak Hour Factor | 0.92 |
| Percent Heavy Veh, % | 2 |
| Cap, veh/h | |
| Arrive On Green | 0.00 |
| Sat Flow, veh/h | 1585 |
| Grp Volume(v), veh/h | 0 |
| Grp Sat Flow(s),veh/h/ln | 1585 |
| Q Serve(g_s), s | 0.0 |
| Cycle Q Clear(g_c), s | 0.0 |
| Prop In Lane | 1.00 |
| Lane Grp Cap(c), veh/h | |
| V/C Ratio(X) | |
| Avail Cap(c_a), veh/h | |
| HCM Platoon Ratio | 1.00 |
| Upstream Filter(l) | 0.00 |
| Uniform Delay (d), s/veh | 0.0 |
| Incr Delay (d2), s/veh | 0.0 |
| Initial Q Delay(d3),s/veh | 0.0 |
| %ile BackOfQ(50%),veh/ln | 0.0 |
| Unsig. Movement Delay, s/veh | |
| LnGrp Delay(d),s/veh | 0.0 |
| LnGrp LOS | |
| Approach Vol, veh/h | A |
| Approach Delay, s/veh | |
| Approach LOS | |
| Timer - Assigned Phs | |
| Unsignalized Delay for [NBR, EBR, WBR, SBR] is excluded from calculations of the approach delay and intersection delay. | |

Timings
2: MERIDIAN ROAD & EASTONVILLE ROAD

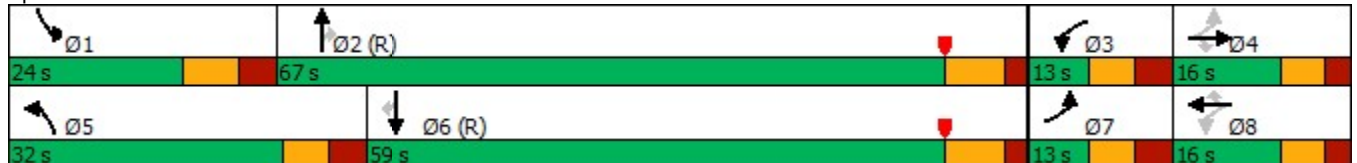
Background 2024 AM
04/10/2023

| Lane Group | EBL | EBT | EBR | WBL | WBT | WBR | NBL | NBT | NBR | SBL | SBT | SBR |
|----------------------|-------|-------|-------|-------|-------|-------|-------|-------|-------|-------|-------|-------|
| Lane Configurations | | | | | | | | | | | | |
| Traffic Volume (vph) | 218 | 52 | 262 | 100 | 56 | 37 | 293 | 434 | 42 | 114 | 1373 | 187 |
| Future Volume (vph) | 218 | 52 | 262 | 100 | 56 | 37 | 293 | 434 | 42 | 114 | 1373 | 187 |
| Turn Type | pm+pt | NA | Perm | pm+pt | NA | Perm | Prot | NA | Perm | Prot | NA | Perm |
| Protected Phases | 7 | 4 | | 3 | 8 | | 5 | 2 | | 1 | 6 | |
| Permitted Phases | 4 | | 4 | 8 | | 8 | | | 2 | | | 6 |
| Detector Phase | 7 | 4 | 4 | 3 | 8 | 8 | 5 | 2 | 2 | 1 | 6 | 6 |
| Switch Phase | | | | | | | | | | | | |
| Minimum Initial (s) | 5.0 | 8.0 | 8.0 | 5.0 | 8.0 | 8.0 | 5.0 | 15.0 | 15.0 | 5.0 | 15.0 | 15.0 |
| Minimum Split (s) | 12.5 | 14.5 | 14.5 | 12.5 | 14.5 | 14.5 | 12.5 | 22.5 | 22.5 | 13.5 | 22.5 | 22.5 |
| Total Split (s) | 13.0 | 16.0 | 16.0 | 13.0 | 16.0 | 16.0 | 32.0 | 67.0 | 67.0 | 24.0 | 59.0 | 59.0 |
| Total Split (%) | 10.8% | 13.3% | 13.3% | 10.8% | 13.3% | 13.3% | 26.7% | 55.8% | 55.8% | 20.0% | 49.2% | 49.2% |
| Yellow Time (s) | 4.0 | 4.0 | 4.0 | 4.0 | 4.0 | 4.0 | 4.0 | 5.5 | 5.5 | 5.0 | 5.5 | 5.5 |
| All-Red Time (s) | 3.5 | 2.5 | 2.5 | 3.5 | 2.5 | 2.5 | 3.5 | 2.0 | 2.0 | 3.5 | 2.0 | 2.0 |
| Lost Time Adjust (s) | 0.0 | 0.0 | 0.0 | 0.0 | 0.0 | 0.0 | 0.0 | 0.0 | 0.0 | 0.0 | 0.0 | 0.0 |
| Total Lost Time (s) | 7.5 | 6.5 | 6.5 | 7.5 | 6.5 | 6.5 | 7.5 | 7.5 | 7.5 | 8.5 | 7.5 | 7.5 |
| Lead/Lag | Lead | Lag | Lag | Lead | Lag | Lag | Lead | Lag | Lag | Lead | Lag | Lag |
| Lead-Lag Optimize? | Yes | Yes | Yes | Yes | Yes | Yes | Yes | Yes | Yes | Yes | Yes | Yes |
| Recall Mode | None | None | None | None | None | None | None | C-Max | C-Max | None | C-Max | C-Max |
| Act Effct Green (s) | 14.9 | 8.9 | 8.9 | 12.0 | 8.9 | 8.9 | 24.8 | 62.6 | 62.6 | 13.0 | 51.8 | 51.8 |
| Actuated g/C Ratio | 0.12 | 0.07 | 0.07 | 0.10 | 0.07 | 0.07 | 0.21 | 0.52 | 0.52 | 0.11 | 0.43 | 0.43 |
| v/c Ratio | 0.75 | 0.44 | 0.85 | 0.71 | 0.43 | 0.11 | 0.95 | 0.28 | 0.05 | 0.65 | 0.99 | 0.25 |
| Control Delay | 61.9 | 63.5 | 32.3 | 71.2 | 63.1 | 0.6 | 77.2 | 14.0 | 1.3 | 76.9 | 43.1 | 3.3 |
| Queue Delay | 0.0 | 0.0 | 0.0 | 0.0 | 0.0 | 0.0 | 0.0 | 0.0 | 0.0 | 0.0 | 0.0 | 0.0 |
| Total Delay | 61.9 | 63.5 | 32.3 | 71.2 | 63.1 | 0.6 | 77.2 | 14.0 | 1.3 | 76.9 | 43.1 | 3.3 |
| LOS | E | E | C | E | E | A | E | B | A | E | D | A |
| Approach Delay | | 47.5 | | | 55.3 | | | 37.4 | | | 40.9 | |
| Approach LOS | | D | | | E | | | D | | | D | |

Intersection Summary

Cycle Length: 120
 Actuated Cycle Length: 120
 Offset: 45 (38%), Referenced to phase 2:NBT and 6:SBT, Start of Yellow
 Natural Cycle: 110
 Control Type: Actuated-Coordinated
 Maximum v/c Ratio: 0.99
 Intersection Signal Delay: 42.0
 Intersection Capacity Utilization 85.0%
 Analysis Period (min) 15
 Intersection LOS: D
 ICU Level of Service E

Splits and Phases: 2: MERIDIAN ROAD & EASTONVILLE ROAD



Queues
2: MERIDIAN ROAD & EASTONVILLE ROAD

Background 2024 AM
04/10/2023



























| Lane Group | EBL | EBT | EBR | WBL | WBT | WBR | NBL | NBT | NBR | SBL | SBT | SBR |
|-------------------------|------|------|------|------|------|------|------|------|------|------|------|------|
| Lane Group Flow (vph) | 256 | 61 | 308 | 108 | 60 | 40 | 345 | 511 | 49 | 125 | 1509 | 205 |
| v/c Ratio | 0.75 | 0.44 | 0.85 | 0.71 | 0.43 | 0.11 | 0.95 | 0.28 | 0.05 | 0.65 | 0.99 | 0.25 |
| Control Delay | 61.9 | 63.5 | 32.3 | 71.2 | 63.1 | 0.6 | 77.2 | 14.0 | 1.3 | 76.9 | 43.1 | 3.3 |
| Queue Delay | 0.0 | 0.0 | 0.0 | 0.0 | 0.0 | 0.0 | 0.0 | 0.0 | 0.0 | 0.0 | 0.0 | 0.0 |
| Total Delay | 61.9 | 63.5 | 32.3 | 71.2 | 63.1 | 0.6 | 77.2 | 14.0 | 1.3 | 76.9 | 43.1 | 3.3 |
| Queue Length 50th (ft) | 91 | 46 | 32 | 74 | 45 | 0 | 282 | 111 | 1 | 82 | 648 | 35 |
| Queue Length 95th (ft) | #147 | 86 | #138 | #136 | 91 | 0 | #420 | 135 | m5 | m137 | #800 | m28 |
| Internal Link Dist (ft) | | 508 | | | 1196 | | | 231 | | | 781 | |
| Turn Bay Length (ft) | 100 | | 100 | 120 | | 100 | 100 | | 400 | 375 | | 400 |
| Base Capacity (vph) | 340 | 147 | 369 | 153 | 147 | 360 | 365 | 1847 | 911 | 228 | 1528 | 823 |
| Starvation Cap Reductn | 0 | 0 | 0 | 0 | 0 | 0 | 0 | 0 | 0 | 0 | 0 | 0 |
| Spillback Cap Reductn | 0 | 0 | 0 | 0 | 0 | 0 | 0 | 0 | 0 | 0 | 0 | 0 |
| Storage Cap Reductn | 0 | 0 | 0 | 0 | 0 | 0 | 0 | 0 | 0 | 0 | 0 | 0 |
| Reduced v/c Ratio | 0.75 | 0.41 | 0.83 | 0.71 | 0.41 | 0.11 | 0.95 | 0.28 | 0.05 | 0.55 | 0.99 | 0.25 |

Intersection Summary

- # 95th percentile volume exceeds capacity, queue may be longer.
Queue shown is maximum after two cycles.
- m Volume for 95th percentile queue is metered by upstream signal.

HCM 6th Signalized Intersection Summary
 2: MERIDIAN ROAD & EASTONVILLE ROAD

Background 2024 AM
 04/10/2023

| |  |  |  |  |  |  |  |  |  |  |  |  |
|------------------------------|---|---|---|---|---|---|---|---|---|---|---|---|
| Movement | EBL | EBT | EBR | WBL | WBT | WBR | NBL | NBT | NBR | SBL | SBT | SBR |
| Lane Configurations |  |  |  |  |  |  |  |  |  |  |  |  |
| Traffic Volume (veh/h) | 218 | 52 | 262 | 100 | 56 | 37 | 293 | 434 | 42 | 114 | 1373 | 187 |
| Future Volume (veh/h) | 218 | 52 | 262 | 100 | 56 | 37 | 293 | 434 | 42 | 114 | 1373 | 187 |
| Initial Q (Qb), veh | 0 | 0 | 0 | 0 | 0 | 0 | 0 | 0 | 0 | 0 | 0 | 0 |
| Ped-Bike Adj(A_pbT) | 1.00 | | 1.00 | 1.00 | | 1.00 | 1.00 | | 1.00 | 1.00 | | 1.00 |
| Parking Bus, Adj | 1.00 | 1.00 | 1.00 | 1.00 | 1.00 | 1.00 | 1.00 | 1.00 | 1.00 | 1.00 | 1.00 | 1.00 |
| Work Zone On Approach | | No | | | No | | | No | | | No | |
| Adj Sat Flow, veh/h/ln | 1870 | 1870 | 1870 | 1870 | 1870 | 1870 | 1870 | 1870 | 1870 | 1870 | 1870 | 1870 |
| Adj Flow Rate, veh/h | 256 | 61 | 0 | 108 | 60 | 0 | 345 | 511 | 49 | 125 | 1509 | 205 |
| Peak Hour Factor | 0.85 | 0.85 | 0.85 | 0.93 | 0.93 | 0.93 | 0.85 | 0.85 | 0.85 | 0.91 | 0.91 | 0.91 |
| Percent Heavy Veh, % | 2 | 2 | 2 | 2 | 2 | 2 | 2 | 2 | 2 | 2 | 2 | 2 |
| Cap, veh/h | 371 | 125 | | 189 | 125 | | 364 | 1962 | 875 | 152 | 1570 | 700 |
| Arrive On Green | 0.05 | 0.07 | 0.00 | 0.05 | 0.07 | 0.00 | 0.20 | 0.55 | 0.55 | 0.09 | 0.44 | 0.44 |
| Sat Flow, veh/h | 3456 | 1870 | 1585 | 1781 | 1870 | 1585 | 1781 | 3554 | 1585 | 1781 | 3554 | 1585 |
| Grp Volume(v), veh/h | 256 | 61 | 0 | 108 | 60 | 0 | 345 | 511 | 49 | 125 | 1509 | 205 |
| Grp Sat Flow(s),veh/h/ln | 1728 | 1870 | 1585 | 1781 | 1870 | 1585 | 1781 | 1777 | 1585 | 1781 | 1777 | 1585 |
| Q Serve(g_s), s | 5.5 | 3.8 | 0.0 | 5.5 | 3.7 | 0.0 | 22.9 | 9.0 | 1.7 | 8.3 | 49.4 | 10.0 |
| Cycle Q Clear(g_c), s | 5.5 | 3.8 | 0.0 | 5.5 | 3.7 | 0.0 | 22.9 | 9.0 | 1.7 | 8.3 | 49.4 | 10.0 |
| Prop In Lane | 1.00 | | 1.00 | 1.00 | | 1.00 | 1.00 | | 1.00 | 1.00 | | 1.00 |
| Lane Grp Cap(c), veh/h | 371 | 125 | | 189 | 125 | | 364 | 1962 | 875 | 152 | 1570 | 700 |
| V/C Ratio(X) | 0.69 | 0.49 | | 0.57 | 0.48 | | 0.95 | 0.26 | 0.06 | 0.82 | 0.96 | 0.29 |
| Avail Cap(c_a), veh/h | 371 | 148 | | 189 | 148 | | 364 | 1962 | 875 | 230 | 1570 | 700 |
| HCM Platoon Ratio | 1.00 | 1.00 | 1.00 | 1.00 | 1.00 | 1.00 | 1.00 | 1.00 | 1.00 | 1.00 | 1.00 | 1.00 |
| Upstream Filter(l) | 1.00 | 1.00 | 0.00 | 1.00 | 1.00 | 0.00 | 1.00 | 1.00 | 1.00 | 1.00 | 1.00 | 1.00 |
| Uniform Delay (d), s/veh | 52.6 | 54.0 | 0.0 | 51.1 | 54.0 | 0.0 | 47.1 | 14.1 | 12.4 | 54.0 | 32.5 | 21.5 |
| Incr Delay (d2), s/veh | 5.3 | 2.9 | 0.0 | 4.1 | 2.9 | 0.0 | 34.0 | 0.3 | 0.1 | 13.4 | 15.2 | 1.1 |
| Initial Q Delay(d3),s/veh | 0.0 | 0.0 | 0.0 | 0.0 | 0.0 | 0.0 | 0.0 | 0.0 | 0.0 | 0.0 | 0.0 | 0.0 |
| %ile BackOfQ(50%),veh/ln | 1.5 | 1.9 | 0.0 | 3.4 | 1.8 | 0.0 | 13.1 | 3.4 | 0.6 | 4.1 | 22.5 | 3.9 |
| Unsig. Movement Delay, s/veh | | | | | | | | | | | | |
| LnGrp Delay(d),s/veh | 57.9 | 57.0 | 0.0 | 55.2 | 56.9 | 0.0 | 81.1 | 14.4 | 12.5 | 67.4 | 47.7 | 22.5 |
| LnGrp LOS | E | E | | E | E | | F | B | B | E | D | C |
| Approach Vol, veh/h | | 317 | A | | 168 | A | | 905 | | | 1839 | |
| Approach Delay, s/veh | | 57.7 | | | 55.8 | | | 39.7 | | | 46.3 | |
| Approach LOS | | E | | | E | | | D | | | D | |
| Timer - Assigned Phs | 1 | 2 | 3 | 4 | 5 | 6 | 7 | 8 | | | | |
| Phs Duration (G+Y+Rc), s | 18.7 | 73.8 | 13.0 | 14.5 | 32.0 | 60.5 | 13.0 | 14.5 | | | | |
| Change Period (Y+Rc), s | 8.5 | 7.5 | 7.5 | 6.5 | 7.5 | 7.5 | 7.5 | 6.5 | | | | |
| Max Green Setting (Gmax), s | 15.5 | 59.5 | 5.5 | 9.5 | 24.5 | 51.5 | 5.5 | 9.5 | | | | |
| Max Q Clear Time (g_c+I1), s | 10.3 | 11.0 | 7.5 | 5.8 | 24.9 | 51.4 | 7.5 | 5.7 | | | | |
| Green Ext Time (p_c), s | 0.1 | 3.3 | 0.0 | 0.1 | 0.0 | 0.0 | 0.0 | 0.1 | | | | |

Intersection Summary

| | |
|--------------------|------|
| HCM 6th Ctrl Delay | 46.0 |
| HCM 6th LOS | D |

Notes

User approved pedestrian interval to be less than phase max green.
 Unsignalized Delay for [EBR, WBR] is excluded from calculations of the approach delay and intersection delay.

Timings
 3: MERIDIAN ROAD & BENT GRASS MEADOWS DRIVE

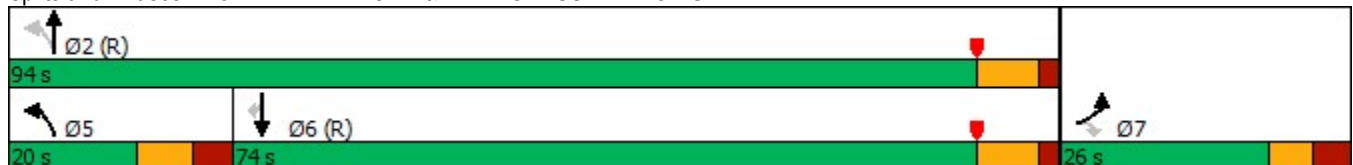


| Lane Group | EBL | EBR | NBL | NBT | SBT | SBR |
|----------------------|-------|-------|-------|-------|-------|-------|
| Lane Configurations | ↖↖ | ↗ | ↖ | ↑↑ | ↑↑ | ↗ |
| Traffic Volume (vph) | 85 | 181 | 105 | 534 | 1451 | 121 |
| Future Volume (vph) | 85 | 181 | 105 | 534 | 1451 | 121 |
| Turn Type | Prot | Perm | pm+pt | NA | NA | Perm |
| Protected Phases | 7 | | 5 | 2 | 6 | |
| Permitted Phases | | 7 | 2 | | | 6 |
| Detector Phase | 7 | 7 | 5 | 2 | 6 | 6 |
| Switch Phase | | | | | | |
| Minimum Initial (s) | 8.0 | 8.0 | 5.0 | 15.0 | 15.0 | 15.0 |
| Minimum Split (s) | 25.5 | 25.5 | 13.5 | 25.5 | 25.5 | 25.5 |
| Total Split (s) | 26.0 | 26.0 | 20.0 | 94.0 | 74.0 | 74.0 |
| Total Split (%) | 21.7% | 21.7% | 16.7% | 78.3% | 61.7% | 61.7% |
| Yellow Time (s) | 4.0 | 4.0 | 5.0 | 5.5 | 5.5 | 5.5 |
| All-Red Time (s) | 3.5 | 3.5 | 3.5 | 2.0 | 2.0 | 2.0 |
| Lost Time Adjust (s) | 0.0 | 0.0 | 0.0 | 0.0 | 0.0 | 0.0 |
| Total Lost Time (s) | 7.5 | 7.5 | 8.5 | 7.5 | 7.5 | 7.5 |
| Lead/Lag | | | Lead | | Lag | Lag |
| Lead-Lag Optimize? | | | Yes | | Yes | Yes |
| Recall Mode | None | None | None | C-Max | C-Max | C-Max |
| Act Effct Green (s) | 10.6 | 10.6 | 93.4 | 94.4 | 76.9 | 76.9 |
| Actuated g/C Ratio | 0.09 | 0.09 | 0.78 | 0.79 | 0.64 | 0.64 |
| v/c Ratio | 0.33 | 0.70 | 0.50 | 0.21 | 0.73 | 0.13 |
| Control Delay | 53.2 | 24.3 | 19.3 | 3.1 | 18.1 | 2.2 |
| Queue Delay | 0.0 | 0.0 | 0.0 | 0.0 | 0.0 | 0.0 |
| Total Delay | 53.2 | 24.3 | 19.3 | 3.1 | 18.1 | 2.2 |
| LOS | D | C | B | A | B | A |
| Approach Delay | 33.5 | | | 5.8 | 16.9 | |
| Approach LOS | C | | | A | B | |

Intersection Summary

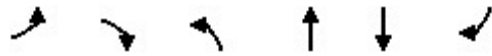
Cycle Length: 120
 Actuated Cycle Length: 120
 Offset: 5 (4%), Referenced to phase 2:NBTL and 6:SBT, Start of Yellow
 Natural Cycle: 90
 Control Type: Actuated-Coordinated
 Maximum v/c Ratio: 0.73
 Intersection Signal Delay: 15.9
 Intersection Capacity Utilization 72.2%
 Analysis Period (min) 15
 Intersection LOS: B
 ICU Level of Service C

Splits and Phases: 3: MERIDIAN ROAD & BENT GRASS MEADOWS DRIVE



3: MERIDIAN ROAD & BENT GRASS MEADOWS DRIVE

04/10/2023



| Lane Group | EBL | EBR | NBL | NBT | SBT | SBR |
|-------------------------|------|------|------|------|------|------|
| Lane Group Flow (vph) | 99 | 210 | 117 | 593 | 1649 | 138 |
| v/c Ratio | 0.33 | 0.70 | 0.50 | 0.21 | 0.73 | 0.13 |
| Control Delay | 53.2 | 24.3 | 19.3 | 3.1 | 18.1 | 2.2 |
| Queue Delay | 0.0 | 0.0 | 0.0 | 0.0 | 0.0 | 0.0 |
| Total Delay | 53.2 | 24.3 | 19.3 | 3.1 | 18.1 | 2.2 |
| Queue Length 50th (ft) | 38 | 25 | 6 | 23 | 389 | 0 |
| Queue Length 95th (ft) | 59 | 87 | m80 | 112 | 617 | 27 |
| Internal Link Dist (ft) | 310 | | | 750 | 1921 | |
| Turn Bay Length (ft) | 150 | | 700 | | | 350 |
| Base Capacity (vph) | 529 | 393 | 272 | 2782 | 2268 | 1064 |
| Starvation Cap Reductn | 0 | 0 | 0 | 0 | 0 | 0 |
| Spillback Cap Reductn | 0 | 0 | 0 | 0 | 0 | 0 |
| Storage Cap Reductn | 0 | 0 | 0 | 0 | 0 | 0 |
| Reduced v/c Ratio | 0.19 | 0.53 | 0.43 | 0.21 | 0.73 | 0.13 |

Intersection Summary

m Volume for 95th percentile queue is metered by upstream signal.

HCM 6th Signalized Intersection Summary
 3: MERIDIAN ROAD & BENT GRASS MEADOWS DRIVE

Background 2024 AM
 04/10/2023



| Movement | EBL | EBR | NBL | NBT | SBT | SBR |
|------------------------------|------|-------|------|------|------|------|
| Lane Configurations | ↖↗ | ↗ | ↖ | ↑↑ | ↑↑ | ↗ |
| Traffic Volume (veh/h) | 85 | 181 | 105 | 534 | 1451 | 121 |
| Future Volume (veh/h) | 85 | 181 | 105 | 534 | 1451 | 121 |
| Initial Q (Qb), veh | 0 | 0 | 0 | 0 | 0 | 0 |
| Ped-Bike Adj(A_pbT) | 1.00 | 1.00 | 1.00 | | | 1.00 |
| Parking Bus, Adj | 1.00 | 1.00 | 1.00 | 1.00 | 1.00 | 1.00 |
| Work Zone On Approach | No | | | No | No | |
| Adj Sat Flow, veh/h/ln | 1870 | 1870 | 1870 | 1870 | 1870 | 1870 |
| Adj Flow Rate, veh/h | 99 | 0 | 117 | 593 | 1649 | 138 |
| Peak Hour Factor | 0.86 | 0.86 | 0.90 | 0.90 | 0.88 | 0.88 |
| Percent Heavy Veh, % | 2 | 2 | 2 | 2 | 2 | 2 |
| Cap, veh/h | 222 | | 249 | 2881 | 2485 | 1108 |
| Arrive On Green | 0.06 | 0.00 | 0.04 | 0.81 | 0.70 | 0.70 |
| Sat Flow, veh/h | 3456 | 1585 | 1781 | 3647 | 3647 | 1585 |
| Grp Volume(v), veh/h | 99 | 0 | 117 | 593 | 1649 | 138 |
| Grp Sat Flow(s),veh/h/ln | 1728 | 1585 | 1781 | 1777 | 1777 | 1585 |
| Q Serve(g_s), s | 3.3 | 0.0 | 2.1 | 4.5 | 31.3 | 3.4 |
| Cycle Q Clear(g_c), s | 3.3 | 0.0 | 2.1 | 4.5 | 31.3 | 3.4 |
| Prop In Lane | 1.00 | 1.00 | 1.00 | | | 1.00 |
| Lane Grp Cap(c), veh/h | 222 | | 249 | 2881 | 2485 | 1108 |
| V/C Ratio(X) | 0.45 | | 0.47 | 0.21 | 0.66 | 0.12 |
| Avail Cap(c_a), veh/h | 533 | | 347 | 2881 | 2485 | 1108 |
| HCM Platoon Ratio | 1.00 | 1.00 | 1.00 | 1.00 | 1.00 | 1.00 |
| Upstream Filter(I) | 1.00 | 0.00 | 1.00 | 1.00 | 1.00 | 1.00 |
| Uniform Delay (d), s/veh | 54.1 | 0.0 | 12.1 | 2.6 | 10.1 | 5.9 |
| Incr Delay (d2), s/veh | 1.4 | 0.0 | 1.4 | 0.2 | 1.4 | 0.2 |
| Initial Q Delay(d3),s/veh | 0.0 | 0.0 | 0.0 | 0.0 | 0.0 | 0.0 |
| %ile BackOfQ(50%),veh/ln | 1.5 | 0.0 | 1.4 | 1.3 | 11.5 | 6.1 |
| Unsig. Movement Delay, s/veh | | | | | | |
| LnGrp Delay(d),s/veh | 55.5 | 0.0 | 13.4 | 2.7 | 11.5 | 6.2 |
| LnGrp LOS | E | | B | A | B | A |
| Approach Vol, veh/h | 99 | A | | 710 | 1787 | |
| Approach Delay, s/veh | 55.5 | | | 4.5 | 11.1 | |
| Approach LOS | E | | | A | B | |
| Timer - Assigned Phs | | 2 | | 4 | 5 | 6 |
| Phs Duration (G+Y+Rc), s | | 104.8 | | 15.2 | 13.4 | 91.4 |
| Change Period (Y+Rc), s | | 7.5 | | 7.5 | 8.5 | 7.5 |
| Max Green Setting (Gmax), s | | 86.5 | | 18.5 | 11.5 | 66.5 |
| Max Q Clear Time (g_c+I1), s | | 6.5 | | 5.3 | 4.1 | 33.3 |
| Green Ext Time (p_c), s | | 4.7 | | 0.2 | 0.1 | 18.4 |
| Intersection Summary | | | | | | |
| HCM 6th Ctrl Delay | | | 11.0 | | | |
| HCM 6th LOS | | | B | | | |

Notes

Unsignalized Delay for [EBR] is excluded from calculations of the approach delay and intersection delay.

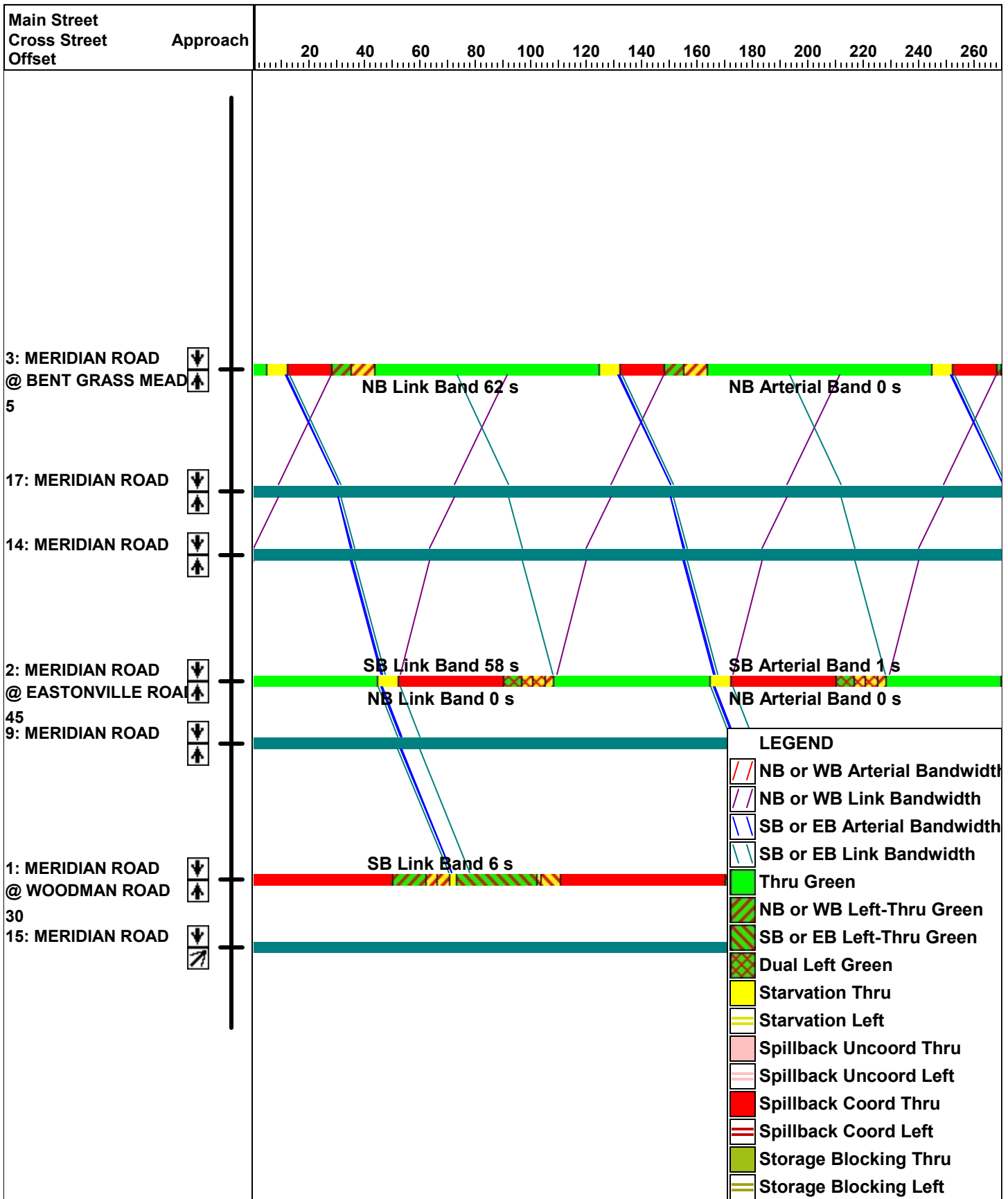
| Intersection | | | | | | |
|--------------------------|------|------|------|------|------|------|
| Int Delay, s/veh | 4.5 | | | | | |
| Movement | EBT | EBR | WBL | WBT | NBL | NBR |
| Lane Configurations | ↑ | ↗ | ↘ | ↑ | ↘ | |
| Traffic Vol, veh/h | 145 | 65 | 158 | 68 | 1 | 121 |
| Future Vol, veh/h | 145 | 65 | 158 | 68 | 1 | 121 |
| Conflicting Peds, #/hr | 0 | 0 | 0 | 0 | 0 | 0 |
| Sign Control | Free | Free | Free | Free | Stop | Stop |
| RT Channelized | - | None | - | None | - | None |
| Storage Length | - | 150 | 100 | - | 0 | - |
| Veh in Median Storage, # | 0 | - | - | 0 | 0 | - |
| Grade, % | 0 | - | - | 0 | 0 | - |
| Peak Hour Factor | 85 | 85 | 85 | 85 | 85 | 85 |
| Heavy Vehicles, % | 2 | 2 | 2 | 2 | 2 | 2 |
| Mvmt Flow | 171 | 76 | 186 | 80 | 1 | 142 |

| Major/Minor | Major1 | Major2 | Minor1 | | |
|----------------------|--------|--------|--------|---|-------|
| Conflicting Flow All | 0 | 0 | 247 | 0 | 623 |
| Stage 1 | - | - | - | - | 171 |
| Stage 2 | - | - | - | - | 452 |
| Critical Hdwy | - | - | 4.12 | - | 6.42 |
| Critical Hdwy Stg 1 | - | - | - | - | 5.42 |
| Critical Hdwy Stg 2 | - | - | - | - | 5.42 |
| Follow-up Hdwy | - | - | 2.218 | - | 3.518 |
| Pot Cap-1 Maneuver | - | - | 1319 | - | 450 |
| Stage 1 | - | - | - | - | 859 |
| Stage 2 | - | - | - | - | 641 |
| Platoon blocked, % | - | - | - | - | - |
| Mov Cap-1 Maneuver | - | - | 1319 | - | 387 |
| Mov Cap-2 Maneuver | - | - | - | - | 387 |
| Stage 1 | - | - | - | - | 859 |
| Stage 2 | - | - | - | - | 551 |

| Approach | EB | WB | NB |
|----------------------|----|-----|----|
| HCM Control Delay, s | 0 | 5.7 | 10 |
| HCM LOS | | | B |

| Minor Lane/Major Mvmt | NBLn1 | EBT | EBR | WBL | WBT |
|-----------------------|-------|-----|-----|-------|-----|
| Capacity (veh/h) | 864 | - | - | 1319 | - |
| HCM Lane V/C Ratio | 0.166 | - | - | 0.141 | - |
| HCM Control Delay (s) | 10 | - | - | 8.2 | - |
| HCM Lane LOS | B | - | - | A | - |
| HCM 95th %tile Q(veh) | 0.6 | - | - | 0.5 | - |

Background 2024 AM Signal Progression



Timings
1: MERIDIAN ROAD & WOODMAN ROAD

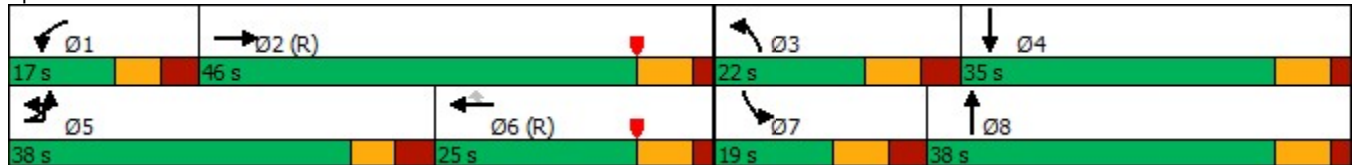
Background 2024 PM
04/15/2023

| Lane Group | EBL | EBT | EBR | WBL | WBT | WBR | NBL | NBT | NBR | SBL | SBT | SBR |
|----------------------|-------|-------|-------|-------|-------|-------|-------|-------|-------|-------|-------|-------|
| Lane Configurations | | | | | | | | | | | | |
| Traffic Volume (vph) | 740 | 474 | 166 | 117 | 388 | 239 | 265 | 788 | 110 | 244 | 574 | 472 |
| Future Volume (vph) | 740 | 474 | 166 | 117 | 388 | 239 | 265 | 788 | 110 | 244 | 574 | 472 |
| Turn Type | Prot | NA | Free | Prot | NA | Perm | Prot | NA | Free | Prot | NA | Free |
| Protected Phases | 5 | 2 | | 1 | 6 | | 3 | 8 | | 7 | 4 | |
| Permitted Phases | | | Free | | | 6 | | | Free | | | Free |
| Detector Phase | 5 | 2 | | 1 | 6 | 6 | 3 | 8 | | 7 | 4 | |
| Switch Phase | | | | | | | | | | | | |
| Minimum Initial (s) | 5.0 | 15.0 | | 5.0 | 15.0 | 15.0 | 5.0 | 15.0 | | 5.0 | 15.0 | |
| Minimum Split (s) | 13.5 | 22.0 | | 13.5 | 22.0 | 22.0 | 13.5 | 22.0 | | 13.5 | 22.0 | |
| Total Split (s) | 38.0 | 46.0 | | 17.0 | 25.0 | 25.0 | 22.0 | 38.0 | | 19.0 | 35.0 | |
| Total Split (%) | 31.7% | 38.3% | | 14.2% | 20.8% | 20.8% | 18.3% | 31.7% | | 15.8% | 29.2% | |
| Yellow Time (s) | 4.0 | 5.0 | | 4.0 | 5.0 | 5.0 | 5.0 | 5.0 | | 5.0 | 5.0 | |
| All-Red Time (s) | 3.5 | 2.0 | | 3.5 | 2.0 | 2.0 | 3.5 | 2.0 | | 3.5 | 2.0 | |
| Lost Time Adjust (s) | 0.0 | 0.0 | | 0.0 | 0.0 | 0.0 | 0.0 | 0.0 | | 0.0 | 0.0 | |
| Total Lost Time (s) | 7.5 | 7.0 | | 7.5 | 7.0 | 7.0 | 8.5 | 7.0 | | 8.5 | 7.0 | |
| Lead/Lag | Lead | Lag | | Lead | Lag | Lag | Lead | Lag | | Lead | Lag | |
| Lead-Lag Optimize? | Yes | Yes | | Yes | Yes | Yes | Yes | Yes | | Yes | Yes | |
| Recall Mode | None | C-Max | | None | C-Max | C-Max | None | None | | None | None | |
| Act Effct Green (s) | 30.1 | 40.2 | 120.0 | 8.9 | 19.0 | 19.0 | 13.0 | 30.5 | 120.0 | 10.5 | 28.0 | 120.0 |
| Actuated g/C Ratio | 0.25 | 0.34 | 1.00 | 0.07 | 0.16 | 0.16 | 0.11 | 0.25 | 1.00 | 0.09 | 0.23 | 1.00 |
| v/c Ratio | 0.95 | 0.43 | 0.11 | 0.50 | 0.76 | 0.57 | 0.75 | 0.92 | 0.07 | 0.86 | 0.73 | 0.31 |
| Control Delay | 64.3 | 32.7 | 0.1 | 60.4 | 58.2 | 11.8 | 65.2 | 60.1 | 0.1 | 55.7 | 52.8 | 0.3 |
| Queue Delay | 0.0 | 0.0 | 0.0 | 0.0 | 0.0 | 0.0 | 0.0 | 0.0 | 0.0 | 0.0 | 0.0 | 0.0 |
| Total Delay | 64.3 | 32.7 | 0.1 | 60.4 | 58.2 | 11.8 | 65.2 | 60.1 | 0.1 | 55.7 | 52.8 | 0.3 |
| LOS | E | C | A | E | E | B | E | E | A | E | D | A |
| Approach Delay | | 46.0 | | | 43.6 | | | 55.6 | | | 34.1 | |
| Approach LOS | | D | | | D | | | E | | | C | |

Intersection Summary

Cycle Length: 120
 Actuated Cycle Length: 120
 Offset: 100 (83%), Referenced to phase 2:EBT and 6:WBT, Start of Yellow
 Natural Cycle: 100
 Control Type: Actuated-Coordinated
 Maximum v/c Ratio: 0.95
 Intersection Signal Delay: 44.7
 Intersection LOS: D
 Intersection Capacity Utilization 87.4%
 ICU Level of Service E
 Analysis Period (min) 15

Splits and Phases: 1: MERIDIAN ROAD & WOODMAN ROAD



Queues
1: MERIDIAN ROAD & WOODMAN ROAD

Background 2024 PM
04/15/2023



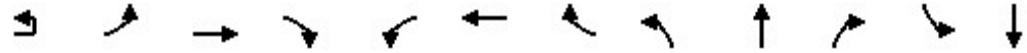
| Lane Group | EBL | EBT | EBR | WBL | WBT | WBR | NBL | NBT | NBR | SBL | SBT | SBR |
|-------------------------|------|------|------|------|------|------|------|------|------|-------|------|------|
| Lane Group Flow (vph) | 812 | 510 | 178 | 127 | 422 | 260 | 279 | 829 | 116 | 257 | 604 | 497 |
| v/c Ratio | 0.95 | 0.43 | 0.11 | 0.50 | 0.76 | 0.57 | 0.75 | 0.92 | 0.07 | 0.86 | 0.73 | 0.31 |
| Control Delay | 64.3 | 32.7 | 0.1 | 60.4 | 58.2 | 11.8 | 65.2 | 60.1 | 0.1 | 55.7 | 52.8 | 0.3 |
| Queue Delay | 0.0 | 0.0 | 0.0 | 0.0 | 0.0 | 0.0 | 0.0 | 0.0 | 0.0 | 0.0 | 0.0 | 0.0 |
| Total Delay | 64.3 | 32.7 | 0.1 | 60.4 | 58.2 | 11.8 | 65.2 | 60.1 | 0.1 | 55.7 | 52.8 | 0.3 |
| Queue Length 50th (ft) | 318 | 163 | 0 | 49 | 168 | 7 | 109 | 328 | 0 | 108 | 258 | 0 |
| Queue Length 95th (ft) | #436 | 215 | 0 | 81 | #237 | 86 | 156 | #442 | 0 | m#160 | 310 | 0 |
| Internal Link Dist (ft) | | 1165 | | | 1100 | | | 342 | | | 860 | |
| Turn Bay Length (ft) | 500 | | 630 | 350 | | 250 | 440 | | 330 | 490 | | 450 |
| Base Capacity (vph) | 872 | 1184 | 1583 | 271 | 558 | 460 | 386 | 914 | 1583 | 300 | 826 | 1583 |
| Starvation Cap Reductn | 0 | 0 | 0 | 0 | 0 | 0 | 0 | 0 | 0 | 0 | 0 | 0 |
| Spillback Cap Reductn | 0 | 0 | 0 | 0 | 0 | 0 | 0 | 0 | 0 | 0 | 0 | 0 |
| Storage Cap Reductn | 0 | 0 | 0 | 0 | 0 | 0 | 0 | 0 | 0 | 0 | 0 | 0 |
| Reduced v/c Ratio | 0.93 | 0.43 | 0.11 | 0.47 | 0.76 | 0.57 | 0.72 | 0.91 | 0.07 | 0.86 | 0.73 | 0.31 |

Intersection Summary

- # 95th percentile volume exceeds capacity, queue may be longer.
Queue shown is maximum after two cycles.
- m Volume for 95th percentile queue is metered by upstream signal.

HCM 6th Signalized Intersection Summary
1: MERIDIAN ROAD & WOODMAN ROAD

Background 2024 PM
04/15/2023



| Movement | EBU | EBL | EBT | EBR | WBL | WBT | WBR | NBL | NBT | NBR | SBL | SBT |
|------------------------------|------|------|------|------|------|------|------|------|------|------|------|------|
| Lane Configurations | | ↔↔ | ↕↕ | ↔ | ↔↔ | ↕↕ | ↔ | ↔↔ | ↕↕ | ↔ | ↔↔ | ↕↕ |
| Traffic Volume (veh/h) | 15 | 740 | 474 | 166 | 117 | 388 | 239 | 265 | 788 | 110 | 244 | 574 |
| Future Volume (veh/h) | 15 | 740 | 474 | 166 | 117 | 388 | 239 | 265 | 788 | 110 | 244 | 574 |
| Initial Q (Qb), veh | | 0 | 0 | 0 | 0 | 0 | 0 | 0 | 0 | 0 | 0 | 0 |
| Ped-Bike Adj(A_pbT) | | 1.00 | | 1.00 | 1.00 | | 1.00 | 1.00 | | 1.00 | 1.00 | |
| Parking Bus, Adj | | 1.00 | 1.00 | 1.00 | 1.00 | 1.00 | 1.00 | 1.00 | 1.00 | 1.00 | 1.00 | 1.00 |
| Work Zone On Approach | | | No | | | No | | | No | | | No |
| Adj Sat Flow, veh/h/ln | | 1870 | 1870 | 1870 | 1870 | 1870 | 1870 | 1870 | 1870 | 1870 | 1870 | 1870 |
| Adj Flow Rate, veh/h | | 796 | 510 | 0 | 127 | 422 | 0 | 279 | 829 | 0 | 257 | 604 |
| Peak Hour Factor | | 0.93 | 0.93 | 0.93 | 0.92 | 0.92 | 0.92 | 0.95 | 0.95 | 0.95 | 0.95 | 0.95 |
| Percent Heavy Veh, % | | 2 | 2 | 2 | 2 | 2 | 2 | 2 | 2 | 2 | 2 | 2 |
| Cap, veh/h | | 852 | 1272 | | 182 | 583 | | 337 | 895 | | 302 | 859 |
| Arrive On Green | | 0.25 | 0.36 | 0.00 | 0.05 | 0.16 | 0.00 | 0.10 | 0.25 | 0.00 | 0.09 | 0.24 |
| Sat Flow, veh/h | | 3456 | 3554 | 1585 | 3456 | 3554 | 1585 | 3456 | 3554 | 1585 | 3456 | 3554 |
| Grp Volume(v), veh/h | | 796 | 510 | 0 | 127 | 422 | 0 | 279 | 829 | 0 | 257 | 604 |
| Grp Sat Flow(s),veh/h/ln | | 1728 | 1777 | 1585 | 1728 | 1777 | 1585 | 1728 | 1777 | 1585 | 1728 | 1777 |
| Q Serve(g_s), s | | 27.1 | 12.9 | 0.0 | 4.3 | 13.5 | 0.0 | 9.5 | 27.3 | 0.0 | 8.8 | 18.6 |
| Cycle Q Clear(g_c), s | | 27.1 | 12.9 | 0.0 | 4.3 | 13.5 | 0.0 | 9.5 | 27.3 | 0.0 | 8.8 | 18.6 |
| Prop In Lane | | 1.00 | | 1.00 | 1.00 | | 1.00 | 1.00 | | 1.00 | 1.00 | |
| Lane Grp Cap(c), veh/h | | 852 | 1272 | | 182 | 583 | | 337 | 895 | | 302 | 859 |
| V/C Ratio(X) | | 0.93 | 0.40 | | 0.70 | 0.72 | | 0.83 | 0.93 | | 0.85 | 0.70 |
| Avail Cap(c_a), veh/h | | 878 | 1272 | | 274 | 583 | | 389 | 918 | | 302 | 859 |
| HCM Platoon Ratio | | 1.00 | 1.00 | 1.00 | 1.00 | 1.00 | 1.00 | 1.00 | 1.00 | 1.00 | 1.00 | 1.00 |
| Upstream Filter(I) | | 1.00 | 1.00 | 0.00 | 1.00 | 1.00 | 0.00 | 1.00 | 1.00 | 0.00 | 1.00 | 1.00 |
| Uniform Delay (d), s/veh | | 44.2 | 28.9 | 0.0 | 55.9 | 47.6 | 0.0 | 53.2 | 43.8 | 0.0 | 54.0 | 41.6 |
| Incr Delay (d2), s/veh | | 16.4 | 0.9 | 0.0 | 4.7 | 7.6 | 0.0 | 12.3 | 14.8 | 0.0 | 19.9 | 2.6 |
| Initial Q Delay(d3),s/veh | | 0.0 | 0.0 | 0.0 | 0.0 | 0.0 | 0.0 | 0.0 | 0.0 | 0.0 | 0.0 | 0.0 |
| %ile BackOfQ(50%),veh/ln | | 13.1 | 5.5 | 0.0 | 2.0 | 6.4 | 0.0 | 4.7 | 13.6 | 0.0 | 4.6 | 8.4 |
| Unsig. Movement Delay, s/veh | | | | | | | | | | | | |
| LnGrp Delay(d),s/veh | | 60.7 | 29.8 | 0.0 | 60.6 | 55.2 | 0.0 | 65.5 | 58.6 | 0.0 | 73.9 | 44.2 |
| LnGrp LOS | | E | C | | E | E | | E | E | | E | D |
| Approach Vol, veh/h | | | 1306 | A | | 549 | A | | 1108 | A | | 861 |
| Approach Delay, s/veh | | | 48.6 | | | 56.5 | | | 60.3 | | | 53.0 |
| Approach LOS | | | D | | | E | | | E | | | D |
| Timer - Assigned Phs | 1 | 2 | 3 | 4 | 5 | 6 | 7 | 8 | | | | |
| Phs Duration (G+Y+Rc), s | 13.8 | 49.9 | 20.2 | 36.0 | 37.1 | 26.7 | 19.0 | 37.2 | | | | |
| Change Period (Y+Rc), s | 7.5 | 7.0 | 8.5 | 7.0 | 7.5 | 7.0 | 8.5 | 7.0 | | | | |
| Max Green Setting (Gmax), s | 9.5 | 39.0 | 13.5 | 28.0 | 30.5 | 18.0 | 10.5 | 31.0 | | | | |
| Max Q Clear Time (g_c+I1), s | 6.3 | 14.9 | 11.5 | 20.6 | 29.1 | 15.5 | 10.8 | 29.3 | | | | |
| Green Ext Time (p_c), s | 0.1 | 3.1 | 0.2 | 2.3 | 0.5 | 0.6 | 0.0 | 0.9 | | | | |

Intersection Summary

| | |
|--------------------|------|
| HCM 6th Ctrl Delay | 54.1 |
| HCM 6th LOS | D |

Notes

- User approved pedestrian interval to be less than phase max green.
- User approved ignoring U-Turning movement.
- Unsignalized Delay for [NBR, EBR, WBR, SBR] is excluded from calculations of the approach delay and intersection delay.

| Movement | SBR |
|------------------------------|------|
| Lane Configurations | |
| Traffic Volume (veh/h) | 472 |
| Future Volume (veh/h) | 472 |
| Initial Q (Qb), veh | 0 |
| Ped-Bike Adj(A_pbT) | 1.00 |
| Parking Bus, Adj | 1.00 |
| Work Zone On Approach | |
| Adj Sat Flow, veh/h/ln | 1870 |
| Adj Flow Rate, veh/h | 0 |
| Peak Hour Factor | 0.95 |
| Percent Heavy Veh, % | 2 |
| Cap, veh/h | |
| Arrive On Green | 0.00 |
| Sat Flow, veh/h | 1585 |
| Grp Volume(v), veh/h | 0 |
| Grp Sat Flow(s),veh/h/ln | 1585 |
| Q Serve(g_s), s | 0.0 |
| Cycle Q Clear(g_c), s | 0.0 |
| Prop In Lane | 1.00 |
| Lane Grp Cap(c), veh/h | |
| V/C Ratio(X) | |
| Avail Cap(c_a), veh/h | |
| HCM Platoon Ratio | 1.00 |
| Upstream Filter(l) | 0.00 |
| Uniform Delay (d), s/veh | 0.0 |
| Incr Delay (d2), s/veh | 0.0 |
| Initial Q Delay(d3),s/veh | 0.0 |
| %ile BackOfQ(50%),veh/ln | 0.0 |
| Unsig. Movement Delay, s/veh | |
| LnGrp Delay(d),s/veh | 0.0 |
| LnGrp LOS | |
| Approach Vol, veh/h | A |
| Approach Delay, s/veh | |
| Approach LOS | |
| Timer - Assigned Phs | |

Timings
2: MERIDIAN ROAD & EASTONVILLE ROAD

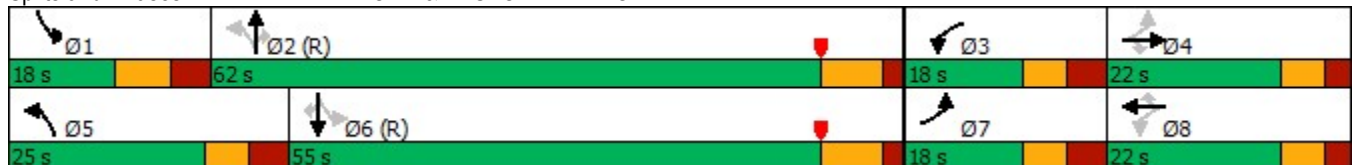
Background 2024 PM
04/15/2023

| Lane Group | EBL | EBT | EBR | WBL | WBT | WBR | NBL | NBT | NBR | SBL | SBT | SBR |
|----------------------|-------|-------|-------|-------|-------|-------|-------|-------|-------|-------|-------|-------|
| Lane Configurations | | | | | | | | | | | | |
| Traffic Volume (vph) | 359 | 125 | 292 | 32 | 79 | 138 | 354 | 1352 | 120 | 85 | 961 | 184 |
| Future Volume (vph) | 359 | 125 | 292 | 32 | 79 | 138 | 354 | 1352 | 120 | 85 | 961 | 184 |
| Turn Type | pm+pt | NA | Perm | pm+pt | NA | Perm | pm+pt | NA | Perm | pm+pt | NA | Perm |
| Protected Phases | 7 | 4 | | 3 | 8 | | 5 | 2 | | 1 | 6 | |
| Permitted Phases | 4 | | 4 | 8 | | 8 | 2 | | 2 | 6 | | 6 |
| Detector Phase | 7 | 4 | 4 | 3 | 8 | 8 | 5 | 2 | 2 | 1 | 6 | 6 |
| Switch Phase | | | | | | | | | | | | |
| Minimum Initial (s) | 5.0 | 8.0 | 8.0 | 5.0 | 8.0 | 8.0 | 5.0 | 15.0 | 15.0 | 5.0 | 15.0 | 15.0 |
| Minimum Split (s) | 12.5 | 24.5 | 24.5 | 12.5 | 24.5 | 24.5 | 12.5 | 25.5 | 25.5 | 13.5 | 25.5 | 25.5 |
| Total Split (s) | 18.0 | 22.0 | 22.0 | 18.0 | 22.0 | 22.0 | 25.0 | 62.0 | 62.0 | 18.0 | 55.0 | 55.0 |
| Total Split (%) | 15.0% | 18.3% | 18.3% | 15.0% | 18.3% | 18.3% | 20.8% | 51.7% | 51.7% | 15.0% | 45.8% | 45.8% |
| Yellow Time (s) | 4.0 | 4.0 | 4.0 | 4.0 | 4.0 | 4.0 | 4.0 | 5.5 | 5.5 | 5.0 | 5.5 | 5.5 |
| All-Red Time (s) | 3.5 | 2.5 | 2.5 | 3.5 | 2.5 | 2.5 | 3.5 | 2.0 | 2.0 | 3.5 | 2.0 | 2.0 |
| Lost Time Adjust (s) | 0.0 | 0.0 | 0.0 | 0.0 | 0.0 | 0.0 | 0.0 | 0.0 | 0.0 | 0.0 | 0.0 | 0.0 |
| Total Lost Time (s) | 7.5 | 6.5 | 6.5 | 7.5 | 6.5 | 6.5 | 7.5 | 7.5 | 7.5 | 8.5 | 7.5 | 7.5 |
| Lead/Lag | Lead | Lag | Lag | Lead | Lag | Lag | Lead | Lag | Lag | Lead | Lag | Lag |
| Lead-Lag Optimize? | Yes | Yes | Yes | Yes | Yes | Yes | Yes | Yes | Yes | Yes | Yes | Yes |
| Recall Mode | None | None | None | None | None | None | None | C-Max | C-Max | None | C-Max | C-Max |
| Act Effct Green (s) | 25.7 | 20.4 | 20.4 | 18.1 | 11.8 | 11.8 | 76.0 | 59.6 | 59.6 | 54.6 | 47.5 | 47.5 |
| Actuated g/C Ratio | 0.21 | 0.17 | 0.17 | 0.15 | 0.10 | 0.10 | 0.63 | 0.50 | 0.50 | 0.46 | 0.40 | 0.40 |
| v/c Ratio | 0.79 | 0.46 | 0.66 | 0.16 | 0.45 | 0.45 | 1.04 | 0.86 | 0.15 | 0.53 | 0.78 | 0.28 |
| Control Delay | 52.2 | 51.8 | 15.1 | 35.9 | 58.1 | 7.3 | 88.2 | 15.0 | 0.6 | 23.2 | 44.8 | 13.7 |
| Queue Delay | 0.0 | 0.0 | 0.0 | 0.0 | 0.0 | 0.0 | 0.0 | 0.0 | 0.0 | 0.0 | 0.0 | 0.0 |
| Total Delay | 52.2 | 51.8 | 15.1 | 35.9 | 58.1 | 7.3 | 88.2 | 15.0 | 0.6 | 23.2 | 44.8 | 13.7 |
| LOS | D | D | B | D | E | A | F | B | A | C | D | B |
| Approach Delay | | 38.2 | | | 27.1 | | | 28.3 | | | 38.6 | |
| Approach LOS | | D | | | C | | | C | | | D | |

Intersection Summary

Cycle Length: 120
 Actuated Cycle Length: 120
 Offset: 89 (74%), Referenced to phase 2:NBTL and 6:SBTL, Start of Yellow
 Natural Cycle: 100
 Control Type: Actuated-Coordinated
 Maximum v/c Ratio: 1.04
 Intersection Signal Delay: 33.3
 Intersection Capacity Utilization 86.4%
 Analysis Period (min) 15
 Intersection LOS: C
 ICU Level of Service E

Splits and Phases: 2: MERIDIAN ROAD & EASTONVILLE ROAD



Queues
2: MERIDIAN ROAD & EASTONVILLE ROAD

Background 2024 PM
04/15/2023



| Lane Group | EBL | EBT | EBR | WBL | WBT | WBR | NBL | NBT | NBR | SBL | SBT | SBR |
|-------------------------|------|------|------|------|------|------|-------|-------|------|------|------|------|
| Lane Group Flow (vph) | 422 | 147 | 344 | 34 | 83 | 145 | 398 | 1519 | 135 | 97 | 1092 | 209 |
| v/c Ratio | 0.79 | 0.46 | 0.66 | 0.16 | 0.45 | 0.45 | 1.04 | 0.86 | 0.15 | 0.53 | 0.78 | 0.28 |
| Control Delay | 52.2 | 51.8 | 15.1 | 35.9 | 58.1 | 7.3 | 88.2 | 15.0 | 0.6 | 23.2 | 44.8 | 13.7 |
| Queue Delay | 0.0 | 0.0 | 0.0 | 0.0 | 0.0 | 0.0 | 0.0 | 0.0 | 0.0 | 0.0 | 0.0 | 0.0 |
| Total Delay | 52.2 | 51.8 | 15.1 | 35.9 | 58.1 | 7.3 | 88.2 | 15.0 | 0.6 | 23.2 | 44.8 | 13.7 |
| Queue Length 50th (ft) | 147 | 110 | 28 | 21 | 62 | 0 | ~235 | 364 | 1 | 40 | 464 | 47 |
| Queue Length 95th (ft) | 177 | 167 | 104 | 46 | 111 | 30 | m#396 | m#600 | m5 | 67 | 509 | 110 |
| Internal Link Dist (ft) | | 508 | | | 1196 | | | 231 | | | 781 | |
| Turn Bay Length (ft) | 100 | | 100 | 120 | | 100 | 100 | | 400 | 375 | | 400 |
| Base Capacity (vph) | 534 | 319 | 523 | 266 | 240 | 366 | 382 | 1757 | 875 | 205 | 1400 | 752 |
| Starvation Cap Reductn | 0 | 0 | 0 | 0 | 0 | 0 | 0 | 0 | 0 | 0 | 0 | 0 |
| Spillback Cap Reductn | 0 | 0 | 0 | 0 | 0 | 0 | 0 | 0 | 0 | 0 | 0 | 0 |
| Storage Cap Reductn | 0 | 0 | 0 | 0 | 0 | 0 | 0 | 0 | 0 | 0 | 0 | 0 |
| Reduced v/c Ratio | 0.79 | 0.46 | 0.66 | 0.13 | 0.35 | 0.40 | 1.04 | 0.86 | 0.15 | 0.47 | 0.78 | 0.28 |




























Intersection Summary

- ~ Volume exceeds capacity, queue is theoretically infinite.
Queue shown is maximum after two cycles.
- # 95th percentile volume exceeds capacity, queue may be longer.
Queue shown is maximum after two cycles.
- m Volume for 95th percentile queue is metered by upstream signal.

HCM 6th Signalized Intersection Summary
2: MERIDIAN ROAD & EASTONVILLE ROAD

Background 2024 PM

04/15/2023

| |  |  |  |  |  |  |  |  |  |  |  |  |
|------------------------------|---|---|---|---|---|---|---|---|---|---|---|---|
| Movement | EBL | EBT | EBR | WBL | WBT | WBR | NBL | NBT | NBR | SBL | SBT | SBR |
| Lane Configurations |   |  |  |  |  |  |  |   |  |  |   |  |
| Traffic Volume (veh/h) | 359 | 125 | 292 | 32 | 79 | 138 | 354 | 1352 | 120 | 85 | 961 | 184 |
| Future Volume (veh/h) | 359 | 125 | 292 | 32 | 79 | 138 | 354 | 1352 | 120 | 85 | 961 | 184 |
| Initial Q (Qb), veh | 0 | 0 | 0 | 0 | 0 | 0 | 0 | 0 | 0 | 0 | 0 | 0 |
| Ped-Bike Adj(A_pbT) | 1.00 | | 1.00 | 1.00 | | 1.00 | 1.00 | | 1.00 | 1.00 | | 1.00 |
| Parking Bus, Adj | 1.00 | 1.00 | 1.00 | 1.00 | 1.00 | 1.00 | 1.00 | 1.00 | 1.00 | 1.00 | 1.00 | 1.00 |
| Work Zone On Approach | | No | | | No | | | No | | | No | |
| Adj Sat Flow, veh/h/ln | 1870 | 1870 | 1870 | 1870 | 1870 | 1870 | 1870 | 1870 | 1870 | 1870 | 1870 | 1870 |
| Adj Flow Rate, veh/h | 422 | 147 | 0 | 34 | 83 | 0 | 398 | 1519 | 135 | 97 | 1092 | 209 |
| Peak Hour Factor | 0.85 | 0.85 | 0.85 | 0.95 | 0.95 | 0.95 | 0.89 | 0.89 | 0.89 | 0.88 | 0.88 | 0.88 |
| Percent Heavy Veh, % | 2 | 2 | 2 | 2 | 2 | 2 | 2 | 2 | 2 | 2 | 2 | 2 |
| Cap, veh/h | 482 | 235 | | 174 | 125 | | 412 | 1961 | 875 | 204 | 1629 | 726 |
| Arrive On Green | 0.09 | 0.13 | 0.00 | 0.03 | 0.07 | 0.00 | 0.15 | 0.55 | 0.55 | 0.04 | 0.46 | 0.46 |
| Sat Flow, veh/h | 3456 | 1870 | 1585 | 1781 | 1870 | 1585 | 1781 | 3554 | 1585 | 1781 | 3554 | 1585 |
| Grp Volume(v), veh/h | 422 | 147 | 0 | 34 | 83 | 0 | 398 | 1519 | 135 | 97 | 1092 | 209 |
| Grp Sat Flow(s),veh/h/ln | 1728 | 1870 | 1585 | 1781 | 1870 | 1585 | 1781 | 1777 | 1585 | 1781 | 1777 | 1585 |
| Q Serve(g_s), s | 10.5 | 8.9 | 0.0 | 2.1 | 5.2 | 0.0 | 16.3 | 40.2 | 5.0 | 3.4 | 28.8 | 9.9 |
| Cycle Q Clear(g_c), s | 10.5 | 8.9 | 0.0 | 2.1 | 5.2 | 0.0 | 16.3 | 40.2 | 5.0 | 3.4 | 28.8 | 9.9 |
| Prop In Lane | 1.00 | | 1.00 | 1.00 | | 1.00 | 1.00 | | 1.00 | 1.00 | | 1.00 |
| Lane Grp Cap(c), veh/h | 482 | 235 | | 174 | 125 | | 412 | 1961 | 875 | 204 | 1629 | 726 |
| V/C Ratio(X) | 0.88 | 0.62 | | 0.20 | 0.67 | | 0.97 | 0.77 | 0.15 | 0.48 | 0.67 | 0.29 |
| Avail Cap(c_a), veh/h | 482 | 242 | | 280 | 242 | | 412 | 1961 | 875 | 267 | 1629 | 726 |
| HCM Platoon Ratio | 1.00 | 1.00 | 1.00 | 1.00 | 1.00 | 1.00 | 1.00 | 1.00 | 1.00 | 1.00 | 1.00 | 1.00 |
| Upstream Filter(l) | 1.00 | 1.00 | 0.00 | 1.00 | 1.00 | 0.00 | 1.00 | 1.00 | 1.00 | 1.00 | 1.00 | 1.00 |
| Uniform Delay (d), s/veh | 49.2 | 49.8 | 0.0 | 50.1 | 54.7 | 0.0 | 27.2 | 21.1 | 13.2 | 20.9 | 25.4 | 20.3 |
| Incr Delay (d2), s/veh | 16.4 | 4.8 | 0.0 | 0.5 | 6.0 | 0.0 | 35.4 | 3.1 | 0.4 | 1.7 | 2.2 | 1.0 |
| Initial Q Delay(d3),s/veh | 0.0 | 0.0 | 0.0 | 0.0 | 0.0 | 0.0 | 0.0 | 0.0 | 0.0 | 0.0 | 0.0 | 0.0 |
| %ile BackOfQ(50%),veh/ln | 2.4 | 4.5 | 0.0 | 1.0 | 2.7 | 0.0 | 10.0 | 15.3 | 1.9 | 1.4 | 11.6 | 3.8 |
| Unsig. Movement Delay, s/veh | | | | | | | | | | | | |
| LnGrp Delay(d),s/veh | 65.6 | 54.5 | 0.0 | 50.7 | 60.7 | 0.0 | 62.5 | 24.1 | 13.5 | 22.6 | 27.6 | 21.3 |
| LnGrp LOS | E | D | | D | E | | E | C | B | C | C | C |
| Approach Vol, veh/h | | 569 | A | | 117 | A | | 2052 | | | 1398 | |
| Approach Delay, s/veh | | 62.7 | | | 57.8 | | | 30.9 | | | 26.3 | |
| Approach LOS | | E | | | E | | | C | | | C | |
| Timer - Assigned Phs | 1 | 2 | 3 | 4 | 5 | 6 | 7 | 8 | | | | |
| Phs Duration (G+Y+Rc), s | 13.8 | 73.7 | 10.9 | 21.6 | 25.0 | 62.5 | 18.0 | 14.5 | | | | |
| Change Period (Y+Rc), s | 8.5 | 7.5 | 7.5 | 6.5 | 7.5 | 7.5 | 7.5 | 6.5 | | | | |
| Max Green Setting (Gmax), s | 9.5 | 54.5 | 10.5 | 15.5 | 17.5 | 47.5 | 10.5 | 15.5 | | | | |
| Max Q Clear Time (g_c+I1), s | 5.4 | 42.2 | 4.1 | 10.9 | 18.3 | 30.8 | 12.5 | 7.2 | | | | |
| Green Ext Time (p_c), s | 0.1 | 7.8 | 0.0 | 0.2 | 0.0 | 7.0 | 0.0 | 0.2 | | | | |

Intersection Summary

| | |
|--------------------|------|
| HCM 6th Ctrl Delay | 34.5 |
| HCM 6th LOS | C |

Notes

User approved pedestrian interval to be less than phase max green.

Unsignalized Delay for [EBR, WBR] is excluded from calculations of the approach delay and intersection delay.

Timings
3: MERIDIAN ROAD & BENT GRASS MEADOWS DRIVE

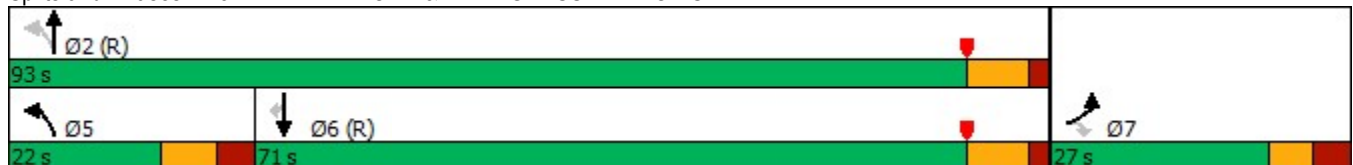


| Lane Group | EBL | EBR | NBL | NBT | SBT | SBR |
|----------------------|-------|-------|-------|-------|-------|-------|
| Lane Configurations | ↖↖ | ↗ | ↖ | ↑↑ | ↑↑ | ↗ |
| Traffic Volume (vph) | 102 | 135 | 141 | 1651 | 1045 | 135 |
| Future Volume (vph) | 102 | 135 | 141 | 1651 | 1045 | 135 |
| Turn Type | Prot | Perm | pm+pt | NA | NA | Perm |
| Protected Phases | 7 | | 5 | 2 | 6 | |
| Permitted Phases | | 7 | 2 | | | 6 |
| Detector Phase | 7 | 7 | 5 | 2 | 6 | 6 |
| Switch Phase | | | | | | |
| Minimum Initial (s) | 8.0 | 8.0 | 5.0 | 15.0 | 15.0 | 15.0 |
| Minimum Split (s) | 25.5 | 25.5 | 13.5 | 25.5 | 25.5 | 25.5 |
| Total Split (s) | 27.0 | 27.0 | 22.0 | 93.0 | 71.0 | 71.0 |
| Total Split (%) | 22.5% | 22.5% | 18.3% | 77.5% | 59.2% | 59.2% |
| Yellow Time (s) | 4.0 | 4.0 | 5.0 | 5.5 | 5.5 | 5.5 |
| All-Red Time (s) | 3.5 | 3.5 | 3.5 | 2.0 | 2.0 | 2.0 |
| Lost Time Adjust (s) | 0.0 | 0.0 | 0.0 | 0.0 | 0.0 | 0.0 |
| Total Lost Time (s) | 7.5 | 7.5 | 8.5 | 7.5 | 7.5 | 7.5 |
| Lead/Lag | | | Lead | | Lag | Lag |
| Lead-Lag Optimize? | | | Yes | | Yes | Yes |
| Recall Mode | None | None | None | C-Max | C-Max | C-Max |
| Act Effct Green (s) | 9.9 | 9.9 | 94.1 | 95.1 | 78.7 | 78.7 |
| Actuated g/C Ratio | 0.08 | 0.08 | 0.78 | 0.79 | 0.66 | 0.66 |
| v/c Ratio | 0.42 | 0.58 | 0.39 | 0.62 | 0.48 | 0.13 |
| Control Delay | 56.6 | 16.6 | 5.5 | 4.4 | 11.6 | 1.7 |
| Queue Delay | 0.0 | 0.0 | 0.0 | 0.0 | 0.0 | 0.0 |
| Total Delay | 56.6 | 16.6 | 5.5 | 4.4 | 11.6 | 1.7 |
| LOS | E | B | A | A | B | A |
| Approach Delay | 33.8 | | | 4.5 | 10.4 | |
| Approach LOS | C | | | A | B | |

Intersection Summary

Cycle Length: 120
 Actuated Cycle Length: 120
 Offset: 27 (23%), Referenced to phase 2:NBTL and 6:SBT, Start of Yellow
 Natural Cycle: 75
 Control Type: Actuated-Coordinated
 Maximum v/c Ratio: 0.62
 Intersection Signal Delay: 9.0
 Intersection Capacity Utilization 64.8%
 Analysis Period (min) 15
 Intersection LOS: A
 ICU Level of Service C

Splits and Phases: 3: MERIDIAN ROAD & BENT GRASS MEADOWS DRIVE



3: MERIDIAN ROAD & BENT GRASS MEADOWS DRIVE

04/15/2023



| Lane Group | EBL | EBR | NBL | NBT | SBT | SBR |
|-------------------------|------|------|------|------|------|------|
| Lane Group Flow (vph) | 120 | 159 | 148 | 1738 | 1112 | 144 |
| v/c Ratio | 0.42 | 0.58 | 0.39 | 0.62 | 0.48 | 0.13 |
| Control Delay | 56.6 | 16.6 | 5.5 | 4.4 | 11.6 | 1.7 |
| Queue Delay | 0.0 | 0.0 | 0.0 | 0.0 | 0.0 | 0.0 |
| Total Delay | 56.6 | 16.6 | 5.5 | 4.4 | 11.6 | 1.7 |
| Queue Length 50th (ft) | 46 | 0 | 22 | 136 | 207 | 0 |
| Queue Length 95th (ft) | 71 | 54 | m26 | 167 | 291 | 24 |
| Internal Link Dist (ft) | 310 | | | 750 | 1921 | |
| Turn Bay Length (ft) | 150 | | 700 | | | 350 |
| Base Capacity (vph) | 557 | 390 | 442 | 2804 | 2320 | 1087 |
| Starvation Cap Reductn | 0 | 0 | 0 | 0 | 0 | 0 |
| Spillback Cap Reductn | 0 | 0 | 0 | 0 | 0 | 0 |
| Storage Cap Reductn | 0 | 0 | 0 | 0 | 0 | 0 |
| Reduced v/c Ratio | 0.22 | 0.41 | 0.33 | 0.62 | 0.48 | 0.13 |

Intersection Summary

m Volume for 95th percentile queue is metered by upstream signal.

HCM 6th Signalized Intersection Summary
 3: MERIDIAN ROAD & BENT GRASS MEADOWS DRIVE

Background 2024 PM
 04/15/2023



| Movement | EBL | EBR | NBL | NBT | SBT | SBR |
|------------------------------|------|-------|------|------|------|------|
| Lane Configurations | ↖↗ | ↗ | ↖ | ↑↑ | ↑↑ | ↗ |
| Traffic Volume (veh/h) | 102 | 135 | 141 | 1651 | 1045 | 135 |
| Future Volume (veh/h) | 102 | 135 | 141 | 1651 | 1045 | 135 |
| Initial Q (Qb), veh | 0 | 0 | 0 | 0 | 0 | 0 |
| Ped-Bike Adj(A_pbT) | 1.00 | 1.00 | 1.00 | | | 1.00 |
| Parking Bus, Adj | 1.00 | 1.00 | 1.00 | 1.00 | 1.00 | 1.00 |
| Work Zone On Approach | No | | | No | No | |
| Adj Sat Flow, veh/h/ln | 1870 | 1870 | 1870 | 1870 | 1870 | 1870 |
| Adj Flow Rate, veh/h | 120 | 0 | 148 | 1738 | 1112 | 144 |
| Peak Hour Factor | 0.85 | 0.85 | 0.95 | 0.95 | 0.94 | 0.94 |
| Percent Heavy Veh, % | 2 | 2 | 2 | 2 | 2 | 2 |
| Cap, veh/h | 226 | | 381 | 2877 | 2478 | 1105 |
| Arrive On Green | 0.07 | 0.00 | 0.04 | 0.81 | 0.70 | 0.70 |
| Sat Flow, veh/h | 3456 | 1585 | 1781 | 3647 | 3647 | 1585 |
| Grp Volume(v), veh/h | 120 | 0 | 148 | 1738 | 1112 | 144 |
| Grp Sat Flow(s),veh/h/ln | 1728 | 1585 | 1781 | 1777 | 1777 | 1585 |
| Q Serve(g_s), s | 4.0 | 0.0 | 2.7 | 21.9 | 16.5 | 3.6 |
| Cycle Q Clear(g_c), s | 4.0 | 0.0 | 2.7 | 21.9 | 16.5 | 3.6 |
| Prop In Lane | 1.00 | 1.00 | 1.00 | | | 1.00 |
| Lane Grp Cap(c), veh/h | 226 | | 381 | 2877 | 2478 | 1105 |
| V/C Ratio(X) | 0.53 | | 0.39 | 0.60 | 0.45 | 0.13 |
| Avail Cap(c_a), veh/h | 562 | | 508 | 2877 | 2478 | 1105 |
| HCM Platoon Ratio | 1.00 | 1.00 | 1.00 | 1.00 | 1.00 | 1.00 |
| Upstream Filter(l) | 1.00 | 0.00 | 1.00 | 1.00 | 1.00 | 1.00 |
| Uniform Delay (d), s/veh | 54.3 | 0.0 | 6.1 | 4.3 | 8.0 | 6.0 |
| Incr Delay (d2), s/veh | 1.9 | 0.0 | 0.6 | 0.9 | 0.6 | 0.2 |
| Initial Q Delay(d3),s/veh | 0.0 | 0.0 | 0.0 | 0.0 | 0.0 | 0.0 |
| %ile BackOfQ(50%),veh/ln | 1.8 | 0.0 | 0.9 | 6.3 | 6.0 | 6.3 |
| Unsig. Movement Delay, s/veh | | | | | | |
| LnGrp Delay(d),s/veh | 56.2 | 0.0 | 6.7 | 5.2 | 8.6 | 6.3 |
| LnGrp LOS | E | | A | A | A | A |
| Approach Vol, veh/h | 120 | A | | 1886 | 1256 | |
| Approach Delay, s/veh | 56.2 | | | 5.3 | 8.3 | |
| Approach LOS | E | | | A | A | |
| Timer - Assigned Phs | | 2 | | 4 | 5 | 6 |
| Phs Duration (G+Y+Rc), s | | 104.6 | | 15.4 | 13.5 | 91.2 |
| Change Period (Y+Rc), s | | 7.5 | | 7.5 | 8.5 | 7.5 |
| Max Green Setting (Gmax), s | | 85.5 | | 19.5 | 13.5 | 63.5 |
| Max Q Clear Time (g_c+I1), s | | 23.9 | | 6.0 | 4.7 | 18.5 |
| Green Ext Time (p_c), s | | 25.3 | | 0.3 | 0.2 | 11.7 |

Intersection Summary

| | |
|--------------------|-----|
| HCM 6th Ctrl Delay | 8.4 |
| HCM 6th LOS | A |

Notes

Unsignalized Delay for [EBR] is excluded from calculations of the approach delay and intersection delay.

| Intersection | | | | | | |
|--------------------------|------|------|------|------|------|------|
| Int Delay, s/veh | 3.6 | | | | | |
| Movement | EBT | EBR | WBL | WBT | NBL | NBR |
| Lane Configurations | ↑ | ↗ | ↘ | ↑ | ↘ | |
| Traffic Vol, veh/h | 123 | 42 | 109 | 166 | 2 | 114 |
| Future Vol, veh/h | 123 | 42 | 109 | 166 | 2 | 114 |
| Conflicting Peds, #/hr | 0 | 0 | 0 | 0 | 0 | 0 |
| Sign Control | Free | Free | Free | Free | Stop | Stop |
| RT Channelized | - | None | - | None | - | None |
| Storage Length | - | 150 | 100 | - | 0 | - |
| Veh in Median Storage, # | 0 | - | - | 0 | 0 | - |
| Grade, % | 0 | - | - | 0 | 0 | - |
| Peak Hour Factor | 85 | 85 | 85 | 85 | 85 | 85 |
| Heavy Vehicles, % | 2 | 2 | 2 | 2 | 2 | 2 |
| Mvmt Flow | 145 | 49 | 128 | 195 | 2 | 134 |

| Major/Minor | Major1 | Major2 | Minor1 | | |
|----------------------|--------|--------|--------|---|-------|
| Conflicting Flow All | 0 | 0 | 194 | 0 | 596 |
| Stage 1 | - | - | - | - | 145 |
| Stage 2 | - | - | - | - | 451 |
| Critical Hdwy | - | - | 4.12 | - | 6.42 |
| Critical Hdwy Stg 1 | - | - | - | - | 5.42 |
| Critical Hdwy Stg 2 | - | - | - | - | 5.42 |
| Follow-up Hdwy | - | - | 2.218 | - | 3.518 |
| Pot Cap-1 Maneuver | - | - | 1379 | - | 466 |
| Stage 1 | - | - | - | - | 882 |
| Stage 2 | - | - | - | - | 642 |
| Platoon blocked, % | - | - | - | - | - |
| Mov Cap-1 Maneuver | - | - | 1379 | - | 423 |
| Mov Cap-2 Maneuver | - | - | - | - | 423 |
| Stage 1 | - | - | - | - | 882 |
| Stage 2 | - | - | - | - | 582 |

| Approach | EB | WB | NB |
|----------------------|----|-----|-----|
| HCM Control Delay, s | 0 | 3.1 | 9.8 |
| HCM LOS | | | A |

| Minor Lane/Major Mvmt | NBLn1 | EBT | EBR | WBL | WBT |
|-----------------------|-------|-----|-----|-------|-----|
| Capacity (veh/h) | 885 | - | - | 1379 | - |
| HCM Lane V/C Ratio | 0.154 | - | - | 0.093 | - |
| HCM Control Delay (s) | 9.8 | - | - | 7.9 | - |
| HCM Lane LOS | A | - | - | A | - |
| HCM 95th %tile Q(veh) | 0.5 | - | - | 0.3 | - |

Timings
1: MERIDIAN ROAD & WOODMAN ROAD

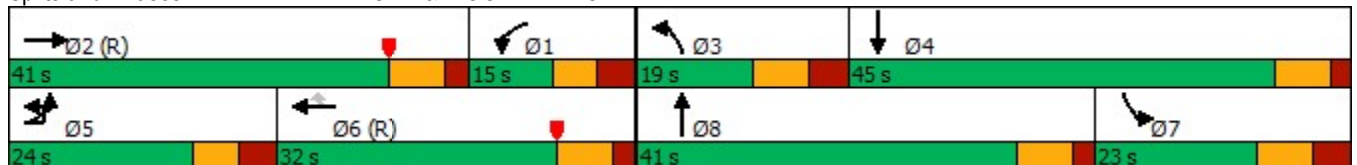
Background 2040 AM
04/01/2023

| Lane Group | EBL | EBT | EBR | WBL | WBT | WBR | NBL | NBT | NBR | SBL | SBT | SBR |
|----------------------|-------|-------|-------|-------|-------|-------|-------|-------|-------|-------|-------|-------|
| Lane Configurations | | | | | | | | | | | | |
| Traffic Volume (vph) | 368 | 321 | 167 | 84 | 564 | 158 | 227 | 386 | 24 | 226 | 977 | 1007 |
| Future Volume (vph) | 368 | 321 | 167 | 84 | 564 | 158 | 227 | 386 | 24 | 226 | 977 | 1007 |
| Turn Type | Prot | NA | Free | Prot | NA | Perm | Prot | NA | Free | Prot | NA | Free |
| Protected Phases | 5 | 2 | | 1 | 6 | | 3 | 8 | | 7 | 4 | |
| Permitted Phases | | | Free | | | 6 | | | Free | | | Free |
| Detector Phase | 5 | 2 | | 1 | 6 | 6 | 3 | 8 | | 7 | 4 | |
| Switch Phase | | | | | | | | | | | | |
| Minimum Initial (s) | 5.0 | 15.0 | | 5.0 | 15.0 | 15.0 | 5.0 | 15.0 | | 5.0 | 15.0 | |
| Minimum Split (s) | 13.5 | 22.0 | | 13.5 | 22.0 | 22.0 | 13.5 | 22.0 | | 13.5 | 22.0 | |
| Total Split (s) | 24.0 | 41.0 | | 15.0 | 32.0 | 32.0 | 19.0 | 41.0 | | 23.0 | 45.0 | |
| Total Split (%) | 20.0% | 34.2% | | 12.5% | 26.7% | 26.7% | 15.8% | 34.2% | | 19.2% | 37.5% | |
| Yellow Time (s) | 4.0 | 5.0 | | 4.0 | 5.0 | 5.0 | 5.0 | 5.0 | | 5.0 | 5.0 | |
| All-Red Time (s) | 3.5 | 2.0 | | 3.5 | 2.0 | 2.0 | 3.5 | 2.0 | | 3.5 | 2.0 | |
| Lost Time Adjust (s) | 0.0 | 0.0 | | 0.0 | 0.0 | 0.0 | 0.0 | 0.0 | | 0.0 | 0.0 | |
| Total Lost Time (s) | 7.5 | 7.0 | | 7.5 | 7.0 | 7.0 | 8.5 | 7.0 | | 8.5 | 7.0 | |
| Lead/Lag | Lead | Lead | | Lag | Lag | Lag | Lead | Lead | | Lag | Lag | |
| Lead-Lag Optimize? | Yes | Yes | | Yes | Yes | Yes | Yes | Yes | | Yes | Yes | |
| Recall Mode | None | C-Max | | None | C-Max | C-Max | None | None | | None | None | |
| Act Effct Green (s) | 16.2 | 34.6 | 120.0 | 7.5 | 25.9 | 25.9 | 10.5 | 19.4 | 120.0 | 28.5 | 37.5 | 120.0 |
| Actuated g/C Ratio | 0.14 | 0.29 | 1.00 | 0.06 | 0.22 | 0.22 | 0.09 | 0.16 | 1.00 | 0.24 | 0.31 | 1.00 |
| v/c Ratio | 0.86 | 0.33 | 0.11 | 0.41 | 0.78 | 0.31 | 0.80 | 0.71 | 0.02 | 0.29 | 0.93 | 0.67 |
| Control Delay | 69.7 | 34.9 | 0.1 | 60.2 | 52.7 | 1.4 | 73.8 | 54.5 | 0.0 | 40.2 | 46.4 | 5.9 |
| Queue Delay | 0.0 | 0.0 | 0.0 | 0.0 | 0.0 | 0.0 | 0.0 | 0.0 | 0.0 | 0.0 | 0.0 | 0.0 |
| Total Delay | 69.7 | 34.9 | 0.1 | 60.2 | 52.7 | 1.4 | 73.8 | 54.5 | 0.0 | 40.2 | 46.4 | 5.9 |
| LOS | E | C | A | E | D | A | E | D | A | D | D | A |
| Approach Delay | | 43.4 | | | 43.4 | | | 59.3 | | | 27.3 | |
| Approach LOS | | D | | | D | | | E | | | C | |

Intersection Summary

Cycle Length: 120
 Actuated Cycle Length: 120
 Offset: 30 (25%), Referenced to phase 2:EBT and 6:WBT, Start of Yellow
 Natural Cycle: 90
 Control Type: Actuated-Coordinated
 Maximum v/c Ratio: 0.93
 Intersection Signal Delay: 37.8
 Intersection LOS: D
 Intersection Capacity Utilization 84.9%
 ICU Level of Service E
 Analysis Period (min) 15

Splits and Phases: 1: MERIDIAN ROAD & WOODMAN ROAD



Queues
1: MERIDIAN ROAD & WOODMAN ROAD

Background 2040 AM
04/01/2023



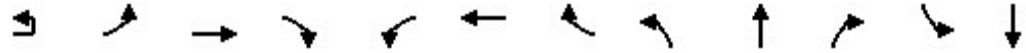
| Lane Group | EBL | EBT | EBR | WBL | WBT | WBR | NBL | NBT | NBR | SBL | SBT | SBR |
|-------------------------|------|------|------|------|------|------|------|------|------|------|------|------|
| Lane Group Flow (vph) | 398 | 338 | 176 | 88 | 594 | 166 | 239 | 406 | 25 | 238 | 1028 | 1060 |
| v/c Ratio | 0.86 | 0.33 | 0.11 | 0.41 | 0.78 | 0.31 | 0.80 | 0.71 | 0.02 | 0.29 | 0.93 | 0.67 |
| Control Delay | 69.7 | 34.9 | 0.1 | 60.2 | 52.7 | 1.4 | 73.8 | 54.5 | 0.0 | 40.2 | 46.4 | 5.9 |
| Queue Delay | 0.0 | 0.0 | 0.0 | 0.0 | 0.0 | 0.0 | 0.0 | 0.0 | 0.0 | 0.0 | 0.0 | 0.0 |
| Total Delay | 69.7 | 34.9 | 0.1 | 60.2 | 52.7 | 1.4 | 73.8 | 54.5 | 0.0 | 40.2 | 46.4 | 5.9 |
| Queue Length 50th (ft) | 157 | 109 | 0 | 34 | 232 | 0 | 95 | 158 | 0 | 93 | 447 | 115 |
| Queue Length 95th (ft) | #236 | 152 | 0 | 62 | 300 | 0 | #157 | 203 | 0 | m90 | m423 | m61 |
| Internal Link Dist (ft) | | 1165 | | | 1100 | | | 342 | | | 860 | |
| Turn Bay Length (ft) | 500 | | 630 | 350 | | 250 | 440 | | 330 | 490 | | 450 |
| Base Capacity (vph) | 472 | 1019 | 1583 | 214 | 764 | 544 | 300 | 1002 | 1583 | 815 | 1120 | 1583 |
| Starvation Cap Reductn | 0 | 0 | 0 | 0 | 0 | 0 | 0 | 0 | 0 | 0 | 0 | 0 |
| Spillback Cap Reductn | 0 | 0 | 0 | 0 | 0 | 0 | 0 | 0 | 0 | 0 | 0 | 0 |
| Storage Cap Reductn | 0 | 0 | 0 | 0 | 0 | 0 | 0 | 0 | 0 | 0 | 0 | 0 |
| Reduced v/c Ratio | 0.84 | 0.33 | 0.11 | 0.41 | 0.78 | 0.31 | 0.80 | 0.41 | 0.02 | 0.29 | 0.92 | 0.67 |

Intersection Summary

- # 95th percentile volume exceeds capacity, queue may be longer.
Queue shown is maximum after two cycles.
- m Volume for 95th percentile queue is metered by upstream signal.

HCM 6th Signalized Intersection Summary
1: MERIDIAN ROAD & WOODMAN ROAD

Background 2040 AM
04/01/2023



| Movement | EBU | EBL | EBT | EBR | WBL | WBT | WBR | NBL | NBT | NBR | SBL | SBT |
|------------------------------|------|------|------|-------|------|-------|------|------|------|------|------|------|
| Lane Configurations | | ↔↔ | ↕↕ | ↔ | ↔↔ | ↕↕ | ↔ | ↔↔ | ↕↕ | ↔ | ↔↔ | ↕↕ |
| Traffic Volume (veh/h) | 10 | 368 | 321 | 167 | 84 | 564 | 158 | 227 | 386 | 24 | 226 | 977 |
| Future Volume (veh/h) | 10 | 368 | 321 | 167 | 84 | 564 | 158 | 227 | 386 | 24 | 226 | 977 |
| Initial Q (Qb), veh | | 0 | 0 | 0 | 0 | 0 | 0 | 0 | 0 | 0 | 0 | 0 |
| Ped-Bike Adj(A_pbT) | | 1.00 | | 1.00 | 1.00 | | 1.00 | 1.00 | | 1.00 | 1.00 | |
| Parking Bus, Adj | | 1.00 | 1.00 | 1.00 | 1.00 | 1.00 | 1.00 | 1.00 | 1.00 | 1.00 | 1.00 | 1.00 |
| Work Zone On Approach | | | No | | | No | | | No | | | No |
| Adj Sat Flow, veh/h/ln | | 1870 | 1870 | 1870 | 1870 | 1870 | 1870 | 1870 | 1870 | 1870 | 1870 | 1870 |
| Adj Flow Rate, veh/h | | 387 | 338 | 0 | 88 | 594 | 0 | 239 | 406 | 0 | 238 | 1028 |
| Peak Hour Factor | | 0.95 | 0.95 | 0.95 | 0.95 | 0.95 | 0.95 | 0.95 | 0.95 | 0.95 | 0.95 | 0.95 |
| Percent Heavy Veh, % | | 2 | 2 | 2 | 2 | 2 | 2 | 2 | 2 | 2 | 2 | 2 |
| Cap, veh/h | | 443 | 1007 | | 206 | 748 | | 293 | 522 | | 899 | 1100 |
| Arrive On Green | | 0.13 | 0.28 | 0.00 | 0.06 | 0.21 | 0.00 | 0.08 | 0.15 | 0.00 | 0.26 | 0.31 |
| Sat Flow, veh/h | | 3456 | 3554 | 1585 | 3456 | 3554 | 1585 | 3456 | 3554 | 1585 | 3456 | 3554 |
| Grp Volume(v), veh/h | | 387 | 338 | 0 | 88 | 594 | 0 | 239 | 406 | 0 | 238 | 1028 |
| Grp Sat Flow(s),veh/h/ln | | 1728 | 1777 | 1585 | 1728 | 1777 | 1585 | 1728 | 1777 | 1585 | 1728 | 1777 |
| Q Serve(g_s), s | | 13.2 | 9.0 | 0.0 | 2.9 | 19.0 | 0.0 | 8.2 | 13.2 | 0.0 | 6.6 | 33.7 |
| Cycle Q Clear(g_c), s | | 13.2 | 9.0 | 0.0 | 2.9 | 19.0 | 0.0 | 8.2 | 13.2 | 0.0 | 6.6 | 33.7 |
| Prop In Lane | | 1.00 | | 1.00 | 1.00 | | 1.00 | 1.00 | | 1.00 | 1.00 | |
| Lane Grp Cap(c), veh/h | | 443 | 1007 | | 206 | 748 | | 293 | 522 | | 899 | 1100 |
| V/C Ratio(X) | | 0.87 | 0.34 | | 0.43 | 0.79 | | 0.81 | 0.78 | | 0.26 | 0.93 |
| Avail Cap(c_a), veh/h | | 475 | 1007 | | 216 | 748 | | 302 | 1007 | | 899 | 1125 |
| HCM Platoon Ratio | | 1.00 | 1.00 | 1.00 | 1.00 | 1.00 | 1.00 | 1.00 | 1.00 | 1.00 | 1.00 | 1.00 |
| Upstream Filter(I) | | 1.00 | 1.00 | 0.00 | 1.00 | 1.00 | 0.00 | 1.00 | 1.00 | 0.00 | 1.00 | 1.00 |
| Uniform Delay (d), s/veh | | 51.3 | 34.1 | 0.0 | 54.4 | 44.9 | 0.0 | 54.0 | 49.3 | 0.0 | 35.3 | 40.2 |
| Incr Delay (d2), s/veh | | 15.5 | 0.9 | 0.0 | 1.4 | 8.5 | 0.0 | 15.3 | 2.5 | 0.0 | 0.2 | 13.7 |
| Initial Q Delay(d3),s/veh | | 0.0 | 0.0 | 0.0 | 0.0 | 0.0 | 0.0 | 0.0 | 0.0 | 0.0 | 0.0 | 0.0 |
| %ile BackOfQ(50%),veh/ln | | 6.5 | 3.9 | 0.0 | 1.3 | 9.0 | 0.0 | 4.1 | 6.0 | 0.0 | 2.8 | 16.5 |
| Unsig. Movement Delay, s/veh | | | | | | | | | | | | |
| LnGrp Delay(d),s/veh | | 66.9 | 35.0 | 0.0 | 55.8 | 53.4 | 0.0 | 69.3 | 51.9 | 0.0 | 35.4 | 54.0 |
| LnGrp LOS | | E | C | | E | D | | E | D | | D | D |
| Approach Vol, veh/h | | | 725 | A | | 682 | A | | 645 | A | | 1266 |
| Approach Delay, s/veh | | | 52.0 | | | 53.7 | | | 58.3 | | | 50.5 |
| Approach LOS | | | D | | | D | | | E | | | D |
| Timer - Assigned Phs | 1 | 2 | 3 | 4 | 5 | 6 | 7 | 8 | | | | |
| Phs Duration (G+Y+Rc), s | 14.7 | 41.0 | 18.7 | 45.7 | 22.9 | 32.8 | 39.7 | 24.6 | | | | |
| Change Period (Y+Rc), s | 7.5 | 7.0 | 8.5 | * 8.5 | 7.5 | * 7.5 | 8.5 | 7.0 | | | | |
| Max Green Setting (Gmax), s | 7.5 | 34.0 | 10.5 | * 38 | 16.5 | * 25 | 14.5 | 34.0 | | | | |
| Max Q Clear Time (g_c+I1), s | 4.9 | 11.0 | 10.2 | 35.7 | 15.2 | 21.0 | 8.6 | 15.2 | | | | |
| Green Ext Time (p_c), s | 0.0 | 1.9 | 0.0 | 1.4 | 0.2 | 1.3 | 0.4 | 2.4 | | | | |

Intersection Summary

| | |
|--------------------|------|
| HCM 6th Ctrl Delay | 53.0 |
| HCM 6th LOS | D |

Notes

- User approved pedestrian interval to be less than phase max green.
- User approved ignoring U-Turning movement.
- * HCM 6th computational engine requires equal clearance times for the phases crossing the barrier.

| | |
|---|------|
| Movement | SBR |
| Lane Configurations | |
| Traffic Volume (veh/h) | 1007 |
| Future Volume (veh/h) | 1007 |
| Initial Q (Qb), veh | 0 |
| Ped-Bike Adj(A_pbT) | 1.00 |
| Parking Bus, Adj | 1.00 |
| Work Zone On Approach | |
| Adj Sat Flow, veh/h/ln | 1870 |
| Adj Flow Rate, veh/h | 0 |
| Peak Hour Factor | 0.95 |
| Percent Heavy Veh, % | 2 |
| Cap, veh/h | |
| Arrive On Green | 0.00 |
| Sat Flow, veh/h | 1585 |
| Grp Volume(v), veh/h | 0 |
| Grp Sat Flow(s),veh/h/ln | 1585 |
| Q Serve(g_s), s | 0.0 |
| Cycle Q Clear(g_c), s | 0.0 |
| Prop In Lane | 1.00 |
| Lane Grp Cap(c), veh/h | |
| V/C Ratio(X) | |
| Avail Cap(c_a), veh/h | |
| HCM Platoon Ratio | 1.00 |
| Upstream Filter(l) | 0.00 |
| Uniform Delay (d), s/veh | 0.0 |
| Incr Delay (d2), s/veh | 0.0 |
| Initial Q Delay(d3),s/veh | 0.0 |
| %ile BackOfQ(50%),veh/ln | 0.0 |
| Unsig. Movement Delay, s/veh | |
| LnGrp Delay(d),s/veh | 0.0 |
| LnGrp LOS | |
| Approach Vol, veh/h | A |
| Approach Delay, s/veh | |
| Approach LOS | |
| Timer - Assigned Phs | |
| Unsignalized Delay for [NBR, EBR, WBR, SBR] is excluded from calculations of the approach delay and intersection delay. | |

Timings
2: MERIDIAN ROAD & EASTONVILLE ROAD

Background AM 2040

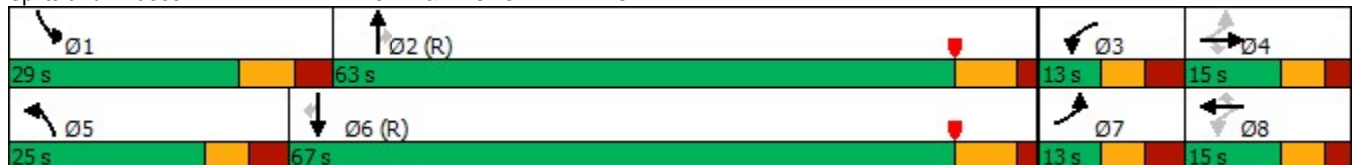
04/01/2023

| Lane Group | EBL | EBT | EBR | WBL | WBT | WBR | NBL | NBT | NBR | SBL | SBT | SBR |
|----------------------|-------|-------|-------|-------|-------|-------|-------|-------|-------|-------|-------|-------|
| Lane Configurations | | | | | | | | | | | | |
| Traffic Volume (vph) | 215 | 61 | 259 | 137 | 71 | 51 | 288 | 622 | 57 | 157 | 1846 | 181 |
| Future Volume (vph) | 215 | 61 | 259 | 137 | 71 | 51 | 288 | 622 | 57 | 157 | 1846 | 181 |
| Turn Type | pm+pt | NA | Perm | pm+pt | NA | Perm | Prot | NA | Perm | Prot | NA | Perm |
| Protected Phases | 7 | 4 | | 3 | 8 | | 5 | 2 | | 1 | 6 | |
| Permitted Phases | 4 | | 4 | 8 | | 8 | | | 2 | | | 6 |
| Detector Phase | 7 | 4 | 4 | 3 | 8 | 8 | 5 | 2 | 2 | 1 | 6 | 6 |
| Switch Phase | | | | | | | | | | | | |
| Minimum Initial (s) | 5.0 | 8.0 | 8.0 | 5.0 | 8.0 | 8.0 | 5.0 | 15.0 | 15.0 | 5.0 | 15.0 | 15.0 |
| Minimum Split (s) | 12.5 | 14.5 | 14.5 | 12.5 | 14.5 | 14.5 | 12.5 | 22.5 | 22.5 | 13.5 | 22.5 | 22.5 |
| Total Split (s) | 13.0 | 15.0 | 15.0 | 13.0 | 15.0 | 15.0 | 25.0 | 63.0 | 63.0 | 29.0 | 67.0 | 67.0 |
| Total Split (%) | 10.8% | 12.5% | 12.5% | 10.8% | 12.5% | 12.5% | 20.8% | 52.5% | 52.5% | 24.2% | 55.8% | 55.8% |
| Yellow Time (s) | 4.0 | 4.0 | 4.0 | 4.0 | 4.0 | 4.0 | 4.0 | 5.5 | 5.5 | 5.0 | 5.5 | 5.5 |
| All-Red Time (s) | 3.5 | 2.5 | 2.5 | 3.5 | 2.5 | 2.5 | 3.5 | 2.0 | 2.0 | 3.5 | 2.0 | 2.0 |
| Lost Time Adjust (s) | 0.0 | 0.0 | 0.0 | 0.0 | 0.0 | 0.0 | 0.0 | 0.0 | 0.0 | 0.0 | 0.0 | 0.0 |
| Total Lost Time (s) | 7.5 | 6.5 | 6.5 | 7.5 | 6.5 | 6.5 | 7.5 | 7.5 | 7.5 | 8.5 | 7.5 | 7.5 |
| Lead/Lag | Lead | Lag | Lag | Lead | Lag | Lag | Lead | Lag | Lag | Lead | Lag | Lag |
| Lead-Lag Optimize? | Yes | Yes | Yes | Yes | Yes | Yes | Yes | Yes | Yes | Yes | Yes | Yes |
| Recall Mode | None | None | None | None | None | None | None | C-Max | C-Max | None | C-Max | C-Max |
| Act Effct Green (s) | 14.4 | 8.4 | 8.4 | 11.5 | 8.4 | 8.4 | 17.6 | 60.1 | 60.1 | 16.0 | 59.5 | 59.5 |
| Actuated g/C Ratio | 0.12 | 0.07 | 0.07 | 0.10 | 0.07 | 0.07 | 0.15 | 0.50 | 0.50 | 0.13 | 0.50 | 0.50 |
| v/c Ratio | 0.68 | 0.49 | 0.78 | 0.98 | 0.58 | 0.20 | 1.17 | 0.37 | 0.07 | 0.70 | 1.11 | 0.22 |
| Control Delay | 58.2 | 67.2 | 24.9 | 118.5 | 72.2 | 1.6 | 140.7 | 15.4 | 2.3 | 70.5 | 74.0 | 1.3 |
| Queue Delay | 0.0 | 0.0 | 0.0 | 0.0 | 0.0 | 0.0 | 0.0 | 0.0 | 0.0 | 0.0 | 0.0 | 0.0 |
| Total Delay | 58.2 | 67.2 | 24.9 | 118.5 | 72.2 | 1.6 | 140.7 | 15.4 | 2.3 | 70.5 | 74.0 | 1.3 |
| LOS | E | E | C | F | E | A | F | B | A | E | E | A |
| Approach Delay | | 43.1 | | | 82.6 | | | 51.9 | | | 67.7 | |
| Approach LOS | | D | | | F | | | D | | | E | |

Intersection Summary

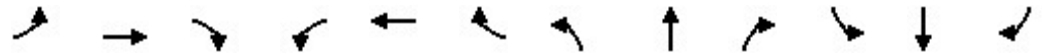
Cycle Length: 120
 Actuated Cycle Length: 120
 Offset: 45 (38%), Referenced to phase 2:NBT and 6:SBT, Start of Yellow
 Natural Cycle: 150
 Control Type: Actuated-Coordinated
 Maximum v/c Ratio: 1.17
 Intersection Signal Delay: 61.5
 Intersection Capacity Utilization 99.2%
 Analysis Period (min) 15
 Intersection LOS: E
 ICU Level of Service F

Splits and Phases: 2: MERIDIAN ROAD & EASTONVILLE ROAD



Queues
2: MERIDIAN ROAD & EASTONVILLE ROAD

Background AM 2040
04/01/2023



| Lane Group | EBL | EBT | EBR | WBL | WBT | WBR | NBL | NBT | NBR | SBL | SBT | SBR |
|-------------------------|------|------|------|-------|------|------|-------|------|------|------|--------|------|
| Lane Group Flow (vph) | 226 | 64 | 273 | 144 | 75 | 54 | 303 | 655 | 60 | 165 | 1943 | 191 |
| v/c Ratio | 0.68 | 0.49 | 0.78 | 0.98 | 0.58 | 0.20 | 1.17 | 0.37 | 0.07 | 0.70 | 1.11 | 0.22 |
| Control Delay | 58.2 | 67.2 | 24.9 | 118.5 | 72.2 | 1.6 | 140.7 | 15.4 | 2.3 | 70.5 | 74.0 | 1.3 |
| Queue Delay | 0.0 | 0.0 | 0.0 | 0.0 | 0.0 | 0.0 | 0.0 | 0.0 | 0.0 | 0.0 | 0.0 | 0.0 |
| Total Delay | 58.2 | 67.2 | 24.9 | 118.5 | 72.2 | 1.6 | 140.7 | 15.4 | 2.3 | 70.5 | 74.0 | 1.3 |
| Queue Length 50th (ft) | 80 | 49 | 13 | 102 | 57 | 0 | ~286 | 149 | 3 | 119 | ~933 | 11 |
| Queue Length 95th (ft) | #144 | 96 | #133 | #225 | #116 | 0 | m#431 | m184 | m10 | m127 | m#1066 | m13 |
| Internal Link Dist (ft) | | 508 | | | 1196 | | | 231 | | | 781 | |
| Turn Bay Length (ft) | 100 | | 100 | 120 | | 100 | 100 | | 400 | 375 | | 400 |
| Base Capacity (vph) | 330 | 131 | 349 | 147 | 131 | 276 | 259 | 1771 | 876 | 302 | 1754 | 880 |
| Starvation Cap Reductn | 0 | 0 | 0 | 0 | 0 | 0 | 0 | 0 | 0 | 0 | 0 | 0 |
| Spillback Cap Reductn | 0 | 0 | 0 | 0 | 0 | 0 | 0 | 0 | 0 | 0 | 0 | 0 |
| Storage Cap Reductn | 0 | 0 | 0 | 0 | 0 | 0 | 0 | 0 | 0 | 0 | 0 | 0 |
| Reduced v/c Ratio | 0.68 | 0.49 | 0.78 | 0.98 | 0.57 | 0.20 | 1.17 | 0.37 | 0.07 | 0.55 | 1.11 | 0.22 |

























Intersection Summary

- ~ Volume exceeds capacity, queue is theoretically infinite.
Queue shown is maximum after two cycles.
- # 95th percentile volume exceeds capacity, queue may be longer.
Queue shown is maximum after two cycles.
- m Volume for 95th percentile queue is metered by upstream signal.

HCM 6th Signalized Intersection Summary
 2: MERIDIAN ROAD & EASTONVILLE ROAD

Background AM 2040

04/01/2023

| |  |  |  |  |  |  |  |  |  |  |  |  |
|------------------------------|---|---|---|---|---|---|---|---|---|---|---|---|
| Movement | EBL | EBT | EBR | WBL | WBT | WBR | NBL | NBT | NBR | SBL | SBT | SBR |
| Lane Configurations |  |  |  |  |  |  |  |  |  |  |  |  |
| Traffic Volume (veh/h) | 215 | 61 | 259 | 137 | 71 | 51 | 288 | 622 | 57 | 157 | 1846 | 181 |
| Future Volume (veh/h) | 215 | 61 | 259 | 137 | 71 | 51 | 288 | 622 | 57 | 157 | 1846 | 181 |
| Initial Q (Qb), veh | 0 | 0 | 0 | 0 | 0 | 0 | 0 | 0 | 0 | 0 | 0 | 0 |
| Ped-Bike Adj(A_pbT) | 1.00 | | 1.00 | 1.00 | | 1.00 | 1.00 | | 1.00 | 1.00 | | 1.00 |
| Parking Bus, Adj | 1.00 | 1.00 | 1.00 | 1.00 | 1.00 | 1.00 | 1.00 | 1.00 | 1.00 | 1.00 | 1.00 | 1.00 |
| Work Zone On Approach | | No | | | No | | | No | | | No | |
| Adj Sat Flow, veh/h/ln | 1870 | 1870 | 1870 | 1870 | 1870 | 1870 | 1870 | 1870 | 1870 | 1870 | 1870 | 1870 |
| Adj Flow Rate, veh/h | 226 | 64 | 0 | 144 | 75 | 0 | 303 | 655 | 60 | 165 | 1943 | 191 |
| Peak Hour Factor | 0.95 | 0.95 | 0.95 | 0.95 | 0.95 | 0.95 | 0.95 | 0.95 | 0.95 | 0.95 | 0.95 | 0.95 |
| Percent Heavy Veh, % | 2 | 2 | 2 | 2 | 2 | 2 | 2 | 2 | 2 | 2 | 2 | 2 |
| Cap, veh/h | 350 | 125 | | 187 | 125 | | 260 | 1878 | 838 | 194 | 1777 | 793 |
| Arrive On Green | 0.05 | 0.07 | 0.00 | 0.05 | 0.07 | 0.00 | 0.15 | 0.53 | 0.53 | 0.11 | 0.50 | 0.50 |
| Sat Flow, veh/h | 3456 | 1870 | 1585 | 1781 | 1870 | 1585 | 1781 | 3554 | 1585 | 1781 | 3554 | 1585 |
| Grp Volume(v), veh/h | 226 | 64 | 0 | 144 | 75 | 0 | 303 | 655 | 60 | 165 | 1943 | 191 |
| Grp Sat Flow(s),veh/h/ln | 1728 | 1870 | 1585 | 1781 | 1870 | 1585 | 1781 | 1777 | 1585 | 1781 | 1777 | 1585 |
| Q Serve(g_s), s | 5.5 | 4.0 | 0.0 | 5.5 | 4.7 | 0.0 | 17.5 | 12.8 | 2.2 | 10.9 | 60.0 | 8.2 |
| Cycle Q Clear(g_c), s | 5.5 | 4.0 | 0.0 | 5.5 | 4.7 | 0.0 | 17.5 | 12.8 | 2.2 | 10.9 | 60.0 | 8.2 |
| Prop In Lane | 1.00 | | 1.00 | 1.00 | | 1.00 | 1.00 | | 1.00 | 1.00 | | 1.00 |
| Lane Grp Cap(c), veh/h | 350 | 125 | | 187 | 125 | | 260 | 1878 | 838 | 194 | 1777 | 793 |
| V/C Ratio(X) | 0.65 | 0.51 | | 0.77 | 0.60 | | 1.17 | 0.35 | 0.07 | 0.85 | 1.09 | 0.24 |
| Avail Cap(c_a), veh/h | 350 | 132 | | 187 | 132 | | 260 | 1878 | 838 | 304 | 1777 | 793 |
| HCM Platoon Ratio | 1.00 | 1.00 | 1.00 | 1.00 | 1.00 | 1.00 | 1.00 | 1.00 | 1.00 | 1.00 | 1.00 | 1.00 |
| Upstream Filter(l) | 1.00 | 1.00 | 0.00 | 1.00 | 1.00 | 0.00 | 1.00 | 1.00 | 1.00 | 1.00 | 1.00 | 1.00 |
| Uniform Delay (d), s/veh | 51.9 | 54.1 | 0.0 | 53.3 | 54.5 | 0.0 | 51.3 | 16.4 | 13.9 | 52.5 | 30.0 | 17.1 |
| Incr Delay (d2), s/veh | 4.1 | 3.2 | 0.0 | 17.8 | 6.7 | 0.0 | 108.4 | 0.5 | 0.2 | 12.5 | 51.7 | 0.7 |
| Initial Q Delay(d3),s/veh | 0.0 | 0.0 | 0.0 | 0.0 | 0.0 | 0.0 | 0.0 | 0.0 | 0.0 | 0.0 | 0.0 | 0.0 |
| %ile BackOfQ(50%),veh/ln | 1.0 | 2.0 | 0.0 | 2.6 | 2.4 | 0.0 | 15.3 | 4.8 | 0.8 | 5.3 | 35.3 | 3.1 |
| Unsig. Movement Delay, s/veh | | | | | | | | | | | | |
| LnGrp Delay(d),s/veh | 56.0 | 57.4 | 0.0 | 71.1 | 61.2 | 0.0 | 159.7 | 16.9 | 14.0 | 65.0 | 81.7 | 17.8 |
| LnGrp LOS | E | E | | E | E | | F | B | B | E | F | B |
| Approach Vol, veh/h | | 290 | A | | 219 | A | | 1018 | | | 2299 | |
| Approach Delay, s/veh | | 56.3 | | | 67.7 | | | 59.2 | | | 75.2 | |
| Approach LOS | | E | | | E | | | E | | | E | |
| Timer - Assigned Phs | 1 | 2 | 3 | 4 | 5 | 6 | 7 | 8 | | | | |
| Phs Duration (G+Y+Rc), s | 21.6 | 70.9 | 13.0 | 14.5 | 25.0 | 67.5 | 13.0 | 14.5 | | | | |
| Change Period (Y+Rc), s | 8.5 | 7.5 | 7.5 | 6.5 | 7.5 | 7.5 | 7.5 | 6.5 | | | | |
| Max Green Setting (Gmax), s | 20.5 | 55.5 | 5.5 | 8.5 | 17.5 | 59.5 | 5.5 | 8.5 | | | | |
| Max Q Clear Time (g_c+I1), s | 12.9 | 14.8 | 7.5 | 6.0 | 19.5 | 62.0 | 7.5 | 6.7 | | | | |
| Green Ext Time (p_c), s | 0.2 | 4.4 | 0.0 | 0.0 | 0.0 | 0.0 | 0.0 | 0.0 | | | | |

Intersection Summary

| | |
|--------------------|------|
| HCM 6th Ctrl Delay | 69.1 |
| HCM 6th LOS | E |

Notes

- User approved pedestrian interval to be less than phase max green.
- Unsignalized Delay for [EBR, WBR] is excluded from calculations of the approach delay and intersection delay.

Timings
3: MERIDIAN ROAD & BENT GRASS MEADOWS DRIVE

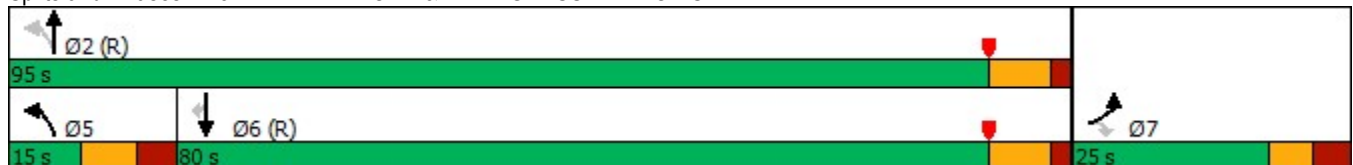


| Lane Group | EBL | EBR | NBL | NBT | SBT | SBR |
|----------------------|-------|-------|-------|-------|-------|-------|
| Lane Configurations | ↖↗ | ↗ | ↖ | ↑↑ | ↑↑ | ↗ |
| Traffic Volume (vph) | 109 | 215 | 136 | 700 | 1926 | 163 |
| Future Volume (vph) | 109 | 215 | 136 | 700 | 1926 | 163 |
| Turn Type | Prot | Perm | pm+pt | NA | NA | Perm |
| Protected Phases | 7 | | 5 | 2 | 6 | |
| Permitted Phases | | 7 | 2 | | | 6 |
| Detector Phase | 7 | 7 | 5 | 2 | 6 | 6 |
| Switch Phase | | | | | | |
| Minimum Initial (s) | 8.0 | 8.0 | 5.0 | 15.0 | 15.0 | 15.0 |
| Minimum Split (s) | 25.5 | 25.5 | 13.5 | 25.5 | 25.5 | 25.5 |
| Total Split (s) | 25.0 | 25.0 | 15.0 | 95.0 | 80.0 | 80.0 |
| Total Split (%) | 20.8% | 20.8% | 12.5% | 79.2% | 66.7% | 66.7% |
| Yellow Time (s) | 4.0 | 4.0 | 5.0 | 5.5 | 5.5 | 5.5 |
| All-Red Time (s) | 3.5 | 3.5 | 3.5 | 2.0 | 2.0 | 2.0 |
| Lost Time Adjust (s) | 0.0 | 0.0 | 0.0 | 0.0 | 0.0 | 0.0 |
| Total Lost Time (s) | 7.5 | 7.5 | 8.5 | 7.5 | 7.5 | 7.5 |
| Lead/Lag | | | Lead | | Lag | Lag |
| Lead-Lag Optimize? | | | Yes | | Yes | Yes |
| Recall Mode | None | None | None | C-Max | C-Max | C-Max |
| Act Effct Green (s) | 14.2 | 14.2 | 89.8 | 90.8 | 74.0 | 74.0 |
| Actuated g/C Ratio | 0.12 | 0.12 | 0.75 | 0.76 | 0.62 | 0.62 |
| v/c Ratio | 0.28 | 0.82 | 0.79 | 0.28 | 0.93 | 0.17 |
| Control Delay | 49.0 | 51.5 | 54.2 | 4.5 | 30.2 | 1.8 |
| Queue Delay | 0.0 | 0.0 | 0.0 | 0.0 | 0.0 | 0.0 |
| Total Delay | 49.0 | 51.5 | 54.2 | 4.5 | 30.2 | 1.8 |
| LOS | D | D | D | A | C | A |
| Approach Delay | 50.7 | | | 12.5 | 27.9 | |
| Approach LOS | D | | | B | C | |

Intersection Summary

Cycle Length: 120
 Actuated Cycle Length: 120
 Offset: 5 (4%), Referenced to phase 2:NBTL and 6:SBT, Start of Yellow
 Natural Cycle: 110
 Control Type: Actuated-Coordinated
 Maximum v/c Ratio: 0.93
 Intersection Signal Delay: 26.2
 Intersection Capacity Utilization 87.0%
 Analysis Period (min) 15
 Intersection LOS: C
 ICU Level of Service E

Splits and Phases: 3: MERIDIAN ROAD & BENT GRASS MEADOWS DRIVE



3: MERIDIAN ROAD & BENT GRASS MEADOWS DRIVE



| Lane Group | EBL | EBR | NBL | NBT | SBT | SBR |
|-------------------------|------|------|-------|------|------|------|
| Lane Group Flow (vph) | 115 | 226 | 143 | 737 | 2027 | 172 |
| v/c Ratio | 0.28 | 0.82 | 0.79 | 0.28 | 0.93 | 0.17 |
| Control Delay | 49.0 | 51.5 | 54.2 | 4.5 | 30.2 | 1.8 |
| Queue Delay | 0.0 | 0.0 | 0.0 | 0.0 | 0.0 | 0.0 |
| Total Delay | 49.0 | 51.5 | 54.2 | 4.5 | 30.2 | 1.8 |
| Queue Length 50th (ft) | 41 | 95 | 74 | 126 | 720 | 0 |
| Queue Length 95th (ft) | 70 | #198 | m#175 | 155 | #951 | 27 |
| Internal Link Dist (ft) | 310 | | | 750 | 1921 | |
| Turn Bay Length (ft) | 150 | | 700 | | | 350 |
| Base Capacity (vph) | 500 | 316 | 182 | 2677 | 2183 | 1042 |
| Starvation Cap Reductn | 0 | 0 | 0 | 0 | 0 | 0 |
| Spillback Cap Reductn | 0 | 0 | 0 | 0 | 0 | 0 |
| Storage Cap Reductn | 0 | 0 | 0 | 0 | 0 | 0 |
| Reduced v/c Ratio | 0.23 | 0.72 | 0.79 | 0.28 | 0.93 | 0.17 |

Intersection Summary

95th percentile volume exceeds capacity, queue may be longer.

Queue shown is maximum after two cycles.

m Volume for 95th percentile queue is metered by upstream signal.

HCM 6th Signalized Intersection Summary
 3: MERIDIAN ROAD & BENT GRASS MEADOWS DRIVE

Background 2040 AM
 04/01/2023



| Movement | EBL | EBR | NBL | NBT | SBT | SBR |
|------------------------------|------|-------|------|------|------|------|
| Lane Configurations | ↖↗ | ↗ | ↖ | ↑↑ | ↑↑ | ↗ |
| Traffic Volume (veh/h) | 109 | 215 | 136 | 700 | 1926 | 163 |
| Future Volume (veh/h) | 109 | 215 | 136 | 700 | 1926 | 163 |
| Initial Q (Qb), veh | 0 | 0 | 0 | 0 | 0 | 0 |
| Ped-Bike Adj(A_pbT) | 1.00 | 1.00 | 1.00 | | | 1.00 |
| Parking Bus, Adj | 1.00 | 1.00 | 1.00 | 1.00 | 1.00 | 1.00 |
| Work Zone On Approach | No | | | No | No | |
| Adj Sat Flow, veh/h/ln | 1870 | 1870 | 1870 | 1870 | 1870 | 1870 |
| Adj Flow Rate, veh/h | 115 | 0 | 143 | 737 | 2027 | 172 |
| Peak Hour Factor | 0.95 | 0.95 | 0.95 | 0.95 | 0.95 | 0.95 |
| Percent Heavy Veh, % | 2 | 2 | 2 | 2 | 2 | 2 |
| Cap, veh/h | 225 | | 186 | 2878 | 2479 | 1106 |
| Arrive On Green | 0.07 | 0.00 | 0.04 | 0.81 | 0.70 | 0.70 |
| Sat Flow, veh/h | 3456 | 1585 | 1781 | 3647 | 3647 | 1585 |
| Grp Volume(v), veh/h | 115 | 0 | 143 | 737 | 2027 | 172 |
| Grp Sat Flow(s),veh/h/ln | 1728 | 1585 | 1781 | 1777 | 1777 | 1585 |
| Q Serve(g_s), s | 3.9 | 0.0 | 2.6 | 6.0 | 48.2 | 4.4 |
| Cycle Q Clear(g_c), s | 3.9 | 0.0 | 2.6 | 6.0 | 48.2 | 4.4 |
| Prop In Lane | 1.00 | 1.00 | 1.00 | | | 1.00 |
| Lane Grp Cap(c), veh/h | 225 | | 186 | 2878 | 2479 | 1106 |
| V/C Ratio(X) | 0.51 | | 0.77 | 0.26 | 0.82 | 0.16 |
| Avail Cap(c_a), veh/h | 504 | | 209 | 2878 | 2479 | 1106 |
| HCM Platoon Ratio | 1.00 | 1.00 | 1.00 | 1.00 | 1.00 | 1.00 |
| Upstream Filter(I) | 1.00 | 0.00 | 1.00 | 1.00 | 1.00 | 1.00 |
| Uniform Delay (d), s/veh | 54.2 | 0.0 | 28.0 | 2.7 | 12.8 | 6.2 |
| Incr Delay (d2), s/veh | 1.8 | 0.0 | 14.3 | 0.2 | 3.1 | 0.3 |
| Initial Q Delay(d3),s/veh | 0.0 | 0.0 | 0.0 | 0.0 | 0.0 | 0.0 |
| %ile BackOfQ(50%),veh/ln | 1.7 | 0.0 | 3.7 | 1.7 | 18.0 | 7.6 |
| Unsig. Movement Delay, s/veh | | | | | | |
| LnGrp Delay(d),s/veh | 56.0 | 0.0 | 42.3 | 3.0 | 15.9 | 6.5 |
| LnGrp LOS | E | | D | A | B | A |
| Approach Vol, veh/h | 115 | A | | 880 | 2199 | |
| Approach Delay, s/veh | 56.0 | | | 9.3 | 15.2 | |
| Approach LOS | E | | | A | B | |
| Timer - Assigned Phs | | 2 | | 4 | 5 | 6 |
| Phs Duration (G+Y+Rc), s | | 104.7 | | 15.3 | 13.5 | 91.2 |
| Change Period (Y+Rc), s | | 7.5 | | 7.5 | 8.5 | 7.5 |
| Max Green Setting (Gmax), s | | 87.5 | | 17.5 | 6.5 | 72.5 |
| Max Q Clear Time (g_c+I1), s | | 8.0 | | 5.9 | 4.6 | 50.2 |
| Green Ext Time (p_c), s | | 6.2 | | 0.2 | 0.1 | 17.6 |
| Intersection Summary | | | | | | |
| HCM 6th Ctrl Delay | | | 15.0 | | | |
| HCM 6th LOS | | | B | | | |

Notes

Unsignalized Delay for [EBR] is excluded from calculations of the approach delay and intersection delay.

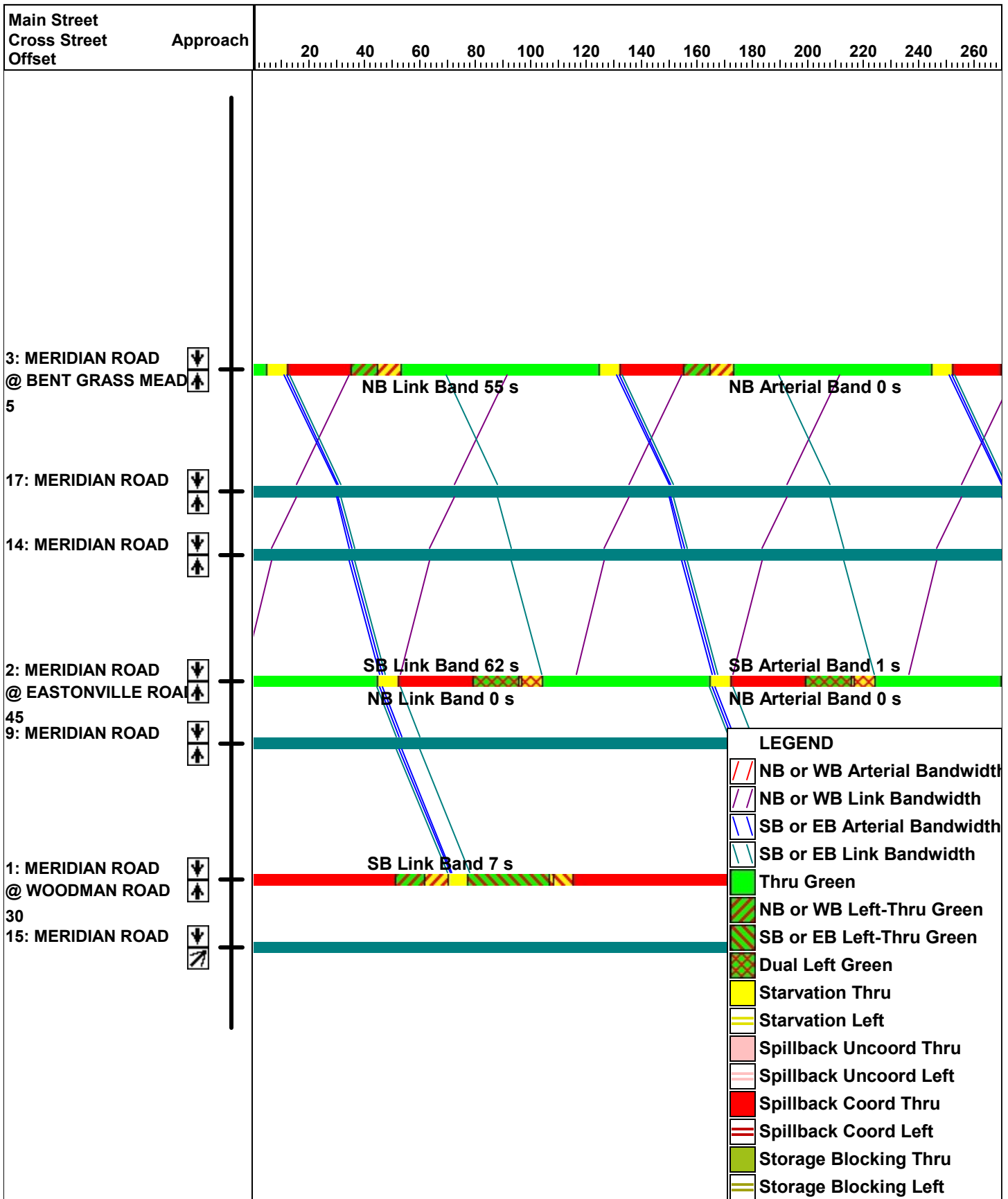
| Intersection | | | | | | |
|--------------------------|------|------|------|------|------|------|
| Int Delay, s/veh | 4.9 | | | | | |
| Movement | EBT | EBR | WBL | WBT | NBL | NBR |
| Lane Configurations | ↑ | ↗ | ↖ | ↑ | ↘ | ↙ |
| Traffic Vol, veh/h | 158 | 89 | 217 | 82 | 1 | 166 |
| Future Vol, veh/h | 158 | 89 | 217 | 82 | 1 | 166 |
| Conflicting Peds, #/hr | 0 | 0 | 0 | 0 | 0 | 0 |
| Sign Control | Free | Free | Free | Free | Stop | Stop |
| RT Channelized | - | None | - | None | - | None |
| Storage Length | - | 150 | 100 | - | 0 | - |
| Veh in Median Storage, # | 0 | - | - | 0 | 0 | - |
| Grade, % | 0 | - | - | 0 | 0 | - |
| Peak Hour Factor | 95 | 95 | 95 | 95 | 95 | 95 |
| Heavy Vehicles, % | 2 | 2 | 2 | 2 | 2 | 2 |
| Mvmt Flow | 166 | 94 | 228 | 86 | 1 | 175 |

| Major/Minor | Major1 | Major2 | Minor1 | | |
|----------------------|--------|--------|--------|---|-------|
| Conflicting Flow All | 0 | 0 | 260 | 0 | 708 |
| Stage 1 | - | - | - | - | 166 |
| Stage 2 | - | - | - | - | 542 |
| Critical Hdwy | - | - | 4.12 | - | 6.42 |
| Critical Hdwy Stg 1 | - | - | - | - | 5.42 |
| Critical Hdwy Stg 2 | - | - | - | - | 5.42 |
| Follow-up Hdwy | - | - | 2.218 | - | 3.518 |
| Pot Cap-1 Maneuver | - | - | 1304 | - | 401 |
| Stage 1 | - | - | - | - | 863 |
| Stage 2 | - | - | - | - | 583 |
| Platoon blocked, % | - | - | - | - | - |
| Mov Cap-1 Maneuver | - | - | 1304 | - | 331 |
| Mov Cap-2 Maneuver | - | - | - | - | 331 |
| Stage 1 | - | - | - | - | 863 |
| Stage 2 | - | - | - | - | 481 |

| Approach | EB | WB | NB |
|----------------------|----|-----|------|
| HCM Control Delay, s | 0 | 6.1 | 10.2 |
| HCM LOS | | | B |

| Minor Lane/Major Mvmt | NBLn1 | EBT | EBR | WBL | WBT |
|-----------------------|-------|-----|-----|-------|-----|
| Capacity (veh/h) | 869 | - | - | 1304 | - |
| HCM Lane V/C Ratio | 0.202 | - | - | 0.175 | - |
| HCM Control Delay (s) | 10.2 | - | - | 8.3 | - |
| HCM Lane LOS | B | - | - | A | - |
| HCM 95th %tile Q(veh) | 0.8 | - | - | 0.6 | - |

Background 2040 AM Signal Progression



Timings
1: MERIDIAN ROAD & WOODMAN ROAD

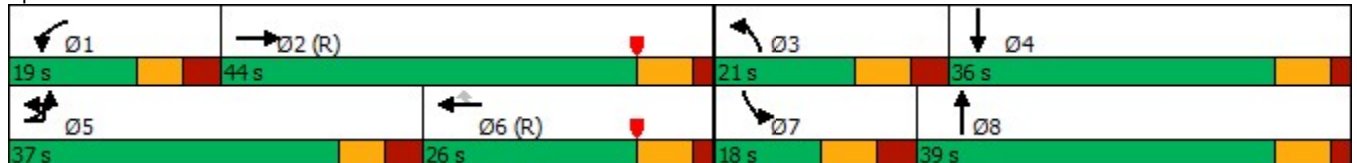
Background 2040 PM
04/01/2023

| Lane Group | EBL | EBT | EBR | WBL | WBT | WBR | NBL | NBT | NBR | SBL | SBT | SBR |
|----------------------|-------|-------|-------|-------|-------|-------|-------|-------|-------|-------|-------|-------|
| Lane Configurations | | | | | | | | | | | | |
| Traffic Volume (vph) | 993 | 671 | 229 | 160 | 521 | 295 | 296 | 1069 | 151 | 291 | 712 | 609 |
| Future Volume (vph) | 993 | 671 | 229 | 160 | 521 | 295 | 296 | 1069 | 151 | 291 | 712 | 609 |
| Turn Type | Prot | NA | Free | Prot | NA | Perm | Prot | NA | Free | Prot | NA | Free |
| Protected Phases | 5 | 2 | | 1 | 6 | | 3 | 8 | | 7 | 4 | |
| Permitted Phases | | | Free | | | 6 | | | Free | | | Free |
| Detector Phase | 5 | 2 | | 1 | 6 | 6 | 3 | 8 | | 7 | 4 | |
| Switch Phase | | | | | | | | | | | | |
| Minimum Initial (s) | 5.0 | 15.0 | | 5.0 | 15.0 | 15.0 | 5.0 | 15.0 | | 5.0 | 15.0 | |
| Minimum Split (s) | 13.5 | 22.0 | | 13.5 | 22.0 | 22.0 | 13.5 | 22.0 | | 13.5 | 22.0 | |
| Total Split (s) | 37.0 | 44.0 | | 19.0 | 26.0 | 26.0 | 21.0 | 39.0 | | 18.0 | 36.0 | |
| Total Split (%) | 30.8% | 36.7% | | 15.8% | 21.7% | 21.7% | 17.5% | 32.5% | | 15.0% | 30.0% | |
| Yellow Time (s) | 4.0 | 5.0 | | 4.0 | 5.0 | 5.0 | 5.0 | 5.0 | | 5.0 | 5.0 | |
| All-Red Time (s) | 3.5 | 2.0 | | 3.5 | 2.0 | 2.0 | 3.5 | 2.0 | | 3.5 | 2.0 | |
| Lost Time Adjust (s) | 0.0 | 0.0 | | 0.0 | 0.0 | 0.0 | 0.0 | 0.0 | | 0.0 | 0.0 | |
| Total Lost Time (s) | 7.5 | 7.0 | | 7.5 | 7.0 | 7.0 | 8.5 | 7.0 | | 8.5 | 7.0 | |
| Lead/Lag | Lead | Lag | | Lead | Lag | Lag | Lead | Lag | | Lead | Lag | |
| Lead-Lag Optimize? | Yes | Yes | | Yes | Yes | Yes | Yes | Yes | | Yes | Yes | |
| Recall Mode | None | C-Max | | None | C-Max | C-Max | None | None | | None | None | |
| Act Effct Green (s) | 29.5 | 38.1 | 120.0 | 10.4 | 19.0 | 19.0 | 12.5 | 32.0 | 120.0 | 9.5 | 29.0 | 120.0 |
| Actuated g/C Ratio | 0.25 | 0.32 | 1.00 | 0.09 | 0.16 | 0.16 | 0.10 | 0.27 | 1.00 | 0.08 | 0.24 | 1.00 |
| v/c Ratio | 1.26 | 0.63 | 0.15 | 0.56 | 0.98 | 0.67 | 0.87 | 1.19 | 0.10 | 1.13 | 0.88 | 0.40 |
| Control Delay | 164.3 | 38.2 | 0.2 | 60.0 | 83.6 | 18.9 | 77.7 | 136.4 | 0.1 | 111.3 | 54.8 | 0.8 |
| Queue Delay | 0.0 | 0.0 | 0.0 | 0.0 | 0.0 | 0.0 | 0.0 | 0.0 | 0.0 | 0.0 | 0.0 | 0.0 |
| Total Delay | 164.3 | 38.2 | 0.2 | 60.0 | 83.6 | 18.9 | 77.7 | 136.4 | 0.1 | 111.3 | 54.8 | 0.8 |
| LOS | F | D | A | E | F | B | E | F | A | F | D | A |
| Approach Delay | | 100.3 | | | 60.2 | | | 111.4 | | | 44.6 | |
| Approach LOS | | F | | | E | | | F | | | D | |

Intersection Summary

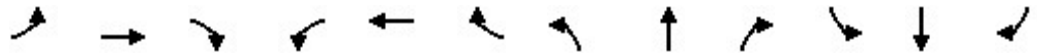
Cycle Length: 120
 Actuated Cycle Length: 120
 Offset: 100 (83%), Referenced to phase 2:EBT and 6:WBT, Start of Yellow
 Natural Cycle: 150
 Control Type: Actuated-Coordinated
 Maximum v/c Ratio: 1.26
 Intersection Signal Delay: 81.6
 Intersection Capacity Utilization 105.6%
 Analysis Period (min) 15
 Intersection LOS: F
 ICU Level of Service G

Splits and Phases: 1: MERIDIAN ROAD & WOODMAN ROAD



Queues
1: MERIDIAN ROAD & WOODMAN ROAD

Background 2040 PM
04/01/2023



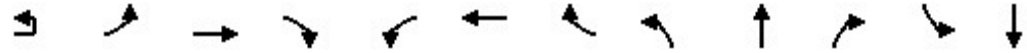
| Lane Group | EBL | EBT | EBR | WBL | WBT | WBR | NBL | NBT | NBR | SBL | SBT | SBR |
|-------------------------|-------|------|------|------|------|------|------|-------|------|-------|------|------|
| Lane Group Flow (vph) | 1061 | 706 | 241 | 168 | 548 | 311 | 312 | 1125 | 159 | 306 | 749 | 641 |
| v/c Ratio | 1.26 | 0.63 | 0.15 | 0.56 | 0.98 | 0.67 | 0.87 | 1.19 | 0.10 | 1.13 | 0.88 | 0.40 |
| Control Delay | 164.3 | 38.2 | 0.2 | 60.0 | 83.6 | 18.9 | 77.7 | 136.4 | 0.1 | 111.3 | 54.8 | 0.8 |
| Queue Delay | 0.0 | 0.0 | 0.0 | 0.0 | 0.0 | 0.0 | 0.0 | 0.0 | 0.0 | 0.0 | 0.0 | 0.0 |
| Total Delay | 164.3 | 38.2 | 0.2 | 60.0 | 83.6 | 18.9 | 77.7 | 136.4 | 0.1 | 111.3 | 54.8 | 0.8 |
| Queue Length 50th (ft) | ~530 | 247 | 0 | 64 | 225 | 42 | 124 | ~554 | 0 | ~145 | 323 | 0 |
| Queue Length 95th (ft) | #662 | 315 | 0 | 102 | #341 | 142 | #203 | #688 | 0 | m#173 | m352 | m0 |
| Internal Link Dist (ft) | | 1165 | | | 1100 | | | 342 | | | | 860 |
| Turn Bay Length (ft) | 500 | | 630 | 350 | | 250 | 440 | | 330 | 490 | | 450 |
| Base Capacity (vph) | 843 | 1122 | 1583 | 328 | 560 | 461 | 357 | 943 | 1583 | 271 | 855 | 1583 |
| Starvation Cap Reductn | 0 | 0 | 0 | 0 | 0 | 0 | 0 | 0 | 0 | 0 | 0 | 0 |
| Spillback Cap Reductn | 0 | 0 | 0 | 0 | 0 | 0 | 0 | 0 | 0 | 0 | 0 | 0 |
| Storage Cap Reductn | 0 | 0 | 0 | 0 | 0 | 0 | 0 | 0 | 0 | 0 | 0 | 0 |
| Reduced v/c Ratio | 1.26 | 0.63 | 0.15 | 0.51 | 0.98 | 0.67 | 0.87 | 1.19 | 0.10 | 1.13 | 0.88 | 0.40 |

Intersection Summary

- ~ Volume exceeds capacity, queue is theoretically infinite.
Queue shown is maximum after two cycles.
- # 95th percentile volume exceeds capacity, queue may be longer.
Queue shown is maximum after two cycles.
- m Volume for 95th percentile queue is metered by upstream signal.

HCM 6th Signalized Intersection Summary
1: MERIDIAN ROAD & WOODMAN ROAD

Background 2040 PM
04/01/2023



| Movement | EBU | EBL | EBT | EBR | WBL | WBT | WBR | NBL | NBT | NBR | SBL | SBT |
|------------------------------|------|-------|-------|------|------|------|------|------|-------|------|-------|------|
| Lane Configurations | | ↔↔ | ↕↕ | ↔ | ↔↔ | ↕↕ | ↔↔ | ↔ | ↔↔ | ↕ | ↔↔ | ↕↕ |
| Traffic Volume (veh/h) | 15 | 993 | 671 | 229 | 160 | 521 | 295 | 296 | 1069 | 151 | 291 | 712 |
| Future Volume (veh/h) | 15 | 993 | 671 | 229 | 160 | 521 | 295 | 296 | 1069 | 151 | 291 | 712 |
| Initial Q (Qb), veh | | 0 | 0 | 0 | 0 | 0 | 0 | 0 | 0 | 0 | 0 | 0 |
| Ped-Bike Adj(A_pbT) | | 1.00 | | 1.00 | 1.00 | | 1.00 | 1.00 | | 1.00 | 1.00 | |
| Parking Bus, Adj | | 1.00 | 1.00 | 1.00 | 1.00 | 1.00 | 1.00 | 1.00 | 1.00 | 1.00 | 1.00 | 1.00 |
| Work Zone On Approach | | | No | | | No | | | No | | | No |
| Adj Sat Flow, veh/h/ln | | 1870 | 1870 | 1870 | 1870 | 1870 | 1870 | 1870 | 1870 | 1870 | 1870 | 1870 |
| Adj Flow Rate, veh/h | | 1045 | 706 | 0 | 168 | 548 | 0 | 312 | 1125 | 0 | 306 | 749 |
| Peak Hour Factor | | 0.95 | 0.95 | 0.95 | 0.95 | 0.95 | 0.95 | 0.95 | 0.95 | 0.95 | 0.95 | 0.95 |
| Percent Heavy Veh, % | | 2 | 2 | 2 | 2 | 2 | 2 | 2 | 2 | 2 | 2 | 2 |
| Cap, veh/h | | 850 | 1203 | | 226 | 563 | | 360 | 948 | | 274 | 859 |
| Arrive On Green | | 0.25 | 0.34 | 0.00 | 0.07 | 0.16 | 0.00 | 0.10 | 0.27 | 0.00 | 0.08 | 0.24 |
| Sat Flow, veh/h | | 3456 | 3554 | 1585 | 3456 | 3554 | 1585 | 3456 | 3554 | 1585 | 3456 | 3554 |
| Grp Volume(v), veh/h | | 1045 | 706 | 0 | 168 | 548 | 0 | 312 | 1125 | 0 | 306 | 749 |
| Grp Sat Flow(s),veh/h/ln | | 1728 | 1777 | 1585 | 1728 | 1777 | 1585 | 1728 | 1777 | 1585 | 1728 | 1777 |
| Q Serve(g_s), s | | 29.5 | 19.7 | 0.0 | 5.7 | 18.4 | 0.0 | 10.7 | 32.0 | 0.0 | 9.5 | 24.3 |
| Cycle Q Clear(g_c), s | | 29.5 | 19.7 | 0.0 | 5.7 | 18.4 | 0.0 | 10.7 | 32.0 | 0.0 | 9.5 | 24.3 |
| Prop In Lane | | 1.00 | | 1.00 | 1.00 | | 1.00 | 1.00 | | 1.00 | 1.00 | |
| Lane Grp Cap(c), veh/h | | 850 | 1203 | | 226 | 563 | | 360 | 948 | | 274 | 859 |
| V/C Ratio(X) | | 1.23 | 0.59 | | 0.74 | 0.97 | | 0.87 | 1.19 | | 1.12 | 0.87 |
| Avail Cap(c_a), veh/h | | 850 | 1203 | | 331 | 563 | | 360 | 948 | | 274 | 859 |
| HCM Platoon Ratio | | 1.00 | 1.00 | 1.00 | 1.00 | 1.00 | 1.00 | 1.00 | 1.00 | 1.00 | 1.00 | 1.00 |
| Upstream Filter(I) | | 1.00 | 1.00 | 0.00 | 1.00 | 1.00 | 0.00 | 1.00 | 1.00 | 0.00 | 1.00 | 1.00 |
| Uniform Delay (d), s/veh | | 45.2 | 32.7 | 0.0 | 55.1 | 50.3 | 0.0 | 52.9 | 44.0 | 0.0 | 55.3 | 43.7 |
| Incr Delay (d2), s/veh | | 113.8 | 2.1 | 0.0 | 5.0 | 32.0 | 0.0 | 19.4 | 94.9 | 0.0 | 90.1 | 9.8 |
| Initial Q Delay(d3),s/veh | | 0.0 | 0.0 | 0.0 | 0.0 | 0.0 | 0.0 | 0.0 | 0.0 | 0.0 | 0.0 | 0.0 |
| %ile BackOfQ(50%),veh/ln | | 25.6 | 8.5 | 0.0 | 2.6 | 10.4 | 0.0 | 5.6 | 26.3 | 0.0 | 7.5 | 11.7 |
| Unsig. Movement Delay, s/veh | | | | | | | | | | | | |
| LnGrp Delay(d),s/veh | | 159.1 | 34.8 | 0.0 | 60.1 | 82.3 | 0.0 | 72.4 | 138.9 | 0.0 | 145.3 | 53.5 |
| LnGrp LOS | | F | C | | E | F | | E | F | | F | D |
| Approach Vol, veh/h | | | 1751 | A | | 716 | A | | 1437 | A | | 1055 |
| Approach Delay, s/veh | | | 109.0 | | | 77.1 | | | 124.5 | | | 80.1 |
| Approach LOS | | | F | | | E | | | F | | | F |
| Timer - Assigned Phs | 1 | 2 | 3 | 4 | 5 | 6 | 7 | 8 | | | | |
| Phs Duration (G+Y+Rc), s | 15.4 | 47.6 | 21.0 | 36.0 | 37.0 | 26.0 | 18.0 | 39.0 | | | | |
| Change Period (Y+Rc), s | 7.5 | 7.0 | 8.5 | 7.0 | 7.5 | 7.0 | 8.5 | 7.0 | | | | |
| Max Green Setting (Gmax), s | 11.5 | 37.0 | 12.5 | 29.0 | 29.5 | 19.0 | 9.5 | 32.0 | | | | |
| Max Q Clear Time (g_c+I1), s | 7.7 | 21.7 | 12.7 | 26.3 | 31.5 | 20.4 | 11.5 | 34.0 | | | | |
| Green Ext Time (p_c), s | 0.2 | 3.9 | 0.0 | 1.3 | 0.0 | 0.0 | 0.0 | 0.0 | | | | |

Intersection Summary

| | |
|--------------------|-------|
| HCM 6th Ctrl Delay | 102.7 |
| HCM 6th LOS | F |

Notes

- User approved pedestrian interval to be less than phase max green.
- User approved ignoring U-Turning movement.
- Unsignalized Delay for [NBR, EBR, WBR, SBR] is excluded from calculations of the approach delay and intersection delay.

HCM 6th Signalized Intersection Summary
 1: MERIDIAN ROAD & WOODMAN ROAD

Background 2040 PM
 04/01/2023

| | |
|------------------------------|------|
| Movement | SBR |
| Lane Configurations | |
| Traffic Volume (veh/h) | 609 |
| Future Volume (veh/h) | 609 |
| Initial Q (Qb), veh | 0 |
| Ped-Bike Adj(A_pbT) | 1.00 |
| Parking Bus, Adj | 1.00 |
| Work Zone On Approach | |
| Adj Sat Flow, veh/h/ln | 1870 |
| Adj Flow Rate, veh/h | 0 |
| Peak Hour Factor | 0.95 |
| Percent Heavy Veh, % | 2 |
| Cap, veh/h | |
| Arrive On Green | 0.00 |
| Sat Flow, veh/h | 1585 |
| Grp Volume(v), veh/h | 0 |
| Grp Sat Flow(s),veh/h/ln | 1585 |
| Q Serve(g_s), s | 0.0 |
| Cycle Q Clear(g_c), s | 0.0 |
| Prop In Lane | 1.00 |
| Lane Grp Cap(c), veh/h | |
| V/C Ratio(X) | |
| Avail Cap(c_a), veh/h | |
| HCM Platoon Ratio | 1.00 |
| Upstream Filter(l) | 0.00 |
| Uniform Delay (d), s/veh | 0.0 |
| Incr Delay (d2), s/veh | 0.0 |
| Initial Q Delay(d3),s/veh | 0.0 |
| %ile BackOfQ(50%),veh/ln | 0.0 |
| Unsig. Movement Delay, s/veh | |
| LnGrp Delay(d),s/veh | 0.0 |
| LnGrp LOS | |
| Approach Vol, veh/h | A |
| Approach Delay, s/veh | |
| Approach LOS | |
| Timer - Assigned Phs | |

Timings
2: MERIDIAN ROAD & EASTONVILLE ROAD

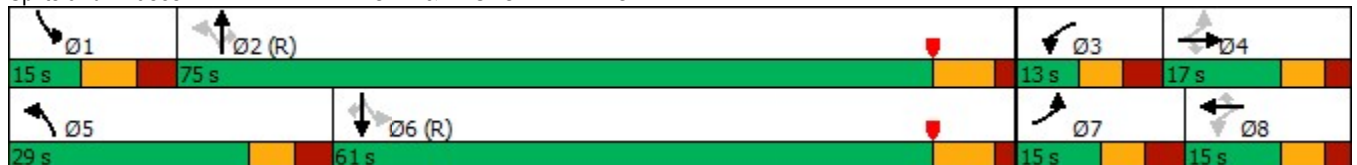
Background 2040 PM
04/01/2023

| Lane Group | EBL | EBT | EBR | WBL | WBT | WBR | NBL | NBT | NBR | SBL | SBT | SBR |
|----------------------|-------|-------|-------|-------|-------|-------|-------|-------|-------|-------|-------|-------|
| Lane Configurations | | | | | | | | | | | | |
| Traffic Volume (vph) | 330 | 146 | 283 | 44 | 100 | 190 | 370 | 1882 | 164 | 117 | 1263 | 174 |
| Future Volume (vph) | 330 | 146 | 283 | 44 | 100 | 190 | 370 | 1882 | 164 | 117 | 1263 | 174 |
| Turn Type | pm+pt | NA | Perm | pm+pt | NA | Perm | pm+pt | NA | Perm | pm+pt | NA | Perm |
| Protected Phases | 7 | 4 | | 3 | 8 | | 5 | 2 | | 1 | 6 | |
| Permitted Phases | 4 | | 4 | 8 | | 8 | 2 | | 2 | 6 | | 6 |
| Detector Phase | 7 | 4 | 4 | 3 | 8 | 8 | 5 | 2 | 2 | 1 | 6 | 6 |
| Switch Phase | | | | | | | | | | | | |
| Minimum Initial (s) | 5.0 | 8.0 | 8.0 | 5.0 | 8.0 | 8.0 | 5.0 | 15.0 | 15.0 | 5.0 | 15.0 | 15.0 |
| Minimum Split (s) | 12.5 | 14.5 | 14.5 | 12.5 | 14.5 | 14.5 | 12.5 | 25.5 | 25.5 | 13.5 | 25.5 | 25.5 |
| Total Split (s) | 15.0 | 17.0 | 17.0 | 13.0 | 15.0 | 15.0 | 29.0 | 75.0 | 75.0 | 15.0 | 61.0 | 61.0 |
| Total Split (%) | 12.5% | 14.2% | 14.2% | 10.8% | 12.5% | 12.5% | 24.2% | 62.5% | 62.5% | 12.5% | 50.8% | 50.8% |
| Yellow Time (s) | 4.0 | 4.0 | 4.0 | 4.0 | 4.0 | 4.0 | 4.0 | 5.5 | 5.5 | 5.0 | 5.5 | 5.5 |
| All-Red Time (s) | 3.5 | 2.5 | 2.5 | 3.5 | 2.5 | 2.5 | 3.5 | 2.0 | 2.0 | 3.5 | 2.0 | 2.0 |
| Lost Time Adjust (s) | 0.0 | 0.0 | 0.0 | 0.0 | 0.0 | 0.0 | 0.0 | 0.0 | 0.0 | 0.0 | 0.0 | 0.0 |
| Total Lost Time (s) | 7.5 | 6.5 | 6.5 | 7.5 | 6.5 | 6.5 | 7.5 | 7.5 | 7.5 | 8.5 | 7.5 | 7.5 |
| Lead/Lag | Lead | Lag | Lag | Lead | Lag | Lag | Lead | Lag | Lag | Lead | Lag | Lag |
| Lead-Lag Optimize? | Yes | Yes | Yes | Yes | Yes | Yes | Yes | Yes | Yes | Yes | Yes | Yes |
| Recall Mode | None | None | None | None | None | None | None | C-Max | C-Max | None | C-Max | C-Max |
| Act Effct Green (s) | 18.1 | 13.1 | 13.1 | 13.0 | 8.5 | 8.5 | 82.5 | 67.5 | 67.5 | 59.0 | 53.5 | 53.5 |
| Actuated g/C Ratio | 0.15 | 0.11 | 0.11 | 0.11 | 0.07 | 0.07 | 0.69 | 0.56 | 0.56 | 0.49 | 0.45 | 0.45 |
| v/c Ratio | 0.92 | 0.76 | 0.74 | 0.30 | 0.80 | 0.57 | 1.02 | 1.00 | 0.18 | 0.78 | 0.84 | 0.22 |
| Control Delay | 77.1 | 76.8 | 23.0 | 46.5 | 94.2 | 9.0 | 73.9 | 19.8 | 1.0 | 55.3 | 40.7 | 6.8 |
| Queue Delay | 0.0 | 0.0 | 0.0 | 0.0 | 0.0 | 0.0 | 0.0 | 0.0 | 0.0 | 0.0 | 0.0 | 0.0 |
| Total Delay | 77.1 | 76.8 | 23.0 | 46.5 | 94.2 | 9.0 | 73.9 | 19.8 | 1.0 | 55.3 | 40.7 | 6.8 |
| LOS | E | E | C | D | F | A | E | B | A | E | D | A |
| Approach Delay | | 56.9 | | | 39.4 | | | 26.8 | | | 38.0 | |
| Approach LOS | | E | | | D | | | C | | | D | |

Intersection Summary

Cycle Length: 120
 Actuated Cycle Length: 120
 Offset: 89 (74%), Referenced to phase 2:NBTL and 6:SBTL, Start of Yellow
 Natural Cycle: 110
 Control Type: Actuated-Coordinated
 Maximum v/c Ratio: 1.02
 Intersection Signal Delay: 35.6
 Intersection Capacity Utilization 98.8%
 Analysis Period (min) 15
 Intersection LOS: D
 ICU Level of Service F

Splits and Phases: 2: MERIDIAN ROAD & EASTONVILLE ROAD



Queues
2: MERIDIAN ROAD & EASTONVILLE ROAD

Background 2040 PM
04/01/2023



| Lane Group | EBL | EBT | EBR | WBL | WBT | WBR | NBL | NBT | NBR | SBL | SBT | SBR |
|-------------------------|------|------|------|------|------|------|------|------|------|-------|------|------|
| Lane Group Flow (vph) | 347 | 154 | 298 | 46 | 105 | 200 | 389 | 1981 | 173 | 123 | 1329 | 183 |
| v/c Ratio | 0.92 | 0.76 | 0.74 | 0.30 | 0.80 | 0.57 | 1.02 | 1.00 | 0.18 | 0.78 | 0.84 | 0.22 |
| Control Delay | 77.1 | 76.8 | 23.0 | 46.5 | 94.2 | 9.0 | 73.9 | 19.8 | 1.0 | 55.3 | 40.7 | 6.8 |
| Queue Delay | 0.0 | 0.0 | 0.0 | 0.0 | 0.0 | 0.0 | 0.0 | 0.0 | 0.0 | 0.0 | 0.0 | 0.0 |
| Total Delay | 77.1 | 76.8 | 23.0 | 46.5 | 94.2 | 9.0 | 73.9 | 19.8 | 1.0 | 55.3 | 40.7 | 6.8 |
| Queue Length 50th (ft) | 126 | 121 | 32 | 30 | 82 | 0 | ~276 | 608 | 4 | 31 | 573 | 31 |
| Queue Length 95th (ft) | #174 | #254 | #167 | 64 | #179 | 29 | m234 | m175 | m3 | m#128 | 643 | 75 |
| Internal Link Dist (ft) | | 508 | | | 1196 | | | 231 | | | | 781 |
| Turn Bay Length (ft) | 100 | | 100 | 120 | | 100 | 100 | | 400 | 375 | | 400 |
| Base Capacity (vph) | 377 | 203 | 400 | 154 | 131 | 349 | 380 | 1990 | 967 | 158 | 1577 | 841 |
| Starvation Cap Reductn | 0 | 0 | 0 | 0 | 0 | 0 | 0 | 0 | 0 | 0 | 0 | 0 |
| Spillback Cap Reductn | 0 | 0 | 0 | 0 | 0 | 0 | 0 | 0 | 0 | 0 | 0 | 0 |
| Storage Cap Reductn | 0 | 0 | 0 | 0 | 0 | 0 | 0 | 0 | 0 | 0 | 0 | 0 |
| Reduced v/c Ratio | 0.92 | 0.76 | 0.74 | 0.30 | 0.80 | 0.57 | 1.02 | 1.00 | 0.18 | 0.78 | 0.84 | 0.22 |

Intersection Summary

- ~ Volume exceeds capacity, queue is theoretically infinite.
Queue shown is maximum after two cycles.
- # 95th percentile volume exceeds capacity, queue may be longer.
Queue shown is maximum after two cycles.
- m Volume for 95th percentile queue is metered by upstream signal.

HCM 6th Signalized Intersection Summary
2: MERIDIAN ROAD & EASTONVILLE ROAD

Background 2040 PM
04/01/2023



| Movement | EBL | EBT | EBR | WBL | WBT | WBR | NBL | NBT | NBR | SBL | SBT | SBR |
|------------------------------|------|------|------|------|------|------|------|------|------|------|------|------|
| Lane Configurations | ↖↗ | ↑ | ↖ | ↖ | ↑ | ↖ | ↖ | ↑↑ | ↖ | ↖ | ↑↑ | ↖ |
| Traffic Volume (veh/h) | 330 | 146 | 283 | 44 | 100 | 190 | 370 | 1882 | 164 | 117 | 1263 | 174 |
| Future Volume (veh/h) | 330 | 146 | 283 | 44 | 100 | 190 | 370 | 1882 | 164 | 117 | 1263 | 174 |
| Initial Q (Qb), veh | 0 | 0 | 0 | 0 | 0 | 0 | 0 | 0 | 0 | 0 | 0 | 0 |
| Ped-Bike Adj(A_pbT) | 1.00 | | 1.00 | 1.00 | | 1.00 | 1.00 | | 1.00 | 1.00 | | 1.00 |
| Parking Bus, Adj | 1.00 | 1.00 | 1.00 | 1.00 | 1.00 | 1.00 | 1.00 | 1.00 | 1.00 | 1.00 | 1.00 | 1.00 |
| Work Zone On Approach | | No | | | No | | | No | | | No | |
| Adj Sat Flow, veh/h/ln | 1870 | 1870 | 1870 | 1870 | 1870 | 1870 | 1870 | 1870 | 1870 | 1870 | 1870 | 1870 |
| Adj Flow Rate, veh/h | 347 | 154 | 0 | 46 | 105 | 0 | 389 | 1981 | 173 | 123 | 1329 | 183 |
| Peak Hour Factor | 0.95 | 0.95 | 0.95 | 0.95 | 0.95 | 0.95 | 0.95 | 0.95 | 0.95 | 0.95 | 0.95 | 0.95 |
| Percent Heavy Veh, % | 2 | 2 | 2 | 2 | 2 | 2 | 2 | 2 | 2 | 2 | 2 | 2 |
| Cap, veh/h | 375 | 188 | | 143 | 132 | | 413 | 2004 | 894 | 157 | 1601 | 714 |
| Arrive On Green | 0.06 | 0.10 | 0.00 | 0.03 | 0.07 | 0.00 | 0.17 | 0.56 | 0.56 | 0.05 | 0.45 | 0.45 |
| Sat Flow, veh/h | 3456 | 1870 | 1585 | 1781 | 1870 | 1585 | 1781 | 3554 | 1585 | 1781 | 3554 | 1585 |
| Grp Volume(v), veh/h | 347 | 154 | 0 | 46 | 105 | 0 | 389 | 1981 | 173 | 123 | 1329 | 183 |
| Grp Sat Flow(s),veh/h/ln | 1728 | 1870 | 1585 | 1781 | 1870 | 1585 | 1781 | 1777 | 1585 | 1781 | 1777 | 1585 |
| Q Serve(g_s), s | 7.5 | 9.7 | 0.0 | 2.9 | 6.6 | 0.0 | 18.9 | 65.9 | 6.4 | 4.4 | 39.4 | 8.6 |
| Cycle Q Clear(g_c), s | 7.5 | 9.7 | 0.0 | 2.9 | 6.6 | 0.0 | 18.9 | 65.9 | 6.4 | 4.4 | 39.4 | 8.6 |
| Prop In Lane | 1.00 | | 1.00 | 1.00 | | 1.00 | 1.00 | | 1.00 | 1.00 | | 1.00 |
| Lane Grp Cap(c), veh/h | 375 | 188 | | 143 | 132 | | 413 | 2004 | 894 | 157 | 1601 | 714 |
| V/C Ratio(X) | 0.93 | 0.82 | | 0.32 | 0.79 | | 0.94 | 0.99 | 0.19 | 0.79 | 0.83 | 0.26 |
| Avail Cap(c_a), veh/h | 375 | 188 | | 166 | 132 | | 421 | 2004 | 894 | 159 | 1601 | 714 |
| HCM Platoon Ratio | 1.00 | 1.00 | 1.00 | 1.00 | 1.00 | 1.00 | 1.00 | 1.00 | 1.00 | 1.00 | 1.00 | 1.00 |
| Upstream Filter(I) | 1.00 | 1.00 | 0.00 | 1.00 | 1.00 | 0.00 | 1.00 | 1.00 | 1.00 | 1.00 | 1.00 | 1.00 |
| Uniform Delay (d), s/veh | 52.3 | 52.9 | 0.0 | 49.7 | 54.9 | 0.0 | 34.1 | 25.8 | 12.8 | 28.1 | 29.0 | 20.5 |
| Incr Delay (d2), s/veh | 28.5 | 23.8 | 0.0 | 1.3 | 27.1 | 0.0 | 29.2 | 17.5 | 0.5 | 22.1 | 5.2 | 0.9 |
| Initial Q Delay(d3),s/veh | 0.0 | 0.0 | 0.0 | 0.0 | 0.0 | 0.0 | 0.0 | 0.0 | 0.0 | 0.0 | 0.0 | 0.0 |
| %ile BackOfQ(50%),veh/ln | 3.1 | 5.8 | 0.0 | 1.3 | 4.1 | 0.0 | 14.1 | 28.5 | 2.4 | 2.6 | 16.3 | 3.4 |
| Unsig. Movement Delay, s/veh | | | | | | | | | | | | |
| LnGrp Delay(d),s/veh | 80.8 | 76.7 | 0.0 | 50.9 | 82.0 | 0.0 | 63.3 | 43.3 | 13.3 | 50.1 | 34.1 | 21.4 |
| LnGrp LOS | F | E | | D | F | | E | D | B | D | C | C |
| Approach Vol, veh/h | | 501 | A | | 151 | A | | 2543 | | | 1635 | |
| Approach Delay, s/veh | | 79.5 | | | 72.6 | | | 44.3 | | | 33.9 | |
| Approach LOS | | E | | | E | | | D | | | C | |
| Timer - Assigned Phs | 1 | 2 | 3 | 4 | 5 | 6 | 7 | 8 | | | | |
| Phs Duration (G+Y+Rc), s | 14.8 | 75.2 | 11.4 | 18.6 | 28.5 | 61.5 | 15.0 | 15.0 | | | | |
| Change Period (Y+Rc), s | 8.5 | 7.5 | 7.5 | 6.5 | 7.5 | 7.5 | 7.5 | 6.5 | | | | |
| Max Green Setting (Gmax), s | 6.5 | 67.5 | 5.5 | 10.5 | 21.5 | 53.5 | 7.5 | 8.5 | | | | |
| Max Q Clear Time (g_c+I1), s | 6.4 | 67.9 | 4.9 | 11.7 | 20.9 | 41.4 | 9.5 | 8.6 | | | | |
| Green Ext Time (p_c), s | 0.0 | 0.0 | 0.0 | 0.0 | 0.1 | 6.9 | 0.0 | 0.0 | | | | |

Intersection Summary

| | |
|--------------------|------|
| HCM 6th Ctrl Delay | 45.3 |
| HCM 6th LOS | D |

Notes

User approved pedestrian interval to be less than phase max green.
Unsignalized Delay for [EBR, WBR] is excluded from calculations of the approach delay and intersection delay.

Timings
3: MERIDIAN ROAD & BENT GRASS MEADOWS DRIVE

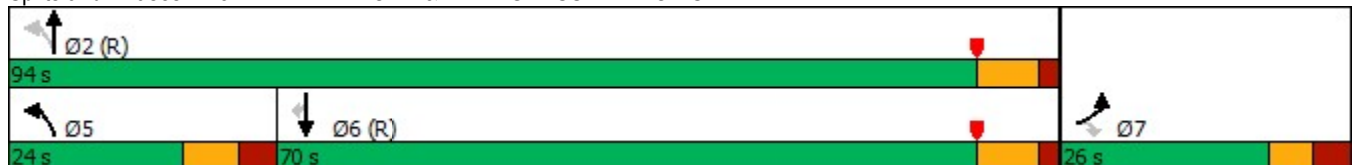


| Lane Group | EBL | EBR | NBL | NBT | SBT | SBR |
|----------------------|-------|-------|-------|-------|-------|-------|
| Lane Configurations | ↖↗ | ↗ | ↖ | ↑↑ | ↑↑ | ↗ |
| Traffic Volume (vph) | 133 | 163 | 166 | 2174 | 1340 | 173 |
| Future Volume (vph) | 133 | 163 | 166 | 2174 | 1340 | 173 |
| Turn Type | Prot | Perm | pm+pt | NA | NA | Perm |
| Protected Phases | 7 | | 5 | 2 | 6 | |
| Permitted Phases | | 7 | 2 | | | 6 |
| Detector Phase | 7 | 7 | 5 | 2 | 6 | 6 |
| Switch Phase | | | | | | |
| Minimum Initial (s) | 8.0 | 8.0 | 5.0 | 15.0 | 15.0 | 15.0 |
| Minimum Split (s) | 25.5 | 25.5 | 13.5 | 25.5 | 25.5 | 25.5 |
| Total Split (s) | 26.0 | 26.0 | 24.0 | 94.0 | 70.0 | 70.0 |
| Total Split (%) | 21.7% | 21.7% | 20.0% | 78.3% | 58.3% | 58.3% |
| Yellow Time (s) | 4.0 | 4.0 | 5.0 | 5.5 | 5.5 | 5.5 |
| All-Red Time (s) | 3.5 | 3.5 | 3.5 | 2.0 | 2.0 | 2.0 |
| Lost Time Adjust (s) | 0.0 | 0.0 | 0.0 | 0.0 | 0.0 | 0.0 |
| Total Lost Time (s) | 7.5 | 7.5 | 8.5 | 7.5 | 7.5 | 7.5 |
| Lead/Lag | | | Lead | | Lag | Lag |
| Lead-Lag Optimize? | | | Yes | | Yes | Yes |
| Recall Mode | None | None | None | C-Max | C-Max | C-Max |
| Act Effct Green (s) | 10.4 | 10.4 | 93.6 | 94.6 | 75.4 | 75.4 |
| Actuated g/C Ratio | 0.09 | 0.09 | 0.78 | 0.79 | 0.63 | 0.63 |
| v/c Ratio | 0.47 | 0.59 | 0.57 | 0.82 | 0.63 | 0.17 |
| Control Delay | 57.2 | 16.0 | 19.8 | 5.4 | 16.3 | 2.1 |
| Queue Delay | 0.0 | 0.0 | 0.0 | 0.0 | 0.0 | 0.0 |
| Total Delay | 57.2 | 16.0 | 19.8 | 5.4 | 16.3 | 2.1 |
| LOS | E | B | B | A | B | A |
| Approach Delay | 34.5 | | | 6.5 | 14.7 | |
| Approach LOS | C | | | A | B | |

Intersection Summary

Cycle Length: 120
 Actuated Cycle Length: 120
 Offset: 27 (23%), Referenced to phase 2:NBTL and 6:SBT, Start of Yellow
 Natural Cycle: 90
 Control Type: Actuated-Coordinated
 Maximum v/c Ratio: 0.82
 Intersection Signal Delay: 11.5
 Intersection LOS: B
 Intersection Capacity Utilization 79.3%
 ICU Level of Service D
 Analysis Period (min) 15

Splits and Phases: 3: MERIDIAN ROAD & BENT GRASS MEADOWS DRIVE



3: MERIDIAN ROAD & BENT GRASS MEADOWS DRIVE

04/01/2023



| Lane Group | EBL | EBR | NBL | NBT | SBT | SBR |
|-------------------------|------|------|------|------|------|------|
| Lane Group Flow (vph) | 140 | 172 | 175 | 2288 | 1411 | 182 |
| v/c Ratio | 0.47 | 0.59 | 0.57 | 0.82 | 0.63 | 0.17 |
| Control Delay | 57.2 | 16.0 | 19.8 | 5.4 | 16.3 | 2.1 |
| Queue Delay | 0.0 | 0.0 | 0.0 | 0.0 | 0.0 | 0.0 |
| Total Delay | 57.2 | 16.0 | 19.8 | 5.4 | 16.3 | 2.1 |
| Queue Length 50th (ft) | 54 | 0 | 36 | 124 | 321 | 0 |
| Queue Length 95th (ft) | 85 | 66 | m40 | m139 | 491 | 32 |
| Internal Link Dist (ft) | 310 | | | 750 | 1921 | |
| Turn Bay Length (ft) | 150 | | 700 | | | 350 |
| Base Capacity (vph) | 529 | 389 | 373 | 2791 | 2225 | 1062 |
| Starvation Cap Reductn | 0 | 0 | 0 | 0 | 0 | 0 |
| Spillback Cap Reductn | 0 | 0 | 0 | 0 | 0 | 0 |
| Storage Cap Reductn | 0 | 0 | 0 | 0 | 0 | 0 |
| Reduced v/c Ratio | 0.26 | 0.44 | 0.47 | 0.82 | 0.63 | 0.17 |

Intersection Summary

m Volume for 95th percentile queue is metered by upstream signal.

HCM 6th Signalized Intersection Summary
 3: MERIDIAN ROAD & BENT GRASS MEADOWS DRIVE

Background 2040 PM
 04/01/2023



| Movement | EBL | EBR | NBL | NBT | SBT | SBR |
|------------------------------|------|-------|------|------|------|------|
| Lane Configurations | ↖↗ | ↗ | ↖ | ↑↑ | ↑↑ | ↗ |
| Traffic Volume (veh/h) | 133 | 163 | 166 | 2174 | 1340 | 173 |
| Future Volume (veh/h) | 133 | 163 | 166 | 2174 | 1340 | 173 |
| Initial Q (Qb), veh | 0 | 0 | 0 | 0 | 0 | 0 |
| Ped-Bike Adj(A_pbT) | 1.00 | 1.00 | 1.00 | | | 1.00 |
| Parking Bus, Adj | 1.00 | 1.00 | 1.00 | 1.00 | 1.00 | 1.00 |
| Work Zone On Approach | No | | | No | No | |
| Adj Sat Flow, veh/h/ln | 1870 | 1870 | 1870 | 1870 | 1870 | 1870 |
| Adj Flow Rate, veh/h | 140 | 0 | 175 | 2288 | 1411 | 182 |
| Peak Hour Factor | 0.95 | 0.95 | 0.95 | 0.95 | 0.95 | 0.95 |
| Percent Heavy Veh, % | 2 | 2 | 2 | 2 | 2 | 2 |
| Cap, veh/h | 228 | | 298 | 2875 | 2460 | 1097 |
| Arrive On Green | 0.07 | 0.00 | 0.05 | 0.81 | 0.69 | 0.69 |
| Sat Flow, veh/h | 3456 | 1585 | 1781 | 3647 | 3647 | 1585 |
| Grp Volume(v), veh/h | 140 | 0 | 175 | 2288 | 1411 | 182 |
| Grp Sat Flow(s),veh/h/ln | 1728 | 1585 | 1781 | 1777 | 1777 | 1585 |
| Q Serve(g_s), s | 4.7 | 0.0 | 3.2 | 41.4 | 24.3 | 4.8 |
| Cycle Q Clear(g_c), s | 4.7 | 0.0 | 3.2 | 41.4 | 24.3 | 4.8 |
| Prop In Lane | 1.00 | 1.00 | 1.00 | | | 1.00 |
| Lane Grp Cap(c), veh/h | 228 | | 298 | 2875 | 2460 | 1097 |
| V/C Ratio(X) | 0.61 | | 0.59 | 0.80 | 0.57 | 0.17 |
| Avail Cap(c_a), veh/h | 533 | | 447 | 2875 | 2460 | 1097 |
| HCM Platoon Ratio | 1.00 | 1.00 | 1.00 | 1.00 | 1.00 | 1.00 |
| Upstream Filter(l) | 1.00 | 0.00 | 1.00 | 1.00 | 1.00 | 1.00 |
| Uniform Delay (d), s/veh | 54.5 | 0.0 | 10.4 | 6.1 | 9.4 | 6.4 |
| Incr Delay (d2), s/veh | 2.7 | 0.0 | 1.8 | 2.4 | 1.0 | 0.3 |
| Initial Q Delay(d3),s/veh | 0.0 | 0.0 | 0.0 | 0.0 | 0.0 | 0.0 |
| %ile BackOfQ(50%),veh/ln | 2.1 | 0.0 | 1.9 | 12.2 | 9.0 | 8.0 |
| Unsig. Movement Delay, s/veh | | | | | | |
| LnGrp Delay(d),s/veh | 57.2 | 0.0 | 12.2 | 8.5 | 10.4 | 6.7 |
| LnGrp LOS | E | | B | A | B | A |
| Approach Vol, veh/h | 140 | A | | 2463 | 1593 | |
| Approach Delay, s/veh | 57.2 | | | 8.8 | 10.0 | |
| Approach LOS | E | | | A | A | |
| Timer - Assigned Phs | | 2 | | 4 | 5 | 6 |
| Phs Duration (G+Y+Rc), s | | 104.6 | | 15.4 | 14.0 | 90.6 |
| Change Period (Y+Rc), s | | 7.5 | | 7.5 | 8.5 | 7.5 |
| Max Green Setting (Gmax), s | | 86.5 | | 18.5 | 15.5 | 62.5 |
| Max Q Clear Time (g_c+I1), s | | 43.4 | | 6.7 | 5.2 | 26.3 |
| Green Ext Time (p_c), s | | 32.2 | | 0.3 | 0.3 | 15.8 |
| Intersection Summary | | | | | | |
| HCM 6th Ctrl Delay | | | 10.9 | | | |
| HCM 6th LOS | | | B | | | |

Notes

Unsignalized Delay for [EBR] is excluded from calculations of the approach delay and intersection delay.

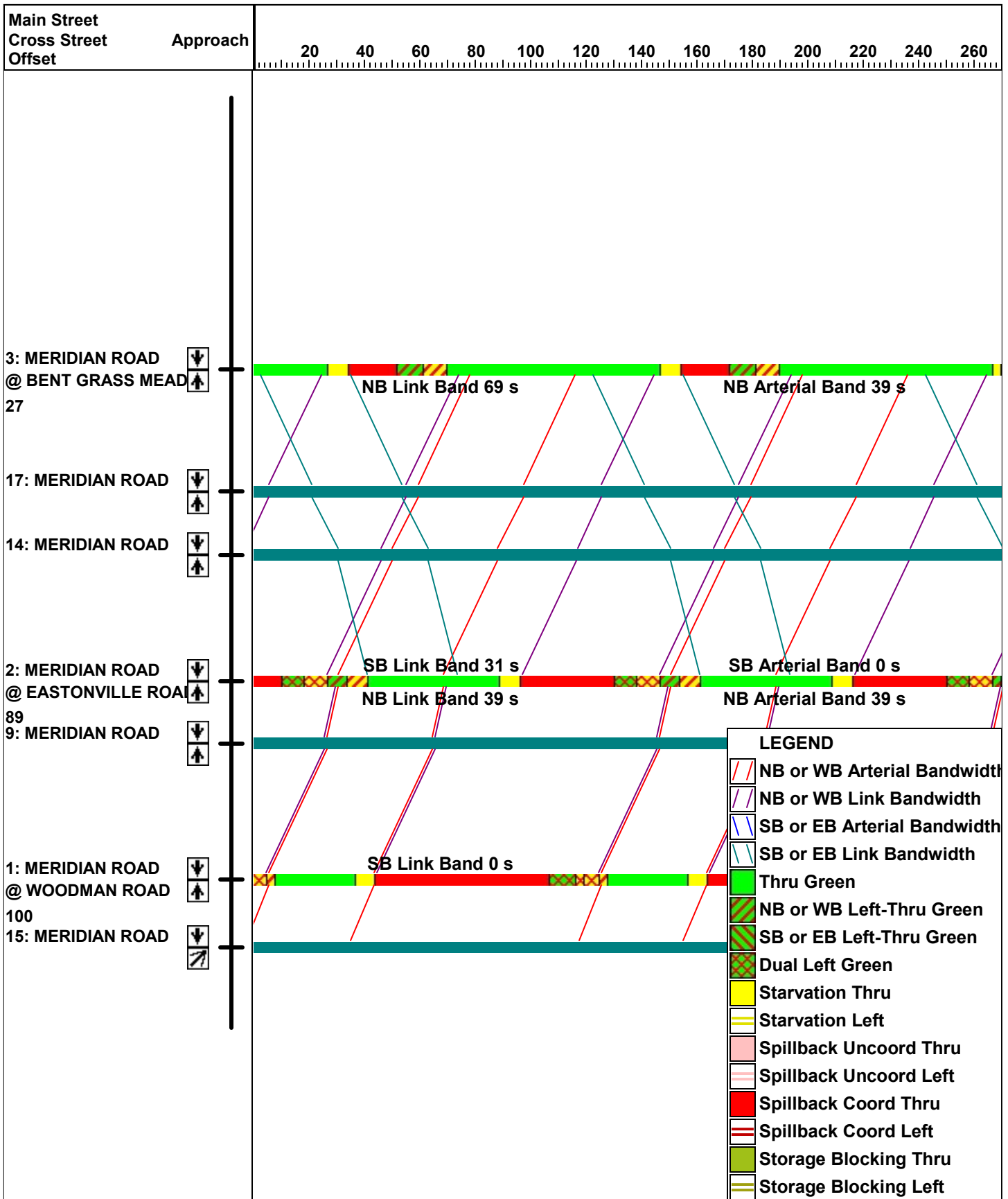
| Intersection | | | | | | |
|--------------------------|------|------|------|------|------|------|
| Int Delay, s/veh | 4 | | | | | |
| Movement | EBT | EBR | WBL | WBT | NBL | NBR |
| Lane Configurations | ↑ | ↗ | ↘ | ↑ | ↘ | ↗ |
| Traffic Vol, veh/h | 139 | 57 | 150 | 189 | 3 | 157 |
| Future Vol, veh/h | 139 | 57 | 150 | 189 | 3 | 157 |
| Conflicting Peds, #/hr | 0 | 0 | 0 | 0 | 0 | 0 |
| Sign Control | Free | Free | Free | Free | Stop | Stop |
| RT Channelized | - | None | - | None | - | None |
| Storage Length | - | 150 | 100 | - | 0 | - |
| Veh in Median Storage, # | 0 | - | - | 0 | 0 | - |
| Grade, % | 0 | - | - | 0 | 0 | - |
| Peak Hour Factor | 95 | 95 | 95 | 95 | 95 | 95 |
| Heavy Vehicles, % | 2 | 2 | 2 | 2 | 2 | 2 |
| Mvmt Flow | 146 | 60 | 158 | 199 | 3 | 165 |

| Major/Minor | Major1 | Major2 | Minor1 | | |
|----------------------|--------|--------|--------|---|-------------|
| Conflicting Flow All | 0 | 0 | 206 | 0 | 661 146 |
| Stage 1 | - | - | - | - | 146 - |
| Stage 2 | - | - | - | - | 515 - |
| Critical Hdwy | - | - | 4.12 | - | 6.42 6.22 |
| Critical Hdwy Stg 1 | - | - | - | - | 5.42 - |
| Critical Hdwy Stg 2 | - | - | - | - | 5.42 - |
| Follow-up Hdwy | - | - | 2.218 | - | 3.518 3.318 |
| Pot Cap-1 Maneuver | - | - | 1365 | - | 427 901 |
| Stage 1 | - | - | - | - | 881 - |
| Stage 2 | - | - | - | - | 600 - |
| Platoon blocked, % | - | - | - | - | - |
| Mov Cap-1 Maneuver | - | - | 1365 | - | 377 901 |
| Mov Cap-2 Maneuver | - | - | - | - | 377 - |
| Stage 1 | - | - | - | - | 881 - |
| Stage 2 | - | - | - | - | 530 - |

| Approach | EB | WB | NB |
|----------------------|----|-----|------|
| HCM Control Delay, s | 0 | 3.5 | 10.1 |
| HCM LOS | | | B |

| Minor Lane/Major Mvmt | NBLn1 | EBT | EBR | WBL | WBT |
|-----------------------|-------|-----|-----|-------|-----|
| Capacity (veh/h) | 878 | - | - | 1365 | - |
| HCM Lane V/C Ratio | 0.192 | - | - | 0.116 | - |
| HCM Control Delay (s) | 10.1 | - | - | 8 | - |
| HCM Lane LOS | B | - | - | A | - |
| HCM 95th %tile Q(veh) | 0.7 | - | - | 0.4 | - |

Background 2040 PM Signal Progression



APPENDIX G – Total 2024 & 2040 Synchro Outputs

Timings
1: MERIDIAN ROAD & WOODMAN ROAD

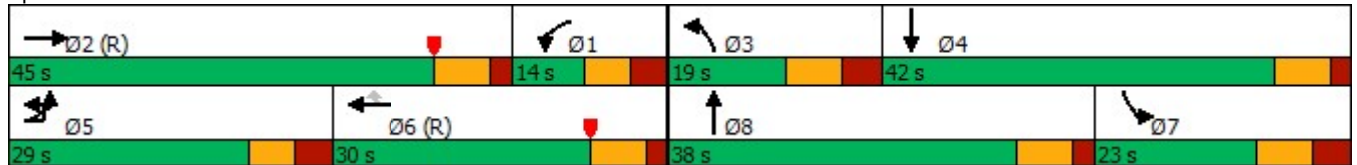
Total 2024 Shopping Center AM
04/10/2023

| Lane Group | EBL | EBT | EBR | WBL | WBT | WBR | NBL | NBT | NBR | SBL | SBT | SBR |
|----------------------|-------|-------|-------|-------|-------|-------|-------|-------|-------|-------|-------|-------|
| Lane Configurations | | | | | | | | | | | | |
| Traffic Volume (vph) | 410 | 226 | 122 | 61 | 413 | 176 | 182 | 363 | 18 | 223 | 779 | 835 |
| Future Volume (vph) | 410 | 226 | 122 | 61 | 413 | 176 | 182 | 363 | 18 | 223 | 779 | 835 |
| Turn Type | Prot | NA | Free | Prot | NA | Perm | Prot | NA | Free | Prot | NA | Free |
| Protected Phases | 5 | 2 | | 1 | 6 | | 3 | 8 | | 7 | 4 | |
| Permitted Phases | | | Free | | | 6 | | | Free | | | Free |
| Detector Phase | 5 | 2 | | 1 | 6 | 6 | 3 | 8 | | 7 | 4 | |
| Switch Phase | | | | | | | | | | | | |
| Minimum Initial (s) | 5.0 | 15.0 | | 5.0 | 15.0 | 15.0 | 5.0 | 15.0 | | 5.0 | 15.0 | |
| Minimum Split (s) | 13.5 | 22.0 | | 13.5 | 22.0 | 22.0 | 13.5 | 22.0 | | 13.5 | 22.0 | |
| Total Split (s) | 29.0 | 45.0 | | 14.0 | 30.0 | 30.0 | 19.0 | 38.0 | | 23.0 | 42.0 | |
| Total Split (%) | 24.2% | 37.5% | | 11.7% | 25.0% | 25.0% | 15.8% | 31.7% | | 19.2% | 35.0% | |
| Yellow Time (s) | 4.0 | 5.0 | | 4.0 | 5.0 | 5.0 | 5.0 | 5.0 | | 5.0 | 5.0 | |
| All-Red Time (s) | 3.5 | 2.0 | | 3.5 | 2.0 | 2.0 | 3.5 | 2.0 | | 3.5 | 2.0 | |
| Lost Time Adjust (s) | 0.0 | 0.0 | | 0.0 | 0.0 | 0.0 | 0.0 | 0.0 | | 0.0 | 0.0 | |
| Total Lost Time (s) | 7.5 | 7.0 | | 7.5 | 7.0 | 7.0 | 8.5 | 7.0 | | 8.5 | 7.0 | |
| Lead/Lag | Lead | Lead | | Lag | Lag | Lag | Lead | Lead | | Lag | Lag | |
| Lead-Lag Optimize? | Yes | Yes | | Yes | Yes | Yes | Yes | Yes | | Yes | Yes | |
| Recall Mode | None | C-Max | | None | C-Max | C-Max | None | None | | None | None | |
| Act Effct Green (s) | 20.4 | 43.0 | 120.0 | 6.3 | 26.3 | 26.3 | 10.1 | 18.6 | 120.0 | 24.7 | 33.1 | 120.0 |
| Actuated g/C Ratio | 0.17 | 0.36 | 1.00 | 0.05 | 0.22 | 0.22 | 0.08 | 0.16 | 1.00 | 0.21 | 0.28 | 1.00 |
| v/c Ratio | 0.85 | 0.21 | 0.09 | 0.36 | 0.57 | 0.34 | 0.66 | 0.69 | 0.01 | 0.34 | 0.87 | 0.57 |
| Control Delay | 62.4 | 29.0 | 0.1 | 60.6 | 46.2 | 2.7 | 64.6 | 54.6 | 0.0 | 33.8 | 36.7 | 4.5 |
| Queue Delay | 0.0 | 0.0 | 0.0 | 0.0 | 0.0 | 0.0 | 0.0 | 0.0 | 0.0 | 0.0 | 0.0 | 0.0 |
| Total Delay | 62.4 | 29.0 | 0.1 | 60.6 | 46.2 | 2.7 | 64.6 | 54.6 | 0.0 | 33.8 | 36.7 | 4.5 |
| LOS | E | C | A | E | D | A | E | D | A | C | D | A |
| Approach Delay | | 42.6 | | | 35.8 | | | 56.1 | | | 21.7 | |
| Approach LOS | | D | | | D | | | E | | | C | |

Intersection Summary

Cycle Length: 120
 Actuated Cycle Length: 120
 Offset: 30 (25%), Referenced to phase 2:EBT and 6:WBT, Start of Yellow
 Natural Cycle: 90
 Control Type: Actuated-Coordinated
 Maximum v/c Ratio: 0.87
 Intersection Signal Delay: 33.4
 Intersection LOS: C
 Intersection Capacity Utilization 76.2%
 ICU Level of Service D
 Analysis Period (min) 15

Splits and Phases: 1: MERIDIAN ROAD & WOODMAN ROAD



Queues
1: MERIDIAN ROAD & WOODMAN ROAD

Total 2024 Shopping Center AM
04/10/2023



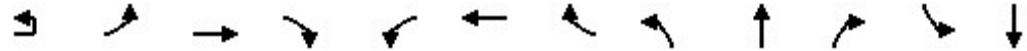
| Lane Group | EBL | EBT | EBR | WBL | WBT | WBR | NBL | NBT | NBR | SBL | SBT | SBR |
|-------------------------|------|------|------|------|------|------|------|------|------|------|------|------|
| Lane Group Flow (vph) | 494 | 266 | 144 | 65 | 439 | 187 | 190 | 378 | 19 | 242 | 847 | 908 |
| v/c Ratio | 0.85 | 0.21 | 0.09 | 0.36 | 0.57 | 0.34 | 0.66 | 0.69 | 0.01 | 0.34 | 0.87 | 0.57 |
| Control Delay | 62.4 | 29.0 | 0.1 | 60.6 | 46.2 | 2.7 | 64.6 | 54.6 | 0.0 | 33.8 | 36.7 | 4.5 |
| Queue Delay | 0.0 | 0.0 | 0.0 | 0.0 | 0.0 | 0.0 | 0.0 | 0.0 | 0.0 | 0.0 | 0.0 | 0.0 |
| Total Delay | 62.4 | 29.0 | 0.1 | 60.6 | 46.2 | 2.7 | 64.6 | 54.6 | 0.0 | 33.8 | 36.7 | 4.5 |
| Queue Length 50th (ft) | 191 | 80 | 0 | 25 | 166 | 0 | 74 | 148 | 0 | 90 | 344 | 83 |
| Queue Length 95th (ft) | 236 | 108 | 0 | 49 | 223 | 13 | 114 | 191 | 0 | m89 | m317 | m42 |
| Internal Link Dist (ft) | | 1165 | | | 1100 | | | 342 | | | | 860 |
| Turn Bay Length (ft) | 500 | | 630 | 350 | | 250 | 440 | | 330 | 490 | | 450 |
| Base Capacity (vph) | 615 | 1269 | 1583 | 185 | 775 | 549 | 300 | 914 | 1583 | 705 | 1032 | 1583 |
| Starvation Cap Reductn | 0 | 0 | 0 | 0 | 0 | 0 | 0 | 0 | 0 | 0 | 0 | 0 |
| Spillback Cap Reductn | 0 | 0 | 0 | 0 | 0 | 0 | 0 | 0 | 0 | 0 | 0 | 0 |
| Storage Cap Reductn | 0 | 0 | 0 | 0 | 0 | 0 | 0 | 0 | 0 | 0 | 0 | 0 |
| Reduced v/c Ratio | 0.80 | 0.21 | 0.09 | 0.35 | 0.57 | 0.34 | 0.63 | 0.41 | 0.01 | 0.34 | 0.82 | 0.57 |

Intersection Summary

m Volume for 95th percentile queue is metered by upstream signal.

HCM 6th Signalized Intersection Summary
1: MERIDIAN ROAD & WOODMAN ROAD

Total 2024 Shopping Center AM
04/10/2023



| Movement | EBU | EBL | EBT | EBR | WBL | WBT | WBR | NBL | NBT | NBR | SBL | SBT |
|------------------------------|------|------|------|-------|------|-------|------|------|------|------|------|------|
| Lane Configurations | | ↔↔ | ↕↕ | ↔ | ↔↔ | ↕↕ | ↔ | ↔↔ | ↕↕ | ↔ | ↔↔ | ↕↕ |
| Traffic Volume (veh/h) | 10 | 410 | 226 | 122 | 61 | 413 | 176 | 182 | 363 | 18 | 223 | 779 |
| Future Volume (veh/h) | 10 | 410 | 226 | 122 | 61 | 413 | 176 | 182 | 363 | 18 | 223 | 779 |
| Initial Q (Qb), veh | | 0 | 0 | 0 | 0 | 0 | 0 | 0 | 0 | 0 | 0 | 0 |
| Ped-Bike Adj(A_pbT) | | 1.00 | | 1.00 | 1.00 | | 1.00 | 1.00 | | 1.00 | 1.00 | |
| Parking Bus, Adj | | 1.00 | 1.00 | 1.00 | 1.00 | 1.00 | 1.00 | 1.00 | 1.00 | 1.00 | 1.00 | 1.00 |
| Work Zone On Approach | | | No | | | No | | | No | | | No |
| Adj Sat Flow, veh/h/ln | | 1870 | 1870 | 1870 | 1870 | 1870 | 1870 | 1870 | 1870 | 1870 | 1870 | 1870 |
| Adj Flow Rate, veh/h | | 482 | 266 | 0 | 65 | 439 | 0 | 190 | 378 | 0 | 242 | 847 |
| Peak Hour Factor | | 0.85 | 0.85 | 0.85 | 0.94 | 0.94 | 0.94 | 0.96 | 0.96 | 0.96 | 0.92 | 0.92 |
| Percent Heavy Veh, % | | 2 | 2 | 2 | 2 | 2 | 2 | 2 | 2 | 2 | 2 | 2 |
| Cap, veh/h | | 546 | 1125 | | 283 | 840 | | 247 | 487 | | 741 | 951 |
| Arrive On Green | | 0.16 | 0.32 | 0.00 | 0.08 | 0.24 | 0.00 | 0.07 | 0.14 | 0.00 | 0.21 | 0.27 |
| Sat Flow, veh/h | | 3456 | 3554 | 1585 | 3456 | 3554 | 1585 | 3456 | 3554 | 1585 | 3456 | 3554 |
| Grp Volume(v), veh/h | | 482 | 266 | 0 | 65 | 439 | 0 | 190 | 378 | 0 | 242 | 847 |
| Grp Sat Flow(s),veh/h/ln | | 1728 | 1777 | 1585 | 1728 | 1777 | 1585 | 1728 | 1777 | 1585 | 1728 | 1777 |
| Q Serve(g_s), s | | 16.4 | 6.6 | 0.0 | 2.1 | 12.9 | 0.0 | 6.5 | 12.3 | 0.0 | 7.1 | 27.5 |
| Cycle Q Clear(g_c), s | | 16.4 | 6.6 | 0.0 | 2.1 | 12.9 | 0.0 | 6.5 | 12.3 | 0.0 | 7.1 | 27.5 |
| Prop In Lane | | 1.00 | | 1.00 | 1.00 | | 1.00 | 1.00 | | 1.00 | 1.00 | |
| Lane Grp Cap(c), veh/h | | 546 | 1125 | | 283 | 840 | | 247 | 487 | | 741 | 951 |
| V/C Ratio(X) | | 0.88 | 0.24 | | 0.23 | 0.52 | | 0.77 | 0.78 | | 0.33 | 0.89 |
| Avail Cap(c_a), veh/h | | 619 | 1125 | | 283 | 840 | | 302 | 918 | | 741 | 1036 |
| HCM Platoon Ratio | | 1.00 | 1.00 | 1.00 | 1.00 | 1.00 | 1.00 | 1.00 | 1.00 | 1.00 | 1.00 | 1.00 |
| Upstream Filter(I) | | 1.00 | 1.00 | 0.00 | 1.00 | 1.00 | 0.00 | 1.00 | 1.00 | 0.00 | 1.00 | 1.00 |
| Uniform Delay (d), s/veh | | 49.4 | 30.3 | 0.0 | 51.6 | 39.9 | 0.0 | 54.7 | 50.0 | 0.0 | 39.8 | 42.3 |
| Incr Delay (d2), s/veh | | 13.0 | 0.5 | 0.0 | 0.4 | 2.3 | 0.0 | 9.3 | 2.7 | 0.0 | 0.3 | 9.3 |
| Initial Q Delay(d3),s/veh | | 0.0 | 0.0 | 0.0 | 0.0 | 0.0 | 0.0 | 0.0 | 0.0 | 0.0 | 0.0 | 0.0 |
| %ile BackOfQ(50%),veh/ln | | 7.8 | 2.8 | 0.0 | 0.9 | 5.8 | 0.0 | 3.1 | 5.6 | 0.0 | 3.0 | 13.1 |
| Unsig. Movement Delay, s/veh | | | | | | | | | | | | |
| LnGrp Delay(d),s/veh | | 62.5 | 30.8 | 0.0 | 52.0 | 42.2 | 0.0 | 64.0 | 52.7 | 0.0 | 40.1 | 51.5 |
| LnGrp LOS | | E | C | | D | D | | E | D | | D | D |
| Approach Vol, veh/h | | | 748 | A | | 504 | A | | 568 | A | | 1089 |
| Approach Delay, s/veh | | | 51.2 | | | 43.5 | | | 56.5 | | | 49.0 |
| Approach LOS | | | D | | | D | | | E | | | D |
| Timer - Assigned Phs | 1 | 2 | 3 | 4 | 5 | 6 | 7 | 8 | | | | |
| Phs Duration (G+Y+Rc), s | 17.3 | 45.0 | 17.1 | 40.6 | 26.5 | 35.9 | 34.2 | 23.4 | | | | |
| Change Period (Y+Rc), s | 7.5 | 7.0 | 8.5 | * 8.5 | 7.5 | * 7.5 | 8.5 | 7.0 | | | | |
| Max Green Setting (Gmax), s | 6.5 | 38.0 | 10.5 | * 35 | 21.5 | * 23 | 14.5 | 31.0 | | | | |
| Max Q Clear Time (g_c+I1), s | 4.1 | 8.6 | 8.5 | 29.5 | 18.4 | 14.9 | 9.1 | 14.3 | | | | |
| Green Ext Time (p_c), s | 0.0 | 1.6 | 0.1 | 2.6 | 0.6 | 1.6 | 0.4 | 2.1 | | | | |

Intersection Summary

| | |
|--------------------|------|
| HCM 6th Ctrl Delay | 50.1 |
| HCM 6th LOS | D |

Notes

- User approved pedestrian interval to be less than phase max green.
- User approved ignoring U-Turning movement.
- * HCM 6th computational engine requires equal clearance times for the phases crossing the barrier.

| | |
|---|------|
| Movement | SBR |
| Lane Configurations | |
| Traffic Volume (veh/h) | 835 |
| Future Volume (veh/h) | 835 |
| Initial Q (Qb), veh | 0 |
| Ped-Bike Adj(A_pbT) | 1.00 |
| Parking Bus, Adj | 1.00 |
| Work Zone On Approach | |
| Adj Sat Flow, veh/h/ln | 1870 |
| Adj Flow Rate, veh/h | 0 |
| Peak Hour Factor | 0.92 |
| Percent Heavy Veh, % | 2 |
| Cap, veh/h | |
| Arrive On Green | 0.00 |
| Sat Flow, veh/h | 1585 |
| Grp Volume(v), veh/h | 0 |
| Grp Sat Flow(s),veh/h/ln | 1585 |
| Q Serve(g_s), s | 0.0 |
| Cycle Q Clear(g_c), s | 0.0 |
| Prop In Lane | 1.00 |
| Lane Grp Cap(c), veh/h | |
| V/C Ratio(X) | |
| Avail Cap(c_a), veh/h | |
| HCM Platoon Ratio | 1.00 |
| Upstream Filter(l) | 0.00 |
| Uniform Delay (d), s/veh | 0.0 |
| Incr Delay (d2), s/veh | 0.0 |
| Initial Q Delay(d3),s/veh | 0.0 |
| %ile BackOfQ(50%),veh/ln | 0.0 |
| Unsig. Movement Delay, s/veh | |
| LnGrp Delay(d),s/veh | 0.0 |
| LnGrp LOS | |
| Approach Vol, veh/h | A |
| Approach Delay, s/veh | |
| Approach LOS | |
| Timer - Assigned Phs | |
| Unsignalized Delay for [NBR, EBR, WBR, SBR] is excluded from calculations of the approach delay and intersection delay. | |

Timings
2: MERIDIAN ROAD & EASTONVILLE ROAD

Total 2024 Shopping Center AM
04/10/2023

| Lane Group | EBL | EBT | EBR | WBL | WBT | WBR | NBL | NBT | NBR | SBL | SBT | SBR |
|----------------------|-------|-------|-------|-------|-------|-------|-------|-------|-------|-------|-------|-------|
| Lane Configurations | | | | | | | | | | | | |
| Traffic Volume (vph) | 218 | 52 | 352 | 100 | 56 | 37 | 439 | 522 | 42 | 114 | 1427 | 187 |
| Future Volume (vph) | 218 | 52 | 352 | 100 | 56 | 37 | 439 | 522 | 42 | 114 | 1427 | 187 |
| Turn Type | pm+pt | NA | Perm | pm+pt | NA | Perm | Prot | NA | Perm | Prot | NA | Perm |
| Protected Phases | 7 | 4 | | 3 | 8 | | 5 | 2 | | 1 | 6 | |
| Permitted Phases | 4 | | 4 | 8 | | 8 | | | 2 | | | 6 |
| Detector Phase | 7 | 4 | 4 | 3 | 8 | 8 | 5 | 2 | 2 | 1 | 6 | 6 |
| Switch Phase | | | | | | | | | | | | |
| Minimum Initial (s) | 5.0 | 8.0 | 8.0 | 5.0 | 8.0 | 8.0 | 5.0 | 15.0 | 15.0 | 5.0 | 15.0 | 15.0 |
| Minimum Split (s) | 12.5 | 14.5 | 14.5 | 12.5 | 14.5 | 14.5 | 12.5 | 22.5 | 22.5 | 13.5 | 22.5 | 22.5 |
| Total Split (s) | 13.0 | 15.0 | 15.0 | 13.0 | 15.0 | 15.0 | 36.0 | 68.0 | 68.0 | 24.0 | 56.0 | 56.0 |
| Total Split (%) | 10.8% | 12.5% | 12.5% | 10.8% | 12.5% | 12.5% | 30.0% | 56.7% | 56.7% | 20.0% | 46.7% | 46.7% |
| Yellow Time (s) | 4.0 | 4.0 | 4.0 | 4.0 | 4.0 | 4.0 | 4.0 | 5.5 | 5.5 | 5.0 | 5.5 | 5.5 |
| All-Red Time (s) | 3.5 | 2.5 | 2.5 | 3.5 | 2.5 | 2.5 | 3.5 | 2.0 | 2.0 | 3.5 | 2.0 | 2.0 |
| Lost Time Adjust (s) | 0.0 | 0.0 | 0.0 | 0.0 | 0.0 | 0.0 | 0.0 | 0.0 | 0.0 | 0.0 | 0.0 | 0.0 |
| Total Lost Time (s) | 7.5 | 6.5 | 6.5 | 7.5 | 6.5 | 6.5 | 7.5 | 7.5 | 7.5 | 8.5 | 7.5 | 7.5 |
| Lead/Lag | Lead | Lag | Lag | Lead | Lag | Lag | Lead | Lag | Lag | Lead | Lag | Lag |
| Lead-Lag Optimize? | Yes | Yes | Yes | Yes | Yes | Yes | Yes | Yes | Yes | Yes | Yes | Yes |
| Recall Mode | None | None | None | None | None | None | None | C-Max | C-Max | None | C-Max | C-Max |
| Act Effct Green (s) | 14.5 | 8.5 | 8.5 | 11.5 | 8.4 | 8.4 | 28.5 | 63.0 | 63.0 | 13.0 | 48.5 | 48.5 |
| Actuated g/C Ratio | 0.12 | 0.07 | 0.07 | 0.10 | 0.07 | 0.07 | 0.24 | 0.52 | 0.52 | 0.11 | 0.40 | 0.40 |
| v/c Ratio | 0.77 | 0.47 | 1.02 | 0.73 | 0.46 | 0.11 | 1.23 | 0.33 | 0.05 | 0.65 | 1.10 | 0.26 |
| Control Delay | 63.9 | 65.7 | 65.0 | 75.2 | 65.6 | 0.7 | 159.1 | 12.8 | 0.6 | 82.7 | 76.6 | 2.6 |
| Queue Delay | 0.0 | 0.0 | 0.0 | 0.0 | 0.0 | 0.0 | 0.0 | 0.0 | 0.0 | 0.0 | 0.0 | 0.0 |
| Total Delay | 63.9 | 65.7 | 65.0 | 75.2 | 65.6 | 0.7 | 159.1 | 12.8 | 0.6 | 82.7 | 76.6 | 2.6 |
| LOS | E | E | E | E | E | A | F | B | A | F | E | A |
| Approach Delay | | 64.7 | | | 58.1 | | | 76.3 | | | 69.0 | |
| Approach LOS | | E | | | E | | | E | | | E | |

Intersection Summary

Cycle Length: 120
 Actuated Cycle Length: 120
 Offset: 45 (38%), Referenced to phase 2:NBT and 6:SBT, Start of Yellow
 Natural Cycle: 150
 Control Type: Actuated-Coordinated
 Maximum v/c Ratio: 1.23
 Intersection Signal Delay: 69.8
 Intersection Capacity Utilization 94.6%
 Analysis Period (min) 15
 Intersection LOS: E
 ICU Level of Service F

Splits and Phases: 2: MERIDIAN ROAD & EASTONVILLE ROAD



Queues
2: MERIDIAN ROAD & EASTONVILLE ROAD

Total 2024 Shopping Center AM
04/10/2023



























| Lane Group | EBL | EBT | EBR | WBL | WBT | WBR | NBL | NBT | NBR | SBL | SBT | SBR |
|-------------------------|------|------|------|------|------|------|-------|------|------|------|------|------|
| Lane Group Flow (vph) | 256 | 61 | 414 | 108 | 60 | 40 | 516 | 614 | 49 | 125 | 1568 | 205 |
| v/c Ratio | 0.77 | 0.47 | 1.02 | 0.73 | 0.46 | 0.11 | 1.23 | 0.33 | 0.05 | 0.65 | 1.10 | 0.26 |
| Control Delay | 63.9 | 65.7 | 65.0 | 75.2 | 65.6 | 0.7 | 159.1 | 12.8 | 0.6 | 82.7 | 76.6 | 2.6 |
| Queue Delay | 0.0 | 0.0 | 0.0 | 0.0 | 0.0 | 0.0 | 0.0 | 0.0 | 0.0 | 0.0 | 0.0 | 0.0 |
| Total Delay | 63.9 | 65.7 | 65.0 | 75.2 | 65.6 | 0.7 | 159.1 | 12.8 | 0.6 | 82.7 | 76.6 | 2.6 |
| Queue Length 50th (ft) | 92 | 46 | ~96 | 75 | 46 | 0 | ~507 | 123 | 0 | 94 | ~746 | 27 |
| Queue Length 95th (ft) | #123 | 86 | #248 | #147 | 91 | 0 | #669 | 147 | m2 | m136 | #891 | m24 |
| Internal Link Dist (ft) | | 508 | | | 1196 | | | 231 | | | | 781 |
| Turn Bay Length (ft) | 100 | | 100 | 120 | | 100 | 100 | | 400 | 375 | | 400 |
| Base Capacity (vph) | 332 | 131 | 405 | 147 | 131 | 349 | 420 | 1859 | 915 | 228 | 1430 | 785 |
| Starvation Cap Reductn | 0 | 0 | 0 | 0 | 0 | 0 | 0 | 0 | 0 | 0 | 0 | 0 |
| Spillback Cap Reductn | 0 | 0 | 0 | 0 | 0 | 0 | 0 | 0 | 0 | 0 | 0 | 0 |
| Storage Cap Reductn | 0 | 0 | 0 | 0 | 0 | 0 | 0 | 0 | 0 | 0 | 0 | 0 |
| Reduced v/c Ratio | 0.77 | 0.47 | 1.02 | 0.73 | 0.46 | 0.11 | 1.23 | 0.33 | 0.05 | 0.55 | 1.10 | 0.26 |

Intersection Summary

- ~ Volume exceeds capacity, queue is theoretically infinite.
Queue shown is maximum after two cycles.
- # 95th percentile volume exceeds capacity, queue may be longer.
Queue shown is maximum after two cycles.
- m Volume for 95th percentile queue is metered by upstream signal.

HCM 6th Signalized Intersection Summary
2: MERIDIAN ROAD & EASTONVILLE ROAD

Total 2024 Shopping Center AM
04/10/2023

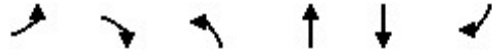
| |  |  |  |  |  |  |  |  |  |  |  |  |
|------------------------------|---|---|---|---|---|---|---|---|---|---|---|---|
| Movement | EBL | EBT | EBR | WBL | WBT | WBR | NBL | NBT | NBR | SBL | SBT | SBR |
| Lane Configurations |  |  |  |  |  |  |  |  |  |  |  |  |
| Traffic Volume (veh/h) | 218 | 52 | 352 | 100 | 56 | 37 | 439 | 522 | 42 | 114 | 1427 | 187 |
| Future Volume (veh/h) | 218 | 52 | 352 | 100 | 56 | 37 | 439 | 522 | 42 | 114 | 1427 | 187 |
| Initial Q (Qb), veh | 0 | 0 | 0 | 0 | 0 | 0 | 0 | 0 | 0 | 0 | 0 | 0 |
| Ped-Bike Adj(A_pbT) | 1.00 | | 1.00 | 1.00 | | 1.00 | 1.00 | | 1.00 | 1.00 | | 1.00 |
| Parking Bus, Adj | 1.00 | 1.00 | 1.00 | 1.00 | 1.00 | 1.00 | 1.00 | 1.00 | 1.00 | 1.00 | 1.00 | 1.00 |
| Work Zone On Approach | | No | | | No | | | No | | | No | |
| Adj Sat Flow, veh/h/ln | 1870 | 1870 | 1870 | 1870 | 1870 | 1870 | 1870 | 1870 | 1870 | 1870 | 1870 | 1870 |
| Adj Flow Rate, veh/h | 256 | 61 | 0 | 108 | 60 | 0 | 516 | 614 | 49 | 125 | 1568 | 205 |
| Peak Hour Factor | 0.85 | 0.85 | 0.85 | 0.93 | 0.93 | 0.93 | 0.85 | 0.85 | 0.85 | 0.91 | 0.91 | 0.91 |
| Percent Heavy Veh, % | 2 | 2 | 2 | 2 | 2 | 2 | 2 | 2 | 2 | 2 | 2 | 2 |
| Cap, veh/h | 371 | 125 | | 189 | 125 | | 423 | 1962 | 875 | 152 | 1451 | 647 |
| Arrive On Green | 0.05 | 0.07 | 0.00 | 0.05 | 0.07 | 0.00 | 0.24 | 0.55 | 0.55 | 0.09 | 0.41 | 0.41 |
| Sat Flow, veh/h | 3456 | 1870 | 1585 | 1781 | 1870 | 1585 | 1781 | 3554 | 1585 | 1781 | 3554 | 1585 |
| Grp Volume(v), veh/h | 256 | 61 | 0 | 108 | 60 | 0 | 516 | 614 | 49 | 125 | 1568 | 205 |
| Grp Sat Flow(s),veh/h/ln | 1728 | 1870 | 1585 | 1781 | 1870 | 1585 | 1781 | 1777 | 1585 | 1781 | 1777 | 1585 |
| Q Serve(g_s), s | 5.5 | 3.8 | 0.0 | 5.5 | 3.7 | 0.0 | 28.5 | 11.2 | 1.7 | 8.3 | 49.0 | 10.5 |
| Cycle Q Clear(g_c), s | 5.5 | 3.8 | 0.0 | 5.5 | 3.7 | 0.0 | 28.5 | 11.2 | 1.7 | 8.3 | 49.0 | 10.5 |
| Prop In Lane | 1.00 | | 1.00 | 1.00 | | 1.00 | 1.00 | | 1.00 | 1.00 | | 1.00 |
| Lane Grp Cap(c), veh/h | 371 | 125 | | 189 | 125 | | 423 | 1962 | 875 | 152 | 1451 | 647 |
| V/C Ratio(X) | 0.69 | 0.49 | | 0.57 | 0.48 | | 1.22 | 0.31 | 0.06 | 0.82 | 1.08 | 0.32 |
| Avail Cap(c_a), veh/h | 371 | 132 | | 189 | 132 | | 423 | 1962 | 875 | 230 | 1451 | 647 |
| HCM Platoon Ratio | 1.00 | 1.00 | 1.00 | 1.00 | 1.00 | 1.00 | 1.00 | 1.00 | 1.00 | 1.00 | 1.00 | 1.00 |
| Upstream Filter(I) | 1.00 | 1.00 | 0.00 | 1.00 | 1.00 | 0.00 | 1.00 | 1.00 | 1.00 | 1.00 | 1.00 | 1.00 |
| Uniform Delay (d), s/veh | 52.6 | 54.0 | 0.0 | 51.1 | 54.0 | 0.0 | 45.8 | 14.5 | 12.4 | 54.0 | 35.5 | 24.1 |
| Incr Delay (d2), s/veh | 5.3 | 2.9 | 0.0 | 4.1 | 2.9 | 0.0 | 118.6 | 0.4 | 0.1 | 13.4 | 48.7 | 1.3 |
| Initial Q Delay(d3),s/veh | 0.0 | 0.0 | 0.0 | 0.0 | 0.0 | 0.0 | 0.0 | 0.0 | 0.0 | 0.0 | 0.0 | 0.0 |
| %ile BackOfQ(50%),veh/ln | 1.5 | 1.9 | 0.0 | 3.4 | 1.8 | 0.0 | 25.8 | 4.2 | 0.6 | 4.1 | 29.1 | 4.2 |
| Unsig. Movement Delay, s/veh | | | | | | | | | | | | |
| LnGrp Delay(d),s/veh | 57.9 | 57.0 | 0.0 | 55.2 | 56.9 | 0.0 | 164.3 | 15.0 | 12.5 | 67.4 | 84.2 | 25.4 |
| LnGrp LOS | E | E | | E | E | | F | B | B | E | F | C |
| Approach Vol, veh/h | | 317 | A | | 168 | A | | 1179 | | | 1898 | |
| Approach Delay, s/veh | | 57.7 | | | 55.8 | | | 80.2 | | | 76.7 | |
| Approach LOS | | E | | | E | | | F | | | E | |
| Timer - Assigned Phs | 1 | 2 | 3 | 4 | 5 | 6 | 7 | 8 | | | | |
| Phs Duration (G+Y+Rc), s | 18.7 | 73.8 | 13.0 | 14.5 | 36.0 | 56.5 | 13.0 | 14.5 | | | | |
| Change Period (Y+Rc), s | 8.5 | 7.5 | 7.5 | 6.5 | 7.5 | 7.5 | 7.5 | 6.5 | | | | |
| Max Green Setting (Gmax), s | 15.5 | 60.5 | 5.5 | 8.5 | 28.5 | 48.5 | 5.5 | 8.5 | | | | |
| Max Q Clear Time (g_c+I1), s | 10.3 | 13.2 | 7.5 | 5.8 | 30.5 | 51.0 | 7.5 | 5.7 | | | | |
| Green Ext Time (p_c), s | 0.1 | 4.1 | 0.0 | 0.0 | 0.0 | 0.0 | 0.0 | 0.0 | | | | |

| Intersection Summary | | | | | | | | | | | | |
|----------------------|--|--|--|------|--|--|--|--|--|--|--|--|
| HCM 6th Ctrl Delay | | | | 75.2 | | | | | | | | |
| HCM 6th LOS | | | | E | | | | | | | | |

Notes
User approved pedestrian interval to be less than phase max green.
Unsignalized Delay for [EBR, WBR] is excluded from calculations of the approach delay and intersection delay.

Timings
3: MERIDIAN ROAD & BENT GRASS MEADOWS DRIVE

Total 2024 Shopping Center AM
04/10/2023

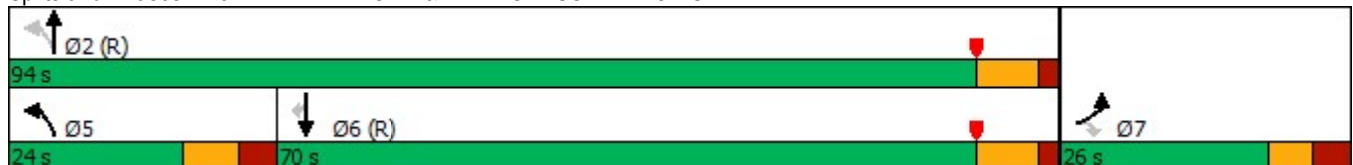


| Lane Group | EBL | EBR | NBL | NBT | SBT | SBR |
|----------------------|-------|-------|-------|-------|-------|-------|
| Lane Configurations | ↖↗ | ↗ | ↖ | ↑↑ | ↑↑ | ↗ |
| Traffic Volume (vph) | 121 | 235 | 193 | 534 | 1451 | 179 |
| Future Volume (vph) | 121 | 235 | 193 | 534 | 1451 | 179 |
| Turn Type | Prot | Perm | pm+pt | NA | NA | Perm |
| Protected Phases | 7 | | 5 | 2 | 6 | |
| Permitted Phases | | 7 | 2 | | | 6 |
| Detector Phase | 7 | 7 | 5 | 2 | 6 | 6 |
| Switch Phase | | | | | | |
| Minimum Initial (s) | 8.0 | 8.0 | 5.0 | 15.0 | 15.0 | 15.0 |
| Minimum Split (s) | 25.5 | 25.5 | 13.5 | 25.5 | 25.5 | 25.5 |
| Total Split (s) | 26.0 | 26.0 | 24.0 | 94.0 | 70.0 | 70.0 |
| Total Split (%) | 21.7% | 21.7% | 20.0% | 78.3% | 58.3% | 58.3% |
| Yellow Time (s) | 4.0 | 4.0 | 5.0 | 5.5 | 5.5 | 5.5 |
| All-Red Time (s) | 3.5 | 3.5 | 3.5 | 2.0 | 2.0 | 2.0 |
| Lost Time Adjust (s) | 0.0 | 0.0 | 0.0 | 0.0 | 0.0 | 0.0 |
| Total Lost Time (s) | 7.5 | 7.5 | 8.5 | 7.5 | 7.5 | 7.5 |
| Lead/Lag | | | Lead | | Lag | Lag |
| Lead-Lag Optimize? | | | Yes | | Yes | Yes |
| Recall Mode | None | None | None | C-Max | C-Max | C-Max |
| Act Effect Green (s) | 11.9 | 11.9 | 92.1 | 93.1 | 70.7 | 70.7 |
| Actuated g/C Ratio | 0.10 | 0.10 | 0.77 | 0.78 | 0.59 | 0.59 |
| v/c Ratio | 0.42 | 0.75 | 0.77 | 0.22 | 0.79 | 0.20 |
| Control Delay | 53.5 | 24.6 | 48.6 | 3.5 | 24.0 | 2.4 |
| Queue Delay | 0.0 | 0.0 | 0.0 | 0.0 | 0.0 | 0.0 |
| Total Delay | 53.5 | 24.6 | 48.6 | 3.5 | 24.0 | 2.4 |
| LOS | D | C | D | A | C | A |
| Approach Delay | 34.4 | | | 15.5 | 21.6 | |
| Approach LOS | C | | | B | C | |

Intersection Summary

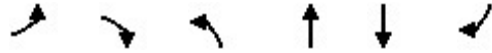
Cycle Length: 120
 Actuated Cycle Length: 120
 Offset: 5 (4%), Referenced to phase 2:NBTL and 6:SBT, Start of Yellow
 Natural Cycle: 90
 Control Type: Actuated-Coordinated
 Maximum v/c Ratio: 0.79
 Intersection Signal Delay: 21.7
 Intersection LOS: C
 Intersection Capacity Utilization 77.1%
 ICU Level of Service D
 Analysis Period (min) 15

Splits and Phases: 3: MERIDIAN ROAD & BENT GRASS MEADOWS DRIVE



Queues
 3: MERIDIAN ROAD & BENT GRASS MEADOWS DRIVE

Total 2024 Shopping Center AM
 04/10/2023



| Lane Group | EBL | EBR | NBL | NBT | SBT | SBR |
|-------------------------|------|------|-------|------|------|------|
| Lane Group Flow (vph) | 141 | 273 | 214 | 593 | 1649 | 203 |
| v/c Ratio | 0.42 | 0.75 | 0.77 | 0.22 | 0.79 | 0.20 |
| Control Delay | 53.5 | 24.6 | 48.6 | 3.5 | 24.0 | 2.4 |
| Queue Delay | 0.0 | 0.0 | 0.0 | 0.0 | 0.0 | 0.0 |
| Total Delay | 53.5 | 24.6 | 48.6 | 3.5 | 24.0 | 2.4 |
| Queue Length 50th (ft) | 54 | 33 | 117 | 78 | 486 | 0 |
| Queue Length 95th (ft) | 77 | 104 | m#200 | 112 | 670 | 33 |
| Internal Link Dist (ft) | 310 | | | 750 | 1921 | |
| Turn Bay Length (ft) | 150 | | 700 | | | 350 |
| Base Capacity (vph) | 529 | 436 | 309 | 2746 | 2085 | 1016 |
| Starvation Cap Reductn | 0 | 0 | 0 | 0 | 0 | 0 |
| Spillback Cap Reductn | 0 | 0 | 0 | 0 | 0 | 0 |
| Storage Cap Reductn | 0 | 0 | 0 | 0 | 0 | 0 |
| Reduced v/c Ratio | 0.27 | 0.63 | 0.69 | 0.22 | 0.79 | 0.20 |

Intersection Summary

- # 95th percentile volume exceeds capacity, queue may be longer.
 Queue shown is maximum after two cycles.
- m Volume for 95th percentile queue is metered by upstream signal.

HCM 6th Signalized Intersection Summary
 3: MERIDIAN ROAD & BENT GRASS MEADOWS DRIVE

Total 2024 Shopping Center AM
 04/10/2023



| Movement | EBL | EBR | NBL | NBT | SBT | SBR |
|------------------------------|------|-------|------|------|------|------|
| Lane Configurations | ↖↗ | ↖ | ↗ | ↑↑ | ↑↑ | ↖ |
| Traffic Volume (veh/h) | 121 | 235 | 193 | 534 | 1451 | 179 |
| Future Volume (veh/h) | 121 | 235 | 193 | 534 | 1451 | 179 |
| Initial Q (Qb), veh | 0 | 0 | 0 | 0 | 0 | 0 |
| Ped-Bike Adj(A_pbT) | 1.00 | 1.00 | 1.00 | | | 1.00 |
| Parking Bus, Adj | 1.00 | 1.00 | 1.00 | 1.00 | 1.00 | 1.00 |
| Work Zone On Approach | No | | | No | No | |
| Adj Sat Flow, veh/h/ln | 1870 | 1870 | 1870 | 1870 | 1870 | 1870 |
| Adj Flow Rate, veh/h | 141 | 0 | 214 | 593 | 1649 | 203 |
| Peak Hour Factor | 0.86 | 0.86 | 0.90 | 0.90 | 0.88 | 0.88 |
| Percent Heavy Veh, % | 2 | 2 | 2 | 2 | 2 | 2 |
| Cap, veh/h | 228 | | 258 | 2875 | 2433 | 1085 |
| Arrive On Green | 0.07 | 0.00 | 0.05 | 0.81 | 0.68 | 0.68 |
| Sat Flow, veh/h | 3456 | 1585 | 1781 | 3647 | 3647 | 1585 |
| Grp Volume(v), veh/h | 141 | 0 | 214 | 593 | 1649 | 203 |
| Grp Sat Flow(s),veh/h/ln | 1728 | 1585 | 1781 | 1777 | 1777 | 1585 |
| Q Serve(g_s), s | 4.8 | 0.0 | 4.0 | 4.6 | 32.8 | 5.6 |
| Cycle Q Clear(g_c), s | 4.8 | 0.0 | 4.0 | 4.6 | 32.8 | 5.6 |
| Prop In Lane | 1.00 | 1.00 | 1.00 | | | 1.00 |
| Lane Grp Cap(c), veh/h | 228 | | 258 | 2875 | 2433 | 1085 |
| V/C Ratio(X) | 0.62 | | 0.83 | 0.21 | 0.68 | 0.19 |
| Avail Cap(c_a), veh/h | 533 | | 392 | 2875 | 2433 | 1085 |
| HCM Platoon Ratio | 1.00 | 1.00 | 1.00 | 1.00 | 1.00 | 1.00 |
| Upstream Filter(l) | 1.00 | 0.00 | 1.00 | 1.00 | 1.00 | 1.00 |
| Uniform Delay (d), s/veh | 54.6 | 0.0 | 21.8 | 2.6 | 11.1 | 6.8 |
| Incr Delay (d2), s/veh | 2.7 | 0.0 | 8.8 | 0.2 | 1.5 | 0.4 |
| Initial Q Delay(d3),s/veh | 0.0 | 0.0 | 0.0 | 0.0 | 0.0 | 0.0 |
| %ile BackOfQ(50%),veh/ln | 2.1 | 0.0 | 5.0 | 1.3 | 12.3 | 9.0 |
| Unsig. Movement Delay, s/veh | | | | | | |
| LnGrp Delay(d),s/veh | 57.3 | 0.0 | 30.6 | 2.8 | 12.7 | 7.2 |
| LnGrp LOS | E | | C | A | B | A |
| Approach Vol, veh/h | 141 | A | | 807 | 1852 | |
| Approach Delay, s/veh | 57.3 | | | 10.2 | 12.1 | |
| Approach LOS | E | | | B | B | |
| Timer - Assigned Phs | | 2 | | 4 | 5 | 6 |
| Phs Duration (G+Y+Rc), s | | 104.6 | | 15.4 | 14.9 | 89.7 |
| Change Period (Y+Rc), s | | 7.5 | | 7.5 | 8.5 | 7.5 |
| Max Green Setting (Gmax), s | | 86.5 | | 18.5 | 15.5 | 62.5 |
| Max Q Clear Time (g_c+I1), s | | 6.6 | | 6.8 | 6.0 | 34.8 |
| Green Ext Time (p_c), s | | 4.7 | | 0.3 | 0.4 | 16.9 |

Intersection Summary

| | |
|--------------------|------|
| HCM 6th Ctrl Delay | 13.8 |
| HCM 6th LOS | B |

Notes

Unsignalized Delay for [EBR] is excluded from calculations of the approach delay and intersection delay.

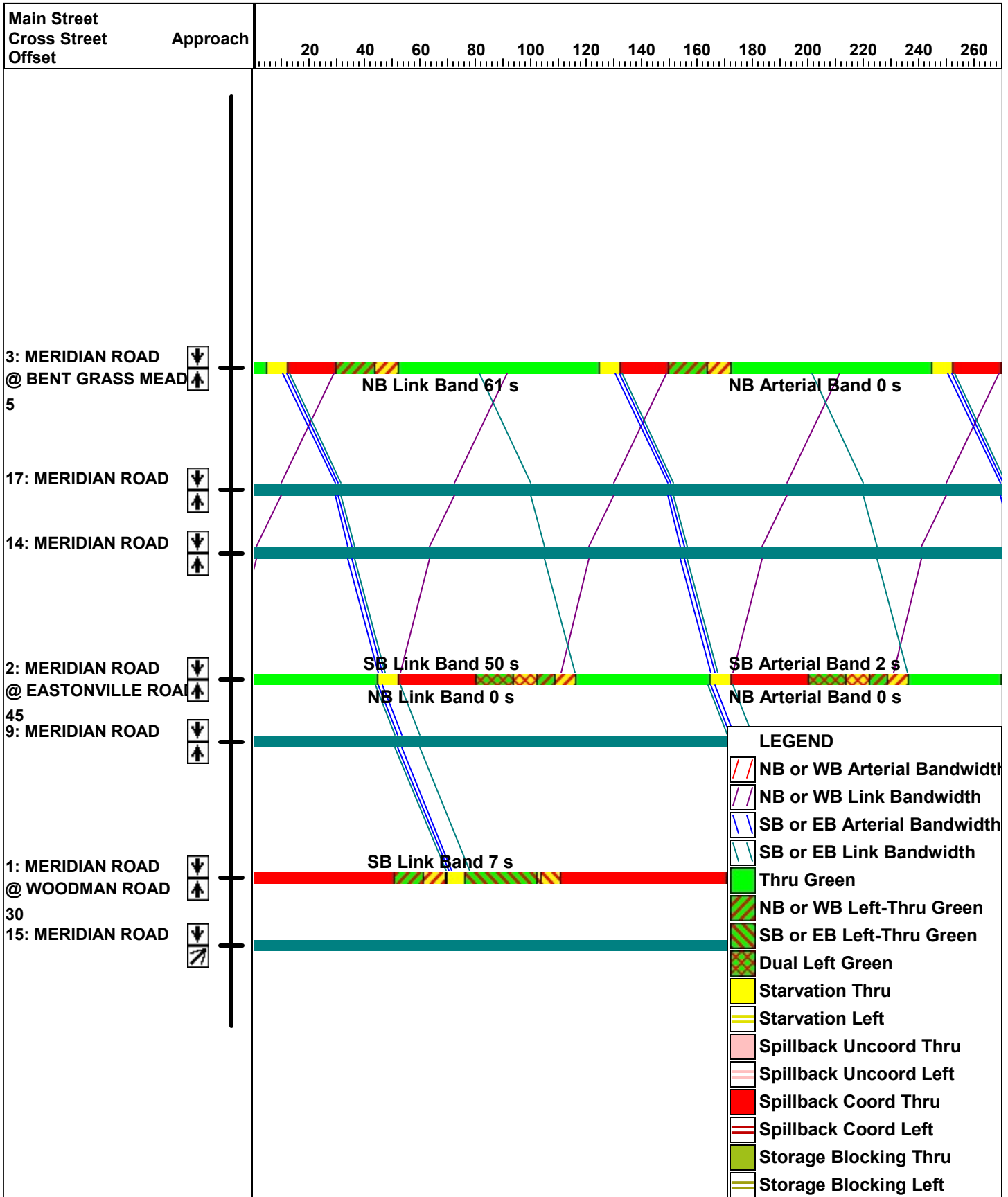
| Intersection | | | | | | |
|--------------------------|------|------|------|------|------|------|
| Int Delay, s/veh | 6.2 | | | | | |
| Movement | EBT | EBR | WBL | WBT | NBL | NBR |
| Lane Configurations | ↑ | ↗ | ↘ | ↑ | ↘ | |
| Traffic Vol, veh/h | 145 | 65 | 304 | 68 | 1 | 211 |
| Future Vol, veh/h | 145 | 65 | 304 | 68 | 1 | 211 |
| Conflicting Peds, #/hr | 0 | 0 | 0 | 0 | 0 | 0 |
| Sign Control | Free | Free | Free | Free | Stop | Stop |
| RT Channelized | - | None | - | None | - | None |
| Storage Length | - | 150 | 100 | - | 0 | - |
| Veh in Median Storage, # | 0 | - | - | 0 | 0 | - |
| Grade, % | 0 | - | - | 0 | 0 | - |
| Peak Hour Factor | 85 | 85 | 85 | 85 | 85 | 85 |
| Heavy Vehicles, % | 2 | 2 | 2 | 2 | 2 | 2 |
| Mvmt Flow | 171 | 76 | 358 | 80 | 1 | 248 |

| Major/Minor | Major1 | Major2 | Minor1 | | |
|----------------------|--------|--------|--------|---|-------|
| Conflicting Flow All | 0 | 0 | 247 | 0 | 967 |
| Stage 1 | - | - | - | - | 171 |
| Stage 2 | - | - | - | - | 796 |
| Critical Hdwy | - | - | 4.12 | - | 6.42 |
| Critical Hdwy Stg 1 | - | - | - | - | 5.42 |
| Critical Hdwy Stg 2 | - | - | - | - | 5.42 |
| Follow-up Hdwy | - | - | 2.218 | - | 3.518 |
| Pot Cap-1 Maneuver | - | - | 1319 | - | 282 |
| Stage 1 | - | - | - | - | 859 |
| Stage 2 | - | - | - | - | 444 |
| Platoon blocked, % | - | - | - | - | - |
| Mov Cap-1 Maneuver | - | - | 1319 | - | 206 |
| Mov Cap-2 Maneuver | - | - | - | - | 206 |
| Stage 1 | - | - | - | - | 859 |
| Stage 2 | - | - | - | - | 324 |

| Approach | EB | WB | NB |
|----------------------|----|-----|------|
| HCM Control Delay, s | 0 | 7.1 | 10.9 |
| HCM LOS | | | B |

| Minor Lane/Major Mvmt | NBLn1 | EBT | EBR | WBL | WBT |
|-----------------------|-------|-----|-----|-------|-----|
| Capacity (veh/h) | 860 | - | - | 1319 | - |
| HCM Lane V/C Ratio | 0.29 | - | - | 0.271 | - |
| HCM Control Delay (s) | 10.9 | - | - | 8.7 | - |
| HCM Lane LOS | B | - | - | A | - |
| HCM 95th %tile Q(veh) | 1.2 | - | - | 1.1 | - |

Total AM 2024 Shopping Center



Timings
1: MERIDIAN ROAD & WOODMAN ROAD

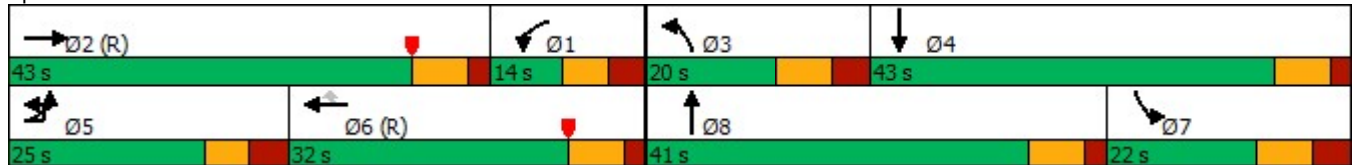
Total 2024 Storage AM
04/10/2023

| Lane Group | EBL | EBT | EBR | WBL | WBT | WBR | NBL | NBT | NBR | SBL | SBT | SBR |
|----------------------|-------|-------|-------|-------|-------|-------|-------|-------|-------|-------|-------|-------|
| Lane Configurations | | | | | | | | | | | | |
| Traffic Volume (vph) | 280 | 226 | 122 | 61 | 413 | 132 | 182 | 305 | 18 | 196 | 743 | 754 |
| Future Volume (vph) | 280 | 226 | 122 | 61 | 413 | 132 | 182 | 305 | 18 | 196 | 743 | 754 |
| Turn Type | Prot | NA | Free | Prot | NA | Perm | Prot | NA | Free | Prot | NA | Free |
| Protected Phases | 5 | 2 | | 1 | 6 | | 3 | 8 | | 7 | 4 | |
| Permitted Phases | | | Free | | | 6 | | | Free | | | Free |
| Detector Phase | 5 | 2 | | 1 | 6 | 6 | 3 | 8 | | 7 | 4 | |
| Switch Phase | | | | | | | | | | | | |
| Minimum Initial (s) | 5.0 | 15.0 | | 5.0 | 15.0 | 15.0 | 5.0 | 15.0 | | 5.0 | 15.0 | |
| Minimum Split (s) | 13.5 | 22.0 | | 13.5 | 22.0 | 22.0 | 13.5 | 22.0 | | 13.5 | 22.0 | |
| Total Split (s) | 25.0 | 43.0 | | 14.0 | 32.0 | 32.0 | 20.0 | 41.0 | | 22.0 | 43.0 | |
| Total Split (%) | 20.8% | 35.8% | | 11.7% | 26.7% | 26.7% | 16.7% | 34.2% | | 18.3% | 35.8% | |
| Yellow Time (s) | 4.0 | 5.0 | | 4.0 | 5.0 | 5.0 | 5.0 | 5.0 | | 5.0 | 5.0 | |
| All-Red Time (s) | 3.5 | 2.0 | | 3.5 | 2.0 | 2.0 | 3.5 | 2.0 | | 3.5 | 2.0 | |
| Lost Time Adjust (s) | 0.0 | 0.0 | | 0.0 | 0.0 | 0.0 | 0.0 | 0.0 | | 0.0 | 0.0 | |
| Total Lost Time (s) | 7.5 | 7.0 | | 7.5 | 7.0 | 7.0 | 8.5 | 7.0 | | 8.5 | 7.0 | |
| Lead/Lag | Lead | Lead | | Lag | Lag | Lag | Lead | Lead | | Lag | Lag | |
| Lead-Lag Optimize? | Yes | Yes | | Yes | Yes | Yes | Yes | Yes | | Yes | Yes | |
| Recall Mode | None | C-Max | | None | C-Max | C-Max | None | None | | None | None | |
| Act Effct Green (s) | 16.0 | 42.7 | 120.0 | 6.3 | 30.4 | 30.4 | 10.7 | 16.9 | 120.0 | 26.7 | 32.8 | 120.0 |
| Actuated g/C Ratio | 0.13 | 0.36 | 1.00 | 0.05 | 0.25 | 0.25 | 0.09 | 0.14 | 1.00 | 0.22 | 0.27 | 1.00 |
| v/c Ratio | 0.74 | 0.21 | 0.09 | 0.36 | 0.49 | 0.24 | 0.62 | 0.64 | 0.01 | 0.28 | 0.84 | 0.52 |
| Control Delay | 60.5 | 29.6 | 0.1 | 60.6 | 41.8 | 0.9 | 61.8 | 54.7 | 0.0 | 34.3 | 41.7 | 2.1 |
| Queue Delay | 0.0 | 0.0 | 0.0 | 0.0 | 0.0 | 0.0 | 0.0 | 0.0 | 0.0 | 0.0 | 0.0 | 0.0 |
| Total Delay | 60.5 | 29.6 | 0.1 | 60.6 | 41.8 | 0.9 | 61.8 | 54.7 | 0.0 | 34.3 | 41.7 | 2.1 |
| LOS | E | C | A | E | D | A | E | D | A | C | D | A |
| Approach Delay | | 38.0 | | | 34.8 | | | 55.3 | | | 23.2 | |
| Approach LOS | | D | | | C | | | E | | | C | |

Intersection Summary













Cycle Length: 120
 Actuated Cycle Length: 120
 Offset: 30 (25%), Referenced to phase 2:EBT and 6:WBT, Start of Yellow
 Natural Cycle: 80
 Control Type: Actuated-Coordinated
 Maximum v/c Ratio: 0.84
 Intersection Signal Delay: 32.6
 Intersection Capacity Utilization 71.5%
 Analysis Period (min) 15
 Intersection LOS: C
 ICU Level of Service C

Splits and Phases: 1: MERIDIAN ROAD & WOODMAN ROAD



Queues
1: MERIDIAN ROAD & WOODMAN ROAD

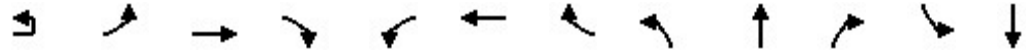
Total 2024 Storage AM
04/10/2023

| |  |  |  |  |  |  |  |  |  |  |  |  |
|-------------------------|---|---|---|---|---|---|--|---|---|---|---|---|
| Lane Group | EBL | EBT | EBR | WBL | WBT | WBR | NBL | NBT | NBR | SBL | SBT | SBR |
| Lane Group Flow (vph) | 341 | 266 | 144 | 65 | 439 | 140 | 190 | 318 | 19 | 213 | 808 | 820 |
| v/c Ratio | 0.74 | 0.21 | 0.09 | 0.36 | 0.49 | 0.24 | 0.62 | 0.64 | 0.01 | 0.28 | 0.84 | 0.52 |
| Control Delay | 60.5 | 29.6 | 0.1 | 60.6 | 41.8 | 0.9 | 61.8 | 54.7 | 0.0 | 34.3 | 41.7 | 2.1 |
| Queue Delay | 0.0 | 0.0 | 0.0 | 0.0 | 0.0 | 0.0 | 0.0 | 0.0 | 0.0 | 0.0 | 0.0 | 0.0 |
| Total Delay | 60.5 | 29.6 | 0.1 | 60.6 | 41.8 | 0.9 | 61.8 | 54.7 | 0.0 | 34.3 | 41.7 | 2.1 |
| Queue Length 50th (ft) | 131 | 80 | 0 | 25 | 158 | 0 | 73 | 125 | 0 | 80 | 334 | 10 |
| Queue Length 95th (ft) | 170 | 111 | 0 | 49 | 218 | 0 | 113 | 167 | 0 | m87 | m347 | m22 |
| Internal Link Dist (ft) | | 1165 | | | 1100 | | | 342 | | | 860 | |
| Turn Bay Length (ft) | 500 | | 630 | 350 | | 250 | 440 | | 330 | 490 | | 450 |
| Base Capacity (vph) | 500 | 1260 | 1583 | 185 | 897 | 594 | 328 | 1002 | 1583 | 763 | 1061 | 1583 |
| Starvation Cap Reductn | 0 | 0 | 0 | 0 | 0 | 0 | 0 | 0 | 0 | 0 | 0 | 0 |
| Spillback Cap Reductn | 0 | 0 | 0 | 0 | 0 | 0 | 0 | 0 | 0 | 0 | 0 | 0 |
| Storage Cap Reductn | 0 | 0 | 0 | 0 | 0 | 0 | 0 | 0 | 0 | 0 | 0 | 0 |
| Reduced v/c Ratio | 0.68 | 0.21 | 0.09 | 0.35 | 0.49 | 0.24 | 0.58 | 0.32 | 0.01 | 0.28 | 0.76 | 0.52 |

Intersection Summary
m Volume for 95th percentile queue is metered by upstream signal.

HCM 6th Signalized Intersection Summary
 1: MERIDIAN ROAD & WOODMAN ROAD

Total 2024 Storage AM
 04/10/2023



| Movement | EBU | EBL | EBT | EBR | WBL | WBT | WBR | NBL | NBT | NBR | SBL | SBT |
|------------------------------|------|------|------|-------|------|-------|------|------|------|------|------|------|
| Lane Configurations | | ↗↘ | ↕ | ↖ | ↗↘ | ↕ | ↖ | ↗↘ | ↕ | ↖ | ↗↘ | ↕ |
| Traffic Volume (veh/h) | 10 | 280 | 226 | 122 | 61 | 413 | 132 | 182 | 305 | 18 | 196 | 743 |
| Future Volume (veh/h) | 10 | 280 | 226 | 122 | 61 | 413 | 132 | 182 | 305 | 18 | 196 | 743 |
| Initial Q (Qb), veh | | 0 | 0 | 0 | 0 | 0 | 0 | 0 | 0 | 0 | 0 | 0 |
| Ped-Bike Adj(A_pbT) | | 1.00 | | 1.00 | 1.00 | | 1.00 | 1.00 | | 1.00 | 1.00 | |
| Parking Bus, Adj | | 1.00 | 1.00 | 1.00 | 1.00 | 1.00 | 1.00 | 1.00 | 1.00 | 1.00 | 1.00 | 1.00 |
| Work Zone On Approach | | | No | | | No | | | No | | | No |
| Adj Sat Flow, veh/h/ln | | 1870 | 1870 | 1870 | 1870 | 1870 | 1870 | 1870 | 1870 | 1870 | 1870 | 1870 |
| Adj Flow Rate, veh/h | | 329 | 266 | 0 | 65 | 439 | 0 | 190 | 318 | 0 | 213 | 808 |
| Peak Hour Factor | | 0.85 | 0.85 | 0.85 | 0.94 | 0.94 | 0.94 | 0.96 | 0.96 | 0.96 | 0.92 | 0.92 |
| Percent Heavy Veh, % | | 2 | 2 | 2 | 2 | 2 | 2 | 2 | 2 | 2 | 2 | 2 |
| Cap, veh/h | | 393 | 1066 | | 361 | 1018 | | 248 | 444 | | 763 | 928 |
| Arrive On Green | | 0.11 | 0.30 | 0.00 | 0.10 | 0.29 | 0.00 | 0.07 | 0.13 | 0.00 | 0.22 | 0.26 |
| Sat Flow, veh/h | | 3456 | 3554 | 1585 | 3456 | 3554 | 1585 | 3456 | 3554 | 1585 | 3456 | 3554 |
| Grp Volume(v), veh/h | | 329 | 266 | 0 | 65 | 439 | 0 | 190 | 318 | 0 | 213 | 808 |
| Grp Sat Flow(s),veh/h/ln | | 1728 | 1777 | 1585 | 1728 | 1777 | 1585 | 1728 | 1777 | 1585 | 1728 | 1777 |
| Q Serve(g_s), s | | 11.2 | 6.8 | 0.0 | 2.1 | 12.1 | 0.0 | 6.5 | 10.3 | 0.0 | 6.1 | 26.1 |
| Cycle Q Clear(g_c), s | | 11.2 | 6.8 | 0.0 | 2.1 | 12.1 | 0.0 | 6.5 | 10.3 | 0.0 | 6.1 | 26.1 |
| Prop In Lane | | 1.00 | | 1.00 | 1.00 | | 1.00 | 1.00 | | 1.00 | 1.00 | |
| Lane Grp Cap(c), veh/h | | 393 | 1066 | | 361 | 1018 | | 248 | 444 | | 763 | 928 |
| V/C Ratio(X) | | 0.84 | 0.25 | | 0.18 | 0.43 | | 0.76 | 0.72 | | 0.28 | 0.87 |
| Avail Cap(c_a), veh/h | | 504 | 1066 | | 361 | 1018 | | 331 | 1007 | | 763 | 1066 |
| HCM Platoon Ratio | | 1.00 | 1.00 | 1.00 | 1.00 | 1.00 | 1.00 | 1.00 | 1.00 | 1.00 | 1.00 | 1.00 |
| Upstream Filter(I) | | 1.00 | 1.00 | 0.00 | 1.00 | 1.00 | 0.00 | 1.00 | 1.00 | 0.00 | 1.00 | 1.00 |
| Uniform Delay (d), s/veh | | 52.1 | 31.8 | 0.0 | 49.1 | 34.9 | 0.0 | 54.7 | 50.5 | 0.0 | 38.8 | 42.4 |
| Incr Delay (d2), s/veh | | 9.5 | 0.6 | 0.0 | 0.2 | 1.3 | 0.0 | 7.3 | 2.2 | 0.0 | 0.2 | 7.2 |
| Initial Q Delay(d3),s/veh | | 0.0 | 0.0 | 0.0 | 0.0 | 0.0 | 0.0 | 0.0 | 0.0 | 0.0 | 0.0 | 0.0 |
| %ile BackOfQ(50%),veh/ln | | 5.2 | 2.9 | 0.0 | 0.9 | 5.3 | 0.0 | 3.0 | 4.7 | 0.0 | 2.6 | 12.2 |
| Unsig. Movement Delay, s/veh | | | | | | | | | | | | |
| LnGrp Delay(d),s/veh | | 61.6 | 32.3 | 0.0 | 49.3 | 36.2 | 0.0 | 62.0 | 52.6 | 0.0 | 39.0 | 49.6 |
| LnGrp LOS | | E | C | | D | D | | E | D | | D | D |
| Approach Vol, veh/h | | | 595 | A | | 504 | A | | 508 | A | | 1021 |
| Approach Delay, s/veh | | | 48.5 | | | 37.9 | | | 56.1 | | | 47.4 |
| Approach LOS | | | D | | | D | | | E | | | D |
| Timer - Assigned Phs | 1 | 2 | 3 | 4 | 5 | 6 | 7 | 8 | | | | |
| Phs Duration (G+Y+Rc), s | 20.0 | 43.0 | 17.1 | 39.8 | 21.1 | 41.9 | 35.0 | 22.0 | | | | |
| Change Period (Y+Rc), s | 7.5 | 7.0 | 8.5 | * 8.5 | 7.5 | * 7.5 | 8.5 | 7.0 | | | | |
| Max Green Setting (Gmax), s | 6.5 | 36.0 | 11.5 | * 36 | 17.5 | * 25 | 13.5 | 34.0 | | | | |
| Max Q Clear Time (g_c+I1), s | 4.1 | 8.8 | 8.5 | 28.1 | 13.2 | 14.1 | 8.1 | 12.3 | | | | |
| Green Ext Time (p_c), s | 0.0 | 1.5 | 0.2 | 3.3 | 0.5 | 1.9 | 0.3 | 1.9 | | | | |

Intersection Summary

| | |
|--------------------|------|
| HCM 6th Ctrl Delay | 47.5 |
| HCM 6th LOS | D |

Notes

- User approved pedestrian interval to be less than phase max green.
- User approved ignoring U-Turning movement.
- * HCM 6th computational engine requires equal clearance times for the phases crossing the barrier.

| | |
|---|------|
| Movement | SBR |
| Lane Configurations | |
| Traffic Volume (veh/h) | 754 |
| Future Volume (veh/h) | 754 |
| Initial Q (Qb), veh | 0 |
| Ped-Bike Adj(A_pbT) | 1.00 |
| Parking Bus, Adj | 1.00 |
| Work Zone On Approach | |
| Adj Sat Flow, veh/h/ln | 1870 |
| Adj Flow Rate, veh/h | 0 |
| Peak Hour Factor | 0.92 |
| Percent Heavy Veh, % | 2 |
| Cap, veh/h | |
| Arrive On Green | 0.00 |
| Sat Flow, veh/h | 1585 |
| Grp Volume(v), veh/h | 0 |
| Grp Sat Flow(s),veh/h/ln | 1585 |
| Q Serve(g_s), s | 0.0 |
| Cycle Q Clear(g_c), s | 0.0 |
| Prop In Lane | 1.00 |
| Lane Grp Cap(c), veh/h | |
| V/C Ratio(X) | |
| Avail Cap(c_a), veh/h | |
| HCM Platoon Ratio | 1.00 |
| Upstream Filter(l) | 0.00 |
| Uniform Delay (d), s/veh | 0.0 |
| Incr Delay (d2), s/veh | 0.0 |
| Initial Q Delay(d3),s/veh | 0.0 |
| %ile BackOfQ(50%),veh/ln | 0.0 |
| Unsig. Movement Delay, s/veh | |
| LnGrp Delay(d),s/veh | 0.0 |
| LnGrp LOS | |
| Approach Vol, veh/h | A |
| Approach Delay, s/veh | |
| Approach LOS | |
| Timer - Assigned Phs | |
| Unsignalized Delay for [NBR, EBR, WBR, SBR] is excluded from calculations of the approach delay and intersection delay. | |

Timings
2: MERIDIAN ROAD & EASTONVILLE ROAD

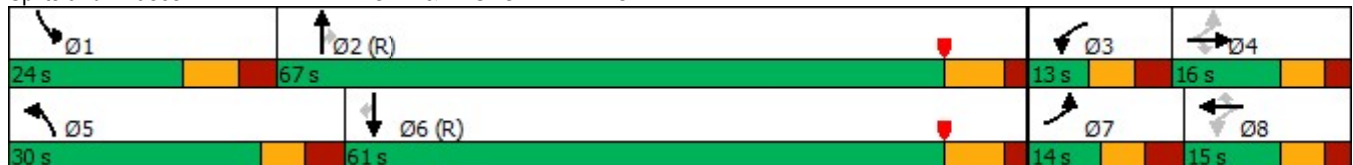
Total 2024 Storage AM
04/10/2023

| Lane Group | EBL | EBT | EBR | WBL | WBT | WBR | NBL | NBT | NBR | SBL | SBT | SBR |
|----------------------|-------|-------|-------|-------|-------|-------|-------|-------|-------|-------|-------|-------|
| Lane Configurations | | | | | | | | | | | | |
| Traffic Volume (vph) | 218 | 52 | 263 | 100 | 56 | 37 | 294 | 435 | 42 | 114 | 1373 | 187 |
| Future Volume (vph) | 218 | 52 | 263 | 100 | 56 | 37 | 294 | 435 | 42 | 114 | 1373 | 187 |
| Turn Type | pm+pt | NA | Perm | pm+pt | NA | Perm | Prot | NA | Perm | Prot | NA | Perm |
| Protected Phases | 7 | 4 | | 3 | 8 | | 5 | 2 | | 1 | 6 | |
| Permitted Phases | 4 | | 4 | 8 | | 8 | | | 2 | | | 6 |
| Detector Phase | 7 | 4 | 4 | 3 | 8 | 8 | 5 | 2 | 2 | 1 | 6 | 6 |
| Switch Phase | | | | | | | | | | | | |
| Minimum Initial (s) | 5.0 | 8.0 | 8.0 | 5.0 | 8.0 | 8.0 | 5.0 | 15.0 | 15.0 | 5.0 | 15.0 | 15.0 |
| Minimum Split (s) | 12.5 | 14.5 | 14.5 | 12.5 | 14.5 | 14.5 | 12.5 | 22.5 | 22.5 | 13.5 | 22.5 | 22.5 |
| Total Split (s) | 14.0 | 16.0 | 16.0 | 13.0 | 15.0 | 15.0 | 30.0 | 67.0 | 67.0 | 24.0 | 61.0 | 61.0 |
| Total Split (%) | 11.7% | 13.3% | 13.3% | 10.8% | 12.5% | 12.5% | 25.0% | 55.8% | 55.8% | 20.0% | 50.8% | 50.8% |
| Yellow Time (s) | 4.0 | 4.0 | 4.0 | 4.0 | 4.0 | 4.0 | 4.0 | 5.5 | 5.5 | 5.0 | 5.5 | 5.5 |
| All-Red Time (s) | 3.5 | 2.5 | 2.5 | 3.5 | 2.5 | 2.5 | 3.5 | 2.0 | 2.0 | 3.5 | 2.0 | 2.0 |
| Lost Time Adjust (s) | 0.0 | 0.0 | 0.0 | 0.0 | 0.0 | 0.0 | 0.0 | 0.0 | 0.0 | 0.0 | 0.0 | 0.0 |
| Total Lost Time (s) | 7.5 | 6.5 | 6.5 | 7.5 | 6.5 | 6.5 | 7.5 | 7.5 | 7.5 | 8.5 | 7.5 | 7.5 |
| Lead/Lag | Lead | Lag | Lag | Lead | Lag | Lag | Lead | Lag | Lag | Lead | Lag | Lag |
| Lead-Lag Optimize? | Yes | Yes | Yes | Yes | Yes | Yes | Yes | Yes | Yes | Yes | Yes | Yes |
| Recall Mode | None | None | None | None | None | None | None | C-Max | C-Max | None | C-Max | C-Max |
| Act Effct Green (s) | 15.9 | 9.1 | 9.1 | 11.4 | 8.3 | 8.3 | 22.9 | 62.4 | 62.4 | 13.0 | 53.5 | 53.5 |
| Actuated g/C Ratio | 0.13 | 0.08 | 0.08 | 0.10 | 0.07 | 0.07 | 0.19 | 0.52 | 0.52 | 0.11 | 0.45 | 0.45 |
| v/c Ratio | 0.72 | 0.43 | 0.88 | 0.74 | 0.47 | 0.14 | 1.03 | 0.28 | 0.05 | 0.65 | 0.96 | 0.25 |
| Control Delay | 58.2 | 62.8 | 37.7 | 75.4 | 66.0 | 1.1 | 97.7 | 14.1 | 1.3 | 76.8 | 36.1 | 3.7 |
| Queue Delay | 0.0 | 0.0 | 0.0 | 0.0 | 0.0 | 0.0 | 0.0 | 0.0 | 0.0 | 0.0 | 0.0 | 0.0 |
| Total Delay | 58.2 | 62.8 | 37.7 | 75.4 | 66.0 | 1.1 | 97.7 | 14.1 | 1.3 | 76.8 | 36.1 | 3.7 |
| LOS | E | E | D | E | E | A | F | B | A | E | D | A |
| Approach Delay | | 48.6 | | | 58.4 | | | 45.3 | | | 35.2 | |
| Approach LOS | | D | | | E | | | D | | | D | |

Intersection Summary

Cycle Length: 120
 Actuated Cycle Length: 120
 Offset: 45 (38%), Referenced to phase 2:NBT and 6:SBT, Start of Yellow
 Natural Cycle: 110
 Control Type: Actuated-Coordinated
 Maximum v/c Ratio: 1.03
 Intersection Signal Delay: 41.5
 Intersection Capacity Utilization 85.0%
 Analysis Period (min) 15
 Intersection LOS: D
 ICU Level of Service E

Splits and Phases: 2: MERIDIAN ROAD & EASTONVILLE ROAD



Queues
2: MERIDIAN ROAD & EASTONVILLE ROAD

Total 2024 Storage AM
04/10/2023






























| Lane Group | EBL | EBT | EBR | WBL | WBT | WBR | NBL | NBT | NBR | SBL | SBT | SBR |
|-------------------------|------|------|------|------|------|------|------|------|------|------|------|------|
| Lane Group Flow (vph) | 256 | 61 | 309 | 108 | 60 | 40 | 346 | 512 | 49 | 125 | 1509 | 205 |
| v/c Ratio | 0.72 | 0.43 | 0.88 | 0.74 | 0.47 | 0.14 | 1.03 | 0.28 | 0.05 | 0.65 | 0.96 | 0.25 |
| Control Delay | 58.2 | 62.8 | 37.7 | 75.4 | 66.0 | 1.1 | 97.7 | 14.1 | 1.3 | 76.8 | 36.1 | 3.7 |
| Queue Delay | 0.0 | 0.0 | 0.0 | 0.0 | 0.0 | 0.0 | 0.0 | 0.0 | 0.0 | 0.0 | 0.0 | 0.0 |
| Total Delay | 58.2 | 62.8 | 37.7 | 75.4 | 66.0 | 1.1 | 97.7 | 14.1 | 1.3 | 76.8 | 36.1 | 3.7 |
| Queue Length 50th (ft) | 91 | 46 | 43 | 74 | 46 | 0 | ~298 | 111 | 1 | 82 | 631 | 40 |
| Queue Length 95th (ft) | #141 | 86 | #160 | #146 | 91 | 0 | #447 | 135 | m6 | m135 | #774 | m31 |
| Internal Link Dist (ft) | | 508 | | | 1196 | | | 231 | | | 781 | |
| Turn Bay Length (ft) | 100 | | 100 | 120 | | 100 | 100 | | 400 | 375 | | 400 |
| Base Capacity (vph) | 356 | 147 | 357 | 146 | 131 | 284 | 337 | 1841 | 908 | 228 | 1577 | 819 |
| Starvation Cap Reductn | 0 | 0 | 0 | 0 | 0 | 0 | 0 | 0 | 0 | 0 | 0 | 0 |
| Spillback Cap Reductn | 0 | 0 | 0 | 0 | 0 | 0 | 0 | 0 | 0 | 0 | 0 | 0 |
| Storage Cap Reductn | 0 | 0 | 0 | 0 | 0 | 0 | 0 | 0 | 0 | 0 | 0 | 0 |
| Reduced v/c Ratio | 0.72 | 0.41 | 0.87 | 0.74 | 0.46 | 0.14 | 1.03 | 0.28 | 0.05 | 0.55 | 0.96 | 0.25 |

Intersection Summary

- ~ Volume exceeds capacity, queue is theoretically infinite.
Queue shown is maximum after two cycles.
- # 95th percentile volume exceeds capacity, queue may be longer.
Queue shown is maximum after two cycles.
- m Volume for 95th percentile queue is metered by upstream signal.

HCM 6th Signalized Intersection Summary
 2: MERIDIAN ROAD & EASTONVILLE ROAD

Total 2024 Storage AM
 04/10/2023

| |  |  |  |  |  |  |  |  |  |  |  |  |
|------------------------------|---|---|---|---|---|---|--|---|---|---|---|---|
| Movement | EBL | EBT | EBR | WBL | WBT | WBR | NBL | NBT | NBR | SBL | SBT | SBR |
| Lane Configurations |   |  |  |  |  |  |  |   |  |  |   |  |
| Traffic Volume (veh/h) | 218 | 52 | 263 | 100 | 56 | 37 | 294 | 435 | 42 | 114 | 1373 | 187 |
| Future Volume (veh/h) | 218 | 52 | 263 | 100 | 56 | 37 | 294 | 435 | 42 | 114 | 1373 | 187 |
| Initial Q (Qb), veh | 0 | 0 | 0 | 0 | 0 | 0 | 0 | 0 | 0 | 0 | 0 | 0 |
| Ped-Bike Adj(A_pbT) | 1.00 | | 1.00 | 1.00 | | 1.00 | 1.00 | | 1.00 | 1.00 | | 1.00 |
| Parking Bus, Adj | 1.00 | 1.00 | 1.00 | 1.00 | 1.00 | 1.00 | 1.00 | 1.00 | 1.00 | 1.00 | 1.00 | 1.00 |
| Work Zone On Approach | | No | | | No | | | No | | | No | |
| Adj Sat Flow, veh/h/ln | 1870 | 1870 | 1870 | 1870 | 1870 | 1870 | 1870 | 1870 | 1870 | 1870 | 1870 | 1870 |
| Adj Flow Rate, veh/h | 256 | 61 | 0 | 108 | 60 | 0 | 346 | 512 | 49 | 125 | 1509 | 205 |
| Peak Hour Factor | 0.85 | 0.85 | 0.85 | 0.93 | 0.93 | 0.93 | 0.85 | 0.85 | 0.85 | 0.91 | 0.91 | 0.91 |
| Percent Heavy Veh, % | 2 | 2 | 2 | 2 | 2 | 2 | 2 | 2 | 2 | 2 | 2 | 2 |
| Cap, veh/h | 400 | 140 | | 200 | 125 | | 334 | 1933 | 862 | 152 | 1599 | 713 |
| Arrive On Green | 0.05 | 0.07 | 0.00 | 0.05 | 0.07 | 0.00 | 0.19 | 0.54 | 0.54 | 0.09 | 0.45 | 0.45 |
| Sat Flow, veh/h | 3456 | 1870 | 1585 | 1781 | 1870 | 1585 | 1781 | 3554 | 1585 | 1781 | 3554 | 1585 |
| Grp Volume(v), veh/h | 256 | 61 | 0 | 108 | 60 | 0 | 346 | 512 | 49 | 125 | 1509 | 205 |
| Grp Sat Flow(s),veh/h/ln | 1728 | 1870 | 1585 | 1781 | 1870 | 1585 | 1781 | 1777 | 1585 | 1781 | 1777 | 1585 |
| Q Serve(g_s), s | 6.5 | 3.7 | 0.0 | 5.5 | 3.7 | 0.0 | 22.5 | 9.2 | 1.7 | 8.3 | 48.7 | 9.8 |
| Cycle Q Clear(g_c), s | 6.5 | 3.7 | 0.0 | 5.5 | 3.7 | 0.0 | 22.5 | 9.2 | 1.7 | 8.3 | 48.7 | 9.8 |
| Prop In Lane | 1.00 | | 1.00 | 1.00 | | 1.00 | 1.00 | | 1.00 | 1.00 | | 1.00 |
| Lane Grp Cap(c), veh/h | 400 | 140 | | 200 | 125 | | 334 | 1933 | 862 | 152 | 1599 | 713 |
| V/C Ratio(X) | 0.64 | 0.44 | | 0.54 | 0.48 | | 1.04 | 0.26 | 0.06 | 0.82 | 0.94 | 0.29 |
| Avail Cap(c_a), veh/h | 400 | 148 | | 200 | 132 | | 334 | 1933 | 862 | 230 | 1599 | 713 |
| HCM Platoon Ratio | 1.00 | 1.00 | 1.00 | 1.00 | 1.00 | 1.00 | 1.00 | 1.00 | 1.00 | 1.00 | 1.00 | 1.00 |
| Upstream Filter(l) | 1.00 | 1.00 | 0.00 | 1.00 | 1.00 | 0.00 | 1.00 | 1.00 | 1.00 | 1.00 | 1.00 | 1.00 |
| Uniform Delay (d), s/veh | 51.1 | 53.1 | 0.0 | 50.9 | 54.0 | 0.0 | 48.8 | 14.6 | 12.9 | 54.0 | 31.5 | 20.8 |
| Incr Delay (d2), s/veh | 3.4 | 2.1 | 0.0 | 2.9 | 2.9 | 0.0 | 58.9 | 0.3 | 0.1 | 13.4 | 12.6 | 1.0 |
| Initial Q Delay(d3),s/veh | 0.0 | 0.0 | 0.0 | 0.0 | 0.0 | 0.0 | 0.0 | 0.0 | 0.0 | 0.0 | 0.0 | 0.0 |
| %ile BackOfQ(50%),veh/ln | 0.9 | 1.8 | 0.0 | 3.3 | 1.8 | 0.0 | 14.9 | 3.4 | 0.7 | 4.1 | 21.6 | 3.8 |
| Unsig. Movement Delay, s/veh | | | | | | | | | | | | |
| LnGrp Delay(d),s/veh | 54.5 | 55.2 | 0.0 | 53.8 | 56.9 | 0.0 | 107.6 | 14.9 | 13.0 | 67.4 | 44.1 | 21.9 |
| LnGrp LOS | D | E | | D | E | | F | B | B | E | D | C |
| Approach Vol, veh/h | | 317 | A | | 168 | A | | 907 | | | 1839 | |
| Approach Delay, s/veh | | 54.6 | | | 54.9 | | | 50.2 | | | 43.2 | |
| Approach LOS | | D | | | D | | | D | | | D | |
| Timer - Assigned Phs | 1 | 2 | 3 | 4 | 5 | 6 | 7 | 8 | | | | |
| Phs Duration (G+Y+Rc), s | 18.7 | 72.8 | 13.0 | 15.5 | 30.0 | 61.5 | 14.0 | 14.5 | | | | |
| Change Period (Y+Rc), s | 8.5 | 7.5 | 7.5 | 6.5 | 7.5 | 7.5 | 7.5 | 6.5 | | | | |
| Max Green Setting (Gmax), s | 15.5 | 59.5 | 5.5 | 9.5 | 22.5 | 53.5 | 6.5 | 8.5 | | | | |
| Max Q Clear Time (g_c+I1), s | 10.3 | 11.2 | 7.5 | 5.7 | 24.5 | 50.7 | 8.5 | 5.7 | | | | |
| Green Ext Time (p_c), s | 0.1 | 3.3 | 0.0 | 0.1 | 0.0 | 2.2 | 0.0 | 0.0 | | | | |

Intersection Summary

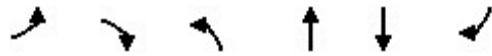
| | |
|--------------------|------|
| HCM 6th Ctrl Delay | 46.9 |
| HCM 6th LOS | D |

Notes

User approved pedestrian interval to be less than phase max green.
 Unsignalized Delay for [EBR, WBR] is excluded from calculations of the approach delay and intersection delay.

3: MERIDIAN ROAD & BENT GRASS MEADOWS DRIVE

04/10/2023

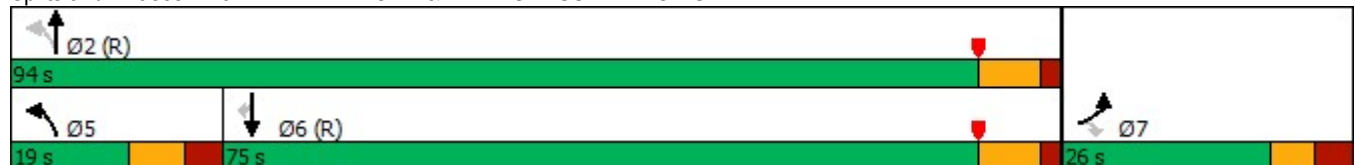


| Lane Group | EBL | EBR | NBL | NBT | SBT | SBR |
|----------------------|-------|-------|-------|-------|-------|-------|
| Lane Configurations | ↗↗ | ↗ | ↖ | ↑↑ | ↑↑ | ↖ |
| Traffic Volume (vph) | 85 | 181 | 106 | 534 | 1451 | 121 |
| Future Volume (vph) | 85 | 181 | 106 | 534 | 1451 | 121 |
| Turn Type | Prot | Perm | pm+pt | NA | NA | Perm |
| Protected Phases | 7 | | 5 | 2 | 6 | |
| Permitted Phases | | 7 | 2 | | | 6 |
| Detector Phase | 7 | 7 | 5 | 2 | 6 | 6 |
| Switch Phase | | | | | | |
| Minimum Initial (s) | 8.0 | 8.0 | 5.0 | 15.0 | 15.0 | 15.0 |
| Minimum Split (s) | 25.5 | 25.5 | 13.5 | 25.5 | 25.5 | 25.5 |
| Total Split (s) | 26.0 | 26.0 | 19.0 | 94.0 | 75.0 | 75.0 |
| Total Split (%) | 21.7% | 21.7% | 15.8% | 78.3% | 62.5% | 62.5% |
| Yellow Time (s) | 4.0 | 4.0 | 5.0 | 5.5 | 5.5 | 5.5 |
| All-Red Time (s) | 3.5 | 3.5 | 3.5 | 2.0 | 2.0 | 2.0 |
| Lost Time Adjust (s) | 0.0 | 0.0 | 0.0 | 0.0 | 0.0 | 0.0 |
| Total Lost Time (s) | 7.5 | 7.5 | 8.5 | 7.5 | 7.5 | 7.5 |
| Lead/Lag | | | Lead | | Lag | Lag |
| Lead-Lag Optimize? | | | Yes | | Yes | Yes |
| Recall Mode | None | None | None | C-Max | C-Max | C-Max |
| Act Effect Green (s) | 11.1 | 11.1 | 92.9 | 93.9 | 76.8 | 76.8 |
| Actuated g/C Ratio | 0.09 | 0.09 | 0.77 | 0.78 | 0.64 | 0.64 |
| v/c Ratio | 0.31 | 0.71 | 0.52 | 0.21 | 0.73 | 0.13 |
| Control Delay | 52.2 | 27.3 | 20.4 | 3.3 | 18.2 | 2.2 |
| Queue Delay | 0.0 | 0.0 | 0.0 | 0.0 | 0.0 | 0.0 |
| Total Delay | 52.2 | 27.3 | 20.4 | 3.3 | 18.2 | 2.2 |
| LOS | D | C | C | A | B | A |
| Approach Delay | 35.3 | | | 6.1 | 16.9 | |
| Approach LOS | D | | | A | B | |

Intersection Summary

Cycle Length: 120
 Actuated Cycle Length: 120
 Offset: 5 (4%), Referenced to phase 2:NBTL and 6:SBT, Start of Yellow
 Natural Cycle: 90
 Control Type: Actuated-Coordinated
 Maximum v/c Ratio: 0.73
 Intersection Signal Delay: 16.2
 Intersection Capacity Utilization 72.2%
 Analysis Period (min) 15
 Intersection LOS: B
 ICU Level of Service C

Splits and Phases: 3: MERIDIAN ROAD & BENT GRASS MEADOWS DRIVE



Queues
 3: MERIDIAN ROAD & BENT GRASS MEADOWS DRIVE

Total 2024 Storage AM
 04/10/2023



| Lane Group | EBL | EBR | NBL | NBT | SBT | SBR |
|-------------------------|------|------|------|------|------|------|
| Lane Group Flow (vph) | 99 | 210 | 118 | 593 | 1649 | 138 |
| v/c Ratio | 0.31 | 0.71 | 0.52 | 0.21 | 0.73 | 0.13 |
| Control Delay | 52.2 | 27.3 | 20.4 | 3.3 | 18.2 | 2.2 |
| Queue Delay | 0.0 | 0.0 | 0.0 | 0.0 | 0.0 | 0.0 |
| Total Delay | 52.2 | 27.3 | 20.4 | 3.3 | 18.2 | 2.2 |
| Queue Length 50th (ft) | 38 | 35 | 6 | 41 | 396 | 0 |
| Queue Length 95th (ft) | 58 | 97 | m83 | 113 | 604 | 26 |
| Internal Link Dist (ft) | 310 | | | 750 | 1921 | |
| Turn Bay Length (ft) | 150 | | 700 | | | 350 |
| Base Capacity (vph) | 529 | 382 | 255 | 2768 | 2263 | 1062 |
| Starvation Cap Reductn | 0 | 0 | 0 | 0 | 0 | 0 |
| Spillback Cap Reductn | 0 | 0 | 0 | 0 | 0 | 0 |
| Storage Cap Reductn | 0 | 0 | 0 | 0 | 0 | 0 |
| Reduced v/c Ratio | 0.19 | 0.55 | 0.46 | 0.21 | 0.73 | 0.13 |

Intersection Summary

m Volume for 95th percentile queue is metered by upstream signal.

HCM 6th Signalized Intersection Summary
 3: MERIDIAN ROAD & BENT GRASS MEADOWS DRIVE

Total 2024 Storage AM
 04/10/2023



| Movement | EBL | EBR | NBL | NBT | SBT | SBR |
|------------------------------|------|-------|------|------|------|------|
| Lane Configurations | ↖↗ | ↖ | ↗ | ↕ | ↕ | ↗ |
| Traffic Volume (veh/h) | 85 | 181 | 106 | 534 | 1451 | 121 |
| Future Volume (veh/h) | 85 | 181 | 106 | 534 | 1451 | 121 |
| Initial Q (Qb), veh | 0 | 0 | 0 | 0 | 0 | 0 |
| Ped-Bike Adj(A_pbT) | 1.00 | 1.00 | 1.00 | | | 1.00 |
| Parking Bus, Adj | 1.00 | 1.00 | 1.00 | 1.00 | 1.00 | 1.00 |
| Work Zone On Approach | No | | | No | No | |
| Adj Sat Flow, veh/h/ln | 1870 | 1870 | 1870 | 1870 | 1870 | 1870 |
| Adj Flow Rate, veh/h | 99 | 0 | 118 | 593 | 1649 | 138 |
| Peak Hour Factor | 0.86 | 0.86 | 0.90 | 0.90 | 0.88 | 0.88 |
| Percent Heavy Veh, % | 2 | 2 | 2 | 2 | 2 | 2 |
| Cap, veh/h | 222 | | 249 | 2881 | 2484 | 1108 |
| Arrive On Green | 0.06 | 0.00 | 0.04 | 0.81 | 0.70 | 0.70 |
| Sat Flow, veh/h | 3456 | 1585 | 1781 | 3647 | 3647 | 1585 |
| Grp Volume(v), veh/h | 99 | 0 | 118 | 593 | 1649 | 138 |
| Grp Sat Flow(s),veh/h/ln | 1728 | 1585 | 1781 | 1777 | 1777 | 1585 |
| Q Serve(g_s), s | 3.3 | 0.0 | 2.1 | 4.5 | 31.3 | 3.4 |
| Cycle Q Clear(g_c), s | 3.3 | 0.0 | 2.1 | 4.5 | 31.3 | 3.4 |
| Prop In Lane | 1.00 | 1.00 | 1.00 | | | 1.00 |
| Lane Grp Cap(c), veh/h | 222 | | 249 | 2881 | 2484 | 1108 |
| V/C Ratio(X) | 0.45 | | 0.47 | 0.21 | 0.66 | 0.12 |
| Avail Cap(c_a), veh/h | 533 | | 332 | 2881 | 2484 | 1108 |
| HCM Platoon Ratio | 1.00 | 1.00 | 1.00 | 1.00 | 1.00 | 1.00 |
| Upstream Filter(l) | 1.00 | 0.00 | 1.00 | 1.00 | 1.00 | 1.00 |
| Uniform Delay (d), s/veh | 54.1 | 0.0 | 12.1 | 2.6 | 10.1 | 6.0 |
| Incr Delay (d2), s/veh | 1.4 | 0.0 | 1.4 | 0.2 | 1.4 | 0.2 |
| Initial Q Delay(d3),s/veh | 0.0 | 0.0 | 0.0 | 0.0 | 0.0 | 0.0 |
| %ile BackOfQ(50%),veh/ln | 1.5 | 0.0 | 1.4 | 1.3 | 11.5 | 6.1 |
| Unsig. Movement Delay, s/veh | | | | | | |
| LnGrp Delay(d),s/veh | 55.5 | 0.0 | 13.5 | 2.7 | 11.6 | 6.2 |
| LnGrp LOS | E | | B | A | B | A |
| Approach Vol, veh/h | 99 | A | | 711 | 1787 | |
| Approach Delay, s/veh | 55.5 | | | 4.5 | 11.1 | |
| Approach LOS | E | | | A | B | |
| Timer - Assigned Phs | | 2 | | 4 | 5 | 6 |
| Phs Duration (G+Y+Rc), s | | 104.8 | | 15.2 | 13.4 | 91.4 |
| Change Period (Y+Rc), s | | 7.5 | | 7.5 | 8.5 | 7.5 |
| Max Green Setting (Gmax), s | | 86.5 | | 18.5 | 10.5 | 67.5 |
| Max Q Clear Time (g_c+I1), s | | 6.5 | | 5.3 | 4.1 | 33.3 |
| Green Ext Time (p_c), s | | 4.7 | | 0.2 | 0.1 | 18.7 |

Intersection Summary

| | |
|--------------------|------|
| HCM 6th Ctrl Delay | 11.0 |
| HCM 6th LOS | B |

Notes

Unsignalized Delay for [EBR] is excluded from calculations of the approach delay and intersection delay.

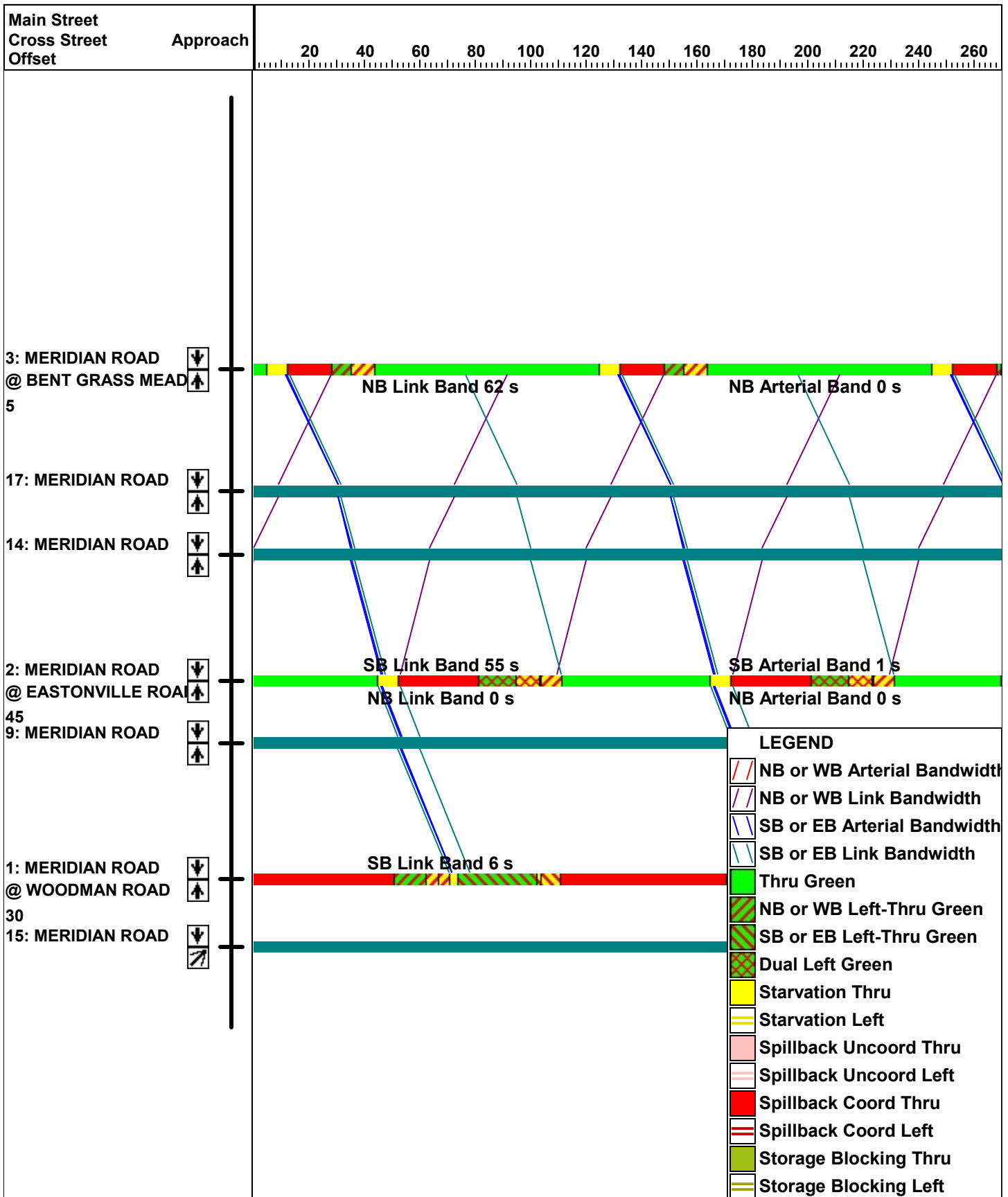
| Intersection | | | | | | |
|--------------------------|------|------|------|------|------|------|
| Int Delay, s/veh | 4.5 | | | | | |
| Movement | EBT | EBR | WBL | WBT | NBL | NBR |
| Lane Configurations | ↑ | ↗ | ↘ | ↑ | ↘ | |
| Traffic Vol, veh/h | 145 | 65 | 159 | 68 | 1 | 122 |
| Future Vol, veh/h | 145 | 65 | 159 | 68 | 1 | 122 |
| Conflicting Peds, #/hr | 0 | 0 | 0 | 0 | 0 | 0 |
| Sign Control | Free | Free | Free | Free | Stop | Stop |
| RT Channelized | - | None | - | None | - | None |
| Storage Length | - | 150 | 100 | - | 0 | - |
| Veh in Median Storage, # | 0 | - | - | 0 | 0 | - |
| Grade, % | 0 | - | - | 0 | 0 | - |
| Peak Hour Factor | 85 | 85 | 85 | 85 | 85 | 85 |
| Heavy Vehicles, % | 2 | 2 | 2 | 2 | 2 | 2 |
| Mvmt Flow | 171 | 76 | 187 | 80 | 1 | 144 |

| Major/Minor | Major1 | Major2 | Minor1 | | |
|----------------------|--------|--------|--------|---|-------|
| Conflicting Flow All | 0 | 0 | 247 | 0 | 625 |
| Stage 1 | - | - | - | - | 171 |
| Stage 2 | - | - | - | - | 454 |
| Critical Hdwy | - | - | 4.12 | - | 6.42 |
| Critical Hdwy Stg 1 | - | - | - | - | 5.42 |
| Critical Hdwy Stg 2 | - | - | - | - | 5.42 |
| Follow-up Hdwy | - | - | 2.218 | - | 3.518 |
| Pot Cap-1 Maneuver | - | - | 1319 | - | 449 |
| Stage 1 | - | - | - | - | 859 |
| Stage 2 | - | - | - | - | 640 |
| Platoon blocked, % | - | - | - | - | - |
| Mov Cap-1 Maneuver | - | - | 1319 | - | 385 |
| Mov Cap-2 Maneuver | - | - | - | - | 385 |
| Stage 1 | - | - | - | - | 859 |
| Stage 2 | - | - | - | - | 549 |

| Approach | EB | WB | NB |
|----------------------|----|-----|----|
| HCM Control Delay, s | 0 | 5.7 | 10 |
| HCM LOS | | | B |

| Minor Lane/Major Mvmt | NBLn1 | EBT | EBR | WBL | WBT |
|-----------------------|-------|-----|-----|-------|-----|
| Capacity (veh/h) | 864 | - | - | 1319 | - |
| HCM Lane V/C Ratio | 0.167 | - | - | 0.142 | - |
| HCM Control Delay (s) | 10 | - | - | 8.2 | - |
| HCM Lane LOS | B | - | - | A | - |
| HCM 95th %tile Q(veh) | 0.6 | - | - | 0.5 | - |

Total AM 2024 Storage Signal Progression



Timings
1: MERIDIAN ROAD & WOODMAN ROAD

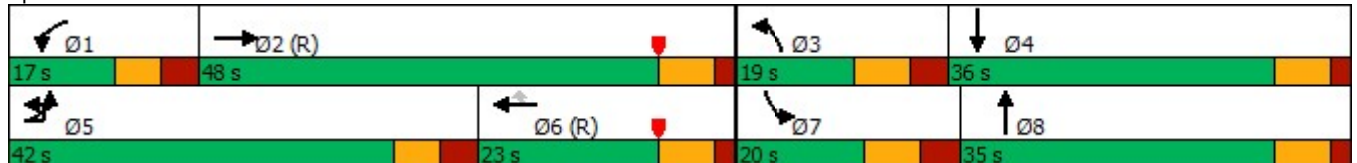
Total 2024 Shopping Center PM
04/10/2023

| Lane Group | EBL | EBT | EBR | WBL | WBT | WBR | NBL | NBT | NBR | SBL | SBT | SBR |
|----------------------|-------|-------|-------|-------|-------|-------|-------|-------|-------|-------|-------|-------|
| Lane Configurations | | | | | | | | | | | | |
| Traffic Volume (vph) | 987 | 474 | 166 | 117 | 388 | 321 | 265 | 898 | 110 | 333 | 693 | 739 |
| Future Volume (vph) | 987 | 474 | 166 | 117 | 388 | 321 | 265 | 898 | 110 | 333 | 693 | 739 |
| Turn Type | Prot | NA | Free | Prot | NA | Perm | Prot | NA | Free | Prot | NA | Free |
| Protected Phases | 5 | 2 | | 1 | 6 | | 3 | 8 | | 7 | 4 | |
| Permitted Phases | | | Free | | | 6 | | | Free | | | Free |
| Detector Phase | 5 | 2 | | 1 | 6 | 6 | 3 | 8 | | 7 | 4 | |
| Switch Phase | | | | | | | | | | | | |
| Minimum Initial (s) | 5.0 | 15.0 | | 5.0 | 15.0 | 15.0 | 5.0 | 15.0 | | 5.0 | 15.0 | |
| Minimum Split (s) | 13.5 | 22.0 | | 13.5 | 22.0 | 22.0 | 13.5 | 22.0 | | 13.5 | 22.0 | |
| Total Split (s) | 42.0 | 48.0 | | 17.0 | 23.0 | 23.0 | 19.0 | 35.0 | | 20.0 | 36.0 | |
| Total Split (%) | 35.0% | 40.0% | | 14.2% | 19.2% | 19.2% | 15.8% | 29.2% | | 16.7% | 30.0% | |
| Yellow Time (s) | 4.0 | 5.0 | | 4.0 | 5.0 | 5.0 | 5.0 | 5.0 | | 5.0 | 5.0 | |
| All-Red Time (s) | 3.5 | 2.0 | | 3.5 | 2.0 | 2.0 | 3.5 | 2.0 | | 3.5 | 2.0 | |
| Lost Time Adjust (s) | 0.0 | 0.0 | | 0.0 | 0.0 | 0.0 | 0.0 | 0.0 | | 0.0 | 0.0 | |
| Total Lost Time (s) | 7.5 | 7.0 | | 7.5 | 7.0 | 7.0 | 8.5 | 7.0 | | 8.5 | 7.0 | |
| Lead/Lag | Lead | Lag | | Lead | Lag | Lag | Lead | Lag | | Lead | Lag | |
| Lead-Lag Optimize? | Yes | Yes | | Yes | Yes | Yes | Yes | Yes | | Yes | Yes | |
| Recall Mode | None | C-Max | | None | C-Max | C-Max | None | None | | None | None | |
| Act Effct Green (s) | 34.5 | 41.6 | 120.0 | 8.9 | 16.0 | 16.0 | 10.5 | 28.0 | 120.0 | 11.5 | 29.0 | 120.0 |
| Actuated g/C Ratio | 0.29 | 0.35 | 1.00 | 0.07 | 0.13 | 0.13 | 0.09 | 0.23 | 1.00 | 0.10 | 0.24 | 1.00 |
| v/c Ratio | 1.09 | 0.42 | 0.11 | 0.50 | 0.90 | 0.82 | 0.93 | 1.15 | 0.07 | 1.07 | 0.85 | 0.49 |
| Control Delay | 97.7 | 31.3 | 0.1 | 60.4 | 73.8 | 31.3 | 91.4 | 121.3 | 0.1 | 73.6 | 40.8 | 3.1 |
| Queue Delay | 0.0 | 0.0 | 0.0 | 0.0 | 0.0 | 0.0 | 0.0 | 0.0 | 0.0 | 0.0 | 0.0 | 0.0 |
| Total Delay | 97.7 | 31.3 | 0.1 | 60.4 | 73.8 | 31.3 | 91.4 | 121.3 | 0.1 | 73.6 | 40.8 | 3.1 |
| LOS | F | C | A | E | E | C | F | F | A | E | D | A |
| Approach Delay | | 68.7 | | | 55.4 | | | 104.6 | | | 31.2 | |
| Approach LOS | | E | | | E | | | F | | | C | |

Intersection Summary

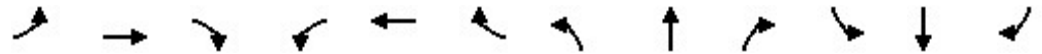
Cycle Length: 120
 Actuated Cycle Length: 120
 Offset: 100 (83%), Referenced to phase 2:EBT and 6:WBT, Start of Yellow
 Natural Cycle: 140
 Control Type: Actuated-Coordinated
 Maximum v/c Ratio: 1.15
 Intersection Signal Delay: 63.0
 Intersection LOS: E
 Intersection Capacity Utilization 100.0%
 ICU Level of Service F
 Analysis Period (min) 15

Splits and Phases: 1: MERIDIAN ROAD & WOODMAN ROAD



Queues
1: MERIDIAN ROAD & WOODMAN ROAD

Total 2024 Shopping Center PM
04/10/2023



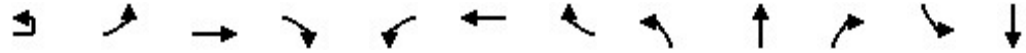
| Lane Group | EBL | EBT | EBR | WBL | WBT | WBR | NBL | NBT | NBR | SBL | SBT | SBR |
|-------------------------|------|------|------|------|------|------|------|-------|------|------|------|------|
| Lane Group Flow (vph) | 1077 | 510 | 178 | 127 | 422 | 349 | 279 | 945 | 116 | 351 | 729 | 778 |
| v/c Ratio | 1.09 | 0.42 | 0.11 | 0.50 | 0.90 | 0.82 | 0.93 | 1.15 | 0.07 | 1.07 | 0.85 | 0.49 |
| Control Delay | 97.7 | 31.3 | 0.1 | 60.4 | 73.8 | 31.3 | 91.4 | 121.3 | 0.1 | 73.6 | 40.8 | 3.1 |
| Queue Delay | 0.0 | 0.0 | 0.0 | 0.0 | 0.0 | 0.0 | 0.0 | 0.0 | 0.0 | 0.0 | 0.0 | 0.0 |
| Total Delay | 97.7 | 31.3 | 0.1 | 60.4 | 73.8 | 31.3 | 91.4 | 121.3 | 0.1 | 73.6 | 40.8 | 3.1 |
| Queue Length 50th (ft) | ~485 | 158 | 0 | 49 | 171 | 73 | 112 | ~451 | 0 | ~159 | 297 | 65 |
| Queue Length 95th (ft) | #617 | 209 | 0 | 81 | #263 | #225 | #195 | #583 | 0 | m127 | m255 | m8 |
| Internal Link Dist (ft) | | 1165 | | | 1100 | | | 342 | | | | 860 |
| Turn Bay Length (ft) | 500 | | 630 | 350 | | 250 | 440 | | 330 | 490 | | 450 |
| Base Capacity (vph) | 986 | 1228 | 1583 | 271 | 471 | 427 | 300 | 825 | 1583 | 328 | 855 | 1583 |
| Starvation Cap Reductn | 0 | 0 | 0 | 0 | 0 | 0 | 0 | 0 | 0 | 0 | 0 | 0 |
| Spillback Cap Reductn | 0 | 0 | 0 | 0 | 0 | 0 | 0 | 0 | 0 | 0 | 0 | 0 |
| Storage Cap Reductn | 0 | 0 | 0 | 0 | 0 | 0 | 0 | 0 | 0 | 0 | 0 | 0 |
| Reduced v/c Ratio | 1.09 | 0.42 | 0.11 | 0.47 | 0.90 | 0.82 | 0.93 | 1.15 | 0.07 | 1.07 | 0.85 | 0.49 |

Intersection Summary

- ~ Volume exceeds capacity, queue is theoretically infinite.
Queue shown is maximum after two cycles.
- # 95th percentile volume exceeds capacity, queue may be longer.
Queue shown is maximum after two cycles.
- m Volume for 95th percentile queue is metered by upstream signal.

HCM 6th Signalized Intersection Summary
1: MERIDIAN ROAD & WOODMAN ROAD

Total 2024 Shopping Center PM
04/10/2023



| Movement | EBU | EBL | EBT | EBR | WBL | WBT | WBR | NBL | NBT | NBR | SBL | SBT |
|------------------------------|------|------|------|------|------|------|------|------|-------|------|-------|------|
| Lane Configurations | | ↔↔ | ↕↕ | ↔ | ↔↔ | ↕↕ | ↔ | ↔↔ | ↕↕ | ↔ | ↔↔ | ↕↕ |
| Traffic Volume (veh/h) | 15 | 987 | 474 | 166 | 117 | 388 | 321 | 265 | 898 | 110 | 333 | 693 |
| Future Volume (veh/h) | 15 | 987 | 474 | 166 | 117 | 388 | 321 | 265 | 898 | 110 | 333 | 693 |
| Initial Q (Qb), veh | | 0 | 0 | 0 | 0 | 0 | 0 | 0 | 0 | 0 | 0 | 0 |
| Ped-Bike Adj(A_pbT) | | 1.00 | | 1.00 | 1.00 | | 1.00 | 1.00 | | 1.00 | 1.00 | |
| Parking Bus, Adj | | 1.00 | 1.00 | 1.00 | 1.00 | 1.00 | 1.00 | 1.00 | 1.00 | 1.00 | 1.00 | 1.00 |
| Work Zone On Approach | | | No | | | No | | | No | | | No |
| Adj Sat Flow, veh/h/ln | | 1870 | 1870 | 1870 | 1870 | 1870 | 1870 | 1870 | 1870 | 1870 | 1870 | 1870 |
| Adj Flow Rate, veh/h | | 1061 | 510 | 0 | 127 | 422 | 0 | 279 | 945 | 0 | 351 | 729 |
| Peak Hour Factor | | 0.93 | 0.93 | 0.93 | 0.92 | 0.92 | 0.92 | 0.95 | 0.95 | 0.95 | 0.95 | 0.95 |
| Percent Heavy Veh, % | | 2 | 2 | 2 | 2 | 2 | 2 | 2 | 2 | 2 | 2 | 2 |
| Cap, veh/h | | 994 | 1308 | | 182 | 474 | | 302 | 829 | | 331 | 859 |
| Arrive On Green | | 0.29 | 0.37 | 0.00 | 0.05 | 0.13 | 0.00 | 0.09 | 0.23 | 0.00 | 0.10 | 0.24 |
| Sat Flow, veh/h | | 3456 | 3554 | 1585 | 3456 | 3554 | 1585 | 3456 | 3554 | 1585 | 3456 | 3554 |
| Grp Volume(v), veh/h | | 1061 | 510 | 0 | 127 | 422 | 0 | 279 | 945 | 0 | 351 | 729 |
| Grp Sat Flow(s),veh/h/ln | | 1728 | 1777 | 1585 | 1728 | 1777 | 1585 | 1728 | 1777 | 1585 | 1728 | 1777 |
| Q Serve(g_s), s | | 34.5 | 12.7 | 0.0 | 4.3 | 14.0 | 0.0 | 9.6 | 28.0 | 0.0 | 11.5 | 23.5 |
| Cycle Q Clear(g_c), s | | 34.5 | 12.7 | 0.0 | 4.3 | 14.0 | 0.0 | 9.6 | 28.0 | 0.0 | 11.5 | 23.5 |
| Prop In Lane | | 1.00 | | 1.00 | 1.00 | | 1.00 | 1.00 | | 1.00 | 1.00 | |
| Lane Grp Cap(c), veh/h | | 994 | 1308 | | 182 | 474 | | 302 | 829 | | 331 | 859 |
| V/C Ratio(X) | | 1.07 | 0.39 | | 0.70 | 0.89 | | 0.92 | 1.14 | | 1.06 | 0.85 |
| Avail Cap(c_a), veh/h | | 994 | 1308 | | 274 | 474 | | 302 | 829 | | 331 | 859 |
| HCM Platoon Ratio | | 1.00 | 1.00 | 1.00 | 1.00 | 1.00 | 1.00 | 1.00 | 1.00 | 1.00 | 1.00 | 1.00 |
| Upstream Filter(I) | | 1.00 | 1.00 | 0.00 | 1.00 | 1.00 | 0.00 | 1.00 | 1.00 | 0.00 | 1.00 | 1.00 |
| Uniform Delay (d), s/veh | | 42.8 | 28.0 | 0.0 | 55.9 | 51.1 | 0.0 | 54.3 | 46.0 | 0.0 | 54.3 | 43.4 |
| Incr Delay (d2), s/veh | | 48.5 | 0.9 | 0.0 | 4.7 | 21.5 | 0.0 | 32.4 | 77.3 | 0.0 | 66.1 | 8.0 |
| Initial Q Delay(d3),s/veh | | 0.0 | 0.0 | 0.0 | 0.0 | 0.0 | 0.0 | 0.0 | 0.0 | 0.0 | 0.0 | 0.0 |
| %ile BackOfQ(50%),veh/ln | | 20.8 | 5.4 | 0.0 | 2.0 | 7.5 | 0.0 | 5.5 | 21.0 | 0.0 | 8.0 | 11.1 |
| Unsig. Movement Delay, s/veh | | | | | | | | | | | | |
| LnGrp Delay(d),s/veh | | 91.3 | 28.9 | 0.0 | 60.6 | 72.7 | 0.0 | 86.7 | 123.3 | 0.0 | 120.4 | 51.4 |
| LnGrp LOS | | F | C | | E | E | | F | F | | F | D |
| Approach Vol, veh/h | | | 1571 | A | | 549 | A | | 1224 | A | | 1080 |
| Approach Delay, s/veh | | | 71.0 | | | 69.9 | | | 114.9 | | | 73.8 |
| Approach LOS | | | E | | | E | | | F | | | E |
| Timer - Assigned Phs | 1 | 2 | 3 | 4 | 5 | 6 | 7 | 8 | | | | |
| Phs Duration (G+Y+Rc), s | 13.8 | 51.2 | 19.0 | 36.0 | 42.0 | 23.0 | 20.0 | 35.0 | | | | |
| Change Period (Y+Rc), s | 7.5 | 7.0 | 8.5 | 7.0 | 7.5 | 7.0 | 8.5 | 7.0 | | | | |
| Max Green Setting (Gmax), s | 9.5 | 41.0 | 10.5 | 29.0 | 34.5 | 16.0 | 11.5 | 28.0 | | | | |
| Max Q Clear Time (g_c+I1), s | 6.3 | 14.7 | 11.6 | 25.5 | 36.5 | 16.0 | 13.5 | 30.0 | | | | |
| Green Ext Time (p_c), s | 0.1 | 3.2 | 0.0 | 1.6 | 0.0 | 0.0 | 0.0 | 0.0 | | | | |

Intersection Summary

| | |
|--------------------|------|
| HCM 6th Ctrl Delay | 83.7 |
| HCM 6th LOS | F |

Notes

- User approved pedestrian interval to be less than phase max green.
- User approved ignoring U-Turning movement.
- Unsignalized Delay for [NBR, EBR, WBR, SBR] is excluded from calculations of the approach delay and intersection delay.

| | |
|------------------------------|------|
| Movement | SBR |
| Lane Configurations | |
| Traffic Volume (veh/h) | 739 |
| Future Volume (veh/h) | 739 |
| Initial Q (Qb), veh | 0 |
| Ped-Bike Adj(A_pbT) | 1.00 |
| Parking Bus, Adj | 1.00 |
| Work Zone On Approach | |
| Adj Sat Flow, veh/h/ln | 1870 |
| Adj Flow Rate, veh/h | 0 |
| Peak Hour Factor | 0.95 |
| Percent Heavy Veh, % | 2 |
| Cap, veh/h | |
| Arrive On Green | 0.00 |
| Sat Flow, veh/h | 1585 |
| Grp Volume(v), veh/h | 0 |
| Grp Sat Flow(s),veh/h/ln | 1585 |
| Q Serve(g_s), s | 0.0 |
| Cycle Q Clear(g_c), s | 0.0 |
| Prop In Lane | 1.00 |
| Lane Grp Cap(c), veh/h | |
| V/C Ratio(X) | |
| Avail Cap(c_a), veh/h | |
| HCM Platoon Ratio | 1.00 |
| Upstream Filter(l) | 0.00 |
| Uniform Delay (d), s/veh | 0.0 |
| Incr Delay (d2), s/veh | 0.0 |
| Initial Q Delay(d3),s/veh | 0.0 |
| %ile BackOfQ(50%),veh/ln | 0.0 |
| Unsig. Movement Delay, s/veh | |
| LnGrp Delay(d),s/veh | 0.0 |
| LnGrp LOS | |
| Approach Vol, veh/h | A |
| Approach Delay, s/veh | |
| Approach LOS | |
| Timer - Assigned Phs | |

Timings
2: MERIDIAN ROAD & EASTONVILLE ROAD

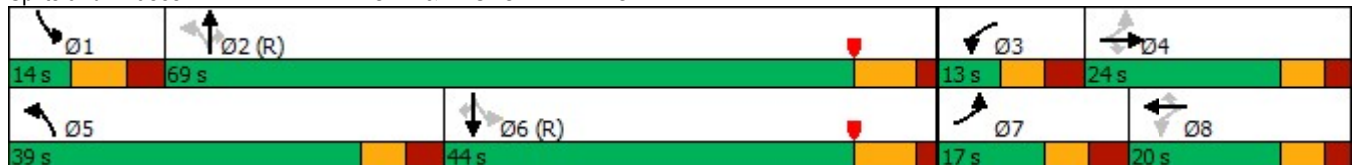
Total 2024 Shopping Center PM
04/10/2023

| Lane Group | EBL | EBT | EBR | WBL | WBT | WBR | NBL | NBT | NBR | SBL | SBT | SBR |
|----------------------|-------|-------|-------|-------|-------|-------|-------|-------|-------|-------|-------|-------|
| Lane Configurations | | | | | | | | | | | | |
| Traffic Volume (vph) | 359 | 125 | 589 | 32 | 79 | 138 | 628 | 1516 | 120 | 85 | 1139 | 184 |
| Future Volume (vph) | 359 | 125 | 589 | 32 | 79 | 138 | 628 | 1516 | 120 | 85 | 1139 | 184 |
| Turn Type | pm+pt | NA | Perm | pm+pt | NA | Perm | pm+pt | NA | Perm | pm+pt | NA | Perm |
| Protected Phases | 7 | 4 | | 3 | 8 | | 5 | 2 | | 1 | 6 | |
| Permitted Phases | 4 | | 4 | 8 | | 8 | 2 | | 2 | 6 | | 6 |
| Detector Phase | 7 | 4 | 4 | 3 | 8 | 8 | 5 | 2 | 2 | 1 | 6 | 6 |
| Switch Phase | | | | | | | | | | | | |
| Minimum Initial (s) | 5.0 | 8.0 | 8.0 | 5.0 | 8.0 | 8.0 | 5.0 | 15.0 | 15.0 | 5.0 | 15.0 | 15.0 |
| Minimum Split (s) | 12.5 | 14.5 | 14.5 | 12.5 | 14.5 | 14.5 | 12.5 | 25.5 | 25.5 | 13.5 | 25.5 | 25.5 |
| Total Split (s) | 17.0 | 24.0 | 24.0 | 13.0 | 20.0 | 20.0 | 39.0 | 69.0 | 69.0 | 14.0 | 44.0 | 44.0 |
| Total Split (%) | 14.2% | 20.0% | 20.0% | 10.8% | 16.7% | 16.7% | 32.5% | 57.5% | 57.5% | 11.7% | 36.7% | 36.7% |
| Yellow Time (s) | 4.0 | 4.0 | 4.0 | 4.0 | 4.0 | 4.0 | 4.0 | 5.5 | 5.5 | 5.0 | 5.5 | 5.5 |
| All-Red Time (s) | 3.5 | 2.5 | 2.5 | 3.5 | 2.5 | 2.5 | 3.5 | 2.0 | 2.0 | 3.5 | 2.0 | 2.0 |
| Lost Time Adjust (s) | 0.0 | 0.0 | 0.0 | 0.0 | 0.0 | 0.0 | 0.0 | 0.0 | 0.0 | 0.0 | 0.0 | 0.0 |
| Total Lost Time (s) | 7.5 | 6.5 | 6.5 | 7.5 | 6.5 | 6.5 | 7.5 | 7.5 | 7.5 | 8.5 | 7.5 | 7.5 |
| Lead/Lag | Lead | Lag | Lag | Lead | Lag | Lag | Lead | Lag | Lag | Lead | Lag | Lag |
| Lead-Lag Optimize? | Yes | Yes | Yes | Yes | Yes | Yes | Yes | Yes | Yes | Yes | Yes | Yes |
| Recall Mode | None | None | None | None | None | None | None | C-Max | C-Max | None | C-Max | C-Max |
| Act Effct Green (s) | 27.4 | 22.7 | 22.7 | 18.0 | 13.5 | 13.5 | 75.5 | 61.5 | 61.5 | 41.0 | 36.5 | 36.5 |
| Actuated g/C Ratio | 0.23 | 0.19 | 0.19 | 0.15 | 0.11 | 0.11 | 0.63 | 0.51 | 0.51 | 0.34 | 0.30 | 0.30 |
| v/c Ratio | 0.77 | 0.42 | 1.04 | 0.16 | 0.40 | 0.36 | 1.33 | 0.94 | 0.15 | 0.66 | 1.20 | 0.32 |
| Control Delay | 51.1 | 49.2 | 63.7 | 37.4 | 55.7 | 2.5 | 182.8 | 16.1 | 0.2 | 51.1 | 136.8 | 10.3 |
| Queue Delay | 0.0 | 0.0 | 0.0 | 0.0 | 0.0 | 0.0 | 0.0 | 0.0 | 0.0 | 0.0 | 0.0 | 0.0 |
| Total Delay | 51.1 | 49.2 | 63.7 | 37.4 | 55.7 | 2.5 | 182.8 | 16.1 | 0.2 | 51.1 | 136.8 | 10.3 |
| LOS | D | D | E | D | E | A | F | B | A | D | F | B |
| Approach Delay | | 57.8 | | | 23.9 | | | 61.5 | | | 115.1 | |
| Approach LOS | | E | | | C | | | E | | | F | |

Intersection Summary

Cycle Length: 120
 Actuated Cycle Length: 120
 Offset: 89 (74%), Referenced to phase 2:NBTL and 6:SBTL, Start of Yellow
 Natural Cycle: 150
 Control Type: Actuated-Coordinated
 Maximum v/c Ratio: 1.33
 Intersection Signal Delay: 74.1
 Intersection Capacity Utilization 106.5%
 Analysis Period (min) 15
 Intersection LOS: E
 ICU Level of Service G

Splits and Phases: 2: MERIDIAN ROAD & EASTONVILLE ROAD



Queues
2: MERIDIAN ROAD & EASTONVILLE ROAD

Total 2024 Shopping Center PM
04/10/2023


































| Lane Group | EBL | EBT | EBR | WBL | WBT | WBR | NBL | NBT | NBR | SBL | SBT | SBR |
|-------------------------|------|------|------|------|------|------|-------|------|------|------|-------|------|
| Lane Group Flow (vph) | 422 | 147 | 693 | 34 | 83 | 145 | 706 | 1703 | 135 | 97 | 1294 | 209 |
| v/c Ratio | 0.77 | 0.42 | 1.04 | 0.16 | 0.40 | 0.36 | 1.33 | 0.94 | 0.15 | 0.66 | 1.20 | 0.32 |
| Control Delay | 51.1 | 49.2 | 63.7 | 37.4 | 55.7 | 2.5 | 182.8 | 16.1 | 0.2 | 51.1 | 136.8 | 10.3 |
| Queue Delay | 0.0 | 0.0 | 0.0 | 0.0 | 0.0 | 0.0 | 0.0 | 0.0 | 0.0 | 0.0 | 0.0 | 0.0 |
| Total Delay | 51.1 | 49.2 | 63.7 | 37.4 | 55.7 | 2.5 | 182.8 | 16.1 | 0.2 | 51.1 | 136.8 | 10.3 |
| Queue Length 50th (ft) | 145 | 107 | ~300 | 20 | 61 | 0 | ~644 | 426 | 1 | 30 | ~657 | 48 |
| Queue Length 95th (ft) | 184 | 165 | #461 | 48 | 113 | 0 | m#596 | m401 | m1 | m#97 | #770 | 112 |
| Internal Link Dist (ft) | | 508 | | | 1196 | | | 231 | | | 781 | |
| Turn Bay Length (ft) | 100 | | 100 | 120 | | 100 | 100 | | 400 | 375 | | 400 |
| Base Capacity (vph) | 547 | 352 | 665 | 209 | 209 | 404 | 531 | 1813 | 897 | 146 | 1076 | 651 |
| Starvation Cap Reductn | 0 | 0 | 0 | 0 | 0 | 0 | 0 | 0 | 0 | 0 | 0 | 0 |
| Spillback Cap Reductn | 0 | 0 | 0 | 0 | 0 | 0 | 0 | 0 | 0 | 0 | 0 | 0 |
| Storage Cap Reductn | 0 | 0 | 0 | 0 | 0 | 0 | 0 | 0 | 0 | 0 | 0 | 0 |
| Reduced v/c Ratio | 0.77 | 0.42 | 1.04 | 0.16 | 0.40 | 0.36 | 1.33 | 0.94 | 0.15 | 0.66 | 1.20 | 0.32 |

Intersection Summary

- ~ Volume exceeds capacity, queue is theoretically infinite.
Queue shown is maximum after two cycles.
- # 95th percentile volume exceeds capacity, queue may be longer.
Queue shown is maximum after two cycles.
- m Volume for 95th percentile queue is metered by upstream signal.

HCM 6th Signalized Intersection Summary
2: MERIDIAN ROAD & EASTONVILLE ROAD

Total 2024 Shopping Center PM
04/10/2023

| |  |  |  |  |  |  |  |  |  |  |  |  |
|------------------------------|---|---|---|---|---|--|---|---|---|---|---|---|
| Movement | EBL | EBT | EBR | WBL | WBT | WBR | NBL | NBT | NBR | SBL | SBT | SBR |
| Lane Configurations |   |  |   |   |  |   |   |   |   |   |  | |
| Traffic Volume (veh/h) | 359 | 125 | 589 | 32 | 79 | 138 | 628 | 1516 | 120 | 85 | 1139 | 184 |
| Future Volume (veh/h) | 359 | 125 | 589 | 32 | 79 | 138 | 628 | 1516 | 120 | 85 | 1139 | 184 |
| Initial Q (Qb), veh | 0 | 0 | 0 | 0 | 0 | 0 | 0 | 0 | 0 | 0 | 0 | 0 |
| Ped-Bike Adj(A_pbT) | 1.00 | | 1.00 | 1.00 | | 1.00 | 1.00 | | 1.00 | 1.00 | | 1.00 |
| Parking Bus, Adj | 1.00 | 1.00 | 1.00 | 1.00 | 1.00 | 1.00 | 1.00 | 1.00 | 1.00 | 1.00 | 1.00 | 1.00 |
| Work Zone On Approach | | No | | | No | | | No | | | No | |
| Adj Sat Flow, veh/h/ln | 1870 | 1870 | 1870 | 1870 | 1870 | 1870 | 1870 | 1870 | 1870 | 1870 | 1870 | 1870 |
| Adj Flow Rate, veh/h | 422 | 147 | 0 | 34 | 83 | 0 | 706 | 1703 | 135 | 97 | 1294 | 209 |
| Peak Hour Factor | 0.85 | 0.85 | 0.85 | 0.95 | 0.95 | 0.95 | 0.89 | 0.89 | 0.89 | 0.88 | 0.88 | 0.88 |
| Percent Heavy Veh, % | 2 | 2 | 2 | 2 | 2 | 2 | 2 | 2 | 2 | 2 | 2 | 2 |
| Cap, veh/h | 453 | 220 | | 163 | 125 | | 528 | 1984 | 885 | 180 | 1244 | 555 |
| Arrive On Green | 0.08 | 0.12 | 0.00 | 0.03 | 0.07 | 0.00 | 0.26 | 0.56 | 0.56 | 0.05 | 0.35 | 0.35 |
| Sat Flow, veh/h | 3456 | 1870 | 1585 | 1781 | 1870 | 1585 | 1781 | 3554 | 1585 | 1781 | 3554 | 1585 |
| Grp Volume(v), veh/h | 422 | 147 | 0 | 34 | 83 | 0 | 706 | 1703 | 135 | 97 | 1294 | 209 |
| Grp Sat Flow(s),veh/h/ln | 1728 | 1870 | 1585 | 1781 | 1870 | 1585 | 1781 | 1777 | 1585 | 1781 | 1777 | 1585 |
| Q Serve(g_s), s | 9.5 | 9.0 | 0.0 | 2.1 | 5.2 | 0.0 | 31.5 | 48.8 | 4.9 | 4.2 | 42.0 | 11.8 |
| Cycle Q Clear(g_c), s | 9.5 | 9.0 | 0.0 | 2.1 | 5.2 | 0.0 | 31.5 | 48.8 | 4.9 | 4.2 | 42.0 | 11.8 |
| Prop In Lane | 1.00 | | 1.00 | 1.00 | | 1.00 | 1.00 | | 1.00 | 1.00 | | 1.00 |
| Lane Grp Cap(c), veh/h | 453 | 220 | | 163 | 125 | | 528 | 1984 | 885 | 180 | 1244 | 555 |
| V/C Ratio(X) | 0.93 | 0.67 | | 0.21 | 0.67 | | 1.34 | 0.86 | 0.15 | 0.54 | 1.04 | 0.38 |
| Avail Cap(c_a), veh/h | 453 | 273 | | 194 | 210 | | 528 | 1984 | 885 | 180 | 1244 | 555 |
| HCM Platoon Ratio | 1.00 | 1.00 | 1.00 | 1.00 | 1.00 | 1.00 | 1.00 | 1.00 | 1.00 | 1.00 | 1.00 | 1.00 |
| Upstream Filter(I) | 1.00 | 1.00 | 0.00 | 1.00 | 1.00 | 0.00 | 1.00 | 1.00 | 1.00 | 1.00 | 1.00 | 1.00 |
| Uniform Delay (d), s/veh | 51.1 | 50.7 | 0.0 | 50.1 | 54.7 | 0.0 | 37.4 | 22.5 | 12.8 | 27.0 | 39.0 | 29.2 |
| Incr Delay (d2), s/veh | 26.1 | 4.4 | 0.0 | 0.6 | 6.0 | 0.0 | 164.6 | 5.1 | 0.4 | 3.2 | 36.6 | 1.9 |
| Initial Q Delay(d3),s/veh | 0.0 | 0.0 | 0.0 | 0.0 | 0.0 | 0.0 | 0.0 | 0.0 | 0.0 | 0.0 | 0.0 | 0.0 |
| %ile BackOfQ(50%),veh/ln | 3.5 | 4.5 | 0.0 | 1.0 | 2.7 | 0.0 | 38.7 | 18.9 | 1.8 | 1.8 | 23.2 | 4.8 |
| Unsig. Movement Delay, s/veh | | | | | | | | | | | | |
| LnGrp Delay(d),s/veh | 77.2 | 55.1 | 0.0 | 50.8 | 60.7 | 0.0 | 202.0 | 27.6 | 13.2 | 30.2 | 75.6 | 31.1 |
| LnGrp LOS | E | E | | D | E | | F | C | B | C | F | C |
| Approach Vol, veh/h | | 569 | A | | 117 | A | | 2544 | | | 1600 | |
| Approach Delay, s/veh | | 71.5 | | | 57.8 | | | 75.2 | | | 67.1 | |
| Approach LOS | | E | | | E | | | E | | | E | |
| Timer - Assigned Phs | 1 | 2 | 3 | 4 | 5 | 6 | 7 | 8 | | | | |
| Phs Duration (G+Y+Rc), s | 14.0 | 74.5 | 10.9 | 20.6 | 39.0 | 49.5 | 17.0 | 14.5 | | | | |
| Change Period (Y+Rc), s | 8.5 | 7.5 | 7.5 | 6.5 | 7.5 | 7.5 | 7.5 | 6.5 | | | | |
| Max Green Setting (Gmax), s | 5.5 | 61.5 | 5.5 | 17.5 | 31.5 | 36.5 | 9.5 | 13.5 | | | | |
| Max Q Clear Time (g_c+I1), s | 6.2 | 50.8 | 4.1 | 11.0 | 33.5 | 44.0 | 11.5 | 7.2 | | | | |
| Green Ext Time (p_c), s | 0.0 | 7.7 | 0.0 | 0.3 | 0.0 | 0.0 | 0.0 | 0.1 | | | | |

Intersection Summary

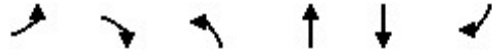
| | |
|--------------------|------|
| HCM 6th Ctrl Delay | 71.7 |
| HCM 6th LOS | E |

Notes

User approved pedestrian interval to be less than phase max green.
Unsignalized Delay for [EBR, WBR] is excluded from calculations of the approach delay and intersection delay.

Timings
3: MERIDIAN ROAD & BENT GRASS MEADOWS DRIVE

Total 2024 Shopping Center PM
04/10/2023

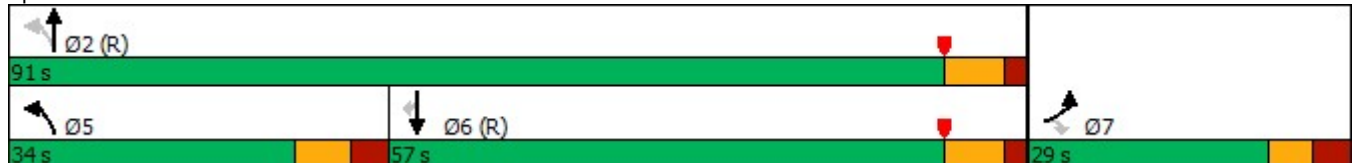


| Lane Group | EBL | EBR | NBL | NBT | SBT | SBR |
|----------------------|-------|-------|-------|-------|-------|-------|
| Lane Configurations | ↖↗ | ↗ | ↖ | ↑↑ | ↑↑ | ↗ |
| Traffic Volume (vph) | 221 | 313 | 305 | 1651 | 1045 | 245 |
| Future Volume (vph) | 221 | 313 | 305 | 1651 | 1045 | 245 |
| Turn Type | Prot | Perm | pm+pt | NA | NA | Perm |
| Protected Phases | 7 | | 5 | 2 | 6 | |
| Permitted Phases | | 7 | 2 | | | 6 |
| Detector Phase | 7 | 7 | 5 | 2 | 6 | 6 |
| Switch Phase | | | | | | |
| Minimum Initial (s) | 8.0 | 8.0 | 5.0 | 15.0 | 15.0 | 15.0 |
| Minimum Split (s) | 25.5 | 25.5 | 13.5 | 25.5 | 25.5 | 25.5 |
| Total Split (s) | 29.0 | 29.0 | 34.0 | 91.0 | 57.0 | 57.0 |
| Total Split (%) | 24.2% | 24.2% | 28.3% | 75.8% | 47.5% | 47.5% |
| Yellow Time (s) | 4.0 | 4.0 | 5.0 | 5.5 | 5.5 | 5.5 |
| All-Red Time (s) | 3.5 | 3.5 | 3.5 | 2.0 | 2.0 | 2.0 |
| Lost Time Adjust (s) | 0.0 | 0.0 | 0.0 | 0.0 | 0.0 | 0.0 |
| Total Lost Time (s) | 7.5 | 7.5 | 8.5 | 7.5 | 7.5 | 7.5 |
| Lead/Lag | | | Lead | | Lag | Lag |
| Lead-Lag Optimize? | | | Yes | | Yes | Yes |
| Recall Mode | None | None | None | C-Max | C-Max | C-Max |
| Act Effct Green (s) | 14.6 | 14.6 | 89.4 | 90.4 | 63.3 | 63.3 |
| Actuated g/C Ratio | 0.12 | 0.12 | 0.74 | 0.75 | 0.53 | 0.53 |
| v/c Ratio | 0.62 | 0.71 | 0.72 | 0.65 | 0.60 | 0.27 |
| Control Delay | 56.4 | 13.1 | 30.3 | 4.8 | 23.2 | 3.3 |
| Queue Delay | 0.0 | 0.0 | 0.0 | 0.0 | 0.0 | 0.0 |
| Total Delay | 56.4 | 13.1 | 30.3 | 4.8 | 23.2 | 3.3 |
| LOS | E | B | C | A | C | A |
| Approach Delay | 31.0 | | | 8.7 | 19.4 | |
| Approach LOS | C | | | A | B | |

Intersection Summary

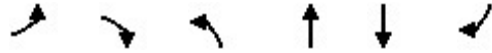
Cycle Length: 120
 Actuated Cycle Length: 120
 Offset: 27 (23%), Referenced to phase 2:NBTL and 6:SBT, Start of Yellow
 Natural Cycle: 90
 Control Type: Actuated-Coordinated
 Maximum v/c Ratio: 0.72
 Intersection Signal Delay: 15.8
 Intersection Capacity Utilization 72.0%
 Analysis Period (min) 15
 Intersection LOS: B
 ICU Level of Service C

Splits and Phases: 3: MERIDIAN ROAD & BENT GRASS MEADOWS DRIVE



Queues
 3: MERIDIAN ROAD & BENT GRASS MEADOWS DRIVE

Total 2024 Shopping Center PM
 04/10/2023



| Lane Group | EBL | EBR | NBL | NBT | SBT | SBR |
|-------------------------|------|------|------|------|------|------|
| Lane Group Flow (vph) | 260 | 368 | 321 | 1738 | 1112 | 261 |
| v/c Ratio | 0.62 | 0.71 | 0.72 | 0.65 | 0.60 | 0.27 |
| Control Delay | 56.4 | 13.1 | 30.3 | 4.8 | 23.2 | 3.3 |
| Queue Delay | 0.0 | 0.0 | 0.0 | 0.0 | 0.0 | 0.0 |
| Total Delay | 56.4 | 13.1 | 30.3 | 4.8 | 23.2 | 3.3 |
| Queue Length 50th (ft) | 100 | 0 | 123 | 127 | 301 | 0 |
| Queue Length 95th (ft) | 129 | 64 | m133 | m145 | 467 | 50 |
| Internal Link Dist (ft) | 310 | | | 750 | 1921 | |
| Turn Bay Length (ft) | 150 | | 700 | | | 350 |
| Base Capacity (vph) | 615 | 585 | 535 | 2665 | 1865 | 958 |
| Starvation Cap Reductn | 0 | 0 | 0 | 0 | 0 | 0 |
| Spillback Cap Reductn | 0 | 0 | 0 | 0 | 0 | 0 |
| Storage Cap Reductn | 0 | 0 | 0 | 0 | 0 | 0 |
| Reduced v/c Ratio | 0.42 | 0.63 | 0.60 | 0.65 | 0.60 | 0.27 |

Intersection Summary

m Volume for 95th percentile queue is metered by upstream signal.

HCM 6th Signalized Intersection Summary
 3: MERIDIAN ROAD & BENT GRASS MEADOWS DRIVE

Total 2024 Shopping Center PM
 04/10/2023



| Movement | EBL | EBR | NBL | NBT | SBT | SBR |
|--|------|-------|------|------|------|------|
| Lane Configurations | ↖↗ | ↗ | ↖ | ↑↑ | ↑↑ | ↗ |
| Traffic Volume (veh/h) | 221 | 313 | 305 | 1651 | 1045 | 245 |
| Future Volume (veh/h) | 221 | 313 | 305 | 1651 | 1045 | 245 |
| Initial Q (Qb), veh | 0 | 0 | 0 | 0 | 0 | 0 |
| Ped-Bike Adj(A_pbT) | 1.00 | 1.00 | 1.00 | | | 1.00 |
| Parking Bus, Adj | 1.00 | 1.00 | 1.00 | 1.00 | 1.00 | 1.00 |
| Work Zone On Approach | No | | | No | No | |
| Adj Sat Flow, veh/h/ln | 1870 | 1870 | 1870 | 1870 | 1870 | 1870 |
| Adj Flow Rate, veh/h | 260 | 0 | 321 | 1738 | 1112 | 261 |
| Peak Hour Factor | 0.85 | 0.85 | 0.95 | 0.95 | 0.94 | 0.94 |
| Percent Heavy Veh, % | 2 | 2 | 2 | 2 | 2 | 2 |
| Cap, veh/h | 330 | | 389 | 2770 | 2219 | 990 |
| Arrive On Green | 0.10 | 0.00 | 0.08 | 0.78 | 0.62 | 0.62 |
| Sat Flow, veh/h | 3456 | 1585 | 1781 | 3647 | 3647 | 1585 |
| Grp Volume(v), veh/h | 260 | 0 | 321 | 1738 | 1112 | 261 |
| Grp Sat Flow(s),veh/h/ln | 1728 | 1585 | 1781 | 1777 | 1777 | 1585 |
| Q Serve(g_s), s | 8.8 | 0.0 | 7.2 | 25.3 | 20.5 | 8.9 |
| Cycle Q Clear(g_c), s | 8.8 | 0.0 | 7.2 | 25.3 | 20.5 | 8.9 |
| Prop In Lane | 1.00 | 1.00 | 1.00 | | | 1.00 |
| Lane Grp Cap(c), veh/h | 330 | | 389 | 2770 | 2219 | 990 |
| V/C Ratio(X) | 0.79 | | 0.82 | 0.63 | 0.50 | 0.26 |
| Avail Cap(c_a), veh/h | 619 | | 618 | 2770 | 2219 | 990 |
| HCM Platoon Ratio | 1.00 | 1.00 | 1.00 | 1.00 | 1.00 | 1.00 |
| Upstream Filter(I) | 1.00 | 0.00 | 1.00 | 1.00 | 1.00 | 1.00 |
| Uniform Delay (d), s/veh | 53.1 | 0.0 | 15.0 | 5.7 | 12.3 | 10.1 |
| Incr Delay (d2), s/veh | 4.2 | 0.0 | 5.0 | 1.1 | 0.8 | 0.7 |
| Initial Q Delay(d3),s/veh | 0.0 | 0.0 | 0.0 | 0.0 | 0.0 | 0.0 |
| %ile BackOfQ(50%),veh/ln | 4.0 | 0.0 | 6.3 | 8.0 | 8.0 | 12.1 |
| Unsig. Movement Delay, s/veh | | | | | | |
| LnGrp Delay(d),s/veh | 57.3 | 0.0 | 20.0 | 6.8 | 13.1 | 10.8 |
| LnGrp LOS | E | | C | A | B | B |
| Approach Vol, veh/h | 260 | A | | 2059 | 1373 | |
| Approach Delay, s/veh | 57.3 | | | 8.9 | 12.7 | |
| Approach LOS | E | | | A | B | |
| Timer - Assigned Phs | | 2 | | 4 | 5 | 6 |
| Phs Duration (G+Y+Rc), s | | 101.0 | | 19.0 | 18.6 | 82.4 |
| Change Period (Y+Rc), s | | 7.5 | | 7.5 | 8.5 | 7.5 |
| Max Green Setting (Gmax), s | | 83.5 | | 21.5 | 25.5 | 49.5 |
| Max Q Clear Time (g_c+I1), s | | 27.3 | | 10.8 | 9.2 | 22.5 |
| Green Ext Time (p_c), s | | 24.5 | | 0.6 | 0.9 | 10.7 |
| Intersection Summary | | | | | | |
| HCM 6th Ctrl Delay | | | 13.7 | | | |
| HCM 6th LOS | | | B | | | |
| Notes | | | | | | |
| Unsignalized Delay for [EBR] is excluded from calculations of the approach delay and intersection delay. | | | | | | |

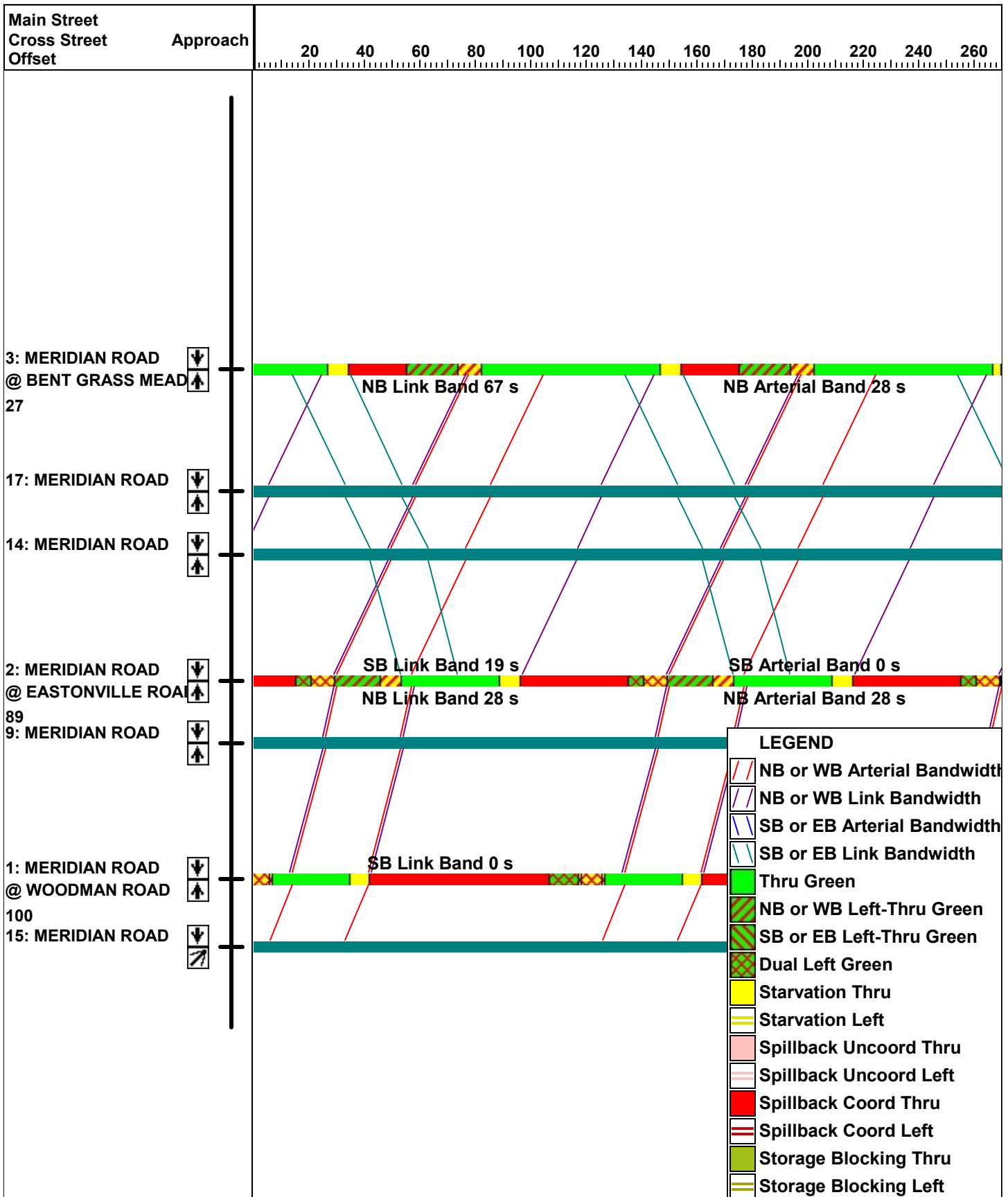
| Intersection | | | | | | |
|--------------------------|------|------|------|------|------|------|
| Int Delay, s/veh | 8.2 | | | | | |
| Movement | EBT | EBR | WBL | WBT | NBL | NBR |
| Lane Configurations | ↑ | ↗ | ↖ | ↑ | ↘ | ↙ |
| Traffic Vol, veh/h | 123 | 42 | 383 | 166 | 2 | 411 |
| Future Vol, veh/h | 123 | 42 | 383 | 166 | 2 | 411 |
| Conflicting Peds, #/hr | 0 | 0 | 0 | 0 | 0 | 0 |
| Sign Control | Free | Free | Free | Free | Stop | Stop |
| RT Channelized | - | None | - | None | - | None |
| Storage Length | - | 150 | 100 | - | 0 | - |
| Veh in Median Storage, # | 0 | - | - | 0 | 0 | - |
| Grade, % | 0 | - | - | 0 | 0 | - |
| Peak Hour Factor | 85 | 85 | 85 | 85 | 85 | 85 |
| Heavy Vehicles, % | 2 | 2 | 2 | 2 | 2 | 2 |
| Mvmt Flow | 145 | 49 | 451 | 195 | 2 | 484 |

| Major/Minor | Major1 | Major2 | Minor1 | | |
|----------------------|--------|--------|--------|---|-------|
| Conflicting Flow All | 0 | 0 | 194 | 0 | 1242 |
| Stage 1 | - | - | - | - | 145 |
| Stage 2 | - | - | - | - | 1097 |
| Critical Hdwy | - | - | 4.12 | - | 6.42 |
| Critical Hdwy Stg 1 | - | - | - | - | 5.42 |
| Critical Hdwy Stg 2 | - | - | - | - | 5.42 |
| Follow-up Hdwy | - | - | 2.218 | - | 3.518 |
| Pot Cap-1 Maneuver | - | - | 1379 | - | 193 |
| Stage 1 | - | - | - | - | 882 |
| Stage 2 | - | - | - | - | 320 |
| Platoon blocked, % | - | - | - | - | - |
| Mov Cap-1 Maneuver | - | - | 1379 | - | 130 |
| Mov Cap-2 Maneuver | - | - | - | - | 130 |
| Stage 1 | - | - | - | - | 882 |
| Stage 2 | - | - | - | - | 215 |

| Approach | EB | WB | NB |
|----------------------|----|-----|------|
| HCM Control Delay, s | 0 | 6.2 | 14.1 |
| HCM LOS | | | B |

| Minor Lane/Major Mvmt | NBLn1 | EBT | EBR | WBL | WBT |
|-----------------------|-------|-----|-----|-------|-----|
| Capacity (veh/h) | 877 | - | - | 1379 | - |
| HCM Lane V/C Ratio | 0.554 | - | - | 0.327 | - |
| HCM Control Delay (s) | 14.1 | - | - | 8.9 | - |
| HCM Lane LOS | B | - | - | A | - |
| HCM 95th %tile Q(veh) | 3.5 | - | - | 1.4 | - |

Total PM 2024 Shopping Center



Timings
1: MERIDIAN ROAD & WOODMAN ROAD

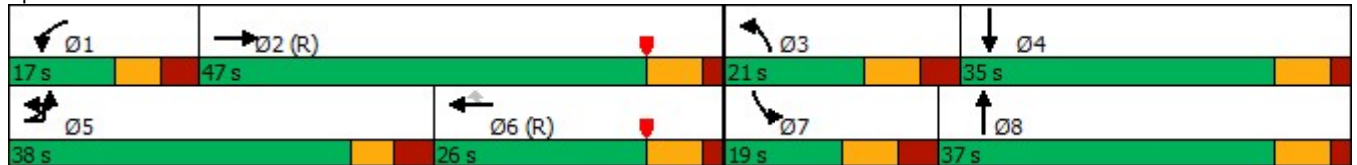
Total 2024 Storage PM
04/10/2023

| Lane Group | EBL | EBT | EBR | WBL | WBT | WBR | NBL | NBT | NBR | SBL | SBT | SBR |
|----------------------|-------|-------|-------|-------|-------|-------|-------|-------|-------|-------|-------|-------|
| Lane Configurations | | | | | | | | | | | | |
| Traffic Volume (vph) | 741 | 474 | 166 | 117 | 388 | 239 | 265 | 788 | 110 | 244 | 574 | 473 |
| Future Volume (vph) | 741 | 474 | 166 | 117 | 388 | 239 | 265 | 788 | 110 | 244 | 574 | 473 |
| Turn Type | Prot | NA | Free | Prot | NA | Perm | Prot | NA | Free | Prot | NA | Free |
| Protected Phases | 5 | 2 | | 1 | 6 | | 3 | 8 | | 7 | 4 | |
| Permitted Phases | | | Free | | | 6 | | | Free | | | Free |
| Detector Phase | 5 | 2 | | 1 | 6 | 6 | 3 | 8 | | 7 | 4 | |
| Switch Phase | | | | | | | | | | | | |
| Minimum Initial (s) | 5.0 | 15.0 | | 5.0 | 15.0 | 15.0 | 5.0 | 15.0 | | 5.0 | 15.0 | |
| Minimum Split (s) | 13.5 | 22.0 | | 13.5 | 22.0 | 22.0 | 13.5 | 22.0 | | 13.5 | 22.0 | |
| Total Split (s) | 38.0 | 47.0 | | 17.0 | 26.0 | 26.0 | 21.0 | 37.0 | | 19.0 | 35.0 | |
| Total Split (%) | 31.7% | 39.2% | | 14.2% | 21.7% | 21.7% | 17.5% | 30.8% | | 15.8% | 29.2% | |
| Yellow Time (s) | 4.0 | 5.0 | | 4.0 | 5.0 | 5.0 | 5.0 | 5.0 | | 5.0 | 5.0 | |
| All-Red Time (s) | 3.5 | 2.0 | | 3.5 | 2.0 | 2.0 | 3.5 | 2.0 | | 3.5 | 2.0 | |
| Lost Time Adjust (s) | 0.0 | 0.0 | | 0.0 | 0.0 | 0.0 | 0.0 | 0.0 | | 0.0 | 0.0 | |
| Total Lost Time (s) | 7.5 | 7.0 | | 7.5 | 7.0 | 7.0 | 8.5 | 7.0 | | 8.5 | 7.0 | |
| Lead/Lag | Lead | Lag | | Lead | Lag | Lag | Lead | Lag | | Lead | Lag | |
| Lead-Lag Optimize? | Yes | Yes | | Yes | Yes | Yes | Yes | Yes | | Yes | Yes | |
| Recall Mode | None | C-Max | | None | C-Max | C-Max | None | None | | None | None | |
| Act Effct Green (s) | 30.1 | 40.8 | 120.0 | 8.9 | 19.6 | 19.6 | 12.3 | 29.8 | 120.0 | 10.5 | 28.1 | 120.0 |
| Actuated g/C Ratio | 0.25 | 0.34 | 1.00 | 0.07 | 0.16 | 0.16 | 0.10 | 0.25 | 1.00 | 0.09 | 0.23 | 1.00 |
| v/c Ratio | 0.95 | 0.42 | 0.11 | 0.50 | 0.73 | 0.56 | 0.80 | 0.94 | 0.07 | 0.86 | 0.73 | 0.31 |
| Control Delay | 64.4 | 32.1 | 0.1 | 60.4 | 56.2 | 11.4 | 69.9 | 63.9 | 0.1 | 51.9 | 50.3 | 0.3 |
| Queue Delay | 0.0 | 0.0 | 0.0 | 0.0 | 0.0 | 0.0 | 0.0 | 0.0 | 0.0 | 0.0 | 0.0 | 0.0 |
| Total Delay | 64.4 | 32.1 | 0.1 | 60.4 | 56.2 | 11.4 | 69.9 | 63.9 | 0.1 | 51.9 | 50.3 | 0.3 |
| LOS | E | C | A | E | E | B | E | E | A | D | D | A |
| Approach Delay | | 45.8 | | | 42.5 | | | 59.2 | | | 32.3 | |
| Approach LOS | | D | | | D | | | E | | | C | |

Intersection Summary

Cycle Length: 120
 Actuated Cycle Length: 120
 Offset: 100 (83%), Referenced to phase 2:EBT and 6:WBT, Start of Yellow
 Natural Cycle: 100
 Control Type: Actuated-Coordinated
 Maximum v/c Ratio: 0.95
 Intersection Signal Delay: 44.9
 Intersection LOS: D
 Intersection Capacity Utilization 87.4%
 ICU Level of Service E
 Analysis Period (min) 15

Splits and Phases: 1: MERIDIAN ROAD & WOODMAN ROAD



Queues
1: MERIDIAN ROAD & WOODMAN ROAD

Total 2024 Storage PM
04/10/2023



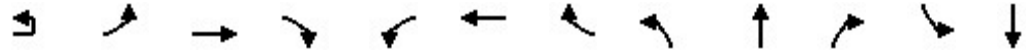
| Lane Group | EBL | EBT | EBR | WBL | WBT | WBR | NBL | NBT | NBR | SBL | SBT | SBR |
|-------------------------|------|------|------|------|------|------|------|------|------|-------|------|------|
| Lane Group Flow (vph) | 813 | 510 | 178 | 127 | 422 | 260 | 279 | 829 | 116 | 257 | 604 | 498 |
| v/c Ratio | 0.95 | 0.42 | 0.11 | 0.50 | 0.73 | 0.56 | 0.80 | 0.94 | 0.07 | 0.86 | 0.73 | 0.31 |
| Control Delay | 64.4 | 32.1 | 0.1 | 60.4 | 56.2 | 11.4 | 69.9 | 63.9 | 0.1 | 51.9 | 50.3 | 0.3 |
| Queue Delay | 0.0 | 0.0 | 0.0 | 0.0 | 0.0 | 0.0 | 0.0 | 0.0 | 0.0 | 0.0 | 0.0 | 0.0 |
| Total Delay | 64.4 | 32.1 | 0.1 | 60.4 | 56.2 | 11.4 | 69.9 | 63.9 | 0.1 | 51.9 | 50.3 | 0.3 |
| Queue Length 50th (ft) | 318 | 161 | 0 | 49 | 166 | 7 | 110 | 332 | 0 | 108 | 257 | 0 |
| Queue Length 95th (ft) | #437 | 212 | 0 | 81 | 224 | 85 | #172 | #455 | 0 | m#147 | m314 | m0 |
| Internal Link Dist (ft) | | 1165 | | | 1100 | | | 342 | | | | 860 |
| Turn Bay Length (ft) | 500 | | 630 | 350 | | 250 | 440 | | 330 | 490 | | 450 |
| Base Capacity (vph) | 872 | 1203 | 1583 | 271 | 578 | 468 | 357 | 884 | 1583 | 300 | 827 | 1583 |
| Starvation Cap Reductn | 0 | 0 | 0 | 0 | 0 | 0 | 0 | 0 | 0 | 0 | 0 | 0 |
| Spillback Cap Reductn | 0 | 0 | 0 | 0 | 0 | 0 | 0 | 0 | 0 | 0 | 0 | 0 |
| Storage Cap Reductn | 0 | 0 | 0 | 0 | 0 | 0 | 0 | 0 | 0 | 0 | 0 | 0 |
| Reduced v/c Ratio | 0.93 | 0.42 | 0.11 | 0.47 | 0.73 | 0.56 | 0.78 | 0.94 | 0.07 | 0.86 | 0.73 | 0.31 |

Intersection Summary

- # 95th percentile volume exceeds capacity, queue may be longer.
Queue shown is maximum after two cycles.
- m Volume for 95th percentile queue is metered by upstream signal.

HCM 6th Signalized Intersection Summary
 1: MERIDIAN ROAD & WOODMAN ROAD

Total 2024 Storage PM
 04/10/2023



| Movement | EBU | EBL | EBT | EBR | WBL | WBT | WBR | NBL | NBT | NBR | SBL | SBT |
|------------------------------|------|------|------|------|------|------|------|------|------|------|------|------|
| Lane Configurations | | ↔↔ | ↕↕ | ↔ | ↔↔ | ↕↕ | ↔ | ↔↔ | ↕↕ | ↔ | ↔↔ | ↕↕ |
| Traffic Volume (veh/h) | 15 | 741 | 474 | 166 | 117 | 388 | 239 | 265 | 788 | 110 | 244 | 574 |
| Future Volume (veh/h) | 15 | 741 | 474 | 166 | 117 | 388 | 239 | 265 | 788 | 110 | 244 | 574 |
| Initial Q (Qb), veh | | 0 | 0 | 0 | 0 | 0 | 0 | 0 | 0 | 0 | 0 | 0 |
| Ped-Bike Adj(A_pbT) | | 1.00 | | 1.00 | 1.00 | | 1.00 | 1.00 | | 1.00 | 1.00 | |
| Parking Bus, Adj | | 1.00 | 1.00 | 1.00 | 1.00 | 1.00 | 1.00 | 1.00 | 1.00 | 1.00 | 1.00 | 1.00 |
| Work Zone On Approach | | | No | | | No | | | No | | | No |
| Adj Sat Flow, veh/h/ln | | 1870 | 1870 | 1870 | 1870 | 1870 | 1870 | 1870 | 1870 | 1870 | 1870 | 1870 |
| Adj Flow Rate, veh/h | | 797 | 510 | 0 | 127 | 422 | 0 | 279 | 829 | 0 | 257 | 604 |
| Peak Hour Factor | | 0.93 | 0.93 | 0.93 | 0.92 | 0.92 | 0.92 | 0.95 | 0.95 | 0.95 | 0.95 | 0.95 |
| Percent Heavy Veh, % | | 2 | 2 | 2 | 2 | 2 | 2 | 2 | 2 | 2 | 2 | 2 |
| Cap, veh/h | | 853 | 1285 | | 182 | 596 | | 335 | 881 | | 302 | 848 |
| Arrive On Green | | 0.25 | 0.36 | 0.00 | 0.05 | 0.17 | 0.00 | 0.10 | 0.25 | 0.00 | 0.09 | 0.24 |
| Sat Flow, veh/h | | 3456 | 3554 | 1585 | 3456 | 3554 | 1585 | 3456 | 3554 | 1585 | 3456 | 3554 |
| Grp Volume(v), veh/h | | 797 | 510 | 0 | 127 | 422 | 0 | 279 | 829 | 0 | 257 | 604 |
| Grp Sat Flow(s),veh/h/ln | | 1728 | 1777 | 1585 | 1728 | 1777 | 1585 | 1728 | 1777 | 1585 | 1728 | 1777 |
| Q Serve(g_s), s | | 27.1 | 12.8 | 0.0 | 4.3 | 13.5 | 0.0 | 9.5 | 27.5 | 0.0 | 8.8 | 18.7 |
| Cycle Q Clear(g_c), s | | 27.1 | 12.8 | 0.0 | 4.3 | 13.5 | 0.0 | 9.5 | 27.5 | 0.0 | 8.8 | 18.7 |
| Prop In Lane | | 1.00 | | 1.00 | 1.00 | | 1.00 | 1.00 | | 1.00 | 1.00 | |
| Lane Grp Cap(c), veh/h | | 853 | 1285 | | 182 | 596 | | 335 | 881 | | 302 | 848 |
| V/C Ratio(X) | | 0.93 | 0.40 | | 0.70 | 0.71 | | 0.83 | 0.94 | | 0.85 | 0.71 |
| Avail Cap(c_a), veh/h | | 878 | 1285 | | 274 | 596 | | 360 | 888 | | 302 | 848 |
| HCM Platoon Ratio | | 1.00 | 1.00 | 1.00 | 1.00 | 1.00 | 1.00 | 1.00 | 1.00 | 1.00 | 1.00 | 1.00 |
| Upstream Filter(I) | | 1.00 | 1.00 | 0.00 | 1.00 | 1.00 | 0.00 | 1.00 | 1.00 | 0.00 | 1.00 | 1.00 |
| Uniform Delay (d), s/veh | | 44.2 | 28.5 | 0.0 | 55.9 | 47.2 | 0.0 | 53.2 | 44.3 | 0.0 | 54.0 | 41.9 |
| Incr Delay (d2), s/veh | | 16.5 | 0.9 | 0.0 | 4.7 | 7.0 | 0.0 | 14.6 | 17.5 | 0.0 | 19.9 | 2.8 |
| Initial Q Delay(d3),s/veh | | 0.0 | 0.0 | 0.0 | 0.0 | 0.0 | 0.0 | 0.0 | 0.0 | 0.0 | 0.0 | 0.0 |
| %ile BackOfQ(50%),veh/ln | | 13.1 | 5.4 | 0.0 | 2.0 | 6.4 | 0.0 | 4.8 | 14.0 | 0.0 | 4.6 | 8.4 |
| Unsig. Movement Delay, s/veh | | | | | | | | | | | | |
| LnGrp Delay(d),s/veh | | 60.7 | 29.5 | 0.0 | 60.6 | 54.1 | 0.0 | 67.9 | 61.7 | 0.0 | 73.9 | 44.7 |
| LnGrp LOS | | E | C | | E | D | | E | E | | E | D |
| Approach Vol, veh/h | | | 1307 | A | | 549 | A | | 1108 | A | | 861 |
| Approach Delay, s/veh | | | 48.5 | | | 55.6 | | | 63.3 | | | 53.4 |
| Approach LOS | | | D | | | E | | | E | | | D |
| Timer - Assigned Phs | 1 | 2 | 3 | 4 | 5 | 6 | 7 | 8 | | | | |
| Phs Duration (G+Y+Rc), s | 13.8 | 50.4 | 20.1 | 35.6 | 37.1 | 27.1 | 19.0 | 36.8 | | | | |
| Change Period (Y+Rc), s | 7.5 | 7.0 | 8.5 | 7.0 | 7.5 | 7.0 | 8.5 | 7.0 | | | | |
| Max Green Setting (Gmax), s | 9.5 | 40.0 | 12.5 | 28.0 | 30.5 | 19.0 | 10.5 | 30.0 | | | | |
| Max Q Clear Time (g_c+I1), s | 6.3 | 14.8 | 11.5 | 20.7 | 29.1 | 15.5 | 10.8 | 29.5 | | | | |
| Green Ext Time (p_c), s | 0.1 | 3.1 | 0.1 | 2.3 | 0.5 | 0.8 | 0.0 | 0.3 | | | | |

Intersection Summary

| | |
|--------------------|------|
| HCM 6th Ctrl Delay | 54.9 |
| HCM 6th LOS | D |

Notes

- User approved pedestrian interval to be less than phase max green.
- User approved ignoring U-Turning movement.
- Unsignalized Delay for [NBR, EBR, WBR, SBR] is excluded from calculations of the approach delay and intersection delay.

HCM 6th Signalized Intersection Summary
 1: MERIDIAN ROAD & WOODMAN ROAD

Total 2024 Storage PM
 04/10/2023

| | |
|------------------------------|------|
| Movement | SBR |
| Lane Configurations | |
| Traffic Volume (veh/h) | 473 |
| Future Volume (veh/h) | 473 |
| Initial Q (Qb), veh | 0 |
| Ped-Bike Adj(A_pbT) | 1.00 |
| Parking Bus, Adj | 1.00 |
| Work Zone On Approach | |
| Adj Sat Flow, veh/h/ln | 1870 |
| Adj Flow Rate, veh/h | 0 |
| Peak Hour Factor | 0.95 |
| Percent Heavy Veh, % | 2 |
| Cap, veh/h | |
| Arrive On Green | 0.00 |
| Sat Flow, veh/h | 1585 |
| Grp Volume(v), veh/h | 0 |
| Grp Sat Flow(s),veh/h/ln | 1585 |
| Q Serve(g_s), s | 0.0 |
| Cycle Q Clear(g_c), s | 0.0 |
| Prop In Lane | 1.00 |
| Lane Grp Cap(c), veh/h | |
| V/C Ratio(X) | |
| Avail Cap(c_a), veh/h | |
| HCM Platoon Ratio | 1.00 |
| Upstream Filter(l) | 0.00 |
| Uniform Delay (d), s/veh | 0.0 |
| Incr Delay (d2), s/veh | 0.0 |
| Initial Q Delay(d3),s/veh | 0.0 |
| %ile BackOfQ(50%),veh/ln | 0.0 |
| Unsig. Movement Delay, s/veh | |
| LnGrp Delay(d),s/veh | 0.0 |
| LnGrp LOS | |
| Approach Vol, veh/h | A |
| Approach Delay, s/veh | |
| Approach LOS | |
| Timer - Assigned Phs | |

Timings
2: MERIDIAN ROAD & EASTONVILLE ROAD

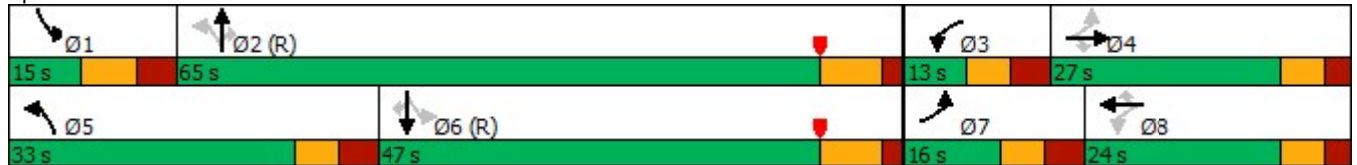
Total 2024 Storage PM
04/10/2023

| Lane Group | EBL | EBT | EBR | WBL | WBT | WBR | NBL | NBT | NBR | SBL | SBT | SBR |
|----------------------|-------|-------|-------|-------|-------|-------|-------|-------|-------|-------|-------|-------|
| Lane Configurations | | | | | | | | | | | | |
| Traffic Volume (vph) | 359 | 125 | 293 | 32 | 79 | 138 | 355 | 1353 | 120 | 85 | 962 | 184 |
| Future Volume (vph) | 359 | 125 | 293 | 32 | 79 | 138 | 355 | 1353 | 120 | 85 | 962 | 184 |
| Turn Type | pm+pt | NA | Perm | pm+pt | NA | Perm | pm+pt | NA | Perm | pm+pt | NA | Perm |
| Protected Phases | 7 | 4 | | 3 | 8 | | 5 | 2 | | 1 | 6 | |
| Permitted Phases | 4 | | 4 | 8 | | 8 | 2 | | 2 | 6 | | 6 |
| Detector Phase | 7 | 4 | 4 | 3 | 8 | 8 | 5 | 2 | 2 | 1 | 6 | 6 |
| Switch Phase | | | | | | | | | | | | |
| Minimum Initial (s) | 5.0 | 8.0 | 8.0 | 5.0 | 8.0 | 8.0 | 5.0 | 15.0 | 15.0 | 5.0 | 15.0 | 15.0 |
| Minimum Split (s) | 12.5 | 24.5 | 24.5 | 12.5 | 24.5 | 24.5 | 12.5 | 25.5 | 25.5 | 13.5 | 25.5 | 25.5 |
| Total Split (s) | 16.0 | 27.0 | 27.0 | 13.0 | 24.0 | 24.0 | 33.0 | 65.0 | 65.0 | 15.0 | 47.0 | 47.0 |
| Total Split (%) | 13.3% | 22.5% | 22.5% | 10.8% | 20.0% | 20.0% | 27.5% | 54.2% | 54.2% | 12.5% | 39.2% | 39.2% |
| Yellow Time (s) | 4.0 | 4.0 | 4.0 | 4.0 | 4.0 | 4.0 | 4.0 | 5.5 | 5.5 | 5.0 | 5.5 | 5.5 |
| All-Red Time (s) | 3.5 | 2.5 | 2.5 | 3.5 | 2.5 | 2.5 | 3.5 | 2.0 | 2.0 | 3.5 | 2.0 | 2.0 |
| Lost Time Adjust (s) | 0.0 | 0.0 | 0.0 | 0.0 | 0.0 | 0.0 | 0.0 | 0.0 | 0.0 | 0.0 | 0.0 | 0.0 |
| Total Lost Time (s) | 7.5 | 6.5 | 6.5 | 7.5 | 6.5 | 6.5 | 7.5 | 7.5 | 7.5 | 8.5 | 7.5 | 7.5 |
| Lead/Lag | Lead | Lag | Lag | Lead | Lag | Lag | Lead | Lag | Lag | Lead | Lag | Lag |
| Lead-Lag Optimize? | Yes | Yes | Yes | Yes | Yes | Yes | Yes | Yes | Yes | Yes | Yes | Yes |
| Recall Mode | None | None | None | None | None | None | None | C-Max | C-Max | None | C-Max | C-Max |
| Act Effct Green (s) | 24.5 | 20.4 | 20.4 | 16.7 | 12.2 | 12.2 | 77.8 | 61.9 | 61.9 | 51.0 | 44.6 | 44.6 |
| Actuated g/C Ratio | 0.20 | 0.17 | 0.17 | 0.14 | 0.10 | 0.10 | 0.65 | 0.52 | 0.52 | 0.42 | 0.37 | 0.37 |
| v/c Ratio | 0.85 | 0.47 | 0.62 | 0.17 | 0.44 | 0.37 | 0.90 | 0.83 | 0.15 | 0.56 | 0.83 | 0.28 |
| Control Delay | 59.6 | 51.1 | 10.0 | 37.4 | 56.9 | 2.7 | 54.7 | 11.6 | 0.5 | 28.5 | 50.0 | 13.4 |
| Queue Delay | 0.0 | 0.0 | 0.0 | 0.0 | 0.0 | 0.0 | 0.0 | 0.0 | 0.0 | 0.0 | 0.0 | 0.0 |
| Total Delay | 59.6 | 51.1 | 10.0 | 37.4 | 56.9 | 2.7 | 54.7 | 11.6 | 0.5 | 28.5 | 50.0 | 13.4 |
| LOS | E | D | B | D | E | A | D | B | A | C | D | B |
| Approach Delay | | 39.5 | | | 24.4 | | | 19.3 | | | 43.1 | |
| Approach LOS | | D | | | C | | | B | | | D | |

Intersection Summary

Cycle Length: 120
 Actuated Cycle Length: 120
 Offset: 89 (74%), Referenced to phase 2:NBTL and 6:SBTL, Start of Yellow
 Natural Cycle: 100
 Control Type: Actuated-Coordinated
 Maximum v/c Ratio: 0.90
 Intersection Signal Delay: 30.7
 Intersection Capacity Utilization 86.5%
 Analysis Period (min) 15
 Intersection LOS: C
 ICU Level of Service E

Splits and Phases: 2: MERIDIAN ROAD & EASTONVILLE ROAD



Queues
2: MERIDIAN ROAD & EASTONVILLE ROAD

Total 2024 Storage PM
04/10/2023



























| Lane Group | EBL | EBT | EBR | WBL | WBT | WBR | NBL | NBT | NBR | SBL | SBT | SBR |
|-------------------------|------|------|------|------|------|------|-------|------|------|------|------|------|
| Lane Group Flow (vph) | 422 | 147 | 345 | 34 | 83 | 145 | 399 | 1520 | 135 | 97 | 1093 | 209 |
| v/c Ratio | 0.85 | 0.47 | 0.62 | 0.17 | 0.44 | 0.37 | 0.90 | 0.83 | 0.15 | 0.56 | 0.83 | 0.28 |
| Control Delay | 59.6 | 51.1 | 10.0 | 37.4 | 56.9 | 2.7 | 54.7 | 11.6 | 0.5 | 28.5 | 50.0 | 13.4 |
| Queue Delay | 0.0 | 0.0 | 0.0 | 0.0 | 0.0 | 0.0 | 0.0 | 0.0 | 0.0 | 0.0 | 0.0 | 0.0 |
| Total Delay | 59.6 | 51.1 | 10.0 | 37.4 | 56.9 | 2.7 | 54.7 | 11.6 | 0.5 | 28.5 | 50.0 | 13.4 |
| Queue Length 50th (ft) | 160 | 110 | 0 | 21 | 62 | 0 | 179 | 348 | 0 | 39 | 470 | 36 |
| Queue Length 95th (ft) | 177 | 160 | 62 | 46 | 109 | 0 | m#284 | m408 | m3 | #92 | #560 | 98 |
| Internal Link Dist (ft) | | 508 | | | 1196 | | | 231 | | | | 781 |
| Turn Bay Length (ft) | 100 | | 100 | 120 | | 100 | 100 | | 400 | 375 | | 400 |
| Base Capacity (vph) | 495 | 343 | 572 | 196 | 271 | 448 | 461 | 1824 | 901 | 175 | 1314 | 742 |
| Starvation Cap Reductn | 0 | 0 | 0 | 0 | 0 | 0 | 0 | 0 | 0 | 0 | 0 | 0 |
| Spillback Cap Reductn | 0 | 0 | 0 | 0 | 0 | 0 | 0 | 0 | 0 | 0 | 0 | 0 |
| Storage Cap Reductn | 0 | 0 | 0 | 0 | 0 | 0 | 0 | 0 | 0 | 0 | 0 | 0 |
| Reduced v/c Ratio | 0.85 | 0.43 | 0.60 | 0.17 | 0.31 | 0.32 | 0.87 | 0.83 | 0.15 | 0.55 | 0.83 | 0.28 |

Intersection Summary

- # 95th percentile volume exceeds capacity, queue may be longer.
Queue shown is maximum after two cycles.
- m Volume for 95th percentile queue is metered by upstream signal.

HCM 6th Signalized Intersection Summary
2: MERIDIAN ROAD & EASTONVILLE ROAD

Total 2024 Storage PM
04/10/2023

| |  |  |  |  |  |  |  |  |  |  |  |  |
|------------------------------|---|---|---|---|---|---|---|---|---|---|---|---|
| Movement | EBL | EBT | EBR | WBL | WBT | WBR | NBL | NBT | NBR | SBL | SBT | SBR |
| Lane Configurations |  |  |  |  |  |  |  |  |  |  |  |  |
| Traffic Volume (veh/h) | 359 | 125 | 293 | 32 | 79 | 138 | 355 | 1353 | 120 | 85 | 962 | 184 |
| Future Volume (veh/h) | 359 | 125 | 293 | 32 | 79 | 138 | 355 | 1353 | 120 | 85 | 962 | 184 |
| Initial Q (Qb), veh | 0 | 0 | 0 | 0 | 0 | 0 | 0 | 0 | 0 | 0 | 0 | 0 |
| Ped-Bike Adj(A_pbT) | 1.00 | | 1.00 | 1.00 | | 1.00 | 1.00 | | 1.00 | 1.00 | | 1.00 |
| Parking Bus, Adj | 1.00 | 1.00 | 1.00 | 1.00 | 1.00 | 1.00 | 1.00 | 1.00 | 1.00 | 1.00 | 1.00 | 1.00 |
| Work Zone On Approach | | No | | | No | | | No | | | No | |
| Adj Sat Flow, veh/h/ln | 1870 | 1870 | 1870 | 1870 | 1870 | 1870 | 1870 | 1870 | 1870 | 1870 | 1870 | 1870 |
| Adj Flow Rate, veh/h | 422 | 147 | 0 | 34 | 83 | 0 | 399 | 1520 | 135 | 97 | 1093 | 209 |
| Peak Hour Factor | 0.85 | 0.85 | 0.85 | 0.95 | 0.95 | 0.95 | 0.89 | 0.89 | 0.89 | 0.88 | 0.88 | 0.88 |
| Percent Heavy Veh, % | 2 | 2 | 2 | 2 | 2 | 2 | 2 | 2 | 2 | 2 | 2 | 2 |
| Cap, veh/h | 424 | 204 | | 152 | 125 | | 431 | 2023 | 902 | 212 | 1662 | 741 |
| Arrive On Green | 0.07 | 0.11 | 0.00 | 0.03 | 0.07 | 0.00 | 0.15 | 0.57 | 0.57 | 0.04 | 0.47 | 0.47 |
| Sat Flow, veh/h | 3456 | 1870 | 1585 | 1781 | 1870 | 1585 | 1781 | 3554 | 1585 | 1781 | 3554 | 1585 |
| Grp Volume(v), veh/h | 422 | 147 | 0 | 34 | 83 | 0 | 399 | 1520 | 135 | 97 | 1093 | 209 |
| Grp Sat Flow(s),veh/h/ln | 1728 | 1870 | 1585 | 1781 | 1870 | 1585 | 1781 | 1777 | 1585 | 1781 | 1777 | 1585 |
| Q Serve(g_s), s | 8.5 | 9.1 | 0.0 | 2.1 | 5.2 | 0.0 | 15.6 | 38.6 | 4.8 | 3.4 | 28.4 | 9.7 |
| Cycle Q Clear(g_c), s | 8.5 | 9.1 | 0.0 | 2.1 | 5.2 | 0.0 | 15.6 | 38.6 | 4.8 | 3.4 | 28.4 | 9.7 |
| Prop In Lane | 1.00 | | 1.00 | 1.00 | | 1.00 | 1.00 | | 1.00 | 1.00 | | 1.00 |
| Lane Grp Cap(c), veh/h | 424 | 204 | | 152 | 125 | | 431 | 2023 | 902 | 212 | 1662 | 741 |
| V/C Ratio(X) | 0.99 | 0.72 | | 0.22 | 0.67 | | 0.93 | 0.75 | 0.15 | 0.46 | 0.66 | 0.28 |
| Avail Cap(c_a), veh/h | 424 | 320 | | 183 | 273 | | 536 | 2023 | 902 | 231 | 1662 | 741 |
| HCM Platoon Ratio | 1.00 | 1.00 | 1.00 | 1.00 | 1.00 | 1.00 | 1.00 | 1.00 | 1.00 | 1.00 | 1.00 | 1.00 |
| Upstream Filter(l) | 1.00 | 1.00 | 0.00 | 1.00 | 1.00 | 0.00 | 1.00 | 1.00 | 1.00 | 1.00 | 1.00 | 1.00 |
| Uniform Delay (d), s/veh | 52.7 | 51.7 | 0.0 | 50.2 | 54.7 | 0.0 | 26.0 | 19.5 | 12.2 | 19.5 | 24.6 | 19.6 |
| Incr Delay (d2), s/veh | 42.2 | 4.7 | 0.0 | 0.7 | 6.0 | 0.0 | 19.7 | 2.6 | 0.4 | 1.5 | 2.1 | 1.0 |
| Initial Q Delay(d3),s/veh | 0.0 | 0.0 | 0.0 | 0.0 | 0.0 | 0.0 | 0.0 | 0.0 | 0.0 | 0.0 | 0.0 | 0.0 |
| %ile BackOfQ(50%),veh/ln | 4.8 | 4.5 | 0.0 | 1.0 | 2.7 | 0.0 | 8.0 | 14.5 | 1.8 | 1.3 | 11.3 | 3.8 |
| Unsig. Movement Delay, s/veh | | | | | | | | | | | | |
| LnGrp Delay(d),s/veh | 94.9 | 56.4 | 0.0 | 50.9 | 60.7 | 0.0 | 45.7 | 22.1 | 12.5 | 21.0 | 26.6 | 20.5 |
| LnGrp LOS | F | E | | D | E | | D | C | B | C | C | C |
| Approach Vol, veh/h | | 569 | A | | 117 | A | | 2054 | | | 1399 | |
| Approach Delay, s/veh | | 85.0 | | | 57.8 | | | 26.0 | | | 25.3 | |
| Approach LOS | | F | | | E | | | C | | | C | |
| Timer - Assigned Phs | 1 | 2 | 3 | 4 | 5 | 6 | 7 | 8 | | | | |
| Phs Duration (G+Y+Rc), s | 13.7 | 75.8 | 10.9 | 19.6 | 25.9 | 63.6 | 16.0 | 14.5 | | | | |
| Change Period (Y+Rc), s | 8.5 | 7.5 | 7.5 | 6.5 | 7.5 | 7.5 | 7.5 | 6.5 | | | | |
| Max Green Setting (Gmax), s | 6.5 | 57.5 | 5.5 | 20.5 | 25.5 | 39.5 | 8.5 | 17.5 | | | | |
| Max Q Clear Time (g_c+I1), s | 5.4 | 40.6 | 4.1 | 11.1 | 17.6 | 30.4 | 10.5 | 7.2 | | | | |
| Green Ext Time (p_c), s | 0.0 | 9.6 | 0.0 | 0.4 | 0.8 | 4.8 | 0.0 | 0.2 | | | | |

Intersection Summary

| | |
|--------------------|------|
| HCM 6th Ctrl Delay | 34.8 |
| HCM 6th LOS | C |

Notes

- User approved pedestrian interval to be less than phase max green.
- Unsignalized Delay for [EBR, WBR] is excluded from calculations of the approach delay and intersection delay.

Timings
3: MERIDIAN ROAD & BENT GRASS MEADOWS DRIVE

Total 2024 Storage PM
04/10/2023

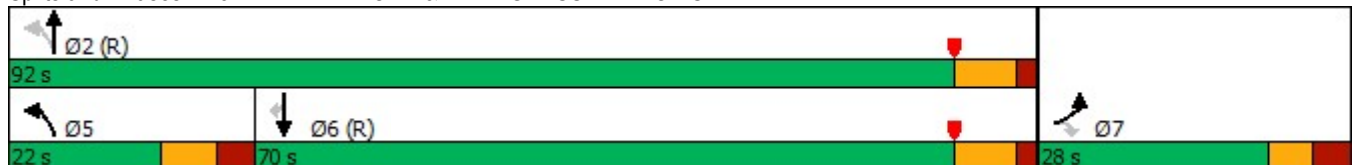


| Lane Group | EBL | EBR | NBL | NBT | SBT | SBR |
|----------------------|-------|-------|-------|-------|-------|-------|
| Lane Configurations | ↖↖ | ↗ | ↖ | ↑↑ | ↑↑ | ↗ |
| Traffic Volume (vph) | 102 | 136 | 142 | 1651 | 1045 | 135 |
| Future Volume (vph) | 102 | 136 | 142 | 1651 | 1045 | 135 |
| Turn Type | Prot | Perm | pm+pt | NA | NA | Perm |
| Protected Phases | 7 | | 5 | 2 | 6 | |
| Permitted Phases | | 7 | 2 | | | 6 |
| Detector Phase | 7 | 7 | 5 | 2 | 6 | 6 |
| Switch Phase | | | | | | |
| Minimum Initial (s) | 8.0 | 8.0 | 5.0 | 15.0 | 15.0 | 15.0 |
| Minimum Split (s) | 25.5 | 25.5 | 13.5 | 25.5 | 25.5 | 25.5 |
| Total Split (s) | 28.0 | 28.0 | 22.0 | 92.0 | 70.0 | 70.0 |
| Total Split (%) | 23.3% | 23.3% | 18.3% | 76.7% | 58.3% | 58.3% |
| Yellow Time (s) | 4.0 | 4.0 | 5.0 | 5.5 | 5.5 | 5.5 |
| All-Red Time (s) | 3.5 | 3.5 | 3.5 | 2.0 | 2.0 | 2.0 |
| Lost Time Adjust (s) | 0.0 | 0.0 | 0.0 | 0.0 | 0.0 | 0.0 |
| Total Lost Time (s) | 7.5 | 7.5 | 8.5 | 7.5 | 7.5 | 7.5 |
| Lead/Lag | | | Lead | | Lag | Lag |
| Lead-Lag Optimize? | | | Yes | | Yes | Yes |
| Recall Mode | None | None | None | C-Max | C-Max | C-Max |
| Act Effect Green (s) | 9.9 | 9.9 | 94.1 | 95.1 | 78.7 | 78.7 |
| Actuated g/C Ratio | 0.08 | 0.08 | 0.78 | 0.79 | 0.66 | 0.66 |
| v/c Ratio | 0.42 | 0.58 | 0.40 | 0.62 | 0.48 | 0.13 |
| Control Delay | 56.6 | 16.5 | 5.2 | 4.2 | 11.6 | 1.7 |
| Queue Delay | 0.0 | 0.0 | 0.0 | 0.0 | 0.0 | 0.0 |
| Total Delay | 56.6 | 16.5 | 5.2 | 4.2 | 11.6 | 1.7 |
| LOS | E | B | A | A | B | A |
| Approach Delay | 33.7 | | | 4.3 | 10.5 | |
| Approach LOS | C | | | A | B | |

Intersection Summary

Cycle Length: 120
 Actuated Cycle Length: 120
 Offset: 27 (23%), Referenced to phase 2:NBTL and 6:SBT, Start of Yellow
 Natural Cycle: 75
 Control Type: Actuated-Coordinated
 Maximum v/c Ratio: 0.62
 Intersection Signal Delay: 9.0
 Intersection Capacity Utilization 64.8%
 Analysis Period (min) 15
 Intersection LOS: A
 ICU Level of Service C

Splits and Phases: 3: MERIDIAN ROAD & BENT GRASS MEADOWS DRIVE



Queues
 3: MERIDIAN ROAD & BENT GRASS MEADOWS DRIVE

Total 2024 Storage PM
 04/10/2023



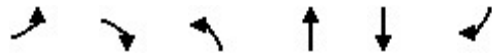
| Lane Group | EBL | EBR | NBL | NBT | SBT | SBR |
|-------------------------|------|------|------|------|------|------|
| Lane Group Flow (vph) | 120 | 160 | 149 | 1738 | 1112 | 144 |
| v/c Ratio | 0.42 | 0.58 | 0.40 | 0.62 | 0.48 | 0.13 |
| Control Delay | 56.6 | 16.5 | 5.2 | 4.2 | 11.6 | 1.7 |
| Queue Delay | 0.0 | 0.0 | 0.0 | 0.0 | 0.0 | 0.0 |
| Total Delay | 56.6 | 16.5 | 5.2 | 4.2 | 11.6 | 1.7 |
| Queue Length 50th (ft) | 46 | 0 | 23 | 136 | 207 | 0 |
| Queue Length 95th (ft) | 71 | 54 | m25 | 160 | 291 | 25 |
| Internal Link Dist (ft) | 310 | | | 750 | 1921 | |
| Turn Bay Length (ft) | 150 | | 700 | | | 350 |
| Base Capacity (vph) | 586 | 403 | 442 | 2804 | 2320 | 1087 |
| Starvation Cap Reductn | 0 | 0 | 0 | 0 | 0 | 0 |
| Spillback Cap Reductn | 0 | 0 | 0 | 0 | 0 | 0 |
| Storage Cap Reductn | 0 | 0 | 0 | 0 | 0 | 0 |
| Reduced v/c Ratio | 0.20 | 0.40 | 0.34 | 0.62 | 0.48 | 0.13 |

Intersection Summary

m Volume for 95th percentile queue is metered by upstream signal.

3: MERIDIAN ROAD & BENT GRASS MEADOWS DRIVE

04/10/2023



| Movement | EBL | EBR | NBL | NBT | SBT | SBR |
|--|------|-------|------|------|------|------|
| Lane Configurations | ↔↔ | ↔ | ↔ | ↑↑ | ↓↓ | ↔ |
| Traffic Volume (veh/h) | 102 | 136 | 142 | 1651 | 1045 | 135 |
| Future Volume (veh/h) | 102 | 136 | 142 | 1651 | 1045 | 135 |
| Initial Q (Qb), veh | 0 | 0 | 0 | 0 | 0 | 0 |
| Ped-Bike Adj(A_pbT) | 1.00 | 1.00 | 1.00 | | | 1.00 |
| Parking Bus, Adj | 1.00 | 1.00 | 1.00 | 1.00 | 1.00 | 1.00 |
| Work Zone On Approach | No | | | No | No | |
| Adj Sat Flow, veh/h/ln | 1870 | 1870 | 1870 | 1870 | 1870 | 1870 |
| Adj Flow Rate, veh/h | 120 | 0 | 149 | 1738 | 1112 | 144 |
| Peak Hour Factor | 0.85 | 0.85 | 0.95 | 0.95 | 0.94 | 0.94 |
| Percent Heavy Veh, % | 2 | 2 | 2 | 2 | 2 | 2 |
| Cap, veh/h | 226 | | 381 | 2877 | 2478 | 1105 |
| Arrive On Green | 0.07 | 0.00 | 0.04 | 0.81 | 0.70 | 0.70 |
| Sat Flow, veh/h | 3456 | 1585 | 1781 | 3647 | 3647 | 1585 |
| Grp Volume(v), veh/h | 120 | 0 | 149 | 1738 | 1112 | 144 |
| Grp Sat Flow(s),veh/h/ln | 1728 | 1585 | 1781 | 1777 | 1777 | 1585 |
| Q Serve(g_s), s | 4.0 | 0.0 | 2.7 | 21.9 | 16.5 | 3.6 |
| Cycle Q Clear(g_c), s | 4.0 | 0.0 | 2.7 | 21.9 | 16.5 | 3.6 |
| Prop In Lane | 1.00 | 1.00 | 1.00 | | | 1.00 |
| Lane Grp Cap(c), veh/h | 226 | | 381 | 2877 | 2478 | 1105 |
| V/C Ratio(X) | 0.53 | | 0.39 | 0.60 | 0.45 | 0.13 |
| Avail Cap(c_a), veh/h | 590 | | 508 | 2877 | 2478 | 1105 |
| HCM Platoon Ratio | 1.00 | 1.00 | 1.00 | 1.00 | 1.00 | 1.00 |
| Upstream Filter(l) | 1.00 | 0.00 | 1.00 | 1.00 | 1.00 | 1.00 |
| Uniform Delay (d), s/veh | 54.3 | 0.0 | 6.1 | 4.3 | 8.0 | 6.0 |
| Incr Delay (d2), s/veh | 1.9 | 0.0 | 0.7 | 0.9 | 0.6 | 0.2 |
| Initial Q Delay(d3),s/veh | 0.0 | 0.0 | 0.0 | 0.0 | 0.0 | 0.0 |
| %ile BackOfQ(50%),veh/ln | 1.8 | 0.0 | 0.9 | 6.3 | 6.0 | 6.3 |
| Unsig. Movement Delay, s/veh | | | | | | |
| LnGrp Delay(d),s/veh | 56.2 | 0.0 | 6.7 | 5.2 | 8.6 | 6.3 |
| LnGrp LOS | E | | A | A | A | A |
| Approach Vol, veh/h | 120 | A | | 1887 | 1256 | |
| Approach Delay, s/veh | 56.2 | | | 5.3 | 8.3 | |
| Approach LOS | E | | | A | A | |
| Timer - Assigned Phs | | 2 | | 4 | 5 | 6 |
| Phs Duration (G+Y+Rc), s | | 104.6 | | 15.4 | 13.5 | 91.2 |
| Change Period (Y+Rc), s | | 7.5 | | 7.5 | 8.5 | 7.5 |
| Max Green Setting (Gmax), s | | 84.5 | | 20.5 | 13.5 | 62.5 |
| Max Q Clear Time (g_c+I1), s | | 23.9 | | 6.0 | 4.7 | 18.5 |
| Green Ext Time (p_c), s | | 25.1 | | 0.3 | 0.2 | 11.6 |
| Intersection Summary | | | | | | |
| HCM 6th Ctrl Delay | | | 8.4 | | | |
| HCM 6th LOS | | | A | | | |
| Notes | | | | | | |
| Unsignalized Delay for [EBR] is excluded from calculations of the approach delay and intersection delay. | | | | | | |

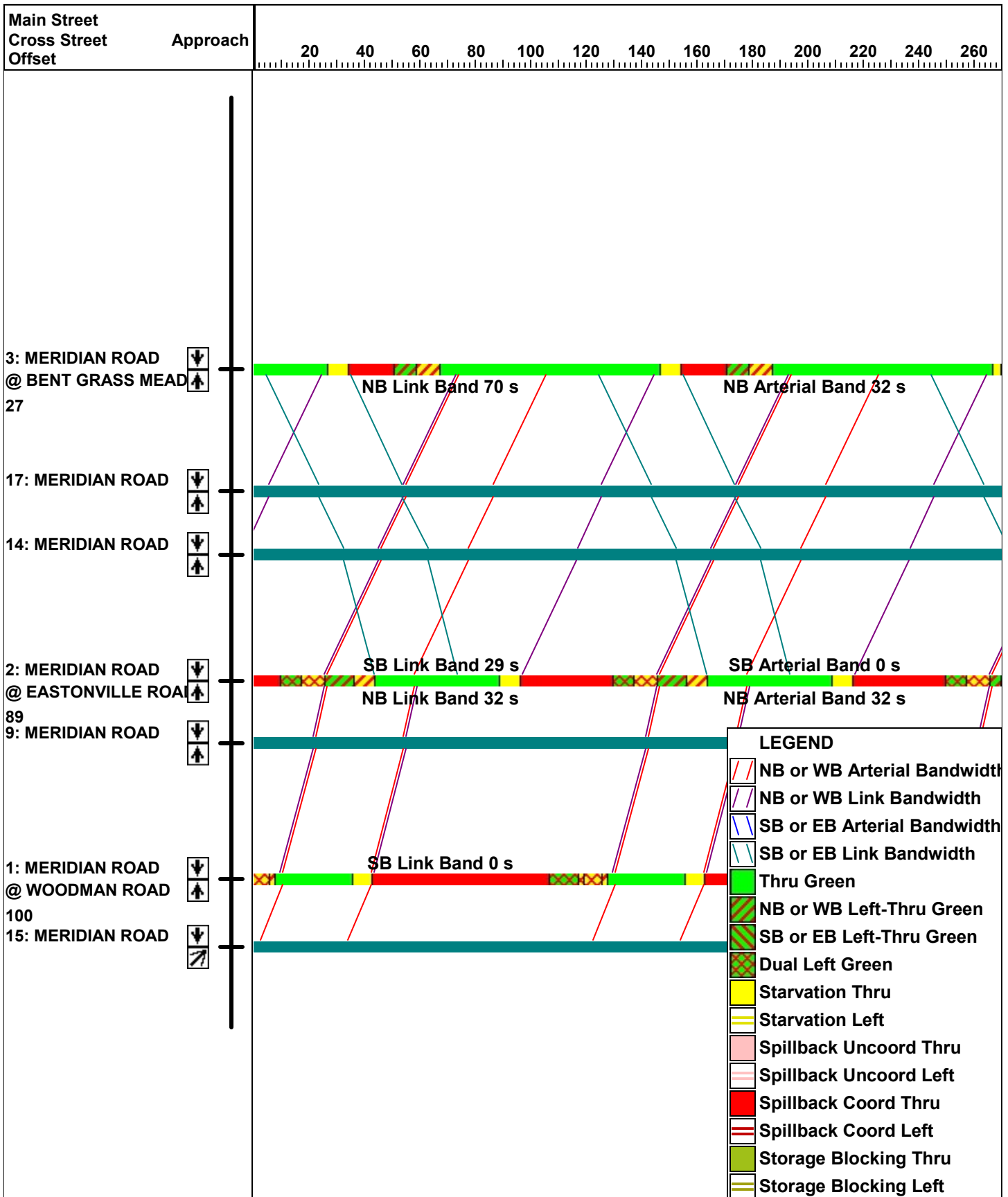
| Intersection | | | | | | |
|--------------------------|------|------|------|------|------|------|
| Int Delay, s/veh | 3.6 | | | | | |
| Movement | EBT | EBR | WBL | WBT | NBL | NBR |
| Lane Configurations | ↑ | ↗ | ↖ | ↑ | ↘ | ↙ |
| Traffic Vol, veh/h | 123 | 42 | 110 | 166 | 2 | 115 |
| Future Vol, veh/h | 123 | 42 | 110 | 166 | 2 | 115 |
| Conflicting Peds, #/hr | 0 | 0 | 0 | 0 | 0 | 0 |
| Sign Control | Free | Free | Free | Free | Stop | Stop |
| RT Channelized | - | None | - | None | - | None |
| Storage Length | - | 150 | 100 | - | 0 | - |
| Veh in Median Storage, # | 0 | - | - | 0 | 0 | - |
| Grade, % | 0 | - | - | 0 | 0 | - |
| Peak Hour Factor | 85 | 85 | 85 | 85 | 85 | 85 |
| Heavy Vehicles, % | 2 | 2 | 2 | 2 | 2 | 2 |
| Mvmt Flow | 145 | 49 | 129 | 195 | 2 | 135 |

| Major/Minor | Major1 | Major2 | Minor1 | | |
|----------------------|--------|--------|--------|---|-------------|
| Conflicting Flow All | 0 | 0 | 194 | 0 | 598 145 |
| Stage 1 | - | - | - | - | 145 - |
| Stage 2 | - | - | - | - | 453 - |
| Critical Hdwy | - | - | 4.12 | - | 6.42 6.22 |
| Critical Hdwy Stg 1 | - | - | - | - | 5.42 - |
| Critical Hdwy Stg 2 | - | - | - | - | 5.42 - |
| Follow-up Hdwy | - | - | 2.218 | - | 3.518 3.318 |
| Pot Cap-1 Maneuver | - | - | 1379 | - | 465 902 |
| Stage 1 | - | - | - | - | 882 - |
| Stage 2 | - | - | - | - | 640 - |
| Platoon blocked, % | - | - | - | - | - |
| Mov Cap-1 Maneuver | - | - | 1379 | - | 421 902 |
| Mov Cap-2 Maneuver | - | - | - | - | 421 - |
| Stage 1 | - | - | - | - | 882 - |
| Stage 2 | - | - | - | - | 580 - |

| Approach | EB | WB | NB |
|----------------------|----|-----|-----|
| HCM Control Delay, s | 0 | 3.1 | 9.8 |
| HCM LOS | | | A |

| Minor Lane/Major Mvmt | NBLn1 | EBT | EBR | WBL | WBT |
|-----------------------|-------|-----|-----|-------|-----|
| Capacity (veh/h) | 885 | - | - | 1379 | - |
| HCM Lane V/C Ratio | 0.156 | - | - | 0.094 | - |
| HCM Control Delay (s) | 9.8 | - | - | 7.9 | - |
| HCM Lane LOS | A | - | - | A | - |
| HCM 95th %tile Q(veh) | 0.5 | - | - | 0.3 | - |

Total PM 2024 Storage Signal Progression



Timings
1: MERIDIAN ROAD & WOODMAN ROAD

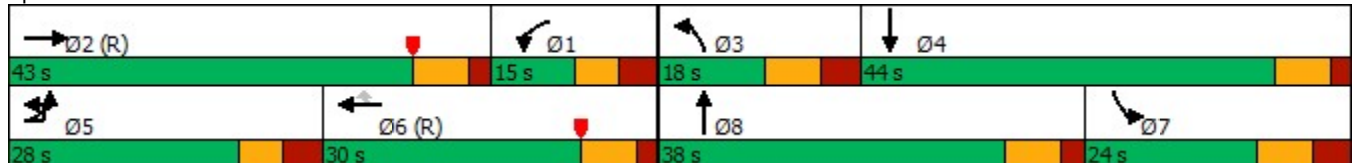
Total AM 40 Shopping
04/01/2023

| Lane Group | EBL | EBT | EBR | WBL | WBT | WBR | NBL | NBT | NBR | SBL | SBT | SBR |
|----------------------|-------|-------|-------|-------|-------|-------|-------|-------|-------|-------|-------|-------|
| Lane Configurations | | | | | | | | | | | | |
| Traffic Volume (vph) | 499 | 321 | 167 | 84 | 564 | 202 | 227 | 444 | 24 | 253 | 1013 | 1088 |
| Future Volume (vph) | 499 | 321 | 167 | 84 | 564 | 202 | 227 | 444 | 24 | 253 | 1013 | 1088 |
| Turn Type | Prot | NA | Free | Prot | NA | Perm | Prot | NA | Free | Prot | NA | Free |
| Protected Phases | 5 | 2 | | 1 | 6 | | 3 | 8 | | 7 | 4 | |
| Permitted Phases | | | Free | | | 6 | | | Free | | | Free |
| Detector Phase | 5 | 2 | | 1 | 6 | 6 | 3 | 8 | | 7 | 4 | |
| Switch Phase | | | | | | | | | | | | |
| Minimum Initial (s) | 5.0 | 15.0 | | 5.0 | 15.0 | 15.0 | 5.0 | 15.0 | | 5.0 | 15.0 | |
| Minimum Split (s) | 13.5 | 22.0 | | 13.5 | 22.0 | 22.0 | 13.5 | 22.0 | | 13.5 | 22.0 | |
| Total Split (s) | 28.0 | 43.0 | | 15.0 | 30.0 | 30.0 | 18.0 | 38.0 | | 24.0 | 44.0 | |
| Total Split (%) | 23.3% | 35.8% | | 12.5% | 25.0% | 25.0% | 15.0% | 31.7% | | 20.0% | 36.7% | |
| Yellow Time (s) | 4.0 | 5.0 | | 4.0 | 5.0 | 5.0 | 5.0 | 5.0 | | 5.0 | 5.0 | |
| All-Red Time (s) | 3.5 | 2.0 | | 3.5 | 2.0 | 2.0 | 3.5 | 2.0 | | 3.5 | 2.0 | |
| Lost Time Adjust (s) | 0.0 | 0.0 | | 0.0 | 0.0 | 0.0 | 0.0 | 0.0 | | 0.0 | 0.0 | |
| Total Lost Time (s) | 7.5 | 7.0 | | 7.5 | 7.0 | 7.0 | 8.5 | 7.0 | | 8.5 | 7.0 | |
| Lead/Lag | Lead | Lead | | Lag | Lag | Lag | Lead | Lead | | Lag | Lag | |
| Lead-Lag Optimize? | Yes | Yes | | Yes | Yes | Yes | Yes | Yes | | Yes | Yes | |
| Recall Mode | None | C-Max | | None | C-Max | C-Max | None | None | | None | None | |
| Act Effct Green (s) | 20.3 | 36.0 | 120.0 | 7.5 | 23.2 | 23.2 | 9.5 | 21.4 | 120.0 | 25.1 | 37.0 | 120.0 |
| Actuated g/C Ratio | 0.17 | 0.30 | 1.00 | 0.06 | 0.19 | 0.19 | 0.08 | 0.18 | 1.00 | 0.21 | 0.31 | 1.00 |
| v/c Ratio | 0.92 | 0.32 | 0.11 | 0.41 | 0.87 | 0.41 | 0.88 | 0.74 | 0.02 | 0.37 | 0.98 | 0.72 |
| Control Delay | 71.7 | 33.5 | 0.1 | 60.2 | 61.6 | 4.6 | 86.2 | 53.8 | 0.0 | 39.8 | 45.5 | 10.4 |
| Queue Delay | 0.0 | 0.0 | 0.0 | 0.0 | 0.0 | 0.0 | 0.0 | 0.0 | 0.0 | 0.0 | 0.0 | 0.0 |
| Total Delay | 71.7 | 33.5 | 0.1 | 60.2 | 61.6 | 4.6 | 86.2 | 53.8 | 0.0 | 39.8 | 45.5 | 10.4 |
| LOS | E | C | A | E | E | A | F | D | A | D | D | B |
| Approach Delay | | 47.4 | | | 47.9 | | | 62.6 | | | 28.7 | |
| Approach LOS | | D | | | D | | | E | | | C | |

Intersection Summary

Cycle Length: 120
 Actuated Cycle Length: 120
 Offset: 30 (25%), Referenced to phase 2:EBT and 6:WBT, Start of Yellow
 Natural Cycle: 100
 Control Type: Actuated-Coordinated
 Maximum v/c Ratio: 0.98
 Intersection Signal Delay: 40.6
 Intersection LOS: D
 Intersection Capacity Utilization 89.2%
 ICU Level of Service E
 Analysis Period (min) 15

Splits and Phases: 1: MERIDIAN ROAD & WOODMAN ROAD



Queues
1: MERIDIAN ROAD & WOODMAN ROAD

Total AM 40 Shopping
04/01/2023



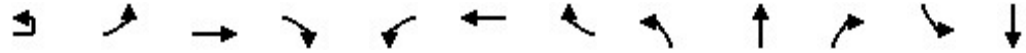
| Lane Group | EBL | EBT | EBR | WBL | WBT | WBR | NBL | NBT | NBR | SBL | SBT | SBR |
|-------------------------|------|------|------|------|------|------|------|------|------|------|------|------|
| Lane Group Flow (vph) | 536 | 338 | 176 | 88 | 594 | 213 | 239 | 467 | 25 | 266 | 1066 | 1145 |
| v/c Ratio | 0.92 | 0.32 | 0.11 | 0.41 | 0.87 | 0.41 | 0.88 | 0.74 | 0.02 | 0.37 | 0.98 | 0.72 |
| Control Delay | 71.7 | 33.5 | 0.1 | 60.2 | 61.6 | 4.6 | 86.2 | 53.8 | 0.0 | 39.8 | 45.5 | 10.4 |
| Queue Delay | 0.0 | 0.0 | 0.0 | 0.0 | 0.0 | 0.0 | 0.0 | 0.0 | 0.0 | 0.0 | 0.0 | 0.0 |
| Total Delay | 71.7 | 33.5 | 0.1 | 60.2 | 61.6 | 4.6 | 86.2 | 53.8 | 0.0 | 39.8 | 45.5 | 10.4 |
| Queue Length 50th (ft) | 212 | 106 | 0 | 34 | 237 | 0 | 96 | 182 | 0 | 104 | 464 | 258 |
| Queue Length 95th (ft) | #313 | 148 | 0 | 62 | #334 | 33 | #169 | 228 | 0 | m88 | m368 | m82 |
| Internal Link Dist (ft) | | 1165 | | | 1100 | | | 342 | | | 860 | |
| Turn Bay Length (ft) | 500 | | 630 | 350 | | 250 | 440 | | 330 | 490 | | 450 |
| Base Capacity (vph) | 586 | 1061 | 1583 | 214 | 683 | 514 | 271 | 914 | 1583 | 717 | 1091 | 1583 |
| Starvation Cap Reductn | 0 | 0 | 0 | 0 | 0 | 0 | 0 | 0 | 0 | 0 | 0 | 0 |
| Spillback Cap Reductn | 0 | 0 | 0 | 0 | 0 | 0 | 0 | 0 | 0 | 0 | 0 | 0 |
| Storage Cap Reductn | 0 | 0 | 0 | 0 | 0 | 0 | 0 | 0 | 0 | 0 | 0 | 0 |
| Reduced v/c Ratio | 0.91 | 0.32 | 0.11 | 0.41 | 0.87 | 0.41 | 0.88 | 0.51 | 0.02 | 0.37 | 0.98 | 0.72 |

Intersection Summary

- # 95th percentile volume exceeds capacity, queue may be longer.
Queue shown is maximum after two cycles.
- m Volume for 95th percentile queue is metered by upstream signal.

HCM 6th Signalized Intersection Summary
1: MERIDIAN ROAD & WOODMAN ROAD

Total AM 40 Shopping
04/01/2023



| Movement | EBU | EBL | EBT | EBR | WBL | WBT | WBR | NBL | NBT | NBR | SBL | SBT |
|------------------------------|------|------|------|-------|------|-------|------|------|------|------|------|------|
| Lane Configurations | | ↔↔ | ↕↕ | ↔ | ↔↔ | ↕↕ | ↔ | ↔↔ | ↕↕ | ↔ | ↔↔ | ↕↕ |
| Traffic Volume (veh/h) | 10 | 499 | 321 | 167 | 84 | 564 | 202 | 227 | 444 | 24 | 253 | 1013 |
| Future Volume (veh/h) | 10 | 499 | 321 | 167 | 84 | 564 | 202 | 227 | 444 | 24 | 253 | 1013 |
| Initial Q (Qb), veh | | 0 | 0 | 0 | 0 | 0 | 0 | 0 | 0 | 0 | 0 | 0 |
| Ped-Bike Adj(A_pbT) | | 1.00 | | 1.00 | 1.00 | | 1.00 | 1.00 | | 1.00 | 1.00 | |
| Parking Bus, Adj | | 1.00 | 1.00 | 1.00 | 1.00 | 1.00 | 1.00 | 1.00 | 1.00 | 1.00 | 1.00 | 1.00 |
| Work Zone On Approach | | | No | | | No | | | No | | | No |
| Adj Sat Flow, veh/h/ln | | 1870 | 1870 | 1870 | 1870 | 1870 | 1870 | 1870 | 1870 | 1870 | 1870 | 1870 |
| Adj Flow Rate, veh/h | | 525 | 338 | 0 | 88 | 594 | 0 | 239 | 467 | 0 | 266 | 1066 |
| Peak Hour Factor | | 0.95 | 0.95 | 0.95 | 0.95 | 0.95 | 0.95 | 0.95 | 0.95 | 0.95 | 0.95 | 0.95 |
| Percent Heavy Veh, % | | 2 | 2 | 2 | 2 | 2 | 2 | 2 | 2 | 2 | 2 | 2 |
| Cap, veh/h | | 577 | 1066 | | 1686 | 2191 | | 274 | 582 | | 816 | 1096 |
| Arrive On Green | | 0.17 | 0.30 | 0.00 | 0.49 | 0.62 | 0.00 | 0.08 | 0.16 | 0.00 | 0.24 | 0.31 |
| Sat Flow, veh/h | | 3456 | 3554 | 1585 | 3456 | 3554 | 1585 | 3456 | 3554 | 1585 | 3456 | 3554 |
| Grp Volume(v), veh/h | | 525 | 338 | 0 | 88 | 594 | 0 | 239 | 467 | 0 | 266 | 1066 |
| Grp Sat Flow(s),veh/h/ln | | 1728 | 1777 | 1585 | 1728 | 1777 | 1585 | 1728 | 1777 | 1585 | 1728 | 1777 |
| Q Serve(g_s), s | | 17.9 | 8.8 | 0.0 | 1.6 | 9.2 | 0.0 | 8.2 | 15.2 | 0.0 | 7.6 | 35.6 |
| Cycle Q Clear(g_c), s | | 17.9 | 8.8 | 0.0 | 1.6 | 9.2 | 0.0 | 8.2 | 15.2 | 0.0 | 7.6 | 35.6 |
| Prop In Lane | | 1.00 | | 1.00 | 1.00 | | 1.00 | 1.00 | | 1.00 | 1.00 | |
| Lane Grp Cap(c), veh/h | | 577 | 1066 | | 1686 | 2191 | | 274 | 582 | | 816 | 1096 |
| V/C Ratio(X) | | 0.91 | 0.32 | | 0.05 | 0.27 | | 0.87 | 0.80 | | 0.33 | 0.97 |
| Avail Cap(c_a), veh/h | | 590 | 1066 | | 1686 | 2191 | | 274 | 918 | | 816 | 1096 |
| HCM Platoon Ratio | | 1.00 | 1.00 | 1.00 | 1.00 | 1.00 | 1.00 | 1.00 | 1.00 | 1.00 | 1.00 | 1.00 |
| Upstream Filter(I) | | 1.00 | 1.00 | 0.00 | 1.00 | 1.00 | 0.00 | 1.00 | 1.00 | 0.00 | 1.00 | 1.00 |
| Uniform Delay (d), s/veh | | 49.1 | 32.5 | 0.0 | 16.1 | 10.6 | 0.0 | 54.7 | 48.3 | 0.0 | 37.9 | 41.0 |
| Incr Delay (d2), s/veh | | 17.9 | 0.8 | 0.0 | 0.0 | 0.3 | 0.0 | 25.3 | 2.8 | 0.0 | 0.2 | 20.8 |
| Initial Q Delay(d3),s/veh | | 0.0 | 0.0 | 0.0 | 0.0 | 0.0 | 0.0 | 0.0 | 0.0 | 0.0 | 0.0 | 0.0 |
| %ile BackOfQ(50%),veh/ln | | 8.9 | 3.8 | 0.0 | 0.6 | 3.4 | 0.0 | 4.5 | 6.9 | 0.0 | 3.2 | 18.3 |
| Unsig. Movement Delay, s/veh | | | | | | | | | | | | |
| LnGrp Delay(d),s/veh | | 67.0 | 33.3 | 0.0 | 16.2 | 10.9 | 0.0 | 79.9 | 51.1 | 0.0 | 38.2 | 61.8 |
| LnGrp LOS | | E | C | | B | B | | E | D | | D | E |
| Approach Vol, veh/h | | | 863 | A | | 682 | A | | 706 | A | | 1332 |
| Approach Delay, s/veh | | | 53.8 | | | 11.6 | | | 60.8 | | | 57.1 |
| Approach LOS | | | D | | | B | | | E | | | E |
| Timer - Assigned Phs | 1 | 2 | 3 | 4 | 5 | 6 | 7 | 8 | | | | |
| Phs Duration (G+Y+Rc), s | 67.6 | 43.0 | 18.0 | 45.5 | 27.5 | 83.0 | 36.8 | 26.7 | | | | |
| Change Period (Y+Rc), s | 7.5 | 7.0 | 8.5 | * 8.5 | 7.5 | * 7.5 | 8.5 | 7.0 | | | | |
| Max Green Setting (Gmax), s | 7.5 | 36.0 | 9.5 | * 37 | 20.5 | * 23 | 15.5 | 31.0 | | | | |
| Max Q Clear Time (g_c+I1), s | 3.6 | 10.8 | 10.2 | 37.6 | 19.9 | 11.2 | 9.6 | 17.2 | | | | |
| Green Ext Time (p_c), s | 0.1 | 2.0 | 0.0 | 0.0 | 0.1 | 2.8 | 0.4 | 2.5 | | | | |

Intersection Summary

| | |
|--------------------|------|
| HCM 6th Ctrl Delay | 48.4 |
| HCM 6th LOS | D |

Notes

- User approved pedestrian interval to be less than phase max green.
- User approved ignoring U-Turning movement.
- * HCM 6th computational engine requires equal clearance times for the phases crossing the barrier.

HCM 6th Signalized Intersection Summary
 1: MERIDIAN ROAD & WOODMAN ROAD

Total AM 40 Shopping
 04/01/2023

| | |
|---|------|
| Movement | SBR |
| Lane Configurations | |
| Traffic Volume (veh/h) | 1088 |
| Future Volume (veh/h) | 1088 |
| Initial Q (Qb), veh | 0 |
| Ped-Bike Adj(A_pbT) | 1.00 |
| Parking Bus, Adj | 1.00 |
| Work Zone On Approach | |
| Adj Sat Flow, veh/h/ln | 1870 |
| Adj Flow Rate, veh/h | 0 |
| Peak Hour Factor | 0.95 |
| Percent Heavy Veh, % | 2 |
| Cap, veh/h | |
| Arrive On Green | 0.00 |
| Sat Flow, veh/h | 1585 |
| Grp Volume(v), veh/h | 0 |
| Grp Sat Flow(s),veh/h/ln | 1585 |
| Q Serve(g_s), s | 0.0 |
| Cycle Q Clear(g_c), s | 0.0 |
| Prop In Lane | 1.00 |
| Lane Grp Cap(c), veh/h | |
| V/C Ratio(X) | |
| Avail Cap(c_a), veh/h | |
| HCM Platoon Ratio | 1.00 |
| Upstream Filter(l) | 0.00 |
| Uniform Delay (d), s/veh | 0.0 |
| Incr Delay (d2), s/veh | 0.0 |
| Initial Q Delay(d3),s/veh | 0.0 |
| %ile BackOfQ(50%),veh/ln | 0.0 |
| Unsig. Movement Delay, s/veh | |
| LnGrp Delay(d),s/veh | 0.0 |
| LnGrp LOS | |
| Approach Vol, veh/h | A |
| Approach Delay, s/veh | |
| Approach LOS | |
| Timer - Assigned Phs | |
| Unsignalized Delay for [NBR, EBR, WBR, SBR] is excluded from calculations of the approach delay and intersection delay. | |

Timings 2: MERIDIAN ROAD & EASTONVILLE ROAD

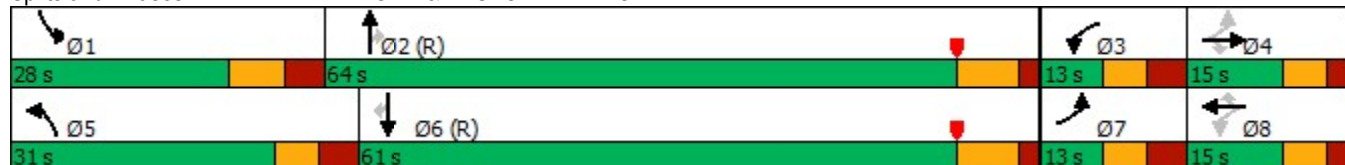
| Lane Group | EBL | EBT | EBR | WBL | WBT | WBR | NBL | NBT | NBR | SBL | SBT | SBR |
|----------------------|-------|-------|-------|-------|-------|-------|-------|-------|-------|-------|-------|-------|
| Lane Configurations | | | | | | | | | | | | |
| Traffic Volume (vph) | 215 | 61 | 349 | 137 | 71 | 51 | 434 | 710 | 57 | 157 | 1900 | 181 |
| Future Volume (vph) | 215 | 61 | 349 | 137 | 71 | 51 | 434 | 710 | 57 | 157 | 1900 | 181 |
| Turn Type | pm+pt | NA | Perm | pm+pt | NA | Perm | Prot | NA | Perm | Prot | NA | Perm |
| Protected Phases | 7 | 4 | | 3 | 8 | | 5 | 2 | | 1 | 6 | |
| Permitted Phases | 4 | | 4 | 8 | | 8 | | | 2 | | | 6 |
| Detector Phase | 7 | 4 | 4 | 3 | 8 | 8 | 5 | 2 | 2 | 1 | 6 | 6 |
| Switch Phase | | | | | | | | | | | | |
| Minimum Initial (s) | 5.0 | 8.0 | 8.0 | 5.0 | 8.0 | 8.0 | 5.0 | 15.0 | 15.0 | 5.0 | 15.0 | 15.0 |
| Minimum Split (s) | 12.5 | 14.5 | 14.5 | 12.5 | 14.5 | 14.5 | 12.5 | 22.5 | 22.5 | 13.5 | 22.5 | 22.5 |
| Total Split (s) | 13.0 | 15.0 | 15.0 | 13.0 | 15.0 | 15.0 | 31.0 | 64.0 | 64.0 | 28.0 | 61.0 | 61.0 |
| Total Split (%) | 10.8% | 12.5% | 12.5% | 10.8% | 12.5% | 12.5% | 25.8% | 53.3% | 53.3% | 23.3% | 50.8% | 50.8% |
| Yellow Time (s) | 4.0 | 4.0 | 4.0 | 4.0 | 4.0 | 4.0 | 4.0 | 5.5 | 5.5 | 5.0 | 5.5 | 5.5 |
| All-Red Time (s) | 3.5 | 2.5 | 2.5 | 3.5 | 2.5 | 2.5 | 3.5 | 2.0 | 2.0 | 3.5 | 2.0 | 2.0 |
| Lost Time Adjust (s) | 0.0 | 0.0 | 0.0 | 0.0 | 0.0 | 0.0 | 0.0 | 0.0 | 0.0 | 0.0 | 0.0 | 0.0 |
| Total Lost Time (s) | 7.5 | 6.5 | 6.5 | 7.5 | 6.5 | 6.5 | 7.5 | 7.5 | 7.5 | 8.5 | 7.5 | 7.5 |
| Lead/Lag | Lead | Lag | Lag | Lead | Lag | Lag | Lead | Lag | Lag | Lead | Lag | Lag |
| Lead-Lag Optimize? | Yes | Yes | Yes | Yes | Yes | Yes | Yes | Yes | Yes | Yes | Yes | Yes |
| Recall Mode | None | None | None | None | None | None | None | C-Max | C-Max | None | C-Max | C-Max |
| Act Effect Green (s) | 14.5 | 8.5 | 8.5 | 11.5 | 8.4 | 8.4 | 23.5 | 60.2 | 60.2 | 15.8 | 53.5 | 53.5 |
| Actuated g/C Ratio | 0.12 | 0.07 | 0.07 | 0.10 | 0.07 | 0.07 | 0.20 | 0.50 | 0.50 | 0.13 | 0.45 | 0.45 |
| v/c Ratio | 0.68 | 0.49 | 0.98 | 0.98 | 0.58 | 0.19 | 1.32 | 0.42 | 0.07 | 0.71 | 1.27 | 0.24 |
| Control Delay | 57.9 | 66.8 | 56.9 | 118.5 | 72.2 | 1.5 | 193.0 | 14.6 | 1.1 | 74.3 | 143.7 | 1.5 |
| Queue Delay | 0.0 | 0.0 | 0.0 | 0.0 | 0.0 | 0.0 | 0.0 | 0.0 | 0.0 | 0.0 | 0.0 | 0.0 |
| Total Delay | 57.9 | 66.8 | 56.9 | 118.5 | 72.2 | 1.5 | 193.0 | 14.6 | 1.1 | 74.3 | 143.7 | 1.5 |
| LOS | E | E | E | F | E | A | F | B | A | E | F | A |
| Approach Delay | | 58.2 | | | 82.6 | | | 78.5 | | | 127.3 | |
| Approach LOS | | E | | | F | | | E | | | F | |

Intersection Summary

Cycle Length: 120
 Actuated Cycle Length: 120
 Offset: 45 (38%), Referenced to phase 2:NBT and 6:SBT, Start of Yellow
 Natural Cycle: 150
 Control Type: Actuated-Coordinated
 Maximum v/c Ratio: 1.32
 Intersection Signal Delay: 101.1
 Intersection Capacity Utilization 108.7%
 Analysis Period (min) 15

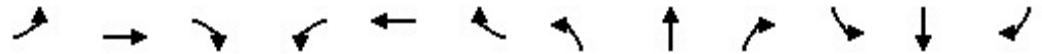
Intersection LOS: F
 ICU Level of Service G

Splits and Phases: 2: MERIDIAN ROAD & EASTONVILLE ROAD



Queues
2: MERIDIAN ROAD & EASTONVILLE ROAD

Total AM 2040 Shopping Center
04/01/2023


































| Lane Group | EBL | EBT | EBR | WBL | WBT | WBR | NBL | NBT | NBR | SBL | SBT | SBR |
|-------------------------|------|------|------|-------|------|------|-------|------|------|------|--------|------|
| Lane Group Flow (vph) | 226 | 64 | 367 | 144 | 75 | 54 | 457 | 747 | 60 | 165 | 2000 | 191 |
| v/c Ratio | 0.68 | 0.49 | 0.98 | 0.98 | 0.58 | 0.19 | 1.32 | 0.42 | 0.07 | 0.71 | 1.27 | 0.24 |
| Control Delay | 57.9 | 66.8 | 56.9 | 118.5 | 72.2 | 1.5 | 193.0 | 14.6 | 1.1 | 74.3 | 143.7 | 1.5 |
| Queue Delay | 0.0 | 0.0 | 0.0 | 0.0 | 0.0 | 0.0 | 0.0 | 0.0 | 0.0 | 0.0 | 0.0 | 0.0 |
| Total Delay | 57.9 | 66.8 | 56.9 | 118.5 | 72.2 | 1.5 | 193.0 | 14.6 | 1.1 | 74.3 | 143.7 | 1.5 |
| Queue Length 50th (ft) | 80 | 49 | 66 | 102 | 57 | 0 | ~470 | 160 | 0 | 129 | ~1061 | 13 |
| Queue Length 95th (ft) | #145 | 96 | #267 | #225 | #116 | 0 | m#620 | m193 | m4 | m128 | m#1048 | m14 |
| Internal Link Dist (ft) | | 508 | | | 1196 | | | 231 | | | 781 | |
| Turn Bay Length (ft) | 100 | | 100 | 120 | | 100 | 100 | | 400 | 375 | | 400 |
| Base Capacity (vph) | 332 | 131 | 374 | 147 | 131 | 284 | 346 | 1775 | 882 | 287 | 1577 | 803 |
| Starvation Cap Reductn | 0 | 0 | 0 | 0 | 0 | 0 | 0 | 0 | 0 | 0 | 0 | 0 |
| Spillback Cap Reductn | 0 | 0 | 0 | 0 | 0 | 0 | 0 | 0 | 0 | 0 | 0 | 0 |
| Storage Cap Reductn | 0 | 0 | 0 | 0 | 0 | 0 | 0 | 0 | 0 | 0 | 0 | 0 |
| Reduced v/c Ratio | 0.68 | 0.49 | 0.98 | 0.98 | 0.57 | 0.19 | 1.32 | 0.42 | 0.07 | 0.57 | 1.27 | 0.24 |

Intersection Summary

- ~ Volume exceeds capacity, queue is theoretically infinite.
Queue shown is maximum after two cycles.
- # 95th percentile volume exceeds capacity, queue may be longer.
Queue shown is maximum after two cycles.
- m Volume for 95th percentile queue is metered by upstream signal.

HCM 6th Signalized Intersection Summary
2: MERIDIAN ROAD & EASTONVILLE ROAD

Total AM 2040 Shoping Center
04/01/2023

| |  |  |  |  |  |  |  |  |  |  |  |  |
|------------------------------|---|---|---|---|---|--|---|---|---|---|---|---|
| Movement | EBL | EBT | EBR | WBL | WBT | WBR | NBL | NBT | NBR | SBL | SBT | SBR |
| Lane Configurations |   |  |   |   |  |   |   |   |   |   |  | |
| Traffic Volume (veh/h) | 215 | 61 | 349 | 137 | 71 | 51 | 434 | 710 | 57 | 157 | 1900 | 181 |
| Future Volume (veh/h) | 215 | 61 | 349 | 137 | 71 | 51 | 434 | 710 | 57 | 157 | 1900 | 181 |
| Initial Q (Qb), veh | 0 | 0 | 0 | 0 | 0 | 0 | 0 | 0 | 0 | 0 | 0 | 0 |
| Ped-Bike Adj(A_pbT) | 1.00 | | 1.00 | 1.00 | | 1.00 | 1.00 | | 1.00 | 1.00 | | 1.00 |
| Parking Bus, Adj | 1.00 | 1.00 | 1.00 | 1.00 | 1.00 | 1.00 | 1.00 | 1.00 | 1.00 | 1.00 | 1.00 | 1.00 |
| Work Zone On Approach | | No | | | No | | | No | | | No | |
| Adj Sat Flow, veh/h/ln | 1870 | 1870 | 1870 | 1870 | 1870 | 1870 | 1870 | 1870 | 1870 | 1870 | 1870 | 1870 |
| Adj Flow Rate, veh/h | 226 | 64 | 0 | 144 | 75 | 0 | 457 | 747 | 60 | 165 | 2000 | 191 |
| Peak Hour Factor | 0.95 | 0.95 | 0.95 | 0.95 | 0.95 | 0.95 | 0.95 | 0.95 | 0.95 | 0.95 | 0.95 | 0.95 |
| Percent Heavy Veh, % | 2 | 2 | 2 | 2 | 2 | 2 | 2 | 2 | 2 | 2 | 2 | 2 |
| Cap, veh/h | 350 | 125 | | 187 | 125 | | 349 | 1879 | 838 | 194 | 1599 | 713 |
| Arrive On Green | 0.05 | 0.07 | 0.00 | 0.05 | 0.07 | 0.00 | 0.20 | 0.53 | 0.53 | 0.11 | 0.45 | 0.45 |
| Sat Flow, veh/h | 3456 | 1870 | 1585 | 1781 | 1870 | 1585 | 1781 | 3554 | 1585 | 1781 | 3554 | 1585 |
| Grp Volume(v), veh/h | 226 | 64 | 0 | 144 | 75 | 0 | 457 | 747 | 60 | 165 | 2000 | 191 |
| Grp Sat Flow(s),veh/h/ln | 1728 | 1870 | 1585 | 1781 | 1870 | 1585 | 1781 | 1777 | 1585 | 1781 | 1777 | 1585 |
| Q Serve(g_s), s | 5.5 | 4.0 | 0.0 | 5.5 | 4.7 | 0.0 | 23.5 | 15.1 | 2.2 | 10.9 | 54.0 | 9.0 |
| Cycle Q Clear(g_c), s | 5.5 | 4.0 | 0.0 | 5.5 | 4.7 | 0.0 | 23.5 | 15.1 | 2.2 | 10.9 | 54.0 | 9.0 |
| Prop In Lane | 1.00 | | 1.00 | 1.00 | | 1.00 | 1.00 | | 1.00 | 1.00 | | 1.00 |
| Lane Grp Cap(c), veh/h | 350 | 125 | | 187 | 125 | | 349 | 1879 | 838 | 194 | 1599 | 713 |
| V/C Ratio(X) | 0.65 | 0.51 | | 0.77 | 0.60 | | 1.31 | 0.40 | 0.07 | 0.85 | 1.25 | 0.27 |
| Avail Cap(c_a), veh/h | 350 | 132 | | 187 | 132 | | 349 | 1879 | 838 | 289 | 1599 | 713 |
| HCM Platoon Ratio | 1.00 | 1.00 | 1.00 | 1.00 | 1.00 | 1.00 | 1.00 | 1.00 | 1.00 | 1.00 | 1.00 | 1.00 |
| Upstream Filter(l) | 1.00 | 1.00 | 0.00 | 1.00 | 1.00 | 0.00 | 1.00 | 1.00 | 1.00 | 1.00 | 1.00 | 1.00 |
| Uniform Delay (d), s/veh | 51.9 | 54.1 | 0.0 | 53.3 | 54.5 | 0.0 | 48.3 | 16.9 | 13.9 | 52.5 | 33.0 | 20.6 |
| Incr Delay (d2), s/veh | 4.1 | 3.2 | 0.0 | 17.8 | 6.7 | 0.0 | 158.7 | 0.6 | 0.2 | 14.2 | 118.2 | 0.9 |
| Initial Q Delay(d3),s/veh | 0.0 | 0.0 | 0.0 | 0.0 | 0.0 | 0.0 | 0.0 | 0.0 | 0.0 | 0.0 | 0.0 | 0.0 |
| %ile BackOfQ(50%),veh/ln | 1.0 | 2.0 | 0.0 | 2.6 | 2.4 | 0.0 | 25.3 | 5.7 | 0.8 | 5.4 | 47.1 | 3.5 |
| Unsig. Movement Delay, s/veh | | | | | | | | | | | | |
| LnGrp Delay(d),s/veh | 56.0 | 57.4 | 0.0 | 71.1 | 61.2 | 0.0 | 206.9 | 17.5 | 14.0 | 66.7 | 151.2 | 21.6 |
| LnGrp LOS | E | E | | E | E | | F | B | B | E | F | C |
| Approach Vol, veh/h | | 290 | A | | 219 | A | | 1264 | | | 2356 | |
| Approach Delay, s/veh | | 56.3 | | | 67.7 | | | 85.8 | | | 134.7 | |
| Approach LOS | | E | | | E | | | F | | | F | |
| Timer - Assigned Phs | 1 | 2 | 3 | 4 | 5 | 6 | 7 | 8 | | | | |
| Phs Duration (G+Y+Rc), s | 21.6 | 70.9 | 13.0 | 14.5 | 31.0 | 61.5 | 13.0 | 14.5 | | | | |
| Change Period (Y+Rc), s | 8.5 | 7.5 | 7.5 | 6.5 | 7.5 | 7.5 | 7.5 | 6.5 | | | | |
| Max Green Setting (Gmax), s | 19.5 | 56.5 | 5.5 | 8.5 | 23.5 | 53.5 | 5.5 | 8.5 | | | | |
| Max Q Clear Time (g_c+I1), s | 12.9 | 17.1 | 7.5 | 6.0 | 25.5 | 56.0 | 7.5 | 6.7 | | | | |
| Green Ext Time (p_c), s | 0.2 | 5.1 | 0.0 | 0.0 | 0.0 | 0.0 | 0.0 | 0.0 | | | | |

Intersection Summary

| | |
|--------------------|-------|
| HCM 6th Ctrl Delay | 110.7 |
| HCM 6th LOS | F |

Notes

- User approved pedestrian interval to be less than phase max green.
- Unsignalized Delay for [EBR, WBR] is excluded from calculations of the approach delay and intersection delay.

Timings
3: MERIDIAN ROAD & BENT GRASS MEADOWS DRIVE

Total AM 40 Shopping
04/01/2023

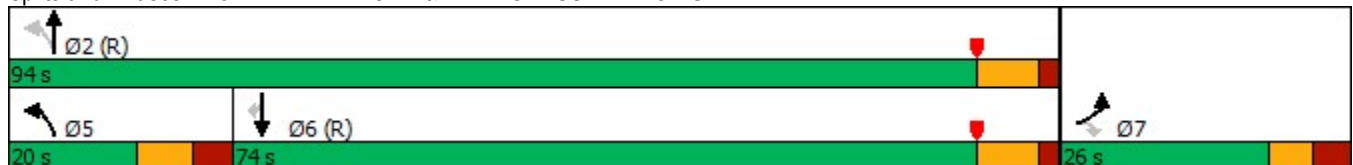


| Lane Group | EBL | EBR | NBL | NBT | SBT | SBR |
|----------------------|-------|-------|-------|-------|-------|-------|
| Lane Configurations | ↖↖ | ↖ | ↖ | ↑↑ | ↑↑ | ↖ |
| Traffic Volume (vph) | 145 | 269 | 224 | 700 | 1926 | 221 |
| Future Volume (vph) | 145 | 269 | 224 | 700 | 1926 | 221 |
| Turn Type | Prot | Perm | pm+pt | NA | NA | Perm |
| Protected Phases | 7 | | 5 | 2 | 6 | |
| Permitted Phases | | 7 | 2 | | | 6 |
| Detector Phase | 7 | 7 | 5 | 2 | 6 | 6 |
| Switch Phase | | | | | | |
| Minimum Initial (s) | 8.0 | 8.0 | 5.0 | 15.0 | 15.0 | 15.0 |
| Minimum Split (s) | 25.5 | 25.5 | 13.5 | 25.5 | 25.5 | 25.5 |
| Total Split (s) | 26.0 | 26.0 | 20.0 | 94.0 | 74.0 | 74.0 |
| Total Split (%) | 21.7% | 21.7% | 16.7% | 78.3% | 61.7% | 61.7% |
| Yellow Time (s) | 4.0 | 4.0 | 5.0 | 5.5 | 5.5 | 5.5 |
| All-Red Time (s) | 3.5 | 3.5 | 3.5 | 2.0 | 2.0 | 2.0 |
| Lost Time Adjust (s) | 0.0 | 0.0 | 0.0 | 0.0 | 0.0 | 0.0 |
| Total Lost Time (s) | 7.5 | 7.5 | 8.5 | 7.5 | 7.5 | 7.5 |
| Lead/Lag | | | Lead | | Lag | Lag |
| Lead-Lag Optimize? | | | Yes | | Yes | Yes |
| Recall Mode | None | None | None | C-Max | C-Max | C-Max |
| Act Effct Green (s) | 14.4 | 14.4 | 89.6 | 90.6 | 67.2 | 67.2 |
| Actuated g/C Ratio | 0.12 | 0.12 | 0.75 | 0.76 | 0.56 | 0.56 |
| v/c Ratio | 0.37 | 0.84 | 0.84 | 0.28 | 1.02 | 0.24 |
| Control Delay | 50.2 | 42.5 | 59.4 | 4.3 | 53.1 | 2.7 |
| Queue Delay | 0.0 | 0.0 | 0.0 | 0.0 | 0.0 | 0.0 |
| Total Delay | 50.2 | 42.5 | 59.4 | 4.3 | 53.1 | 2.7 |
| LOS | D | D | E | A | D | A |
| Approach Delay | 45.2 | | | 17.7 | 47.9 | |
| Approach LOS | D | | | B | D | |

Intersection Summary

Cycle Length: 120
 Actuated Cycle Length: 120
 Offset: 5 (4%), Referenced to phase 2:NBTL and 6:SBT, Start of Yellow
 Natural Cycle: 130
 Control Type: Actuated-Coordinated
 Maximum v/c Ratio: 1.02
 Intersection Signal Delay: 39.6
 Intersection Capacity Utilization 91.9%
 Analysis Period (min) 15
 Intersection LOS: D
 ICU Level of Service F

Splits and Phases: 3: MERIDIAN ROAD & BENT GRASS MEADOWS DRIVE



3: MERIDIAN ROAD & BENT GRASS MEADOWS DRIVE



| Lane Group | EBL | EBR | NBL | NBT | SBT | SBR |
|-------------------------|------|------|-------|------|-------|------|
| Lane Group Flow (vph) | 153 | 283 | 236 | 737 | 2027 | 233 |
| v/c Ratio | 0.37 | 0.84 | 0.84 | 0.28 | 1.02 | 0.24 |
| Control Delay | 50.2 | 42.5 | 59.4 | 4.3 | 53.1 | 2.7 |
| Queue Delay | 0.0 | 0.0 | 0.0 | 0.0 | 0.0 | 0.0 |
| Total Delay | 50.2 | 42.5 | 59.4 | 4.3 | 53.1 | 2.7 |
| Queue Length 50th (ft) | 56 | 88 | 145 | 123 | ~887 | 4 |
| Queue Length 95th (ft) | 87 | #204 | m#314 | 154 | #1025 | 40 |
| Internal Link Dist (ft) | 310 | | | 750 | 1921 | |
| Turn Bay Length (ft) | 150 | | 700 | | | 350 |
| Base Capacity (vph) | 529 | 385 | 281 | 2673 | 1982 | 983 |
| Starvation Cap Reductn | 0 | 0 | 0 | 0 | 0 | 0 |
| Spillback Cap Reductn | 0 | 0 | 0 | 0 | 0 | 0 |
| Storage Cap Reductn | 0 | 0 | 0 | 0 | 0 | 0 |
| Reduced v/c Ratio | 0.29 | 0.74 | 0.84 | 0.28 | 1.02 | 0.24 |

Intersection Summary

~ Volume exceeds capacity, queue is theoretically infinite.

Queue shown is maximum after two cycles.

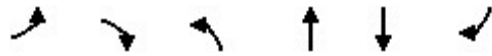
95th percentile volume exceeds capacity, queue may be longer.

Queue shown is maximum after two cycles.

m Volume for 95th percentile queue is metered by upstream signal.

HCM 6th Signalized Intersection Summary
 3: MERIDIAN ROAD & BENT GRASS MEADOWS DRIVE

Total AM 40 Shopping
 04/01/2023



| Movement | EBL | EBR | NBL | NBT | SBT | SBR |
|--|------|-------|------|------|------|------|
| Lane Configurations | ↖↗ | ↗ | ↖ | ↑↑ | ↑↑ | ↗ |
| Traffic Volume (veh/h) | 145 | 269 | 224 | 700 | 1926 | 221 |
| Future Volume (veh/h) | 145 | 269 | 224 | 700 | 1926 | 221 |
| Initial Q (Qb), veh | 0 | 0 | 0 | 0 | 0 | 0 |
| Ped-Bike Adj(A_pbT) | 1.00 | 1.00 | 1.00 | | | 1.00 |
| Parking Bus, Adj | 1.00 | 1.00 | 1.00 | 1.00 | 1.00 | 1.00 |
| Work Zone On Approach | No | | | No | No | |
| Adj Sat Flow, veh/h/ln | 1870 | 1870 | 1870 | 1870 | 1870 | 1870 |
| Adj Flow Rate, veh/h | 153 | 0 | 236 | 737 | 2027 | 233 |
| Peak Hour Factor | 0.95 | 0.95 | 0.95 | 0.95 | 0.95 | 0.95 |
| Percent Heavy Veh, % | 2 | 2 | 2 | 2 | 2 | 2 |
| Cap, veh/h | 229 | | 259 | 2874 | 2282 | 1018 |
| Arrive On Green | 0.07 | 0.00 | 0.10 | 0.81 | 0.64 | 0.64 |
| Sat Flow, veh/h | 3456 | 1585 | 1781 | 3647 | 3647 | 1585 |
| Grp Volume(v), veh/h | 153 | 0 | 236 | 737 | 2027 | 233 |
| Grp Sat Flow(s),veh/h/ln | 1728 | 1585 | 1781 | 1777 | 1777 | 1585 |
| Q Serve(g_s), s | 5.2 | 0.0 | 9.8 | 6.0 | 57.0 | 7.4 |
| Cycle Q Clear(g_c), s | 5.2 | 0.0 | 9.8 | 6.0 | 57.0 | 7.4 |
| Prop In Lane | 1.00 | 1.00 | 1.00 | | | 1.00 |
| Lane Grp Cap(c), veh/h | 229 | | 259 | 2874 | 2282 | 1018 |
| V/C Ratio(X) | 0.67 | | 0.91 | 0.26 | 0.89 | 0.23 |
| Avail Cap(c_a), veh/h | 533 | | 259 | 2874 | 2282 | 1018 |
| HCM Platoon Ratio | 1.00 | 1.00 | 1.00 | 1.00 | 1.00 | 1.00 |
| Upstream Filter(l) | 1.00 | 0.00 | 1.00 | 1.00 | 1.00 | 1.00 |
| Uniform Delay (d), s/veh | 54.7 | 0.0 | 39.5 | 2.8 | 17.9 | 9.0 |
| Incr Delay (d2), s/veh | 3.3 | 0.0 | 33.8 | 0.2 | 5.6 | 0.5 |
| Initial Q Delay(d3),s/veh | 0.0 | 0.0 | 0.0 | 0.0 | 0.0 | 0.0 |
| %ile BackOfQ(50%),veh/ln | 2.3 | 0.0 | 9.4 | 1.7 | 23.1 | 10.7 |
| Unsig. Movement Delay, s/veh | | | | | | |
| LnGrp Delay(d),s/veh | 58.1 | 0.0 | 73.3 | 3.0 | 23.5 | 9.5 |
| LnGrp LOS | E | | E | A | C | A |
| Approach Vol, veh/h | 153 | A | | 973 | 2260 | |
| Approach Delay, s/veh | 58.1 | | | 20.0 | 22.1 | |
| Approach LOS | E | | | C | C | |
| Timer - Assigned Phs | | 2 | | 4 | 5 | 6 |
| Phs Duration (G+Y+Rc), s | | 104.5 | | 15.5 | 20.0 | 84.5 |
| Change Period (Y+Rc), s | | 7.5 | | 7.5 | 8.5 | 7.5 |
| Max Green Setting (Gmax), s | | 86.5 | | 18.5 | 11.5 | 66.5 |
| Max Q Clear Time (g_c+I1), s | | 8.0 | | 7.2 | 11.8 | 59.0 |
| Green Ext Time (p_c), s | | 6.2 | | 0.3 | 0.0 | 6.7 |
| Intersection Summary | | | | | | |
| HCM 6th Ctrl Delay | | | 23.1 | | | |
| HCM 6th LOS | | | C | | | |
| Notes | | | | | | |
| Unsignalized Delay for [EBR] is excluded from calculations of the approach delay and intersection delay. | | | | | | |

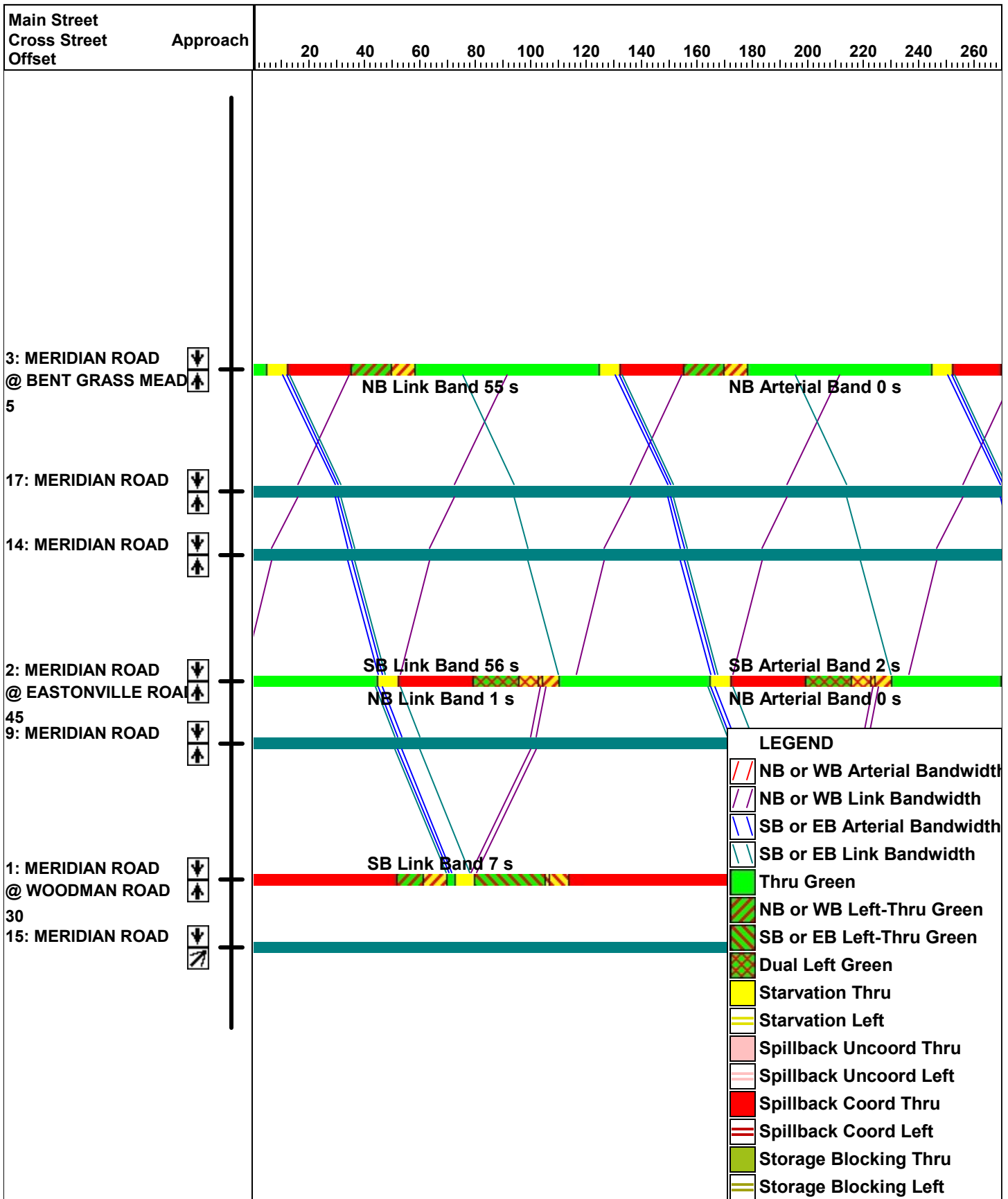
| Intersection | | | | | | |
|--------------------------|------|------|------|------|------|------|
| Int Delay, s/veh | 6.4 | | | | | |
| Movement | EBT | EBR | WBL | WBT | NBL | NBR |
| Lane Configurations | ↑ | ↗ | ↘ | ↑ | ↘ | |
| Traffic Vol, veh/h | 158 | 89 | 363 | 82 | 1 | 256 |
| Future Vol, veh/h | 158 | 89 | 363 | 82 | 1 | 256 |
| Conflicting Peds, #/hr | 0 | 0 | 0 | 0 | 0 | 0 |
| Sign Control | Free | Free | Free | Free | Stop | Stop |
| RT Channelized | - | None | - | None | - | None |
| Storage Length | - | 150 | 100 | - | 0 | - |
| Veh in Median Storage, # | 0 | - | - | 0 | 0 | - |
| Grade, % | 0 | - | - | 0 | 0 | - |
| Peak Hour Factor | 95 | 95 | 95 | 95 | 95 | 95 |
| Heavy Vehicles, % | 2 | 2 | 2 | 2 | 2 | 2 |
| Mvmt Flow | 166 | 94 | 382 | 86 | 1 | 269 |

| Major/Minor | Major1 | Major2 | Minor1 | | |
|----------------------|--------|--------|--------|---|-------|
| Conflicting Flow All | 0 | 0 | 260 | 0 | 1016 |
| Stage 1 | - | - | - | - | 166 |
| Stage 2 | - | - | - | - | 850 |
| Critical Hdwy | - | - | 4.12 | - | 6.42 |
| Critical Hdwy Stg 1 | - | - | - | - | 5.42 |
| Critical Hdwy Stg 2 | - | - | - | - | 5.42 |
| Follow-up Hdwy | - | - | 2.218 | - | 3.518 |
| Pot Cap-1 Maneuver | - | - | 1304 | - | 264 |
| Stage 1 | - | - | - | - | 863 |
| Stage 2 | - | - | - | - | 419 |
| Platoon blocked, % | - | - | - | - | - |
| Mov Cap-1 Maneuver | - | - | 1304 | - | 187 |
| Mov Cap-2 Maneuver | - | - | - | - | 187 |
| Stage 1 | - | - | - | - | 863 |
| Stage 2 | - | - | - | - | 296 |

| Approach | EB | WB | NB |
|----------------------|----|-----|----|
| HCM Control Delay, s | 0 | 7.3 | 11 |
| HCM LOS | | | B |

| Minor Lane/Major Mvmt | NBLn1 | EBT | EBR | WBL | WBT |
|-----------------------|-------|-----|-----|-------|-----|
| Capacity (veh/h) | 866 | - | - | 1304 | - |
| HCM Lane V/C Ratio | 0.312 | - | - | 0.293 | - |
| HCM Control Delay (s) | 11 | - | - | 8.9 | - |
| HCM Lane LOS | B | - | - | A | - |
| HCM 95th %tile Q(veh) | 1.3 | - | - | 1.2 | - |

Total AM 2040 Shopping Center



Timings
1: MERIDIAN ROAD & WOODMAN ROAD

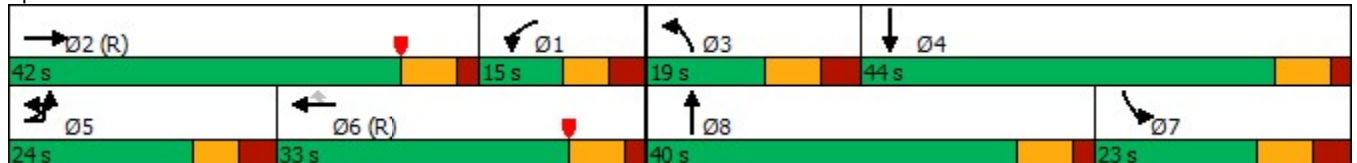
Total AM 40 Storage
04/01/2023

| Lane Group | EBL | EBT | EBR | WBL | WBT | WBR | NBL | NBT | NBR | SBL | SBT | SBR |
|----------------------|-------|-------|-------|-------|-------|-------|-------|-------|-------|-------|-------|-------|
| Lane Configurations | | | | | | | | | | | | |
| Traffic Volume (vph) | 369 | 321 | 167 | 84 | 564 | 158 | 227 | 386 | 24 | 226 | 977 | 1007 |
| Future Volume (vph) | 369 | 321 | 167 | 84 | 564 | 158 | 227 | 386 | 24 | 226 | 977 | 1007 |
| Turn Type | Prot | NA | Free | Prot | NA | Perm | Prot | NA | Free | Prot | NA | Free |
| Protected Phases | 5 | 2 | | 1 | 6 | | 3 | 8 | | 7 | 4 | |
| Permitted Phases | | | Free | | | 6 | | | Free | | | Free |
| Detector Phase | 5 | 2 | | 1 | 6 | 6 | 3 | 8 | | 7 | 4 | |
| Switch Phase | | | | | | | | | | | | |
| Minimum Initial (s) | 5.0 | 15.0 | | 5.0 | 15.0 | 15.0 | 5.0 | 15.0 | | 5.0 | 15.0 | |
| Minimum Split (s) | 13.5 | 22.0 | | 13.5 | 22.0 | 22.0 | 13.5 | 22.0 | | 13.5 | 22.0 | |
| Total Split (s) | 24.0 | 42.0 | | 15.0 | 33.0 | 33.0 | 19.0 | 40.0 | | 23.0 | 44.0 | |
| Total Split (%) | 20.0% | 35.0% | | 12.5% | 27.5% | 27.5% | 15.8% | 33.3% | | 19.2% | 36.7% | |
| Yellow Time (s) | 4.0 | 5.0 | | 4.0 | 5.0 | 5.0 | 5.0 | 5.0 | | 5.0 | 5.0 | |
| All-Red Time (s) | 3.5 | 2.0 | | 3.5 | 2.0 | 2.0 | 3.5 | 2.0 | | 3.5 | 2.0 | |
| Lost Time Adjust (s) | 0.0 | 0.0 | | 0.0 | 0.0 | 0.0 | 0.0 | 0.0 | | 0.0 | 0.0 | |
| Total Lost Time (s) | 7.5 | 7.0 | | 7.5 | 7.0 | 7.0 | 8.5 | 7.0 | | 8.5 | 7.0 | |
| Lead/Lag | Lead | Lead | | Lag | Lag | Lag | Lead | Lead | | Lag | Lag | |
| Lead-Lag Optimize? | Yes | Yes | | Yes | Yes | Yes | Yes | Yes | | Yes | Yes | |
| Recall Mode | None | C-Max | | None | C-Max | C-Max | None | None | | None | None | |
| Act Effct Green (s) | 16.2 | 35.3 | 120.0 | 7.5 | 26.6 | 26.6 | 10.5 | 19.4 | 120.0 | 27.8 | 36.8 | 120.0 |
| Actuated g/C Ratio | 0.14 | 0.29 | 1.00 | 0.06 | 0.22 | 0.22 | 0.09 | 0.16 | 1.00 | 0.23 | 0.31 | 1.00 |
| v/c Ratio | 0.86 | 0.33 | 0.11 | 0.41 | 0.76 | 0.30 | 0.80 | 0.71 | 0.02 | 0.30 | 0.95 | 0.67 |
| Control Delay | 69.8 | 34.2 | 0.1 | 60.2 | 51.0 | 1.4 | 73.8 | 54.5 | 0.0 | 40.3 | 47.0 | 5.9 |
| Queue Delay | 0.0 | 0.0 | 0.0 | 0.0 | 0.0 | 0.0 | 0.0 | 0.0 | 0.0 | 0.0 | 0.0 | 0.0 |
| Total Delay | 69.8 | 34.2 | 0.1 | 60.2 | 51.0 | 1.4 | 73.8 | 54.5 | 0.0 | 40.3 | 47.0 | 5.9 |
| LOS | E | C | A | E | D | A | E | D | A | D | D | A |
| Approach Delay | | 43.2 | | | 42.3 | | | 59.3 | | | 27.6 | |
| Approach LOS | | D | | | D | | | E | | | C | |

Intersection Summary

Cycle Length: 120
 Actuated Cycle Length: 120
 Offset: 30 (25%), Referenced to phase 2:EBT and 6:WBT, Start of Yellow
 Natural Cycle: 90
 Control Type: Actuated-Coordinated
 Maximum v/c Ratio: 0.95
 Intersection Signal Delay: 37.7
 Intersection LOS: D
 Intersection Capacity Utilization 84.9%
 ICU Level of Service E
 Analysis Period (min) 15

Splits and Phases: 1: MERIDIAN ROAD & WOODMAN ROAD



Queues
1: MERIDIAN ROAD & WOODMAN ROAD

Total AM 40 Storage
04/01/2023



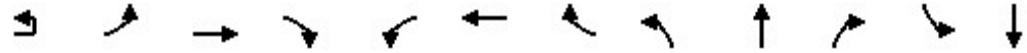
| Lane Group | EBL | EBT | EBR | WBL | WBT | WBR | NBL | NBT | NBR | SBL | SBT | SBR |
|-------------------------|------|------|------|------|------|------|------|------|------|------|------|------|
| Lane Group Flow (vph) | 399 | 338 | 176 | 88 | 594 | 166 | 239 | 406 | 25 | 238 | 1028 | 1060 |
| v/c Ratio | 0.86 | 0.33 | 0.11 | 0.41 | 0.76 | 0.30 | 0.80 | 0.71 | 0.02 | 0.30 | 0.95 | 0.67 |
| Control Delay | 69.8 | 34.2 | 0.1 | 60.2 | 51.0 | 1.4 | 73.8 | 54.5 | 0.0 | 40.3 | 47.0 | 5.9 |
| Queue Delay | 0.0 | 0.0 | 0.0 | 0.0 | 0.0 | 0.0 | 0.0 | 0.0 | 0.0 | 0.0 | 0.0 | 0.0 |
| Total Delay | 69.8 | 34.2 | 0.1 | 60.2 | 51.0 | 1.4 | 73.8 | 54.5 | 0.0 | 40.3 | 47.0 | 5.9 |
| Queue Length 50th (ft) | 157 | 107 | 0 | 34 | 229 | 0 | 95 | 158 | 0 | 93 | 447 | 113 |
| Queue Length 95th (ft) | #236 | 150 | 0 | 62 | 297 | 0 | #157 | 203 | 0 | m90 | m424 | m61 |
| Internal Link Dist (ft) | | 1165 | | | 1100 | | | 342 | | | | 860 |
| Turn Bay Length (ft) | 500 | | 630 | 350 | | 250 | 440 | | 330 | 490 | | 450 |
| Base Capacity (vph) | 472 | 1040 | 1583 | 214 | 784 | 552 | 300 | 973 | 1583 | 795 | 1091 | 1583 |
| Starvation Cap Reductn | 0 | 0 | 0 | 0 | 0 | 0 | 0 | 0 | 0 | 0 | 0 | 0 |
| Spillback Cap Reductn | 0 | 0 | 0 | 0 | 0 | 0 | 0 | 0 | 0 | 0 | 0 | 0 |
| Storage Cap Reductn | 0 | 0 | 0 | 0 | 0 | 0 | 0 | 0 | 0 | 0 | 0 | 0 |
| Reduced v/c Ratio | 0.85 | 0.33 | 0.11 | 0.41 | 0.76 | 0.30 | 0.80 | 0.42 | 0.02 | 0.30 | 0.94 | 0.67 |

Intersection Summary

- # 95th percentile volume exceeds capacity, queue may be longer.
Queue shown is maximum after two cycles.
- m Volume for 95th percentile queue is metered by upstream signal.

HCM 6th Signalized Intersection Summary
1: MERIDIAN ROAD & WOODMAN ROAD

Total AM 40 Storage
04/01/2023



| Movement | EBU | EBL | EBT | EBR | WBL | WBT | WBR | NBL | NBT | NBR | SBL | SBT |
|------------------------------|------|------|------|-------|------|-------|------|------|------|------|------|------|
| Lane Configurations | | ↖↗ | ↕ | ↗ | ↖↗ | ↕ | ↗ | ↖↗ | ↕ | ↗ | ↖↗ | ↕ |
| Traffic Volume (veh/h) | 10 | 369 | 321 | 167 | 84 | 564 | 158 | 227 | 386 | 24 | 226 | 977 |
| Future Volume (veh/h) | 10 | 369 | 321 | 167 | 84 | 564 | 158 | 227 | 386 | 24 | 226 | 977 |
| Initial Q (Qb), veh | | 0 | 0 | 0 | 0 | 0 | 0 | 0 | 0 | 0 | 0 | 0 |
| Ped-Bike Adj(A_pbT) | | 1.00 | | 1.00 | 1.00 | | 1.00 | 1.00 | | 1.00 | 1.00 | |
| Parking Bus, Adj | | 1.00 | 1.00 | 1.00 | 1.00 | 1.00 | 1.00 | 1.00 | 1.00 | 1.00 | 1.00 | 1.00 |
| Work Zone On Approach | | | No | | | No | | | No | | | No |
| Adj Sat Flow, veh/h/ln | | 1870 | 1870 | 1870 | 1870 | 1870 | 1870 | 1870 | 1870 | 1870 | 1870 | 1870 |
| Adj Flow Rate, veh/h | | 388 | 338 | 0 | 88 | 594 | 0 | 239 | 406 | 0 | 238 | 1028 |
| Peak Hour Factor | | 0.95 | 0.95 | 0.95 | 0.95 | 0.95 | 0.95 | 0.95 | 0.95 | 0.95 | 0.95 | 0.95 |
| Percent Heavy Veh, % | | 2 | 2 | 2 | 2 | 2 | 2 | 2 | 2 | 2 | 2 | 2 |
| Cap, veh/h | | 444 | 1036 | | 434 | 1011 | | 293 | 520 | | 885 | 1085 |
| Arrive On Green | | 0.13 | 0.29 | 0.00 | 0.13 | 0.28 | 0.00 | 0.08 | 0.15 | 0.00 | 0.26 | 0.31 |
| Sat Flow, veh/h | | 3456 | 3554 | 1585 | 3456 | 3554 | 1585 | 3456 | 3554 | 1585 | 3456 | 3554 |
| Grp Volume(v), veh/h | | 388 | 338 | 0 | 88 | 594 | 0 | 239 | 406 | 0 | 238 | 1028 |
| Grp Sat Flow(s),veh/h/ln | | 1728 | 1777 | 1585 | 1728 | 1777 | 1585 | 1728 | 1777 | 1585 | 1728 | 1777 |
| Q Serve(g_s), s | | 13.2 | 8.9 | 0.0 | 2.7 | 17.2 | 0.0 | 8.2 | 13.2 | 0.0 | 6.6 | 33.9 |
| Cycle Q Clear(g_c), s | | 13.2 | 8.9 | 0.0 | 2.7 | 17.2 | 0.0 | 8.2 | 13.2 | 0.0 | 6.6 | 33.9 |
| Prop In Lane | | 1.00 | | 1.00 | 1.00 | | 1.00 | 1.00 | | 1.00 | 1.00 | |
| Lane Grp Cap(c), veh/h | | 444 | 1036 | | 434 | 1011 | | 293 | 520 | | 885 | 1085 |
| V/C Ratio(X) | | 0.87 | 0.33 | | 0.20 | 0.59 | | 0.81 | 0.78 | | 0.27 | 0.95 |
| Avail Cap(c_a), veh/h | | 475 | 1036 | | 434 | 1011 | | 302 | 977 | | 885 | 1096 |
| HCM Platoon Ratio | | 1.00 | 1.00 | 1.00 | 1.00 | 1.00 | 1.00 | 1.00 | 1.00 | 1.00 | 1.00 | 1.00 |
| Upstream Filter(I) | | 1.00 | 1.00 | 0.00 | 1.00 | 1.00 | 0.00 | 1.00 | 1.00 | 0.00 | 1.00 | 1.00 |
| Uniform Delay (d), s/veh | | 51.3 | 33.3 | 0.0 | 47.1 | 36.9 | 0.0 | 54.0 | 49.4 | 0.0 | 35.6 | 40.7 |
| Incr Delay (d2), s/veh | | 15.6 | 0.8 | 0.0 | 0.2 | 2.5 | 0.0 | 15.3 | 2.6 | 0.0 | 0.2 | 16.1 |
| Initial Q Delay(d3),s/veh | | 0.0 | 0.0 | 0.0 | 0.0 | 0.0 | 0.0 | 0.0 | 0.0 | 0.0 | 0.0 | 0.0 |
| %ile BackOfQ(50%),veh/ln | | 6.5 | 3.9 | 0.0 | 1.2 | 7.6 | 0.0 | 4.1 | 6.0 | 0.0 | 2.8 | 16.9 |
| Unsig. Movement Delay, s/veh | | | | | | | | | | | | |
| LnGrp Delay(d),s/veh | | 67.0 | 34.1 | 0.0 | 47.3 | 39.4 | 0.0 | 69.3 | 51.9 | 0.0 | 35.8 | 56.8 |
| LnGrp LOS | | E | C | | D | D | | E | D | | D | E |
| Approach Vol, veh/h | | | 726 | A | | 682 | A | | 645 | A | | 1266 |
| Approach Delay, s/veh | | | 51.7 | | | 40.4 | | | 58.4 | | | 52.9 |
| Approach LOS | | | D | | | D | | | E | | | D |
| Timer - Assigned Phs | 1 | 2 | 3 | 4 | 5 | 6 | 7 | 8 | | | | |
| Phs Duration (G+Y+Rc), s | 22.8 | 42.0 | 18.7 | 45.1 | 22.9 | 41.9 | 39.2 | 24.6 | | | | |
| Change Period (Y+Rc), s | 7.5 | 7.0 | 8.5 | * 8.5 | 7.5 | * 7.5 | 8.5 | 7.0 | | | | |
| Max Green Setting (Gmax), s | 7.5 | 35.0 | 10.5 | * 37 | 16.5 | * 26 | 14.5 | 33.0 | | | | |
| Max Q Clear Time (g_c+I1), s | 4.7 | 10.9 | 10.2 | 35.9 | 15.2 | 19.2 | 8.6 | 15.2 | | | | |
| Green Ext Time (p_c), s | 0.0 | 1.9 | 0.0 | 0.7 | 0.2 | 2.0 | 0.4 | 2.4 | | | | |

Intersection Summary

| | |
|--------------------|------|
| HCM 6th Ctrl Delay | 51.1 |
| HCM 6th LOS | D |

Notes

- User approved pedestrian interval to be less than phase max green.
- User approved ignoring U-Turning movement.
- * HCM 6th computational engine requires equal clearance times for the phases crossing the barrier.

HCM 6th Signalized Intersection Summary
 1: MERIDIAN ROAD & WOODMAN ROAD

Total AM 40 Storage
 04/01/2023

| | |
|---|------|
| Movement | SBR |
| Lane Configurations | |
| Traffic Volume (veh/h) | 1007 |
| Future Volume (veh/h) | 1007 |
| Initial Q (Qb), veh | 0 |
| Ped-Bike Adj(A_pbT) | 1.00 |
| Parking Bus, Adj | 1.00 |
| Work Zone On Approach | |
| Adj Sat Flow, veh/h/ln | 1870 |
| Adj Flow Rate, veh/h | 0 |
| Peak Hour Factor | 0.95 |
| Percent Heavy Veh, % | 2 |
| Cap, veh/h | |
| Arrive On Green | 0.00 |
| Sat Flow, veh/h | 1585 |
| Grp Volume(v), veh/h | 0 |
| Grp Sat Flow(s),veh/h/ln | 1585 |
| Q Serve(g_s), s | 0.0 |
| Cycle Q Clear(g_c), s | 0.0 |
| Prop In Lane | 1.00 |
| Lane Grp Cap(c), veh/h | |
| V/C Ratio(X) | |
| Avail Cap(c_a), veh/h | |
| HCM Platoon Ratio | 1.00 |
| Upstream Filter(l) | 0.00 |
| Uniform Delay (d), s/veh | 0.0 |
| Incr Delay (d2), s/veh | 0.0 |
| Initial Q Delay(d3),s/veh | 0.0 |
| %ile BackOfQ(50%),veh/ln | 0.0 |
| Unsig. Movement Delay, s/veh | |
| LnGrp Delay(d),s/veh | 0.0 |
| LnGrp LOS | |
| Approach Vol, veh/h | A |
| Approach Delay, s/veh | |
| Approach LOS | |
| Timer - Assigned Phs | |
| Unsignalized Delay for [NBR, EBR, WBR, SBR] is excluded from calculations of the approach delay and intersection delay. | |

Timings
2: MERIDIAN ROAD & EASTONVILLE ROAD

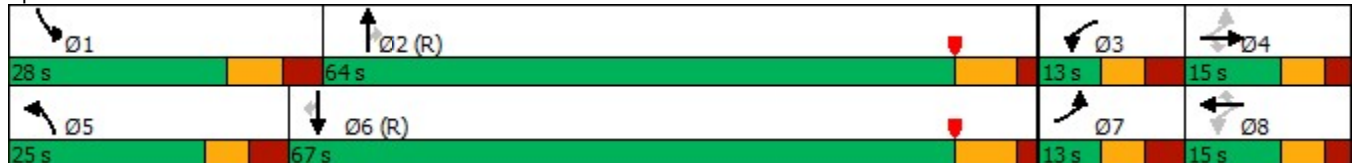
Total AM 2040 Storage
04/01/2023

| Lane Group | EBL | EBT | EBR | WBL | WBT | WBR | NBL | NBT | NBR | SBL | SBT | SBR |
|----------------------|-------|-------|-------|-------|-------|-------|-------|-------|-------|-------|-------|-------|
| Lane Configurations | | | | | | | | | | | | |
| Traffic Volume (vph) | 215 | 61 | 260 | 137 | 71 | 51 | 289 | 623 | 57 | 157 | 1846 | 181 |
| Future Volume (vph) | 215 | 61 | 260 | 137 | 71 | 51 | 289 | 623 | 57 | 157 | 1846 | 181 |
| Turn Type | pm+pt | NA | Perm | pm+pt | NA | Perm | Prot | NA | Perm | Prot | NA | Perm |
| Protected Phases | 7 | 4 | | 3 | 8 | | 5 | 2 | | 1 | 6 | |
| Permitted Phases | 4 | | 4 | 8 | | 8 | | | 2 | | | 6 |
| Detector Phase | 7 | 4 | 4 | 3 | 8 | 8 | 5 | 2 | 2 | 1 | 6 | 6 |
| Switch Phase | | | | | | | | | | | | |
| Minimum Initial (s) | 5.0 | 8.0 | 8.0 | 5.0 | 8.0 | 8.0 | 5.0 | 15.0 | 15.0 | 5.0 | 15.0 | 15.0 |
| Minimum Split (s) | 12.5 | 14.5 | 14.5 | 12.5 | 14.5 | 14.5 | 12.5 | 22.5 | 22.5 | 13.5 | 22.5 | 22.5 |
| Total Split (s) | 13.0 | 15.0 | 15.0 | 13.0 | 15.0 | 15.0 | 25.0 | 64.0 | 64.0 | 28.0 | 67.0 | 67.0 |
| Total Split (%) | 10.8% | 12.5% | 12.5% | 10.8% | 12.5% | 12.5% | 20.8% | 53.3% | 53.3% | 23.3% | 55.8% | 55.8% |
| Yellow Time (s) | 4.0 | 4.0 | 4.0 | 4.0 | 4.0 | 4.0 | 4.0 | 5.5 | 5.5 | 5.0 | 5.5 | 5.5 |
| All-Red Time (s) | 3.5 | 2.5 | 2.5 | 3.5 | 2.5 | 2.5 | 3.5 | 2.0 | 2.0 | 3.5 | 2.0 | 2.0 |
| Lost Time Adjust (s) | 0.0 | 0.0 | 0.0 | 0.0 | 0.0 | 0.0 | 0.0 | 0.0 | 0.0 | 0.0 | 0.0 | 0.0 |
| Total Lost Time (s) | 7.5 | 6.5 | 6.5 | 7.5 | 6.5 | 6.5 | 7.5 | 7.5 | 7.5 | 8.5 | 7.5 | 7.5 |
| Lead/Lag | Lead | Lag | Lag | Lead | Lag | Lag | Lead | Lag | Lag | Lead | Lag | Lag |
| Lead-Lag Optimize? | Yes | Yes | Yes | Yes | Yes | Yes | Yes | Yes | Yes | Yes | Yes | Yes |
| Recall Mode | None | None | None | None | None | None | None | C-Max | C-Max | None | C-Max | C-Max |
| Act Effct Green (s) | 14.4 | 8.4 | 8.4 | 11.5 | 8.4 | 8.4 | 17.6 | 60.3 | 60.3 | 15.8 | 59.5 | 59.5 |
| Actuated g/C Ratio | 0.12 | 0.07 | 0.07 | 0.10 | 0.07 | 0.07 | 0.15 | 0.50 | 0.50 | 0.13 | 0.50 | 0.50 |
| v/c Ratio | 0.68 | 0.49 | 0.79 | 0.98 | 0.58 | 0.20 | 1.17 | 0.37 | 0.07 | 0.71 | 1.11 | 0.22 |
| Control Delay | 58.2 | 67.2 | 26.1 | 118.5 | 72.2 | 1.6 | 142.2 | 15.3 | 2.3 | 72.1 | 73.7 | 1.2 |
| Queue Delay | 0.0 | 0.0 | 0.0 | 0.0 | 0.0 | 0.0 | 0.0 | 0.0 | 0.0 | 0.0 | 0.0 | 0.0 |
| Total Delay | 58.2 | 67.2 | 26.1 | 118.5 | 72.2 | 1.6 | 142.2 | 15.3 | 2.3 | 72.1 | 73.7 | 1.2 |
| LOS | E | E | C | F | E | A | F | B | A | E | E | A |
| Approach Delay | | 43.6 | | | 82.6 | | | 52.3 | | | 67.5 | |
| Approach LOS | | D | | | F | | | D | | | E | |

Intersection Summary

Cycle Length: 120
 Actuated Cycle Length: 120
 Offset: 45 (38%), Referenced to phase 2:NBT and 6:SBT, Start of Yellow
 Natural Cycle: 150
 Control Type: Actuated-Coordinated
 Maximum v/c Ratio: 1.17
 Intersection Signal Delay: 61.5
 Intersection Capacity Utilization 99.2%
 Analysis Period (min) 15
 Intersection LOS: E
 ICU Level of Service F

Splits and Phases: 2: MERIDIAN ROAD & EASTONVILLE ROAD



Queues
2: MERIDIAN ROAD & EASTONVILLE ROAD

Total AM 2040 Storage
04/01/2023



























| Lane Group | EBL | EBT | EBR | WBL | WBT | WBR | NBL | NBT | NBR | SBL | SBT | SBR |
|-------------------------|------|------|------|-------|------|------|-------|------|------|------|--------|------|
| Lane Group Flow (vph) | 226 | 64 | 274 | 144 | 75 | 54 | 304 | 656 | 60 | 165 | 1943 | 191 |
| v/c Ratio | 0.68 | 0.49 | 0.79 | 0.98 | 0.58 | 0.20 | 1.17 | 0.37 | 0.07 | 0.71 | 1.11 | 0.22 |
| Control Delay | 58.2 | 67.2 | 26.1 | 118.5 | 72.2 | 1.6 | 142.2 | 15.3 | 2.3 | 72.1 | 73.7 | 1.2 |
| Queue Delay | 0.0 | 0.0 | 0.0 | 0.0 | 0.0 | 0.0 | 0.0 | 0.0 | 0.0 | 0.0 | 0.0 | 0.0 |
| Total Delay | 58.2 | 67.2 | 26.1 | 118.5 | 72.2 | 1.6 | 142.2 | 15.3 | 2.3 | 72.1 | 73.7 | 1.2 |
| Queue Length 50th (ft) | 80 | 49 | 16 | 102 | 57 | 0 | ~287 | 149 | 3 | 122 | ~933 | 9 |
| Queue Length 95th (ft) | #144 | 96 | #139 | #225 | #116 | 0 | m#431 | m183 | m10 | m132 | m#1058 | m12 |
| Internal Link Dist (ft) | | 508 | | | 1196 | | | 231 | | | 781 | |
| Turn Bay Length (ft) | 100 | | 100 | 120 | | 100 | 100 | | 400 | 375 | | 400 |
| Base Capacity (vph) | 330 | 131 | 347 | 147 | 131 | 276 | 259 | 1778 | 879 | 287 | 1754 | 880 |
| Starvation Cap Reductn | 0 | 0 | 0 | 0 | 0 | 0 | 0 | 0 | 0 | 0 | 0 | 0 |
| Spillback Cap Reductn | 0 | 0 | 0 | 0 | 0 | 0 | 0 | 0 | 0 | 0 | 0 | 0 |
| Storage Cap Reductn | 0 | 0 | 0 | 0 | 0 | 0 | 0 | 0 | 0 | 0 | 0 | 0 |
| Reduced v/c Ratio | 0.68 | 0.49 | 0.79 | 0.98 | 0.57 | 0.20 | 1.17 | 0.37 | 0.07 | 0.57 | 1.11 | 0.22 |

Intersection Summary

- ~ Volume exceeds capacity, queue is theoretically infinite.
Queue shown is maximum after two cycles.
- # 95th percentile volume exceeds capacity, queue may be longer.
Queue shown is maximum after two cycles.
- m Volume for 95th percentile queue is metered by upstream signal.

HCM 6th Signalized Intersection Summary
2: MERIDIAN ROAD & EASTONVILLE ROAD

Total AM 2040 Storage
04/01/2023

| |  |  |  |  |  |  |  |  |  |  |  |  |
|------------------------------|---|---|---|---|---|---|---|---|---|---|---|---|
| Movement | EBL | EBT | EBR | WBL | WBT | WBR | NBL | NBT | NBR | SBL | SBT | SBR |
| Lane Configurations |  |  |  |  |  |  |  |  |  |  |  |  |
| Traffic Volume (veh/h) | 215 | 61 | 260 | 137 | 71 | 51 | 289 | 623 | 57 | 157 | 1846 | 181 |
| Future Volume (veh/h) | 215 | 61 | 260 | 137 | 71 | 51 | 289 | 623 | 57 | 157 | 1846 | 181 |
| Initial Q (Qb), veh | 0 | 0 | 0 | 0 | 0 | 0 | 0 | 0 | 0 | 0 | 0 | 0 |
| Ped-Bike Adj(A_pbT) | 1.00 | | 1.00 | 1.00 | | 1.00 | 1.00 | | 1.00 | 1.00 | | 1.00 |
| Parking Bus, Adj | 1.00 | 1.00 | 1.00 | 1.00 | 1.00 | 1.00 | 1.00 | 1.00 | 1.00 | 1.00 | 1.00 | 1.00 |
| Work Zone On Approach | | No | | | No | | | No | | | No | |
| Adj Sat Flow, veh/h/ln | 1870 | 1870 | 1870 | 1870 | 1870 | 1870 | 1870 | 1870 | 1870 | 1870 | 1870 | 1870 |
| Adj Flow Rate, veh/h | 226 | 64 | 0 | 144 | 75 | 0 | 304 | 656 | 60 | 165 | 1943 | 191 |
| Peak Hour Factor | 0.95 | 0.95 | 0.95 | 0.95 | 0.95 | 0.95 | 0.95 | 0.95 | 0.95 | 0.95 | 0.95 | 0.95 |
| Percent Heavy Veh, % | 2 | 2 | 2 | 2 | 2 | 2 | 2 | 2 | 2 | 2 | 2 | 2 |
| Cap, veh/h | 350 | 125 | | 187 | 125 | | 260 | 1879 | 838 | 194 | 1777 | 793 |
| Arrive On Green | 0.05 | 0.07 | 0.00 | 0.05 | 0.07 | 0.00 | 0.15 | 0.53 | 0.53 | 0.11 | 0.50 | 0.50 |
| Sat Flow, veh/h | 3456 | 1870 | 1585 | 1781 | 1870 | 1585 | 1781 | 3554 | 1585 | 1781 | 3554 | 1585 |
| Grp Volume(v), veh/h | 226 | 64 | 0 | 144 | 75 | 0 | 304 | 656 | 60 | 165 | 1943 | 191 |
| Grp Sat Flow(s),veh/h/ln | 1728 | 1870 | 1585 | 1781 | 1870 | 1585 | 1781 | 1777 | 1585 | 1781 | 1777 | 1585 |
| Q Serve(g_s), s | 5.5 | 4.0 | 0.0 | 5.5 | 4.7 | 0.0 | 17.5 | 12.8 | 2.2 | 10.9 | 60.0 | 8.2 |
| Cycle Q Clear(g_c), s | 5.5 | 4.0 | 0.0 | 5.5 | 4.7 | 0.0 | 17.5 | 12.8 | 2.2 | 10.9 | 60.0 | 8.2 |
| Prop In Lane | 1.00 | | 1.00 | 1.00 | | 1.00 | 1.00 | | 1.00 | 1.00 | | 1.00 |
| Lane Grp Cap(c), veh/h | 350 | 125 | | 187 | 125 | | 260 | 1879 | 838 | 194 | 1777 | 793 |
| V/C Ratio(X) | 0.65 | 0.51 | | 0.77 | 0.60 | | 1.17 | 0.35 | 0.07 | 0.85 | 1.09 | 0.24 |
| Avail Cap(c_a), veh/h | 350 | 132 | | 187 | 132 | | 260 | 1879 | 838 | 289 | 1777 | 793 |
| HCM Platoon Ratio | 1.00 | 1.00 | 1.00 | 1.00 | 1.00 | 1.00 | 1.00 | 1.00 | 1.00 | 1.00 | 1.00 | 1.00 |
| Upstream Filter(l) | 1.00 | 1.00 | 0.00 | 1.00 | 1.00 | 0.00 | 1.00 | 1.00 | 1.00 | 1.00 | 1.00 | 1.00 |
| Uniform Delay (d), s/veh | 51.9 | 54.1 | 0.0 | 53.3 | 54.5 | 0.0 | 51.3 | 16.4 | 13.9 | 52.5 | 30.0 | 17.1 |
| Incr Delay (d2), s/veh | 4.1 | 3.2 | 0.0 | 17.8 | 6.7 | 0.0 | 109.8 | 0.5 | 0.2 | 14.2 | 51.7 | 0.7 |
| Initial Q Delay(d3),s/veh | 0.0 | 0.0 | 0.0 | 0.0 | 0.0 | 0.0 | 0.0 | 0.0 | 0.0 | 0.0 | 0.0 | 0.0 |
| %ile BackOfQ(50%),veh/ln | 1.0 | 2.0 | 0.0 | 2.6 | 2.4 | 0.0 | 15.4 | 4.8 | 0.8 | 5.4 | 35.3 | 3.1 |
| Unsig. Movement Delay, s/veh | | | | | | | | | | | | |
| LnGrp Delay(d),s/veh | 56.0 | 57.4 | 0.0 | 71.1 | 61.2 | 0.0 | 161.1 | 16.9 | 14.0 | 66.7 | 81.7 | 17.8 |
| LnGrp LOS | E | E | | E | E | | F | B | B | E | F | B |
| Approach Vol, veh/h | | 290 | A | | 219 | A | | 1020 | | | 2299 | |
| Approach Delay, s/veh | | 56.3 | | | 67.7 | | | 59.7 | | | 75.3 | |
| Approach LOS | | E | | | E | | | E | | | E | |
| Timer - Assigned Phs | 1 | 2 | 3 | 4 | 5 | 6 | 7 | 8 | | | | |
| Phs Duration (G+Y+Rc), s | 21.6 | 70.9 | 13.0 | 14.5 | 25.0 | 67.5 | 13.0 | 14.5 | | | | |
| Change Period (Y+Rc), s | 8.5 | 7.5 | 7.5 | 6.5 | 7.5 | 7.5 | 7.5 | 6.5 | | | | |
| Max Green Setting (Gmax), s | 19.5 | 56.5 | 5.5 | 8.5 | 17.5 | 59.5 | 5.5 | 8.5 | | | | |
| Max Q Clear Time (g_c+I1), s | 12.9 | 14.8 | 7.5 | 6.0 | 19.5 | 62.0 | 7.5 | 6.7 | | | | |
| Green Ext Time (p_c), s | 0.2 | 4.4 | 0.0 | 0.0 | 0.0 | 0.0 | 0.0 | 0.0 | | | | |

| Intersection Summary | | | | | | | | | | | | |
|----------------------|--|--|--|--|--|--|--|--|--|--|------|--|
| HCM 6th Ctrl Delay | | | | | | | | | | | 69.3 | |
| HCM 6th LOS | | | | | | | | | | | E | |

Notes
User approved pedestrian interval to be less than phase max green.
Unsignalized Delay for [EBR, WBR] is excluded from calculations of the approach delay and intersection delay.

Timings
3: MERIDIAN ROAD & BENT GRASS MEADOWS DRIVE

Total AM 40 Storage
04/01/2023

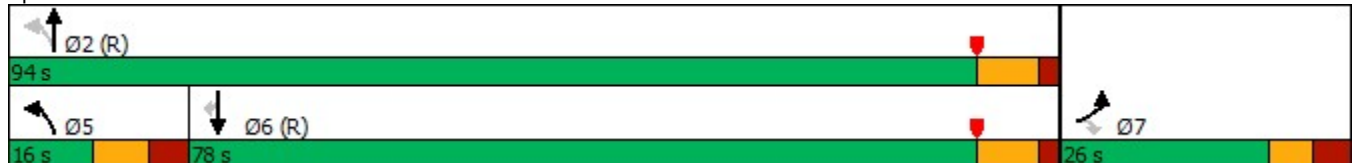


| Lane Group | EBL | EBR | NBL | NBT | SBT | SBR |
|----------------------|-------|-------|-------|-------|-------|-------|
| Lane Configurations | ↖↗ | ↗ | ↖ | ↑↑ | ↑↑ | ↗ |
| Traffic Volume (vph) | 109 | 215 | 137 | 700 | 1926 | 163 |
| Future Volume (vph) | 109 | 215 | 137 | 700 | 1926 | 163 |
| Turn Type | Prot | Perm | pm+pt | NA | NA | Perm |
| Protected Phases | 7 | | 5 | 2 | 6 | |
| Permitted Phases | | 7 | 2 | | | 6 |
| Detector Phase | 7 | 7 | 5 | 2 | 6 | 6 |
| Switch Phase | | | | | | |
| Minimum Initial (s) | 8.0 | 8.0 | 5.0 | 15.0 | 15.0 | 15.0 |
| Minimum Split (s) | 25.5 | 25.5 | 13.5 | 25.5 | 25.5 | 25.5 |
| Total Split (s) | 26.0 | 26.0 | 16.0 | 94.0 | 78.0 | 78.0 |
| Total Split (%) | 21.7% | 21.7% | 13.3% | 78.3% | 65.0% | 65.0% |
| Yellow Time (s) | 4.0 | 4.0 | 5.0 | 5.5 | 5.5 | 5.5 |
| All-Red Time (s) | 3.5 | 3.5 | 3.5 | 2.0 | 2.0 | 2.0 |
| Lost Time Adjust (s) | 0.0 | 0.0 | 0.0 | 0.0 | 0.0 | 0.0 |
| Total Lost Time (s) | 7.5 | 7.5 | 8.5 | 7.5 | 7.5 | 7.5 |
| Lead/Lag | | | Lead | | Lag | Lag |
| Lead-Lag Optimize? | | | Yes | | Yes | Yes |
| Recall Mode | None | None | None | C-Max | C-Max | C-Max |
| Act Effect Green (s) | 14.0 | 14.0 | 90.0 | 91.0 | 73.6 | 73.6 |
| Actuated g/C Ratio | 0.12 | 0.12 | 0.75 | 0.76 | 0.61 | 0.61 |
| v/c Ratio | 0.29 | 0.80 | 0.75 | 0.27 | 0.93 | 0.17 |
| Control Delay | 49.0 | 45.3 | 49.2 | 4.5 | 31.3 | 2.0 |
| Queue Delay | 0.0 | 0.0 | 0.0 | 0.0 | 0.0 | 0.0 |
| Total Delay | 49.0 | 45.3 | 49.2 | 4.5 | 31.3 | 2.0 |
| LOS | D | D | D | A | C | A |
| Approach Delay | 46.6 | | | 11.8 | 29.0 | |
| Approach LOS | D | | | B | C | |

Intersection Summary

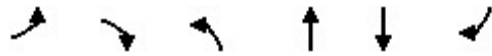
Cycle Length: 120
 Actuated Cycle Length: 120
 Offset: 5 (4%), Referenced to phase 2:NBTL and 6:SBT, Start of Yellow
 Natural Cycle: 110
 Control Type: Actuated-Coordinated
 Maximum v/c Ratio: 0.93
 Intersection Signal Delay: 26.3
 Intersection Capacity Utilization 87.1%
 Analysis Period (min) 15
 Intersection LOS: C
 ICU Level of Service E

Splits and Phases: 3: MERIDIAN ROAD & BENT GRASS MEADOWS DRIVE



3: MERIDIAN ROAD & BENT GRASS MEADOWS DRIVE

04/01/2023



| Lane Group | EBL | EBR | NBL | NBT | SBT | SBR |
|-------------------------|------|------|-------|------|------|------|
| Lane Group Flow (vph) | 115 | 226 | 144 | 737 | 2027 | 172 |
| v/c Ratio | 0.29 | 0.80 | 0.75 | 0.27 | 0.93 | 0.17 |
| Control Delay | 49.0 | 45.3 | 49.2 | 4.5 | 31.3 | 2.0 |
| Queue Delay | 0.0 | 0.0 | 0.0 | 0.0 | 0.0 | 0.0 |
| Total Delay | 49.0 | 45.3 | 49.2 | 4.5 | 31.3 | 2.0 |
| Queue Length 50th (ft) | 42 | 86 | 72 | 126 | 754 | 0 |
| Queue Length 95th (ft) | 69 | 171 | m#176 | 155 | #975 | 29 |
| Internal Link Dist (ft) | 310 | | | 750 | 1921 | |
| Turn Bay Length (ft) | 150 | | 700 | | | 350 |
| Base Capacity (vph) | 529 | 339 | 192 | 2684 | 2171 | 1037 |
| Starvation Cap Reductn | 0 | 0 | 0 | 0 | 0 | 0 |
| Spillback Cap Reductn | 0 | 0 | 0 | 0 | 0 | 0 |
| Storage Cap Reductn | 0 | 0 | 0 | 0 | 0 | 0 |
| Reduced v/c Ratio | 0.22 | 0.67 | 0.75 | 0.27 | 0.93 | 0.17 |

Intersection Summary

95th percentile volume exceeds capacity, queue may be longer.

Queue shown is maximum after two cycles.

m Volume for 95th percentile queue is metered by upstream signal.

HCM 6th Signalized Intersection Summary
 3: MERIDIAN ROAD & BENT GRASS MEADOWS DRIVE

Total AM 40 Storage
 04/01/2023



| Movement | EBL | EBR | NBL | NBT | SBT | SBR |
|------------------------------|------|-------|------|------|------|------|
| Lane Configurations | ↖↗ | ↗ | ↖ | ↑↑ | ↑↑ | ↗ |
| Traffic Volume (veh/h) | 109 | 215 | 137 | 700 | 1926 | 163 |
| Future Volume (veh/h) | 109 | 215 | 137 | 700 | 1926 | 163 |
| Initial Q (Qb), veh | 0 | 0 | 0 | 0 | 0 | 0 |
| Ped-Bike Adj(A_pbT) | 1.00 | 1.00 | 1.00 | | | 1.00 |
| Parking Bus, Adj | 1.00 | 1.00 | 1.00 | 1.00 | 1.00 | 1.00 |
| Work Zone On Approach | No | | | No | No | |
| Adj Sat Flow, veh/h/ln | 1870 | 1870 | 1870 | 1870 | 1870 | 1870 |
| Adj Flow Rate, veh/h | 115 | 0 | 144 | 737 | 2027 | 172 |
| Peak Hour Factor | 0.95 | 0.95 | 0.95 | 0.95 | 0.95 | 0.95 |
| Percent Heavy Veh, % | 2 | 2 | 2 | 2 | 2 | 2 |
| Cap, veh/h | 225 | | 186 | 2878 | 2479 | 1106 |
| Arrive On Green | 0.07 | 0.00 | 0.04 | 0.81 | 0.70 | 0.70 |
| Sat Flow, veh/h | 3456 | 1585 | 1781 | 3647 | 3647 | 1585 |
| Grp Volume(v), veh/h | 115 | 0 | 144 | 737 | 2027 | 172 |
| Grp Sat Flow(s),veh/h/ln | 1728 | 1585 | 1781 | 1777 | 1777 | 1585 |
| Q Serve(g_s), s | 3.9 | 0.0 | 2.6 | 6.0 | 48.2 | 4.4 |
| Cycle Q Clear(g_c), s | 3.9 | 0.0 | 2.6 | 6.0 | 48.2 | 4.4 |
| Prop In Lane | 1.00 | 1.00 | 1.00 | | | 1.00 |
| Lane Grp Cap(c), veh/h | 225 | | 186 | 2878 | 2479 | 1106 |
| V/C Ratio(X) | 0.51 | | 0.77 | 0.26 | 0.82 | 0.16 |
| Avail Cap(c_a), veh/h | 533 | | 224 | 2878 | 2479 | 1106 |
| HCM Platoon Ratio | 1.00 | 1.00 | 1.00 | 1.00 | 1.00 | 1.00 |
| Upstream Filter(I) | 1.00 | 0.00 | 1.00 | 1.00 | 1.00 | 1.00 |
| Uniform Delay (d), s/veh | 54.2 | 0.0 | 28.0 | 2.7 | 12.8 | 6.2 |
| Incr Delay (d2), s/veh | 1.8 | 0.0 | 13.0 | 0.2 | 3.1 | 0.3 |
| Initial Q Delay(d3),s/veh | 0.0 | 0.0 | 0.0 | 0.0 | 0.0 | 0.0 |
| %ile BackOfQ(50%),veh/ln | 1.7 | 0.0 | 3.7 | 1.7 | 18.0 | 7.6 |
| Unsig. Movement Delay, s/veh | | | | | | |
| LnGrp Delay(d),s/veh | 56.0 | 0.0 | 41.0 | 3.0 | 15.9 | 6.5 |
| LnGrp LOS | E | | D | A | B | A |
| Approach Vol, veh/h | 115 | A | | 881 | 2199 | |
| Approach Delay, s/veh | 56.0 | | | 9.2 | 15.2 | |
| Approach LOS | E | | | A | B | |
| Timer - Assigned Phs | | 2 | | 4 | 5 | 6 |
| Phs Duration (G+Y+Rc), s | | 104.7 | | 15.3 | 13.5 | 91.2 |
| Change Period (Y+Rc), s | | 7.5 | | 7.5 | 8.5 | 7.5 |
| Max Green Setting (Gmax), s | | 86.5 | | 18.5 | 7.5 | 70.5 |
| Max Q Clear Time (g_c+I1), s | | 8.0 | | 5.9 | 4.6 | 50.2 |
| Green Ext Time (p_c), s | | 6.2 | | 0.2 | 0.1 | 16.3 |
| Intersection Summary | | | | | | |
| HCM 6th Ctrl Delay | | | 15.0 | | | |
| HCM 6th LOS | | | B | | | |

Notes

Unsignalized Delay for [EBR] is excluded from calculations of the approach delay and intersection delay.

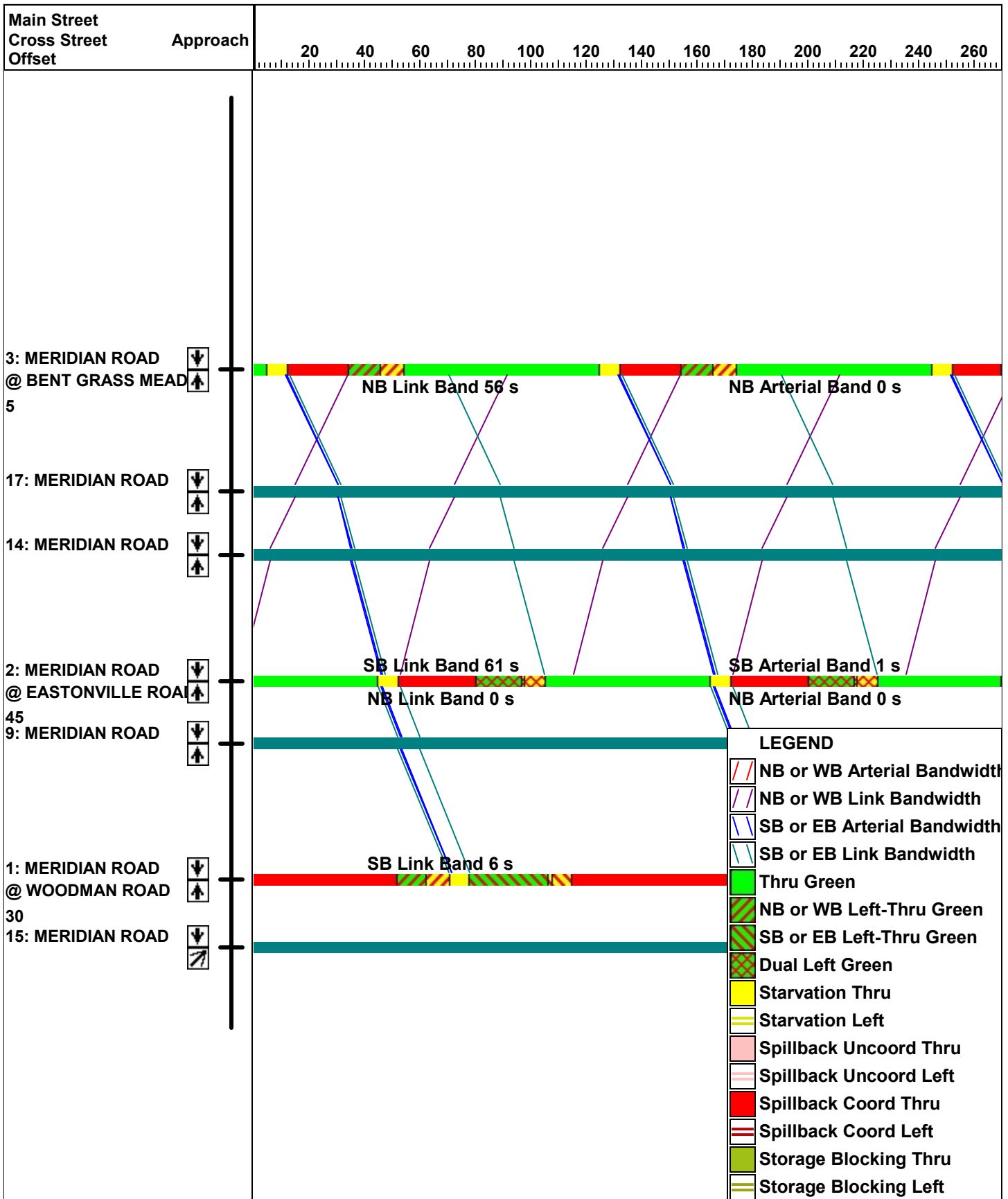
| Intersection | | | | | | |
|--------------------------|------|------|------|------|------|------|
| Int Delay, s/veh | 5 | | | | | |
| Movement | EBT | EBR | WBL | WBT | NBL | NBR |
| Lane Configurations | ↑ | ↗ | ↘ | ↑ | ↘ | |
| Traffic Vol, veh/h | 158 | 89 | 218 | 82 | 1 | 167 |
| Future Vol, veh/h | 158 | 89 | 218 | 82 | 1 | 167 |
| Conflicting Peds, #/hr | 0 | 0 | 0 | 0 | 0 | 0 |
| Sign Control | Free | Free | Free | Free | Stop | Stop |
| RT Channelized | - | None | - | None | - | None |
| Storage Length | - | 150 | 100 | - | 0 | - |
| Veh in Median Storage, # | 0 | - | - | 0 | 0 | - |
| Grade, % | 0 | - | - | 0 | 0 | - |
| Peak Hour Factor | 95 | 95 | 95 | 95 | 95 | 95 |
| Heavy Vehicles, % | 2 | 2 | 2 | 2 | 2 | 2 |
| Mvmt Flow | 166 | 94 | 229 | 86 | 1 | 176 |

| Major/Minor | Major1 | Major2 | Minor1 | | |
|----------------------|--------|--------|--------|---|-------|
| Conflicting Flow All | 0 | 0 | 260 | 0 | 710 |
| Stage 1 | - | - | - | - | 166 |
| Stage 2 | - | - | - | - | 544 |
| Critical Hdwy | - | - | 4.12 | - | 6.42 |
| Critical Hdwy Stg 1 | - | - | - | - | 5.42 |
| Critical Hdwy Stg 2 | - | - | - | - | 5.42 |
| Follow-up Hdwy | - | - | 2.218 | - | 3.518 |
| Pot Cap-1 Maneuver | - | - | 1304 | - | 400 |
| Stage 1 | - | - | - | - | 863 |
| Stage 2 | - | - | - | - | 582 |
| Platoon blocked, % | - | - | - | - | - |
| Mov Cap-1 Maneuver | - | - | 1304 | - | 330 |
| Mov Cap-2 Maneuver | - | - | - | - | 330 |
| Stage 1 | - | - | - | - | 863 |
| Stage 2 | - | - | - | - | 480 |

| Approach | EB | WB | NB |
|----------------------|----|-----|------|
| HCM Control Delay, s | 0 | 6.1 | 10.2 |
| HCM LOS | | | B |

| Minor Lane/Major Mvmt | NBLn1 | EBT | EBR | WBL | WBT |
|-----------------------|-------|-----|-----|-------|-----|
| Capacity (veh/h) | 869 | - | - | 1304 | - |
| HCM Lane V/C Ratio | 0.204 | - | - | 0.176 | - |
| HCM Control Delay (s) | 10.2 | - | - | 8.3 | - |
| HCM Lane LOS | B | - | - | A | - |
| HCM 95th %tile Q(veh) | 0.8 | - | - | 0.6 | - |

Total AM 2040 Storage Signal Progression



Timings
1: MERIDIAN ROAD & WOODMAN ROAD

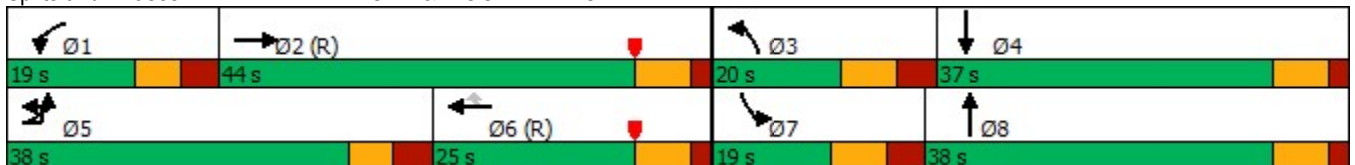
Total PM 40 Shopping Center
04/01/2023

| Lane Group | EBL | EBT | EBR | WBL | WBT | WBR | NBL | NBT | NBR | SBL | SBT | SBR |
|----------------------|-------|-------|-------|-------|-------|-------|-------|-------|-------|-------|-------|-------|
| Lane Configurations | | | | | | | | | | | | |
| Traffic Volume (vph) | 1240 | 671 | 229 | 160 | 521 | 377 | 296 | 1179 | 151 | 380 | 831 | 876 |
| Future Volume (vph) | 1240 | 671 | 229 | 160 | 521 | 377 | 296 | 1179 | 151 | 380 | 831 | 876 |
| Turn Type | Prot | NA | Free | Prot | NA | Perm | Prot | NA | Free | Prot | NA | Free |
| Protected Phases | 5 | 2 | | 1 | 6 | | 3 | 8 | | 7 | 4 | |
| Permitted Phases | | | Free | | | 6 | | | Free | | | Free |
| Detector Phase | 5 | 2 | | 1 | 6 | 6 | 3 | 8 | | 7 | 4 | |
| Switch Phase | | | | | | | | | | | | |
| Minimum Initial (s) | 5.0 | 15.0 | | 5.0 | 15.0 | 15.0 | 5.0 | 15.0 | | 5.0 | 15.0 | |
| Minimum Split (s) | 13.5 | 22.0 | | 13.5 | 22.0 | 22.0 | 13.5 | 22.0 | | 13.5 | 22.0 | |
| Total Split (s) | 38.0 | 44.0 | | 19.0 | 25.0 | 25.0 | 20.0 | 38.0 | | 19.0 | 37.0 | |
| Total Split (%) | 31.7% | 36.7% | | 15.8% | 20.8% | 20.8% | 16.7% | 31.7% | | 15.8% | 30.8% | |
| Yellow Time (s) | 4.0 | 5.0 | | 4.0 | 5.0 | 5.0 | 5.0 | 5.0 | | 5.0 | 5.0 | |
| All-Red Time (s) | 3.5 | 2.0 | | 3.5 | 2.0 | 2.0 | 3.5 | 2.0 | | 3.5 | 2.0 | |
| Lost Time Adjust (s) | 0.0 | 0.0 | | 0.0 | 0.0 | 0.0 | 0.0 | 0.0 | | 0.0 | 0.0 | |
| Total Lost Time (s) | 7.5 | 7.0 | | 7.5 | 7.0 | 7.0 | 8.5 | 7.0 | | 8.5 | 7.0 | |
| Lead/Lag | Lead | Lag | | Lead | Lag | Lag | Lead | Lag | | Lead | Lag | |
| Lead-Lag Optimize? | Yes | Yes | | Yes | Yes | Yes | Yes | Yes | | Yes | Yes | |
| Recall Mode | None | C-Max | | None | C-Max | C-Max | None | None | | None | None | |
| Act Effct Green (s) | 30.5 | 38.1 | 120.0 | 10.4 | 18.0 | 18.0 | 11.5 | 31.0 | 120.0 | 10.5 | 30.0 | 120.0 |
| Actuated g/C Ratio | 0.25 | 0.32 | 1.00 | 0.09 | 0.15 | 0.15 | 0.10 | 0.26 | 1.00 | 0.09 | 0.25 | 1.00 |
| v/c Ratio | 1.51 | 0.63 | 0.15 | 0.56 | 1.03 | 0.88 | 0.95 | 1.36 | 0.10 | 1.33 | 0.99 | 0.58 |
| Control Delay | 270.6 | 38.2 | 0.2 | 60.0 | 97.9 | 40.5 | 92.9 | 203.9 | 0.1 | 182.6 | 49.7 | 5.9 |
| Queue Delay | 0.0 | 0.0 | 0.0 | 0.0 | 0.0 | 0.0 | 0.0 | 0.0 | 0.0 | 0.0 | 0.0 | 0.0 |
| Total Delay | 270.6 | 38.2 | 0.2 | 60.0 | 97.9 | 40.5 | 92.9 | 203.9 | 0.1 | 182.6 | 49.7 | 5.9 |
| LOS | F | D | A | E | F | D | F | F | A | F | D | A |
| Approach Delay | | 169.5 | | | 71.7 | | | 164.8 | | | 55.5 | |
| Approach LOS | | F | | | E | | | F | | | E | |

Intersection Summary

Cycle Length: 120
 Actuated Cycle Length: 120
 Offset: 100 (83%), Referenced to phase 2:EBT and 6:WBT, Start of Yellow
 Natural Cycle: 150
 Control Type: Actuated-Coordinated
 Maximum v/c Ratio: 1.51
 Intersection Signal Delay: 119.1
 Intersection Capacity Utilization 118.2%
 Analysis Period (min) 15

Splits and Phases: 1: MERIDIAN ROAD & WOODMAN ROAD



Queues
1: MERIDIAN ROAD & WOODMAN ROAD

Total PM 40 Shopping Center
04/01/2023



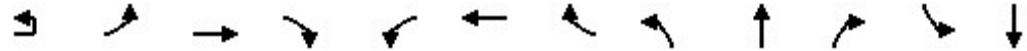
| Lane Group | EBL | EBT | EBR | WBL | WBT | WBR | NBL | NBT | NBR | SBL | SBT | SBR |
|-------------------------|-------|------|------|------|------|------|------|-------|------|-------|------|------|
| Lane Group Flow (vph) | 1321 | 706 | 241 | 168 | 548 | 397 | 312 | 1241 | 159 | 400 | 875 | 922 |
| v/c Ratio | 1.51 | 0.63 | 0.15 | 0.56 | 1.03 | 0.88 | 0.95 | 1.36 | 0.10 | 1.33 | 0.99 | 0.58 |
| Control Delay | 270.6 | 38.2 | 0.2 | 60.0 | 97.9 | 40.5 | 92.9 | 203.9 | 0.1 | 182.6 | 49.7 | 5.9 |
| Queue Delay | 0.0 | 0.0 | 0.0 | 0.0 | 0.0 | 0.0 | 0.0 | 0.0 | 0.0 | 0.0 | 0.0 | 0.0 |
| Total Delay | 270.6 | 38.2 | 0.2 | 60.0 | 97.9 | 40.5 | 92.9 | 203.9 | 0.1 | 182.6 | 49.7 | 5.9 |
| Queue Length 50th (ft) | ~735 | 247 | 0 | 64 | ~239 | 117 | 125 | ~664 | 0 | ~210 | 372 | 144 |
| Queue Length 95th (ft) | #869 | 315 | 0 | 102 | #354 | #299 | #215 | #801 | 0 | m#160 | m304 | m44 |
| Internal Link Dist (ft) | | 1165 | | | 1100 | | | 342 | | | | 860 |
| Turn Bay Length (ft) | 500 | | 630 | 350 | | 250 | 440 | | 330 | 490 | | 450 |
| Base Capacity (vph) | 872 | 1122 | 1583 | 328 | 530 | 449 | 328 | 914 | 1583 | 300 | 884 | 1583 |
| Starvation Cap Reductn | 0 | 0 | 0 | 0 | 0 | 0 | 0 | 0 | 0 | 0 | 0 | 0 |
| Spillback Cap Reductn | 0 | 0 | 0 | 0 | 0 | 0 | 0 | 0 | 0 | 0 | 0 | 0 |
| Storage Cap Reductn | 0 | 0 | 0 | 0 | 0 | 0 | 0 | 0 | 0 | 0 | 0 | 0 |
| Reduced v/c Ratio | 1.51 | 0.63 | 0.15 | 0.51 | 1.03 | 0.88 | 0.95 | 1.36 | 0.10 | 1.33 | 0.99 | 0.58 |

Intersection Summary

- ~ Volume exceeds capacity, queue is theoretically infinite.
Queue shown is maximum after two cycles.
- # 95th percentile volume exceeds capacity, queue may be longer.
Queue shown is maximum after two cycles.
- m Volume for 95th percentile queue is metered by upstream signal.

HCM 6th Signalized Intersection Summary
1: MERIDIAN ROAD & WOODMAN ROAD

Total PM 40 Shopping Center
04/01/2023



| Movement | EBU | EBL | EBT | EBR | WBL | WBT | WBR | NBL | NBT | NBR | SBL | SBT |
|------------------------------|------|-------|-------|------|------|------|------|------|-------|------|-------|-------|
| Lane Configurations | | ↔↔ | ↕↕ | ↗ | ↔↔ | ↕↕ | ↗ | ↔↔ | ↕↕ | ↗ | ↔↔ | ↕↕ |
| Traffic Volume (veh/h) | 15 | 1240 | 671 | 229 | 160 | 521 | 377 | 296 | 1179 | 151 | 380 | 831 |
| Future Volume (veh/h) | 15 | 1240 | 671 | 229 | 160 | 521 | 377 | 296 | 1179 | 151 | 380 | 831 |
| Initial Q (Qb), veh | | 0 | 0 | 0 | 0 | 0 | 0 | 0 | 0 | 0 | 0 | 0 |
| Ped-Bike Adj(A_pbT) | | 1.00 | | 1.00 | 1.00 | | 1.00 | 1.00 | | 1.00 | 1.00 | |
| Parking Bus, Adj | | 1.00 | 1.00 | 1.00 | 1.00 | 1.00 | 1.00 | 1.00 | 1.00 | 1.00 | 1.00 | 1.00 |
| Work Zone On Approach | | | No | | | No | | | No | | | No |
| Adj Sat Flow, veh/h/ln | | 1870 | 1870 | 1870 | 1870 | 1870 | 1870 | 1870 | 1870 | 1870 | 1870 | 1870 |
| Adj Flow Rate, veh/h | | 1305 | 706 | 0 | 168 | 548 | 0 | 312 | 1241 | 0 | 400 | 875 |
| Peak Hour Factor | | 0.95 | 0.95 | 0.95 | 0.95 | 0.95 | 0.95 | 0.95 | 0.95 | 0.95 | 0.95 | 0.95 |
| Percent Heavy Veh, % | | 2 | 2 | 2 | 2 | 2 | 2 | 2 | 2 | 2 | 2 | 2 |
| Cap, veh/h | | 878 | 1203 | | 226 | 533 | | 331 | 918 | | 302 | 888 |
| Arrive On Green | | 0.25 | 0.34 | 0.00 | 0.07 | 0.15 | 0.00 | 0.10 | 0.26 | 0.00 | 0.09 | 0.25 |
| Sat Flow, veh/h | | 3456 | 3554 | 1585 | 3456 | 3554 | 1585 | 3456 | 3554 | 1585 | 3456 | 3554 |
| Grp Volume(v), veh/h | | 1305 | 706 | 0 | 168 | 548 | 0 | 312 | 1241 | 0 | 400 | 875 |
| Grp Sat Flow(s),veh/h/ln | | 1728 | 1777 | 1585 | 1728 | 1777 | 1585 | 1728 | 1777 | 1585 | 1728 | 1777 |
| Q Serve(g_s), s | | 30.5 | 19.7 | 0.0 | 5.7 | 18.0 | 0.0 | 10.8 | 31.0 | 0.0 | 10.5 | 29.4 |
| Cycle Q Clear(g_c), s | | 30.5 | 19.7 | 0.0 | 5.7 | 18.0 | 0.0 | 10.8 | 31.0 | 0.0 | 10.5 | 29.4 |
| Prop In Lane | | 1.00 | | 1.00 | 1.00 | | 1.00 | 1.00 | | 1.00 | 1.00 | |
| Lane Grp Cap(c), veh/h | | 878 | 1203 | | 226 | 533 | | 331 | 918 | | 302 | 888 |
| V/C Ratio(X) | | 1.49 | 0.59 | | 0.74 | 1.03 | | 0.94 | 1.35 | | 1.32 | 0.98 |
| Avail Cap(c_a), veh/h | | 878 | 1203 | | 331 | 533 | | 331 | 918 | | 302 | 888 |
| HCM Platoon Ratio | | 1.00 | 1.00 | 1.00 | 1.00 | 1.00 | 1.00 | 1.00 | 1.00 | 1.00 | 1.00 | 1.00 |
| Upstream Filter(I) | | 1.00 | 1.00 | 0.00 | 1.00 | 1.00 | 0.00 | 1.00 | 1.00 | 0.00 | 1.00 | 1.00 |
| Uniform Delay (d), s/veh | | 44.8 | 32.7 | 0.0 | 55.1 | 51.0 | 0.0 | 53.9 | 44.5 | 0.0 | 54.8 | 44.8 |
| Incr Delay (d2), s/veh | | 224.7 | 2.1 | 0.0 | 5.0 | 46.3 | 0.0 | 34.6 | 165.5 | 0.0 | 166.6 | 26.4 |
| Initial Q Delay(d3),s/veh | | 0.0 | 0.0 | 0.0 | 0.0 | 0.0 | 0.0 | 0.0 | 0.0 | 0.0 | 0.0 | 0.0 |
| %ile BackOfQ(50%),veh/ln | | 40.0 | 8.5 | 0.0 | 2.6 | 11.2 | 0.0 | 6.2 | 34.5 | 0.0 | 11.5 | 16.0 |
| Unsig. Movement Delay, s/veh | | | | | | | | | | | | |
| LnGrp Delay(d),s/veh | | 269.4 | 34.8 | 0.0 | 60.1 | 97.3 | 0.0 | 88.5 | 210.0 | 0.0 | 221.3 | 71.2 |
| LnGrp LOS | | F | C | | E | F | | F | F | | F | E |
| Approach Vol, veh/h | | | 2011 | A | | 716 | A | | 1553 | A | | 1275 |
| Approach Delay, s/veh | | | 187.1 | | | 88.6 | | | 185.6 | | | 118.3 |
| Approach LOS | | | F | | | F | | | F | | | F |
| Timer - Assigned Phs | 1 | 2 | 3 | 4 | 5 | 6 | 7 | 8 | | | | |
| Phs Duration (G+Y+Rc), s | 15.4 | 47.6 | 20.0 | 37.0 | 38.0 | 25.0 | 19.0 | 38.0 | | | | |
| Change Period (Y+Rc), s | 7.5 | 7.0 | 8.5 | 7.0 | 7.5 | 7.0 | 8.5 | 7.0 | | | | |
| Max Green Setting (Gmax), s | 11.5 | 37.0 | 11.5 | 30.0 | 30.5 | 18.0 | 10.5 | 31.0 | | | | |
| Max Q Clear Time (g_c+I1), s | 7.7 | 21.7 | 12.8 | 31.4 | 32.5 | 20.0 | 12.5 | 33.0 | | | | |
| Green Ext Time (p_c), s | 0.2 | 3.9 | 0.0 | 0.0 | 0.0 | 0.0 | 0.0 | 0.0 | | | | |

Intersection Summary

| | |
|--------------------|-------|
| HCM 6th Ctrl Delay | 158.2 |
| HCM 6th LOS | F |

Notes

- User approved pedestrian interval to be less than phase max green.
- User approved ignoring U-Turning movement.
- Unsignalized Delay for [NBR, EBR, WBR, SBR] is excluded from calculations of the approach delay and intersection delay.

HCM 6th Signalized Intersection Summary
 1: MERIDIAN ROAD & WOODMAN ROAD

Total PM 40 Shopping Center
 04/01/2023

| | |
|------------------------------|------|
| Movement | SBR |
| Lane Configurations | |
| Traffic Volume (veh/h) | 876 |
| Future Volume (veh/h) | 876 |
| Initial Q (Qb), veh | 0 |
| Ped-Bike Adj(A_pbT) | 1.00 |
| Parking Bus, Adj | 1.00 |
| Work Zone On Approach | |
| Adj Sat Flow, veh/h/ln | 1870 |
| Adj Flow Rate, veh/h | 0 |
| Peak Hour Factor | 0.95 |
| Percent Heavy Veh, % | 2 |
| Cap, veh/h | |
| Arrive On Green | 0.00 |
| Sat Flow, veh/h | 1585 |
| Grp Volume(v), veh/h | 0 |
| Grp Sat Flow(s),veh/h/ln | 1585 |
| Q Serve(g_s), s | 0.0 |
| Cycle Q Clear(g_c), s | 0.0 |
| Prop In Lane | 1.00 |
| Lane Grp Cap(c), veh/h | |
| V/C Ratio(X) | |
| Avail Cap(c_a), veh/h | |
| HCM Platoon Ratio | 1.00 |
| Upstream Filter(l) | 0.00 |
| Uniform Delay (d), s/veh | 0.0 |
| Incr Delay (d2), s/veh | 0.0 |
| Initial Q Delay(d3),s/veh | 0.0 |
| %ile BackOfQ(50%),veh/ln | 0.0 |
| Unsig. Movement Delay, s/veh | |
| LnGrp Delay(d),s/veh | 0.0 |
| LnGrp LOS | |
| Approach Vol, veh/h | A |
| Approach Delay, s/veh | |
| Approach LOS | |
| Timer - Assigned Phs | |

Timings
2: MERIDIAN ROAD & EASTONVILLE ROAD

Total 2040 PM Shopping Center
04/01/2023

| Lane Group | EBL | EBT | EBR | WBL | WBT | WBR | NBL | NBT | NBR | SBL | SBT | SBR |
|----------------------|-------|-------|-------|-------|-------|-------|-------|-------|-------|-------|-------|-------|
| Lane Configurations | | | | | | | | | | | | |
| Traffic Volume (vph) | 330 | 146 | 580 | 44 | 100 | 190 | 644 | 2046 | 164 | 117 | 1441 | 174 |
| Future Volume (vph) | 330 | 146 | 580 | 44 | 100 | 190 | 644 | 2046 | 164 | 117 | 1441 | 174 |
| Turn Type | pm+pt | NA | Perm | pm+pt | NA | Perm | pm+pt | NA | Perm | pm+pt | NA | Perm |
| Protected Phases | 7 | 4 | | 3 | 8 | | 5 | 2 | | 1 | 6 | |
| Permitted Phases | 4 | | 4 | 8 | | 8 | 2 | | 2 | 6 | | 6 |
| Detector Phase | 7 | 4 | 4 | 3 | 8 | 8 | 5 | 2 | 2 | 1 | 6 | 6 |
| Switch Phase | | | | | | | | | | | | |
| Minimum Initial (s) | 5.0 | 8.0 | 8.0 | 5.0 | 8.0 | 8.0 | 5.0 | 15.0 | 15.0 | 5.0 | 15.0 | 15.0 |
| Minimum Split (s) | 12.5 | 14.5 | 14.5 | 12.5 | 14.5 | 14.5 | 12.5 | 25.5 | 25.5 | 13.5 | 25.5 | 25.5 |
| Total Split (s) | 16.0 | 22.0 | 22.0 | 13.0 | 19.0 | 19.0 | 35.0 | 71.0 | 71.0 | 14.0 | 50.0 | 50.0 |
| Total Split (%) | 13.3% | 18.3% | 18.3% | 10.8% | 15.8% | 15.8% | 29.2% | 59.2% | 59.2% | 11.7% | 41.7% | 41.7% |
| Yellow Time (s) | 4.0 | 4.0 | 4.0 | 4.0 | 4.0 | 4.0 | 4.0 | 5.5 | 5.5 | 5.0 | 5.5 | 5.5 |
| All-Red Time (s) | 3.5 | 2.5 | 2.5 | 3.5 | 2.5 | 2.5 | 3.5 | 2.0 | 2.0 | 3.5 | 2.0 | 2.0 |
| Lost Time Adjust (s) | 0.0 | 0.0 | 0.0 | 0.0 | 0.0 | 0.0 | 0.0 | 0.0 | 0.0 | 0.0 | 0.0 | 0.0 |
| Total Lost Time (s) | 7.5 | 6.5 | 6.5 | 7.5 | 6.5 | 6.5 | 7.5 | 7.5 | 7.5 | 8.5 | 7.5 | 7.5 |
| Lead/Lag | Lead | Lag | Lag | Lead | Lag | Lag | Lead | Lag | Lag | Lead | Lag | Lag |
| Lead-Lag Optimize? | Yes | Yes | Yes | Yes | Yes | Yes | Yes | Yes | Yes | Yes | Yes | Yes |
| Recall Mode | None | None | None | None | None | None | None | C-Max | C-Max | None | C-Max | C-Max |
| Act Effct Green (s) | 23.9 | 18.1 | 18.1 | 17.0 | 12.5 | 12.5 | 77.5 | 63.5 | 63.5 | 47.0 | 42.5 | 42.5 |
| Actuated g/C Ratio | 0.20 | 0.15 | 0.15 | 0.14 | 0.10 | 0.10 | 0.65 | 0.53 | 0.53 | 0.39 | 0.35 | 0.35 |
| v/c Ratio | 0.71 | 0.55 | 1.12 | 0.23 | 0.54 | 0.51 | 1.45 | 1.15 | 0.19 | 0.85 | 1.21 | 0.25 |
| Control Delay | 50.0 | 56.9 | 94.3 | 40.3 | 62.1 | 6.8 | 238.4 | 87.9 | 1.2 | 73.2 | 133.0 | 5.6 |
| Queue Delay | 0.0 | 0.0 | 0.0 | 0.0 | 0.0 | 0.0 | 0.0 | 0.0 | 0.0 | 0.0 | 0.0 | 0.0 |
| Total Delay | 50.0 | 56.9 | 94.3 | 40.3 | 62.1 | 6.8 | 238.4 | 87.9 | 1.2 | 73.2 | 133.0 | 5.6 |
| LOS | D | E | F | D | E | A | F | F | A | E | F | A |
| Approach Delay | | 75.3 | | | 27.8 | | | 116.9 | | | 116.1 | |
| Approach LOS | | E | | | C | | | F | | | F | |

Intersection Summary

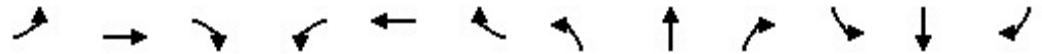
Cycle Length: 120
 Actuated Cycle Length: 120
 Offset: 89 (74%), Referenced to phase 2:NBTL and 6:SBTL, Start of Yellow
 Natural Cycle: 150
 Control Type: Actuated-Coordinated
 Maximum v/c Ratio: 1.45
 Intersection Signal Delay: 104.3
 Intersection Capacity Utilization 114.9%
 Analysis Period (min) 15
 Intersection LOS: F
 ICU Level of Service H

Splits and Phases: 2: MERIDIAN ROAD & EASTONVILLE ROAD



Queues
2: MERIDIAN ROAD & EASTONVILLE ROAD

Total 2040 PM Shopping Center
04/01/2023



| Lane Group | EBL | EBT | EBR | WBL | WBT | WBR | NBL | NBT | NBR | SBL | SBT | SBR |
|-------------------------|------|------|------|------|------|------|-------|-------|------|------|-------|------|
| Lane Group Flow (vph) | 347 | 154 | 611 | 46 | 105 | 200 | 678 | 2154 | 173 | 123 | 1517 | 183 |
| v/c Ratio | 0.71 | 0.55 | 1.12 | 0.23 | 0.54 | 0.51 | 1.45 | 1.15 | 0.19 | 0.85 | 1.21 | 0.25 |
| Control Delay | 50.0 | 56.9 | 94.3 | 40.3 | 62.1 | 6.8 | 238.4 | 87.9 | 1.2 | 73.2 | 133.0 | 5.6 |
| Queue Delay | 0.0 | 0.0 | 0.0 | 0.0 | 0.0 | 0.0 | 0.0 | 0.0 | 0.0 | 0.0 | 0.0 | 0.0 |
| Total Delay | 50.0 | 56.9 | 94.3 | 40.3 | 62.1 | 6.8 | 238.4 | 87.9 | 1.2 | 73.2 | 133.0 | 5.6 |
| Queue Length 50th (ft) | 119 | 115 | ~303 | 28 | 78 | 0 | ~655 | ~1012 | 5 | 56 | ~777 | 38 |
| Queue Length 95th (ft) | 165 | 188 | #532 | 61 | 138 | 28 | m#399 | m309 | m2 | m#95 | #917 | m47 |
| Internal Link Dist (ft) | | 508 | | | 1196 | | | 231 | | | 781 | |
| Turn Bay Length (ft) | 100 | | 100 | 120 | | 100 | 100 | | 400 | 375 | | 400 |
| Base Capacity (vph) | 489 | 280 | 547 | 198 | 194 | 393 | 469 | 1872 | 921 | 144 | 1253 | 718 |
| Starvation Cap Reductn | 0 | 0 | 0 | 0 | 0 | 0 | 0 | 0 | 0 | 0 | 0 | 0 |
| Spillback Cap Reductn | 0 | 0 | 0 | 0 | 0 | 0 | 0 | 0 | 0 | 0 | 0 | 0 |
| Storage Cap Reductn | 0 | 0 | 0 | 0 | 0 | 0 | 0 | 0 | 0 | 0 | 0 | 0 |
| Reduced v/c Ratio | 0.71 | 0.55 | 1.12 | 0.23 | 0.54 | 0.51 | 1.45 | 1.15 | 0.19 | 0.85 | 1.21 | 0.25 |

Intersection Summary

- ~ Volume exceeds capacity, queue is theoretically infinite.
Queue shown is maximum after two cycles.
- # 95th percentile volume exceeds capacity, queue may be longer.
Queue shown is maximum after two cycles.
- m Volume for 95th percentile queue is metered by upstream signal.

HCM 6th Signalized Intersection Summary
2: MERIDIAN ROAD & EASTONVILLE ROAD

Total 2040 PM Shopping Center
04/01/2023



| Movement | EBL | EBT | EBR | WBL | WBT | WBR | NBL | NBT | NBR | SBL | SBT | SBR |
|------------------------------|------|------|------|------|------|------|-------|-------|------|------|------|------|
| Lane Configurations | ↖↗ | ↑ | ↖ | ↖ | ↑ | ↖ | ↖ | ↑↑ | ↖ | ↖ | ↑↑ | ↖ |
| Traffic Volume (veh/h) | 330 | 146 | 580 | 44 | 100 | 190 | 644 | 2046 | 164 | 117 | 1441 | 174 |
| Future Volume (veh/h) | 330 | 146 | 580 | 44 | 100 | 190 | 644 | 2046 | 164 | 117 | 1441 | 174 |
| Initial Q (Qb), veh | 0 | 0 | 0 | 0 | 0 | 0 | 0 | 0 | 0 | 0 | 0 | 0 |
| Ped-Bike Adj(A_pbT) | 1.00 | | 1.00 | 1.00 | | 1.00 | 1.00 | | 1.00 | 1.00 | | 1.00 |
| Parking Bus, Adj | 1.00 | 1.00 | 1.00 | 1.00 | 1.00 | 1.00 | 1.00 | 1.00 | 1.00 | 1.00 | 1.00 | 1.00 |
| Work Zone On Approach | | No | | | No | | | No | | | No | |
| Adj Sat Flow, veh/h/ln | 1870 | 1870 | 1870 | 1870 | 1870 | 1870 | 1870 | 1870 | 1870 | 1870 | 1870 | 1870 |
| Adj Flow Rate, veh/h | 347 | 154 | 0 | 46 | 105 | 0 | 678 | 2154 | 173 | 123 | 1517 | 183 |
| Peak Hour Factor | 0.95 | 0.95 | 0.95 | 0.95 | 0.95 | 0.95 | 0.95 | 0.95 | 0.95 | 0.95 | 0.95 | 0.95 |
| Percent Heavy Veh, % | 2 | 2 | 2 | 2 | 2 | 2 | 2 | 2 | 2 | 2 | 2 | 2 |
| Cap, veh/h | 409 | 208 | | 157 | 136 | | 468 | 1992 | 888 | 142 | 1370 | 611 |
| Arrive On Green | 0.07 | 0.11 | 0.00 | 0.03 | 0.07 | 0.00 | 0.23 | 0.56 | 0.56 | 0.05 | 0.39 | 0.39 |
| Sat Flow, veh/h | 3456 | 1870 | 1585 | 1781 | 1870 | 1585 | 1781 | 3554 | 1585 | 1781 | 3554 | 1585 |
| Grp Volume(v), veh/h | 347 | 154 | 0 | 46 | 105 | 0 | 678 | 2154 | 173 | 123 | 1517 | 183 |
| Grp Sat Flow(s),veh/h/ln | 1728 | 1870 | 1585 | 1781 | 1870 | 1585 | 1781 | 1777 | 1585 | 1781 | 1777 | 1585 |
| Q Serve(g_s), s | 8.5 | 9.6 | 0.0 | 2.8 | 6.6 | 0.0 | 27.5 | 67.2 | 6.5 | 5.1 | 46.2 | 9.6 |
| Cycle Q Clear(g_c), s | 8.5 | 9.6 | 0.0 | 2.8 | 6.6 | 0.0 | 27.5 | 67.2 | 6.5 | 5.1 | 46.2 | 9.6 |
| Prop In Lane | 1.00 | | 1.00 | 1.00 | | 1.00 | 1.00 | | 1.00 | 1.00 | | 1.00 |
| Lane Grp Cap(c), veh/h | 409 | 208 | | 157 | 136 | | 468 | 1992 | 888 | 142 | 1370 | 611 |
| V/C Ratio(X) | 0.85 | 0.74 | | 0.29 | 0.77 | | 1.45 | 1.08 | 0.19 | 0.87 | 1.11 | 0.30 |
| Avail Cap(c_a), veh/h | 409 | 242 | | 180 | 195 | | 468 | 1992 | 888 | 142 | 1370 | 611 |
| HCM Platoon Ratio | 1.00 | 1.00 | 1.00 | 1.00 | 1.00 | 1.00 | 1.00 | 1.00 | 1.00 | 1.00 | 1.00 | 1.00 |
| Upstream Filter(l) | 1.00 | 1.00 | 0.00 | 1.00 | 1.00 | 0.00 | 1.00 | 1.00 | 1.00 | 1.00 | 1.00 | 1.00 |
| Uniform Delay (d), s/veh | 50.7 | 51.7 | 0.0 | 49.4 | 54.6 | 0.0 | 38.8 | 26.4 | 13.0 | 29.8 | 36.9 | 25.6 |
| Incr Delay (d2), s/veh | 15.3 | 9.9 | 0.0 | 1.0 | 11.1 | 0.0 | 213.4 | 46.2 | 0.5 | 39.8 | 59.4 | 1.3 |
| Initial Q Delay(d3),s/veh | 0.0 | 0.0 | 0.0 | 0.0 | 0.0 | 0.0 | 0.0 | 0.0 | 0.0 | 0.0 | 0.0 | 0.0 |
| %ile BackOfQ(50%),veh/ln | 2.0 | 5.0 | 0.0 | 1.3 | 3.5 | 0.0 | 40.8 | 36.9 | 2.4 | 3.5 | 29.7 | 3.9 |
| Unsig. Movement Delay, s/veh | | | | | | | | | | | | |
| LnGrp Delay(d),s/veh | 66.0 | 61.5 | 0.0 | 50.4 | 65.7 | 0.0 | 252.2 | 72.6 | 13.5 | 69.6 | 96.3 | 26.9 |
| LnGrp LOS | E | E | | D | E | | F | F | B | E | F | C |
| Approach Vol, veh/h | | 501 | A | | 151 | A | | 3005 | | | 1823 | |
| Approach Delay, s/veh | | 64.6 | | | 61.0 | | | 109.7 | | | 87.5 | |
| Approach LOS | | E | | | E | | | F | | | F | |
| Timer - Assigned Phs | 1 | 2 | 3 | 4 | 5 | 6 | 7 | 8 | | | | |
| Phs Duration (G+Y+Rc), s | 14.0 | 74.7 | 11.4 | 19.8 | 35.0 | 53.7 | 16.0 | 15.3 | | | | |
| Change Period (Y+Rc), s | 8.5 | 7.5 | 7.5 | 6.5 | 7.5 | 7.5 | 7.5 | 6.5 | | | | |
| Max Green Setting (Gmax), s | 5.5 | 63.5 | 5.5 | 15.5 | 27.5 | 42.5 | 8.5 | 12.5 | | | | |
| Max Q Clear Time (g_c+I1), s | 7.1 | 69.2 | 4.8 | 11.6 | 29.5 | 48.2 | 10.5 | 8.6 | | | | |
| Green Ext Time (p_c), s | 0.0 | 0.0 | 0.0 | 0.2 | 0.0 | 0.0 | 0.0 | 0.1 | | | | |

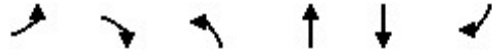
Intersection Summary

| | |
|--------------------|------|
| HCM 6th Ctrl Delay | 96.9 |
| HCM 6th LOS | F |

Notes

User approved pedestrian interval to be less than phase max green.
Unsignalized Delay for [EBR, WBR] is excluded from calculations of the approach delay and intersection delay.

Timings
 3: MERIDIAN ROAD & BENT GRASS MEADOWS DRIVE

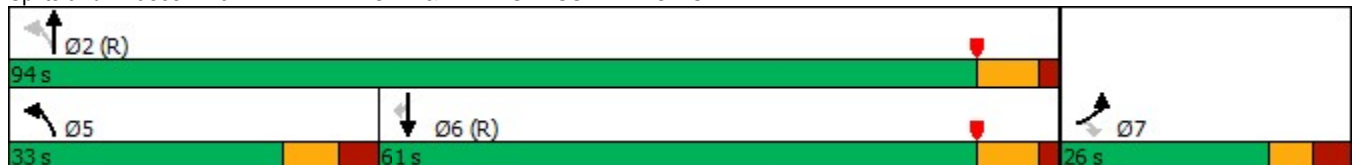


| Lane Group | EBL | EBR | NBL | NBT | SBT | SBR |
|----------------------|-------|-------|-------|-------|-------|-------|
| Lane Configurations | ↖↖ | ↗ | ↖ | ↑↑ | ↑↑ | ↗ |
| Traffic Volume (vph) | 252 | 341 | 330 | 2174 | 1340 | 283 |
| Future Volume (vph) | 252 | 341 | 330 | 2174 | 1340 | 283 |
| Turn Type | Prot | Perm | pm+pt | NA | NA | Perm |
| Protected Phases | 7 | | 5 | 2 | 6 | |
| Permitted Phases | | 7 | 2 | | | 6 |
| Detector Phase | 7 | 7 | 5 | 2 | 6 | 6 |
| Switch Phase | | | | | | |
| Minimum Initial (s) | 8.0 | 8.0 | 5.0 | 15.0 | 15.0 | 15.0 |
| Minimum Split (s) | 25.5 | 25.5 | 13.5 | 25.5 | 25.5 | 25.5 |
| Total Split (s) | 26.0 | 26.0 | 33.0 | 94.0 | 61.0 | 61.0 |
| Total Split (%) | 21.7% | 21.7% | 27.5% | 78.3% | 50.8% | 50.8% |
| Yellow Time (s) | 4.0 | 4.0 | 5.0 | 5.5 | 5.5 | 5.5 |
| All-Red Time (s) | 3.5 | 3.5 | 3.5 | 2.0 | 2.0 | 2.0 |
| Lost Time Adjust (s) | 0.0 | 0.0 | 0.0 | 0.0 | 0.0 | 0.0 |
| Total Lost Time (s) | 7.5 | 7.5 | 8.5 | 7.5 | 7.5 | 7.5 |
| Lead/Lag | | | Lead | | Lag | Lag |
| Lead-Lag Optimize? | | | Yes | | Yes | Yes |
| Recall Mode | None | None | None | C-Max | C-Max | C-Max |
| Act Effct Green (s) | 14.5 | 14.5 | 89.5 | 90.5 | 59.5 | 59.5 |
| Actuated g/C Ratio | 0.12 | 0.12 | 0.75 | 0.75 | 0.50 | 0.50 |
| v/c Ratio | 0.64 | 0.72 | 0.86 | 0.86 | 0.80 | 0.32 |
| Control Delay | 57.1 | 14.0 | 50.8 | 6.1 | 31.1 | 3.2 |
| Queue Delay | 0.0 | 0.0 | 0.0 | 0.0 | 0.0 | 0.0 |
| Total Delay | 57.1 | 14.0 | 50.8 | 6.1 | 31.1 | 3.2 |
| LOS | E | B | D | A | C | A |
| Approach Delay | 32.3 | | | 12.0 | 26.2 | |
| Approach LOS | C | | | B | C | |

Intersection Summary

Cycle Length: 120
 Actuated Cycle Length: 120
 Offset: 27 (23%), Referenced to phase 2:NBTL and 6:SBT, Start of Yellow
 Natural Cycle: 90
 Control Type: Actuated-Coordinated
 Maximum v/c Ratio: 0.86
 Intersection Signal Delay: 19.4
 Intersection Capacity Utilization 82.1%
 Analysis Period (min) 15
 Intersection LOS: B
 ICU Level of Service E

Splits and Phases: 3: MERIDIAN ROAD & BENT GRASS MEADOWS DRIVE



Queues
3: MERIDIAN ROAD & BENT GRASS MEADOWS DRIVE

Total PM 40 Shopping Center
04/01/2023



| Lane Group | EBL | EBR | NBL | NBT | SBT | SBR |
|-------------------------|------|------|------|------|------|------|
| Lane Group Flow (vph) | 265 | 359 | 347 | 2288 | 1411 | 298 |
| v/c Ratio | 0.64 | 0.72 | 0.86 | 0.86 | 0.80 | 0.32 |
| Control Delay | 57.1 | 14.0 | 50.8 | 6.1 | 31.1 | 3.2 |
| Queue Delay | 0.0 | 0.0 | 0.0 | 0.0 | 0.0 | 0.0 |
| Total Delay | 57.1 | 14.0 | 50.8 | 6.1 | 31.1 | 3.2 |
| Queue Length 50th (ft) | 102 | 4 | 210 | 118 | 486 | 0 |
| Queue Length 95th (ft) | 142 | 97 | m181 | m120 | 627 | 50 |
| Internal Link Dist (ft) | 310 | | | 750 | 1921 | |
| Turn Bay Length (ft) | 150 | | 700 | | | 350 |
| Base Capacity (vph) | 529 | 542 | 438 | 2668 | 1755 | 935 |
| Starvation Cap Reductn | 0 | 0 | 0 | 0 | 0 | 0 |
| Spillback Cap Reductn | 0 | 0 | 0 | 0 | 0 | 0 |
| Storage Cap Reductn | 0 | 0 | 0 | 0 | 0 | 0 |
| Reduced v/c Ratio | 0.50 | 0.66 | 0.79 | 0.86 | 0.80 | 0.32 |

Intersection Summary

m Volume for 95th percentile queue is metered by upstream signal.

HCM 6th Signalized Intersection Summary
 3: MERIDIAN ROAD & BENT GRASS MEADOWS DRIVE

Total PM 40 Shopping Center
 04/01/2023



| Movement | EBL | EBR | NBL | NBT | SBT | SBR |
|------------------------------|------|-------|------|------|------|------|
| Lane Configurations | ↖↗ | ↗ | ↖ | ↑↑ | ↑↑ | ↗ |
| Traffic Volume (veh/h) | 252 | 341 | 330 | 2174 | 1340 | 283 |
| Future Volume (veh/h) | 252 | 341 | 330 | 2174 | 1340 | 283 |
| Initial Q (Qb), veh | 0 | 0 | 0 | 0 | 0 | 0 |
| Ped-Bike Adj(A_pbT) | 1.00 | 1.00 | 1.00 | | | 1.00 |
| Parking Bus, Adj | 1.00 | 1.00 | 1.00 | 1.00 | 1.00 | 1.00 |
| Work Zone On Approach | No | | | No | No | |
| Adj Sat Flow, veh/h/ln | 1870 | 1870 | 1870 | 1870 | 1870 | 1870 |
| Adj Flow Rate, veh/h | 265 | 0 | 347 | 2288 | 1411 | 298 |
| Peak Hour Factor | 0.95 | 0.95 | 0.95 | 0.95 | 0.95 | 0.95 |
| Percent Heavy Veh, % | 2 | 2 | 2 | 2 | 2 | 2 |
| Cap, veh/h | 332 | | 380 | 2768 | 2047 | 913 |
| Arrive On Green | 0.10 | 0.00 | 0.13 | 0.78 | 0.58 | 0.58 |
| Sat Flow, veh/h | 3456 | 1585 | 1781 | 3647 | 3647 | 1585 |
| Grp Volume(v), veh/h | 265 | 0 | 347 | 2288 | 1411 | 298 |
| Grp Sat Flow(s),veh/h/ln | 1728 | 1585 | 1781 | 1777 | 1777 | 1585 |
| Q Serve(g_s), s | 9.0 | 0.0 | 13.1 | 48.0 | 33.5 | 11.8 |
| Cycle Q Clear(g_c), s | 9.0 | 0.0 | 13.1 | 48.0 | 33.5 | 11.8 |
| Prop In Lane | 1.00 | 1.00 | 1.00 | | | 1.00 |
| Lane Grp Cap(c), veh/h | 332 | | 380 | 2768 | 2047 | 913 |
| V/C Ratio(X) | 0.80 | | 0.91 | 0.83 | 0.69 | 0.33 |
| Avail Cap(c_a), veh/h | 533 | | 509 | 2768 | 2047 | 913 |
| HCM Platoon Ratio | 1.00 | 1.00 | 1.00 | 1.00 | 1.00 | 1.00 |
| Upstream Filter(I) | 1.00 | 0.00 | 1.00 | 1.00 | 1.00 | 1.00 |
| Uniform Delay (d), s/veh | 53.1 | 0.0 | 30.0 | 8.2 | 17.9 | 13.3 |
| Incr Delay (d2), s/veh | 4.4 | 0.0 | 17.3 | 3.0 | 1.9 | 1.0 |
| Initial Q Delay(d3),s/veh | 0.0 | 0.0 | 0.0 | 0.0 | 0.0 | 0.0 |
| %ile BackOfQ(50%),veh/ln | 4.1 | 0.0 | 11.9 | 15.6 | 13.7 | 14.4 |
| Unsig. Movement Delay, s/veh | | | | | | |
| LnGrp Delay(d),s/veh | 57.5 | 0.0 | 47.3 | 11.2 | 19.8 | 14.2 |
| LnGrp LOS | E | | D | B | B | B |
| Approach Vol, veh/h | 265 | A | | 2635 | 1709 | |
| Approach Delay, s/veh | 57.5 | | | 16.0 | 18.8 | |
| Approach LOS | E | | | B | B | |
| Timer - Assigned Phs | | 2 | | 4 | 5 | 6 |
| Phs Duration (G+Y+Rc), s | | 101.0 | | 19.0 | 24.3 | 76.6 |
| Change Period (Y+Rc), s | | 7.5 | | 7.5 | 8.5 | 7.5 |
| Max Green Setting (Gmax), s | | 86.5 | | 18.5 | 24.5 | 53.5 |
| Max Q Clear Time (g_c+I1), s | | 50.0 | | 11.0 | 15.1 | 35.5 |
| Green Ext Time (p_c), s | | 28.4 | | 0.5 | 0.8 | 11.2 |

Intersection Summary

| | |
|--------------------|------|
| HCM 6th Ctrl Delay | 19.4 |
| HCM 6th LOS | B |

Notes

Unsignalized Delay for [EBR] is excluded from calculations of the approach delay and intersection delay.

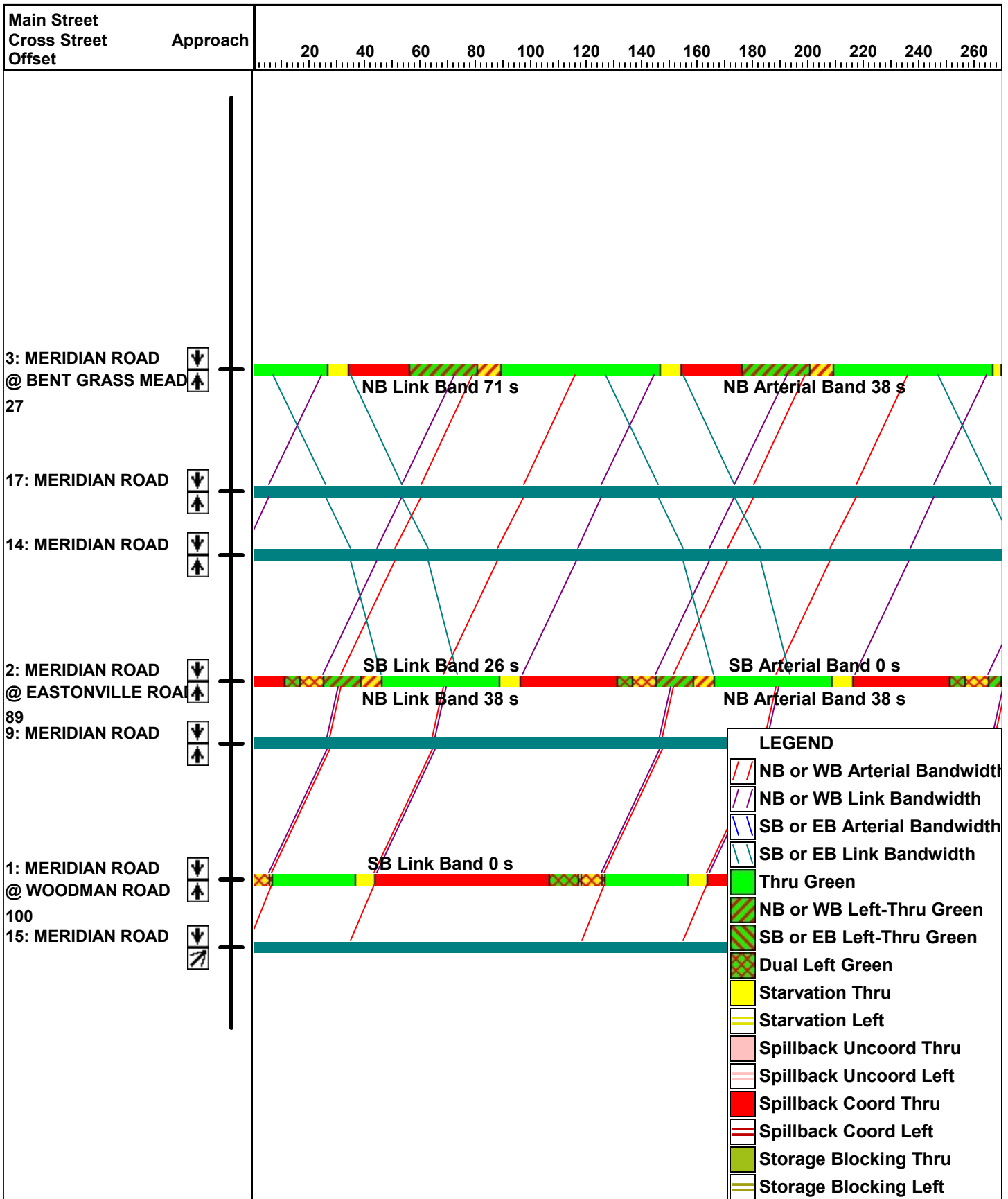
| Intersection | | | | | | |
|--------------------------|------|------|------|------|------|------|
| Int Delay, s/veh | 8.1 | | | | | |
| Movement | EBT | EBR | WBL | WBT | NBL | NBR |
| Lane Configurations | ↑ | ↗ | ↘ | ↑ | ↘ | ↗ |
| Traffic Vol, veh/h | 139 | 57 | 424 | 189 | 3 | 454 |
| Future Vol, veh/h | 139 | 57 | 424 | 189 | 3 | 454 |
| Conflicting Peds, #/hr | 0 | 0 | 0 | 0 | 0 | 0 |
| Sign Control | Free | Free | Free | Free | Stop | Stop |
| RT Channelized | - | None | - | None | - | None |
| Storage Length | - | 150 | 100 | - | 0 | - |
| Veh in Median Storage, # | 0 | - | - | 0 | 0 | - |
| Grade, % | 0 | - | - | 0 | 0 | - |
| Peak Hour Factor | 95 | 95 | 95 | 95 | 95 | 95 |
| Heavy Vehicles, % | 2 | 2 | 2 | 2 | 2 | 2 |
| Mvmt Flow | 146 | 60 | 446 | 199 | 3 | 478 |

| Major/Minor | Major1 | Major2 | Minor1 | | |
|----------------------|--------|--------|--------|---|-------------|
| Conflicting Flow All | 0 | 0 | 206 | 0 | 1237 146 |
| Stage 1 | - | - | - | - | 146 - |
| Stage 2 | - | - | - | - | 1091 - |
| Critical Hdwy | - | - | 4.12 | - | 6.42 6.22 |
| Critical Hdwy Stg 1 | - | - | - | - | 5.42 - |
| Critical Hdwy Stg 2 | - | - | - | - | 5.42 - |
| Follow-up Hdwy | - | - | 2.218 | - | 3.518 3.318 |
| Pot Cap-1 Maneuver | - | - | 1365 | - | 194 901 |
| Stage 1 | - | - | - | - | 881 - |
| Stage 2 | - | - | - | - | 322 - |
| Platoon blocked, % | - | - | - | - | - |
| Mov Cap-1 Maneuver | - | - | 1365 | - | 131 901 |
| Mov Cap-2 Maneuver | - | - | - | - | 131 - |
| Stage 1 | - | - | - | - | 881 - |
| Stage 2 | - | - | - | - | 217 - |

| Approach | EB | WB | NB |
|----------------------|----|-----|------|
| HCM Control Delay, s | 0 | 6.2 | 14.2 |
| HCM LOS | | | B |

| Minor Lane/Major Mvmt | NBLn1 | EBT | EBR | WBL | WBT |
|-----------------------|-------|-----|-----|-------|-----|
| Capacity (veh/h) | 868 | - | - | 1365 | - |
| HCM Lane V/C Ratio | 0.554 | - | - | 0.327 | - |
| HCM Control Delay (s) | 14.2 | - | - | 8.9 | - |
| HCM Lane LOS | B | - | - | A | - |
| HCM 95th %tile Q(veh) | 3.5 | - | - | 1.4 | - |

Total PM 2040 Shopping Center Signal Progression



Timings
1: MERIDIAN ROAD & WOODMAN ROAD

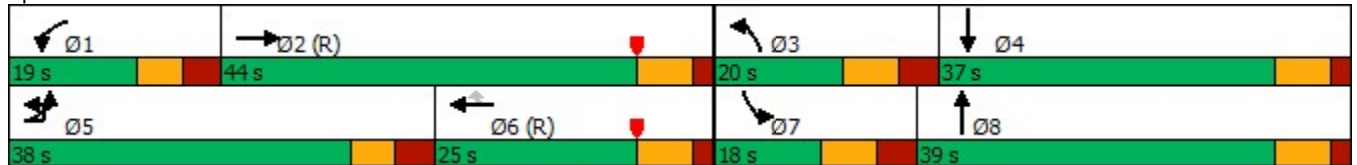
Total PM 2040 Storage
04/01/2023

| Lane Group | EBL | EBT | EBR | WBL | WBT | WBR | NBL | NBT | NBR | SBL | SBT | SBR |
|----------------------|-------|-------|-------|-------|-------|-------|-------|-------|-------|-------|-------|-------|
| Lane Configurations | | | | | | | | | | | | |
| Traffic Volume (vph) | 994 | 671 | 229 | 160 | 521 | 295 | 296 | 1069 | 151 | 291 | 712 | 610 |
| Future Volume (vph) | 994 | 671 | 229 | 160 | 521 | 295 | 296 | 1069 | 151 | 291 | 712 | 610 |
| Turn Type | Prot | NA | Free | Prot | NA | Perm | Prot | NA | Free | Prot | NA | Free |
| Protected Phases | 5 | 2 | | 1 | 6 | | 3 | 8 | | 7 | 4 | |
| Permitted Phases | | | Free | | | 6 | | | Free | | | Free |
| Detector Phase | 5 | 2 | | 1 | 6 | 6 | 3 | 8 | | 7 | 4 | |
| Switch Phase | | | | | | | | | | | | |
| Minimum Initial (s) | 5.0 | 15.0 | | 5.0 | 15.0 | 15.0 | 5.0 | 15.0 | | 5.0 | 15.0 | |
| Minimum Split (s) | 13.5 | 22.0 | | 13.5 | 22.0 | 22.0 | 13.5 | 22.0 | | 13.5 | 22.0 | |
| Total Split (s) | 38.0 | 44.0 | | 19.0 | 25.0 | 25.0 | 20.0 | 39.0 | | 18.0 | 37.0 | |
| Total Split (%) | 31.7% | 36.7% | | 15.8% | 20.8% | 20.8% | 16.7% | 32.5% | | 15.0% | 30.8% | |
| Yellow Time (s) | 4.0 | 5.0 | | 4.0 | 5.0 | 5.0 | 5.0 | 5.0 | | 5.0 | 5.0 | |
| All-Red Time (s) | 3.5 | 2.0 | | 3.5 | 2.0 | 2.0 | 3.5 | 2.0 | | 3.5 | 2.0 | |
| Lost Time Adjust (s) | 0.0 | 0.0 | | 0.0 | 0.0 | 0.0 | 0.0 | 0.0 | | 0.0 | 0.0 | |
| Total Lost Time (s) | 7.5 | 7.0 | | 7.5 | 7.0 | 7.0 | 8.5 | 7.0 | | 8.5 | 7.0 | |
| Lead/Lag | Lead | Lag | | Lead | Lag | Lag | Lead | Lag | | Lead | Lag | |
| Lead-Lag Optimize? | Yes | Yes | | Yes | Yes | Yes | Yes | Yes | | Yes | Yes | |
| Recall Mode | None | C-Max | | None | C-Max | C-Max | None | None | | None | None | |
| Act Effct Green (s) | 30.5 | 38.1 | 120.0 | 10.4 | 18.0 | 18.0 | 11.5 | 32.0 | 120.0 | 9.5 | 30.0 | 120.0 |
| Actuated g/C Ratio | 0.25 | 0.32 | 1.00 | 0.09 | 0.15 | 0.15 | 0.10 | 0.27 | 1.00 | 0.08 | 0.25 | 1.00 |
| v/c Ratio | 1.22 | 0.63 | 0.15 | 0.56 | 1.03 | 0.69 | 0.95 | 1.19 | 0.10 | 1.13 | 0.85 | 0.41 |
| Control Delay | 147.4 | 38.2 | 0.2 | 60.0 | 97.9 | 20.0 | 92.9 | 136.4 | 0.1 | 108.7 | 51.3 | 1.1 |
| Queue Delay | 0.0 | 0.0 | 0.0 | 0.0 | 0.0 | 0.0 | 0.0 | 0.0 | 0.0 | 0.0 | 0.0 | 0.0 |
| Total Delay | 147.4 | 38.2 | 0.2 | 60.0 | 97.9 | 20.0 | 92.9 | 136.4 | 0.1 | 108.7 | 51.3 | 1.1 |
| LOS | F | D | A | E | F | B | F | F | A | F | D | A |
| Approach Delay | | 91.4 | | | 68.1 | | | 114.3 | | | 42.6 | |
| Approach LOS | | F | | | E | | | F | | | D | |

Intersection Summary

Cycle Length: 120
 Actuated Cycle Length: 120
 Offset: 100 (83%), Referenced to phase 2:EBT and 6:WBT, Start of Yellow
 Natural Cycle: 150
 Control Type: Actuated-Coordinated
 Maximum v/c Ratio: 1.22
 Intersection Signal Delay: 80.3
 Intersection LOS: F
 Intersection Capacity Utilization 105.6%
 ICU Level of Service G
 Analysis Period (min) 15

Splits and Phases: 1: MERIDIAN ROAD & WOODMAN ROAD



Queues
1: MERIDIAN ROAD & WOODMAN ROAD

Total PM 2040 Storage
04/01/2023



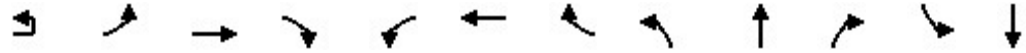
| Lane Group | EBL | EBT | EBR | WBL | WBT | WBR | NBL | NBT | NBR | SBL | SBT | SBR |
|-------------------------|-------|------|------|------|------|------|------|-------|------|-------|------|------|
| Lane Group Flow (vph) | 1062 | 706 | 241 | 168 | 548 | 311 | 312 | 1125 | 159 | 306 | 749 | 642 |
| v/c Ratio | 1.22 | 0.63 | 0.15 | 0.56 | 1.03 | 0.69 | 0.95 | 1.19 | 0.10 | 1.13 | 0.85 | 0.41 |
| Control Delay | 147.4 | 38.2 | 0.2 | 60.0 | 97.9 | 20.0 | 92.9 | 136.4 | 0.1 | 108.7 | 51.3 | 1.1 |
| Queue Delay | 0.0 | 0.0 | 0.0 | 0.0 | 0.0 | 0.0 | 0.0 | 0.0 | 0.0 | 0.0 | 0.0 | 0.0 |
| Total Delay | 147.4 | 38.2 | 0.2 | 60.0 | 97.9 | 20.0 | 92.9 | 136.4 | 0.1 | 108.7 | 51.3 | 1.1 |
| Queue Length 50th (ft) | ~520 | 247 | 0 | 64 | ~239 | 42 | 125 | ~554 | 0 | ~142 | 322 | 0 |
| Queue Length 95th (ft) | #651 | 315 | 0 | 102 | #354 | 143 | #215 | #688 | 0 | m#164 | m340 | m0 |
| Internal Link Dist (ft) | | 1165 | | | 1100 | | | 342 | | | | 860 |
| Turn Bay Length (ft) | 500 | | 630 | 350 | | 250 | 440 | | 330 | 490 | | 450 |
| Base Capacity (vph) | 872 | 1122 | 1583 | 328 | 530 | 449 | 328 | 943 | 1583 | 271 | 884 | 1583 |
| Starvation Cap Reductn | 0 | 0 | 0 | 0 | 0 | 0 | 0 | 0 | 0 | 0 | 0 | 0 |
| Spillback Cap Reductn | 0 | 0 | 0 | 0 | 0 | 0 | 0 | 0 | 0 | 0 | 0 | 0 |
| Storage Cap Reductn | 0 | 0 | 0 | 0 | 0 | 0 | 0 | 0 | 0 | 0 | 0 | 0 |
| Reduced v/c Ratio | 1.22 | 0.63 | 0.15 | 0.51 | 1.03 | 0.69 | 0.95 | 1.19 | 0.10 | 1.13 | 0.85 | 0.41 |

Intersection Summary

- ~ Volume exceeds capacity, queue is theoretically infinite.
Queue shown is maximum after two cycles.
- # 95th percentile volume exceeds capacity, queue may be longer.
Queue shown is maximum after two cycles.
- m Volume for 95th percentile queue is metered by upstream signal.

HCM 6th Signalized Intersection Summary
1: MERIDIAN ROAD & WOODMAN ROAD

Total PM 2040 Storage
04/01/2023



| Movement | EBU | EBL | EBT | EBR | WBL | WBT | WBR | NBL | NBT | NBR | SBL | SBT |
|------------------------------|------|-------|------|------|------|------|------|------|-------|------|-------|------|
| Lane Configurations | | ↔↔ | ↕↕ | ↗ | ↔↔ | ↕↕ | ↗ | ↔↔ | ↕↕ | ↗ | ↔↔ | ↕↕ |
| Traffic Volume (veh/h) | 15 | 994 | 671 | 229 | 160 | 521 | 295 | 296 | 1069 | 151 | 291 | 712 |
| Future Volume (veh/h) | 15 | 994 | 671 | 229 | 160 | 521 | 295 | 296 | 1069 | 151 | 291 | 712 |
| Initial Q (Qb), veh | | 0 | 0 | 0 | 0 | 0 | 0 | 0 | 0 | 0 | 0 | 0 |
| Ped-Bike Adj(A_pbT) | | 1.00 | | 1.00 | 1.00 | | 1.00 | 1.00 | | 1.00 | 1.00 | |
| Parking Bus, Adj | | 1.00 | 1.00 | 1.00 | 1.00 | 1.00 | 1.00 | 1.00 | 1.00 | 1.00 | 1.00 | 1.00 |
| Work Zone On Approach | | | No | | | No | | | No | | | No |
| Adj Sat Flow, veh/h/ln | | 1870 | 1870 | 1870 | 1870 | 1870 | 1870 | 1870 | 1870 | 1870 | 1870 | 1870 |
| Adj Flow Rate, veh/h | | 1046 | 706 | 0 | 168 | 548 | 0 | 312 | 1125 | 0 | 306 | 749 |
| Peak Hour Factor | | 0.95 | 0.95 | 0.95 | 0.95 | 0.95 | 0.95 | 0.95 | 0.95 | 0.95 | 0.95 | 0.95 |
| Percent Heavy Veh, % | | 2 | 2 | 2 | 2 | 2 | 2 | 2 | 2 | 2 | 2 | 2 |
| Cap, veh/h | | 878 | 1203 | | 226 | 533 | | 331 | 948 | | 274 | 888 |
| Arrive On Green | | 0.25 | 0.34 | 0.00 | 0.07 | 0.15 | 0.00 | 0.10 | 0.27 | 0.00 | 0.08 | 0.25 |
| Sat Flow, veh/h | | 3456 | 3554 | 1585 | 3456 | 3554 | 1585 | 3456 | 3554 | 1585 | 3456 | 3554 |
| Grp Volume(v), veh/h | | 1046 | 706 | 0 | 168 | 548 | 0 | 312 | 1125 | 0 | 306 | 749 |
| Grp Sat Flow(s),veh/h/ln | | 1728 | 1777 | 1585 | 1728 | 1777 | 1585 | 1728 | 1777 | 1585 | 1728 | 1777 |
| Q Serve(g_s), s | | 30.5 | 19.7 | 0.0 | 5.7 | 18.0 | 0.0 | 10.8 | 32.0 | 0.0 | 9.5 | 24.0 |
| Cycle Q Clear(g_c), s | | 30.5 | 19.7 | 0.0 | 5.7 | 18.0 | 0.0 | 10.8 | 32.0 | 0.0 | 9.5 | 24.0 |
| Prop In Lane | | 1.00 | | 1.00 | 1.00 | | 1.00 | 1.00 | | 1.00 | 1.00 | |
| Lane Grp Cap(c), veh/h | | 878 | 1203 | | 226 | 533 | | 331 | 948 | | 274 | 888 |
| V/C Ratio(X) | | 1.19 | 0.59 | | 0.74 | 1.03 | | 0.94 | 1.19 | | 1.12 | 0.84 |
| Avail Cap(c_a), veh/h | | 878 | 1203 | | 331 | 533 | | 331 | 948 | | 274 | 888 |
| HCM Platoon Ratio | | 1.00 | 1.00 | 1.00 | 1.00 | 1.00 | 1.00 | 1.00 | 1.00 | 1.00 | 1.00 | 1.00 |
| Upstream Filter(I) | | 1.00 | 1.00 | 0.00 | 1.00 | 1.00 | 0.00 | 1.00 | 1.00 | 0.00 | 1.00 | 1.00 |
| Uniform Delay (d), s/veh | | 44.8 | 32.7 | 0.0 | 55.1 | 51.0 | 0.0 | 53.9 | 44.0 | 0.0 | 55.3 | 42.8 |
| Incr Delay (d2), s/veh | | 97.2 | 2.1 | 0.0 | 5.0 | 46.3 | 0.0 | 34.6 | 94.9 | 0.0 | 90.1 | 7.4 |
| Initial Q Delay(d3),s/veh | | 0.0 | 0.0 | 0.0 | 0.0 | 0.0 | 0.0 | 0.0 | 0.0 | 0.0 | 0.0 | 0.0 |
| %ile BackOfQ(50%),veh/ln | | 24.4 | 8.5 | 0.0 | 2.6 | 11.2 | 0.0 | 6.2 | 26.3 | 0.0 | 7.5 | 11.3 |
| Unsig. Movement Delay, s/veh | | | | | | | | | | | | |
| LnGrp Delay(d),s/veh | | 142.0 | 34.8 | 0.0 | 60.1 | 97.3 | 0.0 | 88.5 | 138.9 | 0.0 | 145.3 | 50.2 |
| LnGrp LOS | | F | C | | E | F | | F | F | | F | D |
| Approach Vol, veh/h | | | 1752 | A | | 716 | A | | 1437 | A | | 1055 |
| Approach Delay, s/veh | | | 98.8 | | | 88.6 | | | 128.0 | | | 77.8 |
| Approach LOS | | | F | | | F | | | F | | | E |
| Timer - Assigned Phs | 1 | 2 | 3 | 4 | 5 | 6 | 7 | 8 | | | | |
| Phs Duration (G+Y+Rc), s | 15.4 | 47.6 | 20.0 | 37.0 | 38.0 | 25.0 | 18.0 | 39.0 | | | | |
| Change Period (Y+Rc), s | 7.5 | 7.0 | 8.5 | 7.0 | 7.5 | 7.0 | 8.5 | 7.0 | | | | |
| Max Green Setting (Gmax), s | 11.5 | 37.0 | 11.5 | 30.0 | 30.5 | 18.0 | 9.5 | 32.0 | | | | |
| Max Q Clear Time (g_c+I1), s | 7.7 | 21.7 | 12.8 | 26.0 | 32.5 | 20.0 | 11.5 | 34.0 | | | | |
| Green Ext Time (p_c), s | 0.2 | 3.9 | 0.0 | 1.8 | 0.0 | 0.0 | 0.0 | 0.0 | | | | |

Intersection Summary

| | |
|--------------------|-------|
| HCM 6th Ctrl Delay | 101.3 |
| HCM 6th LOS | F |

Notes

- User approved pedestrian interval to be less than phase max green.
- User approved ignoring U-Turning movement.
- Unsignalized Delay for [NBR, EBR, WBR, SBR] is excluded from calculations of the approach delay and intersection delay.




































HCM 6th Signalized Intersection Summary
 1: MERIDIAN ROAD & WOODMAN ROAD

Total PM 2040 Storage
 04/01/2023

| | |
|------------------------------|------|
| Movement | SBR |
| Lane Configurations | |
| Traffic Volume (veh/h) | 610 |
| Future Volume (veh/h) | 610 |
| Initial Q (Qb), veh | 0 |
| Ped-Bike Adj(A_pbT) | 1.00 |
| Parking Bus, Adj | 1.00 |
| Work Zone On Approach | |
| Adj Sat Flow, veh/h/ln | 1870 |
| Adj Flow Rate, veh/h | 0 |
| Peak Hour Factor | 0.95 |
| Percent Heavy Veh, % | 2 |
| Cap, veh/h | |
| Arrive On Green | 0.00 |
| Sat Flow, veh/h | 1585 |
| Grp Volume(v), veh/h | 0 |
| Grp Sat Flow(s),veh/h/ln | 1585 |
| Q Serve(g_s), s | 0.0 |
| Cycle Q Clear(g_c), s | 0.0 |
| Prop In Lane | 1.00 |
| Lane Grp Cap(c), veh/h | |
| V/C Ratio(X) | |
| Avail Cap(c_a), veh/h | |
| HCM Platoon Ratio | 1.00 |
| Upstream Filter(l) | 0.00 |
| Uniform Delay (d), s/veh | 0.0 |
| Incr Delay (d2), s/veh | 0.0 |
| Initial Q Delay(d3),s/veh | 0.0 |
| %ile BackOfQ(50%),veh/ln | 0.0 |
| Unsig. Movement Delay, s/veh | |
| LnGrp Delay(d),s/veh | 0.0 |
| LnGrp LOS | |
| Approach Vol, veh/h | A |
| Approach Delay, s/veh | |
| Approach LOS | |
| Timer - Assigned Phs | |

Timings
2: MERIDIAN ROAD & EASTONVILLE ROAD

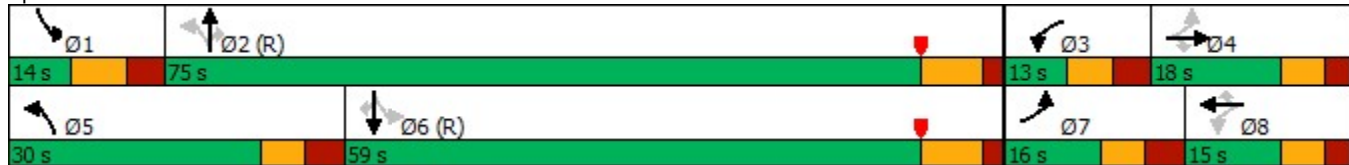
Total 2040 PM Storage
04/01/2023

| |  |  |  |  |  |  |  |  |  |  |  |  |
|----------------------|---|---|---|---|---|---|---|---|---|---|---|---|
| Lane Group | EBL | EBT | EBR | WBL | WBT | WBR | NBL | NBT | NBR | SBL | SBT | SBR |
| Lane Configurations |   |  |   |   |   |   |   |   |   |   |   |   |
| Traffic Volume (vph) | 330 | 146 | 284 | 44 | 100 | 190 | 371 | 1883 | 164 | 117 | 1263 | 174 |
| Future Volume (vph) | 330 | 146 | 284 | 44 | 100 | 190 | 371 | 1883 | 164 | 117 | 1263 | 174 |
| Turn Type | pm+pt | NA | Perm | pm+pt | NA | Perm | pm+pt | NA | Perm | pm+pt | NA | Perm |
| Protected Phases | 7 | 4 | | 3 | 8 | | 5 | 2 | | 1 | 6 | |
| Permitted Phases | 4 | | 4 | 8 | | 8 | 2 | | 2 | 6 | | 6 |
| Detector Phase | 7 | 4 | 4 | 3 | 8 | 8 | 5 | 2 | 2 | 1 | 6 | 6 |
| Switch Phase | | | | | | | | | | | | |
| Minimum Initial (s) | 5.0 | 8.0 | 8.0 | 5.0 | 8.0 | 8.0 | 5.0 | 15.0 | 15.0 | 5.0 | 15.0 | 15.0 |
| Minimum Split (s) | 12.5 | 14.5 | 14.5 | 12.5 | 14.5 | 14.5 | 12.5 | 25.5 | 25.5 | 13.5 | 25.5 | 25.5 |
| Total Split (s) | 16.0 | 18.0 | 18.0 | 13.0 | 15.0 | 15.0 | 30.0 | 75.0 | 75.0 | 14.0 | 59.0 | 59.0 |
| Total Split (%) | 13.3% | 15.0% | 15.0% | 10.8% | 12.5% | 12.5% | 25.0% | 62.5% | 62.5% | 11.7% | 49.2% | 49.2% |
| Yellow Time (s) | 4.0 | 4.0 | 4.0 | 4.0 | 4.0 | 4.0 | 4.0 | 5.5 | 5.5 | 5.0 | 5.5 | 5.5 |
| All-Red Time (s) | 3.5 | 2.5 | 2.5 | 3.5 | 2.5 | 2.5 | 3.5 | 2.0 | 2.0 | 3.5 | 2.0 | 2.0 |
| Lost Time Adjust (s) | 0.0 | 0.0 | 0.0 | 0.0 | 0.0 | 0.0 | 0.0 | 0.0 | 0.0 | 0.0 | 0.0 | 0.0 |
| Total Lost Time (s) | 7.5 | 6.5 | 6.5 | 7.5 | 6.5 | 6.5 | 7.5 | 7.5 | 7.5 | 8.5 | 7.5 | 7.5 |
| Lead/Lag | Lead | Lag | Lag | Lead | Lag | Lag | Lead | Lag | Lag | Lead | Lag | Lag |
| Lead-Lag Optimize? | Yes | Yes | Yes | Yes | Yes | Yes | Yes | Yes | Yes | Yes | Yes | Yes |
| Recall Mode | None | None | None | None | None | None | None | C-Max | C-Max | None | C-Max | C-Max |
| Act Effct Green (s) | 19.9 | 14.1 | 14.1 | 13.0 | 8.5 | 8.5 | 81.5 | 67.5 | 67.5 | 56.0 | 51.5 | 51.5 |
| Actuated g/C Ratio | 0.17 | 0.12 | 0.12 | 0.11 | 0.07 | 0.07 | 0.68 | 0.56 | 0.56 | 0.47 | 0.43 | 0.43 |
| v/c Ratio | 0.86 | 0.71 | 0.71 | 0.29 | 0.80 | 0.57 | 0.99 | 1.00 | 0.18 | 0.86 | 0.88 | 0.22 |
| Control Delay | 65.7 | 70.5 | 18.8 | 45.5 | 94.2 | 9.0 | 66.7 | 20.5 | 1.1 | 69.0 | 44.0 | 7.2 |
| Queue Delay | 0.0 | 0.0 | 0.0 | 0.0 | 0.0 | 0.0 | 0.0 | 0.0 | 0.0 | 0.0 | 0.0 | 0.0 |
| Total Delay | 65.7 | 70.5 | 18.8 | 45.5 | 94.2 | 9.0 | 66.7 | 20.5 | 1.1 | 69.0 | 44.0 | 7.2 |
| LOS | E | E | B | D | F | A | E | C | A | E | D | A |
| Approach Delay | 49.1 | | | | 39.3 | | 26.3 | | | | 41.7 | |
| Approach LOS | D | | | | D | | C | | | | D | |

Intersection Summary

Cycle Length: 120
 Actuated Cycle Length: 120
 Offset: 89 (74%), Referenced to phase 2:NBTL and 6:SBTL, Start of Yellow
 Natural Cycle: 110
 Control Type: Actuated-Coordinated
 Maximum v/c Ratio: 1.00
 Intersection Signal Delay: 35.3 Intersection LOS: D
 Intersection Capacity Utilization 98.8% ICU Level of Service F
 Analysis Period (min) 15

Splits and Phases: 2: MERIDIAN ROAD & EASTONVILLE ROAD



Queues
2: MERIDIAN ROAD & EASTONVILLE ROAD

Total 2040 PM Storage
04/01/2023



| Lane Group | EBL | EBT | EBR | WBL | WBT | WBR | NBL | NBT | NBR | SBL | SBT | SBR |
|-------------------------|------|------|------|------|------|------|------|------|------|-------|------|------|
| Lane Group Flow (vph) | 347 | 154 | 299 | 46 | 105 | 200 | 391 | 1982 | 173 | 123 | 1329 | 183 |
| v/c Ratio | 0.86 | 0.71 | 0.71 | 0.29 | 0.80 | 0.57 | 0.99 | 1.00 | 0.18 | 0.86 | 0.88 | 0.22 |
| Control Delay | 65.7 | 70.5 | 18.8 | 45.5 | 94.2 | 9.0 | 66.7 | 20.5 | 1.1 | 69.0 | 44.0 | 7.2 |
| Queue Delay | 0.0 | 0.0 | 0.0 | 0.0 | 0.0 | 0.0 | 0.0 | 0.0 | 0.0 | 0.0 | 0.0 | 0.0 |
| Total Delay | 65.7 | 70.5 | 18.8 | 45.5 | 94.2 | 9.0 | 66.7 | 20.5 | 1.1 | 69.0 | 44.0 | 7.2 |
| Queue Length 50th (ft) | 125 | 120 | 21 | 30 | 82 | 0 | 271 | 615 | 5 | 33 | 574 | 32 |
| Queue Length 95th (ft) | #207 | #241 | #139 | 64 | #179 | 29 | m239 | m185 | m4 | m#140 | 649 | 80 |
| Internal Link Dist (ft) | | 508 | | | 1196 | | | 231 | | | | 781 |
| Turn Bay Length (ft) | 100 | | 100 | 120 | | 100 | 100 | | 400 | 375 | | 400 |
| Base Capacity (vph) | 405 | 218 | 424 | 157 | 131 | 349 | 395 | 1990 | 967 | 143 | 1518 | 819 |
| Starvation Cap Reductn | 0 | 0 | 0 | 0 | 0 | 0 | 0 | 0 | 0 | 0 | 0 | 0 |
| Spillback Cap Reductn | 0 | 0 | 0 | 0 | 0 | 0 | 0 | 0 | 0 | 0 | 0 | 0 |
| Storage Cap Reductn | 0 | 0 | 0 | 0 | 0 | 0 | 0 | 0 | 0 | 0 | 0 | 0 |
| Reduced v/c Ratio | 0.86 | 0.71 | 0.71 | 0.29 | 0.80 | 0.57 | 0.99 | 1.00 | 0.18 | 0.86 | 0.88 | 0.22 |

Intersection Summary

- # 95th percentile volume exceeds capacity, queue may be longer.
Queue shown is maximum after two cycles.
- m Volume for 95th percentile queue is metered by upstream signal.

HCM 6th Signalized Intersection Summary
2: MERIDIAN ROAD & EASTONVILLE ROAD

Total 2040 PM Storage
04/01/2023



| Movement | EBL | EBT | EBR | WBL | WBT | WBR | NBL | NBT | NBR | SBL | SBT | SBR |
|------------------------------|------|------|------|------|------|------|------|------|------|------|------|------|
| Lane Configurations | ↔↔ | ↑ | ↔ | ↔ | ↑ | ↔ | ↔ | ↑↑ | ↔ | ↔ | ↑↑ | ↔ |
| Traffic Volume (veh/h) | 330 | 146 | 284 | 44 | 100 | 190 | 371 | 1883 | 164 | 117 | 1263 | 174 |
| Future Volume (veh/h) | 330 | 146 | 284 | 44 | 100 | 190 | 371 | 1883 | 164 | 117 | 1263 | 174 |
| Initial Q (Qb), veh | 0 | 0 | 0 | 0 | 0 | 0 | 0 | 0 | 0 | 0 | 0 | 0 |
| Ped-Bike Adj(A_pbT) | 1.00 | | 1.00 | 1.00 | | 1.00 | 1.00 | | 1.00 | 1.00 | | 1.00 |
| Parking Bus, Adj | 1.00 | 1.00 | 1.00 | 1.00 | 1.00 | 1.00 | 1.00 | 1.00 | 1.00 | 1.00 | 1.00 | 1.00 |
| Work Zone On Approach | | No | | | No | | | No | | | No | |
| Adj Sat Flow, veh/h/ln | 1870 | 1870 | 1870 | 1870 | 1870 | 1870 | 1870 | 1870 | 1870 | 1870 | 1870 | 1870 |
| Adj Flow Rate, veh/h | 347 | 154 | 0 | 46 | 105 | 0 | 391 | 1982 | 173 | 123 | 1329 | 183 |
| Peak Hour Factor | 0.95 | 0.95 | 0.95 | 0.95 | 0.95 | 0.95 | 0.95 | 0.95 | 0.95 | 0.95 | 0.95 | 0.95 |
| Percent Heavy Veh, % | 2 | 2 | 2 | 2 | 2 | 2 | 2 | 2 | 2 | 2 | 2 | 2 |
| Cap, veh/h | 404 | 204 | | 154 | 132 | | 416 | 1999 | 892 | 144 | 1550 | 691 |
| Arrive On Green | 0.07 | 0.11 | 0.00 | 0.03 | 0.07 | 0.00 | 0.18 | 0.56 | 0.56 | 0.05 | 0.44 | 0.44 |
| Sat Flow, veh/h | 3456 | 1870 | 1585 | 1781 | 1870 | 1585 | 1781 | 3554 | 1585 | 1781 | 3554 | 1585 |
| Grp Volume(v), veh/h | 347 | 154 | 0 | 46 | 105 | 0 | 391 | 1982 | 173 | 123 | 1329 | 183 |
| Grp Sat Flow(s),veh/h/ln | 1728 | 1870 | 1585 | 1781 | 1870 | 1585 | 1781 | 1777 | 1585 | 1781 | 1777 | 1585 |
| Q Serve(g_s), s | 8.5 | 9.6 | 0.0 | 2.9 | 6.6 | 0.0 | 19.5 | 66.2 | 6.4 | 4.6 | 40.4 | 8.8 |
| Cycle Q Clear(g_c), s | 8.5 | 9.6 | 0.0 | 2.9 | 6.6 | 0.0 | 19.5 | 66.2 | 6.4 | 4.6 | 40.4 | 8.8 |
| Prop In Lane | 1.00 | | 1.00 | 1.00 | | 1.00 | 1.00 | | 1.00 | 1.00 | | 1.00 |
| Lane Grp Cap(c), veh/h | 404 | 204 | | 154 | 132 | | 416 | 1999 | 892 | 144 | 1550 | 691 |
| V/C Ratio(X) | 0.86 | 0.76 | | 0.30 | 0.79 | | 0.94 | 0.99 | 0.19 | 0.86 | 0.86 | 0.26 |
| Avail Cap(c_a), veh/h | 404 | 204 | | 177 | 132 | | 428 | 1999 | 892 | 144 | 1550 | 691 |
| HCM Platoon Ratio | 1.00 | 1.00 | 1.00 | 1.00 | 1.00 | 1.00 | 1.00 | 1.00 | 1.00 | 1.00 | 1.00 | 1.00 |
| Upstream Filter(I) | 1.00 | 1.00 | 0.00 | 1.00 | 1.00 | 0.00 | 1.00 | 1.00 | 1.00 | 1.00 | 1.00 | 1.00 |
| Uniform Delay (d), s/veh | 50.9 | 51.9 | 0.0 | 49.6 | 54.9 | 0.0 | 34.8 | 26.0 | 12.9 | 28.7 | 30.5 | 21.6 |
| Incr Delay (d2), s/veh | 16.8 | 14.8 | 0.0 | 1.1 | 27.1 | 0.0 | 28.6 | 18.2 | 0.5 | 36.9 | 6.3 | 0.9 |
| Initial Q Delay(d3),s/veh | 0.0 | 0.0 | 0.0 | 0.0 | 0.0 | 0.0 | 0.0 | 0.0 | 0.0 | 0.0 | 0.0 | 0.0 |
| %ile BackOfQ(50%),veh/ln | 2.1 | 5.3 | 0.0 | 1.3 | 4.1 | 0.0 | 14.1 | 28.7 | 2.4 | 3.2 | 17.1 | 3.5 |
| Unsig. Movement Delay, s/veh | | | | | | | | | | | | |
| LnGrp Delay(d),s/veh | 67.7 | 66.7 | 0.0 | 50.7 | 82.0 | 0.0 | 63.3 | 44.2 | 13.4 | 65.6 | 36.8 | 22.5 |
| LnGrp LOS | E | E | | D | F | | E | D | B | E | D | C |
| Approach Vol, veh/h | | 501 | A | | 151 | A | | 2546 | | | 1635 | |
| Approach Delay, s/veh | | 67.4 | | | 72.5 | | | 45.0 | | | 37.4 | |
| Approach LOS | | E | | | E | | | D | | | D | |
| Timer - Assigned Phs | 1 | 2 | 3 | 4 | 5 | 6 | 7 | 8 | | | | |
| Phs Duration (G+Y+Rc), s | 14.0 | 75.0 | 11.4 | 19.6 | 29.2 | 59.8 | 16.0 | 15.0 | | | | |
| Change Period (Y+Rc), s | 8.5 | 7.5 | 7.5 | 6.5 | 7.5 | 7.5 | 7.5 | 6.5 | | | | |
| Max Green Setting (Gmax), s | 5.5 | 67.5 | 5.5 | 11.5 | 22.5 | 51.5 | 8.5 | 8.5 | | | | |
| Max Q Clear Time (g_c+I1), s | 6.6 | 68.2 | 4.9 | 11.6 | 21.5 | 42.4 | 10.5 | 8.6 | | | | |
| Green Ext Time (p_c), s | 0.0 | 0.0 | 0.0 | 0.0 | 0.1 | 5.6 | 0.0 | 0.0 | | | | |

Intersection Summary

| | |
|--------------------|------|
| HCM 6th Ctrl Delay | 45.6 |
| HCM 6th LOS | D |

Notes

User approved pedestrian interval to be less than phase max green.
Unsignalized Delay for [EBR, WBR] is excluded from calculations of the approach delay and intersection delay.

Timings
3: MERIDIAN ROAD & BENT GRASS MEADOWS DRIVE

Total PM 2040 Storage
 04/01/2023

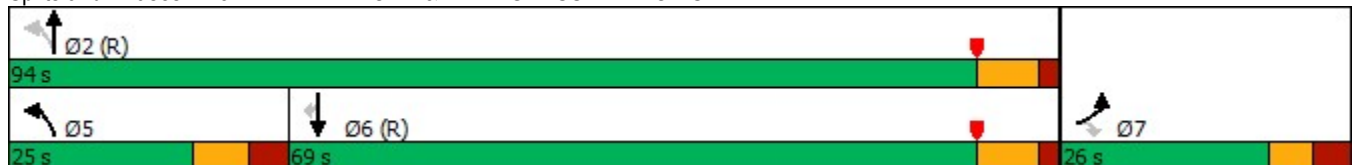


| Lane Group | EBL | EBR | NBL | NBT | SBT | SBR |
|----------------------|-------|-------|-------|-------|-------|-------|
| Lane Configurations | ↖↖ | ↗ | ↖ | ↑↑ | ↑↑ | ↗ |
| Traffic Volume (vph) | 133 | 164 | 167 | 2174 | 1340 | 173 |
| Future Volume (vph) | 133 | 164 | 167 | 2174 | 1340 | 173 |
| Turn Type | Prot | Perm | pm+pt | NA | NA | Perm |
| Protected Phases | 7 | | 5 | 2 | 6 | |
| Permitted Phases | | 7 | 2 | | | 6 |
| Detector Phase | 7 | 7 | 5 | 2 | 6 | 6 |
| Switch Phase | | | | | | |
| Minimum Initial (s) | 8.0 | 8.0 | 5.0 | 15.0 | 15.0 | 15.0 |
| Minimum Split (s) | 25.5 | 25.5 | 13.5 | 25.5 | 25.5 | 25.5 |
| Total Split (s) | 26.0 | 26.0 | 25.0 | 94.0 | 69.0 | 69.0 |
| Total Split (%) | 21.7% | 21.7% | 20.8% | 78.3% | 57.5% | 57.5% |
| Yellow Time (s) | 4.0 | 4.0 | 5.0 | 5.5 | 5.5 | 5.5 |
| All-Red Time (s) | 3.5 | 3.5 | 3.5 | 2.0 | 2.0 | 2.0 |
| Lost Time Adjust (s) | 0.0 | 0.0 | 0.0 | 0.0 | 0.0 | 0.0 |
| Total Lost Time (s) | 7.5 | 7.5 | 8.5 | 7.5 | 7.5 | 7.5 |
| Lead/Lag | | | Lead | | Lag | Lag |
| Lead-Lag Optimize? | | | Yes | | Yes | Yes |
| Recall Mode | None | None | None | C-Max | C-Max | C-Max |
| Act Effct Green (s) | 10.4 | 10.4 | 93.6 | 94.6 | 75.2 | 75.2 |
| Actuated g/C Ratio | 0.09 | 0.09 | 0.78 | 0.79 | 0.63 | 0.63 |
| v/c Ratio | 0.47 | 0.59 | 0.57 | 0.82 | 0.64 | 0.17 |
| Control Delay | 57.2 | 16.0 | 20.5 | 5.8 | 16.5 | 2.1 |
| Queue Delay | 0.0 | 0.0 | 0.0 | 0.0 | 0.0 | 0.0 |
| Total Delay | 57.2 | 16.0 | 20.5 | 5.8 | 16.5 | 2.1 |
| LOS | E | B | C | A | B | A |
| Approach Delay | 34.4 | | | 6.9 | 14.9 | |
| Approach LOS | C | | | A | B | |

Intersection Summary

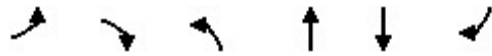
Cycle Length: 120
 Actuated Cycle Length: 120
 Offset: 27 (23%), Referenced to phase 2:NBTL and 6:SBT, Start of Yellow
 Natural Cycle: 90
 Control Type: Actuated-Coordinated
 Maximum v/c Ratio: 0.82
 Intersection Signal Delay: 11.8
 Intersection Capacity Utilization 79.3%
 Analysis Period (min) 15
 Intersection LOS: B
 ICU Level of Service D

Splits and Phases: 3: MERIDIAN ROAD & BENT GRASS MEADOWS DRIVE



3: MERIDIAN ROAD & BENT GRASS MEADOWS DRIVE

04/01/2023



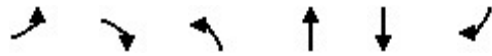
| Lane Group | EBL | EBR | NBL | NBT | SBT | SBR |
|-------------------------|------|------|------|------|------|------|
| Lane Group Flow (vph) | 140 | 173 | 176 | 2288 | 1411 | 182 |
| v/c Ratio | 0.47 | 0.59 | 0.57 | 0.82 | 0.64 | 0.17 |
| Control Delay | 57.2 | 16.0 | 20.5 | 5.8 | 16.5 | 2.1 |
| Queue Delay | 0.0 | 0.0 | 0.0 | 0.0 | 0.0 | 0.0 |
| Total Delay | 57.2 | 16.0 | 20.5 | 5.8 | 16.5 | 2.1 |
| Queue Length 50th (ft) | 54 | 0 | 39 | 123 | 325 | 0 |
| Queue Length 95th (ft) | 85 | 67 | m43 | m137 | 495 | 32 |
| Internal Link Dist (ft) | 310 | | | 750 | 1921 | |
| Turn Bay Length (ft) | 150 | | 700 | | | 350 |
| Base Capacity (vph) | 529 | 390 | 383 | 2791 | 2219 | 1060 |
| Starvation Cap Reductn | 0 | 0 | 0 | 0 | 0 | 0 |
| Spillback Cap Reductn | 0 | 0 | 0 | 0 | 0 | 0 |
| Storage Cap Reductn | 0 | 0 | 0 | 0 | 0 | 0 |
| Reduced v/c Ratio | 0.26 | 0.44 | 0.46 | 0.82 | 0.64 | 0.17 |

Intersection Summary

m Volume for 95th percentile queue is metered by upstream signal.

HCM 6th Signalized Intersection Summary
 3: MERIDIAN ROAD & BENT GRASS MEADOWS DRIVE

Total PM 2040 Storage
 04/01/2023



| Movement | EBL | EBR | NBL | NBT | SBT | SBR |
|--|------|-------|------|------|------|------|
| Lane Configurations | ↖↗ | ↗ | ↖ | ↑↑ | ↑↑ | ↗ |
| Traffic Volume (veh/h) | 133 | 164 | 167 | 2174 | 1340 | 173 |
| Future Volume (veh/h) | 133 | 164 | 167 | 2174 | 1340 | 173 |
| Initial Q (Qb), veh | 0 | 0 | 0 | 0 | 0 | 0 |
| Ped-Bike Adj(A_pbT) | 1.00 | 1.00 | 1.00 | | | 1.00 |
| Parking Bus, Adj | 1.00 | 1.00 | 1.00 | 1.00 | 1.00 | 1.00 |
| Work Zone On Approach | No | | | No | No | |
| Adj Sat Flow, veh/h/ln | 1870 | 1870 | 1870 | 1870 | 1870 | 1870 |
| Adj Flow Rate, veh/h | 140 | 0 | 176 | 2288 | 1411 | 182 |
| Peak Hour Factor | 0.95 | 0.95 | 0.95 | 0.95 | 0.95 | 0.95 |
| Percent Heavy Veh, % | 2 | 2 | 2 | 2 | 2 | 2 |
| Cap, veh/h | 228 | | 299 | 2875 | 2459 | 1097 |
| Arrive On Green | 0.07 | 0.00 | 0.05 | 0.81 | 0.69 | 0.69 |
| Sat Flow, veh/h | 3456 | 1585 | 1781 | 3647 | 3647 | 1585 |
| Grp Volume(v), veh/h | 140 | 0 | 176 | 2288 | 1411 | 182 |
| Grp Sat Flow(s),veh/h/ln | 1728 | 1585 | 1781 | 1777 | 1777 | 1585 |
| Q Serve(g_s), s | 4.7 | 0.0 | 3.2 | 41.4 | 24.4 | 4.8 |
| Cycle Q Clear(g_c), s | 4.7 | 0.0 | 3.2 | 41.4 | 24.4 | 4.8 |
| Prop In Lane | 1.00 | 1.00 | 1.00 | | | 1.00 |
| Lane Grp Cap(c), veh/h | 228 | | 299 | 2875 | 2459 | 1097 |
| V/C Ratio(X) | 0.61 | | 0.59 | 0.80 | 0.57 | 0.17 |
| Avail Cap(c_a), veh/h | 533 | | 461 | 2875 | 2459 | 1097 |
| HCM Platoon Ratio | 1.00 | 1.00 | 1.00 | 1.00 | 1.00 | 1.00 |
| Upstream Filter(I) | 1.00 | 0.00 | 1.00 | 1.00 | 1.00 | 1.00 |
| Uniform Delay (d), s/veh | 54.5 | 0.0 | 10.4 | 6.1 | 9.4 | 6.4 |
| Incr Delay (d2), s/veh | 2.7 | 0.0 | 1.8 | 2.4 | 1.0 | 0.3 |
| Initial Q Delay(d3),s/veh | 0.0 | 0.0 | 0.0 | 0.0 | 0.0 | 0.0 |
| %ile BackOfQ(50%),veh/ln | 2.1 | 0.0 | 1.9 | 12.2 | 9.0 | 8.0 |
| Unsig. Movement Delay, s/veh | | | | | | |
| LnGrp Delay(d),s/veh | 57.2 | 0.0 | 12.3 | 8.5 | 10.4 | 6.8 |
| LnGrp LOS | E | | B | A | B | A |
| Approach Vol, veh/h | 140 | A | | 2464 | 1593 | |
| Approach Delay, s/veh | 57.2 | | | 8.8 | 10.0 | |
| Approach LOS | E | | | A | B | |
| Timer - Assigned Phs | | 2 | | 4 | 5 | 6 |
| Phs Duration (G+Y+Rc), s | | 104.6 | | 15.4 | 14.1 | 90.5 |
| Change Period (Y+Rc), s | | 7.5 | | 7.5 | 8.5 | 7.5 |
| Max Green Setting (Gmax), s | | 86.5 | | 18.5 | 16.5 | 61.5 |
| Max Q Clear Time (g_c+I1), s | | 43.4 | | 6.7 | 5.2 | 26.4 |
| Green Ext Time (p_c), s | | 32.2 | | 0.3 | 0.3 | 15.6 |
| Intersection Summary | | | | | | |
| HCM 6th Ctrl Delay | | | 10.9 | | | |
| HCM 6th LOS | | | B | | | |
| Notes | | | | | | |
| Unsignalized Delay for [EBR] is excluded from calculations of the approach delay and intersection delay. | | | | | | |

| Intersection | | | | | | |
|--------------------------|------|------|------|------|------|------|
| Int Delay, s/veh | 4 | | | | | |
| Movement | EBT | EBR | WBL | WBT | NBL | NBR |
| Lane Configurations | ↑ | ↗ | ↘ | ↑ | ↘ | ↗ |
| Traffic Vol, veh/h | 139 | 57 | 151 | 189 | 3 | 158 |
| Future Vol, veh/h | 139 | 57 | 151 | 189 | 3 | 158 |
| Conflicting Peds, #/hr | 0 | 0 | 0 | 0 | 0 | 0 |
| Sign Control | Free | Free | Free | Free | Stop | Stop |
| RT Channelized | - | None | - | None | - | None |
| Storage Length | - | 150 | 100 | - | 0 | - |
| Veh in Median Storage, # | 0 | - | - | 0 | 0 | - |
| Grade, % | 0 | - | - | 0 | 0 | - |
| Peak Hour Factor | 95 | 95 | 95 | 95 | 95 | 95 |
| Heavy Vehicles, % | 2 | 2 | 2 | 2 | 2 | 2 |
| Mvmt Flow | 146 | 60 | 159 | 199 | 3 | 166 |

| Major/Minor | Major1 | Major2 | Minor1 | | |
|----------------------|--------|--------|--------|---|-------------|
| Conflicting Flow All | 0 | 0 | 206 | 0 | 663 146 |
| Stage 1 | - | - | - | - | 146 - |
| Stage 2 | - | - | - | - | 517 - |
| Critical Hdwy | - | - | 4.12 | - | 6.42 6.22 |
| Critical Hdwy Stg 1 | - | - | - | - | 5.42 - |
| Critical Hdwy Stg 2 | - | - | - | - | 5.42 - |
| Follow-up Hdwy | - | - | 2.218 | - | 3.518 3.318 |
| Pot Cap-1 Maneuver | - | - | 1365 | - | 426 901 |
| Stage 1 | - | - | - | - | 881 - |
| Stage 2 | - | - | - | - | 598 - |
| Platoon blocked, % | - | - | - | - | - |
| Mov Cap-1 Maneuver | - | - | 1365 | - | 377 901 |
| Mov Cap-2 Maneuver | - | - | - | - | 377 - |
| Stage 1 | - | - | - | - | 881 - |
| Stage 2 | - | - | - | - | 529 - |

| Approach | EB | WB | NB |
|----------------------|----|-----|------|
| HCM Control Delay, s | 0 | 3.5 | 10.1 |
| HCM LOS | | | B |

| Minor Lane/Major Mvmt | NBLn1 | EBT | EBR | WBL | WBT |
|-----------------------|-------|-----|-----|-------|-----|
| Capacity (veh/h) | 878 | - | - | 1365 | - |
| HCM Lane V/C Ratio | 0.193 | - | - | 0.116 | - |
| HCM Control Delay (s) | 10.1 | - | - | 8 | - |
| HCM Lane LOS | B | - | - | A | - |
| HCM 95th %tile Q(veh) | 0.7 | - | - | 0.4 | - |

Total PM 2040 Storage

