



# TRAFFIC IMPACT STUDY

## OWL PLACE STORAGE TRAFFIC IMPACT STUDY

El Paso County, Colorado

Please refer to rezone project CS224 for comments regarding this traffic study for the rezone application.

GALLOWAY  
RESPONSE

REZONE NOW APPROVED. INCLUDED SIGNED TIS COPY WITH REQUESTED ACCESS DESIGN FOR STACKING/QUEING AND TURN RADIUS.

A separate traffic memo analyzing the proposed access points (two on lot 1 and one on lot 2 per the CD's) for this site shall be submitted with this final plat application in order to not hold up the rezone project. Refer to ECM 2.4 for access design criteria.

The Traffic memo shall analyze and state whether any aux. turn lanes or TWLT striping is recommended/proposed along Meridian park drive for turn movements into the two proposed lots. Provide recommendations for the proposed gate locations to ensure sufficient queuing without blocking Meridian Park Drive. Additionally, provide recommendations for curb return radius providing the appropriate Autoturn analysis for the design vehicles for the RV/boat storage access.



**Traffic Engineer's Statement**

The attached traffic report and supporting information were prepared under my responsible charge and they comport with the standard of care. So far as is consistent with the standard of care, said report was prepared in general conformance with the criteria established by the County for traffic reports.

Max Rusch	4/21/2023
_____ <i>Max Rusch, P.E. PTOE #55895</i>	_____ Date

**Developer's Statement**

I, the Developer, have read and will comply with all commitments made on my behalf within this report.

_____ <i>Mike Texer</i> <i>Meridian Storage, LLC</i> <i>11750 Owl Place Peyton,</i> <i>CO 80831</i>	_____ <i>Date</i>
---	----------------------

## TABLE OF CONTENTS

Executive Summary .....	6
Site Location and Study Area .....	6
Conclusions and Recommendations .....	6
Conclusions .....	6
Recommendations .....	7
I. Introduction .....	8
Overview .....	8
Site Location and Study Area .....	8
Site Description and Access .....	9
Figure 1-1 Site Location .....	10
Figure 1-2 Site Plan .....	11
Figure 1-3 Zoning .....	12
II. Background Information .....	13
Study Area .....	13
Study Assumptions .....	13
Study Methodology .....	13
Existing Roadway Network .....	13
Figure 2-1 Existing Lane Use and Traffic Control .....	15
III. Analysis of Existing Conditions .....	16
Traffic Volumes .....	16
Existing Operational Analysis .....	16
Existing Intersection Queues .....	17
Figure 3-1 Existing 2022 Volumes .....	18
Figure 3-2 Existing 2022 Levels of Service .....	19
Table 3-1 Existing 2022 Levels of Service .....	20
Table 3-2 Existing 2022 Queues .....	21
IV. Analysis of Background 2024 & 2040 Conditions .....	22
Methodology .....	22
Roadway Improvements .....	22
Regional Growth .....	22
Pipeline Developments .....	22
Background 2024 & 2040 Traffic Forecasts .....	23
Background 2024 & 2040 Levels of Service .....	23

Background 2024 & 2040 Intersection Queues .....	24
Background 2024 & 2040 Recommended Mitigation .....	25
Figure 4-1 Background Lane Use and Traffic Control .....	26
Figure 4-2 Owl PI Rerouted Trips .....	27
Figure 4-3 Background 2024 Growth.....	28
Figure 4-4 Background 2040 Growth.....	29
Figure 4-5 Pipeline Locations .....	30
Figure 4-6 Owl Place Commercial Pipeline Trip Distribution .....	31
Figure 4-7 Falcon Marketplace Pipeline Trip Distribution (2024) .....	32
Figure 4-8 Falcon Marketplace Pipeline Trip Distribution (2040) .....	33
Figure 4-9 Falcon Meadows at Bent Grass Pipeline Trip Distribution .....	34
Figure 4-10 Background 2024 Forecasts .....	35
Figure 4-11 Background 2040 Forecasts .....	36
Figure 4-12 Background 2024 Level of Service.....	37
Figure 4-13 Background 2040 Level of Service.....	38
Table 4-1 Background 2024 & 2040 Levels of Service.....	39
Table 4-2 Background 2024 & 2040 Queues .....	40
V. Site Analysis .....	41
Overview .....	41
Proposed Site Access .....	41
Trip Generation .....	41
Figure 5-1 Proposed Development (Warehouse) Site Trips.....	42
Figure 5-2 Maximum Trip Generator (Shopping Plaza) Site Trips .....	43
Table 5-1 Site Trip Generation.....	44
VI. Analysis of Total 2024 & 2040 Conditions (Proposed Development) .....	45
Total 2024 & 2040 Traffic Forecasts.....	45
Total 2024 & 2040 Levels of Service .....	45
Total 2024 & 2040 Intersection Queues .....	46
Total 2024 & 2040 Recommended Mitigation.....	46
Figure 6-1 Total 2024 Forecasts.....	47
Figure 6-2 Total 2040 Forecasts.....	48
Figure 6-3 Total 2024 LOS .....	49
Figure 6-4 Total 2040 LOS .....	50
Table 6-1 Total 2024 & 2040 Levels of Service .....	51
Table 6-2 Total 2024 & 2040 Queues.....	52



VII. Analysis of Total 2024 & 2040 Conditions (Maximum Trip Generator) .....	53
Total 2024 & 2040 Traffic Forecasts .....	53
Total 2024 & 2040 Levels of Service .....	53
Total 2024 & 2040 Intersection Queues .....	54
Total 2024 & 2040 Recommended Mitigation.....	54
Figure 7-1 Total 2024 Forecasts (Max Trip Generator).....	55
Figure 7-2 Total 2040 Forecasts (Max Trip Generator).....	56
Figure 7-3 Total 2024 LOS (Max Trip Generator).....	57
Figure 7-4 Total 2040 LOS (Max Trip Generator).....	58
Table 7-1 Total 2024 & 2040 Levels of Service (Max Trip Generator) .....	59
Table 7-2 Total 2024 & 2040 Queues (Max Trip Generator).....	60
VIII. Pedestrian and Bicycle Connectivity .....	61
IX. Conclusions and Recommendations .....	61
Conclusions .....	61
Recommendations .....	62

Appendices:

- A. Full Sized Site Plan
- B. LOS Descriptions
- C. Traffic Counts
- D. Existing Synchro Outputs
- E. Pipeline TIS Excerpts
- F. Background 2024 & 2040 (without site development) Synchro Outputs
- G. Total 2024 & 2040 (with site development) Synchro Outputs

## Executive Summary

This traffic impact study (TIS) analyzes the impact that the proposed Owl Place Storage development in El Paso County, CO will have on traffic operations at the intersections proximate to the site and determines whether any additional improvements are needed to accommodate the development through the study area. The effects of the several other nearby pipeline developments, as well as background growth, were incorporated into the future analysis.

## Site Location and Study Area

The Applicant, Meridian Storage, proposes to develop the site with 158 self-storage units as well as 96 RV/Boat storage spaces. Since the site will be rezoned, El Paso County has requested that the maximum trip generating land use allowed on the rezoned area be analyzed as well. As such, this study will analyze a scenario in which a 133,294 SF shopping plaza has been developed, although it should be noted that the developer has no intention of developing this higher trip generating option.

The site is bound by Eastonville Rd to the south, Meridian Road to the east, and property lines to the north and west, as detailed in Figure 1-1. The study area for the project includes the following intersections that may see impacts to traffic operations as a result of the proposed development:

- Woodman Rd & Meridian Rd
- Meridian Rd & Eastonville Rd
- Meridian Rd & Owl Pl
- Meridian Rd & Bent Grass Meadows Dr
- Bent Grass Meadows Dr & Meridian Park Dr

## Conclusions and Recommendations

### Conclusions

Based on the results of this traffic impact study, the following may be concluded:

- Under existing conditions, the signalized intersections operate at LOS D or better. The intersection of Meridian Rd & Eastonville Rd was modeled as a three-legged stop-control intersection and is shown to fail during both peak time periods. Several of the thru queues will block adjacent turn lanes.
- In the background 2024 scenario, all intersections operate at LOS D or better. Queueing remains similar to the existing scenario, however, many of the queues at Meridian Rd & Eastonville Rd are shown to exceed their respective storage lengths.
- In the background 2040 scenario, Woodmen Rd & Meridian Rd will operate at LOS F in the PM peak and Meridian Rd & Eastonville Rd will operate at LOS E in the AM peak. The remaining intersections will operate acceptably. The forecasted ADTs along Meridian Rd will exceed the El Paso County Roadway ADT Threshold Capacity. Many of the queues will exceed their respective storage lengths by 2040.
- The proposed warehouse development will generate 3 weekday AM and 4 weekday PM peak hour vehicle trips as well as 46 weekday daily trips.

- The total scenarios in which the warehouse has been built will have very similar operations to the background scenarios. As such, it is not the responsibility of the developer to mitigate the failing traffic operations since these are problems expected to occur regardless of whether the site is developed.
- As requested by El Paso County, the maximum trip generator allowed on a site zoned as Commercial Service was analyzed. This was found to be a 133,294 SF shopping plaza. In this scenario, the shopping plaza would generate 471 weekday AM and 1,141 weekday PM peak hour vehicle trips as well as 11,671 weekday daily trips.
- The total 2024 scenario where the maximum trip generator was assumed instead of the proposed warehouse shows an increase in intersection delay. The intersection of Woodmen Rd & Meridian Rd will fail in the PM peak hour and the intersection of Meridian Rd & Eastonville Rd will operate at LOS E. The ADT along the southern portion of Meridian Rd is forecasted to exceed the El Paso County Roadway ADT Threshold Capacity while the northern portion of Meridian Rd will remain under capacity.
- In the total 2040 scenario for which the maximum trip generator is assumed, the Intersection of Woodmen Rd & Meridian Rd will fail in the PM peak, and the intersection of Meridian Rd & Eastonville Rd will fail during both the AM and PM peaks. The ADT along Meridian Rd will exceed capacity as well. The analysis for the maximum trip generator is a requirement of El Paso County. The developer has no intention of building a shopping center, and therefore, no roadway improvements are needed to mitigate the failing operations reported in this scenario.
- Traffic operations are reported to be almost identical between the background scenario and the total scenario in which the proposed warehouse development has been constructed. There are no intersection or individual movements found to operate acceptably in the background scenario and then unacceptable in the total warehouse scenario. It is the responsibility of El Paso County, not the developer, to provide mitigation solutions to achieve acceptable traffic operations through the year 2040.

## Recommendations

- It is recommended that the proposed development be designed as shown in the site plan.
- It is recommended that El Paso County implement the mitigation recommendations detailed in Section IV of this report in order to achieve acceptable traffic operations through the study area.

## I. Introduction

### Overview

This Traffic Impact Study (TIS) was conducted in support of Meridian Storage proposed Owl Place Storage development in El Paso County, Colorado. This study evaluates an existing conditions scenario, year 2024 background and total scenarios, and year 2040 background and total scenarios. By analyzing and comparing the background and total future scenarios, this study will be able to assess the impact that the site will have on traffic operations through the immediate roadway network. In addition, El Paso County has requested that the maximum trip generator allowed on a site zoned as Commercial Service be analyzed. As such, this study will analyze a scenario in which the maximum trip generator has been constructed in place of the proposed storage use.

### Site Location and Study Area

The property that comprises the application area is located on El Paso County Parcel Numbers 5301001001, 5301001002, and 5301001014. Upon completion, the site will be bounded by Eastonville Rd to the south, Meridian Road to the east, and property lines to the north and west. The site is currently zoned as Residential Rural (RR-5) and is mostly vacant with only several residential homes on site. The site is in the process of being rezoned to Commercial Service (CS). Access to the southern side of the proposed development will be provided via one full movement access along Owl Place. In addition, Meridian Park Dr will be extended to the south, providing access to the northern side of the development. The southern parcel is shown to have two access points via Owl Pl, however, there are no immediate plans to develop this parcel.

The Applicant proposes to develop the site with 158 self-storage units as well as 96 RV/Boat storage spaces. A reduction of the Applicant's proposed conceptual site plan is provided in Figure 1-2. A full-size copy of the plan is provided in Appendix A.

Tasks undertaken in the course of this study included the following:

1. The Applicant's proposed development plans and other background data were reviewed.
2. A virtual field reconnaissance of existing roadway and intersection geometries, traffic controls, and speed limits was conducted.
3. Turning movement counts that were taken on Wednesday, June 1, 2022 for the Owl Place Commercial traffic study were used in this study.
4. Using Synchro 11, the Level of Service (LOS) for each intersection was reported based on the methodology prescribed by the Highway Capacity Guidelines 6<sup>th</sup> Edition. Synchro was also used to conduct a queuing analysis and signal progression analysis for each scenario.
5. The AM and PM peak hour background 2024 and background 2040 traffic volumes were forecasted by using the existing volumes, a background growth rate, and the trips expected to be generated from the identified pipeline developments.
6. The LOS for the background scenarios was reported by incorporating the forecasted background volumes.

7. The site trip generation was calculated utilizing the Institute of Transportation Engineers (ITE) Trip Generation 11<sup>th</sup> Ed.
8. The total 2024 and 2040 traffic forecasts were calculated by adding the background volume forecasts and the projected site trips.
9. The LOS was reported for the total scenarios by incorporating the forecasted total future volumes.
10. The trip generation for the maximum trip generating scenario was calculated utilizing the Institute of Transportation Engineers (ITE) Trip Generation 11<sup>th</sup> Ed.
11. The total 2024 and 2040 traffic forecasts were calculated by adding the background volume forecasts and the projected maximum use site.
12. The LOS was reported for the maximum use scenarios by incorporating the forecasted total future volumes.

Sources of data for this analysis included the Highway Capacity Guidelines (HCM) 6th, ITE 11<sup>th</sup> Ed, El Paso County, and the files/library of Galloway.

## Site Description and Access

### **Site Conditions**

The topography proximate to and surrounding the site is generally classified as “level”.

### **Hazardous Conditions**

Based on the field reconnaissance in the vicinity of the subject site, no hazardous features or constraints were identified.

### **Proposed Site Access**

The site will have one full movement access on Owl Pl. Meridian Park Dr will be extended to the south, where it will provide a second access to the proposed site.

### **Existing Zoning**

The site is currently zoned as Residential Rural and is being rezoned to Commercial Service. The existing zoning is shown in Figure 1-3.

### **Nearby Uses**

The properties surrounding the subject site are primarily residential, however, the existing land use immediate north of the site and the proposed land uses immediately south of the site are commercial. The parcel number 5301001015 will be rezoned to commercial use as well.



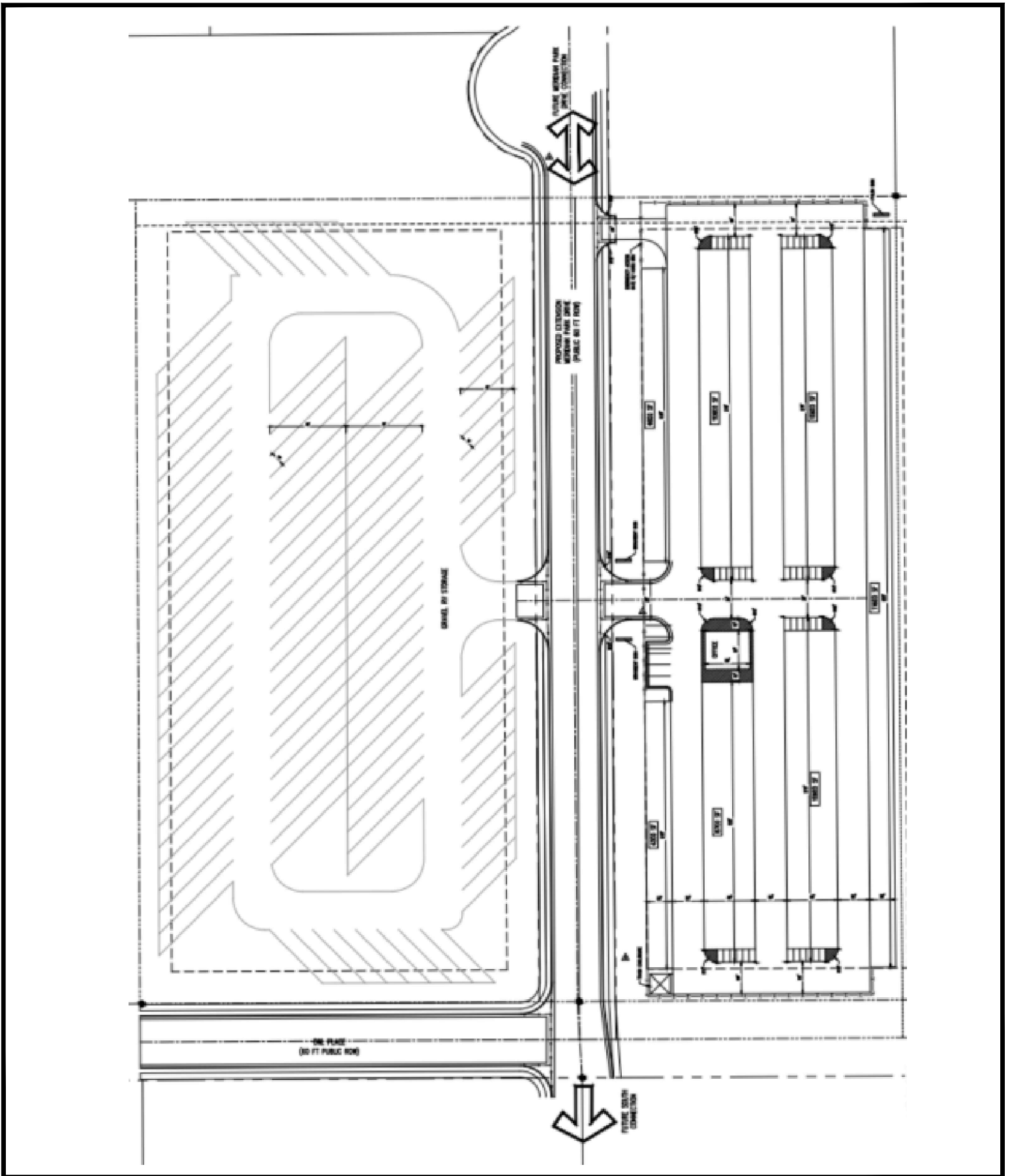
**FIGURE 1-1**  
**Site Location**

Meridian Storage  
 El Paso County, CO

- ← MOVEMENT
- 🚦 SIGNALIZED INTERSECTION
- 🛑 STOP SIGN
- 🚧 YIELD SIGN

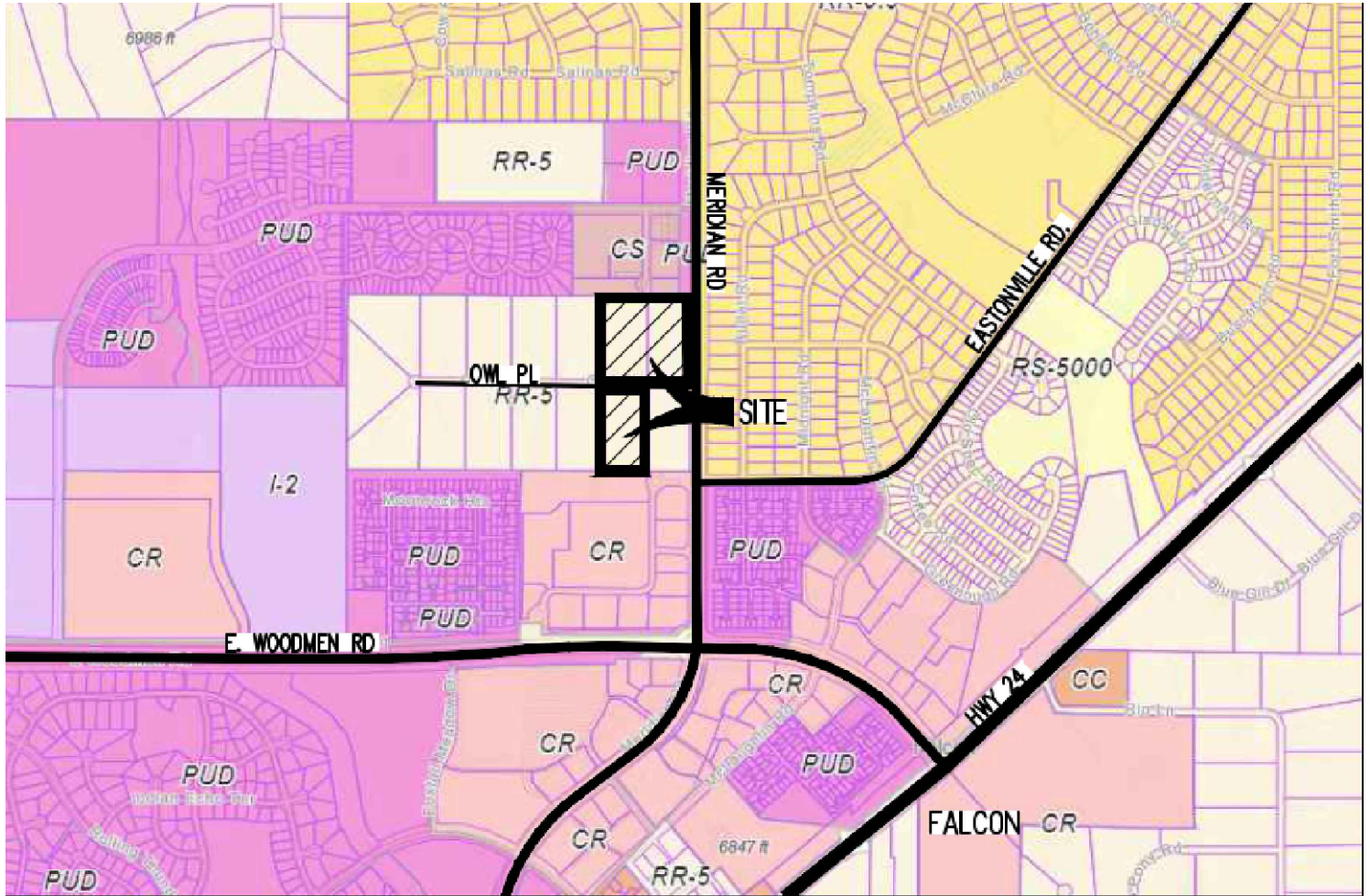






**FIGURE 1-2**  
**Site Plan**

Meridian Storage  
El Paso County, CO



**FIGURE 1-3**  
Zoning Map

Meridian Storage  
El Paso County, CO

- ← MOVEMENT
- 🚦 SIGNALIZED INTERSECTION
- 🛑 STOP SIGN
- 🚦 YIELD SIGN





## II. Background Information

### Study Area

The study area was determined by a review of intersections that would experience a significant portion of turning movement volumes generated by the site. The study area for the project includes the following intersections that may see impacts to traffic operations as a result of the proposed development:

#### **Study Intersections**

- Woodman Rd & Meridian Rd
- Meridian Rd & Eastonville Rd
- Meridian Rd & Owl PI
- Meridian Rd & Bent Grass Meadows Dr
- Bent Grass Meadows Dr & Meridian Park Dr

### Study Assumptions

For purposes of this analysis only, it is assumed that the proposed development will be completed by 2024. It is assumed that the nearby pipeline developments of Falcon Meadows at Bent Grass, Owl Place Commercial, and Falcon Marketplace will be built and operating by year 2024. A background growth rate of 2% year was applied to the existing turning movement counts.

### Study Methodology

Synchro software version 11 was used to evaluate levels of service at each of the study intersections during the weekday AM and PM peak hours. Synchro is a macroscopic model used for optimizing traffic signal timing and performing capacity analyses. The software can model existing traffic signal timings or optimize splits, offsets, and cycle lengths for individual intersections, an arterial, or a complete network. Synchro allows the user to evaluate the effects of changing intersection geometrics, traffic demands, traffic control, and/or traffic signal settings as well as optimize traffic signal timings.

The levels of service reported for the signalized and unsignalized intersections analyzed were taken from the Highway Capacity Manual (HCM) 6<sup>th</sup> reports, generated by Synchro 11. Level of service descriptions are included in Appendix B.

### Existing Roadway Network

Figure 2-1 depicts existing lane use and traffic controls in the vicinity of the subject site. The following provides a description of each of the roadways within the study network.

#### **Woodmen Rd**

Woodmen Rd is a four-lane, east/west, divided highway with a posted speed limit of 45 mph through the study area. It provides access to US-24 east of the site and to CO-21 west of the site.

#### **Meridian Rd**

Meridian Rd is a four-lane, north/south, divided highway with a posted speed limit of 55 mph through the study area. It provides access to many of the nearby residential developments, as well as several commercial uses.

#### **Bent Grass Meadows Dr**

Bent Grass Meadows Dr is an east/west local road with a posted speed limit of 35 mph and provides access to the newly constructed housing development Falcon Meadows at Bent Grass.

**Meridian Park Dr**

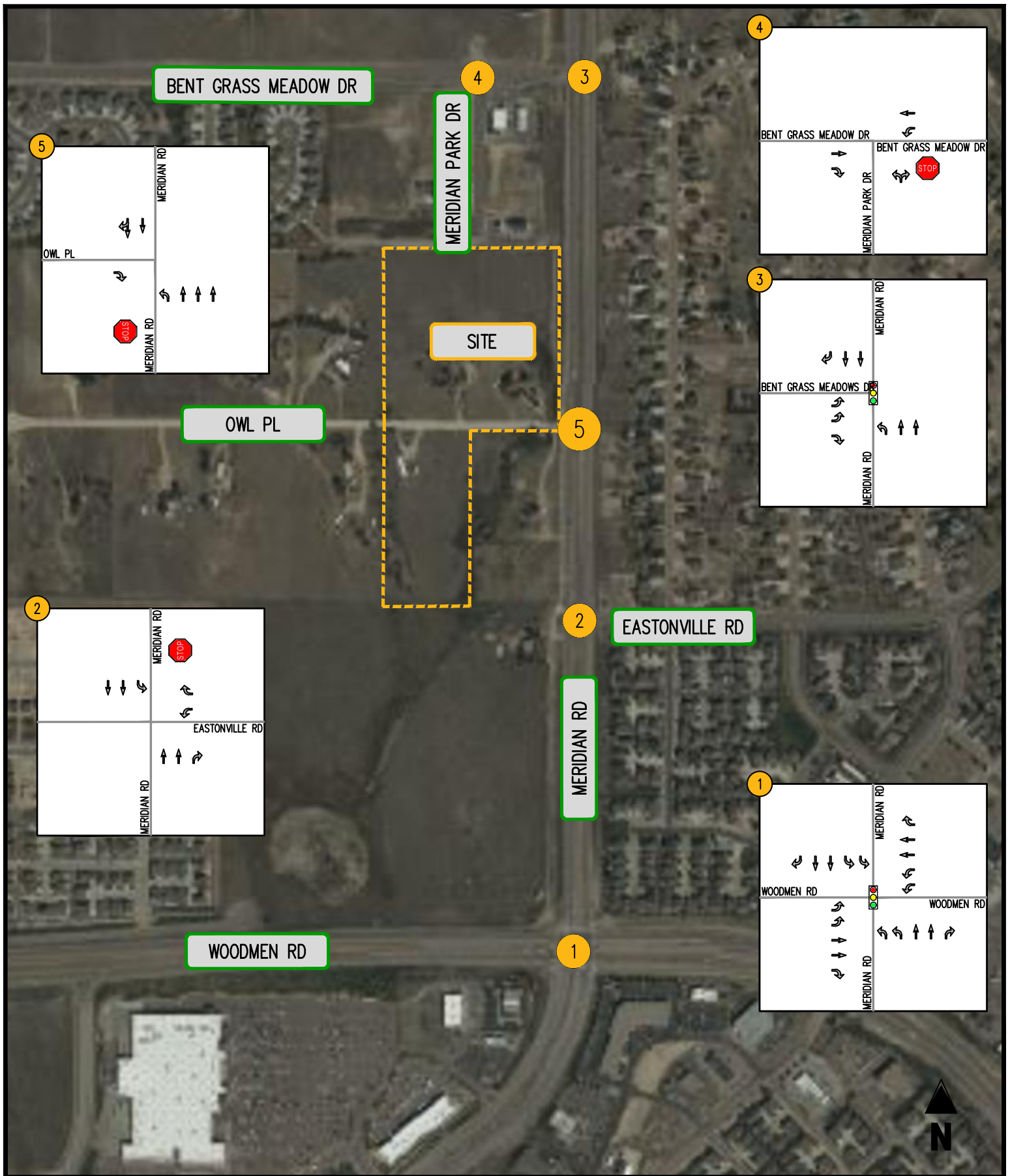
Meridian Park Dr is a two lane, north/south local road. It currently dead ends just north of the proposed development. Upon completion of the development, Meridian Park Dr will be extended to the south and will provide site access.

**Owl PI**

Owl PI is a two-lane, east/west, local road that provides access to several single-family homes. Owl PI currently intersects Meridian Rd in a stop-controlled intersection. There are plans to close access to Meridian Rd in the future. When this access is closed, an extension will be constructed between Owl PI and Eastonville Rd, allowing Owl PI residents to access Eastonville Rd and then access Meridian Rd from there. The trips on and off Owl PI have been rerouted along this extension to Eastonville Rd in the future scenarios.

**Eastonville Rd**

Eastonville Rd is a two-lane, east/west road. It intersects with Meridian Rd in a four-leg, signalized intersection. At the time of the traffic counts in June 2022, the intersection of Eastonville Rd & Meridian Rd was a three-legged stop-controlled intersection, as the west leg had not been built. The existing conditions analysis in this study assumes that the west leg of Eastonville Rd has not yet been constructed to match the geometry at the time of the counts. All future analysis in this study assume that the west leg has been built and that Eastonville Rd intersects Meridian Rd in a signalized intersection.



**FIGURE 2-1**  
**Existing Lane Use and Traffic Control**

Meridian Storage  
 El Paso County, CO



### III. Analysis of Existing Conditions

#### Traffic Volumes

The Owl Place Commercial traffic study, conducted by SM Rocha LLC in September 2022 studied four of the same intersections as this traffic study. The turning movement counts collected on Wednesday, June 1, 2022, for the SM Rocha study were used as the existing volumes in this study for all intersections except for Bent Grass Meadows Dr & Meridian Park Dr. The traffic counts taken for the Bent Grass East Commercial Filing No. 3 TIS conducted by LSC Transportation Consultants, Inc. in May 2021 were used for the volumes at Bent Grass Meadows Dr & Meridian Park Dr. At the time of the counts for the Bent Grass study, there was an access to the 7-Eleven along Bent Grass Meadows Dr. At the time of this study, the access has been closed and vehicles will have to access the 7-Eleven from Meridian Park Dr. As such, the trips that had been using the access along Bent Grass Meadows Dr were rerouted onto Meridian Park Dr for the existing conditions analysis in this study.

The volumes were balanced along Meridian Rd by increasing the thru movements to balance with the highest intersection. The eastbound and westbound thru volumes along Bent Grass Meadows Dr at the intersection of Bent Grass Meadows Dr & Meridian Park Dr were balanced with the intersection of Meridian Rd & Bent Grass Meadows Dr. The raw traffic counts are provided in Appendix C. The existing traffic volumes are presented in Figure 3-1.

#### Existing Operational Analysis

Capacity/level of service (LOS) analyses were conducted at the study intersections based on the existing lane use and traffic controls shown in Figure 2-1, and existing traffic volumes shown in Figure 3-1. Per the El Paso County Transportation Impact Study Guidelines, the peak hour factors (PHF) were calculated or set to 0.85, whichever was higher. The signal timings for the two signals in the study area were incorporated into the Synchro models. Using the Time Space Diagram analysis in Synchro, a progression analysis was conducted along Meridian Rd. A detailed results report is presented in Appendix D and is summarized in Table 3-1 and in Figure 3-2. The Synchro printouts are included in Appendix D.

The signalized intersection of Woodmen Rd & Meridian Rd operates at LOS D during both the AM and PM peak hours. The signalized intersection of Bent Grass Meadows Dr & Meridian Rd operates at LOS A during both time periods, as does the stop-controlled intersection of Bent Grass Meadows Dr & Meridian Park Dr. The stop-controlled intersection of Meridian Rd & Owl PI operates at LOS C or better. The stop-controlled intersection of Meridian Rd & Eastonville Rd operates at LOS F during both the AM and PM peak hours due to the westbound left turn movement. It should be noted that this intersection is modeled as a three-legged stop-controlled intersection to match the configuration from when the counts were taken. It has recently been improved to a four-legged signalized intersection, which negates the LOS F found in this analysis. As such, there are no operational concerns in the existing conditions scenario.

The El Paso County Roadway ADT Threshold Capacities were reviewed for a 4-lane principal arterial to ensure that Meridian Rd is operating under capacity in the existing conditions, and is reported in Table 3-1. Based on the ADT counts taken in September 2022 from the Owl Place Commercial study, it was found that the ADT along Meridian both immediately south of Bent Grass Meadows and immediately north of Woodman Rd were under capacity.

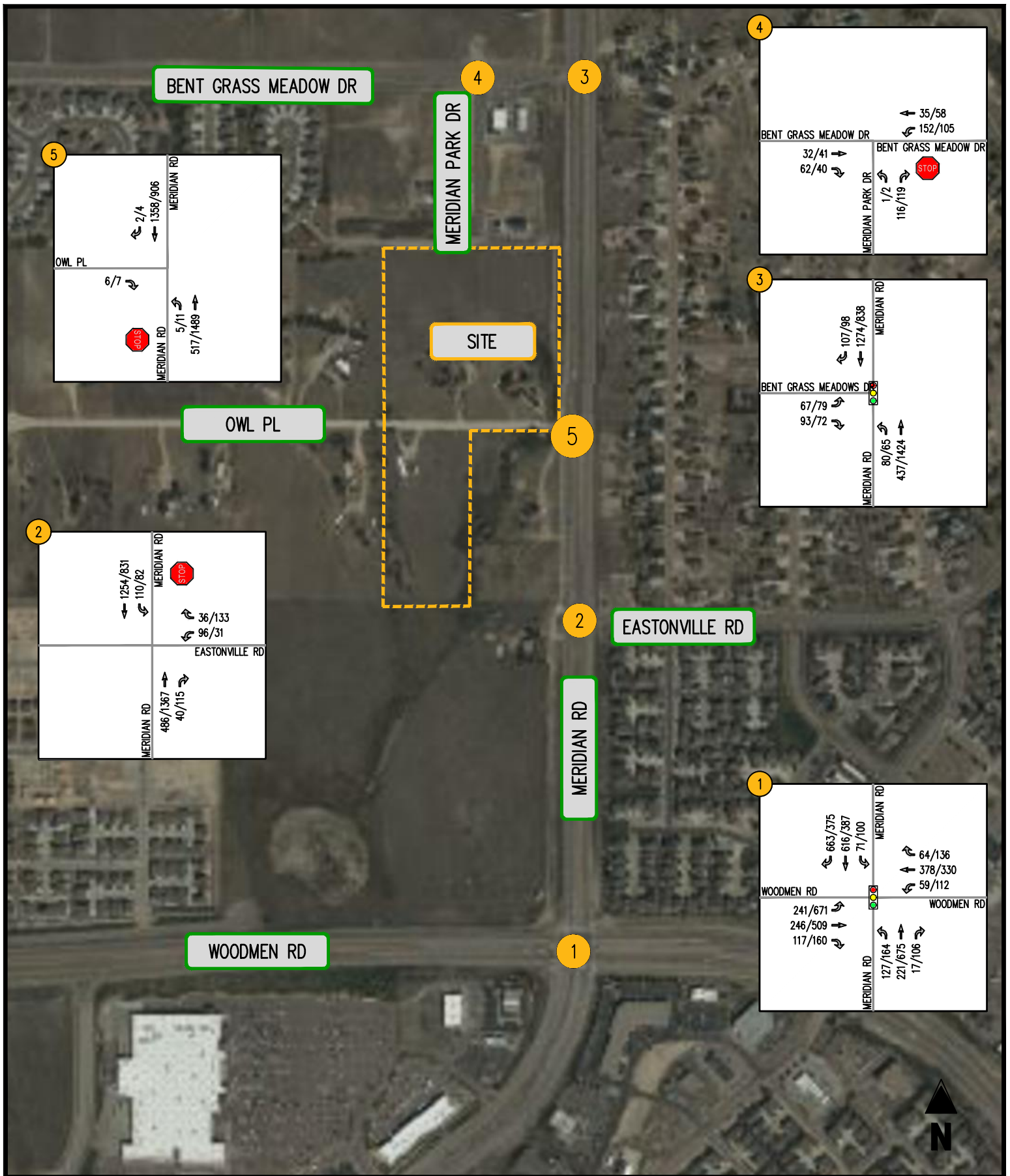
The signal progression analysis along Meridian Rd was conducted using the Synchro time space diagrams and the results are reported in Table 3-1 with the Synchro printouts included in Appendix D. It was found that with a 120 second cycle length, the NB bandwidth is 22 seconds in the AM and 32

seconds in the PM between the signals of Woodmen Rd & Meridian Rd while the SB bandwidth is 30 seconds in the AM and 37 seconds in the PM. Since the intersection of Meridian Rd & Woodmen Rd is a major intersection that must provide a large proportion of the available green time to movements other than the NB and SB thru movements, it would be difficult to expand the bandwidth along Meridian Rd.

### Existing Intersection Queues

The 95% queue lengths were reported for each movement within the study area using the Synchro queuing reports. The results are summarized in Table 3-2. The movements highlighted in yellow indicate that the queue exceeds its respective storage length or extends past the adjacent storage, possible blocking vehicles trying to enter an adjacent turn lane. Queues highlighted in orange exceed capacity indicate that the movement exceeds capacity, and the queues highlighted in red exceed capacity and extend past the adjacent storage or their own storage. Generally, the queueing is minor in the existing conditions, however, several queues were identified as having the potential to affect traffic operations. The NBT queue at Woodmen Rd & Meridian Rd extends 338 feet in the PM peak hour, while the adjacent NBR storage is only 330'. Although this indicates that the thru movement may block the right turn storage by 8', it is unlikely to affect operations since the queue length only barely exceeds the adjacent storage length. The westbound left turn queue at Meridian Rd & Eastonville Rd was reported to extend 165' in the AM and 92.5' in the PM with an available storage length of 120'. Since this movement is over capacity and Synchro becomes unreliable once capacity is exceeded, it is possible that the queue extends further than reported. This queue is no longer a problem, however, since this intersection has recently been signalized and has a different geometric layout. The SBT queue at Meridian Rd & Bent Grass Meadows Dr extends 386' in the AM peak hour, while the adjacent SBR storage is only 350'. Although the thru movement may periodically extend past the adjacent right turn storage, it is unlikely to cause operations problems since it does not exceed the storage length by much more than a car length.





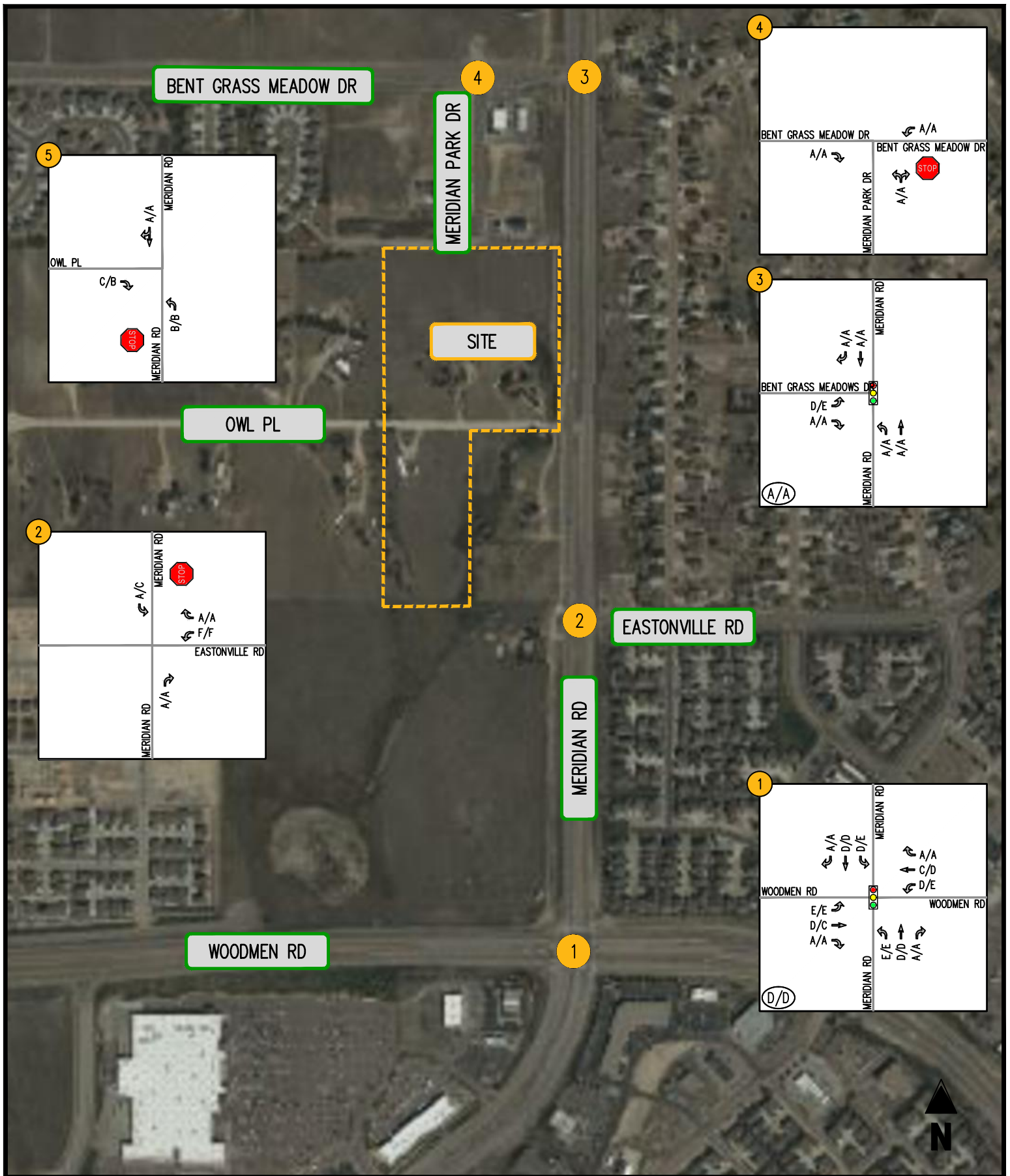
**FIGURE 3-1**  
**Existing 2023 Volumes**

0000/0000 (AM PEAK HOUR/PM PEAK HOUR)

- MOVEMENT
- SIGNALIZED INTERSECTION
- STOP SIGN
- YIELD SIGN

Meridian Storage  
 El Paso County, CO





**FIGURE 3-2**  
**Existing 2023 Level of Service**

Meridian Storage  
 El Paso County, CO

(A/A) INTERSECTION LOS  
 0000/0000 (AM PEAK HOUR/PM PEAK HOUR)  
 19

- MOVEMENT
- SIGNALIZED INTERSECTION
- STOP SIGN
- YIELD SIGN



Table 3-1  
Meridian Storage  
Existing Intersection Level of Service Summary (1) (2)

Intersection	Operating Condition	Street Name	Approach/Movement	Existing 2023	
				AM Peak Hour	PM Peak Hour
1 Woodmen Rd/Meridian Rd	SIGNAL	Woodmen Road	EBL	E (57.3)	E (57.6)
			EBT	D (38.6)	C (24.5)
			EBR	A (0.0)	A (0.0)
		Woodmen Road	WBL	D (37.3)	E (60.1)
			WBT	C (28.8)	D (39.6)
			WBR	A (0.0)	A (0.0)
		Meridian Road	NBL	E (60.5)	E (64.5)
			NBT	D (50.1)	D (52.1)
			NBR	A (0.0)	A (0.0)
		Meridian Road	SBL	D (43.0)	E (61.0)
			SBT	D (50.0)	D (42.9)
		SBR	A (0.0)	A (0.0)	
		<b>Overall</b>	<b>D (45.5)</b>	<b>D (47.2)</b>	
2 Meridian Rd/Eastonville Rd	STOP	Eastonville Road	WBL	F [186.2]	F [409.6]
			WBR	A [0.0]	A [0.0]
		Meridian Rd	NBT	A [0.0]	A [0.0]
			NBR	A [0.0]	A [0.0]
			SBL	A [9.3]	C [17.4]
3 Meridian Rd/Bent Grass Meadows Dr	SIGNAL	Bent Grass Meadows Drive	EBL	D (55.0)	E (56.1)
			EBR	A (0.0)	A (0.0)
		Meridian Road	NBL	A (8.2)	A (4.8)
			NBT	A (2.5)	A (4.4)
		Meridian Road	SBT	A (9.9)	A (7.5)
			SBR	A (5.9)	A (5.9)
				<b>Overall</b>	<b>A (9.4)</b>
4 Bent Grass Meadows Dr/Meridian Park Dr	STOP	Bent Grass Meadows Drive	EBR	A [0.0]	A [0.0]
			WBL	A [7.8]	A [7.6]
		Meridian Park Drive	NBLR	A [9.1]	A [9.1]
5 Meridain Rd & Owl Pl	STOP	Owl Pl	EBR	C [16.2]	B [12.5]
		Meridian Road	NBL	B [14.0]	B [10.7]
		Meridian Road	SBTR	A [0.0]	A [0.0]
<b>Street Name</b>				<b>Existing 2023</b>	
				<b>ADT</b>	<b>ADT Capacity</b>
<b>El Paso County Roadway ADT Threshold Capacity</b>		Meridian Rd (S.O. Bent Grass Meadows)		24,989	40,000
<b>Principal Arterial (4-Lane)</b>		Meridian Rd (N.O. Woodman Rd)		24,416	40,000
<b>Meridian Rd Signal Progression</b>			<b>NB</b>	<b>AM</b>	<b>PM</b>
<b>Arterial Band (Seconds Per Cycle)</b>			<b>SB</b>	22	32
				30	37

Notes (1) Numbers in brackets [] represent delay at unsignalized intersections in seconds per vehicle.  
(2) Numbers in parenthesis () represent delay at signalized intersections in seconds per vehicle.



Table 3-2  
 Meridian Storage  
 Existing Intersection Queueing Summary (1)

Intersection	Operating Condition	Street Name	Approach/ Movement	Available Storage	Existing 2023	
					AM Peak Hour	PM Peak Hour
1 Woodmen Rd/Meridian Rd	SIGNAL	Woodmen Road	EBL	500	141	347
			EBT	-	130	240
			EBR	630	0	0
		Woodmen Road	WBL	350	44	77
			WBT	-	197	193
			WBR	250	0	0
		Meridian Road	NBL	440	84	106
			NBT	-	129	338
			NBR	330	0	0
			SBL	490	34	67
Meridian Road	SBT	-	225	188		
	SBR	450	6	0		
2 Meridian Rd/Eastonville Rd	STOP	Eastonville Road	WBL	120	165	92.5
			WBR	-	0	0
		Meridian Rd	NBR	400	0	0
			SBL	375	10	22.5
3 Meridian Rd/Bent Grass Meadows Dr	SIGNAL	Bent Grass Meadows Drive	EBL	150	48	55
			EBR	-	47	19
		Meridian Road	NBL	700	25	6
			NBT	-	10	249
		Meridian Road	SBT	-	386	201
			SBR	350	20	20
4 Bent Grass Meadows Dr/Meridian Park Dr	STOP	Bent Grass Meadows Drive	EBR	150	0	0
		Bent Grass Meadows Drive	WBL	100	10	7.5
		Meridian Park Drive	NBLR	-	12.5	12.5
5 Meridain Rd & Owl PI	STOP	Owl PI	EBR	-	2.5	2.5
		Meridian Road	NBL	270	0	2.5
		Meridian Road	SBTR	-	0	0

Notes: (1) Queue length is based on the 95th percentile queue as reported by Synchro, Version 11.

## **IV. Analysis of Background 2024 & 2040 Conditions**

### **Methodology**

The background scenarios analyze traffic operations assuming that the site has not been developed but that traffic volumes have increased due to background growth.

### **Roadway Improvements**

The background scenarios model the intersection of Meridian Rd & Eastonville Rd as a four-legged signalized intersection. It is assumed that the connection between Owl PI and Meridian Rd has been closed. The proposed development (Owl Place Commercial) on the southwest corner of Meridian Rd & Owl PI will provide access between Owl PI and Eastonville Rd. Upon completion, vehicles that would have previously accessed Meridian Rd from Owl PI will travel south to Eastonville Rd to do so. Figure 4-1 shows the assumed lane use and traffic control for the background scenarios. Figure 4-2 shows the rerouted trips from Owl PI, and the impact in terms of vph that this will have on the turning movements through the study area.

### **Regional Growth**

A 2% annual growth rate was applied to the existing traffic volumes. The resulting increases in background traffic volumes within the study area are reflected in Figure 4-3 for the background 2024 scenario and in Figure 4-4 for the background 2040 scenario.

### **Pipeline Developments**

Three nearby pipeline developments were identified and analyzed to determine their volume contributions through the study area. An accompanying TIS for each development was provided. For purposes of this study, it is assumed that two of the pipeline developments will be completed by 2024 and the third will have phase 1 completed by 2024 and will be fully built by 2040. Figure 4-5 shows the location of the pipeline developments in respect to the proposed site.

The Owl Place Commercial development will be located on the southwest corner of Meridian Rd & Owl PI. The Owl Place Commercial Traffic Impact Study conducted by SM Rocha, LLC in September 2022 was referenced to determine the trip generation and distribution from the development. The development will consist of a fast-food restaurant, a coffee/donut shop, a gas station with convenience store, and a car wash. When this development is constructed, access between Owl PI and Meridian Rd will be restricted. The trip generation figures from the Owl Place Commercial study distributes the trips with the assumption that the connection between Owl PI and Meridian Rd is still open. Since this study assumes that it will not be open, the trips have been rerouted to access Meridian Rd via Eastonville Rd. Vehicles will use the access road on the west side of the site to reach Eastonville Rd where they will be able to access Meridian Rd. Figure 4-6 details the trip distribution of the development through the study area.

The Falcon Marketplace Development is located on the northwest corner of Woodmen Rd & Meridian Rd. The Falcon Marketplace Development Traffic Impact Study conducted by LSC Transportation Consultants, INC in September 2018 was referenced to determine the trip generation and distribution. The table below shows the land uses that were analyzed in the LSC traffic study:

866	Pet Supply Superstore	15 KSF
850	Supermarket	123 KSF
944	Gasoline/Service Station	18 VFP
934	Fast-Food Restaurant with Drive-Through Window	2.5 KSF
820	Shopping Center	5 KSF
848	Tire Store	7.72 KSF
934	Fast-Food Restaurant with Drive-Through Window	3.5 KSF
934	Fast-Food Restaurant with Drive-Through Window	2.5 KSF
610	Clinic	7.8 KSF
820	Shopping Center	8 KSF
937	Coffee/Donut Shop With Drive-Through Window	1.3 KSF

The Falcon Marketplace Development will be constructed in two phases, with the first phase expected to be completed by 2024 and the second phase expected to be completed by 2040. Figure 4-7 shows the trip distribution for phase 1 of the development and Figure 4-8 shows phase 2 of the development.

The third identified pipeline is the Falcon Meadows at Bent Grass Development. This development was studied in the Falcon Meadows at Bent Grass (Filing Numbers 1-4) conducted by LSC Transportation Consultants, INC. Each filing was conducted for a section of the development, with the most recent Filing 4, conducted in October 2022. Filing 4 was referenced in this study, as it includes trip generation from the entire pipeline development. Falcon Meadows at Bent Grass will be located west of Bent Grass Meadows Dr, to the northwest of the proposed development. Falcon Meadows at Bent Grass is a large development that will consist of residential housing, a shopping center, a marketplace, and a school. Figure 4-9 shows the trip distribution for Falcon Meadows at Bent Grass.

The relevant pages from the pipeline development TIS's are included in Appendix E.

### Background 2024 & 2040 Traffic Forecasts

The background 2024 traffic forecast, shown in Figure 4-10, was calculated by taking the existing volumes from Figure 3-1, incorporating the redistributed movements from Owl PI (Figure 4-2), adding the background 2024 growth (Figure 4-3), and the pipeline trip distributions (Figures 4-6, 4-7, and 4-9).

The background 2040 traffic forecast, shown in Figure 4-11, was calculated by taking the existing volumes from Figure 3-1, incorporating the redistributed movements from Owl PI (Figure 4-2), adding the background 2040 growth (Figure 4-4), and the pipeline trip distributions (Figures 4-6, 4-8, and 4-9).

### Background 2024 & 2040 Levels of Service

Capacity analyses of the background scenarios are provided in Appendix F. The background 2024 forecasted levels of service are shown in Table 4-1 and depicted graphically in Figure 4-12. The background 2040 forecasted levels of service are shown in Table 4-1 and depicted graphically in Figure 4-13. The Synchro models were updated with the future background volumes. Per the El Paso County Transportation

Impact Study Guidelines, the peak hour factors (PHF) were calculated or set to 0.95, whichever was higher. The signal timings for Meridian Rd & Eastonville Rd were provided by the County and incorporated into the Synchro models, while the splits for the other two signals were optimized. The cycle lengths and offsets remain the same as in the existing scenario. Using the Time Space Diagram analysis in Synchro, a progression analysis was conducted along Meridian Rd. A detailed results report is presented in Appendix F and is summarized in Table 4-1. The Synchro printouts are included in Appendix F.

The signalized intersection of Woodmen Rd & Meridian Rd operates at LOS D during both peak hours in the background 2024 scenario but will operate at LOS F in the background 2040 scenario. Many of the movements are reported to exceed capacity by the 2040 PM peak, with the EBL exceeding capacity the most severely. There will be 993 eastbound left turns and only dual left turn lanes. In order for this movement to operate acceptably, triple left turn lanes would likely be necessary. The signal at Meridian Rd & Eastonville Rd operates at LOS D or better in 2024 and operates at LOS E in the background 2040 AM peak hour. The southbound thru movement and the northbound left turn movement exceed capacity in this scenario, contributing to the high overall delay. The signalized intersection of Meridian Rd & Bent Grass Meadows Dr operates at LOS B during all background scenarios, with no operational concerns. The stop-controlled intersection of Bent Grass Meadows Dr & Meridian Park Dr operates at LOS B or better during all background scenarios as well.

The El Paso County Roadway ADT Threshold Capacities were reviewed for a 4-lane principal arterial to ensure that Meridian Rd is operating under capacity in the background scenarios. The results are reported in Table 4-1. The ADT counts that were taken in September 2022 were grown for the background scenarios by the same proportion that the turning movements onto and off of each of the links increased between the existing and background scenarios. It was reported that Meridian Rd will operate below the capacity threshold in the background 2024 scenario and over capacity in the background 2040 scenario. Meridian Rd exceeding capacity in the background 2040 scenario is the primary reason for the poor operations at the signalized intersections through the study area. Widening Meridian Rd to 6-lanes would likely be necessary for the signals to operate acceptably in 2040.

The signal progression analysis along Meridian Rd was conducted using the Synchro time space diagrams and the results are reported in Table 4-1 with the Synchro printouts included in Appendix F. In the background 2025 scenario with a 120 second cycle length, the NB bandwidth is 0 seconds in the AM and 31 seconds in the PM between the signals of Woodmen Rd & Meridian Rd while the SB bandwidth is 1 seconds in the AM and 0 seconds in the PM. It was found for the background 2040 scenario that with a 120 second cycle length, the NB bandwidth is 0 seconds in the AM and 39 seconds in the PM between the signals of Woodmen Rd & Meridian Rd while the SB bandwidth is 1 seconds in the AM and 0 seconds in the PM. This poor progression is to be expected due to unacceptable delays at the signalized intersections and the fact that Meridian Rd will exceed capacity by 2040. It is expected that if Meridian Rd were to be widened to 6-lanes, progression could be improved between signals. Another option to be considered is increasing the cycle length to provide a longer green time along Meridian Rd.

## **Background 2024 & 2040 Intersection Queues**

The 95% queue lengths were reported for each movement within the study area using the Synchro queuing reports. The results are summarized in Table 4-2. The movements highlighted in yellow indicate that the queue exceeds its respective storage length or extends past the adjacent storage, possible blocking vehicles trying to enter an adjacent turn lane. Queues highlighted in orange exceed capacity

indicate that the movement exceeds capacity, and. the queues highlighted in red exceed capacity and extend past the adjacent storage or their own storage.

The storage lengths for the intersection of Meridian Rd & Eastonville Rd were taken from the Owl Place Commercial TIS by SM Rocha, LLC, as imagery of the newly configured intersection is not yet available. As can be seen in Table 4-1, many of the queues at the intersection of Meridian Rd & Eastonville Rd will exceed their respective storage lengths. It is not clear if the final intersection design of Meridian Rd & Eastonville Rd will have longer storages than what was reported by the Owl Place Commercial TIS, however, since this TIS was approved by El Paso County, it is assumed to be accurate. The eastbound queues at Meridian Rd & Eastonville Rd will extend 167' in the background 2024 scenario and 254' in the background 2040 scenario. There is a roundabout located approximately 150' west of the signal along Eastonville Rd, meaning that in the future queues will likely extend into the roundabout. It should be noted that the Owl Place Commercial traffic study by SM Rocha, LLC reported that the queue from this signal would extend into the roundabout. Given the roundabouts close proximity to a major signal, it will be difficult to prevent queuing into the roundabout. One solution could be to run the signal on a half cycle of 60 seconds, however, that will hurt progression along Meridian Rd.

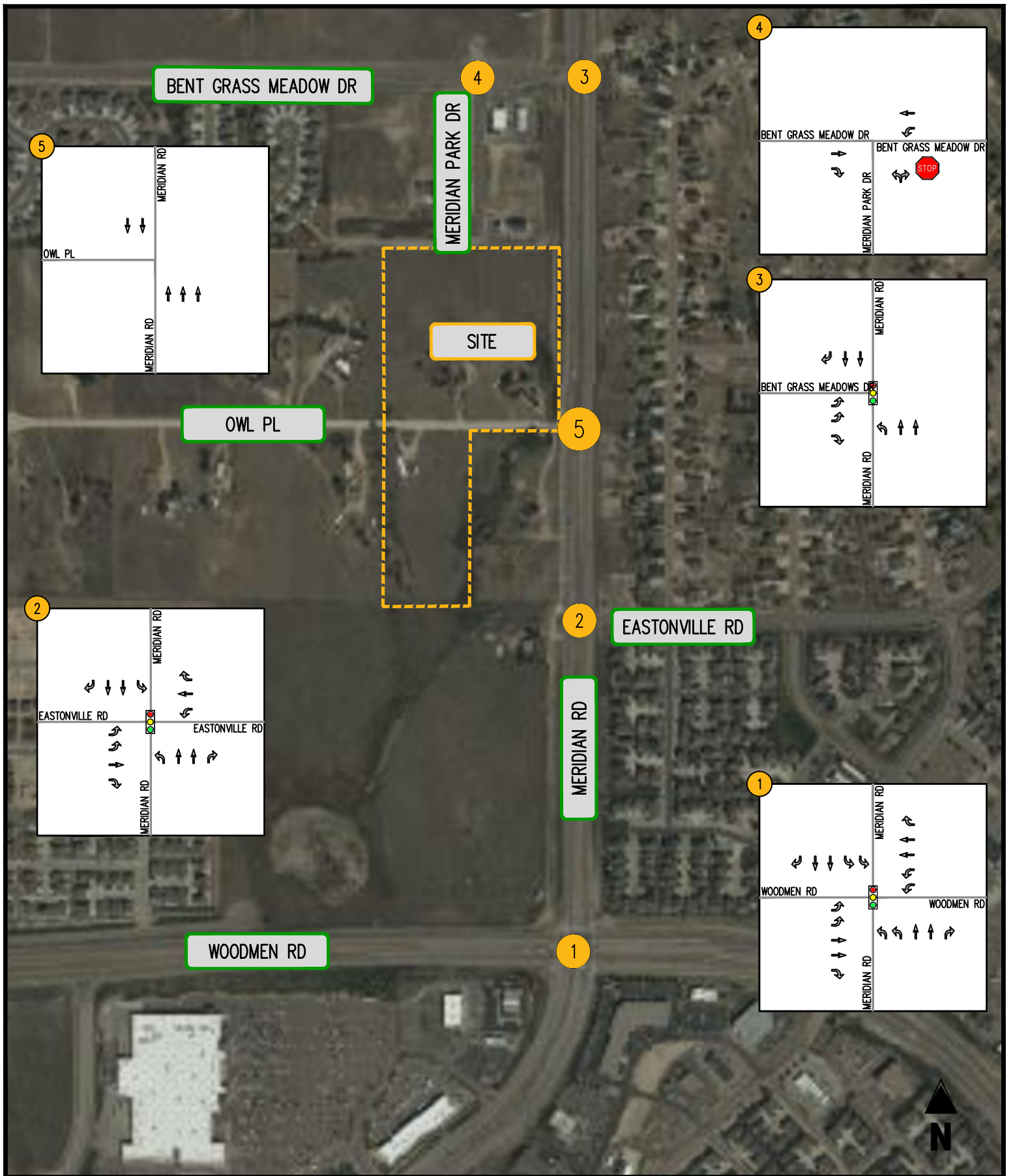
In the background 2024 scenario, the NBT queue at Woodmen Rd & Meridian Rd extends 442' in the PM peak hour, while the adjacent NBR storage is only 330'. This could potentially block vehicles trying to enter the NBR turn lane. The SBT queue at Meridian Rd & Bent Grass Meadows Dr extends 617' in the AM peak hour, while the adjacent SBR storage is only 350'. Since this movement is under capacity, even though it may block the SBR storage, it will likely clear each cycle.

The queues in the background 2040 scenario have increased, with many of the PM queues at Woodmen Rd & Meridian Rd expected to exceed their respective storage lengths or the adjacent storage lengths. As previously discussed, this intersection will exceed capacity in the 2040 scenario. Implementing the recommended mitigation measures, discussed in the section below, will help the queuing at this intersection. The SBT queue at Meridian Rd & Bent Grass Meadows Dr extends 951' in the AM peak hour and 491' in the PM peak hour, while the adjacent SBR storage is only 350'. Since this movement is under capacity, even though it may block the SBR storage, it will likely clear each cycle.

## **Background 2024 & 2040 Recommended Mitigation**

The following measures are recommended to help achieve acceptable traffic operations through the background 2040 scenario.

- Improve Meridian Rd to a 6-lane highway through the entire study area
- Install triple left turn lanes for the EBL at Meridian Rd & Woodman Rd
- Install dual left turn lanes for the NBL movement at Meridian Rd & Eastonville Rd
- Ensure that the storage lengths at Meridian Rd & Eastonville Rd are long enough to accommodate their forecasted queues.



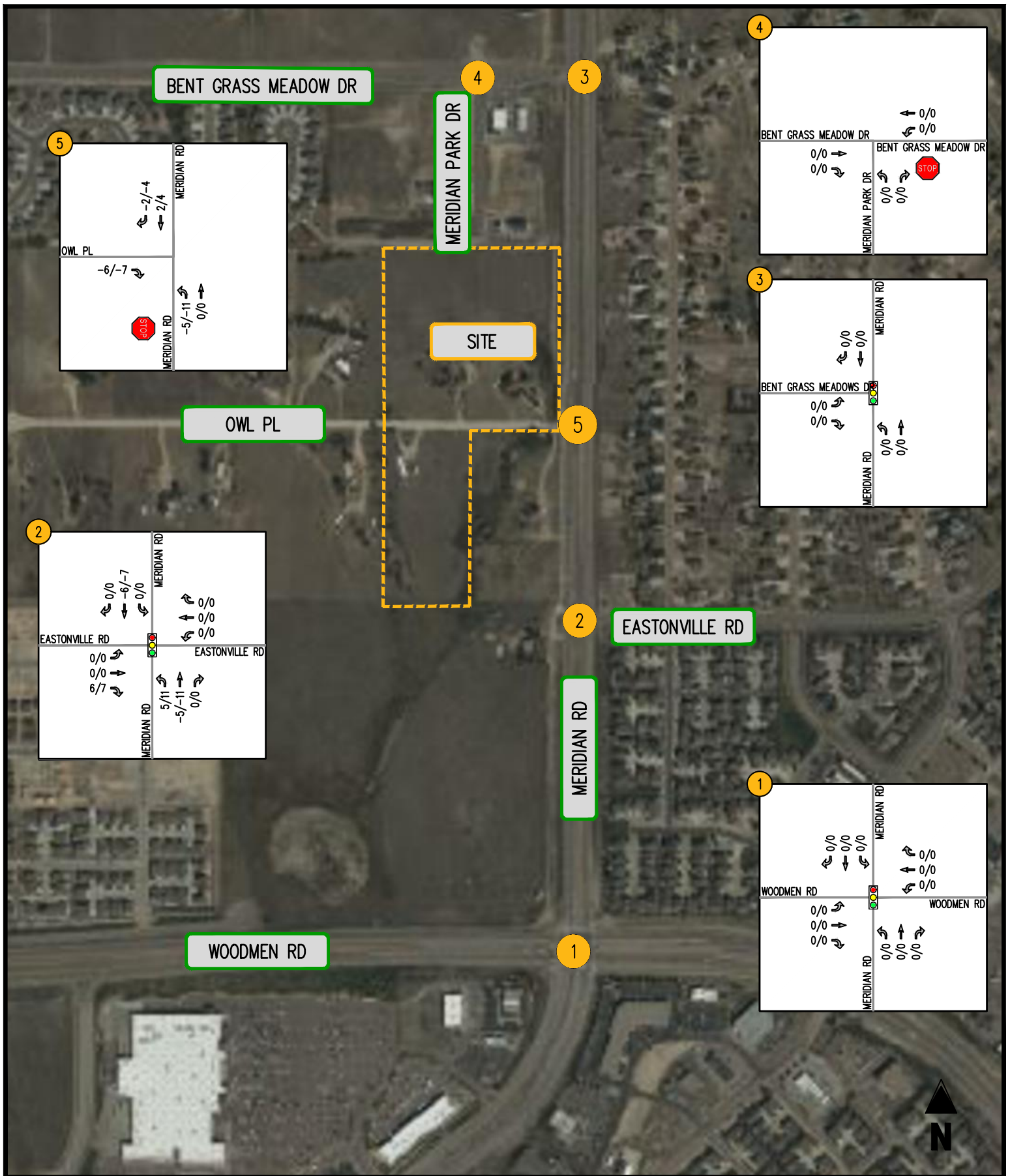
**FIGURE 4-1**  
**Background Lane Use and Traffic Control**

Meridian Storage  
 El Paso County, CO

- MOVEMENT
- SIGNALIZED INTERSECTION
- STOP SIGN
- YIELD SIGN







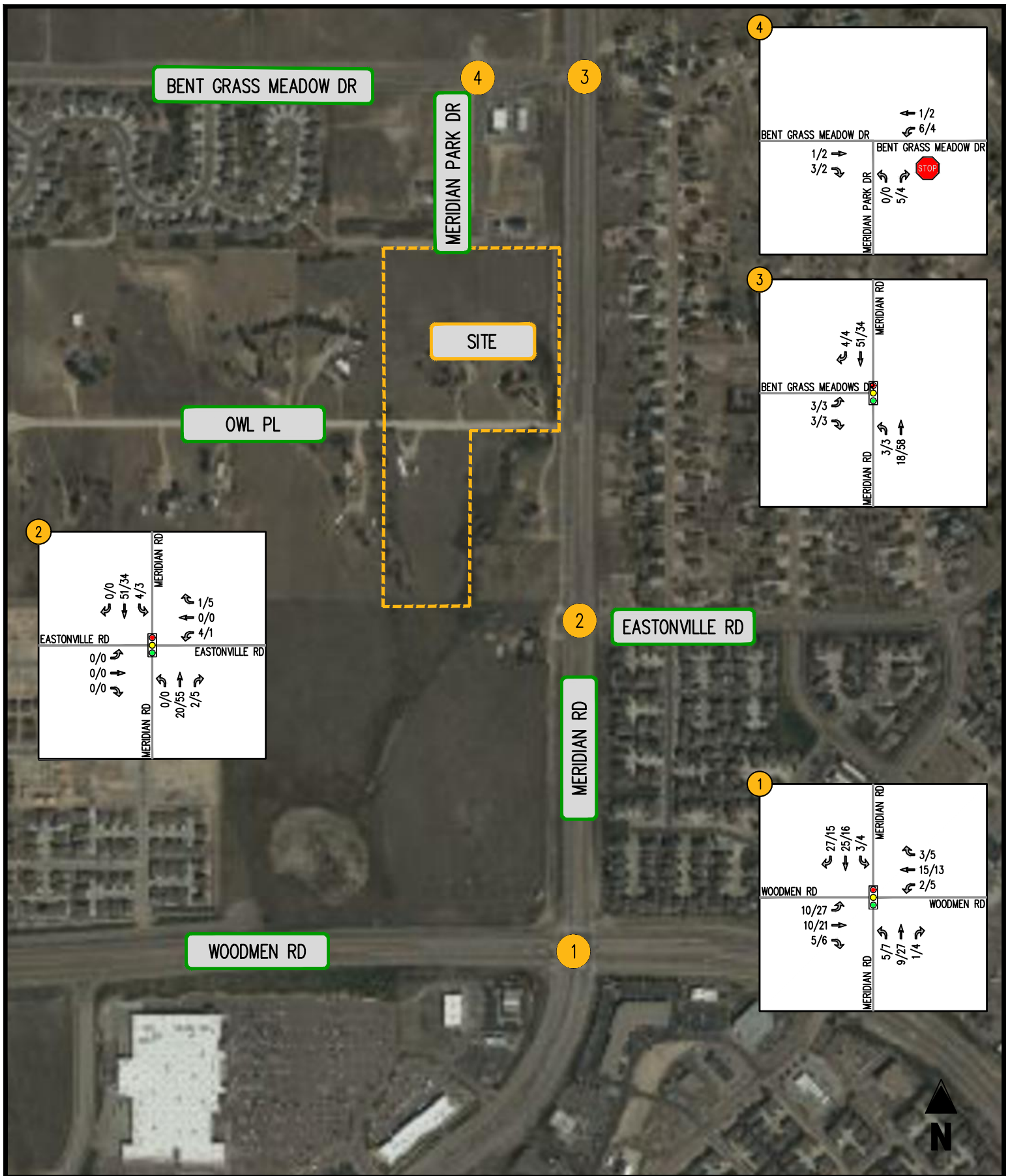
**FIGURE 4-2**  
**Owl Pl Rerouted Trips**

Meridian Storage  
 El Paso County, CO

0000/0000 (AM PEAK HOUR/PM PEAK HOUR)

- ← MOVEMENT
- 🚦 SIGNALIZED INTERSECTION
- 🛑 STOP SIGN
- 🚧 YIELD SIGN





**FIGURE 4-3**  
**Background 2024 Growth**

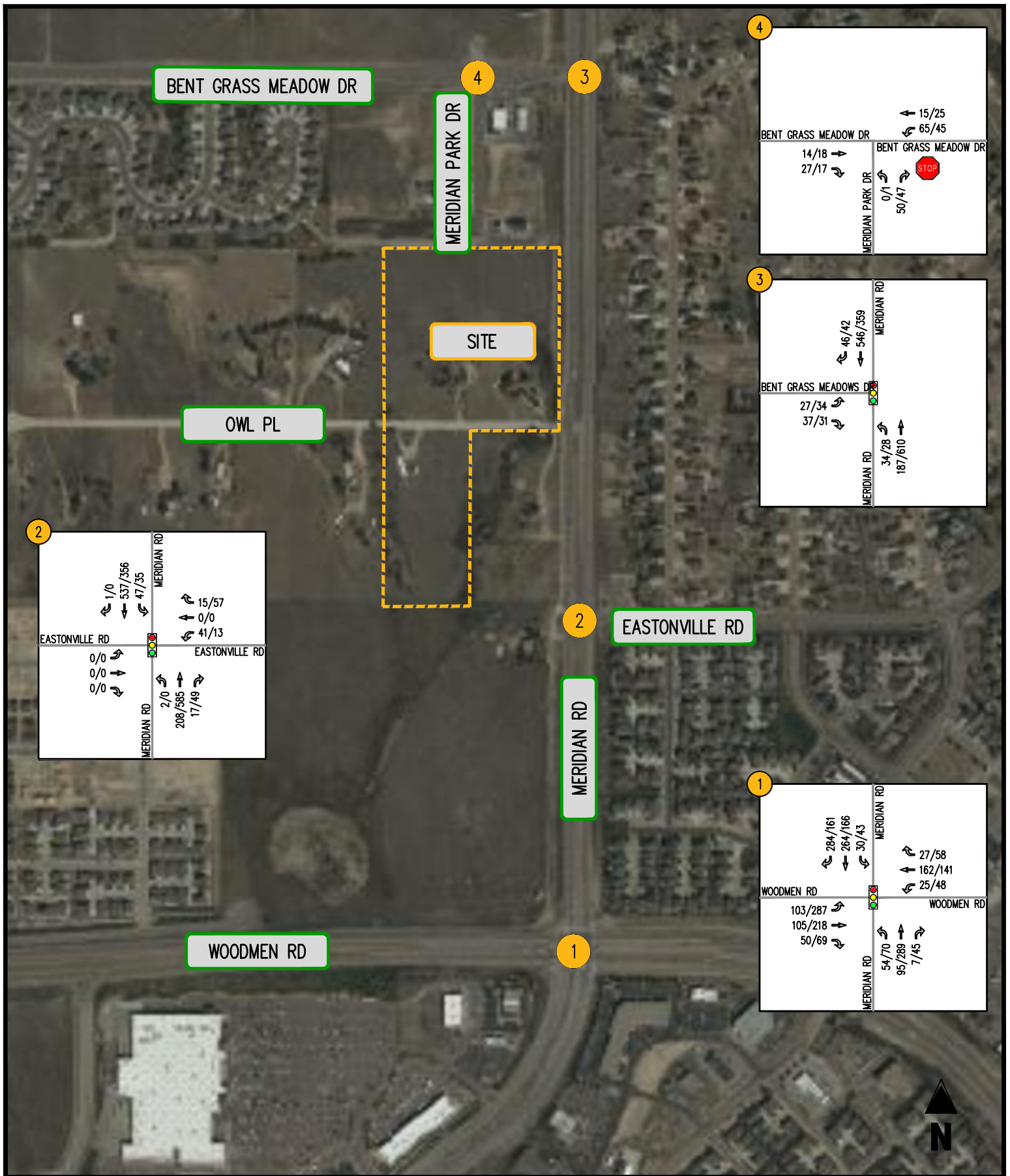
Meridian Storage  
 El Paso County, CO

0000/0000 (AM PEAK HOUR/PM PEAK HOUR)

- MOVEMENT
- SIGNALIZED INTERSECTION
- STOP SIGN
- YIELD SIGN







**FIGURE 4-4**  
Background 2040 Growth

Meridian Storage  
El Paso County, CO

0000/0000 (AM PEAK HOUR/PM PEAK HOUR)





- ← MOVEMENT
- SIGNALIZED INTERSECTION
- STOP SIGN
- YIELD SIGN





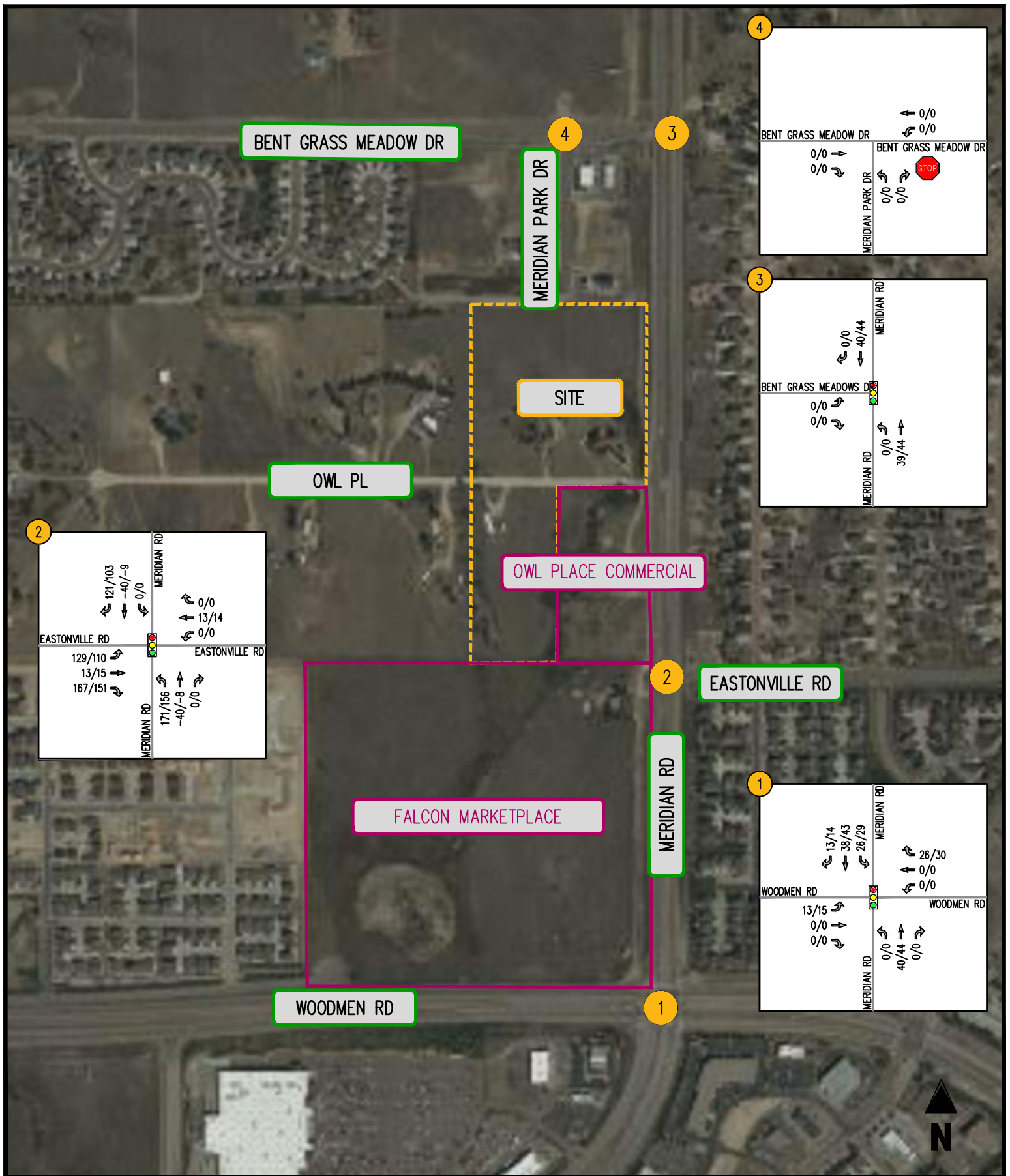
**FIGURE 4-5**  
**Pipeline Locations**

Meridian Storage  
 El Paso County, CO

-  MOVEMENT
-  SIGNALIZED INTERSECTION
-  STOP SIGN
-  YIELD SIGN







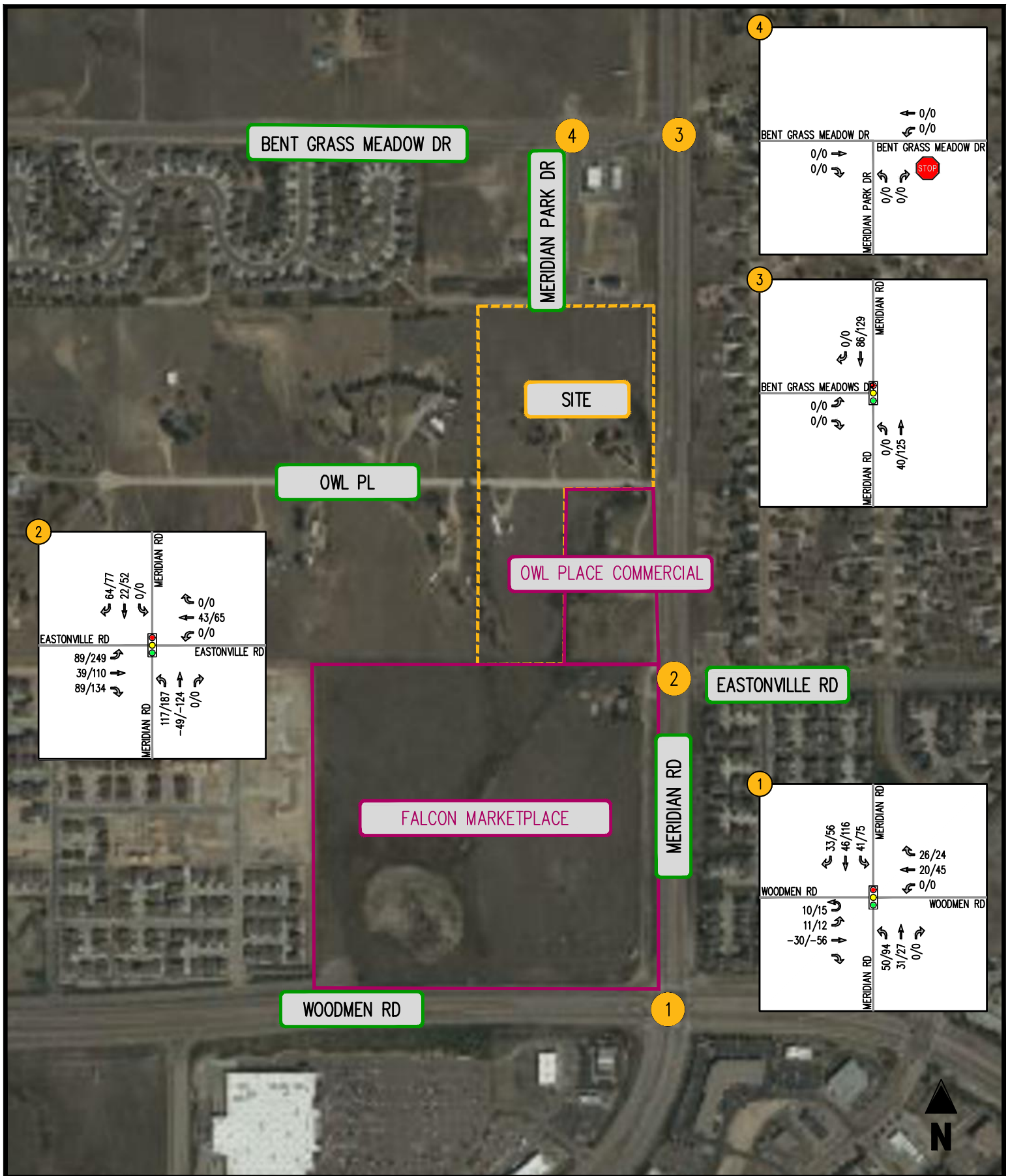
**FIGURE 4-6**  
**Pipeline Site Trips: Owl Place Commercial**

Meridian Storage  
 El Paso County, CO

0000/0000 (AM PEAK HOUR/PM PEAK HOUR)

- ← MOVEMENT
- 🚦 SIGNALIZED INTERSECTION
- 🛑 STOP SIGN
- 🚧 YIELD SIGN





**FIGURE 4-7**  
**Pipeline Site Trips: Falcon Marketplace 2024**

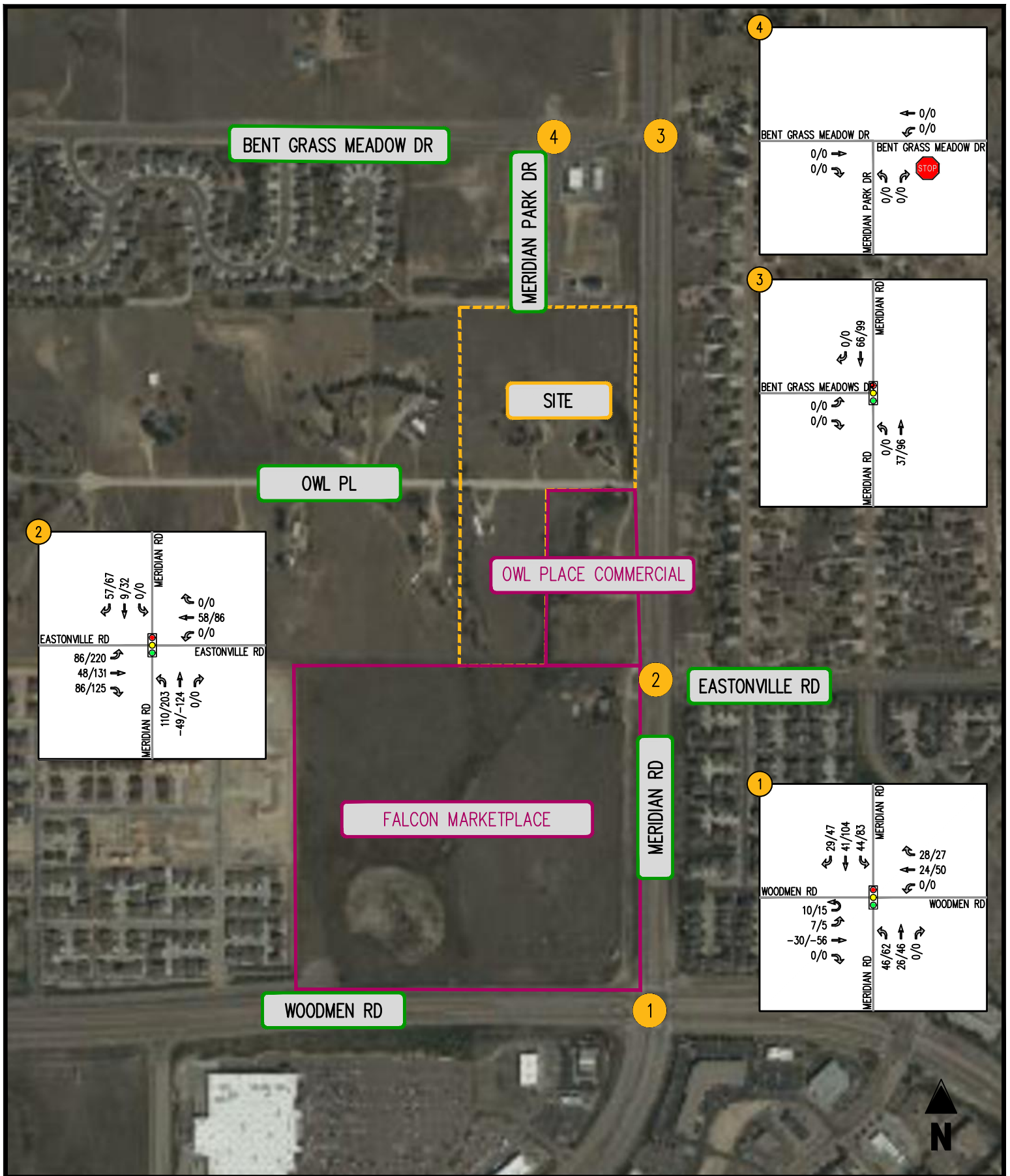
Meridian Storage  
 El Paso County, CO

0000/0000 (AM PEAK HOUR/PM PEAK HOUR)

- ← MOVEMENT
- 🚦 SIGNALIZED INTERSECTION
- 🛑 STOP SIGN
- 🚧 YIELD SIGN







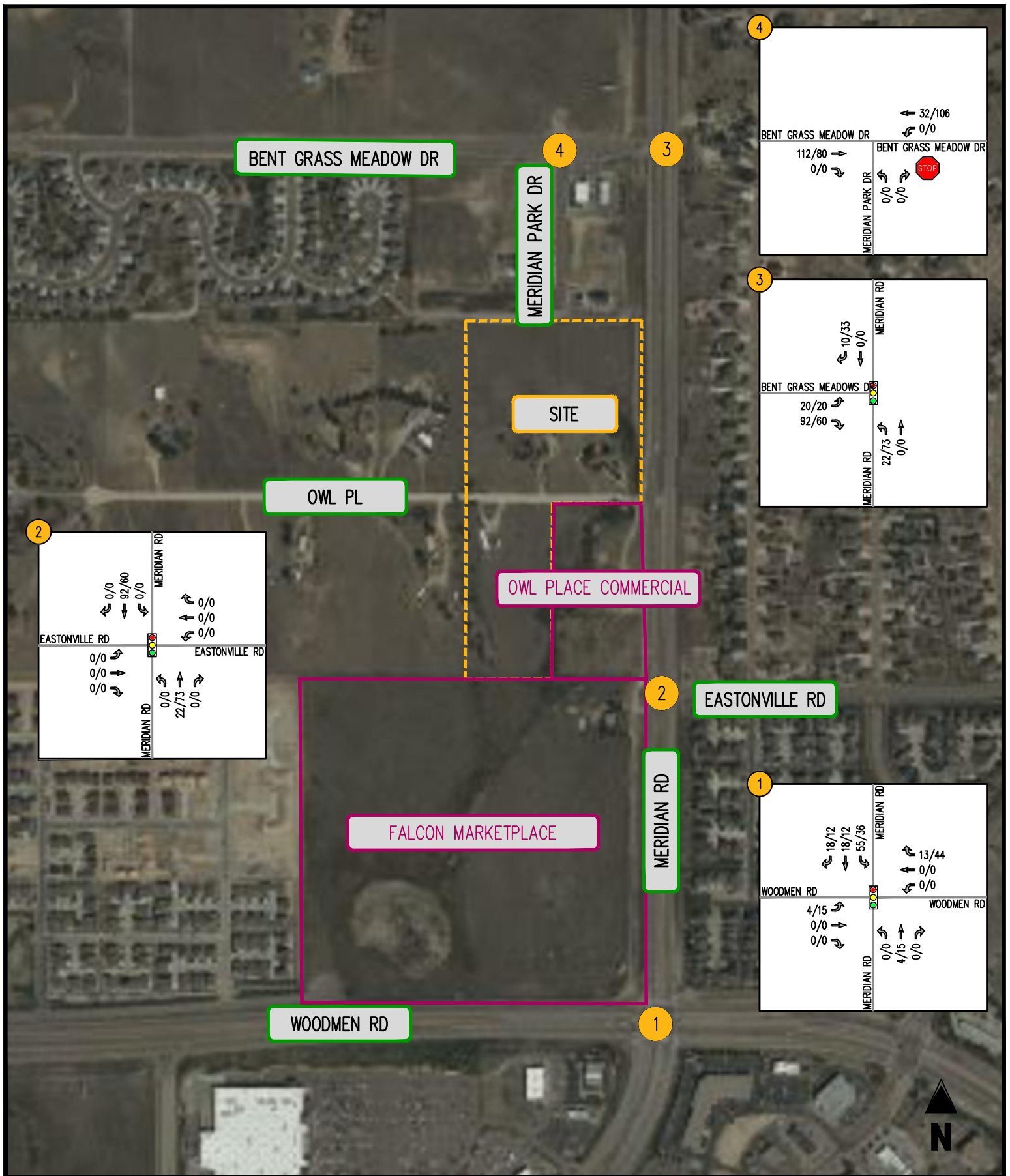
**FIGURE 4-8**  
**Pipeline Site Trips: Falcon Marketplace 2040**

Meridian Storage  
 El Paso County, CO

0000/0000 (AM PEAK HOUR/PM PEAK HOUR)

- ← MOVEMENT
- 🚦 SIGNALIZED INTERSECTION
- 🛑 STOP SIGN
- 🚧 YIELD SIGN





**FIGURE 4-9**  
**Pipeline Site Trips: Bent Grass Filing 4**

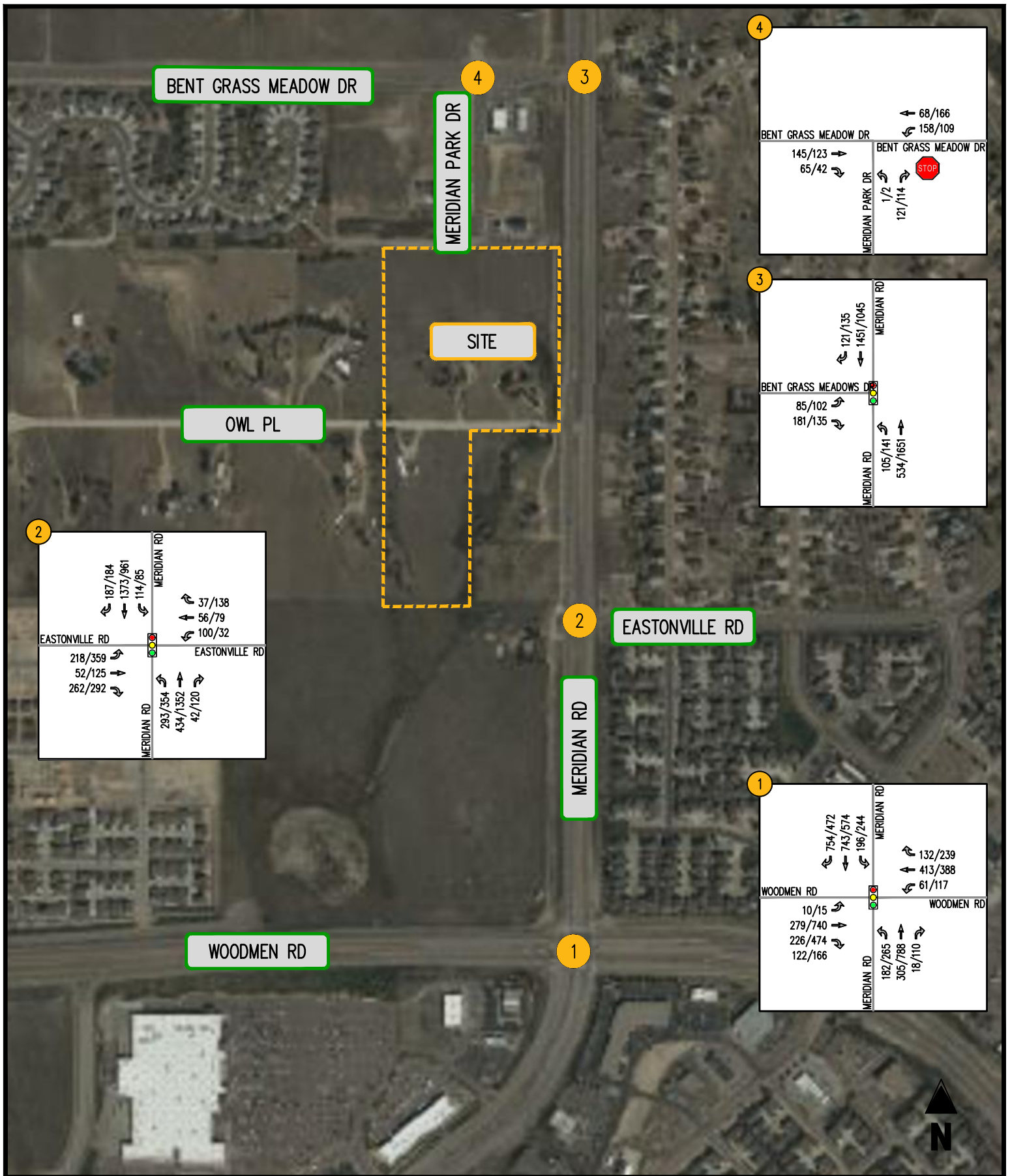
Meridian Storage  
 El Paso County, CO

0000/0000 (AM PEAK HOUR/PM PEAK HOUR)

- ← MOVEMENT
- 🚦 SIGNALIZED INTERSECTION
- 🛑 STOP SIGN
- 🚧 YIELD SIGN







**FIGURE 4-10**  
**Background 2024 Forecasts**

0000/0000 (AM PEAK HOUR/PM PEAK HOUR)

Meridian Storage  
 El Paso County, CO

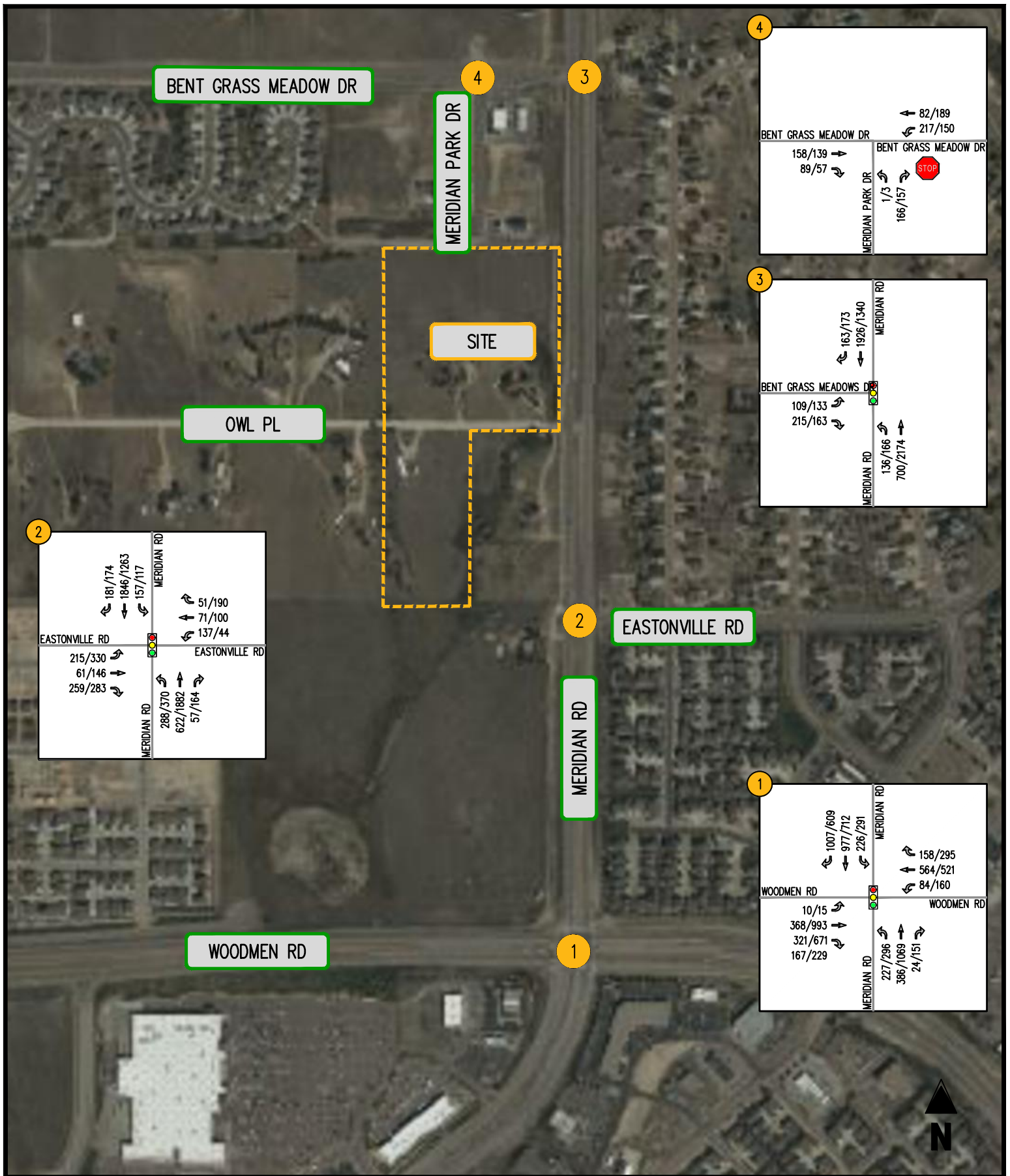
← MOVEMENT

SIGNALIZED INTERSECTION

STOP SIGN

YIELD SIGN





**FIGURE 4-11**  
**Background 2040 Forecasts**

0000/0000 (AM PEAK HOUR/PM PEAK HOUR)

Meridian Storage  
 El Paso County, CO

← MOVEMENT

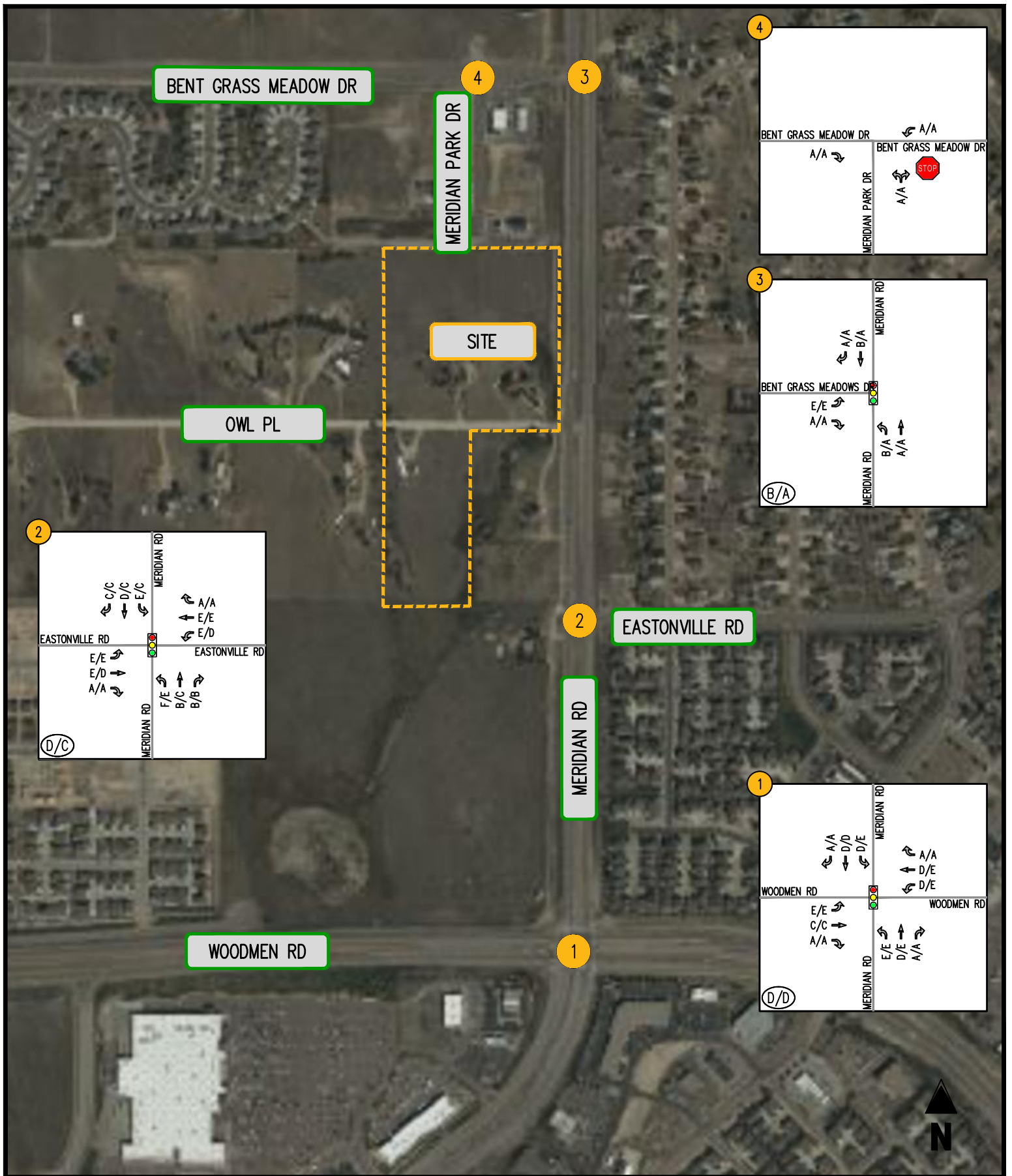
SIGNALIZED INTERSECTION

STOP SIGN

YIELD SIGN







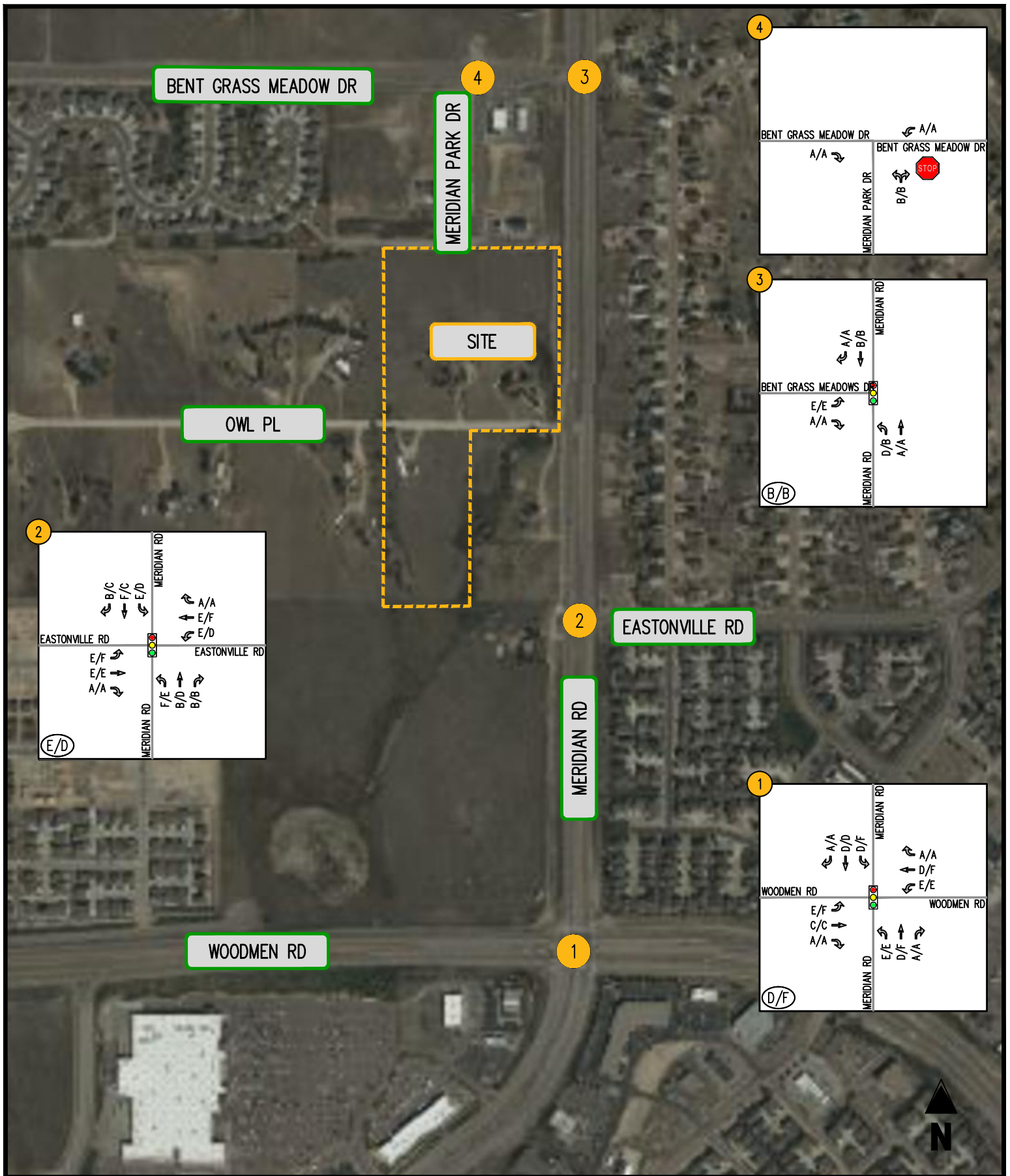
**FIGURE 4-12**  
**Background 2024 Levels of Service**

Meridian Storage  
 El Paso County, CO

(A/A) INTERSECTION LOS  
 0000/0000 (AM PEAK HOUR/PM PEAK HOUR)  
 37

- ← MOVEMENT
- 🚦 SIGNALIZED INTERSECTION
- 🛑 STOP SIGN
- 🚧 YIELD SIGN





**FIGURE 4-13**  
**Background 2040 Levels of Service**

Meridian Storage  
 El Paso County, CO

(A/A) INTERSECTION LOS  
 0000/0000 (AM PEAK HOUR/PM PEAK HOUR)  
 38

- ← MOVEMENT
- SIGNALIZED INTERSECTION
- STOP SIGN
- YIELD SIGN



Table 4-1  
 Meridian Storage  
 Background Intersection Level of Service Summary (1) (2)

Intersection	Operating Condition	Street Name	Approach/Movement	Existing 2023		Background 2024		Background 2040	
				AM Peak Hour	PM Peak Hour	AM Peak Hour	PM Peak Hour	AM Peak Hour	PM Peak Hour
1 Woodmen Rd/Meridian Rd	SIGNAL	Woodmen Road	EBL	E (57.3)	E (57.6)	E (61.5)	E (60.7)	E (66.9)	F (159.1)
			EBT	D (38.6)	C (24.5)	C (33.1)	C (29.8)	C (35.0)	C (34.8)
			EBR	A (0.0)	A (0.0)	A (0.0)	A (0.0)	A (0.0)	A (0.0)
		Woodmen Road	WBL	D (37.3)	E (60.1)	D (48.4)	E (60.6)	E (55.8)	E (60.1)
			WBT	C (28.8)	D (39.6)	D (36.2)	E (55.2)	D (53.4)	F (82.3)
			WBR	A (0.0)	A (0.0)	A (0.0)	A (0.0)	A (0.0)	A (0.0)
		Meridian Road	NBL	E (60.5)	E (64.5)	E (60.3)	E (65.5)	E (69.3)	E (72.4)
			NBT	D (50.1)	D (52.1)	D (52.6)	E (58.6)	D (51.9)	F (138.9)
			NBR	A (0.0)	A (0.0)	A (0.0)	A (0.0)	A (0.0)	A (0.0)
		Meridian Road	SBL	D (43.0)	E (61.0)	D (39.0)	E (73.9)	D (35.4)	F (145.3)
			SBT	D (50.0)	D (42.9)	D (49.6)	D (44.2)	D (54.0)	D (53.5)
SBR	A (0.0)		A (0.0)	A (0.0)	A (0.0)	A (0.0)	A (0.0)		
<b>Overall</b>				<b>D (45.5)</b>	<b>D (47.2)</b>	<b>D (47.4)</b>	<b>D (54.1)</b>	<b>D (53.0)</b>	<b>F (102.7)</b>
2 Meridian Rd/Eastonville Rd	STOP	Eastonville Road	WBL	F [186.2]	F [409.6]	N/A	N/A	N/A	N/A
			WBR	A [0.0]	A [0.0]	N/A	N/A	N/A	N/A
			NBT	A [0.0]	A [0.0]	N/A	N/A	N/A	N/A
		Meridian Rd	NBR	A [0.0]	A [0.0]	N/A	N/A	N/A	N/A
			SBL	A [9.3]	C [17.4]	N/A	N/A	N/A	N/A
2 Meridian Rd/Eastonville Rd 4-Legged Signalized	SIGNAL	Eastonville Road	EBL	N/A	N/A	E (57.9)	E (65.6)	E (56.0)	F (80.8)
			EBT	N/A	N/A	E (57.0)	D (54.5)	E (57.4)	E (76.7)
			EBR	N/A	N/A	A (0.0)	A (0.0)	A (0.0)	A (0.0)
		Eastonville Road	WBL	N/A	N/A	E (55.2)	D (50.7)	E (71.1)	D (50.9)
			WBT	N/A	N/A	E (56.9)	E (60.7)	E (61.2)	F (82.0)
			WBR	N/A	N/A	A (0.0)	A (0.0)	A (0.0)	A (0.0)
		Meridian Road	NBL	N/A	N/A	F (81.1)	E (62.5)	F (159.7)	E (63.3)
			NBT	N/A	N/A	B (14.4)	C (24.1)	B (16.9)	D (43.3)
			NBR	N/A	N/A	B (12.5)	B (13.5)	B (14.0)	B (13.3)
		Meridian Road	SBL	N/A	N/A	E (67.4)	C (22.6)	E (65.0)	D (50.1)
			SBT	N/A	N/A	D (47.7)	C (27.6)	F (81.7)	C (34.1)
SBR	N/A		N/A	C (22.5)	C (21.3)	C (21.8)	C (21.4)		
<b>Overall</b>				<b>N/A</b>	<b>N/A</b>	<b>D (46.0)</b>	<b>C (34.5)</b>	<b>E (69.1)</b>	<b>D (45.3)</b>
3 Meridian Rd/Bent Grass Meadows Dr	SIGNAL	Bent Grass Meadows Drive	EBL	D (55.0)	E (56.1)	E (55.5)	E (56.2)	E (56.0)	E (57.2)
			EBR	A (0.0)	A (0.0)	A (0.0)	A (0.0)	A (0.0)	A (0.0)
		Meridian Road	NBL	A (8.2)	A (4.8)	B (13.4)	A (6.7)	D (42.3)	B (12.2)
			NBT	A (2.5)	A (4.4)	A (2.7)	A (5.2)	A (3.0)	A (8.5)
		Meridian Road	SBT	A (9.9)	A (7.5)	B (11.5)	A (8.6)	B (15.9)	B (10.4)
			SBR	A (5.9)	A (5.9)	A (6.2)	A (6.3)	A (6.5)	A (6.7)
<b>Overall</b>				<b>A (9.4)</b>	<b>A (7.8)</b>	<b>B (11.0)</b>	<b>A (8.4)</b>	<b>B (15.0)</b>	<b>B (10.9)</b>
4 Bent Grass Meadows Dr/Meridian Park Dr	STOP	Bent Grass Meadows Drive	EBR	A [0.0]	A [0.0]	A [0.0]	A [0.0]	A [0.0]	A [0.0]
			WBL	A [7.8]	A [7.6]	A [8.2]	A [7.9]	A [8.3]	A [8.0]
		Meridian Park Drive	NBLR	A [9.1]	A [9.1]	A [10.0]	A [9.8]	B [10.2]	B [10.1]
5 Meridain Rd & Owl Pl	STOP	Owl Pl	EBR	C [16.2]	B [12.5]	N/A	N/A	N/A	N/A
		Meridian Road	NBL	B [14.0]	B [10.7]	N/A	N/A	N/A	N/A
		Meridian Road	SBTR	A [0.0]	A [0.0]	N/A	N/A	N/A	N/A
<b>Street Name</b>				<b>Existing 2023</b>		<b>Background 2024</b>		<b>Background 2040</b>	
				<b>ADT</b>	<b>ADT Capacity</b>	<b>ADT</b>	<b>LOS</b>	<b>AM</b>	<b>PM</b>
<b>El Paso County Roadway ADT Threshold Capacity</b>		Meridian Rd (S.O. Bent Grass Meadows)		24,989	40,000	30,958	40,000	40,030	40,000
<b>Principal Arterial (4-Lane)</b>		Meridian Rd (N.O. Woodman Rd)		24,416	40,000	32,405	40,000	41,728	40,000
<b>Meridian Rd Signal Progression</b>				<b>AM</b>	<b>PM</b>	<b>AM</b>	<b>PM</b>	<b>AM</b>	<b>PM</b>
<b>Arterial Band (Seconds Per Cycle)</b>				22	32	0	31	0	39
				30	37	1	0	1	0

Notes (1) Numbers in brackets [] represent delay at unsignalized intersections in seconds per vehicle.  
 (2) Numbers in parenthesis () represent delay at signalized intersections in seconds per vehicle.

Table 4-2  
 Meridian Storage  
 Background Intersection Queueing Summary (1)

Intersection	Operating Condition	Street Name	Approach/ Available Movement Storage	Existing 2023		Background 2024		Background 2040		
				AM Peak Hour	PM Peak Hour	AM Peak Hour	PM Peak Hour	AM Peak Hour	PM Peak Hour	
1 Woodmen Rd/Meridian Rd	SIGNAL	Woodmen Road	EBL	500	141	347	170	436	236	662
			EBT	-	130	240	112	215	152	315
			EBR	630	0	0	0	0	0	0
		Woodmen Road	WBL	350	44	77	49	81	62	102
			WBT	-	197	193	221	237	300	341
			WBR	250	0	0	0	86	0	142
		Meridian Road	NBL	440	84	106	111	156	157	203
			NBT	-	129	338	167	442	203	688
			NBR	330	0	0	0	0	0	0
			SBL	490	34	67	85	160	90	173
			SBR	-	225	188	345	310	423	352
			SBR	450	6	0	29	0	61	0
2 Meridian Rd/Eastonville Rd	STOP	Eastonville Road	WBL	120	165	92.5	N/A	N/A	N/A	N/A
		Meridian Rd	WBR	-	0	0	N/A	N/A	N/A	N/A
		Meridian Rd	NBR	400	0	0	N/A	N/A	N/A	N/A
		Meridian Rd	SBL	375	10	22.5	N/A	N/A	N/A	N/A
2 Meridian Rd/Eastonville Rd 4-Legged Signalized	SIGNAL	Eastonville Road	EBL	100	N/A	N/A	147	177	144	174
			EBT	-	N/A	N/A	86	167	96	254
			EBR	100	N/A	N/A	138	104	133	167
		Eastonville Road	WBL	120	N/A	N/A	136	46	225	64
			WBT	-	N/A	N/A	91	111	116	179
			WBR	100	N/A	N/A	0	30	0	29
		Meridian Road	NBL	100	N/A	N/A	420	396	431	234
			NBT	-	N/A	N/A	135	600	184	175
			NBR	400	N/A	N/A	5	5	10	3
			SBL	375	N/A	N/A	137	67	127	128
		Meridian Road	SBT	-	N/A	N/A	800	509	1066	643
			SBR	400	N/A	N/A	28	110	13	75
3 Meridian Rd/Bent Grass Meadows Dr	SIGNAL	Bent Grass Meadows Drive	EBL	150	48	55	59	71	70	85
			EBR	-	47	19	87	54	198	66
		Meridian Road	NBL	700	25	6	80	26	175	40
			NBT	-	10	249	112	167	155	139
		Meridian Road	SBT	-	386	201	617	291	951	491
			SBR	350	20	20	27	24	27	32
4 Bent Grass Meadows Dr/Meridian Park Dr	STOP	Bent Grass Meadows Drive	EBR	150	0	0	0	0	0	0
		Bent Grass Meadows Drive	WBL	100	10	7.5	12.5	7.5	15	10
		Meridian Park Drive	NBLR	-	12.5	12.5	15	12.5	20	17.5
5 Meridain Rd & Owl PI	STOP	Owl PI	EBR	-	2.5	2.5	N/A	N/A	N/A	N/A
		Meridian Road	NBL	270	0	2.5	N/A	N/A	N/A	N/A
		Meridian Road	SBTR	-	0	0	N/A	N/A	N/A	N/A

Notes: (1) Queue length is based on the 95th percentile queue as reported by Synchro, Version 11.



## V. Site Analysis

### Overview

The Applicant proposes to construct a development consisting of 158 self-storage units and 96 RV/Boat storage spaces. Since the site is currently zoned as Residential Rural and is being rezoned to Commercial Service, El Paso County has requested that this study also analyze the highest trip generating development that would be allowed on the proposed zoning. It was determined that a shopping plaza would be the highest realistic trip generator. Typically, this type of development is allowed to occupy 20% of a site's square footage. Since the site is 15.3 acres, it would allow for a 133,294 SF shopping plaza.

### Proposed Site Access

Upon completion, the proposed site will have two full movement accesses. One access will be located along Owl Pl. Meridian Park Dr will be extended to the south, where it will provide a second access to the site. The site plan shows two access points to the southern parcel, however, this parcel is not expected to be developed with this project. The self-storage will be entirely contained by the northern two parcels. A detailed site plan has been included in Appendix A.

### Trip Generation

Trip generation estimates for the weekday AM and PM peak hours, as well as the weekday average daily traffic (ADT), were derived from the standard Institute of Transportation Engineers (ITE) Trip Generation Manual rates/equations, as published in the 11<sup>th</sup> edition.

#### **Site Trips**

The site trips for both the proposed development (Mini-Warehouse) and the maximum trip generator (Shopping Plaza) are shown in Table 5-1. As shown in Table 5-1, the proposed development will generate 3 vph in the AM peak hour, 4 vph in the PM peak hour, and 46 daily weekday trips. The maximum trip generator will generate 471 vph in the AM peak hour, 1,141 vph in the PM peak hour, and 11,671 daily weekday trips.

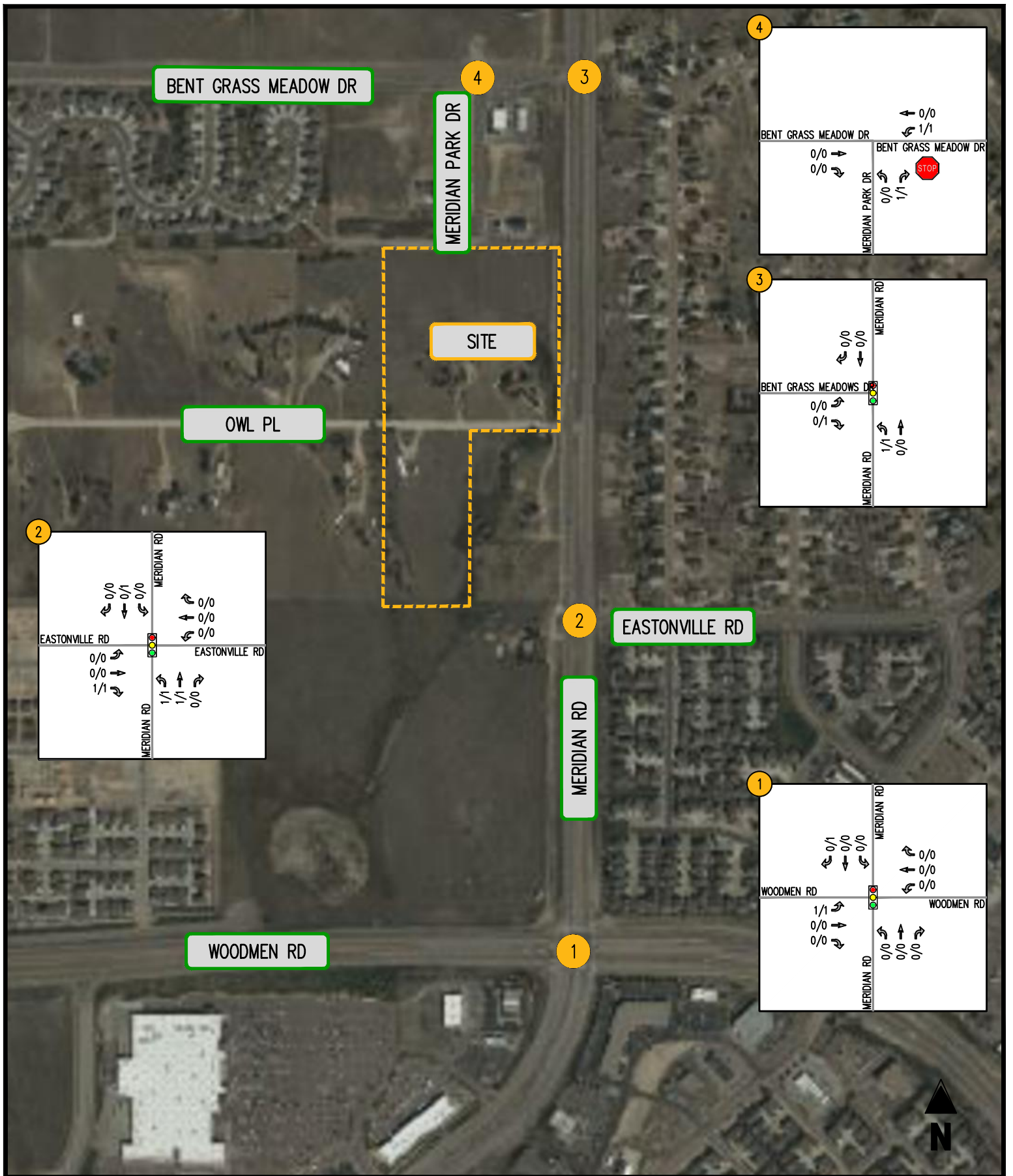
#### **Site Trip Distributions**

The distribution of the generated trips was based on an examination of existing traffic counts as well as the development's location relative to nearby population centers and major roads. The following trip distribution was used for the site generated trips:

- To/from the north on Meridian Rd: 20%
- To/from the south on Meridian Rd: 20%
- To/from the east on Woodman Rd: 15%
- To/from the west on Woodman Rd: 45%

The site trips were distributed through the study area based on the distribution above. The trip distribution for the proposed warehouse is shown in Figure 5-1. The trip distribution for the maximum trip generator (shopping plaza) is shown in Figure 5-2. While the site trips will use Meridian Park Dr to enter and exit the site, since the number of site trips are so low, Meridian Park Dr will remain classified as a local road.





**FIGURE 5-1**  
**Site Trips Warehouse**

Meridian Storage  
 El Paso County, CO

0000/0000 (AM PEAK HOUR/PM PEAK HOUR)

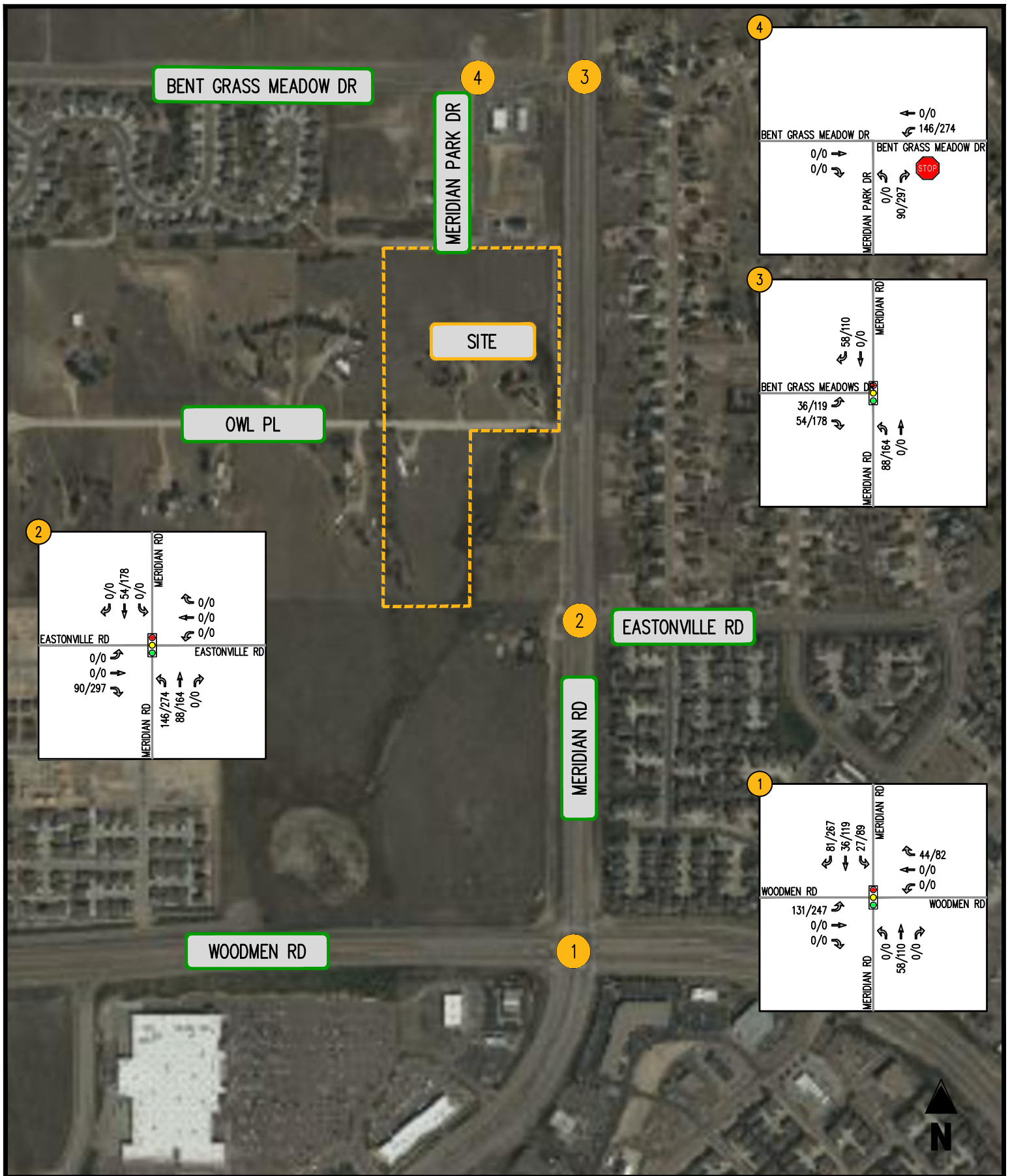
← MOVEMENT

SIGNALIZED INTERSECTION

STOP SIGN

YIELD SIGN





**FIGURE 5-2**  
**Site Trips Shopping Center**

0000/0000 (AM PEAK HOUR/PM PEAK HOUR)

Meridian Storage  
 El Paso County, CO

← MOVEMENT

SIGNALIZED INTERSECTION

STOP SIGN

YIELD SIGN



Table 5-1

Meridian Storage  
 Site Trip Generation

Land Use	Use Code	Amount	Units	AM Peak Hour			PM Peak Hour			Average Daily Trips
				In	Out	Total	In	Out	Total	
<b>Proposed Development (Mini-Warehouse)</b>	<b>151</b>	<b>254</b>	<b>Units</b>	<b>2</b>	<b>1</b>	<b>3</b>	<b>2</b>	<b>2</b>	<b>4</b>	<b>46</b>
<b>Maximum Trip Generator (Shopping Plaza 40-150K)</b>	<b>821</b>	<b>133,294</b>	<b>SF</b>	<b>292</b>	<b>179</b>	<b>471</b>	<b>548</b>	<b>593</b>	<b>1,141</b>	<b>11,671</b>

Note(s):  
 (1) Trip generation based on the Institute of Transportation Engineers' Trip Generation Manual, 11th Edition

## **VI. Analysis of Total 2024 & 2040 Conditions (Proposed Development)**

### **Total 2024 & 2040 Traffic Forecasts**

The 2024 total traffic forecasts, shown in Figure 6-1, were developed by combining the background 2024 forecasts (Figure 4-10) and the proposed development site trip assignments (Figure 5-1). The 2040 total traffic forecasts, shown in Figure 6-2, were developed by combining the background 2040 forecasts (Figure 4-11) and the proposed development site trip assignments (Figure 5-1).

### **Total 2024 & 2040 Levels of Service**

Capacity analyses of the total scenarios are provided in Appendix G. The total 2024 forecasted levels of service are shown in Table 6-1 and depicted graphically in Figure 6-3. The total 2040 forecasted levels of service are shown in Table 6-1 and depicted graphically in Figure 6-4. The Synchro models were updated with the total volumes. Per the El Paso County Transportation Impact Study Guidelines, the peak hour factors (PHF) were calculated or set to 0.95, whichever was higher. The signal splits were optimized, and the cycle lengths and offsets were kept the same as in the existing conditions. Using the Time Space Diagram analysis in Synchro, a progression analysis was conducted along Meridian Rd. A detailed results report is presented in Appendix G and is summarized in Table 6-1. The Synchro printouts are included in Appendix G.

Since the proposed development will only generate three vehicles in the AM peak hour and four vehicles in the PM peak hour, the traffic operations remain almost identical to the background scenarios. The signalized intersection of Woodmen Rd & Meridian Rd operates at LOS D during both peak hours in the 2024 total scenarios and at LOS F in the 2040 PM peak total scenario, as it does in the background scenarios. Many of the movements are reported to exceed capacity by the 2040 PM peak, with the EBL exceeding capacity the most severely. There will be 994 eastbound left turns served by dual left turn lanes. In order for this movement to operate acceptably, triple left turn lanes would likely be necessary. The signal at Meridian Rd & Eastonville Rd operates at LOS D or better in 2024 and operates at LOS E in the total 2040 AM peak hour. The signalized intersection of Meridian Rd & Bent Grass Meadows Dr operates at LOS B or better during the total scenarios, as does the stop-controlled intersection of Bent Grass Meadows Dr & Meridian Park Dr. It should be noted that all of these results are consistent with the results reported in the background scenarios. There are no intersections in the study area that operate acceptably in the background scenario and unacceptably in the total scenarios. As such, it is the responsibility of the county to provide roadway improvements to mitigate the failing traffic operations.

The El Paso County Roadway ADT Threshold Capacities were reviewed for a 4-lane principal arterial to ensure that Meridian Rd is operating under capacity in the total scenarios, in which the proposed development has been constructed. The results are reported in Table 6-1. The 46 daily trips that will be generated by the proposed development were distributed through the network and were added to the background ADT forecasts. Consistent with the background scenarios, it was reported that Meridian Rd will operate below the capacity threshold in the total 2024 scenario and over capacity in the total 2040 scenario. As discussed in the background scenario, Meridian Rd will likely need to be widened to 6-lanes by 2040 in order to achieve acceptable operations at the signals along the highway.

The signal progression analysis along Meridian Rd was conducted using the Synchro time space diagrams and the results are reported in Table 6-1 with the Synchro printouts included in Appendix G. The cycle length was held at 120 seconds for all three signals. In the total 2025 scenario, the NB



bandwidth between the signalized intersection of Woodmen Rd & Meridian Rd is 0 seconds in the AM and 32 seconds in the PM while the SB bandwidth is 1 seconds in the AM and 0 seconds in the PM. It was found for the total 2040 scenario that the NB bandwidth is 0 seconds in the AM and 39 seconds in the PM between the signals of Woodmen Rd & Meridian Rd while the SB bandwidth is 1 seconds in the AM and 0 seconds in the PM. This poor progression is to be expected due to unacceptable delays at the signalized intersections and the fact that Meridian Rd will exceed capacity by 2040. It is expected that if Meridian Rd were to be widened to 6-lanes, progression could be improved between signals.

### Total 2024 & 2040 Intersection Queues

The 95% queue lengths were reported for each movement within the study area using the Synchro queuing reports. The results are summarized in Table 6-2. The movements highlighted in yellow indicate that the queue exceeds its respective storage length or extends past the adjacent storage, possibly blocking vehicles trying to enter an adjacent turn lane. Queues highlighted in orange exceed capacity indicate that the movement exceeds capacity, and, the queues highlighted in red exceed capacity and extend past the adjacent storage or their own storage.

As can be seen in table, the total queues are very similar to the background queues, with the same movements anticipated to exceed their respective storage lengths. Many of the queues at the intersection of Meridian Rd & Eastonville Rd will exceed their respective storage lengths. It is not clear if the final intersection design of Meridian Rd & Eastonville Rd will have longer storages than what was reported by the Owl Place Commercial TIS, however, since this TIS was approved by El Paso County, it is assumed to be accurate.

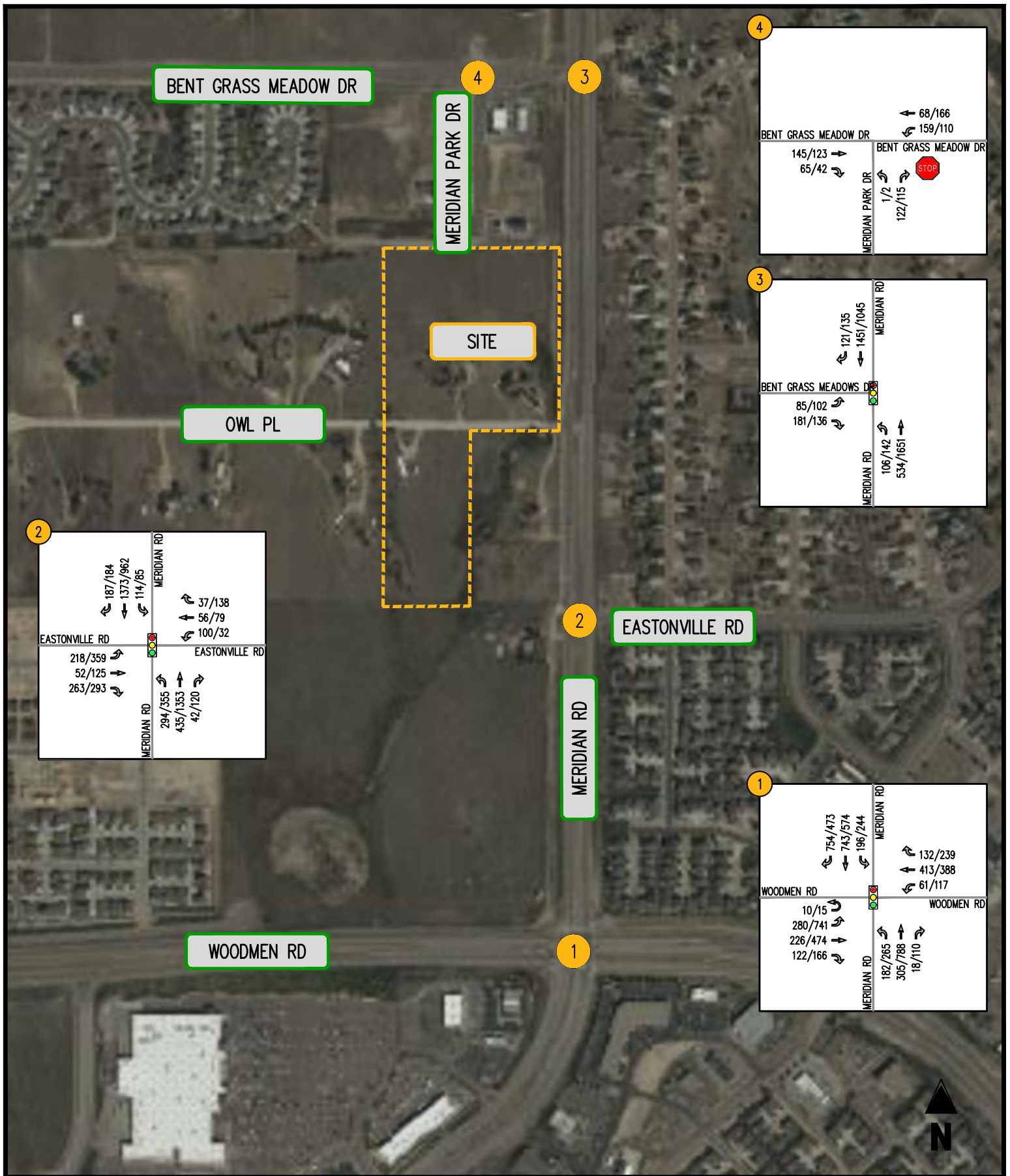
In the total 2024 scenario, the NBT queue at Woodmen Rd & Meridian Rd extends 455' in the PM peak hour, while the adjacent NBR storage is only 330'. This could potentially block vehicles trying to enter the NBR turn lane. The SBT queue at Meridian Rd & Bent Grass Meadows Dr extends 604' in the AM peak hour, while the adjacent SBR storage is only 350'. Since this movement is under capacity, even though it may block the SBR storage, it will likely clear each cycle.

The queues in the total 2040 scenario have increased, with many of the PM queues at Woodmen Rd & Meridian Rd expected to exceed their respective storage lengths or the adjacent storage lengths. As previously discussed, this intersection will exceed capacity in the 2040 scenario. The SBT queue at Meridian Rd & Bent Grass Meadows Dr extends 975' in the AM peak hour and 495' in the PM peak hour, while the adjacent SBR storage is only 350'. Since this movement is under capacity, even though it may block the SBR storage, it will likely clear each cycle.

### Total 2024 & 2040 Recommended Mitigation

There is no intersection or movement reported to operate acceptably in the background scenarios and unacceptable during the total scenarios. This is to be expected as the proposed development only generates 3 AM peak hour trips and 4 PM peak hour trips. As such, it is the responsibility of the El Paso County rather than the developer to provide mitigation solutions. Refer to the "Recommended Mitigation" part of Section IV for the list of recommended measures to ensure acceptable traffic operations through year 2040.





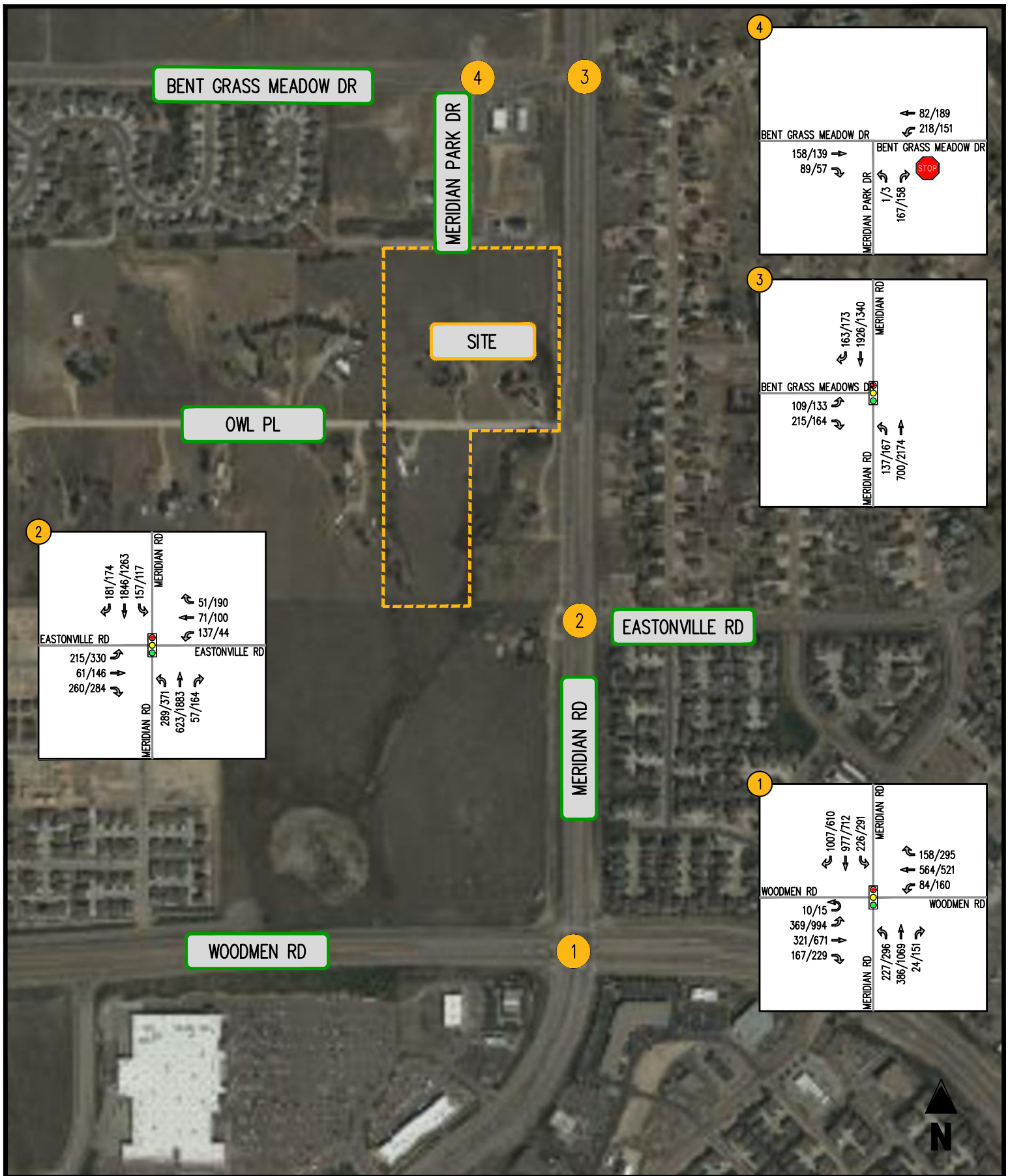
**FIGURE 6-1**  
**Total Future 2024 Forecasts Warehouse**

Meridian Storage  
 El Paso County, CO

0000/0000 (AM PEAK HOUR/PM PEAK HOUR)

- MOVEMENT
- SIGNALIZED INTERSECTION
- STOP SIGN
- YIELD SIGN





**FIGURE 6-2**  
**Total Future 2040 Forecasts Warehouse**

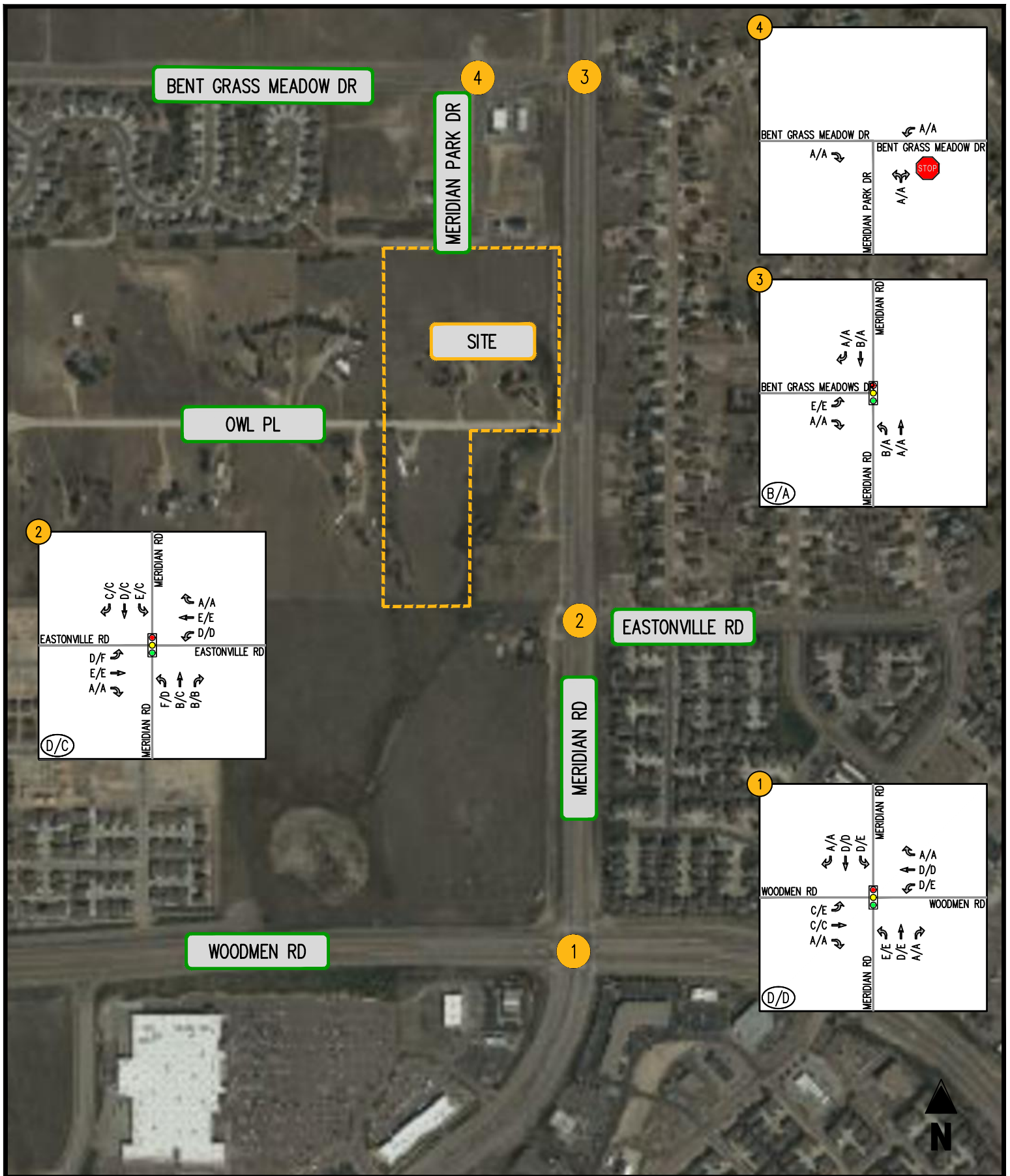
Meridian Storage  
 El Paso County, CO

0000/0000 (AM PEAK HOUR/PM PEAK HOUR)

- MOVEMENT
- SIGNALIZED INTERSECTION
- STOP SIGN
- YIELD SIGN







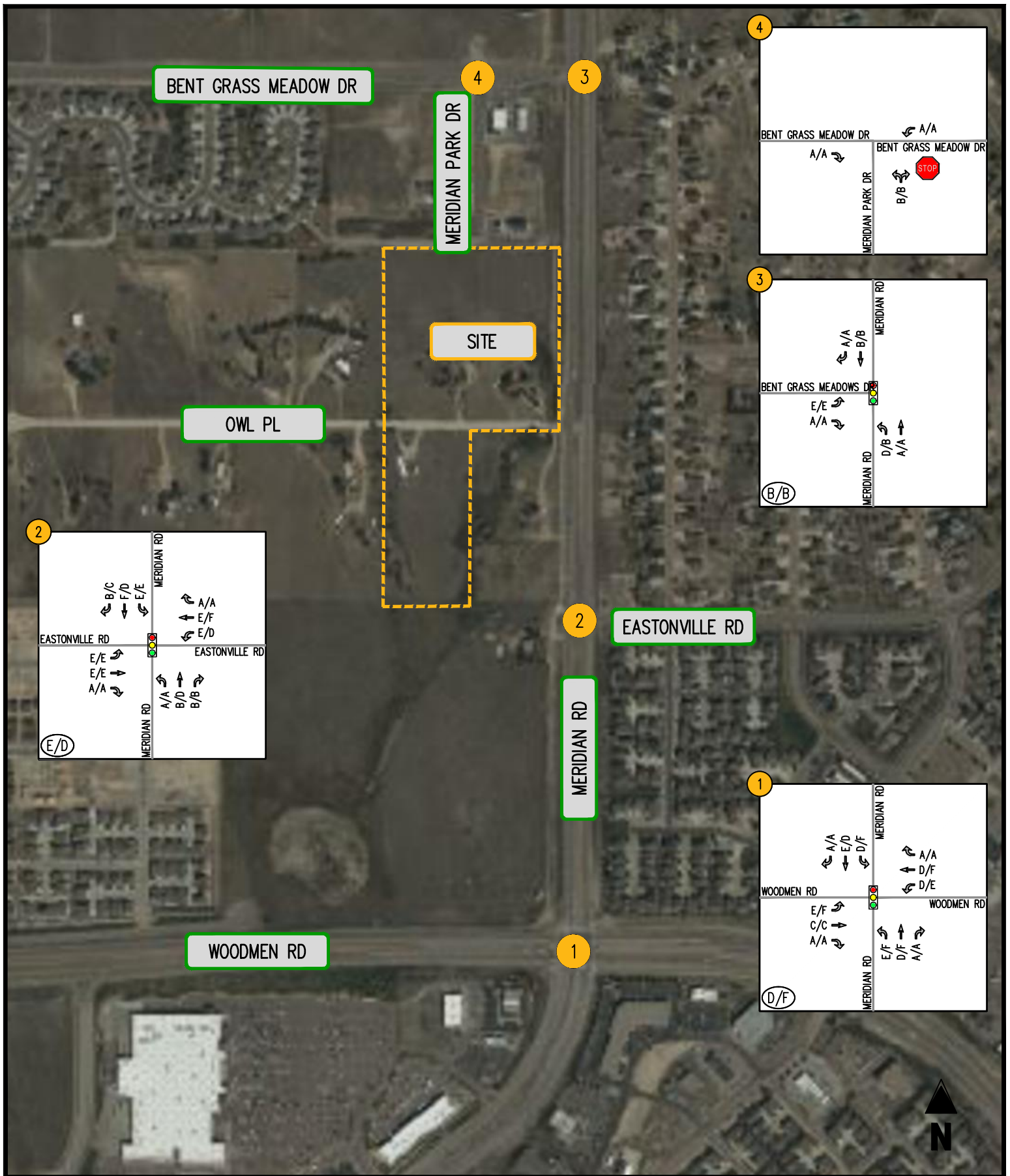
**FIGURE 6-3**  
**Total Future 2024 Levels of Service Warehouse**

Meridian Storage  
 El Paso County, CO

(A/A) INTERSECTION LOS  
 0000/0000 (AM PEAK HOUR/PM PEAK HOUR)  
 49

- ← MOVEMENT
- 🚦 SIGNALIZED INTERSECTION
- 🛑 STOP SIGN
- 🚧 YIELD SIGN





**FIGURE 6-4**  
**Total Future 2040 Levels of Service Warehouse**

Meridian Storage  
 El Paso County, CO

(A/A) INTERSECTION LOS  
 0000/0000 (AM PEAK HOUR/PM PEAK HOUR)  
 50

- ← MOVEMENT
- 🚦 SIGNALIZED INTERSECTION
- 🛑 STOP SIGN
- 🚧 YIELD SIGN





Table 6-1  
Meridian Storage  
Total Intersection Level of Service Summary (1) (2)

Intersection	Operating Condition	Street Name	Approach/ Movement	Background 2024		Background 2040		Total Future 2024 Warehouse		Total Future 2040 Warehouse		
				AM Peak Hour	PM Peak Hour	AM Peak Hour	PM Peak Hour	AM Peak Hour	PM Peak Hour	AM Peak Hour	PM Peak Hour	
1 Woodmen Rd/Meridian Rd	SIGNAL	Woodmen Road	EBL	E (61.5)	E (60.7)	E (66.9)	F (159.1)	C (31.6)	E (60.7)	E (67.0)	F (142.0)	
			EBT	C (33.1)	C (29.8)	C (35.0)	C (34.8)	C (32.3)	C (29.5)	C (34.1)	C (34.8)	
			EBR	A (0.0)	A (0.0)	A (0.0)	A (0.0)	A (0.0)	A (0.0)	A (0.0)	A (0.0)	
		Woodmen Road	WBL	D (48.4)	E (60.6)	E (55.8)	E (60.1)	D (49.3)	E (60.6)	D (47.3)	E (60.1)	
			WBT	D (36.2)	E (55.2)	D (53.4)	F (82.3)	D (36.2)	D (54.1)	D (39.4)	F (97.3)	
			WBR	A (0.0)	A (0.0)	A (0.0)	A (0.0)	A (0.0)	A (0.0)	A (0.0)	A (0.0)	
		Meridian Road	NBL	E (60.3)	E (65.5)	E (69.3)	E (72.4)	E (62.0)	E (67.9)	E (69.3)	F (88.5)	
			NBT	D (52.6)	E (58.6)	D (51.9)	F (138.9)	D (52.6)	E (61.7)	D (51.9)	F (138.9)	
			NBR	A (0.0)	A (0.0)	A (0.0)	A (0.0)	A (0.0)	A (0.0)	A (0.0)	A (0.0)	
		Meridian Road	SBL	D (39.0)	E (73.9)	D (35.4)	F (145.3)	D (39.0)	E (73.9)	D (35.8)	F (145.3)	
			SBT	D (49.6)	D (44.2)	D (54.0)	D (53.5)	D (49.6)	D (44.7)	E (56.8)	D (50.2)	
			SBR	A (0.0)	A (0.0)	A (0.0)	A (0.0)	A (0.0)	A (0.0)	A (0.0)	A (0.0)	
		<b>Overall</b>			<b>D (47.4)</b>	<b>D (54.1)</b>	<b>D (53.0)</b>	<b>F (102.7)</b>	<b>D (47.5)</b>	<b>D (54.9)</b>	<b>D (51.1)</b>	<b>F (101.3)</b>
2 Meridian Rd/Eastonville Rd 4-Legged Signalized	SIGNAL	Eastonville Road	EBL	E (57.9)	E (65.6)	E (56.0)	F (80.8)	D (54.5)	F (94.9)	E (56.0)	E (67.7)	
			EBT	E (57.0)	D (54.5)	E (57.4)	E (76.7)	E (55.2)	E (56.4)	E (57.4)	E (66.7)	
			EBR	A (0.0)	A (0.0)	A (0.0)	A (0.0)	A (0.0)	A (0.0)	A (0.0)	A (0.0)	
		Eastonville Road	WBL	E (55.2)	D (50.7)	E (71.1)	D (50.9)	D (53.8)	D (50.9)	E (71.1)	D (50.7)	
			WBT	E (56.9)	E (60.7)	E (61.2)	F (82.0)	E (56.9)	E (60.7)	E (61.2)	F (82.0)	
			WBR	A (0.0)	A (0.0)	A (0.0)	A (0.0)	A (0.0)	A (0.0)	A (0.0)	A (0.0)	
		Meridian Road	NBL	F (81.1)	E (62.5)	F (159.7)	E (63.3)	F (107.6)	D (45.7)	F (161.1)	E (63.3)	
			NBT	B (14.4)	C (24.1)	B (16.9)	D (43.3)	B (14.9)	C (22.1)	B (16.9)	D (44.2)	
			NBR	B (12.5)	B (13.5)	B (14.0)	B (13.3)	B (13.0)	B (12.5)	B (14.0)	B (13.4)	
		Meridian Road	SBL	E (67.4)	C (22.6)	E (65.0)	D (50.1)	E (67.4)	C (21.0)	E (66.7)	E (65.6)	
			SBT	D (47.7)	C (27.6)	F (81.7)	C (34.1)	D (44.1)	C (26.6)	F (81.7)	D (36.8)	
			SBR	C (22.5)	C (21.3)	B (17.8)	C (21.4)	C (21.9)	C (20.5)	B (17.8)	C (22.5)	
		<b>Overall</b>			<b>D (46.0)</b>	<b>C (34.5)</b>	<b>E (69.1)</b>	<b>D (45.3)</b>	<b>D (46.9)</b>	<b>C (34.8)</b>	<b>E (69.3)</b>	<b>D (45.6)</b>
3 Meridian Rd/Bent Grass Meadows Dr	SIGNAL	Bent Grass Meadows Drive	EBL	E (55.5)	E (56.2)	E (56.0)	E (57.2)	E (55.5)	E (56.2)	E (56.0)	E (57.2)	
			EBR	A (0.0)	A (0.0)	A (0.0)	A (0.0)	A (0.0)	A (0.0)	A (0.0)	A (0.0)	
			NBL	B (13.4)	A (6.7)	D (42.3)	B (12.2)	B (13.5)	A (6.7)	D (41.0)	B (12.3)	
		Meridian Road	NBT	A (2.7)	A (5.2)	A (3.0)	A (8.5)	A (2.7)	A (5.2)	A (3.0)	A (8.5)	
			SBT	B (11.5)	A (8.6)	B (15.9)	B (10.4)	B (11.6)	A (8.6)	B (15.9)	B (10.4)	
		Meridian Road	SBR	A (6.2)	A (6.3)	A (6.5)	A (6.7)	A (6.2)	A (6.3)	A (6.5)	A (6.8)	
			<b>Overall</b>			<b>B (11.0)</b>	<b>A (8.4)</b>	<b>B (15.0)</b>	<b>B (10.9)</b>	<b>B (11.0)</b>	<b>A (8.4)</b>	<b>B (15.0)</b>
4 Bent Grass Meadows Dr/Meridian Park Dr	STOP	Bent Grass Meadows Drive Bent Grass Meadows Drive Meridian Park Drive	EBR	A [0.0]	A [0.0]	A [0.0]	A [0.0]	A [0.0]	A [0.0]	A [0.0]	A [0.0]	
			WBL	A [8.2]	A [7.9]	A [8.3]	A [8.0]	A [8.2]	A [7.9]	A [8.3]	A [8.0]	
			NBLR	A [10.0]	A [9.8]	B [10.2]	B [10.1]	A [10.0]	A [9.8]	B [10.2]	B [10.1]	
<b>Street Name</b>				<b>Background 2024</b>		<b>Background 2040</b>		<b>Total Future 2024 Warehouse</b>		<b>Total Future 2040 Warehouse</b>		
				<b>ADT</b>	<b>LOS</b>	<b>AM</b>	<b>PM</b>	<b>ADT</b>	<b>LOS</b>	<b>AM</b>	<b>PM</b>	
<b>El Paso County Roadway ADT Threshold Capacity Principal Arterial (4-Lane)</b>				Meridian Rd (S.O. Bent Grass Meadows)	30,958	40,000	40,030	40,000	30,978	40,000	40,051	40,000
				Meridian Rd (N.O. Woodman Rd)	32,405	40,000	41,728	40,000	32,447	40,000	41,759	40,000
<b>Meridian Rd Signal Progression Arterial Band (Seconds Per Cycle)</b>				<b>AM</b>	<b>PM</b>	<b>AM</b>	<b>PM</b>	<b>AM</b>	<b>PM</b>	<b>AM</b>	<b>PM</b>	
				<b>NB</b>	0	31	0	39	0	32	0	39
				<b>SB</b>	1	0	1	0	1	0	1	0

Notes (1) Numbers in brackets [] represent delay at unsignalized intersections in seconds per vehicle.  
(2) Numbers in parenthesis () represent delay at signalized intersections in seconds per vehicle.

Table 6-2  
 Meridian Storage  
 Total Future Intersection Queueing Summary (1)

Intersection	Operating Condition	Street Name	Approach/ Movement	Available Storage	Background 2024		Background 2040		Total Future 2024 Warehouse		Total Future 2040 Warehouse	
					AM Peak Hour	PM Peak Hour	AM Peak Hour	PM Peak Hour	AM Peak Hour	PM Peak Hour	AM Peak Hour	PM Peak Hour
1 Woodmen Rd/Meridian Rd	SIGNAL	Woodmen Road	EBL	500	170	436	236	662	170	437	236	651
			EBT	-	112	215	152	315	111	212	150	315
			EBR	630	0	0	0	0	0	0	0	0
			WBL	350	49	81	62	102	49	81	62	102
		Woodmen Road	WBT	-	221	237	300	341	218	224	297	354
			WBR	250	0	86	0	142	0	85	0	143
			NBL	440	111	156	157	203	113	172	157	215
			NBT	-	167	442	203	688	167	455	203	688
		Meridian Road	NBR	330	0	0	0	0	0	0	0	0
			SBL	490	85	160	90	173	87	147	90	164
			SBT	-	345	310	423	352	347	314	424	340
			SBR	450	29	0	61	0	22	0	61	0
2 Meridian Rd/Eastonville Rd 4-Legged Signalized	SIGNAL	Eastonville Road	EBL	100	147	177	144	174	141	177	144	207
			EBT	-	86	167	96	254	86	160	96	241
			EBR	100	138	104	133	167	160	62	139	139
			WBL	120	136	46	225	64	146	46	225	64
		Eastonville Road	WBT	-	91	111	116	179	91	109	116	179
			WBR	100	0	30	0	29	0	0	0	29
			NBL	100	420	396	431	234	447	284	431	239
			NBT	-	135	600	184	175	135	408	183	185
		Meridian Road	NBR	400	5	5	10	3	6	3	10	4
			SBL	375	137	67	127	128	135	92	132	140
			SBT	-	800	509	1066	643	774	560	1058	649
			SBR	400	28	110	13	75	31	98	12	80
3 Meridian Rd/Bent Grass Meadows Dr	SIGNAL	Bent Grass Meadows Drive	EBL	150	59	71	70	85	58	71	69	85
			EBR	-	87	54	198	66	97	54	171	67
			NBL	700	80	26	175	40	83	25	176	43
		Meridian Road	NBT	-	112	167	155	139	113	160	155	137
			SBT	-	617	291	951	491	604	291	975	495
			SBR	350	27	24	27	32	26	25	29	32
4 Bent Grass Meadows Dr/Meridian Park Dr	STOP	Bent Grass Meadows Drive	EBR	150	0	0	0	0	0	0	0	
		Bent Grass Meadows Drive	WBL	100	12.5	7.5	15	10	12.5	7.5	15	10
		Meridian Park Drive	NBLR	-	15	12.5	20	17.5	15	12.5	20	17.5

Note: (1) Queue length is based on the 95th percentile queue as reported by Synchro, Version 11.

## VII. Analysis of Total 2024 & 2040 Conditions (Maximum Trip Generator)

Since the site is being rezoned to Commercial Service, El Paso County has requested that in addition to analyzing the study area with the proposed warehouse development, the study area be analyzed with the highest allowed trip generating land use. It was determined that out of the land uses allowed on an area zoned as Commercial Service, a shopping plaza would generate the most trips. It was assumed that 20% of the site would be occupied by the building, meaning that the shopping plaza would be 133,294 SF.

The developer has no intention of constructing a shopping plaza on the site, and the following analysis is required by El Paso County since the site is being rezoned.

### Total 2024 & 2040 Traffic Forecasts

The 2024 total traffic forecasts, shown in Figure 7-1, were developed by combining the background 2024 forecasts (Figure 4-10) and the proposed development site trip assignments (Figure 5-2). The 2040 total traffic forecasts, shown in Figure 7-2, were developed by combining the background 2040 forecasts (Figure 4-11) and the proposed development site trip assignments (Figure 5-2).

### Total 2024 & 2040 Levels of Service

Capacity analyses of the total scenarios are provided in Appendix G. The total 2024 forecasted levels of service are shown in Table 7-1 and depicted graphically in Figure 7-3. The total 2040 forecasted levels of service are shown in Table 7-1 and depicted graphically in Figure 7-4. The Synchro models were updated with the total volumes. Per the El Paso County Transportation Impact Study Guidelines, the peak hour factors (PHF) were calculated or set to 0.95, whichever was higher. The signal splits were optimized, and the cycle lengths and offsets were kept the same as in the existing conditions. Using the Time Space Diagram analysis in Synchro, a progression analysis was conducted along Meridian Rd. A detailed results report is presented in Appendix G and is summarized in Table 7-1. The Synchro printouts are included in Appendix G.

As can be seen in the table, if a shopping center were to be built instead of the proposed storage facility, the delays through the study area would generally increase. Since the proposed development will only generate three vehicles in the AM peak hour and four vehicles in the PM peak hour, the traffic operations remain almost identical to the background scenarios. The signalized intersection of Woodmen Rd & Meridian Rd operates at LOS D in the AM peak and LOS F in the PM peak for both the total 2024 and total 2040 scenarios. Many of the movements are reported to exceed capacity by the 2040 PM peak, with the EBL exceeding capacity the most severely. There will be 1240 eastbound left turns served by dual left turn lanes. At a minimum, triple left turns would be needed to accommodate this movement. The signal at Meridian Rd & Eastonville Rd operates at LOS E or better in 2024 and operates at LOS F during both total 2040 peak periods. The intersections of Meridian Rd & Bent Grass Meadows Dr and Bent Grass Meadows Dr & Meridian Park Dr will operate at LOS C or better with no operational concerns.

The El Paso County Roadway ADT Threshold Capacities were reviewed for a 4-lane principal arterial to ensure that Meridian Rd is operating under capacity in the total scenarios in which the proposed development has been constructed. The results are reported in Table 7-1. The 11,671 daily trips that will be generated by the proposed development were distributed through the network and were added to the background ADT forecasts. The southern portion of Meridian Rd, just north of Woodman Rd will exceed capacity in 2024 while the northern part, just south of Bent Grass Meadows will remain under capacity. All

of Meridian Rd through the study area will exceed capacity by 2040. Meridian Rd would need to be widened to 6-lanes by 2040 in order to achieve acceptable operations at the signals along the highway.

The signal progression analysis along Meridian Rd was conducted using the Synchro time space diagrams and the results are reported in Table 7-1 with the Synchro printouts included in Appendix G. The cycle length remains at 120 seconds for all three signals. In the total 2025 scenario, the NB bandwidth between the signalized intersection of Woodmen Rd & Meridian Rd is 0 seconds in the AM and 28 seconds in the PM while the SB bandwidth is 2 seconds in the AM and 0 seconds in the PM. It was found for the total 2040 scenario that the NB bandwidth is 0 seconds in the AM and 38 seconds in the PM between the signals of Woodmen Rd & Meridian Rd while the SB bandwidth is 2 seconds in the AM and 0 seconds in the PM. This poor progression is to be expected due to much of the study area operating over capacity. It is expected that if Meridian Rd were to be widened to 6-lanes, progression could be improved between signals.

### Total 2024 & 2040 Intersection Queues

The 95% queue lengths were reported for each movement within the study area using the Synchro queuing reports. The results are summarized in Table 7-2. The movements highlighted in yellow indicate that the queue exceeds its respective storage length or extends past the adjacent storage, possible blocking vehicles trying to enter an adjacent turn lane. Queues highlighted in orange exceed capacity indicate that the movement exceeds capacity, and the queues highlighted in red exceed capacity and extend past the adjacent storage or their own storage.

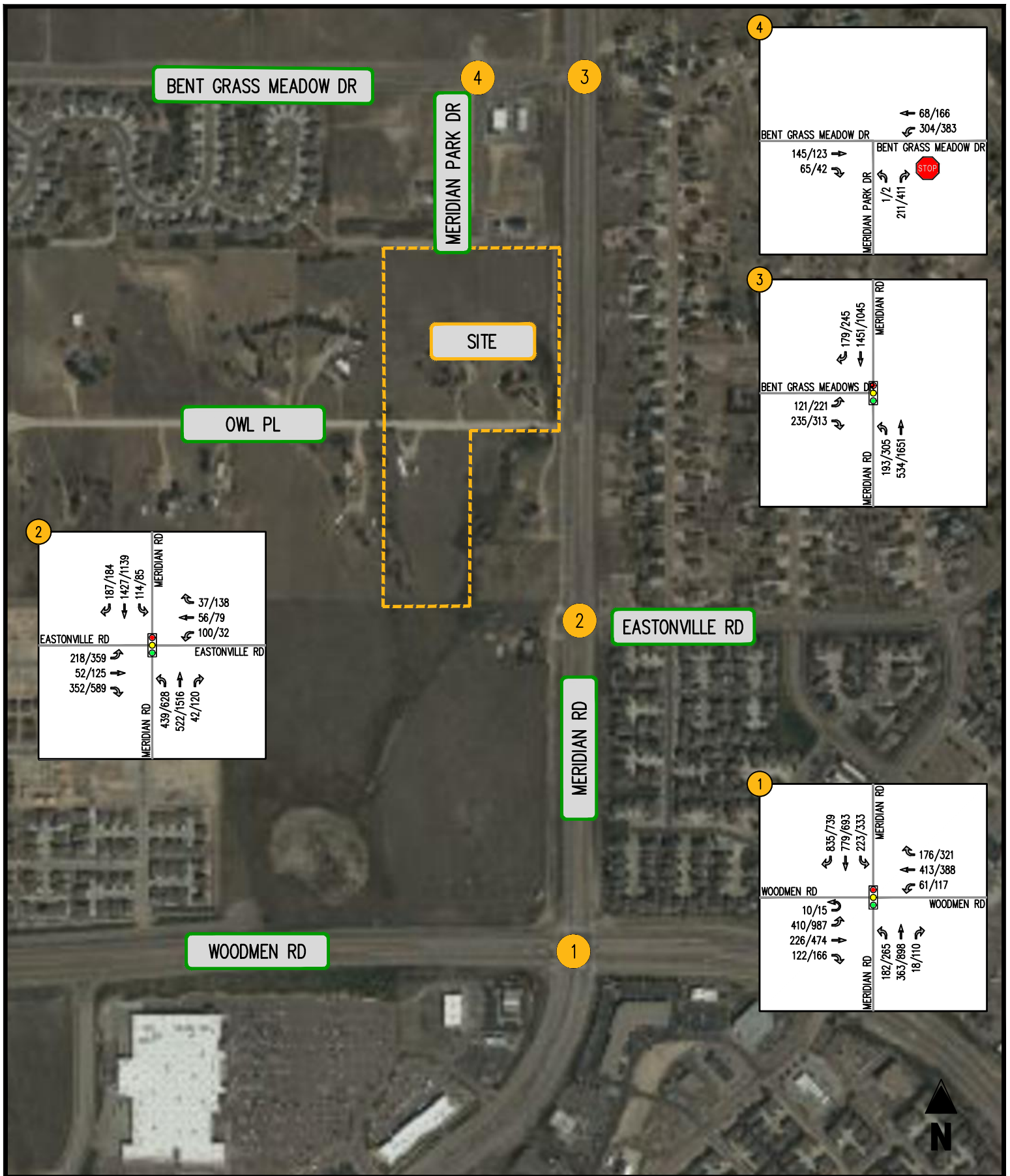
As can be seen in the table, the queue lengths have increased when compared to the lengths reported in the storage facility scenarios. Much of the queueing problem identified in the table is a result of intersection and roadway capacity being exceeded. In order to achieve acceptable queue lengths, the capacity deficiencies throughout the study area will need to be addressed. As such, it is advised that the "Recommended Mitigation" section below be referenced as a solution to achieving acceptable queue lengths. In addition, the storage lengths at Meridian Rd & Eastonville Rd should be reviewed since they are likely too short even if acceptable intersection operations are achieved.

### Total 2024 & 2040 Recommended Mitigation

The following measures are recommended to help achieve acceptable traffic operations through the total 2040 scenario. It should be noted that this is for a hypothetical scenario in which the lot is developed to the maximum extent. The developer has no intention of developing the lot with a shopping center.

- Improve Meridian Rd to a 6-lane highway through the entire study area
  - Meridian Rd will need 4 NBT lanes through the intersection of Meridian Rd & Woodman Rd. The outside thru lane can turn into the right turn only lane at Meridian Rd & Eastonville Rd
- Improve Woodman Rd to a 6-lane highway through the study area
- Install triple left turn lanes for the EBL at Meridian Rd & Woodman Rd
- Install dual left turn lanes for the NBL movement at Meridian Rd & Eastonville Rd
- Ensure that the storage lengths at Meridian Rd & Eastonville Rd are long enough to accommodate their forecasted queues.
- Install dual left turn lanes for the NBL movement at Meridian Rd & Bent Grass Meadows





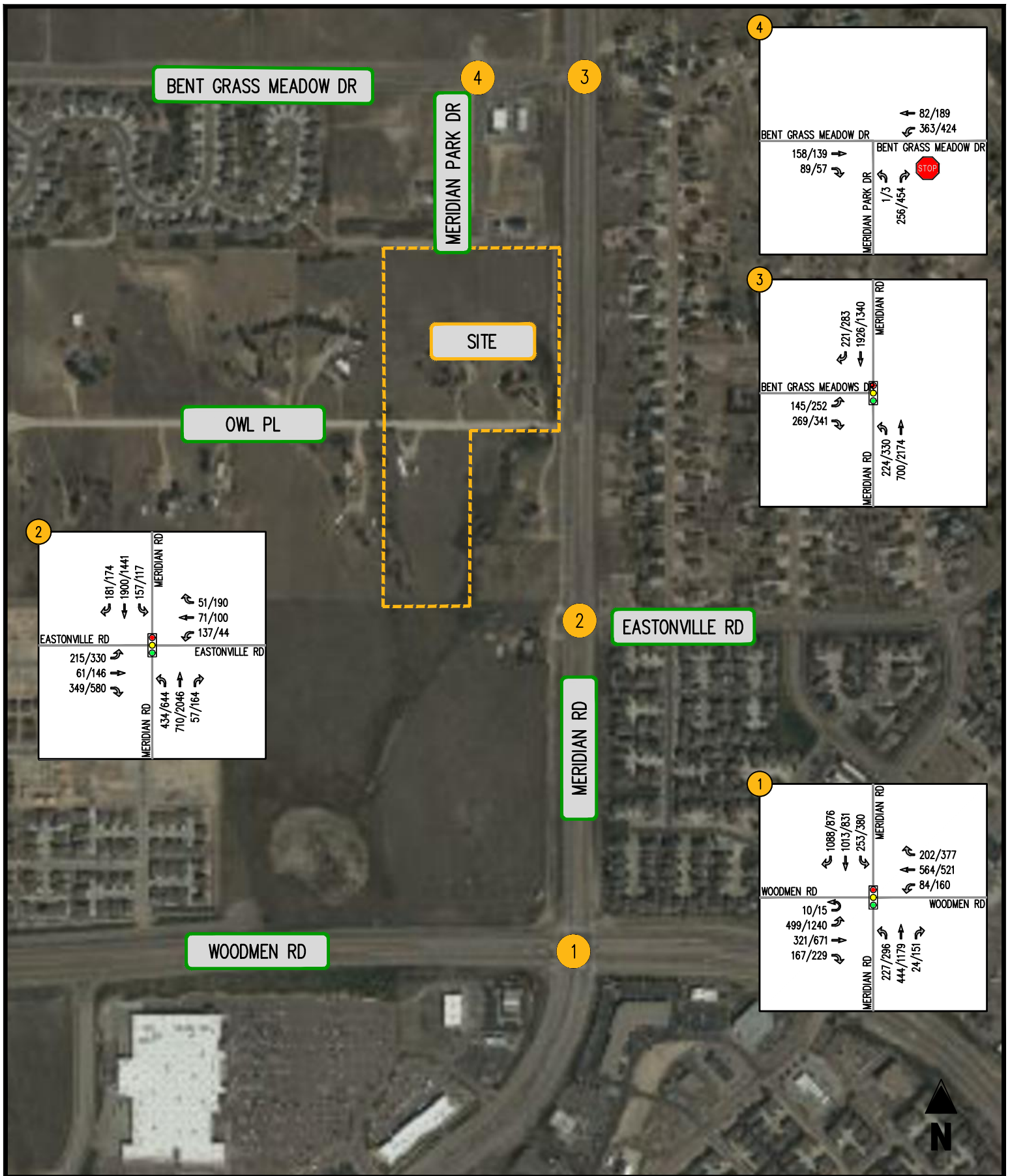
**FIGURE 7-1**  
**Total Future 2024 Forecasts Shopping Center**

Meridian Storage  
 El Paso County, CO

0000/0000 (AM PEAK HOUR/PM PEAK HOUR)

- MOVEMENT
- SIGNALIZED INTERSECTION
- STOP SIGN
- YIELD SIGN









**FIGURE 7-2**  
**Total Future 2040 Forecasts Shopping Center**

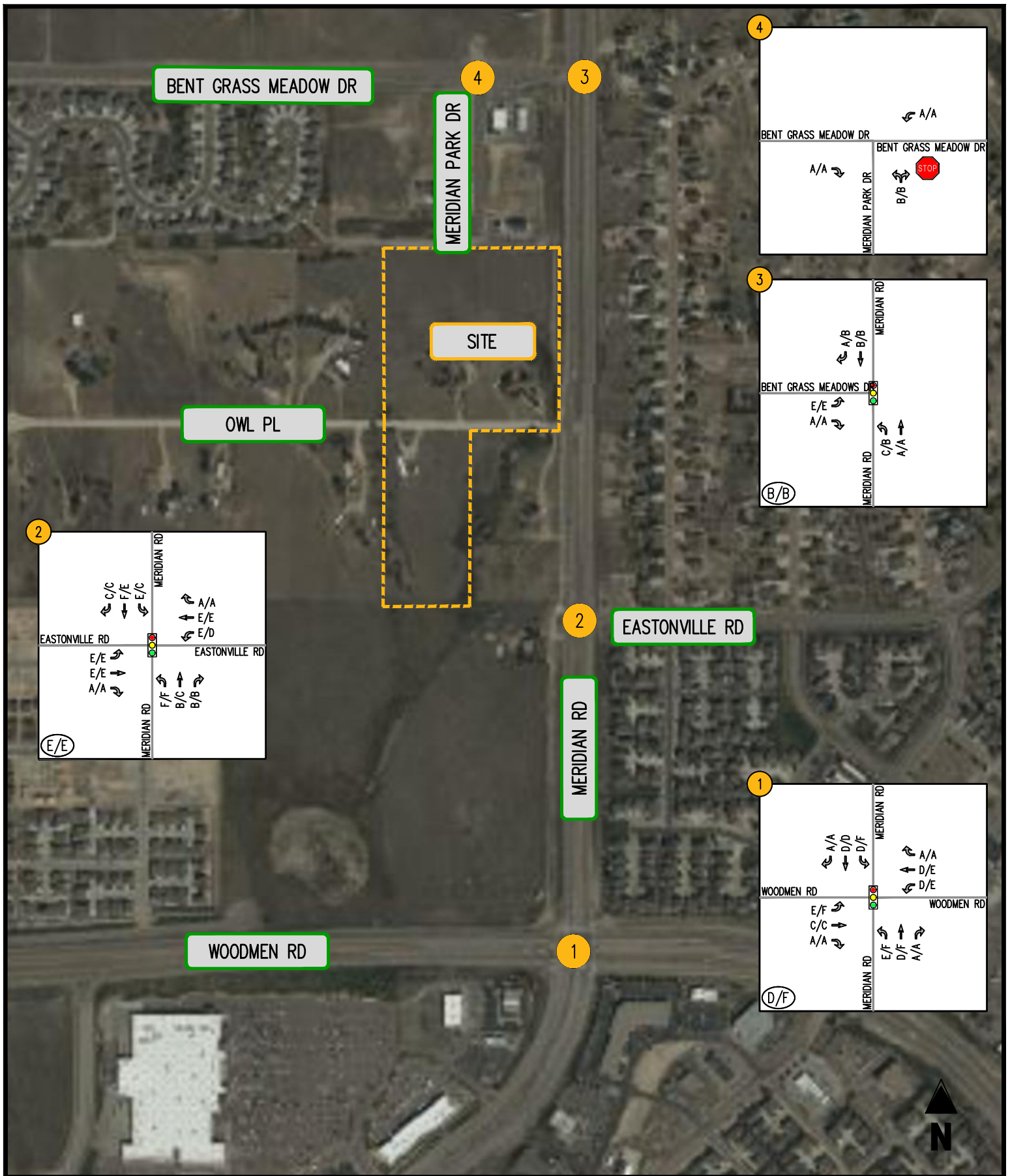
Meridian Storage  
 El Paso County, CO

0000/0000 (AM PEAK HOUR/PM PEAK HOUR)

-  MOVEMENT
-  SIGNALIZED INTERSECTION
-  STOP SIGN
-  YIELD SIGN







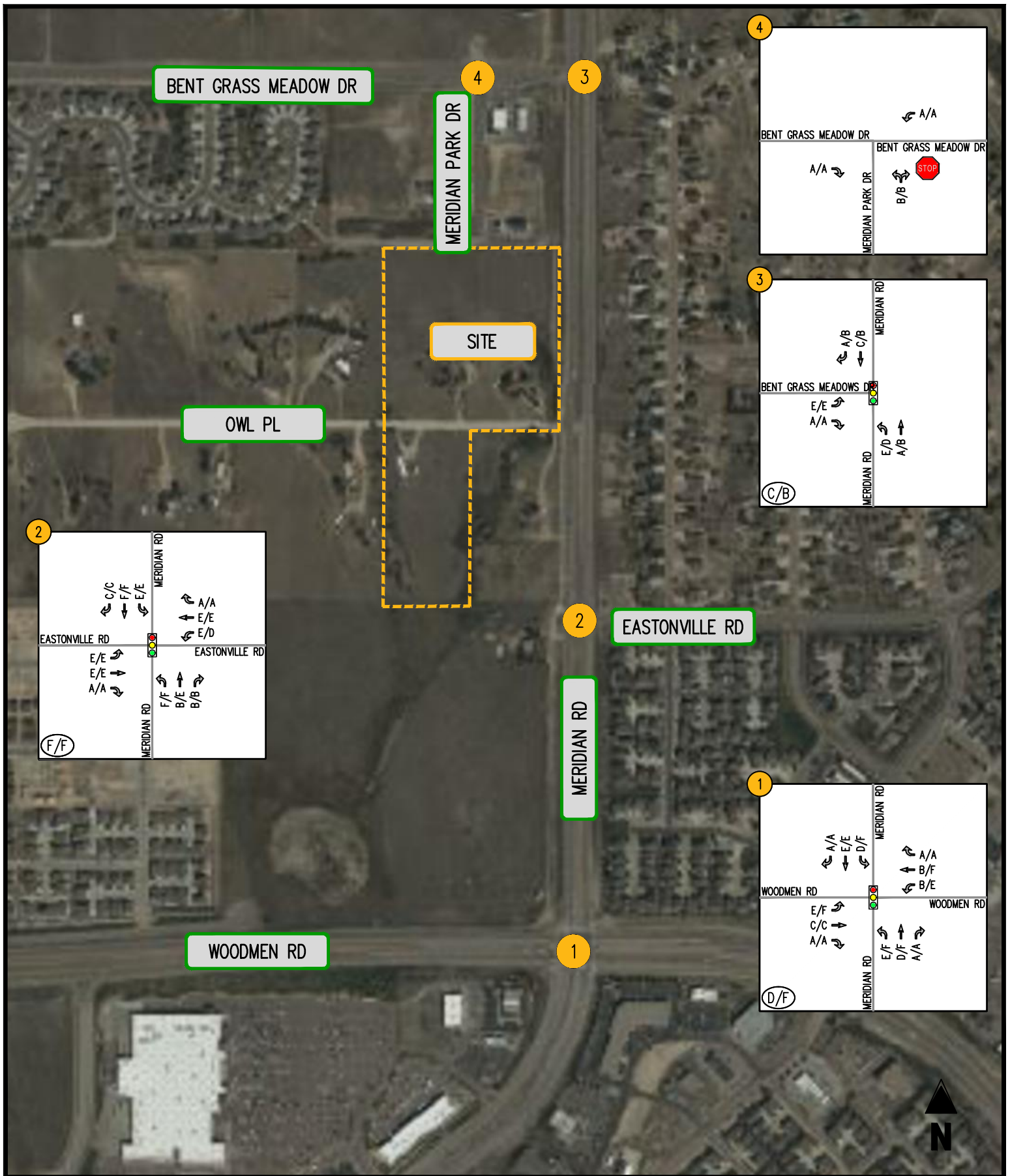
**FIGURE 7-3**  
**Total Future 2024 Levels of Service Shopping Center**

Meridian Storage  
 El Paso County, CO

(A/A) INTERSECTION LOS  
 0000/0000 (AM PEAK HOUR/PM PEAK HOUR)  
 57

- ← MOVEMENT
- SIGNALIZED INTERSECTION
- STOP SIGN
- YIELD SIGN





**FIGURE 7-4**  
**Total Future 2040 Levels of Service Shopping Center**

Meridian Storage  
 El Paso County, CO

(A/A) INTERSECTION LOS  
 0000/0000 (AM PEAK HOUR/PM PEAK HOUR)  
 58

- ← MOVEMENT
- 🚦 SIGNALIZED INTERSECTION
- 🛑 STOP SIGN
- 🚧 YIELD SIGN





Table 7-1  
Meridian Storage  
Total Intersection Level of Service Summary (1) (2)

Intersection	Operating Condition	Street Name	Approach/Movement	Background 2024		Background 2040		Total Future 2024 Shopping Center		Total Future 2040 Shopping Center	
				AM Peak Hour	PM Peak Hour	AM Peak Hour	PM Peak Hour	AM Peak Hour	PM Peak Hour	AM Peak Hour	PM Peak Hour
1 Woodmen Rd/Meridian Rd	SIGNAL	Woodmen Road	EBL	E (61.5)	E (60.7)	E (66.9)	F (159.1)	E (62.5)	F (91.3)	E (67.0)	F (269.4)
			EBT	C (33.1)	C (29.8)	C (35.0)	C (34.8)	C (30.8)	C (28.9)	C (33.3)	C (34.8)
			EBR	A (0.0)	A (0.0)	A (0.0)	A (0.0)	A (0.0)	A (0.0)	A (0.0)	A (0.0)
		Woodmen Road	WBL	D (48.4)	E (60.6)	E (55.8)	E (60.1)	D (52.0)	E (60.6)	B (16.2)	E (60.1)
			WBT	D (36.2)	E (55.2)	D (53.4)	F (82.3)	D (42.2)	E (72.7)	B (10.9)	F (97.3)
			WBR	A (0.0)	A (0.0)	A (0.0)	A (0.0)	A (0.0)	A (0.0)	A (0.0)	A (0.0)
		Meridian Road	NBL	E (60.3)	E (65.5)	E (69.3)	E (72.4)	E (64.0)	F (86.7)	E (79.9)	F (88.5)
			NBT	D (52.6)	E (58.6)	D (51.9)	F (138.9)	D (52.7)	F (123.3)	D (51.1)	F (210.0)
			NBR	A (0.0)	A (0.0)	A (0.0)	A (0.0)	A (0.0)	A (0.0)	A (0.0)	A (0.0)
		Meridian Road	SBL	D (39.0)	E (73.9)	D (35.4)	F (145.3)	D (40.1)	F (120.4)	D (38.2)	F (221.3)
			SBT	D (49.6)	D (44.2)	D (54.0)	D (53.5)	D (51.5)	D (51.4)	E (61.8)	E (71.2)
			SBR	A (0.0)	A (0.0)	A (0.0)	A (0.0)	A (0.0)	A (0.0)	A (0.0)	A (0.0)
		<b>Overall</b>			<b>D (47.4)</b>	<b>D (54.1)</b>	<b>D (53.0)</b>	<b>F (102.7)</b>	<b>D (50.1)</b>	<b>F (83.7)</b>	<b>D (48.4)</b>
2 Meridian Rd/Eastonville Rd <i>4-Legged Signalized</i>	SIGNAL	Eastonville Road	EBL	E (57.9)	E (65.6)	E (56.0)	F (80.8)	E (57.9)	E (77.2)	E (56.0)	E (66.0)
			EBT	E (57.0)	D (54.5)	E (57.4)	E (76.7)	E (57.0)	E (55.1)	E (57.4)	E (61.5)
			EBR	A (0.0)	A (0.0)	A (0.0)	A (0.0)	A (0.0)	A (0.0)	A (0.0)	A (0.0)
		Eastonville Road	WBL	E (55.2)	D (50.7)	E (71.1)	D (50.9)	E (55.2)	D (50.8)	E (71.1)	D (50.4)
			WBT	E (56.9)	E (60.7)	E (61.2)	F (82.0)	E (56.9)	E (60.7)	E (61.2)	E (65.7)
			WBR	A (0.0)	A (0.0)	A (0.0)	A (0.0)	A (0.0)	A (0.0)	A (0.0)	A (0.0)
		Meridian Road	NBL	F (81.1)	E (62.5)	F (159.7)	E (63.3)	F (164.3)	F (202.0)	F (206.9)	F (252.2)
			NBT	B (14.4)	C (24.1)	B (16.9)	D (43.3)	B (15.0)	C (27.6)	B (15.0)	E (72.6)
			NBR	B (12.5)	B (13.5)	B (14.0)	B (13.3)	B (12.5)	B (13.2)	B (14.0)	B (13.5)
		Meridian Road	SBL	E (67.4)	C (22.6)	E (65.0)	D (50.1)	E (67.4)	C (30.2)	E (66.7)	E (69.6)
			SBT	D (47.7)	C (27.6)	F (81.7)	C (34.1)	F (84.2)	E (75.6)	F (151.2)	F (96.3)
			SBR	C (22.5)	C (21.3)	B (17.8)	C (21.4)	C (25.4)	C (31.1)	C (21.6)	C (26.9)
		<b>Overall</b>			<b>D (46.0)</b>	<b>C (34.5)</b>	<b>E (69.1)</b>	<b>D (45.3)</b>	<b>E (75.2)</b>	<b>E (71.7)</b>	<b>F (110.7)</b>
3 Meridian Rd/Bent Grass Meadows Dr	SIGNAL	Bent Grass Meadows Drive	EBL	E (55.5)	E (56.2)	E (56.0)	E (57.2)	E (57.3)	E (57.3)	E (58.1)	E (57.5)
			EBR	A (0.0)	A (0.0)	A (0.0)	A (0.0)	A (0.0)	A (0.0)	A (0.0)	A (0.0)
			NBL	B (13.4)	A (6.7)	D (42.3)	B (12.2)	C (30.6)	B (20.0)	E (73.3)	D (47.3)
		Meridian Road	NBT	A (2.7)	A (5.2)	A (3.0)	A (8.5)	A (2.8)	A (6.8)	A (3.0)	B (11.2)
			SBT	B (11.5)	A (8.6)	B (15.9)	B (10.4)	B (12.7)	B (13.1)	C (23.5)	B (19.8)
		Meridian Road	SBR	A (6.2)	A (6.3)	A (6.5)	A (6.7)	A (7.2)	B (10.8)	A (9.5)	B (14.2)
		<b>Overall</b>			<b>B (11.0)</b>	<b>A (8.4)</b>	<b>B (15.0)</b>	<b>B (10.9)</b>	<b>B (13.8)</b>	<b>B (13.7)</b>	<b>C (23.1)</b>
4 Bent Grass Meadows Dr/Meridian Park Dr	STOP	Bent Grass Meadows Drive	EBR	A [0.0]	A [0.0]	A [0.0]	A [0.0]	A [0.0]	A [0.0]	A [0.0]	A [0.0]
			WBL	A [8.2]	A [7.9]	A [8.3]	A [8.0]	A [8.7]	A [8.9]	A [8.9]	A [8.9]
		Bent Grass Meadows Drive	WBL	A [8.2]	A [7.9]	A [8.3]	A [8.0]	A [8.7]	A [8.9]	A [8.9]	A [8.9]
		Meridian Park Drive	NBLR	A [10.0]	A [9.8]	B [10.2]	B [10.1]	B [10.9]	B [14.1]	B [11.0]	B [14.2]
<b>Street Name</b>				<b>Background 2024</b>		<b>Background 2040</b>		<b>Total Future 2024 Shopping Plaza</b>		<b>Total Future 2040 Shopping Plaza</b>	
				<b>ADT</b>	<b>LOS</b>	<b>AM</b>	<b>PM</b>	<b>ADT</b>	<b>LOS</b>	<b>ADT</b>	<b>LOS</b>
<b>El Paso County Roadway ADT Threshold Capacity</b>		Meridian Rd (S.O. Bent Grass Meadows)		30,958	40,000	40,030	40,000	34,520	40,000	43,593	40,000
		Meridian Rd (N.O. Woodman Rd)		32,405	40,000	41,728	40,000	41,916	40,000	51,238	40,000
<b>Meridian Rd Signal Progression</b>			<b>NB</b>	<b>AM</b>	<b>PM</b>	<b>AM</b>	<b>PM</b>	<b>AM</b>	<b>PM</b>	<b>AM</b>	<b>PM</b>
			<b>SB</b>	0	31	0	39	0	28	0	38
<b>Arterial Band (Seconds Per Cycle)</b>			<b>NB</b>	1	0	1	0	2	0	2	0
			<b>SB</b>	1	0	1	0	2	0	2	0

Notes (1) Numbers in brackets [] represent delay at unsignalized intersections in seconds per vehicle.  
(2) Numbers in parenthesis () represent delay at signalized intersections in seconds per vehicle.

Table 7-2  
 Meridian Storage  
 Total Future Intersection Queueing Summary (1)

Intersection	Operating Condition	Street Name	Approach/ Movement	Available Storage	Background 2024		Background 2040		Total Future 2024 Shopping Center		Total Future 2040 Shopping Center	
					AM Peak Hour	PM Peak Hour	AM Peak Hour	PM Peak Hour	AM Peak Hour	PM Peak Hour	AM Peak Hour	PM Peak Hour
1 Woodmen Rd/Meridian Rd	SIGNAL	Woodmen Road	EBL	500	170	436	236	662	226	597	313	868
			EBT	-	112	215	152	315	104	204	148	315
			EBR	630	0	0	0	0	0	0	0	0
			WBL	350	49	81	62	102	48	79	62	102
		Woodmen Road	WBT	-	221	237	300	341	221	250	334	354
			WBR	250	0	86	0	142	12	207	33	299
			NBL	440	111	156	157	203	115	195	169	215
			NBT	-	167	442	203	688	193	583	228	801
		Meridian Road	NBR	330	0	0	0	0	0	0	0	0
			SBL	490	85	160	90	173	92	142	88	160
			SBT	-	345	310	423	352	325	274	368	304
			SBR	450	29	0	61	0	61	45	82	44
2 Meridian Rd/Eastonville Rd 4-Legged Signalized	SIGNAL	Eastonville Road	EBL	100	147	177	144	174	147	176	145	165
			EBT	-	86	167	96	254	86	160	96	188
			EBR	100	138	104	133	167	219	409	267	532
			WBL	120	136	46	225	64	138	48	225	61
		Eastonville Road	WBT	-	91	111	116	179	90	113	116	138
			WBR	100	0	30	0	29	0	0	0	28
			NBL	100	420	396	431	234	630	527	620	399
			NBT	-	135	600	184	175	147	364	193	309
		Meridian Road	NBR	400	5	5	10	3	3	0	4	2
			SBL	375	137	67	127	128	143	88	128	95
			SBT	-	800	509	1066	643	831	716	1048	917
			SBR	400	28	110	13	75	27	116	14	47
3 Meridian Rd/Bent Grass Meadows Dr	SIGNAL	Bent Grass Meadows Drive	EBL	150	59	71	70	85	76	126	87	142
			EBR	-	87	54	198	66	90	86	204	97
		Meridian Road	NBL	700	80	26	175	40	167	150	314	181
			NBT	-	112	167	155	139	108	143	154	120
		Meridian Road	SBT	-	617	291	951	491	610	457	1025	627
			SBR	350	27	24	27	32	35	50	40	50
4 Bent Grass Meadows Dr/Meridian Park Dr	STOP	Bent Grass Meadows Drive	EBR	150	0	0	0	0	0	0	0	0
		Bent Grass Meadows Drive	WBL	100	12.5	7.5	15	10	22.5	30	30	35
		Meridian Park Drive	NBLR	-	15	12.5	20	17.5	25	67.5	32.5	67.5

Note: (1) Queue length is based on the 95th percentile queue as reported by Synchro, Version 11.

## VIII. Pedestrian and Bicycle Connectivity

The El Paso County Major Transportation Corridor Plan (MTCP) was referenced to determine whether the proposed development would affect any of the existing pedestrian or bike routes in the area and whether there are any planned pedestrian or bike routes through the study area. The study area in general does not see much pedestrian activity, and there are no marked bike lanes on any of the study roads.

The MTCP has marked Meridian Rd as a proposed bicycle route. There is also a proposed secondary regional trail that will run north/south to the west of the study area but will not intersect any of the roadway segments within the study area. Since the proposed development will generate four trips in the peak hour, it will not affect operations along Meridian Rd and therefore will not have an impact on bicycle safety along Meridian Rd.

Given the location of the proposed site and the nature of its use, it is not expected to generate pedestrian trips. In addition, there are no existing or proposed pedestrian or bicycle routes traveling through the proposed site. As such, the developer does not need to provide connectivity to any existing or proposed pedestrian or bicycle routes.

## IX. Conclusions and Recommendations

### Conclusions

Based on the results of this traffic impact study, the following may be concluded:

- Under existing conditions, the signalized intersections operate at LOS D or better. The intersection of Meridian Rd & Eastonville Rd was modeled as a three-legged stop-control intersection and is shown to fail during both peak time periods. Several of the thru queues will block adjacent turn lanes.
- In the background 2024 scenario, all intersections operate at LOS D or better. Queueing remains similar to the existing scenario, however, many of the queues at Meridian Rd & Eastonville Rd are shown to exceed their respective storage lengths.
- In the background 2040 scenario, Woodmen Rd & Meridian Rd will operate at LOS F in the PM peak and Meridian Rd & Eastonville Rd will operate at LOS E in the AM peak. The remaining intersections will operate acceptably. The forecasted ADTs along Meridian Rd will exceed the El Paso County Roadway ADT Threshold Capacity. Many of the queues will exceed their respective storage lengths by 2040.
- The proposed warehouse development will generate 3 weekday AM and 4 weekday PM peak hour vehicle trips as well as 46 weekday daily trips.
- The total scenarios in which the warehouse has been built will have very similar operations to the background scenarios. As such, it is not the responsibility of the developer to mitigate the failing traffic operations since these are problems expected to occur regardless of whether the site is developed.

- As requested by El Paso County, the maximum trip generator allowed on a site zoned as Commercial Service was analyzed. This was found to be a 133,294 SF shopping plaza. In this scenario, the shopping plaza would generate 471 weekday AM and 1,141 weekday PM peak hour vehicle trips as well as 11,671 weekday daily trips.
- The total 2024 scenario where the maximum trip generator was assumed instead of the proposed warehouse shows an increase in intersection delay. The intersection of Woodmen Rd & Meridian Rd will fail in the PM peak hour and the intersection of Meridian Rd & Eastonville Rd will operate at LOS E. The ADT along the southern portion of Meridian Rd is forecasted to exceed the El Paso County Roadway ADT Threshold Capacity while the northern portion of Meridian Rd will remain under capacity.
- In the total 2040 scenario for which the maximum trip generator is assumed, the Intersection of Woodmen Rd & Meridian Rd will fail in the PM peak, and the intersection of Meridian Rd & Eastonville Rd will fail during both the AM and PM peaks. The ADT along Meridian Rd will exceed capacity as well. The analysis for the maximum trip generator is a requirement of El Paso County. The developer has no intention of building a shopping center, and therefore, no roadway improvements are needed to mitigate the failing operations reported in this scenario.
- Traffic operations are reported to be almost identical between the background scenario and the total scenario in which the proposed warehouse development has been constructed. There are no intersection or individual movements found to operate acceptably in the background scenario and then unacceptable in the total warehouse scenario. It is the responsibility of El Paso County, not the developer, to provide mitigation solutions to achieve acceptable traffic operations through the year 2040.

## Recommendations

- It is recommended that the proposed development be designed as shown in the site plan.
- It is recommended that El Paso County implement the mitigation recommendations detailed in Section IV of this report in order to achieve acceptable traffic operations through the study area.



## **APPENDIX A – Full Sized Site Plan**

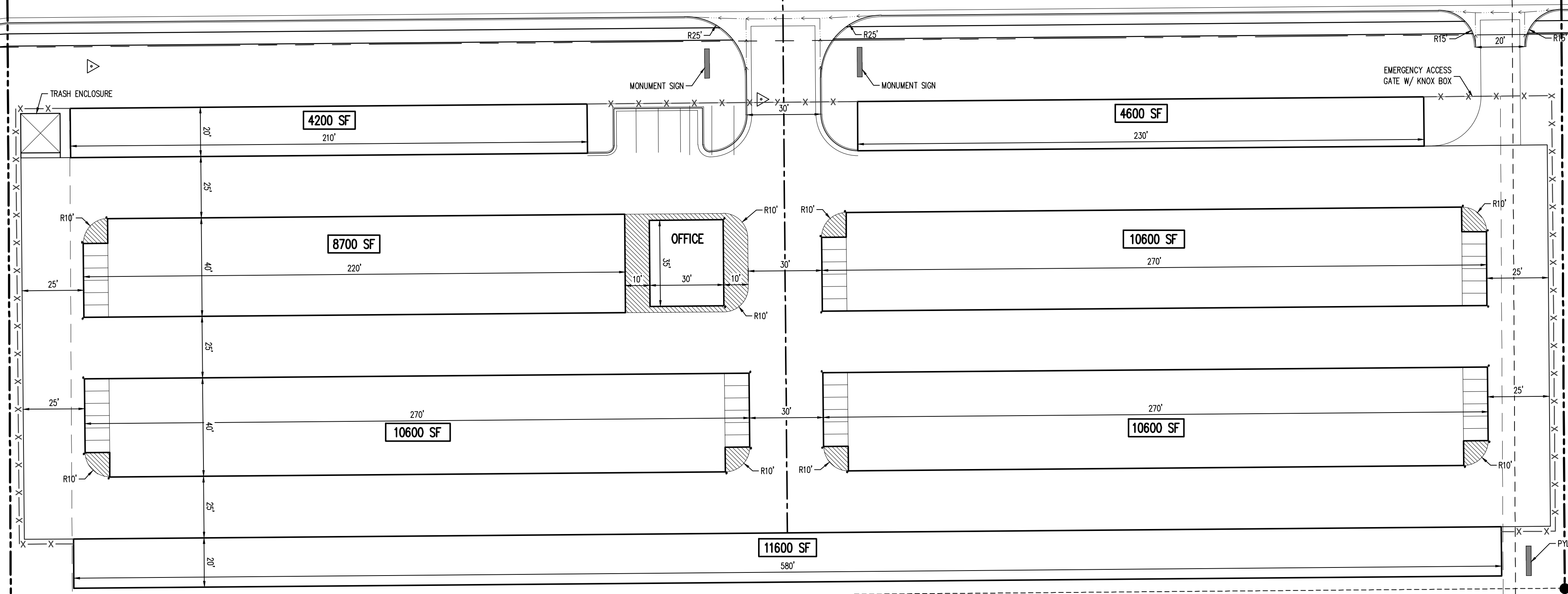
OWL PLACE  
(60 FT PUBLIC ROW)

GRAVEL RV STORAGE

PROPOSED EXTENSION  
MERIDIAN PARK DRIVE  
(PUBLIC 60 FT ROW)

FUTURE MERIDIAN PARK  
DRIVE CONNECTION

FUTURE SOUTH  
CONNECTION



CLOSE OWL PLACE  
INTERSECTION



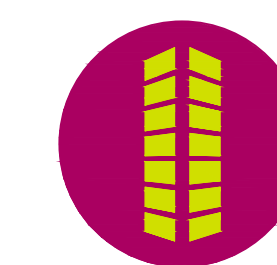
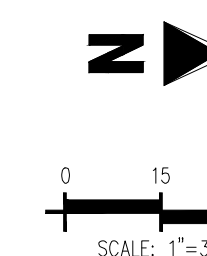
# OWL PLACE STORAGE

MERIDIAN STORAGE, LLC

## LOT 1 & 2 CONCEPTUAL SITE PLAN

01.11.2023

This information is copyrighted by Galloway & Company, Inc. All rights reserved.



## **APPENDIX B – LOS Descriptions**

## Level of Service for Signalized Intersections

Level of service for signalized intersections is defined in terms of delay, which is a measure of driver discomfort and frustration, fuel consumption, and lost travel time. Specifically, level-of-service (LOS) criteria are stated in terms of the average stopped delay per vehicle for a 15-min analysis period. The criteria are given in Exhibit 16-2. Delay may be measured in the field or estimated using procedures presented later in this chapter. Delay is a complex measure and is dependent on a number of variables, including the quality of progression, the cycle length, the green ratio, and the  $v/c$  ratio for the lane group in question.

**LOS A** describes operations with very low delay, up to 10 sec per vehicle. This level of service occurs when progression is extremely favorable and most vehicles arrive during the green phase. Most vehicles do not stop at all. Short cycle lengths may also contribute to low delay.

**LOS B** describes operations with delay greater than 10 and up to 20 sec per vehicle. This level generally occurs with good progression, short cycle lengths, or both. More vehicles stop than with LOS A, causing higher levels of average delay.

Exhibit 16-2. Level-of-Service Criteria for Signalized Intersections

LEVEL OF SERVICE	STOPPED DELAY PER VEHICLE (SEC)
A	$\leq 10.0$
B	$> 10.0$ and $\leq 20.0$
C	$> 20.0$ and $\leq 35.0$
D	$> 35.0$ and $\leq 55.0$
E	$> 55.0$ and $\leq 80.0$
F	$> 80.0$

**LOS C** describes operations with delay greater than 20 and up to 35 sec per vehicle. These higher delays may result from fair progression, longer cycle lengths, or both. Individual cycle failures may begin to appear at this level. The number of vehicles stopping is significant at this level, though many still pass through the intersection without stopping.

**LOS D** describes operations with delay greater than 35 and up to 55 sec per vehicle. At level D, the influence of congestion becomes more noticeable. Longer delays may result from some combination of unfavorable progression, long cycle lengths, or high  $v/c$  ratios. Many vehicles stop, and the proportion of vehicles not stopping declines. Individual cycle failures are noticeable.

**LOS E** describes operations with delay greater than 55 and up to 80 sec per vehicle. This level is considered by many agencies to be the limit of acceptable delay. These high delay values generally indicate poor progression, long cycle lengths, and high  $v/c$  ratios. Individual cycle failures are frequent occurrences.

**LOS F** describes operations with delay in excess of 80 sec per vehicle. This level, considered to be unacceptable to most drivers, often occurs with oversaturation, that is, when arrival flow rates exceed the capacity of the intersection. It may also occur at high  $v/c$  ratios below 1.0 with many individual cycle failures. Poor progression and long cycle lengths may also be major contributing causes to such delay levels.

Source: [Highway Capacity Manual, 2000](#). Transportation Research Board, National Research Council



## Level of Service Criteria for Stop Sign Controlled Intersections

The level of service criteria are given in Table 17-2. As used here, control delay is defined as the total elapsed time from the time a vehicle stops at the end of the queue until the vehicle departs from the stop line; this time includes the time required for the vehicle to travel from the last-in-queue position to the first-in-queue position, including deceleration of vehicles from free-flow speed to the speed of vehicles in queue.

The average total delay for any particular minor movement is a function of the service rate or capacity of the approach and the degree of saturation. . . .

Table 17-2. Level of Service Criteria for TWSC Intersections

LEVEL OF SERVICE	AVERAGE CONTROL DELAY (sec/veh)
A	$\leq 10$
B	$> 10$ and $\leq 15$
C	$> 15$ and $\leq 25$
D	$> 25$ and $\leq 35$
E	$> 35$ and $\leq 50$
F	$> 50$

Average total delay less than 10 sec/veh is defined as Level of Service (LOS) A. Follow-up times of less than 5 sec have been measured when there is no conflicting traffic for a minor street movement, so control delays of less than 10 sec/veh are appropriate for low flow conditions. To remain consistent with the AWSC intersection analysis procedure described later in this chapter, a total delay of 50 sec/veh is assumed as the break point between LOS E and F.

The proposed level of service criteria for TWSC intersections are somewhat different from the criteria used in Chapter 16 for signalized intersections. The primary reason for this difference is that drivers expect different levels of performance from different kinds of transportation facilities. The expectation is that a signalized intersection is designed to carry higher traffic volumes than an unsignalized intersection. Additionally, several driver behavior considerations combine to make delays at signalized intersections less onerous than at unsignalized intersections. For example, drivers at signalized intersections are able to relax during the red interval, where drivers on the minor approaches to unsignalized intersections must remain attentive to the task of identifying acceptable gaps and vehicle conflicts. Also, there is often much more variability in the amount of delay experienced by individual drivers at unsignalized than signalized intersections. For these reasons, it is considered that the total delay threshold for any given level of service is less for an unsignalized intersection than for a signalized intersection. . . .

LOS F exists when there are insufficient gaps of suitable size to allow a side street demand to cross safely through a major street traffic stream. This level of service is generally evident from extremely long total delays experienced by side street traffic and by queueing on the minor approaches. The method, however, is based on a constant critical gap size - that is, the critical gap remains constant, no matter how long the side street motorist waits. LOS F may also appear in the form of side street vehicles' selecting smaller-than-usual gaps. In such cases, safety may be a problem and some disruption to the major traffic stream may result. It is important to note that LOS F may not always result in long queues but may result in adjustments to normal gap acceptance behavior. The latter is more difficult to observe on the field than queueing, which is more obvious.

Source: Highway Capacity Manual, 2000. Transportation Research Board, National Research Council

## **APPENDIX C – Traffic Counts**

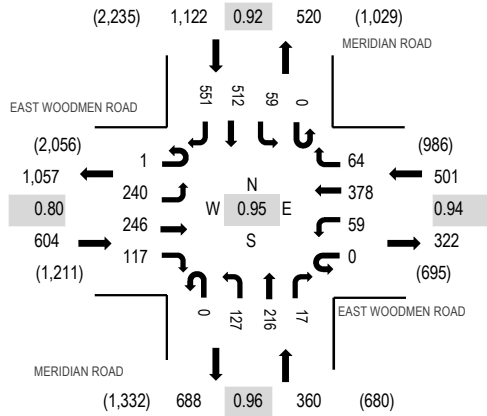
Location: 1 MERIDIAN ROAD & EAST WOODMEN ROAD AM

Date: Wednesday, June 1, 2022

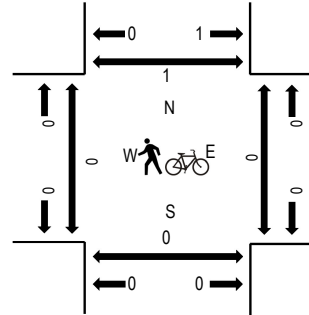
Peak Hour: 07:15 AM - 08:15 AM

Peak 15-Minutes: 07:15 AM - 07:30 AM

### Peak Hour - All Vehicles



### Peak Hour - Pedestrians/Bicycles on Crosswalk



Note: Total study counts contained in parentheses.

### Traffic Counts

Interval Start Time	EAST WOODMEN ROAD Eastbound				EAST WOODMEN ROAD Westbound				MERIDIAN ROAD Northbound				MERIDIAN ROAD Southbound				Total	Rolling Hour	Pedestrian Crossings			
	U-Turn	Left	Thru	Right	U-Turn	Left	Thru	Right	U-Turn	Left	Thru	Right	U-Turn	Left	Thru	Right			West	East	South	North
7:00 AM	0	41	45	41	0	9	112	15	0	26	47	7	0	9	165	127	644	2,584	0	0	0	0
7:15 AM	0	45	61	32	0	16	104	19	0	40	52	1	0	8	144	156	678	2,587	0	0	0	0
7:30 AM	0	55	64	26	0	8	113	17	0	32	52	6	0	13	150	142	678	2,550	0	0	0	0
7:45 AM	0	72	72	30	0	20	78	10	0	28	51	4	0	19	105	95	584	2,509	0	0	0	1
8:00 AM	1	68	49	29	0	15	83	18	0	27	61	6	0	19	113	158	647	2,528	0	0	0	0
8:15 AM	0	60	60	13	0	9	101	17	2	20	56	6	0	25	120	152	641		0	0	0	0
8:30 AM	0	71	67	14	0	15	73	19	0	27	47	7	0	17	123	157	637		0	0	0	0
8:45 AM	0	78	94	23	0	25	69	21	2	27	36	10	1	26	83	108	603		0	0	0	0
Count Total	1	490	512	208	0	117	733	136	4	227	402	47	1	136	1,003	1,095	5,112		0	0	0	1
Peak Hour	1	240	246	117	0	59	378	64	0	127	216	17	0	59	512	551	2,587		0	0	0	1

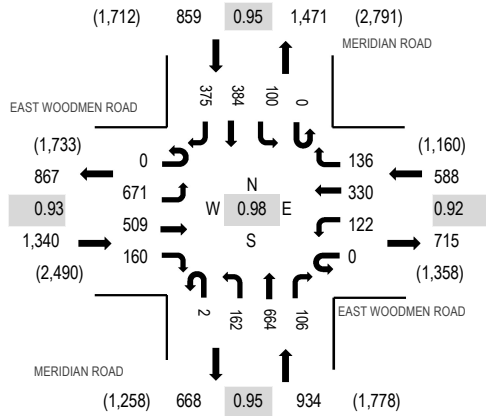
Location: 1 MERIDIAN ROAD & EAST WOODMEN ROAD PM

Date: Wednesday, June 1, 2022

Peak Hour: 04:45 PM - 05:45 PM

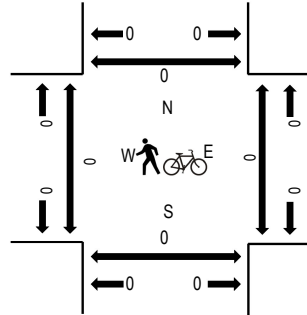
Peak 15-Minutes: 05:30 PM - 05:45 PM

### Peak Hour - All Vehicles



Note: Total study counts contained in parentheses.

### Peak Hour - Pedestrians/Bicycles on Crosswalk



### Traffic Counts

Interval Start Time	EAST WOODMEN ROAD Eastbound				EAST WOODMEN ROAD Westbound				MERIDIAN ROAD Northbound				MERIDIAN ROAD Southbound				Total	Rolling Hour	Pedestrian Crossings			
	U-Turn	Left	Thru	Right	U-Turn	Left	Thru	Right	U-Turn	Left	Thru	Right	U-Turn	Left	Thru	Right			West	East	South	North
4:00 PM	0	108	100	28	0	21	80	36	0	40	132	23	0	22	100	107	797	3,490	0	0	0	0
4:15 PM	0	142	136	41	1	31	75	33	2	31	141	22	0	24	85	104	868	3,609	0	0	0	0
4:30 PM	0	160	129	25	0	25	82	32	3	32	190	21	0	17	91	100	907	3,678	0	0	0	0
4:45 PM	0	166	113	48	0	26	75	35	1	45	158	32	0	23	100	96	918	3,721	0	0	0	0
5:00 PM	0	147	137	43	0	35	82	29	0	44	171	21	0	31	90	86	916	3,650	0	0	0	0
5:15 PM	0	180	119	27	0	31	89	45	0	30	164	27	0	21	110	94	937		0	0	0	0
5:30 PM	0	178	140	42	0	30	84	27	1	43	171	26	0	25	84	99	950		0	0	0	0
5:45 PM	0	154	101	26	1	24	94	37	0	30	155	22	0	24	88	91	847		0	0	0	0
Count Total	0	1,235	975	280	2	223	661	274	7	295	1,282	194	0	187	748	777	7,140		0	0	0	0
Peak Hour	0	671	509	160	0	122	330	136	2	162	664	106	0	100	384	375	3,721		0	0	0	0





ALL TRAFFIC DATA SERVICES

(303) 216-2439

www.alltrafficdata.net

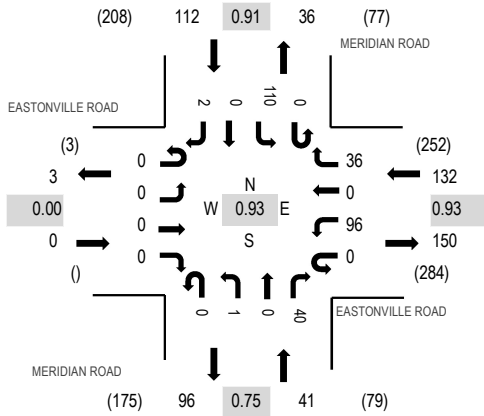
Location: 2 MERIDIAN ROAD & EASTONVILLE ROAD AM

Date: Wednesday, June 1, 2022

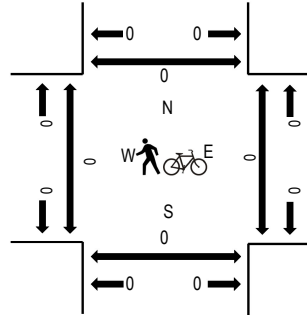
Peak Hour: 07:45 AM - 08:45 AM

Peak 15-Minutes: 08:00 AM - 08:15 AM

Peak Hour - All Vehicles



Peak Hour - Pedestrians/Bicycles on Crosswalk



Note: Total study counts contained in parentheses.

Traffic Counts

Interval Start Time	EASTONVILLE ROAD Eastbound				EASTONVILLE ROAD Westbound				MERIDIAN ROAD Northbound				MERIDIAN ROAD Southbound				Total	Rolling Hour	Pedestrian Crossings			
	U-Turn	Left	Thru	Right	U-Turn	Left	Thru	Right	U-Turn	Left	Thru	Right	U-Turn	Left	Thru	Right			West	East	South	North
7:00 AM	0	0	0	0	0	14	0	12	0	0	0	8	0	21	0	0	55	254	0	0	0	0
7:15 AM	0	0	0	0	0	17	0	11	0	0	0	9	0	24	0	0	61	276	0	0	0	0
7:30 AM	0	0	0	0	0	19	0	9	0	0	0	12	0	29	0	0	69	283	0	0	0	0
7:45 AM	0	0	0	0	0	21	0	7	0	0	0	9	0	31	0	1	69	285	0	0	0	0
8:00 AM	0	0	0	0	0	23	0	10	0	1	0	14	0	29	0	0	77	285	0	0	0	0
8:15 AM	0	0	0	0	0	27	0	8	0	0	0	7	0	26	0	0	68		0	0	0	0
8:30 AM	0	0	0	0	0	25	0	11	0	0	0	10	0	24	0	1	71		0	0	0	0
8:45 AM	0	0	0	0	0	29	0	9	0	0	0	9	0	22	0	0	69		0	0	0	0
Count Total	0	0	0	0	0	175	0	77	0	1	0	78	0	206	0	2	539		0	0	0	0
Peak Hour	0	0	0	0	0	96	0	36	0	1	0	40	0	110	0	2	285		0	0	0	0



ALL TRAFFIC DATA SERVICES

(303) 216-2439

www.alltrafficdata.net

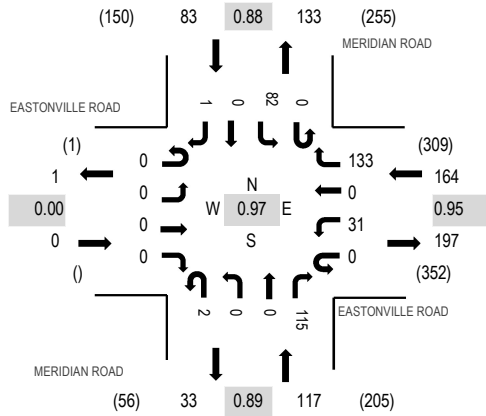
Location: 2 MERIDIAN ROAD & EASTONVILLE ROAD PM

Date: Wednesday, June 1, 2022

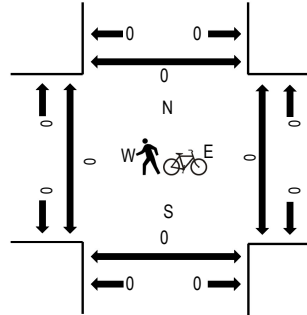
Peak Hour: 05:00 PM - 06:00 PM

Peak 15-Minutes: 05:15 PM - 05:30 PM

### Peak Hour - All Vehicles



### Peak Hour - Pedestrians/Bicycles on Crosswalk



Note: Total study counts contained in parentheses.

### Traffic Counts

Interval Start Time	EASTONVILLE ROAD Eastbound				EASTONVILLE ROAD Westbound				MERIDIAN ROAD Northbound				MERIDIAN ROAD Southbound				Total	Rolling Hour	Pedestrian Crossings			
	U-Turn	Left	Thru	Right	U-Turn	Left	Thru	Right	U-Turn	Left	Thru	Right	U-Turn	Left	Thru	Right			West	East	South	North
4:00 PM	0	0	0	0	0	4	0	23	0	0	0	12	0	14	0	0	53	300	0	0	0	0
4:15 PM	0	0	0	0	0	7	0	27	0	0	0	23	0	13	0	0	70	336	0	0	0	0
4:30 PM	0	0	0	0	0	9	0	39	0	0	0	25	0	16	0	0	89	360	0	0	0	0
4:45 PM	0	0	0	0	0	3	0	33	0	0	0	28	0	24	0	0	88	359	0	0	0	0
5:00 PM	0	0	0	0	0	7	0	36	0	0	0	23	0	23	0	0	89	364	0	0	0	0
5:15 PM	0	0	0	0	0	5	0	31	2	0	0	31	0	24	0	1	94		0	0	0	0
5:30 PM	0	0	0	0	0	9	0	34	0	0	0	30	0	15	0	0	88		0	0	0	0
5:45 PM	0	0	0	0	0	10	0	32	0	0	0	31	0	20	0	0	93		0	0	0	0
Count Total	0	0	0	0	0	54	0	255	2	0	0	203	0	149	0	1	664		0	0	0	0
Peak Hour	0	0	0	0	0	31	0	133	2	0	0	115	0	82	0	1	364		0	0	0	0



ALL TRAFFIC DATA SERVICES

(303) 216-2439

www.alltrafficdata.net

Location: 3 MERIDIAN ROAD & OWL PLACE AM

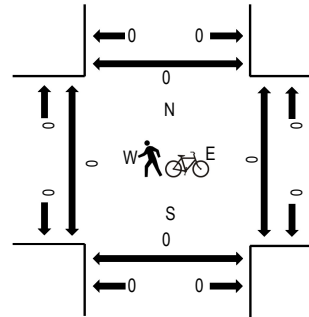
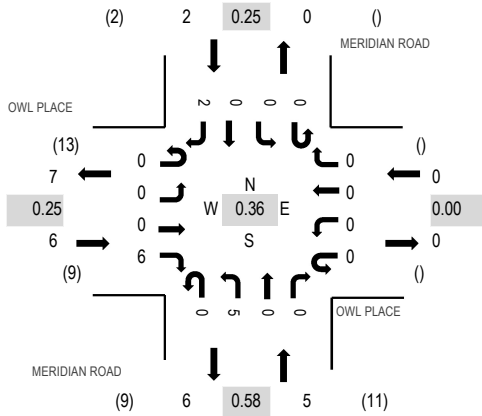
Date: Wednesday, June 1, 2022

Peak Hour: 07:00 AM - 08:00 AM

Peak 15-Minutes: 07:00 AM - 07:15 AM

Peak Hour - All Vehicles

Peak Hour - Pedestrians/Bicycles on Crosswalk



Note: Total study counts contained in parentheses.

Traffic Counts

Interval Start Time	OWL PLACE Eastbound				OWL PLACE Westbound				MERIDIAN ROAD Northbound				MERIDIAN ROAD Southbound				Total	Rolling Hour	Pedestrian Crossings						
	U-Turn	Left	Thru	Right	U-Turn	Left	Thru	Right	U-Turn	Left	Thru	Right	U-Turn	Left	Thru	Right			West	East	South	North			
7:00 AM	0	0	0	6	0	0	0	0	0	0	1	0	0	0	0	0	0	0	2	9	13	0	0	0	0
7:15 AM	0	0	0	0	0	0	0	0	0	0	1	0	0	0	0	0	0	0	1	7	0	0	0	0	
7:30 AM	0	0	0	0	0	0	0	0	0	0	1	0	0	0	0	0	0	0	1	8	0	0	0	0	
7:45 AM	0	0	0	0	0	0	0	0	0	0	2	0	0	0	0	0	0	0	2	8	0	0	0	0	
8:00 AM	0	0	0	0	0	0	0	0	0	0	3	0	0	0	0	0	0	0	3	9	0	0	0	0	
8:15 AM	0	0	0	2	0	0	0	0	0	0	0	0	0	0	0	0	0	0	2		0	0	0	0	
8:30 AM	0	0	0	1	0	0	0	0	0	0	0	0	0	0	0	0	0	0	1		0	0	0	0	
8:45 AM	0	0	0	0	0	0	0	0	0	0	3	0	0	0	0	0	0	0	3		0	0	0	0	
Count Total	0	0	0	9	0	0	0	0	0	0	11	0	0	0	0	0	0	2	22		0	0	0	0	
Peak Hour	0	0	0	6	0	0	0	0	0	0	5	0	0	0	0	0	0	2	13		0	0	0	0	

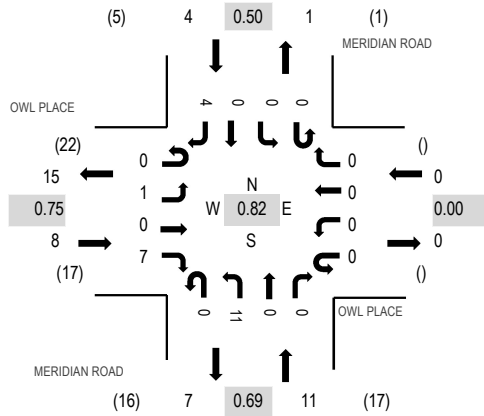
Location: 3 MERIDIAN ROAD & OWL PLACE PM

Date: Wednesday, June 1, 2022

Peak Hour: 04:00 PM - 05:00 PM

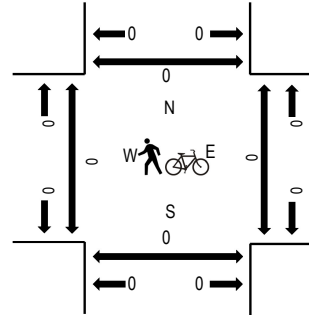
Peak 15-Minutes: 04:00 PM - 04:15 PM

### Peak Hour - All Vehicles



Note: Total study counts contained in parentheses.

### Peak Hour - Pedestrians/Bicycles on Crosswalk



### Traffic Counts

Interval Start Time	OWL PLACE Eastbound				OWL PLACE Westbound				MERIDIAN ROAD Northbound			MERIDIAN ROAD Southbound				Total	Rolling Hour	Pedestrian Crossings				
	U-Turn	Left	Thru	Right	U-Turn	Left	Thru	Right	U-Turn	Left	Thru	Right	U-Turn	Left	Thru			Right	West	East	South	North
4:00 PM	0	0	0	2	0	0	0	0	0	3	0	0	0	0	0	2	7	23	0	0	0	0
4:15 PM	0	1	0	2	0	0	0	0	0	2	0	0	0	0	0	1	6	21	0	0	0	0
4:30 PM	0	0	0	2	0	0	0	0	0	4	0	0	0	0	0	0	6	18	0	0	0	0
4:45 PM	0	0	0	1	0	0	0	0	0	2	0	0	0	0	0	1	4	15	0	0	0	0
5:00 PM	0	0	0	3	0	0	0	0	0	2	0	0	0	0	0	0	5	16	0	0	0	0
5:15 PM	0	0	0	3	0	0	0	0	0	0	0	0	0	0	0	0	3		0	0	0	0
5:30 PM	0	0	0	1	0	0	0	0	0	2	0	0	0	0	0	0	3		0	0	0	0
5:45 PM	0	0	0	2	0	0	0	0	0	2	0	0	0	0	0	1	5		0	0	0	0
Count Total	0	1	0	16	0	0	0	0	0	17	0	0	0	0	0	5	39		0	0	0	0
Peak Hour	0	1	0	7	0	0	0	0	0	11	0	0	0	0	0	4	23		0	0	0	0



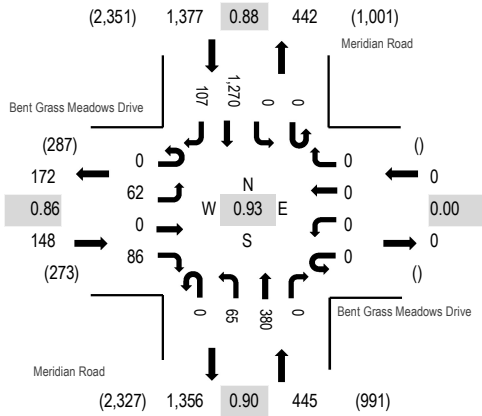
**Location:** 1 Meridian Road & Bent Grass Meadows Drive AM

**Date:** Tuesday, March 29, 2022

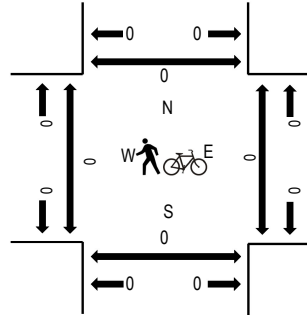
**Peak Hour:** 07:00 AM - 08:00 AM

**Peak 15-Minutes:** 07:15 AM - 07:30 AM

**Peak Hour - All Vehicles**



**Peak Hour - Pedestrians/Bicycles on Crosswalk**



Note: Total study counts contained in parentheses.

**Traffic Counts**

Interval Start Time	Bent Grass Meadows Drive Eastbound				Bent Grass Meadows Drive Westbound				Meridian Road Northbound			Meridian Road Southbound				Total	Rolling Hour	Pedestrian Crossings				
	U-Turn	Left	Thru	Right	U-Turn	Left	Thru	Right	U-Turn	Left	Thru	Right	U-Turn	Left	Thru			Right	West	East	South	North
7:00 AM	0	17	0	18	0	0	0	0	0	19	63	0	0	0	341	36	494	1,970	0	0	0	0
7:15 AM	0	14	0	29	0	0	0	0	0	17	79	0	0	0	366	26	531	1,912	0	0	0	0
7:30 AM	0	13	0	24	0	0	0	0	0	16	97	0	0	0	307	21	478	1,794	0	0	0	0
7:45 AM	0	18	0	15	0	0	0	0	0	13	141	0	0	0	256	24	467	1,718	0	0	0	0
8:00 AM	0	12	0	15	0	0	0	0	0	12	111	0	0	0	259	27	436	1,645	0	0	0	0
8:15 AM	0	16	0	15	0	0	0	0	0	16	138	0	0	0	210	18	413		0	0	0	0
8:30 AM	0	18	0	21	0	0	0	0	1	9	115	0	0	0	229	9	402		0	0	0	0
8:45 AM	0	13	0	15	0	0	0	0	1	7	136	0	0	0	205	17	394		0	0	0	0
Count Total	0	121	0	152	0	0	0	0	2	109	880	0	0	0	2,173	178	3,615		0	0	0	0
Peak Hour	0	62	0	86	0	0	0	0	0	65	380	0	0	0	1,270	107	1,970		0	0	0	0

**Location:** 1 Meridian Road & Bent Grass Meadows Drive PM

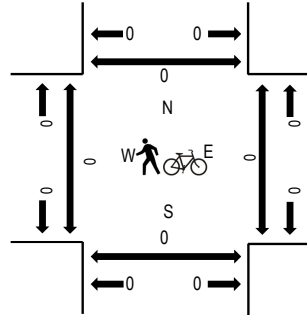
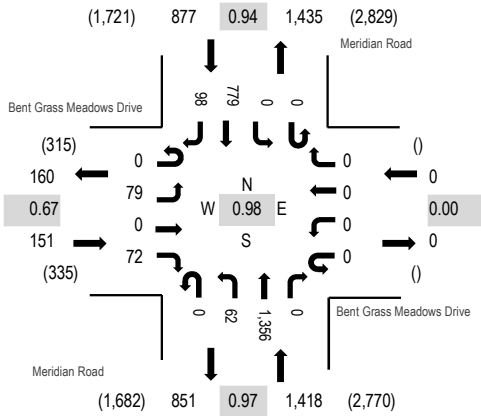
**Date:** Tuesday, March 29, 2022

**Peak Hour:** 04:30 PM - 05:30 PM

**Peak 15-Minutes:** 04:30 PM - 04:45 PM

**Peak Hour - All Vehicles**

**Peak Hour - Pedestrians/Bicycles on Crosswalk**



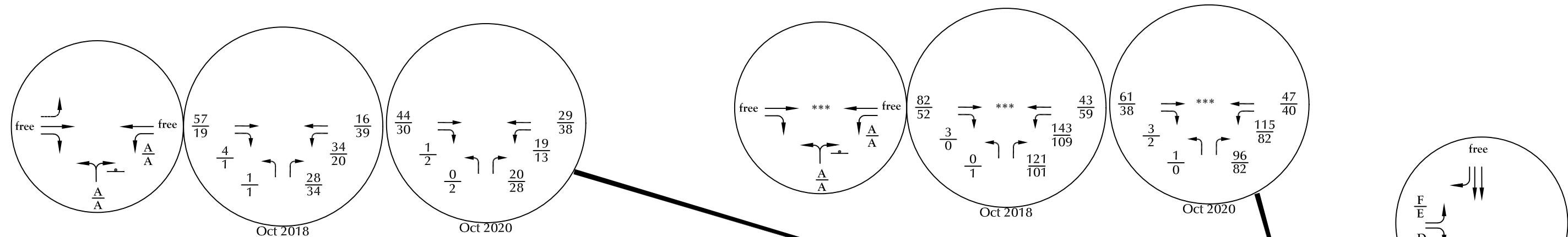
Note: Total study counts contained in parentheses.

**Traffic Counts**

Interval Start Time	Bent Grass Meadows Drive Eastbound				Bent Grass Meadows Drive Westbound				Meridian Road Northbound			Meridian Road Southbound				Total	Rolling Hour	Pedestrian Crossings				
	U-Turn	Left	Thru	Right	U-Turn	Left	Thru	Right	U-Turn	Left	Thru	Right	U-Turn	Left	Thru			Right	West	East	South	North
4:00 PM	0	19	0	21	0	0	0	0	0	17	324	0	0	0	196	22	599	2,398	0	0	0	0
4:15 PM	0	21	0	23	0	0	0	0	0	13	308	0	0	0	171	31	567	2,417	0	0	0	0
4:30 PM	0	20	0	19	0	0	0	0	0	15	336	0	0	0	208	25	623	2,446	0	0	0	0
4:45 PM	0	19	0	17	0	0	0	0	0	17	348	0	0	0	182	26	609	2,446	0	0	0	0
5:00 PM	0	20	0	23	0	0	0	0	0	13	342	0	0	0	198	22	618	2,428	0	0	0	0
5:15 PM	0	20	0	13	0	0	0	0	0	17	330	0	0	0	191	25	596		0	0	0	0
5:30 PM	0	47	0	19	0	0	0	0	0	12	317	0	0	0	203	25	623		0	0	0	0
5:45 PM	0	17	0	17	0	0	0	0	0	20	341	0	0	0	181	15	591		0	0	0	0
Count Total	0	183	0	152	0	0	0	0	0	124	2,646	0	0	0	1,530	191	4,826		0	0	0	0
Peak Hour	0	79	0	72	0	0	0	0	0	62	1,356	0	0	0	779	98	2,446		0	0	0	0

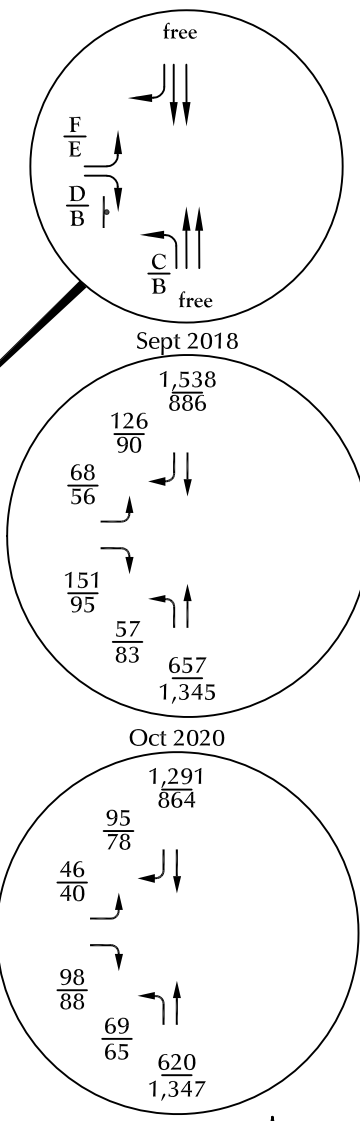
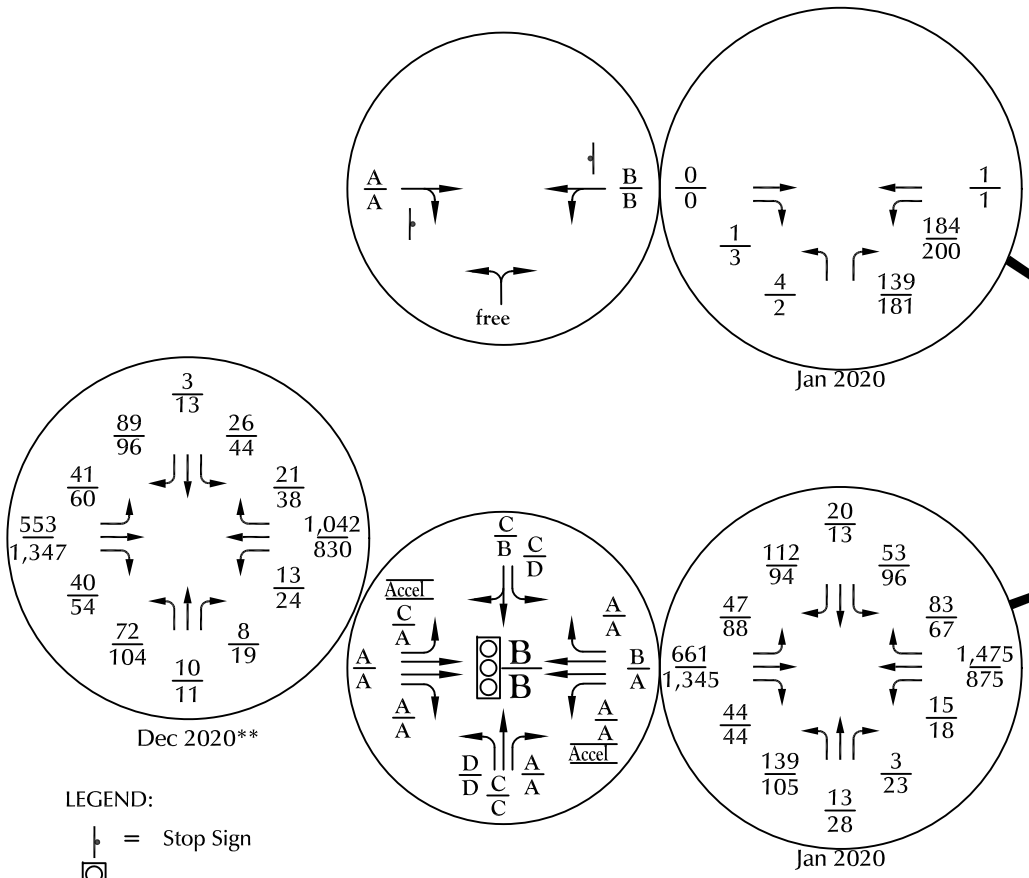
Date Start: 29-Mar-22  
Site Code: 3  
Station ID: 3  
MERIDIAN RD S.O. BENT GRASS MEADOWS DR

Start Time	29-Mar-22 Tue	NB	SB	Total
12:00 AM		50	15	65
01:00		19	11	30
02:00		12	18	30
03:00		11	45	56
04:00		24	138	162
05:00		58	358	416
06:00		211	1018	1229
07:00		447	1364	1811
08:00		547	967	1514
09:00		512	805	1317
10:00		562	757	1319
11:00		656	745	1401
12:00 PM		774	756	1530
01:00		798	723	1521
02:00		836	808	1644
03:00		1115	796	1911
04:00		1379	846	2225
05:00		1400	836	2236
06:00		1001	670	1671
07:00		782	438	1220
08:00		521	287	808
09:00		332	164	496
10:00		184	75	259
11:00		77	41	118
Total		12308	12681	24989
Percent		49.3%	50.7%	
AM Peak	-	11:00	07:00	-
Vol.	-	656	1364	-
PM Peak	-	17:00	16:00	-
Vol.	-	1400	846	-
Grand Total		12308	12681	24989
Percent		49.3%	50.7%	
ADT		ADT 24,989	ADT 24,989	

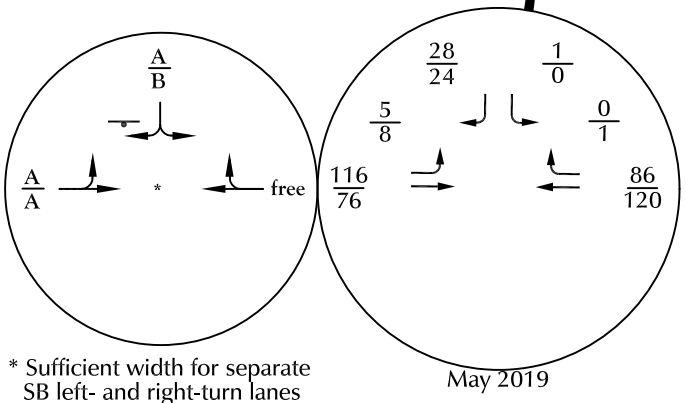


\*\*This traffic count was conducted following the completion of Bent Grass Meadows Drive between the Woodmen frontage road and Meridian Ranch. All other counts were conducted prior to this connection being made.

\*\*\*This access was closed after the traffic counts were conducted.



- LEGEND:
- = Stop Sign
  - = Traffic Signal
  - $\frac{XX}{XX}$  = AM Weekday Peak-Hour Traffic (vehicles per hour)  
PM Weekday Peak-Hour Traffic (vehicles per hour)
  - $\frac{A}{B}$  = AM Individual Movement Peak-Hour Level of Service  
PM Individual Movement Peak-Hour Level of Service
  - $\frac{C}{C}$  = AM Entire Intersection Peak-Hour Level of Service  
PM Entire Intersection Peak-Hour Level of Service
  - X,XXX = Average Daily Traffic (vehicles per day)



\* Sufficient width for separate SB left- and right-turn lanes

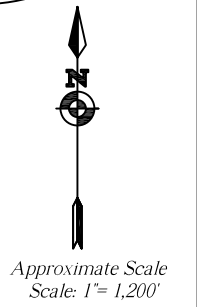


Figure 5  
Existing Traffic, Lane Geometry,  
Traffic Control and Level of Service  
Bent Grass East Commercial Filing 3 (LSC #204660)



## **APPENDIX D – Existing Synchro Outputs**



Timings  
1: MERIDIAN ROAD & WOODMAN ROAD

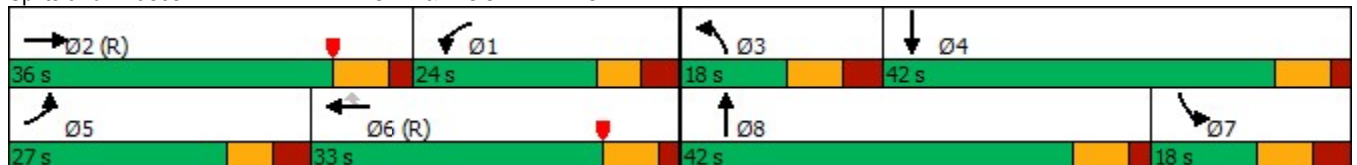
Existing AM  
03/30/2023

Lane Group	EBL	EBT	EBR	WBL	WBT	WBR	NBL	NBT	NBR	SBL	SBT	SBR
Lane Configurations												
Traffic Volume (vph)	241	246	117	59	378	64	127	221	17	71	616	663
Future Volume (vph)	241	246	117	59	378	64	127	221	17	71	616	663
Turn Type	Prot	NA	Free	Prot	NA	Perm	Prot	NA	Free	Prot	NA	Free
Protected Phases	5	2		1	6		3	8		7	4	
Permitted Phases			Free			6			Free			Free
Detector Phase	5	2		1	6	6	3	8		7	4	
Switch Phase												
Minimum Initial (s)	5.0	15.0		5.0	15.0	15.0	5.0	15.0		5.0	15.0	
Minimum Split (s)	13.5	22.0		13.5	22.0	22.0	13.5	22.0		13.5	22.0	
Total Split (s)	27.0	36.0		24.0	33.0	33.0	18.0	42.0		18.0	42.0	
Total Split (%)	22.5%	30.0%		20.0%	27.5%	27.5%	15.0%	35.0%		15.0%	35.0%	
Yellow Time (s)	4.0	5.0		4.0	5.0	5.0	5.0	5.0		5.0	5.0	
All-Red Time (s)	3.5	2.0		3.5	2.0	2.0	3.5	2.0		3.5	2.0	
Lost Time Adjust (s)	0.0	0.0		0.0	0.0	0.0	0.0	0.0		0.0	0.0	
Total Lost Time (s)	7.5	7.0		7.5	7.0	7.0	8.5	7.0		8.5	7.0	
Lead/Lag	Lead	Lead		Lag	Lag	Lag	Lead	Lead		Lag	Lag	
Lead-Lag Optimize?	Yes	Yes		Yes	Yes	Yes	Yes	Yes		Yes	Yes	
Recall Mode	None	C-Max		None	C-Max	C-Max	None	None		None	None	
Act Effct Green (s)	15.2	40.7	120.0	14.3	37.3	37.3	8.9	19.9	120.0	20.6	28.7	120.0
Actuated g/C Ratio	0.13	0.34	1.00	0.12	0.31	0.31	0.07	0.17	1.00	0.17	0.24	1.00
v/c Ratio	0.66	0.24	0.09	0.15	0.37	0.10	0.52	0.39	0.01	0.13	0.79	0.46
Control Delay	57.1	32.5	0.1	46.8	35.3	0.3	61.0	49.0	0.0	42.5	47.3	1.2
Queue Delay	0.0	0.0	0.0	0.0	0.0	0.0	0.0	0.0	0.0	0.0	0.0	0.0
Total Delay	57.1	32.5	0.1	46.8	35.3	0.3	61.0	49.0	0.0	42.5	47.3	1.2
LOS	E	C	A	D	D	A	E	D	A	D	D	A
Approach Delay		36.0			32.2			50.8			24.4	
Approach LOS		D			C			D			C	

Intersection Summary

Cycle Length: 120  
 Actuated Cycle Length: 120  
 Offset: 30 (25%), Referenced to phase 2:EBT and 6:WBT, Start of Yellow  
 Natural Cycle: 75  
 Control Type: Actuated-Coordinated  
 Maximum v/c Ratio: 0.79  
 Intersection Signal Delay: 31.7  
 Intersection Capacity Utilization 65.6%  
 Analysis Period (min) 15  
 Intersection LOS: C  
 ICU Level of Service C

Splits and Phases: 1: MERIDIAN ROAD & WOODMAN ROAD



Queues  
1: MERIDIAN ROAD & WOODMAN ROAD

Existing AM  
03/30/2023



Lane Group	EBL	EBT	EBR	WBL	WBT	WBR	NBL	NBT	NBR	SBL	SBT	SBR
Lane Group Flow (vph)	284	289	138	63	402	68	132	230	18	77	670	721
v/c Ratio	0.66	0.24	0.09	0.15	0.37	0.10	0.52	0.39	0.01	0.13	0.79	0.46
Control Delay	57.1	32.5	0.1	46.8	35.3	0.3	61.0	49.0	0.0	42.5	47.3	1.2
Queue Delay	0.0	0.0	0.0	0.0	0.0	0.0	0.0	0.0	0.0	0.0	0.0	0.0
Total Delay	57.1	32.5	0.1	46.8	35.3	0.3	61.0	49.0	0.0	42.5	47.3	1.2
Queue Length 50th (ft)	109	90	0	22	128	0	51	88	0	19	182	2
Queue Length 95th (ft)	141	130	0	44	197	0	84	129	0	m34	225	6
Internal Link Dist (ft)		1165			1100			344			1171	
Turn Bay Length (ft)	500		630	350		250	440		330	490		450
Base Capacity (vph)	557	1201	1583	472	1099	670	271	1047	1583	609	1032	1583
Starvation Cap Reductn	0	0	0	0	0	0	0	0	0	0	0	0
Spillback Cap Reductn	0	0	0	0	0	0	0	0	0	0	0	0
Storage Cap Reductn	0	0	0	0	0	0	0	0	0	0	0	0
Reduced v/c Ratio	0.51	0.24	0.09	0.13	0.37	0.10	0.49	0.22	0.01	0.13	0.65	0.46

Intersection Summary

m Volume for 95th percentile queue is metered by upstream signal.

HCM 6th Signalized Intersection Summary  
1: MERIDIAN ROAD & WOODMAN ROAD

Existing AM  
03/30/2023



Movement	EBL	EBT	EBR	WBL	WBT	WBR	NBL	NBT	NBR	SBL	SBT	SBR
Lane Configurations	↔↔	↑↑	↗	↔↔	↑↑	↗	↔↔	↑↑	↗	↔↔	↑↑	↗
Traffic Volume (veh/h)	241	246	117	59	378	64	127	221	17	71	616	663
Future Volume (veh/h)	241	246	117	59	378	64	127	221	17	71	616	663
Initial Q (Qb), veh	0	0	0	0	0	0	0	0	0	0	0	0
Ped-Bike Adj(A_pbT)	1.00		1.00	1.00		1.00	1.00		1.00	1.00		1.00
Parking Bus, Adj	1.00	1.00	1.00	1.00	1.00	1.00	1.00	1.00	1.00	1.00	1.00	1.00
Work Zone On Approach		No			No			No			No	
Adj Sat Flow, veh/h/ln	1870	1870	1870	1870	1870	1870	1870	1870	1870	1870	1870	1870
Adj Flow Rate, veh/h	284	289	0	63	402	0	132	230	0	77	670	0
Peak Hour Factor	0.85	0.85	0.85	0.94	0.94	0.94	0.96	0.96	0.96	0.92	0.92	0.92
Percent Heavy Veh, %	2	2	2	2	2	2	2	2	2	2	2	2
Cap, veh/h	352	859		758	1261		188	444		567	790	
Arrive On Green	0.10	0.24	0.00	0.22	0.35	0.00	0.05	0.13	0.00	0.16	0.22	0.00
Sat Flow, veh/h	3456	3554	1585	3456	3554	1585	3456	3554	1585	3456	3554	1585
Grp Volume(v), veh/h	284	289	0	63	402	0	132	230	0	77	670	0
Grp Sat Flow(s),veh/h/ln	1728	1777	1585	1728	1777	1585	1728	1777	1585	1728	1777	1585
Q Serve(g_s), s	9.7	8.1	0.0	1.7	9.9	0.0	4.5	7.3	0.0	2.3	21.7	0.0
Cycle Q Clear(g_c), s	9.7	8.1	0.0	1.7	9.9	0.0	4.5	7.3	0.0	2.3	21.7	0.0
Prop In Lane	1.00		1.00	1.00		1.00	1.00		1.00	1.00		1.00
Lane Grp Cap(c), veh/h	352	859		758	1261		188	444		567	790	
V/C Ratio(X)	0.81	0.34		0.08	0.32		0.70	0.52		0.14	0.85	
Avail Cap(c_a), veh/h	562	859		758	1261		274	1036		567	1036	
HCM Platoon Ratio	1.00	1.00	1.00	1.00	1.00	1.00	1.00	1.00	1.00	1.00	1.00	1.00
Upstream Filter(I)	1.00	1.00	0.00	1.00	1.00	0.00	1.00	1.00	0.00	1.00	1.00	0.00
Uniform Delay (d), s/veh	52.7	37.6	0.0	37.2	28.1	0.0	55.8	49.1	0.0	42.9	44.7	0.0
Incr Delay (d2), s/veh	4.6	1.1	0.0	0.0	0.7	0.0	4.7	0.9	0.0	0.1	5.3	0.0
Initial Q Delay(d3),s/veh	0.0	0.0	0.0	0.0	0.0	0.0	0.0	0.0	0.0	0.0	0.0	0.0
%ile BackOfQ(50%),veh/ln	4.3	3.5	0.0	0.7	4.2	0.0	2.1	3.3	0.0	0.9	9.6	0.0
Unsig. Movement Delay, s/veh												
LnGrp Delay(d),s/veh	57.3	38.6	0.0	37.3	28.8	0.0	60.5	50.1	0.0	43.0	50.0	0.0
LnGrp LOS	E	D		D	C		E	D		D	D	
Approach Vol, veh/h		573	A		465	A		362	A		747	A
Approach Delay, s/veh		47.9			30.0			53.9			49.3	
Approach LOS		D			C			D			D	
Timer - Assigned Phs	1	2	3	4	5	6	7	8				
Phs Duration (G+Y+Rc), s	33.8	36.0	15.0	35.2	19.7	50.1	28.2	22.0				
Change Period (Y+Rc), s	7.5	7.0	8.5	* 8.5	7.5	* 7.5	8.5	7.0				
Max Green Setting (Gmax), s	16.5	29.0	9.5	* 35	19.5	* 26	9.5	35.0				
Max Q Clear Time (g_c+I1), s	3.7	10.1	6.5	23.7	11.7	11.9	4.3	9.3				
Green Ext Time (p_c), s	0.1	1.5	0.1	3.0	0.6	2.0	0.1	1.4				

Intersection Summary

HCM 6th Ctrl Delay	45.5
HCM 6th LOS	D

Notes

- User approved pedestrian interval to be less than phase max green.
- \* HCM 6th computational engine requires equal clearance times for the phases crossing the barrier.
- Unsignalized Delay for [NBR, EBR, WBR, SBR] is excluded from calculations of the approach delay and intersection delay.

Intersection						
Int Delay, s/veh	9.2					
Movement	WBL	WBR	NBT	NBR	SBL	SBT
Lane Configurations	↘	↗	↑↑	↗	↘	↑↑
Traffic Vol, veh/h	96	36	486	40	110	1254
Future Vol, veh/h	96	36	486	40	110	1254
Conflicting Peds, #/hr	0	0	0	0	0	0
Sign Control	Stop	Stop	Free	Free	Free	Free
RT Channelized	-	Free	-	None	-	None
Storage Length	120	0	-	400	375	-
Veh in Median Storage, #	0	-	0	-	-	0
Grade, %	0	-	0	-	-	0
Peak Hour Factor	93	93	85	85	91	91
Heavy Vehicles, %	2	2	2	2	2	2
Mvmt Flow	103	39	572	47	121	1378

Major/Minor	Minor1	Major1	Major2		
Conflicting Flow All	1503	-	0	0	619
Stage 1	572	-	-	-	-
Stage 2	931	-	-	-	-
Critical Hdwy	6.84	-	-	-	4.14
Critical Hdwy Stg 1	5.84	-	-	-	-
Critical Hdwy Stg 2	5.84	-	-	-	-
Follow-up Hdwy	3.52	-	-	-	2.22
Pot Cap-1 Maneuver	112	0	-	-	957
Stage 1	528	0	-	-	-
Stage 2	344	0	-	-	-
Platoon blocked, %					
Mov Cap-1 Maneuver	~ 98	-	-	-	957
Mov Cap-2 Maneuver	~ 98	-	-	-	-
Stage 1	528	-	-	-	-
Stage 2	301	-	-	-	-

Approach	WB	NB	SB
HCM Control Delay, s	186.2	0	0.8
HCM LOS	F		

Minor Lane/Major Mvmt	NBT	NBRWBLn1	WBLn2	SBL	SBT
Capacity (veh/h)	-	-	98	-	957
HCM Lane V/C Ratio	-	-	1.053	-	0.126
HCM Control Delay (s)	-	-	186.2	0	9.3
HCM Lane LOS	-	-	F	A	A
HCM 95th %tile Q(veh)	-	-	6.6	-	0.4

Notes  
 ~: Volume exceeds capacity    \$: Delay exceeds 300s    +: Computation Not Defined    \*: All major volume in platoon

Timings  
3: MERIDIAN ROAD & BENT GRASS MEADOWS DRIVE

Existing AM  
03/30/2023

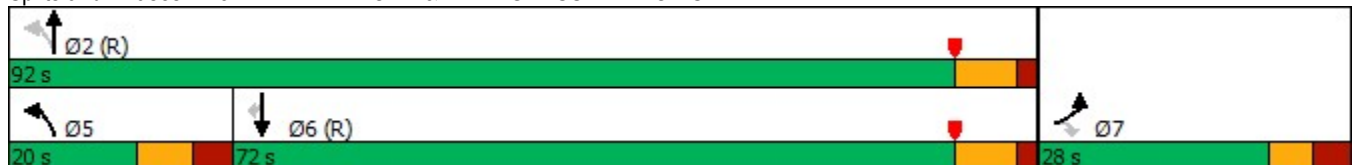


Lane Group	EBL	EBR	NBL	NBT	SBT	SBR
Lane Configurations	↖↗	↗	↖	↑↑	↑↑	↗
Traffic Volume (vph)	62	86	80	437	1274	107
Future Volume (vph)	62	86	80	437	1274	107
Turn Type	Prot	Perm	pm+pt	NA	NA	Perm
Protected Phases	7		5	2	6	
Permitted Phases		7	2			6
Detector Phase	7	7	5	2	6	6
Switch Phase						
Minimum Initial (s)	8.0	8.0	5.0	15.0	15.0	15.0
Minimum Split (s)	25.5	25.5	13.5	25.5	25.5	25.5
Total Split (s)	28.0	28.0	20.0	92.0	72.0	72.0
Total Split (%)	23.3%	23.3%	16.7%	76.7%	60.0%	60.0%
Yellow Time (s)	4.0	4.0	5.0	5.5	5.5	5.5
All-Red Time (s)	3.5	3.5	3.5	2.0	2.0	2.0
Lost Time Adjust (s)	0.0	0.0	0.0	0.0	0.0	0.0
Total Lost Time (s)	7.5	7.5	8.5	7.5	7.5	7.5
Lead/Lag			Lead		Lag	Lag
Lead-Lag Optimize?			Yes		Yes	Yes
Recall Mode	None	None	None	C-Max	C-Max	C-Max
Act Effct Green (s)	8.7	8.7	95.3	96.3	80.8	80.8
Actuated g/C Ratio	0.07	0.07	0.79	0.80	0.67	0.67
v/c Ratio	0.29	0.48	0.33	0.17	0.61	0.11
Control Delay	55.4	18.2	11.2	0.9	12.4	1.6
Queue Delay	0.0	0.0	0.0	0.0	0.0	0.0
Total Delay	55.4	18.2	11.2	0.9	12.4	1.6
LOS	E	B	B	A	B	A
Approach Delay	33.8			2.5	11.6	
Approach LOS	C			A	B	

Intersection Summary

Cycle Length: 120  
 Actuated Cycle Length: 120  
 Offset: 5 (4%), Referenced to phase 2:NBTL and 6:SBT, Start of Yellow  
 Natural Cycle: 80  
 Control Type: Actuated-Coordinated  
 Maximum v/c Ratio: 0.61  
 Intersection Signal Delay: 11.0  
 Intersection Capacity Utilization 65.9%  
 Analysis Period (min) 15  
 Intersection LOS: B  
 ICU Level of Service C

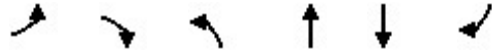
Splits and Phases: 3: MERIDIAN ROAD & BENT GRASS MEADOWS DRIVE





## 3: MERIDIAN ROAD &amp; BENT GRASS MEADOWS DRIVE

03/30/2023

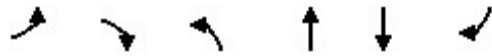


Lane Group	EBL	EBR	NBL	NBT	SBT	SBR
Lane Group Flow (vph)	72	100	89	486	1448	122
v/c Ratio	0.29	0.48	0.33	0.17	0.61	0.11
Control Delay	55.4	18.2	11.2	0.9	12.4	1.6
Queue Delay	0.0	0.0	0.0	0.0	0.0	0.0
Total Delay	55.4	18.2	11.2	0.9	12.4	1.6
Queue Length 50th (ft)	27	0	7	6	288	0
Queue Length 95th (ft)	48	47	25	10	386	20
Internal Link Dist (ft)	310			750	1921	
Turn Bay Length (ft)	150		700			350
Base Capacity (vph)	586	353	328	2838	2384	1106
Starvation Cap Reductn	0	0	0	0	0	0
Spillback Cap Reductn	0	0	0	0	0	0
Storage Cap Reductn	0	0	0	0	0	0
Reduced v/c Ratio	0.12	0.28	0.27	0.17	0.61	0.11

## Intersection Summary

HCM 6th Signalized Intersection Summary  
 3: MERIDIAN ROAD & BENT GRASS MEADOWS DRIVE

Existing AM  
 03/30/2023



Movement	EBL	EBR	NBL	NBT	SBT	SBR
Lane Configurations	↖↗	↖	↖	↑↑	↑↑	↖
Traffic Volume (veh/h)	62	86	80	437	1274	107
Future Volume (veh/h)	62	86	80	437	1274	107
Initial Q (Qb), veh	0	0	0	0	0	0
Ped-Bike Adj(A_pbT)	1.00	1.00	1.00			1.00
Parking Bus, Adj	1.00	1.00	1.00	1.00	1.00	1.00
Work Zone On Approach	No			No	No	
Adj Sat Flow, veh/h/ln	1870	1870	1870	1870	1870	1870
Adj Flow Rate, veh/h	72	0	89	486	1448	122
Peak Hour Factor	0.86	0.86	0.90	0.90	0.88	0.88
Percent Heavy Veh, %	2	2	2	2	2	2
Cap, veh/h	209		294	2894	2502	1116
Arrive On Green	0.06	0.00	0.04	0.81	0.70	0.70
Sat Flow, veh/h	3456	1585	1781	3647	3647	1585
Grp Volume(v), veh/h	72	0	89	486	1448	122
Grp Sat Flow(s),veh/h/ln	1728	1585	1781	1777	1777	1585
Q Serve(g_s), s	2.4	0.0	1.5	3.5	24.4	3.0
Cycle Q Clear(g_c), s	2.4	0.0	1.5	3.5	24.4	3.0
Prop In Lane	1.00	1.00	1.00			1.00
Lane Grp Cap(c), veh/h	209		294	2894	2502	1116
V/C Ratio(X)	0.34		0.30	0.17	0.58	0.11
Avail Cap(c_a), veh/h	590		394	2894	2502	1116
HCM Platoon Ratio	1.00	1.00	1.00	1.00	1.00	1.00
Upstream Filter(I)	1.00	0.00	1.00	1.00	1.00	1.00
Uniform Delay (d), s/veh	54.1	0.0	7.6	2.4	8.9	5.7
Incr Delay (d2), s/veh	1.0	0.0	0.6	0.1	1.0	0.2
Initial Q Delay(d3),s/veh	0.0	0.0	0.0	0.0	0.0	0.0
%ile BackOfQ(50%),veh/ln	1.1	0.0	0.5	0.7	7.5	5.3
Unsig. Movement Delay, s/veh						
LnGrp Delay(d),s/veh	55.0	0.0	8.2	2.5	9.9	5.9
LnGrp LOS	E		A	A	A	A
Approach Vol, veh/h	72	A		575	1570	
Approach Delay, s/veh	55.0			3.4	9.5	
Approach LOS	E			A	A	
Timer - Assigned Phs		2		4	5	6
Phs Duration (G+Y+Rc), s		105.2		14.8	13.2	92.0
Change Period (Y+Rc), s		7.5		7.5	8.5	7.5
Max Green Setting (Gmax), s		84.5		20.5	11.5	64.5
Max Q Clear Time (g_c+I1), s		5.5		4.4	3.5	26.4
Green Ext Time (p_c), s		3.0		0.1	0.1	13.3
<b>Intersection Summary</b>						
HCM 6th Ctrl Delay			9.4			
HCM 6th LOS			A			
<b>Notes</b>						
Unsignalized Delay for [EBR] is excluded from calculations of the approach delay and intersection delay.						

Intersection						
Int Delay, s/veh	5.6					
Movement	EBT	EBR	WBL	WBT	NBL	NBR
Lane Configurations	↑	↗	↖	↑	↘	↙
Traffic Vol, veh/h	32	62	152	35	1	116
Future Vol, veh/h	32	62	152	35	1	116
Conflicting Peds, #/hr	0	0	0	0	0	0
Sign Control	Free	Free	Free	Free	Stop	Stop
RT Channelized	-	None	-	None	-	None
Storage Length	-	150	100	-	0	-
Veh in Median Storage, #	0	-	-	0	0	-
Grade, %	0	-	-	0	0	-
Peak Hour Factor	85	85	85	85	85	85
Heavy Vehicles, %	2	2	2	2	2	2
Mvmt Flow	38	73	179	41	1	136

Major/Minor	Major1	Major2	Minor1		
Conflicting Flow All	0	0	111	0	437 38
Stage 1	-	-	-	-	38 -
Stage 2	-	-	-	-	399 -
Critical Hdwy	-	-	4.12	-	6.42 6.22
Critical Hdwy Stg 1	-	-	-	-	5.42 -
Critical Hdwy Stg 2	-	-	-	-	5.42 -
Follow-up Hdwy	-	-	2.218	-	3.518 3.318
Pot Cap-1 Maneuver	-	-	1479	-	577 1034
Stage 1	-	-	-	-	984 -
Stage 2	-	-	-	-	678 -
Platoon blocked, %	-	-	-	-	-
Mov Cap-1 Maneuver	-	-	1479	-	507 1034
Mov Cap-2 Maneuver	-	-	-	-	507 -
Stage 1	-	-	-	-	984 -
Stage 2	-	-	-	-	596 -

Approach	EB	WB	NB
HCM Control Delay, s	0	6.3	9.1
HCM LOS			A

Minor Lane/Major Mvmt	NBLn1	EBT	EBR	WBL	WBT
Capacity (veh/h)	1025	-	-	1479	-
HCM Lane V/C Ratio	0.134	-	-	0.121	-
HCM Control Delay (s)	9.1	-	-	7.8	-
HCM Lane LOS	A	-	-	A	-
HCM 95th %tile Q(veh)	0.5	-	-	0.4	-

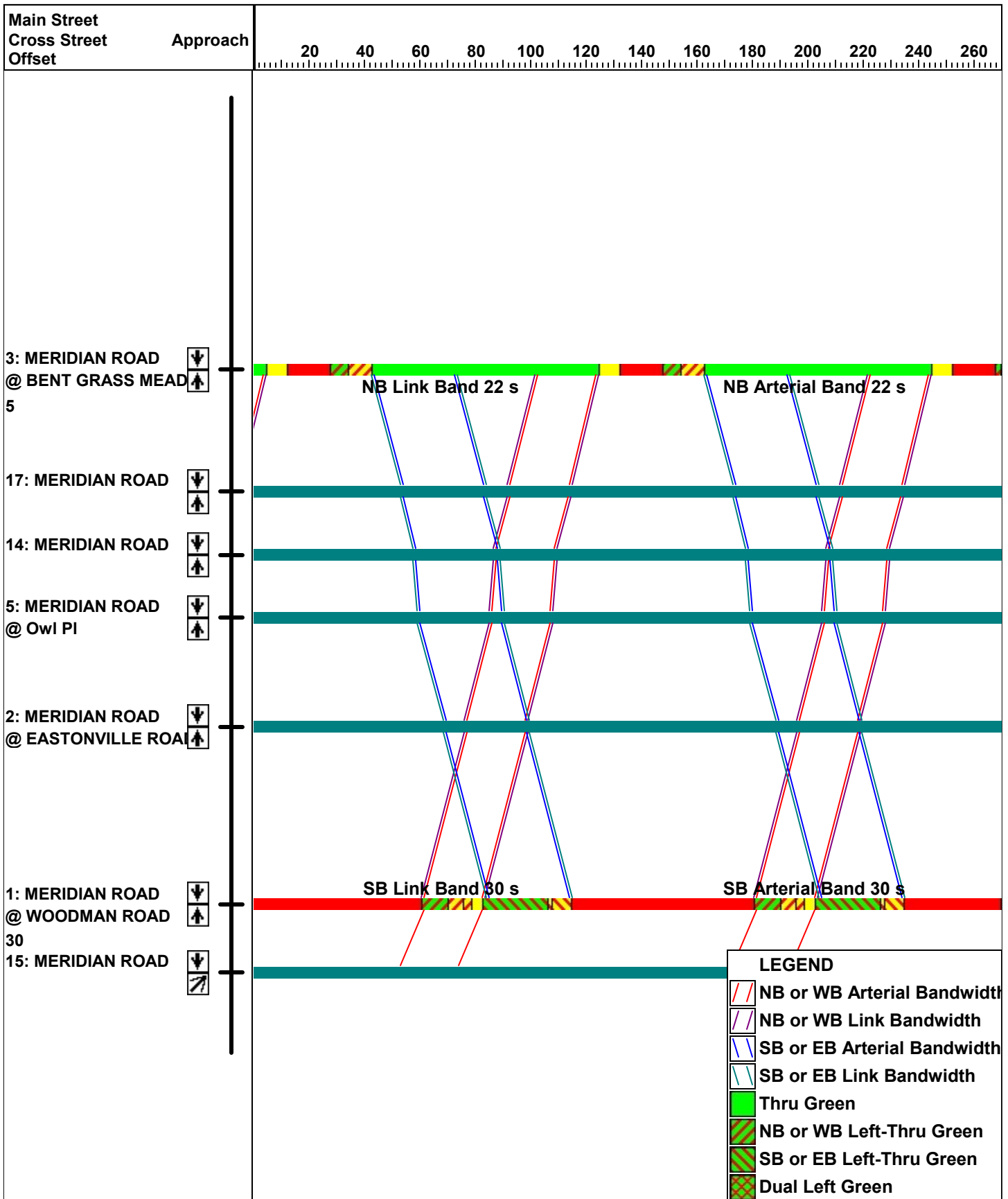
Intersection						
Int Delay, s/veh	0.1					
Movement	EBL	EBR	NBL	NBT	SBT	SBR
Lane Configurations		↗	↘	↑↑↑	↑↑	
Traffic Vol, veh/h	0	6	5	517	1358	2
Future Vol, veh/h	0	6	5	517	1358	2
Conflicting Peds, #/hr	0	0	0	0	0	0
Sign Control	Stop	Stop	Free	Free	Free	Free
RT Channelized	-	None	-	None	-	None
Storage Length	-	0	270	-	-	-
Veh in Median Storage, #	0	-	-	0	0	-
Grade, %	0	-	-	0	0	-
Peak Hour Factor	85	85	85	85	85	85
Heavy Vehicles, %	2	2	2	2	2	2
Mvmt Flow	0	7	6	608	1598	2

Major/Minor	Minor2	Major1	Major2		
Conflicting Flow All	-	800	1600	0	0
Stage 1	-	-	-	-	-
Stage 2	-	-	-	-	-
Critical Hdwy	-	6.94	4.14	-	-
Critical Hdwy Stg 1	-	-	-	-	-
Critical Hdwy Stg 2	-	-	-	-	-
Follow-up Hdwy	-	3.32	2.22	-	-
Pot Cap-1 Maneuver	0	328	405	-	-
Stage 1	0	-	-	-	-
Stage 2	0	-	-	-	-
Platoon blocked, %				-	-
Mov Cap-1 Maneuver	-	328	405	-	-
Mov Cap-2 Maneuver	-	-	-	-	-
Stage 1	-	-	-	-	-
Stage 2	-	-	-	-	-

Approach	EB	NB	SB
HCM Control Delay, s	16.2	0.1	0
HCM LOS	C		

Minor Lane/Major Mvmt	NBL	NBT	EBLn1	SBT	SBR
Capacity (veh/h)	405	-	328	-	-
HCM Lane V/C Ratio	0.015	-	0.022	-	-
HCM Control Delay (s)	14	-	16.2	-	-
HCM Lane LOS	B	-	C	-	-
HCM 95th %tile Q(veh)	0	-	0.1	-	-

# Existing AM Signal Progression





Timings  
1: MERIDIAN ROAD & WOODMAN ROAD

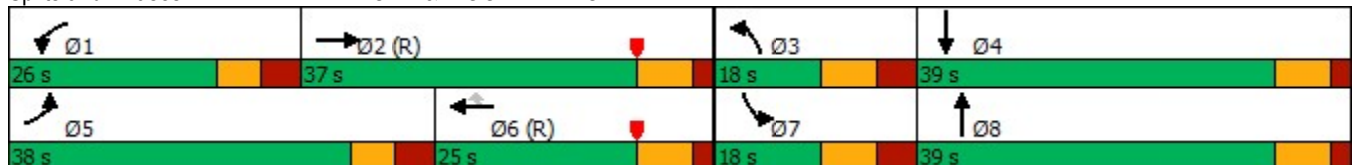
Existing PM  
03/30/2023

Lane Group	EBL	EBT	EBR	WBL	WBT	WBR	NBL	NBT	NBR	SBL	SBT	SBR
Lane Configurations												
Traffic Volume (vph)	671	509	160	112	330	136	164	675	106	100	387	375
Future Volume (vph)	671	509	160	112	330	136	164	675	106	100	387	375
Turn Type	Prot	NA	Free	Prot	NA	Perm	Prot	NA	Free	Prot	NA	Free
Protected Phases	5	2		1	6		3	8		7	4	
Permitted Phases			Free			6			Free			Free
Detector Phase	5	2		1	6	6	3	8		7	4	
Switch Phase												
Minimum Initial (s)	5.0	15.0		5.0	15.0	15.0	5.0	15.0		5.0	15.0	
Minimum Split (s)	13.5	22.0		13.5	22.0	22.0	13.5	22.0		13.5	22.0	
Total Split (s)	38.0	37.0		26.0	25.0	25.0	18.0	39.0		18.0	39.0	
Total Split (%)	31.7%	30.8%		21.7%	20.8%	20.8%	15.0%	32.5%		15.0%	32.5%	
Yellow Time (s)	4.0	5.0		4.0	5.0	5.0	5.0	5.0		5.0	5.0	
All-Red Time (s)	3.5	2.0		3.5	2.0	2.0	3.5	2.0		3.5	2.0	
Lost Time Adjust (s)	0.0	0.0		0.0	0.0	0.0	0.0	0.0		0.0	0.0	
Total Lost Time (s)	7.5	7.0		7.5	7.0	7.0	8.5	7.0		8.5	7.0	
Lead/Lag	Lead	Lag		Lead	Lag	Lag	Lead	Lag		Lead	Lag	
Lead-Lag Optimize?	Yes	Yes		Yes	Yes	Yes	Yes	Yes		Yes	Yes	
Recall Mode	None	C-Max		None	C-Max	C-Max	None	None		None	None	
Act Effct Green (s)	28.7	42.6	120.0	9.6	23.6	23.6	9.2	29.2	120.0	8.5	28.5	120.0
Actuated g/C Ratio	0.24	0.36	1.00	0.08	0.20	0.20	0.08	0.24	1.00	0.07	0.24	1.00
v/c Ratio	0.88	0.44	0.11	0.44	0.52	0.29	0.66	0.83	0.07	0.43	0.48	0.25
Control Delay	57.0	32.1	0.1	57.4	47.9	1.4	66.2	51.7	0.1	67.9	34.3	0.4
Queue Delay	0.0	0.0	0.0	0.0	0.0	0.0	0.0	0.0	0.0	0.0	0.0	0.0
Total Delay	57.0	32.1	0.1	57.4	47.9	1.4	66.2	51.7	0.1	67.9	34.3	0.4
LOS	E	C	A	E	D	A	E	D	A	E	C	A
Approach Delay		40.7			38.8			48.4			23.4	
Approach LOS		D			D			D			C	

Intersection Summary

Cycle Length: 120  
 Actuated Cycle Length: 120  
 Offset: 100 (83%), Referenced to phase 2:EBT and 6:WBT, Start of Yellow  
 Natural Cycle: 90  
 Control Type: Actuated-Coordinated  
 Maximum v/c Ratio: 0.88  
 Intersection Signal Delay: 38.4  
 Intersection LOS: D  
 Intersection Capacity Utilization 79.1%  
 ICU Level of Service D  
 Analysis Period (min) 15

Splits and Phases: 1: MERIDIAN ROAD & WOODMAN ROAD



Queues  
1: MERIDIAN ROAD & WOODMAN ROAD

Existing PM  
03/30/2023



Lane Group	EBL	EBT	EBR	WBL	WBT	WBR	NBL	NBT	NBR	SBL	SBT	SBR
Lane Group Flow (vph)	722	547	172	122	359	148	173	711	112	105	407	395
v/c Ratio	0.88	0.44	0.11	0.44	0.52	0.29	0.66	0.83	0.07	0.43	0.48	0.25
Control Delay	57.0	32.1	0.1	57.4	47.9	1.4	66.2	51.7	0.1	67.9	34.3	0.4
Queue Delay	0.0	0.0	0.0	0.0	0.0	0.0	0.0	0.0	0.0	0.0	0.0	0.0
Total Delay	57.0	32.1	0.1	57.4	47.9	1.4	66.2	51.7	0.1	67.9	34.3	0.4
Queue Length 50th (ft)	273	173	0	47	137	0	68	271	0	34	141	0
Queue Length 95th (ft)	347	240	0	77	193	0	106	338	0	67	188	0
Internal Link Dist (ft)		1165			1100			344			1171	
Turn Bay Length (ft)	500		630	350		250	440		330	490		450
Base Capacity (vph)	872	1257	1583	529	694	511	271	943	1583	271	943	1583
Starvation Cap Reductn	0	0	0	0	0	0	0	0	0	0	0	0
Spillback Cap Reductn	0	0	0	0	0	0	0	0	0	0	0	0
Storage Cap Reductn	0	0	0	0	0	0	0	0	0	0	0	0
Reduced v/c Ratio	0.83	0.44	0.11	0.23	0.52	0.29	0.64	0.75	0.07	0.39	0.43	0.25

Intersection Summary

HCM 6th Signalized Intersection Summary  
1: MERIDIAN ROAD & WOODMAN ROAD

Existing PM  
03/30/2023



Movement	EBL	EBT	EBR	WBL	WBT	WBR	NBL	NBT	NBR	SBL	SBT	SBR
Lane Configurations	↔↔	↑↑	↗	↔↔	↑↑	↗	↔↔	↑↑	↗	↔↔	↑↑	↗
Traffic Volume (veh/h)	671	509	160	112	330	136	164	675	106	100	387	375
Future Volume (veh/h)	671	509	160	112	330	136	164	675	106	100	387	375
Initial Q (Qb), veh	0	0	0	0	0	0	0	0	0	0	0	0
Ped-Bike Adj(A_pbT)	1.00		1.00	1.00		1.00	1.00		1.00	1.00		1.00
Parking Bus, Adj	1.00	1.00	1.00	1.00	1.00	1.00	1.00	1.00	1.00	1.00	1.00	1.00
Work Zone On Approach		No			No			No			No	
Adj Sat Flow, veh/h/ln	1870	1870	1870	1870	1870	1870	1870	1870	1870	1870	1870	1870
Adj Flow Rate, veh/h	722	547	0	122	359	0	173	711	0	105	407	0
Peak Hour Factor	0.93	0.93	0.93	0.92	0.92	0.92	0.95	0.95	0.95	0.95	0.95	0.95
Percent Heavy Veh, %	2	2	2	2	2	2	2	2	2	2	2	2
Cap, veh/h	794	1496		181	866		229	820		158	747	
Arrive On Green	0.23	0.42	0.00	0.05	0.24	0.00	0.07	0.23	0.00	0.05	0.21	0.00
Sat Flow, veh/h	3456	3554	1585	3456	3554	1585	3456	3554	1585	3456	3554	1585
Grp Volume(v), veh/h	722	547	0	122	359	0	173	711	0	105	407	0
Grp Sat Flow(s),veh/h/ln	1728	1777	1585	1728	1777	1585	1728	1777	1585	1728	1777	1585
Q Serve(g_s), s	24.4	12.6	0.0	4.2	10.2	0.0	5.9	23.1	0.0	3.6	12.3	0.0
Cycle Q Clear(g_c), s	24.4	12.6	0.0	4.2	10.2	0.0	5.9	23.1	0.0	3.6	12.3	0.0
Prop In Lane	1.00		1.00	1.00		1.00	1.00		1.00	1.00		1.00
Lane Grp Cap(c), veh/h	794	1496		181	866		229	820		158	747	
V/C Ratio(X)	0.91	0.37		0.67	0.41		0.75	0.87		0.66	0.54	
Avail Cap(c_a), veh/h	878	1496		533	866		274	948		274	948	
HCM Platoon Ratio	1.00	1.00	1.00	1.00	1.00	1.00	1.00	1.00	1.00	1.00	1.00	1.00
Upstream Filter(l)	1.00	1.00	0.00	1.00	1.00	0.00	1.00	1.00	0.00	1.00	1.00	0.00
Uniform Delay (d), s/veh	45.0	23.8	0.0	55.8	38.2	0.0	55.1	44.4	0.0	56.3	42.3	0.0
Incr Delay (d2), s/veh	12.6	0.7	0.0	4.3	1.5	0.0	9.4	7.7	0.0	4.7	0.6	0.0
Initial Q Delay(d3),s/veh	0.0	0.0	0.0	0.0	0.0	0.0	0.0	0.0	0.0	0.0	0.0	0.0
%ile BackOfQ(50%),veh/ln	11.5	5.2	0.0	1.9	4.5	0.0	2.9	10.9	0.0	1.6	5.2	0.0
Unsig. Movement Delay, s/veh												
LnGrp Delay(d),s/veh	57.6	24.5	0.0	60.1	39.6	0.0	64.5	52.1	0.0	61.0	42.9	0.0
LnGrp LOS	E	C		E	D		E	D		E	D	
Approach Vol, veh/h		1269	A		481	A		884	A		512	A
Approach Delay, s/veh		43.3			44.8			54.5			46.6	
Approach LOS		D			D			D			D	
Timer - Assigned Phs	1	2	3	4	5	6	7	8				
Phs Duration (G+Y+Rc), s	13.8	57.5	16.5	32.2	35.1	36.2	14.0	34.7				
Change Period (Y+Rc), s	7.5	7.0	8.5	7.0	7.5	7.0	8.5	7.0				
Max Green Setting (Gmax), s	18.5	30.0	9.5	32.0	30.5	18.0	9.5	32.0				
Max Q Clear Time (g_c+I1), s	6.2	14.6	7.9	14.3	26.4	12.2	5.6	25.1				
Green Ext Time (p_c), s	0.2	2.9	0.1	2.1	1.2	1.0	0.1	2.6				

Intersection Summary

HCM 6th Ctrl Delay	47.2
HCM 6th LOS	D

Notes

User approved pedestrian interval to be less than phase max green.  
Unsignalized Delay for [NBR, EBR, WBR, SBR] is excluded from calculations of the approach delay and intersection delay.

Intersection						
Int Delay, s/veh	5.5					
Movement	WBL	WBR	NBT	NBR	SBL	SBT
Lane Configurations	↘	↗	↑↑	↗	↘	↑↑
Traffic Vol, veh/h	31	133	1367	115	82	831
Future Vol, veh/h	31	133	1367	115	82	831
Conflicting Peds, #/hr	0	0	0	0	0	0
Sign Control	Stop	Stop	Free	Free	Free	Free
RT Channelized	-	Free	-	None	-	None
Storage Length	120	0	-	400	375	-
Veh in Median Storage, #	0	-	0	-	-	0
Grade, %	0	-	0	-	-	0
Peak Hour Factor	95	95	89	89	88	88
Heavy Vehicles, %	2	2	2	2	2	2
Mvmt Flow	33	140	1536	129	93	944

Major/Minor	Minor1	Major1	Major2		
Conflicting Flow All	2194	-	0	0	1665
Stage 1	1536	-	-	-	-
Stage 2	658	-	-	-	-
Critical Hdwy	6.84	-	-	-	4.14
Critical Hdwy Stg 1	5.84	-	-	-	-
Critical Hdwy Stg 2	5.84	-	-	-	-
Follow-up Hdwy	3.52	-	-	-	2.22
Pot Cap-1 Maneuver	38	0	-	-	382
Stage 1	164	0	-	-	-
Stage 2	477	0	-	-	-
Platoon blocked, %					
Mov Cap-1 Maneuver	~ 29	-	-	-	382
Mov Cap-2 Maneuver	~ 29	-	-	-	-
Stage 1	164	-	-	-	-
Stage 2	361	-	-	-	-

Approach	WB	NB	SB
HCM Control Delay, s	409.6	0	1.6
HCM LOS	F		

Minor Lane/Major Mvmt	NBT	NBR	WBLn1	WBLn2	SBL	SBT
Capacity (veh/h)	-	-	29	-	382	-
HCM Lane V/C Ratio	-	-	1.125	-	0.244	-
HCM Control Delay (s)	-	-	409.6	0	17.4	-
HCM Lane LOS	-	-	F	A	C	-
HCM 95th %tile Q(veh)	-	-	3.7	-	0.9	-

Notes  
 ~: Volume exceeds capacity    \$: Delay exceeds 300s    +: Computation Not Defined    \*: All major volume in platoon

Timings  
3: MERIDIAN ROAD & BENT GRASS MEADOWS DRIVE

Existing PM  
03/30/2023

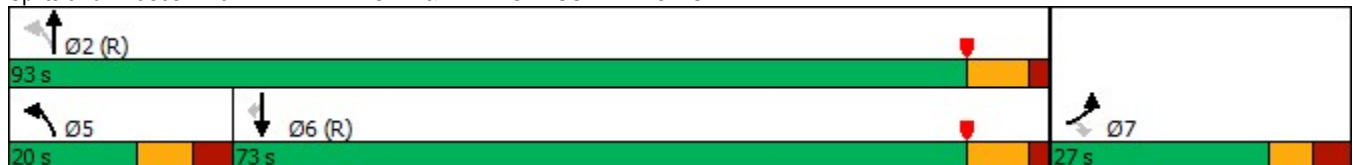


Lane Group	EBL	EBR	NBL	NBT	SBT	SBR
Lane Configurations	↖↗	↗	↖	↑↑	↑↑	↗
Traffic Volume (vph)	79	72	65	1424	838	98
Future Volume (vph)	79	72	65	1424	838	98
Turn Type	Prot	Perm	pm+pt	NA	NA	Perm
Protected Phases	7		5	2	6	
Permitted Phases		7	2			6
Detector Phase	7	7	5	2	6	6
Switch Phase						
Minimum Initial (s)	8.0	8.0	5.0	15.0	15.0	15.0
Minimum Split (s)	25.5	25.5	13.5	25.5	25.5	25.5
Total Split (s)	27.0	27.0	20.0	93.0	73.0	73.0
Total Split (%)	22.5%	22.5%	16.7%	77.5%	60.8%	60.8%
Yellow Time (s)	4.0	4.0	5.0	5.5	5.5	5.5
All-Red Time (s)	3.5	3.5	3.5	2.0	2.0	2.0
Lost Time Adjust (s)	0.0	0.0	0.0	0.0	0.0	0.0
Total Lost Time (s)	7.5	7.5	8.5	7.5	7.5	7.5
Lead/Lag			Lead		Lag	Lag
Lead-Lag Optimize?			Yes		Yes	Yes
Recall Mode	None	None	None	C-Max	C-Max	C-Max
Act Effect Green (s)	9.7	9.7	94.3	95.3	83.1	83.1
Actuated g/C Ratio	0.08	0.08	0.79	0.79	0.69	0.69
v/c Ratio	0.43	0.47	0.15	0.53	0.36	0.09
Control Delay	57.0	16.8	1.7	4.2	8.9	1.7
Queue Delay	0.0	0.0	0.0	0.0	0.0	0.0
Total Delay	57.0	16.8	1.7	4.2	8.9	1.7
LOS	E	B	A	A	A	A
Approach Delay	37.9			4.1	8.1	
Approach LOS	D			A	A	

Intersection Summary

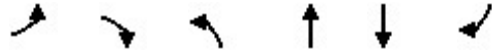
Cycle Length: 120  
 Actuated Cycle Length: 120  
 Offset: 27 (23%), Referenced to phase 2:NBTL and 6:SBT, Start of Yellow  
 Natural Cycle: 65  
 Control Type: Actuated-Coordinated  
 Maximum v/c Ratio: 0.53  
 Intersection Signal Delay: 8.2  
 Intersection Capacity Utilization 58.5%  
 Analysis Period (min) 15  
 Intersection LOS: A  
 ICU Level of Service B

Splits and Phases: 3: MERIDIAN ROAD & BENT GRASS MEADOWS DRIVE





## 3: MERIDIAN ROAD &amp; BENT GRASS MEADOWS DRIVE



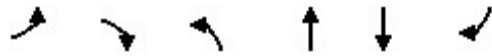
Lane Group	EBL	EBR	NBL	NBT	SBT	SBR
Lane Group Flow (vph)	118	107	68	1499	891	104
v/c Ratio	0.43	0.47	0.15	0.53	0.36	0.09
Control Delay	57.0	16.8	1.7	4.2	8.9	1.7
Queue Delay	0.0	0.0	0.0	0.0	0.0	0.0
Total Delay	57.0	16.8	1.7	4.2	8.9	1.7
Queue Length 50th (ft)	45	0	2	203	145	0
Queue Length 95th (ft)	55	19	m6	249	201	20
Internal Link Dist (ft)	310			750	1921	
Turn Bay Length (ft)	150		700			350
Base Capacity (vph)	557	346	512	2810	2450	1127
Starvation Cap Reductn	0	0	0	0	0	0
Spillback Cap Reductn	0	0	0	0	0	0
Storage Cap Reductn	0	0	0	0	0	0
Reduced v/c Ratio	0.21	0.31	0.13	0.53	0.36	0.09

## Intersection Summary

m Volume for 95th percentile queue is metered by upstream signal.

HCM 6th Signalized Intersection Summary  
 3: MERIDIAN ROAD & BENT GRASS MEADOWS DRIVE

Existing PM  
 03/30/2023



Movement	EBL	EBR	NBL	NBT	SBT	SBR
Lane Configurations	↖↗	↗	↖	↑↑	↑↑	↗
Traffic Volume (veh/h)	79	72	65	1424	838	98
Future Volume (veh/h)	79	72	65	1424	838	98
Initial Q (Qb), veh	0	0	0	0	0	0
Ped-Bike Adj(A_pbT)	1.00	1.00	1.00			1.00
Parking Bus, Adj	1.00	1.00	1.00	1.00	1.00	1.00
Work Zone On Approach	No			No	No	
Adj Sat Flow, veh/h/ln	1870	1870	1870	1870	1870	1870
Adj Flow Rate, veh/h	118	0	68	1499	891	104
Peak Hour Factor	0.67	0.67	0.95	0.95	0.94	0.94
Percent Heavy Veh, %	2	2	2	2	2	2
Cap, veh/h	226		467	2877	2493	1112
Arrive On Green	0.07	0.00	0.04	0.81	0.70	0.70
Sat Flow, veh/h	3456	1585	1781	3647	3647	1585
Grp Volume(v), veh/h	118	0	68	1499	891	104
Grp Sat Flow(s),veh/h/ln	1728	1585	1781	1777	1777	1585
Q Serve(g_s), s	4.0	0.0	1.2	16.7	12.0	2.5
Cycle Q Clear(g_c), s	4.0	0.0	1.2	16.7	12.0	2.5
Prop In Lane	1.00	1.00	1.00			1.00
Lane Grp Cap(c), veh/h	226		467	2877	2493	1112
V/C Ratio(X)	0.52		0.15	0.52	0.36	0.09
Avail Cap(c_a), veh/h	562		571	2877	2493	1112
HCM Platoon Ratio	1.00	1.00	1.00	1.00	1.00	1.00
Upstream Filter(I)	1.00	0.00	1.00	1.00	1.00	1.00
Uniform Delay (d), s/veh	54.3	0.0	4.7	3.8	7.1	5.7
Incr Delay (d2), s/veh	1.9	0.0	0.1	0.7	0.4	0.2
Initial Q Delay(d3),s/veh	0.0	0.0	0.0	0.0	0.0	0.0
%ile BackOfQ(50%),veh/ln	1.8	0.0	0.3	3.3	3.7	4.6
Unsig. Movement Delay, s/veh						
LnGrp Delay(d),s/veh	56.1	0.0	4.8	4.4	7.5	5.9
LnGrp LOS	E		A	A	A	A
Approach Vol, veh/h	118	A		1567	995	
Approach Delay, s/veh	56.1			4.5	7.4	
Approach LOS	E			A	A	
Timer - Assigned Phs		2		4	5	6
Phs Duration (G+Y+Rc), s		104.7		15.3	13.0	91.7
Change Period (Y+Rc), s		7.5		7.5	8.5	7.5
Max Green Setting (Gmax), s		85.5		19.5	11.5	65.5
Max Q Clear Time (g_c+I1), s		18.7		6.0	3.2	14.0
Green Ext Time (p_c), s		14.8		0.3	0.1	6.7

Intersection Summary

HCM 6th Ctrl Delay	7.8
HCM 6th LOS	A

Notes

Unsignalized Delay for [EBR] is excluded from calculations of the approach delay and intersection delay.

Intersection						
Int Delay, s/veh	5.1					
Movement	EBT	EBR	WBL	WBT	NBL	NBR
Lane Configurations	↑	↗	↖	↑	↘	↙
Traffic Vol, veh/h	41	40	105	58	2	110
Future Vol, veh/h	41	40	105	58	2	110
Conflicting Peds, #/hr	0	0	0	0	0	0
Sign Control	Free	Free	Free	Free	Stop	Stop
RT Channelized	-	None	-	None	-	None
Storage Length	-	150	100	-	0	-
Veh in Median Storage, #	0	-	-	0	0	-
Grade, %	0	-	-	0	0	-
Peak Hour Factor	85	85	85	85	85	85
Heavy Vehicles, %	2	2	2	2	2	2
Mvmt Flow	48	47	124	68	2	129

Major/Minor	Major1	Major2	Minor1		
Conflicting Flow All	0	0	95	0	364 48
Stage 1	-	-	-	-	48 -
Stage 2	-	-	-	-	316 -
Critical Hdwy	-	-	4.12	-	6.42 6.22
Critical Hdwy Stg 1	-	-	-	-	5.42 -
Critical Hdwy Stg 2	-	-	-	-	5.42 -
Follow-up Hdwy	-	-	2.218	-	3.518 3.318
Pot Cap-1 Maneuver	-	-	1499	-	635 1021
Stage 1	-	-	-	-	974 -
Stage 2	-	-	-	-	739 -
Platoon blocked, %	-	-	-	-	-
Mov Cap-1 Maneuver	-	-	1499	-	582 1021
Mov Cap-2 Maneuver	-	-	-	-	582 -
Stage 1	-	-	-	-	974 -
Stage 2	-	-	-	-	678 -

Approach	EB	WB	NB
HCM Control Delay, s	0	4.9	9.1
HCM LOS			A

Minor Lane/Major Mvmt	NBLn1	EBT	EBR	WBL	WBT
Capacity (veh/h)	1007	-	-	1499	-
HCM Lane V/C Ratio	0.131	-	-	0.082	-
HCM Control Delay (s)	9.1	-	-	7.6	-
HCM Lane LOS	A	-	-	A	-
HCM 95th %tile Q(veh)	0.5	-	-	0.3	-

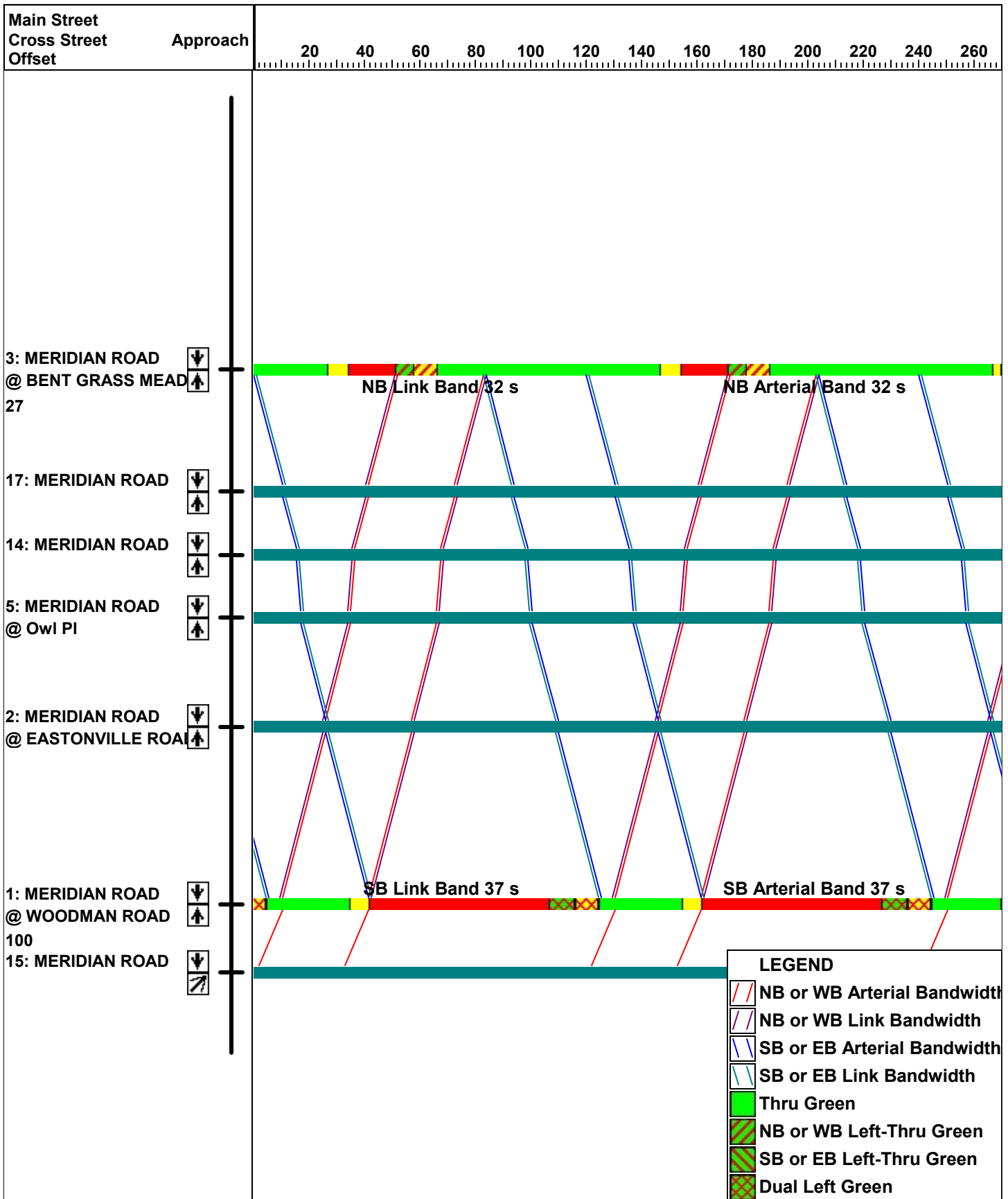
Intersection						
Int Delay, s/veh	0.1					
Movement	EBL	EBR	NBL	NBT	SBT	SBR
Lane Configurations		↗	↘	↑↑↑	↑↑	
Traffic Vol, veh/h	0	7	11	1489	906	4
Future Vol, veh/h	0	7	11	1489	906	4
Conflicting Peds, #/hr	0	0	0	0	0	0
Sign Control	Stop	Stop	Free	Free	Free	Free
RT Channelized	-	None	-	None	-	None
Storage Length	-	0	270	-	-	-
Veh in Median Storage, #	0	-	-	0	0	-
Grade, %	0	-	-	0	0	-
Peak Hour Factor	85	85	85	85	85	85
Heavy Vehicles, %	2	2	2	2	2	2
Mvmt Flow	0	8	13	1752	1066	5

Major/Minor	Minor2	Major1	Major2			
Conflicting Flow All	-	536	1071	0	-	0
Stage 1	-	-	-	-	-	-
Stage 2	-	-	-	-	-	-
Critical Hdwy	-	6.94	4.14	-	-	-
Critical Hdwy Stg 1	-	-	-	-	-	-
Critical Hdwy Stg 2	-	-	-	-	-	-
Follow-up Hdwy	-	3.32	2.22	-	-	-
Pot Cap-1 Maneuver	0	489	647	-	-	-
Stage 1	0	-	-	-	-	-
Stage 2	0	-	-	-	-	-
Platoon blocked, %				-	-	-
Mov Cap-1 Maneuver	-	489	647	-	-	-
Mov Cap-2 Maneuver	-	-	-	-	-	-
Stage 1	-	-	-	-	-	-
Stage 2	-	-	-	-	-	-

Approach	EB	NB	SB
HCM Control Delay, s	12.5	0.1	0
HCM LOS	B		

Minor Lane/Major Mvmt	NBL	NBT	EBLn1	SBT	SBR
Capacity (veh/h)	647	-	489	-	-
HCM Lane V/C Ratio	0.02	-	0.017	-	-
HCM Control Delay (s)	10.7	-	12.5	-	-
HCM Lane LOS	B	-	B	-	-
HCM 95th %tile Q(veh)	0.1	-	0.1	-	-

# Existing PM Signal Progression





## **APPENDIX E – Pipeline TIS Excerpts**

# TRAFFIC IMPACT STUDY

For

**Owl Place Commercial  
El Paso County, Colorado  
PCD File No. CR221**

June 2022  
Revised:  
September 2022

Prepared for:

First Cup  
106 S Kyrene Road, Suite 2  
Chandler, AZ 85226

Prepared by:



**SM ROCHA, LLC**  
TRAFFIC AND TRANSPORTATION CONSULTANTS

8703 Yates Drive, Suite 210  
Westminster, Colorado 80031  
(303) 458-9798

6 South Tejon Street, Suite 515  
Colorado Springs, Colorado 80903  
(719) 203-6639

Project Engineer:  
Stephen Simon, EIT

Engineer in Responsible Charge:  
Fred Lantz, PE



22-051673

**Traffic Engineer's Statement**

The attached traffic report and supporting information were prepared under my responsible charge and they comport with the standard of care. So far as is consistent with the standard of care, said report was prepared in general conformance with the criteria established by the County for traffic reports.

---

*Fred Lantz, P.E. #23410*

---

Date

**Developer's Statement**

I, the Developer, have read and will comply with all commitments made on my behalf within this report.

---

*Brian Zurek  
First Cup  
106 S Kyrene Road, Suite 2  
Chandler, AZ 85226*

---

Date

## Table of Contents

<b>I. Introduction .....</b>	<b>1</b>
Project Overview.....	1
Study Area .....	1
Site Description.....	1
Existing and Committed Surface Transportation Network.....	5
<b>II. Existing Traffic Conditions .....</b>	<b>7</b>
Peak Hour Intersection Levels of Service – Existing Traffic.....	9
Existing Traffic Analysis Results .....	9
<b>III. Future Traffic Conditions Without Proposed Development.....</b>	<b>11</b>
Peak Hour Intersection Levels of Service – Background Traffic .....	14
Background Traffic Analysis Results – Year 2024 .....	14
Background Traffic Analysis Results – Year 2040 .....	15
<b>IV. Proposed Project Traffic .....</b>	<b>16</b>
Trip Generation.....	16
Adjustments to Trip Generation Rates .....	17
Trip Distribution.....	18
Trip Assignment.....	19
<b>V. Future Traffic Conditions With Proposed Developments .....</b>	<b>21</b>
<b>VI. Project Impacts .....</b>	<b>24</b>
Peak Hour Intersection Levels of Service – Total Traffic .....	24
Total Traffic Analysis Results Upon Development Build-Out .....	25
Auxiliary Lane Analysis .....	26
Queue Length Analysis.....	26
Pedestrian Circulation & Safety Analysis .....	27
Transportation Demand Management Plan .....	27
Recommended Improvements .....	28
<b>VII. Conclusion .....</b>	<b>29</b>

### List of Figures

Figure 1 – Location.....	3
Figure 2 – Conceptual Site Plan.....	4
Figure 3 – Existing Traffic Volumes & Intersection Geometry .....	8
Figure 4 – Background Traffic Volumes & Intersection Geometry – Year 2024.....	12
Figure 5 – Background Traffic Volumes & Intersection Geometry – Year 2040.....	13
Figure 6 – Distribution and Site-Generated Assignment.....	20
Figure 7 – Total Traffic Volumes & Intersection Geometry – Year 2024.....	22
Figure 8 – Total Traffic Volumes & Intersection Geometry – Year 2040.....	23

### List of Tables

Table 1 – Intersection Capacity Analysis Summary – Existing Traffic .....	9
Table 2 – Intersection Capacity Analysis Summary – Background Traffic – Year 2024 .....	14
Table 3 – Intersection Capacity Analysis Summary – Background Traffic – Year 2040 .....	15
Table 4 – Trip Generation Rates .....	16
Table 5 – Trip Generation Summary .....	17
Table 6 – Trip Generation Summary with Pass-By Trip Reductions.....	18
Table 7 – Intersection Capacity Analysis Summary – Total Traffic – Year 2024 .....	24
Table 8 – Intersection Capacity Analysis Summary – Total Traffic – Year 2040 .....	24
Table 9 – Recommended Improvements Summary .....	28

### Appendices

APPENDIX A	TRAFFIC COUNT DATA SIGNAL TIMING INFORMATION
APPENDIX B	LEVEL OF SERVICE DEFINITIONS
APPENDIX C	CAPACITY WORKSHEETS



## I. Introduction

### Project Overview

This traffic impact study is provided as a planning document and addresses the capacity, geometric, and control requirements associated with the development entitled Owl Place Commercial.

This traffic impact study has been revised to address County review comments made to the June 2022 version of the traffic impact study regarding inclusion of additional analyses and recommendations with corresponding revisions to figures and tables pursuant to the latest conceptual site plan.

This proposed commercial development consists of various potential uses including a gas station convenience store, coffee/donut shop with drive-through window, automated car wash, and quick-serve restaurants. The development is located at the southwest corner of the intersection of Meridian Road with Owl Place in El Paso County, Colorado.

### Study Area

The study area to be examined in this analysis encompasses Meridian Road between the intersections of Bent Grass Meadows Drive and E Woodmen Road.

Figure 1 illustrates location of the site and study intersections.

### Site Description

Land for the development is currently occupied by a single-family dwelling unit and is surrounded by a mix of residential, commercial, and open space land uses.

The proposed development is conceptual and no specific land uses have been determined. However, for purposes of this analysis, there is assumed to be construction for an approximate 5,300 square foot gas station convenience store supporting up to 12 vehicle fueling positions, an approximate 2,000 square foot coffee/donut shop with drive-through window, a 4,170 square foot automated car wash with one wash tunnel, and an approximate 3,420 square foot high-turnover quick-serve restaurant.

Proposed access to the development is provided at the following locations: one full-movement access onto Owl Place (referred to as Access A), and one full-movement access onto Eastonville Road as an extension of Falcon Market Place (referred to as Access B). For analysis purposes and given the conceptual nature of proposed land uses, proposed accesses are considered to be internal to the overall development area and are not specifically analyzed. Access operations are generally considered to be comparable to or better than that of the closest major intersection.

For purposes of this study, it is anticipated that development construction would be completed by end of Year 2024. General site and access locations are shown on Figure 1.

A conceptual site plan, as prepared by Baseline Engineering Corporation, is shown on Figure 2. This plan is provided for illustrative purposes only.





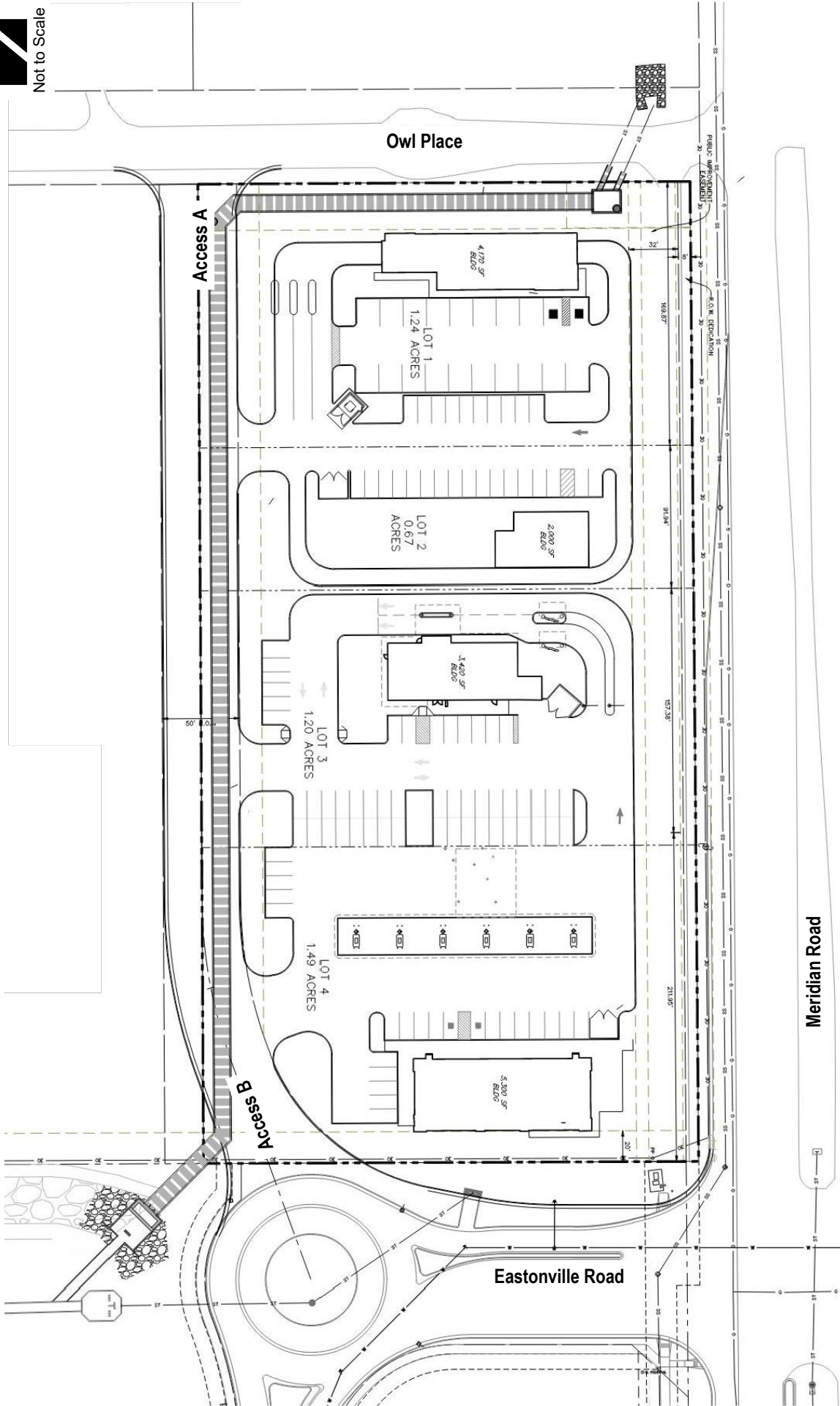
**OWL PLACE COMMERCIAL**  
Traffic Impact Study

**Figure 1**  
**SITE LOCATION**

**SM ROCHA, LLC**  
Traffic and Transportation Consultants







## Existing and Committed Surface Transportation Network

Within the study area, Meridian Road is the primary roadway that will accommodate traffic to and from the proposed development. The secondary roadways include E Woodmen Road, Eastonville Road, Owl Place, and Bent Grass Meadows Drive. A brief description of each roadway, based on the County's 2040 Major Transportation Corridors Plan (MTCP)<sup>1</sup> and Engineering Criteria Manual (ECM)<sup>2</sup>, is provided below:

Meridian Road is a north-south principal arterial roadway having four through lanes (two lanes in each direction) with exclusive turn lanes at the intersections within the study area. Meridian Road provides a posted speed limit of 55 MPH.

E Woodmen Road is an east-west principal arterial roadway having four through lanes (two lanes in each direction) with exclusive turn lanes at the intersection within the study area. E Woodmen Road provides a posted speed limit of 55 MPH.

Eastonville Road is an east-west arterial roadway having two through lanes (one lane in each direction) with a combination of shared and exclusive turn lanes at the intersection within the study area. Eastonville Road provides a posted speed limit of 35 MPH.

Owl Place is an east-west unpaved roadway having two through lanes (one lane in each direction) with shared turn lanes at the intersection within the study area. Owl Place is unclassified in County's MTCP. However, per Standard Drawing 2-10 of County ECM and the roadway's estimated ROW width, Owl Place is assumed to be classified as a local roadway and provides a posted speed limit of 30 MPH.

Bent Grass Meadows Drive is an east-west collector roadway having two through lanes (one lanes in each direction) with exclusive turn lanes at the intersections within the study area. Bent Grass Meadows Drive provides a posted speed limit of 35 MPH.

The study intersections of Meridian Road with E Woodmen Road, Eastonville Road, and Bent Grass Meadows Drive are signalized. All other study intersections operate under a stop-controlled condition. A stop-controlled intersection is defined as a roadway intersection where vehicle rights-of-way are controlled by one or more "STOP" signs.

---

<sup>1</sup> El Paso County 2016 Major Transportation Corridors Plan Update, Felsburg Holt & Ullevig, December 2016.

<sup>2</sup> El Paso County Engineering Criteria Manual, El Paso County, December 2016.



It is however noted that signal installation at Eastonville Road and Meridian Road is a recent occurrence with associated extension of Eastonville Road west of Meridian Road. Due to the ongoing development within the area, the newly constructed west leg of the study intersection was observed to experience low volumes associated with construction traffic only. Therefore, for analysis purposes, the study intersection was assumed to not currently operate at its anticipated capacity and was considered as a three-leg stop-controlled intersection for existing conditions only.

In reference to the County's MTCP, E Woodmen Road is planned to become a six-lane, expressway by Year 2040. The remaining study area roadways appear to be built to their ultimate cross-sections excluding potential improvements required due to the proposed development.

## II. Existing Traffic Conditions

Morning (AM) and afternoon (PM) peak hour traffic counts were collected at the intersections of Meridian Road with E Woodmen Road, Eastonville Road, and Owl Place. Counts were collected on June 1, 2022, with AM peak hour counts being collected during the period of 7:00 a.m. to 9:00 a.m. and PM peak hour counts being collected during the period of 4:00 p.m. to 6:00 p.m.

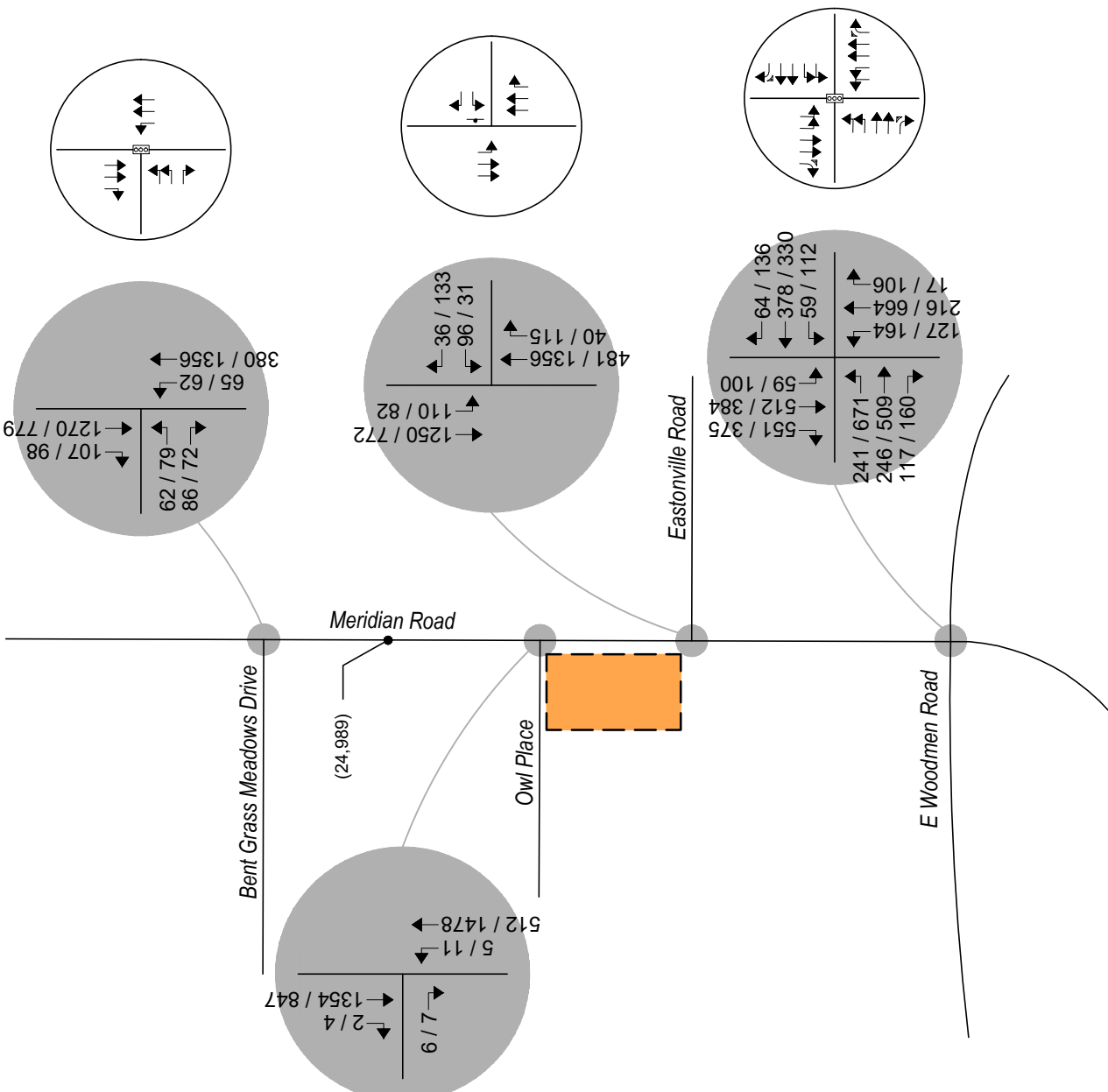
Peak hour traffic counts and 24-hour traffic volumes shown for Meridian Road and the intersection of Meridian Road with Bent Grass Meadows Drive were obtained from a previous traffic study<sup>3</sup>. Referenced counts were collected on March 29, 2022.

Newly collected and referenced counts representing existing traffic volumes, as well as existing intersection geometries, are shown on Figure 3.

Existing signal timing parameters for the intersections of Meridian Road with E Woodmen Road and Bent Grass Meadows Drive were obtained from County Staff and used throughout this study to the best extent possible in order to remain consistent with existing signal coordination plans. City signal timing information received is included for reference in Appendix A.

---

<sup>3</sup> Bent Grass Dunkin' Donuts, SM ROCHA, LLC, April 2022.



**LEGEND**

- Study Intersection Volumes
- Study Intersection Lane Geometry
- Development Site

**Figure 3**  
**EXISTING TRAFFIC**  
Volumes & Intersection Geometry  
AM / PM Peak Hour  
(ADT) : Average Daily Traffic

## Peak Hour Intersection Levels of Service – Existing Traffic

The Signalized and Unsignalized Intersection Analysis techniques, as published in the Highway Capacity Manual (HCM), 6<sup>th</sup> Edition, by the Transportation Research Board and as incorporated into the SYNCHRO computer program, were used to analyze the study intersections for existing and future traffic conditions. These nationally accepted techniques allow for the determination of intersection level of service (LOS) based on the congestion and delay of each traffic movement.

Level of service is a method of measurement used by transportation professionals to quantify a driver's perception of travel conditions that include travel time, number of stops, and total amount of stopped delay experienced on a roadway network. The HCM categorizes level of service into a range from "A" which indicates little, if any, vehicle delay, to "F" which indicates a level of operation considered unacceptable to most drivers. These levels of service grades with brief descriptions of the operating condition, for unsignalized and signalized intersections, are included for reference in Appendix B and have been used throughout this study.

The level of service analyses results for existing conditions are summarized in Table 1.

Intersection capacity worksheets developed for this study are provided in Appendix C.

**Table 1 – Intersection Capacity Analysis Summary – Existing Traffic**

INTERSECTION LANE GROUPS	LEVEL OF SERVICE	
	AM PEAK HOUR	PM PEAK HOUR
Meridian Road / E Woodmen Road (Signalized)	C (30.5)	D (37.8)
Meridian Road / Bent Grass Meadows Drive (Signalized)	A (9.9)	A (7.6)
Meridian Road / Eastonville Road (Stop-Controlled)		
Westbound Left	B	F
Westbound Right	A	B
Southbound Left	A	B
Meridian Road / Owl Place (Stop-Controlled)		
Eastbound Right	B	A
Northbound Left	A	A

Key: Signalized Intersection: Level of Service (Control Delay in sec/veh)  
Stop-Controlled Intersection: Level of Service

## Existing Traffic Analysis Results

Under existing conditions, operational analysis shows that the signalized intersection of Meridian Road with E Woodmen Road has overall operations at LOS C during the morning peak traffic hour and LOS D during the afternoon peak traffic hour.

The signalized intersection of Meridian Road with Bent Grass Meadows Drive has overall operations at LOS A during both the morning and afternoon peak traffic hours.

The unsignalized intersection of Meridian Road with Eastonville Road has turning movement operations at or better than LOS B during either peak traffic hour. Exceptions would include the westbound left turning movement which operates at LOS F during the PM peak traffic hour. The LOS F operation is attributed to the high through traffic volumes along Meridian Road and the stop-controlled nature of the intersection. However, as previously discussed, given the recent signalization of the study intersection, actual operations are expected to be better than shown.

The unsignalized intersection of Meridian Road with Owl Place has turning movement operations at or better than LOS B during the morning peak traffic hour and LOS A during the afternoon peak traffic hour.

It is to be noted that it is not uncommon for unsignalized movements to or from an arterial roadway, in urban areas, to operate with noticeable delays during peak traffic hours.



### III. Future Traffic Conditions Without Proposed Development

Background traffic is the traffic projected to be on area roadways without consideration of the proposed development. Background traffic includes traffic generated by development of vacant parcels in the area.

To account for projected increases in background traffic for Years 2024 and 2040, a compounded annual growth rate was determined using population growth estimates provided by the Pikes Peak Area Council of Governments' (PPACG) 2045 Long Range Transportation Plan<sup>4</sup> which anticipates a 20-year growth rate of less than two percent. Therefore, in order to provide for a conservative analysis, a growth rate of two percent was applied to existing traffic volumes.

To account for projected traffic from adjacent developments not yet built, trip generations from the previously prepared Falcon Marketplace Traffic Impact Analysis<sup>5</sup>, provided by the County's Electronic Development Application Review Program (EDARP), were added to background traffic volumes.

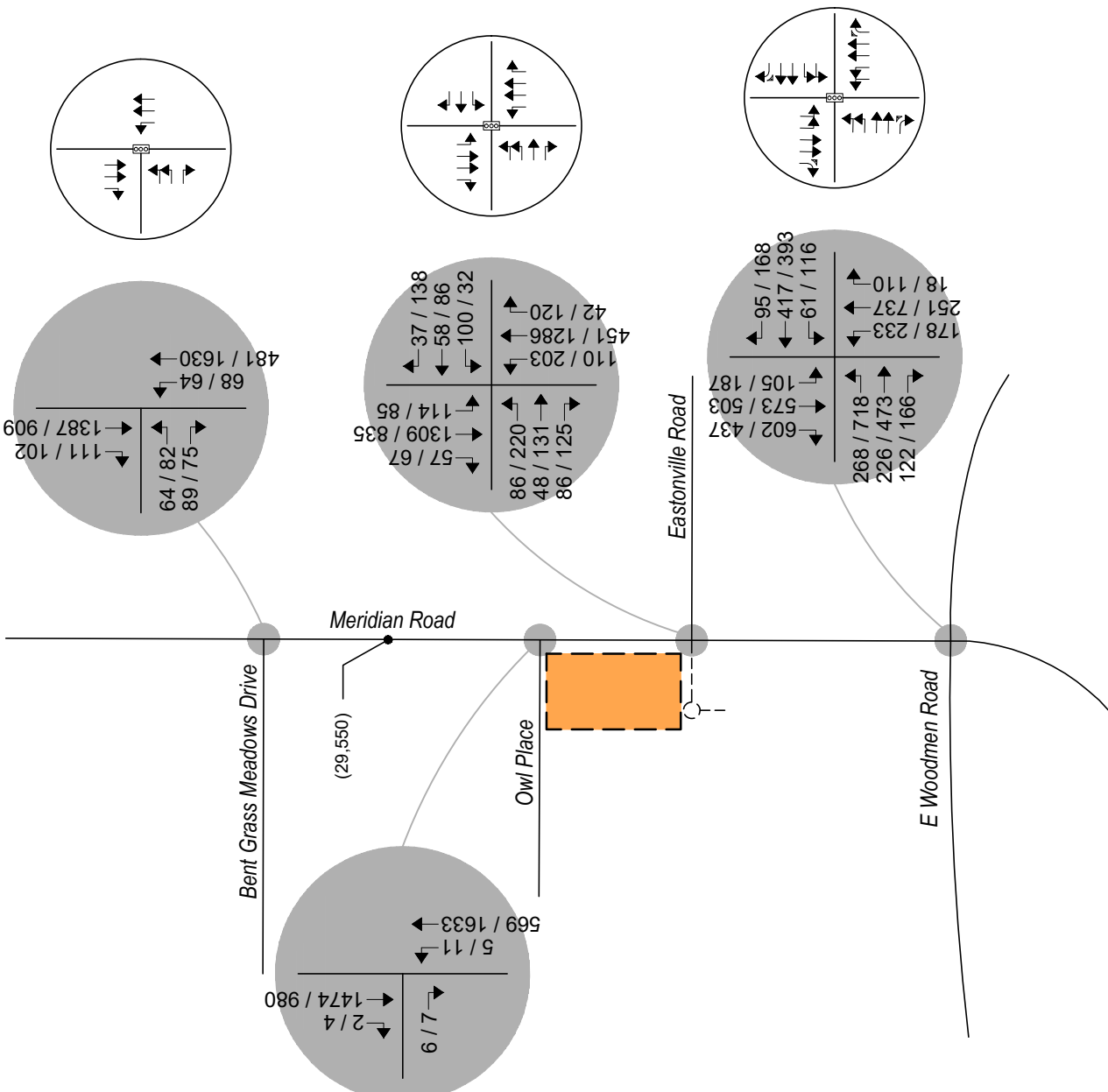
Pursuant to the proposed and committed area roadway improvements discussed in Section I, Year 2024 and Year 2040 background traffic conditions assume the completion of the Eastonville Road extension west of Meridian Road and the improvement of the intersection including signalization. Year 2040 also assumes signal timing parameters for the Meridian Road intersections with optimized intersection splits in effort to better long-term intersection performance.

Projected background traffic volumes and intersection geometry for Years 2024 and 2040 are shown on Figure 4 and Figure 5, respectively.

---

<sup>4</sup> Moving Forward 2045: Pikes Peak Area Regional Transportation Plan, PPACG, January 2020.

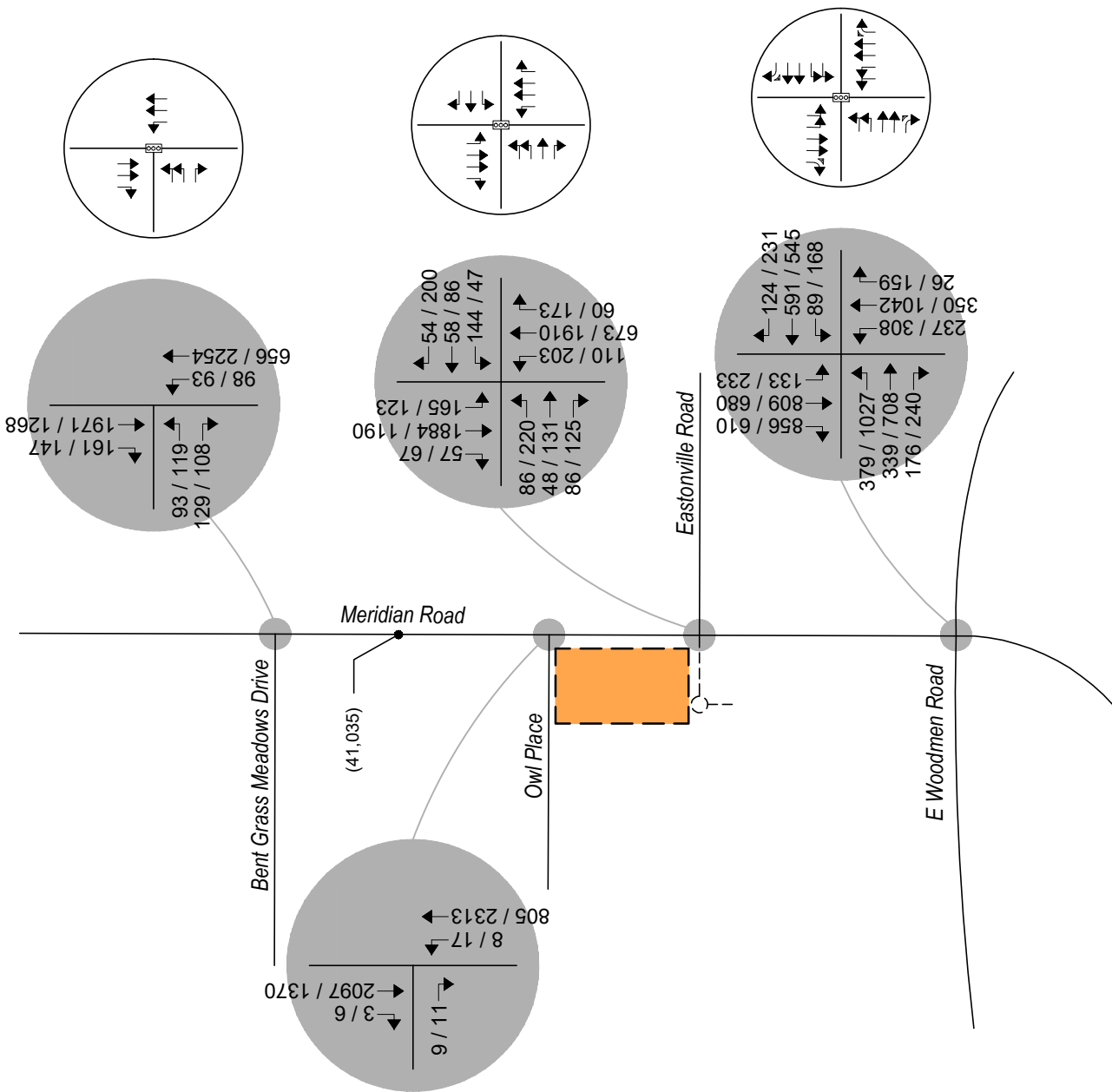
<sup>5</sup> Falcon Marketplace Traffic Impact Analysis, LSC Transportation Consultants Inc., September 2018.



**LEGEND**

- Study Intersection Volumes
- Study Intersection Lane Geometry
- Development Site

**Figure 4**  
**BACKGROUND TRAFFIC - YEAR 2024**  
Volumes & Intersection Geometry  
AM / PM Peak Hour  
(ADT) : Average Daily Traffic



**Figure 5**  
**BACKGROUND TRAFFIC - YEAR 2040**  
Volumes & Intersection Geometry  
AM / PM Peak Hour  
(ADT) : Average Daily Traffic

**LEGEND**

- Study Intersection Volumes
- Study Intersection Lane Geometry
- Development Site

### Peak Hour Intersection Levels of Service – Background Traffic

As with existing traffic conditions, the operations of study intersections were analyzed under background conditions, without the proposed development, using the SYNCHRO computer program.

Background traffic level of service analysis results for Year 2024 are listed in Table 2. Year 2040 operational results are summarized in Table 3.

Definitions of levels of service are given in Appendix B. Intersection capacity worksheets are provided in Appendix C.

**Table 2 – Intersection Capacity Analysis Summary – Background Traffic – Year 2024**

INTERSECTION LANE GROUPS	LEVEL OF SERVICE	
	AM PEAK HOUR	PM PEAK HOUR
Meridian Road / E Woodmen Road (Signalized)	C (31.6)	D (45.1)
Meridian Road / Bent Grass Meadows Drive (Signalized)	B (10.2)	A (5.9)
Meridian Road / Eastonville Road (Signalized)	D (35.3)	C (23.2)
Meridian Road / Owl Place (Stop-Controlled)		
Eastbound Right	B	B
Northbound Left	B	A

Key: Signalized Intersection: Level of Service (Control Delay in sec/veh)  
Stop-Controlled Intersection: Level of Service

### Background Traffic Analysis Results – Year 2024

Year 2024 background traffic analysis indicates that the signalized intersection of Meridian Road with E Woodmen Road has overall operations at LOS C during the AM peak traffic hour and LOS D during the PM peak traffic hour.

The signalized intersection of Meridian Road with Bent Grass Meadows Drive has overall operations at LOS B during the AM peak traffic hour and LOS A during the PM peak traffic hour.

The signalized intersection of Meridian Road with Eastonville Road has overall operations at LOS D during the AM peak traffic hour and LOS C during the PM peak traffic hour.

The unsignalized intersection of Meridian Road with Owl Place operates at or better than LOS B during both AM and PM peak traffic periods.

**Table 3 – Intersection Capacity Analysis Summary – Background Traffic – Year 2040**

INTERSECTION LANE GROUPS	LEVEL OF SERVICE	
	AM PEAK HOUR	PM PEAK HOUR
Meridian Road / E Woodmen Road (Signalized)	D (39.0)	F (86.8)
Meridian Road / Bent Grass Meadows Drive (Signalized)	B (19.6)	B (11.9)
Meridian Road / Eastonville Road (Signalized)	D (38.6)	C (30.6)
Meridian Road / Owl Place (Stop-Controlled)		
Eastbound Right	C	B
Northbound Left	C	A

Key: Signalized Intersection: Level of Service (Control Delay in sec/veh)  
 Stop-Controlled Intersection: Level of Service

### Background Traffic Analysis Results – Year 2040

By Year 2040 and without the proposed development, the study intersection of Meridian Road with E Woodmen Road experiences LOS D operations during the AM peak traffic hour and LOS F during the PM peak traffic hour. The LOS F operation is primarily attributed to the high eastbound, northbound and southbound left turning volumes. In order to provide mitigation to the poor overall operation and increase available intersection capacity, potential improvements may include the widening of E Woodmen Road to six-lanes, pursuant to its future classification as an expressway, as well as further optimization of traffic signal timings to accommodate future regional demand. It is noted that long-term operations may be better than shown given the potential for future planned roadway connections to the west along E Woodmen Road to influence vehicle routes. As example, planned construction of future Banning Lewis Parkway within the City of Colorado Springs along E Woodmen Road will provide an additional major north-south arterial roadway which may reduce some of the volumes projected to utilize Meridian Road for north-south travel. It is recommended that County Staff continues to monitor the study intersection in order to determine what mitigation may be most applicable and when implementation of said improvements becomes necessary.

The study intersection of Meridian Road with Bent Grass Meadows Drive experiences LOS B operations during both the AM and PM peak traffic hours.

The study intersection of Meridian Road with Eastonville Road experiences LOS D operations during the AM peak traffic hour and LOS C operations during the PM peak traffic hour.

The study intersection of Meridian Road with Owl Place experiences LOS C operations during the AM peak traffic hour and LOS B or better operations during the PM peak traffic hour.

It is not recommended that access onto Meridian Road from Owl Place be more limited than that already existing. Limited access will interfere with the existing and proposed developments' ability to equally distribute traffic within the site and out to available roadways, thus impacting existing and future traffic in the surrounding area and potentially cause the adjacent roadway network to be used in a manner not intended or cause additional delay that could impact emergency response times.



## IV. Proposed Project Traffic

### Trip Generation

Standard traffic generation characteristics compiled by the Institute of Transportation Engineers (ITE) in their report entitled Trip Generation Manual, 11<sup>th</sup> Edition, were applied to the proposed land use in order to estimate average daily traffic (ADT), AM Peak Hour, and PM Peak Hour vehicle trips. A vehicle trip is defined as a one-way vehicle movement from a point of origin to a point of destination.

The ITE land use codes 934 (Fast-Food Restaurant with Drive-Through Window), 937 (Coffee/Donut Shop with Drive-Through Window), 945 (Convenience Store/Gas Station), and 948 (Automated Car Wash) were used for estimating trip generation because of their conservative rates and best fit to the anticipated land use descriptions.

As actual land uses, densities or site plans within the Owl Place Commercial development area become defined over time, it is expected that traffic generation characteristics considered within this study will need to be updated by more specific traffic analyses or studies to help assess if transportation improvements are needed to mitigate potential traffic impacts.

Trip generation rates used in this study are presented in Table 4.

**Table 4 – Trip Generation Rates**

ITE CODE      LAND USE      UNIT			TRIP GENERATION RATES						
			24 HOUR	AM PEAK HOUR			PM PEAK HOUR		
				ENTER	EXIT	TOTAL	ENTER	EXIT	TOTAL
934	Fast-Food Restaurant w/DTW	KSF	467.48	22.75	21.86	44.61	17.18	15.85	33.03
937	Coffee/Donut Shop w/DTW	KSF	533.57	43.80	42.08	85.88	19.50	19.50	38.99
945	Convenience Store/Gas Station	KSF	700.43	28.26	28.26	56.52	27.26	27.26	54.52
948	Automated Car Wash	CWT	775.00	*	*	*	38.75	38.75	77.50

Key: KSF = Thousand Square Feet Gross Floor Area. CWT = Car Wash Tunnels.

\* = ITE does not report significant AM peak hour generation due to the nature of the business (ie, operating hours typically open after AM peak).

Note: All data and calculations above are subject to being rounded to nearest value.

Table 5 illustrates projected ADT, AM Peak Hour, and PM Peak Hour traffic volumes likely generated by the proposed development upon build-out.

**Table 5 – Trip Generation Summary**

ITE CODE	LAND USE	SIZE	TOTAL TRIPS GENERATED						
			24 HOUR	AM PEAK HOUR			PM PEAK HOUR		
				ENTER	EXIT	TOTAL	ENTER	EXIT	TOTAL
934	Fast-Food Restaurant w/DTW	3.4 KSF	1,599	78	75	153	59	54	113
937	Coffee/Donut Shop w/DTW	2.0 KSF	1,067	88	84	172	39	39	78
945	Convenience Store/Gas Station	5.3 KSF	3,712	150	150	300	144	144	289
948	Automated Car Wash	1 CWT	775	*	*	*	39	39	78
<i>Proposed Total:</i>			<i>7,153</i>	<i>315</i>	<i>309</i>	<i>624</i>	<i>281</i>	<i>276</i>	<i>557</i>

Key: KSF = Thousand Square Feet Gross Floor Area. CWT = Car Wash Tunnels.

\* = ITE does not report significant AM peak hour generation due to the nature of the business (ie, operating hours typically open after AM peak).

Note: All data and calculations above are subject to being rounded to nearest value.

Upon build-out, Table 5 illustrates that the proposed development has the potential to generate approximately 7,153 daily vehicle trips with 624 of those occurring during the morning peak hour and 557 during the afternoon peak hour.

### Adjustments to Trip Generation Rates

A development of this type is likely to attract pass-by trips from the adjacent roadway system. ITE defines a pass-by trip as an intermediate stop on the way from an origin to a primary trip destination without a route diversion. Due to this behavior, pass-by trips are not considered as “new” traffic generated by the development since the trips are already present on the roadway network enroute to their primary destination.

Pass-by trips are especially common to fast-food restaurant, coffee/donut shop, and gas station land uses given the convenience provided by these businesses on the way to another primary destination such as a place of work or home. As example, published ITE pass-by and diverted link trip data indicates an average trip generation reduction rate of 49 percent during the AM peak traffic hour and 50 percent during the PM peak traffic hour as typical to fast-food restaurants with drive-through window.

It is also considered likely that a mixed-use development of this type will attract trips from within area land uses as well as from the adjacent Falcon Marketplace development. However, due to the conceptual nature of proposed land uses, specific internal capture rates can only be assumed. Therefore, no trip reduction was taken in this analysis. This assumption provides for a conservative analysis.

Upon consideration of the proposed land use, reductions were applied pursuant to ITE average data to the proposed land use in order to account for the high probability of pass-by trip generation. ITE average pass-by trip percentages used are presented in Table 6.

Table 6 illustrates projected ADT, AM Peak Hour, and PM Peak Hour traffic volumes likely generated by the proposed development upon build-out with reductions applied due to pass-by trips. Average daily (24-Hour) pass-by trip percentages were estimated as the average between the AM and PM peak hour rates indicated by ITE.

**Table 6 – Trip Generation Summary with Pass-By Trip Reductions**

ITE CODE	LAND USE	SIZE	TOTAL NEW TRIPS GENERATED						
			24 HOUR	AM PEAK HOUR			PM PEAK HOUR		
				ENTER	EXIT	TOTAL	ENTER	EXIT	TOTAL
<i>Pass-By Trip Reduction:</i>			50%	49%	49%	49%	50%	50%	50%
934	Fast-Food Restaurant w/DTW	3.4 KSF	807	40	38	78	29	27	56
<i>Pass-By Trip Reduction:</i>			60%	60%	60%	60%	60%	60%	60%
937	Coffee/Donut Shop w/DTW	2.0 KSF	427	35	34	69	16	16	31
<i>Pass-By Trip Reduction:</i>			59%	62%	62%	62%	56%	56%	56%
945	Convenience Store/Gas Station	5.3 KSF	1,522	57	57	114	64	64	127
<i>Pass-By Trip Reduction:</i>			0%	0%	0%	0%	0%	0%	0%
948	Automated Car Wash	1.0 CWT	775	*	*	*	39	39	78
<i>Proposed Total:</i>			3,531	132	129	260	147	145	292

Key: KSF = Thousand Square Feet Gross Floor Area. CWT = Car Wash Tunnels.

\* = ITE does not report significant AM peak hour generation due to the nature of the business (ie, operating hours typically open after AM peak).

Note: All data and calculations above are subject to being rounded to nearest value.

Upon build-out and with consideration for pass-by trip reductions, Table 6 illustrates that the proposed development has the potential to generate approximately 3,531 new daily trips with 260 of those occurring during the morning peak hour and 292 during the afternoon peak hour.

### Trip Distribution

The overall directional distribution of site-generated traffic was determined based on the location of development site within the County, proposed and existing area land uses, allowed turning movements, available roadway network, assumptions made for previous studies within the area, and in reference to distribution patterns of existing traffic count data.

Additional pass-by trip distribution is assumed to include vehicle routes heading north-south along Meridian Road. Distribution percentages utilized for pass-by trips are anticipated to be 50 percent from the north and south.

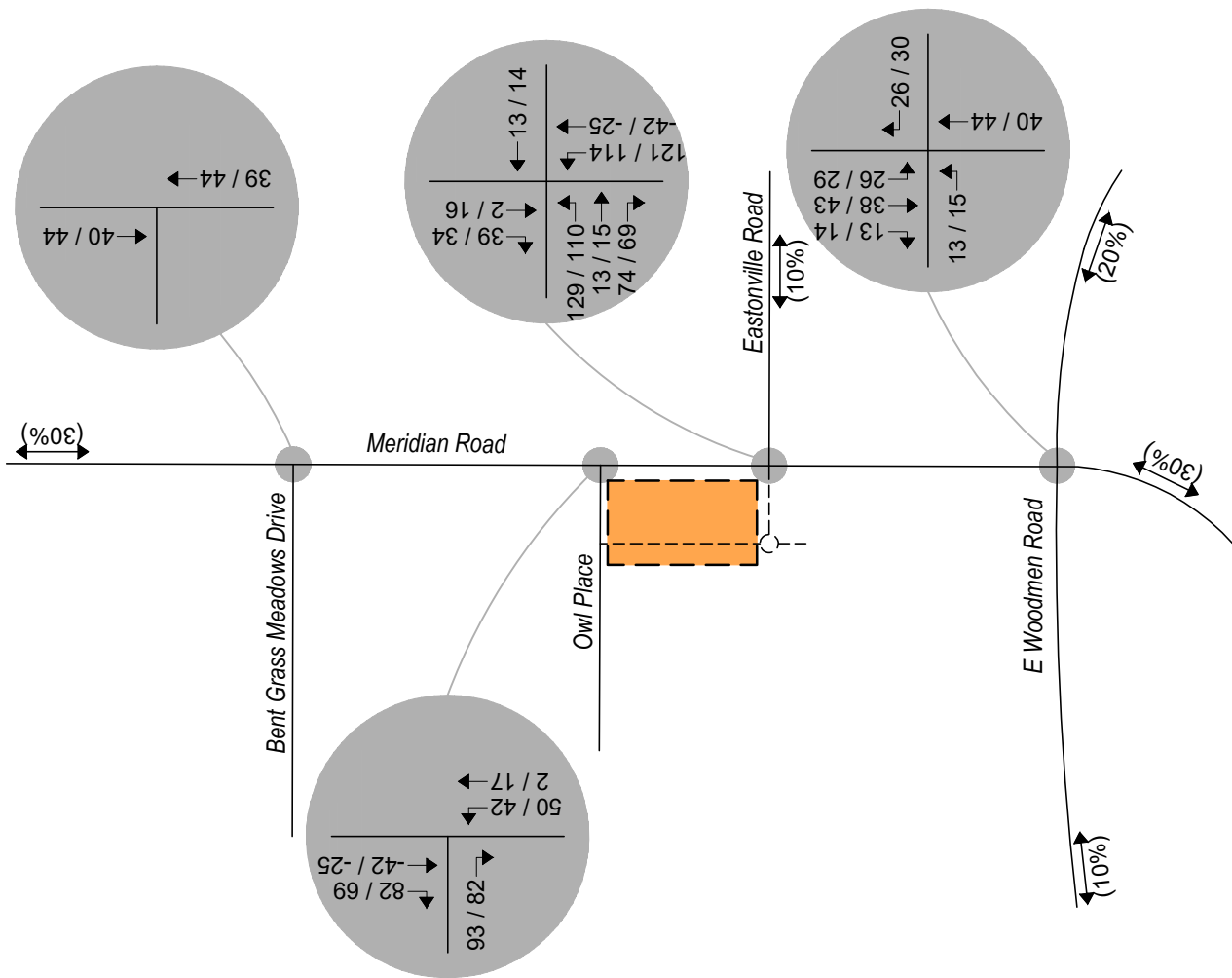
Overall trip distribution patterns for the development are shown on Figure 6.

## **Trip Assignment**

Trip assignment is how generated and distributed vehicle trips are expected to be loaded onto the available roadway network.

Applying trip distribution patterns to site-generated traffic provides the overall site-generated trip assignments shown on Figure 6.

It is to be noted that the overall site-generated trip assignments shown on Figure 6 represent the combination of both primary trip generation and pass-by trips. Due to the application of pass-by trips, some negative site-generated trips are shown at the study intersections. These negative trips are the result of redistributing existing through volumes along Meridian Road to site-generated ingress volumes.



**LEGEND**

- Study Intersection
- Volumes
- Development Site

**OWL PLACE COMMERCIAL**  
Traffic Impact Study



**SM ROCHA, LLC**  
Traffic and Transportation Consultants

**Figure 6**  
**SITE DEVELOPMENT DISTRIBUTION**  
(%) : Overall  
**SITE-GENERATED**  
AM / PM Peak Hour

# Falcon Marketplace

## Updated Traffic Impact Analysis

Prepared for:

Hummel Investments, LLC  
8117 Preston Road, Suite 120  
Dallas, TX 75225  
(214) 416-9820

Prepared by:

LSC Transportation Consultants, Inc.  
545 East Pikes Peak Avenue  
Colorado Springs, CO 80903  
(719) 633-2868

LSC #164350

October 23, 2017  
Revised September 5, 2018



# TABLE OF CONTENTS

Chapter	Title	Page
	EXECUTIVE SUMMARY .....	1
	Traffic Report .....	1
	Material Change to the Right-in Design and Benefits of New Design .....	1
	Summary of Traffic Operations Analysis and Comparison .....	2
	Right-In-Only Access/Roundabout .....	3
	Meridian/Eastonville Intersection .....	3
	Meridian/Woodmen Intersection .....	3
1	INTRODUCTION .....	4
	Report Contents .....	7
2	SITE LAND USE AND ACCESS/CIRCULATION PLAN .....	8
	Site Context .....	8
	Land Use .....	8
	Access and Circulation .....	8
	Intersection/Access Sight Distance Analysis .....	8
	Truck Turning Analysis .....	9
3	EXISTING ROADWAY AND TRAFFIC CONDITIONS .....	13
	Area Roadways .....	13
	Existing Traffic Conditions .....	14
	Accident/Crash History .....	14
	Existing Levels of Service .....	16
4	PROJECTED FUTURE BACKGROUND TRAFFIC CONDITIONS .....	17
	Short-Term Background Traffic .....	17
	2040 Background Traffic .....	22
5	TRIP GENERATION, DISTRIBUTION, AND TRAFFIC VOLUME ESTIMATES .....	27
	Trip Generation .....	27
	Trip Distribution and Assignment .....	29
	Short-Term Total Traffic .....	35
	2040 Total Traffic .....	40
6	TRAFFIC OPERATIONS ANALYSIS .....	49
	Projected Levels of Service .....	49
	Intersection Levels of Service .....	49
	Woodmen/Meridian .....	52
	Meridian/Eastonville .....	52
	Meridian/Right-In/Right-Out-Only Site Access .....	52
	Woodmen Frontage Road Intersections .....	53
	Roundabout Level of Service .....	53

Internal Public Road Intersections .....	53
Weaving Section Level of Service .....	53
Vehicle Queuing Analysis .....	58
Roundabout Queuing Analysis .....	58
Roundabout Design Vehicle and Fastest Path Analysis .....	60
Traffic Signal Warrant Analysis .....	60
7 COMPARISON OF ANALYSIS SCENARIOS .....	62
Meridian/Eastonville Intersection Operations .....	62
Meridian/Woodmen Intersection Operations .....	63
Woodmen Road Operations .....	63
Woodmen Frontage Road Access .....	64
8 RECOMMENDED IMPROVEMENTS .....	65
9 SUMMARY AND CONCLUSIONS .....	80
Woodmen Right-In-Only Access with Roundabout .....	80
Trip Generation .....	80
Projected Levels of Service .....	80
Comparison of Analysis Scenarios .....	81
Recommended Improvements .....	81

APPENDICES:

- Summary of Crash/Accident History
- Internal Trip Calculations
- Southwest Roundabout Analysis Exhibits
- Rodel Analysis Reports
- Traffic Count Reports
- Intersection Level of Service Reports
- Weaving Level of Service Reports
- Queuing Level of Service Reports

## LIST OF TABULATIONS

Table	Title	Page
1	Intersection Levels of Service Delay Ranges .....	16
2	Trip Generation Estimate .....	28
3	Short-Term Total Traffic Level of Service E Movements .....	50
4	2040 Projected Total Traffic Level of Service E and F Movements .....	51
5	Weaving Traffic Volumes .....	55
6	Projected Queue Lengths .....	59
7a	Roadway Improvements Without Proposed Right-In Access to Woodmen Road .....	66
7b	Roadway Improvements with Proposed Right-In Access to Woodmen Road .....	67

## LIST OF ILLUSTRATIONS

Figure	Title	Page
1	Vicinity Map	6
2	Woodmen Road Intersection/Access Spacing	10
3	Meridian Road Intersection/Access Spacing	11
4	Sight Distance for Meridian Road	12
5	Existing Traffic, Lane Geometry, Traffic Control and Levels of Service	15
6a	Short-Term Background Traffic Without Proposed Right-In Access	18
6b	Short-Term Background Lane Geometry, Traffic Control and Levels of Service Without Proposed Right-In Access	19
7a	Short-Term Background Traffic With Proposed Right-In Access	20
7b	Short-Term Background Lane Geometry, Traffic Control and Levels of Service With Proposed Right-In Access	21
8a	Year 2040 Background Traffic Without Proposed Right-In Access	23
8b	Year 2040 Background Lane Geometry, Traffic Control and Levels of Service Without Proposed Right-In Access	24
9a	Year 2040 Background Traffic With Proposed Right-In Access	25
9b	Year 2040 Background Lane Geometry Traffic Control and Levels of Service With Proposed Right-In Access	26
10	Directional Distribution of Site-Generated Traffic	30
11	Short-Term Assignment of Site-Generated Traffic Without Proposed Right-In Access	31
12	Short-Term Assignment of Site-Generated Traffic With Proposed Right-In Access	32
13	Long-Term Assignment of Site-Generated Traffic Without Proposed Right-In Access	33
14	Long-Term Assignment of Site-Generated Traffic With Proposed Right-In Access	34
15a	Short-Term Total Traffic Without Proposed Right-in Access	36
15b	Short-Term Total Lane Geometry, Traffic Control and Levels of Service Without Proposed Right-In Access	37
16a	Short-Term Total Traffic With Proposed Right-In Access	37
16b	Short-Term Total Lane Geometry, Traffic Control and Levels of Service With Proposed Right-In Access	38
17a	Year 2040 Total Traffic Without Proposed Right-In Access	41
17b	Year 2040 Total Traffic Without Proposed Right-In Access	42
17c	Year 2040 Total Lane Geometry, Traffic Control and Levels of Service Without Proposed Right-In Access	43
17d	Year 2040 Total Lane Geometry, Traffic Control and Levels of Service Without Proposed Right-In Access	44
18a	Year 2040 Total Traffic With Proposed Right-In Access	45
18b	Year 2040 Total Traffic With Proposed Right-In Access	46
18c	Year 2040 Total Lane Geometry, Traffic Control and Levels of Service With Proposed Right-In Access	47

18d	Year 2040 Total Lane Geometry, Traffic Control and levels of Service With Proposed Right-In Access .....	48
19	Weaving and Non-Weaving Movements .....	56
20	Traffic Signal Warrant Analysis .....	61
21a	Recommended Improvement Locations Without Right-In Access to Woodmen (East Area) .....	68
21b	Recommended Improvement Locations Without Right-In Access to Woodmen (West Area) .....	69
22a	Recommended Improvement Locations With Right-In Access to Woodmen (East Area) .....	70
22b	Recommended Improvement Locations With Right-In Access to Woodmen (West Area) .....	71
23	Accel/Decel Distances for Meridian Road North of Woodmen Road .....	74
24	Existing & ECM-Prescribed Accel/Decel Lane Lengths for Woodmen Road .....	75
25	Woodmen Road Acceleration, Deceleration and Stacking Lengths .....	76
26	Woodmen Road Acceleration/Deceleration Lane Signing & Striping .....	77
27	Short-Term Meridian Road South of Woodmen Road NB Left-Turn Deceleration Lane, Taper and Stacking Lengths .....	78
28	Potential Future Long-Term Meridian Road South of Woodmen Road NB Left-Turn Deceleration Lane, Taper and Stacking Lengths .....	79

# Executive Summary

---

---

## TRAFFIC REPORT

- This updated traffic report has been prepared to address staff comments.
- This report presents analysis of the proposed right-in-only access to Woodmen Road combined with a proposed roundabout intersection with the Woodmen Frontage Road in the southwest corner of the site.
- The report also includes, for comparison purposes, analysis assuming no right-in-only access.
- This report contains short- and long-term traffic projections for Falcon Marketplace, other area properties, and study area roadways and intersections. Traffic analysis has been performed based on the projected volumes.
- Based on the analysis, detailed findings and study area roadway improvements have been presented for both “**with**” and “**without**” the proposed **right-in access** (and accompanying roundabout) scenarios.
- The overall report recommendation is to approve the proposed right-in-only access from Woodmen Road and accompanying roundabout. **Analysis results indicate significantly improved area traffic circulation and benefits to operations at the study area intersections.**

## MATERIAL CHANGE TO THE RIGHT-IN DESIGN AND BENEFITS OF NEW DESIGN

- The inclusion of a roundabout into the design of the right-in access **will provide for public access to the westbound frontage road**—a significant change to the previous design. This enhancement will not only **provide better access** for these nearby residential and non-residential developments, but will also offer **superior access for emergency response vehicles** thereby reducing their response times to all properties on the north side of Woodmen between Meridian and Golden Sage—a significant and meaningful change.
- The new design for the right-in with a roundabout **allows for direct public access to the Woodmen Frontage Road** for passenger vehicles, trucks, and buses, as well as fire and emergency response vehicles as requested by the Falcon Fire Protection District. This accommodation will significantly improve the access to the Courtyards residential development, Mountain View Electric Association (MVEA), Falcon School District 49 (and other properties), which currently have poor access.
- Due to its configuration, the previously requested right-in-only access would have essentially served only the proposed Falcon Marketplace development as there was no public access from the right-in to the Woodmen Frontage Road. Additionally, the new configuration includes changing the required internal roadway (required by the 2008 BOCC-approved rezoning of the

site), which extends from Eastonville to the Woodmen Frontage Road, from a private access easement drive to a public right-of-way.

- The previously requested right-in-only was configured to direct traffic from westbound Woodmen northward into the site only, with no "direct" access for westbound travel to the neighboring residential and non-residential properties along the Woodmen Frontage Road west of the proposed Falcon Marketplace development. In the previous design, access for westbound travel along the Woodmen Frontage Road would have required a circuitous route into Falcon Marketplace in order to reverse direction.
- With this new design of the right-in combined with a roundabout, residents, employees, and other motorists traveling to the properties along the frontage road from westbound Woodmen or northbound Meridian (many traveling from eastbound US Highway 24) would have a **new direct connection to the east end of the Woodmen Frontage Road** and will no longer need to do either of the following to access their destination:
  - travel west for over a mile along Woodmen Road to the Golden Sage/Woodmen intersection, make a 180-degree turn and travel back to the east along the Woodmen Frontage Road, or alternatively,
  - travel north to the Eastonville/Meridian intersection, turn left and travel through the proposed Falcon Marketplace development, a route of over one-half mile including a traffic signal.
- The proposed right-in-only with the roundabout would also **benefit operations at the Woodmen/Golden Sage and Woodmen Frontage Road/Golden Sage** intersection by reducing existing and future traffic turning movements from these closely spaced intersections.
- This site is within the commercial “node” of Falcon as defined in the Falcon/Peyton Small Area Master Plan and an access from Woodmen Road at the proposed location is reasonable for a regional commercial development as allowed by the Commercial Regional zoning approved for the site in 2008. Furthermore, additional access points to Woodmen were contemplated by the BOCC-approved resolution adopting the Woodmen Road Access Management Plan.

## **SUMMARY OF TRAFFIC OPERATIONS ANALYSIS AND COMPARISON**

- The three key intersections within this study are (a) the southwest roundabout at the proposed right-in-only access from Woodmen, (b) the meridian/Eastonville intersection, and (3) the Meridian/Woodmen intersection.
- The comparison between the two analysis scenarios (**with** and **without** the proposed right-in-only access from Woodmen) with respect to operations at the Meridian/Eastonville intersection shows significantly better operations with the proposed Woodmen access/roundabout. In addition to the intersection analysis, the right-in-only access would significantly reduce overall travel times and emergency response times for those traveling to destinations along the frontage road and Falcon Marketplace.



### **Right-In-Only Access/Roundabout**

- The continuous lane along westbound Woodmen Road between Meridian and the access is projected to operate at weaving LOS C during the morning peak hour and LOS B during the afternoon peak hour.
- Multiple methods of analysis indicate level of service A for all roundabout approaches during the peak hours **based on 2040 volumes**.
- The southwest roundabout will see **minimal queuing** for traffic exiting Woodmen Road and entering the roundabout. A maximum queue during the peak hour of about 100-120 feet is projected and even this maximum queue will clear quickly as the queue will be more of a **“rolling” queue**.
- The proposed Woodmen access will have **little effect** on the operation of Woodmen Road as the turning movements will be right-turn in-only from westbound Woodmen Road with a continuous acceleration/deceleration lane between Meridian and the point of right-turn entry into the site.
- The roundabout has been designed to accommodate large tractor-trailer trucks/semis.

### **Meridian/Eastonville Intersection**

- The northbound left turn at this intersection is projected to operate at **LOS F** during the afternoon peak hour **without the right-in-only access off Woodmen. However, it will operate at LOS D** during the afternoon peak hour with the right-in-only access off of Woodmen with the roundabout.
- The northbound left-turn queue would be **significantly longer without the Woodmen-access scenario. Without the right-in-only access off of Woodmen** the projected maximum queue will fill the dual left-turn lanes (457-foot queue within the lanes) and will **overspill** into the adjacent northbound through lane during the peak analysis interval unless the lanes are lengthened. Any significant lengthening would reduce the storage length of the southbound left turn lane for the Woodmen/Meridian intersection to the south as this northbound left turn lane is "back-to-back" with the southbound left turn lane at the Woodmen/Meridian intersection. There is a shared transition taper for both lanes and any lengthening would require either shortening the shared taper and/or shortening of that southbound left turn lane at Woodmen/Meridian (likely both).

### **Meridian/Woodmen Intersection**

- The addition of the proposed right-in-only access off of Woodmen will provide motorists approaching from the south the option to utilize the existing dual left-turn lanes to go westbound on Woodmen to enter the project site. This allows motorists to adjust to the path of least congestion and will benefit the overall intersection. Providing this option will reduce the quantity of northbound through traffic. This will be especially helpful during the afternoon peak hour. Although the overall intersection delays shown in the table are comparable, the

analysis shows failure of the northbound through movement (with two northbound through lanes) **without** the right-in-only access off of Woodmen. A comparison with **three** northbound through lanes on this intersection approach has also been included in this report as required by staff. Analysis results with an additional northbound through lane indicate improvement to LOS D for this approach. However, the implementation of three through lanes at this one intersection in advance of an overall project to convert Meridian Road from a four to six-lane arterial would involve significant cost for improvements at this intersection and to the north to create three-northbound “receiving” lanes and a merge lane back to two northbound through lanes. Moreover, from an operational standpoint, although a third through lane would add capacity at the intersection, this would introduce a potentially confusing and awkward “lane-add” followed by a lane reduction/merge just downstream to the north.

- Without the requested right-in-only from Woodmen, the northbound through movement is projected to operate at **LOS F** during the 2040 afternoon peak hour (LOS D when analyzing assuming three northbound through lanes as explained in the previous paragraph).

## Introduction

---

---

LSC Transportation Consultants, Inc. has prepared this updated traffic impact analysis for the 36-acre Falcon Marketplace to be located west of Meridian Road and north of Woodmen Road in the Falcon area of El Paso County, Colorado. The site is planned to be developed for a mixture of commercial and medical office land uses. Figure 1 shows the site location. Access is proposed to Meridian Road and the Woodmen Road Frontage Road. The previous report date was August 7, 2017.

The report has been updated to include analysis of a right-in-only access from Woodmen Road combined with a roundabout intersection with the Woodmen Frontage Road in the southwest corner of the site. This new right-in-only access with the proposed roundabout intersection connecting to the Woodmen Frontage Road would significantly improve access not only to the site, but also to the properties to the west along the Woodmen Frontage Road. This new provision for public access from westbound Woodmen Road to the westbound Woodmen Frontage Road is a **significant change** from the previously proposed right-in-only access configuration, which essentially only served the proposed Falcon Marketplace.

The salient points of the significant change are:

- Allows direct public access to east end of the frontage road.
- Provides badly needed access for emergency response vehicles.
- Takes traffic off of the Golden Sage intersection by providing access from the east.
- Addition of roundabout keeps traffic moving at a steady flow.
- Reduces potential backup on the frontage road.



Approximate Scale  
Scale: 1" = 1,200'

Figure 1  
**Vicinity  
Map**

Falcon Marketplace (LSC #164350)

## **REPORT CONTENTS**

The report contains the following:

- The proposed site land uses and circulation plan for the site.
- The proposed plan to allow for a public street connection through the site between the current terminus of the Woodmen Frontage Road and Meridian Road.
- The existing and planned roadways in the study area including the number of lanes, classifications, posted speed limits, lane geometries, traffic controls, etc.
- Traffic volumes for the Meridian/Woodmen and Meridian/Eastonville intersections plus added traffic count data for the intersection of Woodmen Road and Golden Sage Road.
- The projected future peak-hour traffic volumes for the access points, internal intersections and the intersections adjacent to the site, the intersection of Golden Sage/Woodmen and along the Woodmen Frontage Road with and without the proposed right-in-only access from Woodmen Road.
- The resulting traffic impacts. The traffic impacts have been quantified by determining the future levels of service at the access points, internal intersections and adjacent intersections with and without the proposed right-in-only access from Woodmen Road.
- Recommended improvements.

## Site Land Use and Access/Circulation Plan

---

---

### SITE CONTEXT

The site is located within the downtown Falcon commercial/service area. This site is part of the Falcon “commercial node.” Several shopping centers exist south and southeast of this site on the south side of Woodmen Road. The Safeway shopping center is located to the east, and the Bent Grass Commercial Center is directly north of the site and the Owl Lane area.

### LAND USE

The 36-acre site is located north of Woodmen Road and west of Meridian Road. The site is planned to contain a large grocery store anchor with associated gas station. The peripheral development lots are planned to include a pet supply store, in-line retail buildings, three free-standing fast-food restaurants, a coffee shop with drive-through, and an urgent/primary care clinic.

### ACCESS AND CIRCULATION

Full-movement site access is proposed from Meridian Road aligning with Eastonville Road and via a connection to the current terminus of the Woodmen Frontage Road. A right-in/right-out access to Meridian Road is also proposed between Eastonville and Woodmen. In addition to the connection to the current terminus of the Woodmen Frontage Road, a right-in-only access from westbound Woodmen Road is also proposed in the southwest corner of the site.

Figures 2 and 3 show the access/intersection spacing for Woodmen Road and Meridian Road, respectively.

The site plan also shows a street stub to the property to the north to allow for a planned future connection to Bent Grass Meadows Drive. The access points and the proposed public street connection through the site is also shown on the site plan.

### INTERSECTION/ACCESS SIGHT DISTANCE ANALYSIS

Figure 4 shows the sight distance analysis for the Meridian Road access points. There are currently no posted speed limit signs for southbound traffic on the approach to Eastonville Road and the speed limit to the north is 55 miles per hour (mph). This analysis assumes (following development of the site) a future posted speed limit of 45 mph (design speed of 50 mph) for southbound Meridian in the vicinity of and adjacent to the site. This is based on the *Meridian Road North Corridor Plan* dated December 2009.

Sight distance analysis for the internal intersections within the Preliminary Plan is included with the deviation request for Falcon Market Place.



## **Truck Turning Analysis**

Truck turning analysis using AutoTurn for the internal intersections within the Preliminary Plan is included with the deviation request for Falcon Market Place. The truck turning analysis for the roundabout proposed for the southwest corner of the site is included in this report as it is directly associated with the driveway permit application.



Figure 2

### Woodmen Road Intersection/Access Spacing

Falcon Marketplace (LSC #164350)




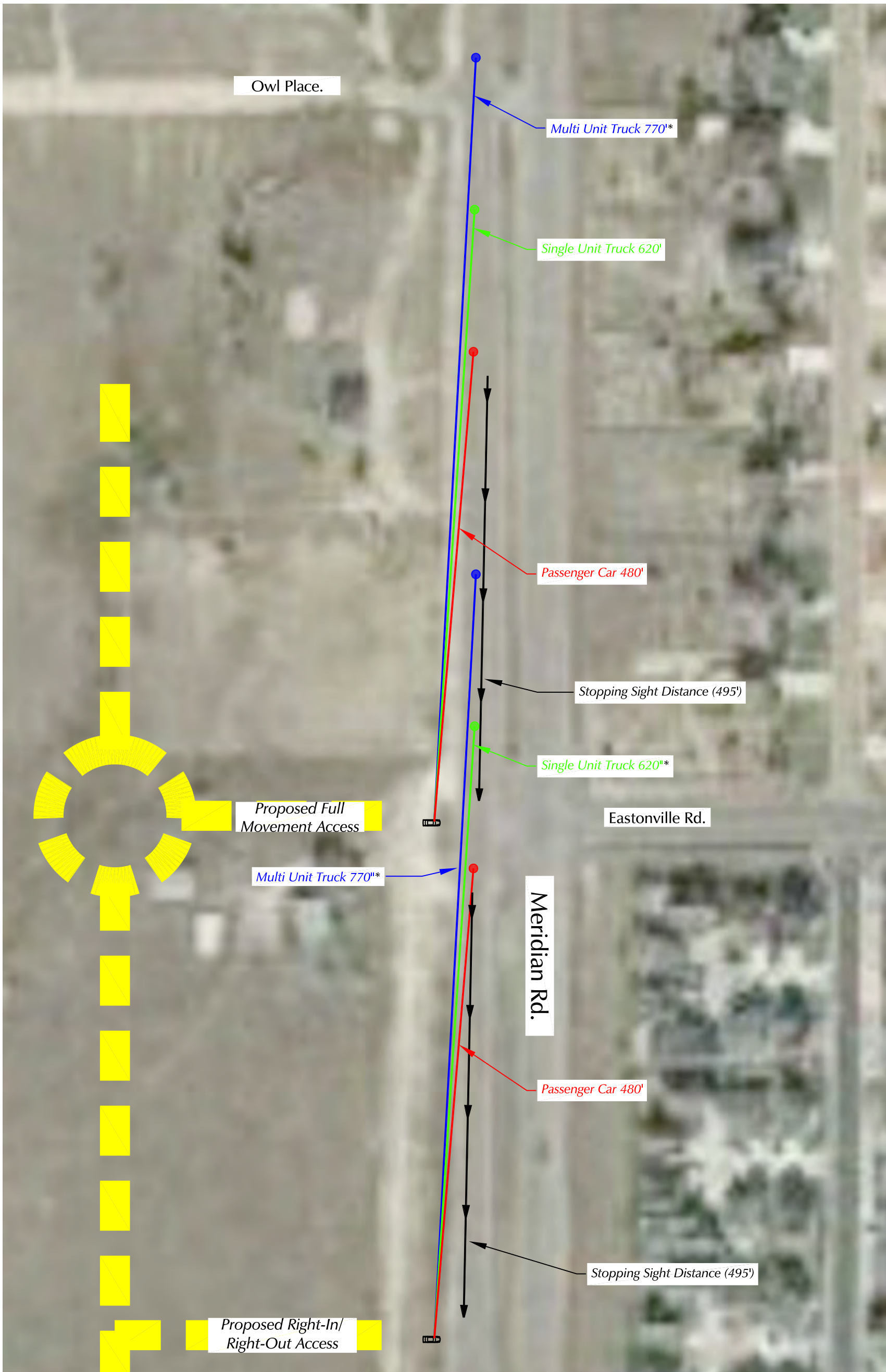
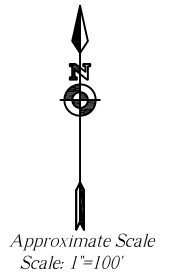
  
 Approximate Scale  
 Scale: 1"=600'

Figure 3  
**Meridian Road Intersection/Access Spacing**  
 Falcon Marketplace (LSC #164350)





**LEGEND:**

- = Required intersection sight distance for passenger cars
- = Required intersection sight distance for single-unit trucks
- = Required intersection sight distance for multi-unit trucks
- ↕ = Required stopping sight distance

Based on an anticipated post-development speed limit of 45mph (50 mph design speed)



Figure 4  
**Sight Distance for Meridian Road**  
Falcon Marketplace (LSC #164350)

## Existing Roadway and Traffic Conditions

---

---

### AREA ROADWAYS

The roadways in the study area are shown on Figure 1 and are described below.

- **US Highway (US) 24** is generally a two-lane State Highway extending east/west across Colorado connecting the Buena Vista, Colorado Springs, and Limon areas. US 24 is planned to be widened to four lanes through the Falcon area. US 24 is classified as an Expressway by the Colorado Department of Transportation (CDOT) and the *El Paso County Major Transportation Corridors Plan (MTCP)*. The posted speed limit on US 24 in the vicinity of Woodmen Road is 50 mph.
- **Woodmen Road** is shown on the *El Paso County 2040 Major Transportation Corridors Plan* and the *Preserved Corridor Network Plan* as a four-lane Expressway adjacent to and in the vicinity of the site. The posted speed limit on Woodmen Road adjacent to the site is 45 mph. The posted speed limit on Woodmen Road just west of the site is 55 mph.
- **Woodmen Frontage Road** is a paved two-lane frontage road along the north side of Woodmen Road. The Woodmen Frontage Road extends west from this site to its current terminus west of Golden Sage Road. The posted speed limit on the Woodmen Frontage Road is 30 mph.
- **Meridian Road** is shown on the MTCP as a four-lane Principal Arterial adjacent to the site. Meridian Road is currently four lanes plus some auxiliary turn lanes at intersections north of Rolling Thunder. There is a center median adjacent to the site. There are no speed limit signs specifically for the section of Meridian adjacent to the site. However, the posted limit on the section to the north is 55 mph. Meridian Road south of Rolling Thunder is not currently open and the road does not connect to US Highway 24. However, Meridian Road is planned to be opened south from Rolling Thunder to a new intersection with US 24 and extended south to Falcon Highway in the near future.
- **Eastonville Road** is a two-lane roadway extending northeast from Meridian Road to past Hodgen Road. It is shown as a two-lane Minor Arterial on the MTCP. The intersection of Meridian Road and Eastonville Road is currently stop-sign controlled.

## EXISTING TRAFFIC CONDITIONS

Figure 5 shows the morning and afternoon peak-hour traffic volumes at the intersections of Woodmen Road/Meridian Road, Woodmen Road/Golden Sage Road, and Eastonville Road/Meridian Road based on counts conducted by LSC in September 2015, February 2016, March 2017, and June 2017. The traffic count reports are attached. The traffic volumes at Woodmen/Meridian have been adjusted to balance with more recent counts to the west and north.

## ACCIDENT/CRASH HISTORY

Traffic accident/crash data at study area intersections are attached. These have been provided by the Colorado State Patrol. The data show crashes by calendar year for 2014, 2015, and 2016 as well as year-to-date crashes for 2017.

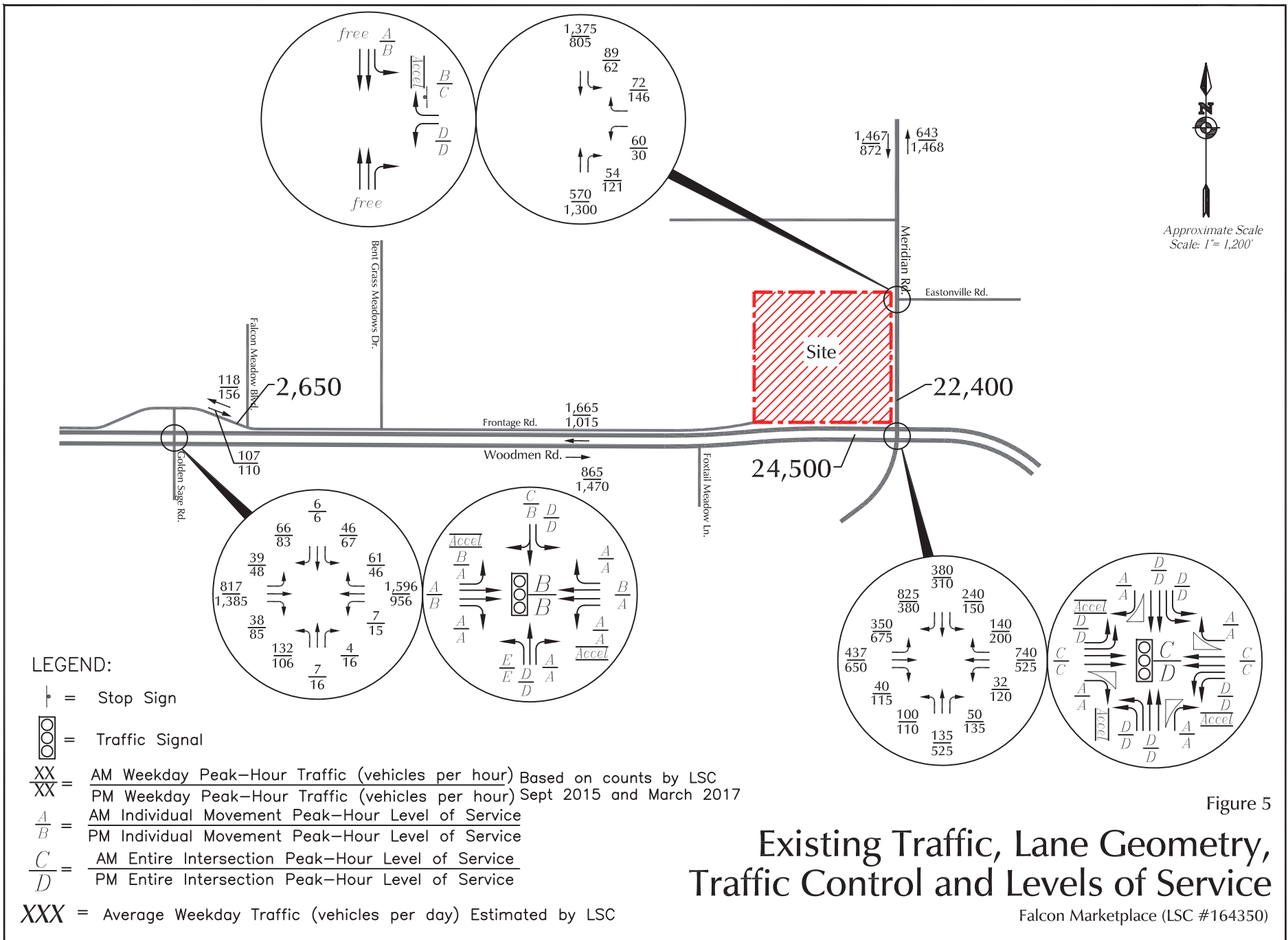
There were seven reported crashes at the Woodmen/Golden Sage intersection in 2016. Five of the seven crashes in 2016 were non-intersection related. The remaining two crashes were rear-end crashes involving eastbound vehicles. The first crash resulted in property damage only and the second crash resulted in two injuries. There have also been seven crashes in 2017 (from January 1 to July 26). Of these crashes, two were non-intersection related. One involved an eastbound left-turning vehicle hitting a westbound through vehicle. This crash resulted in a fatality. The remaining four crashes were rear-end crashes (two involving westbound vehicles and two involving eastbound vehicles). These rear-end crashes all resulted in property damage only.

There were six reported crashes at the Woodmen/Meridian intersection in 2016. One of the crashes was non-intersection related. This was the only crash at this intersection in 2016 and 2017 that resulted in an injury. Three of the 2016 crashes were rear-end crashes (two involved vehicles in the westbound through lanes and one involved vehicles in the southbound to westbound acceleration lane). One 2016 crash involved a westbound vehicle that failed to stop for the red light and hit a northbound vehicle. The final 2016 crash involved a single vehicle traveling the wrong direction in the westbound acceleration lane hitting the pedestrian island in the northwest corner of the intersection. Based on the data provided, there has been one reported accident in 2017 (from January 1 to July 26). This crash was a rear-end accident involving vehicles in the eastbound left-turn lanes.

There were two reported crashes at the Eastonville/Meridian intersection in 2016. In the first crash, two vehicles were attempting to turn left from Eastonville Road onto Meridian Road. The first vehicle attempted a two-stage left turn, stopping in the median on Meridian Road, and was rear-ended by the second vehicle. This crash resulted in property damage only. The second crash involved an eastbound left-turn vehicle and a bicycle in the northbound shoulder. This crash resulted in an injury. There has been one crash at this intersection recorded in 2017 (from January 1 to July 26). This injury crash involved a southbound left-turning vehicle turning in front of a northbound through vehicle.

The estimated three-year crash/accident rate at Woodmen/Meridian is 0.46. This is based on an estimated average of 33,500 entering vehicles per day and 17 total intersection-related crashes in three years. **This is a relatively low accident rate.** For comparison, the Powers and Barnes intersection, which is one of the City of Colorado Springs' high accident locations, had a 2016 accident rate of about 2.25.





## EXISTING LEVELS OF SERVICE

Level of service (LOS) is a quantitative measure of the level of congestion or delay at an intersection. Level of service is indicated on a scale from “A” to “F.” LOS A represents control delay of less than 10 seconds for unsignalized and signalized intersections. LOS F represents control delay of more than 50 seconds for unsignalized intersections and more than 80 seconds for signalized intersections. For reference, Table 1 shows the level of service delay ranges.

<b>Table 1 Intersection Levels of Service Delay Ranges</b>			
<b>Level of Service</b>	<b>Signalized Intersections</b>		<b>Unsignalized Intersections</b>
	<b>Average Control Delay (seconds per vehicle)</b>	<b>V/C<sup>(1)</sup></b>	<b>Average Control Delay (seconds per vehicle)<sup>(2)</sup></b>
A	10.0 sec or less	less than 0.60	10.0 sec or less
B	10.1-20.0 sec	0.60-0.69	10.1-15.0 sec
C	20.1-35.0 sec	0.70-0.79	15.1-25.0 sec
D	35.1-55.0 sec	0.80-0.89	25.1-35.0 sec
E	55.1-80.0 sec	0.90-0.99	35.1-50.0 sec
F	80.1 sec or more	1.00 and greater	50.1 sec or more

(1) Source: *Transportation Research Circular 212*  
 (2) For unsignalized intersections if V/C ratio is greater than 1.0 the level of service is LOS F regardless of the projected average control delay per vehicle.

The intersections of Woodmen Road/Meridian Road and Woodmen Road/Golden Sage Road were analyzed to determine the existing levels of service using Synchro. The intersection of Eastonville Road/Meridian Road was analyzed based on the unsignalized method of analysis procedures found in the *Highway Capacity Manual, 6<sup>th</sup> Edition* by the Transportation Research Board. As shown on Figure 5, these intersections are operating at acceptable levels of service during peak periods. **The detailed level of service analysis reports are attached.**

## Projected Future Background Traffic Conditions

---

---

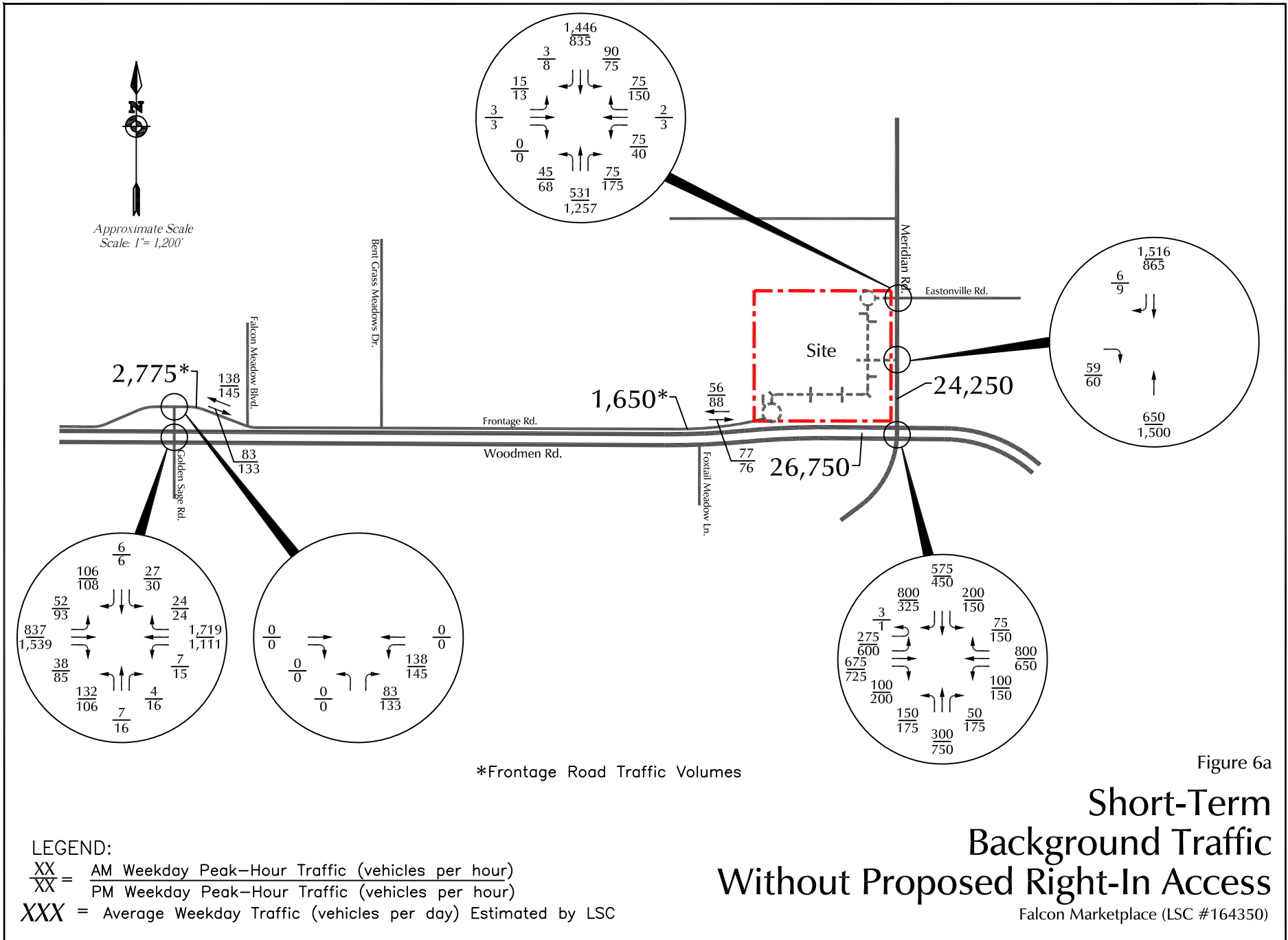
Baseline or “background” traffic is the traffic estimated to be on the adjacent roadways and at adjacent intersections without the proposed development’s trip generation and resulting added traffic volumes (site traffic is presented in the following chapter). New baseline/background traffic is the difference between future background traffic and existing traffic.

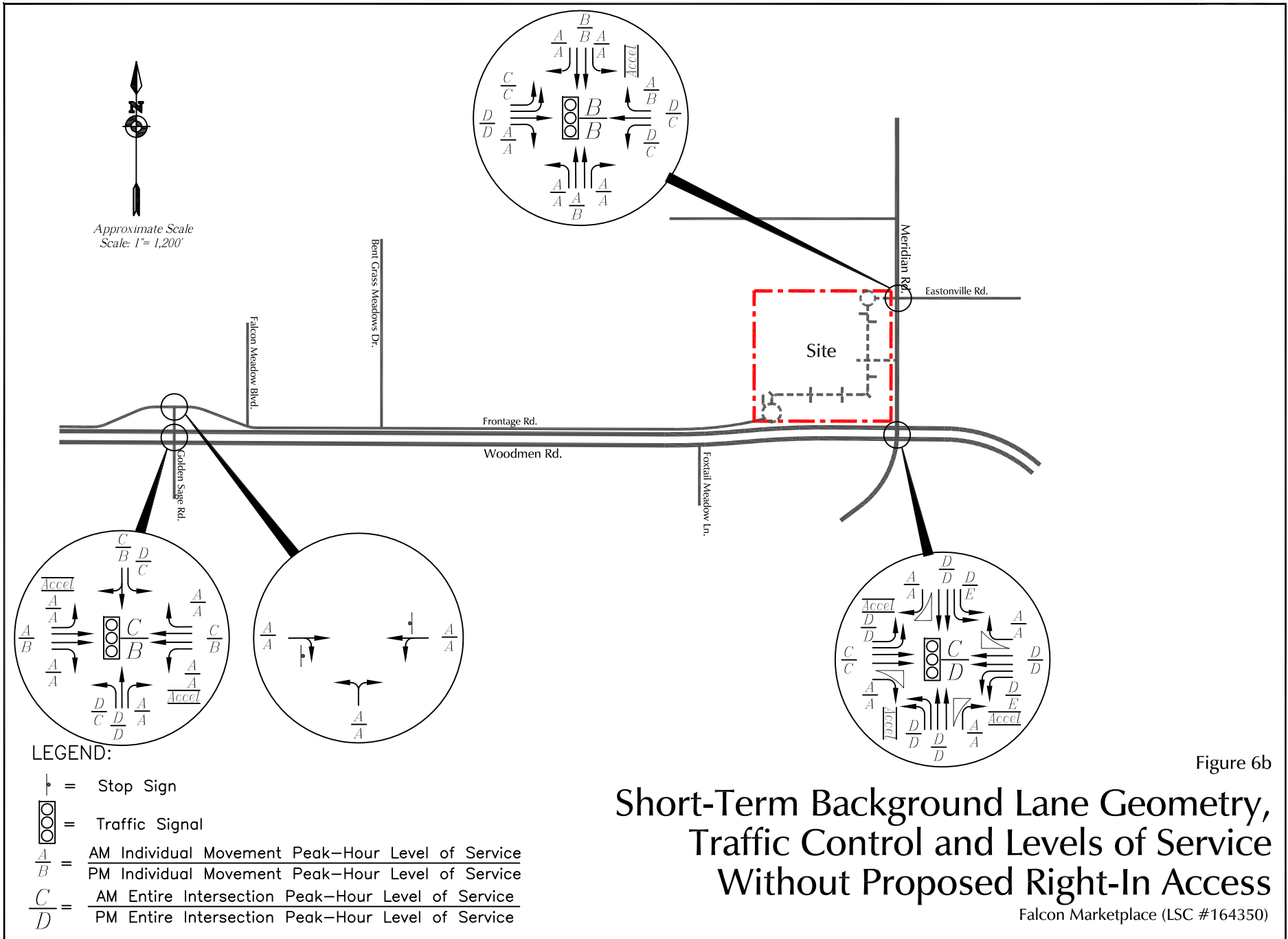
The background traffic analysis hypothetically assumes the site street connections and access points to be in place (but without site traffic). Background traffic includes the through traffic and the traffic generated by nearby developments, but hypothetically assumes zero traffic generated by the site for analysis purposes.

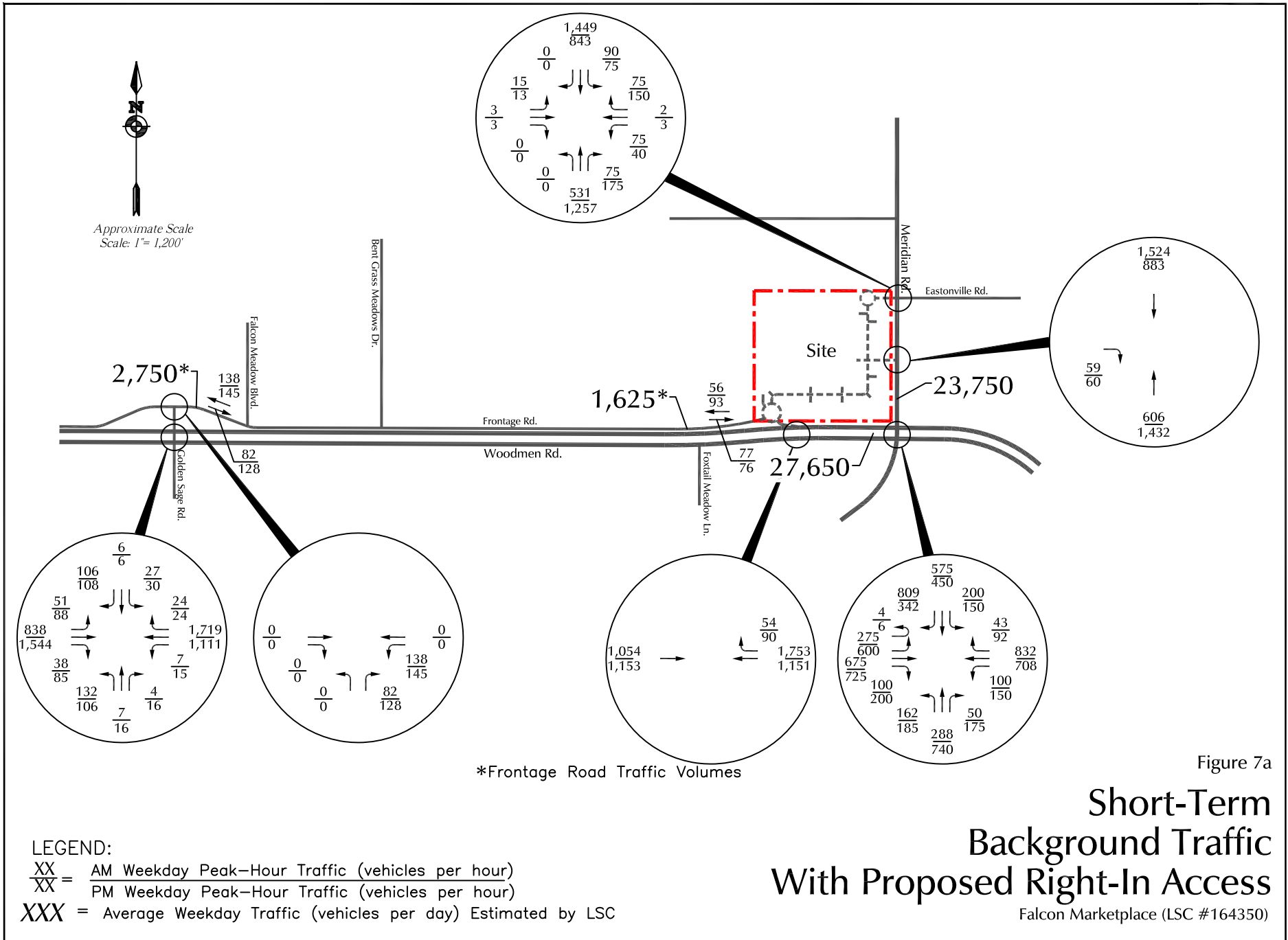
### SHORT-TERM BACKGROUND TRAFFIC

Background traffic is the traffic estimated to be on the adjacent roadways and at adjacent intersections without the proposed development’s trip generation and resulting site-generated traffic volumes. However, the site street connections and access points were assumed to be in place. Background traffic includes the through traffic and the traffic generated by nearby developments, but hypothetically assumes zero traffic generated by the site for analysis purposes. Figure 6a and 7a show the background traffic volumes traveling through the site and in the vicinity of the site for the short term. The short-term background traffic volumes were based on some growth in existing traffic volumes shown in Figure 5, with some adjustments to the existing traffic patterns due to the planned Meridian Road project to the south, the proposed vehicular connection through the site (between the end of the Woodmen Frontage Road and Eastonville Road) via access easement(s) and internal commercial drives, and the new west leg of the intersection of Meridian Road and Eastonville Road. The volumes shown in Figure 6a assume no access to Woodmen Road and the volumes shown in Figure 7a assume the proposed right-in-only access from Woodmen Road. The short-term background traffic volumes assume some additional traffic due to buildout of the Woodmen Courtyards development just west of the site.

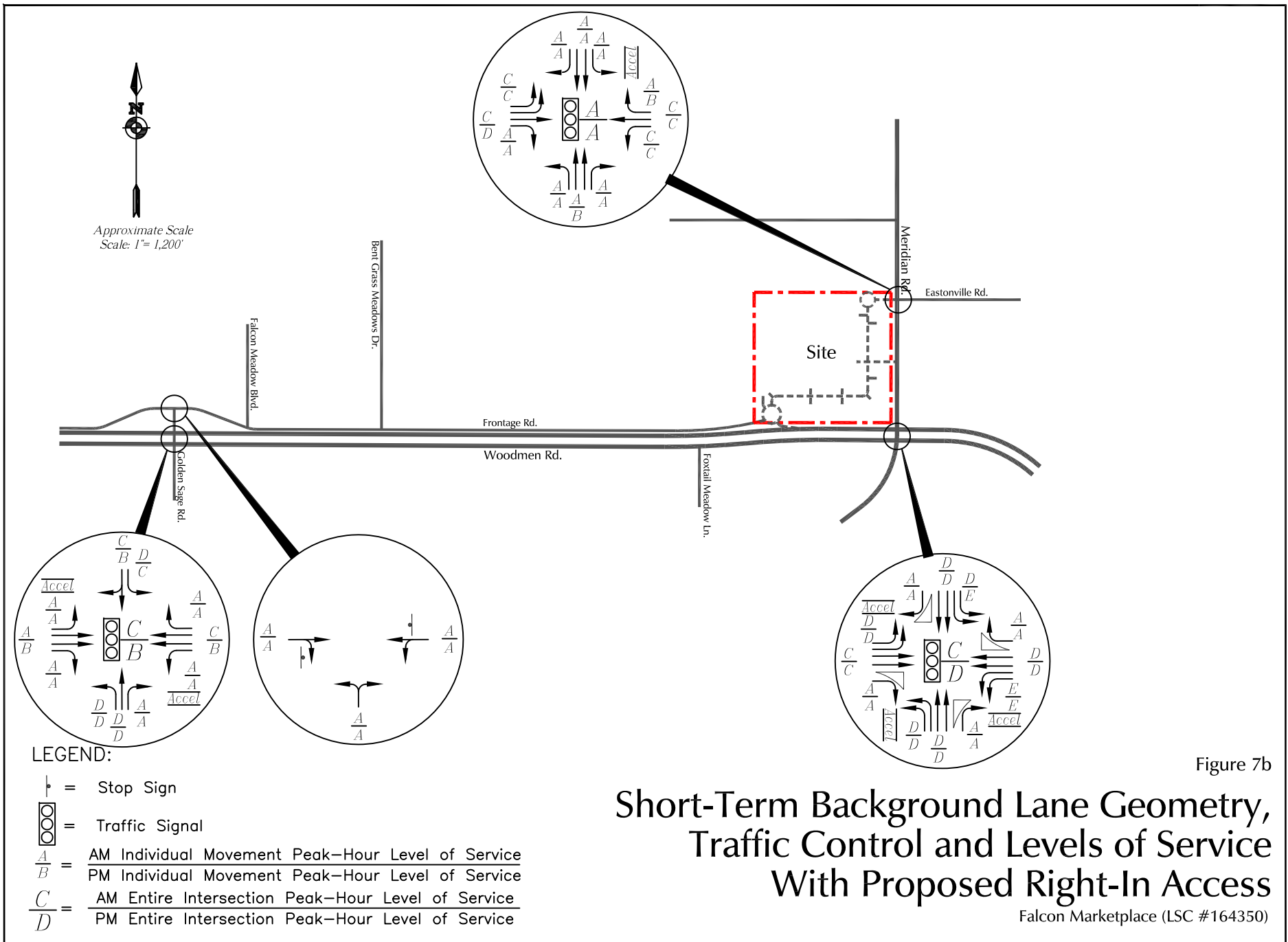
Figures 6b and 7b show the lane geometry, traffic control, and level of service at the key intersections based on the short-term background volumes.







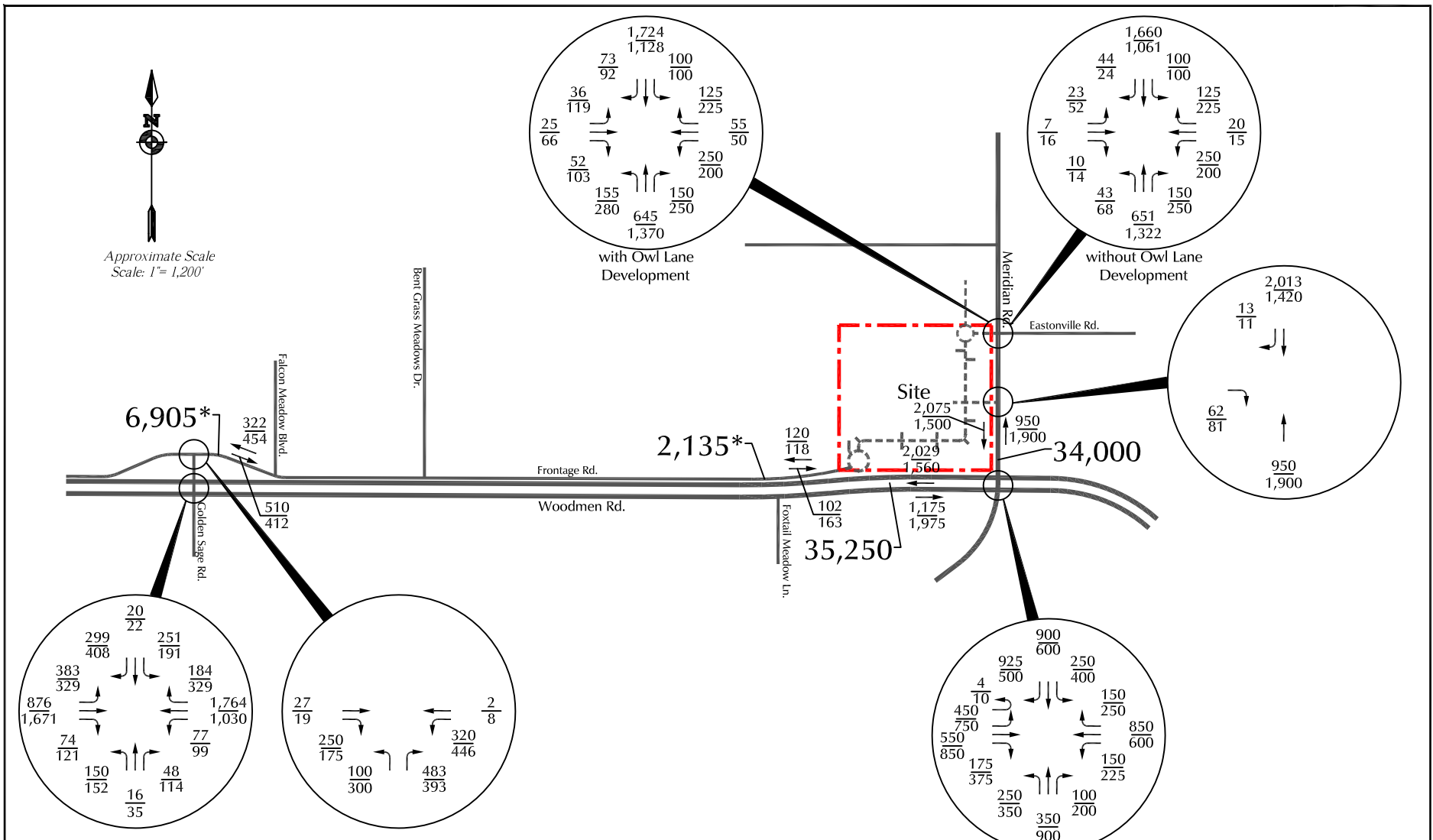




## **2040 BACKGROUND TRAFFIC**

Figures 8a and 9a show the background traffic volumes for the year 2040. The volumes shown in Figure 8a assume no access from Woodmen Road and the volumes shown in Figure 9a assume the proposed right-in-only access. The 2040 background traffic volume estimates were based on the *El Paso County Major Transportation Corridors Plan (MTCP) 2040* and previous work completed in the area by LSC, including the Bent Grass Subdivision PUD/Preliminary Plan Updated Traffic Impact Study and the previous studies for this site, other area traffic studies, and traffic count data. The 2040 background traffic includes buildout of the Bent Grass subdivision, the Latigo site northeast of Bent Grass Meadows Drive/Woodmen Frontage Road (assuming the current I-2 industrial zoning -- although previous reports have been prepared contemplating rezoning to commercial/shopping center land uses), and potential Owl Lane redevelopment for commercial land uses with the planned north/south street connection between Eastonville and Bent Grass Meadows Drive. Increases in through traffic are also included. The 2040 background traffic estimates also take into account the Stapleton Drive extension to the west to the Briargate Parkway/Black Forest Road intersection.

Figures 8b and 9b show the lane geometry, traffic control, and level of service at the key intersections based on the 2040 background volumes.



\*Frontage Road Traffic Volumes

Figure 8a

# Year 2040 Background Traffic Without Proposed Right-In Access

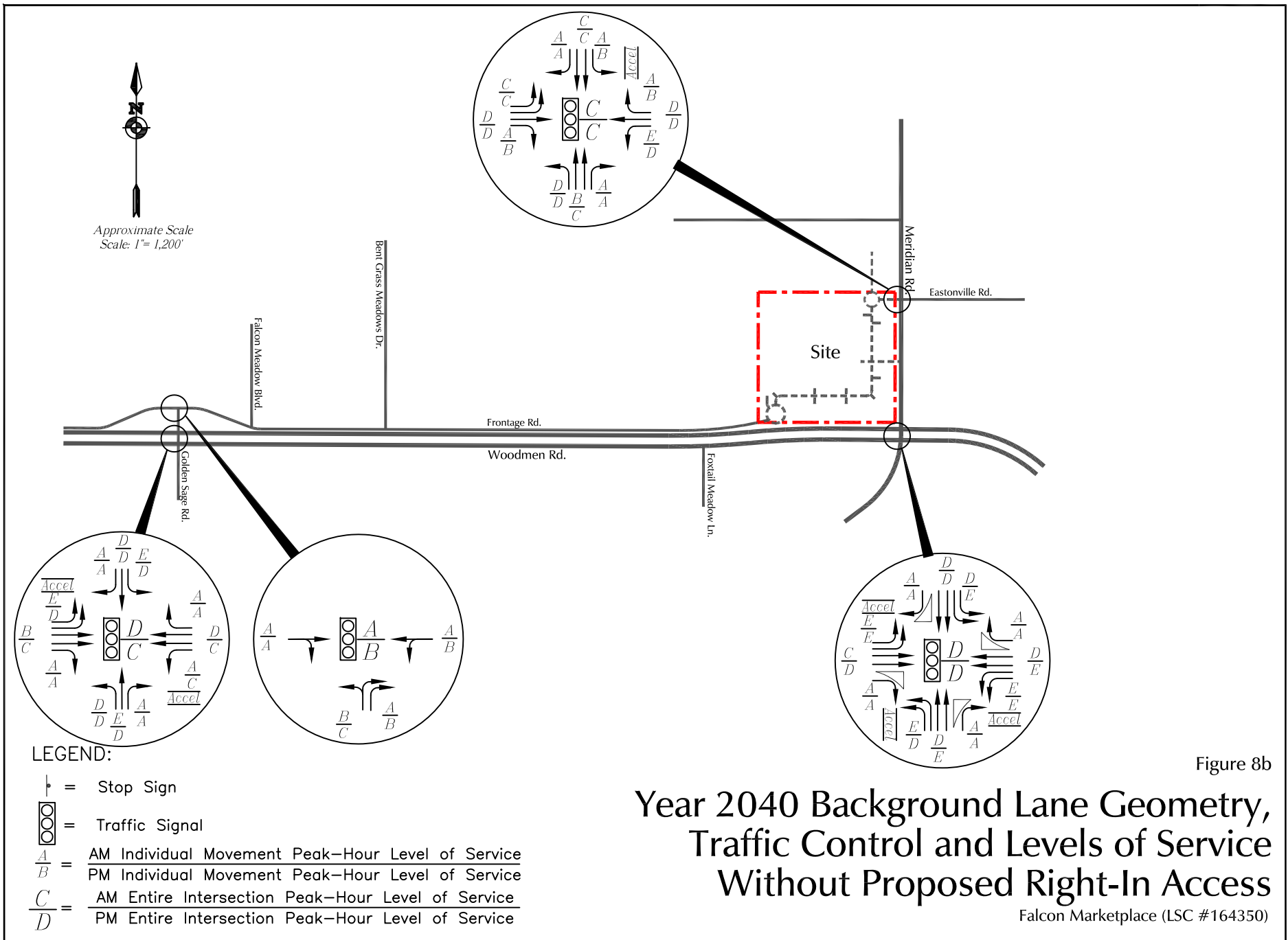
Falcon Marketplace (LSC #164350)

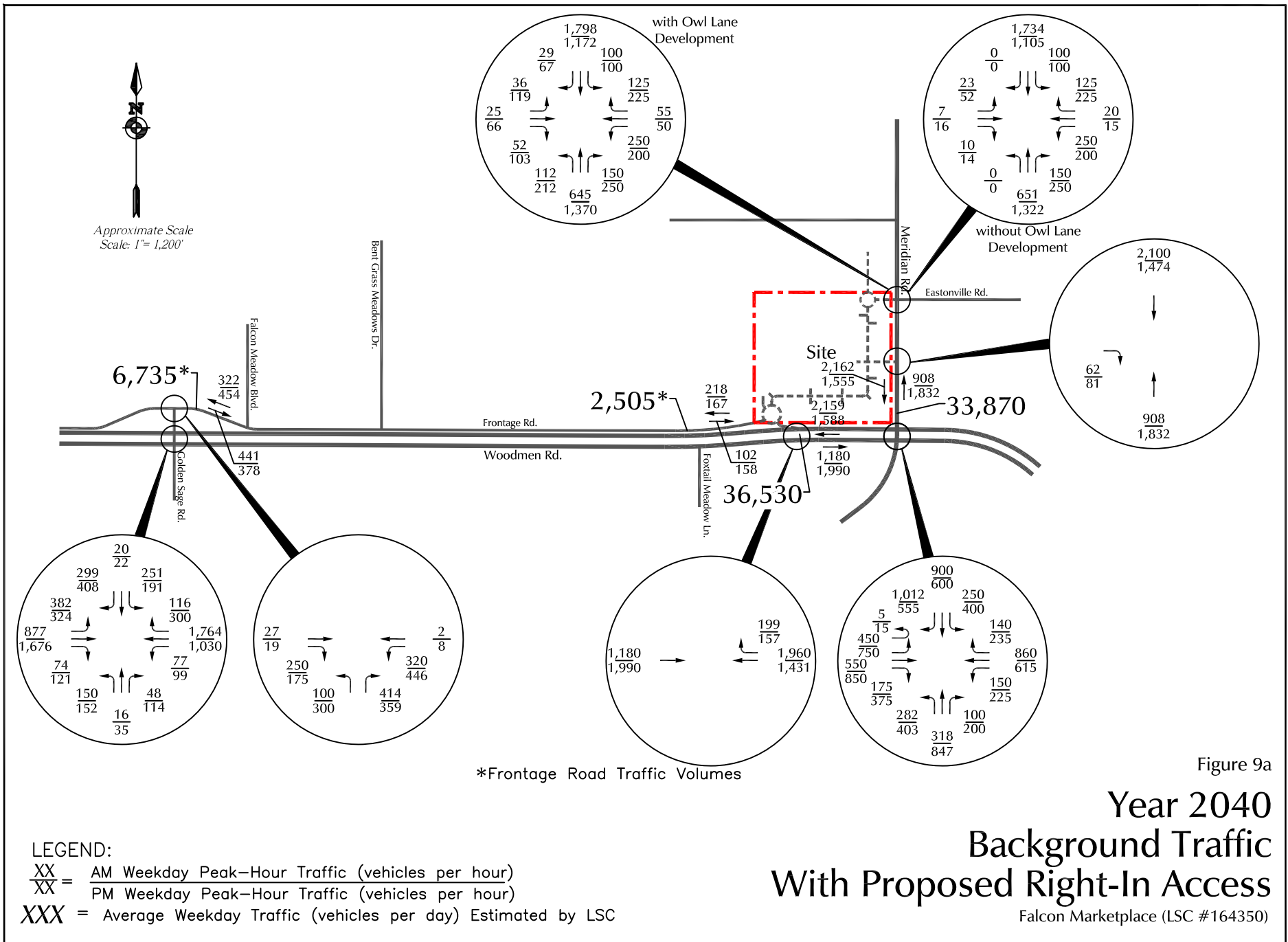
**LEGEND:**

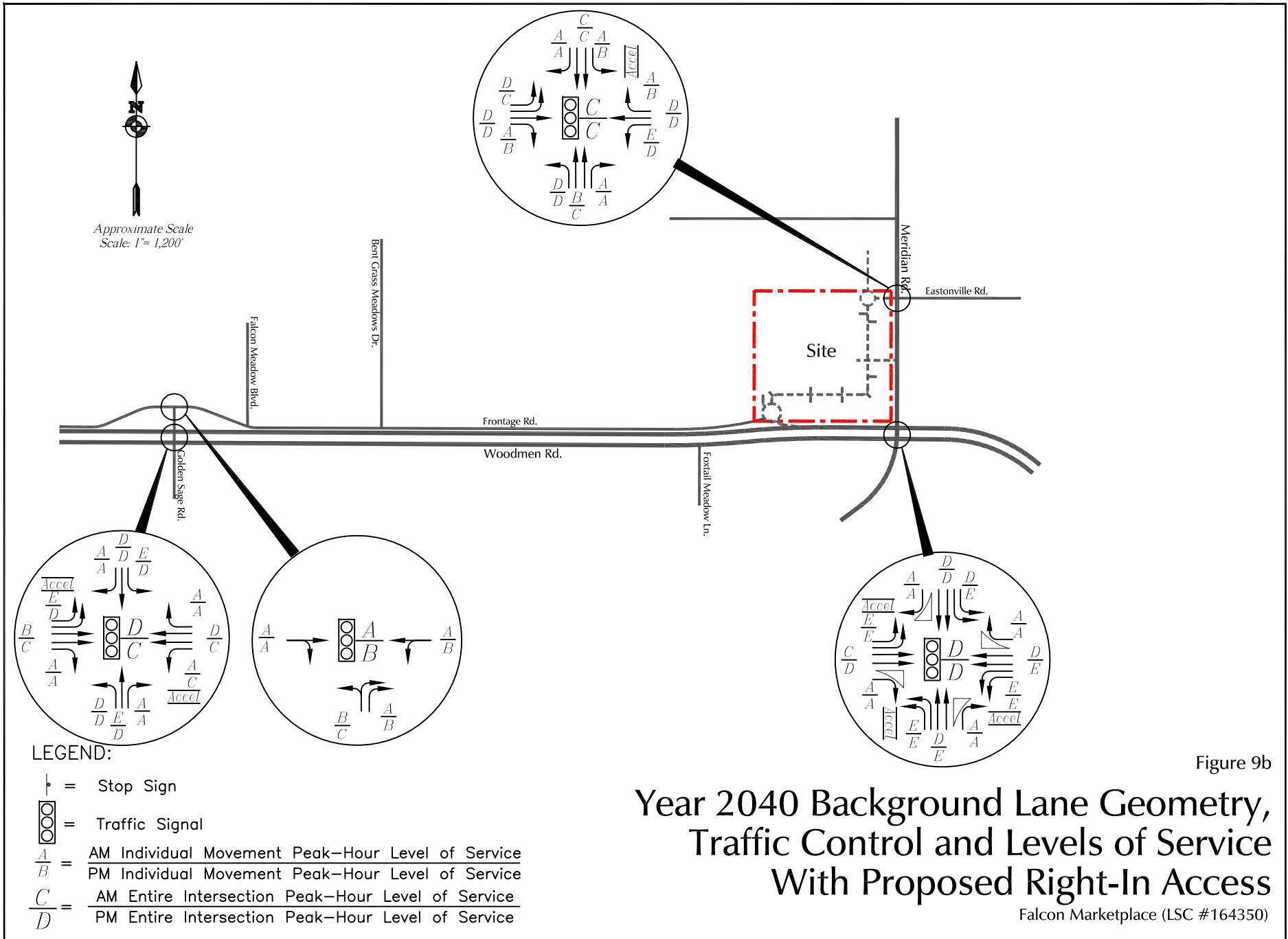
$\frac{XX}{XX}$  = AM Weekday Peak-Hour Traffic (vehicles per hour)

$\frac{XX}{XX}$  = PM Weekday Peak-Hour Traffic (vehicles per hour)

XXX = Average Weekday Traffic (vehicles per day) Estimated by LSC









# Trip Generation, Distribution, and Traffic Volume Estimates

---

---

## TRIP GENERATION

Estimates of the traffic volumes expected to be generated by the existing and proposed land uses within the study area were made using the nationally published trip generation rates found in *Trip Generation, 9th Edition, 2012* by the Institute of Transportation Engineers (ITE). Table 2 shows the trip generation estimates.

The total number of vehicle-trips generated by the land uses has been reduced to account for the internal vehicle-trips made within the site between land uses, without use of the external streets surrounding the site. Table 2 shows the number of internal trips assumed for each land use. The internal trip reduction is an estimate by LSC based on National Highway Cooperative Highway Research Program (NCHRP) Report 684 *Enhancing Internal Trip Capture Estimation for Mixed-Use Developments*. The results of the spreadsheet model are attached.

The total number of external new impact vehicle-trips generated by the retail land uses has been reduced to take into account the “pass-by” and “diverted link” phenomena. A pass-by trip is made by a motorist who would already be on the adjacent roadways regardless of the proposed development, but who stops in at the site while passing by. The motorist would then continue on his or her way to a final destination in the original direction. The pass-by percentages shown on Table 2 are from the *Trip Generation Handbook - An ITE Proposed Recommended Practice, 3rd Edition, 2014* by ITE. A diverted link trip is one made by a motorist who would already be traveling on a nearby (but not adjacent) roadway regardless of this development who now uses another roadway to access the site before continuing on his or her way to a final destination in the original direction. Diverted link trips are included in the distribution percentages.

The site is projected to generate about 9,558 new external vehicle-trips on the average weekday, with about half entering and half exiting the site during a 24-hour period.

Figure 8a

**Table 2  
Trip Generation Estimate  
Falcon Marketplace**

Lot	Land Use Code	Land Use Description	Trip Generation Units	Trip Generation Rates <sup>(1)</sup>				Total Trips Generated				Internal Trips <sup>(7)</sup>				Total External Trips Generated				Pass-By Trips <sup>(2)</sup>	New External Trips Generated Average New Weekday Traffic				
				Average Weekday Traffic	Morning Peak Hour In	Afternoon Peak Hour Out	Afternoon Peak Hour In	Morning Peak Hour Out	Average Weekday Traffic	Morning Peak Hour In	Afternoon Peak Hour Out	Afternoon Peak Hour In	Morning Peak Hour Out	Average Weekday Traffic	Morning Peak Hour In	Afternoon Peak Hour Out	Afternoon Peak Hour In	Morning Peak Hour Out							
<b>Trip Generation Estimate Based on the Currently Proposed Plan</b>																									
1	866	Pet Supply Superstore <sup>(3)</sup>	15 KSF <sup>(4)</sup>	38.24	0.53	0.33	1.69	1.69	574	8	5	25	25	54	1	2	3	2	520	7	3	22	23	10%	468
2	850	Supermarket	123 KSF	78.26	2.11	1.29	3.76	3.62	9,626	259	159	463	445	909	17	26	48	37	8,717	242	133	415	408	36%	5,579
3	944	Gasoline/Service Station	18 VFP <sup>(5)</sup>	168.56	6.20	5.96	6.94	6.94	3,034	112	107	125	125	286	5	8	15	12	2,748	107	99	110	113	56%	1,209
4	934	Fast-Food Restaurant with Drive-Through Window <sup>(6)</sup>	2.5 KSF	496.12	0.42	0.39	16.98	15.67	1,240	1	1	42	39	380	0	0	12	17	860	1	1	30	22	50%	430
5	820	Shopping Center	5 KSF	55.14	0.77	0.47	2.36	2.51	276	4	2	12	13	26	1	0	1	1	250	3	2	11	12	34%	165
6	848	Tire Store	7.72 KSF	24.87	1.82	1.07	1.78	2.37	192	14	8	14	18	18	0	1	1	1	174	14	7	13	17	28%	125
7	934	Fast-Food Restaurant with Drive-Through Window	3.5 KSF	496.12	23.16	22.26	16.98	15.67	1,736	81	78	59	55	532	26	12	17	24	1,204	55	66	42	31	50%	602
8	934	Fast-Food Restaurant with Drive-Through Window <sup>(6)</sup>	2.5 KSF	496.12	0.42	0.39	16.98	15.67	1,240	1	1	42	39	380	0	0	12	17	860	1	1	30	22	50%	430
9	610	Clinic	7.8 KSF	31.45	2.19	2.19	2.12	3.06	245	17	17	17	24	40	3	16	10	5	205	14	1	7	19	0%	205
10	820	Shopping Center	8 KSF	55.14	0.77	0.47	2.36	2.51	441	6	4	19	20	42	1	1	2	2	399	5	3	17	18	34%	263
11	937	Coffee/Donut Shop With Drive-Through Window	1.3 KSF	818.58	51.30	49.28	21.40	21.40	1,064	67	64	28	28	326	21	10	9	12	738	46	54	19	16	89%	81
									<b>19,669</b>	<b>570</b>	<b>446</b>	<b>846</b>	<b>831</b>	<b>2,993</b>	<b>75</b>	<b>76</b>	<b>130</b>	<b>130</b>	<b>16,676</b>	<b>495</b>	<b>370</b>	<b>716</b>	<b>701</b>		<b>9,558</b>

Notes:

- (1) Source: "Trip Generation, 9th Edition, 2012" by the Institute of Transportation Engineers (ITE)
- (2) Source: "Trip Generation Handbook - An ITE Proposed Recommended Practice" 3rd Edition, 2014
- (3) Daily and morning peak-hour trip generation rates for Pet Supply Superstore are estimates by LSC
- (4) KSF = 1,000 square feet of floor space
- (5) VFP = vehicle fueling position
- (6) The AM peak-hour trip generation rates have been reduced by LSC as the proposed fast-food restaurant does not serve breakfast
- (6) See attached NCHRP 684 Internal Trip Capture Estimate Tool Sheets

Source: LSC Transportation Consultants, Inc.

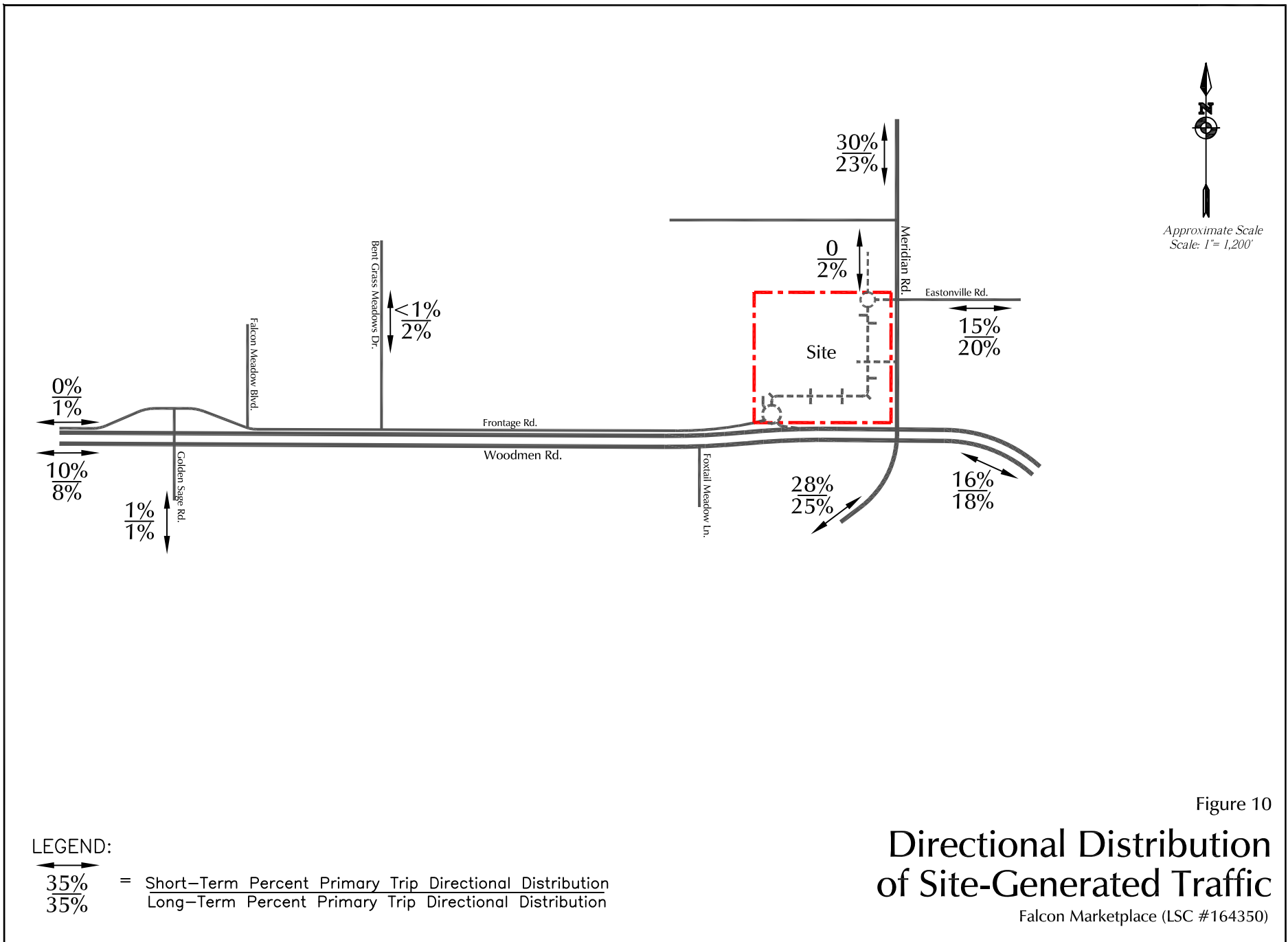
During the morning peak hour, which generally occurs for one hour between 6:30 and 8:30 a.m., about 495 vehicles would enter and 370 vehicles would exit the site.

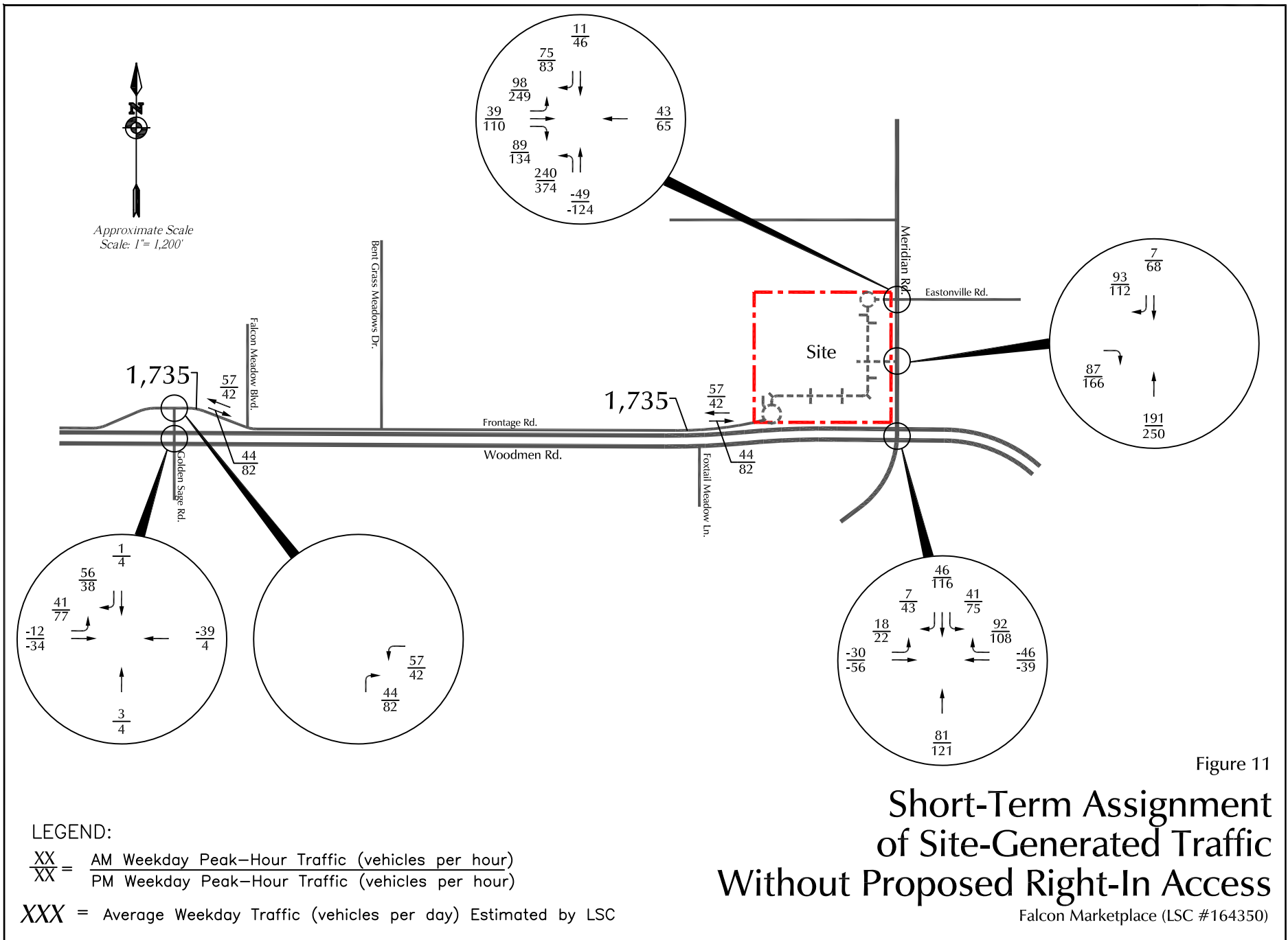
During the afternoon peak hour, which generally occurs for one hour between 4:15 and 6:15 p.m., about 716 vehicles would enter and 701 vehicles would exit the site.

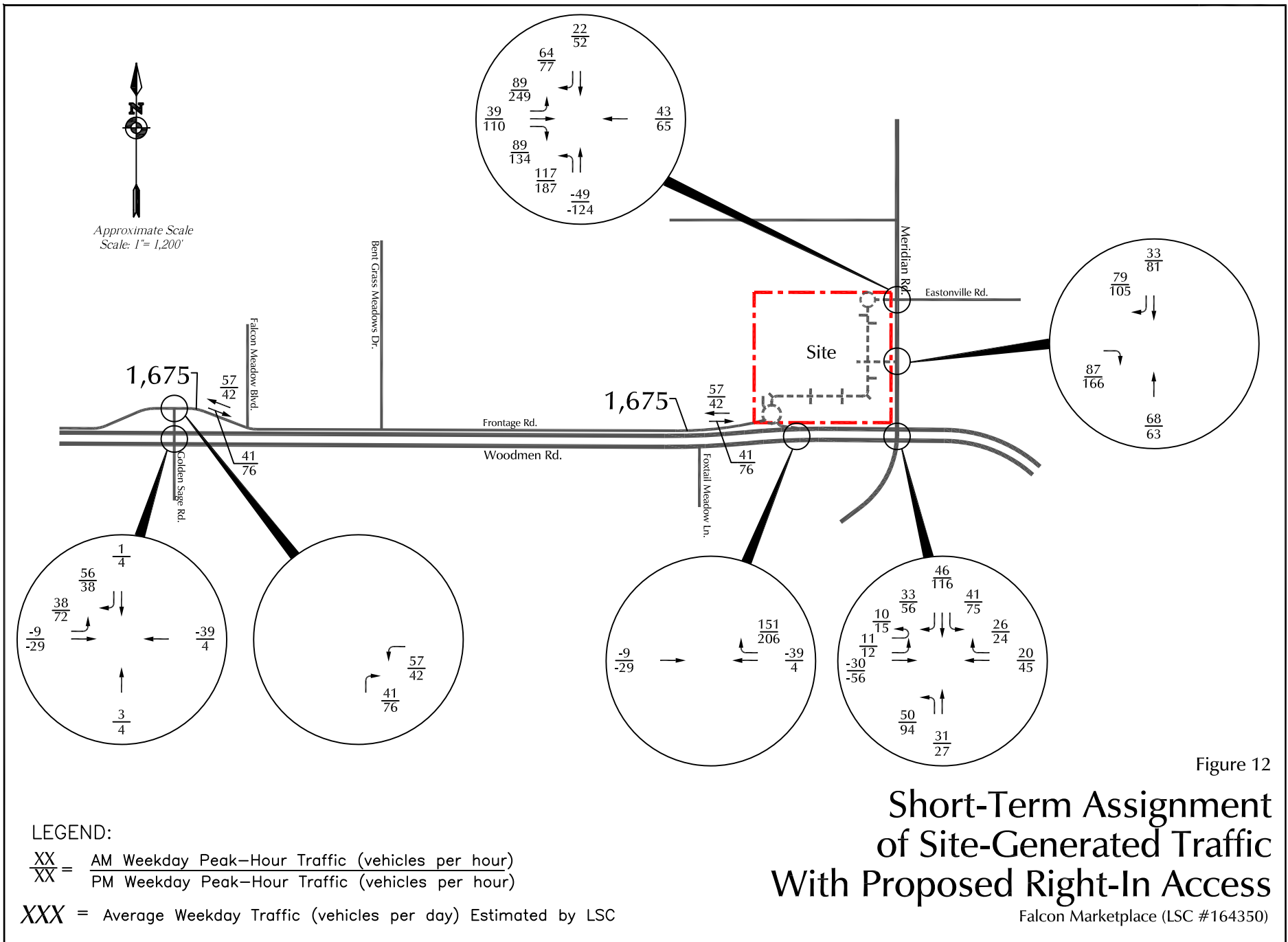
## **TRIP DISTRIBUTION AND ASSIGNMENT**

The estimated directional distribution of the site-generated traffic volumes on the adjacent roadways is an important factor in determining the site's traffic impacts. Figure 10 shows the directional distribution estimates for the primary site-generated traffic. The estimates have been based on the following factors: the site's location with respect to the Falcon area's residential, employment, and commercial areas; the balance of the northeast Colorado Springs metropolitan area and the rural areas of the county to the east; the site's proposed land uses; the site's proposed access and circulation system; and the roadway system serving the site. The short-term distribution estimate assumes the existing street network plus the Meridian Road project, and the long-term estimate assumes the future Stapleton extension to the west and additional east-west potential connections west of US 24 through Banning Lewis Ranch such as Dublin Boulevard. The pass-by trips and diverted trips were assigned based in large part on the magnitude and direction of the existing and projected background traffic volumes on the adjacent roadways.

When the distribution percentages (from Figure 10) were applied to the trip generation estimates (from Table 2), the site-generated traffic volumes on the area roadways were determined. Figures 11 and 12 show the short-term site-generated traffic volumes without and with the proposed right-in-only access from Woodmen Road, respectively. Figures 13 and 14 show the long-term site-generated traffic volumes with no access to Woodmen Road and with the proposed right-in-only access from Woodmen Road, respectively.









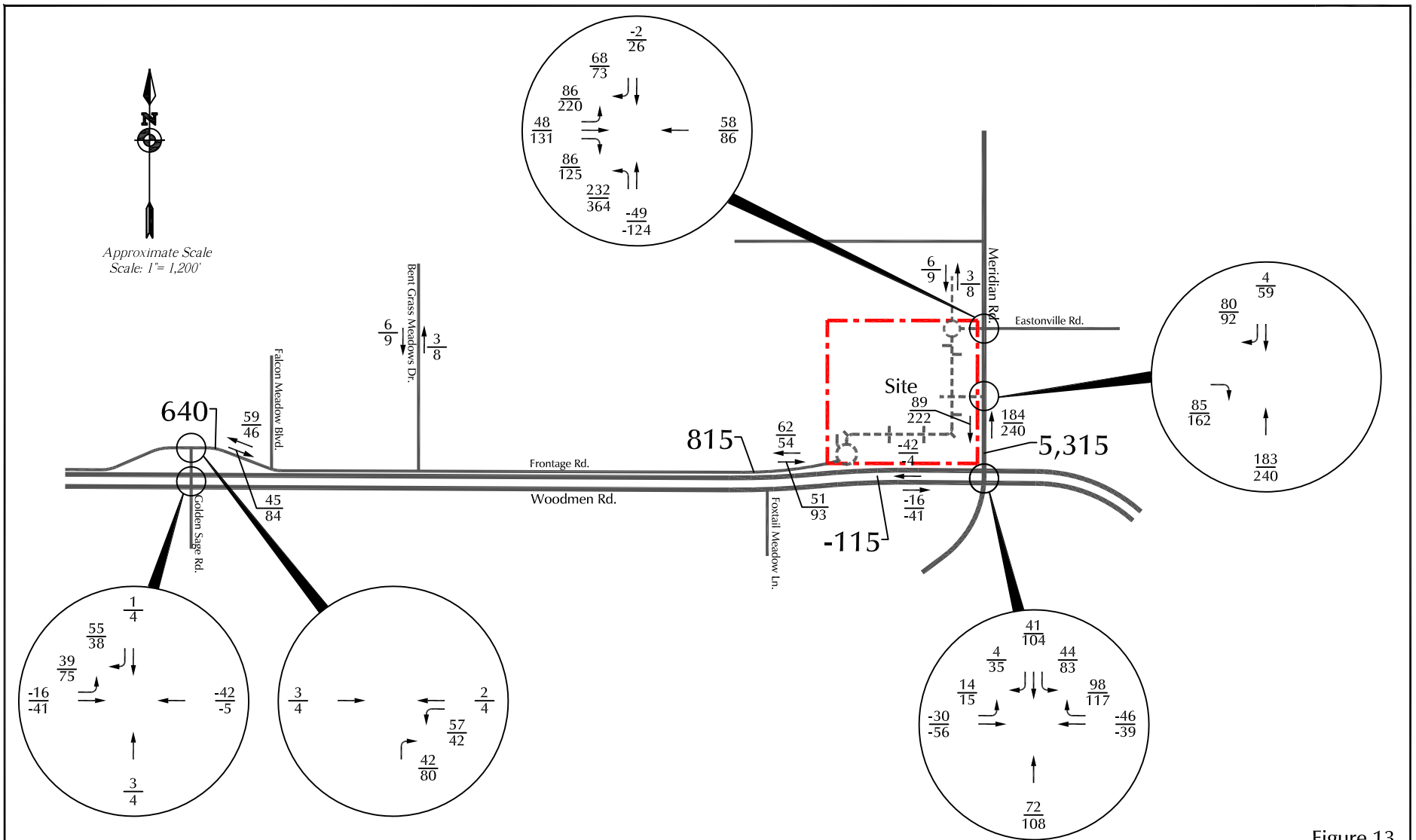


Figure 13

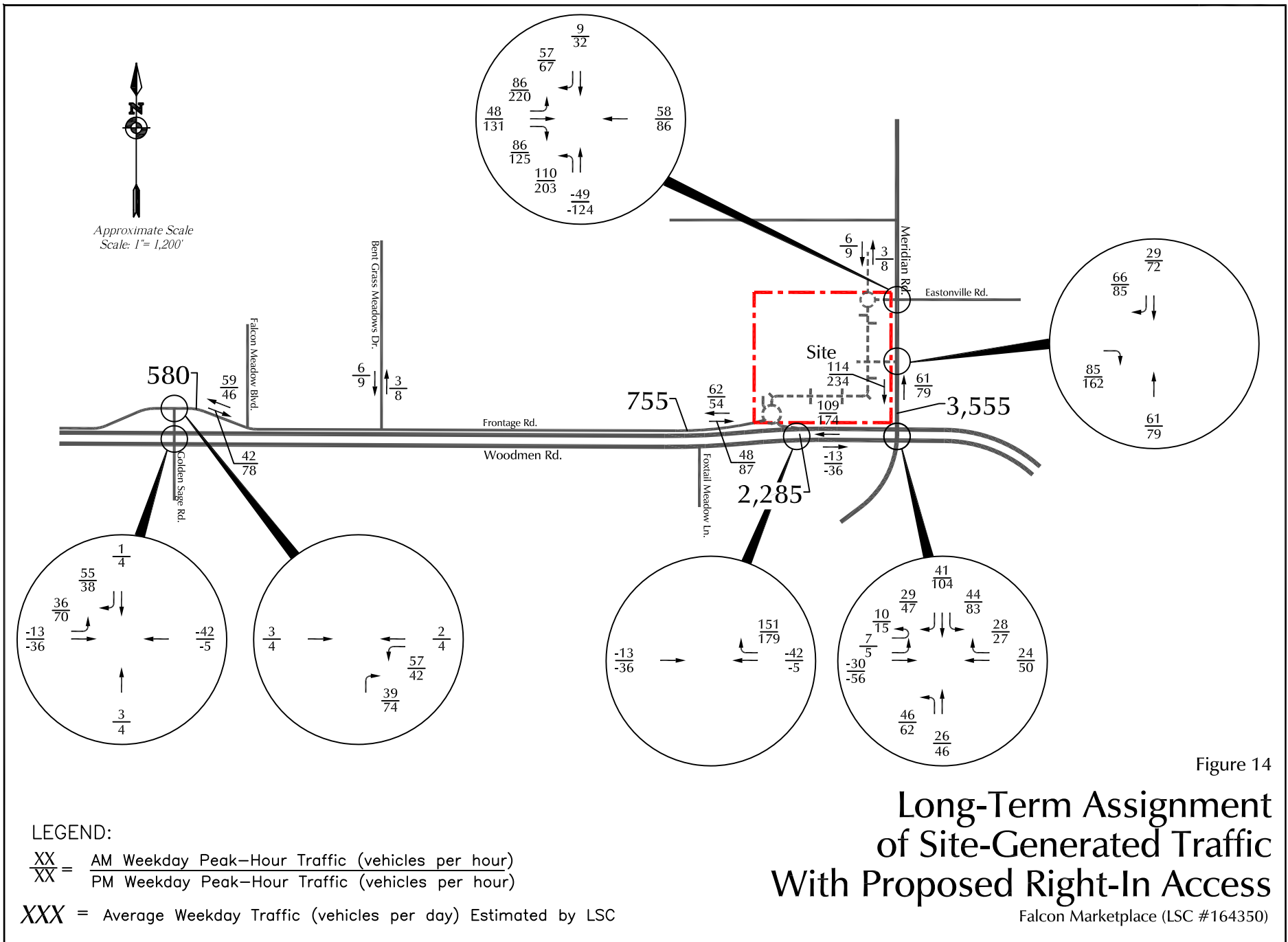
# Long-Term Assignment of Site-Generated Traffic Without Proposed Right-In Access

Falcon Marketplce (LSC #164350)

**LEGEND:**

$\frac{XX}{XX}$  =  $\frac{\text{AM Weekday Peak-Hour Traffic (vehicles per hour)}}{\text{PM Weekday Peak-Hour Traffic (vehicles per hour)}}$

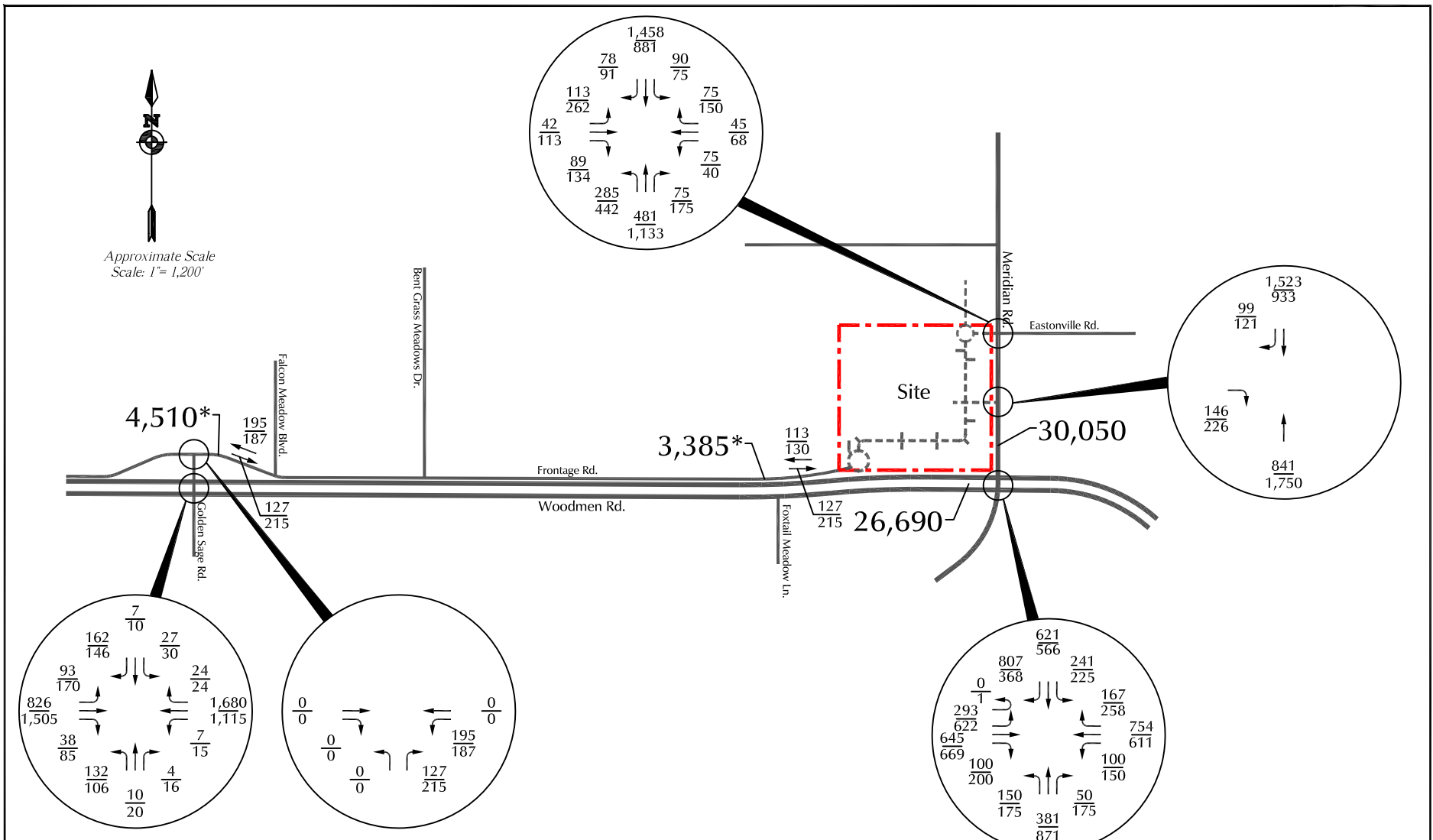
XXX = Average Weekday Traffic (vehicles per day) Estimated by LSC



## **SHORT-TERM TOTAL TRAFFIC**

Figures 15a and 16a show the short-term total traffic volumes at the access points and key intersections adjacent to the site with no access to Woodmen Road and with the proposed right-in-only access from Woodmen Road, respectively. The volumes are the sum of the short-term background traffic volumes from Figures 6a and 7a, plus the short-term site-generated traffic volumes from Figures 11 and 12. The volumes shown in Figures 15a and 16a represent the short-term impacts of the development.

Figures 15b and 16b show the lane geometry, traffic control, and level of service at the key intersections based on the short-term total volumes.



\*Frontage Road Traffic Volumes

Figure 15a

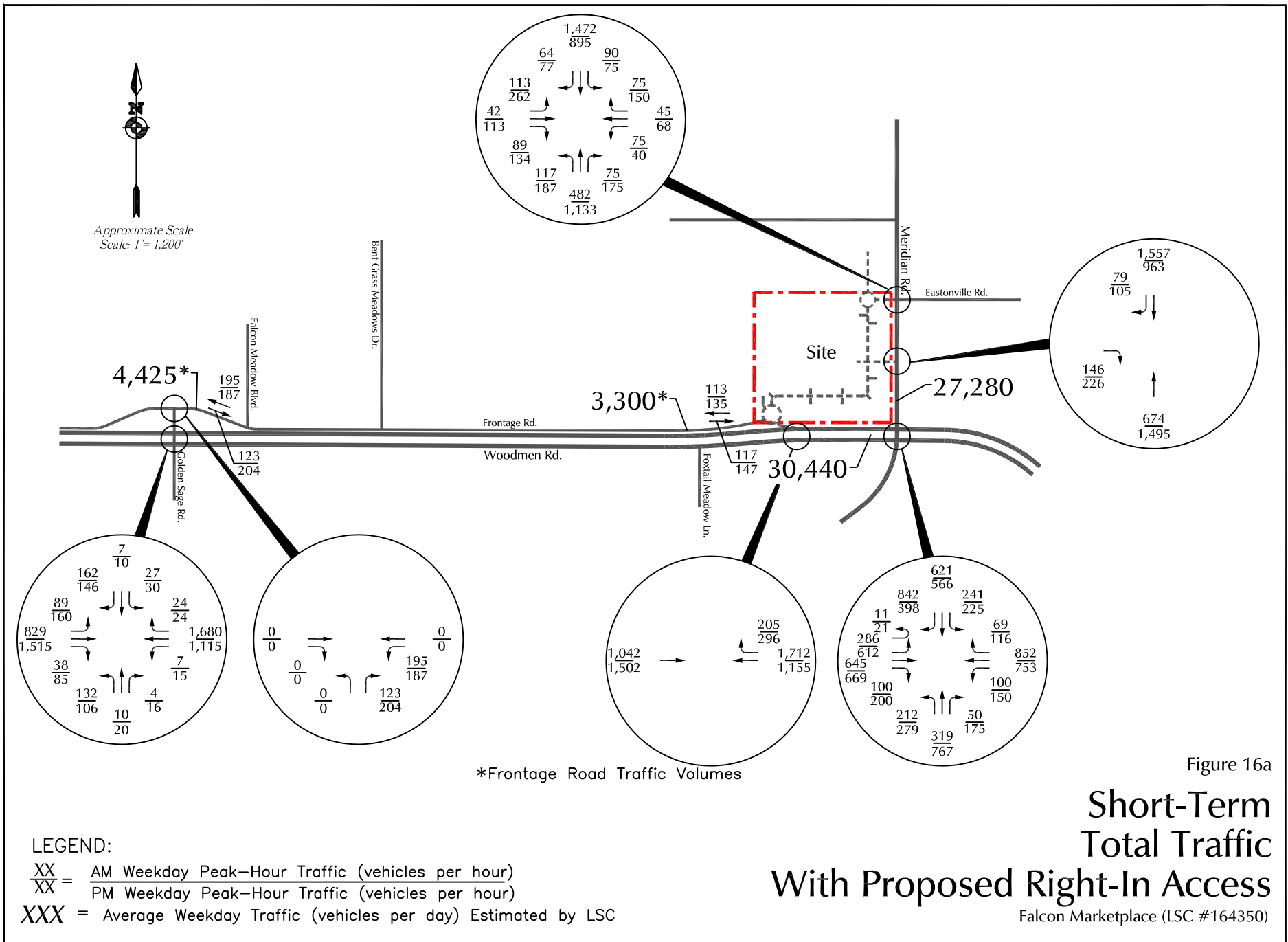
LEGEND:

- $\frac{XX}{XX}$  = AM Weekday Peak-Hour Traffic (vehicles per hour)
- $\frac{XX}{XX}$  = PM Weekday Peak-Hour Traffic (vehicles per hour)
- XXX = Average Weekday Traffic (vehicles per day) Estimated by LSC

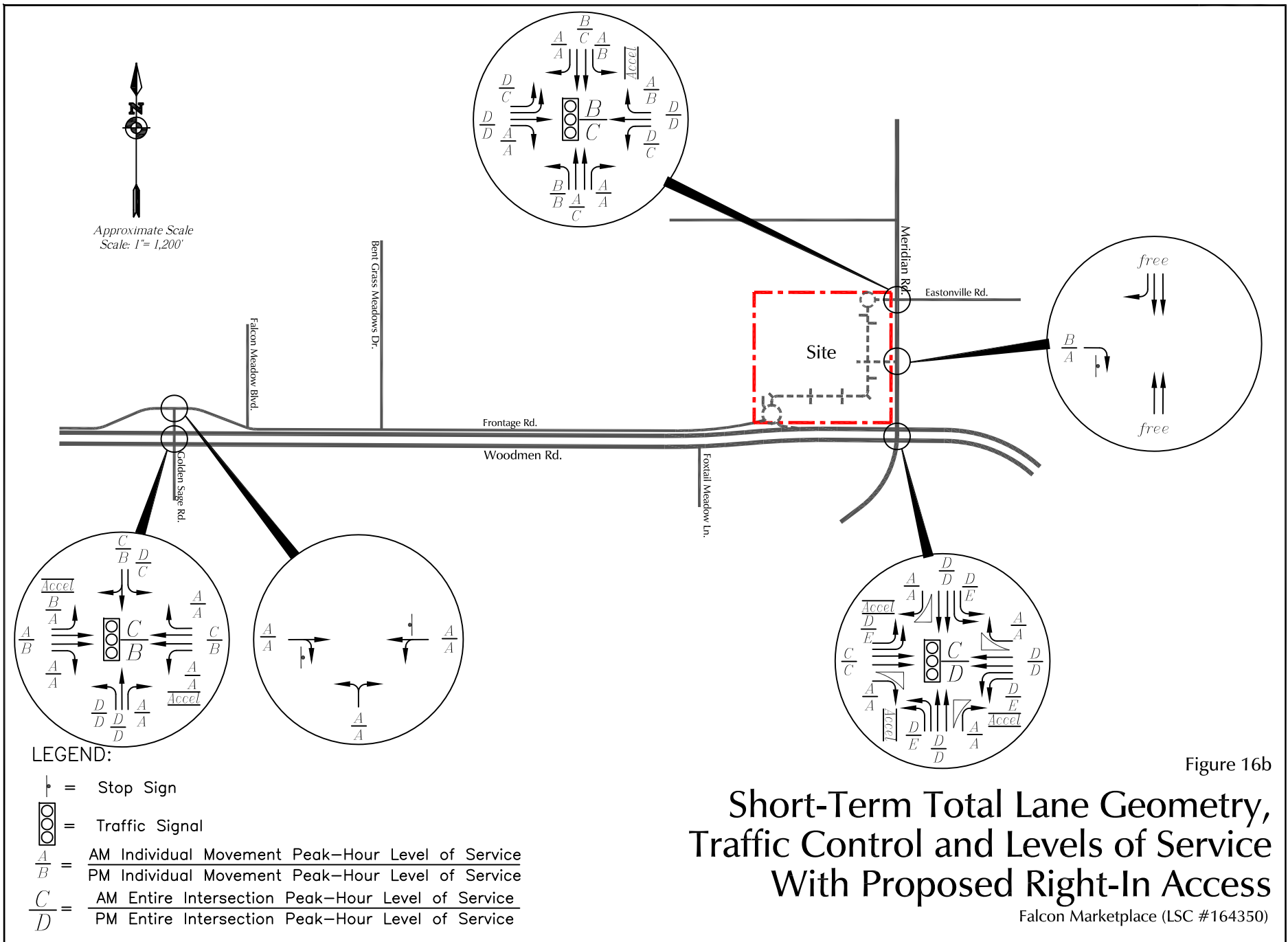
# Short-Term Total Traffic Without Proposed Right-In Access

Falcon Marketplce (LSC #164350)





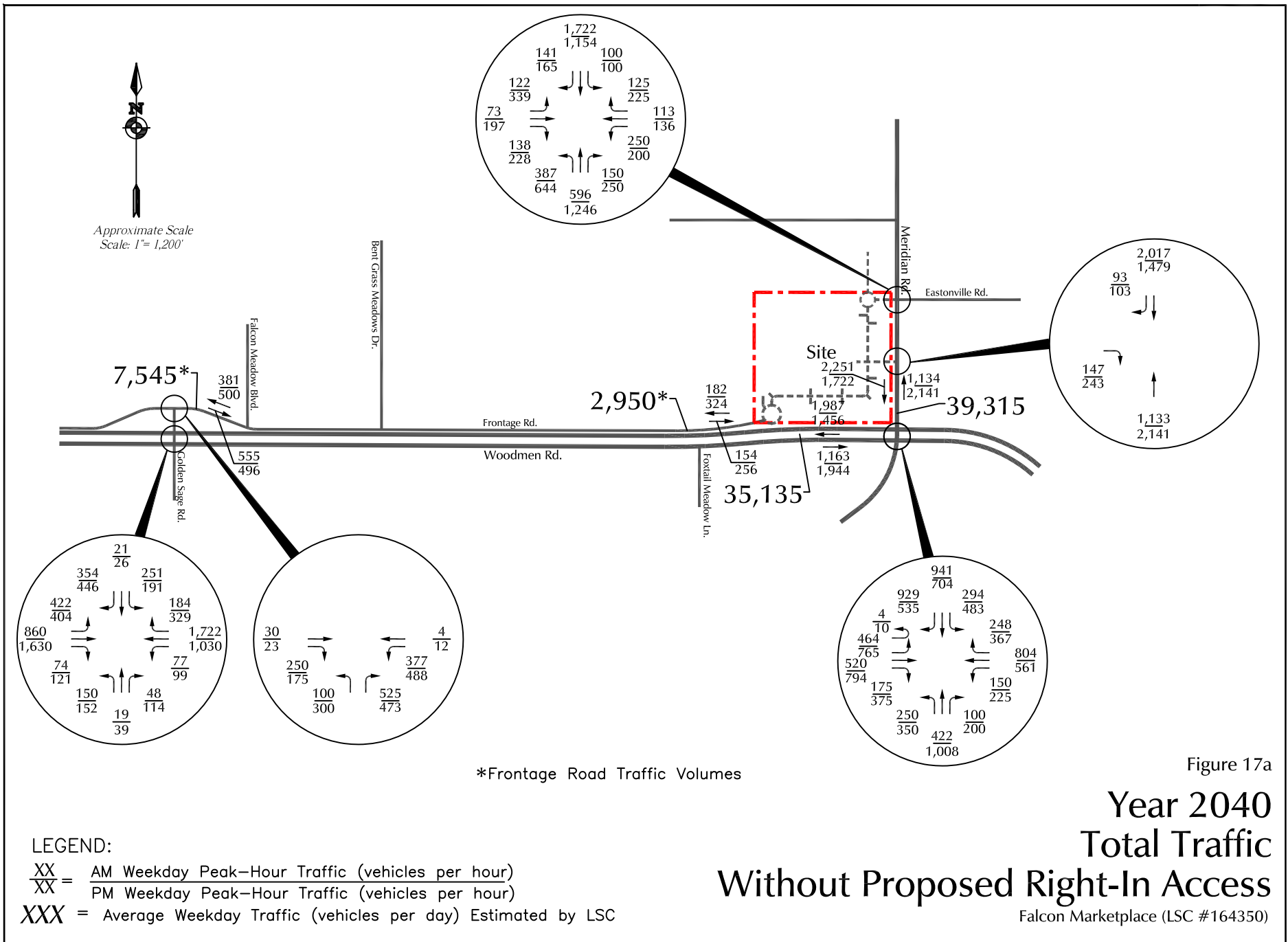




## **2040 TOTAL TRAFFIC**

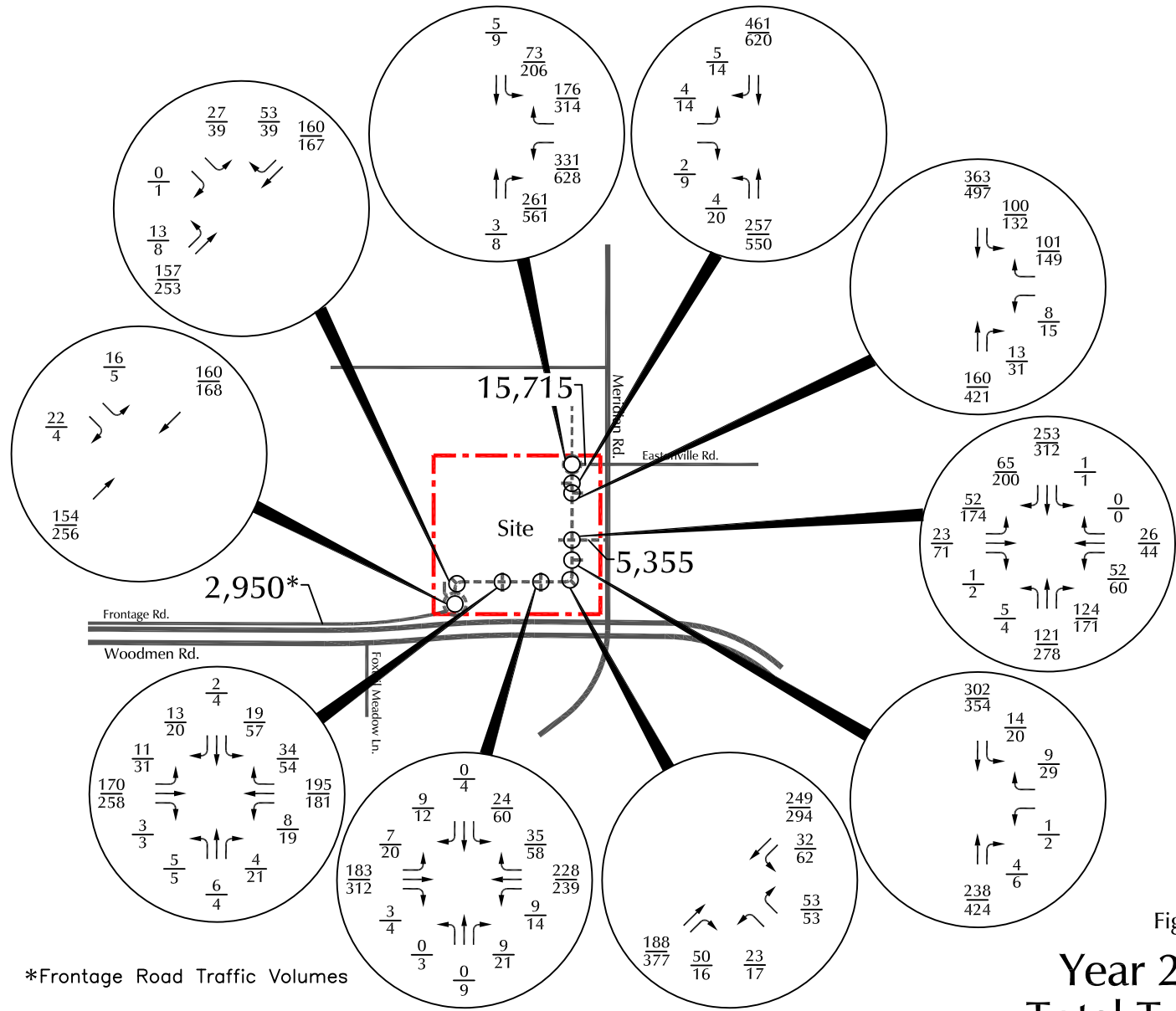
Figures 17a and 18a show the 2040 total traffic volumes at the site access points and key intersections adjacent to the site with no access to Woodmen Road and with the proposed right-in-only access from Woodmen Road, respectively. The volumes are the sum of the 2040 background traffic volumes from Figures 8a and 9a, plus the long-term site-generated traffic volumes from Figures 13 and 14. Figures 17b and 18b show the 2040 total traffic volumes at all of the proposed access points to the public internal road, which extends from the terminus of the Woodmen Frontage Road to Eastonville Road.

Figures 17c and 18c show the lane geometry, traffic control, and level of service at the site access points and key intersections adjacent to the site based on the 2040 total volumes. Figures 17d and 18d show the lane geometry, traffic control, and level of service at the site access points and key intersections adjacent to the site based on the 2040 total volumes. Figures 17d and 18d show the lane geometry, traffic control, and level of service at all of the proposed access points to the public internal road, which extends from the terminus of the Woodmen Frontage Road to Eastonville Road.





Approximate Scale  
Scale: 1" = 1,200'

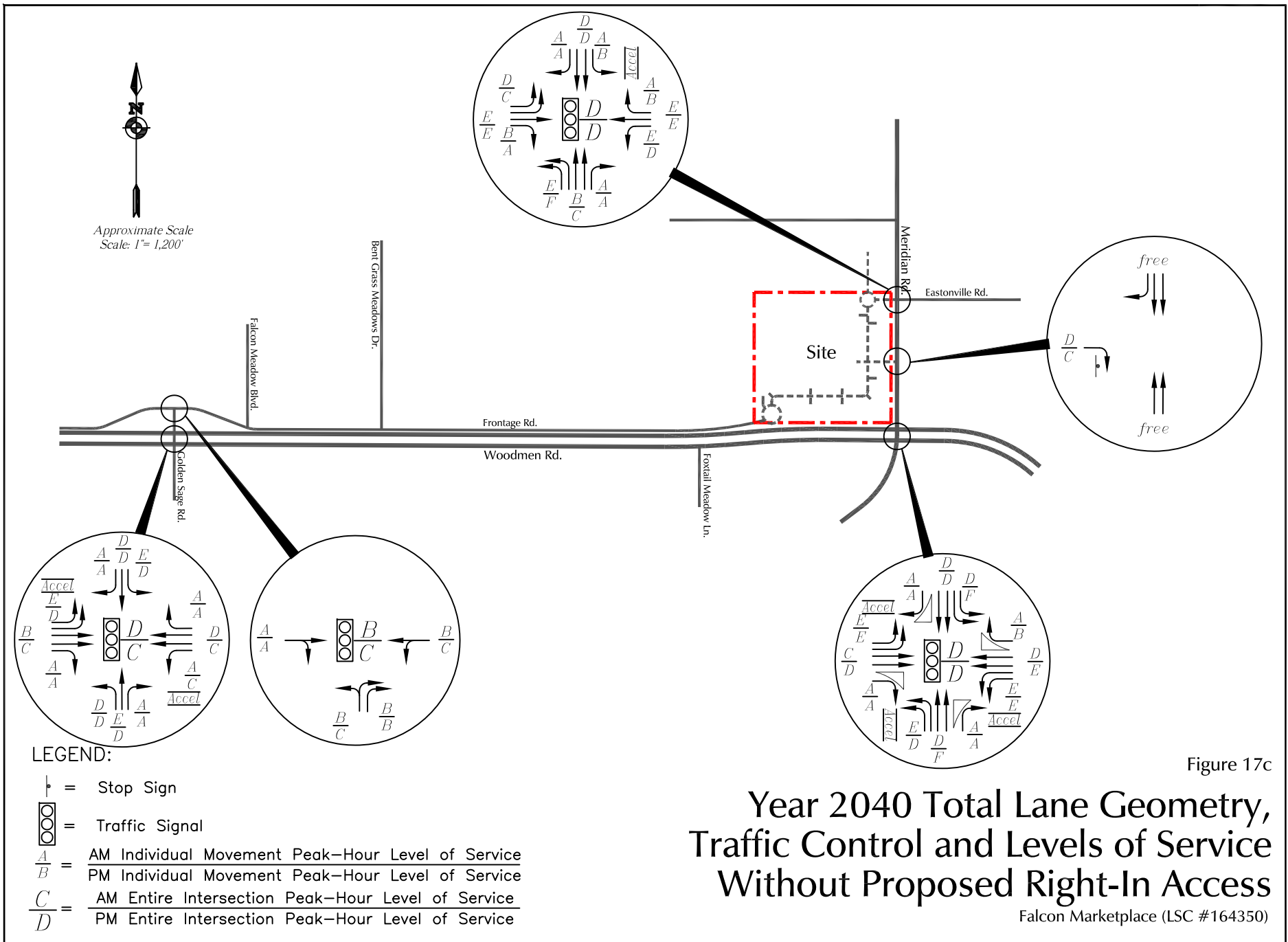


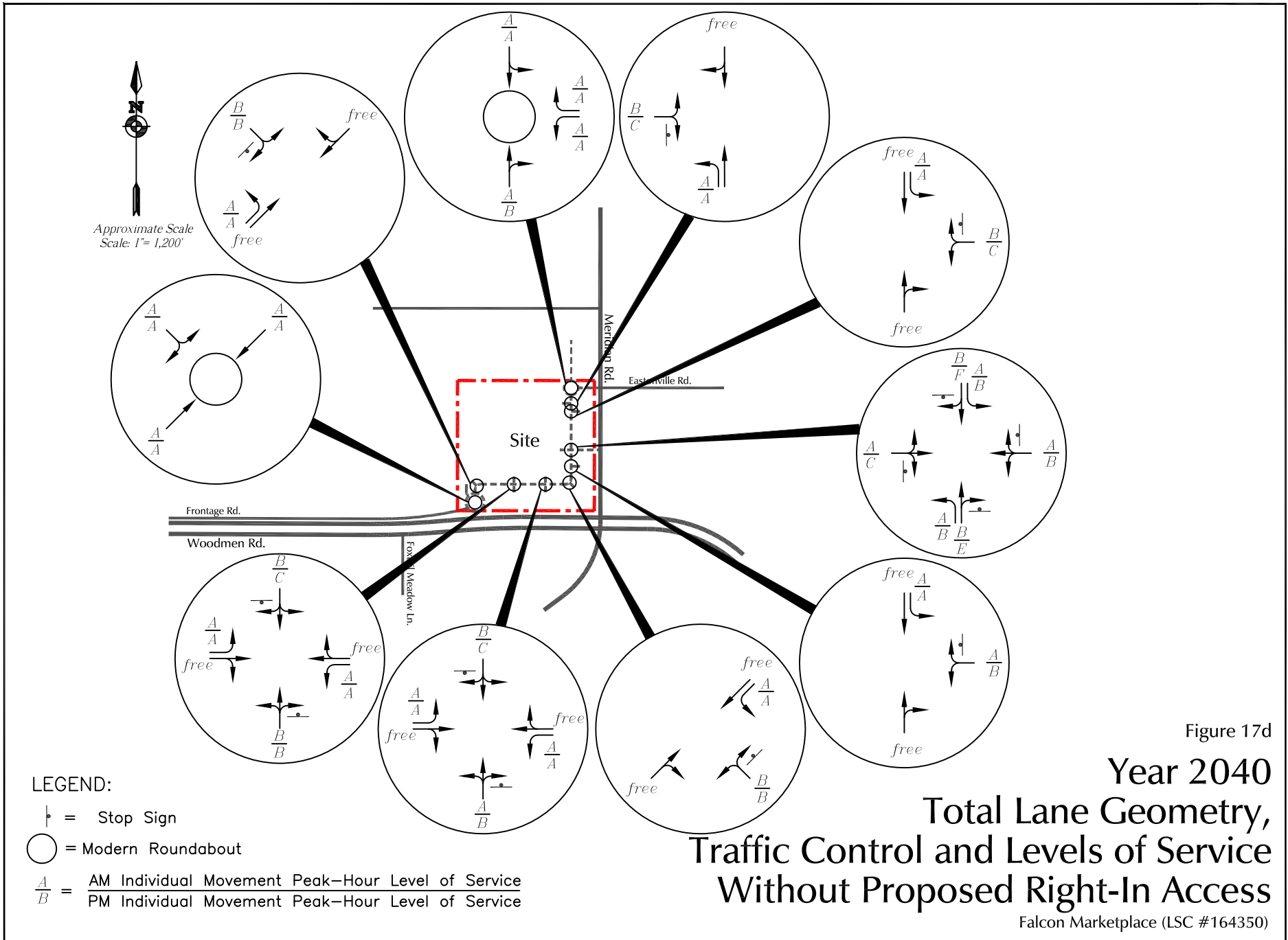
\*Frontage Road Traffic Volumes

LEGEND:

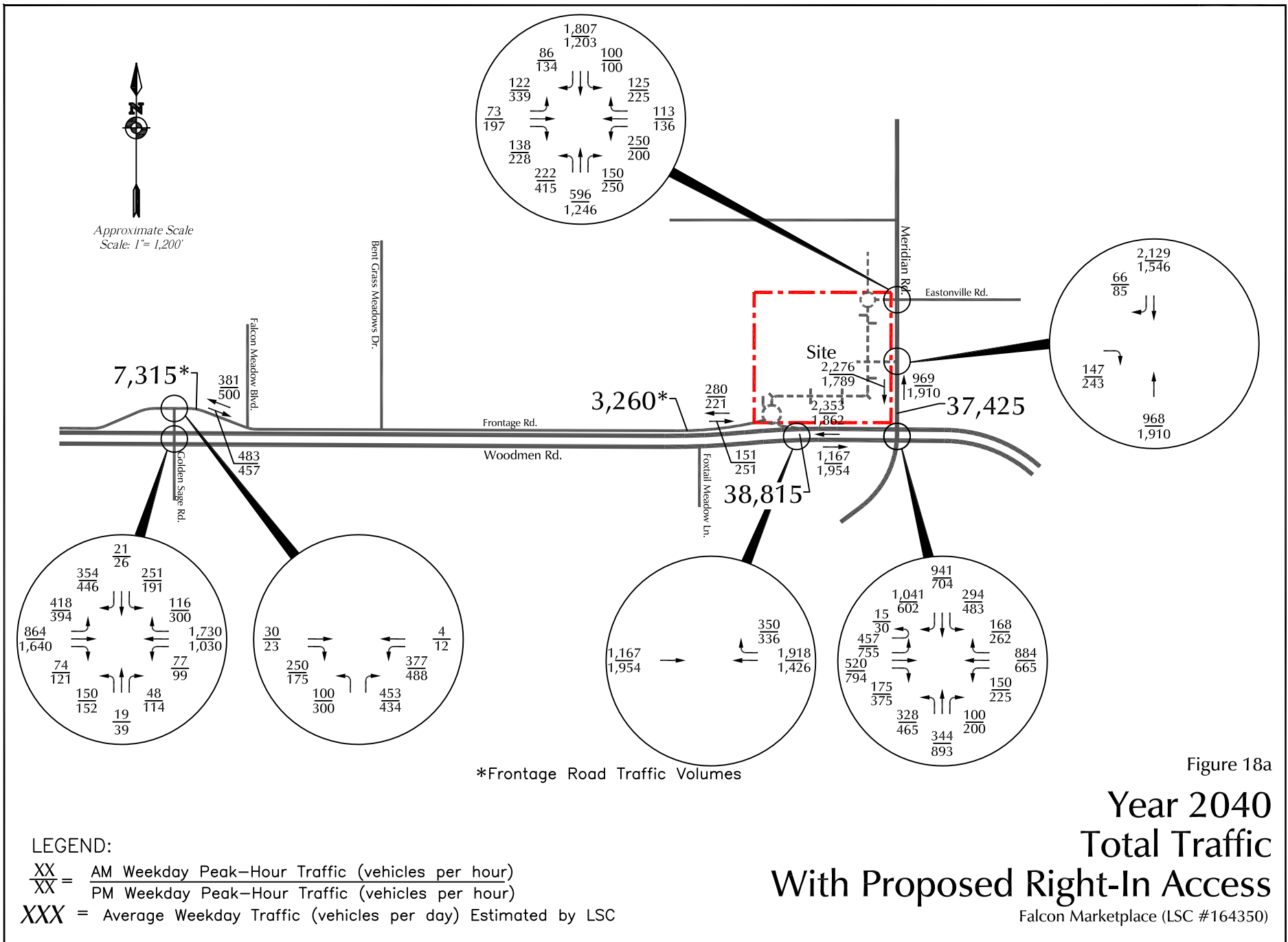
- $\frac{XX}{XX}$  = AM Weekday Peak-Hour Traffic (vehicles per hour)
- $\frac{XX}{XX}$  = PM Weekday Peak-Hour Traffic (vehicles per hour)
- XXX = Average Weekday Traffic (vehicles per day) Estimated by LSC

Figure 17b  
**Year 2040  
 Total Traffic  
 Without Proposed Right-In Access**  
 Falcon Marketplace (LSC #164350)











Approximate Scale  
Scale: 1" = 1,200'

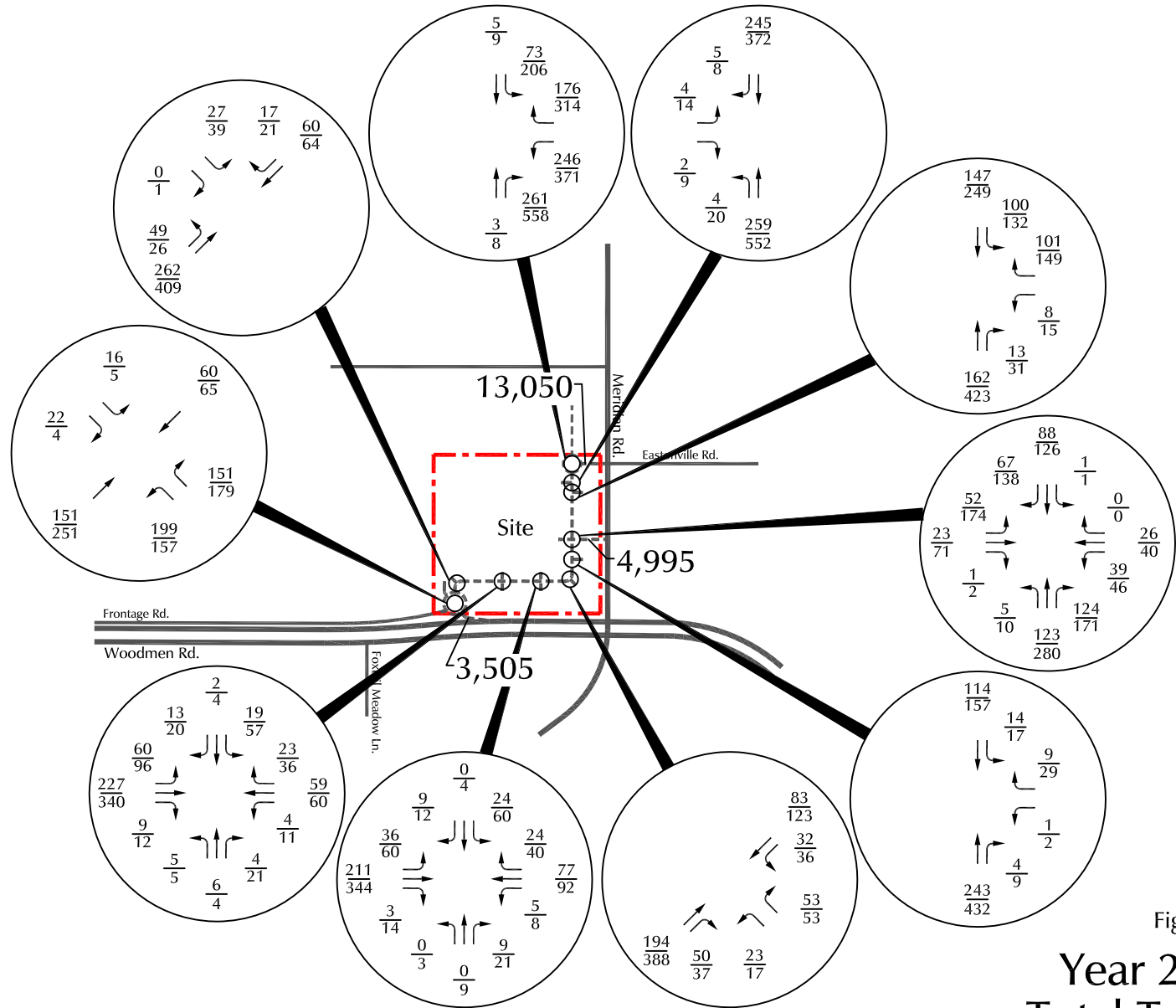


Figure 18b

# Year 2040 Total Traffic With Proposed Right-In Access

Falcon MarketPlace (LSC #164350)

**LEGEND:**

$\frac{XX}{XX}$  = AM Weekday Peak-Hour Traffic (vehicles per hour)

$\frac{XX}{XX}$  = PM Weekday Peak-Hour Traffic (vehicles per hour)

XXX = Average Weekday Traffic (vehicles per day) Estimated by LSC

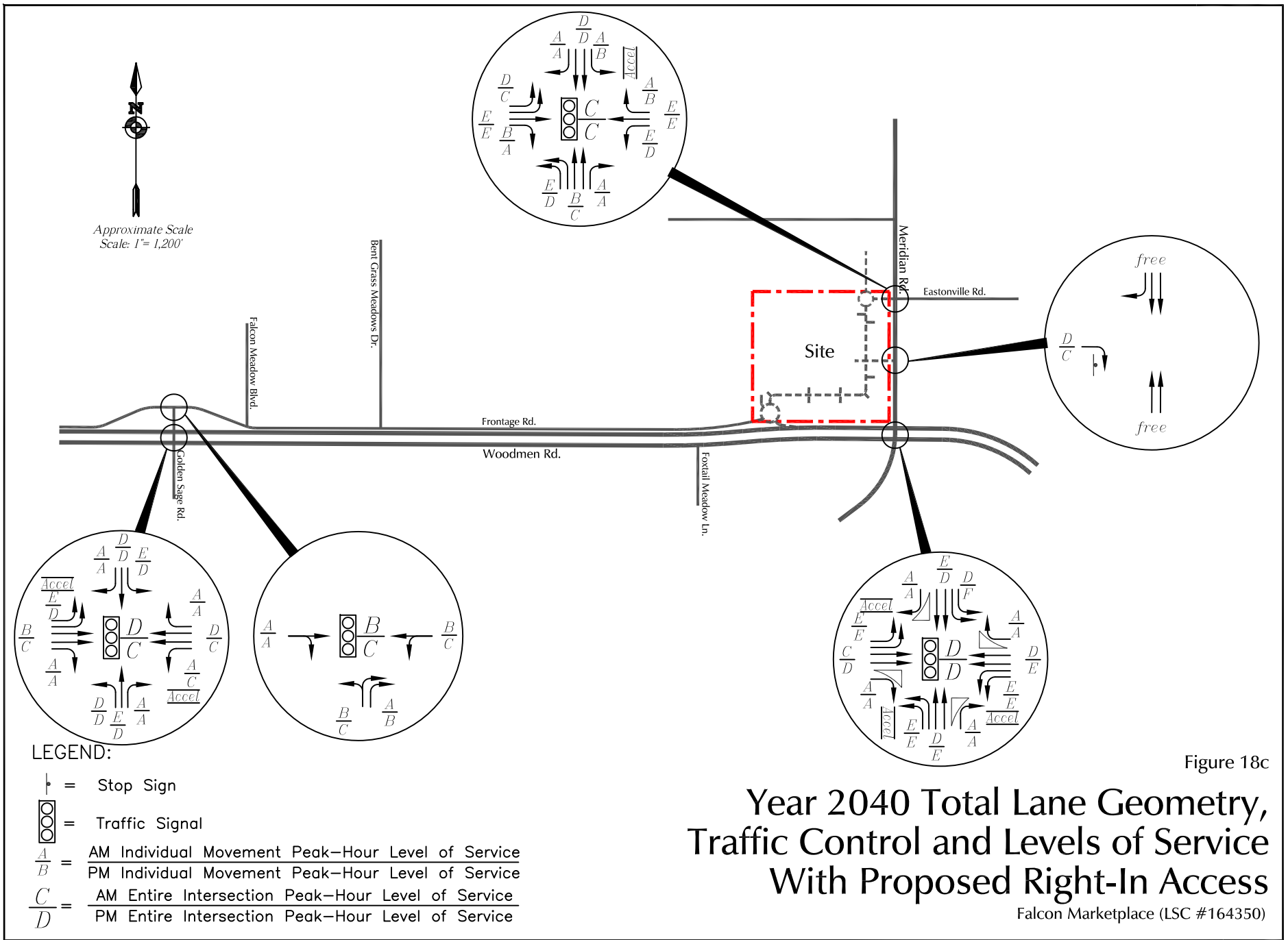


Figure 18c

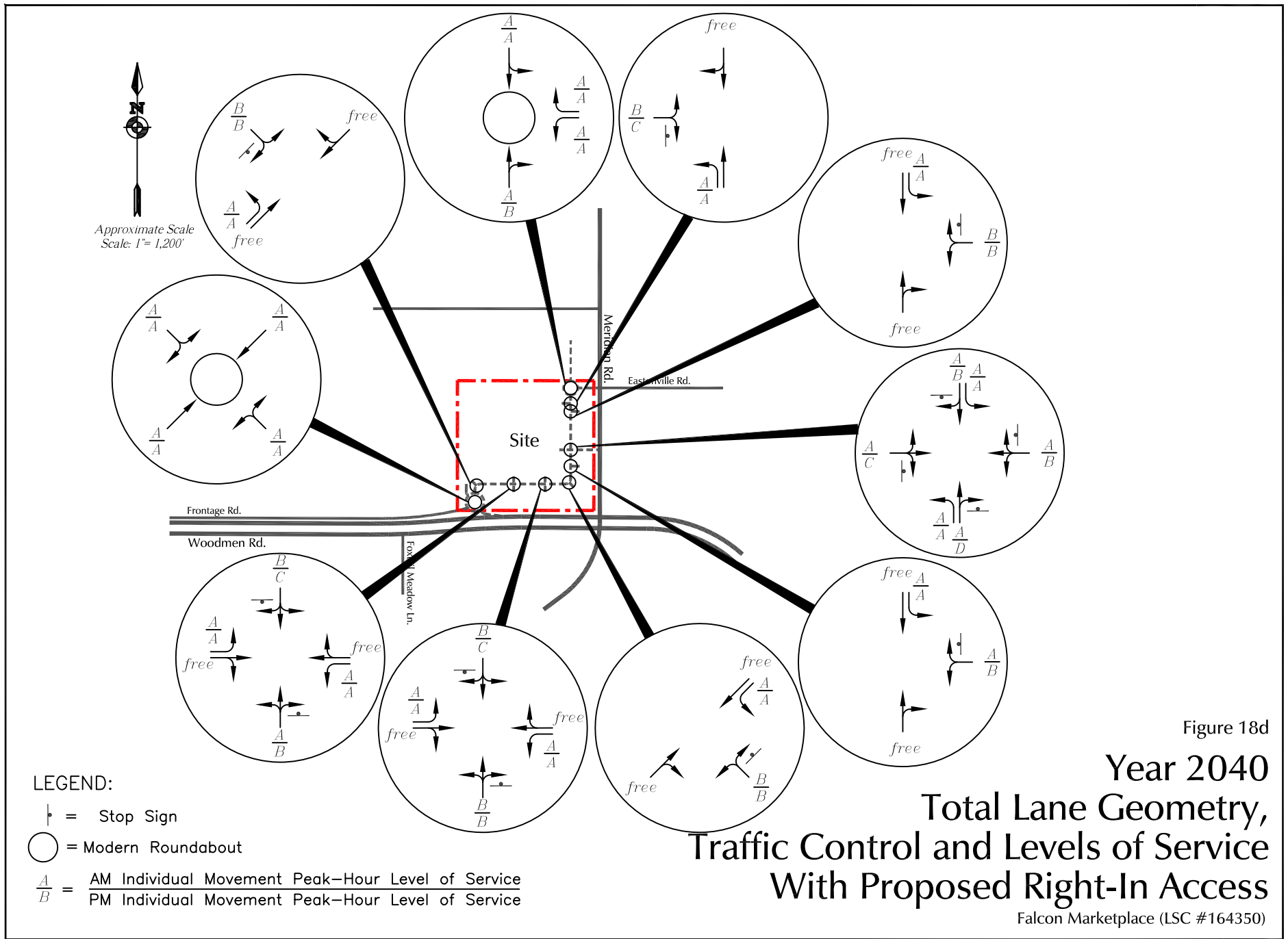


Figure 18d

# Year 2040 Total Lane Geometry, Traffic Control and Levels of Service With Proposed Right-In Access

Falcon Marketplace (LSC #164350)



LSC TRANSPORTATION CONSULTANTS, INC.  
2504 East Pikes Peak Avenue, Suite 304  
Colorado Springs, CO 80909  
(719) 633-2868  
FAX (719) 633-5430  
E-mail: [lsc@lsctrans.com](mailto:lsc@lsctrans.com)  
Website: <http://www.lsctrans.com>

## Falcon Meadows at Bent Grass Filing No. 4 Transportation Memorandum (LSC #S214333) October 7, 2022

### Traffic Engineer's Statement

This traffic report and supporting information were prepared under my responsible charge and they comport with the standard of care. So far as is consistent with the standard of care, said report was prepared in general conformance with the criteria established by the County for traffic reports.



### Developer's Statement

I, the Developer, have read and will comply with all commitments made on my behalf within this report.

---

\_\_\_\_\_  
Date

# **Falcon Meadows at Bent Grass**

## **Filing No. 4**

### **Transportation Memorandum**

Prepared for:  
Mr. Jim Byers  
VP of Community Development  
Challenger Homes  
8605 Explorer Dr, Suite 250  
Colorado Springs, CO 80920

**OCTOBER 7, 2022**

---

LSC Transportation Consultants  
Prepared by: Kirstin D. Ferrin, P.E.  
Reviewed by: Jeffrey C. Hodsdon, P.E.

LSC #S214333





## CONTENTS

LAND USE AND ACCESS .....	1
Land Use.....	1
Access .....	1
Sight Distance.....	2
Pedestrian Routes to Schools.....	2
EXISTING TRAFFIC CONDITIONS .....	2
TRIP GENERATION.....	3
PROJECTED SHORT-TERM ADDITIONAL TRAFFIC.....	3
SHORT-TERM TOTAL TRAFFIC .....	3
2040 TOTAL TRAFFIC.....	3
REQUIRED IMPROVEMENTS.....	4
ROADWAY CLASSIFICATIONS .....	6
ROAD IMPROVEMENT FEE PROGRAM .....	6
Enclosures:.....	6

Tables 1-2

Figures 1-7

Pages from the *Falcon Meadows at Bent Grass Updated Traffic Impact Study*  
December 11, 2020 (with updates noted)

Traffic Counts

Falcon Marketplace TIS Report Addendum



LSC TRANSPORTATION CONSULTANTS, INC.  
2504 East Pikes Peak Avenue, Suite 304  
Colorado Springs, CO 80909  
(719) 633-2868  
FAX (719) 633-5430  
E-mail: [lsc@lsctrans.com](mailto:lsc@lsctrans.com)  
Website: <http://www.lsctrans.com>

October 7, 2022

Mr. Jim Byers  
VP of Community Development  
Challenger Homes  
8605 Explorer Dr, Suite 250  
Colorado Springs, CO 80920

RE: Falcon Meadows at Bent Grass Filing No. 4  
El Paso County, CO  
Updated Transportation Memorandum  
LSC #S214333

Dear Mr. Byers,

LSC Transportation Consultants, Inc. has prepared this updated Transportation Memorandum for Falcon Meadows at Bent Grass Filing No. 4. The location of the site is shown in Figure 1. This report is intended as a site-specific, final-plat traffic report for the currently-proposed Filing 4.

LSC recently completed a traffic impact study (TIS) for the Falcon Meadows at Bent Grass PUD (PUDSP-20-005). This report was dated December 11, 2020. The land use and access currently proposed for Filing No. 4 is consistent with the land use and trip generation estimated and evaluated in that report.

Memos were also prepared for Filing 1 (dated September 28, 2021), Filing 2 (dated March 18, 2022), and Filing 3 (dated April 7, 2022).

## **LAND USE AND ACCESS**

### **Land Use**

Filing No. 4 is planned to include a total of 39 lots for single-family homes. The location of the lots to be included as part of currently-proposed Filing No. 4 was included in traffic-analysis zone (TAZ) 1 in the PUD TIS.

### **Access**

Two full-movement access points (Rowena Way and Henzilee Place) to the recently-completed section of Bent Grass Meadows Drive were approved as part of Falcon Meadows at Bent Grass

Filing No. 2. An additional access point (Lemon Grass Road) is proposed to be constructed as part of Filing No. 4. Please refer to the attached site-plan exhibit. Figure 2 shows the location of the access points.

### **Sight Distance**

Figure 3 shows a sight-distance analysis at the proposed Falcon Meadows at Bent Grass access points to Bent Grass Meadows Drive. Based on a design speed of 40 miles per hour (mph) on Bent Grass Meadows Drive and the criteria contained in Table 2-21 of the *Engineering Criteria Manual (ECM)*, the required intersection sight distance at the proposed site-access points is 445 feet. The required stopping sight distance from *ECM* Table 2-17 is also shown in the figure. The required intersection sight distance and stopping sight distance can be met at both intersections if the areas between the sight-distance lines and the curb line have low-level landscaping and are kept free of other obstructions (such as monument signs and parking areas) that would restrict the drivers' line of sight. Landscaping should be low — about 18 inches or lower in height — to the east of the passenger-vehicle lines of sight shown. Please refer to *ECM* Sections 2.3.6.G.1 and 2.

### **Pedestrian Routes to Schools**

- Woodmen and Meridian are shown as proposed bike routes on the *Major Transportation Corridors Plan (MTCP)* Non-Motorized Plan. Also shown is a proposed secondary regional trail west of the site.
- Bent Grass Meadows Drive is sufficiently wide for bicycles with the paved shoulder.
- There are developing pedestrian connections along the north side of the Woodmen North Frontage Road, Bent Grass Meadows Drive, and Meridian Park Drive. Other area sections of sidewalk/trail connections are being added as development occurs.
- Sidewalks have been added along Bent Grass Meadows Drive with the connection south to the frontage road, adjacent to the School District 49 headquarters.
- The subdivision streets will all have sidewalks to connect to the sidewalk along Bent Grass Meadows Drive.

### **EXISTING TRAFFIC CONDITIONS**

Figure 4 shows the existing morning and afternoon peak-hour traffic volumes at the intersections of Woodmen Road/Golden Sage Road and Meridian Road/Bent Grass Meadows Drive. The counts at the intersection of Woodmen Road/Golden Sage Road were counted in January 2020 and again in December 2020. The January 2020 counts were conducted prior to the completion of Bent Grass Meadows Drive between the Woodmen frontage road and Meridian Road, but before the restrictions due to the COVID-19 pandemic were put in place. Figure 4 shows the results of both the October 2018 counts and the October 2020 counts, as the more current counts were likely impacted by the COVID-19 pandemic. The traffic-count reports are attached.

## **TRIP GENERATION**

The site-generated vehicle trips were estimated using the nationally-published trip-generation rates from *Trip Generation, 11th Edition, 2021* by the Institute of Transportation Engineers (ITE). Table 1 shows the trip-generation estimates for Falcon Meadows at Bent Grass Filing No. 4.

Falcon Meadows at Bent Grass Filing No. 4 is expected to generate about 368 vehicle trips on the average weekday, with about half entering and half exiting the site during a 24-hour period. During the morning peak hour, which generally occurs for one hour between 6:30 a.m. and 8:30 a.m., about 7 vehicles would enter and 22 vehicles would exit the site. During the afternoon peak hour, which generally occurs for one hour between 4:15 p.m. and 6:15 p.m., about 24 vehicles would enter and 14 vehicles would exit the site.

## **PROJECTED SHORT-TERM ADDITIONAL TRAFFIC**

Figure 5 shows the projected additional traffic volumes at the intersections of Woodmen/Golden Sage and Meridian/Bent Grass Meadows due to Falcon Meadows at Bent Grass Filing No. 4. These volumes were calculated by applying the external trip-distribution percentages shown in Figure 7 of the PUD TIS to the trip generation shown in Table 1. Trips with destinations and/or origins within the area bound by Woodmen Road on the south and Meridian Road on the east have been assigned separately, based on the location of the future commercial and school uses within the study area.

Figure 5 also shows the projected additional traffic volumes at the intersections of Woodmen/Golden Sage and Meridian/Bent Grass Meadows due to Bent Grass Residential Filing 2 taken from the TIS dated January 24, 2020 (PCD File No. SF-1914), due to Falcon Meadows at Bent Grass Filing No. 1 taken from the September 2021 memorandum (PCD File NO. SF-2034), due to Falcon Meadows at Bent Grass Filing No. 2 taken from the March 2022 memorandum (PCD File NO. SF-2134), and due to Falcon Meadows at Bent Grass Filing No. 3 taken from the April 2022 memorandum (PCD File NO. SF-2216).

## **SHORT-TERM TOTAL TRAFFIC**

Figure 6 shows the projected short-term total traffic volumes at the intersections of Woodmen/Golden Sage and Meridian/Bent Grass Meadows. The volumes are the sum of the January 2020 traffic volumes (from Figure 4) plus the additional short-term traffic volumes (from Figure 5). Please refer to the PUD TIS for short-term total traffic volumes at the other area intersections and the short-term level of service analysis.

## **2040 TOTAL TRAFFIC**

Please refer to the PUD TIS for the 2040-total traffic volumes and level of service analysis.

## REQUIRED IMPROVEMENTS

Based on the projected short-term total traffic volumes from the PUD TIS, the classification of Bent Grass Meadows Drive as an Urban Non-Residential Collector, and the criteria contained in the *ECM*, right-turn deceleration lanes are **not** projected to be warranted on Bent Grass Meadows Drive approaching any of the Falcon Meadows at Bent Grass access points (Rowena Way, Henzlee Place, and Lemon Grass Road).

Based on the projected short-term total traffic volumes from the PUD TIS, the classification of Bent Grass Meadows Drive as an Urban Non-Residential Collector, and the criteria contained in the *ECM*, northeast-bound left-turn lanes are projected to be warranted on Bent Grass Meadows Drive approaching all of the Falcon Meadows at Bent Grass access points (Rowena Way, Henzlee Place, and Lemon Grass Road). Bent Grass Meadows Drive has been constructed with a center two-way, left-turn lane that will meet these criteria.

Please see a copy of Table 4 Roadway System Improvements from the PUD TIS with annotations added in September 2021 (as part of the Filing 1 memo), March 2022 (as part of the Filing 2 memo), April 2022 (as part of the Filing 3 memo) and June 2022 (for this memo) indicating the status of each improvement.

Regarding Improvement F, note that Bent Grass Meadows Drive has been completed between the Woodmen frontage road and Meridian Road since completion of the PUD TIS. The approved Filing 1 in Falcon Meadows at Bent Grass required construction, paving, and associated repairs to Bent Grass Meadows Drive south of the site, as deemed appropriate by the PCD Director and the County Engineer, including design and construction of an eastbound left-turn lane on Woodmen Frontage Road at Bent Grass Meadows Drive, if warranted, to meet the minimum standards of a Non-Residential Collector in accordance with the *Engineering Criteria Manual*. These road improvements may be eligible for cost recovery from adjacent developers.

Meeting were held with El Paso County PCD staff and City Traffic Engineering on March 14, 2022 and March 29, 2022 to discuss items G,H, I, and J in this table. The intersection is under city ownership/jurisdiction, however the ownership of the intersection of Golden Sage/N. Frontage Road is not clear. The city will be researching the ownership and the availability of potential additional ROW (if possible) to accommodate potential future alternative intersection options for the intersection of Golden Sage/N. Frontage Road and the approach legs to the south, east and west. It was determined that item H would not be needed at this time. Item I would likely be needed in the short term; however, it was agreed that Falcon Meadows at Bent Grass would only be required to provide escrow towards this improvement for future construction once ownership and the availability of potential additional ROW is determined.

As of the week of **June 20, 2022**, and a conversation with City Traffic staff, there are no updates to the above meeting notes. City staff indicated they would like the County to collect the escrow from this and all future Falcon Meadows at Bent Grass filings and then give the money to the City

to go towards future improvements at Golden Sage/Woodmen and Golden Sage/North Frontage Road.

Regarding Improvement G, protected/permitted phasing has been added to the intersection of Golden Sage/Woodmen. This improvement is complete.

Regarding Improvement H, the *Falcon Marketplace TIS Report Addendum* by LSC dated July 21, 2020 (PCD File No. SP-17-001/CDR-16-007) identified the trigger for the need to lengthen the current eastbound single left-turn deceleration lane on Woodmen Road approaching Golden Sage Road as when the eastbound left-turn volume is greater than 200 vehicles per hour (vph) during the afternoon peak hour. As shown in Figure 6, following buildout of Bent Grass Residential Filing No. 1 and Falcon Meadows at Bent Grass Filings Nos. 1, 2, 3 and 4, the projected volume for this movement is 222 vph during the afternoon peak hour. However, it should be noted that our understanding is that control over the intersection of Golden Sage/Woodmen has been transferred to the City of Colorado Springs as part of the Banning Lewis Ranch North Annexation (CPC A 19-00022). The outcome of a meeting with the city was that item H would not be needed at this time.

Regarding Improvement I, the *Falcon Marketplace TIS Report Addendum* by LSC dated July 21, 2020 (PCD File No. SP-17-001/CDR-16-007) identified the trigger for the need to for an exclusive southbound right-turn deceleration lane on Golden Sage Road approaching Woodmen Road as when the southbound left-turn volume is greater than 167 to 192 vph during the morning peak hour. As shown in Figure 6, following buildout of Bent Grass Residential Filing No. 1 and Falcon Meadows at Bent Grass Filings Nos. 1, 2, 3 and 4, the projected volume for this movement is 225 vph during the morning peak hour. This exceeds the estimated trigger identified that would require the construction of an exclusive southbound right-turn deceleration lane. However, recent analysis suggests that the existing laneage will accommodate Filing 4 traffic. Also note that control over the intersection of Golden Sage/Woodmen has transferred to the City of Colorado Springs as part of the Banning Lewis Ranch North Annexation (CPC A 19-00022). The outcome of meetings with the city was that escrow would be collected for improvement I for future construction once right-of-way and ownership issues are resolved.

Table 2 shows the percentage of the projected 2040 total traffic due to Falcon Meadows at Bent Grass Filing No 4 for Improvements H, I, and J. These percentages could be used to determine the pro-rata share of the cost of intersection improvements. However, it should be noted that control over the intersection of Golden Sage/Woodmen has been transferred to the City of Colorado Springs as part of the Banning Lewis Ranch North Annexation (CPC A 19-00022). Per the paragraph above, additional research is underway which will be helpful in determining a solution for Golden Sage/N. Frontage Road.



## **ROADWAY CLASSIFICATIONS**

Figure 7 shows the recommended internal street classifications.

## **ROAD IMPROVEMENT FEE PROGRAM**

Applicable fees will need to be paid to the Woodmen Road District pursuant to the agreement between El Paso County and the Woodmen Road District.

\* \* \* \* \*

Please contact me if you have any questions regarding this report.

Respectfully Submitted,

LSC TRANSPORTATION CONSULTANTS, INC.

By: Jeffrey C. Hodsdon, P.E.  
Principal

JCH/KDF:jas

Enclosures: Tables 1-2  
Figures 1-7  
Pages from the *Falcon Meadows at Bent Grass Updated Traffic Impact Study*  
December 11, 2020 (with updates noted)  
Traffic Counts  
Falcon Marketplace TIS Report Addendum

# Tables 1-2

---



**Table 1  
Trip Generation Estimate  
Falcon Meadows at Bent Grass Filing No. 4**

Land Use Code	Land Use Description	Trip Generation Units	Trip Generation Rates <sup>(1)</sup>				Total Trips Generated					
			Average Weekday Traffic	Morning Peak Hour		Afternoon Peak Hour		Average Weekday Traffic	Morning Peak Hour		Afternoon Peak Hour	
				In	Out	In	Out		In	Out	In	Out
210	Single-Family Detached Housing	39 DU <sup>(2)</sup>	9.44	0.19	0.56	0.62	0.37	368	7	22	24	14

Notes:  
(1) Source: "Trip Generation, 11th Edition, 2017" by the Institute of Transportation Engineers (ITE)  
(2) DU = dwelling unit

Source: LSC Transportation Consultants, Inc. Jun-22

**Table 2**  
**Prorata Share Contribution Calculations<sup>(1)</sup>**  
**Falcon Meadows at Bent Grass Filing No. 4**

Item	Improvement Description and Estimated Cost		AM	PM	AM + PM	
H	Lengthening of the current eastbound single left-turn deceleration lane on Woodmen approaching Golden Sage Road		Site-Generated Traffic <sup>(2)</sup> (vehicles per hour)	4	12	16
			2040 Total Traffic <sup>(2)</sup> (vehicles per hour)	319	447	766
			%	1.25%	2.68%	2.09%
	Estimated Improvement Cost:	\$ 200,000	Estimated Fair-Share Portion for this project based on calculated AM + PM percentage:	\$ 4,178		
I	Southbound exclusive right-turn lane on Golden Sage Road approaching Woodmen Road		Site-Generated Traffic <sup>(3)</sup> (vehicles per hour)	11	7	18
			2040 Total Traffic <sup>(3)</sup> (vehicles per hour)	392	391	783
			%	2.81%	1.79%	2.30%
	Estimated Improvement Cost:	\$ 100,000	Estimated Fair-Share Portion for this project based on calculated AM + PM percentage:	\$ 2,299		
J	Signalization of Golden Sage Road/Woodmen Frontage Road or reconstruction as a modern roundabout; Future additional laneage may be necessary at this intersection to accommodate vehicle queues and for traffic operations.		Site-Generated Traffic <sup>(4)</sup> (vehicles per hour)	15	19	34
			2040 Total Traffic <sup>(4)</sup> (vehicles per hour)	979	1183	2162
			%	1.53%	1.61%	1.57%
	Estimated Improvement Cost:	\$ 350,000	Estimated Fair-Share Portion for this project based on calculated AM + PM percentage:	\$ 5,504		

Notes:

(1) The improvements and fair shares are to be verified with an updated traffic impact analysis or memorandum as appropriate with each final plat in the Falcon Meadows at Bent Grass development. An escrow agreement, including a financial assurance estimate for the intersection improvements, as approved by the Planning and Community Development Department Director and the County Attorney's Office shall be completed and escrow deposited with each final plat for the respective improvements within the County's jurisdiction. It should be noted that our understanding is that control over the intersection of Golden Sage/Woodmen is being transferred to the City of Colorado Springs as part of the Banning Lewis Ranch North Annexation (CPC A 19-00022).

(2) Eastbound left-turn volume at the intersection of Woodmen/Golden Sage

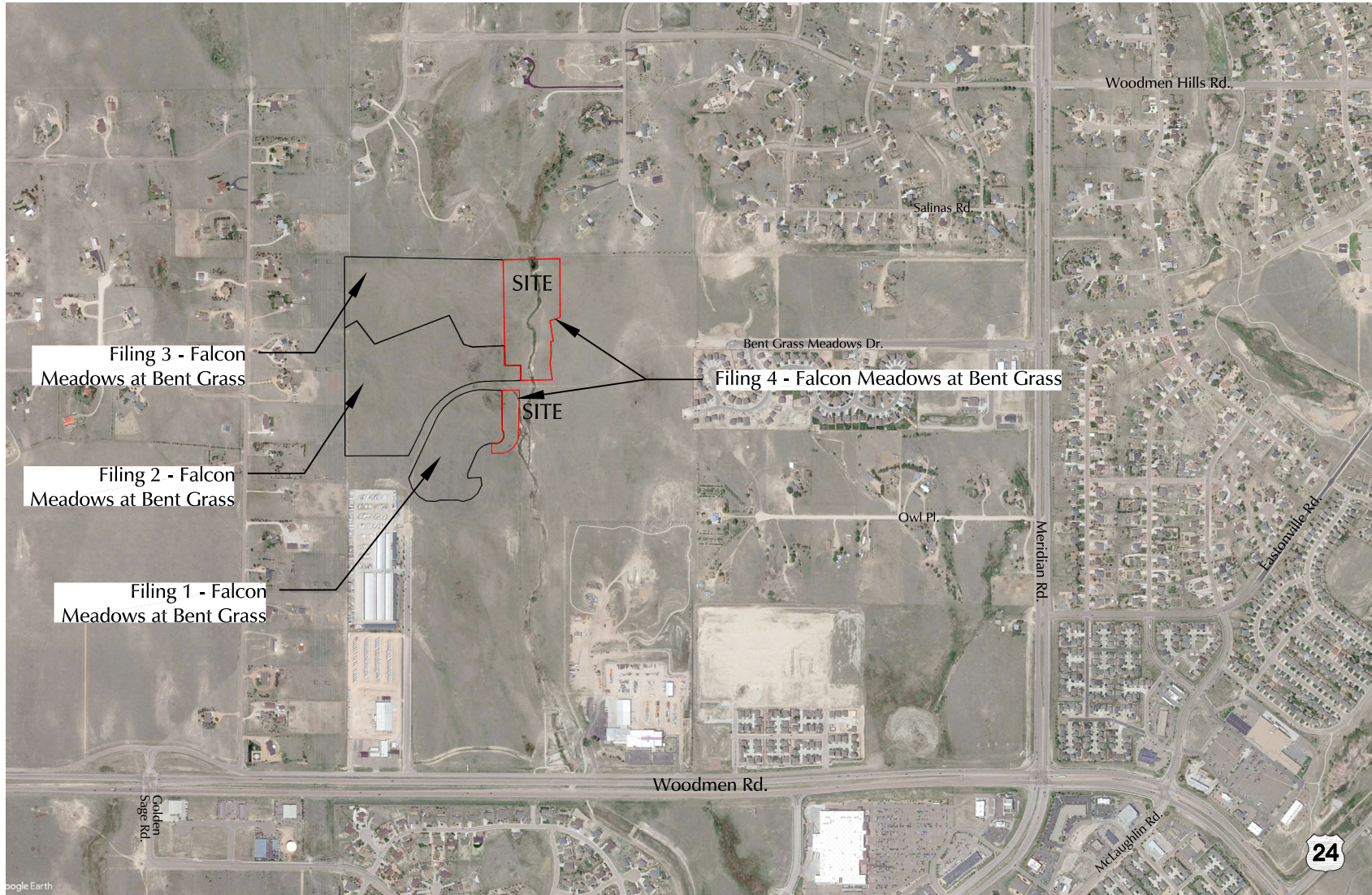
(3) Southbound right-turn volume at the intersection of Woodmen/Golden Sage

(4) Sum of all traffic volumes at the intersection of Golden Sage/Woodmen frontage road

# Figures 1-7

---






  
 Approximate Scale  
 Scale: 1" = 1,200'

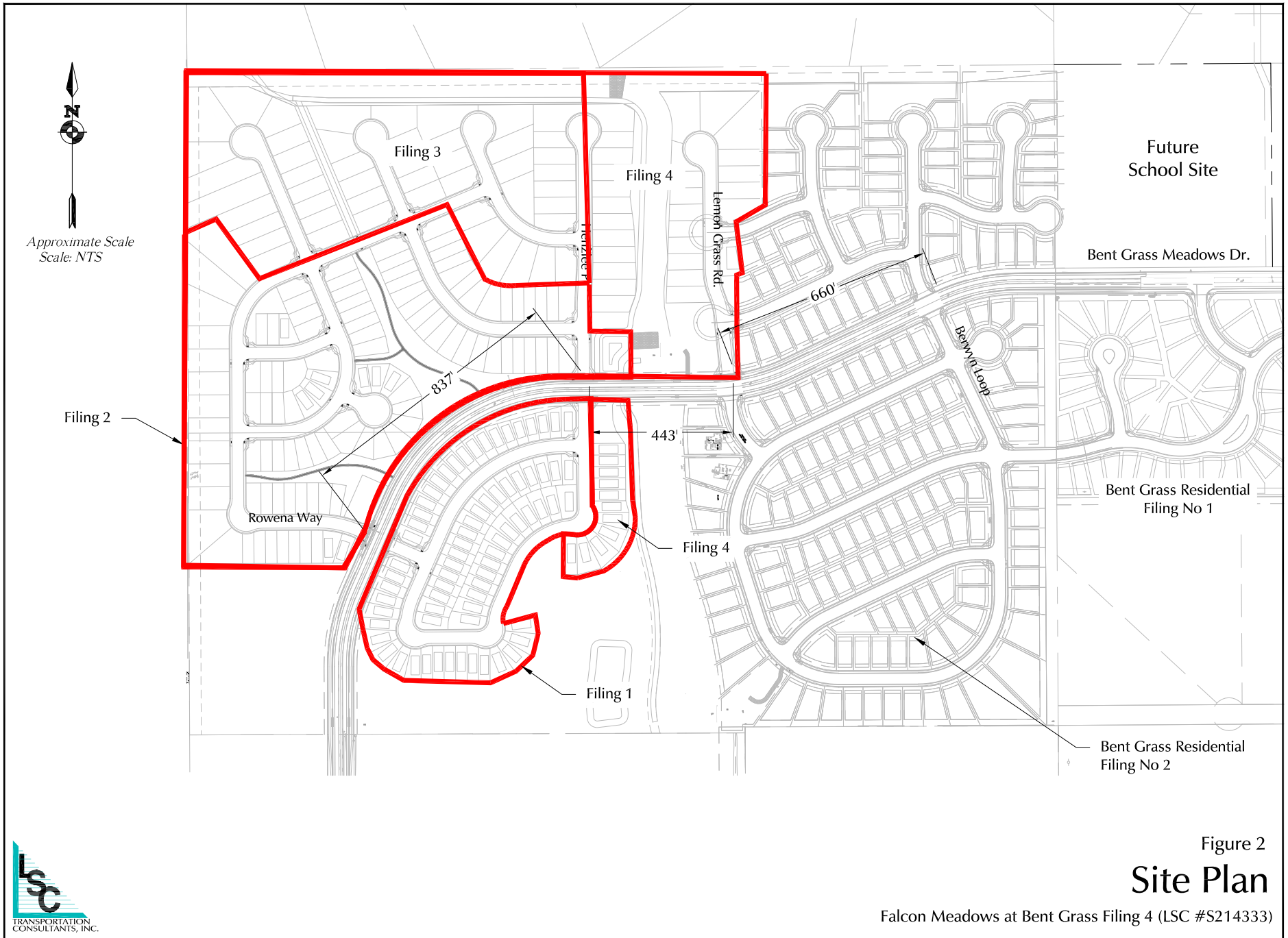
Figure 1

# Vicinity Map

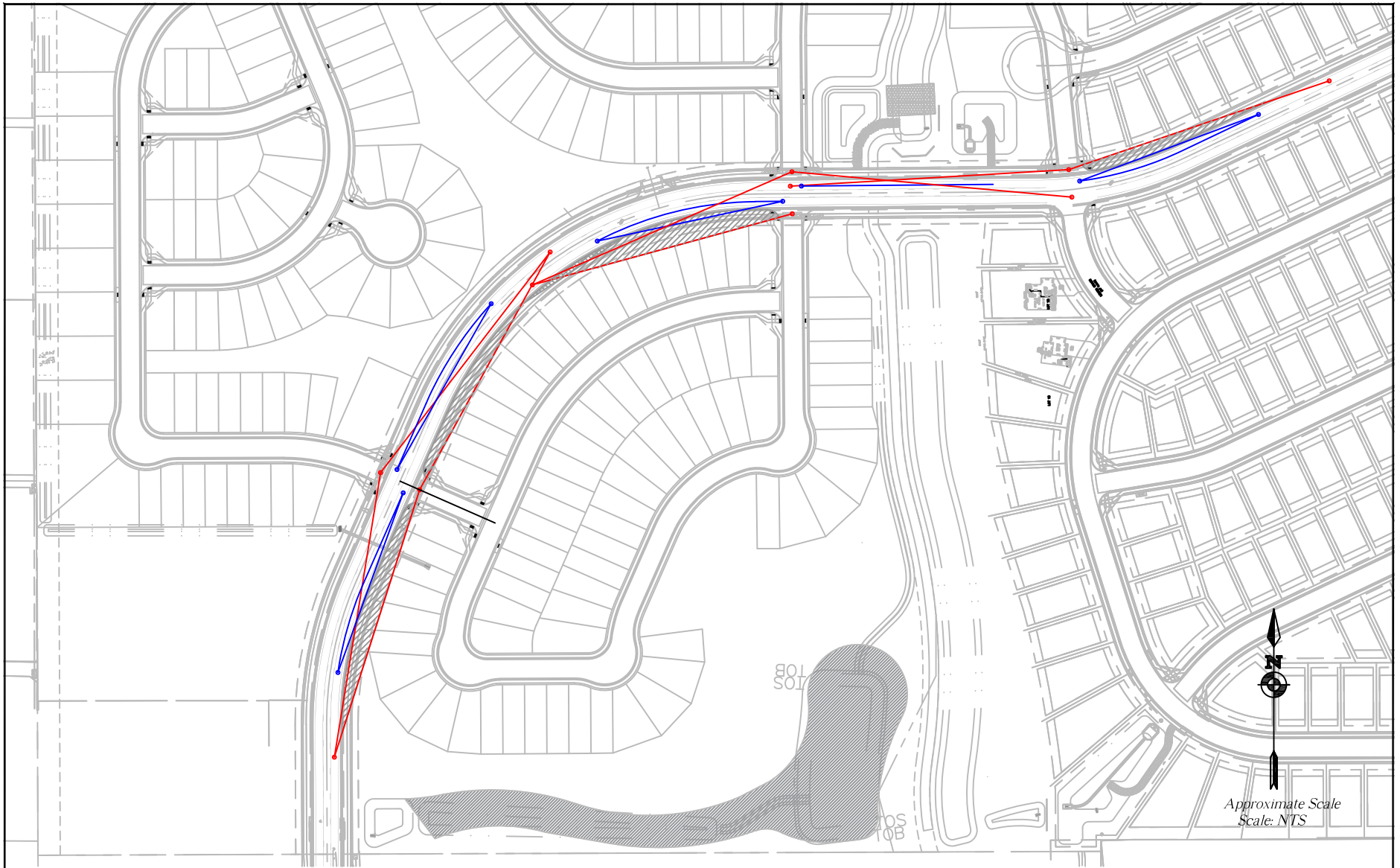
Falcon Meadows at Bent Grass Filing 4 (LSC #S214333)











Approximate Scale  
Scale: NTS

LEGEND:

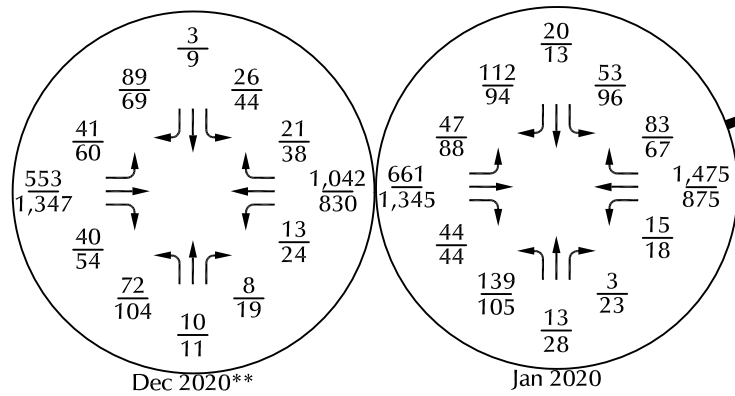
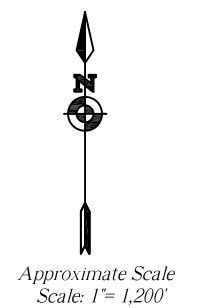
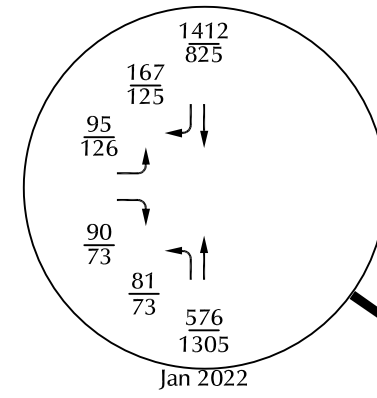
- = ECM Required Intersection Sight Distance (445' based on design speed of 40mph from Table 2-21)
- ←←← = ECM Required Stopping Sight Distance Travel Path (305' based on design speed of 40mph from Table 2-17)
- = Stopping Sight Distance Sight Line
- = Area must be kept clear of obstructions to intersection distance line of sight.



Figure 3  
**Sight Distance**

Falcon Meadows at Bent Grass Filing 4 (LSC #S214333)

\*\*The January 2020 counts were conducted prior to the completion of Bent Grass Meadows Drive between the Woodmen frontage road and Meridian Ranch, but before impacts of the COVID-19 pandemic. The December 2020 counts were conducted following the completion of Bent Grass Meadows Drive between the Woodmen frontage road and Meridian Ranch, but during the COVID-19 pandemic.



LEGEND:

$\frac{XX}{XX}$  = AM Weekday Peak-Hour Traffic (vehicles per hour)  
 $\frac{XX}{XX}$  = PM Weekday Peak-Hour Traffic (vehicles per hour)

X,XXX= Average Daily Traffic (vehicles per day)

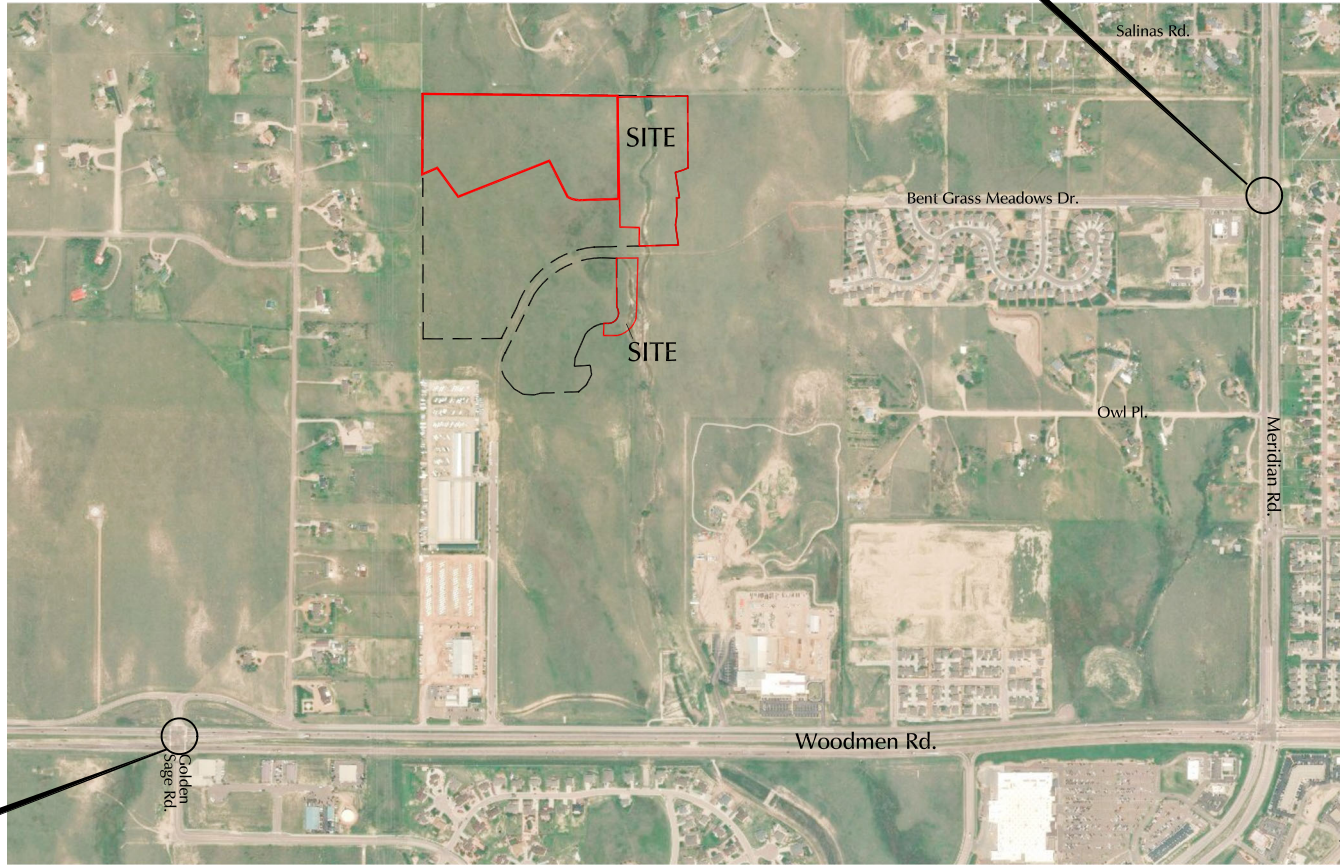
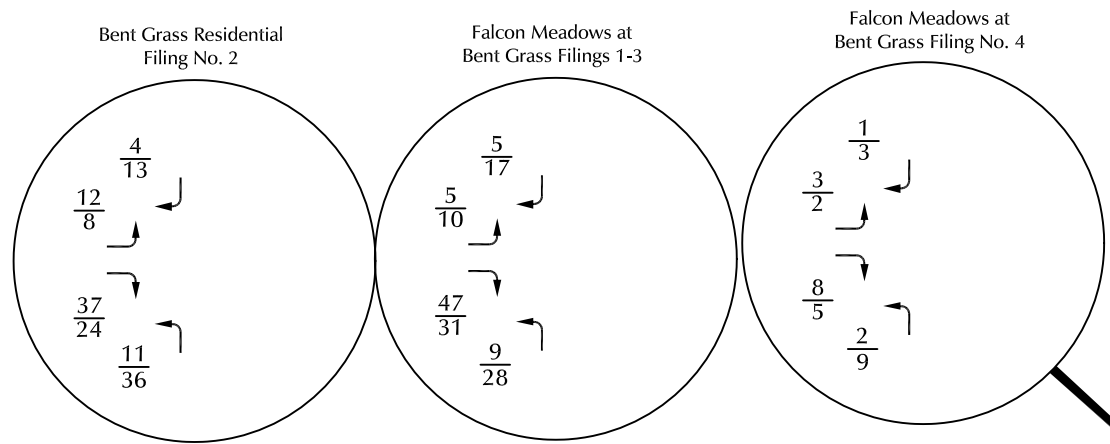


Figure 4

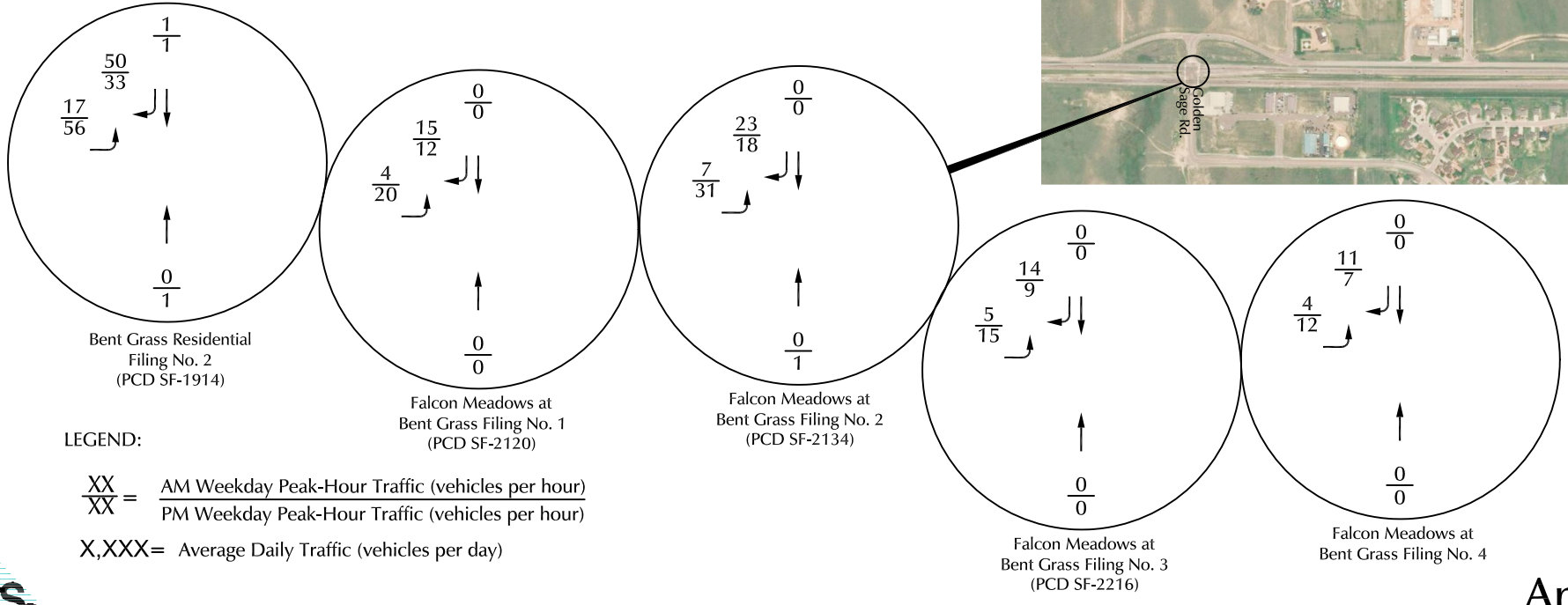
# Existing Traffic

Falcon Meadows at Bent Grass Filing 4 (LSC #S214333)





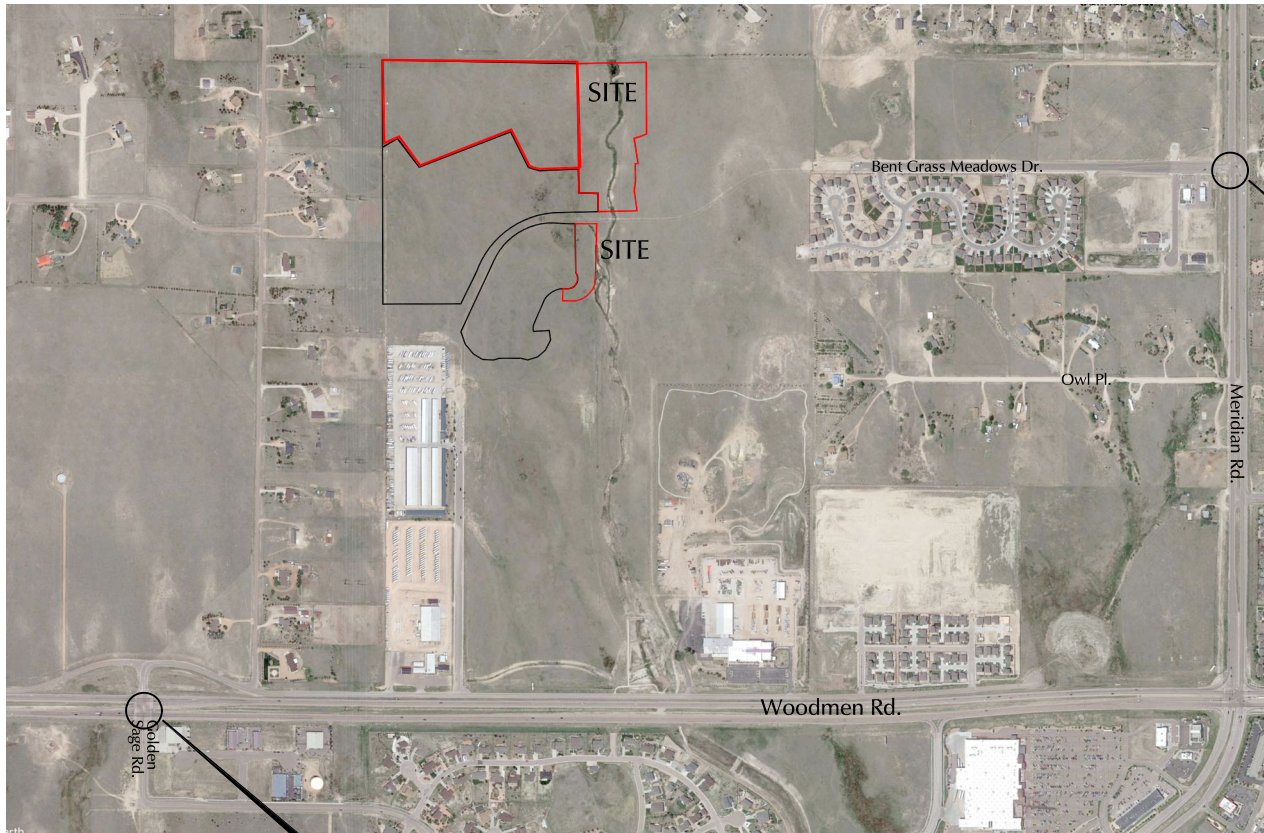
Approximate Scale  
Scale: 1" = 1,200'



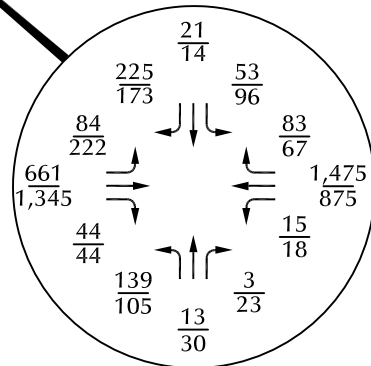
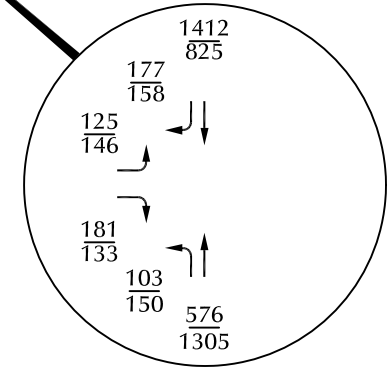
LEGEND:  
 $\frac{XX}{XX}$  = AM Weekday Peak-Hour Traffic (vehicles per hour)  
 $\frac{XX}{XX}$  = PM Weekday Peak-Hour Traffic (vehicles per hour)  
 X,XXX= Average Daily Traffic (vehicles per day)



Figure 5  
**Anticipated Additional Short-Term Traffic Volumes**  
 Falcon Meadows at Bent Grass Filing 4 (LSC #S214333)



Approximate Scale  
NTS



\*The short-term total traffic volumes are the sum of the January 2020 volumes from Figure 4 plus the anticipated additional short-term traffic volumes from Figure 5.



LEGEND:

$\frac{XX}{XX}$  = AM Weekday Peak-Hour Traffic (vehicles per hour)  
 $\frac{XX}{XX}$  = PM Weekday Peak-Hour Traffic (vehicles per hour)

Figure 6  
**Short-Term Total\* Traffic**  
 Falcon Meadows at Bent Grass Filing 4 (LSC #S214333)

**APPENDIX F - Background 2024 & 2040 Synchro Outputs**



Timings  
1: MERIDIAN ROAD & WOODMAN ROAD

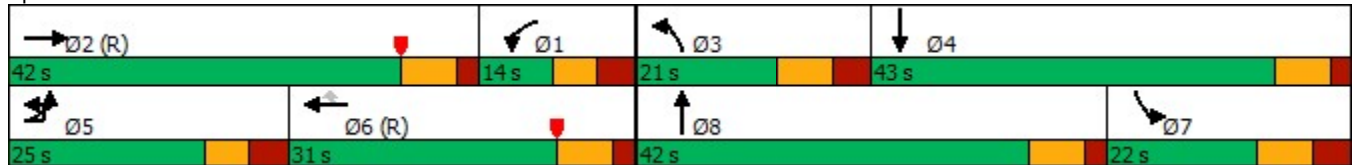
Background 2024 AM  
04/10/2023

Lane Group	EBL	EBT	EBR	WBL	WBT	WBR	NBL	NBT	NBR	SBL	SBT	SBR
Lane Configurations												
Traffic Volume (vph)	279	226	122	61	413	132	182	305	18	196	743	754
Future Volume (vph)	279	226	122	61	413	132	182	305	18	196	743	754
Turn Type	Prot	NA	Free	Prot	NA	Perm	Prot	NA	Free	Prot	NA	Free
Protected Phases	5	2		1	6		3	8		7	4	
Permitted Phases			Free			6			Free			Free
Detector Phase	5	2		1	6	6	3	8		7	4	
Switch Phase												
Minimum Initial (s)	5.0	15.0		5.0	15.0	15.0	5.0	15.0		5.0	15.0	
Minimum Split (s)	13.5	22.0		13.5	22.0	22.0	13.5	22.0		13.5	22.0	
Total Split (s)	25.0	42.0		14.0	31.0	31.0	21.0	42.0		22.0	43.0	
Total Split (%)	20.8%	35.0%		11.7%	25.8%	25.8%	17.5%	35.0%		18.3%	35.8%	
Yellow Time (s)	4.0	5.0		4.0	5.0	5.0	5.0	5.0		5.0	5.0	
All-Red Time (s)	3.5	2.0		3.5	2.0	2.0	3.5	2.0		3.5	2.0	
Lost Time Adjust (s)	0.0	0.0		0.0	0.0	0.0	0.0	0.0		0.0	0.0	
Total Lost Time (s)	7.5	7.0		7.5	7.0	7.0	8.5	7.0		8.5	7.0	
Lead/Lag	Lead	Lead		Lag	Lag	Lag	Lead	Lead		Lag	Lag	
Lead-Lag Optimize?	Yes	Yes		Yes	Yes	Yes	Yes	Yes		Yes	Yes	
Recall Mode	None	C-Max		None	C-Max	C-Max	None	None		None	None	
Act Effct Green (s)	16.0	42.3	120.0	6.3	30.0	30.0	11.2	16.9	120.0	27.2	32.8	120.0
Actuated g/C Ratio	0.13	0.35	1.00	0.05	0.25	0.25	0.09	0.14	1.00	0.23	0.27	1.00
v/c Ratio	0.74	0.21	0.09	0.36	0.50	0.24	0.59	0.64	0.01	0.27	0.84	0.52
Control Delay	60.4	30.1	0.1	60.6	42.4	0.9	59.9	54.7	0.0	33.4	41.1	2.4
Queue Delay	0.0	0.0	0.0	0.0	0.0	0.0	0.0	0.0	0.0	0.0	0.0	0.0
Total Delay	60.4	30.1	0.1	60.6	42.4	0.9	59.9	54.7	0.0	33.4	41.1	2.4
LOS	E	C	A	E	D	A	E	D	A	C	D	A
Approach Delay		38.1			35.3			54.6			23.0	
Approach LOS		D			D			D			C	

Intersection Summary

Cycle Length: 120  
 Actuated Cycle Length: 120  
 Offset: 30 (25%), Referenced to phase 2:EBT and 6:WBT, Start of Yellow  
 Natural Cycle: 80  
 Control Type: Actuated-Coordinated  
 Maximum v/c Ratio: 0.84  
 Intersection Signal Delay: 32.5  
 Intersection LOS: C  
 Intersection Capacity Utilization 71.5%  
 ICU Level of Service C  
 Analysis Period (min) 15

Splits and Phases: 1: MERIDIAN ROAD & WOODMAN ROAD



Queues  
1: MERIDIAN ROAD & WOODMAN ROAD

Background 2024 AM  
04/10/2023



Lane Group	EBL	EBT	EBR	WBL	WBT	WBR	NBL	NBT	NBR	SBL	SBT	SBR
Lane Group Flow (vph)	340	266	144	65	439	140	190	318	19	213	808	820
v/c Ratio	0.74	0.21	0.09	0.36	0.50	0.24	0.59	0.64	0.01	0.27	0.84	0.52
Control Delay	60.4	30.1	0.1	60.6	42.4	0.9	59.9	54.7	0.0	33.4	41.1	2.4
Queue Delay	0.0	0.0	0.0	0.0	0.0	0.0	0.0	0.0	0.0	0.0	0.0	0.0
Total Delay	60.4	30.1	0.1	60.6	42.4	0.9	59.9	54.7	0.0	33.4	41.1	2.4
Queue Length 50th (ft)	130	80	0	25	158	0	73	125	0	80	338	13
Queue Length 95th (ft)	170	112	0	49	221	0	111	167	0	m85	m345	m29
Internal Link Dist (ft)		1165			1100			342				860
Turn Bay Length (ft)	500		630	350		250	440		330	490		450
Base Capacity (vph)	500	1246	1583	185	883	589	357	1032	1583	776	1061	1583
Starvation Cap Reductn	0	0	0	0	0	0	0	0	0	0	0	0
Spillback Cap Reductn	0	0	0	0	0	0	0	0	0	0	0	0
Storage Cap Reductn	0	0	0	0	0	0	0	0	0	0	0	0
Reduced v/c Ratio	0.68	0.21	0.09	0.35	0.50	0.24	0.53	0.31	0.01	0.27	0.76	0.52

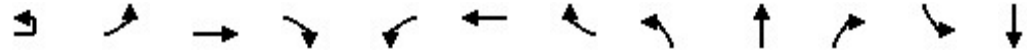
Intersection Summary

m Volume for 95th percentile queue is metered by upstream signal.



HCM 6th Signalized Intersection Summary  
1: MERIDIAN ROAD & WOODMAN ROAD

Background 2024 AM  
04/10/2023



Movement	EBU	EBL	EBT	EBR	WBL	WBT	WBR	NBL	NBT	NBR	SBL	SBT
Lane Configurations		↔↔	↕↕	↔	↔↔	↕↕	↔↔	↔	↔↔	↔	↔↔	↕↕
Traffic Volume (veh/h)	10	279	226	122	61	413	132	182	305	18	196	743
Future Volume (veh/h)	10	279	226	122	61	413	132	182	305	18	196	743
Initial Q (Qb), veh		0	0	0	0	0	0	0	0	0	0	0
Ped-Bike Adj(A_pbT)		1.00		1.00	1.00		1.00	1.00		1.00	1.00	
Parking Bus, Adj		1.00	1.00	1.00	1.00	1.00	1.00	1.00	1.00	1.00	1.00	1.00
Work Zone On Approach			No			No			No			No
Adj Sat Flow, veh/h/ln		1870	1870	1870	1870	1870	1870	1870	1870	1870	1870	1870
Adj Flow Rate, veh/h		328	266	0	65	439	0	190	318	0	213	808
Peak Hour Factor		0.85	0.85	0.85	0.94	0.94	0.94	0.96	0.96	0.96	0.92	0.92
Percent Heavy Veh, %		2	2	2	2	2	2	2	2	2	2	2
Cap, veh/h		392	1036		388	1018		250	444		764	928
Arrive On Green		0.11	0.29	0.00	0.11	0.29	0.00	0.07	0.13	0.00	0.22	0.26
Sat Flow, veh/h		3456	3554	1585	3456	3554	1585	3456	3554	1585	3456	3554
Grp Volume(v), veh/h		328	266	0	65	439	0	190	318	0	213	808
Grp Sat Flow(s),veh/h/ln		1728	1777	1585	1728	1777	1585	1728	1777	1585	1728	1777
Q Serve(g_s), s		11.2	6.9	0.0	2.0	12.1	0.0	6.5	10.3	0.0	6.1	26.1
Cycle Q Clear(g_c), s		11.2	6.9	0.0	2.0	12.1	0.0	6.5	10.3	0.0	6.1	26.1
Prop In Lane		1.00		1.00	1.00		1.00	1.00		1.00	1.00	
Lane Grp Cap(c), veh/h		392	1036		388	1018		250	444		764	928
V/C Ratio(X)		0.84	0.26		0.17	0.43		0.76	0.72		0.28	0.87
Avail Cap(c_a), veh/h		504	1036		388	1018		360	1036		764	1066
HCM Platoon Ratio		1.00	1.00	1.00	1.00	1.00	1.00	1.00	1.00	1.00	1.00	1.00
Upstream Filter(I)		1.00	1.00	0.00	1.00	1.00	0.00	1.00	1.00	0.00	1.00	1.00
Uniform Delay (d), s/veh		52.1	32.5	0.0	48.2	34.9	0.0	54.6	50.5	0.0	38.8	42.4
Incr Delay (d2), s/veh		9.4	0.6	0.0	0.2	1.3	0.0	5.7	2.2	0.0	0.2	7.2
Initial Q Delay(d3),s/veh		0.0	0.0	0.0	0.0	0.0	0.0	0.0	0.0	0.0	0.0	0.0
%ile BackOfQ(50%),veh/ln		5.2	3.0	0.0	0.9	5.3	0.0	3.0	4.7	0.0	2.6	12.2
Unsig. Movement Delay, s/veh												
LnGrp Delay(d),s/veh		61.5	33.1	0.0	48.4	36.2	0.0	60.3	52.6	0.0	39.0	49.6
LnGrp LOS		E	C		D	D		E	D		D	D
Approach Vol, veh/h			594	A		504	A		508	A		1021
Approach Delay, s/veh			48.8			37.8			55.5			47.4
Approach LOS			D			D			E			D
Timer - Assigned Phs	1	2	3	4	5	6	7	8				
Phs Duration (G+Y+Rc), s	21.0	42.0	17.2	39.8	21.1	41.9	35.0	22.0				
Change Period (Y+Rc), s	7.5	7.0	8.5	* 8.5	7.5	* 7.5	8.5	7.0				
Max Green Setting (Gmax), s	6.5	35.0	12.5	* 36	17.5	* 24	13.5	35.0				
Max Q Clear Time (g_c+I1), s	4.0	8.9	8.5	28.1	13.2	14.1	8.1	12.3				
Green Ext Time (p_c), s	0.0	1.5	0.2	3.3	0.5	1.8	0.3	1.9				

Intersection Summary

HCM 6th Ctrl Delay	47.4
HCM 6th LOS	D

Notes

- User approved pedestrian interval to be less than phase max green.
- User approved ignoring U-Turning movement.
- \* HCM 6th computational engine requires equal clearance times for the phases crossing the barrier.

Movement	SBR
Lane Configurations	
Traffic Volume (veh/h)	754
Future Volume (veh/h)	754
Initial Q (Qb), veh	0
Ped-Bike Adj(A_pbT)	1.00
Parking Bus, Adj	1.00
Work Zone On Approach	
Adj Sat Flow, veh/h/ln	1870
Adj Flow Rate, veh/h	0
Peak Hour Factor	0.92
Percent Heavy Veh, %	2
Cap, veh/h	
Arrive On Green	0.00
Sat Flow, veh/h	1585
Grp Volume(v), veh/h	0
Grp Sat Flow(s),veh/h/ln	1585
Q Serve(g_s), s	0.0
Cycle Q Clear(g_c), s	0.0
Prop In Lane	1.00
Lane Grp Cap(c), veh/h	
V/C Ratio(X)	
Avail Cap(c_a), veh/h	
HCM Platoon Ratio	1.00
Upstream Filter(l)	0.00
Uniform Delay (d), s/veh	0.0
Incr Delay (d2), s/veh	0.0
Initial Q Delay(d3),s/veh	0.0
%ile BackOfQ(50%),veh/ln	0.0
Unsig. Movement Delay, s/veh	
LnGrp Delay(d),s/veh	0.0
LnGrp LOS	
Approach Vol, veh/h	A
Approach Delay, s/veh	
Approach LOS	
Timer - Assigned Phs	
Unsignalized Delay for [NBR, EBR, WBR, SBR] is excluded from calculations of the approach delay and intersection delay.	

Timings  
2: MERIDIAN ROAD & EASTONVILLE ROAD

Background 2024 AM  
04/10/2023

Lane Group	EBL	EBT	EBR	WBL	WBT	WBR	NBL	NBT	NBR	SBL	SBT	SBR
Lane Configurations												
Traffic Volume (vph)	218	52	262	100	56	37	293	434	42	114	1373	187
Future Volume (vph)	218	52	262	100	56	37	293	434	42	114	1373	187
Turn Type	pm+pt	NA	Perm	pm+pt	NA	Perm	Prot	NA	Perm	Prot	NA	Perm
Protected Phases	7	4		3	8		5	2		1	6	
Permitted Phases	4		4	8		8			2			6
Detector Phase	7	4	4	3	8	8	5	2	2	1	6	6
Switch Phase												
Minimum Initial (s)	5.0	8.0	8.0	5.0	8.0	8.0	5.0	15.0	15.0	5.0	15.0	15.0
Minimum Split (s)	12.5	14.5	14.5	12.5	14.5	14.5	12.5	22.5	22.5	13.5	22.5	22.5
Total Split (s)	13.0	16.0	16.0	13.0	16.0	16.0	32.0	67.0	67.0	24.0	59.0	59.0
Total Split (%)	10.8%	13.3%	13.3%	10.8%	13.3%	13.3%	26.7%	55.8%	55.8%	20.0%	49.2%	49.2%
Yellow Time (s)	4.0	4.0	4.0	4.0	4.0	4.0	4.0	5.5	5.5	5.0	5.5	5.5
All-Red Time (s)	3.5	2.5	2.5	3.5	2.5	2.5	3.5	2.0	2.0	3.5	2.0	2.0
Lost Time Adjust (s)	0.0	0.0	0.0	0.0	0.0	0.0	0.0	0.0	0.0	0.0	0.0	0.0
Total Lost Time (s)	7.5	6.5	6.5	7.5	6.5	6.5	7.5	7.5	7.5	8.5	7.5	7.5
Lead/Lag	Lead	Lag	Lag	Lead	Lag	Lag	Lead	Lag	Lag	Lead	Lag	Lag
Lead-Lag Optimize?	Yes	Yes	Yes	Yes	Yes	Yes	Yes	Yes	Yes	Yes	Yes	Yes
Recall Mode	None	None	None	None	None	None	None	C-Max	C-Max	None	C-Max	C-Max
Act Effct Green (s)	14.9	8.9	8.9	12.0	8.9	8.9	24.8	62.6	62.6	13.0	51.8	51.8
Actuated g/C Ratio	0.12	0.07	0.07	0.10	0.07	0.07	0.21	0.52	0.52	0.11	0.43	0.43
v/c Ratio	0.75	0.44	0.85	0.71	0.43	0.11	0.95	0.28	0.05	0.65	0.99	0.25
Control Delay	61.9	63.5	32.3	71.2	63.1	0.6	77.2	14.0	1.3	76.9	43.1	3.3
Queue Delay	0.0	0.0	0.0	0.0	0.0	0.0	0.0	0.0	0.0	0.0	0.0	0.0
Total Delay	61.9	63.5	32.3	71.2	63.1	0.6	77.2	14.0	1.3	76.9	43.1	3.3
LOS	E	E	C	E	E	A	E	B	A	E	D	A
Approach Delay		47.5			55.3			37.4			40.9	
Approach LOS		D			E			D			D	

Intersection Summary

Cycle Length: 120  
 Actuated Cycle Length: 120  
 Offset: 45 (38%), Referenced to phase 2:NBT and 6:SBT, Start of Yellow  
 Natural Cycle: 110  
 Control Type: Actuated-Coordinated  
 Maximum v/c Ratio: 0.99  
 Intersection Signal Delay: 42.0  
 Intersection Capacity Utilization 85.0%  
 Analysis Period (min) 15  
 Intersection LOS: D  
 ICU Level of Service E

Splits and Phases: 2: MERIDIAN ROAD & EASTONVILLE ROAD



Queues  
2: MERIDIAN ROAD & EASTONVILLE ROAD

Background 2024 AM  
04/10/2023



Lane Group	EBL	EBT	EBR	WBL	WBT	WBR	NBL	NBT	NBR	SBL	SBT	SBR
Lane Group Flow (vph)	256	61	308	108	60	40	345	511	49	125	1509	205
v/c Ratio	0.75	0.44	0.85	0.71	0.43	0.11	0.95	0.28	0.05	0.65	0.99	0.25
Control Delay	61.9	63.5	32.3	71.2	63.1	0.6	77.2	14.0	1.3	76.9	43.1	3.3
Queue Delay	0.0	0.0	0.0	0.0	0.0	0.0	0.0	0.0	0.0	0.0	0.0	0.0
Total Delay	61.9	63.5	32.3	71.2	63.1	0.6	77.2	14.0	1.3	76.9	43.1	3.3
Queue Length 50th (ft)	91	46	32	74	45	0	282	111	1	82	648	35
Queue Length 95th (ft)	#147	86	#138	#136	91	0	#420	135	m5	m137	#800	m28
Internal Link Dist (ft)		508			1196			231			781	
Turn Bay Length (ft)	100		100	120		100	100		400	375		400
Base Capacity (vph)	340	147	369	153	147	360	365	1847	911	228	1528	823
Starvation Cap Reductn	0	0	0	0	0	0	0	0	0	0	0	0
Spillback Cap Reductn	0	0	0	0	0	0	0	0	0	0	0	0
Storage Cap Reductn	0	0	0	0	0	0	0	0	0	0	0	0
Reduced v/c Ratio	0.75	0.41	0.83	0.71	0.41	0.11	0.95	0.28	0.05	0.55	0.99	0.25

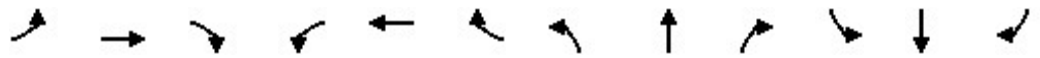
Intersection Summary

- # 95th percentile volume exceeds capacity, queue may be longer.  
Queue shown is maximum after two cycles.
- m Volume for 95th percentile queue is metered by upstream signal.

HCM 6th Signalized Intersection Summary  
 2: MERIDIAN ROAD & EASTONVILLE ROAD

Background 2024 AM

04/10/2023



Movement	EBL	EBT	EBR	WBL	WBT	WBR	NBL	NBT	NBR	SBL	SBT	SBR
Lane Configurations	↖↗	↑	↖	↖	↑	↖	↖	↑↑	↖	↖	↑↑	↖
Traffic Volume (veh/h)	218	52	262	100	56	37	293	434	42	114	1373	187
Future Volume (veh/h)	218	52	262	100	56	37	293	434	42	114	1373	187
Initial Q (Qb), veh	0	0	0	0	0	0	0	0	0	0	0	0
Ped-Bike Adj(A_pbT)	1.00		1.00	1.00		1.00	1.00		1.00	1.00		1.00
Parking Bus, Adj	1.00	1.00	1.00	1.00	1.00	1.00	1.00	1.00	1.00	1.00	1.00	1.00
Work Zone On Approach		No			No			No			No	
Adj Sat Flow, veh/h/ln	1870	1870	1870	1870	1870	1870	1870	1870	1870	1870	1870	1870
Adj Flow Rate, veh/h	256	61	0	108	60	0	345	511	49	125	1509	205
Peak Hour Factor	0.85	0.85	0.85	0.93	0.93	0.93	0.85	0.85	0.85	0.91	0.91	0.91
Percent Heavy Veh, %	2	2	2	2	2	2	2	2	2	2	2	2
Cap, veh/h	371	125		189	125		364	1962	875	152	1570	700
Arrive On Green	0.05	0.07	0.00	0.05	0.07	0.00	0.20	0.55	0.55	0.09	0.44	0.44
Sat Flow, veh/h	3456	1870	1585	1781	1870	1585	1781	3554	1585	1781	3554	1585
Grp Volume(v), veh/h	256	61	0	108	60	0	345	511	49	125	1509	205
Grp Sat Flow(s),veh/h/ln	1728	1870	1585	1781	1870	1585	1781	1777	1585	1781	1777	1585
Q Serve(g_s), s	5.5	3.8	0.0	5.5	3.7	0.0	22.9	9.0	1.7	8.3	49.4	10.0
Cycle Q Clear(g_c), s	5.5	3.8	0.0	5.5	3.7	0.0	22.9	9.0	1.7	8.3	49.4	10.0
Prop In Lane	1.00		1.00	1.00		1.00	1.00		1.00	1.00		1.00
Lane Grp Cap(c), veh/h	371	125		189	125		364	1962	875	152	1570	700
V/C Ratio(X)	0.69	0.49		0.57	0.48		0.95	0.26	0.06	0.82	0.96	0.29
Avail Cap(c_a), veh/h	371	148		189	148		364	1962	875	230	1570	700
HCM Platoon Ratio	1.00	1.00	1.00	1.00	1.00	1.00	1.00	1.00	1.00	1.00	1.00	1.00
Upstream Filter(I)	1.00	1.00	0.00	1.00	1.00	0.00	1.00	1.00	1.00	1.00	1.00	1.00
Uniform Delay (d), s/veh	52.6	54.0	0.0	51.1	54.0	0.0	47.1	14.1	12.4	54.0	32.5	21.5
Incr Delay (d2), s/veh	5.3	2.9	0.0	4.1	2.9	0.0	34.0	0.3	0.1	13.4	15.2	1.1
Initial Q Delay(d3),s/veh	0.0	0.0	0.0	0.0	0.0	0.0	0.0	0.0	0.0	0.0	0.0	0.0
%ile BackOfQ(50%),veh/ln	1.5	1.9	0.0	3.4	1.8	0.0	13.1	3.4	0.6	4.1	22.5	3.9
Unsig. Movement Delay, s/veh												
LnGrp Delay(d),s/veh	57.9	57.0	0.0	55.2	56.9	0.0	81.1	14.4	12.5	67.4	47.7	22.5
LnGrp LOS	E	E		E	E		F	B	B	E	D	C
Approach Vol, veh/h		317	A		168	A		905			1839	
Approach Delay, s/veh		57.7			55.8			39.7			46.3	
Approach LOS		E			E			D			D	
Timer - Assigned Phs	1	2	3	4	5	6	7	8				
Phs Duration (G+Y+Rc), s	18.7	73.8	13.0	14.5	32.0	60.5	13.0	14.5				
Change Period (Y+Rc), s	8.5	7.5	7.5	6.5	7.5	7.5	7.5	6.5				
Max Green Setting (Gmax), s	15.5	59.5	5.5	9.5	24.5	51.5	5.5	9.5				
Max Q Clear Time (g_c+I1), s	10.3	11.0	7.5	5.8	24.9	51.4	7.5	5.7				
Green Ext Time (p_c), s	0.1	3.3	0.0	0.1	0.0	0.0	0.0	0.1				

Intersection Summary

HCM 6th Ctrl Delay	46.0
HCM 6th LOS	D

Notes

- User approved pedestrian interval to be less than phase max green.
- Unsignalized Delay for [EBR, WBR] is excluded from calculations of the approach delay and intersection delay.

Timings  
3: MERIDIAN ROAD & BENT GRASS MEADOWS DRIVE

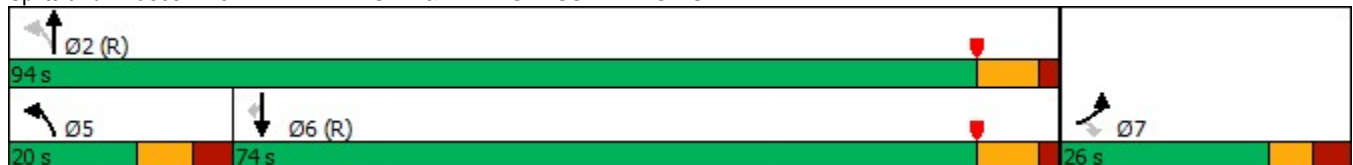


Lane Group	EBL	EBR	NBL	NBT	SBT	SBR
Lane Configurations	↖↖	↗	↖	↑↑	↑↑	↗
Traffic Volume (vph)	85	181	105	534	1451	121
Future Volume (vph)	85	181	105	534	1451	121
Turn Type	Prot	Perm	pm+pt	NA	NA	Perm
Protected Phases	7		5	2	6	
Permitted Phases		7	2			6
Detector Phase	7	7	5	2	6	6
Switch Phase						
Minimum Initial (s)	8.0	8.0	5.0	15.0	15.0	15.0
Minimum Split (s)	25.5	25.5	13.5	25.5	25.5	25.5
Total Split (s)	26.0	26.0	20.0	94.0	74.0	74.0
Total Split (%)	21.7%	21.7%	16.7%	78.3%	61.7%	61.7%
Yellow Time (s)	4.0	4.0	5.0	5.5	5.5	5.5
All-Red Time (s)	3.5	3.5	3.5	2.0	2.0	2.0
Lost Time Adjust (s)	0.0	0.0	0.0	0.0	0.0	0.0
Total Lost Time (s)	7.5	7.5	8.5	7.5	7.5	7.5
Lead/Lag			Lead		Lag	Lag
Lead-Lag Optimize?			Yes		Yes	Yes
Recall Mode	None	None	None	C-Max	C-Max	C-Max
Act Effct Green (s)	10.6	10.6	93.4	94.4	76.9	76.9
Actuated g/C Ratio	0.09	0.09	0.78	0.79	0.64	0.64
v/c Ratio	0.33	0.70	0.50	0.21	0.73	0.13
Control Delay	53.2	24.3	19.3	3.1	18.1	2.2
Queue Delay	0.0	0.0	0.0	0.0	0.0	0.0
Total Delay	53.2	24.3	19.3	3.1	18.1	2.2
LOS	D	C	B	A	B	A
Approach Delay	33.5			5.8	16.9	
Approach LOS	C			A	B	

Intersection Summary

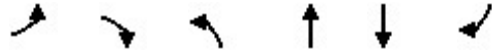
Cycle Length: 120  
 Actuated Cycle Length: 120  
 Offset: 5 (4%), Referenced to phase 2:NBTL and 6:SBT, Start of Yellow  
 Natural Cycle: 90  
 Control Type: Actuated-Coordinated  
 Maximum v/c Ratio: 0.73  
 Intersection Signal Delay: 15.9  
 Intersection Capacity Utilization 72.2%  
 Analysis Period (min) 15  
 Intersection LOS: B  
 ICU Level of Service C

Splits and Phases: 3: MERIDIAN ROAD & BENT GRASS MEADOWS DRIVE





## 3: MERIDIAN ROAD &amp; BENT GRASS MEADOWS DRIVE



Lane Group	EBL	EBR	NBL	NBT	SBT	SBR
Lane Group Flow (vph)	99	210	117	593	1649	138
v/c Ratio	0.33	0.70	0.50	0.21	0.73	0.13
Control Delay	53.2	24.3	19.3	3.1	18.1	2.2
Queue Delay	0.0	0.0	0.0	0.0	0.0	0.0
Total Delay	53.2	24.3	19.3	3.1	18.1	2.2
Queue Length 50th (ft)	38	25	6	23	389	0
Queue Length 95th (ft)	59	87	m80	112	617	27
Internal Link Dist (ft)	310			750	1921	
Turn Bay Length (ft)	150		700			350
Base Capacity (vph)	529	393	272	2782	2268	1064
Starvation Cap Reductn	0	0	0	0	0	0
Spillback Cap Reductn	0	0	0	0	0	0
Storage Cap Reductn	0	0	0	0	0	0
Reduced v/c Ratio	0.19	0.53	0.43	0.21	0.73	0.13

## Intersection Summary

m Volume for 95th percentile queue is metered by upstream signal.

HCM 6th Signalized Intersection Summary  
 3: MERIDIAN ROAD & BENT GRASS MEADOWS DRIVE

Background 2024 AM  
 04/10/2023



Movement	EBL	EBR	NBL	NBT	SBT	SBR
Lane Configurations	↖↗	↗	↖	↑↑	↑↑	↗
Traffic Volume (veh/h)	85	181	105	534	1451	121
Future Volume (veh/h)	85	181	105	534	1451	121
Initial Q (Qb), veh	0	0	0	0	0	0
Ped-Bike Adj(A_pbT)	1.00	1.00	1.00			1.00
Parking Bus, Adj	1.00	1.00	1.00	1.00	1.00	1.00
Work Zone On Approach	No			No	No	
Adj Sat Flow, veh/h/ln	1870	1870	1870	1870	1870	1870
Adj Flow Rate, veh/h	99	0	117	593	1649	138
Peak Hour Factor	0.86	0.86	0.90	0.90	0.88	0.88
Percent Heavy Veh, %	2	2	2	2	2	2
Cap, veh/h	222		249	2881	2485	1108
Arrive On Green	0.06	0.00	0.04	0.81	0.70	0.70
Sat Flow, veh/h	3456	1585	1781	3647	3647	1585
Grp Volume(v), veh/h	99	0	117	593	1649	138
Grp Sat Flow(s),veh/h/ln	1728	1585	1781	1777	1777	1585
Q Serve(g_s), s	3.3	0.0	2.1	4.5	31.3	3.4
Cycle Q Clear(g_c), s	3.3	0.0	2.1	4.5	31.3	3.4
Prop In Lane	1.00	1.00	1.00			1.00
Lane Grp Cap(c), veh/h	222		249	2881	2485	1108
V/C Ratio(X)	0.45		0.47	0.21	0.66	0.12
Avail Cap(c_a), veh/h	533		347	2881	2485	1108
HCM Platoon Ratio	1.00	1.00	1.00	1.00	1.00	1.00
Upstream Filter(I)	1.00	0.00	1.00	1.00	1.00	1.00
Uniform Delay (d), s/veh	54.1	0.0	12.1	2.6	10.1	5.9
Incr Delay (d2), s/veh	1.4	0.0	1.4	0.2	1.4	0.2
Initial Q Delay(d3),s/veh	0.0	0.0	0.0	0.0	0.0	0.0
%ile BackOfQ(50%),veh/ln	1.5	0.0	1.4	1.3	11.5	6.1
Unsig. Movement Delay, s/veh						
LnGrp Delay(d),s/veh	55.5	0.0	13.4	2.7	11.5	6.2
LnGrp LOS	E		B	A	B	A
Approach Vol, veh/h	99	A		710	1787	
Approach Delay, s/veh	55.5			4.5	11.1	
Approach LOS	E			A	B	
Timer - Assigned Phs		2		4	5	6
Phs Duration (G+Y+Rc), s		104.8		15.2	13.4	91.4
Change Period (Y+Rc), s		7.5		7.5	8.5	7.5
Max Green Setting (Gmax), s		86.5		18.5	11.5	66.5
Max Q Clear Time (g_c+I1), s		6.5		5.3	4.1	33.3
Green Ext Time (p_c), s		4.7		0.2	0.1	18.4
<b>Intersection Summary</b>						
HCM 6th Ctrl Delay			11.0			
HCM 6th LOS			B			

Notes

Unsignalized Delay for [EBR] is excluded from calculations of the approach delay and intersection delay.

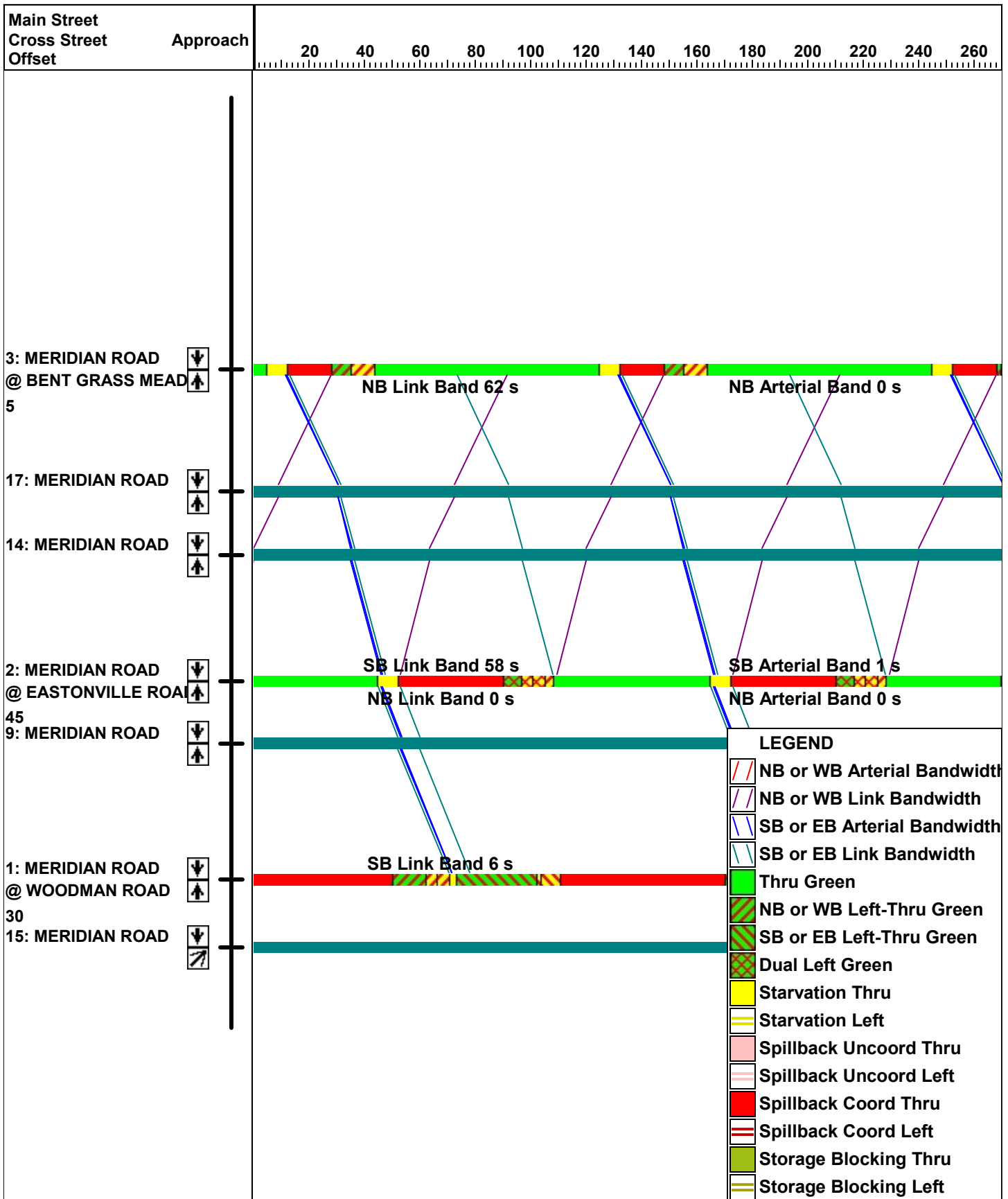
Intersection						
Int Delay, s/veh	4.5					
Movement	EBT	EBR	WBL	WBT	NBL	NBR
Lane Configurations	↑	↗	↖	↑	↘	↙
Traffic Vol, veh/h	145	65	158	68	1	121
Future Vol, veh/h	145	65	158	68	1	121
Conflicting Peds, #/hr	0	0	0	0	0	0
Sign Control	Free	Free	Free	Free	Stop	Stop
RT Channelized	-	None	-	None	-	None
Storage Length	-	150	100	-	0	-
Veh in Median Storage, #	0	-	-	0	0	-
Grade, %	0	-	-	0	0	-
Peak Hour Factor	85	85	85	85	85	85
Heavy Vehicles, %	2	2	2	2	2	2
Mvmt Flow	171	76	186	80	1	142

Major/Minor	Major1	Major2	Minor1		
Conflicting Flow All	0	0	247	0	623
Stage 1	-	-	-	-	171
Stage 2	-	-	-	-	452
Critical Hdwy	-	-	4.12	-	6.42
Critical Hdwy Stg 1	-	-	-	-	5.42
Critical Hdwy Stg 2	-	-	-	-	5.42
Follow-up Hdwy	-	-	2.218	-	3.518
Pot Cap-1 Maneuver	-	-	1319	-	450
Stage 1	-	-	-	-	859
Stage 2	-	-	-	-	641
Platoon blocked, %	-	-	-	-	-
Mov Cap-1 Maneuver	-	-	1319	-	387
Mov Cap-2 Maneuver	-	-	-	-	387
Stage 1	-	-	-	-	859
Stage 2	-	-	-	-	551

Approach	EB	WB	NB
HCM Control Delay, s	0	5.7	10
HCM LOS			B

Minor Lane/Major Mvmt	NBLn1	EBT	EBR	WBL	WBT
Capacity (veh/h)	864	-	-	1319	-
HCM Lane V/C Ratio	0.166	-	-	0.141	-
HCM Control Delay (s)	10	-	-	8.2	-
HCM Lane LOS	B	-	-	A	-
HCM 95th %tile Q(veh)	0.6	-	-	0.5	-

# Background 2024 AM Signal Progression



Timings  
1: MERIDIAN ROAD & WOODMAN ROAD

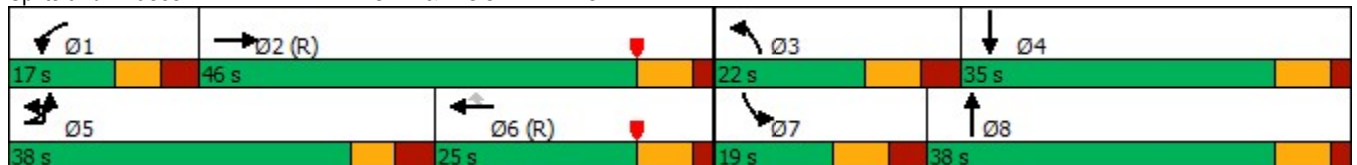
Background 2024 PM  
04/15/2023

Lane Group	EBL	EBT	EBR	WBL	WBT	WBR	NBL	NBT	NBR	SBL	SBT	SBR
Lane Configurations												
Traffic Volume (vph)	740	474	166	117	388	239	265	788	110	244	574	472
Future Volume (vph)	740	474	166	117	388	239	265	788	110	244	574	472
Turn Type	Prot	NA	Free	Prot	NA	Perm	Prot	NA	Free	Prot	NA	Free
Protected Phases	5	2		1	6		3	8		7	4	
Permitted Phases			Free			6			Free			Free
Detector Phase	5	2		1	6	6	3	8		7	4	
Switch Phase												
Minimum Initial (s)	5.0	15.0		5.0	15.0	15.0	5.0	15.0		5.0	15.0	
Minimum Split (s)	13.5	22.0		13.5	22.0	22.0	13.5	22.0		13.5	22.0	
Total Split (s)	38.0	46.0		17.0	25.0	25.0	22.0	38.0		19.0	35.0	
Total Split (%)	31.7%	38.3%		14.2%	20.8%	20.8%	18.3%	31.7%		15.8%	29.2%	
Yellow Time (s)	4.0	5.0		4.0	5.0	5.0	5.0	5.0		5.0	5.0	
All-Red Time (s)	3.5	2.0		3.5	2.0	2.0	3.5	2.0		3.5	2.0	
Lost Time Adjust (s)	0.0	0.0		0.0	0.0	0.0	0.0	0.0		0.0	0.0	
Total Lost Time (s)	7.5	7.0		7.5	7.0	7.0	8.5	7.0		8.5	7.0	
Lead/Lag	Lead	Lag		Lead	Lag	Lag	Lead	Lag		Lead	Lag	
Lead-Lag Optimize?	Yes	Yes		Yes	Yes	Yes	Yes	Yes		Yes	Yes	
Recall Mode	None	C-Max		None	C-Max	C-Max	None	None		None	None	
Act Effct Green (s)	30.1	40.2	120.0	8.9	19.0	19.0	13.0	30.5	120.0	10.5	28.0	120.0
Actuated g/C Ratio	0.25	0.34	1.00	0.07	0.16	0.16	0.11	0.25	1.00	0.09	0.23	1.00
v/c Ratio	0.95	0.43	0.11	0.50	0.76	0.57	0.75	0.92	0.07	0.86	0.73	0.31
Control Delay	64.3	32.7	0.1	60.4	58.2	11.8	65.2	60.1	0.1	55.7	52.8	0.3
Queue Delay	0.0	0.0	0.0	0.0	0.0	0.0	0.0	0.0	0.0	0.0	0.0	0.0
Total Delay	64.3	32.7	0.1	60.4	58.2	11.8	65.2	60.1	0.1	55.7	52.8	0.3
LOS	E	C	A	E	E	B	E	E	A	E	D	A
Approach Delay		46.0			43.6			55.6			34.1	
Approach LOS		D			D			E			C	

Intersection Summary

Cycle Length: 120  
 Actuated Cycle Length: 120  
 Offset: 100 (83%), Referenced to phase 2:EBT and 6:WBT, Start of Yellow  
 Natural Cycle: 100  
 Control Type: Actuated-Coordinated  
 Maximum v/c Ratio: 0.95  
 Intersection Signal Delay: 44.7  
 Intersection LOS: D  
 Intersection Capacity Utilization 87.4%  
 ICU Level of Service E  
 Analysis Period (min) 15

Splits and Phases: 1: MERIDIAN ROAD & WOODMAN ROAD



Queues  
1: MERIDIAN ROAD & WOODMAN ROAD

Background 2024 PM  
04/15/2023



Lane Group	EBL	EBT	EBR	WBL	WBT	WBR	NBL	NBT	NBR	SBL	SBT	SBR
Lane Group Flow (vph)	812	510	178	127	422	260	279	829	116	257	604	497
v/c Ratio	0.95	0.43	0.11	0.50	0.76	0.57	0.75	0.92	0.07	0.86	0.73	0.31
Control Delay	64.3	32.7	0.1	60.4	58.2	11.8	65.2	60.1	0.1	55.7	52.8	0.3
Queue Delay	0.0	0.0	0.0	0.0	0.0	0.0	0.0	0.0	0.0	0.0	0.0	0.0
Total Delay	64.3	32.7	0.1	60.4	58.2	11.8	65.2	60.1	0.1	55.7	52.8	0.3
Queue Length 50th (ft)	318	163	0	49	168	7	109	328	0	108	258	0
Queue Length 95th (ft)	#436	215	0	81	#237	86	156	#442	0	m#160	310	0
Internal Link Dist (ft)		1165			1100			342			860	
Turn Bay Length (ft)	500		630	350		250	440		330	490		450
Base Capacity (vph)	872	1184	1583	271	558	460	386	914	1583	300	826	1583
Starvation Cap Reductn	0	0	0	0	0	0	0	0	0	0	0	0
Spillback Cap Reductn	0	0	0	0	0	0	0	0	0	0	0	0
Storage Cap Reductn	0	0	0	0	0	0	0	0	0	0	0	0
Reduced v/c Ratio	0.93	0.43	0.11	0.47	0.76	0.57	0.72	0.91	0.07	0.86	0.73	0.31

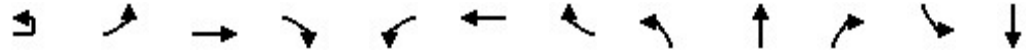
Intersection Summary

- # 95th percentile volume exceeds capacity, queue may be longer.  
Queue shown is maximum after two cycles.
- m Volume for 95th percentile queue is metered by upstream signal.



HCM 6th Signalized Intersection Summary  
1: MERIDIAN ROAD & WOODMAN ROAD

Background 2024 PM  
04/15/2023



Movement	EBU	EBL	EBT	EBR	WBL	WBT	WBR	NBL	NBT	NBR	SBL	SBT
Lane Configurations		↔↔	↕↕	↔	↔↔	↕↕	↔↔	↔	↔↔	↔	↔↔	↕↕
Traffic Volume (veh/h)	15	740	474	166	117	388	239	265	788	110	244	574
Future Volume (veh/h)	15	740	474	166	117	388	239	265	788	110	244	574
Initial Q (Qb), veh		0	0	0	0	0	0	0	0	0	0	0
Ped-Bike Adj(A_pbT)		1.00		1.00	1.00		1.00	1.00		1.00	1.00	
Parking Bus, Adj		1.00	1.00	1.00	1.00	1.00	1.00	1.00	1.00	1.00	1.00	1.00
Work Zone On Approach			No			No			No			No
Adj Sat Flow, veh/h/ln		1870	1870	1870	1870	1870	1870	1870	1870	1870	1870	1870
Adj Flow Rate, veh/h		796	510	0	127	422	0	279	829	0	257	604
Peak Hour Factor		0.93	0.93	0.93	0.92	0.92	0.92	0.95	0.95	0.95	0.95	0.95
Percent Heavy Veh, %		2	2	2	2	2	2	2	2	2	2	2
Cap, veh/h		852	1272		182	583		337	895		302	859
Arrive On Green		0.25	0.36	0.00	0.05	0.16	0.00	0.10	0.25	0.00	0.09	0.24
Sat Flow, veh/h		3456	3554	1585	3456	3554	1585	3456	3554	1585	3456	3554
Grp Volume(v), veh/h		796	510	0	127	422	0	279	829	0	257	604
Grp Sat Flow(s),veh/h/ln		1728	1777	1585	1728	1777	1585	1728	1777	1585	1728	1777
Q Serve(g_s), s		27.1	12.9	0.0	4.3	13.5	0.0	9.5	27.3	0.0	8.8	18.6
Cycle Q Clear(g_c), s		27.1	12.9	0.0	4.3	13.5	0.0	9.5	27.3	0.0	8.8	18.6
Prop In Lane		1.00		1.00	1.00		1.00	1.00		1.00	1.00	
Lane Grp Cap(c), veh/h		852	1272		182	583		337	895		302	859
V/C Ratio(X)		0.93	0.40		0.70	0.72		0.83	0.93		0.85	0.70
Avail Cap(c_a), veh/h		878	1272		274	583		389	918		302	859
HCM Platoon Ratio		1.00	1.00	1.00	1.00	1.00	1.00	1.00	1.00	1.00	1.00	1.00
Upstream Filter(I)		1.00	1.00	0.00	1.00	1.00	0.00	1.00	1.00	0.00	1.00	1.00
Uniform Delay (d), s/veh		44.2	28.9	0.0	55.9	47.6	0.0	53.2	43.8	0.0	54.0	41.6
Incr Delay (d2), s/veh		16.4	0.9	0.0	4.7	7.6	0.0	12.3	14.8	0.0	19.9	2.6
Initial Q Delay(d3),s/veh		0.0	0.0	0.0	0.0	0.0	0.0	0.0	0.0	0.0	0.0	0.0
%ile BackOfQ(50%),veh/ln		13.1	5.5	0.0	2.0	6.4	0.0	4.7	13.6	0.0	4.6	8.4
Unsig. Movement Delay, s/veh												
LnGrp Delay(d),s/veh		60.7	29.8	0.0	60.6	55.2	0.0	65.5	58.6	0.0	73.9	44.2
LnGrp LOS		E	C		E	E		E	E		E	D
Approach Vol, veh/h			1306	A		549	A		1108	A		861
Approach Delay, s/veh			48.6			56.5			60.3			53.0
Approach LOS			D			E			E			D
Timer - Assigned Phs	1	2	3	4	5	6	7	8				
Phs Duration (G+Y+Rc), s	13.8	49.9	20.2	36.0	37.1	26.7	19.0	37.2				
Change Period (Y+Rc), s	7.5	7.0	8.5	7.0	7.5	7.0	8.5	7.0				
Max Green Setting (Gmax), s	9.5	39.0	13.5	28.0	30.5	18.0	10.5	31.0				
Max Q Clear Time (g_c+I1), s	6.3	14.9	11.5	20.6	29.1	15.5	10.8	29.3				
Green Ext Time (p_c), s	0.1	3.1	0.2	2.3	0.5	0.6	0.0	0.9				

Intersection Summary

HCM 6th Ctrl Delay	54.1
HCM 6th LOS	D

Notes

- User approved pedestrian interval to be less than phase max green.
- User approved ignoring U-Turning movement.
- Unsignalized Delay for [NBR, EBR, WBR, SBR] is excluded from calculations of the approach delay and intersection delay.

Movement	SBR
Lane Configurations	
Traffic Volume (veh/h)	472
Future Volume (veh/h)	472
Initial Q (Qb), veh	0
Ped-Bike Adj(A_pbT)	1.00
Parking Bus, Adj	1.00
Work Zone On Approach	
Adj Sat Flow, veh/h/ln	1870
Adj Flow Rate, veh/h	0
Peak Hour Factor	0.95
Percent Heavy Veh, %	2
Cap, veh/h	
Arrive On Green	0.00
Sat Flow, veh/h	1585
Grp Volume(v), veh/h	0
Grp Sat Flow(s),veh/h/ln	1585
Q Serve(g_s), s	0.0
Cycle Q Clear(g_c), s	0.0
Prop In Lane	1.00
Lane Grp Cap(c), veh/h	
V/C Ratio(X)	
Avail Cap(c_a), veh/h	
HCM Platoon Ratio	1.00
Upstream Filter(l)	0.00
Uniform Delay (d), s/veh	0.0
Incr Delay (d2), s/veh	0.0
Initial Q Delay(d3),s/veh	0.0
%ile BackOfQ(50%),veh/ln	0.0
Unsig. Movement Delay, s/veh	
LnGrp Delay(d),s/veh	0.0
LnGrp LOS	
Approach Vol, veh/h	A
Approach Delay, s/veh	
Approach LOS	
Timer - Assigned Phs	



Queues  
2: MERIDIAN ROAD & EASTONVILLE ROAD

Background 2024 PM  
04/15/2023



Lane Group	EBL	EBT	EBR	WBL	WBT	WBR	NBL	NBT	NBR	SBL	SBT	SBR
Lane Group Flow (vph)	422	147	344	34	83	145	398	1519	135	97	1092	209
v/c Ratio	0.79	0.46	0.66	0.16	0.45	0.45	1.04	0.86	0.15	0.53	0.78	0.28
Control Delay	52.2	51.8	15.1	35.9	58.1	7.3	88.2	15.0	0.6	23.2	44.8	13.7
Queue Delay	0.0	0.0	0.0	0.0	0.0	0.0	0.0	0.0	0.0	0.0	0.0	0.0
Total Delay	52.2	51.8	15.1	35.9	58.1	7.3	88.2	15.0	0.6	23.2	44.8	13.7
Queue Length 50th (ft)	147	110	28	21	62	0	~235	364	1	40	464	47
Queue Length 95th (ft)	177	167	104	46	111	30	m#396	m#600	m5	67	509	110
Internal Link Dist (ft)		508			1196			231				781
Turn Bay Length (ft)	100		100	120		100	100		400	375		400
Base Capacity (vph)	534	319	523	266	240	366	382	1757	875	205	1400	752
Starvation Cap Reductn	0	0	0	0	0	0	0	0	0	0	0	0
Spillback Cap Reductn	0	0	0	0	0	0	0	0	0	0	0	0
Storage Cap Reductn	0	0	0	0	0	0	0	0	0	0	0	0
Reduced v/c Ratio	0.79	0.46	0.66	0.13	0.35	0.40	1.04	0.86	0.15	0.47	0.78	0.28

























Intersection Summary

- ~ Volume exceeds capacity, queue is theoretically infinite.  
Queue shown is maximum after two cycles.
- # 95th percentile volume exceeds capacity, queue may be longer.  
Queue shown is maximum after two cycles.
- m Volume for 95th percentile queue is metered by upstream signal.

HCM 6th Signalized Intersection Summary  
2: MERIDIAN ROAD & EASTONVILLE ROAD

Background 2024 PM

04/15/2023

												
Movement	EBL	EBT	EBR	WBL	WBT	WBR	NBL	NBT	NBR	SBL	SBT	SBR
Lane Configurations												
Traffic Volume (veh/h)	359	125	292	32	79	138	354	1352	120	85	961	184
Future Volume (veh/h)	359	125	292	32	79	138	354	1352	120	85	961	184
Initial Q (Qb), veh	0	0	0	0	0	0	0	0	0	0	0	0
Ped-Bike Adj(A_pbT)	1.00		1.00	1.00		1.00	1.00		1.00	1.00		1.00
Parking Bus, Adj	1.00	1.00	1.00	1.00	1.00	1.00	1.00	1.00	1.00	1.00	1.00	1.00
Work Zone On Approach		No			No			No			No	
Adj Sat Flow, veh/h/ln	1870	1870	1870	1870	1870	1870	1870	1870	1870	1870	1870	1870
Adj Flow Rate, veh/h	422	147	0	34	83	0	398	1519	135	97	1092	209
Peak Hour Factor	0.85	0.85	0.85	0.95	0.95	0.95	0.89	0.89	0.89	0.88	0.88	0.88
Percent Heavy Veh, %	2	2	2	2	2	2	2	2	2	2	2	2
Cap, veh/h	482	235		174	125		412	1961	875	204	1629	726
Arrive On Green	0.09	0.13	0.00	0.03	0.07	0.00	0.15	0.55	0.55	0.04	0.46	0.46
Sat Flow, veh/h	3456	1870	1585	1781	1870	1585	1781	3554	1585	1781	3554	1585
Grp Volume(v), veh/h	422	147	0	34	83	0	398	1519	135	97	1092	209
Grp Sat Flow(s),veh/h/ln	1728	1870	1585	1781	1870	1585	1781	1777	1585	1781	1777	1585
Q Serve(g_s), s	10.5	8.9	0.0	2.1	5.2	0.0	16.3	40.2	5.0	3.4	28.8	9.9
Cycle Q Clear(g_c), s	10.5	8.9	0.0	2.1	5.2	0.0	16.3	40.2	5.0	3.4	28.8	9.9
Prop In Lane	1.00		1.00	1.00		1.00	1.00		1.00	1.00		1.00
Lane Grp Cap(c), veh/h	482	235		174	125		412	1961	875	204	1629	726
V/C Ratio(X)	0.88	0.62		0.20	0.67		0.97	0.77	0.15	0.48	0.67	0.29
Avail Cap(c_a), veh/h	482	242		280	242		412	1961	875	267	1629	726
HCM Platoon Ratio	1.00	1.00	1.00	1.00	1.00	1.00	1.00	1.00	1.00	1.00	1.00	1.00
Upstream Filter(l)	1.00	1.00	0.00	1.00	1.00	0.00	1.00	1.00	1.00	1.00	1.00	1.00
Uniform Delay (d), s/veh	49.2	49.8	0.0	50.1	54.7	0.0	27.2	21.1	13.2	20.9	25.4	20.3
Incr Delay (d2), s/veh	16.4	4.8	0.0	0.5	6.0	0.0	35.4	3.1	0.4	1.7	2.2	1.0
Initial Q Delay(d3),s/veh	0.0	0.0	0.0	0.0	0.0	0.0	0.0	0.0	0.0	0.0	0.0	0.0
%ile BackOfQ(50%),veh/ln	2.4	4.5	0.0	1.0	2.7	0.0	10.0	15.3	1.9	1.4	11.6	3.8
Unsig. Movement Delay, s/veh												
LnGrp Delay(d),s/veh	65.6	54.5	0.0	50.7	60.7	0.0	62.5	24.1	13.5	22.6	27.6	21.3
LnGrp LOS	E	D		D	E		E	C	B	C	C	C
Approach Vol, veh/h		569	A		117	A		2052			1398	
Approach Delay, s/veh		62.7			57.8			30.9			26.3	
Approach LOS		E			E			C			C	
Timer - Assigned Phs	1	2	3	4	5	6	7	8				
Phs Duration (G+Y+Rc), s	13.8	73.7	10.9	21.6	25.0	62.5	18.0	14.5				
Change Period (Y+Rc), s	8.5	7.5	7.5	6.5	7.5	7.5	7.5	6.5				
Max Green Setting (Gmax), s	9.5	54.5	10.5	15.5	17.5	47.5	10.5	15.5				
Max Q Clear Time (g_c+I1), s	5.4	42.2	4.1	10.9	18.3	30.8	12.5	7.2				
Green Ext Time (p_c), s	0.1	7.8	0.0	0.2	0.0	7.0	0.0	0.2				

Intersection Summary

HCM 6th Ctrl Delay	34.5
HCM 6th LOS	C

Notes

User approved pedestrian interval to be less than phase max green.  
Unsignalized Delay for [EBR, WBR] is excluded from calculations of the approach delay and intersection delay.

Timings  
3: MERIDIAN ROAD & BENT GRASS MEADOWS DRIVE

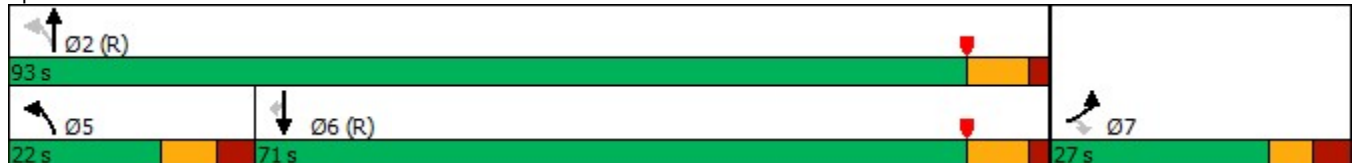


Lane Group	EBL	EBR	NBL	NBT	SBT	SBR
Lane Configurations	↖↖	↖	↖	↑↑	↑↑	↖
Traffic Volume (vph)	102	135	141	1651	1045	135
Future Volume (vph)	102	135	141	1651	1045	135
Turn Type	Prot	Perm	pm+pt	NA	NA	Perm
Protected Phases	7		5	2	6	
Permitted Phases		7	2			6
Detector Phase	7	7	5	2	6	6
Switch Phase						
Minimum Initial (s)	8.0	8.0	5.0	15.0	15.0	15.0
Minimum Split (s)	25.5	25.5	13.5	25.5	25.5	25.5
Total Split (s)	27.0	27.0	22.0	93.0	71.0	71.0
Total Split (%)	22.5%	22.5%	18.3%	77.5%	59.2%	59.2%
Yellow Time (s)	4.0	4.0	5.0	5.5	5.5	5.5
All-Red Time (s)	3.5	3.5	3.5	2.0	2.0	2.0
Lost Time Adjust (s)	0.0	0.0	0.0	0.0	0.0	0.0
Total Lost Time (s)	7.5	7.5	8.5	7.5	7.5	7.5
Lead/Lag			Lead		Lag	Lag
Lead-Lag Optimize?			Yes		Yes	Yes
Recall Mode	None	None	None	C-Max	C-Max	C-Max
Act Effct Green (s)	9.9	9.9	94.1	95.1	78.7	78.7
Actuated g/C Ratio	0.08	0.08	0.78	0.79	0.66	0.66
v/c Ratio	0.42	0.58	0.39	0.62	0.48	0.13
Control Delay	56.6	16.6	5.5	4.4	11.6	1.7
Queue Delay	0.0	0.0	0.0	0.0	0.0	0.0
Total Delay	56.6	16.6	5.5	4.4	11.6	1.7
LOS	E	B	A	A	B	A
Approach Delay	33.8			4.5	10.4	
Approach LOS	C			A	B	

Intersection Summary

Cycle Length: 120  
 Actuated Cycle Length: 120  
 Offset: 27 (23%), Referenced to phase 2:NBTL and 6:SBT, Start of Yellow  
 Natural Cycle: 75  
 Control Type: Actuated-Coordinated  
 Maximum v/c Ratio: 0.62  
 Intersection Signal Delay: 9.0  
 Intersection Capacity Utilization 64.8%  
 Analysis Period (min) 15  
 Intersection LOS: A  
 ICU Level of Service C

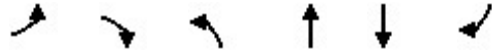
Splits and Phases: 3: MERIDIAN ROAD & BENT GRASS MEADOWS DRIVE





## 3: MERIDIAN ROAD &amp; BENT GRASS MEADOWS DRIVE

04/15/2023



Lane Group	EBL	EBR	NBL	NBT	SBT	SBR
Lane Group Flow (vph)	120	159	148	1738	1112	144
v/c Ratio	0.42	0.58	0.39	0.62	0.48	0.13
Control Delay	56.6	16.6	5.5	4.4	11.6	1.7
Queue Delay	0.0	0.0	0.0	0.0	0.0	0.0
Total Delay	56.6	16.6	5.5	4.4	11.6	1.7
Queue Length 50th (ft)	46	0	22	136	207	0
Queue Length 95th (ft)	71	54	m26	167	291	24
Internal Link Dist (ft)	310			750	1921	
Turn Bay Length (ft)	150		700			350
Base Capacity (vph)	557	390	442	2804	2320	1087
Starvation Cap Reductn	0	0	0	0	0	0
Spillback Cap Reductn	0	0	0	0	0	0
Storage Cap Reductn	0	0	0	0	0	0
Reduced v/c Ratio	0.22	0.41	0.33	0.62	0.48	0.13

## Intersection Summary

m Volume for 95th percentile queue is metered by upstream signal.

HCM 6th Signalized Intersection Summary  
 3: MERIDIAN ROAD & BENT GRASS MEADOWS DRIVE

Background 2024 PM  
 04/15/2023



Movement	EBL	EBR	NBL	NBT	SBT	SBR
Lane Configurations	↖↗	↗	↖	↑↑	↑↑	↗
Traffic Volume (veh/h)	102	135	141	1651	1045	135
Future Volume (veh/h)	102	135	141	1651	1045	135
Initial Q (Qb), veh	0	0	0	0	0	0
Ped-Bike Adj(A_pbT)	1.00	1.00	1.00			1.00
Parking Bus, Adj	1.00	1.00	1.00	1.00	1.00	1.00
Work Zone On Approach	No			No	No	
Adj Sat Flow, veh/h/ln	1870	1870	1870	1870	1870	1870
Adj Flow Rate, veh/h	120	0	148	1738	1112	144
Peak Hour Factor	0.85	0.85	0.95	0.95	0.94	0.94
Percent Heavy Veh, %	2	2	2	2	2	2
Cap, veh/h	226		381	2877	2478	1105
Arrive On Green	0.07	0.00	0.04	0.81	0.70	0.70
Sat Flow, veh/h	3456	1585	1781	3647	3647	1585
Grp Volume(v), veh/h	120	0	148	1738	1112	144
Grp Sat Flow(s),veh/h/ln	1728	1585	1781	1777	1777	1585
Q Serve(g_s), s	4.0	0.0	2.7	21.9	16.5	3.6
Cycle Q Clear(g_c), s	4.0	0.0	2.7	21.9	16.5	3.6
Prop In Lane	1.00	1.00	1.00			1.00
Lane Grp Cap(c), veh/h	226		381	2877	2478	1105
V/C Ratio(X)	0.53		0.39	0.60	0.45	0.13
Avail Cap(c_a), veh/h	562		508	2877	2478	1105
HCM Platoon Ratio	1.00	1.00	1.00	1.00	1.00	1.00
Upstream Filter(I)	1.00	0.00	1.00	1.00	1.00	1.00
Uniform Delay (d), s/veh	54.3	0.0	6.1	4.3	8.0	6.0
Incr Delay (d2), s/veh	1.9	0.0	0.6	0.9	0.6	0.2
Initial Q Delay(d3),s/veh	0.0	0.0	0.0	0.0	0.0	0.0
%ile BackOfQ(50%),veh/ln	1.8	0.0	0.9	6.3	6.0	6.3
Unsig. Movement Delay, s/veh						
LnGrp Delay(d),s/veh	56.2	0.0	6.7	5.2	8.6	6.3
LnGrp LOS	E		A	A	A	A
Approach Vol, veh/h	120	A		1886	1256	
Approach Delay, s/veh	56.2			5.3	8.3	
Approach LOS	E			A	A	
Timer - Assigned Phs		2		4	5	6
Phs Duration (G+Y+Rc), s		104.6		15.4	13.5	91.2
Change Period (Y+Rc), s		7.5		7.5	8.5	7.5
Max Green Setting (Gmax), s		85.5		19.5	13.5	63.5
Max Q Clear Time (g_c+I1), s		23.9		6.0	4.7	18.5
Green Ext Time (p_c), s		25.3		0.3	0.2	11.7

Intersection Summary

HCM 6th Ctrl Delay	8.4
HCM 6th LOS	A

Notes

Unsignalized Delay for [EBR] is excluded from calculations of the approach delay and intersection delay.

Intersection						
Int Delay, s/veh	3.6					
Movement	EBT	EBR	WBL	WBT	NBL	NBR
Lane Configurations	↑	↗	↘	↑	↘	
Traffic Vol, veh/h	123	42	109	166	2	114
Future Vol, veh/h	123	42	109	166	2	114
Conflicting Peds, #/hr	0	0	0	0	0	0
Sign Control	Free	Free	Free	Free	Stop	Stop
RT Channelized	-	None	-	None	-	None
Storage Length	-	150	100	-	0	-
Veh in Median Storage, #	0	-	-	0	0	-
Grade, %	0	-	-	0	0	-
Peak Hour Factor	85	85	85	85	85	85
Heavy Vehicles, %	2	2	2	2	2	2
Mvmt Flow	145	49	128	195	2	134

Major/Minor	Major1	Major2	Minor1		
Conflicting Flow All	0	0	194	0	596
Stage 1	-	-	-	-	145
Stage 2	-	-	-	-	451
Critical Hdwy	-	-	4.12	-	6.42
Critical Hdwy Stg 1	-	-	-	-	5.42
Critical Hdwy Stg 2	-	-	-	-	5.42
Follow-up Hdwy	-	-	2.218	-	3.518
Pot Cap-1 Maneuver	-	-	1379	-	466
Stage 1	-	-	-	-	882
Stage 2	-	-	-	-	642
Platoon blocked, %	-	-	-	-	-
Mov Cap-1 Maneuver	-	-	1379	-	423
Mov Cap-2 Maneuver	-	-	-	-	423
Stage 1	-	-	-	-	882
Stage 2	-	-	-	-	582

Approach	EB	WB	NB
HCM Control Delay, s	0	3.1	9.8
HCM LOS			A

Minor Lane/Major Mvmt	NBLn1	EBT	EBR	WBL	WBT
Capacity (veh/h)	885	-	-	1379	-
HCM Lane V/C Ratio	0.154	-	-	0.093	-
HCM Control Delay (s)	9.8	-	-	7.9	-
HCM Lane LOS	A	-	-	A	-
HCM 95th %tile Q(veh)	0.5	-	-	0.3	-

Timings  
1: MERIDIAN ROAD & WOODMAN ROAD

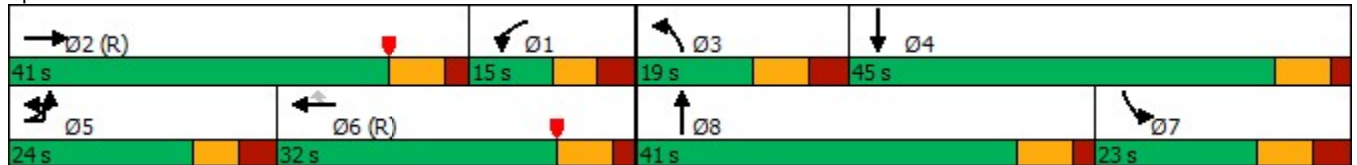
Background 2040 AM  
04/01/2023

Lane Group	EBL	EBT	EBR	WBL	WBT	WBR	NBL	NBT	NBR	SBL	SBT	SBR
Lane Configurations												
Traffic Volume (vph)	368	321	167	84	564	158	227	386	24	226	977	1007
Future Volume (vph)	368	321	167	84	564	158	227	386	24	226	977	1007
Turn Type	Prot	NA	Free	Prot	NA	Perm	Prot	NA	Free	Prot	NA	Free
Protected Phases	5	2		1	6		3	8		7	4	
Permitted Phases			Free			6			Free			Free
Detector Phase	5	2		1	6	6	3	8		7	4	
Switch Phase												
Minimum Initial (s)	5.0	15.0		5.0	15.0	15.0	5.0	15.0		5.0	15.0	
Minimum Split (s)	13.5	22.0		13.5	22.0	22.0	13.5	22.0		13.5	22.0	
Total Split (s)	24.0	41.0		15.0	32.0	32.0	19.0	41.0		23.0	45.0	
Total Split (%)	20.0%	34.2%		12.5%	26.7%	26.7%	15.8%	34.2%		19.2%	37.5%	
Yellow Time (s)	4.0	5.0		4.0	5.0	5.0	5.0	5.0		5.0	5.0	
All-Red Time (s)	3.5	2.0		3.5	2.0	2.0	3.5	2.0		3.5	2.0	
Lost Time Adjust (s)	0.0	0.0		0.0	0.0	0.0	0.0	0.0		0.0	0.0	
Total Lost Time (s)	7.5	7.0		7.5	7.0	7.0	8.5	7.0		8.5	7.0	
Lead/Lag	Lead	Lead		Lag	Lag	Lag	Lead	Lead		Lag	Lag	
Lead-Lag Optimize?	Yes	Yes		Yes	Yes	Yes	Yes	Yes		Yes	Yes	
Recall Mode	None	C-Max		None	C-Max	C-Max	None	None		None	None	
Act Effct Green (s)	16.2	34.6	120.0	7.5	25.9	25.9	10.5	19.4	120.0	28.5	37.5	120.0
Actuated g/C Ratio	0.14	0.29	1.00	0.06	0.22	0.22	0.09	0.16	1.00	0.24	0.31	1.00
v/c Ratio	0.86	0.33	0.11	0.41	0.78	0.31	0.80	0.71	0.02	0.29	0.93	0.67
Control Delay	69.7	34.9	0.1	60.2	52.7	1.4	73.8	54.5	0.0	40.2	46.4	5.9
Queue Delay	0.0	0.0	0.0	0.0	0.0	0.0	0.0	0.0	0.0	0.0	0.0	0.0
Total Delay	69.7	34.9	0.1	60.2	52.7	1.4	73.8	54.5	0.0	40.2	46.4	5.9
LOS	E	C	A	E	D	A	E	D	A	D	D	A
Approach Delay		43.4			43.4			59.3			27.3	
Approach LOS		D			D			E			C	

Intersection Summary

Cycle Length: 120  
 Actuated Cycle Length: 120  
 Offset: 30 (25%), Referenced to phase 2:EBT and 6:WBT, Start of Yellow  
 Natural Cycle: 90  
 Control Type: Actuated-Coordinated  
 Maximum v/c Ratio: 0.93  
 Intersection Signal Delay: 37.8  
 Intersection LOS: D  
 Intersection Capacity Utilization 84.9%  
 ICU Level of Service E  
 Analysis Period (min) 15

Splits and Phases: 1: MERIDIAN ROAD & WOODMAN ROAD



Queues  
1: MERIDIAN ROAD & WOODMAN ROAD

Background 2040 AM  
04/01/2023



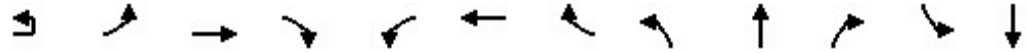
Lane Group	EBL	EBT	EBR	WBL	WBT	WBR	NBL	NBT	NBR	SBL	SBT	SBR
Lane Group Flow (vph)	398	338	176	88	594	166	239	406	25	238	1028	1060
v/c Ratio	0.86	0.33	0.11	0.41	0.78	0.31	0.80	0.71	0.02	0.29	0.93	0.67
Control Delay	69.7	34.9	0.1	60.2	52.7	1.4	73.8	54.5	0.0	40.2	46.4	5.9
Queue Delay	0.0	0.0	0.0	0.0	0.0	0.0	0.0	0.0	0.0	0.0	0.0	0.0
Total Delay	69.7	34.9	0.1	60.2	52.7	1.4	73.8	54.5	0.0	40.2	46.4	5.9
Queue Length 50th (ft)	157	109	0	34	232	0	95	158	0	93	447	115
Queue Length 95th (ft)	#236	152	0	62	300	0	#157	203	0	m90	m423	m61
Internal Link Dist (ft)		1165			1100			342			860	
Turn Bay Length (ft)	500		630	350		250	440		330	490		450
Base Capacity (vph)	472	1019	1583	214	764	544	300	1002	1583	815	1120	1583
Starvation Cap Reductn	0	0	0	0	0	0	0	0	0	0	0	0
Spillback Cap Reductn	0	0	0	0	0	0	0	0	0	0	0	0
Storage Cap Reductn	0	0	0	0	0	0	0	0	0	0	0	0
Reduced v/c Ratio	0.84	0.33	0.11	0.41	0.78	0.31	0.80	0.41	0.02	0.29	0.92	0.67

Intersection Summary

- # 95th percentile volume exceeds capacity, queue may be longer.  
Queue shown is maximum after two cycles.
- m Volume for 95th percentile queue is metered by upstream signal.

HCM 6th Signalized Intersection Summary  
1: MERIDIAN ROAD & WOODMAN ROAD

Background 2040 AM  
04/01/2023



Movement	EBU	EBL	EBT	EBR	WBL	WBT	WBR	NBL	NBT	NBR	SBL	SBT
Lane Configurations		↔↔	↕↕	↔	↔↔	↕↕	↔↔	↔	↔↔	↕	↔↔	↕↕
Traffic Volume (veh/h)	10	368	321	167	84	564	158	227	386	24	226	977
Future Volume (veh/h)	10	368	321	167	84	564	158	227	386	24	226	977
Initial Q (Qb), veh		0	0	0	0	0	0	0	0	0	0	0
Ped-Bike Adj(A_pbT)		1.00		1.00	1.00		1.00	1.00		1.00	1.00	
Parking Bus, Adj		1.00	1.00	1.00	1.00	1.00	1.00	1.00	1.00	1.00	1.00	1.00
Work Zone On Approach			No			No			No			No
Adj Sat Flow, veh/h/ln		1870	1870	1870	1870	1870	1870	1870	1870	1870	1870	1870
Adj Flow Rate, veh/h		387	338	0	88	594	0	239	406	0	238	1028
Peak Hour Factor		0.95	0.95	0.95	0.95	0.95	0.95	0.95	0.95	0.95	0.95	0.95
Percent Heavy Veh, %		2	2	2	2	2	2	2	2	2	2	2
Cap, veh/h		443	1007		206	748		293	522		899	1100
Arrive On Green		0.13	0.28	0.00	0.06	0.21	0.00	0.08	0.15	0.00	0.26	0.31
Sat Flow, veh/h		3456	3554	1585	3456	3554	1585	3456	3554	1585	3456	3554
Grp Volume(v), veh/h		387	338	0	88	594	0	239	406	0	238	1028
Grp Sat Flow(s),veh/h/ln		1728	1777	1585	1728	1777	1585	1728	1777	1585	1728	1777
Q Serve(g_s), s		13.2	9.0	0.0	2.9	19.0	0.0	8.2	13.2	0.0	6.6	33.7
Cycle Q Clear(g_c), s		13.2	9.0	0.0	2.9	19.0	0.0	8.2	13.2	0.0	6.6	33.7
Prop In Lane		1.00		1.00	1.00		1.00	1.00		1.00	1.00	
Lane Grp Cap(c), veh/h		443	1007		206	748		293	522		899	1100
V/C Ratio(X)		0.87	0.34		0.43	0.79		0.81	0.78		0.26	0.93
Avail Cap(c_a), veh/h		475	1007		216	748		302	1007		899	1125
HCM Platoon Ratio		1.00	1.00	1.00	1.00	1.00	1.00	1.00	1.00	1.00	1.00	1.00
Upstream Filter(I)		1.00	1.00	0.00	1.00	1.00	0.00	1.00	1.00	0.00	1.00	1.00
Uniform Delay (d), s/veh		51.3	34.1	0.0	54.4	44.9	0.0	54.0	49.3	0.0	35.3	40.2
Incr Delay (d2), s/veh		15.5	0.9	0.0	1.4	8.5	0.0	15.3	2.5	0.0	0.2	13.7
Initial Q Delay(d3),s/veh		0.0	0.0	0.0	0.0	0.0	0.0	0.0	0.0	0.0	0.0	0.0
%ile BackOfQ(50%),veh/ln		6.5	3.9	0.0	1.3	9.0	0.0	4.1	6.0	0.0	2.8	16.5
Unsig. Movement Delay, s/veh												
LnGrp Delay(d),s/veh		66.9	35.0	0.0	55.8	53.4	0.0	69.3	51.9	0.0	35.4	54.0
LnGrp LOS		E	C		E	D		E	D		D	D
Approach Vol, veh/h			725	A		682	A		645	A		1266
Approach Delay, s/veh			52.0			53.7			58.3			50.5
Approach LOS			D			D			E			D
Timer - Assigned Phs	1	2	3	4	5	6	7	8				
Phs Duration (G+Y+Rc), s	14.7	41.0	18.7	45.7	22.9	32.8	39.7	24.6				
Change Period (Y+Rc), s	7.5	7.0	8.5	* 8.5	7.5	* 7.5	8.5	7.0				
Max Green Setting (Gmax), s	7.5	34.0	10.5	* 38	16.5	* 25	14.5	34.0				
Max Q Clear Time (g_c+I1), s	4.9	11.0	10.2	35.7	15.2	21.0	8.6	15.2				
Green Ext Time (p_c), s	0.0	1.9	0.0	1.4	0.2	1.3	0.4	2.4				

Intersection Summary

HCM 6th Ctrl Delay	53.0
HCM 6th LOS	D

Notes

- User approved pedestrian interval to be less than phase max green.
- User approved ignoring U-Turning movement.
- \* HCM 6th computational engine requires equal clearance times for the phases crossing the barrier.

Movement	SBR
Lane Configurations	
Traffic Volume (veh/h)	1007
Future Volume (veh/h)	1007
Initial Q (Qb), veh	0
Ped-Bike Adj(A_pbT)	1.00
Parking Bus, Adj	1.00
Work Zone On Approach	
Adj Sat Flow, veh/h/ln	1870
Adj Flow Rate, veh/h	0
Peak Hour Factor	0.95
Percent Heavy Veh, %	2
Cap, veh/h	
Arrive On Green	0.00
Sat Flow, veh/h	1585
Grp Volume(v), veh/h	0
Grp Sat Flow(s),veh/h/ln	1585
Q Serve(g_s), s	0.0
Cycle Q Clear(g_c), s	0.0
Prop In Lane	1.00
Lane Grp Cap(c), veh/h	
V/C Ratio(X)	
Avail Cap(c_a), veh/h	
HCM Platoon Ratio	1.00
Upstream Filter(l)	0.00
Uniform Delay (d), s/veh	0.0
Incr Delay (d2), s/veh	0.0
Initial Q Delay(d3),s/veh	0.0
%ile BackOfQ(50%),veh/ln	0.0
Unsig. Movement Delay, s/veh	
LnGrp Delay(d),s/veh	0.0
LnGrp LOS	
Approach Vol, veh/h	A
Approach Delay, s/veh	
Approach LOS	
Timer - Assigned Phs	
Unsignalized Delay for [NBR, EBR, WBR, SBR] is excluded from calculations of the approach delay and intersection delay.	



Timings  
2: MERIDIAN ROAD & EASTONVILLE ROAD

Background AM 2040

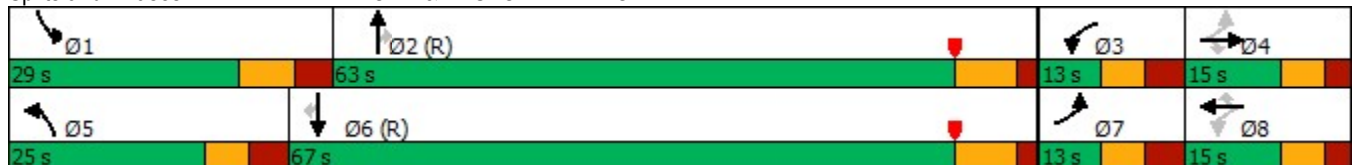
04/01/2023

Lane Group	EBL	EBT	EBR	WBL	WBT	WBR	NBL	NBT	NBR	SBL	SBT	SBR
Lane Configurations												
Traffic Volume (vph)	215	61	259	137	71	51	288	622	57	157	1846	181
Future Volume (vph)	215	61	259	137	71	51	288	622	57	157	1846	181
Turn Type	pm+pt	NA	Perm	pm+pt	NA	Perm	Prot	NA	Perm	Prot	NA	Perm
Protected Phases	7	4		3	8		5	2		1	6	
Permitted Phases	4		4	8		8			2			6
Detector Phase	7	4	4	3	8	8	5	2	2	1	6	6
Switch Phase												
Minimum Initial (s)	5.0	8.0	8.0	5.0	8.0	8.0	5.0	15.0	15.0	5.0	15.0	15.0
Minimum Split (s)	12.5	14.5	14.5	12.5	14.5	14.5	12.5	22.5	22.5	13.5	22.5	22.5
Total Split (s)	13.0	15.0	15.0	13.0	15.0	15.0	25.0	63.0	63.0	29.0	67.0	67.0
Total Split (%)	10.8%	12.5%	12.5%	10.8%	12.5%	12.5%	20.8%	52.5%	52.5%	24.2%	55.8%	55.8%
Yellow Time (s)	4.0	4.0	4.0	4.0	4.0	4.0	4.0	5.5	5.5	5.0	5.5	5.5
All-Red Time (s)	3.5	2.5	2.5	3.5	2.5	2.5	3.5	2.0	2.0	3.5	2.0	2.0
Lost Time Adjust (s)	0.0	0.0	0.0	0.0	0.0	0.0	0.0	0.0	0.0	0.0	0.0	0.0
Total Lost Time (s)	7.5	6.5	6.5	7.5	6.5	6.5	7.5	7.5	7.5	8.5	7.5	7.5
Lead/Lag	Lead	Lag	Lag	Lead	Lag	Lag	Lead	Lag	Lag	Lead	Lag	Lag
Lead-Lag Optimize?	Yes	Yes	Yes	Yes	Yes	Yes	Yes	Yes	Yes	Yes	Yes	Yes
Recall Mode	None	None	None	None	None	None	None	C-Max	C-Max	None	C-Max	C-Max
Act Effct Green (s)	14.4	8.4	8.4	11.5	8.4	8.4	17.6	60.1	60.1	16.0	59.5	59.5
Actuated g/C Ratio	0.12	0.07	0.07	0.10	0.07	0.07	0.15	0.50	0.50	0.13	0.50	0.50
v/c Ratio	0.68	0.49	0.78	0.98	0.58	0.20	1.17	0.37	0.07	0.70	1.11	0.22
Control Delay	58.2	67.2	24.9	118.5	72.2	1.6	140.7	15.4	2.3	70.5	74.0	1.3
Queue Delay	0.0	0.0	0.0	0.0	0.0	0.0	0.0	0.0	0.0	0.0	0.0	0.0
Total Delay	58.2	67.2	24.9	118.5	72.2	1.6	140.7	15.4	2.3	70.5	74.0	1.3
LOS	E	E	C	F	E	A	F	B	A	E	E	A
Approach Delay		43.1			82.6			51.9			67.7	
Approach LOS		D			F			D			E	

Intersection Summary

Cycle Length: 120  
 Actuated Cycle Length: 120  
 Offset: 45 (38%), Referenced to phase 2:NBT and 6:SBT, Start of Yellow  
 Natural Cycle: 150  
 Control Type: Actuated-Coordinated  
 Maximum v/c Ratio: 1.17  
 Intersection Signal Delay: 61.5  
 Intersection Capacity Utilization 99.2%  
 Analysis Period (min) 15  
 Intersection LOS: E  
 ICU Level of Service F

Splits and Phases: 2: MERIDIAN ROAD & EASTONVILLE ROAD



Queues  
2: MERIDIAN ROAD & EASTONVILLE ROAD

Background AM 2040  
04/01/2023



Lane Group	EBL	EBT	EBR	WBL	WBT	WBR	NBL	NBT	NBR	SBL	SBT	SBR
Lane Group Flow (vph)	226	64	273	144	75	54	303	655	60	165	1943	191
v/c Ratio	0.68	0.49	0.78	0.98	0.58	0.20	1.17	0.37	0.07	0.70	1.11	0.22
Control Delay	58.2	67.2	24.9	118.5	72.2	1.6	140.7	15.4	2.3	70.5	74.0	1.3
Queue Delay	0.0	0.0	0.0	0.0	0.0	0.0	0.0	0.0	0.0	0.0	0.0	0.0
Total Delay	58.2	67.2	24.9	118.5	72.2	1.6	140.7	15.4	2.3	70.5	74.0	1.3
Queue Length 50th (ft)	80	49	13	102	57	0	~286	149	3	119	~933	11
Queue Length 95th (ft)	#144	96	#133	#225	#116	0	m#431	m184	m10	m127	m#1066	m13
Internal Link Dist (ft)		508			1196			231			781	
Turn Bay Length (ft)	100		100	120		100	100		400	375		400
Base Capacity (vph)	330	131	349	147	131	276	259	1771	876	302	1754	880
Starvation Cap Reductn	0	0	0	0	0	0	0	0	0	0	0	0
Spillback Cap Reductn	0	0	0	0	0	0	0	0	0	0	0	0
Storage Cap Reductn	0	0	0	0	0	0	0	0	0	0	0	0
Reduced v/c Ratio	0.68	0.49	0.78	0.98	0.57	0.20	1.17	0.37	0.07	0.55	1.11	0.22

Intersection Summary

- ~ Volume exceeds capacity, queue is theoretically infinite.  
Queue shown is maximum after two cycles.
- # 95th percentile volume exceeds capacity, queue may be longer.  
Queue shown is maximum after two cycles.
- m Volume for 95th percentile queue is metered by upstream signal.

HCM 6th Signalized Intersection Summary  
 2: MERIDIAN ROAD & EASTONVILLE ROAD

Background AM 2040  
 04/01/2023

Movement	EBL	EBT	EBR	WBL	WBT	WBR	NBL	NBT	NBR	SBL	SBT	SBR
Lane Configurations												
Traffic Volume (veh/h)	215	61	259	137	71	51	288	622	57	157	1846	181
Future Volume (veh/h)	215	61	259	137	71	51	288	622	57	157	1846	181
Initial Q (Qb), veh	0	0	0	0	0	0	0	0	0	0	0	0
Ped-Bike Adj(A_pbT)	1.00		1.00	1.00		1.00	1.00		1.00	1.00		1.00
Parking Bus, Adj	1.00	1.00	1.00	1.00	1.00	1.00	1.00	1.00	1.00	1.00	1.00	1.00
Work Zone On Approach		No			No			No			No	
Adj Sat Flow, veh/h/ln	1870	1870	1870	1870	1870	1870	1870	1870	1870	1870	1870	1870
Adj Flow Rate, veh/h	226	64	0	144	75	0	303	655	60	165	1943	191
Peak Hour Factor	0.95	0.95	0.95	0.95	0.95	0.95	0.95	0.95	0.95	0.95	0.95	0.95
Percent Heavy Veh, %	2	2	2	2	2	2	2	2	2	2	2	2
Cap, veh/h	350	125		187	125		260	1878	838	194	1777	793
Arrive On Green	0.05	0.07	0.00	0.05	0.07	0.00	0.15	0.53	0.53	0.11	0.50	0.50
Sat Flow, veh/h	3456	1870	1585	1781	1870	1585	1781	3554	1585	1781	3554	1585
Grp Volume(v), veh/h	226	64	0	144	75	0	303	655	60	165	1943	191
Grp Sat Flow(s),veh/h/ln	1728	1870	1585	1781	1870	1585	1781	1777	1585	1781	1777	1585
Q Serve(g_s), s	5.5	4.0	0.0	5.5	4.7	0.0	17.5	12.8	2.2	10.9	60.0	8.2
Cycle Q Clear(g_c), s	5.5	4.0	0.0	5.5	4.7	0.0	17.5	12.8	2.2	10.9	60.0	8.2
Prop In Lane	1.00		1.00	1.00		1.00	1.00		1.00	1.00		1.00
Lane Grp Cap(c), veh/h	350	125		187	125		260	1878	838	194	1777	793
V/C Ratio(X)	0.65	0.51		0.77	0.60		1.17	0.35	0.07	0.85	1.09	0.24
Avail Cap(c_a), veh/h	350	132		187	132		260	1878	838	304	1777	793
HCM Platoon Ratio	1.00	1.00	1.00	1.00	1.00	1.00	1.00	1.00	1.00	1.00	1.00	1.00
Upstream Filter(l)	1.00	1.00	0.00	1.00	1.00	0.00	1.00	1.00	1.00	1.00	1.00	1.00
Uniform Delay (d), s/veh	51.9	54.1	0.0	53.3	54.5	0.0	51.3	16.4	13.9	52.5	30.0	17.1
Incr Delay (d2), s/veh	4.1	3.2	0.0	17.8	6.7	0.0	108.4	0.5	0.2	12.5	51.7	0.7
Initial Q Delay(d3),s/veh	0.0	0.0	0.0	0.0	0.0	0.0	0.0	0.0	0.0	0.0	0.0	0.0
%ile BackOfQ(50%),veh/ln	1.0	2.0	0.0	2.6	2.4	0.0	15.3	4.8	0.8	5.3	35.3	3.1
Unsig. Movement Delay, s/veh												
LnGrp Delay(d),s/veh	56.0	57.4	0.0	71.1	61.2	0.0	159.7	16.9	14.0	65.0	81.7	17.8
LnGrp LOS	E	E		E	E		F	B	B	E	F	B
Approach Vol, veh/h		290	A		219	A		1018			2299	
Approach Delay, s/veh		56.3			67.7			59.2			75.2	
Approach LOS		E			E			E			E	
Timer - Assigned Phs	1	2	3	4	5	6	7	8				
Phs Duration (G+Y+Rc), s	21.6	70.9	13.0	14.5	25.0	67.5	13.0	14.5				
Change Period (Y+Rc), s	8.5	7.5	7.5	6.5	7.5	7.5	7.5	6.5				
Max Green Setting (Gmax), s	20.5	55.5	5.5	8.5	17.5	59.5	5.5	8.5				
Max Q Clear Time (g_c+I1), s	12.9	14.8	7.5	6.0	19.5	62.0	7.5	6.7				
Green Ext Time (p_c), s	0.2	4.4	0.0	0.0	0.0	0.0	0.0	0.0				

Intersection Summary

HCM 6th Ctrl Delay	69.1
HCM 6th LOS	E

Notes

User approved pedestrian interval to be less than phase max green.  
 Unsignalized Delay for [EBR, WBR] is excluded from calculations of the approach delay and intersection delay.

Timings  
 3: MERIDIAN ROAD & BENT GRASS MEADOWS DRIVE

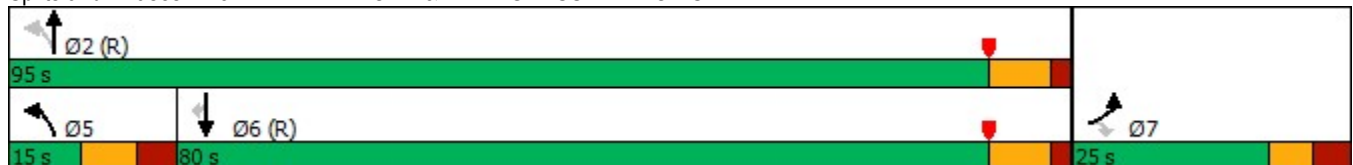


Lane Group	EBL	EBR	NBL	NBT	SBT	SBR
Lane Configurations	↖↗	↗	↖	↑↑	↑↑	↗
Traffic Volume (vph)	109	215	136	700	1926	163
Future Volume (vph)	109	215	136	700	1926	163
Turn Type	Prot	Perm	pm+pt	NA	NA	Perm
Protected Phases	7		5	2	6	
Permitted Phases		7	2			6
Detector Phase	7	7	5	2	6	6
Switch Phase						
Minimum Initial (s)	8.0	8.0	5.0	15.0	15.0	15.0
Minimum Split (s)	25.5	25.5	13.5	25.5	25.5	25.5
Total Split (s)	25.0	25.0	15.0	95.0	80.0	80.0
Total Split (%)	20.8%	20.8%	12.5%	79.2%	66.7%	66.7%
Yellow Time (s)	4.0	4.0	5.0	5.5	5.5	5.5
All-Red Time (s)	3.5	3.5	3.5	2.0	2.0	2.0
Lost Time Adjust (s)	0.0	0.0	0.0	0.0	0.0	0.0
Total Lost Time (s)	7.5	7.5	8.5	7.5	7.5	7.5
Lead/Lag			Lead		Lag	Lag
Lead-Lag Optimize?			Yes		Yes	Yes
Recall Mode	None	None	None	C-Max	C-Max	C-Max
Act Effct Green (s)	14.2	14.2	89.8	90.8	74.0	74.0
Actuated g/C Ratio	0.12	0.12	0.75	0.76	0.62	0.62
v/c Ratio	0.28	0.82	0.79	0.28	0.93	0.17
Control Delay	49.0	51.5	54.2	4.5	30.2	1.8
Queue Delay	0.0	0.0	0.0	0.0	0.0	0.0
Total Delay	49.0	51.5	54.2	4.5	30.2	1.8
LOS	D	D	D	A	C	A
Approach Delay	50.7			12.5	27.9	
Approach LOS	D			B	C	

Intersection Summary

Cycle Length: 120  
 Actuated Cycle Length: 120  
 Offset: 5 (4%), Referenced to phase 2:NBTL and 6:SBT, Start of Yellow  
 Natural Cycle: 110  
 Control Type: Actuated-Coordinated  
 Maximum v/c Ratio: 0.93  
 Intersection Signal Delay: 26.2  
 Intersection Capacity Utilization 87.0%  
 Analysis Period (min) 15  
 Intersection LOS: C  
 ICU Level of Service E

Splits and Phases: 3: MERIDIAN ROAD & BENT GRASS MEADOWS DRIVE



## 3: MERIDIAN ROAD &amp; BENT GRASS MEADOWS DRIVE

04/01/2023



Lane Group	EBL	EBR	NBL	NBT	SBT	SBR
Lane Group Flow (vph)	115	226	143	737	2027	172
v/c Ratio	0.28	0.82	0.79	0.28	0.93	0.17
Control Delay	49.0	51.5	54.2	4.5	30.2	1.8
Queue Delay	0.0	0.0	0.0	0.0	0.0	0.0
Total Delay	49.0	51.5	54.2	4.5	30.2	1.8
Queue Length 50th (ft)	41	95	74	126	720	0
Queue Length 95th (ft)	70	#198	m#175	155	#951	27
Internal Link Dist (ft)	310			750	1921	
Turn Bay Length (ft)	150		700			350
Base Capacity (vph)	500	316	182	2677	2183	1042
Starvation Cap Reductn	0	0	0	0	0	0
Spillback Cap Reductn	0	0	0	0	0	0
Storage Cap Reductn	0	0	0	0	0	0
Reduced v/c Ratio	0.23	0.72	0.79	0.28	0.93	0.17

## Intersection Summary

# 95th percentile volume exceeds capacity, queue may be longer.

Queue shown is maximum after two cycles.

m Volume for 95th percentile queue is metered by upstream signal.

HCM 6th Signalized Intersection Summary  
 3: MERIDIAN ROAD & BENT GRASS MEADOWS DRIVE

Background 2040 AM  
 04/01/2023



Movement	EBL	EBR	NBL	NBT	SBT	SBR
Lane Configurations	↖↗	↗	↖	↑↑	↑↑	↗
Traffic Volume (veh/h)	109	215	136	700	1926	163
Future Volume (veh/h)	109	215	136	700	1926	163
Initial Q (Qb), veh	0	0	0	0	0	0
Ped-Bike Adj(A_pbT)	1.00	1.00	1.00			1.00
Parking Bus, Adj	1.00	1.00	1.00	1.00	1.00	1.00
Work Zone On Approach	No			No	No	
Adj Sat Flow, veh/h/ln	1870	1870	1870	1870	1870	1870
Adj Flow Rate, veh/h	115	0	143	737	2027	172
Peak Hour Factor	0.95	0.95	0.95	0.95	0.95	0.95
Percent Heavy Veh, %	2	2	2	2	2	2
Cap, veh/h	225		186	2878	2479	1106
Arrive On Green	0.07	0.00	0.04	0.81	0.70	0.70
Sat Flow, veh/h	3456	1585	1781	3647	3647	1585
Grp Volume(v), veh/h	115	0	143	737	2027	172
Grp Sat Flow(s),veh/h/ln	1728	1585	1781	1777	1777	1585
Q Serve(g_s), s	3.9	0.0	2.6	6.0	48.2	4.4
Cycle Q Clear(g_c), s	3.9	0.0	2.6	6.0	48.2	4.4
Prop In Lane	1.00	1.00	1.00			1.00
Lane Grp Cap(c), veh/h	225		186	2878	2479	1106
V/C Ratio(X)	0.51		0.77	0.26	0.82	0.16
Avail Cap(c_a), veh/h	504		209	2878	2479	1106
HCM Platoon Ratio	1.00	1.00	1.00	1.00	1.00	1.00
Upstream Filter(I)	1.00	0.00	1.00	1.00	1.00	1.00
Uniform Delay (d), s/veh	54.2	0.0	28.0	2.7	12.8	6.2
Incr Delay (d2), s/veh	1.8	0.0	14.3	0.2	3.1	0.3
Initial Q Delay(d3),s/veh	0.0	0.0	0.0	0.0	0.0	0.0
%ile BackOfQ(50%),veh/ln	1.7	0.0	3.7	1.7	18.0	7.6
Unsig. Movement Delay, s/veh						
LnGrp Delay(d),s/veh	56.0	0.0	42.3	3.0	15.9	6.5
LnGrp LOS	E		D	A	B	A
Approach Vol, veh/h	115	A		880	2199	
Approach Delay, s/veh	56.0			9.3	15.2	
Approach LOS	E			A	B	
Timer - Assigned Phs		2		4	5	6
Phs Duration (G+Y+Rc), s		104.7		15.3	13.5	91.2
Change Period (Y+Rc), s		7.5		7.5	8.5	7.5
Max Green Setting (Gmax), s		87.5		17.5	6.5	72.5
Max Q Clear Time (g_c+I1), s		8.0		5.9	4.6	50.2
Green Ext Time (p_c), s		6.2		0.2	0.1	17.6
<b>Intersection Summary</b>						
HCM 6th Ctrl Delay			15.0			
HCM 6th LOS			B			
<b>Notes</b>						
Unsignalized Delay for [EBR] is excluded from calculations of the approach delay and intersection delay.						

Intersection						
Int Delay, s/veh	4.9					
Movement	EBT	EBR	WBL	WBT	NBL	NBR
Lane Configurations	↑	↗	↖	↑	↘	
Traffic Vol, veh/h	158	89	217	82	1	166
Future Vol, veh/h	158	89	217	82	1	166
Conflicting Peds, #/hr	0	0	0	0	0	0
Sign Control	Free	Free	Free	Free	Stop	Stop
RT Channelized	-	None	-	None	-	None
Storage Length	-	150	100	-	0	-
Veh in Median Storage, #	0	-	-	0	0	-
Grade, %	0	-	-	0	0	-
Peak Hour Factor	95	95	95	95	95	95
Heavy Vehicles, %	2	2	2	2	2	2
Mvmt Flow	166	94	228	86	1	175

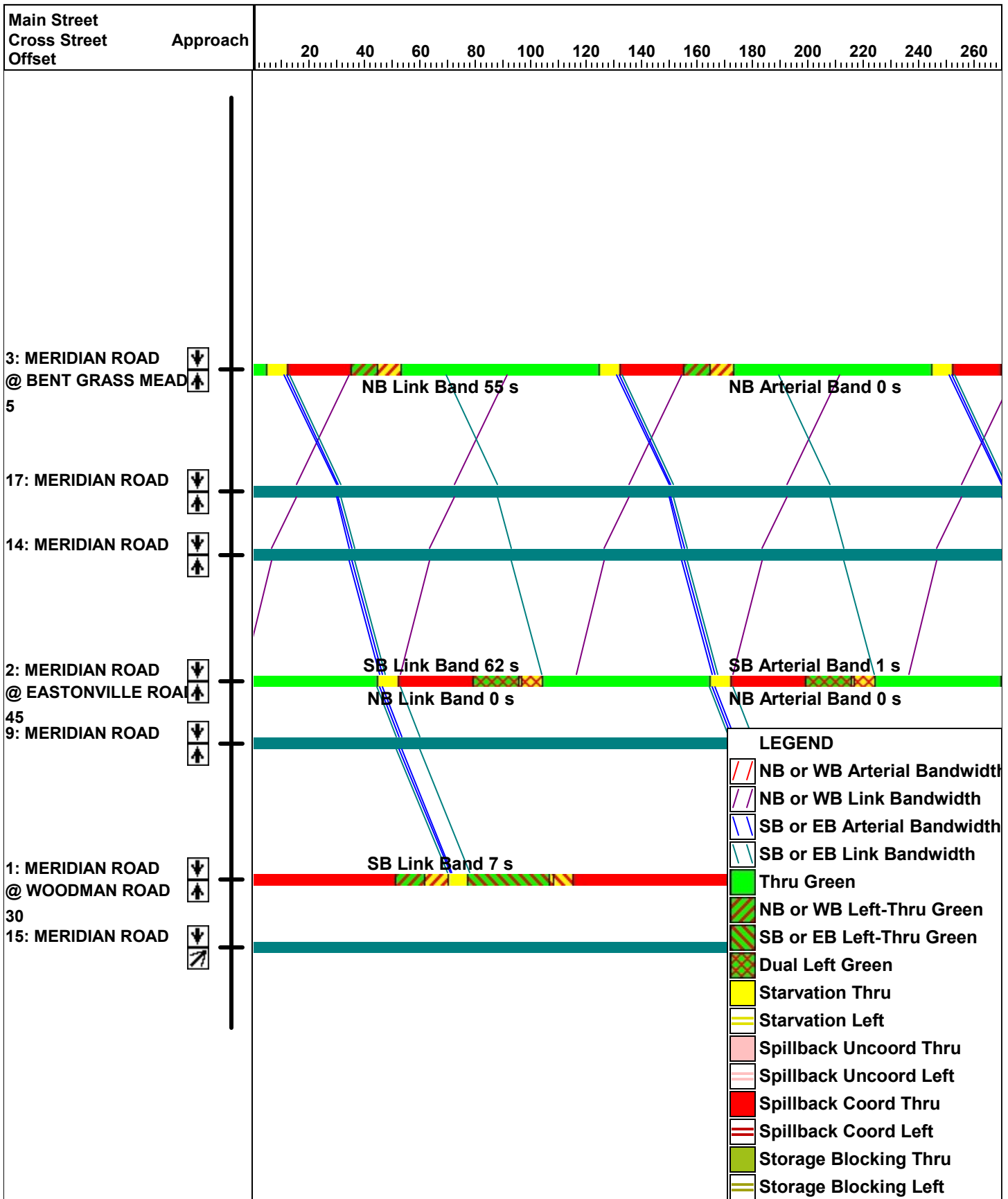
Major/Minor	Major1	Major2	Minor1		
Conflicting Flow All	0	0	260	0	708
Stage 1	-	-	-	-	166
Stage 2	-	-	-	-	542
Critical Hdwy	-	-	4.12	-	6.42
Critical Hdwy Stg 1	-	-	-	-	5.42
Critical Hdwy Stg 2	-	-	-	-	5.42
Follow-up Hdwy	-	-	2.218	-	3.518
Pot Cap-1 Maneuver	-	-	1304	-	401
Stage 1	-	-	-	-	863
Stage 2	-	-	-	-	583
Platoon blocked, %	-	-	-	-	-
Mov Cap-1 Maneuver	-	-	1304	-	331
Mov Cap-2 Maneuver	-	-	-	-	331
Stage 1	-	-	-	-	863
Stage 2	-	-	-	-	481

Approach	EB	WB	NB
HCM Control Delay, s	0	6.1	10.2
HCM LOS			B

Minor Lane/Major Mvmt	NBLn1	EBT	EBR	WBL	WBT
Capacity (veh/h)	869	-	-	1304	-
HCM Lane V/C Ratio	0.202	-	-	0.175	-
HCM Control Delay (s)	10.2	-	-	8.3	-
HCM Lane LOS	B	-	-	A	-
HCM 95th %tile Q(veh)	0.8	-	-	0.6	-



# Background 2040 AM Signal Progression



Timings  
1: MERIDIAN ROAD & WOODMAN ROAD

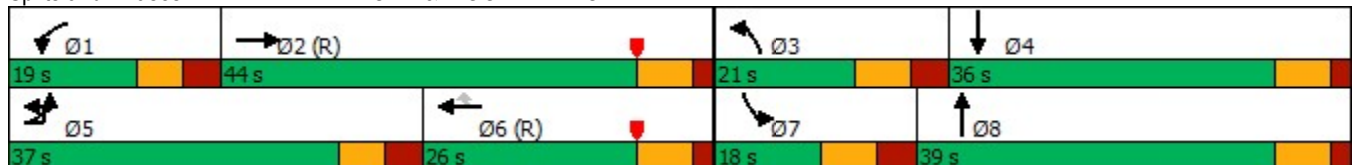
Background 2040 PM  
04/01/2023

Lane Group	EBL	EBT	EBR	WBL	WBT	WBR	NBL	NBT	NBR	SBL	SBT	SBR
Lane Configurations												
Traffic Volume (vph)	993	671	229	160	521	295	296	1069	151	291	712	609
Future Volume (vph)	993	671	229	160	521	295	296	1069	151	291	712	609
Turn Type	Prot	NA	Free	Prot	NA	Perm	Prot	NA	Free	Prot	NA	Free
Protected Phases	5	2		1	6		3	8		7	4	
Permitted Phases			Free			6			Free			Free
Detector Phase	5	2		1	6	6	3	8		7	4	
Switch Phase												
Minimum Initial (s)	5.0	15.0		5.0	15.0	15.0	5.0	15.0		5.0	15.0	
Minimum Split (s)	13.5	22.0		13.5	22.0	22.0	13.5	22.0		13.5	22.0	
Total Split (s)	37.0	44.0		19.0	26.0	26.0	21.0	39.0		18.0	36.0	
Total Split (%)	30.8%	36.7%		15.8%	21.7%	21.7%	17.5%	32.5%		15.0%	30.0%	
Yellow Time (s)	4.0	5.0		4.0	5.0	5.0	5.0	5.0		5.0	5.0	
All-Red Time (s)	3.5	2.0		3.5	2.0	2.0	3.5	2.0		3.5	2.0	
Lost Time Adjust (s)	0.0	0.0		0.0	0.0	0.0	0.0	0.0		0.0	0.0	
Total Lost Time (s)	7.5	7.0		7.5	7.0	7.0	8.5	7.0		8.5	7.0	
Lead/Lag	Lead	Lag		Lead	Lag	Lag	Lead	Lag		Lead	Lag	
Lead-Lag Optimize?	Yes	Yes		Yes	Yes	Yes	Yes	Yes		Yes	Yes	
Recall Mode	None	C-Max		None	C-Max	C-Max	None	None		None	None	
Act Effct Green (s)	29.5	38.1	120.0	10.4	19.0	19.0	12.5	32.0	120.0	9.5	29.0	120.0
Actuated g/C Ratio	0.25	0.32	1.00	0.09	0.16	0.16	0.10	0.27	1.00	0.08	0.24	1.00
v/c Ratio	1.26	0.63	0.15	0.56	0.98	0.67	0.87	1.19	0.10	1.13	0.88	0.40
Control Delay	164.3	38.2	0.2	60.0	83.6	18.9	77.7	136.4	0.1	111.3	54.8	0.8
Queue Delay	0.0	0.0	0.0	0.0	0.0	0.0	0.0	0.0	0.0	0.0	0.0	0.0
Total Delay	164.3	38.2	0.2	60.0	83.6	18.9	77.7	136.4	0.1	111.3	54.8	0.8
LOS	F	D	A	E	F	B	E	F	A	F	D	A
Approach Delay		100.3			60.2			111.4			44.6	
Approach LOS		F			E			F			D	

Intersection Summary

Cycle Length: 120  
 Actuated Cycle Length: 120  
 Offset: 100 (83%), Referenced to phase 2:EBT and 6:WBT, Start of Yellow  
 Natural Cycle: 150  
 Control Type: Actuated-Coordinated  
 Maximum v/c Ratio: 1.26  
 Intersection Signal Delay: 81.6  
 Intersection Capacity Utilization 105.6%  
 Analysis Period (min) 15  
 Intersection LOS: F  
 ICU Level of Service G

Splits and Phases: 1: MERIDIAN ROAD & WOODMAN ROAD



Queues  
1: MERIDIAN ROAD & WOODMAN ROAD

Background 2040 PM  
04/01/2023



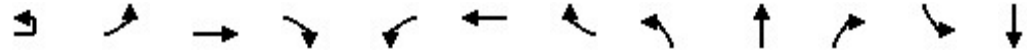
Lane Group	EBL	EBT	EBR	WBL	WBT	WBR	NBL	NBT	NBR	SBL	SBT	SBR
Lane Group Flow (vph)	1061	706	241	168	548	311	312	1125	159	306	749	641
v/c Ratio	1.26	0.63	0.15	0.56	0.98	0.67	0.87	1.19	0.10	1.13	0.88	0.40
Control Delay	164.3	38.2	0.2	60.0	83.6	18.9	77.7	136.4	0.1	111.3	54.8	0.8
Queue Delay	0.0	0.0	0.0	0.0	0.0	0.0	0.0	0.0	0.0	0.0	0.0	0.0
Total Delay	164.3	38.2	0.2	60.0	83.6	18.9	77.7	136.4	0.1	111.3	54.8	0.8
Queue Length 50th (ft)	~530	247	0	64	225	42	124	~554	0	~145	323	0
Queue Length 95th (ft)	#662	315	0	102	#341	142	#203	#688	0	m#173	m352	m0
Internal Link Dist (ft)		1165			1100			342				860
Turn Bay Length (ft)	500		630	350		250	440		330	490		450
Base Capacity (vph)	843	1122	1583	328	560	461	357	943	1583	271	855	1583
Starvation Cap Reductn	0	0	0	0	0	0	0	0	0	0	0	0
Spillback Cap Reductn	0	0	0	0	0	0	0	0	0	0	0	0
Storage Cap Reductn	0	0	0	0	0	0	0	0	0	0	0	0
Reduced v/c Ratio	1.26	0.63	0.15	0.51	0.98	0.67	0.87	1.19	0.10	1.13	0.88	0.40

Intersection Summary

- ~ Volume exceeds capacity, queue is theoretically infinite.  
Queue shown is maximum after two cycles.
- # 95th percentile volume exceeds capacity, queue may be longer.  
Queue shown is maximum after two cycles.
- m Volume for 95th percentile queue is metered by upstream signal.

HCM 6th Signalized Intersection Summary  
1: MERIDIAN ROAD & WOODMAN ROAD

Background 2040 PM  
04/01/2023



Movement	EBU	EBL	EBT	EBR	WBL	WBT	WBR	NBL	NBT	NBR	SBL	SBT
Lane Configurations		↔↔	↕↕	↔	↔↔	↕↕	↔	↔↔	↕↕	↔	↔↔	↕↕
Traffic Volume (veh/h)	15	993	671	229	160	521	295	296	1069	151	291	712
Future Volume (veh/h)	15	993	671	229	160	521	295	296	1069	151	291	712
Initial Q (Qb), veh		0	0	0	0	0	0	0	0	0	0	0
Ped-Bike Adj(A_pbT)		1.00		1.00	1.00		1.00	1.00		1.00	1.00	
Parking Bus, Adj		1.00	1.00	1.00	1.00	1.00	1.00	1.00	1.00	1.00	1.00	1.00
Work Zone On Approach			No			No			No			No
Adj Sat Flow, veh/h/ln		1870	1870	1870	1870	1870	1870	1870	1870	1870	1870	1870
Adj Flow Rate, veh/h		1045	706	0	168	548	0	312	1125	0	306	749
Peak Hour Factor		0.95	0.95	0.95	0.95	0.95	0.95	0.95	0.95	0.95	0.95	0.95
Percent Heavy Veh, %		2	2	2	2	2	2	2	2	2	2	2
Cap, veh/h		850	1203		226	563		360	948		274	859
Arrive On Green		0.25	0.34	0.00	0.07	0.16	0.00	0.10	0.27	0.00	0.08	0.24
Sat Flow, veh/h		3456	3554	1585	3456	3554	1585	3456	3554	1585	3456	3554
Grp Volume(v), veh/h		1045	706	0	168	548	0	312	1125	0	306	749
Grp Sat Flow(s),veh/h/ln		1728	1777	1585	1728	1777	1585	1728	1777	1585	1728	1777
Q Serve(g_s), s		29.5	19.7	0.0	5.7	18.4	0.0	10.7	32.0	0.0	9.5	24.3
Cycle Q Clear(g_c), s		29.5	19.7	0.0	5.7	18.4	0.0	10.7	32.0	0.0	9.5	24.3
Prop In Lane		1.00		1.00	1.00		1.00	1.00		1.00	1.00	
Lane Grp Cap(c), veh/h		850	1203		226	563		360	948		274	859
V/C Ratio(X)		1.23	0.59		0.74	0.97		0.87	1.19		1.12	0.87
Avail Cap(c_a), veh/h		850	1203		331	563		360	948		274	859
HCM Platoon Ratio		1.00	1.00	1.00	1.00	1.00	1.00	1.00	1.00	1.00	1.00	1.00
Upstream Filter(I)		1.00	1.00	0.00	1.00	1.00	0.00	1.00	1.00	0.00	1.00	1.00
Uniform Delay (d), s/veh		45.2	32.7	0.0	55.1	50.3	0.0	52.9	44.0	0.0	55.3	43.7
Incr Delay (d2), s/veh		113.8	2.1	0.0	5.0	32.0	0.0	19.4	94.9	0.0	90.1	9.8
Initial Q Delay(d3),s/veh		0.0	0.0	0.0	0.0	0.0	0.0	0.0	0.0	0.0	0.0	0.0
%ile BackOfQ(50%),veh/ln		25.6	8.5	0.0	2.6	10.4	0.0	5.6	26.3	0.0	7.5	11.7
Unsig. Movement Delay, s/veh												
LnGrp Delay(d),s/veh		159.1	34.8	0.0	60.1	82.3	0.0	72.4	138.9	0.0	145.3	53.5
LnGrp LOS		F	C		E	F		E	F		F	D
Approach Vol, veh/h			1751	A		716	A		1437	A		1055
Approach Delay, s/veh			109.0			77.1			124.5			80.1
Approach LOS			F			E			F			F
Timer - Assigned Phs	1	2	3	4	5	6	7	8				
Phs Duration (G+Y+Rc), s	15.4	47.6	21.0	36.0	37.0	26.0	18.0	39.0				
Change Period (Y+Rc), s	7.5	7.0	8.5	7.0	7.5	7.0	8.5	7.0				
Max Green Setting (Gmax), s	11.5	37.0	12.5	29.0	29.5	19.0	9.5	32.0				
Max Q Clear Time (g_c+I1), s	7.7	21.7	12.7	26.3	31.5	20.4	11.5	34.0				
Green Ext Time (p_c), s	0.2	3.9	0.0	1.3	0.0	0.0	0.0	0.0				

Intersection Summary

HCM 6th Ctrl Delay	102.7
HCM 6th LOS	F

Notes

- User approved pedestrian interval to be less than phase max green.
- User approved ignoring U-Turning movement.
- Unsignalized Delay for [NBR, EBR, WBR, SBR] is excluded from calculations of the approach delay and intersection delay.

Movement	SBR
Lane Configurations	
Traffic Volume (veh/h)	609
Future Volume (veh/h)	609
Initial Q (Qb), veh	0
Ped-Bike Adj(A_pbT)	1.00
Parking Bus, Adj	1.00
Work Zone On Approach	
Adj Sat Flow, veh/h/ln	1870
Adj Flow Rate, veh/h	0
Peak Hour Factor	0.95
Percent Heavy Veh, %	2
Cap, veh/h	
Arrive On Green	0.00
Sat Flow, veh/h	1585
Grp Volume(v), veh/h	0
Grp Sat Flow(s),veh/h/ln	1585
Q Serve(g_s), s	0.0
Cycle Q Clear(g_c), s	0.0
Prop In Lane	1.00
Lane Grp Cap(c), veh/h	
V/C Ratio(X)	
Avail Cap(c_a), veh/h	
HCM Platoon Ratio	1.00
Upstream Filter(l)	0.00
Uniform Delay (d), s/veh	0.0
Incr Delay (d2), s/veh	0.0
Initial Q Delay(d3),s/veh	0.0
%ile BackOfQ(50%),veh/ln	0.0
Unsig. Movement Delay, s/veh	
LnGrp Delay(d),s/veh	0.0
LnGrp LOS	
Approach Vol, veh/h	A
Approach Delay, s/veh	
Approach LOS	
Timer - Assigned Phs	

Timings  
2: MERIDIAN ROAD & EASTONVILLE ROAD

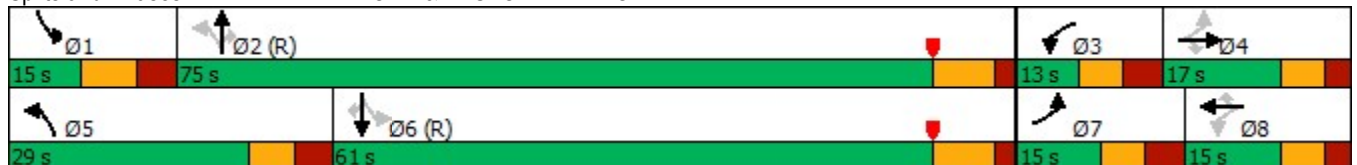
Background 2040 PM  
04/01/2023

Lane Group	EBL	EBT	EBR	WBL	WBT	WBR	NBL	NBT	NBR	SBL	SBT	SBR
Lane Configurations												
Traffic Volume (vph)	330	146	283	44	100	190	370	1882	164	117	1263	174
Future Volume (vph)	330	146	283	44	100	190	370	1882	164	117	1263	174
Turn Type	pm+pt	NA	Perm	pm+pt	NA	Perm	pm+pt	NA	Perm	pm+pt	NA	Perm
Protected Phases	7	4		3	8		5	2		1	6	
Permitted Phases	4		4	8		8	2		2	6		6
Detector Phase	7	4	4	3	8	8	5	2	2	1	6	6
Switch Phase												
Minimum Initial (s)	5.0	8.0	8.0	5.0	8.0	8.0	5.0	15.0	15.0	5.0	15.0	15.0
Minimum Split (s)	12.5	14.5	14.5	12.5	14.5	14.5	12.5	25.5	25.5	13.5	25.5	25.5
Total Split (s)	15.0	17.0	17.0	13.0	15.0	15.0	29.0	75.0	75.0	15.0	61.0	61.0
Total Split (%)	12.5%	14.2%	14.2%	10.8%	12.5%	12.5%	24.2%	62.5%	62.5%	12.5%	50.8%	50.8%
Yellow Time (s)	4.0	4.0	4.0	4.0	4.0	4.0	4.0	5.5	5.5	5.0	5.5	5.5
All-Red Time (s)	3.5	2.5	2.5	3.5	2.5	2.5	3.5	2.0	2.0	3.5	2.0	2.0
Lost Time Adjust (s)	0.0	0.0	0.0	0.0	0.0	0.0	0.0	0.0	0.0	0.0	0.0	0.0
Total Lost Time (s)	7.5	6.5	6.5	7.5	6.5	6.5	7.5	7.5	7.5	8.5	7.5	7.5
Lead/Lag	Lead	Lag	Lag	Lead	Lag	Lag	Lead	Lag	Lag	Lead	Lag	Lag
Lead-Lag Optimize?	Yes	Yes	Yes	Yes	Yes	Yes	Yes	Yes	Yes	Yes	Yes	Yes
Recall Mode	None	None	None	None	None	None	None	C-Max	C-Max	None	C-Max	C-Max
Act Effct Green (s)	18.1	13.1	13.1	13.0	8.5	8.5	82.5	67.5	67.5	59.0	53.5	53.5
Actuated g/C Ratio	0.15	0.11	0.11	0.11	0.07	0.07	0.69	0.56	0.56	0.49	0.45	0.45
v/c Ratio	0.92	0.76	0.74	0.30	0.80	0.57	1.02	1.00	0.18	0.78	0.84	0.22
Control Delay	77.1	76.8	23.0	46.5	94.2	9.0	73.9	19.8	1.0	55.3	40.7	6.8
Queue Delay	0.0	0.0	0.0	0.0	0.0	0.0	0.0	0.0	0.0	0.0	0.0	0.0
Total Delay	77.1	76.8	23.0	46.5	94.2	9.0	73.9	19.8	1.0	55.3	40.7	6.8
LOS	E	E	C	D	F	A	E	B	A	E	D	A
Approach Delay		56.9			39.4			26.8			38.0	
Approach LOS		E			D			C			D	

Intersection Summary

Cycle Length: 120  
 Actuated Cycle Length: 120  
 Offset: 89 (74%), Referenced to phase 2:NBTL and 6:SBTL, Start of Yellow  
 Natural Cycle: 110  
 Control Type: Actuated-Coordinated  
 Maximum v/c Ratio: 1.02  
 Intersection Signal Delay: 35.6  
 Intersection Capacity Utilization 98.8%  
 Analysis Period (min) 15  
 Intersection LOS: D  
 ICU Level of Service F

Splits and Phases: 2: MERIDIAN ROAD & EASTONVILLE ROAD



Queues  
2: MERIDIAN ROAD & EASTONVILLE ROAD

Background 2040 PM  
04/01/2023



Lane Group	EBL	EBT	EBR	WBL	WBT	WBR	NBL	NBT	NBR	SBL	SBT	SBR
Lane Group Flow (vph)	347	154	298	46	105	200	389	1981	173	123	1329	183
v/c Ratio	0.92	0.76	0.74	0.30	0.80	0.57	1.02	1.00	0.18	0.78	0.84	0.22
Control Delay	77.1	76.8	23.0	46.5	94.2	9.0	73.9	19.8	1.0	55.3	40.7	6.8
Queue Delay	0.0	0.0	0.0	0.0	0.0	0.0	0.0	0.0	0.0	0.0	0.0	0.0
Total Delay	77.1	76.8	23.0	46.5	94.2	9.0	73.9	19.8	1.0	55.3	40.7	6.8
Queue Length 50th (ft)	126	121	32	30	82	0	~276	608	4	31	573	31
Queue Length 95th (ft)	#174	#254	#167	64	#179	29	m234	m175	m3	m#128	643	75
Internal Link Dist (ft)		508			1196			231				781
Turn Bay Length (ft)	100		100	120		100	100		400	375		400
Base Capacity (vph)	377	203	400	154	131	349	380	1990	967	158	1577	841
Starvation Cap Reductn	0	0	0	0	0	0	0	0	0	0	0	0
Spillback Cap Reductn	0	0	0	0	0	0	0	0	0	0	0	0
Storage Cap Reductn	0	0	0	0	0	0	0	0	0	0	0	0
Reduced v/c Ratio	0.92	0.76	0.74	0.30	0.80	0.57	1.02	1.00	0.18	0.78	0.84	0.22

Intersection Summary

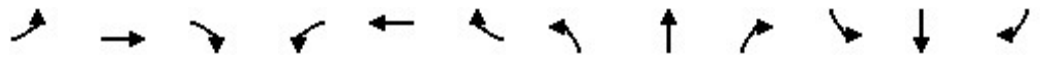
- ~ Volume exceeds capacity, queue is theoretically infinite.  
Queue shown is maximum after two cycles.
- # 95th percentile volume exceeds capacity, queue may be longer.  
Queue shown is maximum after two cycles.
- m Volume for 95th percentile queue is metered by upstream signal.



HCM 6th Signalized Intersection Summary  
2: MERIDIAN ROAD & EASTONVILLE ROAD

Background 2040 PM

04/01/2023



Movement	EBL	EBT	EBR	WBL	WBT	WBR	NBL	NBT	NBR	SBL	SBT	SBR
Lane Configurations	↖↗	↑	↖	↖	↑	↖	↖	↑↑	↖	↖	↑↑	↖
Traffic Volume (veh/h)	330	146	283	44	100	190	370	1882	164	117	1263	174
Future Volume (veh/h)	330	146	283	44	100	190	370	1882	164	117	1263	174
Initial Q (Qb), veh	0	0	0	0	0	0	0	0	0	0	0	0
Ped-Bike Adj(A_pbT)	1.00		1.00	1.00		1.00	1.00		1.00	1.00		1.00
Parking Bus, Adj	1.00	1.00	1.00	1.00	1.00	1.00	1.00	1.00	1.00	1.00	1.00	1.00
Work Zone On Approach		No			No			No			No	
Adj Sat Flow, veh/h/ln	1870	1870	1870	1870	1870	1870	1870	1870	1870	1870	1870	1870
Adj Flow Rate, veh/h	347	154	0	46	105	0	389	1981	173	123	1329	183
Peak Hour Factor	0.95	0.95	0.95	0.95	0.95	0.95	0.95	0.95	0.95	0.95	0.95	0.95
Percent Heavy Veh, %	2	2	2	2	2	2	2	2	2	2	2	2
Cap, veh/h	375	188		143	132		413	2004	894	157	1601	714
Arrive On Green	0.06	0.10	0.00	0.03	0.07	0.00	0.17	0.56	0.56	0.05	0.45	0.45
Sat Flow, veh/h	3456	1870	1585	1781	1870	1585	1781	3554	1585	1781	3554	1585
Grp Volume(v), veh/h	347	154	0	46	105	0	389	1981	173	123	1329	183
Grp Sat Flow(s),veh/h/ln	1728	1870	1585	1781	1870	1585	1781	1777	1585	1781	1777	1585
Q Serve(g_s), s	7.5	9.7	0.0	2.9	6.6	0.0	18.9	65.9	6.4	4.4	39.4	8.6
Cycle Q Clear(g_c), s	7.5	9.7	0.0	2.9	6.6	0.0	18.9	65.9	6.4	4.4	39.4	8.6
Prop In Lane	1.00		1.00	1.00		1.00	1.00		1.00	1.00		1.00
Lane Grp Cap(c), veh/h	375	188		143	132		413	2004	894	157	1601	714
V/C Ratio(X)	0.93	0.82		0.32	0.79		0.94	0.99	0.19	0.79	0.83	0.26
Avail Cap(c_a), veh/h	375	188		166	132		421	2004	894	159	1601	714
HCM Platoon Ratio	1.00	1.00	1.00	1.00	1.00	1.00	1.00	1.00	1.00	1.00	1.00	1.00
Upstream Filter(I)	1.00	1.00	0.00	1.00	1.00	0.00	1.00	1.00	1.00	1.00	1.00	1.00
Uniform Delay (d), s/veh	52.3	52.9	0.0	49.7	54.9	0.0	34.1	25.8	12.8	28.1	29.0	20.5
Incr Delay (d2), s/veh	28.5	23.8	0.0	1.3	27.1	0.0	29.2	17.5	0.5	22.1	5.2	0.9
Initial Q Delay(d3),s/veh	0.0	0.0	0.0	0.0	0.0	0.0	0.0	0.0	0.0	0.0	0.0	0.0
%ile BackOfQ(50%),veh/ln	3.1	5.8	0.0	1.3	4.1	0.0	14.1	28.5	2.4	2.6	16.3	3.4
Unsig. Movement Delay, s/veh												
LnGrp Delay(d),s/veh	80.8	76.7	0.0	50.9	82.0	0.0	63.3	43.3	13.3	50.1	34.1	21.4
LnGrp LOS	F	E		D	F		E	D	B	D	C	C
Approach Vol, veh/h		501	A		151	A		2543			1635	
Approach Delay, s/veh		79.5			72.6			44.3			33.9	
Approach LOS		E			E			D			C	
Timer - Assigned Phs	1	2	3	4	5	6	7	8				
Phs Duration (G+Y+Rc), s	14.8	75.2	11.4	18.6	28.5	61.5	15.0	15.0				
Change Period (Y+Rc), s	8.5	7.5	7.5	6.5	7.5	7.5	7.5	6.5				
Max Green Setting (Gmax), s	6.5	67.5	5.5	10.5	21.5	53.5	7.5	8.5				
Max Q Clear Time (g_c+I1), s	6.4	67.9	4.9	11.7	20.9	41.4	9.5	8.6				
Green Ext Time (p_c), s	0.0	0.0	0.0	0.0	0.1	6.9	0.0	0.0				

Intersection Summary

HCM 6th Ctrl Delay	45.3
HCM 6th LOS	D

Notes

User approved pedestrian interval to be less than phase max green.  
Unsignalized Delay for [EBR, WBR] is excluded from calculations of the approach delay and intersection delay.

Timings  
 3: MERIDIAN ROAD & BENT GRASS MEADOWS DRIVE

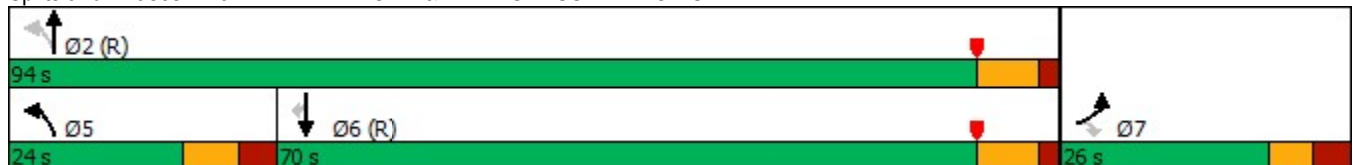


Lane Group	EBL	EBR	NBL	NBT	SBT	SBR
Lane Configurations	↖↖	↗	↖	↑↑	↑↑	↗
Traffic Volume (vph)	133	163	166	2174	1340	173
Future Volume (vph)	133	163	166	2174	1340	173
Turn Type	Prot	Perm	pm+pt	NA	NA	Perm
Protected Phases	7		5	2	6	
Permitted Phases		7	2			6
Detector Phase	7	7	5	2	6	6
Switch Phase						
Minimum Initial (s)	8.0	8.0	5.0	15.0	15.0	15.0
Minimum Split (s)	25.5	25.5	13.5	25.5	25.5	25.5
Total Split (s)	26.0	26.0	24.0	94.0	70.0	70.0
Total Split (%)	21.7%	21.7%	20.0%	78.3%	58.3%	58.3%
Yellow Time (s)	4.0	4.0	5.0	5.5	5.5	5.5
All-Red Time (s)	3.5	3.5	3.5	2.0	2.0	2.0
Lost Time Adjust (s)	0.0	0.0	0.0	0.0	0.0	0.0
Total Lost Time (s)	7.5	7.5	8.5	7.5	7.5	7.5
Lead/Lag			Lead		Lag	Lag
Lead-Lag Optimize?			Yes		Yes	Yes
Recall Mode	None	None	None	C-Max	C-Max	C-Max
Act Effct Green (s)	10.4	10.4	93.6	94.6	75.4	75.4
Actuated g/C Ratio	0.09	0.09	0.78	0.79	0.63	0.63
v/c Ratio	0.47	0.59	0.57	0.82	0.63	0.17
Control Delay	57.2	16.0	19.8	5.4	16.3	2.1
Queue Delay	0.0	0.0	0.0	0.0	0.0	0.0
Total Delay	57.2	16.0	19.8	5.4	16.3	2.1
LOS	E	B	B	A	B	A
Approach Delay	34.5			6.5	14.7	
Approach LOS	C			A	B	

Intersection Summary

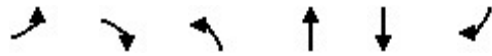
Cycle Length: 120  
 Actuated Cycle Length: 120  
 Offset: 27 (23%), Referenced to phase 2:NBTL and 6:SBT, Start of Yellow  
 Natural Cycle: 90  
 Control Type: Actuated-Coordinated  
 Maximum v/c Ratio: 0.82  
 Intersection Signal Delay: 11.5  
 Intersection Capacity Utilization 79.3%  
 Analysis Period (min) 15  
 Intersection LOS: B  
 ICU Level of Service D

Splits and Phases: 3: MERIDIAN ROAD & BENT GRASS MEADOWS DRIVE



## 3: MERIDIAN ROAD &amp; BENT GRASS MEADOWS DRIVE

04/01/2023



Lane Group	EBL	EBR	NBL	NBT	SBT	SBR
Lane Group Flow (vph)	140	172	175	2288	1411	182
v/c Ratio	0.47	0.59	0.57	0.82	0.63	0.17
Control Delay	57.2	16.0	19.8	5.4	16.3	2.1
Queue Delay	0.0	0.0	0.0	0.0	0.0	0.0
Total Delay	57.2	16.0	19.8	5.4	16.3	2.1
Queue Length 50th (ft)	54	0	36	124	321	0
Queue Length 95th (ft)	85	66	m40	m139	491	32
Internal Link Dist (ft)	310			750	1921	
Turn Bay Length (ft)	150		700			350
Base Capacity (vph)	529	389	373	2791	2225	1062
Starvation Cap Reductn	0	0	0	0	0	0
Spillback Cap Reductn	0	0	0	0	0	0
Storage Cap Reductn	0	0	0	0	0	0
Reduced v/c Ratio	0.26	0.44	0.47	0.82	0.63	0.17

## Intersection Summary

m Volume for 95th percentile queue is metered by upstream signal.

HCM 6th Signalized Intersection Summary  
 3: MERIDIAN ROAD & BENT GRASS MEADOWS DRIVE

Background 2040 PM  
 04/01/2023



Movement	EBL	EBR	NBL	NBT	SBT	SBR
Lane Configurations	↖↗	↗	↖	↑↑	↑↑	↗
Traffic Volume (veh/h)	133	163	166	2174	1340	173
Future Volume (veh/h)	133	163	166	2174	1340	173
Initial Q (Qb), veh	0	0	0	0	0	0
Ped-Bike Adj(A_pbT)	1.00	1.00	1.00			1.00
Parking Bus, Adj	1.00	1.00	1.00	1.00	1.00	1.00
Work Zone On Approach	No			No	No	
Adj Sat Flow, veh/h/ln	1870	1870	1870	1870	1870	1870
Adj Flow Rate, veh/h	140	0	175	2288	1411	182
Peak Hour Factor	0.95	0.95	0.95	0.95	0.95	0.95
Percent Heavy Veh, %	2	2	2	2	2	2
Cap, veh/h	228		298	2875	2460	1097
Arrive On Green	0.07	0.00	0.05	0.81	0.69	0.69
Sat Flow, veh/h	3456	1585	1781	3647	3647	1585
Grp Volume(v), veh/h	140	0	175	2288	1411	182
Grp Sat Flow(s),veh/h/ln	1728	1585	1781	1777	1777	1585
Q Serve(g_s), s	4.7	0.0	3.2	41.4	24.3	4.8
Cycle Q Clear(g_c), s	4.7	0.0	3.2	41.4	24.3	4.8
Prop In Lane	1.00	1.00	1.00			1.00
Lane Grp Cap(c), veh/h	228		298	2875	2460	1097
V/C Ratio(X)	0.61		0.59	0.80	0.57	0.17
Avail Cap(c_a), veh/h	533		447	2875	2460	1097
HCM Platoon Ratio	1.00	1.00	1.00	1.00	1.00	1.00
Upstream Filter(I)	1.00	0.00	1.00	1.00	1.00	1.00
Uniform Delay (d), s/veh	54.5	0.0	10.4	6.1	9.4	6.4
Incr Delay (d2), s/veh	2.7	0.0	1.8	2.4	1.0	0.3
Initial Q Delay(d3),s/veh	0.0	0.0	0.0	0.0	0.0	0.0
%ile BackOfQ(50%),veh/ln	2.1	0.0	1.9	12.2	9.0	8.0
Unsig. Movement Delay, s/veh						
LnGrp Delay(d),s/veh	57.2	0.0	12.2	8.5	10.4	6.7
LnGrp LOS	E		B	A	B	A
Approach Vol, veh/h	140	A		2463	1593	
Approach Delay, s/veh	57.2			8.8	10.0	
Approach LOS	E			A	A	
Timer - Assigned Phs		2		4	5	6
Phs Duration (G+Y+Rc), s		104.6		15.4	14.0	90.6
Change Period (Y+Rc), s		7.5		7.5	8.5	7.5
Max Green Setting (Gmax), s		86.5		18.5	15.5	62.5
Max Q Clear Time (g_c+I1), s		43.4		6.7	5.2	26.3
Green Ext Time (p_c), s		32.2		0.3	0.3	15.8
<b>Intersection Summary</b>						
HCM 6th Ctrl Delay			10.9			
HCM 6th LOS			B			

Notes

Unsignalized Delay for [EBR] is excluded from calculations of the approach delay and intersection delay.

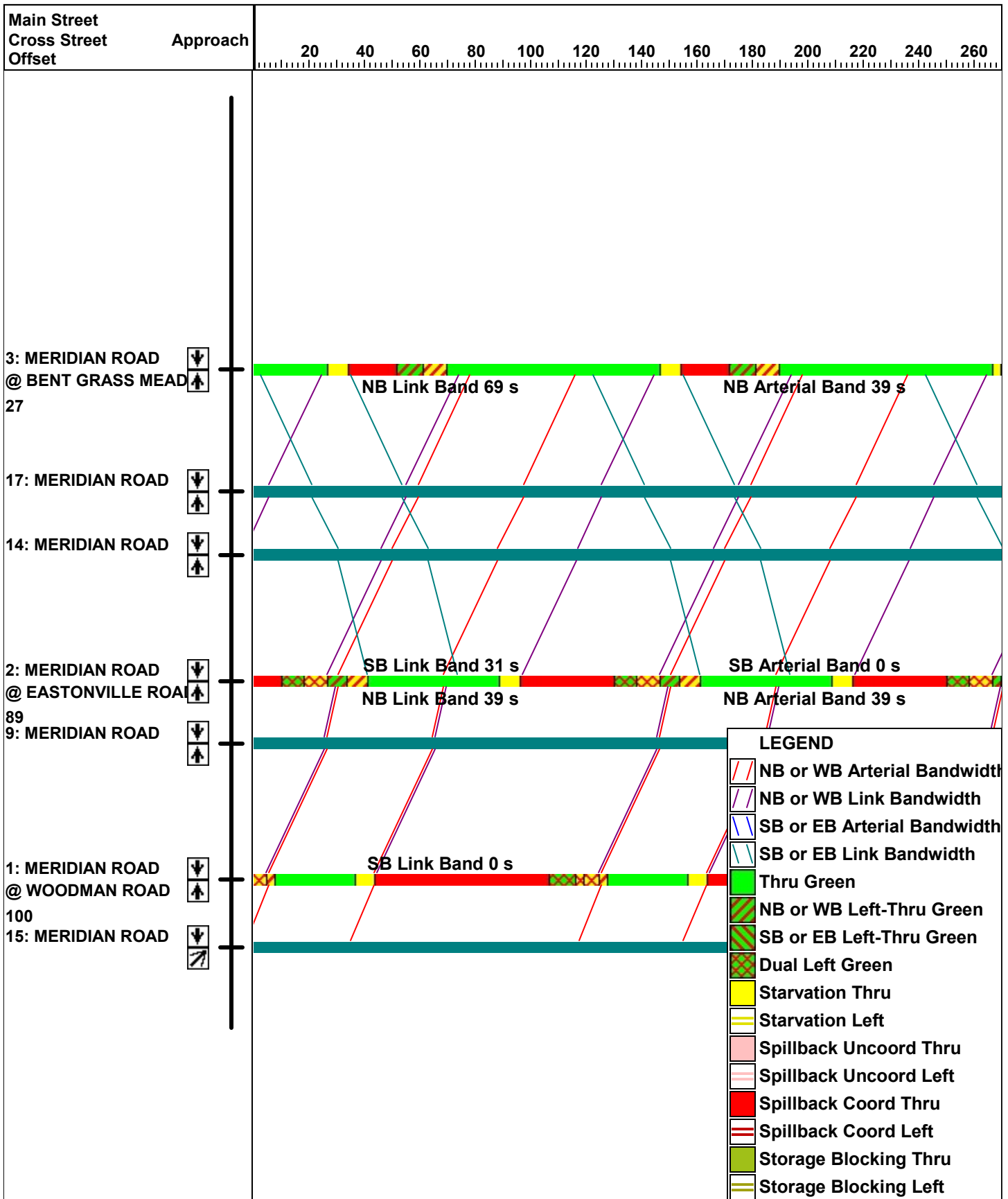
Intersection						
Int Delay, s/veh	4					
Movement	EBT	EBR	WBL	WBT	NBL	NBR
Lane Configurations	↑	↗	↘	↑	↘	↗
Traffic Vol, veh/h	139	57	150	189	3	157
Future Vol, veh/h	139	57	150	189	3	157
Conflicting Peds, #/hr	0	0	0	0	0	0
Sign Control	Free	Free	Free	Free	Stop	Stop
RT Channelized	-	None	-	None	-	None
Storage Length	-	150	100	-	0	-
Veh in Median Storage, #	0	-	-	0	0	-
Grade, %	0	-	-	0	0	-
Peak Hour Factor	95	95	95	95	95	95
Heavy Vehicles, %	2	2	2	2	2	2
Mvmt Flow	146	60	158	199	3	165

Major/Minor	Major1	Major2	Minor1		
Conflicting Flow All	0	0	206	0	661 146
Stage 1	-	-	-	-	146 -
Stage 2	-	-	-	-	515 -
Critical Hdwy	-	-	4.12	-	6.42 6.22
Critical Hdwy Stg 1	-	-	-	-	5.42 -
Critical Hdwy Stg 2	-	-	-	-	5.42 -
Follow-up Hdwy	-	-	2.218	-	3.518 3.318
Pot Cap-1 Maneuver	-	-	1365	-	427 901
Stage 1	-	-	-	-	881 -
Stage 2	-	-	-	-	600 -
Platoon blocked, %	-	-	-	-	-
Mov Cap-1 Maneuver	-	-	1365	-	377 901
Mov Cap-2 Maneuver	-	-	-	-	377 -
Stage 1	-	-	-	-	881 -
Stage 2	-	-	-	-	530 -

Approach	EB	WB	NB
HCM Control Delay, s	0	3.5	10.1
HCM LOS			B

Minor Lane/Major Mvmt	NBLn1	EBT	EBR	WBL	WBT
Capacity (veh/h)	878	-	-	1365	-
HCM Lane V/C Ratio	0.192	-	-	0.116	-
HCM Control Delay (s)	10.1	-	-	8	-
HCM Lane LOS	B	-	-	A	-
HCM 95th %tile Q(veh)	0.7	-	-	0.4	-

# Background 2040 PM Signal Progression



## **APPENDIX G – Total 2024 & 2040 Synchro Outputs**



Timings  
1: MERIDIAN ROAD & WOODMAN ROAD

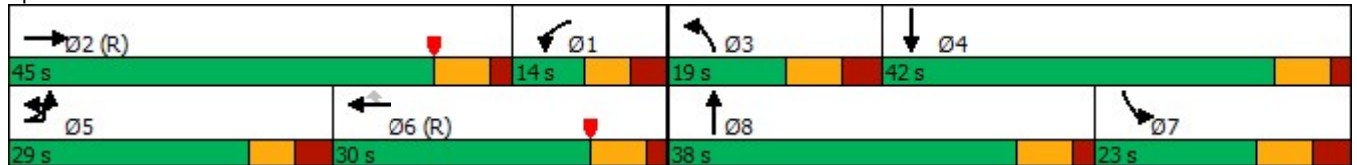
Total 2024 Shopping Center AM  
04/10/2023

Lane Group	EBL	EBT	EBR	WBL	WBT	WBR	NBL	NBT	NBR	SBL	SBT	SBR
Lane Configurations												
Traffic Volume (vph)	410	226	122	61	413	176	182	363	18	223	779	835
Future Volume (vph)	410	226	122	61	413	176	182	363	18	223	779	835
Turn Type	Prot	NA	Free	Prot	NA	Perm	Prot	NA	Free	Prot	NA	Free
Protected Phases	5	2		1	6		3	8		7	4	
Permitted Phases			Free			6			Free			Free
Detector Phase	5	2		1	6	6	3	8		7	4	
Switch Phase												
Minimum Initial (s)	5.0	15.0		5.0	15.0	15.0	5.0	15.0		5.0	15.0	
Minimum Split (s)	13.5	22.0		13.5	22.0	22.0	13.5	22.0		13.5	22.0	
Total Split (s)	29.0	45.0		14.0	30.0	30.0	19.0	38.0		23.0	42.0	
Total Split (%)	24.2%	37.5%		11.7%	25.0%	25.0%	15.8%	31.7%		19.2%	35.0%	
Yellow Time (s)	4.0	5.0		4.0	5.0	5.0	5.0	5.0		5.0	5.0	
All-Red Time (s)	3.5	2.0		3.5	2.0	2.0	3.5	2.0		3.5	2.0	
Lost Time Adjust (s)	0.0	0.0		0.0	0.0	0.0	0.0	0.0		0.0	0.0	
Total Lost Time (s)	7.5	7.0		7.5	7.0	7.0	8.5	7.0		8.5	7.0	
Lead/Lag	Lead	Lead		Lag	Lag	Lag	Lead	Lead		Lag	Lag	
Lead-Lag Optimize?	Yes	Yes		Yes	Yes	Yes	Yes	Yes		Yes	Yes	
Recall Mode	None	C-Max		None	C-Max	C-Max	None	None		None	None	
Act Effct Green (s)	20.4	43.0	120.0	6.3	26.3	26.3	10.1	18.6	120.0	24.7	33.1	120.0
Actuated g/C Ratio	0.17	0.36	1.00	0.05	0.22	0.22	0.08	0.16	1.00	0.21	0.28	1.00
v/c Ratio	0.85	0.21	0.09	0.36	0.57	0.34	0.66	0.69	0.01	0.34	0.87	0.57
Control Delay	62.4	29.0	0.1	60.6	46.2	2.7	64.6	54.6	0.0	33.8	36.7	4.5
Queue Delay	0.0	0.0	0.0	0.0	0.0	0.0	0.0	0.0	0.0	0.0	0.0	0.0
Total Delay	62.4	29.0	0.1	60.6	46.2	2.7	64.6	54.6	0.0	33.8	36.7	4.5
LOS	E	C	A	E	D	A	E	D	A	C	D	A
Approach Delay		42.6			35.8			56.1			21.7	
Approach LOS		D			D			E			C	

Intersection Summary

Cycle Length: 120  
 Actuated Cycle Length: 120  
 Offset: 30 (25%), Referenced to phase 2:EBT and 6:WBT, Start of Yellow  
 Natural Cycle: 90  
 Control Type: Actuated-Coordinated  
 Maximum v/c Ratio: 0.87  
 Intersection Signal Delay: 33.4  
 Intersection LOS: C  
 Intersection Capacity Utilization 76.2%  
 ICU Level of Service D  
 Analysis Period (min) 15

Splits and Phases: 1: MERIDIAN ROAD & WOODMAN ROAD



Queues  
1: MERIDIAN ROAD & WOODMAN ROAD

Total 2024 Shopping Center AM  
04/10/2023



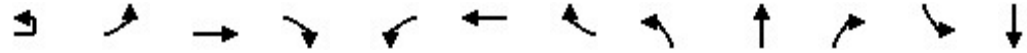
Lane Group	EBL	EBT	EBR	WBL	WBT	WBR	NBL	NBT	NBR	SBL	SBT	SBR
Lane Group Flow (vph)	494	266	144	65	439	187	190	378	19	242	847	908
v/c Ratio	0.85	0.21	0.09	0.36	0.57	0.34	0.66	0.69	0.01	0.34	0.87	0.57
Control Delay	62.4	29.0	0.1	60.6	46.2	2.7	64.6	54.6	0.0	33.8	36.7	4.5
Queue Delay	0.0	0.0	0.0	0.0	0.0	0.0	0.0	0.0	0.0	0.0	0.0	0.0
Total Delay	62.4	29.0	0.1	60.6	46.2	2.7	64.6	54.6	0.0	33.8	36.7	4.5
Queue Length 50th (ft)	191	80	0	25	166	0	74	148	0	90	344	83
Queue Length 95th (ft)	236	108	0	49	223	13	114	191	0	m89	m317	m42
Internal Link Dist (ft)		1165			1100			342				860
Turn Bay Length (ft)	500		630	350		250	440		330	490		450
Base Capacity (vph)	615	1269	1583	185	775	549	300	914	1583	705	1032	1583
Starvation Cap Reductn	0	0	0	0	0	0	0	0	0	0	0	0
Spillback Cap Reductn	0	0	0	0	0	0	0	0	0	0	0	0
Storage Cap Reductn	0	0	0	0	0	0	0	0	0	0	0	0
Reduced v/c Ratio	0.80	0.21	0.09	0.35	0.57	0.34	0.63	0.41	0.01	0.34	0.82	0.57

Intersection Summary

m Volume for 95th percentile queue is metered by upstream signal.

HCM 6th Signalized Intersection Summary  
1: MERIDIAN ROAD & WOODMAN ROAD

Total 2024 Shopping Center AM  
04/10/2023



Movement	EBU	EBL	EBT	EBR	WBL	WBT	WBR	NBL	NBT	NBR	SBL	SBT
Lane Configurations		↔↔	↕↕	↔	↔↔	↕↕	↔	↔↔	↕↕	↔	↔↔	↕↕
Traffic Volume (veh/h)	10	410	226	122	61	413	176	182	363	18	223	779
Future Volume (veh/h)	10	410	226	122	61	413	176	182	363	18	223	779
Initial Q (Qb), veh		0	0	0	0	0	0	0	0	0	0	0
Ped-Bike Adj(A_pbT)		1.00		1.00	1.00		1.00	1.00		1.00	1.00	
Parking Bus, Adj		1.00	1.00	1.00	1.00	1.00	1.00	1.00	1.00	1.00	1.00	1.00
Work Zone On Approach			No			No			No			No
Adj Sat Flow, veh/h/ln		1870	1870	1870	1870	1870	1870	1870	1870	1870	1870	1870
Adj Flow Rate, veh/h		482	266	0	65	439	0	190	378	0	242	847
Peak Hour Factor		0.85	0.85	0.85	0.94	0.94	0.94	0.96	0.96	0.96	0.92	0.92
Percent Heavy Veh, %		2	2	2	2	2	2	2	2	2	2	2
Cap, veh/h		546	1125		283	840		247	487		741	951
Arrive On Green		0.16	0.32	0.00	0.08	0.24	0.00	0.07	0.14	0.00	0.21	0.27
Sat Flow, veh/h		3456	3554	1585	3456	3554	1585	3456	3554	1585	3456	3554
Grp Volume(v), veh/h		482	266	0	65	439	0	190	378	0	242	847
Grp Sat Flow(s),veh/h/ln		1728	1777	1585	1728	1777	1585	1728	1777	1585	1728	1777
Q Serve(g_s), s		16.4	6.6	0.0	2.1	12.9	0.0	6.5	12.3	0.0	7.1	27.5
Cycle Q Clear(g_c), s		16.4	6.6	0.0	2.1	12.9	0.0	6.5	12.3	0.0	7.1	27.5
Prop In Lane		1.00		1.00	1.00		1.00	1.00		1.00	1.00	
Lane Grp Cap(c), veh/h		546	1125		283	840		247	487		741	951
V/C Ratio(X)		0.88	0.24		0.23	0.52		0.77	0.78		0.33	0.89
Avail Cap(c_a), veh/h		619	1125		283	840		302	918		741	1036
HCM Platoon Ratio		1.00	1.00	1.00	1.00	1.00	1.00	1.00	1.00	1.00	1.00	1.00
Upstream Filter(I)		1.00	1.00	0.00	1.00	1.00	0.00	1.00	1.00	0.00	1.00	1.00
Uniform Delay (d), s/veh		49.4	30.3	0.0	51.6	39.9	0.0	54.7	50.0	0.0	39.8	42.3
Incr Delay (d2), s/veh		13.0	0.5	0.0	0.4	2.3	0.0	9.3	2.7	0.0	0.3	9.3
Initial Q Delay(d3),s/veh		0.0	0.0	0.0	0.0	0.0	0.0	0.0	0.0	0.0	0.0	0.0
%ile BackOfQ(50%),veh/ln		7.8	2.8	0.0	0.9	5.8	0.0	3.1	5.6	0.0	3.0	13.1
Unsig. Movement Delay, s/veh												
LnGrp Delay(d),s/veh		62.5	30.8	0.0	52.0	42.2	0.0	64.0	52.7	0.0	40.1	51.5
LnGrp LOS		E	C		D	D		E	D		D	D
Approach Vol, veh/h			748	A		504	A		568	A		1089
Approach Delay, s/veh			51.2			43.5			56.5			49.0
Approach LOS			D			D			E			D
Timer - Assigned Phs	1	2	3	4	5	6	7	8				
Phs Duration (G+Y+Rc), s	17.3	45.0	17.1	40.6	26.5	35.9	34.2	23.4				
Change Period (Y+Rc), s	7.5	7.0	8.5	* 8.5	7.5	* 7.5	8.5	7.0				
Max Green Setting (Gmax), s	6.5	38.0	10.5	* 35	21.5	* 23	14.5	31.0				
Max Q Clear Time (g_c+I1), s	4.1	8.6	8.5	29.5	18.4	14.9	9.1	14.3				
Green Ext Time (p_c), s	0.0	1.6	0.1	2.6	0.6	1.6	0.4	2.1				

Intersection Summary

HCM 6th Ctrl Delay	50.1
HCM 6th LOS	D

Notes

- User approved pedestrian interval to be less than phase max green.
- User approved ignoring U-Turning movement.
- \* HCM 6th computational engine requires equal clearance times for the phases crossing the barrier.

Movement	SBR
Lane Configurations	
Traffic Volume (veh/h)	835
Future Volume (veh/h)	835
Initial Q (Qb), veh	0
Ped-Bike Adj(A_pbT)	1.00
Parking Bus, Adj	1.00
Work Zone On Approach	
Adj Sat Flow, veh/h/ln	1870
Adj Flow Rate, veh/h	0
Peak Hour Factor	0.92
Percent Heavy Veh, %	2
Cap, veh/h	
Arrive On Green	0.00
Sat Flow, veh/h	1585
Grp Volume(v), veh/h	0
Grp Sat Flow(s),veh/h/ln	1585
Q Serve(g_s), s	0.0
Cycle Q Clear(g_c), s	0.0
Prop In Lane	1.00
Lane Grp Cap(c), veh/h	
V/C Ratio(X)	
Avail Cap(c_a), veh/h	
HCM Platoon Ratio	1.00
Upstream Filter(l)	0.00
Uniform Delay (d), s/veh	0.0
Incr Delay (d2), s/veh	0.0
Initial Q Delay(d3),s/veh	0.0
%ile BackOfQ(50%),veh/ln	0.0
Unsig. Movement Delay, s/veh	
LnGrp Delay(d),s/veh	0.0
LnGrp LOS	
Approach Vol, veh/h	A
Approach Delay, s/veh	
Approach LOS	
Timer - Assigned Phs	
Unsignalized Delay for [NBR, EBR, WBR, SBR] is excluded from calculations of the approach delay and intersection delay.	

Timings  
2: MERIDIAN ROAD & EASTONVILLE ROAD

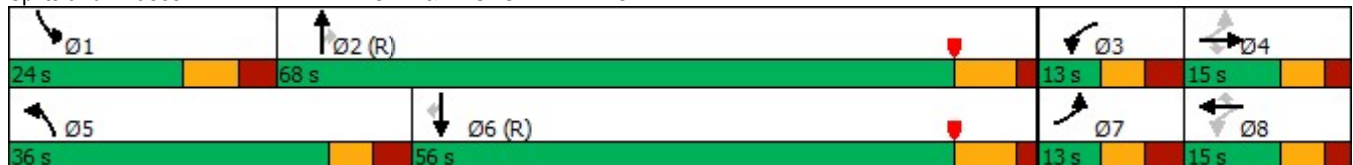
Total 2024 Shopping Center AM  
04/10/2023

Lane Group	EBL	EBT	EBR	WBL	WBT	WBR	NBL	NBT	NBR	SBL	SBT	SBR
Lane Configurations												
Traffic Volume (vph)	218	52	352	100	56	37	439	522	42	114	1427	187
Future Volume (vph)	218	52	352	100	56	37	439	522	42	114	1427	187
Turn Type	pm+pt	NA	Perm	pm+pt	NA	Perm	Prot	NA	Perm	Prot	NA	Perm
Protected Phases	7	4		3	8		5	2		1	6	
Permitted Phases	4		4	8		8			2			6
Detector Phase	7	4	4	3	8	8	5	2	2	1	6	6
Switch Phase												
Minimum Initial (s)	5.0	8.0	8.0	5.0	8.0	8.0	5.0	15.0	15.0	5.0	15.0	15.0
Minimum Split (s)	12.5	14.5	14.5	12.5	14.5	14.5	12.5	22.5	22.5	13.5	22.5	22.5
Total Split (s)	13.0	15.0	15.0	13.0	15.0	15.0	36.0	68.0	68.0	24.0	56.0	56.0
Total Split (%)	10.8%	12.5%	12.5%	10.8%	12.5%	12.5%	30.0%	56.7%	56.7%	20.0%	46.7%	46.7%
Yellow Time (s)	4.0	4.0	4.0	4.0	4.0	4.0	4.0	5.5	5.5	5.0	5.5	5.5
All-Red Time (s)	3.5	2.5	2.5	3.5	2.5	2.5	3.5	2.0	2.0	3.5	2.0	2.0
Lost Time Adjust (s)	0.0	0.0	0.0	0.0	0.0	0.0	0.0	0.0	0.0	0.0	0.0	0.0
Total Lost Time (s)	7.5	6.5	6.5	7.5	6.5	6.5	7.5	7.5	7.5	8.5	7.5	7.5
Lead/Lag	Lead	Lag	Lag	Lead	Lag	Lag	Lead	Lag	Lag	Lead	Lag	Lag
Lead-Lag Optimize?	Yes	Yes	Yes	Yes	Yes	Yes	Yes	Yes	Yes	Yes	Yes	Yes
Recall Mode	None	None	None	None	None	None	None	C-Max	C-Max	None	C-Max	C-Max
Act Effct Green (s)	14.5	8.5	8.5	11.5	8.4	8.4	28.5	63.0	63.0	13.0	48.5	48.5
Actuated g/C Ratio	0.12	0.07	0.07	0.10	0.07	0.07	0.24	0.52	0.52	0.11	0.40	0.40
v/c Ratio	0.77	0.47	1.02	0.73	0.46	0.11	1.23	0.33	0.05	0.65	1.10	0.26
Control Delay	63.9	65.7	65.0	75.2	65.6	0.7	159.1	12.8	0.6	82.7	76.6	2.6
Queue Delay	0.0	0.0	0.0	0.0	0.0	0.0	0.0	0.0	0.0	0.0	0.0	0.0
Total Delay	63.9	65.7	65.0	75.2	65.6	0.7	159.1	12.8	0.6	82.7	76.6	2.6
LOS	E	E	E	E	E	A	F	B	A	F	E	A
Approach Delay		64.7			58.1			76.3			69.0	
Approach LOS		E			E			E			E	

Intersection Summary

Cycle Length: 120  
 Actuated Cycle Length: 120  
 Offset: 45 (38%), Referenced to phase 2:NBT and 6:SBT, Start of Yellow  
 Natural Cycle: 150  
 Control Type: Actuated-Coordinated  
 Maximum v/c Ratio: 1.23  
 Intersection Signal Delay: 69.8  
 Intersection Capacity Utilization 94.6%  
 Analysis Period (min) 15  
 Intersection LOS: E  
 ICU Level of Service F

Splits and Phases: 2: MERIDIAN ROAD & EASTONVILLE ROAD



Queues  
2: MERIDIAN ROAD & EASTONVILLE ROAD

Total 2024 Shopping Center AM  
04/10/2023






























Lane Group	EBL	EBT	EBR	WBL	WBT	WBR	NBL	NBT	NBR	SBL	SBT	SBR
Lane Group Flow (vph)	256	61	414	108	60	40	516	614	49	125	1568	205
v/c Ratio	0.77	0.47	1.02	0.73	0.46	0.11	1.23	0.33	0.05	0.65	1.10	0.26
Control Delay	63.9	65.7	65.0	75.2	65.6	0.7	159.1	12.8	0.6	82.7	76.6	2.6
Queue Delay	0.0	0.0	0.0	0.0	0.0	0.0	0.0	0.0	0.0	0.0	0.0	0.0
Total Delay	63.9	65.7	65.0	75.2	65.6	0.7	159.1	12.8	0.6	82.7	76.6	2.6
Queue Length 50th (ft)	92	46	~96	75	46	0	~507	123	0	94	~746	27
Queue Length 95th (ft)	#123	86	#248	#147	91	0	#669	147	m2	m136	#891	m24
Internal Link Dist (ft)		508			1196			231				781
Turn Bay Length (ft)	100		100	120		100	100		400	375		400
Base Capacity (vph)	332	131	405	147	131	349	420	1859	915	228	1430	785
Starvation Cap Reductn	0	0	0	0	0	0	0	0	0	0	0	0
Spillback Cap Reductn	0	0	0	0	0	0	0	0	0	0	0	0
Storage Cap Reductn	0	0	0	0	0	0	0	0	0	0	0	0
Reduced v/c Ratio	0.77	0.47	1.02	0.73	0.46	0.11	1.23	0.33	0.05	0.55	1.10	0.26

Intersection Summary

- ~ Volume exceeds capacity, queue is theoretically infinite.  
Queue shown is maximum after two cycles.
- # 95th percentile volume exceeds capacity, queue may be longer.  
Queue shown is maximum after two cycles.
- m Volume for 95th percentile queue is metered by upstream signal.

HCM 6th Signalized Intersection Summary  
2: MERIDIAN ROAD & EASTONVILLE ROAD

Total 2024 Shopping Center AM  
04/10/2023

												
Movement	EBL	EBT	EBR	WBL	WBT	WBR	NBL	NBT	NBR	SBL	SBT	SBR
Lane Configurations	 							 			 	
Traffic Volume (veh/h)	218	52	352	100	56	37	439	522	42	114	1427	187
Future Volume (veh/h)	218	52	352	100	56	37	439	522	42	114	1427	187
Initial Q (Qb), veh	0	0	0	0	0	0	0	0	0	0	0	0
Ped-Bike Adj(A_pbT)	1.00		1.00	1.00		1.00	1.00		1.00	1.00		1.00
Parking Bus, Adj	1.00	1.00	1.00	1.00	1.00	1.00	1.00	1.00	1.00	1.00	1.00	1.00
Work Zone On Approach		No			No			No			No	
Adj Sat Flow, veh/h/ln	1870	1870	1870	1870	1870	1870	1870	1870	1870	1870	1870	1870
Adj Flow Rate, veh/h	256	61	0	108	60	0	516	614	49	125	1568	205
Peak Hour Factor	0.85	0.85	0.85	0.93	0.93	0.93	0.85	0.85	0.85	0.91	0.91	0.91
Percent Heavy Veh, %	2	2	2	2	2	2	2	2	2	2	2	2
Cap, veh/h	371	125		189	125		423	1962	875	152	1451	647
Arrive On Green	0.05	0.07	0.00	0.05	0.07	0.00	0.24	0.55	0.55	0.09	0.41	0.41
Sat Flow, veh/h	3456	1870	1585	1781	1870	1585	1781	3554	1585	1781	3554	1585
Grp Volume(v), veh/h	256	61	0	108	60	0	516	614	49	125	1568	205
Grp Sat Flow(s),veh/h/ln	1728	1870	1585	1781	1870	1585	1781	1777	1585	1781	1777	1585
Q Serve(g_s), s	5.5	3.8	0.0	5.5	3.7	0.0	28.5	11.2	1.7	8.3	49.0	10.5
Cycle Q Clear(g_c), s	5.5	3.8	0.0	5.5	3.7	0.0	28.5	11.2	1.7	8.3	49.0	10.5
Prop In Lane	1.00		1.00	1.00		1.00	1.00		1.00	1.00		1.00
Lane Grp Cap(c), veh/h	371	125		189	125		423	1962	875	152	1451	647
V/C Ratio(X)	0.69	0.49		0.57	0.48		1.22	0.31	0.06	0.82	1.08	0.32
Avail Cap(c_a), veh/h	371	132		189	132		423	1962	875	230	1451	647
HCM Platoon Ratio	1.00	1.00	1.00	1.00	1.00	1.00	1.00	1.00	1.00	1.00	1.00	1.00
Upstream Filter(I)	1.00	1.00	0.00	1.00	1.00	0.00	1.00	1.00	1.00	1.00	1.00	1.00
Uniform Delay (d), s/veh	52.6	54.0	0.0	51.1	54.0	0.0	45.8	14.5	12.4	54.0	35.5	24.1
Incr Delay (d2), s/veh	5.3	2.9	0.0	4.1	2.9	0.0	118.6	0.4	0.1	13.4	48.7	1.3
Initial Q Delay(d3),s/veh	0.0	0.0	0.0	0.0	0.0	0.0	0.0	0.0	0.0	0.0	0.0	0.0
%ile BackOfQ(50%),veh/ln	1.5	1.9	0.0	3.4	1.8	0.0	25.8	4.2	0.6	4.1	29.1	4.2
Unsig. Movement Delay, s/veh												
LnGrp Delay(d),s/veh	57.9	57.0	0.0	55.2	56.9	0.0	164.3	15.0	12.5	67.4	84.2	25.4
LnGrp LOS	E	E		E	E		F	B	B	E	F	C
Approach Vol, veh/h		317	A		168	A		1179			1898	
Approach Delay, s/veh		57.7			55.8			80.2			76.7	
Approach LOS		E			E			F			E	
Timer - Assigned Phs	1	2	3	4	5	6	7	8				
Phs Duration (G+Y+Rc), s	18.7	73.8	13.0	14.5	36.0	56.5	13.0	14.5				
Change Period (Y+Rc), s	8.5	7.5	7.5	6.5	7.5	7.5	7.5	6.5				
Max Green Setting (Gmax), s	15.5	60.5	5.5	8.5	28.5	48.5	5.5	8.5				
Max Q Clear Time (g_c+I1), s	10.3	13.2	7.5	5.8	30.5	51.0	7.5	5.7				
Green Ext Time (p_c), s	0.1	4.1	0.0	0.0	0.0	0.0	0.0	0.0				

Intersection Summary

HCM 6th Ctrl Delay	75.2
HCM 6th LOS	E

Notes

- User approved pedestrian interval to be less than phase max green.
- Unsignalized Delay for [EBR, WBR] is excluded from calculations of the approach delay and intersection delay.



Timings  
3: MERIDIAN ROAD & BENT GRASS MEADOWS DRIVE

Total 2024 Shopping Center AM  
04/10/2023



Lane Group	EBL	EBR	NBL	NBT	SBT	SBR
Lane Configurations	↖↗	↗	↖	↑↑	↑↑	↗
Traffic Volume (vph)	121	235	193	534	1451	179
Future Volume (vph)	121	235	193	534	1451	179
Turn Type	Prot	Perm	pm+pt	NA	NA	Perm
Protected Phases	7		5	2	6	
Permitted Phases		7	2			6
Detector Phase	7	7	5	2	6	6
Switch Phase						
Minimum Initial (s)	8.0	8.0	5.0	15.0	15.0	15.0
Minimum Split (s)	25.5	25.5	13.5	25.5	25.5	25.5
Total Split (s)	26.0	26.0	24.0	94.0	70.0	70.0
Total Split (%)	21.7%	21.7%	20.0%	78.3%	58.3%	58.3%
Yellow Time (s)	4.0	4.0	5.0	5.5	5.5	5.5
All-Red Time (s)	3.5	3.5	3.5	2.0	2.0	2.0
Lost Time Adjust (s)	0.0	0.0	0.0	0.0	0.0	0.0
Total Lost Time (s)	7.5	7.5	8.5	7.5	7.5	7.5
Lead/Lag			Lead		Lag	Lag
Lead-Lag Optimize?			Yes		Yes	Yes
Recall Mode	None	None	None	C-Max	C-Max	C-Max
Act Effect Green (s)	11.9	11.9	92.1	93.1	70.7	70.7
Actuated g/C Ratio	0.10	0.10	0.77	0.78	0.59	0.59
v/c Ratio	0.42	0.75	0.77	0.22	0.79	0.20
Control Delay	53.5	24.6	48.6	3.5	24.0	2.4
Queue Delay	0.0	0.0	0.0	0.0	0.0	0.0
Total Delay	53.5	24.6	48.6	3.5	24.0	2.4
LOS	D	C	D	A	C	A
Approach Delay	34.4			15.5	21.6	
Approach LOS	C			B	C	

Intersection Summary

Cycle Length: 120  
 Actuated Cycle Length: 120  
 Offset: 5 (4%), Referenced to phase 2:NBTL and 6:SBT, Start of Yellow  
 Natural Cycle: 90  
 Control Type: Actuated-Coordinated  
 Maximum v/c Ratio: 0.79  
 Intersection Signal Delay: 21.7  
 Intersection LOS: C  
 Intersection Capacity Utilization 77.1%  
 ICU Level of Service D  
 Analysis Period (min) 15

Splits and Phases: 3: MERIDIAN ROAD & BENT GRASS MEADOWS DRIVE



Queues  
 3: MERIDIAN ROAD & BENT GRASS MEADOWS DRIVE

Total 2024 Shopping Center AM  
 04/10/2023



Lane Group	EBL	EBR	NBL	NBT	SBT	SBR
Lane Group Flow (vph)	141	273	214	593	1649	203
v/c Ratio	0.42	0.75	0.77	0.22	0.79	0.20
Control Delay	53.5	24.6	48.6	3.5	24.0	2.4
Queue Delay	0.0	0.0	0.0	0.0	0.0	0.0
Total Delay	53.5	24.6	48.6	3.5	24.0	2.4
Queue Length 50th (ft)	54	33	117	78	486	0
Queue Length 95th (ft)	77	104	m#200	112	670	33
Internal Link Dist (ft)	310			750	1921	
Turn Bay Length (ft)	150		700			350
Base Capacity (vph)	529	436	309	2746	2085	1016
Starvation Cap Reductn	0	0	0	0	0	0
Spillback Cap Reductn	0	0	0	0	0	0
Storage Cap Reductn	0	0	0	0	0	0
Reduced v/c Ratio	0.27	0.63	0.69	0.22	0.79	0.20

Intersection Summary

- # 95th percentile volume exceeds capacity, queue may be longer.  
 Queue shown is maximum after two cycles.
- m Volume for 95th percentile queue is metered by upstream signal.

HCM 6th Signalized Intersection Summary  
 3: MERIDIAN ROAD & BENT GRASS MEADOWS DRIVE

Total 2024 Shopping Center AM  
 04/10/2023



Movement	EBL	EBR	NBL	NBT	SBT	SBR
Lane Configurations	↖↗	↗	↖	↑↑	↑↑	↗
Traffic Volume (veh/h)	121	235	193	534	1451	179
Future Volume (veh/h)	121	235	193	534	1451	179
Initial Q (Qb), veh	0	0	0	0	0	0
Ped-Bike Adj(A_pbT)	1.00	1.00	1.00			1.00
Parking Bus, Adj	1.00	1.00	1.00	1.00	1.00	1.00
Work Zone On Approach	No			No	No	
Adj Sat Flow, veh/h/ln	1870	1870	1870	1870	1870	1870
Adj Flow Rate, veh/h	141	0	214	593	1649	203
Peak Hour Factor	0.86	0.86	0.90	0.90	0.88	0.88
Percent Heavy Veh, %	2	2	2	2	2	2
Cap, veh/h	228		258	2875	2433	1085
Arrive On Green	0.07	0.00	0.05	0.81	0.68	0.68
Sat Flow, veh/h	3456	1585	1781	3647	3647	1585
Grp Volume(v), veh/h	141	0	214	593	1649	203
Grp Sat Flow(s),veh/h/ln	1728	1585	1781	1777	1777	1585
Q Serve(g_s), s	4.8	0.0	4.0	4.6	32.8	5.6
Cycle Q Clear(g_c), s	4.8	0.0	4.0	4.6	32.8	5.6
Prop In Lane	1.00	1.00	1.00			1.00
Lane Grp Cap(c), veh/h	228		258	2875	2433	1085
V/C Ratio(X)	0.62		0.83	0.21	0.68	0.19
Avail Cap(c_a), veh/h	533		392	2875	2433	1085
HCM Platoon Ratio	1.00	1.00	1.00	1.00	1.00	1.00
Upstream Filter(I)	1.00	0.00	1.00	1.00	1.00	1.00
Uniform Delay (d), s/veh	54.6	0.0	21.8	2.6	11.1	6.8
Incr Delay (d2), s/veh	2.7	0.0	8.8	0.2	1.5	0.4
Initial Q Delay(d3),s/veh	0.0	0.0	0.0	0.0	0.0	0.0
%ile BackOfQ(50%),veh/ln	2.1	0.0	5.0	1.3	12.3	9.0
Unsig. Movement Delay, s/veh						
LnGrp Delay(d),s/veh	57.3	0.0	30.6	2.8	12.7	7.2
LnGrp LOS	E		C	A	B	A
Approach Vol, veh/h	141	A		807	1852	
Approach Delay, s/veh	57.3			10.2	12.1	
Approach LOS	E			B	B	
Timer - Assigned Phs		2		4	5	6
Phs Duration (G+Y+Rc), s		104.6		15.4	14.9	89.7
Change Period (Y+Rc), s		7.5		7.5	8.5	7.5
Max Green Setting (Gmax), s		86.5		18.5	15.5	62.5
Max Q Clear Time (g_c+I1), s		6.6		6.8	6.0	34.8
Green Ext Time (p_c), s		4.7		0.3	0.4	16.9

Intersection Summary

HCM 6th Ctrl Delay	13.8
HCM 6th LOS	B

Notes

Unsignalized Delay for [EBR] is excluded from calculations of the approach delay and intersection delay.

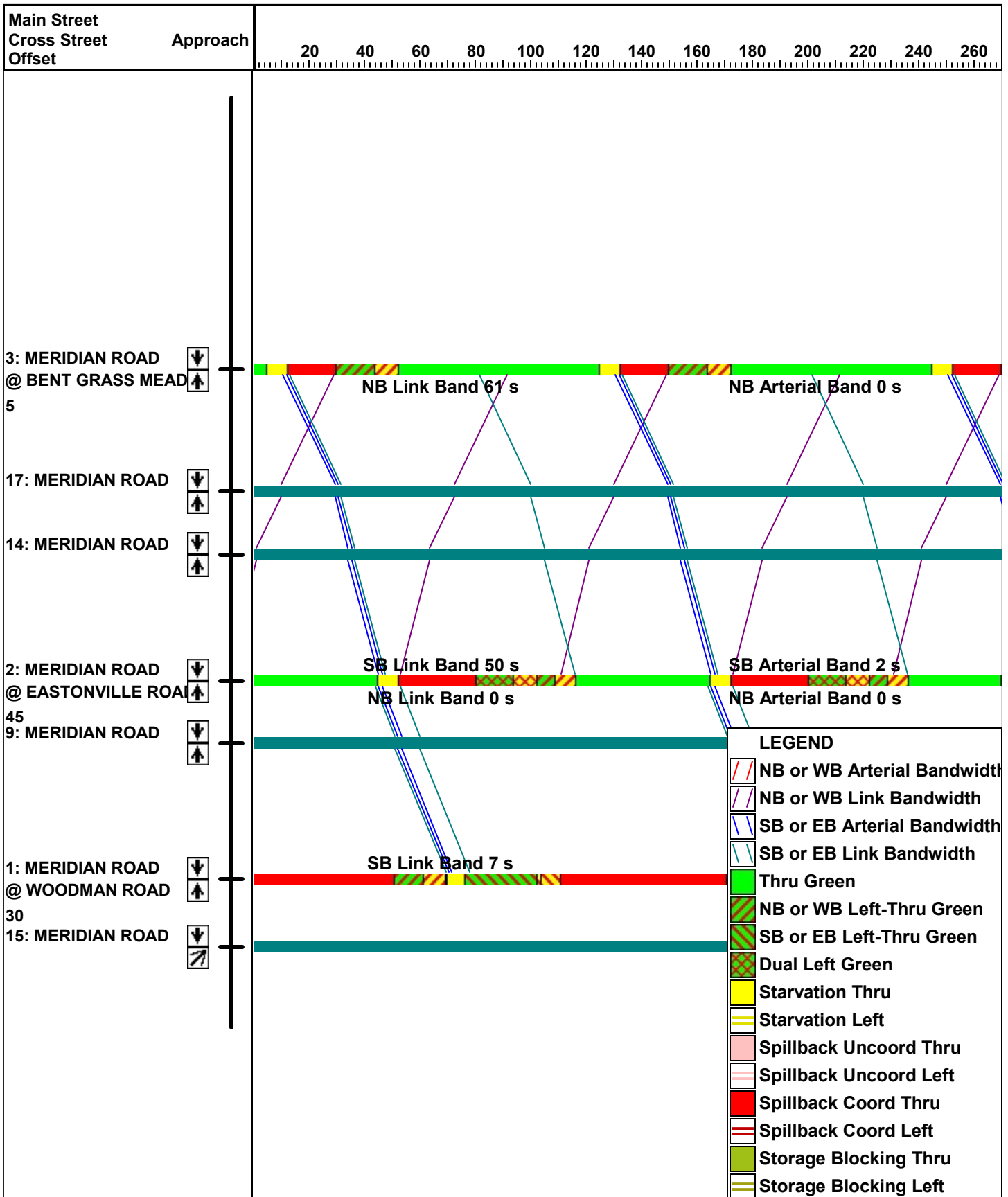
Intersection						
Int Delay, s/veh	6.2					
Movement	EBT	EBR	WBL	WBT	NBL	NBR
Lane Configurations	↑	↗	↘	↑	↘	
Traffic Vol, veh/h	145	65	304	68	1	211
Future Vol, veh/h	145	65	304	68	1	211
Conflicting Peds, #/hr	0	0	0	0	0	0
Sign Control	Free	Free	Free	Free	Stop	Stop
RT Channelized	-	None	-	None	-	None
Storage Length	-	150	100	-	0	-
Veh in Median Storage, #	0	-	-	0	0	-
Grade, %	0	-	-	0	0	-
Peak Hour Factor	85	85	85	85	85	85
Heavy Vehicles, %	2	2	2	2	2	2
Mvmt Flow	171	76	358	80	1	248

Major/Minor	Major1	Major2	Minor1		
Conflicting Flow All	0	0	247	0	967
Stage 1	-	-	-	-	171
Stage 2	-	-	-	-	796
Critical Hdwy	-	-	4.12	-	6.42
Critical Hdwy Stg 1	-	-	-	-	5.42
Critical Hdwy Stg 2	-	-	-	-	5.42
Follow-up Hdwy	-	-	2.218	-	3.518
Pot Cap-1 Maneuver	-	-	1319	-	282
Stage 1	-	-	-	-	859
Stage 2	-	-	-	-	444
Platoon blocked, %	-	-	-	-	-
Mov Cap-1 Maneuver	-	-	1319	-	206
Mov Cap-2 Maneuver	-	-	-	-	206
Stage 1	-	-	-	-	859
Stage 2	-	-	-	-	324

Approach	EB	WB	NB
HCM Control Delay, s	0	7.1	10.9
HCM LOS			B

Minor Lane/Major Mvmt	NBLn1	EBT	EBR	WBL	WBT
Capacity (veh/h)	860	-	-	1319	-
HCM Lane V/C Ratio	0.29	-	-	0.271	-
HCM Control Delay (s)	10.9	-	-	8.7	-
HCM Lane LOS	B	-	-	A	-
HCM 95th %tile Q(veh)	1.2	-	-	1.1	-

Total AM 2024 Shopping Center



Timings  
1: MERIDIAN ROAD & WOODMAN ROAD

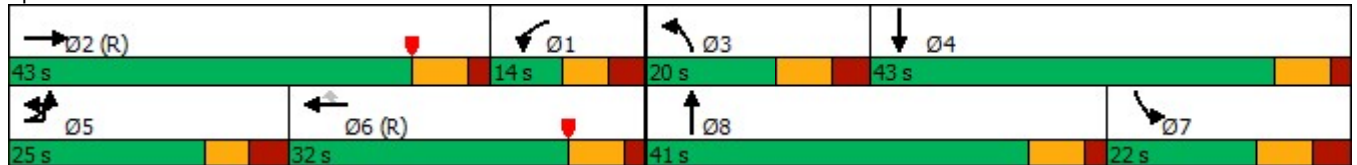
Total 2024 Storage AM  
04/10/2023

Lane Group	EBL	EBT	EBR	WBL	WBT	WBR	NBL	NBT	NBR	SBL	SBT	SBR
Lane Configurations												
Traffic Volume (vph)	280	226	122	61	413	132	182	305	18	196	743	754
Future Volume (vph)	280	226	122	61	413	132	182	305	18	196	743	754
Turn Type	Prot	NA	Free	Prot	NA	Perm	Prot	NA	Free	Prot	NA	Free
Protected Phases	5	2		1	6		3	8		7	4	
Permitted Phases			Free			6			Free			Free
Detector Phase	5	2		1	6	6	3	8		7	4	
Switch Phase												
Minimum Initial (s)	5.0	15.0		5.0	15.0	15.0	5.0	15.0		5.0	15.0	
Minimum Split (s)	13.5	22.0		13.5	22.0	22.0	13.5	22.0		13.5	22.0	
Total Split (s)	25.0	43.0		14.0	32.0	32.0	20.0	41.0		22.0	43.0	
Total Split (%)	20.8%	35.8%		11.7%	26.7%	26.7%	16.7%	34.2%		18.3%	35.8%	
Yellow Time (s)	4.0	5.0		4.0	5.0	5.0	5.0	5.0		5.0	5.0	
All-Red Time (s)	3.5	2.0		3.5	2.0	2.0	3.5	2.0		3.5	2.0	
Lost Time Adjust (s)	0.0	0.0		0.0	0.0	0.0	0.0	0.0		0.0	0.0	
Total Lost Time (s)	7.5	7.0		7.5	7.0	7.0	8.5	7.0		8.5	7.0	
Lead/Lag	Lead	Lead		Lag	Lag	Lag	Lead	Lead		Lag	Lag	
Lead-Lag Optimize?	Yes	Yes		Yes	Yes	Yes	Yes	Yes		Yes	Yes	
Recall Mode	None	C-Max		None	C-Max	C-Max	None	None		None	None	
Act Effct Green (s)	16.0	42.7	120.0	6.3	30.4	30.4	10.7	16.9	120.0	26.7	32.8	120.0
Actuated g/C Ratio	0.13	0.36	1.00	0.05	0.25	0.25	0.09	0.14	1.00	0.22	0.27	1.00
v/c Ratio	0.74	0.21	0.09	0.36	0.49	0.24	0.62	0.64	0.01	0.28	0.84	0.52
Control Delay	60.5	29.6	0.1	60.6	41.8	0.9	61.8	54.7	0.0	34.3	41.7	2.1
Queue Delay	0.0	0.0	0.0	0.0	0.0	0.0	0.0	0.0	0.0	0.0	0.0	0.0
Total Delay	60.5	29.6	0.1	60.6	41.8	0.9	61.8	54.7	0.0	34.3	41.7	2.1
LOS	E	C	A	E	D	A	E	D	A	C	D	A
Approach Delay		38.0			34.8			55.3			23.2	
Approach LOS		D			C			E			C	

Intersection Summary













Cycle Length: 120  
 Actuated Cycle Length: 120  
 Offset: 30 (25%), Referenced to phase 2:EBT and 6:WBT, Start of Yellow  
 Natural Cycle: 80  
 Control Type: Actuated-Coordinated  
 Maximum v/c Ratio: 0.84  
 Intersection Signal Delay: 32.6  
 Intersection Capacity Utilization 71.5%  
 Analysis Period (min) 15  
 Intersection LOS: C  
 ICU Level of Service C

Splits and Phases: 1: MERIDIAN ROAD & WOODMAN ROAD



Queues  
1: MERIDIAN ROAD & WOODMAN ROAD

Total 2024 Storage AM  
04/10/2023

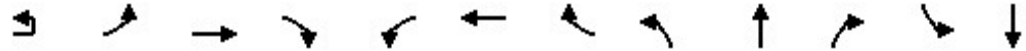
												
Lane Group	EBL	EBT	EBR	WBL	WBT	WBR	NBL	NBT	NBR	SBL	SBT	SBR
Lane Group Flow (vph)	341	266	144	65	439	140	190	318	19	213	808	820
v/c Ratio	0.74	0.21	0.09	0.36	0.49	0.24	0.62	0.64	0.01	0.28	0.84	0.52
Control Delay	60.5	29.6	0.1	60.6	41.8	0.9	61.8	54.7	0.0	34.3	41.7	2.1
Queue Delay	0.0	0.0	0.0	0.0	0.0	0.0	0.0	0.0	0.0	0.0	0.0	0.0
Total Delay	60.5	29.6	0.1	60.6	41.8	0.9	61.8	54.7	0.0	34.3	41.7	2.1
Queue Length 50th (ft)	131	80	0	25	158	0	73	125	0	80	334	10
Queue Length 95th (ft)	170	111	0	49	218	0	113	167	0	m87	m347	m22
Internal Link Dist (ft)		1165			1100			342			860	
Turn Bay Length (ft)	500		630	350		250	440		330	490		450
Base Capacity (vph)	500	1260	1583	185	897	594	328	1002	1583	763	1061	1583
Starvation Cap Reductn	0	0	0	0	0	0	0	0	0	0	0	0
Spillback Cap Reductn	0	0	0	0	0	0	0	0	0	0	0	0
Storage Cap Reductn	0	0	0	0	0	0	0	0	0	0	0	0
Reduced v/c Ratio	0.68	0.21	0.09	0.35	0.49	0.24	0.58	0.32	0.01	0.28	0.76	0.52

**Intersection Summary**  
m Volume for 95th percentile queue is metered by upstream signal.



HCM 6th Signalized Intersection Summary  
 1: MERIDIAN ROAD & WOODMAN ROAD

Total 2024 Storage AM  
 04/10/2023



Movement	EBU	EBL	EBT	EBR	WBL	WBT	WBR	NBL	NBT	NBR	SBL	SBT
Lane Configurations		↖↗	↕	↗	↖↗	↕	↗	↖↗	↕	↗	↖↗	↕
Traffic Volume (veh/h)	10	280	226	122	61	413	132	182	305	18	196	743
Future Volume (veh/h)	10	280	226	122	61	413	132	182	305	18	196	743
Initial Q (Qb), veh		0	0	0	0	0	0	0	0	0	0	0
Ped-Bike Adj(A_pbT)		1.00		1.00	1.00		1.00	1.00		1.00	1.00	
Parking Bus, Adj		1.00	1.00	1.00	1.00	1.00	1.00	1.00	1.00	1.00	1.00	1.00
Work Zone On Approach			No			No			No			No
Adj Sat Flow, veh/h/ln		1870	1870	1870	1870	1870	1870	1870	1870	1870	1870	1870
Adj Flow Rate, veh/h		329	266	0	65	439	0	190	318	0	213	808
Peak Hour Factor		0.85	0.85	0.85	0.94	0.94	0.94	0.96	0.96	0.96	0.92	0.92
Percent Heavy Veh, %		2	2	2	2	2	2	2	2	2	2	2
Cap, veh/h		393	1066		361	1018		248	444		763	928
Arrive On Green		0.11	0.30	0.00	0.10	0.29	0.00	0.07	0.13	0.00	0.22	0.26
Sat Flow, veh/h		3456	3554	1585	3456	3554	1585	3456	3554	1585	3456	3554
Grp Volume(v), veh/h		329	266	0	65	439	0	190	318	0	213	808
Grp Sat Flow(s),veh/h/ln		1728	1777	1585	1728	1777	1585	1728	1777	1585	1728	1777
Q Serve(g_s), s		11.2	6.8	0.0	2.1	12.1	0.0	6.5	10.3	0.0	6.1	26.1
Cycle Q Clear(g_c), s		11.2	6.8	0.0	2.1	12.1	0.0	6.5	10.3	0.0	6.1	26.1
Prop In Lane		1.00		1.00	1.00		1.00	1.00		1.00	1.00	
Lane Grp Cap(c), veh/h		393	1066		361	1018		248	444		763	928
V/C Ratio(X)		0.84	0.25		0.18	0.43		0.76	0.72		0.28	0.87
Avail Cap(c_a), veh/h		504	1066		361	1018		331	1007		763	1066
HCM Platoon Ratio		1.00	1.00	1.00	1.00	1.00	1.00	1.00	1.00	1.00	1.00	1.00
Upstream Filter(I)		1.00	1.00	0.00	1.00	1.00	0.00	1.00	1.00	0.00	1.00	1.00
Uniform Delay (d), s/veh		52.1	31.8	0.0	49.1	34.9	0.0	54.7	50.5	0.0	38.8	42.4
Incr Delay (d2), s/veh		9.5	0.6	0.0	0.2	1.3	0.0	7.3	2.2	0.0	0.2	7.2
Initial Q Delay(d3),s/veh		0.0	0.0	0.0	0.0	0.0	0.0	0.0	0.0	0.0	0.0	0.0
%ile BackOfQ(50%),veh/ln		5.2	2.9	0.0	0.9	5.3	0.0	3.0	4.7	0.0	2.6	12.2
Unsig. Movement Delay, s/veh												
LnGrp Delay(d),s/veh		61.6	32.3	0.0	49.3	36.2	0.0	62.0	52.6	0.0	39.0	49.6
LnGrp LOS		E	C		D	D		E	D		D	D
Approach Vol, veh/h			595	A		504	A		508	A		1021
Approach Delay, s/veh			48.5			37.9			56.1			47.4
Approach LOS			D			D			E			D
Timer - Assigned Phs	1	2	3	4	5	6	7	8				
Phs Duration (G+Y+Rc), s	20.0	43.0	17.1	39.8	21.1	41.9	35.0	22.0				
Change Period (Y+Rc), s	7.5	7.0	8.5	* 8.5	7.5	* 7.5	8.5	7.0				
Max Green Setting (Gmax), s	6.5	36.0	11.5	* 36	17.5	* 25	13.5	34.0				
Max Q Clear Time (g_c+I1), s	4.1	8.8	8.5	28.1	13.2	14.1	8.1	12.3				
Green Ext Time (p_c), s	0.0	1.5	0.2	3.3	0.5	1.9	0.3	1.9				

Intersection Summary

HCM 6th Ctrl Delay	47.5
HCM 6th LOS	D

Notes

- User approved pedestrian interval to be less than phase max green.
- User approved ignoring U-Turning movement.
- \* HCM 6th computational engine requires equal clearance times for the phases crossing the barrier.

HCM 6th Signalized Intersection Summary  
 1: MERIDIAN ROAD & WOODMAN ROAD

Total 2024 Storage AM  
 04/10/2023

Movement	SBR
Lane Configurations	
Traffic Volume (veh/h)	754
Future Volume (veh/h)	754
Initial Q (Qb), veh	0
Ped-Bike Adj(A_pbT)	1.00
Parking Bus, Adj	1.00
Work Zone On Approach	
Adj Sat Flow, veh/h/ln	1870
Adj Flow Rate, veh/h	0
Peak Hour Factor	0.92
Percent Heavy Veh, %	2
Cap, veh/h	
Arrive On Green	0.00
Sat Flow, veh/h	1585
Grp Volume(v), veh/h	0
Grp Sat Flow(s),veh/h/ln	1585
Q Serve(g_s), s	0.0
Cycle Q Clear(g_c), s	0.0
Prop In Lane	1.00
Lane Grp Cap(c), veh/h	
V/C Ratio(X)	
Avail Cap(c_a), veh/h	
HCM Platoon Ratio	1.00
Upstream Filter(l)	0.00
Uniform Delay (d), s/veh	0.0
Incr Delay (d2), s/veh	0.0
Initial Q Delay(d3),s/veh	0.0
%ile BackOfQ(50%),veh/ln	0.0
Unsig. Movement Delay, s/veh	
LnGrp Delay(d),s/veh	0.0
LnGrp LOS	
Approach Vol, veh/h	A
Approach Delay, s/veh	
Approach LOS	
Timer - Assigned Phs	
Unsignalized Delay for [NBR, EBR, WBR, SBR] is excluded from calculations of the approach delay and intersection delay.	

Timings  
2: MERIDIAN ROAD & EASTONVILLE ROAD

Total 2024 Storage AM  
04/10/2023

Lane Group	EBL	EBT	EBR	WBL	WBT	WBR	NBL	NBT	NBR	SBL	SBT	SBR
Lane Configurations												
Traffic Volume (vph)	218	52	263	100	56	37	294	435	42	114	1373	187
Future Volume (vph)	218	52	263	100	56	37	294	435	42	114	1373	187
Turn Type	pm+pt	NA	Perm	pm+pt	NA	Perm	Prot	NA	Perm	Prot	NA	Perm
Protected Phases	7	4		3	8		5	2		1	6	
Permitted Phases	4		4	8		8			2			6
Detector Phase	7	4	4	3	8	8	5	2	2	1	6	6
Switch Phase												
Minimum Initial (s)	5.0	8.0	8.0	5.0	8.0	8.0	5.0	15.0	15.0	5.0	15.0	15.0
Minimum Split (s)	12.5	14.5	14.5	12.5	14.5	14.5	12.5	22.5	22.5	13.5	22.5	22.5
Total Split (s)	14.0	16.0	16.0	13.0	15.0	15.0	30.0	67.0	67.0	24.0	61.0	61.0
Total Split (%)	11.7%	13.3%	13.3%	10.8%	12.5%	12.5%	25.0%	55.8%	55.8%	20.0%	50.8%	50.8%
Yellow Time (s)	4.0	4.0	4.0	4.0	4.0	4.0	4.0	5.5	5.5	5.0	5.5	5.5
All-Red Time (s)	3.5	2.5	2.5	3.5	2.5	2.5	3.5	2.0	2.0	3.5	2.0	2.0
Lost Time Adjust (s)	0.0	0.0	0.0	0.0	0.0	0.0	0.0	0.0	0.0	0.0	0.0	0.0
Total Lost Time (s)	7.5	6.5	6.5	7.5	6.5	6.5	7.5	7.5	7.5	8.5	7.5	7.5
Lead/Lag	Lead	Lag	Lag	Lead	Lag	Lag	Lead	Lag	Lag	Lead	Lag	Lag
Lead-Lag Optimize?	Yes	Yes	Yes	Yes	Yes	Yes	Yes	Yes	Yes	Yes	Yes	Yes
Recall Mode	None	None	None	None	None	None	None	C-Max	C-Max	None	C-Max	C-Max
Act Effct Green (s)	15.9	9.1	9.1	11.4	8.3	8.3	22.9	62.4	62.4	13.0	53.5	53.5
Actuated g/C Ratio	0.13	0.08	0.08	0.10	0.07	0.07	0.19	0.52	0.52	0.11	0.45	0.45
v/c Ratio	0.72	0.43	0.88	0.74	0.47	0.14	1.03	0.28	0.05	0.65	0.96	0.25
Control Delay	58.2	62.8	37.7	75.4	66.0	1.1	97.7	14.1	1.3	76.8	36.1	3.7
Queue Delay	0.0	0.0	0.0	0.0	0.0	0.0	0.0	0.0	0.0	0.0	0.0	0.0
Total Delay	58.2	62.8	37.7	75.4	66.0	1.1	97.7	14.1	1.3	76.8	36.1	3.7
LOS	E	E	D	E	E	A	F	B	A	E	D	A
Approach Delay		48.6			58.4			45.3			35.2	
Approach LOS		D			E			D			D	

Intersection Summary

Cycle Length: 120  
 Actuated Cycle Length: 120  
 Offset: 45 (38%), Referenced to phase 2:NBT and 6:SBT, Start of Yellow  
 Natural Cycle: 110  
 Control Type: Actuated-Coordinated  
 Maximum v/c Ratio: 1.03  
 Intersection Signal Delay: 41.5  
 Intersection Capacity Utilization 85.0%  
 Analysis Period (min) 15  
 Intersection LOS: D  
 ICU Level of Service E

Splits and Phases: 2: MERIDIAN ROAD & EASTONVILLE ROAD



Queues  
2: MERIDIAN ROAD & EASTONVILLE ROAD

Total 2024 Storage AM  
04/10/2023






























Lane Group	EBL	EBT	EBR	WBL	WBT	WBR	NBL	NBT	NBR	SBL	SBT	SBR
Lane Group Flow (vph)	256	61	309	108	60	40	346	512	49	125	1509	205
v/c Ratio	0.72	0.43	0.88	0.74	0.47	0.14	1.03	0.28	0.05	0.65	0.96	0.25
Control Delay	58.2	62.8	37.7	75.4	66.0	1.1	97.7	14.1	1.3	76.8	36.1	3.7
Queue Delay	0.0	0.0	0.0	0.0	0.0	0.0	0.0	0.0	0.0	0.0	0.0	0.0
Total Delay	58.2	62.8	37.7	75.4	66.0	1.1	97.7	14.1	1.3	76.8	36.1	3.7
Queue Length 50th (ft)	91	46	43	74	46	0	~298	111	1	82	631	40
Queue Length 95th (ft)	#141	86	#160	#146	91	0	#447	135	m6	m135	#774	m31
Internal Link Dist (ft)		508			1196			231			781	
Turn Bay Length (ft)	100		100	120		100	100		400	375		400
Base Capacity (vph)	356	147	357	146	131	284	337	1841	908	228	1577	819
Starvation Cap Reductn	0	0	0	0	0	0	0	0	0	0	0	0
Spillback Cap Reductn	0	0	0	0	0	0	0	0	0	0	0	0
Storage Cap Reductn	0	0	0	0	0	0	0	0	0	0	0	0
Reduced v/c Ratio	0.72	0.41	0.87	0.74	0.46	0.14	1.03	0.28	0.05	0.55	0.96	0.25

Intersection Summary

- ~ Volume exceeds capacity, queue is theoretically infinite.  
Queue shown is maximum after two cycles.
- # 95th percentile volume exceeds capacity, queue may be longer.  
Queue shown is maximum after two cycles.
- m Volume for 95th percentile queue is metered by upstream signal.

HCM 6th Signalized Intersection Summary  
2: MERIDIAN ROAD & EASTONVILLE ROAD

Total 2024 Storage AM  
04/10/2023

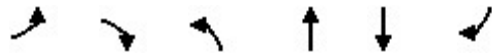
												
Movement	EBL	EBT	EBR	WBL	WBT	WBR	NBL	NBT	NBR	SBL	SBT	SBR
Lane Configurations	 							 			 	
Traffic Volume (veh/h)	218	52	263	100	56	37	294	435	42	114	1373	187
Future Volume (veh/h)	218	52	263	100	56	37	294	435	42	114	1373	187
Initial Q (Qb), veh	0	0	0	0	0	0	0	0	0	0	0	0
Ped-Bike Adj(A_pbT)	1.00		1.00	1.00		1.00	1.00		1.00	1.00		1.00
Parking Bus, Adj	1.00	1.00	1.00	1.00	1.00	1.00	1.00	1.00	1.00	1.00	1.00	1.00
Work Zone On Approach		No			No			No			No	
Adj Sat Flow, veh/h/ln	1870	1870	1870	1870	1870	1870	1870	1870	1870	1870	1870	1870
Adj Flow Rate, veh/h	256	61	0	108	60	0	346	512	49	125	1509	205
Peak Hour Factor	0.85	0.85	0.85	0.93	0.93	0.93	0.85	0.85	0.85	0.91	0.91	0.91
Percent Heavy Veh, %	2	2	2	2	2	2	2	2	2	2	2	2
Cap, veh/h	400	140		200	125		334	1933	862	152	1599	713
Arrive On Green	0.05	0.07	0.00	0.05	0.07	0.00	0.19	0.54	0.54	0.09	0.45	0.45
Sat Flow, veh/h	3456	1870	1585	1781	1870	1585	1781	3554	1585	1781	3554	1585
Grp Volume(v), veh/h	256	61	0	108	60	0	346	512	49	125	1509	205
Grp Sat Flow(s),veh/h/ln	1728	1870	1585	1781	1870	1585	1781	1777	1585	1781	1777	1585
Q Serve(g_s), s	6.5	3.7	0.0	5.5	3.7	0.0	22.5	9.2	1.7	8.3	48.7	9.8
Cycle Q Clear(g_c), s	6.5	3.7	0.0	5.5	3.7	0.0	22.5	9.2	1.7	8.3	48.7	9.8
Prop In Lane	1.00		1.00	1.00		1.00	1.00		1.00	1.00		1.00
Lane Grp Cap(c), veh/h	400	140		200	125		334	1933	862	152	1599	713
V/C Ratio(X)	0.64	0.44		0.54	0.48		1.04	0.26	0.06	0.82	0.94	0.29
Avail Cap(c_a), veh/h	400	148		200	132		334	1933	862	230	1599	713
HCM Platoon Ratio	1.00	1.00	1.00	1.00	1.00	1.00	1.00	1.00	1.00	1.00	1.00	1.00
Upstream Filter(I)	1.00	1.00	0.00	1.00	1.00	0.00	1.00	1.00	1.00	1.00	1.00	1.00
Uniform Delay (d), s/veh	51.1	53.1	0.0	50.9	54.0	0.0	48.8	14.6	12.9	54.0	31.5	20.8
Incr Delay (d2), s/veh	3.4	2.1	0.0	2.9	2.9	0.0	58.9	0.3	0.1	13.4	12.6	1.0
Initial Q Delay(d3),s/veh	0.0	0.0	0.0	0.0	0.0	0.0	0.0	0.0	0.0	0.0	0.0	0.0
%ile BackOfQ(50%),veh/ln	0.9	1.8	0.0	3.3	1.8	0.0	14.9	3.4	0.7	4.1	21.6	3.8
Unsig. Movement Delay, s/veh												
LnGrp Delay(d),s/veh	54.5	55.2	0.0	53.8	56.9	0.0	107.6	14.9	13.0	67.4	44.1	21.9
LnGrp LOS	D	E		D	E		F	B	B	E	D	C
Approach Vol, veh/h		317	A		168	A		907			1839	
Approach Delay, s/veh		54.6			54.9			50.2			43.2	
Approach LOS		D			D			D			D	
Timer - Assigned Phs	1	2	3	4	5	6	7	8				
Phs Duration (G+Y+Rc), s	18.7	72.8	13.0	15.5	30.0	61.5	14.0	14.5				
Change Period (Y+Rc), s	8.5	7.5	7.5	6.5	7.5	7.5	7.5	6.5				
Max Green Setting (Gmax), s	15.5	59.5	5.5	9.5	22.5	53.5	6.5	8.5				
Max Q Clear Time (g_c+I1), s	10.3	11.2	7.5	5.7	24.5	50.7	8.5	5.7				
Green Ext Time (p_c), s	0.1	3.3	0.0	0.1	0.0	2.2	0.0	0.0				

Intersection Summary												
HCM 6th Ctrl Delay			46.9									
HCM 6th LOS			D									

**Notes**  
 User approved pedestrian interval to be less than phase max green.  
 Unsignalized Delay for [EBR, WBR] is excluded from calculations of the approach delay and intersection delay.

3: MERIDIAN ROAD & BENT GRASS MEADOWS DRIVE

04/10/2023

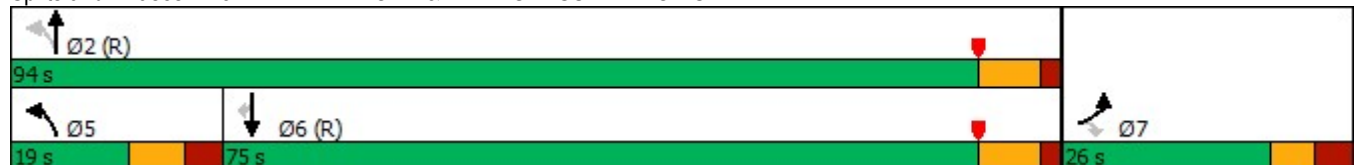


Lane Group	EBL	EBR	NBL	NBT	SBT	SBR
Lane Configurations	↗↗	↗	↖	↑↑	↑↑	↖
Traffic Volume (vph)	85	181	106	534	1451	121
Future Volume (vph)	85	181	106	534	1451	121
Turn Type	Prot	Perm	pm+pt	NA	NA	Perm
Protected Phases	7		5	2	6	
Permitted Phases		7	2			6
Detector Phase	7	7	5	2	6	6
Switch Phase						
Minimum Initial (s)	8.0	8.0	5.0	15.0	15.0	15.0
Minimum Split (s)	25.5	25.5	13.5	25.5	25.5	25.5
Total Split (s)	26.0	26.0	19.0	94.0	75.0	75.0
Total Split (%)	21.7%	21.7%	15.8%	78.3%	62.5%	62.5%
Yellow Time (s)	4.0	4.0	5.0	5.5	5.5	5.5
All-Red Time (s)	3.5	3.5	3.5	2.0	2.0	2.0
Lost Time Adjust (s)	0.0	0.0	0.0	0.0	0.0	0.0
Total Lost Time (s)	7.5	7.5	8.5	7.5	7.5	7.5
Lead/Lag			Lead		Lag	Lag
Lead-Lag Optimize?			Yes		Yes	Yes
Recall Mode	None	None	None	C-Max	C-Max	C-Max
Act Effct Green (s)	11.1	11.1	92.9	93.9	76.8	76.8
Actuated g/C Ratio	0.09	0.09	0.77	0.78	0.64	0.64
v/c Ratio	0.31	0.71	0.52	0.21	0.73	0.13
Control Delay	52.2	27.3	20.4	3.3	18.2	2.2
Queue Delay	0.0	0.0	0.0	0.0	0.0	0.0
Total Delay	52.2	27.3	20.4	3.3	18.2	2.2
LOS	D	C	C	A	B	A
Approach Delay	35.3			6.1	16.9	
Approach LOS	D			A	B	

Intersection Summary

Cycle Length: 120  
 Actuated Cycle Length: 120  
 Offset: 5 (4%), Referenced to phase 2:NBTL and 6:SBT, Start of Yellow  
 Natural Cycle: 90  
 Control Type: Actuated-Coordinated  
 Maximum v/c Ratio: 0.73  
 Intersection Signal Delay: 16.2  
 Intersection Capacity Utilization 72.2%  
 Analysis Period (min) 15  
 Intersection LOS: B  
 ICU Level of Service C

Splits and Phases: 3: MERIDIAN ROAD & BENT GRASS MEADOWS DRIVE



Queues  
 3: MERIDIAN ROAD & BENT GRASS MEADOWS DRIVE

Total 2024 Storage AM  
 04/10/2023



Lane Group	EBL	EBR	NBL	NBT	SBT	SBR
Lane Group Flow (vph)	99	210	118	593	1649	138
v/c Ratio	0.31	0.71	0.52	0.21	0.73	0.13
Control Delay	52.2	27.3	20.4	3.3	18.2	2.2
Queue Delay	0.0	0.0	0.0	0.0	0.0	0.0
Total Delay	52.2	27.3	20.4	3.3	18.2	2.2
Queue Length 50th (ft)	38	35	6	41	396	0
Queue Length 95th (ft)	58	97	m83	113	604	26
Internal Link Dist (ft)	310			750	1921	
Turn Bay Length (ft)	150		700			350
Base Capacity (vph)	529	382	255	2768	2263	1062
Starvation Cap Reductn	0	0	0	0	0	0
Spillback Cap Reductn	0	0	0	0	0	0
Storage Cap Reductn	0	0	0	0	0	0
Reduced v/c Ratio	0.19	0.55	0.46	0.21	0.73	0.13

Intersection Summary

m Volume for 95th percentile queue is metered by upstream signal.



HCM 6th Signalized Intersection Summary  
 3: MERIDIAN ROAD & BENT GRASS MEADOWS DRIVE

Total 2024 Storage AM  
 04/10/2023



Movement	EBL	EBR	NBL	NBT	SBT	SBR
Lane Configurations	↖↗	↗	↖	↑↑	↑↑	↗
Traffic Volume (veh/h)	85	181	106	534	1451	121
Future Volume (veh/h)	85	181	106	534	1451	121
Initial Q (Qb), veh	0	0	0	0	0	0
Ped-Bike Adj(A_pbT)	1.00	1.00	1.00			1.00
Parking Bus, Adj	1.00	1.00	1.00	1.00	1.00	1.00
Work Zone On Approach	No			No	No	
Adj Sat Flow, veh/h/ln	1870	1870	1870	1870	1870	1870
Adj Flow Rate, veh/h	99	0	118	593	1649	138
Peak Hour Factor	0.86	0.86	0.90	0.90	0.88	0.88
Percent Heavy Veh, %	2	2	2	2	2	2
Cap, veh/h	222		249	2881	2484	1108
Arrive On Green	0.06	0.00	0.04	0.81	0.70	0.70
Sat Flow, veh/h	3456	1585	1781	3647	3647	1585
Grp Volume(v), veh/h	99	0	118	593	1649	138
Grp Sat Flow(s),veh/h/ln	1728	1585	1781	1777	1777	1585
Q Serve(g_s), s	3.3	0.0	2.1	4.5	31.3	3.4
Cycle Q Clear(g_c), s	3.3	0.0	2.1	4.5	31.3	3.4
Prop In Lane	1.00	1.00	1.00			1.00
Lane Grp Cap(c), veh/h	222		249	2881	2484	1108
V/C Ratio(X)	0.45		0.47	0.21	0.66	0.12
Avail Cap(c_a), veh/h	533		332	2881	2484	1108
HCM Platoon Ratio	1.00	1.00	1.00	1.00	1.00	1.00
Upstream Filter(I)	1.00	0.00	1.00	1.00	1.00	1.00
Uniform Delay (d), s/veh	54.1	0.0	12.1	2.6	10.1	6.0
Incr Delay (d2), s/veh	1.4	0.0	1.4	0.2	1.4	0.2
Initial Q Delay(d3),s/veh	0.0	0.0	0.0	0.0	0.0	0.0
%ile BackOfQ(50%),veh/ln	1.5	0.0	1.4	1.3	11.5	6.1
Unsig. Movement Delay, s/veh						
LnGrp Delay(d),s/veh	55.5	0.0	13.5	2.7	11.6	6.2
LnGrp LOS	E		B	A	B	A
Approach Vol, veh/h	99	A		711	1787	
Approach Delay, s/veh	55.5			4.5	11.1	
Approach LOS	E			A	B	
Timer - Assigned Phs		2		4	5	6
Phs Duration (G+Y+Rc), s		104.8		15.2	13.4	91.4
Change Period (Y+Rc), s		7.5		7.5	8.5	7.5
Max Green Setting (Gmax), s		86.5		18.5	10.5	67.5
Max Q Clear Time (g_c+I1), s		6.5		5.3	4.1	33.3
Green Ext Time (p_c), s		4.7		0.2	0.1	18.7
<b>Intersection Summary</b>						
HCM 6th Ctrl Delay			11.0			
HCM 6th LOS			B			
<b>Notes</b>						
Unsignalized Delay for [EBR] is excluded from calculations of the approach delay and intersection delay.						

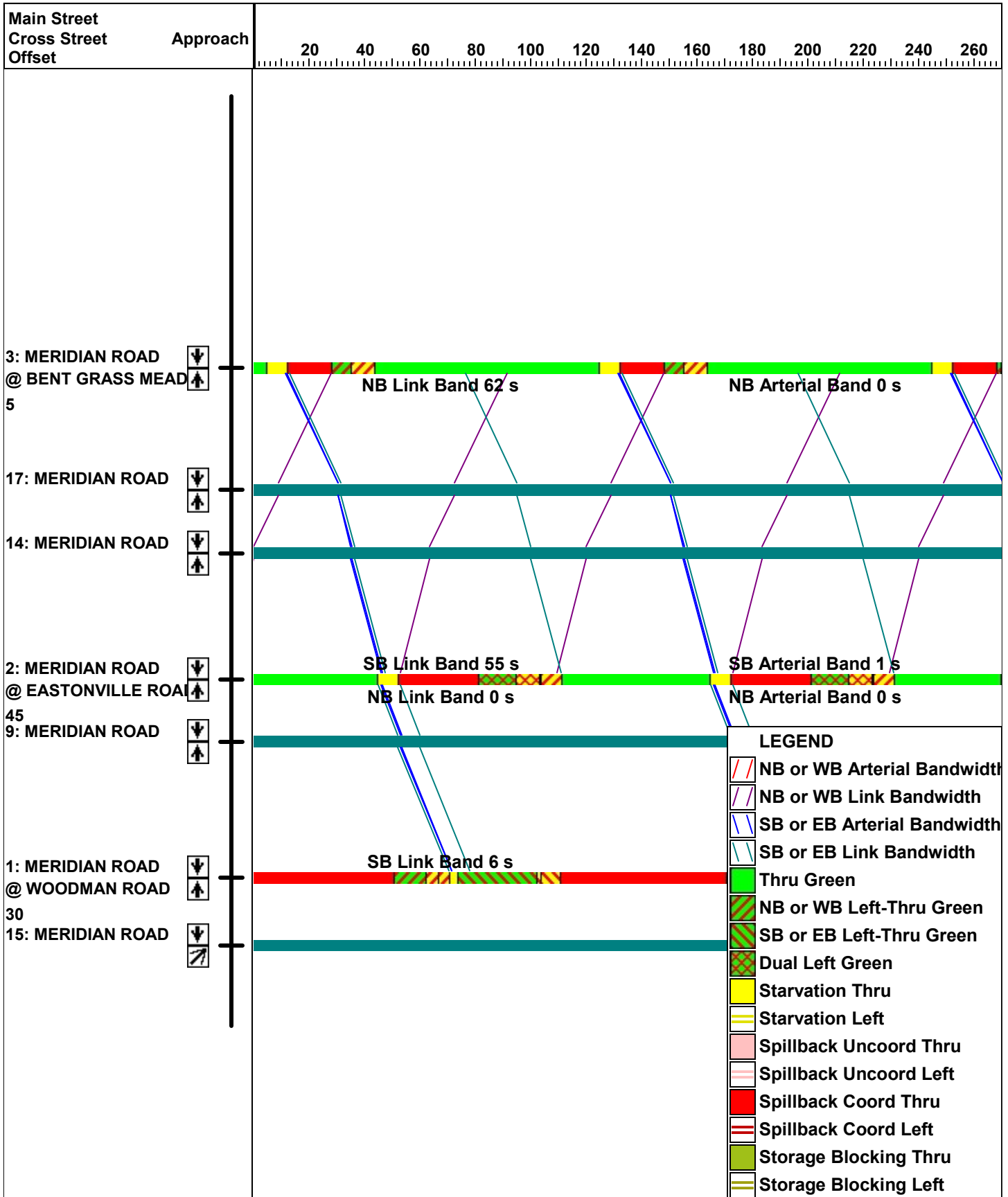
Intersection						
Int Delay, s/veh	4.5					
Movement	EBT	EBR	WBL	WBT	NBL	NBR
Lane Configurations	↑	↗	↖	↑	↘	↙
Traffic Vol, veh/h	145	65	159	68	1	122
Future Vol, veh/h	145	65	159	68	1	122
Conflicting Peds, #/hr	0	0	0	0	0	0
Sign Control	Free	Free	Free	Free	Stop	Stop
RT Channelized	-	None	-	None	-	None
Storage Length	-	150	100	-	0	-
Veh in Median Storage, #	0	-	-	0	0	-
Grade, %	0	-	-	0	0	-
Peak Hour Factor	85	85	85	85	85	85
Heavy Vehicles, %	2	2	2	2	2	2
Mvmt Flow	171	76	187	80	1	144

Major/Minor	Major1	Major2	Minor1		
Conflicting Flow All	0	0	247	0	625
Stage 1	-	-	-	-	171
Stage 2	-	-	-	-	454
Critical Hdwy	-	-	4.12	-	6.42
Critical Hdwy Stg 1	-	-	-	-	5.42
Critical Hdwy Stg 2	-	-	-	-	5.42
Follow-up Hdwy	-	-	2.218	-	3.518
Pot Cap-1 Maneuver	-	-	1319	-	449
Stage 1	-	-	-	-	859
Stage 2	-	-	-	-	640
Platoon blocked, %	-	-	-	-	-
Mov Cap-1 Maneuver	-	-	1319	-	385
Mov Cap-2 Maneuver	-	-	-	-	385
Stage 1	-	-	-	-	859
Stage 2	-	-	-	-	549

Approach	EB	WB	NB
HCM Control Delay, s	0	5.7	10
HCM LOS			B

Minor Lane/Major Mvmt	NBLn1	EBT	EBR	WBL	WBT
Capacity (veh/h)	864	-	-	1319	-
HCM Lane V/C Ratio	0.167	-	-	0.142	-
HCM Control Delay (s)	10	-	-	8.2	-
HCM Lane LOS	B	-	-	A	-
HCM 95th %tile Q(veh)	0.6	-	-	0.5	-

# Total AM 2024 Storage Signal Progression



Timings  
1: MERIDIAN ROAD & WOODMAN ROAD

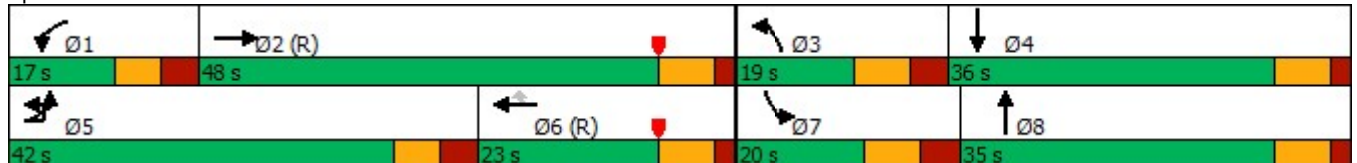
Total 2024 Shopping Center PM  
04/10/2023

Lane Group	EBL	EBT	EBR	WBL	WBT	WBR	NBL	NBT	NBR	SBL	SBT	SBR
Lane Configurations												
Traffic Volume (vph)	987	474	166	117	388	321	265	898	110	333	693	739
Future Volume (vph)	987	474	166	117	388	321	265	898	110	333	693	739
Turn Type	Prot	NA	Free	Prot	NA	Perm	Prot	NA	Free	Prot	NA	Free
Protected Phases	5	2		1	6		3	8		7	4	
Permitted Phases			Free			6			Free			Free
Detector Phase	5	2		1	6	6	3	8		7	4	
Switch Phase												
Minimum Initial (s)	5.0	15.0		5.0	15.0	15.0	5.0	15.0		5.0	15.0	
Minimum Split (s)	13.5	22.0		13.5	22.0	22.0	13.5	22.0		13.5	22.0	
Total Split (s)	42.0	48.0		17.0	23.0	23.0	19.0	35.0		20.0	36.0	
Total Split (%)	35.0%	40.0%		14.2%	19.2%	19.2%	15.8%	29.2%		16.7%	30.0%	
Yellow Time (s)	4.0	5.0		4.0	5.0	5.0	5.0	5.0		5.0	5.0	
All-Red Time (s)	3.5	2.0		3.5	2.0	2.0	3.5	2.0		3.5	2.0	
Lost Time Adjust (s)	0.0	0.0		0.0	0.0	0.0	0.0	0.0		0.0	0.0	
Total Lost Time (s)	7.5	7.0		7.5	7.0	7.0	8.5	7.0		8.5	7.0	
Lead/Lag	Lead	Lag		Lead	Lag	Lag	Lead	Lag		Lead	Lag	
Lead-Lag Optimize?	Yes	Yes		Yes	Yes	Yes	Yes	Yes		Yes	Yes	
Recall Mode	None	C-Max		None	C-Max	C-Max	None	None		None	None	
Act Effct Green (s)	34.5	41.6	120.0	8.9	16.0	16.0	10.5	28.0	120.0	11.5	29.0	120.0
Actuated g/C Ratio	0.29	0.35	1.00	0.07	0.13	0.13	0.09	0.23	1.00	0.10	0.24	1.00
v/c Ratio	1.09	0.42	0.11	0.50	0.90	0.82	0.93	1.15	0.07	1.07	0.85	0.49
Control Delay	97.7	31.3	0.1	60.4	73.8	31.3	91.4	121.3	0.1	73.6	40.8	3.1
Queue Delay	0.0	0.0	0.0	0.0	0.0	0.0	0.0	0.0	0.0	0.0	0.0	0.0
Total Delay	97.7	31.3	0.1	60.4	73.8	31.3	91.4	121.3	0.1	73.6	40.8	3.1
LOS	F	C	A	E	E	C	F	F	A	E	D	A
Approach Delay		68.7			55.4			104.6			31.2	
Approach LOS		E			E			F			C	

Intersection Summary

Cycle Length: 120  
 Actuated Cycle Length: 120  
 Offset: 100 (83%), Referenced to phase 2:EBT and 6:WBT, Start of Yellow  
 Natural Cycle: 140  
 Control Type: Actuated-Coordinated  
 Maximum v/c Ratio: 1.15  
 Intersection Signal Delay: 63.0  
 Intersection LOS: E  
 Intersection Capacity Utilization 100.0%  
 ICU Level of Service F  
 Analysis Period (min) 15

Splits and Phases: 1: MERIDIAN ROAD & WOODMAN ROAD



Queues  
1: MERIDIAN ROAD & WOODMAN ROAD

Total 2024 Shopping Center PM  
04/10/2023



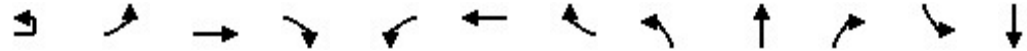
Lane Group	EBL	EBT	EBR	WBL	WBT	WBR	NBL	NBT	NBR	SBL	SBT	SBR
Lane Group Flow (vph)	1077	510	178	127	422	349	279	945	116	351	729	778
v/c Ratio	1.09	0.42	0.11	0.50	0.90	0.82	0.93	1.15	0.07	1.07	0.85	0.49
Control Delay	97.7	31.3	0.1	60.4	73.8	31.3	91.4	121.3	0.1	73.6	40.8	3.1
Queue Delay	0.0	0.0	0.0	0.0	0.0	0.0	0.0	0.0	0.0	0.0	0.0	0.0
Total Delay	97.7	31.3	0.1	60.4	73.8	31.3	91.4	121.3	0.1	73.6	40.8	3.1
Queue Length 50th (ft)	~485	158	0	49	171	73	112	~451	0	~159	297	65
Queue Length 95th (ft)	#617	209	0	81	#263	#225	#195	#583	0	m127	m255	m8
Internal Link Dist (ft)		1165			1100			342				860
Turn Bay Length (ft)	500		630	350		250	440		330	490		450
Base Capacity (vph)	986	1228	1583	271	471	427	300	825	1583	328	855	1583
Starvation Cap Reductn	0	0	0	0	0	0	0	0	0	0	0	0
Spillback Cap Reductn	0	0	0	0	0	0	0	0	0	0	0	0
Storage Cap Reductn	0	0	0	0	0	0	0	0	0	0	0	0
Reduced v/c Ratio	1.09	0.42	0.11	0.47	0.90	0.82	0.93	1.15	0.07	1.07	0.85	0.49

Intersection Summary

- ~ Volume exceeds capacity, queue is theoretically infinite.  
Queue shown is maximum after two cycles.
- # 95th percentile volume exceeds capacity, queue may be longer.  
Queue shown is maximum after two cycles.
- m Volume for 95th percentile queue is metered by upstream signal.

HCM 6th Signalized Intersection Summary  
1: MERIDIAN ROAD & WOODMAN ROAD

Total 2024 Shopping Center PM  
04/10/2023



Movement	EBU	EBL	EBT	EBR	WBL	WBT	WBR	NBL	NBT	NBR	SBL	SBT
Lane Configurations		↔↔	↕↕	↔	↔↔	↕↕	↔	↔↔	↕↕	↔	↔↔	↕↕
Traffic Volume (veh/h)	15	987	474	166	117	388	321	265	898	110	333	693
Future Volume (veh/h)	15	987	474	166	117	388	321	265	898	110	333	693
Initial Q (Qb), veh		0	0	0	0	0	0	0	0	0	0	0
Ped-Bike Adj(A_pbT)		1.00		1.00	1.00		1.00	1.00		1.00	1.00	
Parking Bus, Adj		1.00	1.00	1.00	1.00	1.00	1.00	1.00	1.00	1.00	1.00	1.00
Work Zone On Approach			No			No			No			No
Adj Sat Flow, veh/h/ln		1870	1870	1870	1870	1870	1870	1870	1870	1870	1870	1870
Adj Flow Rate, veh/h		1061	510	0	127	422	0	279	945	0	351	729
Peak Hour Factor		0.93	0.93	0.93	0.92	0.92	0.92	0.95	0.95	0.95	0.95	0.95
Percent Heavy Veh, %		2	2	2	2	2	2	2	2	2	2	2
Cap, veh/h		994	1308		182	474		302	829		331	859
Arrive On Green		0.29	0.37	0.00	0.05	0.13	0.00	0.09	0.23	0.00	0.10	0.24
Sat Flow, veh/h		3456	3554	1585	3456	3554	1585	3456	3554	1585	3456	3554
Grp Volume(v), veh/h		1061	510	0	127	422	0	279	945	0	351	729
Grp Sat Flow(s),veh/h/ln		1728	1777	1585	1728	1777	1585	1728	1777	1585	1728	1777
Q Serve(g_s), s		34.5	12.7	0.0	4.3	14.0	0.0	9.6	28.0	0.0	11.5	23.5
Cycle Q Clear(g_c), s		34.5	12.7	0.0	4.3	14.0	0.0	9.6	28.0	0.0	11.5	23.5
Prop In Lane		1.00		1.00	1.00		1.00	1.00		1.00	1.00	
Lane Grp Cap(c), veh/h		994	1308		182	474		302	829		331	859
V/C Ratio(X)		1.07	0.39		0.70	0.89		0.92	1.14		1.06	0.85
Avail Cap(c_a), veh/h		994	1308		274	474		302	829		331	859
HCM Platoon Ratio		1.00	1.00	1.00	1.00	1.00	1.00	1.00	1.00	1.00	1.00	1.00
Upstream Filter(I)		1.00	1.00	0.00	1.00	1.00	0.00	1.00	1.00	0.00	1.00	1.00
Uniform Delay (d), s/veh		42.8	28.0	0.0	55.9	51.1	0.0	54.3	46.0	0.0	54.3	43.4
Incr Delay (d2), s/veh		48.5	0.9	0.0	4.7	21.5	0.0	32.4	77.3	0.0	66.1	8.0
Initial Q Delay(d3),s/veh		0.0	0.0	0.0	0.0	0.0	0.0	0.0	0.0	0.0	0.0	0.0
%ile BackOfQ(50%),veh/ln		20.8	5.4	0.0	2.0	7.5	0.0	5.5	21.0	0.0	8.0	11.1
Unsig. Movement Delay, s/veh												
LnGrp Delay(d),s/veh		91.3	28.9	0.0	60.6	72.7	0.0	86.7	123.3	0.0	120.4	51.4
LnGrp LOS		F	C		E	E		F	F		F	D
Approach Vol, veh/h			1571	A		549	A		1224	A		1080
Approach Delay, s/veh			71.0			69.9			114.9			73.8
Approach LOS			E			E			F			E
Timer - Assigned Phs	1	2	3	4	5	6	7	8				
Phs Duration (G+Y+Rc), s	13.8	51.2	19.0	36.0	42.0	23.0	20.0	35.0				
Change Period (Y+Rc), s	7.5	7.0	8.5	7.0	7.5	7.0	8.5	7.0				
Max Green Setting (Gmax), s	9.5	41.0	10.5	29.0	34.5	16.0	11.5	28.0				
Max Q Clear Time (g_c+I1), s	6.3	14.7	11.6	25.5	36.5	16.0	13.5	30.0				
Green Ext Time (p_c), s	0.1	3.2	0.0	1.6	0.0	0.0	0.0	0.0				

Intersection Summary

HCM 6th Ctrl Delay	83.7
HCM 6th LOS	F

Notes

- User approved pedestrian interval to be less than phase max green.
- User approved ignoring U-Turning movement.
- Unsignalized Delay for [NBR, EBR, WBR, SBR] is excluded from calculations of the approach delay and intersection delay.

Movement	SBR
Lane Configurations	
Traffic Volume (veh/h)	739
Future Volume (veh/h)	739
Initial Q (Qb), veh	0
Ped-Bike Adj(A_pbT)	1.00
Parking Bus, Adj	1.00
Work Zone On Approach	
Adj Sat Flow, veh/h/ln	1870
Adj Flow Rate, veh/h	0
Peak Hour Factor	0.95
Percent Heavy Veh, %	2
Cap, veh/h	
Arrive On Green	0.00
Sat Flow, veh/h	1585
Grp Volume(v), veh/h	0
Grp Sat Flow(s),veh/h/ln	1585
Q Serve(g_s), s	0.0
Cycle Q Clear(g_c), s	0.0
Prop In Lane	1.00
Lane Grp Cap(c), veh/h	
V/C Ratio(X)	
Avail Cap(c_a), veh/h	
HCM Platoon Ratio	1.00
Upstream Filter(l)	0.00
Uniform Delay (d), s/veh	0.0
Incr Delay (d2), s/veh	0.0
Initial Q Delay(d3),s/veh	0.0
%ile BackOfQ(50%),veh/ln	0.0
Unsig. Movement Delay, s/veh	
LnGrp Delay(d),s/veh	0.0
LnGrp LOS	
Approach Vol, veh/h	A
Approach Delay, s/veh	
Approach LOS	
Timer - Assigned Phs	



Timings  
2: MERIDIAN ROAD & EASTONVILLE ROAD

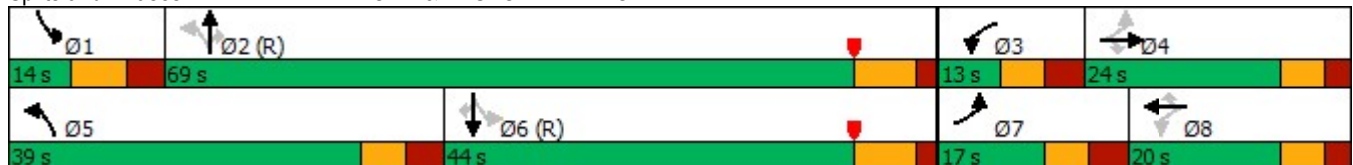
Total 2024 Shopping Center PM  
04/10/2023

Lane Group	EBL	EBT	EBR	WBL	WBT	WBR	NBL	NBT	NBR	SBL	SBT	SBR
Lane Configurations												
Traffic Volume (vph)	359	125	589	32	79	138	628	1516	120	85	1139	184
Future Volume (vph)	359	125	589	32	79	138	628	1516	120	85	1139	184
Turn Type	pm+pt	NA	Perm	pm+pt	NA	Perm	pm+pt	NA	Perm	pm+pt	NA	Perm
Protected Phases	7	4		3	8		5	2		1	6	
Permitted Phases	4		4	8		8	2		2	6		6
Detector Phase	7	4	4	3	8	8	5	2	2	1	6	6
Switch Phase												
Minimum Initial (s)	5.0	8.0	8.0	5.0	8.0	8.0	5.0	15.0	15.0	5.0	15.0	15.0
Minimum Split (s)	12.5	14.5	14.5	12.5	14.5	14.5	12.5	25.5	25.5	13.5	25.5	25.5
Total Split (s)	17.0	24.0	24.0	13.0	20.0	20.0	39.0	69.0	69.0	14.0	44.0	44.0
Total Split (%)	14.2%	20.0%	20.0%	10.8%	16.7%	16.7%	32.5%	57.5%	57.5%	11.7%	36.7%	36.7%
Yellow Time (s)	4.0	4.0	4.0	4.0	4.0	4.0	4.0	5.5	5.5	5.0	5.5	5.5
All-Red Time (s)	3.5	2.5	2.5	3.5	2.5	2.5	3.5	2.0	2.0	3.5	2.0	2.0
Lost Time Adjust (s)	0.0	0.0	0.0	0.0	0.0	0.0	0.0	0.0	0.0	0.0	0.0	0.0
Total Lost Time (s)	7.5	6.5	6.5	7.5	6.5	6.5	7.5	7.5	7.5	8.5	7.5	7.5
Lead/Lag	Lead	Lag	Lag	Lead	Lag	Lag	Lead	Lag	Lag	Lead	Lag	Lag
Lead-Lag Optimize?	Yes	Yes	Yes	Yes	Yes	Yes	Yes	Yes	Yes	Yes	Yes	Yes
Recall Mode	None	None	None	None	None	None	None	C-Max	C-Max	None	C-Max	C-Max
Act Effct Green (s)	27.4	22.7	22.7	18.0	13.5	13.5	75.5	61.5	61.5	41.0	36.5	36.5
Actuated g/C Ratio	0.23	0.19	0.19	0.15	0.11	0.11	0.63	0.51	0.51	0.34	0.30	0.30
v/c Ratio	0.77	0.42	1.04	0.16	0.40	0.36	1.33	0.94	0.15	0.66	1.20	0.32
Control Delay	51.1	49.2	63.7	37.4	55.7	2.5	182.8	16.1	0.2	51.1	136.8	10.3
Queue Delay	0.0	0.0	0.0	0.0	0.0	0.0	0.0	0.0	0.0	0.0	0.0	0.0
Total Delay	51.1	49.2	63.7	37.4	55.7	2.5	182.8	16.1	0.2	51.1	136.8	10.3
LOS	D	D	E	D	E	A	F	B	A	D	F	B
Approach Delay		57.8			23.9			61.5			115.1	
Approach LOS		E			C			E			F	

Intersection Summary

Cycle Length: 120  
 Actuated Cycle Length: 120  
 Offset: 89 (74%), Referenced to phase 2:NBTL and 6:SBTL, Start of Yellow  
 Natural Cycle: 150  
 Control Type: Actuated-Coordinated  
 Maximum v/c Ratio: 1.33  
 Intersection Signal Delay: 74.1  
 Intersection Capacity Utilization 106.5%  
 Analysis Period (min) 15  
 Intersection LOS: E  
 ICU Level of Service G

Splits and Phases: 2: MERIDIAN ROAD & EASTONVILLE ROAD



Queues  
2: MERIDIAN ROAD & EASTONVILLE ROAD

Total 2024 Shopping Center PM  
04/10/2023



Lane Group	EBL	EBT	EBR	WBL	WBT	WBR	NBL	NBT	NBR	SBL	SBT	SBR
Lane Group Flow (vph)	422	147	693	34	83	145	706	1703	135	97	1294	209
v/c Ratio	0.77	0.42	1.04	0.16	0.40	0.36	1.33	0.94	0.15	0.66	1.20	0.32
Control Delay	51.1	49.2	63.7	37.4	55.7	2.5	182.8	16.1	0.2	51.1	136.8	10.3
Queue Delay	0.0	0.0	0.0	0.0	0.0	0.0	0.0	0.0	0.0	0.0	0.0	0.0
Total Delay	51.1	49.2	63.7	37.4	55.7	2.5	182.8	16.1	0.2	51.1	136.8	10.3
Queue Length 50th (ft)	145	107	~300	20	61	0	~644	426	1	30	~657	48
Queue Length 95th (ft)	184	165	#461	48	113	0	m#596	m401	m1	m#97	#770	112
Internal Link Dist (ft)		508			1196			231			781	
Turn Bay Length (ft)	100		100	120		100	100		400	375		400
Base Capacity (vph)	547	352	665	209	209	404	531	1813	897	146	1076	651
Starvation Cap Reductn	0	0	0	0	0	0	0	0	0	0	0	0
Spillback Cap Reductn	0	0	0	0	0	0	0	0	0	0	0	0
Storage Cap Reductn	0	0	0	0	0	0	0	0	0	0	0	0
Reduced v/c Ratio	0.77	0.42	1.04	0.16	0.40	0.36	1.33	0.94	0.15	0.66	1.20	0.32

Intersection Summary

- ~ Volume exceeds capacity, queue is theoretically infinite.  
Queue shown is maximum after two cycles.
- # 95th percentile volume exceeds capacity, queue may be longer.  
Queue shown is maximum after two cycles.
- m Volume for 95th percentile queue is metered by upstream signal.

HCM 6th Signalized Intersection Summary  
2: MERIDIAN ROAD & EASTONVILLE ROAD

Total 2024 Shopping Center PM  
04/10/2023



Movement	EBL	EBT	EBR	WBL	WBT	WBR	NBL	NBT	NBR	SBL	SBT	SBR
Lane Configurations	↔↔	↑	↔	↔	↑	↔	↔	↑↑	↔	↔	↑↑	↔
Traffic Volume (veh/h)	359	125	589	32	79	138	628	1516	120	85	1139	184
Future Volume (veh/h)	359	125	589	32	79	138	628	1516	120	85	1139	184
Initial Q (Qb), veh	0	0	0	0	0	0	0	0	0	0	0	0
Ped-Bike Adj(A_pbT)	1.00		1.00	1.00		1.00	1.00		1.00	1.00		1.00
Parking Bus, Adj	1.00	1.00	1.00	1.00	1.00	1.00	1.00	1.00	1.00	1.00	1.00	1.00
Work Zone On Approach		No			No			No			No	
Adj Sat Flow, veh/h/ln	1870	1870	1870	1870	1870	1870	1870	1870	1870	1870	1870	1870
Adj Flow Rate, veh/h	422	147	0	34	83	0	706	1703	135	97	1294	209
Peak Hour Factor	0.85	0.85	0.85	0.95	0.95	0.95	0.89	0.89	0.89	0.88	0.88	0.88
Percent Heavy Veh, %	2	2	2	2	2	2	2	2	2	2	2	2
Cap, veh/h	453	220		163	125		528	1984	885	180	1244	555
Arrive On Green	0.08	0.12	0.00	0.03	0.07	0.00	0.26	0.56	0.56	0.05	0.35	0.35
Sat Flow, veh/h	3456	1870	1585	1781	1870	1585	1781	3554	1585	1781	3554	1585
Grp Volume(v), veh/h	422	147	0	34	83	0	706	1703	135	97	1294	209
Grp Sat Flow(s),veh/h/ln	1728	1870	1585	1781	1870	1585	1781	1777	1585	1781	1777	1585
Q Serve(g_s), s	9.5	9.0	0.0	2.1	5.2	0.0	31.5	48.8	4.9	4.2	42.0	11.8
Cycle Q Clear(g_c), s	9.5	9.0	0.0	2.1	5.2	0.0	31.5	48.8	4.9	4.2	42.0	11.8
Prop In Lane	1.00		1.00	1.00		1.00	1.00		1.00	1.00		1.00
Lane Grp Cap(c), veh/h	453	220		163	125		528	1984	885	180	1244	555
V/C Ratio(X)	0.93	0.67		0.21	0.67		1.34	0.86	0.15	0.54	1.04	0.38
Avail Cap(c_a), veh/h	453	273		194	210		528	1984	885	180	1244	555
HCM Platoon Ratio	1.00	1.00	1.00	1.00	1.00	1.00	1.00	1.00	1.00	1.00	1.00	1.00
Upstream Filter(I)	1.00	1.00	0.00	1.00	1.00	0.00	1.00	1.00	1.00	1.00	1.00	1.00
Uniform Delay (d), s/veh	51.1	50.7	0.0	50.1	54.7	0.0	37.4	22.5	12.8	27.0	39.0	29.2
Incr Delay (d2), s/veh	26.1	4.4	0.0	0.6	6.0	0.0	164.6	5.1	0.4	3.2	36.6	1.9
Initial Q Delay(d3),s/veh	0.0	0.0	0.0	0.0	0.0	0.0	0.0	0.0	0.0	0.0	0.0	0.0
%ile BackOfQ(50%),veh/ln	3.5	4.5	0.0	1.0	2.7	0.0	38.7	18.9	1.8	1.8	23.2	4.8
Unsig. Movement Delay, s/veh												
LnGrp Delay(d),s/veh	77.2	55.1	0.0	50.8	60.7	0.0	202.0	27.6	13.2	30.2	75.6	31.1
LnGrp LOS	E	E		D	E		F	C	B	C	F	C
Approach Vol, veh/h		569	A		117	A		2544			1600	
Approach Delay, s/veh		71.5			57.8			75.2			67.1	
Approach LOS		E			E			E			E	
Timer - Assigned Phs	1	2	3	4	5	6	7	8				
Phs Duration (G+Y+Rc), s	14.0	74.5	10.9	20.6	39.0	49.5	17.0	14.5				
Change Period (Y+Rc), s	8.5	7.5	7.5	6.5	7.5	7.5	7.5	6.5				
Max Green Setting (Gmax), s	5.5	61.5	5.5	17.5	31.5	36.5	9.5	13.5				
Max Q Clear Time (g_c+I1), s	6.2	50.8	4.1	11.0	33.5	44.0	11.5	7.2				
Green Ext Time (p_c), s	0.0	7.7	0.0	0.3	0.0	0.0	0.0	0.1				

Intersection Summary

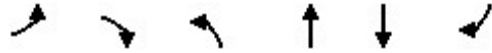
HCM 6th Ctrl Delay	71.7
HCM 6th LOS	E

Notes

User approved pedestrian interval to be less than phase max green.  
Unsignalized Delay for [EBR, WBR] is excluded from calculations of the approach delay and intersection delay.

Timings  
3: MERIDIAN ROAD & BENT GRASS MEADOWS DRIVE

Total 2024 Shopping Center PM  
04/10/2023

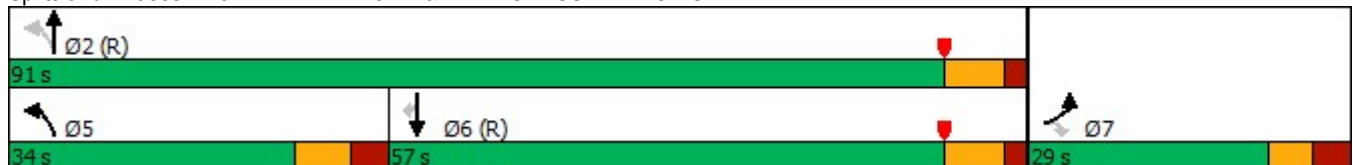


Lane Group	EBL	EBR	NBL	NBT	SBT	SBR
Lane Configurations	↖↗	↗	↖	↑↑	↑↑	↗
Traffic Volume (vph)	221	313	305	1651	1045	245
Future Volume (vph)	221	313	305	1651	1045	245
Turn Type	Prot	Perm	pm+pt	NA	NA	Perm
Protected Phases	7		5	2	6	
Permitted Phases		7	2			6
Detector Phase	7	7	5	2	6	6
Switch Phase						
Minimum Initial (s)	8.0	8.0	5.0	15.0	15.0	15.0
Minimum Split (s)	25.5	25.5	13.5	25.5	25.5	25.5
Total Split (s)	29.0	29.0	34.0	91.0	57.0	57.0
Total Split (%)	24.2%	24.2%	28.3%	75.8%	47.5%	47.5%
Yellow Time (s)	4.0	4.0	5.0	5.5	5.5	5.5
All-Red Time (s)	3.5	3.5	3.5	2.0	2.0	2.0
Lost Time Adjust (s)	0.0	0.0	0.0	0.0	0.0	0.0
Total Lost Time (s)	7.5	7.5	8.5	7.5	7.5	7.5
Lead/Lag			Lead		Lag	Lag
Lead-Lag Optimize?			Yes		Yes	Yes
Recall Mode	None	None	None	C-Max	C-Max	C-Max
Act Effct Green (s)	14.6	14.6	89.4	90.4	63.3	63.3
Actuated g/C Ratio	0.12	0.12	0.74	0.75	0.53	0.53
v/c Ratio	0.62	0.71	0.72	0.65	0.60	0.27
Control Delay	56.4	13.1	30.3	4.8	23.2	3.3
Queue Delay	0.0	0.0	0.0	0.0	0.0	0.0
Total Delay	56.4	13.1	30.3	4.8	23.2	3.3
LOS	E	B	C	A	C	A
Approach Delay	31.0			8.7	19.4	
Approach LOS	C			A	B	

Intersection Summary

Cycle Length: 120  
 Actuated Cycle Length: 120  
 Offset: 27 (23%), Referenced to phase 2:NBTL and 6:SBT, Start of Yellow  
 Natural Cycle: 90  
 Control Type: Actuated-Coordinated  
 Maximum v/c Ratio: 0.72  
 Intersection Signal Delay: 15.8  
 Intersection Capacity Utilization 72.0%  
 Analysis Period (min) 15  
 Intersection LOS: B  
 ICU Level of Service C

Splits and Phases: 3: MERIDIAN ROAD & BENT GRASS MEADOWS DRIVE



Queues  
 3: MERIDIAN ROAD & BENT GRASS MEADOWS DRIVE

Total 2024 Shopping Center PM  
 04/10/2023



Lane Group	EBL	EBR	NBL	NBT	SBT	SBR
Lane Group Flow (vph)	260	368	321	1738	1112	261
v/c Ratio	0.62	0.71	0.72	0.65	0.60	0.27
Control Delay	56.4	13.1	30.3	4.8	23.2	3.3
Queue Delay	0.0	0.0	0.0	0.0	0.0	0.0
Total Delay	56.4	13.1	30.3	4.8	23.2	3.3
Queue Length 50th (ft)	100	0	123	127	301	0
Queue Length 95th (ft)	129	64	m133	m145	467	50
Internal Link Dist (ft)	310			750	1921	
Turn Bay Length (ft)	150		700			350
Base Capacity (vph)	615	585	535	2665	1865	958
Starvation Cap Reductn	0	0	0	0	0	0
Spillback Cap Reductn	0	0	0	0	0	0
Storage Cap Reductn	0	0	0	0	0	0
Reduced v/c Ratio	0.42	0.63	0.60	0.65	0.60	0.27

Intersection Summary

m Volume for 95th percentile queue is metered by upstream signal.

HCM 6th Signalized Intersection Summary  
 3: MERIDIAN ROAD & BENT GRASS MEADOWS DRIVE

Total 2024 Shopping Center PM  
 04/10/2023



Movement	EBL	EBR	NBL	NBT	SBT	SBR
Lane Configurations	↖↗	↗	↖	↑↑	↑↑	↗
Traffic Volume (veh/h)	221	313	305	1651	1045	245
Future Volume (veh/h)	221	313	305	1651	1045	245
Initial Q (Qb), veh	0	0	0	0	0	0
Ped-Bike Adj(A_pbT)	1.00	1.00	1.00			1.00
Parking Bus, Adj	1.00	1.00	1.00	1.00	1.00	1.00
Work Zone On Approach	No			No	No	
Adj Sat Flow, veh/h/ln	1870	1870	1870	1870	1870	1870
Adj Flow Rate, veh/h	260	0	321	1738	1112	261
Peak Hour Factor	0.85	0.85	0.95	0.95	0.94	0.94
Percent Heavy Veh, %	2	2	2	2	2	2
Cap, veh/h	330		389	2770	2219	990
Arrive On Green	0.10	0.00	0.08	0.78	0.62	0.62
Sat Flow, veh/h	3456	1585	1781	3647	3647	1585
Grp Volume(v), veh/h	260	0	321	1738	1112	261
Grp Sat Flow(s),veh/h/ln	1728	1585	1781	1777	1777	1585
Q Serve(g_s), s	8.8	0.0	7.2	25.3	20.5	8.9
Cycle Q Clear(g_c), s	8.8	0.0	7.2	25.3	20.5	8.9
Prop In Lane	1.00	1.00	1.00			1.00
Lane Grp Cap(c), veh/h	330		389	2770	2219	990
V/C Ratio(X)	0.79		0.82	0.63	0.50	0.26
Avail Cap(c_a), veh/h	619		618	2770	2219	990
HCM Platoon Ratio	1.00	1.00	1.00	1.00	1.00	1.00
Upstream Filter(l)	1.00	0.00	1.00	1.00	1.00	1.00
Uniform Delay (d), s/veh	53.1	0.0	15.0	5.7	12.3	10.1
Incr Delay (d2), s/veh	4.2	0.0	5.0	1.1	0.8	0.7
Initial Q Delay(d3),s/veh	0.0	0.0	0.0	0.0	0.0	0.0
%ile BackOfQ(50%),veh/ln	4.0	0.0	6.3	8.0	8.0	12.1
Unsig. Movement Delay, s/veh						
LnGrp Delay(d),s/veh	57.3	0.0	20.0	6.8	13.1	10.8
LnGrp LOS	E		C	A	B	B
Approach Vol, veh/h	260	A		2059	1373	
Approach Delay, s/veh	57.3			8.9	12.7	
Approach LOS	E			A	B	
Timer - Assigned Phs		2		4	5	6
Phs Duration (G+Y+Rc), s		101.0		19.0	18.6	82.4
Change Period (Y+Rc), s		7.5		7.5	8.5	7.5
Max Green Setting (Gmax), s		83.5		21.5	25.5	49.5
Max Q Clear Time (g_c+I1), s		27.3		10.8	9.2	22.5
Green Ext Time (p_c), s		24.5		0.6	0.9	10.7
<b>Intersection Summary</b>						
HCM 6th Ctrl Delay			13.7			
HCM 6th LOS			B			
<b>Notes</b>						
Unsignalized Delay for [EBR] is excluded from calculations of the approach delay and intersection delay.						

Intersection						
Int Delay, s/veh	8.2					
Movement	EBT	EBR	WBL	WBT	NBL	NBR
Lane Configurations	↑	↗	↖	↑	↘	↙
Traffic Vol, veh/h	123	42	383	166	2	411
Future Vol, veh/h	123	42	383	166	2	411
Conflicting Peds, #/hr	0	0	0	0	0	0
Sign Control	Free	Free	Free	Free	Stop	Stop
RT Channelized	-	None	-	None	-	None
Storage Length	-	150	100	-	0	-
Veh in Median Storage, #	0	-	-	0	0	-
Grade, %	0	-	-	0	0	-
Peak Hour Factor	85	85	85	85	85	85
Heavy Vehicles, %	2	2	2	2	2	2
Mvmt Flow	145	49	451	195	2	484

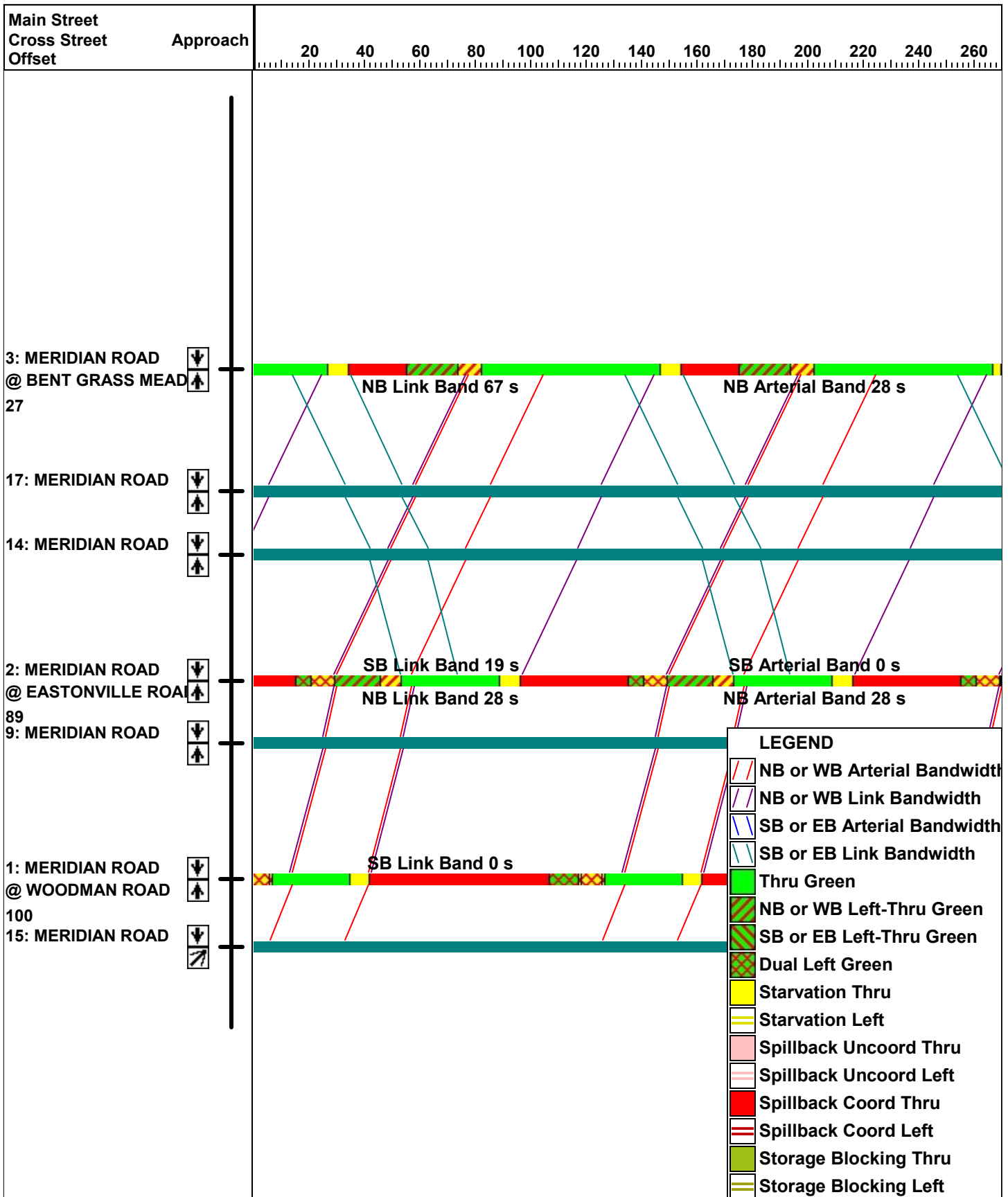
Major/Minor	Major1	Major2	Minor1	Minor2	Minor3
Conflicting Flow All	0	0	194	0	1242
Stage 1	-	-	-	-	145
Stage 2	-	-	-	-	1097
Critical Hdwy	-	-	4.12	-	6.42
Critical Hdwy Stg 1	-	-	-	-	5.42
Critical Hdwy Stg 2	-	-	-	-	5.42
Follow-up Hdwy	-	-	2.218	-	3.518
Pot Cap-1 Maneuver	-	-	1379	-	193
Stage 1	-	-	-	-	882
Stage 2	-	-	-	-	320
Platoon blocked, %	-	-	-	-	-
Mov Cap-1 Maneuver	-	-	1379	-	130
Mov Cap-2 Maneuver	-	-	-	-	130
Stage 1	-	-	-	-	882
Stage 2	-	-	-	-	215

Approach	EB	WB	NB
HCM Control Delay, s	0	6.2	14.1
HCM LOS			B

Minor Lane/Major Mvmt	NBLn1	EBT	EBR	WBL	WBT
Capacity (veh/h)	877	-	-	1379	-
HCM Lane V/C Ratio	0.554	-	-	0.327	-
HCM Control Delay (s)	14.1	-	-	8.9	-
HCM Lane LOS	B	-	-	A	-
HCM 95th %tile Q(veh)	3.5	-	-	1.4	-



# Total PM 2024 Shopping Center



Timings  
1: MERIDIAN ROAD & WOODMAN ROAD

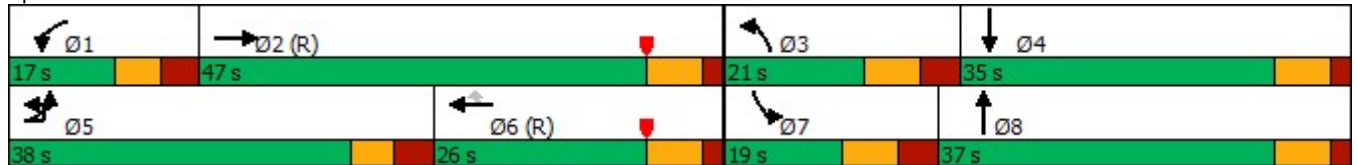
Total 2024 Storage PM  
04/10/2023

Lane Group	EBL	EBT	EBR	WBL	WBT	WBR	NBL	NBT	NBR	SBL	SBT	SBR
Lane Configurations												
Traffic Volume (vph)	741	474	166	117	388	239	265	788	110	244	574	473
Future Volume (vph)	741	474	166	117	388	239	265	788	110	244	574	473
Turn Type	Prot	NA	Free	Prot	NA	Perm	Prot	NA	Free	Prot	NA	Free
Protected Phases	5	2		1	6		3	8		7	4	
Permitted Phases			Free			6			Free			Free
Detector Phase	5	2		1	6	6	3	8		7	4	
Switch Phase												
Minimum Initial (s)	5.0	15.0		5.0	15.0	15.0	5.0	15.0		5.0	15.0	
Minimum Split (s)	13.5	22.0		13.5	22.0	22.0	13.5	22.0		13.5	22.0	
Total Split (s)	38.0	47.0		17.0	26.0	26.0	21.0	37.0		19.0	35.0	
Total Split (%)	31.7%	39.2%		14.2%	21.7%	21.7%	17.5%	30.8%		15.8%	29.2%	
Yellow Time (s)	4.0	5.0		4.0	5.0	5.0	5.0	5.0		5.0	5.0	
All-Red Time (s)	3.5	2.0		3.5	2.0	2.0	3.5	2.0		3.5	2.0	
Lost Time Adjust (s)	0.0	0.0		0.0	0.0	0.0	0.0	0.0		0.0	0.0	
Total Lost Time (s)	7.5	7.0		7.5	7.0	7.0	8.5	7.0		8.5	7.0	
Lead/Lag	Lead	Lag		Lead	Lag	Lag	Lead	Lag		Lead	Lag	
Lead-Lag Optimize?	Yes	Yes		Yes	Yes	Yes	Yes	Yes		Yes	Yes	
Recall Mode	None	C-Max		None	C-Max	C-Max	None	None		None	None	
Act Effct Green (s)	30.1	40.8	120.0	8.9	19.6	19.6	12.3	29.8	120.0	10.5	28.1	120.0
Actuated g/C Ratio	0.25	0.34	1.00	0.07	0.16	0.16	0.10	0.25	1.00	0.09	0.23	1.00
v/c Ratio	0.95	0.42	0.11	0.50	0.73	0.56	0.80	0.94	0.07	0.86	0.73	0.31
Control Delay	64.4	32.1	0.1	60.4	56.2	11.4	69.9	63.9	0.1	51.9	50.3	0.3
Queue Delay	0.0	0.0	0.0	0.0	0.0	0.0	0.0	0.0	0.0	0.0	0.0	0.0
Total Delay	64.4	32.1	0.1	60.4	56.2	11.4	69.9	63.9	0.1	51.9	50.3	0.3
LOS	E	C	A	E	E	B	E	E	A	D	D	A
Approach Delay		45.8			42.5			59.2			32.3	
Approach LOS		D			D			E			C	

Intersection Summary

Cycle Length: 120  
 Actuated Cycle Length: 120  
 Offset: 100 (83%), Referenced to phase 2:EBT and 6:WBT, Start of Yellow  
 Natural Cycle: 100  
 Control Type: Actuated-Coordinated  
 Maximum v/c Ratio: 0.95  
 Intersection Signal Delay: 44.9  
 Intersection Capacity Utilization 87.4%  
 Analysis Period (min) 15  
 Intersection LOS: D  
 ICU Level of Service E

Splits and Phases: 1: MERIDIAN ROAD & WOODMAN ROAD



Queues  
1: MERIDIAN ROAD & WOODMAN ROAD

Total 2024 Storage PM  
04/10/2023



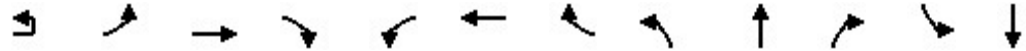
Lane Group	EBL	EBT	EBR	WBL	WBT	WBR	NBL	NBT	NBR	SBL	SBT	SBR
Lane Group Flow (vph)	813	510	178	127	422	260	279	829	116	257	604	498
v/c Ratio	0.95	0.42	0.11	0.50	0.73	0.56	0.80	0.94	0.07	0.86	0.73	0.31
Control Delay	64.4	32.1	0.1	60.4	56.2	11.4	69.9	63.9	0.1	51.9	50.3	0.3
Queue Delay	0.0	0.0	0.0	0.0	0.0	0.0	0.0	0.0	0.0	0.0	0.0	0.0
Total Delay	64.4	32.1	0.1	60.4	56.2	11.4	69.9	63.9	0.1	51.9	50.3	0.3
Queue Length 50th (ft)	318	161	0	49	166	7	110	332	0	108	257	0
Queue Length 95th (ft)	#437	212	0	81	224	85	#172	#455	0	m#147	m314	m0
Internal Link Dist (ft)		1165			1100			342				860
Turn Bay Length (ft)	500		630	350		250	440		330	490		450
Base Capacity (vph)	872	1203	1583	271	578	468	357	884	1583	300	827	1583
Starvation Cap Reductn	0	0	0	0	0	0	0	0	0	0	0	0
Spillback Cap Reductn	0	0	0	0	0	0	0	0	0	0	0	0
Storage Cap Reductn	0	0	0	0	0	0	0	0	0	0	0	0
Reduced v/c Ratio	0.93	0.42	0.11	0.47	0.73	0.56	0.78	0.94	0.07	0.86	0.73	0.31

Intersection Summary

- # 95th percentile volume exceeds capacity, queue may be longer.  
Queue shown is maximum after two cycles.
- m Volume for 95th percentile queue is metered by upstream signal.

HCM 6th Signalized Intersection Summary  
 1: MERIDIAN ROAD & WOODMAN ROAD

Total 2024 Storage PM  
 04/10/2023



Movement	EBU	EBL	EBT	EBR	WBL	WBT	WBR	NBL	NBT	NBR	SBL	SBT
Lane Configurations		↖↗	↕	↖	↖↗	↕	↖	↖↗	↕	↖	↖↗	↕
Traffic Volume (veh/h)	15	741	474	166	117	388	239	265	788	110	244	574
Future Volume (veh/h)	15	741	474	166	117	388	239	265	788	110	244	574
Initial Q (Qb), veh		0	0	0	0	0	0	0	0	0	0	0
Ped-Bike Adj(A_pbT)		1.00		1.00	1.00		1.00	1.00		1.00	1.00	
Parking Bus, Adj		1.00	1.00	1.00	1.00	1.00	1.00	1.00	1.00	1.00	1.00	1.00
Work Zone On Approach			No			No			No			No
Adj Sat Flow, veh/h/ln		1870	1870	1870	1870	1870	1870	1870	1870	1870	1870	1870
Adj Flow Rate, veh/h		797	510	0	127	422	0	279	829	0	257	604
Peak Hour Factor		0.93	0.93	0.93	0.92	0.92	0.92	0.95	0.95	0.95	0.95	0.95
Percent Heavy Veh, %		2	2	2	2	2	2	2	2	2	2	2
Cap, veh/h		853	1285		182	596		335	881		302	848
Arrive On Green		0.25	0.36	0.00	0.05	0.17	0.00	0.10	0.25	0.00	0.09	0.24
Sat Flow, veh/h		3456	3554	1585	3456	3554	1585	3456	3554	1585	3456	3554
Grp Volume(v), veh/h		797	510	0	127	422	0	279	829	0	257	604
Grp Sat Flow(s),veh/h/ln		1728	1777	1585	1728	1777	1585	1728	1777	1585	1728	1777
Q Serve(g_s), s		27.1	12.8	0.0	4.3	13.5	0.0	9.5	27.5	0.0	8.8	18.7
Cycle Q Clear(g_c), s		27.1	12.8	0.0	4.3	13.5	0.0	9.5	27.5	0.0	8.8	18.7
Prop In Lane		1.00		1.00	1.00		1.00	1.00		1.00	1.00	
Lane Grp Cap(c), veh/h		853	1285		182	596		335	881		302	848
V/C Ratio(X)		0.93	0.40		0.70	0.71		0.83	0.94		0.85	0.71
Avail Cap(c_a), veh/h		878	1285		274	596		360	888		302	848
HCM Platoon Ratio		1.00	1.00	1.00	1.00	1.00	1.00	1.00	1.00	1.00	1.00	1.00
Upstream Filter(I)		1.00	1.00	0.00	1.00	1.00	0.00	1.00	1.00	0.00	1.00	1.00
Uniform Delay (d), s/veh		44.2	28.5	0.0	55.9	47.2	0.0	53.2	44.3	0.0	54.0	41.9
Incr Delay (d2), s/veh		16.5	0.9	0.0	4.7	7.0	0.0	14.6	17.5	0.0	19.9	2.8
Initial Q Delay(d3),s/veh		0.0	0.0	0.0	0.0	0.0	0.0	0.0	0.0	0.0	0.0	0.0
%ile BackOfQ(50%),veh/ln		13.1	5.4	0.0	2.0	6.4	0.0	4.8	14.0	0.0	4.6	8.4
Unsig. Movement Delay, s/veh												
LnGrp Delay(d),s/veh		60.7	29.5	0.0	60.6	54.1	0.0	67.9	61.7	0.0	73.9	44.7
LnGrp LOS		E	C		E	D		E	E		E	D
Approach Vol, veh/h			1307	A		549	A		1108	A		861
Approach Delay, s/veh			48.5			55.6			63.3			53.4
Approach LOS			D			E			E			D
Timer - Assigned Phs	1	2	3	4	5	6	7	8				
Phs Duration (G+Y+Rc), s	13.8	50.4	20.1	35.6	37.1	27.1	19.0	36.8				
Change Period (Y+Rc), s	7.5	7.0	8.5	7.0	7.5	7.0	8.5	7.0				
Max Green Setting (Gmax), s	9.5	40.0	12.5	28.0	30.5	19.0	10.5	30.0				
Max Q Clear Time (g_c+I1), s	6.3	14.8	11.5	20.7	29.1	15.5	10.8	29.5				
Green Ext Time (p_c), s	0.1	3.1	0.1	2.3	0.5	0.8	0.0	0.3				

Intersection Summary

HCM 6th Ctrl Delay	54.9
HCM 6th LOS	D

Notes

- User approved pedestrian interval to be less than phase max green.
- User approved ignoring U-Turning movement.
- Unsignalized Delay for [NBR, EBR, WBR, SBR] is excluded from calculations of the approach delay and intersection delay.

HCM 6th Signalized Intersection Summary  
 1: MERIDIAN ROAD & WOODMAN ROAD

Total 2024 Storage PM  
 04/10/2023

Movement	SBR
Lane Configurations	
Traffic Volume (veh/h)	473
Future Volume (veh/h)	473
Initial Q (Qb), veh	0
Ped-Bike Adj(A_pbT)	1.00
Parking Bus, Adj	1.00
Work Zone On Approach	
Adj Sat Flow, veh/h/ln	1870
Adj Flow Rate, veh/h	0
Peak Hour Factor	0.95
Percent Heavy Veh, %	2
Cap, veh/h	
Arrive On Green	0.00
Sat Flow, veh/h	1585
Grp Volume(v), veh/h	0
Grp Sat Flow(s),veh/h/ln	1585
Q Serve(g_s), s	0.0
Cycle Q Clear(g_c), s	0.0
Prop In Lane	1.00
Lane Grp Cap(c), veh/h	
V/C Ratio(X)	
Avail Cap(c_a), veh/h	
HCM Platoon Ratio	1.00
Upstream Filter(l)	0.00
Uniform Delay (d), s/veh	0.0
Incr Delay (d2), s/veh	0.0
Initial Q Delay(d3),s/veh	0.0
%ile BackOfQ(50%),veh/ln	0.0
Unsig. Movement Delay, s/veh	
LnGrp Delay(d),s/veh	0.0
LnGrp LOS	
Approach Vol, veh/h	A
Approach Delay, s/veh	
Approach LOS	
Timer - Assigned Phs	

Timings  
2: MERIDIAN ROAD & EASTONVILLE ROAD

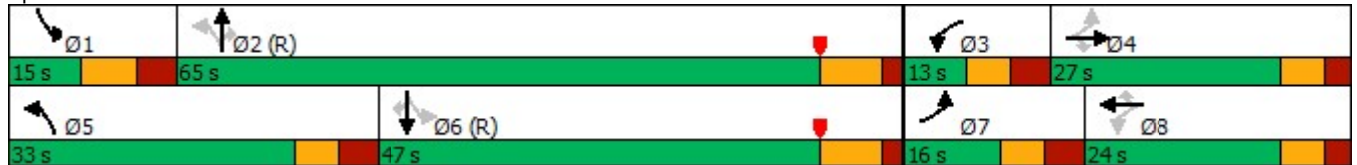
Total 2024 Storage PM  
04/10/2023

Lane Group	EBL	EBT	EBR	WBL	WBT	WBR	NBL	NBT	NBR	SBL	SBT	SBR
Lane Configurations												
Traffic Volume (vph)	359	125	293	32	79	138	355	1353	120	85	962	184
Future Volume (vph)	359	125	293	32	79	138	355	1353	120	85	962	184
Turn Type	pm+pt	NA	Perm	pm+pt	NA	Perm	pm+pt	NA	Perm	pm+pt	NA	Perm
Protected Phases	7	4		3	8		5	2		1	6	
Permitted Phases	4		4	8		8	2		2	6		6
Detector Phase	7	4	4	3	8	8	5	2	2	1	6	6
Switch Phase												
Minimum Initial (s)	5.0	8.0	8.0	5.0	8.0	8.0	5.0	15.0	15.0	5.0	15.0	15.0
Minimum Split (s)	12.5	24.5	24.5	12.5	24.5	24.5	12.5	25.5	25.5	13.5	25.5	25.5
Total Split (s)	16.0	27.0	27.0	13.0	24.0	24.0	33.0	65.0	65.0	15.0	47.0	47.0
Total Split (%)	13.3%	22.5%	22.5%	10.8%	20.0%	20.0%	27.5%	54.2%	54.2%	12.5%	39.2%	39.2%
Yellow Time (s)	4.0	4.0	4.0	4.0	4.0	4.0	4.0	5.5	5.5	5.0	5.5	5.5
All-Red Time (s)	3.5	2.5	2.5	3.5	2.5	2.5	3.5	2.0	2.0	3.5	2.0	2.0
Lost Time Adjust (s)	0.0	0.0	0.0	0.0	0.0	0.0	0.0	0.0	0.0	0.0	0.0	0.0
Total Lost Time (s)	7.5	6.5	6.5	7.5	6.5	6.5	7.5	7.5	7.5	8.5	7.5	7.5
Lead/Lag	Lead	Lag	Lag	Lead	Lag	Lag	Lead	Lag	Lag	Lead	Lag	Lag
Lead-Lag Optimize?	Yes	Yes	Yes	Yes	Yes	Yes	Yes	Yes	Yes	Yes	Yes	Yes
Recall Mode	None	None	None	None	None	None	None	C-Max	C-Max	None	C-Max	C-Max
Act Effct Green (s)	24.5	20.4	20.4	16.7	12.2	12.2	77.8	61.9	61.9	51.0	44.6	44.6
Actuated g/C Ratio	0.20	0.17	0.17	0.14	0.10	0.10	0.65	0.52	0.52	0.42	0.37	0.37
v/c Ratio	0.85	0.47	0.62	0.17	0.44	0.37	0.90	0.83	0.15	0.56	0.83	0.28
Control Delay	59.6	51.1	10.0	37.4	56.9	2.7	54.7	11.6	0.5	28.5	50.0	13.4
Queue Delay	0.0	0.0	0.0	0.0	0.0	0.0	0.0	0.0	0.0	0.0	0.0	0.0
Total Delay	59.6	51.1	10.0	37.4	56.9	2.7	54.7	11.6	0.5	28.5	50.0	13.4
LOS	E	D	B	D	E	A	D	B	A	C	D	B
Approach Delay		39.5			24.4			19.3			43.1	
Approach LOS		D			C			B			D	

Intersection Summary

Cycle Length: 120  
 Actuated Cycle Length: 120  
 Offset: 89 (74%), Referenced to phase 2:NBTL and 6:SBTL, Start of Yellow  
 Natural Cycle: 100  
 Control Type: Actuated-Coordinated  
 Maximum v/c Ratio: 0.90  
 Intersection Signal Delay: 30.7  
 Intersection Capacity Utilization 86.5%  
 Analysis Period (min) 15  
 Intersection LOS: C  
 ICU Level of Service E

Splits and Phases: 2: MERIDIAN ROAD & EASTONVILLE ROAD



Queues  
2: MERIDIAN ROAD & EASTONVILLE ROAD

Total 2024 Storage PM  
04/10/2023



Lane Group	EBL	EBT	EBR	WBL	WBT	WBR	NBL	NBT	NBR	SBL	SBT	SBR
Lane Group Flow (vph)	422	147	345	34	83	145	399	1520	135	97	1093	209
v/c Ratio	0.85	0.47	0.62	0.17	0.44	0.37	0.90	0.83	0.15	0.56	0.83	0.28
Control Delay	59.6	51.1	10.0	37.4	56.9	2.7	54.7	11.6	0.5	28.5	50.0	13.4
Queue Delay	0.0	0.0	0.0	0.0	0.0	0.0	0.0	0.0	0.0	0.0	0.0	0.0
Total Delay	59.6	51.1	10.0	37.4	56.9	2.7	54.7	11.6	0.5	28.5	50.0	13.4
Queue Length 50th (ft)	160	110	0	21	62	0	179	348	0	39	470	36
Queue Length 95th (ft)	177	160	62	46	109	0	m#284	m408	m3	#92	#560	98
Internal Link Dist (ft)		508			1196			231				781
Turn Bay Length (ft)	100		100	120		100	100		400	375		400
Base Capacity (vph)	495	343	572	196	271	448	461	1824	901	175	1314	742
Starvation Cap Reductn	0	0	0	0	0	0	0	0	0	0	0	0
Spillback Cap Reductn	0	0	0	0	0	0	0	0	0	0	0	0
Storage Cap Reductn	0	0	0	0	0	0	0	0	0	0	0	0
Reduced v/c Ratio	0.85	0.43	0.60	0.17	0.31	0.32	0.87	0.83	0.15	0.55	0.83	0.28




























Intersection Summary

- # 95th percentile volume exceeds capacity, queue may be longer.  
Queue shown is maximum after two cycles.
- m Volume for 95th percentile queue is metered by upstream signal.



HCM 6th Signalized Intersection Summary  
2: MERIDIAN ROAD & EASTONVILLE ROAD

Total 2024 Storage PM  
04/10/2023

												
Movement	EBL	EBT	EBR	WBL	WBT	WBR	NBL	NBT	NBR	SBL	SBT	SBR
Lane Configurations	 							 			 	
Traffic Volume (veh/h)	359	125	293	32	79	138	355	1353	120	85	962	184
Future Volume (veh/h)	359	125	293	32	79	138	355	1353	120	85	962	184
Initial Q (Qb), veh	0	0	0	0	0	0	0	0	0	0	0	0
Ped-Bike Adj(A_pbT)	1.00		1.00	1.00		1.00	1.00		1.00	1.00		1.00
Parking Bus, Adj	1.00	1.00	1.00	1.00	1.00	1.00	1.00	1.00	1.00	1.00	1.00	1.00
Work Zone On Approach		No			No			No			No	
Adj Sat Flow, veh/h/ln	1870	1870	1870	1870	1870	1870	1870	1870	1870	1870	1870	1870
Adj Flow Rate, veh/h	422	147	0	34	83	0	399	1520	135	97	1093	209
Peak Hour Factor	0.85	0.85	0.85	0.95	0.95	0.95	0.89	0.89	0.89	0.88	0.88	0.88
Percent Heavy Veh, %	2	2	2	2	2	2	2	2	2	2	2	2
Cap, veh/h	424	204		152	125		431	2023	902	212	1662	741
Arrive On Green	0.07	0.11	0.00	0.03	0.07	0.00	0.15	0.57	0.57	0.04	0.47	0.47
Sat Flow, veh/h	3456	1870	1585	1781	1870	1585	1781	3554	1585	1781	3554	1585
Grp Volume(v), veh/h	422	147	0	34	83	0	399	1520	135	97	1093	209
Grp Sat Flow(s),veh/h/ln	1728	1870	1585	1781	1870	1585	1781	1777	1585	1781	1777	1585
Q Serve(g_s), s	8.5	9.1	0.0	2.1	5.2	0.0	15.6	38.6	4.8	3.4	28.4	9.7
Cycle Q Clear(g_c), s	8.5	9.1	0.0	2.1	5.2	0.0	15.6	38.6	4.8	3.4	28.4	9.7
Prop In Lane	1.00		1.00	1.00		1.00	1.00		1.00	1.00		1.00
Lane Grp Cap(c), veh/h	424	204		152	125		431	2023	902	212	1662	741
V/C Ratio(X)	0.99	0.72		0.22	0.67		0.93	0.75	0.15	0.46	0.66	0.28
Avail Cap(c_a), veh/h	424	320		183	273		536	2023	902	231	1662	741
HCM Platoon Ratio	1.00	1.00	1.00	1.00	1.00	1.00	1.00	1.00	1.00	1.00	1.00	1.00
Upstream Filter(I)	1.00	1.00	0.00	1.00	1.00	0.00	1.00	1.00	1.00	1.00	1.00	1.00
Uniform Delay (d), s/veh	52.7	51.7	0.0	50.2	54.7	0.0	26.0	19.5	12.2	19.5	24.6	19.6
Incr Delay (d2), s/veh	42.2	4.7	0.0	0.7	6.0	0.0	19.7	2.6	0.4	1.5	2.1	1.0
Initial Q Delay(d3),s/veh	0.0	0.0	0.0	0.0	0.0	0.0	0.0	0.0	0.0	0.0	0.0	0.0
%ile BackOfQ(50%),veh/ln	4.8	4.5	0.0	1.0	2.7	0.0	8.0	14.5	1.8	1.3	11.3	3.8
Unsig. Movement Delay, s/veh												
LnGrp Delay(d),s/veh	94.9	56.4	0.0	50.9	60.7	0.0	45.7	22.1	12.5	21.0	26.6	20.5
LnGrp LOS	F	E		D	E		D	C	B	C	C	C
Approach Vol, veh/h		569	A		117	A		2054			1399	
Approach Delay, s/veh		85.0			57.8			26.0			25.3	
Approach LOS		F			E			C			C	
Timer - Assigned Phs	1	2	3	4	5	6	7	8				
Phs Duration (G+Y+Rc), s	13.7	75.8	10.9	19.6	25.9	63.6	16.0	14.5				
Change Period (Y+Rc), s	8.5	7.5	7.5	6.5	7.5	7.5	7.5	6.5				
Max Green Setting (Gmax), s	6.5	57.5	5.5	20.5	25.5	39.5	8.5	17.5				
Max Q Clear Time (g_c+I1), s	5.4	40.6	4.1	11.1	17.6	30.4	10.5	7.2				
Green Ext Time (p_c), s	0.0	9.6	0.0	0.4	0.8	4.8	0.0	0.2				

Intersection Summary

HCM 6th Ctrl Delay	34.8
HCM 6th LOS	C

Notes

User approved pedestrian interval to be less than phase max green.  
Unsignalized Delay for [EBR, WBR] is excluded from calculations of the approach delay and intersection delay.

Timings  
3: MERIDIAN ROAD & BENT GRASS MEADOWS DRIVE

Total 2024 Storage PM  
04/10/2023

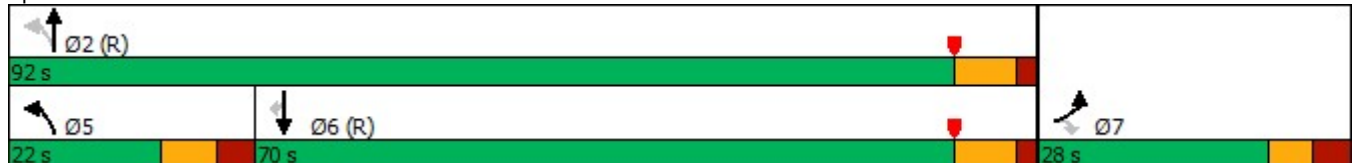


Lane Group	EBL	EBR	NBL	NBT	SBT	SBR
Lane Configurations	↖↖	↗	↖	↑↑	↑↑	↗
Traffic Volume (vph)	102	136	142	1651	1045	135
Future Volume (vph)	102	136	142	1651	1045	135
Turn Type	Prot	Perm	pm+pt	NA	NA	Perm
Protected Phases	7		5	2	6	
Permitted Phases		7	2			6
Detector Phase	7	7	5	2	6	6
Switch Phase						
Minimum Initial (s)	8.0	8.0	5.0	15.0	15.0	15.0
Minimum Split (s)	25.5	25.5	13.5	25.5	25.5	25.5
Total Split (s)	28.0	28.0	22.0	92.0	70.0	70.0
Total Split (%)	23.3%	23.3%	18.3%	76.7%	58.3%	58.3%
Yellow Time (s)	4.0	4.0	5.0	5.5	5.5	5.5
All-Red Time (s)	3.5	3.5	3.5	2.0	2.0	2.0
Lost Time Adjust (s)	0.0	0.0	0.0	0.0	0.0	0.0
Total Lost Time (s)	7.5	7.5	8.5	7.5	7.5	7.5
Lead/Lag			Lead		Lag	Lag
Lead-Lag Optimize?			Yes		Yes	Yes
Recall Mode	None	None	None	C-Max	C-Max	C-Max
Act Effct Green (s)	9.9	9.9	94.1	95.1	78.7	78.7
Actuated g/C Ratio	0.08	0.08	0.78	0.79	0.66	0.66
v/c Ratio	0.42	0.58	0.40	0.62	0.48	0.13
Control Delay	56.6	16.5	5.2	4.2	11.6	1.7
Queue Delay	0.0	0.0	0.0	0.0	0.0	0.0
Total Delay	56.6	16.5	5.2	4.2	11.6	1.7
LOS	E	B	A	A	B	A
Approach Delay	33.7			4.3	10.5	
Approach LOS	C			A	B	

Intersection Summary

Cycle Length: 120  
 Actuated Cycle Length: 120  
 Offset: 27 (23%), Referenced to phase 2:NBTL and 6:SBT, Start of Yellow  
 Natural Cycle: 75  
 Control Type: Actuated-Coordinated  
 Maximum v/c Ratio: 0.62  
 Intersection Signal Delay: 9.0  
 Intersection Capacity Utilization 64.8%  
 Analysis Period (min) 15  
 Intersection LOS: A  
 ICU Level of Service C

Splits and Phases: 3: MERIDIAN ROAD & BENT GRASS MEADOWS DRIVE



Queues  
 3: MERIDIAN ROAD & BENT GRASS MEADOWS DRIVE

Total 2024 Storage PM  
 04/10/2023



Lane Group	EBL	EBR	NBL	NBT	SBT	SBR
Lane Group Flow (vph)	120	160	149	1738	1112	144
v/c Ratio	0.42	0.58	0.40	0.62	0.48	0.13
Control Delay	56.6	16.5	5.2	4.2	11.6	1.7
Queue Delay	0.0	0.0	0.0	0.0	0.0	0.0
Total Delay	56.6	16.5	5.2	4.2	11.6	1.7
Queue Length 50th (ft)	46	0	23	136	207	0
Queue Length 95th (ft)	71	54	m25	160	291	25
Internal Link Dist (ft)	310			750	1921	
Turn Bay Length (ft)	150		700			350
Base Capacity (vph)	586	403	442	2804	2320	1087
Starvation Cap Reductn	0	0	0	0	0	0
Spillback Cap Reductn	0	0	0	0	0	0
Storage Cap Reductn	0	0	0	0	0	0
Reduced v/c Ratio	0.20	0.40	0.34	0.62	0.48	0.13

Intersection Summary

m Volume for 95th percentile queue is metered by upstream signal.

3: MERIDIAN ROAD & BENT GRASS MEADOWS DRIVE

04/10/2023



Movement	EBL	EBR	NBL	NBT	SBT	SBR
Lane Configurations	↖↗	↗	↖	↑↑	↑↑	↗
Traffic Volume (veh/h)	102	136	142	1651	1045	135
Future Volume (veh/h)	102	136	142	1651	1045	135
Initial Q (Qb), veh	0	0	0	0	0	0
Ped-Bike Adj(A_pbT)	1.00	1.00	1.00			1.00
Parking Bus, Adj	1.00	1.00	1.00	1.00	1.00	1.00
Work Zone On Approach	No			No	No	
Adj Sat Flow, veh/h/ln	1870	1870	1870	1870	1870	1870
Adj Flow Rate, veh/h	120	0	149	1738	1112	144
Peak Hour Factor	0.85	0.85	0.95	0.95	0.94	0.94
Percent Heavy Veh, %	2	2	2	2	2	2
Cap, veh/h	226		381	2877	2478	1105
Arrive On Green	0.07	0.00	0.04	0.81	0.70	0.70
Sat Flow, veh/h	3456	1585	1781	3647	3647	1585
Grp Volume(v), veh/h	120	0	149	1738	1112	144
Grp Sat Flow(s),veh/h/ln	1728	1585	1781	1777	1777	1585
Q Serve(g_s), s	4.0	0.0	2.7	21.9	16.5	3.6
Cycle Q Clear(g_c), s	4.0	0.0	2.7	21.9	16.5	3.6
Prop In Lane	1.00	1.00	1.00			1.00
Lane Grp Cap(c), veh/h	226		381	2877	2478	1105
V/C Ratio(X)	0.53		0.39	0.60	0.45	0.13
Avail Cap(c_a), veh/h	590		508	2877	2478	1105
HCM Platoon Ratio	1.00	1.00	1.00	1.00	1.00	1.00
Upstream Filter(I)	1.00	0.00	1.00	1.00	1.00	1.00
Uniform Delay (d), s/veh	54.3	0.0	6.1	4.3	8.0	6.0
Incr Delay (d2), s/veh	1.9	0.0	0.7	0.9	0.6	0.2
Initial Q Delay(d3),s/veh	0.0	0.0	0.0	0.0	0.0	0.0
%ile BackOfQ(50%),veh/ln	1.8	0.0	0.9	6.3	6.0	6.3
Unsig. Movement Delay, s/veh						
LnGrp Delay(d),s/veh	56.2	0.0	6.7	5.2	8.6	6.3
LnGrp LOS	E		A	A	A	A
Approach Vol, veh/h	120	A		1887	1256	
Approach Delay, s/veh	56.2			5.3	8.3	
Approach LOS	E			A	A	
Timer - Assigned Phs		2		4	5	6
Phs Duration (G+Y+Rc), s		104.6		15.4	13.5	91.2
Change Period (Y+Rc), s		7.5		7.5	8.5	7.5
Max Green Setting (Gmax), s		84.5		20.5	13.5	62.5
Max Q Clear Time (g_c+I1), s		23.9		6.0	4.7	18.5
Green Ext Time (p_c), s		25.1		0.3	0.2	11.6

Intersection Summary

HCM 6th Ctrl Delay	8.4
HCM 6th LOS	A

Notes

Unsignalized Delay for [EBR] is excluded from calculations of the approach delay and intersection delay.

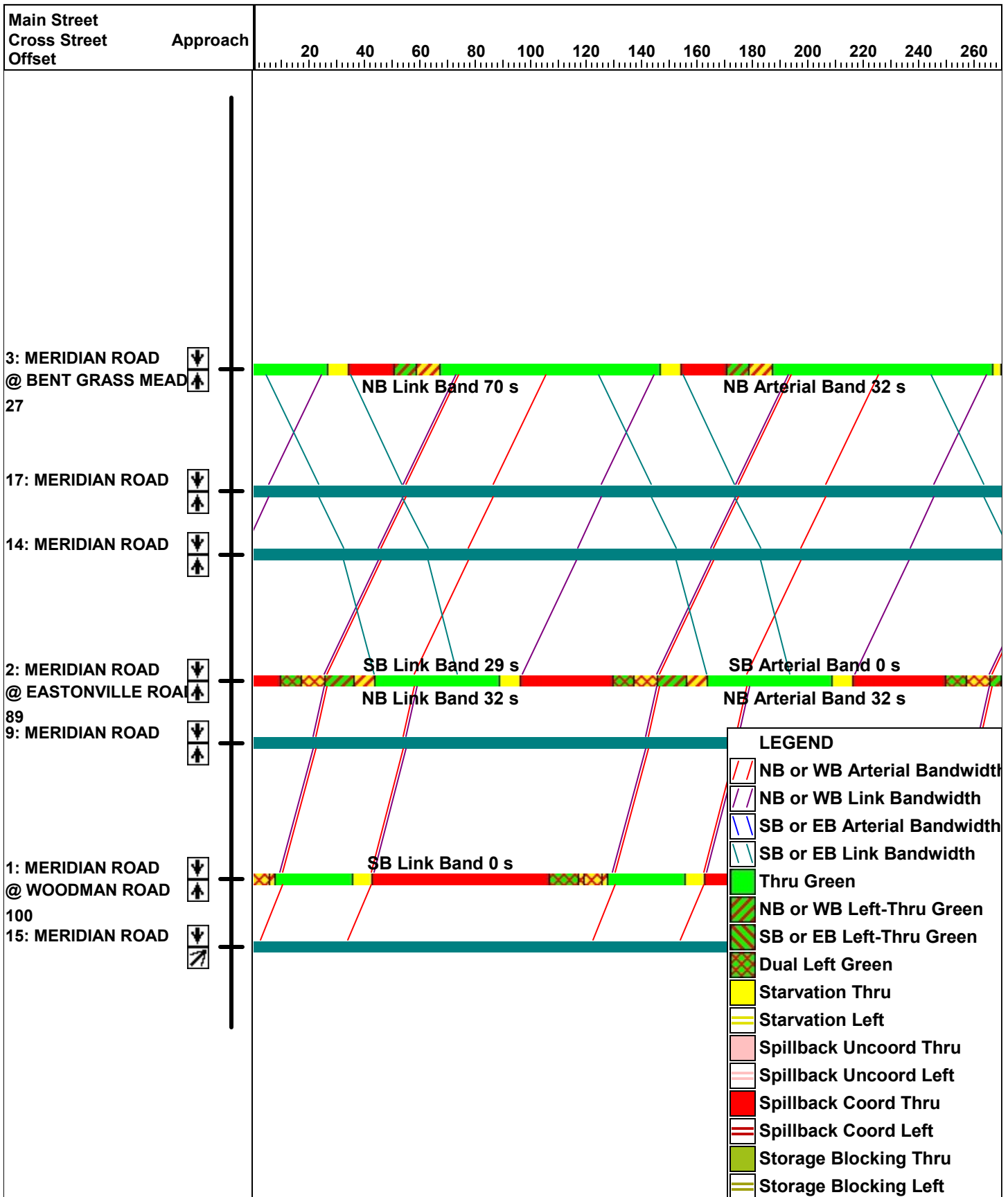
Intersection						
Int Delay, s/veh	3.6					
Movement	EBT	EBR	WBL	WBT	NBL	NBR
Lane Configurations	↑	↗	↖	↑	↘	↙
Traffic Vol, veh/h	123	42	110	166	2	115
Future Vol, veh/h	123	42	110	166	2	115
Conflicting Peds, #/hr	0	0	0	0	0	0
Sign Control	Free	Free	Free	Free	Stop	Stop
RT Channelized	-	None	-	None	-	None
Storage Length	-	150	100	-	0	-
Veh in Median Storage, #	0	-	-	0	0	-
Grade, %	0	-	-	0	0	-
Peak Hour Factor	85	85	85	85	85	85
Heavy Vehicles, %	2	2	2	2	2	2
Mvmt Flow	145	49	129	195	2	135

Major/Minor	Major1	Major2	Minor1		
Conflicting Flow All	0	0	194	0	598
Stage 1	-	-	-	-	145
Stage 2	-	-	-	-	453
Critical Hdwy	-	-	4.12	-	6.42
Critical Hdwy Stg 1	-	-	-	-	5.42
Critical Hdwy Stg 2	-	-	-	-	5.42
Follow-up Hdwy	-	-	2.218	-	3.518
Pot Cap-1 Maneuver	-	-	1379	-	465
Stage 1	-	-	-	-	882
Stage 2	-	-	-	-	640
Platoon blocked, %	-	-	-	-	-
Mov Cap-1 Maneuver	-	-	1379	-	421
Mov Cap-2 Maneuver	-	-	-	-	421
Stage 1	-	-	-	-	882
Stage 2	-	-	-	-	580

Approach	EB	WB	NB
HCM Control Delay, s	0	3.1	9.8
HCM LOS			A

Minor Lane/Major Mvmt	NBLn1	EBT	EBR	WBL	WBT
Capacity (veh/h)	885	-	-	1379	-
HCM Lane V/C Ratio	0.156	-	-	0.094	-
HCM Control Delay (s)	9.8	-	-	7.9	-
HCM Lane LOS	A	-	-	A	-
HCM 95th %tile Q(veh)	0.5	-	-	0.3	-

# Total PM 2024 Storage Signal Progression



Timings  
1: MERIDIAN ROAD & WOODMAN ROAD

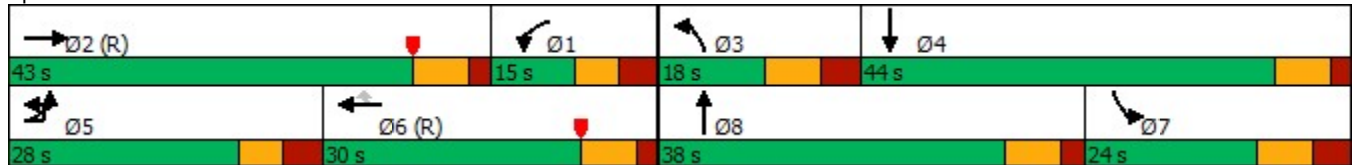
Total AM 40 Shopping  
04/01/2023

Lane Group	EBL	EBT	EBR	WBL	WBT	WBR	NBL	NBT	NBR	SBL	SBT	SBR
Lane Configurations												
Traffic Volume (vph)	499	321	167	84	564	202	227	444	24	253	1013	1088
Future Volume (vph)	499	321	167	84	564	202	227	444	24	253	1013	1088
Turn Type	Prot	NA	Free	Prot	NA	Perm	Prot	NA	Free	Prot	NA	Free
Protected Phases	5	2		1	6		3	8		7	4	
Permitted Phases			Free			6			Free			Free
Detector Phase	5	2		1	6	6	3	8		7	4	
Switch Phase												
Minimum Initial (s)	5.0	15.0		5.0	15.0	15.0	5.0	15.0		5.0	15.0	
Minimum Split (s)	13.5	22.0		13.5	22.0	22.0	13.5	22.0		13.5	22.0	
Total Split (s)	28.0	43.0		15.0	30.0	30.0	18.0	38.0		24.0	44.0	
Total Split (%)	23.3%	35.8%		12.5%	25.0%	25.0%	15.0%	31.7%		20.0%	36.7%	
Yellow Time (s)	4.0	5.0		4.0	5.0	5.0	5.0	5.0		5.0	5.0	
All-Red Time (s)	3.5	2.0		3.5	2.0	2.0	3.5	2.0		3.5	2.0	
Lost Time Adjust (s)	0.0	0.0		0.0	0.0	0.0	0.0	0.0		0.0	0.0	
Total Lost Time (s)	7.5	7.0		7.5	7.0	7.0	8.5	7.0		8.5	7.0	
Lead/Lag	Lead	Lead		Lag	Lag	Lag	Lead	Lead		Lag	Lag	
Lead-Lag Optimize?	Yes	Yes		Yes	Yes	Yes	Yes	Yes		Yes	Yes	
Recall Mode	None	C-Max		None	C-Max	C-Max	None	None		None	None	
Act Effct Green (s)	20.3	36.0	120.0	7.5	23.2	23.2	9.5	21.4	120.0	25.1	37.0	120.0
Actuated g/C Ratio	0.17	0.30	1.00	0.06	0.19	0.19	0.08	0.18	1.00	0.21	0.31	1.00
v/c Ratio	0.92	0.32	0.11	0.41	0.87	0.41	0.88	0.74	0.02	0.37	0.98	0.72
Control Delay	71.7	33.5	0.1	60.2	61.6	4.6	86.2	53.8	0.0	39.8	45.5	10.4
Queue Delay	0.0	0.0	0.0	0.0	0.0	0.0	0.0	0.0	0.0	0.0	0.0	0.0
Total Delay	71.7	33.5	0.1	60.2	61.6	4.6	86.2	53.8	0.0	39.8	45.5	10.4
LOS	E	C	A	E	E	A	F	D	A	D	D	B
Approach Delay		47.4			47.9			62.6			28.7	
Approach LOS		D			D			E			C	

Intersection Summary

Cycle Length: 120  
 Actuated Cycle Length: 120  
 Offset: 30 (25%), Referenced to phase 2:EBT and 6:WBT, Start of Yellow  
 Natural Cycle: 100  
 Control Type: Actuated-Coordinated  
 Maximum v/c Ratio: 0.98  
 Intersection Signal Delay: 40.6  
 Intersection Capacity Utilization 89.2%  
 Analysis Period (min) 15  
 Intersection LOS: D  
 ICU Level of Service E

Splits and Phases: 1: MERIDIAN ROAD & WOODMAN ROAD





Queues  
1: MERIDIAN ROAD & WOODMAN ROAD

Total AM 40 Shopping  
04/01/2023



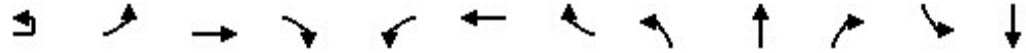
Lane Group	EBL	EBT	EBR	WBL	WBT	WBR	NBL	NBT	NBR	SBL	SBT	SBR
Lane Group Flow (vph)	536	338	176	88	594	213	239	467	25	266	1066	1145
v/c Ratio	0.92	0.32	0.11	0.41	0.87	0.41	0.88	0.74	0.02	0.37	0.98	0.72
Control Delay	71.7	33.5	0.1	60.2	61.6	4.6	86.2	53.8	0.0	39.8	45.5	10.4
Queue Delay	0.0	0.0	0.0	0.0	0.0	0.0	0.0	0.0	0.0	0.0	0.0	0.0
Total Delay	71.7	33.5	0.1	60.2	61.6	4.6	86.2	53.8	0.0	39.8	45.5	10.4
Queue Length 50th (ft)	212	106	0	34	237	0	96	182	0	104	464	258
Queue Length 95th (ft)	#313	148	0	62	#334	33	#169	228	0	m88	m368	m82
Internal Link Dist (ft)		1165			1100			342			860	
Turn Bay Length (ft)	500		630	350		250	440		330	490		450
Base Capacity (vph)	586	1061	1583	214	683	514	271	914	1583	717	1091	1583
Starvation Cap Reductn	0	0	0	0	0	0	0	0	0	0	0	0
Spillback Cap Reductn	0	0	0	0	0	0	0	0	0	0	0	0
Storage Cap Reductn	0	0	0	0	0	0	0	0	0	0	0	0
Reduced v/c Ratio	0.91	0.32	0.11	0.41	0.87	0.41	0.88	0.51	0.02	0.37	0.98	0.72

Intersection Summary

- # 95th percentile volume exceeds capacity, queue may be longer.  
Queue shown is maximum after two cycles.
- m Volume for 95th percentile queue is metered by upstream signal.

HCM 6th Signalized Intersection Summary  
 1: MERIDIAN ROAD & WOODMAN ROAD

Total AM 40 Shopping  
 04/01/2023



Movement	EBU	EBL	EBT	EBR	WBL	WBT	WBR	NBL	NBT	NBR	SBL	SBT
Lane Configurations		↔↔	↕↕	↔	↔↔	↕↕	↔	↔↔	↕↕	↔	↔↔	↕↕
Traffic Volume (veh/h)	10	499	321	167	84	564	202	227	444	24	253	1013
Future Volume (veh/h)	10	499	321	167	84	564	202	227	444	24	253	1013
Initial Q (Qb), veh		0	0	0	0	0	0	0	0	0	0	0
Ped-Bike Adj(A_pbT)		1.00		1.00	1.00		1.00	1.00		1.00	1.00	
Parking Bus, Adj		1.00	1.00	1.00	1.00	1.00	1.00	1.00	1.00	1.00	1.00	1.00
Work Zone On Approach			No			No			No			No
Adj Sat Flow, veh/h/ln		1870	1870	1870	1870	1870	1870	1870	1870	1870	1870	1870
Adj Flow Rate, veh/h		525	338	0	88	594	0	239	467	0	266	1066
Peak Hour Factor		0.95	0.95	0.95	0.95	0.95	0.95	0.95	0.95	0.95	0.95	0.95
Percent Heavy Veh, %		2	2	2	2	2	2	2	2	2	2	2
Cap, veh/h		577	1066		1686	2191		274	582		816	1096
Arrive On Green		0.17	0.30	0.00	0.49	0.62	0.00	0.08	0.16	0.00	0.24	0.31
Sat Flow, veh/h		3456	3554	1585	3456	3554	1585	3456	3554	1585	3456	3554
Grp Volume(v), veh/h		525	338	0	88	594	0	239	467	0	266	1066
Grp Sat Flow(s),veh/h/ln		1728	1777	1585	1728	1777	1585	1728	1777	1585	1728	1777
Q Serve(g_s), s		17.9	8.8	0.0	1.6	9.2	0.0	8.2	15.2	0.0	7.6	35.6
Cycle Q Clear(g_c), s		17.9	8.8	0.0	1.6	9.2	0.0	8.2	15.2	0.0	7.6	35.6
Prop In Lane		1.00		1.00	1.00		1.00	1.00		1.00	1.00	
Lane Grp Cap(c), veh/h		577	1066		1686	2191		274	582		816	1096
V/C Ratio(X)		0.91	0.32		0.05	0.27		0.87	0.80		0.33	0.97
Avail Cap(c_a), veh/h		590	1066		1686	2191		274	918		816	1096
HCM Platoon Ratio		1.00	1.00	1.00	1.00	1.00	1.00	1.00	1.00	1.00	1.00	1.00
Upstream Filter(I)		1.00	1.00	0.00	1.00	1.00	0.00	1.00	1.00	0.00	1.00	1.00
Uniform Delay (d), s/veh		49.1	32.5	0.0	16.1	10.6	0.0	54.7	48.3	0.0	37.9	41.0
Incr Delay (d2), s/veh		17.9	0.8	0.0	0.0	0.3	0.0	25.3	2.8	0.0	0.2	20.8
Initial Q Delay(d3),s/veh		0.0	0.0	0.0	0.0	0.0	0.0	0.0	0.0	0.0	0.0	0.0
%ile BackOfQ(50%),veh/ln		8.9	3.8	0.0	0.6	3.4	0.0	4.5	6.9	0.0	3.2	18.3
Unsig. Movement Delay, s/veh												
LnGrp Delay(d),s/veh		67.0	33.3	0.0	16.2	10.9	0.0	79.9	51.1	0.0	38.2	61.8
LnGrp LOS		E	C		B	B		E	D		D	E
Approach Vol, veh/h			863	A		682	A		706	A		1332
Approach Delay, s/veh			53.8			11.6			60.8			57.1
Approach LOS			D			B			E			E
Timer - Assigned Phs	1	2	3	4	5	6	7	8				
Phs Duration (G+Y+Rc), s	67.6	43.0	18.0	45.5	27.5	83.0	36.8	26.7				
Change Period (Y+Rc), s	7.5	7.0	8.5	* 8.5	7.5	* 7.5	8.5	7.0				
Max Green Setting (Gmax), s	7.5	36.0	9.5	* 37	20.5	* 23	15.5	31.0				
Max Q Clear Time (g_c+I1), s	3.6	10.8	10.2	37.6	19.9	11.2	9.6	17.2				
Green Ext Time (p_c), s	0.1	2.0	0.0	0.0	0.1	2.8	0.4	2.5				

Intersection Summary

HCM 6th Ctrl Delay	48.4
HCM 6th LOS	D

Notes

- User approved pedestrian interval to be less than phase max green.
- User approved ignoring U-Turning movement.
- \* HCM 6th computational engine requires equal clearance times for the phases crossing the barrier.

HCM 6th Signalized Intersection Summary  
 1: MERIDIAN ROAD & WOODMAN ROAD

Total AM 40 Shopping  
 04/01/2023

Movement	SBR
Lane Configurations	
Traffic Volume (veh/h)	1088
Future Volume (veh/h)	1088
Initial Q (Qb), veh	0
Ped-Bike Adj(A_pbT)	1.00
Parking Bus, Adj	1.00
Work Zone On Approach	
Adj Sat Flow, veh/h/ln	1870
Adj Flow Rate, veh/h	0
Peak Hour Factor	0.95
Percent Heavy Veh, %	2
Cap, veh/h	
Arrive On Green	0.00
Sat Flow, veh/h	1585
Grp Volume(v), veh/h	0
Grp Sat Flow(s),veh/h/ln	1585
Q Serve(g_s), s	0.0
Cycle Q Clear(g_c), s	0.0
Prop In Lane	1.00
Lane Grp Cap(c), veh/h	
V/C Ratio(X)	
Avail Cap(c_a), veh/h	
HCM Platoon Ratio	1.00
Upstream Filter(l)	0.00
Uniform Delay (d), s/veh	0.0
Incr Delay (d2), s/veh	0.0
Initial Q Delay(d3),s/veh	0.0
%ile BackOfQ(50%),veh/ln	0.0
Unsig. Movement Delay, s/veh	
LnGrp Delay(d),s/veh	0.0
LnGrp LOS	
Approach Vol, veh/h	A
Approach Delay, s/veh	
Approach LOS	
Timer - Assigned Phs	
Unsignalized Delay for [NBR, EBR, WBR, SBR] is excluded from calculations of the approach delay and intersection delay.	

Timings  
2: MERIDIAN ROAD & EASTONVILLE ROAD

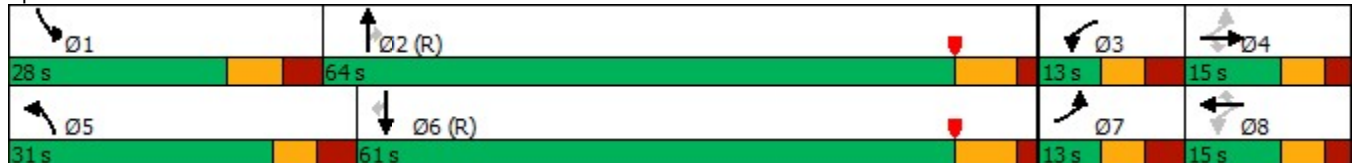
Total AM 2040 Shopping Center  
04/01/2023

Lane Group	EBL	EBT	EBR	WBL	WBT	WBR	NBL	NBT	NBR	SBL	SBT	SBR
Lane Configurations												
Traffic Volume (vph)	215	61	349	137	71	51	434	710	57	157	1900	181
Future Volume (vph)	215	61	349	137	71	51	434	710	57	157	1900	181
Turn Type	pm+pt	NA	Perm	pm+pt	NA	Perm	Prot	NA	Perm	Prot	NA	Perm
Protected Phases	7	4		3	8		5	2		1	6	
Permitted Phases	4		4	8		8			2			6
Detector Phase	7	4	4	3	8	8	5	2	2	1	6	6
Switch Phase												
Minimum Initial (s)	5.0	8.0	8.0	5.0	8.0	8.0	5.0	15.0	15.0	5.0	15.0	15.0
Minimum Split (s)	12.5	14.5	14.5	12.5	14.5	14.5	12.5	22.5	22.5	13.5	22.5	22.5
Total Split (s)	13.0	15.0	15.0	13.0	15.0	15.0	31.0	64.0	64.0	28.0	61.0	61.0
Total Split (%)	10.8%	12.5%	12.5%	10.8%	12.5%	12.5%	25.8%	53.3%	53.3%	23.3%	50.8%	50.8%
Yellow Time (s)	4.0	4.0	4.0	4.0	4.0	4.0	4.0	5.5	5.5	5.0	5.5	5.5
All-Red Time (s)	3.5	2.5	2.5	3.5	2.5	2.5	3.5	2.0	2.0	3.5	2.0	2.0
Lost Time Adjust (s)	0.0	0.0	0.0	0.0	0.0	0.0	0.0	0.0	0.0	0.0	0.0	0.0
Total Lost Time (s)	7.5	6.5	6.5	7.5	6.5	6.5	7.5	7.5	7.5	8.5	7.5	7.5
Lead/Lag	Lead	Lag	Lag	Lead	Lag	Lag	Lead	Lag	Lag	Lead	Lag	Lag
Lead-Lag Optimize?	Yes	Yes	Yes	Yes	Yes	Yes	Yes	Yes	Yes	Yes	Yes	Yes
Recall Mode	None	None	None	None	None	None	None	C-Max	C-Max	None	C-Max	C-Max
Act Effct Green (s)	14.5	8.5	8.5	11.5	8.4	8.4	23.5	60.2	60.2	15.8	53.5	53.5
Actuated g/C Ratio	0.12	0.07	0.07	0.10	0.07	0.07	0.20	0.50	0.50	0.13	0.45	0.45
v/c Ratio	0.68	0.49	0.98	0.98	0.58	0.19	1.32	0.42	0.07	0.71	1.27	0.24
Control Delay	57.9	66.8	56.9	118.5	72.2	1.5	193.0	14.6	1.1	74.3	143.7	1.5
Queue Delay	0.0	0.0	0.0	0.0	0.0	0.0	0.0	0.0	0.0	0.0	0.0	0.0
Total Delay	57.9	66.8	56.9	118.5	72.2	1.5	193.0	14.6	1.1	74.3	143.7	1.5
LOS	E	E	E	F	E	A	F	B	A	E	F	A
Approach Delay		58.2			82.6			78.5			127.3	
Approach LOS		E			F			E			F	

Intersection Summary

Cycle Length: 120  
 Actuated Cycle Length: 120  
 Offset: 45 (38%), Referenced to phase 2:NBT and 6:SBT, Start of Yellow  
 Natural Cycle: 150  
 Control Type: Actuated-Coordinated  
 Maximum v/c Ratio: 1.32  
 Intersection Signal Delay: 101.1  
 Intersection Capacity Utilization 108.7%  
 Analysis Period (min) 15  
 Intersection LOS: F  
 ICU Level of Service G

Splits and Phases: 2: MERIDIAN ROAD & EASTONVILLE ROAD



Queues  
2: MERIDIAN ROAD & EASTONVILLE ROAD

Total AM 2040 Shopping Center  
04/01/2023
































Lane Group	EBL	EBT	EBR	WBL	WBT	WBR	NBL	NBT	NBR	SBL	SBT	SBR
Lane Group Flow (vph)	226	64	367	144	75	54	457	747	60	165	2000	191
v/c Ratio	0.68	0.49	0.98	0.98	0.58	0.19	1.32	0.42	0.07	0.71	1.27	0.24
Control Delay	57.9	66.8	56.9	118.5	72.2	1.5	193.0	14.6	1.1	74.3	143.7	1.5
Queue Delay	0.0	0.0	0.0	0.0	0.0	0.0	0.0	0.0	0.0	0.0	0.0	0.0
Total Delay	57.9	66.8	56.9	118.5	72.2	1.5	193.0	14.6	1.1	74.3	143.7	1.5
Queue Length 50th (ft)	80	49	66	102	57	0	~470	160	0	129	~1061	13
Queue Length 95th (ft)	#145	96	#267	#225	#116	0	m#620	m193	m4	m128	m#1048	m14
Internal Link Dist (ft)		508			1196			231			781	
Turn Bay Length (ft)	100		100	120		100	100		400	375		400
Base Capacity (vph)	332	131	374	147	131	284	346	1775	882	287	1577	803
Starvation Cap Reductn	0	0	0	0	0	0	0	0	0	0	0	0
Spillback Cap Reductn	0	0	0	0	0	0	0	0	0	0	0	0
Storage Cap Reductn	0	0	0	0	0	0	0	0	0	0	0	0
Reduced v/c Ratio	0.68	0.49	0.98	0.98	0.57	0.19	1.32	0.42	0.07	0.57	1.27	0.24

Intersection Summary

- ~ Volume exceeds capacity, queue is theoretically infinite.  
Queue shown is maximum after two cycles.
- # 95th percentile volume exceeds capacity, queue may be longer.  
Queue shown is maximum after two cycles.
- m Volume for 95th percentile queue is metered by upstream signal.

HCM 6th Signalized Intersection Summary  
 2: MERIDIAN ROAD & EASTONVILLE ROAD

Total AM 2040 Shoping Center  
 04/01/2023

												
Movement	EBL	EBT	EBR	WBL	WBT	WBR	NBL	NBT	NBR	SBL	SBT	SBR
Lane Configurations	 		 	 		 	 	 	 			
Traffic Volume (veh/h)	215	61	349	137	71	51	434	710	57	157	1900	181
Future Volume (veh/h)	215	61	349	137	71	51	434	710	57	157	1900	181
Initial Q (Qb), veh	0	0	0	0	0	0	0	0	0	0	0	0
Ped-Bike Adj(A_pbT)	1.00		1.00	1.00		1.00	1.00		1.00	1.00		1.00
Parking Bus, Adj	1.00	1.00	1.00	1.00	1.00	1.00	1.00	1.00	1.00	1.00	1.00	1.00
Work Zone On Approach		No			No			No			No	
Adj Sat Flow, veh/h/ln	1870	1870	1870	1870	1870	1870	1870	1870	1870	1870	1870	1870
Adj Flow Rate, veh/h	226	64	0	144	75	0	457	747	60	165	2000	191
Peak Hour Factor	0.95	0.95	0.95	0.95	0.95	0.95	0.95	0.95	0.95	0.95	0.95	0.95
Percent Heavy Veh, %	2	2	2	2	2	2	2	2	2	2	2	2
Cap, veh/h	350	125		187	125		349	1879	838	194	1599	713
Arrive On Green	0.05	0.07	0.00	0.05	0.07	0.00	0.20	0.53	0.53	0.11	0.45	0.45
Sat Flow, veh/h	3456	1870	1585	1781	1870	1585	1781	3554	1585	1781	3554	1585
Grp Volume(v), veh/h	226	64	0	144	75	0	457	747	60	165	2000	191
Grp Sat Flow(s),veh/h/ln	1728	1870	1585	1781	1870	1585	1781	1777	1585	1781	1777	1585
Q Serve(g_s), s	5.5	4.0	0.0	5.5	4.7	0.0	23.5	15.1	2.2	10.9	54.0	9.0
Cycle Q Clear(g_c), s	5.5	4.0	0.0	5.5	4.7	0.0	23.5	15.1	2.2	10.9	54.0	9.0
Prop In Lane	1.00		1.00	1.00		1.00	1.00		1.00	1.00		1.00
Lane Grp Cap(c), veh/h	350	125		187	125		349	1879	838	194	1599	713
V/C Ratio(X)	0.65	0.51		0.77	0.60		1.31	0.40	0.07	0.85	1.25	0.27
Avail Cap(c_a), veh/h	350	132		187	132		349	1879	838	289	1599	713
HCM Platoon Ratio	1.00	1.00	1.00	1.00	1.00	1.00	1.00	1.00	1.00	1.00	1.00	1.00
Upstream Filter(l)	1.00	1.00	0.00	1.00	1.00	0.00	1.00	1.00	1.00	1.00	1.00	1.00
Uniform Delay (d), s/veh	51.9	54.1	0.0	53.3	54.5	0.0	48.3	16.9	13.9	52.5	33.0	20.6
Incr Delay (d2), s/veh	4.1	3.2	0.0	17.8	6.7	0.0	158.7	0.6	0.2	14.2	118.2	0.9
Initial Q Delay(d3),s/veh	0.0	0.0	0.0	0.0	0.0	0.0	0.0	0.0	0.0	0.0	0.0	0.0
%ile BackOfQ(50%),veh/ln	1.0	2.0	0.0	2.6	2.4	0.0	25.3	5.7	0.8	5.4	47.1	3.5
Unsig. Movement Delay, s/veh												
LnGrp Delay(d),s/veh	56.0	57.4	0.0	71.1	61.2	0.0	206.9	17.5	14.0	66.7	151.2	21.6
LnGrp LOS	E	E		E	E		F	B	B	E	F	C
Approach Vol, veh/h		290	A		219	A		1264			2356	
Approach Delay, s/veh		56.3			67.7			85.8			134.7	
Approach LOS		E			E			F			F	
Timer - Assigned Phs	1	2	3	4	5	6	7	8				
Phs Duration (G+Y+Rc), s	21.6	70.9	13.0	14.5	31.0	61.5	13.0	14.5				
Change Period (Y+Rc), s	8.5	7.5	7.5	6.5	7.5	7.5	7.5	6.5				
Max Green Setting (Gmax), s	19.5	56.5	5.5	8.5	23.5	53.5	5.5	8.5				
Max Q Clear Time (g_c+I1), s	12.9	17.1	7.5	6.0	25.5	56.0	7.5	6.7				
Green Ext Time (p_c), s	0.2	5.1	0.0	0.0	0.0	0.0	0.0	0.0				

Intersection Summary												
HCM 6th Ctrl Delay	110.7											
HCM 6th LOS	F											

Notes  
 User approved pedestrian interval to be less than phase max green.  
 Unsignalized Delay for [EBR, WBR] is excluded from calculations of the approach delay and intersection delay.

Timings  
 3: MERIDIAN ROAD & BENT GRASS MEADOWS DRIVE

Total AM 40 Shopping  
 04/01/2023

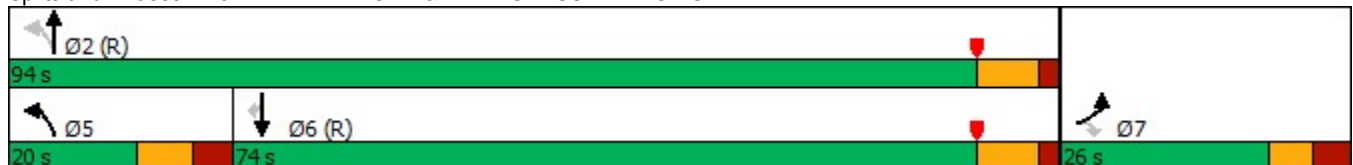


Lane Group	EBL	EBR	NBL	NBT	SBT	SBR
Lane Configurations	↖↖	↗	↖	↑↑	↑↑	↗
Traffic Volume (vph)	145	269	224	700	1926	221
Future Volume (vph)	145	269	224	700	1926	221
Turn Type	Prot	Perm	pm+pt	NA	NA	Perm
Protected Phases	7		5	2	6	
Permitted Phases		7	2			6
Detector Phase	7	7	5	2	6	6
Switch Phase						
Minimum Initial (s)	8.0	8.0	5.0	15.0	15.0	15.0
Minimum Split (s)	25.5	25.5	13.5	25.5	25.5	25.5
Total Split (s)	26.0	26.0	20.0	94.0	74.0	74.0
Total Split (%)	21.7%	21.7%	16.7%	78.3%	61.7%	61.7%
Yellow Time (s)	4.0	4.0	5.0	5.5	5.5	5.5
All-Red Time (s)	3.5	3.5	3.5	2.0	2.0	2.0
Lost Time Adjust (s)	0.0	0.0	0.0	0.0	0.0	0.0
Total Lost Time (s)	7.5	7.5	8.5	7.5	7.5	7.5
Lead/Lag			Lead		Lag	Lag
Lead-Lag Optimize?			Yes		Yes	Yes
Recall Mode	None	None	None	C-Max	C-Max	C-Max
Act Effct Green (s)	14.4	14.4	89.6	90.6	67.2	67.2
Actuated g/C Ratio	0.12	0.12	0.75	0.76	0.56	0.56
v/c Ratio	0.37	0.84	0.84	0.28	1.02	0.24
Control Delay	50.2	42.5	59.4	4.3	53.1	2.7
Queue Delay	0.0	0.0	0.0	0.0	0.0	0.0
Total Delay	50.2	42.5	59.4	4.3	53.1	2.7
LOS	D	D	E	A	D	A
Approach Delay	45.2			17.7	47.9	
Approach LOS	D			B	D	

Intersection Summary

Cycle Length: 120  
 Actuated Cycle Length: 120  
 Offset: 5 (4%), Referenced to phase 2:NBTL and 6:SBT, Start of Yellow  
 Natural Cycle: 130  
 Control Type: Actuated-Coordinated  
 Maximum v/c Ratio: 1.02  
 Intersection Signal Delay: 39.6  
 Intersection Capacity Utilization 91.9%  
 Analysis Period (min) 15  
 Intersection LOS: D  
 ICU Level of Service F

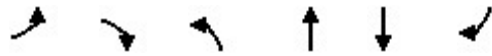
Splits and Phases: 3: MERIDIAN ROAD & BENT GRASS MEADOWS DRIVE





## 3: MERIDIAN ROAD &amp; BENT GRASS MEADOWS DRIVE

04/01/2023



Lane Group	EBL	EBR	NBL	NBT	SBT	SBR
Lane Group Flow (vph)	153	283	236	737	2027	233
v/c Ratio	0.37	0.84	0.84	0.28	1.02	0.24
Control Delay	50.2	42.5	59.4	4.3	53.1	2.7
Queue Delay	0.0	0.0	0.0	0.0	0.0	0.0
Total Delay	50.2	42.5	59.4	4.3	53.1	2.7
Queue Length 50th (ft)	56	88	145	123	~887	4
Queue Length 95th (ft)	87	#204	m#314	154	#1025	40
Internal Link Dist (ft)	310			750	1921	
Turn Bay Length (ft)	150		700			350
Base Capacity (vph)	529	385	281	2673	1982	983
Starvation Cap Reductn	0	0	0	0	0	0
Spillback Cap Reductn	0	0	0	0	0	0
Storage Cap Reductn	0	0	0	0	0	0
Reduced v/c Ratio	0.29	0.74	0.84	0.28	1.02	0.24

## Intersection Summary

~ Volume exceeds capacity, queue is theoretically infinite.

Queue shown is maximum after two cycles.

# 95th percentile volume exceeds capacity, queue may be longer.

Queue shown is maximum after two cycles.

m Volume for 95th percentile queue is metered by upstream signal.

HCM 6th Signalized Intersection Summary  
 3: MERIDIAN ROAD & BENT GRASS MEADOWS DRIVE

Total AM 40 Shopping  
 04/01/2023



Movement	EBL	EBR	NBL	NBT	SBT	SBR
Lane Configurations	↖↗	↗	↖	↑↑	↑↑	↗
Traffic Volume (veh/h)	145	269	224	700	1926	221
Future Volume (veh/h)	145	269	224	700	1926	221
Initial Q (Qb), veh	0	0	0	0	0	0
Ped-Bike Adj(A_pbT)	1.00	1.00	1.00			1.00
Parking Bus, Adj	1.00	1.00	1.00	1.00	1.00	1.00
Work Zone On Approach	No			No	No	
Adj Sat Flow, veh/h/ln	1870	1870	1870	1870	1870	1870
Adj Flow Rate, veh/h	153	0	236	737	2027	233
Peak Hour Factor	0.95	0.95	0.95	0.95	0.95	0.95
Percent Heavy Veh, %	2	2	2	2	2	2
Cap, veh/h	229		259	2874	2282	1018
Arrive On Green	0.07	0.00	0.10	0.81	0.64	0.64
Sat Flow, veh/h	3456	1585	1781	3647	3647	1585
Grp Volume(v), veh/h	153	0	236	737	2027	233
Grp Sat Flow(s),veh/h/ln	1728	1585	1781	1777	1777	1585
Q Serve(g_s), s	5.2	0.0	9.8	6.0	57.0	7.4
Cycle Q Clear(g_c), s	5.2	0.0	9.8	6.0	57.0	7.4
Prop In Lane	1.00	1.00	1.00			1.00
Lane Grp Cap(c), veh/h	229		259	2874	2282	1018
V/C Ratio(X)	0.67		0.91	0.26	0.89	0.23
Avail Cap(c_a), veh/h	533		259	2874	2282	1018
HCM Platoon Ratio	1.00	1.00	1.00	1.00	1.00	1.00
Upstream Filter(I)	1.00	0.00	1.00	1.00	1.00	1.00
Uniform Delay (d), s/veh	54.7	0.0	39.5	2.8	17.9	9.0
Incr Delay (d2), s/veh	3.3	0.0	33.8	0.2	5.6	0.5
Initial Q Delay(d3),s/veh	0.0	0.0	0.0	0.0	0.0	0.0
%ile BackOfQ(50%),veh/ln	2.3	0.0	9.4	1.7	23.1	10.7
Unsig. Movement Delay, s/veh						
LnGrp Delay(d),s/veh	58.1	0.0	73.3	3.0	23.5	9.5
LnGrp LOS	E		E	A	C	A
Approach Vol, veh/h	153	A		973	2260	
Approach Delay, s/veh	58.1			20.0	22.1	
Approach LOS	E			C	C	
Timer - Assigned Phs		2		4	5	6
Phs Duration (G+Y+Rc), s		104.5		15.5	20.0	84.5
Change Period (Y+Rc), s		7.5		7.5	8.5	7.5
Max Green Setting (Gmax), s		86.5		18.5	11.5	66.5
Max Q Clear Time (g_c+I1), s		8.0		7.2	11.8	59.0
Green Ext Time (p_c), s		6.2		0.3	0.0	6.7
<b>Intersection Summary</b>						
HCM 6th Ctrl Delay			23.1			
HCM 6th LOS			C			
<b>Notes</b>						
Unsignalized Delay for [EBR] is excluded from calculations of the approach delay and intersection delay.						

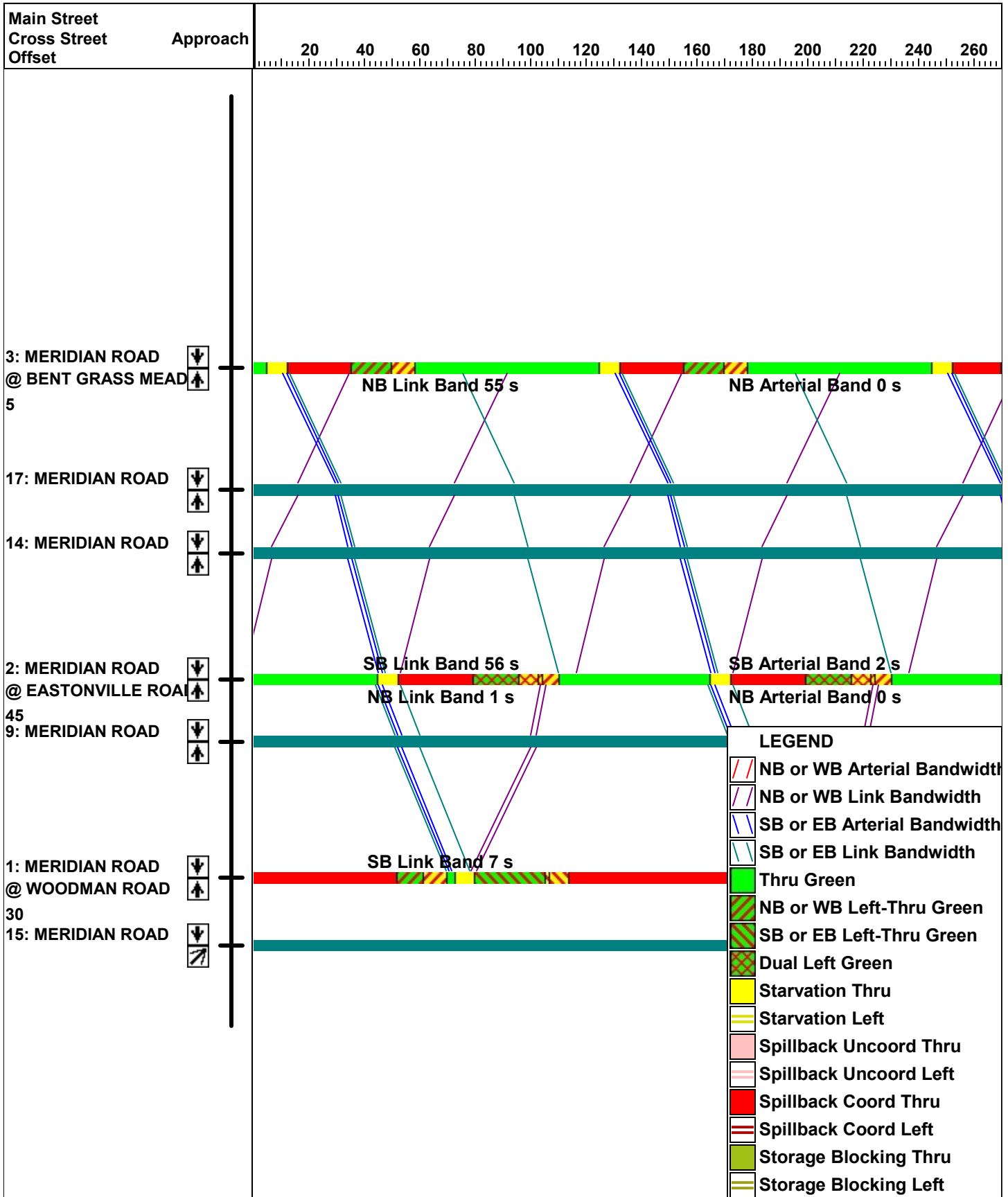
Intersection						
Int Delay, s/veh	6.4					
Movement	EBT	EBR	WBL	WBT	NBL	NBR
Lane Configurations	↑	↗	↘	↑	↘	
Traffic Vol, veh/h	158	89	363	82	1	256
Future Vol, veh/h	158	89	363	82	1	256
Conflicting Peds, #/hr	0	0	0	0	0	0
Sign Control	Free	Free	Free	Free	Stop	Stop
RT Channelized	-	None	-	None	-	None
Storage Length	-	150	100	-	0	-
Veh in Median Storage, #	0	-	-	0	0	-
Grade, %	0	-	-	0	0	-
Peak Hour Factor	95	95	95	95	95	95
Heavy Vehicles, %	2	2	2	2	2	2
Mvmt Flow	166	94	382	86	1	269

Major/Minor	Major1	Major2	Minor1		
Conflicting Flow All	0	0	260	0	1016
Stage 1	-	-	-	-	166
Stage 2	-	-	-	-	850
Critical Hdwy	-	-	4.12	-	6.42
Critical Hdwy Stg 1	-	-	-	-	5.42
Critical Hdwy Stg 2	-	-	-	-	5.42
Follow-up Hdwy	-	-	2.218	-	3.518
Pot Cap-1 Maneuver	-	-	1304	-	264
Stage 1	-	-	-	-	863
Stage 2	-	-	-	-	419
Platoon blocked, %	-	-	-	-	-
Mov Cap-1 Maneuver	-	-	1304	-	187
Mov Cap-2 Maneuver	-	-	-	-	187
Stage 1	-	-	-	-	863
Stage 2	-	-	-	-	296

Approach	EB	WB	NB
HCM Control Delay, s	0	7.3	11
HCM LOS			B

Minor Lane/Major Mvmt	NBLn1	EBT	EBR	WBL	WBT
Capacity (veh/h)	866	-	-	1304	-
HCM Lane V/C Ratio	0.312	-	-	0.293	-
HCM Control Delay (s)	11	-	-	8.9	-
HCM Lane LOS	B	-	-	A	-
HCM 95th %tile Q(veh)	1.3	-	-	1.2	-

Total AM 2040 Shopping Center



Timings  
1: MERIDIAN ROAD & WOODMAN ROAD

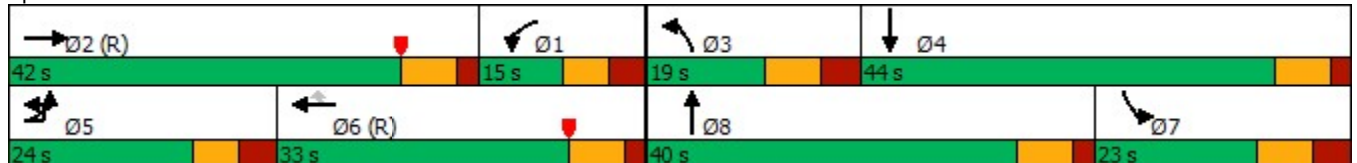
Total AM 40 Storage  
04/01/2023

Lane Group	EBL	EBT	EBR	WBL	WBT	WBR	NBL	NBT	NBR	SBL	SBT	SBR
Lane Configurations												
Traffic Volume (vph)	369	321	167	84	564	158	227	386	24	226	977	1007
Future Volume (vph)	369	321	167	84	564	158	227	386	24	226	977	1007
Turn Type	Prot	NA	Free	Prot	NA	Perm	Prot	NA	Free	Prot	NA	Free
Protected Phases	5	2		1	6		3	8		7	4	
Permitted Phases			Free			6			Free			Free
Detector Phase	5	2		1	6	6	3	8		7	4	
Switch Phase												
Minimum Initial (s)	5.0	15.0		5.0	15.0	15.0	5.0	15.0		5.0	15.0	
Minimum Split (s)	13.5	22.0		13.5	22.0	22.0	13.5	22.0		13.5	22.0	
Total Split (s)	24.0	42.0		15.0	33.0	33.0	19.0	40.0		23.0	44.0	
Total Split (%)	20.0%	35.0%		12.5%	27.5%	27.5%	15.8%	33.3%		19.2%	36.7%	
Yellow Time (s)	4.0	5.0		4.0	5.0	5.0	5.0	5.0		5.0	5.0	
All-Red Time (s)	3.5	2.0		3.5	2.0	2.0	3.5	2.0		3.5	2.0	
Lost Time Adjust (s)	0.0	0.0		0.0	0.0	0.0	0.0	0.0		0.0	0.0	
Total Lost Time (s)	7.5	7.0		7.5	7.0	7.0	8.5	7.0		8.5	7.0	
Lead/Lag	Lead	Lead		Lag	Lag	Lag	Lead	Lead		Lag	Lag	
Lead-Lag Optimize?	Yes	Yes		Yes	Yes	Yes	Yes	Yes		Yes	Yes	
Recall Mode	None	C-Max		None	C-Max	C-Max	None	None		None	None	
Act Effct Green (s)	16.2	35.3	120.0	7.5	26.6	26.6	10.5	19.4	120.0	27.8	36.8	120.0
Actuated g/C Ratio	0.14	0.29	1.00	0.06	0.22	0.22	0.09	0.16	1.00	0.23	0.31	1.00
v/c Ratio	0.86	0.33	0.11	0.41	0.76	0.30	0.80	0.71	0.02	0.30	0.95	0.67
Control Delay	69.8	34.2	0.1	60.2	51.0	1.4	73.8	54.5	0.0	40.3	47.0	5.9
Queue Delay	0.0	0.0	0.0	0.0	0.0	0.0	0.0	0.0	0.0	0.0	0.0	0.0
Total Delay	69.8	34.2	0.1	60.2	51.0	1.4	73.8	54.5	0.0	40.3	47.0	5.9
LOS	E	C	A	E	D	A	E	D	A	D	D	A
Approach Delay		43.2			42.3			59.3			27.6	
Approach LOS		D			D			E			C	

Intersection Summary

Cycle Length: 120  
 Actuated Cycle Length: 120  
 Offset: 30 (25%), Referenced to phase 2:EBT and 6:WBT, Start of Yellow  
 Natural Cycle: 90  
 Control Type: Actuated-Coordinated  
 Maximum v/c Ratio: 0.95  
 Intersection Signal Delay: 37.7  
 Intersection LOS: D  
 Intersection Capacity Utilization 84.9%  
 ICU Level of Service E  
 Analysis Period (min) 15

Splits and Phases: 1: MERIDIAN ROAD & WOODMAN ROAD



Queues  
1: MERIDIAN ROAD & WOODMAN ROAD

Total AM 40 Storage  
04/01/2023



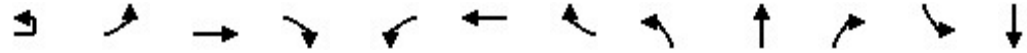
Lane Group	EBL	EBT	EBR	WBL	WBT	WBR	NBL	NBT	NBR	SBL	SBT	SBR
Lane Group Flow (vph)	399	338	176	88	594	166	239	406	25	238	1028	1060
v/c Ratio	0.86	0.33	0.11	0.41	0.76	0.30	0.80	0.71	0.02	0.30	0.95	0.67
Control Delay	69.8	34.2	0.1	60.2	51.0	1.4	73.8	54.5	0.0	40.3	47.0	5.9
Queue Delay	0.0	0.0	0.0	0.0	0.0	0.0	0.0	0.0	0.0	0.0	0.0	0.0
Total Delay	69.8	34.2	0.1	60.2	51.0	1.4	73.8	54.5	0.0	40.3	47.0	5.9
Queue Length 50th (ft)	157	107	0	34	229	0	95	158	0	93	447	113
Queue Length 95th (ft)	#236	150	0	62	297	0	#157	203	0	m90	m424	m61
Internal Link Dist (ft)		1165			1100			342			860	
Turn Bay Length (ft)	500		630	350		250	440		330	490		450
Base Capacity (vph)	472	1040	1583	214	784	552	300	973	1583	795	1091	1583
Starvation Cap Reductn	0	0	0	0	0	0	0	0	0	0	0	0
Spillback Cap Reductn	0	0	0	0	0	0	0	0	0	0	0	0
Storage Cap Reductn	0	0	0	0	0	0	0	0	0	0	0	0
Reduced v/c Ratio	0.85	0.33	0.11	0.41	0.76	0.30	0.80	0.42	0.02	0.30	0.94	0.67

Intersection Summary

- # 95th percentile volume exceeds capacity, queue may be longer.  
Queue shown is maximum after two cycles.
- m Volume for 95th percentile queue is metered by upstream signal.

HCM 6th Signalized Intersection Summary  
1: MERIDIAN ROAD & WOODMAN ROAD

Total AM 40 Storage  
04/01/2023



Movement	EBU	EBL	EBT	EBR	WBL	WBT	WBR	NBL	NBT	NBR	SBL	SBT
Lane Configurations		↖↗	↕	↗	↖↗	↕	↗	↖↗	↕	↗	↖↗	↕
Traffic Volume (veh/h)	10	369	321	167	84	564	158	227	386	24	226	977
Future Volume (veh/h)	10	369	321	167	84	564	158	227	386	24	226	977
Initial Q (Qb), veh		0	0	0	0	0	0	0	0	0	0	0
Ped-Bike Adj(A_pbT)		1.00		1.00	1.00		1.00	1.00		1.00	1.00	
Parking Bus, Adj		1.00	1.00	1.00	1.00	1.00	1.00	1.00	1.00	1.00	1.00	1.00
Work Zone On Approach			No			No			No			No
Adj Sat Flow, veh/h/ln		1870	1870	1870	1870	1870	1870	1870	1870	1870	1870	1870
Adj Flow Rate, veh/h		388	338	0	88	594	0	239	406	0	238	1028
Peak Hour Factor		0.95	0.95	0.95	0.95	0.95	0.95	0.95	0.95	0.95	0.95	0.95
Percent Heavy Veh, %		2	2	2	2	2	2	2	2	2	2	2
Cap, veh/h		444	1036		434	1011		293	520		885	1085
Arrive On Green		0.13	0.29	0.00	0.13	0.28	0.00	0.08	0.15	0.00	0.26	0.31
Sat Flow, veh/h		3456	3554	1585	3456	3554	1585	3456	3554	1585	3456	3554
Grp Volume(v), veh/h		388	338	0	88	594	0	239	406	0	238	1028
Grp Sat Flow(s),veh/h/ln		1728	1777	1585	1728	1777	1585	1728	1777	1585	1728	1777
Q Serve(g_s), s		13.2	8.9	0.0	2.7	17.2	0.0	8.2	13.2	0.0	6.6	33.9
Cycle Q Clear(g_c), s		13.2	8.9	0.0	2.7	17.2	0.0	8.2	13.2	0.0	6.6	33.9
Prop In Lane		1.00		1.00	1.00		1.00	1.00		1.00	1.00	
Lane Grp Cap(c), veh/h		444	1036		434	1011		293	520		885	1085
V/C Ratio(X)		0.87	0.33		0.20	0.59		0.81	0.78		0.27	0.95
Avail Cap(c_a), veh/h		475	1036		434	1011		302	977		885	1096
HCM Platoon Ratio		1.00	1.00	1.00	1.00	1.00	1.00	1.00	1.00	1.00	1.00	1.00
Upstream Filter(I)		1.00	1.00	0.00	1.00	1.00	0.00	1.00	1.00	0.00	1.00	1.00
Uniform Delay (d), s/veh		51.3	33.3	0.0	47.1	36.9	0.0	54.0	49.4	0.0	35.6	40.7
Incr Delay (d2), s/veh		15.6	0.8	0.0	0.2	2.5	0.0	15.3	2.6	0.0	0.2	16.1
Initial Q Delay(d3),s/veh		0.0	0.0	0.0	0.0	0.0	0.0	0.0	0.0	0.0	0.0	0.0
%ile BackOfQ(50%),veh/ln		6.5	3.9	0.0	1.2	7.6	0.0	4.1	6.0	0.0	2.8	16.9
Unsig. Movement Delay, s/veh												
LnGrp Delay(d),s/veh		67.0	34.1	0.0	47.3	39.4	0.0	69.3	51.9	0.0	35.8	56.8
LnGrp LOS		E	C		D	D		E	D		D	E
Approach Vol, veh/h			726	A		682	A		645	A		1266
Approach Delay, s/veh			51.7			40.4			58.4			52.9
Approach LOS			D			D			E			D
Timer - Assigned Phs	1	2	3	4	5	6	7	8				
Phs Duration (G+Y+Rc), s	22.8	42.0	18.7	45.1	22.9	41.9	39.2	24.6				
Change Period (Y+Rc), s	7.5	7.0	8.5	* 8.5	7.5	* 7.5	8.5	7.0				
Max Green Setting (Gmax), s	7.5	35.0	10.5	* 37	16.5	* 26	14.5	33.0				
Max Q Clear Time (g_c+I1), s	4.7	10.9	10.2	35.9	15.2	19.2	8.6	15.2				
Green Ext Time (p_c), s	0.0	1.9	0.0	0.7	0.2	2.0	0.4	2.4				

Intersection Summary

HCM 6th Ctrl Delay	51.1
HCM 6th LOS	D

Notes

- User approved pedestrian interval to be less than phase max green.
- User approved ignoring U-Turning movement.
- \* HCM 6th computational engine requires equal clearance times for the phases crossing the barrier.



HCM 6th Signalized Intersection Summary  
 1: MERIDIAN ROAD & WOODMAN ROAD

Total AM 40 Storage  
 04/01/2023

Movement	SBR
Lane Configurations	
Traffic Volume (veh/h)	1007
Future Volume (veh/h)	1007
Initial Q (Qb), veh	0
Ped-Bike Adj(A_pbT)	1.00
Parking Bus, Adj	1.00
Work Zone On Approach	
Adj Sat Flow, veh/h/ln	1870
Adj Flow Rate, veh/h	0
Peak Hour Factor	0.95
Percent Heavy Veh, %	2
Cap, veh/h	
Arrive On Green	0.00
Sat Flow, veh/h	1585
Grp Volume(v), veh/h	0
Grp Sat Flow(s),veh/h/ln	1585
Q Serve(g_s), s	0.0
Cycle Q Clear(g_c), s	0.0
Prop In Lane	1.00
Lane Grp Cap(c), veh/h	
V/C Ratio(X)	
Avail Cap(c_a), veh/h	
HCM Platoon Ratio	1.00
Upstream Filter(l)	0.00
Uniform Delay (d), s/veh	0.0
Incr Delay (d2), s/veh	0.0
Initial Q Delay(d3),s/veh	0.0
%ile BackOfQ(50%),veh/ln	0.0
Unsig. Movement Delay, s/veh	
LnGrp Delay(d),s/veh	0.0
LnGrp LOS	
Approach Vol, veh/h	A
Approach Delay, s/veh	
Approach LOS	
Timer - Assigned Phs	
Unsignalized Delay for [NBR, EBR, WBR, SBR] is excluded from calculations of the approach delay and intersection delay.	

Timings  
2: MERIDIAN ROAD & EASTONVILLE ROAD

Total AM 2040 Storage  
04/01/2023

Lane Group	EBL	EBT	EBR	WBL	WBT	WBR	NBL	NBT	NBR	SBL	SBT	SBR
Lane Configurations												
Traffic Volume (vph)	215	61	260	137	71	51	289	623	57	157	1846	181
Future Volume (vph)	215	61	260	137	71	51	289	623	57	157	1846	181
Turn Type	pm+pt	NA	Perm	pm+pt	NA	Perm	Prot	NA	Perm	Prot	NA	Perm
Protected Phases	7	4		3	8		5	2		1	6	
Permitted Phases	4		4	8		8			2			6
Detector Phase	7	4	4	3	8	8	5	2	2	1	6	6
Switch Phase												
Minimum Initial (s)	5.0	8.0	8.0	5.0	8.0	8.0	5.0	15.0	15.0	5.0	15.0	15.0
Minimum Split (s)	12.5	14.5	14.5	12.5	14.5	14.5	12.5	22.5	22.5	13.5	22.5	22.5
Total Split (s)	13.0	15.0	15.0	13.0	15.0	15.0	25.0	64.0	64.0	28.0	67.0	67.0
Total Split (%)	10.8%	12.5%	12.5%	10.8%	12.5%	12.5%	20.8%	53.3%	53.3%	23.3%	55.8%	55.8%
Yellow Time (s)	4.0	4.0	4.0	4.0	4.0	4.0	4.0	5.5	5.5	5.0	5.5	5.5
All-Red Time (s)	3.5	2.5	2.5	3.5	2.5	2.5	3.5	2.0	2.0	3.5	2.0	2.0
Lost Time Adjust (s)	0.0	0.0	0.0	0.0	0.0	0.0	0.0	0.0	0.0	0.0	0.0	0.0
Total Lost Time (s)	7.5	6.5	6.5	7.5	6.5	6.5	7.5	7.5	7.5	8.5	7.5	7.5
Lead/Lag	Lead	Lag	Lag	Lead	Lag	Lag	Lead	Lag	Lag	Lead	Lag	Lag
Lead-Lag Optimize?	Yes	Yes	Yes	Yes	Yes	Yes	Yes	Yes	Yes	Yes	Yes	Yes
Recall Mode	None	None	None	None	None	None	None	C-Max	C-Max	None	C-Max	C-Max
Act Effct Green (s)	14.4	8.4	8.4	11.5	8.4	8.4	17.6	60.3	60.3	15.8	59.5	59.5
Actuated g/C Ratio	0.12	0.07	0.07	0.10	0.07	0.07	0.15	0.50	0.50	0.13	0.50	0.50
v/c Ratio	0.68	0.49	0.79	0.98	0.58	0.20	1.17	0.37	0.07	0.71	1.11	0.22
Control Delay	58.2	67.2	26.1	118.5	72.2	1.6	142.2	15.3	2.3	72.1	73.7	1.2
Queue Delay	0.0	0.0	0.0	0.0	0.0	0.0	0.0	0.0	0.0	0.0	0.0	0.0
Total Delay	58.2	67.2	26.1	118.5	72.2	1.6	142.2	15.3	2.3	72.1	73.7	1.2
LOS	E	E	C	F	E	A	F	B	A	E	E	A
Approach Delay		43.6			82.6			52.3			67.5	
Approach LOS		D			F			D			E	

Intersection Summary

Cycle Length: 120  
 Actuated Cycle Length: 120  
 Offset: 45 (38%), Referenced to phase 2:NBT and 6:SBT, Start of Yellow  
 Natural Cycle: 150  
 Control Type: Actuated-Coordinated  
 Maximum v/c Ratio: 1.17  
 Intersection Signal Delay: 61.5  
 Intersection Capacity Utilization 99.2%  
 Analysis Period (min) 15  
 Intersection LOS: E  
 ICU Level of Service F

Splits and Phases: 2: MERIDIAN ROAD & EASTONVILLE ROAD



Queues  
2: MERIDIAN ROAD & EASTONVILLE ROAD

Total AM 2040 Storage  
04/01/2023



Lane Group	EBL	EBT	EBR	WBL	WBT	WBR	NBL	NBT	NBR	SBL	SBT	SBR
Lane Group Flow (vph)	226	64	274	144	75	54	304	656	60	165	1943	191
v/c Ratio	0.68	0.49	0.79	0.98	0.58	0.20	1.17	0.37	0.07	0.71	1.11	0.22
Control Delay	58.2	67.2	26.1	118.5	72.2	1.6	142.2	15.3	2.3	72.1	73.7	1.2
Queue Delay	0.0	0.0	0.0	0.0	0.0	0.0	0.0	0.0	0.0	0.0	0.0	0.0
Total Delay	58.2	67.2	26.1	118.5	72.2	1.6	142.2	15.3	2.3	72.1	73.7	1.2
Queue Length 50th (ft)	80	49	16	102	57	0	~287	149	3	122	~933	9
Queue Length 95th (ft)	#144	96	#139	#225	#116	0	m#431	m183	m10	m132	m#1058	m12
Internal Link Dist (ft)		508			1196			231				781
Turn Bay Length (ft)	100		100	120		100	100		400	375		400
Base Capacity (vph)	330	131	347	147	131	276	259	1778	879	287	1754	880
Starvation Cap Reductn	0	0	0	0	0	0	0	0	0	0	0	0
Spillback Cap Reductn	0	0	0	0	0	0	0	0	0	0	0	0
Storage Cap Reductn	0	0	0	0	0	0	0	0	0	0	0	0
Reduced v/c Ratio	0.68	0.49	0.79	0.98	0.57	0.20	1.17	0.37	0.07	0.57	1.11	0.22

Intersection Summary

- ~ Volume exceeds capacity, queue is theoretically infinite.  
Queue shown is maximum after two cycles.
- # 95th percentile volume exceeds capacity, queue may be longer.  
Queue shown is maximum after two cycles.
- m Volume for 95th percentile queue is metered by upstream signal.

HCM 6th Signalized Intersection Summary  
 2: MERIDIAN ROAD & EASTONVILLE ROAD

Total AM 2040 Storage  
 04/01/2023

Movement	EBL	EBT	EBR	WBL	WBT	WBR	NBL	NBT	NBR	SBL	SBT	SBR
Lane Configurations												
Traffic Volume (veh/h)	215	61	260	137	71	51	289	623	57	157	1846	181
Future Volume (veh/h)	215	61	260	137	71	51	289	623	57	157	1846	181
Initial Q (Qb), veh	0	0	0	0	0	0	0	0	0	0	0	0
Ped-Bike Adj(A_pbT)	1.00		1.00	1.00		1.00	1.00		1.00	1.00		1.00
Parking Bus, Adj	1.00	1.00	1.00	1.00	1.00	1.00	1.00	1.00	1.00	1.00	1.00	1.00
Work Zone On Approach		No			No			No			No	
Adj Sat Flow, veh/h/ln	1870	1870	1870	1870	1870	1870	1870	1870	1870	1870	1870	1870
Adj Flow Rate, veh/h	226	64	0	144	75	0	304	656	60	165	1943	191
Peak Hour Factor	0.95	0.95	0.95	0.95	0.95	0.95	0.95	0.95	0.95	0.95	0.95	0.95
Percent Heavy Veh, %	2	2	2	2	2	2	2	2	2	2	2	2
Cap, veh/h	350	125		187	125		260	1879	838	194	1777	793
Arrive On Green	0.05	0.07	0.00	0.05	0.07	0.00	0.15	0.53	0.53	0.11	0.50	0.50
Sat Flow, veh/h	3456	1870	1585	1781	1870	1585	1781	3554	1585	1781	3554	1585
Grp Volume(v), veh/h	226	64	0	144	75	0	304	656	60	165	1943	191
Grp Sat Flow(s),veh/h/ln	1728	1870	1585	1781	1870	1585	1781	1777	1585	1781	1777	1585
Q Serve(g_s), s	5.5	4.0	0.0	5.5	4.7	0.0	17.5	12.8	2.2	10.9	60.0	8.2
Cycle Q Clear(g_c), s	5.5	4.0	0.0	5.5	4.7	0.0	17.5	12.8	2.2	10.9	60.0	8.2
Prop In Lane	1.00		1.00	1.00		1.00	1.00		1.00	1.00		1.00
Lane Grp Cap(c), veh/h	350	125		187	125		260	1879	838	194	1777	793
V/C Ratio(X)	0.65	0.51		0.77	0.60		1.17	0.35	0.07	0.85	1.09	0.24
Avail Cap(c_a), veh/h	350	132		187	132		260	1879	838	289	1777	793
HCM Platoon Ratio	1.00	1.00	1.00	1.00	1.00	1.00	1.00	1.00	1.00	1.00	1.00	1.00
Upstream Filter(l)	1.00	1.00	0.00	1.00	1.00	0.00	1.00	1.00	1.00	1.00	1.00	1.00
Uniform Delay (d), s/veh	51.9	54.1	0.0	53.3	54.5	0.0	51.3	16.4	13.9	52.5	30.0	17.1
Incr Delay (d2), s/veh	4.1	3.2	0.0	17.8	6.7	0.0	109.8	0.5	0.2	14.2	51.7	0.7
Initial Q Delay(d3),s/veh	0.0	0.0	0.0	0.0	0.0	0.0	0.0	0.0	0.0	0.0	0.0	0.0
%ile BackOfQ(50%),veh/ln	1.0	2.0	0.0	2.6	2.4	0.0	15.4	4.8	0.8	5.4	35.3	3.1
Unsig. Movement Delay, s/veh												
LnGrp Delay(d),s/veh	56.0	57.4	0.0	71.1	61.2	0.0	161.1	16.9	14.0	66.7	81.7	17.8
LnGrp LOS	E	E		E	E		F	B	B	E	F	B
Approach Vol, veh/h		290	A		219	A		1020			2299	
Approach Delay, s/veh		56.3			67.7			59.7			75.3	
Approach LOS		E			E			E			E	
Timer - Assigned Phs	1	2	3	4	5	6	7	8				
Phs Duration (G+Y+Rc), s	21.6	70.9	13.0	14.5	25.0	67.5	13.0	14.5				
Change Period (Y+Rc), s	8.5	7.5	7.5	6.5	7.5	7.5	7.5	6.5				
Max Green Setting (Gmax), s	19.5	56.5	5.5	8.5	17.5	59.5	5.5	8.5				
Max Q Clear Time (g_c+I1), s	12.9	14.8	7.5	6.0	19.5	62.0	7.5	6.7				
Green Ext Time (p_c), s	0.2	4.4	0.0	0.0	0.0	0.0	0.0	0.0				

Intersection Summary												
HCM 6th Ctrl Delay											69.3	
HCM 6th LOS											E	

Notes  
 User approved pedestrian interval to be less than phase max green.  
 Unsignalized Delay for [EBR, WBR] is excluded from calculations of the approach delay and intersection delay.

Timings  
3: MERIDIAN ROAD & BENT GRASS MEADOWS DRIVE

Total AM 40 Storage  
04/01/2023

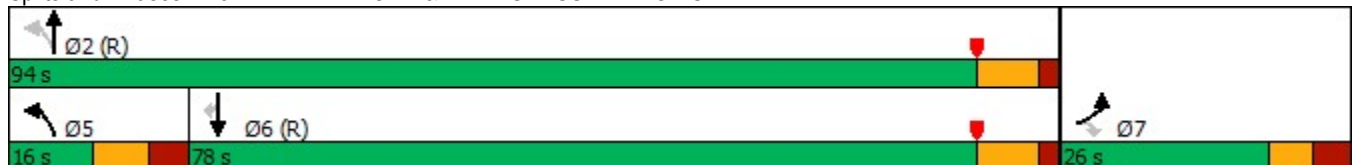


Lane Group	EBL	EBR	NBL	NBT	SBT	SBR
Lane Configurations	↖↗	↗	↖	↑↑	↑↑	↗
Traffic Volume (vph)	109	215	137	700	1926	163
Future Volume (vph)	109	215	137	700	1926	163
Turn Type	Prot	Perm	pm+pt	NA	NA	Perm
Protected Phases	7		5	2	6	
Permitted Phases		7	2			6
Detector Phase	7	7	5	2	6	6
Switch Phase						
Minimum Initial (s)	8.0	8.0	5.0	15.0	15.0	15.0
Minimum Split (s)	25.5	25.5	13.5	25.5	25.5	25.5
Total Split (s)	26.0	26.0	16.0	94.0	78.0	78.0
Total Split (%)	21.7%	21.7%	13.3%	78.3%	65.0%	65.0%
Yellow Time (s)	4.0	4.0	5.0	5.5	5.5	5.5
All-Red Time (s)	3.5	3.5	3.5	2.0	2.0	2.0
Lost Time Adjust (s)	0.0	0.0	0.0	0.0	0.0	0.0
Total Lost Time (s)	7.5	7.5	8.5	7.5	7.5	7.5
Lead/Lag			Lead		Lag	Lag
Lead-Lag Optimize?			Yes		Yes	Yes
Recall Mode	None	None	None	C-Max	C-Max	C-Max
Act Effect Green (s)	14.0	14.0	90.0	91.0	73.6	73.6
Actuated g/C Ratio	0.12	0.12	0.75	0.76	0.61	0.61
v/c Ratio	0.29	0.80	0.75	0.27	0.93	0.17
Control Delay	49.0	45.3	49.2	4.5	31.3	2.0
Queue Delay	0.0	0.0	0.0	0.0	0.0	0.0
Total Delay	49.0	45.3	49.2	4.5	31.3	2.0
LOS	D	D	D	A	C	A
Approach Delay	46.6			11.8	29.0	
Approach LOS	D			B	C	

Intersection Summary

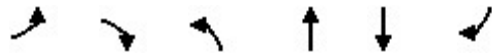
Cycle Length: 120  
 Actuated Cycle Length: 120  
 Offset: 5 (4%), Referenced to phase 2:NBTL and 6:SBT, Start of Yellow  
 Natural Cycle: 110  
 Control Type: Actuated-Coordinated  
 Maximum v/c Ratio: 0.93  
 Intersection Signal Delay: 26.3  
 Intersection Capacity Utilization 87.1%  
 Analysis Period (min) 15  
 Intersection LOS: C  
 ICU Level of Service E

Splits and Phases: 3: MERIDIAN ROAD & BENT GRASS MEADOWS DRIVE



## 3: MERIDIAN ROAD &amp; BENT GRASS MEADOWS DRIVE

04/01/2023



Lane Group	EBL	EBR	NBL	NBT	SBT	SBR
Lane Group Flow (vph)	115	226	144	737	2027	172
v/c Ratio	0.29	0.80	0.75	0.27	0.93	0.17
Control Delay	49.0	45.3	49.2	4.5	31.3	2.0
Queue Delay	0.0	0.0	0.0	0.0	0.0	0.0
Total Delay	49.0	45.3	49.2	4.5	31.3	2.0
Queue Length 50th (ft)	42	86	72	126	754	0
Queue Length 95th (ft)	69	171	m#176	155	#975	29
Internal Link Dist (ft)	310			750	1921	
Turn Bay Length (ft)	150		700			350
Base Capacity (vph)	529	339	192	2684	2171	1037
Starvation Cap Reductn	0	0	0	0	0	0
Spillback Cap Reductn	0	0	0	0	0	0
Storage Cap Reductn	0	0	0	0	0	0
Reduced v/c Ratio	0.22	0.67	0.75	0.27	0.93	0.17

## Intersection Summary

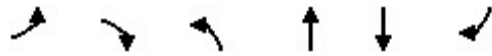
# 95th percentile volume exceeds capacity, queue may be longer.

Queue shown is maximum after two cycles.

m Volume for 95th percentile queue is metered by upstream signal.

HCM 6th Signalized Intersection Summary  
 3: MERIDIAN ROAD & BENT GRASS MEADOWS DRIVE

Total AM 40 Storage  
 04/01/2023



Movement	EBL	EBR	NBL	NBT	SBT	SBR
Lane Configurations	↖↗	↗	↖	↑↑	↑↑	↗
Traffic Volume (veh/h)	109	215	137	700	1926	163
Future Volume (veh/h)	109	215	137	700	1926	163
Initial Q (Qb), veh	0	0	0	0	0	0
Ped-Bike Adj(A_pbT)	1.00	1.00	1.00			1.00
Parking Bus, Adj	1.00	1.00	1.00	1.00	1.00	1.00
Work Zone On Approach	No			No	No	
Adj Sat Flow, veh/h/ln	1870	1870	1870	1870	1870	1870
Adj Flow Rate, veh/h	115	0	144	737	2027	172
Peak Hour Factor	0.95	0.95	0.95	0.95	0.95	0.95
Percent Heavy Veh, %	2	2	2	2	2	2
Cap, veh/h	225		186	2878	2479	1106
Arrive On Green	0.07	0.00	0.04	0.81	0.70	0.70
Sat Flow, veh/h	3456	1585	1781	3647	3647	1585
Grp Volume(v), veh/h	115	0	144	737	2027	172
Grp Sat Flow(s),veh/h/ln	1728	1585	1781	1777	1777	1585
Q Serve(g_s), s	3.9	0.0	2.6	6.0	48.2	4.4
Cycle Q Clear(g_c), s	3.9	0.0	2.6	6.0	48.2	4.4
Prop In Lane	1.00	1.00	1.00			1.00
Lane Grp Cap(c), veh/h	225		186	2878	2479	1106
V/C Ratio(X)	0.51		0.77	0.26	0.82	0.16
Avail Cap(c_a), veh/h	533		224	2878	2479	1106
HCM Platoon Ratio	1.00	1.00	1.00	1.00	1.00	1.00
Upstream Filter(I)	1.00	0.00	1.00	1.00	1.00	1.00
Uniform Delay (d), s/veh	54.2	0.0	28.0	2.7	12.8	6.2
Incr Delay (d2), s/veh	1.8	0.0	13.0	0.2	3.1	0.3
Initial Q Delay(d3),s/veh	0.0	0.0	0.0	0.0	0.0	0.0
%ile BackOfQ(50%),veh/ln	1.7	0.0	3.7	1.7	18.0	7.6
Unsig. Movement Delay, s/veh						
LnGrp Delay(d),s/veh	56.0	0.0	41.0	3.0	15.9	6.5
LnGrp LOS	E		D	A	B	A
Approach Vol, veh/h	115	A		881	2199	
Approach Delay, s/veh	56.0			9.2	15.2	
Approach LOS	E			A	B	
Timer - Assigned Phs		2		4	5	6
Phs Duration (G+Y+Rc), s		104.7		15.3	13.5	91.2
Change Period (Y+Rc), s		7.5		7.5	8.5	7.5
Max Green Setting (Gmax), s		86.5		18.5	7.5	70.5
Max Q Clear Time (g_c+I1), s		8.0		5.9	4.6	50.2
Green Ext Time (p_c), s		6.2		0.2	0.1	16.3
<b>Intersection Summary</b>						
HCM 6th Ctrl Delay			15.0			
HCM 6th LOS			B			
<b>Notes</b>						
Unsignalized Delay for [EBR] is excluded from calculations of the approach delay and intersection delay.						



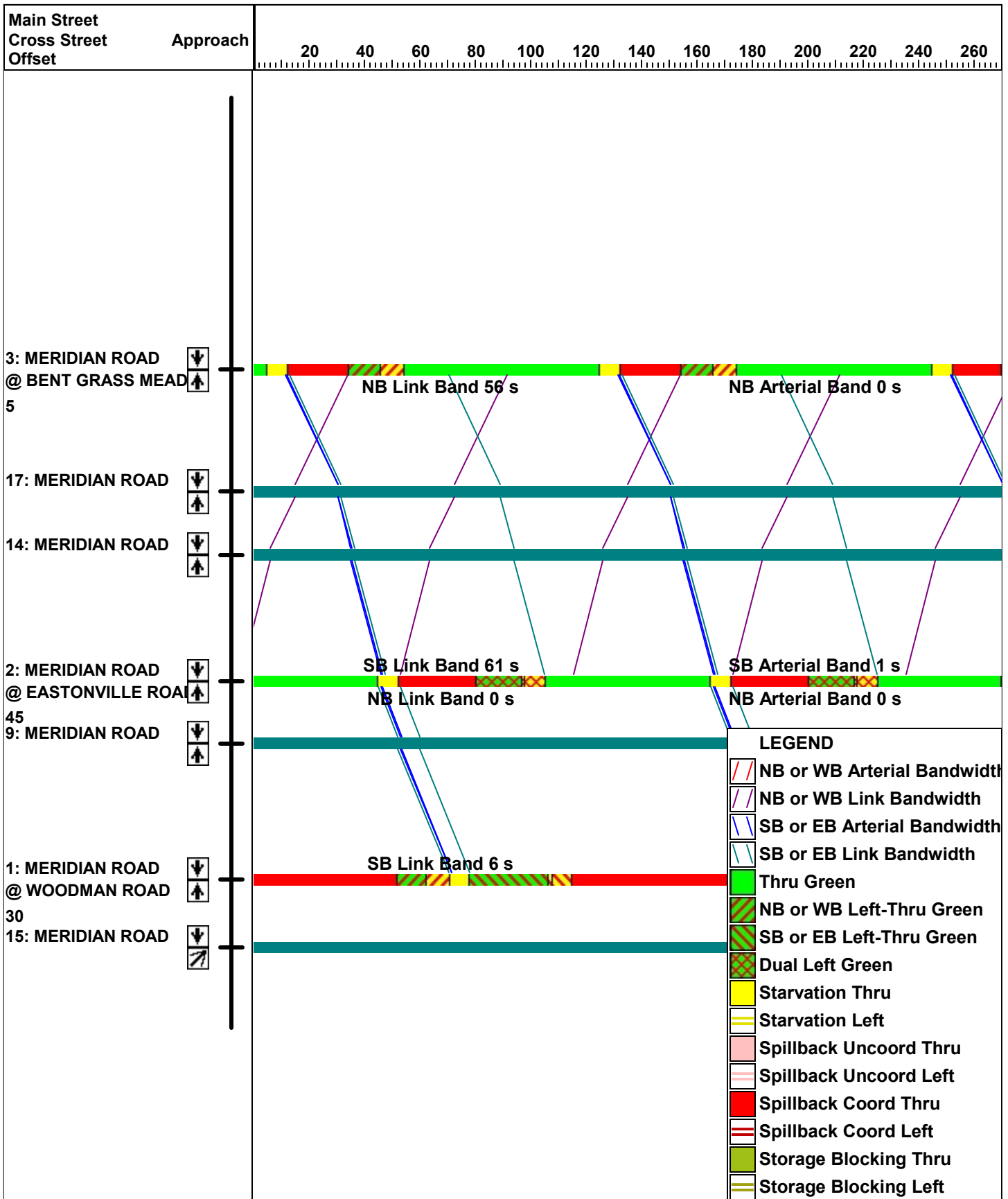
Intersection						
Int Delay, s/veh	5					
Movement	EBT	EBR	WBL	WBT	NBL	NBR
Lane Configurations	↑	↗	↘	↑	↘	
Traffic Vol, veh/h	158	89	218	82	1	167
Future Vol, veh/h	158	89	218	82	1	167
Conflicting Peds, #/hr	0	0	0	0	0	0
Sign Control	Free	Free	Free	Free	Stop	Stop
RT Channelized	-	None	-	None	-	None
Storage Length	-	150	100	-	0	-
Veh in Median Storage, #	0	-	-	0	0	-
Grade, %	0	-	-	0	0	-
Peak Hour Factor	95	95	95	95	95	95
Heavy Vehicles, %	2	2	2	2	2	2
Mvmt Flow	166	94	229	86	1	176

Major/Minor	Major1	Major2	Minor1		
Conflicting Flow All	0	0	260	0	710
Stage 1	-	-	-	-	166
Stage 2	-	-	-	-	544
Critical Hdwy	-	-	4.12	-	6.42
Critical Hdwy Stg 1	-	-	-	-	5.42
Critical Hdwy Stg 2	-	-	-	-	5.42
Follow-up Hdwy	-	-	2.218	-	3.518
Pot Cap-1 Maneuver	-	-	1304	-	400
Stage 1	-	-	-	-	863
Stage 2	-	-	-	-	582
Platoon blocked, %	-	-	-	-	-
Mov Cap-1 Maneuver	-	-	1304	-	330
Mov Cap-2 Maneuver	-	-	-	-	330
Stage 1	-	-	-	-	863
Stage 2	-	-	-	-	480

Approach	EB	WB	NB
HCM Control Delay, s	0	6.1	10.2
HCM LOS			B

Minor Lane/Major Mvmt	NBLn1	EBT	EBR	WBL	WBT
Capacity (veh/h)	869	-	-	1304	-
HCM Lane V/C Ratio	0.204	-	-	0.176	-
HCM Control Delay (s)	10.2	-	-	8.3	-
HCM Lane LOS	B	-	-	A	-
HCM 95th %tile Q(veh)	0.8	-	-	0.6	-

# Total AM 2040 Storage Signal Progression



Timings  
1: MERIDIAN ROAD & WOODMAN ROAD

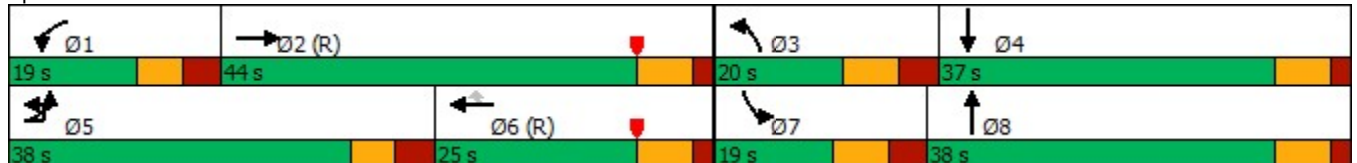
Total PM 40 Shopping Center  
04/01/2023

Lane Group	EBL	EBT	EBR	WBL	WBT	WBR	NBL	NBT	NBR	SBL	SBT	SBR
Lane Configurations												
Traffic Volume (vph)	1240	671	229	160	521	377	296	1179	151	380	831	876
Future Volume (vph)	1240	671	229	160	521	377	296	1179	151	380	831	876
Turn Type	Prot	NA	Free	Prot	NA	Perm	Prot	NA	Free	Prot	NA	Free
Protected Phases	5	2		1	6		3	8		7	4	
Permitted Phases			Free			6			Free			Free
Detector Phase	5	2		1	6	6	3	8		7	4	
Switch Phase												
Minimum Initial (s)	5.0	15.0		5.0	15.0	15.0	5.0	15.0		5.0	15.0	
Minimum Split (s)	13.5	22.0		13.5	22.0	22.0	13.5	22.0		13.5	22.0	
Total Split (s)	38.0	44.0		19.0	25.0	25.0	20.0	38.0		19.0	37.0	
Total Split (%)	31.7%	36.7%		15.8%	20.8%	20.8%	16.7%	31.7%		15.8%	30.8%	
Yellow Time (s)	4.0	5.0		4.0	5.0	5.0	5.0	5.0		5.0	5.0	
All-Red Time (s)	3.5	2.0		3.5	2.0	2.0	3.5	2.0		3.5	2.0	
Lost Time Adjust (s)	0.0	0.0		0.0	0.0	0.0	0.0	0.0		0.0	0.0	
Total Lost Time (s)	7.5	7.0		7.5	7.0	7.0	8.5	7.0		8.5	7.0	
Lead/Lag	Lead	Lag		Lead	Lag	Lag	Lead	Lag		Lead	Lag	
Lead-Lag Optimize?	Yes	Yes		Yes	Yes	Yes	Yes	Yes		Yes	Yes	
Recall Mode	None	C-Max		None	C-Max	C-Max	None	None		None	None	
Act Effct Green (s)	30.5	38.1	120.0	10.4	18.0	18.0	11.5	31.0	120.0	10.5	30.0	120.0
Actuated g/C Ratio	0.25	0.32	1.00	0.09	0.15	0.15	0.10	0.26	1.00	0.09	0.25	1.00
v/c Ratio	1.51	0.63	0.15	0.56	1.03	0.88	0.95	1.36	0.10	1.33	0.99	0.58
Control Delay	270.6	38.2	0.2	60.0	97.9	40.5	92.9	203.9	0.1	182.6	49.7	5.9
Queue Delay	0.0	0.0	0.0	0.0	0.0	0.0	0.0	0.0	0.0	0.0	0.0	0.0
Total Delay	270.6	38.2	0.2	60.0	97.9	40.5	92.9	203.9	0.1	182.6	49.7	5.9
LOS	F	D	A	E	F	D	F	F	A	F	D	A
Approach Delay		169.5			71.7			164.8			55.5	
Approach LOS		F			E			F			E	

Intersection Summary

Cycle Length: 120  
 Actuated Cycle Length: 120  
 Offset: 100 (83%), Referenced to phase 2:EBT and 6:WBT, Start of Yellow  
 Natural Cycle: 150  
 Control Type: Actuated-Coordinated  
 Maximum v/c Ratio: 1.51  
 Intersection Signal Delay: 119.1  
 Intersection Capacity Utilization 118.2%  
 Analysis Period (min) 15  
 Intersection LOS: F  
 ICU Level of Service H

Splits and Phases: 1: MERIDIAN ROAD & WOODMAN ROAD



Queues  
1: MERIDIAN ROAD & WOODMAN ROAD

Total PM 40 Shopping Center  
04/01/2023



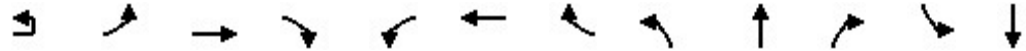
Lane Group	EBL	EBT	EBR	WBL	WBT	WBR	NBL	NBT	NBR	SBL	SBT	SBR
Lane Group Flow (vph)	1321	706	241	168	548	397	312	1241	159	400	875	922
v/c Ratio	1.51	0.63	0.15	0.56	1.03	0.88	0.95	1.36	0.10	1.33	0.99	0.58
Control Delay	270.6	38.2	0.2	60.0	97.9	40.5	92.9	203.9	0.1	182.6	49.7	5.9
Queue Delay	0.0	0.0	0.0	0.0	0.0	0.0	0.0	0.0	0.0	0.0	0.0	0.0
Total Delay	270.6	38.2	0.2	60.0	97.9	40.5	92.9	203.9	0.1	182.6	49.7	5.9
Queue Length 50th (ft)	~735	247	0	64	~239	117	125	~664	0	~210	372	144
Queue Length 95th (ft)	#869	315	0	102	#354	#299	#215	#801	0	m#160	m304	m44
Internal Link Dist (ft)		1165			1100			342				860
Turn Bay Length (ft)	500		630	350		250	440		330	490		450
Base Capacity (vph)	872	1122	1583	328	530	449	328	914	1583	300	884	1583
Starvation Cap Reductn	0	0	0	0	0	0	0	0	0	0	0	0
Spillback Cap Reductn	0	0	0	0	0	0	0	0	0	0	0	0
Storage Cap Reductn	0	0	0	0	0	0	0	0	0	0	0	0
Reduced v/c Ratio	1.51	0.63	0.15	0.51	1.03	0.88	0.95	1.36	0.10	1.33	0.99	0.58

Intersection Summary

- ~ Volume exceeds capacity, queue is theoretically infinite.  
Queue shown is maximum after two cycles.
- # 95th percentile volume exceeds capacity, queue may be longer.  
Queue shown is maximum after two cycles.
- m Volume for 95th percentile queue is metered by upstream signal.

HCM 6th Signalized Intersection Summary  
1: MERIDIAN ROAD & WOODMAN ROAD

Total PM 40 Shopping Center  
04/01/2023



Movement	EBU	EBL	EBT	EBR	WBL	WBT	WBR	NBL	NBT	NBR	SBL	SBT
Lane Configurations		↔↔	↕↕	↗	↔↔	↕↕	↗	↔↔	↕↕	↗	↔↔	↕↕
Traffic Volume (veh/h)	15	1240	671	229	160	521	377	296	1179	151	380	831
Future Volume (veh/h)	15	1240	671	229	160	521	377	296	1179	151	380	831
Initial Q (Qb), veh		0	0	0	0	0	0	0	0	0	0	0
Ped-Bike Adj(A_pbT)		1.00		1.00	1.00		1.00	1.00		1.00	1.00	
Parking Bus, Adj		1.00	1.00	1.00	1.00	1.00	1.00	1.00	1.00	1.00	1.00	1.00
Work Zone On Approach			No			No			No			No
Adj Sat Flow, veh/h/ln		1870	1870	1870	1870	1870	1870	1870	1870	1870	1870	1870
Adj Flow Rate, veh/h		1305	706	0	168	548	0	312	1241	0	400	875
Peak Hour Factor		0.95	0.95	0.95	0.95	0.95	0.95	0.95	0.95	0.95	0.95	0.95
Percent Heavy Veh, %		2	2	2	2	2	2	2	2	2	2	2
Cap, veh/h		878	1203		226	533		331	918		302	888
Arrive On Green		0.25	0.34	0.00	0.07	0.15	0.00	0.10	0.26	0.00	0.09	0.25
Sat Flow, veh/h		3456	3554	1585	3456	3554	1585	3456	3554	1585	3456	3554
Grp Volume(v), veh/h		1305	706	0	168	548	0	312	1241	0	400	875
Grp Sat Flow(s),veh/h/ln		1728	1777	1585	1728	1777	1585	1728	1777	1585	1728	1777
Q Serve(g_s), s		30.5	19.7	0.0	5.7	18.0	0.0	10.8	31.0	0.0	10.5	29.4
Cycle Q Clear(g_c), s		30.5	19.7	0.0	5.7	18.0	0.0	10.8	31.0	0.0	10.5	29.4
Prop In Lane		1.00		1.00	1.00		1.00	1.00		1.00	1.00	
Lane Grp Cap(c), veh/h		878	1203		226	533		331	918		302	888
V/C Ratio(X)		1.49	0.59		0.74	1.03		0.94	1.35		1.32	0.98
Avail Cap(c_a), veh/h		878	1203		331	533		331	918		302	888
HCM Platoon Ratio		1.00	1.00	1.00	1.00	1.00	1.00	1.00	1.00	1.00	1.00	1.00
Upstream Filter(I)		1.00	1.00	0.00	1.00	1.00	0.00	1.00	1.00	0.00	1.00	1.00
Uniform Delay (d), s/veh		44.8	32.7	0.0	55.1	51.0	0.0	53.9	44.5	0.0	54.8	44.8
Incr Delay (d2), s/veh		224.7	2.1	0.0	5.0	46.3	0.0	34.6	165.5	0.0	166.6	26.4
Initial Q Delay(d3),s/veh		0.0	0.0	0.0	0.0	0.0	0.0	0.0	0.0	0.0	0.0	0.0
%ile BackOfQ(50%),veh/ln		40.0	8.5	0.0	2.6	11.2	0.0	6.2	34.5	0.0	11.5	16.0
Unsig. Movement Delay, s/veh												
LnGrp Delay(d),s/veh		269.4	34.8	0.0	60.1	97.3	0.0	88.5	210.0	0.0	221.3	71.2
LnGrp LOS		F	C		E	F		F	F		F	E
Approach Vol, veh/h			2011	A		716	A		1553	A		1275
Approach Delay, s/veh			187.1			88.6			185.6			118.3
Approach LOS			F			F			F			F
Timer - Assigned Phs	1	2	3	4	5	6	7	8				
Phs Duration (G+Y+Rc), s	15.4	47.6	20.0	37.0	38.0	25.0	19.0	38.0				
Change Period (Y+Rc), s	7.5	7.0	8.5	7.0	7.5	7.0	8.5	7.0				
Max Green Setting (Gmax), s	11.5	37.0	11.5	30.0	30.5	18.0	10.5	31.0				
Max Q Clear Time (g_c+I1), s	7.7	21.7	12.8	31.4	32.5	20.0	12.5	33.0				
Green Ext Time (p_c), s	0.2	3.9	0.0	0.0	0.0	0.0	0.0	0.0				

Intersection Summary

HCM 6th Ctrl Delay	158.2
HCM 6th LOS	F

Notes

- User approved pedestrian interval to be less than phase max green.
- User approved ignoring U-Turning movement.
- Unsignalized Delay for [NBR, EBR, WBR, SBR] is excluded from calculations of the approach delay and intersection delay.

HCM 6th Signalized Intersection Summary  
 1: MERIDIAN ROAD & WOODMAN ROAD

Total PM 40 Shopping Center  
 04/01/2023

Movement	SBR
Lane Configurations	
Traffic Volume (veh/h)	876
Future Volume (veh/h)	876
Initial Q (Qb), veh	0
Ped-Bike Adj(A_pbT)	1.00
Parking Bus, Adj	1.00
Work Zone On Approach	
Adj Sat Flow, veh/h/ln	1870
Adj Flow Rate, veh/h	0
Peak Hour Factor	0.95
Percent Heavy Veh, %	2
Cap, veh/h	
Arrive On Green	0.00
Sat Flow, veh/h	1585
Grp Volume(v), veh/h	0
Grp Sat Flow(s),veh/h/ln	1585
Q Serve(g_s), s	0.0
Cycle Q Clear(g_c), s	0.0
Prop In Lane	1.00
Lane Grp Cap(c), veh/h	
V/C Ratio(X)	
Avail Cap(c_a), veh/h	
HCM Platoon Ratio	1.00
Upstream Filter(l)	0.00
Uniform Delay (d), s/veh	0.0
Incr Delay (d2), s/veh	0.0
Initial Q Delay(d3),s/veh	0.0
%ile BackOfQ(50%),veh/ln	0.0
Unsig. Movement Delay, s/veh	
LnGrp Delay(d),s/veh	0.0
LnGrp LOS	
Approach Vol, veh/h	A
Approach Delay, s/veh	
Approach LOS	
Timer - Assigned Phs	

Timings  
2: MERIDIAN ROAD & EASTONVILLE ROAD

Total 2040 PM Shopping Center  
04/01/2023

Lane Group	EBL	EBT	EBR	WBL	WBT	WBR	NBL	NBT	NBR	SBL	SBT	SBR
Lane Configurations												
Traffic Volume (vph)	330	146	580	44	100	190	644	2046	164	117	1441	174
Future Volume (vph)	330	146	580	44	100	190	644	2046	164	117	1441	174
Turn Type	pm+pt	NA	Perm	pm+pt	NA	Perm	pm+pt	NA	Perm	pm+pt	NA	Perm
Protected Phases	7	4		3	8		5	2		1	6	
Permitted Phases	4		4	8		8	2		2	6		6
Detector Phase	7	4	4	3	8	8	5	2	2	1	6	6
Switch Phase												
Minimum Initial (s)	5.0	8.0	8.0	5.0	8.0	8.0	5.0	15.0	15.0	5.0	15.0	15.0
Minimum Split (s)	12.5	14.5	14.5	12.5	14.5	14.5	12.5	25.5	25.5	13.5	25.5	25.5
Total Split (s)	16.0	22.0	22.0	13.0	19.0	19.0	35.0	71.0	71.0	14.0	50.0	50.0
Total Split (%)	13.3%	18.3%	18.3%	10.8%	15.8%	15.8%	29.2%	59.2%	59.2%	11.7%	41.7%	41.7%
Yellow Time (s)	4.0	4.0	4.0	4.0	4.0	4.0	4.0	5.5	5.5	5.0	5.5	5.5
All-Red Time (s)	3.5	2.5	2.5	3.5	2.5	2.5	3.5	2.0	2.0	3.5	2.0	2.0
Lost Time Adjust (s)	0.0	0.0	0.0	0.0	0.0	0.0	0.0	0.0	0.0	0.0	0.0	0.0
Total Lost Time (s)	7.5	6.5	6.5	7.5	6.5	6.5	7.5	7.5	7.5	8.5	7.5	7.5
Lead/Lag	Lead	Lag	Lag	Lead	Lag	Lag	Lead	Lag	Lag	Lead	Lag	Lag
Lead-Lag Optimize?	Yes	Yes	Yes	Yes	Yes	Yes	Yes	Yes	Yes	Yes	Yes	Yes
Recall Mode	None	None	None	None	None	None	None	C-Max	C-Max	None	C-Max	C-Max
Act Effct Green (s)	23.9	18.1	18.1	17.0	12.5	12.5	77.5	63.5	63.5	47.0	42.5	42.5
Actuated g/C Ratio	0.20	0.15	0.15	0.14	0.10	0.10	0.65	0.53	0.53	0.39	0.35	0.35
v/c Ratio	0.71	0.55	1.12	0.23	0.54	0.51	1.45	1.15	0.19	0.85	1.21	0.25
Control Delay	50.0	56.9	94.3	40.3	62.1	6.8	238.4	87.9	1.2	73.2	133.0	5.6
Queue Delay	0.0	0.0	0.0	0.0	0.0	0.0	0.0	0.0	0.0	0.0	0.0	0.0
Total Delay	50.0	56.9	94.3	40.3	62.1	6.8	238.4	87.9	1.2	73.2	133.0	5.6
LOS	D	E	F	D	E	A	F	F	A	E	F	A
Approach Delay		75.3			27.8			116.9			116.1	
Approach LOS		E			C			F			F	

Intersection Summary

Cycle Length: 120  
 Actuated Cycle Length: 120  
 Offset: 89 (74%), Referenced to phase 2:NBTL and 6:SBTL, Start of Yellow  
 Natural Cycle: 150  
 Control Type: Actuated-Coordinated  
 Maximum v/c Ratio: 1.45  
 Intersection Signal Delay: 104.3  
 Intersection Capacity Utilization 114.9%  
 Analysis Period (min) 15  
 Intersection LOS: F  
 ICU Level of Service H

Splits and Phases: 2: MERIDIAN ROAD & EASTONVILLE ROAD





Queues  
2: MERIDIAN ROAD & EASTONVILLE ROAD

Total 2040 PM Shopping Center  
04/01/2023






























Lane Group	EBL	EBT	EBR	WBL	WBT	WBR	NBL	NBT	NBR	SBL	SBT	SBR
Lane Group Flow (vph)	347	154	611	46	105	200	678	2154	173	123	1517	183
v/c Ratio	0.71	0.55	1.12	0.23	0.54	0.51	1.45	1.15	0.19	0.85	1.21	0.25
Control Delay	50.0	56.9	94.3	40.3	62.1	6.8	238.4	87.9	1.2	73.2	133.0	5.6
Queue Delay	0.0	0.0	0.0	0.0	0.0	0.0	0.0	0.0	0.0	0.0	0.0	0.0
Total Delay	50.0	56.9	94.3	40.3	62.1	6.8	238.4	87.9	1.2	73.2	133.0	5.6
Queue Length 50th (ft)	119	115	~303	28	78	0	~655	~1012	5	56	~777	38
Queue Length 95th (ft)	165	188	#532	61	138	28	m#399	m309	m2	m#95	#917	m47
Internal Link Dist (ft)		508			1196			231			781	
Turn Bay Length (ft)	100		100	120		100	100		400	375		400
Base Capacity (vph)	489	280	547	198	194	393	469	1872	921	144	1253	718
Starvation Cap Reductn	0	0	0	0	0	0	0	0	0	0	0	0
Spillback Cap Reductn	0	0	0	0	0	0	0	0	0	0	0	0
Storage Cap Reductn	0	0	0	0	0	0	0	0	0	0	0	0
Reduced v/c Ratio	0.71	0.55	1.12	0.23	0.54	0.51	1.45	1.15	0.19	0.85	1.21	0.25

Intersection Summary

- ~ Volume exceeds capacity, queue is theoretically infinite.  
Queue shown is maximum after two cycles.
- # 95th percentile volume exceeds capacity, queue may be longer.  
Queue shown is maximum after two cycles.
- m Volume for 95th percentile queue is metered by upstream signal.

HCM 6th Signalized Intersection Summary  
2: MERIDIAN ROAD & EASTONVILLE ROAD

Total 2040 PM Shopping Center  
04/01/2023

												
Movement	EBL	EBT	EBR	WBL	WBT	WBR	NBL	NBT	NBR	SBL	SBT	SBR
Lane Configurations	 							 			 	
Traffic Volume (veh/h)	330	146	580	44	100	190	644	2046	164	117	1441	174
Future Volume (veh/h)	330	146	580	44	100	190	644	2046	164	117	1441	174
Initial Q (Qb), veh	0	0	0	0	0	0	0	0	0	0	0	0
Ped-Bike Adj(A_pbT)	1.00		1.00	1.00		1.00	1.00		1.00	1.00		1.00
Parking Bus, Adj	1.00	1.00	1.00	1.00	1.00	1.00	1.00	1.00	1.00	1.00	1.00	1.00
Work Zone On Approach		No			No			No			No	
Adj Sat Flow, veh/h/ln	1870	1870	1870	1870	1870	1870	1870	1870	1870	1870	1870	1870
Adj Flow Rate, veh/h	347	154	0	46	105	0	678	2154	173	123	1517	183
Peak Hour Factor	0.95	0.95	0.95	0.95	0.95	0.95	0.95	0.95	0.95	0.95	0.95	0.95
Percent Heavy Veh, %	2	2	2	2	2	2	2	2	2	2	2	2
Cap, veh/h	409	208		157	136		468	1992	888	142	1370	611
Arrive On Green	0.07	0.11	0.00	0.03	0.07	0.00	0.23	0.56	0.56	0.05	0.39	0.39
Sat Flow, veh/h	3456	1870	1585	1781	1870	1585	1781	3554	1585	1781	3554	1585
Grp Volume(v), veh/h	347	154	0	46	105	0	678	2154	173	123	1517	183
Grp Sat Flow(s),veh/h/ln	1728	1870	1585	1781	1870	1585	1781	1777	1585	1781	1777	1585
Q Serve(g_s), s	8.5	9.6	0.0	2.8	6.6	0.0	27.5	67.2	6.5	5.1	46.2	9.6
Cycle Q Clear(g_c), s	8.5	9.6	0.0	2.8	6.6	0.0	27.5	67.2	6.5	5.1	46.2	9.6
Prop In Lane	1.00		1.00	1.00		1.00	1.00		1.00	1.00		1.00
Lane Grp Cap(c), veh/h	409	208		157	136		468	1992	888	142	1370	611
V/C Ratio(X)	0.85	0.74		0.29	0.77		1.45	1.08	0.19	0.87	1.11	0.30
Avail Cap(c_a), veh/h	409	242		180	195		468	1992	888	142	1370	611
HCM Platoon Ratio	1.00	1.00	1.00	1.00	1.00	1.00	1.00	1.00	1.00	1.00	1.00	1.00
Upstream Filter(l)	1.00	1.00	0.00	1.00	1.00	0.00	1.00	1.00	1.00	1.00	1.00	1.00
Uniform Delay (d), s/veh	50.7	51.7	0.0	49.4	54.6	0.0	38.8	26.4	13.0	29.8	36.9	25.6
Incr Delay (d2), s/veh	15.3	9.9	0.0	1.0	11.1	0.0	213.4	46.2	0.5	39.8	59.4	1.3
Initial Q Delay(d3),s/veh	0.0	0.0	0.0	0.0	0.0	0.0	0.0	0.0	0.0	0.0	0.0	0.0
%ile BackOfQ(50%),veh/ln	2.0	5.0	0.0	1.3	3.5	0.0	40.8	36.9	2.4	3.5	29.7	3.9
Unsig. Movement Delay, s/veh												
LnGrp Delay(d),s/veh	66.0	61.5	0.0	50.4	65.7	0.0	252.2	72.6	13.5	69.6	96.3	26.9
LnGrp LOS	E	E		D	E		F	F	B	E	F	C
Approach Vol, veh/h		501	A		151	A		3005			1823	
Approach Delay, s/veh		64.6			61.0			109.7			87.5	
Approach LOS		E			E			F			F	
Timer - Assigned Phs	1	2	3	4	5	6	7	8				
Phs Duration (G+Y+Rc), s	14.0	74.7	11.4	19.8	35.0	53.7	16.0	15.3				
Change Period (Y+Rc), s	8.5	7.5	7.5	6.5	7.5	7.5	7.5	6.5				
Max Green Setting (Gmax), s	5.5	63.5	5.5	15.5	27.5	42.5	8.5	12.5				
Max Q Clear Time (g_c+I1), s	7.1	69.2	4.8	11.6	29.5	48.2	10.5	8.6				
Green Ext Time (p_c), s	0.0	0.0	0.0	0.2	0.0	0.0	0.0	0.1				

Intersection Summary												
HCM 6th Ctrl Delay											96.9	
HCM 6th LOS											F	

Notes  
User approved pedestrian interval to be less than phase max green.  
Unsignalized Delay for [EBR, WBR] is excluded from calculations of the approach delay and intersection delay.

Timings  
3: MERIDIAN ROAD & BENT GRASS MEADOWS DRIVE

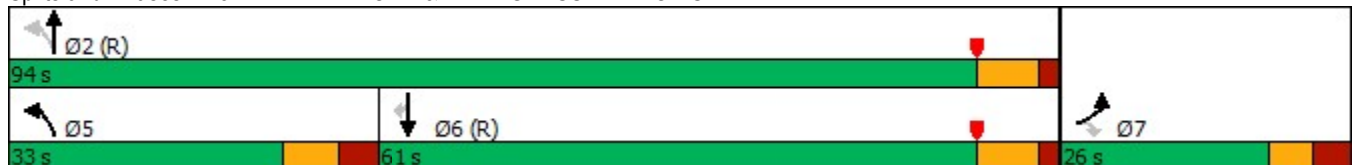


Lane Group	EBL	EBR	NBL	NBT	SBT	SBR
Lane Configurations	↖↖	↗	↖	↑↑	↑↑	↗
Traffic Volume (vph)	252	341	330	2174	1340	283
Future Volume (vph)	252	341	330	2174	1340	283
Turn Type	Prot	Perm	pm+pt	NA	NA	Perm
Protected Phases	7		5	2	6	
Permitted Phases		7	2			6
Detector Phase	7	7	5	2	6	6
Switch Phase						
Minimum Initial (s)	8.0	8.0	5.0	15.0	15.0	15.0
Minimum Split (s)	25.5	25.5	13.5	25.5	25.5	25.5
Total Split (s)	26.0	26.0	33.0	94.0	61.0	61.0
Total Split (%)	21.7%	21.7%	27.5%	78.3%	50.8%	50.8%
Yellow Time (s)	4.0	4.0	5.0	5.5	5.5	5.5
All-Red Time (s)	3.5	3.5	3.5	2.0	2.0	2.0
Lost Time Adjust (s)	0.0	0.0	0.0	0.0	0.0	0.0
Total Lost Time (s)	7.5	7.5	8.5	7.5	7.5	7.5
Lead/Lag			Lead		Lag	Lag
Lead-Lag Optimize?			Yes		Yes	Yes
Recall Mode	None	None	None	C-Max	C-Max	C-Max
Act Effct Green (s)	14.5	14.5	89.5	90.5	59.5	59.5
Actuated g/C Ratio	0.12	0.12	0.75	0.75	0.50	0.50
v/c Ratio	0.64	0.72	0.86	0.86	0.80	0.32
Control Delay	57.1	14.0	50.8	6.1	31.1	3.2
Queue Delay	0.0	0.0	0.0	0.0	0.0	0.0
Total Delay	57.1	14.0	50.8	6.1	31.1	3.2
LOS	E	B	D	A	C	A
Approach Delay	32.3			12.0	26.2	
Approach LOS	C			B	C	

Intersection Summary

Cycle Length: 120  
 Actuated Cycle Length: 120  
 Offset: 27 (23%), Referenced to phase 2:NBTL and 6:SBT, Start of Yellow  
 Natural Cycle: 90  
 Control Type: Actuated-Coordinated  
 Maximum v/c Ratio: 0.86  
 Intersection Signal Delay: 19.4  
 Intersection Capacity Utilization 82.1%  
 Analysis Period (min) 15  
 Intersection LOS: B  
 ICU Level of Service E

Splits and Phases: 3: MERIDIAN ROAD & BENT GRASS MEADOWS DRIVE

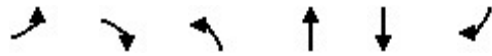


## Queues

Total PM 40 Shopping Center

## 3: MERIDIAN ROAD &amp; BENT GRASS MEADOWS DRIVE

04/01/2023



Lane Group	EBL	EBR	NBL	NBT	SBT	SBR
Lane Group Flow (vph)	265	359	347	2288	1411	298
v/c Ratio	0.64	0.72	0.86	0.86	0.80	0.32
Control Delay	57.1	14.0	50.8	6.1	31.1	3.2
Queue Delay	0.0	0.0	0.0	0.0	0.0	0.0
Total Delay	57.1	14.0	50.8	6.1	31.1	3.2
Queue Length 50th (ft)	102	4	210	118	486	0
Queue Length 95th (ft)	142	97	m181	m120	627	50
Internal Link Dist (ft)	310			750	1921	
Turn Bay Length (ft)	150		700			350
Base Capacity (vph)	529	542	438	2668	1755	935
Starvation Cap Reductn	0	0	0	0	0	0
Spillback Cap Reductn	0	0	0	0	0	0
Storage Cap Reductn	0	0	0	0	0	0
Reduced v/c Ratio	0.50	0.66	0.79	0.86	0.80	0.32

## Intersection Summary

m Volume for 95th percentile queue is metered by upstream signal.

HCM 6th Signalized Intersection Summary  
 3: MERIDIAN ROAD & BENT GRASS MEADOWS DRIVE

Total PM 40 Shopping Center  
 04/01/2023



Movement	EBL	EBR	NBL	NBT	SBT	SBR
Lane Configurations	↖↗	↗	↖	↑↑	↑↑	↗
Traffic Volume (veh/h)	252	341	330	2174	1340	283
Future Volume (veh/h)	252	341	330	2174	1340	283
Initial Q (Qb), veh	0	0	0	0	0	0
Ped-Bike Adj(A_pbT)	1.00	1.00	1.00			1.00
Parking Bus, Adj	1.00	1.00	1.00	1.00	1.00	1.00
Work Zone On Approach	No			No	No	
Adj Sat Flow, veh/h/ln	1870	1870	1870	1870	1870	1870
Adj Flow Rate, veh/h	265	0	347	2288	1411	298
Peak Hour Factor	0.95	0.95	0.95	0.95	0.95	0.95
Percent Heavy Veh, %	2	2	2	2	2	2
Cap, veh/h	332		380	2768	2047	913
Arrive On Green	0.10	0.00	0.13	0.78	0.58	0.58
Sat Flow, veh/h	3456	1585	1781	3647	3647	1585
Grp Volume(v), veh/h	265	0	347	2288	1411	298
Grp Sat Flow(s),veh/h/ln	1728	1585	1781	1777	1777	1585
Q Serve(g_s), s	9.0	0.0	13.1	48.0	33.5	11.8
Cycle Q Clear(g_c), s	9.0	0.0	13.1	48.0	33.5	11.8
Prop In Lane	1.00	1.00	1.00			1.00
Lane Grp Cap(c), veh/h	332		380	2768	2047	913
V/C Ratio(X)	0.80		0.91	0.83	0.69	0.33
Avail Cap(c_a), veh/h	533		509	2768	2047	913
HCM Platoon Ratio	1.00	1.00	1.00	1.00	1.00	1.00
Upstream Filter(l)	1.00	0.00	1.00	1.00	1.00	1.00
Uniform Delay (d), s/veh	53.1	0.0	30.0	8.2	17.9	13.3
Incr Delay (d2), s/veh	4.4	0.0	17.3	3.0	1.9	1.0
Initial Q Delay(d3),s/veh	0.0	0.0	0.0	0.0	0.0	0.0
%ile BackOfQ(50%),veh/ln	4.1	0.0	11.9	15.6	13.7	14.4
Unsig. Movement Delay, s/veh						
LnGrp Delay(d),s/veh	57.5	0.0	47.3	11.2	19.8	14.2
LnGrp LOS	E		D	B	B	B
Approach Vol, veh/h	265	A		2635	1709	
Approach Delay, s/veh	57.5			16.0	18.8	
Approach LOS	E			B	B	
Timer - Assigned Phs		2		4	5	6
Phs Duration (G+Y+Rc), s		101.0		19.0	24.3	76.6
Change Period (Y+Rc), s		7.5		7.5	8.5	7.5
Max Green Setting (Gmax), s		86.5		18.5	24.5	53.5
Max Q Clear Time (g_c+I1), s		50.0		11.0	15.1	35.5
Green Ext Time (p_c), s		28.4		0.5	0.8	11.2

Intersection Summary

HCM 6th Ctrl Delay	19.4
HCM 6th LOS	B

Notes

Unsignalized Delay for [EBR] is excluded from calculations of the approach delay and intersection delay.

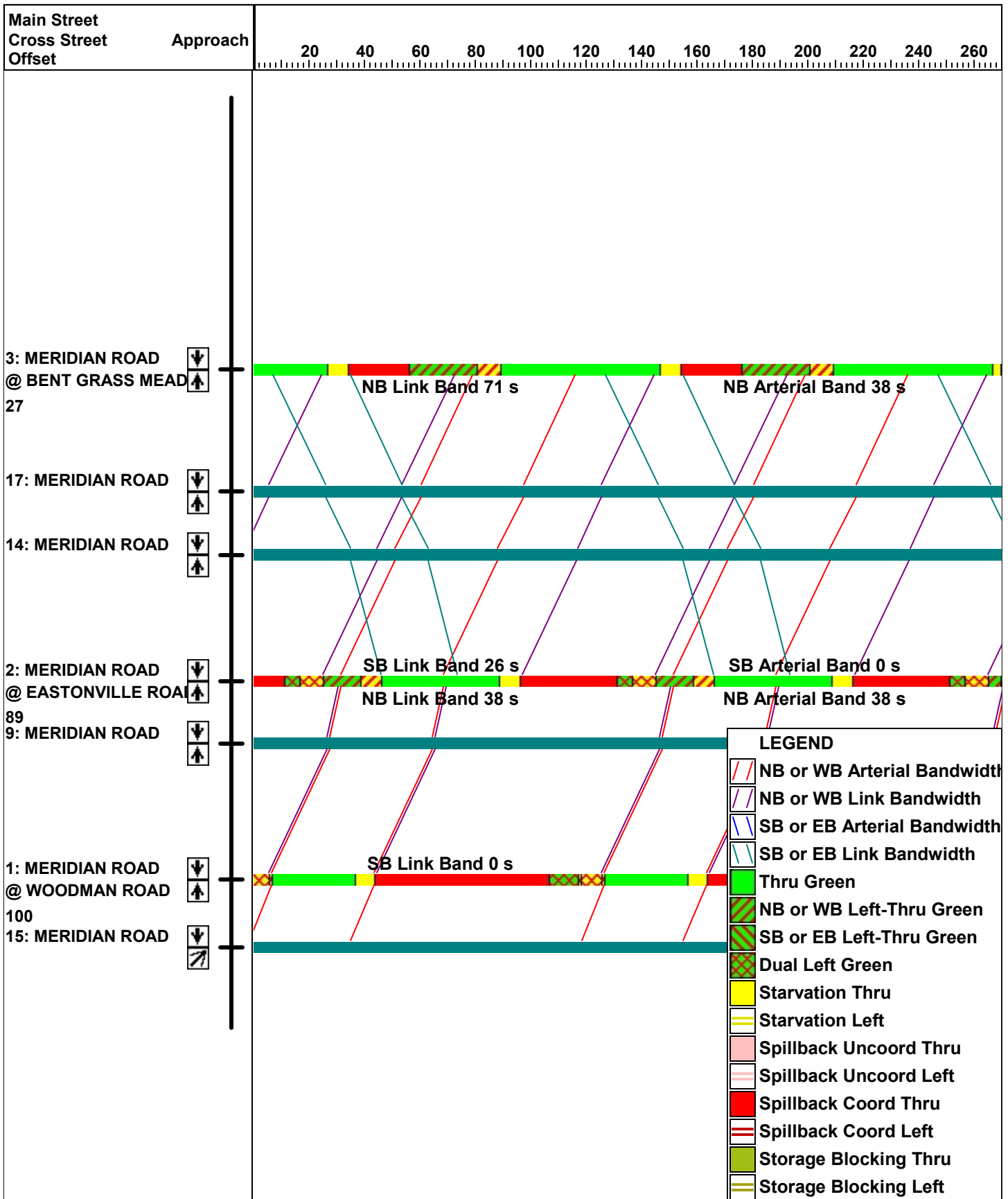
Intersection						
Int Delay, s/veh	8.1					
Movement	EBT	EBR	WBL	WBT	NBL	NBR
Lane Configurations	↑	↗	↘	↑	↘	↗
Traffic Vol, veh/h	139	57	424	189	3	454
Future Vol, veh/h	139	57	424	189	3	454
Conflicting Peds, #/hr	0	0	0	0	0	0
Sign Control	Free	Free	Free	Free	Stop	Stop
RT Channelized	-	None	-	None	-	None
Storage Length	-	150	100	-	0	-
Veh in Median Storage, #	0	-	-	0	0	-
Grade, %	0	-	-	0	0	-
Peak Hour Factor	95	95	95	95	95	95
Heavy Vehicles, %	2	2	2	2	2	2
Mvmt Flow	146	60	446	199	3	478

Major/Minor	Major1	Major2	Minor1		
Conflicting Flow All	0	0	206	0	1237 146
Stage 1	-	-	-	-	146 -
Stage 2	-	-	-	-	1091 -
Critical Hdwy	-	-	4.12	-	6.42 6.22
Critical Hdwy Stg 1	-	-	-	-	5.42 -
Critical Hdwy Stg 2	-	-	-	-	5.42 -
Follow-up Hdwy	-	-	2.218	-	3.518 3.318
Pot Cap-1 Maneuver	-	-	1365	-	194 901
Stage 1	-	-	-	-	881 -
Stage 2	-	-	-	-	322 -
Platoon blocked, %	-	-	-	-	-
Mov Cap-1 Maneuver	-	-	1365	-	131 901
Mov Cap-2 Maneuver	-	-	-	-	131 -
Stage 1	-	-	-	-	881 -
Stage 2	-	-	-	-	217 -

Approach	EB	WB	NB
HCM Control Delay, s	0	6.2	14.2
HCM LOS			B

Minor Lane/Major Mvmt	NBLn1	EBT	EBR	WBL	WBT
Capacity (veh/h)	868	-	-	1365	-
HCM Lane V/C Ratio	0.554	-	-	0.327	-
HCM Control Delay (s)	14.2	-	-	8.9	-
HCM Lane LOS	B	-	-	A	-
HCM 95th %tile Q(veh)	3.5	-	-	1.4	-

# Total PM 2040 Shopping Center Signal Progression





Timings  
1: MERIDIAN ROAD & WOODMAN ROAD

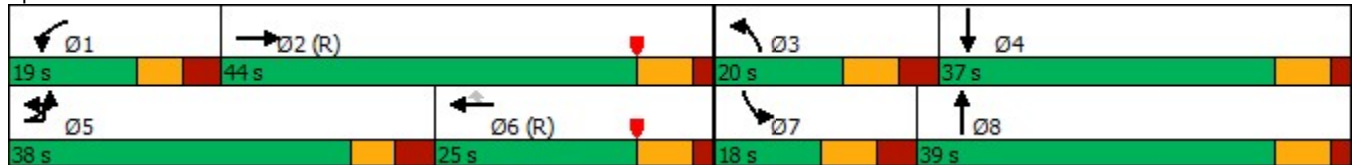
Total PM 2040 Storage  
04/01/2023

Lane Group	EBL	EBT	EBR	WBL	WBT	WBR	NBL	NBT	NBR	SBL	SBT	SBR
Lane Configurations												
Traffic Volume (vph)	994	671	229	160	521	295	296	1069	151	291	712	610
Future Volume (vph)	994	671	229	160	521	295	296	1069	151	291	712	610
Turn Type	Prot	NA	Free	Prot	NA	Perm	Prot	NA	Free	Prot	NA	Free
Protected Phases	5	2		1	6		3	8		7	4	
Permitted Phases			Free			6			Free			Free
Detector Phase	5	2		1	6	6	3	8		7	4	
Switch Phase												
Minimum Initial (s)	5.0	15.0		5.0	15.0	15.0	5.0	15.0		5.0	15.0	
Minimum Split (s)	13.5	22.0		13.5	22.0	22.0	13.5	22.0		13.5	22.0	
Total Split (s)	38.0	44.0		19.0	25.0	25.0	20.0	39.0		18.0	37.0	
Total Split (%)	31.7%	36.7%		15.8%	20.8%	20.8%	16.7%	32.5%		15.0%	30.8%	
Yellow Time (s)	4.0	5.0		4.0	5.0	5.0	5.0	5.0		5.0	5.0	
All-Red Time (s)	3.5	2.0		3.5	2.0	2.0	3.5	2.0		3.5	2.0	
Lost Time Adjust (s)	0.0	0.0		0.0	0.0	0.0	0.0	0.0		0.0	0.0	
Total Lost Time (s)	7.5	7.0		7.5	7.0	7.0	8.5	7.0		8.5	7.0	
Lead/Lag	Lead	Lag		Lead	Lag	Lag	Lead	Lag		Lead	Lag	
Lead-Lag Optimize?	Yes	Yes		Yes	Yes	Yes	Yes	Yes		Yes	Yes	
Recall Mode	None	C-Max		None	C-Max	C-Max	None	None		None	None	
Act Effct Green (s)	30.5	38.1	120.0	10.4	18.0	18.0	11.5	32.0	120.0	9.5	30.0	120.0
Actuated g/C Ratio	0.25	0.32	1.00	0.09	0.15	0.15	0.10	0.27	1.00	0.08	0.25	1.00
v/c Ratio	1.22	0.63	0.15	0.56	1.03	0.69	0.95	1.19	0.10	1.13	0.85	0.41
Control Delay	147.4	38.2	0.2	60.0	97.9	20.0	92.9	136.4	0.1	108.7	51.3	1.1
Queue Delay	0.0	0.0	0.0	0.0	0.0	0.0	0.0	0.0	0.0	0.0	0.0	0.0
Total Delay	147.4	38.2	0.2	60.0	97.9	20.0	92.9	136.4	0.1	108.7	51.3	1.1
LOS	F	D	A	E	F	B	F	F	A	F	D	A
Approach Delay		91.4			68.1			114.3			42.6	
Approach LOS		F			E			F			D	

Intersection Summary

Cycle Length: 120  
 Actuated Cycle Length: 120  
 Offset: 100 (83%), Referenced to phase 2:EBT and 6:WBT, Start of Yellow  
 Natural Cycle: 150  
 Control Type: Actuated-Coordinated  
 Maximum v/c Ratio: 1.22  
 Intersection Signal Delay: 80.3  
 Intersection LOS: F  
 Intersection Capacity Utilization 105.6%  
 ICU Level of Service G  
 Analysis Period (min) 15

Splits and Phases: 1: MERIDIAN ROAD & WOODMAN ROAD



Queues

Total PM 2040 Storage

1: MERIDIAN ROAD & WOODMAN ROAD

04/01/2023



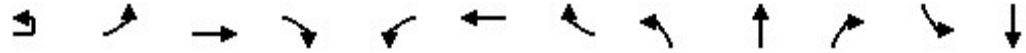
Lane Group	EBL	EBT	EBR	WBL	WBT	WBR	NBL	NBT	NBR	SBL	SBT	SBR
Lane Group Flow (vph)	1062	706	241	168	548	311	312	1125	159	306	749	642
v/c Ratio	1.22	0.63	0.15	0.56	1.03	0.69	0.95	1.19	0.10	1.13	0.85	0.41
Control Delay	147.4	38.2	0.2	60.0	97.9	20.0	92.9	136.4	0.1	108.7	51.3	1.1
Queue Delay	0.0	0.0	0.0	0.0	0.0	0.0	0.0	0.0	0.0	0.0	0.0	0.0
Total Delay	147.4	38.2	0.2	60.0	97.9	20.0	92.9	136.4	0.1	108.7	51.3	1.1
Queue Length 50th (ft)	~520	247	0	64	~239	42	125	~554	0	~142	322	0
Queue Length 95th (ft)	#651	315	0	102	#354	143	#215	#688	0	m#164	m340	m0
Internal Link Dist (ft)		1165			1100			342				860
Turn Bay Length (ft)	500		630	350		250	440		330	490		450
Base Capacity (vph)	872	1122	1583	328	530	449	328	943	1583	271	884	1583
Starvation Cap Reductn	0	0	0	0	0	0	0	0	0	0	0	0
Spillback Cap Reductn	0	0	0	0	0	0	0	0	0	0	0	0
Storage Cap Reductn	0	0	0	0	0	0	0	0	0	0	0	0
Reduced v/c Ratio	1.22	0.63	0.15	0.51	1.03	0.69	0.95	1.19	0.10	1.13	0.85	0.41

Intersection Summary

- ~ Volume exceeds capacity, queue is theoretically infinite.  
Queue shown is maximum after two cycles.
- # 95th percentile volume exceeds capacity, queue may be longer.  
Queue shown is maximum after two cycles.
- m Volume for 95th percentile queue is metered by upstream signal.

HCM 6th Signalized Intersection Summary  
 1: MERIDIAN ROAD & WOODMAN ROAD

Total PM 2040 Storage  
 04/01/2023



Movement	EBU	EBL	EBT	EBR	WBL	WBT	WBR	NBL	NBT	NBR	SBL	SBT
Lane Configurations		↔↔	↕↕	↗	↔↔	↕↕	↗	↔↔	↕↕	↗	↔↔	↕↕
Traffic Volume (veh/h)	15	994	671	229	160	521	295	296	1069	151	291	712
Future Volume (veh/h)	15	994	671	229	160	521	295	296	1069	151	291	712
Initial Q (Qb), veh		0	0	0	0	0	0	0	0	0	0	0
Ped-Bike Adj(A_pbT)		1.00		1.00	1.00		1.00	1.00		1.00	1.00	
Parking Bus, Adj		1.00	1.00	1.00	1.00	1.00	1.00	1.00	1.00	1.00	1.00	1.00
Work Zone On Approach			No			No			No			No
Adj Sat Flow, veh/h/ln		1870	1870	1870	1870	1870	1870	1870	1870	1870	1870	1870
Adj Flow Rate, veh/h		1046	706	0	168	548	0	312	1125	0	306	749
Peak Hour Factor		0.95	0.95	0.95	0.95	0.95	0.95	0.95	0.95	0.95	0.95	0.95
Percent Heavy Veh, %		2	2	2	2	2	2	2	2	2	2	2
Cap, veh/h		878	1203		226	533		331	948		274	888
Arrive On Green		0.25	0.34	0.00	0.07	0.15	0.00	0.10	0.27	0.00	0.08	0.25
Sat Flow, veh/h		3456	3554	1585	3456	3554	1585	3456	3554	1585	3456	3554
Grp Volume(v), veh/h		1046	706	0	168	548	0	312	1125	0	306	749
Grp Sat Flow(s),veh/h/ln		1728	1777	1585	1728	1777	1585	1728	1777	1585	1728	1777
Q Serve(g_s), s		30.5	19.7	0.0	5.7	18.0	0.0	10.8	32.0	0.0	9.5	24.0
Cycle Q Clear(g_c), s		30.5	19.7	0.0	5.7	18.0	0.0	10.8	32.0	0.0	9.5	24.0
Prop In Lane		1.00		1.00	1.00		1.00	1.00		1.00	1.00	
Lane Grp Cap(c), veh/h		878	1203		226	533		331	948		274	888
V/C Ratio(X)		1.19	0.59		0.74	1.03		0.94	1.19		1.12	0.84
Avail Cap(c_a), veh/h		878	1203		331	533		331	948		274	888
HCM Platoon Ratio		1.00	1.00	1.00	1.00	1.00	1.00	1.00	1.00	1.00	1.00	1.00
Upstream Filter(I)		1.00	1.00	0.00	1.00	1.00	0.00	1.00	1.00	0.00	1.00	1.00
Uniform Delay (d), s/veh		44.8	32.7	0.0	55.1	51.0	0.0	53.9	44.0	0.0	55.3	42.8
Incr Delay (d2), s/veh		97.2	2.1	0.0	5.0	46.3	0.0	34.6	94.9	0.0	90.1	7.4
Initial Q Delay(d3),s/veh		0.0	0.0	0.0	0.0	0.0	0.0	0.0	0.0	0.0	0.0	0.0
%ile BackOfQ(50%),veh/ln		24.4	8.5	0.0	2.6	11.2	0.0	6.2	26.3	0.0	7.5	11.3
Unsig. Movement Delay, s/veh												
LnGrp Delay(d),s/veh		142.0	34.8	0.0	60.1	97.3	0.0	88.5	138.9	0.0	145.3	50.2
LnGrp LOS		F	C		E	F		F	F		F	D
Approach Vol, veh/h			1752	A		716	A		1437	A		1055
Approach Delay, s/veh			98.8			88.6			128.0			77.8
Approach LOS			F			F			F			E
Timer - Assigned Phs	1	2	3	4	5	6	7	8				
Phs Duration (G+Y+Rc), s	15.4	47.6	20.0	37.0	38.0	25.0	18.0	39.0				
Change Period (Y+Rc), s	7.5	7.0	8.5	7.0	7.5	7.0	8.5	7.0				
Max Green Setting (Gmax), s	11.5	37.0	11.5	30.0	30.5	18.0	9.5	32.0				
Max Q Clear Time (g_c+I1), s	7.7	21.7	12.8	26.0	32.5	20.0	11.5	34.0				
Green Ext Time (p_c), s	0.2	3.9	0.0	1.8	0.0	0.0	0.0	0.0				

Intersection Summary

HCM 6th Ctrl Delay	101.3
HCM 6th LOS	F

Notes

- User approved pedestrian interval to be less than phase max green.
- User approved ignoring U-Turning movement.
- Unsignalized Delay for [NBR, EBR, WBR, SBR] is excluded from calculations of the approach delay and intersection delay.

HCM 6th Signalized Intersection Summary  
 1: MERIDIAN ROAD & WOODMAN ROAD

Total PM 2040 Storage  
 04/01/2023

Movement	SBR
Lane Configurations	
Traffic Volume (veh/h)	610
Future Volume (veh/h)	610
Initial Q (Qb), veh	0
Ped-Bike Adj(A_pbT)	1.00
Parking Bus, Adj	1.00
Work Zone On Approach	
Adj Sat Flow, veh/h/ln	1870
Adj Flow Rate, veh/h	0
Peak Hour Factor	0.95
Percent Heavy Veh, %	2
Cap, veh/h	
Arrive On Green	0.00
Sat Flow, veh/h	1585
Grp Volume(v), veh/h	0
Grp Sat Flow(s),veh/h/ln	1585
Q Serve(g_s), s	0.0
Cycle Q Clear(g_c), s	0.0
Prop In Lane	1.00
Lane Grp Cap(c), veh/h	
V/C Ratio(X)	
Avail Cap(c_a), veh/h	
HCM Platoon Ratio	1.00
Upstream Filter(l)	0.00
Uniform Delay (d), s/veh	0.0
Incr Delay (d2), s/veh	0.0
Initial Q Delay(d3),s/veh	0.0
%ile BackOfQ(50%),veh/ln	0.0
Unsig. Movement Delay, s/veh	
LnGrp Delay(d),s/veh	0.0
LnGrp LOS	
Approach Vol, veh/h	A
Approach Delay, s/veh	
Approach LOS	
Timer - Assigned Phs	

Timings  
2: MERIDIAN ROAD & EASTONVILLE ROAD

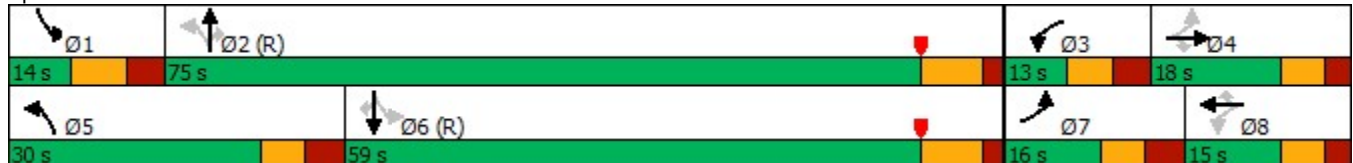
Total 2040 PM Storage  
04/01/2023

Lane Group	EBL	EBT	EBR	WBL	WBT	WBR	NBL	NBT	NBR	SBL	SBT	SBR
Lane Configurations												
Traffic Volume (vph)	330	146	284	44	100	190	371	1883	164	117	1263	174
Future Volume (vph)	330	146	284	44	100	190	371	1883	164	117	1263	174
Turn Type	pm+pt	NA	Perm	pm+pt	NA	Perm	pm+pt	NA	Perm	pm+pt	NA	Perm
Protected Phases	7	4		3	8		5	2		1	6	
Permitted Phases	4		4	8		8	2		2	6		6
Detector Phase	7	4	4	3	8	8	5	2	2	1	6	6
Switch Phase												
Minimum Initial (s)	5.0	8.0	8.0	5.0	8.0	8.0	5.0	15.0	15.0	5.0	15.0	15.0
Minimum Split (s)	12.5	14.5	14.5	12.5	14.5	14.5	12.5	25.5	25.5	13.5	25.5	25.5
Total Split (s)	16.0	18.0	18.0	13.0	15.0	15.0	30.0	75.0	75.0	14.0	59.0	59.0
Total Split (%)	13.3%	15.0%	15.0%	10.8%	12.5%	12.5%	25.0%	62.5%	62.5%	11.7%	49.2%	49.2%
Yellow Time (s)	4.0	4.0	4.0	4.0	4.0	4.0	4.0	5.5	5.5	5.0	5.5	5.5
All-Red Time (s)	3.5	2.5	2.5	3.5	2.5	2.5	3.5	2.0	2.0	3.5	2.0	2.0
Lost Time Adjust (s)	0.0	0.0	0.0	0.0	0.0	0.0	0.0	0.0	0.0	0.0	0.0	0.0
Total Lost Time (s)	7.5	6.5	6.5	7.5	6.5	6.5	7.5	7.5	7.5	8.5	7.5	7.5
Lead/Lag	Lead	Lag	Lag	Lead	Lag	Lag	Lead	Lag	Lag	Lead	Lag	Lag
Lead-Lag Optimize?	Yes	Yes	Yes	Yes	Yes	Yes	Yes	Yes	Yes	Yes	Yes	Yes
Recall Mode	None	None	None	None	None	None	None	C-Max	C-Max	None	C-Max	C-Max
Act Effct Green (s)	19.9	14.1	14.1	13.0	8.5	8.5	81.5	67.5	67.5	56.0	51.5	51.5
Actuated g/C Ratio	0.17	0.12	0.12	0.11	0.07	0.07	0.68	0.56	0.56	0.47	0.43	0.43
v/c Ratio	0.86	0.71	0.71	0.29	0.80	0.57	0.99	1.00	0.18	0.86	0.88	0.22
Control Delay	65.7	70.5	18.8	45.5	94.2	9.0	66.7	20.5	1.1	69.0	44.0	7.2
Queue Delay	0.0	0.0	0.0	0.0	0.0	0.0	0.0	0.0	0.0	0.0	0.0	0.0
Total Delay	65.7	70.5	18.8	45.5	94.2	9.0	66.7	20.5	1.1	69.0	44.0	7.2
LOS	E	E	B	D	F	A	E	C	A	E	D	A
Approach Delay		49.1			39.3			26.3			41.7	
Approach LOS		D			D			C			D	

Intersection Summary

Cycle Length: 120  
 Actuated Cycle Length: 120  
 Offset: 89 (74%), Referenced to phase 2:NBTL and 6:SBTL, Start of Yellow  
 Natural Cycle: 110  
 Control Type: Actuated-Coordinated  
 Maximum v/c Ratio: 1.00  
 Intersection Signal Delay: 35.3  
 Intersection Capacity Utilization 98.8%  
 Analysis Period (min) 15  
 Intersection LOS: D  
 ICU Level of Service F

Splits and Phases: 2: MERIDIAN ROAD & EASTONVILLE ROAD



Queues  
2: MERIDIAN ROAD & EASTONVILLE ROAD

Total 2040 PM Storage  
04/01/2023



Lane Group	EBL	EBT	EBR	WBL	WBT	WBR	NBL	NBT	NBR	SBL	SBT	SBR
Lane Group Flow (vph)	347	154	299	46	105	200	391	1982	173	123	1329	183
v/c Ratio	0.86	0.71	0.71	0.29	0.80	0.57	0.99	1.00	0.18	0.86	0.88	0.22
Control Delay	65.7	70.5	18.8	45.5	94.2	9.0	66.7	20.5	1.1	69.0	44.0	7.2
Queue Delay	0.0	0.0	0.0	0.0	0.0	0.0	0.0	0.0	0.0	0.0	0.0	0.0
Total Delay	65.7	70.5	18.8	45.5	94.2	9.0	66.7	20.5	1.1	69.0	44.0	7.2
Queue Length 50th (ft)	125	120	21	30	82	0	271	615	5	33	574	32
Queue Length 95th (ft)	#207	#241	#139	64	#179	29	m239	m185	m4	m#140	649	80
Internal Link Dist (ft)		508			1196			231				781
Turn Bay Length (ft)	100		100	120		100	100		400	375		400
Base Capacity (vph)	405	218	424	157	131	349	395	1990	967	143	1518	819
Starvation Cap Reductn	0	0	0	0	0	0	0	0	0	0	0	0
Spillback Cap Reductn	0	0	0	0	0	0	0	0	0	0	0	0
Storage Cap Reductn	0	0	0	0	0	0	0	0	0	0	0	0
Reduced v/c Ratio	0.86	0.71	0.71	0.29	0.80	0.57	0.99	1.00	0.18	0.86	0.88	0.22

Intersection Summary




























# 95th percentile volume exceeds capacity, queue may be longer.

Queue shown is maximum after two cycles.

m Volume for 95th percentile queue is metered by upstream signal.

HCM 6th Signalized Intersection Summary  
 2: MERIDIAN ROAD & EASTONVILLE ROAD

Total 2040 PM Storage  
 04/01/2023

												
Movement	EBL	EBT	EBR	WBL	WBT	WBR	NBL	NBT	NBR	SBL	SBT	SBR
Lane Configurations	 							 			 	
Traffic Volume (veh/h)	330	146	284	44	100	190	371	1883	164	117	1263	174
Future Volume (veh/h)	330	146	284	44	100	190	371	1883	164	117	1263	174
Initial Q (Qb), veh	0	0	0	0	0	0	0	0	0	0	0	0
Ped-Bike Adj(A_pbT)	1.00		1.00	1.00		1.00	1.00		1.00	1.00		1.00
Parking Bus, Adj	1.00	1.00	1.00	1.00	1.00	1.00	1.00	1.00	1.00	1.00	1.00	1.00
Work Zone On Approach		No			No			No			No	
Adj Sat Flow, veh/h/ln	1870	1870	1870	1870	1870	1870	1870	1870	1870	1870	1870	1870
Adj Flow Rate, veh/h	347	154	0	46	105	0	391	1982	173	123	1329	183
Peak Hour Factor	0.95	0.95	0.95	0.95	0.95	0.95	0.95	0.95	0.95	0.95	0.95	0.95
Percent Heavy Veh, %	2	2	2	2	2	2	2	2	2	2	2	2
Cap, veh/h	404	204		154	132		416	1999	892	144	1550	691
Arrive On Green	0.07	0.11	0.00	0.03	0.07	0.00	0.18	0.56	0.56	0.05	0.44	0.44
Sat Flow, veh/h	3456	1870	1585	1781	1870	1585	1781	3554	1585	1781	3554	1585
Grp Volume(v), veh/h	347	154	0	46	105	0	391	1982	173	123	1329	183
Grp Sat Flow(s),veh/h/ln	1728	1870	1585	1781	1870	1585	1781	1777	1585	1781	1777	1585
Q Serve(g_s), s	8.5	9.6	0.0	2.9	6.6	0.0	19.5	66.2	6.4	4.6	40.4	8.8
Cycle Q Clear(g_c), s	8.5	9.6	0.0	2.9	6.6	0.0	19.5	66.2	6.4	4.6	40.4	8.8
Prop In Lane	1.00		1.00	1.00		1.00	1.00		1.00	1.00		1.00
Lane Grp Cap(c), veh/h	404	204		154	132		416	1999	892	144	1550	691
V/C Ratio(X)	0.86	0.76		0.30	0.79		0.94	0.99	0.19	0.86	0.86	0.26
Avail Cap(c_a), veh/h	404	204		177	132		428	1999	892	144	1550	691
HCM Platoon Ratio	1.00	1.00	1.00	1.00	1.00	1.00	1.00	1.00	1.00	1.00	1.00	1.00
Upstream Filter(I)	1.00	1.00	0.00	1.00	1.00	0.00	1.00	1.00	1.00	1.00	1.00	1.00
Uniform Delay (d), s/veh	50.9	51.9	0.0	49.6	54.9	0.0	34.8	26.0	12.9	28.7	30.5	21.6
Incr Delay (d2), s/veh	16.8	14.8	0.0	1.1	27.1	0.0	28.6	18.2	0.5	36.9	6.3	0.9
Initial Q Delay(d3),s/veh	0.0	0.0	0.0	0.0	0.0	0.0	0.0	0.0	0.0	0.0	0.0	0.0
%ile BackOfQ(50%),veh/ln	2.1	5.3	0.0	1.3	4.1	0.0	14.1	28.7	2.4	3.2	17.1	3.5
Unsig. Movement Delay, s/veh												
LnGrp Delay(d),s/veh	67.7	66.7	0.0	50.7	82.0	0.0	63.3	44.2	13.4	65.6	36.8	22.5
LnGrp LOS	E	E		D	F		E	D	B	E	D	C
Approach Vol, veh/h		501	A		151	A		2546			1635	
Approach Delay, s/veh		67.4			72.5			45.0			37.4	
Approach LOS		E			E			D			D	
Timer - Assigned Phs	1	2	3	4	5	6	7	8				
Phs Duration (G+Y+Rc), s	14.0	75.0	11.4	19.6	29.2	59.8	16.0	15.0				
Change Period (Y+Rc), s	8.5	7.5	7.5	6.5	7.5	7.5	7.5	6.5				
Max Green Setting (Gmax), s	5.5	67.5	5.5	11.5	22.5	51.5	8.5	8.5				
Max Q Clear Time (g_c+I1), s	6.6	68.2	4.9	11.6	21.5	42.4	10.5	8.6				
Green Ext Time (p_c), s	0.0	0.0	0.0	0.0	0.1	5.6	0.0	0.0				

Intersection Summary												
HCM 6th Ctrl Delay			45.6									
HCM 6th LOS			D									

Notes  
 User approved pedestrian interval to be less than phase max green.  
 Unsignalized Delay for [EBR, WBR] is excluded from calculations of the approach delay and intersection delay.



Timings  
 3: MERIDIAN ROAD & BENT GRASS MEADOWS DRIVE

Total PM 2040 Storage  
 04/01/2023

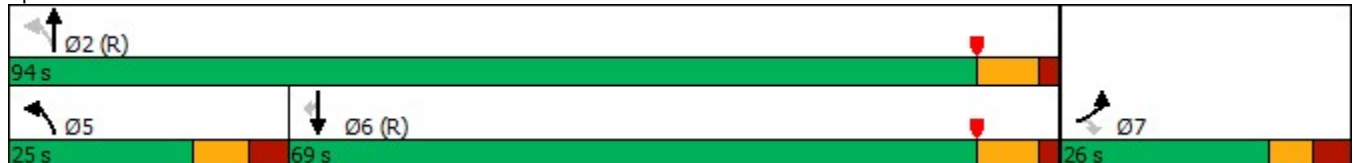


Lane Group	EBL	EBR	NBL	NBT	SBT	SBR
Lane Configurations	↖↖	↗	↖	↑↑	↑↑	↗
Traffic Volume (vph)	133	164	167	2174	1340	173
Future Volume (vph)	133	164	167	2174	1340	173
Turn Type	Prot	Perm	pm+pt	NA	NA	Perm
Protected Phases	7		5	2	6	
Permitted Phases		7	2			6
Detector Phase	7	7	5	2	6	6
Switch Phase						
Minimum Initial (s)	8.0	8.0	5.0	15.0	15.0	15.0
Minimum Split (s)	25.5	25.5	13.5	25.5	25.5	25.5
Total Split (s)	26.0	26.0	25.0	94.0	69.0	69.0
Total Split (%)	21.7%	21.7%	20.8%	78.3%	57.5%	57.5%
Yellow Time (s)	4.0	4.0	5.0	5.5	5.5	5.5
All-Red Time (s)	3.5	3.5	3.5	2.0	2.0	2.0
Lost Time Adjust (s)	0.0	0.0	0.0	0.0	0.0	0.0
Total Lost Time (s)	7.5	7.5	8.5	7.5	7.5	7.5
Lead/Lag			Lead		Lag	Lag
Lead-Lag Optimize?			Yes		Yes	Yes
Recall Mode	None	None	None	C-Max	C-Max	C-Max
Act Effct Green (s)	10.4	10.4	93.6	94.6	75.2	75.2
Actuated g/C Ratio	0.09	0.09	0.78	0.79	0.63	0.63
v/c Ratio	0.47	0.59	0.57	0.82	0.64	0.17
Control Delay	57.2	16.0	20.5	5.8	16.5	2.1
Queue Delay	0.0	0.0	0.0	0.0	0.0	0.0
Total Delay	57.2	16.0	20.5	5.8	16.5	2.1
LOS	E	B	C	A	B	A
Approach Delay	34.4			6.9	14.9	
Approach LOS	C			A	B	

Intersection Summary

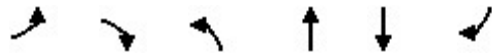
Cycle Length: 120  
 Actuated Cycle Length: 120  
 Offset: 27 (23%), Referenced to phase 2:NBTL and 6:SBT, Start of Yellow  
 Natural Cycle: 90  
 Control Type: Actuated-Coordinated  
 Maximum v/c Ratio: 0.82  
 Intersection Signal Delay: 11.8  
 Intersection LOS: B  
 Intersection Capacity Utilization 79.3%  
 ICU Level of Service D  
 Analysis Period (min) 15

Splits and Phases: 3: MERIDIAN ROAD & BENT GRASS MEADOWS DRIVE



## 3: MERIDIAN ROAD &amp; BENT GRASS MEADOWS DRIVE

04/01/2023



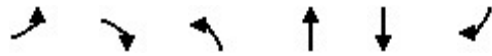
Lane Group	EBL	EBR	NBL	NBT	SBT	SBR
Lane Group Flow (vph)	140	173	176	2288	1411	182
v/c Ratio	0.47	0.59	0.57	0.82	0.64	0.17
Control Delay	57.2	16.0	20.5	5.8	16.5	2.1
Queue Delay	0.0	0.0	0.0	0.0	0.0	0.0
Total Delay	57.2	16.0	20.5	5.8	16.5	2.1
Queue Length 50th (ft)	54	0	39	123	325	0
Queue Length 95th (ft)	85	67	m43	m137	495	32
Internal Link Dist (ft)	310			750	1921	
Turn Bay Length (ft)	150		700			350
Base Capacity (vph)	529	390	383	2791	2219	1060
Starvation Cap Reductn	0	0	0	0	0	0
Spillback Cap Reductn	0	0	0	0	0	0
Storage Cap Reductn	0	0	0	0	0	0
Reduced v/c Ratio	0.26	0.44	0.46	0.82	0.64	0.17

## Intersection Summary

m Volume for 95th percentile queue is metered by upstream signal.

HCM 6th Signalized Intersection Summary  
 3: MERIDIAN ROAD & BENT GRASS MEADOWS DRIVE

Total PM 2040 Storage  
 04/01/2023



Movement	EBL	EBR	NBL	NBT	SBT	SBR
Lane Configurations	↖↗	↗	↖	↑↑	↑↑	↗
Traffic Volume (veh/h)	133	164	167	2174	1340	173
Future Volume (veh/h)	133	164	167	2174	1340	173
Initial Q (Qb), veh	0	0	0	0	0	0
Ped-Bike Adj(A_pbT)	1.00	1.00	1.00			1.00
Parking Bus, Adj	1.00	1.00	1.00	1.00	1.00	1.00
Work Zone On Approach	No			No	No	
Adj Sat Flow, veh/h/ln	1870	1870	1870	1870	1870	1870
Adj Flow Rate, veh/h	140	0	176	2288	1411	182
Peak Hour Factor	0.95	0.95	0.95	0.95	0.95	0.95
Percent Heavy Veh, %	2	2	2	2	2	2
Cap, veh/h	228		299	2875	2459	1097
Arrive On Green	0.07	0.00	0.05	0.81	0.69	0.69
Sat Flow, veh/h	3456	1585	1781	3647	3647	1585
Grp Volume(v), veh/h	140	0	176	2288	1411	182
Grp Sat Flow(s),veh/h/ln	1728	1585	1781	1777	1777	1585
Q Serve(g_s), s	4.7	0.0	3.2	41.4	24.4	4.8
Cycle Q Clear(g_c), s	4.7	0.0	3.2	41.4	24.4	4.8
Prop In Lane	1.00	1.00	1.00			1.00
Lane Grp Cap(c), veh/h	228		299	2875	2459	1097
V/C Ratio(X)	0.61		0.59	0.80	0.57	0.17
Avail Cap(c_a), veh/h	533		461	2875	2459	1097
HCM Platoon Ratio	1.00	1.00	1.00	1.00	1.00	1.00
Upstream Filter(I)	1.00	0.00	1.00	1.00	1.00	1.00
Uniform Delay (d), s/veh	54.5	0.0	10.4	6.1	9.4	6.4
Incr Delay (d2), s/veh	2.7	0.0	1.8	2.4	1.0	0.3
Initial Q Delay(d3),s/veh	0.0	0.0	0.0	0.0	0.0	0.0
%ile BackOfQ(50%),veh/ln	2.1	0.0	1.9	12.2	9.0	8.0
Unsig. Movement Delay, s/veh						
LnGrp Delay(d),s/veh	57.2	0.0	12.3	8.5	10.4	6.8
LnGrp LOS	E		B	A	B	A
Approach Vol, veh/h	140	A		2464	1593	
Approach Delay, s/veh	57.2			8.8	10.0	
Approach LOS	E			A	B	
Timer - Assigned Phs		2		4	5	6
Phs Duration (G+Y+Rc), s		104.6		15.4	14.1	90.5
Change Period (Y+Rc), s		7.5		7.5	8.5	7.5
Max Green Setting (Gmax), s		86.5		18.5	16.5	61.5
Max Q Clear Time (g_c+I1), s		43.4		6.7	5.2	26.4
Green Ext Time (p_c), s		32.2		0.3	0.3	15.6

Intersection Summary

HCM 6th Ctrl Delay	10.9
HCM 6th LOS	B

Notes

Unsignalized Delay for [EBR] is excluded from calculations of the approach delay and intersection delay.

Intersection						
Int Delay, s/veh	4					
Movement	EBT	EBR	WBL	WBT	NBL	NBR
Lane Configurations	↑	↗	↘	↑	↘	↗
Traffic Vol, veh/h	139	57	151	189	3	158
Future Vol, veh/h	139	57	151	189	3	158
Conflicting Peds, #/hr	0	0	0	0	0	0
Sign Control	Free	Free	Free	Free	Stop	Stop
RT Channelized	-	None	-	None	-	None
Storage Length	-	150	100	-	0	-
Veh in Median Storage, #	0	-	-	0	0	-
Grade, %	0	-	-	0	0	-
Peak Hour Factor	95	95	95	95	95	95
Heavy Vehicles, %	2	2	2	2	2	2
Mvmt Flow	146	60	159	199	3	166

Major/Minor	Major1	Major2	Minor1		
Conflicting Flow All	0	0	206	0	663 146
Stage 1	-	-	-	-	146 -
Stage 2	-	-	-	-	517 -
Critical Hdwy	-	-	4.12	-	6.42 6.22
Critical Hdwy Stg 1	-	-	-	-	5.42 -
Critical Hdwy Stg 2	-	-	-	-	5.42 -
Follow-up Hdwy	-	-	2.218	-	3.518 3.318
Pot Cap-1 Maneuver	-	-	1365	-	426 901
Stage 1	-	-	-	-	881 -
Stage 2	-	-	-	-	598 -
Platoon blocked, %	-	-	-	-	-
Mov Cap-1 Maneuver	-	-	1365	-	377 901
Mov Cap-2 Maneuver	-	-	-	-	377 -
Stage 1	-	-	-	-	881 -
Stage 2	-	-	-	-	529 -

Approach	EB	WB	NB
HCM Control Delay, s	0	3.5	10.1
HCM LOS			B

Minor Lane/Major Mvmt	NBLn1	EBT	EBR	WBL	WBT
Capacity (veh/h)	878	-	-	1365	-
HCM Lane V/C Ratio	0.193	-	-	0.116	-
HCM Control Delay (s)	10.1	-	-	8	-
HCM Lane LOS	B	-	-	A	-
HCM 95th %tile Q(veh)	0.7	-	-	0.4	-

Total PM 2040 Storage

