

See comment on Prelim Plan
Drawing in regards to the need
for a permanent WQ facility

PRELIMINARY/FINAL DRAINAGE REPORT FOR PINE VIEW ESTATES

JUNE 2020

Prepared for:

Alice Owens
18430 Lost Ranger Road
Peyton, CO 80831

Prepared By:



321 W. Henrietta Ave, Suite A
Woodland Park, CO 80863
719-426-2124

SP-20-004

PCD FILE NO's: SP-20-____
SF-20-____

SF-20-019

PRELIMINARY/FINAL DRAINAGE REPORT
PINE VIEW ESTATES

Engineer's Statement:

The attached drainage plan and report were prepared under my direction and supervision and are correct to the best of my knowledge and belief. Said drainage report has been prepared according the criteria established for drainage reports and said report is in conformity with the master plan of the drainage basin. I accept responsibility for any liability caused by any negligent acts, errors, or omissions on my part in preparing this report.

Certification Statement:

This report and plan for the preliminary and final drainage design for the PINE VIEW ESTATES was prepared by me (or under my direct supervision) in accordance with the provisions of City of Colorado Springs/El Paso County Drainage Criteria Manual Volumes 1 and 2 Drainage Design and Technical Criteria for the owners thereof. I understand that El Paso County does not and will not assume liability for drainage facilities designed by others.

David L. Mijares, Colorado PE #40510
For and on behalf of Catamount Engineering

Date

Developer's Statement:

I, the developer have read and will comply with all of the requirements specified in this drainage report and plan.

John Jennings hereby certifies that the drainage facilities for PINE VIEW ESTATES shall be constructed according to the design presented in this report. I understand that El Paso County does not and will not assume liability for the drainage facilities designed and or certified by my engineer and that the El Paso County reviews drainage plans pursuant to Colorado Revised Statues, Title 30, Article 28; but cannot, on behalf of PINE VIEW ESTATES, guarantee that final drainage design review will absolve ALICE OWENS and/or their successors and/or assigns of future liability for improper design. I further understand that approval of the final plat does not imply approval of my engineer's drainage design.

Alice Owens
Business Name

By: _____

Title: _____

Address: _____ 18430 Lost Ranger Road

Peyton, CO 80831

El Paso County:

Filed in accordance with the requirements of the El Paso County land Development Code and the Drainage Criteria manual Volumes 1 and 2, and the El Paso County Engineering Criteria Manual, latest revision.

Jennifer Irvine, PE
County Engineer/ECM Administrator

Date

Conditions:

PRELIMINARY/FINAL DRAINAGE REPORT for PINE VIEW ESTATES

PURPOSE

The purpose of this drainage report is to identify existing drainage patterns, quantify developed storm water runoff, and establish outfall scenarios from the proposed development.

GENERAL LOCATION AND DESCRIPTION

The subject 38.828 acres consists of unplatted land to be developed into 7 rural residential lots (RR-5 zoning) located within the SW ¼ of the NW ¼ of Section 13, Township 11 South, Range 64 West of the 6th principal meridian in unincorporated El Paso County. The parcel is bounded to the north by unplatted land, to the east and south by platted RR-5 residential lots within Peyton Pines Filing No. 4, and to the west by unplatted agricultural land. Access to the parcel is from existing Red Barn Road to the east of the parcel, a gravel county local roadway.

The parcel is located on a ridge within the Bijou Creek drainage. The westerly portion of the parcel sheet flows west to an unnamed tributary of West Bijou Creek within the adjacent agriculturally zoned unplatted parcel at slopes between 2% and 6%. The southeasterly portion of the parcel sheet flows east to an unnamed tributary of West Bijou Creek within adjacent 5-acre residential parcels at slopes between 2% and 5%. The northeasterly portion of the parcel sheet flows north at slopes between 2% and 5% through a historic stock pond and continues north to an unnamed tributary of West Bijou Creek. The site is located within the Bijou Creek Basin.

Existing soils on the site consist of Brusset loam, hydrologic soil group B (86.8%), and Peyton - Pring complex, hydrologic soil group B (13.2%) as determined by the Natural Resources Conservation Service Web Soil Survey. The site is vegetated with native grasses. Moderate shrub and tree cover are evident and increases within the westerly portions of the site

No portion of the site lies within an F.E.M.A. designated floodplain per FIRM 08041C0350 G, effective December 07, 2018. A firmette exhibiting the parcel has been included in the appendix of this report.

EXISTING DRAINAGE CONDITIONS

No existing studies on the site or overall basin have been identified. The parcel exists on a minor ridge between two unnamed tributaries of West Bijou Creek generally draining to the north. Parcel was historically used for agricultural grazing and an existing minor stock pond exists within the northerly reach of Basin E1. The stock pond was not used in hydrologic calculations. As the parcel is located on a ridge between minor tributaries, no significant offsite runoff enters the parcel.

Basin E1 (11.5 Acres, $Q_2=0.7$ cfs, $Q_5=2.5$ cfs, $Q_{10}=5.5$ cfs, $Q_{25}=9.6$ cfs, $Q_{50}=12.9$ cfs, and $Q_{100}=16.7$ cfs) consists of that portion within the westerly portion of the parcel that sheetflow west to the westerly unnamed tributary of West Bijou Creek.

Basin E2 (12.47 Acres, $Q_2=0.6$ cfs, $Q_5=2.4$ cfs, $Q_{10}=5.2$ cfs, $Q_{25}=9.1$ cfs, $Q_{50}=12.2$ cfs, and $Q_{100}=15.9$ cfs) consists of the southeasterly portion of the parcel that sheet flows easterly to the easterly unnamed tributary of West Bijou Creek.

Basin E3 (14.77 Acres, $Q_2=0.8$ cfs, $Q_5=2.9$ cfs, $Q_{10}=6.4$ cfs, $Q_{25}=11.2$ cfs, $Q_{50}=15.1$ cfs, and $Q_{100}=19.6$ cfs) consists of the central and northerly portion of the parcel that flows northerly to the historic stock pond prior to release to the easterly unnamed tributary of West Bijou Creek.

DEVELOPED DRAINAGE BASINS

The majority of the area within developed basins was modeled as agricultural land. A 1 acre developed area was assumed for each lot located in respective basins. Proposed roadway and shoulders were modeled as gravel where proposed.

Basin A1 (11.57 Acres, $Q_2=1.1$ cfs, $Q_5=3.3$ cfs, $Q_{10}=6.6$ cfs, $Q_{25}=11.0$ cfs, $Q_{50}=14.7$ cfs, and $Q_{100}=18.8$ cfs) represents portions of the proposed residential lots within the westerly portion of the parcel (Historic Basin E1). Runoff generated within the basin will sheetflow east in the historic pattern.

Basin A2 (14.42 Acres, $Q_2=1.5$ cfs, $Q_5=4.0$ cfs, $Q_{10}=7.5$ cfs, $Q_{25}=12.4$ cfs, $Q_{50}=16.3$ cfs, and $Q_{100}=20.8$ cfs) represents portions of the proposed residential lots and the southerly half of the proposed roadway within the southeasterly portion of the parcel (Historic Basin E2). Runoff generated within the basin will sheetflow north and be conveyed in the proposed roadside ditch easterly to the existing roadside ditch within the ROW of existing Red Barn Road. Runoff will be conveyed in the ditch to the easterly unnamed tributary of West Bijou Creek.

Basin A3 (11.34 Acres, $Q_2=1.2$ cfs, $Q_5=3.1$ cfs, $Q_{10}=6.1$ cfs, $Q_{25}=10.1$ cfs, $Q_{50}=13.4$ cfs, and $Q_{100}=17.1$ cfs) represents portions of the proposed residential lots and the westerly portion of the northern half of the proposed roadway within the central and northern portion of the parcel (Historic Basin E3). Runoff generated within the basin will sheetflow north to the existing stock pond within the northerly portion of the development. Runoff from Basin A3 will continue to the existing easterly reach of the unnamed tributary of West Bijou Creek.

Basin A4 (1.48 Acres, $Q_2=0.3$ cfs, $Q_5=0.6$ cfs, $Q_{10}=1.1$ cfs, $Q_{25}=1.8$ cfs, $Q_{50}=2.3$ cfs, and $Q_{100}=2.9$ cfs) represents portions of the proposed residential lots and the easterly portion of the northerly half of the proposed roadway within the easterly portion of the ROW and represents the portion of historic Basin E2 truncated by the proposed roadway. Runoff generated within the basin will sheetflow northeasterly to the unnamed easterly tributary of West Bijou Creek.

The rational methodology was utilized in analyzing on-site basins for development of on-site improvements. The minor increase in impervious area due to roadway and homesite development within the 38.83-acre subdivision would not substantially impact historic drainage

patterns. Detention is not typically pursued in rural development scenarios unless undetained upstream development would negatively affect the development. A significant portion of runoff generated within typical rural development does not flow directly into County stormwater systems, but leaves improved areas as sheetflow into undeveloped and vegetated portions of lots and infiltrates into the ground. The site was analyzed for Site-Level Low Impact Development (LID) Design Credit by Impervious Reduction Factor (IRF) exhibiting reductions from proposed building site, assuming a 5,000-sf impervious footprint per lot, and gravel roadways outfalling to substantial receiving pervious areas.

See Appendix for Calculations.

WATER QUALITY/4-STEP PROCESS

The development addresses Low Impact Development strategies primarily through the utilization of large impervious areas and utilization of landscape swales receiving runoff generated within impervious roadways.

Step 1-Employ Runoff Reduction Practices

Impervious areas generated within the development will flow across pervious disconnected areas prior to offsite discharge. Runoff generated within roadway improvements will be directed to grassed roadside ditches and conveyed to grassed channels no curb or storm sewer improvements are proposed with the development.

Step2-Stabilize Drainageway

Proposed channel improvements are designed at sizes and grades allowing development as grass lined swales rather than hard-sided improvements. The unnamed tributaries of West Bijou Creek adjacent to the project are not directly adjacent to the parcel and reduced runoff due to substantial conveyance across both onsite and offsite pervious area at relatively flat grades will mitigate minor increases in impervious area with 5-acre lot development prior to affecting the drainageways.

Step3-Provide Water Quality Capture Volume

Permanent water quality facility is not proposed for development of 5 acre lots per the requirements of El Paso County Engineering Criteria Manual Section I.7.1B. Runoff reduction (IRF) indicates effective site imperviousness of 0.7%.

Step4-Consider Need for Industrial and Commercial BMP's

A Grading, Erosion Control, and Stormwater Quality Plan and narrative have been submitted concurrently for the development and will be subject to county approval prior to any soil disturbance. The erosion control plan included specific source control BMP's as well as defined overall site management practices for the construction period. No industrial or Commercial density development is proposed.

COST ESTIMATE

No drainage improvements are proposed with development of 5-acre residential lots.

DRAINAGE FEE CALCULATION

The development proposes to plat 38.828 acres within El Paso County, all contained within the Bijou Creek Drainage Basin. The Bijou Creek Drainage Basin has not been studied and no drainage or bridge fees have been adopted.

DRAINAGE METHODOLOGY

This drainage report was prepared in accordance to the criteria established in the El Paso County Drainage Criteria Manual Volumes 1 and 2, as revised May 2014.

The rational method for drainage basin study areas of less than 100 acres was utilized in the on-site analysis. For the Rational Method, flows were calculated for the 2, 5, 10, 25, 50, and 100-year recurrence intervals. The average runoff coefficients, 'C' values, are taken from Table 6-6 and the Intensity-Duration-Frequency curves are taken from Figure 6-5 of the City Drainage Criteria Manual. Time of concentration for overland flow and storm drain or gutter flow are calculated per Section 3.2 of the City Drainage Criteria Manual. Calculations for the Rational Method are shown in the Appendix of this report.

SUMMARY

The Pine View Estates development consists of large lot development with minor increases in impervious areas consistent with surrounding development. The development will not adversely affect downstream properties or facilities.

REFERENCES:

County of El Paso Drainage Criteria Manual Volumes 1 and 2, revised May 2014

Flood Insurance rate map 08041C00350 G, December 07. 2018

Natural Resources Conservation Service Web Soil Survey

APPENDIX

PROPOSED HYDROLOGY

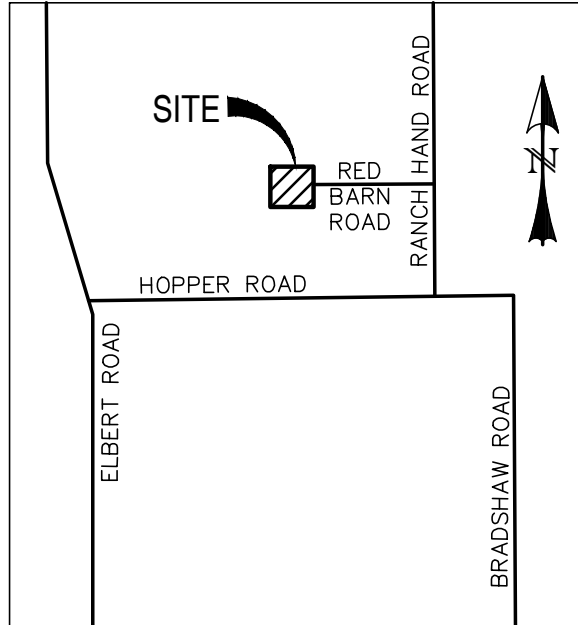

VICINITY MAP
SCALE: N.T.S.

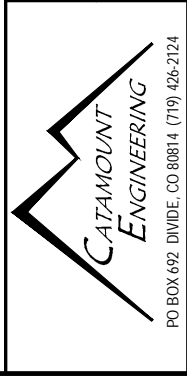
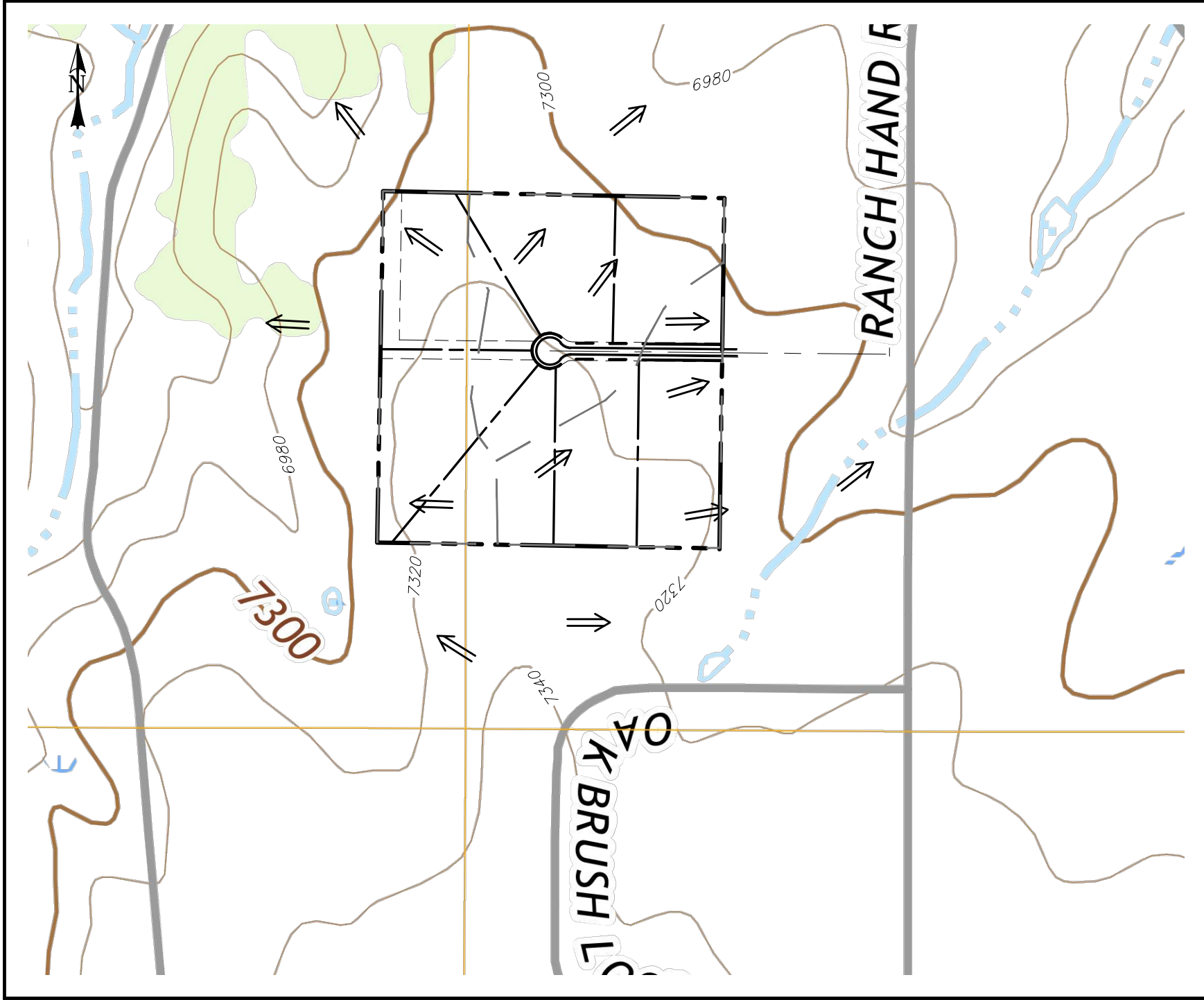

PO BOX 692 DIVIDE, CO 80814 (719) 426-2124

PINE VIEW ESTATES

OFFSITE TOPOGRAPHY

SCALE: 1"=500'

JOB NO.: 18-158

DATE: 07/18/20

SHEET: 1 OF 1

National Flood Hazard Layer FIRMMette



104°31'5"W 39°5'50"N



Legend

SEE FIS REPORT FOR DETAILED LEGEND AND INDEX MAP FOR FIRM PANEL LAYOUT

- | | | |
|------------------------------------|--|--|
| SPECIAL FLOOD HAZARD AREAS | | Without Base Flood Elevation (BFE)
<i>Zone A, V, A99</i> |
| | | With BFE or Depth <i>Zone AE, AO, AH, VE, AR</i> |
| | | Regulatory Floodway |
| OTHER AREAS OF FLOOD HAZARD | | 0.2% Annual Chance Flood Hazard, Areas of 1% annual chance flood with average depth less than one foot or with drainage areas of less than one square mile <i>Zone X</i> |
| | | Future Conditions 1% Annual Chance Flood Hazard <i>Zone X</i> |
| | | Area with Reduced Flood Risk due to Levee. See Notes. <i>Zone X</i> |
| | | Area with Flood Risk due to Levee <i>Zone D</i> |
| OTHER AREAS | | NO SCREEN Area of Minimal Flood Hazard <i>Zone X</i> |
| | | Effective LOMRs |
| GENERAL STRUCTURES | | Area of Undetermined Flood Hazard <i>Zone D</i> |
| | | Channel, Culvert, or Storm Sewer |
| | | Levee, Dike, or Floodwall |
| OTHER FEATURES | | 20.2 Cross Sections with 1% Annual Chance |
| | | 17.5 Water Surface Elevation |
| | | Coastal Transect |
| | | Base Flood Elevation Line (BFE) |
| | | Limit of Study |
| | | Jurisdiction Boundary |
| MAP PANELS | | Coastal Transect Baseline |
| | | Profile Baseline |
| | | Hydrographic Feature |
| | | Digital Data Available |
| | | No Digital Data Available |
| | | Unmapped |



The pin displayed on the map is an approximate point selected by the user and does not represent an authoritative property location.

This map complies with FEMA's standards for the use of digital flood maps if it is not void as described below. The basemap shown complies with FEMA's basemap accuracy standards

The flood hazard information is derived directly from the authoritative NFHL web services provided by FEMA. This map was exported on **7/19/2020 at 2:51 PM** and does not reflect changes or amendments subsequent to this date and time. The NFHL and effective information may change or become superseded by new data over time.

This map image is void if the one or more of the following map elements do not appear: basemap imagery, flood zone labels, legend, scale bar, map creation date, community identifiers, FIRM panel number, and FIRM effective date. Map images for unmapped and unmodernized areas cannot be used for regulatory purposes.

USGS The National Map: Orthoimagery. Data refreshed April 2020

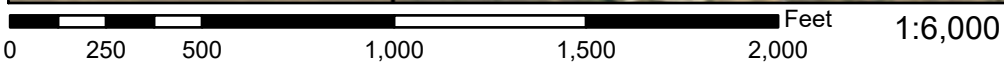

104°30'28"W 39°5'22"N

Hydrologic Soil Group—El Paso County Area, Colorado
(PINE VIEW ESTATES)

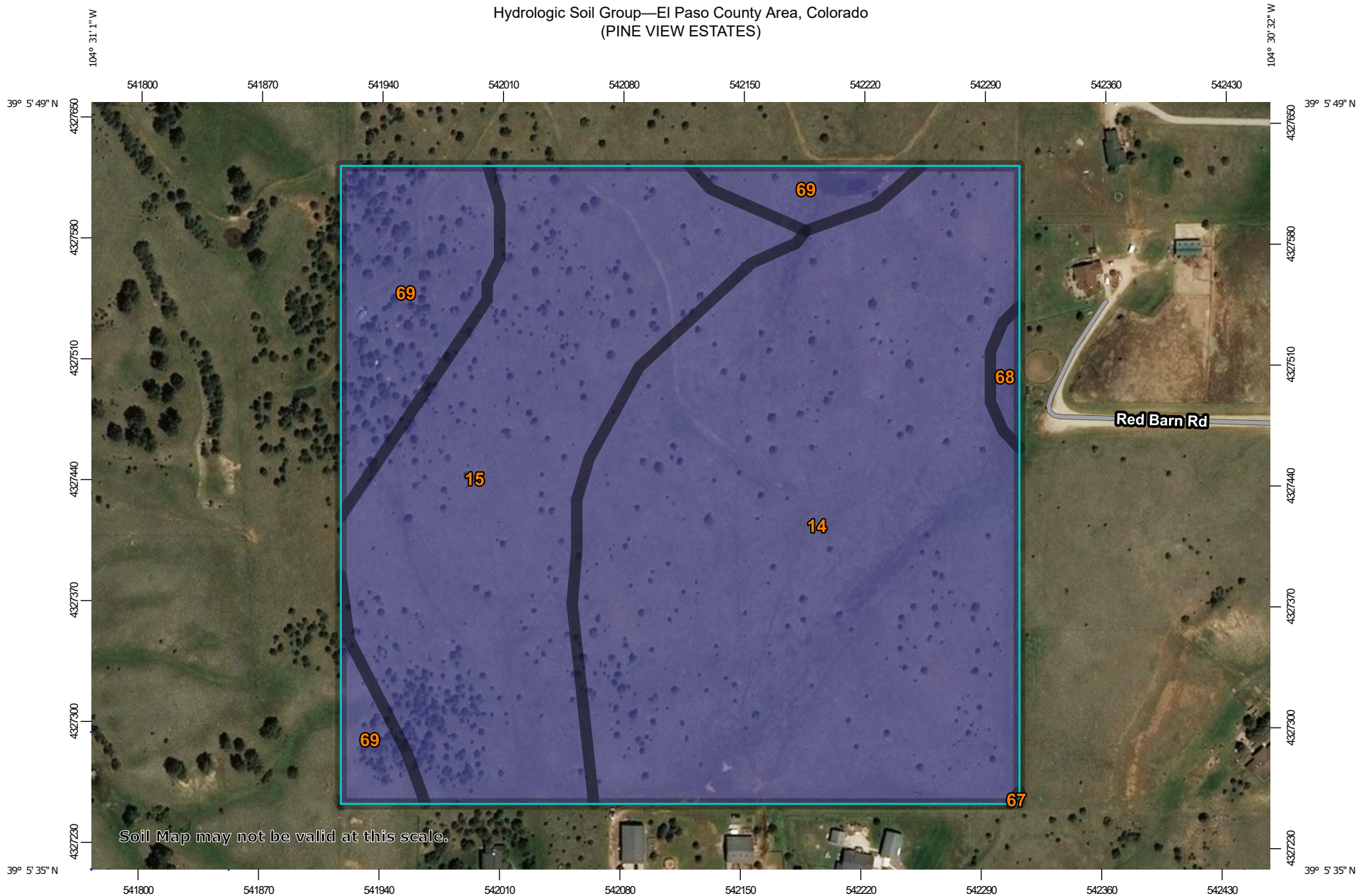

Soil Map may not be valid at this scale.

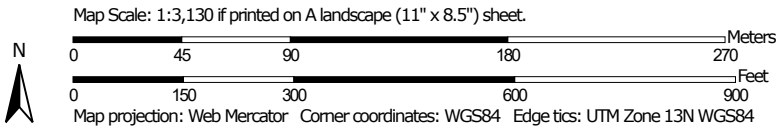

Hydrologic Soil Group—El Paso County Area, Colorado
(PINE VIEW ESTATES)

MAP LEGEND

Area of Interest (AOI)









 Area of Interest (AOI)

Soils

Soil Rating Polygons

-  A
-  A/D
-  B
-  B/D
-  C
-  C/D
-  D
-  Not rated or not available

Soil Rating Lines

-  A
-  A/D
-  B
-  B/D
-  C
-  C/D
-  D
-  Not rated or not available

Soil Rating Points





-  A
-  A/D
-  B
-  B/D

-  C
-  C/D
-  D
-  Not rated or not available

Water Features

 Streams and Canals

Transportation

-  Rails
-  Interstate Highways
-  US Routes
-  Major Roads
-  Local Roads

Background

 Aerial Photography

MAP INFORMATION

The soil surveys that comprise your AOI were mapped at 1:24,000.

Warning: Soil Map may not be valid at this scale.

Enlargement of maps beyond the scale of mapping can cause misunderstanding of the detail of mapping and accuracy of soil line placement. The maps do not show the small areas of contrasting soils that could have been shown at a more detailed scale.

Please rely on the bar scale on each map sheet for map measurements.

Source of Map: Natural Resources Conservation Service
Web Soil Survey URL:
Coordinate System: Web Mercator (EPSG:3857)

Maps from the Web Soil Survey are based on the Web Mercator projection, which preserves direction and shape but distorts distance and area. A projection that preserves area, such as the Albers equal-area conic projection, should be used if more accurate calculations of distance or area are required.

This product is generated from the USDA-NRCS certified data as of the version date(s) listed below.

Soil Survey Area: El Paso County Area, Colorado
Survey Area Data: Version 18, Jun 5, 2020

Soil map units are labeled (as space allows) for map scales 1:50,000 or larger.

Date(s) aerial images were photographed: Sep 8, 2018—May 26, 2019

The orthophoto or other base map on which the soil lines were compiled and digitized probably differs from the background imagery displayed on these maps. As a result, some minor shifting of map unit boundaries may be evident.

Hydrologic Soil Group

Map unit symbol	Map unit name	Rating	Acres in AOI	Percent of AOI
14	Brussett loam, 1 to 3 percent slopes	B	19.7	54.5%
15	Brussett loam, 3 to 5 percent slopes	B	11.7	32.3%
67	Peyton sandy loam, 5 to 9 percent slopes	B	0.0	0.0%
68	Peyton-Pring complex, 3 to 8 percent slopes	B	0.3	0.7%
69	Peyton-Pring complex, 8 to 15 percent slopes	B	4.5	12.4%
Totals for Area of Interest			36.2	100.0%

Description

Hydrologic soil groups are based on estimates of runoff potential. Soils are assigned to one of four groups according to the rate of water infiltration when the soils are not protected by vegetation, are thoroughly wet, and receive precipitation from long-duration storms.

The soils in the United States are assigned to four groups (A, B, C, and D) and three dual classes (A/D, B/D, and C/D). The groups are defined as follows:

Group A. Soils having a high infiltration rate (low runoff potential) when thoroughly wet. These consist mainly of deep, well drained to excessively drained sands or gravelly sands. These soils have a high rate of water transmission.

Group B. Soils having a moderate infiltration rate when thoroughly wet. These consist chiefly of moderately deep or deep, moderately well drained or well drained soils that have moderately fine texture to moderately coarse texture. These soils have a moderate rate of water transmission.

Group C. Soils having a slow infiltration rate when thoroughly wet. These consist chiefly of soils having a layer that impedes the downward movement of water or soils of moderately fine texture or fine texture. These soils have a slow rate of water transmission.

Group D. Soils having a very slow infiltration rate (high runoff potential) when thoroughly wet. These consist chiefly of clays that have a high shrink-swell potential, soils that have a high water table, soils that have a claypan or clay layer at or near the surface, and soils that are shallow over nearly impervious material. These soils have a very slow rate of water transmission.

If a soil is assigned to a dual hydrologic group (A/D, B/D, or C/D), the first letter is for drained areas and the second is for undrained areas. Only the soils that in their natural condition are in group D are assigned to dual classes.

Rating Options

Aggregation Method: Dominant Condition

Component Percent Cutoff: None Specified

Tie-break Rule: Higher

Only next page is existing. The page after that is Proposed. Please revise to clarify



EXISTING HYDROLOGY

BASIN	AREA TOTAL (Acres)								CONVEYANCE TC							TT	INTENSITY						TOTAL FLOWS							
		C ₂	C ₅	C ₁₀	C ₂₅	C ₅₀	C ₁₀₀	Length (ft)	Height (ft)	TI (min)	Length (ft)	Height (ft)	C _v	Slope (%)	Velocity (fps)	TC (min)	TOTAL (min)	I ₂ (in/hr)	I ₅ (in/hr)	I ₁₀ (in/hr)	I ₂₅ (in/hr)	I ₅₀ (in/hr)	I ₁₀₀ (in/hr)	Q ₂ (c.f.s.)	Q ₅ (c.f.s.)	Q ₁₀ (c.f.s.)	Q ₂₅ (c.f.s.)	Q ₅₀ (c.f.s.)	Q ₁₀₀ (c.f.s.)	
E1 <i>AGRICULTURE</i>	11.57	0.03	0.09	0.17	0.26	0.31	0.36	200	4	21.7	664	32	5	4.8%	1.1	10.1	31.8	1.9	2.4	2.8	3.2	3.6	4.0	0.7	2.5	5.5	9.6	12.9	16.7	
E2 <i>AGRICULTURE</i>	12.47	0.03	0.09	0.17	0.26	0.31	0.36	200	8	17.3	1019	26	5	2.6%	0.8	21.3	38.6	1.7	2.1	2.5	2.8	3.2	3.5	0.6	2.4	5.2	9.1	12.2	15.9	
E3 <i>AGRICULTURE</i>	14.77	0.03	0.09	0.17	0.26	0.31	0.36	200	5	20.2	943	36	5	3.8%	1.0	16.1	36.3	1.8	2.2	2.6	2.9	3.3	3.7	0.8	2.9	6.4	11.2	15.1	19.6	

Calculated by: DLM
Date: 7/16/2020

BASIN	AREA TOTAL (Acres)	CONVEYANCE TC						TT			INTENSITY						TOTAL FLOWS													
		C ₂	C ₅	C ₁₀	C ₂₅	C ₅₀	C ₁₀₀	Length (ft)	Height (ft)	TI (min)	Length (ft)	Height (ft)	C _v	Slope (%)	Velocity (fps)	TC (min)	TOTAL (min)	I ₂ (in/hr)	I ₅ (in/hr)	I ₁₀ (in/hr)	I ₂₅ (in/hr)	I ₅₀ (in/hr)	I ₁₀₀ (in/hr)	Q ₂ (c.f.s.)	Q ₅ (c.f.s.)	Q ₁₀ (c.f.s.)	Q ₂₅ (c.f.s.)	Q ₅₀ (c.f.s.)	Q ₁₀₀ (c.f.s.)	
A1	11.57	0.05	0.11	0.19	0.28	0.33	0.37	100	2	15.1	764	31	5	4.1%	1.0	12.6	27.8	2.1	2.6	3.0	3.5	3.9	4.4	1.1	3.3	6.6	11.0	14.7	18.8	
RESIDENTIAL	2.00	0.12	0.20	0.27	0.35	0.40	0.44																							
AGRICULTURE	9.57	0.03	0.09	0.17	0.26	0.31	0.36																							
A2	14.42	0.06	0.12	0.20	0.29	0.34	0.38	100	4	11.9	1041	23	5	2.2%	0.7	23.3	35.2	1.8	2.2	2.6	3.0	3.4	3.8	1.5	4.0	7.5	12.4	16.3	20.8	
RESIDENTIAL	3.00	0.12	0.20	0.27	0.35	0.40	0.44																							
GRAVEL	0.29	0.57	0.59	0.63	0.66	0.68	0.70																							
AGRICULTURE	11.13	0.03	0.09	0.17	0.26	0.31	0.36																							
A3	11.34	0.05	0.12	0.19	0.28	0.33	0.38	100	2	15.0	974	35	5	3.6%	0.9	17.1	32.1	1.9	2.4	2.8	3.2	3.6	4.0	1.2	3.1	6.1	10.1	13.4	17.1	
RESIDENTIAL	1.75	0.12	0.20	0.27	0.35	0.40	0.44																							
GRAVEL	0.22	0.57	0.59	0.63	0.66	0.68	0.70																							
AGRICULTURE	9.37	0.03	0.09	0.17	0.26	0.31	0.36																							
A4	1.48	0.09	0.15	0.22	0.30	0.35	0.40	100	2	14.6	299	6	5	2.0%	0.7	7.0	21.6	2.4	3.0	3.5	4.0	4.5	5.0	0.3	0.6	1.1	1.8	2.3	2.9	
RESIDENTIAL	0.25	0.12	0.20	0.27	0.35	0.40	0.44																							
GRAVEL	0.11	0.57	0.59	0.63	0.66	0.68	0.70																							
AGRICULTURE	1.12	0.03	0.09	0.17	0.26	0.31	0.36																							

Calculated by: DLM
Date: 7/16/2020

HYDRAULIC CALCULATIONS

Site-Level Low Impact Development (LID) Design Effective Impervious Calculator LID Credit by Impervious Reduction Factor (IRF) Method

UD-BMP (Version 3.06, November 2016)

User Input			
Calculated cells			
***Design Storm: 1-Hour Rain Depth	WQCV Event	1.19	inches
***Minor Storm: 1-Hour Rain Depth	10-Year Event	1.50	inches
***Major Storm: 1-Hour Rain Depth	100-Year Event	2.52	inches
Optional User Defined Storm	CUHP		
(CUHP) NOAA 1 Hour Rainfall Depth and Frequency for User Defined Storm	100-Year Event		
Max Intensity for Optional User Defined Storm		0	

Designer: David Miajres
 Company: Catamount Engineering
 Date: July 19, 2020
 Project: Pine View Estates
 Location: Peyton, CO

SITE INFORMATION (USER-INPUT)

Sub-basin Identifier	A1	A2	A3	A4													
Receiving Pervious Area Soil Type	Loam	Loam	Loam	Loam													
Total Area (ac., Sum of DCIA, UIA, RPA, & SPA)	11.570	14.420	11.340	1.480													
Directly Connected Impervious Area (DCIA, acres)	0.000	0.000	0.000	0.000													
Unconnected Impervious Area (UIA, acres)	0.230	0.630	0.420	0.140													
Receiving Pervious Area (RPA, acres)	11.340	13.790	10.920	1.340													
Separate Pervious Area (SPA, acres)	0.000	0.000	0.000	0.000													
RPA Treatment Type: Conveyance (C), Volume (V), or Permeable Pavement (PP)	C	C	C	C													

CALCULATED RESULTS (OUTPUT)

Total Calculated Area (ac, check against input)	11.570	14.420	11.340	1.480													
Directly Connected Impervious Area (DCIA, %)	0.0%	0.0%	0.0%	0.0%													
Unconnected Impervious Area (UIA, %)	2.0%	4.4%	3.7%	9.5%													
Receiving Pervious Area (RPA, %)	98.0%	95.6%	96.3%	90.5%													
Separate Pervious Area (SPA, %)	0.0%	0.0%	0.0%	0.0%													
A _s (RPA / UIA)	49.304	21.889	26.000	9.571													
I _s Check	0.020	0.040	0.040	0.090													
f / I for WQCV Event:	0.4	0.4	0.4	0.4													
f / I for 10-Year Event:	0.4	0.4	0.4	0.4													
f / I for 100-Year Event:	0.2	0.2	0.2	0.2													
f / I for Optional User Defined Storm CUHP:																	
IRF for WQCV Event:	0.09	0.17	0.17	0.39													
IRF for 10-Year Event:	0.09	0.18	0.18	0.39													
IRF for 100-Year Event:	0.09	0.18	0.18	0.42													
IRF for Optional User Defined Storm CUHP:																	
Total Site Imperviousness: I _{total}	2.0%	4.4%	3.7%	9.5%													
Effective Imperviousness for WQCV Event:	0.2%	0.8%	0.6%	3.7%													
Effective Imperviousness for 10-Year Event:	0.2%	0.8%	0.6%	3.7%													
Effective Imperviousness for 100-Year Event:	0.2%	0.8%	0.7%	3.9%													
Effective Imperviousness for Optional User Defined Storm CUHP:																	

LID / EFFECTIVE IMPERVIOUSNESS CREDITS

WQCV Event CREDIT: Reduce Detention By:	91.0%	81.6%	81.7%	57.2%	N/A	N/A	N/A	N/A	N/A	N/A	N/A	N/A	N/A	N/A	N/A	N/A
10-Year Event CREDIT**: Reduce Detention By:	-14989.9%	152.2%	179.4%	77.0%	N/A	N/A	N/A	N/A	N/A	N/A	N/A	N/A	N/A	N/A	N/A	N/A
100-Year Event CREDIT**: Reduce Detention By:	-10882.4%	150.9%	178.0%	74.1%	N/A	N/A	N/A	N/A	N/A	N/A	N/A	N/A	N/A	N/A	N/A	N/A
User Defined CUHP CREDIT: Reduce Detention By:																

Total Site Imperviousness:	3.7%
Total Site Effective Imperviousness for WQCV Event:	0.7%
Total Site Effective Imperviousness for 10-Year Event:	0.7%
Total Site Effective Imperviousness for 100-Year Event:	0.7%
Total Site Effective Imperviousness for Optional User Defined Storm CUHP:	

Notes:
 * Use Green-Ampt average infiltration rate values from Table 3-3.
 ** Flood control detention volume credits based on empirical equations from Storage Chapter of USDCM.
 *** Method assumes that 1-hour rainfall depth is equivalent to 1-hour intensity for calculation purposed

DRAINAGE MAPS

ZONE: A-35
USE: AG. GRAZING LAND
OWNER: ADAM W. MOLLACCO

ZONE: A-35
USE: AG. GRAZING LAND
OWNER: MIRMOHAMMAD ADLI

LOT 258
ZONE: RR-5
USE: SINGLE FAMILY RESIDENCE
OWNER: GREENE FAMILY LIVING TRUST

LOT 259
ZONE: RR-5
USE: SINGLE FAMILY RESIDENCE
OWNER: SANDRA STROH

PEYTON PINES FILING NO. 4
RECEPTION NO. 785849

LOT 260
ZONE: RR-5
USE: SINGLE FAMILY RESIDENCE
OWNER: MICHAEL MCHALE

RED BARN ROAD
(RURAL LOCAL)
(60' PUBLIC R.O.W.)

LOT 261
ZONE: RR-5
USE: VACANT
OWNER: FRANK W & TINA Y CHO

LOT 262
ZONE: RR-5
USE: SINGLE FAMILY RESIDENCE
OWNER: MICHAEL H BARRAGAN

LOT 267
ZONE: RR-5
USE: SINGLE FAMILY RESIDENCE
OWNER: JANICE W KELLER REVOCABLE
LIVING TRUST

LOT 266
ZONE: RR-5
USE: SINGLE FAMILY RESIDENCE
OWNER: CHAD L ANDERSON

LOT 265
ZONE: RR-5
USE: SINGLE FAMILY RESIDENCE
OWNER: ROBERT M & D'ANN R AREA

LOT 264
ZONE: RR-5
USE: VACANT
OWNER: ROBERTO GARZA

LOT 263
ZONE: RR-5
USE: VACANT
OWNER: ROBERTO GARZA

PEYTON PINES FILING NO. 4
RECEPTION NO. 785849

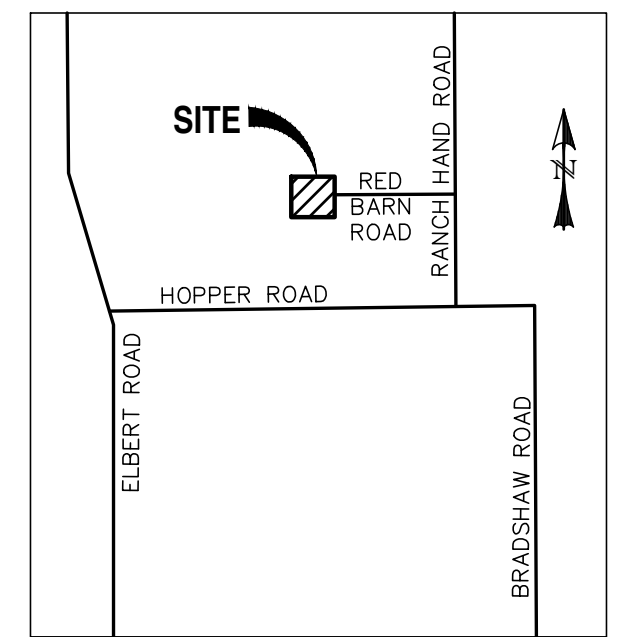
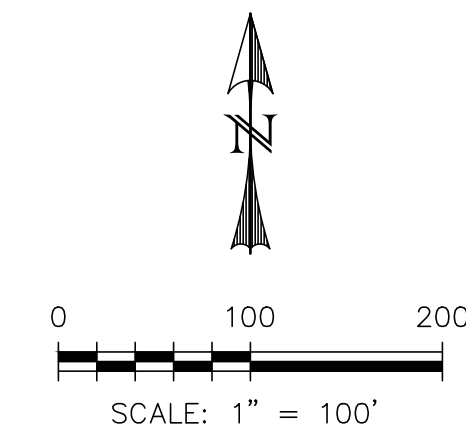

VICINITY MAP
SCALE: N.T.S.

EXISTING DRAINAGE BASINS							
BASIN	AREA (ACRES)	Q2 (CFS)	Q5 (CFS)	Q10 (CFS)	Q25 (CFS)	Q50 (CFS)	Q100 (CFS)
E1	11.57	0.7	2.5	5.5	9.6	12.9	16.7
E2	12.47	0.6	2.4	5.2	9.1	12.2	15.9
E3	14.77	0.8	2.9	6.4	11.2	15.1	19.6

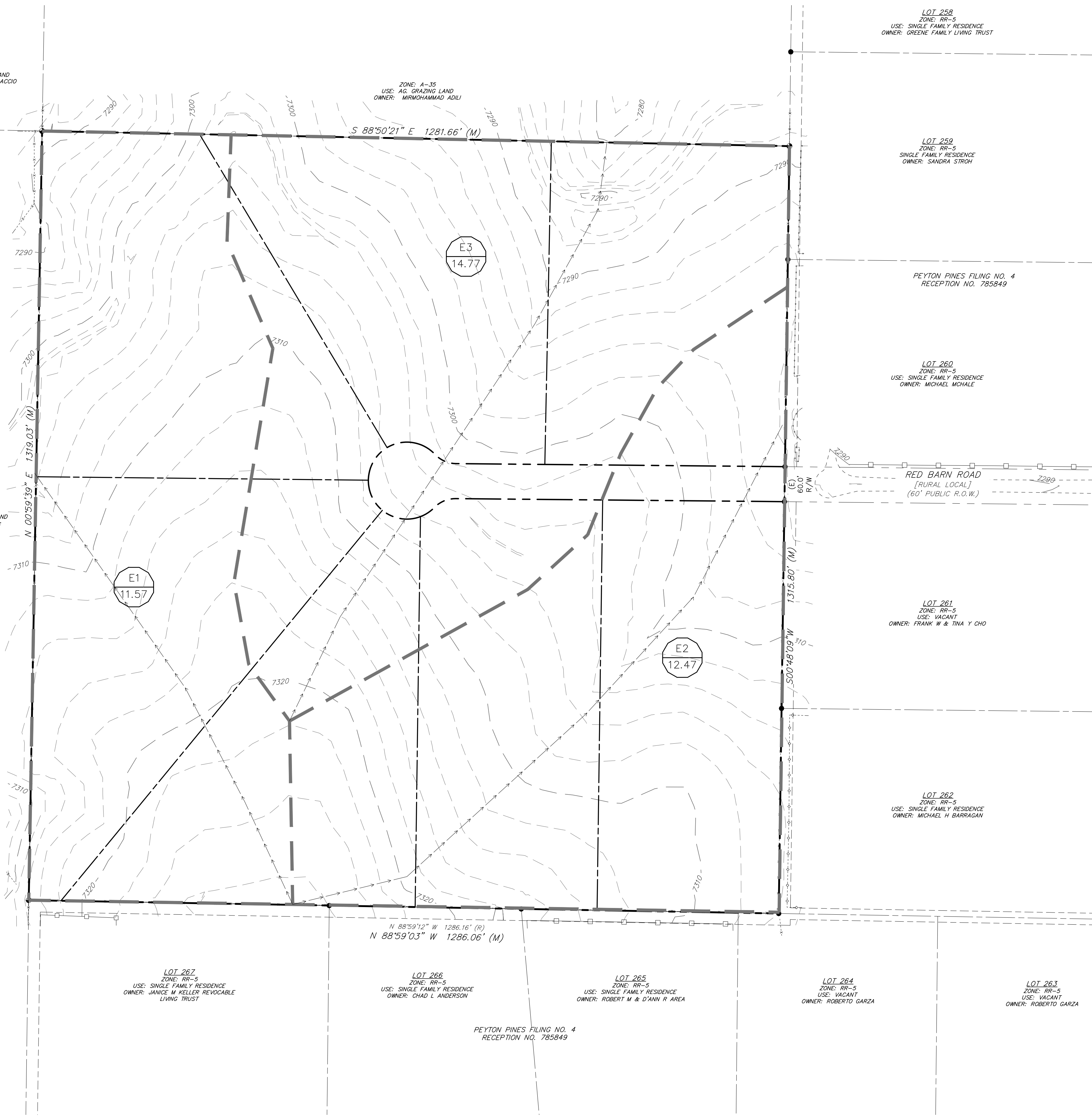

LEGEND

EXISTING	(E)
PROPOSED	(P)
BOUNDARY	---
RIGHT-OF-WAY	----
LOT LINE	=====
EASEMENT	-----
(E) CONTOUR, INDEX	---8820---
(E) CONTOUR	-----
(P) CONTOUR, INDEX	---8820---
(P) CONTOUR	-----

REV.	DESCRIPTION	DATE



PREPARED FOR:

ALICE OWENS

18430 LOST RANGER ROAD
PEYTON, CO 80831-7650
PHONE: (719) 596-7447

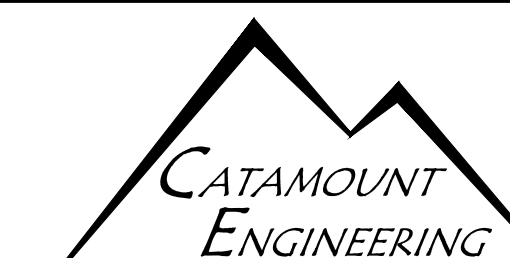

PO BOX 221 WOODLAND PARK, CO 80866 (719) 426-2124

PINE VIEW ESTATES

EXISTING CONDITIONS

DESIGNED BY: DLM	DRAWN BY:
SCALE: 1"=150'	DATE: 07/09/20
JOB NUMBER	SHEET
18-158	1 OF 1

ZONE: A-35
USE: AG. GRAZING LAND
OWNER: ADAM W. MCGILVERO

ZONE: A-35
USE: AG. GRAZING LAND
OWNER: MIRMOHAMMAD ADLI

LOT 258
ZONE: RR-5
USE: SINGLE FAMILY RESIDENCE
OWNER: GREENE FAMILY LIVING TRUST

LOT 259
ZONE: RR-5
USE: SINGLE FAMILY RESIDENCE
OWNER: SANDRA STROTH

PEYTON PINES FILING NO. 4
RECEPTION NO. 785849

LOT 260
ZONE: RR-5
USE: SINGLE FAMILY RESIDENCE
OWNER: MICHAEL MCMALE

LOT 261
ZONE: RR-5
USE: VACANT
OWNER: FRANK W & TINA Y CHO

LOT 262
ZONE: RR-5
USE: SINGLE FAMILY RESIDENCE
OWNER: MICHAEL H BARRAGAN

LOT 267
ZONE: RR-5
USE: SINGLE FAMILY RESIDENCE
OWNER: JAVIER W KELLER REVOCABLE LIVING TRUST

LOT 266
ZONE: RR-5
USE: SINGLE FAMILY RESIDENCE
OWNER: CHAD L ANDERSON

LOT 265
ZONE: RR-5
USE: SINGLE FAMILY RESIDENCE
OWNER: ROBERT M & D'ANN R AREA

LOT 264
ZONE: RR-5
USE: VACANT
OWNER: ROBERTO GARZA

LOT 263
ZONE: RR-5
USE: VACANT
OWNER: ROBERTO GARZA

PEYTON PINES FILING NO. 4
RECEPTION NO. 785849

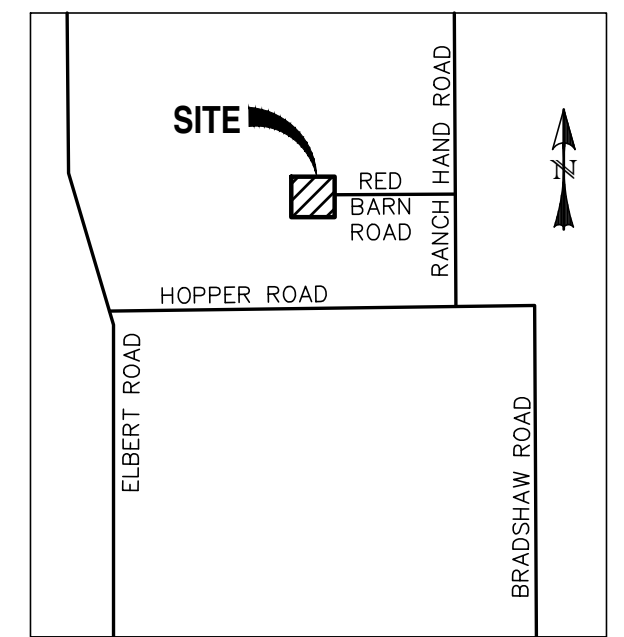
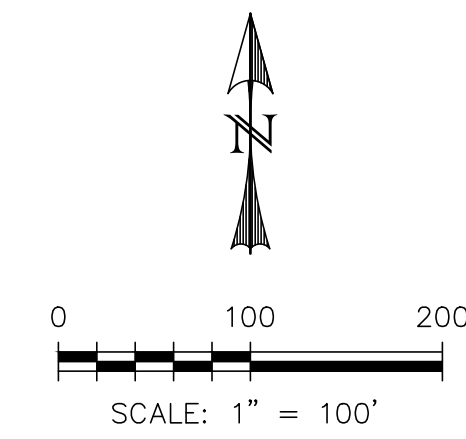

VICINITY MAP
SCALE: N.T.S.

PROPOSED DRAINAGE BASINS							
BASIN	AREA (ACRES)	Q2 (CFS)	Q5 (CFS)	Q10 (CFS)	Q25 (CFS)	Q50 (CFS)	Q100 (CFS)
A1	11.57	1.1	3.3	6.6	11.0	14.7	18.8
A2	14.42	1.5	4.0	7.5	12.4	16.3	20.8
A3	11.34	1.2	3.1	6.1	10.1	13.4	17.1
A4	1.48	0.3	0.6	1.1	1.8	2.3	2.9

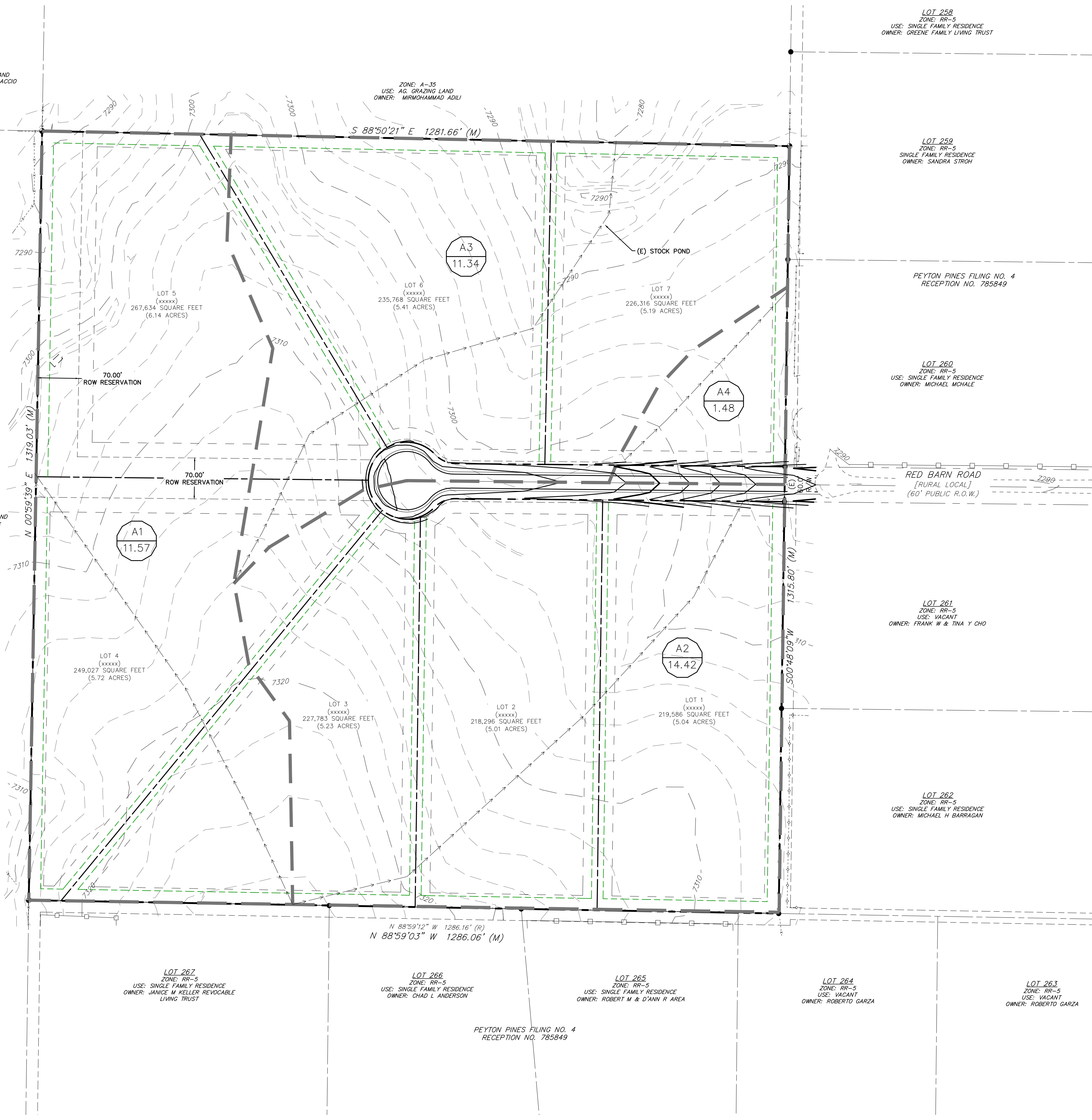

LEGEND

EXISTING	(E)
PROPOSED	(P)
BOUNDARY	---
RIGHT-OF-WAY	----
LOT LINE	=====
EASEMENT	-----
(E) CONTOUR, INDEX	---8820---
(E) CONTOUR	-----
(P) CONTOUR, INDEX	---6820---
(P) CONTOUR	-----

PROPOSED
EXISTING CONDITIONS

REV.	DESCRIPTION	DATE

811 Know what's below.
Call 72 hours before you dig.
For more details visit:
www.call811.com

PREPARED FOR:
ALICE OWENS
18430 LOST RANGER ROAD
PEYTON, CO 80831-7650
PHONE: (719) 596-7447



PINE VIEW ESTATES

DESIGNED BY: DLM	DRAWN BY:
SCALE: 1"=150'	DATE: 07/09/20
JOB NUMBER	SHEET
18-158	1 OF 1