



FINAL DRAINAGE REPORT

FALCON RANCHETTES FILING NO. 1A
MERIDIAN STORAGE
El Paso County, Colorado

PCD File No. VR239 & PPR2336

PREPARED FOR:

Mike D. Texer
11750 Owl Place
Peyton, CO 80831
Contact: Mike D. Texer
Phone: (719) 641-9261

PREPARED BY:

Galloway & Company, Inc.
1155 Kelly Johnson Blvd., Suite 305
Colorado Springs, CO 80920
Contact: Brady Shyrock
Phone: (719) 338-9732

DATE:

October 20, 2023



Signature Page
Falcon Ranchettes Filing No. 1a (Meridian Storage)

Engineer's Statement

The attached drainage plan and report were prepared under my direction and supervision and are correct to the best of my knowledge and belief. Said drainage report has been prepared according to the criteria established by the County for drainage reports and said report is in conformity with the applicable master plan of the drainage basin. I accept responsibility for any liability caused by any negligent acts, errors or omissions on my part in preparing this report.

Brady Shyrock, PE # 38164
For and on behalf of Galloway & Company, Inc.

Date

Developer's Certification

I, the developer, have read and will comply with all of the requirements specified in this drainage report and plan.

By: _____

Address: Mike D. Texer
 11750 Owl Place
 Petyon, CO 80831

Date

El Paso County Certification

Filed in accordance with the requirements of the Drainage Criteria Manual, Volumes 1 and 2, El Paso County Engineering Criteria Manual and Land Development Code as amended.

Joshua Palmer, P.E.
County Engineer/ECM Administrator

Date

Conditions:

TABLE OF CONTENTS

I. Introduction.....	4
II. Drainage Design Criteria.....	5
Development Criteria Reference	5
Hydrologic Criteria	5
Hydraulic Criteria	7
Four Step Process	8
III. Existing Drainage Patterns and Features	9
Existing Drainage Patterns.....	9
Sub-Basin Descriptions.....	9
IV. Proposed Drainage Patterns and Features.....	10
Proposed Drainage Plan	10
Sub-Basin Descriptions.....	11
Proposed Pond #1 Full Spectrum Extended Detention Basin.....	14
Sub-Regional Detention Pond (SR4) Outfall	15
Drainage Channel Improvements – UTBSC East Branch (RMT064).....	15
Existing 36” Twin Culverts.....	18
V. Ownership & Maintenance.....	19
VI. Fee Development.....	19
Drainage & Bridge Fees.....	19
Improvements and Reimbursable Costs	20
VII. Conclusion	22
VIII. References.....	22

Appendices:

- A. Exhibits and Figures
- B. Existing Drainage Reports
- C. Hydrologic Computations
- D. Hydraulic Computations
- E. Pond Calculations
- F. Drainage Maps

I. Introduction

This document is the Final Drainage Report for Falcon Ranchettes Filing No. 1a (Meridian Storage). The project consists of two lots and public right-of-way that make up 9.604 acres. This project proposes storage units, an office building, roadway and utility infrastructure, RV parking, a water quality treatment pond, and drainage channel improvements to the existing east branch of Unnamed Tributary to Black Squirrel Creek (UTBSC East Branch).

Purpose

The purpose of this report is to identify on and offsite drainage patterns and confirm that the new development has no significant changes to existing drainage patterns.

Previous Drainage Studies

- Falcon Drainage Basin Planning Study, dated September 2015 – Referred to as **Falcon DBPS** hereon.
- Bent Grass MDDP Amendment & DBPS Amendment, dated September 2021 – Referred to as **Bent Grass MDDP** hereon.
- Request for Conditional Letter of Map Revision, Unnamed Tributary to Black Squirrel Creek, Falcon Owl Place, dated October 25, 2022 – Referred to as Falcon **Owl Place CLOMR** hereon.
- Request for Letter of Map Revision, Unnamed Tributary to Black Squirrel Creek, Falcon Marketplace, dated March 15, 2021 – Referred to as **Falcon Marketplace LOMR** hereon.
- Final Drainage Report for Falcon Marketplace, dated November 4, 2019 – Referred to as **Falcon Marketplace FDR** hereon.

Relevant excerpts from existing drainage reports are provided in **Appendix B** for reference.

Location

Falcon Ranchettes Filing No. 1a is located in the Southeast Quarter of Section 1, Township 13 South, Range 65 West of the 6th Principal Meridian, County of El Paso, State of Colorado.

The project site is located at the northwest corner of Owl Place and Meridian Road, bounded to the North by Lot 2A Bent Grass East Commercial Fil No 2a and Tract A Bent Grass East Commercial Fil No 2, to the south by Lots 14 & 15 of Falcon Ranchettes, to the East by Meridian Road right-of-way, to the West by Lot 3 of Falcon Ranchettes. A Vicinity Map is provided in **Appendix A**.

Description of Property

The existing parcel is currently developed with two residential properties (*Lot 1 & 2 of Falcon Ranchettes*). Two single-family homes occupy the site, but the majority of the existing parcels are covered by native prairie grass land. An existing drainage-way flows north to south along the eastern property line adjacent to Meridian Road right-of-way, named “Unnamed Tributary to Black Squirrel Creek - East Branch”.

Soils

According to the U.S. Department of Agriculture Natural Resources Conservation Service Soil Survey of El Paso County, Colorado (See **Appendix A**) the primary soil found is Columbine gravelly sandy loam, classified as Soil Conservation Service (SCS) hydrologic soil group “A”.

Climate

This area of El Paso County is located at the foothills of the Southern Rocky Mountains. Classified as an alpine desert, Falcon, CO averages 300 days of sunshine with low humidity. Annual precipitation ranges between 10-16 inches, occurring mostly in spring and summer months.

Geotechnical Recommendations

Positive drainage away from the structures should be provided during construction and maintained throughout the life of the structures. Any downspouts, roof drains or scuppers should discharge into splash blocks or extensions and away from the structures. Backfill against footings, exterior walls and in utility trenches should be properly compacted and free of all construction debris to reduce the possibility of moisture infiltration. Refer to the Geotechnical Exploration Report prepared by Universal Engineering Sciences for more detailed information.

Flood Insurance Rate Map

According to the Federal Emergency Management Agency (FEMA) Flood Insurance Rate Map (FIRM) #08041C0553G, effective date December 7, 2018. The project site is located in Zone X (Areas determined to be outside of the 0.2% annual chance floodplain). A copy of the FIRM map is provided in **Appendix A** for reference.

Major Drainage Basin

Falcon Ranchettes Filing No. 1a is located within the MT060 drainage basin as described in the **Falcon DBPS**. The Falcon Watershed is located in the north central portion of El Paso County and flows southeasterly from the southern slope of the Black Forest. The Falcon watershed contains three perennial streams and has a contributing drainage area of approximately 10.6 square miles at its confluence with Black Squirrel Creek.

Detailed recommendations from the **Falcon DBPS** are included below under "*IV. Proposed Drainage Patterns and Features*".

II. Drainage Design Criteria

Development Criteria Reference

The analysis and design of the drainage concept and stormwater management system for this project was prepared in accordance with the criteria set forth in the Mile High Flood District (MHFD) Urban Storm Drainage Criteria Manual (USDCM) dated January 2016 and the adopted chapters 6 & 13 from the City of Colorado Springs Drainage Criteria Manual (DCM) Vol. 1, last revised January 2021

Hydrologic Criteria

The rational method was used to calculate peak flows as the tributary areas are less than 100 acres. An analysis of the hydrology using the rational method can be found in **Appendix C** - Hydrologic Calculations. The rational method has proved to be accurate for basins of this size and is based on the following formula:

$$Q = CIA$$

Where:

- Q = Peak Discharge (cfs)
- C = Runoff Coefficient
- I = Runoff intensity (inches/hour)
- A = Drainage area (acres)

The rainfall intensity calculations are based on the DCM Figure 6-5 and IDF equations. The one hour point rainfall data for the design are listed in Table 1 below.

Table 1 - Precipitation Data (Table 6.2 in DCM Vol. 1)

Return Period	One Hour Depth (in.)	Intensity (in/hr)
5-year	1.50	5.17
100-year	2.52	8.68

Time of concentrations have been adapted from equation 6-7 of The City of Colorado Springs Drainage Criteria Manual, Volume 1 which are as follows:

$$T_c = T_i + T_t$$

Where:

- T_c = time of concentration (min)
- T_i = overland (initial) flow time (min)
- T_t = travel time in the ditch, channel, gutter, storm sewer, etc. (min)

Overland (Initial) Flow Time: from equations 6-8 from the City of Colorado Springs Drainage Criteria Manual, Volume 1.

$$t_t = \frac{0.395(1.1 - C_5)\sqrt{L}}{S^{0.33}}$$

Where:

- T_i = overland (initial) flow (min)
- C₅ = runoff coefficient for 5-year frequency
- L = length of overland flow (ft) (300 ft maximum for non-urban land uses, 100 ft maximum for urban land uses)
- S = average basin slope (ft/ft)

Travel Time

$$V = C_v * S_w^{0.5}$$

Where:

V = Velocity (ft/s)
 C_v = conveyance coefficient
 S_w = watercourse slope (ft/ft)

The runoff coefficients are calculated based on land use, percent imperviousness, and design storm for each basin, as shown in the DCM, (Table 6-6).

Hydraulic Criteria

Storm Pipe

Hydraulic design and analysis for this report were performed through the usage of StormCAD. A tabular summary from analysis performed by StormCAD can be found in **Appendix D** - Hydraulic Calculations. Additionally, the table below shows the parameters used for StormCAD Standard Method Coefficients taken from *DCM Vol 1 Chapter 9 Table 9-4*.

BEND LOSS		
BEND ANGLE	K COEFFICIENT	
0°	0.05	
22.5°	0.10	
45°	0.40	
60°	0.64	
90°	1.32	
LATERAL LOSS		
ONE LATERAL K COEFFICIENT		
BEND ANGLE	NON -SURCHARGED	SURCHARGES
45°	0.27	0.47
60°	0.52	0.90
90°	1.02	1.77
TWO LATERAL K COEFFICIENT		
45°	0.96	
60°	1.16	
90°	1.52	

Storm Inlets

CDOT-Type R Storm Curb Inlets and CDOT Type C Area Inlets are sized using the UD-Inlet_v5.02 spreadsheet from Mile High Flood District. Additionally, CDOT Type 13 area inlets are sized using a depth to capacity line graph. These calculations are provided in **Appendix D**.

Detention Pond

As shown in Part IV: Onsite PWQ Requirements, Documentation and Considerations of the PBMP Applicability Form, this project is required to provide treatment for the Water Quality Capture Volume (WQCV) Standard.

Proposed *Pond #1* was designed using the Mile High Flood District (MHFD) software spreadsheets; It is the recommended design software because it provides tabulated results of the WQCV, EURV, 2-, 5-, 10-,

25-, 50-, 100- and 500-year storm events routed through the pond. The detention criteria provided by the MHFD's design spreadsheets *MHFD-Detention_v4.06* was used to determine the adequate storage capacity of the detention pond, and the associated elements of the outlet structure. The UDFCD Manual provides approximate, empirical equations that are utilized in the spreadsheet provided by MHFD. These equations and methods are further described in the USDCM Vol. 2, Ch. 12. The required volume calculations as well as the outlet structure design calculations are provided in **Appendix E – Pond Calculations** of this report.

Detailed water surface elevations and pond design information are included below under “*IV. Proposed Drainage Patterns and Features*”.

Drainage Channel

Proposed improvements to UTBSC East Branch was analyzed using Bentley software *FlowMaster* to properly size a trapezoidal channel to safely convey stormwater while providing 1.0-ft minimum of freeboard. Additionally, the 3 proposed grouted stepped boulder drop structures were designed using criteria set forth in USDCM from Mile High Flood District. FlowMaster calculations can be found in **Appendix D**.

Detailed steps of the Simplified Design Procedure as shown in the USDCM are included below under “*IV. Proposed Drainage Patterns and Features*”.

Four Step Process

The Four Step Process is used to minimize the adverse impacts of urbanization and is a vital component of developing a balanced, sustainable project. Below identifies the approach to the four-step process:

1. Employ Runoff Reduction Practices

This step uses low impact development (LID) practices to reduce runoff at the source. Generally, rather than creating point discharges that are directly connected to impervious areas runoff is routed through pervious areas to promote infiltration. The Impervious Reduction Factor (IRF) method was used and calculations can be found in Appendix E.

2. Implement BMP's That Provide a Water Quality Capture Volume with Slow Release

This step utilizes formalized water quality capture volume to slow the release of runoff from the site, while the WQCV will release in no less than 40 hours. Proposed Pond #1 will provide water quality treatment for all developed areas prior to the runoff being released into existing sub-regional detention pond SR-4.

3. Stabilize Drainageways

This step implements stabilization to channels to accommodate developed flows while protecting infrastructure and controlling sediment loading from erosion in the drainageways. Drainage channel improvements are proposed to the existing UTBSC East Branch (RMT064), including widening the existing channel with 3 proposed grouted stepped boulder drop structures.

4. Implement Site Specific and Other Source Control BMPs

The biggest source control BMP is public education which can be found on the City of Colorado Springs website and discuss topics such as: pet waste, car washing, private maintenance

landscaping, fall leaves, and snow melt and deicer. A no vehicle maintenance policy will be enforced to avoid the potential contaminations caused from vehicle fluid replacement, and equipment replacement and repair. In addition, the landscaping and snow removal is handled completely by the property management to ensure proper lawn mowing and grass clipping disposal, lawn aeration, and fertilizer application is being followed. Snow removal will also be handled by the property manager to ensure proper consideration of snow pile placement and use of deicing chemicals.

III. Existing Drainage Patterns and Features

Existing Drainage Patterns

On-Site:

The existing drainage pattern sheet flows from north to south. Basin **MT060** represents all flows from the existing roadside ditch entering the project site, including the 24" pond outfall from Bent Grass. Flows from basin **EX-1** sheet flow into the existing roadside ditch (RMT064) and then conveyed to **DP1** where existing 36" twin CMP culverts pipe conveys flows under Owl Place. The culverts are severely undersized and partially filled with sediment, a detailed analysis of these culverts is provided in the **Owl Place CLOMR**. Basins **EX-2** and **EX-3** flow south and pool along the north edge Owl Place near **DP2** and **DP3**. Flows eventually overtop the gravel road and continue south.

Off-Site:

Basins **EX-4**, **OS-1**, **OS-2** and **OS-3** flow south and pool at **DP4**. These flows eventually overtop the gravel road and continue south.

Sub-Basin Descriptions

Note: an existing drainage map is provided in **Appendix F** and should be referenced when reading the basin descriptions below.

Basin MT060 (Q5 = 304.6 cfs, Q100 = 915.3 cfs): a basin that encompasses all flows from the existing roadside ditch (RMT064) entering the project site at the northeast corner, including the 24" pond outfall from Bent Grass. Flows are conveyed south to **DP1** where existing 36" twin CMP culverts pipe flows under Owl Place. Existing drainage channel (RMT064) conveys flows south to sub-regional detention pond SR4.

Basin EX-1 (4.97 acres, Q5 = 1.6 cfs, Q100 = 7.7 cfs): a basin that encompasses the northeast portion of the project site. Runoff sheet flows from north to south and eventually spills into the existing Meridian Road roadside ditch, RMT064. Flows continue south to **DP1** where existing 36" twin CMP culverts pipe flows under Owl Place. Existing drainage channel (RMT064) conveys flows south to sub-regional detention pond SR4.

Basin EX-2 (2.32 acres, Q5 = 0.6 cfs, Q100 = 3.2 cfs): a basin that encompasses a portion of the center of the site. Flows drain from north to south to **DP2** where flows pool along the north edge of Owl Place until eventually overtopping the gravel road and continuing south, ultimately to sub-regional detention pond SR4.

Basin EX-3 (2.85 acres, Q5 = 0.3 cfs, Q100 = 3.0 cfs): a basin that encompasses the west portion of the site. Flows drain from north to south to **DP3** where flows pool along the north edge of Owl Place until eventually overtopping the gravel road and continuing south, ultimately to sub-regional detention pond SR4.

Basin EX-4 (1.08 acres, Q5 = 0.0 cfs, Q100 = 0.9 cfs): a basin that encompasses the far west portion of the site. Flows drain from north to south to **DP4** where flows pool along the north edge of Owl Place until eventually overtopping the gravel road and continuing south, ultimately to sub-regional detention pond SR4.

Basin OS-1 (3.89 acres, Q5 = 0.7 cfs, Q100 = 4.5 cfs): a basin that is associated with Lot 3 and 4 Falcon Ranchettes, and portions of the rear of lots 24, 25 and 26 of Bent Grass Residential Filing No. 1. Runoff sheet flows into a shallow swale and then conveyed from north to south to **DP4** where flows pool along the north edge of Owl Place until eventually overtopping the gravel road and continuing south, ultimately to sub-regional detention pond SR4.

Basin OS-2 (2.35 acres, Q5 = 0.6 cfs, Q100 = 3.0 cfs): a basin that is associated with Lot 3 and 4 Falcon Ranchettes, and portions of the rear of lots 26 and 27 of Bent Grass Residential Filing No. 1. Runoff sheet from north to south to **DP4** where flows pool along the north edge of Owl Place until eventually overtopping the gravel road and continuing south, ultimately to sub-regional detention pond SR4.

Basin OS-3 (0.24 acres, Q5 = 0.0 cfs, Q100 = 0.2 cfs): a basin that is associated with Lot 3 Falcon Ranchettes, a parcel immediately west of the project site. Flows drain from north to south to **DP4** where flows pool along the north edge of Owl Place until eventually overtopping the gravel road and continuing south, ultimately to sub-regional detention pond SR4.

Basin OS-4E (0.05 acres, Q5 = 0.2 cfs, Q100 = 0.4 cfs): a basin that encompasses the existing cul-de-sac in Meridian Park Drive ROW. This basin represents the limits of disturbance for roadway improvements and should be compared to proposed basin **OS-4P** located below in “*IV. Proposed Drainage Patterns and Features*”. Runoff sheet flows north onto Type A curb and gutter and conveyed to an existing 6' CDOT Type 'R' Sump Inlet (Public), **DP14**.

IV. Proposed Drainage Patterns and Features

Proposed Drainage Plan

On-Site:

Proposed Lot 1a consists of 1 office building and 9 self-storage. Access is provided from Meridian Park Drive near the center of the site, with an emergency access drive to the north for emergency services only. An inverted crowned roadway with concrete valley gutter are used for all internal drive aisles to route runoff to proposed storm drain infrastructure. Flows are then piped to Pond #1 providing detention and treatment for the WQCV, EURV, and 100-Year. The pond outfall conveys flows south, directly outfalling into existing sub-regional pond (SR-4).

Proposed Lot 2a consists of RV Parking, Pond #1 is located at the southern end of the lot. RV Parking will likely be a temporary condition until Lot 2a is eventually redeveloped into additional self-storage units. Pond #1 is designed to accommodate the future self-storage imperviousness.

The proposed public roadway improvements convey runoff using curb and gutter and routing flows to proposed storm drain infrastructure and then piped to Pond #1 to provide detention and treatment for the WQCV. The pond outfall conveys flows south directly to an existing sub-regional pond (SR-4).

Drainage channel improvements to the existing RMT064 is discussed below under “IV. Proposed Drainage Patterns and Features”, including the existing culvert crossing at Owl Place.

Off-Site:

The existing drainage pattern of OS-1, OS-2 and OS-3 remains unchanged. However, to avoid the stormwater pooling and overtopping at Owl Place, a CDOT Type C Area Inlet (Private) is proposed to capture flows and route the runoff safely to Pond SR-4.

Sub-Basin Descriptions

Note: a proposed drainage map is provided in **Appendix F** and should be referenced when reading the basin descriptions below.

Basin MT060 (Q₅ = 304.6 cfs, Q₁₀₀ = 915.3 cfs): a basin that encompasses all flows from the existing roadside ditch (RMT064) entering the project site at the northeast corner, including the 24” pond outfall from Bent Grass. Flows are conveyed south to **DP1** where existing 36” twin CMP culverts pipe flows under Owl Place. Existing drainage channel (RMT064) conveys flows south to sub-regional detention pond SR4.

Basin A-1 (2.10 AC, Q₅ = 3.0 cfs, Q₁₀₀ = 7.2 cfs): a basin that encompasses the far east side of the site, this basin consists of the proposed drainage channel, the roof of Building D, and a portion of Meridian Road. Runoff from this basin will sheet flow into the drainage channel and then be conveyed south to **DP1** where existing 36” twin culverts pipes flows under Owl Place. Existing drainage channel (RMT064) conveys flows south to sub-regional detention pond SR4. Total flows at DP1 we’re increased in the 5-year event and remain the same in the 100-year event. The change to flows at DP1 is due to the decreased tributary area and slight increase in imperviousness from Building D. *The majority of Basin A-1 is eligible for WQ treatment exclusion as defined in Permit Part I E.4.a.i.(H). Refer to Appendix F for Water Quality Drainage Map, DR-4.*

Basin B-1 (1.31 AC, Q₅ = 5.5 cfs, Q₁₀₀ = 9.7 cfs): a basin that encompasses the north half of the storage unit buildings and drive aisles. Runoff from this basin collects into a roof drain system and outfalls onto the proposed drive aisles. Then, an inverted crowned roadway with concrete valley gutter will convey flows south to a proposed CDOT Type 13 Area Inlet-Triple (Private), **DP3**. Lastly, flows are conveyed to Pond #1 via storm pipe, then routed south after treatment to sub-regional detention pond SR4.

Basin B-2 (1.04 AC, Q₅ = 4.6 cfs, Q₁₀₀ = 7.9 cfs): a basin that encompasses the south half of the storage unit buildings and drive aisles. Runoff from this basin collects into a roof drain system and outfalls onto the proposed drive aisles. Then, an inverted crowned roadway with concrete valley gutter will convey flows south to a proposed CDOT Type 13 Area Inlet-Triple (Private), **DP4**. Lastly, flows are conveyed to Pond #1 via storm pipe, then routed south after treatment to sub-regional detention pond SR4.

CORRECT. ADDED ANOTHER SENTENCE CLARIFYING FOR THE 5 AND 100 YEAR STORM

per the calculation, 100% of the flow is captured and there is no bypass flows

Basin B-3 (0.95 AC, $Q_5 = 2.1$ cfs, $Q_{100} = 4.4$ cfs): a basin that encompasses the east half of Meridian Park Drive, landscaping and buildings A and E. Runoff from this basin will sheet flow onto Type A curb and gutter and conveyed south to a 10' CDOT Type 'R' On-Grade Curb Inlet (Public), **DP5**. Captured flows are conveyed to Pond #1 via storm pipe, then routed south after treatment to sub-regional detention pond SR4. Any bypass flow will continue south to a riprap pad, DP12. Flows are ultimately conveyed to sub-regional detention pond SR4 via existing RMT064.

Basin B-4 (0.52 AC, $Q_5 = 1.6$ cfs, $Q_{100} = 3.1$ cfs): a basin that encompasses the east half of Meridian Park Drive. Runoff from this basin will sheet flow onto Type A curb and gutter and conveyed south to a 10' CDOT Type 'R' On-Grade Curb Inlet (Public), **DP6**. Captured flows are conveyed to Pond #1 via storm pipe, then routed south after treatment to sub-regional detention pond SR4. Any bypass flow will continue south to a riprap pad, DP13. Flows are ultimately conveyed to sub-regional detention pond SR4 via existing RMT064.

Basin B-5 (0.13 AC, $Q_5 = 0.5$ cfs, $Q_{100} = 0.9$ cfs): a basin that encompasses the south half of Owl Place improvements. Runoff from this basin will sheet flow onto Type A curb and gutter and conveyed east to a 5' CDOT Type 'R' On-Grade Curb Inlet (Public), **DP7**. Captured flows are conveyed to Pond #1 via storm pipe, then routed south after treatment to sub-regional detention pond SR4. Any bypass flow will continue east to a riprap pad, DP13. Flows are ultimately conveyed to sub-regional detention pond SR4 via existing RMT064.

Basin B-6 (0.16 AC, $Q_5 = 0.4$ cfs, $Q_{100} = 0.9$ cfs): a basin that encompasses the south half of Owl Place improvements. Runoff from this basin will sheet flow onto Type A curb and gutter and conveyed east to a 5' CDOT Type 'R' On-Grade Curb Inlet (Public), **DP8**. Captured flows are conveyed to Pond #1 via storm pipe, then routed south after treatment to sub-regional detention pond SR4. Any bypass flow will continue east to a riprap pad, DP13. Flows are ultimately conveyed to sub-regional detention pond SR4 via existing RMT064.

Basin B-7 (0.56 AC, $Q_5 = 0.2$ cfs, $Q_{100} = 1.1$ cfs): a basin that encompasses Pond #1 (Private) Full Spectrum Extended Detention Basin. Runoff from this basin sheet flows onto a concrete trick channel and conveyed to the outlet structure, **DP9**. After treatment, flows are conveyed via storm pipe to sub-regional detention pond SR4.

Basin C-1 (0.29 AC, $Q_5 = 0.3$ cfs, $Q_{100} = 0.8$ cfs): a basin that encompasses a portion of RV Storage and landscaping. Runoff from this basin will sheet flow onto Type A curb and gutter and conveyed south to a 10' CDOT Type 'R' On-Grade Curb Inlet (Public), **DP6**. Captured flows are conveyed to Pond #1 via storm pipe, then routed south after treatment to sub-regional detention pond SR4. Any bypass flow will continue south to a riprap pad, DP13. Flows are ultimately conveyed to sub-regional detention pond SR4 via existing RMT064.

Basin C-2 (3.12 AC, $Q_5 = 5.2$ cfs, $Q_{100} = 11.3$ cfs): a basin that encompasses most of Lot 2a and RV Storage. Runoff from this basin sheet flows south and directly enters Pond #1. Runoff is collected by a concrete trick channel and conveyed to the outlet structure, **DP9**. After treatment, flows are conveyed via storm pipe to sub-regional detention pond SR4.

Basin C-3 (0.29 AC, $Q_5 = 0.4$ cfs, $Q_{100} = 1.0$ cfs): a basin that encompasses the southwest corner of RV Storage. Runoff from this basin will sheet flow onto Type A curb and gutter and conveyed east to a 5'

CDOT Type 'R' On-Grade Curb Inlet (Public), **DP8**. Captured flows are conveyed to Pond #1 via storm pipe, then routed south after treatment to sub-regional detention pond SR4. A riprap pad, DP13. Flows are ultimately conveyed to sub-regional detention pond SR4 via existing RMT064.

ADDED SENTENCE
FOR WQ TREATMENT

Unresolved from Submittal 1: Discuss any WQ treatment exclusions (i.e. I.7.1.C.1)

Basin C-4 (0.09 AC, $Q_5 = 0.0$ cfs, $Q_{100} = 0.1$ cfs): a basin that is associated with the proposed drainage swale, located at the southwest corner of proposed Lot 2a. Flows are conveyed south via a drainage swale to a proposed CDOT Type C Area Inlet-Sump (Private), **DP10**. Flows are conveyed via storm pipe and directly outfall into proposed Forebay B at sub-regional detention pond SR4.

Basin D-1 (0.20 AC, $Q_5 = 0.2$ cfs, $Q_{100} = 0.6$ cfs): a basin that encompasses the north half of unimproved Owl Place containing gravel and native grasses and shrubs. Flows collect at **DP2** and spill into a proposed cross pan that conveys flows to a riprap pad, **DP12**. Flows are ultimately routed to sub-regional detention pond SR4 via existing RMT064. *A portion of Basin D-1 is eligible for WQ treatment exclusion as defined in Permit Part I E.4.a.i.(G). Refer to Appendix F for Water Quality Drainage Map, DR-4.*

Basin D-2 (0.11 AC, $Q_5 = 0.3$ cfs, $Q_{100} = 0.6$ cfs): a basin that encompasses the east side of Meridian Park Drive & Owl Place intersection. Flows collect in a proposed cross pan that conveys flows to a riprap pad, **DP12**. Flows are ultimately routed to sub-regional detention pond SR4 via existing RMT064. *A portion of Basin D-2 is eligible for WQ treatment exclusion as defined in Permit Part I E.4.a.i.(C). Refer to Appendix F for Water Quality Drainage Map, DR-4.*

Basin D-3 (0.33 AC, $Q_5 = 1.0$ cfs, $Q_{100} = 2.0$ cfs): a basin that encompasses the west side of Meridian Park Drive & Owl Place intersection. Flows collect in a proposed cross pan that conveys flows to a riprap pad, **DP13**. Flows are ultimately routed to sub-regional detention pond SR4 via existing RMT064. *A portion of Basin D-2 is eligible for WQ treatment exclusion as defined in Permit Part I E.4.a.i.(C). Refer to Appendix F for Water Quality Drainage Map, DR-4.*

Basin OS-1 (3.89 acres, $Q_5 = 0.7$ cfs, $Q_{100} = 4.5$ cfs): a basin that is associated with Lot 3 and 4 Falcon Ranchettes, and portions of the rear of lots 24, 25 and 26 of Bent Grass Residential Filing No. 1. Runoff sheet flows into a shallow swale and conveyed from north to south to a proposed CDOT Type C Area Inlet-Sump (Private), **DP10**. Flows are conveyed via storm pipe and directly outfall into proposed Forebay B at sub-regional detention pond SR4.

Basin OS-2 (2.35 acres, $Q_5 = 0.6$ cfs, $Q_{100} = 3.0$ cfs): a basin that is associated with Lot 3 and 4 Falcon Ranchettes, and portions of the rear of lots 26 and 27 of Bent Grass Residential Filing No. 1. Runoff sheet from north to south to a proposed CDOT Type C Area Inlet-Sump (Private), **DP10**. Flows are conveyed via storm pipe and directly outfall into proposed Forebay B at sub-regional detention pond SR4.

Basin OS-3 (0.24 acres, $Q_5 = 0.0$ cfs, $Q_{100} = 0.2$ cfs): a basin that is associated with Lot 3 Falcon Ranchettes, a parcel immediately west of the project site. Flows drain from north to south to a proposed CDOT Type C Area Inlet-Sump (Private), **DP10**. Flows are conveyed via storm pipe and directly outfall into proposed Forebay B at sub-regional detention pond SR4.

Basin OS-4P (0.07 acres, $Q_5 = 0.3$ cfs, $Q_{100} = 0.5$ cfs): a basin that is associated with the improvements to the existing cul-de-sac in Meridian Park Drive ROW. This basin represents increased tributary area and runoff and should be compared to existing basin **OS-4E** located above in "III. Existing Drainage Patterns

and Features". Runoff sheet flows north onto Type A curb and gutter and conveyed to an existing 6' CDOT Type 'R' Sump Inlet (Public), **DP14**. The total flow to DP14 increased by 0.1 cfs in the 5-year and 100-year storm event. The increase in flow is considered nominal, and therefore, no analysis is provided for the downstream infrastructure.

Basin OS-5 (0.19 AC, $Q_5 = 0.0$ cfs, $Q_{100} = 0.2$ cfs): a basin that is associated with Tract A, Bent Grass East Commercial Filing No. 2, located just north of proposed Lot 2a, Falcon Ranchettes Filing No. 1a. This basin consists of the outside berm of the existing detention pond. Runoff from this basin sheet flows south and directly enters Pond #1. Runoff is collected by a concrete trick channel and conveyed to the outlet structure, **DP9**. After treatment, flows are conveyed via storm pipe to sub-regional detention pond SR4.

Basin OS-6 (0.08 AC, $Q_5 = 0.0$ cfs, $Q_{100} = 0.1$ cfs): a basin that is associated with Lot 2a, Bent Grass East Commercial Filing No. 2, located just north of proposed Lot 1a, Falcon Ranchettes Filing No. 1a. Flows are conveyed east by a drainage swale created from tie-back grading. Flows enter improved RMT064 and conveyed south to **DP1** where existing 36" twin culverts pipes flows under Owl Place. Existing drainage channel (RMT064) conveys flows south to sub-regional detention pond SR4. Total flows at DP1 we're increased in the 5-year event and remain the same in the 100-year event. The change to flows at DP1 is due to the decreased tributary area and slight increase in imperviousness from Building D.

Proposed Pond #1 Full Spectrum Extended Detention Basin

Pond #1 consists of 2 forebays, trickle channel, micropool, outlet structure (with trash rack, orifice plate, and overflow weir), and emergency spillway. Pond #1 provides treatment for the WQCV, EURV, and 100-Year.

Zone	Required Volume	Provided Volume
Water Quality Capture Volume (WQCV)	0.255 (ac-ft)	0.256 (ac-ft)
Excess Urban Runoff Volume (EURV)	0.714 (ac-ft)	0.972 (ac-ft)
100-Year	0.403 (ac-ft)	1.264 (ac-ft)
Total	1.372 (ac-ft)	2.492 (ac-ft)

The provided volume is excessively greater due to the hydraulic design of the storm sewer system. In order to keep 100-Year HGL's greater than 1 foot below finish grade, the pond footprint was increased to lower the tailwater elevation (100-Year water surface elevation of Pond #1).

All drainage basins adjacent to Pond #1 are included in determining the tributary drainage area and imperviousness for Pond #1. It is anticipated that all C-Group basins will soon develop into additional storage units or similar commercial use. Therefore, the C-Group drainage basins imperviousness are "overridden" to 100% imperviousness to accommodate for future development.

Refer to **Appendix E** for Pond #1 calculations.

ADDED MORE DETAIL DISCUSSION
AND SPECIFIC FLOW COMPARISONS

Clearly state if regional pond SR4 was designed to accept this lot and if it has capacity to accept the 11.2 cfs from the project site

Sub-Regional Detention Pond (SR4) Outfall

The outfall pipe for Pond #1 is routed south, directly into pond SR4. The calculated 100-Year storm event will result in 11.2 cfs. A concrete forebay is provided to adequately dissipate the proposed flows into pond SR4. A concrete trickle channel is proposed to directly connect to the existing trickle channel.

Drainage Channel Improvements – UTBSC East Branch (RMT064)

Falcon DBPS Analysis:

El Paso County completed hydrologic and hydraulic analyses summarized in the **Falcon DBPS**. The **Falcon DBPS** watershed encompasses three major basins, including the “Middle Tributary” which includes the subject property. The unnamed tributary to Black Squirrel Creek (UTBSC) in the Middle Tributary consists of an “East Branch” and “West Branch” that converges at the Falcon Marketplace site. The UTBSC East Branch is located along the eastern edge of the project site adjacent to Meridian Road, the West Branch does not cross the subject property.

The Falcon DBPS provides junctions north and south of the project site, named JMT050 and JMT060. These junctions are summarized below, also see **Appendix B** for Falcon DBPS excerpts showing the physical location of each junction.

Future Peak Discharges from Falcon DBPS				
Falcon DBPS Model Location	Physical Location	Branch	Proximity to Project Site	Future Flow Q100 (cfs)
JMT050	Bent Grass Meadows Drive & Meridian Road	East Branch	Upstream from Project Site	850
JMT060	Eastonville Road & Meridian Road	East and West Convergence	Downstream from Project Site	1,000

The **Falcon DBPS** specifies reach improvements between junctions JMT050 and JMT060, the reach between these two junctions is named “RMT064”. This is visually shown in the **Falcon DBPS**, *Figure 6-1. Selected Plan*, located in **Appendix B**. These improvements include small drop structures w/ toe protection.

Bent Grass MDDP Analysis:

A drainage diversion took place as part of the Bent Grass Residential Filing No. 1 development. The UTBSC West Branch was rerouted to the East towards the intersection of Meridian Road and Bent Grass Meadows Drive. This diversion is discussed extensively in the **Bent Grass MDDP**.

Because of the diversion, a new junction was created in the Middle Tributary named JMT060a. This junction is primarily known as “Design Point 20” in the text and drainage maps in **Bent Grass MDDP**. This new junction is located just south of JMT050 from the **Falcon DBPS** and summarized in the table below.

Future Peak Discharges from Bent Grass MDDP				
Bent Grass MDDP Model Location	Physical Location	Branch	Proximity to Project Site	Future Flow Q100 (cfs)
JMT060a	Bent Grass Meadows Drive & Meridian Road	East Branch	Upstream from Project Site	909.3

The **Bent Grass MDDP** specifies a 15' wide bottom channel with 4:1 side slopes, 6.5' deep and a longitudinal slope of 0.30% for RMT064 of the UTBSC East Branch. An excerpt of these calculations is provided in **Appendix B**.

Owl Place CLOMR Analysis:

The Falcon Owl Place development (located south of the project site across Owl Place) includes regrading and rerouting a portion of the UTBSC East Branch. The improvements intercept the existing creek immediately north of Owl Place and conveys it via a 10'x6' box culvert to the subregional detention pond (SR4). The box culvert is designed to convey the full 100-year discharge.

The **Falcon DBPS** did not include a junction on the East Branch immediately upstream of the convergence (Pond SR4). Therefore, the **Owl Place CLOMR** modified the HMS model to create a new junction located at the southern boundary of the Falcon Owl Place development, immediately upstream of Pond SR4. This junction is summarized in the table below.

Peak Discharges from Owl Place CLOMR				
Owl Place CLOMR Model Location	Physical Location	Branch	Proximity to Project Site	Future Flow Q100 (cfs)
JMT051	Immediately Upstream of Pond SR4	East Branch	Downstream from Project Site	920

Previous Reports Conclusions:

Per **Falcon DBPS**, channel improvements are required to stabilize the adjacent RMT064 of UTBSC East Branch. A design flow of 925 cfs was used as the design flow for these improvements, as specified in the **Bent Grass MDDP**. The table below compares the proposed design flow against previous reports.

Proposed Design Flow Comparison				
Model Location	Physical Location	Branch	Proximity to Project Site	Future Flow Q100 (cfs)
RMT064	North of Owl Place, South of Bent Grass Meadows Drive	East Branch	-	925
<i>JMT050 (Falcon DBPS)</i>	<i>Bent Grass Meadows Drive & Meridian Road</i>	<i>East Branch</i>	<i>Upstream from Project Site</i>	<i>850</i>

<i>JMT060a (Bent Grass MDDP)</i>	<i>Bent Grass Meadows Drive & Meridian Road</i>	<i>East Branch</i>	<i>Upstream from Project Site</i>	<i>909.3</i>
<i>JMT051 (Owl Place CLOMR)</i>	<i>Immediately Upstream of Pond SR4</i>	<i>East Branch</i>	<i>Downstream from Project Site</i>	<i>920</i>

Because of added junctions (JMT060a & JMT051) from **Bent Grass MDDP** and **Owl Place CLOMR**, no revisions to existing HMS models are needed for identifying the proposed design flow for RMT064. As shown above, the design flow of 925 cfs exceeds all projected HMS models for junctions north and south of RMT064.

Due to the design slope of 0.30%, 3 drop structures are required. The USDCM provides guidance for a “Simplified Design Procedure” for drop structure design that requires no hydraulic analysis. This method was used to design the grade control structures for RMT064.

Urban Storm Drainage Criteria Manual (USDCM) Design Guidance:

The USDCM Vol. 2, Chapter 9, Section 2 includes guidance and design procedures for Grade Control Structures.

The simplified design procedure can be used for grade control structures meeting design criteria provided in the table below and where all of the following criteria are met:

- Maximum unit discharge for the design event (typically the 100-year) over any portion of the drop structure is 35 cfs/ft or less,
- Net drop height (upstream channel invert less downstream channel invert exclusive of stilling basin depth) is 5 feet or less,
- Drop structure is constructed of GSB or SC,
- Drop structure is located within a tangent section and at least twice the distance of the width of the drop at the crest both upstream and downstream from a point of curvature,
- Drop structure is located in a reach that has been evaluated per the design requirements of the Open Channel chapter.

The table below summarizes the specific design and geometric parameters used for RMT064.

Note: Channel construction drawings were prepared for the RMT064 improvements and should be referenced when reading this table.

Design Parameter	Requirement to Use Simplified Design Procedure (As shown in USDCM)	Proposed Design	Meets or Exceeds Criteria?
Maximum Net Drop Height (Hd)	5 feet	3 feet	Yes
Maximum Unit Discharge over any Portion of Drop Width	35 cfs per foot of drop width	25.9 cfs*	Yes
Maximum Longitudinal Slope (Steepest Face Slope)	4(H):1(V)	4:1	Yes
Minimum Stilling Basin Depression (Db)	1 foot	N/A**	Yes
Minimum Length of Approach Riprap	8 feet	10 feet	Yes
Minimum Stilling Basin Length (Lb)	Determine using Figure 9-1	N/A**	Yes
Minimum Stilling Basin Width (B)	Same as crest width	N/A**	Yes
Minimum Cutoff Wall Depth	6 feet	6 feet	Yes
Minimum Length of Riprap Downstream of Stilling Basin	10 feet	N/A**	Yes
Minimum D50 for Approach and Downstream Riprap	12 inches	12 inches (Type M Riprap)	Yes
Minimum Boulder Size for Drop Structure	Per Figure 9-1	24" Boulder Size	Yes

*Results from FlowMaster were used to calculate the approximate unit discharge per foot of drop width

**Due to the sandy soils on site and within the channel, future degradation is expected. Therefore, the stilling basins were removed and replaced with a sloping face extending five feet below the downstream toe invert of each drop structure.

Existing 36" Twin Culverts

The two 36" CMP culverts located at the southeast end of the project site, crossing Owl Place are severely undersized and partially filled with sediment. As stated in the **Owl Place CLOMR**, the culverts only convey 86-95 cfs, depending on tailwater depth. The remaining flow (approximately 825-834 cfs) in the 100-year event overtops Owl Place.

The Falcon Owl Place development (located south of the project site across Owl Place) includes regrading and rerouting a portion of the UTBSC East Branch. The improvements intercept the existing creek immediately north of Owl Place and conveys it via a 10'x6' box culvert to pond (SR4). The proposed box culvert begins just north of Owl Place and will replace existing culverts. Per discussions with the adjacent developer, construction is expected to begin in 2024. The Meridian Storage project. If the proposed culvert replacements are not completed prior to the completion of Meridian Storage, flows will continue to overtop Owl Place.

ADDED REFERENCE TO O&M MANUAL

see comment on the plat regarding the full ownership and maintenance of the channel

Construction plans for the culvert replacement and associated improvements are located in Appendix B.

V. Ownership & Maintenance

After completion of construction and upon the Board of County Commissioners acceptance, it is anticipated all public drainage facilities are to be owned and maintained by El Paso County. All private drainage facilities are to be owned and maintained by Meridian Storage, LLC. The table below provides a summary of each facilities' ownership & maintenance responsibilities.

Drainage Facility	Ownership and Maintenance Entity
Drainage Channel (UTBSC East Branch) – RMT064	El Paso County
Pond #1	Meridian Storage, LLC
Public Storm Drain Infrastructure (See Construction Drawings, and "VI. Fee Development" below for breakdown)	El Paso County
Private Storm Drain Infrastructure (See Construction Drawings, and "VI. Fee Development" below for breakdown)	Meridian Storage, LLC

VI. Fee Development

Drainage & Bridge Fees

The project is located within the Falcon drainage basin. The property is already platted, however, due to requirements in the ECM Appendix L 3.13a, if a replat results in an increase in the impervious acreage, drainage basin fees shall be assessed on the additional impervious acreage. If the replat was a vacation and replat were previously platted as 5-acre residential, the drainage basin fees shall approximate the existing impervious acres by multiplying the total impervious acres by 3%.

ADDED ALL PROPOSED AREAS PART OF THE FINAL PLAT DRAWINGS. ALSO UPDATED IMPERVIOUS EXHIBIT IN APPENDIX A

Note: a proposed impervious exhibit is provided in Appendix A. The table below.

	Existing Impervious Acres	Proposed Impervious Acres	Impervious Acres Eligible for Fee Calculation
Lot 1a	3% x 5.00 = 0.150	2.832	2.832 - 0.150 = 2.682
Lot 2a	3% x 4.61 = 0.138	3.598	3.598 - 0.138 = 3.460
		Total =	6.142

Drainage Fee

\$37,256 x 6.142 Impervious Acres = \$228,826

Please account for the extension of Meridian park Drive roadway & sidewalk imperviousness

Bridge Fee

\$5,118 x 6.142 Impervious Acres = \$31,434

Improvements and Reimbursable Costs

The Falcon Drainage Basin Planning Study – Fee Development, categorizes improvements into Developer Costs, County Costs, and Metro District Costs. Items identified as Developer Costs (those incurred by the Developer) are eligible for reimbursement. County Costs and Metro District Costs are not eligible for reimbursement. The applicable reach is classified in the DBPS as follows:

Reach/Feature	Reach Length (ft)	Improvement	Cost Category	Eligible for Reimbursement	Cost As Shown in Falcon DBPS
RMT064	3,358	Small Drop Structures w/ Toe Protection	County	No	\$1,231,110 (\$366/LF)

The developer intends to amend the Falcon DBPS to allow for the costs of ~700 LF of RMT064 (starting at Owl Place and measuring north) to become reimbursable by the process outlined below:

1. Drainage Reimbursement request application with PCD.
2. Prepare an amendment to the DBPS outlining the request for a portion of RMT064 changed from a County Cost to Developer Cost
 - a. Amendment request hearing to the Drainage Board and Board of County Commissioners (BOCC).
3. Once construction of the reimbursable facilities is completed, procedures for Drainage Improvement Credits and Reimbursement outlined in Chapter 3 of the Drainage Criteria Manual will be utilized.

An Engineering Opinion of Probable Cost (OPC) for all drainage improvements is provided below:

Non-Reimbursable Public Facilities Estimate Total				
(Anticipated to be eligible for reimbursement pending DBPS Amendment)				
Item	Quantity	Unit	Unit Cost	Cost
Drainage Channel Improvements				
Drainage Channel Construction	700	LF	\$ 100.00	\$ 25,000.00
Type M Riprap	180	CY	\$ 135.00	\$ 24,300.00
Grouted Boulders (24")	514	SY	\$ 225.00	\$115,650.00
6' Concrete Cutoff Wall	106	CY	\$ 631.00	\$ 66,886.00
Reimbursable Public Facilities Estimate Total	\$231,836.00			

Non-Reimbursable Public Facilities Estimate Total				
Item	Quantity	Unit	Unit Cost	Cost
Sub-Regional Detention Pond (SR4) Improvements				
Grouted Sloped Boulder Removal	20	SF	\$ 250.00	\$ 5,000.00
Concrete Forebay	1	EA	\$10,000.00	\$ 10,000.00
Guard Rail Fence (Forebay)	35	LF	\$ 6.00	\$ 210.00
Type M Riprap (Forebay Apron)	5	CY	\$ 125.00	\$ 625.00
Trickle Channel	60	LF	\$ 35.00	\$ 2,100.00
Subtotal				\$ 12,935.00
Storm Drain Improvements				
15" Reinforced Concrete Pipe	49	LF	\$ 55.00	\$ 2,695.00
18" Reinforced Concrete Pipe	123	LF	\$ 76.00	\$ 9,348.00
24" Reinforced Concrete Pipe	8	LF	\$ 91.00	\$ 728.00
36" Reinforced Concrete Pipe	47	LF	\$ 140.00	\$ 6,580.00
18" Flared End Section	1	EA	\$ 456.00	\$ 456.00
5' CDOT Type R Curb Inlet	2	EA	\$ 8,715.00	\$ 17,430.00
10' CDOT Type R Curb Inlet	2	EA	\$ 9,507.00	\$ 19,014.00
Subtotal				\$ 43,480.00
Non-Reimbursable Public Facilities Estimate Total				\$ 56,415.00

Private Facilities Estimate Total				
Item	Quantity	Unit	Unit Cost	Cost
Pond #1				
Earthwork	5000	CY	\$ 10.00	\$ 50,000.00
Forebay	2	EA	\$ 5,000.00	\$ 10,000.00
Guard Rail Fence (Forebays & Micropool)	165	LF	\$ 6.00	\$ 990.00
Type M Riprap (Forebay Aprons)	10	CY	\$ 125.00	\$ 1,250.00
Type L Riprap (Emergency Spillway)	60	CY	\$ 100.00	\$ 6,000.00
Trickle Channel	130	LF	\$ 15.00	\$ 1,950.00
Outlet Structure w/ Concrete Micropool	1	EA	\$15,000.00	\$ 15,000.00
Pond Access Road (CDOT Class 6 Gravel)	95	CY	\$ 45.00	\$ 4,275.00
Subtotal				\$ 89,465.00
Storm Drain Improvements				
15" Reinforced Concrete Pipe	40	LF	\$ 55.00	\$ 2,200.00

18" Reinforced Concrete Pipe	1025	LF	\$ 76.00	\$ 77,900.00
24" Reinforced Concrete Pipe	117	LF	\$ 91.00	\$ 10,647.00
36" Reinforced Concrete Pipe	39	LF	\$ 140.00	\$ 5,460.00
4' Storm Drain Manhole, Box Base	1	EA	\$14,109.00	\$ 14,109.00
CDOT Type C Area Inlet	1	EA	\$ 4,500.00	\$ 4,500.00
CDOT Typ 13 Area Inlet (Triple)	2	EA	\$14,105.00	\$ 28,210.00
Subtotal				\$ 62,926.00
Non-Reimbursable Public Facilities Estimate Total				\$152,391.00

VII. Conclusion

This Final Drainage Report for Falcon Ranchettes Filing No. 1a was prepared using the criteria and methods as described in the Mile High Flood District (MHFD) Urban Storm Drainage Criteria Manual (USDCM) and the adopted chapters 6 & 13 from the City of Colorado Springs Drainage Criteria Manual (DCM) Vol. 1. The downstream facilities are adequate to protect the runoff proposed from the site. The site runoff will not adversely affect the downstream and surrounding developments. This report is in general conformance with all previously prepared reports that included this site.

VIII. References

1. Drainage Criteria Manual Volume 1, City of Colorado Springs, May 2014, revised January 2021.
2. Drainage Criteria Manual Volume 2, City of Colorado Springs, May 2014, revised December 2020.
3. El Paso County Board Resolution No. 15-042: El Paso County adoption of Chapter and Section 3.2.1, Chapter 14 of the City of Colorado Springs Drainage Criteria Manual Volume 1, May 2014
4. Urban Storm Drainage Criteria Manuals, Mile High Flood District, latest revisions.
5. Flood Insurance Rate Map, El Paso County Area, Colorado and Incorporated Areas, Map Number 08041C0553G, Effective Date December 7, 2018
6. Soil Map, El Paso County Area, Colorado as available through the Natural Resources Conservation Service National Cooperative Soil Survey website via Web Soil Survey 2.0
7. Geotechnical Exploration Report for 11690 and 11750 Owl Place, Prepared by Universal Engineering Sciences, April 18, 2023
8. Falcon Drainage Basin Planning Study, Prepared by Matrix Design Group, September 2015
9. Bent Grass MDDP Amendment & DBPS Amendment, Prepared by Galloway & Company, Inc., September 2021
10. Request for Conditional Letter of Map Revision, Unnamed Tributary to Black Squirrel Creek, Falcon Owl Place, Prepared by Drexel, Barrel & Co., October 25, 2022

11. Request for Letter of Map Revision, Unnamed Tributary to Black Squirrel Creek, Falcon Marketplace, Prepared by Drexel, Barrel & Co., March 15, 2021
12. Final Drainage Report for Falcon Marketplace, Prepared by Drexel, Barrel & Co., November 4, 2019

APPENDIX A



MERIDIAN STORAGE
 FALCON RANCHETTES FILING NO. 1A

VICINITY MAP

Project No:	MRS01
Drawn By:	CMWJ
Checked By:	RGD
Date:	09/08/2023

Galloway

1155 Kelly Johnson Blvd., Suite 305
 Colorado Springs, CO 80920
 719.900.7220 • GallowayUS.com

Hydrologic Soil Group—El Paso County Area, Colorado
(Falcon Ranchettes Filing No. 1a)

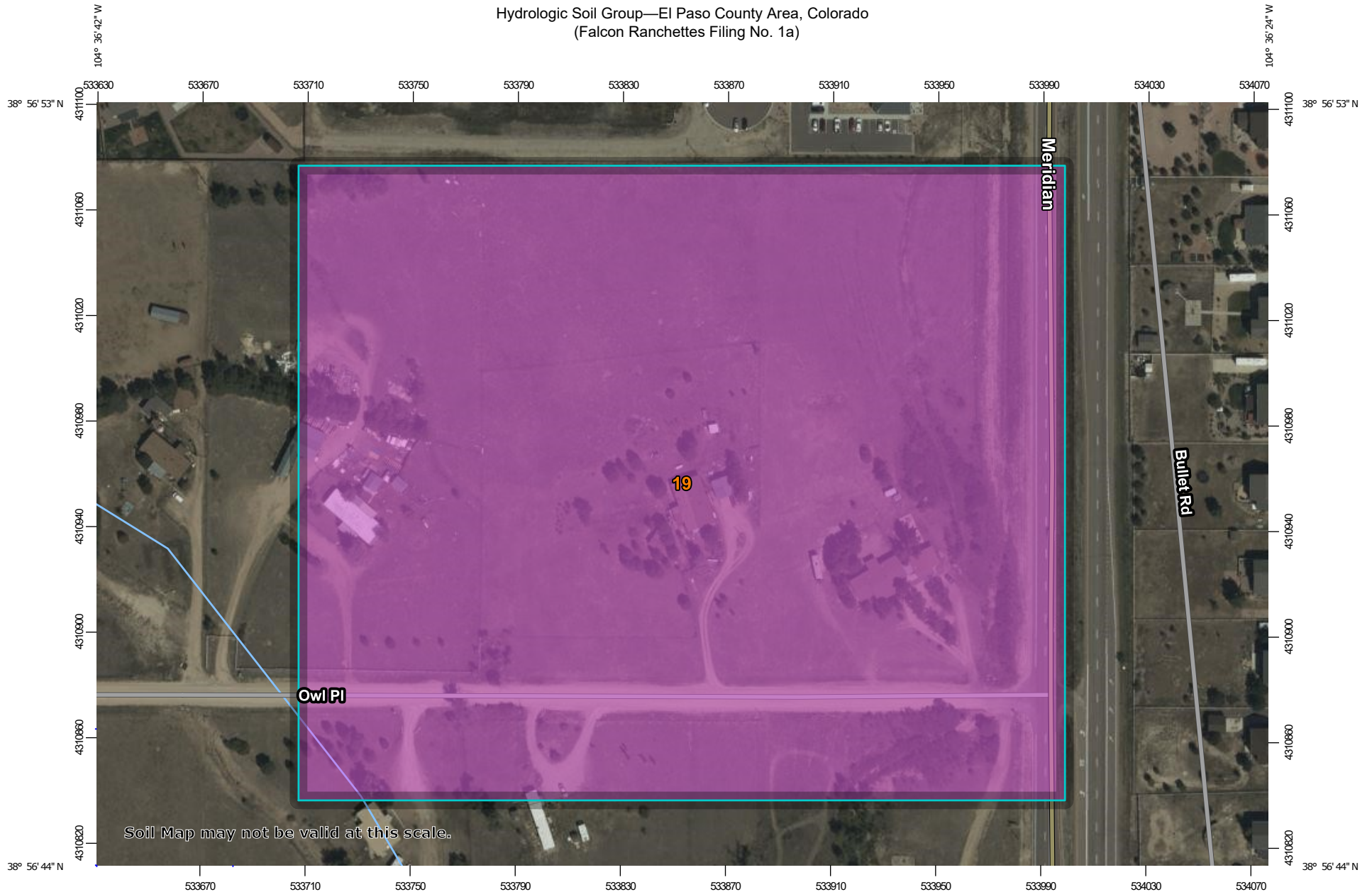

Map Scale: 1:2,040 if printed on A landscape (11" x 8.5") sheet.

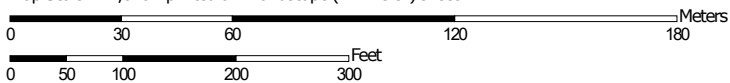

Map projection: Web Mercator Corner coordinates: WGS84 Edge tics: UTM Zone 13N WGS84



MAP LEGEND

Area of Interest (AOI)









 Area of Interest (AOI)

Soils

Soil Rating Polygons





 A
 A/D
 B
 B/D
 C
 C/D
 D
 Not rated or not available

Soil Rating Lines

 A
 A/D
 B
 B/D
 C
 C/D
 D
 Not rated or not available

Soil Rating Points





 A
 A/D
 B
 B/D

 C
 C/D
 D
 Not rated or not available

Water Features

 Streams and Canals

Transportation

 Rails
 Interstate Highways
 US Routes
 Major Roads
 Local Roads

Background

 Aerial Photography

MAP INFORMATION

The soil surveys that comprise your AOI were mapped at 1:24,000.

Warning: Soil Map may not be valid at this scale.

Enlargement of maps beyond the scale of mapping can cause misunderstanding of the detail of mapping and accuracy of soil line placement. The maps do not show the small areas of contrasting soils that could have been shown at a more detailed scale.

Please rely on the bar scale on each map sheet for map measurements.

Source of Map: Natural Resources Conservation Service
 Web Soil Survey URL:
 Coordinate System: Web Mercator (EPSG:3857)

Maps from the Web Soil Survey are based on the Web Mercator projection, which preserves direction and shape but distorts distance and area. A projection that preserves area, such as the Albers equal-area conic projection, should be used if more accurate calculations of distance or area are required.

This product is generated from the USDA-NRCS certified data as of the version date(s) listed below.

Soil Survey Area: El Paso County Area, Colorado
 Survey Area Data: Version 20, Sep 2, 2022

Soil map units are labeled (as space allows) for map scales 1:50,000 or larger.

Date(s) aerial images were photographed: Sep 11, 2018—Oct 20, 2018

The orthophoto or other base map on which the soil lines were compiled and digitized probably differs from the background imagery displayed on these maps. As a result, some minor shifting of map unit boundaries may be evident.

Hydrologic Soil Group

Map unit symbol	Map unit name	Rating	Acres in AOI	Percent of AOI
19	Columbine gravelly sandy loam, 0 to 3 percent slopes	A	17.4	100.0%
Totals for Area of Interest			17.4	100.0%

Description

Hydrologic soil groups are based on estimates of runoff potential. Soils are assigned to one of four groups according to the rate of water infiltration when the soils are not protected by vegetation, are thoroughly wet, and receive precipitation from long-duration storms.

The soils in the United States are assigned to four groups (A, B, C, and D) and three dual classes (A/D, B/D, and C/D). The groups are defined as follows:

Group A. Soils having a high infiltration rate (low runoff potential) when thoroughly wet. These consist mainly of deep, well drained to excessively drained sands or gravelly sands. These soils have a high rate of water transmission.

Group B. Soils having a moderate infiltration rate when thoroughly wet. These consist chiefly of moderately deep or deep, moderately well drained or well drained soils that have moderately fine texture to moderately coarse texture. These soils have a moderate rate of water transmission.

Group C. Soils having a slow infiltration rate when thoroughly wet. These consist chiefly of soils having a layer that impedes the downward movement of water or soils of moderately fine texture or fine texture. These soils have a slow rate of water transmission.

Group D. Soils having a very slow infiltration rate (high runoff potential) when thoroughly wet. These consist chiefly of clays that have a high shrink-swell potential, soils that have a high water table, soils that have a claypan or clay layer at or near the surface, and soils that are shallow over nearly impervious material. These soils have a very slow rate of water transmission.

If a soil is assigned to a dual hydrologic group (A/D, B/D, or C/D), the first letter is for drained areas and the second is for undrained areas. Only the soils that in their natural condition are in group D are assigned to dual classes.

Rating Options

Aggregation Method: Dominant Condition

Component Percent Cutoff: None Specified

Tie-break Rule: Higher

NOTES TO USERS

This map is for use in administering the National Flood Insurance Program. It does not necessarily identify all areas subject to flooding, particularly from local drainage sources of small size. The community map repository should be consulted for updated or additional flood hazard information.

To obtain more detailed information in areas where **Base Flood Elevations (BFEs)** and/or **floodways** have been determined, users are encouraged to consult the Flood Profiles and Floodway Data and/or Summary of Stillwater Elevations tables contained within the Flood Insurance Study (FIS) report that accompanies this FIRM. Users should be aware that BFEs shown on the FIRM represent rounded whole-foot elevations. These BFEs are intended for flood insurance rating purposes only and should not be used as the sole source of flood elevation information. Accordingly, flood elevation data presented in the FIS report should be utilized in conjunction with the FIRM for purposes of construction and/or floodplain management.

Coastal Base Flood Elevations shown on this map apply only landward of 0.0' North American Vertical Datum of 1988 (NAVD88). Users of this FIRM should be aware that coastal flood elevations are also provided in the Summary of Stillwater Elevations table in the Flood Insurance Study report for this jurisdiction. Elevations shown in the Summary of Stillwater Elevations table should be used for construction and/or floodplain management purposes when they are higher than the elevations shown on this FIRM.

Boundaries of the **floodways** were computed at cross sections and interpolated between cross sections. The floodways were based on hydraulic considerations with regard to requirements of the National Flood Insurance Program. Floodway widths and other pertinent floodway data are provided in the Flood Insurance Study report for this jurisdiction.

Certain areas not in Special Flood Hazard Areas may be protected by **flood control structures**. Refer to section 2.4 "Flood Protection Measures" of the Flood Insurance Study report for information on flood control structures for this jurisdiction.

The **projection** used in the preparation of this map was Universal Transverse Mercator (UTM) zone 13. The **horizontal datum** was NAD83, GRS80 spheroid. Differences in datum, spheroid, projection or UTM zones zones used in the production of FIRMs for adjacent jurisdictions may result in slight positional differences in map features across jurisdiction boundaries. These differences do not affect the accuracy of this FIRM.

Flood elevations on this map are referenced to the **North American Vertical Datum of 1988 (NAVD88)**. These flood elevations must be compared to structure and ground elevations referenced to the same vertical datum. For information regarding conversion between the National Geodetic Vertical Datum of 1929 and the North American Vertical Datum of 1988, visit the National Geodetic Survey website at <http://www.ngs.noaa.gov/> or contact the National Geodetic Survey at the following address:

NGS Information Services
NOAA, NINGS12
National Geodetic Survey
SMC-3, #9202
1315 East-West Highway
Silver Spring, MD 20910-3282

To obtain current elevation, description, and/or location information for **bench marks** shown on this map, please contact the Information Services Branch of the National Geodetic Survey at (301) 713-3242 or visit its website at <http://www.ngs.noaa.gov/>.

Base Map information shown on this FIRM was provided in digital format by El Paso County, Colorado Springs Utilities, City of Fountain, Bureau of Land Management, National Oceanic and Atmospheric Administration, United States Geological Survey, and Anderson Consulting Engineers, Inc. These data are current as of 2006.

This map reflects more detailed and up-to-date **stream channel configurations and floodplain delineations** than those shown on the previous FIRM for this jurisdiction. The floodplains and floodways that were transferred from the previous FIRM may have been adjusted to conform to these new stream channel configurations. As a result, the Flood Profiles and Floodway Data tables in the Flood Insurance Study Report (which contains authoritative hydraulic data) may reflect stream channel distances that differ from what is shown on this map. The profile baselines depicted on this map represent the hydraulic modeling baselines that match the flood profiles and Floodway Data Tables if applicable, in the FIS report. As a result, the profile baselines may deviate significantly from the new base map channel representation and may appear outside of the floodplain.

Corporate limits shown on this map are based on the best data available at the time of publication. Because changes due to annexations or de-annexations may have occurred after this map was published, map users should contact appropriate community officials to verify current corporate limit locations.

Please refer to the separately printed **Map Index** for an overview map of the county showing the layout of map panels; community map repository addresses; and a Listing of Communities table containing National Flood Insurance Program dates for each community as well as a listing of the panels on which each community is located.

Contact **FEMA Map Service Center (MSC)** via the FEMA Map Information eXchange (FMIX) 1-877-336-2627 for information on available products associated with this FIRM. Available products may include previously issued Letters of Map Change, a Flood Insurance Study Report, and/or digital versions of this map. The MSC may also be reached by Fax at 1-800-358-9620 and its website at <http://www.msc.fema.gov/>.

If you have **questions about this map** or questions concerning the National Flood Insurance Program in general, please call 1-877-FEMA MAP (1-877-336-2627) or visit the FEMA website at <http://www.fema.gov/business/nfp>.

El Paso County Vertical Datum Offset Table	
Flooding Source	Vertical Datum Offset (ft)
REFER TO SECTION 3.3 OF THE EL PASO COUNTY FLOOD INSURANCE STUDY FOR STREAM BY STREAM VERTICAL DATUM CONVERSION INFORMATION	

Panel Location Map

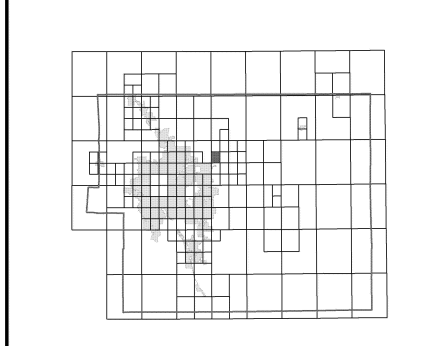

This Digital Flood Insurance Rate Map (DFIRM) was produced through a Cooperating Technical Partner (CTP) agreement between the State of Colorado Water Conservation Board (CWCB) and the Federal Emergency Management Agency (FEMA).

Additional Flood Hazard information and resources are available from local communities and the Colorado Water Conservation Board.

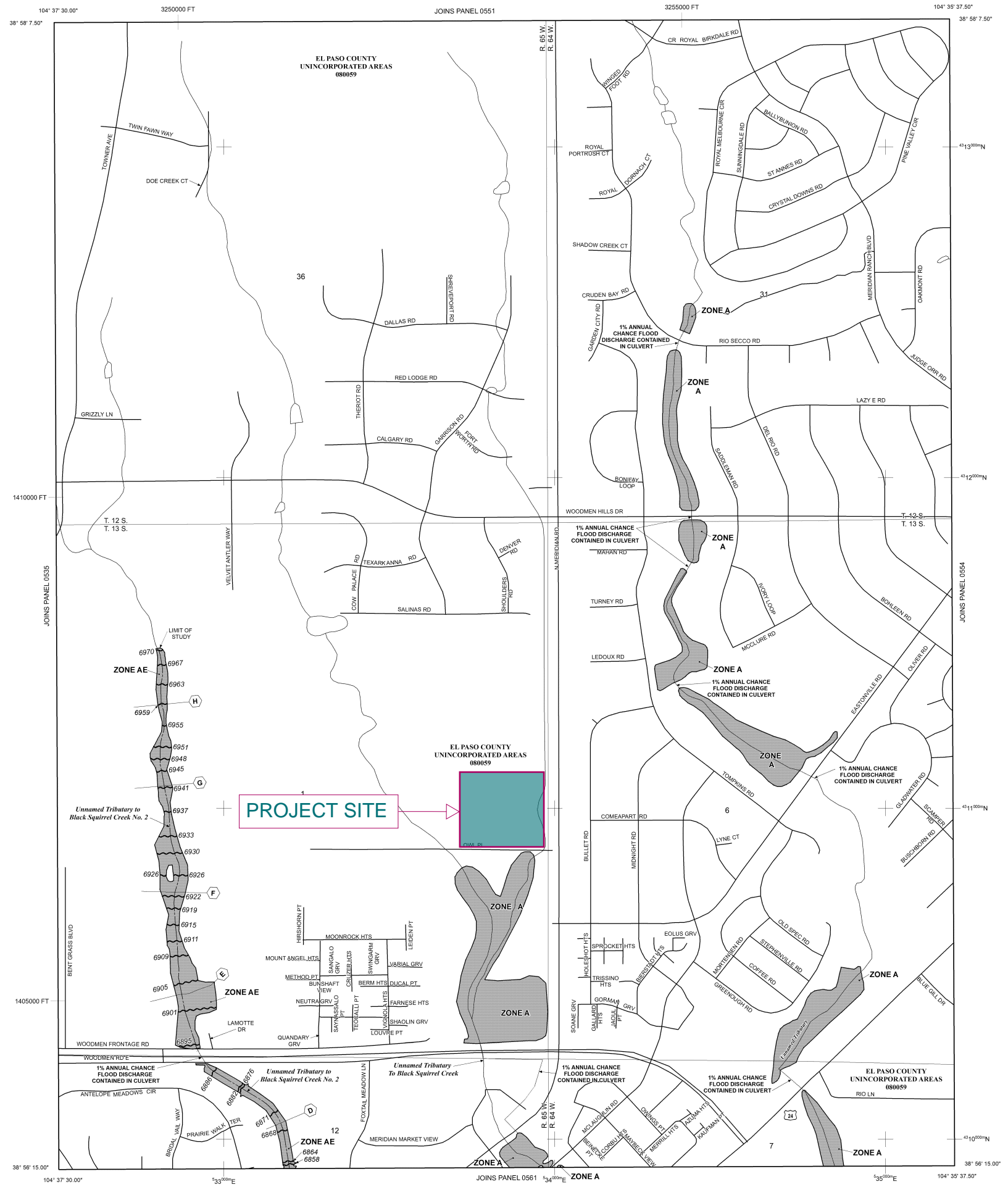

LEGEND

SPECIAL FLOOD HAZARD AREAS (SFHAS) SUBJECT TO INUNDATION BY THE 1% ANNUAL CHANCE FLOOD

The 1% annual chance flood (100-year flood), also known as the base flood, is the flood that has a 1% chance of being equaled or exceeded in any given year. The Special Flood Hazard Area is the area subject to flooding by the 1% annual chance flood. Areas of Special Flood Hazard include Zones A, AE, AH, AO, AR, A99, V, and VE. The Base Flood Elevation is the water-surface elevation of the 1% annual chance flood.

ZONE A No Base Flood Elevations determined.

ZONE AE Base Flood Elevations determined.

ZONE AH Flood depths of 1 to 3 feet (usually areas of ponding); Base Flood Elevations determined.

ZONE AO Flood depths of 1 to 3 feet (usually sheet flow on sloping terrain); average depths determined. For areas of alluvial fan flooding, velocities also determined.

ZONE AR Special Flood Hazard Area Formerly protected from the 1% annual chance flood by a flood control system that was subsequently decertified. Zone AR indicates that the former flood control system is being restored to provide protection from the 1% annual chance or greater flood.

ZONE A99 Area to be protected from 1% annual chance flood by a Federal flood protection system under construction; no Base Flood Elevations determined.

ZONE V Coastal flood zone with velocity hazard (wave action); no Base Flood Elevations determined.

ZONE VE Coastal flood zone with velocity hazard (wave action); Base Flood Elevations determined.

FLOODWAY AREAS IN ZONE AE

The floodway is the channel of a stream plus any adjacent floodplain areas that must be kept free of encroachment so that the 1% annual chance flood can be carried without substantial increases in flood heights.

OTHER FLOOD AREAS

ZONE X Areas of 0.2% annual chance flood; areas of 1% annual chance flood with average depths of less than 1 foot or with drainage areas less than 1 square mile; and areas protected by levees from 1% annual chance flood.

OTHER AREAS

ZONE X Areas determined to be outside the 0.2% annual chance floodplain.

ZONE D Areas in which flood hazards are undetermined, but possible.

COASTAL BARRIER RESOURCES SYSTEM (CBRS) AREAS

OTHERWISE PROTECTED AREAS (OPAs)

CBRS areas and OPAs are normally located within or adjacent to Special Flood Hazard Areas.

— Floodplain boundary
— Floodway boundary
— Zone D Boundary
— CBRS and OPA boundary

— Boundary dividing Special Flood Hazard Areas of different Base Flood Elevations, flood depths or flood velocities.
— Base Flood Elevation line and value; elevation in feet* (EL 987)
— Base Flood Elevation value where uniform within zone; elevation in feet*

* Referenced to the North American Vertical Datum of 1988 (NAVD 88)

— A — Cross section line
— 23 — Transect line

97° 07' 30.00" 32° 22' 30.00" 4750000N
1000-meter Universal Transverse Mercator grid ticks, zone 13

6000000 FT 5000-foot grid ticks: Colorado State Plane coordinate system, central zone (FIPS ZONE 0502), Lambert Conformal Conic Projection

DX5510 X Bench mark (see explanation in Notes to Users section of this FIRM panel)

M1.5 River Mile

MAP REPOSITORIES
Refer to Map Repositories list on Map Index

EFFECTIVE DATE OF COUNTYWIDE FLOOD INSURANCE RATE MAP
MARCH 17, 1997

EFFECTIVE DATE(S) OF REVISION(S) TO THIS PANEL
DECEMBER 7, 2018 to update corporate limits, to change Base Flood Elevations and Special Flood Hazard Areas, to update map format, to add roads and road names, and to incorporate previously issued Letters of Map Revision.

For community map revision history prior to countywide mapping, refer to the Community Map History Table located in the Flood Insurance Study report for this jurisdiction.

To determine if flood insurance is available in this community, contact your insurance agent or call the National Flood Insurance Program at 1-800-638-6620.

MAP SCALE 1" = 500'

250 500 1000 FEET
150 0 150 300 METERS

NFP

PANEL 0553G

FIRM
FLOOD INSURANCE RATE MAP
EL PASO COUNTY,
COLORADO
AND INCORPORATED AREAS

PANEL 553 OF 1300
(SEE MAP INDEX FOR FIRM PANEL LAYOUT)

CONTAINS:	COMMUNITY	NUMBER	PANEL	SUFFIX
	EL PASO COUNTY	05029	0553	G

Notice: This map was released on 05/15/2020 to make a correction. This version replaces any previous versions. See the Notice-to-User Letter that accompanied this correction for details.

Notice to User: The Map Number shown below should be used when placing map orders. The Community Number shown above should be used on insurance applications for the subject community.

MAP NUMBER
08041C0553G

MAP REVISED
DECEMBER 7, 2018
Federal Emergency Management Agency

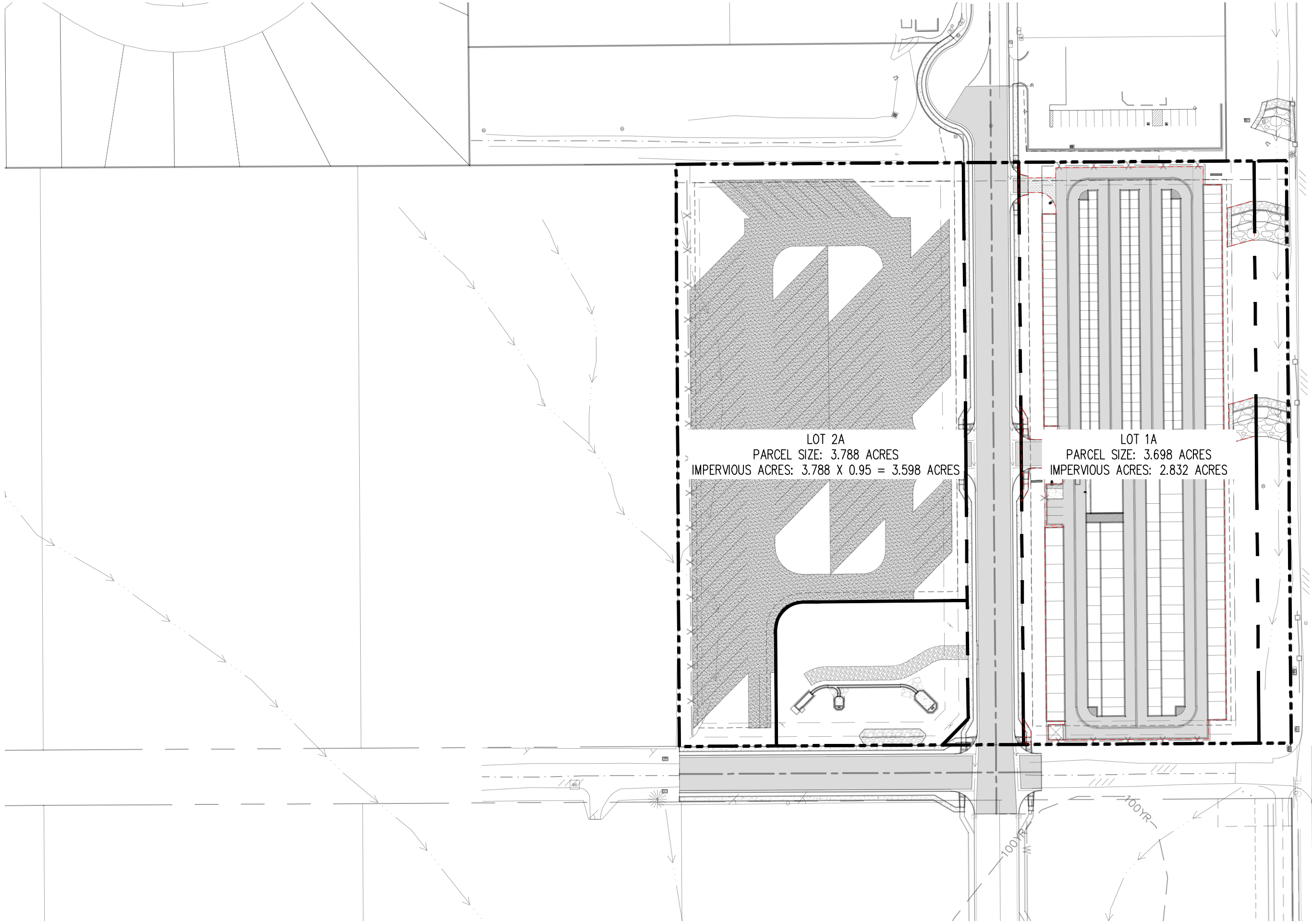

LOT 2A
 PARCEL SIZE: 3.788 ACRES
 IMPERVIOUS ACRES: 3.788 X 0.95 = 3.598 ACRES

LOT 1A
 PARCEL SIZE: 3.698 ACRES
 IMPERVIOUS ACRES: 2.832 ACRES

Project No:	MRS02
Drawn By:	CMMJ
Checked By:	BAS
Date:	10/20/2023

APPENDIX B

FALCON DRAINAGE BASIN PLANNING STUDY
SELECTED PLAN REPORT
FINAL - SEPTEMBER 2015

Prepared for:



El Paso County Public Services Department
3275 Akers Drive
Colorado Springs, CO 80922

Prepared By:



Matrix Design Group
2435 Research Parkway, Suite 300
Colorado Springs, CO 80920

Matrix Project No. 10.122.003

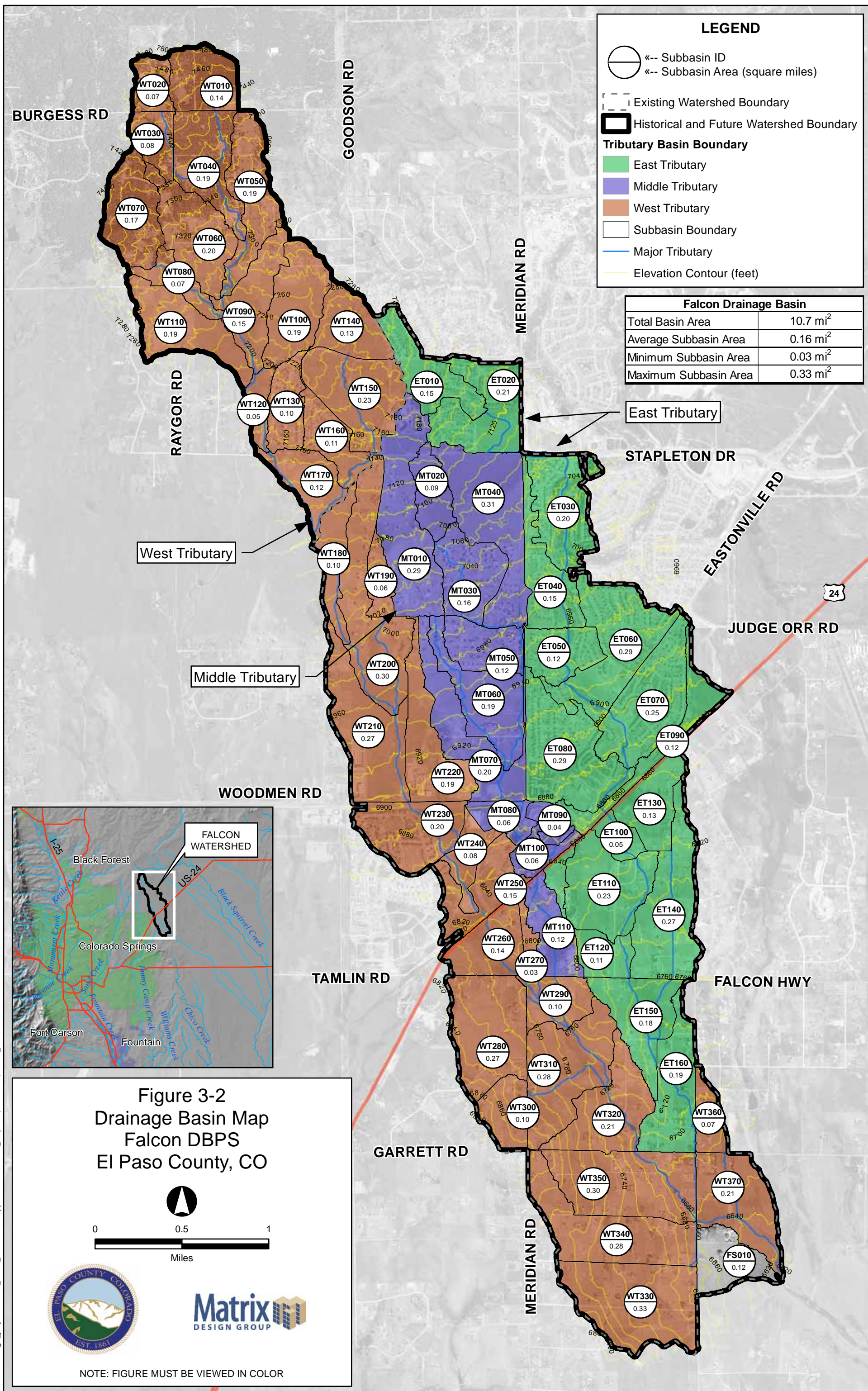
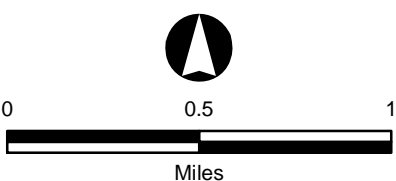

Figure 3-2
 Drainage Basin Map
 Falcon DBPS
 El Paso County, CO



NOTE: FIGURE MUST BE VIEWED IN COLOR

FILE: G:\gis_projects\Falcon_Creek_DBPS\active\apps\20110613\basin_map.mxd, 8/29/2011, wilson_wheeler

BURGESS RD

GOODSON RD

MERIDIAN RD

STAPLETON DR

EASTONVILLE RD

JUDGE ORR RD

WOODMEN RD

TAMLIN RD

GARRETT RD

FALCON HWY

LEGEND

- ⊕ ← Subbasin ID
- ⊕ ← 2-yr & 100-yr Flows (cfs)
- ◊ Detention Pond
- △ Junctions
- - - Existing Watershed Boundary
- ▭ Historical and Future Watershed Boundary
- ▭ Tributary Basin Boundary
- ▭ Subbasin Boundary
- Major Tributary

Hydrologic Element	Area (sq mi)	Future Peak Flows (cfs)		Hydrologic Element	Area (sq mi)	Future Peak Flows (cfs)	
		2-year	100-year			2-year	100-year
ET010	0.15	38	200	RET050	0.71	27	570
ET030	0.21	73	360	RET060	0.83	11	530
ET040	0.20	45	240	RET070	1.11	13	430
ET040	0.15	28	170	RET080	1.36	65	420
ET050	0.12	37	200	RET090	1.66	15	350
ET060	0.29	110	530	RET100	1.78	26	390
ET070	0.25	94	460	RET110	1.83	27	390
ET080	0.29	110	520	RET120	2.05	39	430
ET090	0.12	26	130	RET140	0.13	11	85
ET100	0.05	11	72	RET152	2.16	49	450
ET110	0.23	24	200	RET154	0.40	26	200
ET120	0.11	11	89	RET156	2.57	50	650
ET130	0.13	11	85	RET162	2.74	59	680
ET140	0.27	16	120	RET164	2.93	66	710
ET150	0.18	17	140	RMT030	0.09	25	140
ET160	0.19	19	140	RMT040	0.25	49	290
FS010	0.12	6	75	RMT050	0.56	110	750
JET010	0.15	29	150	RMT062	0.29	1	160
JET020	0.36	74	390	RMT064	0.67	120	850
JET030	0.56	97	580	RMT070	1.16	130	1,000
JET040	0.71	27	570	RMT080	1.36	150	1,200
JET050	0.83	11	520	RMT090	0.04	9	32
JET060	1.11	13	430	RMT102	1.42	86	1,200
JET070	1.36	94	480	RMT104	0.04	9	32
JET080	1.66	15	350	RMT106	1.46	91	1,200
JET090	1.78	26	390	RMT112	1.52	92	1,200
JET100	1.83	27	390	RMT114	1.64	94	1,200
JET110	2.05	40	460	RMT030	0.07	4	42
JET120	2.16	49	450	RMT042	0.14	9	85
JET130	0.13	11	85	RMT044	0.14	9	89
JET140	0.40	26	200	RMT046	0.28	15	170
JET152	2.57	51	650	RMT054	0.46	24	260
JET154	2.74	62	680	RMT080	0.17	14	130
JET160	2.93	66	710	RMT092	0.85	43	480
FS010	0.12	6	75	RMT094	1.09	54	610
JMT010	0.29	1	160	RMT122	1.43	68	730
JMT020	0.09	26	140	RMT124	1.63	77	840
JMT030	0.25	50	290	RMT150	0.13	32	180
JMT040	0.56	110	750	RMT160	0.36	15	170
JMT050	0.67	120	850	RMT170	1.77	85	920
JMT060	1.16	130	1,000	RMT176	2.24	98	960
JMT070	1.36	150	1,200	RMT180	2.36	100	990
JMT080	1.42	86	1,200	RMT202	2.46	100	1,000
JMT090	0.04	9	32	RMT204	0.06	4	43
JMT102	1.46	91	1,200	RMT210	2.82	110	1,200
JMT104	0.04	9	32	RMT232	3.09	120	1,300
JMT106	1.52	92	1,200	RMT234	0.19	47	250
JMT110	1.64	94	1,200	RMT236	3.28	120	1,400
JMT110	0.14	9	89	RMT240	3.47	130	1,400
JMT120	0.07	4	42	RMT240			
JMT130	0.14	9	85	Diversion			
JMT142	0.28	15	170	RMT252	3.55	30	39
JMT144	0.46	24	260	RMT250	3.55	83	1,100
JMT150	0.85	43	480	RMT260	3.70	85	1,100
JMT170	0.17	14	130	RMT291	3.84	86	1,100
JMT180	1.09	54	610	RMT292	0.03	11	57
JMT190	1.43	68	730	RMT294	0.27	33	250
JMT210	1.63	77	840	RMT295	3.87	86	1,100
JMT220	1.77	85	920	RMT296	4.13	94	1,100
JMT230	0.13	32	180	RMT312	0.10	12	91
JMT240	0.36	15	170	RMT314	5.88	160	1,700
JMT250	0.47	35	190	RMT320	6.25	160	1,700
JMT272	2.24	99	960	RMT344	0.33	32	250
JMT274	2.36	100	990	RMT352	6.46	160	1,700
JMT280	2.46	100	1,000	RMT354	9.69	210	2,400
JMT290	0.06	4	43	RMT372	10.30	230	2,500
JMT200	2.82	110	1,200	RMT374	0.07	7	55
JMT210	3.09	120	1,300	RMT376	10.36	230	2,500
JMT220	0.19	47	250	M1	0.06	4	43
JMT232	3.28	120	1,400	M2	0.29	1	160
JMT234	3.47	130	1,400	WH North	0.71	28	570
JMT240	3.55	83	1,100	WH South	0.71	27	520
JMT250	3.70	85	1,100	WH2	0.83	11	530
JMT260	3.84	86	1,100	WH3	1.11	13	430
JMT270	0.03	11	57	WH4	1.66	15	350
JMT280	0.27	33	250	WH5	0.04	9	32
JMT292	3.87	86	1,100	WHH	0.56	110	750
JMT294	4.13	96	1,100	WT010	0.14	9	89
JMT296	5.88	160	1,700	WT020	0.07	4	42
JMT300	0.10	12	92	WT030	0.08	9	75
JMT310	6.25	160	1,700	WT040	0.19	9	93
JMT320	6.46	160	1,700	WT050	0.19	17	140
JMT330	0.33	32	250	WT060	0.20	14	120
JMT352	9.69	210	2,400	WT070	0.17	14	130
JMT354	10.30	230	2,500	WT080	0.07	9	67
JMT360	0.07	7	55	WT090	0.15	22	160
JMT372	10.36	230	2,500	WT100	0.19	56	300
JMT374				WT110	0.19	22	170
OUTLET	10.58	230	2,500	WT120	0.05	8	55
RWU	0.29	28	210	WT130	0.10	35	170
MT020	0.09	26	140	WT140	0.13	32	180
MT030	0.16	39	230	WT150	0.23	49	250
MT040	0.31	95	460	WT160	0.11	35	180
MT050	0.12	17	110	WT170	0.12	21	140
MT060	0.19	30	200	WT180	0.10	8	66
MT070	0.20	25	170	WT190	0.06	11	75
MT080	0.06	62	190	WT200	0.30	25	190
MT090	0.04	40	130	WT210	0.27	32	190
MT100	0.06	17	88	WT220	0.19	47	250
MT110	0.12	19	120	WT230	0.20	71	350
PBH4	0.15	29	150	WT240	0.08	36	160
PBH1	0.10	10	130	WT250	0.15	63	290
PBH2	0.36	51	270	WT260	0.14	10	78
PBH3	0.36	51	270	WT270	0.03	11	57
PBHC	0.19	11	160	WT280	0.27	33	250
RMN	1.42	86	1,200	WT290	0.10	15	110
RWU				WT300	0.10	12	92
Diversion	3.55	83	1,100	WT310	0.28	31	250
RWU North	3.55	110	1,400	WT320	0.21	27	200
RWU South	3.55	55	1,000	WT330	0.33	32	250
RET020	0.15	29	150	WT340	0.28	19	150
RET030	0.36	71	380	WT350	0.30	38	280
RET040	0.56	95	580	WT360	0.07	7	55
				WT370	0.21	7	120

Figure 3-13 Future Hydrology Falcon DBPS El Paso County, CO

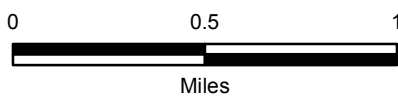

NOTE: FIGURE MUST BE VIEWED IN COLOR

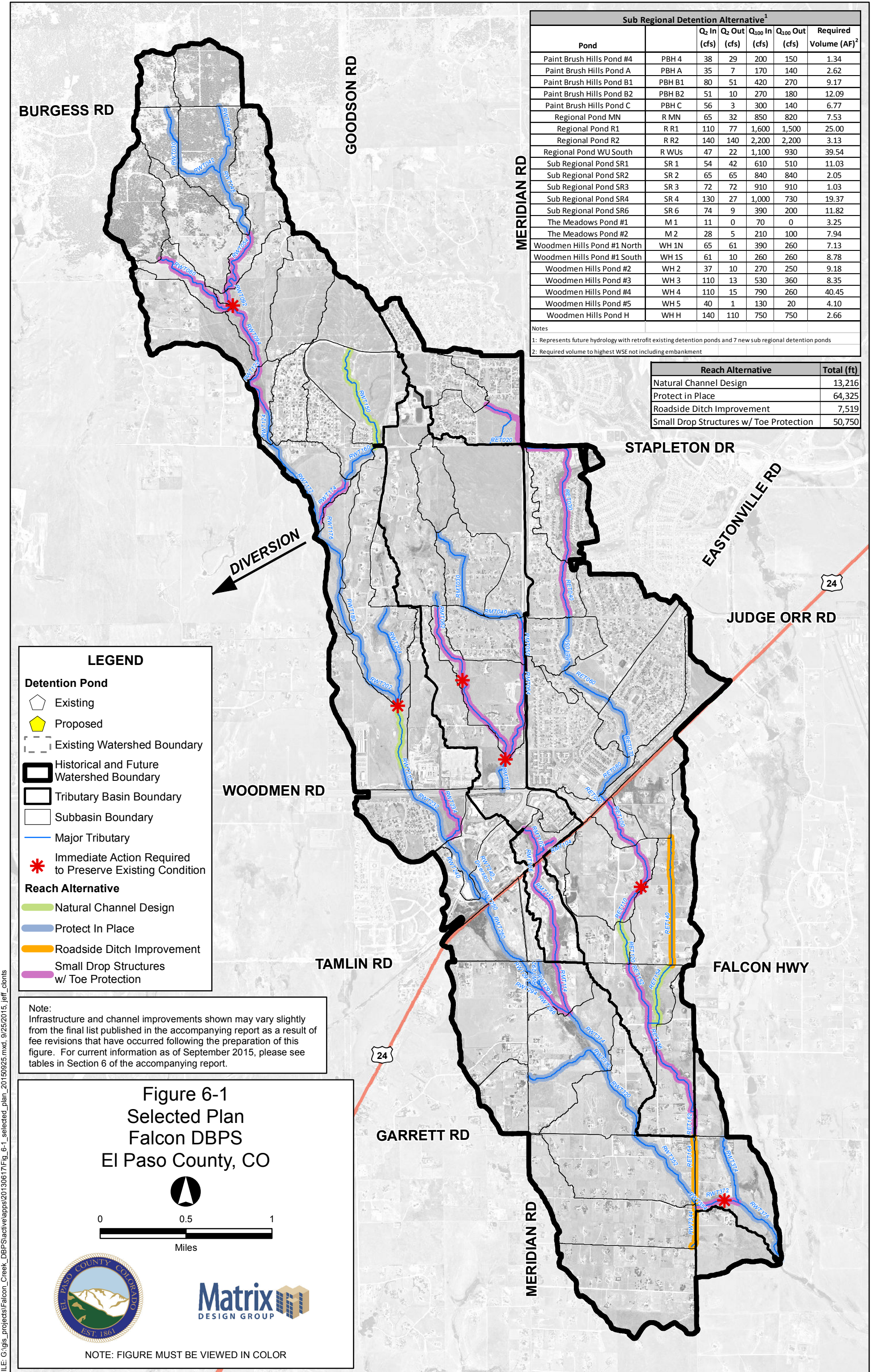

Sub Regional Detention Alternative ¹						
Pond		Q ₂ In (cfs)	Q ₂ Out (cfs)	Q ₁₀₀ In (cfs)	Q ₁₀₀ Out (cfs)	Required Volume (AF) ²
Paint Brush Hills Pond #4	PBH 4	38	29	200	150	1.34
Paint Brush Hills Pond A	PBH A	35	7	170	140	2.62
Paint Brush Hills Pond B1	PBH B1	80	51	420	270	9.17
Paint Brush Hills Pond B2	PBH B2	51	10	270	180	12.09
Paint Brush Hills Pond C	PBH C	56	3	300	140	6.77
Regional Pond MN	R MN	65	32	850	820	7.53
Regional Pond R1	R R1	110	77	1,600	1,500	25.00
Regional Pond R2	R R2	140	140	2,200	2,200	3.13
Regional Pond WU South	R WUs	47	22	1,100	930	39.54
Sub Regional Pond SR1	SR 1	54	42	610	510	11.03
Sub Regional Pond SR2	SR 2	65	65	840	840	2.05
Sub Regional Pond SR3	SR 3	72	72	910	910	1.03
Sub Regional Pond SR4	SR 4	130	27	1,000	730	19.37
Sub Regional Pond SR6	SR 6	74	9	390	200	11.82
The Meadows Pond #1	M 1	11	0	70	0	3.25
The Meadows Pond #2	M 2	28	5	210	100	7.94
Woodmen Hills Pond #1 North	WH 1N	65	61	390	260	7.13
Woodmen Hills Pond #1 South	WH 1S	61	10	260	260	8.78
Woodmen Hills Pond #2	WH 2	37	10	270	250	9.18
Woodmen Hills Pond #3	WH 3	110	13	530	360	8.35
Woodmen Hills Pond #4	WH 4	110	15	790	260	40.45
Woodmen Hills Pond #5	WH 5	40	1	130	20	4.10
Woodmen Hills Pond H	WH H	140	110	750	750	2.66

Reach Alternative	Total (ft)
Natural Channel Design	13,216
Protect in Place	64,325
Roadside Ditch Improvement	7,519
Small Drop Structures w/ Toe Protection	50,750

Notes
 1: Represents future hydrology with retrofit existing detention ponds and 7 new sub regional detention ponds
 2: Required volume to highest WSE not including embankment

LEGEND

Detention Pond
 Existing (White pentagon)
 Proposed (Yellow pentagon)

Existing Watershed Boundary (Dashed line)
 Historical and Future Watershed Boundary (Thick black line)
 Tributary Basin Boundary (Thin black line)
 Subbasin Boundary (Thin grey line)

Major Tributary (Blue line)

Immediate Action Required to Preserve Existing Condition (Red asterisk)

Reach Alternative
 Natural Channel Design (Green line)
 Protect In Place (Blue line)
 Roadside Ditch Improvement (Orange line)
 Small Drop Structures w/ Toe Protection (Purple line)

Note:
 Infrastructure and channel improvements shown may vary slightly from the final list published in the accompanying report as a result of fee revisions that have occurred following the preparation of this figure. For current information as of September 2015, please see tables in Section 6 of the accompanying report.

**Figure 6-1
 Selected Plan
 Falcon DBPS
 El Paso County, CO**

0 0.5 1
 Miles

NOTE: FIGURE MUST BE VIEWED IN COLOR

Sheet 6-23 Falcon DBPS Conceptual Plan Middle Tributary El Paso County, CO

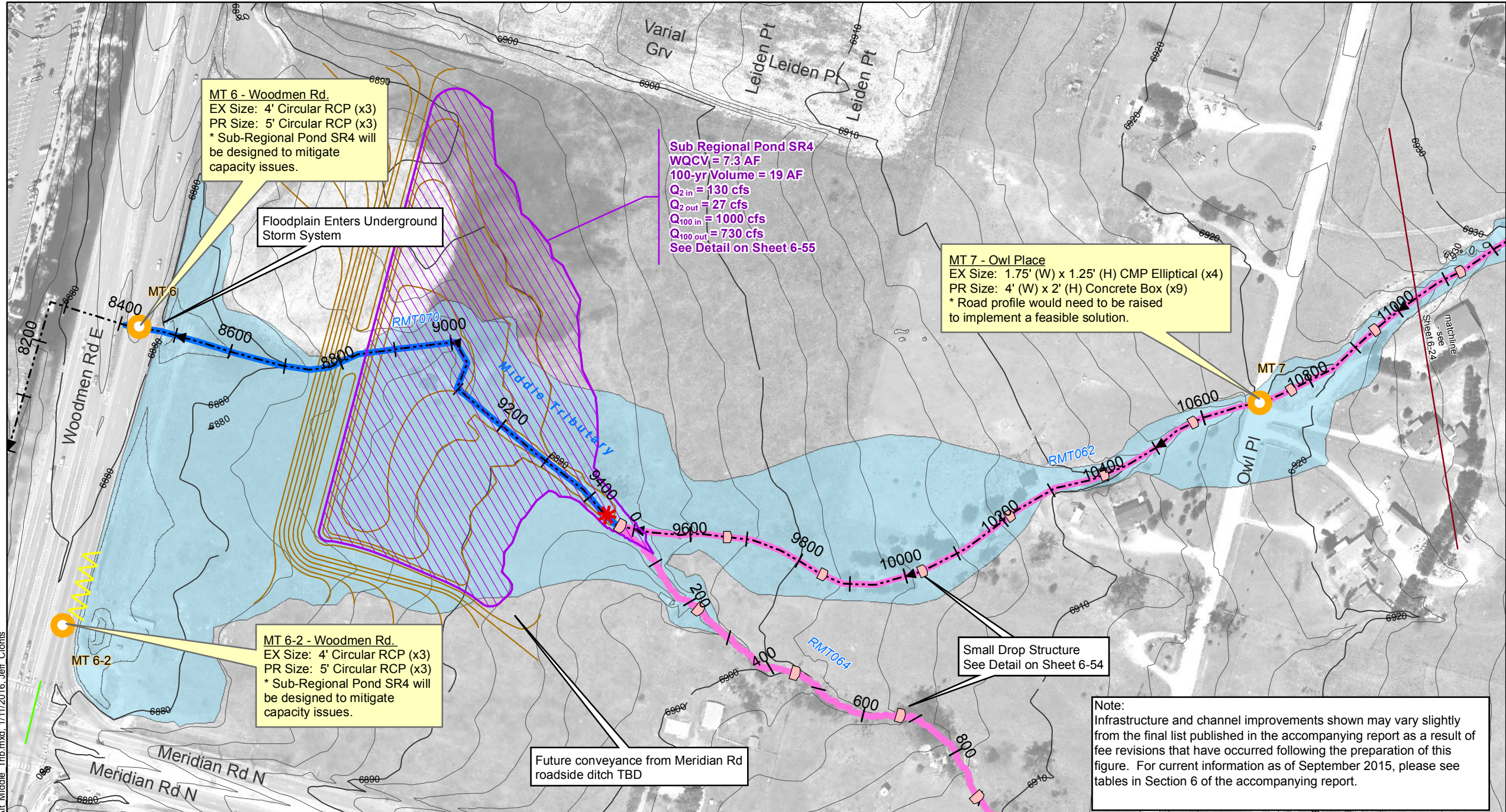

- Drainageway Crossing
- Stream Centerline
- Existing Approximate 100-yr Floodplain*
- Floodplain Study Limit
- Storm Sewer
 - Inlet
 - Manhole
 - Pipe
- Reach Improvements
 - Natural Channel Design
 - Protect In Place
 - Roadside Ditch Improvement
 - Small Drop Structures w/ Toe Protection
 - Existing Detention
 - Proposed Detention
 - Proposed Detention Grading
 - Small Drop Structure
 - Cross Vane
 - Immediate Action Required to Preserve Existing Condition

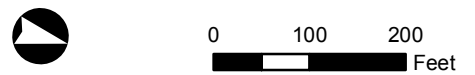

* These approximate 100-yr floodplain boundaries are for planning purposes only. This information is not intended to replace the information provided on the FEMA Flood Insurance Rate Maps for this area.
** These are conceptual design drawings and are subject to change. These drawings are not intended for construction purposes.



Note:
Infrastructure and channel improvements shown may vary slightly from the final list published in the accompanying report as a result of fee revisions that have occurred following the preparation of this figure. For current information as of September 2015, please see tables in Section 6 of the accompanying report.

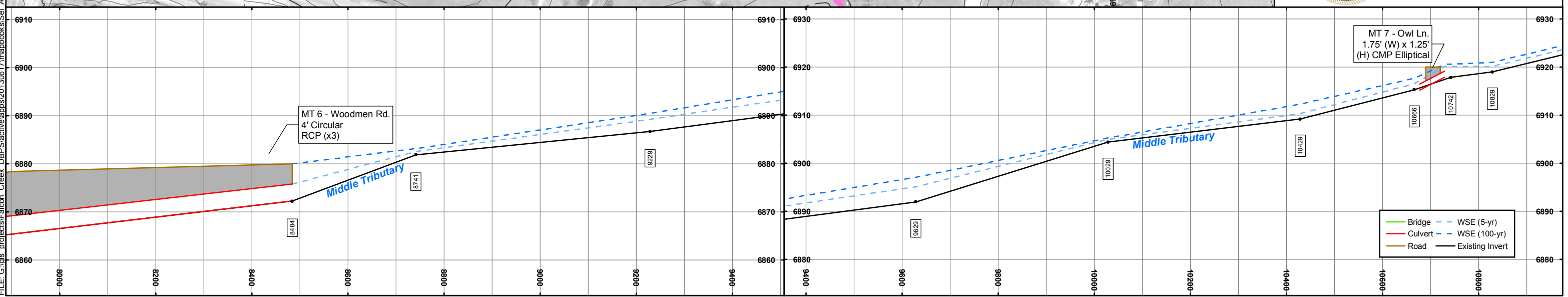

FILE: G:\gis_projects\Falcon_Creek_DBPS\active\ppps20130617\mapbooks\sel Alt Middle Trib.mxd, 1/11/2016, Jeff Clonis

Sheet 6-24 Falcon DBPS Conceptual Plan Middle Tributary El Paso County, CO

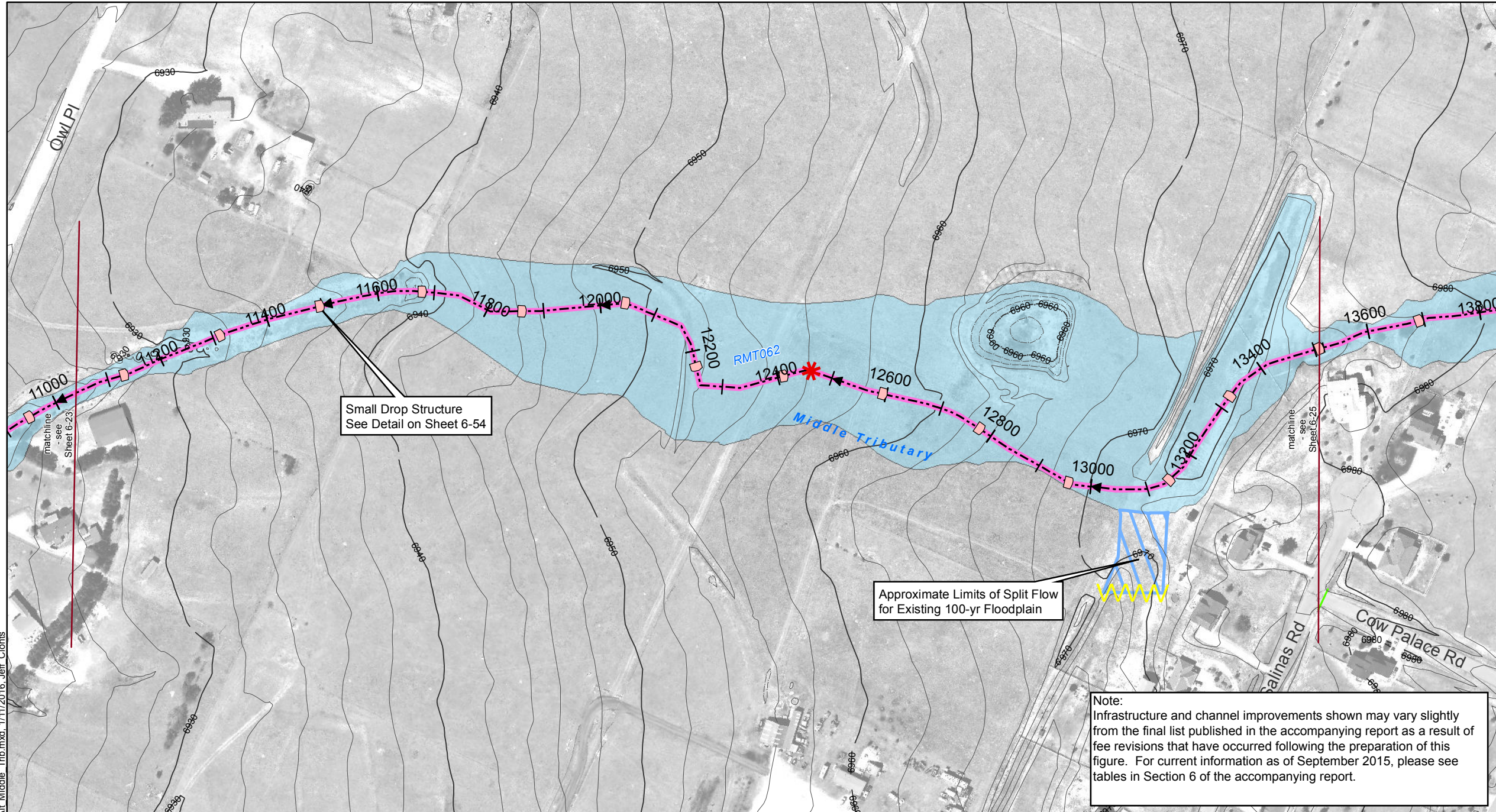

Drainageway Crossing	Reach Improvements
Stream Centerline	Natural Channel Design
Existing Approximate 100-yr Floodplain*	Protect In Place
Floodplain Study Limit	Roadside Ditch Improvement
Storm Sewer	Small Drop Structures w/ Toe Protection
Inlet	Existing Detention
Manhole	Proposed Detention
Pipe	Proposed Detention Grading
	Small Drop Structure
	Cross Vane
	Immediate Action Required to Preserve Existing Condition

0 100 200 Feet

* These approximate 100-yr floodplain boundaries are for planning purposes only. This information is not intended to replace the information provided on the FEMA Flood Insurance Rate Maps for this area.
** These are conceptual design drawings and are subject to change. These drawings are not intended for construction purposes.

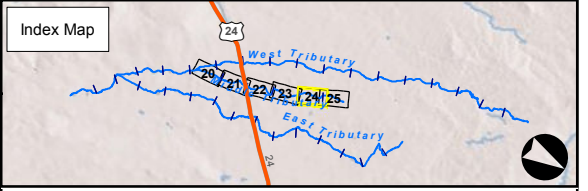

Note:
Infrastructure and channel improvements shown may vary slightly from the final list published in the accompanying report as a result of fee revisions that have occurred following the preparation of this figure. For current information as of September 2015, please see tables in Section 6 of the accompanying report.

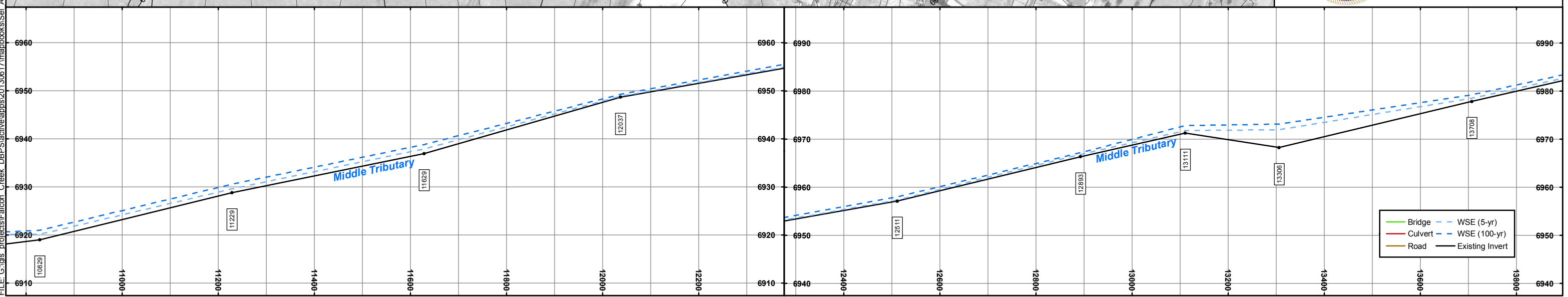

FILE: G:\gis\projects\Falcon_Creek_DBPS\active\apps\20130617\mapbooks\sel_Alt_Middle_Trib.mxd, 1/11/2016, Jeff Clontis

7.0 FEE DEVELOPMENT

7.1. Introduction

The objective of the fee development exercise was to determine the equitable share of drainage improvement costs that a developer is responsible for paying to El Paso County if they wish to plat a property. This fee is a function of the total cost for the selected plan outlined in Section 6 and will be used by the County to pay for drainage improvements that are necessary as a result of development. The product of this calculation is a unit fee (cost/impervious acre) that is a one-time charge to the developer based on the number of impervious acres within the platted property.

7.2. Developable Land

The Falcon Watershed has a total area of 6,847 acres. The entirety of the watershed is within the County with 1,969 acres unplatted, according to the GIS dataset received from the County. This dataset also includes unplatted areas that can't be developed because of specific land use designations. Table 7-1 provides a summary of land classifications in the Falcon Watershed. A complete summary of unplatted area land use is provided in Appendix E.

Table 7-1. Land Classification

Classification	Area (acres)
Platted	3,670
Unplatted	1,969
Other	1,208
Total	6,847

The projected impervious acreage within unplatted areas totals 645.58 acres. A summary of land classification within the Falcon Watershed is provided in Figure 7-3.

7.3. Fee Calculation & County Cost

The total cost for the Selected Plan was separated into a Development Fee, County Cost, Metropolitan District Cost, and Drainage and Bridge Funds. A description of how the aforementioned were defined is as follows:

- **County Cost** – Drainage improvement costs that are the responsibility of the County as shown in Figure 7-1.
- **Metropolitan District Cost** – Drainage improvement costs that are the responsibility of a metropolitan district as shown in Figure 7-2.
- **Development Fee** – All drainage improvement costs that are directly associated with new development.
- **Drainage and Bridge Funds** – The balance of drainage and bridge funds as of August 2015 was \$584,134 and \$510,777, respectively, with a liability of \$300,000 cost for this DBPS (an additional contract amendment increased the cost of this DBPS to \$339,088).

The anticipated reimbursements due for work completed in the Falcon Watershed are approximately equivalent to the available drainage and bridge funds. As a result, reimbursements were not included in

the fee calculation. Drainage improvements that are required as a result of new development are listed in Appendix E.

The costs apportioned to County and metropolitan district drainage improvements are provided in Table 7-2 and Table 7-3. The bridge improvement fees shown in Table 7-2 and Table 7-3 were determined by classification of the crossing as either a bridge or a culvert. This classification was based on the DCM criteria.

Table 7-2. County Cost

Drainage Improvements	\$ 24,051,349
Bridge Improvements	\$ 2,887,437
Total Cost	\$ 26,938,786

Table 7-3. Metropolitan District Cost

Drainage Improvements	\$ 3,972,407
Bridge Improvements	\$ 1,855,620
Total Cost	\$ 5,828,027

The development cost and corresponding fee calculations based on impervious acreage are provided in Table 7-4 and 7-5.

Table 7-4. Development Drainage Cost and Fee

Drainage Improvements	\$ 14,649,163
DBPS Cost	\$ 339,088
Total Cost	\$ 14,988,251
Drainage Fee (per imp. ac.)	\$ 23,217

Table 7-5. Development Bridge Cost and Fee

Bridge Improvements	\$ 2,058,474
Total Cost	\$ 2,058,474
Bridge Fee (per imp. ac.)	\$ 3,189

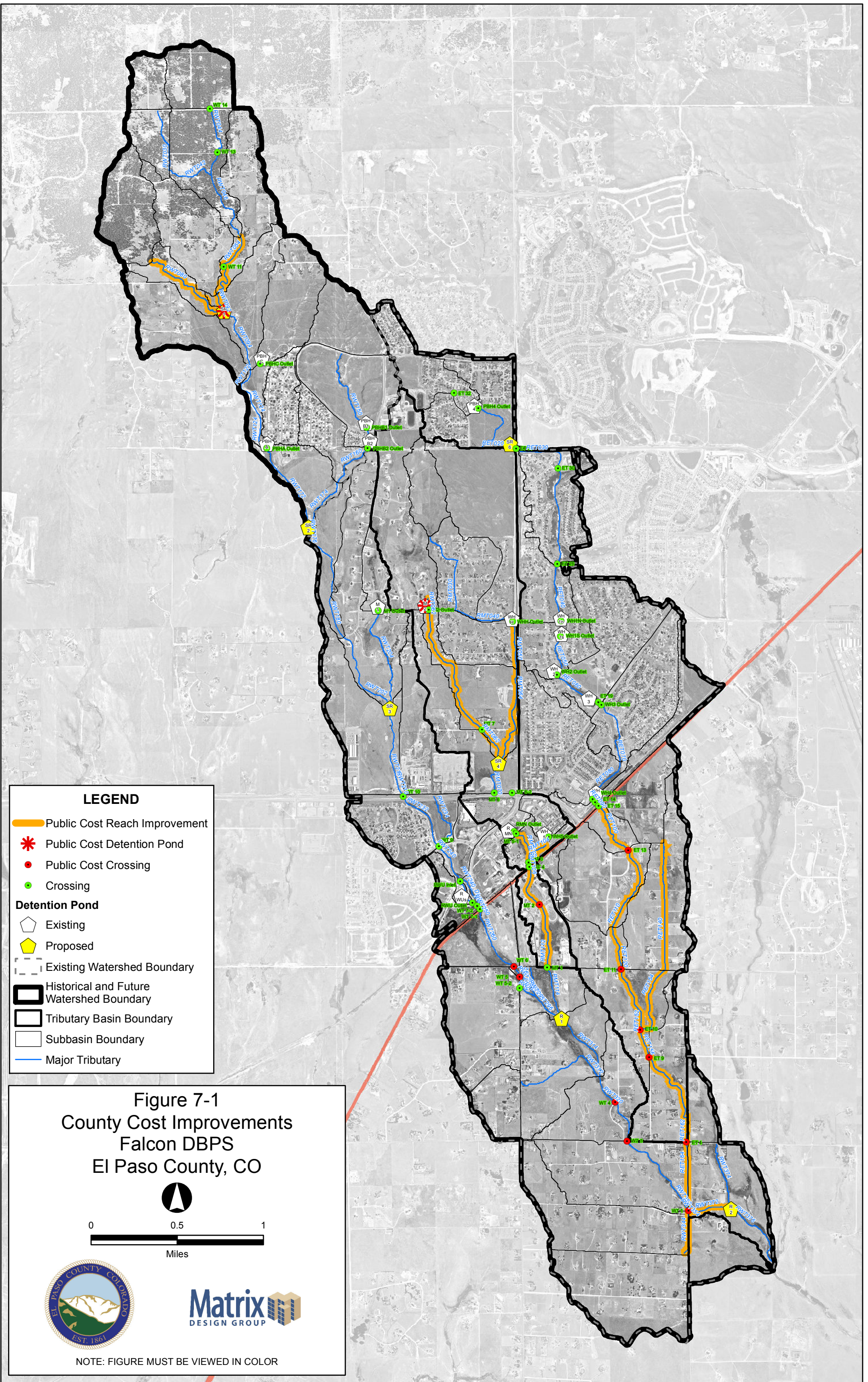

LEGEND











-  Public Cost Reach Improvement
-  Public Cost Detention Pond
-  Public Cost Crossing
-  Crossing
- Detention Pond**
-  Existing
-  Proposed
-  Existing Watershed Boundary
-  Historical and Future Watershed Boundary
-  Tributary Basin Boundary
-  Subbasin Boundary
-  Major Tributary

Figure 7-1
County Cost Improvements
Falcon DBPS
El Paso County, CO



Miles

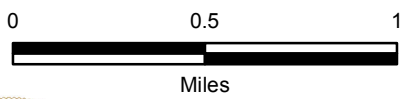

NOTE: FIGURE MUST BE VIEWED IN COLOR

**Falcon DBPS
County Costs**

Drainage Fees			
Reach/Pond	Reach Length (ft)	Improvement	Cost
RWT344	1,379	Roadside Ditch Improvement	\$ 167,006
RET140	4,052	Roadside Ditch Improvement	\$ 295,914
RET164	2,072	Roadside Ditch Improvement	\$ 132,703
RET100	1,791	Small Drop Structures w/Toe Protection	\$ 1,342,120
RET110	2,751	Small Drop Structures w/Toe Protection	\$ 1,055,516
RET152	2,030	Small Drop Structures w/Toe Protection	\$ 1,081,390
RET120	1,379	Natural Channel Design	\$ 72,798
RET162	3,256	Small Drop Structures w/Toe Protection	\$ 656,460
RMT050	1,568	Small Drop Structures w/Toe Protection	\$ 814,189
RMT062	5,688	Small Drop Structures w/Toe Protection	\$ 2,381,127
RMT064	3,358	Small Drop Structures w/Toe Protection	\$ 1,231,110
RMT112	3,372	Small Drop Structures w/Toe Protection	\$ 1,276,142
RWT054	2,497	Small Drop Structures w/Toe Protection	\$ 1,414,531
RWT080	3,494	Small Drop Structures w/Toe Protection	\$ 2,345,153
RWT092	626	Small Drop Structures w/Toe Protection	\$ 414,434
RWT372	1,377	Small Drop Structures w/Toe Protection	\$ 947,221
RMT102	1,021	Small Drop Structures w/Toe Protection	\$ 636,082
RMT104	874	Small Drop Structures w/Toe Protection	\$ 186,349
RET154	2,357	Natural Channel Design	\$ 468,927
RET156	942	Natural Channel Design	\$ 73,722
WT 5	43	Crossing - Culvert	\$ 8,651
ET 13	50	Crossing - Culvert	\$ 113,991
ET 11	40	Crossing - Culvert	\$ 84,348
ET 9	40	Crossing - Culvert	\$ 84,102
ET 4	61	Crossing - Culvert	\$ 106,060
Sub Regional Pond SR1		Detention Pond	\$ 405,769
The Meadows Pond #2		Detention Pond	\$ 20,000
		Subtotal	\$ 17,815,814
		Engineering/Construction Admin (15%)	\$ 2,672,372
		Contingency (20%)	\$ 3,563,163
		Total	\$ 24,051,349

Bridge Fees			
Reach/Pond	Reach Length (ft)	Improvement	Cost
WT 6	43	Crossing - Bridge	\$ 249,775
WT 4	48	Crossing - Bridge	\$ 528,324
WT 3	46	Crossing - Bridge	\$ 218,292
WT 1	40	Crossing - Bridge	\$ 636,648
MT 2	83	Crossing - Bridge	\$ 343,147
ET 10	44	Crossing - Bridge	\$ 162,656
		Subtotal	\$ 2,138,842
		Engineering/Construction Admin (15%)	\$ 320,826
		Contingency (20%)	\$ 427,768
		Total	\$ 2,887,437



MDDP & DBPS AMENDMENT

BENT GRASS DEVELOPMENT

El Paso County, Colorado

PREPARED FOR:
Challenger Communities, LLC
8605 Explorer Dr., Suite 250
Colorado Springs, CO 80920

PREPARED BY:
Galloway & Company, Inc.
1155 Kelly Johnson Blvd., Suite 305
Colorado Springs, CO 80920

DATE:
January 2021
Revised: March 2021
Revised: April 2021
Revised: June 2021
Revised: August 2021
Revised: September 2021

PUDSP-20-005



recommendations from the Falcon DBPS, when additional land is obtained to expand the ROW along the southbound portion of Meridian Road.

In the interim condition, it has been proposed to add a temporary lining to the existing channel to handle the excess velocities and depth associated with the DBPS flows and Bent Grass development re-routed flows. This analysis has been included in the Appendix.

The West Tributary Channel will be natural, vegetated facility, helping to ensure that the overall velocities will be reduced, flow depth will not exceed 5' and minimize any potential for scour. If needed, grade control structures may be designed as proposed in the DBPS to ensure these criteria are met.

3. Implement BMPs That Provide a Water Quality Capture Volume with Slow Release

This step utilizes formalized water quality capture volume to slow the release of runoff from the site. The WQCV will release in no less than 40 hours. On-site water quality control volume detention ponds will provide water quality treatment prior to the runoff being released into the channel. WQCV facilities will be designed as Extended Detention Basins.

The Falcon Meadows at Bent Grass development, west of Bent Grass Residential, Filing No. 1 and No. 2, will include several water quality ponds throughout the site to ensure flows will be treated prior to being released into the West Tributary Channel, running through the site. Only a small area, less than 1.0 acres will not be treated prior to releasing into the channel.

Currently, the existing Meridian Road roadside ditch, ultimately conveys runoff to the existing detention and water quality pond MN, as shown and discussed in the Falcon DBPS. The Falcon DBPS also shows a future detention and water quality pond SR-4 that is to receive flows from basin MT060 and discharge into basin MT070, ultimately routing to existing Pond MN. Flows from Bent Grass Meadows Drive are listed in basin MT060 but are being routed to the existing roadside ditch along Meridian Road, which is in basin MT070. The flows from the "School Site" and upstream basins will release into the east side of Pond SR-4 (west of Falcon Market Place). Pond SR-4 is currently under construction. The proposed improvements impact on the existing drainage basin and both Pond MN and Pond SR-4 are discussed later in the report.

4. Consider Need for Industrial and Commercial BMPs

Source control BMPs for homeowners include the use of garages as the primary area where pollutants can be stored. The single-family detached homes provide garages which can act as storage areas. The proposed development does not include outdoor storage or the potential for introduction of contaminants to the Counties' MS4, thus no targeted source control BMPs are necessary. The biggest source control BMP is public education and discuss topics such as: pet waste, car washing, lawn care, fall leaves, and snow melt and deicer.

Bent Grass East Commercial Filing No. 1 contains commercial development. This area will need to consider the need for Industrial & Commercial BMPs. No industrial uses or outside storage is proposed for this area. Drainage will be routed through water quality ponds prior to leaving the site to minimize contaminants into the public system.

VII. Future Drainage Conditions

MIDDLE TRIBUTARY

Design Point 30 and Basins OS-25 and OS-26 are as described under Existing Drainage Conditions. However, Basins OS-25 and OS-26 now route through proposed “future” detention pond, on what’s been previously referred to as the “School Site”, north of Bent Grass Meadows Drive and just west of Bent Grass Filing No. 2. This “future” pond will replace the current sedimentation pond on the “School Site”. Upon any additional development within the Middle Tributary area of the Bent Grass Development and north of Bent Grass Meadows Drive, this pond will need to be constructed to accommodate the re-routed flows from the Meadows Pond #2 at DP 30.

This future facility will need to provide 2.76 ac-ft of water quality, 6.26 ac-ft for EURV and 11.98 ac-ft for 100-year storage volume. Preliminary release rates for the 5 and 100-year storms are 3.8 cfs and 32.2 cfs. These flows were then routed to Bent Grass Meadows to the south. With the decrease in flows, flows will not overtop Bent Grass Meadows Drive and continue east to the future box culvert under Bent Grass Meadows Drive at DP BG20 (5-year flow=292.5 cfs, 100-year flow=909.3 cfs). Flows were still checked against street capacity on the north and south side of Bent Grass Meadows Drive, as it continues to the east. With the construction of the future pond, Bent Grass Meadows Drive will be able to adequately handle the flows and no additional storm infrastructure would need to be built to carry these future developed flows. Any area north of Bent Grass Meadows Drive that will develop in the future will need to provide its own on-site detention. Should future development not be able to release flows into Bent Grass Meadows Drive, a 42” RCP would be able to convey the flows of DP BG 15n (Q100=40.9 cfs, Q5=8.8 cfs) to the northwest corner of the Bent Grass Meadows Drive and Meridian Road intersection. Analysis for this culvert sizing has been included in the appendix.

At the Bent Grass Meadows Drive/Meridian Road intersection, the elliptical rcp’s will need to be replaced with a double 16’ x 4’ rcbc. The future roadside ditch will have a 15’ wide bottom channel with 4:1 side slope, 6.5’ deep and a longitudinal slope of 0.30%. This will result in a flow depth of 5.15’ and velocity of 5.04 fps. This channel will direct flows to Owl Place where the existing twin cmp’s will be replaced with a 20’ x 4’ rcbc or equivalent. This structure will need to be built when any development west of Meridian Road at the intersection of Owl Place happens. With future development, it is anticipated that the existing channel conveying flows to the south will be removed to accommodate the new development. The new channel will need to be a 35’ wide bottom channel with 4:1 sides, 5’ deep and a longitudinal slope of 0.30%. This will produce a flow depth of 3.7’ and a velocity of 4.6 fps. If the channel option is not viable, twin 78” rcp’s at a minimum 0.50% slope would be able to handle this future flow. Analysis for this design option has been included in the appendix.

Calculations are provided in Appendix C for the future culverts and roadside channel.

WEST TRIBUTARY

Offsite flows entering the west tributary location of Bent Grass have not changed from what was discussed under Current Conditions. Reach RWT202 at the northwest corner of the development has a 100-year flow of 1000 cfs and Reach RWT204 has a flow of 43 cfs. These were obtained from the DBPS by Matrix. The Flood Insurance Study (FIS) by FEMA does not have flows evaluated this far north. They have a flow of 1482 cfs beginning at RWT210. The 8 undeveloped on-site basins for Bent Grass West have been replaced with 17 developed basins. These basins are found in the Falcon Meadows for Bent Grass PDR. A summary of these basins is provided below and are part of the hydrology analysis provided in Appendix B.

Sub Regional Detention Alternative ¹						
Pond		Q ₂ In (cfs)	Q ₂ Out (cfs)	Q ₁₀₀ In (cfs)	Q ₁₀₀ Out (cfs)	Required Volume (AF) ²
Paint Brush Hills Pond #4	PBH 4	38	29	200	150	1.34
Paint Brush Hills Pond A	PBH A	35	7	170	140	2.62
Paint Brush Hills Pond B1	PBH B1	80	51	420	270	9.17
Paint Brush Hills Pond B2	PBH B2	51	10	270	180	12.09
Paint Brush Hills Pond C	PBH C	56	3	300	140	6.77
Regional Pond MN	R MN	65	32	850	820	7.53
Regional Pond R1	R R1	110	77	1,600	1,500	25.00
Regional Pond R2	R R2	140	140	2,100	2,100	7.90
Regional Pond WU South	R WU	47	22	1,070	930	39.54
Sub Regional Pond SR1	SR 1	54	42	610	510	11.03
Sub Regional Pond SR2	SR 2	65	65	840	840	2.05
Sub Regional Pond SR3	SR 3	72	72	910	910	1.03
Sub Regional Pond SR4	SR 4	130	27	1,000	730	19.37
Sub Regional Pond SR6	SR 6	74	9	390	200	11.82
The Meadows Pond #1	M 1	11	0	75	2	3.25
The Meadows Pond #2	M 2	28	5	210	99	7.94
Woodmen Hills Pond #1 North	WH 1N	65	61	390	260	7.13
Woodmen Hills Pond #1 South	WH 1S	61	10	260	260	8.78
Woodmen Hills Pond #2	WH 2	37	10	270	250	9.18
Woodmen Hills Pond #3	WH 3	105	13	530	360	8.35
Woodmen Hills Pond #4	WH 4	110	15	790	260	40.45
Woodmen Hills Pond #5	WH 5	40	1	130	19	4.10
Woodmen Hills Pond H	WH H	140	110	750	750	2.66

Notes
1: Represents future hydrology with retrofit existing detention ponds and 5 new subregional detention ponds
2: Required volume to highest WSE

Reach Alternative	Total (ft)
Protect In Place	30,066
Natural Channel Design	32,359
Small Drop Structures w/ Toe Protection	76,812
Large Drop Structures w/ Toe Protection	0

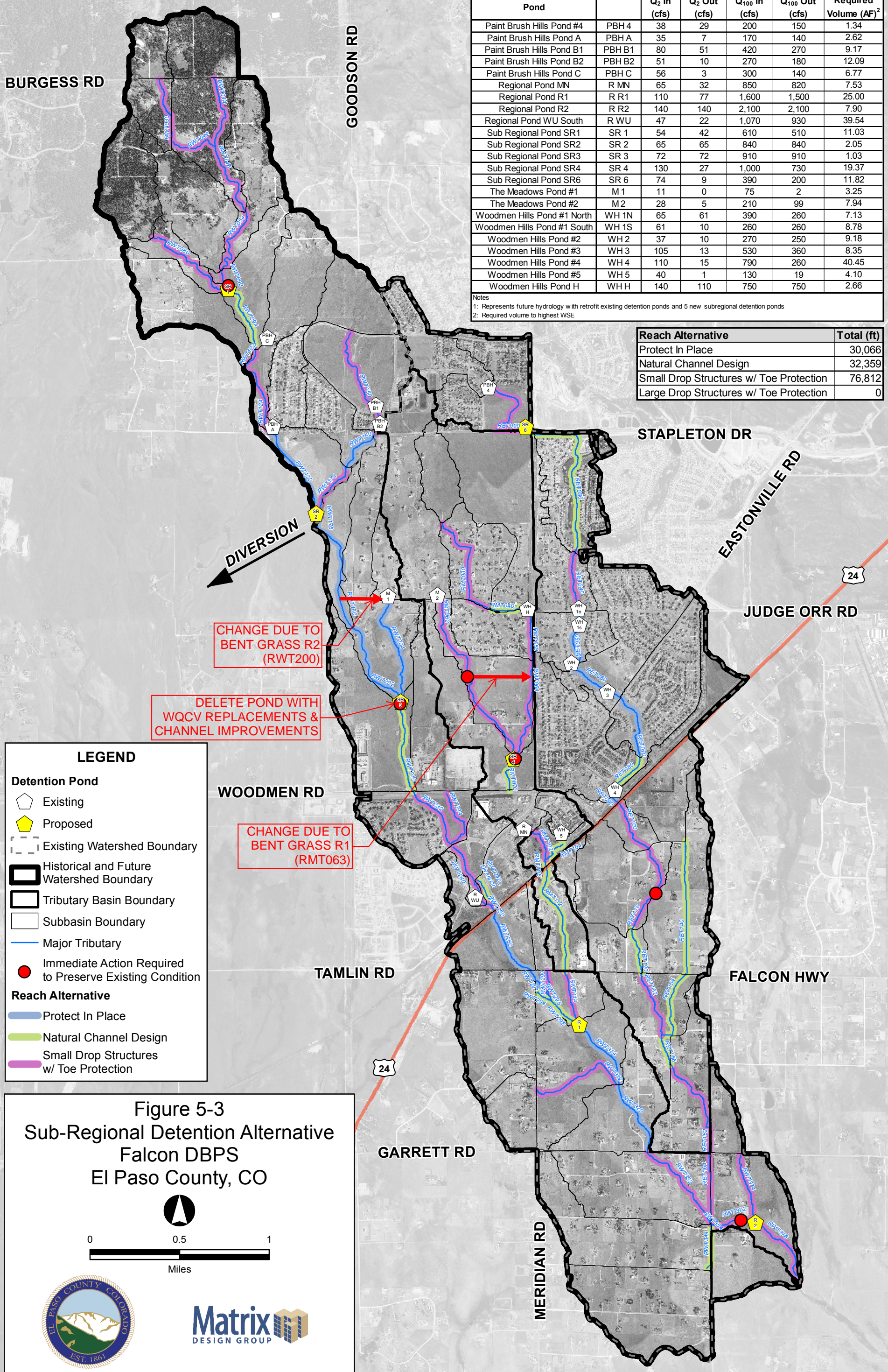

LEGEND

Detention Pond

- Existing (White pentagon)
- Proposed (Yellow pentagon)

Watershed Boundary

- Existing Watershed Boundary (Dashed line)
- Historical and Future Watershed Boundary (Thick black line)
- Tributary Basin Boundary (Thin black line)
- Subbasin Boundary (Thin grey line)

Major Tributary

- Major Tributary (Blue line)

Immediate Action Required to Preserve Existing Condition

- Immediate Action Required to Preserve Existing Condition (Red circle)

Reach Alternative

- Protect In Place (Blue line)
- Natural Channel Design (Green line)
- Small Drop Structures w/ Toe Protection (Purple line)

Figure 5-3
Sub-Regional Detention Alternative
Falcon DBPS
El Paso County, CO

0 0.5 1
Miles

NOTE: FIGURE MUST BE VIEWED IN COLOR

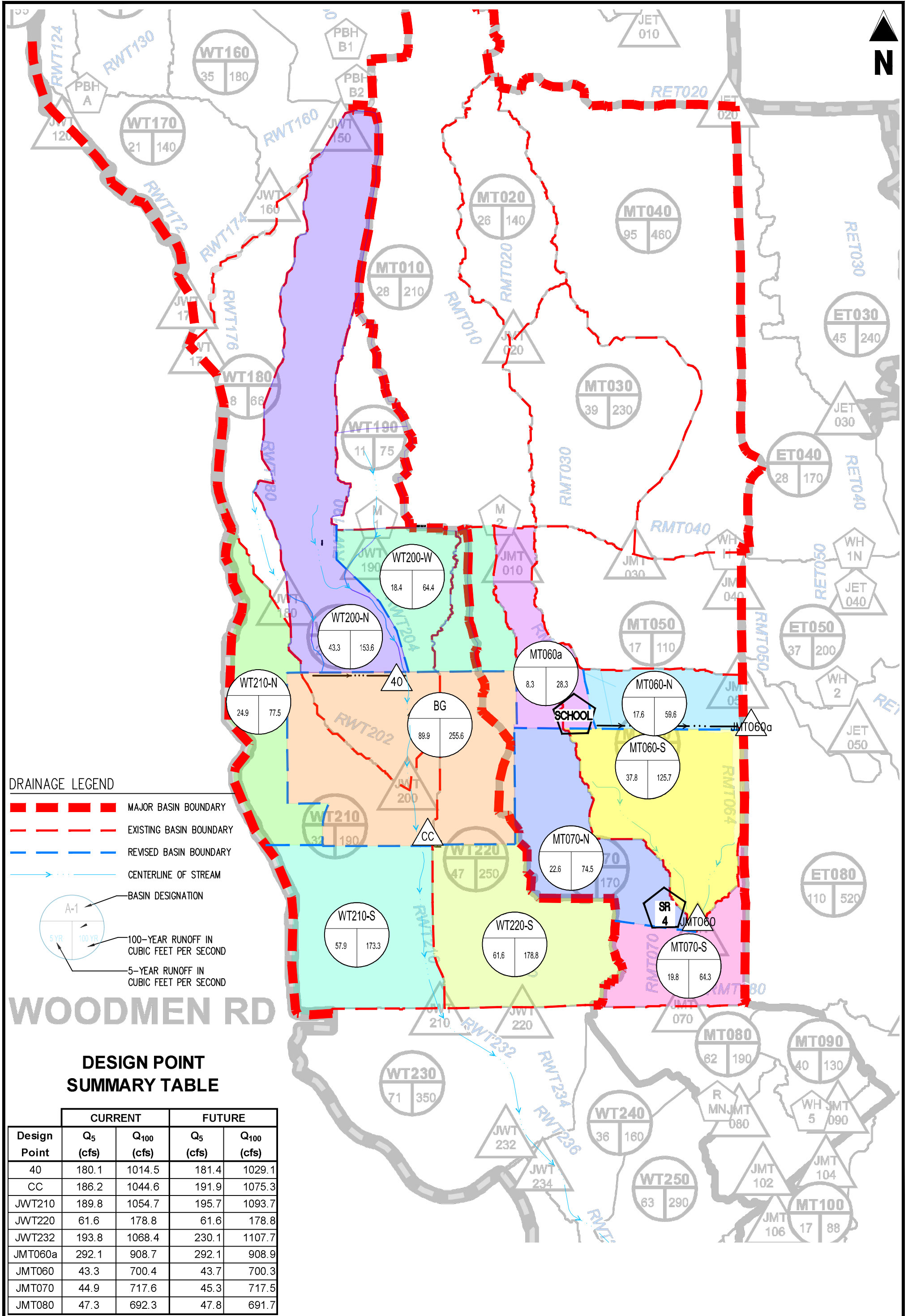

DRAINAGE LEGEND

- MAJOR BASIN BOUNDARY
- EXISTING BASIN BOUNDARY
- REVISED BASIN BOUNDARY
- CENTERLINE OF STREAM
- BASIN DESIGNATION
- 100-YEAR RUNOFF IN CUBIC FEET PER SECOND
- 5-YEAR RUNOFF IN CUBIC FEET PER SECOND

WOODMEN RD

DESIGN POINT SUMMARY TABLE

Design Point	CURRENT		FUTURE	
	Q ₅ (cfs)	Q ₁₀₀ (cfs)	Q ₅ (cfs)	Q ₁₀₀ (cfs)
40	180.1	1014.5	181.4	1029.1
CC	186.2	1044.6	191.9	1075.3
JWT210	189.8	1054.7	195.7	1093.7
JWT220	61.6	178.8	61.6	178.8
JWT232	193.8	1068.4	230.1	1107.7
JMT060a	292.1	908.7	292.1	908.9
JMT060	43.3	700.4	43.7	700.3
JMT070	44.9	717.6	45.3	717.5
JMT080	47.3	692.3	47.8	691.7

FALCON MEADOWS AT BENT GRASS
MDDP

REVISED BASIN HYDROLOGY - HMS MODEL

Project No: CLH0017
 Drawn By: CMD
 Checked By: GD
 Date: 06/16/21

Galloway
 6162 S. Willow Drive, Suite 320
 Greenwood Village, CO 80111
 303.770.8884 • GallowayUS.com

MERIDIAN ROAD

Worksheet for Fut Channel - Pr 100 Yr Flow-MR

Project Description

Friction Method	Manning Formula
Solve For	Normal Depth

Input Data

Roughness Coefficient	0.035
Channel Slope	0.30 %
Left Side Slope	4.00 ft/ft (H:V)
Right Side Slope	4.00 ft/ft (H:V)
Bottom Width	15.00 ft
Discharge	925.00 ft ³ /s

Results

Normal Depth	5.15 ft
Flow Area	183.50 ft ²
Wetted Perimeter	57.49 ft
Hydraulic Radius	3.19 ft
Top Width	56.22 ft
Critical Depth	3.58 ft
Critical Slope	0.01368 ft/ft
Velocity	5.04 ft/s
Velocity Head	0.39 ft
Specific Energy	5.55 ft
Froude Number	0.49
Flow Type	Subcritical

GVF Input Data

Downstream Depth	0.00 ft
Length	0.00 ft
Number Of Steps	0

GVF Output Data

Upstream Depth	0.00 ft
Profile Description	
Profile Headloss	0.00 ft
Downstream Velocity	Infinity ft/s
Upstream Velocity	Infinity ft/s
Normal Depth	5.15 ft
Critical Depth	3.58 ft
Channel Slope	0.30 %

**REQUEST FOR
CONDITIONAL LETTER OF MAP REVISION**

**UNNAMED TRIBUTARY TO
BLACK SQUIRREL CREEK,
FALCON OWL PLACE**

Falcon, Colorado
October 25, 2022

Prepared by:

Drexel, Barrell & Co.
1376 Miners Drive, Suite 107
Lafayette, Colorado 80026
(303) 442-4338

Contact: Michelle Iblings, P.E., CFM

Prepared for:

BH RE Investments, LLC
106 S. Kyrene Road, Suite 2
Chandler, AZ 85226
(480) 590-8403

Contacts: Lubertus Hayenga, Brian Zurek

DBC Project No. 21611-00BLWR

3.0 HYDROLOGIC ANALYSIS

3.1 Falcon DBPS

The Falcon DBPS completed hydrologic analysis for the Falcon Basin Watershed, using HEC-HMS v3.5 software, for historical, existing, and future land use conditions by applying a 24-hour storm event with 2-, 5-, 10-, 25-, 50-, and 100-year recurrence intervals and current drainage infrastructure. Chapter 3 and Appendix A of the Falcon DBPS include a detailed discussion of the hydrologic analysis. An electronic copy of the HEC-HMS model (File: Aug15_Working_Falcon_DBPS_S.hms) is also provided.

The Falcon DBPS identified Subregional Pond SR4 to be installed on the Falcon Marketplace property. Pond SR4 was constructed in early 2021 and the property floodplain mapping was updated in LOMR Case Number 21-08-0534P.

El Paso County requires regional drainage infrastructure to be sized for future land use conditions. Therefore, peak discharges with existing drainage infrastructure and future land use conditions near Owl Place are summarized in Table 3-1.

Table 3-1. Future Land Use Conditions Peak Discharges near Falcon Owl Place on the Middle Tributary, Falcon DBPS

Model Location	Physical Location	Branch	Proximity to Owl Place	Q100 (cfs)
JMT050	Bent Grass Meadows Drive	Only East Branch	Upstream of Site	850
JMT060	Eastonville Road (Pond SR4 inflow)	Both East and West Branches	Downstream of Site	1,000

3.2 Falcon Owl Place

The Falcon DBPS HEC-HMS model with existing drainage infrastructure and future land use (Existing Conditions) was used as the basis for the Falcon Owl Place hydrologic analysis. The Existing Conditions model was replicated in HEC-HMS version 4.7.1, due to instabilities and runtime issues with the prior, outdated model version (3.5). The Existing model produced 100-year peak flows of 859 and 1,023 cfs upstream (JMT050) and downstream (JMT060) of the site, which are comparable to and more conservative than the 850 and 1,000 cfs in the DBPS. It should be noted that in Existing Conditions, JMT050 is on the East Branch of the Middle Tributary, whereas JMT060 includes flows from both the West and East Branches, immediately upstream of Pond SR4.

REQUEST FOR CONDITIONAL LETTER OF MAP REVISION
UNNAMED TRIBUTARY TO BLACK SQUIRREL CREEK,
FALCON OWL PLACE

The Falcon watershed did not include a design point on the East Branch immediately upstream of Pond SR4. Therefore, it was necessary to modify the HMS model to obtain a design flow for Owl Place. In the Proposed Conditions basin model, the junction JMT051 was created on the East Branch of the UTBSC at the southern boundary of the Falcon Owl Place property, immediately upstream of Pond SR4.

The lag time and drainage area for Basin MT060 were reduced to 0.077 square miles and 17 minutes, respectively. The length and slope of Routing RMT060 were also updated. The NRCS soils for the proposed basin are Columbine gravelly sandy loam with a Hydrologic Soil Group (HSG) A. The basin is zoned for a combination of 5-acre residential, commercial, and planned unit development (PUD). The nearby PUD (Bent Grass Meadows) is residential with an average lot size of 0.22 acres. Based on TR-55 Table 2-2a, areas with 0.22-acre lots and HSG A have a Curve Number (CN) of 65. However, it is unknown how and when this area will develop in the future. For example, the Owl Place site is currently being rezoned from RR-5 to CS, which would increase the CN from 46 to 89. The future conditions CN of 66 used in the Falcon DBPS is a reasonable representation of the future development potential in the basin and was used in the proposed conditions model.

The hydrologic parameter calculations, base mapping, and select output from the HEC-HMS model is included in **Appendix 4**, and the model files (HEC-HMS file: Falcon_OwlCLOMR.hms) are provided. Proposed peak discharges used for the Falcon Owl Place development are summarized in Table 3-2.

Table 3-2. Proposed Peak Discharges at Falcon Owl Place (East Branch of the UTBSC)

Recurrence Interval	Q100 (cfs)
100-year	920
5-year	288.5

4.0 HYDRAULIC ANALYSIS

4.1 General

The effective FIRM identifies an approximate Zone A floodplain across the Falcon Owl Place property with no flood profiles, discharges, or BFE's defined. The Falcon Owl Place development includes filling and regrading the site and rerouting the East Branch of the UTBSC through a box culvert across the site.

4.2 Vertical Datum

The effective FIRM is on the North American Vertical Datum of 1988 (NAVD88). The ALTA survey completed for the site (Olsson, 2021) and the design and construction

drawings are on the National Geodetic Vertical Datum of 1929 (NGVD29). The Falcon DBPS and the hydraulic analysis for this CLOMR were both completed on the NGVD29. The difference between the NGVD29 and NAVD88 is 3.8 feet on the Falcon Owl Place.

4.3 Horizontal Datum

The field survey, design, construction drawings and hydraulic modeling for the Falcon Owl Place project were completed on the North American Datum of 1983 (NAD83), Colorado State Plane coordinate system, Central Zone.

4.4 Box Culvert Hydraulic Analysis

Under existing and proposed conditions, the East Branch of the UTBSC leaving the Falcon Owl Place site discharges to Pond SR4 on the Falcon Marketplace. The pond was designed for a 100-year discharge of 1,016 cfs, which includes both West and East branches of the UTBSC. The 100-year water surface elevation upstream of the pond as shown in the LOMR is 6902.5 (NAVD88), or 6898.7 (NGVD29). The starting HGL for the box culvert analysis was conservatively placed at the top of pipe elevation of 6895.84 feet (NGVD29) for analyzing flows to the East branch only. However, an additional analysis was performed with a starting HGL of 6898.7, to evaluate the backwater effects from the pond.

StormCAD was used to evaluate the hydraulic performance of the 10'x6' box culvert. The profile and output for the 100-year storm event is included in **Appendix 5**, and the model files are provided.

4.5 Existing and Proposed Owl Place Culverts

The East Branch of the UTBSC is currently conveyed under Owl Place via two 36" CMP near the northeast corner of the site. The HY-8 software was used to analyze the existing culverts for the 100-year storm event.

The 2-36" CMP culverts are severely undersized and partially filled with sediment as shown in the photo below. The culverts only convey 86-95 cfs, depending on tailwater depth. The remaining flow (approximately 825-834 cfs) in the 100-year event overtops Owl Place. The proposed box culvert will convey the entire 100-year event (920 cfs) with an HGL of 6911.31 at the proposed headwall upstream of Owl Place, which is more than one foot below Owl Place and contained within the existing and proposed channel upstream. Channel grading will be required for approximately 30 feet to tie into the existing creek profile upstream. The channel side slopes will be reduced from approximately 5.5H:1V to 1.8H:1V and protected with riprap.

The HY-8 output is included in **Appendix 5** and the model file (Owl Place.hy8) is provided.

REQUEST FOR CONDITIONAL LETTER OF MAP REVISION
UNNAMED TRIBUTARY TO BLACK SQUIRREL CREEK,
FALCON OWL PLACE



Existing 2-36" CMP under Owl Place (Upstream Inlets)

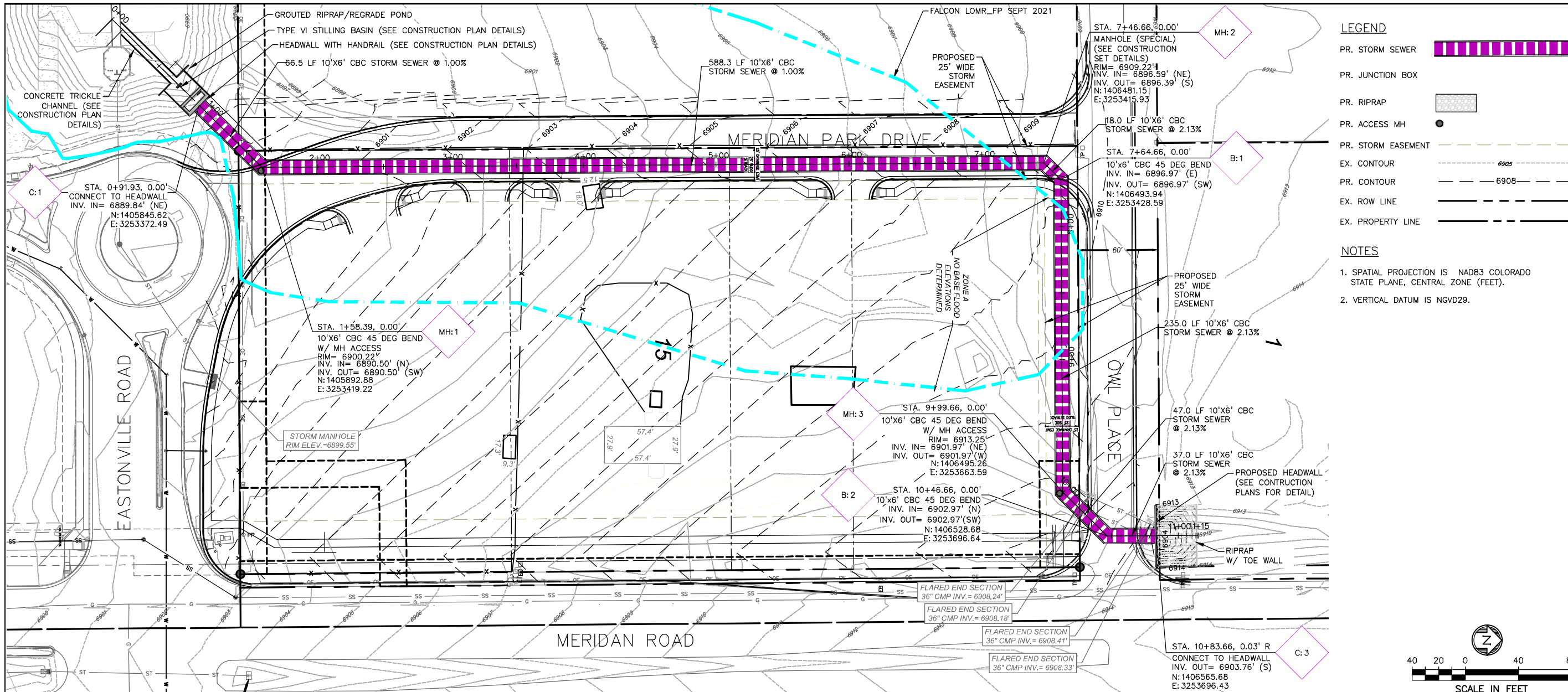

LEGEND

PR. STORM SEWER	
PR. JUNCTION BOX	
PR. RIPRAP	
PR. ACCESS MH	
PR. STORM EASEMENT	
EX. CONTOUR	
PR. CONTOUR	
EX. ROW LINE	
EX. PROPERTY LINE	

NOTES

- SPATIAL PROJECTION IS NAD83 COLORADO STATE PLANE, CENTRAL ZONE (FEET).
- VERTICAL DATUM IS NGVD29.

PREPARED BY:
DBC
 Drexel, Barrell & Co.
 Engineers-Surveyors
 1376 MINERS DRIVE, STE 107
 LAFAYETTE, COLORADO 80026
 CONTACT: MICHELLE IBLINGS, P.E.
 (303) 442-4338
 LAFAYETTE
 COLORADO SPRINGS

OWNER/CLIENT:
 LUBERTUS HAYENGA
 BH RE INVESTMENTS, LLC
 106 S. KYRENE RD., STE 2
 CHANDLER, AZ 85226

EXHIBIT FOR:
FALCON
OWL PLACE
 FALCON, COLORADO

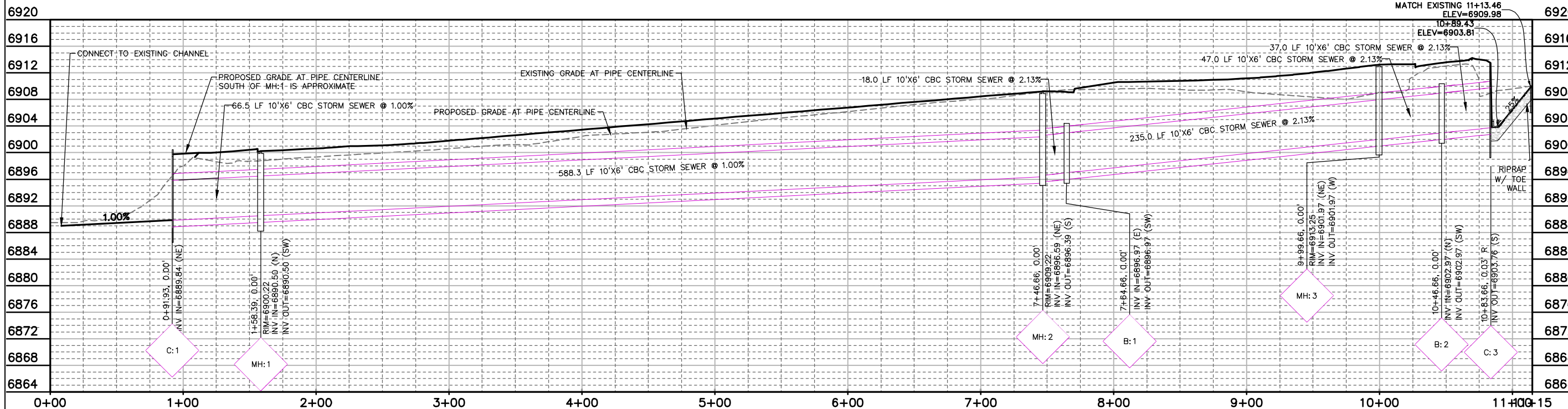
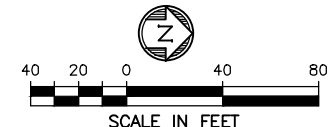

ISSUE	DATE
EXHIBIT	10/17/22

DESIGNED BY: MLI
 DRAWN BY: CAF
 CHECKED BY: MLI
 FILE NAME: EX01

NOT FOR CONSTRUCTION

DRAWING SCALE:
 HORIZONTAL: SEE PLAN
 VERTICAL: SEE PLAN

PIPE SYSTEM EXHIBIT

PROJECT: 21611-00BLWR
 DRAWING NO.

EX01

H:\21611-00BLWR\Plans\Sheets\EX01.dwg, 10/14/2022 7:46:58 AM

H:\21611-00BLWR\Plans\Sheets\Hydrologic Base Map\HBM.dwg, 6/7/2022 8:28:16 AM

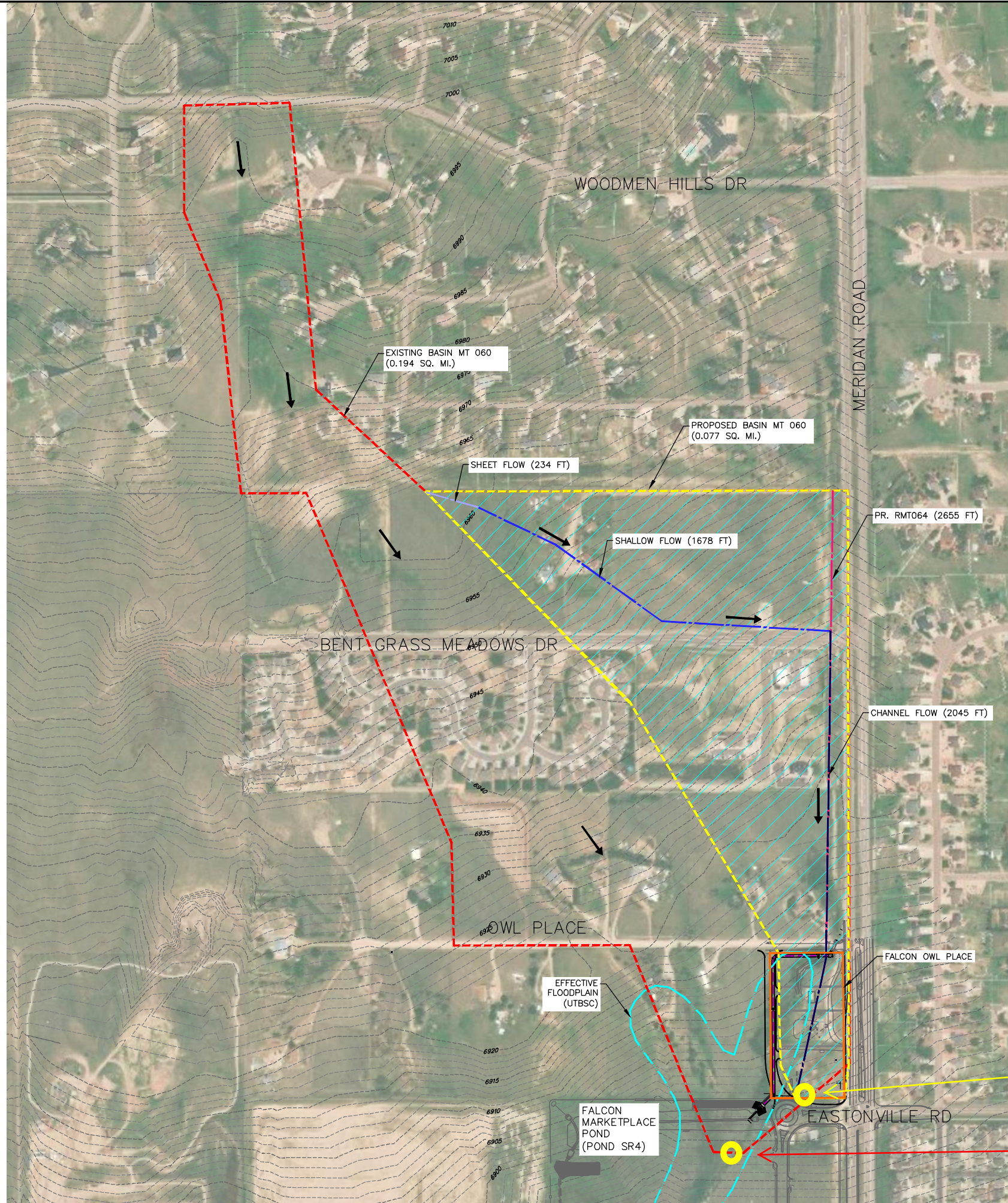

LEGEND

EX. CONTOUR	
PR. STORM SEWER	
EFFECTIVE 100-YR FLOODPLAIN	
EX. BASIN MT060	
PR. BASIN MT060	
PR. BASIN MT060 AREA	
PR. SHEET FLOW	
PR. SHALLOW FLOW	
PR. CHANNEL FLOW	
PR. RMT064	
EX. FALCON OWL PLACE PROPERTY BOUNDARY	
FLOW DIRECTION	

NOTES

1. SPATIAL PROJECTION IS NAD83 COLORADO STATE PLANE, CENTRAL ZONE (FEET).
2. VERTICAL DATUM IS NGVD29.

The existing basin delineation is approximated from the Falcon DBPS, which was developed in 2015.

The existing conditions contours are from Lidar, and may not reflect roadway and drainage infrastructure that is shown on the aerial image.

The proposed basin delineation is based on a combination of Lidar contours, drainage and roadway infrastructure, aerial mapping, and site survey.

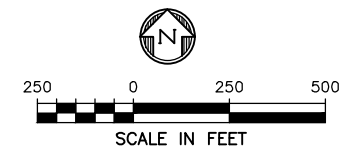

JMT051
(proposed)

JMT060
(existing)

PREPARED BY:

DBC
Drexel, Barrell & Co.
Engineers-Surveyors
1800 38TH STREET
BOULDER, COLORADO 80301
CONTACT: MICHELLE IBLINGS, P.E.
(303) 442-4338
BOULDER
COLORADO SPRINGS
GREELEY

OWNER/CLIENT:

EXHIBIT FOR:
FALCON OWL PLACE
FALCON, COLORADO

ISSUE	DATE
EXHIBIT	06/07/22
DESIGNED BY:	MLI
DRAWN BY:	CAF
CHECKED BY:	MLI
FILE NAME:	HBM

NOT FOR CONSTRUCTION

DRAWING SCALE:
HORIZONTAL: SEE PLAN
VERTICAL: N/A

HYDROLOGIC BASE MAP

PROJECT: 21611-00BLWR
DRAWING NO.

HBM

SHEET: 1 OF 1

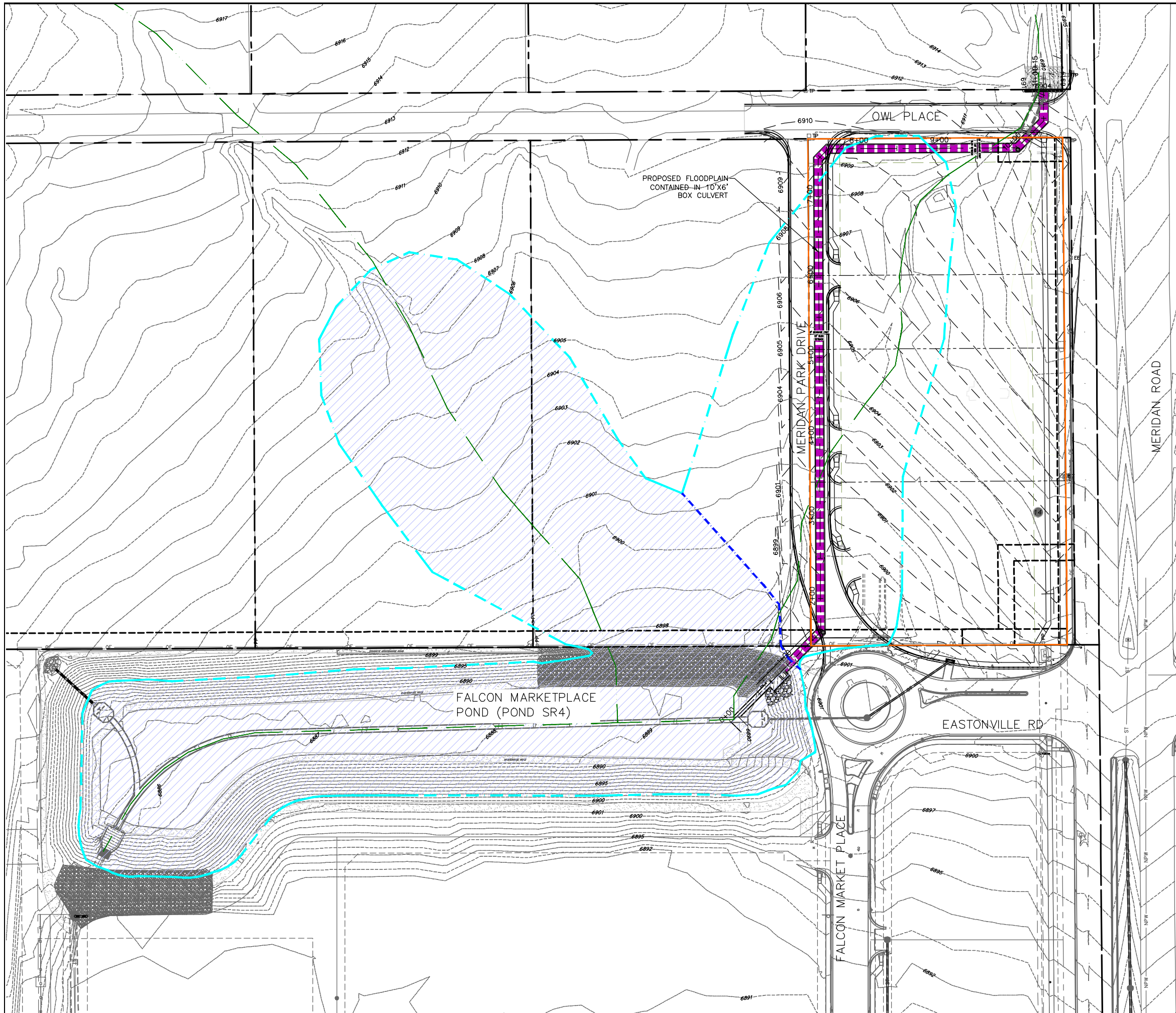

LEGEND

EX. CONTOUR	---	6905
PR. CONTOUR	---	6905
EX. STORM SEWER	---	ST
OR	---	
PR. STORM SEWER	█	
EFFECTIVE FEMA STREAMLINE	---	
EFFECTIVE LOMR FLOODPLAIN	---	
FALCON OWL PLACE PROPERTY BOUNDARY	---	
PROPOSED 100-YEAR FLOODPLAIN	---	
PROPOSED 100-YEAR FLOODPLAIN	▨	
PROPOSED CURB LINE	---	
EX. ROW LINE	---	
EX. PROPERTY LINE	---	
EX. EASEMENT	---	

- NOTES**
1. SPATIAL PROJECTION IS NAD83 COLORADO STATE PLANE, CENTRAL ZONE (FEET).
 2. VERTICAL DATUM IS NGVD29.

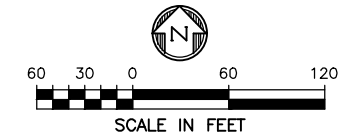

PREPARED BY:

DBC
 Drexel, Barrell & Co.
 Engineers • Surveyors
 1376 MINERS DRIVE, STE 107
 LAFAYETTE, COLORADO 800026
 CONTACT: MICHELLE IBLINGS, P.E.
 (303) 442-4338
 LAFAYETTE
 COLORADO SPRINGS

OWNER/CLIENT:

LUBERTUS HAYENGA
 BH RE INVESTMENTS, LLC
 106 S. KYRENE RD., STE 2
 CHANDLER, AZ 85226

EXHIBIT FOR:
**FALCON
 OWL PLACE**
 FALCON, COLORADO

ISSUE	DATE
EXHIBIT	10/25/22
DESIGNED BY:	MLI
DRAWN BY:	CAF
CHECKED BY:	MLI
FILE NAME:	FPWM



DRAWING SCALE:
 HORIZONTAL: SEE PLAN
 VERTICAL: N/A

**CLOMR
 FLOODPLAIN
 WORK MAP**

PROJECT: 21611-00BLWR
 DRAWING NO.

FPWM

Effective FIRM taken from LOMR 21-08-0534P, annotated for the Falcon Owl Place CLOMR October 25, 2022

1% Annual Chance Flood Discharge Contained in Culvert

Falcon Owl Place Property Limits

Proposed Zone A Floodplain Limits (Effective Floodplain remains to the West of the blue line, and removed to the East due to Culvert)

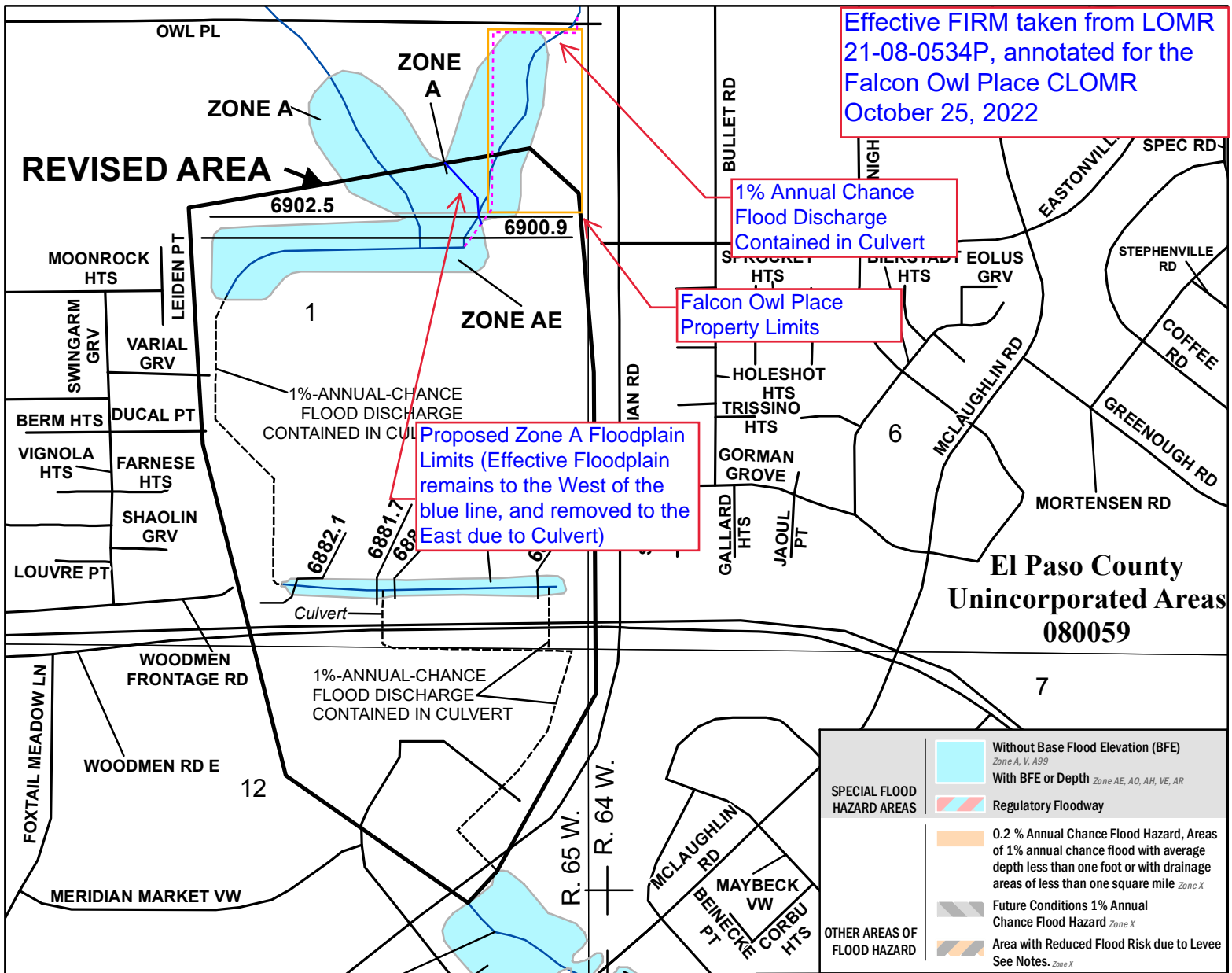

El Paso County Unincorporated Areas 080059

SPECIAL FLOOD HAZARD AREAS

- Without Base Flood Elevation (BFE) Zone A, V, A99
- With BFE or Depth Zone AE, AO, AH, VE, AR
- Regulatory Floodway

OTHER AREAS OF FLOOD HAZARD

- 0.2 % Annual Chance Flood Hazard, Areas of 1% annual chance flood with average depth less than one foot or with drainage areas of less than one square mile Zone X
- Future Conditions 1% Annual Chance Flood Hazard Zone X
- Area with Reduced Flood Risk due to Levee See Notes, Zone X

SCALE

Map Projection: Universal Transverse Mercator/NAD 1983 UTM Zone 13N
Western Hemisphere; Vertical Datum: NAVD 88

1 inch = 500 feet 1:6,000

0 250 500 1,000 Feet

0 62.5 125 250 Meters

FEMA National Flood Insurance Program

NATIONAL FLOOD INSURANCE PROGRAM FLOOD INSURANCE RATE MAP

EL PASO COUNTY, COLORADO and Incorporated Areas

PANEL 553 of 1300

Panel Contains:

COMMUNITY	NUMBER	PANEL	SUFFIX
EL PASO COUNTY	080059	0553	G

REVISED TO REFLECT LOMR EFFECTIVE: February 22, 2022

VERSION NUMBER 1.1.1.0
MAP NUMBER 08041C0553G
MAP REVISED DECEMBER 7, 2018

JOINS PANEL 0561

Unnamed Tributary To Black Squirrel Creek

534⁰⁰⁰m E



May 27, 2022

Wetlands

- Estuarine and Marine Deepwater
- Freshwater Emergent Wetland
- Estuarine and Marine Wetland
- Freshwater Forested/Shrub Wetland
- Freshwater Pond
- Lake
- Other
- Riverine

This map is for general reference only. The US Fish and Wildlife Service is not responsible for the accuracy or currentness of the base data shown on this map. All wetlands related data should be used in accordance with the layer metadata found on the Wetlands Mapper web site.

APPENDIX C

COMPOSITE % IMPERVIOUS CALCULATIONS

Subdivision: Falcon Ranchettes Filing No. 1A
Location: CO, Colorado Springs

Project Name: Meridian Storage
Project No.: MRS01
Calculated By: CMWJ
Checked By: BAS
Date: 9/8/23

Basin ID	Total Area (ac)	Roads			Lawns			Roofs			Basins Total Weighted % Imp.
		% Imp.	Area (ac)	Weighted % Imp.	% Imp.	Area (ac)	Weighted % Imp.	% Imp.	Area (ac)	Weighted % Imp.	
EX-1	4.97	100	0.68	13.7	2	4.27	1.7	100	0.02	0.40	15.8
EX-2	2.32	80	0.26	9.0	2	1.99	1.7	100	0.07	3.00	13.7
EX-3	2.85	80	0.12	3.4	2	2.67	1.9	100	0.06	2.10	7.4
EX-4	1.08	80	0.01	0.7	2	1.07	2.0	100	0.00	0.00	2.7
OS-1	3.89	80	0.38	7.8	2	3.46	1.8	100	0.05	1.30	10.9
OS-2	2.35	80	0.30	10.2	2	2.00	1.7	100	0.05	2.10	14.0
OS-3	0.24	100	0.00	0.0	2	0.24	2.0	100	0.00	0.00	2.0
OS-4E	0.05	100	0.05	100.0	2	0.00	0.0	100	0.00	0.00	100.0
A-1	2.10	100	0.68	32.4	2	1.42	1.4	100	0.27	12.90	46.7
B-1	1.31	100	0.89	67.9	2	0.06	0.1	100	0.36	27.50	95.5
B-2	1.04	100	0.59	56.7	2	0.01	0.0	100	0.44	42.30	99.0
B-3	0.95	100	0.41	43.2	2	0.37	0.8	100	0.17	17.90	61.9
B-4	0.52	100	0.41	78.9	2	0.11	0.4	100	0.00	0.00	79.3
B-5	0.13	100	0.11	84.6	2	0.02	0.3	100	0.00	0.00	84.9
B-6	0.16	100	0.11	68.8	2	0.05	0.6	100	0.00	0.00	69.4
B-7	0.56	100	0.07	12.5	2	0.49	1.8	100	0.00	0.00	14.3
C-1	0.29	80	0.15	41.4	2	0.14	1.0	100	0.00	0.00	42.4
C-2	3.12	80	2.25	57.7	2	0.87	0.6	100	0.00	0.00	58.3
C-3	0.29	80	0.19	52.4	2	0.10	0.7	100	0.00	0.00	53.1
C-4	0.09	100	0.00	0.0	2	0.09	2.0	100	0.00	0.00	2.0
D-1	0.20	100	0.07	35.0	2	0.13	1.3	100	0.00	0.00	36.3
D-2	0.11	100	0.08	72.7	2	0.03	0.5	100	0.00	0.00	73.2
D-3	0.33	100	0.25	75.8	2	0.08	0.5	100	0.00	0.00	76.3
OS-4P	0.07	100	0.06	85.7	2	0.01	0.3	100	0.00	0.00	86.0
OS-5	0.19	100	0.00	0.0	2	0.19	2.0	100	0.00	0.00	2.0
OS-6	0.08	100	0.00	0.0	2	0.08	2.0	100	0.00	0.00	2.0

*Impervious values are taken directly from "Table 6-6 Runoff Coefficients for Rational Method"

STANDARD FORM SF-2
TIME OF CONCENTRATION

Subdivision: Falcon Ranchettes Filing No. 1A
Location: CO, Colorado Springs

Project Name: Meridian Storage
Project No.: MRS01
Calculated By: CMWJ
Checked By: BAS
Date: 9/8/23

SUB-BASIN DATA						INITIAL/OVERLAND (T _i)			TRAVEL TIME (T _t)					T _c CHECK (URBANIZED BASINS)			FINAL T _c (MIN)
BASIN ID	D.A. (AC)	Hydrologic Soils Group	Impervious (%)	C ₁₀₀	C _s	L (FT)	S (%)	T _i (MIN)	L (FT)	S (%)	C _v	VEL. (FPS)	T _t (MIN)	COMP. T _c (MIN)	TOTAL LENGTH (FT)	Urbanized T _c (MIN)	T _c (MIN)
EX-1	4.97	A	15.8	0.23	0.08	25	15.0	3.8	830	1.8	15.0	2.0	6.9	10.7	855.0	14.8	10.7
EX-2	2.32	A	13.7	0.22	0.07	15	1.0	7.3	540	1.9	5.0	0.7	13.1	20.4	555.0	13.1	13.1
EX-3	2.85	A	7.4	0.17	0.03	25	15.0	4.0	650	2.2	5.0	0.7	14.6	18.6	675.0	13.8	13.8
EX-4	1.08	A	2.7	0.13	0.01	25	1.0	10.0	620	2.3	5.0	0.8	13.6	23.6	645.0	13.6	13.6
OS-1	3.89	A	10.9	0.19	0.05	100	5.3	11.1	600	2.1	10.0	1.4	6.9	18.0	700.0	13.9	13.9
OS-2	2.35	A	14.0	0.22	0.07	100	5.3	10.8	900	1.9	7.0	1.0	15.5	26.4	1000.0	15.6	15.6
OS-3	0.24	A	2.0	0.13	0.01	25	10.0	4.6	325	2.4	7.0	1.1	5.0	9.6	350.0	11.9	9.6
OS-4E	0.05	A	100.0	0.89	0.86	10	1.0	1.4	80	1.0	15.0	1.5	0.9	2.3	90.0	10.5	5.0
A-1	2.10	A	46.7	0.47	0.33	25	25.0	2.4	620	1.3	15.0	1.7	6.2	8.6	645.0	13.6	8.6
B-1	1.31	A	95.5	0.85	0.81	60	7.0	2.2	350	2.0	20.0	2.8	2.1	4.2	410.0	12.3	5.0
B-2	1.04	A	99.0	0.88	0.85	12.5	2.0	1.3	335	1.2	20.0	2.2	2.5	3.8	347.5	11.9	5.0
B-3	0.95	A	61.9	0.59	0.47	20	2.0	4.1	640	3.2	20.0	3.6	3.0	7.1	660.0	13.7	7.1
B-4	0.52	A	79.3	0.73	0.64	20	2.0	3.0	640	3.2	20.0	3.6	3.0	6.0	660.0	13.7	6.0
B-5	0.13	A	84.9	0.77	0.70	30	2.2	3.1	148	0.8	20.0	1.8	1.4	4.5	178.0	11.0	5.0
B-6	0.16	A	69.4	0.65	0.54	30	2.2	4.3	154	0.8	20.0	1.8	1.4	5.8	184.0	11.0	5.8
B-7	0.56	A	14.3	0.22	0.07	25	25.0	3.2	125	3.0	7.0	1.2	1.7	4.9	150.0	10.8	5.0
C-1	0.29	A	42.4	0.44	0.29	100	2.8	10.5	190	2.8	20.0	3.3	0.9	11.5	290.0	11.6	11.5
C-2	3.12	A	58.3	0.56	0.43	100	2.2	9.4	450	2.2	20.0	3.0	2.5	12.0	550.0	13.1	12.0
C-3	0.29	A	53.1	0.52	0.38	100	2.3	10.0	200	2.3	20.0	3.0	1.1	11.1	300.0	11.7	11.1
C-4	0.09	A	2.0	0.13	0.01	5	25.0	1.5	250	2.0	15.0	2.1	2.0	3.5	255.0	11.4	5.0
D-1	0.20	A	36.3	0.39	0.24	25	2.2	6.1	200	1.0	15.0	1.5	2.2	8.3	225.0	11.3	8.3
D-2	0.11	A	73.2	0.68	0.58	15	15.0	1.5	100	1.5	20.0	2.4	0.7	2.2	115.0	10.6	5.0
D-3	0.33	A	76.3	0.70	0.61	30	2.0	3.9	166	1.0	20.0	2.0	1.4	5.3	196.0	11.1	5.3
OS-4P	0.07	A	86.0	0.78	0.71	20	2.0	2.5	46	1.0	20.0	2.0	0.4	2.9	66.0	10.4	5.0
OS-5	0.19	A	2.0	0.13	0.01	25	15.0	4.0	1	1.0	5.0	0.5	0.0	4.1	26.0	10.1	5.0
OS-6	0.08	A	2.0	0.13	0.01	25	15.0	4.0	160	1.0	5.0	0.5	5.3	9.4	185.0	11.0	9.4

NOTES:

$T_i = (0.395 * (1.1 - C_s) * (L^{0.5}) / ((S)^{0.33}))$, S in ft/ft

$T_t = L / 60V$ (Velocity From Fig. 501)

Velocity $V = C_v * S^{0.5}$, S in ft/ft

$T_c \text{ Check} = 10 + L / 180$

For Urbanized basins a minimum T_c of 5.0 minutes is required.

For non-urbanized basins a minimum T_c of 10.0 minutes is required

STANDARD FORM SF-3
STORM DRAINAGE SYSTEM DESIGN
(RATIONAL METHOD PROCEDURE)

Subdivision: Falcon Ranchettes Filing No. 1A
Location: CO, Colorado Springs
Design Storm: 5-Year

Project Name: Meridian Storage
Project No.: MRS01
Calculated By: CMWJ
Checked By: BAS
Date: 9/8/23

STREET	Design Point	DIRECT RUNOFF							TOTAL RUNOFF				STREET	PIPE			TRAVEL TIME			REMARKS	
		Basin ID	Area (Ac)	Runoff Coeff.	Tc (min)	C*A (Ac)	I (in/hr)	Q (cfs)	Tc (min)	C*A (Ac)	I (in/hr)	Q (cfs)	Slope (%)	Street Flow (cfs)	Design Flow (cfs)	Slope (%)	Pipe Size (inches)	Length (ft)	Velocity (fps)		Tt (min)
	1	MT060									304.6										Flows from upstream offsite basin = 304.6 cfs
	1	EX-1	4.97	0.08	10.7	0.40	4.03	1.6													Flows from project site at DP1 = 1.6 cfs
	1										306.2										Total flow at DP1 = 306.2 cfs
	2	EX-2	2.32	0.07	13.1	0.16	3.73	0.6													Total flow at DP2 = 0.6 cfs
	3	EX-3	2.85	0.03	13.8	0.09	3.65	0.3													Total flow at DP3 = 0.3 cfs
	4	EX-4	1.08	0.01	13.6	0.01	3.67	0.0													Flows from basin at DP4 = 0 cfs
	4	OS-1	3.89	0.05	13.9	0.19	3.64	0.7													Flows from basin at DP4 = 0.7 cfs
	4	OS-2	2.35	0.07	15.6	0.16	3.47	0.6													Flows from basin at DP4 = 0.6 cfs
	4	OS-3	0.24	0.01	9.6	0.00	4.19	0.0													Flows from basin at DP4 = 0 cfs
	4								15.6	0.36	3.47	1.2									Total flow at DP4 = 1.2 cfs
See basin comparison OS-4E / OS-4P	14	OS-4E	0.05	0.86	5.0	0.04	5.17	0.2													Existing condition of contributing flow to DP14 = 0.2 cfs
	1	MT060									304.6										Flows from upstream offsite basin = 304.6 cfs
	1	OS-6	0.08	0.01	9.4	0.00	4.22	0.0													Flows from basin = 0 cfs
	1	A-1	2.10	0.33	8.6	0.69	4.36	3.0													Flows from basin = 3 cfs
	1								9.4	0.69	4.22	307.5									Total flow at DP1 = 307.5 cfs
	2	D-1	0.20	0.24	8.3	0.05	4.41	0.2													Total flow at DP2 = 0.2 cfs
	3	B-1	1.31	0.81	5.0	1.06	5.17	5.5					5.5	1.3			290	2.2	2.2		Total flow captured by inlet, DP3 = 5.5 cfs
	4	B-2	1.04	0.85	5.0	0.88	5.17	4.5													Total flow captured by inlet, DP4 = 4.5 cfs
	4								7.2	1.94	4.63	9.0			9.0	1.0		128	2.0	1.1	Total flow in storm system, DP4 = 9 cfs
Proposed on-grade 10' CDOT Type R	5	B-3	0.95	0.47	7.1	0.45	4.65	2.1					1.5	0.0	2.1			95	2.4	0.6	Qcap = 2.1 cfs, Qbyp = 0 cfs; Qbyp to DP12
	5								8.2	2.39	4.42	10.6			10.6	0.5		41	1.4	0.5	Total flow in storm system, DP5 = 10.6 cfs
	6	B-4	0.52	0.64	6.0	0.33	4.90	1.6					2.15	0.3				210	2.9	1.2	Flows from basin = 1.6 cfs Flows from basin to DP6 = 0.3 cfs
Proposed on-grade 10' CDOT Type R	6	C-1	0.29	0.29	11.5	0.08	3.92	0.3					1.5	0.0	1.5			95	2.4	0.6	Qcap = 1.5 cfs, Qbyp = 0 cfs; Qbyp to DP13
	6								12.7	2.79	3.77	10.5			10.5	1.0		29	2.0	0.2	Total flow in storm system, DP6 = 10.5 cfs; piped to Forebay A
Proposed on-grade 5' CDOT Type R	7	B-5	0.13	0.70	5.0	0.09	5.17	0.5					0.8	0.0	0.5	1.0		150	1.8	1.4	Qcap = 0.5 cfs, Qbyp = 0 cfs; Qbyp to DP13
	8	C-3	0.29	0.38	11.1	0.11	3.97	0.4					0.5	0.4				75	1.4	0.9	Flows from basin to DP8 = 0.4 cfs
	8	B-6	0.16	0.54	5.8	0.09	4.96	0.4					1.5	0.0				95	2.4	0.6	Flows from basin = 0.4 cfs Qcap = 0.8 cfs, Qbyp = 0 cfs; Qbyp to DP13
Proposed on-grade 5' CDOT Type R	8								12.0	0.20	3.86	0.8			0.8						Total flow in storm system, DP8 = 1.1 cfs; piped to Forebay D
	8								12.9	0.30	3.75	1.1									
	9	OS-3	0.24	0.01	9.6	0.00	4.19	0.0													Flows from basin = 0 cfs
	9	OS-5	0.19	0.01	5.0	0.00	5.17	0.0													Flows from basin = 0 cfs
	9	C-2	3.12	0.43	12.0	1.34	3.86	5.2													Flows from basin = 5.2 cfs
	9	B-7	0.56	0.07	5.0	0.04	5.17	0.2													Flows from basin = 0.2 cfs
Flow taken from UD-Detention Worksheet	9												18.0								Total Flow entering Pond #1 = 18 cfs
Flow taken from UD-Detention Worksheet	9												0.4		0.4	10.0		140	6.3	0.4	Peak Outflow from Pond #1 = 0.4 cfs
	10	OS-1	3.89	0.05	13.9	0.19	3.64	0.7													Flows from basin at DP10 = 0.7 cfs
	10	OS-2	2.35	0.07	15.6	0.16	3.47	0.6													Flows from basin at DP10 = 0.6 cfs
	10	C-4	0.09	0.01	5.0	0.00	5.17	0.0													Flows from basin at DP10 = 0 cfs
	10								15.6	0.35	3.47	1.2			1.2	10.0		40	6.3	0.1	Total flow captured by inlet, DP10 = 1.2 cfs
	11								15.7	0.35	3.46	1.6									Total flow at manhole, DP11 = 1.6 cfs; conveyed to Subregional Pond SR4
	12	D-2	0.11	0.58	5.0	0.06	5.17	0.3													Flows from basin = 0.3 cfs
	12								5.0	0.11	5.17	0.6									Add flows from DP2 and bypassed flows from DP5 Total flow at DP12 = 0.6 cfs
	13	D-3	0.33	0.61	5.3	0.20	5.09	1.0													Flows from basin = 1 cfs
	13								5.3	0.20	5.09	1.0									Add bypassed flows from DP6, DP7, DP8 Total flow at DP13 = 1 cfs
See basin comparison OS-4P / OS-4E	14	OS-4P	0.07	0.71	5.0	0.05	5.17	0.3													Proposed condition of contributing flow to DP14 = 0.3 cfs

DESIGNER NOTES: Street flows & travel time located at top of cell, pipe flows & travel time located at bottom of cell

STANDARD FORM SF-3
STORM DRAINAGE SYSTEM DESIGN
(RATIONAL METHOD PROCEDURE)

Subdivision: Falcon Ranchettes Filing No. 1A
Location: CO, Colorado Springs
Design Storm: 100-Year

Project Name: Meridian Storage
Project No.: MRS01
Calculated By: CMWJ
Checked By: BAS
Date: 9/8/23

STREET	Design Point	DIRECT RUNOFF							TOTAL RUNOFF				STREET		PIPE			TRAVEL TIME			REMARKS
		Basin ID	Area (Ac)	Runoff Coeff.	Tc (min)	C* A (Ac)	I (in/hr)	Q (cfs)	Tc (min)	C* A (Ac)	I (in/hr)	Q (cfs)	Slope (%)	Street Flow (cfs)	Design Flow (cfs)	Slope (%)	Pipe Size (inches)	Length (ft)	Velocity (fps)	Tt (min)	
	1	MT060						915.3													Flows from upstream offsite basin = 915.3 cfs
	1	EX-1	4.97	0.23	10.7	1.14	6.77	7.7													Flows from project site at DP1 = 7.7 cfs
	1										923.0										Total flow at DP1 = 923 cfs
	2	EX-2	2.32	0.22	13.1	0.51	6.26	3.2													Total flow at DP2 = 3.2 cfs
	3	EX-3	2.85	0.17	13.8	0.48	6.13	2.9													Total flow at DP3 = 2.9 cfs
	4	EX-4	1.08	0.13	13.6	0.14	6.16	0.9													Flows from basin at DP4 = 0.9 cfs
	4	OS-1	3.89	0.19	13.9	0.74	6.10	4.5													Flows from basin at DP4 = 4.5 cfs
	4	OS-2	2.35	0.22	15.6	0.52	5.82	3.0													Flows from basin at DP4 = 3 cfs
	4	OS-3	0.24	0.13	9.6	0.03	7.03	0.2													Flows from basin at DP4 = 0.2 cfs
	4								15.6	1.43	5.82	8.3									Total flow at DP4 = 8.3 cfs
See basin comparison OS-4E / OS-4P	14	OS-4E	0.05	0.89	5.0	0.04	8.68	0.3													Existing condition of contributing flow to DP14 = 0.3 cfs
	1	MT060						915.3													Flows from upstream offsite basin = 915.3 cfs
	1	OS-6	0.08	0.13	9.4	0.01	7.09	0.1													Flows from basin = 0.1 cfs
	1	A-1	2.10	0.47	8.6	0.99	7.32	7.2													Flows from basin = 7.2 cfs
	1								9.4	1.00	7.09	922.4									Total flow at DP1 = 922.4 cfs
	2	D-1	0.20	0.39	8.3	0.08	7.41	0.6													Total flow at DP2 = 0.6 cfs
	3	B-1	1.31	0.85	5.0	1.11	8.68	9.6					9.6	1.3			290	2.2	2.2		Total flow captured by inlet, DP3 = 9.6 cfs
	4	B-2	1.04	0.88	5.0	0.92	8.68	8.0													Total flow captured by inlet, DP4 = 8 cfs
	4								7.2	2.03	7.77	15.8			15.8	1.0		128	2.0	1.1	Total flow in storm system, DP4 = 15.8 cfs
Proposed on-grade 10' CDOT Type R	5	B-3	0.95	0.59	7.1	0.56	7.80	4.4					1.5	0.2	4.2			95	2.4	0.6	Qcap = 4.2 cfs, Qbyp = 0.2 cfs; Qbyp to DP12
	5								8.2	2.57	7.42	19.1			19.1	0.5		41	1.4	0.5	Total flow in storm system, DP5 = 19.1 cfs
	6	B-4	0.52	0.73	6.0	0.38	8.23	3.1													Flows from basin = 3.1 cfs
	6	C-1	0.29	0.44	11.5	0.13	6.59	0.9					2.15	0.9				210	2.9	1.2	Flows from basin to DP6 = 0.9 cfs
Proposed on-grade 10' CDOT Type R	6								12.7	0.51	6.34	3.2			3.2			95	2.4	0.6	Qcap = 3.2 cfs, Qbyp = 0 cfs; Qbyp to DP13
	6								12.7	3.07	6.34	19.5			19.5	1.0		29	2.0	0.2	Total flow in storm system, DP6 = 19.5 cfs; piped to Forebay A
Proposed on-grade 5' CDOT Type R	7	B-5	0.13	0.77	5.0	0.10	8.68	0.9					0.8	0.0	0.9	1.0		150	1.8	1.4	Qcap = 0.9 cfs, Qbyp = 0 cfs; Qbyp to DP13
	8	C-3	0.29	0.52	11.1	0.15	6.67	1.0					0.5	1.0				75	1.4	0.9	Flows from basin to DP8 = 1 cfs
	8	B-6	0.16	0.65	5.8	0.10	8.33	0.8													Flows from basin = 0.8 cfs
Proposed on-grade 5' CDOT Type R	8								12.0	0.25	6.48	1.6			1.5			95	2.4	0.6	Qcap = 1.5 cfs, Qbyp = 0.1 cfs; Qbyp to DP13
	8								12.9	0.34	6.29	2.1									Total flow in storm system, DP8 = 2.1 cfs; piped to Forebay D
	9	OS-3	0.24	0.13	9.6	0.03	7.03	0.2													Flows from basin = 0.2 cfs
	9	OS-5	0.19	0.13	5.0	0.02	8.68	0.2													Flows from basin = 0.2 cfs
	9	C-2	3.12	0.56	12.0	1.75	6.48	11.3													Flows from basin = 11.3 cfs
	9	B-7	0.56	0.22	5.0	0.12	8.68	1.0													Flows from basin = 1 cfs
Flow taken from UD-Detention Worksheet	9																				Total Flow entering Pond #1 = 33 cfs
Flow taken from UD-Detention Worksheet	9														3.8	10.0		140	6.3	0.4	Peak Outflow from Pond #1 = 3.8 cfs
	10	OS-1	3.89	0.19	13.9	0.74	6.10	4.5													Flows from basin at DP10 = 4.5 cfs
	10	OS-2	2.35	0.22	15.6	0.52	5.82	3.0													Flows from basin at DP10 = 3 cfs
	10	C-4	0.09	0.13	5.0	0.01	8.68	0.1													Flows from basin at DP10 = 0.1 cfs
	10								15.6	1.27	5.82	7.4			7.4	10.0		40	6.3	0.1	Total flow captured by inlet, DP10 = 7.4 cfs
	11								15.7	1.27	5.80	11.2									Total flow at manhole, DP11 = 11.2 cfs; conveyed to Subregional Pond SR4
	12	D-2	0.11	0.68	5.0	0.07	8.68	0.6													Flows from basin = 0.6 cfs
	12								5.0	0.17	8.68	1.5									Add flows from DP2 and bypassed flows from DP5 Total flow at DP12 = 1.5 cfs
	13	D-3	0.33	0.70	5.3	0.23	8.54	2.0													Flows from basin = 2 cfs
	13								5.3	0.25	8.54	2.1									Add bypassed flows from DP6, DP7, DP8 Total flow at DP13 = 2.1 cfs
See basin comparison OS-4P / OS-4E	14	OS-4P	0.07	0.78	5.0	0.05	8.68	0.4													Proposed condition of contributing flow to DP14 = 0.4 cfs

DESIGNER NOTES: Street flows & travel time located at top of cell, pipe flows & travel time located at bottom of cell

APPENDIX D

StormCAD Layout

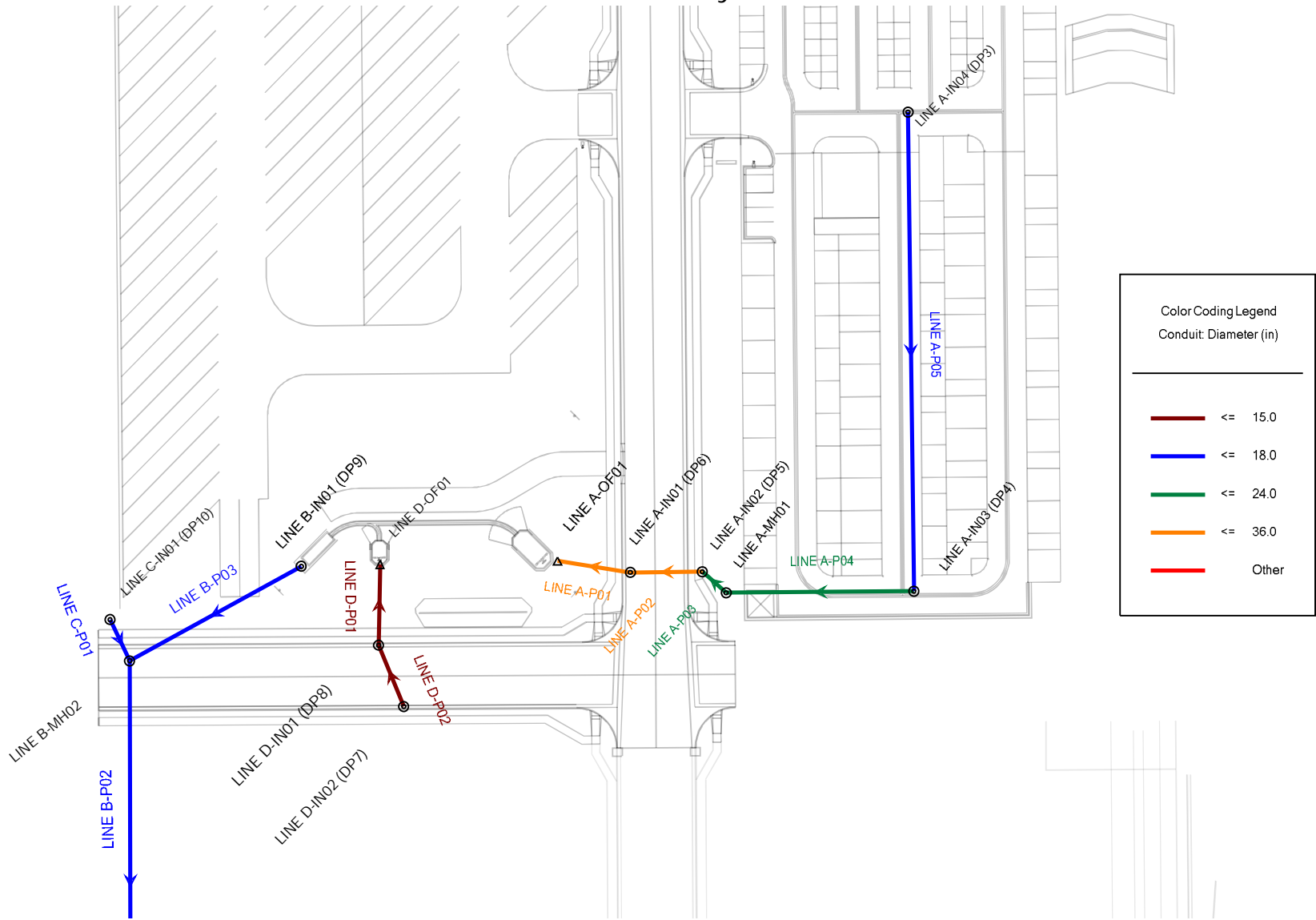

StormCAD Layout

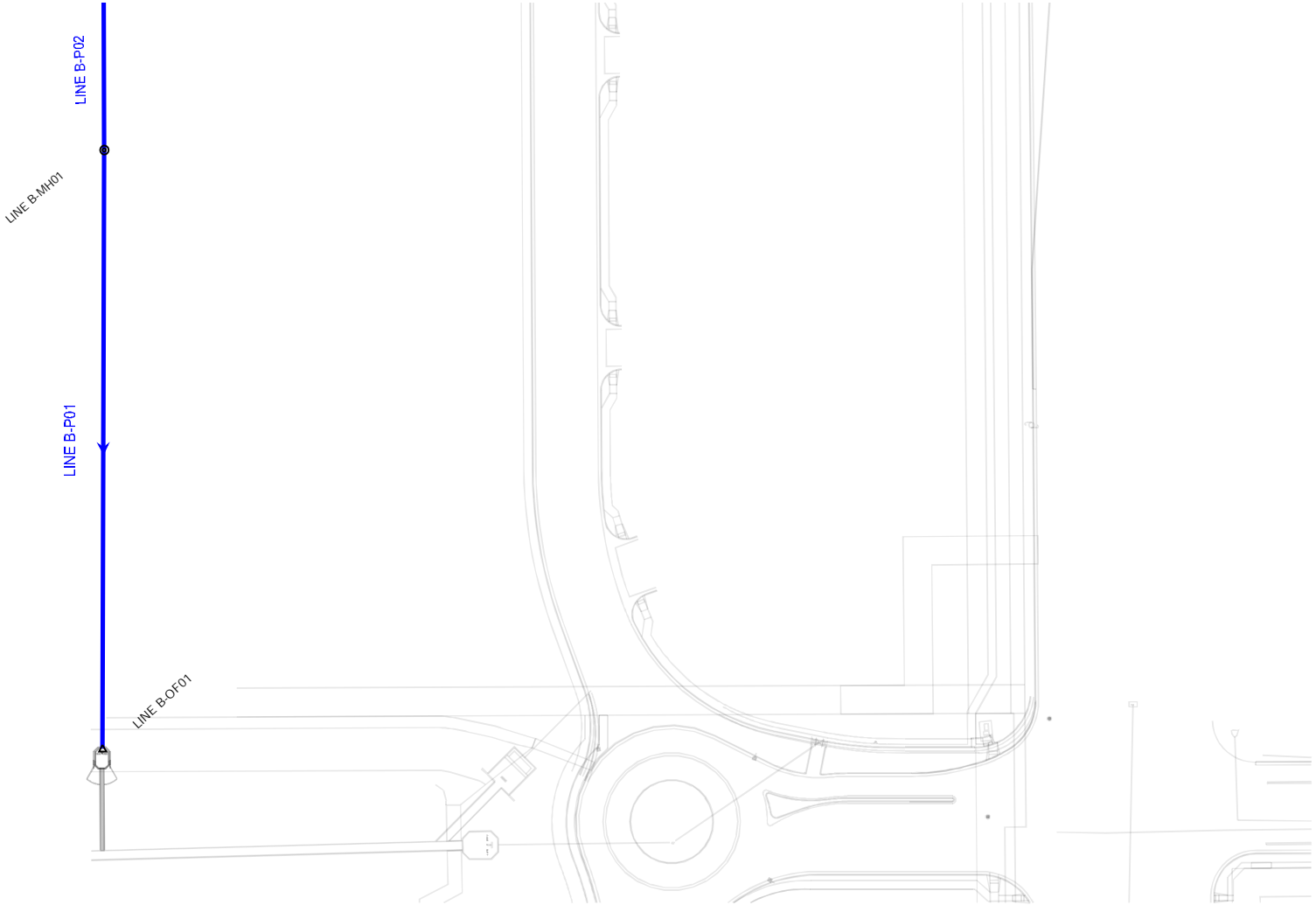

FlexTable: Conduit Table

Active Scenario: 5-Year

Label	Start Node	Stop Node	Invert (Start) (ft)	Invert (Stop) (ft)	Length (User Defined) (ft)	Slope (Calculated) (ft/ft)	Section Type	Diameter (in)	Manning's n	Flow (cfs)	Velocity (ft/s)	Capacity (Full Flow) (cfs)	Hydraulic Grade Line (In) (ft)	Hydraulic Grade Line (Out) (ft)	Energy Grade Line (In) (ft)	Energy Grade Line (Out) (ft)
LINE A-P04	LINE A-IN03 (DP4)	LINE A-MH01	6,907.71	6,906.44	101.6	0.013	Circle	24.0	0.013	9.00	7.37	25.29	6,908.78	6,907.26	6,909.21	6,908.11
LINE B-P03	LINE B-IN01 (DP9)	LINE B-MH02	6,901.92	6,900.67	125.1	0.010	Circle	18.0	0.013	0.40	2.86	10.50	6,902.15	6,901.02	6,902.23	6,901.05
LINE C-P01	LINE C-IN01 (DP10)	LINE B-MH02	6,906.50	6,901.37	36.0	0.143	Circle	18.0	0.013	1.20	10.06	39.67	6,906.91	6,901.55	6,907.06	6,903.12
LINE A-P03	LINE A-MH01	LINE A-IN02 (DP5)	6,906.34	6,906.05	23.3	0.012	Circle	24.0	0.013	9.00	7.35	25.22	6,907.41	6,907.25	6,907.84	6,907.57
LINE A-P02	LINE A-IN02 (DP5)	LINE A-IN01 (DP6)	6,905.05	6,904.64	41.3	0.010	Circle	36.0	0.013	10.60	6.88	66.43	6,907.24	6,907.25	6,907.30	6,907.29
LINE A-P01	LINE A-IN01 (DP6)	LINE A-OF01	6,904.54	6,904.08	45.4	0.010	Circle	36.0	0.013	10.50	6.92	67.16	6,907.24	6,907.24	6,907.28	6,907.27
LINE A-P05	LINE A-IN04 (DP3)	LINE A-IN03 (DP4)	6,911.91	6,908.21	295.9	0.013	Circle	18.0	0.013	5.50	6.54	11.75	6,912.81	6,909.35	6,913.19	6,909.57
LINE D-P02	LINE D-IN02 (DP7)	LINE D-IN01 (DP8)	6,906.75	6,906.32	42.8	0.010	Circle	15.0	0.013	0.40	2.93	6.47	6,907.24	6,907.25	6,907.26	6,907.25
LINE D-P01	LINE D-IN01 (DP8)	LINE D-OF01	6,906.22	6,903.94	45.9	0.050	Circle	15.0	0.013	1.10	6.94	14.40	6,907.25	6,907.24	6,907.26	6,907.25
LINE B-P02	LINE B-MH02	LINE B-MH01	6,900.37	6,897.69	268.3	0.010	Circle	18.0	0.013	1.60	4.29	10.50	6,900.85	6,898.09	6,901.02	6,898.37
LINE B-P01	LINE B-MH01	LINE B-OF01	6,897.59	6,889.40	425.0	0.019	Circle	18.0	0.013	1.60	5.42	14.58	6,898.06	6,894.20	6,898.24	6,894.21

FlexTable: Manhole Table

Active Scenario: 5-Year

Label	Elevation (Rim) (ft)	Flow (Total Out) (cfs)	Headloss Method	Headloss Coefficient (Standard)	Headloss (ft)	Hydraulic Grade Line (In) (ft)	Hydraulic Grade Line (Out) (ft)	Energy Grade Line (In) (ft)	Energy Grade Line (Out) (ft)
LINE A-IN03 (DP4)	6,912.81	9.00	Standard	1.320	0.57	6,909.35	6,908.78	6,909.58	6,909.21
LINE B-MH02	6,911.39	1.60	Standard	1.020	0.18	6,901.02	6,900.85	6,901.05	6,901.02
LINE C-IN01 (DP10)	6,909.45	1.20	Standard	0.000	0.00	6,906.91	6,906.91	6,907.06	6,907.06
LINE A-MH01	6,912.52	9.00	Standard	0.100	0.04	6,907.45	6,907.41	6,908.30	6,907.84
LINE A-IN02 (DP5)	6,910.46	10.60	Standard	0.100	0.01	6,907.25	6,907.24	6,907.57	6,907.30
LINE A-IN01 (DP6)	6,910.45	10.50	Standard	0.100	0.00	6,907.25	6,907.24	6,907.29	6,907.28
LINE B-IN01 (DP9)	6,907.92	0.40	Standard	0.000	0.00	6,902.15	6,902.15	6,902.23	6,902.23
LINE A-IN04 (DP3)	6,916.23	5.50	Standard	0.000	0.00	6,912.81	6,912.81	6,913.19	6,913.19
LINE D-IN01 (DP8)	6,910.66	1.10	Standard	0.100	0.00	6,907.25	6,907.25	6,907.25	6,907.26
LINE D-IN02 (DP7)	6,910.30	0.40	Standard	0.000	0.00	6,907.24	6,907.24	6,907.26	6,907.26
LINE B-MH01	6,905.18	1.60	Standard	0.100	0.02	6,898.08	6,898.06	6,898.37	6,898.24

FlexTable: Outfall Table

Active Scenario: 5-Year

Label	Elevation (Ground) (ft)	Elevation (Invert) (ft)	Boundary Condition Type	Elevation (User Defined Tailwater) (ft)	Flow (Total Out) (cfs)	Hydraulic Grade (ft)	Energy Grade Line (ft)
LINE B-OF01	6,898.00	6,888.65	User Defined Tailwater	6,894.20	1.60	6,894.20	6,894.20
LINE A-OF01	6,908.93	6,903.33	User Defined Tailwater	6,907.24	10.50	6,907.24	6,907.24
LINE D-OF01	6,906.80	6,903.19	User Defined Tailwater	6,907.24	1.10	6,907.24	6,907.24

Profile Report

Engineering Profile - LINE A (MRS01_StormCAD.stsw)

Active Scenario: 5-Year

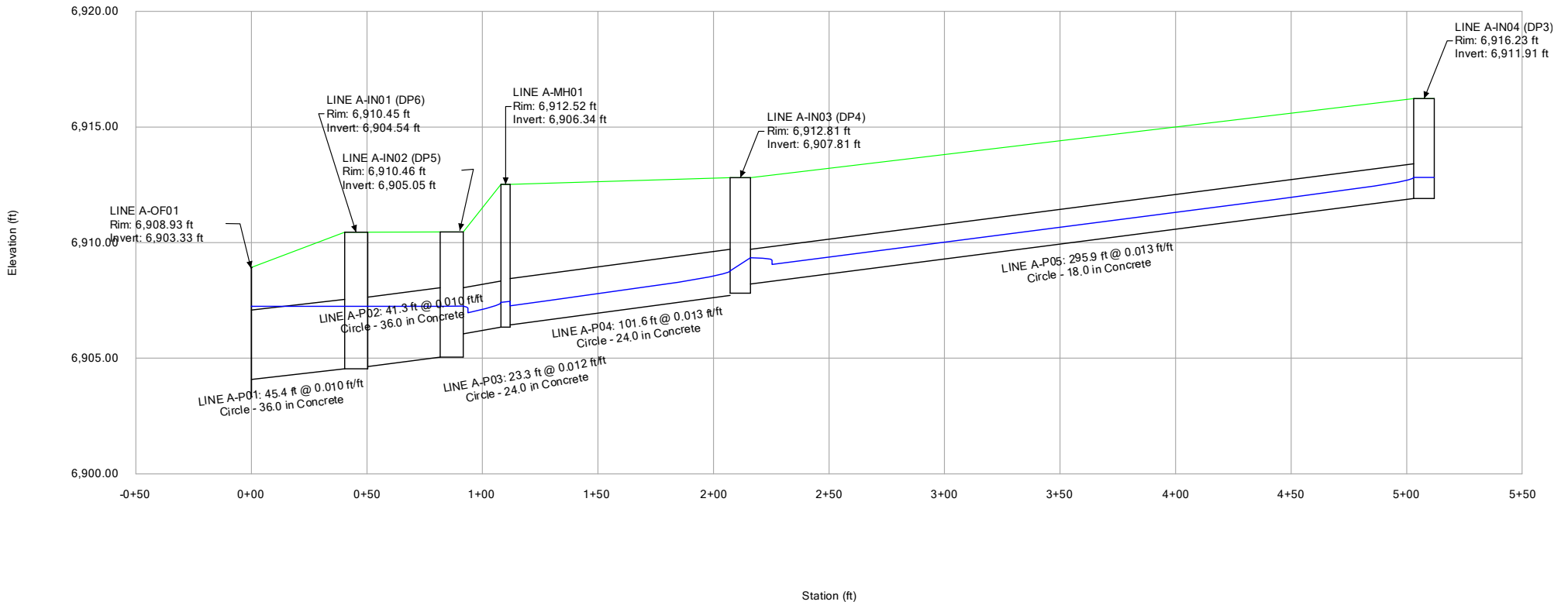

Profile Report
Engineering Profile - LINE B (MRS01_StormCAD.stsw)
Active Scenario: 5-Year

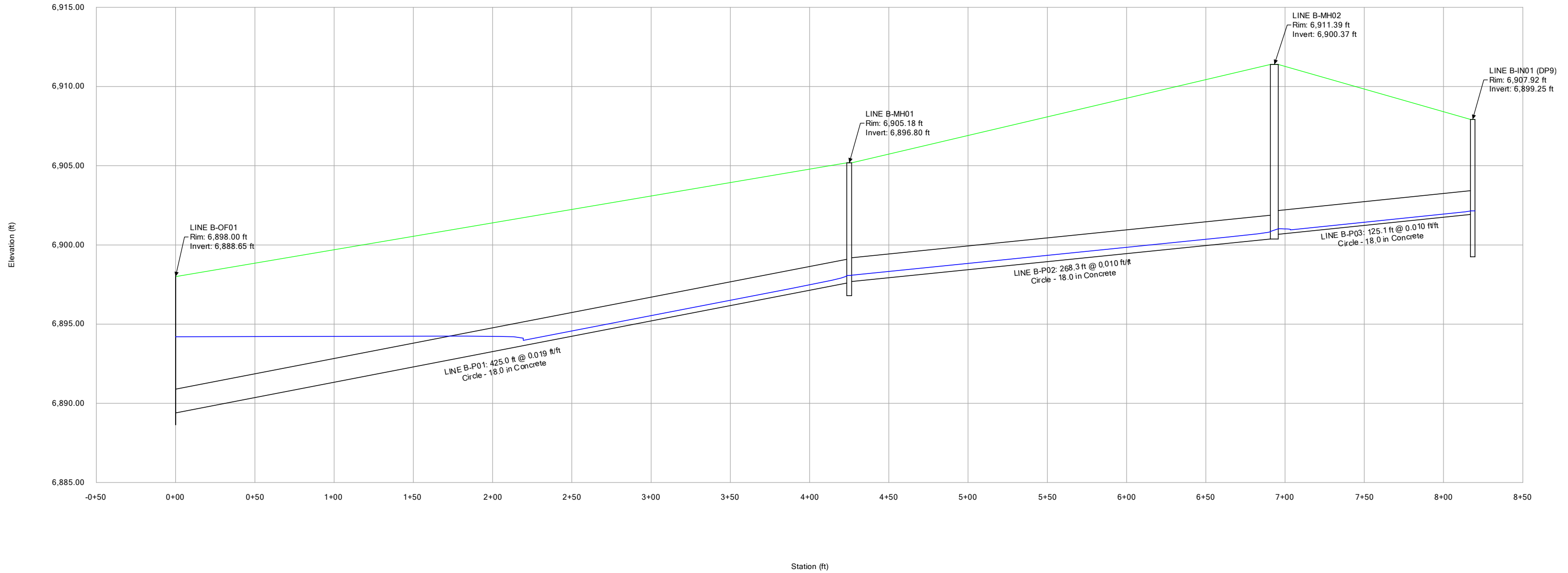

Profile Report
Engineering Profile - LINE C (MRS01_StormCAD.stsw)
Active Scenario: 5-Year

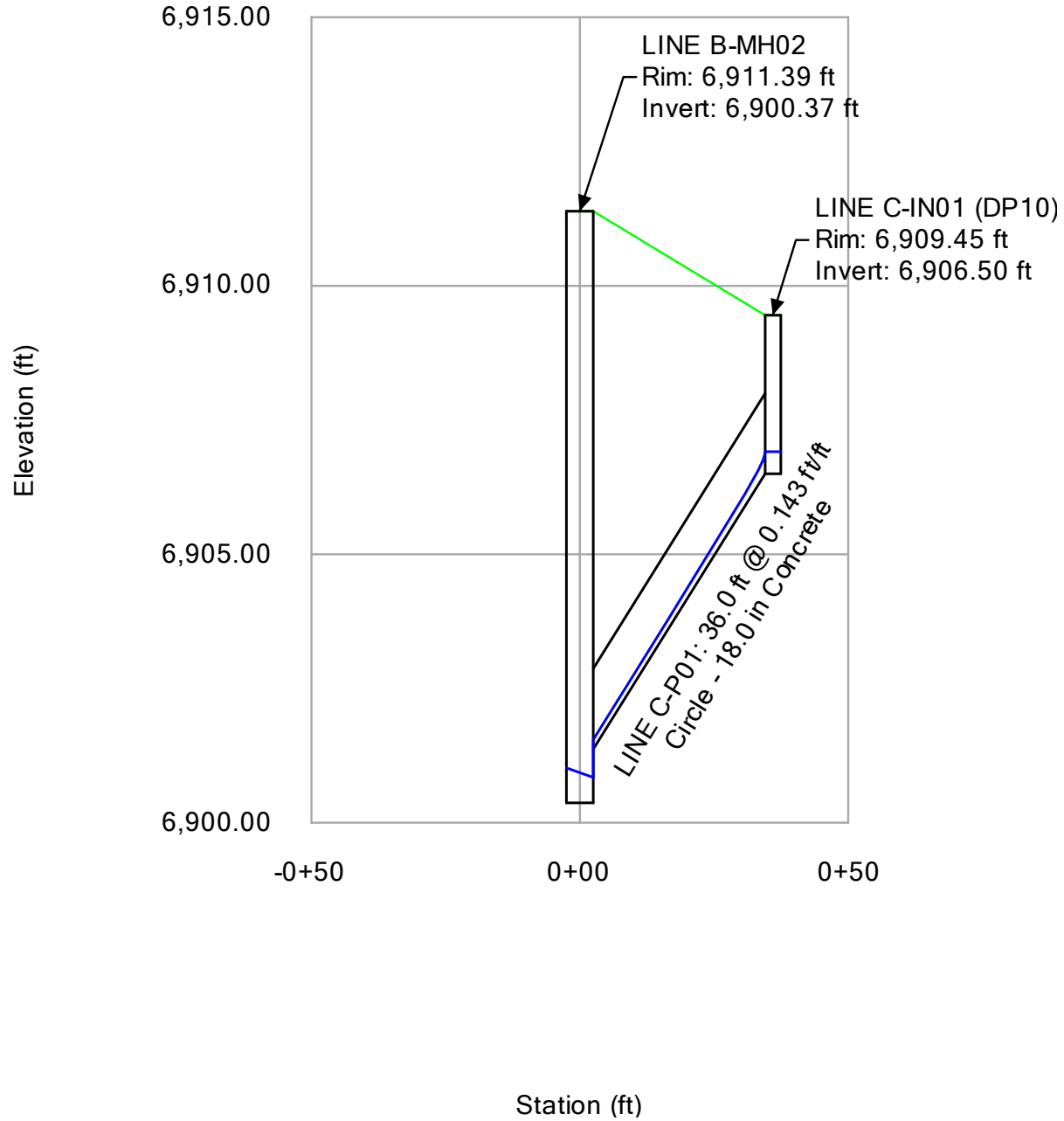

Profile Report
Engineering Profile - LINE D (MRS01_StormCAD.stsw)
Active Scenario: 5-Year

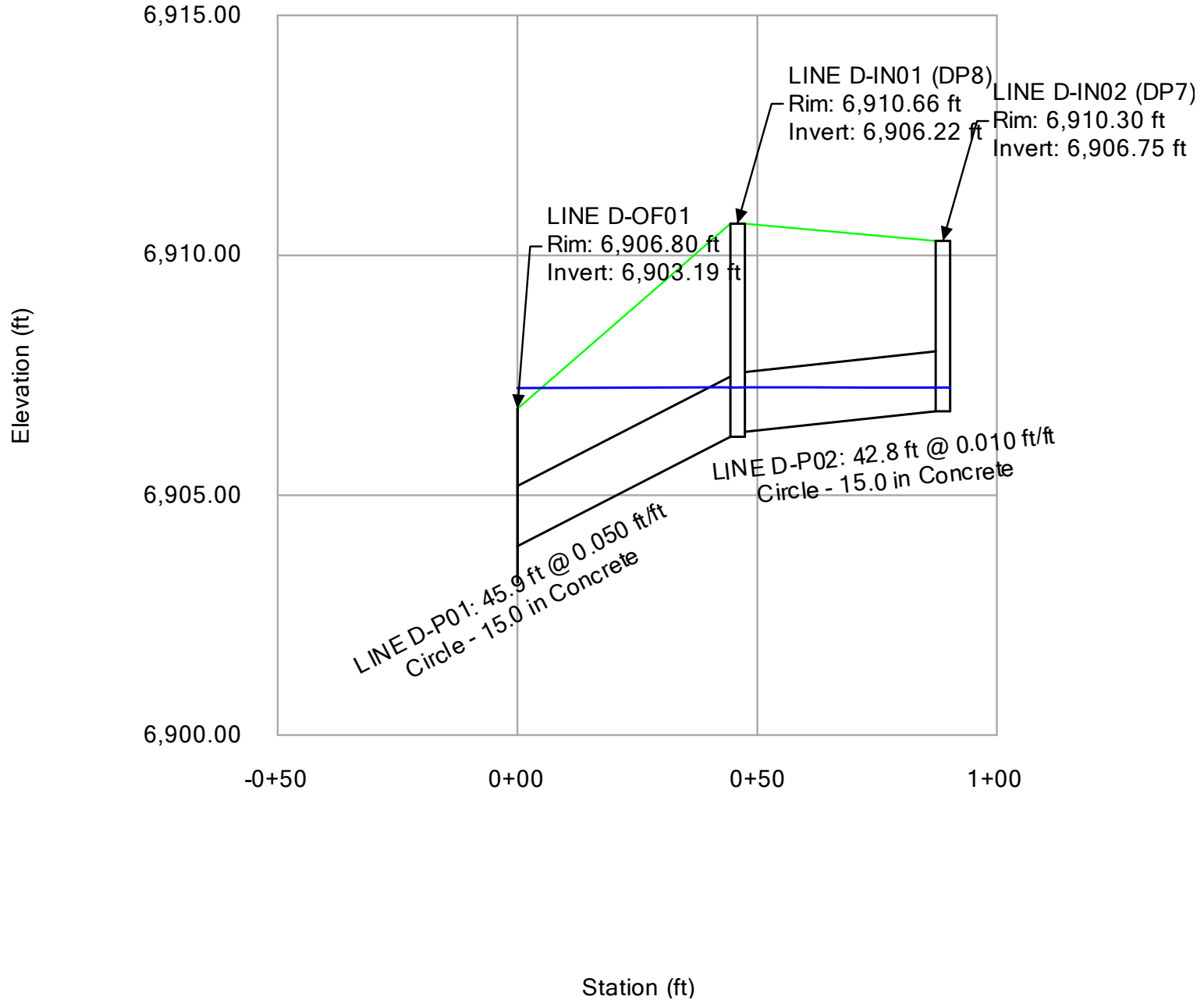

FlexTable: Conduit Table
Active Scenario: 100-Year

Label	Start Node	Stop Node	Invert (Start) (ft)	Invert (Stop) (ft)	Length (User Defined) (ft)	Slope (Calculated) (ft/ft)	Section Type	Diameter (in)	Manning's n	Flow (cfs)	Velocity (ft/s)	Capacity (Full Flow) (cfs)	Hydraulic Grade Line (In) (ft)	Hydraulic Grade Line (Out) (ft)	Energy Grade Line (In) (ft)	Energy Grade Line (Out) (ft)
LINE A-P04	LINE A-IN03 (DP4)	LINE A-MH01	6,907.71	6,906.44	101.6	0.013	Circle	24.0	0.013	15.80	8.49	25.29	6,909.14	6,908.82	6,909.81	6,909.21
LINE B-P03	LINE B-IN01 (DP9)	LINE B-MH02	6,901.92	6,900.67	125.1	0.010	Circle	18.0	0.013	3.80	2.15	10.50	6,905.75	6,905.58	6,905.82	6,905.65
LINE C-P01	LINE C-IN01 (DP10)	LINE B-MH02	6,906.50	6,901.37	36.0	0.143	Circle	18.0	0.013	7.40	17.18	39.67	6,907.55	6,905.58	6,908.04	6,905.85
LINE A-P03	LINE A-MH01	LINE A-IN02 (DP5)	6,906.34	6,906.05	23.3	0.012	Circle	24.0	0.013	15.80	5.03	25.22	6,908.78	6,908.67	6,909.17	6,909.06
LINE A-P02	LINE A-IN02 (DP5)	LINE A-IN01 (DP6)	6,905.05	6,904.64	41.3	0.010	Circle	36.0	0.013	19.10	2.70	66.43	6,908.65	6,908.62	6,908.77	6,908.73
LINE A-P01	LINE A-IN01 (DP6)	LINE A-OF01	6,904.54	6,904.08	45.4	0.010	Circle	36.0	0.013	19.50	2.76	67.16	6,908.61	6,908.57	6,908.73	6,908.69
LINE A-P05	LINE A-IN04 (DP3)	LINE A-IN03 (DP4)	6,911.91	6,908.21	295.9	0.013	Circle	18.0	0.013	9.60	7.41	11.75	6,913.11	6,910.03	6,913.73	6,910.48
LINE D-P02	LINE D-IN02 (DP7)	LINE D-IN01 (DP8)	6,906.75	6,906.32	42.8	0.010	Circle	15.0	0.013	0.80	0.65	6.47	6,908.63	6,908.62	6,908.64	6,908.63
LINE D-P01	LINE D-IN01 (DP8)	LINE D-OF01	6,906.22	6,903.94	45.9	0.050	Circle	15.0	0.013	2.10	1.71	14.40	6,908.62	6,908.57	6,908.66	6,908.62
LINE B-P02	LINE B-MH02	LINE B-MH01	6,900.37	6,897.69	268.3	0.010	Circle	18.0	0.013	11.20	6.34	10.50	6,904.94	6,901.89	6,905.57	6,902.52
LINE B-P01	LINE B-MH01	LINE B-OF01	6,897.59	6,889.40	425.0	0.019	Circle	18.0	0.013	11.20	6.34	14.58	6,901.83	6,897.00	6,902.46	6,897.62

FlexTable: Manhole Table
Active Scenario: 100-Year

Label	Elevation (Rim) (ft)	Flow (Total Out) (cfs)	Headloss Method	Headloss Coefficient (Standard)	Headloss (ft)	Hydraulic Grade Line (In) (ft)	Hydraulic Grade Line (Out) (ft)	Energy Grade Line (In) (ft)	Energy Grade Line (Out) (ft)
LINE A-IN03 (DP4)	6,912.81	15.80	Standard	1.320	0.88	6,910.03	6,909.14	6,910.48	6,909.81
LINE B-MH02	6,911.39	11.20	Standard	1.020	0.64	6,905.58	6,904.94	6,905.85	6,905.57
LINE C-IN01 (DP10)	6,909.45	7.40	Standard	0.000	0.00	6,907.55	6,907.55	6,908.04	6,908.04
LINE A-MH01	6,912.52	15.80	Standard	0.100	0.04	6,908.82	6,908.78	6,909.21	6,909.17
LINE A-IN02 (DP5)	6,910.46	19.10	Standard	0.100	0.01	6,908.67	6,908.65	6,909.06	6,908.77
LINE A-IN01 (DP6)	6,910.45	19.50	Standard	0.100	0.01	6,908.62	6,908.61	6,908.73	6,908.73
LINE B-IN01 (DP9)	6,907.92	3.80	Standard	0.000	0.00	6,905.75	6,905.75	6,905.82	6,905.82
LINE A-IN04 (DP3)	6,916.23	9.60	Standard	0.000	0.00	6,913.11	6,913.11	6,913.73	6,913.73
LINE D-IN01 (DP8)	6,910.66	2.10	Standard	0.100	0.00	6,908.62	6,908.62	6,908.63	6,908.66
LINE D-IN02 (DP7)	6,910.30	0.80	Standard	0.000	0.00	6,908.63	6,908.63	6,908.64	6,908.64
LINE B-MH01	6,905.18	11.20	Standard	0.100	0.06	6,901.89	6,901.83	6,902.52	6,902.46

FlexTable: Outfall Table
Active Scenario: 100-Year

Label	Elevation (Ground) (ft)	Elevation (Invert) (ft)	Boundary Condition Type	Elevation (User Defined Tailwater) (ft)	Flow (Total Out) (cfs)	Hydraulic Grade (ft)	Energy Grade Line (ft)
LINE B-OF01	6,898.00	6,888.65	User Defined Tailwater	6,897.00	11.20	6,897.00	6,897.00
LINE A-OF01	6,908.93	6,903.33	User Defined Tailwater	6,908.57	19.50	6,908.57	6,908.57
LINE D-OF01	6,906.80	6,903.19	User Defined Tailwater	6,908.57	2.10	6,908.57	6,908.57

Profile Report

Engineering Profile - LINE A (MRS01_StormCAD.stsw)

Active Scenario: 100-Year

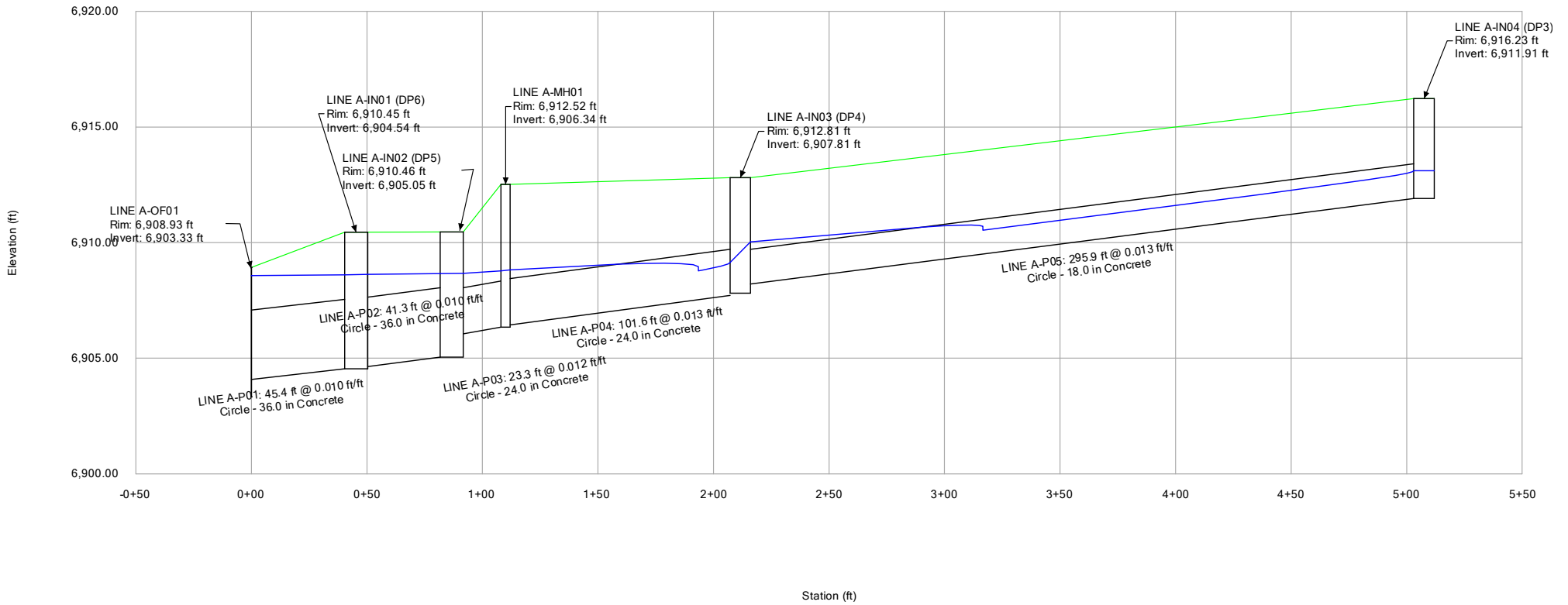

Profile Report
Engineering Profile - LINE B (MRS01_StormCAD.stsw)
Active Scenario: 100-Year

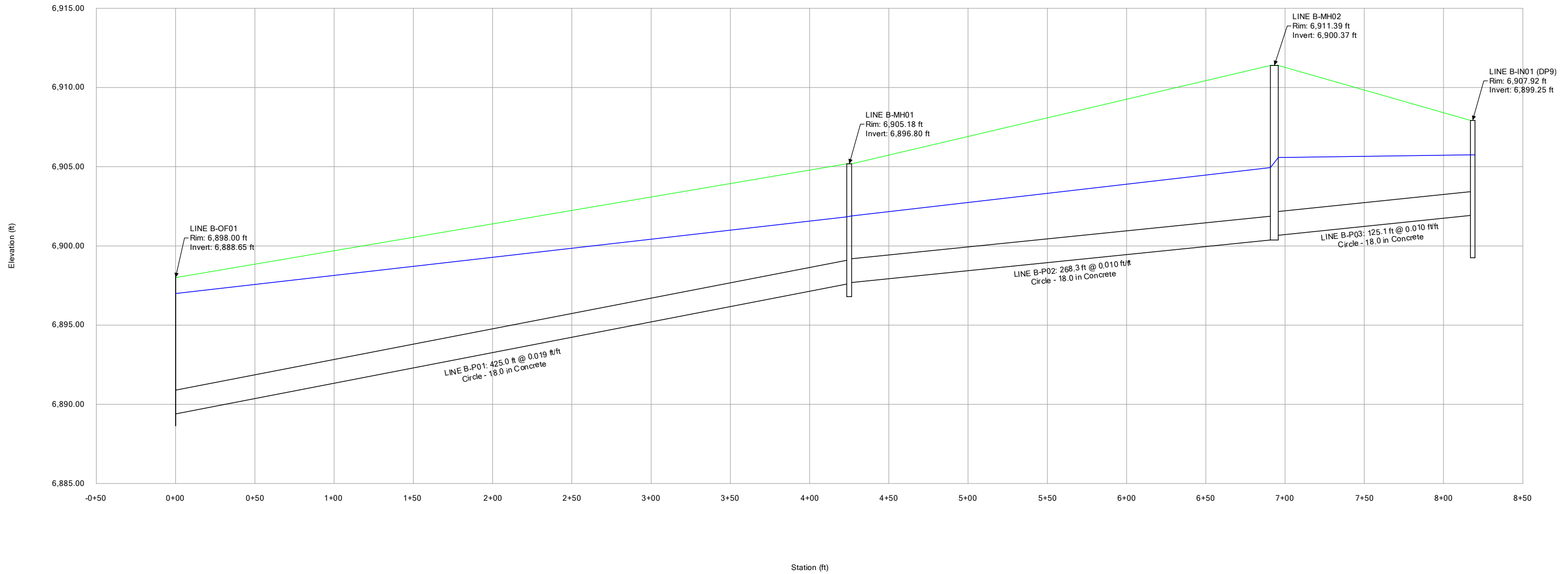

Profile Report
Engineering Profile - LINE C (MRS01_StormCAD.stsw)
Active Scenario: 100-Year

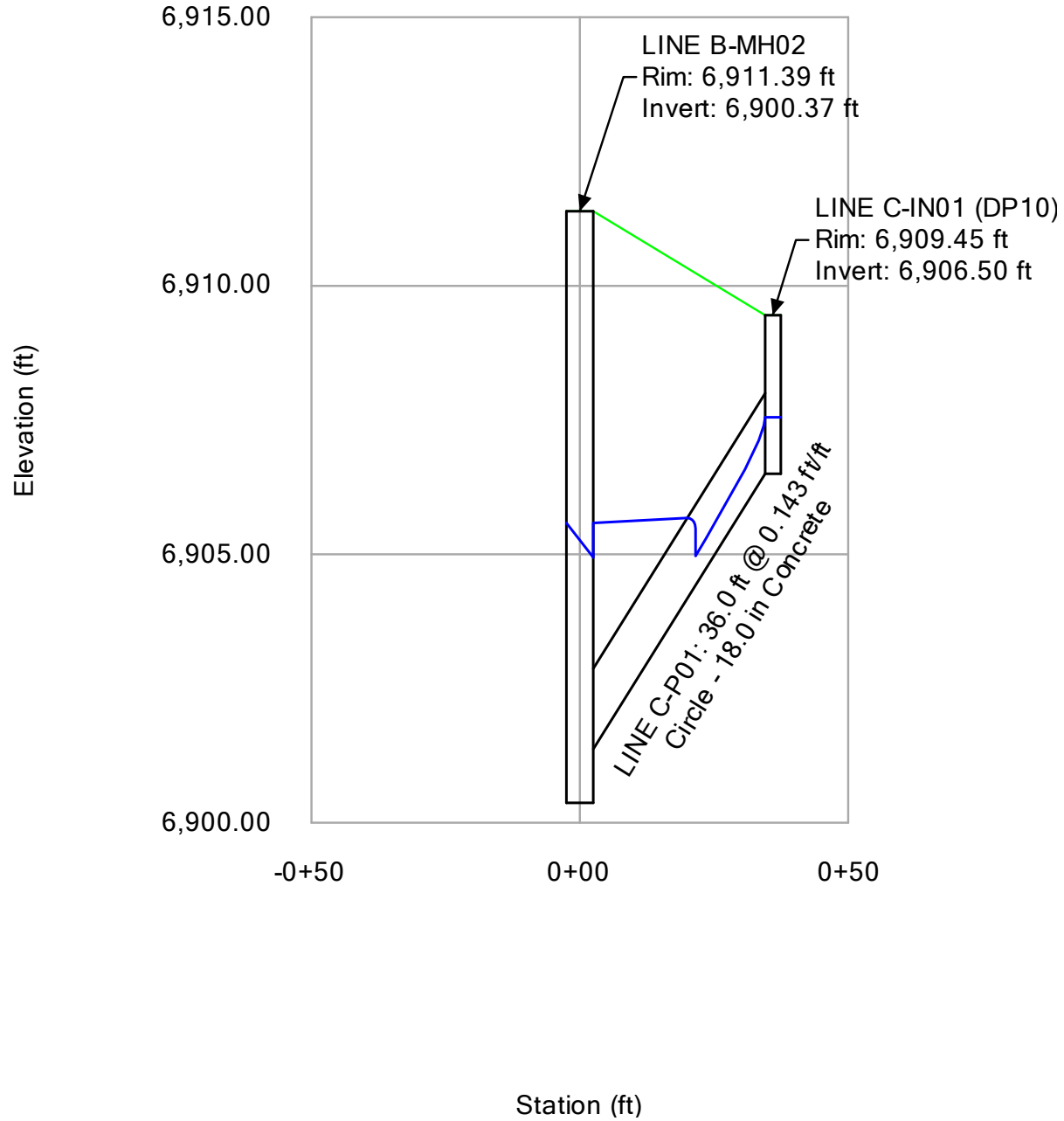

Profile Report
Engineering Profile - LINE D (MRS01_StormCAD.stsw)
Active Scenario: 100-Year

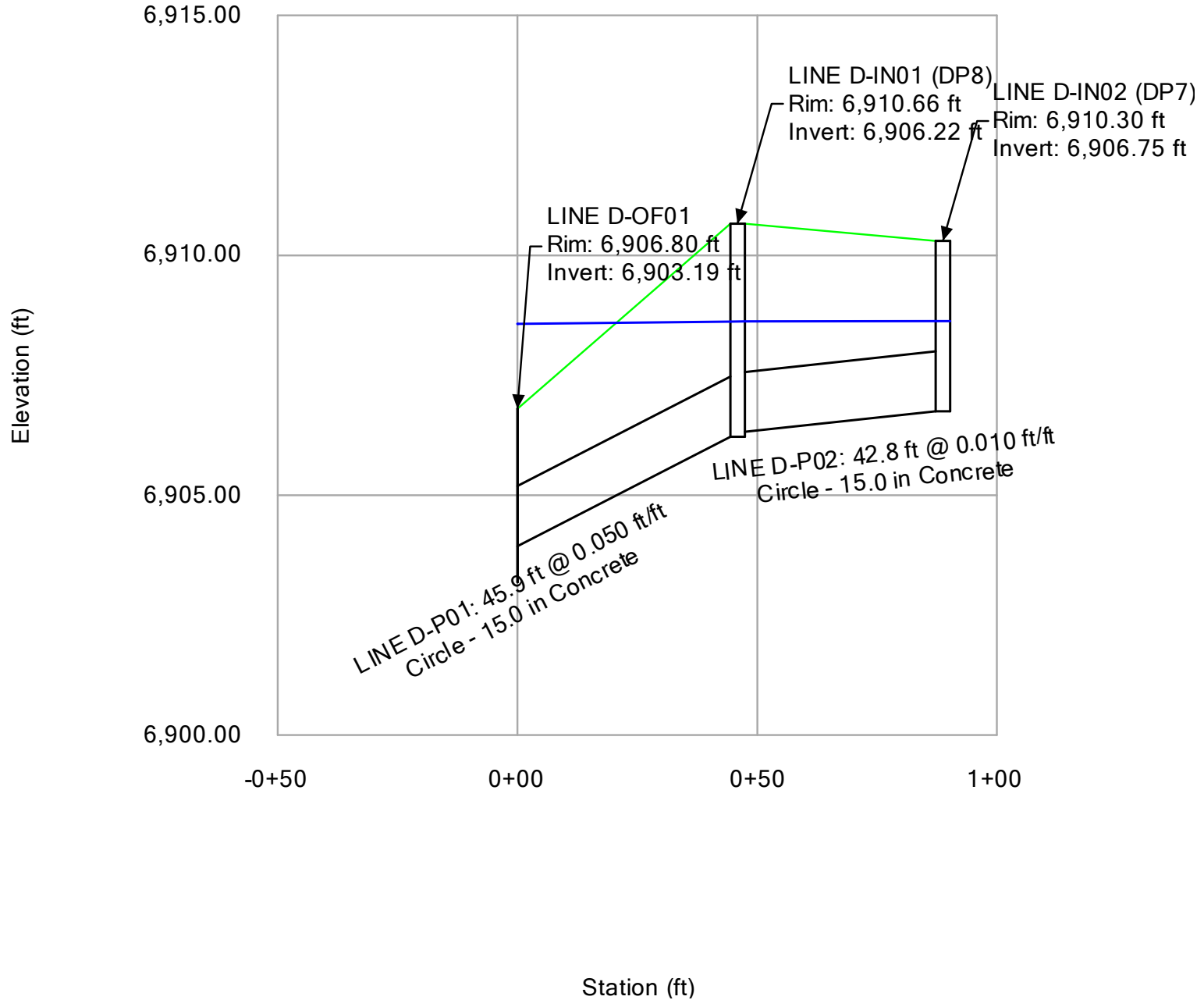

Type 13 Inlet Capacity Chart

Subdivision: Falcon Ranchettes Filing No. 1a
Location: El Paso County, CO

Project Name: Meridian Storage
Project No.: MRS01
Calculated By: CMWJ
Checked By: BAS
Date: 9/8/23

Type 13 Inlet Capacity

Depth (in)	Single	Double	Triple
	Capacity (cfs)	Capacity (cfs)	Capacity (cfs)
0	0.00	0.00	0.00
1	0.38	0.76	1.14
2	1.07	2.14	3.21
3	1.96	3.92	5.88
4	3.02	6.04	9.06
5	3.47	6.94	10.41
6	3.80	7.60	11.40
7	4.10	8.20	12.30
8	4.39	8.78	13.17
9	4.65	9.30	13.95
10	4.90	9.80	14.70
11	5.14	10.28	15.42
12	5.37	10.74	16.11

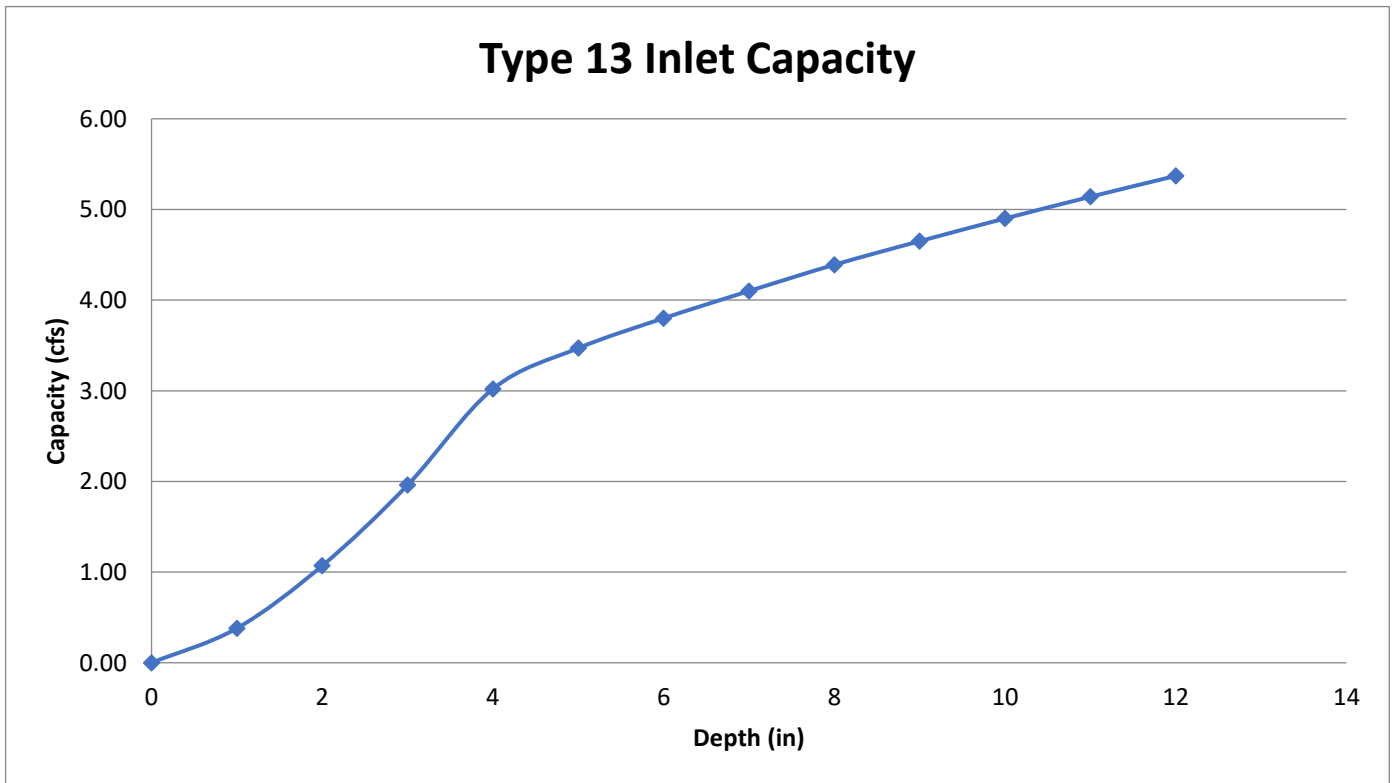

Calculations include a 50% clogging factor.

ALLOWABLE CAPACITY FOR ONE-HALF OF STREET (Minor & Major Storm)

(Based on Regulated Criteria for Maximum Allowable Flow Depth and Spread)

Project: Falcon Ranchettes Filing No. 1a (Meridian Storage)
Inlet ID: DP5

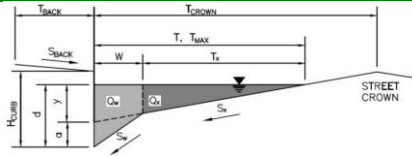

Gutter Geometry:									
Maximum Allowable Width for Spread Behind Curb	$T_{BACK} = 10.0$ ft								
Side Slope Behind Curb (leave blank for no conveyance credit behind curb)	$S_{BACK} = 0.020$ ft/ft								
Manning's Roughness Behind Curb (typically between 0.012 and 0.020)	$n_{BACK} = 0.013$								
Height of Curb at Gutter Flow Line	$H_{CURB} = 6.00$ inches								
Distance from Curb Face to Street Crown	$T_{CROWN} = 20.0$ ft								
Gutter Width	$W = 2.00$ ft								
Street Transverse Slope	$S_X = 0.020$ ft/ft								
Gutter Cross Slope (typically 2 inches over 24 inches or 0.083 ft/ft)	$S_W = 0.083$ ft/ft								
Street Longitudinal Slope - Enter 0 for sump condition	$S_0 = 0.014$ ft/ft								
Manning's Roughness for Street Section (typically between 0.012 and 0.020)	$n_{STREET} = 0.016$								
Max. Allowable Spread for Minor & Major Storm	<table border="1" style="display: inline-table; border-collapse: collapse;"> <tr> <td></td> <td style="text-align: center;">Minor Storm</td> <td style="text-align: center;">Major Storm</td> <td></td> </tr> <tr> <td>$T_{MAX} =$</td> <td style="text-align: center;">20.0</td> <td style="text-align: center;">20.0</td> <td>ft</td> </tr> </table>		Minor Storm	Major Storm		$T_{MAX} =$	20.0	20.0	ft
	Minor Storm	Major Storm							
$T_{MAX} =$	20.0	20.0	ft						
Max. Allowable Depth at Gutter Flowline for Minor & Major Storm	<table border="1" style="display: inline-table; border-collapse: collapse;"> <tr> <td></td> <td style="text-align: center;">Minor Storm</td> <td style="text-align: center;">Major Storm</td> <td></td> </tr> <tr> <td>$d_{MAX} =$</td> <td style="text-align: center;">6.0</td> <td style="text-align: center;">8.4</td> <td>inches</td> </tr> </table>		Minor Storm	Major Storm		$d_{MAX} =$	6.0	8.4	inches
	Minor Storm	Major Storm							
$d_{MAX} =$	6.0	8.4	inches						
Allow Flow Depth at Street Crown (check box for yes, leave blank for no)	<input type="checkbox"/> <input checked="" type="checkbox"/>								
MINOR STORM Allowable Capacity is based on Depth Criterion									
MAJOR STORM Allowable Capacity is based on Depth Criterion									
Minor storm max. allowable capacity GOOD - greater than the design peak flow of 2.10 cfs on sheet 'Inlet Management'									
Major storm max. allowable capacity GOOD - greater than the design peak flow of 4.40 cfs on sheet 'Inlet Management'									
	<table border="1" style="display: inline-table; border-collapse: collapse;"> <tr> <td></td> <td style="text-align: center;">Minor Storm</td> <td style="text-align: center;">Major Storm</td> <td></td> </tr> <tr> <td>$Q_{allow} =$</td> <td style="text-align: center;">16.3</td> <td style="text-align: center;">50.3</td> <td>cfs</td> </tr> </table>		Minor Storm	Major Storm		$Q_{allow} =$	16.3	50.3	cfs
	Minor Storm	Major Storm							
$Q_{allow} =$	16.3	50.3	cfs						

INLET ON A CONTINUOUS GRADE

MHFD-Inlet, Version 5.02 (August 2022)

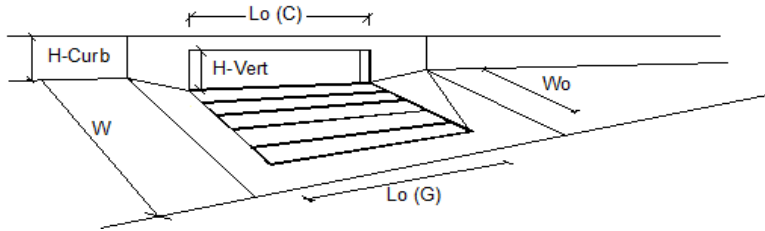

Design Information (Input)	MINOR	MAJOR	
Type of Inlet	CDOT Type R Curb Opening		
Local Depression (additional to continuous gutter depression 'a')	3.0	3.0	inches
Total Number of Units in the Inlet (Grate or Curb Opening)	1	1	
Length of a Single Unit Inlet (Grate or Curb Opening)	10.00	10.00	ft
Width of a Unit Grate (cannot be greater than W, Gutter Width)	N/A	N/A	ft
Clogging Factor for a Single Unit Grate (typical min. value = 0.5)	N/A	N/A	
Clogging Factor for a Single Unit Curb Opening (typical min. value = 0.1)	0.10	0.10	
Street Hydraulics: OK - Q < Allowable Street Capacity			
Total Inlet Interception Capacity	Q = 2.1	4.2	cfs
Total Inlet Carry-Over Flow (flow bypassing inlet)	Q_b = 0.0	0.2	cfs
Capture Percentage = Q _i /Q _s	C% = 100	96	%

ALLOWABLE CAPACITY FOR ONE-HALF OF STREET (Minor & Major Storm)

(Based on Regulated Criteria for Maximum Allowable Flow Depth and Spread)

Project: Falcon Ranchettes Filing No. 1a (Meridian Storage)
Inlet ID: DP6

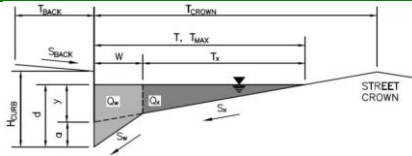

Gutter Geometry:									
Maximum Allowable Width for Spread Behind Curb	$T_{BACK} = 10.0$ ft								
Side Slope Behind Curb (leave blank for no conveyance credit behind curb)	$S_{BACK} = 0.020$ ft/ft								
Manning's Roughness Behind Curb (typically between 0.012 and 0.020)	$n_{BACK} = 0.013$								
Height of Curb at Gutter Flow Line	$H_{CURB} = 6.00$ inches								
Distance from Curb Face to Street Crown	$T_{CROWN} = 20.0$ ft								
Gutter Width	$W = 2.00$ ft								
Street Transverse Slope	$S_X = 0.020$ ft/ft								
Gutter Cross Slope (typically 2 inches over 24 inches or 0.083 ft/ft)	$S_W = 0.083$ ft/ft								
Street Longitudinal Slope - Enter 0 for sump condition	$S_O = 0.014$ ft/ft								
Manning's Roughness for Street Section (typically between 0.012 and 0.020)	$n_{STREET} = 0.016$								
Max. Allowable Spread for Minor & Major Storm	<table border="1" style="display: inline-table; border-collapse: collapse;"> <tr> <td></td> <td style="text-align: center;">Minor Storm</td> <td style="text-align: center;">Major Storm</td> <td></td> </tr> <tr> <td>$T_{MAX} =$</td> <td style="text-align: center;">20.0</td> <td style="text-align: center;">20.0</td> <td>ft</td> </tr> </table>		Minor Storm	Major Storm		$T_{MAX} =$	20.0	20.0	ft
	Minor Storm	Major Storm							
$T_{MAX} =$	20.0	20.0	ft						
Max. Allowable Depth at Gutter Flowline for Minor & Major Storm	<table border="1" style="display: inline-table; border-collapse: collapse;"> <tr> <td></td> <td style="text-align: center;">Minor Storm</td> <td style="text-align: center;">Major Storm</td> <td></td> </tr> <tr> <td>$d_{MAX} =$</td> <td style="text-align: center;">6.0</td> <td style="text-align: center;">8.4</td> <td>inches</td> </tr> </table>		Minor Storm	Major Storm		$d_{MAX} =$	6.0	8.4	inches
	Minor Storm	Major Storm							
$d_{MAX} =$	6.0	8.4	inches						
Allow Flow Depth at Street Crown (check box for yes, leave blank for no)	<input type="checkbox"/> <input checked="" type="checkbox"/>								
MINOR STORM Allowable Capacity is based on Depth Criterion									
MAJOR STORM Allowable Capacity is based on Depth Criterion									
Minor storm max. allowable capacity GOOD - greater than the design peak flow of 1.50 cfs on sheet 'Inlet Management'									
Major storm max. allowable capacity GOOD - greater than the design peak flow of 3.20 cfs on sheet 'Inlet Management'									
	<table border="1" style="display: inline-table; border-collapse: collapse;"> <tr> <td></td> <td style="text-align: center;">Minor Storm</td> <td style="text-align: center;">Major Storm</td> <td></td> </tr> <tr> <td>$Q_{allow} =$</td> <td style="text-align: center;">16.3</td> <td style="text-align: center;">50.3</td> <td>cfs</td> </tr> </table>		Minor Storm	Major Storm		$Q_{allow} =$	16.3	50.3	cfs
	Minor Storm	Major Storm							
$Q_{allow} =$	16.3	50.3	cfs						

INLET ON A CONTINUOUS GRADE

MHFD-Inlet, Version 5.02 (August 2022)

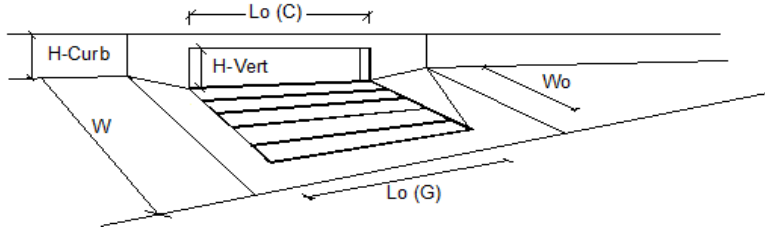

Design Information (Input)	MINOR	MAJOR	
Type of Inlet	CDOT Type R Curb Opening		
Local Depression (additional to continuous gutter depression 'a')	3.0	3.0	inches
Total Number of Units in the Inlet (Grate or Curb Opening)	1	1	
Length of a Single Unit Inlet (Grate or Curb Opening)	10.00	10.00	ft
Width of a Unit Grate (cannot be greater than W, Gutter Width)	N/A	N/A	ft
Clogging Factor for a Single Unit Grate (typical min. value = 0.5)	N/A	N/A	
Clogging Factor for a Single Unit Curb Opening (typical min. value = 0.1)	0.10	0.10	
Street Hydraulics: OK - Q < Allowable Street Capacity			
Total Inlet Interception Capacity	Q = 1.5	Q = 3.2	cfs
Total Inlet Carry-Over Flow (flow bypassing inlet)	Q_b = 0.0	Q_b = 0.0	cfs
Capture Percentage = Q _i /Q _s	C% = 100	C% = 100	%

ALLOWABLE CAPACITY FOR ONE-HALF OF STREET (Minor & Major Storm)

(Based on Regulated Criteria for Maximum Allowable Flow Depth and Spread)

Project: Falcon Ranchettes Filing No. 1a (Meridian Storage)
Inlet ID: DP7

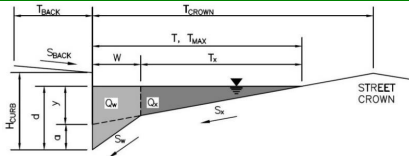

Gutter Geometry:

Maximum Allowable Width for Spread Behind Curb
 Side Slope Behind Curb (leave blank for no conveyance credit behind curb)
 Manning's Roughness Behind Curb (typically between 0.012 and 0.020)

T_{BACK}	=	10.0	ft
S_{BACK}	=	0.020	ft/ft
n_{BACK}	=	0.013	

Height of Curb at Gutter Flow Line
 Distance from Curb Face to Street Crown
 Gutter Width
 Street Transverse Slope
 Gutter Cross Slope (typically 2 inches over 24 inches or 0.083 ft/ft)
 Street Longitudinal Slope - Enter 0 for sump condition
 Manning's Roughness for Street Section (typically between 0.012 and 0.020)

H_{CURB}	=	6.00	inches
T_{CROWN}	=	20.0	ft
W	=	2.00	ft
S_x	=	0.020	ft/ft
S_w	=	0.083	ft/ft
S_o	=	0.008	ft/ft
n_{STREET}	=	0.016	

Max. Allowable Spread for Minor & Major Storm
 Max. Allowable Depth at Gutter Flowline for Minor & Major Storm
 Allow Flow Depth at Street Crown (check box for yes, leave blank for no)

	Minor Storm	Major Storm	
T_{MAX}	=	20.0	20.0 ft
d_{MAX}	=	6.0	8.4 inches
		<input type="checkbox"/>	<input checked="" type="checkbox"/>

MINOR STORM Allowable Capacity is based on Depth Criterion
 MAJOR STORM Allowable Capacity is based on Depth Criterion

	Minor Storm	Major Storm	
Q_{allow}	=	12.3	38.0 cfs

Minor storm max. allowable capacity GOOD - greater than the design peak flow of 0.50 cfs on sheet 'Inlet Management'
Major storm max. allowable capacity GOOD - greater than the design peak flow of 0.90 cfs on sheet 'Inlet Management'

INLET ON A CONTINUOUS GRADE

MHFD-Inlet, Version 5.02 (August 2022)

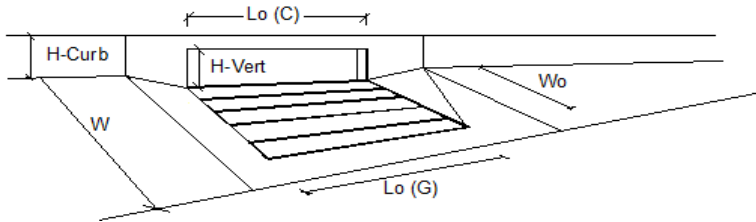

Design Information (Input)	MINOR	MAJOR	
Type of Inlet	CDOT Type R Curb Opening		
Local Depression (additional to continuous gutter depression 'a')	3.0	3.0	inches
Total Number of Units in the Inlet (Grate or Curb Opening)	1	1	
Length of a Single Unit Inlet (Grate or Curb Opening)	5.00	5.00	ft
Width of a Unit Grate (cannot be greater than W, Gutter Width)	N/A	N/A	ft
Clogging Factor for a Single Unit Grate (typical min. value = 0.5)	N/A	N/A	
Clogging Factor for a Single Unit Curb Opening (typical min. value = 0.1)	0.10	0.10	
Street Hydraulics: OK - Q < Allowable Street Capacity			
Total Inlet Interception Capacity	0.5	0.9	cfs
Total Inlet Carry-Over Flow (flow bypassing inlet)	0.0	0.0	cfs
Capture Percentage = Q_i/Q_o	100	100	%

ALLOWABLE CAPACITY FOR ONE-HALF OF STREET (Minor & Major Storm)

(Based on Regulated Criteria for Maximum Allowable Flow Depth and Spread)

Project: **Falcon Ranchettes Filing No. 1a (Meridian Storage)**
 Inlet ID: **DP8**

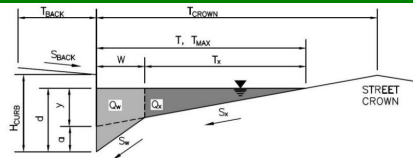

Gutter Geometry:

Maximum Allowable Width for Spread Behind Curb
 Side Slope Behind Curb (leave blank for no conveyance credit behind curb)
 Manning's Roughness Behind Curb (typically between 0.012 and 0.020)

Height of Curb at Gutter Flow Line
 Distance from Curb Face to Street Crown
 Gutter Width
 Street Transverse Slope
 Gutter Cross Slope (typically 2 inches over 24 inches or 0.083 ft/ft)
 Street Longitudinal Slope - Enter 0 for sump condition
 Manning's Roughness for Street Section (typically between 0.012 and 0.020)

Max. Allowable Spread for Minor & Major Storm
 Max. Allowable Depth at Gutter Flowline for Minor & Major Storm
 Allow Flow Depth at Street Crown (check box for yes, leave blank for no)

MINOR STORM Allowable Capacity is based on Depth Criterion
 MAJOR STORM Allowable Capacity is based on Depth Criterion

Minor storm max. allowable capacity GOOD - greater than the design peak flow of 0.80 cfs on sheet 'Inlet Management'
Major storm max. allowable capacity GOOD - greater than the design peak flow of 1.60 cfs on sheet 'Inlet Management'

T_{BACK} =	10.0	ft
S_{BACK} =	0.020	ft/ft
n_{BACK} =	0.013	
H_{CURB} =	6.00	inches
T_{CROWN} =	20.0	ft
W =	2.00	ft
S_x =	0.020	ft/ft
S_w =	0.083	ft/ft
S_o =	0.005	ft/ft
n_{STREET} =	0.016	

	Minor Storm	Major Storm	
T_{MAX} =	20.0	20.0	ft
d_{MAX} =	6.0	8.4	inches
	<input type="checkbox"/>	<input checked="" type="checkbox"/>	

	Minor Storm	Major Storm	
Q_{allow} =	9.7	30.1	cfs

INLET ON A CONTINUOUS GRADE

MHFD-Inlet, Version 5.02 (August 2022)

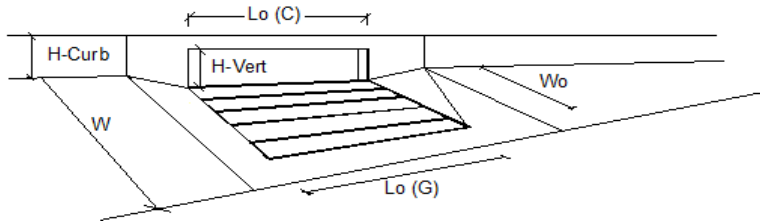

Design Information (Input)	MINOR	MAJOR	
Type of Inlet	CDOT Type R Curb Opening		
Local Depression (additional to continuous gutter depression 'a')	3.0	3.0	inches
Total Number of Units in the Inlet (Grate or Curb Opening)	1	1	
Length of a Single Unit Inlet (Grate or Curb Opening)	5.00	5.00	ft
Width of a Unit Grate (cannot be greater than W, Gutter Width)	N/A	N/A	ft
Clogging Factor for a Single Unit Grate (typical min. value = 0.5)	N/A	N/A	
Clogging Factor for a Single Unit Curb Opening (typical min. value = 0.1)	0.10	0.10	
Street Hydraulics: OK - Q < Allowable Street Capacity			
Total Inlet Interception Capacity	0.8	1.5	cfs
Total Inlet Carry-Over Flow (flow bypassing inlet)	0.0	0.1	cfs
Capture Percentage = Q_i/Q_o	100	93	%

AREA INLET IN A SWALE

Falcon Ranchettes Filing No. 1a (Meridian Storage)

DP10

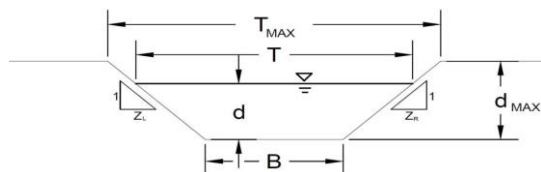

This worksheet uses the NRCS vegetal retardance method to determine Manning's n.

For more information see Section 7.2.3 of the USDCM.

Analysis of Trapezoidal Grass-Lined Channel Using SCS Method

NRCS Vegetal Retardance (A, B, C, D, or E)

Manning's n (Leave cell D16 blank to manually enter an n value)

Channel Invert Slope

Bottom Width

Left Side Slope

Right Side Slope

Check one of the following soil types:

Soil Type:	Max. Velocity (V _{MAX})	Max Froude No. (F _{MAX})
Non-Cohesive	5.0 fps	0.60
Cohesive	7.0 fps	0.80
Paved	N/A	N/A

A, B, C, D, or E =

n =	0.030
S ₀ =	0.0200 ft/ft
B =	3.00 ft
Z1 =	4.00 ft/ft
Z2 =	4.00 ft/ft

Choose One:

- Non-Cohesive
 Cohesive
 Paved

Maximum Allowable Top Width of Channel for Minor & Major Storm

Maximum Allowable Water Depth in Channel for Minor & Major Storm

	Minor Storm	Major Storm	
T _{MAX} =	11.00	11.00	ft
d _{MAX} =	1.00	1.00	ft

Allowable Channel Capacity Based On Channel Geometry

MINOR STORM Allowable Capacity is based on Depth Criterion

MAJOR STORM Allowable Capacity is based on Depth Criterion

	Minor Storm	Major Storm	
Q _{allow} =	35.8	35.8	cfs
d _{allow} =	1.00	1.00	ft

Water Depth in Channel Based On Design Peak Flow

Design Peak Flow

Water Depth

Q _o =	1.2	7.4	cfs
d =	0.17	0.46	ft

Minor storm max. allowable capacity GOOD - greater than the design flow given on sheet 'Inlet Management'
Major storm max. allowable capacity GOOD - greater than the design flow given on sheet 'Inlet Management'

MHFD-Inlet, Version 5.02 (August 2022)
AREA INLET IN A SWALE

Falcon Ranchettes Filing No. 1a (Meridian Storage)
 DP10

Inlet Design Information (Input)																					
Type of Inlet	CDOT Type C (Depressed)																				
Inlet Type =	CDOT Type C (Depressed)																				
Angle of Inclined Grate (must be <= 30 degrees)	$\theta = 10.00$ degrees																				
Width of Grate	$W = 3.00$ ft																				
Length of Grate	$L = 3.00$ ft																				
Open Area Ratio	$A_{RATIO} = 0.70$																				
Height of Inclined Grate	$H_B = 0.52$ ft																				
Clogging Factor	$C_f = 0.50$																				
Grate Discharge Coefficient	$C_d = 0.57$																				
Orifice Coefficient	$C_o = 0.38$																				
Weir Coefficient	$C_w = 1.23$																				
	<table border="1"> <thead> <tr> <th></th> <th>MINOR</th> <th>MAJOR</th> <th></th> </tr> </thead> <tbody> <tr> <td>$d =$</td> <td>1.17</td> <td>1.46</td> <td></td> </tr> <tr> <td>$Q_a =$</td> <td>11.4</td> <td>16.4</td> <td>cfs</td> </tr> <tr> <td>$Q_b =$</td> <td>0.0</td> <td>0.0</td> <td>cfs</td> </tr> <tr> <td>$C\% =$</td> <td>100</td> <td>100</td> <td>%</td> </tr> </tbody> </table>		MINOR	MAJOR		$d =$	1.17	1.46		$Q_a =$	11.4	16.4	cfs	$Q_b =$	0.0	0.0	cfs	$C\% =$	100	100	%
	MINOR	MAJOR																			
$d =$	1.17	1.46																			
$Q_a =$	11.4	16.4	cfs																		
$Q_b =$	0.0	0.0	cfs																		
$C\% =$	100	100	%																		
Water Depth at Inlet (for depressed inlets, 1 foot is added for depression)																					
Total Inlet Interception Capacity (assumes clogged condition)																					
Bypassed Flow																					
Capture Percentage = Q_a/Q_o																					

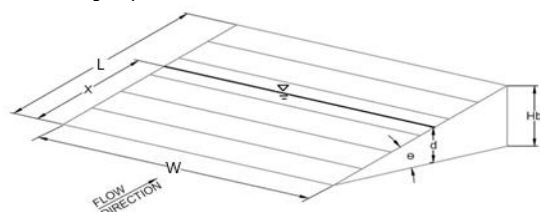

Warning 04: Froude No. exceeds USDCM Volume I recommendation.

PIPE OUTFALL RIPRAP SIZING CALCULATIONS

Subdivision: Falcon Ranchettes Filing No. 1A
Location: CO, Colorado Springs

Project Name: Meridian Storage
Project No.: MRS01
Calculated By: CMWJ
Checked By: BAS
Date: 9/8/23

	STORM DRAIN SYSTEM		
	DP-12	DP-13	
Q100 (cfs)	1.5	2.1	Flows are the greater of proposed vs. future
D or H (in)	6	6	
W (ft)	2	2	
Slope (%)	1.40	1.40	
Yn (in)	6.00	6.00	
Yt (ft)	Unknown	Unknown	If "unknown" Yt/D=0.4
Yt/D, Yt/H	0.40	0.40	Per section 11-3
Supercritical	Yes	Yes	
Q/D ^{2.5} , Q/WH ^{1.5}	2.11	3.02	
Q/D ^{1.5} , Q/WH ^{0.5}			
Da, Ha (in) *	6.00	6.00	Da=0.5(D+Yn), Ha=0.5(H+Yn)
Q/Da ^{1.5} , Q/WHa ^{0.5} *	1.05	1.51	
d50 (in), Required	0.44	0.63	
Required Riprap Size	L	L	Fig. 8-34
Use Riprap Size	L	L	
d50 (in)	9	9	Fig. 8-34
1/(2 tan q)	4.75	2.90	Fig. 9-35 OR Fig 9-36
Erosive Soils	Yes	Yes	
At	0.27	0.39	At=Q/5.5
L	-3.1	-0.2	L=(1/(2 tan q))(At/Yt - D)
Min L	1.5	1.5	Min L=3D or 3H
Max L	5.0	5.0	Max L=10D or 10H
Length (ft)	1.5	1.5	
Bottom Width (ft)	6.0	6.0	Width=3D (Minimum)
Riprap Depth (in)	18	18	Depth=2(d50)
Type II Base Depth (in)	6	6	Table 8-34 fine grained soils
Cutoff Wall	No	No	
Cutoff Wall Depth (ft)			Depth of Riprap and Base
Cutoff Wall Width (ft)			
<p>Note: No Type II Base to be used if Soil Riprap is specified within the plans * For use when the flow in the culvert is supercritical (and less than full). CEDP--CONCRETE ENERGY DISIPATING BASIN</p>			

Unnamed Tributary to Black Squirrel Creek - East Branch (RMT064)

Project Description

Friction Method Manning Formula
Solve For Normal Depth

Input Data

Roughness Coefficient	0.035
Channel Slope	0.00300 ft/ft
Left Side Slope	4.00 ft/ft (H:V)
Right Side Slope	4.00 ft/ft (H:V)
Bottom Width	15.00 ft
Discharge	925.00 ft ³ /s

Results

Normal Depth	5.15 ft
Flow Area	183.50 ft ²
Wetted Perimeter	57.49 ft
Hydraulic Radius	3.19 ft
Top Width	56.22 ft
Critical Depth	3.58 ft
Critical Slope	0.01368 ft/ft
Velocity	5.04 ft/s
Velocity Head	0.39 ft
Specific Energy	5.55 ft
Froude Number	0.49
Flow Type	Subcritical

GVF Input Data

Downstream Depth	0.00 ft
Length	0.00 ft
Number Of Steps	0

GVF Output Data

Upstream Depth	0.00 ft
Profile Description	
Profile Headloss	0.00 ft
Downstream Velocity	Infinity ft/s
Upstream Velocity	Infinity ft/s
Normal Depth	5.15 ft
Critical Depth	3.58 ft
Channel Slope	0.00300 ft/ft
Critical Slope	0.01368 ft/ft

APPENDIX E

DETENTION POND TRIBUTARY AREAS

Subdivision: Falcon Ranchettes Filing No. 1A
Location: CO, Colorado Springs

Project Name: Meridian Storage
Project No.: MRS01
Calculated By: CMWJ
Checked By: BAS
Date: 9/8/23

Detention Pond #1

Basin	Area	% Imp
B-1	1.31	95.5
B-2	1.04	99.0
B-3	0.95	61.9
B-4	0.52	79.3
B-5	0.16	69.4
B-6	0.13	84.9
B-7	0.56	14.3
* C-1	0.29	100.0
* C-2	3.12	100.0
* C-3	0.29	100.0
OS-3	0.24	2.0
OS-5	0.19	2.0
Total	8.8	82.9

*All "C" group basins' imperviousness changed to 100%.
This will accomdate the future build out of the
associated lot and provide full spectrum detention and
avoid construction of an additional pond.

DETENTION BASIN STAGE-STORAGE TABLE BUILDER

MHFD-Detention, Version 4.06 (July 2022)

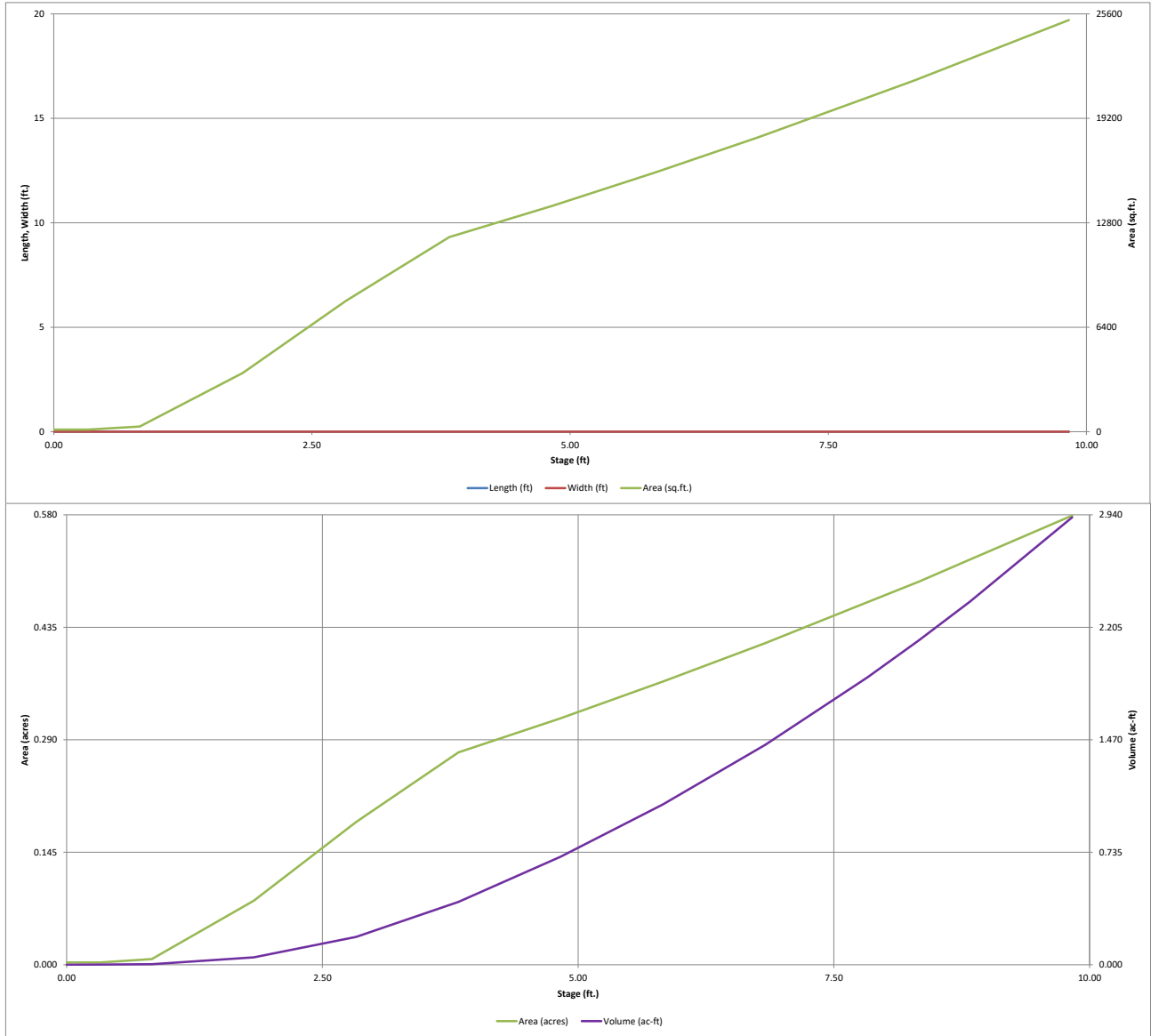

DETENTION BASIN OUTLET STRUCTURE DESIGN

MHFD-Detention, Version 4.06 (July 2022)

Project: Falcon Ranchettes Filing No. 1a (Meridian Storage)

Basin ID: Pond #1

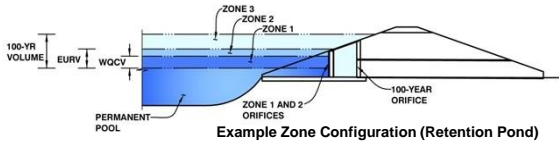

Example Zone Configuration (Retention Pond)

	Estimated Stage (ft)	Estimated Volume (ac-ft)	Outlet Type
Zone 1 (WQCV)	3.20	0.255	Orifice Plate
Zone 2 (EURV)	5.62	0.714	Orifice Plate
Zone 3 (100-year)	6.68	0.403	Weir&Pipe (Restrict)
Total (all zones)		1.372	

User Input: Orifice at Underdrain Outlet (typically used to drain WQCV in a Filtration BMP)

Underdrain Orifice Invert Depth =	N/A	ft (distance below the filtration media surface)
Underdrain Orifice Diameter =	N/A	inches

Calculated Parameters for Underdrain		
Underdrain Orifice Area =	N/A	ft ²
Underdrain Orifice Centroid =	N/A	feet

User Input: Orifice Plate with one or more orifices or Elliptical Slot Weir (typically used to drain WQCV and/or EURV in a sedimentation BMP)

Centroid of Lowest Orifice =	0.00	ft (relative to basin bottom at Stage = 0 ft)
Depth at top of Zone using Orifice Plate =	5.62	ft (relative to basin bottom at Stage = 0 ft)
Orifice Plate: Orifice Vertical Spacing =	N/A	inches
Orifice Plate: Orifice Area per Row =	N/A	sq. inches

Calculated Parameters for Plate		
WQ Orifice Area per Row =	N/A	ft ²
Elliptical Half-Width =	N/A	feet
Elliptical Slot Centroid =	N/A	feet
Elliptical Slot Area =	N/A	ft ²

User Input: Stage and Total Area of Each Orifice Row (numbered from lowest to highest)

	Row 1 (required)	Row 2 (optional)	Row 3 (optional)	Row 4 (optional)	Row 5 (optional)	Row 6 (optional)	Row 7 (optional)	Row 8 (optional)
Stage of Orifice Centroid (ft)	0.00	1.67	3.50					
Orifice Area (sq. inches)	0.99	1.22	7.06					

	Row 9 (optional)	Row 10 (optional)	Row 11 (optional)	Row 12 (optional)	Row 13 (optional)	Row 14 (optional)	Row 15 (optional)	Row 16 (optional)
Stage of Orifice Centroid (ft)								
Orifice Area (sq. inches)								

User Input: Vertical Orifice (Circular or Rectangular)

	Not Selected	Not Selected	
Invert of Vertical Orifice =	N/A	N/A	ft (relative to basin bottom at Stage = 0 ft)
Depth at top of Zone using Vertical Orifice =	N/A	N/A	ft (relative to basin bottom at Stage = 0 ft)
Vertical Orifice Diameter =	N/A	N/A	inches

Calculated Parameters for Vertical Orifice		
Vertical Orifice Area =	N/A	ft ²
Vertical Orifice Centroid =	N/A	feet

User Input: Overflow Weir (Dropbox with Flat or Sloped Grate and Outlet Pipe OR Rectangular/Trapezoidal Weir and No Outlet Pipe)

	Zone 3 Weir	Not Selected	
Overflow Weir Front Edge Height, H _o =	5.75	N/A	ft (relative to basin bottom at Stage = 0 ft)
Overflow Weir Front Edge Length =	2.92	N/A	feet
Overflow Weir Grate Slope =	4.00	N/A	H:V
Horiz. Length of Weir Sides =	2.92	N/A	feet
Overflow Grate Type =	Close Mesh Grate	N/A	
Debris Clogging % =	50%	N/A	%

Calculated Parameters for Overflow Weir		
Height of Grate Upper Edge, H _g =	6.48	ft
Overflow Weir Slope Length =	3.01	feet
Grate Open Area / 100-yr Orifice Area =	13.18	
Overflow Grate Open Area w/o Debris =	6.95	ft ²
Overflow Grate Open Area w/ Debris =	3.48	ft ²

User Input: Outlet Pipe w/ Flow Restriction Plate (Circular Orifice, Restrictor Plate, or Rectangular Orifice)

	Zone 3 Restrictor	Not Selected	
Depth to Invert of Outlet Pipe =	0.25	N/A	ft (distance below basin bottom at Stage = 0 ft)
Outlet Pipe Diameter =	18.00	N/A	inches
Restrictor Plate Height Above Pipe Invert =	6.00	N/A	inches

Calculated Parameters for Outlet Pipe w/ Flow Restriction Plate		
Outlet Orifice Area =	0.53	ft ²
Outlet Orifice Centroid =	0.30	feet
Half-Central Angle of Restrictor Plate on Pipe =	1.24	radians

Trapezoidal

8.00	feet
60.00	feet
4.00	H:V
1.18	feet

ADDED SLOPE LABELS TO GEC PLAN

See GEC Plan Comments

Calculated Parameters for Spillway		
Spillway Design Flow Depth =	0.32	feet
Stage at Top of Freeboard =	9.83	feet
Basin Area at Top of Freeboard =	0.58	acres
Basin Volume at Top of Freeboard =	2.92	acre-ft

The user can override the default CUHP hydrographs and runoff volumes by entering new values in the Inflow Hydrographs table (Columns W through AF).

WQCV	EURV	2 Year	5 Year	10 Year	25 Year	50 Year	100 Year	500 Year
N/A	N/A	1.19	1.50	1.75	2.00	2.25	2.52	3.68
0.255	0.969	0.651	0.843	0.997	1.173	1.345	1.543	2.373
N/A	N/A	0.651	0.843	0.997	1.173	1.345	1.543	2.373
N/A	N/A	0.1	0.2	0.2	2.1	4.1	6.8	17.1
N/A	N/A							
N/A	N/A	0.01	0.02	0.03	0.24	0.47	0.77	1.95
N/A	N/A	13.8	18.0	21.3	25.6	29.6	33.0	51.1
0.1	0.5	0.4	0.4	0.5	0.9	2.0	3.8	7.0
N/A	N/A	N/A	2.5	2.0	0.4	0.5	0.6	0.4
Plate	Plate	Plate	Plate	Plate	Overflow Weir 1	Overflow Weir 1	Overflow Weir 1	Outlet Plate 1
N/A	N/A	N/A	N/A	N/A	0.0	0.2	0.5	0.9
N/A	N/A	N/A	N/A	N/A	N/A	N/A	N/A	N/A
39	62	57	61	63	65	65	64	60
41	68	62	66	70	72	73	72	70
3.20	5.62	4.50	5.07	5.50	5.94	6.18	6.41	7.59
0.22	0.36	0.30	0.33	0.35	0.37	0.38	0.39	0.45
0.256	0.972	0.604	0.781	0.930	1.088	1.179	1.264	1.768

CANNOT GET CLOSE TO 1.00 WITHOUT EXCEEDING A 72 HOUR DRAIN TIME FOR THE 5-YEAR STORM TO MEET COLORAD REVISED STATUTE 37-92-602 (8)

FURTHERMORE, THE DIFFERENCE IN FLOW IS 0.2 CFS AND SHOULD BE CONSIDERED A NOMINAL INCREASE

Verify and update so the ratios are not above 1

DETENTION BASIN OUTLET STRUCTURE DESIGN

MHFD-Detention, Version 4.06 (July 2022)

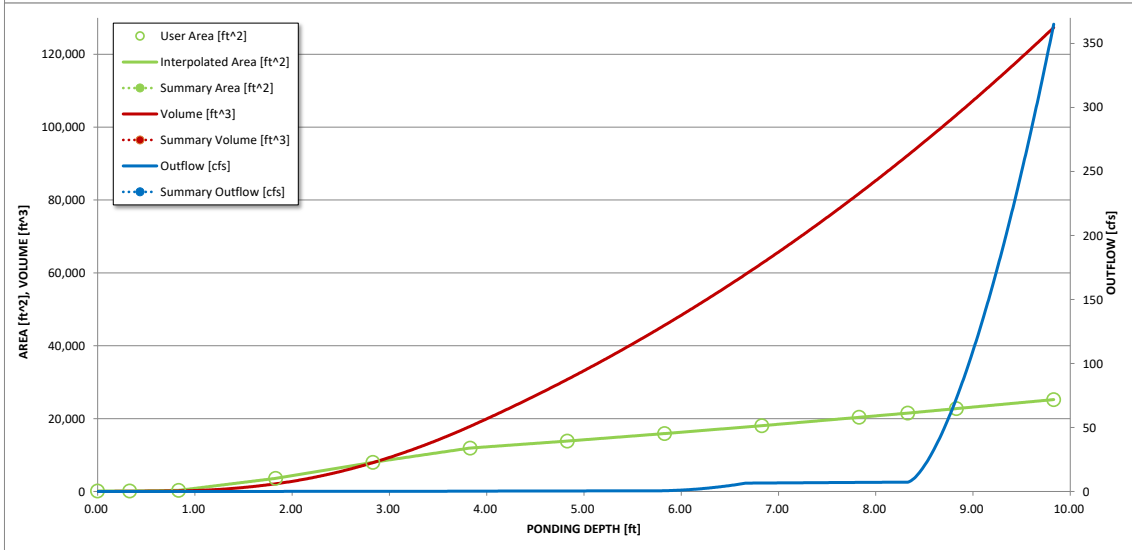
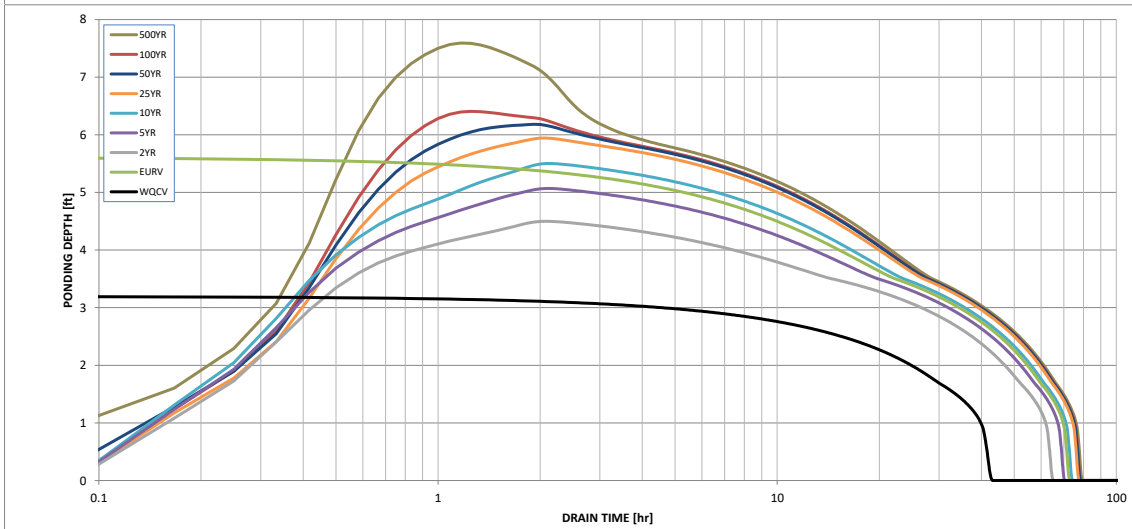
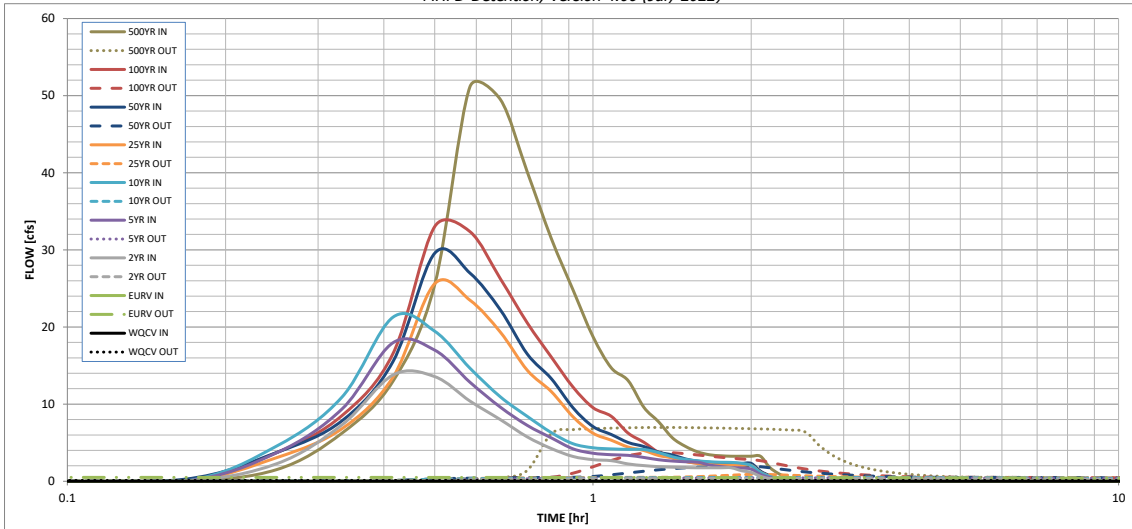

S-A-V-D Chart Axis Override	X-axis	Left Y-Axis	Right Y-Axis
minimum bound			
maximum bound			

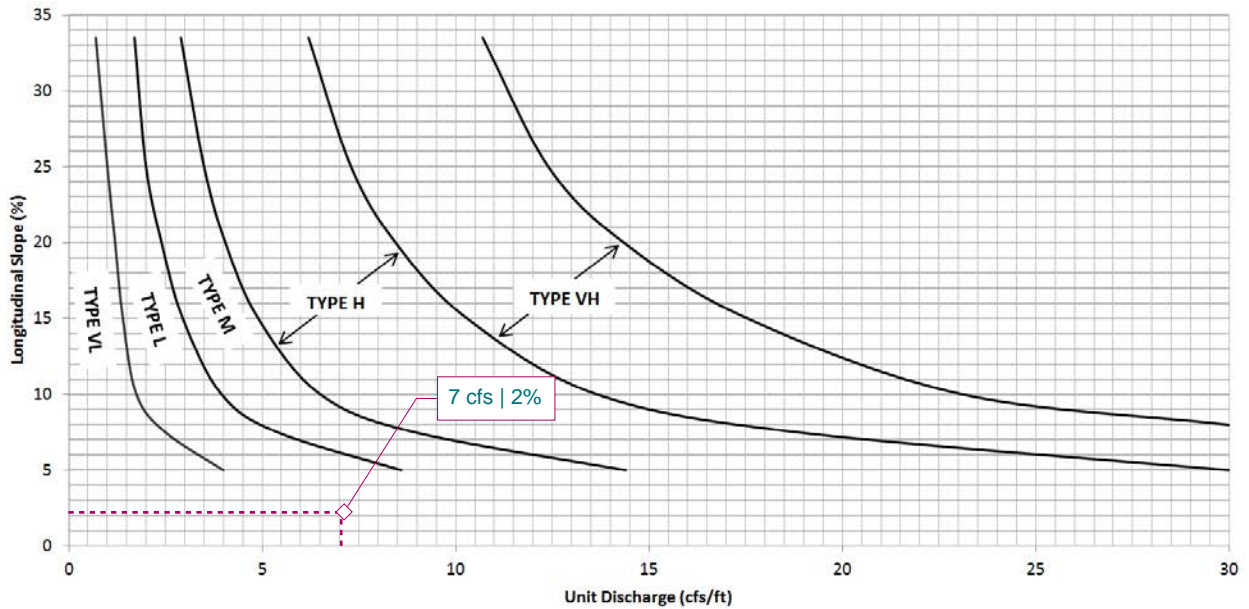
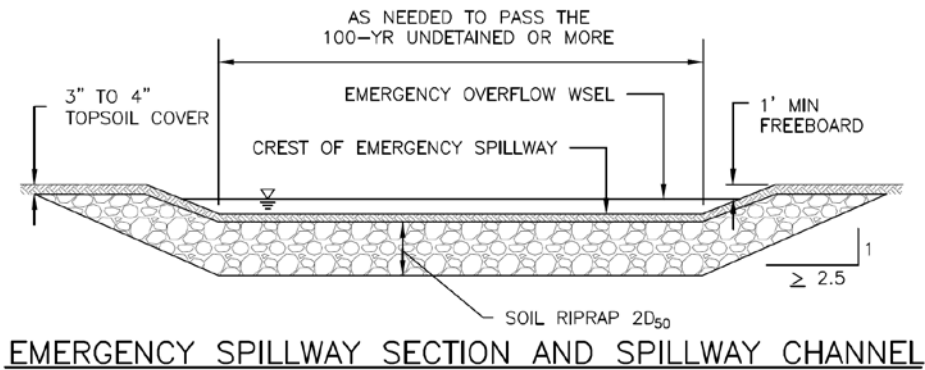
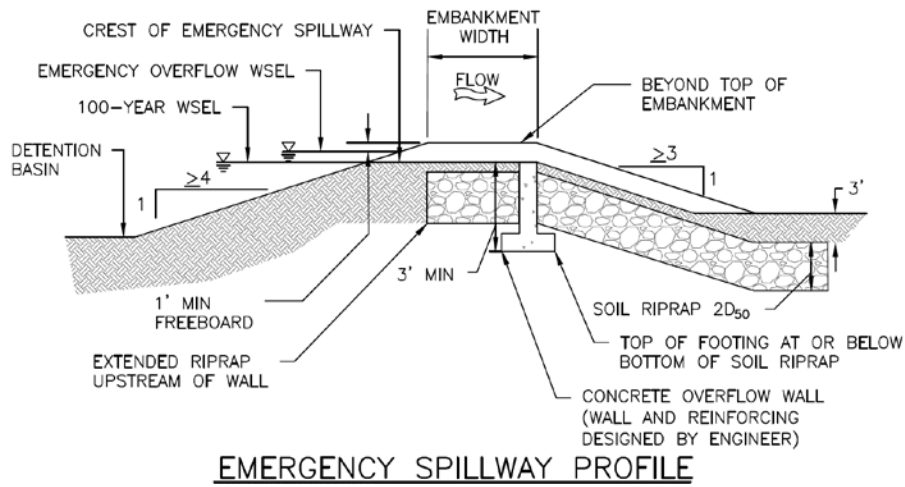

Figure 12-21. Embankment protection details and rock sizing chart (adapted from Arapahoe County)

Micropool/ISV SIZING CALCULATIONS

Subdivision: Falcon Ranchettes Filing No. 1a
Location: CO, El Paso County

Project Name: Meridian Storage
Project No.: MRS01
Calculated By: CMWJ
Checked By: BAS
Date: 9/11/23

	Pond #1			
WQCV Volume (Ac-Ft)	0.255			From MHFD-Detention Spreadsheet
Provided ISV Depth (in)	4.00			4" Min. per USDCM, Volume 3
Provided Micropool/ISV Area (Sq. Ft.)	129.00			
Provided ISV Volume (Cu. Ft.)	43.00			
Micropool/ISV Design Results				
Minimum Micropool Area (Sq. Ft.)	100			Assuming ISV above - Min. 10 ft² per USDCM, Volume 3
Required ISV Volume (Cu. Ft.)	33			0.3% of WQCV, per USDCM, Volume 3
Is Required Micropool Area Met?	YES			
Is Required ISV Volume Met?	YES			

FOREBAY TRIBUTARY AREAS

Subdivision: Falcon Ranchettes Filing No. 1A
Location: CO, Colorado Springs

Project Name: Meridian Storage
Project No.: MRS01
Calculated By: CMWJ
Checked By: BAS
Date: 9/8/23

Forebay A

Basin	Area	% Imp
B-1	1.31	95.54
B-2	1.04	99.03
B-3	0.95	61.86
B-4	0.52	79.25
* C-1	0.29	100
Total	4.11	86.9

*All "C" group basins' imperviousness changed to 100%.
This will accomdate the future build out of the associated lot and provide sufficient area and imperviousness for future access drives.

FOREBAY TRIBUTARY AREAS

Subdivision: Falcon Ranchettes Filing No. 1A
Location: CO, Colorado Springs

Project Name: Meridian Storage
Project No.: MRS01
Calculated By: CMWJ
Checked By: BAS
Date: 9/8/23

Forebay B

Basin	Area	% Imp
OS-1	3.89	10.91
OS-2	2.35	14.01
OS-3	0.24	2
C-4	0.09	2
Total	6.57	11.6

FOREBAY TRIBUTARY AREAS

Subdivision: Falcon Ranchettes Filing No. 1A
Location: CO, Colorado Springs

Project Name: Meridian Storage
Project No.: MRS01
Calculated By: CMWJ
Checked By: BAS
Date: 9/8/23

Forebay D

Basin	Area	% Imp
B-5	0.13	84.92
B-6	0.16	69.35
* C-3	0.29	100
Total	0.58	88.2

*All "C" group basins' imperviousness changed to 100%.
This will accomdate the future build out of the associated lot and provide sufficient area and imperviousness for future access drives.

FOREBAY SIZING CALCULATIONS

Subdivision: Falcon Ranchettes Filing No. 1a

Location: CO, El Paso County

Project Name: Meridian Storage

Project No.: MRS01

Calculated By: CMWJ

Checked By: BAS

Date: 10/27/23

Pond #1

	Forebay A	Forebay B	Forebay D	
Impervious % (I)	86.9%	11.60%	88.20%	Total impervious area of contributing upstream basins
WQCV Drain Time Coeff (a)	1	1	1	a = 1 for 40 Hr WQCV Drain Time
Tributary Area (Ac)	4.11	6.57	0.58	
Forebay Depth (Ft)	1.50	1.50	1.50	(see Table EDB-4 of the USDCM Volume 3 for depth requirement)
% of WQCV for Forebay Volume	3.0%	2.0%	3.0%	(see Table EDB-4 of the USDCM Volume 3 for requirement)
100-year Discharge (Q)	19.5	11.20	2.10	100-Year Flow entering Forebay (undetained)
WQCV Depth (in)	0.38	0.08	0.39	WQCV Depth = $a(0.91 * I^3 - 1.19 * I^2 + 0.78 * I)$
WQCV Volume (Ac-Ft)	0.13	0.04	0.02	
Forebay Volume (Cu. Ft.)	168	36	24	
Forebay Discharge (Q)	0.39	0.22	0.04	(Release 2% of 100-year discharge via notch or berm/pipe configuration)
Forebay Notch Height (in)	15.00	15.00	15.00	(3" depression @ top of forebay assumed per COS DCM Volume 1, 13-30)
Forebay Design Results				
Minimum Forebay Area (Sq. Ft.)	112	24	16	
Forebay Notch width (in)	3	3	3	From $Q=C_w * W * H^{1.5}$ assuming $C_w=3.33$ for sharp-crested weir - If notch width <3", use 3" minimum.

APPENDIX F

