



Master Traffic Impact Study
Amended August 25, 2022

Citizen on Constitution El Paso County, Colorado

PCD File No. P218

Prepared for:
The Garrett Companies, Inc.

Kimley»»Horn



MASTER TRAFFIC IMPACT STUDY

Traffic Engineer's Statement

The attached traffic report and supporting information were prepared under my responsible charge and they comport with the standard of care. So far as is consistent with the standard of care, said report was prepared in general conformance with the criteria established by the County for traffic reports.

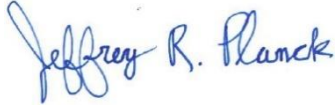

Jeffrey R. Planck, P.E., PE #53006

August 25, 2022
Date

Developer's Statement

I, the Developer, have read and will comply with all commitments made on my behalf within this report.



Mr. Karl Stout
The Garrett Companies, Inc.
1051 Greenwood Springs Boulevard
Suite 101
Greenwood, Indiana 46143

September 08, 2022
Date

Citizen on Constitution

PCD File No. P218

El Paso County, Colorado

Prepared for
The Garrett Companies, Inc.
1051 Greenwood Springs Boulevard
Suite 101
Greenwood, Indiana 46143

Prepared by
Kimley-Horn and Associates, Inc.
4582 South Ulster Street
Suite 1500
Denver, Colorado 80237
(303) 228-2300

August 2022



This document, together with the concepts and designs presented herein, as an instrument of service, is intended only for the specific purpose and client for which it was prepared. Reuse of and improper reliance on this document without written authorization and adaptation by Kimley-Horn and Associates, Inc. shall be without liability to Kimley-Horn and Associates, Inc.

TABLE OF CONTENTS

TABLE OF CONTENTS	i
LIST OF TABLES	ii
LIST OF FIGURES	ii
1.0 EXECUTIVE SUMMARY	1
2.0 INTRODUCTION	6
3.0 EXISTING AND FUTURE CONDITIONS	8
3.1 Existing Study Area	8
3.2 Existing and Future Roadway Network	8
3.3 Existing Traffic Volumes	12
3.4 Unspecified Development Traffic Growth	12
4.0 PROJECT TRAFFIC CHARACTERISTICS	16
4.1 Trip Generation	16
4.2 Trip Distribution	17
4.3 Traffic Assignment	17
4.4 Total (Background Plus Project) Traffic	17
5.0 TRAFFIC OPERATIONS ANALYSIS	22
5.1 Analysis Methodology	22
5.2 Key Intersection Operational Analysis	23
5.3 El Paso County Turn Lane Requirement Analysis	27
5.4 Vehicle Queuing Analysis	29
5.5 Access Spacing Requirements and Internal Roadway Classifications	30
5.6 Sight Distance Evaluation	33
5.7 Bicycle and Pedestrian Access	34
5.8 Road Impact Fees and Right-of-Way Designation	35
5.9 Improvement Summary	35
6.0 CONCLUSIONS AND RECOMMENDATIONS	38

APPENDICES

- Appendix A – Intersection Count Sheets
- Appendix B – Future Traffic Projections
- Appendix C – Trip Generation Worksheets
- Appendix D – Intersection Analysis Worksheets
- Appendix E – Signal Warrant Figure
- Appendix F – Queue Analysis Worksheets
- Appendix G – Conceptual Site Plan

LIST OF TABLES

Table 1 – Citizen on Constitution Traffic Generation	16
Table 2 – Level of Service Definitions	22
Table 3 – Constitution Avenue & Akers Drive LOS Results.....	24
Table 4 – Constitution Avenue & Marksheffel Road LOS Results.....	25
Table 5 – Project Access Level of Service Results.....	26
Table 6 – Turn Lane Queuing Analysis Results.....	29
Table 7 – Road Impact Fees	35

LIST OF FIGURES

Figure 1 – Vicinity Map.....	7
Figure 2 – Existing Lane Configurations and Control.....	11
Figure 3 – 2021 Existing Traffic Volumes	13
Figure 4 – 2023 Background Traffic Volumes.....	14
Figure 5 – 2045 Background Traffic Volumes.....	15
Figure 6 – Project Trip Distribution	18
Figure 7 – Project Traffic Assignment	19
Figure 8 – 2023 Background Plus Project Traffic Volumes.....	20
Figure 9 – 2045 Background Plus Project Traffic Volumes.....	21
Figure 10 – Circulation Plan	32
Figure 11 – 2023 Recommended Lane Configurations and Control	36
Figure 12 – 2045 Recommended Lane Configurations and Control	37

1.0 EXECUTIVE SUMMARY

This report has been prepared to document the results of the Traffic Study for the Citizen on Constitution development proposed to be located on the southwest corner of the Constitution Avenue and Marksheffel Road intersection in El Paso County, Colorado. For the purposes of this analysis, Citizen on Constitution is anticipated to include approximately 226 multifamily housing residences. It is expected that Citizen on Constitution will be completed in the next couple of years; therefore, analysis was conducted for the 2023 and 2045 horizons.

The purpose of this traffic study is to identify project traffic generation characteristics to determine potential project traffic related impacts on the local street system and to develop the necessary mitigation measures required for the identified traffic impacts. The following intersections were incorporated into this traffic study in accordance with the El Paso County standards and requirements:

- Constitution Avenue and Akers Drive
- Constitution Avenue and Marksheffel Road

In addition, the proposed full movement access along the future extension of Akers Drive and a right-out access along Marksheffel Road were evaluated.

Regional access to the Citizen on Constitution project will be provided by US Highway 24 (US-24), Powers Boulevard (SH-21), and State Highway 94 (SH-94). Primary access will be provided by Constitution Avenue and Marksheffel Road. Direct access will be provided by a full movement access along Akers Drive located approximately 300 feet south of Constitution Avenue (measured edge line to centerline) and a right-out access along Marksheffel Road approximately 400 feet south of Constitution Avenue (measured edge line to center).

Citizen on Constitution is expected to generate approximately 1,230 weekday daily trips, with 76 of these trips occurring during the morning peak hour and 97 of these trips occurring during the afternoon peak hour.

Based on the analysis presented in this report, Kimley-Horn believes Citizen on Constitution will be successfully incorporated into the existing and future roadway network. Analysis of the existing

street network, the proposed project development, and expected traffic volumes resulted in the following conclusions and recommendations:

2023 Recommendations:

- With construction of the Citizen on Constitution development, a south leg is proposed to be constructed at the existing Constitution Avenue and Akers Drive intersection. Based on configuration of the north leg of this intersection providing chevron striping for a future through lane, it is believed that this leg will provide a southbound through lane when the south leg is constructed. Based on El Paso County Engineering Criteria Manual (ECM), a northbound left turn lane will likely be warranted at the Constitution Avenue and Akers Drive intersection; however, a separate northbound right turn lane is not expected to be warranted with buildout future traffic projections. As such, it is recommended that the south leg of the Constitution Avenue and Akers Drive intersection provide a left turn lane and a shared through/right turn lane. It is also recommended that this intersection continue to operate with stop control and a R1-1 “STOP” sign be installed on the northbound approach. To meet El Paso County standards, an eastbound right turn lane should be provided at this intersection. To be consistent with the intersections in the surrounding area, it is recommended that the third eastbound through lane (outside through lane) at this intersection be dropped as a forced right turn lane.
- With completion of the Citizen on Constitution project, a full movement access is proposed along the new south leg of Akers Drive approximately 300 feet south of Constitution Avenue (measured edge line to center) and a right-out only access is proposed along Marksheffel Road approximately 400 feet south of Constitution Avenue (measured edge line to center). Based on prior coordination, the project access along Akers Drive will be constructed as a single lane roundabout with yield control on all three approaches. It is recommended that a R1-1 “STOP” sign be installed on the eastbound exiting approach at the right-out only access along Marksheffel Road. To further identify the proposed access along Marksheffel Road as a right-out only driveway, it is recommended that a R3-2 “NO LEFT TURN” sign be placed underneath the STOP sign. Further, a R6-1(R) “ONE WAY” sign should also be installed within the raised center median of Marksheffel Road. To restrict right turn entrance as well, a R3-1 “NO RIGHT TURN” sign should be installed facing drivers traveling southbound along Marksheffel Road as well as a R5-1 “DO NOT ENTER” sign to be placed behind the STOP

sign. The driveway throat at the proposed right-out only access should be oriented to further restrict entering movements.

Deviations Required

The following deviations will be provided at the subdivision stage (i.e. preliminary plan/final plat) for the ECM administrators consideration:

- A deviation will be provided to request full movement access from a future south leg of Akers Drive at Constitution Avenue. The future south leg of Akers Drive along Constitution Avenue will be located approximately 1,050 feet west of Marksheffel Road (measured edge line to center), and approximately 825 feet east of Hannah Ridge Drive. According to the El Paso Engineering Criteria Manual (ECM) section 2.2.5.B, spacing of roads accessing an urban principal arterial that will result in a full movement intersection shall be planned at one-half mile. However, as stated in the ECM, one parcel access shall be granted to each existing lot, if it does not create safety or operational problems. The intersection of Constitution Avenue and Akers Drive is expected to meet operational, vehicle queue, and sight distance standards; therefore, it is believed that a south leg of Akers Drive at Constitution Avenue should be granted to allow for one full movement access to the existing lot.
- A deviation will be provided in support of allowing a right-out only access along Marksheffel Road. The proposed right-out access along Marksheffel Road will be located approximately 400 feet south of Constitution Avenue (measured edge line to center). The proposed right-out only access along Marksheffel Road is expected to meet operational, vehicle queue, and sight distance standards; therefore, it is believed that this access should be granted to only allow right-turn exiting movements.
- The access along the new south leg of Akers Drive will be approximately 300 feet south of Constitution Avenue (measured edge line to center). According to the El Paso County Engineering Criteria Manual section 2.2.5.D, spacing of intersections along urban collector roadways from an arterial roadway should be 330 feet from the right-of-way line of the arterial to the centerline of the access roadway. Therefore, the proposed access along the new south leg of Akers Drive does not meet ECM standards. The access along Akers Drive is expected

to meet operational, vehicle queue, and sight distance standards. A deviation will need to be provided to request for this proposed access to remain at the proposed location.

- A northbound left turn lane is warranted at the Constitution Avenue and Akers Drive intersection and based on an El Paso County ECM design speed of 40 miles per hour for an Urban Non-Residential Collector, the deceleration lane length required is 155 feet plus a 160-foot taper. Additionally, 50 feet of storage is required by El Paso County due to the peak hour volume. Therefore, this left turn lane is recommended to provide a length of 205 feet plus a 160-foot taper. The proposed spacing between Constitution Avenue and the access intersection is not sufficient to allow for a 205-foot northbound left turn lane plus 160-foot taper at the Constitution Avenue and Akers Drive intersection. It should be noted a 105-foot northbound left turn lane plus a 50-foot taper is the maximum possible length that can be provided due to the recent requirement to increase the diameter of the roundabout and constraints with the existing box culvert on the southeast corner of the intersection. A deviation will be requested to allow for the northbound left turn lane at the Constitution Avenue and Akers Drive intersection be constructed with a maximum possible length.

2045 Recommendations:

- A traffic signal is warranted with 2045 traffic volume projections at the intersection of Constitution Avenue and Akers Drive. It is recommended that El Paso County monitor traffic volumes at this intersection in the future to determine if signalization is the appropriate control. It should be noted the north leg of this intersection is the controlling approach that triggers the need for signal control and project traffic is only expected to utilize the south leg of this intersection.
- If future traffic volumes are realized by 2045, Marksheffel Road may need to have three through lanes in each direction northbound and southbound along the project frontage. With this improvement, it is recommended that the westbound right turn lane at the intersection of Constitution Avenue and Marksheffel Road operate with yield control.

General Recommendations

- Any on-site or offsite improvements should be incorporated into the Civil Drawings and conform to standards of the El Paso County and the Manual on Uniform Traffic Control Devices (MUTCD) – 2009 Edition.

2.0 INTRODUCTION

Kimley-Horn and Associates, Inc. has prepared this report to document the results of the Traffic Study for the Citizen on Constitution development proposed to be located on the southwest corner of the Constitution Avenue and Marksheffel Road intersection in El Paso County, Colorado. A vicinity map illustrating the Citizen on Constitution development is shown in **Figure 1**. For the purposes of this analysis, the project is anticipated to include approximately 226 multifamily housing units. A conceptual land use plan is attached in **Appendix G**. It is expected that Citizen on Constitution will be completed in the next two years; therefore, analysis was conducted for the 2023 and 2045 horizons.

The purpose of this traffic study is to identify project traffic generation characteristics to determine potential project traffic related impacts on the local street system and to develop the necessary mitigation measures required for the identified traffic impacts. The following intersections were incorporated into this traffic study in accordance with the El Paso County standards and requirements:

- Constitution Avenue and Akers Drive
- Constitution Avenue and Marksheffel Road

In addition, the proposed full movement access along the future extension of Akers Drive and a right-out access along Marksheffel Road were evaluated.

Regional access to the Citizen on Constitution project will be provided by US Highway 24 (US-24), Powers Boulevard (SH-21), and State Highway 94 (SH-94). Primary access will be provided by Constitution Avenue and Marksheffel Road. Direct access will be provided by a full movement access along Akers Drive located approximately 300 feet south of Constitution Avenue (measured edge line to centerline) and a right-out access along Marksheffel Road approximately 400 feet south of Constitution Avenue (measured edge line to center).



CITIZEN ON CONSTITUTION
EL PASO COUNTY, COLORADO
VICINITY MAP

FIGURE 1

3.0 EXISTING AND FUTURE CONDITIONS

3.1 Existing Study Area

The existing site is comprised of vacant land. Industrial uses and some residential uses are located north and south of the site. A retail center and residential uses are located to the east while residential developments are located to the west of the project. The extended area consists primarily of single-family residences with undeveloped land to the east.

3.2 Existing and Future Roadway Network

Constitution Avenue extends eastbound and westbound with two through lanes in each direction with a posted speed limit of 50 miles per hour and is classified as a principal arterial roadway. Marksheffel Road extends in the north-south direction with two through lanes in each direction and has a posted speed limit of 50 miles per hour and is classified as a principal arterial roadway. Akers Drive extends north-south with one through lane in each direction and is classified as a collector roadway.

The El Paso County 2016 Major Transportation Corridor Plan Update (MTCP) does not identify any roadway improvement projects within the study limits of this project.

The unsignalized T-intersection of Constitution Avenue and Akers Drive (#1) operates with stop control on the southbound approach. The eastbound approach of this intersection consists of a left turn lane and three through lanes while the westbound approach provides a left turn lane, two through lanes, and a right turn lane. The southbound approach includes a left turn lane and a channelized right turn lane operating with free movements. An aerial photo of the existing intersection configuration is below (north is up - typical).



Constitution Avenue and Akers Drive (#1)

The signalized intersection of Constitution Avenue and Marksheffel Road (#2) operates with protected left turn phasing on the northbound and southbound approaches and protective-permissive left turn phasing on the eastbound and westbound approaches. The eastbound and westbound approaches of this intersection consist of a left turn lane, two through lanes, and a right turn lane. The eastbound right turn lane operates with yield control while the westbound right turn lane operates as a free movement. The northbound and southbound approaches consist of dual left turn lanes, two through lanes, and a free right turn lane. An aerial photo of the existing intersection configuration is below.





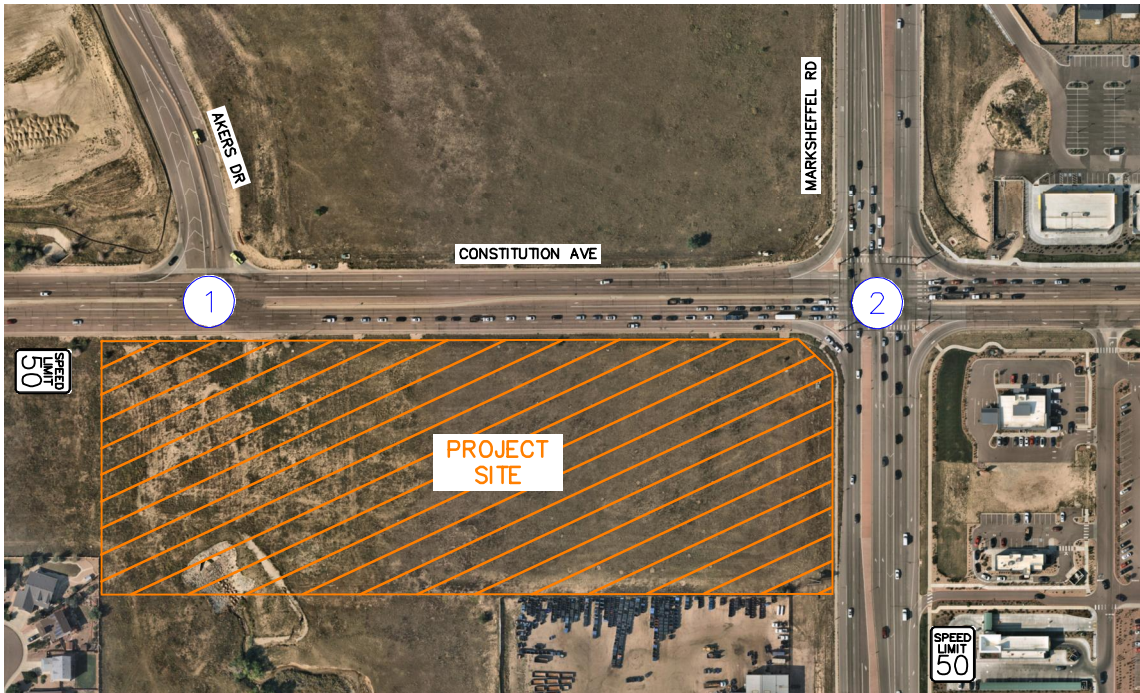
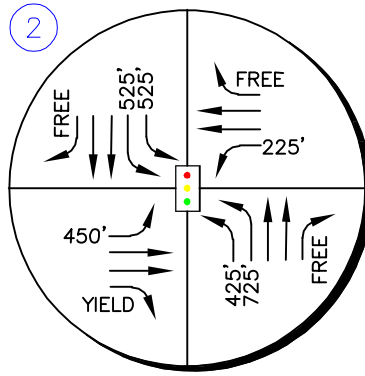
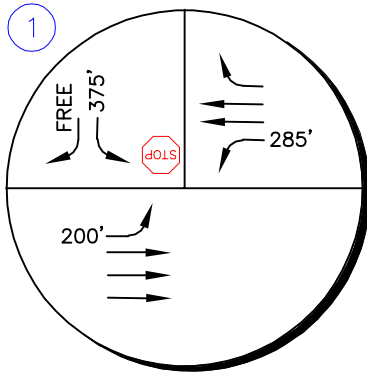

Constitution Avenue and Marksheffel Road (#2)

The intersection lane configuration and control for the study area intersections are shown in **Figure 2**.



LEGEND

-  Study Area Key Intersection
-  Signalized Intersection
-  Stop Controlled Approach
-  Roadway Speed Limit
-  100' Turn Lane Length (feet)

CITIZEN ON CONSTITUTION
 EL PASO COUNTY, COLORADO
 EXISTING GEOMETRY AND CONTROL

FIGURE 2

3.3 Existing Traffic Volumes

Existing turning movement counts were conducted at the study intersections on Tuesday, September 21, 2021 during the morning and afternoon peak hours. The counts were conducted during the morning and afternoon peak hours of adjacent street traffic in 15-minute intervals from 7:00 AM to 9:00 AM and 4:00 PM to 6:00 PM on this count date. The existing intersection traffic volumes are shown in **Figure 3** with count sheets provided in **Appendix A**.

3.4 Unspecified Development Traffic Growth

According to traffic projections from the El Paso County 2016 Major Transportation Corridor Plan Update (MTCP) traffic model, the area surrounding the site is expected to have an average 25-year growth factor of 1.31. This growth factor equates to an annual growth rate of 1.10 percent. Future traffic volume projections and growth rate calculations are provided in **Appendix B**. However, to be conservative and consistent with the recently approved Urban Collection at Palmer Village Traffic Study, a two (2) percent annual growth rate was used to calculate future traffic volumes at the study area key intersections. This annual growth rate was used to estimate short-term 2023 and long-term 2045 traffic volume projections at the key intersections. In addition, traffic volume potential from the undeveloped parcels surrounding the future Akers Drive south of Constitution Avenue was conservatively included as background traffic in 2045. Through coordination with County staff, these future parcels to the south were evaluated with multifamily residential use. In addition, it is believed that Akers Drive will eventually provide a connection with Colorado Tech Drive in the long-term future; however, all adjacent development residential traffic was routed to the Constitution Avenue and Akers Drive intersection to provide a conservative analysis. The calculated background traffic volumes for 2023 and 2045 are shown in **Figure 4** and **Figure 5**, respectively.

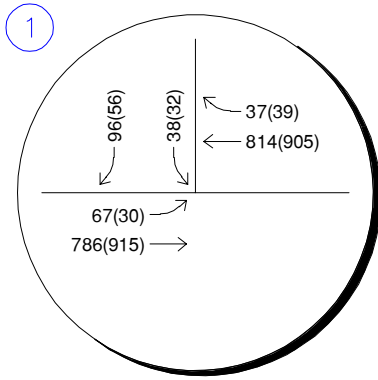

Tuesday, September 21, 2021
7:15 to 8:15AM (4:15 to 5:15PM)

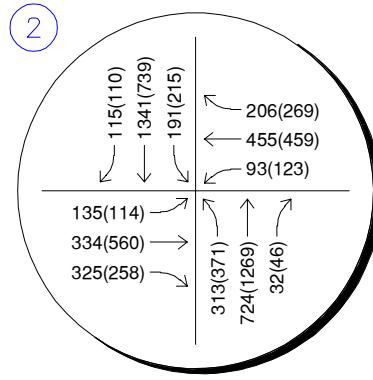

Tuesday, September 21, 2021
7:00 to 8:00AM (4:30 to 5:30PM)

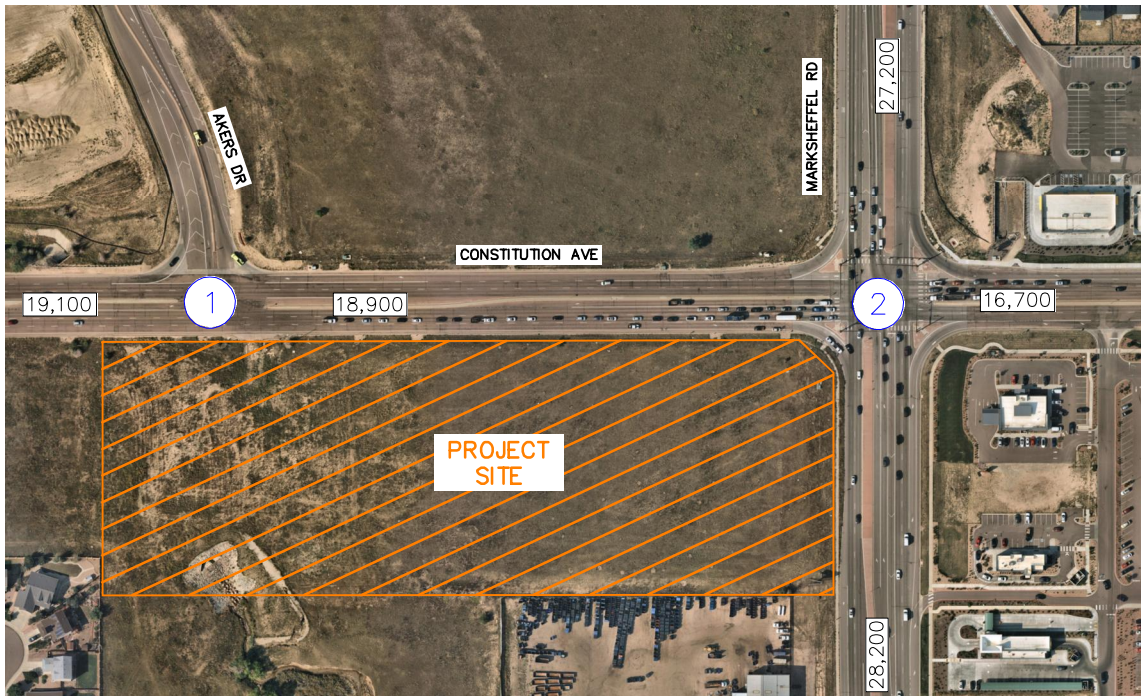

LEGEND

- (X) Study Area Key Intersection
- XXX(XXX) Weekday AM(PM) Peak Hour Traffic Volumes
- XX,X00 Estimated Daily Traffic Volume

CITIZEN ON CONSTITUTION
EL PASO COUNTY, COLORADO
2021 EXISTING TRAFFIC VOLUMES

FIGURE 3

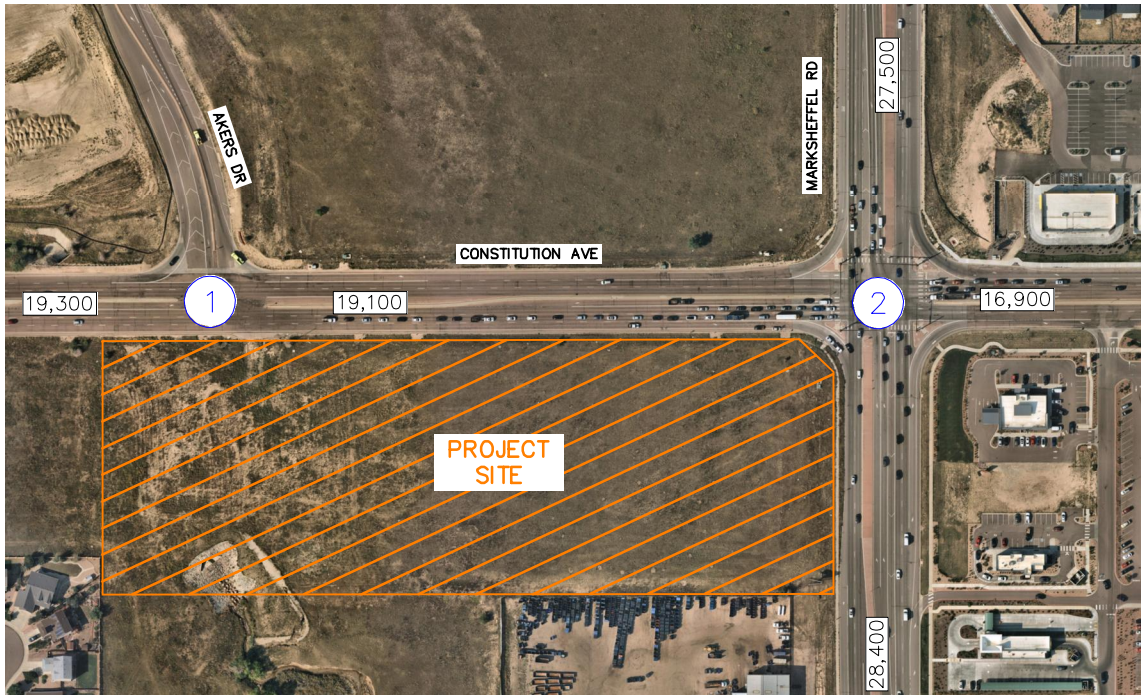
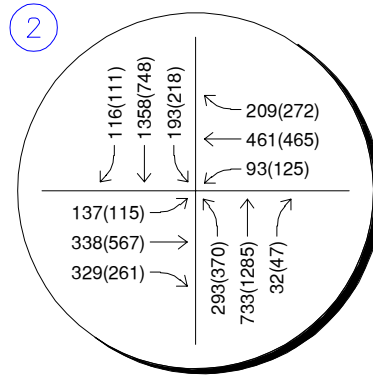
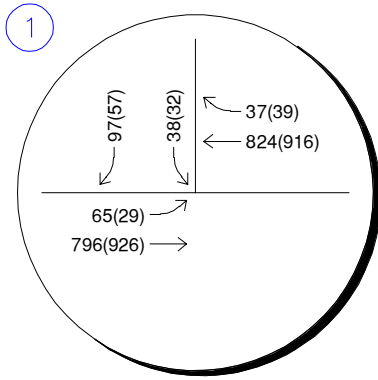

LEGEND

(X) Study Area Key Intersection

XXX(XXX) Weekday AM(PM)
Peak Hour Traffic Volumes

XX,X00 Estimated Daily Traffic Volume

CITIZEN ON CONSTITUTION
EL PASO COUNTY, COLORADO
2023 BACKGROUND TRAFFIC VOLUMES

FIGURE 4

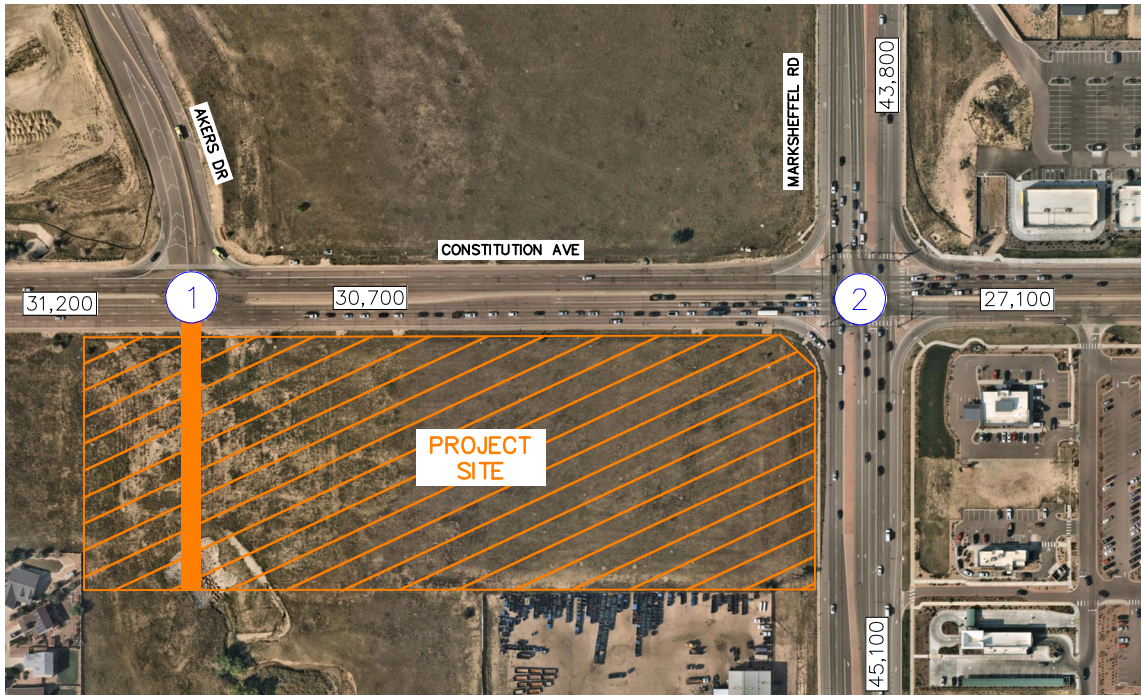
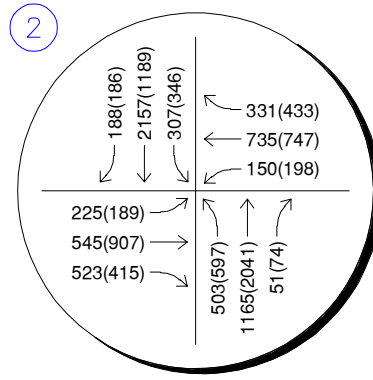
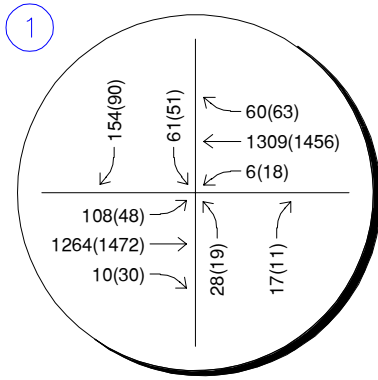

LEGEND

- (X) Study Area Key Intersection
- XXX(XXX) Weekday AM(PM) Peak Hour Traffic Volumes
- XX,X00 Estimated Daily Traffic Volume

CITIZEN ON CONSTITUTION
 EL PASO COUNTY, COLORADO
 2045 BACKGROUND TRAFFIC VOLUMES

FIGURE 5

4.0 PROJECT TRAFFIC CHARACTERISTICS

4.1 Trip Generation

Site-generated traffic estimates are determined through a process known as trip generation. Rates and equations are applied to the proposed land use to estimate traffic generated by the development during a specific time interval. The acknowledged source for trip generation rates is the *Trip Generation Manual*¹ published by the Institute of Transportation Engineers (ITE). ITE has established trip rates in nationwide studies of similar land uses. For this study, Kimley-Horn used the ITE Trip Generation Report fitted curve equations that apply to Mid-Rise Multifamily Housing (ITE Land Use Code 221), for traffic associated with the development.

Citizen on Constitution is expected to generate approximately 1,230 weekday daily trips, with 76 of these trips occurring during the morning peak hour and 97 of these trips occurring during the afternoon peak hour. Calculations were based on the procedure and information provided in the ITE *Trip Generation Manual, 10th Edition – Volume 1: User’s Guide and Handbook*, 2017. **Table 1** summarizes the estimated trip generation for the Citizen on Constitution. The trip generation worksheets are included in **Appendix C**.

Table 1 – Citizen on Constitution Traffic Generation

Land Use and Size	Weekday Vehicle Trips						
	Daily	AM Peak Hour			PM Peak Hour		
		In	Out	Total	In	Out	Total
Mid-Rise Multifamily Housing (ITE 221) – 226 Dwelling Units	1,230	20	56	76	59	38	97

¹ Institute of Transportation Engineers, *Trip Generation Manual*, Tenth Edition, Washington DC, 2017.

4.2 Trip Distribution

Distribution of site traffic on the street system was based on the area street system characteristics, existing traffic patterns, existing and anticipated surrounding demographic information, existing and anticipated surrounding employment areas, and the proposed access system for the project. Due to the residential nature of the site, a cursory observation of the number of office/businesses within an approximate 12-mile radius of the site and commercial properties within a 5-mile radius of the site was utilized as a basis for trip distribution. It is believed that residents travelling west of the site will travel along Constitution Avenue to the west to access Powers Boulevard, whereas residents travelling further from the project site will use Marksheffel Road to the south and Constitution Avenue to the east to access Highway 24. Finally, relatively low employment opportunities and commercial sites exist directly north of the site as shown by the small distribution to the north along Marksheffel Road. The directional distribution of traffic is a means to quantify the percentage of site-generated traffic that approaches the site from a given direction and departs the site back to the original source. The project trip distribution for the proposed development is illustrated in **Figure 6**.

4.3 Traffic Assignment

Citizen on Constitution traffic assignment was obtained by applying the project trip distribution to the estimated traffic generation of the development shown in **Table 1**. Traffic assignment is shown in **Figure 7**.

4.4 Total (Background Plus Project) Traffic

Site traffic volumes were added to the background volumes to represent estimated traffic conditions for the short-term 2023 buildout horizon and long-term 2045 twenty-year planning horizon. These total traffic volumes for the study area are illustrated for the 2023 and 2045 horizon years in **Figures 8** and **9**, respectively.

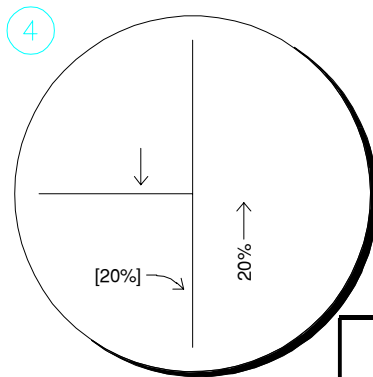
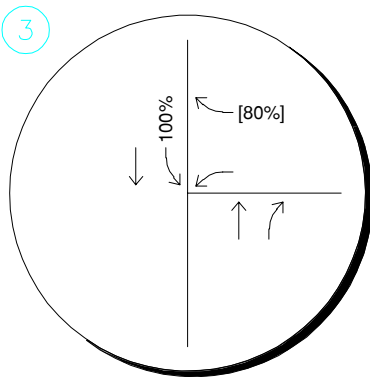
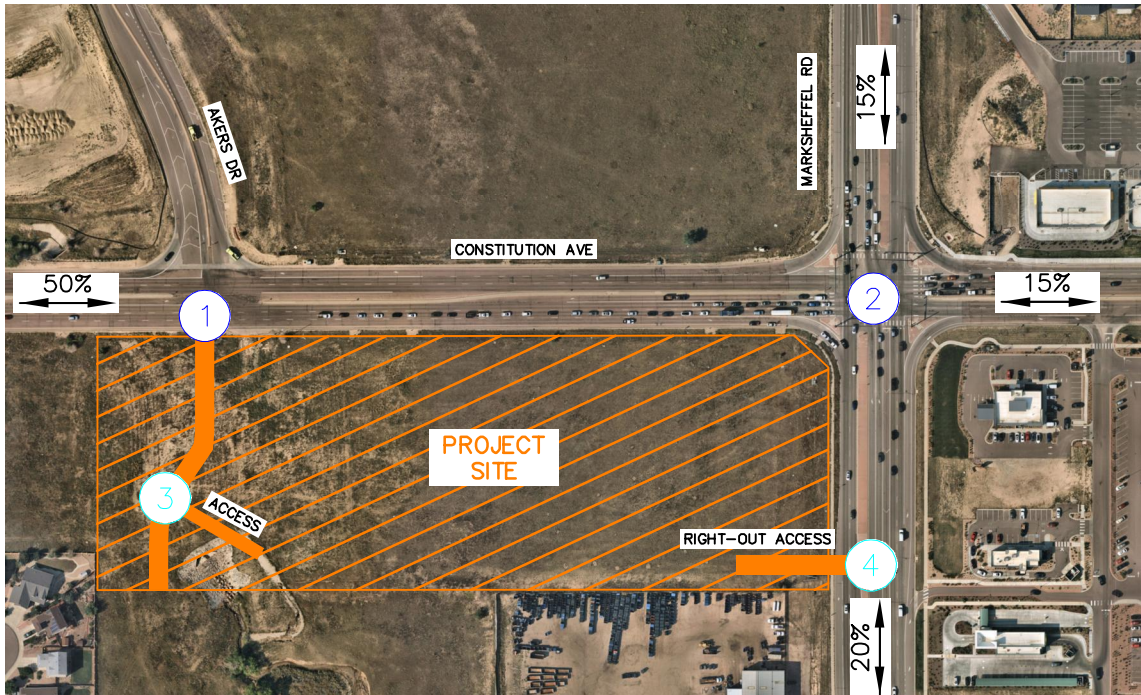
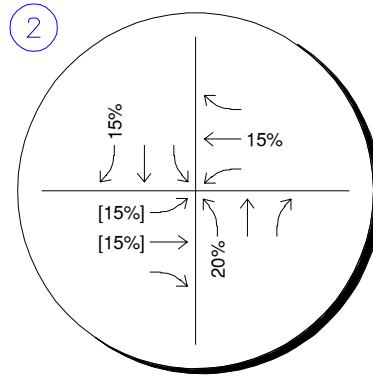
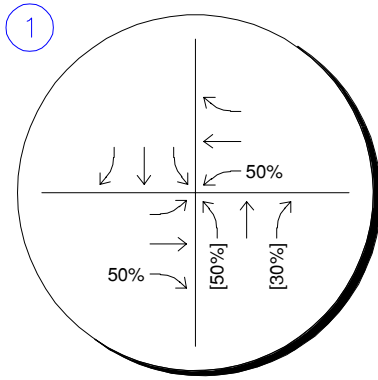

LEGEND

- Study Area Key Intersection
- Project Access Intersection
- External Trip Distribution Percentage
- Entering[Exiting] Trip Distribution Percentage

CITIZEN ON CONSTITUTION
 EL PASO COUNTY, COLORADO
 PROJECT TRIP DISTRIBUTION

FIGURE 6

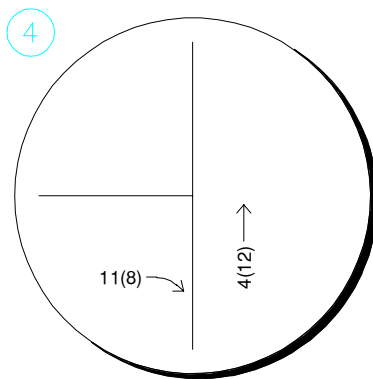
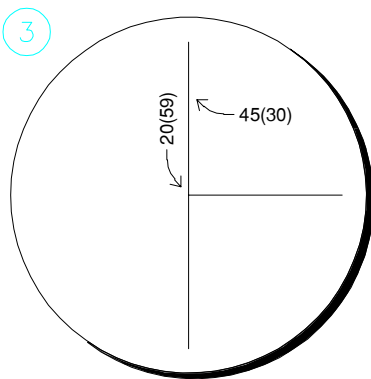
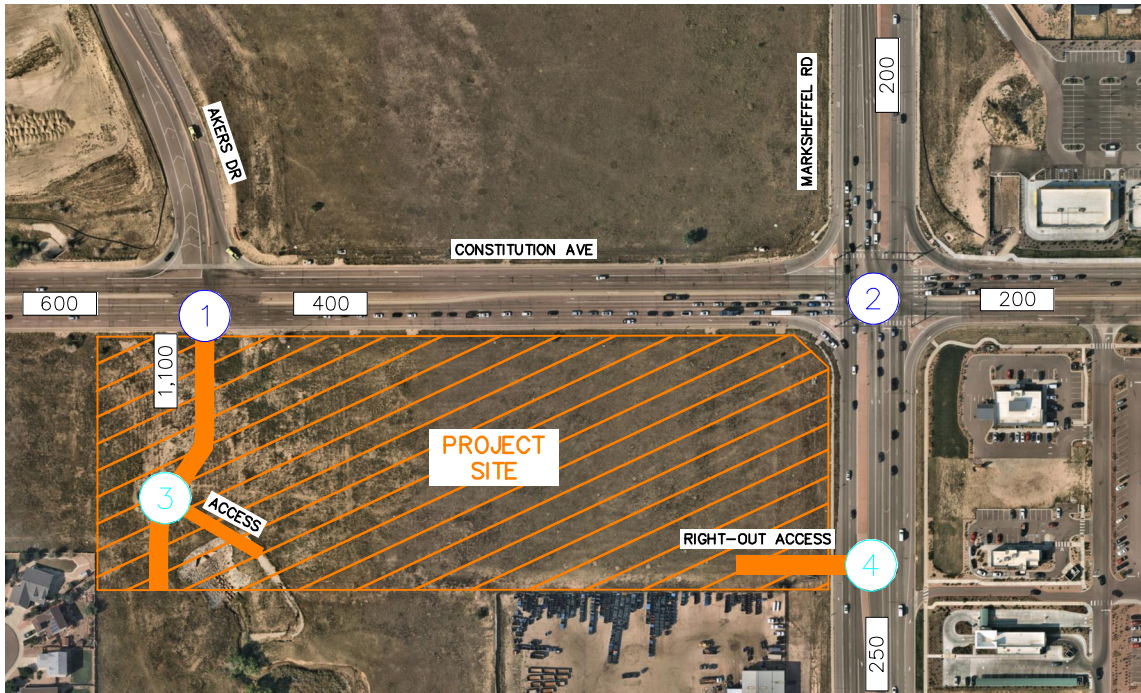
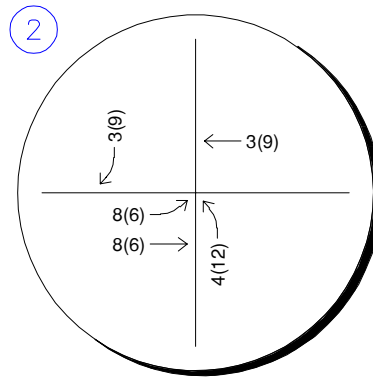
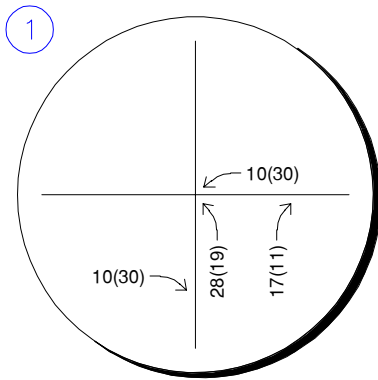

LEGEND

- X Study Area Key Intersection
- X Project Access Intersection
- XXX(XXX) Weekday AM(PM)
Peak Hour Traffic Volumes
- XX,X00 Estimated Daily Traffic Volume

CITIZEN ON CONSTITUTION
 EL PASO COUNTY, COLORADO
 PROJECT TRAFFIC ASSIGNMENT

FIGURE 7

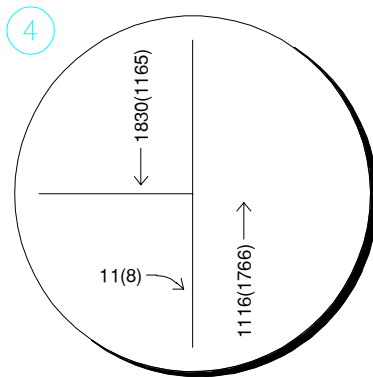
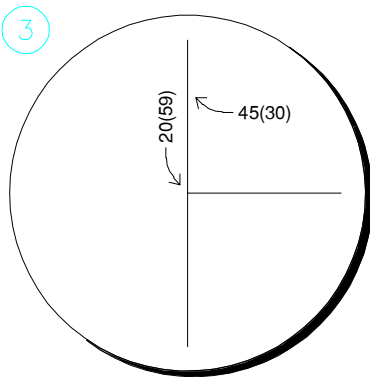
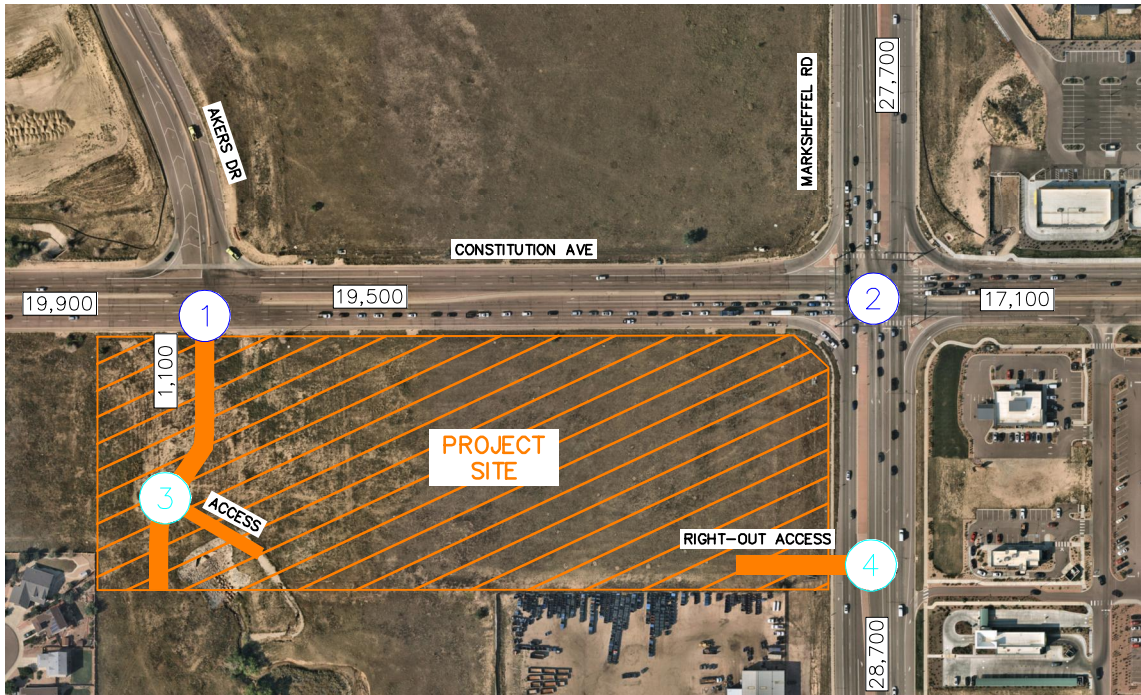
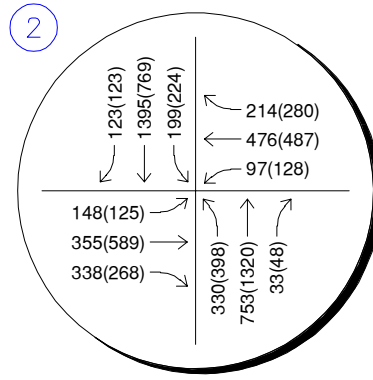
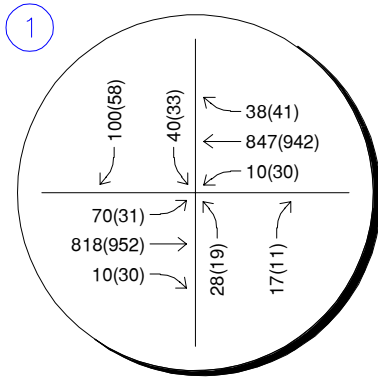

LEGEND

- Study Area Key Intersection
- Project Access Intersection
- XXX(XXX) Weekday AM(PM)
Peak Hour Traffic Volumes
- Estimated Daily Traffic Volume

CITIZEN ON CONSTITUTION
EL PASO COUNTY, COLORADO
2023 TOTAL TRAFFIC VOLUMES

FIGURE 8

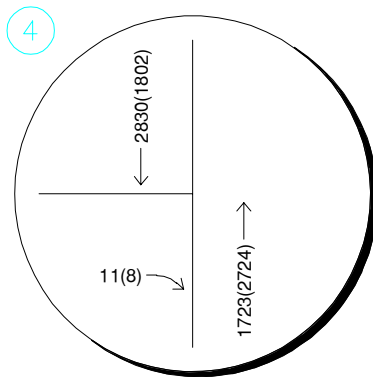
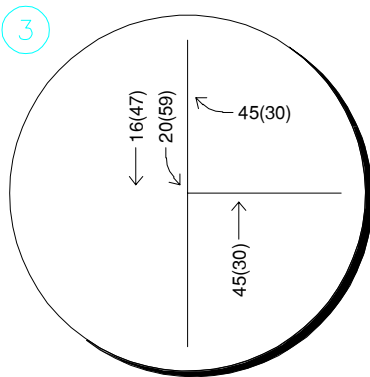
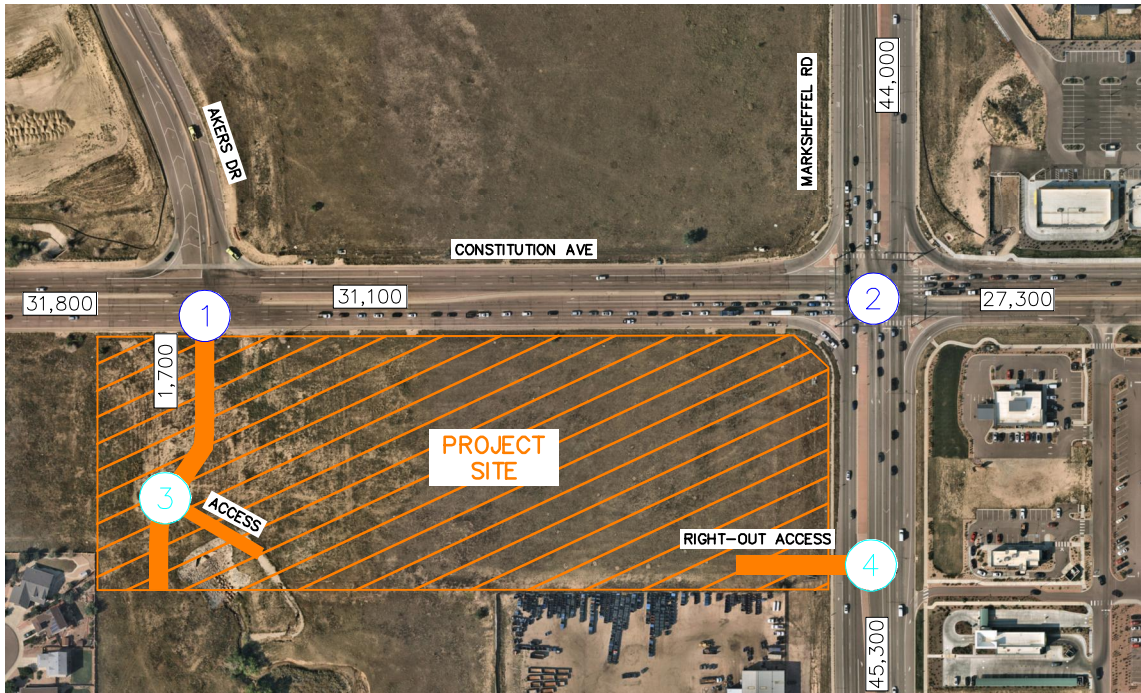
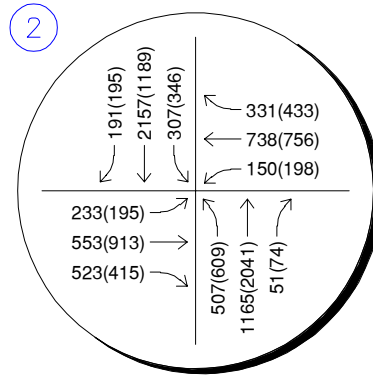
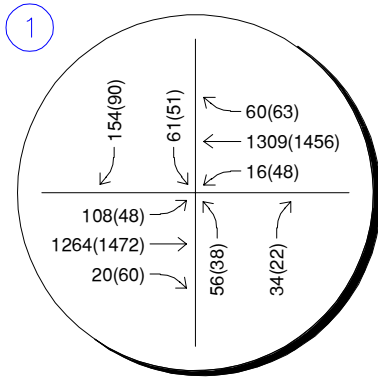

LEGEND

- X Study Area Key Intersection
- X Project Access Intersection
- XXX(XXX) Weekday AM(PM)
Peak Hour Traffic Volumes
- XX,X00 Estimated Daily Traffic Volume

CITIZEN ON CONSTITUTION
EL PASO COUNTY, COLORADO
2045 TOTAL TRAFFIC VOLUMES

FIGURE 9

5.0 TRAFFIC OPERATIONS ANALYSIS

Kimley-Horn’s analysis of traffic operations in the site vicinity was conducted to determine potential capacity deficiencies in the 2023 and 2045 development horizons at the identified key intersections. The acknowledged source for determining overall capacity is the current edition of the *Highway Capacity Manual (HCM)*².

5.1 Analysis Methodology

Capacity analysis results are listed in terms of Level of Service (LOS). LOS is a qualitative term describing operating conditions a driver will experience while traveling on a particular street or highway during a specific time interval. It ranges from A (very little delay) to F (long delays and congestion). Based on El Paso County standards, the threshold for acceptable LOS is not less than LOS D during peak hours. **Table 2** shows the definition of level of service for signalized and unsignalized intersections.

Table 2 – Level of Service Definitions

Level of Service	Signalized Intersection Average Total Delay (sec/veh)	Unsignalized Intersection Average Total Delay (sec/veh)
A	≤ 10	≤ 10
B	> 10 and ≤ 20	> 10 and ≤ 15
C	> 20 and ≤ 35	> 15 and ≤ 25
D	> 35 and ≤ 55	> 25 and ≤ 35
E	> 55 and ≤ 80	> 35 and ≤ 50
F	> 80	> 50

Definitions provided from the Highway Capacity Manual, Sixth Edition, Transportation Research Board, 2016.

Study area intersections were analyzed based on average total delay analysis for signalized and unsignalized intersections. Under the unsignalized analysis, the LOS for a two-way stop-controlled intersection is determined by the computed or measured control delay and is defined for each minor movement. LOS for a two-way stop-controlled intersection is not defined for the intersection as a whole. LOS for signalized, roundabout, and four-way stop controlled intersections are defined for each approach and for the overall intersection.

² Transportation Research Board, *Highway Capacity Manual*, Sixth Edition, Washington DC, 2016.

5.2 Key Intersection Operational Analysis

Calculations for the operational level of service at the key intersections for the study area are provided in **Appendix D**. The existing year analysis is based on the lane geometry and intersection control shown in **Figure 2**. Existing peak hour factors were utilized in the existing and 2023 horizon analysis years while the HCM urban standard of 0.92 was used for the long-term 2045 horizon analysis. The signalized intersection analysis utilizes the observed cycle lengths with optimized phasing and timing. Based on increased national attention given to establishing appropriate yellow and all-red clearance intervals to improve intersection safety, these have been calculated and are applied for approaches at the signalized intersections. The increase in yellow and all red time sacrifices intersection capacity for improved safety. Synchro traffic analysis software was used to analyze the signalized, and unsignalized key intersections for HCM level of service.

Constitution Avenue & Akers Drive (#1)

The unsignalized T-intersection of Constitution Avenue and Akers Drive (#1) operates with stop control on the southbound approach. The intersection movements operate acceptably at LOS C or better during both peak hours under existing conditions. With construction of the Citizen on Constitution development, a south leg is proposed to be constructed at this intersection to align with Akers Drive to the north. Based on configuration of the north leg of this intersection providing chevron striping for a future through lane, it is believed that this leg will provide a southbound through lane when the south leg is constructed. Based on El Paso County Engineering Criteria Manual (ECM), a northbound left turn lane will likely be warranted at this intersection; however, a separate northbound right turn lane is not expected to be warranted with buildout future traffic projections. As such, it is recommended that the south leg of the Constitution Avenue and Akers Drive intersection provide a left turn lane and a shared through/right turn lane. It is also recommended that this intersection continue to operate with stop control and a R1-1 "STOP" sign be installed on the northbound approach. To meet El Paso County standards, an eastbound right turn lane should be provided at this intersection. To be consistent with the intersections in the surrounding area, it is recommended that the third eastbound through lane (outside through lane) at this intersection be dropped as a forced right turn lane. With these improvements and project traffic, all movements at this intersection are anticipated to continue operating at an acceptable LOS D or better during the peak hours in 2023.

With future traffic projections in 2045 including the development of the surrounding parcels south of Constitution Avenue and Akers Drive, multiple movements at this intersection may operate with LOS F during the afternoon peak hour in 2045. To meet El Paso County standards for acceptable intersection operations, a four-hour vehicular volume signal warrant was completed at this intersection and it was found that a signal is warranted in 2045 (warrant Figure attached in **Appendix E**). It should be noted that the signal warrant was met due to traffic on the north leg of the intersection and not project traffic. With signalization, this intersection is anticipated to operate acceptably in 2045 with project traffic. **Table 3** provides the results of the LOS analysis conducted at this intersection.

Table 3 – Constitution Avenue & Akers Drive LOS Results

Scenario	AM Peak Hour		PM Peak Hour	
	Delay (sec/veh)	LOS	Delay (sec/veh)	LOS
2021 Existing				
Eastbound Left	10.7	B	10.7	B
Southbound Left	20.9	C	20.5	C
Southbound Right	0.0	A	0.0	A
2023 Background				
Eastbound Left	11.0	B	10.9	B
Southbound Left	22.2	C	21.6	C
Southbound Right	0.0	A	0.0	A
2023 Background Plus Project #				
Northbound Left	29.0	D	27.3	D
Northbound Through/Right	11.9	B	12.4	B
Eastbound Left	11.0	B	10.9	B
Westbound Left	10.0	B	10.9	B
Southbound Left	29.1	D	29.5	D
Southbound Through	0.0	A	0.0	A
Southbound Right	0.0	A	0.0	A
2045 Background #				
Northbound Left	84.1	F	107.8	F
Northbound Through/Right	14.7	B	16.8	C
Eastbound Left	15.9	C	15.7	C
Westbound Left	12.4	B	15.9	C
Southbound Left	126.4	F	144.7	F
Southbound Through	0.0	A	0.0	A
Southbound Right	0.0	A	0.0	A
2045 Total Traffic ##	8.0	A	9.0	A

= Stop controlled south leg, southbound through lane, northbound left turn lane, northbound right turn/through lane, and an eastbound right turn lane
 ## = # + Signalized

Constitution Avenue & Marksheffel Road (#2)

The signalized intersection of Constitution Avenue and Marksheffel Road (#2) operates with protected left turn phasing on the northbound and southbound approaches and protective-permissive left turn phasing on the eastbound and westbound approaches. The intersection operates acceptably at LOS D during both peak hours under existing conditions. With project traffic and the existing lane configurations and control, this intersection is anticipated to continue operating at an acceptable level of service during the peak hours throughout the 2023 horizon. If future traffic volumes are realized by 2045, Marksheffel Road may need to have three through lanes in each direction northbound and southbound at the intersection with Constitution Avenue. With the widening of Marksheffel Road at this intersection, it is recommended that the westbound right turn lane at this intersection operate with yield control. With these improvements this intersection is anticipated to operate acceptably in 2045 with project traffic. **Table 4** provides the results of the LOS analysis conducted at this intersection.

Table 4 – Constitution Avenue & Marksheffel Road LOS Results

Scenario	AM Peak Hour		PM Peak Hour	
	Delay (sec/veh)	LOS	Delay (sec/veh)	LOS
2021 Existing	42.1	D	43.2	D
2023 Background	44.5	D	45.1	D
2023 Background Plus Project	48.8	D	45.2	D
2045 Background	94.9	F	96.3	F
2045 Background Plus Project #	54.7	D	54.3	D

= Three northbound and southbound through lanes, and a yield controlled westbound right turn lane

Project Accesses

With completion of the Citizen on Constitution project, a full movement access is proposed along the new south leg of Akers Drive approximately 300 feet south of Constitution Avenue (measured edge line to center) and a right-out only access is proposed along Marksheffel Road approximately 400 feet south of Constitution Avenue (measured edge line to center). Based on prior coordination, the project access along Akers Drive will be constructed as a single lane roundabout with yield control on all three approaches. It is recommended that a R1-1 “STOP” sign be installed on the eastbound exiting approach at the right-out only access along Marksheffel Road. To further identify the proposed access along Marksheffel Road as a right-out only driveway, it is recommended that a R3-2 “NO LEFT TURN” sign be placed underneath the STOP sign. Further, a R6-1(R) “ONE WAY” sign should also be installed within the raised center median of Marksheffel Road. To restrict right turn entrance as well, a R3-1 “NO RIGHT TURN” sign should be installed facing drivers traveling southbound along Marksheffel Road as well as a R5-1 “DO NOT ENTER” sign to be placed behind the STOP sign. The driveway throat at the proposed right-out only access should be oriented to further restrict entering movements. **Table 5** provides the results of the level of service for these project street accesses. As shown in the table, the Akers Drive access is anticipated with LOS A with roundabout control throughout 2045. The eastbound approach Marksheffel Road Access is anticipated to operate acceptably in 2023. However, by 2045 Marksheffel Road may need to be reconstructed with three through lanes in each direction. With this improvement, the Marksheffel Road Access is anticipated to operate acceptably in 2045.

Table 5 – Project Access Level of Service Results

Intersection	2023 Total Traffic				2045 Total Traffic			
	AM Peak Hour		PM Peak Hour		AM Peak Hour		PM Peak Hour	
	Delay (sec/veh)	LOS	Delay (sec/veh)	LOS	Delay (sec/veh)	LOS	Delay (sec/veh)	LOS
Akers Dr Access (#3)	2.9	A	3.0	A	3.0	A	3.2	A
Marksheffel Rd Access (#4) Eastbound Approach	17.8	C	11.0	B	20.2 #	C #	12.4 #	B #

= Three northbound and southbound through lanes

5.3 El Paso County Turn Lane Requirement Analysis

The El Paso County ECM was used to determine if left and right turn lanes are warranted along Constitution Avenue and Marksheffel Road. El Paso County classifies Constitution Avenue and Marksheffel Road as Principal Arterial roadways. According to El Paso County ECM guidelines for Principal Arterials, a left turn lane is required for any access with a projected peak hour left turning volume of 10 vehicles per hour or greater, a right turn lane is required for any access with a projected peak hour right turning volume of 25 vehicles per hour or greater, and a right turn acceleration lane is required for any access with a projected peak hour right turning volume of 50 vehicles per hour or greater when the posted speed on the roadway is greater than 40 miles per hour.

It is anticipated that the south leg of Akers Drive will be classified as a collector roadway. According to El Paso County ECM guidelines for Minor Arterials and Lower Classifications, a left turn lane is required for any access with a projected peak hour left turning volume of 25 vehicles per hour or greater, a right turn lane is required for any access with a projected peak hour right turning volume of 50 vehicles per hour or greater, and a right turn acceleration lane is generally not required.

Constitution Avenue and Akers Drive:

- A westbound left turn lane exists and **is** warranted at this intersection based on projected 2023 total traffic volumes being 30 westbound left turns during the peak hour and the threshold being 10 vehicles per hour. The existing westbound left turn lane is 225 feet with a 200-foot taper. Based on the 50-mile per hour speed limit, the deceleration lane length is 235 feet, plus a 200-foot taper. Additionally, 50 feet of storage is required by El Paso County due to the peak hour volume. Therefore, this left turn lane should provide a length of 285 feet plus a 200-foot taper which is the current length of this turn lane.
- A northbound left turn lane **is** warranted at this intersection based on projected 2023 total traffic volumes being 28 northbound left turns during the peak hour and the threshold being 25 vehicles per hour. Based on an El Paso County ECM design speed of 40 miles per hour for an Urban Non-Residential Collector, the deceleration lane length required is 155 feet plus a 160-foot taper. Additionally, 50 feet of storage is required by El Paso County due to the peak hour volume. Therefore, this left turn lane is recommended to provide a

length of 205 feet plus a 160-foot taper. With the roundabout control development scenario at the Akers Drive Access, the proposed spacing between Constitution Avenue and the roundabout is not sufficient to allow for the taper of the northbound left turn lane at the Constitution Avenue and Akers Drive intersection. It should be noted a 105-foot northbound left turn lane plus a 50-foot taper is the maximum possible length that can be provided due to the recent requirement to increase the diameter of the roundabout and constraints with the existing box culvert on the southeast corner of the intersection. A deviation will be requested to allow for the northbound left turn lane at the Constitution Avenue and Akers Drive intersection to be constructed with the maximum possible length.

- An eastbound right turn lane **is** warranted at this intersection based on projected 2023 total traffic volumes being 30 eastbound right turns during the peak hour and the threshold being 25 vehicles per hour. Based on the 50-mile per hour speed limit, the deceleration lane length is 235 feet, plus a 200-foot taper. Additionally, 50 feet of storage is required by El Paso County due to the peak hour volume. Therefore, this right turn lane should provide a length of 285 feet plus a 200-foot taper. However, to be consistent with the intersections in the surrounding area, it is recommended that the third eastbound through lane (outside through lane) at this intersection be dropped as a forced right turn lane.
- A northbound right turn lane **is not** warranted at this intersection based on projected 2023 total traffic volumes being 17 northbound right turns during the peak hour and the threshold being 25 vehicles per hour.
- A northbound right to eastbound acceleration lane **is not** warranted at this intersection based on projected 2023 total traffic volumes being 17 northbound right turns during the peak hour and the threshold being 50 vehicles per hour.

Marksheffel Road Access:

- An eastbound right to southbound acceleration lane **is not** warranted at this intersection based on projected 2023 total traffic volumes being 11 eastbound right turns during the peak hour and the threshold being 50 vehicles per hour.

5.4 Vehicle Queuing Analysis

A vehicle queuing analysis was conducted for the study area intersections. The queuing analysis was performed using Synchro presenting the results of the 95th percentile queue lengths. Results are shown in the following **Table 6** with calculations provided within the level of service operational sheets of **Appendix D** for unsignalized intersections and **Appendix F** for signalized intersections.

Table 6 – Turn Lane Queuing Analysis Results

Intersection Turn Lane	Existing Turn Lane Length (feet)	2023 Calculated Queue (feet)	2023 Recommended Length (feet)	2045 Calculated Queue (feet)	2045 Recommended Length (feet)
Constitution Ave & Akers Dr (#1)					
Eastbound Left	200'	25'	200'	82'	200'
Eastbound Right	DNE	25'	C (EC)	25'	C (EC)
Westbound Left	285'	25'	285'	25'	285'
Northbound Left	DNE	25'	105'+50'T (EC)	86'	105'+50'T (EC)
Southbound Left	375'	25'	375'	92'	375'
Constitution Ave & Marksheffel Rd (#2)					
Eastbound Left	450'	137'	450'	348'	450'
Westbound Left	225'	140'	225'	223'	225'
Northbound Left	425/725'DL	216'	425/725'DL	369'	425/725'DL
Southbound Left	525' DL	162'	525' DL	250'	525' DL

DNE = Does Not Exist; C = Continuous; EC = El Paso County Standards; DL = Dual Left Turn Lanes; **Blue** Text = Recommendation

As shown in the table above, all vehicle queues are expected to be managed in the available turn lane lengths throughout 2045.

5.5 Access Spacing Requirements and Internal Roadway Classifications

According to El Paso County 2016 Major Transportation Corridors Plan Update, Constitution Avenue and Marksheffel Road are classified as Principal Arterials while the south leg of Akers Drive will have the character of a collector roadway. The following identifies the intersection spacing requirements for the access intersections associated with the project:

Constitution Avenue and Akers Drive

The future south leg of Akers Drive along Constitution Avenue will be located approximately 1,050 feet west of Marksheffel Road (measured edge line to center), and approximately 825 feet east of Hannah Ridge Drive. According to the El Paso Engineering Criteria Manual (ECM), spacing of roads accessing an urban principal arterial that will result in a full movement intersection shall be planned at one-half mile and should the one-half mile spacing not be “viable of practical” for providing access to adjacent lane, a deviation may be considered by the ECM administrator. However, as stated in the ECM, one parcel access shall be granted to each existing lot, if it does not create safety or operational problems. The intersection of Constitution Avenue and Akers Drive is expected to meet operational, vehicle queue, and sight distance standards; therefore, it is believed that a south leg of Akers Drive at Constitution Avenue should be granted to allow for one full movement access to the existing lot. A deviation will be provided to request full movement access from a future south leg of Akers Drive at Constitution Avenue.

Akers Drive Access

The access along the new south leg of Akers Drive will be approximately 300 feet south of Constitution Avenue (measured edge line to center). According to the El Paso County Engineering Criteria Manual, spacing of intersections along urban collector roadways from an arterial roadway should be 330 feet from the right-of-way line of the arterial to the centerline of the access roadway. Therefore, the proposed access along the new south leg of Akers Drive does not meet ECM standards. The access along Akers Drive is expected to meet operational, vehicle queue, and sight distance standards. With the roundabout at the Akers Drive Access, the proposed spacing between Constitution Avenue and the access intersection would allow for a 105-foot northbound left turn lane plus 50-taper at the Constitution Avenue and Akers Drive intersection. A deviation will need to be provided to request for this proposed access to remain at the proposed location.

Marksheffel Road Right-Out Only Access

The proposed right-out access along Marksheffel Road will be located approximately 400 feet south of Constitution Avenue (measured edge line to center). The proposed right-out only access along Marksheffel Road is expected to meet operational, vehicle queue, and sight distance standards; therefore, it is believed that this access should be granted to only allow right-turn exiting movements. A deviation will be provided in support of allowing a right-out only access along Marksheffel Road. The future segment of Akers Drive south of Constitution Avenue and the Project Access meets El Paso County average daily traffic threshold standard of 3,000 vehicles per day for a local street; however, this segment of roadway will be classified as an urban non-residential collector. Specifically, Akers Drive south of Constitution Avenue is expected to have approximately 1,100 vehicles per day. Constitution Avenue and Marksheffel Road meet the El Paso County average daily threshold standard of 40,000 vehicles per day for an Urban Arterial 4-lane roadway in 2023. Attached **Figure 10** illustrates the circulation plan and street classification map for roadways internal and external to the Citizen on Constitution project.

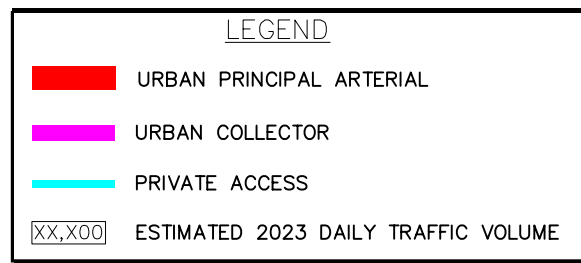
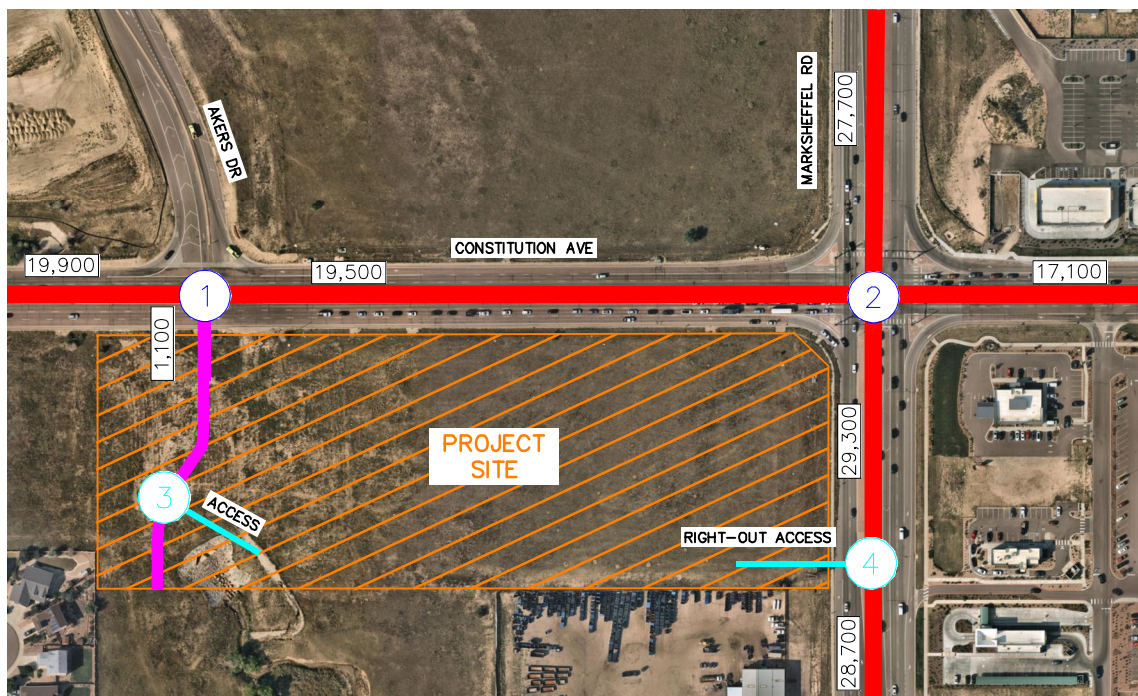

CITIZEN ON CONSTITUTION
 EL PASO COUNTY, COLORADO
 CIRCULATION PLAN

FIGURE 10

5.6 Sight Distance Evaluation

It is recommended that sight triangles be provided at all site access points to give drivers exiting the site a clear view of oncoming traffic. Landscaping and objects within sight triangles must not obstruct drivers' views of the adjacent travel lanes. El Paso County ECM design intersection sight distances for left turn and right turn from stop (from Table 2-35) were evaluated at the accesses along Constitution Avenue, Akers Drive, and Marksheffel Road. Further, ECM design sight distances for left turn from stop from public street intersections (Table 2-21) was evaluated at the intersection of Constitution Avenue and Akers Drive. ECM does not provide sight distances for right-turning vehicles from stop for public street intersections; therefore, AASHTO standards were used for right-turn from stop distances at the intersection of Constitution Avenue and Akers Drive. The following identifies sight distance requirements for the access intersections:

Marksheffel Road Right-Out Only Access

According to Table 2-35 (Entering Sight Distance for Driveways) from ECM and a posted speed limit of 50 miles per hour along Marksheffel Road, the intersection sight distance for a vehicle turning right from stop along a four-lane roadway is 600 feet. Therefore, all obstructions for right turning vehicles from stop should be clear to the left within the triangle created with a vertex point located 10 feet from the edge of the major road traveled way and a line-of-sight distance of 600 feet located in the middle of the nearest southbound through lane along Marksheffel Road for the right-out access. It is believed that the proposed right-out only access along Marksheffel Road is appropriately located to provide the necessary sight distance needed for through volumes along Marksheffel Road. As this access is located approximately 400 feet from Constitution Avenue, sight distances of 600 feet will not be provided for vehicles turning from Constitution Avenue to southbound Marksheffel Road; however, these vehicles will be traveling at speeds much slower than 50 miles per hour. It is believed that vehicles are traveling at a speed of approximately 15 mph when turning from Constitution Avenue to Marksheffel Road and can be traveling at a speed of approximately 45 mph by the time they reach the proposed Marksheffel access. This equates to average speed of 30 mph. Table 2-35 has a sight distance of 420 feet with a speed limit of 35 mph along a four-lane roadway. Extrapolating to a speed limit of 30 mph (data parameter not given in Table 2-35) would equate to a sight distance of 360 feet. Therefore, it is believed that the proposed access along Marksheffel Road is appropriately located to provide necessary sight distances.

Constitution Avenue and Akers Drive

According to Table 2-21 from ECM and a roadway design speed of 50 miles per hour along Constitution Avenue, the intersection sight distance for a vehicle turning left from stop is 555 feet for a two-lane roadway. Since Constitution Avenue is not a two-lane roadway and crosses two additional lanes and a median, additional sight distance needs to be added based on factors from AASHTO. According to AASHTO 9.5.3.2.1 Case B1 – Left Turn from the Minor Road, for left turns onto two-way roadways with more than two lanes, including turn lanes, 0.5 seconds should be added to the time gap for passenger cars for each additional lane while median widths should be converted to equivalent number of lanes (i.e. 18-foot median would require an additional lane and a half and 0.75 seconds). Based on this, two additional lanes and median accounts for an additional 1.75 seconds and approximately 130 feet of sight distance ($1.75 \text{ sec} * 50 \text{ mph} * 5280 \text{ ft/mi} / 3600 \text{ sec/hr}$) and a total of 685 feet of sight distance (555 feet + 130 feet).

With AASHTO standards, the sight distance for a vehicle turning right from stop is 480 feet. Therefore, all obstructions for left turning vehicles from stop should be clear to the right within the triangle created with a vertex point located 10 feet from the edge of the major road traveled way (typical position of the minor road driver's eye when stopped) and a line-of-sight distance of 685 feet located in the middle of the nearest westbound through lane along Constitution Avenue for the Constitution Avenue and Akers Drive intersection. Likewise, all obstructions for right turning vehicles from stop should be clear to the left within the triangle created with a vertex point located 13 feet from the edge of the major road traveled way and a line-of-sight distance of 480 feet located in the middle of the nearest eastbound through lane along Constitution Avenue. It is believed that the intersection of Constitution Avenue and Akers Drive is appropriately located to provide necessary sight distances.

5.7 Bicycle and Pedestrian Access

Sidewalks are provided along both sides of the Marksheffel Road. A sidewalk is provided on the south side of Constitution Avenue east of Marksheffel Road. Adjacent to the site, there are no bicycle lanes along Marksheffel Road or Constitution Avenue. Sidewalks are proposed with the project adjacent to the property frontages along Constitution Avenue and Akers Drive.

5.8 Road Impact Fees and Right-of-Way Designation

Road impact fees were evaluated based on the El Paso County Road Impact Fee Schedule. Based on these fee schedule guidelines, the fee per multi-family dwelling unit is \$2,407. Therefore, the road impact fee for the proposed 226 multi-family residences is expected to be \$543,982. Road impact fee calculations are shown in **Table 7**. During the final plat process, the project team will determine if the impact fees are paid up front or if the property will be included in one of the available public improvement districts with reduced upfront costs. The project team will determine payment methods with the final plat.

Table 7 – Road Impact Fees

Use	Units	Fee / Unit	Total Fee
Multi-Family Housing	226	\$2,407	\$543,982

El Paso County has requested that right-of-way be dedicated along Constitution Avenue. The project is dedicating 20 feet of right-of-way along Constitution Avenue to account for their share of the future 160 feet of right-of-way.

5.9 Improvement Summary

Based on the results of the intersection operational, turn lane evaluations, and vehicle queuing analysis, the key intersection recommended improvements and control are shown in **Figure 11** for 2023 and **Figure 12** for 2045.

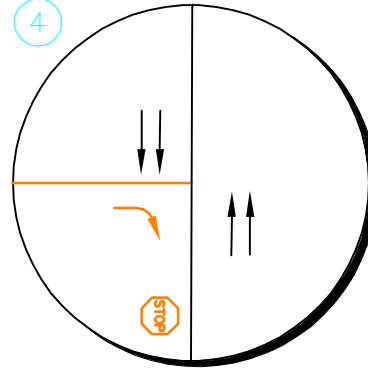
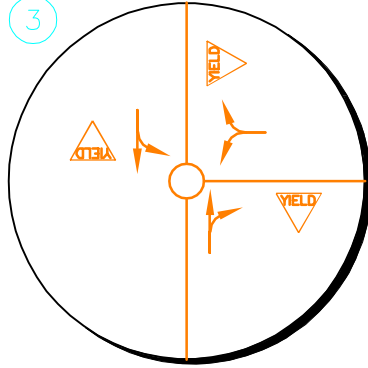
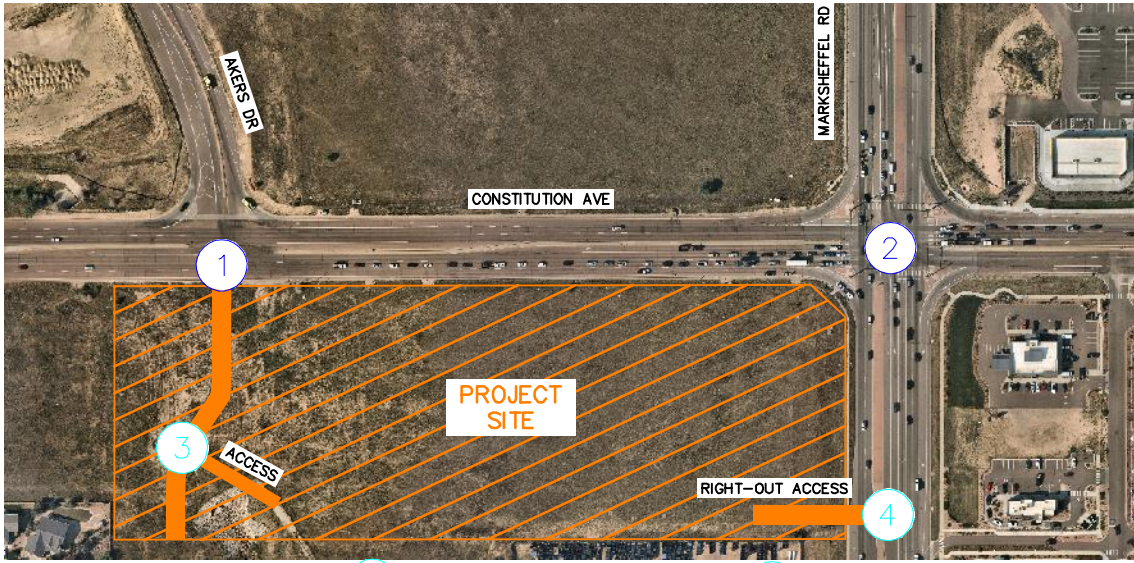
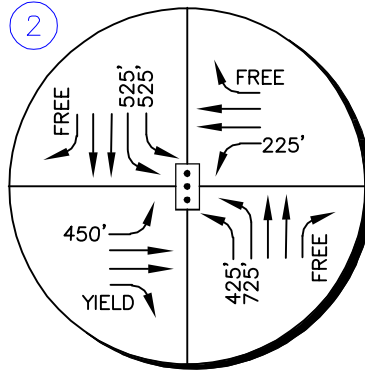
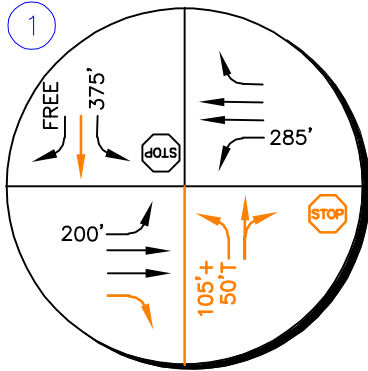

LEGEND	
(X)	Study Area Key Intersection
(X)	Project Access Intersection
○	Roundabout
▽	Yield Controlled Approach
⋮	Signalized Intersection
STOP	Stop Controlled Approach
→	Improvement
↩	100' Turn Lane Length (feet)

CITIZEN ON CONSTITUTION
 EL PASO COUNTY, COLORADO
 2023 RECOMMENDATIONS

FIGURE 11

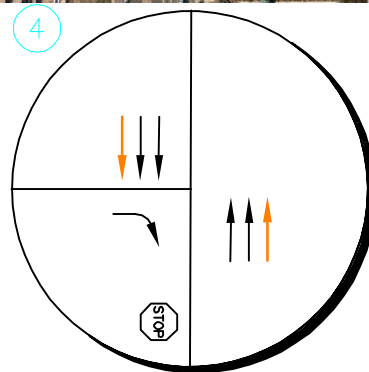
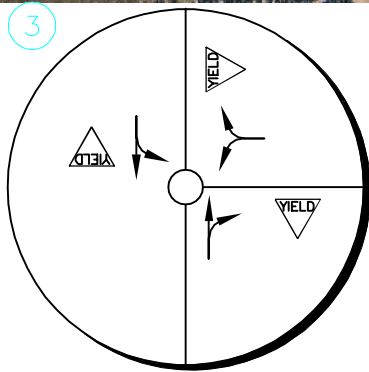
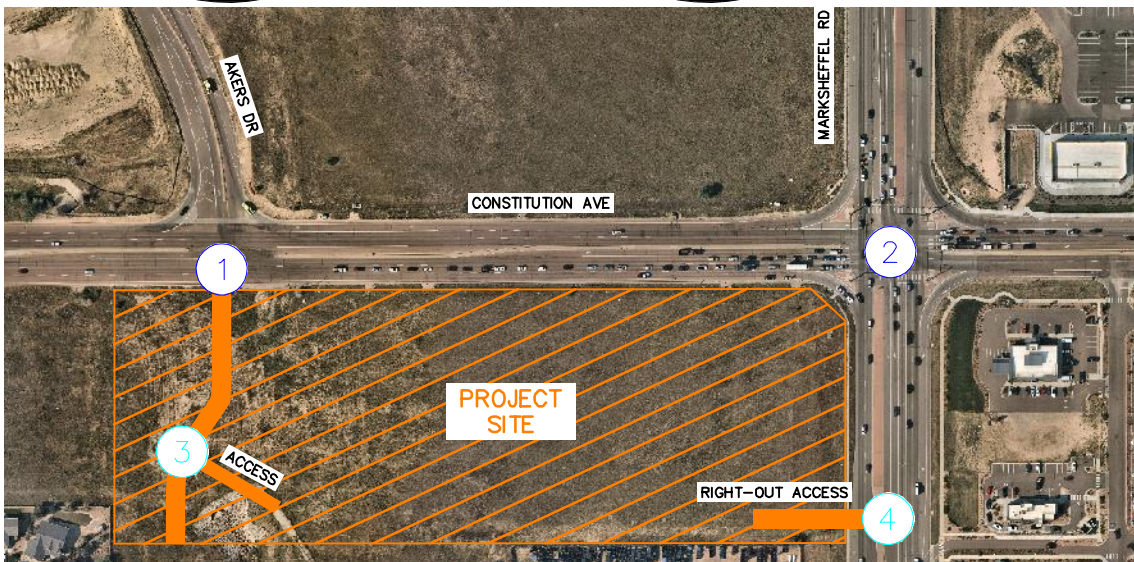
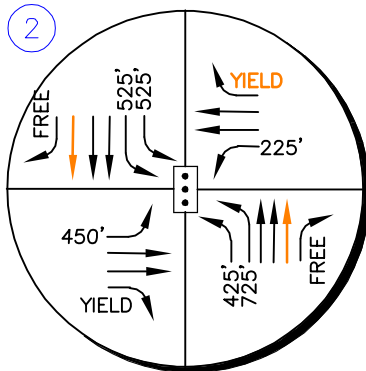
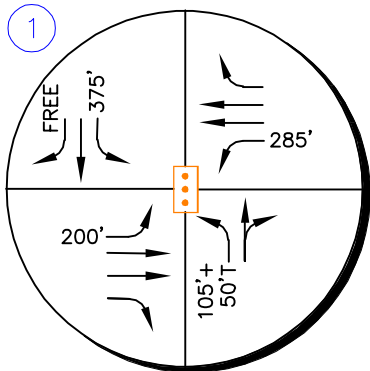

LEGEND	
	Study Area Key Intersection
	Project Access Intersection
	Roundabout
	Yield Controlled Approach
	Signalized Intersection
	Stop Controlled Approach
	Improvement
	100' Turn Lane Length (feet)

CITIZEN ON CONSTITUTION
 EL PASO COUNTY, COLORADO
 2045 RECOMMENDATIONS

FIGURE 12

6.0 CONCLUSIONS AND RECOMMENDATIONS

Based on the analysis presented in this report, Kimley-Horn believes Citizen on Constitution will be successfully incorporated into the existing and future roadway network. Analysis of the existing street network, the proposed project development, and expected traffic volumes resulted in the following conclusions and recommendations:

2023 Recommendations:

- With construction of the Citizen on Constitution development, a south leg is proposed to be constructed at the existing Constitution Avenue and Akers Drive intersection. Based on configuration of the north leg of this intersection providing chevron striping for a future through lane, it is believed that this leg will provide a southbound through lane when the south leg is constructed. Based on El Paso County Engineering Criteria Manual (ECM), a northbound left turn lane will likely be warranted at the Constitution Avenue and Akers Drive intersection; however, a separate northbound right turn lane is not expected to be warranted with buildout future traffic projections. As such, it is recommended that the south leg of the Constitution Avenue and Akers Drive intersection provide a left turn lane and a shared through/right turn lane. It is also recommended that this intersection continue to operate with stop control and a R1-1 “STOP” sign be installed on the northbound approach. To meet El Paso County standards, an eastbound right turn lane should be provided at this intersection. To be consistent with the intersections in the surrounding area, it is recommended that the third eastbound through lane (outside through lane) at this intersection be dropped as a forced right turn lane.
- With completion of the Citizen on Constitution project, a full movement access is proposed along the new south leg of Akers Drive approximately 300 feet south of Constitution Avenue (measured edge line to center) and a right-out only access is proposed along Marksheffel Road approximately 400 feet south of Constitution Avenue (measured edge line to center). Based on prior coordination, the project access along Akers Drive will be constructed as a single lane roundabout with yield control on all three approaches. It is recommended that a R1-1 “STOP” sign be installed on the eastbound exiting approach at the right-out only access along Marksheffel Road. To further identify the proposed access along Marksheffel Road as a right-out only driveway, it is recommended that a R3-2 “NO LEFT TURN” sign be placed

underneath the STOP sign. Further, a R6-1(R) "ONE WAY" sign should also be installed within the raised center median of Marksheffel Road. To restrict right turn entrance as well, a R3-1 "NO RIGHT TURN" sign should be installed facing drivers traveling southbound along Marksheffel Road as well as a R5-1 "DO NOT ENTER" sign to be placed behind the STOP sign. The driveway throat at the proposed right-out only access should be oriented to further restrict entering movements.

Deviations Required

The following deviations will be provided at the subdivision stage (i.e. preliminary plan/final plat) for the ECM administrators consideration:

- A deviation will be provided to request full movement access from a future south leg of Akers Drive at Constitution Avenue. The future south leg of Akers Drive along Constitution Avenue will be located approximately 1,050 feet west of Marksheffel Road (measured edge line to center), and approximately 825 feet east of Hannah Ridge Drive. According to the El Paso Engineering Criteria Manual (ECM) section 2.2.5.B, spacing of roads accessing an urban principal arterial that will result in a full movement intersection shall be planned at one-half mile. However, as stated in the ECM, one parcel access shall be granted to each existing lot, if it does not create safety or operational problems. The intersection of Constitution Avenue and Akers Drive is expected to meet operational, vehicle queue, and sight distance standards; therefore, it is believed that a south leg of Akers Drive at Constitution Avenue should be granted to allow for one full movement access to the existing lot.
- A deviation will be provided in support of allowing a right-out only access along Marksheffel Road. The proposed right-out access along Marksheffel Road will be located approximately 400 feet south of Constitution Avenue (measured edge line to center). The proposed right-out only access along Marksheffel Road is expected to meet operational, vehicle queue, and sight distance standards; therefore, it is believed that this access should be granted to only allow right-turn exiting movements.
- The access along the new south leg of Akers Drive will be approximately 300 feet south of Constitution Avenue (measured edge line to center). According to the El Paso County Engineering Criteria Manual section 2.2.5.D, spacing of intersections along urban collector

roadways from an arterial roadway should be 330 feet from the right-of-way line of the arterial to the centerline of the access roadway. Therefore, the proposed access along the new south leg of Akers Drive does not meet ECM standards. The access along Akers Drive is expected to meet operational, vehicle queue, and sight distance standards. A deviation will need to be provided to request for this proposed access to remain at the proposed location.

- A northbound left turn lane is warranted at the Constitution Avenue and Akers Drive intersection and based on an El Paso County ECM design speed of 40 miles per hour for an Urban Non-Residential Collector, the deceleration lane length required is 155 feet plus a 160-foot taper. Additionally, 50 feet of storage is required by El Paso County due to the peak hour volume. Therefore, this left turn lane is recommended to provide a length of 205 feet plus a 160-foot taper. The proposed spacing between Constitution Avenue and the access intersection is not sufficient to allow for a 205-foot northbound left turn lane plus 160-foot taper at the Constitution Avenue and Akers Drive intersection. It should be noted a 105-foot northbound left turn lane plus a 50-foot taper is the maximum possible length that can be provided due to the recent requirement to increase the diameter of the roundabout and constraints with the existing box culvert on the southeast corner of the intersection. A deviation will be requested to allow for the northbound left turn lane at the Constitution Avenue and Akers Drive intersection be constructed with a maximum possible length.

2045 Recommendations:

- A traffic signal is warranted with 2045 traffic volume projections at the intersection of Constitution Avenue and Akers Drive. It is recommended that El Paso County monitor traffic volumes at this intersection in the future to determine if signalization is the appropriate control. It should be noted the north leg of this intersection is the controlling approach that triggers the need for signal control and project traffic is only expected to utilize the south leg of this intersection.
- If future traffic volumes are realized by 2045, Marksheffel Road may need to have three through lanes in each direction northbound and southbound along the project frontage. With this improvement, it is recommended that the westbound right turn lane at the intersection of Constitution Avenue and Marksheffel Road operate with yield control.

General Recommendations

- Any on-site or offsite improvements should be incorporated into the Civil Drawings and conform to standards of the El Paso County and the Manual on Uniform Traffic Control Devices (MUTCD) – 2009 Edition.

APPENDICES

APPENDIX A

Intersection Count Sheets

AKERS DR CONSTITUTION AVE



Date: Tue, Sep 21, 2021
 Count Period: 7:00 AM to 9:00 AM
 Peak Hour: 7:15 AM to 8:15 AM

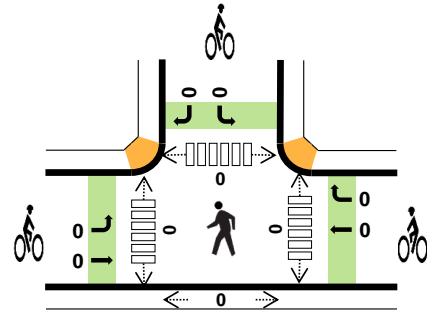
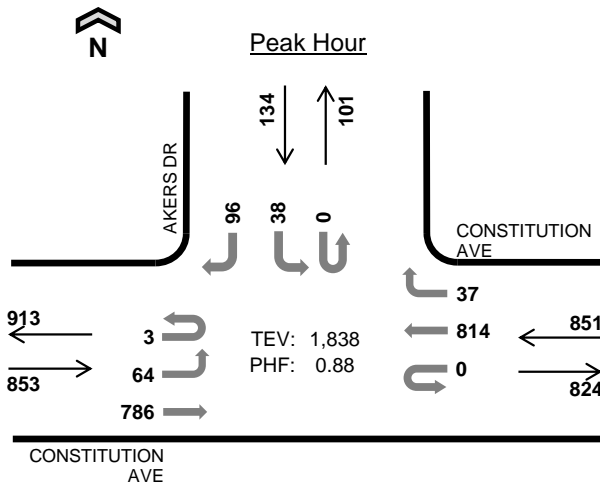

	HV %:	PHF
EB	4.0%	0.89
WB	3.3%	0.83
NB	-	-
SB	3.7%	0.74
TOTAL	3.6%	0.88

Two-Hour Count Summaries

Interval Start	CONSTITUTION AVE				CONSTITUTION AVE				0				AKERS DR				15-min Total	Rolling One Hour
	Eastbound		Westbound		Northbound		Southbound		Eastbound		Westbound		Southbound					
	UT	LT	TH	RT	UT	LT	TH	RT	UT	LT	TH	RT	UT	LT	TH	RT		
7:00 AM	2	7	150	0	0	0	169	11	0	0	0	0	0	5	0	12	356	0
7:15 AM	2	13	168	0	0	0	191	6	0	0	0	0	0	5	0	24	409	0
7:30 AM	0	19	221	0	0	0	213	9	0	0	0	0	0	16	0	29	507	0
7:45 AM	1	24	213	0	0	0	238	18	0	0	0	0	0	6	0	24	524	1,796
8:00 AM	0	8	184	0	0	0	172	4	0	0	0	0	0	11	0	19	398	1,838
8:15 AM	0	9	180	0	0	0	148	9	0	0	0	0	0	8	0	11	365	1,794
8:30 AM	0	5	146	0	0	0	133	5	0	0	0	0	0	8	0	6	303	1,590
8:45 AM	1	7	116	0	0	0	148	6	0	0	0	0	0	5	0	8	291	1,357
Count Total	6	92	1,378	0	0	0	1,412	68	0	0	0	0	0	64	0	133	3,153	0
Peak Hour	All	3	64	786	0	0	814	37	0	0	0	0	0	38	0	96	1,838	0
	HV	0	3	31	0	0	27	1	0	0	0	0	0	3	0	2	67	0
	HV%	0%	5%	4%	-	-	-	3%	3%	-	-	-	-	-	8%	-	2%	4%

Note: Two-hour count summary volumes include heavy vehicles but exclude bicycles in overall count.

Interval Start	Heavy Vehicle Totals					Bicycles					Pedestrians (Crossing Leg)				
	EB	WB	NB	SB	Total	EB	WB	NB	SB	Total	East	West	North	South	Total
7:00 AM	8	6	0	4	18	0	0	0	0	0	0	0	0	0	0
7:15 AM	3	6	0	1	10	0	0	0	0	0	0	0	0	0	0
7:30 AM	12	4	0	1	17	0	0	0	0	0	0	0	0	0	0
7:45 AM	12	7	0	1	20	0	0	0	0	0	0	0	0	0	0
8:00 AM	7	11	0	2	20	0	0	0	0	0	0	0	0	0	0
8:15 AM	15	8	0	4	27	0	0	0	0	0	0	0	0	0	0
8:30 AM	11	4	0	1	16	0	0	0	0	0	0	0	0	0	0
8:45 AM	6	12	0	5	23	0	0	0	0	0	0	0	0	0	0
Count Total	74	58	0	19	151	0	0	0	0	0	0	0	0	0	0
Peak Hr	34	28	0	5	67	0	0	0	0	0	0	0	0	0	0

Two-Hour Count Summaries - Heavy Vehicles														15-min Total	Rolling One Hour			
Interval Start	CONSTITUTION AVE				CONSTITUTION AVE				0				AKERS DR					
	Eastbound				Westbound				Northbound				Southbound					
	UT	LT	TH	RT	UT	LT	TH	RT	UT	LT	TH	RT	UT	LT	TH	RT		
7:00 AM	0	2	6	0	0	0	6	0	0	0	0	0	0	1	0	3	18	0
7:15 AM	0	0	3	0	0	0	6	0	0	0	0	0	0	1	0	0	10	0
7:30 AM	0	3	9	0	0	0	4	0	0	0	0	0	0	0	0	1	17	0
7:45 AM	0	0	12	0	0	0	6	1	0	0	0	0	0	1	0	0	20	65
8:00 AM	0	0	7	0	0	0	11	0	0	0	0	0	0	1	0	1	20	67
8:15 AM	0	0	15	0	0	0	4	4	0	0	0	0	0	1	0	3	27	84
8:30 AM	0	1	10	0	0	0	4	0	0	0	0	0	0	0	0	1	16	83
8:45 AM	0	1	5	0	0	0	11	1	0	0	0	0	0	2	0	3	23	86
Count Total	0	7	67	0	0	0	52	6	0	0	0	0	0	7	0	12	151	0
Peak Hour	0	3	31	0	0	0	27	1	0	0	0	0	0	3	0	2	67	0

Two-Hour Count Summaries - Bikes														15-min Total	Rolling One Hour			
Interval Start	CONSTITUTION AVE			CONSTITUTION AVE			0			AKERS DR								
	Eastbound			Westbound			Northbound			Southbound								
	LT	TH	RT	LT	TH	RT	LT	TH	RT	LT	TH	RT						
7:00 AM	0	0	0	0	0	0	0	0	0	0	0	0	0	0	0	0	0	0
7:15 AM	0	0	0	0	0	0	0	0	0	0	0	0	0	0	0	0	0	0
7:30 AM	0	0	0	0	0	0	0	0	0	0	0	0	0	0	0	0	0	0
7:45 AM	0	0	0	0	0	0	0	0	0	0	0	0	0	0	0	0	0	0
8:00 AM	0	0	0	0	0	0	0	0	0	0	0	0	0	0	0	0	0	0
8:15 AM	0	0	0	0	0	0	0	0	0	0	0	0	0	0	0	0	0	0
8:30 AM	0	0	0	0	0	0	0	0	0	0	0	0	0	0	0	0	0	0
8:45 AM	0	0	0	0	0	0	0	0	0	0	0	0	0	0	0	0	0	0
Count Total	0	0	0	0	0	0	0	0	0	0	0	0	0	0	0	0	0	0
Peak Hour	0	0	0	0	0	0	0	0	0	0	0	0	0	0	0	0	0	0

Note: U-Turn volumes for bikes are included in Left-Turn, if any.

AKERS DR CONSTITUTION AVE



Date: Tue, Sep 21, 2021
 Count Period: 4:00 PM to 6:00 PM
 Peak Hour: 4:15 PM to 5:15 PM

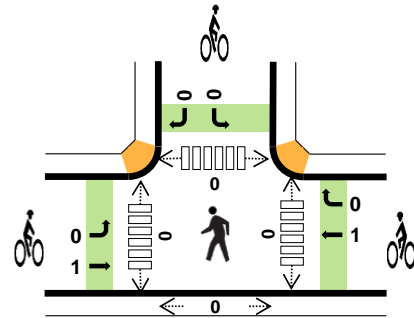
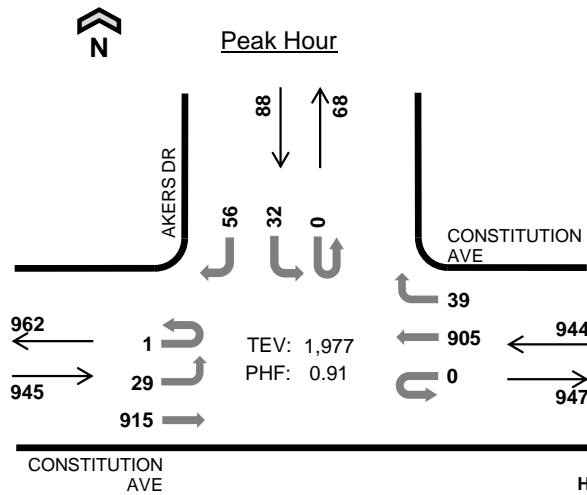

	HV %:	PHF
EB	2.0%	0.95
WB	1.6%	0.92
NB	-	-
SB	2.3%	0.55
TOTAL	1.8%	0.91

Two-Hour Count Summaries

Interval Start	CONSTITUTION AVE Eastbound				CONSTITUTION AVE Westbound				0 Northbound				AKERS DR Southbound				15-min Total	Rolling One Hour
	UT	LT	TH	RT	UT	LT	TH	RT	UT	LT	TH	RT	UT	LT	TH	RT		
4:00 PM	1	8	232	0	0	0	203	15	0	0	0	0	0	5	0	12	476	0
4:15 PM	1	2	233	0	0	0	197	9	0	0	0	0	0	11	0	8	461	0
4:30 PM	0	6	225	0	0	0	240	14	0	0	0	0	0	7	0	10	502	0
4:45 PM	0	11	218	0	0	0	220	8	0	0	0	0	0	4	0	8	469	1,908
5:00 PM	0	10	239	0	0	0	248	8	0	0	0	0	0	10	0	30	545	1,977
5:15 PM	0	8	210	0	0	0	191	5	0	0	0	0	0	2	0	7	423	1,939
5:30 PM	1	9	260	0	0	0	225	8	0	0	0	0	0	7	0	5	515	1,952
5:45 PM	0	7	197	0	0	0	185	11	0	0	0	0	0	2	0	3	405	1,888
Count Total	3	61	1,814	0	0	0	1,709	78	0	0	0	0	0	48	0	83	3,796	0
Peak Hour	All	1	29	915	0	0	905	39	0	0	0	0	0	32	0	56	1,977	0
	HV	0	0	19	0	0	0	13	2	0	0	0	0	2	0	0	36	0
	HV%	0%	0%	2%	-	-	-	1%	5%	-	-	-	-	6%	-	0%	2%	0

Note: Two-hour count summary volumes include heavy vehicles but exclude bicycles in overall count.

Interval Start	Heavy Vehicle Totals					Bicycles					Pedestrians (Crossing Leg)				
	EB	WB	NB	SB	Total	EB	WB	NB	SB	Total	East	West	North	South	Total
4:00 PM	6	10	0	2	18	0	0	0	1	1	0	0	0	0	0
4:15 PM	4	5	0	0	9	0	0	0	0	0	0	0	0	0	0
4:30 PM	7	5	0	1	13	1	0	0	0	1	0	0	0	0	0
4:45 PM	6	2	0	0	8	0	1	0	0	1	0	0	0	0	0
5:00 PM	2	3	0	1	6	0	0	0	0	0	0	0	0	0	0
5:15 PM	4	3	0	0	7	0	0	0	0	0	0	0	0	0	0
5:30 PM	2	3	0	2	7	0	0	0	0	0	0	0	0	0	0
5:45 PM	1	3	0	0	4	0	0	0	0	0	0	0	0	0	0
Count Total	32	34	0	6	72	1	1	0	1	3	0	0	0	0	0
Peak Hr	19	15	0	2	36	1	1	0	0	2	0	0	0	0	0

Two-Hour Count Summaries - Heavy Vehicles														15-min Total	Rolling One Hour			
Interval Start	CONSTITUTION AVE				CONSTITUTION AVE				0				AKERS DR					
	Eastbound				Westbound				Northbound				Southbound					
	UT	LT	TH	RT	UT	LT	TH	RT	UT	LT	TH	RT	UT	LT	TH	RT		
4:00 PM	0	0	6	0	0	0	4	6	0	0	0	0	0	1	0	1	18	0
4:15 PM	0	0	4	0	0	0	5	0	0	0	0	0	0	0	0	0	9	0
4:30 PM	0	0	7	0	0	0	5	0	0	0	0	0	0	1	0	0	13	0
4:45 PM	0	0	6	0	0	0	1	1	0	0	0	0	0	0	0	0	8	48
5:00 PM	0	0	2	0	0	0	2	1	0	0	0	0	0	1	0	0	6	36
5:15 PM	0	2	2	0	0	0	3	0	0	0	0	0	0	0	0	0	7	34
5:30 PM	0	0	2	0	0	0	3	0	0	0	0	0	0	2	0	0	7	28
5:45 PM	0	0	1	0	0	0	3	0	0	0	0	0	0	0	0	0	4	24
Count Total	0	2	30	0	0	0	26	8	0	0	0	0	0	5	0	1	72	0
Peak Hour	0	0	19	0	0	0	13	2	0	0	0	0	0	2	0	0	36	0

Two-Hour Count Summaries - Bikes														15-min Total	Rolling One Hour		
Interval Start	CONSTITUTION AVE			CONSTITUTION AVE			0			AKERS DR							
	Eastbound			Westbound			Northbound			Southbound							
	LT	TH	RT	LT	TH	RT	LT	TH	RT	LT	TH	RT					
4:00 PM	0	0	0	0	0	0	0	0	0	1	0	0	1	0	0	1	0
4:15 PM	0	0	0	0	0	0	0	0	0	0	0	0	0	0	0	0	0
4:30 PM	0	1	0	0	0	0	0	0	0	0	0	0	0	0	0	1	0
4:45 PM	0	0	0	0	1	0	0	0	0	0	0	0	0	0	0	1	3
5:00 PM	0	0	0	0	0	0	0	0	0	0	0	0	0	0	0	0	2
5:15 PM	0	0	0	0	0	0	0	0	0	0	0	0	0	0	0	0	2
5:30 PM	0	0	0	0	0	0	0	0	0	0	0	0	0	0	0	0	1
5:45 PM	0	0	0	0	0	0	0	0	0	0	0	0	0	0	0	0	0
Count Total	0	1	0	0	1	0	0	0	0	1	0	0	3	0	0	3	0
Peak Hour	0	1	0	0	1	0	0	0	0	0	0	0	2	0	0	2	0

Note: U-Turn volumes for bikes are included in Left-Turn, if any.

MARKSHEFFEL RD CONSTITUTION AVE



Date: Tue, Sep 21, 2021
 Count Period: 7:00 AM to 9:00 AM
 Peak Hour: 7:00 AM to 8:00 AM

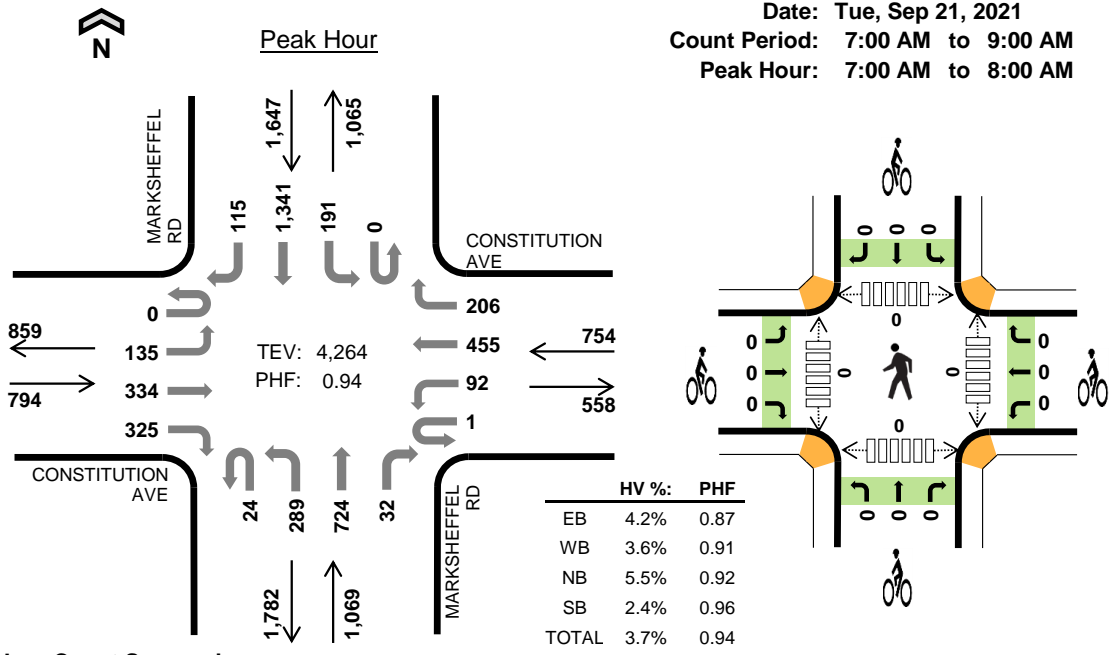

Two-Hour Count Summaries

Interval Start	CONSTITUTION AVE				CONSTITUTION AVE				MARKSHEFFEL RD				MARKSHEFFEL RD				15-min Total	Rolling One Hour	
	Eastbound		Westbound		Northbound		Southbound		UT	LT	TH	RT	UT	LT	TH	RT			
7:00 AM	0	29	58	71	1	23	90	47	8	71	174	6	0	34	370	24	1,006	0	
7:15 AM	0	32	67	83	0	27	108	59	0	67	166	9	0	43	330	24	1,015	0	
7:30 AM	0	35	103	89	0	18	125	49	11	69	202	10	0	55	341	23	1,130	0	
7:45 AM	0	39	106	82	0	24	132	51	5	82	182	7	0	59	300	44	1,113	4,264	
8:00 AM	0	24	81	85	0	25	89	40	5	67	160	10	0	47	282	25	940	4,198	
8:15 AM	0	33	94	62	0	26	85	33	3	40	129	8	0	41	208	23	785	3,968	
8:30 AM	0	25	67	55	0	23	65	29	7	55	133	9	0	43	206	20	737	3,575	
8:45 AM	0	20	60	48	0	25	79	28	5	55	116	8	0	21	160	25	650	3,112	
Count Total	0	237	636	575	1	191	773	336	44	506	1,262	67	0	343	2,197	208	7,376	0	
Peak Hour	All	0	135	334	325	1	92	455	206	24	289	724	32	0	191	1,341	115	4,264	0
	HV	0	15	11	7	0	5	11	11	0	9	42	8	0	3	34	3	159	0
	HV%	-	11%	3%	2%	0%	5%	2%	5%	0%	3%	6%	25%	-	2%	3%	3%	4%	0

Note: Two-hour count summary volumes include heavy vehicles but exclude bicycles in overall count.

Interval Start	Heavy Vehicle Totals					Bicycles					Pedestrians (Crossing Leg)				
	EB	WB	NB	SB	Total	EB	WB	NB	SB	Total	East	West	North	South	Total
7:00 AM	7	6	17	11	41	0	0	0	0	0	0	0	0	0	0
7:15 AM	4	6	15	9	34	0	0	0	0	0	0	0	0	0	0
7:30 AM	7	4	11	10	32	0	0	0	0	0	0	0	0	0	0
7:45 AM	15	11	16	10	52	0	0	0	0	0	0	0	0	0	0
8:00 AM	8	10	20	15	53	0	0	0	0	0	0	0	0	0	0
8:15 AM	17	8	14	9	48	0	0	0	0	0	0	0	0	0	0
8:30 AM	9	8	20	11	48	0	0	0	0	0	0	0	0	0	0
8:45 AM	7	11	14	12	44	0	0	0	0	0	0	0	0	0	0
Count Total	74	64	127	87	352	0	0	0	0	0	0	0	0	0	0
Peak Hour	33	27	59	40	159	0	0	0	0	0	0	0	0	0	0

Two-Hour Count Summaries - Heavy Vehicles														15-min Total	Rolling One Hour			
Interval Start	CONSTITUTION AVE				CONSTITUTION AVE				MARKSHEFFEL RD				MARKSHEFFEL RD					
	Eastbound				Westbound				Northbound				Southbound					
	UT	LT	TH	RT	UT	LT	TH	RT	UT	LT	TH	RT	UT	LT	TH	RT		
7:00 AM	0	2	1	4	0	0	3	3	0	2	14	1	0	1	8	2	41	0
7:15 AM	0	3	0	1	0	3	1	2	0	2	11	2	0	2	7	0	34	0
7:30 AM	0	4	2	1	0	1	2	1	0	4	6	1	0	0	10	0	32	0
7:45 AM	0	6	8	1	0	1	5	5	0	1	11	4	0	0	9	1	52	159
8:00 AM	0	1	5	2	0	3	5	2	0	7	11	2	0	1	13	1	53	171
8:15 AM	0	7	7	3	0	4	4	0	0	2	12	0	0	3	5	1	48	185
8:30 AM	0	5	3	1	0	4	3	1	0	1	15	4	0	3	8	0	48	201
8:45 AM	0	1	4	2	0	4	4	3	0	4	8	2	0	0	9	3	44	193
Count Total	0	29	30	15	0	20	27	17	0	23	88	16	0	10	69	8	352	0
Peak Hour	0	15	11	7	0	5	11	11	0	9	42	8	0	3	34	3	159	0

Two-Hour Count Summaries - Bikes														15-min Total	Rolling One Hour			
Interval Start	CONSTITUTION AVE			CONSTITUTION AVE			MARKSHEFFEL RD			MARKSHEFFEL RD								
	LT	TH	RT	LT	TH	RT	LT	TH	RT	LT	TH	RT						
7:00 AM	0	0	0	0	0	0	0	0	0	0	0	0	0	0	0	0	0	0
7:15 AM	0	0	0	0	0	0	0	0	0	0	0	0	0	0	0	0	0	0
7:30 AM	0	0	0	0	0	0	0	0	0	0	0	0	0	0	0	0	0	0
7:45 AM	0	0	0	0	0	0	0	0	0	0	0	0	0	0	0	0	0	0
8:00 AM	0	0	0	0	0	0	0	0	0	0	0	0	0	0	0	0	0	0
8:15 AM	0	0	0	0	0	0	0	0	0	0	0	0	0	0	0	0	0	0
8:30 AM	0	0	0	0	0	0	0	0	0	0	0	0	0	0	0	0	0	0
8:45 AM	0	0	0	0	0	0	0	0	0	0	0	0	0	0	0	0	0	0
Count Total	0	0	0	0	0	0	0	0	0	0	0	0	0	0	0	0	0	0
Peak Hour	0	0	0	0	0	0	0	0	0	0	0	0	0	0	0	0	0	0

Note: U-Turn volumes for bikes are included in Left-Turn, if any.

MARKSHEFFEL RD CONSTITUTION AVE



Date: Tue, Sep 21, 2021
 Count Period: 4:00 PM to 6:00 PM
 Peak Hour: 4:30 PM to 5:30 PM

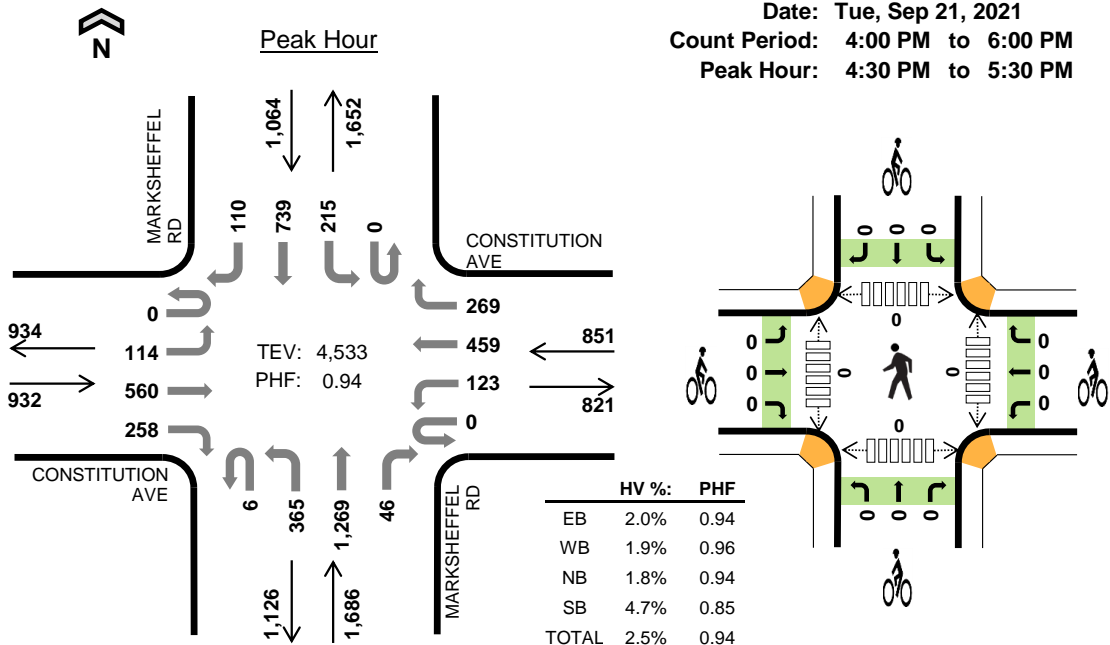

Two-Hour Count Summaries

Interval Start	CONSTITUTION AVE				CONSTITUTION AVE				MARKSHEFFEL RD				MARKSHEFFEL RD				15-min Total	Rolling One Hour	
	Eastbound		Westbound		Northbound		Southbound		UT	LT	TH	RT	UT	LT	TH	RT			
4:00 PM	0	37	151	63	0	34	92	57	4	94	259	10	0	46	156	32	1,035	0	
4:15 PM	0	27	149	62	0	23	85	49	1	101	297	12	0	53	166	29	1,054	0	
4:30 PM	0	25	127	70	0	39	118	65	0	90	332	13	0	48	151	29	1,107	0	
4:45 PM	0	22	146	62	0	33	118	69	1	106	301	13	0	58	184	30	1,143	4,339	
5:00 PM	0	35	140	72	0	22	102	76	3	96	338	10	0	49	233	30	1,206	4,510	
5:15 PM	0	32	147	54	0	29	121	59	2	73	298	10	0	60	171	21	1,077	4,533	
5:30 PM	0	21	150	70	0	22	90	62	2	98	293	8	0	67	164	34	1,081	4,507	
5:45 PM	0	30	120	58	0	27	97	60	4	61	251	21	0	57	131	32	949	4,313	
Count Total	0	229	1,130	511	0	229	823	497	17	719	2,369	97	0	438	1,356	237	8,652	0	
Peak Hour	All	0	114	560	258	0	123	459	269	6	365	1,269	46	0	215	739	110	4,533	0
	HV	0	3	5	11	0	4	6	6	0	5	24	1	0	7	43	0	115	0
	HV%	-	3%	1%	4%	-	3%	1%	2%	0%	1%	2%	2%	-	3%	6%	0%	3%	0

Note: Two-hour count summary volumes include heavy vehicles but exclude bicycles in overall count.

Interval Start	Heavy Vehicle Totals					Bicycles					Pedestrians (Crossing Leg)				
	EB	WB	NB	SB	Total	EB	WB	NB	SB	Total	East	West	North	South	Total
4:00 PM	7	15	15	16	53	0	0	0	0	0	0	0	0	0	0
4:15 PM	4	4	11	14	33	0	0	0	0	0	0	0	0	0	0
4:30 PM	7	4	12	13	36	0	0	0	0	0	0	0	0	0	0
4:45 PM	7	4	7	9	27	0	0	0	0	0	0	0	0	0	0
5:00 PM	2	1	7	13	23	0	0	0	0	0	0	0	0	0	0
5:15 PM	3	7	4	15	29	0	0	0	0	0	0	0	0	0	0
5:30 PM	4	0	4	11	19	0	0	0	0	0	0	0	0	0	0
5:45 PM	1	3	4	3	11	0	0	0	0	0	0	0	0	0	0
Count Total	35	38	64	94	231	0	0	0	0	0	0	0	0	0	0
Peak Hour	19	16	30	50	115	0	0	0	0	0	0	0	0	0	0

Two-Hour Count Summaries - Heavy Vehicles																		
Interval Start	CONSTITUTION AVE				CONSTITUTION AVE				MARKSHEFFEL RD				MARKSHEFFEL RD				15-min Total	Rolling One Hour
	Eastbound				Westbound				Northbound				Southbound					
	UT	LT	TH	RT	UT	LT	TH	RT	UT	LT	TH	RT	UT	LT	TH	RT		
4:00 PM	0	3	1	3	0	6	7	2	0	5	9	1	0	3	11	2	53	0
4:15 PM	0	1	0	3	0	2	2	0	0	2	6	3	0	2	12	0	33	0
4:30 PM	0	1	3	3	0	2	2	0	0	2	10	0	0	2	11	0	36	0
4:45 PM	0	1	1	5	0	1	0	3	0	0	6	1	0	1	8	0	27	149
5:00 PM	0	0	1	1	0	0	1	0	0	3	4	0	0	1	12	0	23	119
5:15 PM	0	1	0	2	0	1	3	3	0	0	4	0	0	3	12	0	29	115
5:30 PM	0	0	2	2	0	0	0	0	0	0	3	1	0	1	9	1	19	98
5:45 PM	0	1	0	0	0	0	3	0	0	0	2	2	0	2	1	0	11	82
Count Total	0	8	8	19	0	12	18	8	0	12	44	8	0	15	76	3	231	0
Peak Hour	0	3	5	11	0	4	6	6	0	5	24	1	0	7	43	0	115	0

Two-Hour Count Summaries - Bikes																		
Interval Start	CONSTITUTION AVE			CONSTITUTION AVE			MARKSHEFFEL RD			MARKSHEFFEL RD			15-min Total	Rolling One Hour				
	Eastbound			Westbound			Northbound			Southbound								
	LT	TH	RT	LT	TH	RT	LT	TH	RT	LT	TH	RT						
4:00 PM	0	0	0	0	0	0	0	0	0	0	0	0	0	0	0	0	0	0
4:15 PM	0	0	0	0	0	0	0	0	0	0	0	0	0	0	0	0	0	0
4:30 PM	0	0	0	0	0	0	0	0	0	0	0	0	0	0	0	0	0	0
4:45 PM	0	0	0	0	0	0	0	0	0	0	0	0	0	0	0	0	0	0
5:00 PM	0	0	0	0	0	0	0	0	0	0	0	0	0	0	0	0	0	0
5:15 PM	0	0	0	0	0	0	0	0	0	0	0	0	0	0	0	0	0	0
5:30 PM	0	0	0	0	0	0	0	0	0	0	0	0	0	0	0	0	0	0
5:45 PM	0	0	0	0	0	0	0	0	0	0	0	0	0	0	0	0	0	0
Count Total	0	0	0	0	0	0	0	0	0	0	0	0	0	0	0	0	0	0
Peak Hour	0	0	0	0	0	0	0	0	0	0	0	0	0	0	0	0	0	0

Note: U-Turn volumes for bikes are included in Left-Turn, if any.

APPENDIX B

Future Traffic Projections

MTCP Growth Rate: Citizen on Constitution

Location	2015 AADT	2040 AADT	Growth Factor	Growth Rate
Constitution Ave W/O Marksheffel Rd	10800	14200	1.31	1.10%

APPENDIX C

Trip Generation Worksheets

Project Citizen on Constitution
 Subject Trip Generation for Multifamily Housing (Mid-Rise)
 Designed by TES Date September 21, 2021 Job No. 096481004
 Checked by _____ Date _____ Sheet No. 1 of 1

TRIP GENERATION MANUAL TECHNIQUES

ITE Trip Generation Manual 10th Edition, Fitted Curve Equations

Land Use Code - Multifamily Housing (Mid-Rise) (221)

Independent Variable - Dwelling Units (X)

X = 226
 T = Average Vehicle Trip Ends

Peak Hour of Adjacent Street Traffic, One Hour Between 7 and 9 a.m. (Series 200 Page 74)

$\ln(T) = 0.98 \ln(X) - 0.98$ $\ln(T) = 0.98 * \ln(226.0) - 0.98$	Directional Distribution: 26% ent. 74% exit. T = 76 Average Vehicle Trip Ends 20 entering 56 exiting 20 + 56 = 76
--	--

Peak Hour of Adjacent Street Traffic, One Hour Between 4 and 6 p.m. (Series 200 Page 75)

$\ln(T) = 0.96 \ln(X) - 0.63$ $\ln(T) = 0.96 * \ln(226.0) - 0.63$	Directional Distribution: 61% ent. 39% exit. T = 97 Average Vehicle Trip Ends 59 entering 38 exiting 59 + 38 = 97
--	--

Weekday (Series 200 Page 73)

$(T) = 5.45*(X) - 1.75$ $(T) = 5.45 * 226 - 1.75$	Directional Distribution: 50% ent. 50% exit. T = 1230 Average Vehicle Trip Ends 615 entering 615 exiting 615 + 615 = 1230
--	--

Peak Hour of Generator, Saturday (Series 200 Page 79)

$(T) = 0.42*(X) + 6.73$ $(T) = 0.42 * 226 + 6.73$	Directional Distribution: 49% ent. 51% exit. T = 102 Average Vehicle Trip Ends 50 entering 52 exiting 50 + 52 = 102
--	--

APPENDIX D

Intersection Analysis Worksheets

Intersection						
Int Delay, s/veh	0.8					
Movement	EBL	EBT	WBT	WBR	SBL	SBR
Lane Configurations	↘	↑↑↑	↑↑	↗	↘	↗
Traffic Vol, veh/h	67	786	814	37	38	96
Future Vol, veh/h	67	786	814	37	38	96
Conflicting Peds, #/hr	0	0	0	0	0	0
Sign Control	Free	Free	Free	Free	Stop	Stop
RT Channelized	-	None	-	None	-	Free
Storage Length	200	-	-	0	375	0
Veh in Median Storage, #	-	0	0	-	2	-
Grade, %	-	0	0	-	0	-
Peak Hour Factor	88	88	88	88	88	88
Heavy Vehicles, %	2	2	2	2	2	2
Mvmt Flow	76	893	925	42	43	109

Major/Minor	Major1	Major2	Minor2
Conflicting Flow All	967	0	0 1434
Stage 1	-	-	- 925
Stage 2	-	-	- 509
Critical Hdwy	4.14	-	- 6.29
Critical Hdwy Stg 1	-	-	- 5.84
Critical Hdwy Stg 2	-	-	- 6.04
Follow-up Hdwy	2.22	-	- 3.67
Pot Cap-1 Maneuver	708	-	- 152 0
Stage 1	-	-	- 338 0
Stage 2	-	-	- 535 0
Platoon blocked, %	-	-	-
Mov Cap-1 Maneuver	708	-	- 136
Mov Cap-2 Maneuver	-	-	- 269
Stage 1	-	-	- 302
Stage 2	-	-	- 535

Approach	EB	WB	SB
HCM Control Delay, s	0.8	0	20.9
HCM LOS			C

Minor Lane/Major Mvmt	EBL	EBT	WBT	WBR	SBLn1	SBLn2
Capacity (veh/h)	708	-	-	-	269	-
HCM Lane V/C Ratio	0.108	-	-	-	0.161	-
HCM Control Delay (s)	10.7	-	-	-	20.9	0
HCM Lane LOS	B	-	-	-	C	A
HCM 95th %tile Q(veh)	0.4	-	-	-	0.6	-

Intersection						
Int Delay, s/veh	0.5					
Movement	EBL	EBT	WBT	WBR	SBL	SBR
Lane Configurations	↘	↑↑↑	↑↑	↗	↘	↗
Traffic Vol, veh/h	30	915	905	39	32	56
Future Vol, veh/h	30	915	905	39	32	56
Conflicting Peds, #/hr	0	0	0	0	0	0
Sign Control	Free	Free	Free	Free	Stop	Stop
RT Channelized	-	None	-	None	-	Free
Storage Length	200	-	-	0	375	0
Veh in Median Storage, #	-	0	0	-	2	-
Grade, %	-	0	0	-	0	-
Peak Hour Factor	91	91	91	91	91	91
Heavy Vehicles, %	2	2	2	2	2	2
Mvmt Flow	33	1005	995	43	35	62

Major/Minor	Major1	Major2	Minor2
Conflicting Flow All	1038	0	0 1463
Stage 1	-	-	- 995
Stage 2	-	-	- 468
Critical Hdwy	4.14	-	- 6.29
Critical Hdwy Stg 1	-	-	- 5.84
Critical Hdwy Stg 2	-	-	- 6.04
Follow-up Hdwy	2.22	-	- 3.67
Pot Cap-1 Maneuver	665	-	- 146 0
Stage 1	-	-	- 311 0
Stage 2	-	-	- 562 0
Platoon blocked, %	-	-	-
Mov Cap-1 Maneuver	665	-	- 139
Mov Cap-2 Maneuver	-	-	- 267
Stage 1	-	-	- 295
Stage 2	-	-	- 562

Approach	EB	WB	SB
HCM Control Delay, s	0.3	0	20.5
HCM LOS			C

Minor Lane/Major Mvmt	EBL	EBT	WBT	WBR	SBLn1	SBLn2
Capacity (veh/h)	665	-	-	-	267	-
HCM Lane V/C Ratio	0.05	-	-	-	0.132	-
HCM Control Delay (s)	10.7	-	-	-	20.5	0
HCM Lane LOS	B	-	-	-	C	A
HCM 95th %tile Q(veh)	0.2	-	-	-	0.4	-

Intersection						
Int Delay, s/veh	0.9					
Movement	EBL	EBT	WBT	WBR	SBL	SBR
Lane Configurations	↘	↑↑↑	↑↑	↗	↘	↗
Traffic Vol, veh/h	70	818	847	38	40	100
Future Vol, veh/h	70	818	847	38	40	100
Conflicting Peds, #/hr	0	0	0	0	0	0
Sign Control	Free	Free	Free	Free	Stop	Stop
RT Channelized	-	None	-	None	-	Free
Storage Length	200	-	-	0	375	0
Veh in Median Storage, #	-	0	0	-	2	-
Grade, %	-	0	0	-	0	-
Peak Hour Factor	88	88	88	88	88	88
Heavy Vehicles, %	2	2	2	2	2	2
Mvmt Flow	80	930	963	43	45	114

Major/Minor	Major1	Major2	Minor2
Conflicting Flow All	1006	0	0 1495
Stage 1	-	-	- 963
Stage 2	-	-	- 532
Critical Hdwy	4.14	-	- 6.29
Critical Hdwy Stg 1	-	-	- 5.84
Critical Hdwy Stg 2	-	-	- 6.04
Follow-up Hdwy	2.22	-	- 3.67
Pot Cap-1 Maneuver	684	-	- 140 0
Stage 1	-	-	- 323 0
Stage 2	-	-	- 521 0
Platoon blocked, %	-	-	-
Mov Cap-1 Maneuver	684	-	- 124
Mov Cap-2 Maneuver	-	-	- 254
Stage 1	-	-	- 285
Stage 2	-	-	- 521

Approach	EB	WB	SB
HCM Control Delay, s	0.9	0	22.2
HCM LOS			C

Minor Lane/Major Mvmt	EBL	EBT	WBT	WBR	SBLn1	SBLn2
Capacity (veh/h)	684	-	-	-	254	-
HCM Lane V/C Ratio	0.116	-	-	-	0.179	-
HCM Control Delay (s)	11	-	-	-	22.2	0
HCM Lane LOS	B	-	-	-	C	A
HCM 95th %tile Q(veh)	0.4	-	-	-	0.6	-

Intersection						
Int Delay, s/veh	0.5					
Movement	EBL	EBT	WBT	WBR	SBL	SBR
Lane Configurations	↘	↑↑↑	↑↑	↗	↘	↗
Traffic Vol, veh/h	31	952	942	41	33	58
Future Vol, veh/h	31	952	942	41	33	58
Conflicting Peds, #/hr	0	0	0	0	0	0
Sign Control	Free	Free	Free	Free	Stop	Stop
RT Channelized	-	None	-	None	-	Free
Storage Length	200	-	-	0	375	0
Veh in Median Storage, #	-	0	0	-	2	-
Grade, %	-	0	0	-	0	-
Peak Hour Factor	91	91	91	91	91	91
Heavy Vehicles, %	2	2	2	2	2	2
Mvmt Flow	34	1046	1035	45	36	64

Major/Minor	Major1	Major2	Minor2
Conflicting Flow All	1080	0	0 1521
Stage 1	-	-	- 1035
Stage 2	-	-	- 486
Critical Hdwy	4.14	-	- 6.29
Critical Hdwy Stg 1	-	-	- 5.84
Critical Hdwy Stg 2	-	-	- 6.04
Follow-up Hdwy	2.22	-	- 3.67
Pot Cap-1 Maneuver	641	-	- 135 0
Stage 1	-	-	- 296 0
Stage 2	-	-	- 550 0
Platoon blocked, %	-	-	-
Mov Cap-1 Maneuver	641	-	- 128
Mov Cap-2 Maneuver	-	-	- 253
Stage 1	-	-	- 280
Stage 2	-	-	- 550

Approach	EB	WB	SB
HCM Control Delay, s	0.3	0	21.6
HCM LOS			C

Minor Lane/Major Mvmt	EBL	EBT	WBT	WBR	SBLn1	SBLn2
Capacity (veh/h)	641	-	-	-	253	-
HCM Lane V/C Ratio	0.053	-	-	-	0.143	-
HCM Control Delay (s)	10.9	-	-	-	21.6	0
HCM Lane LOS	B	-	-	-	C	A
HCM 95th %tile Q(veh)	0.2	-	-	-	0.5	-

Intersection

Int Delay, s/veh 1.6

Movement	EBL	EBT	EBR	WBL	WBT	WBR	NBL	NBT	NBR	SBL	SBT	SBR
Lane Configurations	↘	↗	↘	↘	↗	↘	↘	↗		↘	↗	↘
Traffic Vol, veh/h	70	818	10	10	847	38	28	0	17	40	0	100
Future Vol, veh/h	70	818	10	10	847	38	28	0	17	40	0	100
Conflicting Peds, #/hr	0	0	0	0	0	0	0	0	0	0	0	0
Sign Control	Free	Free	Free	Free	Free	Free	Stop	Stop	Stop	Stop	Stop	Stop
RT Channelized	-	-	None	-	-	None	-	-	None	-	-	Free
Storage Length	200	-	0	225	-	0	150	-	-	375	-	0
Veh in Median Storage, #	-	0	-	-	0	-	-	2	-	-	2	-
Grade, %	-	0	-	-	0	-	-	0	-	-	0	-
Peak Hour Factor	88	88	92	92	88	88	92	92	92	88	92	88
Heavy Vehicles, %	2	2	2	2	2	2	2	2	2	2	2	2
Mvmt Flow	80	930	11	11	963	43	30	0	18	45	0	114

Major/Minor	Major1	Major2	Minor1	Minor2
Conflicting Flow All	1006	0	0	941
Stage 1	-	-	-	-
Stage 2	-	-	-	-
Critical Hdwy	4.14	-	-	4.14
Critical Hdwy Stg 1	-	-	-	-
Critical Hdwy Stg 2	-	-	-	-
Follow-up Hdwy	2.22	-	-	2.22
Pot Cap-1 Maneuver	684	-	-	724
Stage 1	-	-	-	-
Stage 2	-	-	-	-
Platoon blocked, %	-	-	-	-
Mov Cap-1 Maneuver	684	-	-	724
Mov Cap-2 Maneuver	-	-	-	-
Stage 1	-	-	-	-
Stage 2	-	-	-	-

Approach	EB	WB	NB	SB
HCM Control Delay, s	0.9	0.1	22.5	29.1
HCM LOS			C	D

Minor Lane/Major Mvmt	NBLn1	NBLn2	EBL	EBT	EBR	WBL	WBT	WBR	SBLn1	SBLn2	SBLn3
Capacity (veh/h)	180	544	684	-	-	724	-	-	194	-	-
HCM Lane V/C Ratio	0.169	0.034	0.116	-	-	0.015	-	-	0.234	-	-
HCM Control Delay (s)	29	11.9	11	-	-	10	-	-	29.1	0	0
HCM Lane LOS	D	B	B	-	-	B	-	-	D	A	A
HCM 95th %tile Q(veh)	0.6	0.1	0.4	-	-	0	-	-	0.9	-	-

Intersection												
Int Delay, s/veh	1.1											
Movement	EBL	EBT	EBR	WBL	WBT	WBR	NBL	NBT	NBR	SBL	SBT	SBR
Lane Configurations	↖	↗	↘	↖	↗	↘	↖	↗	↘	↖	↗	↘
Traffic Vol, veh/h	31	952	30	30	942	41	19	0	11	33	0	58
Future Vol, veh/h	31	952	30	30	942	41	19	0	11	33	0	58
Conflicting Peds, #/hr	0	0	0	0	0	0	0	0	0	0	0	0
Sign Control	Free	Free	Free	Free	Free	Free	Stop	Stop	Stop	Stop	Stop	Stop
RT Channelized	-	-	None	-	-	None	-	-	None	-	-	Free
Storage Length	200	-	0	225	-	0	150	-	-	375	-	0
Veh in Median Storage, #	-	0	-	-	0	-	-	2	-	-	2	-
Grade, %	-	0	-	-	0	-	-	0	-	-	0	-
Peak Hour Factor	91	91	92	92	91	91	92	92	92	91	92	91
Heavy Vehicles, %	2	2	2	2	2	2	2	2	2	2	2	2
Mvmt Flow	34	1046	33	33	1035	45	21	0	12	36	0	64

Major/Minor	Major1			Major2			Minor1			Minor2		
Conflicting Flow All	1080	0	0	1079	0	0	1698	2260	523	1692	2248	-
Stage 1	-	-	-	-	-	-	1114	1114	-	1101	1101	-
Stage 2	-	-	-	-	-	-	584	1146	-	591	1147	-
Critical Hdwy	4.14	-	-	4.14	-	-	7.54	6.54	6.94	7.54	6.54	-
Critical Hdwy Stg 1	-	-	-	-	-	-	6.54	5.54	-	6.54	5.54	-
Critical Hdwy Stg 2	-	-	-	-	-	-	6.54	5.54	-	6.54	5.54	-
Follow-up Hdwy	2.22	-	-	2.22	-	-	3.52	4.02	3.32	3.52	4.02	-
Pot Cap-1 Maneuver	641	-	-	642	-	-	60	40	499	60	41	0
Stage 1	-	-	-	-	-	-	222	282	-	226	286	0
Stage 2	-	-	-	-	-	-	465	272	-	460	272	0
Platoon blocked, %	-	-	-	-	-	-	-	-	-	-	-	-
Mov Cap-1 Maneuver	641	-	-	642	-	-	55	36	499	54	37	-
Mov Cap-2 Maneuver	-	-	-	-	-	-	182	165	-	183	167	-
Stage 1	-	-	-	-	-	-	210	267	-	214	271	-
Stage 2	-	-	-	-	-	-	441	258	-	425	258	-

Approach	EB			WB			NB			SB		
HCM Control Delay, s	0.3			0.3			21.8			29.5		
HCM LOS							C			D		

Minor Lane/Major Mvmt	NBLn1	NBLn2	EBL	EBT	EBR	WBL	WBT	WBR	SBLn1	SBLn2	SBLn3
Capacity (veh/h)	182	499	641	-	-	642	-	-	183	-	-
HCM Lane V/C Ratio	0.113	0.024	0.053	-	-	0.051	-	-	0.198	-	-
HCM Control Delay (s)	27.3	12.4	10.9	-	-	10.9	-	-	29.5	0	0
HCM Lane LOS	D	B	B	-	-	B	-	-	D	A	A
HCM 95th %tile Q(veh)	0.4	0.1	0.2	-	-	0.2	-	-	0.7	-	-

Intersection												
Int Delay, s/veh	4.2											
Movement	EBL	EBT	EBR	WBL	WBT	WBR	NBL	NBT	NBR	SBL	SBT	SBR
Lane Configurations	↘	↑↑	↗	↘	↑↑	↗	↘	↗		↘	↑	↗
Traffic Vol, veh/h	108	1264	10	6	1309	60	28	0	17	61	0	154
Future Vol, veh/h	108	1264	10	6	1309	60	28	0	17	61	0	154
Conflicting Peds, #/hr	0	0	0	0	0	0	0	0	0	0	0	0
Sign Control	Free	Free	Free	Free	Free	Free	Stop	Stop	Stop	Stop	Stop	Stop
RT Channelized	-	-	None	-	-	None	-	-	None	-	-	Free
Storage Length	200	-	0	225	-	0	150	-	-	375	-	0
Veh in Median Storage, #	-	0	-	-	0	-	-	2	-	-	2	-
Grade, %	-	0	-	-	0	-	-	0	-	-	0	-
Peak Hour Factor	92	92	92	92	92	92	92	92	92	92	92	92
Heavy Vehicles, %	2	2	2	2	2	2	2	2	2	2	2	2
Mvmt Flow	117	1374	11	7	1423	65	30	0	18	66	0	167

Major/Minor	Major1			Major2			Minor1			Minor2		
Conflicting Flow All	1488	0	0	1385	0	0	2334	3110	687	2358	3056	-
Stage 1	-	-	-	-	-	-	1608	1608	-	1437	1437	-
Stage 2	-	-	-	-	-	-	726	1502	-	921	1619	-
Critical Hdwy	4.14	-	-	4.14	-	-	7.54	6.54	6.94	7.54	6.54	-
Critical Hdwy Stg 1	-	-	-	-	-	-	6.54	5.54	-	6.54	5.54	-
Critical Hdwy Stg 2	-	-	-	-	-	-	6.54	5.54	-	6.54	5.54	-
Follow-up Hdwy	2.22	-	-	2.22	-	-	3.52	4.02	3.32	3.52	4.02	-
Pot Cap-1 Maneuver	448	-	-	490	-	-	~ 20	11	389	~ 19	12	0
Stage 1	-	-	-	-	-	-	109	162	-	140	197	0
Stage 2	-	-	-	-	-	-	382	183	-	291	160	0
Platoon blocked, %	-	-	-	-	-	-	-	-	-	-	-	-
Mov Cap-1 Maneuver	448	-	-	490	-	-	~ 16	8	389	~ 14	9	-
Mov Cap-2 Maneuver	-	-	-	-	-	-	74	53	-	86	89	-
Stage 1	-	-	-	-	-	-	81	120	-	103	194	-
Stage 2	-	-	-	-	-	-	377	180	-	205	118	-

Approach	EB			WB			NB			SB		
HCM Control Delay, s	1.2			0.1			57.9			126.4		
HCM LOS							F			F		

Minor Lane/Major Mvmt	NBLn1	NBLn2	EBL	EBT	EBR	WBL	WBT	WBR	SBLn1	SBLn2	SBLn3
Capacity (veh/h)	74	389	448	-	-	490	-	-	86	-	-
HCM Lane V/C Ratio	0.411	0.048	0.262	-	-	0.013	-	-	0.771	-	-
HCM Control Delay (s)	84.1	14.7	15.9	-	-	12.4	-	-	126.4	0	0
HCM Lane LOS	F	B	C	-	-	B	-	-	F	A	A
HCM 95th %tile Q(veh)	1.6	0.1	1	-	-	0	-	-	3.9	-	-

Notes
 -: Volume exceeds capacity \$: Delay exceeds 300s +: Computation Not Defined *: All major volume in platoon

Intersection												
Int Delay, s/veh	4.1											
Movement	EBL	EBT	EBR	WBL	WBT	WBR	NBL	NBT	NBR	SBL	SBT	SBR
Lane Configurations	↘	↑↑	↗	↘	↑↑	↗	↘	↗		↘	↑	↗
Traffic Vol, veh/h	48	1472	60	48	1456	63	38	0	22	51	0	90
Future Vol, veh/h	48	1472	60	48	1456	63	38	0	22	51	0	90
Conflicting Peds, #/hr	0	0	0	0	0	0	0	0	0	0	0	0
Sign Control	Free	Free	Free	Free	Free	Free	Stop	Stop	Stop	Stop	Stop	Stop
RT Channelized	-	-	None	-	-	None	-	-	None	-	-	Free
Storage Length	200	-	0	225	-	0	150	-	-	375	-	0
Veh in Median Storage, #	-	0	-	-	0	-	-	2	-	-	2	-
Grade, %	-	0	-	-	0	-	-	0	-	-	0	-
Peak Hour Factor	92	92	92	92	92	92	92	92	92	92	92	92
Heavy Vehicles, %	2	2	2	2	2	2	2	2	2	2	2	2
Mvmt Flow	52	1600	65	52	1583	68	41	0	24	55	0	98

Major/Minor	Major1			Major2			Minor1			Minor2		
Conflicting Flow All	1651	0	0	1665	0	0	2600	3459	800	2591	3456	-
Stage 1	-	-	-	-	-	-	1704	1704	-	1687	1687	-
Stage 2	-	-	-	-	-	-	896	1755	-	904	1769	-
Critical Hdwy	4.14	-	-	4.14	-	-	7.54	6.54	6.94	7.54	6.54	-
Critical Hdwy Stg 1	-	-	-	-	-	-	6.54	5.54	-	6.54	5.54	-
Critical Hdwy Stg 2	-	-	-	-	-	-	6.54	5.54	-	6.54	5.54	-
Follow-up Hdwy	2.22	-	-	2.22	-	-	3.52	4.02	3.32	3.52	4.02	-
Pot Cap-1 Maneuver	387	-	-	382	-	-	~ 12	7	328	~ 12	7	0
Stage 1	-	-	-	-	-	-	95	145	-	97	148	0
Stage 2	-	-	-	-	-	-	301	137	-	298	135	0
Platoon blocked, %	-	-	-	-	-	-	-	-	-	-	-	-
Mov Cap-1 Maneuver	387	-	-	382	-	-	~ 10	5	328	~ 9	5	-
Mov Cap-2 Maneuver	-	-	-	-	-	-	72	54	-	72	54	-
Stage 1	-	-	-	-	-	-	82	126	-	84	128	-
Stage 2	-	-	-	-	-	-	260	118	-	239	117	-

Approach	EB			WB			NB			SB		
HCM Control Delay, s	0.5			0.5			74.4			144.7		
HCM LOS							F			F		

Minor Lane/Major Mvmt	NBLn1	NBLn2	EBL	EBT	EBR	WBL	WBT	WBR	SBLn1	SBLn2	SBLn3
Capacity (veh/h)	72	328	387	-	-	382	-	-	72	-	-
HCM Lane V/C Ratio	0.574	0.073	0.135	-	-	0.137	-	-	0.77	-	-
HCM Control Delay (s)	107.8	16.8	15.7	-	-	15.9	-	-	144.7	0	0
HCM Lane LOS	F	C	C	-	-	C	-	-	F	A	A
HCM 95th %tile Q(veh)	2.5	0.2	0.5	-	-	0.5	-	-	3.6	-	-

Notes
 -: Volume exceeds capacity \$: Delay exceeds 300s +: Computation Not Defined *: All major volume in platoon

Timings
1: Akers Dr & Constitution Ave

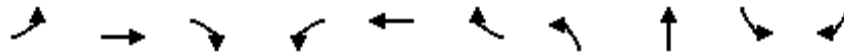

Lane Group	EBL	EBT	EBR	WBL	WBT	WBR	NBL	NBT	SBL	SBR
Lane Configurations	↖	↗	↘	↖	↗	↘	↖	↗	↘	↖
Traffic Volume (vph)	108	1264	20	16	1309	60	56	0	61	154
Future Volume (vph)	108	1264	20	16	1309	60	56	0	61	154
Turn Type	Perm	NA	Perm	Perm	NA	Perm	Perm	NA	Perm	Perm
Protected Phases		4			8			2		
Permitted Phases	4		4	8		8	2		6	6
Detector Phase	4	4	4	8	8	8	2	2	6	6
Switch Phase										
Minimum Initial (s)	5.0	5.0	5.0	5.0	5.0	5.0	5.0	5.0	5.0	5.0
Minimum Split (s)	22.5	22.5	22.5	22.5	22.5	22.5	22.5	22.5	22.5	22.5
Total Split (s)	97.5	97.5	97.5	97.5	97.5	97.5	22.5	22.5	22.5	22.5
Total Split (%)	81.3%	81.3%	81.3%	81.3%	81.3%	81.3%	18.8%	18.8%	18.8%	18.8%
Yellow Time (s)	3.5	3.5	3.5	3.5	3.5	3.5	3.5	3.5	3.5	3.5
All-Red Time (s)	1.0	1.0	1.0	1.0	1.0	1.0	1.0	1.0	1.0	1.0
Lost Time Adjust (s)	0.0	0.0	0.0	0.0	0.0	0.0	0.0	0.0	0.0	0.0
Total Lost Time (s)	4.5	4.5	4.5	4.5	4.5	4.5	4.5	4.5	4.5	4.5
Lead/Lag										
Lead-Lag Optimize?										
Recall Mode	C-Max	C-Max	C-Max	C-Max	C-Max	C-Max	Max	Max	Max	Max
Act Effect Green (s)	93.0	93.0	93.0	93.0	93.0	93.0	18.0	18.0	18.0	18.0
Actuated g/C Ratio	0.78	0.78	0.78	0.78	0.78	0.78	0.15	0.15	0.15	0.15
v/c Ratio	0.52	0.50	0.02	0.07	0.52	0.05	0.29	0.11	0.32	0.53
Control Delay	14.5	5.7	1.2	6.7	20.7	3.8	49.5	0.7	50.5	27.5
Queue Delay	0.0	0.0	0.0	0.0	0.0	0.0	0.0	0.0	0.0	0.0
Total Delay	14.5	5.7	1.2	6.7	20.7	3.8	49.5	0.7	50.5	27.5
LOS	B	A	A	A	C	A	D	A	D	C
Approach Delay		6.3			19.8			31.1		
Approach LOS		A			B			C		

Intersection Summary

Cycle Length: 120
 Actuated Cycle Length: 120
 Offset: 0 (0%), Referenced to phase 4:EBTL and 8:WBTL, Start of Green
 Natural Cycle: 75
 Control Type: Actuated-Coordinated
 Maximum v/c Ratio: 0.53
 Intersection Signal Delay: 15.0
 Intersection Capacity Utilization 63.5%
 Analysis Period (min) 15

Intersection LOS: B
 ICU Level of Service B

Splits and Phases: 1: Akers Dr & Constitution Ave

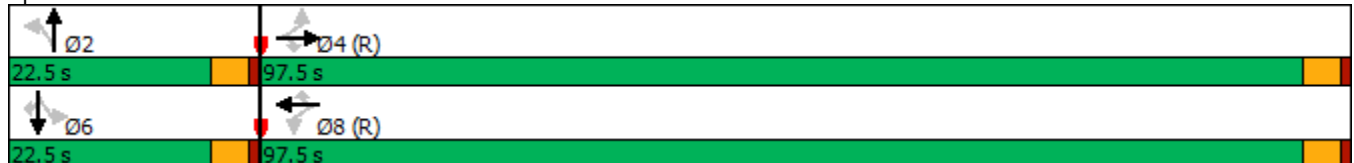

HCM 6th Signalized Intersection Summary

2045 Total AM w Adj. Development.syn

1: Akers Dr & Constitution Ave

12/21/2021

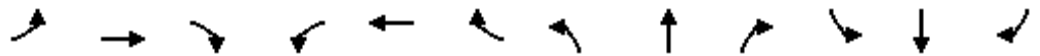

Movement	EBL	EBT	EBR	WBL	WBT	WBR	NBL	NBT	NBR	SBL	SBT	SBR
Lane Configurations	↖	↗	↘	↖	↗	↘	↖	↗	↘	↖	↗	↘
Traffic Volume (veh/h)	108	1264	20	16	1309	60	56	0	34	61	0	154
Future Volume (veh/h)	108	1264	20	16	1309	60	56	0	34	61	0	154
Initial Q (Qb), veh	0	0	0	0	0	0	0	0	0	0	0	0
Ped-Bike Adj(A_pbT)	1.00		1.00	1.00		1.00	1.00		1.00	1.00		1.00
Parking Bus, Adj	1.00	1.00	1.00	1.00	1.00	1.00	1.00	1.00	1.00	1.00	1.00	1.00
Work Zone On Approach		No			No			No			No	
Adj Sat Flow, veh/h/ln	1870	1870	1870	1870	1870	1870	1870	1870	1870	1870	1870	1870
Adj Flow Rate, veh/h	117	1374	22	17	1423	65	61	0	37	66	0	0
Peak Hour Factor	0.92	0.92	0.92	0.92	0.92	0.92	0.92	0.92	0.92	0.92	0.92	0.92
Percent Heavy Veh, %	2	2	2	2	2	2	2	2	2	2	2	2
Cap, veh/h	281	2754	1228	305	2754	1228	273	0	238	238	281	
Arrive On Green	0.77	0.77	0.77	0.77	0.77	0.77	0.15	0.00	0.15	0.15	0.00	0.00
Sat Flow, veh/h	354	3554	1585	387	3554	1585	1418	0	1585	1371	1870	1585
Grp Volume(v), veh/h	117	1374	22	17	1423	65	61	0	37	66	0	0
Grp Sat Flow(s),veh/h/ln	354	1777	1585	387	1777	1585	1418	0	1585	1371	1870	1585
Q Serve(g_s), s	22.2	17.0	0.4	2.0	18.0	1.2	4.6	0.0	2.4	5.3	0.0	0.0
Cycle Q Clear(g_c), s	40.3	17.0	0.4	19.0	18.0	1.2	4.6	0.0	2.4	7.7	0.0	0.0
Prop In Lane	1.00		1.00	1.00		1.00	1.00		1.00	1.00		1.00
Lane Grp Cap(c), veh/h	281	2754	1228	305	2754	1228	273	0	238	238	281	
V/C Ratio(X)	0.42	0.50	0.02	0.06	0.52	0.05	0.22	0.00	0.16	0.28	0.00	
Avail Cap(c_a), veh/h	281	2754	1228	305	2754	1228	273	0	238	238	281	
HCM Platoon Ratio	1.00	1.00	1.00	1.00	1.00	1.00	1.00	1.00	1.00	1.00	1.00	1.00
Upstream Filter(l)	1.00	1.00	1.00	0.09	0.09	0.09	1.00	0.00	1.00	1.00	0.00	0.00
Uniform Delay (d), s/veh	12.6	5.0	3.1	8.4	5.1	3.2	45.3	0.0	44.4	47.7	0.0	0.0
Incr Delay (d2), s/veh	4.5	0.6	0.0	0.0	0.1	0.0	1.9	0.0	1.4	2.9	0.0	0.0
Initial Q Delay(d3),s/veh	0.0	0.0	0.0	0.0	0.0	0.0	0.0	0.0	0.0	0.0	0.0	0.0
%ile BackOfQ(50%),veh/ln	2.0	5.4	0.1	0.2	5.5	0.3	1.8	0.0	1.1	2.0	0.0	0.0
Unsig. Movement Delay, s/veh												
LnGrp Delay(d),s/veh	17.1	5.6	3.1	8.5	5.1	3.2	47.2	0.0	45.8	50.6	0.0	0.0
LnGrp LOS	B	A	A	A	A	A	D	A	D	D	A	
Approach Vol, veh/h		1513			1505			98			66	A
Approach Delay, s/veh		6.5			5.1			46.7			50.6	
Approach LOS		A			A			D			D	
Timer - Assigned Phs		2		4		6		8				
Phs Duration (G+Y+Rc), s		22.5		97.5		22.5		97.5				
Change Period (Y+Rc), s		4.5		4.5		4.5		4.5				
Max Green Setting (Gmax), s		18.0		93.0		18.0		93.0				
Max Q Clear Time (g_c+I1), s		6.6		42.3		9.7		21.0				
Green Ext Time (p_c), s		0.2		20.6		0.1		19.0				

Intersection Summary

HCM 6th Ctrl Delay	8.0
HCM 6th LOS	A

Notes

Unsignalized Delay for [SBR] is excluded from calculations of the approach delay and intersection delay.

Timings
1: Akers Dr & Constitution Ave

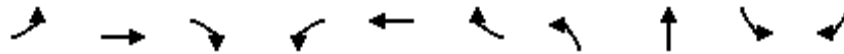

Lane Group	EBL	EBT	EBR	WBL	WBT	WBR	NBL	NBT	SBL	SBR
Lane Configurations	↖	↗	↘	↖	↗	↘	↖	↗	↘	↖
Traffic Volume (vph)	48	1472	60	48	1456	63	38	0	51	90
Future Volume (vph)	48	1472	60	48	1456	63	38	0	51	90
Turn Type	Perm	NA	Perm	Perm	NA	Perm	Perm	NA	Perm	Perm
Protected Phases		4			8			2		
Permitted Phases	4		4	8		8	2		6	6
Detector Phase	4	4	4	8	8	8	2	2	6	6
Switch Phase										
Minimum Initial (s)	5.0	5.0	5.0	5.0	5.0	5.0	5.0	5.0	5.0	5.0
Minimum Split (s)	22.5	22.5	22.5	22.5	22.5	22.5	22.5	22.5	22.5	22.5
Total Split (s)	94.0	94.0	94.0	94.0	94.0	94.0	26.0	26.0	26.0	26.0
Total Split (%)	78.3%	78.3%	78.3%	78.3%	78.3%	78.3%	21.7%	21.7%	21.7%	21.7%
Yellow Time (s)	3.5	3.5	3.5	3.5	3.5	3.5	3.5	3.5	3.5	3.5
All-Red Time (s)	1.0	1.0	1.0	1.0	1.0	1.0	1.0	1.0	1.0	1.0
Lost Time Adjust (s)	0.0	0.0	0.0	0.0	0.0	0.0	0.0	0.0	0.0	0.0
Total Lost Time (s)	4.5	4.5	4.5	4.5	4.5	4.5	4.5	4.5	4.5	4.5
Lead/Lag										
Lead-Lag Optimize?										
Recall Mode	C-Max	C-Max	C-Max	C-Max	C-Max	C-Max	Max	Max	Max	Max
Act Effct Green (s)	89.5	89.5	89.5	89.5	89.5	89.5	21.5	21.5	21.5	21.5
Actuated g/C Ratio	0.75	0.75	0.75	0.75	0.75	0.75	0.18	0.18	0.18	0.18
v/c Ratio	0.31	0.61	0.05	0.32	0.60	0.06	0.16	0.07	0.22	0.29
Control Delay	10.8	8.3	1.1	13.8	14.4	4.9	43.7	0.4	44.9	20.1
Queue Delay	0.0	0.0	0.0	0.0	0.0	0.0	0.0	0.0	0.0	0.0
Total Delay	10.8	8.3	1.1	13.8	14.4	4.9	43.7	0.4	44.9	20.1
LOS	B	A	A	B	B	A	D	A	D	C
Approach Delay		8.1			14.0			27.7		
Approach LOS		A			B			C		

Intersection Summary

Cycle Length: 120
 Actuated Cycle Length: 120
 Offset: 28 (23%), Referenced to phase 4:EBTL and 8:WBTL, Start of Green
 Natural Cycle: 60
 Control Type: Actuated-Coordinated
 Maximum v/c Ratio: 0.61
 Intersection Signal Delay: 12.1
 Intersection LOS: B
 Intersection Capacity Utilization 61.2%
 ICU Level of Service B
 Analysis Period (min) 15

Splits and Phases: 1: Akers Dr & Constitution Ave

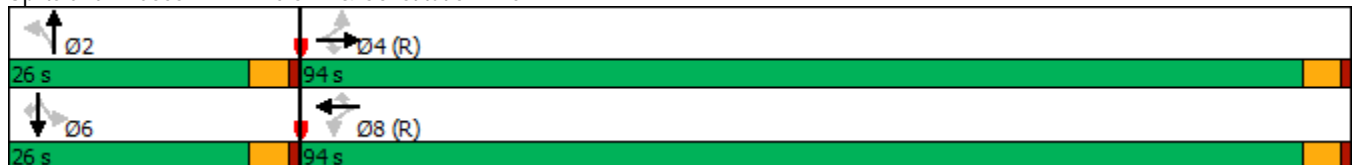

HCM 6th Signalized Intersection Summary
 1: Akers Dr & Constitution Ave

2045 Total PM w Adj. Development.syn

12/21/2021

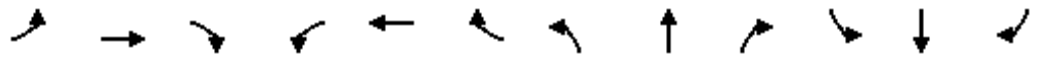

Movement	EBL	EBT	EBR	WBL	WBT	WBR	NBL	NBT	NBR	SBL	SBT	SBR
Lane Configurations	↖	↗	↘	↖	↗	↘	↖	↗	↘	↖	↗	↘
Traffic Volume (veh/h)	48	1472	60	48	1456	63	38	0	22	51	0	90
Future Volume (veh/h)	48	1472	60	48	1456	63	38	0	22	51	0	90
Initial Q (Qb), veh	0	0	0	0	0	0	0	0	0	0	0	0
Ped-Bike Adj(A_pbT)	1.00		1.00	1.00		1.00	1.00		1.00	1.00		1.00
Parking Bus, Adj	1.00	1.00	1.00	1.00	1.00	1.00	1.00	1.00	1.00	1.00	1.00	1.00
Work Zone On Approach		No			No			No			No	
Adj Sat Flow, veh/h/ln	1870	1870	1870	1870	1870	1870	1870	1870	1870	1870	1870	1870
Adj Flow Rate, veh/h	52	1600	65	52	1583	68	41	0	24	55	0	0
Peak Hour Factor	0.92	0.92	0.92	0.92	0.92	0.92	0.92	0.92	0.92	0.92	0.92	0.92
Percent Heavy Veh, %	2	2	2	2	2	2	2	2	2	2	2	2
Cap, veh/h	224	2650	1182	220	2650	1182	314	0	284	291	335	
Arrive On Green	0.75	0.75	0.75	0.75	0.75	0.75	0.18	0.00	0.18	0.18	0.00	0.00
Sat Flow, veh/h	302	3554	1585	298	3554	1585	1418	0	1585	1387	1870	1585
Grp Volume(v), veh/h	52	1600	65	52	1583	68	41	0	24	55	0	0
Grp Sat Flow(s),veh/h/ln	302	1777	1585	298	1777	1585	1418	0	1585	1387	1870	1585
Q Serve(g_s), s	11.4	25.0	1.3	11.7	24.5	1.4	2.9	0.0	1.5	4.1	0.0	0.0
Cycle Q Clear(g_c), s	35.9	25.0	1.3	36.7	24.5	1.4	2.9	0.0	1.5	5.6	0.0	0.0
Prop In Lane	1.00		1.00	1.00		1.00	1.00		1.00	1.00		1.00
Lane Grp Cap(c), veh/h	224	2650	1182	220	2650	1182	314	0	284	291	335	
V/C Ratio(X)	0.23	0.60	0.05	0.24	0.60	0.06	0.13	0.00	0.08	0.19	0.00	
Avail Cap(c_a), veh/h	224	2650	1182	220	2650	1182	314	0	284	291	335	
HCM Platoon Ratio	1.00	1.00	1.00	1.00	1.00	1.00	1.00	1.00	1.00	1.00	1.00	1.00
Upstream Filter(I)	1.00	1.00	1.00	0.21	0.21	0.21	1.00	0.00	1.00	1.00	0.00	0.00
Uniform Delay (d), s/veh	15.2	7.1	4.0	15.5	7.0	4.0	41.6	0.0	41.0	43.4	0.0	0.0
Incr Delay (d2), s/veh	2.4	1.0	0.1	0.5	0.2	0.0	0.9	0.0	0.6	1.4	0.0	0.0
Initial Q Delay(d3),s/veh	0.0	0.0	0.0	0.0	0.0	0.0	0.0	0.0	0.0	0.0	0.0	0.0
%ile BackOfQ(50%),veh/ln	0.9	8.5	0.4	0.8	8.0	0.4	1.1	0.0	0.6	1.5	0.0	0.0
Unsig. Movement Delay, s/veh												
LnGrp Delay(d),s/veh	17.6	8.1	4.1	16.1	7.2	4.1	42.5	0.0	41.6	44.8	0.0	0.0
LnGrp LOS	B	A	A	B	A	A	D	A	D	D	A	
Approach Vol, veh/h		1717			1703			65			55	A
Approach Delay, s/veh		8.2			7.3			42.2			44.8	
Approach LOS		A			A			D			D	
Timer - Assigned Phs		2		4		6		8				
Phs Duration (G+Y+Rc), s		26.0		94.0		26.0		94.0				
Change Period (Y+Rc), s		4.5		4.5		4.5		4.5				
Max Green Setting (Gmax), s		21.5		89.5		21.5		89.5				
Max Q Clear Time (g_c+I1), s		4.9		37.9		7.6		38.7				
Green Ext Time (p_c), s		0.1		23.6		0.1		23.1				

Intersection Summary

HCM 6th Ctrl Delay	9.0
HCM 6th LOS	A

Notes

Unsignalized Delay for [SBR] is excluded from calculations of the approach delay and intersection delay.

HCM 6th Signalized Intersection Summary
2: Marksheffel Rd & Constitution Ave

2021 Existing AM.syn
12/21/2021



Movement	EBL	EBT	EBR	WBL	WBT	WBR	NBL	NBT	NBR	SBL	SBT	SBR
Lane Configurations	↘	↑↑	↗	↘	↑↑	↗	↘↗	↑↑	↗	↘↗	↑↑	↗
Traffic Volume (veh/h)	135	334	325	93	455	206	313	724	32	191	1341	115
Future Volume (veh/h)	135	334	325	93	455	206	313	724	32	191	1341	115
Initial Q (Qb), veh	0	0	0	0	0	0	0	0	0	0	0	0
Ped-Bike Adj(A_pbT)	1.00		1.00	1.00		1.00	1.00		1.00	1.00		1.00
Parking Bus, Adj	1.00	1.00	1.00	1.00	1.00	1.00	1.00	1.00	1.00	1.00	1.00	1.00
Work Zone On Approach		No			No			No			No	
Adj Sat Flow, veh/h/ln	1870	1870	1870	1870	1870	1870	1870	1870	1870	1870	1870	1870
Adj Flow Rate, veh/h	144	355	0	99	484	0	333	770	0	203	1427	0
Peak Hour Factor	0.94	0.94	0.94	0.94	0.94	0.94	0.94	0.94	0.94	0.94	0.94	0.94
Percent Heavy Veh, %	2	2	2	2	2	2	2	2	2	2	2	2
Cap, veh/h	199	587		242	551		374	1786		262	1670	
Arrive On Green	0.07	0.17	0.00	0.06	0.15	0.00	0.11	0.50	0.00	0.08	0.47	0.00
Sat Flow, veh/h	1781	3554	1585	1781	3554	1585	3456	3554	1585	3456	3554	1585
Grp Volume(v), veh/h	144	355	0	99	484	0	333	770	0	203	1427	0
Grp Sat Flow(s),veh/h/ln	1781	1777	1585	1781	1777	1585	1728	1777	1585	1728	1777	1585
Q Serve(g_s), s	8.0	11.1	0.0	5.5	16.0	0.0	11.4	16.5	0.0	6.9	42.7	0.0
Cycle Q Clear(g_c), s	8.0	11.1	0.0	5.5	16.0	0.0	11.4	16.5	0.0	6.9	42.7	0.0
Prop In Lane	1.00		1.00	1.00		1.00	1.00		1.00	1.00		1.00
Lane Grp Cap(c), veh/h	199	587		242	551		374	1786		262	1670	
V/C Ratio(X)	0.73	0.61		0.41	0.88		0.89	0.43		0.77	0.85	
Avail Cap(c_a), veh/h	199	587		269	589		374	1786		346	1670	
HCM Platoon Ratio	1.00	1.00	1.00	1.00	1.00	1.00	1.00	1.00	1.00	1.00	1.00	1.00
Upstream Filter(I)	1.00	1.00	0.00	1.00	1.00	0.00	1.00	1.00	0.00	1.00	1.00	0.00
Uniform Delay (d), s/veh	41.2	46.5	0.0	39.5	49.6	0.0	52.8	19.0	0.0	54.4	28.2	0.0
Incr Delay (d2), s/veh	12.4	1.8	0.0	1.1	13.7	0.0	22.1	0.8	0.0	7.8	5.8	0.0
Initial Q Delay(d3),s/veh	0.0	0.0	0.0	0.0	0.0	0.0	0.0	0.0	0.0	0.0	0.0	0.0
%ile BackOfQ(50%),veh/ln	4.3	5.1	0.0	2.5	8.1	0.0	6.1	6.9	0.0	3.3	18.9	0.0
Unsig. Movement Delay, s/veh												
LnGrp Delay(d),s/veh	53.6	48.2	0.0	40.6	63.2	0.0	74.9	19.7	0.0	62.2	34.0	0.0
LnGrp LOS	D	D		D	E		E	B		E	C	
Approach Vol, veh/h		499	A		583	A		1103	A		1630	A
Approach Delay, s/veh		49.8			59.4			36.4			37.5	
Approach LOS		D			E			D			D	
Timer - Assigned Phs	1	2	3	4	5	6	7	8				
Phs Duration (G+Y+Rc), s	15.1	66.3	12.8	25.8	19.0	62.4	14.0	24.6				
Change Period (Y+Rc), s	6.0	6.0	5.5	6.0	6.0	6.0	6.0	* 6				
Max Green Setting (Gmax), s	12.0	56.6	9.1	18.8	13.0	55.6	8.0	* 20				
Max Q Clear Time (g_c+I1), s	8.9	18.5	7.5	13.1	13.4	44.7	10.0	18.0				
Green Ext Time (p_c), s	0.2	6.4	0.0	1.1	0.0	7.2	0.0	0.6				

Intersection Summary

HCM 6th Ctrl Delay	42.1
HCM 6th LOS	D

Notes

* HCM 6th computational engine requires equal clearance times for the phases crossing the barrier.
Unsignalized Delay for [NBR, EBR, WBR, SBR] is excluded from calculations of the approach delay and intersection delay.

HCM 6th Signalized Intersection Summary
2: Marksheffel Rd & Constitution Ave

2021 Existing PM.syn
12/21/2021



Movement	EBL	EBT	EBR	WBL	WBT	WBR	NBL	NBT	NBR	SBL	SBT	SBR
Lane Configurations	↖	↗	↘	↖	↗	↘	↖	↗	↘	↖	↗	↘
Traffic Volume (veh/h)	114	560	258	123	459	269	371	1269	46	215	739	110
Future Volume (veh/h)	114	560	258	123	459	269	371	1269	46	215	739	110
Initial Q (Qb), veh	0	0	0	0	0	0	0	0	0	0	0	0
Ped-Bike Adj(A_pbT)	1.00		1.00	1.00		1.00	1.00		1.00	1.00		1.00
Parking Bus, Adj	1.00	1.00	1.00	1.00	1.00	1.00	1.00	1.00	1.00	1.00	1.00	1.00
Work Zone On Approach		No			No			No			No	
Adj Sat Flow, veh/h/ln	1870	1870	1870	1870	1870	1870	1870	1870	1870	1870	1870	1870
Adj Flow Rate, veh/h	121	596	0	131	488	0	395	1350	0	229	786	0
Peak Hour Factor	0.94	0.94	0.94	0.94	0.94	0.94	0.94	0.94	0.94	0.94	0.94	0.94
Percent Heavy Veh, %	2	2	2	2	2	2	2	2	2	2	2	2
Cap, veh/h	236	668		212	680		462	1635		283	1451	
Arrive On Green	0.07	0.19	0.00	0.07	0.19	0.00	0.13	0.46	0.00	0.08	0.41	0.00
Sat Flow, veh/h	1781	3554	1585	1781	3554	1585	3456	3554	1585	3456	3554	1585
Grp Volume(v), veh/h	121	596	0	131	488	0	395	1350	0	229	786	0
Grp Sat Flow(s),veh/h/ln	1781	1777	1585	1781	1777	1585	1728	1777	1585	1728	1777	1585
Q Serve(g_s), s	6.5	19.6	0.0	7.0	15.4	0.0	13.4	39.7	0.0	7.8	20.2	0.0
Cycle Q Clear(g_c), s	6.5	19.6	0.0	7.0	15.4	0.0	13.4	39.7	0.0	7.8	20.2	0.0
Prop In Lane	1.00		1.00	1.00		1.00	1.00		1.00	1.00		1.00
Lane Grp Cap(c), veh/h	236	668		212	680		462	1635		283	1451	
V/C Ratio(X)	0.51	0.89		0.62	0.72		0.85	0.83		0.81	0.54	
Avail Cap(c_a), veh/h	236	711		212	737		576	1635		288	1451	
HCM Platoon Ratio	1.00	1.00	1.00	1.00	1.00	1.00	1.00	1.00	1.00	1.00	1.00	1.00
Upstream Filter(l)	1.00	1.00	0.00	1.00	1.00	0.00	1.00	1.00	0.00	1.00	1.00	0.00
Uniform Delay (d), s/veh	36.9	47.5	0.0	37.2	45.5	0.0	50.8	28.2	0.0	54.2	27.0	0.0
Incr Delay (d2), s/veh	1.9	13.1	0.0	5.3	3.1	0.0	10.1	4.9	0.0	15.5	1.5	0.0
Initial Q Delay(d3),s/veh	0.0	0.0	0.0	0.0	0.0	0.0	0.0	0.0	0.0	0.0	0.0	0.0
%ile BackOfQ(50%),veh/ln	3.0	9.9	0.0	3.4	7.1	0.0	6.4	17.6	0.0	4.0	8.8	0.0
Unsig. Movement Delay, s/veh												
LnGrp Delay(d),s/veh	38.7	60.6	0.0	42.5	48.6	0.0	60.9	33.1	0.0	69.7	28.4	0.0
LnGrp LOS	D	E		D	D		E	C		E	C	
Approach Vol, veh/h		717	A		619	A		1745	A		1015	A
Approach Delay, s/veh		56.9			47.3			39.4			37.7	
Approach LOS		E			D			D			D	
Timer - Assigned Phs	1	2	3	4	5	6	7	8				
Phs Duration (G+Y+Rc), s	15.8	61.2	14.4	28.6	22.0	55.0	14.0	29.0				
Change Period (Y+Rc), s	6.0	6.0	5.5	6.0	6.0	6.0	6.0	* 6				
Max Green Setting (Gmax), s	10.0	53.6	8.9	24.0	20.0	43.6	8.0	* 25				
Max Q Clear Time (g_c+I1), s	9.8	41.7	9.0	21.6	15.4	22.2	8.5	17.4				
Green Ext Time (p_c), s	0.0	7.4	0.0	0.9	0.6	5.7	0.0	1.9				

Intersection Summary

HCM 6th Ctrl Delay	43.2
HCM 6th LOS	D

Notes

* HCM 6th computational engine requires equal clearance times for the phases crossing the barrier.
Unsignalized Delay for [NBR, EBR, WBR, SBR] is excluded from calculations of the approach delay and intersection delay.

Timings
2: Marksheffel Rd & Constitution Ave

Lane Group	EBL	EBT	EBR	WBL	WBT	WBR	NBL	NBT	NBR	SBL	SBT	SBR
Lane Configurations												
Traffic Volume (vph)	140	347	338	97	473	214	326	753	33	199	1395	120
Future Volume (vph)	140	347	338	97	473	214	326	753	33	199	1395	120
Turn Type	pm+pt	NA	Free	pm+pt	NA	Free	Prot	NA	Free	Prot	NA	Free
Protected Phases	7	4		3	8		5	2		1	6	
Permitted Phases	4		Free	8		Free			Free			Free
Detector Phase	7	4		3	8		5	2		1	6	
Switch Phase												
Minimum Initial (s)	5.0	5.0		5.0	5.0		5.0	5.0		5.0	5.0	
Minimum Split (s)	11.0	24.0		10.5	23.5		11.0	24.0		11.0	24.0	
Total Split (s)	14.0	24.8		14.6	25.4		19.0	62.6		18.0	61.6	
Total Split (%)	11.7%	20.7%		12.2%	21.2%		15.8%	52.2%		15.0%	51.3%	
Yellow Time (s)	4.5	4.5		4.5	4.5		4.5	4.5		4.5	4.5	
All-Red Time (s)	1.5	1.5		1.0	1.0		1.5	1.5		1.5	1.5	
Lost Time Adjust (s)	0.0	0.0		0.0	0.0		0.0	0.0		0.0	0.0	
Total Lost Time (s)	6.0	6.0		5.5	5.5		6.0	6.0		6.0	6.0	
Lead/Lag	Lead	Lag		Lead	Lag		Lead	Lag		Lead	Lag	
Lead-Lag Optimize?	Yes	Yes		Yes	Yes		Yes	Yes		Yes	Yes	
Recall Mode	None	None		None	None		None	C-Max		None	C-Max	
Act Effct Green (s)	26.7	18.7	120.0	28.1	19.4	120.0	13.4	57.8	120.0	11.3	55.7	120.0
Actuated g/C Ratio	0.22	0.16	1.00	0.23	0.16	1.00	0.11	0.48	1.00	0.09	0.46	1.00
v/c Ratio	0.83	0.67	0.23	0.44	0.88	0.14	0.91	0.47	0.02	0.66	0.90	0.08
Control Delay	71.5	54.4	0.3	39.4	66.7	0.2	81.3	22.2	0.0	62.6	38.8	0.1
Queue Delay	0.0	0.0	0.0	0.0	0.0	0.0	0.0	0.0	0.0	0.0	0.0	0.0
Total Delay	71.5	54.4	0.3	39.4	66.7	0.2	81.3	22.2	0.0	62.6	38.8	0.1
LOS	E	D	A	D	E	A	F	C	A	E	D	A
Approach Delay		35.1			45.2			38.9			38.8	
Approach LOS		D			D			D			D	

Intersection Summary

Cycle Length: 120
 Actuated Cycle Length: 120
 Offset: 0 (0%), Referenced to phase 2:NBT and 6:SBT, Start of Green
 Natural Cycle: 90
 Control Type: Actuated-Coordinated
 Maximum v/c Ratio: 0.91
 Intersection Signal Delay: 39.3
 Intersection LOS: D
 Intersection Capacity Utilization 88.3%
 ICU Level of Service E
 Analysis Period (min) 15

Splits and Phases: 2: Marksheffel Rd & Constitution Ave



HCM 6th Signalized Intersection Summary
 2: Marksheffel Rd & Constitution Ave

2023 Background AM.syn

12/21/2021

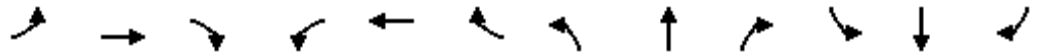

Movement	EBL	EBT	EBR	WBL	WBT	WBR	NBL	NBT	NBR	SBL	SBT	SBR
Lane Configurations	↘	↑↑	↗	↘	↑↑	↗	↘↗	↑↑	↗	↘↗	↑↑	↗
Traffic Volume (veh/h)	140	347	338	97	473	214	326	753	33	199	1395	120
Future Volume (veh/h)	140	347	338	97	473	214	326	753	33	199	1395	120
Initial Q (Qb), veh	0	0	0	0	0	0	0	0	0	0	0	0
Ped-Bike Adj(A_pbT)	1.00		1.00	1.00		1.00	1.00		1.00	1.00		1.00
Parking Bus, Adj	1.00	1.00	1.00	1.00	1.00	1.00	1.00	1.00	1.00	1.00	1.00	1.00
Work Zone On Approach		No			No			No			No	
Adj Sat Flow, veh/h/ln	1870	1870	1870	1870	1870	1870	1870	1870	1870	1870	1870	1870
Adj Flow Rate, veh/h	149	369	0	103	503	0	347	801	0	212	1484	0
Peak Hour Factor	0.94	0.94	0.94	0.94	0.94	0.94	0.94	0.94	0.94	0.94	0.94	0.94
Percent Heavy Veh, %	2	2	2	2	2	2	2	2	2	2	2	2
Cap, veh/h	197	594		243	565		374	1763		271	1656	
Arrive On Green	0.07	0.17	0.00	0.06	0.16	0.00	0.11	0.50	0.00	0.08	0.47	0.00
Sat Flow, veh/h	1781	3554	1585	1781	3554	1585	3456	3554	1585	3456	3554	1585
Grp Volume(v), veh/h	149	369	0	103	503	0	347	801	0	212	1484	0
Grp Sat Flow(s),veh/h/ln	1781	1777	1585	1781	1777	1585	1728	1777	1585	1728	1777	1585
Q Serve(g_s), s	8.0	11.6	0.0	5.7	16.6	0.0	11.9	17.6	0.0	7.2	45.9	0.0
Cycle Q Clear(g_c), s	8.0	11.6	0.0	5.7	16.6	0.0	11.9	17.6	0.0	7.2	45.9	0.0
Prop In Lane	1.00		1.00	1.00		1.00	1.00		1.00	1.00		1.00
Lane Grp Cap(c), veh/h	197	594		243	565		374	1763		271	1656	
V/C Ratio(X)	0.76	0.62		0.42	0.89		0.93	0.45		0.78	0.90	
Avail Cap(c_a), veh/h	197	594		267	589		374	1763		346	1656	
HCM Platoon Ratio	1.00	1.00	1.00	1.00	1.00	1.00	1.00	1.00	1.00	1.00	1.00	1.00
Upstream Filter(l)	1.00	1.00	0.00	1.00	1.00	0.00	1.00	1.00	0.00	1.00	1.00	0.00
Uniform Delay (d), s/veh	41.5	46.4	0.0	39.1	49.4	0.0	53.0	19.7	0.0	54.3	29.4	0.0
Incr Delay (d2), s/veh	15.4	2.0	0.0	1.2	15.3	0.0	28.8	0.8	0.0	8.7	8.0	0.0
Initial Q Delay(d3),s/veh	0.0	0.0	0.0	0.0	0.0	0.0	0.0	0.0	0.0	0.0	0.0	0.0
%ile BackOfQ(50%),veh/ln	4.6	5.3	0.0	2.6	8.6	0.0	6.7	7.4	0.0	3.5	20.8	0.0
Unsig. Movement Delay, s/veh												
LnGrp Delay(d),s/veh	56.9	48.4	0.0	40.3	64.7	0.0	81.8	20.5	0.0	63.0	37.4	0.0
LnGrp LOS	E	D		D	E		F	C		E	D	
Approach Vol, veh/h		518	A		606	A		1148	A		1696	A
Approach Delay, s/veh		50.9			60.6			39.0			40.6	
Approach LOS		D			E			D			D	
Timer - Assigned Phs	1	2	3	4	5	6	7	8				
Phs Duration (G+Y+Rc), s	15.4	65.5	13.0	26.1	19.0	61.9	14.0	25.1				
Change Period (Y+Rc), s	6.0	6.0	5.5	6.0	6.0	6.0	6.0	* 6				
Max Green Setting (Gmax), s	12.0	56.6	9.1	18.8	13.0	55.6	8.0	* 20				
Max Q Clear Time (g_c+I1), s	9.2	19.6	7.7	13.6	13.9	47.9	10.0	18.6				
Green Ext Time (p_c), s	0.2	6.7	0.0	1.0	0.0	5.6	0.0	0.4				

Intersection Summary

HCM 6th Ctrl Delay	44.5
HCM 6th LOS	D

Notes

* HCM 6th computational engine requires equal clearance times for the phases crossing the barrier.
 Unsignalized Delay for [NBR, EBR, WBR, SBR] is excluded from calculations of the approach delay and intersection delay.

Timings
2: Marksheffel Rd & Constitution Ave

Lane Group	EBL	EBT	EBR	WBL	WBT	WBR	NBL	NBT	NBR	SBL	SBT	SBR
Lane Configurations												
Traffic Volume (vph)	119	583	268	128	478	280	386	1320	48	224	769	114
Future Volume (vph)	119	583	268	128	478	280	386	1320	48	224	769	114
Turn Type	pm+pt	NA	Free	pm+pt	NA	Free	Prot	NA	Free	Prot	NA	Free
Protected Phases	7	4		3	8		5	2		1	6	
Permitted Phases	4		Free	8		Free			Free			Free
Detector Phase	7	4		3	8		5	2		1	6	
Switch Phase												
Minimum Initial (s)	5.0	5.0		5.0	5.0		5.0	5.0		5.0	5.0	
Minimum Split (s)	11.0	24.0		10.5	23.5		11.0	24.0		11.0	24.0	
Total Split (s)	14.0	30.0		14.4	30.4		26.0	59.6		16.0	49.6	
Total Split (%)	11.7%	25.0%		12.0%	25.3%		21.7%	49.7%		13.3%	41.3%	
Yellow Time (s)	4.5	4.5		4.5	4.5		4.5	4.5		4.5	4.5	
All-Red Time (s)	1.5	1.5		1.0	1.0		1.5	1.5		1.5	1.5	
Lost Time Adjust (s)	0.0	0.0		0.0	0.0		0.0	0.0		0.0	0.0	
Total Lost Time (s)	6.0	6.0		5.5	5.5		6.0	6.0		6.0	6.0	
Lead/Lag	Lead	Lag		Lead	Lag		Lead	Lag		Lead	Lag	
Lead-Lag Optimize?	Yes	Yes		Yes	Yes		Yes	Yes		Yes	Yes	
Recall Mode	None	None		None	None		None	C-Max		None	C-Max	
Act Effct Green (s)	31.4	23.4	120.0	33.1	24.3	120.0	18.3	54.2	120.0	10.1	45.9	120.0
Actuated g/C Ratio	0.26	0.20	1.00	0.28	0.20	1.00	0.15	0.45	1.00	0.08	0.38	1.00
v/c Ratio	0.61	0.90	0.18	0.71	0.71	0.19	0.78	0.88	0.03	0.82	0.60	0.08
Control Delay	44.7	64.3	0.2	51.8	50.7	0.3	60.0	37.8	0.0	77.1	32.6	0.1
Queue Delay	0.0	0.0	0.0	0.0	0.0	0.0	0.0	0.0	0.0	0.0	0.0	0.0
Total Delay	44.7	64.3	0.2	51.8	50.7	0.3	60.0	37.8	0.0	77.1	32.6	0.1
LOS	D	E	A	D	D	A	E	D	A	E	C	A
Approach Delay		44.2			34.9			41.7			38.3	
Approach LOS		D			C			D			D	

Intersection Summary

Cycle Length: 120
 Actuated Cycle Length: 120
 Offset: 0 (0%), Referenced to phase 2:NBT and 6:SBT, Start of Green
 Natural Cycle: 90
 Control Type: Actuated-Coordinated
 Maximum v/c Ratio: 0.90
 Intersection Signal Delay: 40.1
 Intersection LOS: D
 Intersection Capacity Utilization 85.7%
 ICU Level of Service E
 Analysis Period (min) 15

Splits and Phases: 2: Marksheffel Rd & Constitution Ave

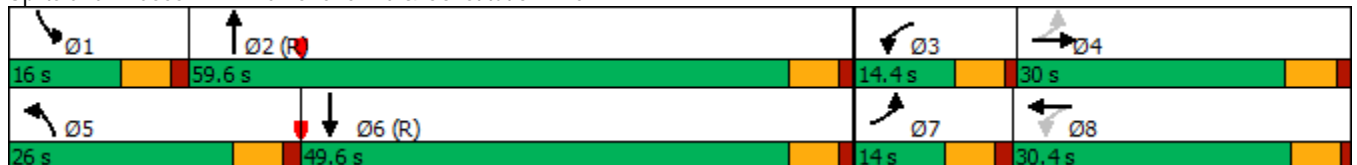

HCM 6th Signalized Intersection Summary
 2: Marksheffel Rd & Constitution Ave

2023 Background PM.syn

12/21/2021

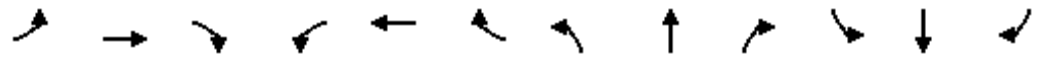

Movement	EBL	EBT	EBR	WBL	WBT	WBR	NBL	NBT	NBR	SBL	SBT	SBR
Lane Configurations	↖	↗	↘	↖	↗	↘	↖	↗	↘	↖	↗	↘
Traffic Volume (veh/h)	119	583	268	128	478	280	386	1320	48	224	769	114
Future Volume (veh/h)	119	583	268	128	478	280	386	1320	48	224	769	114
Initial Q (Qb), veh	0	0	0	0	0	0	0	0	0	0	0	0
Ped-Bike Adj(A_pbT)	1.00		1.00	1.00		1.00	1.00		1.00	1.00		1.00
Parking Bus, Adj	1.00	1.00	1.00	1.00	1.00	1.00	1.00	1.00	1.00	1.00	1.00	1.00
Work Zone On Approach		No			No			No			No	
Adj Sat Flow, veh/h/ln	1870	1870	1870	1870	1870	1870	1870	1870	1870	1870	1870	1870
Adj Flow Rate, veh/h	127	620	0	136	509	0	411	1404	0	238	818	0
Peak Hour Factor	0.94	0.94	0.94	0.94	0.94	0.94	0.94	0.94	0.94	0.94	0.94	0.94
Percent Heavy Veh, %	2	2	2	2	2	2	2	2	2	2	2	2
Cap, veh/h	234	685		210	696		477	1613		288	1419	
Arrive On Green	0.07	0.19	0.00	0.07	0.20	0.00	0.14	0.45	0.00	0.08	0.40	0.00
Sat Flow, veh/h	1781	3554	1585	1781	3554	1585	3456	3554	1585	3456	3554	1585
Grp Volume(v), veh/h	127	620	0	136	509	0	411	1404	0	238	818	0
Grp Sat Flow(s),veh/h/ln	1781	1777	1585	1781	1777	1585	1728	1777	1585	1728	1777	1585
Q Serve(g_s), s	6.8	20.5	0.0	7.3	16.1	0.0	14.0	42.8	0.0	8.1	21.6	0.0
Cycle Q Clear(g_c), s	6.8	20.5	0.0	7.3	16.1	0.0	14.0	42.8	0.0	8.1	21.6	0.0
Prop In Lane	1.00		1.00	1.00		1.00	1.00		1.00	1.00		1.00
Lane Grp Cap(c), veh/h	234	685		210	696		477	1613		288	1419	
V/C Ratio(X)	0.54	0.91		0.65	0.73		0.86	0.87		0.83	0.58	
Avail Cap(c_a), veh/h	234	711		210	737		576	1613		288	1419	
HCM Platoon Ratio	1.00	1.00	1.00	1.00	1.00	1.00	1.00	1.00	1.00	1.00	1.00	1.00
Upstream Filter(I)	1.00	1.00	0.00	1.00	1.00	0.00	1.00	1.00	0.00	1.00	1.00	0.00
Uniform Delay (d), s/veh	36.6	47.4	0.0	37.0	45.3	0.0	50.6	29.6	0.0	54.1	28.1	0.0
Incr Delay (d2), s/veh	2.6	14.9	0.0	6.8	3.5	0.0	11.0	6.7	0.0	17.7	1.7	0.0
Initial Q Delay(d3),s/veh	0.0	0.0	0.0	0.0	0.0	0.0	0.0	0.0	0.0	0.0	0.0	0.0
%ile BackOfQ(50%),veh/ln	3.1	10.4	0.0	3.6	7.4	0.0	6.8	19.3	0.0	4.2	9.4	0.0
Unsig. Movement Delay, s/veh												
LnGrp Delay(d),s/veh	39.2	62.3	0.0	43.8	48.8	0.0	61.6	36.3	0.0	71.8	29.8	0.0
LnGrp LOS	D	E		D	D		E	D		E	C	
Approach Vol, veh/h		747	A		645	A		1815	A		1056	A
Approach Delay, s/veh		58.4			47.7			42.0			39.3	
Approach LOS		E			D			D			D	
Timer - Assigned Phs	1	2	3	4	5	6	7	8				
Phs Duration (G+Y+Rc), s	16.0	60.5	14.4	29.1	22.6	53.9	14.0	29.5				
Change Period (Y+Rc), s	6.0	6.0	5.5	6.0	6.0	6.0	6.0	* 6				
Max Green Setting (Gmax), s	10.0	53.6	8.9	24.0	20.0	43.6	8.0	* 25				
Max Q Clear Time (g_c+l1), s	10.1	44.8	9.3	22.5	16.0	23.6	8.8	18.1				
Green Ext Time (p_c), s	0.0	6.0	0.0	0.6	0.6	5.8	0.0	1.8				

Intersection Summary

HCM 6th Ctrl Delay	45.1
HCM 6th LOS	D

Notes

* HCM 6th computational engine requires equal clearance times for the phases crossing the barrier.
 Unsignalized Delay for [NBR, EBR, WBR, SBR] is excluded from calculations of the approach delay and intersection delay.

Timings
2: Marksheffel Rd & Constitution Ave

2023 Total AM.syn
12/21/2021

Lane Group	EBL	EBT	EBR	WBL	WBT	WBR	NBL	NBT	NBR	SBL	SBT	SBR
Lane Configurations												
Traffic Volume (vph)	148	355	338	97	476	214	330	753	33	199	1395	123
Future Volume (vph)	148	355	338	97	476	214	330	753	33	199	1395	123
Turn Type	pm+pt	NA	Free	pm+pt	NA	Free	Prot	NA	Free	Prot	NA	Free
Protected Phases	7	4		3	8		5	2		1	6	
Permitted Phases	4		Free	8		Free			Free			Free
Detector Phase	7	4		3	8		5	2		1	6	
Switch Phase												
Minimum Initial (s)	5.0	5.0		5.0	5.0		5.0	5.0		5.0	5.0	
Minimum Split (s)	11.0	24.0		10.5	23.5		11.0	24.0		11.0	24.0	
Total Split (s)	23.5	36.5		23.5	36.5		23.5	36.5		23.5	36.5	
Total Split (%)	19.6%	30.4%		19.6%	30.4%		19.6%	30.4%		19.6%	30.4%	
Yellow Time (s)	4.5	4.5		4.5	4.5		4.5	4.5		4.5	4.5	
All-Red Time (s)	1.5	1.5		1.0	1.0		1.5	1.5		1.5	1.5	
Lost Time Adjust (s)	0.0	0.0		0.0	0.0		0.0	0.0		0.0	0.0	
Total Lost Time (s)	6.0	6.0		5.5	5.5		6.0	6.0		6.0	6.0	
Lead/Lag	Lead	Lag		Lead	Lag		Lead	Lag		Lead	Lag	
Lead-Lag Optimize?	Yes	Yes		Yes	Yes		Yes	Yes		Yes	Yes	
Recall Mode	None	None		None	None		None	C-Max		None	C-Max	
Act Effct Green (s)	40.1	26.5	120.0	33.3	23.0	120.0	16.9	47.1	120.0	12.7	42.9	120.0
Actuated g/C Ratio	0.33	0.22	1.00	0.28	0.19	1.00	0.14	0.39	1.00	0.11	0.36	1.00
v/c Ratio	0.55	0.48	0.23	0.32	0.75	0.14	0.73	0.58	0.02	0.58	1.17	0.08
Control Delay	33.9	42.2	0.3	27.6	52.5	0.2	58.3	32.8	0.0	57.4	122.4	0.1
Queue Delay	0.0	0.0	0.0	0.0	0.0	0.0	0.0	0.0	0.0	0.0	0.0	0.0
Total Delay	33.9	42.2	0.3	27.6	52.5	0.2	58.3	32.8	0.0	57.4	122.4	0.1
LOS	C	D	A	C	D	A	E	C	A	E	F	A
Approach Delay		23.9			35.2			39.4			106.1	
Approach LOS		C			D			D			F	

Intersection Summary

Cycle Length: 120
 Actuated Cycle Length: 120
 Offset: 0 (0%), Referenced to phase 2:NBT and 6:SBT, Start of Green
 Natural Cycle: 90
 Control Type: Actuated-Coordinated
 Maximum v/c Ratio: 1.17
 Intersection Signal Delay: 61.4
 Intersection LOS: E
 Intersection Capacity Utilization 88.9%
 ICU Level of Service E
 Analysis Period (min) 15

Splits and Phases: 2: Marksheffel Rd & Constitution Ave

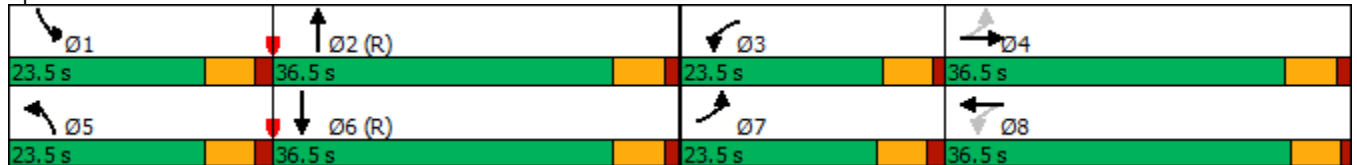

HCM 6th Signalized Intersection Summary

2023 Total AM.syn

2: Marksheffel Rd & Constitution Ave

12/21/2021



Movement	EBL	EBT	EBR	WBL	WBT	WBR	NBL	NBT	NBR	SBL	SBT	SBR
Lane Configurations	↖	↗	↘	↖	↗	↘	↖	↗	↘	↖	↗	↘
Traffic Volume (veh/h)	148	355	338	97	476	214	330	753	33	199	1395	123
Future Volume (veh/h)	148	355	338	97	476	214	330	753	33	199	1395	123
Initial Q (Qb), veh	0	0	0	0	0	0	0	0	0	0	0	0
Ped-Bike Adj(A_pbT)	1.00		1.00	1.00		1.00	1.00		1.00	1.00		1.00
Parking Bus, Adj	1.00	1.00	1.00	1.00	1.00	1.00	1.00	1.00	1.00	1.00	1.00	1.00
Work Zone On Approach		No			No			No			No	
Adj Sat Flow, veh/h/ln	1870	1870	1870	1870	1870	1870	1870	1870	1870	1870	1870	1870
Adj Flow Rate, veh/h	157	378	0	103	506	0	351	801	0	212	1484	0
Peak Hour Factor	0.94	0.94	0.94	0.94	0.94	0.94	0.94	0.94	0.94	0.94	0.94	0.94
Percent Heavy Veh, %	2	2	2	2	2	2	2	2	2	2	2	2
Cap, veh/h	254	734		284	626		414	1616		277	1475	
Arrive On Green	0.09	0.21	0.00	0.06	0.18	0.00	0.12	0.45	0.00	0.08	0.42	0.00
Sat Flow, veh/h	1781	3554	1585	1781	3554	1585	3456	3554	1585	3456	3554	1585
Grp Volume(v), veh/h	157	378	0	103	506	0	351	801	0	212	1484	0
Grp Sat Flow(s),veh/h/ln	1781	1777	1585	1781	1777	1585	1728	1777	1585	1728	1777	1585
Q Serve(g_s), s	8.5	11.3	0.0	5.6	16.4	0.0	11.9	19.0	0.0	7.2	49.8	0.0
Cycle Q Clear(g_c), s	8.5	11.3	0.0	5.6	16.4	0.0	11.9	19.0	0.0	7.2	49.8	0.0
Prop In Lane	1.00		1.00	1.00		1.00	1.00		1.00	1.00		1.00
Lane Grp Cap(c), veh/h	254	734		284	626		414	1616		277	1475	
V/C Ratio(X)	0.62	0.51		0.36	0.81		0.85	0.50		0.76	1.01	
Avail Cap(c_a), veh/h	355	903		440	918		504	1616		504	1475	
HCM Platoon Ratio	1.00	1.00	1.00	1.00	1.00	1.00	1.00	1.00	1.00	1.00	1.00	1.00
Upstream Filter(I)	1.00	1.00	0.00	1.00	1.00	0.00	1.00	1.00	0.00	1.00	1.00	0.00
Uniform Delay (d), s/veh	36.9	42.3	0.0	37.2	47.5	0.0	51.7	23.0	0.0	54.1	35.1	0.0
Incr Delay (d2), s/veh	2.5	0.6	0.0	0.8	3.5	0.0	10.9	1.1	0.0	4.4	24.9	0.0
Initial Q Delay(d3),s/veh	0.0	0.0	0.0	0.0	0.0	0.0	0.0	0.0	0.0	0.0	0.0	0.0
%ile BackOfQ(50%),veh/ln	3.9	5.0	0.0	2.5	7.5	0.0	5.8	8.2	0.0	3.3	26.0	0.0
Unsig. Movement Delay, s/veh												
LnGrp Delay(d),s/veh	39.4	42.8	0.0	38.0	51.0	0.0	62.6	24.1	0.0	58.4	60.0	0.0
LnGrp LOS	D	D		D	D		E	C		E	F	
Approach Vol, veh/h		535	A		609	A		1152	A		1696	A
Approach Delay, s/veh		41.8			48.8			35.9			59.8	
Approach LOS		D			D			D			E	
Timer - Assigned Phs	1	2	3	4	5	6	7	8				
Phs Duration (G+Y+Rc), s	15.6	60.6	13.0	30.8	20.4	55.8	16.7	27.1				
Change Period (Y+Rc), s	6.0	6.0	5.5	6.0	6.0	6.0	6.0	* 6				
Max Green Setting (Gmax), s	17.5	30.5	18.0	30.5	17.5	30.5	17.5	* 31				
Max Q Clear Time (g_c+I1), s	9.2	21.0	7.6	13.3	13.9	51.8	10.5	18.4				
Green Ext Time (p_c), s	0.4	3.8	0.2	2.2	0.4	0.0	0.2	2.7				

Intersection Summary

HCM 6th Ctrl Delay	48.8
HCM 6th LOS	D

Notes

* HCM 6th computational engine requires equal clearance times for the phases crossing the barrier.

Unsignalized Delay for [NBR, EBR, WBR, SBR] is excluded from calculations of the approach delay and intersection delay.

Timings
2: Marksheffel Rd & Constitution Ave

2023 Total PM.syn
12/21/2021

Lane Group	EBL	EBT	EBR	WBL	WBT	WBR	NBL	NBT	NBR	SBL	SBT	SBR
Lane Configurations												
Traffic Volume (vph)	125	589	268	128	487	280	398	1320	48	224	769	123
Future Volume (vph)	125	589	268	128	487	280	398	1320	48	224	769	123
Turn Type	pm+pt	NA	Free	pm+pt	NA	Free	Prot	NA	Free	Prot	NA	Free
Protected Phases	7	4		3	8		5	2		1	6	
Permitted Phases	4		Free	8		Free			Free			Free
Detector Phase	7	4		3	8		5	2		1	6	
Switch Phase												
Minimum Initial (s)	5.0	5.0		5.0	5.0		5.0	5.0		5.0	5.0	
Minimum Split (s)	11.0	24.0		10.5	23.5		11.0	24.0		11.0	24.0	
Total Split (s)	13.0	30.0		14.4	31.4		27.0	59.6		16.0	48.6	
Total Split (%)	10.8%	25.0%		12.0%	26.2%		22.5%	49.7%		13.3%	40.5%	
Yellow Time (s)	4.5	4.5		4.5	4.5		4.5	4.5		4.5	4.5	
All-Red Time (s)	1.5	1.5		1.0	1.0		1.5	1.5		1.5	1.5	
Lost Time Adjust (s)	0.0	0.0		0.0	0.0		0.0	0.0		0.0	0.0	
Total Lost Time (s)	6.0	6.0		5.5	5.5		6.0	6.0		6.0	6.0	
Lead/Lag	Lead	Lag		Lead	Lag		Lead	Lag		Lead	Lag	
Lead-Lag Optimize?	Yes	Yes		Yes	Yes		Yes	Yes		Yes	Yes	
Recall Mode	None	None		None	None		None	C-Max		None	C-Max	
Act Effct Green (s)	30.5	23.5	120.0	34.1	25.3	120.0	19.0	54.1	120.0	10.1	45.2	120.0
Actuated g/C Ratio	0.25	0.20	1.00	0.28	0.21	1.00	0.16	0.45	1.00	0.08	0.38	1.00
v/c Ratio	0.67	0.91	0.18	0.71	0.70	0.19	0.78	0.88	0.03	0.82	0.61	0.08
Control Delay	49.7	65.1	0.2	51.8	49.3	0.3	59.1	37.9	0.0	77.1	33.3	0.1
Queue Delay	0.0	0.0	0.0	0.0	0.0	0.0	0.0	0.0	0.0	0.0	0.0	0.0
Total Delay	49.7	65.1	0.2	51.8	49.3	0.3	59.1	37.9	0.0	77.1	33.3	0.1
LOS	D	E	A	D	D	A	E	D	A	E	C	A
Approach Delay		45.5			34.3			41.7			38.4	
Approach LOS		D			C			D			D	

Intersection Summary

Cycle Length: 120
 Actuated Cycle Length: 120
 Offset: 0 (0%), Referenced to phase 2:NBT and 6:SBT, Start of Green
 Natural Cycle: 90
 Control Type: Actuated-Coordinated
 Maximum v/c Ratio: 0.91
 Intersection Signal Delay: 40.3
 Intersection LOS: D
 Intersection Capacity Utilization 85.8%
 ICU Level of Service E
 Analysis Period (min) 15

Splits and Phases: 2: Marksheffel Rd & Constitution Ave



HCM 6th Signalized Intersection Summary
 2: Marksheffel Rd & Constitution Ave

2023 Total PM.syn
 12/21/2021

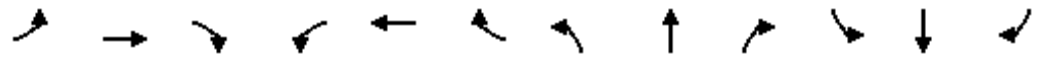

Movement	EBL	EBT	EBR	WBL	WBT	WBR	NBL	NBT	NBR	SBL	SBT	SBR
Lane Configurations	↖	↗	↘	↖	↗	↘	↖	↗	↘	↖	↗	↘
Traffic Volume (veh/h)	125	589	268	128	487	280	398	1320	48	224	769	123
Future Volume (veh/h)	125	589	268	128	487	280	398	1320	48	224	769	123
Initial Q (Qb), veh	0	0	0	0	0	0	0	0	0	0	0	0
Ped-Bike Adj(A_pbT)	1.00		1.00	1.00		1.00	1.00		1.00	1.00		1.00
Parking Bus, Adj	1.00	1.00	1.00	1.00	1.00	1.00	1.00	1.00	1.00	1.00	1.00	1.00
Work Zone On Approach		No			No			No			No	
Adj Sat Flow, veh/h/ln	1870	1870	1870	1870	1870	1870	1870	1870	1870	1870	1870	1870
Adj Flow Rate, veh/h	133	627	0	136	518	0	423	1404	0	238	818	0
Peak Hour Factor	0.94	0.94	0.94	0.94	0.94	0.94	0.94	0.94	0.94	0.94	0.94	0.94
Percent Heavy Veh, %	2	2	2	2	2	2	2	2	2	2	2	2
Cap, veh/h	226	689		209	731		491	1609		288	1400	
Arrive On Green	0.06	0.19	0.00	0.07	0.21	0.00	0.14	0.45	0.00	0.08	0.39	0.00
Sat Flow, veh/h	1781	3554	1585	1781	3554	1585	3456	3554	1585	3456	3554	1585
Grp Volume(v), veh/h	133	627	0	136	518	0	423	1404	0	238	818	0
Grp Sat Flow(s),veh/h/ln	1781	1777	1585	1781	1777	1585	1728	1777	1585	1728	1777	1585
Q Serve(g_s), s	7.0	20.7	0.0	7.3	16.3	0.0	14.4	42.9	0.0	8.1	21.7	0.0
Cycle Q Clear(g_c), s	7.0	20.7	0.0	7.3	16.3	0.0	14.4	42.9	0.0	8.1	21.7	0.0
Prop In Lane	1.00		1.00	1.00		1.00	1.00		1.00	1.00		1.00
Lane Grp Cap(c), veh/h	226	689		209	731		491	1609		288	1400	
V/C Ratio(X)	0.59	0.91		0.65	0.71		0.86	0.87		0.83	0.58	
Avail Cap(c_a), veh/h	226	711		209	767		605	1609		288	1400	
HCM Platoon Ratio	1.00	1.00	1.00	1.00	1.00	1.00	1.00	1.00	1.00	1.00	1.00	1.00
Upstream Filter(l)	1.00	1.00	0.00	1.00	1.00	0.00	1.00	1.00	0.00	1.00	1.00	0.00
Uniform Delay (d), s/veh	37.8	47.3	0.0	36.9	44.3	0.0	50.3	29.7	0.0	54.1	28.6	0.0
Incr Delay (d2), s/veh	4.0	15.5	0.0	6.9	2.9	0.0	10.3	6.8	0.0	17.7	1.8	0.0
Initial Q Delay(d3),s/veh	0.0	0.0	0.0	0.0	0.0	0.0	0.0	0.0	0.0	0.0	0.0	0.0
%ile BackOfQ(50%),veh/ln	3.4	10.6	0.0	3.6	7.5	0.0	6.9	19.4	0.0	4.2	9.6	0.0
Unsig. Movement Delay, s/veh												
LnGrp Delay(d),s/veh	41.8	62.9	0.0	43.8	47.2	0.0	60.6	36.6	0.0	71.8	30.4	0.0
LnGrp LOS	D	E		D	D		E	D		E	C	
Approach Vol, veh/h		760	A		654	A		1827	A		1056	A
Approach Delay, s/veh		59.2			46.5			42.1			39.8	
Approach LOS		E			D			D			D	
Timer - Assigned Phs	1	2	3	4	5	6	7	8				
Phs Duration (G+Y+Rc), s	16.0	60.3	14.4	29.3	23.1	53.3	13.0	30.7				
Change Period (Y+Rc), s	6.0	6.0	5.5	6.0	6.0	6.0	6.0	* 6				
Max Green Setting (Gmax), s	10.0	53.6	8.9	24.0	21.0	42.6	7.0	* 26				
Max Q Clear Time (g_c+l1), s	10.1	44.9	9.3	22.7	16.4	23.7	9.0	18.3				
Green Ext Time (p_c), s	0.0	6.0	0.0	0.6	0.7	5.6	0.0	2.0				

Intersection Summary

HCM 6th Ctrl Delay	45.2
HCM 6th LOS	D

Notes

* HCM 6th computational engine requires equal clearance times for the phases crossing the barrier.
 Unsignalized Delay for [NBR, EBR, WBR, SBR] is excluded from calculations of the approach delay and intersection delay.

Timings

2: Marksheffel Rd & Constitution Ave

12/21/2021

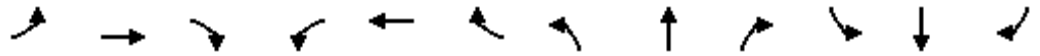

Lane Group	EBL	EBT	EBR	WBL	WBT	WBR	NBL	NBT	NBR	SBL	SBT	SBR
Lane Configurations	↘	↗	↘	↘	↗	↘	↗	↗	↘	↗	↗	↘
Traffic Volume (vph)	225	545	523	150	735	331	503	1165	51	307	2157	188
Future Volume (vph)	225	545	523	150	735	331	503	1165	51	307	2157	188
Turn Type	pm+pt	NA	Free	pm+pt	NA	Free	Prot	NA	Free	Prot	NA	Free
Protected Phases	7	4		3	8		5	2		1	6	
Permitted Phases	4		Free	8		Free			Free			Free
Detector Phase	7	4		3	8		5	2		1	6	
Switch Phase												
Minimum Initial (s)	5.0	5.0		5.0	5.0		5.0	5.0		5.0	5.0	
Minimum Split (s)	11.0	24.0		10.5	23.5		11.0	24.0		11.0	24.0	
Total Split (s)	13.0	27.8		13.2	28.0		19.0	59.0		20.0	60.0	
Total Split (%)	10.8%	23.2%		11.0%	23.3%		15.8%	49.2%		16.7%	50.0%	
Yellow Time (s)	4.5	4.5		4.5	4.5		4.5	4.5		4.5	4.5	
All-Red Time (s)	1.5	1.5		1.0	1.0		1.5	1.5		1.5	1.5	
Lost Time Adjust (s)	0.0	0.0		0.0	0.0		0.0	0.0		0.0	0.0	
Total Lost Time (s)	6.0	6.0		5.5	5.5		6.0	6.0		6.0	6.0	
Lead/Lag	Lead	Lag		Lead	Lag		Lead	Lag		Lead	Lag	
Lead-Lag Optimize?	Yes	Yes		Yes	Yes		Yes	Yes		Yes	Yes	
Recall Mode	None	None		None	None		None	C-Max		None	C-Max	
Act Effct Green (s)	28.8	21.8	120.0	30.2	22.5	120.0	13.0	53.3	120.0	13.7	54.0	120.0
Actuated g/C Ratio	0.24	0.18	1.00	0.25	0.19	1.00	0.11	0.44	1.00	0.11	0.45	1.00
v/c Ratio	1.45	0.90	0.35	0.91	1.18	0.22	1.44	0.79	0.03	0.83	1.44	0.13
Control Delay	262.7	66.8	0.6	85.7	138.6	0.3	252.1	33.2	0.0	70.6	231.0	0.2
Queue Delay	0.0	0.0	0.0	0.0	0.0	0.0	0.0	0.0	0.0	0.0	0.0	0.0
Total Delay	262.7	66.8	0.6	85.7	138.6	0.3	252.1	33.2	0.0	70.6	231.0	0.2
LOS	F	E	A	F	F	A	F	C	A	E	F	A
Approach Delay		74.1			94.4			96.3			196.0	
Approach LOS		E			F			F			F	

Intersection Summary

Cycle Length: 120
 Actuated Cycle Length: 120
 Offset: 0 (0%), Referenced to phase 2:NBT and 6:SBT, Start of Green
 Natural Cycle: 150
 Control Type: Actuated-Coordinated
 Maximum v/c Ratio: 1.45
 Intersection Signal Delay: 130.2
 Intersection LOS: F
 Intersection Capacity Utilization 126.3%
 ICU Level of Service H
 Analysis Period (min) 15

Splits and Phases: 2: Marksheffel Rd & Constitution Ave



HCM 6th Signalized Intersection Summary
 2: Marksheffel Rd & Constitution Ave

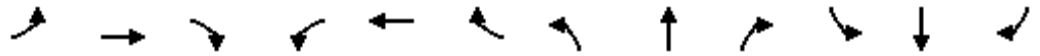

Movement	EBL	EBT	EBR	WBL	WBT	WBR	NBL	NBT	NBR	SBL	SBT	SBR
Lane Configurations	↖	↗	↘	↖	↗	↘	↖	↗	↘	↖	↗	↘
Traffic Volume (veh/h)	225	545	523	150	735	331	503	1165	51	307	2157	188
Future Volume (veh/h)	225	545	523	150	735	331	503	1165	51	307	2157	188
Initial Q (Qb), veh	0	0	0	0	0	0	0	0	0	0	0	0
Ped-Bike Adj(A_pbT)	1.00		1.00	1.00		1.00	1.00		1.00	1.00		1.00
Parking Bus, Adj	1.00	1.00	1.00	1.00	1.00	1.00	1.00	1.00	1.00	1.00	1.00	1.00
Work Zone On Approach		No			No			No			No	
Adj Sat Flow, veh/h/ln	1870	1870	1870	1870	1870	1870	1870	1870	1870	1870	1870	1870
Adj Flow Rate, veh/h	239	580	0	160	782	0	535	1239	0	327	2295	0
Peak Hour Factor	0.94	0.94	0.94	0.94	0.94	0.94	0.94	0.94	0.94	0.94	0.94	0.94
Percent Heavy Veh, %	2	2	2	2	2	2	2	2	2	2	2	2
Cap, veh/h	164	660		197	666		374	2080		382	2088	
Arrive On Green	0.06	0.19	0.00	0.06	0.19	0.00	0.11	0.59	0.00	0.11	0.59	0.00
Sat Flow, veh/h	1781	3554	1585	1781	3554	1585	3456	3554	1585	3456	3554	1585
Grp Volume(v), veh/h	239	580	0	160	782	0	535	1239	0	327	2295	0
Grp Sat Flow(s),veh/h/ln	1781	1777	1585	1781	1777	1585	1728	1777	1585	1728	1777	1585
Q Serve(g_s), s	7.0	19.1	0.0	7.7	22.5	0.0	13.0	26.6	0.0	11.2	70.5	0.0
Cycle Q Clear(g_c), s	7.0	19.1	0.0	7.7	22.5	0.0	13.0	26.6	0.0	11.2	70.5	0.0
Prop In Lane	1.00		1.00	1.00		1.00	1.00		1.00	1.00		1.00
Lane Grp Cap(c), veh/h	164	660		197	666		374	2080		382	2088	
V/C Ratio(X)	1.46	0.88		0.81	1.17		1.43	0.60		0.86	1.10	
Avail Cap(c_a), veh/h	164	660		197	666		374	2080		403	2088	
HCM Platoon Ratio	1.00	1.00	1.00	1.00	1.00	1.00	1.00	1.00	1.00	1.00	1.00	1.00
Upstream Filter(l)	1.00	1.00	0.00	1.00	1.00	0.00	1.00	1.00	0.00	1.00	1.00	0.00
Uniform Delay (d), s/veh	43.6	47.5	0.0	41.1	48.8	0.0	53.5	15.8	0.0	52.4	24.7	0.0
Incr Delay (d2), s/veh	236.6	12.9	0.0	22.2	93.4	0.0	208.0	1.3	0.0	15.8	52.7	0.0
Initial Q Delay(d3),s/veh	0.0	0.0	0.0	0.0	0.0	0.0	0.0	0.0	0.0	0.0	0.0	0.0
%ile BackOfQ(50%),veh/ln	12.3	9.6	0.0	2.3	18.6	0.0	16.4	10.8	0.0	5.7	42.8	0.0
Unsig. Movement Delay, s/veh												
LnGrp Delay(d),s/veh	280.3	60.4	0.0	63.3	142.2	0.0	261.5	17.1	0.0	68.3	77.5	0.0
LnGrp LOS	F	E		E	F		F	B		E	F	
Approach Vol, veh/h		819	A		942	A		1774	A		2622	A
Approach Delay, s/veh		124.6			128.8			90.8			76.3	
Approach LOS		F			F			F			E	
Timer - Assigned Phs	1	2	3	4	5	6	7	8				
Phs Duration (G+Y+Rc), s	19.3	76.7	13.2	28.3	19.0	77.0	13.0	28.5				
Change Period (Y+Rc), s	6.0	6.0	5.5	6.0	6.0	6.0	6.0	* 6				
Max Green Setting (Gmax), s	14.0	53.0	7.7	21.8	13.0	54.0	7.0	* 23				
Max Q Clear Time (g_c+l1), s	13.2	28.6	9.7	21.1	15.0	72.5	9.0	24.5				
Green Ext Time (p_c), s	0.1	10.4	0.0	0.3	0.0	0.0	0.0	0.0				

Intersection Summary

HCM 6th Ctrl Delay	94.9
HCM 6th LOS	F

Notes

* HCM 6th computational engine requires equal clearance times for the phases crossing the barrier.
 Unsignalized Delay for [NBR, EBR, WBR, SBR] is excluded from calculations of the approach delay and intersection delay.

Timings

2: Marksheffel Rd & Constitution Ave

12/21/2021

Lane Group	EBL	EBT	EBR	WBL	WBT	WBR	NBL	NBT	NBR	SBL	SBT	SBR
Lane Configurations												
Traffic Volume (vph)	195	913	415	198	756	433	609	2041	74	346	1189	195
Future Volume (vph)	195	913	415	198	756	433	609	2041	74	346	1189	195
Turn Type	pm+pt	NA	Free	pm+pt	NA	Free	Prot	NA	Free	Prot	NA	Free
Protected Phases	7	4		3	8		5	2		1	6	
Permitted Phases	4		Free	8		Free			Free			Free
Detector Phase	7	4		3	8		5	2		1	6	
Switch Phase												
Minimum Initial (s)	5.0	5.0		5.0	5.0		5.0	5.0		5.0	5.0	
Minimum Split (s)	11.0	24.0		10.5	23.5		11.0	24.0		11.0	24.0	
Total Split (s)	13.0	32.0		12.0	31.0		27.0	61.0		15.0	49.0	
Total Split (%)	10.8%	26.7%		10.0%	25.8%		22.5%	50.8%		12.5%	40.8%	
Yellow Time (s)	4.5	4.5		4.5	4.5		4.5	4.5		4.5	4.5	
All-Red Time (s)	1.5	1.5		1.0	1.0		1.5	1.5		1.5	1.5	
Lost Time Adjust (s)	0.0	0.0		0.0	0.0		0.0	0.0		0.0	0.0	
Total Lost Time (s)	6.0	6.0		5.5	5.5		6.0	6.0		6.0	6.0	
Lead/Lag	Lead	Lag		Lead	Lag		Lead	Lag		Lead	Lag	
Lead-Lag Optimize?	Yes	Yes		Yes	Yes		Yes	Yes		Yes	Yes	
Recall Mode	None	None		None	None		None	C-Max		None	C-Max	
Act Effct Green (s)	33.0	26.0	120.0	32.0	25.5	120.0	21.0	55.0	120.0	9.0	43.0	120.0
Actuated g/C Ratio	0.28	0.22	1.00	0.27	0.21	1.00	0.18	0.46	1.00	0.08	0.36	1.00
v/c Ratio	1.25	1.27	0.28	1.34	1.07	0.29	1.08	1.34	0.05	1.43	1.00	0.13
Control Delay	186.3	169.9	0.4	221.6	97.9	0.5	106.8	186.0	0.1	255.0	63.4	0.2
Queue Delay	0.0	0.0	0.0	0.0	0.0	0.0	0.0	0.0	0.0	0.0	0.0	0.0
Total Delay	186.3	169.9	0.4	221.6	97.9	0.5	106.8	186.0	0.1	255.0	63.4	0.2
LOS	F	F	A	F	F	A	F	F	A	F	E	A
Approach Delay		125.8			85.2			163.3			94.6	
Approach LOS		F			F			F			F	

Intersection Summary

Cycle Length: 120
 Actuated Cycle Length: 120
 Offset: 0 (0%), Referenced to phase 2:NBT and 6:SBT, Start of Green
 Natural Cycle: 150
 Control Type: Actuated-Coordinated
 Maximum v/c Ratio: 1.43
 Intersection Signal Delay: 124.7
 Intersection LOS: F
 Intersection Capacity Utilization 122.1%
 ICU Level of Service H
 Analysis Period (min) 15

Splits and Phases: 2: Marksheffel Rd & Constitution Ave

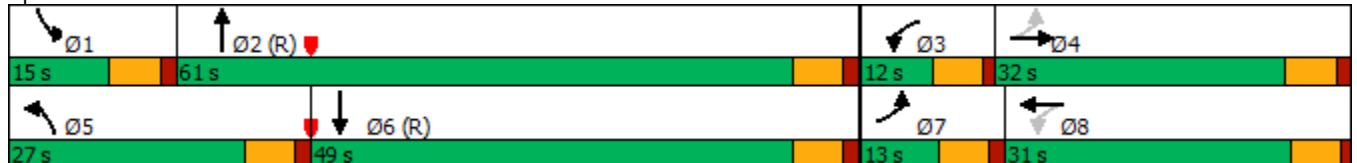

HCM 6th Signalized Intersection Summary
2: Marksheffel Rd & Constitution Ave

2045 Background PM w Adj. Development.syn

12/21/2021

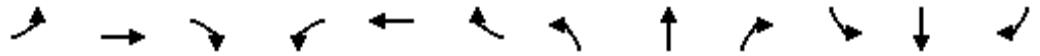

Movement	EBL	EBT	EBR	WBL	WBT	WBR	NBL	NBT	NBR	SBL	SBT	SBR
Lane Configurations	↖	↗	↘	↖	↗	↘	↖	↗	↘	↖	↗	↘
Traffic Volume (veh/h)	195	913	415	198	756	433	609	2041	74	346	1189	195
Future Volume (veh/h)	195	913	415	198	756	433	609	2041	74	346	1189	195
Initial Q (Qb), veh	0	0	0	0	0	0	0	0	0	0	0	0
Ped-Bike Adj(A_pbT)	1.00		1.00	1.00		1.00	1.00		1.00	1.00		1.00
Parking Bus, Adj	1.00	1.00	1.00	1.00	1.00	1.00	1.00	1.00	1.00	1.00	1.00	1.00
Work Zone On Approach		No			No			No			No	
Adj Sat Flow, veh/h/ln	1870	1870	1870	1870	1870	1870	1870	1870	1870	1870	1870	1870
Adj Flow Rate, veh/h	207	971	0	211	804	0	648	2171	0	368	1265	0
Peak Hour Factor	0.94	0.94	0.94	0.94	0.94	0.94	0.94	0.94	0.94	0.94	0.94	0.94
Percent Heavy Veh, %	2	2	2	2	2	2	2	2	2	2	2	2
Cap, veh/h	164	785		156	755		605	2117		259	1762	
Arrive On Green	0.06	0.22	0.00	0.05	0.21	0.00	0.17	0.60	0.00	0.08	0.50	0.00
Sat Flow, veh/h	1781	3554	1585	1781	3554	1585	3456	3554	1585	3456	3554	1585
Grp Volume(v), veh/h	207	971	0	211	804	0	648	2171	0	368	1265	0
Grp Sat Flow(s),veh/h/ln	1781	1777	1585	1781	1777	1585	1728	1777	1585	1728	1777	1585
Q Serve(g_s), s	7.0	26.5	0.0	6.5	25.5	0.0	21.0	71.5	0.0	9.0	33.4	0.0
Cycle Q Clear(g_c), s	7.0	26.5	0.0	6.5	25.5	0.0	21.0	71.5	0.0	9.0	33.4	0.0
Prop In Lane	1.00		1.00	1.00		1.00	1.00		1.00	1.00		1.00
Lane Grp Cap(c), veh/h	164	785		156	755		605	2117		259	1762	
V/C Ratio(X)	1.26	1.24		1.35	1.06		1.07	1.03		1.42	0.72	
Avail Cap(c_a), veh/h	164	785		156	755		605	2117		259	1762	
HCM Platoon Ratio	1.00	1.00	1.00	1.00	1.00	1.00	1.00	1.00	1.00	1.00	1.00	1.00
Upstream Filter(I)	1.00	1.00	0.00	1.00	1.00	0.00	1.00	1.00	0.00	1.00	1.00	0.00
Uniform Delay (d), s/veh	41.6	46.8	0.0	42.3	47.2	0.0	49.5	24.3	0.0	55.5	23.7	0.0
Incr Delay (d2), s/veh	157.8	117.6	0.0	192.9	51.3	0.0	57.3	26.3	0.0	210.1	2.5	0.0
Initial Q Delay(d3),s/veh	0.0	0.0	0.0	0.0	0.0	0.0	0.0	0.0	0.0	0.0	0.0	0.0
%ile BackOfQ(50%),veh/ln	8.7	24.4	0.0	9.9	16.6	0.0	13.8	35.4	0.0	11.5	14.3	0.0
Unsig. Movement Delay, s/veh												
LnGrp Delay(d),s/veh	199.5	164.4	0.0	235.2	98.6	0.0	106.8	50.6	0.0	265.6	26.2	0.0
LnGrp LOS	F	F		F	F		F	F		F	C	
Approach Vol, veh/h		1178	A		1015	A		2819	A		1633	A
Approach Delay, s/veh		170.6			127.0			63.5			80.2	
Approach LOS		F			F			E			F	
Timer - Assigned Phs	1	2	3	4	5	6	7	8				
Phs Duration (G+Y+Rc), s	15.0	78.0	12.0	32.5	27.0	66.0	13.0	31.5				
Change Period (Y+Rc), s	6.0	6.0	5.5	6.0	6.0	6.0	6.0	* 6				
Max Green Setting (Gmax), s	9.0	55.0	6.5	26.0	21.0	43.0	7.0	* 26				
Max Q Clear Time (g_c+l1), s	11.0	73.5	8.5	28.5	23.0	35.4	9.0	27.5				
Green Ext Time (p_c), s	0.0	0.0	0.0	0.0	0.0	4.9	0.0	0.0				

Intersection Summary

HCM 6th Ctrl Delay	96.3
HCM 6th LOS	F

Notes

* HCM 6th computational engine requires equal clearance times for the phases crossing the barrier.
Unsignalized Delay for [NBR, EBR, WBR, SBR] is excluded from calculations of the approach delay and intersection delay.

Timings

2: Marksheffel Rd & Constitution Ave

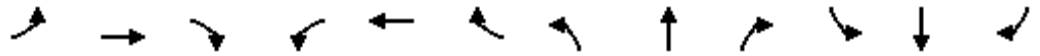

Lane Group	EBL	EBT	EBR	WBL	WBT	WBR	NBL	NBT	NBR	SBL	SBT	SBR
Lane Configurations	↖	↗	↘	↖	↗	↘	↖	↗	↘	↖	↗	↘
Traffic Volume (vph)	233	553	523	150	738	331	507	1165	51	307	2157	191
Future Volume (vph)	233	553	523	150	738	331	507	1165	51	307	2157	191
Turn Type	pm+pt	NA	Perm	pm+pt	NA	Perm	Prot	NA	Free	Prot	NA	Free
Protected Phases	7	4		3	8		5	2		1	6	
Permitted Phases	4		4	8		8			Free			Free
Detector Phase	7	4	4	3	8	8	5	2		1	6	
Switch Phase												
Minimum Initial (s)	5.0	5.0	5.0	5.0	5.0	5.0	5.0	5.0		5.0	5.0	
Minimum Split (s)	11.0	24.0	24.0	10.5	23.5	23.5	11.0	24.0		11.0	24.0	
Total Split (s)	17.0	28.4	28.4	19.6	31.0	31.0	22.0	48.0		24.0	50.0	
Total Split (%)	14.2%	23.7%	23.7%	16.3%	25.8%	25.8%	18.3%	40.0%		20.0%	41.7%	
Yellow Time (s)	4.5	4.5	4.5	4.5	4.5	4.5	4.5	4.5		4.5	4.5	
All-Red Time (s)	1.5	1.5	1.5	1.0	1.0	1.0	1.5	1.5		1.5	1.5	
Lost Time Adjust (s)	0.0	0.0	0.0	0.0	0.0	0.0	0.0	0.0		0.0	0.0	
Total Lost Time (s)	6.0	6.0	6.0	5.5	5.5	5.5	6.0	6.0		6.0	6.0	
Lead/Lag	Lead	Lag	Lag	Lead	Lag	Lag	Lead	Lag		Lead	Lag	
Lead-Lag Optimize?	Yes	Yes	Yes	Yes	Yes	Yes	Yes	Yes		Yes	Yes	
Recall Mode	None	None	None	None	None	None	None	C-Max		None	C-Max	
Act Effct Green (s)	35.2	24.2	24.2	37.8	25.5	25.5	16.0	44.0	120.0	16.0	44.0	120.0
Actuated g/C Ratio	0.29	0.20	0.20	0.32	0.21	0.21	0.13	0.37	1.00	0.13	0.37	1.00
v/c Ratio	1.11	0.82	0.99	0.63	1.04	0.64	1.18	0.66	0.03	0.72	1.23	0.13
Control Delay	118.4	52.5	55.0	39.6	90.7	16.7	146.5	34.2	0.0	59.0	143.2	0.2
Queue Delay	0.0	0.0	0.0	0.0	0.0	0.0	0.0	0.0	0.0	0.0	0.0	0.0
Total Delay	118.4	52.5	55.0	39.6	90.7	16.7	146.5	34.2	0.0	59.0	143.2	0.2
LOS	F	D	D	D	F	B	F	C	A	E	F	A
Approach Delay		65.2			64.3			66.3			123.1	
Approach LOS		E			E			E			F	

Intersection Summary

Cycle Length: 120
 Actuated Cycle Length: 120
 Offset: 0 (0%), Referenced to phase 2:NBT and 6:SBT, Start of Green
 Natural Cycle: 150
 Control Type: Actuated-Coordinated
 Maximum v/c Ratio: 1.23
 Intersection Signal Delay: 87.6
 Intersection LOS: F
 Intersection Capacity Utilization 109.0%
 ICU Level of Service H
 Analysis Period (min) 15

Splits and Phases: 2: Marksheffel Rd & Constitution Ave

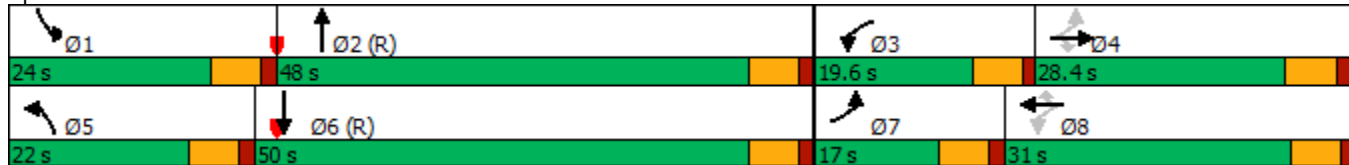



Movement	EBL	EBT	EBR	WBL	WBT	WBR	NBL	NBT	NBR	SBL	SBT	SBR
Lane Configurations	↘	↗↗	↘	↘	↗↗	↘	↘↘	↗↗↗	↘	↘↘	↗↗↗	↘
Traffic Volume (veh/h)	233	553	523	150	738	331	507	1165	51	307	2157	191
Future Volume (veh/h)	233	553	523	150	738	331	507	1165	51	307	2157	191
Initial Q (Qb), veh	0	0	0	0	0	0	0	0	0	0	0	0
Ped-Bike Adj(A_pbT)	1.00		1.00	1.00		1.00	1.00		1.00	1.00		1.00
Parking Bus, Adj	1.00	1.00	1.00	1.00	1.00	1.00	1.00	1.00	1.00	1.00	1.00	1.00
Work Zone On Approach		No			No			No			No	
Adj Sat Flow, veh/h/ln	1870	1870	1870	1870	1870	1870	1870	1870	1870	1870	1870	1870
Adj Flow Rate, veh/h	248	588	0	160	785	0	539	1239	0	327	2295	0
Peak Hour Factor	0.94	0.94	0.94	0.94	0.94	0.94	0.94	0.94	0.94	0.94	0.94	0.94
Percent Heavy Veh, %	2	2	2	2	2	2	2	2	2	2	2	2
Cap, veh/h	223	788		264	755		461	2675		393	2574	
Arrive On Green	0.03	0.07	0.00	0.09	0.21	0.00	0.13	0.52	0.00	0.11	0.50	0.00
Sat Flow, veh/h	1781	3554	1585	1781	3554	1585	3456	5106	1585	3456	5106	1585
Grp Volume(v), veh/h	248	588	0	160	785	0	539	1239	0	327	2295	0
Grp Sat Flow(s),veh/h/ln	1781	1777	1585	1781	1777	1585	1728	1702	1585	1728	1702	1585
Q Serve(g_s), s	11.0	19.5	0.0	8.3	25.5	0.0	16.0	18.3	0.0	11.1	48.6	0.0
Cycle Q Clear(g_c), s	11.0	19.5	0.0	8.3	25.5	0.0	16.0	18.3	0.0	11.1	48.6	0.0
Prop In Lane	1.00		1.00	1.00		1.00	1.00		1.00	1.00		1.00
Lane Grp Cap(c), veh/h	223	788		264	755		461	2675		393	2574	
V/C Ratio(X)	1.11	0.75		0.61	1.04		1.17	0.46		0.83	0.89	
Avail Cap(c_a), veh/h	223	788		319	755		461	2675		518	2574	
HCM Platoon Ratio	0.33	0.33	0.33	1.00	1.00	1.00	1.00	1.00	1.00	1.00	1.00	1.00
Upstream Filter(I)	0.86	0.86	0.00	1.00	1.00	0.00	1.00	1.00	0.00	1.00	1.00	0.00
Uniform Delay (d), s/veh	39.3	52.3	0.0	34.1	47.2	0.0	52.0	18.0	0.0	52.1	26.8	0.0
Incr Delay (d2), s/veh	88.8	3.4	0.0	2.3	43.4	0.0	97.5	0.6	0.0	8.6	5.2	0.0
Initial Q Delay(d3),s/veh	0.0	0.0	0.0	0.0	0.0	0.0	0.0	0.0	0.0	0.0	0.0	0.0
%ile BackOfQ(50%),veh/ln	6.8	9.7	0.0	3.8	15.7	0.0	13.2	7.2	0.0	5.3	20.2	0.0
Unsig. Movement Delay, s/veh												
LnGrp Delay(d),s/veh	128.1	55.7	0.0	36.4	90.7	0.0	149.5	18.5	0.0	60.7	32.0	0.0
LnGrp LOS	F	E		D	F		F	B		E	C	
Approach Vol, veh/h		836	A		945	A		1778	A		2622	A
Approach Delay, s/veh		77.2			81.5			58.2			35.6	
Approach LOS		E			F			E			D	
Timer - Assigned Phs	1	2	3	4	5	6	7	8				
Phs Duration (G+Y+Rc), s	19.6	69.4	15.9	32.6	22.0	67.0	17.0	31.5				
Change Period (Y+Rc), s	6.0	6.0	5.5	6.0	6.0	6.0	6.0	* 6				
Max Green Setting (Gmax), s	18.0	42.0	14.1	22.4	16.0	44.0	11.0	* 26				
Max Q Clear Time (g_c+I1), s	13.1	20.3	10.3	21.5	18.0	50.6	13.0	27.5				
Green Ext Time (p_c), s	0.5	9.5	0.1	0.4	0.0	0.0	0.0	0.0				

Intersection Summary

HCM 6th Ctrl Delay	54.7
HCM 6th LOS	D

Notes

* HCM 6th computational engine requires equal clearance times for the phases crossing the barrier.
 Unsignalized Delay for [NBR, EBR, WBR, SBR] is excluded from calculations of the approach delay and intersection delay.

Timings

2: Marksheffel Rd & Constitution Ave

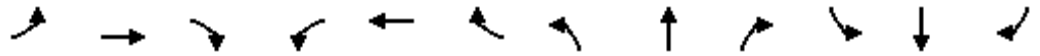

Lane Group	EBL	EBT	EBR	WBL	WBT	WBR	NBL	NBT	NBR	SBL	SBT	SBR
Lane Configurations	↘	↑↑	↗	↘	↑↑	↗	↘↗	↑↑↑	↗	↘↗	↑↑↑	↗
Traffic Volume (vph)	195	913	415	198	756	433	609	2041	74	346	1189	195
Future Volume (vph)	195	913	415	198	756	433	609	2041	74	346	1189	195
Turn Type	pm+pt	NA	Perm	pm+pt	NA	Perm	Prot	NA	Free	Prot	NA	Free
Protected Phases	7	4		3	8		5	2		1	6	
Permitted Phases	4		4	8		8			Free			Free
Detector Phase	7	4	4	3	8	8	5	2		1	6	
Switch Phase												
Minimum Initial (s)	5.0	5.0	5.0	5.0	5.0	5.0	5.0	5.0		5.0	5.0	
Minimum Split (s)	11.0	24.0	24.0	10.5	23.5	23.5	11.0	24.0		11.0	24.0	
Total Split (s)	18.0	32.0	32.0	20.0	34.0	34.0	36.0	49.0		19.0	32.0	
Total Split (%)	15.0%	26.7%	26.7%	16.7%	28.3%	28.3%	30.0%	40.8%		15.8%	26.7%	
Yellow Time (s)	4.5	4.5	4.5	4.5	4.5	4.5	4.5	4.5		4.5	4.5	
All-Red Time (s)	1.5	1.5	1.5	1.0	1.0	1.0	1.5	1.5		1.5	1.5	
Lost Time Adjust (s)	0.0	0.0	0.0	0.0	0.0	0.0	0.0	0.0		0.0	0.0	
Total Lost Time (s)	6.0	6.0	6.0	5.5	5.5	5.5	6.0	6.0		6.0	6.0	
Lead/Lag	Lead	Lag	Lag	Lead	Lag	Lag	Lead	Lag		Lead	Lag	
Lead-Lag Optimize?	Yes	Yes	Yes	Yes	Yes	Yes	Yes	Yes		Yes	Yes	
Recall Mode	None	None	None	None	None	None	None	C-Max		None	C-Max	
Act Effct Green (s)	38.8	26.8	26.8	42.2	28.5	28.5	26.9	43.0	120.0	13.0	29.1	120.0
Actuated g/C Ratio	0.32	0.22	0.22	0.35	0.24	0.24	0.22	0.36	1.00	0.11	0.24	1.00
v/c Ratio	0.87	1.23	0.69	0.80	0.96	0.81	0.84	1.19	0.05	0.99	1.03	0.13
Control Delay	67.5	149.2	12.8	51.1	67.7	31.0	55.1	127.1	0.1	98.4	77.7	0.2
Queue Delay	0.0	0.0	0.0	0.0	0.0	0.0	0.0	0.0	0.0	0.0	0.0	0.0
Total Delay	67.5	149.2	12.8	51.1	67.7	31.0	55.1	127.1	0.1	98.4	77.7	0.2
LOS	E	F	B	D	E	C	E	F	A	F	E	A
Approach Delay		101.6			53.8			107.6			73.1	
Approach LOS		F			D			F			E	

Intersection Summary

Cycle Length: 120
 Actuated Cycle Length: 120
 Offset: 0 (0%), Referenced to phase 2:NBT and 6:SBT, Start of Green
 Natural Cycle: 130
 Control Type: Actuated-Coordinated
 Maximum v/c Ratio: 1.23
 Intersection Signal Delay: 88.1
 Intersection LOS: F
 Intersection Capacity Utilization 105.1%
 ICU Level of Service G
 Analysis Period (min) 15

Splits and Phases: 2: Marksheffel Rd & Constitution Ave



HCM 6th Signalized Intersection Summary
 2: Marksheffel Rd & Constitution Ave

2045 Total PM w Adj. Development.syn

12/21/2021

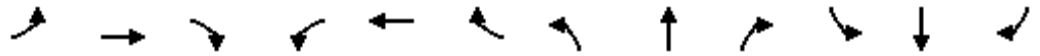

Movement	EBL	EBT	EBR	WBL	WBT	WBR	NBL	NBT	NBR	SBL	SBT	SBR
Lane Configurations	↖	↗	↘	↖	↗	↘	↖	↗	↘	↖	↗	↘
Traffic Volume (veh/h)	195	913	415	198	756	433	609	2041	74	346	1189	195
Future Volume (veh/h)	195	913	415	198	756	433	609	2041	74	346	1189	195
Initial Q (Qb), veh	0	0	0	0	0	0	0	0	0	0	0	0
Ped-Bike Adj(A_pbT)	1.00		1.00	1.00		1.00	1.00		1.00	1.00		1.00
Parking Bus, Adj	1.00	1.00	1.00	1.00	1.00	1.00	1.00	1.00	1.00	1.00	1.00	1.00
Work Zone On Approach		No			No			No			No	
Adj Sat Flow, veh/h/ln	1870	1870	1870	1870	1870	1870	1870	1870	1870	1870	1870	1870
Adj Flow Rate, veh/h	207	971	0	211	804	0	648	2171	0	368	1265	0
Peak Hour Factor	0.94	0.94	0.94	0.94	0.94	0.94	0.94	0.94	0.94	0.94	0.94	0.94
Percent Heavy Veh, %	2	2	2	2	2	2	2	2	2	2	2	2
Cap, veh/h	248	838		249	844		728	2532		374	2009	
Arrive On Green	0.20	0.47	0.00	0.11	0.24	0.00	0.21	0.50	0.00	0.11	0.39	0.00
Sat Flow, veh/h	1781	3554	1585	1781	3554	1585	3456	5106	1585	3456	5106	1585
Grp Volume(v), veh/h	207	971	0	211	804	0	648	2171	0	368	1265	0
Grp Sat Flow(s),veh/h/ln	1781	1777	1585	1781	1777	1585	1728	1702	1585	1728	1702	1585
Q Serve(g_s), s	10.7	28.3	0.0	10.6	26.8	0.0	21.9	44.8	0.0	12.8	24.0	0.0
Cycle Q Clear(g_c), s	10.7	28.3	0.0	10.6	26.8	0.0	21.9	44.8	0.0	12.8	24.0	0.0
Prop In Lane	1.00		1.00	1.00		1.00	1.00		1.00	1.00		1.00
Lane Grp Cap(c), veh/h	248	838		249	844		728	2532		374	2009	
V/C Ratio(X)	0.83	1.16		0.85	0.95		0.89	0.86		0.98	0.63	
Avail Cap(c_a), veh/h	248	838		275	844		864	2532		374	2009	
HCM Platoon Ratio	2.00	2.00	2.00	1.00	1.00	1.00	1.00	1.00	1.00	1.00	1.00	1.00
Upstream Filter(l)	0.78	0.78	0.00	1.00	1.00	0.00	1.00	1.00	0.00	1.00	1.00	0.00
Uniform Delay (d), s/veh	29.6	31.7	0.0	32.8	45.1	0.0	46.0	26.5	0.0	53.4	29.3	0.0
Incr Delay (d2), s/veh	17.2	82.3	0.0	19.9	20.3	0.0	10.1	4.0	0.0	41.8	1.5	0.0
Initial Q Delay(d3),s/veh	0.0	0.0	0.0	0.0	0.0	0.0	0.0	0.0	0.0	0.0	0.0	0.0
%ile BackOfQ(50%),veh/ln	5.1	19.0	0.0	5.9	14.1	0.0	10.4	18.5	0.0	7.7	10.0	0.0
Unsig. Movement Delay, s/veh												
LnGrp Delay(d),s/veh	46.8	114.0	0.0	52.7	65.4	0.0	56.1	30.6	0.0	95.2	30.8	0.0
LnGrp LOS	D	F		D	E		E	C		F	C	
Approach Vol, veh/h		1178	A		1015	A		2819	A		1633	A
Approach Delay, s/veh		102.2			62.8			36.4			45.4	
Approach LOS		F			E			D			D	
Timer - Assigned Phs	1	2	3	4	5	6	7	8				
Phs Duration (G+Y+Rc), s	19.0	66.0	18.2	34.3	31.3	53.7	18.0	34.5				
Change Period (Y+Rc), s	6.0	6.0	5.5	6.0	6.0	6.0	6.0	* 6				
Max Green Setting (Gmax), s	13.0	43.0	14.5	26.0	30.0	26.0	12.0	* 29				
Max Q Clear Time (g_c+l1), s	14.8	46.8	12.6	30.3	23.9	26.0	12.7	28.8				
Green Ext Time (p_c), s	0.0	0.0	0.1	0.0	1.4	0.0	0.0	0.0				

Intersection Summary

HCM 6th Ctrl Delay	54.3
HCM 6th LOS	D

Notes

* HCM 6th computational engine requires equal clearance times for the phases crossing the barrier.
 Unsignalized Delay for [NBR, EBR, WBR, SBR] is excluded from calculations of the approach delay and intersection delay.

Intersection			
Intersection Delay, s/veh	2.9		
Intersection LOS	A		
Approach	WB	NB	SB
Entry Lanes	1	1	1
Conflicting Circle Lanes	1	1	1
Adj Approach Flow, veh/h	49	0	22
Demand Flow Rate, veh/h	50	0	22
Vehicles Circulating, veh/h	0	22	0
Vehicles Exiting, veh/h	22	0	50
Ped Vol Crossing Leg, #/h	0	0	0
Ped Cap Adj	1.000	1.000	1.000
Approach Delay, s/veh	2.9	0.0	2.7
Approach LOS	A	-	A
Lane	Left	Left	Left
Designated Moves	LR	TR	LT
Assumed Moves	LR	TR	LT
RT Channelized			
Lane Util	1.000	1.000	1.000
Follow-Up Headway, s	2.609	2.609	2.609
Critical Headway, s	4.976	4.976	4.976
Entry Flow, veh/h	50	0	22
Cap Entry Lane, veh/h	1380	1349	1380
Entry HV Adj Factor	0.980	1.000	1.000
Flow Entry, veh/h	49	0	22
Cap Entry, veh/h	1352	1349	1380
V/C Ratio	0.036	0.000	0.016
Control Delay, s/veh	2.9	2.7	2.7
LOS	A	A	A
95th %tile Queue, veh	0	0	0

Intersection			
Intersection Delay, s/veh	3.0		
Intersection LOS	A		
Approach	WB	NB	SB
Entry Lanes	1	1	1
Conflicting Circle Lanes	1	1	1
Adj Approach Flow, veh/h	33	0	64
Demand Flow Rate, veh/h	34	0	65
Vehicles Circulating, veh/h	0	65	0
Vehicles Exiting, veh/h	65	0	34
Ped Vol Crossing Leg, #/h	0	0	0
Ped Cap Adj	1.000	1.000	1.000
Approach Delay, s/veh	2.9	0.0	3.0
Approach LOS	A	-	A
Lane	Left	Left	Left
Designated Moves	LR	TR	LT
Assumed Moves	LR	TR	LT
RT Channelized			
Lane Util	1.000	1.000	1.000
Follow-Up Headway, s	2.609	2.609	2.609
Critical Headway, s	4.976	4.976	4.976
Entry Flow, veh/h	34	0	65
Cap Entry Lane, veh/h	1380	1291	1380
Entry HV Adj Factor	0.971	1.000	0.985
Flow Entry, veh/h	33	0	64
Cap Entry, veh/h	1339	1291	1359
V/C Ratio	0.025	0.000	0.047
Control Delay, s/veh	2.9	2.8	3.0
LOS	A	A	A
95th %tile Queue, veh	0	0	0

Intersection			
Intersection Delay, s/veh	3.0		
Intersection LOS	A		
Approach	WB	NB	SB
Entry Lanes	1	1	1
Conflicting Circle Lanes	1	1	1
Adj Approach Flow, veh/h	49	49	39
Demand Flow Rate, veh/h	50	50	39
Vehicles Circulating, veh/h	50	22	0
Vehicles Exiting, veh/h	22	17	100
Ped Vol Crossing Leg, #/h	0	0	0
Ped Cap Adj	1.000	1.000	1.000
Approach Delay, s/veh	3.1	3.0	2.8
Approach LOS	A	A	A
Lane	Left	Left	Left
Designated Moves	LR	TR	LT
Assumed Moves	LR	TR	LT
RT Channelized			
Lane Util	1.000	1.000	1.000
Follow-Up Headway, s	2.609	2.609	2.609
Critical Headway, s	4.976	4.976	4.976
Entry Flow, veh/h	50	50	39
Cap Entry Lane, veh/h	1311	1349	1380
Entry HV Adj Factor	0.980	0.980	0.991
Flow Entry, veh/h	49	49	39
Cap Entry, veh/h	1285	1323	1368
V/C Ratio	0.038	0.037	0.028
Control Delay, s/veh	3.1	3.0	2.8
LOS	A	A	A
95th %tile Queue, veh	0	0	0

Intersection			
Intersection Delay, s/veh	3.2		
Intersection LOS	A		
Approach	WB	NB	SB
Entry Lanes	1	1	1
Conflicting Circle Lanes	1	1	1
Adj Approach Flow, veh/h	33	33	115
Demand Flow Rate, veh/h	34	34	117
Vehicles Circulating, veh/h	34	65	0
Vehicles Exiting, veh/h	65	52	68
Ped Vol Crossing Leg, #/h	0	0	0
Ped Cap Adj	1.000	1.000	1.000
Approach Delay, s/veh	3.0	3.1	3.3
Approach LOS	A	A	A
Lane	Left	Left	Left
Designated Moves	LR	TR	LT
Assumed Moves	LR	TR	LT
RT Channelized			
Lane Util	1.000	1.000	1.000
Follow-Up Headway, s	2.609	2.609	2.609
Critical Headway, s	4.976	4.976	4.976
Entry Flow, veh/h	34	34	117
Cap Entry Lane, veh/h	1333	1291	1380
Entry HV Adj Factor	0.971	0.980	0.983
Flow Entry, veh/h	33	33	115
Cap Entry, veh/h	1294	1266	1356
V/C Ratio	0.026	0.026	0.085
Control Delay, s/veh	3.0	3.1	3.3
LOS	A	A	A
95th %tile Queue, veh	0	0	0

Intersection						
Int Delay, s/veh	0.1					
Movement	EBL	EBR	NBL	NBT	SBT	SBR
Lane Configurations		↗		↑↑	↑↑	
Traffic Vol, veh/h	0	11	0	1116	1830	0
Future Vol, veh/h	0	11	0	1116	1830	0
Conflicting Peds, #/hr	0	0	0	0	0	0
Sign Control	Stop	Stop	Free	Free	Free	Free
RT Channelized	-	None	-	None	-	None
Storage Length	-	0	-	-	-	-
Veh in Median Storage, #	2	-	-	0	0	-
Grade, %	0	-	-	0	0	-
Peak Hour Factor	92	92	92	92	92	92
Heavy Vehicles, %	2	2	2	2	2	2
Mvmt Flow	0	12	0	1213	1989	0

Major/Minor	Minor2	Major1	Major2		
Conflicting Flow All	-	995	-	0	-
Stage 1	-	-	-	-	-
Stage 2	-	-	-	-	-
Critical Hdwy	-	6.94	-	-	-
Critical Hdwy Stg 1	-	-	-	-	-
Critical Hdwy Stg 2	-	-	-	-	-
Follow-up Hdwy	-	3.32	-	-	-
Pot Cap-1 Maneuver	0	*294	0	-	-
Stage 1	0	-	0	-	-
Stage 2	0	-	0	-	-
Platoon blocked, %		1		-	-
Mov Cap-1 Maneuver	-	*294	-	-	-
Mov Cap-2 Maneuver	-	-	-	-	-
Stage 1	-	-	-	-	-
Stage 2	-	-	-	-	-

Approach	EB	NB	SB
HCM Control Delay, s	17.8	0	0
HCM LOS	C		

Minor Lane/Major Mvmt	NBT EBLn1	SBT
Capacity (veh/h)	- 294	-
HCM Lane V/C Ratio	- 0.041	-
HCM Control Delay (s)	- 17.8	-
HCM Lane LOS	- C	-
HCM 95th %tile Q(veh)	- 0.1	-

Notes
 -: Volume exceeds capacity \$: Delay exceeds 300s +: Computation Not Defined *: All major volume in platoon

Intersection						
Int Delay, s/veh	0					
Movement	EBL	EBR	NBL	NBT	SBT	SBR
Lane Configurations		↗		↑↑	↑↑	
Traffic Vol, veh/h	0	8	0	1766	1165	0
Future Vol, veh/h	0	8	0	1766	1165	0
Conflicting Peds, #/hr	0	0	0	0	0	0
Sign Control	Stop	Stop	Free	Free	Free	Free
RT Channelized	-	None	-	None	-	None
Storage Length	-	0	-	-	-	-
Veh in Median Storage, #	2	-	-	0	0	-
Grade, %	0	-	-	0	0	-
Peak Hour Factor	92	92	92	92	92	92
Heavy Vehicles, %	2	2	2	2	2	2
Mvmt Flow	0	9	0	1920	1266	0

Major/Minor	Minor2	Major1	Major2
Conflicting Flow All	-	633	0
Stage 1	-	-	-
Stage 2	-	-	-
Critical Hdwy	-	6.94	-
Critical Hdwy Stg 1	-	-	-
Critical Hdwy Stg 2	-	-	-
Follow-up Hdwy	-	3.32	-
Pot Cap-1 Maneuver	0	*607	0
Stage 1	0	-	0
Stage 2	0	-	0
Platoon blocked, %		1	-
Mov Cap-1 Maneuver	-	*607	-
Mov Cap-2 Maneuver	-	-	-
Stage 1	-	-	-
Stage 2	-	-	-

Approach	EB	NB	SB
HCM Control Delay, s	11	0	0
HCM LOS	B		

Minor Lane/Major Mvmt	NBT EBLn1	SBT
Capacity (veh/h)	- 607	-
HCM Lane V/C Ratio	- 0.014	-
HCM Control Delay (s)	- 11	-
HCM Lane LOS	- B	-
HCM 95th %tile Q(veh)	- 0	-

Notes
 -: Volume exceeds capacity \$: Delay exceeds 300s +: Computation Not Defined *: All major volume in platoon

Intersection						
Int Delay, s/veh	0					
Movement	EBL	EBR	NBL	NBT	SBT	SBR
Lane Configurations		↗		↑↑↑	↑↑↑	
Traffic Vol, veh/h	0	11	0	1723	2830	0
Future Vol, veh/h	0	11	0	1723	2830	0
Conflicting Peds, #/hr	0	0	0	0	0	0
Sign Control	Stop	Stop	Free	Free	Free	Free
RT Channelized	-	None	-	None	-	None
Storage Length	-	0	-	-	-	-
Veh in Median Storage, #	2	-	-	0	0	-
Grade, %	0	-	-	0	0	-
Peak Hour Factor	92	92	92	92	92	92
Heavy Vehicles, %	2	2	2	2	2	2
Mvmt Flow	0	12	0	1873	3076	0

Major/Minor	Minor2	Major1	Major2		
Conflicting Flow All	-	1538	-	0	0
Stage 1	-	-	-	-	-
Stage 2	-	-	-	-	-
Critical Hdwy	-	7.14	-	-	-
Critical Hdwy Stg 1	-	-	-	-	-
Critical Hdwy Stg 2	-	-	-	-	-
Follow-up Hdwy	-	3.92	-	-	-
Pot Cap-1 Maneuver	0	*249	0	-	0
Stage 1	0	-	0	-	0
Stage 2	0	-	0	-	0
Platoon blocked, %		1		-	-
Mov Cap-1 Maneuver	-	*249	-	-	-
Mov Cap-2 Maneuver	-	-	-	-	-
Stage 1	-	-	-	-	-
Stage 2	-	-	-	-	-

Approach	EB	NB	SB
HCM Control Delay, s	20.2	0	0
HCM LOS	C		

Minor Lane/Major Mvmt	NBT EBLn1	SBT
Capacity (veh/h)	- 249	-
HCM Lane V/C Ratio	- 0.048	-
HCM Control Delay (s)	- 20.2	-
HCM Lane LOS	- C	-
HCM 95th %tile Q(veh)	- 0.2	-

Notes
 -: Volume exceeds capacity \$: Delay exceeds 300s +: Computation Not Defined *: All major volume in platoon

Intersection						
Int Delay, s/veh	0					
Movement	EBL	EBR	NBL	NBT	SBT	SBR
Lane Configurations		↗		↑↑↑	↑↑↑	
Traffic Vol, veh/h	0	8	0	2724	1802	0
Future Vol, veh/h	0	8	0	2724	1802	0
Conflicting Peds, #/hr	0	0	0	0	0	0
Sign Control	Stop	Stop	Free	Free	Free	Free
RT Channelized	-	None	-	None	-	None
Storage Length	-	0	-	-	-	-
Veh in Median Storage, #	2	-	-	0	0	-
Grade, %	0	-	-	0	0	-
Peak Hour Factor	92	92	92	92	92	92
Heavy Vehicles, %	2	2	2	2	2	2
Mvmt Flow	0	9	0	2961	1959	0

Major/Minor	Minor2	Major1	Major2		
Conflicting Flow All	-	980	-	0	0
Stage 1	-	-	-	-	-
Stage 2	-	-	-	-	-
Critical Hdwy	-	7.14	-	-	-
Critical Hdwy Stg 1	-	-	-	-	-
Critical Hdwy Stg 2	-	-	-	-	-
Follow-up Hdwy	-	3.92	-	-	-
Pot Cap-1 Maneuver	0	*492	0	-	0
Stage 1	0	-	0	-	0
Stage 2	0	-	0	-	0
Platoon blocked, %		1		-	-
Mov Cap-1 Maneuver	-	*492	-	-	-
Mov Cap-2 Maneuver	-	-	-	-	-
Stage 1	-	-	-	-	-
Stage 2	-	-	-	-	-

Approach	EB	NB	SB
HCM Control Delay, s	12.4	0	0
HCM LOS	B		

Minor Lane/Major Mvmt	NBT EBLn1	SBT
Capacity (veh/h)	- 492	-
HCM Lane V/C Ratio	- 0.018	-
HCM Control Delay (s)	- 12.4	-
HCM Lane LOS	- B	-
HCM 95th %tile Q(veh)	- 0.1	-

Notes
 -: Volume exceeds capacity \$: Delay exceeds 300s +: Computation Not Defined *: All major volume in platoon

APPENDIX E

Signal Warrant Figure

WARRANT 2 - FOUR HOUR VEHICULAR VOLUME (70% FACTOR)
 (COMMUNITY LESS THAN 10,000 POPULATION OR ABOVE 70 km/h (40 mph) ON MAJOR STREET)

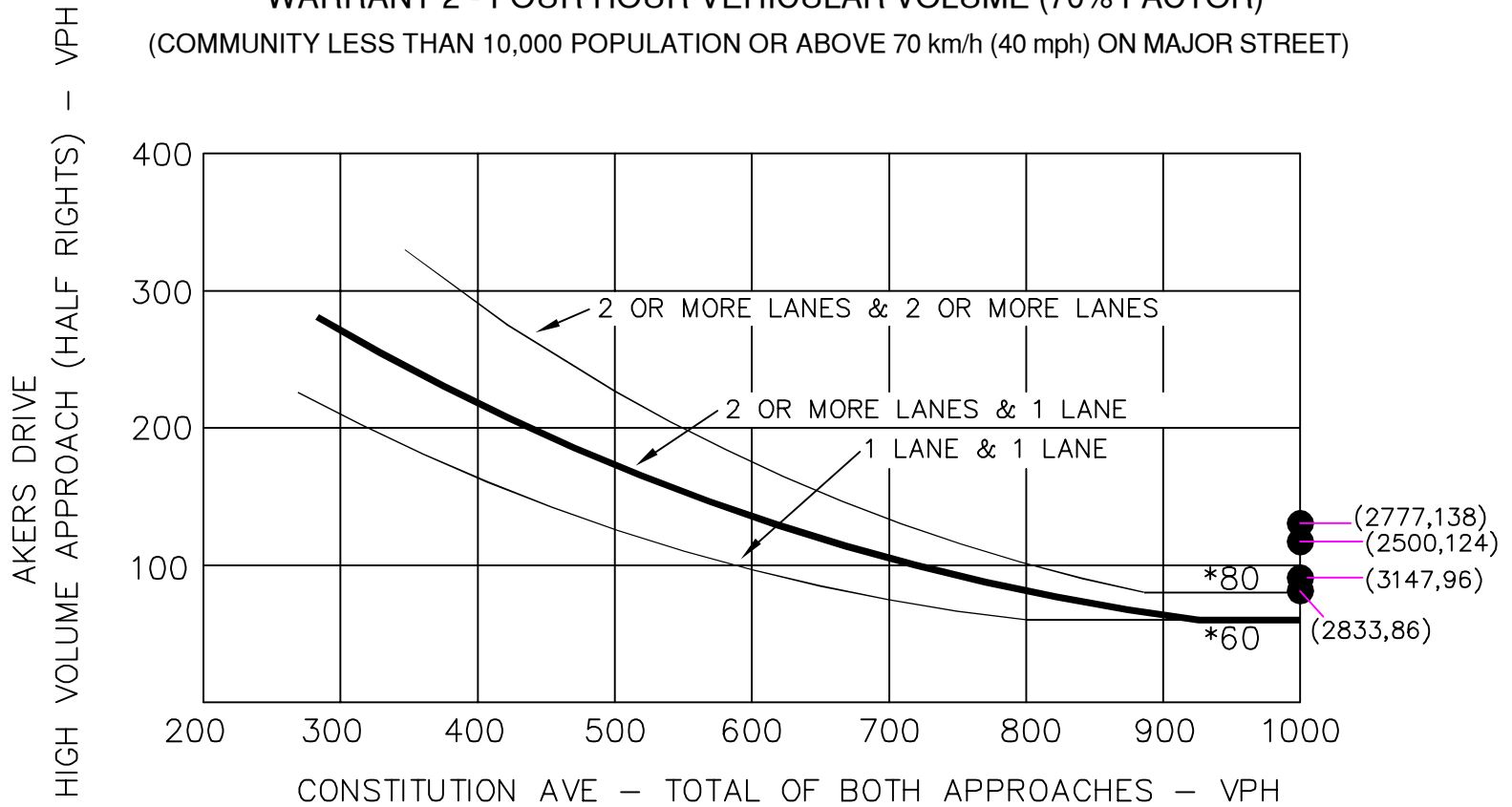

* NOTE: 80 VPH APPLIES AS THE LOWER THRESHOLD VOLUME FOR A MINOR STREET APPROACH WITH TWO OR MORE LANES AND 60 VPH APPLIES AS THE LOWER THRESHOLD VOLUME FOR A MINOR STREET APPROACHING WITH ONE LANE.

CONSTITUTION AVE & AKERS DR
 SIGNAL WARRANT ANALYSIS
 FOUR HOUR VOLUME WARRANT

● 2045 TOTAL TRAFFIC DATA POINT

Source: Manual of Uniform Traffic Control Devices 2009



APPENDIX F

Queue Analysis Worksheets

Queues

1: Akers Dr & Constitution Ave

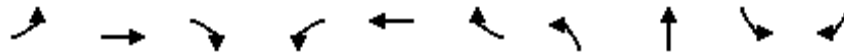

Lane Group	EBL	EBT	EBR	WBL	WBT	WBR	NBL	NBT	SBL	SBR
Lane Group Flow (vph)	117	1374	22	17	1423	65	61	37	66	167
v/c Ratio	0.52	0.50	0.02	0.07	0.52	0.05	0.29	0.11	0.32	0.53
Control Delay	14.5	5.7	1.2	6.7	20.7	3.8	49.5	0.7	50.5	27.5
Queue Delay	0.0	0.0	0.0	0.0	0.0	0.0	0.0	0.0	0.0	0.0
Total Delay	14.5	5.7	1.2	6.7	20.7	3.8	49.5	0.7	50.5	27.5
Queue Length 50th (ft)	28	172	0	6	587	14	43	0	46	50
Queue Length 95th (ft)	82	208	5	m6	m434	m11	86	0	92	123
Internal Link Dist (ft)		512			1058			252		
Turn Bay Length (ft)	200			225			150		375	
Base Capacity (vph)	227	2742	1231	242	2742	1241	211	325	204	318
Starvation Cap Reductn	0	0	0	0	0	0	0	0	0	0
Spillback Cap Reductn	0	0	0	0	0	0	0	0	0	0
Storage Cap Reductn	0	0	0	0	0	0	0	0	0	0
Reduced v/c Ratio	0.52	0.50	0.02	0.07	0.52	0.05	0.29	0.11	0.32	0.53

Intersection Summary

m Volume for 95th percentile queue is metered by upstream signal.

Queues

1: Akers Dr & Constitution Ave

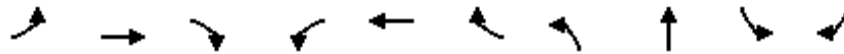

Lane Group	EBL	EBT	EBR	WBL	WBT	WBR	NBL	NBT	SBL	SBR
Lane Group Flow (vph)	52	1600	65	52	1583	68	41	24	55	98
v/c Ratio	0.31	0.61	0.05	0.32	0.60	0.06	0.16	0.07	0.22	0.29
Control Delay	10.8	8.3	1.1	13.8	14.4	4.9	43.7	0.4	44.9	20.1
Queue Delay	0.0	0.0	0.0	0.0	0.0	0.0	0.0	0.0	0.0	0.0
Total Delay	10.8	8.3	1.1	13.8	14.4	4.9	43.7	0.4	44.9	20.1
Queue Length 50th (ft)	12	261	0	18	305	10	27	0	37	22
Queue Length 95th (ft)	34	315	10	m20	m293	m12	61	0	77	72
Internal Link Dist (ft)		512			1058			252		
Turn Bay Length (ft)	200			225			150		375	
Base Capacity (vph)	167	2639	1197	164	2639	1197	252	334	247	336
Starvation Cap Reductn	0	0	0	0	0	0	0	0	0	0
Spillback Cap Reductn	0	0	0	0	0	0	0	0	0	0
Storage Cap Reductn	0	0	0	0	0	0	0	0	0	0
Reduced v/c Ratio	0.31	0.61	0.05	0.32	0.60	0.06	0.16	0.07	0.22	0.29

Intersection Summary

m Volume for 95th percentile queue is metered by upstream signal.

2: Marksheffel Rd & Constitution Ave

12/21/2021

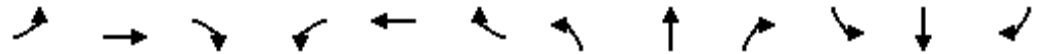

Lane Group	EBL	EBT	EBR	WBL	WBT	WBR	NBL	NBT	NBR	SBL	SBT	SBR
Lane Group Flow (vph)	157	378	360	103	506	228	351	801	35	212	1484	131
v/c Ratio	0.55	0.48	0.23	0.32	0.75	0.14	0.73	0.58	0.02	0.58	1.17	0.08
Control Delay	33.9	42.2	0.3	27.6	52.5	0.2	58.3	32.8	0.0	57.4	122.4	0.1
Queue Delay	0.0	0.0	0.0	0.0	0.0	0.0	0.0	0.0	0.0	0.0	0.0	0.0
Total Delay	33.9	42.2	0.3	27.6	52.5	0.2	58.3	32.8	0.0	57.4	122.4	0.1
Queue Length 50th (ft)	85	134	0	54	195	0	135	255	0	81	~734	0
Queue Length 95th (ft)	121	170	0	83	241	0	183	381	0	119	#1016	0
Internal Link Dist (ft)		1058			960			381			511	
Turn Bay Length (ft)	450			225			575			525		
Base Capacity (vph)	333	917	1583	435	914	1583	521	1388	1583	500	1264	1583
Starvation Cap Reductn	0	0	0	0	0	0	0	0	0	0	0	0
Spillback Cap Reductn	0	0	0	0	0	0	0	0	0	0	0	0
Storage Cap Reductn	0	0	0	0	0	0	0	0	0	0	0	0
Reduced v/c Ratio	0.47	0.41	0.23	0.24	0.55	0.14	0.67	0.58	0.02	0.42	1.17	0.08

Intersection Summary

- ~ Volume exceeds capacity, queue is theoretically infinite.
Queue shown is maximum after two cycles.
- # 95th percentile volume exceeds capacity, queue may be longer.
Queue shown is maximum after two cycles.

2: Marksheffel Rd & Constitution Ave

12/21/2021



Lane Group	EBL	EBT	EBR	WBL	WBT	WBR	NBL	NBT	NBR	SBL	SBT	SBR
Lane Group Flow (vph)	133	627	285	136	518	298	423	1404	51	238	818	131
v/c Ratio	0.67	0.91	0.18	0.71	0.70	0.19	0.78	0.88	0.03	0.82	0.61	0.08
Control Delay	49.7	65.1	0.2	51.8	49.3	0.3	59.1	37.9	0.0	77.1	33.3	0.1
Queue Delay	0.0	0.0	0.0	0.0	0.0	0.0	0.0	0.0	0.0	0.0	0.0	0.0
Total Delay	49.7	65.1	0.2	51.8	49.3	0.3	59.1	37.9	0.0	77.1	33.3	0.1
Queue Length 50th (ft)	76	250	0	77	195	0	162	514	0	95	273	0
Queue Length 95th (ft)	#137	#351	0	#140	257	0	216	622	0	#162	347	0
Internal Link Dist (ft)		1058			960			381			511	
Turn Bay Length (ft)	450			225			575			525		
Base Capacity (vph)	199	707	1583	193	763	1583	600	1595	1583	289	1334	1583
Starvation Cap Reductn	0	0	0	0	0	0	0	0	0	0	0	0
Spillback Cap Reductn	0	0	0	0	0	0	0	0	0	0	0	0
Storage Cap Reductn	0	0	0	0	0	0	0	0	0	0	0	0
Reduced v/c Ratio	0.67	0.89	0.18	0.70	0.68	0.19	0.70	0.88	0.03	0.82	0.61	0.08

Intersection Summary

95th percentile volume exceeds capacity, queue may be longer.

Queue shown is maximum after two cycles.



Lane Group	EBL	EBT	EBR	WBL	WBT	WBR	NBL	NBT	NBR	SBL	SBT	SBR
Lane Group Flow (vph)	248	588	556	160	785	352	539	1239	54	327	2295	203
v/c Ratio	1.11	0.82	0.99	0.63	1.04	0.64	1.18	0.66	0.03	0.72	1.23	0.13
Control Delay	118.4	52.5	55.0	39.6	90.7	16.7	146.5	34.2	0.0	59.0	143.2	0.2
Queue Delay	0.0	0.0	0.0	0.0	0.0	0.0	0.0	0.0	0.0	0.0	0.0	0.0
Total Delay	118.4	52.5	55.0	39.6	90.7	16.7	146.5	34.2	0.0	59.0	143.2	0.2
Queue Length 50th (ft)	~172	235	~241	87	~346	53	~257	294	0	125	~804	0
Queue Length 95th (ft)	#348	#335	#480	142	#472	158	#369	354	0	173	#898	0
Internal Link Dist (ft)		1058			960			381			511	
Turn Bay Length (ft)	450			225			575			525		
Base Capacity (vph)	224	714	559	280	752	549	457	1866	1583	514	1864	1583
Starvation Cap Reductn	0	0	0	0	0	0	0	0	0	0	0	0
Spillback Cap Reductn	0	0	0	0	0	0	0	0	0	0	0	0
Storage Cap Reductn	0	0	0	0	0	0	0	0	0	0	0	0
Reduced v/c Ratio	1.11	0.82	0.99	0.57	1.04	0.64	1.18	0.66	0.03	0.64	1.23	0.13

Intersection Summary

- ~ Volume exceeds capacity, queue is theoretically infinite.
Queue shown is maximum after two cycles.
- # 95th percentile volume exceeds capacity, queue may be longer.
Queue shown is maximum after two cycles.



Lane Group	EBL	EBT	EBR	WBL	WBT	WBR	NBL	NBT	NBR	SBL	SBT	SBR
Lane Group Flow (vph)	207	971	441	211	804	461	648	2171	79	368	1265	207
v/c Ratio	0.87	1.23	0.69	0.80	0.96	0.81	0.84	1.19	0.05	0.99	1.03	0.13
Control Delay	67.5	149.2	12.8	51.1	67.7	31.0	55.1	127.1	0.1	98.4	77.7	0.2
Queue Delay	0.0	0.0	0.0	0.0	0.0	0.0	0.0	0.0	0.0	0.0	0.0	0.0
Total Delay	67.5	149.2	12.8	51.1	67.7	31.0	55.1	127.1	0.1	98.4	77.7	0.2
Queue Length 50th (ft)	125	-485	31	112	325	157	246	-743	0	148	-393	0
Queue Length 95th (ft)	#257	#623	120	#223	#452	#327	308	#838	0	#250	#517	0
Internal Link Dist (ft)		1058			960			381			511	
Turn Bay Length (ft)	450			225			575			525		
Base Capacity (vph)	239	790	636	275	840	571	858	1822	1583	371	1232	1583
Starvation Cap Reductn	0	0	0	0	0	0	0	0	0	0	0	0
Spillback Cap Reductn	0	0	0	0	0	0	0	0	0	0	0	0
Storage Cap Reductn	0	0	0	0	0	0	0	0	0	0	0	0
Reduced v/c Ratio	0.87	1.23	0.69	0.77	0.96	0.81	0.76	1.19	0.05	0.99	1.03	0.13

Intersection Summary

- ~ Volume exceeds capacity, queue is theoretically infinite.
Queue shown is maximum after two cycles.
- # 95th percentile volume exceeds capacity, queue may be longer.
Queue shown is maximum after two cycles.

APPENDIX G

Conceptual Site Plan

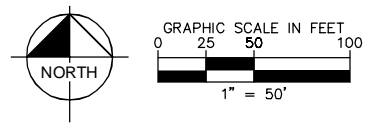
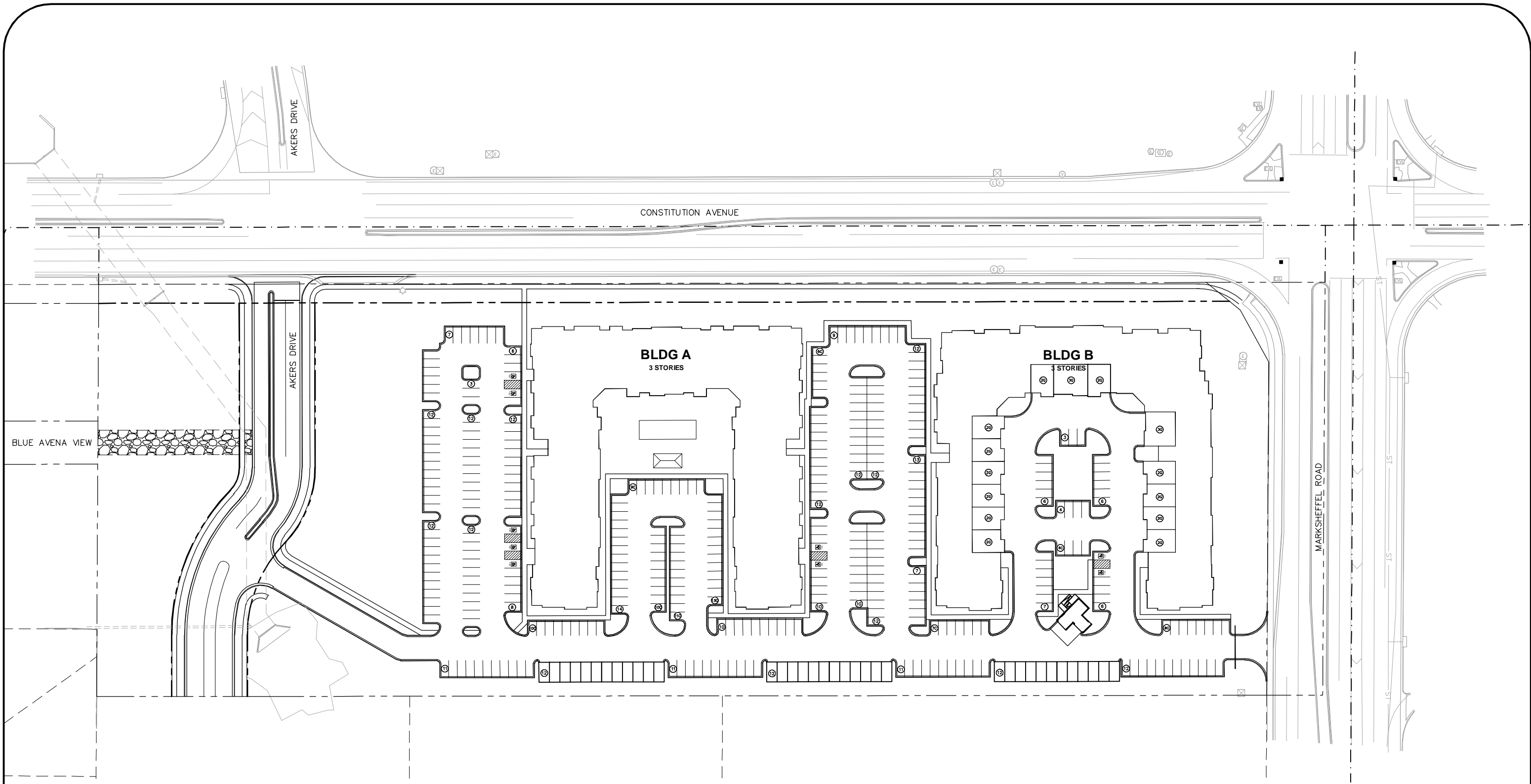

THE CITIZEN AT CONSTITUTION
 PRELIMINARY SITE PLAN
 12/14/2021

Kimley»Horn
© 2021 KIMLEY-HORN AND ASSOCIATES, INC.
 2 NORTH NEVADA AVENUE, SUITE 300, COLORADO SPRINGS, COLORADO
 PHONE: (719) 453-0180