



WYOMING ESTATES SUBDIVISION

FILING NO. 2

(A REPLAT OF A PORTION OF WYOMING ESTATES FILING NO. 1)

PRELIMINARY/FINAL DRAINAGE REPORT



PREPARED BY

Mike Bartusek
RESPEC
5540 Tech Center Dr., Suite 100
Colorado Springs, CO 80919
719-640-8057

PREPARED FOR

Home Run Restorations, Inc.
710 S. Blaney Road
Colorado Springs, CO 80929
719-649-7241

FEBRUARY 2024

Project Number W0562.23001

PCD File No. SP237 and SF2322





ENGINEER'S STATEMENT:

The attached drainage plan and report were prepared under my direction and supervision and are correct to the best of my knowledge and belief. Said drainage report has been prepared according to the criteria established by the County for drainage reports, and said report is in conformity with the master plan of the drainage basin. I accept responsibility for any liability caused by any negligent acts, errors or omissions on my part in preparing this report.

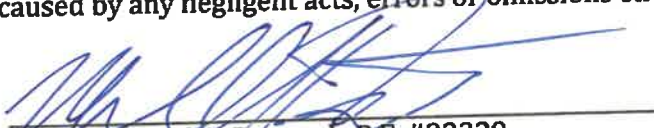
Michael A. Bartusek, P.E. #23329



DEVELOPER'S STATEMENT:

I, the Developer, have read and will comply with all of the requirements specified in this drainage report and plan.

By: 
Shawn Shafer

Title: Owner

Address: Home Run Restorations, Inc.
710 S. Blaney road
Colorado Springs, CO 80929

Filed in accordance with the El Paso County Land Development Code, Drainage Criteria Manual Volumes 1 and 2, and the Engineering Criteria Manual, as amended.

El Paso County Engineer/ECM Administrator

Date

Conditions:

PRELIMINARY/FINAL DRAINAGE REPORT
WYOMING ESTATES SUBDIVISION FILING NO. 2

PROJECT DESCRIPTION

This drainage report is for the development of the Wyoming Estates Subdivision Filing No. 2 which is a replat of a portion of Wyoming Estates Subdivision Filing No.1. Wyoming Estates Subdivision Filing No. 2 encompasses 25.34 of the total 40.01 acres site. The project is located west of Curtis Road approximately 2.5 miles north of SH 94. Of the 40.01 acres, 3.53 acres have been dedicated to El Paso County for future Curtis Road expansion. It is further described as the southern portion of Section 33, Township 13 South, Range 64 West of the 6th Principal Meridian in El Paso County, Colorado.

All of this development is located in the Curtis Ranch and Livestock Company Drainage Basin. Flows from the site drain into the west ditch of Curtis Road and flow north to the West Fork of Squirrel Creek.

SOILS

The soil on the site can be described as having a rapid permeability, medium-surface runoff, and moderate to high hazard of erosion. The soils within the site are:

- | | | |
|------|----------------------|---|
| • 8 | Blakeland Loamy Sand | A |
| • 95 | Truckton Sandy Loams | B |

FLOODPLAIN STATEMENT

No portion of the developed site is located within a designated FEMA 100-year floodplain according to the information published in the Federal Emergency Management Agency Flood Plain Map No. 08041C0785G, dated December 7, 2018.

METHOD OF COMPUTATION

The methodology utilized for this report is in accordance with the *El Paso County Drainage Criteria Manual, Volumes 1*, dated May 2014. The Rational Method for computation of runoff was used for determining Sub-Basin flows.

$Q = cia$

Where

- Q = maximum rate of runoff in cubic feet per second
- c = runoff coefficient representing drainage area characteristics
- i = average rainfall intensity, in inches per hour, for the duration required for the runoff to become established
- a = drainage basin size in acres

EXISTING DRAINAGE CONDITIONS

Currently the site improvements are completely developed with all roadway and drainage structures in place.

DEVELOPED DRAINAGE CONDITIONS

The proposed replatted portion of the subdivision will consist of four (4) lots with Lot 1 containing 5.13 acres, Lot 2 containing 5.41 acres, Lot 3 containing 9.44 acres and Lot 4 containing 6.36 acres. The remaining portion of Wyoming Estates Subdivision Filing No. 1 will consist of two (2) lots with Lot 2 containing 5.08 acres and Lot 3 containing 5.06 acres. It also contains an existing asphalt cul-de-sac located across from Patton Drive with an existing private

gravel road extending from the cul-de-sac and connecting to the existing access road to the west. These new lots are assumed to be developed with 3000 sf homes and 12 ft gravel drives. No overlot grading will take place within the proposed subdivision. No revisions to the Sub-basin boundaries delineated in the approved Final Drainage Report for the Wyoming Estates Subdivision Filing No. 1 are required.

Sub-Basin A contains 3.66 acres and will continue to drain to the southwest corner of the site. It produces flows of 0.9 cfs for the 5-year storm and 7.1 cfs for the 100-year storm. These flows travel off the site to the south.

Sub-Basin B1 contains 4.75 acres and will contain one (1) home and drains the eastern area of the site adjacent to Curtis Road. This area drains to the east and northeast and is tributary Sub-Basin OS1 which contains the west ditch along Curtis Road. This sub-basin produces flows of 1.6 cfs for the 5-year storm and 10.1 cfs for the 100-year storm.

Sub-basin OS1A contains 2.62 acres and is located east of the site and contains the Curtis Road ROW. This Sub-basin will produce flows of 1.5 cfs and 6.6 cfs respectively. The combined flows from Sub-Basins B1 and OS1A at DP1 will be 3.0 cfs for the 5-year storm and 16.4 cfs for the 100-year storm.

Sub-basin B2A1 contains 0.20 acres and is located in the area northcentral area of the site, along the south side of the gravel road. This roadway area sheet flows into the ditch in Sub-basin B2B1 and produces flows of 0.4 cfs for the 5-year storm and 1.0 cfs for the 100-year storm.

Sub-Basin B2B1 contains 1.20 acres and drains the northcentral portion of the site and contains a small portion of Lot 1. This area drains to the northeast toward the proposed ditch along Teleo Point. This sub-basin produces flows of 0.8 cfs for the 5-year storm and 3.1 cfs for the 100-year storm. These flows will combine with the flows from Sub-basin B2A1 at DP2 to produce flows of 1.1 cfs for the 5-year storm and 3.8 cfs for the 100-year storm. These flows continue east into Sub-Basin B2B2.

Sub-basin OS2A contains 1.26 acres and is located northwest of the site. This undeveloped area sheet flows onto the site and produces flows of 0.3 cfs for the 5-year storm and 1.9 cfs for the 100-year storm. These flows sheet flow into Sub-Basin B2.

Sub-Basin B2B2 contains 16.31 acres and will contain three (3) homes and drains the northcentral portion of the site. It contains a large portion of Lots 2, 3 and 4 and a small portion of Wyoming Estates Subdivision Filing No. 1 Lot 3. This area drains to the northeast toward the proposed ditch along Teleo Point. This Sub-basin produces revised flows of 4.0 cfs for the 5-year storm and 28.1 cfs for the 100-year storm. These flows will combine with the flows from Sub-basin OS2A at DP3 to produce flows of 3.9 cfs for the 5-year storm and 27.6 cfs for the 100-year storm. These flows will combine with the flows from DP2 at DP4 to produce flows of 5.2 cfs for the 5-year storm and 31.4 cfs for the 100-year storm. These ditch flows continue east toward the Curtis Road ditch. They will then combine with the flows from DP1 at the proposed public 30"x19" RCEP culvert under the Teleo Point cul-de-sac. The combined flows of DP1 and DP4 at DP5 will be 7.4 cfs for the 5-year storm and 43.5 cfs for the 100-year storm. These flows continue north into Sub-Basin OS1B.

Sub-basin B3A1 contains 0.165 acres and is located in the northwest area of the site, along the south side of the gravel road. This roadway area sheet flows into the ditch in Sub-basin B3B and produces flows of 0.4 cfs for the 5-year storm and 0.9 cfs for the 100-year storm.

Sub-basin B3A2 contains 0.165 acres and is located in the northwest area of the site approximately 275 ft from the west property line along the south side of the gravel road. This roadway area sheet flows into the ditch in Sub-basin B3B and produces flows of 0.4 cfs for the 5-year storm and 0.9 cfs for the 100-year storm.

Sub-basin OS2B contains 5.60 acres and is located in the northwest area of the site. This undeveloped area sheet flows onto the site and produces flows of 1.1 cfs for the 5-year storm and 8.2 cfs for the 100-year storm. These flows sheet flow into Sub-Basin B3.

Sub-Basin B3B contains 4.11 acres and will contain one (1) home and drains the northwestern portion of the site and contains a large portion of Lot 1. This area drains to the east toward the proposed ditch and sump along the new gravel access road. This sub-basin produces flows of 1.1 cfs for the 5-year storm and 8.0 cfs for the 100-year storm. The flows from Sub-basin B3B will combine with the flows from Sub-basin OS2B at DP8 to produce flows of 1.9 cfs for the 5-year storm and 13.7 cfs for the 100-year storm. These flows will combine with the flows from Sub-basins B3A1 and B3A2 at DP9 to produce flows of 2.2 cfs for the 5-year storm and 14.6 cfs for the 100-year storm. These flows travel into Sub-Basin B4A2 through a private 30" cmp.

Sub-basin B4A1 contains 0.44 acres and is located in the northwest area of the site, along the north side of the gravel road. This roadway area sheet flows south along the roadway and into Sub-basin B4A2 and produces flows of 0.7 cfs for the 5-year storm and 2.1 cfs for the 100-year storm. These flows will combine with the flows from DP9 at DP10 to produce flows of 2.5 cfs for the 5-year storm and 15.4 cfs for the 100-year storm.

Sub-Basin B4A2 contains 4.40 acres and drains the northeastern portion of the site and contains Lot 2. This area drains to the east toward the existing ditch along the west property line which will be enlarged and stabilized. This sub-basin produces flows of 1.3 cfs for the 5-year storm and 9.0 cfs for the 100-year storm. These flows will combine with the flows from DP10 at DP11 to produce flows of 3.1 cfs for the 5-year storm and 19.2 cfs for the 100-year storm. These flows will then flow into the ditch along Curtis Road.

Sub-Basin B4B1 contains 0.38 acres and drains the northern portion of the Teleo Point gravel road. This area drains to the east toward Curtis Road. This sub-basin produces flows of 0.5 cfs for the 5-year storm and 1.6 cfs for the 100-year storm. These flows will then flow into Sub-basin B4B2.

Sub-Basin B4B2 contains 0.56 acres and drains the northern portion of the Teleo Point asphalt road. This area drains to the east toward Curtis Road. This sub-basin produces flows of 1.4 cfs for the 5-year storm and 3.3 cfs for the 100-year storm. These flows will combine with the flows from DP5 at DP6 to produce flows of 8.2 cfs for the 5-year storm and 45.5 cfs for the 100-year storm. These flows will then flow into the ditch along Curtis Road.

Sub-basin OS1B contains 0.91 acres and is located east of the site and north of Teleo Point cul-de-sac and contains the Curtis Road ROW. Sub-basin will produce flows of 0.6 cfs and 2.6 cfs respectively. These flows will combine with the flows from DP6 at DP7 to produce flows of 8.2 cfs for the 5-year storm and 44.8 cfs for the 100-year storm.

The combined flows of OS1B, DP7 and DP11 at DP12 will be 10.1 cfs for the 5-year storm and 58.1 cfs for the 100-year storm. These flows will continue within the west Curtis Road ditch to the West Fork of Squirrel Creek.

WATER QUALITY AND DETENTION

Water quality basins are not required for subdivisions containing lots greater than 5.0 acres per the Engineering Criteria Manual Section 1.7.1.B.5. Runoff Reduction calculations have been provided to eliminate the need for water quality basins.

Based on the large lots and longer Time of Concentration distances, the estimated Developed flows are less than the Existing Conditions flows so no detention facilities are warranted.

PRIVATE DRAINAGE FACILITIES

The proposed drainage improvements have been constructed. The private culvert and ditch improvements construction and maintenance will be the responsibility of Wyoming Estates Subdivision HOA.

DRAINAGE BASIN FEES

The proposed development is located within the Curtis Ranch and Livestock Company drainage basin. The Livestock Company Drainage Basin encompasses 3.66 acres of the site and has fees associated with it. The Curtis Ranch Drainage Basin encompasses the remainder of the area and has no fees associated with it. No fees were paid at the time of the Wyoming Estates Subdivision Filing No. 1 plat approval; therefore, the fees are required at this time and are as follows:

$3.66 \text{ acres} \times 7\% \text{ (imperviousness)} = 0.256 \text{ acres}$
Livestock Company Drainage Basin Fee = \$22,973/acre
Livestock Company Bridge Fee = \$273/acre

Basin Fee Required = $0.256 \times \$22,973 = \$5,881$
Bridge Fee Required = $0.256 \times \$273 = \70

drainage fees were paid with filing 1. Only the increase in impervious due to the additional lots is required to be paid. Please update as necessary with the fees due.

CONCLUSION

The proposed development and subsequent lot developments follow the "Four Step Process" as mandated by the EPA as follows:

Step 1: Employ runoff reduction practices

Runoff has been reduced by disconnecting impervious areas where possible, eliminating "unnecessary" impervious areas and encouraging infiltration into suitable soils.

- Impervious areas have been directed to the existing earth swales and ditches to encourage infiltration.
- A gravel roadway has been used for the upper portion of the project to reduce the impervious of the areas.

Step 2: Stabilize drainageways

All drainageways, ditches and channels have been stabilized by the following methods:

- Tributaries have been left in their relatively natural state where possible.
- New ditches have been stabilized with either riprap or erosion control fabric depending on the erosion potential.

Step 3: Provide water quality capture volume (WQCV)

Based on the Runoff Reduction calculations performed for the proposed development, the 2.2 acres for the asphalt and gravel roadway construction does not require any water quality basins, however a temporary sedimentation basin will be constructed.

Step 4: Consider need for industrial and commercial BMP's.

No industrial and commercial development is proposed for the site.

Based on longer times of concentration and minimal development, the proposed development flows of 58.1 cfs for the 100-year storm are below the historic levels of 63.5 cfs for the 100-year storm. Therefore, the proposed development will not adversely affect downstream or surrounding properties.

REFERENCES

1. City of Colorado Springs and El Paso County (2014). *Drainage Criteria Manual Volume 1* (DCM).
2. City of Colorado Springs and El Paso County (2014)
3. *Drainage Criteria Manual Volume II* (DCM) as amended.
4. Soil Survey of El Paso County Area, Colorado by USDA, NRCS.
5. *El Paso County (January 2016) Engineering Criteria Manual*.
6. Urban Drainage and Flood Control District (June 2017). *Urban Storm Drainage Criteria Manual, Volume 1-3*.
7. Final Drainage Report Wyoming Estates Subdivision, prepared by Respec, Nov. 2020.

APPENDIX A

MAPS

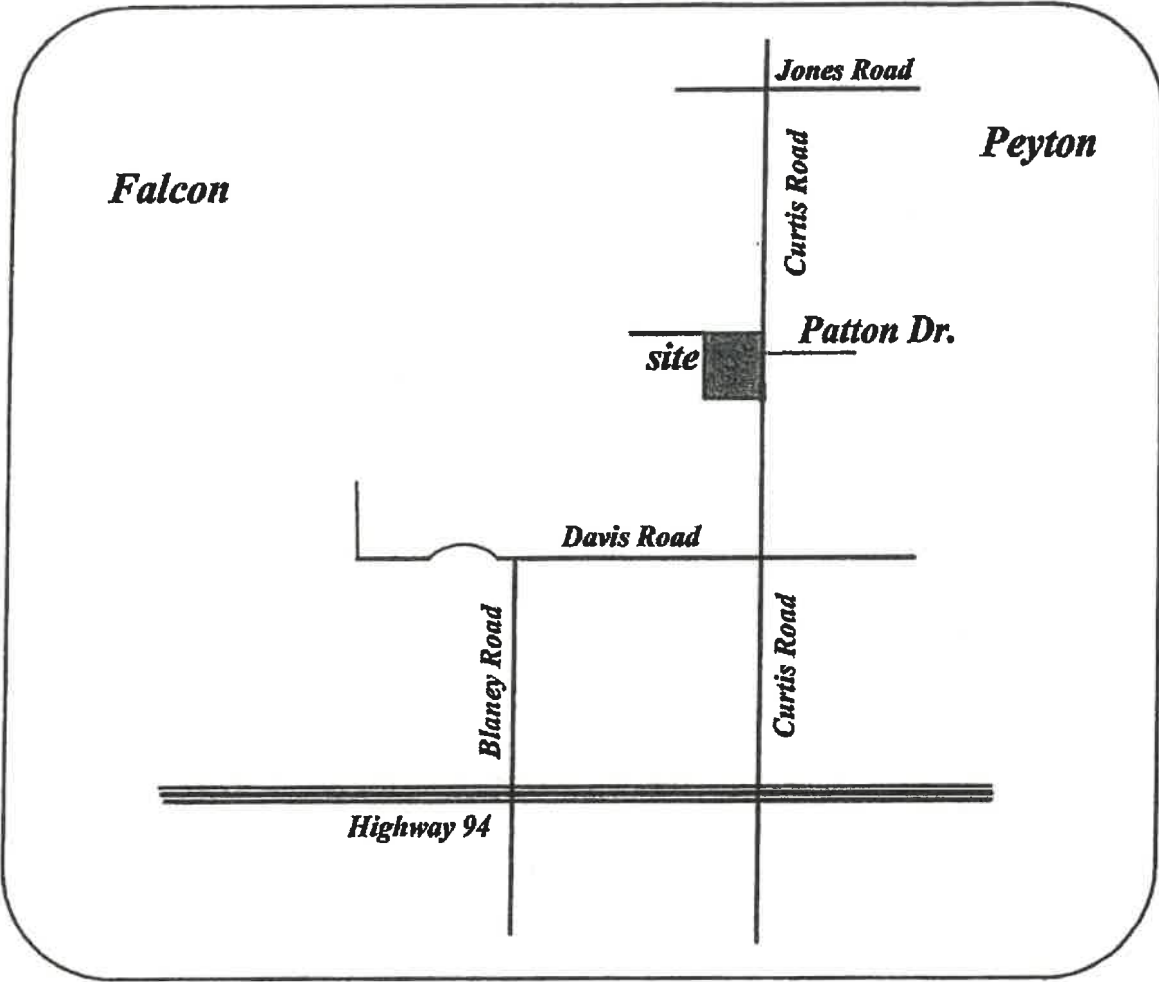

VICINITY MAP

N.T.S.



121 S Tejon St., Suite 1110 Colorado Springs, CO 80903
Phone: (719) 283-7671

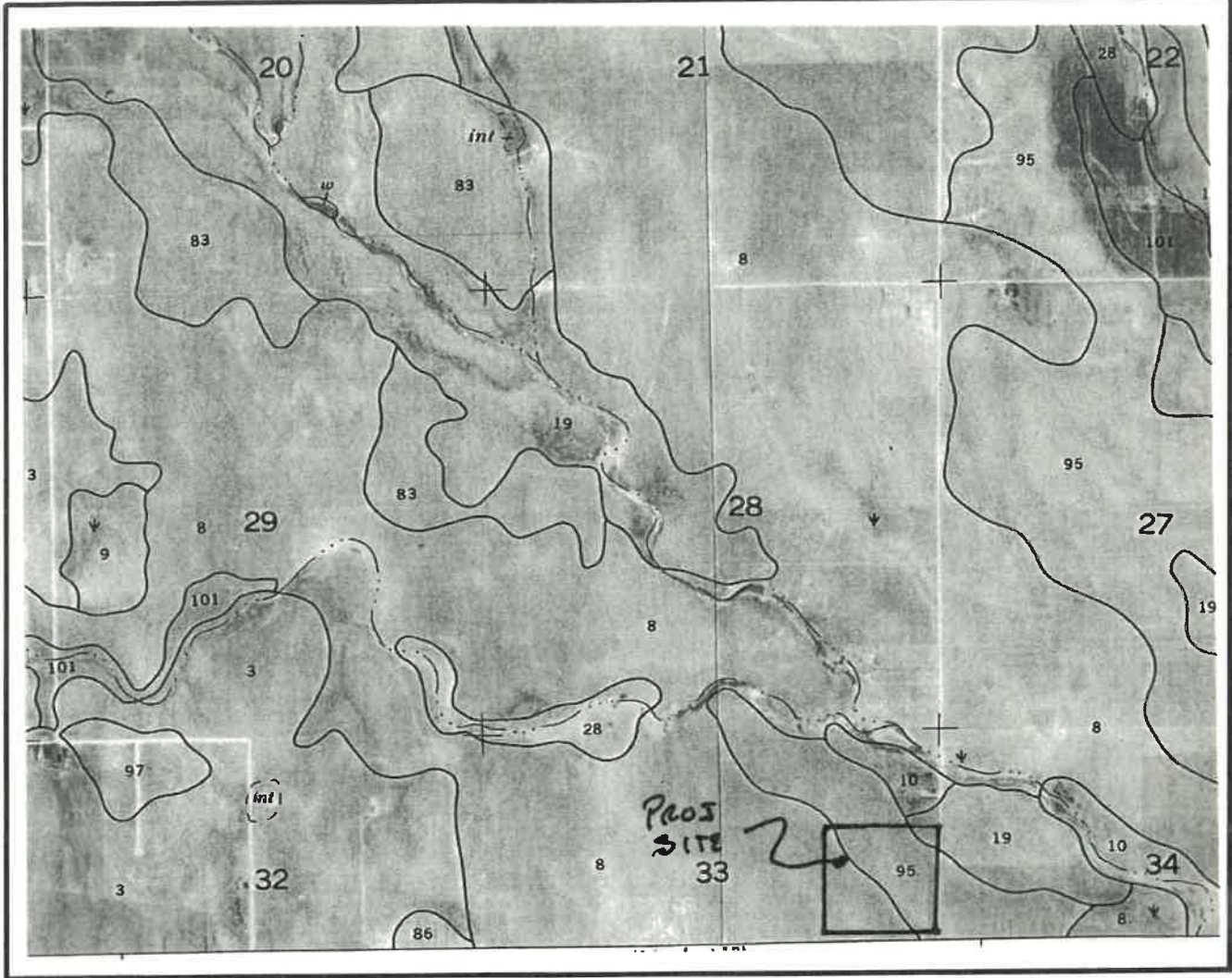

SOILS MAP
N.T.S.



121 S Tejon St., Suite 1110 Colorado Springs, CO 80903
Phone: (719) 283-7671



PANEL 0568G

FIRM FLOOD INSURANCE RATE MAP EL PASO COUNTY, COLORADO AND INCORPORATED AREAS

PANEL 568 OF 1300
(SEE MAP INDEX FOR FIRM PANEL LAYOUT)

CONTAINS:

COMMUNITY	NUMBER	PANEL	SUFFIX
EL PASO COUNTY	08041C	698	G

Notice to User: The Map Number shown below should be used when placing map orders. The Community Number shown above should be used on insurance applications for the subject community.

MAP NUMBER
08041C0568G



MAP REVISED
DECEMBER 7, 2018

Federal Emergency Management Agency

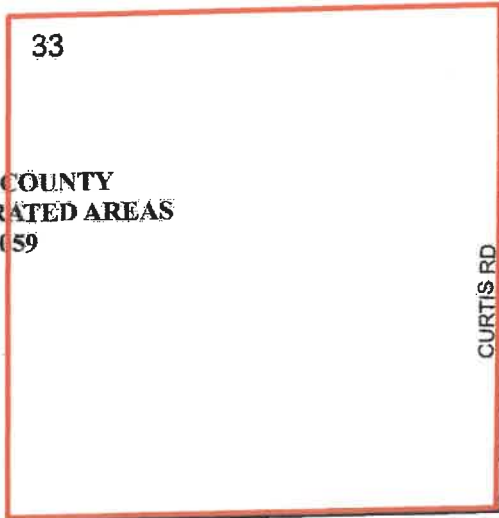
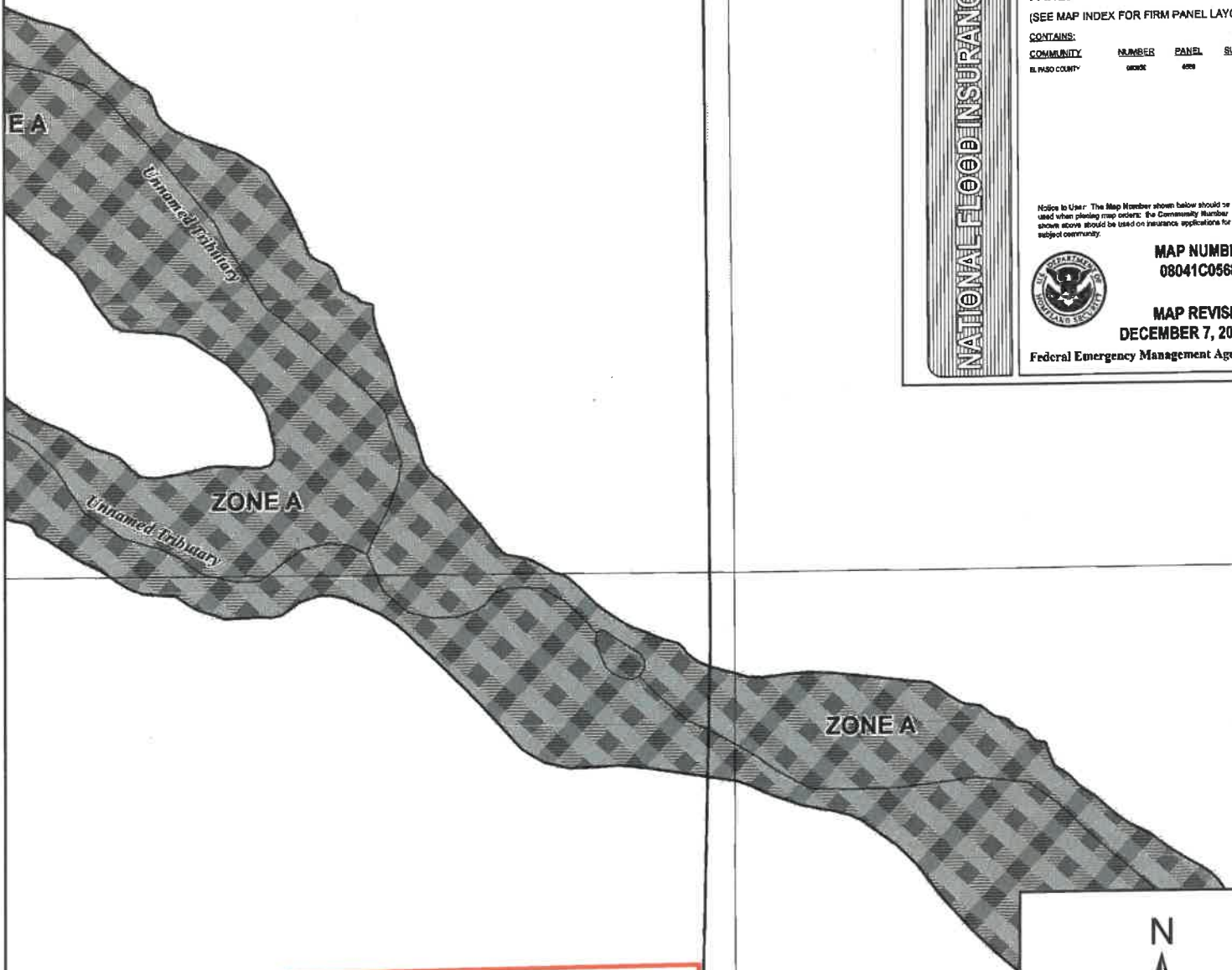

PATTON DR

CURTIS RD

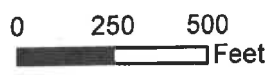

Prepared by:



RESPEC

121 S. TEJON ST., SUITE 1110
COLORADO SPRINGS, CO 80903
WWW.RESPEC.COM (719) 266-5212

WYOMING ESTATES SUBDIVISION

FIRM MAP

From: N:\Processes\Potential Projects\1004\1004_Potential_Estates\12_0718\Workarea_El Paso\Workarea_El Paso.dwg

APPENDIX B

DESIGN CALCULATIONS

Design Procedure Form: Runoff Reduction

UD-BMP (Version 3.07, March 2018)

Sheet 1 of 1

Designer: Mike Bartusek
Company: Respec
Date: February 28, 2024
Project: Wyoming Estates Sub Fil No. 2
Location: 3050 Curtis Road

SITE INFORMATION (User input in Blue Cells)

WQCV Rainfall Depth = 0.60 inches
 Depth of Average Runoff Producing Storm, d_s = 0.43 inches (for Watersheds Outside of the Denver Region, Figure 3-1 in USDCM Vol. 3)

Area Type	UIA:RPA	SPA	UIA:RPA	SPA	UIA:RPA	UIA:RPA	SPA	UIA:RPA	UIA:RPA	UIA:RPA	SPA
Area ID	B2A1	B2B1	B2A2	B2B2+OS2A	B3A1	B3A2	B3B+OS28	B4A1	B4B1	B4B2	B4A2
Downstream Design Point ID	2	2	4	4	9	9	9	10	6	6	11
Downstream BMP Type	None	None	None	None	None	None	None	None	None	None	None
DCIA (ft ²)	--	--	--	--	--	--	--	--	--	--	--
UIA (ft ²)	5,230	--	8,275	--	4,575	4,575	--	9,150	5,230	9,150	--
RPA (ft ²)	3,500	--	6,970	--	3,485	3,485	--	10,020	22,770	12,200	--
SPA (ft ²)	--	5,225	--	76,500	--	--	42,300	--	--	--	191,600
HSG A (%)	0%	0%	0%	0%	0%	0%	0%	0%	0%	0%	0%
HSG B (%)	100%	100%	100%	100%	100%	100%	100%	100%	100%	100%	100%
HSG C/D (%)	0%	0%	0%	0%	0%	0%	0%	0%	0%	0%	0%
Average Slope of RPA (ft/ft)	0.250	--	0.250	--	0.250	0.250	--	0.250	0.250	0.250	--
UIA:RPA Interface Width (ft)	300.00	--	480.00	--	275.00	275.00	--	550.00	300.00	480.00	--

CALCULATED RUNOFF RESULTS

Area ID	B2A1	B2B1	B2A2	B2B2+OS2A	B3A1	B3A2	B3B+OS28	B4A1	B4B1	B4B2	B4A2
UIA:RPA Area (ft ²)	8,730	--	15,245	--	8,060	8,060	--	19,170	28,000	21,350	--
L / W Ratio	0.10	--	0.07	--	0.11	0.11	--	0.06	0.31	0.09	--
UIA / Area	0.5991	--	0.5428	--	0.5676	0.5676	--	0.4773	0.1868	0.4286	--
Runoff (in)	0.00	0.00	0.00	0.00	0.00	0.00	0.00	0.00	0.00	0.00	0.00
Runoff (ft ³)	0	0	0	0	0	0	0	0	0	0	0
Runoff Reduction (ft ³)	218	261	345	3825	191	191	2115	381	218	381	9580

CALCULATED WQCV RESULTS

Area ID	B2A1	B2B1	B2A2	B2B2+OS2A	B3A1	B3A2	B3B+OS28	B4A1	B4B1	B4B2	B4A2
WQCV (ft ³)	218	0	345	0	191	191	0	381	218	381	0
WQCV Reduction (ft ³)	218	0	345	0	191	191	0	381	218	381	0
WQCV Reduction (%)	100%	0%	100%	0%	100%	100%	0%	100%	100%	100%	0%
Untreated WQCV (ft ³)	0	0	0	0	0	0	0	0	0	0	0

CALCULATED DESIGN POINT RESULTS (sums results from all columns with the same Downstream Design Point ID)

Downstream Design Point ID	2	2	4	4	9	9	9	10	6	6	11
DCIA (ft ²)	0	0	0	0	0	0	0	0	0	0	0
UIA (ft ²)	5,230	5,230	8,275	8,275	9,150	9,150	9,150	9,150	14,380	14,380	0
RPA (ft ²)	3,500	3,500	6,970	6,970	6,970	6,970	6,970	10,020	34,970	34,970	0
SPA (ft ²)	5,225	5,225	76,500	76,500	42,300	42,300	42,300	0	0	0	191,600
Total Area (ft ²)	13,955	13,955	91,745	91,745	58,420	58,420	58,420	19,170	49,350	49,350	191,600
Total Impervious Area (ft ²)	5,230	5,230	8,275	8,275	9,150	9,150	9,150	9,150	14,380	14,380	0
WQCV (ft ³)	218	218	345	345	381	381	381	381	599	599	0
WQCV Reduction (ft ³)	218	218	345	345	381	381	381	381	599	599	0
WQCV Reduction (%)	100%	100%	100%	100%	100%	100%	100%	100%	100%	100%	0%
Untreated WQCV (ft ³)	0	0	0	0	0	0	0	0	0	0	0

CALCULATED SITE RESULTS (sums results from all columns in worksheet)

Total Area (ft ²)	696,130
Total Impervious Area (ft ²)	92,370
WQCV (ft ³)	1,924
WQCV Reduction (ft ³)	1,924
WQCV Reduction (%)	100%
Untreated WQCV (ft ³)	0

**WYOMING ESTATES SUBDIVISION
C FACTOR CALCULATION SHEET**

**EXISTING CONDITIONS
RUNOFF COEFFICIENT**

TYPE A/B SOILS

LAND USE	Imperv %	5 YR	100 YR
UNDEV	0	0.08	0.35
GRAVEL ROAD	80	0.59	0.7
ASPHALT ROAD	100	0.9	0.96
ROOFS	90	0.73	0.81

AREA DESIG.	TOTAL	SURFACE CONDITION AREAS				CALCULATED C	
	AREA (acre)	UNDEV	GRAVEL ROAD	ASPHALT ROAD	ROOFS	5 YR	100 YR
Aex	3.66	3.66	0.00	0.00	0.00	0.08	0.35
B1ex	19.80	19.80	0.00	0.00	0.00	0.08	0.35
B2ex	13.02	12.47	0.55	0.00	0.00	0.10	0.36
OS1	3.53	3.17	0.00	0.36	0.00	0.16	0.41
OS2	6.20	6.20	0.00	0.00	0.00	0.08	0.35
Aex+B1ex+B2ex	36.48	35.93	0.55	0.36	0.00		
	0.8	0.00	0.44	0.36	0.00		
Imperviousness = (0.44)/37.29 = 2.2%							

**DEVELOPED CONDITIONS
RUNOFF COEFFICIENT**

TYPE A/B SOILS

LAND USE	Imperv %	5 YR	100 YR
UNDEV	0	0.08	0.35
GRAVEL ROAD	80	0.59	0.7
ASPHALT ROAD	100	0.9	0.96
ROOFS	90	0.73	0.81

Developed Conditions								
	TOTAL	SURFACE CONDITION AREAS				CALCULATED C		
AREA	AREA	UNDEV	GRAVEL	ASPHALT	ROOFS	5	100	
DESIG.	(acre)		ROAD	ROAD		YR	YR	
A	3.66	3.66	0.00	0.00	0.00	0.08	0.35	
B1	4.75	4.62	0.06	0.00	0.07	0.10	0.36	
B2A1	0.20	0.08	0.12	0.00	0.00	0.39	0.56	
B2A2	0.35	0.16	0.00	0.19	0.00	0.53	0.68	
B2B1	1.20	0.95	0.25	0.00	0.00	0.19	0.42	
B2B2	16.31	15.89	0.21	0.00	0.21	0.09	0.36	
B3A	0.17	0.04	0.13	0.00	0.00	0.47	0.62	
B3A	0.17	0.04	0.13	0.00	0.00	0.47	0.62	
B3B	4.11	4.04	0.00	0.00	0.07	0.09	0.36	
B4A1	0.44	0.23	0.21	0.00	0.00	0.32	0.52	
B4A2	4.40	4.33	0.00	0.00	0.07	0.09	0.36	
B4B1	0.38	0.26	0.12	0.00	0.00	0.24	0.46	
B4B2	0.56	0.28	0.00	0.21	0.07	0.47	0.64	
OS1A	2.62	2.35	0.00	0.27	0.00	0.16	0.41	
OS1B	0.91	0.82	0.00	0.09	0.00	0.16	0.41	
OS2A	1.26	1.26	0.00	0.00	0.00	0.08	0.35	
OS2B	5.60	5.60	0.00	0.00	0.00	0.08	0.35	
Avg House = 3000 sf w/ avg 250'x12' gravel driveway								

Wyoming Estates Subdivision
 PROJ. #03433
 DRAINAGE CALCULATION SHEET
 file:curtis rd dr
 11/23/20

AREA DESIG.	AREA (acre)	C5 (5 yr)	C100 (100 yr)	C5 X A	C100 X A	Initial Tci Slope (%)	ti (min)	L (ft)	Slope (%)	Travel Time		Tt (min)	TC (min)	I5 (in/hr)	I100 (in/hr)	Q5 (cfs)	Q100 (cfs)	length L (feet)	vel. V (fps)	t (min)	AREA DESIG.
										V (fps)	L (ft)										
EXISTING CONDITIONS																					
Aex	3.66	0.08	0.35	0.29	1.28	3.00	13.27	440	4.50	2.00	3.67	16.94	3.18	5.55	0.93	7.11					Aex
B1ex	19.80	0.08	0.35	1.58	6.93	3.50	12.62	1270	6.00	2.40	8.82	21.43	2.81	4.90	4.45	33.98	450	3.40	2.21	B1ex	
OS1	3.53	0.16	0.41	0.56	1.45	7.00	9.25	1230	4.40	3.20	6.41	15.66	3.30	5.77	1.87	8.35				OS1	
DP1(OS1+B1ex)	23.33			2.15	8.38							21.43	2.81	4.90	6.03	41.08				DP1(OS	
OS2	6.86	0.19	0.43	1.30	2.95	2.00	23.45	200	2.00	1.50	2.22	25.67	2.54	4.43	3.31	13.08				OS2	
B2ex	13.02	0.10	0.36	1.30	4.69	3.00	22.54	1130	5.50	2.20	8.56	31.10	2.27	3.96	2.95	18.58				B2ex	
DP2(OS@+B2ex)	19.88			2.61	7.64							31.10	2.27	3.96	5.91	30.27				DP2(OS	
DP3(DP1+DP2)	43.21			4.75	16.01							31.10	2.27	3.96	10.79	63.48				DP3(DP	
DEVELOPED CONDITIONS																					
A	3.66	0.08	0.35	0.29	1.28	3.00	13.27	440	4.50	2.00	3.67	16.94	3.18	5.55	0.93	7.11				A	
B1	4.75	0.10	0.36	0.48	1.71	3.50	12.37	450	7.70	2.80	2.68	15.05	3.37	5.88	1.60	10.06				B1	
OS1A	2.62	0.16	0.41	0.42	1.07	7.00	9.25	890	4.40	3.20	4.64	13.88	3.50	6.11	1.47	6.57				OS1A	
DP1(OS1A+B1)	7.37			0.89	2.78							15.05	3.37	5.88	3.01	16.38				DP1(OS	
B2A1	0.20	0.39	0.56	0.08	0.11	10.00	3.17	0	4.40	3.20	0.00	5.00	5.19	9.06	0.40	1.02				B2A1	
B2B1	1.20	0.19	0.42	0.23	0.50	7.00	8.95	890	4.40	3.20	4.64	13.59	3.54	6.18	0.81	3.11				B2B1	
DP2(B2A1+B2B1)	1.40			0.31	0.62							13.59	3.54	6.18	1.08	3.80				DP2(B2	
OS2A	1.26	0.08	0.35	0.10	0.44	2.00	26.28	0	3.00	1.80	0.00	26.28	2.74	4.38	0.25	1.93				OS2A	
B2B2	16.31	0.09	0.36	1.47	5.87	3.00	13.14	1230	5.20	2.20	9.32	22.46	2.74	4.78	4.02	28.06				B2B2	
DP3(OS2A+B2B2)	17.57			1.57	6.31							26.28	2.50	4.38	3.93	27.62				DP3(OS	
B2A2	0.35	0.53	0.68	0.19	0.24	10.00	2.54	890	4.40	3.20	4.64	7.18	4.61	8.05	0.85	1.91				B2A2	
DP4(DP2+DP3+B2A2)	19.32			2.06	7.17							26.28	2.50	4.38	5.16	31.36				DP4(DP	
DP5(DP1+DP4)	26.69			2.95	9.95							26.28	2.50	4.38	7.40	43.54				DP5(DP	
B4B1	0.38	0.24	0.46	0.09	0.17	10.00	3.84	0	6.00	2.30	0.00	5.00	5.19	9.06	0.47	1.58				B4B1	
B4B2	0.56	0.47	0.64	0.26	0.36	10.00	2.81	0	6.00	2.30	0.00	5.00	5.19	9.06	1.37	3.25				B4B2	
DP6(B4B1+B4B2)	0.94			0.35	0.53							26.62	2.49	4.34	0.88	2.32				DP6(B4	
OS1B	0.91	0.16	0.41	0.15	0.37	6.00	8.70	80	2.00	2.10	1.98	10.69	3.94	6.88	0.57	2.57				OS1B	
DP7(DP5+DP6+OB1B)	28.54			3.45	10.86							29.12	2.36	4.12	8.15	44.76				DP7(DP	
OS2B	5.60	0.08	0.35	0.45	1.96	2.00	26.28	200	2.00	1.50	2.22	28.50	2.39	4.17	1.07	8.18				OS2B	
B3B	4.11	0.09	0.36	0.37	1.48	4.00	11.95	650	3.40	1.90	5.70	17.65	3.11	5.43	1.15	8.04				B3B	
DP8(OS2B+B3B)	9.71			0.82	3.44							30.71	2.29	3.99	1.87	13.74				DP8(OS	
B3A1	0.17	0.47	0.62	0.08	0.10	10.00	2.81	0	4.40	3.20	0.00	5.00	5.19	9.06	0.40	0.93				B3A1	
B3A2	0.17	0.47	0.62	0.08	0.10	10.00	2.81	0	4.40	3.20	0.00	5.00	5.19	9.06	0.40	0.93				B3A2	
DP9(DP8+B3A1+B3A2)	10.04			0.97	3.64							30.71	2.29	3.99	2.22	14.56				DP9(DP	
B4A1	0.44	0.32	0.52	0.14	0.23	10.00	3.48	0	6.00	2.30	0.00	5.00	5.19	9.06	0.73	2.07				B4A1	
DP10(DP9+B4A1)	10.48			1.11	3.87							31.04	2.27	3.97	2.53	15.37				DP10(D	
B4A2	4.19	0.09	0.36	0.38	1.51	7.00	9.94	890	4.40	3.20	4.64	14.57	3.42	5.97	1.29	9.01				B4A2	
DP11(DP10+B4A2)	14.67			1.49	5.38							36.84	2.05	3.58	3.05	19.24				DP11(D	
DP12(DP7+DP11)	43.21			4.95	16.24							36.84	2.05	3.58	10.12	58.06				DP12(D	

DITCH CAPACITY CALCULATION SHEET

Location	Q5 cfs	Q100 cfs	S %	B ft	Z	D ft	d100 ft	V fps	Froude #	Riprap Size
A1 (DP9)	2.2	14.6	4.5	0.0	4:1.3:1	1.5	0.9	5.2	1.35	ECM
A2 (DP2)	1.1	3.1	6.4	0.0	4:1.3:1	2.0	0.5	4.0	1.45	ECM
A3 (B4B1)	0.5	1.6	6.4	0.0	4:1.3:1	1.5	0.4	3.4	1.39	ECM
B (DP10)	2.5	15.4	6.0	2.0	4:1	1.5	0.6	5.5	1.55	0.34 Use Type D50=12" Riprap
C (DP11)	3.1	19.2	10.0	2.0	4:1	1.5	0.6	7.1	2.00	0.67 Use Type D50=12" Riprap
D2 (DP4)	4.8	30.6	8.0	0.0	4:1.3:1	2.0	1.1	7.7	1.86	0.73 Use Type D50=12" Riprap
E (DP1)	3.0	16.4	4.4	2.0	4:1.3:1	2.0	0.7	5.2	1.35	Existing Curtis Rd Ditch
F2 (DP6)	0.9	2.3	8.0	0.0	4:1.3:1	1.5	0.5	4.0	1.58	ECM
G (D7)	8.2	44.8	1.0	2.0	4:1.3:1	2.0	1.6	3.9	0.72	

Note: In ditches with low velocities & flows but higher Froude Numbers. Erosion Control Mats used in lieu of riprap
 Riprap Size D50= $\frac{1.49 \times V^2}{(FS)^{0.66}}$

PROJECT: WYOMING ESTIMATES SIG FILZ STATION: 0+37 CULVERT DESIGN FORM

SHEET OF DESIGNER / DATE: MAB / 6/19/82 REVIEWER / DATE: / /

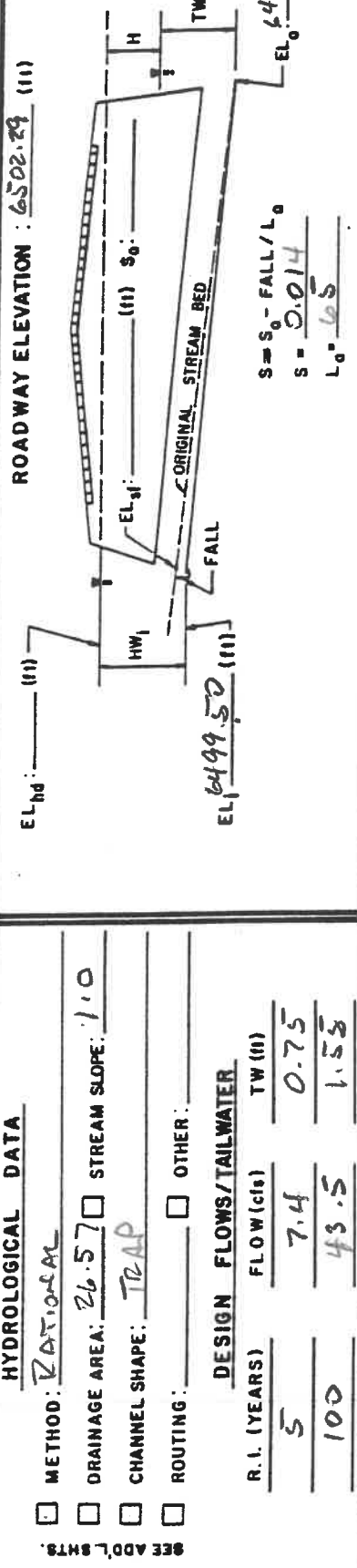

CULVERT DESCRIPTION:	TOTAL FLOW (cfs)	FLOW PER BARREL (cfs)	HEADWATER CALCULATIONS								COMMENTS			
			INLET CONTROL				OUTLET CONTROL							
			HW ₁ /D (2)	HW ₁ (3)	EL _{h1} (4)	TW (5)	d _c (6)	$\frac{d_c + D}{2}$ (7)	h _o (8)	H (9)		EL _{ho} (10)		
EXIST 2-RCEP-30" X 19" w/FeS	7.4	3.7	0.47	0.74	1.0	99.24	0.75	0.7	1.14	0.2	0.1	99.7	99.7	EXIST 4' X 6' R1124P
	43.5	21.8	1.40	2.21	1.0	100.71	1.53	1.35	1.47	0.2	1.30	101.35	101.35	

TECHNICAL FOOTNOTES:
 (1) USE Q/NB FOR BOX CULVERTS
 (2) HW₁/D = HW₁/D OR HW₁/D FROM DESIGN CHARTS
 (3) FALL = HW₁ - (EL_{hd} - EL_{g1}); FALL IS ZERO FOR CULVERTS ON GRADE
 (4) EL_{hd} = HW₁; EL₁ (INVERT OF INLET CONTROL SECTION)
 (5) TW BASED ON DOWN STREAM CONTROL OR FLOW DEPTH IN CHANNEL.
 (6) h_o = TW or (d_c + D/2) (WHICHEVER IS GREATER)
 (7) H = [1 + h_o + (29n² L) / R^{1.33}] V² / 2g
 (8) EL_{ho} = EL_o + H + h_o

SUBSCRIPT DEFINITIONS:
 0. APPROXIMATE
 1. CULVERT FACE
 2. DESIGN HEADWATER
 3. HEADWATER IN INLET CONTROL
 4. HEADWATER IN OUTLET CONTROL
 5. INLET CONTROL SECTION
 6. OUTLET CONTROL SECTION
 7. STREAMBED AT CULVERT FACE
 8. TAILWATER

COMMENTS / DISCUSSION:

CULVERT BARREL SELECTED:
 SIZE: _____
 SHAPE: _____
 MATERIAL: _____
 ENTRANCE: _____

Determination of Culvert Headwater and Outlet Protection

Project: **Wyoming Subdivision**
 Basin ID: **DP7**

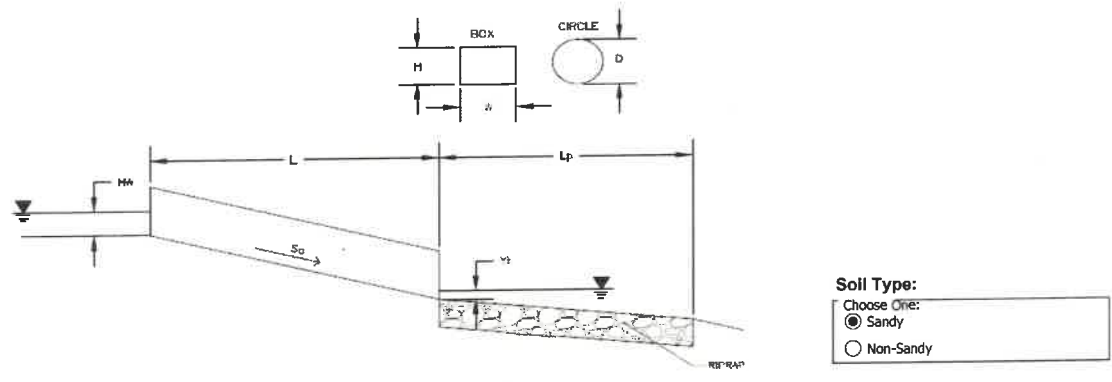

Supercritical Flow! Using Ha to calculate protection type.

Design Information (Input):	
Design Discharge	Q = <input type="text" value="43.5"/> cfs
Circular Culvert:	D = <input type="text" value="24"/> inches
Barrel Diameter in Inches	Square End Projection <input type="checkbox"/>
Inlet Edge Type (Choose from pull-down list)	OR
Box Culvert:	Height (Rise) = <input type="text" value="1.58"/> ft
Barrel Height (Rise) in Feet	Width (Span) = <input type="text" value="2.5"/> ft
Barrel Width (Span) in Feet	1.5 : 1 Bevel w/ 90 Deg. Headwall <input type="checkbox"/>
Inlet Edge Type (Choose from pull-down list)	No = <input type="text" value="2"/>
Number of Barrels	Elev IN = <input type="text" value="6499.5"/> ft
Inlet Elevation	Elev OUT = <input type="text" value="6498.5"/> ft
Outlet Elevation OR Slope	L = <input type="text" value="65"/> ft
Culvert Length	n = <input type="text" value="0.012"/>
Manning's Roughness	k _b = <input type="text" value="0"/>
Bend Loss Coefficient	k _x = <input type="text" value="1"/>
Exit Loss Coefficient	Elev Y _t = <input type="text" value="6499.9"/> ft
Tailwater Surface Elevation	V = <input type="text" value="5"/> ft/s
Max Allowable Channel Velocity	

Required Protection (Output):	
Tailwater Surface Height	Y _t = <input type="text" value="1.40"/> ft
Flow Area at Max Channel Velocity	A _v = <input type="text" value="4.41"/> ft ²
Culvert Cross Sectional Area Available	A = <input type="text" value="3.95"/> ft ²
Entrance Loss Coefficient	k _e = <input type="text" value="0.20"/>
Friction Loss Coefficient	k _f = <input type="text" value="0.94"/>
Sum of All Losses Coefficients	k _s = <input type="text" value="2.14"/> ft
Culvert Normal Depth	Y _n = <input type="text" value="0.89"/> ft
Culvert Critical Depth	Y _c = <input type="text" value="1.34"/> ft
Tailwater Depth for Design	d = <input type="text" value="1.46"/> ft
Adjusted Diameter OR Adjusted Rise	H _a = <input type="text" value="1.23"/> ft
Expansion Factor	1/(2*tan(θ)) = <input type="text" value="6.45"/>
Flow/Diameter ^{2.5} OR Flow/(Span * Rise ^{1.5})	Q/WH ^{1.5} = <input type="text" value="4.44"/> ft ^{0.5} /s
Froude Number	Fr = <input type="text" value="1.86"/> Supercritical!
Tailwater/Adjusted Diameter OR Tailwater/Adjusted Rise	Y _t /H = <input type="text" value="1.13"/>
Inlet Control Headwater	HW _i = <input type="text" value="2.11"/> ft
Outlet Control Headwater	HW _o = <input type="text" value="1.49"/> ft
Design Headwater Elevation	HW = <input type="text" value="6,501.61"/> ft
Headwater/Diameter OR Headwater/Rise Ratio	HW/H = <input type="text" value="1.33"/>
Minimum Theoretical Riprap Size	d ₅₀ = <input type="text" value="1"/> in
Nominal Riprap Size	d ₅₀ = <input type="text" value="6"/> in
UDFCD Riprap Type	Type = <input type="text" value="VL"/>
Length of Protection	L _p = <input type="text" value="5"/> ft
Width of Protection	T = <input type="text" value="4"/> ft

PROJECT: Widening Existing Sub Filz (EXIST) STATION: 7+58.36 CULVERT DESIGN FORM
 SHEET 1 OF 1 DESIGNER / DATE: MAB / 9/25
 REVIEWER / DATE: _____

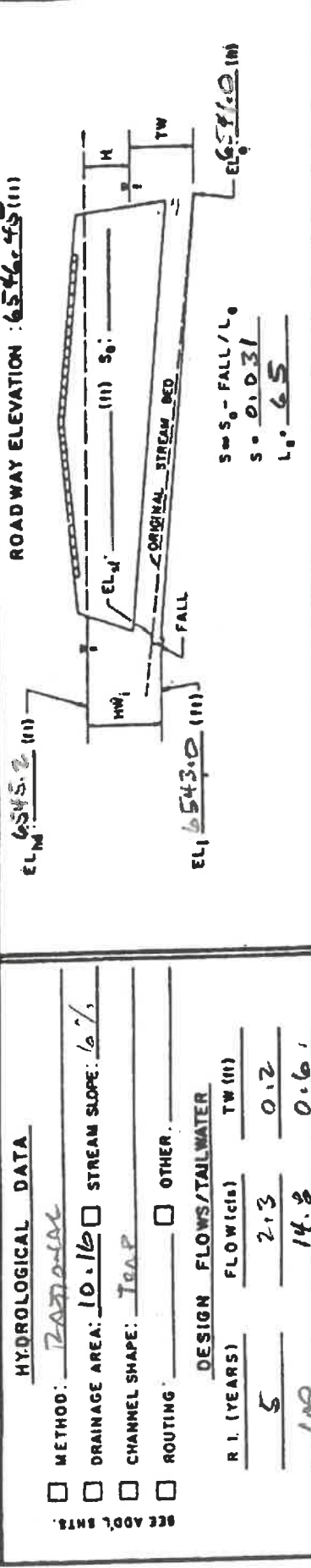

HYDROLOGICAL DATA

METHOD: RATIONAL

DRAINAGE AREA: 10.16 □ STREAM SLOPE: 6%

CHANNEL SHAPE: TRAP

ROUTING: □ OTHER: □

DESIGN FLOWS/TAIWATER

R 1. (YEARS) FLOW (cfs) TW (11)

5 2.3 0.2

100 14.8 0.6

SEE ADD'L NTS

CULVERT DESCRIPTION: MATERIAL - SHAPE - SIZE - ENTRANCE

24" CORR W/RES

TOTAL FLOW Q (cfs)	FLOW PER BARREL Q/N	INLET CONTROL			OUTLET CONTROL				COMMENTS					
		HW/D (2)	HW ₁ (3)	FALL (4)	EL _N (5)	TW (6)	d _c (7)	H ₀ (8)		H (9)	EL _{N0} (10)			
2.3	2.3	0.3	0.6	2.0	41.6	0.2	0.75	1.38	0.2	0.1	42.4	42.46	5	5' x 13' CORR BARREL
14.8	14.8	1.1	2.20	2.0	43.2	0.6	1.40	1.70	0.2	1.6	44.3	44.30	5	

TECHNICAL FOOTNOTES:

(1) USE Q/NB FOR BOX CULVERTS

(2) HW₁/D = HW/D OR HW₁/D FROM DESIGN CHARTS

(3) FALL = HW₁ - (EL_{N0} - EL₁); FALL IS ZERO FOR CULVERTS ON GRADE

(4) EL_N = HW₁ + EL₁ (INVERT OF INLET CONTROL SECTION)

(5) TW BASED ON DOWN STREAM CONTROL OR FLOW DEPTH IN CHANNEL.

(6) H₀ = TW or (4 * D / 2) WHICHEVER IS GREATER

(7) H₀ = [(0.1 * h₀ + (29 * L) / (R * 133)] * V² / 20

(8) EL_{N0} = EL₀ + H₀

SUBSCRIPT DEFINITIONS:

0. APPROXIMATE

1. CULVERT FACE

2. DESIGN HEADWATER

3. HEADWATER IN INLET CONTROL

4. HEADWATER IN OUTLET CONTROL

5. INLET CONTROL SECTION

6. OUTLET

7. STREAMBED AT CULVERT FACE

8. TAILWATER

COMMENTS / DISCUSSION:

CULVERT BARREL SELECTED:

SIZE: _____

SHAPE: _____

MATERIAL: _____

ENTRANCE: _____

Determination of Culvert Headwater and Outlet Protection

Project: **Wyoming Subdivision**

Basin ID: **DP9 (EXIST)**

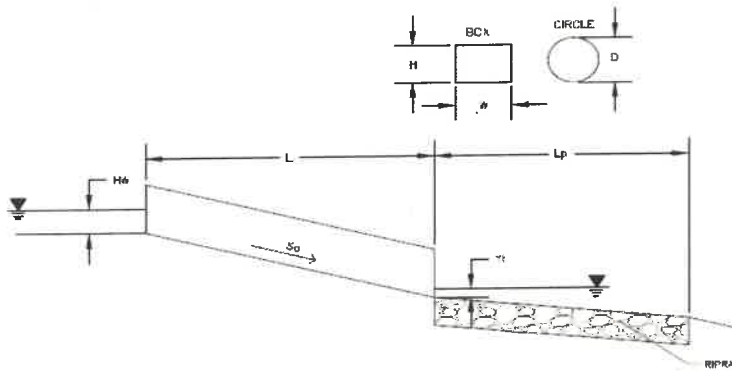

Soil Type:

Choose One:

Sandy

Non-Sandy

Supercritical Flow! Using D_a to calculate protection type.

Design Information (Input):

Design Discharge

Q = 14.6 cfs

Circular Culvert:

Barrel Diameter in Inches

D = 24 inches

Inlet Edge Type (Choose from pull-down list)

Grooved End Projection

OR

Box Culvert:

Barrel Height (Rise) in Feet

Height (Rise) = ft

Barrel Width (Span) in Feet

Width (Span) = ft

Inlet Edge Type (Choose from pull-down list)

Number of Barrels

No = 1

Inlet Elevation

Elev IN = 6543 ft

Outlet Elevation OR Slope

Elev OUT = 6541 ft

Culvert Length

L = 65 ft

Manning's Roughness

n = 0.024

Bend Loss Coefficient

k_b = 0

Exit Loss Coefficient

k_x = 1

Tailwater Surface Elevation

Elev Y_t = 6541.7 ft

Max Allowable Channel Velocity

V = 5 ft/s

Required Protection (Output):

Tailwater Surface Height

Y_t = 0.70 ft

Flow Area at Max Channel Velocity

A_v = 2.92 ft^2

Culvert Cross Sectional Area Available

A = 3.14 ft^2

Entrance Loss Coefficient

k_e = 0.20

Friction Loss Coefficient

k_f = 2.74

Sum of All Losses Coefficients

k_s = 3.94

Culvert Normal Depth

Y_n = 1.21 ft

Culvert Critical Depth

Y_c = 1.38 ft

Tailwater Depth for Design

d = 1.69 ft

Adjusted Diameter OR Adjusted Rise

D_a = 1.60 ft

Expansion Factor

$1/(2*\tan(\theta))$ = 5.50

Flow/Diameter^{2.5} OR Flow/(Span * Rise^{1.5})

$Q/D^{2.5}$ = 2.58 $ft^{0.5}/s$

Froude Number

Fr = 1.29 Supercritical!

Tailwater/Adjusted Diameter OR Tailwater/Adjusted Rise

Y_t/D = 0.44

Inlet Control Headwater

HW_i = 2.04 ft

Outlet Control Headwater

HW_o = 1.01

Design Headwater Elevation

HW = 6,545.04 ft

Headwater/Diameter OR Headwater/Rise Ratio

HW/D = 1.02

Minimum Theoretical Riprap Size

d_{50} = 5 in

Nominal Riprap Size

d_{50} = 6 in

UDFCD Riprap Type

Type = VL

Length of Protection

L_p = 12 ft

Width of Protection

T = 5 ft

APPENDIX C
DESIGN CHARTS

Table 6-6. Runoff Coefficients for Rational Method
(Source: UDFCD 2001)

Land Use or Surface Characteristics	Percent Impervious	Runoff Coefficients											
		2-year		5-year		10-year		25-year		50-year		100-year	
		HSG A&B	HSG C&D	HSG A&B	HSG C&D	HSG A&B	HSG C&D	HSG A&B	HSG C&D	HSG A&B	HSG C&D	HSG A&B	HSG C&D
Business													
Commercial Areas	95	0.79	0.80	0.81	0.82	0.83	0.84	0.85	0.87	0.87	0.88	0.88	0.89
Neighborhood Areas	70	0.45	0.49	0.49	0.53	0.53	0.57	0.58	0.62	0.60	0.65	0.62	0.68
Residential													
1/8 Acre or less	65	0.41	0.45	0.45	0.49	0.49	0.54	0.54	0.59	0.57	0.62	0.59	0.65
1/4 Acre	40	0.23	0.28	0.30	0.35	0.36	0.42	0.42	0.50	0.46	0.54	0.50	0.58
1/3 Acre	30	0.18	0.22	0.25	0.30	0.32	0.38	0.39	0.47	0.43	0.52	0.47	0.57
1/2 Acre	25	0.15	0.20	0.22	0.28	0.30	0.36	0.37	0.46	0.41	0.51	0.46	0.56
1 Acre	20	0.12	0.17	0.20	0.26	0.27	0.34	0.35	0.44	0.40	0.50	0.44	0.55
Industrial													
Light Areas	80	0.57	0.60	0.59	0.63	0.63	0.66	0.66	0.70	0.68	0.72	0.70	0.74
Heavy Areas	90	0.71	0.73	0.73	0.75	0.75	0.77	0.78	0.80	0.80	0.82	0.81	0.83
Parks and Cemeteries													
Parks and Cemeteries	7	0.05	0.09	0.12	0.19	0.20	0.29	0.30	0.40	0.34	0.46	0.39	0.52
Playgrounds	13	0.07	0.13	0.16	0.23	0.24	0.31	0.32	0.42	0.37	0.48	0.41	0.54
Railroad Yard Areas	40	0.23	0.28	0.30	0.35	0.36	0.42	0.42	0.50	0.46	0.54	0.50	0.58
Undeveloped Areas													
Historic Flow Analysis-- Greenbelts, Agriculture	2	0.03	0.05	0.09	0.16	0.17	0.26	0.26	0.38	0.31	0.45	0.36	0.51
Pasture /Meadow	0	0.02	0.04	0.08	0.15	0.15	0.25	0.25	0.37	0.30	0.44	0.35	0.50
Forest	0	0.02	0.04	0.08	0.15	0.15	0.25	0.25	0.37	0.30	0.44	0.35	0.50
Exposed Rock	100	0.89	0.89	0.90	0.90	0.92	0.92	0.94	0.94	0.95	0.95	0.96	0.96
Offsite Flow Analysis (when landuse is undefined)	45	0.26	0.31	0.32	0.37	0.38	0.44	0.44	0.51	0.48	0.55	0.51	0.59
Streets													
Paved	100	0.89	0.89	0.90	0.90	0.92	0.92	0.94	0.94	0.95	0.95	0.96	0.96
Gravel	80	0.57	0.60	0.59	0.63	0.63	0.66	0.66	0.70	0.68	0.72	0.70	0.74
Drive and Walks													
Drive and Walks	100	0.89	0.89	0.90	0.90	0.92	0.92	0.94	0.94	0.95	0.95	0.96	0.96
Roofs	90	0.71	0.73	0.73	0.75	0.75	0.77	0.78	0.80	0.80	0.82	0.81	0.83
Lawns	0	0.02	0.04	0.08	0.15	0.15	0.25	0.25	0.37	0.30	0.44	0.35	0.50

Figure 6-25. Estimate of Average Concentrated Shallow Flow

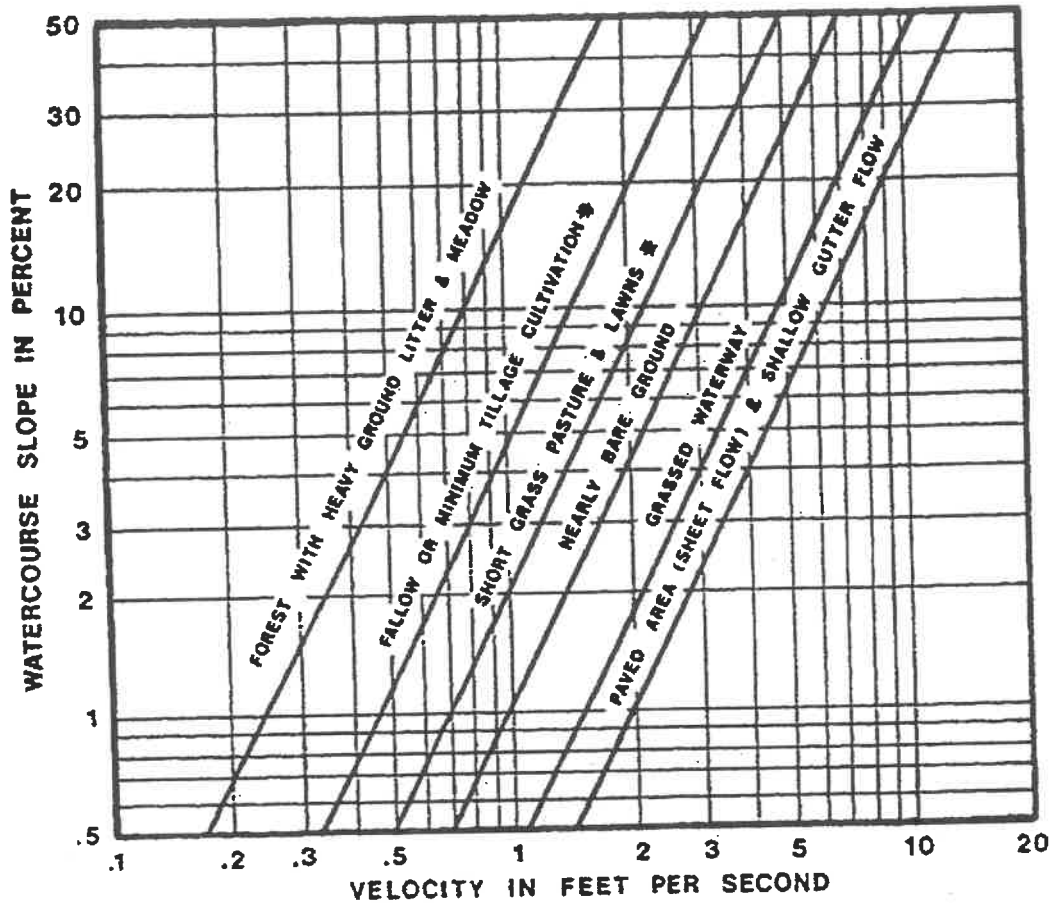
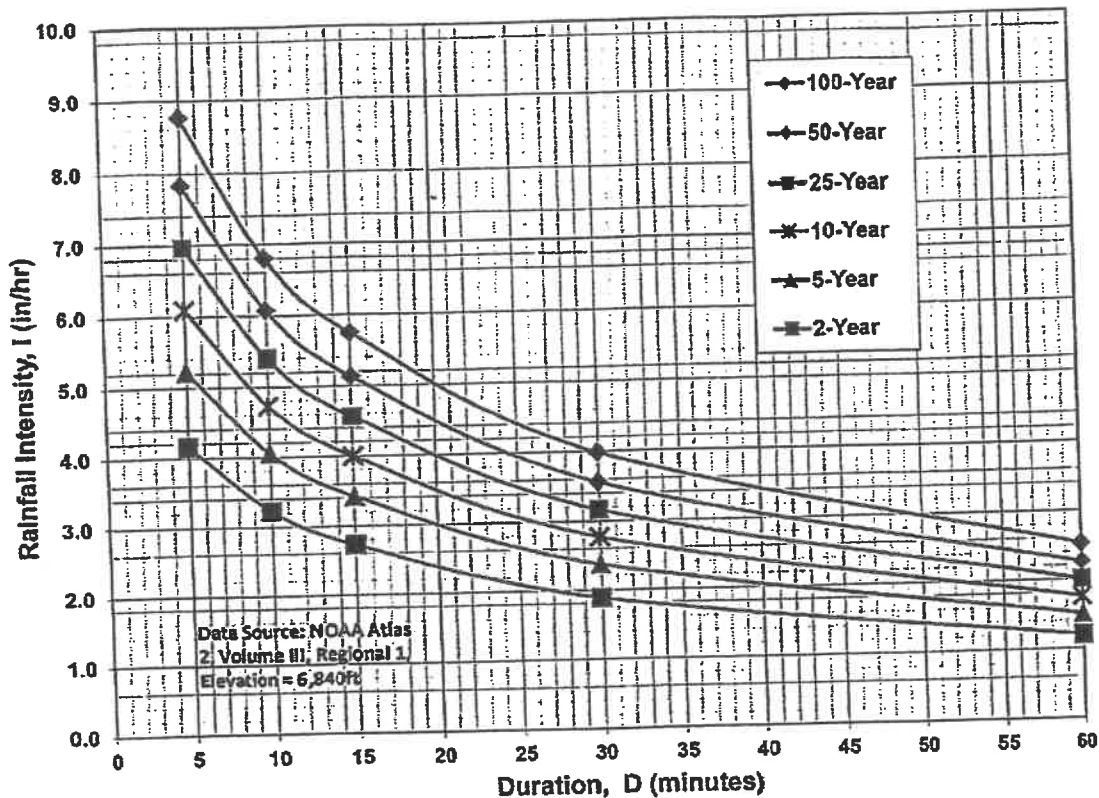

Figure 6-5. Colorado Springs Rainfall Intensity Duration Frequency



IDF Equations

$$I_{100} = -2.52 \ln(D) + 12.735$$

$$I_{50} = -2.25 \ln(D) + 11.375$$

$$I_{25} = -2.00 \ln(D) + 10.111$$

$$I_{10} = -1.75 \ln(D) + 8.847$$

$$I_5 = -1.50 \ln(D) + 7.583$$

$$I_2 = -1.19 \ln(D) + 6.035$$

Note: Values calculated by equations may not precisely duplicate values read from figure.

DESIGNED BY: MAB
 DRAWN BY: HJG
 CHECKED BY: MAB
 DATE: 02/08/21

RESPEC (FORMERLY ADP)
 121 S. TEJON ST.
 SUITE 1110
 COLORADO SPRINGS, CO 80918
 PHONE (719) 266-5212

STAMP

811
 Know what's below.
 Call before you dig.
 PROJ NO. 03433
 DWG NM. 03433-GrdgEros

HOME RUN RESTORATIONS, INC
 5090 WILEY RD
 PEYTON, CO 80831

WYOMING ESTATES
 SUBDIVISION
 EL PASO COUNTY, CO

DRAINAGE PLAN
 EXISTING
 CONDITIONS

DRAWING NUMBER:

C
 SHEET 1

VICINITY MAP:

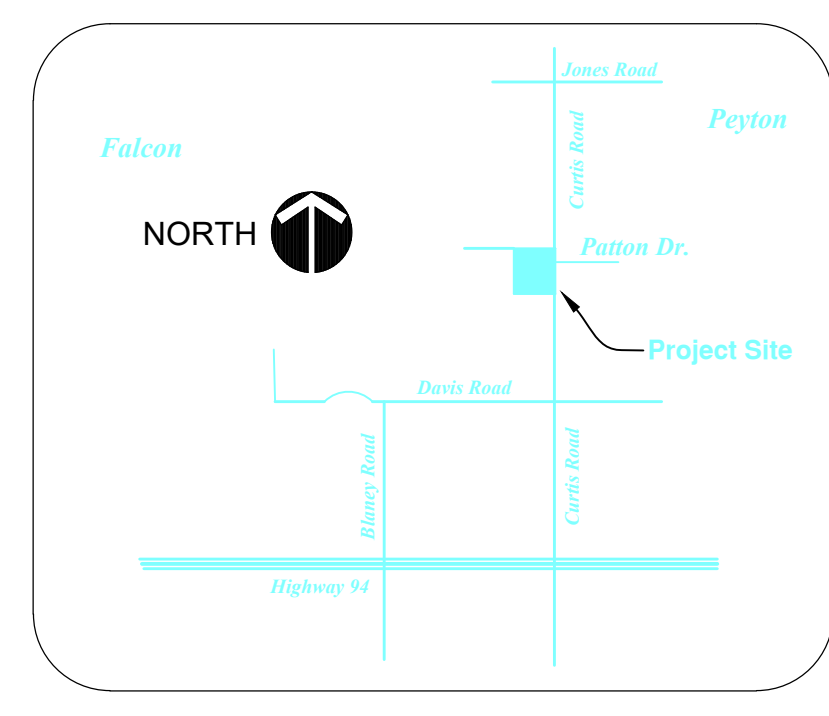

LEGEND

- A1A BASIN DESIGNATION
- XX BASIN AREA, ACRES
- XX 5 YEAR STORM, CFS
- XX 100 YEAR STORM, CFS
- XX 5 YEAR ACCUMULATED FLOW, CFS
- XX 100 YEAR ACCUMULATED FLOW, CFS
- SUB-BASIN BOUNDARY
- DIRECTION OF DRAINAGE FLOW

EXISTING CONDITIONS

AREA DESIGNATION	Q5	Q100	ACRES
A	0.9	7.1	3.66
B1	1.6	10.1	4.75
B2A1	0.4	1.0	0.20
B2A2	0.9	1.9	0.35
B2B1	0.8	3.1	1.20
B2B2	3.6	27.2	16.31
B3A1	0.4	0.9	0.165
B3A2	0.4	0.9	0.165
B3B	1.2	8.0	4.11
B4A1	0.7	2.1	0.44
B4A2	1.3	9.0	4.19
B4B1	0.5	1.6	0.38
B4B2	1.4	3.3	0.56
OS1A	1.5	6.6	2.62
OS1B	0.6	2.6	0.91
OS2A	0.3	1.9	1.26
OS2B	1.1	8.2	5.60
DP1(OS1A&B1)	3.0	16.3	7.37
DP2(B2A1+B2B1)	1.1	3.8	1.40
DP3(OS2A+B2B2)	3.5	26.9	17.57
DP4(DP2+DP3+B2A2)	4.8	30.6	19.32
DP5(DP1+DP4)	7.0	42.8	26.69
DP6(B4B1+B4B2)	1.5	4.0	0.94
DP7(DP5+DP6+OS1B)	7.8	44.1	27.63
DP8(OS2B+B3B)	1.9	13.7	28.54
DP9(DP8+B3A)	2.2	14.6	9.71
DP10(DP9+B4A1)	2.5	15.4	10.04
DP11(DP10+B4A2)	3.1	19.2	10.48
DP12(DP7+DP11)	9.8	57.5	43.21

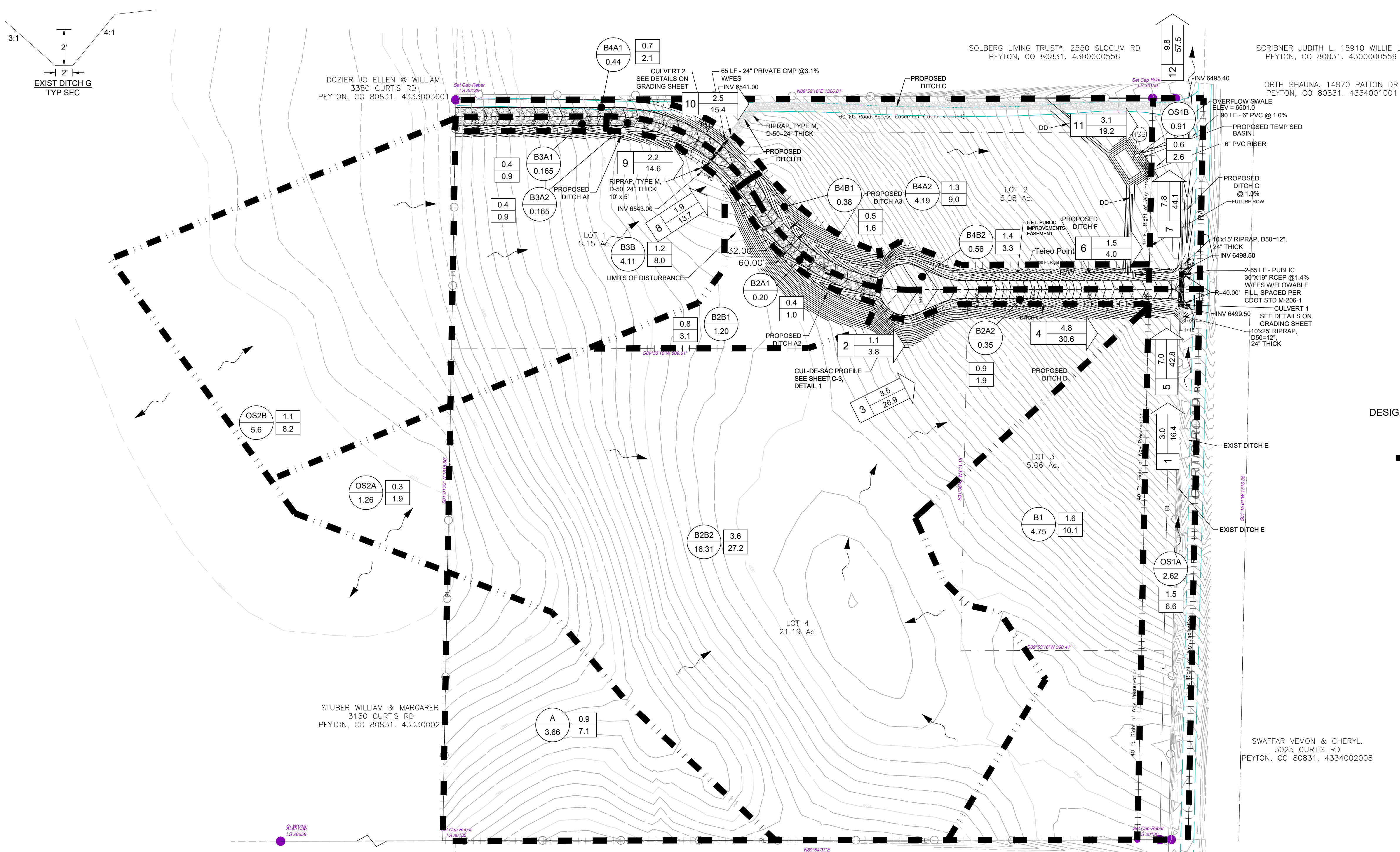
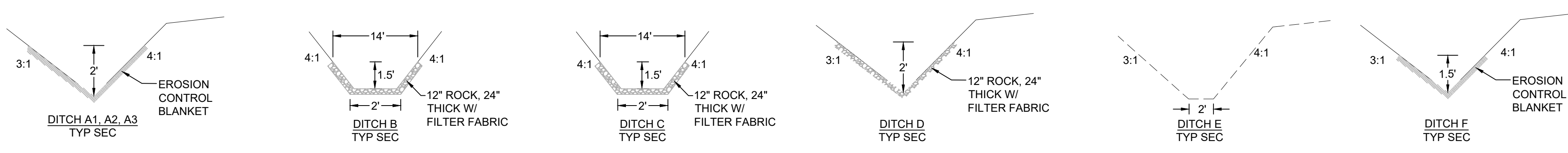

Basis of Bearings

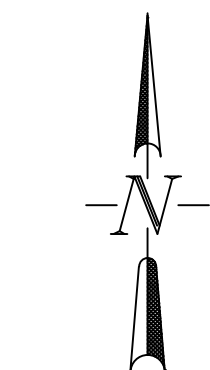

GRAPHIC SCALE

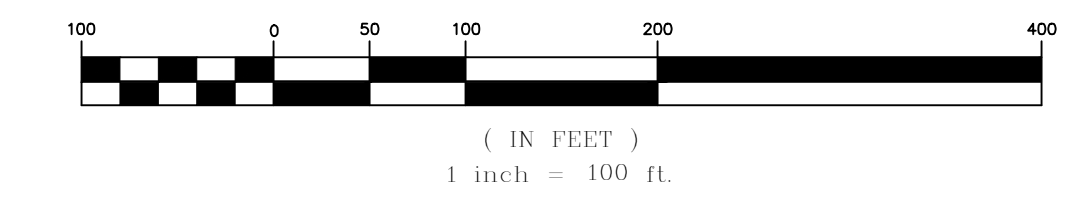

NAME: N:\PROJECTS\03433 - 3050 CURTIS ROAD\DWG\03433-DRNGDEV.DWG
 PLOT DATE: February 28, 2024 8:17 AM BY: MICHAEL (MIKE) BARTUSEK

NAME: N:\Projects\Potential Projects\CDSS Proposals\### Wyoming Estates\### Wyoming Estates\3_DWG\5_Sheets\Drainage Plans\03433-Dwg\Dev.dwg PLOT DATE: Jun 19, 2023 11:05am

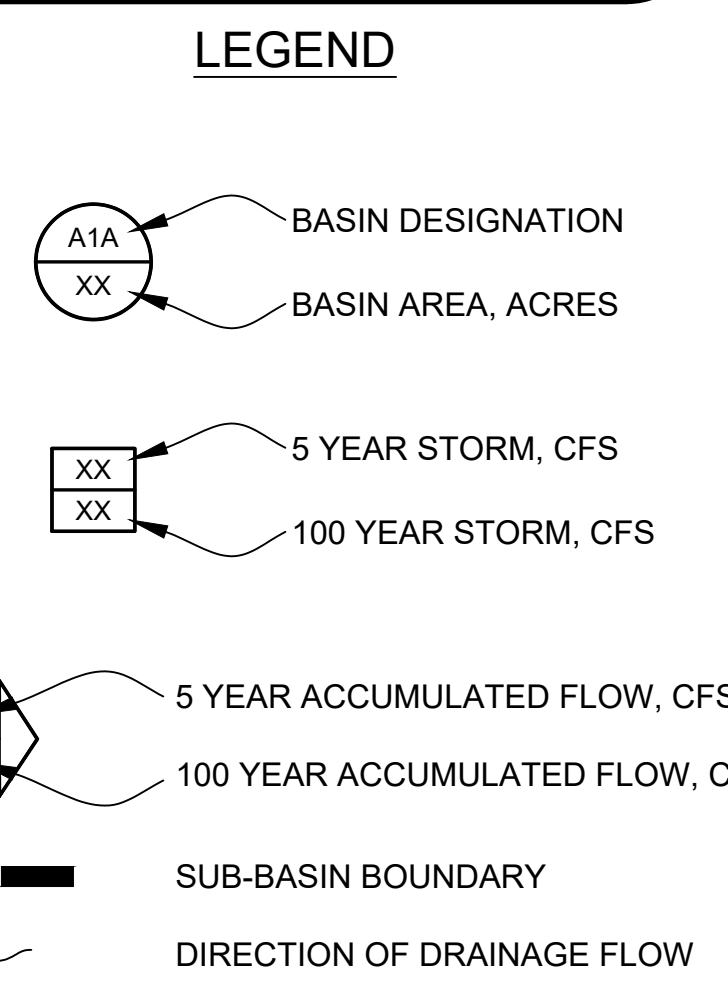
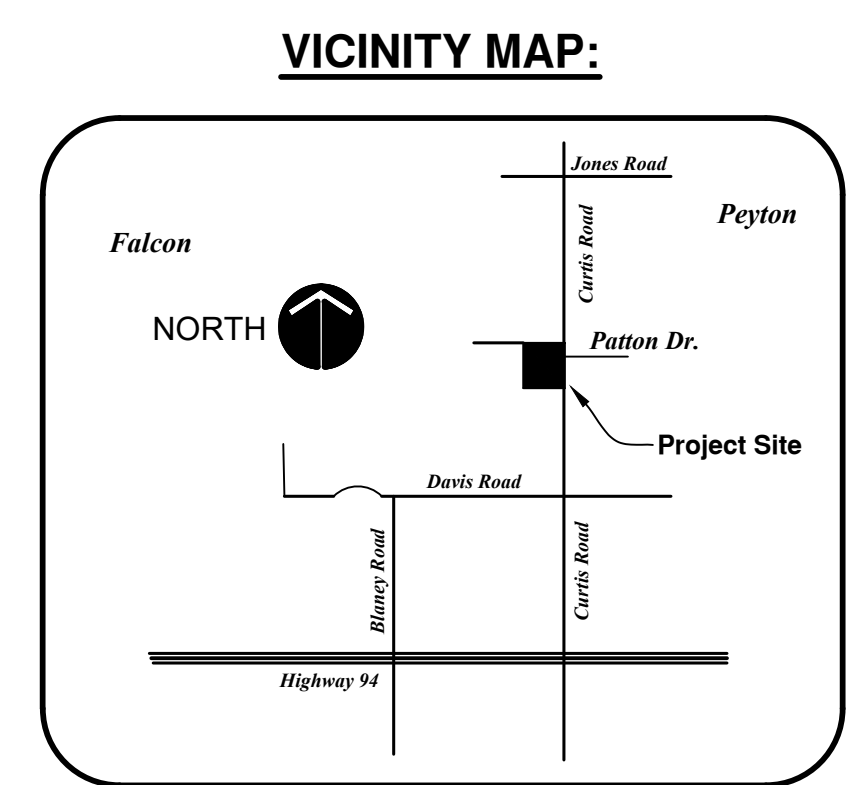
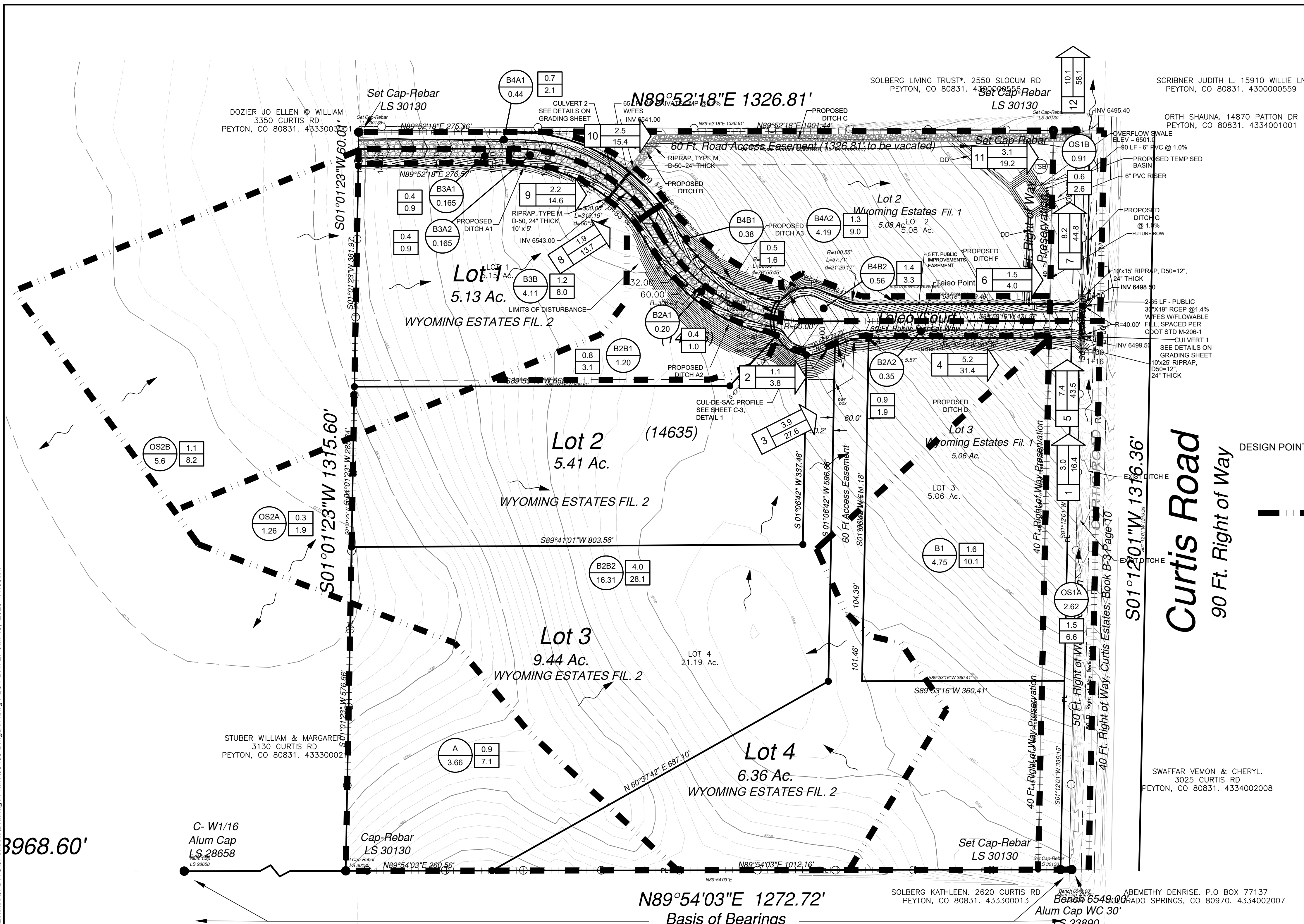

PROPOSED CONDITIONS			
AREA DESIGNATION	Q5	Q100	ACRES
A	0.9	7.1	3.66
B1	1.6	10.1	4.75
B2A1	0.4	1.0	0.20
B2A2	0.9	1.9	0.35
B2B1	0.8	3.1	1.20
B2B2	4.0	28.1	16.31
B3A1	0.4	0.9	0.165
B3A2	0.4	0.9	0.165
B3B	1.2	8.0	4.11
B4A1	0.7	2.1	0.44
B4A2	1.3	9.0	4.19
B4B1	0.5	1.6	0.38
B4B2	1.4	3.3	0.56
OS1A	1.5	6.6	2.62
OS1B	0.6	2.6	0.91
OS2A	0.3	1.9	1.26
OS2B	1.1	8.2	5.60
DP1(OS1A+B1)	3.0	16.3	7.37
DP2(B2A1+B2B1)	1.1	3.8	1.40
DP3(OS2A+B2B2)	3.9	27.6	17.57
DP4(DP2+DP3+B2A2)	5.1	31.4	19.32
DP5(DP1+DP4)	7.4	43.5	26.69
DP6(B4B1+B4B2)	1.5	4.0	0.94
DP7(DP5+DP6+OS1B)	8.2	44.8	27.63
DP8(OS2B+B3B)	1.9	13.7	28.54
DP9(DP8+B3A1+B3A2)	2.2	14.6	9.71
DP10(DP9+B4A1)	2.5	15.4	10.04
DP11(DP10+B4A2)	3.1	19.2	10.48
DP12(DP7+DP11)	10.1	58.1	43.21

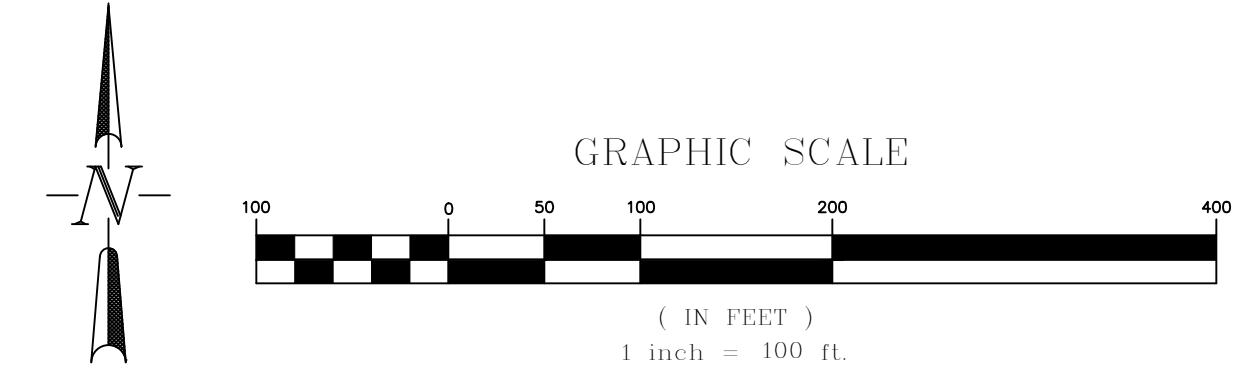
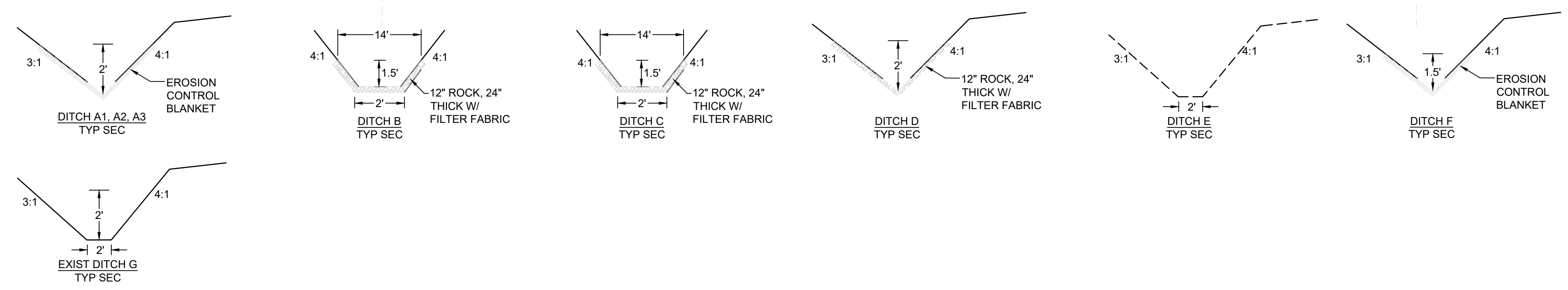

DESIGNED: MAB
 DRAWN: HUG
 CHECKED: MAB
 DATE: 6.19.2023

REVISION

RESPEC
 COMMUNITY DESIGN SOLUTIONS
 1500 W. 10TH ST. SUITE 100
 PEARSON, CO 80854
 WWW.RESPEC.COM PHONE: (719) 298-8212

STAMP

PRELIMINARY
 NOT FOR CONSTRUCTION
 6/2023

THIS DRAWING IS INCOMPLETE AND NOT TO BE USED FOR CONSTRUCTION UNLESS IT IS STAMPED, SIGNED AND DATED

811
 Know what's below.
 Call before you dig.

PROJECT NAME: HOME RUN RESTORATIONS, INC
 5090 WILEY RD
 PEYTON, CO 80831

SHEET TITLE: WYOMING ESTATES
 SUBDIVISION FIL. NO. 2
 EL PASO COUNTY, CO

SUBMITTED FOR: DRAINAGE PLAN DEVELOPED CONDITIONS

SHEET NUMBER: C 2