



LSC TRANSPORTATION CONSULTANTS, INC.
2504 East Pikes Peak Avenue, Suite 304
Colorado Springs, CO 80909
(719) 633-2868
FAX (719) 633-5430
E-mail: lsc@lsctrans.com
Website: <http://www.lsctrans.com>

Peaceful Ridge at Fountain Valley
Traffic Impact Analysis
(LSC #S214530)
May 11, 2023
PCD File No. CDR-22-015

Traffic Engineer's Statement

This traffic report and supporting information were prepared under my responsible charge and they comport with the standard of care. So far as is consistent with the standard of care, said report was prepared in general conformance with the criteria established by the County for traffic reports.

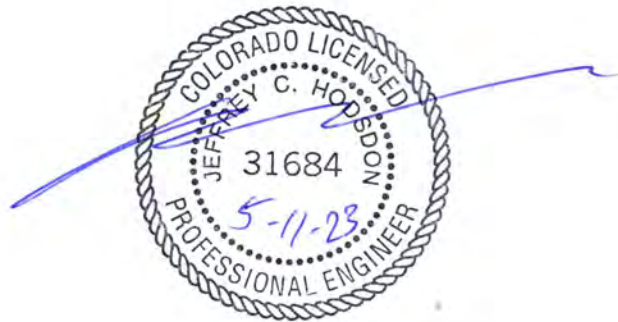

Developer's Statement

I, the Developer, have read and will comply with all commitments made on my behalf within this report.

A handwritten signature in black ink, appearing to be 'J. Hobson', written over a horizontal line.

November 1st, 2023

Date

Peaceful Ridge

Traffic Impact Study

Prepared for:

Mr. J. Ryan Watson
Fountain Valley Investment
3 Widefield Boulevard
Colorado Springs, CO 80911

MAY 11, 2023

LSC Transportation Consultants
Prepared by: Jeffrey C. Hodsdon, P.E.

LSC #S214530
PCD File No.: CDR-22-015



CONTENTS

REPORT CONTENTS 1

STUDY AREA 2

PRIOR AREA TRAFFIC REPORTS 2

LAND USE AND ACCESS 3

 Proposed Land Use and Adjacent Development Information 3

 Proposed Site Access 3

ROAD AND TRAFFIC CONDITIONS 3

 Existing Traffic Volumes 4

 Existing Intersection Level of Service 4

 Crash/Accident History 4

SHORT-TERM BASELINE TRAFFIC VOLUMES 4

SIGHT DISTANCE 5

 El Paso County Requirements 5

 Entering Sight Distance 5

TRIP GENERATION 5

TRIP DISTRIBUTION AND ASSIGNMENT 6

 Trip Directional Distribution 6

 Site-Generated Traffic 6

 Short Term 6

 Long Term 6

 Short-Term Baseline-Plus-Site-Generated Traffic Volumes 6

 Estimated Future 2043 Background Traffic Volumes 6

 Future 2043 Total Traffic Volumes 7

LEVEL OF SERVICE ANALYSIS 7

 Fontaine Boulevard/Sleepy Meadows Drive 8

 Marksheffel Road/Peaceful Ridge Drive (RIRO) 8

 Marksheffel Road/Bradley Ridge Drive 8

 Bradley Ridge Drive/Bridgagate Place 8

 Peaceful Ridge Drive/Bridgagate Place 8

AUXILIARY TURN-LANE ANALYSIS 9

 Marksheffel Road/Peaceful Ridge Drive(RI/RO) 9

Left-Turn Deceleration Lane	9
Right-Turn Deceleration Lane	9
Right-Turn Acceleration Lane	9
Fontaine Boulevard/Sleepy Meadows Drive Intersection	9
Left-Turn Deceleration Lane	9
Right-Turn Deceleration Lane (El Paso County)	10
Right-Turn Acceleration Lane	10
ROADWAY IMPROVEMENTS	11
SUBDIVISION STREET CLASSIFICATIONS	11
MTCP CONFORMANCE	11
Roadway Classifications	11
Reimbursable Improvements	11
MULTI-MODAL TRANSPORTATION AND TDM OPPORTUNITIES	11
DEVIATION REQUESTS	12
COUNTY TRANSPORTATION IMPROVEMENT FEE PROGRAM	12
CONCLUSIONS	12
Enclosures:	13
Table 3 and Table 4	
Figure 1 - Figure 10	
Traffic Count Reports	
Synchro LOS Reports	
MTCP Maps	



LSC TRANSPORTATION CONSULTANTS, INC.
2504 East Pikes Peak Avenue, Suite 304
Colorado Springs, CO 80909
(719) 633-2868
FAX (719) 633-5430
E-mail: lsc@lsctrans.com
Website: <http://www.lsctrans.com>

May 11, 2023

Mr. J. Ryan Watson
Fountain Valley Investment
3 Widefield Boulevard
Colorado Springs, CO 80911

RE: Peaceful Ridge
Traffic Impact Study
El Paso County, CO
LSC # S214530
PCD File No. CDR-22-015

Dear Mr. Watson,

LSC Transportation Consultants, Inc. has prepared this traffic impact study for the proposed Peaceful Ridge residential development. The site is located west of Marksheffel Road and north of Fontaine Boulevard in El Paso County, Colorado. The land use is 253 single-family (detached) dwelling units. Access would be to Marksheffel Road, Fontaine Boulevard (via Sleepy Meadows Drive), and Bridgegate Place to the north (planned street connection).

This report has been prepared for submittal to El Paso County.

REPORT CONTENTS

The preparation of this report included the following:

- Inventory of existing adjacent and nearby area street system. This included surface conditions, functional classifications, roadway widths, lane configurations, traffic control, posted speed limits, pavement markings, intersection and access spacing, roadway and intersection alignments, auxiliary left- and right-turn lanes, intersection sight distances, etc.;
- Results of morning and late-afternoon peak-hour turning-movement traffic counts at the “study-area” intersections; other nearby count data.
 - Fontaine Boulevard/Cottonwood Grove Drive
 - Fontaine Boulevard/Sleepy Meadows Drive
- Short-term baseline traffic-volume estimates.

- Review of previously-completed traffic studies in the vicinity of this site for information and findings relative to this development. Other recent studies completed in the area and any applicable data/transferrable information/analysis etc. from previous LSC studies adjacent to the site were also utilized;
- Evaluation of intersection/access sight distance at the proposed access-point intersections on Marksheffel Road and Fontaine Boulevard, based on current criteria in the County's *Engineering Criteria Manual*.
- Estimates of average weekday and peak-hour trip generation for the proposed development;
- Estimation of directional distribution of site-generated vehicle trips on the area street system, at the study-area intersections, and at the proposed site access points;
- Projections of site-generated turning-movement traffic volumes;
- Estimates of short- and long-term background traffic volumes at the study-area intersections and access points;
- Total traffic (site traffic-plus-background traffic) projections at the study-area intersections for the short and long term;
- Level of service (LOS) analysis at the study-area intersections;
- Evaluation of existing, short-term, and long-term projected intersection volumes to determine the potential need for any new auxiliary right-/left-turn lanes;
- Other recommended improvements/modifications to the study-area streets/intersections; and
- Summary of compiled data, analysis, findings, and recommendations.

STUDY AREA

The study area for this report includes the following intersections:

- Marksheffel Road/Peaceful Ridge Drive (RIRO)
- Fontaine Boulevard/Sleepy Meadows Drive
- Bradley Ridge/Bridgeway Place
- Marksheffel Road/Bradley Ridge

Note: Intersections to the north have been added to the study area since the prior iteration of this report. The intersection of Marksheffel Road/Fontaine Boulevard is not included in the study area as per the criteria contained in ECM Appendix B.2.3.B. The impact of Peaceful Ridge traffic at this intersection is below ten percent. The nearest major intersection is the planned Marksheffel Road/Bradley Ridge Drive (included in this study).

PRIOR AREA TRAFFIC REPORTS

LSC utilized the following previous traffic reports to assist in the production of this report:

- Grand Mountain School – LSC Transportation Consultants, Inc. (July 21, 2021)
- *Bradley Heights, Filing 1* – LSC Transportation Consultants, Inc. (May 19, 2021)

- *Glen at Widefield, Filings 10 and 11* – LSC Transportation Consultants, Inc. (July 9, 2021)
- *The Hills at Lorson Ranch* – LSC Transportation Consultants, Inc. (July 2021)
- *Peaceful Ridge at Fountain Valley* – LSC Transportation Consultants, Inc. (May 2006)
- *Bradley Ridge, Filing 1* – Matrix Design Group (June 8, 2022)

LAND USE AND ACCESS

Proposed Land Use and Adjacent Development Information

Figure 1 shows the site location relative to the adjacent and nearby streets. The site is located west of Marksheffel Road and north of Fontaine Boulevard in El Paso County, Colorado. Approximately 253 single-family (detached) dwelling units are proposed. A copy of the site plan is shown in Figure 2.

The planned Bradley Ridge Filing No. 1 site is located just to the north of Peaceful Ridge. The traffic report information from that project, including traffic volumes and planned street connections are included in this updated report.

Proposed Site Access

Access points proposed for the property include:

- Right-in/right-out (RIRO) access to Marksheffel Road, via Peaceful Ridge Drive – 0.5 miles north of Fontaine Boulevard/Marksheffel Road. This access is across from Cider Mill Place on the east side of Marksheffel Road (although left-turn movements and east/west through traffic are prohibited).
- Fontaine Boulevard via existing Sleepy Meadows Drive
- Bridgegate Place, a future connection from Peaceful Ridge Drive north to Bradley Ridge Drive, is located approximately 900 feet west of Marksheffel Road/.

ROAD AND TRAFFIC CONDITIONS

Figure 1 shows the streets adjacent to and in the vicinity of the site. Adjacent streets serving the site are identified below followed by a brief description of each:

Marksheffel Road extends north from the Link Road/C&S Road intersection in Fountain, Colorado to north of Woodmen Road. Marksheffel Road is shown as a future four-lane Expressway on the County's *Major Transportation Corridors Plan (MTCP)*. Marksheffel Road is now under the jurisdiction of the City of Colorado Springs. The recently-adopted (2023) PlanCOS classification of Marksheffel is Principal Arterial). The posted speed limit on Marksheffel Road at Fontaine Boulevard is 55 miles per hour (mph). Auxiliary left- and right-turn lanes exist on all approaches at the signalized intersection of Marksheffel/Fontaine.

Fontaine Boulevard is designated as a four-lane Principal Arterial west of Marksheffel Road in the vicinity of the site. The posted speed limit on Fontaine Boulevard is generally 35 mph just west of Marksheffel and 45 mph west of Sleepy Meadows Drive. Auxiliary right-turn deceleration lanes exist on all approaches at the stop-sign-controlled intersections of Fontaine Boulevard/Sleepy Meadows Drive and Fontaine Boulevard/Cottonwood Grove Drive. Additionally, short southbound-to-westbound right-turn acceleration lanes exist for both of the previously-mentioned intersections on Fontaine Boulevard.

Cottonwood Grove Drive is a two-lane local street extending north-to-south for 0.3 miles between Summer Meadows Drive and Weeping Willow Drive. The Fontaine/Cottonwood Grove intersection is a four-leg, full-movement intersection with stop-sign control on the minor-street approaches. The posted speed limit on Cottonwood Grove Drive is 25 mph.

Sleepy Meadows Drive is a two-lane local street extending north from Fontaine Boulevard for about a quarter-mile. The Fontaine/Sleepy Meadows intersection is currently a full-movement T-intersection with stop-sign control on the southbound approach. The posted speed limit on Sleepy Meadows Drive is 25 mph.

Existing Traffic Volumes

Figure 2 shows the results of traffic data collected. Peak-hour intersection volumes are shown as well as estimates of daily traffic volumes based on factored peak-hour data.

Existing Intersection Level of Service

Existing intersection levels of service are also shown in Figure 3. Please refer to the LEVEL OF SERVICE section of this report for level of service information and discussion.

Crash/Accident History

Three years of crash-history data (from February 2020 through April 2023) were obtained from the Colorado State Patrol Central Records Unit. During the three-year period, zero crashes were reported at the intersection of Fontaine Boulevard/Sleepy Meadows Drive. Zero crashes were reported at the intersection of Fontaine Boulevard/Cottonwood Grove Drive adjacent to the site.

SHORT-TERM BASELINE TRAFFIC VOLUMES

Figure 4 shows estimated “short-term baseline” traffic volumes on the study-area streets and at the study-area intersections (short-term peak-hour turning-movement volumes). The short-term baseline volumes include the street connection to the north and the short-term traffic volumes shown in the Bradley Ridge Filing No. 1 TIS report.

SIGHT DISTANCE

El Paso County Requirements

Access points (planned public-roadway intersections) must meet *Engineering Criteria Manual* or *City Traffic Criteria Manual* standards for sight distance. The north site-access point, Peaceful Ridge Drive, will be a stop-controlled, RI/RO intersection with Marksheffel. LSC completed a field visit to measure the current sight distance. All sight-distance field measurements utilized a driver’s eye height of 3.5 feet and a height of 3.5 feet for a southbound vehicle approaching from the north. Please see Figure 12 for more details.

Entering Sight Distance

Based on the 55-mph posted speed limit on Marksheffel (60-mph design speed), the required entering sight distance for eastbound right-turning vehicles on Peaceful Ridge Drive is 750 feet for single-unit trucks (and school buses) per section 9.5.3.2.2 of the AASHTO “Green Book” Case B2—Right Turn from the Minor Road. These criteria have been utilized, as the *ECM* does not specifically list entering sight distance criteria for a 60-mph design speed). The sight distance to the north for eastbound approach at the proposed Marksheffel Road/Peaceful Ridge Drive intersection exceeds the 750-foot requirement for single-unit trucks. Field measurements recorded 807 feet of sight distance looking to the north.

TRIP GENERATION

Estimates of the existing and projected vehicle trips to be generated by the site have been made using nationally-published average trip-generation rates for land-use code “210 – Single-Family (Detached) Housing” in *Trip Generation, 11th Edition, 2021* by the Institute of Transportation Engineers (ITE).

Table 1 below presents a summary of the estimated site trip generation. A detailed trip-generation estimate for the development, including ITE rates for the proposed land uses, is presented in Table 3 (attached).

Table 1: Estimated External Site Vehicle-Trip Generation

Analysis Period	Weekday		
	In	Out	Total
Morning Peak Hour	45	128	173
Evening Peak Hour	150	88	238
Daily/24-hour	1,193	1,193	2,386

Based on the ITE estimate for the proposed residential development, the site would generate about 2,386 external vehicle trips on the average weekday. During the weekday morning peak

hour, approximately 45 vehicles would enter and 128 vehicles would exit the site. Approximately 150 entering vehicles and 88 exiting vehicles are projected for the weekday afternoon peak hour.

TRIP DISTRIBUTION AND ASSIGNMENT

Trip Directional Distribution

Estimating the directional distribution of site-generated vehicle trips to the study-area roads and intersections is a necessary component in determining the site's traffic impacts. Figure 5 shows the percentages of the site-generated vehicle trips projected to be oriented to and from the site's major approaches. Estimates have been based on the following factors: the proposed land use, the existing and planned area street and road system serving the site, previously-conducted traffic studies for the site and recent studies for Bradley Ridge to the north, and the site's geographic location relative to the Fountain Valley area and the City of Colorado Springs.

Site-Generated Traffic

Short Term

Figure 6 shows the projected short-term site-generated traffic volumes for the weekday morning and evening peak hours. Site-generated traffic volumes at the study-area intersections have been calculated by applying the directional-distribution percentages estimated by LSC (from Figure 5) to the trip-generation estimates (from Table 3).

Long Term

Figure 7 shows the projected long-term site-generated traffic volumes for the weekday morning and evening peak hours. Site-generated traffic volumes at the study-area intersections have been calculated by applying the directional-distribution percentages estimated by LSC (from Figure 5) to the trip-generation estimates (from Table 3).

Short-Term Baseline-Plus-Site-Generated Traffic Volumes

Figure 8 shows the sum of the short-term baseline traffic volumes (from Figure 4) and site-generated peak-hour traffic volumes (shown in Figure 6).

Estimated Future 2043 Background Traffic Volumes

Figure 9 shows the projected 20-year background traffic volumes for the year 2043. Estimated 2043 background through-traffic volumes on Fontaine Boulevard and Marksheffel Road account for projected background traffic growth on these roadways and align with long-term traffic projections

from recent LSC traffic studies in the vicinity of the site. Projected 20-year background traffic volumes do **not** include projected traffic to be generated by the proposed Peaceful Ridge development.

Annual growth rates reflected in projected future traffic projections are as follows:

- Marksheffel Road (northbound approach) – 3.5 percent per year
- Marksheffel Road (southbound approach) – 3.25 percent per year
- Fontaine Boulevard (eastbound approach) – 8.37 percent per year
- Fontaine Boulevard (westbound approach) – 5.65 percent per year

Future 2043 Total Traffic Volumes

Figure 10 shows the projected 2043 total traffic volumes, which are the sum of 2043 background traffic volumes (from Figure 9) plus the site-generated traffic volumes (from Figure 6).

LEVEL OF SERVICE ANALYSIS

The following intersections have been analyzed to determine the projected intersection levels of service for short- and long-term traffic scenarios for the morning and evening peak-hour time periods:

- Marksheffel Road/Fontaine Boulevard
- Marksheffel Road/proposed north site access (RIRO)
- Fontaine Boulevard/Sleepy Meadows Boulevard
- Fontaine Boulevard/Cottonwood Grove Drive

Level of service (LOS) is a quantitative measure of the level of congestion or delay at an intersection and is indicated on a scale from “A” to “F.” LOS A is indicative of little congestion or delay. LOS F indicates a high level of congestion or delay. Table 2 shows the level of service delay ranges for signalized and unsignalized intersections.

Table 2: Intersection Levels of Service Delay Ranges

Level of Service	Signalized Intersections	Unsignalized Intersections
	Average Control Delay (Seconds per Vehicle)	Average Control Delay (Seconds per Vehicle) ⁽¹⁾
A	10.0 sec or less	10.0 sec or less
B	10.1-20.0 sec	10.1-15.0 sec
C	20.1-35.0 sec	15.1-25.0 sec
D	35.1-55.0 sec	25.1-35.0 sec
E	55.1-80.0 sec	35.1-50.0 sec
F	80.1 sec or more	50.1 sec or more

(1) For unsignalized intersections, if V/C ratio is greater than 1.0 the level of service is LOS F, regardless of the projected average control delay per vehicle.

Detailed Synchro reports are attached. A summary of LOS during the weekday morning and evening peak hours for the following unsignalized intersections is shown in the following figures:

- Figure 3: Existing Traffic, Lane Geometry, Traffic Control, and LOS
- Figure 4: Short-Term Baseline Traffic, Lane Geometry, Traffic Control, and LOS
- Figure 8: Short-Term Total Traffic, Lane Geometry, Traffic Control, and LOS
- Figure 9: 2043 Background Traffic, Lane Geometry, Traffic Control, and LOS
- Figure 10: 2043 Background + Site Traffic, Lane Geometry, Traffic Control, and LOS

Fontaine Boulevard/Sleepy Meadows Drive

All individual turning movements and single-lane approaches are projected to operate at LOS C or better during both short-term peak hours through the 20-year horizon, with or without the addition of site-generated traffic.

Marksheffel Road/Peaceful Ridge Drive (RIRO)

All approaches and individual turning movements at the proposed Peaceful Ridge Drive RIRO site access on Marksheffel Road are projected to operate at LOS C or better (for the eastbound-to-southbound right-turn movement) during both peak hours through the 20-year horizon.

Marksheffel Road/Bradley Ridge Drive

All individual turning movements and single-lane approaches are projected to operate at LOS D or better during both peak hours through the 20-year horizon, with or without the addition of site-generated traffic. LSC has assumed that this full-movement intersection will be signalized with auxiliary turn lanes to be consistent with recommendations made in the *Bradley Ridge, Filing 1* traffic study (by Matrix Design Group).

Bradley Ridge Drive/Bridgegate Place

All individual turning movements and single-lane approaches are projected to operate at LOS B or better during both peak hours through the 20-year horizon, with or without the addition of site-generated traffic.

Peaceful Ridge Drive/Bridgegate Place

All individual turning movements and single-lane approaches are projected to operate at LOS A during both peak hours through the 20-year horizon, with or without the addition of site-generated traffic.

AUXILIARY TURN-LANE ANALYSIS

The *Engineering Criteria Manual* and the City of Colorado Springs' *Traffic Criteria Manual* contain turning-volume thresholds which require auxiliary left- or right-turn lanes by roadway classifications. Roadway classifications for key thoroughfares in the vicinity of the site are based on the City's recently-adopted *PlanCOS* and the El Paso County *Major Transportation Corridors Plan (MTCP)*. Marksheffel Road adjacent to the site and Fontaine Boulevard are classified as Principal Arterial Streets.

Marksheffel Road/Peaceful Ridge Drive(RI/RO)

Left-Turn Deceleration Lane

This intersection is a right-in/right-out intersection. As such, a northbound left-turn deceleration lane would **not** apply.

Right-Turn Deceleration Lane

Right-turn deceleration auxiliary turn lanes are required for Principal Arterials within the City of Colorado Springs with a projected peak-hour right-ingress turning volume of 25 vph or greater. The southbound right-turn volume is projected to exceed this 25-vph threshold during both peak hours following the completion of the Peaceful Ridge residential development and with the planned connection to Bradley Ridge to the north.

The posted speed limit on Marksheffel Road is 55 mph. Per the City Traffic Criteria Manual, the required total lane length on Marksheffel Road will need to be 636 feet (with a grade-adjustment factor of 1.20 applied, per Table 4 of the City's *Traffic Criteria Manual*), consisting of 396 feet of full-width lane length plus a 240-foot approach taper.

Right-Turn Acceleration Lane

Right-turn acceleration auxiliary turn lanes are not required for Principal Arterials within the City of Colorado Springs.

Fontaine Boulevard/Sleepy Meadows Drive Intersection

Please refer to Figure 10 for the recommended laneage at this intersection. Fontaine Boulevard west of Sleepy Meadows is within the City of Colorado Springs.

Left-Turn Deceleration Lane

Left-turn deceleration auxiliary turn lanes are required for a Principal Arterial access with a projected peak-hour left-turn-ingress turning volume of 10 vph or greater. The eastbound

left-turn volume currently exceeds and is projected to remain above this 10-vph threshold during both peak hours following the completion of the Peaceful Ridge residential development.

The posted speed limit in the eastbound direction on Fontaine Boulevard west of Sleepy Meadows Drive is 45 mph. Per the City *Traffic Criteria Manual*, the required total lane length on Fontaine Boulevard is 480 feet, consisting of 200 feet of full-width lane length, a 180-foot approach taper, and 100 feet of storage length. Redirect tapers west of the turn lane and east of Sleepy Meadows would be required (45:1 taper ratio).

Regarding the redirect taper required east of Sleepy Meadows, Fontaine Boulevard currently transitions from a 45-mph zone to a 35-mph zone west of Sleepy Meadows Drive. LSC recommends the placement (westbound) and relocation (eastbound) of speed limit signs on Fontaine Boulevard west of Sleepy Meadows as shown in Figure 11. Based on a 35-mph speed limit, the redirect taper associated with the proposed left-turn deceleration lane on Fontaine Boulevard should be 240 feet (20:1 ratio). This assumes widening to the south only for the left-turn lane.

Please refer to Figure 10 for more detail regarding proposed striping modifications adjacent to the intersection of Fontaine Boulevard/Sleepy Meadows Drive.

Right-Turn Deceleration Lane (El Paso County)

Currently, the westbound right-turn deceleration lane is 300 feet long, consisting of 215 feet of lane length and an 85-foot approach taper. Per the *Engineering Criteria Manual*, the required turn-lane length on this Principal Arterial is 315 feet, consisting of 155 feet of lane length and a 160-foot transition taper (based on the westbound posted speed limit of 35 mph and assumed 40-mph design speed).

The combined lane-plus-taper length is short of *ECM* criteria by 15 feet (based on a 40-mph design speed) due to the shorter-than-standard taper length. The existing full-width lane length (215 feet) exceeds the *ECM* requirement for full-width lane length (155 feet). Please refer to the deviation request included with this resubmittal to allow use of the existing lane in its current configuration.

Right-Turn Acceleration Lane

Currently, a westbound right-turn acceleration lane exists (for southbound-to-westbound right turns). This lane is 275 feet long, consisting of about 200 feet of lane length and a 100-foot taper. Note: right-turn acceleration auxiliary turn lanes are not required for Principal Arterials within the City of Colorado Springs.

ROADWAY IMPROVEMENTS

Please refer to the attached Table 4 which outlines the roadway improvements.

SUBDIVISION STREET CLASSIFICATIONS

All streets within this subdivision should be classified as Urban Local.

MTCP CONFORMANCE

Roadway Classifications

The following study-area roadway improvements are shown on Map 13 of El Paso County's 2016 *MTCP*. The County will require these roadways to be constructed to County standards (*ECM* Table 2-5 presents a summary of roadways design standards):

- Marksheffel Road – 4-lane Rural Expressway (Note: the City PlanCOS classification of Marksheffel is **Principal Arterial**)
- Fontaine Boulevard – 4-lane Urban Minor Arterial (Note: the City PlanCOS classification of Marksheffel is **Principal Arterial**)
- Internal roadways within the proposed residential development – Urban Local

Reimbursable Improvements

The following roadway improvement projects have been identified as being needed by the year 2040 per Map 13 and Table 4 of El Paso County's 2016 *MTCP*:

- C4 – Marksheffel Road from 0.5 miles north of Fontaine to Link Road (\$20,816,000)
 - Existing conditions – 2-lane Rural Minor Arterial
 - Future conditions – 4-lane Rural Expressway (Note: the City PlanCOS classification of Marksheffel is **Principal Arterial**)
- C5 – Fontaine Boulevard from Marksheffel Road to Easy Street (\$42,449,000) (Note: the City PlanCOS classification of Marksheffel is **Principal Arterial**)
 - Existing conditions – 2-lane Urban Minor Arterial
 - Future conditions – 4-lane Urban Minor Arterial

See the attached *MTCP* maps for reference.

MULTI-MODAL TRANSPORTATION AND TDM OPPORTUNITIES

The following multi-modal improvement project has been identified as being needed by the year 2040 per Map 15 and Table 5 of El Paso County's 2016 *MTCP*:

- Crews Gulch Trail – proposed bicycle route and roadway upgrades/widenings

DEVIATION REQUESTS

The following deviation requests have been prepared and are included with this resubmittal:

- Westbound right-turn lane at Fontaine Boulevard/Sleepy Meadows: Allow use of the existing lane and defer any modifications until a Fontaine Boulevard widening project in the future.
- Local street knuckle design

COUNTY TRANSPORTATION IMPROVEMENT FEE PROGRAM

This project will be required to participate in the El Paso County Road Improvement Fee Program. Peaceful Ridge will join the ten-mil PID. The ten-mil PID building permit fee portion associated with this option is \$1,221 per single-family dwelling unit. The total building permit fee would be \$308,913 for the 253 dwelling units.

Note: This is based on the current rate, which is subject to change. El Paso County updates this rate periodically.

CONCLUSIONS

- The site is projected to generate about 2,386 new driveway vehicle trips on the average weekday.
- During the weekday morning peak hour of adjacent street traffic, 45 vehicles would enter the site while 128 vehicles would exit.
- During the weekday evening peak hour of adjacent street traffic, 150 vehicles would enter the site while 88 vehicles would exit.
- Please refer to the “Level of Service” section above for detailed LOS analysis results for individual turning movements and approaches at all studied intersections, during both peak hours through the 2043 horizon year.
- Please refer to the “Auxiliary Turn-Lane Analysis” section for required auxiliary turn lanes at the study-area intersections.

* * * * *

Please contact me if you have any questions regarding this report.

Respectfully Submitted,

LSC TRANSPORTATION CONSULTANTS, INC.

By: Jeffrey C. Hodsdon, P.E.
Principal

JCH/JAB:jas

Enclosures: Table 3 and Table 4
Figure 1 - Figure 10
Traffic Count Reports
Synchro LOS Reports
MTCP Maps

Tables



Table 3: Total Trips Generated

ITE		Value	Units ¹	Trip Generation Rates ²					Driveway Trips				
Code	Description			Average Weekday	A.M.		P.M.		Average Weekday	A.M.		P.M.	
				In	Out	In	Out	In	Out	In	Out		
210	Single-Family (Detached) Housing	253	DU	9.43	0.18	0.51	0.59	0.35	2386	45	128	150	88

¹ DU = dwelling units

² Source: *Trip Generation*, 11th Edition (2021) by the Institute of Transportation Engineers (ITE)

Table 4: Roadway Improvements

Peaceful Ridge Subdivision

1: Offsite Intersections				
Item #	Improvement	Timing	Jurisdiction	Responsibility
1.1: Fontaine Boulevard & Sleepy Meadows Drive				
1.1.a	Auxiliary Turn Lane (new): Eastbound left-turn deceleration lane on Fontaine Boulevard; associated redirect tapers. See Figure 10 for details.	With the with development	The road segment west of Sleepy Meadows intersection is within the City of Colorado Springs, but the intersection itself is in El Paso County.	Applicant
1.1.b	Auxiliary Turn Lane Modification: Minor Lengthening of the existing westbound right-turn deceleration lane on Fontaine Boulevard. Please refer to the deviation request for details.	Deviation Request is submitted to defer until future Fontaine Boulevard widening project (per item No. 3.2)	El Paso County	Part of a future Fontaine Boulevard Widening project
1.1.c	Intersection signing and markings as needed associated with new left-turn deceleration lane and as shown on Figure 10 . Left Lane Must Turn Left signs (if required by the City of Colorado Springs); relocation of speed limit signs if LSC recommendation is accepted; changes in pavement markings.	With the with development	The road segment west of Sleepy Meadows intersection is within the City of Colorado Springs, but the intersection itself is in El Paso County.	Applicant with potential for future cost-recovery.
2: Adjacent Roadway ROW Requirements				
2.1: Marksheffel Road				
2.1.a	Right-of-way was dedicated with the plat.	Applicant	City of Colorado Springs	Applicant
3: Roadway Segment Improvements				
3.1 Marksheffel Road				
3.1	2016 MTCP Improvement C4 – Marksheffel Road: Widen to a – 4-lane Rural Expressway from 0.5 miles north of Fontaine to Link Road (Note: the City <i>PlanCOS</i> classification of Marksheffel is Principal Arterial)	Shown in 2016 MTCP	City of Colorado Springs	MTCP Identified Improvement, however it is our understanding that the roadway is now under Colorado Springs jurisdiction.
3.2 Fontaine Boulevard				
3.2	2016 MTCP Improvement C5 – Fontaine Boulevard: Widen to a – 4-lane Urban Minor Arterial from Marksheffel Road to Easy Street; (Note: the City <i>PlanCOS</i> classification of Fontaine Boulevard is Principal Arterial)	Shown in 2016 MTCP	City of Colorado Springs and El Paso County	MTCP Identified Improvement. It is our understanding that the roadway is under Colorado Springs jurisdiction west of Sleepy Meadows Drive.
4: Internal Subdivision Roadways				
4.1	Construct subdivision streets to County Urban Local Standards	Per the Construction Plans	El Paso County	Applicant
5: Adjacent Intersection and Access Intersections				
5.1 Marksheffel Road/Peaceful Ridge Drive				
5.1.a	Auxiliary Turn Lane: Southbound right-turn deceleration lane on Marksheffel Road. Please refer to Figure 11 for details.	With the with development	City of Colorado Springs	Applicant
5.1.b	Intersection signing and markings for new west leg: Stop Sign for Traffic control, signs associated with RI/RO intersection - i.e., No Left Turn and One Way signs, Wrong Way signs, Right Lane Must Turn Right Signs, Object Markers, Changes in pavement markings	With the construction of Peaceful Ridge Drive and prior to the opening of the intersection	City of Colorado Springs	Applicant

Figures



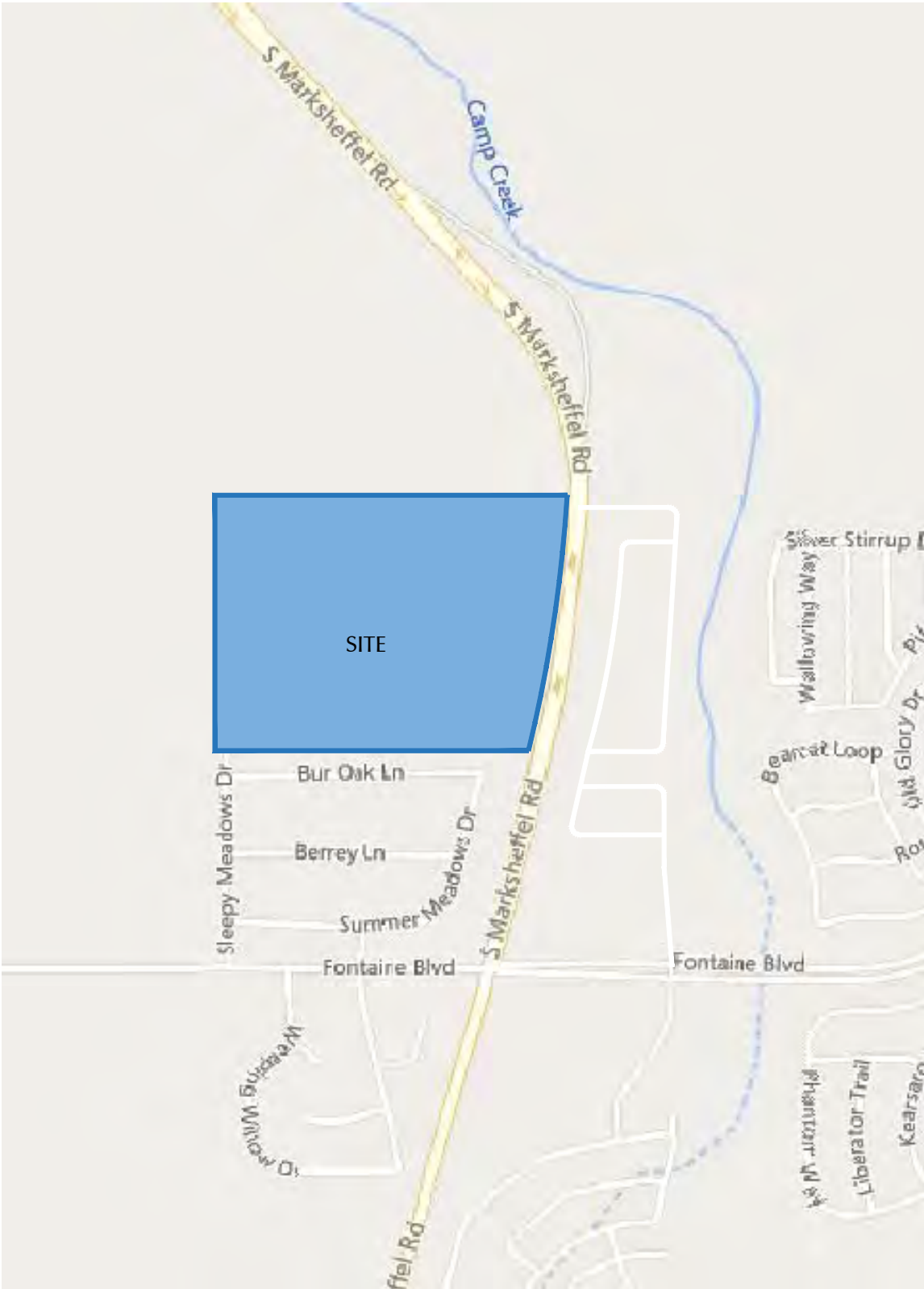
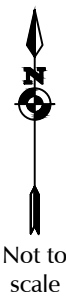

Figure 1
Vicinity Map
Peaceful Ridge (LSC# S214530)





Right-in/Right-out Intersection (Peaceful Ridge Dr)
Access Connection to Bridgegate Blvd. in Bradley Ridge

Street Connection

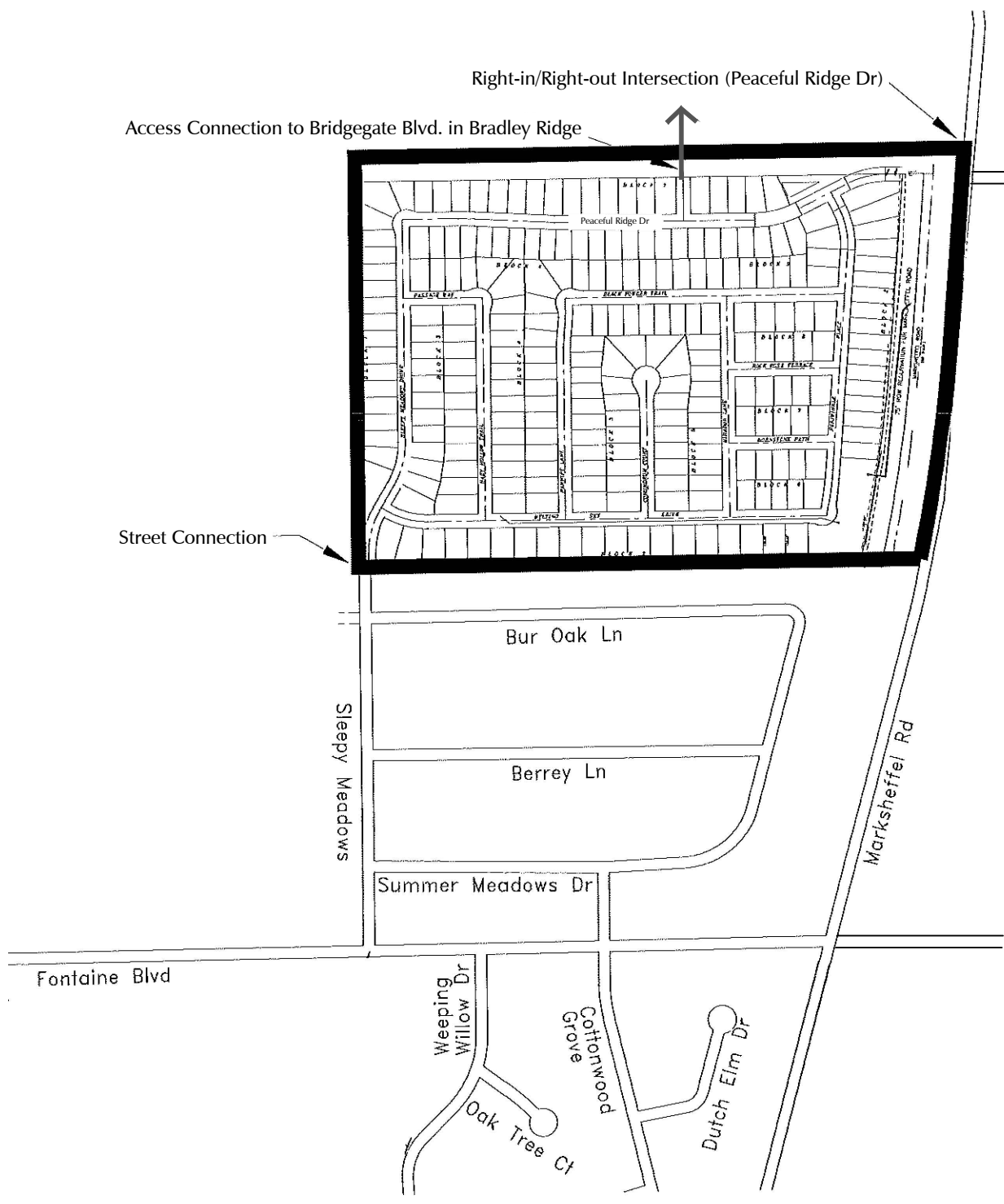
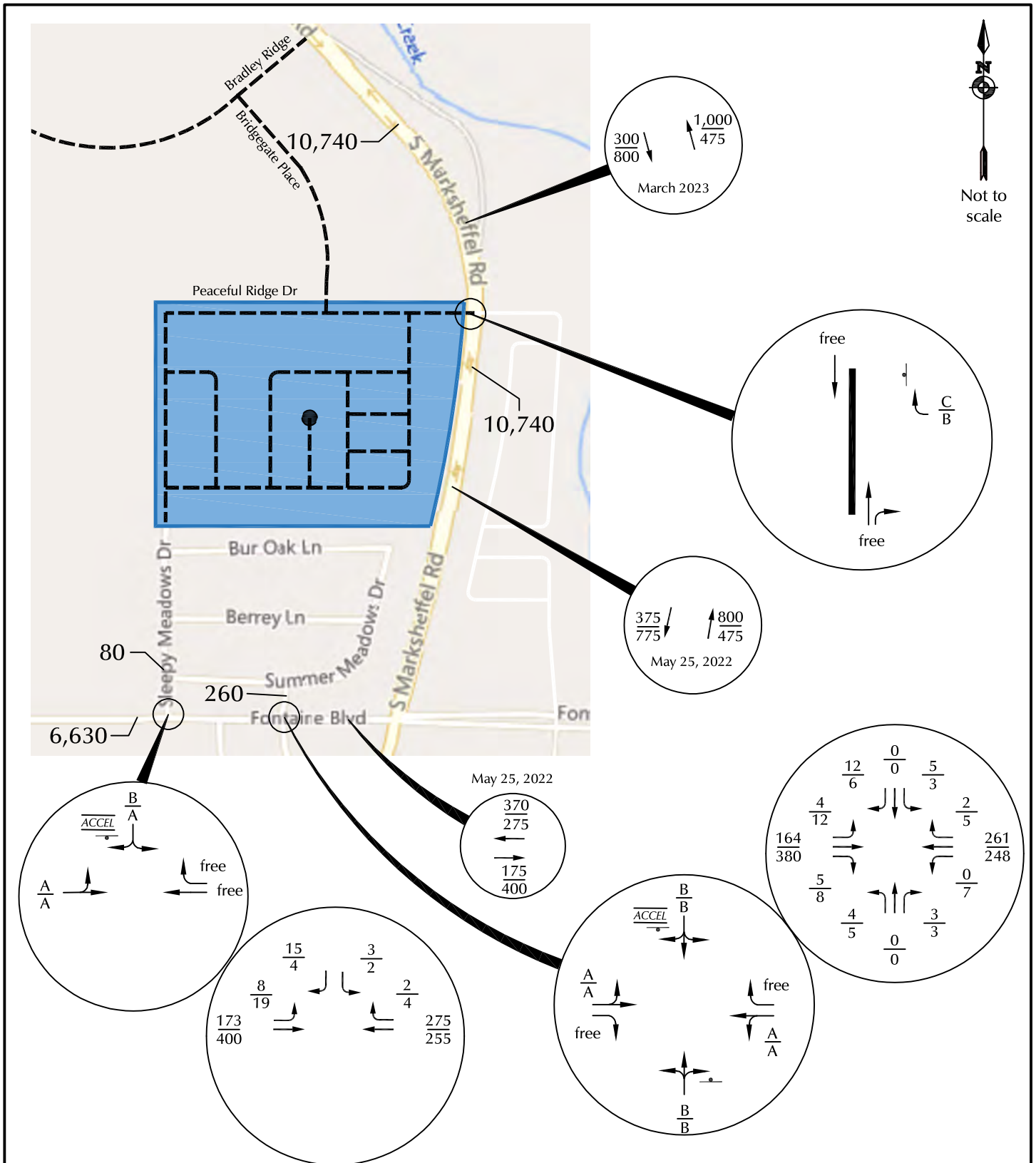

Figure 2
Site Plan
Peaceful Ridge (LSC# S214530)



Peak Period Intersection Counts by LSC (June 2021) (except where noted)

- = Traffic Signal = Stop Sign
- $\frac{X}{X}$ = AM Individual Movement Peak-Hour LOS
PM Individual Movement Peak-Hour LOS
- $\frac{XX}{XX}$ = AM Weekday Peak-Hour Traffic (Veh/Hour)
PM Weekday Peak-Hour Traffic (Veh/Hour)
- X,XXX = Average Daily Traffic (Vehicles/Day) (Estimates by LSC)



Figure 3
Existing Traffic, Lane
Geometry, Traffic
Control, and LOS

Peaceful Ridge (LSC# S214530)

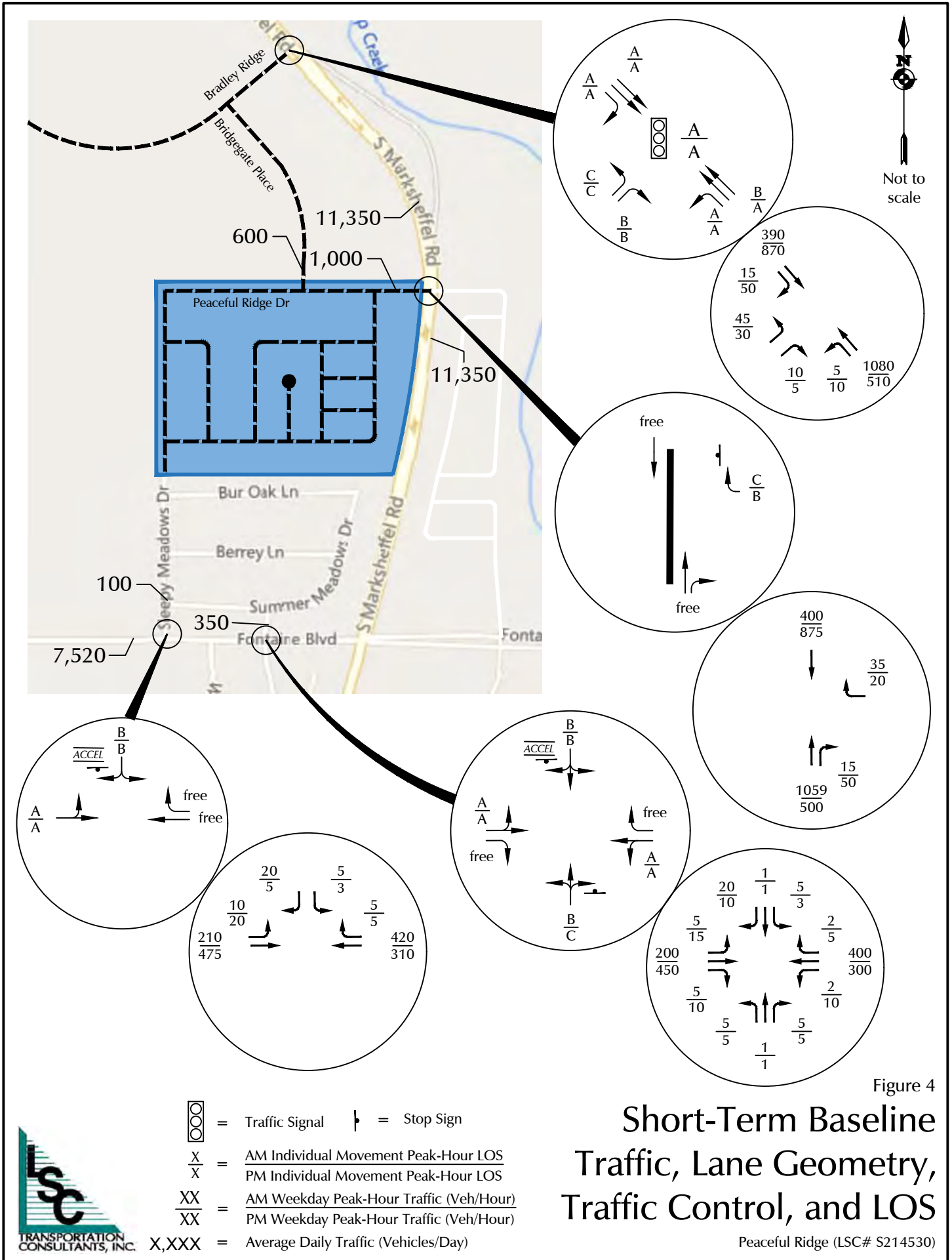

Figure 4

Short-Term Baseline Traffic, Lane Geometry, Traffic Control, and LOS

Peaceful Ridge (LSC# S214530)



Not to scale

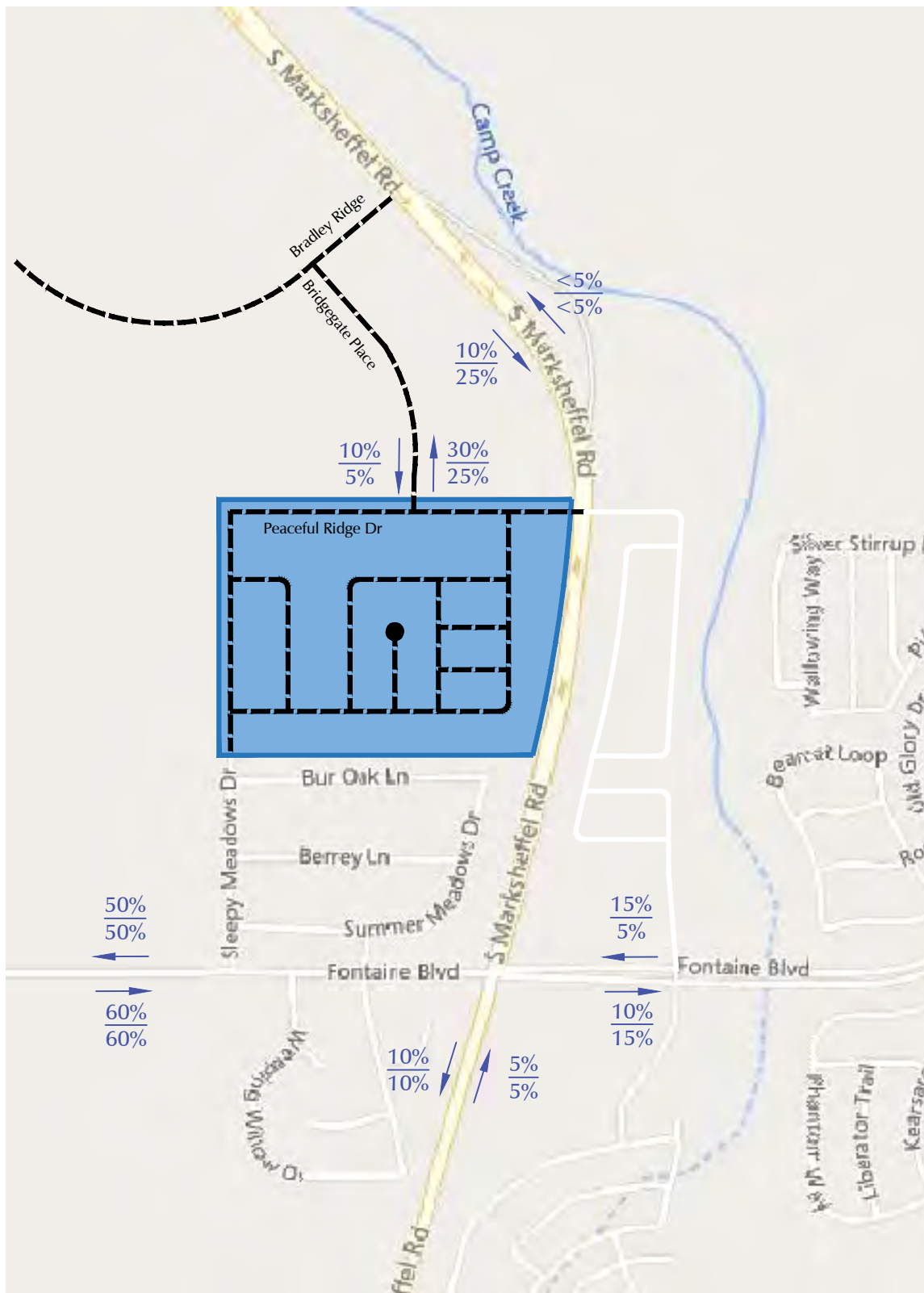

$\frac{XX\%}{XX\%}$ = % Distribution of Site Trips (AM)
 $\frac{XX\%}{XX\%}$ = % Distribution of Site Trips (PM)

Figure 5
Directional Distribution

Peaceful Ridge (LSC# S214530)

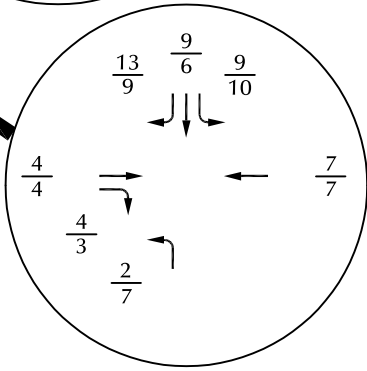
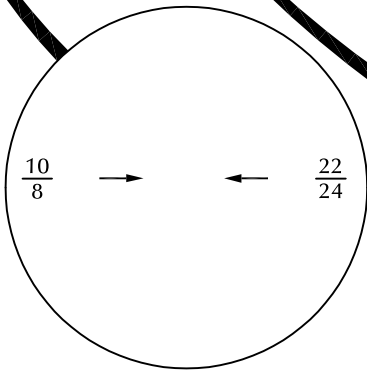
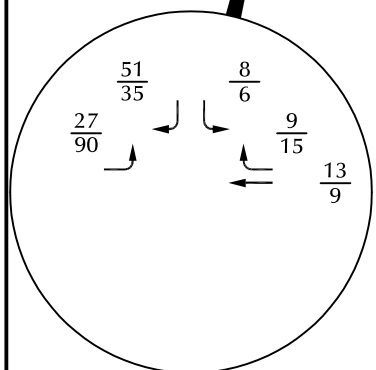
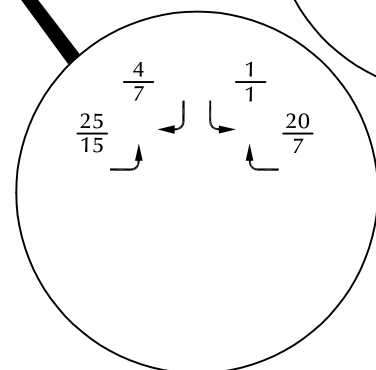
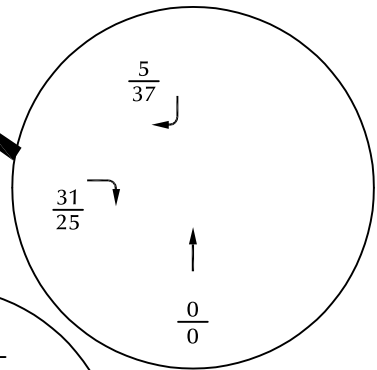
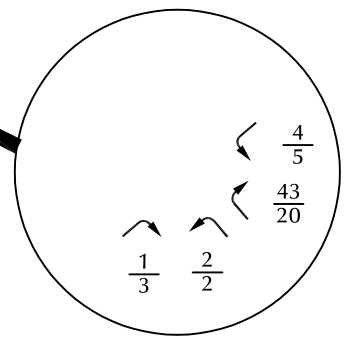
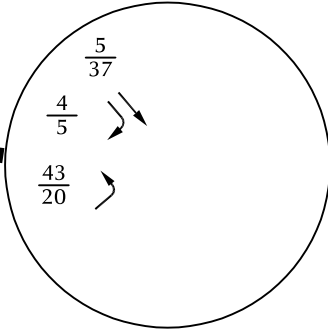
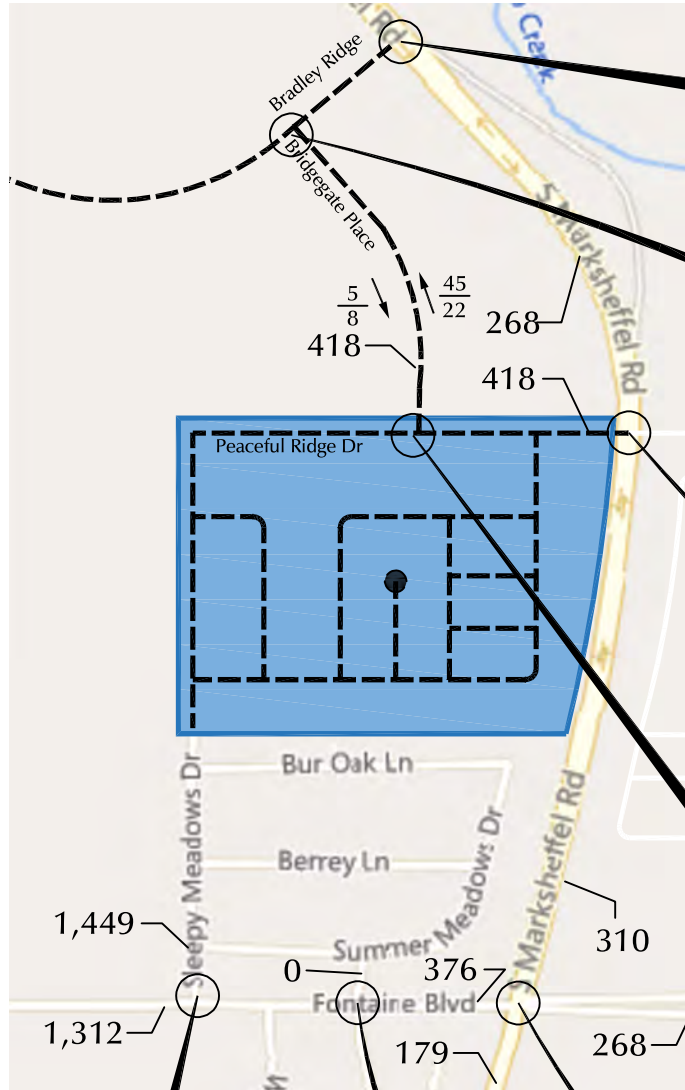

$\frac{XX}{XX}$ = AM Weekday Peak-Hour Traffic (Veh/Hour)
 $\frac{XX}{XX}$ = PM Weekday Peak-Hour Traffic (Veh/Hour)
 X,XXX = Average Daily Traffic (Vehicles/Day)

Figure 6
Site-Generated Traffic

Peaceful Ridge (LSC# S214530)

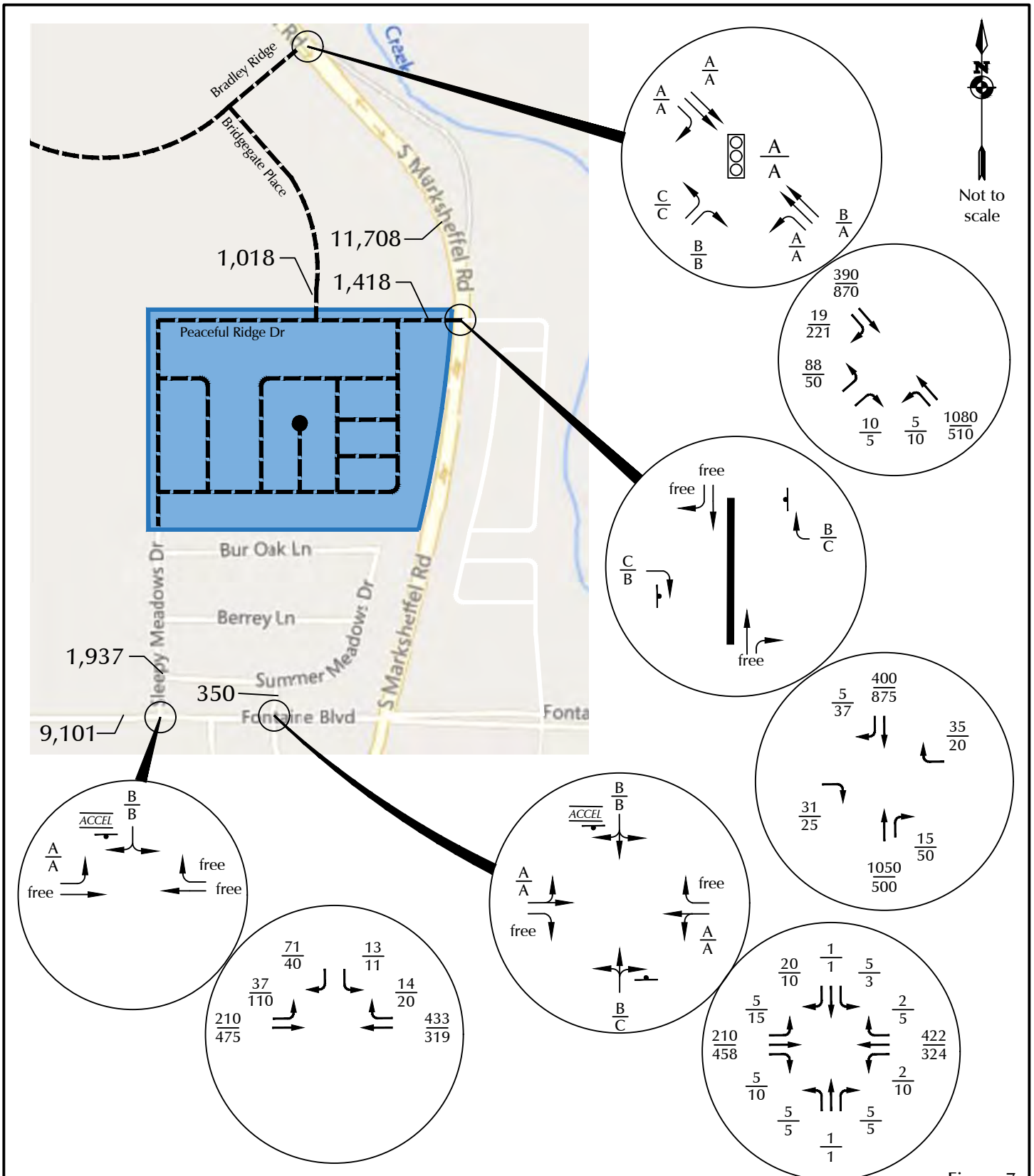

- = Traffic Signal = Stop Sign
- $\frac{X}{X}$ = AM Individual Movement Peak-Hour LOS
PM Individual Movement Peak-Hour LOS
- $\frac{XX}{XX}$ = AM Weekday Peak-Hour Traffic (Veh/Hour)
PM Weekday Peak-Hour Traffic (Veh/Hour)
- X,XXX = Average Daily Traffic (Vehicles/Day)



Figure 7
**Short-Term Total
 Traffic, Lane Geometry,
 Traffic Control, and LOS**

Peaceful Ridge (LSC# S214530)

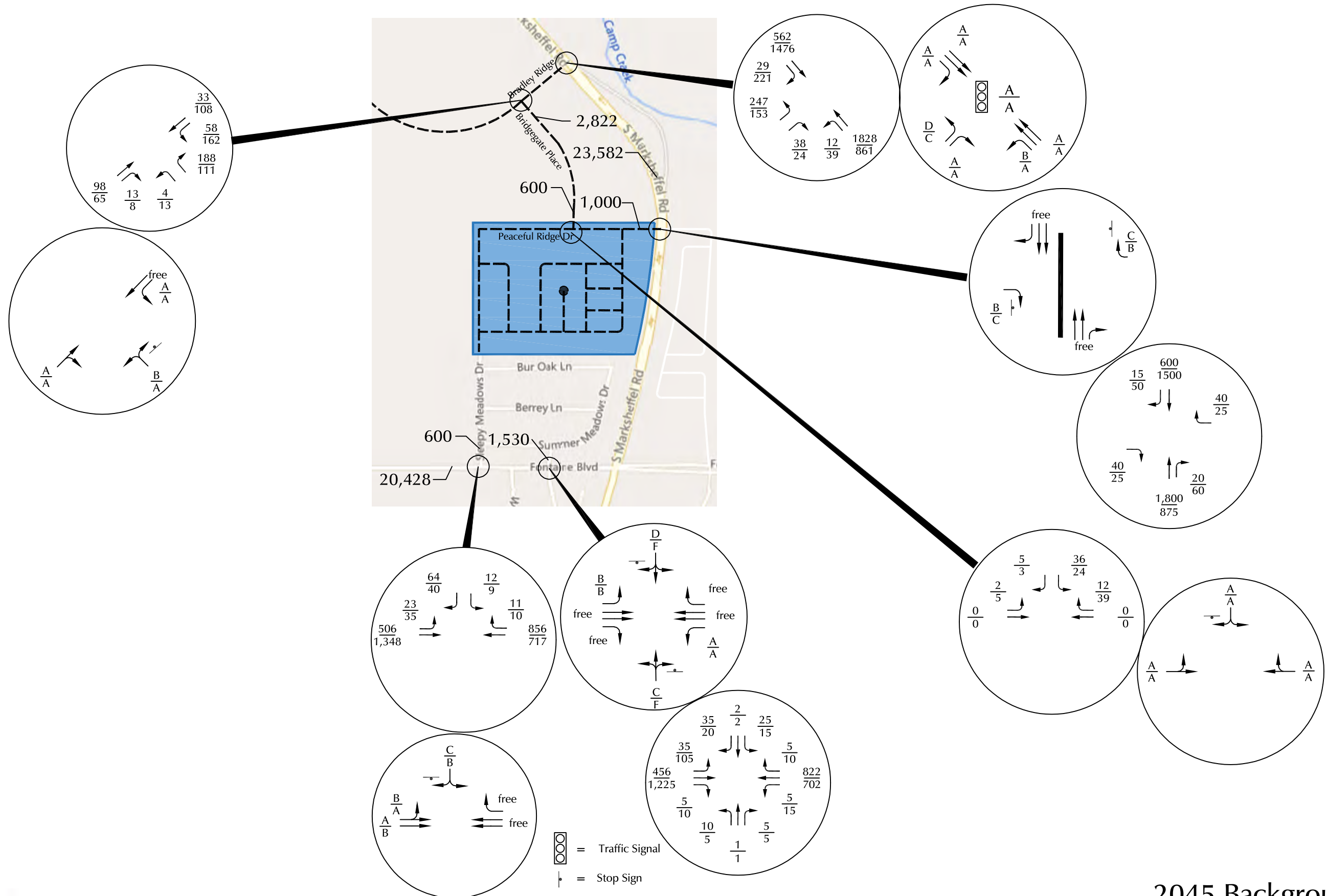
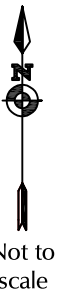

= Traffic Signal
 = Stop Sign
 $\frac{X}{X}$ = AM Individual Movement Peak-Hour LOS
 $\frac{X}{X}$ = PM Individual Movement Peak-Hour LOS
 $\frac{XX}{XX}$ = AM Weekday Peak-Hour Traffic (Veh/Hour)
 $\frac{XX}{XX}$ = PM Weekday Peak-Hour Traffic (Veh/Hour)
 X,XXX = Average Daily Traffic (Vehicles/Day)

Figure 8
 2045 Background Traffic,
 Lane Geometry, Traffic
 Control, and LOS
 Peaceful Ridge (LSC# S214530)



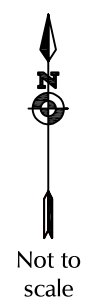
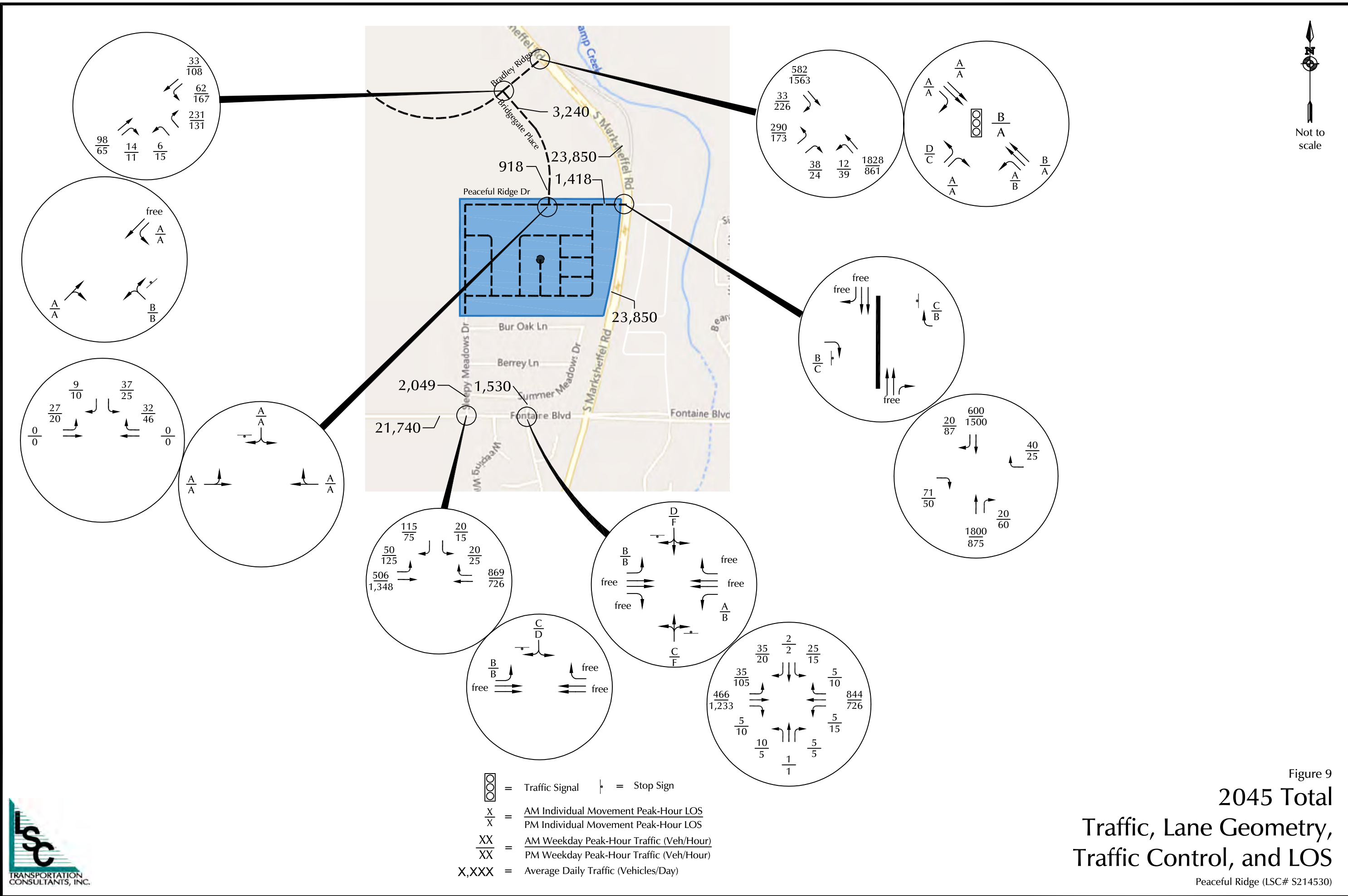
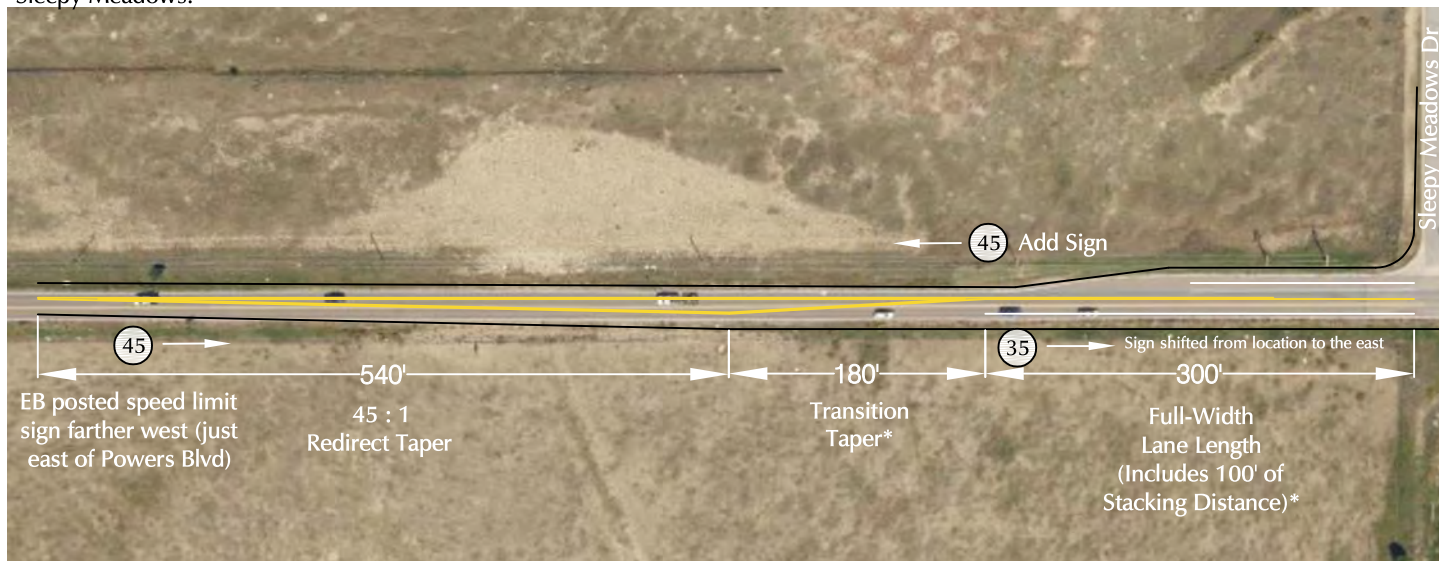

Figure 9
2045 Total
Traffic, Lane Geometry,
Traffic Control, and LOS
 Peaceful Ridge (LSC# S214530)



Note: this concept shows the westbound through lane alignment unchanged, but shifts the eastbound thru lane south to accommodate the proposed eastbound left turn lane at Sleepy Meadows. This is due to existing overhead utility poles along the north side of Fontaine west of Sleepy Meadows.



* Adjust for grade, if needed

(XX) Posted speed limit sign location (mph)

Please refer to report text for discussion regarding westbound-right turn lane at Fontaine Blvd/Sleepy Meadows Drive. Also, please refer to deviation request.



Figure 10

Recommended Laneage Improvements Fontaine Boulevard/Sleepy Meadows Drive





1" = 150'
scale

Figure 11
**Recommended Laneage -
 Peaceful Ridge Drive &
 Marksheffel Road**

Peaceful Ridge (LSC# S214530)



1" = 150'
scale

- 750' = Required entering sight distance for single-unit truck (or school bus) - AASTHO "Green Book" Section 9.5.3.2.2 Case B2 - Right Turn from the Minor Road
- XXX' = field-measured entering sight distance
- - - Line-of-Sight necessary for prescribed entering sight distance

Figure 12
Sight Distance
Analysis

Peaceful Ridge (LSC# S214530)

Traffic Counts



LSC Transportation Consultants, Inc.

2504 E Pikes Peak Ave, Suite 304
 Colorado Springs, CO 80909
 719-633-2868

File Name : Cotton Wood Dr - Fontaine Blvd
 AM Site Code : S214530
 Start Date : 6/23/2021
 Page No : 1

Groups Printed- Unshifted

Start Time	Cottonwood Dr Southbound					Fontaine Blvd Westbound					Cottonwood Dr Northbound					Fontaine Blvd Eastbound					Int. Total
	L	T	R	U	App. Total	L	T	R	U	App. Total	L	T	R	U	App. Total	L	T	R	U	App. Total	
06:30 AM	5	0	3	0	8	0	62	0	0	62	1	0	0	0	1	0	26	0	0	26	97
06:45 AM	0	0	1	0	1	0	54	0	0	54	2	0	1	0	3	0	45	1	0	46	104
Total	5	0	4	0	9	0	116	0	0	116	3	0	1	0	4	0	71	1	0	72	201
07:00 AM	1	0	2	0	3	0	60	1	0	61	2	0	1	0	3	3	39	2	0	44	111
07:15 AM	3	0	6	0	9	0	65	0	0	65	0	0	1	0	1	0	34	1	0	35	110
07:30 AM	1	0	3	0	4	0	82	1	0	83	0	0	0	0	0	1	46	1	0	48	135
07:45 AM	0	0	0	0	0	0	62	1	0	63	1	0	2	0	3	0	30	1	0	31	97
Total	5	0	11	0	16	0	269	3	0	272	3	0	4	0	7	4	149	5	0	158	453
08:00 AM	0	0	1	0	1	2	56	1	0	59	1	0	0	0	1	1	45	2	0	48	109
08:15 AM	1	0	1	0	2	3	61	0	0	64	1	0	1	0	2	1	46	0	0	47	115
Grand Total	11	0	17	0	28	5	502	4	0	511	8	0	6	0	14	6	311	8	0	325	878
Apprch %	39.3	0	60.7	0		1	98.2	0.8	0		57.1	0	42.9	0		1.8	95.7	2.5	0		
Total %	1.3	0	1.9	0	3.2	0.6	57.2	0.5	0	58.2	0.9	0	0.7	0	1.6	0.7	35.4	0.9	0	37	

LSC Transportation Consultants, Inc.

2504 E Pikes Peak Ave, Suite 304
 Colorado Springs, CO 80909
 719-633-2868

File Name : Cotton Wood Dr - Fontaine Blvd
 AM Site Code : S214530
 Start Date : 6/23/2021
 Page No : 2

Start Time	Cottonwood Dr Southbound					Fontaine Blvd Westbound					Cottonwood Dr Northbound					Fontaine Blvd Eastbound					Int. Total
	L	T	R	U	App. Total	L	T	R	U	App. Total	L	T	R	U	App. Total	L	T	R	U	App. Total	
Peak Hour Analysis From 6:30:00 AM to 8:15:00 AM - Peak 1 of 1																					
Peak Hour for Entire Intersection Begins at 6:45:00 AM																					
6:45:00 AM	0	0	1	0	1	0	54	0	0	54	2	0	1	0	3	0	45	1	0	46	104
7:00:00 AM	1	0	2	0	3	0	60	1	0	61	2	0	1	0	3	3	39	2	0	44	111
7:15:00 AM	3	0	6	0	9	0	65	0	0	65	0	0	1	0	1	0	34	1	0	35	110
7:30:00 AM	1	0	3	0	4	0	82	1	0	83	0	0	0	0	0	1	46	1	0	48	135
Total Volume	5	0	12	0	17	0	261	2	0	263	4	0	3	0	7	4	164	5	0	173	460
% App. Total	29.4	0	70.6	0		0	99.2	0.8	0		57.1	0	42.9	0		2.3	94.8	2.9	0		
PHF	.417	.000	.500	.000	.472	.000	.796	.500	.000	.792	.500	.000	.750	.000	.583	.333	.891	.625	.000	.901	.852

LSC Transportation Consultants, Inc.

2504 E Pikes Peak Ave, Suite 304
 Colorado Springs, CO 80909
 719-633-2868

File Name : Cotton Wood Dr - Fontaine Blvd
 AM Site Code : S214530
 Start Date : 6/23/2021
 Page No : 3

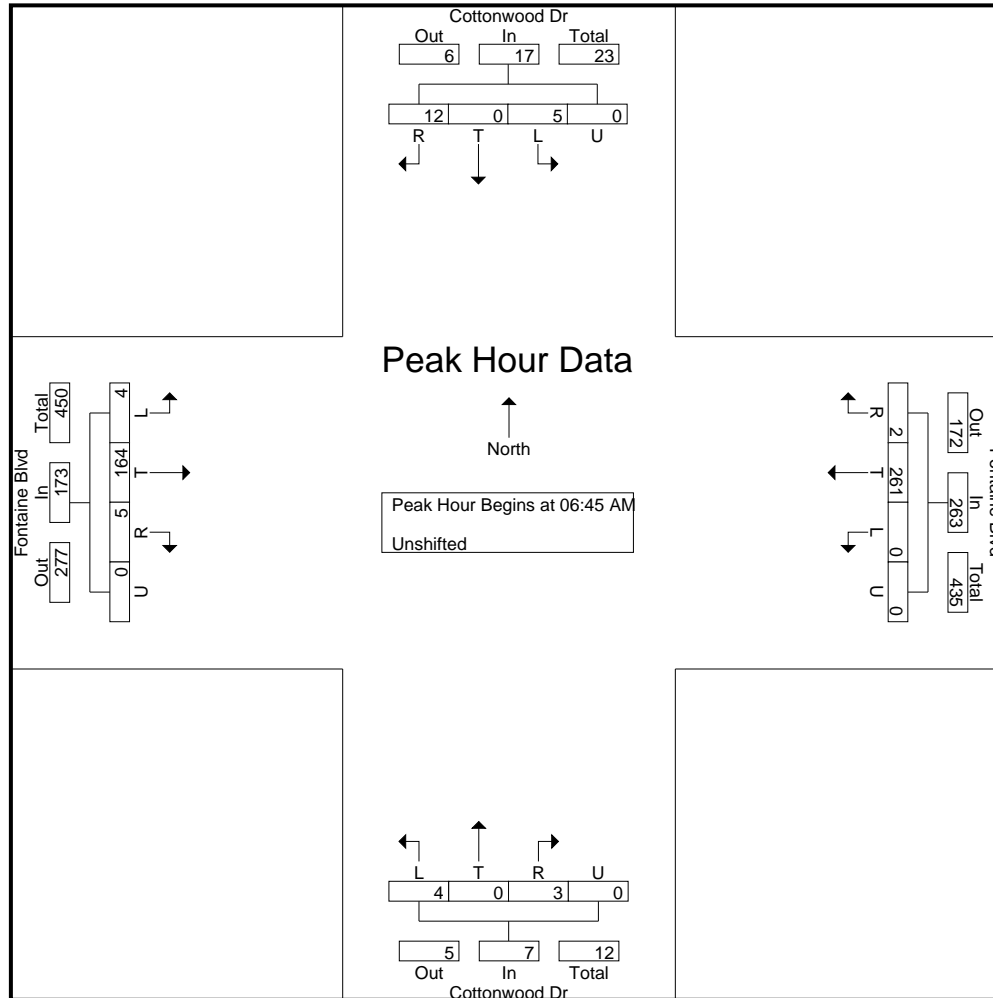

LSC Transportation Consultants, Inc.

2504 E Pikes Peak Ave, Suite 304
 Colorado Springs, CO 80909
 719-633-2868

File Name : Cotton Wood Dr - Fontaine Blvd
 AM Site Code : S214530
 Start Date : 6/23/2021
 Page No : 4

Start Time	Cottonwood Dr Southbound					Fontaine Blvd Westbound					Cottonwood Dr Northbound					Fontaine Blvd Eastbound					Int. Total
	L	T	R	U	App. Total	L	T	R	U	App. Total	L	T	R	U	App. Total	L	T	R	U	App. Total	

Peak Hour Analysis From 6:30:00 AM to 8:15:00 AM - Peak 1 of 1

Peak Hour for Each Approach Begins at:

	6:30:00 AM					7:00:00 AM					6:30:00 AM					7:30:00 AM				
+0 mins.	5	0	3	0	8	0	60	1	0	61	1	0	0	0	1	1	46	1	0	48
+5 mins.	0	0	1	0	1	0	65	0	0	65	2	0	1	0	3	0	30	1	0	31
+10 mins.	1	0	2	0	3	0	82	1	0	83	2	0	1	0	3	1	45	2	0	48
+15 mins.	3	0	6	0	9	0	62	1	0	63	0	0	1	0	1	1	46	0	0	47
Total Volume	9	0	12	0	21	0	269	3	0	272	5	0	3	0	8	3	167	4	0	174
% App. Total	42.9	0	57.1	0		0	98.9	1.1	0		62.5	0	37.5	0		1.7	96	2.3	0	
PHF	.450	.000	.500	.000	.583	.000	.820	.750	.000	.819	.625	.000	.750	.000	.667	.750	.908	.500	.000	.906

LSC Transportation Consultants, Inc.

2504 E Pikes Peak Ave, Suite 304
Colorado Springs, CO 80909
719-633-2868

File Name : Cotton Wood Dr - Fontaine Blvd
AM Site Code : S214530
Start Date : 6/23/2021
Page No : 5

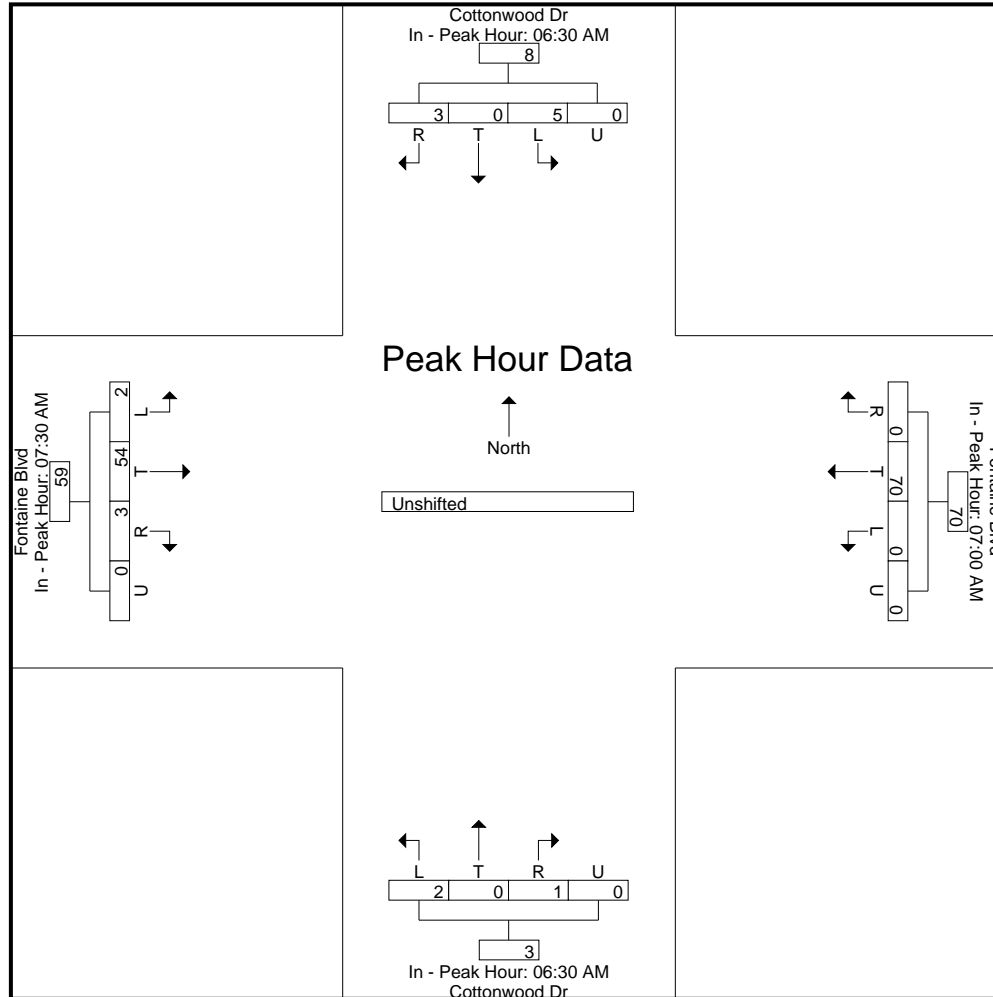

LSC Transportation Consultants, Inc.

2504 E Pikes Peak Ave, Suite 304
 Colorado Springs, CO 80909
 719-633-2868

File Name : Cotton Wood Dr - Fontaine Blvd
 PM Site Code : S214530
 Start Date : 6/29/2021
 Page No : 1

Groups Printed- Unshifted

Start Time	Cottonwood Dr Southbound					Fontaine Blvd Westbound					Cottonwood Dr Northbound					Fontaine Blvd Eastbound					Int. Total
	L	T	R	U	App. Total	L	T	R	U	App. Total	L	T	R	U	App. Total	L	T	R	U	App. Total	
04:00 PM	0	0	1	0	1	2	52	1	0	55	0	0	1	0	1	2	69	3	0	74	131
04:15 PM	0	0	2	0	2	1	57	1	0	59	0	0	2	0	2	1	108	2	0	111	174
04:30 PM	1	0	1	0	2	2	66	0	0	68	4	0	0	0	4	4	90	2	0	96	170
04:45 PM	0	0	0	0	0	2	61	0	0	63	3	0	1	0	4	1	80	3	0	84	151
Total	1	0	4	0	5	7	236	2	0	245	7	0	4	0	11	8	347	10	0	365	626
05:00 PM	0	0	0	0	0	3	49	1	0	53	0	0	1	0	1	1	104	2	0	107	161
05:15 PM	1	0	2	0	3	1	65	1	0	67	2	0	1	0	3	3	93	3	0	99	172
05:30 PM	1	0	1	0	2	1	67	3	0	71	2	0	1	0	3	5	103	0	0	108	184
05:45 PM	1	0	3	0	4	2	67	0	0	69	1	0	0	0	1	3	80	3	0	86	160
Total	3	0	6	0	9	7	248	5	0	260	5	0	3	0	8	12	380	8	0	400	677
Grand Total	4	0	10	0	14	14	484	7	0	505	12	0	7	0	19	20	727	18	0	765	1303
Apprch %	28.6	0	71.4	0		2.8	95.8	1.4	0		63.2	0	36.8	0		2.6	95	2.4	0		
Total %	0.3	0	0.8	0	1.1	1.1	37.1	0.5	0	38.8	0.9	0	0.5	0	1.5	1.5	55.8	1.4	0	58.7	

LSC Transportation Consultants, Inc.

2504 E Pikes Peak Ave, Suite 304
 Colorado Springs, CO 80909
 719-633-2868

File Name : Cotton Wood Dr - Fontaine Blvd
 PM Site Code : S214530
 Start Date : 6/29/2021
 Page No : 2

Start Time	Cottonwood Dr Southbound					Fontaine Blvd Westbound					Cottonwood Dr Northbound					Fontaine Blvd Eastbound					Int. Total
	L	T	R	U	App. Total	L	T	R	U	App. Total	L	T	R	U	App. Total	L	T	R	U	App. Total	
Peak Hour Analysis From 4:00:00 PM to 5:45:00 PM - Peak 1 of 1																					
Peak Hour for Entire Intersection Begins at 5:00:00 PM																					
5:00:00 PM	0	0	0	0	0	3	49	1	0	53	0	0	1	0	1	1	104	2	0	107	161
5:15:00 PM	1	0	2	0	3	1	65	1	0	67	2	0	1	0	3	3	93	3	0	99	172
5:30:00 PM	1	0	1	0	2	1	67	3	0	71	2	0	1	0	3	5	103	0	0	108	184
5:45:00 PM	1	0	3	0	4	2	67	0	0	69	1	0	0	0	1	3	80	3	0	86	160
Total Volume	3	0	6	0	9	7	248	5	0	260	5	0	3	0	8	12	380	8	0	400	677
% App. Total	33.3	0	66.7	0		2.7	95.4	1.9	0		62.5	0	37.5	0		3	95	2	0		
PHF	.750	.000	.500	.000	.563	.583	.925	.417	.000	.915	.625	.000	.750	.000	.667	.600	.913	.667	.000	.926	.920

LSC Transportation Consultants, Inc.

2504 E Pikes Peak Ave, Suite 304
 Colorado Springs, CO 80909
 719-633-2868

File Name : Cotton Wood Dr - Fontaine Blvd
 PM Site Code : S214530
 Start Date : 6/29/2021
 Page No : 3

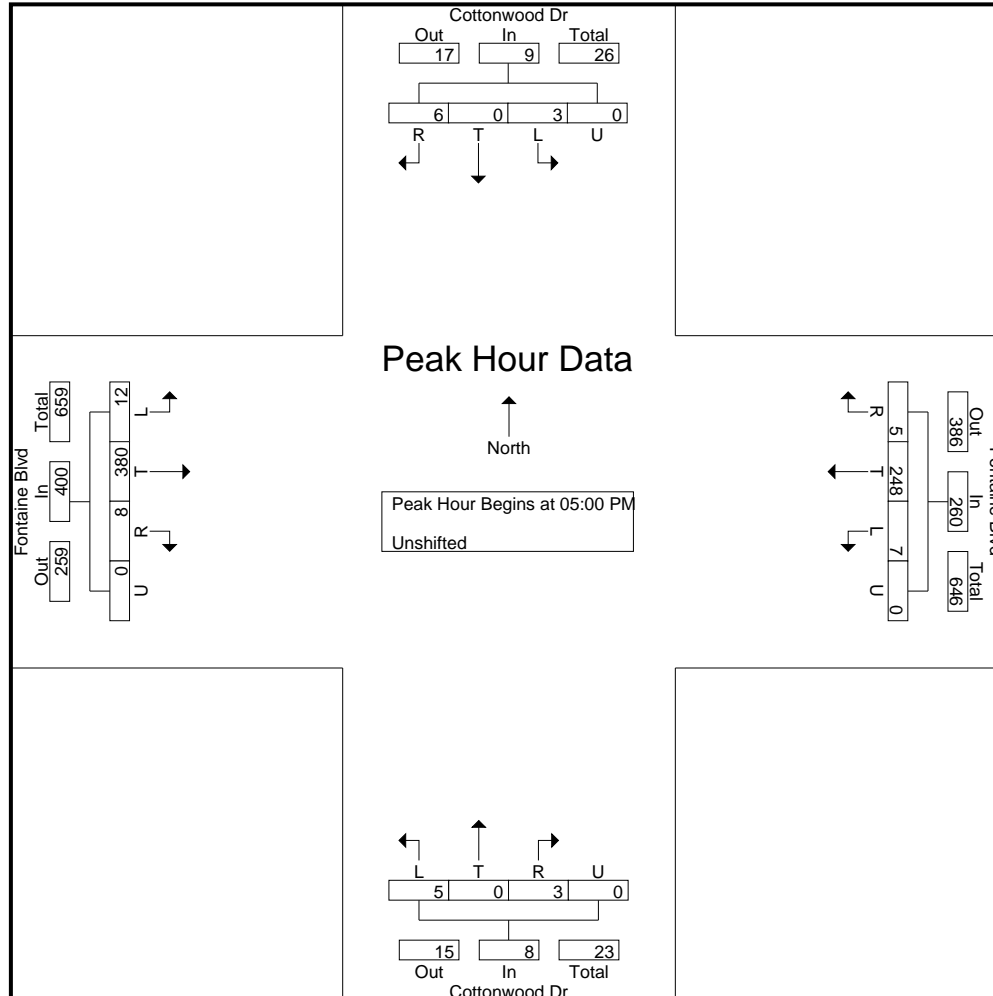

LSC Transportation Consultants, Inc.

2504 E Pikes Peak Ave, Suite 304
 Colorado Springs, CO 80909
 719-633-2868

File Name : Cotton Wood Dr - Fontaine Blvd
 PM Site Code : S214530
 Start Date : 6/29/2021
 Page No : 4

Start Time	Cottonwood Dr Southbound					Fontaine Blvd Westbound					Cottonwood Dr Northbound					Fontaine Blvd Eastbound					Int. Total
	L	T	R	U	App. Total	L	T	R	U	App. Total	L	T	R	U	App. Total	L	T	R	U	App. Total	
Peak Hour Analysis From 4:00:00 PM to 5:45:00 PM - Peak 1 of 1																					
Peak Hour for Each Approach Begins at:																					
	5:00:00 PM					5:00:00 PM					4:30:00 PM					5:00:00 PM					
+0 mins.	0	0	0	0	0	3	49	1	0	53	4	0	0	0	4	1	104	2	0	107	
+5 mins.	1	0	2	0	3	1	65	1	0	67	3	0	1	0	4	3	93	3	0	99	
+10 mins.	1	0	1	0	2	1	67	3	0	71	0	0	1	0	1	5	103	0	0	108	
+15 mins.	1	0	3	0	4	2	67	0	0	69	2	0	1	0	3	3	80	3	0	86	
Total Volume	3	0	6	0	9	7	248	5	0	260	9	0	3	0	12	12	380	8	0	400	
% App. Total	33.3	0	66.7	0		2.7	95.4	1.9	0		75	0	25	0		3	95	2	0		
PHF	.750	.000	.500	.000	.563	.583	.925	.417	.000	.915	.563	.000	.750	.000	.750	.600	.913	.667	.000	.926	

LSC Transportation Consultants, Inc.

2504 E Pikes Peak Ave, Suite 304
Colorado Springs, CO 80909
719-633-2868

File Name : Cotton Wood Dr - Fontaine Blvd
PM Site Code : S214530
Start Date : 6/29/2021
Page No : 5

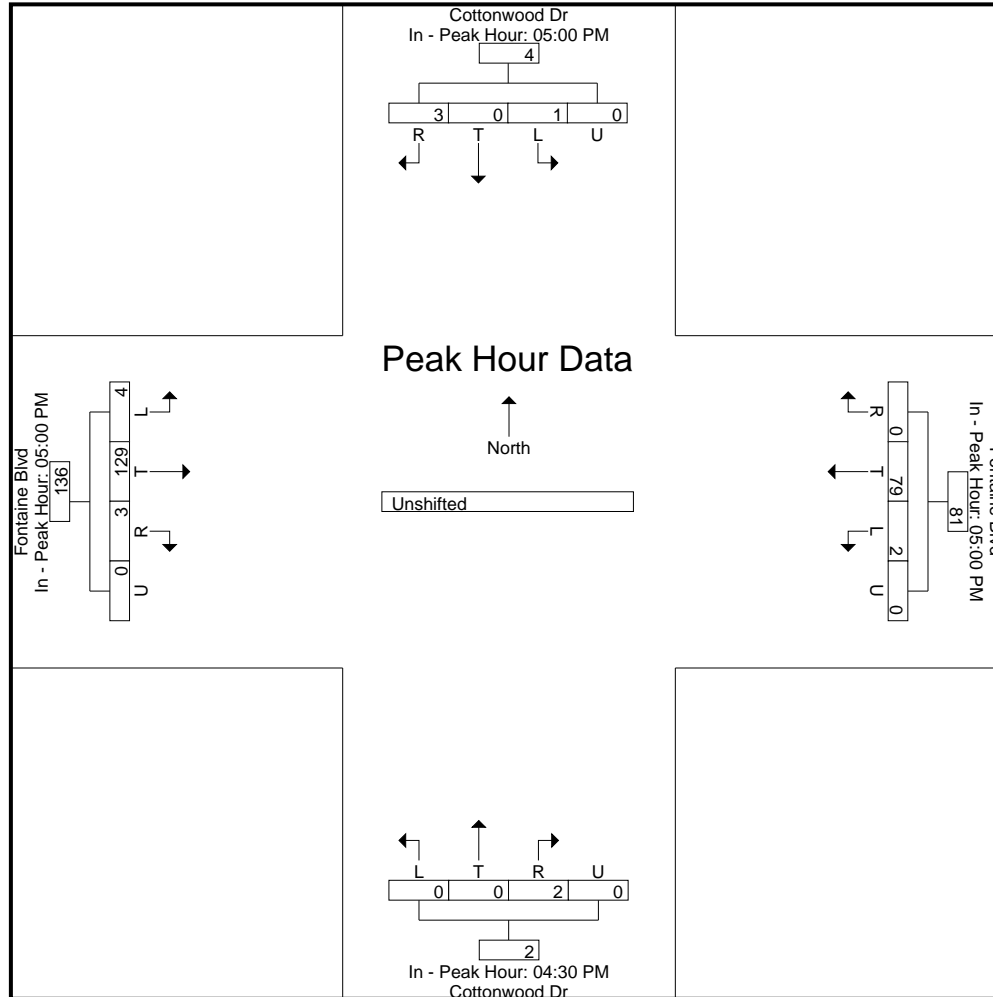

LSC Transportation Consultants, Inc.

2504 E Pikes Peak Ave, Suite 304
 Colorado Springs, CO 80909
 719-633-2868

File Name : Sleepy Meadow Dr - Fontaine Blvd
 AM Site Code : S214530
 Start Date : 6/23/2021
 Page No : 1

Groups Printed- Bank 1

Start Time	Sleepy Meadow Dr Southbound					Fontaine Blvd Westbound					Northbound					Fontaine Blvd Eastbound					Int. Total
	L	T	R	U	App. Total	L	T	R	U	App. Total	L	T	R	U	App. Total	L	T	R	U	App. Total	
06:30 AM	1	0	4	0	5	0	0	0	0	0	0	0	0	0	0	0	0	0	0	0	5
06:45 AM	1	0	5	0	6	0	0	0	0	0	0	0	0	0	0	1	0	0	0	1	7
Total	2	0	9	0	11	0	0	0	0	0	0	0	0	0	0	1	0	0	0	1	12
07:00 AM	0	0	3	0	3	0	0	0	0	0	0	0	0	0	0	2	0	0	0	2	5
07:15 AM	2	0	3	0	5	0	0	1	0	1	0	0	0	0	0	1	0	0	0	1	7
07:30 AM	0	0	5	0	5	0	0	0	0	0	0	0	0	0	0	2	0	0	0	2	7
07:45 AM	0	0	5	0	5	0	0	0	0	0	0	0	0	0	0	3	0	0	0	3	8
Total	2	0	16	0	18	0	0	1	0	1	0	0	0	0	0	8	0	0	0	8	27
08:00 AM	1	0	2	0	3	0	0	1	0	1	0	0	0	0	0	2	0	0	0	2	6
08:15 AM	1	0	3	0	4	0	0	0	0	0	0	0	0	0	0	1	0	0	0	1	5
Grand Total	6	0	30	0	36	0	0	2	0	2	0	0	0	0	0	12	0	0	0	12	50
Apprch %	16.7	0	83.3	0		0	0	100	0		0	0	0	0		100	0	0	0		
Total %	12	0	60	0	72	0	0	4	0	4	0	0	0	0	0	24	0	0	0	24	

LSC Transportation Consultants, Inc.

2504 E Pikes Peak Ave, Suite 304
 Colorado Springs, CO 80909
 719-633-2868

File Name : Sleepy Meadow Dr - Fontaine Blvd
 AM Site Code : S214530
 Start Date : 6/23/2021
 Page No : 2

Start Time	Sleepy Meadow Dr Southbound					Fontaine Blvd Westbound					Northbound					Fontaine Blvd Eastbound					Int. Total
	L	T	R	U	App. Total	L	T	R	U	App. Total	L	T	R	U	App. Total	L	T	R	U	App. Total	
Peak Hour Analysis From 6:30:00 AM to 8:15:00 AM - Peak 1 of 1																					
Peak Hour for Entire Intersection Begins at 7:15:00 AM																					
7:15:00 AM	2	0	3	0	5	0	0	1	0	1	0	0	0	0	0	1	0	0	0	1	7
7:30:00 AM	0	0	5	0	5	0	0	0	0	0	0	0	0	0	0	2	0	0	0	2	7
7:45:00 AM	0	0	5	0	5	0	0	0	0	0	0	0	0	0	0	3	0	0	0	3	8
8:00:00 AM	1	0	2	0	3	0	0	1	0	1	0	0	0	0	0	2	0	0	0	2	6
Total Volume	3	0	15	0	18	0	0	2	0	2	0	0	0	0	0	8	0	0	0	8	28
% App. Total	16.7	0	83.3	0		0	0	100	0		0	0	0	0		100	0	0	0		
PHF	.375	.000	.750	.000	.900	.000	.000	.500	.000	.500	.000	.000	.000	.000	.000	.667	.000	.000	.000	.667	.875

LSC Transportation Consultants, Inc.

2504 E Pikes Peak Ave, Suite 304
 Colorado Springs, CO 80909
 719-633-2868

File Name : Sleepy Meadow Dr - Fontaine Blvd
 AM Site Code : S214530
 Start Date : 6/23/2021
 Page No : 3

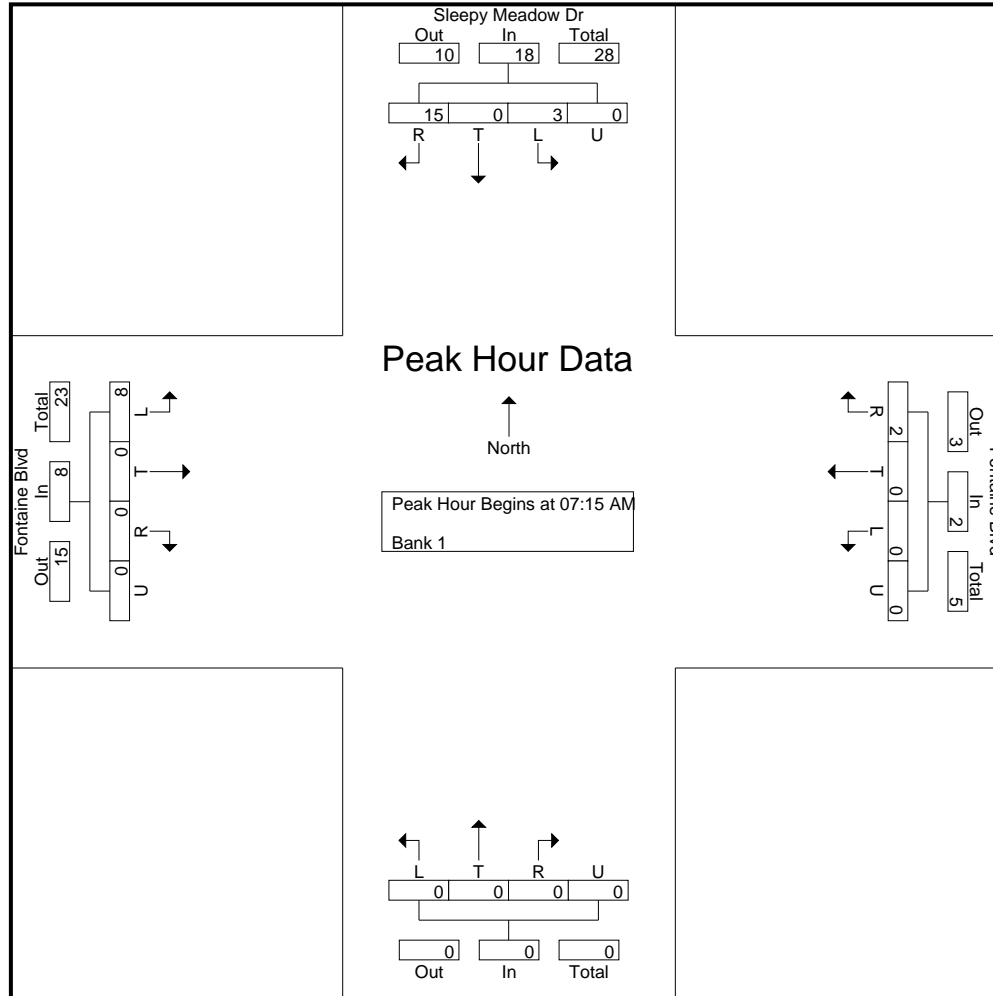

LSC Transportation Consultants, Inc.

2504 E Pikes Peak Ave, Suite 304
 Colorado Springs, CO 80909
 719-633-2868

File Name : Sleepy Meadow Dr - Fontaine Blvd
 AM Site Code : S214530
 Start Date : 6/23/2021
 Page No : 4

Start Time	Sleepy Meadow Dr Southbound					Fontaine Blvd Westbound					Northbound					Fontaine Blvd Eastbound					Int. Total
	L	T	R	U	App. Total	L	T	R	U	App. Total	L	T	R	U	App. Total	L	T	R	U	App. Total	
Peak Hour Analysis From 6:30:00 AM to 8:15:00 AM - Peak 1 of 1																					
Peak Hour for Each Approach Begins at:																					
	6:30:00 AM					7:15:00 AM					6:30:00 AM					7:00:00 AM					
+0 mins.	1	0	4	0	5	0	0	1	0	1	0	0	0	0	0	2	0	0	0	2	
+5 mins.	1	0	5	0	6	0	0	0	0	0	0	0	0	0	0	1	0	0	0	1	
+10 mins.	0	0	3	0	3	0	0	0	0	0	0	0	0	0	0	2	0	0	0	2	
+15 mins.	2	0	3	0	5	0	0	1	0	1	0	0	0	0	0	3	0	0	0	3	
Total Volume	4	0	15	0	19	0	0	2	0	2	0	0	0	0	0	8	0	0	0	8	
% App. Total	21.1	0	78.9	0		0	0	100	0		0	0	0	0		100	0	0	0		
PHF	.500	.000	.750	.000	.792	.000	.000	.500	.000	.500	.000	.000	.000	.000	.000	.667	.000	.000	.000	.667	

LSC Transportation Consultants, Inc.

2504 E Pikes Peak Ave, Suite 304
Colorado Springs, CO 80909
719-633-2868

File Name : Sleepy Meadow Dr - Fontaine Blvd
AM Site Code : S214530
Start Date : 6/23/2021
Page No : 5

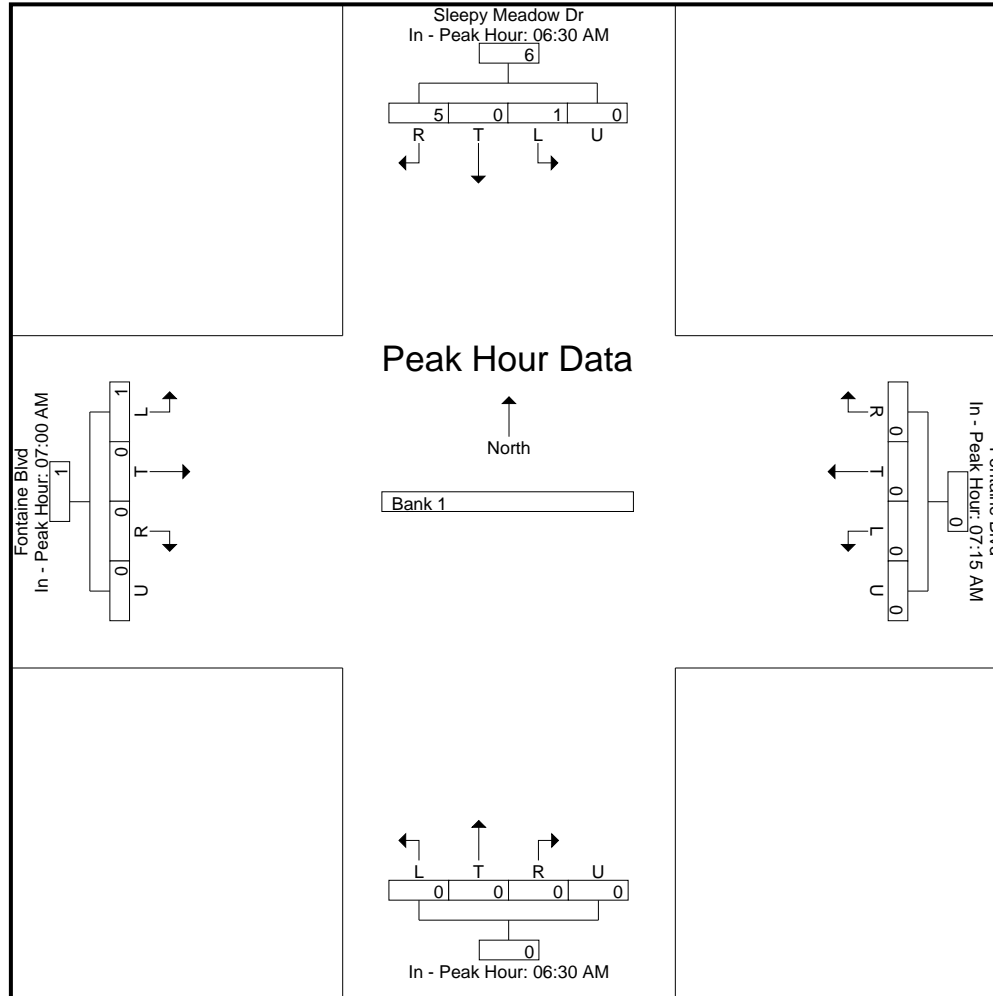

LSC Transportation Consultants, Inc.

2504 E Pikes Peak Ave, Suite 304
 Colorado Springs, CO 80909
 719-633-2868

File Name : Sleepy Meadow Dr - Fontaine Blvd PM
 Site Code : S214530
 Start Date : 6/29/2021
 Page No : 1

Groups Printed- Bank 1

Start Time	Sleepy Meadow Dr Southbound					Fontaine Blvd Westbound					Northbound					Fontaine Blvd Eastbound					Int. Total
	L	T	R	U	App. Total	L	T	R	U	App. Total	L	T	R	U	App. Total	L	T	R	U	App. Total	
04:00 PM	0	0	3	0	3	0	0	0	0	0	0	0	0	0	0	4	0	0	0	4	7
04:15 PM	0	0	2	0	2	0	0	0	0	0	0	0	0	0	0	2	0	0	0	2	4
04:30 PM	1	0	2	0	3	0	0	0	0	0	0	0	0	0	0	3	0	0	0	3	6
04:45 PM	0	0	1	0	1	0	0	0	0	0	0	0	0	0	0	7	0	0	0	7	8
Total	1	0	8	0	9	0	0	0	0	0	0	0	0	0	0	16	0	0	0	16	25
05:00 PM	0	0	0	0	0	0	0	1	0	1	0	0	0	0	0	6	0	0	0	6	7
05:15 PM	0	0	0	0	0	0	0	0	0	0	0	0	0	0	0	1	0	0	0	1	1
05:30 PM	0	0	2	0	2	0	0	1	0	1	0	0	0	0	0	8	0	0	0	8	11
05:45 PM	2	0	2	0	4	0	0	2	0	2	0	0	0	0	0	4	0	0	0	4	10
Total	2	0	4	0	6	0	0	4	0	4	0	0	0	0	0	19	0	0	0	19	29
Grand Total	3	0	12	0	15	0	0	4	0	4	0	0	0	0	0	35	0	0	0	35	54
Apprch %	20	0	80	0		0	0	100	0		0	0	0	0		100	0	0	0		
Total %	5.6	0	22.2	0	27.8	0	0	7.4	0	7.4	0	0	0	0	0	64.8	0	0	0	64.8	

LSC Transportation Consultants, Inc.

2504 E Pikes Peak Ave, Suite 304
 Colorado Springs, CO 80909
 719-633-2868

File Name : Sleepy Meadow Dr - Fontaine Blvd PM
 Site Code : S214530
 Start Date : 6/29/2021
 Page No : 2

Start Time	Sleepy Meadow Dr Southbound					Fontaine Blvd Westbound					Northbound					Fontaine Blvd Eastbound					Int. Total
	L	T	R	U	App. Total	L	T	R	U	App. Total	L	T	R	U	App. Total	L	T	R	U	App. Total	
Peak Hour Analysis From 4:00:00 PM to 5:45:00 PM - Peak 1 of 1																					
Peak Hour for Entire Intersection Begins at 5:00:00 PM																					
5:00:00 PM	0	0	0	0	0	0	0	1	0	1	0	0	0	0	0	6	0	0	0	6	7
5:15:00 PM	0	0	0	0	0	0	0	0	0	0	0	0	0	0	0	1	0	0	0	1	1
5:30:00 PM	0	0	2	0	2	0	0	1	0	1	0	0	0	0	0	8	0	0	0	8	11
5:45:00 PM	2	0	2	0	4	0	0	2	0	2	0	0	0	0	0	4	0	0	0	4	10
Total Volume	2	0	4	0	6	0	0	4	0	4	0	0	0	0	0	19	0	0	0	19	29
% App. Total	33.3	0	66.7	0		0	0	100	0		0	0	0	0		100	0	0	0		
PHF	.250	.000	.500	.000	.375	.000	.000	.500	.000	.500	.000	.000	.000	.000	.000	.594	.000	.000	.000	.594	.659

LSC Transportation Consultants, Inc.

2504 E Pikes Peak Ave, Suite 304
 Colorado Springs, CO 80909
 719-633-2868

File Name : Sleepy Meadow Dr - Fontaine Blvd PM
 Site Code : S214530
 Start Date : 6/29/2021
 Page No : 3

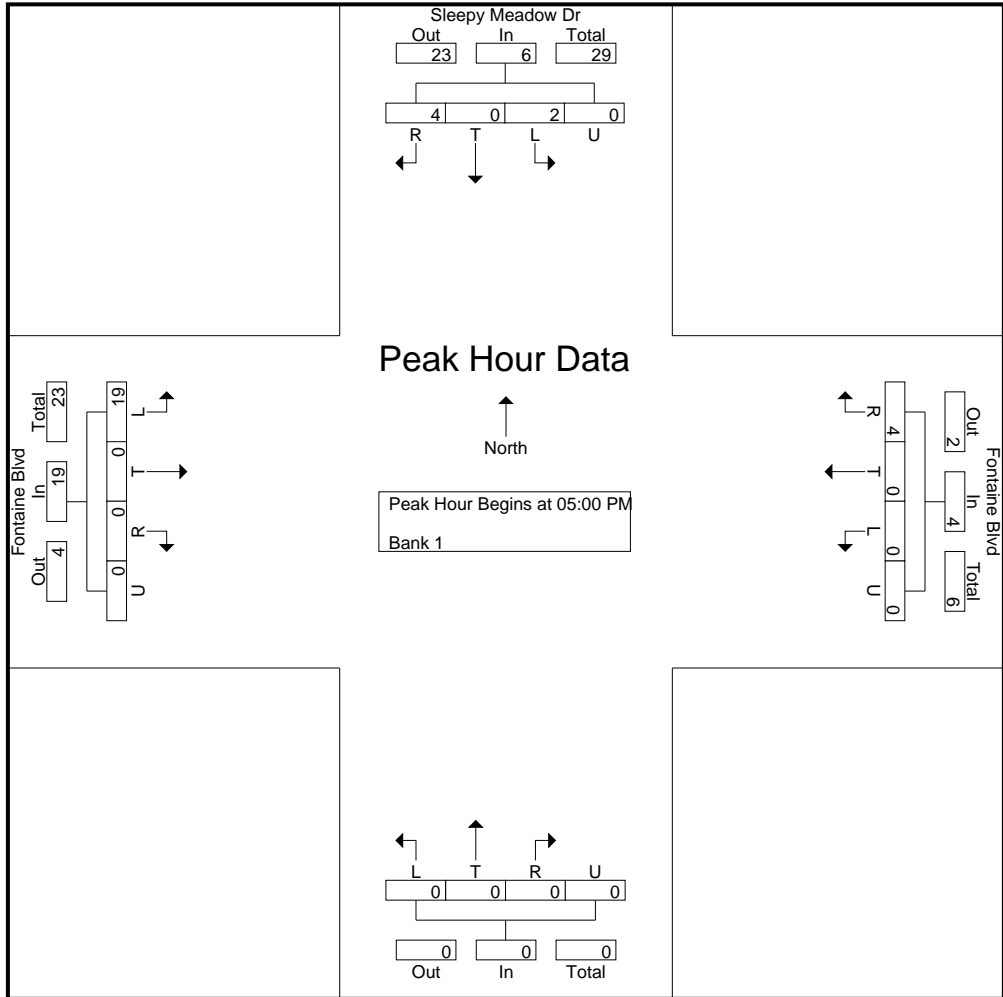

LSC Transportation Consultants, Inc.

2504 E Pikes Peak Ave, Suite 304
 Colorado Springs, CO 80909
 719-633-2868

File Name : Sleepy Meadow Dr - Fontaine Blvd PM
 Site Code : S214530
 Start Date : 6/29/2021
 Page No : 4

Start Time	Sleepy Meadow Dr Southbound					Fontaine Blvd Westbound					Northbound					Fontaine Blvd Eastbound					Int. Total
	L	T	R	U	App. Total	L	T	R	U	App. Total	L	T	R	U	App. Total	L	T	R	U	App. Total	
Peak Hour Analysis From 4:00:00 PM to 5:45:00 PM - Peak 1 of 1																					
Peak Hour for Each Approach Begins at:																					
	4:00:00 PM					5:00:00 PM					4:00:00 PM					4:45:00 PM					
+0 mins.	0	0	3	0	3	0	0	1	0	1	0	0	0	0	0	7	0	0	0	7	
+5 mins.	0	0	2	0	2	0	0	0	0	0	0	0	0	0	0	6	0	0	0	6	
+10 mins.	1	0	2	0	3	0	0	1	0	1	0	0	0	0	0	1	0	0	0	1	
+15 mins.	0	0	1	0	1	0	0	2	0	2	0	0	0	0	0	8	0	0	0	8	
Total Volume	1	0	8	0	9	0	0	4	0	4	0	0	0	0	0	22	0	0	0	22	
% App. Total	11.1	0	88.9	0		0	0	100	0		0	0	0	0		100	0	0	0		
PHF	.250	.000	.667	.000	.750	.000	.000	.500	.000	.500	.000	.000	.000	.000	.000	.688	.000	.000	.000	.688	

LSC Transportation Consultants, Inc.

2504 E Pikes Peak Ave, Suite 304
Colorado Springs, CO 80909
719-633-2868

File Name : Sleepy Meadow Dr - Fontaine Blvd PM
Site Code : S214530
Start Date : 6/29/2021
Page No : 5

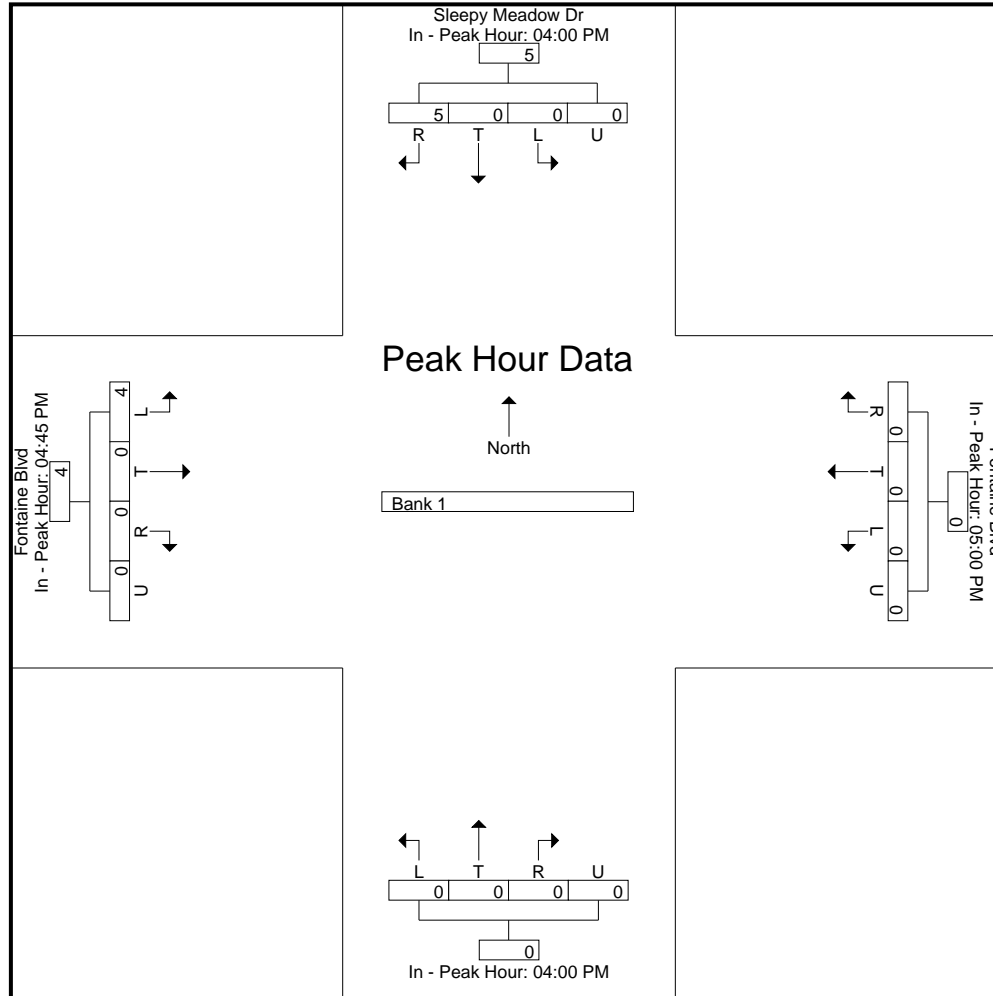

LSC Transportation Consultants, Inc.

2504 E. Pikes Peak Ave, Suite 304
 Colorado Springs, CO 80909
 719-633-2868

File Name : Marksheffel Rd - Fontaine Blvd AM 5-22

Site Code : S214080

Start Date : 5/26/2022

Page No : 1

Groups Printed- Unshifted

Start Time	Marksheffel Rd Southbound					Fontain Blvd Westbound					Marksheffel Rd Northbound					Fontaine Blvd Eastbound					Int. Total
	Right	Thru	Left	Peds	App. Total	Right	Thru	Left	Peds	App. Total	Right	Thru	Left	Peds	App. Total	Right	Thru	Left	Peds	App. Total	
06:30	2	53	19	0	74	68	55	23	0	146	7	117	10	0	134	3	22	7	0	32	386
06:45	2	48	24	0	74	71	44	27	0	142	22	114	10	0	146	11	25	5	0	41	403
Total	4	101	43	0	148	139	99	50	0	288	29	231	20	0	280	14	47	12	0	73	789
07:00	1	54	36	0	91	92	76	36	0	204	14	114	16	0	144	4	19	5	0	28	467
07:15	2	71	24	0	97	92	80	38	0	210	27	142	20	0	189	8	42	6	0	56	552
07:30	7	68	28	0	103	69	91	37	0	197	21	113	10	0	144	9	29	8	0	46	490
07:45	7	61	27	0	95	55	51	37	0	143	28	67	10	0	105	5	31	8	0	44	387
Total	17	254	115	0	386	308	298	148	0	754	90	436	56	0	582	26	121	27	0	174	1896
08:00	2	39	26	0	67	45	50	37	0	132	22	69	7	0	98	5	30	6	0	41	338
08:15	2	56	18	0	76	39	68	57	0	164	20	75	10	0	105	17	29	3	0	49	394
Grand Total	25	450	202	0	677	531	515	292	0	1338	161	811	93	0	1065	62	227	48	0	337	3417
Apprch %	3.7	66.5	29.8	0		39.7	38.5	21.8	0		15.1	76.2	8.7	0		18.4	67.4	14.2	0		
Total %	0.7	13.2	5.9	0	19.8	15.5	15.1	8.5	0	39.2	4.7	23.7	2.7	0	31.2	1.8	6.6	1.4	0	9.9	

LSC Transportation Consultants, Inc.

2504 E. Pikes Peak Ave, Suite 304
 Colorado Springs, CO 80909
 719-633-2868

File Name : Marksheffel Rd - Fontaine Blvd AM 5-22

Site Code : S214080

Start Date : 5/26/2022

Page No : 2

Start Time	Marksheffel Rd Southbound					Fontain Blvd Westbound					Marksheffel Rd Northbound					Fontaine Blvd Eastbound					Int. Total
	Right	Thru	Left	Peds	App. Total	Right	Thru	Left	Peds	App. Total	Right	Thru	Left	Peds	App. Total	Right	Thru	Left	Peds	App. Total	
Peak Hour Analysis From 6:30:00 AM to 8:15:00 AM - Peak 1 of 1																					
Peak Hour for Entire Intersection Begins at 6:45:00 AM																					
6:45:00 AM	2	48	24	0	74	71	44	27	0	142	22	114	10	0	146	11	25	5	0	41	403
7:00:00 AM	1	54	36	0	91	92	76	36	0	204	14	114	16	0	144	4	19	5	0	28	467
7:15:00 AM	2	71	24	0	97	92	80	38	0	210	27	142	20	0	189	8	42	6	0	56	552
7:30:00 AM	7	68	28	0	103	69	91	37	0	197	21	113	10	0	144	9	29	8	0	46	490
Total Volume	12	241	112	0	365	324	291	138	0	753	84	483	56	0	623	32	115	24	0	171	1912
% App. Total	3.3	66	30.7	0		43	38.6	18.3	0		13.5	77.5	9	0		18.7	67.3	14	0		
PHF	.429	.849	.778	.000	.886	.880	.799	.908	.000	.896	.778	.850	.700	.000	.824	.727	.685	.750	.000	.763	.866

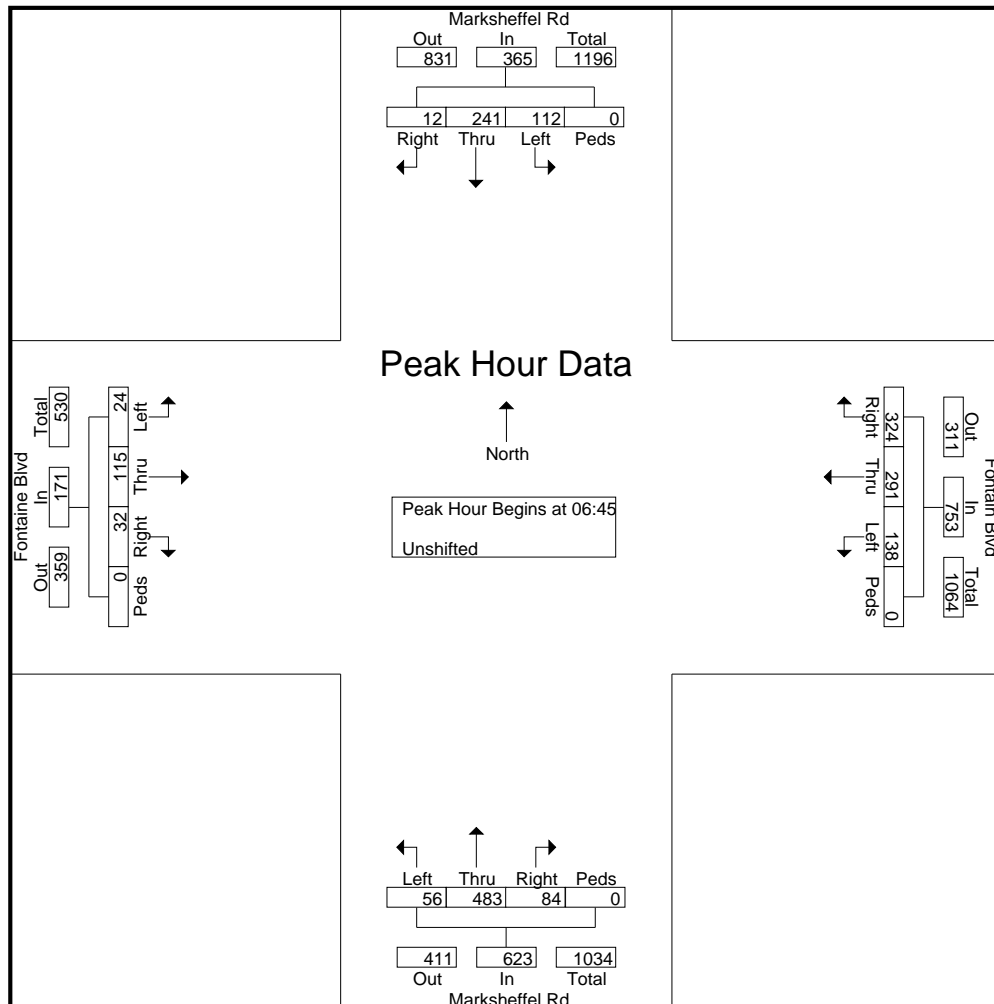

LSC Transportation Consultants, Inc.

2504 E. Pikes Peak Ave, Suite 304
 Colorado Springs, CO 80909
 719-633-2868

File Name : Marksheffel Rd - Fontaine Blvd AM 5-22

Site Code : S214080

Start Date : 5/26/2022

Page No : 3

Start Time	Marksheffel Rd Southbound					Fontain Blvd Westbound					Marksheffel Rd Northbound					Fontaine Blvd Eastbound					Int. Total
	Right	Thru	Left	Peds	App. Total	Right	Thru	Left	Peds	App. Total	Right	Thru	Left	Peds	App. Total	Right	Thru	Left	Peds	App. Total	
Peak Hour Analysis From 6:30:00 AM to 8:15:00 AM - Peak 1 of 1																					
Peak Hour for Each Approach Begins at:																					
	7:00:00 AM					7:00:00 AM					6:45:00 AM					7:15:00 AM					
+0 mins.	1	54	36	0	91	92	76	36	0	204	22	114	10	0	146	8	42	6	0	56	
+5 mins.	2	71	24	0	97	92	80	38	0	210	14	114	16	0	144	9	29	8	0	46	
+10 mins.	7	68	28	0	103	69	91	37	0	197	27	142	20	0	189	5	31	8	0	44	
+15 mins.	7	61	27	0	95	55	51	37	0	143	21	113	10	0	144	5	30	6	0	41	
Total Volume	17	254	115	0	386	308	298	148	0	754	84	483	56	0	623	27	132	28	0	187	
% App. Total	4.4	65.8	29.8	0		40.8	39.5	19.6	0		13.5	77.5	9	0		14.4	70.6	15	0		
PHF	.607	.894	.799	.000	.937	.837	.819	.974	.000	.898	.778	.850	.700	.000	.824	.750	.786	.875	.000	.835	

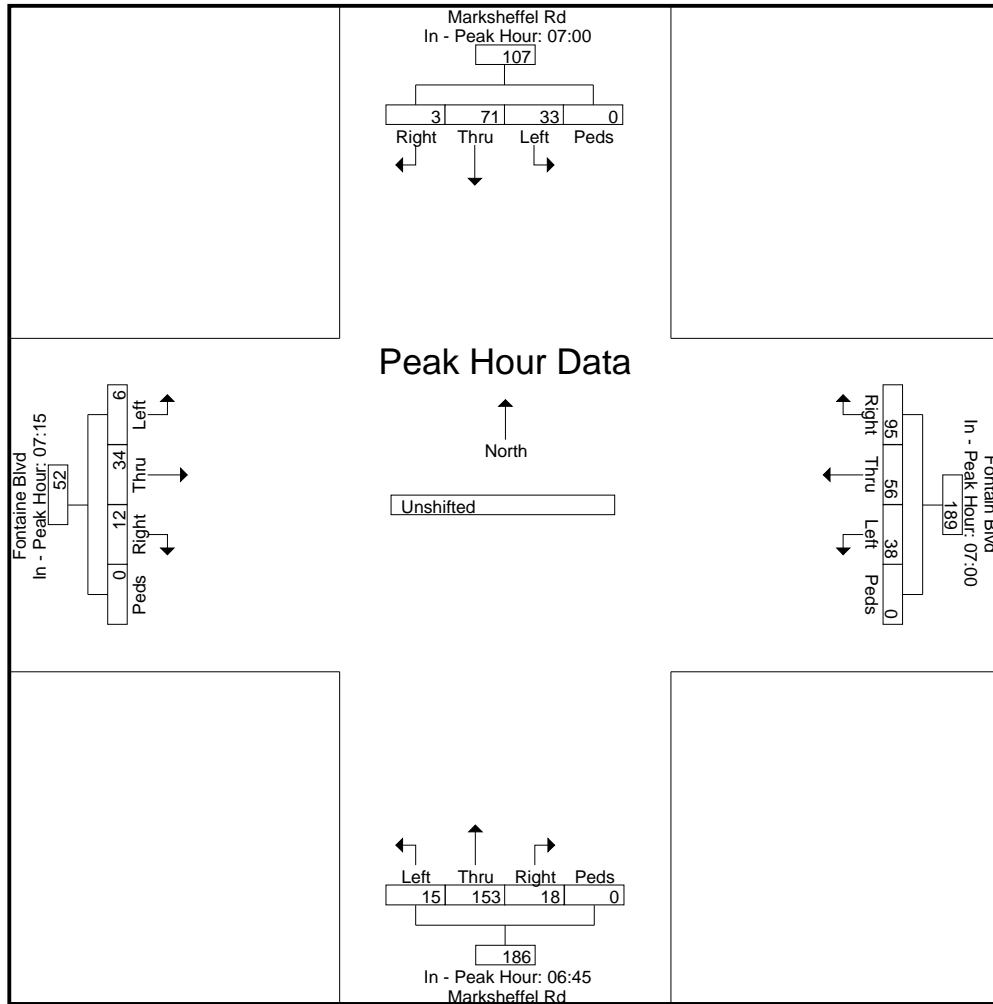

LSC Transportation Consultants, Inc.

2504 E. Pikes Peak Ave, Suite 304
 Colorado Springs, CO 80909
 719-633-2868

File Name : Marksheffel Rd - Fontaine Blvd PM 5-22

Site Code : S214080

Start Date : 5/25/2022

Page No : 1

Groups Printed- Unshifted

Start Time	Marksheffel Rd Southbound					Fontaine Blvd Westbound					Marksheffel Rd Northbound					Fontaine Blvd Eastbound					Int. Total
	Right	Thru	Left	Peds	App. Total	Right	Thru	Left	Peds	App. Total	Right	Thru	Left	Peds	App. Total	Right	Thru	Left	Peds	App. Total	
16:00	3	85	61	0	149	52	52	27	0	131	35	91	11	0	137	9	77	7	0	93	510
16:15	5	83	72	0	160	51	35	24	1	111	33	94	9	0	136	15	83	9	0	107	514
16:30	5	91	62	0	158	34	36	14	0	84	35	101	7	0	143	12	97	7	0	116	501
16:45	6	117	81	0	204	35	41	27	0	103	30	72	13	0	115	11	89	7	0	107	529
Total	19	376	276	0	671	172	164	92	1	429	133	358	40	0	531	47	346	30	0	423	2054
17:00	3	105	73	0	181	45	50	27	0	122	31	71	7	0	109	14	83	6	0	103	515
17:15	5	118	86	0	209	39	53	27	0	119	43	74	19	0	136	18	69	10	0	97	561
17:30	7	104	69	0	180	49	60	19	1	129	34	64	9	0	107	11	78	5	0	94	510
17:45	5	97	60	0	162	36	34	22	0	92	31	45	13	0	89	17	76	9	0	102	445
Total	20	424	288	0	732	169	197	95	1	462	139	254	48	0	441	60	306	30	0	396	2031
Grand Total	39	800	564	0	1403	341	361	187	2	891	272	612	88	0	972	107	652	60	0	819	4085
Apprch %	2.8	57	40.2	0		38.3	40.5	21	0.2		28	63	9.1	0		13.1	79.6	7.3	0		
Total %	1	19.6	13.8	0	34.3	8.3	8.8	4.6	0	21.8	6.7	15	2.2	0	23.8	2.6	16	1.5	0	20	

LSC Transportation Consultants, Inc.

2504 E. Pikes Peak Ave, Suite 304
 Colorado Springs, CO 80909
 719-633-2868

File Name : Marksheffel Rd - Fontaine Blvd PM 5-22

Site Code : S214080

Start Date : 5/25/2022

Page No : 2

Start Time	Marksheffel Rd Southbound					Fontaine Blvd Westbound					Marksheffel Rd Northbound					Fontaine Blvd Eastbound					Int. Total
	Right	Thru	Left	Peds	App. Total	Right	Thru	Left	Peds	App. Total	Right	Thru	Left	Peds	App. Total	Right	Thru	Left	Peds	App. Total	
Peak Hour Analysis From 4:00:00 PM to 5:45:00 PM - Peak 1 of 1																					
Peak Hour for Entire Intersection Begins at 4:45:00 PM																					
4:45:00 PM	6	117	81	0	204	35	41	27	0	103	30	72	13	0	115	11	89	7	0	107	529
5:00:00 PM	3	105	73	0	181	45	50	27	0	122	31	71	7	0	109	14	83	6	0	103	515
5:15:00 PM	5	118	86	0	209	39	53	27	0	119	43	74	19	0	136	18	69	10	0	97	561
5:30:00 PM	7	104	69	0	180	49	60	19	1	129	34	64	9	0	107	11	78	5	0	94	510
Total Volume	21	444	309	0	774	168	204	100	1	473	138	281	48	0	467	54	319	28	0	401	2115
% App. Total	2.7	57.4	39.9	0		35.5	43.1	21.1	0.2		29.6	60.2	10.3	0		13.5	79.6	7	0		
PHF	.750	.941	.898	.000	.926	.857	.850	.926	.250	.917	.802	.949	.632	.000	.858	.750	.896	.700	.000	.937	.943

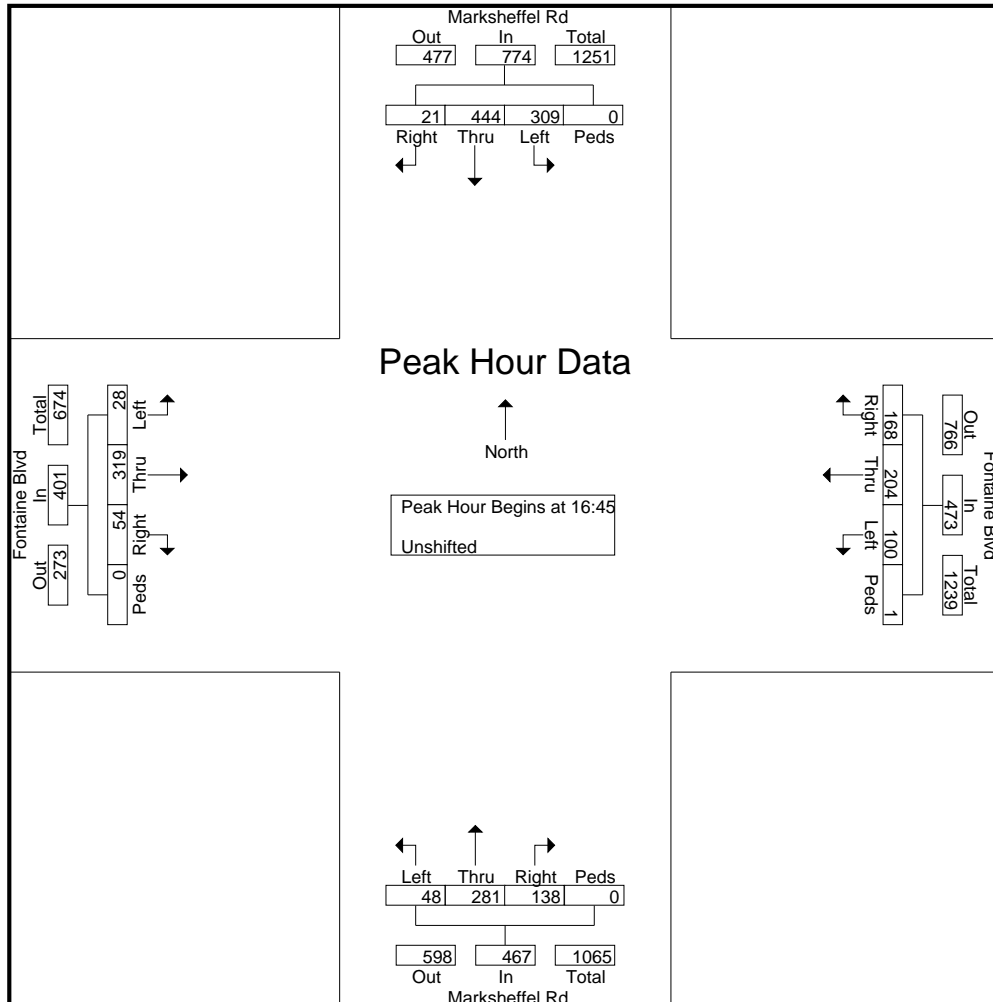

LSC Transportation Consultants, Inc.

2504 E. Pikes Peak Ave, Suite 304
 Colorado Springs, CO 80909
 719-633-2868

File Name : Marksheffel Rd - Fontaine Blvd PM 5-22

Site Code : S214080

Start Date : 5/25/2022

Page No : 3

Start Time	Marksheffel Rd Southbound					Fontaine Blvd Westbound					Marksheffel Rd Northbound					Fontaine Blvd Eastbound					Int. Total
	Right	Thru	Left	Peds	App. Total	Right	Thru	Left	Peds	App. Total	Right	Thru	Left	Peds	App. Total	Right	Thru	Left	Peds	App. Total	

Peak Hour Analysis From 4:00:00 PM to 5:45:00 PM - Peak 1 of 1
 Peak Hour for Each Approach Begins at:

	4:45:00 PM					4:45:00 PM					4:00:00 PM					4:15:00 PM				
+0 mins.	6	117	81	0	204	35	41	27	0	103	35	91	11	0	137	15	83	9	0	107
+5 mins.	3	105	73	0	181	45	50	27	0	122	33	94	9	0	136	12	97	7	0	116
+10 mins.	5	118	86	0	209	39	53	27	0	119	35	101	7	0	143	11	89	7	0	107
+15 mins.	7	104	69	0	180	49	60	19	1	129	30	72	13	0	115	14	83	6	0	103
Total Volume	21	444	309	0	774	168	204	100	1	473	133	358	40	0	531	52	352	29	0	433
% App. Total	2.7	57.4	39.9	0		35.5	43.1	21.1	0.2		25	67.4	7.5	0		12	81.3	6.7	0	
PHF	.750	.941	.898	.000	.926	.857	.850	.926	.250	.917	.950	.886	.769	.000	.928	.867	.907	.806	.000	.933

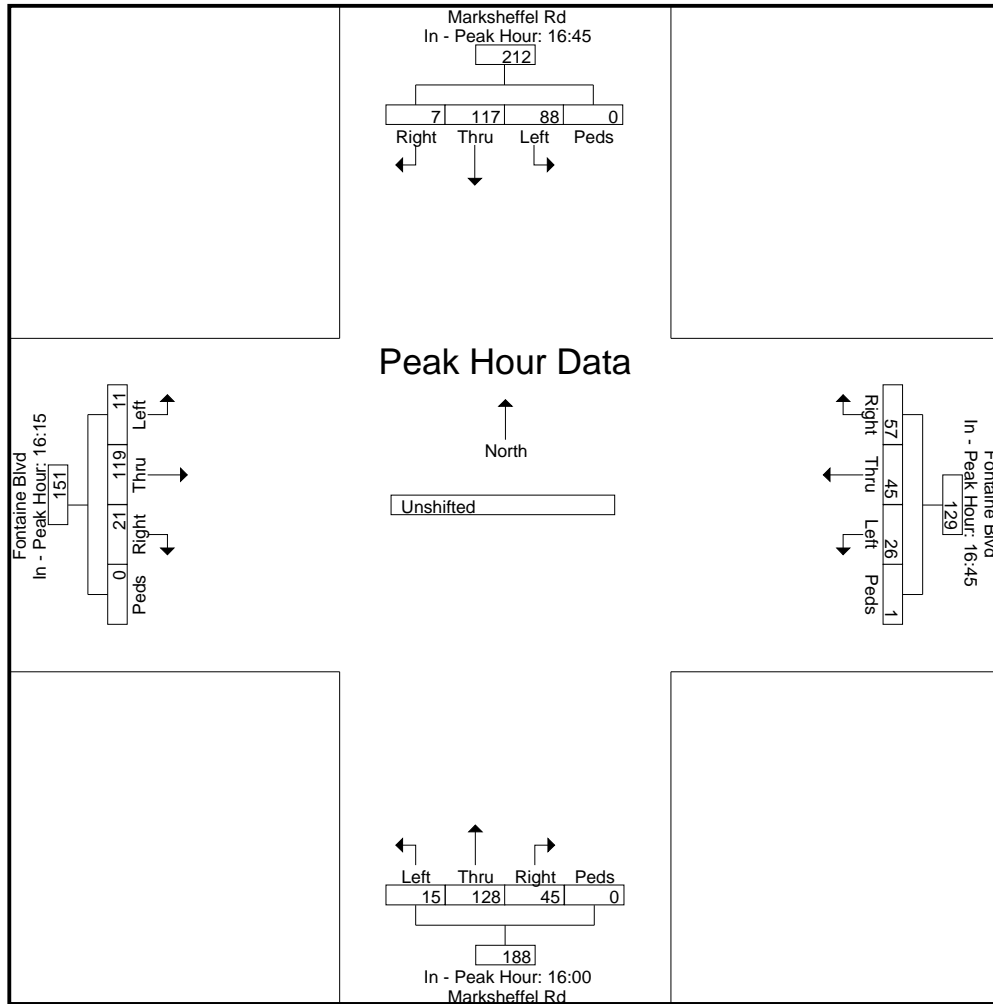

LSC Transportation Consultants, Inc.

2504 E. Pikes Peak Ave, Suite 304
 Colorado Springs, CO 80909
 719-633-2868

File Name : Marksheffel Rd -Bradley Rd AM
 Site Code : S234150
 Start Date : 3/21/2023
 Page No : 1

Groups Printed- Unshifted

Start Time	Marksheffel Rd Southbound					Bradley Rd Westbound					Marksheffel Rd Northbound					Bradley Rd Eastbound					Int. Total
	Right	Thru	Left	Peds	App. Total	Right	Thru	Left	Peds	App. Total	Right	Thru	Left	Peds	App. Total	Right	Thru	Left	Peds	App. Total	
06:30	18	23	1	0	42	0	18	0	0	18	7	52	8	0	67	2	17	22	0	41	168
06:35	15	27	0	0	42	1	16	1	0	18	12	59	6	0	77	1	19	25	0	45	182
06:40	23	24	1	0	48	2	24	1	0	27	8	44	20	0	72	7	24	15	0	46	193
06:45	15	18	0	0	33	0	29	3	0	32	5	36	9	0	50	2	24	18	0	44	159
06:50	24	23	1	0	48	0	22	2	0	24	8	43	18	0	69	6	14	20	0	40	181
06:55	20	12	2	0	34	2	36	3	0	41	6	44	13	0	63	4	27	11	0	42	180
Total	115	127	5	0	247	5	145	10	0	160	46	278	74	0	398	22	125	111	0	258	1063
07:00	23	18	0	0	41	2	42	3	0	47	6	58	16	0	80	3	29	8	0	40	208
07:05	23	16	2	0	41	4	31	4	0	39	11	56	13	0	80	9	21	21	0	51	211
07:10	25	23	1	0	49	1	27	5	0	33	16	70	19	0	105	2	31	22	0	55	242
07:15	14	24	2	0	40	0	36	2	0	38	12	67	28	0	107	2	30	20	0	52	237
07:20	24	29	2	0	55	0	33	3	0	36	11	73	17	0	101	1	26	16	0	43	235
07:25	29	21	0	0	50	0	26	4	0	30	12	49	15	0	76	6	30	29	0	65	221
07:30	26	18	0	0	44	2	19	0	0	21	11	63	29	1	104	5	29	17	0	51	220
07:35	28	19	0	0	47	0	29	1	0	30	16	65	14	0	95	2	29	17	0	48	220
07:40	16	14	3	0	33	4	25	3	0	32	13	65	20	0	98	5	22	26	0	53	216
07:45	20	12	0	0	32	1	23	3	1	28	8	60	13	0	81	2	23	22	0	47	188
07:50	24	20	1	0	45	0	21	2	0	23	11	24	6	0	41	6	22	12	0	40	149
07:55	28	15	1	0	44	3	18	4	0	25	7	31	12	0	50	2	12	19	0	33	152
Total	280	229	12	0	521	17	330	34	1	382	134	681	202	1	1018	45	304	229	0	578	2499
08:00	39	18	0	0	57	4	29	1	0	34	4	37	8	0	49	3	23	8	0	34	174
08:05	17	18	0	0	35	2	27	1	0	30	5	33	4	0	42	3	22	18	0	43	150
08:10	30	12	1	0	43	0	10	0	0	10	9	41	5	0	55	4	17	9	0	30	138
08:15	25	16	0	0	41	1	21	4	0	26	5	29	6	0	40	4	13	18	0	35	142
08:20	23	22	1	0	46	1	19	1	0	21	4	35	8	0	47	3	17	12	0	32	146
08:25	21	11	0	0	32	2	19	2	0	23	5	28	7	0	40	4	23	18	0	45	140
Grand Total	550	453	19	0	1022	32	600	53	1	686	212	1162	314	1	1689	88	544	423	0	1055	4452
Apprch %	53.8	44.3	1.9	0		4.7	87.5	7.7	0.1		12.6	68.8	18.6	0.1		8.3	51.6	40.1	0		
Total %	12.4	10.2	0.4	0	23	0.7	13.5	1.2	0	15.4	4.8	26.1	7.1	0	37.9	2	12.2	9.5	0	23.7	

LSC Transportation Consultants, Inc.

2504 E. Pikes Peak Ave, Suite 304
 Colorado Springs, CO 80909
 719-633-2868

File Name : Marksheffel Rd -Bradley Rd AM

Site Code : S234150

Start Date : 3/21/2023

Page No : 2

Start Time	Marksheffel Rd Southbound					Bradley Rd Westbound					Marksheffel Rd Northbound					Bradley Rd Eastbound					Int. Total
	Right	Thru	Left	Peds	App. Total	Right	Thru	Left	Peds	App. Total	Right	Thru	Left	Peds	App. Total	Right	Thru	Left	Peds	App. Total	
Peak Hour Analysis From 06:30 to 08:25 - Peak 1 of 1																					
Peak Hour for Entire Intersection Begins at 06:50																					
06:50	24	23	1	0	48	0	22	2	0	24	8	43	18	0	69	6	14	20	0	40	181
06:55	20	12	2	0	34	2	36	3	0	41	6	44	13	0	63	4	27	11	0	42	180
07:00	23	18	0	0	41	2	42	3	0	47	6	58	16	0	80	3	29	8	0	40	208
07:05	23	16	2	0	41	4	31	4	0	39	11	56	13	0	80	9	21	21	0	51	211
07:10	25	23	1	0	49	1	27	5	0	33	16	70	19	0	105	2	31	22	0	55	242
07:15	14	24	2	0	40	0	36	2	0	38	12	67	28	0	107	2	30	20	0	52	237
07:20	24	29	2	0	55	0	33	3	0	36	11	73	17	0	101	1	26	16	0	43	235
07:25	29	21	0	0	50	0	26	4	0	30	12	49	15	0	76	6	30	29	0	65	221
07:30	26	18	0	0	44	2	19	0	0	21	11	63	29	1	104	5	29	17	0	51	220
07:35	28	19	0	0	47	0	29	1	0	30	16	65	14	0	95	2	29	17	0	48	220
07:40	16	14	3	0	33	4	25	3	0	32	13	65	20	0	98	5	22	26	0	53	216
07:45	20	12	0	0	32	1	23	3	1	28	8	60	13	0	81	2	23	22	0	47	188
Total Volume	272	229	13	0	514	16	349	33	1	399	130	713	215	1	1059	47	311	229	0	587	2559
% App. Total	52.9	44.6	2.5	0		4	87.5	8.3	0.3		12.3	67.3	20.3	0.1		8	53	39	0		
PHF	.782	.658	.361	.000	.779	.333	.692	.550	.083	.707	.677	.814	.618	.083	.825	.435	.836	.658	.000	.753	.881

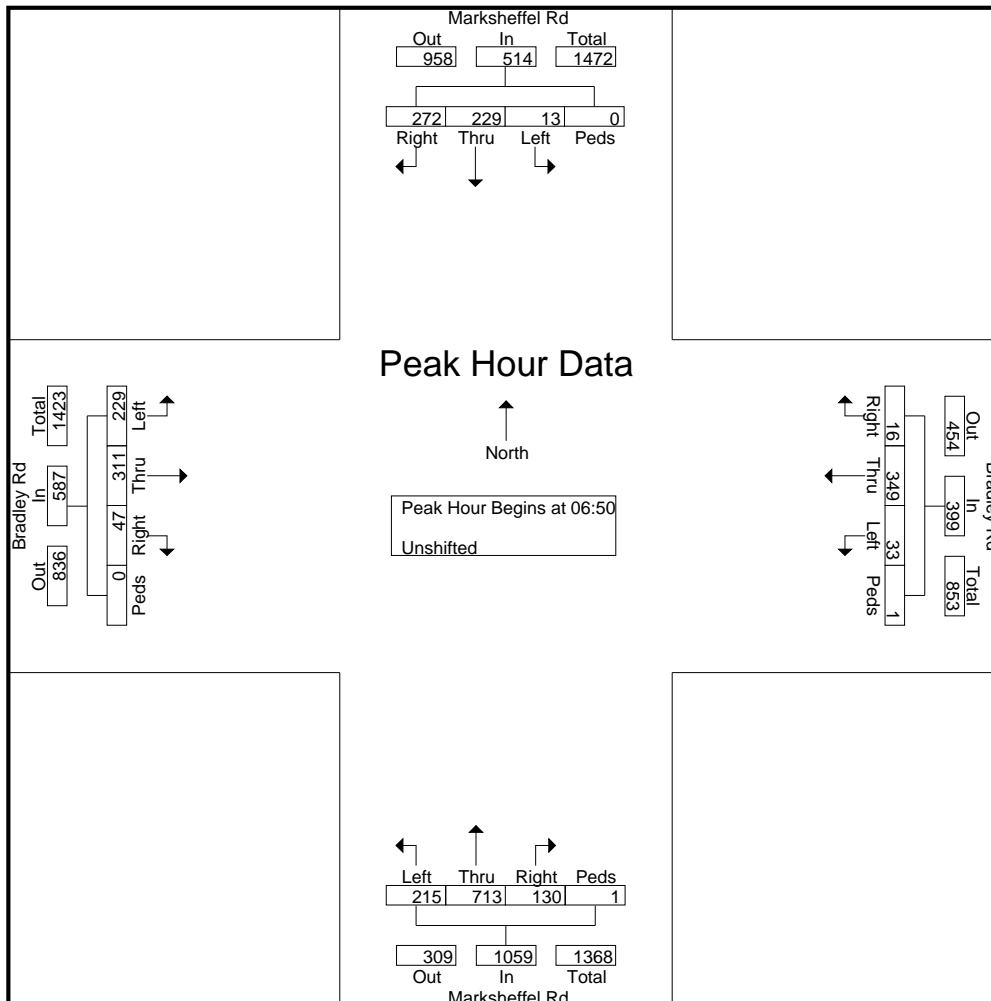

LSC Transportation Consultants, Inc.

2504 E. Pikes Peak Ave, Suite 304
 Colorado Springs, CO 80909
 719-633-2868

File Name : Marksheffel Rd -Bradley Rd AM
 Site Code : S234150
 Start Date : 3/21/2023
 Page No : 3

Start Time	Marksheffel Rd Southbound					Bradley Rd Westbound					Marksheffel Rd Northbound					Bradley Rd Eastbound					Int. Total
	Right	Thru	Left	Peds	App. Total	Right	Thru	Left	Peds	App. Total	Right	Thru	Left	Peds	App. Total	Right	Thru	Left	Peds	App. Total	
Peak Hour Analysis From 06:30 to 08:25 - Peak 1 of 1																					
Peak Hour for Each Approach Begins at:																					
	07:05					06:45					06:50					06:50					
+0 mins.	23	16	2	0	41	0	29	3	0	32	8	43	18	0	69	6	14	20	0	40	
+5 mins.	25	23	1	0	49	0	22	2	0	24	6	44	13	0	63	4	27	11	0	42	
+10 mins.	14	24	2	0	40	2	36	3	0	41	6	58	16	0	80	3	29	8	0	40	
+15 mins.	24	29	2	0	55	2	42	3	0	47	11	56	13	0	80	9	21	21	0	51	
+20 mins.	29	21	0	0	50	4	31	4	0	39	16	70	19	0	105	2	31	22	0	55	
+25 mins.	26	18	0	0	44	1	27	5	0	33	12	67	28	0	107	2	30	20	0	52	
+30 mins.	28	19	0	0	47	0	36	2	0	38	11	73	17	0	101	1	26	16	0	43	
+35 mins.	16	14	3	0	33	0	33	3	0	36	12	49	15	0	76	6	30	29	0	65	
+40 mins.	20	12	0	0	32	0	26	4	0	30	11	63	29	1	104	5	29	17	0	51	
+45 mins.	24	20	1	0	45	2	19	0	0	21	16	65	14	0	95	2	29	17	0	48	
+50 mins.	28	15	1	0	44	0	29	1	0	30	13	65	20	0	98	5	22	26	0	53	
+55 mins.	39	18	0	0	57	4	25	3	0	32	8	60	13	0	81	2	23	22	0	47	
Total Volume	296	229	12	0	537	15	355	33	0	403	130	713	215	1	1059	47	311	229	0	587	
% App. Total	55.1	42.6	2.2	0		3.7	88.1	8.2	0		12.3	67.3	20.3	0.1		8	53	39	0		
PHF	.632	.658	.333	.000	.785	.313	.704	.550	.000	.715	.677	.814	.618	.083	.825	.435	.836	.658	.000	.753	

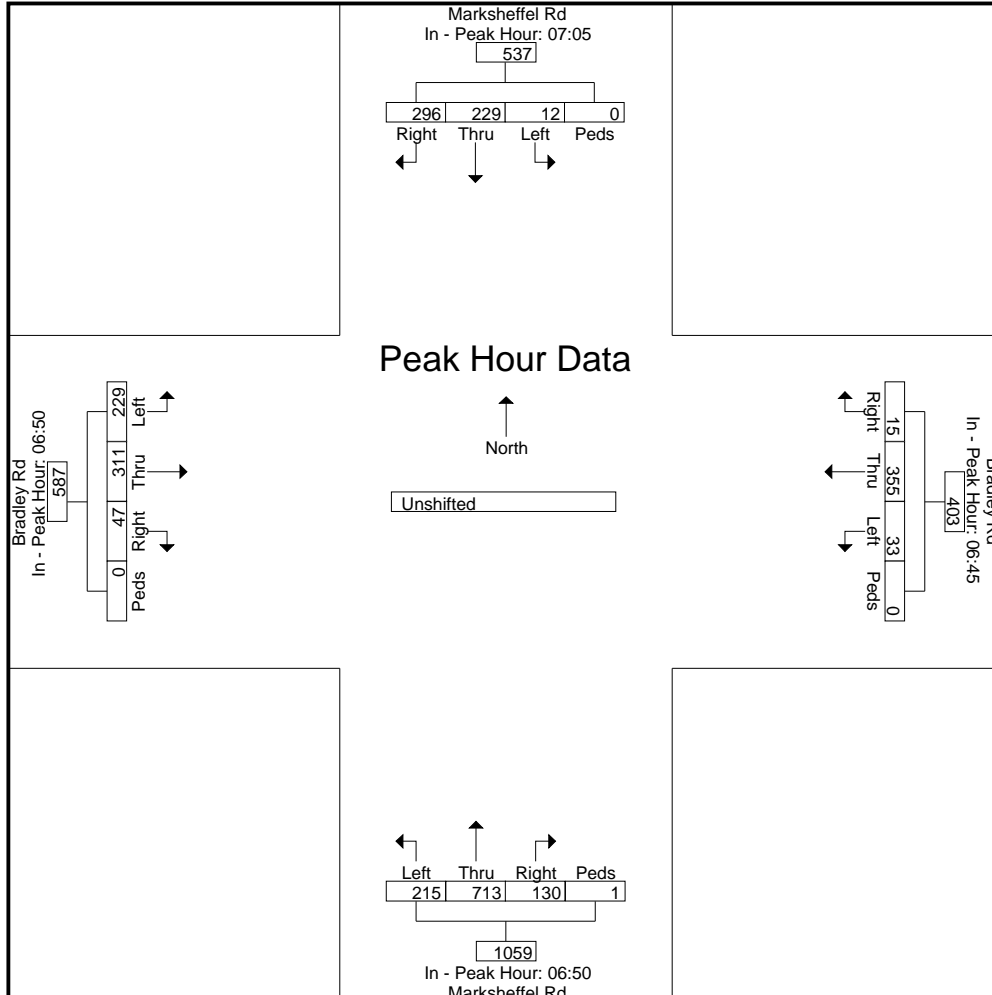

LSC Transportation Consultants, Inc.

2504 E. Pikes Peak Ave, Suite 304
 Colorado Springs, CO 80909
 719-633-2868

File Name : Marksheffel Rd - Bradley Rd PM 3-23

Site Code : S234150

Start Date : 3/21/2023

Page No : 1

Groups Printed- Unshifted

Start Time	Marksheffel Rd Southbound					Bradley Rd Westbound					Marksheffel Rd Northbound					Bradley Rd Eastbound					Int. Total
	Right	Thru	Left	Peds	App. Total	Right	Thru	Left	Peds	App. Total	Right	Thru	Left	Peds	App. Total	Right	Thru	Left	Peds	App. Total	
16:00	12	50	2	0	64	0	25	8	0	33	2	31	6	0	39	5	19	27	0	51	187
16:05	13	53	0	0	66	2	13	5	0	20	3	36	11	0	50	11	19	22	0	52	188
16:10	22	53	0	0	75	2	18	7	0	27	5	31	7	0	43	6	17	29	0	52	197
16:15	23	55	2	0	80	4	31	9	0	44	6	28	6	1	41	5	29	39	0	73	238
16:20	28	48	3	0	79	2	28	8	0	38	2	29	11	0	42	14	24	34	0	72	231
16:25	12	38	3	0	53	1	40	8	0	49	8	32	7	0	47	12	32	37	0	81	230
16:30	20	53	2	0	75	1	16	11	0	28	5	34	8	0	47	12	32	38	0	82	232
16:35	19	66	0	0	85	2	25	15	0	42	2	36	4	1	43	14	17	40	0	71	241
16:40	16	34	0	0	50	2	24	10	0	36	4	27	7	0	38	14	39	46	0	99	223
16:45	20	53	0	0	73	1	25	10	0	36	4	20	2	0	26	10	24	38	0	72	207
16:50	16	48	1	0	65	5	12	9	0	26	7	27	6	0	40	14	19	28	1	62	193
16:55	17	41	2	0	60	1	23	9	0	33	1	27	2	0	30	5	33	46	0	84	207
Total	218	592	15	0	825	23	280	109	0	412	49	358	77	2	486	122	304	424	1	851	2574
17:00	17	61	0	0	78	1	23	5	0	29	4	25	3	0	32	4	16	19	0	39	178
17:05	16	39	1	0	56	1	21	6	0	28	3	23	8	0	34	10	27	38	0	75	193
17:10	20	48	0	0	68	6	8	8	0	22	2	38	7	0	47	6	30	39	0	75	212
17:15	32	48	2	0	82	0	14	7	0	21	8	27	6	0	41	7	30	36	0	73	217
17:20	16	59	6	0	81	0	17	5	0	22	1	33	10	0	44	10	20	37	0	67	214
17:25	19	43	0	0	62	1	9	3	0	13	5	25	6	0	36	5	21	33	0	59	170
17:30	16	38	3	0	57	2	14	0	0	16	1	26	7	0	34	10	22	26	0	58	165
17:35	9	43	0	0	52	2	10	4	0	16	3	30	8	0	41	9	22	35	0	66	175
17:40	19	44	3	0	66	1	7	2	0	10	4	27	6	0	37	12	22	21	0	55	168
17:45	15	44	0	0	59	1	21	4	0	26	5	23	2	0	30	4	18	37	0	59	174
17:50	19	44	2	0	65	0	14	2	0	16	3	27	4	0	34	10	20	18	0	48	163
17:55	8	30	0	0	38	1	10	3	0	14	2	28	4	0	34	10	14	17	0	41	127
Total	206	541	17	0	764	16	168	49	0	233	41	332	71	0	444	97	262	356	0	715	2156
Grand Total	424	1133	32	0	1589	39	448	158	0	645	90	690	148	2	930	219	566	780	1	1566	4730
Apprch %	26.7	71.3	2	0		6	69.5	24.5	0		9.7	74.2	15.9	0.2		14	36.1	49.8	0.1		
Total %	9	24	0.7	0	33.6	0.8	9.5	3.3	0	13.6	1.9	14.6	3.1	0	19.7	4.6	12	16.5	0	33.1	

LSC Transportation Consultants, Inc.

2504 E. Pikes Peak Ave, Suite 304
 Colorado Springs, CO 80909
 719-633-2868

File Name : Marksheffel Rd - Bradley Rd PM 3-23

Site Code : S234150

Start Date : 3/21/2023

Page No : 2

Start Time	Marksheffel Rd Southbound					Bradley Rd Westbound					Marksheffel Rd Northbound					Bradley Rd Eastbound					Int. Total
	Right	Thru	Left	Peds	App. Total	Right	Thru	Left	Peds	App. Total	Right	Thru	Left	Peds	App. Total	Right	Thru	Left	Peds	App. Total	
Peak Hour Analysis From 16:00 to 17:55 - Peak 1 of 1																					
Peak Hour for Entire Intersection Begins at 16:15																					
16:15	23	55	2	0	80	4	31	9	0	44	6	28	6	1	41	5	29	39	0	73	238
16:20	28	48	3	0	79	2	28	8	0	38	2	29	11	0	42	14	24	34	0	72	231
16:25	12	38	3	0	53	1	40	8	0	49	8	32	7	0	47	12	32	37	0	81	230
16:30	20	53	2	0	75	1	16	11	0	28	5	34	8	0	47	12	32	38	0	82	232
16:35	19	66	0	0	85	2	25	15	0	42	2	36	4	1	43	14	17	40	0	71	241
16:40	16	34	0	0	50	2	24	10	0	36	4	27	7	0	38	14	39	46	0	99	223
16:45	20	53	0	0	73	1	25	10	0	36	4	20	2	0	26	10	24	38	0	72	207
16:50	16	48	1	0	65	5	12	9	0	26	7	27	6	0	40	14	19	28	1	62	193
16:55	17	41	2	0	60	1	23	9	0	33	1	27	2	0	30	5	33	46	0	84	207
17:00	17	61	0	0	78	1	23	5	0	29	4	25	3	0	32	4	16	19	0	39	178
17:05	16	39	1	0	56	1	21	6	0	28	3	23	8	0	34	10	27	38	0	75	193
17:10	20	48	0	0	68	6	8	8	0	22	2	38	7	0	47	6	30	39	0	75	212
Total Volume	224	584	14	0	822	27	276	108	0	411	48	346	71	2	467	120	322	442	1	885	2585
% App. Total	27.3	71	1.7	0		6.6	67.2	26.3	0		10.3	74.1	15.2	0.4		13.6	36.4	49.9	0.1		
PHF	.667	.737	.389	.000	.806	.375	.575	.600	.000	.699	.500	.759	.538	.167	.828	.714	.688	.801	.083	.745	.894

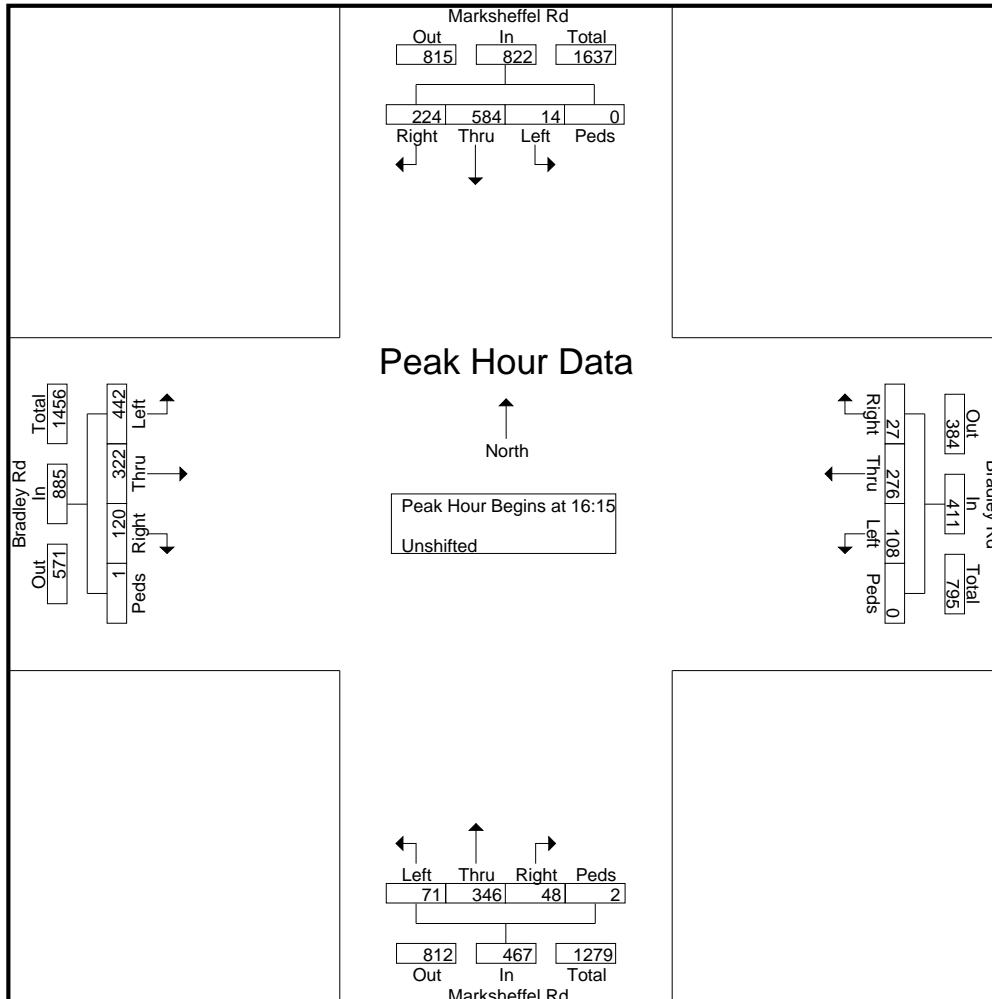

LSC Transportation Consultants, Inc.

2504 E. Pikes Peak Ave, Suite 304
 Colorado Springs, CO 80909
 719-633-2868

File Name : Marksheffel Rd - Bradley Rd PM 3-23

Site Code : S234150

Start Date : 3/21/2023

Page No : 3

Start Time	Marksheffel Rd Southbound					Bradley Rd Westbound					Marksheffel Rd Northbound					Bradley Rd Eastbound					Int. Total
	Right	Thru	Left	Peds	App. Total	Right	Thru	Left	Peds	App. Total	Right	Thru	Left	Peds	App. Total	Right	Thru	Left	Peds	App. Total	

Peak Hour Analysis From 16:00 to 17:55 - Peak 1 of 1

Peak Hour for Each Approach Begins at:

	16:05					16:10					16:00					16:15				
+0 mins.	13	53	0	0	66	2	18	7	0	27	2	31	6	0	39	5	29	39	0	73
+5 mins.	22	53	0	0	75	4	31	9	0	44	3	36	11	0	50	14	24	34	0	72
+10 mins.	23	55	2	0	80	2	28	8	0	38	5	31	7	0	43	12	32	37	0	81
+15 mins.	28	48	3	0	79	1	40	8	0	49	6	28	6	1	41	12	32	38	0	82
+20 mins.	12	38	3	0	53	1	16	11	0	28	2	29	11	0	42	14	17	40	0	71
+25 mins.	20	53	2	0	75	2	25	15	0	42	8	32	7	0	47	14	39	46	0	99
+30 mins.	19	66	0	0	85	2	24	10	0	36	5	34	8	0	47	10	24	38	0	72
+35 mins.	16	34	0	0	50	1	25	10	0	36	2	36	4	1	43	14	19	28	1	62
+40 mins.	20	53	0	0	73	5	12	9	0	26	4	27	7	0	38	5	33	46	0	84
+45 mins.	16	48	1	0	65	1	23	9	0	33	4	20	2	0	26	4	16	19	0	39
+50 mins.	17	41	2	0	60	1	23	5	0	29	7	27	6	0	40	10	27	38	0	75
+55 mins.	17	61	0	0	78	1	21	6	0	28	1	27	2	0	30	6	30	39	0	75
Total Volume	223	603	13	0	839	23	286	107	0	416	49	358	77	2	486	120	322	442	1	885
% App. Total	26.6	71.9	1.5	0		5.5	68.8	25.7	0		10.1	73.7	15.8	0.4		13.6	36.4	49.9	0.1	
PHF	.664	.761	.361	.000	.823	.383	.596	.594	.000	.707	.510	.829	.583	.167	.810	.714	.688	.801	.083	.745

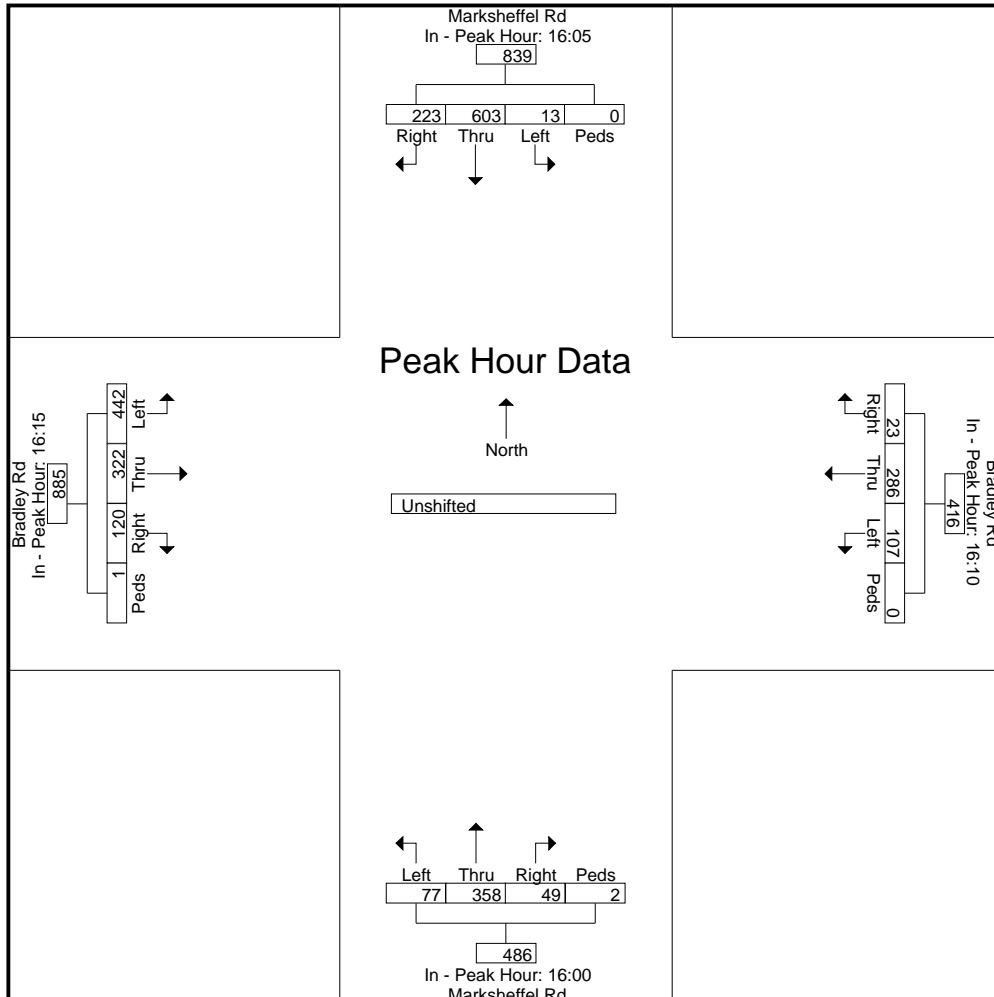

Levels of Service



HCM 6th TWSC
2: Cottonwood Grove & Fontaine Blvd

Existing
AM

Intersection												
Int Delay, s/veh	0.6											
Movement	EBL	EBT	EBR	WBL	WBT	WBR	NBL	NBT	NBR	SBL	SBT	SBR
Lane Configurations		↕	↕		↕	↕		↕			↕	↕
Traffic Vol, veh/h	4	165	5	0	370	2	4	0	3	5	0	12
Future Vol, veh/h	4	165	5	0	370	2	4	0	3	5	0	12
Conflicting Peds, #/hr	0	0	0	0	0	0	0	0	0	0	0	0
Sign Control	Free	Free	Free	Free	Free	Free	Stop	Stop	Stop	Stop	Stop	Stop
RT Channelized	-	-	None	-	-	None	-	-	None	-	-	Stop
Storage Length	-	-	155	-	-	0	-	-	-	-	-	-
Veh in Median Storage, #	-	0	-	-	0	-	-	0	-	-	0	-
Grade, %	-	0	-	-	0	-	-	0	-	-	0	-
Peak Hour Factor	87	87	87	92	92	92	78	78	78	78	78	78
Heavy Vehicles, %	2	2	2	2	2	2	2	2	2	2	2	2
Mvmt Flow	5	190	6	0	402	2	5	0	4	6	0	15

Major/Minor	Major1			Major2			Minor1			Minor2		
Conflicting Flow All	404	0	0	196	0	0	603	604	190	607	608	402
Stage 1	-	-	-	-	-	-	200	200	-	402	402	-
Stage 2	-	-	-	-	-	-	403	404	-	205	206	-
Critical Hdwy	4.12	-	-	4.12	-	-	7.12	6.52	6.22	7.12	6.52	6.22
Critical Hdwy Stg 1	-	-	-	-	-	-	6.12	5.52	-	6.12	5.52	-
Critical Hdwy Stg 2	-	-	-	-	-	-	6.12	5.52	-	6.12	5.52	-
Follow-up Hdwy	2.218	-	-	2.218	-	-	3.518	4.018	3.318	3.518	4.018	3.318
Pot Cap-1 Maneuver	1155	-	-	1377	-	-	411	412	852	408	410	648
Stage 1	-	-	-	-	-	-	802	736	-	625	600	-
Stage 2	-	-	-	-	-	-	624	599	-	797	731	-
Platoon blocked, %	-	-	-	-	-	-	-	-	-	-	-	-
Mov Cap-1 Maneuver	1155	-	-	1377	-	-	400	410	852	405	408	648
Mov Cap-2 Maneuver	-	-	-	-	-	-	400	410	-	405	408	-
Stage 1	-	-	-	-	-	-	798	732	-	622	600	-
Stage 2	-	-	-	-	-	-	609	599	-	789	727	-

Approach	EB			WB			NB			SB		
HCM Control Delay, s	0.2			0			12.1			11.8		
HCM LOS							B			B		

Minor Lane/Major Mvmt	NBLn1	EBL	EBT	EBR	WBL	WBT	WBR	SBLn1
Capacity (veh/h)	518	1155	-	-	1377	-	-	551
HCM Lane V/C Ratio	0.017	0.004	-	-	-	-	-	0.04
HCM Control Delay (s)	12.1	8.1	0	-	0	-	-	11.8
HCM Lane LOS	B	A	A	-	A	-	-	B
HCM 95th %tile Q(veh)	0.1	0	-	-	0	-	-	0.1

HCM 6th TWSC
3: Fontaine Blvd & Sleepy Meadows Dr

Existing
AM

Intersection						
Int Delay, s/veh	0.5					
Movement	EBL	EBT	WBT	WBR	SBL	SBR
Lane Configurations		↔	↕	↕		↕
Traffic Vol, veh/h	8	174	384	2	3	15
Future Vol, veh/h	8	174	384	2	3	15
Conflicting Peds, #/hr	0	0	0	0	0	0
Sign Control	Free	Free	Free	Free	Stop	Stop
RT Channelized	-	None	-	None	-	Stop
Storage Length	-	-	-	185	-	0
Veh in Median Storage, #	-	0	0	-	0	-
Grade, %	-	0	0	-	0	-
Peak Hour Factor	87	87	92	92	78	78
Heavy Vehicles, %	2	2	2	2	2	2
Mvmt Flow	9	200	417	2	4	19

Major/Minor	Major1	Major2	Minor2		
Conflicting Flow All	419	0	-	0	635 417
Stage 1	-	-	-	-	417 -
Stage 2	-	-	-	-	218 -
Critical Hdwy	4.12	-	-	-	6.42 6.22
Critical Hdwy Stg 1	-	-	-	-	5.42 -
Critical Hdwy Stg 2	-	-	-	-	5.42 -
Follow-up Hdwy	2.218	-	-	-	3.518 3.318
Pot Cap-1 Maneuver	1140	-	-	-	443 636
Stage 1	-	-	-	-	665 -
Stage 2	-	-	-	-	818 -
Platoon blocked, %		-	-	-	
Mov Cap-1 Maneuver	1140	-	-	-	439 636
Mov Cap-2 Maneuver	-	-	-	-	439 -
Stage 1	-	-	-	-	659 -
Stage 2	-	-	-	-	818 -

Approach	EB	WB	SB
HCM Control Delay, s	0.4	0	10.8
HCM LOS			B

Minor Lane/Major Mvmt	EBL	EBT	WBT	WBR	SBLn1
Capacity (veh/h)	1140	-	-	-	636
HCM Lane V/C Ratio	0.008	-	-	-	0.03
HCM Control Delay (s)	8.2	0	-	-	10.8
HCM Lane LOS	A	A	-	-	B
HCM 95th %tile Q(veh)	0	-	-	-	0.1

HCM 6th TWSC
4: Marksheffel & Peaceful Ridge/Cider Mill

Existing
AM

Intersection

Int Delay, s/veh 0.7

Movement	EBL	EBT	EBR	WBL	WBT	WBR	NBL	NBT	NBR	SBL	SBT	SBR
Lane Configurations						↗		↖	↗		↖	
Traffic Vol, veh/h	0	0	0	0	0	35	0	1000	15	0	300	0
Future Vol, veh/h	0	0	0	0	0	35	0	1000	15	0	300	0
Conflicting Peds, #/hr	0	0	0	0	0	0	0	0	0	0	0	0
Sign Control	Stop	Stop	Stop	Stop	Stop	Stop	Free	Free	Free	Free	Free	Free
RT Channelized	-	-	None	-	-	None	-	-	None	-	-	None
Storage Length	-	-	-	-	-	0	-	-	280	-	-	-
Veh in Median Storage, #	-	1	-	-	0	-	-	0	-	-	0	-
Grade, %	-	0	-	-	0	-	-	0	-	-	0	-
Peak Hour Factor	92	92	92	78	78	78	93	93	92	92	92	92
Heavy Vehicles, %	2	2	2	2	2	2	2	2	2	2	2	2
Mvmt Flow	0	0	0	0	0	45	0	1075	16	0	326	0

Major/Minor	Minor1	Major1	Major2
Conflicting Flow All	-	1075	0
Stage 1	-	-	-
Stage 2	-	-	-
Critical Hdwy	-	6.22	-
Critical Hdwy Stg 1	-	-	-
Critical Hdwy Stg 2	-	-	-
Follow-up Hdwy	-	3.318	-
Pot Cap-1 Maneuver	0	267	0
Stage 1	0	-	0
Stage 2	0	-	0
Platoon blocked, %			-
Mov Cap-1 Maneuver	-	267	-
Mov Cap-2 Maneuver	-	0	-
Stage 1	-	0	-
Stage 2	-	0	-

Approach	WB	NB	SB
HCM Control Delay, s	21.2	0	0
HCM LOS	C		

Minor Lane/Major Mvmt	NBT	NBRWBLn1	SBT
Capacity (veh/h)	-	267	-
HCM Lane V/C Ratio	-	0.168	-
HCM Control Delay (s)	-	21.2	-
HCM Lane LOS	-	C	-
HCM 95th %tile Q(veh)	-	0.6	-

HCM 6th TWSC
2: Cottonwood Grove & Fontaine Blvd

Existing
PM

Intersection												
Int Delay, s/veh	0.6											
Movement	EBL	EBT	EBR	WBL	WBT	WBR	NBL	NBT	NBR	SBL	SBT	SBR
Lane Configurations		↕	↕		↕	↕		↕			↕	
Traffic Vol, veh/h	12	380	8	7	265	5	5	0	3	3	0	6
Future Vol, veh/h	12	380	8	7	265	5	5	0	3	3	0	6
Conflicting Peds, #/hr	0	0	0	0	0	0	0	0	0	0	0	0
Sign Control	Free	Free	Free	Free	Free	Free	Stop	Stop	Stop	Stop	Stop	Stop
RT Channelized	-	-	None	-	-	None	-	-	None	-	-	Stop
Storage Length	-	-	155	-	-	0	-	-	-	-	-	-
Veh in Median Storage, #	-	0	-	-	0	-	-	0	-	-	0	-
Grade, %	-	0	-	-	0	-	-	0	-	-	0	-
Peak Hour Factor	92	92	92	92	92	92	78	78	78	78	78	78
Heavy Vehicles, %	2	2	2	2	2	2	2	2	2	2	2	2
Mvmt Flow	13	413	9	8	288	5	6	0	4	4	0	8

Major/Minor	Major1			Major2			Minor1			Minor2		
Conflicting Flow All	293	0	0	422	0	0	746	748	413	750	752	288
Stage 1	-	-	-	-	-	-	439	439	-	304	304	-
Stage 2	-	-	-	-	-	-	307	309	-	446	448	-
Critical Hdwy	4.12	-	-	4.12	-	-	7.12	6.52	6.22	7.12	6.52	6.22
Critical Hdwy Stg 1	-	-	-	-	-	-	6.12	5.52	-	6.12	5.52	-
Critical Hdwy Stg 2	-	-	-	-	-	-	6.12	5.52	-	6.12	5.52	-
Follow-up Hdwy	2.218	-	-	2.218	-	-	3.518	4.018	3.318	3.518	4.018	3.318
Pot Cap-1 Maneuver	1269	-	-	1137	-	-	330	341	639	328	339	751
Stage 1	-	-	-	-	-	-	597	578	-	705	663	-
Stage 2	-	-	-	-	-	-	703	660	-	591	573	-
Platoon blocked, %	-	-	-	-	-	-	-	-	-	-	-	-
Mov Cap-1 Maneuver	1269	-	-	1137	-	-	321	334	639	321	332	751
Mov Cap-2 Maneuver	-	-	-	-	-	-	321	334	-	321	332	-
Stage 1	-	-	-	-	-	-	589	570	-	696	658	-
Stage 2	-	-	-	-	-	-	690	655	-	580	566	-

Approach	EB			WB			NB			SB		
HCM Control Delay, s	0.2			0.2			14.4			12.1		
HCM LOS							B			B		

Minor Lane/Major Mvmt	NBLn1	EBL	EBT	EBR	WBL	WBT	WBR	SBLn1
Capacity (veh/h)	395	1269	-	-	1137	-	-	519
HCM Lane V/C Ratio	0.026	0.01	-	-	0.007	-	-	0.022
HCM Control Delay (s)	14.4	7.9	0	-	8.2	0	-	12.1
HCM Lane LOS	B	A	A	-	A	A	-	B
HCM 95th %tile Q(veh)	0.1	0	-	-	0	-	-	0.1

HCM 6th TWSC
3: Fontaine Blvd & Sleepy Meadows Dr

Existing
PM

Intersection						
Int Delay, s/veh	0.3					
Movement	EBL	EBT	WBT	WBR	SBL	SBR
Lane Configurations		↔	↑	↔		↔
Traffic Vol, veh/h	19	400	272	4	2	4
Future Vol, veh/h	19	400	272	4	2	4
Conflicting Peds, #/hr	0	0	0	0	0	0
Sign Control	Free	Free	Free	Free	Stop	Stop
RT Channelized	-	None	-	None	-	Stop
Storage Length	-	-	-	185	-	0
Veh in Median Storage, #	-	0	0	-	0	-
Grade, %	-	0	0	-	0	-
Peak Hour Factor	92	92	92	92	78	78
Heavy Vehicles, %	2	2	2	2	2	2
Mvmt Flow	21	435	296	4	3	5

Major/Minor	Major1	Major2	Minor2		
Conflicting Flow All	300	0	-	0	773
Stage 1	-	-	-	-	296
Stage 2	-	-	-	-	477
Critical Hdwy	4.12	-	-	-	6.42
Critical Hdwy Stg 1	-	-	-	-	5.42
Critical Hdwy Stg 2	-	-	-	-	5.42
Follow-up Hdwy	2.218	-	-	-	3.518
Pot Cap-1 Maneuver	1261	-	-	-	367
Stage 1	-	-	-	-	755
Stage 2	-	-	-	-	624
Platoon blocked, %		-	-	-	
Mov Cap-1 Maneuver	1261	-	-	-	359
Mov Cap-2 Maneuver	-	-	-	-	359
Stage 1	-	-	-	-	738
Stage 2	-	-	-	-	624

Approach	EB	WB	SB
HCM Control Delay, s	0.4	0	9.9
HCM LOS			A

Minor Lane/Major Mvmt	EBL	EBT	WBT	WBR	SBLn1
Capacity (veh/h)	1261	-	-	-	743
HCM Lane V/C Ratio	0.016	-	-	-	0.007
HCM Control Delay (s)	7.9	0	-	-	9.9
HCM Lane LOS	A	A	-	-	A
HCM 95th %tile Q(veh)	0.1	-	-	-	0

HCM 6th TWSC
 4: Marksheffel & Peaceful Ridge/Cider Mill

Existing
 PM

Intersection												
Int Delay, s/veh	0.2											
Movement	EBL	EBT	EBR	WBL	WBT	WBR	NBL	NBT	NBR	SBL	SBT	SBR
Lane Configurations						↗		↖	↗		↖	
Traffic Vol, veh/h	0	0	0	0	0	20	0	475	50	0	800	0
Future Vol, veh/h	0	0	0	0	0	20	0	475	50	0	800	0
Conflicting Peds, #/hr	0	0	0	0	0	0	0	0	0	0	0	0
Sign Control	Stop	Stop	Stop	Stop	Stop	Stop	Free	Free	Free	Free	Free	Free
RT Channelized	-	-	None	-	-	None	-	-	None	-	-	None
Storage Length	-	-	-	-	-	0	-	-	280	-	-	-
Veh in Median Storage, #	-	1	-	-	0	-	-	0	-	-	0	-
Grade, %	-	0	-	-	0	-	-	0	-	-	0	-
Peak Hour Factor	92	92	92	78	78	78	92	92	92	93	93	93
Heavy Vehicles, %	2	2	2	2	2	2	2	2	2	2	2	2
Mvmt Flow	0	0	0	0	0	26	0	516	54	0	860	0













Major/Minor	Minor1	Major1	Major2
Conflicting Flow All	-	- 516	- 0 0
Stage 1	-	-	-
Stage 2	-	-	-
Critical Hdwy	-	- 6.22	-
Critical Hdwy Stg 1	-	-	-
Critical Hdwy Stg 2	-	-	-
Follow-up Hdwy	-	- 3.318	-
Pot Cap-1 Maneuver	0	0 559	0 - - 0 - 0
Stage 1	0	0 -	0 - - 0 - 0
Stage 2	0	0 -	0 - - 0 - 0
Platoon blocked, %			- - -
Mov Cap-1 Maneuver	-	0 559	- - - - -
Mov Cap-2 Maneuver	-	0 -	- - - - -
Stage 1	-	0 -	- - - - -
Stage 2	-	0 -	- - - - -

Approach	WB	NB	SB
HCM Control Delay, s	11.7	0	0
HCM LOS	B		

Minor Lane/Major Mvmt	NBT	NBRWBLn1	SBT
Capacity (veh/h)	-	- 559	-
HCM Lane V/C Ratio	-	- 0.046	-
HCM Control Delay (s)	-	- 11.7	-
HCM Lane LOS	-	- B	-
HCM 95th %tile Q(veh)	-	- 0.1	-

Lanes, Volumes, Timings
18: Bradley Ridge & Marksheffel

Short-Term Baseline
AM

						
Lane Group	SET	SER	NWL	NWT	NEL	NER
Lane Configurations						
Traffic Volume (vph)	390	15	5	1080	45	10
Future Volume (vph)	390	15	5	1080	45	10
Ideal Flow (vphpl)	1900	1900	1900	1900	1900	1900
Storage Length (ft)		280	280		155	0
Storage Lanes		1	1		1	1
Taper Length (ft)			240		160	
Lane Util. Factor	1.00	1.00	1.00	1.00	1.00	1.00
Frt		0.850				0.850
Flt Protected			0.950		0.950	
Satd. Flow (prot)	1863	1583	1770	1863	1770	1583
Flt Permitted			0.515		0.950	
Satd. Flow (perm)	1863	1583	959	1863	1770	1583
Right Turn on Red		Yes				Yes
Satd. Flow (RTOR)		16				11
Link Speed (mph)	55			55	25	
Link Distance (ft)	646			961	618	
Travel Time (s)	8.0			11.9	16.9	
Peak Hour Factor	0.92	0.92	0.92	0.92	0.92	0.92
Adj. Flow (vph)	424	16	5	1174	49	11
Shared Lane Traffic (%)						
Lane Group Flow (vph)	424	16	5	1174	49	11
Enter Blocked Intersection	No	No	No	No	No	No
Lane Alignment	Left	Right	Left	Left	Left	Right
Median Width(ft)	12			12	12	
Link Offset(ft)	0			0	0	
Crosswalk Width(ft)	16			16	16	
Two way Left Turn Lane						
Headway Factor	1.00	1.00	1.00	1.00	1.00	1.00
Turning Speed (mph)		9	15		15	9
Number of Detectors	2	1	1	2	1	1
Detector Template	Thru	Right	Left	Thru	Left	Right
Leading Detector (ft)	100	20	20	100	20	20
Trailing Detector (ft)	0	0	0	0	0	0
Detector 1 Position(ft)	0	0	0	0	0	0
Detector 1 Size(ft)	6	20	20	6	20	20
Detector 1 Type	Cl+Ex	Cl+Ex	Cl+Ex	Cl+Ex	Cl+Ex	Cl+Ex
Detector 1 Channel						
Detector 1 Extend (s)	0.0	0.0	0.0	0.0	0.0	0.0
Detector 1 Queue (s)	0.0	0.0	0.0	0.0	0.0	0.0
Detector 1 Delay (s)	0.0	0.0	0.0	0.0	0.0	0.0
Detector 2 Position(ft)	94			94		
Detector 2 Size(ft)	6			6		
Detector 2 Type	Cl+Ex			Cl+Ex		
Detector 2 Channel						
Detector 2 Extend (s)	0.0			0.0		
Turn Type	NA	Perm	Perm	NA	Prot	Perm
Protected Phases	6			2	4	
Permitted Phases		6	2			4

Lanes, Volumes, Timings
18: Bradley Ridge & Marksheffel

Short-Term Baseline
AM



Lane Group	SET	SER	NWL	NWT	NEL	NER
Detector Phase	6	6	2	2	4	4
Switch Phase						
Minimum Initial (s)	5.0	5.0	5.0	5.0	5.0	5.0
Minimum Split (s)	22.5	22.5	22.5	22.5	22.5	22.5
Total Split (s)	44.0	44.0	44.0	44.0	16.0	16.0
Total Split (%)	73.3%	73.3%	73.3%	73.3%	26.7%	26.7%
Maximum Green (s)	39.5	39.5	39.5	39.5	11.5	11.5
Yellow Time (s)	3.5	3.5	3.5	3.5	3.5	3.5
All-Red Time (s)	1.0	1.0	1.0	1.0	1.0	1.0
Lost Time Adjust (s)	0.0	0.0	0.0	0.0	0.0	0.0
Total Lost Time (s)	4.5	4.5	4.5	4.5	4.5	4.5
Lead/Lag						
Lead-Lag Optimize?						
Vehicle Extension (s)	3.0	3.0	3.0	3.0	3.0	3.0
Recall Mode	Max	Max	Max	Max	None	None
Walk Time (s)	7.0	7.0	7.0	7.0	7.0	7.0
Flash Dont Walk (s)	11.0	11.0	11.0	11.0	11.0	11.0
Pedestrian Calls (#/hr)	0	0	0	0	0	0
Act Effct Green (s)	53.8	53.8	53.8	53.8	7.3	7.3
Actuated g/C Ratio	0.84	0.84	0.84	0.84	0.11	0.11
v/c Ratio	0.27	0.01	0.01	0.75	0.24	0.06
Control Delay	2.8	1.4	2.6	10.1	28.7	14.4
Queue Delay	0.0	0.0	0.0	0.0	0.0	0.0
Total Delay	2.8	1.4	2.6	10.1	28.7	14.4
LOS	A	A	A	B	C	B
Approach Delay	2.8			10.1	26.1	
Approach LOS	A			B	C	
Queue Length 50th (ft)	40	0	1	228	20	0
Queue Length 95th (ft)	79	4	3	#631	42	12
Internal Link Dist (ft)	566			881	538	
Turn Bay Length (ft)		280	280		155	
Base Capacity (vph)	1572	1338	809	1572	321	295
Starvation Cap Reductn	0	0	0	0	0	0
Spillback Cap Reductn	0	0	0	0	0	0
Storage Cap Reductn	0	0	0	0	0	0
Reduced v/c Ratio	0.27	0.01	0.01	0.75	0.15	0.04

Intersection Summary

Area Type:	Other
Cycle Length:	60
Actuated Cycle Length:	63.8
Natural Cycle:	90
Control Type:	Actuated-Uncoordinated
Maximum v/c Ratio:	0.75
Intersection Signal Delay:	8.7
Intersection LOS:	A
Intersection Capacity Utilization:	68.5%
ICU Level of Service:	C
Analysis Period (min):	15
# 95th percentile volume exceeds capacity, queue may be longer. Queue shown is maximum after two cycles.	

Splits and Phases: 18: Bradley Ridge & Marksheffel

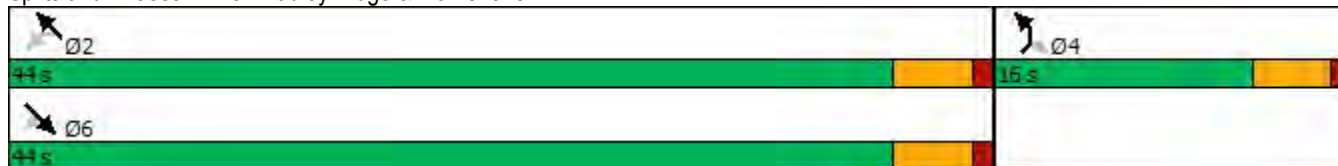

Intersection												
Int Delay, s/veh	0.9											
Movement	EBL	EBT	EBR	WBL	WBT	WBR	NBL	NBT	NBR	SBL	SBT	SBR
Lane Configurations		↕	↕		↕	↕		↕			↕	
Traffic Vol, veh/h	5	200	5	2	400	2	5	1	5	5	1	20
Future Vol, veh/h	5	200	5	2	400	2	5	1	5	5	1	20
Conflicting Peds, #/hr	0	0	0	0	0	0	0	0	0	0	0	0
Sign Control	Free	Free	Free	Free	Free	Free	Stop	Stop	Stop	Stop	Stop	Stop
RT Channelized	-	-	None	-	-	None	-	-	None	-	-	Stop
Storage Length	-	-	155	-	-	0	-	-	-	-	-	-
Veh in Median Storage, #	-	0	-	-	0	-	-	0	-	-	0	-
Grade, %	-	0	-	-	0	-	-	0	-	-	0	-
Peak Hour Factor	87	87	87	92	92	92	78	78	78	78	78	78
Heavy Vehicles, %	2	2	2	2	2	2	2	2	2	2	2	2
Mvmt Flow	6	230	6	2	435	2	6	1	6	6	1	26

Major/Minor	Major1			Major2			Minor1			Minor2		
Conflicting Flow All	437	0	0	236	0	0	683	683	230	688	687	435
Stage 1	-	-	-	-	-	-	242	242	-	439	439	-
Stage 2	-	-	-	-	-	-	441	441	-	249	248	-
Critical Hdwy	4.12	-	-	4.12	-	-	7.12	6.52	6.22	7.12	6.52	6.22
Critical Hdwy Stg 1	-	-	-	-	-	-	6.12	5.52	-	6.12	5.52	-
Critical Hdwy Stg 2	-	-	-	-	-	-	6.12	5.52	-	6.12	5.52	-
Follow-up Hdwy	2.218	-	-	2.218	-	-	3.518	4.018	3.318	3.518	4.018	3.318
Pot Cap-1 Maneuver	1123	-	-	1331	-	-	363	372	809	360	370	621
Stage 1	-	-	-	-	-	-	762	705	-	597	578	-
Stage 2	-	-	-	-	-	-	595	577	-	755	701	-
Platoon blocked, %	-	-	-	-	-	-	-	-	-	-	-	-
Mov Cap-1 Maneuver	1123	-	-	1331	-	-	345	369	809	354	367	621
Mov Cap-2 Maneuver	-	-	-	-	-	-	345	369	-	354	367	-
Stage 1	-	-	-	-	-	-	757	701	-	593	577	-
Stage 2	-	-	-	-	-	-	568	576	-	743	697	-

Approach	EB			WB			NB			SB		
HCM Control Delay, s	0.2			0			12.9			12.2		
HCM LOS							B			B		

Minor Lane/Major Mvmt	NBLn1	EBL	EBT	EBR	WBL	WBT	WBR	SBLn1
Capacity (veh/h)	470	1123	-	-	1331	-	-	530
HCM Lane V/C Ratio	0.03	0.005	-	-	0.002	-	-	0.063
HCM Control Delay (s)	12.9	8.2	0	-	7.7	0	-	12.2
HCM Lane LOS	B	A	A	-	A	A	-	B
HCM 95th %tile Q(veh)	0.1	0	-	-	0	-	-	0.2

Intersection						
Int Delay, s/veh	0.6					
Movement	EBL	EBT	WBT	WBR	SBL	SBR
Lane Configurations		↔	↔	↔		↔
Traffic Vol, veh/h	10	210	420	5	5	20
Future Vol, veh/h	10	210	420	5	5	20
Conflicting Peds, #/hr	0	0	0	0	0	0
Sign Control	Free	Free	Free	Free	Stop	Stop
RT Channelized	-	None	-	None	-	Stop
Storage Length	-	-	-	185	-	0
Veh in Median Storage, #	-	0	0	-	0	-
Grade, %	-	0	0	-	0	-
Peak Hour Factor	87	87	92	92	78	78
Heavy Vehicles, %	2	2	2	2	2	2
Mvmt Flow	11	241	457	5	6	26

Major/Minor	Major1	Major2	Minor2		
Conflicting Flow All	462	0	-	0	720 457
Stage 1	-	-	-	-	457 -
Stage 2	-	-	-	-	263 -
Critical Hdwy	4.12	-	-	-	6.42 6.22
Critical Hdwy Stg 1	-	-	-	-	5.42 -
Critical Hdwy Stg 2	-	-	-	-	5.42 -
Follow-up Hdwy	2.218	-	-	-	3.518 3.318
Pot Cap-1 Maneuver	1099	-	-	-	395 604
Stage 1	-	-	-	-	638 -
Stage 2	-	-	-	-	781 -
Platoon blocked, %		-	-	-	
Mov Cap-1 Maneuver	1099	-	-	-	390 604
Mov Cap-2 Maneuver	-	-	-	-	390 -
Stage 1	-	-	-	-	630 -
Stage 2	-	-	-	-	781 -

Approach	EB	WB	SB
HCM Control Delay, s	0.4	0	11.2
HCM LOS			B

Minor Lane/Major Mvmt	EBL	EBT	WBT	WBR	SBLn1
Capacity (veh/h)	1099	-	-	-	604
HCM Lane V/C Ratio	0.01	-	-	-	0.042
HCM Control Delay (s)	8.3	0	-	-	11.2
HCM Lane LOS	A	A	-	-	B
HCM 95th %tile Q(veh)	0	-	-	-	0.1

Intersection												
Int Delay, s/veh	0.5											
Movement	EBL	EBT	EBR	WBL	WBT	WBR	NBL	NBT	NBR	SBL	SBT	SBR
Lane Configurations			↗			↗		↖	↗		↖	↗
Traffic Vol, veh/h	0	0	0	0	0	35	0	1050	15	0	400	0
Future Vol, veh/h	0	0	0	0	0	35	0	1050	15	0	400	0
Conflicting Peds, #/hr	0	0	0	0	0	0	0	0	0	0	0	0
Sign Control	Stop	Stop	Stop	Stop	Stop	Stop	Free	Free	Free	Free	Free	Free
RT Channelized	-	-	None	-	-	None	-	-	None	-	-	None
Storage Length	-	-	0	-	-	0	-	-	280	-	-	280
Veh in Median Storage, #	-	0	-	-	0	-	-	0	-	-	0	-
Grade, %	-	0	-	-	0	-	-	0	-	-	0	-
Peak Hour Factor	92	92	92	92	92	92	95	95	95	92	92	92
Heavy Vehicles, %	2	2	2	2	2	2	2	2	2	2	2	2
Mvmt Flow	0	0	0	0	0	38	0	1105	16	0	435	0













Major/Minor	Minor2		Minor1		Major1		Major2					
Conflicting Flow All	-	-	435	-	-	1105	-	0	0	-	-	0
Stage 1	-	-	-	-	-	-	-	-	-	-	-	-
Stage 2	-	-	-	-	-	-	-	-	-	-	-	-
Critical Hdwy	-	-	6.22	-	-	6.22	-	-	-	-	-	-
Critical Hdwy Stg 1	-	-	-	-	-	-	-	-	-	-	-	-
Critical Hdwy Stg 2	-	-	-	-	-	-	-	-	-	-	-	-
Follow-up Hdwy	-	-	3.318	-	-	3.318	-	-	-	-	-	-
Pot Cap-1 Maneuver	0	0	621	0	0	256	0	-	-	0	-	-
Stage 1	0	0	-	0	0	-	0	-	-	0	-	-
Stage 2	0	0	-	0	0	-	0	-	-	0	-	-
Platoon blocked, %	-	-	-	-	-	-	-	-	-	-	-	-
Mov Cap-1 Maneuver	-	-	621	-	-	256	-	-	-	-	-	-
Mov Cap-2 Maneuver	-	-	-	-	-	-	-	-	-	-	-	-
Stage 1	-	-	-	-	-	-	-	-	-	-	-	-
Stage 2	-	-	-	-	-	-	-	-	-	-	-	-

Approach	EB	WB	NB	SB
HCM Control Delay, s	0	21.5	0	0
HCM LOS	A	C		

Minor Lane/Major Mvmt	NBT	NBR	EBLn1WBLn1	SBT	SBR
Capacity (veh/h)	-	-	-	256	-
HCM Lane V/C Ratio	-	-	-	0.149	-
HCM Control Delay (s)	-	-	0	21.5	-
HCM Lane LOS	-	-	A	C	-
HCM 95th %tile Q(veh)	-	-	-	0.5	-

Lanes, Volumes, Timings
18: Bradley Ridge

Short-Term Baseline
PM

						
Lane Group	SET	SER	NWL	NWT	NEL	NER
Lane Configurations						
Traffic Volume (vph)	870	50	10	510	30	5
Future Volume (vph)	870	50	10	510	30	5
Ideal Flow (vphpl)	1900	1900	1900	1900	1900	1900
Storage Length (ft)		280	280		155	0
Storage Lanes		1	0		1	1
Taper Length (ft)			240		160	
Lane Util. Factor	1.00	1.00	1.00	1.00	1.00	1.00
Frt		0.850				0.850
Flt Protected			0.950		0.950	
Satd. Flow (prot)	1863	1583	1770	1863	1770	1583
Flt Permitted			0.255		0.950	
Satd. Flow (perm)	1863	1583	475	1863	1770	1583
Right Turn on Red		Yes				Yes
Satd. Flow (RTOR)		54				6
Link Speed (mph)	30			30	30	
Link Distance (ft)	535			956	728	
Travel Time (s)	12.2			21.7	16.5	
Peak Hour Factor	0.93	0.93	0.92	0.92	0.78	0.78
Adj. Flow (vph)	935	54	11	554	38	6
Shared Lane Traffic (%)						
Lane Group Flow (vph)	935	54	11	554	38	6
Enter Blocked Intersection	No	No	No	No	No	No
Lane Alignment	Left	Right	Left	Left	Left	Right
Median Width(ft)	12			12	12	
Link Offset(ft)	0			0	0	
Crosswalk Width(ft)	16			16	16	
Two way Left Turn Lane						
Headway Factor	1.00	1.00	1.00	1.00	1.00	1.00
Turning Speed (mph)		9	15		15	9
Number of Detectors	2	1	1	2	1	1
Detector Template	Thru	Right	Left	Thru	Left	Right
Leading Detector (ft)	100	20	20	100	20	20
Trailing Detector (ft)	0	0	0	0	0	0
Detector 1 Position(ft)	0	0	0	0	0	0
Detector 1 Size(ft)	6	20	20	6	20	20
Detector 1 Type	Cl+Ex	Cl+Ex	Cl+Ex	Cl+Ex	Cl+Ex	Cl+Ex
Detector 1 Channel						
Detector 1 Extend (s)	0.0	0.0	0.0	0.0	0.0	0.0
Detector 1 Queue (s)	0.0	0.0	0.0	0.0	0.0	0.0
Detector 1 Delay (s)	0.0	0.0	0.0	0.0	0.0	0.0
Detector 2 Position(ft)	94			94		
Detector 2 Size(ft)	6			6		
Detector 2 Type	Cl+Ex			Cl+Ex		
Detector 2 Channel						
Detector 2 Extend (s)	0.0			0.0		
Turn Type	NA	Perm	Perm	NA	Prot	Perm
Protected Phases	6			2	4	
Permitted Phases		6	2			4

Lanes, Volumes, Timings
18: Bradley Ridge

Short-Term Baseline
PM



Lane Group	SET	SER	NWL	NWT	NEL	NER
Detector Phase	6	6	2	2	4	4
Switch Phase						
Minimum Initial (s)	5.0	5.0	5.0	5.0	5.0	5.0
Minimum Split (s)	22.5	22.5	22.5	22.5	22.5	22.5
Total Split (s)	44.0	44.0	44.0	44.0	16.0	16.0
Total Split (%)	73.3%	73.3%	73.3%	73.3%	26.7%	26.7%
Maximum Green (s)	39.5	39.5	39.5	39.5	11.5	11.5
Yellow Time (s)	3.5	3.5	3.5	3.5	3.5	3.5
All-Red Time (s)	1.0	1.0	1.0	1.0	1.0	1.0
Lost Time Adjust (s)	0.0	0.0	0.0	0.0	0.0	0.0
Total Lost Time (s)	4.5	4.5	4.5	4.5	4.5	4.5
Lead/Lag						
Lead-Lag Optimize?						
Vehicle Extension (s)	3.0	3.0	3.0	3.0	3.0	3.0
Recall Mode	Min	Min	Min	Min	None	None
Walk Time (s)	7.0	7.0	7.0	7.0	7.0	7.0
Flash Dont Walk (s)	11.0	11.0	11.0	11.0	11.0	11.0
Pedestrian Calls (#/hr)	0	0	0	0	0	0
Act Effct Green (s)	42.5	42.5	42.5	42.5	7.4	7.4
Actuated g/C Ratio	0.90	0.90	0.90	0.90	0.16	0.16
v/c Ratio	0.56	0.04	0.03	0.33	0.14	0.02
Control Delay	4.4	0.9	2.2	2.5	24.8	16.6
Queue Delay	0.0	0.0	0.0	0.0	0.0	0.0
Total Delay	4.4	0.9	2.2	2.5	24.8	16.6
LOS	A	A	A	A	C	B
Approach Delay	4.2			2.5	23.7	
Approach LOS	A			A	C	
Queue Length 50th (ft)	0	0	0	0	7	0
Queue Length 95th (ft)	266	7	4	106	33	8
Internal Link Dist (ft)	455			876	648	
Turn Bay Length (ft)		280	280		155	
Base Capacity (vph)	1670	1425	426	1670	483	436
Starvation Cap Reductn	0	0	0	0	0	0
Spillback Cap Reductn	0	0	0	0	0	0
Storage Cap Reductn	0	0	0	0	0	0
Reduced v/c Ratio	0.56	0.04	0.03	0.33	0.08	0.01

Intersection Summary

Area Type:	Other
Cycle Length:	60
Actuated Cycle Length:	47.4
Natural Cycle:	65
Control Type:	Actuated-Uncoordinated
Maximum v/c Ratio:	0.56
Intersection Signal Delay:	4.1
Intersection LOS:	A
Intersection Capacity Utilization:	57.5%
ICU Level of Service:	B
Analysis Period (min):	15

Splits and Phases: 18: Bradley Ridge

 Ø2	 Ø4
44 s	15 s
 Ø6	
44 s	

Intersection												
Int Delay, s/veh	0.8											
Movement	EBL	EBT	EBR	WBL	WBT	WBR	NBL	NBT	NBR	SBL	SBT	SBR
Lane Configurations		↕	↗		↕	↗		↕			↕	
Traffic Vol, veh/h	15	450	10	10	300	5	5	1	5	3	1	10
Future Vol, veh/h	15	450	10	10	300	5	5	1	5	3	1	10
Conflicting Peds, #/hr	0	0	0	0	0	0	0	0	0	0	0	0
Sign Control	Free	Free	Free	Free	Free	Free	Stop	Stop	Stop	Stop	Stop	Stop
RT Channelized	-	-	None	-	-	None	-	-	None	-	-	Stop
Storage Length	-	-	155	-	-	0	-	-	-	-	-	-
Veh in Median Storage, #	-	0	-	-	0	-	-	0	-	-	0	-
Grade, %	-	0	-	-	0	-	-	0	-	-	0	-
Peak Hour Factor	92	92	92	92	92	92	78	78	78	78	78	78
Heavy Vehicles, %	2	2	2	2	2	2	2	2	2	2	2	2
Mvmt Flow	16	489	11	11	326	5	6	1	6	4	1	13

Major/Minor	Major1			Major2			Minor1			Minor2		
Conflicting Flow All	331	0	0	500	0	0	872	874	489	878	880	326
Stage 1	-	-	-	-	-	-	521	521	-	348	348	-
Stage 2	-	-	-	-	-	-	351	353	-	530	532	-
Critical Hdwy	4.12	-	-	4.12	-	-	7.12	6.52	6.22	7.12	6.52	6.22
Critical Hdwy Stg 1	-	-	-	-	-	-	6.12	5.52	-	6.12	5.52	-
Critical Hdwy Stg 2	-	-	-	-	-	-	6.12	5.52	-	6.12	5.52	-
Follow-up Hdwy	2.218	-	-	2.218	-	-	3.518	4.018	3.318	3.518	4.018	3.318
Pot Cap-1 Maneuver	1228	-	-	1064	-	-	271	288	579	268	286	715
Stage 1	-	-	-	-	-	-	539	532	-	668	634	-
Stage 2	-	-	-	-	-	-	666	631	-	533	526	-
Platoon blocked, %	-	-	-	-	-	-	-	-	-	-	-	-
Mov Cap-1 Maneuver	1228	-	-	1064	-	-	259	279	579	258	277	715
Mov Cap-2 Maneuver	-	-	-	-	-	-	259	279	-	258	277	-
Stage 1	-	-	-	-	-	-	529	522	-	656	626	-
Stage 2	-	-	-	-	-	-	644	623	-	516	517	-

Approach	EB			WB			NB			SB		
HCM Control Delay, s	0.3			0.3			15.7			12.8		
HCM LOS							C			B		

Minor Lane/Major Mvmt	NBLn1	EBL	EBT	EBR	WBL	WBT	WBR	SBLn1
Capacity (veh/h)	349	1228	-	-	1064	-	-	479
HCM Lane V/C Ratio	0.04	0.013	-	-	0.01	-	-	0.037
HCM Control Delay (s)	15.7	8	0	-	8.4	0	-	12.8
HCM Lane LOS	C	A	A	-	A	A	-	B
HCM 95th %tile Q(veh)	0.1	0	-	-	0	-	-	0.1

Intersection						
Int Delay, s/veh	0.3					
Movement	EBL	EBT	WBT	WBR	SBL	SBR
Lane Configurations		↕	↕	↕		↕
Traffic Vol, veh/h	20	475	310	5	5	5
Future Vol, veh/h	20	475	310	5	5	5
Conflicting Peds, #/hr	0	0	0	0	0	0
Sign Control	Free	Free	Free	Free	Stop	Stop
RT Channelized	-	None	-	None	-	Stop
Storage Length	-	-	-	185	-	0
Veh in Median Storage, #	-	0	0	-	0	-
Grade, %	-	0	0	-	0	-
Peak Hour Factor	92	92	92	92	78	78
Heavy Vehicles, %	2	2	2	2	2	2
Mvmt Flow	22	516	337	5	6	6

Major/Minor	Major1	Major2	Minor2		
Conflicting Flow All	342	0	0	897	337
Stage 1	-	-	-	337	-
Stage 2	-	-	-	560	-
Critical Hdwy	4.12	-	-	6.42	6.22
Critical Hdwy Stg 1	-	-	-	5.42	-
Critical Hdwy Stg 2	-	-	-	5.42	-
Follow-up Hdwy	2.218	-	-	3.518	3.318
Pot Cap-1 Maneuver	1217	-	-	310	705
Stage 1	-	-	-	723	-
Stage 2	-	-	-	572	-
Platoon blocked, %	-	-	-	-	-
Mov Cap-1 Maneuver	1217	-	-	302	705
Mov Cap-2 Maneuver	-	-	-	302	-
Stage 1	-	-	-	705	-
Stage 2	-	-	-	572	-

Approach	EB	WB	SB
HCM Control Delay, s	0.3	0	10.2
HCM LOS			B

Minor Lane/Major Mvmt	EBL	EBT	WBT	WBR	SBLn1
Capacity (veh/h)	1217	-	-	-	705
HCM Lane V/C Ratio	0.018	-	-	-	0.009
HCM Control Delay (s)	8	0	-	-	10.2
HCM Lane LOS	A	A	-	-	B
HCM 95th %tile Q(veh)	0.1	-	-	-	0

Intersection												
Int Delay, s/veh	0.2											
Movement	EBL	EBT	EBR	WBL	WBT	WBR	NBL	NBT	NBR	SBL	SBT	SBR
Lane Configurations						↗		↖	↗		↖	
Traffic Vol, veh/h	0	0	0	0	0	20	0	500	50	0	875	0
Future Vol, veh/h	0	0	0	0	0	20	0	500	50	0	875	0
Conflicting Peds, #/hr	0	0	0	0	0	0	0	0	0	0	0	0
Sign Control	Stop	Stop	Stop	Stop	Stop	Stop	Free	Free	Free	Free	Free	Free
RT Channelized	-	-	None	-	-	None	-	-	None	-	-	None
Storage Length	-	-	-	-	-	0	-	-	280	-	-	-
Veh in Median Storage, #	-	1	-	-	0	-	-	0	-	-	0	-
Grade, %	-	0	-	-	0	-	-	0	-	-	0	-
Peak Hour Factor	92	92	92	92	92	92	92	92	92	92	93	93
Heavy Vehicles, %	2	2	2	2	2	2	2	2	2	2	2	2
Mvmt Flow	0	0	0	0	0	22	0	543	54	0	941	0













Major/Minor	Minor1	Major1	Major2
Conflicting Flow All	-	- 543	- 0 0
Stage 1	-	-	-
Stage 2	-	-	-
Critical Hdwy	-	- 6.22	-
Critical Hdwy Stg 1	-	-	-
Critical Hdwy Stg 2	-	-	-
Follow-up Hdwy	-	- 3.318	-
Pot Cap-1 Maneuver	0	0 540	0 - - 0 - 0
Stage 1	0	0 -	0 - - 0 - 0
Stage 2	0	0 -	0 - - 0 - 0
Platoon blocked, %			- - -
Mov Cap-1 Maneuver	-	0 540	- - - - -
Mov Cap-2 Maneuver	-	0 -	- - - - -
Stage 1	-	0 -	- - - - -
Stage 2	-	0 -	- - - - -

Approach	WB	NB	SB
HCM Control Delay, s	11.9	0	0
HCM LOS	B		

Minor Lane/Major Mvmt	NBT	NBRWBLn1	SBT
Capacity (veh/h)	-	- 540	-
HCM Lane V/C Ratio	-	- 0.04	-
HCM Control Delay (s)	-	- 11.9	-
HCM Lane LOS	-	- B	-
HCM 95th %tile Q(veh)	-	- 0.1	-

Lanes, Volumes, Timings
18: Bradley Ridge & Marksheffel

Short-Term Baseline + Site
AM

						
Lane Group	SET	SER	NWL	NWT	NEL	NER
Lane Configurations						
Traffic Volume (vph)	390	19	5	1080	88	10
Future Volume (vph)	390	19	5	1080	88	10
Ideal Flow (vphpl)	1900	1900	1900	1900	1900	1900
Storage Length (ft)		280	280		155	0
Storage Lanes		1	1		1	1
Taper Length (ft)			240		160	
Lane Util. Factor	1.00	1.00	1.00	1.00	1.00	1.00
Frt		0.850				0.850
Flt Protected			0.950		0.950	
Satd. Flow (prot)	1863	1583	1770	1863	1770	1583
Flt Permitted			0.509		0.950	
Satd. Flow (perm)	1863	1583	948	1863	1770	1583
Right Turn on Red		Yes				Yes
Satd. Flow (RTOR)		21				12
Link Speed (mph)	55			55	25	
Link Distance (ft)	530			980	543	
Travel Time (s)	6.6			12.1	14.8	
Peak Hour Factor	0.92	0.92	0.95	0.95	0.83	0.83
Adj. Flow (vph)	424	21	5	1137	106	12
Shared Lane Traffic (%)						
Lane Group Flow (vph)	424	21	5	1137	106	12
Enter Blocked Intersection	No	No	No	No	No	No
Lane Alignment	Left	Right	Left	Left	Left	Right
Median Width(ft)	12			12	12	
Link Offset(ft)	0			0	0	
Crosswalk Width(ft)	16			16	16	
Two way Left Turn Lane						
Headway Factor	1.00	1.00	1.00	1.00	1.00	1.00
Turning Speed (mph)		9	15		15	9
Number of Detectors	2	1	1	2	1	1
Detector Template	Thru	Right	Left	Thru	Left	Right
Leading Detector (ft)	100	20	20	100	20	20
Trailing Detector (ft)	0	0	0	0	0	0
Detector 1 Position(ft)	0	0	0	0	0	0
Detector 1 Size(ft)	6	20	20	6	20	20
Detector 1 Type	Cl+Ex	Cl+Ex	Cl+Ex	Cl+Ex	Cl+Ex	Cl+Ex
Detector 1 Channel						
Detector 1 Extend (s)	0.0	0.0	0.0	0.0	0.0	0.0
Detector 1 Queue (s)	0.0	0.0	0.0	0.0	0.0	0.0
Detector 1 Delay (s)	0.0	0.0	0.0	0.0	0.0	0.0
Detector 2 Position(ft)	94			94		
Detector 2 Size(ft)	6			6		
Detector 2 Type	Cl+Ex			Cl+Ex		
Detector 2 Channel						
Detector 2 Extend (s)	0.0			0.0		
Turn Type	NA	Perm	Perm	NA	Prot	Perm
Protected Phases	6			2	4	
Permitted Phases		6	2			4

Lanes, Volumes, Timings
18: Bradley Ridge & Marksheffel

Short-Term Baseline + Site
AM



Lane Group	SET	SER	NWL	NWT	NEL	NER
Detector Phase	6	6	2	2	4	4
Switch Phase						
Minimum Initial (s)	5.0	5.0	5.0	5.0	5.0	5.0
Minimum Split (s)	22.5	22.5	22.5	22.5	22.5	22.5
Total Split (s)	45.0	45.0	45.0	45.0	15.0	15.0
Total Split (%)	75.0%	75.0%	75.0%	75.0%	25.0%	25.0%
Maximum Green (s)	40.5	40.5	40.5	40.5	10.5	10.5
Yellow Time (s)	3.5	3.5	3.5	3.5	3.5	3.5
All-Red Time (s)	1.0	1.0	1.0	1.0	1.0	1.0
Lost Time Adjust (s)	0.0	0.0	0.0	0.0	0.0	0.0
Total Lost Time (s)	4.5	4.5	4.5	4.5	4.5	4.5
Lead/Lag						
Lead-Lag Optimize?						
Vehicle Extension (s)	3.0	3.0	3.0	3.0	3.0	3.0
Recall Mode	Max	Max	Max	Max	None	None
Walk Time (s)	7.0	7.0	7.0	7.0	7.0	7.0
Flash Dont Walk (s)	11.0	11.0	11.0	11.0	11.0	11.0
Pedestrian Calls (#/hr)	0	0	0	0	0	0
Act Effct Green (s)	49.8	49.8	49.8	49.8	8.8	8.8
Actuated g/C Ratio	0.77	0.77	0.77	0.77	0.14	0.14
v/c Ratio	0.30	0.02	0.01	0.79	0.44	0.05
Control Delay	4.0	1.6	3.2	13.1	30.5	12.5
Queue Delay	0.0	0.0	0.0	0.0	0.0	0.0
Total Delay	4.0	1.6	3.2	13.1	30.5	12.5
LOS	A	A	A	B	C	B
Approach Delay	3.8			13.1	28.7	
Approach LOS	A			B	C	
Queue Length 50th (ft)	47	0	1	250	41	0
Queue Length 95th (ft)	87	5	3	#608	67	11
Internal Link Dist (ft)	450			900	463	
Turn Bay Length (ft)		280	280		155	
Base Capacity (vph)	1437	1226	731	1437	289	269
Starvation Cap Reductn	0	0	0	0	0	0
Spillback Cap Reductn	0	0	0	0	0	0
Storage Cap Reductn	0	0	0	0	0	0
Reduced v/c Ratio	0.30	0.02	0.01	0.79	0.37	0.04

Intersection Summary

Area Type:	Other
Cycle Length:	60
Actuated Cycle Length:	64.5
Natural Cycle:	80
Control Type:	Actuated-Uncoordinated
Maximum v/c Ratio:	0.79
Intersection Signal Delay:	11.7
Intersection LOS:	B
Intersection Capacity Utilization:	69.2%
ICU Level of Service:	C
Analysis Period (min):	15
# 95th percentile volume exceeds capacity, queue may be longer. Queue shown is maximum after two cycles.	

Splits and Phases: 18: Bradley Ridge & Marksheffel



Intersection												
Int Delay, s/veh	0.9											
Movement	EBL	EBT	EBR	WBL	WBT	WBR	NBL	NBT	NBR	SBL	SBT	SBR
Lane Configurations		↕	↕		↕	↕		↕			↕	
Traffic Vol, veh/h	5	210	5	2	422	2	5	1	5	5	1	20
Future Vol, veh/h	5	210	5	2	422	2	5	1	5	5	1	20
Conflicting Peds, #/hr	0	0	0	0	0	0	0	0	0	0	0	0
Sign Control	Free	Free	Free	Free	Free	Free	Stop	Stop	Stop	Stop	Stop	Stop
RT Channelized	-	-	None	-	-	None	-	-	None	-	-	Stop
Storage Length	-	-	155	-	-	0	-	-	-	-	-	-
Veh in Median Storage, #	-	0	-	-	0	-	-	0	-	-	0	-
Grade, %	-	0	-	-	0	-	-	0	-	-	0	-
Peak Hour Factor	87	87	87	92	92	92	78	78	78	78	78	78
Heavy Vehicles, %	2	2	2	2	2	2	2	2	2	2	2	2
Mvmt Flow	6	241	6	2	459	2	6	1	6	6	1	26

Major/Minor	Major1			Major2			Minor1			Minor2		
Conflicting Flow All	461	0	0	247	0	0	718	718	241	723	722	459
Stage 1	-	-	-	-	-	-	253	253	-	463	463	-
Stage 2	-	-	-	-	-	-	465	465	-	260	259	-
Critical Hdwy	4.12	-	-	4.12	-	-	7.12	6.52	6.22	7.12	6.52	6.22
Critical Hdwy Stg 1	-	-	-	-	-	-	6.12	5.52	-	6.12	5.52	-
Critical Hdwy Stg 2	-	-	-	-	-	-	6.12	5.52	-	6.12	5.52	-
Follow-up Hdwy	2.218	-	-	2.218	-	-	3.518	4.018	3.318	3.518	4.018	3.318
Pot Cap-1 Maneuver	1100	-	-	1319	-	-	344	355	798	342	353	602
Stage 1	-	-	-	-	-	-	751	698	-	579	564	-
Stage 2	-	-	-	-	-	-	578	563	-	745	694	-
Platoon blocked, %	-	-	-	-	-	-	-	-	-	-	-	-
Mov Cap-1 Maneuver	1100	-	-	1319	-	-	326	352	798	336	350	602
Mov Cap-2 Maneuver	-	-	-	-	-	-	326	352	-	336	350	-
Stage 1	-	-	-	-	-	-	746	694	-	576	563	-
Stage 2	-	-	-	-	-	-	551	562	-	733	690	-

Approach	EB			WB			NB			SB		
HCM Control Delay, s	0.2			0			13.3			12.6		
HCM LOS							B			B		

Minor Lane/Major Mvmt	NBLn1	EBL	EBT	EBR	WBL	WBT	WBR	SBLn1
Capacity (veh/h)	450	1100	-	-	1319	-	-	510
HCM Lane V/C Ratio	0.031	0.005	-	-	0.002	-	-	0.065
HCM Control Delay (s)	13.3	8.3	0	-	7.7	0	-	12.6
HCM Lane LOS	B	A	A	-	A	A	-	B
HCM 95th %tile Q(veh)	0.1	0	-	-	0	-	-	0.2

Intersection						
Int Delay, s/veh	2					
Movement	EBL	EBT	WBT	WBR	SBL	SBR
Lane Configurations	↘	↗	↗	↘	↘	↘
Traffic Vol, veh/h	37	210	433	14	13	71
Future Vol, veh/h	37	210	433	14	13	71
Conflicting Peds, #/hr	0	0	0	0	0	0
Sign Control	Free	Free	Free	Free	Stop	Stop
RT Channelized	-	None	-	None	-	Stop
Storage Length	155	-	-	185	0	-
Veh in Median Storage, #	-	0	0	-	0	-
Grade, %	-	0	0	-	0	-
Peak Hour Factor	92	92	92	92	83	83
Heavy Vehicles, %	2	2	2	2	2	2
Mvmt Flow	40	228	471	15	16	86

Major/Minor	Major1	Major2	Minor2		
Conflicting Flow All	486	0	-	0	779 471
Stage 1	-	-	-	-	471 -
Stage 2	-	-	-	-	308 -
Critical Hdwy	4.12	-	-	-	6.42 6.22
Critical Hdwy Stg 1	-	-	-	-	5.42 -
Critical Hdwy Stg 2	-	-	-	-	5.42 -
Follow-up Hdwy	2.218	-	-	-	3.518 3.318
Pot Cap-1 Maneuver	1077	-	-	-	364 593
Stage 1	-	-	-	-	628 -
Stage 2	-	-	-	-	745 -
Platoon blocked, %	-	-	-	-	-
Mov Cap-1 Maneuver	1077	-	-	-	351 593
Mov Cap-2 Maneuver	-	-	-	-	351 -
Stage 1	-	-	-	-	605 -
Stage 2	-	-	-	-	745 -

Approach	EB	WB	SB
HCM Control Delay, s	1.3	0	13.3
HCM LOS			B

Minor Lane/Major Mvmt	EBL	EBT	WBT	WBR	SBLn1
Capacity (veh/h)	1077	-	-	-	536
HCM Lane V/C Ratio	0.037	-	-	-	0.189
HCM Control Delay (s)	8.5	-	-	-	13.3
HCM Lane LOS	A	-	-	-	B
HCM 95th %tile Q(veh)	0.1	-	-	-	0.7

Intersection												
Int Delay, s/veh	0.8											
Movement	EBL	EBT	EBR	WBL	WBT	WBR	NBL	NBT	NBR	SBL	SBT	SBR
Lane Configurations			↗			↗		↖	↗		↖	↗
Traffic Vol, veh/h	0	0	31	0	0	35	0	1050	15	0	400	7
Future Vol, veh/h	0	0	31	0	0	35	0	1050	15	0	400	7
Conflicting Peds, #/hr	0	0	0	0	0	0	0	0	0	0	0	0
Sign Control	Stop	Stop	Stop	Stop	Stop	Stop	Free	Free	Free	Free	Free	Free
RT Channelized	-	-	None	-	-	None	-	-	None	-	-	None
Storage Length	-	-	0	-	-	0	-	-	280	-	-	280
Veh in Median Storage, #	-	0	-	-	0	-	-	0	-	-	0	-
Grade, %	-	0	-	-	0	-	-	0	-	-	0	-
Peak Hour Factor	78	78	78	92	92	92	95	95	95	92	92	92
Heavy Vehicles, %	2	2	2	2	2	2	2	2	2	2	2	2
Mvmt Flow	0	0	40	0	0	38	0	1105	16	0	435	8

Major/Minor	Minor2		Minor1		Major1		Major2					
Conflicting Flow All	-	-	435	-	-	1105	-	0	0	-	-	0
Stage 1	-	-	-	-	-	-	-	-	-	-	-	-
Stage 2	-	-	-	-	-	-	-	-	-	-	-	-
Critical Hdwy	-	-	6.22	-	-	6.22	-	-	-	-	-	-
Critical Hdwy Stg 1	-	-	-	-	-	-	-	-	-	-	-	-
Critical Hdwy Stg 2	-	-	-	-	-	-	-	-	-	-	-	-
Follow-up Hdwy	-	-	3.318	-	-	3.318	-	-	-	-	-	-
Pot Cap-1 Maneuver	0	0	621	0	0	256	0	-	-	0	-	-
Stage 1	0	0	-	0	0	-	0	-	-	0	-	-
Stage 2	0	0	-	0	0	-	0	-	-	0	-	-
Platoon blocked, %	-	-	-	-	-	-	-	-	-	-	-	-
Mov Cap-1 Maneuver	-	-	621	-	-	256	-	-	-	-	-	-
Mov Cap-2 Maneuver	-	-	-	-	-	-	-	-	-	-	-	-
Stage 1	-	-	-	-	-	-	-	-	-	-	-	-
Stage 2	-	-	-	-	-	-	-	-	-	-	-	-

Approach	EB		WB		NB		SB	
HCM Control Delay, s	11.2		21.5		0		0	
HCM LOS	B		C					

Minor Lane/Major Mvmt	NBT	NBR	EBLn1	WBLn1	SBT	SBR
Capacity (veh/h)	-	-	621	256	-	-
HCM Lane V/C Ratio	-	-	0.064	0.149	-	-
HCM Control Delay (s)	-	-	11.2	21.5	-	-
HCM Lane LOS	-	-	B	C	-	-
HCM 95th %tile Q(veh)	-	-	0.2	0.5	-	-

Intersection						
Int Delay, s/veh	0					
Movement	NWL	NWR	NET	NER	SWL	SWT
Lane Configurations						
Traffic Vol, veh/h	0	0	0	0	0	0
Future Vol, veh/h	0	0	0	0	0	0
Conflicting Peds, #/hr	0	0	0	0	0	0
Sign Control	Stop	Stop	Free	Free	Free	Free
RT Channelized	-	None	-	None	-	None
Storage Length	0	-	-	-	155	-
Veh in Median Storage, #	0	-	0	-	-	0
Grade, %	0	-	0	-	-	0
Peak Hour Factor	92	92	92	92	92	92
Heavy Vehicles, %	2	2	2	2	2	2
Mvmt Flow	0	0	0	0	0	0













Major/Minor	Minor1	Major1	Major2			
Conflicting Flow All	1	0	0	0	0	0
Stage 1	0	-	-	-	-	-
Stage 2	1	-	-	-	-	-
Critical Hdwy	6.42	6.22	-	-	4.12	-
Critical Hdwy Stg 1	5.42	-	-	-	-	-
Critical Hdwy Stg 2	5.42	-	-	-	-	-
Follow-up Hdwy	3.518	3.318	-	-	2.218	-
Pot Cap-1 Maneuver	1022	-	-	-	-	-
Stage 1	-	-	-	-	-	-
Stage 2	1022	-	-	-	-	-
Platoon blocked, %						
Mov Cap-1 Maneuver	1022	-	-	-	-	-
Mov Cap-2 Maneuver	1022	-	-	-	-	-
Stage 1	-	-	-	-	-	-
Stage 2	1022	-	-	-	-	-

Approach	NW	NE	SW
HCM Control Delay, s	0	0	0
HCM LOS	A		

Minor Lane/Major Mvmt	NET	NERNWLn1	SWL	SWT
Capacity (veh/h)	-	-	-	-
HCM Lane V/C Ratio	-	-	-	-
HCM Control Delay (s)	-	-	0	0
HCM Lane LOS	-	-	A	A
HCM 95th %tile Q(veh)	-	-	-	-

Lanes, Volumes, Timings
18: Bridley Ridge & Marksheffel

Short-Term Baseline + Site
PM

						
Lane Group	SET	SER	NWL	NWT	NEL	NER
Lane Configurations						
Traffic Volume (vph)	870	55	10	510	50	5
Future Volume (vph)	870	55	10	510	50	5
Ideal Flow (vphpl)	1900	1900	1900	1900	1900	1900
Storage Length (ft)		280	280		155	0
Storage Lanes		1	1		1	1
Taper Length (ft)			240		160	
Lane Util. Factor	1.00	1.00	1.00	1.00	1.00	1.00
Frt		0.850				0.850
Flt Protected			0.950		0.950	
Satd. Flow (prot)	1863	1583	1770	1863	1770	1583
Flt Permitted			0.240		0.950	
Satd. Flow (perm)	1863	1583	447	1863	1770	1583
Right Turn on Red		Yes				Yes
Satd. Flow (RTOR)		59				6
Link Speed (mph)	55			55	25	
Link Distance (ft)	615			962	767	
Travel Time (s)	7.6			11.9	20.9	
Peak Hour Factor	0.93	0.93	0.92	0.92	0.83	0.83
Adj. Flow (vph)	935	59	11	554	60	6
Shared Lane Traffic (%)						
Lane Group Flow (vph)	935	59	11	554	60	6
Enter Blocked Intersection	No	No	No	No	No	No
Lane Alignment	Left	Right	Left	Left	Left	Right
Median Width(ft)	12			12	12	
Link Offset(ft)	0			0	0	
Crosswalk Width(ft)	16			16	16	
Two way Left Turn Lane						
Headway Factor	1.00	1.00	1.00	1.00	1.00	1.00
Turning Speed (mph)		9	15		15	9
Number of Detectors	2	1	1	2	1	1
Detector Template	Thru	Right	Left	Thru	Left	Right
Leading Detector (ft)	100	20	20	100	20	20
Trailing Detector (ft)	0	0	0	0	0	0
Detector 1 Position(ft)	0	0	0	0	0	0
Detector 1 Size(ft)	6	20	20	6	20	20
Detector 1 Type	Cl+Ex	Cl+Ex	Cl+Ex	Cl+Ex	Cl+Ex	Cl+Ex
Detector 1 Channel						
Detector 1 Extend (s)	0.0	0.0	0.0	0.0	0.0	0.0
Detector 1 Queue (s)	0.0	0.0	0.0	0.0	0.0	0.0
Detector 1 Delay (s)	0.0	0.0	0.0	0.0	0.0	0.0
Detector 2 Position(ft)	94			94		
Detector 2 Size(ft)	6			6		
Detector 2 Type	Cl+Ex			Cl+Ex		
Detector 2 Channel						
Detector 2 Extend (s)	0.0			0.0		
Turn Type	NA	Perm	Perm	NA	Prot	Perm
Protected Phases	6			2	4	
Permitted Phases		6	2			4

Lanes, Volumes, Timings
18: Bridley Ridge & Marksheffel

Short-Term Baseline + Site
PM



Lane Group	SET	SER	NWL	NWT	NEL	NER
Detector Phase	6	6	2	2	4	4
Switch Phase						
Minimum Initial (s)	5.0	5.0	5.0	5.0	5.0	5.0
Minimum Split (s)	22.5	22.5	22.5	22.5	22.5	22.5
Total Split (s)	45.0	45.0	45.0	45.0	15.0	15.0
Total Split (%)	75.0%	75.0%	75.0%	75.0%	25.0%	25.0%
Maximum Green (s)	40.5	40.5	40.5	40.5	10.5	10.5
Yellow Time (s)	3.5	3.5	3.5	3.5	3.5	3.5
All-Red Time (s)	1.0	1.0	1.0	1.0	1.0	1.0
Lost Time Adjust (s)	0.0	0.0	0.0	0.0	0.0	0.0
Total Lost Time (s)	4.5	4.5	4.5	4.5	4.5	4.5
Lead/Lag						
Lead-Lag Optimize?						
Vehicle Extension (s)	3.0	3.0	3.0	3.0	3.0	3.0
Recall Mode	Min	Min	Min	Min	None	None
Walk Time (s)	7.0	7.0	7.0	7.0	7.0	7.0
Flash Dont Walk (s)	11.0	11.0	11.0	11.0	11.0	11.0
Pedestrian Calls (#/hr)	0	0	0	0	0	0
Act Effect Green (s)	41.8	41.8	41.8	41.8	7.9	7.9
Actuated g/C Ratio	0.83	0.83	0.83	0.83	0.16	0.16
v/c Ratio	0.60	0.04	0.03	0.36	0.22	0.02
Control Delay	6.3	1.0	3.0	3.6	25.6	15.4
Queue Delay	0.0	0.0	0.0	0.0	0.0	0.0
Total Delay	6.3	1.0	3.0	3.6	25.6	15.4
LOS	A	A	A	A	C	B
Approach Delay	5.9			3.6	24.7	
Approach LOS	A			A	C	
Queue Length 50th (ft)	137	0	1	58	20	0
Queue Length 95th (ft)	296	8	5	117	47	8
Internal Link Dist (ft)	535			882	687	
Turn Bay Length (ft)		280	280		155	
Base Capacity (vph)	1546	1324	371	1546	413	374
Starvation Cap Reductn	0	0	0	0	0	0
Spillback Cap Reductn	0	0	0	0	0	0
Storage Cap Reductn	0	0	0	0	0	0
Reduced v/c Ratio	0.60	0.04	0.03	0.36	0.15	0.02

Intersection Summary

Area Type:	Other
Cycle Length:	60
Actuated Cycle Length:	50.4
Natural Cycle:	65
Control Type:	Actuated-Uncoordinated
Maximum v/c Ratio:	0.60
Intersection Signal Delay:	5.9
Intersection LOS:	A
Intersection Capacity Utilization:	57.5%
ICU Level of Service:	B
Analysis Period (min):	15

Splits and Phases: 18: Bridley Ridge & Marksheffel

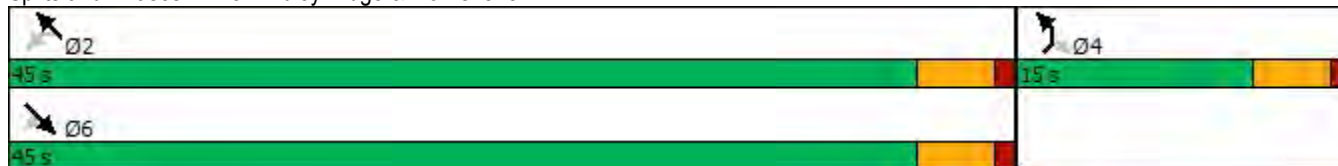

Intersection												
Int Delay, s/veh	0.7											
Movement	EBL	EBT	EBR	WBL	WBT	WBR	NBL	NBT	NBR	SBL	SBT	SBR
Lane Configurations		↕	↗		↕	↗		↕			↕	
Traffic Vol, veh/h	15	458	10	10	324	5	5	1	5	3	1	10
Future Vol, veh/h	15	458	10	10	324	5	5	1	5	3	1	10
Conflicting Peds, #/hr	0	0	0	0	0	0	0	0	0	0	0	0
Sign Control	Free	Free	Free	Free	Free	Free	Stop	Stop	Stop	Stop	Stop	Stop
RT Channelized	-	-	None	-	-	None	-	-	None	-	-	Stop
Storage Length	-	-	155	-	-	0	-	-	-	-	-	-
Veh in Median Storage, #	-	0	-	-	0	-	-	0	-	-	0	-
Grade, %	-	0	-	-	0	-	-	0	-	-	0	-
Peak Hour Factor	92	92	92	92	92	92	78	78	78	78	78	78
Heavy Vehicles, %	2	2	2	2	2	2	2	2	2	2	2	2
Mvmt Flow	16	498	11	11	352	5	6	1	6	4	1	13

Major/Minor	Major1			Major2			Minor1			Minor2		
Conflicting Flow All	357	0	0	509	0	0	907	909	498	913	915	352
Stage 1	-	-	-	-	-	-	530	530	-	374	374	-
Stage 2	-	-	-	-	-	-	377	379	-	539	541	-
Critical Hdwy	4.12	-	-	4.12	-	-	7.12	6.52	6.22	7.12	6.52	6.22
Critical Hdwy Stg 1	-	-	-	-	-	-	6.12	5.52	-	6.12	5.52	-
Critical Hdwy Stg 2	-	-	-	-	-	-	6.12	5.52	-	6.12	5.52	-
Follow-up Hdwy	2.218	-	-	2.218	-	-	3.518	4.018	3.318	3.518	4.018	3.318
Pot Cap-1 Maneuver	1202	-	-	1056	-	-	257	275	572	254	273	692
Stage 1	-	-	-	-	-	-	533	527	-	647	618	-
Stage 2	-	-	-	-	-	-	644	615	-	527	521	-
Platoon blocked, %	-	-	-	-	-	-	-	-	-	-	-	-
Mov Cap-1 Maneuver	1202	-	-	1056	-	-	245	266	572	244	264	692
Mov Cap-2 Maneuver	-	-	-	-	-	-	245	266	-	244	264	-
Stage 1	-	-	-	-	-	-	523	517	-	635	610	-
Stage 2	-	-	-	-	-	-	623	607	-	510	511	-

Approach	EB			WB			NB			SB		
HCM Control Delay, s	0.2			0.2			16.3			13.2		
HCM LOS							C			B		

Minor Lane/Major Mvmt	NBLn1	EBL	EBT	EBR	WBL	WBT	WBR	SBLn1
Capacity (veh/h)	334	1202	-	-	1056	-	-	459
HCM Lane V/C Ratio	0.042	0.014	-	-	0.01	-	-	0.039
HCM Control Delay (s)	16.3	8	0	-	8.4	0	-	13.2
HCM Lane LOS	C	A	A	-	A	A	-	B
HCM 95th %tile Q(veh)	0.1	0	-	-	0	-	-	0.1

Intersection						
Int Delay, s/veh	1.8					
Movement	EBL	EBT	WBT	WBR	SBL	SBR
Lane Configurations						
Traffic Vol, veh/h	110	475	319	20	11	40
Future Vol, veh/h	110	475	319	20	11	40
Conflicting Peds, #/hr	0	0	0	0	0	0
Sign Control	Free	Free	Free	Free	Stop	Stop
RT Channelized	-	None	-	None	-	Stop
Storage Length	155	-	-	185	0	-
Veh in Median Storage, #	-	0	0	-	0	-
Grade, %	-	0	0	-	0	-
Peak Hour Factor	93	93	92	92	83	83
Heavy Vehicles, %	2	2	2	2	2	2
Mvmt Flow	118	511	347	22	13	48

Major/Minor	Major1	Major2	Minor2		
Conflicting Flow All	369	0	-	0	1094 347
Stage 1	-	-	-	-	347 -
Stage 2	-	-	-	-	747 -
Critical Hdwy	4.12	-	-	-	6.42 6.22
Critical Hdwy Stg 1	-	-	-	-	5.42 -
Critical Hdwy Stg 2	-	-	-	-	5.42 -
Follow-up Hdwy	2.218	-	-	-	3.518 3.318
Pot Cap-1 Maneuver	1190	-	-	-	237 696
Stage 1	-	-	-	-	716 -
Stage 2	-	-	-	-	468 -
Platoon blocked, %		-	-	-	
Mov Cap-1 Maneuver	1190	-	-	-	214 696
Mov Cap-2 Maneuver	-	-	-	-	214 -
Stage 1	-	-	-	-	645 -
Stage 2	-	-	-	-	468 -

Approach	EB	WB	SB
HCM Control Delay, s	1.6	0	13.9
HCM LOS			B

Minor Lane/Major Mvmt	EBL	EBT	WBT	WBR	SBLn1
Capacity (veh/h)	1190	-	-	-	468
HCM Lane V/C Ratio	0.099	-	-	-	0.131
HCM Control Delay (s)	8.4	-	-	-	13.9
HCM Lane LOS	A	-	-	-	B
HCM 95th %tile Q(veh)	0.3	-	-	-	0.4

Intersection												
Int Delay, s/veh	0.5											
Movement	EBL	EBT	EBR	WBL	WBT	WBR	NBL	NBT	NBR	SBL	SBT	SBR
Lane Configurations			↗			↗		↖	↗		↖	↗
Traffic Vol, veh/h	0	0	25	0	0	20	0	500	50	0	875	37
Future Vol, veh/h	0	0	25	0	0	20	0	500	50	0	875	37
Conflicting Peds, #/hr	0	0	0	0	0	0	0	0	0	0	0	0
Sign Control	Stop	Stop	Stop	Stop	Stop	Stop	Free	Free	Free	Free	Free	Free
RT Channelized	-	-	None	-	-	None	-	-	None	-	-	None
Storage Length	-	-	0	-	-	0	-	-	280	-	-	280
Veh in Median Storage, #	-	0	-	-	0	-	-	0	-	-	0	-
Grade, %	-	0	-	-	0	-	-	0	-	-	0	-
Peak Hour Factor	78	92	78	92	92	92	92	92	92	92	93	93
Heavy Vehicles, %	2	2	2	2	2	2	2	2	2	2	2	2
Mvmt Flow	0	0	32	0	0	22	0	543	54	0	941	40

Major/Minor	Minor2		Minor1		Major1		Major2					
Conflicting Flow All	-	-	941	-	-	543	-	0	0	-	-	0
Stage 1	-	-	-	-	-	-	-	-	-	-	-	-
Stage 2	-	-	-	-	-	-	-	-	-	-	-	-
Critical Hdwy	-	-	6.22	-	-	6.22	-	-	-	-	-	-
Critical Hdwy Stg 1	-	-	-	-	-	-	-	-	-	-	-	-
Critical Hdwy Stg 2	-	-	-	-	-	-	-	-	-	-	-	-
Follow-up Hdwy	-	-	3.318	-	-	3.318	-	-	-	-	-	-
Pot Cap-1 Maneuver	0	0	319	0	0	540	0	-	-	0	-	-
Stage 1	0	0	-	0	0	-	0	-	-	0	-	-
Stage 2	0	0	-	0	0	-	0	-	-	0	-	-
Platoon blocked, %	-	-	-	-	-	-	-	-	-	-	-	-
Mov Cap-1 Maneuver	-	-	319	-	-	540	-	-	-	-	-	-
Mov Cap-2 Maneuver	-	-	-	-	-	-	-	-	-	-	-	-
Stage 1	-	-	-	-	-	-	-	-	-	-	-	-
Stage 2	-	-	-	-	-	-	-	-	-	-	-	-

Approach	EB		WB		NB		SB	
HCM Control Delay, s	17.5		11.9		0		0	
HCM LOS	C		B					

Minor Lane/Major Mvmt	NBT	NBR	EBLn1	WBLn1	SBT	SBR
Capacity (veh/h)	-	-	319	540	-	-
HCM Lane V/C Ratio	-	-	0.1	0.04	-	-
HCM Control Delay (s)	-	-	17.5	11.9	-	-
HCM Lane LOS	-	-	C	B	-	-
HCM 95th %tile Q(veh)	-	-	0.3	0.1	-	-

Intersection						
Int Delay, s/veh	0					
Movement	NWL	NWR	NET	NER	SWL	SWT
Lane Configurations						
Traffic Vol, veh/h	0	0	0	0	0	0
Future Vol, veh/h	0	0	0	0	0	0
Conflicting Peds, #/hr	0	0	0	0	0	0
Sign Control	Stop	Stop	Free	Free	Free	Free
RT Channelized	-	None	-	None	-	None
Storage Length	0	-	-	-	155	-
Veh in Median Storage, #	0	-	0	-	-	0
Grade, %	0	-	0	-	-	0
Peak Hour Factor	83	83	83	83	83	83
Heavy Vehicles, %	2	2	2	2	2	2
Mvmt Flow	0	0	0	0	0	0







Major/Minor	Minor1	Major1	Major2			
Conflicting Flow All	1	0	0	0	0	0
Stage 1	0	-	-	-	-	-
Stage 2	1	-	-	-	-	-
Critical Hdwy	6.42	6.22	-	-	4.12	-
Critical Hdwy Stg 1	5.42	-	-	-	-	-
Critical Hdwy Stg 2	5.42	-	-	-	-	-
Follow-up Hdwy	3.518	3.318	-	-	2.218	-
Pot Cap-1 Maneuver	1022	-	-	-	-	-
Stage 1	-	-	-	-	-	-
Stage 2	1022	-	-	-	-	-
Platoon blocked, %						
Mov Cap-1 Maneuver	1022	-	-	-	-	-
Mov Cap-2 Maneuver	1022	-	-	-	-	-
Stage 1	-	-	-	-	-	-
Stage 2	1022	-	-	-	-	-

Approach	NW	NE	SW
HCM Control Delay, s	0	0	0
HCM LOS	A		

Minor Lane/Major Mvmt	NET	NERNWLn1	SWL	SWT
Capacity (veh/h)	-	-	-	-
HCM Lane V/C Ratio	-	-	-	-
HCM Control Delay (s)	-	-	0	0
HCM Lane LOS	-	-	A	A
HCM 95th %tile Q(veh)	-	-	-	-

Lanes, Volumes, Timings
18: Bradley Ridge & Marksheffel

2045 Background
AM

						
Lane Group	SET	SER	NWL	NWT	NEL	NER
Lane Configurations	↑↑	↑	↓	↑↑	↓	↓
Traffic Volume (vph)	562	29	12	1828	247	38
Future Volume (vph)	562	29	12	1828	247	38
Ideal Flow (vphpl)	1900	1900	1900	1900	1900	1900
Storage Length (ft)		290	290		155	0
Storage Lanes		1	1		1	1
Taper Length (ft)			240		160	
Lane Util. Factor	0.95	1.00	1.00	0.95	1.00	1.00
Frt		0.850				0.850
Flt Protected			0.950		0.950	
Satd. Flow (prot)	3539	1583	1770	3539	1770	1583
Flt Permitted			0.423		0.950	
Satd. Flow (perm)	3539	1583	788	3539	1770	1583
Right Turn on Red		Yes				Yes
Satd. Flow (RTOR)		31				41
Link Speed (mph)	55			55	25	
Link Distance (ft)	1045			1283	531	
Travel Time (s)	13.0			15.9	14.5	
Peak Hour Factor	0.93	0.93	0.95	0.95	0.92	0.92
Adj. Flow (vph)	604	31	13	1924	268	41
Shared Lane Traffic (%)						
Lane Group Flow (vph)	604	31	13	1924	268	41
Enter Blocked Intersection	No	No	No	No	No	No
Lane Alignment	Left	Right	Left	Left	Left	Right
Median Width(ft)	12			12	12	
Link Offset(ft)	0			0	0	
Crosswalk Width(ft)	16			16	16	
Two way Left Turn Lane						
Headway Factor	1.00	1.00	1.00	1.00	1.00	1.00
Turning Speed (mph)		9	15		15	9
Number of Detectors	2	1	1	2	1	1
Detector Template	Thru	Right	Left	Thru	Left	Right
Leading Detector (ft)	100	20	20	100	20	20
Trailing Detector (ft)	0	0	0	0	0	0
Detector 1 Position(ft)	0	0	0	0	0	0
Detector 1 Size(ft)	6	20	20	6	20	20
Detector 1 Type	Cl+Ex	Cl+Ex	Cl+Ex	Cl+Ex	Cl+Ex	Cl+Ex
Detector 1 Channel						
Detector 1 Extend (s)	0.0	0.0	0.0	0.0	0.0	0.0
Detector 1 Queue (s)	0.0	0.0	0.0	0.0	0.0	0.0
Detector 1 Delay (s)	0.0	0.0	0.0	0.0	0.0	0.0
Detector 2 Position(ft)	94			94		
Detector 2 Size(ft)	6			6		
Detector 2 Type	Cl+Ex			Cl+Ex		
Detector 2 Channel						
Detector 2 Extend (s)	0.0			0.0		
Turn Type	NA	Perm	Perm	NA	Prot	Perm
Protected Phases	6			2	4	
Permitted Phases		6	2			4

Lanes, Volumes, Timings
18: Bradley Ridge & Marksheffel



Lane Group	SET	SER	NWL	NWT	NEL	NER
Detector Phase	6	6	2	2	4	4
Switch Phase						
Minimum Initial (s)	5.0	5.0	5.0	5.0	5.0	5.0
Minimum Split (s)	22.5	22.5	22.5	22.5	22.5	22.5
Total Split (s)	44.0	44.0	44.0	44.0	16.0	16.0
Total Split (%)	73.3%	73.3%	73.3%	73.3%	26.7%	26.7%
Maximum Green (s)	39.5	39.5	39.5	39.5	11.5	11.5
Yellow Time (s)	3.5	3.5	3.5	3.5	3.5	3.5
All-Red Time (s)	1.0	1.0	1.0	1.0	1.0	1.0
Lost Time Adjust (s)	0.0	0.0	0.0	0.0	0.0	0.0
Total Lost Time (s)	4.5	4.5	4.5	4.5	4.5	4.5
Lead/Lag						
Lead-Lag Optimize?						
Vehicle Extension (s)	3.0	3.0	3.0	3.0	3.0	3.0
Recall Mode	Max	Max	Max	Max	None	None
Walk Time (s)	7.0	7.0	7.0	7.0	7.0	7.0
Flash Dont Walk (s)	11.0	11.0	11.0	11.0	11.0	11.0
Pedestrian Calls (#/hr)	0	0	0	0	0	0
Act Effect Green (s)	41.7	41.7	41.7	41.7	11.4	11.4
Actuated g/C Ratio	0.67	0.67	0.67	0.67	0.18	0.18
v/c Ratio	0.25	0.03	0.02	0.81	0.83	0.13
Control Delay	4.4	1.6	3.8	11.2	47.4	8.8
Queue Delay	0.0	0.0	0.0	0.0	0.0	0.0
Total Delay	4.4	1.6	3.8	11.2	47.4	8.8
LOS	A	A	A	B	D	A
Approach Delay	4.3			11.1	42.3	
Approach LOS	A			B	D	
Queue Length 50th (ft)	38	0	1	224	93	0
Queue Length 95th (ft)	57	6	6	322	#202	22
Internal Link Dist (ft)	965			1203	451	
Turn Bay Length (ft)		290	290		155	
Base Capacity (vph)	2375	1072	528	2375	329	327
Starvation Cap Reductn	0	0	0	0	0	0
Spillback Cap Reductn	0	0	0	0	0	0
Storage Cap Reductn	0	0	0	0	0	0
Reduced v/c Ratio	0.25	0.03	0.02	0.81	0.81	0.13

Intersection Summary

Area Type:	Other
Cycle Length:	60
Actuated Cycle Length:	62.1
Natural Cycle:	65
Control Type:	Actuated-Uncoordinated
Maximum v/c Ratio:	0.83
Intersection Signal Delay:	13.0
Intersection LOS:	B
Intersection Capacity Utilization:	71.7%
ICU Level of Service:	C
Analysis Period (min):	15
# 95th percentile volume exceeds capacity, queue may be longer. Queue shown is maximum after two cycles.	

Splits and Phases: 18: Bradley Ridge & Marksheffel

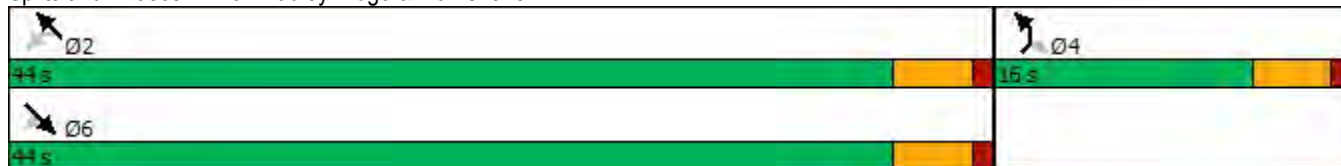

Intersection												
Int Delay, s/veh	2.1											
Movement	EBL	EBT	EBR	WBL	WBT	WBR	NBL	NBT	NBR	SBL	SBT	SBR
Lane Configurations												
Traffic Vol, veh/h	35	456	5	5	822	5	10	1	5	25	2	35
Future Vol, veh/h	35	456	5	5	822	5	10	1	5	25	2	35
Conflicting Peds, #/hr	0	0	0	0	0	0	0	0	0	0	0	0
Sign Control	Free	Free	Free	Free	Free	Free	Stop	Stop	Stop	Stop	Stop	Stop
RT Channelized	-	-	None	-	-	None	-	-	None	-	-	Stop
Storage Length	195	-	155	195	-	195	-	-	-	-	-	-
Veh in Median Storage, #	-	0	-	-	0	-	-	0	-	-	0	-
Grade, %	-	0	-	-	0	-	-	0	-	-	0	-
Peak Hour Factor	92	92	92	93	93	93	89	78	78	78	78	78
Heavy Vehicles, %	2	2	2	2	2	2	2	2	2	2	2	2
Mvmt Flow	38	496	5	5	884	5	11	1	6	32	3	45

Major/Minor	Major1			Major2			Minor1			Minor2		
Conflicting Flow All	889	0	0	501	0	0	1026	1471	248	1219	1471	442
Stage 1	-	-	-	-	-	-	572	572	-	894	894	-
Stage 2	-	-	-	-	-	-	454	899	-	325	577	-
Critical Hdwy	4.14	-	-	4.14	-	-	7.54	6.54	6.94	7.54	6.54	6.94
Critical Hdwy Stg 1	-	-	-	-	-	-	6.54	5.54	-	6.54	5.54	-
Critical Hdwy Stg 2	-	-	-	-	-	-	6.54	5.54	-	6.54	5.54	-
Follow-up Hdwy	2.22	-	-	2.22	-	-	3.52	4.02	3.32	3.52	4.02	3.32
Pot Cap-1 Maneuver	758	-	-	1059	-	-	189	126	752	136	126	563
Stage 1	-	-	-	-	-	-	472	502	-	302	358	-
Stage 2	-	-	-	-	-	-	555	356	-	661	500	-
Platoon blocked, %	-	-	-	-	-	-	-	-	-	-	-	-
Mov Cap-1 Maneuver	758	-	-	1059	-	-	164	119	752	128	119	563
Mov Cap-2 Maneuver	-	-	-	-	-	-	164	119	-	128	119	-
Stage 1	-	-	-	-	-	-	448	477	-	287	356	-
Stage 2	-	-	-	-	-	-	505	354	-	621	475	-

Approach	EB			WB			NB			SB		
HCM Control Delay, s	0.7			0.1			23.3			29.3		
HCM LOS							C			D		

Minor Lane/Major Mvmt	NBLn1	EBL	EBT	EBR	WBL	WBT	WBR	SBLn1
Capacity (veh/h)	216	758	-	-	1059	-	-	226
HCM Lane V/C Ratio	0.088	0.05	-	-	0.005	-	-	0.352
HCM Control Delay (s)	23.3	10	-	-	8.4	-	-	29.3
HCM Lane LOS	C	B	-	-	A	-	-	D
HCM 95th %tile Q(veh)	0.3	0.2	-	-	0	-	-	1.5

Intersection						
Int Delay, s/veh	1.2					
Movement	EBL	EBT	WBT	WBR	SBL	SBR
Lane Configurations		↑↑	↑↑	↑	↑	
Traffic Vol, veh/h	23	506	856	11	12	64
Future Vol, veh/h	23	506	856	11	12	64
Conflicting Peds, #/hr	0	0	0	0	0	0
Sign Control	Free	Free	Free	Free	Stop	Stop
RT Channelized	-	None	-	None	-	Stop
Storage Length	-	-	-	185	0	-
Veh in Median Storage, #	-	0	0	-	0	-
Grade, %	-	0	0	-	0	-
Peak Hour Factor	92	92	95	95	83	83
Heavy Vehicles, %	2	2	2	2	2	2
Mvmt Flow	25	550	901	12	14	77

Major/Minor	Major1	Major2	Minor2		
Conflicting Flow All	913	0	0	1226	451
Stage 1	-	-	-	901	-
Stage 2	-	-	-	325	-
Critical Hdwy	4.14	-	-	6.84	6.94
Critical Hdwy Stg 1	-	-	-	5.84	-
Critical Hdwy Stg 2	-	-	-	5.84	-
Follow-up Hdwy	2.22	-	-	3.52	3.32
Pot Cap-1 Maneuver	742	-	-	171	556
Stage 1	-	-	-	357	-
Stage 2	-	-	-	705	-
Platoon blocked, %	-	-	-	-	-
Mov Cap-1 Maneuver	742	-	-	163	556
Mov Cap-2 Maneuver	-	-	-	163	-
Stage 1	-	-	-	340	-
Stage 2	-	-	-	705	-

Approach	EB	WB	SB
HCM Control Delay, s	0.6	0	16.5
HCM LOS			C

Minor Lane/Major Mvmt	EBL	EBT	WBT	WBR	SBLn1
Capacity (veh/h)	742	-	-	-	403
HCM Lane V/C Ratio	0.034	-	-	-	0.227
HCM Control Delay (s)	10	0.2	-	-	16.5
HCM Lane LOS	B	A	-	-	C
HCM 95th %tile Q(veh)	0.1	-	-	-	0.9

Intersection												
Int Delay, s/veh	0.6											
Movement	EBL	EBT	EBR	WBL	WBT	WBR	NBL	NBT	NBR	SBL	SBT	SBR
Lane Configurations			↗			↗		↕	↗		↕	
Traffic Vol, veh/h	0	0	40	0	0	40	0	1800	20	0	600	15
Future Vol, veh/h	0	0	40	0	0	40	0	1800	20	0	600	15
Conflicting Peds, #/hr	0	0	0	0	0	0	0	0	0	0	0	0
Sign Control	Stop	Stop	Stop	Stop	Stop	Stop	Free	Free	Free	Free	Free	Free
RT Channelized	-	-	None	-	-	None	-	-	None	-	-	None
Storage Length	-	-	0	-	-	0	-	-	290	-	-	-
Veh in Median Storage, #	-	0	-	-	0	-	-	0	-	-	0	-
Grade, %	-	0	-	-	0	-	-	0	-	-	0	-
Peak Hour Factor	78	78	78	92	92	92	95	95	95	92	92	92
Heavy Vehicles, %	2	2	2	2	2	2	2	2	2	2	2	2
Mvmt Flow	0	0	51	0	0	43	0	1895	21	0	652	16

Major/Minor	Minor2		Minor1		Major1		Major2					
Conflicting Flow All	-	-	334	-	-	948	-	0	0	-	-	0
Stage 1	-	-	-	-	-	-	-	-	-	-	-	-
Stage 2	-	-	-	-	-	-	-	-	-	-	-	-
Critical Hdwy	-	-	6.94	-	-	6.94	-	-	-	-	-	-
Critical Hdwy Stg 1	-	-	-	-	-	-	-	-	-	-	-	-
Critical Hdwy Stg 2	-	-	-	-	-	-	-	-	-	-	-	-
Follow-up Hdwy	-	-	3.32	-	-	3.32	-	-	-	-	-	-
Pot Cap-1 Maneuver	0	0	662	0	0	262	0	-	-	0	-	-
Stage 1	0	0	-	0	0	-	0	-	-	0	-	-
Stage 2	0	0	-	0	0	-	0	-	-	0	-	-
Platoon blocked, %	-	-	-	-	-	-	-	-	-	-	-	-
Mov Cap-1 Maneuver	-	-	662	-	-	262	-	-	-	-	-	-
Mov Cap-2 Maneuver	-	-	-	-	-	-	-	-	-	-	-	-
Stage 1	-	-	-	-	-	-	-	-	-	-	-	-
Stage 2	-	-	-	-	-	-	-	-	-	-	-	-

Approach	EB		WB		NB		SB	
HCM Control Delay, s	10.9		21.5		0		0	
HCM LOS	B		C					

Minor Lane/Major Mvmt	NBT	NBR	EBLn1WBLn1	SBT	SBR
Capacity (veh/h)	-	-	662	262	-
HCM Lane V/C Ratio	-	-	0.077	0.166	-
HCM Control Delay (s)	-	-	10.9	21.5	-
HCM Lane LOS	-	-	B	C	-
HCM 95th %tile Q(veh)	-	-	0.3	0.6	-

Intersection						
Int Delay, s/veh	6					
Movement	NWL	NWR	NET	NER	SWL	SWT
Lane Configurations						
Traffic Vol, veh/h	4	188	98	13	58	33
Future Vol, veh/h	4	188	98	13	58	33
Conflicting Peds, #/hr	0	0	0	0	0	0
Sign Control	Stop	Stop	Free	Free	Free	Free
RT Channelized	-	None	-	None	-	None
Storage Length	0	-	-	-	155	-
Veh in Median Storage, #	0	-	0	-	-	0
Grade, %	0	-	0	-	-	0
Peak Hour Factor	87	87	83	83	83	83
Heavy Vehicles, %	2	2	2	2	2	2
Mvmt Flow	5	216	118	16	70	40

Major/Minor	Minor1	Major1	Major2		
Conflicting Flow All	306	126	0	0	134
Stage 1	126	-	-	-	-
Stage 2	180	-	-	-	-
Critical Hdwy	6.42	6.22	-	-	4.12
Critical Hdwy Stg 1	5.42	-	-	-	-
Critical Hdwy Stg 2	5.42	-	-	-	-
Follow-up Hdwy	3.518	3.318	-	-	2.218
Pot Cap-1 Maneuver	686	924	-	-	1451
Stage 1	900	-	-	-	-
Stage 2	851	-	-	-	-
Platoon blocked, %			-	-	-
Mov Cap-1 Maneuver	653	924	-	-	1451
Mov Cap-2 Maneuver	653	-	-	-	-
Stage 1	900	-	-	-	-
Stage 2	810	-	-	-	-

Approach	NW	NE	SW
HCM Control Delay, s	10.2	0	4.8
HCM LOS	B		

Minor Lane/Major Mvmt	NET	NERNWLn1	SWL	SWT
Capacity (veh/h)	-	-	916	1451
HCM Lane V/C Ratio	-	-	0.241	0.048
HCM Control Delay (s)	-	-	10.2	7.6
HCM Lane LOS	-	-	B	A
HCM 95th %tile Q(veh)	-	-	0.9	0.2

Intersection						
Int Delay, s/veh	6.8					
Movement	EBL	EBT	WBT	WBR	SBL	SBR
Lane Configurations		↕	↕		↕	
Traffic Vol, veh/h	2	0	0	12	36	5
Future Vol, veh/h	2	0	0	12	36	5
Conflicting Peds, #/hr	0	0	0	0	0	0
Sign Control	Free	Free	Free	Free	Stop	Stop
RT Channelized	-	None	-	None	-	None
Storage Length	-	-	-	-	0	-
Veh in Median Storage, #	-	0	0	-	0	-
Grade, %	-	0	0	-	0	-
Peak Hour Factor	78	78	78	78	78	78
Heavy Vehicles, %	2	2	2	2	2	2
Mvmt Flow	3	0	0	15	46	6







Major/Minor	Major1	Major2	Minor2		
Conflicting Flow All	15	0	-	0	14 8
Stage 1	-	-	-	-	8 -
Stage 2	-	-	-	-	6 -
Critical Hdwy	4.12	-	-	-	6.42 6.22
Critical Hdwy Stg 1	-	-	-	-	5.42 -
Critical Hdwy Stg 2	-	-	-	-	5.42 -
Follow-up Hdwy	2.218	-	-	-	3.518 3.318
Pot Cap-1 Maneuver	1603	-	-	-	1005 1074
Stage 1	-	-	-	-	1015 -
Stage 2	-	-	-	-	1017 -
Platoon blocked, %		-	-	-	
Mov Cap-1 Maneuver	1603	-	-	-	1003 1074
Mov Cap-2 Maneuver	-	-	-	-	1003 -
Stage 1	-	-	-	-	1013 -
Stage 2	-	-	-	-	1017 -

Approach	EB	WB	SB
HCM Control Delay, s	7.2	0	8.8
HCM LOS			A

Minor Lane/Major Mvmt	EBL	EBT	WBT	WBR	SBLn1
Capacity (veh/h)	1603	-	-	-	1011
HCM Lane V/C Ratio	0.002	-	-	-	0.052
HCM Control Delay (s)	7.2	0	-	-	8.8
HCM Lane LOS	A	A	-	-	A
HCM 95th %tile Q(veh)	0	-	-	-	0.2

Lanes, Volumes, Timings
17: Bradley Ridge & Marksheffel

2045 Background
PM

						
Lane Group	SET	SER	NWL	NWT	NEL	NER
Lane Configurations	↑↑	↑	↘	↑↑	↘	↘
Traffic Volume (vph)	1476	221	39	861	153	24
Future Volume (vph)	1476	221	39	861	153	24
Ideal Flow (vphpl)	1900	1900	1900	1900	1900	1900
Storage Length (ft)		290	290		155	0
Storage Lanes		1	1		1	1
Taper Length (ft)			240		160	
Lane Util. Factor	0.95	1.00	1.00	0.95	1.00	1.00
Frt		0.850				0.850
Flt Protected			0.950		0.950	
Satd. Flow (prot)	3539	1583	1770	3539	1770	1583
Flt Permitted			0.126		0.950	
Satd. Flow (perm)	3539	1583	235	3539	1770	1583
Right Turn on Red		Yes				Yes
Satd. Flow (RTOR)		233				28
Link Speed (mph)	55			55	25	
Link Distance (ft)	833			929	520	
Travel Time (s)	10.3			11.5	14.2	
Peak Hour Factor	0.95	0.95	0.93	0.93	0.87	0.87
Adj. Flow (vph)	1554	233	42	926	176	28
Shared Lane Traffic (%)						
Lane Group Flow (vph)	1554	233	42	926	176	28
Enter Blocked Intersection	No	No	No	No	No	No
Lane Alignment	Left	Right	Left	Left	Left	Right
Median Width(ft)	12			12	12	
Link Offset(ft)	0			0	0	
Crosswalk Width(ft)	16			16	16	
Two way Left Turn Lane						
Headway Factor	1.00	1.00	1.00	1.00	1.00	1.00
Turning Speed (mph)		9	15		15	9
Number of Detectors	2	1	1	2	1	1
Detector Template	Thru	Right	Left	Thru	Left	Right
Leading Detector (ft)	100	20	20	100	20	20
Trailing Detector (ft)	0	0	0	0	0	0
Detector 1 Position(ft)	0	0	0	0	0	0
Detector 1 Size(ft)	6	20	20	6	20	20
Detector 1 Type	Cl+Ex	Cl+Ex	Cl+Ex	Cl+Ex	Cl+Ex	Cl+Ex
Detector 1 Channel						
Detector 1 Extend (s)	0.0	0.0	0.0	0.0	0.0	0.0
Detector 1 Queue (s)	0.0	0.0	0.0	0.0	0.0	0.0
Detector 1 Delay (s)	0.0	0.0	0.0	0.0	0.0	0.0
Detector 2 Position(ft)	94			94		
Detector 2 Size(ft)	6			6		
Detector 2 Type	Cl+Ex			Cl+Ex		
Detector 2 Channel						
Detector 2 Extend (s)	0.0			0.0		
Turn Type	NA	Perm	Perm	NA	Prot	Perm
Protected Phases	6			2	4	
Permitted Phases		6	2			4

Lanes, Volumes, Timings
17: Bradley Ridge & Marksheffel

2045 Background
PM





Lane Group	SET	SER	NWL	NWT	NEL	NER
Detector Phase	6	6	2	2	4	4
Switch Phase						
Minimum Initial (s)	5.0	5.0	5.0	5.0	5.0	5.0
Minimum Split (s)	22.5	22.5	22.5	22.5	22.5	22.5
Total Split (s)	44.0	44.0	44.0	44.0	16.0	16.0
Total Split (%)	73.3%	73.3%	73.3%	73.3%	26.7%	26.7%
Maximum Green (s)	39.5	39.5	39.5	39.5	11.5	11.5
Yellow Time (s)	3.5	3.5	3.5	3.5	3.5	3.5
All-Red Time (s)	1.0	1.0	1.0	1.0	1.0	1.0
Lost Time Adjust (s)	0.0	0.0	0.0	0.0	0.0	0.0
Total Lost Time (s)	4.5	4.5	4.5	4.5	4.5	4.5
Lead/Lag						
Lead-Lag Optimize?						
Vehicle Extension (s)	3.0	3.0	3.0	3.0	3.0	3.0
Recall Mode	Max	Max	Max	Max	None	None
Walk Time (s)	7.0	7.0	7.0	7.0	7.0	7.0
Flash Dont Walk (s)	11.0	11.0	11.0	11.0	11.0	11.0
Pedestrian Calls (#/hr)	0	0	0	0	0	0
Act Effect Green (s)	45.0	45.0	45.0	45.0	10.2	10.2
Actuated g/C Ratio	0.74	0.74	0.74	0.74	0.17	0.17
v/c Ratio	0.59	0.19	0.24	0.35	0.60	0.10
Control Delay	6.5	1.0	8.6	4.4	31.9	9.8
Queue Delay	0.0	0.0	0.0	0.0	0.0	0.0
Total Delay	6.5	1.0	8.6	4.4	31.9	9.8
LOS	A	A	A	A	C	A
Approach Delay	5.7			4.6	28.9	
Approach LOS	A			A	C	
Queue Length 50th (ft)	143	0	5	64	58	0
Queue Length 95th (ft)	205	17	22	94	107	17
Internal Link Dist (ft)	753			849	440	
Turn Bay Length (ft)		290	290		155	
Base Capacity (vph)	2614	1230	173	2614	334	322
Starvation Cap Reductn	0	0	0	0	0	0
Spillback Cap Reductn	0	0	0	0	0	0
Storage Cap Reductn	0	0	0	0	0	0
Reduced v/c Ratio	0.59	0.19	0.24	0.35	0.53	0.09

Intersection Summary

Area Type:	Other
Cycle Length:	60
Actuated Cycle Length:	60.9
Natural Cycle:	60
Control Type:	Actuated-Uncoordinated
Maximum v/c Ratio:	0.60
Intersection Signal Delay:	7.0
Intersection LOS:	A
Intersection Capacity Utilization:	56.8%
ICU Level of Service:	B
Analysis Period (min):	15

Splits and Phases: 17: Bradley Ridge & Marksheffel

 Ø2	 Ø4
44 s	15 s
 Ø6	
44 s	

Intersection												
Int Delay, s/veh	2.6											
Movement	EBL	EBT	EBR	WBL	WBT	WBR	NBL	NBT	NBR	SBL	SBT	SBR
Lane Configurations												
Traffic Vol, veh/h	105	1225	10	15	702	10	5	1	5	15	2	20
Future Vol, veh/h	105	1225	10	15	702	10	5	1	5	15	2	20
Conflicting Peds, #/hr	0	0	0	0	0	0	0	0	0	0	0	0
Sign Control	Free	Free	Free	Free	Free	Free	Stop	Stop	Stop	Stop	Stop	Stop
RT Channelized	-	-	None	-	-	None	-	-	None	-	-	Stop
Storage Length	195	-	155	195	-	195	-	-	-	-	-	-
Veh in Median Storage, #	-	0	-	-	0	-	-	0	-	-	0	-
Grade, %	-	0	-	-	0	-	-	0	-	-	0	-
Peak Hour Factor	95	95	95	93	93	93	78	78	78	78	78	78
Heavy Vehicles, %	2	2	2	2	2	2	2	2	2	2	2	2
Mvmt Flow	111	1289	11	16	755	11	6	1	6	19	3	26

Major/Minor	Major1			Major2			Minor1			Minor2		
Conflicting Flow All	766	0	0	1300	0	0	1922	2309	645	1654	2309	378
Stage 1	-	-	-	-	-	-	1511	1511	-	787	787	-
Stage 2	-	-	-	-	-	-	411	798	-	867	1522	-
Critical Hdwy	4.14	-	-	4.14	-	-	7.54	6.54	6.94	7.54	6.54	6.94
Critical Hdwy Stg 1	-	-	-	-	-	-	6.54	5.54	-	6.54	5.54	-
Critical Hdwy Stg 2	-	-	-	-	-	-	6.54	5.54	-	6.54	5.54	-
Follow-up Hdwy	2.22	-	-	2.22	-	-	3.52	4.02	3.32	3.52	4.02	3.32
Pot Cap-1 Maneuver	843	-	-	529	-	-	40	38	415	65	38	620
Stage 1	-	-	-	-	-	-	126	181	-	351	401	-
Stage 2	-	-	-	-	-	-	589	396	-	314	179	-
Platoon blocked, %	-	-	-	-	-	-	-	-	-	-	-	-
Mov Cap-1 Maneuver	843	-	-	529	-	-	32	32	415	55	32	620
Mov Cap-2 Maneuver	-	-	-	-	-	-	32	32	-	55	32	-
Stage 1	-	-	-	-	-	-	109	157	-	305	389	-
Stage 2	-	-	-	-	-	-	544	384	-	266	155	-

Approach	EB			WB			NB			SB		
HCM Control Delay, s	0.8			0.2			91.7			68.9		
HCM LOS							F			F		

Minor Lane/Major Mvmt	NBLn1	EBL	EBT	EBR	WBL	WBT	WBR	SBLn1
Capacity (veh/h)	55	843	-	-	529	-	-	101
HCM Lane V/C Ratio	0.256	0.131	-	-	0.03	-	-	0.47
HCM Control Delay (s)	91.7	9.9	-	-	12	-	-	68.9
HCM Lane LOS	F	A	-	-	B	-	-	F
HCM 95th %tile Q(veh)	0.9	0.5	-	-	0.1	-	-	2

Intersection						
Int Delay, s/veh	1.1					
Movement	EBL	EBT	WBT	WBR	SBL	SBR
Lane Configurations		↑↑	↑↑	↑		↑
Traffic Vol, veh/h	35	1348	717	10	9	40
Future Vol, veh/h	35	1348	717	10	9	40
Conflicting Peds, #/hr	0	0	0	0	0	0
Sign Control	Free	Free	Free	Free	Stop	Stop
RT Channelized	-	None	-	None	-	Stop
Storage Length	-	-	-	185	-	0
Veh in Median Storage, #	-	0	0	-	0	-
Grade, %	-	0	0	-	0	-
Peak Hour Factor	95	95	93	93	78	78
Heavy Vehicles, %	2	2	2	2	2	2
Mvmt Flow	37	1419	771	11	12	51

Major/Minor	Major1	Major2	Minor2		
Conflicting Flow All	782	0	0	1555	386
Stage 1	-	-	-	771	-
Stage 2	-	-	-	784	-
Critical Hdwy	4.14	-	-	6.84	6.94
Critical Hdwy Stg 1	-	-	-	5.84	-
Critical Hdwy Stg 2	-	-	-	5.84	-
Follow-up Hdwy	2.22	-	-	3.52	3.32
Pot Cap-1 Maneuver	832	-	-	104	612
Stage 1	-	-	-	417	-
Stage 2	-	-	-	410	-
Platoon blocked, %	-	-	-	-	-
Mov Cap-1 Maneuver	832	-	-	82	612
Mov Cap-2 Maneuver	-	-	-	82	-
Stage 1	-	-	-	329	-
Stage 2	-	-	-	410	-

Approach	EB	WB	SB
HCM Control Delay, s	1.2	0	11.4
HCM LOS			B

Minor Lane/Major Mvmt	EBL	EBT	WBT	WBR	SBLn1
Capacity (veh/h)	832	-	-	-	612
HCM Lane V/C Ratio	0.044	-	-	-	0.084
HCM Control Delay (s)	9.5	1	-	-	11.4
HCM Lane LOS	A	A	-	-	B
HCM 95th %tile Q(veh)	0.1	-	-	-	0.3

Intersection												
Int Delay, s/veh	0.3											
Movement	EBL	EBT	EBR	WBL	WBT	WBR	NBL	NBT	NBR	SBL	SBT	SBR
Lane Configurations			↗			↗		↕	↗		↕	↗
Traffic Vol, veh/h	0	0	25	0	0	25	0	875	60	0	1500	50
Future Vol, veh/h	0	0	25	0	0	25	0	875	60	0	1500	50
Conflicting Peds, #/hr	0	0	0	0	0	0	0	0	0	0	0	0
Sign Control	Stop	Stop	Stop	Stop	Stop	Stop	Free	Free	Free	Free	Free	Free
RT Channelized	-	-	None	-	-	None	-	-	None	-	-	None
Storage Length	-	-	0	-	-	0	-	-	290	-	-	290
Veh in Median Storage, #	-	0	-	-	0	-	-	0	-	-	0	-
Grade, %	-	0	-	-	0	-	-	0	-	-	0	-
Peak Hour Factor	78	78	78	78	78	78	95	95	95	92	95	95
Heavy Vehicles, %	2	2	2	2	2	2	2	2	2	2	2	2
Mvmt Flow	0	0	32	0	0	32	0	921	63	0	1579	53

Major/Minor	Minor2		Minor1		Major1		Major2					
Conflicting Flow All	-	-	790	-	-	461	-	0	0	-	-	0
Stage 1	-	-	-	-	-	-	-	-	-	-	-	-
Stage 2	-	-	-	-	-	-	-	-	-	-	-	-
Critical Hdwy	-	-	6.94	-	-	6.94	-	-	-	-	-	-
Critical Hdwy Stg 1	-	-	-	-	-	-	-	-	-	-	-	-
Critical Hdwy Stg 2	-	-	-	-	-	-	-	-	-	-	-	-
Follow-up Hdwy	-	-	3.32	-	-	3.32	-	-	-	-	-	-
Pot Cap-1 Maneuver	0	0	333	0	0	547	0	-	-	0	-	-
Stage 1	0	0	-	0	0	-	0	-	-	0	-	-
Stage 2	0	0	-	0	0	-	0	-	-	0	-	-
Platoon blocked, %	-	-	-	-	-	-	-	-	-	-	-	-
Mov Cap-1 Maneuver	-	-	333	-	-	547	-	-	-	-	-	-
Mov Cap-2 Maneuver	-	-	-	-	-	-	-	-	-	-	-	-
Stage 1	-	-	-	-	-	-	-	-	-	-	-	-
Stage 2	-	-	-	-	-	-	-	-	-	-	-	-

Approach	EB		WB		NB		SB	
HCM Control Delay, s	17		12		0		0	
HCM LOS	C		B					

Minor Lane/Major Mvmt	NBT	NBR	EBLn1WBLn1	SBT	SBR	
Capacity (veh/h)	-	-	333	547	-	-
HCM Lane V/C Ratio	-	-	0.096	0.059	-	-
HCM Control Delay (s)	-	-	17	12	-	-
HCM Lane LOS	-	-	C	B	-	-
HCM 95th %tile Q(veh)	-	-	0.3	0.2	-	-

Intersection						
Int Delay, s/veh	4.6					
Movement	NWL	NWR	NET	NER	SWL	SWT
Lane Configurations						
Traffic Vol, veh/h	13	111	65	8	62	108
Future Vol, veh/h	13	111	65	8	62	108
Conflicting Peds, #/hr	0	0	0	0	0	0
Sign Control	Stop	Stop	Free	Free	Free	Free
RT Channelized	-	None	-	None	-	None
Storage Length	0	-	-	-	155	-
Veh in Median Storage, #	0	-	0	-	-	0
Grade, %	0	-	0	-	-	0
Peak Hour Factor	83	83	83	83	87	87
Heavy Vehicles, %	2	2	2	2	2	2
Mvmt Flow	16	134	78	10	71	124

Major/Minor	Minor1	Major1	Major2
Conflicting Flow All	349	83	0
Stage 1	83	-	-
Stage 2	266	-	-
Critical Hdwy	6.42	6.22	-
Critical Hdwy Stg 1	5.42	-	-
Critical Hdwy Stg 2	5.42	-	-
Follow-up Hdwy	3.518	3.318	-
Pot Cap-1 Maneuver	648	976	-
Stage 1	940	-	-
Stage 2	779	-	-
Platoon blocked, %		-	-
Mov Cap-1 Maneuver	618	976	-
Mov Cap-2 Maneuver	618	-	-
Stage 1	940	-	-
Stage 2	742	-	-

Approach	NW	NE	SW
HCM Control Delay, s	9.7	0	2.7
HCM LOS	A		

Minor Lane/Major Mvmt	NET	NERNWLn1	SWL	SWT
Capacity (veh/h)	-	-	920	1508
HCM Lane V/C Ratio	-	-	0.162	0.047
HCM Control Delay (s)	-	-	9.7	7.5
HCM Lane LOS	-	-	A	A
HCM 95th %tile Q(veh)	-	-	0.6	0.1







Intersection						
Int Delay, s/veh	3.9					
Movement	EBL	EBT	WBT	WBR	SBL	SBR
Lane Configurations		↶	↷		↶	↷
Traffic Vol, veh/h	5	0	0	39	24	3
Future Vol, veh/h	5	0	0	39	24	3
Conflicting Peds, #/hr	0	0	0	0	0	0
Sign Control	Free	Free	Free	Free	Stop	Stop
RT Channelized	-	None	-	None	-	None
Storage Length	-	-	-	-	0	-
Veh in Median Storage, #	-	0	0	-	0	-
Grade, %	-	0	0	-	0	-
Peak Hour Factor	78	78	78	78	78	78
Heavy Vehicles, %	2	2	2	2	2	2
Mvmt Flow	6	0	0	50	31	4

Major/Minor	Major1	Major2	Minor2		
Conflicting Flow All	50	0	-	0	37 25
Stage 1	-	-	-	-	25 -
Stage 2	-	-	-	-	12 -
Critical Hdwy	4.12	-	-	-	6.42 6.22
Critical Hdwy Stg 1	-	-	-	-	5.42 -
Critical Hdwy Stg 2	-	-	-	-	5.42 -
Follow-up Hdwy	2.218	-	-	-	3.518 3.318
Pot Cap-1 Maneuver	1557	-	-	-	975 1051
Stage 1	-	-	-	-	998 -
Stage 2	-	-	-	-	1011 -
Platoon blocked, %		-	-	-	
Mov Cap-1 Maneuver	1557	-	-	-	971 1051
Mov Cap-2 Maneuver	-	-	-	-	971 -
Stage 1	-	-	-	-	994 -
Stage 2	-	-	-	-	1011 -

Approach	EB	WB	SB
HCM Control Delay, s	7.3	0	8.8
HCM LOS			A

Minor Lane/Major Mvmt	EBL	EBT	WBT	WBR	SBLn1
Capacity (veh/h)	1557	-	-	-	979
HCM Lane V/C Ratio	0.004	-	-	-	0.035
HCM Control Delay (s)	7.3	0	-	-	8.8
HCM Lane LOS	A	A	-	-	A
HCM 95th %tile Q(veh)	0	-	-	-	0.1

Lanes, Volumes, Timings
18: Bradley Ridge & Marksheffel

						
Lane Group	SET	SER	NWL	NWT	NEL	NER
Lane Configurations	↑↑	↑	↓	↑↑	↓	↓
Traffic Volume (vph)	582	33	12	1828	290	38
Future Volume (vph)	582	33	12	1828	290	38
Ideal Flow (vphpl)	1900	1900	1900	1900	1900	1900
Storage Length (ft)		290	290		155	0
Storage Lanes		1	1		1	1
Taper Length (ft)			240		160	
Lane Util. Factor	0.95	1.00	1.00	0.95	1.00	1.00
Frt		0.850				0.850
Flt Protected			0.950		0.950	
Satd. Flow (prot)	3539	1583	1770	3539	1770	1583
Flt Permitted			0.411		0.950	
Satd. Flow (perm)	3539	1583	766	3539	1770	1583
Right Turn on Red		Yes				Yes
Satd. Flow (RTOR)		35				41
Link Speed (mph)	55			55	25	
Link Distance (ft)	942			970	596	
Travel Time (s)	11.7			12.0	16.3	
Peak Hour Factor	0.93	0.93	0.95	0.95	0.92	0.92
Adj. Flow (vph)	626	35	13	1924	315	41
Shared Lane Traffic (%)						
Lane Group Flow (vph)	626	35	13	1924	315	41
Enter Blocked Intersection	No	No	No	No	No	No
Lane Alignment	Left	Right	Left	Left	Left	Right
Median Width(ft)	12			12	12	
Link Offset(ft)	0			0	0	
Crosswalk Width(ft)	16			16	16	
Two way Left Turn Lane						
Headway Factor	1.00	1.00	1.00	1.00	1.00	1.00
Turning Speed (mph)		9	15		15	9
Number of Detectors	2	1	1	2	1	1
Detector Template	Thru	Right	Left	Thru	Left	Right
Leading Detector (ft)	100	20	20	100	20	20
Trailing Detector (ft)	0	0	0	0	0	0
Detector 1 Position(ft)	0	0	0	0	0	0
Detector 1 Size(ft)	6	20	20	6	20	20
Detector 1 Type	Cl+Ex	Cl+Ex	Cl+Ex	Cl+Ex	Cl+Ex	Cl+Ex
Detector 1 Channel						
Detector 1 Extend (s)	0.0	0.0	0.0	0.0	0.0	0.0
Detector 1 Queue (s)	0.0	0.0	0.0	0.0	0.0	0.0
Detector 1 Delay (s)	0.0	0.0	0.0	0.0	0.0	0.0
Detector 2 Position(ft)	94			94		
Detector 2 Size(ft)	6			6		
Detector 2 Type	Cl+Ex			Cl+Ex		
Detector 2 Channel						
Detector 2 Extend (s)	0.0			0.0		
Turn Type	NA	Perm	Perm	NA	Prot	Perm
Protected Phases	6			2	4	
Permitted Phases		6	2			4

Lanes, Volumes, Timings
18: Bradley Ridge & Marksheffel



Lane Group	SET	SER	NWL	NWT	NEL	NER
Detector Phase	6	6	2	2	4	4
Switch Phase						
Minimum Initial (s)	5.0	5.0	5.0	5.0	5.0	5.0
Minimum Split (s)	22.5	22.5	22.5	22.5	22.5	22.5
Total Split (s)	43.0	43.0	43.0	43.0	17.0	17.0
Total Split (%)	71.7%	71.7%	71.7%	71.7%	28.3%	28.3%
Maximum Green (s)	38.5	38.5	38.5	38.5	12.5	12.5
Yellow Time (s)	3.5	3.5	3.5	3.5	3.5	3.5
All-Red Time (s)	1.0	1.0	1.0	1.0	1.0	1.0
Lost Time Adjust (s)	0.0	0.0	0.0	0.0	0.0	0.0
Total Lost Time (s)	4.5	4.5	4.5	4.5	4.5	4.5
Lead/Lag						
Lead-Lag Optimize?						
Vehicle Extension (s)	3.0	3.0	3.0	3.0	3.0	3.0
Recall Mode	Max	Max	Max	Max	None	None
Walk Time (s)	7.0	7.0	7.0	7.0	7.0	7.0
Flash Dont Walk (s)	11.0	11.0	11.0	11.0	11.0	11.0
Pedestrian Calls (#/hr)	0	0	0	0	0	0
Act Effct Green (s)	39.6	39.6	39.6	39.6	12.4	12.4
Actuated g/C Ratio	0.65	0.65	0.65	0.65	0.20	0.20
v/c Ratio	0.27	0.03	0.03	0.84	0.88	0.12
Control Delay	5.0	1.7	4.2	13.0	51.3	8.3
Queue Delay	0.0	0.0	0.0	0.0	0.0	0.0
Total Delay	5.0	1.7	4.2	13.0	51.3	8.3
LOS	A	A	A	B	D	A
Approach Delay	4.8			12.9	46.3	
Approach LOS	A			B	D	
Queue Length 50th (ft)	43	0	1	239	110	0
Queue Length 95th (ft)	63	7	6	344	#236	21
Internal Link Dist (ft)	862			890	516	
Turn Bay Length (ft)		290	290		155	
Base Capacity (vph)	2297	1040	497	2297	362	357
Starvation Cap Reductn	0	0	0	0	0	0
Spillback Cap Reductn	0	0	0	0	0	0
Storage Cap Reductn	0	0	0	0	0	0
Reduced v/c Ratio	0.27	0.03	0.03	0.84	0.87	0.11

Intersection Summary

Area Type:	Other
Cycle Length:	60
Actuated Cycle Length:	61
Natural Cycle:	65
Control Type:	Actuated-Uncoordinated
Maximum v/c Ratio:	0.88
Intersection Signal Delay:	15.1
Intersection LOS:	B
Intersection Capacity Utilization:	74.1%
ICU Level of Service:	D
Analysis Period (min):	15
# 95th percentile volume exceeds capacity, queue may be longer. Queue shown is maximum after two cycles.	

Splits and Phases: 18: Bradley Ridge & Marksheffel

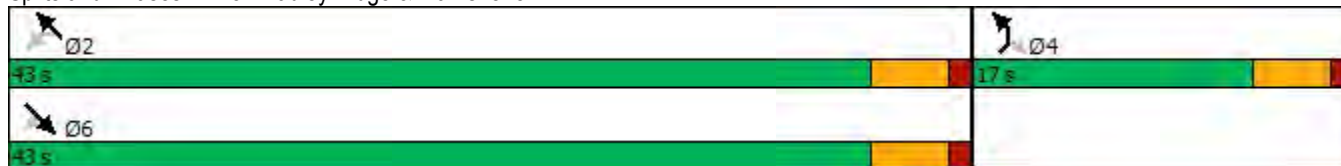

Intersection												
Int Delay, s/veh	2.1											
Movement	EBL	EBT	EBR	WBL	WBT	WBR	NBL	NBT	NBR	SBL	SBT	SBR
Lane Configurations												
Traffic Vol, veh/h	35	466	5	5	844	5	10	1	5	25	2	35
Future Vol, veh/h	35	466	5	5	844	5	10	1	5	25	2	35
Conflicting Peds, #/hr	0	0	0	0	0	0	0	0	0	0	0	0
Sign Control	Free	Free	Free	Free	Free	Free	Stop	Stop	Stop	Stop	Stop	Stop
RT Channelized	-	-	None	-	-	None	-	-	None	-	-	Stop
Storage Length	195	-	155	195	-	195	-	-	-	-	-	-
Veh in Median Storage, #	-	0	-	-	0	-	-	0	-	-	0	-
Grade, %	-	0	-	-	0	-	-	0	-	-	0	-
Peak Hour Factor	92	92	92	93	93	93	78	78	78	78	78	78
Heavy Vehicles, %	2	2	2	2	2	2	2	2	2	2	2	2
Mvmt Flow	38	507	5	5	908	5	13	1	6	32	3	45

Major/Minor	Major1			Major2			Minor1			Minor2		
Conflicting Flow All	913	0	0	512	0	0	1049	1506	254	1248	1506	454
Stage 1	-	-	-	-	-	-	583	583	-	918	918	-
Stage 2	-	-	-	-	-	-	466	923	-	330	588	-
Critical Hdwy	4.14	-	-	4.14	-	-	7.54	6.54	6.94	7.54	6.54	6.94
Critical Hdwy Stg 1	-	-	-	-	-	-	6.54	5.54	-	6.54	5.54	-
Critical Hdwy Stg 2	-	-	-	-	-	-	6.54	5.54	-	6.54	5.54	-
Follow-up Hdwy	2.22	-	-	2.22	-	-	3.52	4.02	3.32	3.52	4.02	3.32
Pot Cap-1 Maneuver	742	-	-	1050	-	-	182	120	745	130	120	553
Stage 1	-	-	-	-	-	-	465	497	-	292	349	-
Stage 2	-	-	-	-	-	-	546	347	-	657	494	-
Platoon blocked, %	-	-	-	-	-	-	-	-	-	-	-	-
Mov Cap-1 Maneuver	742	-	-	1050	-	-	157	113	745	122	113	553
Mov Cap-2 Maneuver	-	-	-	-	-	-	157	113	-	122	113	-
Stage 1	-	-	-	-	-	-	441	472	-	277	347	-
Stage 2	-	-	-	-	-	-	496	345	-	616	469	-

Approach	EB	WB	NB	SB
HCM Control Delay, s	0.7	0	24.8	30.9
HCM LOS			C	D

Minor Lane/Major Mvmt	NBLn1	EBL	EBT	EBR	WBL	WBT	WBR	SBLn1
Capacity (veh/h)	202	742	-	-	1050	-	-	217
HCM Lane V/C Ratio	0.102	0.051	-	-	0.005	-	-	0.366
HCM Control Delay (s)	24.8	10.1	-	-	8.4	-	-	30.9
HCM Lane LOS	C	B	-	-	A	-	-	D
HCM 95th %tile Q(veh)	0.3	0.2	-	-	0	-	-	1.6

Intersection						
Int Delay, s/veh	2.4					
Movement	EBL	EBT	WBT	WBR	SBL	SBR
Lane Configurations						
Traffic Vol, veh/h	50	506	869	20	20	115
Future Vol, veh/h	50	506	869	20	20	115
Conflicting Peds, #/hr	0	0	0	0	0	0
Sign Control	Free	Free	Free	Free	Stop	Stop
RT Channelized	-	None	-	None	-	Stop
Storage Length	155	-	-	185	0	-
Veh in Median Storage, #	-	0	0	-	0	-
Grade, %	-	0	0	-	0	-
Peak Hour Factor	93	93	93	93	83	83
Heavy Vehicles, %	2	2	2	2	2	2
Mvmt Flow	54	544	934	22	24	139

Major/Minor	Major1	Major2	Minor2		
Conflicting Flow All	956	0	-	0	1314 467
Stage 1	-	-	-	-	934 -
Stage 2	-	-	-	-	380 -
Critical Hdwy	4.14	-	-	-	6.84 6.94
Critical Hdwy Stg 1	-	-	-	-	5.84 -
Critical Hdwy Stg 2	-	-	-	-	5.84 -
Follow-up Hdwy	2.22	-	-	-	3.52 3.32
Pot Cap-1 Maneuver	715	-	-	-	150 542
Stage 1	-	-	-	-	343 -
Stage 2	-	-	-	-	661 -
Platoon blocked, %		-	-	-	
Mov Cap-1 Maneuver	715	-	-	-	139 542
Mov Cap-2 Maneuver	-	-	-	-	139 -
Stage 1	-	-	-	-	317 -
Stage 2	-	-	-	-	661 -

Approach	EB	WB	SB
HCM Control Delay, s	0.9	0	21.5
HCM LOS			C

Minor Lane/Major Mvmt	EBL	EBT	WBT	WBR	SBLn1
Capacity (veh/h)	715	-	-	-	379
HCM Lane V/C Ratio	0.075	-	-	-	0.429
HCM Control Delay (s)	10.4	-	-	-	21.5
HCM Lane LOS	B	-	-	-	C
HCM 95th %tile Q(veh)	0.2	-	-	-	2.1

Intersection												
Int Delay, s/veh	0.8											
Movement	EBL	EBT	EBR	WBL	WBT	WBR	NBL	NBT	NBR	SBL	SBT	SBR
Lane Configurations			↗			↗		↕	↗		↕	↗
Traffic Vol, veh/h	0	0	71	0	0	40	0	1800	20	0	600	20
Future Vol, veh/h	0	0	71	0	0	40	0	1800	20	0	600	20
Conflicting Peds, #/hr	0	0	0	0	0	0	0	0	0	0	0	0
Sign Control	Stop	Stop	Stop	Stop	Stop	Stop	Free	Free	Free	Free	Free	Free
RT Channelized	-	-	None	-	-	None	-	-	None	-	-	None
Storage Length	-	-	0	-	-	0	-	-	290	-	-	290
Veh in Median Storage, #	-	0	-	-	0	-	-	0	-	-	0	-
Grade, %	-	0	-	-	0	-	-	0	-	-	0	-
Peak Hour Factor	83	83	83	78	78	78	95	95	95	93	93	93
Heavy Vehicles, %	2	2	2	2	2	2	2	2	2	2	2	2
Mvmt Flow	0	0	86	0	0	51	0	1895	21	0	645	22

Major/Minor	Minor2		Minor1		Major1		Major2	
Conflicting Flow All	-	-	323	-	-	948	-	0
Stage 1	-	-	-	-	-	-	-	-
Stage 2	-	-	-	-	-	-	-	-
Critical Hdwy	-	-	6.94	-	-	6.94	-	-
Critical Hdwy Stg 1	-	-	-	-	-	-	-	-
Critical Hdwy Stg 2	-	-	-	-	-	-	-	-
Follow-up Hdwy	-	-	3.32	-	-	3.32	-	-
Pot Cap-1 Maneuver	0	0	673	0	0	262	0	-
Stage 1	0	0	-	0	0	-	-	0
Stage 2	0	0	-	0	0	-	-	0
Platoon blocked, %	-	-	-	-	-	-	-	-
Mov Cap-1 Maneuver	-	-	673	-	-	262	-	-
Mov Cap-2 Maneuver	-	-	-	-	-	-	-	-
Stage 1	-	-	-	-	-	-	-	-
Stage 2	-	-	-	-	-	-	-	-

Approach	EB		WB		NB		SB	
HCM Control Delay, s	11.1		22.1		0		0	
HCM LOS	B		C					

Minor Lane/Major Mvmt	NBT	NBR	EBLn1	WBLn1	SBT	SBR
Capacity (veh/h)	-	-	673	262	-	-
HCM Lane V/C Ratio	-	-	0.127	0.196	-	-
HCM Control Delay (s)	-	-	11.1	22.1	-	-
HCM Lane LOS	-	-	B	C	-	-
HCM 95th %tile Q(veh)	-	-	0.4	0.7	-	-







Intersection						
Int Delay, s/veh	4.8					
Movement	NWL	NWR	NET	NER	SWL	SWT
Lane Configurations						
Traffic Vol, veh/h	15	131	65	11	67	108
Future Vol, veh/h	15	131	65	11	67	108
Conflicting Peds, #/hr	0	0	0	0	0	0
Sign Control	Stop	Stop	Free	Free	Free	Free
RT Channelized	-	None	-	None	-	None
Storage Length	0	-	-	-	155	-
Veh in Median Storage, #	0	-	0	-	-	0
Grade, %	0	-	0	-	-	0
Peak Hour Factor	87	87	83	83	87	87
Heavy Vehicles, %	2	2	2	2	2	2
Mvmt Flow	17	151	78	13	77	124

Major/Minor	Minor1	Major1	Major2
Conflicting Flow All	363	85	0 0 91 0
Stage 1	85	-	- - - -
Stage 2	278	-	- - - -
Critical Hdwy	6.42	6.22	- - 4.12 -
Critical Hdwy Stg 1	5.42	-	- - - -
Critical Hdwy Stg 2	5.42	-	- - - -
Follow-up Hdwy	3.518	3.318	- - 2.218 -
Pot Cap-1 Maneuver	636	974	- - 1504 -
Stage 1	938	-	- - - -
Stage 2	769	-	- - - -
Platoon blocked, %			- - - -
Mov Cap-1 Maneuver	604	974	- - 1504 -
Mov Cap-2 Maneuver	604	-	- - - -
Stage 1	938	-	- - - -
Stage 2	730	-	- - - -

Approach	NW	NE	SW
HCM Control Delay, s	9.8	0	2.9
HCM LOS	A		

Minor Lane/Major Mvmt	NET	NERNWLn1	SWL	SWT
Capacity (veh/h)	-	-	916	1504
HCM Lane V/C Ratio	-	-	0.183	0.051
HCM Control Delay (s)	-	-	9.8	7.5
HCM Lane LOS	-	-	A	A
HCM 95th %tile Q(veh)	-	-	0.7	0.2

Lanes, Volumes, Timings
18: Bradley Ridge & Marksheffel

						
Lane Group	SET	SER	NWL	NWT	NEL	NER
Lane Configurations	↑↑	↑	↓	↑↑	↓	↓
Traffic Volume (vph)	1563	226	39	861	173	24
Future Volume (vph)	1563	226	39	861	173	24
Ideal Flow (vphpl)	1900	1900	1900	1900	1900	1900
Storage Length (ft)		290	290		155	0
Storage Lanes		1	1		1	1
Taper Length (ft)			240		160	
Lane Util. Factor	0.95	1.00	1.00	0.95	1.00	1.00
Frt		0.850				0.850
Flt Protected			0.950		0.950	
Satd. Flow (prot)	3539	1583	1770	3539	1770	1583
Flt Permitted			0.102		0.950	
Satd. Flow (perm)	3539	1583	190	3539	1770	1583
Right Turn on Red		Yes				Yes
Satd. Flow (RTOR)		238				28
Link Speed (mph)	55			55	25	
Link Distance (ft)	502			1000	586	
Travel Time (s)	6.2			12.4	16.0	
Peak Hour Factor	0.95	0.95	0.93	0.93	0.87	0.87
Adj. Flow (vph)	1645	238	42	926	199	28
Shared Lane Traffic (%)						
Lane Group Flow (vph)	1645	238	42	926	199	28
Enter Blocked Intersection	No	No	No	No	No	No
Lane Alignment	Left	Right	Left	Left	Left	Right
Median Width(ft)	12			12	12	
Link Offset(ft)	0			0	0	
Crosswalk Width(ft)	16			16	16	
Two way Left Turn Lane						
Headway Factor	1.00	1.00	1.00	1.00	1.00	1.00
Turning Speed (mph)		9	15		15	9
Number of Detectors	2	1	1	2	1	1
Detector Template	Thru	Right	Left	Thru	Left	Right
Leading Detector (ft)	100	20	20	100	20	20
Trailing Detector (ft)	0	0	0	0	0	0
Detector 1 Position(ft)	0	0	0	0	0	0
Detector 1 Size(ft)	6	20	20	6	20	20
Detector 1 Type	Cl+Ex	Cl+Ex	Cl+Ex	Cl+Ex	Cl+Ex	Cl+Ex
Detector 1 Channel						
Detector 1 Extend (s)	0.0	0.0	0.0	0.0	0.0	0.0
Detector 1 Queue (s)	0.0	0.0	0.0	0.0	0.0	0.0
Detector 1 Delay (s)	0.0	0.0	0.0	0.0	0.0	0.0
Detector 2 Position(ft)	94			94		
Detector 2 Size(ft)	6			6		
Detector 2 Type	Cl+Ex			Cl+Ex		
Detector 2 Channel						
Detector 2 Extend (s)	0.0			0.0		
Turn Type	NA	Perm	Perm	NA	Prot	Perm
Protected Phases	6			2	4	
Permitted Phases		6	2			4

Lanes, Volumes, Timings
18: Bradley Ridge & Marksheffel





Lane Group	SET	SER	NWL	NWT	NEL	NER
Detector Phase	6	6	2	2	4	4
Switch Phase						
Minimum Initial (s)	5.0	5.0	5.0	5.0	5.0	5.0
Minimum Split (s)	22.5	22.5	22.5	22.5	22.5	22.5
Total Split (s)	44.0	44.0	44.0	44.0	16.0	16.0
Total Split (%)	73.3%	73.3%	73.3%	73.3%	26.7%	26.7%
Maximum Green (s)	39.5	39.5	39.5	39.5	11.5	11.5
Yellow Time (s)	3.5	3.5	3.5	3.5	3.5	3.5
All-Red Time (s)	1.0	1.0	1.0	1.0	1.0	1.0
Lost Time Adjust (s)	0.0	0.0	0.0	0.0	0.0	0.0
Total Lost Time (s)	4.5	4.5	4.5	4.5	4.5	4.5
Lead/Lag						
Lead-Lag Optimize?						
Vehicle Extension (s)	3.0	3.0	3.0	3.0	3.0	3.0
Recall Mode	Max	Max	Max	Max	None	None
Walk Time (s)	7.0	7.0	7.0	7.0	7.0	7.0
Flash Dont Walk (s)	11.0	11.0	11.0	11.0	11.0	11.0
Pedestrian Calls (#/hr)	0	0	0	0	0	0
Act Effct Green (s)	43.2	43.2	43.2	43.2	10.6	10.6
Actuated g/C Ratio	0.69	0.69	0.69	0.69	0.17	0.17
v/c Ratio	0.68	0.20	0.32	0.38	0.67	0.10
Control Delay	7.8	1.1	12.7	4.9	35.0	9.8
Queue Delay	0.0	0.0	0.0	0.0	0.0	0.0
Total Delay	7.8	1.1	12.7	4.9	35.0	9.8
LOS	A	A	B	A	C	A
Approach Delay	7.0			5.2	31.9	
Approach LOS	A			A	C	
Queue Length 50th (ft)	163	0	5	66	66	0
Queue Length 95th (ft)	230	17	28	94	120	17
Internal Link Dist (ft)	422			920	506	
Turn Bay Length (ft)		290	290		155	
Base Capacity (vph)	2432	1162	130	2432	324	313
Starvation Cap Reductn	0	0	0	0	0	0
Spillback Cap Reductn	0	0	0	0	0	0
Storage Cap Reductn	0	0	0	0	0	0
Reduced v/c Ratio	0.68	0.20	0.32	0.38	0.61	0.09

Intersection Summary

Area Type:	Other
Cycle Length:	60
Actuated Cycle Length:	62.9
Natural Cycle:	60
Control Type:	Actuated-Uncoordinated
Maximum v/c Ratio:	0.68
Intersection Signal Delay:	8.3
Intersection LOS:	A
Intersection Capacity Utilization:	60.3%
ICU Level of Service:	B
Analysis Period (min):	15

Splits and Phases: 18: Bradley Ridge & Marksheffel

 Ø2	 Ø4
44 s	15 s
 Ø6	
44 s	

Intersection												
Int Delay, s/veh	2.8											
Movement	EBL	EBT	EBR	WBL	WBT	WBR	NBL	NBT	NBR	SBL	SBT	SBR
Lane Configurations												
Traffic Vol, veh/h	105	1233	10	15	726	10	5	1	5	15	2	20
Future Vol, veh/h	105	1233	10	15	726	10	5	1	5	15	2	20
Conflicting Peds, #/hr	0	0	0	0	0	0	0	0	0	0	0	0
Sign Control	Free	Free	Free	Free	Free	Free	Stop	Stop	Stop	Stop	Stop	Stop
RT Channelized	-	-	None	-	-	None	-	-	None	-	-	Stop
Storage Length	195	-	155	195	-	195	-	-	-	-	-	-
Veh in Median Storage, #	-	0	-	-	0	-	-	0	-	-	0	-
Grade, %	-	0	-	-	0	-	-	0	-	-	0	-
Peak Hour Factor	95	95	95	93	93	93	78	78	78	78	78	78
Heavy Vehicles, %	2	2	2	2	2	2	2	2	2	2	2	2
Mvmt Flow	111	1298	11	16	781	11	6	1	6	19	3	26

Major/Minor	Major1			Major2			Minor1			Minor2		
Conflicting Flow All	792	0	0	1309	0	0	1944	2344	649	1685	2344	391
Stage 1	-	-	-	-	-	-	1520	1520	-	813	813	-
Stage 2	-	-	-	-	-	-	424	824	-	872	1531	-
Critical Hdwy	4.14	-	-	4.14	-	-	7.54	6.54	6.94	7.54	6.54	6.94
Critical Hdwy Stg 1	-	-	-	-	-	-	6.54	5.54	-	6.54	5.54	-
Critical Hdwy Stg 2	-	-	-	-	-	-	6.54	5.54	-	6.54	5.54	-
Follow-up Hdwy	2.22	-	-	2.22	-	-	3.52	4.02	3.32	3.52	4.02	3.32
Pot Cap-1 Maneuver	824	-	-	524	-	-	39	36	412	61	36	608
Stage 1	-	-	-	-	-	-	124	179	-	339	390	-
Stage 2	-	-	-	-	-	-	578	385	-	312	177	-
Platoon blocked, %		-	-		-	-						
Mov Cap-1 Maneuver	824	-	-	524	-	-	31	30	412	51	30	608
Mov Cap-2 Maneuver	-	-	-	-	-	-	31	30	-	51	30	-
Stage 1	-	-	-	-	-	-	107	155	-	293	378	-
Stage 2	-	-	-	-	-	-	533	373	-	264	153	-

Approach	EB			WB			NB			SB		
HCM Control Delay, s	0.8			0.2			95.9			77.2		
HCM LOS							F			F		

Minor Lane/Major Mvmt	NBLn1	EBL	EBT	EBR	WBL	WBT	WBR	SBLn1
Capacity (veh/h)	53	824	-	-	524	-	-	94
HCM Lane V/C Ratio	0.266	0.134	-	-	0.031	-	-	0.505
HCM Control Delay (s)	95.9	10	-	-	12.1	-	-	77.2
HCM Lane LOS	F	B	-	-	B	-	-	F
HCM 95th %tile Q(veh)	0.9	0.5	-	-	0.1	-	-	2.2

Intersection						
Int Delay, s/veh	2					
Movement	EBL	EBT	WBT	WBR	SBL	SBR
Lane Configurations						
Traffic Vol, veh/h	125	1348	726	25	15	75
Future Vol, veh/h	125	1348	726	25	15	75
Conflicting Peds, #/hr	0	0	0	0	0	0
Sign Control	Free	Free	Free	Free	Stop	Stop
RT Channelized	-	None	-	None	-	Stop
Storage Length	155	-	-	185	0	-
Veh in Median Storage, #	-	0	0	-	0	-
Grade, %	-	0	0	-	0	-
Peak Hour Factor	95	95	93	93	78	78
Heavy Vehicles, %	2	2	2	2	2	2
Mvmt Flow	132	1419	781	27	19	96

Major/Minor	Major1	Major2	Minor2		
Conflicting Flow All	808	0	-	0	1755 391
Stage 1	-	-	-	-	781 -
Stage 2	-	-	-	-	974 -
Critical Hdwy	4.14	-	-	-	6.84 6.94
Critical Hdwy Stg 1	-	-	-	-	5.84 -
Critical Hdwy Stg 2	-	-	-	-	5.84 -
Follow-up Hdwy	2.22	-	-	-	3.52 3.32
Pot Cap-1 Maneuver	813	-	-	-	76 608
Stage 1	-	-	-	-	412 -
Stage 2	-	-	-	-	327 -
Platoon blocked, %		-	-	-	
Mov Cap-1 Maneuver	813	-	-	-	64 608
Mov Cap-2 Maneuver	-	-	-	-	64 -
Stage 1	-	-	-	-	345 -
Stage 2	-	-	-	-	327 -

Approach	EB	WB	SB
HCM Control Delay, s	0.9	0	30.8
HCM LOS			D

Minor Lane/Major Mvmt	EBL	EBT	WBT	WBR	SBLn1
Capacity (veh/h)	813	-	-	-	252
HCM Lane V/C Ratio	0.162	-	-	-	0.458
HCM Control Delay (s)	10.3	-	-	-	30.8
HCM Lane LOS	B	-	-	-	D
HCM 95th %tile Q(veh)	0.6	-	-	-	2.2

Intersection												
Int Delay, s/veh	0.5											
Movement	EBL	EBT	EBR	WBL	WBT	WBR	NBL	NBT	NBR	SBL	SBT	SBR
Lane Configurations			↗			↗		↕	↗		↕	↗
Traffic Vol, veh/h	0	0	50	0	0	25	0	875	60	0	1500	87
Future Vol, veh/h	0	0	50	0	0	25	0	875	60	0	1500	87
Conflicting Peds, #/hr	0	0	0	0	0	0	0	0	0	0	0	0
Sign Control	Stop	Stop	Stop	Stop	Stop	Stop	Free	Free	Free	Free	Free	Free
RT Channelized	-	-	None	-	-	None	-	-	None	-	-	None
Storage Length	-	-	0	-	-	0	-	-	290	-	-	290
Veh in Median Storage, #	-	0	-	-	0	-	-	0	-	-	0	-
Grade, %	-	0	-	-	0	-	-	0	-	-	0	-
Peak Hour Factor	83	83	83	78	78	78	95	95	95	95	95	95
Heavy Vehicles, %	2	2	2	2	2	2	2	2	2	2	2	2
Mvmt Flow	0	0	60	0	0	32	0	921	63	0	1579	92

Major/Minor	Minor2		Minor1		Major1		Major2	
Conflicting Flow All	-	-	790	-	-	461	-	0
Stage 1	-	-	-	-	-	-	-	-
Stage 2	-	-	-	-	-	-	-	-
Critical Hdwy	-	-	6.94	-	-	6.94	-	-
Critical Hdwy Stg 1	-	-	-	-	-	-	-	-
Critical Hdwy Stg 2	-	-	-	-	-	-	-	-
Follow-up Hdwy	-	-	3.32	-	-	3.32	-	-
Pot Cap-1 Maneuver	0	0	333	0	0	547	0	-
Stage 1	0	0	-	0	0	-	0	-
Stage 2	0	0	-	0	0	-	0	-
Platoon blocked, %	-	-	-	-	-	-	-	-
Mov Cap-1 Maneuver	-	-	333	-	-	547	-	-
Mov Cap-2 Maneuver	-	-	-	-	-	-	-	-
Stage 1	-	-	-	-	-	-	-	-
Stage 2	-	-	-	-	-	-	-	-

Approach	EB	WB	NB	SB
HCM Control Delay, s	18.2	12	0	0
HCM LOS	C	B		

Minor Lane/Major Mvmt	NBT	NBR	EBLn1WBLn1	SBT	SBR
Capacity (veh/h)	-	-	333	547	-
HCM Lane V/C Ratio	-	-	0.181	0.059	-
HCM Control Delay (s)	-	-	18.2	12	-
HCM Lane LOS	-	-	C	B	-
HCM 95th %tile Q(veh)	-	-	0.7	0.2	-

Intersection						
Int Delay, s/veh	6.6					
Movement	NWL	NWR	NET	NER	SWL	SWT
Lane Configurations						
Traffic Vol, veh/h	6	231	98	14	62	33
Future Vol, veh/h	6	231	98	14	62	33
Conflicting Peds, #/hr	0	0	0	0	0	0
Sign Control	Stop	Stop	Free	Free	Free	Free
RT Channelized	-	None	-	None	-	None
Storage Length	0	-	-	-	155	-
Veh in Median Storage, #	0	-	0	-	-	0
Grade, %	0	-	0	-	-	0
Peak Hour Factor	87	87	83	83	83	83
Heavy Vehicles, %	2	2	2	2	2	2
Mvmt Flow	7	266	118	17	75	40

Major/Minor	Minor1	Major1	Major2		
Conflicting Flow All	317	127	0	0	135
Stage 1	127	-	-	-	-
Stage 2	190	-	-	-	-
Critical Hdwy	6.42	6.22	-	-	4.12
Critical Hdwy Stg 1	5.42	-	-	-	-
Critical Hdwy Stg 2	5.42	-	-	-	-
Follow-up Hdwy	3.518	3.318	-	-	2.218
Pot Cap-1 Maneuver	676	923	-	-	1449
Stage 1	899	-	-	-	-
Stage 2	842	-	-	-	-
Platoon blocked, %			-	-	-
Mov Cap-1 Maneuver	641	923	-	-	1449
Mov Cap-2 Maneuver	641	-	-	-	-
Stage 1	899	-	-	-	-
Stage 2	798	-	-	-	-

Approach	NW	NE	SW
HCM Control Delay, s	10.6	0	5
HCM LOS	B		

Minor Lane/Major Mvmt	NET	NERNWLn1	SWL	SWT
Capacity (veh/h)	-	-	913	1449
HCM Lane V/C Ratio	-	-	0.298	0.052
HCM Control Delay (s)	-	-	10.6	7.6
HCM Lane LOS	-	-	B	A
HCM 95th %tile Q(veh)	-	-	1.3	0.2

MTCP Maps



Map 13: Improvements Map

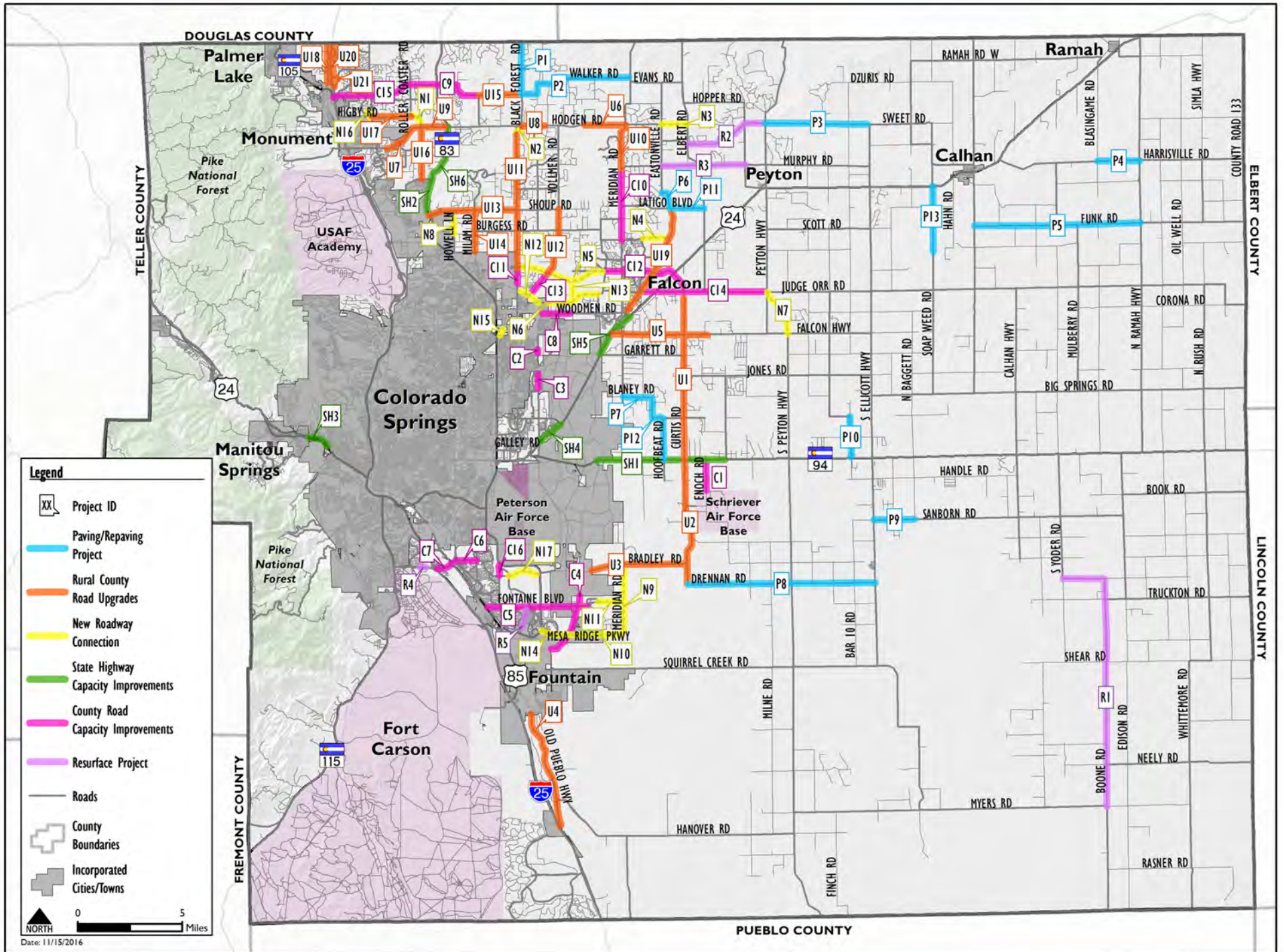

Map 13: Improvements Map

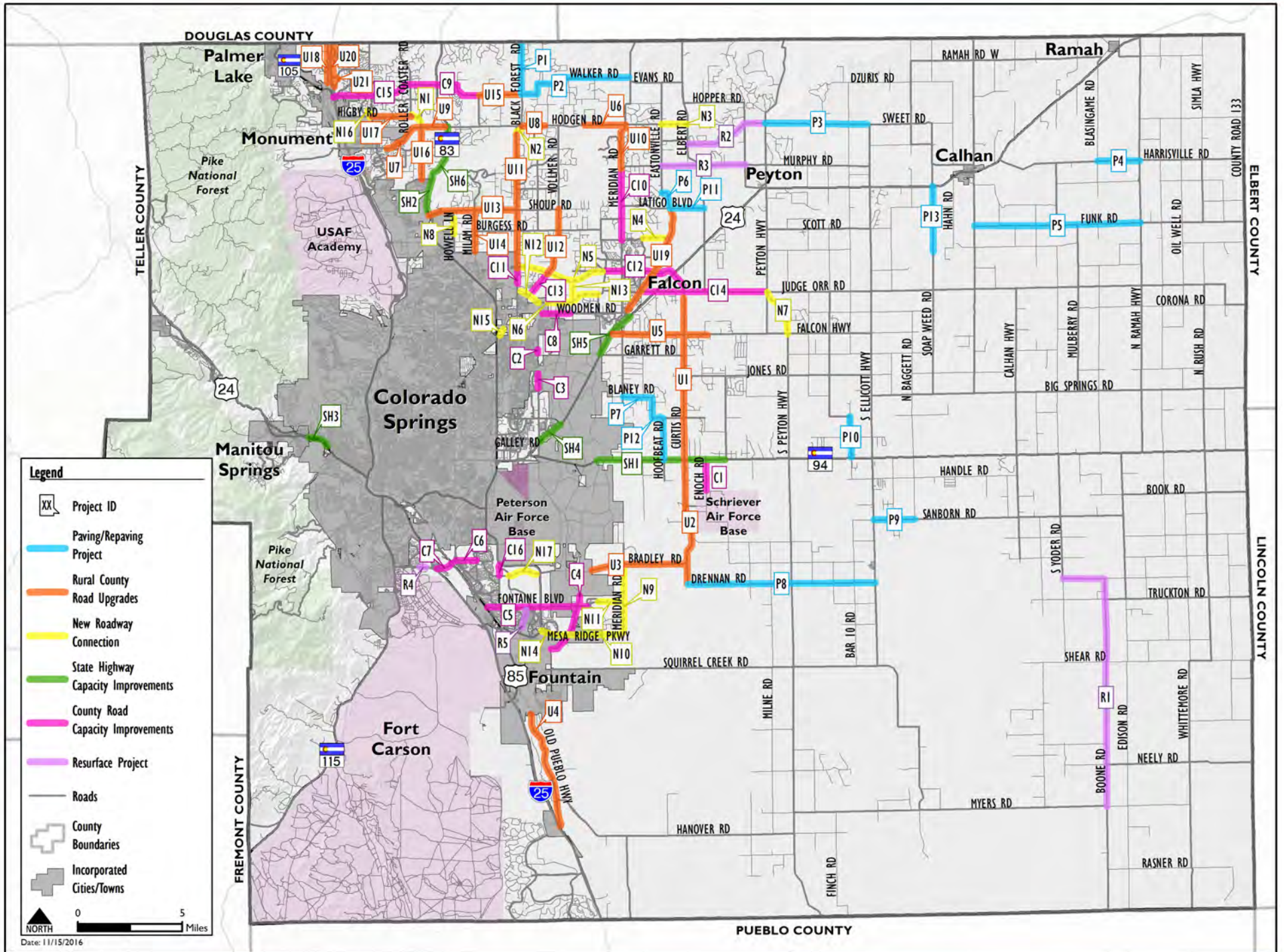

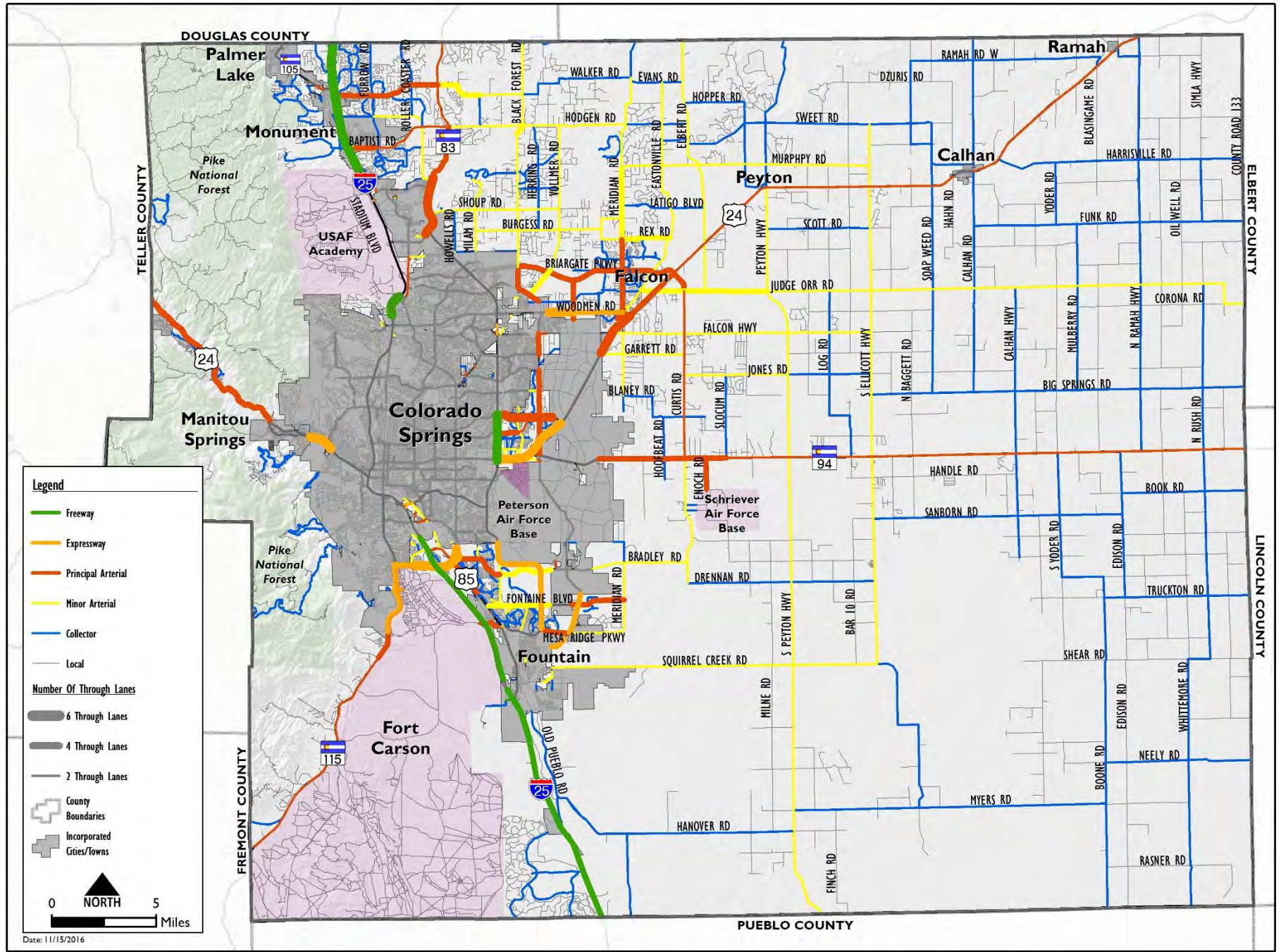

Map 14: 2040 Roadway Plan (Classification and Lanes)

Map 15: Multimodal Improvements

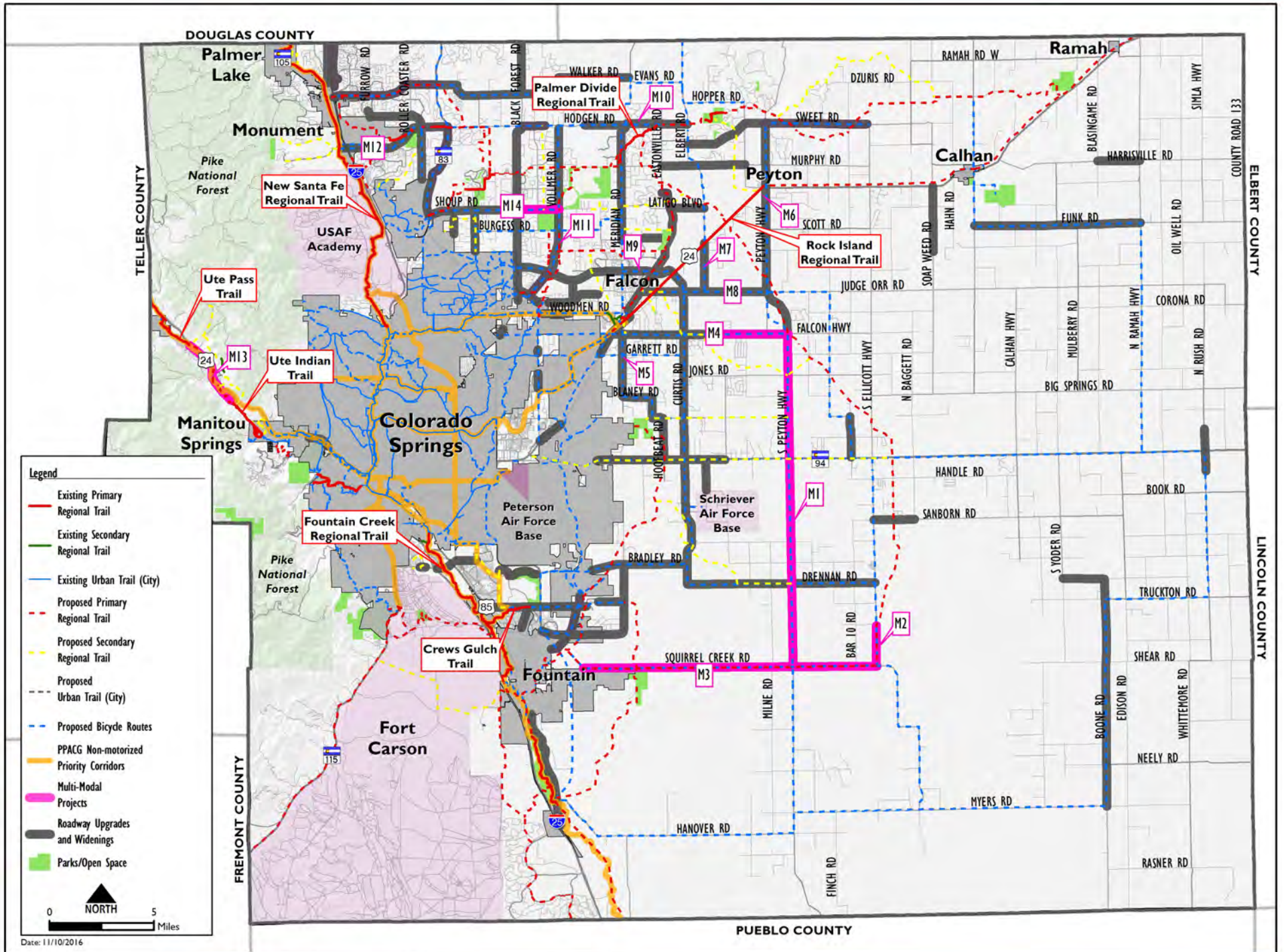

Map 15: Multimodal Improvements

