



LSC TRANSPORTATION CONSULTANTS, INC.
2504 East Pikes Peak Avenue, Suite 304
Colorado Springs, CO 80909
(719) 633-2868
FAX (719) 633-5430
E-mail: lsc@lsctrans.com
Website: <http://www.lsctrans.com>

Sterling Ranch East Filing No. 6
Traffic Impact Study
(LSC #S244250)
September 27, 2024
PCD File No P2414

Traffic Engineer's Statement

This traffic report and supporting information were prepared under my responsible charge and they comport with the standard of care. So far as is consistent with the standard of care, said report was prepared in general conformance with the criteria established by the County for traffic reports.

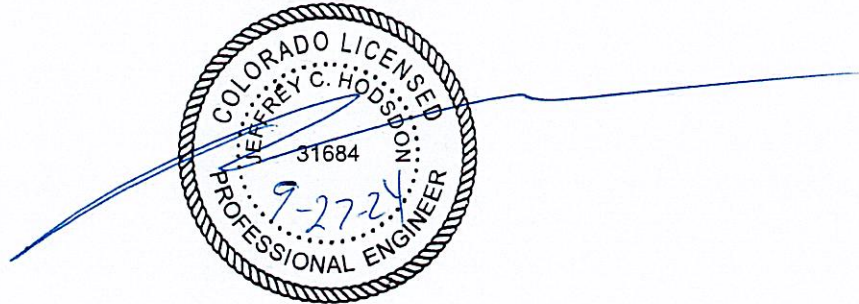

Developer's Statement

I, the Developer, have read and will comply with all commitments made on my behalf within this report.

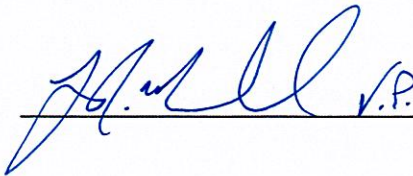

9/30/2024
Date

Sterling Ranch East Filing No. 6

Traffic Impact Study

Prepared for:
Loren J. Moreland
Vice President/ Project Manager
Classic SRJ
2138 Flying Horse Club Drive
Colorado Springs, CO 80921

SEPTEMBER 27, 2024

LSC Transportation Consultants
Prepared by: Kirstin D. Ferrin, P.E.
Reviewed by: Jeffrey C. Hodsdon, P.E.

LSC #S244250

CONTENTS

REPORT CONTENTS 1

RECENT TRAFFIC REPORTS 2

STUDY AREA 2

 Land Use..... 2

 Pedestrian Plan 2

 Proposed Access Points 3

 Sight Distance Analysis..... 3

REPORT SCENARIOS 3

 Short-Term Scenario 3

 Long-Term Scenario 4

EXISTING ROAD AND TRAFFIC CONDITIONS 4

 Existing Traffic Volumes 5

 Existing Levels of Service 5

 Marksheffel Road/Vollmer Road 6

 Burgess Road/Vollmer Road 6

 Safety and Accident Analysis 6

BASELINE CONDITIONS 7

 Short-Term Scenario Baseline Conditions 7

 Long-Term Scenario Baseline Conditions 7

TRIP GENERATION 8

TRIP DISTRIBUTION AND ASSIGNMENT 8

TOTAL TRAFFIC 8

 Short-Term Total Traffic..... 8

 2045 Total Traffic 9

PRELIMINARY SIGNAL-WARRANT-THRESHOLD ANALYSIS (AM AND PM PEAK HOURS) –
MARKSHEFFEL ROAD/VOLLMER ROAD AND MARKSHEFFEL ROAD/STERLING RANCH ROAD 9

LEVEL OF SERVICE ANALYSIS 10

 Intersection #1: Vollmer Road/Burgess Road..... 10

 Intersection #4: Vollmer Road/Briargate Parkway 10

 Intersection #5: Briargate Parkway/Sterling Ranch Road 10

 Intersection #12: Marksheffel Road/Vollmer Road 11

Intersection #13: Marksheffel Road/Sterling Ranch Road	11
Intersection #309 Sterling Ranch Road/Vancouver Street	11
Intersection #310 Sterling Ranch Road/Appleton Drive	12
ROADWAY FUNCTIONAL CLASSIFICATIONS AND LANEAGE	12
DEVIATION REQUESTS	12
AREA MTCP 2050 ROADWAY IMPROVEMENT PROJECTS.....	12
ESCROW ANALYSIS.....	12
TRANSPORTATION IMPROVEMENT FEE PROGRAM AND CREDIT AGREEMENTS.....	12
CONCLUSIONS AND RECOMMENDATIONS.....	13
Trip Generation.....	13
Level of Service	13
Recommended Improvements	13
Escrow Analysis.....	14
Enclosures:	14
Tables 2-6	
Figures 1-14	
Traffic Count Reports	
Level of Service Reports	
Appendix Table 1	
MTCP Maps	
Crash History	



LSC TRANSPORTATION CONSULTANTS, INC.
2504 East Pikes Peak Avenue, Suite 304
Colorado Springs, CO 80909
(719) 633-2868
FAX (719) 633-5430
E-mail: lsc@lsctrans.com
Website: <http://www.lsctrans.com>

September 27, 2024

Loren J. Moreland
Vice President/ Project Manager
Classic SRJ
2138 Flying Horse Club Drive
Colorado Springs, CO 80921

RE: Sterling Ranch East Filing No. 6
Traffic Impact Study
El Paso County, Colorado
LSC #S244250

Dear Mr. Moreland:

LSC Transportation Consultants, Inc. has prepared this updated Traffic Impact Study for the proposed Sterling Ranch Filing No. 6 rezone and preliminary plat. As shown in Figure 1, the site is located east of the future Sterling Ranch Road and north of the future Briargate Parkway in El Paso County, Colorado.

REPORT CONTENTS

The preparation of this report included the following:

- A list of previous Sterling Ranch traffic reports and the context of this project;
- The existing roadway and traffic conditions in the site's vicinity including the roadway widths, surface conditions, lane geometries, traffic controls, and posted speed limits;
- A summary of the proposed land use and access plan;
- Existing traffic-volume data;
- Estimates of projected short-term and long-term baseline traffic volumes;
- The projected average weekday and peak-hour vehicle trips to be generated by the proposed future development within the preliminary plan area;
- The assignment of the projected preliminary-plan site-generated traffic volumes to the area roadways;
- The projected short-term and long-term total traffic volumes on the area roadways;
- The projected levels of service at the key intersections within the study area;
- Signal-warrant threshold analysis;
- The recommended street classifications;

- Findings and recommendations for study-area roadways and intersections, including number of lanes, auxiliary turn lanes, intersection traffic control, etc.; and
- The project's obligation to the County roadway improvement fee program.

RECENT TRAFFIC REPORTS

LSC prepared a previous master traffic impact study (MTIS) for the entire Sterling Ranch development, dated March 17, 2023. LSC also prepared a technical memorandum for the Sterling Ranch Amendment #3 (dated January 17, 2024) and for Sterling Ranch Amendment #4 (dated September 13, 2024). Appendix Table 1, which includes a list of other traffic studies within Sterling Ranch and in the vicinity of area of study completed within the past five years (that LSC is aware of), is attached for reference.

El Paso County is currently studying the Briargate Stapleton Corridor as part of a Pikes Peak Rural Transportation Authority (PPRTA) study. A draft version of the *Briargate-Stapleton Corridor Study* by Wilson & Company was published December 9, 2021.

STUDY AREA

Figure 1 shows the location of Sterling Ranch East Filing No. 6 relative to the overall Sterling Ranch Sketch Plan Area. As shown in Figure 1, the site is located generally in the middle of the Sketch Plan Area adjacent to the future extensions of Sterling Ranch Road and Briargate Parkway.

Land Use

Figure 2 shows the proposed Sterling Ranch Filing No. 6. The site is planned to be developed with 198 residential dwelling units.

Pedestrian Plan

Detached sidewalks will be provided along Briargate Parkway and Sterling Ranch Road. The multi-use paved shoulder on Sterling Ranch Road will accommodate bicycles. Attached 5-foot-wide concrete sidewalks are planned on all of the local streets within Sterling Ranch East Filing No. 6.

There are no existing schools within two miles of the site. However, there are multiple future school sites in the area, including a future K-8 school site southwest of the site (south of Briargate Parkway and west of Sterling Ranch Road) and an elementary school site further south of Briargate Parkway and east of Sterling Ranch Road. No information or plans are available for the school sites and separate site-specific traffic impact studies including pedestrian plans will be required to be approved prior to school-site development.

Proposed Access Points

Figure 3 shows the roadway connections that are planned to be constructed in the short term. As shown in Figure 3, in the short term, Briargate Parkway is planned to be constructed to its final cross section between Vollmer Road and Sterling Ranch Road, Marksheffel Road is planned to be completed between Vollmer Road and Woodmen Road, and Sterling Ranch Road is planned to be constructed from Marksheffel Road to the northern boundary of the currently-proposed Sterling Ranch East Filing No. 6.

Figure 2 shows the proposed access plan. Full-movement access points are proposed to Sterling Ranch Road and Appleton Drive. The proposed spacing is greater than the 330-foot minimum intersection spacing for Urban Non-Residential Collectors when intersecting local roadways, per criteria contained in Table 2-7 of the *El Paso County Engineering Criteria Manual (ECM)*.

An additional right-in/right-out access is proposed to Briargate Parkway about 1,350 feet east of Sterling Ranch Road. This access will require a deviation to the criteria contained in the *ECM*. The Master TIS showed a right-in/right-out only access point in this general location.

Sight Distance Analysis

Figure 4a shows the intersection sight-distance analysis at the intersections of Sterling Ranch Road (Urban Minor Collector)/Vancouver Street (Urban Local), Sterling Ranch Road (Urban Minor Collector)/Appleton Drive (Urban Minor Collector), and Appleton Drive (Urban Minor Collector)/Sioux Falls Way (Urban Local). Based on a design speed of 40 miles per hour (mph) and the criteria contained in Table 2-21 of the *ECM*, the required intersection sight distance at these intersections is 445 feet. As shown in Figure 4a, the intersection sight distance can be met at all three intersections.

Figure 4b shows the intersection sight-distance analysis at the proposed right-in/right-out only access to Briargate Parkway (Principal Arterial). Based on a design speed of 50 miles per hour (mph) and the criteria contained in Table 2-21 of the *ECM*, the required intersection sight distance at the future intersections is 555 feet. As shown on Figure 4b the intersection sight distance can be met at these intersections.

REPORT SCENARIOS

Short-Term Scenario

The short-term scenario includes the roadway segments to be added in the short term only, as shown in Figure 3. This scenario includes the Sterling Ranch East Filing No. 6 area ("the site") as well as traffic to be generated in the short term by buildout of Homestead at Sterling Ranch, Branding Iron at Sterling Ranch, Sterling Ranch Filings 2-4, Copper Chase at Sterling Ranch, Homestead North at Sterling Ranch Filings 1-3, the Retreat at TimberRidge Filings 1-4, the planned FourSquare at Sterling Ranch East development, the approved filings within Sterling

Ranch East Preliminary Plan 1 (Sterling Ranch East Filings 1 and 2), Sterling Ranch East Filing 5 and the Villages at Sterling Ranch East. See Appendix Table 1 for the PCD file numbers associated with the above-mentioned projects.

Note that the short-term scenario assumes no traffic due to future anticipated land uses within Sterling Ranch East Preliminary Plan 1 beyond Sterling Ranch East Filings 1 and 2, including the residential areas east of Sterling Ranch Road and north of Idaho Falls Drive and the future school sites. Trips projected from these other short-term developments outside of the Sterling Ranch East Filing No. 6 boundary are included as short-term “background traffic” in this report.

Long-Term Scenario

The long-term scenario is essentially the same as the 2045 long-term scenario contained in the LSC September 13, 2024 Master TIS Addendum with additional detail added for this application. The study area of this report is more focused than the Sketch Plan. It includes updated analysis of the Arterial/Arterial and Arterial/Collector intersections adjacent to the existing, approved, and currently-proposed preliminary plan areas within the Sterling Ranch Sketch Plan Area (Vollmer Road/Burgess Road [#1], Briargate Parkway/Vollmer Road [#4], Briargate Parkway/Sterling Ranch Road [#5], Research Parkway/Marksheffel Road/Vollmer Road [#12], and Marksheffel Road/Sterling Ranch Road [#13]), and new analysis of two additional access points to Sterling Ranch Road proposed as part of Sterling Ranch East Filing No. 6 [#309 and #310].

EXISTING ROAD AND TRAFFIC CONDITIONS

The adjacent streets are shown in Figure 1 and are described below. Excerpts from the 2024 *El Paso County Major Transportation Corridors Plan (MTCP) 2045 Roadway Functional Classifications (Figure 22) and 2065 Corridor Preservation Plan (Figure 39)* with the site location identified on them have been attached to this report. The 2045 and 2065 *Through Lane Requirements* (Figures 23 and 40, respectively) are also reflected in this report.

Vollmer Road is currently a five-lane urban street within the City of Colorado Springs limits between Black Forest Road and Cowpoke Road and a two-lane, rural, paved roadway north of Cowpoke Road extending to north of Hodgen Road. In the southbound direction, Vollmer Road has a posted speed limit of 45 mph. South of Cowpoke Road, Vollmer Road has a 40-mph posted speed limit. Note: The new *Connect COS* City of Colorado Springs transportation plan shows Vollmer as a Principal Arterial. The 2024 *MTCP* shows Vollmer Road as an Urban – Major Collector in the vicinity of the site. The South Vollmer Road improvements ([CDR2116](#)) which will provide two through lanes in each direction on Vollmer Road in the vicinity of Marksheffel Road, are currently under construction and are anticipated to be completed in the near term.

The North Vollmer Road improvements ([CDR217](#)), which will provide two through lanes in each direction on Vollmer Road in the vicinity of Briargate Parkway, are currently under construction and are anticipated to be completed in the near term.

Marksheffel Road is a Principal Arterial extending north from the City of Fountain to Woodmen Road. Marksheffel Road is planned to ultimately be widened to six lanes and extended north and west from Woodmen Road to connect to Research Parkway at Black Forest Road. Marksheffel Road is shown as a four-lane Principal Arterial through the site on the El Paso County *MTCP*. The City of Colorado Springs intends to take ownership and maintenance of Marksheffel Road when it is constructed from Vollmer to the east and south to where it will connect to the segment constructed north of Woodmen Road in the City.

The section of Marksheffel Road adjacent to Sterling Ranch has been or is planned to be constructed on 107 feet of right-of-way to the City's required cross section(s) and criteria. The section of Marksheffel Road between Sterling Ranch Road and Vollmer Road has recently been completed and the section of Marksheffel Road southeast of Sterling Ranch Road (to connect to the segment recently constructed) will be completed in the short term and will open the connection to Woodmen Road.

Briargate Parkway is a Principal Arterial that extends east from I-25 to Grand Lawn Circle (about one-half mile east of Powers Boulevard). Briargate Parkway is planned ultimately to extend to Towner Drive. The segment of Briargate Parkway between Vollmer Road and Sterling Ranch Road is planned to be constructed to its full 4-lane cross section in the very short term.

Sterling Ranch Road is an Urban Major Collector shown extending through the Sterling Ranch development between Marksheffel Road and the north end of the Sketch Plan area (Arroya Road). Sterling Ranch Road has been constructed between Marksheffel Road and Dines Boulevard and will be constructed north to Briargate Parkway in the short term with the Sterling Ranch East Phase 1 Preliminary Plan.

Existing Traffic Volumes

Figures 5a and 5b show the existing average weekday and peak-hour traffic volumes at the key study-area intersections, respectively. The peak-hour traffic volumes shown are based on manual turning-movement counts by LSC Transportation Consultants in March and April 2024. The average weekday traffic volumes on Vollmer Road north of Marksheffel Road shown in Figure 5a are based on machine counts by LSC in April 2024. The traffic-count sheets are attached.

Existing Levels of Service

Level of service (LOS) is a quantitative measure of the level of congestion or delay at an intersection. Level of service is indicated on a scale from "A" to "F." LOS A represents control delay of less than 10 seconds for unsignalized intersections. LOS F represents control delay of more than 50 seconds for unsignalized intersections. Table 1 shows the level of service delay ranges.

Table 1: Intersection Levels of Service Delay Ranges

Level of Service	Signalized Intersections	Unsignalized Intersections
	Average Control Delay (seconds per vehicle)	Average Control Delay (seconds per vehicle) ⁽¹⁾
A	10.0 sec or less	10.0 sec or less
B	10.1-20.0 sec	10.1-15.0 sec
C	20.1-35.0 sec	15.1-25.0 sec
D	35.1-55.0 sec	25.1-35.0 sec
E	55.1-80.0 sec	35.1-50.0 sec
F	80.1 sec or more	50.1 sec or more

(1) For unsignalized intersections, if V/C ratio is greater than 1.0 the level of service is LOS F, regardless of the projected average control delay per vehicle.

The intersections of Marksheffel Road/Volmer Road and Burgess Road/Vollmer Road have been analyzed based on the unsignalized-intersection analysis procedures from the *Highway Capacity Manual, 6th Edition* by the Transportation Research Board. The results of the analysis are shown in Figure 5c.

Marksheffel Road/Vollmer Road

All movements at the stop-sign-controlled intersection of Marksheffel/Vollmer are currently operating at LOS B or better during the peak hours.

Burgess Road/Vollmer Road

The all-way stop-sign-controlled intersection of Burgess/Vollmer is currently operating at LOS C or better for all approaches during the peak hours.

Safety and Accident Analysis

The Colorado State Patrol (CSP) provided LSC with crash history data for Vollmer Road between Tahiti Drive and Burgess Road from September 2019 through September 2022. During the reported time period, there were twelve reported crashes. Of the twelve reports, ten were single-vehicle non-intersection-related crashes on Vollmer Road. One crash involved a southbound vehicle that turned right onto Poco Road and crashed into several cars parked on Poco Road partially in the lane. The only intersection-related crash occurred in June 2022. A vehicle heading northbound on Vollmer Road was slowing to turn left at Lochwinnoch Road and the vehicle behind them attempted to pass on the left side. The crash history data has been attached.

BASELINE CONDITIONS

Baseline traffic is the traffic estimated to be on the adjacent roadways and at adjacent intersections without the proposed development's trip generation of site-generated traffic volumes. Baseline traffic (for a specified horizon year) includes the through traffic and the traffic generated by nearby developments (existing and planned, including traffic generated by existing and planned developments within the greater Sterling Ranch overall development) but assumes zero traffic generated by land uses within the site (the Sterling Ranch East Filing No. 6 boundary area).

Short-Term Scenario Baseline Conditions

Please refer to the description of the short-term scenario above. Figures 6a and 6b show the projected volumes for the short-term baseline scenario. Note that the short-term baseline scenario assumes only the approved filings within Sterling Ranch East Preliminary Plan 1 (Filing Nos 1 and 2), Sterling Ranch East Filing 5, and the Villages at Sterling Ranch East have been constructed in the short-term. No traffic due to future anticipated land uses within Sterling Ranch East Preliminary Plan 1 beyond Filings 1 and 2, including the residential areas east of Sterling Ranch Road and north of Idaho Falls Drive and the future school sites, are included in the volumes shown in Figures 6a and 6b.

Figure 6c shows the lane geometry, traffic control, and level of service at the key area intersections, based on the short-term scenario baseline volumes.

Long-Term Scenario Baseline Conditions

Figure 7a shows the projected 2045 baseline daily traffic volumes on key street segments at the key area intersections and Figure 7b shows the projected 2045 peak-hour baseline traffic volumes at the key area intersections. These volumes assume buildout of the area street network, including the completion of Marksheffel Road between Vollmer Road and Black Forest Road, Briargate Parkway between Meridian Road and Black Forest Road, and Sterling Ranch Road between Marksheffel Road and Briargate Parkway.

The 2045 baseline traffic volumes are estimates by LSC, based on the traffic projections in the LSC September 13, 2024 Master TIS Addendum. The 2045 baseline daily traffic volumes assume buildout of the land uses within the Sterling Ranch Master Plan that are not included in the Sterling Ranch Filing No. 6 Preliminary Plan area, including the preliminary estimates of future traffic to be generated by the Sterling Ranch school sites. The estimates of future school trip generation and traffic volumes at intersections are only preliminary estimates because no school site plans/student enrollment numbers etc. are available.

Figure 7c shows the lane geometry, traffic control, and level of service at the key area intersections, based on the 2045 baseline volumes.

TRIP GENERATION

The site-generated vehicle trips were estimated using the nationally-published trip-generation rates from *Trip Generation, 11th Edition, 2021* by the Institute of Transportation Engineers (ITE). Table 2 shows the trip-generation estimates.

Sterling Ranch East Filing No. 6 is projected to generate about 1,867 new external vehicle trips on the average weekday, with about half entering and half exiting the site during a 24-hour period. During the morning peak hour, which generally occurs for one hour between 6:30 and 8:30 a.m., about 35 vehicles would enter and 104 vehicles would exit the site. During the afternoon peak hour, which generally occurs for one hour between 4:15 and 6:15 p.m., about 117 vehicles would enter and 69 vehicles would exit the site.

TRIP DISTRIBUTION AND ASSIGNMENT

The directional distribution of the site-generated traffic volumes on the street and roadway system serving the site is an important factor in determining the site's traffic impacts. The distribution estimates for short-term and long-term residential-related traffic are shown in Figure 8. The short-term directional-distribution estimate assumes the short-term roadway network shown in Figure 3 only and the long-term directional-distribution estimate assumes buildout of the roadway network. The directional-distribution estimates are based, in part, on the estimates contained in the sketch plan MTIS report. Factors include: the location of the site with respect to the Colorado Springs metropolitan area, the planned access system for the site, the street and roadway system serving the site, and the land uses proposed for the site.

When the distribution percentages (from Figure 8) are applied to the new, external trip-generation estimates (from Table 2), the resulting site-generated traffic volumes can be determined. Figures 9a and 9b show the short-term site-generated traffic volumes. These volumes assume only the street network shown in Figure 3. Figures 10a and 10b show the long-term residential site-generated traffic volumes, assuming buildout of the area roadway network.

TOTAL TRAFFIC

Short-Term Total Traffic

Figure 11a shows the projected short-term total daily traffic volumes on key street segments and Figure 11b shows the projected short-term-total peak-hour traffic volumes at the key study-area intersections. These volumes are the sum of the short-term-baseline traffic volumes (from Figures 6a and 6b) and the short-term site-generated traffic volumes (from Figures 9a and 9b).

Figure 11c shows the level of service analysis results for the key area intersections based on the projected short-term total volumes. The figure also shows the general intersection lane geometry and intersection traffic control used in the analysis.

2045 Total Traffic

Figure 12a shows the projected 2045 total daily traffic volumes on key street segments and Figure 12b shows the projected 2045 total peak-hour traffic volumes at the key study-area intersections. These volumes are the sum of the 2045 baseline traffic volumes (from Figures 7a and 7b) and the long-term site-generated traffic volumes (from Figures 10a and 10b).

Figure 12c shows the level of service analysis results for the key area intersections, based on the projected 2045 total volumes. The figure also shows the general intersection lane geometry and intersection traffic control used in the analysis.

PRELIMINARY SIGNAL-WARRANT-THRESHOLD ANALYSIS (AM AND PM PEAK HOURS) – MARKSHEFFEL ROAD/VOLLMER ROAD AND MARKSHEFFEL ROAD/STERLING RANCH ROAD

The intersections of Marksheffel/Vollmer and Marksheffel/Sterling Ranch were analyzed to determine if the thresholds for Four-Hour and/or Eight-Hour Vehicular-Volume Traffic-Signal Warrant thresholds would be reached or exceeded, based on the projected short-term peak-hour traffic volumes only. In order for an Eight-Hour Vehicular-Volume Traffic-Signal Warrant to be satisfied, the volume threshold would need to be met for six additional hours of the day and in order for a Four-Hour Vehicular Volume Traffic Signal Warrant to be satisfied, the volume threshold would need to be met for two additional hours of the day. For example, the four-hour warrant would be satisfied with the volume thresholds met for one hour in the morning, two hours (instead of the one-hour peak) during the afternoon peak period, and an hour during the mid-afternoon.

This “cursory”/planning-level analysis has been provided at the Preliminary Plan level to identify intersections which may need to be signalized in the short-term future. Detailed analysis of all applicable signal warrants should be evaluated with each filing submitted. The satisfaction of warrants does not indicate that a signal must be installed. The decision to require a signal to be installed rests with the County.

Table 3 shows the results of the analysis for the intersection of Marksheffel/Vollmer. Based on the projected short-term total traffic volumes, six of the eight hours analyzed are projected to meet the criteria for a Four-Hour Vehicular Volume Warrant. However, only three of the eight hours analyzed are projected to meet the criteria for an Eight-Hour Vehicular-Volume Traffic-Signal Warrant. This analysis indicates that traffic-signal warrant(s) may be met in the short-term. Detailed analysis should be provided with each future filing within Sterling Ranch. Escrow towards this improvement may also need to be provided at the final plat stage of the process.

Table 4 shows the results of the analysis for the intersection of Marksheffel/Sterling Ranch. Based on the projected short-term total traffic volumes, only five of the eight hours analyzed are projected to meet the criteria for an Eight-Hour Vehicular-Volume Warrant and only three of the hours analyzed are projected to meet the criteria for a Four-Hour Vehicular-Volume Traffic-Signal Warrant. This analysis indicates that traffic-signal warrant(s) may not be met in the short-term.

Detailed analysis should be provided with each future filing within Sterling Ranch. Escrow towards this improvement may also need to be provided at the final plat stage of the process.

LEVEL OF SERVICE ANALYSIS

The key area future signalized intersections have been analyzed to determine the projected intersection levels of service for short-term and 2045 baseline and total traffic scenarios for the morning and afternoon peak-hour periods using Synchro. The key area future stop-sign-controlled and modern-roundabout-controlled intersections have been analyzed based on the unsignalized-intersection analysis procedures from the *Highway Capacity Manual 6th Edition*. Figures 6c, 7c, 11c, and 12c show the level of service analysis results. The level of service reports are attached.

Intersection #1: Vollmer Road/Burgess Road

The all-way, stop-sign-controlled intersection of Vollmer/Burgess is projected to operate at LOS C or better for all approaches based on the short-term total traffic volumes. LSC recommends this intersection be reconstructed as a modern one-lane roundabout by 2045. As a modern roundabout, it is projected to operate at LOS C or better for all approaches during the peak hours, based on the projected 2045 total traffic volumes.

Intersection #4: Vollmer Road/Briargate Parkway

The section of Briargate Parkway between Vollmer Road and Sterling Ranch Road is planned to be constructed to its final cross section in the short term. The intersection of Vollmer/Briargate could operate at a satisfactory level of service (LOS B or better) in the short term as a stop-sign-controlled intersection.

By 2045, it was assumed Briargate Parkway would be extended west to Black Forest Road and East to Towner Avenue and that the intersection of Vollmer/Briargate will be converted to traffic-signal control. The intersection of Vollmer/Briargate is projected to operate at an overall LOS C during the peak hours as a signalized intersection, based on the projected 2045 total traffic volumes shown in Figure 12b and the lane geometry shown in Figure 12c.

Intersection #5: Briargate Parkway/Sterling Ranch Road

The section of Briargate Parkway between Vollmer Road and Sterling Ranch Road is planned to be constructed to its final cross section in the short term. The intersection of Briargate/Sterling Ranch is projected to operate at LOS A for all movements in the short term as a stop-sign-controlled intersection.

By 2045, it was assumed Briargate Parkway would be extended west to Black Forest Road and East to Towner Avenue and that the intersection of Briargate/Sterling Ranch will be converted to

traffic-signal control. The intersection of Briargate/Sterling Ranch is projected to operate at an overall LOS C during the peak hours as a signalized intersection, based on the projected 2045 total traffic volumes shown in Figure 12b and the lane geometry shown in Figure 12c.

Intersection #12: Marksheffel Road/Vollmer Road

Marksheffel Road has been recently constructed between Vollmer Road and Sterling Ranch Road. Based on the projected short-term total traffic volumes, the westbound left-turn movement is projected to operate at LOS E during the morning and afternoon peak hours. This intersection is planned as a future signalized intersection. However, traffic-signal warrant(s) may not be met in the short term. It is not uncommon for the minor movements at a stop-sign-controlled intersection to operate at LOS E or F as the traffic volumes approach the levels needed to meet vehicular-volume traffic-signal warrants.

By 2045, it was assumed that Marksheffel Road would be constructed west to Briargate Parkway and that the intersection of Marksheffel/Vollmer will be converted to traffic-signal control. The intersection of Marksheffel/Vollmer is projected to operate at an overall LOS C or better during the peak hours as a signalized intersection, based on the projected 2045 total traffic volumes shown in Figure 12b and the lane geometry shown in Figure 12c. An escrow analysis for these improvements may need to be provided with the final plat.

Intersection #13: Marksheffel Road/Sterling Ranch Road

Marksheffel Road was recently constructed between Sterling Ranch Road and Vollmer Road and the section southeast of Sterling Ranch Road (to connect to the segment recently constructed) will be completed in the short term and will open the connection to Woodmen Road. Based on the projected short-term total traffic volumes, the southbound left-turn movement is projected to operate at LOS F during the afternoon peak hour if it remains stop-sign controlled. This intersection is planned as a future signalized intersection. However, traffic-signal warrant(s) may not be met in the short term. It is not uncommon for the minor movements at a stop-sign-controlled intersection to operate at LOS E or F as the traffic volumes approach the levels needed to meet vehicular-volume traffic-signal warrants. If this intersection is converted to signal control, it is projected to operate at an overall LOS C or better during the peak hours through 2045. An escrow analysis for these improvements may need to be provided with the final plat.

Intersection #309 Sterling Ranch Road/Vancouver Street

The intersection of Sterling Ranch/Vancouver is projected to operate at LOS B or better for all movements as a stop-sign controlled intersection, based on the projected short-term and 2045 total traffic volumes.

Intersection #310 Sterling Ranch Road/Appleton Drive

The intersection of Sterling Ranch/Appleton Drive is projected to operate at LOS B or better for all movements as a stop-sign controlled intersection, based on the projected short-term and 2045 total traffic volumes.

ROADWAY FUNCTIONAL CLASSIFICATIONS AND LANEAGE

Figure 13 shows the recommended functional classifications and number of through lanes for the streets in the study area.

DEVIATION REQUESTS

Please be sure the deviation is submitted, I don't see it in the submittal documents

A deviation to the criteria contained in *Land Development Code (LDC)* and the *El Paso County Engineering Criteria Manual (ECM)* to allow for the proposed right-in/right-out access to Briargate Parkway east of Sterling Ranch Road has been recently submitted as part of this application.

AREA MTCP 2050 ROADWAY IMPROVEMENT PROJECTS

The *El Paso County 2024 Major Transportation Corridors Plan Update* identified the following roadway improvement projects within the study area:

- 158: Vollmer Road from Marksheffel Road to Burgess Road as an Urban Major Collector I
- 166: Stapleton Drive from west of Vollmer Road to Towner Avenue as a 4-Lane Urban Principal Arterial
- 329: Stapleton Drive/Briargate Parkway: from Black Forest Road to west of Vollmer Road and a 4-Lane Urban Principal Arterial

ESCROW ANALYSIS

- Escrow for proportionate shares of the cost of some future roadway improvements may be required. An escrow analysis for each intersection will be provided with the final plat, if needed.

TRANSPORTATION IMPROVEMENT FEE PROGRAM AND CREDIT AGREEMENTS

The applicant will be required to participate in the Countywide Transportation Improvement Fee Program. These projects will annex into the 5 mil PID, which has a per-lot upfront building permit fee of \$2,527 per single-family dwelling unit. The total building permit fee amount for the 198 residential dwelling units would be \$500,346. Note: This is based on the current rate, which is subject to change. El Paso County updates this rate periodically.

A road-fee credit agreement, development agreement, and Subdivision Improvements Agreement will be required to address developer's road-fee credits for construction of Vollmer Road. Additional credit agreements will be needed with each phase of construction to account for reimbursement of costs for the additional lanes and major intersection improvements.

CONCLUSIONS AND RECOMMENDATIONS

Trip Generation

- Sterling Ranch East Filing No. 6 is projected to generate about 1,867 new external vehicle trips on the average weekday, with about half entering and half exiting the site during a 24-hour period. During the morning peak hour, which generally occurs for one hour between 6:30 and 8:30 a.m., about 35 vehicles would enter and 104 vehicles would exit the site. During the afternoon peak hour, which generally occurs for one hour between 4:15 and 6:15 p.m., about 117 vehicles would enter and 69 vehicles would exit the site.

Level of Service

- The stop-sign-controlled intersection of Vollmer/Burgess projected to operate at LOS C or better for all approaches based on the short-term total traffic volumes. LSC recommends this intersection be reconstructed as a modern one-lane roundabout by 2045. As a modern roundabout, it is projected to operate at LOS C or better for all approaches during the peak hours, based on the projected 2045 total traffic volumes.
- The intersections of Vollmer/Briargate and Briargate/Sterling Ranch are projected to operate at a satisfactory level of service as stop-sign-controlled intersections in the short-term future. By 2045, these intersections will likely need to be converted to traffic-signal control. As signalized intersections, all movements are projected to operate at LOS D or better during the peak hours, based on the projected 2045 total traffic volumes.
- Some of the movements at the intersections of Marksheffel Road/Vollmer Road and Marksheffel Road/Sterling Ranch Road are projected to operate at LOS E or LOS F during the peak hours, if they remain stop-sign controlled in the short-term future. Once signalized, all movements at these intersections are projected to operate at LOS D or better, based on the projected short-term and 2045 total traffic volumes. An escrow analysis for these future traffic signals may need to be provided with the final plat.
- The intersections of Sterling Ranch/Vancouver and Sterling Ranch/Appleton are projected to operate at a satisfactory level of service as stop-sign-controlled intersections.

Recommended Improvements

- Table 5 shows detailed **intersection** improvements needed with Sterling Ranch Filing No. 6. The recommended improvements are based on the short-term and 2045 total traffic volumes shown in Figures 12c and the criteria contained in the El Paso County

Engineering Criteria Manual (ECM). The following auxiliary lanes will be required with the currently-proposed Sterling Ranch East Filing No. 6:

- A northbound right-turn deceleration lane on Sterling Ranch Road approaching Vancouver Street. This lane should be 155 feet long plus a 160-foot taper.
- A southbound left-turn lane on Sterling Ranch Road approaching Vancouver Street. A center painted median is part of the standard Urban Minor Collector cross section.
- A northbound right-turn deceleration lane on Sterling Ranch Road approaching Appleton Drive. This lane should be 155 feet long plus a 160-foot taper.
- Table 6 shows a list of the **roadway segment** improvements in the vicinity of the site. Please see Figure 14 for a map of the key street segment locations. These recommendations are consistent with the LSC Sketch Plan TIS report.

Escrow Analysis

Escrow for proportionate shares of the cost of some future roadway improvements may be required. An escrow analysis for each intersection will be provided with the final plat, if needed.

* * * * *

Please contact me if you have any questions regarding this report.

Sincerely,

LSC TRANSPORTATION CONSULTANTS, INC.

By Jeffrey C. Hodsdon, P.E.
Principal

JCH/KDF:jas

Enclosures: Tables 2-6
Figures 1-14
Traffic Count Reports
Level of Service Reports
Appendix Table 1
MTCP Maps
Crash History

Tables 2-6



Table 2
Trip Generation Estimate
Sterling Ranch East Filing No. 6

ITE Code	ITE Land Use	Quantity	Unit	Daily	Trip Generation Rates ⁽¹⁾				Total Trips Generated				
					AM Peak Hour		PM Peak Hour		Daily	AM Peak Hour		PM Peak Hour	
					In	Out	In	Out		In	Out	In	Out
210	Single-Family Detached Housing	198	DU	9.43	0.18	0.53	0.59	0.35	1,867	35	104	117	69

Notes:

(1) Source: "Trip Generation, 11th Edition, 2021" by the Institute of Transportation Engineers (ITE)

(2) DU = Dwelling Unit

Source: LSC Transportation Consultants, Inc.

Sep-24

Table 3
Traffic Signal Warrant Analysis
Marksheffel Road/Vollmer Road

Warrant Analysis ⁽¹⁾																		
Warrant 1: Eight-Hour Vehicular-Volume Evaluation											Warrant 2: Four-Hour Vehicular-Volume Evaluation							
Warrant Thresholds											Warrant Threshold Met?				Short-Term Background		Short-Term Total	
Hour	Short-Term Background Traffic		Sterling Ranch East Filing 6 Generated Traffic		Short-Term Total Traffic		Warrant Thresholds				Short-Term Background		Short-Term Total		Warrant Threshold Minimum	Warrant Threshold Met? WB	Warrant Threshold Minimum	Warrant Threshold Met? WB
	Major ⁽²⁾ Vollmer	Minor ⁽²⁾ Marksheffel	Major Vollmer	Minor Marksheffel	Major Vollmer	Minor Marksheffel	Condition A		Condition B		Condition A	Condition B	Condition A	Condition B				
							Major	Minor	Major	Minor	A	B	A	B				
Short-Term Total Traffic⁽⁴⁾																		
12-1 AM	43	3	5	0	48	3	600	150	900	75	No	No	No	No	Low Volume	No	Low Volume	No
1-2 AM	18	3	2	0	20	3	600	150	900	75	No	No	No	No	Low Volume	No	Low Volume	No
2-3 AM	13	0	1	0	14	0	600	150	900	75	No	No	No	No	Low Volume	No	Low Volume	No
3-4 AM	25	3	2	0	27	3	600	150	900	75	No	No	No	No	Low Volume	No	Low Volume	No
4-5 AM	50	13	5	0	55	13	600	150	900	75	No	No	No	No	Low Volume	No	Low Volume	No
5-6 AM	112	32	11	0	123	32	600	150	900	75	No	No	No	No	Low Volume	No	Low Volume	No
6-7 AM	415	94	33	0	448	94	600	150	900	75	No	No	No	No	Low Volume	No	Low Volume	No
7-8 AM	854	162	60	0	914	162	600	150	900	75	Yes	No	Yes	Yes	187	No	172	No
8-9 AM	749	137	58	0	807	137	600	150	900	75	No	No	No	No	226	No	198	No
9-10 AM	617	86	43	0	660	86	600	150	900	75	No	No	No	No	283	No	266	No
10-11 AM	635	86	50	0	685	86	600	150	900	75	No	No	No	No	276	No	256	No
11-12 PM	792	81	58	0	850	81	600	150	900	75	No	No	No	No	204	No	188	No
12-1 PM	701	87	60	0	761	87	600	150	900	75	No	No	No	No	250	No	220	No
1-2 PM	717	92	65	0	782	92	600	150	900	75	No	No	No	No	242	No	209	No
2-3 PM	811	97	73	0	884	97	600	150	900	75	No	No	No	No	197	No	179	No
3-4 PM	908	94	83	0	991	94	600	150	900	75	No	Yes	No	Yes	173	No	152	No
4-5 PM	1026	117	103	0	1129	117	600	150	900	75	No	Yes	No	Yes	142	No	114	Yes
5-6 PM	981	115	102	0	1083	115	600	150	900	75	No	Yes	No	Yes	155	No	125	No
6-7 PM	598	92	84	0	682	92	600	150	900	75	No	No	No	No	291	No	257	No
7-8 PM	517	67	60	0	577	67	600	150	900	75	No	No	No	No	Low Volume	No	Low Volume	No
8-9 PM	409	48	57	0	466	48	600	150	900	75	No	No	No	No	Low Volume	No	Low Volume	No
9-10 PM	267	37	41	0	308	37	600	150	900	75	No	No	No	No	Low Volume	No	Low Volume	No
10-11 PM	140	17	20	0	160	17	600	150	900	75	No	No	No	No	Low Volume	No	Low Volume	No
11-12 AM	62	11	12	0	74	11	600	150	900	75	No	No	No	No	Low Volume	No	Low Volume	No
Numbers of Hours the Warrant Thresholds Are Met											1	3	1	4				
Warrant Met?											No		No					

Notes:
 (1) Thresholds are based on 2 or more lanes on the major approach and 1 lane on the minor approach (Warrant evaluation assuming the westbound left turn only for the minor street)
 (2) The major-street traffic includes all movements (left, through, and right)
 (3) The minor-street traffic includes only the left turns from the minor street
 (5) Off-peak-hour traffic volumes are based on the projected peak-hour traffic volumes, 72-hour machine counts conducted on Vollmer Road in April 2024 and vehicle time-of-day distribution data for single-family residential published by the Institute of Transportation Engineers

**Table 4
Traffic Signal Warrant Analysis
Marksheffel Road/Sterling Ranch Road**

Warrant Analysis ⁽¹⁾																		
Warrant 1: Eight-Hour Vehicular-Volume Evaluation												Warrant 2: Four-Hour Vehicular-Volume Evaluation						
Short-Term Background Traffic		Sterling Ranch Filing No. 6 Generated Traffic		Short-Term Total Traffic		Warrant Thresholds				Warrant Threshold Met?				Short-Term Background		Short-Term Total		
										Short-Term Background		Short-Term Total		Warrant Threshold Minor Minimum	Warrant Threshold Met?	Warrant Threshold Minor Minimum	Warrant Threshold Met?	
Hour	Major ⁽²⁾ Marksheffel	Minor ⁽³⁾ Sterling Ranch	Major Marksheffel	Minor Sterling Ranch	Major Marksheffel	Minor Sterling Ranch	Condition A		Condition B		Condition A	Condition B	Condition A	Condition B	Warrant Threshold Minor Minimum	Warrant Threshold Met?	Warrant Threshold Minor Minimum	Warrant Threshold Met?
	Major	Minor	Major	Minor	Major	Minor	Major	Minor	Major	Minor	A	B	A	B				
Short-Term Total Traffic⁽⁴⁾																		
12-1 AM	36	9	4	1	40	10	600	150	900	75	No	No	No	No	Low Volume	No	Low Volume	No
1-2 AM	14	9	2	1	16	10	600	150	900	75	No	No	No	No	Low Volume	No	Low Volume	No
2-3 AM	12	0	2	0	14	0	600	150	900	75	No	No	No	No	Low Volume	No	Low Volume	No
3-4 AM	16	9	2	1	18	10	600	150	900	75	No	No	No	No	Low Volume	No	Low Volume	No
4-5 AM	30	34	2	6	32	40	600	150	900	75	No	No	No	No	Low Volume	No	Low Volume	No
5-6 AM	56	85	4	15	60	100	600	150	900	75	No	No	No	No	Low Volume	No	Low Volume	No
6-7 AM	195	252	13	43	208	295	600	150	900	75	No	No	No	No	Low Volume	No	Low Volume	No
7-8 AM	394	435	25	74	419	509	600	150	900	75	No	No	No	No	Low Volume	No	Low Volume	No
8-9 AM	393	367	29	62	422	429	600	150	900	75	No	No	No	No	Low Volume	No	379	Yes
9-10 AM	327	230	25	39	352	269	600	150	900	75	No	No	No	No	Low Volume	No	Low Volume	No
10-11 AM	376	230	33	39	409	269	600	150	900	75	No	No	No	No	Low Volume	No	386	No
11-12 PM	478	218	43	37	521	255	600	150	900	75	No	No	No	No	351	No	330	No
12-1 PM	528	216	43	37	571	253	600	150	900	75	No	No	No	No	326	No	305	No
1-2 PM	561	227	47	39	608	266	600	150	900	75	No	No	Yes	No	Low Volume	No	287	No
2-3 PM	645	239	54	41	699	280	600	150	900	75	Yes	No	Yes	No	272	No	250	Yes
3-4 PM	758	231	65	39	823	270	600	150	900	75	Yes	No	Yes	No	221	Yes	194	Yes
4-5 PM	903	289	81	49	984	338	600	150	900	75	Yes	Yes	Yes	Yes	174	Yes	154	Yes
5-6 PM	876	285	80	48	956	333	600	150	900	75	Yes	No	Yes	Yes	181	Yes	161	Yes
6-7 PM	658	227	66	39	724	266	600	150	900	75	Yes	No	Yes	No	Low Volume	No	238	Yes
7-8 PM	503	166	48	28	551	194	600	150	900	75	No	No	No	No	Low Volume	No	Low Volume	No
8-9 PM	472	119	49	20	521	139	600	150	900	75	No	No	No	No	Low Volume	No	Low Volume	No
9-10 PM	329	92	34	16	363	108	600	150	900	75	No	No	No	No	Low Volume	No	Low Volume	No
10-11 PM	164	42	17	7	181	49	600	150	900	75	No	No	No	No	Low Volume	No	Low Volume	No
11-12 AM	90	27	10	5	100	32	600	150	900	75	No	No	No	No	Low Volume	No	Low Volume	No
Numbers of Hours the Warrant Thresholds Are Met											5	1	6	2				
Warrant Met?											No		No					
											No		No		3		6	Yes

Notes:
 (1) Thresholds are based on 2 or more lanes on the major approach and 1 lane on the minor approach (Warrant evaluation assuming the southbound left turn only for the minor street)
 (2) The major-street traffic includes all movements (left, through, and right)
 (3) The minor-street traffic includes only the left turns from the minor street
 (4) Off-peak-hour traffic volumes are based on the projected peak-hour traffic volumes, 72-hour machine counts conducted on Vollmer Road in April 2024 and vehicle time-of-day distribution data for single-family residential published by the Institute of Transportation Engineers
 Source: LSC Transportation Consultants, Inc.

**Table 5
Sterling Ranch East Filing No. 6
Intersection Improvements**

Item #	Improvement	Trigger	Timing	Responsibility
1) Burgess Road/Vollmer Road				
1	Plan for roundabout as ultimate traffic control in the future depending on intersection conditions - grades, available ROW, etc.	When the LOS degrades below LOS F	Long Term	This intersection may be an eligible intersection under the fee impact program
5) Briargate Parkway/Sterling Ranch Road				
2	Construct an eastbound left-turn lane on Briargate Parkway approaching Sterling Ranch Road. The lane should be 435' long plus a 200' taper.	eastbound left-turn volume > 10 vph	With Sterling Ranch East Filing 1	Sterling Ranch
3	Construct an eastbound right-turn deceleration lane on Briargate Parkway approaching Sterling Ranch Road. The lane should be 235' long plus a 200' taper.	eastbound right-turn volume > 25 vph	With Sterling Ranch East Filing 1	Sterling Ranch
4	Construct a northbound to eastbound right-turn acceleration lane on Briargate Parkway at Sterling Ranch Road. The lane should be 580' long plus a 180' taper.	northbound right-turn volume > 50 vph	With Sterling Ranch East Filing No. 6	Sterling Ranch
5	Construct a westbound left-turn lane on Briargate Parkway approaching Sterling Ranch Road. The lane should be 285' long plus a 200' taper.	westbound left-turn volume > 10 vph	With Sterling Ranch East Filing No. 6	Sterling Ranch
6	Construct an eastbound right-turn deceleration lane on Briargate Parkway approaching Sterling Ranch Road. The lane should be 235' long plus a 200' taper.	eastbound right-turn volume > 25 vph	With Sterling Ranch East Filing No. 6	Sterling Ranch
7	Construct a southbound to westbound right-turn acceleration lane on Briargate Parkway at Sterling Ranch Road. The lane should be 580' long plus a 180' taper.	southbound right-turn volume > 50 vph	With Sterling Ranch East Filing 2	Sterling Ranch
7	Provide interim stop-sign control with a stop sign on the eastbound approach	with construction of the intersection	With Sterling Ranch East Filing 2	Sterling Ranch
8	Signalization of the intersection	If and when warrants are met. The decision on timing of traffic signal installation rests with El Paso County Public Works.	Long Term (note: to be analyzed at the time of development of the school at which point a determination would be made regarding the intersection traffic control beyond TWSC)	Sterling Ranch or potentially the school district
12) Marksheffel Road/Vollmer Road				
9	Signalization of the intersection	Once warrants are met. The decision on timing of traffic signal installation rests with El Paso County Public Works.	Not Anticipated With Sterling Ranch Filing No. 6	This intersection may be an eligible intersection under the fee impact program
13) Marksheffel Road/Sterling Ranch Road				
10	Signalization of the intersection	Once warrants are met. The decision on timing of traffic signal installation rests with The City of Colorado Springs.	A Four-Hour Vehicular Volume Traffic Signal Warrant is Anticipated to be met with Sterling Ranch East Filing No. 6	SRMD#3
104) Briargate Parkway/Sioux Falls Way				
11	Construct an eastbound right-turn deceleration lane on Briargate Parkway approaching Sioux Falls Way. The lane should be 235' long plus a 200' taper.	eastbound right-turn volume > 25 vph	With the construction of Briargate Parkway east of the access	Sterling Ranch
309) Sterling Ranch Road/Vancouver Street				
12	Construct a southbound left-turn lane on Sterling Ranch Road approaching Vancouver Street. The lane should be 205' long plus a 160' taper.	southbound left-turn volume > 25 vph	A center painter median is part of the standard Urban Minor Collector cross section	Sterling Ranch
13	Construct a northbound right-turn deceleration lane on Sterling Ranch Road approaching Vancouver Street. The lane should be 155' long plus a 160' taper.	northboundbound right-turn volume > 50 vph	With Sterling Ranch East Filing 6	Sterling Ranch
310) Sterling Ranch Road/Appleton Drive				
14	Construct a southbound left-turn lane on Sterling Ranch Road approaching Appleton Drive. The lane should be 305' long plus a 160' taper.	southbound left-turn volume > 25 vph	With the construction of Sterling Ranch Parkway north of Banning Lewis Parkway	Sterling Ranch
15	Construct a northbound right-turn deceleration lane on Sterling Ranch Road approaching Appleton Drive. The lane should be 155' long plus a 160' taper.	northboundbound right-turn volume > 50 vph	With Sterling Ranch East Filing 6	Sterling Ranch

Source: LSC Transportation Consultants, Inc. (September 2024)

Table 6

Roadway Segment Improvements

Sterling Ranch East Filing No. 6 Rezone and Preliminary Plat

(Page 1 of 2)

Segment ID ⁽¹⁾ (See Figure 14 for map)	Improvement Description	Timing	Design ADT (vpd)	Projected 2044 ADT (vpd)	Responsibility
V1 (Short-Term) Northbound	UPDATE (November 2023): It is our understanding that a meeting(s) with JR Engineering/the applicant, City staff and County staff were held, that a short-term/interim improvement to segment V1 will not be required. The original LSC recommendation for this segment was for restriping. However, City staff indicated that the striped bike lane in the southbound direction needs to remain.	Updated November 2023 - It is our understanding that following a meeting with the City of Colorado Springs and El Paso County, a V1 interim shoulder improvement will no longer be required.	5,500 (Directional northbound)	15,710	N/A
V1 (Short-Term) Southbound			10,000 (Directional southbound)		
V1	Improve Vollmer Road between Dry Needle Place and the Sterling Ranch south boundary to a standard 4-Lane Urban Minor Arterial Cross Section (Add a second northbound through lane and painted center median) ⁽²⁾ 8/22/2024 Note: the 2024 MTCP shows Vollmer Road as an Urban – Major Collector	Intermediate-Term Future	20,000		Updated November 2023 Adjacent parcel owner which could potentially include: <ul style="list-style-type: none"> “Pioneer Landscape Center Parcel” (5300000742) (redevelopment is unlikely in the foreseeable future) “Schmidt Parcel” west of Vollmer Rd (5200000571) The triangular parcels southeast of Vollmer/Marksheffel (5232400001 and 5232400003)
V2	Improve Vollmer Road between the Sterling Ranch south boundary to Lochwinnoch Lane/Sterling property boundary to a standard 4-Lane Urban Minor Arterial Cross Section ⁽²⁾ 8/22/2024 Note: the 2024 MTCP shows Vollmer Road as an Urban – Major Collector	Updated September 2024: Complete	20,000 (Note: Existing Capacity 8,000 ⁽³⁾)	17,115	Sterling Ranch
V3	Short Term: Improve Vollmer Road from Lochwinnoch Lane to Sterling Ranch boundary (northeast of Glider Loop) to provide 36’ of pavement (existing pavement 1 approx. 23.38’) and stripe for one through lane and plus a 6’ paved, striped outside shoulder in each direction ⁽²⁾	Updated November 2023 – Future as required due to net increase traffic demand. The construction documents have been approved.	11,000 (Note: Existing Capacity 8,000)	17,015	Sterling Ranch
	Long Term: Improve Vollmer Road from Lochwinnoch Lane to Sterling Ranch boundary (northeast of Glider Loop) to a standard 4-Lane Urban Minor Arterial Cross Section ⁽²⁾ 8/22/2024 Note: the 2024 MTCP shows Vollmer Road as an Urban – Major Collector	Long-Term Future	20,000		By others - pursuant to the recent development agreement between Sterling Ranch and EPC.
V4	Improve Vollmer Road from Sterling Ranch boundary (northeast of Glider Loop) to Briargate Parkway to a standard 4-Lane Urban Minor Arterial Cross Section ⁽²⁾ Update November 2023 - with transition section to the existing two-lane section to the south as shown on the Vollmer North CDs. Improvements consist of curb and gutter on west side (as most of the east side is already built) and repaving.	Updated September 2024: Complete	20,000	16,155	Sterling Ranch
V5	Improve Vollmer Road from Briargate Parkway to Jane Kirkham Drive to a standard 4-Lane Urban Minor Arterial Cross Section ⁽²⁾ 8/22/2024 Note: the 2024 MTCP shows Vollmer Road as an Urban – Major Collector	Updated September 2024: Complete	20,000	11,515	Sterling Ranch
V6	Improve Vollmer Road from Jane Kirkham Drive to Sam Bass Drive to a standard 4-Lane Urban Minor Arterial Cross Section ⁽²⁾ 8/22/2024 Note: the 2024 MTCP shows Vollmer Road as an Urban – Major Collector	Updated September 2024: Complete	20,000	11,245	Sterling Ranch
V7	Improve Vollmer Road between Sam Bass Drive and Poco Road to a 4-lane Urban Minor Arterial but with necessary lane transitions, redirect tapers, etc. south of Poco to adequately transition between the 4-Lane Urban Minor Arterial Cross Section and the 2-Lane Rural Arterial Cross Section north of Poco Road. 8/22/2024 Note: the 2024 MTCP shows Vollmer Road as an Urban – Major Collector	Updated September 2024: Complete	20,000	11,010	Sterling Ranch
V8	Improve Vollmer Road from Poco Road to Burgess Road to a 2-Lane Urban – Major Collector Cross Section ⁽²⁾	Long-Term Future	20,000	11,395	El Paso County

Part 1/2 of this table (see Part 2 on next page)

Notes:

(1) See Figure 14

(2) Adequate transition/redirect tapers would be needed between the various cross sections on Vollmer Road. Based on the criteria contained in Table 2-29 of the *El Paso Engineering Criteria Manual* an appropriate taper ratio for a roadway with a design speed of 40 miles per hour is 20:1

(3) Source: Table 20 Road Impact Fee Study Updated November 16, 2016

Source: LSC Transportation Consultants, Inc. (September 2024)

Table 6

Roadway Segment Improvements

Sterling Ranch East Filing No. 6 Rezone and Preliminary Plat

(Page 2 of 2)

Segment ID ⁽¹⁾ (See Figure 12 for map)	Improvement Description	Timing	Design ADT (vpd)	Projected 2042 ADT (vpd)	Responsibility
SR1	Construct Sterling Ranch Road as an Urban Major Collector from Marksheffel Road to Dines Boulevard	<u>Completed</u>	20,000	14,420	Sterling Ranch
SR2	Construct Sterling Ranch Road as an Urban Major Collector from Dines Boulevard to Briargate Parkway	Short-Term - with SRE Preliminary Plan 1	20,000	9,760	Sterling Ranch
SR3	Construct Sterling Ranch Road as an Urban Minor Collector from Briargate Parkway to Vancouver Street	Short-Term - with SRE Preliminary Plan 1	10,000	7,850	Sterling Ranch
SR4	Construct Sterling Ranch Road from Vancouver Street north to ultimate north terminus	Long-Term Future	10,000	4,330	Sterling Ranch
M1	Construct Marksheffel Road as an Urban Principal Arterial to City of Colorado Springs standards in 107' of right-of-way between Vollmer Road and Sterling Ranch Road	<u>Completed</u>	40,000	23,000	Sterling Ranch
M2	Construct Marksheffel Road as an Urban Principal Arterial to City of Colorado Springs standards in 107' of right-of-way between Sterling Ranch Road and the south boundary of the Sterling Ranch Master Plan Area. NOTE: With the completion of this improvement, the connection between Vollmer Road and Woodmen Road will be completed	To be completed in 2024	40,000	28,180	Sterling Ranch
M3	Construct Marksheffel Road between the south boundary of the Sterling Ranch Master Plan Area and Woodmen Road (Note this segment is located within the City of Colorado Springs)	<u>Completed</u> (by Others)	40,000	24,525	Others (Completed)
M4	Construct Marksheffel Road between Black Forest Road and Vollmer Road	Long-Term Future	40,000	27,910	Others
B1	Construct the full section of Briargate Parkway (4-Lane Principal Arterial) between Vollmer Road and Wheatland Drive	<u>Completed</u>	40,000	24,745	Sterling Ranch
B2	Construct Briargate Parkway (full section) as a 4-Lane Principal Arterial between Wheatland Drive and Sterling Ranch Road	Updated September 2024: In Progress Anticipated Completion Fall 2024	40,000	24,190	Sterling Ranch
B3	Construct Briargate Parkway as a 4-Lane Principal Arterial between Sterling Ranch Road and Banning Lewis Parkway	Intermediate Term	40,000	21,680	Sterling Ranch
B4	Construct Stapleton Road as a 4-Lane Principal Arterial between Banning Lewis Parkway and Meridian Road (including upgrade of existing rural two-lane segment between Towner and Meridian)	Long-Term Future	40,000	17,945	Others
B5	Construct Briargate Parkway as a 4-Lane Principal Arterial between its current terminus and Black Forest Road and between Black Forest Road and Vollmer Road	Long-Term Future	40,000	24,340	Others
BL1	Construct Banning Lewis Parkway as a 4-Lane Principal Arterial between the south Sterling Ranch boundary and Briargate Pkwy	Long-Term Future	40,000	20,320	Future - TBD with the future preliminary plan for that area - potentially, financial assurances for half-section, west-side half-section or full-section w/ cost recover may be required
BL2	Construct Banning Lewis Parkway as a 4-Lane Principal Arterial between Woodmen Road and the south Sterling Ranch boundary (Note this segment will be located within the City of Colorado Springs)	Long-Term Future	40,000	28,480	Others
W1	Widen Woodmen Road from 4-lane to 6-lane section from Powers Boulevard to US 24	Long-Term Future	72,000	66,690	Others

Part 2/2 of this table

Notes:

(1) See Figure 12

(2) Adequate transition/redirect tapers would be needed between the various cross sections on Vollmer Road. Based on the criteria contained in Table 2-29 of the *El Paso Engineering Criteria Manual*, an appropriate taper ratio for a roadway with a design speed of 40 miles per hour is 20:1

(3) Source: Table 20 *Road Impact Fee Study Updated* November 16, 2016

Source: LSC Transportation Consultants, Inc. (August 2024)

Figures 1-14



Not to scale

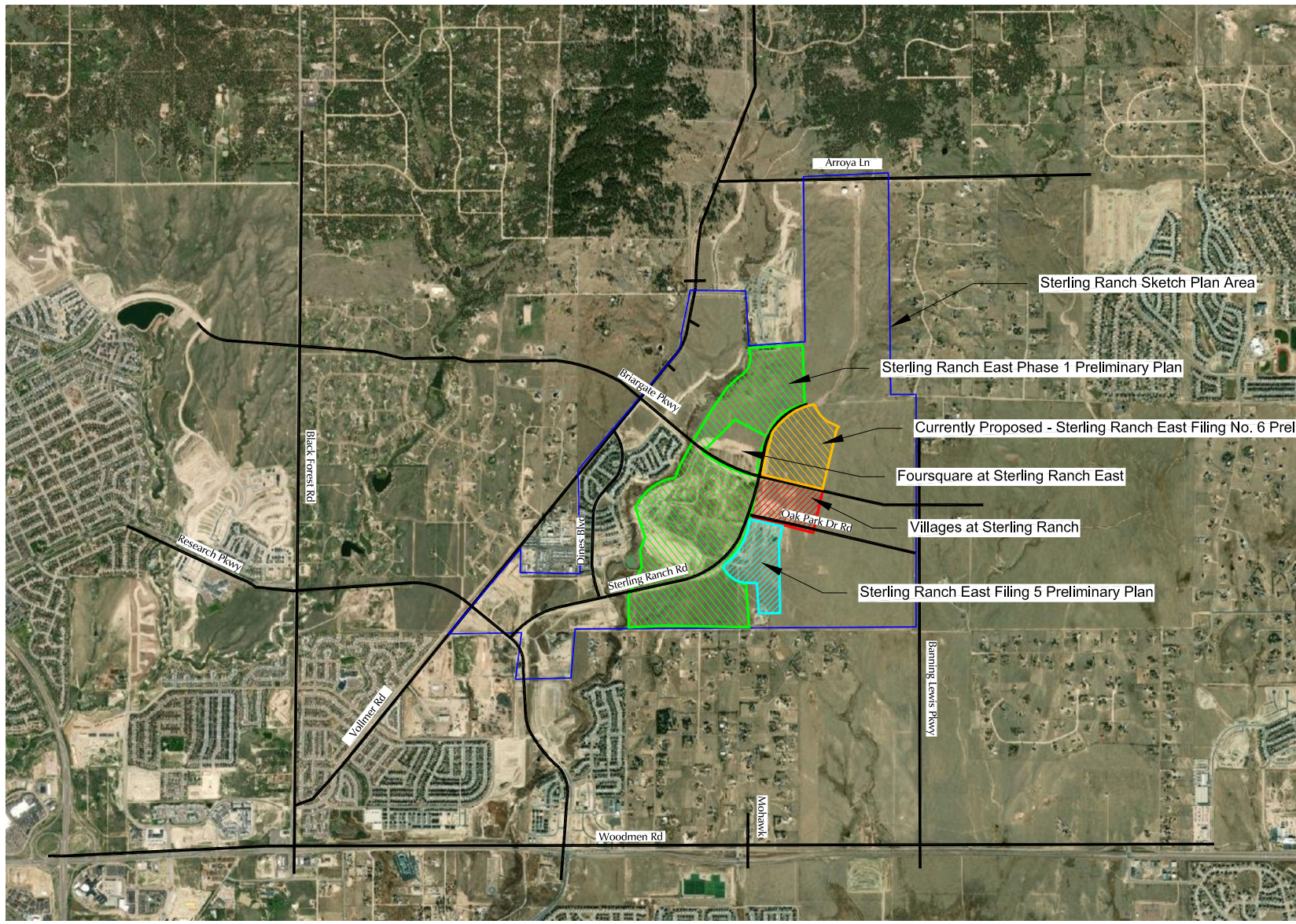

- Sterling Ranch Sketch Plan Area
- Sterling Ranch East Phase 1 Preliminary Plan
- Currently Proposed - Sterling Ranch East Filing No. 6 Preliminary Plan
- Foursquare at Sterling Ranch East
- Villages at Sterling Ranch
- Sterling Ranch East Filing 5 Preliminary Plan

Figure 1

Vicinity Map

Sterling Ranch East Filing No. 6 (LSC# S244250)





Approximate
Scale:
1" = 300'

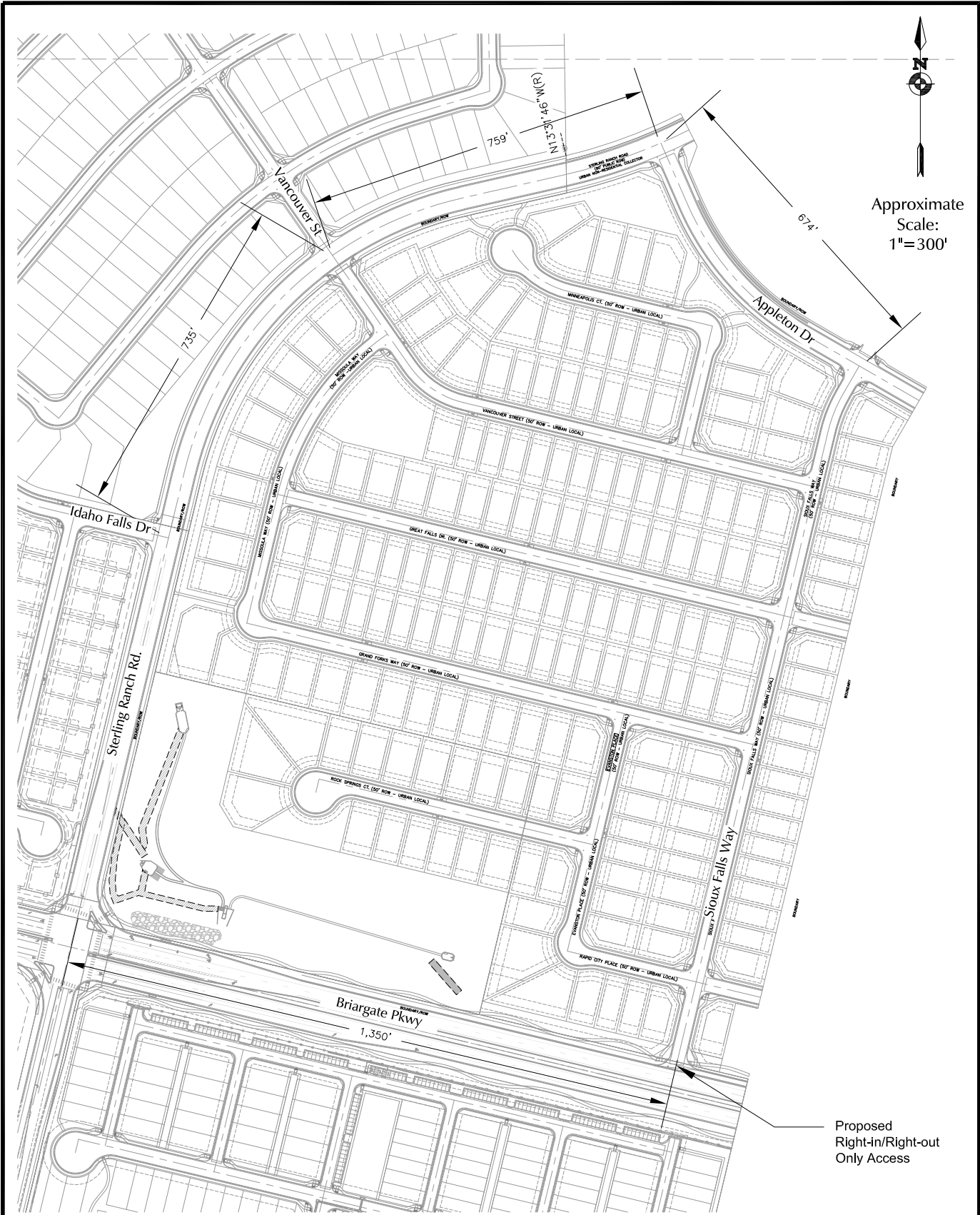

Proposed
Right-in/Right-out
Only Access

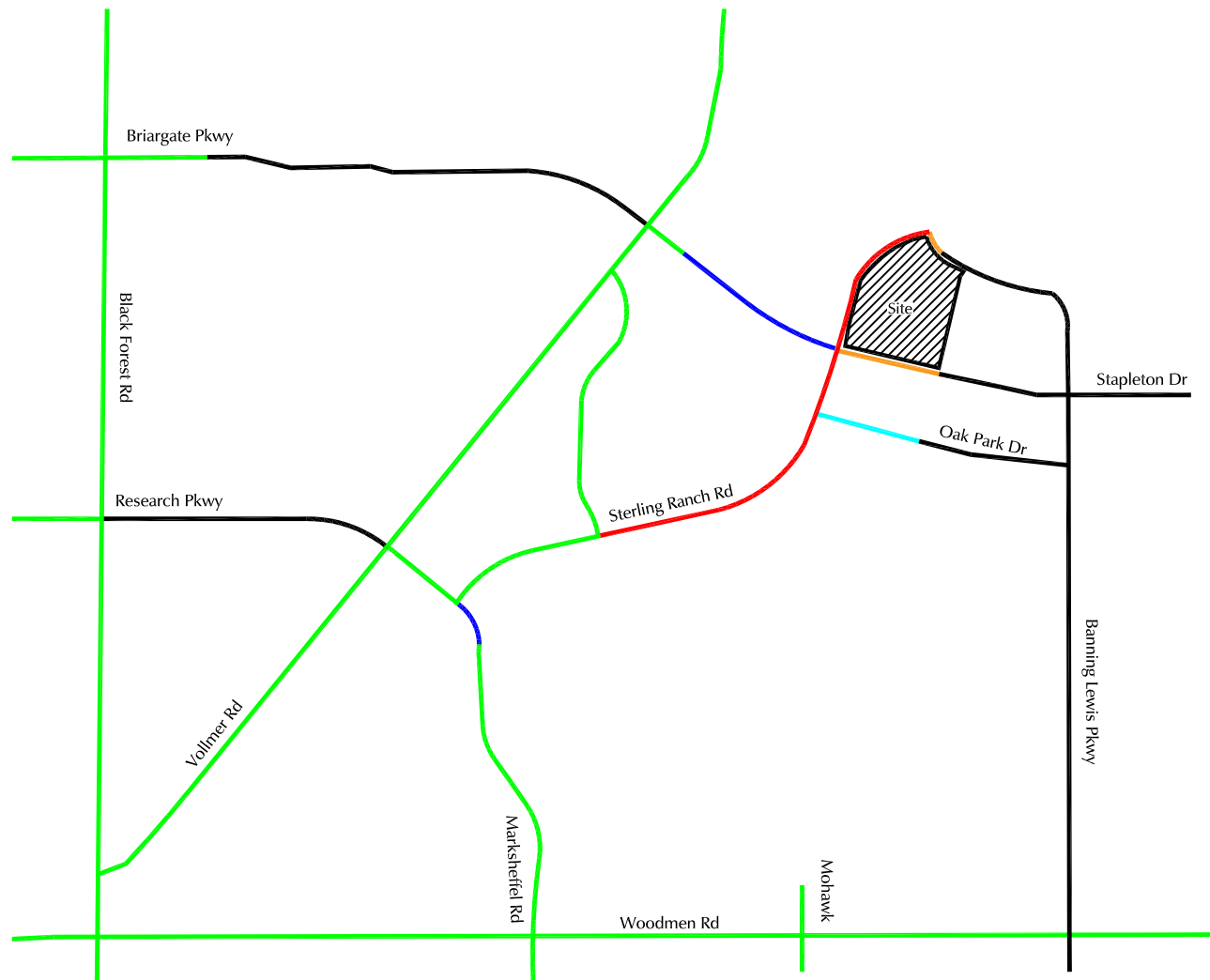







Figure 2
Site Plan

Sterling Ranch East Filing No. 6 (LSC# S244250)



Not to scale



-  Roadway connection planned with Sterling Ranch East Fil. No. 6
-  Roadway connection planned with Sterling Ranch East Preliminary Plan 1
-  Roadway connection planned with Villages at Sterling Ranch
-  Roadway connection planned to be completed in 2024
-  Existing Roadway
-  Future Roadway

Short-Term Roadway Connections

Sterling Ranch East Filing No. 6 (LSC# S244250)

Figure 3

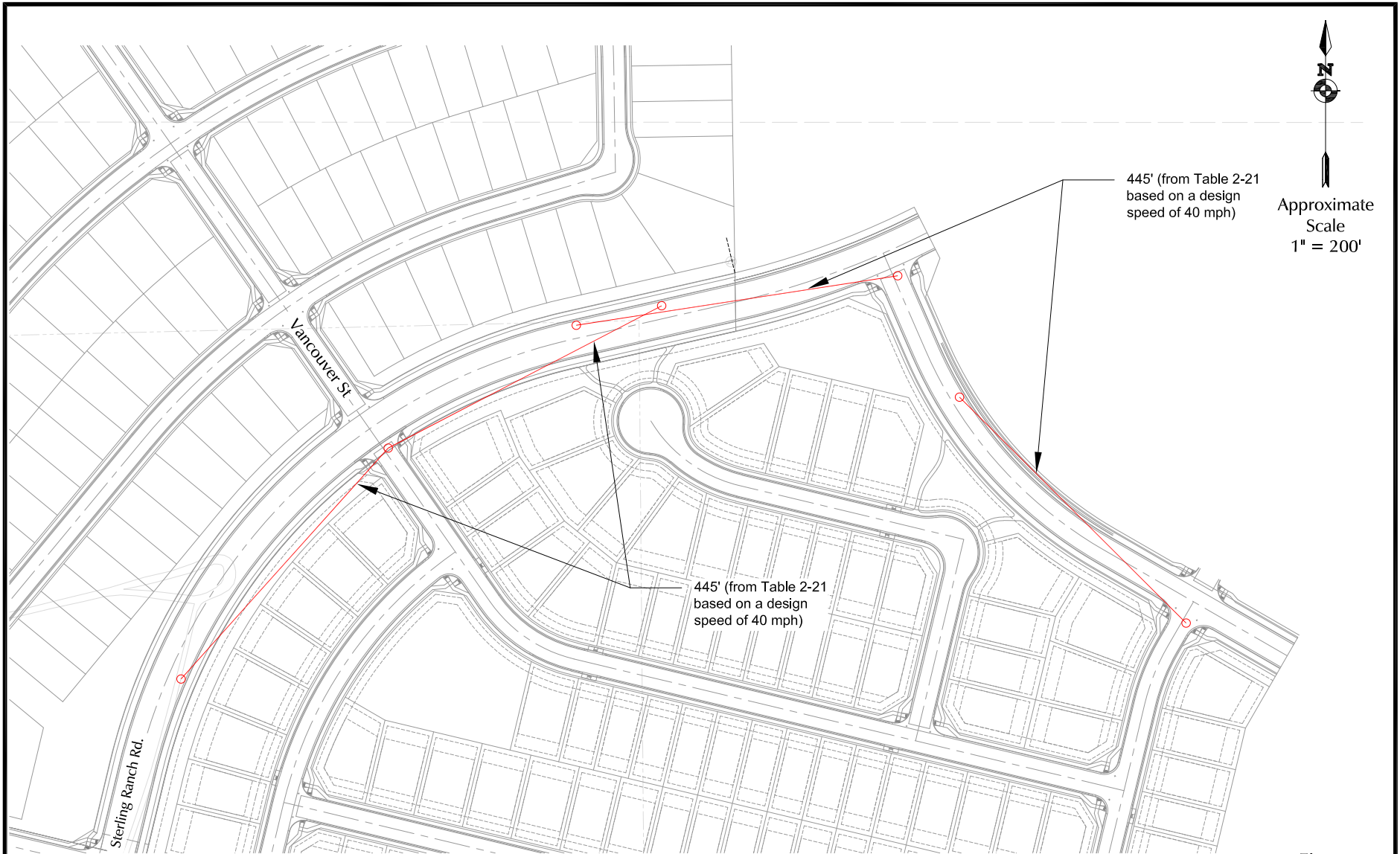

LEGEND:

— ECM Required Intersection Sight Distance

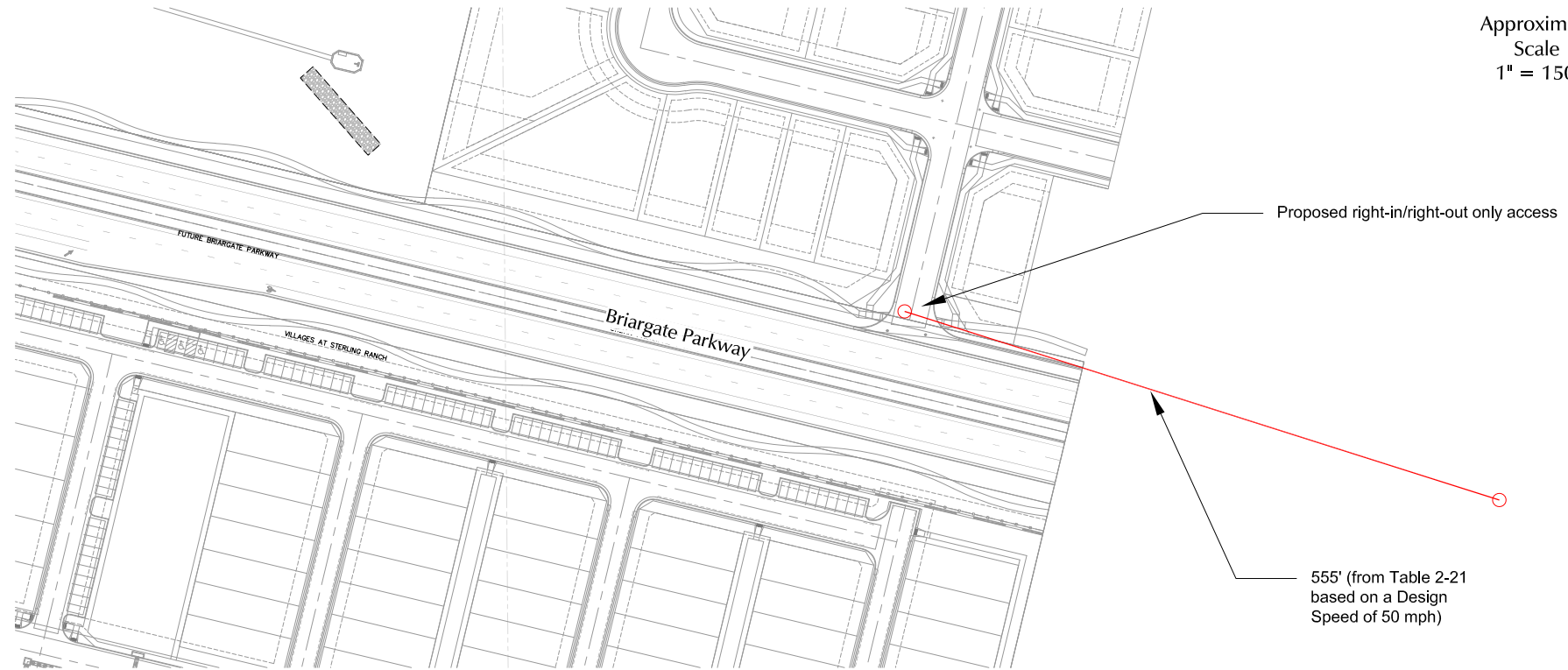

Figure 4a
Sight Distance Analysis-
Collector Intersections

Sterling Ranch East Filing No. 6 (LSC# S244250)



Approximate
Scale
1" = 150'



— ECM Required Intersection Sight Distance

Figure 4b Sight Distance Analysis - Briargate Pkwy Right-in/Right-out Only Access

Sterling Ranch East Filing No. 6 (LSC# S244250)



Not to scale

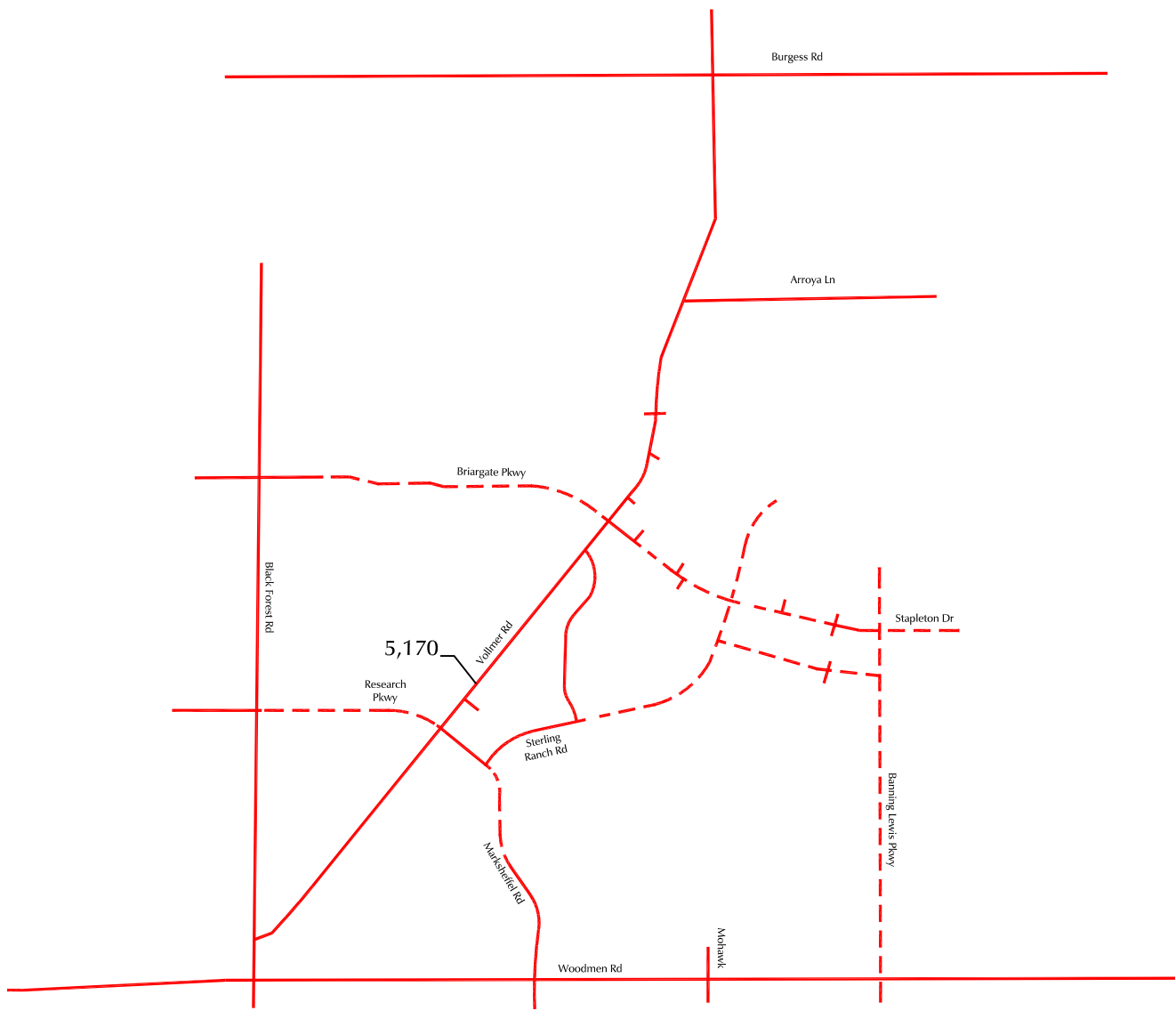

LEGEND:

XXX = Average Weekday Traffic (vehicles per day)(AWT) Based on counts by LSC April 2024

- Existing Roadway
- - - Future Roadway



Existing Average Weekday Traffic

Figure 5a

Sterling Ranch East Filing No. 6 (LSC# S244250)

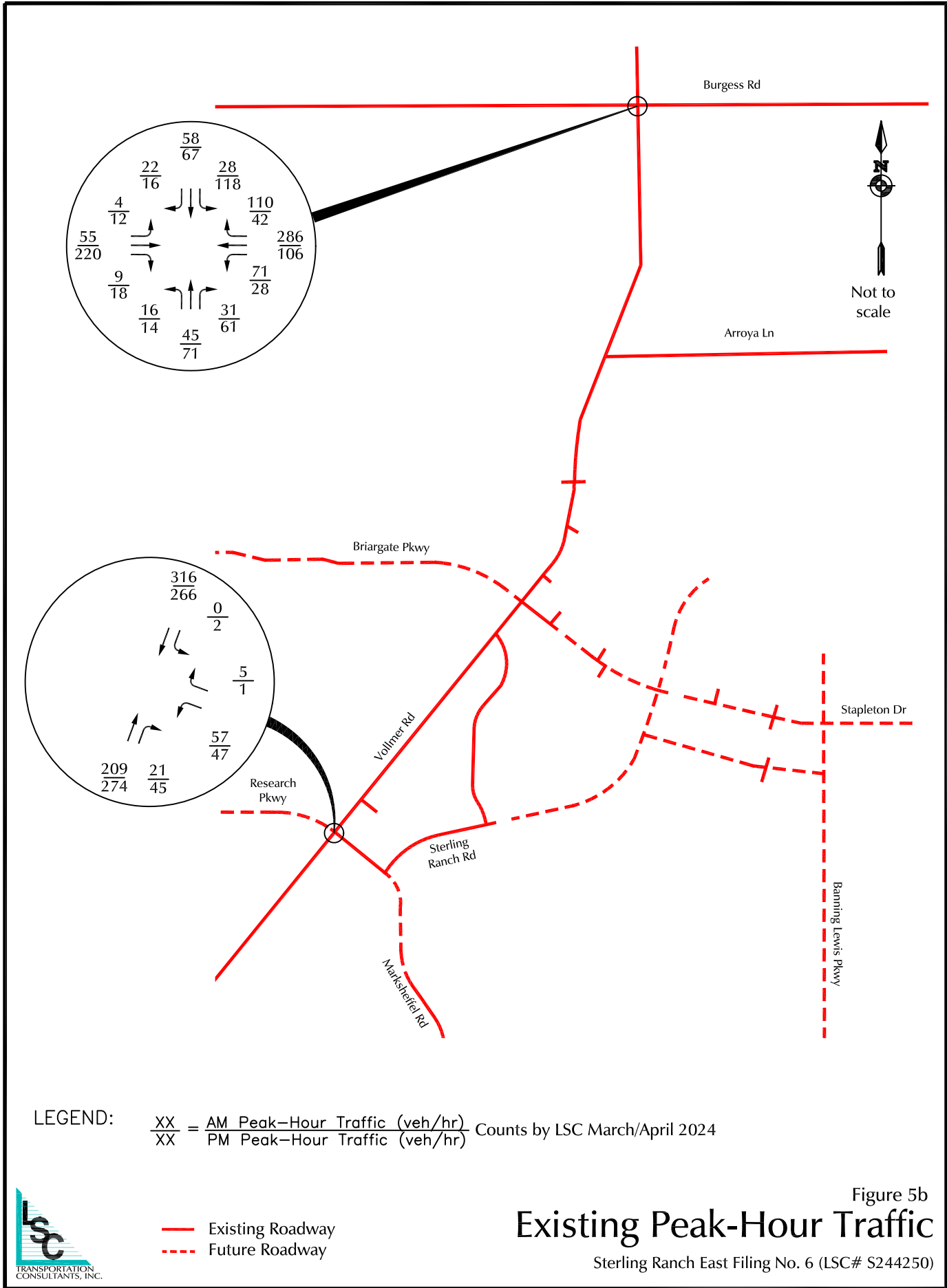

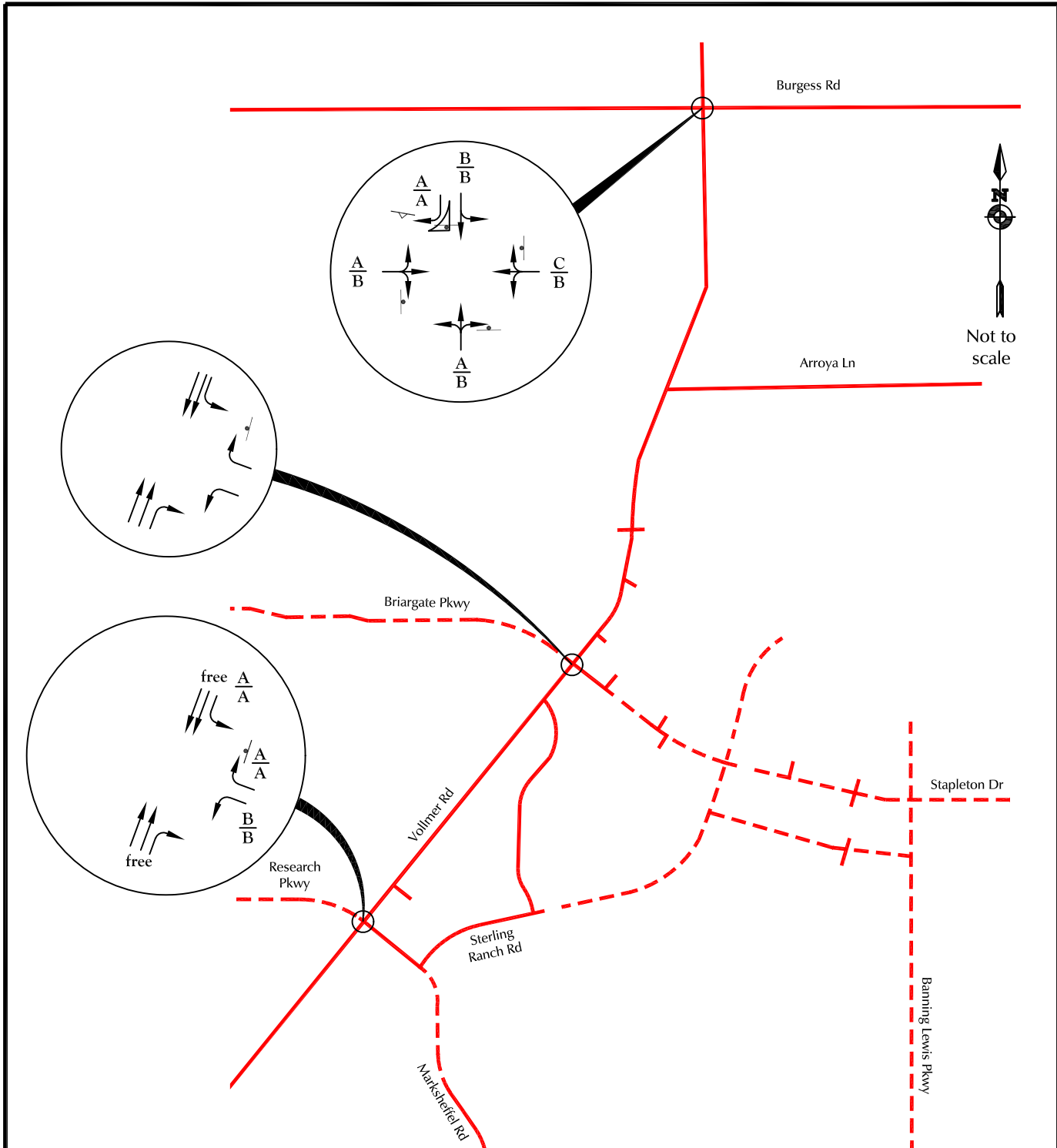

LEGEND:

$$\frac{A}{B} = \frac{\text{AM Individual Movement Peak-Hour Level of Service}}{\text{PM Individual Movement Peak-Hour Level of Service}}$$

┆ = Stop Sign } = Yield Sign

— Existing Roadway
 - - - Future Roadway

Figure 5c

Existing Lane Geometry, Traffic Control, and Level of Service

Sterling Ranch East Filing No. 6 (LSC# S244250)



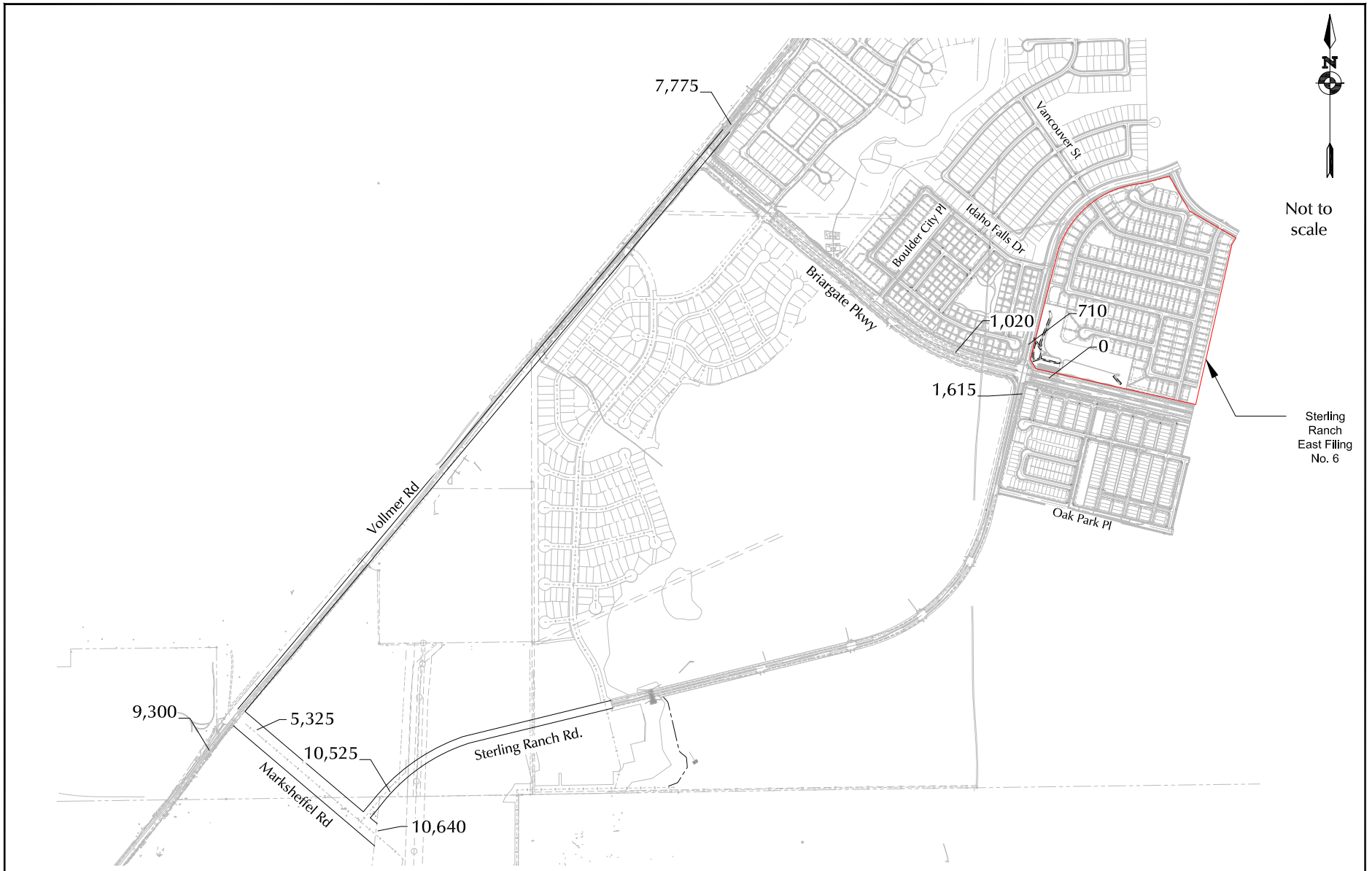

LEGEND: XXX = Average Weekday Traffic (vehicles per day)(AWT)

Figure 6a

Short-Term Background Average Weekday Traffic

Sterling Ranch East Filing No. 6 (LSC# S244250)



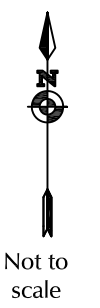
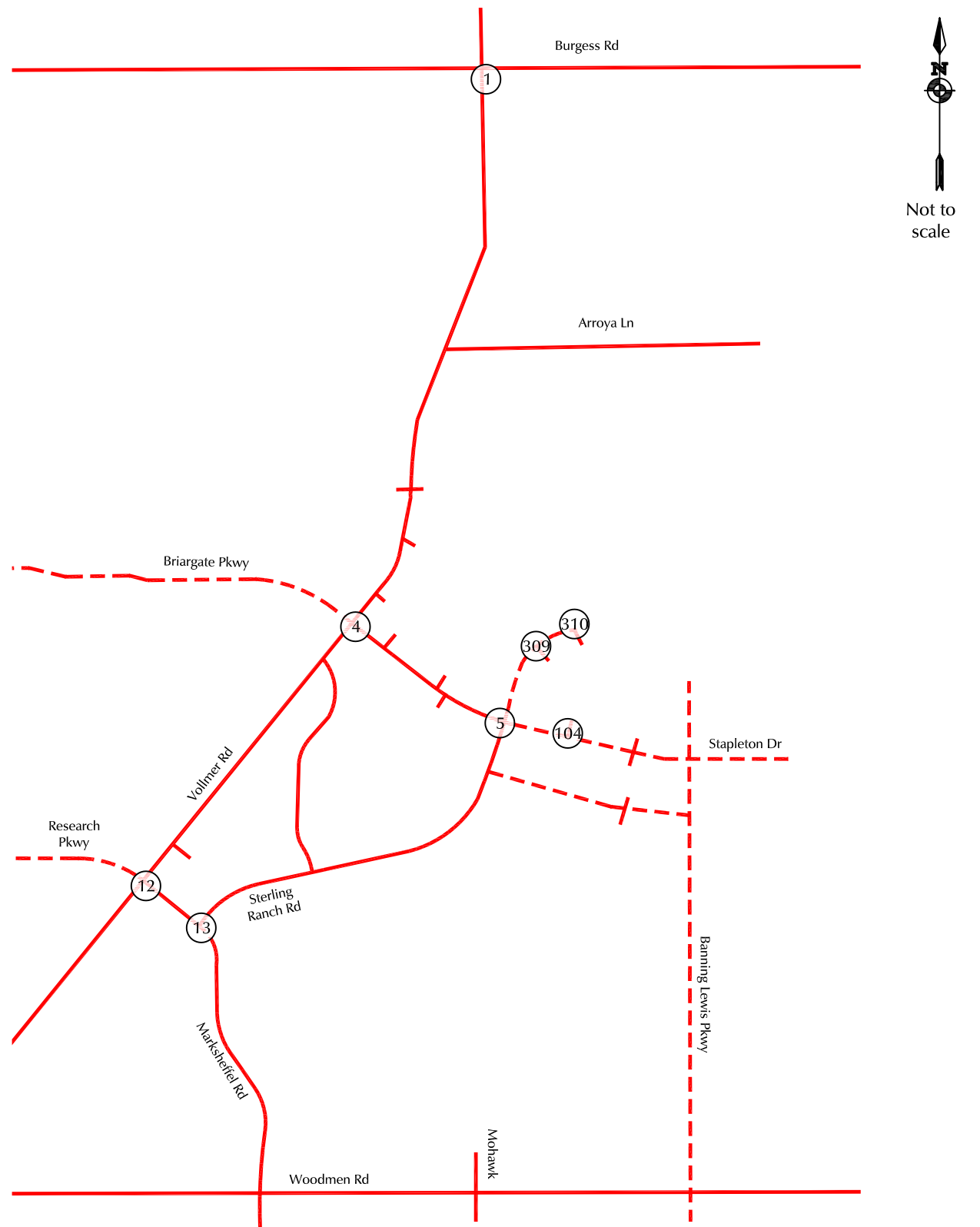
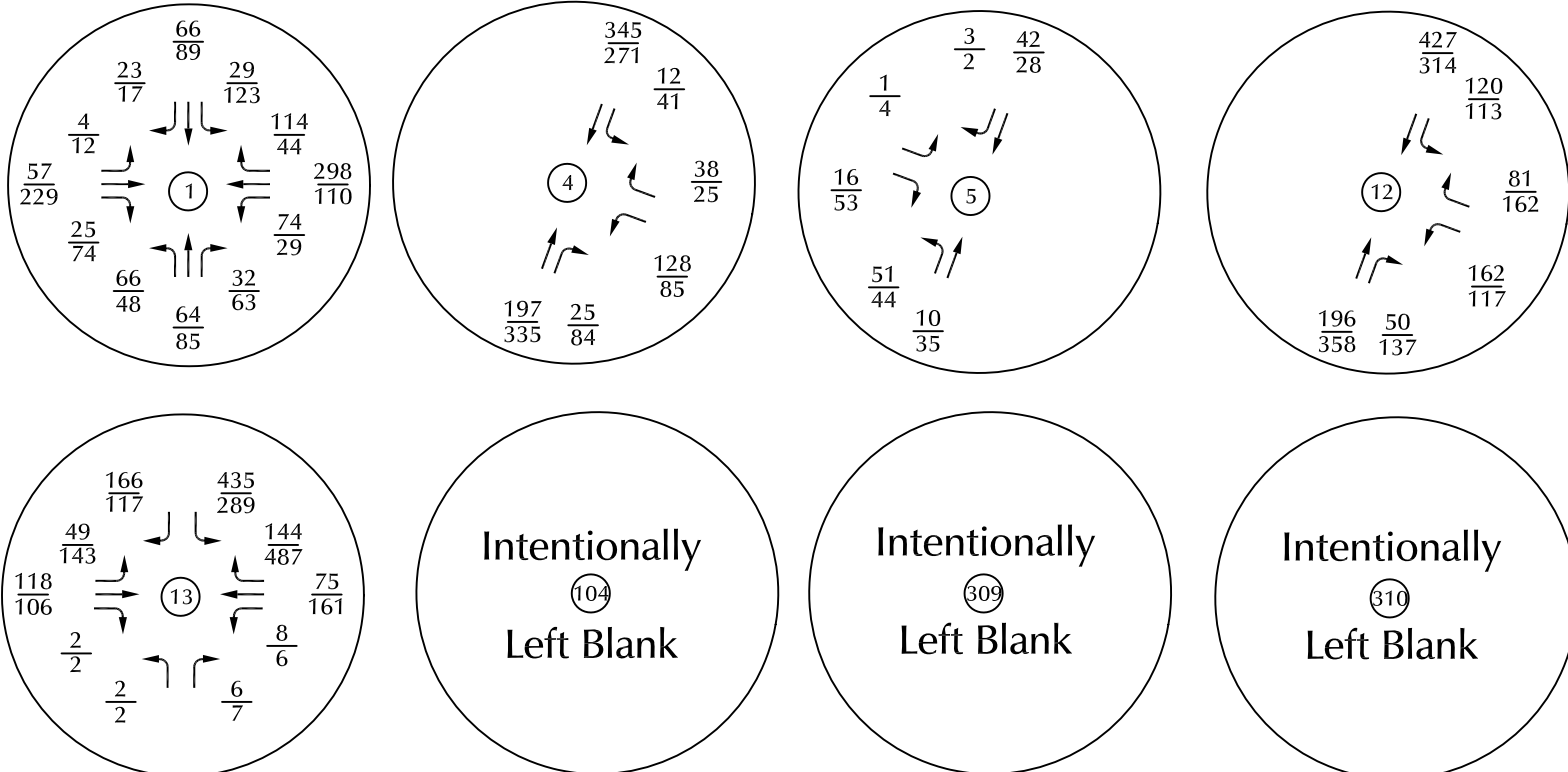

LEGEND: $\frac{XX}{XX} = \frac{\text{AM Peak-Hour Traffic (veh/hr)}}{\text{PM Peak-Hour Traffic (veh/hr)}}$

— Existing Roadway
 - - - Future Roadway



Figure 6b
Short-Term Background Traffic
 Sterling Ranch East Filing No. 6 (LSC# S244250)

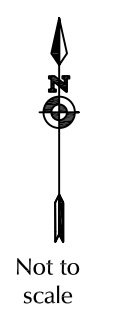
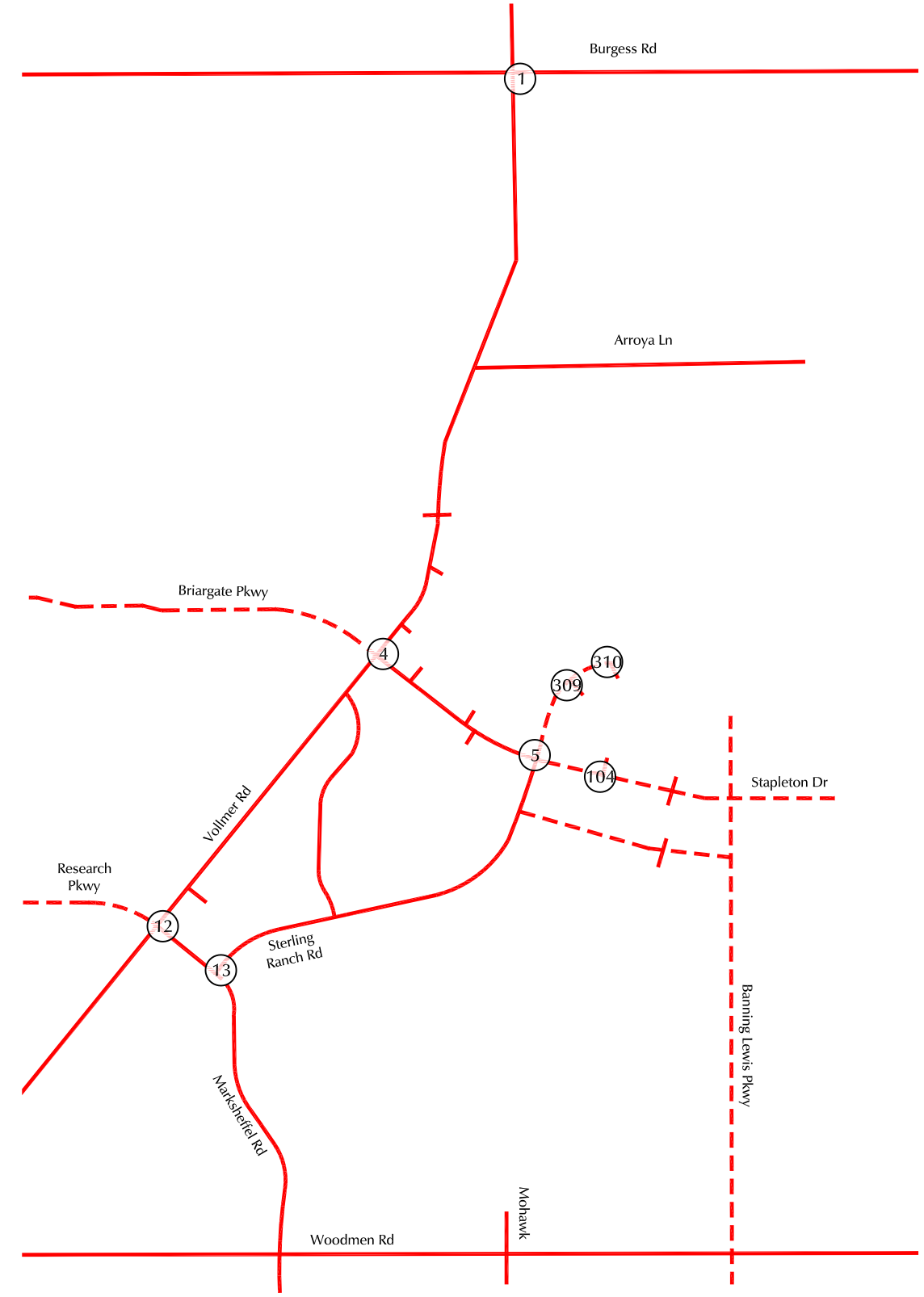
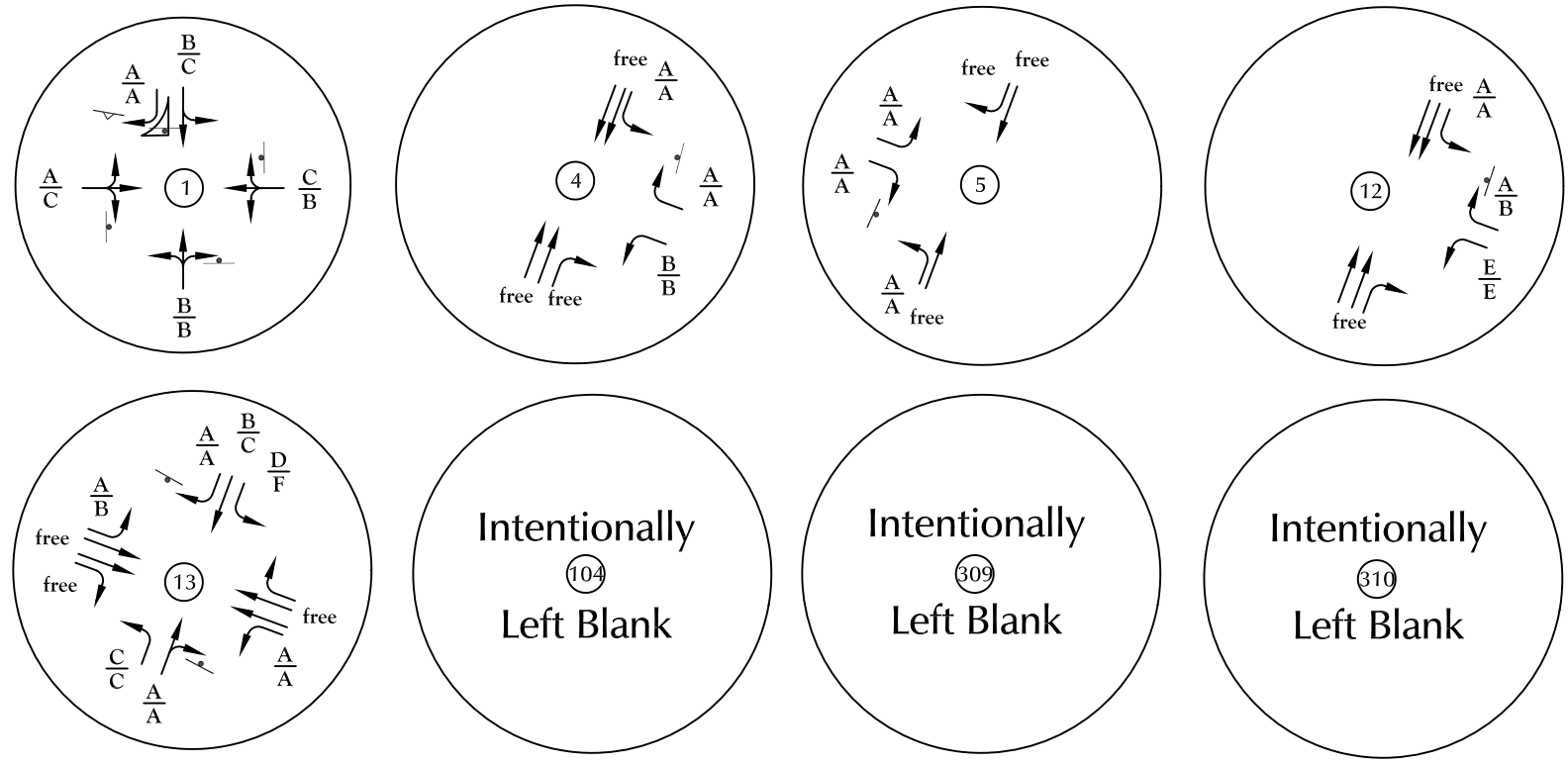

LEGEND:

$\frac{A}{B}$ = AM Individual Movement Peak-Hour Level of Service
 PM Individual Movement Peak-Hour Level of Service
 $\frac{C}{D}$ = AM Entire Intersection Peak-Hour Level of Service
 PM Entire Intersection Peak-Hour Level of Service

= Yield Sign
 = Stop Sign
 = Traffic Signal

Existing Roadway
 Future Roadway



Figure 6c
 Short-Term Background Lane Geometry,
 Traffic Control, and Level of Service

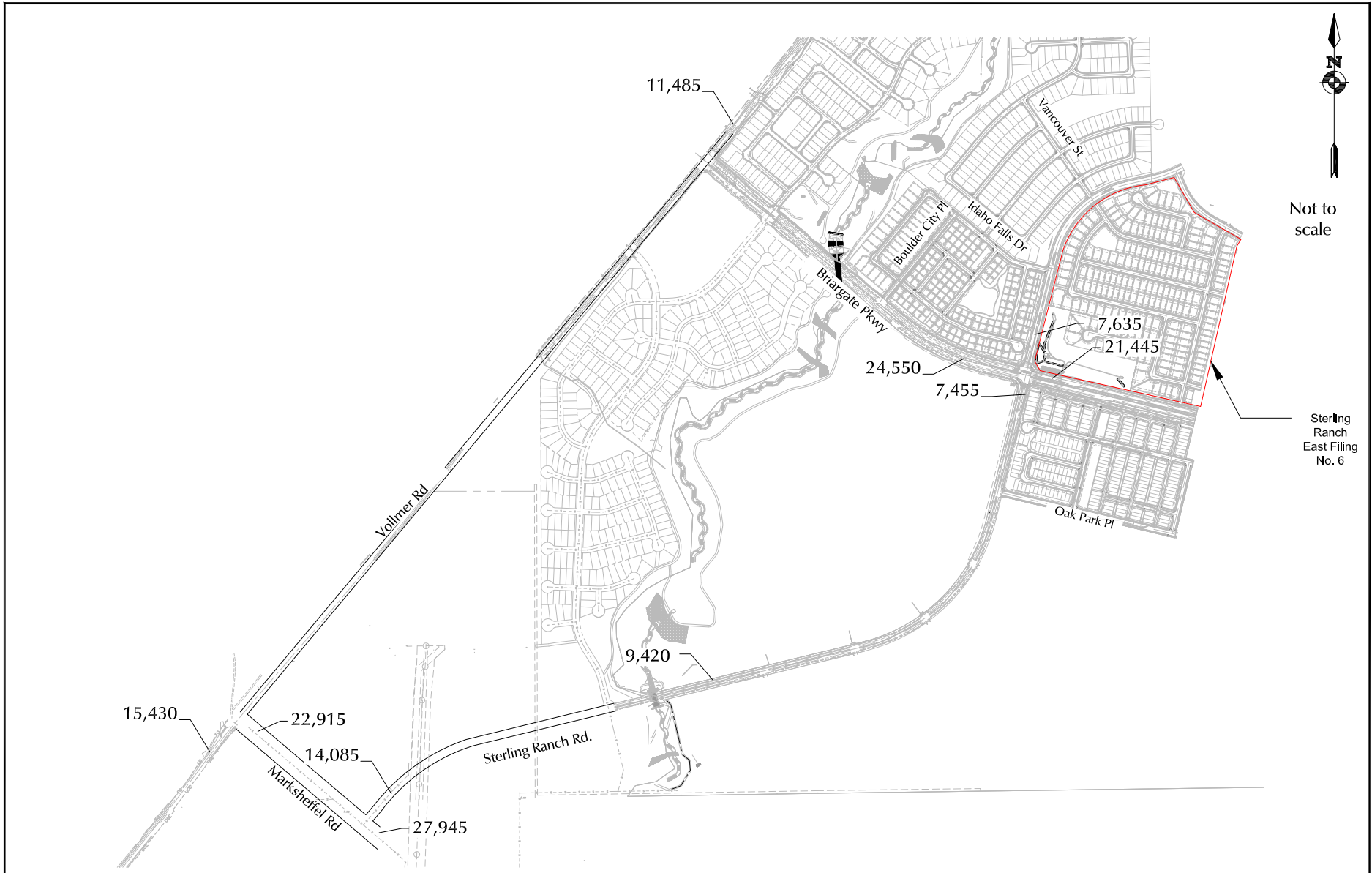

LEGEND: XXX = Average Weekday Traffic (vehicles per day)(AWT)

Figure 7a

2045 Background Average Weekday Traffic

Sterling Ranch East Filing No. 6 (LSC# S244250)



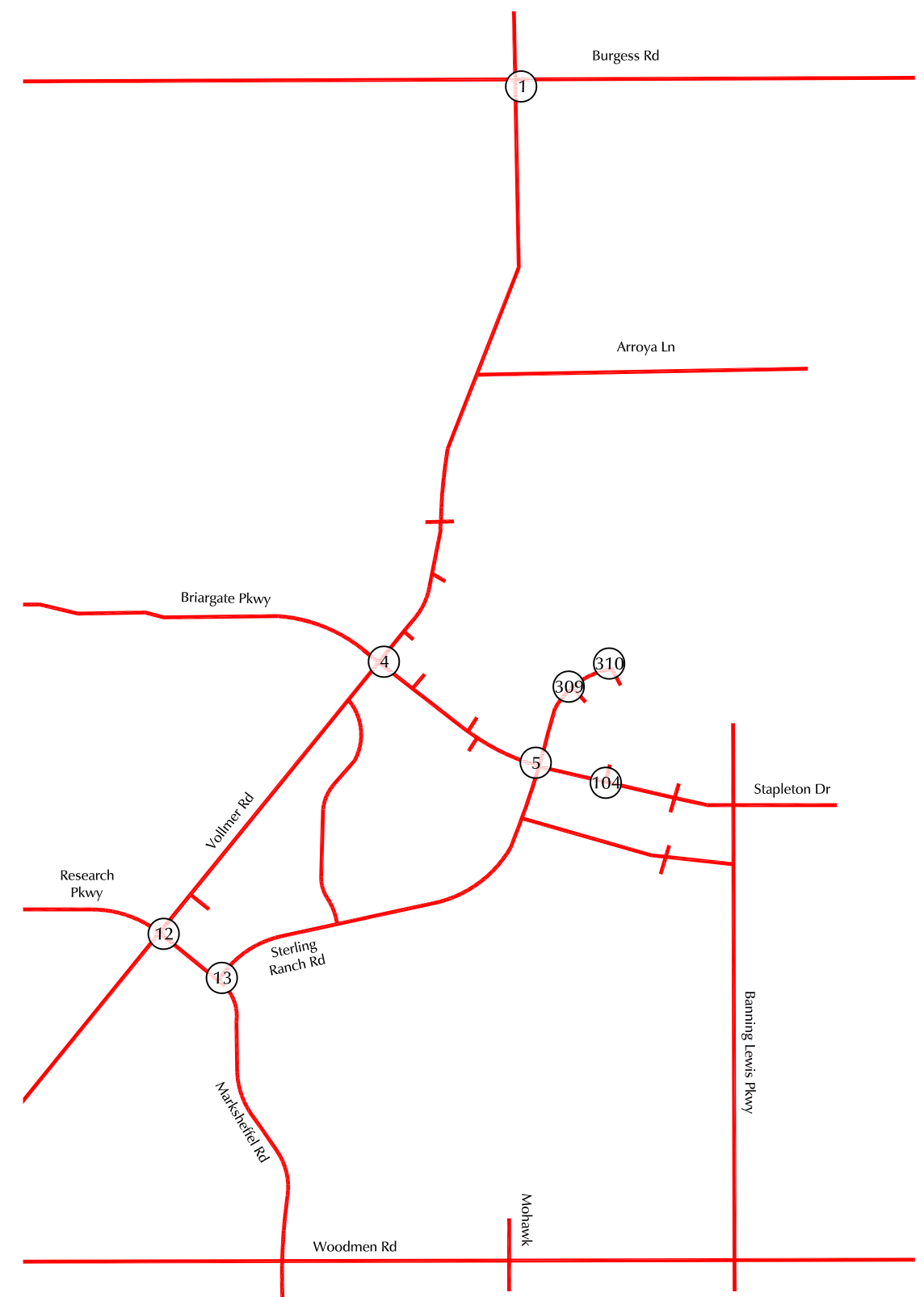
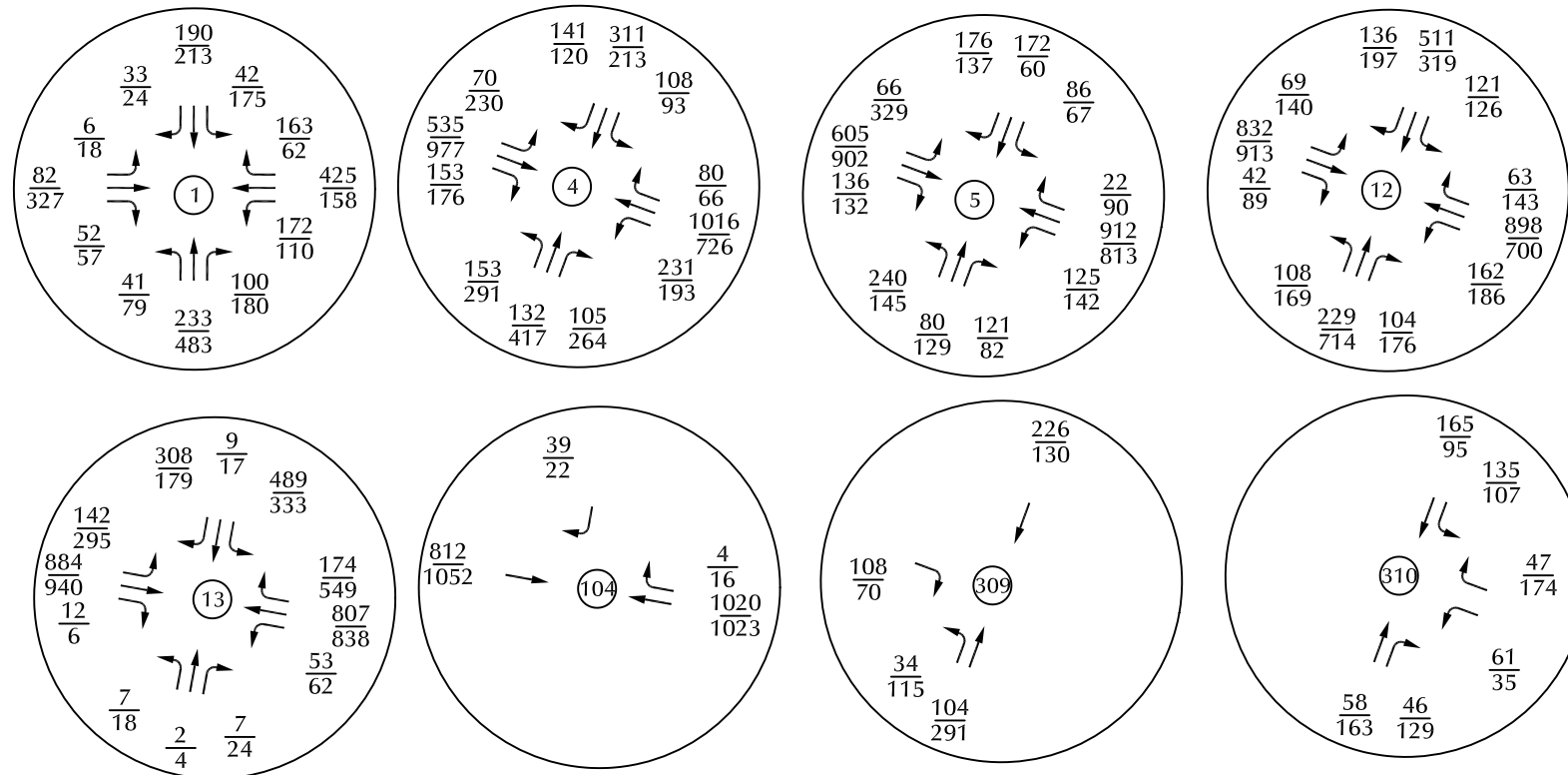

LEGEND: $\frac{XX}{XX}$ = AM Peak-Hour Traffic (veh/hr)
 $\frac{XX}{XX}$ = PM Peak-Hour Traffic (veh/hr)



Figure 7b
2045 Background Traffic

Sterling Ranch East Filing No. 6 (LSC# S244250)

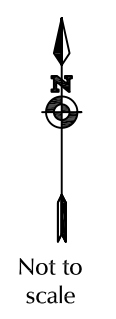
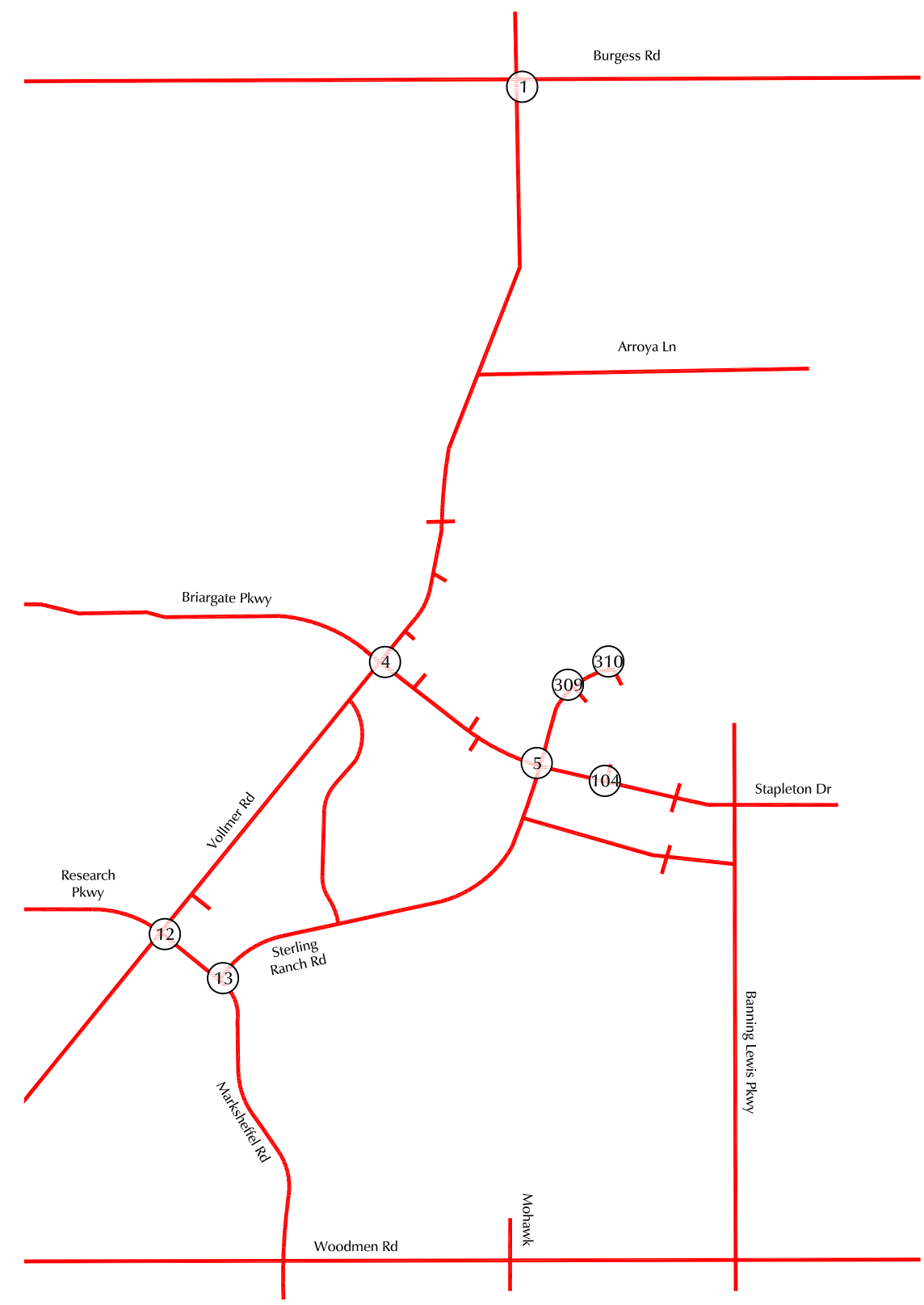
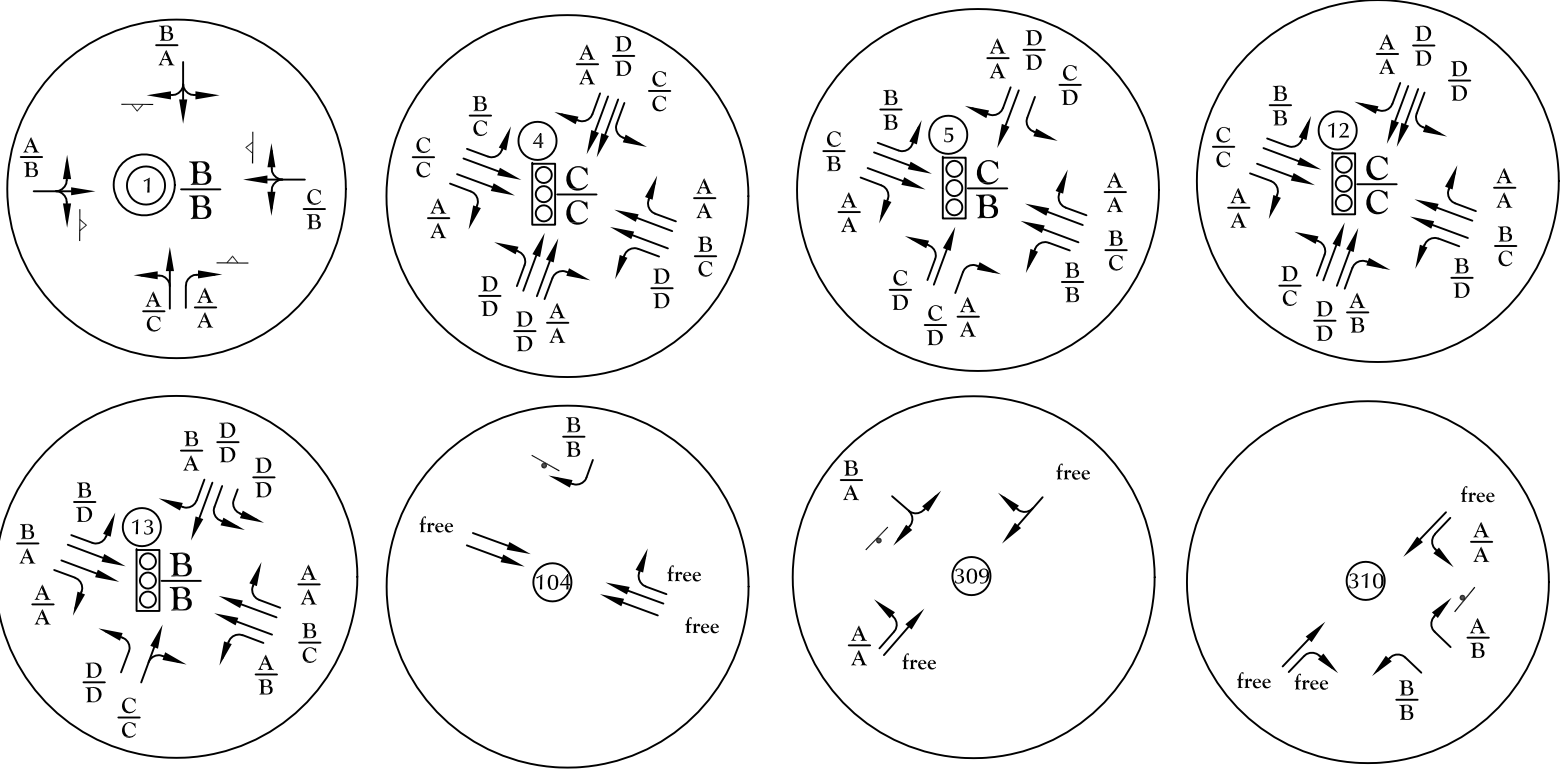

LEGEND:

$\frac{A}{B}$ = AM Individual Movement Peak-Hour Level of Service
 PM Individual Movement Peak-Hour Level of Service
 $\frac{C}{D}$ = AM Entire Intersection Peak-Hour Level of Service
 PM Entire Intersection Peak-Hour Level of Service

† = Stop Sign ‡ = Yield Sign
 = Traffic Signal ○ = Roundabout

Figure 7c
 2044 Background Lane Geometry,
 Traffic Control, and Level of Service





Not to scale

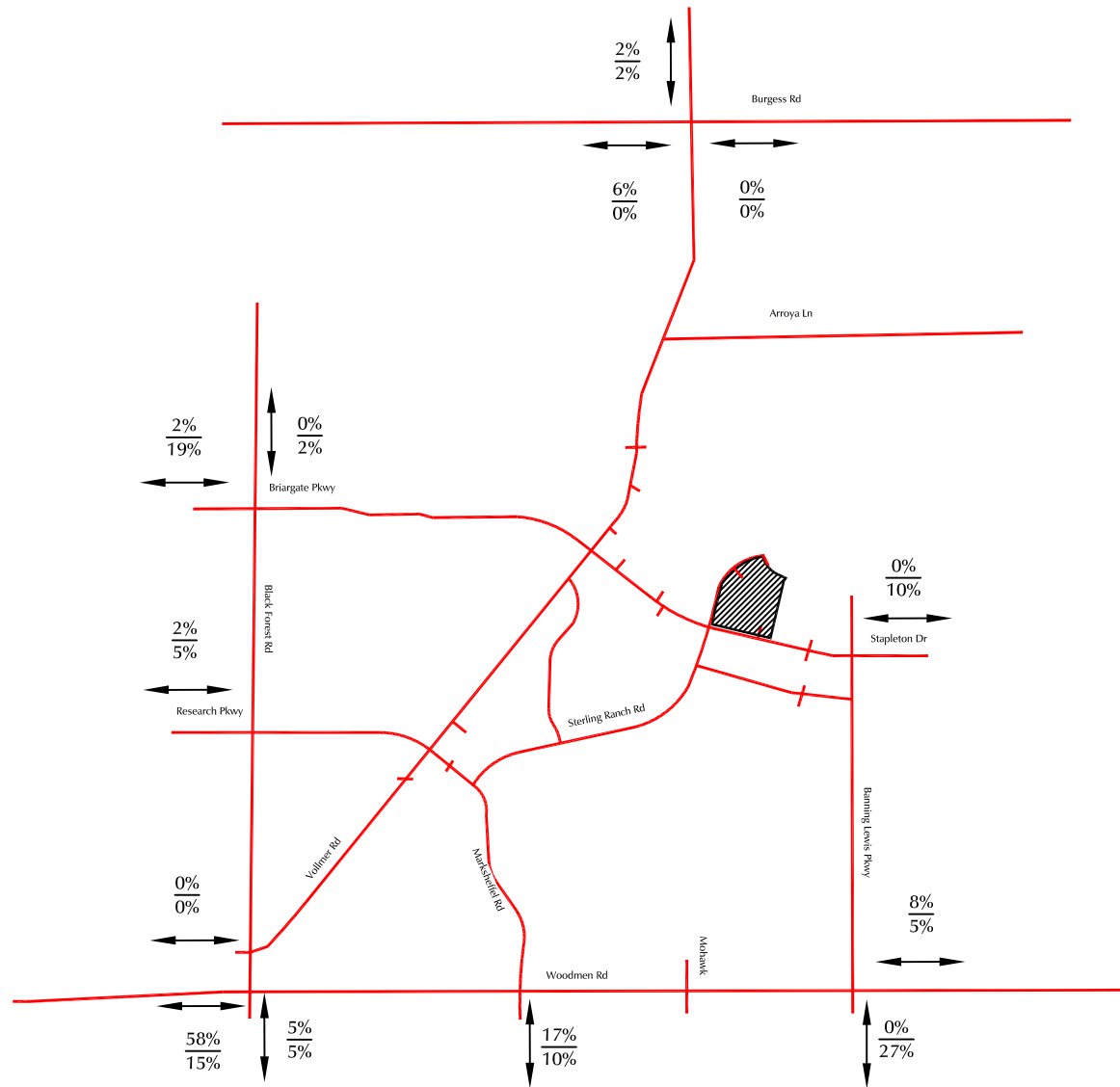

LEGEND:

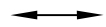

$\frac{XX\%}{XX\%} =$ Percent of Short-Term Trips
 Percent of Buildout Long-Term Trips

Estimated Directional Distribution of Site-Generated Trips

Figure 8

Sterling Ranch East Filing No. 6 (LSC# S244250)

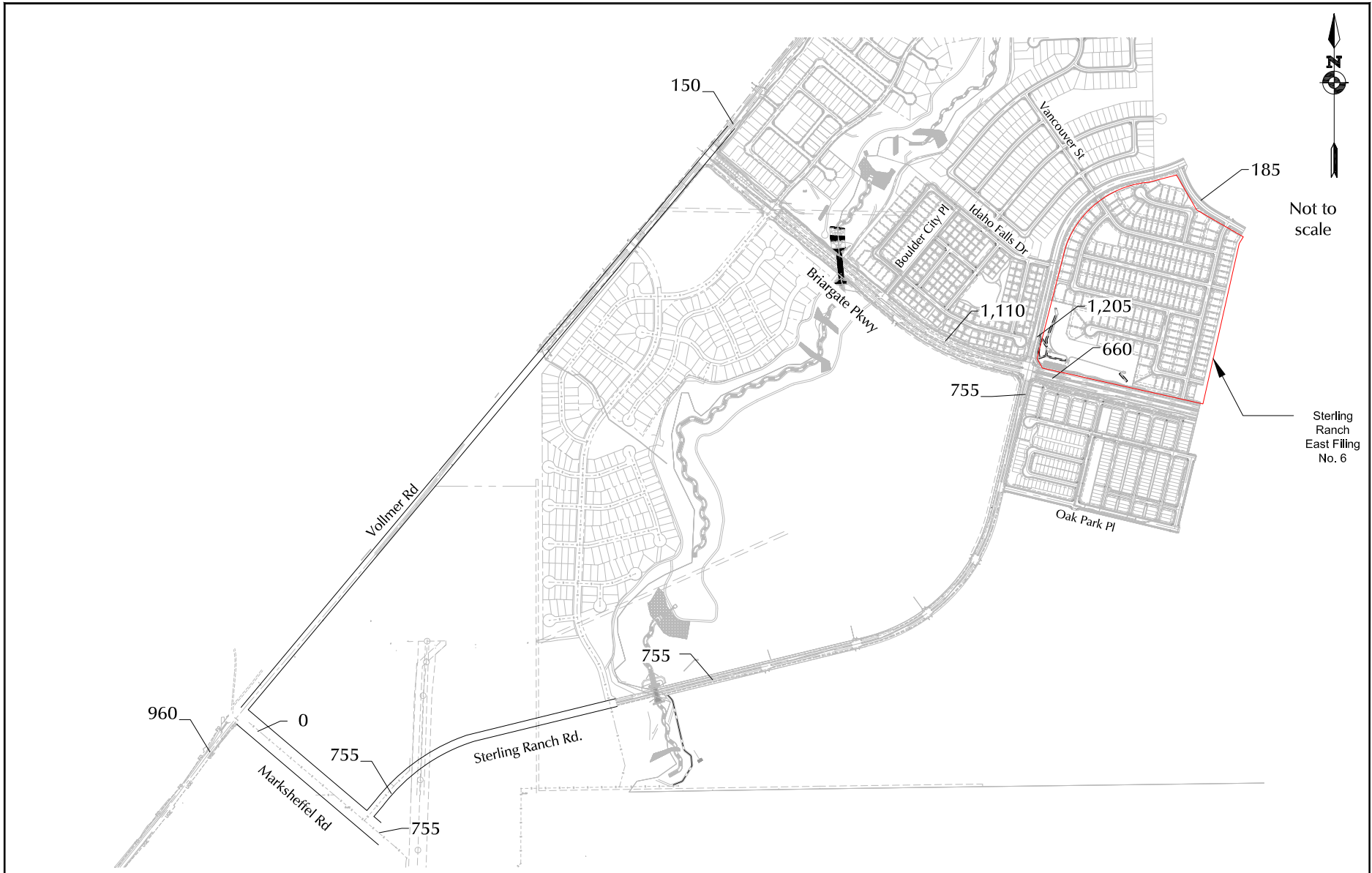

LEGEND: XXX = Average Weekday Traffic (vehicles per day)(AWT)

Short-Term Site Generated Average Weekday Traffic

Figure 9a

Sterling Ranch East Filing No. 6 (LSC# S244250)



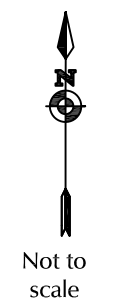
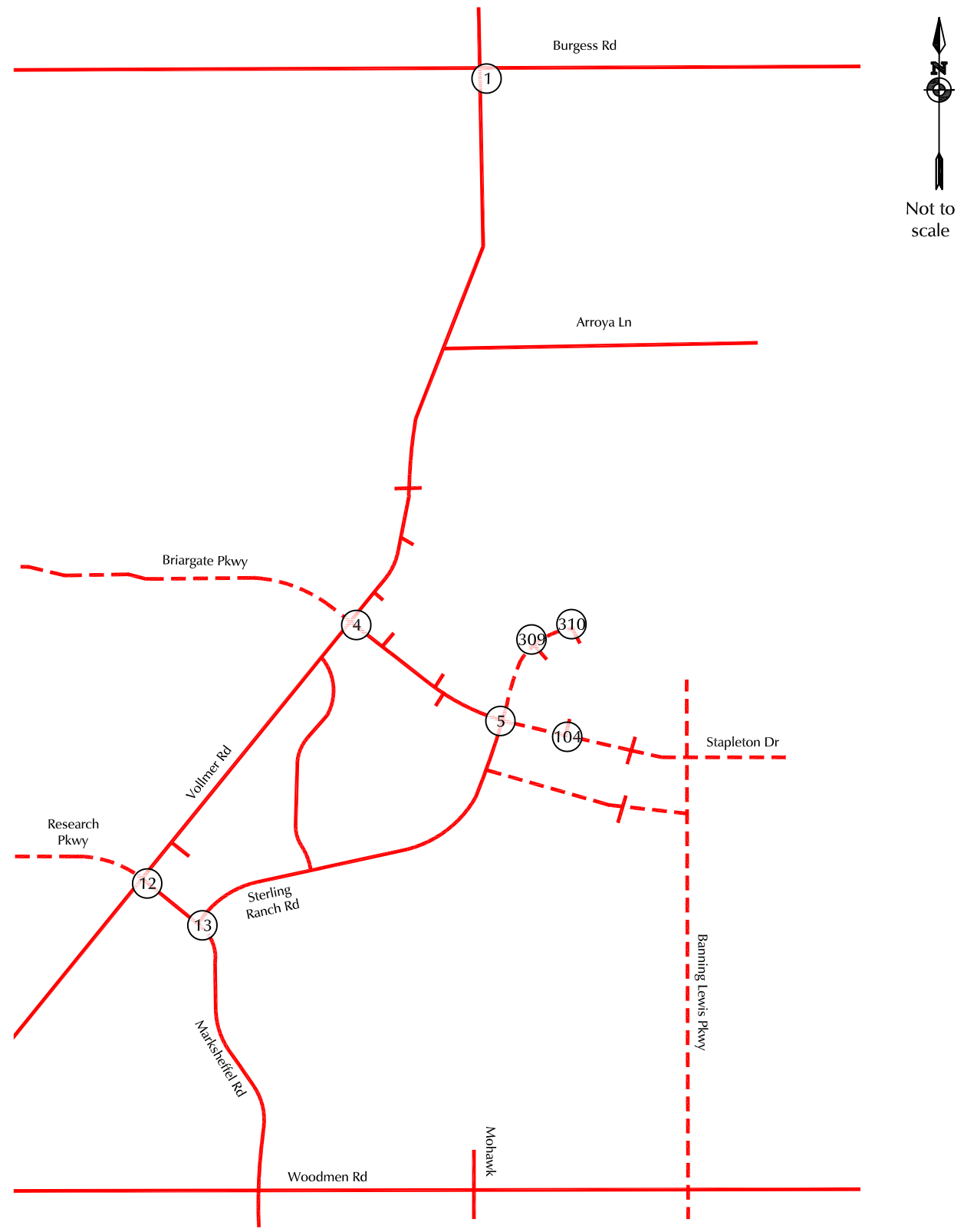
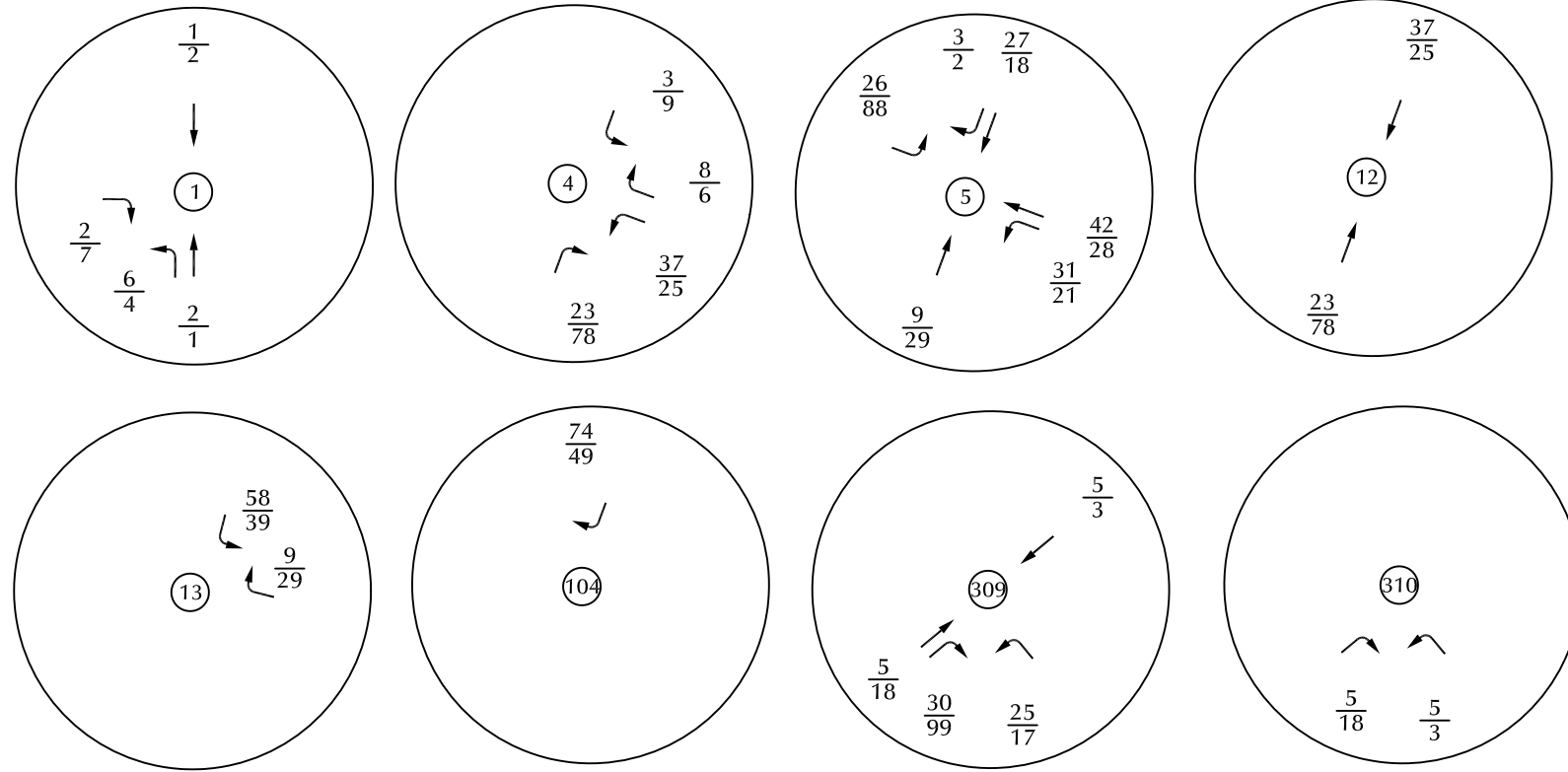

LEGEND: $\frac{XX}{XX} = \frac{\text{AM Peak-Hour Traffic (veh/hr)}}{\text{PM Peak-Hour Traffic (veh/hr)}}$

— Existing Roadway
 - - - Future Roadway



Figure 9b
 Short-Term Site-Generated Traffic

Sterling Ranch East Filing No. 6 (LSC# S244250)

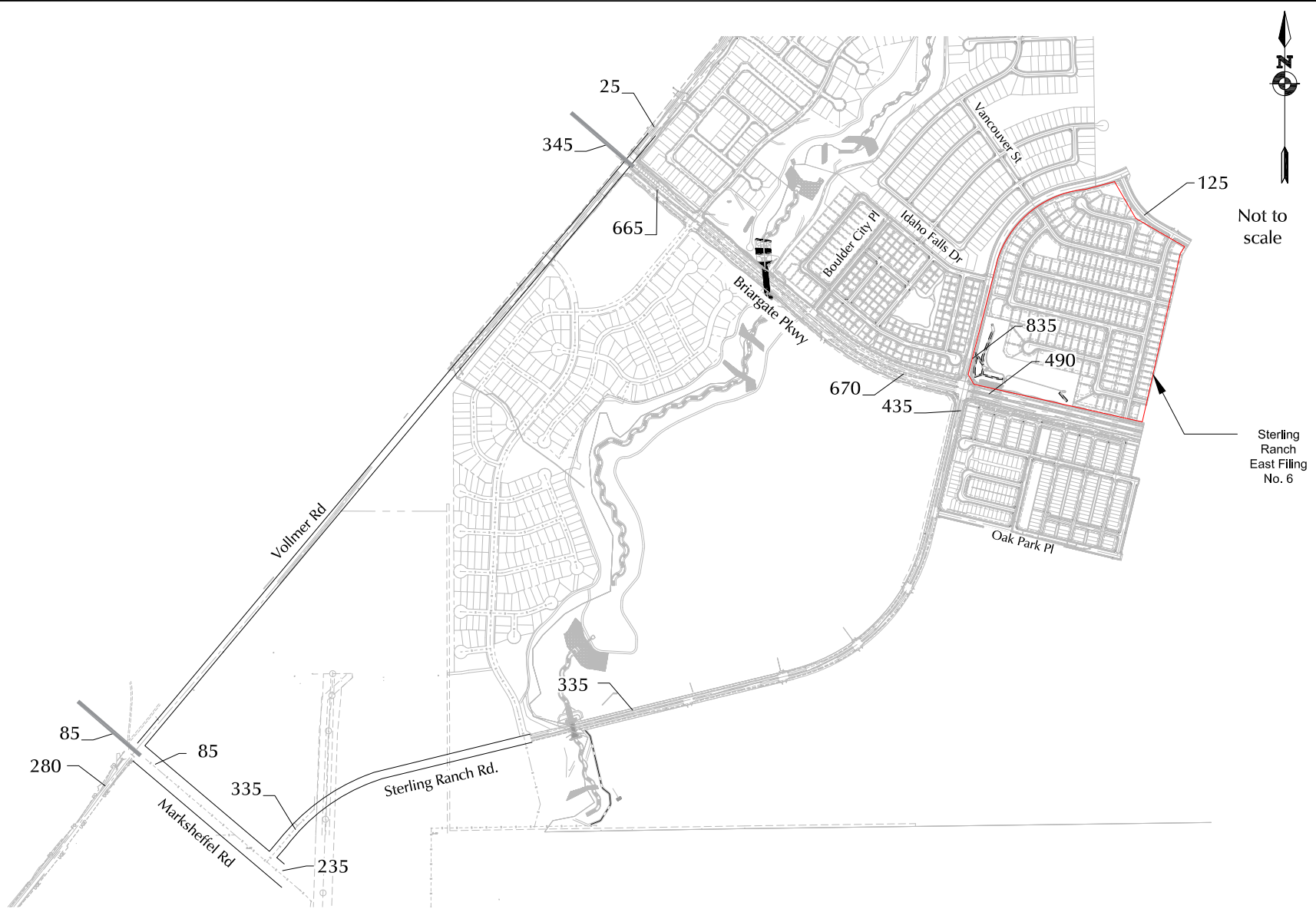

LEGEND: **XXX** = Average Weekday Traffic (vehicles per day)(AWT)

Long-Term Site-Generated Average Weekday Traffic

Sterling Ranch East Filing No. 6 (LSC# S244250)

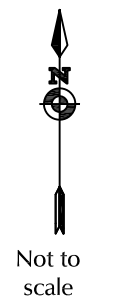
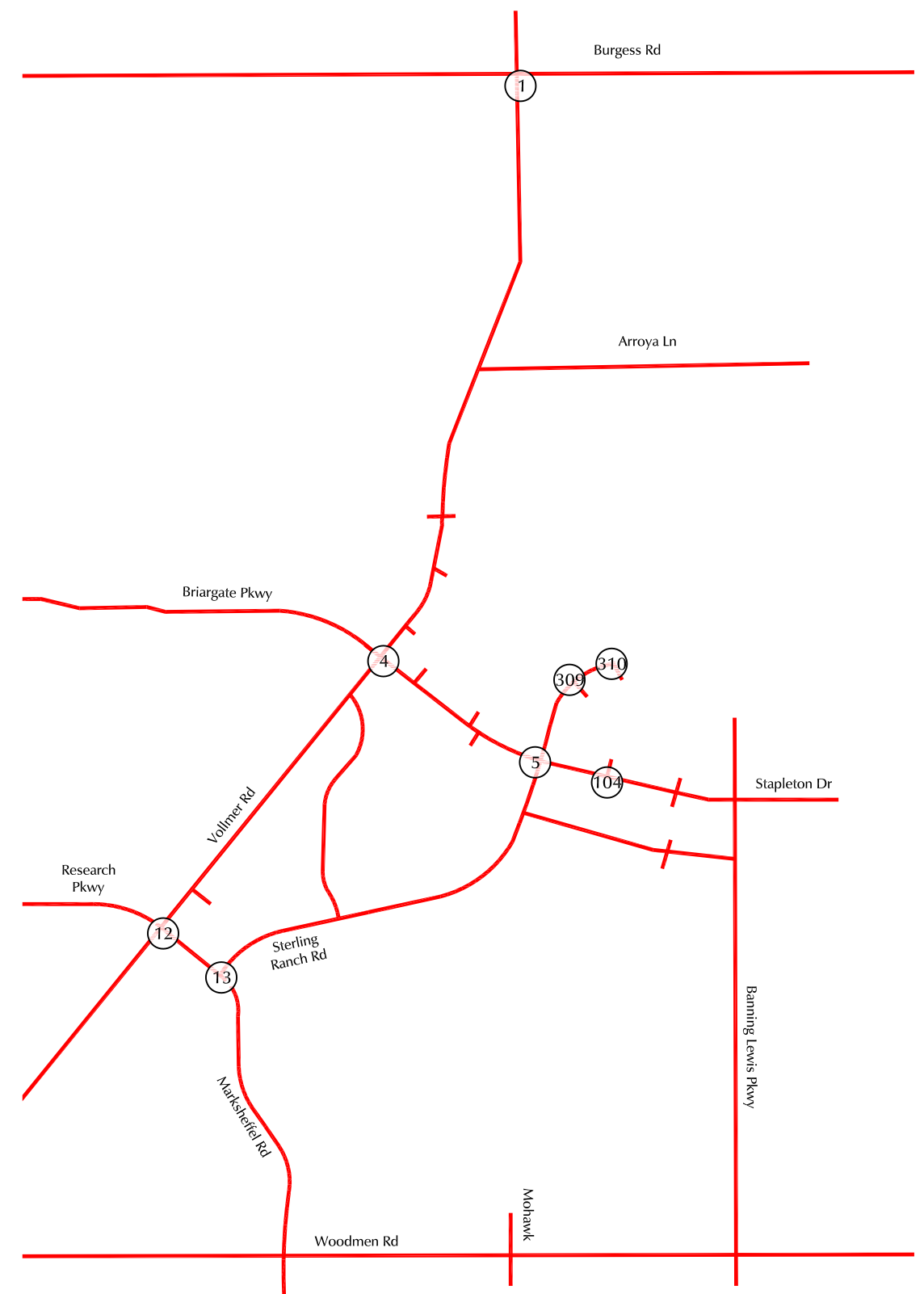
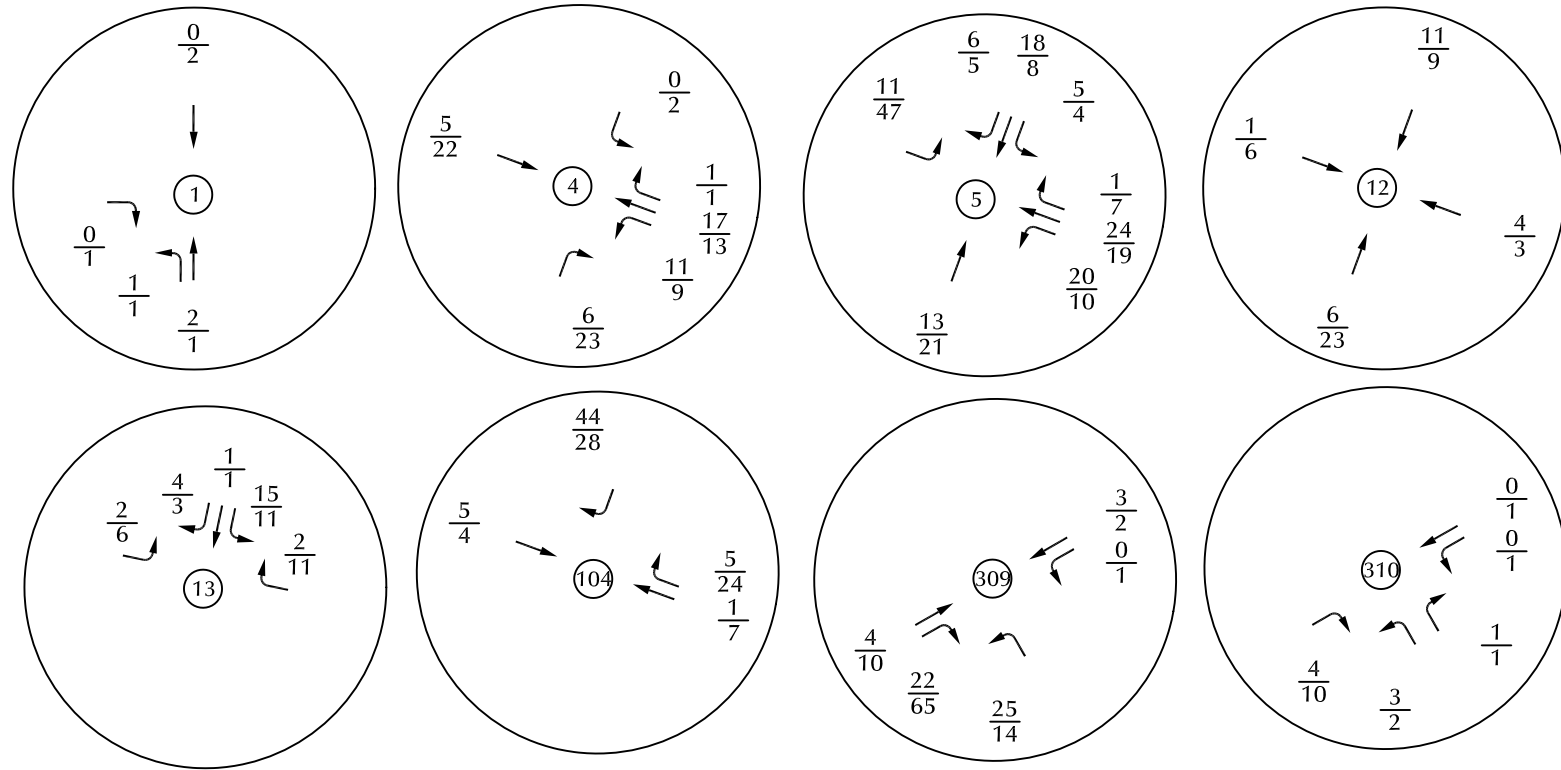

LEGEND: $\frac{XX}{XX} = \frac{\text{AM Peak-Hour Traffic (veh/hr)}}{\text{PM Peak-Hour Traffic (veh/hr)}}$



Figure 10b
Long-Term Site-Generated Traffic

Sterling Ranch East Filing No. 6 (LSC# S244250)

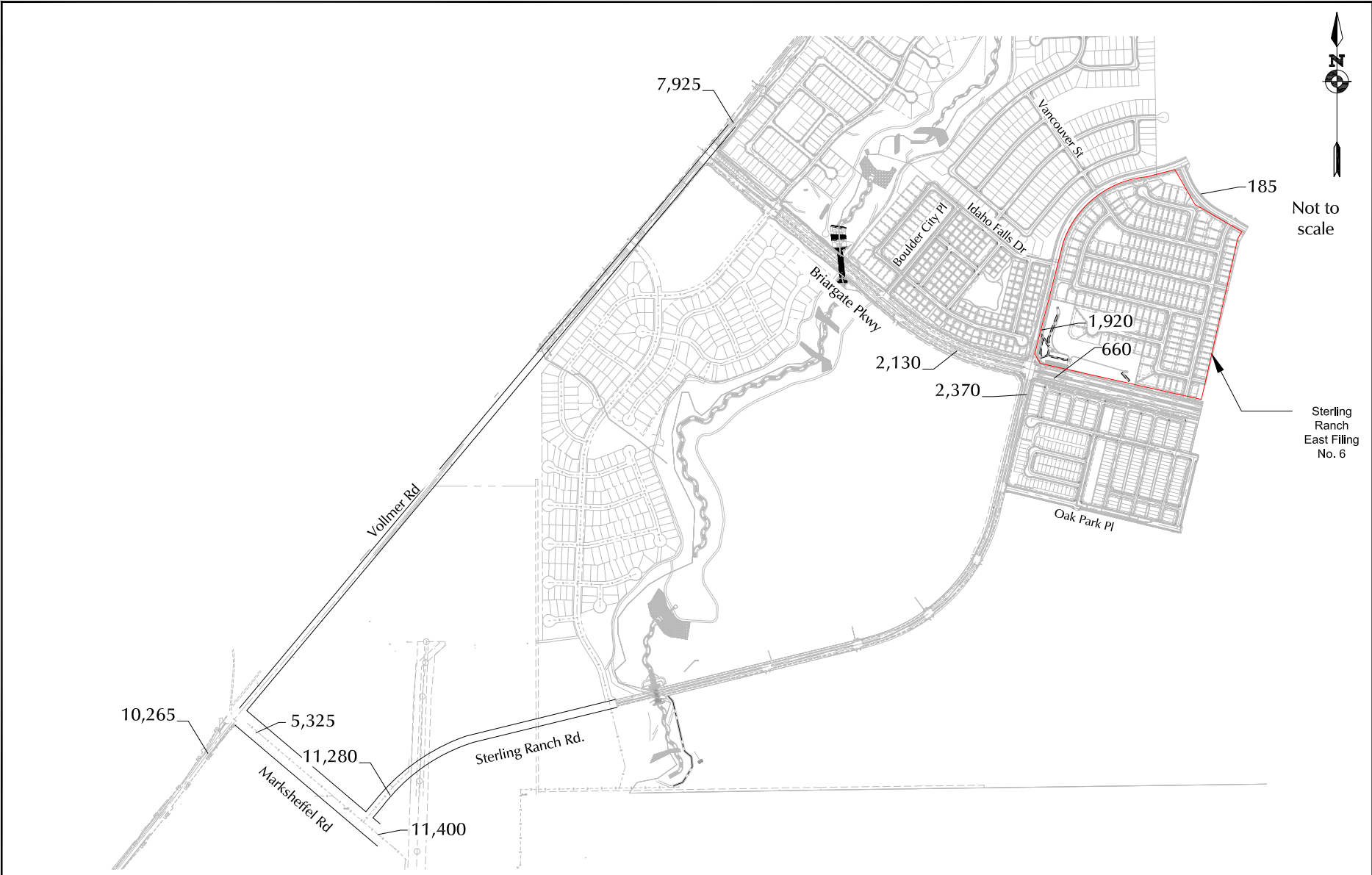

LEGEND: **XXX** = Average Weekday Traffic (vehicles per day)(AWT)

Short-Term Total Average Weekday Traffic

Sterling Ranch East Filing No. 6 (LSC# S244250)



Figure 11a

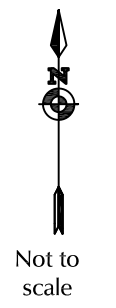
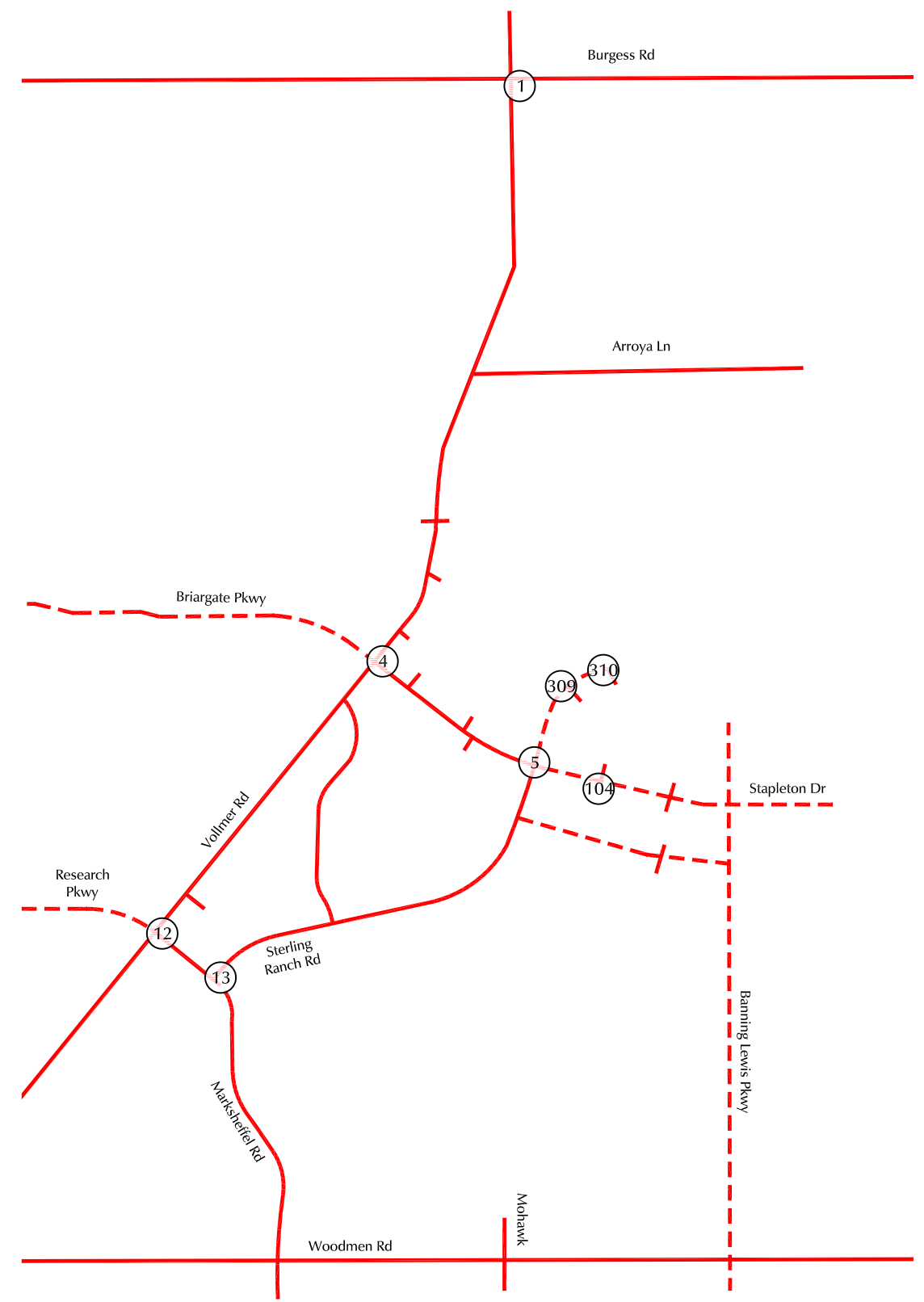
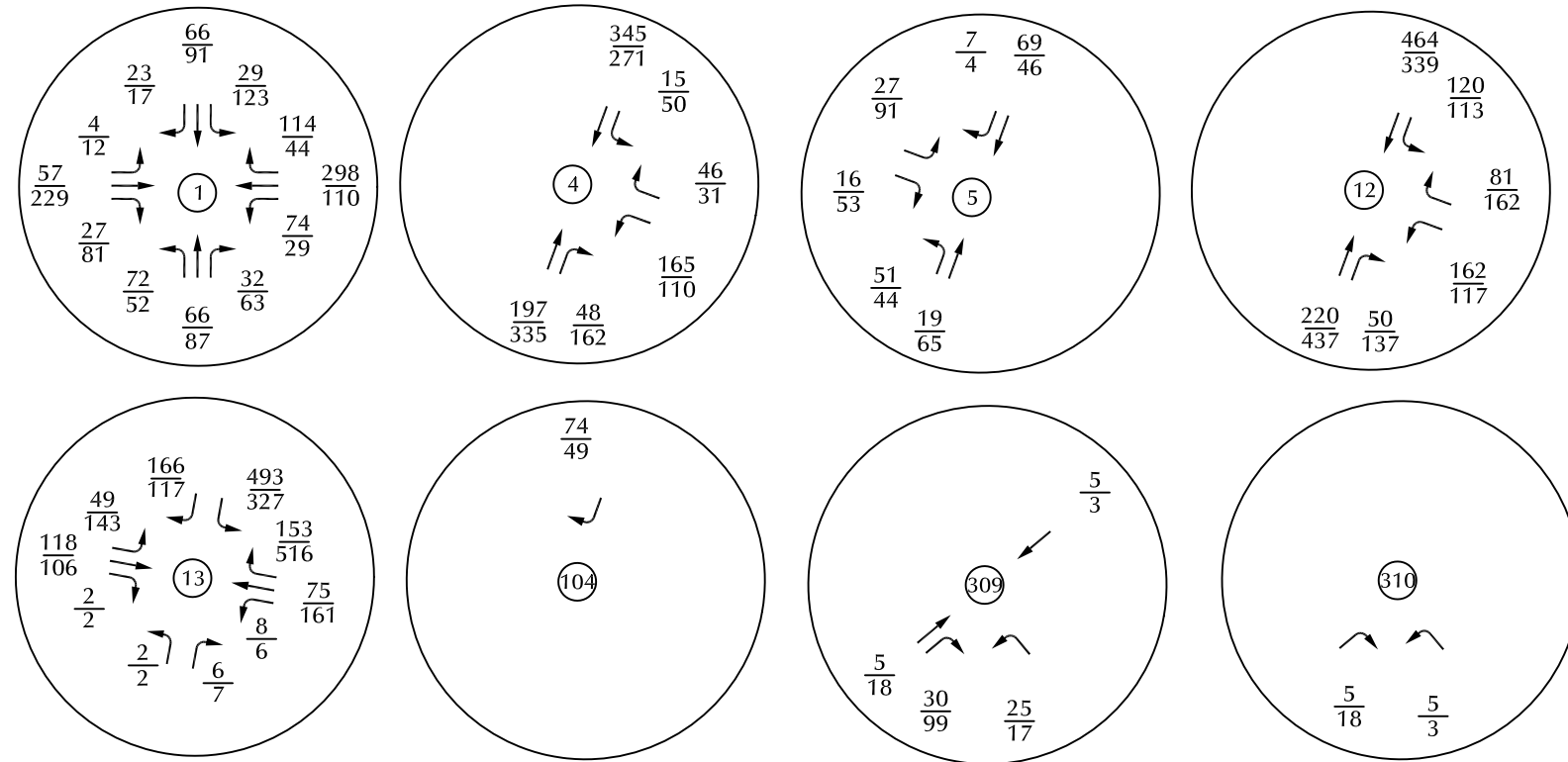

LEGEND: $\frac{XX}{XX} = \frac{\text{AM Peak-Hour Traffic (veh/hr)}}{\text{PM Peak-Hour Traffic (veh/hr)}}$

— Existing Roadway
 - - - Future Roadway



Figure 11b
Short-Term Total Traffic
 Sterling Ranch East Filing No. 6 (LSC# S244250)

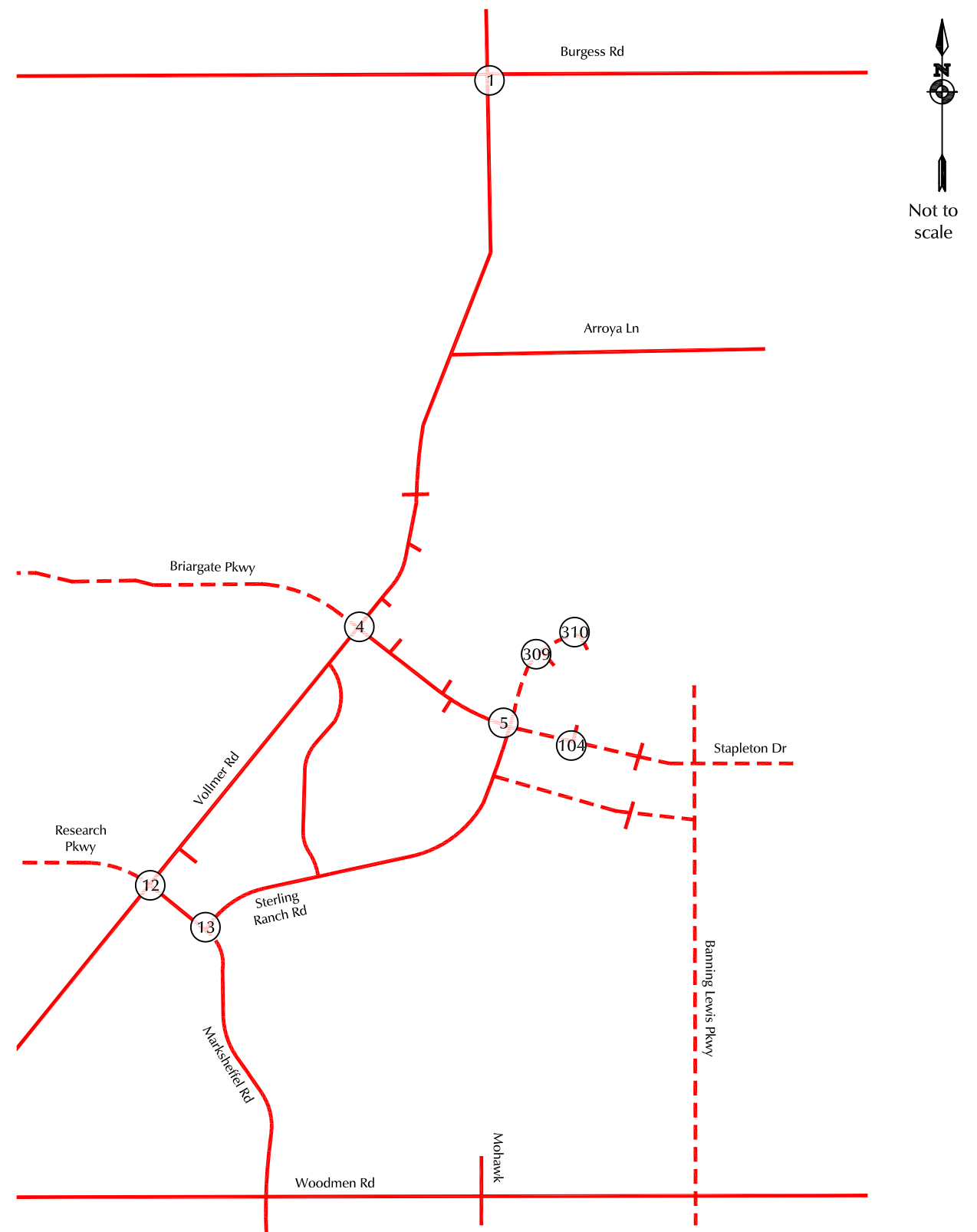
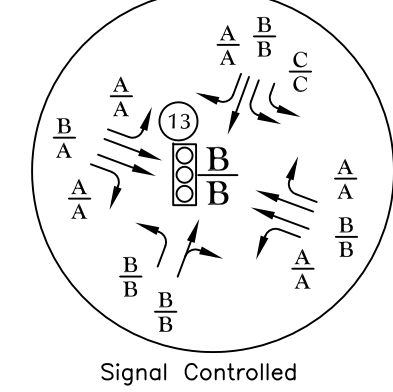
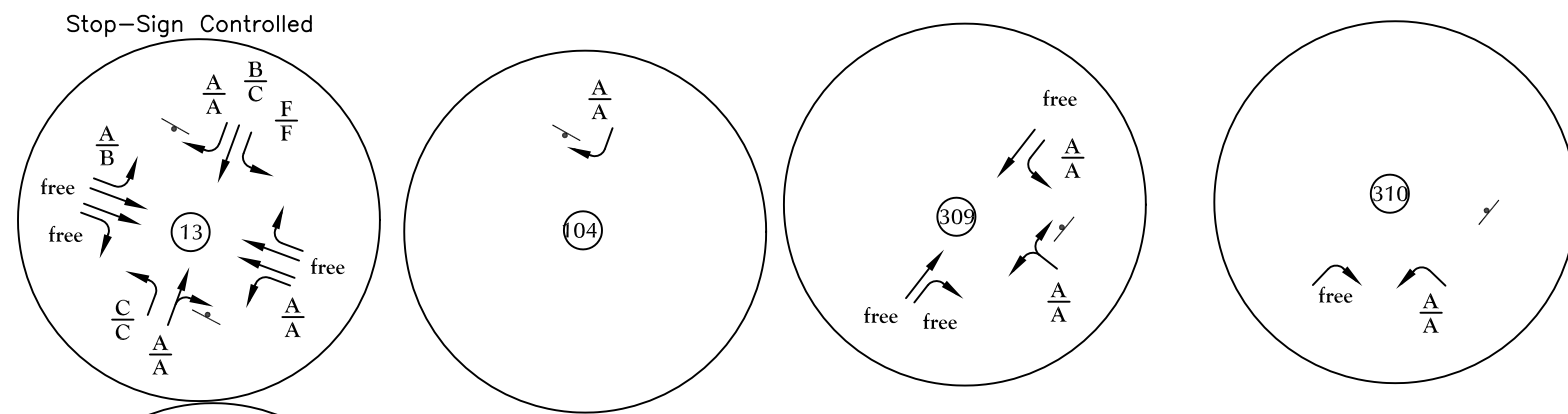
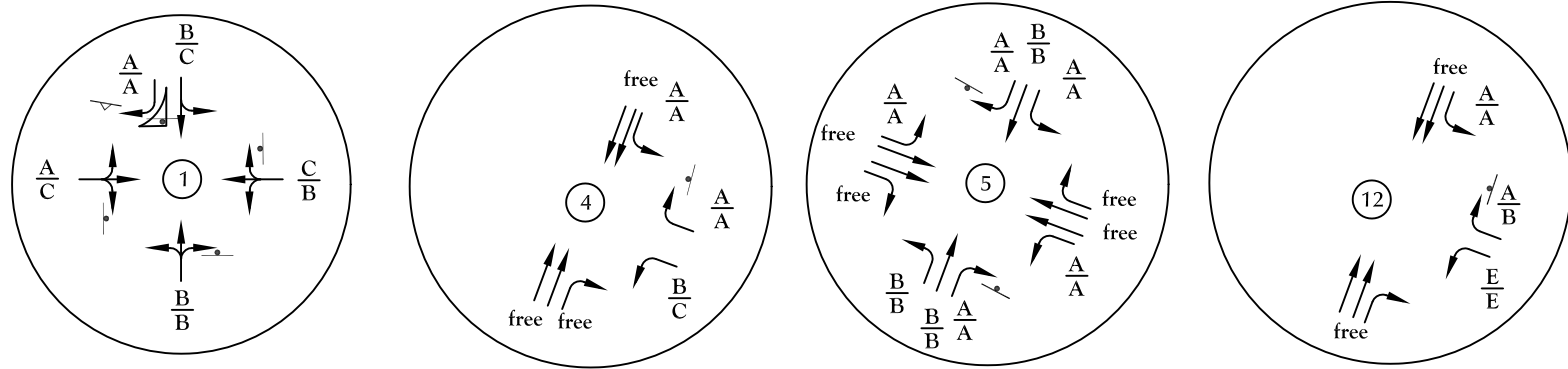

LEGEND:

$\frac{A}{B}$ = AM Individual Movement Peak-Hour Level of Service
 PM Individual Movement Peak-Hour Level of Service
 $\frac{C}{D}$ = AM Entire Intersection Peak-Hour Level of Service
 PM Entire Intersection Peak-Hour Level of Service

= Yield Sign
 = Stop Sign
 = Traffic Signal

= Roundabout
 Existing Roadway
 Future Roadway



Figure 11c
 Short-Term Total Lane Geometry,
 Traffic Control, and Level of Service

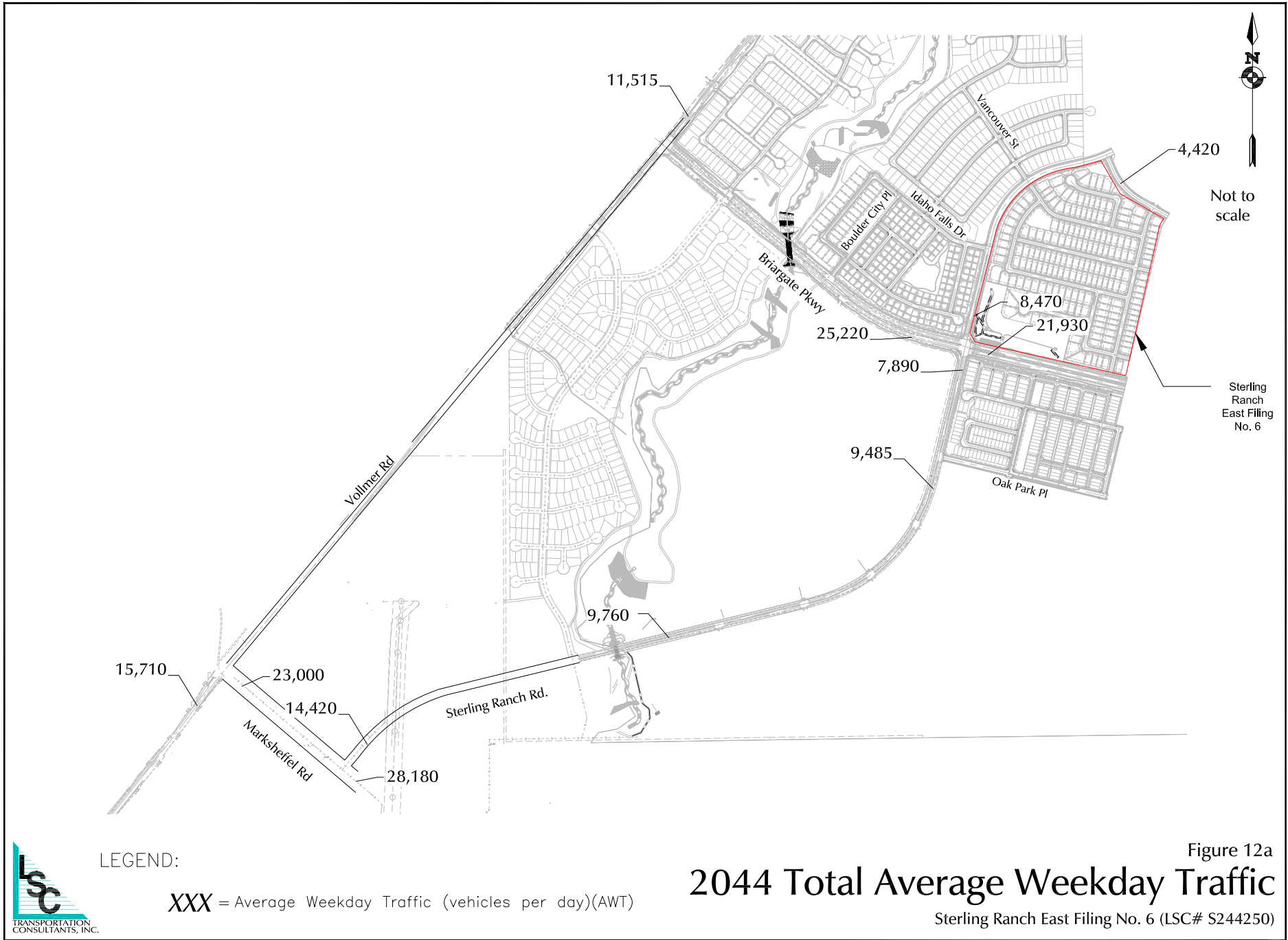
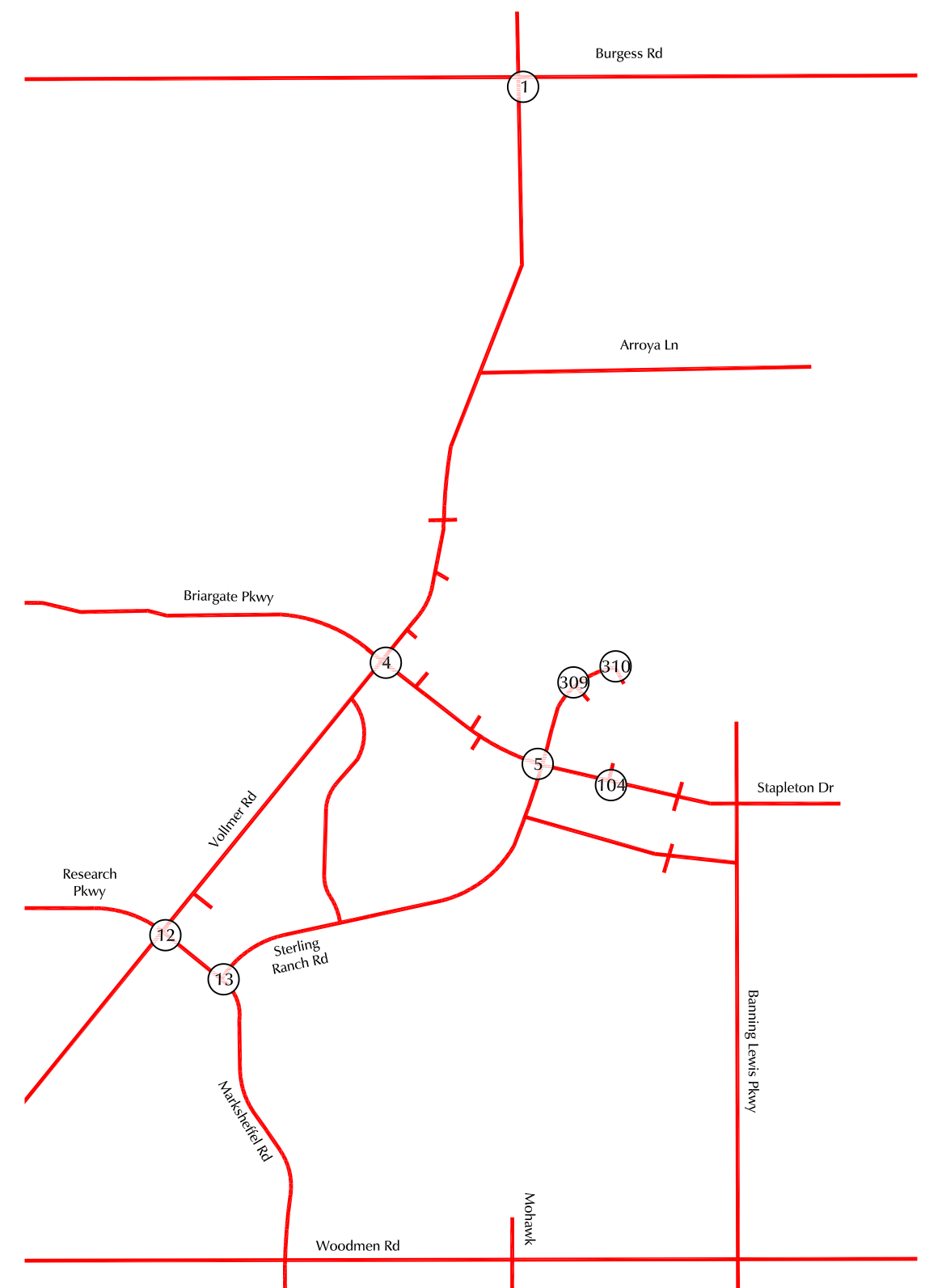
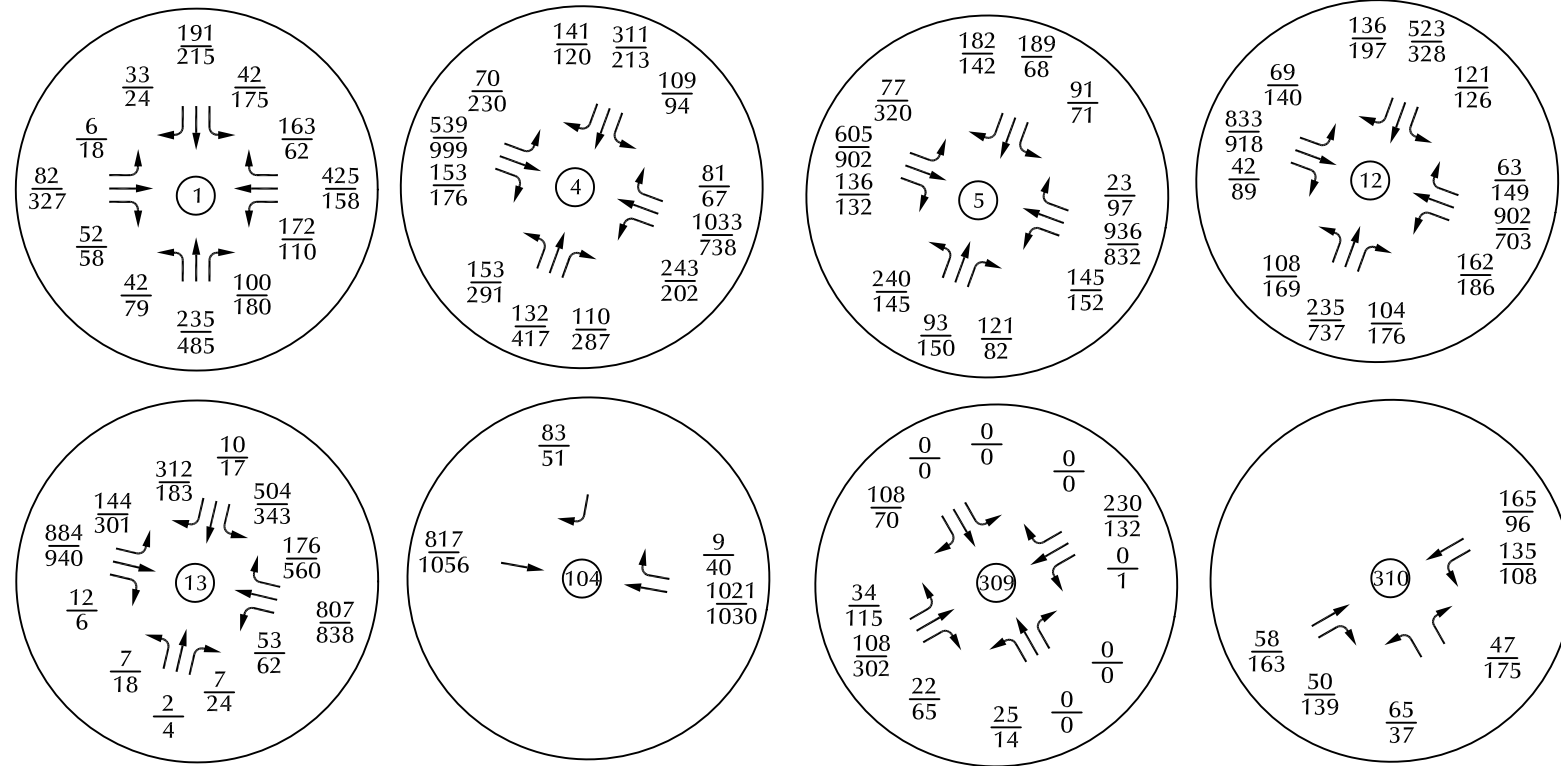

Figure 12a

2044 Total Average Weekday Traffic

Sterling Ranch East Filing No. 6 (LSC# S244250)



LEGEND: $\frac{XX}{XX} = \frac{\text{AM Peak-Hour Traffic (veh/hr)}}{\text{PM Peak-Hour Traffic (veh/hr)}}$



Figure 12b
2044 Total Traffic
 Sterling Ranch East Filing No. 6 (LSC# S244250)

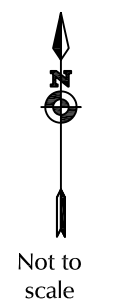
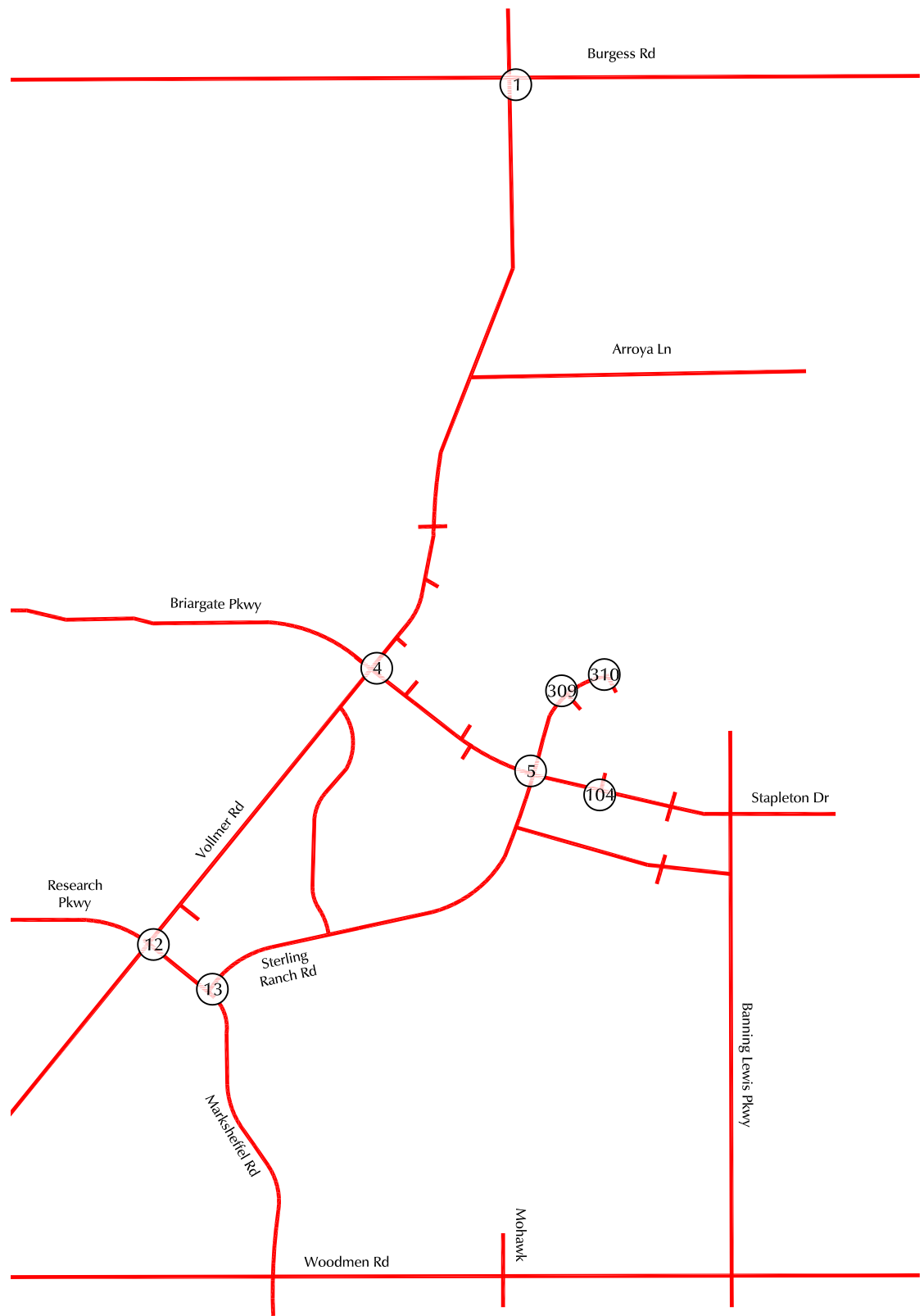
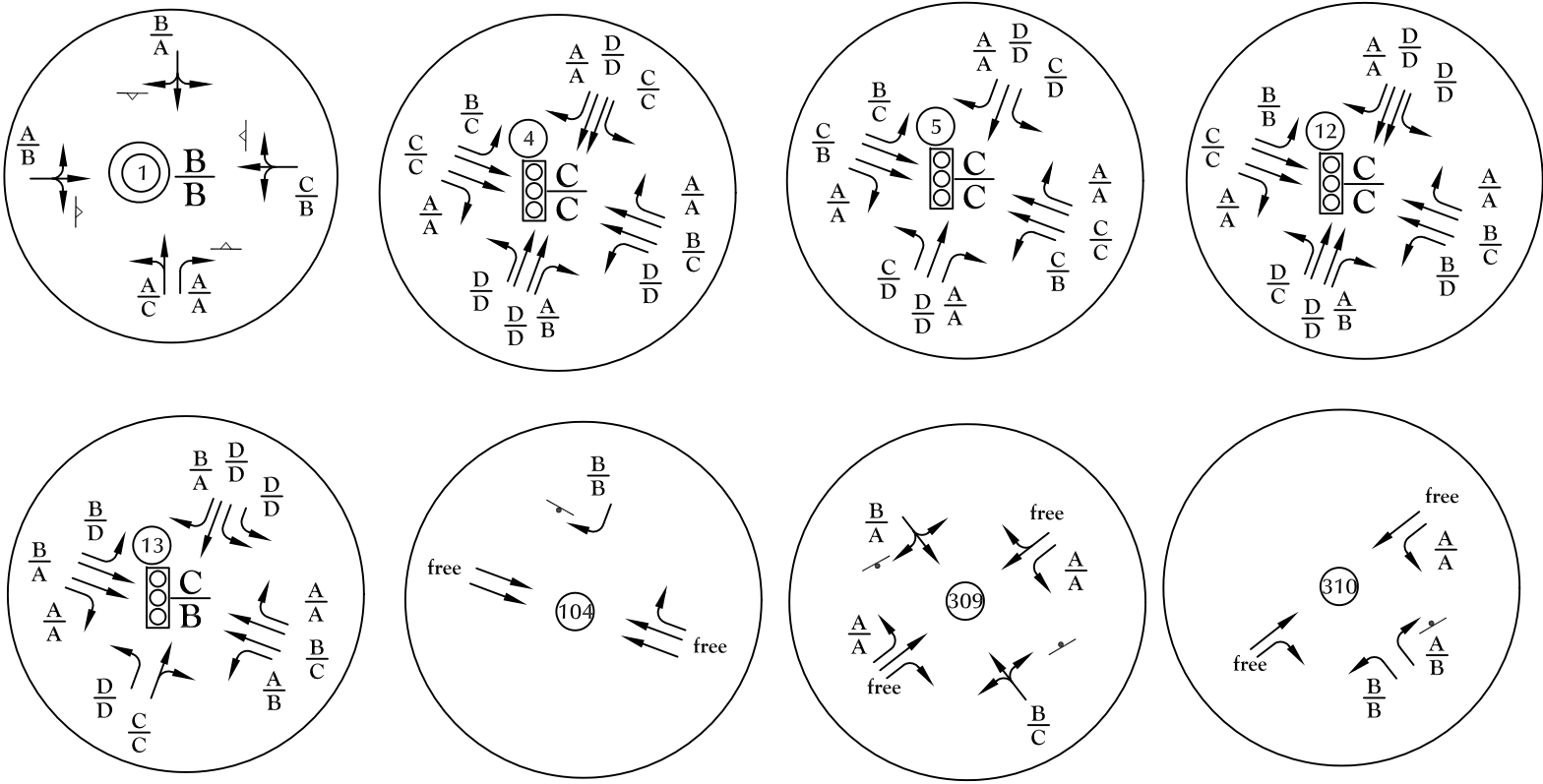

LEGEND:

$\frac{A}{B}$ = AM Individual Movement Peak-Hour Level of Service
 PM Individual Movement Peak-Hour Level of Service
 $\frac{C}{D}$ = AM Entire Intersection Peak-Hour Level of Service
 PM Entire Intersection Peak-Hour Level of Service

⊥ = Stop Sign ⊥ = Yield Sign
 = Traffic Signal ○ = Roundabout



Figure 12c
**2044 Total Lane Geometry,
 Traffic Control, and Level of Service**



Approximate
Scale: NTS



- 4-Lane Urban Principal Arterial
- Urban Major Collector
- - - Urban Minor Collector
- Urban Local
- - - Urban Local (Low Volume)



Figure 13
Roadway Classification
Sterling Ranch East Filing No. 6 (LSC# S244250)



Not to scale

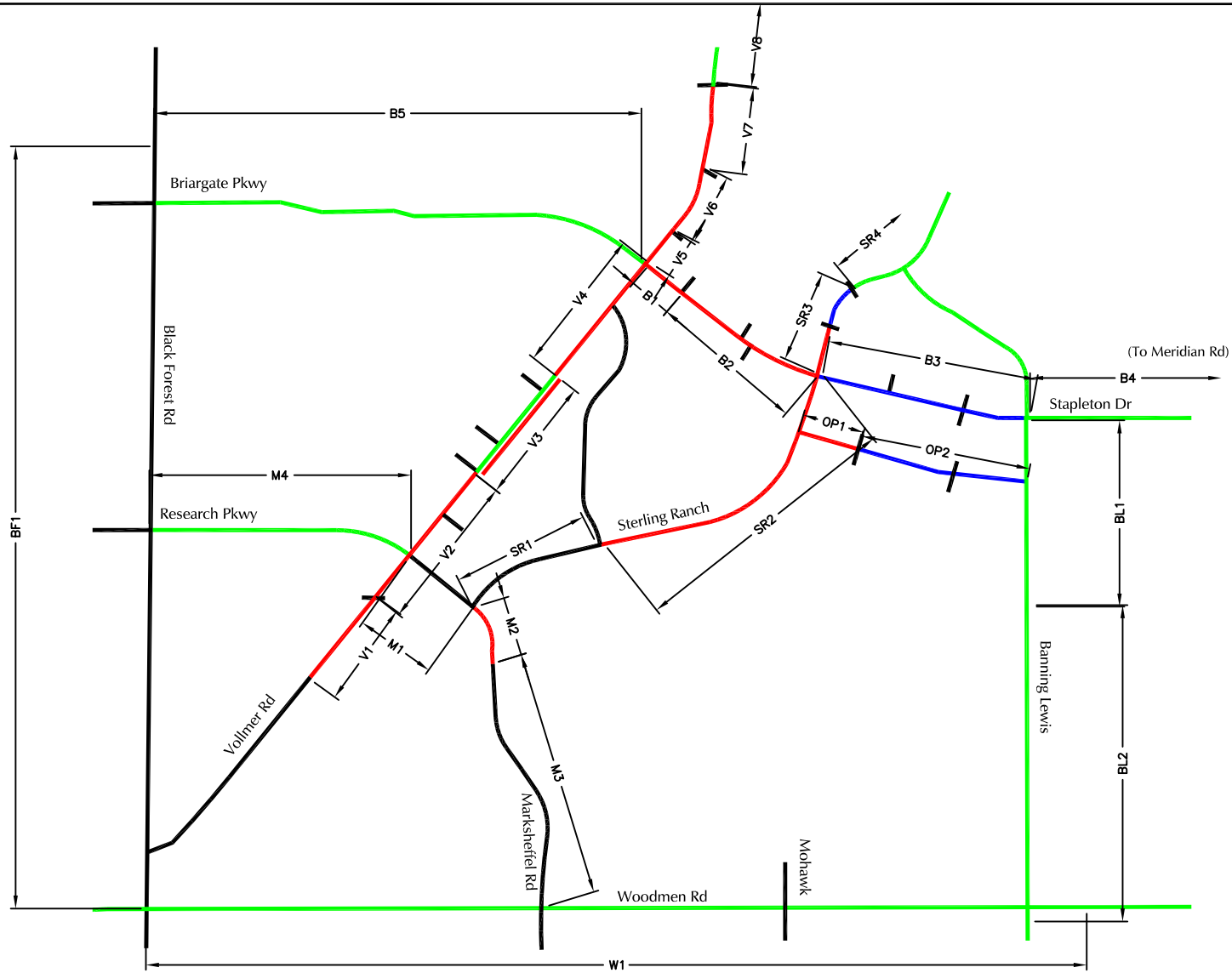

V1, B4, SR3, etc - Segment Identifier*

- Short-Term
- Intermediate-Term
- Long-Term

*See Table 6 for recommended roadway segment improvements for each segment.

Roadway Improvement Segments*

Figure 14

Sterling Ranch East Filing No. 6 (LSC# S244250)



Traffic Counts



LSC Transportation Consultants, Inc.

2504 E. Pikes Peak Ave, Suite 304
 Colorado Springs, CO 80909
 719-633-2868

File Name : Vollmer Rd - Burgess Rd AM 3-6-24

Site Code : S224580

Start Date : 3/6/2024

Page No : 1

Start Time	Vollmer Rd Southbound					Burgess Rd Westbound					Vollmer Rd Northbound					Burgess Rd Eastbound					Int. Total
	Right	Thru	Left	Peds	App. Total	Right	Thru	Left	Peds	App. Total	Right	Thru	Left	Peds	App. Total	Right	Thru	Left	Peds	App. Total	
06:30	1	7	0	0	8	10	16	3	0	29	1	2	0	0	3	0	0	0	0	0	40
06:35	0	5	3	0	8	4	16	5	0	25	0	1	0	0	1	3	3	0	0	0	40
06:40	1	5	0	0	6	4	12	1	0	17	1	5	0	0	6	0	6	0	0	0	35
06:45	0	0	3	0	3	5	19	4	0	28	3	2	0	0	5	1	4	1	0	0	42
06:50	1	2	1	0	4	9	13	5	0	27	0	2	0	0	2	0	2	0	0	0	35
06:55	4	2	2	0	8	4	10	8	0	22	2	0	2	0	4	0	4	0	0	0	38
Total	7	21	9	0	37	36	86	26	0	148	7	12	2	0	21	4	19	1	0	24	230
07:00	0	0	1	0	1	11	30	4	0	45	2	3	3	0	8	1	4	0	0	0	59
07:05	2	1	0	0	3	7	25	4	0	36	2	8	2	0	12	0	4	0	0	0	55
07:10	1	15	2	0	18	9	27	5	0	41	2	3	1	0	6	1	3	0	0	0	69
07:15	2	1	1	0	4	5	27	7	0	39	1	5	2	0	8	0	2	0	0	0	53
07:20	1	5	3	0	9	14	17	2	0	33	1	7	1	0	9	1	5	1	0	0	58
07:25	2	5	6	0	13	12	19	5	0	36	2	2	0	0	4	0	3	0	0	0	56
07:30	2	1	1	0	4	10	28	5	0	43	2	2	1	0	5	0	6	0	0	0	58
07:35	2	12	0	0	14	7	22	9	0	38	4	4	0	0	8	0	6	1	0	0	67
07:40	4	5	3	0	12	6	28	9	0	43	5	2	1	0	8	2	5	1	0	0	71
07:45	1	4	3	0	8	14	28	8	0	50	1	1	3	0	5	1	7	0	0	0	71
07:50	3	8	5	0	16	8	12	9	0	29	2	3	1	0	6	1	5	1	0	0	58
07:55	2	1	3	0	6	7	23	4	0	34	7	5	1	0	13	2	5	0	0	0	60
Total	22	58	28	0	108	110	286	71	0	467	31	45	16	0	92	9	55	4	0	68	735
08:00	2	1	0	0	3	3	16	1	0	20	4	4	1	0	9	3	11	2	0	0	48
08:05	1	7	1	0	9	7	17	0	0	24	5	6	0	0	11	1	1	2	0	0	48
08:10	1	6	3	0	10	6	18	3	0	27	2	3	3	0	8	0	4	0	0	0	49
08:15	3	3	0	0	6	8	10	2	0	20	2	3	1	0	6	0	1	1	0	0	34
08:20	3	9	4	0	16	5	19	4	0	28	3	7	1	0	11	1	3	3	0	0	62
08:25	4	7	5	0	16	4	8	2	0	14	3	6	1	0	10	1	4	3	0	0	48
Grand Total	43	112	50	0	205	179	460	109	0	748	57	86	25	0	168	19	98	16	0	133	1254
Apprch %	21	54.6	24.4	0		23.9	61.5	14.6	0		33.9	51.2	14.9	0		14.3	73.7	12	0		
Total %	3.4	8.9	4	0	16.3	14.3	36.7	8.7	0	59.6	4.5	6.9	2	0	13.4	1.5	7.8	1.3	0	10.6	

LSC Transportation Consultants, Inc.

2504 E. Pikes Peak Ave, Suite 304
 Colorado Springs, CO 80909
 719-633-2868

File Name : Vollmer Rd - Burgess Rd AM 3-6-24

Site Code : S224580

Start Date : 3/6/2024

Page No : 2

Start Time	Vollmer Rd Southbound					Burgess Rd Westbound					Vollmer Rd Northbound					Burgess Rd Eastbound					Int. Total
	Right	Thru	Left	Peds	App. Total	Right	Thru	Left	Peds	App. Total	Right	Thru	Left	Peds	App. Total	Right	Thru	Left	Peds	App. Total	
Peak Hour Analysis From 06:30 to 08:25 - Peak 1 of 1																					
Peak Hour for Entire Intersection Begins at 07:00																					
07:00	0	0	1	0	1	11	30	4	0	45	2	3	3	0	8	1	4	0	0	5	59
07:05	2	1	0	0	3	7	25	4	0	36	2	8	2	0	12	0	4	0	0	4	55
07:10	1	15	2	0	18	9	27	5	0	41	2	3	1	0	6	1	3	0	0	4	69
07:15	2	1	1	0	4	5	27	7	0	39	1	5	2	0	8	0	2	0	0	2	53
07:20	1	5	3	0	9	14	17	2	0	33	1	7	1	0	9	1	5	1	0	7	58
07:25	2	5	6	0	13	12	19	5	0	36	2	2	0	0	4	0	3	0	0	3	56
07:30	2	1	1	0	4	10	28	5	0	43	2	2	1	0	5	0	6	0	0	6	58
07:35	2	12	0	0	14	7	22	9	0	38	4	4	0	0	8	0	6	1	0	7	67
07:40	4	5	3	0	12	6	28	9	0	43	5	2	1	0	8	2	5	1	0	8	71
07:45	1	4	3	0	8	14	28	8	0	50	1	1	3	0	5	1	7	0	0	8	71
07:50	3	8	5	0	16	8	12	9	0	29	2	3	1	0	6	1	5	1	0	7	58
07:55	2	1	3	0	6	7	23	4	0	34	7	5	1	0	13	2	5	0	0	7	60
Total Volume	22	58	28	0	108	110	286	71	0	467	31	45	16	0	92	9	55	4	0	68	735
% App. Total	20.4	53.7	25.9	0		23.6	61.2	15.2	0		33.7	48.9	17.4	0		13.2	80.9	5.9	0		
PHF	.458	.322	.389	.000	.500	.655	.794	.657	.000	.778	.369	.469	.444	.000	.590	.375	.655	.333	.000	.708	.863

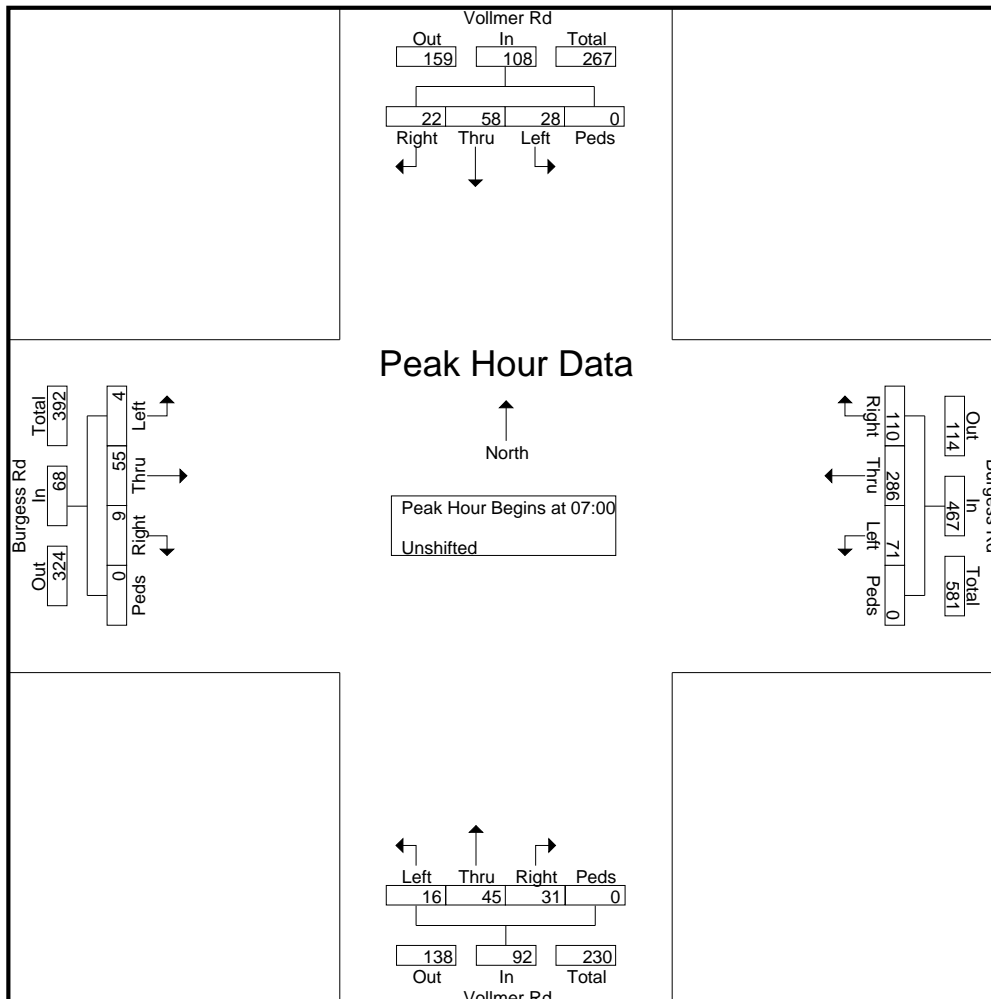

LSC Transportation Consultants, Inc.

2504 E. Pikes Peak Ave, Suite 304
 Colorado Springs, CO 80909
 719-633-2868

File Name : Vollmer Rd - Burgess Rd PM 3-5-24

Site Code : S224580

Start Date : 3/5/2024

Page No : 1

Start Time	Vollmer Rd Southbound					Burgess Rd Westbound					Vollmer Rd Northbound					Burgess Rd Eastbound					Int. Total
	Right	Thru	Left	Peds	App. Total	Right	Thru	Left	Peds	App. Total	Right	Thru	Left	Peds	App. Total	Right	Thru	Left	Peds	App. Total	
16:00	1	8	13	0	22	4	8	4	0	16	4	1	2	0	7	5	15	1	0	21	66
16:05	3	4	6	0	13	4	9	2	0	15	9	5	1	0	15	4	19	1	0	24	67
16:10	1	4	9	0	14	7	7	3	0	17	6	3	2	0	11	1	12	2	0	15	57
16:15	0	6	13	0	19	4	5	1	0	10	3	7	3	0	13	1	18	4	0	23	65
16:20	3	8	8	0	19	2	13	5	0	20	4	8	1	0	13	0	21	1	0	22	74
16:25	1	9	17	0	27	3	9	1	0	13	5	7	1	0	13	2	17	0	0	19	72
16:30	0	7	6	0	13	5	8	0	0	13	5	3	1	0	9	0	19	1	0	20	55
16:35	4	4	11	0	19	4	7	3	0	14	2	6	2	0	10	0	19	1	0	20	63
16:40	1	4	7	0	12	2	11	1	0	14	5	6	0	0	11	1	25	0	0	26	63
16:45	0	6	5	0	11	1	9	2	0	12	8	9	0	0	17	2	19	0	0	21	61
16:50	0	5	14	0	19	4	12	6	0	22	6	8	0	0	14	1	22	1	0	24	79
16:55	2	2	9	0	13	2	8	0	0	10	4	8	1	0	13	1	14	0	0	15	51
Total	16	67	118	0	201	42	106	28	0	176	61	71	14	0	146	18	220	12	0	250	773
17:00	1	2	4	0	7	3	7	2	0	12	1	4	2	0	7	1	17	1	0	19	45
17:05	0	8	11	0	19	4	4	0	0	8	2	5	0	0	7	2	16	1	0	19	53
17:10	3	2	5	0	10	2	13	6	0	21	4	2	0	0	6	0	11	0	0	11	48
17:15	1	4	8	0	13	2	9	3	0	14	10	8	0	0	18	4	14	0	0	18	63
17:20	0	4	8	0	12	7	13	3	0	23	4	2	1	0	7	3	36	1	0	40	82
17:25	0	3	6	0	9	1	7	3	0	11	2	4	1	0	7	2	15	3	0	20	47
17:30	0	2	8	0	10	5	7	1	0	13	8	4	0	0	12	1	15	2	0	18	53
17:35	3	4	13	0	20	9	9	1	0	19	6	4	2	0	12	0	21	1	0	22	73
17:40	1	4	11	0	16	4	5	1	0	10	3	5	0	0	8	0	18	1	0	19	53
17:45	1	0	8	0	9	2	3	0	0	5	4	1	0	0	5	0	13	2	0	15	34
17:50	1	3	6	0	10	2	4	1	0	7	5	2	0	0	7	2	15	1	0	18	42
17:55	2	3	4	0	9	3	3	4	0	10	5	2	1	0	8	1	15	2	0	18	45
Total	13	39	92	0	144	44	84	25	0	153	54	43	7	0	104	16	206	15	0	237	638
Grand Total	29	106	210	0	345	86	190	53	0	329	115	114	21	0	250	34	426	27	0	487	1411
Apprch %	8.4	30.7	60.9	0		26.1	57.8	16.1	0		46	45.6	8.4	0		7	87.5	5.5	0		
Total %	2.1	7.5	14.9	0	24.5	6.1	13.5	3.8	0	23.3	8.2	8.1	1.5	0	17.7	2.4	30.2	1.9	0	34.5	

LSC Transportation Consultants, Inc.

2504 E. Pikes Peak Ave, Suite 304
 Colorado Springs, CO 80909
 719-633-2868

File Name : Vollmer Rd - Burgess Rd PM 3-5-24

Site Code : S224580

Start Date : 3/5/2024

Page No : 2

Start Time	Vollmer Rd Southbound					Burgess Rd Westbound					Vollmer Rd Northbound					Burgess Rd Eastbound					Int. Total
	Right	Thru	Left	Peds	App. Total	Right	Thru	Left	Peds	App. Total	Right	Thru	Left	Peds	App. Total	Right	Thru	Left	Peds	App. Total	
Peak Hour Analysis From 16:00 to 17:55 - Peak 1 of 1																					
Peak Hour for Entire Intersection Begins at 16:00																					
16:00	1	8	13	0	22	4	8	4	0	16	4	1	2	0	7	5	15	1	0	21	66
16:05	3	4	6	0	13	4	9	2	0	15	9	5	1	0	15	4	19	1	0	24	67
16:10	1	4	9	0	14	7	7	3	0	17	6	3	2	0	11	1	12	2	0	15	57
16:15	0	6	13	0	19	4	5	1	0	10	3	7	3	0	13	1	18	4	0	23	65
16:20	3	8	8	0	19	2	13	5	0	20	4	8	1	0	13	0	21	1	0	22	74
16:25	1	9	17	0	27	3	9	1	0	13	5	7	1	0	13	2	17	0	0	19	72
16:30	0	7	6	0	13	5	8	0	0	13	5	3	1	0	9	0	19	1	0	20	55
16:35	4	4	11	0	19	4	7	3	0	14	2	6	2	0	10	0	19	1	0	20	63
16:40	1	4	7	0	12	2	11	1	0	14	5	6	0	0	11	1	25	0	0	26	63
16:45	0	6	5	0	11	1	9	2	0	12	8	9	0	0	17	2	19	0	0	21	61
16:50	0	5	14	0	19	4	12	6	0	22	6	8	0	0	14	1	22	1	0	24	79
16:55	2	2	9	0	13	2	8	0	0	10	4	8	1	0	13	1	14	0	0	15	51
Total Volume	16	67	118	0	201	42	106	28	0	176	61	71	14	0	146	18	220	12	0	250	773
% App. Total	8	33.3	58.7	0		23.9	60.2	15.9	0		41.8	48.6	9.6	0		7.2	88	4.8	0		
PHF	.333	.620	.578	.000	.620	.500	.679	.389	.000	.667	.565	.657	.389	.000	.716	.300	.733	.250	.000	.801	.815

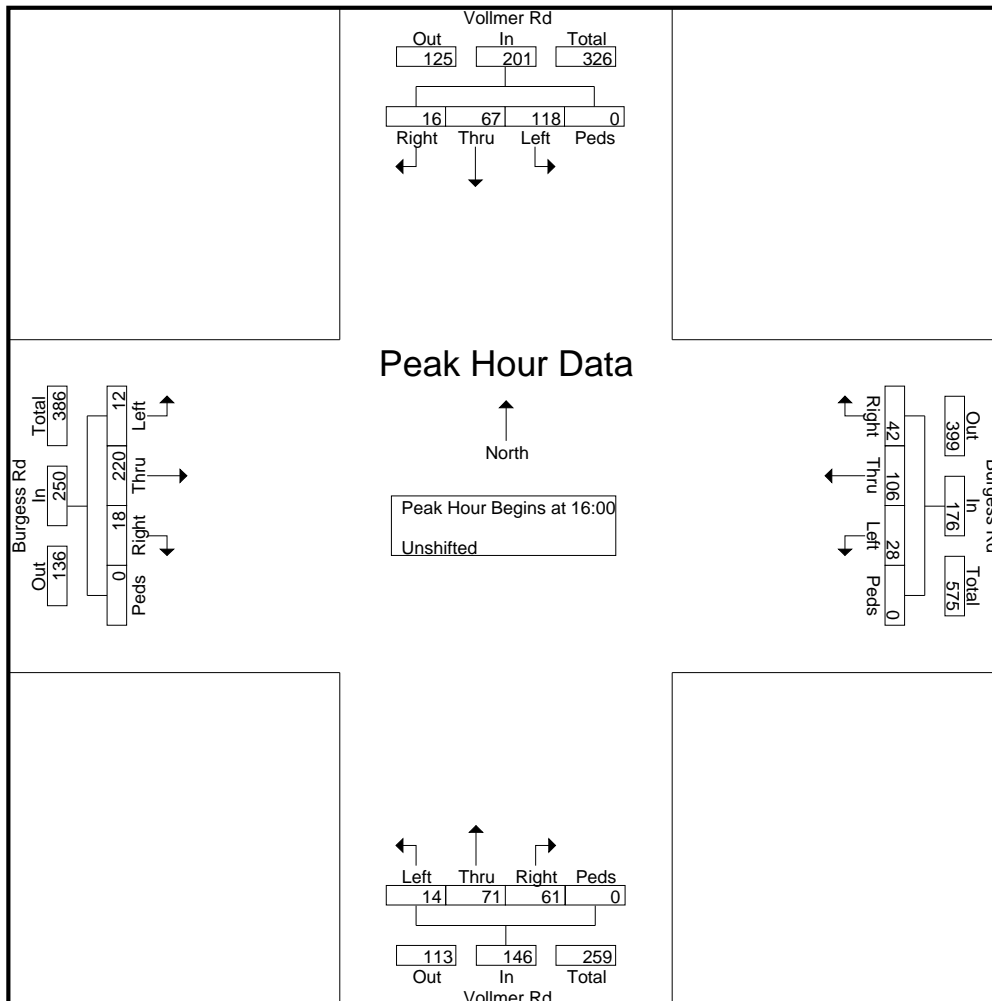

LSC Transportation Consultants, Inc.

2504 E. Pikes Peak Ave, Suite 304
 Colorado Springs, CO 80909
 719-633-2868

File Name : Vollmer Rd - Marksheffel Rd AM
 Site Code : S224580
 Start Date : 4/4/2024
 Page No : 1

Start Time	Vollmer Rd Southbound					Marksheffel Rd Westbound					Vollmer Rd Northbound					Eastbound					Int. Total
	Right	Thru	Left	Peds	App. Total	Right	Thru	Left	Peds	App. Total	Right	Thru	Left	Peds	App. Total	Right	Thru	Left	Peds	App. Total	
06:30	0	19	0	0	19	0	0	1	0	1	0	8	0	0	8	0	0	0	0	0	28
06:35	0	7	0	0	7	0	0	2	0	2	6	10	0	0	16	0	0	0	0	0	25
06:40	0	21	0	0	21	1	0	1	0	2	2	12	0	0	14	0	0	0	0	0	37
06:45	0	17	0	0	17	0	0	4	0	4	2	13	0	0	15	0	0	0	0	0	36
06:50	0	17	0	0	17	0	0	2	0	2	0	18	0	0	18	0	0	0	0	0	37
06:55	0	26	0	0	26	0	0	4	0	4	3	19	0	0	22	0	0	0	0	0	52
Total	0	107	0	0	107	1	0	14	0	15	13	80	0	0	93	0	0	0	0	0	215
07:00	0	20	0	0	20	1	0	6	0	7	2	16	0	0	18	0	0	0	0	0	45
07:05	0	28	0	0	28	1	0	5	0	6	5	17	0	0	22	0	0	0	0	0	56
07:10	0	25	0	0	25	1	0	4	0	5	1	20	0	0	21	0	0	0	0	0	51
07:15	0	22	0	0	22	0	0	5	0	5	1	11	0	0	12	0	0	0	0	0	39
07:20	0	37	0	0	37	0	0	4	0	4	0	12	0	0	12	0	0	0	0	0	53
07:25	0	32	0	0	32	0	0	4	0	4	0	13	0	0	13	0	0	0	0	0	49
07:30	0	28	0	0	28	0	0	6	0	6	0	17	0	0	17	0	0	0	0	0	51
07:35	0	31	0	0	31	1	0	3	0	4	0	16	0	0	16	0	0	0	0	0	51
07:40	0	23	0	0	23	1	0	4	0	5	2	22	0	0	24	0	0	0	0	0	52
07:45	0	22	0	0	22	0	0	9	0	9	1	19	0	0	20	0	0	0	0	0	51
07:50	0	27	0	0	27	0	0	5	0	5	4	16	0	0	20	0	0	0	0	0	52
07:55	0	21	0	0	21	0	0	2	0	2	5	30	0	0	35	0	0	0	0	0	58
Total	0	316	0	0	316	5	0	57	0	62	21	209	0	0	230	0	0	0	0	0	608
08:00	0	12	1	0	13	0	0	2	0	2	1	20	0	0	21	0	0	0	0	0	36
08:05	0	21	0	0	21	0	0	1	0	1	1	17	0	0	18	0	0	0	0	0	40
08:10	0	18	0	0	18	0	0	2	0	2	7	19	0	0	26	0	0	0	0	0	46
08:15	0	26	0	0	26	0	0	1	0	1	8	15	0	0	23	0	0	0	0	0	50
08:20	0	13	0	0	13	0	0	3	0	3	1	14	0	0	15	0	0	0	0	0	31
08:25	0	21	0	0	21	0	0	2	0	2	4	13	0	0	17	0	0	0	0	0	40
Grand Total	0	534	1	0	535	6	0	82	0	88	56	387	0	0	443	0	0	0	0	0	1066
Apprch %	0	99.8	0.2	0		6.8	0	93.2	0		12.6	87.4	0	0		0	0	0	0		
Total %	0	50.1	0.1	0	50.2	0.6	0	7.7	0	8.3	5.3	36.3	0	0	41.6	0	0	0	0	0	

LSC Transportation Consultants, Inc.

2504 E. Pikes Peak Ave, Suite 304
 Colorado Springs, CO 80909
 719-633-2868

File Name : Vollmer Rd - Marksheffel Rd AM

Site Code : S224580

Start Date : 4/4/2024

Page No : 2

Start Time	Vollmer Rd Southbound					Marksheffel Rd Westbound					Vollmer Rd Northbound					Eastbound					Int. Total
	Right	Thru	Left	Peds	App. Total	Right	Thru	Left	Peds	App. Total	Right	Thru	Left	Peds	App. Total	Right	Thru	Left	Peds	App. Total	
Peak Hour Analysis From 06:30 to 08:25 - Peak 1 of 1																					
Peak Hour for Entire Intersection Begins at 07:00																					
07:00	0	20	0	0	20	1	0	6	0	7	2	16	0	0	18	0	0	0	0	0	45
07:05	0	28	0	0	28	1	0	5	0	6	5	17	0	0	22	0	0	0	0	0	56
07:10	0	25	0	0	25	1	0	4	0	5	1	20	0	0	21	0	0	0	0	0	51
07:15	0	22	0	0	22	0	0	5	0	5	1	11	0	0	12	0	0	0	0	0	39
07:20	0	37	0	0	37	0	0	4	0	4	0	12	0	0	12	0	0	0	0	0	53
07:25	0	32	0	0	32	0	0	4	0	4	0	13	0	0	13	0	0	0	0	0	49
07:30	0	28	0	0	28	0	0	6	0	6	0	17	0	0	17	0	0	0	0	0	51
07:35	0	31	0	0	31	1	0	3	0	4	0	16	0	0	16	0	0	0	0	0	51
07:40	0	23	0	0	23	1	0	4	0	5	2	22	0	0	24	0	0	0	0	0	52
07:45	0	22	0	0	22	0	0	9	0	9	1	19	0	0	20	0	0	0	0	0	51
07:50	0	27	0	0	27	0	0	5	0	5	4	16	0	0	20	0	0	0	0	0	52
07:55	0	21	0	0	21	0	0	2	0	2	5	30	0	0	35	0	0	0	0	0	58
Total Volume	0	316	0	0	316	5	0	57	0	62	21	209	0	0	230	0	0	0	0	0	608
% App. Total	0	100	0	0		8.1	0	91.9	0		9.1	90.9	0	0		0	0	0	0		
PHF	.000	.712	.000	.000	.712	.417	.000	.528	.000	.574	.350	.581	.000	.000	.548	.000	.000	.000	.000	.000	.874

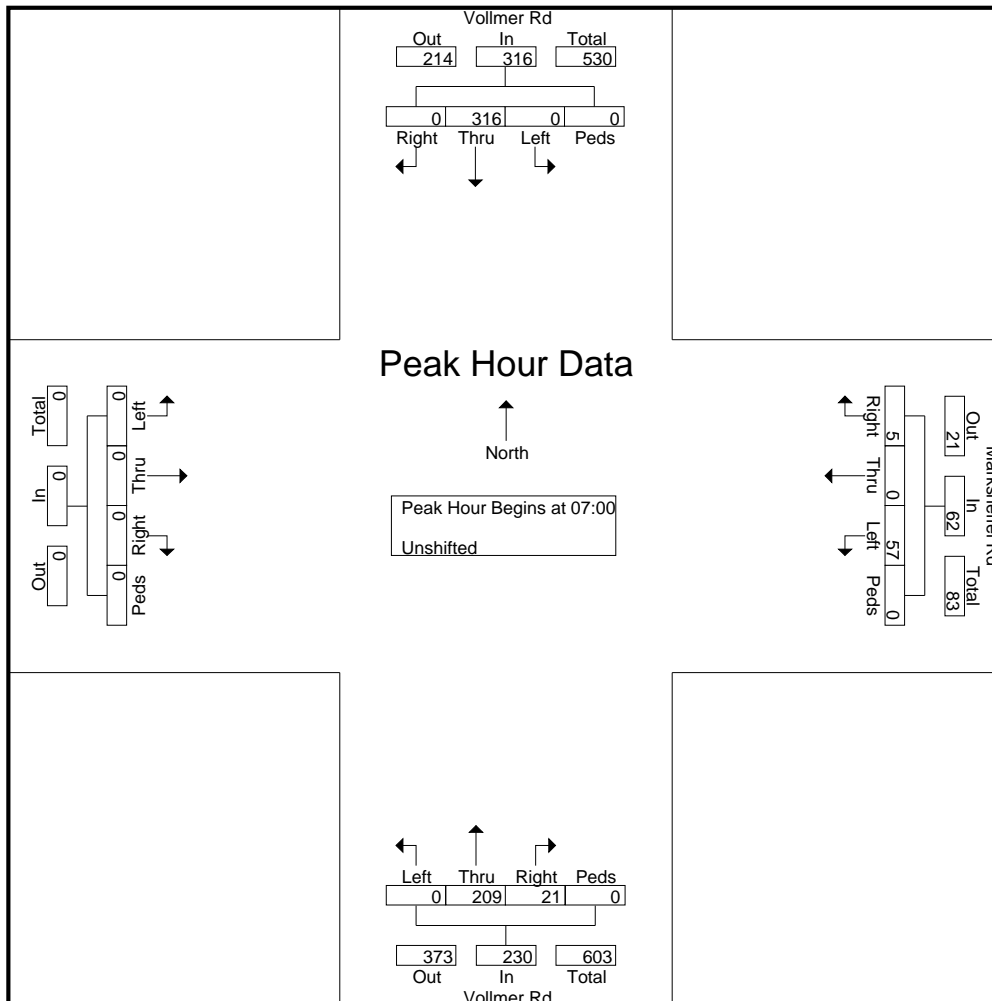

LSC Transportation Consultants, Inc.

2504 E. Pikes Peak Ave, Suite 304
 Colorado Springs, CO 80909
 719-633-2868

File Name : Vollmer Rd - Marksheffel Rd PM

Site Code : S224580

Start Date : 4/4/2024

Page No : 1

Start Time	Vollmer Rd Southbound					Marksheffel Rd Westbound					Vollmer Rd Northbound					Eastbound					Int. Total
	Right	Thru	Left	Peds	App. Total	Right	Thru	Left	Peds	App. Total	Right	Thru	Left	Peds	App. Total	Right	Thru	Left	Peds	App. Total	
16:00	0	26	0	0	26	0	0	0	0	0	1	22	0	0	23	0	0	0	0	0	49
16:05	0	20	0	0	20	0	0	1	0	1	3	25	0	0	28	0	0	0	0	0	49
16:10	0	21	0	0	21	0	0	4	0	4	6	23	0	0	29	0	0	0	0	0	54
16:15	0	21	1	0	22	0	0	4	0	4	4	24	0	0	28	0	0	0	0	0	54
16:20	0	16	0	0	16	1	0	1	0	2	2	26	0	0	28	0	0	0	0	0	46
16:25	0	26	0	0	26	0	0	6	0	6	2	13	0	0	15	0	0	0	0	0	47
16:30	0	24	0	0	24	0	0	3	0	3	3	22	0	0	25	0	0	0	0	0	52
16:35	0	19	0	0	19	0	0	2	0	2	1	29	0	0	30	0	0	0	0	0	51
16:40	0	23	0	0	23	0	0	3	0	3	4	23	0	0	27	0	0	0	0	0	53
16:45	0	22	1	0	23	0	0	6	0	6	6	22	0	0	28	0	0	0	0	0	57
16:50	0	24	0	0	24	0	0	3	0	3	5	26	0	0	31	0	0	0	0	0	58
16:55	0	18	0	0	18	0	0	5	0	5	2	24	0	0	26	0	0	0	0	0	49
Total	0	260	2	0	262	1	0	38	0	39	39	279	0	0	318	0	0	0	0	0	619
17:00	0	29	0	0	29	0	0	6	0	6	3	20	0	0	23	0	0	0	0	0	58
17:05	0	23	0	0	23	0	0	4	0	4	7	22	0	0	29	0	0	0	0	0	56
17:10	0	8	1	0	9	0	0	1	0	1	4	17	0	0	21	0	0	0	0	0	31
17:15	0	19	0	0	19	0	0	4	0	4	4	16	0	0	20	0	0	0	0	0	43
17:20	0	30	0	0	30	0	0	1	0	1	5	14	0	0	19	0	0	0	0	0	50
17:25	0	16	0	0	16	0	0	2	0	2	3	26	0	0	29	0	0	0	0	0	47
17:30	0	14	0	0	14	0	0	0	0	0	0	18	0	0	18	0	0	0	0	0	32
17:35	0	18	0	0	18	0	0	3	0	3	4	27	0	0	31	0	0	0	0	0	52
17:40	0	17	0	0	17	0	0	4	0	4	3	14	0	0	17	0	0	0	0	0	38
17:45	0	16	0	0	16	0	0	3	0	3	9	19	0	0	28	0	0	0	0	0	47
17:50	0	14	0	0	14	0	0	3	0	3	2	22	0	0	24	0	0	0	0	0	41
17:55	0	17	0	0	17	0	0	3	0	3	3	27	0	0	30	0	0	0	0	0	50
Total	0	221	1	0	222	0	0	34	0	34	47	242	0	0	289	0	0	0	0	0	545
Grand Total	0	481	3	0	484	1	0	72	0	73	86	521	0	0	607	0	0	0	0	0	1164
Apprch %	0	99.4	0.6	0		1.4	0	98.6	0		14.2	85.8	0	0		0	0	0	0		
Total %	0	41.3	0.3	0	41.6	0.1	0	6.2	0	6.3	7.4	44.8	0	0	52.1	0	0	0	0	0	

LSC Transportation Consultants, Inc.

2504 E. Pikes Peak Ave, Suite 304
 Colorado Springs, CO 80909
 719-633-2868

File Name : Vollmer Rd - Marksheffel Rd PM

Site Code : S224580

Start Date : 4/4/2024

Page No : 2

Start Time	Vollmer Rd Southbound					Marksheffel Rd Westbound					Vollmer Rd Northbound					Eastbound					Int. Total
	Right	Thru	Left	Peds	App. Total	Right	Thru	Left	Peds	App. Total	Right	Thru	Left	Peds	App. Total	Right	Thru	Left	Peds	App. Total	
Peak Hour Analysis From 16:00 to 17:55 - Peak 1 of 1																					
Peak Hour for Entire Intersection Begins at 16:10																					
16:10	0	21	0	0	21	0	0	4	0	4	6	23	0	0	29	0	0	0	0	0	54
16:15	0	21	1	0	22	0	0	4	0	4	4	24	0	0	28	0	0	0	0	0	54
16:20	0	16	0	0	16	1	0	1	0	2	2	26	0	0	28	0	0	0	0	0	46
16:25	0	26	0	0	26	0	0	6	0	6	2	13	0	0	15	0	0	0	0	0	47
16:30	0	24	0	0	24	0	0	3	0	3	3	22	0	0	25	0	0	0	0	0	52
16:35	0	19	0	0	19	0	0	2	0	2	1	29	0	0	30	0	0	0	0	0	51
16:40	0	23	0	0	23	0	0	3	0	3	4	23	0	0	27	0	0	0	0	0	53
16:45	0	22	1	0	23	0	0	6	0	6	6	22	0	0	28	0	0	0	0	0	57
16:50	0	24	0	0	24	0	0	3	0	3	5	26	0	0	31	0	0	0	0	0	58
16:55	0	18	0	0	18	0	0	5	0	5	2	24	0	0	26	0	0	0	0	0	49
17:00	0	29	0	0	29	0	0	6	0	6	3	20	0	0	23	0	0	0	0	0	58
17:05	0	23	0	0	23	0	0	4	0	4	7	22	0	0	29	0	0	0	0	0	56
Total Volume	0	266	2	0	268	1	0	47	0	48	45	274	0	0	319	0	0	0	0	0	635
% App. Total	0	99.3	0.7	0		2.1	0	97.9	0		14.1	85.9	0	0		0	0	0	0		
PHF	.000	.764	.167	.000	.770	.083	.000	.653	.000	.667	.536	.787	.000	.000	.858	.000	.000	.000	.000	.000	.912

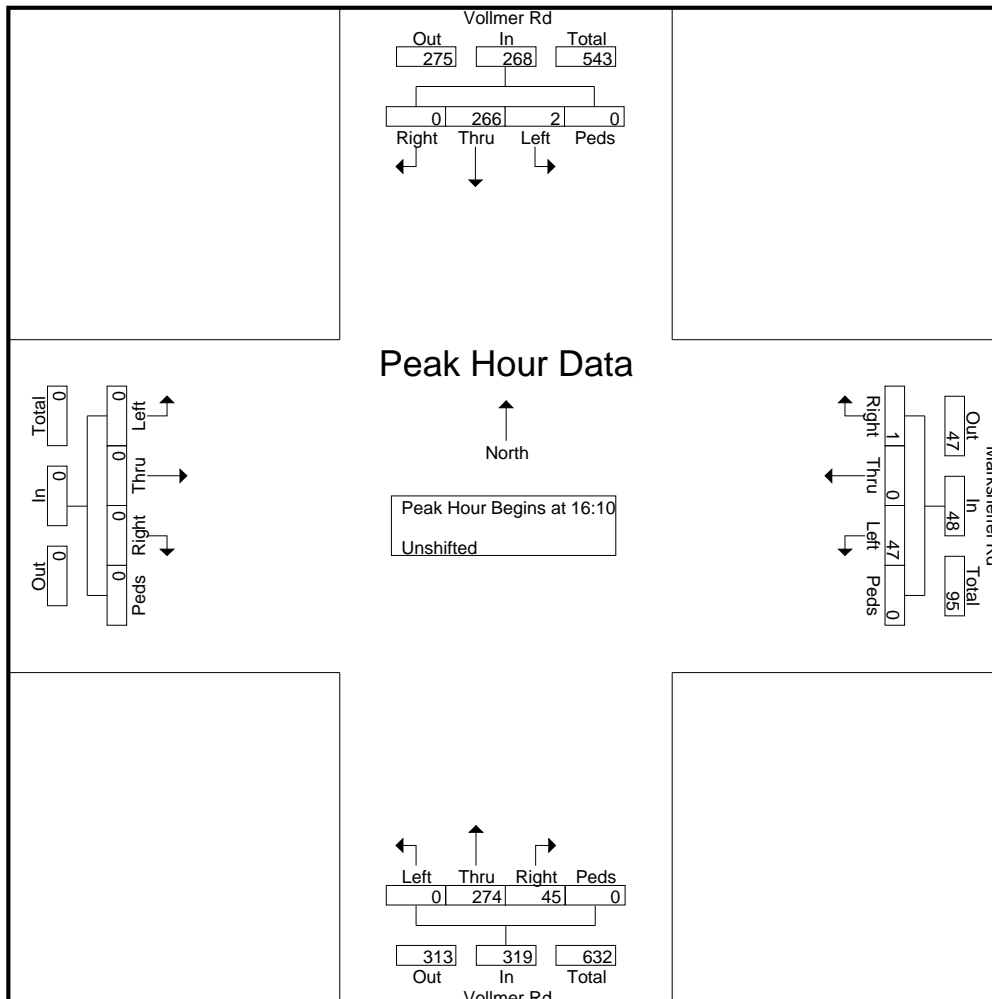

Vollmer Road North of Marksheffel Road

Site Code: 00244080

Station ID:

Location 1:

Location 2:

Location 3:

Location 4:

Comment 1:

Comment 2:

Comment 3:

Comment 4:

Latitude: 0.000000

Longitude: 0.000000

4/2/2024	NB	SB	Total
Time			
12:00 AM	*	*	0
1:00	*	*	0
2:00	*	*	0
3:00	*	*	0
4:00	*	*	0
5:00	*	*	0
6:00	*	*	0
7:00	*	*	0
8:00	*	*	0
9:00	*	*	0
10:00	*	*	0
11:00	*	*	0
12:00 PM	*	*	0
1:00	*	*	0
2:00	*	*	0
3:00	197	159	356
4:00	232	174	406
5:00	208	173	381
6:00	175	107	282
7:00	116	83	199
8:00	91	32	123
9:00	61	20	81
10:00	43	10	53
11:00	13	2	15
Total	1136	760	1896
Percent	59.9%	40.1%	
AM Peak			
Volume			
PM Peak	4:00	4:00	4:00
Volume	232	174	406

Vollmer Road North of Marksheffel Road

Site Code: 00244080

Station ID:

Location 1:

Location 2:

Location 3:

Location 4:

Comment 1:

Comment 2:

Comment 3:

Comment 4:

Latitude: 0.000000

Longitude: 0.000000

4/3/2024	NB	SB	Total
Time			
12:00 AM	7	2	9
1:00	1	5	6
2:00	1	2	3
3:00	5	9	14
4:00	8	20	28
5:00	13	51	64
6:00	88	149	237
7:00	164	333	497
8:00	182	209	391
9:00	141	184	325
10:00	127	159	286
11:00	143	192	335
12:00 PM	132	161	293
1:00	147	154	301
2:00	186	173	359
3:00	215	189	404
4:00	223	195	418
5:00	206	238	444
6:00	196	122	318
7:00	139	73	212
8:00	119	43	162
9:00	71	24	95
10:00	32	10	42
11:00	13	6	19
Total	2559	2703	5262
Percent	48.6%	51.4%	
AM Peak	8:00	7:00	7:00
Volume	182	333	497
PM Peak	4:00	5:00	5:00
Volume	223	238	444

Vollmer Road North of Marksheffel Road

Site Code: 00244080

Station ID:

Location 1:

Location 2:

Location 3:

Location 4:

Comment 1:

Comment 2:

Comment 3:

Comment 4:

Latitude: 0.000000

Longitude: 0.000000

4/4/2024	NB	SB	Total
Time			
12:00 AM	9	5	14
1:00	3	1	4
2:00	1	0	1
3:00	3	4	7
4:00	4	15	19
5:00	10	45	55
6:00	78	152	230
7:00	169	302	471
8:00	191	210	401
9:00	144	171	315
10:00	136	165	301
11:00	197	191	388
12:00 PM	174	175	349
1:00	168	178	346
2:00	173	194	367
3:00	227	201	428
4:00	250	231	481
5:00	218	198	416
6:00	34	19	53
7:00	*	*	0
8:00	*	*	0
9:00	*	*	0
10:00	*	*	0
11:00	*	*	0
Total	2189	2457	4646
Percent	47.1%	52.9%	
AM Peak	11:00	7:00	7:00
Volume	197	302	471
PM Peak	4:00	4:00	4:00
Volume	250	231	481
Grand Total	5884	5920	11804
Percent	49.8%	50.2%	
ADT		ADT: 5,172	AADT: 5,172

Level of Service Reports



Intersection	
Intersection Delay, s/veh	13
Intersection LOS	B

Movement	EBL	EBT	EBR	WBL	WBT	WBR	NBL	NBT	NBR	SBL	SBT	SBR
Lane Configurations		↕			↕			↕			↕	↕
Traffic Vol, veh/h	4	55	9	71	286	110	16	45	31	28	58	22
Future Vol, veh/h	4	55	9	71	286	110	16	45	31	28	58	22
Peak Hour Factor	0.81	0.81	0.81	0.94	0.94	0.94	0.83	0.83	0.83	0.90	0.90	0.90
Heavy Vehicles, %	2	2	2	2	2	2	2	2	2	2	2	2
Mvmt Flow	5	68	11	76	304	117	19	54	37	31	64	24
Number of Lanes	0	1	0	0	1	0	0	1	0	0	1	1

Approach	EB	WB	NB	SB
Opposing Approach	WB	EB	SB	NB
Opposing Lanes	1	1	2	1
Conflicting Approach Left	SB	NB	EB	WB
Conflicting Lanes Left	2	1	1	1
Conflicting Approach Right	NB	SB	WB	EB
Conflicting Lanes Right	1	2	1	1
HCM Control Delay	8.9	15.2	9.7	9.9
HCM LOS	A	C	A	A

Lane	NBLn1	EBLn1	WBLn1	SBLn1	SBLn2
Vol Left, %	17%	6%	15%	33%	0%
Vol Thru, %	49%	81%	61%	67%	0%
Vol Right, %	34%	13%	24%	0%	100%
Sign Control	Stop	Stop	Stop	Stop	Stop
Traffic Vol by Lane	92	68	467	86	22
LT Vol	16	4	71	28	0
Through Vol	45	55	286	58	0
RT Vol	31	9	110	0	22
Lane Flow Rate	111	84	497	96	24
Geometry Grp	4a	2	2	5	5
Degree of Util (X)	0.17	0.121	0.63	0.167	0.037
Departure Headway (Hd)	5.53	5.207	4.563	6.308	5.432
Convergence, Y/N	Yes	Yes	Yes	Yes	Yes
Cap	652	693	785	571	662
Service Time	3.538	3.207	2.638	4.014	3.139
HCM Lane V/C Ratio	0.17	0.121	0.633	0.168	0.036
HCM Control Delay	9.7	8.9	15.2	10.3	8.3
HCM Lane LOS	A	A	C	B	A
HCM 95th-tile Q	0.6	0.4	4.5	0.6	0.1

Intersection						
Int Delay, s/veh	1.3					
Movement	WBL	WBR	NBT	NBR	SBL	SBT
Lane Configurations	↘	↗	↑↑	↗	↘	↑↑
Traffic Vol, veh/h	57	5	209	21	0	316
Future Vol, veh/h	57	5	209	21	0	316
Conflicting Peds, #/hr	0	0	0	0	0	0
Sign Control	Stop	Stop	Free	Free	Free	Free
RT Channelized	-	None	-	None	-	None
Storage Length	300	-	-	155	300	-
Veh in Median Storage, #	0	-	0	-	-	0
Grade, %	0	-	0	-	-	0
Peak Hour Factor	78	78	77	77	87	87
Heavy Vehicles, %	2	2	2	2	2	2
Mvmt Flow	73	6	271	27	0	363

Major/Minor	Minor1	Major1	Major2		
Conflicting Flow All	453	136	0	0	298
Stage 1	271	-	-	-	-
Stage 2	182	-	-	-	-
Critical Hdwy	6.84	6.94	-	-	4.14
Critical Hdwy Stg 1	5.84	-	-	-	-
Critical Hdwy Stg 2	5.84	-	-	-	-
Follow-up Hdwy	3.52	3.32	-	-	2.22
Pot Cap-1 Maneuver	535	888	-	-	1260
Stage 1	750	-	-	-	-
Stage 2	831	-	-	-	-
Platoon blocked, %			-	-	-
Mov Cap-1 Maneuver	535	888	-	-	1260
Mov Cap-2 Maneuver	535	-	-	-	-
Stage 1	750	-	-	-	-
Stage 2	831	-	-	-	-

Approach	WB	NB	SB
HCM Control Delay, s	12.5	0	0
HCM LOS	B		

Minor Lane/Major Mvmt	NBT	NBR	WBLn1	WBLn2	SBL	SBT
Capacity (veh/h)	-	-	535	888	1260	-
HCM Lane V/C Ratio	-	-	0.137	0.007	-	-
HCM Control Delay (s)	-	-	12.8	9.1	0	-
HCM Lane LOS	-	-	B	A	A	-
HCM 95th %tile Q(veh)	-	-	0.5	0	0	-

Intersection	
Intersection Delay, s/veh	12.5
Intersection LOS	B

Movement	EBL	EBT	EBR	WBL	WBT	WBR	NBL	NBT	NBR	SBL	SBT	SBR
Lane Configurations		↕			↕			↕			↕	↕
Traffic Vol, veh/h	12	220	18	28	106	42	14	71	61	118	67	16
Future Vol, veh/h	12	220	18	28	106	42	14	71	61	118	67	16
Peak Hour Factor	0.87	0.87	0.87	0.87	0.87	0.87	0.83	0.83	0.83	0.77	0.77	0.77
Heavy Vehicles, %	2	2	2	2	2	2	2	2	2	2	2	2
Mvmt Flow	14	253	21	32	122	48	17	86	73	153	87	21
Number of Lanes	0	1	0	0	1	0	0	1	0	0	1	1

Approach	EB	WB	NB	SB
Opposing Approach	WB	EB	SB	NB
Opposing Lanes	1	1	2	1
Conflicting Approach Left	SB	NB	EB	WB
Conflicting Lanes Left	2	1	1	1
Conflicting Approach Right	NB	SB	WB	EB
Conflicting Lanes Right	1	2	1	1
HCM Control Delay	13.1	11.4	11	13.8
HCM LOS	B	B	B	B

Lane	NBLn1	EBLn1	WBLn1	SBLn1	SBLn2
Vol Left, %	10%	5%	16%	64%	0%
Vol Thru, %	49%	88%	60%	36%	0%
Vol Right, %	42%	7%	24%	0%	100%
Sign Control	Stop	Stop	Stop	Stop	Stop
Traffic Vol by Lane	146	250	176	185	16
LT Vol	14	12	28	118	0
Through Vol	71	220	106	67	0
RT Vol	61	18	42	0	16
Lane Flow Rate	176	287	202	240	21
Geometry Grp	4a	2	2	5	5
Degree of Util (X)	0.28	0.446	0.318	0.435	0.032
Departure Headway (Hd)	5.729	5.585	5.665	6.52	5.485
Convergence, Y/N	Yes	Yes	Yes	Yes	Yes
Cap	623	641	631	550	650
Service Time	3.798	3.647	3.732	4.281	3.245
HCM Lane V/C Ratio	0.283	0.448	0.32	0.436	0.032
HCM Control Delay	11	13.1	11.4	14.3	8.4
HCM Lane LOS	B	B	B	B	A
HCM 95th-tile Q	1.1	2.3	1.4	2.2	0.1

Intersection						
Int Delay, s/veh	1.2					
Movement	WBL	WBR	NBT	NBR	SBL	SBT
Lane Configurations	↘	↗	↑↑	↗	↘	↑↑
Traffic Vol, veh/h	47	1	274	45	2	266
Future Vol, veh/h	47	1	274	45	2	266
Conflicting Peds, #/hr	0	0	0	0	0	0
Sign Control	Stop	Stop	Free	Free	Free	Free
RT Channelized	-	None	-	None	-	None
Storage Length	300	-	-	155	300	-
Veh in Median Storage, #	0	-	0	-	-	0
Grade, %	0	-	0	-	-	0
Peak Hour Factor	78	78	93	96	96	96
Heavy Vehicles, %	2	2	2	2	2	2
Mvmt Flow	60	1	295	47	2	277

Major/Minor	Minor1	Major1	Major2			
Conflicting Flow All	438	148	0	0	342	0
Stage 1	295	-	-	-	-	-
Stage 2	143	-	-	-	-	-
Critical Hdwy	6.84	6.94	-	-	4.14	-
Critical Hdwy Stg 1	5.84	-	-	-	-	-
Critical Hdwy Stg 2	5.84	-	-	-	-	-
Follow-up Hdwy	3.52	3.32	-	-	2.22	-
Pot Cap-1 Maneuver	547	872	-	-	1214	-
Stage 1	730	-	-	-	-	-
Stage 2	869	-	-	-	-	-
Platoon blocked, %			-	-		-
Mov Cap-1 Maneuver	546	872	-	-	1214	-
Mov Cap-2 Maneuver	546	-	-	-	-	-
Stage 1	730	-	-	-	-	-
Stage 2	867	-	-	-	-	-

Approach	WB	NB	SB
HCM Control Delay, s	12.3	0	0.1
HCM LOS	B		

Minor Lane/Major Mvmt	NBT	NBRWBLn1	WBLn2	SBL	SBT
Capacity (veh/h)	-	-	546	872	1214
HCM Lane V/C Ratio	-	-	0.11	0.001	0.002
HCM Control Delay (s)	-	-	12.4	9.1	8
HCM Lane LOS	-	-	B	A	A
HCM 95th %tile Q(veh)	-	-	0.4	0	0

Intersection	
Intersection Delay, s/veh	15.7
Intersection LOS	C

Movement	EBL	EBT	EBR	WBL	WBT	WBR	NBL	NBT	NBR	SBL	SBT	SBR
Lane Configurations		↕			↕			↕			↕	↕
Traffic Vol, veh/h	4	57	25	74	298	114	66	64	32	29	66	23
Future Vol, veh/h	4	57	25	74	298	114	66	64	32	29	66	23
Peak Hour Factor	0.81	0.81	0.81	0.94	0.94	0.94	0.83	0.83	0.83	0.90	0.90	0.90
Heavy Vehicles, %	2	2	2	2	2	2	2	2	2	2	2	2
Mvmt Flow	5	70	31	79	317	121	80	77	39	32	73	26
Number of Lanes	0	1	0	0	1	0	0	1	0	0	1	1

Approach	EB	WB	NB	SB
Opposing Approach	WB	EB	SB	NB
Opposing Lanes	1	1	2	1
Conflicting Approach Left	SB	NB	EB	WB
Conflicting Lanes Left	2	1	1	1
Conflicting Approach Right	NB	SB	WB	EB
Conflicting Lanes Right	1	2	1	1
HCM Control Delay	9.7	19.7	11.7	10.7
HCM LOS	A	C	B	B

Lane	NBLn1	EBLn1	WBLn1	SBLn1	SBLn2
Vol Left, %	41%	5%	15%	31%	0%
Vol Thru, %	40%	66%	61%	69%	0%
Vol Right, %	20%	29%	23%	0%	100%
Sign Control	Stop	Stop	Stop	Stop	Stop
Traffic Vol by Lane	162	86	486	95	23
LT Vol	66	4	74	29	0
Through Vol	64	57	298	66	0
RT Vol	32	25	114	0	23
Lane Flow Rate	195	106	517	106	26
Geometry Grp	4a	2	2	5	5
Degree of Util (X)	0.32	0.164	0.717	0.196	0.041
Departure Headway (Hd)	5.91	5.555	4.992	6.678	5.809
Convergence, Y/N	Yes	Yes	Yes	Yes	Yes
Cap	607	643	724	536	615
Service Time	3.96	3.608	3.027	4.431	3.562
HCM Lane V/C Ratio	0.321	0.165	0.714	0.198	0.042
HCM Control Delay	11.7	9.7	19.7	11.1	8.8
HCM Lane LOS	B	A	C	B	A
HCM 95th-tile Q	1.4	0.6	6.1	0.7	0.1

Intersection						
Int Delay, s/veh	2.9					
Movement	WBL	WBR	NBT	NBR	SBL	SBT
Lane Configurations	↘	↗	↕↕	↗	↘	↕↕
Traffic Vol, veh/h	128	38	197	25	12	345
Future Vol, veh/h	128	38	197	25	12	345
Conflicting Peds, #/hr	0	0	0	0	0	0
Sign Control	Stop	Stop	Free	Free	Free	Free
RT Channelized	-	None	-	None	-	None
Storage Length	485	-	-	235	385	-
Veh in Median Storage, #	0	-	0	-	-	0
Grade, %	0	-	0	-	-	0
Peak Hour Factor	85	85	85	85	85	85
Heavy Vehicles, %	2	2	2	2	2	2
Mvmt Flow	151	45	232	29	14	406

Major/Minor	Minor1	Major1	Major2			
Conflicting Flow All	463	116	0	0	261	0
Stage 1	232	-	-	-	-	-
Stage 2	231	-	-	-	-	-
Critical Hdwy	6.84	6.94	-	-	4.14	-
Critical Hdwy Stg 1	5.84	-	-	-	-	-
Critical Hdwy Stg 2	5.84	-	-	-	-	-
Follow-up Hdwy	3.52	3.32	-	-	2.22	-
Pot Cap-1 Maneuver	528	914	-	-	1300	-
Stage 1	785	-	-	-	-	-
Stage 2	785	-	-	-	-	-
Platoon blocked, %			-	-	-	-
Mov Cap-1 Maneuver	522	914	-	-	1300	-
Mov Cap-2 Maneuver	594	-	-	-	-	-
Stage 1	785	-	-	-	-	-
Stage 2	776	-	-	-	-	-

Approach	WB	NB	SB
HCM Control Delay, s	12.2	0	0.3
HCM LOS	B		

Minor Lane/Major Mvmt	NBT	NBRWBLn1	WBLn2	SBL	SBT
Capacity (veh/h)	-	-	594	914	1300
HCM Lane V/C Ratio	-	-	0.254	0.049	0.011
HCM Control Delay (s)	-	-	13.1	9.1	7.8
HCM Lane LOS	-	-	B	A	A
HCM 95th %tile Q(veh)	-	-	1	0.2	0

Intersection						
Int Delay, s/veh	7.2					
Movement	WBL	WBR	NBT	NBR	SBL	SBT
Lane Configurations	↘	↗	↑↑	↗	↘	↑↑
Traffic Vol, veh/h	162	81	196	50	120	427
Future Vol, veh/h	162	81	196	50	120	427
Conflicting Peds, #/hr	0	0	0	0	0	0
Sign Control	Stop	Stop	Free	Free	Free	Free
RT Channelized	-	None	-	None	-	None
Storage Length	300	-	-	155	300	-
Veh in Median Storage, #	0	-	0	-	-	0
Grade, %	0	-	0	-	-	0
Peak Hour Factor	85	85	85	85	85	85
Heavy Vehicles, %	2	2	2	2	2	2
Mvmt Flow	191	95	231	59	141	502

Major/Minor	Minor1	Major1	Major2		
Conflicting Flow All	764	116	0	0	290
Stage 1	231	-	-	-	-
Stage 2	533	-	-	-	-
Critical Hdwy	6.84	6.94	-	-	4.14
Critical Hdwy Stg 1	5.84	-	-	-	-
Critical Hdwy Stg 2	5.84	-	-	-	-
Follow-up Hdwy	3.52	3.32	-	-	2.22
Pot Cap-1 Maneuver	340	914	-	-	1269
Stage 1	785	-	-	-	-
Stage 2	553	-	-	-	-
Platoon blocked, %			-	-	-
Mov Cap-1 Maneuver	302	914	-	-	1269
Mov Cap-2 Maneuver	302	-	-	-	-
Stage 1	785	-	-	-	-
Stage 2	492	-	-	-	-

Approach	WB	NB	SB
HCM Control Delay, s	26.7	0	1.8
HCM LOS	D		

Minor Lane/Major Mvmt	NBT	NBR	WBLn1	WBLn2	SBL	SBT
Capacity (veh/h)	-	-	302	914	1269	-
HCM Lane V/C Ratio	-	-	0.631	0.104	0.111	-
HCM Control Delay (s)	-	-	35.3	9.4	8.2	-
HCM Lane LOS	-	-	E	A	A	-
HCM 95th %tile Q(veh)	-	-	4	0.3	0.4	-

Intersection												
Int Delay, s/veh	17.2											
Movement	EBL	EBT	EBR	WBL	WBT	WBR	NBL	NBT	NBR	SBL	SBT	SBR
Lane Configurations	↘	↑↑	↗	↘	↑↑	↗	↘	↗	↘	↘	↑	↗
Traffic Vol, veh/h	49	118	2	8	75	144	2	0	6	435	1	166
Future Vol, veh/h	49	118	2	8	75	144	2	0	6	435	1	166
Conflicting Peds, #/hr	0	0	0	0	0	0	0	0	0	0	0	0
Sign Control	Free	Free	Free	Free	Free	Free	Stop	Stop	Stop	Stop	Stop	Stop
RT Channelized	-	-	None	-	-	None	-	-	None	-	-	None
Storage Length	300	-	200	250	-	205	0	-	-	155	-	0
Veh in Median Storage, #	-	0	-	-	0	-	-	0	-	-	0	-
Grade, %	-	0	-	-	0	-	-	0	-	-	0	-
Peak Hour Factor	85	85	85	85	85	85	85	85	85	85	85	85
Heavy Vehicles, %	2	2	70	70	2	2	88	2	88	2	2	2
Mvmt Flow	58	139	2	9	88	169	2	0	7	512	1	195

Major/Minor	Major1			Major2			Minor1			Minor2		
Conflicting Flow All	257	0	0	141	0	0	318	530	70	292	363	44
Stage 1	-	-	-	-	-	-	255	255	-	106	106	-
Stage 2	-	-	-	-	-	-	63	275	-	186	257	-
Critical Hdwy	4.14	-	-	5.5	-	-	9.26	6.54	8.66	7.54	6.54	6.94
Critical Hdwy Stg 1	-	-	-	-	-	-	8.26	5.54	-	6.54	5.54	-
Critical Hdwy Stg 2	-	-	-	-	-	-	8.26	5.54	-	6.54	5.54	-
Follow-up Hdwy	2.22	-	-	2.9	-	-	4.38	4.02	4.18	3.52	4.02	3.32
Pot Cap-1 Maneuver	1305	-	-	1059	-	-	437	453	758	638	563	1017
Stage 1	-	-	-	-	-	-	533	695	-	888	807	-
Stage 2	-	-	-	-	-	-	739	681	-	798	694	-
Platoon blocked, %	-	-	-	-	-	-	-	-	-	-	-	-
Mov Cap-1 Maneuver	1305	-	-	1059	-	-	338	429	758	607	534	1017
Mov Cap-2 Maneuver	-	-	-	-	-	-	338	429	-	607	534	-
Stage 1	-	-	-	-	-	-	510	664	-	849	801	-
Stage 2	-	-	-	-	-	-	591	676	-	755	663	-

Approach	EB			WB			NB			SB		
HCM Control Delay, s	2.3			0.3			11.3			27.8		
HCM LOS							B			D		

Minor Lane/Major Mvmt	NBLn1	NBLn2	EBL	EBT	EBR	WBL	WBT	WBR	SBLn1	SBLn2	SBLn3
Capacity (veh/h)	338	758	1305	-	-	1059	-	-	607	534	1017
HCM Lane V/C Ratio	0.007	0.009	0.044	-	-	0.009	-	-	0.843	0.002	0.192
HCM Control Delay (s)	15.7	9.8	7.9	-	-	8.4	-	-	34.8	11.8	9.4
HCM Lane LOS		C	A	A	-	-	A	-	D	B	A
HCM 95th %tile Q(veh)	0	0	0.1	-	-	0	-	-	9.1	0	0.7

Intersection	
Intersection Delay, s/veh	14.8
Intersection LOS	B

Movement	EBL	EBT	EBR	WBL	WBT	WBR	NBL	NBT	NBR	SBL	SBT	SBR
Lane Configurations		↕			↕			↕			↕	↕
Traffic Vol, veh/h	12	229	74	29	110	44	48	85	63	123	89	17
Future Vol, veh/h	12	229	74	29	110	44	48	85	63	123	89	17
Peak Hour Factor	0.87	0.87	0.87	0.87	0.87	1.00	0.83	0.83	0.83	0.92	0.92	0.92
Heavy Vehicles, %	2	2	2	2	2	2	2	2	2	2	2	2
Mvmt Flow	14	263	85	33	126	44	58	102	76	134	97	18
Number of Lanes	0	1	0	0	1	0	0	1	0	0	1	1

Approach	EB	WB	NB	SB
Opposing Approach	WB	EB	SB	NB
Opposing Lanes	1	1	2	1
Conflicting Approach Left	SB	NB	EB	WB
Conflicting Lanes Left	2	1	1	1
Conflicting Approach Right	NB	SB	WB	EB
Conflicting Lanes Right	1	2	1	1
HCM Control Delay	16.9	12.5	13.5	14.8
HCM LOS	C	B	B	B

Lane	NBLn1	EBLn1	WBLn1	SBLn1	SBLn2
Vol Left, %	24%	4%	16%	58%	0%
Vol Thru, %	43%	73%	60%	42%	0%
Vol Right, %	32%	23%	24%	0%	100%
Sign Control	Stop	Stop	Stop	Stop	Stop
Traffic Vol by Lane	196	315	183	212	17
LT Vol	48	12	29	123	0
Through Vol	85	229	110	89	0
RT Vol	63	74	44	0	17
Lane Flow Rate	236	362	204	230	18
Geometry Grp	4a	2	2	5	5
Degree of Util (X)	0.408	0.589	0.349	0.448	0.031
Departure Headway (Hd)	6.218	5.858	6.17	7.005	5.995
Convergence, Y/N	Yes	Yes	Yes	Yes	Yes
Cap	579	619	583	514	596
Service Time	4.267	3.858	4.217	4.752	3.741
HCM Lane V/C Ratio	0.408	0.585	0.35	0.447	0.03
HCM Control Delay	13.5	16.9	12.5	15.3	8.9
HCM Lane LOS	B	C	B	C	A
HCM 95th-tile Q	2	3.8	1.6	2.3	0.1

Intersection						
Int Delay, s/veh	2.1					
Movement	WBL	WBR	NBT	NBR	SBL	SBT
Lane Configurations	↘	↗	↑↑	↗	↘	↑↑
Traffic Vol, veh/h	85	25	335	84	41	271
Future Vol, veh/h	85	25	335	84	41	271
Conflicting Peds, #/hr	0	0	0	0	0	0
Sign Control	Stop	Stop	Free	Free	Free	Free
RT Channelized	-	None	-	None	-	None
Storage Length	485	-	-	235	385	-
Veh in Median Storage, #	0	-	0	-	-	0
Grade, %	0	-	0	-	-	0
Peak Hour Factor	85	85	85	85	85	85
Heavy Vehicles, %	2	2	2	2	2	2
Mvmt Flow	100	29	394	99	48	319

Major/Minor	Minor1	Major1	Major2			
Conflicting Flow All	650	197	0	0	493	0
Stage 1	394	-	-	-	-	-
Stage 2	256	-	-	-	-	-
Critical Hdwy	6.84	6.94	-	-	4.14	-
Critical Hdwy Stg 1	5.84	-	-	-	-	-
Critical Hdwy Stg 2	5.84	-	-	-	-	-
Follow-up Hdwy	3.52	3.32	-	-	2.22	-
Pot Cap-1 Maneuver	402	811	-	-	1067	-
Stage 1	650	-	-	-	-	-
Stage 2	763	-	-	-	-	-
Platoon blocked, %			-	-		-
Mov Cap-1 Maneuver	384	811	-	-	1067	-
Mov Cap-2 Maneuver	488	-	-	-	-	-
Stage 1	650	-	-	-	-	-
Stage 2	729	-	-	-	-	-

Approach	WB	NB	SB
HCM Control Delay, s	13.2	0	1.1
HCM LOS	B		

Minor Lane/Major Mvmt	NBT	NBR	WBLn1	WBLn2	SBL	SBT
Capacity (veh/h)	-	-	488	811	1067	-
HCM Lane V/C Ratio	-	-	0.205	0.036	0.045	-
HCM Control Delay (s)	-	-	14.3	9.6	8.5	-
HCM Lane LOS	-	-	B	A	A	-
HCM 95th %tile Q(veh)	-	-	0.8	0.1	0.1	-

Intersection						
Int Delay, s/veh	5.8					
Movement	WBL	WBR	NBT	NBR	SBL	SBT
Lane Configurations	↘	↗	↑↑	↗	↘	↑↑
Traffic Vol, veh/h	117	162	358	137	113	314
Future Vol, veh/h	117	162	358	137	113	314
Conflicting Peds, #/hr	0	0	0	0	0	0
Sign Control	Stop	Stop	Free	Free	Free	Free
RT Channelized	-	None	-	None	-	None
Storage Length	300	-	-	155	300	-
Veh in Median Storage, #	0	-	0	-	-	0
Grade, %	0	-	0	-	-	0
Peak Hour Factor	85	85	85	85	85	85
Heavy Vehicles, %	2	2	2	2	2	2
Mvmt Flow	138	191	421	161	133	369

Major/Minor	Minor1	Major1	Major2			
Conflicting Flow All	872	211	0	0	582	0
Stage 1	421	-	-	-	-	-
Stage 2	451	-	-	-	-	-
Critical Hdwy	6.84	6.94	-	-	4.14	-
Critical Hdwy Stg 1	5.84	-	-	-	-	-
Critical Hdwy Stg 2	5.84	-	-	-	-	-
Follow-up Hdwy	3.52	3.32	-	-	2.22	-
Pot Cap-1 Maneuver	290	794	-	-	988	-
Stage 1	630	-	-	-	-	-
Stage 2	609	-	-	-	-	-
Platoon blocked, %			-	-	-	-
Mov Cap-1 Maneuver	251	794	-	-	988	-
Mov Cap-2 Maneuver	251	-	-	-	-	-
Stage 1	630	-	-	-	-	-
Stage 2	527	-	-	-	-	-

Approach	WB	NB	SB
HCM Control Delay, s	21.3	0	2.4
HCM LOS	C		

Minor Lane/Major Mvmt	NBT	NBRWBLn1	WBLn2	SBL	SBT
Capacity (veh/h)	-	-	251	794	988
HCM Lane V/C Ratio	-	-	0.548	0.24	0.135
HCM Control Delay (s)	-	-	35.5	11	9.2
HCM Lane LOS	-	-	E	B	A
HCM 95th %tile Q(veh)	-	-	3	0.9	0.5

Intersection												
Int Delay, s/veh	25.3											
Movement	EBL	EBT	EBR	WBL	WBT	WBR	NBL	NBT	NBR	SBL	SBT	SBR
Lane Configurations	↘	↑↑	↗	↘	↑↑	↗	↘	↗	↘	↘	↑	↗
Traffic Vol, veh/h	143	106	2	6	161	487	2	0	7	289	1	117
Future Vol, veh/h	143	106	2	6	161	487	2	0	7	289	1	117
Conflicting Peds, #/hr	0	0	0	0	0	0	0	0	0	0	0	0
Sign Control	Free	Free	Free	Free	Free	Free	Stop	Stop	Stop	Stop	Stop	Stop
RT Channelized	-	-	None	-	-	None	-	-	None	-	-	None
Storage Length	300	-	200	250	-	205	0	-	-	155	-	0
Veh in Median Storage, #	-	0	-	-	0	-	-	0	-	-	0	-
Grade, %	-	0	-	-	0	-	-	0	-	-	0	-
Peak Hour Factor	85	85	85	85	85	85	85	85	85	85	85	85
Heavy Vehicles, %	2	2	88	88	2	2	78	2	78	2	2	2
Mvmt Flow	168	125	2	7	189	573	2	0	8	340	1	138

Major/Minor	Major1			Major2			Minor1			Minor2		
Conflicting Flow All	762	0	0	127	0	0	570	1237	63	602	666	95
Stage 1	-	-	-	-	-	-	461	461	-	203	203	-
Stage 2	-	-	-	-	-	-	109	776	-	399	463	-
Critical Hdwy	4.14	-	-	5.86	-	-	9.06	6.54	8.46	7.54	6.54	6.94
Critical Hdwy Stg 1	-	-	-	-	-	-	8.06	5.54	-	6.54	5.54	-
Critical Hdwy Stg 2	-	-	-	-	-	-	8.06	5.54	-	6.54	5.54	-
Follow-up Hdwy	2.22	-	-	3.08	-	-	4.28	4.02	4.08	3.52	4.02	3.32
Pot Cap-1 Maneuver	846	-	-	1003	-	-	276	175	788	383	379	943
Stage 1	-	-	-	-	-	-	389	564	-	780	732	-
Stage 2	-	-	-	-	-	-	703	406	-	598	562	-
Platoon blocked, %	-	-	-	-	-	-	-	-	-	-	-	-
Mov Cap-1 Maneuver	846	-	-	1003	-	-	198	139	788	~ 319	301	943
Mov Cap-2 Maneuver	-	-	-	-	-	-	198	139	-	~ 319	301	-
Stage 1	-	-	-	-	-	-	312	452	-	625	727	-
Stage 2	-	-	-	-	-	-	595	403	-	474	450	-

Approach	EB			WB			NB			SB		
HCM Control Delay, s	5.9			0.1			12.7			78.1		
HCM LOS							B			F		

Minor Lane/Major Mvmt	NBLn1	NBLn2	EBL	EBT	EBR	WBL	WBT	WBR	SBLn1	SBLn2	SBLn3
Capacity (veh/h)	198	788	846	-	-	1003	-	-	319	301	943
HCM Lane V/C Ratio	0.012	0.01	0.199	-	-	0.007	-	-	1.066	0.004	0.146
HCM Control Delay (s)	23.4	9.6	10.3	-	-	8.6	-	-	106.1	17	9.5
HCM Lane LOS	C	A	B	-	-	A	-	-	F	C	A
HCM 95th %tile Q(veh)	0	0	0.7	-	-	0	-	-	12.7	0	0.5

Notes
 ~: Volume exceeds capacity \$: Delay exceeds 300s +: Computation Not Defined *: All major volume in platoon

Intersection	
Intersection Delay, s/veh	15.9
Intersection LOS	C

Movement	EBL	EBT	EBR	WBL	WBT	WBR	NBL	NBT	NBR	SBL	SBT	SBR
Lane Configurations		↕			↕			↕			↕	↕
Traffic Vol, veh/h	4	57	27	74	298	114	72	66	32	29	66	23
Future Vol, veh/h	4	57	27	74	298	114	72	66	32	29	66	23
Peak Hour Factor	0.81	0.81	0.81	0.94	0.94	0.94	0.83	0.83	0.83	0.90	0.90	0.90
Heavy Vehicles, %	2	2	2	2	2	2	2	2	2	2	2	2
Mvmt Flow	5	70	33	79	317	121	87	80	39	32	73	26
Number of Lanes	0	1	0	0	1	0	0	1	0	0	1	1

Approach	EB	WB	NB	SB
Opposing Approach	WB	EB	SB	NB
Opposing Lanes	1	1	2	1
Conflicting Approach Left	SB	NB	EB	WB
Conflicting Lanes Left	2	1	1	1
Conflicting Approach Right	NB	SB	WB	EB
Conflicting Lanes Right	1	2	1	1
HCM Control Delay	9.8	20.1	12	10.7
HCM LOS	A	C	B	B

Lane	NBLn1	EBLn1	WBLn1	SBLn1	SBLn2
Vol Left, %	42%	5%	15%	31%	0%
Vol Thru, %	39%	65%	61%	69%	0%
Vol Right, %	19%	31%	23%	0%	100%
Sign Control	Stop	Stop	Stop	Stop	Stop
Traffic Vol by Lane	170	88	486	95	23
LT Vol	72	4	74	29	0
Through Vol	66	57	298	66	0
RT Vol	32	27	114	0	23
Lane Flow Rate	205	109	517	106	26
Geometry Grp	4a	2	2	5	5
Degree of Util (X)	0.338	0.169	0.722	0.197	0.041
Departure Headway (Hd)	5.936	5.587	5.029	6.713	5.843
Convergence, Y/N	Yes	Yes	Yes	Yes	Yes
Cap	604	639	719	533	610
Service Time	3.989	3.647	3.069	4.472	3.603
HCM Lane V/C Ratio	0.339	0.171	0.719	0.199	0.043
HCM Control Delay	12	9.8	20.1	11.1	8.9
HCM Lane LOS	B	A	C	B	A
HCM 95th-tile Q	1.5	0.6	6.2	0.7	0.1

Intersection						
Int Delay, s/veh	3.5					
Movement	WBL	WBR	NBT	NBR	SBL	SBT
Lane Configurations	↘	↗	↕↕	↗	↘	↕↕
Traffic Vol, veh/h	165	46	197	48	15	345
Future Vol, veh/h	165	46	197	48	15	345
Conflicting Peds, #/hr	0	0	0	0	0	0
Sign Control	Stop	Stop	Free	Free	Free	Free
RT Channelized	-	None	-	None	-	None
Storage Length	485	-	-	235	385	-
Veh in Median Storage, #	0	-	0	-	-	0
Grade, %	0	-	0	-	-	0
Peak Hour Factor	85	85	85	85	85	85
Heavy Vehicles, %	2	2	2	2	2	2
Mvmt Flow	194	54	232	56	18	406

Major/Minor	Minor1	Major1	Major2		
Conflicting Flow All	471	116	0	0	288
Stage 1	232	-	-	-	-
Stage 2	239	-	-	-	-
Critical Hdwy	6.84	6.94	-	-	4.14
Critical Hdwy Stg 1	5.84	-	-	-	-
Critical Hdwy Stg 2	5.84	-	-	-	-
Follow-up Hdwy	3.52	3.32	-	-	2.22
Pot Cap-1 Maneuver	522	914	-	-	1271
Stage 1	785	-	-	-	-
Stage 2	778	-	-	-	-
Platoon blocked, %			-	-	-
Mov Cap-1 Maneuver	515	914	-	-	1271
Mov Cap-2 Maneuver	589	-	-	-	-
Stage 1	785	-	-	-	-
Stage 2	767	-	-	-	-

Approach	WB	NB	SB
HCM Control Delay, s	13	0	0.3
HCM LOS	B		

Minor Lane/Major Mvmt	NBT	NBRWBLn1	WBLn2	SBL	SBT
Capacity (veh/h)	-	-	589	914	1271
HCM Lane V/C Ratio	-	-	0.33	0.059	0.014
HCM Control Delay (s)	-	-	14.1	9.2	7.9
HCM Lane LOS	-	-	B	A	A
HCM 95th %tile Q(veh)	-	-	1.4	0.2	0

Intersection												
Int Delay, s/veh	7.7											
Movement	EBL	EBT	EBR	WBL	WBT	WBR	NBL	NBT	NBR	SBL	SBT	SBR
Lane Configurations	↘	↑↑	↗	↘	↑↑	↗	↘	↑	↗	↘	↑	↗
Traffic Vol, veh/h	27	0	16	31	42	0	51	19	0	0	69	7
Future Vol, veh/h	27	0	16	31	42	0	51	19	0	0	69	7
Conflicting Peds, #/hr	0	0	0	0	0	0	0	0	0	0	0	0
Sign Control	Free	Free	Free	Free	Free	Free	Stop	Stop	Stop	Stop	Stop	Stop
RT Channelized	-	-	None	-	-	None	-	-	None	-	-	None
Storage Length	535	-	200	200	-	200	410	-	155	235	-	155
Veh in Median Storage, #	-	0	-	-	0	-	-	0	-	-	0	-
Grade, %	-	0	-	-	0	-	-	0	-	-	0	-
Peak Hour Factor	85	85	85	85	85	85	85	85	85	85	85	85
Heavy Vehicles, %	2	2	2	2	2	2	2	2	2	2	2	2
Mvmt Flow	32	0	19	36	49	0	60	22	0	0	81	8

Major/Minor	Major1			Major2			Minor1			Minor2		
Conflicting Flow All	49	0	0	19	0	0	201	185	0	196	204	25
Stage 1	-	-	-	-	-	-	64	64	-	121	121	-
Stage 2	-	-	-	-	-	-	137	121	-	75	83	-
Critical Hdwy	4.14	-	-	4.14	-	-	7.54	6.54	6.94	7.54	6.54	6.94
Critical Hdwy Stg 1	-	-	-	-	-	-	6.54	5.54	-	6.54	5.54	-
Critical Hdwy Stg 2	-	-	-	-	-	-	6.54	5.54	-	6.54	5.54	-
Follow-up Hdwy	2.22	-	-	2.22	-	-	3.52	4.02	3.32	3.52	4.02	3.32
Pot Cap-1 Maneuver	1556	-	-	1596	-	-	739	708	-	745	691	1045
Stage 1	-	-	-	-	-	-	939	841	-	870	795	-
Stage 2	-	-	-	-	-	-	852	795	-	926	825	-
Platoon blocked, %	-	-	-	-	-	-	-	-	-	-	-	-
Mov Cap-1 Maneuver	1556	-	-	1596	-	-	643	677	-	-	661	1045
Mov Cap-2 Maneuver	-	-	-	-	-	-	643	677	-	-	661	-
Stage 1	-	-	-	-	-	-	919	823	-	852	777	-
Stage 2	-	-	-	-	-	-	740	777	-	882	808	-

Approach	EB			WB			NB			SB		
HCM Control Delay, s	4.6			3.1			11			11		
HCM LOS							B			B		

Minor Lane/Major Mvmt	NBLn1	NBLn2	NBLn3	EBL	EBT	EBR	WBL	WBT	WBR	SBLn1	SBLn2	SBLn3
Capacity (veh/h)	643	677	-	1556	-	-	1596	-	-	-	661	1045
HCM Lane V/C Ratio	0.093	0.033	-	0.02	-	-	0.023	-	-	-	0.123	0.008
HCM Control Delay (s)	11.2	10.5	0	7.4	-	-	7.3	-	-	0	11.2	8.5
HCM Lane LOS	B	B	A	A	-	-	A	-	-	A	B	A
HCM 95th %tile Q(veh)	0.3	0.1	-	0.1	-	-	0.1	-	-	-	0.4	0

Intersection						
Int Delay, s/veh	7.7					
Movement	WBL	WBR	NBT	NBR	SBL	SBT
Lane Configurations	↘	↗	↑↑	↗	↘	↑↑
Traffic Vol, veh/h	162	81	220	50	120	464
Future Vol, veh/h	162	81	220	50	120	464
Conflicting Peds, #/hr	0	0	0	0	0	0
Sign Control	Stop	Stop	Free	Free	Free	Free
RT Channelized	-	None	-	None	-	None
Storage Length	300	-	-	155	300	-
Veh in Median Storage, #	0	-	0	-	-	0
Grade, %	0	-	0	-	-	0
Peak Hour Factor	85	85	85	85	85	85
Heavy Vehicles, %	2	2	2	2	2	2
Mvmt Flow	191	95	259	59	141	546

Major/Minor	Minor1	Major1	Major2			
Conflicting Flow All	814	130	0	0	318	0
Stage 1	259	-	-	-	-	-
Stage 2	555	-	-	-	-	-
Critical Hdwy	6.84	6.94	-	-	4.14	-
Critical Hdwy Stg 1	5.84	-	-	-	-	-
Critical Hdwy Stg 2	5.84	-	-	-	-	-
Follow-up Hdwy	3.52	3.32	-	-	2.22	-
Pot Cap-1 Maneuver	316	896	-	-	1239	-
Stage 1	761	-	-	-	-	-
Stage 2	539	-	-	-	-	-
Platoon blocked, %			-	-	-	-
Mov Cap-1 Maneuver	280	896	-	-	1239	-
Mov Cap-2 Maneuver	280	-	-	-	-	-
Stage 1	761	-	-	-	-	-
Stage 2	478	-	-	-	-	-

Approach	WB	NB	SB
HCM Control Delay, s	30.8	0	1.7
HCM LOS	D		

Minor Lane/Major Mvmt	NBT	NBR	WBLn1	WBLn2	SBL	SBT
Capacity (veh/h)	-	-	280	896	1239	-
HCM Lane V/C Ratio	-	-	0.681	0.106	0.114	-
HCM Control Delay (s)	-	-	41.4	9.5	8.3	-
HCM Lane LOS	-	-	E	A	A	-
HCM 95th %tile Q(veh)	-	-	4.5	0.4	0.4	-

Intersection												
Int Delay, s/veh	26											
Movement	EBL	EBT	EBR	WBL	WBT	WBR	NBL	NBT	NBR	SBL	SBT	SBR
Lane Configurations	↘	↑↑	↗	↘	↑↑	↗	↘	↗	↘	↘	↑	↗
Traffic Vol, veh/h	49	118	2	8	75	153	2	0	6	493	1	166
Future Vol, veh/h	49	118	2	8	75	153	2	0	6	493	1	166
Conflicting Peds, #/hr	0	0	0	0	0	0	0	0	0	0	0	0
Sign Control	Free	Free	Free	Free	Free	Free	Stop	Stop	Stop	Stop	Stop	Stop
RT Channelized	-	-	None	-	-	None	-	-	None	-	-	None
Storage Length	300	-	200	250	-	205	0	-	-	155	-	0
Veh in Median Storage, #	-	0	-	-	0	-	-	0	-	-	0	-
Grade, %	-	0	-	-	0	-	-	0	-	-	0	-
Peak Hour Factor	85	85	85	85	85	85	85	85	85	85	85	85
Heavy Vehicles, %	2	2	70	70	2	2	88	2	88	2	2	2
Mvmt Flow	58	139	2	9	88	180	2	0	7	580	1	195

Major/Minor	Major1			Major2			Minor1			Minor2		
Conflicting Flow All	268	0	0	141	0	0	318	541	70	292	363	44
Stage 1	-	-	-	-	-	-	255	255	-	106	106	-
Stage 2	-	-	-	-	-	-	63	286	-	186	257	-
Critical Hdwy	4.14	-	-	5.5	-	-	9.26	6.54	8.66	7.54	6.54	6.94
Critical Hdwy Stg 1	-	-	-	-	-	-	8.26	5.54	-	6.54	5.54	-
Critical Hdwy Stg 2	-	-	-	-	-	-	8.26	5.54	-	6.54	5.54	-
Follow-up Hdwy	2.22	-	-	2.9	-	-	4.38	4.02	4.18	3.52	4.02	3.32
Pot Cap-1 Maneuver	1293	-	-	1059	-	-	437	447	758	638	563	1017
Stage 1	-	-	-	-	-	-	533	695	-	888	807	-
Stage 2	-	-	-	-	-	-	739	674	-	798	694	-
Platoon blocked, %	-	-	-	-	-	-	-	-	-	-	-	-
Mov Cap-1 Maneuver	1293	-	-	1059	-	-	338	423	758	607	533	1017
Mov Cap-2 Maneuver	-	-	-	-	-	-	338	423	-	607	533	-
Stage 1	-	-	-	-	-	-	509	664	-	848	801	-
Stage 2	-	-	-	-	-	-	591	669	-	755	663	-

Approach	EB			WB			NB			SB		
HCM Control Delay, s	2.3			0.3			11.3			41.5		
HCM LOS							B			E		

Minor Lane/Major Mvmt	NBLn1	NBLn2	EBL	EBT	EBR	WBL	WBT	WBR	SBLn1	SBLn2	SBLn3
Capacity (veh/h)	338	758	1293	-	-	1059	-	-	607	533	1017
HCM Lane V/C Ratio	0.007	0.009	0.045	-	-	0.009	-	-	0.956	0.002	0.192
HCM Control Delay (s)	15.7	9.8	7.9	-	-	8.4	-	-	52.4	11.8	9.4
HCM Lane LOS	C	A	A	-	-	A	-	-	F	B	A
HCM 95th %tile Q(veh)	0	0	0.1	-	-	0	-	-	13.2	0	0.7

Timings
13: Sterling Ranch Rd & Marksheffel Rd

Short-Term Total Traffic
AM Peak Hour

Lane Group	EBL	EBT	EBR	WBL	WBT	WBR	NBL	NBT	SBL	SBT	SBR	
Lane Configurations												
Traffic Volume (vph)	49	118	2	8	75	153	2	1	493	1	166	
Future Volume (vph)	49	118	2	8	75	153	2	1	493	1	166	
Turn Type	pm+pt	NA	Perm	pm+pt	NA	Perm	pm+pt	NA	Prot	NA	Perm	
Protected Phases	5	2		1	6		3	8	7	4		
Permitted Phases	2		2	6		6	8				4	
Detector Phase	5	2	2	1	6	6	3	8	7	4	4	
Switch Phase												
Minimum Initial (s)	5.0	15.0	15.0	5.0	15.0	15.0	5.0	10.0	5.0	10.0	10.0	
Minimum Split (s)	10.0	23.0	23.0	10.0	23.0	23.0	10.0	23.0	10.0	23.0	23.0	
Total Split (s)	10.0	40.0	40.0	10.0	40.0	40.0	10.0	25.0	15.0	30.0	30.0	
Total Split (%)	11.1%	44.4%	44.4%	11.1%	44.4%	44.4%	11.1%	27.8%	16.7%	33.3%	33.3%	
Yellow Time (s)	3.0	3.0	3.0	3.0	3.0	3.0	3.0	3.0	3.0	3.0	3.0	
All-Red Time (s)	2.0	2.0	2.0	2.0	2.0	2.0	2.0	2.0	2.0	2.0	2.0	
Lost Time Adjust (s)	0.0	0.0	0.0	0.0	0.0	0.0	0.0	0.0	0.0	0.0	0.0	
Total Lost Time (s)	5.0	5.0	5.0	5.0	5.0	5.0	5.0	5.0	5.0	5.0	5.0	
Lead/Lag	Lead	Lag	Lag	Lead	Lag	Lag	Lead	Lag	Lead	Lag	Lag	
Lead-Lag Optimize?	Yes	Yes	Yes	Yes	Yes	Yes	Yes	Yes	Yes	Yes	Yes	
Recall Mode	None	Min	Min	None	Min	Min	None	None	None	None	None	
Act Effct Green (s)	18.3	17.6	17.6	17.3	15.7	15.7	6.6	10.5	10.5	11.2	11.2	
Actuated g/C Ratio	0.44	0.42	0.42	0.41	0.37	0.37	0.16	0.25	0.25	0.27	0.27	
v/c Ratio	0.10	0.09	0.00	0.03	0.07	0.26	0.01	0.03	0.68	0.00	0.35	
Control Delay	8.2	10.4	0.0	8.4	12.2	4.5	13.5	13.0	23.6	15.0	5.5	
Queue Delay	0.0	0.0	0.0	0.0	0.0	0.0	0.0	0.0	0.0	0.0	0.0	
Total Delay	8.2	10.4	0.0	8.4	12.2	4.5	13.5	13.0	23.6	15.0	5.5	
LOS	A	B	A	A	B	A	B	B	C	B	A	
Approach Delay		9.6			7.1			13.1		19.0		
Approach LOS		A			A			B		B		

Intersection Summary

Cycle Length: 90
 Actuated Cycle Length: 42
 Natural Cycle: 75
 Control Type: Actuated-Uncoordinated
 Maximum v/c Ratio: 0.68
 Intersection Signal Delay: 14.9
 Intersection LOS: B
 Intersection Capacity Utilization 41.6%
 ICU Level of Service A
 Analysis Period (min) 15

Splits and Phases: 13: Sterling Ranch Rd & Marksheffel Rd



Intersection						
Int Delay, s/veh	8.5					
Movement	EBL	EBT	WBT	WBR	SBL	SBR
Lane Configurations		↑↑	↑↑	↑		↑
Traffic Vol, veh/h	0	0	0	0	0	74
Future Vol, veh/h	0	0	0	0	0	74
Conflicting Peds, #/hr	0	0	0	0	0	0
Sign Control	Free	Free	Free	Free	Stop	Stop
RT Channelized	-	None	-	None	-	None
Storage Length	-	-	-	0	-	0
Veh in Median Storage, #	-	0	0	-	0	-
Grade, %	-	0	0	-	0	-
Peak Hour Factor	85	85	85	85	85	85
Heavy Vehicles, %	2	2	2	2	2	2
Mvmt Flow	0	0	0	0	0	87

Major/Minor	Major1	Major2	Minor2
Conflicting Flow All	-	0	-
Stage 1	-	-	-
Stage 2	-	-	-
Critical Hdwy	-	-	-
Critical Hdwy Stg 1	-	-	-
Critical Hdwy Stg 2	-	-	-
Follow-up Hdwy	-	-	-
Pot Cap-1 Maneuver	0	-	-
Stage 1	0	-	-
Stage 2	0	-	-
Platoon blocked, %	-	-	-
Mov Cap-1 Maneuver	-	-	-
Mov Cap-2 Maneuver	-	-	-
Stage 1	-	-	-
Stage 2	-	-	-

Approach	EB	WB	SB
HCM Control Delay, s	0	0	8.6
HCM LOS			A

Minor Lane/Major Mvmt	EBT	WBT	WBR	SBLn1
Capacity (veh/h)	-	-	-	1083
HCM Lane V/C Ratio	-	-	-	0.08
HCM Control Delay (s)	-	-	-	8.6
HCM Lane LOS	-	-	-	A
HCM 95th %tile Q(veh)	-	-	-	0.3

Intersection						
Int Delay, s/veh	3.3					
Movement	WBL	WBR	NBT	NBR	SBL	SBT
Lane Configurations	↘	↗	↑	↗	↘	↑
Traffic Vol, veh/h	25	0	5	30	0	5
Future Vol, veh/h	25	0	5	30	0	5
Conflicting Peds, #/hr	0	0	0	0	0	0
Sign Control	Stop	Stop	Free	Free	Free	Free
RT Channelized	-	None	-	None	-	None
Storage Length	0	200	-	200	200	-
Veh in Median Storage, #	0	-	0	-	-	0
Grade, %	0	-	0	-	-	0
Peak Hour Factor	85	85	85	85	85	85
Heavy Vehicles, %	2	2	2	2	2	2
Mvmt Flow	29	0	6	35	0	6

Major/Minor	Minor1	Major1	Major2		
Conflicting Flow All	12	6	0	0	41
Stage 1	6	-	-	-	-
Stage 2	6	-	-	-	-
Critical Hdwy	6.42	6.22	-	-	4.12
Critical Hdwy Stg 1	5.42	-	-	-	-
Critical Hdwy Stg 2	5.42	-	-	-	-
Follow-up Hdwy	3.518	3.318	-	-	2.218
Pot Cap-1 Maneuver	1008	1077	-	-	1568
Stage 1	1017	-	-	-	-
Stage 2	1017	-	-	-	-
Platoon blocked, %			-	-	-
Mov Cap-1 Maneuver	1008	1077	-	-	1568
Mov Cap-2 Maneuver	1008	-	-	-	-
Stage 1	1017	-	-	-	-
Stage 2	1017	-	-	-	-

Approach	WB	NB	SB
HCM Control Delay, s	8.7	0	0
HCM LOS	A		

Minor Lane/Major Mvmt	NBT	NBRWBLn1WBLn2	SBL	SBT
Capacity (veh/h)	-	- 1008	- 1568	-
HCM Lane V/C Ratio	-	- 0.029	-	-
HCM Control Delay (s)	-	- 8.7	0	0
HCM Lane LOS	-	- A	A	A
HCM 95th %tile Q(veh)	-	- 0.1	-	0

Intersection						
Int Delay, s/veh	3.9					
Movement	WBL	WBR	NBT	NBR	SBL	SBT
Lane Configurations	↘	↗	↑	↗	↘	↑
Traffic Vol, veh/h	5	0	0	5	0	0
Future Vol, veh/h	5	0	0	5	0	0
Conflicting Peds, #/hr	0	0	0	0	0	0
Sign Control	Stop	Stop	Free	Free	Free	Free
RT Channelized	-	None	-	None	-	None
Storage Length	0	200	-	200	200	-
Veh in Median Storage, #	0	-	0	-	-	0
Grade, %	0	-	0	-	-	0
Peak Hour Factor	85	85	85	85	85	85
Heavy Vehicles, %	2	2	2	2	2	2
Mvmt Flow	6	0	0	6	0	0

Major/Minor	Minor1	Major1	Major2			
Conflicting Flow All	1	0	0	0	6	0
Stage 1	0	-	-	-	-	-
Stage 2	1	-	-	-	-	-
Critical Hdwy	6.42	6.22	-	-	4.12	-
Critical Hdwy Stg 1	5.42	-	-	-	-	-
Critical Hdwy Stg 2	5.42	-	-	-	-	-
Follow-up Hdwy	3.518	3.318	-	-	2.218	-
Pot Cap-1 Maneuver	1022	-	-	-	1615	-
Stage 1	-	-	-	-	-	-
Stage 2	1022	-	-	-	-	-
Platoon blocked, %						
Mov Cap-1 Maneuver	1022	-	-	-	1615	-
Mov Cap-2 Maneuver	1022	-	-	-	-	-
Stage 1	-	-	-	-	-	-
Stage 2	1022	-	-	-	-	-

Approach	WB	NB	SB
HCM Control Delay, s	8.5	0	0
HCM LOS	A		

Minor Lane/Major Mvmt	NBT	NBRWBLn1WBLn2	SBL	SBT
Capacity (veh/h)	-	- 1022	- 1615	-
HCM Lane V/C Ratio	-	- 0.006	-	-
HCM Control Delay (s)	-	- 8.5	0	0
HCM Lane LOS	-	- A	A	A
HCM 95th %tile Q(veh)	-	- 0	- 0	-

Intersection	
Intersection Delay, s/veh	16.7
Intersection LOS	C

Movement	EBL	EBT	EBR	WBL	WBT	WBR	NBL	NBT	NBR	SBL	SBT	SBR
Lane Configurations		↕			↕			↕			↕	↕
Traffic Vol, veh/h	12	229	81	29	110	44	52	87	63	123	91	17
Future Vol, veh/h	12	229	81	29	110	44	52	87	63	123	91	17
Peak Hour Factor	0.87	0.87	0.87	0.87	0.87	0.87	0.83	0.83	0.83	0.77	0.77	0.77
Heavy Vehicles, %	2	2	2	2	2	2	2	2	2	2	2	2
Mvmt Flow	14	263	93	33	126	51	63	105	76	160	118	22
Number of Lanes	0	1	0	0	1	0	0	1	0	0	1	1

Approach	EB	WB	NB	SB
Opposing Approach	WB	EB	SB	NB
Opposing Lanes	1	1	2	1
Conflicting Approach Left	SB	NB	EB	WB
Conflicting Lanes Left	2	1	1	1
Conflicting Approach Right	NB	SB	WB	EB
Conflicting Lanes Right	1	2	1	1
HCM Control Delay	19	13.6	14.7	17.8
HCM LOS	C	B	B	C

Lane	NBLn1	EBLn1	WBLn1	SBLn1	SBLn2
Vol Left, %	26%	4%	16%	57%	0%
Vol Thru, %	43%	71%	60%	43%	0%
Vol Right, %	31%	25%	24%	0%	100%
Sign Control	Stop	Stop	Stop	Stop	Stop
Traffic Vol by Lane	202	322	183	214	17
LT Vol	52	12	29	123	0
Through Vol	87	229	110	91	0
RT Vol	63	81	44	0	17
Lane Flow Rate	243	370	210	278	22
Geometry Grp	4a	2	2	5	5
Degree of Util (X)	0.441	0.628	0.381	0.554	0.038
Departure Headway (Hd)	6.516	6.113	6.513	7.175	6.165
Convergence, Y/N	Yes	Yes	Yes	Yes	Yes
Cap	550	588	551	503	579
Service Time	4.581	4.168	4.577	4.934	3.924
HCM Lane V/C Ratio	0.442	0.629	0.381	0.553	0.038
HCM Control Delay	14.7	19	13.6	18.5	9.2
HCM Lane LOS	B	C	B	C	A
HCM 95th-tile Q	2.2	4.4	1.8	3.3	0.1

Intersection						
Int Delay, s/veh	2.5					
Movement	WBL	WBR	NBT	NBR	SBL	SBT
Lane Configurations	↘	↗	↕↕	↗	↘	↕↕
Traffic Vol, veh/h	110	31	335	162	50	271
Future Vol, veh/h	110	31	335	162	50	271
Conflicting Peds, #/hr	0	0	0	0	0	0
Sign Control	Stop	Stop	Free	Free	Free	Free
RT Channelized	-	None	-	None	-	None
Storage Length	485	-	-	235	385	-
Veh in Median Storage, #	0	-	0	-	-	0
Grade, %	0	-	0	-	-	0
Peak Hour Factor	85	85	85	85	85	85
Heavy Vehicles, %	2	2	2	2	2	2
Mvmt Flow	129	36	394	191	59	319

Major/Minor	Minor1	Major1	Major2		
Conflicting Flow All	672	197	0	0	585
Stage 1	394	-	-	-	-
Stage 2	278	-	-	-	-
Critical Hdwy	6.84	6.94	-	-	4.14
Critical Hdwy Stg 1	5.84	-	-	-	-
Critical Hdwy Stg 2	5.84	-	-	-	-
Follow-up Hdwy	3.52	3.32	-	-	2.22
Pot Cap-1 Maneuver	389	811	-	-	986
Stage 1	650	-	-	-	-
Stage 2	744	-	-	-	-
Platoon blocked, %			-	-	-
Mov Cap-1 Maneuver	366	811	-	-	986
Mov Cap-2 Maneuver	474	-	-	-	-
Stage 1	650	-	-	-	-
Stage 2	699	-	-	-	-

Approach	WB	NB	SB
HCM Control Delay, s	14.1	0	1.4
HCM LOS	B		

Minor Lane/Major Mvmt	NBT	NBRWBLn1	WBLn2	SBL	SBT
Capacity (veh/h)	-	-	474	811	986
HCM Lane V/C Ratio	-	-	0.273	0.045	0.06
HCM Control Delay (s)	-	-	15.4	9.6	8.9
HCM Lane LOS	-	-	C	A	A
HCM 95th %tile Q(veh)	-	-	1.1	0.1	0.2

HCM 6th TWSC
5: Sterling Ranch Rd & Briargate Pkwy

Short-Term Total Traffic
PM Peak Hour

Intersection												
Int Delay, s/veh	8											
Movement	EBL	EBT	EBR	WBL	WBT	WBR	NBL	NBT	NBR	SBL	SBT	SBR
Lane Configurations	↘	↑↑	↗	↘	↑↑	↗	↘	↑	↗	↘	↑	↗
Traffic Vol, veh/h	91	0	53	21	28	0	44	65	0	0	46	4
Future Vol, veh/h	91	0	53	21	28	0	44	65	0	0	46	4
Conflicting Peds, #/hr	0	0	0	0	0	0	0	0	0	0	0	0
Sign Control	Free	Free	Free	Free	Free	Free	Stop	Stop	Stop	Stop	Stop	Stop
RT Channelized	-	-	None	-	-	None	-	-	None	-	-	None
Storage Length	535	-	200	200	-	200	410	-	155	235	-	155
Veh in Median Storage, #	-	0	-	-	0	-	-	0	-	-	0	-
Grade, %	-	0	-	-	0	-	-	0	-	-	0	-
Peak Hour Factor	85	85	85	85	85	85	85	85	85	85	85	85
Heavy Vehicles, %	2	2	2	2	2	2	2	2	2	2	2	2
Mvmt Flow	107	0	62	25	33	0	52	76	0	0	54	5

Major/Minor	Major1			Major2			Minor1			Minor2		
Conflicting Flow All	33	0	0	62	0	0	308	297	0	335	359	17
Stage 1	-	-	-	-	-	-	214	214	-	83	83	-
Stage 2	-	-	-	-	-	-	94	83	-	252	276	-
Critical Hdwy	4.14	-	-	4.14	-	-	7.54	6.54	6.94	7.54	6.54	6.94
Critical Hdwy Stg 1	-	-	-	-	-	-	6.54	5.54	-	6.54	5.54	-
Critical Hdwy Stg 2	-	-	-	-	-	-	6.54	5.54	-	6.54	5.54	-
Follow-up Hdwy	2.22	-	-	2.22	-	-	3.52	4.02	3.32	3.52	4.02	3.32
Pot Cap-1 Maneuver	1577	-	-	1539	-	-	621	613	-	595	566	1058
Stage 1	-	-	-	-	-	-	768	724	-	916	825	-
Stage 2	-	-	-	-	-	-	902	825	-	730	680	-
Platoon blocked, %	-	-	-	-	-	-	-	-	-	-	-	-
Mov Cap-1 Maneuver	1577	-	-	1539	-	-	533	562	-	-	519	1058
Mov Cap-2 Maneuver	-	-	-	-	-	-	533	562	-	-	519	-
Stage 1	-	-	-	-	-	-	716	675	-	854	812	-
Stage 2	-	-	-	-	-	-	825	812	-	603	634	-

Approach	EB			WB			NB			SB		
HCM Control Delay, s	4.7			3.2			12.4			12.4		
HCM LOS	B			B			B			B		

Minor Lane/Major Mvmt	NBLn1	NBLn2	NBLn3	EBL	EBT	EBR	WBL	WBT	WBR	SBLn1	SBLn2	SBLn3
Capacity (veh/h)	533	562	-	1577	-	-	1539	-	-	-	519	1058
HCM Lane V/C Ratio	0.097	0.136	-	0.068	-	-	0.016	-	-	-	0.104	0.004
HCM Control Delay (s)	12.5	12.4	0	7.4	-	-	7.4	-	-	0	12.7	8.4
HCM Lane LOS	B	B	A	A	-	-	A	-	-	A	B	A
HCM 95th %tile Q(veh)	0.3	0.5	-	0.2	-	-	0	-	-	-	0.3	0

Intersection						
Int Delay, s/veh	6.7					
Movement	WBL	WBR	NBT	NBR	SBL	SBT
Lane Configurations	↘	↗	↕	↗	↘	↕
Traffic Vol, veh/h	117	162	437	137	113	339
Future Vol, veh/h	117	162	437	137	113	339
Conflicting Peds, #/hr	0	0	0	0	0	0
Sign Control	Stop	Stop	Free	Free	Free	Free
RT Channelized	-	None	-	None	-	None
Storage Length	300	-	-	155	300	-
Veh in Median Storage, #	0	-	0	-	-	0
Grade, %	0	-	0	-	-	0
Peak Hour Factor	85	85	85	85	85	85
Heavy Vehicles, %	2	2	2	2	2	2
Mvmt Flow	138	191	514	161	133	399

Major/Minor	Minor1	Major1	Major2		
Conflicting Flow All	980	257	0	0	675
Stage 1	514	-	-	-	-
Stage 2	466	-	-	-	-
Critical Hdwy	6.84	6.94	-	-	4.14
Critical Hdwy Stg 1	5.84	-	-	-	-
Critical Hdwy Stg 2	5.84	-	-	-	-
Follow-up Hdwy	3.52	3.32	-	-	2.22
Pot Cap-1 Maneuver	247	742	-	-	912
Stage 1	565	-	-	-	-
Stage 2	598	-	-	-	-
Platoon blocked, %			-	-	-
Mov Cap-1 Maneuver	211	742	-	-	912
Mov Cap-2 Maneuver	211	-	-	-	-
Stage 1	565	-	-	-	-
Stage 2	511	-	-	-	-

Approach	WB	NB	SB
HCM Control Delay, s	27.4	0	2.4
HCM LOS	D		

Minor Lane/Major Mvmt	NBT	NBRWBLn1	WBLn2	SBL	SBT
Capacity (veh/h)	-	-	211	742	912
HCM Lane V/C Ratio	-	-	0.652	0.257	0.146
HCM Control Delay (s)	-	-	49.3	11.5	9.6
HCM Lane LOS	-	-	E	B	A
HCM 95th %tile Q(veh)	-	-	3.9	1	0.5

Intersection												
Int Delay, s/veh	38.6											
Movement	EBL	EBT	EBR	WBL	WBT	WBR	NBL	NBT	NBR	SBL	SBT	SBR
Lane Configurations	↘	↑↑	↗	↘	↑↑	↗	↘	↗		↘	↑	↗
Traffic Vol, veh/h	143	106	2	6	161	516	2	0	7	327	1	117
Future Vol, veh/h	143	106	2	6	161	516	2	0	7	327	1	117
Conflicting Peds, #/hr	0	0	0	0	0	0	0	0	0	0	0	0
Sign Control	Free	Free	Free	Free	Free	Free	Stop	Stop	Stop	Stop	Stop	Stop
RT Channelized	-	-	None	-	-	None	-	-	None	-	-	None
Storage Length	300	-	200	250	-	205	0	-	-	155	-	0
Veh in Median Storage, #	-	0	-	-	0	-	-	0	-	-	0	-
Grade, %	-	0	-	-	0	-	-	0	-	-	0	-
Peak Hour Factor	85	85	85	85	85	85	85	85	85	85	85	85
Heavy Vehicles, %	2	2	88	88	2	2	78	2	78	2	2	2
Mvmt Flow	168	125	2	7	189	607	2	0	8	385	1	138

Major/Minor	Major1			Major2			Minor1			Minor2		
Conflicting Flow All	796	0	0	127	0	0	570	1271	63	602	666	95
Stage 1	-	-	-	-	-	-	461	461	-	203	203	-
Stage 2	-	-	-	-	-	-	109	810	-	399	463	-
Critical Hdwy	4.14	-	-	5.86	-	-	9.06	6.54	8.46	7.54	6.54	6.94
Critical Hdwy Stg 1	-	-	-	-	-	-	8.06	5.54	-	6.54	5.54	-
Critical Hdwy Stg 2	-	-	-	-	-	-	8.06	5.54	-	6.54	5.54	-
Follow-up Hdwy	2.22	-	-	3.08	-	-	4.28	4.02	4.08	3.52	4.02	3.32
Pot Cap-1 Maneuver	822	-	-	1003	-	-	276	167	788	~ 383	379	943
Stage 1	-	-	-	-	-	-	389	564	-	780	732	-
Stage 2	-	-	-	-	-	-	703	391	-	598	562	-
Platoon blocked, %		-	-	-	-	-						
Mov Cap-1 Maneuver	822	-	-	1003	-	-	197	132	788	~ 318	299	943
Mov Cap-2 Maneuver	-	-	-	-	-	-	197	132	-	~ 318	299	-
Stage 1	-	-	-	-	-	-	310	449	-	621	727	-
Stage 2	-	-	-	-	-	-	595	388	-	471	447	-

Approach	EB			WB			NB			SB		
HCM Control Delay, s	6			0.1			12.7			116.5		
HCM LOS							B			F		

Minor Lane/Major Mvmt	NBLn1	NBLn2	EBL	EBT	EBR	WBL	WBT	WBR	SBLn1	SBLn2	SBLn3
Capacity (veh/h)	197	788	822	-	-	1003	-	-	318	299	943
HCM Lane V/C Ratio	0.012	0.01	0.205	-	-	0.007	-	-	1.21	0.004	0.146
HCM Control Delay (s)	23.5	9.6	10.5	-	-	8.6	-	-	155.1	17.1	9.5
HCM Lane LOS		C	A	B	-	-	A	-	F	C	A
HCM 95th %tile Q(veh)		0	0	0.8	-	-	0	-	16.9	0	0.5

Notes
 ~: Volume exceeds capacity \$: Delay exceeds 300s +: Computation Not Defined *: All major volume in platoon

Timings
13: Sterling Ranch Rd & Marksheffel Rd

Short-Term Total Traffic
PM Peak Hour

Lane Group	EBL	EBT	EBR	WBL	WBT	WBR	NBL	NBT	SBL	SBT	SBR
Lane Configurations											
Traffic Volume (vph)	143	106	2	6	161	516	2	1	327	1	117
Future Volume (vph)	143	106	2	6	161	516	2	1	327	1	117
Turn Type	pm+pt	NA	Perm	pm+pt	NA	Perm	pm+pt	NA	Prot	NA	Perm
Protected Phases	5	2		1	6		3	8	7	4	
Permitted Phases	2		2	6		6	8				4
Detector Phase	5	2	2	1	6	6	3	8	7	4	4
Switch Phase											
Minimum Initial (s)	5.0	15.0	15.0	5.0	15.0	15.0	5.0	10.0	5.0	10.0	10.0
Minimum Split (s)	10.0	23.0	23.0	10.0	23.0	23.0	10.0	23.0	10.0	23.0	23.0
Total Split (s)	10.0	40.0	40.0	10.0	40.0	40.0	10.0	25.0	15.0	30.0	30.0
Total Split (%)	11.1%	44.4%	44.4%	11.1%	44.4%	44.4%	11.1%	27.8%	16.7%	33.3%	33.3%
Yellow Time (s)	3.0	3.0	3.0	3.0	3.0	3.0	3.0	3.0	3.0	3.0	3.0
All-Red Time (s)	2.0	2.0	2.0	2.0	2.0	2.0	2.0	2.0	2.0	2.0	2.0
Lost Time Adjust (s)	0.0	0.0	0.0	0.0	0.0	0.0	0.0	0.0	0.0	0.0	0.0
Total Lost Time (s)	5.0	5.0	5.0	5.0	5.0	5.0	5.0	5.0	5.0	5.0	5.0
Lead/Lag	Lead	Lag	Lag	Lead	Lag	Lag	Lead	Lag	Lead	Lag	Lag
Lead-Lag Optimize?	Yes	Yes	Yes	Yes	Yes	Yes	Yes	Yes	Yes	Yes	Yes
Recall Mode	None	Min	Min	None	Min	Min	None	None	None	None	None
Act Effct Green (s)	25.9	25.1	25.1	21.5	16.4	16.4	6.6	10.2	10.2	11.0	11.0
Actuated g/C Ratio	0.53	0.51	0.51	0.44	0.33	0.33	0.13	0.21	0.21	0.22	0.22
v/c Ratio	0.28	0.07	0.00	0.02	0.16	0.65	0.01	0.04	0.54	0.00	0.30
Control Delay	8.8	9.1	0.0	7.7	13.0	5.5	16.0	14.0	23.1	17.0	6.0
Queue Delay	0.0	0.0	0.0	0.0	0.0	0.0	0.0	0.0	0.0	0.0	0.0
Total Delay	8.8	9.1	0.0	7.7	13.0	5.5	16.0	14.0	23.1	17.0	6.0
LOS	A	A	A	A	B	A	B	B	C	B	A
Approach Delay		8.9			7.3			14.4		18.6	
Approach LOS		A			A			B		B	

Intersection Summary

Cycle Length: 90
 Actuated Cycle Length: 49.3
 Natural Cycle: 70
 Control Type: Actuated-Uncoordinated
 Maximum v/c Ratio: 0.65
 Intersection Signal Delay: 11.3
 Intersection LOS: B
 Intersection Capacity Utilization 60.7%
 ICU Level of Service B
 Analysis Period (min) 15

Splits and Phases: 13: Sterling Ranch Rd & Marksheffel Rd

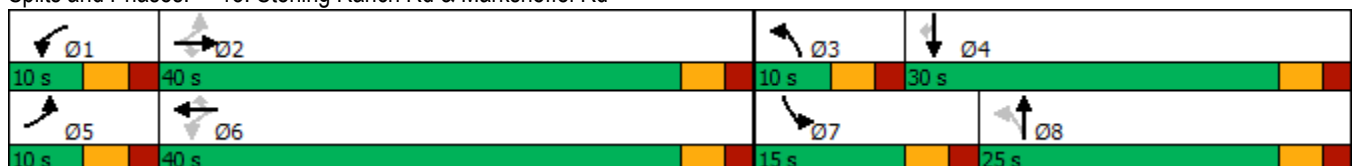

Intersection						
Int Delay, s/veh	8.3					
Movement	EBL	EBT	WBT	WBR	SBL	SBR
Lane Configurations		↑↑	↑↑	↑		↑
Traffic Vol, veh/h	0	0	0	0	0	49
Future Vol, veh/h	0	0	0	0	0	49
Conflicting Peds, #/hr	0	0	0	0	0	0
Sign Control	Free	Free	Free	Free	Stop	Stop
RT Channelized	-	None	-	None	-	None
Storage Length	-	-	-	0	-	0
Veh in Median Storage, #	-	0	0	-	0	-
Grade, %	-	0	0	-	0	-
Peak Hour Factor	85	85	85	85	85	85
Heavy Vehicles, %	2	2	2	2	2	2
Mvmt Flow	0	0	0	0	0	58

Major/Minor	Major1	Major2	Minor2		
Conflicting Flow All	-	0	-	0	- 1
Stage 1	-	-	-	-	-
Stage 2	-	-	-	-	-
Critical Hdwy	-	-	-	-	6.94
Critical Hdwy Stg 1	-	-	-	-	-
Critical Hdwy Stg 2	-	-	-	-	-
Follow-up Hdwy	-	-	-	-	3.32
Pot Cap-1 Maneuver	0	-	-	-	0 1083
Stage 1	0	-	-	-	0 -
Stage 2	0	-	-	-	0 -
Platoon blocked, %	-	-	-	-	-
Mov Cap-1 Maneuver	-	-	-	-	- 1083
Mov Cap-2 Maneuver	-	-	-	-	-
Stage 1	-	-	-	-	-
Stage 2	-	-	-	-	-

Approach	EB	WB	SB
HCM Control Delay, s	0	0	8.5
HCM LOS			A

Minor Lane/Major Mvmt	EBT	WBT	WBR	SBLn1
Capacity (veh/h)	-	-	-	1083
HCM Lane V/C Ratio	-	-	-	0.053
HCM Control Delay (s)	-	-	-	8.5
HCM Lane LOS	-	-	-	A
HCM 95th %tile Q(veh)	-	-	-	0.2

Intersection						
Int Delay, s/veh	1.1					
Movement	WBL	WBR	NBT	NBR	SBL	SBT
Lane Configurations	↙	↗	↑	↗	↙	↑
Traffic Vol, veh/h	17	0	18	99	0	3
Future Vol, veh/h	17	0	18	99	0	3
Conflicting Peds, #/hr	0	0	0	0	0	0
Sign Control	Stop	Stop	Free	Free	Free	Free
RT Channelized	-	None	-	None	-	None
Storage Length	0	200	-	200	200	-
Veh in Median Storage, #	0	-	0	-	-	0
Grade, %	0	-	0	-	-	0
Peak Hour Factor	85	85	85	85	85	85
Heavy Vehicles, %	2	2	2	2	2	2
Mvmt Flow	20	0	21	116	0	4

Major/Minor	Minor1	Major1	Major2		
Conflicting Flow All	25	21	0	0	137
Stage 1	21	-	-	-	-
Stage 2	4	-	-	-	-
Critical Hdwy	6.42	6.22	-	-	4.12
Critical Hdwy Stg 1	5.42	-	-	-	-
Critical Hdwy Stg 2	5.42	-	-	-	-
Follow-up Hdwy	3.518	3.318	-	-	2.218
Pot Cap-1 Maneuver	991	1056	-	-	1447
Stage 1	1002	-	-	-	-
Stage 2	1019	-	-	-	-
Platoon blocked, %			-	-	-
Mov Cap-1 Maneuver	991	1056	-	-	1447
Mov Cap-2 Maneuver	991	-	-	-	-
Stage 1	1002	-	-	-	-
Stage 2	1019	-	-	-	-

Approach	WB	NB	SB
HCM Control Delay, s	8.7	0	0
HCM LOS	A		

Minor Lane/Major Mvmt	NBT	NBRWBLn1	WBLn2	SBL	SBT
Capacity (veh/h)	-	-	991	-	1447
HCM Lane V/C Ratio	-	-	0.02	-	-
HCM Control Delay (s)	-	-	8.7	0	0
HCM Lane LOS	-	-	A	A	A
HCM 95th %tile Q(veh)	-	-	0.1	-	0

Intersection						
Int Delay, s/veh	1.2					
Movement	WBL	WBR	NBT	NBR	SBL	SBT
Lane Configurations	↘	↗	↑	↗	↘	↑
Traffic Vol, veh/h	3	0	0	18	0	0
Future Vol, veh/h	3	0	0	18	0	0
Conflicting Peds, #/hr	0	0	0	0	0	0
Sign Control	Stop	Stop	Free	Free	Free	Free
RT Channelized	-	None	-	None	-	None
Storage Length	0	200	-	200	200	-
Veh in Median Storage, #	0	-	0	-	-	0
Grade, %	0	-	0	-	-	0
Peak Hour Factor	85	85	85	85	85	85
Heavy Vehicles, %	2	2	2	2	2	2
Mvmt Flow	4	0	0	21	0	0

Major/Minor	Minor1	Major1	Major2			
Conflicting Flow All	1	0	0	0	21	0
Stage 1	0	-	-	-	-	-
Stage 2	1	-	-	-	-	-
Critical Hdwy	6.42	6.22	-	-	4.12	-
Critical Hdwy Stg 1	5.42	-	-	-	-	-
Critical Hdwy Stg 2	5.42	-	-	-	-	-
Follow-up Hdwy	3.518	3.318	-	-	2.218	-
Pot Cap-1 Maneuver	1022	-	-	-	1595	-
Stage 1	-	-	-	-	-	-
Stage 2	1022	-	-	-	-	-
Platoon blocked, %						
Mov Cap-1 Maneuver	1022	-	-	-	1595	-
Mov Cap-2 Maneuver	1022	-	-	-	-	-
Stage 1	-	-	-	-	-	-
Stage 2	1022	-	-	-	-	-

Approach	WB	NB	SB
HCM Control Delay, s	8.5	0	0
HCM LOS	A		

Minor Lane/Major Mvmt	NBT	NBRWBLn1	WBLn2	SBL	SBT
Capacity (veh/h)	-	-	1022	-	1595
HCM Lane V/C Ratio	-	-	0.003	-	-
HCM Control Delay (s)	-	-	8.5	0	0
HCM Lane LOS	-	-	A	A	A
HCM 95th %tile Q(veh)	-	-	0	-	0

Intersection					
Intersection Delay, s/veh	13.5				
Intersection LOS	B				
Approach	EB	WB	NB	SB	
Entry Lanes	1	1	1	1	
Conflicting Circle Lanes	1	1	1	1	
Adj Approach Flow, veh/h	147	800	393	279	
Demand Flow Rate, veh/h	150	816	401	285	
Vehicles Circulating, veh/h	434	300	139	685	
Vehicles Exiting, veh/h	536	133	445	431	
Ped Vol Crossing Leg, #/h	0	0	0	0	
Ped Cap Adj	1.000	1.000	1.000	1.000	
Approach Delay, s/veh	5.8	20.5	3.9	11.2	
Approach LOS	A	C	A	B	
Lane	Left	Left	Left	Bypass	Left
Designated Moves	LTR	LTR	LT	R	LTR
Assumed Moves	LTR	LTR	LT	R	LTR
RT Channelized				Free	
Lane Util	1.000	1.000	1.000		1.000
Follow-Up Headway, s	2.609	2.609	2.609		2.609
Critical Headway, s	4.976	4.976	4.976	107	4.976
Entry Flow, veh/h	150	816	294	1938	285
Cap Entry Lane, veh/h	886	1016	1197	0.980	686
Entry HV Adj Factor	0.982	0.980	0.980	105	0.979
Flow Entry, veh/h	147	800	288	1900	279
Cap Entry, veh/h	870	996	1173	0.055	672
V/C Ratio	0.169	0.803	0.246	0.0	0.415
Control Delay, s/veh	5.8	20.5	5.3	A	11.2
LOS	A	C	A	0	B
95th %tile Queue, veh	1	9	1		2

Timings
4: Vollmer Rd & Briargate Pkwy

2045 Background Traffic
AM Peak Hour

Lane Group	EBL	EBT	EBR	WBL	WBT	WBR	NBL	NBT	NBR	SBL	SBT	SBR
Lane Configurations												
Traffic Volume (vph)	70	535	153	231	1016	80	153	132	105	108	311	141
Future Volume (vph)	70	535	153	231	1016	80	153	132	105	108	311	141
Turn Type	pm+pt	NA	Perm	Prot	NA	Perm	pm+pt	NA	Perm	pm+pt	NA	Perm
Protected Phases	5	2		1	6		3	8		7	4	
Permitted Phases	2		2			6	8		8	4		4
Detector Phase	5	2	2	1	6	6	3	8	8	7	4	4
Switch Phase												
Minimum Initial (s)	5.0	15.0	15.0	15.0	15.0	15.0	5.0	5.0	5.0	5.0	5.0	5.0
Minimum Split (s)	10.0	20.0	20.0	20.0	20.0	20.0	10.0	10.0	10.0	10.0	10.0	10.0
Total Split (s)	12.0	57.0	57.0	20.0	65.0	65.0	17.0	28.0	28.0	15.0	26.0	26.0
Total Split (%)	10.0%	47.5%	47.5%	16.7%	54.2%	54.2%	14.2%	23.3%	23.3%	12.5%	21.7%	21.7%
Yellow Time (s)	3.0	3.0	3.0	3.0	3.0	3.0	3.0	3.0	3.0	3.0	3.0	3.0
All-Red Time (s)	2.0	2.0	2.0	2.0	2.0	2.0	2.0	2.0	2.0	2.0	2.0	2.0
Lost Time Adjust (s)	0.0	0.0	0.0	0.0	0.0	0.0	0.0	0.0	0.0	0.0	0.0	0.0
Total Lost Time (s)	5.0	5.0	5.0	5.0	5.0	5.0	5.0	5.0	5.0	5.0	5.0	5.0
Lead/Lag	Lead	Lag	Lag	Lead	Lag	Lag	Lead	Lag	Lag	Lead	Lag	Lag
Lead-Lag Optimize?	Yes	Yes	Yes	Yes	Yes	Yes	Yes	Yes	Yes	Yes	Yes	Yes
Recall Mode	None	Max	Max	None	Max	Max	None	None	None	None	None	None
Act Effct Green (s)	58.8	52.1	52.1	15.0	62.8	62.8	29.3	18.0	18.0	25.4	16.0	16.0
Actuated g/C Ratio	0.51	0.46	0.46	0.13	0.55	0.55	0.26	0.16	0.16	0.22	0.14	0.14
v/c Ratio	0.26	0.34	0.20	0.54	0.55	0.09	0.60	0.24	0.29	0.36	0.66	0.42
Control Delay	12.3	21.4	3.7	52.2	19.5	1.7	42.1	43.2	4.1	34.7	53.4	9.8
Queue Delay	0.0	0.0	0.0	0.0	0.0	0.0	0.0	0.0	0.0	0.0	0.0	0.0
Total Delay	12.3	21.4	3.7	52.2	19.5	1.7	42.1	43.2	4.1	34.7	53.4	9.8
LOS	B	C	A	D	B	A	D	D	A	C	D	A
Approach Delay		16.9			24.1			32.1			38.8	
Approach LOS		B			C			C			D	

Intersection Summary

Cycle Length: 120
 Actuated Cycle Length: 114.5
 Natural Cycle: 60
 Control Type: Actuated-Uncoordinated
 Maximum v/c Ratio: 0.66
 Intersection Signal Delay: 26.1
 Intersection LOS: C
 Intersection Capacity Utilization 66.0%
 ICU Level of Service C
 Analysis Period (min) 15

Splits and Phases: 4: Vollmer Rd & Briargate Pkwy



Timings
5: Sterling Ranch Rd & Briargate Pkwy

2045 Background Traffic
AM Peak Hour

Lane Group	EBL	EBT	EBR	WBL	WBT	WBR	NBL	NBT	NBR	SBL	SBT	SBR
Lane Configurations												
Traffic Volume (vph)	66	605	136	125	912	22	240	80	121	86	172	176
Future Volume (vph)	66	605	136	125	912	22	240	80	121	86	172	176
Turn Type	pm+pt	NA	Perm	pm+pt	NA	Perm	pm+pt	NA	Free	pm+pt	NA	Free
Protected Phases	5	2		1	6		3	8		7	4	
Permitted Phases	2		2	6		6	8		Free	4		Free
Detector Phase	5	2	2	1	6	6	3	8		7	4	
Switch Phase												
Minimum Initial (s)	5.0	5.0	5.0	5.0	5.0	5.0	5.0	20.0		5.0	20.0	
Minimum Split (s)	10.0	10.0	10.0	10.0	10.0	10.0	10.0	25.0		10.0	25.0	
Total Split (s)	12.0	55.0	55.0	12.0	55.0	55.0	21.0	32.0		21.0	32.0	
Total Split (%)	10.0%	45.8%	45.8%	10.0%	45.8%	45.8%	17.5%	26.7%		17.5%	26.7%	
Yellow Time (s)	3.0	3.0	3.0	3.0	3.0	3.0	3.0	3.0		3.0	3.0	
All-Red Time (s)	2.0	2.0	2.0	2.0	2.0	2.0	2.0	2.0		2.0	2.0	
Lost Time Adjust (s)	0.0	0.0	0.0	0.0	0.0	0.0	0.0	0.0		0.0	0.0	
Total Lost Time (s)	5.0	5.0	5.0	5.0	5.0	5.0	5.0	5.0		5.0	5.0	
Lead/Lag	Lead	Lag	Lag	Lead	Lag	Lag	Lead	Lag		Lead	Lag	
Lead-Lag Optimize?	Yes	Yes	Yes	Yes	Yes	Yes	Yes	Yes		Yes	Yes	
Recall Mode	None	C-Max	C-Max	None	C-Max	C-Max	None	Max		None	Max	
Act Effct Green (s)	56.8	50.0	50.0	58.0	52.4	52.4	47.7	33.6	120.0	37.5	28.1	120.0
Actuated g/C Ratio	0.47	0.42	0.42	0.48	0.44	0.44	0.40	0.28	1.00	0.31	0.23	1.00
v/c Ratio	0.29	0.43	0.19	0.38	0.62	0.03	0.57	0.16	0.08	0.20	0.42	0.12
Control Delay	18.0	26.1	4.1	18.8	29.0	0.1	31.0	34.5	0.1	24.6	43.0	0.1
Queue Delay	0.0	0.0	0.0	0.0	0.0	0.0	0.0	0.0	0.0	0.0	0.0	0.0
Total Delay	18.0	26.1	4.1	18.8	29.0	0.1	31.0	34.5	0.1	24.6	43.0	0.1
LOS	B	C	A	B	C	A	C	C	A	C	D	A
Approach Delay		21.7			27.2			23.2			22.0	
Approach LOS		C			C			C			C	

Intersection Summary

Cycle Length: 120
 Actuated Cycle Length: 120
 Offset: 63 (53%), Referenced to phase 2:EBTL and 6:WBTL, Start of Green
 Natural Cycle: 70
 Control Type: Actuated-Coordinated
 Maximum v/c Ratio: 0.62
 Intersection Signal Delay: 24.1
 Intersection LOS: C
 Intersection Capacity Utilization 76.0%
 ICU Level of Service D
 Analysis Period (min) 15

Splits and Phases: 5: Sterling Ranch Rd & Briargate Pkwy

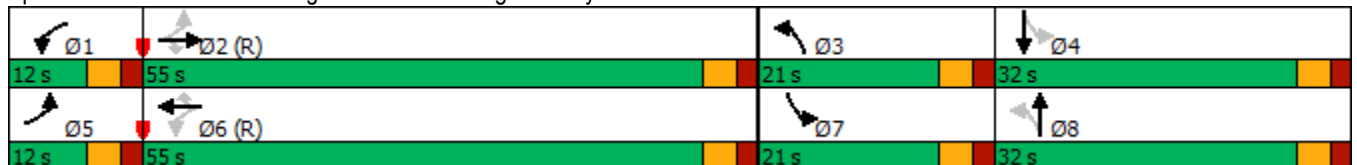

Timings
12: Vollmer Rd & Marksheffel Rd

2045 Background Traffic
AM Peak Hour

Lane Group	EBL	EBT	EBR	WBL	WBT	WBR	NBL	NBT	NBR	SBL	SBT	SBR
Lane Configurations												
Traffic Volume (vph)	69	832	42	162	898	63	108	229	104	121	511	136
Future Volume (vph)	69	832	42	162	898	63	108	229	104	121	511	136
Turn Type	pm+pt	NA	Perm	pm+pt	NA	Perm	pm+pt	NA	Perm	pm+pt	NA	Perm
Protected Phases	5	2		1	6		3	8		7	4	
Permitted Phases	2		2	6		6	8		8	4		4
Detector Phase	5	2	2	1	6	6	3	8	8	7	4	4
Switch Phase												
Minimum Initial (s)	5.0	5.0	5.0	5.0	5.0	5.0	5.0	10.0	10.0	5.0	10.0	10.0
Minimum Split (s)	10.0	23.0	23.0	10.0	23.0	23.0	10.0	23.0	23.0	10.0	23.0	23.0
Total Split (s)	12.0	66.0	66.0	12.0	66.0	66.0	12.0	30.0	30.0	12.0	30.0	30.0
Total Split (%)	10.0%	55.0%	55.0%	10.0%	55.0%	55.0%	10.0%	25.0%	25.0%	10.0%	25.0%	25.0%
Yellow Time (s)	3.0	3.0	3.0	3.0	3.0	3.0	3.0	3.0	3.0	3.0	3.0	3.0
All-Red Time (s)	2.0	2.0	2.0	2.0	2.0	2.0	2.0	2.0	2.0	2.0	2.0	2.0
Lost Time Adjust (s)	0.0	0.0	0.0	0.0	0.0	0.0	0.0	0.0	0.0	0.0	0.0	0.0
Total Lost Time (s)	5.0	5.0	5.0	5.0	5.0	5.0	5.0	5.0	5.0	5.0	5.0	5.0
Lead/Lag	Lead	Lag	Lag	Lead	Lag	Lag	Lead	Lag	Lag	Lead	Lag	Lag
Lead-Lag Optimize?	Yes	Yes	Yes	Yes	Yes	Yes	Yes	Yes	Yes	Yes	Yes	Yes
Recall Mode	None	C-Max	C-Max	None	C-Max	C-Max	None	Max	Max	None	Max	Max
Act Effct Green (s)	67.7	61.0	61.0	69.0	63.4	63.4	32.0	25.0	25.0	32.0	25.0	25.0
Actuated g/C Ratio	0.56	0.51	0.51	0.58	0.53	0.53	0.27	0.21	0.21	0.27	0.21	0.21
v/c Ratio	0.23	0.49	0.05	0.52	0.51	0.07	0.60	0.33	0.26	0.40	0.73	0.33
Control Delay	11.6	20.4	0.1	16.3	11.2	0.3	46.0	41.8	8.9	36.1	51.0	9.3
Queue Delay	0.0	0.0	0.0	0.0	0.0	0.0	0.0	0.0	0.0	0.0	0.0	0.0
Total Delay	11.6	20.4	0.1	16.3	11.2	0.3	46.0	41.8	8.9	36.1	51.0	9.3
LOS	B	C	A	B	B	A	D	D	A	D	D	A
Approach Delay		18.9			11.3			35.1			41.3	
Approach LOS		B			B			D			D	

Intersection Summary

Cycle Length: 120
 Actuated Cycle Length: 120
 Offset: 0 (0%), Referenced to phase 2:EBTL and 6:WBTL, Start of Green
 Natural Cycle: 70
 Control Type: Actuated-Coordinated
 Maximum v/c Ratio: 0.73
 Intersection Signal Delay: 23.7
 Intersection LOS: C
 Intersection Capacity Utilization 68.7%
 ICU Level of Service C
 Analysis Period (min) 15

Splits and Phases: 12: Vollmer Rd & Marksheffel Rd

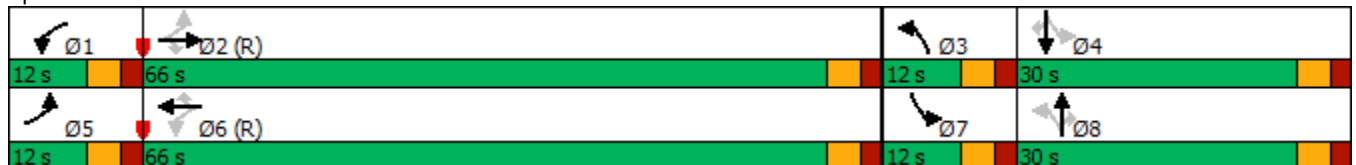

Timings
13: Sterling Ranch Rd & Marksheffel Rd

2045 Background Traffic
AM Peak Hour

Lane Group	EBL	EBT	EBR	WBL	WBT	WBR	NBL	NBT	SBL	SBT	SBR
Lane Configurations											
Traffic Volume (vph)	142	884	12	53	807	174	7	2	489	9	308
Future Volume (vph)	142	884	12	53	807	174	7	2	489	9	308
Turn Type	pm+pt	NA	Perm	pm+pt	NA	Perm	pm+pt	NA	Prot	NA	Perm
Protected Phases	5	2		1	6		3	8	7	4	
Permitted Phases	2		2	6		6	8				4
Detector Phase	5	2	2	1	6	6	3	8	7	4	4
Switch Phase											
Minimum Initial (s)	5.0	15.0	15.0	5.0	15.0	15.0	5.0	10.0	20.0	10.0	10.0
Minimum Split (s)	10.0	20.0	20.0	10.0	20.0	20.0	10.0	15.0	25.0	20.0	20.0
Total Split (s)	12.0	51.0	51.0	12.0	51.0	51.0	12.0	25.0	32.0	45.0	45.0
Total Split (%)	10.0%	42.5%	42.5%	10.0%	42.5%	42.5%	10.0%	20.8%	26.7%	37.5%	37.5%
Yellow Time (s)	3.0	3.0	3.0	3.0	3.0	3.0	3.0	3.0	3.0	3.0	3.0
All-Red Time (s)	2.0	2.0	2.0	2.0	2.0	2.0	2.0	2.0	2.0	2.0	2.0
Lost Time Adjust (s)	0.0	0.0	0.0	0.0	0.0	0.0	0.0	0.0	0.0	0.0	0.0
Total Lost Time (s)	5.0	5.0	5.0	5.0	5.0	5.0	5.0	5.0	5.0	5.0	5.0
Lead/Lag	Lead	Lag	Lag	Lead	Lag	Lag	Lead	Lag	Lead	Lag	Lag
Lead-Lag Optimize?	Yes	Yes	Yes	Yes	Yes	Yes	Yes	Yes	Yes	Yes	Yes
Recall Mode	None	C-Max	C-Max	None	C-Max	C-Max	None	None	None	None	None
Act Effct Green (s)	81.8	74.0	74.0	76.4	69.6	69.6	8.0	10.0	23.3	23.9	23.9
Actuated g/C Ratio	0.68	0.62	0.62	0.64	0.58	0.58	0.07	0.08	0.19	0.20	0.20
v/c Ratio	0.35	0.43	0.01	0.15	0.41	0.18	0.06	0.06	0.77	0.02	0.59
Control Delay	12.3	11.6	0.0	8.8	16.5	3.2	41.1	33.0	54.3	36.1	11.1
Queue Delay	0.0	0.0	0.0	0.0	0.0	0.0	0.0	0.0	0.0	0.0	0.0
Total Delay	12.3	11.6	0.0	8.8	16.5	3.2	41.1	33.0	54.3	36.1	11.1
LOS	B	B	A	A	B	A	D	C	D	D	B
Approach Delay		11.6			13.9			36.6		37.6	
Approach LOS		B			B			D		D	

Intersection Summary

Cycle Length: 120
 Actuated Cycle Length: 120
 Offset: 0 (0%), Referenced to phase 2:EBTL and 6:WBTL, Start of Green
 Natural Cycle: 75
 Control Type: Actuated-Coordinated
 Maximum v/c Ratio: 0.77
 Intersection Signal Delay: 19.8
 Intersection LOS: B
 Intersection Capacity Utilization 63.3%
 ICU Level of Service B
 Analysis Period (min) 15

Splits and Phases: 13: Sterling Ranch Rd & Marksheffel Rd

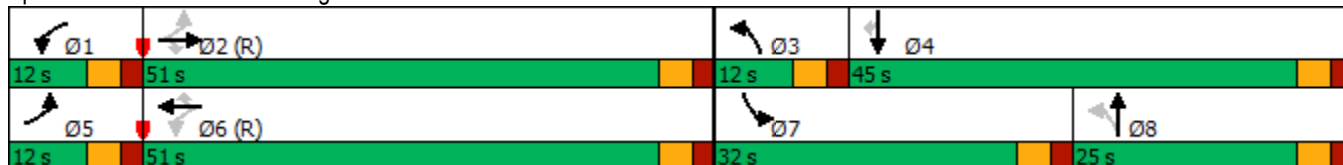

Intersection						
Int Delay, s/veh	0.3					
Movement	EBL	EBT	WBT	WBR	SBL	SBR
Lane Configurations		↑↑	↑↑	↑		↑
Traffic Vol, veh/h	0	812	1020	4	0	39
Future Vol, veh/h	0	812	1020	4	0	39
Conflicting Peds, #/hr	0	0	0	0	0	0
Sign Control	Free	Free	Free	Free	Stop	Stop
RT Channelized	-	None	-	None	-	None
Storage Length	-	-	-	200	-	0
Veh in Median Storage, #	-	0	0	-	0	-
Grade, %	-	0	0	-	0	-
Peak Hour Factor	95	95	95	95	95	95
Heavy Vehicles, %	2	2	2	2	2	2
Mvmt Flow	0	855	1074	4	0	41

Major/Minor	Major1	Major2	Minor2		
Conflicting Flow All	-	0	-	0	537
Stage 1	-	-	-	-	-
Stage 2	-	-	-	-	-
Critical Hdwy	-	-	-	-	6.94
Critical Hdwy Stg 1	-	-	-	-	-
Critical Hdwy Stg 2	-	-	-	-	-
Follow-up Hdwy	-	-	-	-	3.32
Pot Cap-1 Maneuver	0	-	-	-	488
Stage 1	0	-	-	-	-
Stage 2	0	-	-	-	-
Platoon blocked, %	-	-	-	-	-
Mov Cap-1 Maneuver	-	-	-	-	488
Mov Cap-2 Maneuver	-	-	-	-	-
Stage 1	-	-	-	-	-
Stage 2	-	-	-	-	-

Approach	EB	WB	SB
HCM Control Delay, s	0	0	13.1
HCM LOS			B

Minor Lane/Major Mvmt	EBT	WBT	WBR	SBLn1
Capacity (veh/h)	-	-	-	488
HCM Lane V/C Ratio	-	-	-	0.084
HCM Control Delay (s)	-	-	-	13.1
HCM Lane LOS	-	-	-	B
HCM 95th %tile Q(veh)	-	-	-	0.3

Intersection												
Int Delay, s/veh	2.9											
Movement	EBL	EBT	EBR	WBL	WBT	WBR	NBL	NBT	NBR	SBL	SBT	SBR
Lane Configurations		↕			↕		↗	↑	↖	↗	↖	↖
Traffic Vol, veh/h	0	0	108	0	0	0	34	104	0	0	226	0
Future Vol, veh/h	0	0	108	0	0	0	34	104	0	0	226	0
Conflicting Peds, #/hr	0	0	0	0	0	0	0	0	0	0	0	0
Sign Control	Stop	Stop	Stop	Stop	Stop	Stop	Free	Free	Free	Free	Free	Free
RT Channelized	-	-	None	-	-	None	-	-	None	-	-	None
Storage Length	-	-	-	-	-	-	200	-	200	200	-	-
Veh in Median Storage, #	-	0	-	-	0	-	-	0	-	-	0	-
Grade, %	-	0	-	-	0	-	-	0	-	-	0	-
Peak Hour Factor	95	95	95	95	95	95	95	95	95	95	95	95
Heavy Vehicles, %	2	2	2	2	2	2	2	2	2	2	2	2
Mvmt Flow	0	0	114	0	0	0	36	109	0	0	238	0

Major/Minor	Minor2		Minor1		Major1		Major2					
Conflicting Flow All	419	419	238	476	419	109	238	0	0	109	0	0
Stage 1	238	238	-	181	181	-	-	-	-	-	-	-
Stage 2	181	181	-	295	238	-	-	-	-	-	-	-
Critical Hdwy	7.12	6.52	6.22	7.12	6.52	6.22	4.12	-	-	4.12	-	-
Critical Hdwy Stg 1	6.12	5.52	-	6.12	5.52	-	-	-	-	-	-	-
Critical Hdwy Stg 2	6.12	5.52	-	6.12	5.52	-	-	-	-	-	-	-
Follow-up Hdwy	3.518	4.018	3.318	3.518	4.018	3.318	2.218	-	-	2.218	-	-
Pot Cap-1 Maneuver	544	525	801	499	525	945	1329	-	-	1481	-	-
Stage 1	765	708	-	821	750	-	-	-	-	-	-	-
Stage 2	821	750	-	713	708	-	-	-	-	-	-	-
Platoon blocked, %								-	-	-	-	-
Mov Cap-1 Maneuver	533	511	801	419	511	945	1329	-	-	1481	-	-
Mov Cap-2 Maneuver	533	511	-	419	511	-	-	-	-	-	-	-
Stage 1	744	708	-	799	730	-	-	-	-	-	-	-
Stage 2	799	730	-	612	708	-	-	-	-	-	-	-

Approach	EB	WB	NB	SB
HCM Control Delay, s	10.2	0	1.9	0
HCM LOS	B	A		

Minor Lane/Major Mvmt	NBL	NBT	NBR	EBLn1	WBLn1	SBL	SBT	SBR
Capacity (veh/h)	1329	-	-	801	-	1481	-	-
HCM Lane V/C Ratio	0.027	-	-	0.142	-	-	-	-
HCM Control Delay (s)	7.8	-	-	10.2	0	0	-	-
HCM Lane LOS	A	-	-	B	A	A	-	-
HCM 95th %tile Q(veh)	0.1	-	-	0.5	-	0	-	-

Intersection						
Int Delay, s/veh	4.5					
Movement	WBL	WBR	NBT	NBR	SBL	SBT
Lane Configurations	↘	↗	↑	↗	↘	↑
Traffic Vol, veh/h	61	47	58	46	135	165
Future Vol, veh/h	61	47	58	46	135	165
Conflicting Peds, #/hr	0	0	0	0	0	0
Sign Control	Stop	Stop	Free	Free	Free	Free
RT Channelized	-	None	-	None	-	None
Storage Length	0	200	-	200	200	-
Veh in Median Storage, #	0	-	0	-	-	0
Grade, %	0	-	0	-	-	0
Peak Hour Factor	95	95	95	95	95	95
Heavy Vehicles, %	2	2	2	2	2	2
Mvmt Flow	64	49	61	48	142	174

Major/Minor	Minor1	Major1	Major2		
Conflicting Flow All	519	61	0	0	109
Stage 1	61	-	-	-	-
Stage 2	458	-	-	-	-
Critical Hdwy	6.42	6.22	-	-	4.12
Critical Hdwy Stg 1	5.42	-	-	-	-
Critical Hdwy Stg 2	5.42	-	-	-	-
Follow-up Hdwy	3.518	3.318	-	-	2.218
Pot Cap-1 Maneuver	517	1004	-	-	1481
Stage 1	962	-	-	-	-
Stage 2	637	-	-	-	-
Platoon blocked, %			-	-	-
Mov Cap-1 Maneuver	467	1004	-	-	1481
Mov Cap-2 Maneuver	467	-	-	-	-
Stage 1	962	-	-	-	-
Stage 2	576	-	-	-	-

Approach	WB	NB	SB
HCM Control Delay, s	11.7	0	3.5
HCM LOS	B		

Minor Lane/Major Mvmt	NBT	NBRWBLn1	WBLn2	SBL	SBT
Capacity (veh/h)	-	-	467	1004	1481
HCM Lane V/C Ratio	-	-	0.137	0.049	0.096
HCM Control Delay (s)	-	-	13.9	8.8	7.7
HCM Lane LOS	-	-	B	A	A
HCM 95th %tile Q(veh)	-	-	0.5	0.2	0.3

Intersection					
Intersection Delay, s/veh	13.6				
Intersection LOS	B				
Approach	EB	WB	NB	SB	
Entry Lanes	1	1	1	1	
Conflicting Circle Lanes	1	1	1	1	
Adj Approach Flow, veh/h	423	347	780	433	
Demand Flow Rate, veh/h	431	353	796	442	
Vehicles Circulating, veh/h	534	622	558	372	
Vehicles Exiting, veh/h	279	539	407	603	
Ped Vol Crossing Leg, #/h	0	0	0	0	
Ped Cap Adj	1.000	1.000	1.000	1.000	
Approach Delay, s/veh	12.5	12.0	17.1	9.6	
Approach LOS	B	B	C	A	
Lane	Left	Left	Left	Bypass	Left
Designated Moves	LTR	LTR	LT	R	LTR
Assumed Moves	LTR	LTR	LT	R	LTR
RT Channelized				Free	
Lane Util	1.000	1.000	1.000		1.000
Follow-Up Headway, s	2.609	2.609	2.609		2.609
Critical Headway, s	4.976	4.976	4.976	193	4.976
Entry Flow, veh/h	431	353	603	1938	442
Cap Entry Lane, veh/h	800	732	781	0.980	944
Entry HV Adj Factor	0.982	0.982	0.980	189	0.979
Flow Entry, veh/h	423	347	591	1900	433
Cap Entry, veh/h	786	719	765	0.099	924
V/C Ratio	0.538	0.482	0.772	0.0	0.468
Control Delay, s/veh	12.5	12.0	22.6	A	9.6
LOS	B	B	C	0	A
95th %tile Queue, veh	3	3	8		3

Timings
4: Vollmer Rd & Briargate Pkwy

2045 Background Traffic
PM Peak Hour

Lane Group	EBL	EBT	EBR	WBL	WBT	WBR	NBL	NBT	NBR	SBL	SBT	SBR
Lane Configurations												
Traffic Volume (vph)	230	977	176	193	726	66	291	417	264	93	213	120
Future Volume (vph)	230	977	176	193	726	66	291	417	264	93	213	120
Turn Type	pm+pt	NA	Perm	Prot	NA	Perm	pm+pt	NA	Perm	pm+pt	NA	Perm
Protected Phases	5	2		1	6		3	8		7	4	
Permitted Phases	2		2			6	8		8	4		4
Detector Phase	5	2	2	1	6	6	3	8	8	7	4	4
Switch Phase												
Minimum Initial (s)	5.0	15.0	15.0	15.0	15.0	15.0	8.0	5.0	5.0	5.0	5.0	5.0
Minimum Split (s)	10.0	20.0	20.0	20.0	20.0	20.0	13.0	10.0	10.0	10.0	10.0	10.0
Total Split (s)	12.0	53.0	53.0	20.0	61.0	61.0	22.0	28.0	28.0	19.0	25.0	25.0
Total Split (%)	10.0%	44.2%	44.2%	16.7%	50.8%	50.8%	18.3%	23.3%	23.3%	15.8%	20.8%	20.8%
Yellow Time (s)	3.0	3.0	3.0	3.0	3.0	3.0	3.0	3.0	3.0	3.0	3.0	3.0
All-Red Time (s)	2.0	2.0	2.0	2.0	2.0	2.0	2.0	2.0	2.0	2.0	2.0	2.0
Lost Time Adjust (s)	0.0	0.0	0.0	0.0	0.0	0.0	0.0	0.0	0.0	0.0	0.0	0.0
Total Lost Time (s)	5.0	5.0	5.0	5.0	5.0	5.0	5.0	5.0	5.0	5.0	5.0	5.0
Lead/Lag	Lead	Lag	Lag	Lead	Lag	Lag	Lead	Lag	Lag	Lead	Lag	Lag
Lead-Lag Optimize?	Yes	Yes	Yes	Yes	Yes	Yes	Yes	Yes	Yes	Yes	Yes	Yes
Recall Mode	None	Max	Max	None	Max	Max	None	None	None	None	None	None
Act Effct Green (s)	55.1	48.1	48.1	15.0	56.1	56.1	35.0	20.2	20.2	24.0	13.8	13.8
Actuated g/C Ratio	0.49	0.42	0.42	0.13	0.49	0.49	0.31	0.18	0.18	0.21	0.12	0.12
v/c Ratio	0.65	0.67	0.24	0.45	0.44	0.08	0.82	0.68	0.55	0.38	0.52	0.38
Control Delay	24.3	29.6	4.2	49.8	20.1	1.1	51.4	49.8	9.2	33.0	50.9	7.1
Queue Delay	0.0	0.0	0.0	0.0	0.0	0.0	0.0	0.0	0.0	0.0	0.0	0.0
Total Delay	24.3	29.6	4.2	49.8	20.1	1.1	51.4	49.8	9.2	33.0	50.9	7.1
LOS	C	C	A	D	C	A	D	D	A	C	D	A
Approach Delay		25.4			24.7			39.1			34.7	
Approach LOS		C			C			D			C	

Intersection Summary

Cycle Length: 120
 Actuated Cycle Length: 113.5
 Natural Cycle: 75
 Control Type: Actuated-Uncoordinated
 Maximum v/c Ratio: 0.82
 Intersection Signal Delay: 29.8
 Intersection LOS: C
 Intersection Capacity Utilization 78.2%
 ICU Level of Service D
 Analysis Period (min) 15

Splits and Phases: 4: Vollmer Rd & Briargate Pkwy



Timings
12: Vollmer Rd & Marksheffel Rd

2045 Background Traffic
PM Peak Hour

Lane Group	EBL	EBT	EBR	WBL	WBT	WBR	NBL	NBT	NBR	SBL	SBT	SBR
Lane Configurations												
Traffic Volume (vph)	140	913	89	186	700	149	169	714	176	126	319	197
Future Volume (vph)	140	913	89	186	700	149	169	714	176	126	319	197
Turn Type	pm+pt	NA	Perm	pm+pt	NA	Perm	pm+pt	NA	Perm	pm+pt	NA	Perm
Protected Phases	5	2		1	6		3	8		7	4	
Permitted Phases	2		2	6		6	8		8	4		4
Detector Phase	5	2	2	1	6	6	3	8	8	7	4	4
Switch Phase												
Minimum Initial (s)	5.0	5.0	5.0	5.0	5.0	5.0	5.0	10.0	10.0	5.0	10.0	10.0
Minimum Split (s)	10.0	23.0	23.0	10.0	23.0	23.0	10.0	23.0	23.0	10.0	23.0	23.0
Total Split (s)	20.0	50.0	50.0	19.0	49.0	49.0	15.0	36.0	36.0	15.0	36.0	36.0
Total Split (%)	16.7%	41.7%	41.7%	15.8%	40.8%	40.8%	12.5%	30.0%	30.0%	12.5%	30.0%	30.0%
Yellow Time (s)	3.0	3.0	3.0	3.0	3.0	3.0	3.0	3.0	3.0	3.0	3.0	3.0
All-Red Time (s)	2.0	2.0	2.0	2.0	2.0	2.0	2.0	2.0	2.0	2.0	2.0	2.0
Lost Time Adjust (s)	0.0	0.0	0.0	0.0	0.0	0.0	0.0	0.0	0.0	0.0	0.0	0.0
Total Lost Time (s)	5.0	5.0	5.0	5.0	5.0	5.0	5.0	5.0	5.0	5.0	5.0	5.0
Lead/Lag	Lead	Lag	Lag	Lead	Lag	Lag	Lead	Lag	Lag	Lead	Lag	Lag
Lead-Lag Optimize?	Yes	Yes	Yes	Yes	Yes	Yes	Yes	Yes	Yes	Yes	Yes	Yes
Recall Mode	None	C-Max	C-Max	None	C-Max	C-Max	None	Max	Max	None	Max	Max
Act Effct Green (s)	57.6	47.0	47.0	60.4	48.4	48.4	41.3	31.4	31.4	40.7	31.2	31.2
Actuated g/C Ratio	0.48	0.39	0.39	0.50	0.40	0.40	0.34	0.26	0.26	0.34	0.26	0.26
v/c Ratio	0.42	0.69	0.14	0.69	0.52	0.22	0.48	0.81	0.36	0.65	0.37	0.37
Control Delay	18.4	34.1	3.8	48.3	22.1	5.2	30.8	49.7	13.2	40.2	37.8	6.7
Queue Delay	0.0	0.0	0.0	0.0	0.0	0.0	0.0	0.0	0.0	0.0	0.0	0.0
Total Delay	18.4	34.1	3.8	48.3	22.1	5.2	30.8	49.7	13.2	40.2	37.8	6.7
LOS	B	C	A	D	C	A	C	D	B	D	D	A
Approach Delay		29.8			24.4			40.6			28.7	
Approach LOS		C			C			D			C	

Intersection Summary

Cycle Length: 120
 Actuated Cycle Length: 120
 Offset: 0 (0%), Referenced to phase 2:EBTL and 6:WBTL, Start of Green
 Natural Cycle: 70
 Control Type: Actuated-Coordinated
 Maximum v/c Ratio: 0.81
 Intersection Signal Delay: 31.1
 Intersection Capacity Utilization 78.9%
 Analysis Period (min) 15

Splits and Phases: 12: Vollmer Rd & Marksheffel Rd

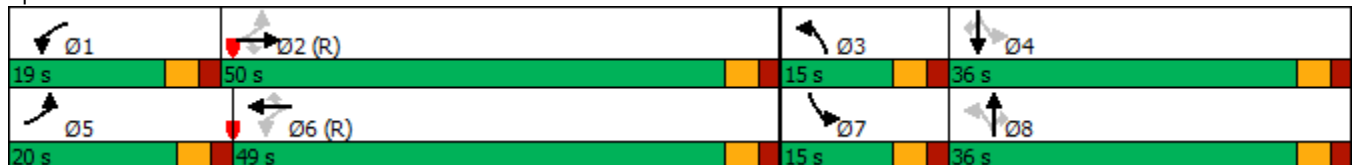

Timings
13: Sterling Ranch Rd & Marksheffel Rd

2045 Background Traffic
PM Peak Hour

Lane Group	EBL	EBT	EBR	WBL	WBT	WBR	NBL	NBT	SBL	SBT	SBR
Lane Configurations											
Traffic Volume (vph)	295	940	6	62	838	549	18	4	333	17	179
Future Volume (vph)	295	940	6	62	838	549	18	4	333	17	179
Turn Type	pm+pt	NA	Perm	pm+pt	NA	Perm	pm+pt	NA	Prot	NA	Perm
Protected Phases	5	2		1	6		3	8	7	4	
Permitted Phases	2		2	6		6	8				4
Detector Phase	5	2	2	1	6	6	3	8	7	4	4
Switch Phase											
Minimum Initial (s)	5.0	15.0	15.0	5.0	15.0	15.0	5.0	10.0	20.0	10.0	10.0
Minimum Split (s)	10.0	20.0	20.0	10.0	20.0	20.0	10.0	15.0	25.0	20.0	20.0
Total Split (s)	20.0	68.0	68.0	12.0	60.0	60.0	10.0	15.0	25.0	30.0	30.0
Total Split (%)	16.7%	56.7%	56.7%	10.0%	50.0%	50.0%	8.3%	12.5%	20.8%	25.0%	25.0%
Yellow Time (s)	3.0	3.0	3.0	3.0	3.0	3.0	3.0	3.0	3.0	3.0	3.0
All-Red Time (s)	2.0	2.0	2.0	2.0	2.0	2.0	2.0	2.0	2.0	2.0	2.0
Lost Time Adjust (s)	0.0	0.0	0.0	0.0	0.0	0.0	0.0	0.0	0.0	0.0	0.0
Total Lost Time (s)	5.0	5.0	5.0	5.0	5.0	5.0	5.0	5.0	5.0	5.0	5.0
Lead/Lag	Lead	Lag	Lag	Lead	Lag	Lag	Lead	Lag	Lead	Lag	Lag
Lead-Lag Optimize?	Yes	Yes	Yes	Yes	Yes	Yes	Yes	Yes	Yes	Yes	Yes
Recall Mode	None	C-Max	C-Max	None	C-Max	C-Max	None	None	None	None	None
Act Effct Green (s)	81.0	71.6	71.6	69.4	62.9	62.9	11.0	10.0	20.0	25.0	25.0
Actuated g/C Ratio	0.68	0.60	0.60	0.58	0.52	0.52	0.09	0.08	0.17	0.21	0.21
v/c Ratio	0.73	0.47	0.01	0.19	0.48	0.52	0.13	0.18	0.61	0.05	0.39
Control Delay	38.4	9.7	0.0	10.2	20.8	3.5	35.7	24.2	51.6	37.5	8.1
Queue Delay	0.0	0.0	0.0	0.0	0.0	0.0	0.0	0.0	0.0	0.0	0.0
Total Delay	38.4	9.7	0.0	10.2	20.8	3.5	35.7	24.2	51.6	37.5	8.1
LOS	D	A	A	B	C	A	D	C	D	D	A
Approach Delay		16.5			13.8			28.8		36.5	
Approach LOS		B			B			C		D	

Intersection Summary

Cycle Length: 120
 Actuated Cycle Length: 120
 Offset: 0 (0%), Referenced to phase 2:EBTL and 6:WBTL, Start of Green
 Natural Cycle: 90
 Control Type: Actuated-Coordinated
 Maximum v/c Ratio: 0.73
 Intersection Signal Delay: 18.7
 Intersection LOS: B
 Intersection Capacity Utilization 71.2%
 ICU Level of Service C
 Analysis Period (min) 15

Splits and Phases: 13: Sterling Ranch Rd & Marksheffel Rd

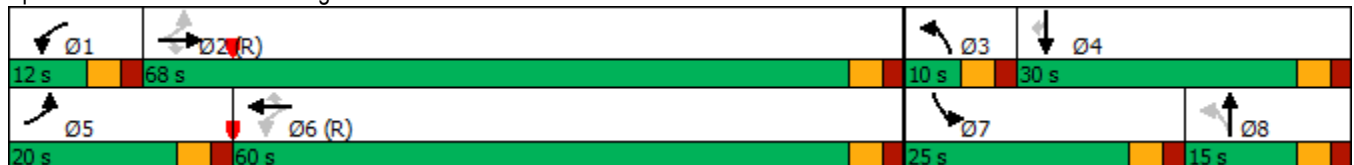

Intersection						
Int Delay, s/veh	0.1					
Movement	EBL	EBT	WBT	WBR	SBL	SBR
Lane Configurations		↑↑	↑↑	↑		↑
Traffic Vol, veh/h	0	1052	1023	16	0	22
Future Vol, veh/h	0	1052	1023	16	0	22
Conflicting Peds, #/hr	0	0	0	0	0	0
Sign Control	Free	Free	Free	Free	Stop	Stop
RT Channelized	-	None	-	None	-	None
Storage Length	-	-	-	200	-	0
Veh in Median Storage, #	-	0	0	-	0	-
Grade, %	-	0	0	-	0	-
Peak Hour Factor	95	95	95	95	95	95
Heavy Vehicles, %	2	2	2	2	2	2
Mvmt Flow	0	1107	1077	17	0	23

Major/Minor	Major1	Major2	Minor2		
Conflicting Flow All	-	0	-	0	539
Stage 1	-	-	-	-	-
Stage 2	-	-	-	-	-
Critical Hdwy	-	-	-	-	6.94
Critical Hdwy Stg 1	-	-	-	-	-
Critical Hdwy Stg 2	-	-	-	-	-
Follow-up Hdwy	-	-	-	-	3.32
Pot Cap-1 Maneuver	0	-	-	-	487
Stage 1	0	-	-	-	-
Stage 2	0	-	-	-	-
Platoon blocked, %	-	-	-	-	-
Mov Cap-1 Maneuver	-	-	-	-	487
Mov Cap-2 Maneuver	-	-	-	-	-
Stage 1	-	-	-	-	-
Stage 2	-	-	-	-	-

Approach	EB	WB	SB
HCM Control Delay, s	0	0	12.8
HCM LOS			B

Minor Lane/Major Mvmt	EBT	WBT	WBR	SBLn1
Capacity (veh/h)	-	-	-	487
HCM Lane V/C Ratio	-	-	-	0.048
HCM Control Delay (s)	-	-	-	12.8
HCM Lane LOS	-	-	-	B
HCM 95th %tile Q(veh)	-	-	-	0.1

Intersection												
Int Delay, s/veh	2.5											
Movement	EBL	EBT	EBR	WBL	WBT	WBR	NBL	NBT	NBR	SBL	SBT	SBR
Lane Configurations		↕			↕		↗	↖	↗	↖	↖	↗
Traffic Vol, veh/h	0	0	70	0	0	0	115	291	0	0	130	0
Future Vol, veh/h	0	0	70	0	0	0	115	291	0	0	130	0
Conflicting Peds, #/hr	0	0	0	0	0	0	0	0	0	0	0	0
Sign Control	Stop	Stop	Stop	Stop	Stop	Stop	Free	Free	Free	Free	Free	Free
RT Channelized	-	-	None	-	-	None	-	-	None	-	-	None
Storage Length	-	-	-	-	-	-	200	-	200	200	-	-
Veh in Median Storage, #	-	0	-	-	0	-	-	0	-	-	0	-
Grade, %	-	0	-	-	0	-	-	0	-	-	0	-
Peak Hour Factor	95	95	95	95	95	95	95	95	95	95	95	95
Heavy Vehicles, %	2	2	2	2	2	2	2	2	2	2	2	2
Mvmt Flow	0	0	74	0	0	0	121	306	0	0	137	0

Major/Minor	Minor2		Minor1		Major1		Major2					
Conflicting Flow All	685	685	137	722	685	306	137	0	0	306	0	0
Stage 1	137	137	-	548	548	-	-	-	-	-	-	-
Stage 2	548	548	-	174	137	-	-	-	-	-	-	-
Critical Hdwy	7.12	6.52	6.22	7.12	6.52	6.22	4.12	-	-	4.12	-	-
Critical Hdwy Stg 1	6.12	5.52	-	6.12	5.52	-	-	-	-	-	-	-
Critical Hdwy Stg 2	6.12	5.52	-	6.12	5.52	-	-	-	-	-	-	-
Follow-up Hdwy	3.518	4.018	3.318	3.518	4.018	3.318	2.218	-	-	2.218	-	-
Pot Cap-1 Maneuver	362	371	911	342	371	734	1447	-	-	1255	-	-
Stage 1	866	783	-	521	517	-	-	-	-	-	-	-
Stage 2	521	517	-	828	783	-	-	-	-	-	-	-
Platoon blocked, %								-	-	-	-	-
Mov Cap-1 Maneuver	339	340	911	294	340	734	1447	-	-	1255	-	-
Mov Cap-2 Maneuver	339	340	-	294	340	-	-	-	-	-	-	-
Stage 1	793	783	-	477	474	-	-	-	-	-	-	-
Stage 2	477	474	-	761	783	-	-	-	-	-	-	-

Approach	EB	WB	NB	SB
HCM Control Delay, s	9.3	0	2.2	0
HCM LOS	A	A		

Minor Lane/Major Mvmt	NBL	NBT	NBR	EBLn1	WBLn1	SBL	SBT	SBR
Capacity (veh/h)	1447	-	-	911	-	1255	-	-
HCM Lane V/C Ratio	0.084	-	-	0.081	-	-	-	-
HCM Control Delay (s)	7.7	-	-	9.3	0	0	-	-
HCM Lane LOS	A	-	-	A	A	A	-	-
HCM 95th %tile Q(veh)	0.3	-	-	0.3	-	0	-	-

Intersection						
Int Delay, s/veh	4.4					
Movement	WBL	WBR	NBT	NBR	SBL	SBT
Lane Configurations	↘	↗	↑	↗	↘	↑
Traffic Vol, veh/h	35	174	163	129	107	95
Future Vol, veh/h	35	174	163	129	107	95
Conflicting Peds, #/hr	0	0	0	0	0	0
Sign Control	Stop	Stop	Free	Free	Free	Free
RT Channelized	-	None	-	None	-	None
Storage Length	0	200	-	200	200	-
Veh in Median Storage, #	0	-	0	-	-	0
Grade, %	0	-	0	-	-	0
Peak Hour Factor	95	95	95	95	95	95
Heavy Vehicles, %	2	2	2	2	2	2
Mvmt Flow	37	183	172	136	113	100

Major/Minor	Minor1	Major1	Major2		
Conflicting Flow All	498	172	0	0	308
Stage 1	172	-	-	-	-
Stage 2	326	-	-	-	-
Critical Hdwy	6.42	6.22	-	-	4.12
Critical Hdwy Stg 1	5.42	-	-	-	-
Critical Hdwy Stg 2	5.42	-	-	-	-
Follow-up Hdwy	3.518	3.318	-	-	2.218
Pot Cap-1 Maneuver	532	872	-	-	1253
Stage 1	858	-	-	-	-
Stage 2	731	-	-	-	-
Platoon blocked, %			-	-	-
Mov Cap-1 Maneuver	484	872	-	-	1253
Mov Cap-2 Maneuver	484	-	-	-	-
Stage 1	858	-	-	-	-
Stage 2	665	-	-	-	-

Approach	WB	NB	SB
HCM Control Delay, s	10.7	0	4.3
HCM LOS	B		

Minor Lane/Major Mvmt	NBT	NBRWBLn1	WBLn2	SBL	SBT
Capacity (veh/h)	-	-	484	872	1253
HCM Lane V/C Ratio	-	-	0.076	0.21	0.09
HCM Control Delay (s)	-	-	13.1	10.2	8.2
HCM Lane LOS	-	-	B	B	A
HCM 95th %tile Q(veh)	-	-	0.2	0.8	0.3

Intersection					
Intersection Delay, s/veh	13.6				
Intersection LOS	B				
Approach	EB	WB	NB	SB	
Entry Lanes	1	1	1	1	
Conflicting Circle Lanes	1	1	1	1	
Adj Approach Flow, veh/h	147	800	396	280	
Demand Flow Rate, veh/h	150	816	404	286	
Vehicles Circulating, veh/h	435	303	139	686	
Vehicles Exiting, veh/h	537	133	446	433	
Ped Vol Crossing Leg, #/h	0	0	0	0	
Ped Cap Adj	1.000	1.000	1.000	1.000	
Approach Delay, s/veh	5.8	20.7	3.9	11.2	
Approach LOS	A	C	A	B	
Lane	Left	Left	Left	Bypass	Left
Designated Moves	LTR	LTR	LT	R	LTR
Assumed Moves	LTR	LTR	LT	R	LTR
RT Channelized				Free	
Lane Util	1.000	1.000	1.000		1.000
Follow-Up Headway, s	2.609	2.609	2.609		2.609
Critical Headway, s	4.976	4.976	4.976	107	4.976
Entry Flow, veh/h	150	816	297	1938	286
Cap Entry Lane, veh/h	885	1013	1197	0.980	685
Entry HV Adj Factor	0.982	0.980	0.980	105	0.979
Flow Entry, veh/h	147	800	291	1900	280
Cap Entry, veh/h	869	993	1174	0.055	671
V/C Ratio	0.169	0.806	0.248	0.0	0.417
Control Delay, s/veh	5.8	20.7	5.3	A	11.2
LOS	A	C	A	0	B
95th %tile Queue, veh	1	9	1		2

Timings
4: Vollmer Rd & Briargate Pkwy

2045 Total Traffic
AM Peak Hour

Lane Group	EBL	EBT	EBR	WBL	WBT	WBR	NBL	NBT	NBR	SBL	SBT	SBR
Lane Configurations												
Traffic Volume (vph)	70	539	153	243	1033	81	153	132	110	109	311	141
Future Volume (vph)	70	539	153	243	1033	81	153	132	110	109	311	141
Turn Type	pm+pt	NA	Perm	Prot	NA	Perm	pm+pt	NA	Perm	pm+pt	NA	Perm
Protected Phases	5	2		1	6		3	8		7	4	
Permitted Phases	2		2			6	8		8	4		4
Detector Phase	5	2	2	1	6	6	3	8	8	7	4	4
Switch Phase												
Minimum Initial (s)	5.0	15.0	15.0	15.0	15.0	15.0	5.0	5.0	5.0	5.0	5.0	5.0
Minimum Split (s)	10.0	20.0	20.0	20.0	20.0	20.0	10.0	10.0	10.0	10.0	10.0	10.0
Total Split (s)	12.0	57.0	57.0	20.0	65.0	65.0	17.0	28.0	28.0	15.0	26.0	26.0
Total Split (%)	10.0%	47.5%	47.5%	16.7%	54.2%	54.2%	14.2%	23.3%	23.3%	12.5%	21.7%	21.7%
Yellow Time (s)	3.0	3.0	3.0	3.0	3.0	3.0	3.0	3.0	3.0	3.0	3.0	3.0
All-Red Time (s)	2.0	2.0	2.0	2.0	2.0	2.0	2.0	2.0	2.0	2.0	2.0	2.0
Lost Time Adjust (s)	0.0	0.0	0.0	0.0	0.0	0.0	0.0	0.0	0.0	0.0	0.0	0.0
Total Lost Time (s)	5.0	5.0	5.0	5.0	5.0	5.0	5.0	5.0	5.0	5.0	5.0	5.0
Lead/Lag	Lead	Lag	Lag	Lead	Lag	Lag	Lead	Lag	Lag	Lead	Lag	Lag
Lead-Lag Optimize?	Yes	Yes	Yes	Yes	Yes	Yes	Yes	Yes	Yes	Yes	Yes	Yes
Recall Mode	None	Max	Max	None	Max	Max	None	None	None	None	None	None
Act Effct Green (s)	58.8	52.1	52.1	15.0	62.8	62.8	29.3	18.0	18.0	25.4	16.0	16.0
Actuated g/C Ratio	0.51	0.46	0.46	0.13	0.55	0.55	0.26	0.16	0.16	0.22	0.14	0.14
v/c Ratio	0.26	0.34	0.20	0.57	0.56	0.09	0.60	0.24	0.31	0.36	0.66	0.42
Control Delay	12.4	21.5	3.7	53.0	19.6	1.8	42.0	43.2	4.7	34.7	53.4	9.8
Queue Delay	0.0	0.0	0.0	0.0	0.0	0.0	0.0	0.0	0.0	0.0	0.0	0.0
Total Delay	12.4	21.5	3.7	53.0	19.6	1.8	42.0	43.2	4.7	34.7	53.4	9.8
LOS	B	C	A	D	B	A	D	D	A	C	D	A
Approach Delay		17.0			24.6			31.9			38.8	
Approach LOS		B			C			C			D	

Intersection Summary

Cycle Length: 120
 Actuated Cycle Length: 114.5
 Natural Cycle: 60
 Control Type: Actuated-Uncoordinated
 Maximum v/c Ratio: 0.66
 Intersection Signal Delay: 26.3
 Intersection LOS: C
 Intersection Capacity Utilization 66.5%
 ICU Level of Service C
 Analysis Period (min) 15

Splits and Phases: 4: Vollmer Rd & Briargate Pkwy



Timings
5: Sterling Ranch Rd & Briargate Pkwy

2045 Total Traffic
AM Peak Hour

Lane Group	EBL	EBT	EBR	WBL	WBT	WBR	NBL	NBT	NBR	SBL	SBT	SBR
Lane Configurations												
Traffic Volume (vph)	77	605	136	145	936	23	240	93	121	91	189	182
Future Volume (vph)	77	605	136	145	936	23	240	93	121	91	189	182
Turn Type	pm+pt	NA	Perm	pm+pt	NA	Perm	pm+pt	NA	Free	pm+pt	NA	Free
Protected Phases	5	2		1	6		3	8		7	4	
Permitted Phases	2		2	6		6	8		Free	4		Free
Detector Phase	5	2	2	1	6	6	3	8		7	4	
Switch Phase												
Minimum Initial (s)	5.0	5.0	5.0	5.0	5.0	5.0	5.0	20.0		5.0	20.0	
Minimum Split (s)	10.0	10.0	10.0	10.0	10.0	10.0	10.0	25.0		10.0	25.0	
Total Split (s)	12.0	55.0	55.0	12.0	55.0	55.0	21.0	32.0		21.0	32.0	
Total Split (%)	10.0%	45.8%	45.8%	10.0%	45.8%	45.8%	17.5%	26.7%		17.5%	26.7%	
Yellow Time (s)	3.0	3.0	3.0	3.0	3.0	3.0	3.0	3.0		3.0	3.0	
All-Red Time (s)	2.0	2.0	2.0	2.0	2.0	2.0	2.0	2.0		2.0	2.0	
Lost Time Adjust (s)	0.0	0.0	0.0	0.0	0.0	0.0	0.0	0.0		0.0	0.0	
Total Lost Time (s)	5.0	5.0	5.0	5.0	5.0	5.0	5.0	5.0		5.0	5.0	
Lead/Lag	Lead	Lag	Lag	Lead	Lag	Lag	Lead	Lag		Lead	Lag	
Lead-Lag Optimize?	Yes	Yes	Yes	Yes	Yes	Yes	Yes	Yes		Yes	Yes	
Recall Mode	None	C-Max	C-Max	None	C-Max	C-Max	None	Max		None	Max	
Act Effct Green (s)	56.8	50.0	50.0	58.0	52.4	52.4	47.6	33.3	120.0	37.7	28.1	120.0
Actuated g/C Ratio	0.47	0.42	0.42	0.48	0.44	0.44	0.40	0.28	1.00	0.31	0.23	1.00
v/c Ratio	0.35	0.43	0.19	0.44	0.64	0.03	0.59	0.19	0.08	0.22	0.46	0.12
Control Delay	19.3	26.1	4.1	20.1	29.4	0.1	31.6	35.2	0.1	24.7	43.9	0.2
Queue Delay	0.0	0.0	0.0	0.0	0.0	0.0	0.0	0.0	0.0	0.0	0.0	0.0
Total Delay	19.3	26.1	4.1	20.1	29.4	0.1	31.6	35.2	0.1	24.7	43.9	0.2
LOS	B	C	A	C	C	A	C	D	A	C	D	A
Approach Delay		21.8			27.6			24.0			22.9	
Approach LOS		C			C			C			C	

Intersection Summary

Cycle Length: 120
 Actuated Cycle Length: 120
 Offset: 63 (53%), Referenced to phase 2:EBTL and 6:WBTL, Start of Green
 Natural Cycle: 70
 Control Type: Actuated-Coordinated
 Maximum v/c Ratio: 0.64
 Intersection Signal Delay: 24.6
 Intersection LOS: C
 Intersection Capacity Utilization 76.8%
 ICU Level of Service D
 Analysis Period (min) 15

Splits and Phases: 5: Sterling Ranch Rd & Briargate Pkwy

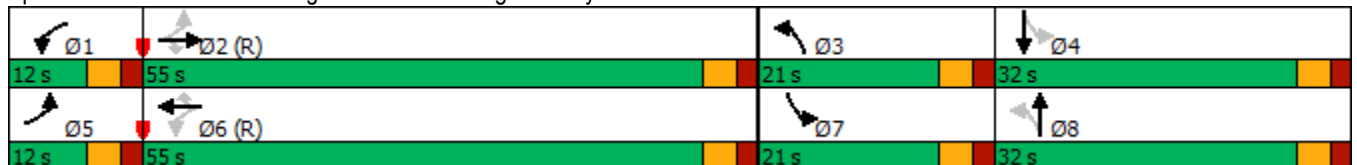

Timings
12: Vollmer Rd & Marksheffel Rd

2045 Total Traffic
AM Peak Hour

Lane Group	EBL	EBT	EBR	WBL	WBT	WBR	NBL	NBT	NBR	SBL	SBT	SBR
Lane Configurations												
Traffic Volume (vph)	69	833	42	162	902	63	108	235	104	121	523	136
Future Volume (vph)	69	833	42	162	902	63	108	235	104	121	523	136
Turn Type	pm+pt	NA	Perm	pm+pt	NA	Perm	pm+pt	NA	Perm	pm+pt	NA	Perm
Protected Phases	5	2		1	6		3	8		7	4	
Permitted Phases	2		2	6		6	8		8	4		4
Detector Phase	5	2	2	1	6	6	3	8	8	7	4	4
Switch Phase												
Minimum Initial (s)	5.0	5.0	5.0	5.0	5.0	5.0	5.0	10.0	10.0	5.0	10.0	10.0
Minimum Split (s)	10.0	23.0	23.0	10.0	23.0	23.0	10.0	23.0	23.0	10.0	23.0	23.0
Total Split (s)	12.0	66.0	66.0	12.0	66.0	66.0	12.0	30.0	30.0	12.0	30.0	30.0
Total Split (%)	10.0%	55.0%	55.0%	10.0%	55.0%	55.0%	10.0%	25.0%	25.0%	10.0%	25.0%	25.0%
Yellow Time (s)	3.0	3.0	3.0	3.0	3.0	3.0	3.0	3.0	3.0	3.0	3.0	3.0
All-Red Time (s)	2.0	2.0	2.0	2.0	2.0	2.0	2.0	2.0	2.0	2.0	2.0	2.0
Lost Time Adjust (s)	0.0	0.0	0.0	0.0	0.0	0.0	0.0	0.0	0.0	0.0	0.0	0.0
Total Lost Time (s)	5.0	5.0	5.0	5.0	5.0	5.0	5.0	5.0	5.0	5.0	5.0	5.0
Lead/Lag	Lead	Lag	Lag	Lead	Lag	Lag	Lead	Lag	Lag	Lead	Lag	Lag
Lead-Lag Optimize?	Yes	Yes	Yes	Yes	Yes	Yes	Yes	Yes	Yes	Yes	Yes	Yes
Recall Mode	None	C-Max	C-Max	None	C-Max	C-Max	None	Max	Max	None	Max	Max
Act Effct Green (s)	67.7	61.0	61.0	69.0	63.4	63.4	32.0	25.0	25.0	32.0	25.0	25.0
Actuated g/C Ratio	0.56	0.51	0.51	0.58	0.53	0.53	0.27	0.21	0.21	0.27	0.21	0.21
v/c Ratio	0.23	0.49	0.05	0.52	0.51	0.07	0.62	0.34	0.26	0.41	0.75	0.33
Control Delay	11.6	20.4	0.1	16.3	11.2	0.3	47.4	41.9	8.9	36.2	51.7	9.9
Queue Delay	0.0	0.0	0.0	0.0	0.0	0.0	0.0	0.0	0.0	0.0	0.0	0.0
Total Delay	11.6	20.4	0.1	16.3	11.2	0.3	47.4	41.9	8.9	36.2	51.7	9.9
LOS	B	C	A	B	B	A	D	D	A	D	D	A
Approach Delay		18.9			11.3			35.6			42.0	
Approach LOS		B			B			D			D	

Intersection Summary

Cycle Length: 120
 Actuated Cycle Length: 120
 Offset: 0 (0%), Referenced to phase 2:EBTL and 6:WBTL, Start of Green
 Natural Cycle: 70
 Control Type: Actuated-Coordinated
 Maximum v/c Ratio: 0.75
 Intersection Signal Delay: 24.0
 Intersection Capacity Utilization 69.1%
 Analysis Period (min) 15
 Intersection LOS: C
 ICU Level of Service C

Splits and Phases: 12: Vollmer Rd & Marksheffel Rd

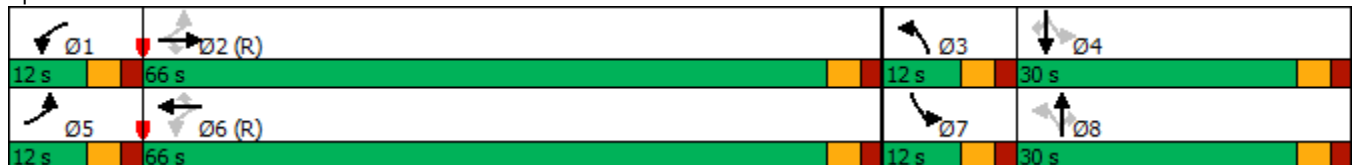

Timings
13: Sterling Ranch Rd & Marksheffel Rd

2045 Total Traffic
AM Peak Hour

Lane Group	EBL	EBT	EBR	WBL	WBT	WBR	NBL	NBT	SBL	SBT	SBR
Lane Configurations											
Traffic Volume (vph)	144	884	12	53	807	176	7	2	504	10	312
Future Volume (vph)	144	884	12	53	807	176	7	2	504	10	312
Turn Type	pm+pt	NA	Perm	pm+pt	NA	Perm	pm+pt	NA	Prot	NA	Perm
Protected Phases	5	2		1	6		3	8	7	4	
Permitted Phases	2		2	6		6	8				4
Detector Phase	5	2	2	1	6	6	3	8	7	4	4
Switch Phase											
Minimum Initial (s)	5.0	15.0	15.0	5.0	15.0	15.0	5.0	10.0	20.0	10.0	10.0
Minimum Split (s)	10.0	20.0	20.0	10.0	20.0	20.0	10.0	15.0	25.0	20.0	20.0
Total Split (s)	12.0	51.0	51.0	12.0	51.0	51.0	12.0	25.0	32.0	45.0	45.0
Total Split (%)	10.0%	42.5%	42.5%	10.0%	42.5%	42.5%	10.0%	20.8%	26.7%	37.5%	37.5%
Yellow Time (s)	3.0	3.0	3.0	3.0	3.0	3.0	3.0	3.0	3.0	3.0	3.0
All-Red Time (s)	2.0	2.0	2.0	2.0	2.0	2.0	2.0	2.0	2.0	2.0	2.0
Lost Time Adjust (s)	0.0	0.0	0.0	0.0	0.0	0.0	0.0	0.0	0.0	0.0	0.0
Total Lost Time (s)	5.0	5.0	5.0	5.0	5.0	5.0	5.0	5.0	5.0	5.0	5.0
Lead/Lag	Lead	Lag	Lag	Lead	Lag	Lag	Lead	Lag	Lead	Lag	Lag
Lead-Lag Optimize?	Yes	Yes	Yes	Yes	Yes	Yes	Yes	Yes	Yes	Yes	Yes
Recall Mode	None	C-Max	C-Max	None	C-Max	C-Max	None	None	None	None	None
Act Effct Green (s)	81.6	73.7	73.7	76.0	69.2	69.2	8.0	10.0	23.6	24.3	24.3
Actuated g/C Ratio	0.68	0.61	0.61	0.63	0.58	0.58	0.07	0.08	0.20	0.20	0.20
v/c Ratio	0.36	0.43	0.01	0.15	0.42	0.19	0.06	0.06	0.79	0.03	0.59
Control Delay	12.9	11.8	0.0	8.9	16.8	3.2	41.1	33.0	54.7	36.1	11.3
Queue Delay	0.0	0.0	0.0	0.0	0.0	0.0	0.0	0.0	0.0	0.0	0.0
Total Delay	12.9	11.8	0.0	8.9	16.8	3.2	41.1	33.0	54.7	36.1	11.3
LOS	B	B	A	A	B	A	D	C	D	D	B
Approach Delay		11.8			14.1			36.6		38.1	
Approach LOS		B			B			D		D	

Intersection Summary

Cycle Length: 120
 Actuated Cycle Length: 120
 Offset: 0 (0%), Referenced to phase 2:EBTL and 6:WBTL, Start of Green
 Natural Cycle: 75
 Control Type: Actuated-Coordinated
 Maximum v/c Ratio: 0.79
 Intersection Signal Delay: 20.2
 Intersection LOS: C
 Intersection Capacity Utilization 63.8%
 ICU Level of Service B
 Analysis Period (min) 15

Splits and Phases: 13: Sterling Ranch Rd & Marksheffel Rd

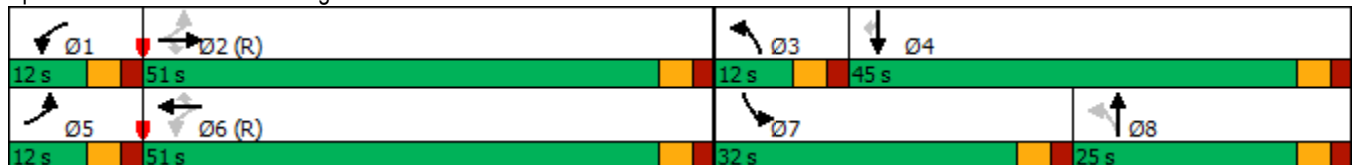

Intersection						
Int Delay, s/veh	0.6					
Movement	EBL	EBT	WBT	WBR	SBL	SBR
Lane Configurations		↑↑	↑↑	↑		↑
Traffic Vol, veh/h	0	817	1021	9	0	83
Future Vol, veh/h	0	817	1021	9	0	83
Conflicting Peds, #/hr	0	0	0	0	0	0
Sign Control	Free	Free	Free	Free	Stop	Stop
RT Channelized	-	None	-	None	-	None
Storage Length	-	-	-	200	-	0
Veh in Median Storage, #	-	0	0	-	0	-
Grade, %	-	0	0	-	0	-
Peak Hour Factor	95	95	95	95	95	95
Heavy Vehicles, %	2	2	2	2	2	2
Mvmt Flow	0	860	1075	9	0	87

Major/Minor	Major1	Major2	Minor2		
Conflicting Flow All	-	0	-	0	538
Stage 1	-	-	-	-	-
Stage 2	-	-	-	-	-
Critical Hdwy	-	-	-	-	6.94
Critical Hdwy Stg 1	-	-	-	-	-
Critical Hdwy Stg 2	-	-	-	-	-
Follow-up Hdwy	-	-	-	-	3.32
Pot Cap-1 Maneuver	0	-	-	-	488
Stage 1	0	-	-	-	-
Stage 2	0	-	-	-	-
Platoon blocked, %	-	-	-	-	-
Mov Cap-1 Maneuver	-	-	-	-	488
Mov Cap-2 Maneuver	-	-	-	-	-
Stage 1	-	-	-	-	-
Stage 2	-	-	-	-	-

Approach	EB	WB	SB
HCM Control Delay, s	0	0	14
HCM LOS			B

Minor Lane/Major Mvmt	EBT	WBT	WBR	SBLn1
Capacity (veh/h)	-	-	-	488
HCM Lane V/C Ratio	-	-	-	0.179
HCM Control Delay (s)	-	-	-	14
HCM Lane LOS	-	-	-	B
HCM 95th %tile Q(veh)	-	-	-	0.6

Intersection												
Int Delay, s/veh	3.3											
Movement	EBL	EBT	EBR	WBL	WBT	WBR	NBL	NBT	NBR	SBL	SBT	SBR
Lane Configurations		↕			↕		↗	↑	↖	↗	↖	↖
Traffic Vol, veh/h	0	0	108	25	0	0	34	108	22	0	230	0
Future Vol, veh/h	0	0	108	25	0	0	34	108	22	0	230	0
Conflicting Peds, #/hr	0	0	0	0	0	0	0	0	0	0	0	0
Sign Control	Stop	Stop	Stop	Stop	Stop	Stop	Free	Free	Free	Free	Free	Free
RT Channelized	-	-	None	-	-	None	-	-	None	-	-	None
Storage Length	-	-	-	-	-	-	200	-	200	200	-	-
Veh in Median Storage, #	-	0	-	-	0	-	-	0	-	-	0	-
Grade, %	-	0	-	-	0	-	-	0	-	-	0	-
Peak Hour Factor	95	95	95	95	95	95	95	95	95	95	95	95
Heavy Vehicles, %	2	2	2	2	2	2	2	2	2	2	2	2
Mvmt Flow	0	0	114	26	0	0	36	114	23	0	242	0

Major/Minor	Minor2		Minor1		Major1		Major2					
Conflicting Flow All	440	451	242	485	428	114	242	0	0	137	0	0
Stage 1	242	242	-	186	186	-	-	-	-	-	-	-
Stage 2	198	209	-	299	242	-	-	-	-	-	-	-
Critical Hdwy	7.12	6.52	6.22	7.12	6.52	6.22	4.12	-	-	4.12	-	-
Critical Hdwy Stg 1	6.12	5.52	-	6.12	5.52	-	-	-	-	-	-	-
Critical Hdwy Stg 2	6.12	5.52	-	6.12	5.52	-	-	-	-	-	-	-
Follow-up Hdwy	3.518	4.018	3.318	3.518	4.018	3.318	2.218	-	-	2.218	-	-
Pot Cap-1 Maneuver	527	504	797	492	519	939	1324	-	-	1447	-	-
Stage 1	762	705	-	816	746	-	-	-	-	-	-	-
Stage 2	804	729	-	710	705	-	-	-	-	-	-	-
Platoon blocked, %								-	-	-	-	-
Mov Cap-1 Maneuver	516	490	797	413	505	939	1324	-	-	1447	-	-
Mov Cap-2 Maneuver	516	490	-	413	505	-	-	-	-	-	-	-
Stage 1	741	705	-	794	726	-	-	-	-	-	-	-
Stage 2	782	709	-	609	705	-	-	-	-	-	-	-

Approach	EB	WB	NB	SB
HCM Control Delay, s	10.3	14.3	1.6	0
HCM LOS	B	B		

Minor Lane/Major Mvmt	NBL	NBT	NBR	EBLn1	WBLn1	SBL	SBT	SBR
Capacity (veh/h)	1324	-	-	797	413	1447	-	-
HCM Lane V/C Ratio	0.027	-	-	0.143	0.064	-	-	-
HCM Control Delay (s)	7.8	-	-	10.3	14.3	0	-	-
HCM Lane LOS	A	-	-	B	B	A	-	-
HCM 95th %tile Q(veh)	0.1	-	-	0.5	0.2	0	-	-

Intersection						
Int Delay, s/veh	4.6					
Movement	WBL	WBR	NBT	NBR	SBL	SBT
Lane Configurations	↘	↗	↑	↗	↘	↑
Traffic Vol, veh/h	65	47	58	50	135	165
Future Vol, veh/h	65	47	58	50	135	165
Conflicting Peds, #/hr	0	0	0	0	0	0
Sign Control	Stop	Stop	Free	Free	Free	Free
RT Channelized	-	None	-	None	-	None
Storage Length	0	200	-	200	200	-
Veh in Median Storage, #	0	-	0	-	-	0
Grade, %	0	-	0	-	-	0
Peak Hour Factor	95	95	95	95	95	95
Heavy Vehicles, %	2	2	2	2	2	2
Mvmt Flow	68	49	61	53	142	174

Major/Minor	Minor1	Major1	Major2			
Conflicting Flow All	519	61	0	0	114	0
Stage 1	61	-	-	-	-	-
Stage 2	458	-	-	-	-	-
Critical Hdwy	6.42	6.22	-	-	4.12	-
Critical Hdwy Stg 1	5.42	-	-	-	-	-
Critical Hdwy Stg 2	5.42	-	-	-	-	-
Follow-up Hdwy	3.518	3.318	-	-	2.218	-
Pot Cap-1 Maneuver	517	1004	-	-	1475	-
Stage 1	962	-	-	-	-	-
Stage 2	637	-	-	-	-	-
Platoon blocked, %			-	-		-
Mov Cap-1 Maneuver	467	1004	-	-	1475	-
Mov Cap-2 Maneuver	467	-	-	-	-	-
Stage 1	962	-	-	-	-	-
Stage 2	576	-	-	-	-	-

Approach	WB	NB	SB
HCM Control Delay, s	11.8	0	3.5
HCM LOS	B		

Minor Lane/Major Mvmt	NBT	NBR	WBLn1	WBLn2	SBL	SBT
Capacity (veh/h)	-	-	467	1004	1475	-
HCM Lane V/C Ratio	-	-	0.147	0.049	0.096	-
HCM Control Delay (s)	-	-	14	8.8	7.7	-
HCM Lane LOS	-	-	B	A	A	-
HCM 95th %tile Q(veh)	-	-	0.5	0.2	0.3	-

Intersection					
Intersection Delay, s/veh	13.7				
Intersection LOS	B				
Approach	EB	WB	NB	SB	
Entry Lanes	1	1	1	1	
Conflicting Circle Lanes	1	1	1	1	
Adj Approach Flow, veh/h	424	347	783	435	
Demand Flow Rate, veh/h	432	353	799	445	
Vehicles Circulating, veh/h	537	625	558	372	
Vehicles Exiting, veh/h	279	539	411	606	
Ped Vol Crossing Leg, #/h	0	0	0	0	
Ped Cap Adj	1.000	1.000	1.000	1.000	
Approach Delay, s/veh	12.6	12.1	17.3	9.7	
Approach LOS	B	B	C	A	
Lane	Left	Left	Left	Bypass	Left
Designated Moves	LTR	LTR	LT	R	LTR
Assumed Moves	LTR	LTR	LT	R	LTR
RT Channelized				Free	
Lane Util	1.000	1.000	1.000		1.000
Follow-Up Headway, s	2.609	2.609	2.609		2.609
Critical Headway, s	4.976	4.976	4.976	193	4.976
Entry Flow, veh/h	432	353	606	1938	445
Cap Entry Lane, veh/h	798	729	781	0.980	944
Entry HV Adj Factor	0.982	0.982	0.980	189	0.979
Flow Entry, veh/h	424	347	594	1900	435
Cap Entry, veh/h	783	716	765	0.099	924
V/C Ratio	0.541	0.484	0.776	0.0	0.471
Control Delay, s/veh	12.6	12.1	22.8	A	9.7
LOS	B	B	C	0	A
95th %tile Queue, veh	3	3	8		3

Timings
4: Vollmer Rd & Briargate Pkwy

2045 Total Traffic
PM Peak Hour

Lane Group	EBL	EBT	EBR	WBL	WBT	WBR	NBL	NBT	NBR	SBL	SBT	SBR
Lane Configurations												
Traffic Volume (vph)	230	999	176	202	738	67	291	417	287	94	213	120
Future Volume (vph)	230	999	176	202	738	67	291	417	287	94	213	120
Turn Type	pm+pt	NA	Perm	Prot	NA	Perm	pm+pt	NA	Perm	pm+pt	NA	Perm
Protected Phases	5	2		1	6		3	8		7	4	
Permitted Phases	2		2			6	8		8	4		4
Detector Phase	5	2	2	1	6	6	3	8	8	7	4	4
Switch Phase												
Minimum Initial (s)	5.0	15.0	15.0	15.0	15.0	15.0	8.0	5.0	5.0	5.0	5.0	5.0
Minimum Split (s)	10.0	20.0	20.0	20.0	20.0	20.0	13.0	10.0	10.0	10.0	10.0	10.0
Total Split (s)	12.0	53.0	53.0	20.0	61.0	61.0	22.0	28.0	28.0	19.0	25.0	25.0
Total Split (%)	10.0%	44.2%	44.2%	16.7%	50.8%	50.8%	18.3%	23.3%	23.3%	15.8%	20.8%	20.8%
Yellow Time (s)	3.0	3.0	3.0	3.0	3.0	3.0	3.0	3.0	3.0	3.0	3.0	3.0
All-Red Time (s)	2.0	2.0	2.0	2.0	2.0	2.0	2.0	2.0	2.0	2.0	2.0	2.0
Lost Time Adjust (s)	0.0	0.0	0.0	0.0	0.0	0.0	0.0	0.0	0.0	0.0	0.0	0.0
Total Lost Time (s)	5.0	5.0	5.0	5.0	5.0	5.0	5.0	5.0	5.0	5.0	5.0	5.0
Lead/Lag	Lead	Lag	Lag	Lead	Lag	Lag	Lead	Lag	Lag	Lead	Lag	Lag
Lead-Lag Optimize?	Yes	Yes	Yes	Yes	Yes	Yes	Yes	Yes	Yes	Yes	Yes	Yes
Recall Mode	None	Max	Max	None	Max	Max	None	None	None	None	None	None
Act Effct Green (s)	55.1	48.1	48.1	15.0	56.1	56.1	35.3	20.4	20.4	24.3	14.1	14.1
Actuated g/C Ratio	0.48	0.42	0.42	0.13	0.49	0.49	0.31	0.18	0.18	0.21	0.12	0.12
v/c Ratio	0.66	0.68	0.24	0.47	0.45	0.09	0.81	0.67	0.58	0.38	0.51	0.38
Control Delay	25.3	30.2	4.5	50.4	20.4	1.2	50.9	49.6	11.1	33.0	50.6	7.0
Queue Delay	0.0	0.0	0.0	0.0	0.0	0.0	0.0	0.0	0.0	0.0	0.0	0.0
Total Delay	25.3	30.2	4.5	50.4	20.4	1.2	50.9	49.6	11.1	33.0	50.6	7.0
LOS	C	C	A	D	C	A	D	D	B	C	D	A
Approach Delay		26.1			25.1			38.7			34.5	
Approach LOS		C			C			D			C	

Intersection Summary

Cycle Length: 120
 Actuated Cycle Length: 113.8
 Natural Cycle: 80
 Control Type: Actuated-Uncoordinated
 Maximum v/c Ratio: 0.81
 Intersection Signal Delay: 30.0
 Intersection LOS: C
 Intersection Capacity Utilization 78.8%
 ICU Level of Service D
 Analysis Period (min) 15

Splits and Phases: 4: Vollmer Rd & Briargate Pkwy



Timings
12: Vollmer Rd & Marksheffel Rd

2045 Total Traffic
PM Peak Hour

Lane Group	EBL	EBT	EBR	WBL	WBT	WBR	NBL	NBT	NBR	SBL	SBT	SBR
Lane Configurations												
Traffic Volume (vph)	140	918	89	186	703	149	169	737	176	126	328	197
Future Volume (vph)	140	918	89	186	703	149	169	737	176	126	328	197
Turn Type	pm+pt	NA	Perm	pm+pt	NA	Perm	pm+pt	NA	Perm	pm+pt	NA	Perm
Protected Phases	5	2		1	6		3	8		7	4	
Permitted Phases	2		2	6		6	8		8	4		4
Detector Phase	5	2	2	1	6	6	3	8	8	7	4	4
Switch Phase												
Minimum Initial (s)	5.0	5.0	5.0	5.0	5.0	5.0	5.0	10.0	10.0	5.0	10.0	10.0
Minimum Split (s)	10.0	23.0	23.0	10.0	23.0	23.0	10.0	23.0	23.0	10.0	23.0	23.0
Total Split (s)	20.0	50.0	50.0	19.0	49.0	49.0	15.0	36.0	36.0	15.0	36.0	36.0
Total Split (%)	16.7%	41.7%	41.7%	15.8%	40.8%	40.8%	12.5%	30.0%	30.0%	12.5%	30.0%	30.0%
Yellow Time (s)	3.0	3.0	3.0	3.0	3.0	3.0	3.0	3.0	3.0	3.0	3.0	3.0
All-Red Time (s)	2.0	2.0	2.0	2.0	2.0	2.0	2.0	2.0	2.0	2.0	2.0	2.0
Lost Time Adjust (s)	0.0	0.0	0.0	0.0	0.0	0.0	0.0	0.0	0.0	0.0	0.0	0.0
Total Lost Time (s)	5.0	5.0	5.0	5.0	5.0	5.0	5.0	5.0	5.0	5.0	5.0	5.0
Lead/Lag	Lead	Lag	Lag	Lead	Lag	Lag	Lead	Lag	Lag	Lead	Lag	Lag
Lead-Lag Optimize?	Yes	Yes	Yes	Yes	Yes	Yes	Yes	Yes	Yes	Yes	Yes	Yes
Recall Mode	None	C-Max	C-Max	None	C-Max	C-Max	None	Max	Max	None	Max	Max
Act Effct Green (s)	57.6	47.0	47.0	60.4	48.4	48.4	41.3	31.4	31.4	40.7	31.2	31.2
Actuated g/C Ratio	0.48	0.39	0.39	0.50	0.40	0.40	0.34	0.26	0.26	0.34	0.26	0.26
v/c Ratio	0.42	0.70	0.14	0.69	0.52	0.22	0.49	0.84	0.36	0.66	0.38	0.37
Control Delay	18.4	34.2	3.8	48.7	22.2	5.2	31.0	51.3	13.9	41.5	37.9	6.7
Queue Delay	0.0	0.0	0.0	0.0	0.0	0.0	0.0	0.0	0.0	0.0	0.0	0.0
Total Delay	18.4	34.2	3.8	48.7	22.2	5.2	31.0	51.3	13.9	41.5	37.9	6.7
LOS	B	C	A	D	C	A	C	D	B	D	D	A
Approach Delay		29.9			24.5			42.0			29.2	
Approach LOS		C			C			D			C	

Intersection Summary

Cycle Length: 120
 Actuated Cycle Length: 120
 Offset: 0 (0%), Referenced to phase 2:EBTL and 6:WBTL, Start of Green
 Natural Cycle: 70
 Control Type: Actuated-Coordinated
 Maximum v/c Ratio: 0.84
 Intersection Signal Delay: 31.7
 Intersection LOS: C
 Intersection Capacity Utilization 79.7%
 ICU Level of Service D
 Analysis Period (min) 15

Splits and Phases: 12: Vollmer Rd & Marksheffel Rd

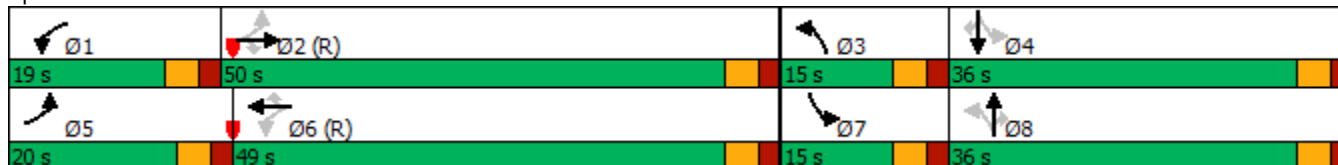

Timings
13: Sterling Ranch Rd & Marksheffel Rd

2045 Total Traffic
PM Peak Hour

Lane Group	EBL	EBT	EBR	WBL	WBT	WBR	NBL	NBT	SBL	SBT	SBR
Lane Configurations											
Traffic Volume (vph)	301	940	6	62	838	560	18	4	344	17	183
Future Volume (vph)	301	940	6	62	838	560	18	4	344	17	183
Turn Type	pm+pt	NA	Perm	pm+pt	NA	Perm	pm+pt	NA	Prot	NA	Perm
Protected Phases	5	2		1	6		3	8	7	4	
Permitted Phases	2		2	6		6	8				4
Detector Phase	5	2	2	1	6	6	3	8	7	4	4
Switch Phase											
Minimum Initial (s)	5.0	15.0	15.0	5.0	15.0	15.0	5.0	10.0	20.0	10.0	10.0
Minimum Split (s)	10.0	20.0	20.0	10.0	20.0	20.0	10.0	15.0	25.0	20.0	20.0
Total Split (s)	20.0	68.0	68.0	12.0	60.0	60.0	10.0	15.0	25.0	30.0	30.0
Total Split (%)	16.7%	56.7%	56.7%	10.0%	50.0%	50.0%	8.3%	12.5%	20.8%	25.0%	25.0%
Yellow Time (s)	3.0	3.0	3.0	3.0	3.0	3.0	3.0	3.0	3.0	3.0	3.0
All-Red Time (s)	2.0	2.0	2.0	2.0	2.0	2.0	2.0	2.0	2.0	2.0	2.0
Lost Time Adjust (s)	0.0	0.0	0.0	0.0	0.0	0.0	0.0	0.0	0.0	0.0	0.0
Total Lost Time (s)	5.0	5.0	5.0	5.0	5.0	5.0	5.0	5.0	5.0	5.0	5.0
Lead/Lag	Lead	Lag	Lag	Lead	Lag	Lag	Lead	Lag	Lead	Lag	Lag
Lead-Lag Optimize?	Yes	Yes	Yes	Yes	Yes	Yes	Yes	Yes	Yes	Yes	Yes
Recall Mode	None	C-Max	C-Max	None	C-Max	C-Max	None	None	None	None	None
Act Effct Green (s)	81.0	71.6	71.6	69.3	62.8	62.8	11.0	10.0	20.0	25.0	25.0
Actuated g/C Ratio	0.68	0.60	0.60	0.58	0.52	0.52	0.09	0.08	0.17	0.21	0.21
v/c Ratio	0.75	0.47	0.01	0.19	0.48	0.53	0.13	0.18	0.63	0.05	0.40
Control Delay	39.6	9.8	0.0	10.2	20.8	3.5	35.7	24.2	52.2	37.5	8.2
Queue Delay	0.0	0.0	0.0	0.0	0.0	0.0	0.0	0.0	0.0	0.0	0.0
Total Delay	39.6	9.8	0.0	10.2	20.8	3.5	35.7	24.2	52.2	37.5	8.2
LOS	D	A	A	B	C	A	D	C	D	D	A
Approach Delay		16.9			13.7			28.8		36.9	
Approach LOS		B			B			C		D	

Intersection Summary

Cycle Length: 120
 Actuated Cycle Length: 120
 Offset: 0 (0%), Referenced to phase 2:EBTL and 6:WBTL, Start of Green
 Natural Cycle: 90
 Control Type: Actuated-Coordinated
 Maximum v/c Ratio: 0.75
 Intersection Signal Delay: 19.0
 Intersection LOS: B
 Intersection Capacity Utilization 72.2%
 ICU Level of Service C
 Analysis Period (min) 15

Splits and Phases: 13: Sterling Ranch Rd & Marksheffel Rd

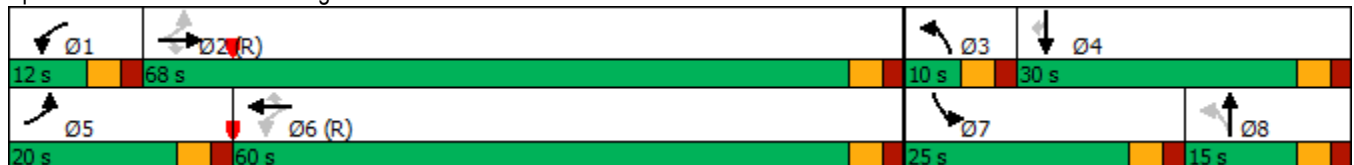

Intersection						
Int Delay, s/veh	0.3					
Movement	EBL	EBT	WBT	WBR	SBL	SBR
Lane Configurations		↑↑	↑↑	↑		↑
Traffic Vol, veh/h	0	1056	1030	40	0	51
Future Vol, veh/h	0	1056	1030	40	0	51
Conflicting Peds, #/hr	0	0	0	0	0	0
Sign Control	Free	Free	Free	Free	Stop	Stop
RT Channelized	-	None	-	None	-	None
Storage Length	-	-	-	200	-	0
Veh in Median Storage, #	-	0	0	-	0	-
Grade, %	-	0	0	-	0	-
Peak Hour Factor	95	95	95	95	95	95
Heavy Vehicles, %	2	2	2	2	2	2
Mvmt Flow	0	1112	1084	42	0	54

Major/Minor	Major1	Major2	Minor2		
Conflicting Flow All	-	0	-	0	542
Stage 1	-	-	-	-	-
Stage 2	-	-	-	-	-
Critical Hdwy	-	-	-	-	6.94
Critical Hdwy Stg 1	-	-	-	-	-
Critical Hdwy Stg 2	-	-	-	-	-
Follow-up Hdwy	-	-	-	-	3.32
Pot Cap-1 Maneuver	0	-	-	-	485
Stage 1	0	-	-	-	-
Stage 2	0	-	-	-	-
Platoon blocked, %	-	-	-	-	-
Mov Cap-1 Maneuver	-	-	-	-	485
Mov Cap-2 Maneuver	-	-	-	-	-
Stage 1	-	-	-	-	-
Stage 2	-	-	-	-	-

Approach	EB	WB	SB
HCM Control Delay, s	0	0	13.3
HCM LOS			B

Minor Lane/Major Mvmt	EBT	WBT	WBR	SBLn1
Capacity (veh/h)	-	-	-	485
HCM Lane V/C Ratio	-	-	-	0.111
HCM Control Delay (s)	-	-	-	13.3
HCM Lane LOS	-	-	-	B
HCM 95th %tile Q(veh)	-	-	-	0.4

Intersection												
Int Delay, s/veh	2.6											
Movement	EBL	EBT	EBR	WBL	WBT	WBR	NBL	NBT	NBR	SBL	SBT	SBR
Lane Configurations		↕			↕		↗	↑	↖	↗	↖	↖
Traffic Vol, veh/h	0	0	70	14	0	0	115	302	65	1	132	0
Future Vol, veh/h	0	0	70	14	0	0	115	302	65	1	132	0
Conflicting Peds, #/hr	0	0	0	0	0	0	0	0	0	0	0	0
Sign Control	Stop	Stop	Stop	Stop	Stop	Stop	Free	Free	Free	Free	Free	Free
RT Channelized	-	-	None	-	-	None	-	-	None	-	-	None
Storage Length	-	-	-	-	-	-	200	-	200	200	-	-
Veh in Median Storage, #	-	0	-	-	0	-	-	0	-	-	0	-
Grade, %	-	0	-	-	0	-	-	0	-	-	0	-
Peak Hour Factor	95	95	95	95	95	95	95	95	95	95	95	95
Heavy Vehicles, %	2	2	2	2	2	2	2	2	2	2	2	2
Mvmt Flow	0	0	74	15	0	0	121	318	68	1	139	0

Major/Minor	Minor2		Minor1		Major1			Major2				
Conflicting Flow All	735	769	139	738	701	318	139	0	0	386	0	0
Stage 1	141	141	-	560	560	-	-	-	-	-	-	-
Stage 2	594	628	-	178	141	-	-	-	-	-	-	-
Critical Hdwy	7.12	6.52	6.22	7.12	6.52	6.22	4.12	-	-	4.12	-	-
Critical Hdwy Stg 1	6.12	5.52	-	6.12	5.52	-	-	-	-	-	-	-
Critical Hdwy Stg 2	6.12	5.52	-	6.12	5.52	-	-	-	-	-	-	-
Follow-up Hdwy	3.518	4.018	3.318	3.518	4.018	3.318	2.218	-	-	2.218	-	-
Pot Cap-1 Maneuver	335	332	909	334	363	723	1445	-	-	1172	-	-
Stage 1	862	780	-	513	511	-	-	-	-	-	-	-
Stage 2	491	476	-	824	780	-	-	-	-	-	-	-
Platoon blocked, %								-	-	-	-	-
Mov Cap-1 Maneuver	313	304	909	287	332	723	1445	-	-	1172	-	-
Mov Cap-2 Maneuver	313	304	-	287	332	-	-	-	-	-	-	-
Stage 1	790	779	-	470	468	-	-	-	-	-	-	-
Stage 2	450	436	-	757	779	-	-	-	-	-	-	-

Approach	EB		WB		NB		SB	
HCM Control Delay, s	9.3		18.2		1.8		0.1	
HCM LOS	A		C					

Minor Lane/Major Mvmt	NBL	NBT	NBR	EBLn1	WBLn1	SBL	SBT	SBR
Capacity (veh/h)	1445	-	-	909	287	1172	-	-
HCM Lane V/C Ratio	0.084	-	-	0.081	0.051	0.001	-	-
HCM Control Delay (s)	7.7	-	-	9.3	18.2	8.1	-	-
HCM Lane LOS	A	-	-	A	C	A	-	-
HCM 95th %tile Q(veh)	0.3	-	-	0.3	0.2	0	-	-

Intersection						
Int Delay, s/veh	4.4					
Movement	WBL	WBR	NBT	NBR	SBL	SBT
Lane Configurations	↘	↗	↑	↗	↘	↑
Traffic Vol, veh/h	37	175	163	139	108	96
Future Vol, veh/h	37	175	163	139	108	96
Conflicting Peds, #/hr	0	0	0	0	0	0
Sign Control	Stop	Stop	Free	Free	Free	Free
RT Channelized	-	None	-	None	-	None
Storage Length	0	200	-	200	200	-
Veh in Median Storage, #	0	-	0	-	-	0
Grade, %	0	-	0	-	-	0
Peak Hour Factor	95	95	95	95	95	95
Heavy Vehicles, %	2	2	2	2	2	2
Mvmt Flow	39	184	172	146	114	101

Major/Minor	Minor1	Major1	Major2		
Conflicting Flow All	501	172	0	0	318
Stage 1	172	-	-	-	-
Stage 2	329	-	-	-	-
Critical Hdwy	6.42	6.22	-	-	4.12
Critical Hdwy Stg 1	5.42	-	-	-	-
Critical Hdwy Stg 2	5.42	-	-	-	-
Follow-up Hdwy	3.518	3.318	-	-	2.218
Pot Cap-1 Maneuver	530	872	-	-	1242
Stage 1	858	-	-	-	-
Stage 2	729	-	-	-	-
Platoon blocked, %			-	-	-
Mov Cap-1 Maneuver	481	872	-	-	1242
Mov Cap-2 Maneuver	481	-	-	-	-
Stage 1	858	-	-	-	-
Stage 2	662	-	-	-	-

Approach	WB	NB	SB
HCM Control Delay, s	10.7	0	4.3
HCM LOS	B		

Minor Lane/Major Mvmt	NBT	NBR	WBLn1	WBLn2	SBL	SBT
Capacity (veh/h)	-	-	481	872	1242	-
HCM Lane V/C Ratio	-	-	0.081	0.211	0.092	-
HCM Control Delay (s)	-	-	13.1	10.2	8.2	-
HCM Lane LOS	-	-	B	B	A	-
HCM 95th %tile Q(veh)	-	-	0.3	0.8	0.3	-

Appendix Table 1



**Appendix Table 1
Area Traffic Impact Studies
Sterling Ranch Sketch Plan Amendment #4**

Study	PCD File No⁽¹⁾	Consultant	Date
Sterling Ranch Reports			
Sterling Ranch Updated Traffic Impact Analysis	SKP07007	LSC Transportation Consultants, Inc	June 5, 2008
Sterling Ranch Phase 1 Traffic Impact Study	P151	LSC Transportation Consultants, Inc	March 16, 2015
Sterling Ranch Phases 1-3 Transportation Memorandum	SP1415	LSC Transportation Consultants, Inc	October 2, 2017
Branding Iron at Sterling Ranch Filing No. 1 and Homestead at Sterling Ranch Filing No. 1 Transportation Memorandum	SF1724 SF1725	LSC Transportation Consultants, Inc	December 19, 2017
Sterling Ranch Filing No. 2 Transportation Memorandum	SF1820	LSC Transportation Consultants, Inc	April 3, 2018
Sterling Ranch Phase 2 Preliminary Plan Traffic Impact Study	SP203	LSC Transportation Consultants, Inc	December 20, 2018
Homestead at Sterling Ranch Filing No. 2 Transportation Memorandum	SF194	LSC Transportation Consultants, Inc	March 3, 2020
Branding Iron at Sterling Ranch Filing No. 2 Transportation Memorandum	SF1918	LSC Transportation Consultants, Inc	May 6, 2020
Sterling Ranch Filing No. 2 and Phase 2 Traffic Impact Study	SF2015 SP191	LSC Transportation Consultants, Inc	June 23, 2021
Sterling Ranch Filing No. 3 Transportation Memorandum	SF2132	LSC Transportation Consultants, Inc	April 19, 2022
Homestead North Phase 1 Updated Transportation Memorandum	SP208	LSC Transportation Consultants, Inc	January 11, 2022
Homestead North Filing No. 1 Traffic Technical Memorandum	SF2213	LSC Transportation Consultants, Inc	February 2, 2022
Homestead North Filing No. 2 Traffic Technical Memorandum	SF2218	LSC Transportation Consultants, Inc	April 15, 2022
Homestead North Filing 3 Traffic Impact Study	SF2229	LSC Transportation Consultants, Inc	June 17, 2022
The Villages at Sterling Ranch East Preliminary Plan/Traffic Generation Analysis	PUDSP226	SM Rocha, LLC	July 1, 2022
Sterling Ranch Sketch Plan Amendment Master Traffic Impact Study	SKP224	LSC Transportation Consultants, Inc	March 17, 2023
Sterling Ranch East - Rezoning & Preliminary Plan Traffic Impact Study	SP-22-004, P-22-012, P-22-013	LSC Transportation Consultants, Inc	March 17, 2023 ⁽²⁾
Sterling Ranch East Filing Nos 1 & 2 Traffic Technical Memorandum	SF2235 SF2237	LSC Transportation Consultants, Inc	February 10, 2023
Sterling Ranch Filing No. 4 Transportation Memorandum	SF2230	LSC Transportation Consultants, Inc	February 21, 2023
Foursquare at Sterling Ranch East Transportation Memorandum	SF2236	LSC Transportation Consultants, Inc	April 20, 2023
Copper Chase at Sterling Ranch Traffic Impact Study	PUDSP222	LSC Transportation Consultants, Inc	April 28, 2023
Sterling Ranch Filing No. 5 Traffic Impact Study	PUDSP-23-002	LSC Transportation Consultants, Inc	November 15, 2023
Sterling Ranch Sketch Plan 2023 Amendment & Rezone Traffic Technical Memorandum	SKP235, P239, P2311	LSC Transportation Consultants, Inc	January 17, 2024
Sterling Ranch East - Filing 5 Rezone & Preliminary Plan Traffic Impact Study	P237 & SP235	LSC Transportation Consultants, Inc	January 15, 2024
Villages at Sterling Ranch Traffic Impact Study	PUDSP226	LSC Transportation Consultants, Inc	August 21, 2024
Sterling Ranch East - Filing 7 Rezone & Sterling Ranch Sketch Plan Amendment #4 Master Traffic Impact Addendum/Technical		LSC Transportation Consultants, Inc	September 13, 2024
Retreat at TimberRidge Reports			
The Retreat at TimberRidge Traffic Impact Analysis	PUD173	LSC Transportation Consultants, Inc	January 25, 2018
The Retreat at TimberRidge Preliminary Plan Traffic Technical Memorandum	SP182	LSC Transportation Consultants, Inc	June 29, 2018
The Retreat at TimberRidge Filing No. 1 Traffic Technical Memorandum	SF199	LSC Transportation Consultants, Inc	April 3, 2020
The Retreat at TimberRidge Filing No. 2 Updated Traffic Technical Memorandum	SF2121	LSC Transportation Consultants, Inc	October 4, 2021
The Retreat at TimberRidge Filing No. 3 Traffic Technical Memorandum	SF2241	LSC Transportation Consultants, Inc	November 15, 2023
The Retreat at TimberRidge Filing No. 4 Traffic Technical Memorandum	SF1827	LSC Transportation Consultants, Inc	February 21, 2024
Other Area Reports			
Wolf Ranch School Site Traffic Impact Study	OAR1720	Matrix Design Group, Inc.	5-May-17
The Ranch Sketch Plan Traffic Impact Analysis	SKP186	LSC Transportation Consultants, Inc	July 9, 2019
Lodge III Traffic Impact Study	OAR	LSC Transportation Consultants, Inc	December 13, 2019
Continental 613 Traffic Impact Study	OAR2177	LSC Transportation Consultants, Inc	July 16, 2021
Solace at Black Forest Traffic Impact and Access Analysis	OAR2134	LSC Transportation Consultants, Inc	August 13, 2021
Traffic Impact Study Addendum for Percheron	OAR2173	SM Rocha, LLC	October, 2021
Woodmen East Commercial Center Traffic Impact Analysis	OAR2191	LSC Transportation Consultants, Inc	December 8, 2021
Traffic Impact Study for Jaynes Property	SKP225	SM Rocha, LLC	May, 2022
Briargate-Stapleton Corridor Study (DRAFT)	briargate-stapleton.com	Wilson & Company	December 9, 2021
Sterling Recycling Facility Transportation Memorandum	PPR2341	LSC Transportation Consultants, Inc	August 24, 2023
Notes:			
(1) Follow the links listed below to obtain the most recent version of each listed study. To obtain a copy of the version of each study used in preparing this report please contact LSC Transportation Consultants, Inc.			
Source: LSC Transportation Consultants, Inc.			

MTCP Maps



Figure 22. 2045 Roadway Functional Classifications

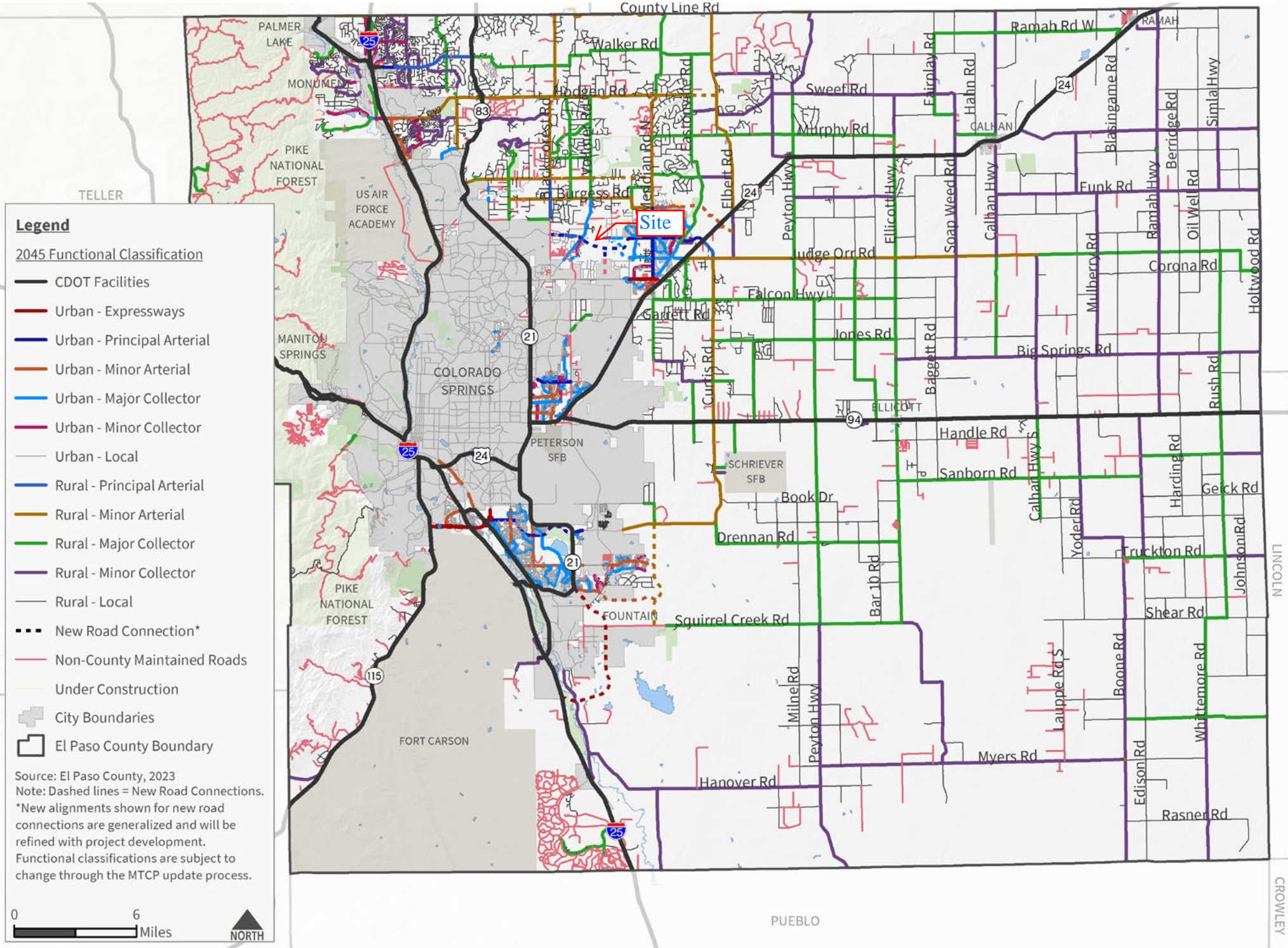
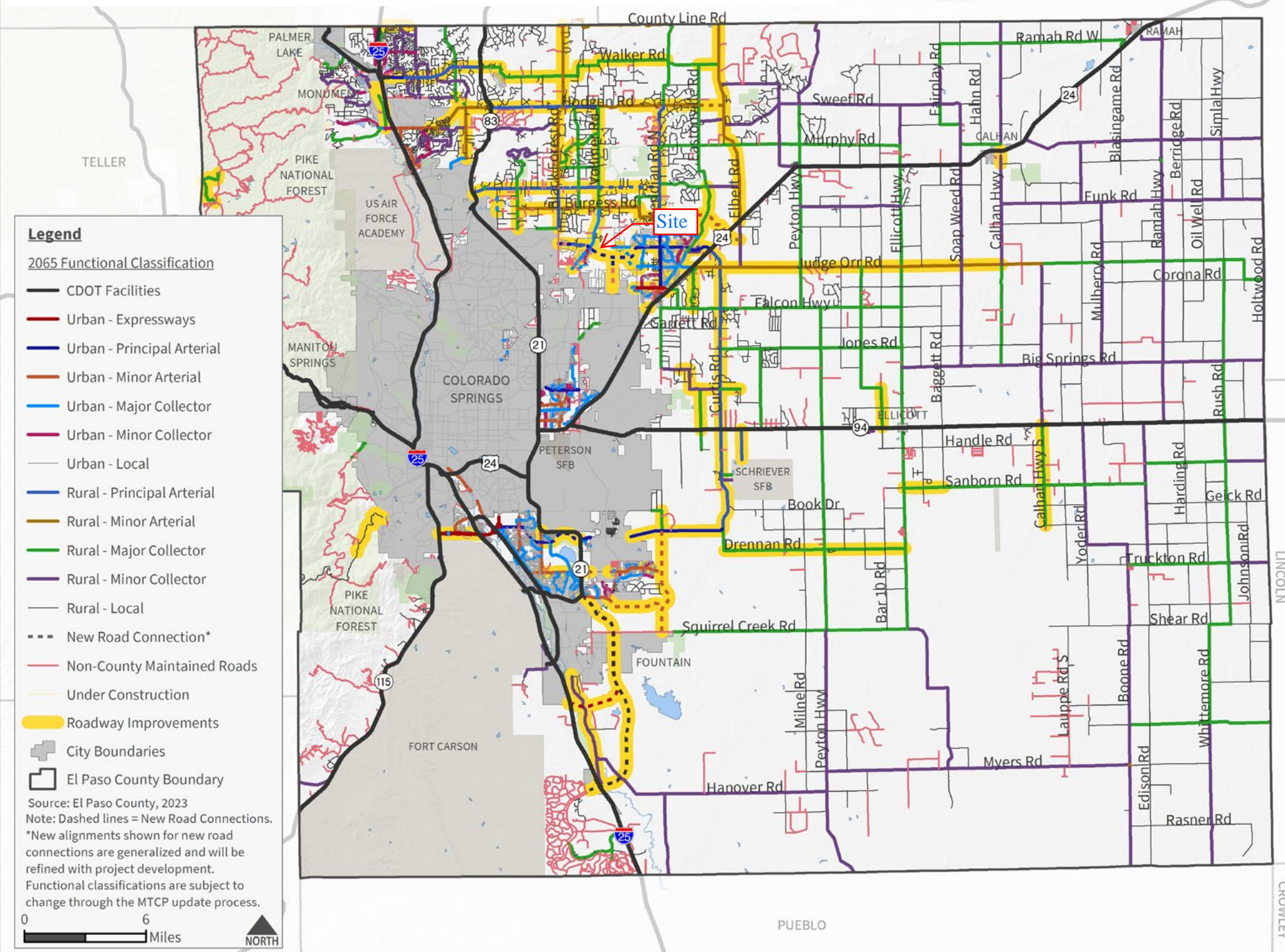

Figure 39. 2065 Corridor Preservation Plan



Crash History



AccidentDate	TotalVehicles	ReferencePointName	ReferencePointAtName	AccidentNarrative
2019-09-29	1	VOLLMER RD	GLIDER LP	Vehicle # 1 was traveling northbound Vollmer Road .8 miles north of Glider Loop. Vehicle # 1's right side tires dropped off the right side of the roadway as it entered a sharp left curve. Vehicle #1 lost control on the roadway for approximately 131' before it traveled approximately 100' off the right side of the roadway. Vehicle # 1 collided its rear with a barbed-wire fence. Vehicle # 1 was moved prior to investigation.
2019-10-01	1	VOLLMER RD	S POCO RD	Vehicle #1 was northbound on Vollmer Road in a left hand curve. Vehicle #1 ran off the right side of the road for 107.3'. Vehicle over corrected, reentered the roadway, spinning counter clockwise. Vehicle #1 was out of control for 98.5'. Vehicle #1 ran off the left side of the road for 99.8', rolling 1 1/2 times. Vehicle #1 came to rest on its top facing west.
2019-11-14	1	VOLLMER RD	GLIDER PL	Vehicle 1 was southbound on Vollmer Road south of Burgess Road. Vehicle 1 was travelling in excessive speed, when it failed to negotiate a right hand bend in the roadway. Vehicle left heavy left side tire skids marks for 115.8 feet in the northbound lane, after which it traveled for 59.4 across the southbound lane. Vehicle 1 ran off the right side of the road for 130.9 feet where it began to overturn, airborne for 20.7 feet, colliding with the ground, traveled another 25.9 feet and rolled another 52.2 feet where it came to final rest facing east on its right side 23.9 feet from the west road edge.
2020-04-23	1	VOLLMER RD	WILDFLOWER RD	Vehicle #1 was traveling south on Vollmer Rd approaching Wildflower Rd. Vehicle #1 failed to navigate the slight left curve in the roadway at which point it ran off the right side of the road. Vehicle #1 crashed through the fence on the right side of the road, traveled southwest into the yard of 8455 Wildflower Rd, rolled, crashed into a well, and came to rest on its wheels facing south.
2020-05-26	1	VOLLMER	WILD FLOWER	Vehicle #1 was southbound on Vollmer. Driver of vehicle #1 lost control and went off the right side of the road and overturned. Vehicle #1 was moved prior to investigation.
2020-07-25	1	VOLLMER RD	POCO RD	Vehicle 1 was traveling in an easterly direction on Vollmer Road approaching a left curve. Vehicle 1 drove on the wrong side of the road to avoid a deceased raccoon in the middle of its lane. Vehicle 1 returned to its lane while navigating the curve. Vehicle 1's right tires dropped off the right edge of the road. Driver 1 pulled the wheel to the left causing Vehicle 1 to spin out of control. Driver 1 overcorrected to the right and the vehicle rolled 3/4 times off the right side of the road. Vehicle 1 came to final rest on top of a fence facing south on its right side.
2021-03-24	1	VOLLMER RD	POCO RD	Vehicle #1 was southbound on Vollmer Road just south of Poco Road. Vehicle #1 lost control on the icy covered roadway and slid off of the west edge of the roadway for approximately 50 feet while rotating 1/4 times clockwise. Vehicle #1 then collided with a barbed wire fence approximately 15 feet west of the road edge and overturned 1/4 times onto its left. Vehicle #1 came to final rest on its left side, approximately 15 feet west of the road edge facing west.
2021-09-13	3	VOLLMER RD	POCO RD	Vehicle #1 was traveling southbound on Vollmer Road. Vehicle #2 was parked on Poco Road, facing east, just west of the intersection of Vollmer Rd. and Poco Rd. Vehicle #2 was partially in the lane and partially on what would be a shoulder, as the entire road is dirt. Vehicle #3 was parked likewise, behind vehicle #2. Vehicle #1 made a right hand turn, to travel westbound on Poco Rd. The left front of vehicle #1 crashed into the left front of vehicle #2. Vehicle #2, being on dirt, slid backwards into the front of vehicle #3. Both vehicles #2 and #3 were unoccupied. Vehicle #1 pulled through and pulled over further down Poco Road to a safe location.
2021-11-11	1	VOLLMER RD	POCO RD	Vehicle #1 was travelling northbound on Vollmer Rd approaching Poco Rd. Vehicle #1 failed to negotiate a curve to the left and travelled off the right side of the road. Vehicle #1 overcorrected to the left, travelled across both lanes of traffic, and drove off the left side of the road. Vehicle #1 rotated counter-clockwise and hit a trip point in the soft dirt. Vehicle #1 rolled 1 and 3/4 times, coming to rest on its left side facing southwest approximately 30 feet off the road. The driver of the vehicle was ejected out of the passenger window during the rollover and came to rest in the field approximately 50 feet northwest of the vehicle.
2022-04-07	1	VOLLMER RD	WILDFLOWER RD	Vehicle 1 was traveling southbound on Vollmer Rd approaching the intersection of Wildflower Rd. Vehicle 1 failed to negotiate a curve and drove off the right side of the roadway at the intersection of Wildflower Rd. Vehicle 1 drove approximately 19 feet off of the right side of the roadway impacting an embankment and came to final rest 85 feet south of Wildflower Rd on the southwest side of the intersection facing south.
2022-06-19	2	VOLLMER RD	LOCHWINNOCH LN	VEHICLE 1 WAS NORTHBOUND ON VOLLMER ROAD. VEHICLE 2 WAS NORTHBOUND ON VOLLMER ROAD, IN FRONT OF VEHICLE 1. VEHICLE 2 BEGAN TO SLOW TO MAKE A LEFT TURN ONTO LOCHWINNOCH ROAD. VEHICLE 1 ATTEMPTED TO PASS VEHICLE 2 ON THE LEFT SIDE IN A MARKED NO PASSING ZONE. VEHICLE 2 BEGAN TO MAKE THE LEFT TURN WHERE VEHICLE 2 WAS STRUCK IN THE FRONT DRIVERS SIDE, BY THE FRONT PASSENGER SIDE OF VEHICLE 1. THE COLLISION OCCURRED WITHIN THE SOUTHBOUND LANE OF VOLLMER ROAD. VEHICLE 1 THEN ROTATED 1/2 TIME CLOCKWISE ACROSS THE NORTHBOUND LANE. VEHICLE 1 THEN DROVE OFF THE NORTHBOUND SIDE OF THE ROAD AND OVERTURNED 1/2 TIME, COMING TO FINAL REST ON ITS ROOF FACING SOUTH. VEHICLE 2 CAME TO A CONTROLLED FINAL REST ON LOCHWINNOCH LN.
2022-07-03	1	VOLLMER RD	POCO RD	Motorcycle was traveling on Vollmer Rd headed northbound. Motorcycle traveled off the right side of the road. Motorcycle lost control and rolled multiple times, the rider was ejected. Motorcycle came to rest on the left side. Rider came to rest on his back.

V1_Traffic Impact Study comments..pdf Markup Summary

Bret (2)

(LSC #S244250)
September 27, 2024
[PCD File No P2414](#)

Subject: Engineer
Page Label: 1
Author: Bret
Date: 11/6/2024 2:55:33 PM
Status:
Color: ■
Layer:
Space:

PCD File No P2414

DNAL CLASSIFICATIONS AND LANEAGE
recommended functional classifications and
area.
Please be sure the
deviation is submitted,
I don't see it in the
submittal documents.
ITS
Criteria contained in Land Development Code
& Manual (ECM) to allow for the proposed
east of Sterling Ranch Road has been rece

Subject: Engineer
Page Label: 16
Author: Bret
Date: 11/6/2024 12:59:05 PM
Status:
Color: ■
Layer:
Space:

Please be sure the deviation is submitted, I don't see it in the submittal documents