



MVE, INC.
ENGINEERS SURVEYORS

1903 kelaray street, suite 200
colorado springs, co 80909
719.635.5736

Preliminary /
Final
Drainage
Report

Koinonia Ranch

Project No. 61148

January 28, 2022

PCD File No. SP-21-004

Preliminary / Final Drainage Report

for

Koinonia Ranch

Project No. 61148

January 28, 2022

prepared for

Koinonia Ranch, LLC

3647 Tuscanna Grove
Colorado Springs, CO 80920

prepared by

MVE, Inc.

1903 Lelaray Street, Suite 200
Colorado Springs, CO 80909
719.635.5736

Copyright © MVE, Inc., 2022

61148-Koinonia Ranch-FDR.odt

Statements and Acknowledgments

Engineer's Statement

The attached drainage plan and report were prepared under my direction and supervision and are correct to the best of my knowledge and belief. Said drainage report has been prepared according to the criteria established by the County for drainage reports and said report is in conformity with the applicable master plan of the drainage basin. I accept responsibility for any liability caused by any negligent acts, errors or omissions on my part in preparing this report.

David R. Gorman, P.E.
For and on Behalf of MVE, Inc.

Colorado No. 31672

Date

Developer's Statement

I, the owner/developer have read and will comply with all of the requirements specified in this drainage report and plan.

Sarah Bartels
Koinonia Ranch, LLC
3647 Tuscanna Grove
Colorado Springs, CO 80920

Date

El Paso County

Filed in accordance with the requirements of the Drainage Criteria Manual, Volumes 1 and 2, El Paso County Engineering Criteria Manual and Land Development Code as amended.

Jennifer Irvine, P.E.,
County Engineer / ECM Administrator

Date

Conditions:

Contents

Statements and Acknowledgments.....	iii
Contents.....	v
Preliminary / Final Drainage Report.....	1
1 General Location and Description.....	1
1.1 Location.....	1
1.2 Description of Property.....	1
2 Drainage Basins and Sub-Basins.....	2
2.1 Major Basin Descriptions.....	2
2.2 Other Drainage Reports.....	2
2.3 Sub-Basin Description.....	2
3 Drainage Design Criteria.....	3
3.1 Development Criteria Reference.....	3
3.2 Hydrologic Criteria.....	4
4 Drainage Facility Design.....	4
4.1 General Concept.....	4
4.2 Specific Details.....	4
4.3 Existing Old Ranch Road Culvert.....	7
4.4 Erosion Control.....	7
4.5 Water Quality Enhancement Best Management Practices.....	7
5 Drainage and Bridge Fees.....	8
6 Conclusion.....	8

References.....	9
Appendices.....	11
7 General Maps and Supporting Data.....	11
8 Hydrologic Calculations.....	12
9 Hydraulic Calculations.....	33
10 Report Maps.....	41

Preliminary / Final Drainage Report

The purpose of this Preliminary / Final Drainage Report is to identify drainage patterns and quantities within and affecting the proposed Koinonia Ranch site. The development project is a residential subdivision with six (6) 5.0± acre lots, and one (1) tract. The report will identify specific solutions to problems on-site and off-site resulting from the proposed project. The report and included maps present results of hydrologic and drainage facilities analyses. The report will discuss the recommended drainage improvements to the site and identify drainage requirements relative to the proposed project. This report has been prepared and submitted in accordance with the requirements of the El Paso County development approval process. An Appendix is included with this report with pertinent calculations and graphs used in the drainage analyses and design.

1 General Location and Description

1.1 Location

The proposed Koinonia Ranch site is located within the southeast one-quarter of the southwest one-quarter of Section 19, Township 12 South, Range 65 west of the 6th principal meridian in El Paso County, Colorado. The 39± acre site is situated north of Old Ranch Road. The site is generally west of Black Forest Road, north of Old Ranch Road. The site contains an existing single-family residential property using the address of 6170 Old Ranch Road. The El Paso County Assessor's Schedule Number for the site is 5219000059. The proposed site has never been platted. A **Vicinity Map** is included in the **Appendix**.

The south edge of the site is adjacent to an unplatted and undeveloped parcel zoned PUD (Planned Unit Development). Unplatted property zoned RR-5 and containing two single family residences is located adjacent to the east side of the site. Unplatted and undeveloped property zoned RR-5 is located adjacent to the west side of the site. The site is located in El Paso County's Cottonwood Creek Drainage Basin.

1.2 Description of Property

The Koinonia Ranch site 39± acres and is zoned RR-5 (Residential Rural (5 Acres)). The property is the location of a single-family residence with an existing unpaved driveway.

The site is covered with native grass and weeds in good condition, and coniferous trees. There is dense tree coverage on the northern portion of the site and sparse tree coverage on the southern portion of the site. The existing site topography slopes to the south towards Old Ranch Road with grades that range from 3% to 30%.

There are no major drainage ways in the Koinonia Ranch site. All storm runoff flows south to Old Ranch Road. An existing culvert discharges the flows south of Old Ranch Road. There is no storm drain system located within Old Ranch Road or the surrounding area. The site is located in the cottonwood creek major drain basin. The flows from the site flow south and eventually enter cottonwood creek, a tributary to Monument creek.

According to the National Resource Conservation Service, there are three (3) soil types in the Koinonia ranch site. Kettle gravelly loamy sand (map unit 40) makes up a portion of the soil in the center of the site where the existing structure is located. The soil is deep and somewhat excessively drained. Permeability is moderately rapid, surface runoff is slow, and the hazard of erosion is slight to moderate. Kettle gravelly loamy sand is classified as being part of Hydrologic Soil Group B.

The second type is Kettle Gravelly Loamy Sand (map unit 41) which makes up the northern portion of the site. The soil is deep and somewhat excessively drained. Permeability is moderately rapid, surface runoff is slow, and the hazard of erosion is slight to moderate. Kettle gravelly loamy sand is classified as being part of Hydrologic Soil Group B.

The last soil type is Pring Coarse Sandy Loam (map unit 71) which makes up the southern side of the site. The soil is deep and well drained. Permeability is moderately rapid, surface runoff is slow, and the hazard of erosion is slight to moderate. Pring Coarse Sandy Loam is classified as being part of Hydrologic Soil Group B.

A portion of the Soil Map and data tables from the National Cooperative Soil Survey and relevant Official Soil Series Descriptions (OSD) are included in the **Appendix**.^{1 2}

There are no major drainage ways in the Koinonia Ranch site.

The current Flood Insurance Study of the region includes Flood Insurance Rate Maps (FIRM), effective on December 7, 2018.³ The proposed subdivision is included in the Community Panel Numbered 08041C0527 G of the Flood Insurance Rate Maps for the El Paso County. No part of the site is shown to be included in a 100-year flood hazard area as determined by FEMA. A portion of the current FEMA Flood Insurance Rate Maps with the site delineated is included in the **Appendix**.

2 Drainage Basins and Sub-Basins

2.1 Major Basin Descriptions

The Koinonia Ranch site is located in the Cottonwood Creek Drainage Basin (FOMO2200) of the Fountain Creek Major Drainage Basin. The Cottonwood Creek Drainage Basin Covers an area of approximately 19 square miles and drains to Monument Creek. The *Cottonwood Creek Drainage Basin Planning Study* provides development recommendations and requirements for drainage development in the Cottonwood Creek Drainage Basin (DBPS).⁴ The Cottonwood Creek Drainage Basin encompasses a part of the northeast portion of the City of Colorado Springs and extends to the north and east. The drainage basin and Cottonwood Creek drain southwest into Monument Creek. The Koinonia Ranch site is located north of Cottonwood Creek as it flows offsite towards Monument Creek. The site is located in sub-basin WR 050, upstream of Design Point 040 of the Drainage Basin Planning Study. No improvements are recommended on or near the project site. The proposed Koinonia Ranch project is in conformance with the DBPS.

2.2 Other Drainage Reports

The drainage report "Geist Subdivision" by Richards Land Surveying Company dated January 4, 1982⁵ was reviewed in preparation of this Preliminary / Final Drainage Report.

2.3 Sub-Basin Description

The existing drainage patterns of the Koinonia Ranch project are described by five on-site drainage basins and five offsite basins. All of these sub-basins are previously undisturbed or developed to a degree as described below. All existing sub-basin delineations and data are depicted on the attached **Existing Drainage Map**.

1 WSS
2 OSD
3 FIRM
4 DBPS
5 DRGS

2.3.1 Existing Drainage Patterns (Off-Site)

Existing off site sub-basin EX-OSA-1, containing pasture/meadow, is located to the west of the site. This sub-basin drains overland to the east onto the site. This flow enters the onsite sub-basin EX-A5 and continues through the site.

Existing off site sub-basin EX-OSA-2, containing pasture/meadow, is located to the west of the site just south of sub-basin EX-OSA-1. This sub-basin drains overland to the east into the site. This flow enters the onsite sub-basin A-5 and continues through the site.

Existing off site sub-basin EX-OSA-3, containing pasture/meadow, is located to the east of the site. This sub-basin drains overland to the west into the site. The flow enters the onsite sub-basin EX-A-5 and continues through the site.

Existing off site sub-basin EX-OSA-6, containing pasture/meadow, is located to the west of the site just south of sub-basin EX-OSA-2. This sub-basin drains overland to the southeast into the site. The flow enters the onsite sub-basin EX-OSA-5 and continues through the site.

Existing off site sub-basin EX-OSB-1, containing pasture/meadow, is located northwest of the site. This sub-basin drains overland to the southeast onto the site. The flow enters the onsite sub-basin EX-B-2 and continues through the site.

2.3.2 Existing Drainage Patterns (On-Site)

The site generally drains to the south. The southeast portion of the site, drains towards the southeast corner of the site. The remaining portion of the site drains south towards the site's southern boundary.

Existing sub-basin EX-B-2, containing pasture/meadow, is located in the northeastern portion of the site. All flows from sub-basin EX-B-2 drain overland to the east into the adjacent site. These flows continue southeast through adjacent properties.

Existing sub-basin EX-A-4, containing pasture/meadow, is located in the western portion of the site, just east of sub-basin EX-OSA-2. The sub-basin contains pasture/meadow. All flows from sub-basin EX-A-4 drain overland and exit the site at the west property line into sub-basin EX-OSA-2.

Existing sub-basin EX-A-5 is centrally located throughout the majority of the site. This sub-basin contains an existing single-family residence, gravel drive, and pasture/meadow areas. The flows generated by this sub-basin drain overland to the south and exit the site at design point 1 through an existing culvert. These flows continue south through the adjacent properties toward Cottonwood Creek. All flows from the site eventually enter Cottonwood Creek.

Existing sub-basin EX-C-1, containing pasture/meadow, is located in the southeast portion of the site. All flows from sub-basin EX-C-1 drain overland and exit the site through the east property line and continue south through adjacent properties into cottonwood creek.

Existing sub-basin EX-D-1, containing pasture/meadow, is also located in the southeast portion of the site just south of sub-basin EX-C-1. All flows from basin EX-D-1 drain overland and exit the site through the east property line and continue south through adjacent properties into cottonwood creek.

3 Drainage Design Criteria

3.1 Development Criteria Reference

This Preliminary / Final Drainage Report for Koinonia Ranch has been prepared according to the report guidelines presented in the latest edition of *El Paso County Drainage Criteria Manual (DCM)*⁶. The County has also adopted portions of the City of Colorado Springs Drainage Criteria Manual Volumes 1 and 2, especially concerning the calculation of rainfall runoff flow rates.^{7 8} The hydrologic

6 DCM Section 4.3 and Section 4.4

7 CS DCM Vol 1

8 CS DCM Vol 2

analysis is based on a collection of data from the DCM, the NRCS Web Soil Survey⁹, and existing topographic data by Land Resource Associates.

3.2 Hydrologic Criteria

For this Preliminary / Final Drainage Report, the Rational Method as described in the *Drainage Criteria Manual* has been used for all Storm Runoff calculations, as the development and all sub-basins are less than 130 acres in area. “Colorado Springs Rainfall Intensity Duration Frequency” curves, Figure 6-5 in the DCM, was used to obtain the design rainfall values; a copy is included in the **Appendix**. The “Overland (Initial) Flow Equation” (Eq. 6-8) in the DCM, and Manning's equation with estimated depths were used in time of concentration calculations. “Runoff Coefficients for Rational Method”, Table 6-6 in the DCM, was utilized as a guide in estimating runoff coefficient and Percent Impervious values; a copy is included in the **Appendix**. Peak runoff discharges were calculated for each drainage sub-basin for both the 5-year storm event and the 100-year storm event with the Rational Method formula, (Eq. 6-5) in the DCM.¹⁰

4 Drainage Facility Design

4.1 General Concept

The intent of the drainage concept presented in this Preliminary / Final Drainage Report is to allow for the development of the six (6) 5-acre lots, and one (1) tract while maintaining the existing drainage patterns on the site. The site will be in compliance with the County's Stormwater Management regulations without the need for permanent water quality treatment facilities. Major and minor storm flows will continue to be safely conveyed through the site and downstream.

The existing and proposed drainage hydrologic conditions are described in more detail below. Input data and results for all calculations are included in the **Appendix**. Drainage maps for the hydrology are also included in the **Appendix**.

4.2 Specific Details

4.2.1 Existing Hydrologic Conditions

The off-site drainage area west of the site, sub-basin EX-OSA-1, contains pasture/meadow. The sub-basin is 5.47± acres in area and drains easterly overland and into sub-basin EX-A-5. Sub-basin EX-OSA-1 generates peak storm runoff discharges of $Q_5 = 1.9$ cfs and $Q_{100} = 14.3$ cfs (existing flows) which drains overland into the site at sub-basin EX-A-5. Once in the site, these flows continue to drain to the south to existing Design Point 1 (EX-DP1).

Existing off-site sub-basin EX-OSA-2 is 12.06 acres in area located west of the site just south of sub-basin EX-OSA-1 and contains pasture/meadow. Sub-basin EX-OSA-2 produces peak discharges of $Q_5 = 3.3$ cfs and $Q_{100} = 21.6$ cfs (existing flows) which drain easterly overland and into sub-basin EX-A-5. Once in the site, these flows continue to drain to the south to EX-DP1.

Existing off-site sub-basin EX-OSA-3, located east of the site is 3.90 acres in area. Sub-basin EX-OSA3 contains a meadow/pasture area. Peak storm runoff rates are $Q_5 = 3.1$ cfs and $Q_{100} = 11.2$ cfs (existing flows) which drain westerly overland into sub-basin EX-A-5. Once in the site, these flows continue to drain overland to the south to EX-DP1.

Existing sub-basin EX-A-4, located on the western portion of the site, is 0.97 acres in area. Sub-basin EX-A-4 contains a meadow/pasture area. The sub-basin generates peak flows of $Q_5 = 0.3$ cfs and $Q_{100} = 2.4$ cfs (existing flow), which drains westerly overland and exits the site into sub-basin EX-OSA-2. These flows, along with the flows from existing sub-basin EX-OSA-2, continue to drain to the south to EX-DP1.

⁹ WSS
¹⁰ DCM

Existing sub-basin EX-A-5, centrally located throughout most of the site, is 30.09 acres in area. Sub-basin EX-A-5 contains an existing single-family residence, a gravel driveway, and a meadow/pasture area. Peak storm runoff rates are $Q_5 = 6.2$ cfs and $Q_{100} = 39.0$ cfs (existing flows) which drains overland to the south to EX-DP1.

Existing offsite sub-basin EX-OSA-6, located west of the site just south of sub-basin EX-OSA-2, is 5.93 acres in area. Sub-basin EX-OSA-6 contains a meadow/pasture area. This sub-basin generates peak storm runoff rates of $Q_5 = 2.2$ cfs and $Q_{100} = 12.6$ cfs (existing flows) which drains easterly overland into sub-basin EX-A-5. These flows continue to drain to the south toward EX-DP1. The combined peak storm runoff rates flowing to EX-DP1 are $Q_5 = 17.8$ cfs and $Q_{100} = 116.7$ cfs (existing flows) which flow south through an existing culvert at Old Ranch Road and continues to flow south through adjacent properties to cottonwood creek.

Existing offsite sub-basin EX-OSB-1, located north of the site, is 1.66 acres in area. Sub-basin EX-OSB1 contains a meadow/pasture area. Sub-basin EX-OSB-1 generates peak storm runoff rates of $Q_5 = 0.6$ cfs and $Q_{100} = 4.3$ cfs (existing flows) which drains to the southeast into sub-basin EX-B-2. These flows continue to drain southeasterly offsite.

Existing sub-basin EX-B-2, located in the northern portion of the site just south of sub-basin EX-OSB-1, is 5.55 acres in area. Sub-basin EX-B-2 contains a meadow pasture area. Peak storm runoff rates generated by this sub-basin are $Q_5 = 1.6$ cfs and $Q_{100} = 11.5$ cfs (existing flows) which drain southeasterly offsite. The combined flows from sub-basin EX-OSB-1 and EX-B-2 are $Q_5 = 2.3$ cfs and $Q_{100} = 16.7$ cfs (existing flows) which flow southeast offsite. These flows continue draining south through adjacent properties to cottonwood creek.

Existing sub-basin EX-C-1, located in the southeast portion of the site just north of sub-basin EX-D-1, is 1.70 acres in area. Sub-basin EX-C-1 contains a meadow pasture area. Peak storm runoff rates generated by this sub-basin are $Q_5 = 0.6$ cfs and $Q_{100} = 4.1$ cfs (existing flows) which drains southeast offsite. These flows continue draining south through adjacent properties to cottonwood creek.

Existing sub-basin EX-D-1, located in the southeast portion of the site just south of sub-basin EX-C-1, is 0.82 acres in area. Sub-basin EX-D-1 contains a meadow pasture area. Peak storm runoff rates generated by this sub-basin are $Q_5 = 0.2$ cfs and $Q_{100} = 1.8$ cfs (existing flows) which drains southeast offsite. These flows continue draining south through adjacent properties to cottonwood creek.

The **Existing Drainage Map** depicts the existing topographic mapping, drainage basin delineations, drainage patterns, existing drives, drainage facilities, and runoff quantities with a data table including drainage areas and flow rates.

4.2.2 Proposed Hydrologic Conditions

Proposed offsite sub-basin OSA-1 (3.14 acres), located east of the site just south of sub-basin OSB1, contains pasture/meadow. Sub-basin OSA-1 will generate peak storm runoff discharges of $Q_5 = 1.1$ cfs and $Q_{100} = 8.3$ cfs (proposed flow) which drains overland to the southeast into sub-basin A-2.

Proposed sub-basin A-2 (14.31 acres), located on the eastern portion of the site, will be developed with two (2) proposed single-family residences with gravel driveways and half of the proposed rural gravel local roadway. Sub-basin A-2 will generate peak storm runoff discharges of $Q_5 = 4.6$ cfs and $Q_{100} = 25.5$ cfs (proposed flow) which drains south in the ditch along the proposed roadway to design point 1 (DP1).

The proposed off-site sub-basin, OSA-3 (2.33 acres), containing pasture/meadow, will drain easterly overland onto the site. Basin OSA-3 generates peak storm runoff discharges of $Q_5 = 0.8$ cfs and $Q_{100} = 5.9$ cfs (proposed flows) which enters proposed sub-basin A-5. Once in the site, these flows continue to drain to the south to design point 2 (DP2).

The proposed off-site sub-basin, OSA-4 (12.06 acres), containing pasture/meadow, will continue to drain into the site as in existing conditions. Basin OSA-4 generates peak storm runoff discharges of $Q_5 = 3.3$ cfs and $Q_{100} = 21.6$ cfs (proposed flows) which enters sub-basin A-5. Once in the site, these flows continue to drain to the south to DP2.

Proposed sub-basin A-5 (15.78 acres), located on the western portion of the site, will be more developed with two (2) proposed single-family residences with gravel driveways and half of a proposed rural gravel local roadway. Sub-basin A-5 will generate peak storm runoff discharges of $Q_5 = 5.9$ cfs and $Q_{100} = 32.1$ cfs (proposed flow) which drains south in the ditch of the proposed roadway to DP2.

The off-site drainage basin, OSA-6 (3.90 acres), containing pasture/ meadow, will drain into the site as in existing conditions. Basin OSA-6 generates peak storm runoff discharges of $Q_5 = 3.1$ cfs and $Q_{100} = 11.2$ cfs (proposed flows) which drains overland and enters the sub-basin A-2 from the east. These flows combine with the flows from sub-basins OSA-1 and A-2 at Design Point 1 (DP1). The combined flows will generate peak storm runoff discharges of $Q_5 = 8.6$ cfs and $Q_{100} = 44.3$ cfs (proposed flow), which drain to the west under proposed Koinonia View through a proposed 36" RCP culvert. Culvert sizing calculations are included in the **Appendix**.

The proposed sub-basin, A-7 (0.97 acres), containing pasture/meadow, will continue to drain off of the site as in existing conditions. Proposed sub-basin A-7 generates peak storm runoff discharges of $Q_5 = 0.3$ cfs and $Q_{100} = 2.4$ cfs (proposed flows) which drains overland into sub-basin OSA-4. These flows continue to drain to the south to DP2.

The off-site sub-basin, OSA-8 (5.93 acres), containing pasture/meadow, will continue to drain into the site as in existing conditions. Basin OSA-8 generates peak storm runoff discharges of $Q_5 = 2.2$ cfs and $Q_{100} = 12.6$ cfs (proposed flows) which enters proposed sub-basin A-5. Once in the site, these flows continue to drain to the south to DP2. The combined flows from sub-basins OSA-3, OSA-3, A-7, A-5 and OSA-8 at DP2 will generate peak storm runoff discharges of $Q_5 = 19.4$ cfs and $Q_{100} = 108.6$ cfs (proposed flow), which represents an increase of $Q_5 = 1.6$ cfs and $Q_{100} = 1.9$ cfs. These flows will drain into an existing 30" corrugated metal pipe culvert at DP2 then continue flowing south through adjacent properties toward cottonwood creek.

The off-site drainage basin, OSB-1 (1.66 acres), containing pasture/meadow, will continue to drain into the site as in existing conditions. Basin OSB-1 generates peak storm runoff discharges of $Q_5 = 0.6$ cfs and $Q_{100} = 4.3$ cfs (proposed flow) which drains overland and enters sub-basin B-2 to the south. These flows continue to drain offsite to the southeast through adjacent properties.

Proposed sub-basin, B-2 (5.55 acres), contains a proposed single-family residence, a proposed gravel driveway and pasture/meadow. Proposed sub-basin B-2 generates peak storm runoff discharges of $Q_5 = 1.9$ cfs and $Q_{100} = 11.9$ cfs (proposed flows) which drains overland to the southeast offsite. These flows combined with the flows from sub-basin OSB-1 will generate peak storm runoff discharges of $Q_5 = 2.6$ cfs and $Q_{100} = 17.1$ cfs (proposed flow), which represents an increase of $Q_5 = 0.3$ cfs and $Q_{100} = 0.4$ cfs. Once off site, these flows continue to drain southeast through adjacent properties.

Proposed sub-basin C-1 (1.70 acres), containing a proposed single-family residence, a proposed gravel driveway, and pasture/meadow, will continue to drain off of the site as in existing conditions. Basin C-1 generates peak storm runoff discharges of $Q_5 = 0.7$ cfs and $Q_{100} = 4.3$ cfs (proposed flows) which drains overland to the southeast offsite. These flows continue to drain southeast through adjacent properties.

The drainage basin, D-1 (0.82 acres), will continue to drain off of the site as in existing conditions. Basin D-1 generates peak storm runoff discharges of $Q_5 = 0.2$ cfs and $Q_{100} = 1.8$ cfs (proposed flows) which drains southeast offsite. Once off site, these flows continue to drain southeast through adjacent properties.

4.3 Existing Old Ranch Road Culvert

The stormwater flows generated from the site generally drain to the south and exit the site through an existing 30" corrugated metal pipe (CMP) culvert. Said culvert runs through Old Ranch Road and is located west of the proposed roadway. The culvert is sized to safely convey the entire 5 year storm event and will overtop during the 100 year storm event. According to Table 6-1 in the DCM¹¹ cross flow with a depth of flow no more than 6 inches at the street shoulder is allowed in a local roadway with a roadside ditch during a major storm event. Cross flow depths do not reach depths greater than 6 inches at the street shoulder in either the existing or the proposed conditions. An HY-8 analysis of the proposed cross flow is included in the **Appendix**.

4.4 Erosion Control

During future construction, best management practices (BMP's) for erosion control will be employed based on the previously referenced City of Colorado Springs Drainage Criteria Manual Volume 2 and the Erosion Control Plan for the site. During Construction, silt fencing, sediment control log, vehicle tracking control and concrete washout area will be in place to minimize erosion from the site. Silt Fencing will be placed along the southern and eastern sides of the disturbed areas. This will inhibit suspended sediment from leaving the site during construction. Vehicle tracking control will be placed at the access point in the private driveway connecting to Old Ranch Road. BMP's will be utilized as deemed necessary by the contractor, engineer, owner, or County inspector and are not limited to the measures described above.

4.5 Water Quality Enhancement Best Management Practices

The El Paso County Engineering Criteria Manual (Appendix I, Section I.7.2) requires the consideration of a "Four Step Process for receiving water protection that focuses on reducing runoff volumes, treating the water quality capture volume (WQCV), stabilizing drainageways, and implementing long term source controls". The Four Step Process is incorporated in this project and the elements are discussed below.

- 1) Runoff Reduction Practices are employed in this project. Impervious surfaces have been reduced as much as practically possible. There is only minimal concrete or other hard surfaces proposed. Minimized Directly Connected Impervious Areas (MDCIA) is employed on the project because runoff passes through a roadside ditch and an open space meadow area before leaving the site.
- 2) All drainage paths on the site are stabilized with appropriate landscape treatment. Rock check dams will be utilized in the ditch running along the roadway to reduce water velocities to promote stabilization. After the installation of the check dams the ditch will be seeded with native grasses. Ditch flow calculations and check dam spacing calculations are included in the **Appendix**.
- 3) The project contains no potentially hazardous uses. The site is exempted from the use of WQCV BMPs by ECM I.7.1.B.5 by virtue of the large lot rural residential nature of the site having percent imperviosness of less than 10%. The runoff generated from the impervious areas of the gravel road will be treated for water quality by utilizing the runoff reduction standard. Stormwater runoff from the proposed roadway will be collected in the roadside ditches and will infiltrate into the ground, evaporate, or evapotranspire a quantity of water equal to at least 60% of what the calculated WQCV would be if all impervious area for the applicable development site discharged without infiltration. Runoff Reduction calculations are included in the appendix.
- 4) The rural residential development is not anticipated to contain storage of potentially harmful substances or use of potentially harmful substances. No site specific or other source control BMPs are required.

11 DCM

5 Drainage and Bridge Fees

The site is located within the Cottonwood Creek Drainage Basin of Fountain Creek, El Paso Basin Number FOMO2200, which was last studied in 1994. Fees associated with this basin are Drainage Fees of \$19,752 per impervious acre and Bridge Fees of \$1,080 per impervious acre. The percent Imperiousness of the 5-acre Rural Residential site is 7% in accordance with El Paso County Engineering Criteria Manual Appendix L Table 3-1. Also, reductions in the per acre Drainage Fee are allowed pursuant to El Paso County Resolution 99-383. A fee reduction in the of 25% for lots 2.5 acres or large is utilized for this project. The Koinonia Ranch site contains 39 acres. Drainage and Bridge Fees for the site are calculated below:

FEE CALCULATION (Cottonwood Creek 2022 Drainage and Bridge Fees)

Drainage Fee =	39 x \$21,134/Imp. Ac x 0.07 Imp.	=	\$57,695.82
Bridge Fee =	39 x \$1,156/Imp. Ac x 0.07 Imp.	=	<u>\$ 3,155.88</u>
	Subtotal	=	\$60,851.70
	25% Drainage Fee Reduction	=	<u>(\$14,423.96)</u>
	Grand Total Fees	=	<u>\$ 46,427.74</u>

6 Conclusion

This Preliminary / Final Drainage Report presents existing and proposed drainage conditions for the proposed Koinonia Ranch project. The development will have negligible and inconsequential effects on the existing site drainage and drainage conditions downstream. The site is exempted from the use of WQCV BMPs by ECM 1.7.1.B.5 by virtue of the large lot rural residential nature of the site having percent imperviousness of less than 10%. The entire site is consists of 5-acre single family residential lots which are excluded from Post Construction Stormwater Management requirements due to the low development density as 5-acre lots. The combined flows from the site at the existing culvert at Old Ranch Road are expected to increase by approximately 1.9 cfs during the 100yr storm event or an increase of about 2%. With such a negligible increase in stormwater flows from the site detention will not be necessary for the proposed development and will not be provided. The proposed project will not, with respect to stormwater runoff, negatively impact the adjacent properties and downstream properties.

References

NRCS Web Soil Survey. United States Department of Agriculture, Natural Resources Conservation Service ("<http://websoilsurvey.nrcs.usda.gov/app/WebSoilSurvey.aspx>", accessed March, 2018).

NRCS Official Soil Series Descriptions. United States Department of Agriculture, Natural Resources Conservation Service ("<http://soils.usda.gov/technical/classification/osd/index.html>", accessed March, 2018).

Flood Insurance Rate Map. Federal Emergency Management Agency, National Flood Insurance Program (Washington D.C.: FEMA, December 7, 2018).

Cottonwood Creek Drainage Basin Planning Study. Matrix Design Group (Colorado Springs: El Paso County, July, 2019).

Drainage Report "Geist Subdivision". Richards Land Surveying Company (Colorado Springs: El Paso County, January 4, 1982).

NCSS Web Soil Survey. United States Department of Agriculture, Natural Resources Conservation Service ("<http://websoilsurvey.nrcs.usda.gov/app/WebSoilSurvey.aspx>", accessed May, 2017).

Drainage Criteria Manual Volume 2, Stormwater Quality Policies, Procedures and Best Management Practices (BMPs). City of Colorado Spring Engineering Division (Colorado Springs: , May 2014).

City of Colorado Springs Drainage Criterial Manual, Volume 1. City of Colorado Springs Engineering Division Staff, Matrix Desgin Group/Wright Water Engineers (Colorado Springs: , May 2014).

City of Colorado Springs/El Paso County Drainage Criteria Manual. City of Colorado Springs, Department of Public Works, Engineering Division; HDR Infrastructure, Inc.; El Paso County, Department of Public Works, Engineering Division (Colorado Springs: City of Colorado Springs, Revised November 1991).

City of Colorado Springs Drainage Criteria Manual Volume 1. City of Colorado Springs Engineering Division with Matrix Design Group and Wright Water Engineers (Colorado Springs, Colorado: , May 2014).

| Appendices

7 General Maps and Supporting Data

- Vicinity Map
- Portions of Flood Insurance Rate Map
- Portion of Drainage Area Identification Study Map
- NRCS Soil Map and Tables
- SCS Soil Type Descriptions
- Hydrologic Soil Group Map and Tables

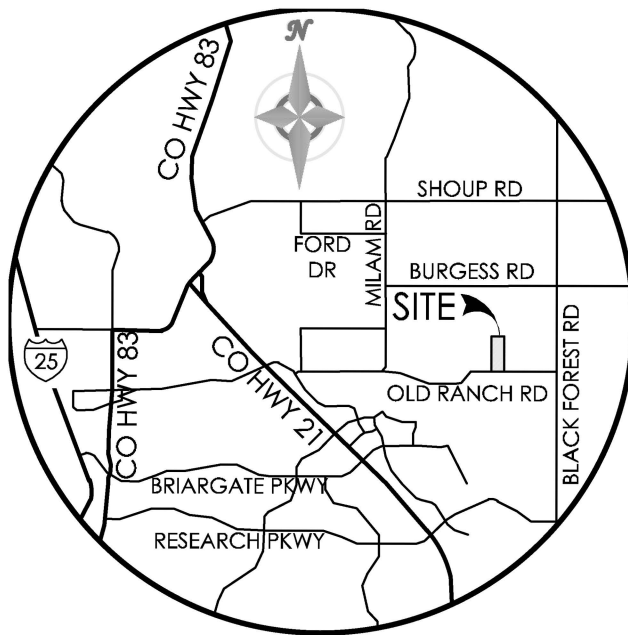

VICINITY MAP

NOT TO SCALE

National Flood Hazard Layer FIRMette

104°43'8"W 38°59'28"N



Legend

SEE FIS REPORT FOR DETAILED LEGEND AND INDEX MAP FOR FIRM PANEL LAYOUT

SPECIAL FLOOD HAZARD AREAS

- Without Base Flood Elevation (BFE)
Zone A, V, A99
- With BFE or Depth
Zone AE, AO, AH, VE, AR
- Regulatory Floodway

0.2% Annual Chance Flood Hazard, Areas of 1% annual chance flood with average depth less than one foot or with drainage areas of less than one square mile
Zone X

OTHER AREAS OF FLOOD HAZARD

- Future Conditions 1% Annual Chance Flood Hazard
Zone X
- Area with Reduced Flood Risk due to Levee. See Notes.
Zone X
- Area with Flood Risk due to Levee
Zone D

OTHER AREAS

- Area of Minimal Flood Hazard
Zone X
- Effective LOMR
- Area of Undetermined Flood Hazard
Zone D

GENERAL STRUCTURES

- Channel, Culvert, or Storm Sewer
- Levee, Dike, or Floodwall

OTHER FEATURES

- Cross Sections with 1% Annual Chance Water Surface Elevation
20.2
17.5
- Coastal Transect
- Base Flood Elevation Line (BFE)
- Limit of Study
- Jurisdiction Boundary
- Coastal Transect Baseline
- Profile Baseline
- Hydrographic Feature

MAP PANELS

- Digital Data Available
- No Digital Data Available
- Unmapped

The pin displayed on the map is an approximate point selected by the user and does not represent an authoritative property location.

This map complies with FEMA's standards for the use of digital flood maps if it is not void as described below. The basemap shown complies with FEMA's basemap accuracy standards

The flood hazard information is derived directly from the authoritative NFHL web services provided by FEMA. This map was exported on **12/21/2020 at 12:51 PM** and does not reflect changes or amendments subsequent to this date and time. The NFHL and effective information may change or become superseded by new data over time.

This map image is void if the one or more of the following map elements do not appear: basemap imagery, flood zone labels, legend, scale bar, map creation date, community identifiers, FIRM panel number, and FIRM effective date. Map images for unmapped and unmodernized areas cannot be used for regulatory purposes.

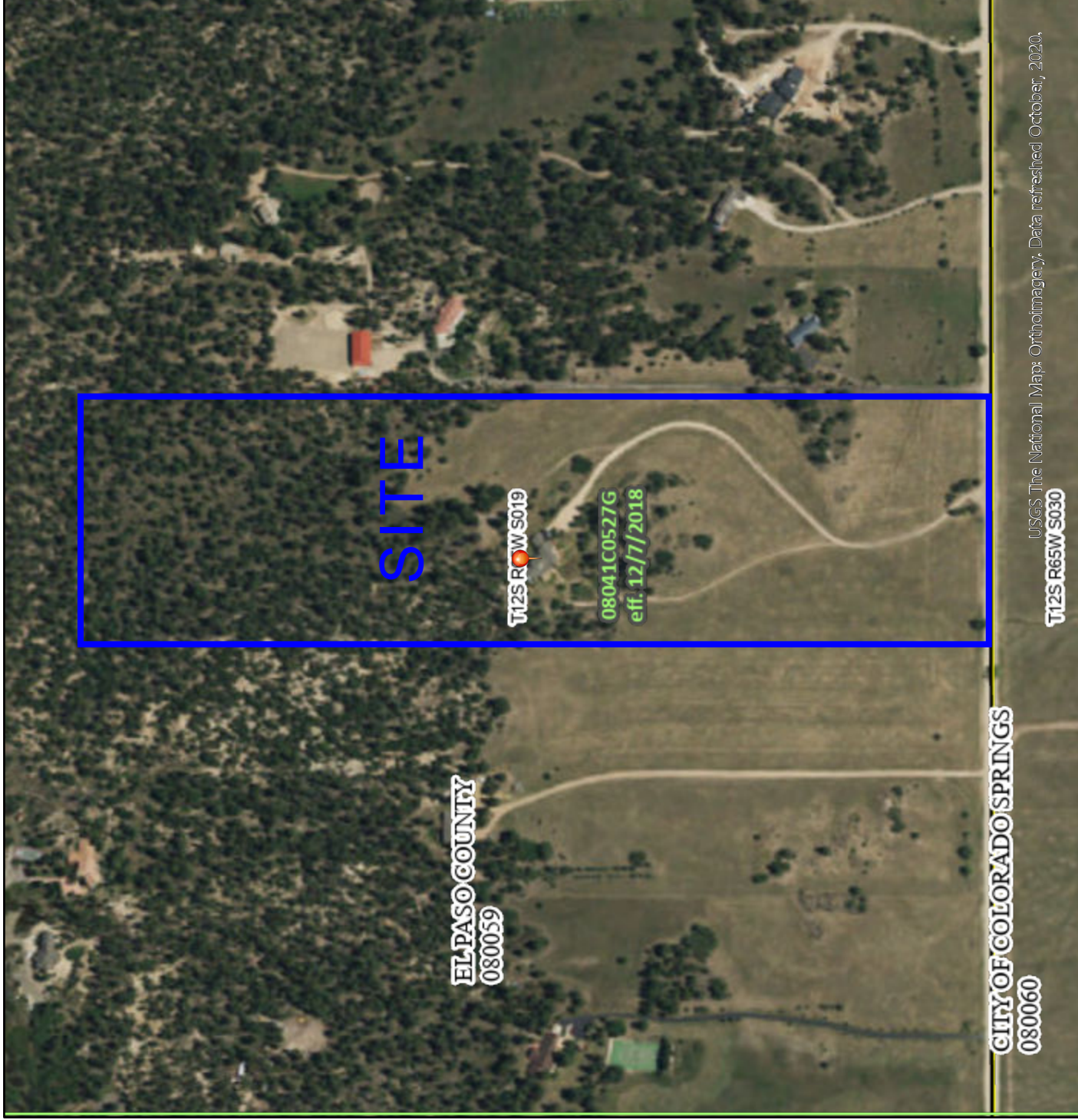

USGS The National Map: Orthoimagery. Data refreshed: October, 2020.

T12S R65W S030



104°42'30"W 38°59'N

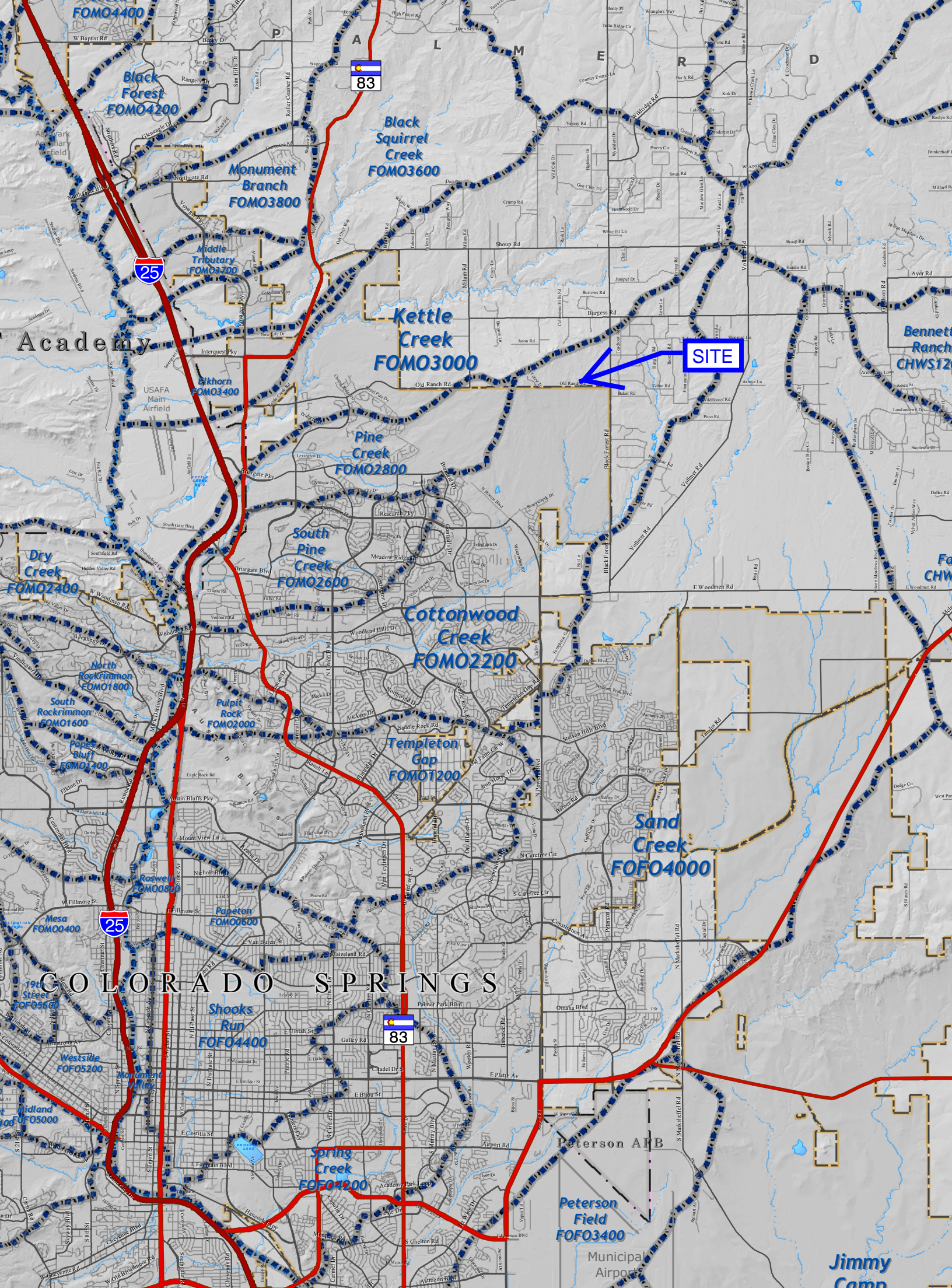

Academy

SITE

83

25

83

25

COLORADO SPRINGS

Peterson AFB

Peterson Field
FOFO3400

Municipal
Airport

Jimmy
Camp

Custom Soil Resource Report Soil Map

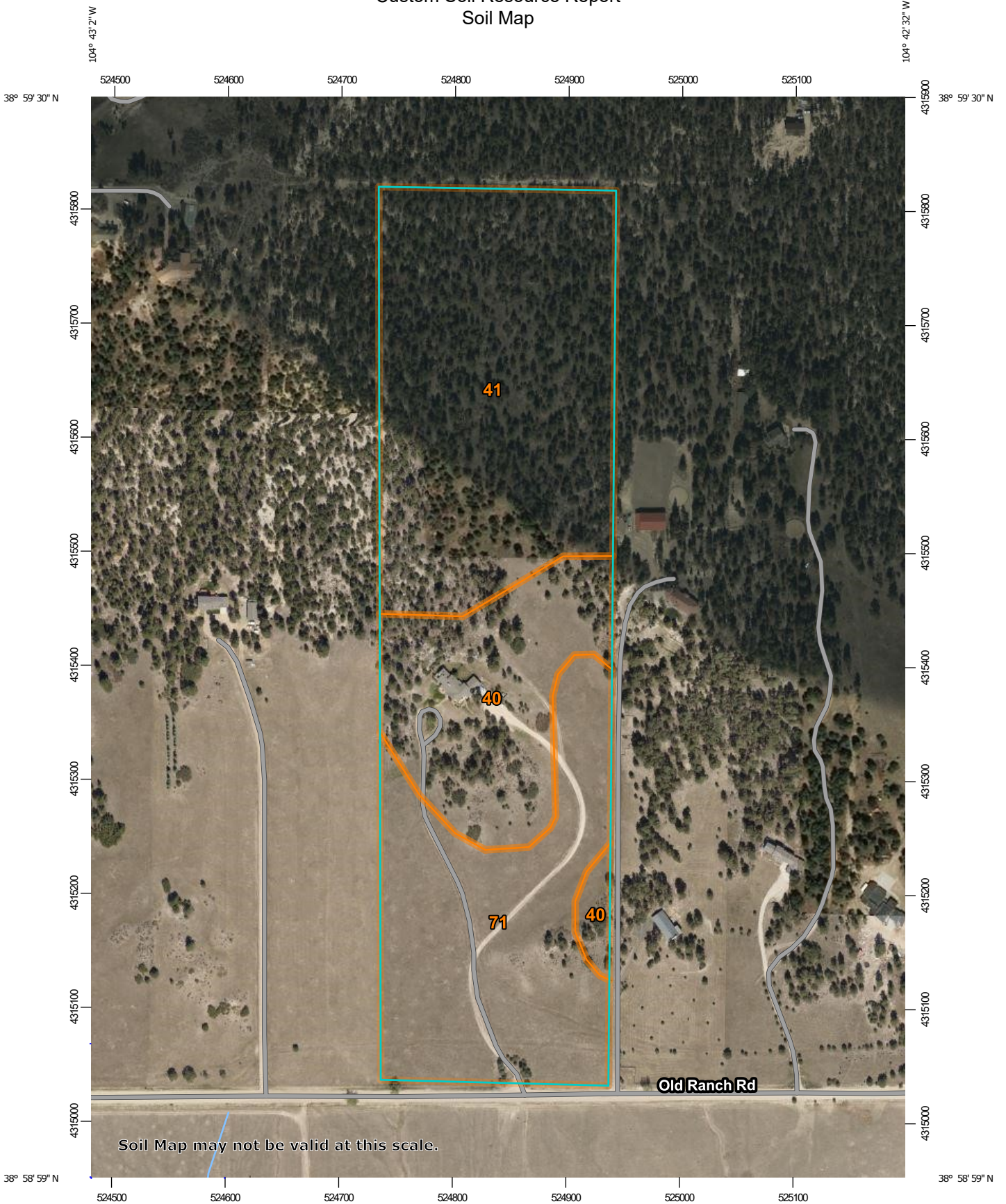



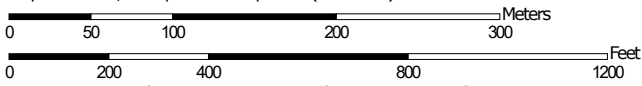

































Map Scale: 1:4,620 if printed on A portrait (8.5" x 11") sheet.



Map projection: Web Mercator Corner coordinates: WGS84 Edge tics: UTM Zone 13N WGS84

MAP LEGEND

- Area of Interest (AOI)**
 -  Area of Interest (AOI)
- Soils**
 -  Soil Map Unit Polygons
 -  Soil Map Unit Lines
 -  Soil Map Unit Points
- Special Point Features**
 -  Blowout
 -  Borrow Pit
 -  Clay Spot
 -  Closed Depression
 -  Gravel Pit
 -  Gravelly Spot
 -  Landfill
 -  Lava Flow
 -  Marsh or swamp
 -  Mine or Quarry
 -  Miscellaneous Water
 -  Perennial Water
 -  Rock Outcrop
 -  Saline Spot
 -  Sandy Spot
 -  Severely Eroded Spot
 -  Sinkhole
 -  Slide or Slip
 -  Sodic Spot
- Water Features**
 -  Streams and Canals
- Transportation**
 -  Rails
 -  Interstate Highways
 -  US Routes
 -  Major Roads
 -  Local Roads
- Background**
 -  Aerial Photography
- Other Features**
 -  Spoil Area
 -  Stony Spot
 -  Very Stony Spot
 -  Wet Spot
 -  Other
 -  Special Line Features

MAP INFORMATION

The soil surveys that comprise your AOI were mapped at 1:24,000.

Warning: Soil Map may not be valid at this scale.

Enlargement of maps beyond the scale of mapping can cause misunderstanding of the detail of mapping and accuracy of soil line placement. The maps do not show the small areas of contrasting soils that could have been shown at a more detailed scale.

Please rely on the bar scale on each map sheet for map measurements.

Source of Map: Natural Resources Conservation Service
 Web Soil Survey URL:
 Coordinate System: Web Mercator (EPSG:3857)

Maps from the Web Soil Survey are based on the Web Mercator projection, which preserves direction and shape but distorts distance and area. A projection that preserves area, such as the Albers equal-area conic projection, should be used if more accurate calculations of distance or area are required.

This product is generated from the USDA-NRCS certified data as of the version date(s) listed below.

Soil Survey Area: El Paso County Area, Colorado
 Survey Area Data: Version 18, Jun 5, 2020

Soil map units are labeled (as space allows) for map scales 1:50,000 or larger.

Date(s) aerial images were photographed: Aug 19, 2018—May 26, 2019

The orthophoto or other base map on which the soil lines were compiled and digitized probably differs from the background imagery displayed on these maps. As a result, some minor shifting of map unit boundaries may be evident.

Map Unit Legend

Map Unit Symbol	Map Unit Name	Acres in AOI	Percent of AOI
40	Kettle gravelly loamy sand, 3 to 8 percent slopes	9.1	22.8%
41	Kettle gravelly loamy sand, 8 to 40 percent slopes	18.1	45.4%
71	Pring coarse sandy loam, 3 to 8 percent slopes	12.7	31.8%
Totals for Area of Interest		39.8	100.0%

Map Unit Descriptions

The map units delineated on the detailed soil maps in a soil survey represent the soils or miscellaneous areas in the survey area. The map unit descriptions, along with the maps, can be used to determine the composition and properties of a unit.

A map unit delineation on a soil map represents an area dominated by one or more major kinds of soil or miscellaneous areas. A map unit is identified and named according to the taxonomic classification of the dominant soils. Within a taxonomic class there are precisely defined limits for the properties of the soils. On the landscape, however, the soils are natural phenomena, and they have the characteristic variability of all natural phenomena. Thus, the range of some observed properties may extend beyond the limits defined for a taxonomic class. Areas of soils of a single taxonomic class rarely, if ever, can be mapped without including areas of other taxonomic classes. Consequently, every map unit is made up of the soils or miscellaneous areas for which it is named and some minor components that belong to taxonomic classes other than those of the major soils.

Most minor soils have properties similar to those of the dominant soil or soils in the map unit, and thus they do not affect use and management. These are called noncontrasting, or similar, components. They may or may not be mentioned in a particular map unit description. Other minor components, however, have properties and behavioral characteristics divergent enough to affect use or to require different management. These are called contrasting, or dissimilar, components. They generally are in small areas and could not be mapped separately because of the scale used. Some small areas of strongly contrasting soils or miscellaneous areas are identified by a special symbol on the maps. If included in the database for a given area, the contrasting minor components are identified in the map unit descriptions along with some characteristics of each. A few areas of minor components may not have been observed, and consequently they are not mentioned in the descriptions, especially where the pattern was so complex that it was impractical to make enough observations to identify all the soils and miscellaneous areas on the landscape.

The presence of minor components in a map unit in no way diminishes the usefulness or accuracy of the data. The objective of mapping is not to delineate pure taxonomic classes but rather to separate the landscape into landforms or

Custom Soil Resource Report

landform segments that have similar use and management requirements. The delineation of such segments on the map provides sufficient information for the development of resource plans. If intensive use of small areas is planned, however, onsite investigation is needed to define and locate the soils and miscellaneous areas.

An identifying symbol precedes the map unit name in the map unit descriptions. Each description includes general facts about the unit and gives important soil properties and qualities.

Soils that have profiles that are almost alike make up a *soil series*. Except for differences in texture of the surface layer, all the soils of a series have major horizons that are similar in composition, thickness, and arrangement.

Soils of one series can differ in texture of the surface layer, slope, stoniness, salinity, degree of erosion, and other characteristics that affect their use. On the basis of such differences, a soil series is divided into *soil phases*. Most of the areas shown on the detailed soil maps are phases of soil series. The name of a soil phase commonly indicates a feature that affects use or management. For example, Alpha silt loam, 0 to 2 percent slopes, is a phase of the Alpha series.

Some map units are made up of two or more major soils or miscellaneous areas. These map units are complexes, associations, or undifferentiated groups.

A *complex* consists of two or more soils or miscellaneous areas in such an intricate pattern or in such small areas that they cannot be shown separately on the maps. The pattern and proportion of the soils or miscellaneous areas are somewhat similar in all areas. Alpha-Beta complex, 0 to 6 percent slopes, is an example.

An *association* is made up of two or more geographically associated soils or miscellaneous areas that are shown as one unit on the maps. Because of present or anticipated uses of the map units in the survey area, it was not considered practical or necessary to map the soils or miscellaneous areas separately. The pattern and relative proportion of the soils or miscellaneous areas are somewhat similar. Alpha-Beta association, 0 to 2 percent slopes, is an example.

An *undifferentiated group* is made up of two or more soils or miscellaneous areas that could be mapped individually but are mapped as one unit because similar interpretations can be made for use and management. The pattern and proportion of the soils or miscellaneous areas in a mapped area are not uniform. An area can be made up of only one of the major soils or miscellaneous areas, or it can be made up of all of them. Alpha and Beta soils, 0 to 2 percent slopes, is an example.

Some surveys include *miscellaneous areas*. Such areas have little or no soil material and support little or no vegetation. Rock outcrop is an example.

El Paso County Area, Colorado

40—Kettle gravelly loamy sand, 3 to 8 percent slopes

Map Unit Setting

National map unit symbol: 368g
Elevation: 7,000 to 7,700 feet
Farmland classification: Not prime farmland

Map Unit Composition

Kettle and similar soils: 85 percent
Estimates are based on observations, descriptions, and transects of the mapunit.

Description of Kettle

Setting

Landform: Hills
Landform position (three-dimensional): Side slope
Down-slope shape: Linear
Across-slope shape: Linear
Parent material: Sandy alluvium derived from arkose

Typical profile

E - 0 to 16 inches: gravelly loamy sand
Bt - 16 to 40 inches: gravelly sandy loam
C - 40 to 60 inches: extremely gravelly loamy sand

Properties and qualities

Slope: 3 to 8 percent
Depth to restrictive feature: More than 80 inches
Drainage class: Somewhat excessively drained
Runoff class: Low
Capacity of the most limiting layer to transmit water (Ksat): High (2.00 to 6.00 in/hr)
Depth to water table: More than 80 inches
Frequency of flooding: None
Frequency of ponding: None
Available water capacity: Low (about 3.4 inches)

Interpretive groups

Land capability classification (irrigated): None specified
Land capability classification (nonirrigated): 4e
Hydrologic Soil Group: B
Hydric soil rating: No

Minor Components

Other soils

Percent of map unit:
Hydric soil rating: No

Pleasant

Percent of map unit:
Landform: Depressions
Hydric soil rating: Yes

41—Kettle gravelly loamy sand, 8 to 40 percent slopes

Map Unit Setting

National map unit symbol: 368h
Elevation: 7,000 to 7,700 feet
Farmland classification: Not prime farmland

Map Unit Composition

Kettle and similar soils: 85 percent
Estimates are based on observations, descriptions, and transects of the mapunit.

Description of Kettle

Setting

Landform: Hills
Landform position (three-dimensional): Side slope
Down-slope shape: Linear
Across-slope shape: Linear
Parent material: Sandy alluvium derived from arkose

Typical profile

E - 0 to 16 inches: gravelly loamy sand
Bt - 16 to 40 inches: gravelly sandy loam
C - 40 to 60 inches: extremely gravelly loamy sand

Properties and qualities

Slope: 8 to 40 percent
Depth to restrictive feature: More than 80 inches
Drainage class: Somewhat excessively drained
Runoff class: Medium
Capacity of the most limiting layer to transmit water (Ksat): High (2.00 to 6.00 in/hr)
Depth to water table: More than 80 inches
Frequency of flooding: None
Frequency of ponding: None
Available water capacity: Low (about 3.4 inches)

Interpretive groups

Land capability classification (irrigated): None specified
Land capability classification (nonirrigated): 7e
Hydrologic Soil Group: B
Hydric soil rating: No

Minor Components

Pleasant

Percent of map unit:
Landform: Depressions
Hydric soil rating: Yes

Other soils

Percent of map unit:
Hydric soil rating: No

71—Pring coarse sandy loam, 3 to 8 percent slopes

Map Unit Setting

National map unit symbol: 369k
Elevation: 6,800 to 7,600 feet
Farmland classification: Not prime farmland

Map Unit Composition

Pring and similar soils: 85 percent
Estimates are based on observations, descriptions, and transects of the mapunit.

Description of Pring

Setting

Landform: Hills
Landform position (three-dimensional): Side slope
Down-slope shape: Linear
Across-slope shape: Linear
Parent material: Arkosic alluvium derived from sedimentary rock

Typical profile

A - 0 to 14 inches: coarse sandy loam
C - 14 to 60 inches: gravelly sandy loam

Properties and qualities

Slope: 3 to 8 percent
Depth to restrictive feature: More than 80 inches
Drainage class: Well drained
Runoff class: Low
Capacity of the most limiting layer to transmit water (Ksat): High (2.00 to 6.00 in/hr)
Depth to water table: More than 80 inches
Frequency of flooding: None
Frequency of ponding: None
Available water capacity: Low (about 6.0 inches)

Interpretive groups

Land capability classification (irrigated): None specified
Land capability classification (nonirrigated): 3e
Hydrologic Soil Group: B
Ecological site: R048AY222CO
Hydric soil rating: No

Minor Components

Pleasant

Percent of map unit:

Custom Soil Resource Report

Landform: Depressions
Hydric soil rating: Yes

Other soils

Percent of map unit:
Hydric soil rating: No

pricklypear occur. Ample amounts of litter and forage should be left on the soil because of the high hazard of soil blowing.

Windbreaks and environmental plantings are generally well suited to this soil. Summer fallow a year prior to planting and continued cultivation for weed control are needed to insure establishment and survival of plantings. Trees that are best suited and have good survival are Rocky Mountain juniper, eastern redcedar, ponderosa pine, Siberian elm, Russian-olive, and hackberry. Shrubs that are best suited are skunkbush sumac, lilac, Siberian peashrub, and American plum.

Depending on land use, this soil can produce habitat that is suitable for either rangeland wildlife, such as antelope, or for openland wildlife, such as pheasant, cottontail, and mourning dove. Availability of irrigation water largely determines the land use. Where no irrigation water is available, this soil is mainly used as rangeland, a use that favors rangeland wildlife. If this soil is used as rangeland, fences, livestock water developments, and proper livestock grazing use are practices that enhance habitat for rangeland wildlife. Production of crops such as wheat, corn, and alfalfa provides suitable habitat for openland wildlife, especially pheasant. Among the practices that increase openland wildlife populations are planting trees and shrubs and providing undisturbed nesting cover.

The main limitation of this soil for urban use is shrink-swell potential. Buildings and roads need to be designed to overcome this limitation. Roads need to be designed to minimize frost-heave damage. Capability subclasses IVE, nonirrigated, and IIe, irrigated.

40—Kettle gravelly loamy sand, 3 to 8 percent slopes. This deep, well drained soil formed in sandy arkosic deposits on uplands. Elevation ranges from 7,000 to 7,700 feet. The average annual precipitation is about 18 inches, the average annual air temperature is about 43 degrees F, and the average frost-free period is about 120 days.

Typically, the surface layer is gray gravelly loamy sand about 3 inches thick. The subsurface layer is light gray gravelly loamy sand about 13 inches thick. The subsoil is very pale brown gravelly sandy loam about 24 inches thick. It consists of a matrix of loamy coarse sand that has thin bands of coarse sandy loam or sandy clay loam. The substratum to a depth of 60 inches or more is light yellowish brown extremely gravelly loamy sand.

Included with this soil in mapping are small areas of Alamosa loam, 1 to 3 percent slopes; Elbeth sandy loam, 3 to 8 percent slopes; Pring coarse sandy loam, 3 to 8 percent slopes; Tomah-Crowfoot loamy sands, 3 to 8 percent slopes; and a few rock outcrops.

Permeability of this Kettle soil is rapid. Effective rooting depth is 60 inches or more. Available water capacity is low to moderate. Surface runoff is slow, and the hazard of erosion is slight to moderate. A few gullies have formed in drainageways.

This soil is used for woodland, livestock grazing, wildlife habitat, recreation, and homesites.

This soil is suited to the production of ponderosa pine. It is capable of producing about 2,240 cubic feet or 4,900 board feet (International rule), of merchantable timber per acre from a fully stocked, even-aged stand of 80-year-old trees. The main limitation for the production or harvesting of timber is the low available water capacity. The low available water capacity also influences seedling survival, especially in areas where understory plants are plentiful. Erosion must be kept to a minimum when harvesting timber.

This soil has good potential for mule deer, tree squirrels, cottontail rabbit, and wild turkey. These animals obtain their food and shelter from pine trees, shrubs, and ground cover, which provide browse, forbs, fruit, and seeds. The presence of ponderosa pine and Gambel oak should encourage wild turkey populations; however, where water is not naturally present, wildlife watering facilities must be provided to attract and maintain wild turkey and other wildlife species. Livestock grazing management is vital on this soil if wildlife populations are to be maintained.

This soil has good potential for use as homesites. Plans for homesite development on this soil should provide for the preservation of as many trees as possible in order to maintain the esthetic value of the sites. During seasons of low precipitation, fire may become a hazard to homesites. This hazard can be minimized by installing firebreaks and reducing the amount of litter on the forest floor. Capability subclass VIe.

41—Kettle gravelly loamy sand, 8 to 40 percent slopes. This deep, well drained soil formed in sandy arkosic deposits on uplands. Elevation ranges from 7,000 to 7,700 feet. The average annual precipitation is about 18 inches, the average annual air temperature is about 43 degrees F, and the average frost-free period is about 120 days.

Typically, the surface layer is gray gravelly loamy sand about 3 inches thick. The subsurface layer is light gray gravelly loamy sand about 13 inches thick. The subsoil is very pale brown gravelly sandy loam about 24 inches thick. It consists of a matrix of loamy coarse sand that has thin bands of coarse sandy loam or sandy clay loam. The substratum to a depth of 60 inches or more is light yellowish brown extremely gravelly loamy sand.

Included with this soil in mapping are small areas of Elbeth sandy loam, 8 to 15 percent slopes; Pring coarse sandy loam, 8 to 15 percent slopes; Tomah-Crowfoot loamy sands, 8 to 15 percent slopes; and a few rock outcrops.

Permeability of this Kettle soil is rapid. Effective rooting depth is 60 inches or more. Available water capacity is low to moderate. Surface runoff is medium, and the hazard of erosion is moderate. Some gullies have formed in drainageways.

The soil is used for woodland, livestock grazing, wildlife habitat, recreation, and homesites.

This soil is suited to the production of ponderosa pine. It is capable of producing 2,240 cubic feet, or 4,900 board

feet (International rule), of merchantable timber per acre from a fully stocked, even-aged stand of 80-year-old trees. The main limitation for this use is the moderate hazard of erosion. Measures must be taken to reduce erosion when harvesting timber, especially on the steeper slopes. The low to moderate available water capacity also influences seedling survival, especially in areas where understory plants are plentiful.

This soil has good potential for mule deer, tree squirrel, cottontail, and wild turkey. These animals obtain their food and shelter from pine trees, shrubs, and ground cover, which provide browse, forbs, fruit, and seeds. The presence of ponderosa pine and Gambel oak should encourage wild turkey populations; however, where water is not naturally present, wildlife watering facilities must be provided to attract and maintain wild turkey and other wildlife species. Livestock grazing management is vital on this soil if wildlife populations are to be maintained.

The moderately sloping to steep slopes limit the suitability of this soil for homesites. Special practices must be provided to minimize surface runoff and thus keep erosion to a minimum. This soil requires special site or building designs because of the slope. Deep cuts, to provide essentially level building sites, may expose bedrock. Access roads must be designed to provide adequate cut-slope grade, and drains must be used to control surface runoff and keep soil losses to a minimum. During seasons of low precipitation, fire may become a hazard to homesites. This hazard can be minimized by installing firebreaks and reducing the amount of litter on the forest floor. Capability subclass VIe.

42—Kettle-Rock outcrop complex. This gently rolling to very steep complex, is mostly on the side slopes of uplands. Slopes range from 8 to 60 percent. Elevation ranges from 6,800 to 7,700 feet. The average annual precipitation is about 18 inches, and average annual air temperature is about 43 degrees F.

The Kettle soil makes up about 60 percent of the complex, Rock outcrop about 20 percent, and other soils about 20 percent.

Included with this complex in mapping are areas of Peyton-Pring complex, 8 to 15 percent slopes; Elbeth sandy loam, 8 to 15 percent slopes; and Elbeth-Pring complex, 5 to 50 percent slopes.

The Kettle soil is deep and well drained. It formed in sandy arkosic deposits, mostly on the lower slopes of the complex. Slope is commonly less than 20 percent. Typically, the surface layer is gray, medium acid or slightly acid gravelly loamy sand about 3 inches thick. The subsurface layer is light gray, medium acid gravelly loamy sand about 13 inches thick. The subsoil is very pale brown, medium acid or slightly acid gravelly sandy loam about 24 inches thick. It consists of loamy coarse sand that has thin bands of coarse sandy loam or sandy clay loam. The substratum to a depth of 60 inches or more is light yellowish brown extremely gravelly loamy sand.

Permeability of the Kettle soil is rapid. Effective rooting depth is more than 60 inches. Available water capaci-

ty is low to moderate. Surface runoff is medium to rapid, and the hazard of erosion is slight to high. Soil slippage and deep gullies are common.

Rock outcrop is mostly in the form of vertical cliffs. Large stones are common on the lower slopes of this complex.

This complex is suited to the production of ponderosa pine. It is capable of producing 2,240 cubic feet, or 4,900 board feet (International rule), of merchantable timber per acre from a fully stocked, even-aged stand of 80-year-old trees. The main limitation of this complex for this use is the presence of Rock outcrop and the moderate hazard of erosion on the Kettle soil. Measures must be taken to minimize erosion when harvesting timber, especially on the steeper slopes. The low to moderate available water capacity also influences seedling survival, especially where understory plants are plentiful.

This complex has good potential for producing habitat for mule deer, tree squirrels, cottontail, and wild turkey. These animals obtain their food and shelter from pine trees, shrubs, and ground cover, which provide browse, forbs, fruit, and seeds. The presence of ponderosa pine and Gambel oak should encourage wild turkey populations; however, where water is not naturally present, wildlife watering facilities must be provided to attract and maintain wild turkey and other wildlife species. Livestock grazing management is vital on this soil if wildlife populations are to be maintained.

The moderate to very steep slopes limit the potential of this complex for homesites. Special practices must be provided to minimize surface runoff and thus keep erosion to a minimum. Special site or building designs are required because of the slope. Deep cuts, to provide essentially level building sites, can expose bedrock. The limitation of large stones on the soil surface can be overcome through the use of heavy equipment when preparing building sites. Access roads must be designed to provide adequate cut-slope grade, and drains must be used to control surface runoff and thus keep soil losses to a minimum. Deep cuts along the uphill side of the roads can expose the bedrock. Capability subclass VIIe.

43—Kim loam, 1 to 8 percent slopes. This deep, well drained soil formed in calcareous loamy sediment on fans and uplands. Elevation ranges from 5,300 to 5,600. The average annual precipitation is about 13 inches, the average annual temperature is about 49 degrees F, and the average frost-free period is about 145 days.

Typically, the surface layer is brown loam about 4 inches thick. The substratum is very pale brown loam to a depth of 60 inches or more.

Included with this soil in mapping are small areas of Fort Collins loam, 3 to 8 percent slopes; Midway clay loam, 3 to 25 percent slopes, and Wiley silt loam, 3 to 9 percent slopes.

Permeability of this Kim soil is moderate. Effective rooting depth is 60 inches or more. Available water capacity is high. Surface runoff is medium, and the hazard of erosion is moderate.

Almost all areas of this soil are used as rangeland.

survival are Rocky Mountain juniper, eastern redcedar, ponderosa pine, Siberian elm, Russian-olive, and hackberry. Shrubs that are best suited are skunkbush sumac, lilac, and Siberian peashrub.

These soils are suited to habitat for openland and rangeland wildlife. Rangeland wildlife, such as pronghorn antelope, can be encouraged by developing livestock watering facilities, properly managing livestock grazing, and reseeding range where needed.

These soils have a good potential for homesites. The main limitations, especially on the Peyton soil, are low bearing strength and frost-action potential. Buildings and roads can be designed to overcome these limitations. Access roads should have adequate cut-slope grade and be provided with drains to control surface runoff and keep soil losses to a minimum. Capability subclass VIe.

69—Peyton-Pring complex, 8 to 15 percent slopes. These gently to moderately sloping soils are on valley side slopes and on uplands. Elevation ranges from 6,800 to 7,600 feet. The average annual precipitation is about 17 inches, the average annual air temperature is about 43 degrees F, and the average frost-free period is about 120 days.

The Peyton soil makes up about 40 percent of the complex, the Pring soil about 30 percent, and other soils about 30 percent.

Included with these soils in mapping are areas of Holderness loam, 8 to 15 percent slopes; Tomah-Crowfoot loamy sands, 8 to 15 percent slopes; Kettle gravelly loamy sand, 8 to 40 percent slopes; and a few areas of Rock outcrop.

The Peyton soil is commonly on the less sloping part of the landscape. It is deep, noncalcareous, and well drained. It formed in alluvium and residuum derived from weathered, arkosic, sedimentary rock. Typically, the surface layer is grayish brown sandy loam about 12 inches thick. The subsoil, about 23 inches thick, is pale brown sandy clay loam in the upper 13 inches and pale brown sandy loam in the lower 10 inches. The substratum is pale brown sandy loam to a depth of 60 inches or more.

Permeability of the Peyton soil is moderate. Effective rooting depth is 60 inches or more. Available water capacity is high. Surface runoff is medium to rapid, and the hazard of erosion is moderate to high. Some gullies have developed along drainageways and livestock trails.

The Pring soil is deep, noncalcareous, and well drained. It formed in sandy sediment derived from weathered, arkosic, sedimentary rock. Typically, the surface layer is dark grayish brown coarse sandy loam about 4 inches thick. The substratum is dark grayish brown coarse sandy loam about 10 inches thick over pale brown gravelly sandy loam that extends to a depth of 60 inches or more.

Permeability of the Pring soil is rapid. Effective rooting depth is 60 inches or more. Available water capacity is moderate. Surface runoff is medium to rapid, and the hazard of erosion is moderate to high. Some gullies have developed along drainageways and livestock trails.

The soils in this complex are used as rangeland, for wildlife habitat, and for homesites.

These soils are well suited to the production of native vegetation suitable for grazing. The dominant native species are mountain muhly, bluestem grasses, needle-andthread, and blue grama. These soils are subject to invasion of Kentucky bluegrass and Gambel oak. Common forbs are hairy goldenrod, geranium, milkvetch, low larkspur, fringed sage, and buckwheat.

Properly locating livestock watering facilities helps to control grazing. Timely deferment of grazing is needed to protect the plant cover.

Windbreaks and environmental plantings generally are suited to these soils. Soil blowing is the main limitation to the establishment of trees and shrubs. This limitation can be overcome by cultivating only in the tree rows and leaving a strip of vegetation between the rows. Supplemental irrigation may be needed when planting and during dry periods. Trees that are best suited and have good survival are Rocky Mountain juniper, eastern redcedar, ponderosa pine, Siberian elm, Russian-olive, and hackberry. Shrubs that are best suited are skunkbush sumac, lilac, and Siberian peashrub.

These soils are well suited to wildlife habitat. They are best suited to habitat for openland and rangeland wildlife. Rangeland wildlife, such as pronghorn antelope, can be encouraged by developing livestock watering facilities, properly managing livestock grazing, and reseeding range where needed.

These soils have good potential for use as homesites. The main limitations are steepness of slope, limited ability to support a load, and frost-action potential. Buildings and roads can be designed to overcome these limitations. These soils also require special site or building designs because of the slope. Access roads should have adequate cut-slope grade, and drains should be provided to control surface runoff and keep soil losses to a minimum. Capability subclass VIe.

70—Pits, gravel. Gravel pits are in nearly level to rolling areas. They are open excavations several feet deep and commonly 5 acres or less in size.

Gravel pits are very low in natural fertility and are highly susceptible to soil blowing. A cover of weeds or straw helps to control erosion.

Windbreaks and environmental plantings generally are not suited to these areas. Onsite investigation is needed to determine if plantings are feasible. Capability subclass VIIIs.

71—Pring coarse sandy loam, 3 to 8 percent slopes. This deep, noncalcareous, well drained soil formed in sandy sediment derived from arkosic sedimentary rock on valley side slopes and on uplands. Elevation ranges from 6,800 to 7,600 feet. The average annual precipitation is about 17 inches, the average annual air temperature is about 43 degrees F, and the average frost-free period is about 120 days.

Typically, the surface layer is dark grayish brown coarse sandy loam about 4 inches thick. The substratum is dark grayish brown coarse sandy loam about 10 inches thick over pale brown gravelly sandy loam that extends to a depth of 60 inches or more.

Included with this soil in mapping are small areas of Alamosa loam, 1 to 3 percent slopes, along drainageways; Cruckton sandy loam, 1 to 9 percent slopes; Peyton sandy loam, 1 to 5 percent slopes; Peyton sandy loam, 5 to 9 percent slopes; and Tomah-Crowfoot loamy sands, 3 to 8 percent slopes. In some places arkose beds of sandstone and shale are at a depth of 0 to 40 inches.

Permeability of this Pring soil is rapid. Effective rooting depth is 60 inches or more. Available water capacity is moderate. Surface runoff is medium, and the hazard of erosion is moderate.

Almost all areas of this soil are used as rangeland. Some areas previously cultivated have been reseeded to grass. This soil is also used for wildlife habitat and homesites.

This soil is well suited to the production of native vegetation suitable for grazing by cattle and sheep. Rangeland vegetation is mainly mountain muhly, little bluestem, needleandthread, Parry oatgrass, and junegrass.

Deferment of grazing in spring helps to maintain vigor and production of the cool-season bunchgrasses. Fencing and properly locating livestock watering facilities help to control grazing.

Windbreaks and environmental plantings generally are suited to this soil. The hazard of soil blowing is the main limitation to the establishment of trees and shrubs. This limitation can be overcome by cultivating only in the tree rows and leaving a strip of vegetation between the rows. Supplemental irrigation may be needed when planting and during dry periods. Trees that are best suited and have good survival are Rocky Mountain juniper, eastern redcedar, ponderosa pine, Siberian elm, Russian-olive, and hackberry. Shrubs that are best suited are skunkbush sumac, lilac, and Siberian peashrub.

This soil is suited to habitat for openland and rangeland wildlife. Rangeland wildlife, such as pronghorn antelope, can be encouraged by developing livestock watering facilities, properly managing livestock grazing, and reseeding range where needed.

This soil is well suited for use as homesites. Erosion control practices are needed to control soil blowing and water erosion on construction sites where the ground cover has been removed. Capability subclass IVe.

72—Pring coarse sandy loam, 8 to 15 percent slopes. This deep, noncalcareous, well drained soil formed in sandy sediment derived from arkosic sedimentary rock on valley side slopes and on uplands. Elevation ranges from 6,800 to 7,600 feet. The average annual precipitation is about 17 inches, the average annual air temperature is about 43 degrees F, and the average frost-free period is about 120 days.

Typically, the surface layer is dark grayish brown coarse sandy loam about 4 inches thick. The substratum is dark grayish brown coarse sandy loam about 10 inches thick over pale brown gravelly sandy loam that extends to a depth of 60 inches or more.

Included with this soil in mapping are small areas of Cruckton sandy loam, 1 to 9 percent slopes; Peyton sandy

loam, 5 to 9 percent slopes; and Tomah-Crowfoot loamy sands, 8 to 15 percent slopes. Arkose beds of sandstone and shale are at a depth of 0 to 40 inches in some places.

Permeability of this Pring soil is rapid. Effective rooting depth is 60 inches or more. Available water capacity is moderate. Surface runoff is medium, and the hazard of erosion is moderate. Some gullies have developed along drainageways.

Almost all areas of this soil are used as rangeland. Some areas previously cultivated have been reseeded to grass. This soil is also used for wildlife habitat and as homesites.

This soil is well suited to the production of native vegetation suitable for grazing by cattle and sheep. The native vegetation is mainly mountain muhly, little bluestem, needleandthread, Parry oatgrass, and junegrass.

Deferment of grazing in spring helps to maintain the vigor and production of the cool-season bunchgrasses. Fencing and properly locating livestock watering facilities help to control grazing.

Windbreaks and environmental plantings generally are suited to this soil. The hazard of soil blowing is the main limitation to the establishment of trees and shrubs. This limitation can be overcome by cultivating only in the tree rows and leaving a strip of vegetation between the rows. Supplemental irrigation may be needed when planting and during dry periods. Trees that are best suited and have good survival are Rocky Mountain juniper, eastern redcedar, ponderosa pine, Siberian elm, Russian-olive, and hackberry. Shrubs that are best suited are skunkbush sumac, lilac, and Siberian peashrub.

This soil is suited to habitat for openland and rangeland wildlife habitat. Rangeland wildlife, such as pronghorn antelope, can be encouraged by developing livestock watering facilities, properly managing livestock grazing, and reseeding range where needed.

This soil has good potential for urban uses. The main limitation is slope. Special site or building designs are needed because of the slope. Access roads must have adequate cut-slope grade and be provided with drains to control surface runoff. Capability subclass VIe.

73—Razor clay loam, 3 to 9 percent slopes. This moderately deep, well drained, clayey soil formed in residuum derived from calcareous shale on uplands. Elevation ranges from 5,300 to 6,100 feet. The average annual precipitation is about 13 inches, the average annual air temperature is about 49 degrees F, and the average frost-free period is about 145 days.







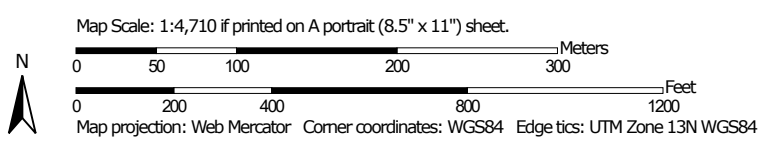
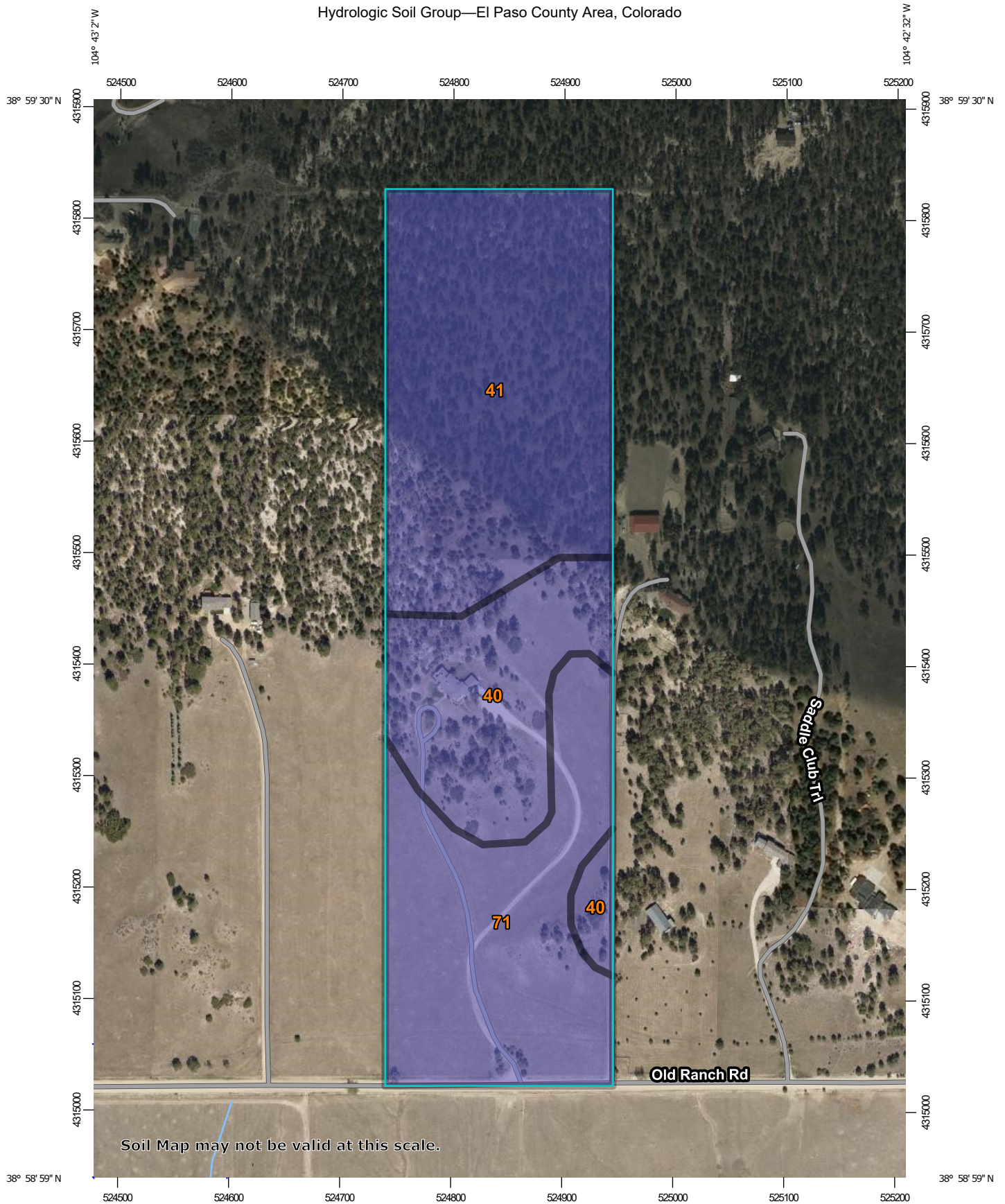

























Typically, the surface layer is light brownish gray clay loam about 3 inches thick. The subsoil is grayish brown heavy clay loam or clay about 15 inches thick. The substratum is grayish brown clay that grades to calcareous shale at a depth of about 31 inches. Visible lime is in the lower part of the subsoil and in the substratum.

Included with this soil in mapping are small areas of Midway clay loam, 3 to 25 percent slopes; Heldt clay loam, 0 to 3 percent slopes; and Stoneham sandy loam, 3 to 8 percent slopes.

Hydrologic Soil Group—El Paso County Area, Colorado



MAP LEGEND

Area of Interest (AOI)	 C
 Area of Interest (AOI)	 C/D
Soils	 D
Soil Rating Polygons	 Not rated or not available
 A	Water Features
 A/D	 Streams and Canals
 B	Transportation
 B/D	 Rails
 C	 Interstate Highways
 C/D	 US Routes
 D	 Major Roads
 Not rated or not available	 Local Roads
Soil Rating Lines	Background
 A	 Aerial Photography
 A/D	
 B	
 B/D	
 C	
 C/D	
 D	
 Not rated or not available	
Soil Rating Points	
 A	
 A/D	
 B	
 B/D	

MAP INFORMATION

The soil surveys that comprise your AOI were mapped at 1:24,000.

Warning: Soil Map may not be valid at this scale.

Enlargement of maps beyond the scale of mapping can cause misunderstanding of the detail of mapping and accuracy of soil line placement. The maps do not show the small areas of contrasting soils that could have been shown at a more detailed scale.

Please rely on the bar scale on each map sheet for map measurements.

Source of Map: Natural Resources Conservation Service
 Web Soil Survey URL:
 Coordinate System: Web Mercator (EPSG:3857)

Maps from the Web Soil Survey are based on the Web Mercator projection, which preserves direction and shape but distorts distance and area. A projection that preserves area, such as the Albers equal-area conic projection, should be used if more accurate calculations of distance or area are required.

This product is generated from the USDA-NRCS certified data as of the version date(s) listed below.

Soil Survey Area: El Paso County Area, Colorado
 Survey Area Data: Version 18, Jun 5, 2020

Soil map units are labeled (as space allows) for map scales 1:50,000 or larger.

Date(s) aerial images were photographed: Aug 19, 2018—May 26, 2019

The orthophoto or other base map on which the soil lines were compiled and digitized probably differs from the background imagery displayed on these maps. As a result, some minor shifting of map unit boundaries may be evident.

Hydrologic Soil Group

Map unit symbol	Map unit name	Rating	Acres in AOI	Percent of AOI
40	Kettle gravelly loamy sand, 3 to 8 percent slopes	B	9.3	22.7%
41	Kettle gravelly loamy sand, 8 to 40 percent slopes	B	18.3	44.6%
71	Pring coarse sandy loam, 3 to 8 percent slopes	B	13.3	32.6%
Totals for Area of Interest			40.9	100.0%

Description

Hydrologic soil groups are based on estimates of runoff potential. Soils are assigned to one of four groups according to the rate of water infiltration when the soils are not protected by vegetation, are thoroughly wet, and receive precipitation from long-duration storms.

The soils in the United States are assigned to four groups (A, B, C, and D) and three dual classes (A/D, B/D, and C/D). The groups are defined as follows:

Group A. Soils having a high infiltration rate (low runoff potential) when thoroughly wet. These consist mainly of deep, well drained to excessively drained sands or gravelly sands. These soils have a high rate of water transmission.

Group B. Soils having a moderate infiltration rate when thoroughly wet. These consist chiefly of moderately deep or deep, moderately well drained or well drained soils that have moderately fine texture to moderately coarse texture. These soils have a moderate rate of water transmission.

Group C. Soils having a slow infiltration rate when thoroughly wet. These consist chiefly of soils having a layer that impedes the downward movement of water or soils of moderately fine texture or fine texture. These soils have a slow rate of water transmission.

Group D. Soils having a very slow infiltration rate (high runoff potential) when thoroughly wet. These consist chiefly of clays that have a high shrink-swell potential, soils that have a high water table, soils that have a claypan or clay layer at or near the surface, and soils that are shallow over nearly impervious material. These soils have a very slow rate of water transmission.

If a soil is assigned to a dual hydrologic group (A/D, B/D, or C/D), the first letter is for drained areas and the second is for undrained areas. Only the soils that in their natural condition are in group D are assigned to dual classes.

Rating Options

Aggregation Method: Dominant Condition

Component Percent Cutoff: None Specified

Tie-break Rule: Higher

8 Hydrologic Calculations

Runoff Coefficients and Percent Imperviousness Table 6-6

Colorado Springs Rainfall Intensity Duration Frequency Table 6-5

Hydrologic Calculations Summary Form SF-1 for Existing & Developed Conditions

Hydrologic Calculations Summary 5-yr Form SF-2 for Existing & Developed Conditions

Hydrologic Calculations Summary 100-yr Form SF-2 for Existing & Developed Conditions

Runoff Reduction Calculations

Runoff Reduction Map

Table 6-6. Runoff Coefficients for Rational Method
(Source: UDFCD 2001)

Land Use or Surface Characteristics	Percent Impervious	Runoff Coefficients											
		2-year		5-year		10-year		25-year		50-year		100-year	
		HSG A&B	HSG C&D	HSG A&B	HSG C&D	HSG A&B	HSG C&D	HSG A&B	HSG C&D	HSG A&B	HSG C&D	HSG A&B	HSG C&D
Business													
Commercial Areas	95	0.79	0.80	0.81	0.82	0.83	0.84	0.85	0.87	0.87	0.88	0.88	0.89
Neighborhood Areas	70	0.45	0.49	0.49	0.53	0.53	0.57	0.58	0.62	0.60	0.65	0.62	0.68
Residential													
1/8 Acre or less	65	0.41	0.45	0.45	0.49	0.49	0.54	0.54	0.59	0.57	0.62	0.59	0.65
1/4 Acre	40	0.23	0.28	0.30	0.35	0.36	0.42	0.42	0.50	0.46	0.54	0.50	0.58
1/3 Acre	30	0.18	0.22	0.25	0.30	0.32	0.38	0.39	0.47	0.43	0.52	0.47	0.57
1/2 Acre	25	0.15	0.20	0.22	0.28	0.30	0.36	0.37	0.46	0.41	0.51	0.46	0.56
1 Acre	20	0.12	0.17	0.20	0.26	0.27	0.34	0.35	0.44	0.40	0.50	0.44	0.55
Industrial													
Light Areas	80	0.57	0.60	0.59	0.63	0.63	0.66	0.66	0.70	0.68	0.72	0.70	0.74
Heavy Areas	90	0.71	0.73	0.73	0.75	0.75	0.77	0.78	0.80	0.80	0.82	0.81	0.83
Parks and Cemeteries	7	0.05	0.09	0.12	0.19	0.20	0.29	0.30	0.40	0.34	0.46	0.39	0.52
Playgrounds	13	0.07	0.13	0.16	0.23	0.24	0.31	0.32	0.42	0.37	0.48	0.41	0.54
Railroad Yard Areas	40	0.23	0.28	0.30	0.35	0.36	0.42	0.42	0.50	0.46	0.54	0.50	0.58
Undeveloped Areas													
Historic Flow Analysis-- Greenbelts, Agriculture	2	0.03	0.05	0.09	0.16	0.17	0.26	0.26	0.38	0.31	0.45	0.36	0.51
Pasture/Meadow	0	0.02	0.04	0.08	0.15	0.15	0.25	0.25	0.37	0.30	0.44	0.35	0.50
Forest	0	0.02	0.04	0.08	0.15	0.15	0.25	0.25	0.37	0.30	0.44	0.35	0.50
Exposed Rock	100	0.89	0.89	0.90	0.90	0.92	0.92	0.94	0.94	0.95	0.95	0.96	0.96
Offsite Flow Analysis (when landuse is undefined)	45	0.26	0.31	0.32	0.37	0.38	0.44	0.44	0.51	0.48	0.55	0.51	0.59
Streets													
Paved	100	0.89	0.89	0.90	0.90	0.92	0.92	0.94	0.94	0.95	0.95	0.96	0.96
Gravel	80	0.57	0.60	0.59	0.63	0.63	0.66	0.66	0.70	0.68	0.72	0.70	0.74
Drive and Walks	100	0.89	0.89	0.90	0.90	0.92	0.92	0.94	0.94	0.95	0.95	0.96	0.96
Roofs	90	0.71	0.73	0.73	0.75	0.75	0.77	0.78	0.80	0.80	0.82	0.81	0.83
Lawns	0	0.02	0.04	0.08	0.15	0.15	0.25	0.25	0.37	0.30	0.44	0.35	0.50

Figure 6-5. Colorado Springs Rainfall Intensity Duration Frequency

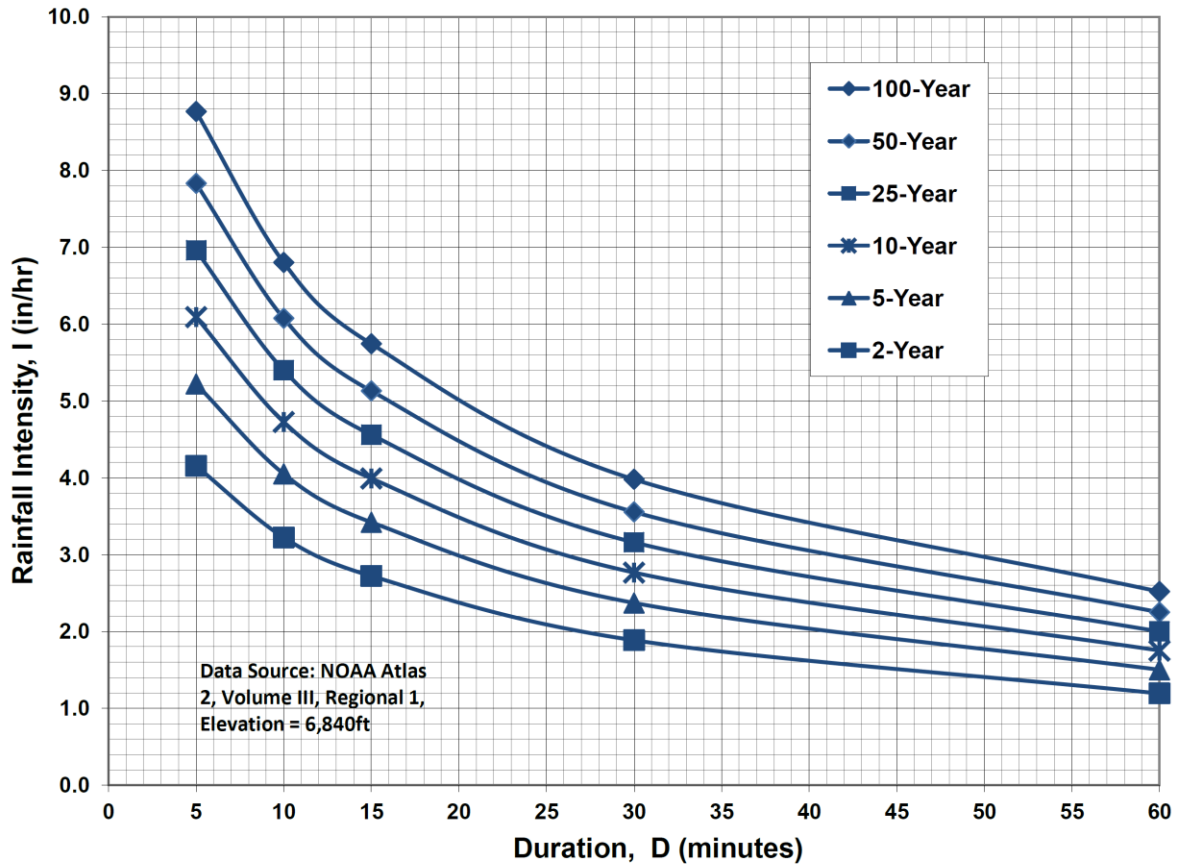

IDF Equations

$$I_{100} = -2.52 \ln(D) + 12.735$$

$$I_{50} = -2.25 \ln(D) + 11.375$$

$$I_{25} = -2.00 \ln(D) + 10.111$$

$$I_{10} = -1.75 \ln(D) + 8.847$$

$$I_5 = -1.50 \ln(D) + 7.583$$

$$I_2 = -1.19 \ln(D) + 6.035$$

Note: Values calculated by equations may not precisely duplicate values read from figure.

Time of Concentration (Modified from Standard Form SF-1)

Sub-Basin	Sub-Basin Data			Overland			Shallow Channel			Channelized				t _c Check				
	Area (Acres)	C ₅	C ₁₀₀ /CN	% Imp.	L ₀ (ft)	S ₀ (%)	t _i (min)	L _{0t} (ft)	S _{0t} (ft/ft)	V _{0sc} (ft/s)	t _t (min)	L _{0c} (ft)	S _{0c} (ft/ft)	V _{0c} (ft/s)	t _c (min)	L (min)	t _{c,alt} (min)	t _c (min)
(Existing)																		
EX-OSA-1	5.47	0.08	0.35	0%	100	28%	6.1	245	0.090	2.1	1.9	0	0.000	0.0	0.0	345	N/A	8.1
EX-OSA-2	12.06	0.09	0.36	2%	100	8%	9.2	1318	0.064	1.8	12.4	0	0.000	0.0	0.0	1418	N/A	21.6
EX-OSA-3	3.90	0.21	0.45	16%	100	10%	7.5	476	0.063	1.8	4.5	0	0.000	0.0	0.0	576	N/A	12.0
EX-A-4	0.97	0.08	0.35	0%	100	13%	7.9	170	0.065	1.8	1.6	0	0.000	0.0	0.0	270	N/A	9.5
EX-A-5	30.09	0.10	0.36	2%	100	11%	8.2	2813	0.052	1.6	29.5	0	0.000	0.0	0.0	2913	N/A	37.7
EX-OSA-6	5.93	0.11	0.37	4%	100	7%	9.4	720	0.065	1.8	6.7	0	0.000	0.0	0.0	820	N/A	16.1
EX-OSB-1	1.66	0.08	0.35	0%	100	22%	6.6	242	0.091	2.1	1.9	0	0.000	0.0	0.0	342	N/A	8.6
EX-B-2	5.55	0.08	0.35	0%	100	7%	9.7	573	0.065	1.8	5.4	0	0.000	0.0	0.0	673	N/A	15.1
EX-C-1	1.70	0.08	0.35	0%	100	12%	8.1	263	0.072	1.9	2.3	0	0.000	0.0	0.0	363	N/A	10.4
EX-D-1	0.82	0.08	0.35	0%	100	5%	10.8	156	0.064	1.8	1.5	0	0.000	0.0	0.0	256	N/A	12.3
(Proposed)																		
OSA-1	3.14	0.08	0.35	0%	100	29%	6.1	266	0.143	2.6	1.7	0	0.000	0.0	0.0	366	N/A	7.7
A-2	14.31	0.11	0.37	5%	100	10%	8.3	996	0.060	1.7	9.7	1702	0.047	5.2	5.5	2798	N/A	23.5
OSA-3	2.33	0.08	0.35	0%	100	14%	7.7	175	0.131	2.5	1.1	0	0.000	0.0	0.0	275	N/A	8.9
OSA-4	12.06	0.09	0.36	2%	100	8%	9.2	1318	0.064	1.8	12.4	0	0.000	0.0	0.0	1418	N/A	21.6
A-5	15.78	0.11	0.37	5%	100	8%	9.0	465	0.060	1.7	4.5	1583	0.051	5.6	4.7	2148	N/A	18.2
OSA-6	3.90	0.21	0.45	16%	100	10%	7.5	476	0.063	1.8	4.5	0	0.000	0.0	0.0	576	N/A	12.0
A-7	0.97	0.08	0.35	0%	100	13%	7.9	170	0.065	1.8	1.6	0	0.000	0.0	0.0	270	N/A	9.5
OSA-8	5.93	0.11	0.37	4%	100	7%	9.4	720	0.065	1.8	6.7	0	0.000	0.0	0.0	820	N/A	16.1
OSB-1	1.66	0.08	0.35	0%	100	22%	6.6	242	0.091	2.1	1.9	0	0.000	0.0	0.0	342	N/A	8.6
B-2	5.55	0.10	0.36	2%	100	7%	9.5	573	0.065	1.8	5.4	0	0.000	0.0	0.0	673	N/A	14.9
C-1	1.70	0.11	0.37	4%	100	12%	7.9	263	0.072	1.9	2.3	0	0.000	0.0	0.0	363	N/A	10.2
D-1	0.82	0.08	0.35	0%	100	5%	10.8	156	0.064	1.8	1.5	0	0.000	0.0	0.0	256	N/A	12.3

Job No.: **61148**
 Project: **Koinonia Ranch**
 Design Storm: **5-Year Storm (20% Probability)**
 Jurisdiction: **DCM**

Date: **1/28/2022 15:18**
 Calcs By: **WCG**
 Checked By:

Sub-Basin and Combined Flows (Modified from Standard Form SF-2)

DP	Sub-Basin	Area (Acres)	C5	Direct Runoff			Combined Runoff			Streetflow			Pipe Flow			Travel Time		
				t _c (min)	CA (Acres)	I5 (in/hr)	Q5 (cfs)	t _c (min)	CA (Acres)	I5 (in/hr)	Q5 (cfs)	Slope (%)	Length (ft)	Q (cfs)	Slope (%)	Length (ft)	n	Length (ft)
(Existing)	EX-OSA-1	5.47	0.08	8.1	0.44	4.45	1.9											
	EX-OSA-2	12.06	0.09	21.6	1.12	2.98	3.3											
	EX-OSA-3	3.90	0.21	12.0	0.82	3.85	3.1											
	EX-A-4	0.97	0.08	9.5	0.88	4.21	0.3											
	EX-A-5	30.09	0.10	37.7	2.88	2.14	6.2											
	EX-OSA-6	5.93	0.11	16.1	0.64	3.41	2.2											
EX-DP1		58.43	0.10					21.6	5.97	2.98	17.8							
	EX-OSB-1	1.66	0.08	8.6	0.13	4.36	0.6											
	EX-B-2	5.55	0.08	15.1	0.44	3.52	1.6											
EX-OSB-1+B-2		7.22	0.08					11.3	0.58	3.94	2.3							
	EX-C-1	1.70	0.08	10.4	0.14	4.06	0.6											
	EX-D-1	0.82	0.08	12.3	0.07	3.82	0.2											
(Proposed)	OSA-1	3.14	0.08	7.7	0.25	4.51	1.1											
	A-2	14.31	0.11	23.5	1.61	2.85	4.6											
	OSA-6	3.90	0.21	12.0	0.82	3.85	3.1											
DP1		21.35	0.13					18.2	2.67	3.23	8.6							
	OSA-3	2.33	0.08	8.9	0.19	4.31	0.8											
	OSA-4	12.06	0.09	21.6	1.12	2.98	3.3											
	A-5	15.78	0.11	18.2	1.81	3.23	5.9											
	A-7	0.97	0.08	9.5	0.88	4.21	0.3											
	OSA-8	5.93	0.11	16.1	0.64	3.41	2.2											
DP2		58.43	0.11					21.6	6.52	2.98	19.4							
	OSB-1	1.66	0.08	8.6	0.13	4.36	0.6											
	B-2	5.55	0.10	14.9	0.53	3.53	1.9											
OSB-1+B-2		7.22	0.09					11.3	0.66	3.94	2.6							
	C-1	1.70	0.11	10.2	0.18	4.10	0.7											
	D-1	0.82	0.08	12.3	0.07	3.82	0.25											

DCM: $I = C1 * In(tc) + C2$
 C1: 1.5
 C1: 7.583

Job No.: 61148
 Project: Koinonia Ranch
 Design Storm: 100-Year Storm (1% Probability)
 Jurisdiction: DCM

Date: 1/28/2022 15:18
 Calcs By: WCG
 Checked By:

Sub-Basin and Combined Flows (Modified from Standard Form SF-2)

DP	Sub-Basin	Area (Acres)	C100	Direct Runoff			Combined Runoff			Streetflow			Pipe Flow			Travel Time				
				t _c (min)	CA (Acres)	I100 (in/hr)	Q100 (cfs)	t _c (min)	CA (Acres)	I100 (in/hr)	Q100 (cfs)	Slope (%)	Length (ft)	Q (cfs)	Slope (%)	Mnngs n	Length (ft)	D _{Pipe} (in)	Length (ft)	V _{vac} (ft/s)
(Existing)	EX-OSA-1	5.47	0.35	8.1	1.92	7.47	14.3													
	EX-OSA-2	12.06	0.36	21.6	4.33	4.99	21.6													
	EX-OSA-3	3.90	0.45	12.0	1.74	6.47	11.2													
	EX-A-4	0.97	0.35	9.5	0.34	7.06	2.4													
	EX-A-5	30.09	0.36	37.7	10.86	3.59	39.0													
	EX-OSA-6	5.93	0.37	16.1	2.19	5.73	12.6													
	EX-DP1	58.43	0.37					21.6	21.37	4.99	106.7									
	EX-OSB-1	1.66	0.35	8.6	0.58	7.33	4.3													
	EX-B-2	5.55	0.35	15.1	1.94	5.90	11.5													
	EX-OSB-1+B-2	7.22	0.35					11.3	2.53	6.62	16.7									
	EX-C-1	1.70	0.35	10.4	0.60	6.82	4.1													
	EX-D-1	0.82	0.35	12.3	0.29	6.41	1.8													
(Proposed)	OSA-1	3.14	0.35	7.7	1.10	7.58	8.3													
	A-2	14.31	0.37	23.5	5.33	4.78	25.5													
	OSA-6	3.90	0.45	12.0	1.74	6.47	11.2													
DP1		21.35	0.38					18.2	8.17	5.42	44.3									
	OSA-3	2.33	0.35	8.9	0.81	7.24	5.9													
	OSA-4	12.06	0.36	21.6	4.33	4.99	21.6													
	A-5	15.78	0.37	18.2	5.91	5.43	32.1													
	A-7	0.97	0.35	9.5	0.34	7.06	2.4													
	OSA-8	5.93	0.37	16.1	2.19	5.73	12.6													
DP2		58.43	0.37					21.6	21.75	4.99	108.6									
	OSB-1	1.66	0.35	8.6	0.58	7.33	4.3													
	B-2	5.55	0.36	14.9	2.00	5.93	11.9													
OSB-1+B-2		7.22	0.36					11.3	2.59	6.62	17.1									
	C-1	1.70	0.37	10.2	0.63	6.88	4.3													
	D-1	0.82	0.35	12.3	0.29	6.41	1.84													

DCM: I = C1 * In (tc) + C2
 C1: 2.52
 C1: 12.735

Sub-Basin Ex-OSA-1 Runoff Calculations

Job No.: 61148
 Project: Koinonia Ranch
 Jurisdiction: DCM
 Runoff Coefficient: Surface Type

Date: 1/28/2022 15:18
 Calcs by: WCG
 Checked by: _____
 Soil Type: B
 Urbanization: Non-Urban

Basin Land Use Characteristics

Surface	Area		Runoff Coefficient						% Imperv.
	(SF)	(Acres)	C2	C5	C10	C25	C50	C100	
Pasture/Meadow	238,369	5.47	0.02	0.08	0.15	0.25	0.3	0.35	0%
Combined	238,369	5.47	0.02	0.08	0.15	0.25	0.30	0.35	0.0%

238369

Basin Travel Time

	Shallow Channel Ground Cover		Short Pasture/Lawns			
	$L_{max,Overland}$	300 ft	S_0 (ft/ft)	v (ft/s)	t (min)	t_{Alt} (min)
Total	345	50	-	-	-	-
Initial Time	100	28	0.280	-	6.1	N/A DCM Eq. 6-8
Shallow Channel	245	22	0.090	2.1	1.9	- DCM Eq. 6-9
Channelized			0.000	0.0	0.0	- V-Ditch
				t_c	8.1 min.	

Rainfall Intensity & Runoff

	2-Yr	5-Yr	10-Yr	25-Yr	50-Yr	100-Yr
Intensity (in/hr)	3.55	4.45	5.19	5.93	6.67	7.47
Runoff (cfs)	0.4	1.9	4.3	8.1	11.0	14.3
Release Rates (cfs/ac)	-	-	-	-	-	-
Allowed Release (cfs)	0.4	1.9	4.3	8.1	11.0	14.3

Notes

Sub-Basin Ex-OSA-2 Runoff Calculations

Job No.: 61148
 Project: Koinonia Ranch
 Jurisdiction: DCM
 Runoff Coefficient: Surface Type

Date: 1/28/2022 15:18
 Calcs by: WCG
 Checked by: _____
 Soil Type: B
 Urbanization: Non-Urban

Basin Land Use Characteristics

Surface	Area		Runoff Coefficient						% Imperv.
	(SF)	(Acres)	C2	C5	C10	C25	C50	C100	
Pasture/Meadow	511,773	11.75	0.02	0.08	0.15	0.25	0.3	0.35	0%
Gravel	13,610	0.31	0.57	0.59	0.63	0.66	0.68	0.7	80%
Combined	525,383	12.06	0.03	0.09	0.16	0.26	0.31	0.36	2.1%

525383

Basin Travel Time

	Shallow Channel Ground Cover		Short Pasture/Lawns			
	$L_{max,Overland}$ (ft)	ΔZ_0 (ft)	S_0 (ft/ft)	v (ft/s)	t (min)	t_{Alt} (min)
Total	1,418	92	-	-	-	-
Initial Time	100	8	0.080	-	9.2	N/A DCM Eq. 6-8
Shallow Channel	1,318	84	0.064	1.8	12.4	- DCM Eq. 6-9
Channelized			0.000	0.0	0.0	- V-Ditch
				t_c	21.6 min.	

Rainfall Intensity & Runoff

	2-Yr	5-Yr	10-Yr	25-Yr	50-Yr	100-Yr
Intensity (in/hr)	2.38	2.98	3.47	3.97	4.46	4.99
Runoff (cfs)	1.0	3.3	6.8	12.5	16.7	21.6
Release Rates (cfs/ac)	-	-	-	-	-	-
Allowed Release (cfs)	1.0	3.3	6.8	12.5	16.7	21.6

Notes

Sub-Basin Ex-OSA-3 Runoff Calculations

Job No.: 61148
 Project: Koinonia Ranch
 Jurisdiction: DCM
 Runoff Coefficient: Surface Type

Date: 1/28/2022 15:18
 Calcs by: WCG
 Checked by: _____
 Soil Type: B
 Urbanization: Non-Urban

Basin Land Use Characteristics

Surface	Area		Runoff Coefficient						% Imperv.
	(SF)	(Acres)	C2	C5	C10	C25	C50	C100	
Pasture/Meadow	142,935	3.28	0.02	0.08	0.15	0.25	0.3	0.35	0%
Paved	26,770	0.61	0.89	0.9	0.92	0.94	0.95	0.96	100%
Combined	169,705	3.90	0.16	0.21	0.27	0.36	0.40	0.45	15.8%

169705

Basin Travel Time

	Shallow Channel Ground Cover		Short Pasture/Lawns			
	$L_{max,Overland}$	ft	S_0 (ft/ft)	v (ft/s)	t (min)	t_{Alt} (min)
Total	576	40	-	-	-	-
Initial Time	100	10	0.100	-	7.5	N/A DCM Eq. 6-8
Shallow Channel	476	30	0.063	1.8	4.5	- DCM Eq. 6-9
Channelized			0.000	0.0	0.0	- V-Ditch
				t_c	12.0 min.	

Rainfall Intensity & Runoff

	2-Yr	5-Yr	10-Yr	25-Yr	50-Yr	100-Yr
Intensity (in/hr)	3.07	3.85	4.49	5.14	5.78	6.47
Runoff (cfs)	1.9	3.1	4.8	7.2	9.1	11.2
Release Rates (cfs/ac)	-	-	-	-	-	-
Allowed Release (cfs)	1.9	3.1	4.8	7.2	9.1	11.2

Notes

Sub-Basin Ex-A-4 Runoff Calculations

Job No.: 61148
 Project: Koinonia Ranch
 Jurisdiction: DCM
 Runoff Coefficient: Surface Type

Date: 1/28/2022 15:18
 Calcs by: WCG
 Checked by: _____
 Soil Type: B
 Urbanization: Non-Urban

Basin Land Use Characteristics

Surface	Area		Runoff Coefficient						% Imperv.
	(SF)	(Acres)	C2	C5	C10	C25	C50	C100	
Pasture/Meadow	42,213	0.97	0.02	0.08	0.15	0.25	0.3	0.35	0%
Combined	42,213	0.97	0.02	0.08	0.15	0.25	0.30	0.35	0.0%

Basin Travel Time

	Shallow Channel Ground Cover		Short Pasture/Lawns			
	$L_{max,Overland}$	300 ft	S_0 (ft/ft)	v (ft/s)	t (min)	t_{Alt} (min)
Total	270	24	-	-	-	-
Initial Time	100	13	0.130	-	7.9	N/A DCM Eq. 6-8
Shallow Channel	170	11	0.065	1.8	1.6	- DCM Eq. 6-9
Channelized			0.000	0.0	0.0	- V-Ditch
				t_c	9.5 min.	

Rainfall Intensity & Runoff

	2-Yr	5-Yr	10-Yr	25-Yr	50-Yr	100-Yr
Intensity (in/hr)	3.36	4.21	4.91	5.61	6.31	7.06
Runoff (cfs)	0.1	0.3	0.7	1.4	1.8	2.4
Release Rates (cfs/ac)	-	-	-	-	-	-
Allowed Release (cfs)	0.1	0.3	0.7	1.4	1.8	2.4

Notes

Sub-Basin Ex-A-5 Runoff Calculations

Job No.: 61148
 Project: Koinonia Ranch
 Jurisdiction: DCM
 Runoff Coefficient: Surface Type

Date: 1/28/2022 15:18
 Calcs by: WCG
 Checked by: _____
 Soil Type: B
 Urbanization: Non-Urban

Basin Land Use Characteristics

Surface	Area		Runoff Coefficient						% Imperv.
	(SF)	(Acres)	C2	C5	C10	C25	C50	C100	
Pasture/Meadow	1,273,550	29.24	0.02	0.08	0.15	0.25	0.3	0.35	0%
Gravel	30,428	0.70	0.57	0.59	0.63	0.66	0.68	0.7	80%
Roofs	4,265	0.10	0.71	0.73	0.75	0.78	0.8	0.81	90%
Paved	2,631	0.06	0.89	0.9	0.92	0.94	0.95	0.96	100%
Combined	1,310,874	30.09	0.04	0.10	0.16	0.26	0.31	0.36	2.4%

1310874

Basin Travel Time

	Shallow Channel Ground Cover		Short Pasture/Lawns			
	$L_{max,Overland}$	300 ft	S_0 (ft/ft)	v (ft/s)	t (min)	t_{Alt} (min)
Total	2,913	156	-	-	-	-
Initial Time	100	11	0.110	-	8.2	N/A DCM Eq. 6-8
Shallow Channel	2,813	145	0.052	1.6	29.5	- DCM Eq. 6-9
Channelized			0.000	0.0	0.0	- V-Ditch
				t_c	37.7 min.	

Rainfall Intensity & Runoff

	2-Yr	5-Yr	10-Yr	25-Yr	50-Yr	100-Yr
Intensity (in/hr)	1.72	2.14	2.49	2.85	3.21	3.59
Runoff (cfs)	1.9	6.2	12.4	22.5	30.1	39.0
Release Rates (cfs/ac)	-	-	-	-	-	-
Allowed Release (cfs)	1.9	6.2	12.4	22.5	30.1	39.0

Notes

Sub-Basin Ex-OSA-6 Runoff Calculations

Job No.: 61148
 Project: Koinonia Ranch
 Jurisdiction: DCM
 Runoff Coefficient: Surface Type

Date: 1/28/2022 15:18
 Calcs by: WCG
 Checked by: _____
 Soil Type: B
 Urbanization: Non-Urban

Basin Land Use Characteristics

Surface	Area		Runoff Coefficient						% Imperv.
	(SF)	(Acres)	C2	C5	C10	C25	C50	C100	
Pasture/Meadow	244,140	5.60	0.02	0.08	0.15	0.25	0.3	0.35	0%
Gravel	14,320	0.33	0.57	0.59	0.63	0.66	0.68	0.7	80%
Combined	258,460	5.93	0.05	0.11	0.18	0.27	0.32	0.37	4.4%

258460

Basin Travel Time

	Shallow Channel Ground Cover		Short Pasture/Lawns				
	$L_{max,Overland}$	300 ft	S_0 (ft/ft)	v (ft/s)	t (min)	t_{Alt} (min)	C_v
Total	820	54	-	-	-	-	7
Initial Time	100	7	0.070	-	9.4	N/A	DCM Eq. 6-8
Shallow Channel	720	47	0.065	1.8	6.7	-	DCM Eq. 6-9
Channelized			0.000	0.0	0.0	-	V-Ditch
				t_c	16.1 min.		

Rainfall Intensity & Runoff

	2-Yr	5-Yr	10-Yr	25-Yr	50-Yr	100-Yr
Intensity (in/hr)	2.73	3.41	3.98	4.55	5.12	5.73
Runoff (cfs)	0.8	2.2	4.2	7.4	9.8	12.6
Release Rates (cfs/ac)	-	-	-	-	-	-
Allowed Release (cfs)	0.8	2.2	4.2	7.4	9.8	12.6

Notes

Sub-Basin Ex-OSB-1 Runoff Calculations

Job No.: 61148
 Project: Koinonia Ranch
 Jurisdiction: DCM
 Runoff Coefficient: Surface Type

Date: 1/28/2022 15:18
 Calcs by: WCG
 Checked by: _____
 Soil Type: B
 Urbanization: Non-Urban

Basin Land Use Characteristics

Surface	Area		Runoff Coefficient						% Imperv.
	(SF)	(Acres)	C2	C5	C10	C25	C50	C100	
Pasture/Meadow	72,445	1.66	0.02	0.08	0.15	0.25	0.3	0.35	0%
Combined	72,445	1.66	0.02	0.08	0.15	0.25	0.30	0.35	0.0%

Basin Travel Time

	Shallow Channel Ground Cover		Short Pasture/Lawns			
	$L_{max,Overland}$	300 ft	S_0 (ft/ft)	v (ft/s)	t (min)	t_{Alt} (min)
Total	342	44	-	-	-	-
Initial Time	100	22	0.220	-	6.6	N/A DCM Eq. 6-8
Shallow Channel	242	22	0.091	2.1	1.9	- DCM Eq. 6-9
Channelized			0.000	0.0	0.0	- V-Ditch
				t_c	8.6 min.	

Rainfall Intensity & Runoff

	2-Yr	5-Yr	10-Yr	25-Yr	50-Yr	100-Yr
Intensity (in/hr)	3.48	4.36	5.09	5.82	6.55	7.33
Runoff (cfs)	0.1	0.6	1.3	2.4	3.3	4.3
Release Rates (cfs/ac)	-	-	-	-	-	-
Allowed Release (cfs)	0.1	0.6	1.3	2.4	3.3	4.3

Notes

Sub-Basin Ex-B-2 Runoff Calculations

Job No.: 61148
 Project: Koinonia Ranch
 Jurisdiction: DCM
 Runoff Coefficient: Surface Type

Date: 1/28/2022 15:18
 Calcs by: WCG
 Checked by: _____
 Soil Type: B
 Urbanization: Non-Urban

Basin Land Use Characteristics

Surface	Area		Runoff Coefficient						% Imperv.
	(SF)	(Acres)	C2	C5	C10	C25	C50	C100	
Pasture/Meadow	241,936	5.55	0.02	0.08	0.15	0.25	0.3	0.35	0%
Combined	241,936	5.55	0.02	0.08	0.15	0.25	0.30	0.35	0.0%

241936

Basin Travel Time

	Shallow Channel Ground Cover		Short Pasture/Lawns			
	$L_{max,Overland}$	300 ft	S_0 (ft/ft)	v (ft/s)	t (min)	t_{Alt} (min)
Total	673	44	-	-	-	-
Initial Time	100	7	0.070	-	9.7	N/A DCM Eq. 6-8
Shallow Channel	573	37	0.065	1.8	5.4	- DCM Eq. 6-9
Channelized			0.000	0.0	0.0	- V-Ditch
				t_c	15.1 min.	

Rainfall Intensity & Runoff

	2-Yr	5-Yr	10-Yr	25-Yr	50-Yr	100-Yr
Intensity (in/hr)	2.81	3.52	4.10	4.69	5.27	5.90
Runoff (cfs)	0.3	1.6	3.4	6.5	8.8	11.5
Release Rates (cfs/ac)	-	-	-	-	-	-
Allowed Release (cfs)	0.3	1.6	3.4	6.5	8.8	11.5

Notes

Sub-Basin Ex-C-1 Runoff Calculations

Job No.: 61148
 Project: Koinonia Ranch
 Jurisdiction: DCM
 Runoff Coefficient: Surface Type

Date: 1/28/2022 15:18
 Calcs by: WCG
 Checked by: _____
 Soil Type: B
 Urbanization: Non-Urban

Basin Land Use Characteristics

Surface	Area		Runoff Coefficient						% Imperv.
	(SF)	(Acres)	C2	C5	C10	C25	C50	C100	
Pasture/Meadow	74,158	1.70	0.02	0.08	0.15	0.25	0.3	0.35	0%
Combined	74,158	1.70	0.02	0.08	0.15	0.25	0.30	0.35	0.0%

Basin Travel Time

	Shallow Channel Ground Cover		Short Pasture/Lawns				
	$L_{max,Overland}$	300 ft	S_0 (ft/ft)	v (ft/s)	t (min)	t_{Alt} (min)	C_v
Total	363	31	-	-	-	-	7
Initial Time	100	12	0.120	-	8.1	N/A	DCM Eq. 6-8
Shallow Channel	263	19	0.072	1.9	2.3	-	DCM Eq. 6-9
Channelized			0.000	0.0	0.0	-	V-Ditch
				t_c	10.4 min.		

Rainfall Intensity & Runoff

	2-Yr	5-Yr	10-Yr	25-Yr	50-Yr	100-Yr
Intensity (in/hr)	3.24	4.06	4.74	5.42	6.10	6.82
Runoff (cfs)	0.1	0.6	1.2	2.3	3.1	4.1
Release Rates (cfs/ac)	-	-	-	-	-	-
Allowed Release (cfs)	0.1	0.6	1.2	2.3	3.1	4.1

Notes

Sub-Basin Ex-D-1 Runoff Calculations

Job No.: 61148
 Project: Koinonia Ranch
 Jurisdiction: DCM
 Runoff Coefficient: Surface Type

Date: 1/28/2022 15:18
 Calcs by: WCG
 Checked by: _____
 Soil Type: B
 Urbanization: Non-Urban

Basin Land Use Characteristics

Surface	Area		Runoff Coefficient						% Imperv.
	(SF)	(Acres)	C2	C5	C10	C25	C50	C100	
Pasture/Meadow	35,573	0.82	0.02	0.08	0.15	0.25	0.3	0.35	0%
Combined	35,573	0.82	0.02	0.08	0.15	0.25	0.30	0.35	0.0%

Basin Travel Time

	Shallow Channel Ground Cover		Short Pasture/Lawns			
	$L_{max,Overland}$	300 ft	S_0 (ft/ft)	v (ft/s)	t (min)	t_{Alt} (min)
Total	256	15	-	-	-	-
Initial Time	100	5	0.050	-	10.8	N/A DCM Eq. 6-8
Shallow Channel	156	10	0.064	1.8	1.5	- DCM Eq. 6-9
Channelized			0.000	0.0	0.0	- V-Ditch
				t_c	12.3 min.	

Rainfall Intensity & Runoff

	2-Yr	5-Yr	10-Yr	25-Yr	50-Yr	100-Yr
Intensity (in/hr)	3.05	3.82	4.46	5.09	5.73	6.41
Runoff (cfs)	0.0	0.2	0.5	1.0	1.4	1.8
Release Rates (cfs/ac)	-	-	-	-	-	-
Allowed Release (cfs)	0.0	0.2	0.5	1.0	1.4	1.8

Notes

Combined Sub-Basin Runoff Calculations (EX-DP1)

Includes Basins EX-OSA-1 EX-OSA-2 EX-OSA-3 EX-A-4 EX-A-5 EX-OSA-6

Job No.:	<u>61148</u>	Date:	<u>1/28/2022 15:18</u>
Project:	<u>Koinonia Ranch</u>	Calcs by:	<u>WCG</u>
Jurisdiction	<u>DCM</u>	Checked by:	
Runoff Coefficient	<u>Surface Type</u>	Soil Type	<u>B</u>
		Urbanization	<u>Non-Urban</u>

Basin Land Use Characteristics

Surface	Area		Runoff Coefficient						% Imperv.
	(SF)	(Acres)	C2	C5	C10	C25	C50	C100	
Paved	29,401	0.67	0.89	0.9	0.92	0.94	0.95	0.96	100%
Pasture/Meadow	2,452,980	56.31	0.02	0.08	0.15	0.25	0.3	0.35	0%
Roofs	4,265	0.10	0.71	0.73	0.75	0.78	0.8	0.81	90%
Gravel	58,358	1.34	0.57	0.59	0.63	0.66	0.68	0.7	80%
Combined	2,545,004	58.43	0.04	0.10	0.17	0.27	0.32	0.37	3.1%

Basin Travel Time

	Sub-basin or Channel Type	Material Type	L (ft)	Elev. ΔZ ₀ (ft)	Q _i (cfs)	Base or Dia (ft)	Sides z:1 (ft/ft)	v (ft/s)	t (min)
Furthest Reach	EX-OSA-2	-	1,418	92	-	-	-	-	21.6
Channelized-1									
Channelized-2									
Channelized-3									
Total			1,418	92					
								t_c (min)	21.6

Contributing Offsite Flows (Added to Runoff and Allowed Release, below.)

Contributing Basins/Areas: _____

Q_{Minor}: _____ (cfs) - 5-year Storm

Q_{Major}: _____ (cfs) - 100-year Storm

Rainfall Intensity & Runoff

	2-Yr	5-Yr	10-Yr	25-Yr	50-Yr	100-Yr
Intensity (in/hr)	2.38	2.98	3.47	3.97	4.46	4.99
Site Runoff (cfs)	6.09	17.77	34.66	62.18	82.68	106.74
OffSite Runoff (cfs)	-	0.00	-	-	-	0.00
Release Rates (cfs/ac)	-	-	-	-	-	-
Allowed Release (cfs)	-	17.8	-	-	-	106.7

DCM: $I = C1 * \ln(tc) + C2$

C1	1.19	1.5	1.75	2	2.25	2.52
C2	6.035	7.583	8.847	10.111	11.375	12.735

Combined Sub-Basin Runoff Calculations (EX-OSB1+B2)

Includes Basins EX-OSB-1 EX-B-2

Job No.:	61148	Date:	1/28/2022 15:18
Project:	Koinonia Ranch	Calcs by:	WCG
Jurisdiction	DCM	Checked by:	
Runoff Coefficient	Surface Type	Soil Type	B
		Urbanization	Non-Urban

Basin Land Use Characteristics

Surface	Area		Runoff Coefficient						% Imperv.
	(SF)	(Acres)	C2	C5	C10	C25	C50	C100	
Pasture/Meadow	314,381	7.22	0.02	0.08	0.15	0.25	0.3	0.35	0%
Combined	314,381	7.22	0.02	0.08	0.15	0.25	0.30	0.35	0.0%

Basin Travel Time

	Sub-basin or Channel Type	Material Type	L (ft)	Elev. ΔZ ₀ (ft)	Q _i (cfs)	Base or Dia (ft)	Sides z:1 (ft/ft)	v (ft/s)	t (min)
Furthest Reach	EX-OSB-1	-	342	44	-	-	-	-	8.6
Channelized-1	V-Ditch	2	672	45	4	0	2	4.1	2.8
Channelized-2									
Channelized-3									
Total			1,014	89					

2 = Natural, Winding, minimal vegetation/shallow grass

t_c (min) 11.3

Contributing Offsite Flows (Added to Runoff and Allowed Release, below.)

Contributing Basins/Areas

Q_{Minor} (cfs) - 5-year Storm

Q_{Major} (cfs) - 100-year Storm

Rainfall Intensity & Runoff

	2-Yr	5-Yr	10-Yr	25-Yr	50-Yr	100-Yr
Intensity (in/hr)	3.15	3.94	4.60	5.26	5.92	6.62
Site Runoff (cfs)	0.45	2.28	4.98	9.49	12.81	16.73
OffSite Runoff (cfs)	-	0.00	-	-	-	0.00
Release Rates (cfs/ac)	-	-	-	-	-	-
Allowed Release (cfs)	-	2.3	-	-	-	16.7

DCM: $I = C1 * \ln(tc) + C2$

C1	1.19	1.5	1.75	2	2.25	2.52
C2	6.035	7.583	8.847	10.111	11.375	12.735

Sub-Basin OSA-1 Runoff Calculations

Job No.: 61148
 Project: Koinonia Ranch
 Jurisdiction: DCM
 Runoff Coefficient: Surface Type

Date: 1/28/2022 15:18
 Calcs by: WCG
 Checked by: _____
 Soil Type: B
 Urbanization: Non-Urban

Basin Land Use Characteristics

Surface	Area		Runoff Coefficient						% Imperv.
	(SF)	(Acres)	C2	C5	C10	C25	C50	C100	
Pasture/Meadow	136,951	3.14	0.02	0.08	0.15	0.25	0.3	0.35	0%
Combined	136,951	3.14	0.02	0.08	0.15	0.25	0.30	0.35	0.0%

136951

Basin Travel Time

	Shallow Channel Ground Cover		Short Pasture/Lawns			
	$L_{max,Overland}$	ft	S_0 (ft/ft)	v (ft/s)	t (min)	t_{Alt} (min)
Total	366	67	-	-	-	-
Initial Time	100	29	0.290	-	6.1	N/A DCM Eq. 6-8
Shallow Channel	266	38	0.143	2.6	1.7	- DCM Eq. 6-9
Channelized			0.000	0.0	0.0	- V-Ditch
				t_c	7.7 min.	

Rainfall Intensity & Runoff

	2-Yr	5-Yr	10-Yr	25-Yr	50-Yr	100-Yr
Intensity (in/hr)	3.60	4.51	5.27	6.02	6.77	7.58
Runoff (cfs)	0.2	1.1	2.5	4.7	6.4	8.3
Release Rates (cfs/ac)	-	-	-	-	-	-
Allowed Release (cfs)	0.2	1.1	2.5	4.7	6.4	8.3

Notes

Sub-Basin A-2 Runoff Calculations

Job No.: 61148
 Project: Koinonia Ranch
 Jurisdiction: DCM
 Runoff Coefficient: Surface Type

Date: 1/28/2022 15:18
 Calcs by: WCG
 Checked by: _____
 Soil Type: B
 Urbanization: Non-Urban

Basin Land Use Characteristics

Surface	Area		Runoff Coefficient						% Imperv.
	(SF)	(Acres)	C2	C5	C10	C25	C50	C100	
Pasture/Meadow	586,765	13.47	0.02	0.08	0.15	0.25	0.3	0.35	0%
Gravel	27,653	0.63	0.57	0.59	0.63	0.66	0.68	0.7	80%
Roofs	8,000	0.18	0.71	0.73	0.75	0.78	0.8	0.81	90%
Paved	1,000	0.02	0.89	0.9	0.92	0.94	0.95	0.96	100%
Combined	623,418	14.31	0.05	0.11	0.18	0.28	0.32	0.37	4.9%

623418

Basin Travel Time

	Shallow Channel Ground Cover		Short Pasture/Lawns			
	$L_{max,Overland}$	300 ft	S_0 (ft/ft)	v (ft/s)	t (min)	t_{Alt} (min)
Total	2,798	150	-	-	-	-
Initial Time	100	10	0.100	-	8.3	N/A DCM Eq. 6-8
Shallow Channel	996	60	0.060	1.7	9.7	- DCM Eq. 6-9
Channelized	1,702	80	0.047	5.2	5.5	- V-Ditch
			t_c 23.5 min.			

Rainfall Intensity & Runoff

	2-Yr	5-Yr	10-Yr	25-Yr	50-Yr	100-Yr
Intensity (in/hr)	2.28	2.85	3.32	3.80	4.27	4.78
Runoff (cfs)	1.8	4.6	8.6	15.0	19.8	25.5
Release Rates (cfs/ac)	-	-	-	-	-	-
Allowed Release (cfs)	1.8	4.6	8.6	15.0	19.8	25.5

Notes

Sub-Basin OSA-3 Runoff Calculations

Job No.: 61148
 Project: Koinonia Ranch
 Jurisdiction: DCM
 Runoff Coefficient: Surface Type

Date: 1/28/2022 15:18
 Calcs by: WCG
 Checked by: _____
 Soil Type: B
 Urbanization: Non-Urban

Basin Land Use Characteristics

Surface	Area		Runoff Coefficient						% Imperv.
	(SF)	(Acres)	C2	C5	C10	C25	C50	C100	
Pasture/Meadow	101,417	2.33	0.02	0.08	0.15	0.25	0.3	0.35	0%
Combined	101,417	2.33	0.02	0.08	0.15	0.25	0.30	0.35	0.0%

101417

Basin Travel Time

	Shallow Channel Ground Cover		Short Pasture/Lawns			
	$L_{max,Overland}$ (ft)	ΔZ_0 (ft)	S_0 (ft/ft)	v (ft/s)	t (min)	t_{Alt} (min)
Total	275	37	-	-	-	-
Initial Time	100	14	0.140	-	7.7	N/A DCM Eq. 6-8
Shallow Channel	175	23	0.131	2.5	1.1	- DCM Eq. 6-9
Channelized			0.000	0.0	0.0	- V-Ditch
				t_c	8.9 min.	

Rainfall Intensity & Runoff

	2-Yr	5-Yr	10-Yr	25-Yr	50-Yr	100-Yr
Intensity (in/hr)	3.44	4.31	5.03	5.75	6.47	7.24
Runoff (cfs)	0.2	0.8	1.8	3.3	4.5	5.9
Release Rates (cfs/ac)	-	-	-	-	-	-
Allowed Release (cfs)	0.2	0.8	1.8	3.3	4.5	5.9

Notes

Sub-Basin OSA-4 Runoff Calculations

Job No.: 61148
 Project: Koinonia Ranch
 Jurisdiction: DCM
 Runoff Coefficient: Surface Type

Date: 1/28/2022 15:18
 Calcs by: WCG
 Checked by: _____
 Soil Type: B
 Urbanization: Non-Urban

Basin Land Use Characteristics

Surface	Area		Runoff Coefficient						% Imperv.
	(SF)	(Acres)	C2	C5	C10	C25	C50	C100	
Pasture/Meadow	511,773	11.75	0.02	0.08	0.15	0.25	0.3	0.35	0%
Gravel	13,610	0.31	0.57	0.59	0.63	0.66	0.68	0.7	80%
Combined	525,383	12.06	0.03	0.09	0.16	0.26	0.31	0.36	2.1%

Basin Travel Time

	Shallow Channel	Ground Cover	Short Pasture/Lawns				
	$L_{max,Overland}$	300 ft	C_v	7			
	L (ft)	ΔZ_0 (ft)	S_0 (ft/ft)	v (ft/s)	t (min)	t_{Alt} (min)	
Total	1,418	92	-	-	-	-	
Initial Time	100	8	0.080	-	9.2	N/A	DCM Eq. 6-8
Shallow Channel	1,318	84	0.064	1.8	12.4	-	DCM Eq. 6-9
Channelized			0.000	0.0	0.0	-	V-Ditch
				t_c	21.6 min.		

Rainfall Intensity & Runoff

	2-Yr	5-Yr	10-Yr	25-Yr	50-Yr	100-Yr
Intensity (in/hr)	2.38	2.98	3.47	3.97	4.46	4.99
Runoff (cfs)	1.0	3.3	6.8	12.5	16.7	21.6
Release Rates (cfs/ac)	-	-	-	-	-	-
Allowed Release (cfs)	1.0	3.3	6.8	12.5	16.7	21.6

Notes

Sub-Basin A-5 Runoff Calculations

Job No.: 61148
 Project: Koinonia Ranch
 Jurisdiction: DCM
 Runoff Coefficient: Surface Type

Date: 1/28/2022 15:18
 Calcs by: WCG
 Checked by: _____
 Soil Type: B
 Urbanization: Non-Urban

Basin Land Use Characteristics

Surface	Area		Runoff Coefficient						% Imperv.
	(SF)	(Acres)	C2	C5	C10	C25	C50	C100	
Pasture/Meadow	645,554	14.82	0.02	0.08	0.15	0.25	0.3	0.35	0%
Roofs	10,000	0.23	0.71	0.73	0.75	0.78	0.8	0.81	90%
Paved	4,000	0.09	0.89	0.9	0.92	0.94	0.95	0.96	100%
Gravel	27,899	0.64	0.57	0.59	0.63	0.66	0.68	0.7	80%
Combined	687,453	15.78	0.06	0.11	0.18	0.28	0.33	0.37	5.1%

687453

Basin Travel Time

	Shallow Channel Ground Cover		Short Pasture/Lawns			
	$L_{max,Overland}$ (ft)	ΔZ_0 (ft)	S_0 (ft/ft)	v (ft/s)	t (min)	t_{Alt} (min)
Total	2,148	116	-	-	-	-
Initial Time	100	8	0.080	-	9.0	N/A DCM Eq. 6-8
Shallow Channel	465	28	0.060	1.7	4.5	- DCM Eq. 6-9
Channelized	1,583	80	0.051	5.6	4.7	- V-Ditch
t_c					18.2 min.	

Rainfall Intensity & Runoff

	2-Yr	5-Yr	10-Yr	25-Yr	50-Yr	100-Yr
Intensity (in/hr)	2.59	3.23	3.77	4.31	4.85	5.43
Runoff (cfs)	2.3	5.9	10.9	18.9	25.0	32.1
Release Rates (cfs/ac)	-	-	-	-	-	-
Allowed Release (cfs)	2.3	5.9	10.9	18.9	25.0	32.1

Notes

Sub-Basin OSA-6 Runoff Calculations

Job No.: 61148
 Project: Koinonia Ranch
 Jurisdiction: DCM
 Runoff Coefficient: Surface Type

Date: 1/28/2022 15:18
 Calcs by: WCG
 Checked by: _____
 Soil Type: B
 Urbanization: Non-Urban

Basin Land Use Characteristics

Surface	Area		Runoff Coefficient						% Imperv.
	(SF)	(Acres)	C2	C5	C10	C25	C50	C100	
Pasture/Meadow	142,935	3.28	0.02	0.08	0.15	0.25	0.3	0.35	0%
Paved	26,770	0.61	0.89	0.9	0.92	0.94	0.95	0.96	100%
Combined	169,705	3.90	0.16	0.21	0.27	0.36	0.40	0.45	15.8%

169705

Basin Travel Time

	Shallow Channel Ground Cover		Short Pasture/Lawns			
	$L_{max,Overland}$	ft	S_0 (ft/ft)	v (ft/s)	t (min)	t_{Alt} (min)
Total	576	40	-	-	-	-
Initial Time	100	10	0.100	-	7.5	N/A DCM Eq. 6-8
Shallow Channel	476	30	0.063	1.8	4.5	- DCM Eq. 6-9
Channelized			0.000	0.0	0.0	- V-Ditch
				t_c	12.0 min.	

Rainfall Intensity & Runoff

	2-Yr	5-Yr	10-Yr	25-Yr	50-Yr	100-Yr
Intensity (in/hr)	3.07	3.85	4.49	5.14	5.78	6.47
Runoff (cfs)	1.9	3.1	4.8	7.2	9.1	11.2
Release Rates (cfs/ac)	-	-	-	-	-	-
Allowed Release (cfs)	1.9	3.1	4.8	7.2	9.1	11.2

Notes

Sub-Basin A-7 Runoff Calculations

Job No.: 61148
 Project: Koinonia Ranch
 Jurisdiction: DCM
 Runoff Coefficient: Surface Type

Date: 1/28/2022 15:18
 Calcs by: WCG
 Checked by: _____
 Soil Type: B
 Urbanization: Non-Urban

Basin Land Use Characteristics

Surface	Area		Runoff Coefficient						% Imperv.
	(SF)	(Acres)	C2	C5	C10	C25	C50	C100	
Pasture/Meadow	42,213	0.97	0.02	0.08	0.15	0.25	0.3	0.35	0%
Combined	42,213	0.97	0.02	0.08	0.15	0.25	0.30	0.35	0.0%

Basin Travel Time

	Shallow Channel Ground Cover		Short Pasture/Lawns			
	$L_{max,Overland}$ (ft)	ΔZ_0 (ft)	S_0 (ft/ft)	v (ft/s)	t (min)	t_{Alt} (min)
Total	270	24	-	-	-	-
Initial Time	100	13	0.130	-	7.9	N/A DCM Eq. 6-8
Shallow Channel	170	11	0.065	1.8	1.6	- DCM Eq. 6-9
Channelized			0.000	0.0	0.0	- V-Ditch
				t_c	9.5 min.	

Rainfall Intensity & Runoff

	2-Yr	5-Yr	10-Yr	25-Yr	50-Yr	100-Yr
Intensity (in/hr)	3.36	4.21	4.91	5.61	6.31	7.06
Runoff (cfs)	0.1	0.3	0.7	1.4	1.8	2.4
Release Rates (cfs/ac)	-	-	-	-	-	-
Allowed Release (cfs)	0.1	0.3	0.7	1.4	1.8	2.4

Notes

Sub-Basin OSA-8 Runoff Calculations

Job No.: 61148
 Project: Koinonia Ranch
 Jurisdiction: DCM
 Runoff Coefficient: Surface Type

Date: 1/28/2022 15:18
 Calcs by: WCG
 Checked by: _____
 Soil Type: B
 Urbanization: Non-Urban

Basin Land Use Characteristics

Surface	Area		Runoff Coefficient						% Imperv.
	(SF)	(Acres)	C2	C5	C10	C25	C50	C100	
Pasture/Meadow	244,140	5.60	0.02	0.08	0.15	0.25	0.3	0.35	0%
Gravel	14,320	0.33	0.57	0.59	0.63	0.66	0.68	0.7	80%
Combined	258,460	5.93	0.05	0.11	0.18	0.27	0.32	0.37	4.4%

258460

Basin Travel Time

	Shallow Channel Ground Cover		Short Pasture/Lawns			
	$L_{max,Overland}$	300 ft	S_0 (ft/ft)	v (ft/s)	t (min)	t_{Alt} (min)
Total	820	54	-	-	-	-
Initial Time	100	7	0.070	-	9.4	N/A DCM Eq. 6-8
Shallow Channel	720	47	0.065	1.8	6.7	- DCM Eq. 6-9
Channelized			0.000	0.0	0.0	- V-Ditch
				t_c	16.1 min.	

Rainfall Intensity & Runoff

	2-Yr	5-Yr	10-Yr	25-Yr	50-Yr	100-Yr
Intensity (in/hr)	2.73	3.41	3.98	4.55	5.12	5.73
Runoff (cfs)	0.8	2.2	4.2	7.4	9.8	12.6
Release Rates (cfs/ac)	-	-	-	-	-	-
Allowed Release (cfs)	0.8	2.2	4.2	7.4	9.8	12.6

Notes

Sub-Basin OSB-1 Runoff Calculations

Job No.: 61148
 Project: Koinonia Ranch
 Jurisdiction: DCM
 Runoff Coefficient: Surface Type

Date: 1/28/2022 15:18
 Calcs by: WCG
 Checked by: _____
 Soil Type: B
 Urbanization: Non-Urban

Basin Land Use Characteristics

Surface	Area		Runoff Coefficient						% Imperv.
	(SF)	(Acres)	C2	C5	C10	C25	C50	C100	
Pasture/Meadow	72,445	1.66	0.02	0.08	0.15	0.25	0.3	0.35	0%
Combined	72,445	1.66	0.02	0.08	0.15	0.25	0.30	0.35	0.0%

Basin Travel Time

	Shallow Channel Ground Cover		Short Pasture/Lawns			
	$L_{max,Overland}$	300 ft	S_0 (ft/ft)	v (ft/s)	t (min)	t_{Alt} (min)
Total	342	44	-	-	-	-
Initial Time	100	22	0.220	-	6.6	N/A DCM Eq. 6-8
Shallow Channel	242	22	0.091	2.1	1.9	- DCM Eq. 6-9
Channelized			0.000	0.0	0.0	- V-Ditch
				t_c	8.6 min.	

Rainfall Intensity & Runoff

	2-Yr	5-Yr	10-Yr	25-Yr	50-Yr	100-Yr
Intensity (in/hr)	3.48	4.36	5.09	5.82	6.55	7.33
Runoff (cfs)	0.1	0.6	1.3	2.4	3.3	4.3
Release Rates (cfs/ac)	-	-	-	-	-	-
Allowed Release (cfs)	0.1	0.6	1.3	2.4	3.3	4.3

Notes

Sub-Basin B-2 Runoff Calculations

Job No.: 61148
 Project: Koinonia Ranch
 Jurisdiction: DCM
 Runoff Coefficient: Surface Type

Date: 1/28/2022 15:18
 Calcs by: WCG
 Checked by: _____
 Soil Type: B
 Urbanization: Non-Urban

Basin Land Use Characteristics

Surface	Area		Runoff Coefficient						% Imperv.
	(SF)	(Acres)	C2	C5	C10	C25	C50	C100	
Pasture/Meadow	235,986	5.42	0.02	0.08	0.15	0.25	0.3	0.35	0%
Roofs	4,000	0.09	0.71	0.73	0.75	0.78	0.8	0.81	90%
Paved	500	0.01	0.89	0.9	0.92	0.94	0.95	0.96	100%
Gravel	1,450	0.03	0.57	0.59	0.63	0.66	0.68	0.7	80%
Combined	241,936	5.55	0.04	0.10	0.16	0.26	0.31	0.36	2.2%

241936

Basin Travel Time

	Shallow Channel Ground Cover		Short Pasture/Lawns			
	$L_{max,Overland}$	300 ft	S_0 (ft/ft)	v (ft/s)	t (min)	t_{Alt} (min)
Total	673	44	-	-	-	-
Initial Time	100	7	0.070	-	9.5	N/A DCM Eq. 6-8
Shallow Channel	573	37	0.065	1.8	5.4	- DCM Eq. 6-9
Channelized			0.000	0.0	0.0	- V-Ditch
				t_c	14.9 min.	

Rainfall Intensity & Runoff

	2-Yr	5-Yr	10-Yr	25-Yr	50-Yr	100-Yr
Intensity (in/hr)	2.82	3.53	4.12	4.71	5.30	5.93
Runoff (cfs)	0.6	1.9	3.8	6.9	9.2	11.9
Release Rates (cfs/ac)	-	-	-	-	-	-
Allowed Release (cfs)	0.6	1.9	3.8	6.9	9.2	11.9

Notes

Sub-Basin C-1 Runoff Calculations

Job No.: 61148
 Project: Koinonia Ranch
 Jurisdiction: DCM
 Runoff Coefficient: Surface Type

Date: 1/28/2022 15:18
 Calcs by: WCG
 Checked by: _____
 Soil Type: B
 Urbanization: Non-Urban

Basin Land Use Characteristics

Surface	Area		Runoff Coefficient						% Imperv.
	(SF)	(Acres)	C2	C5	C10	C25	C50	C100	
Pasture/Meadow	70,898	1.63	0.02	0.08	0.15	0.25	0.3	0.35	0%
Roofs	2,000	0.05	0.71	0.73	0.75	0.78	0.8	0.81	90%
Paved	250	0.01	0.89	0.9	0.92	0.94	0.95	0.96	100%
Gravel	1,010	0.02	0.57	0.59	0.63	0.66	0.68	0.7	80%
Combined	74,158	1.70	0.05	0.11	0.18	0.27	0.32	0.37	3.9%

Basin Travel Time

	Shallow Channel Ground Cover		Short Pasture/Lawns			
	$L_{max,Overland}$	300 ft	S_0 (ft/ft)	v (ft/s)	t (min)	t_{Alt} (min)
Total	363	31	-	-	-	-
Initial Time	100	12	0.120	-	7.9	N/A DCM Eq. 6-8
Shallow Channel	263	19	0.072	1.9	2.3	- DCM Eq. 6-9
Channelized			0.000	0.0	0.0	- V-Ditch
				t_c	10.2 min.	

Rainfall Intensity & Runoff

	2-Yr	5-Yr	10-Yr	25-Yr	50-Yr	100-Yr
Intensity (in/hr)	3.27	4.10	4.78	5.46	6.14	6.88
Runoff (cfs)	0.3	0.7	1.4	2.5	3.4	4.3
Release Rates (cfs/ac)	-	-	-	-	-	-
Allowed Release (cfs)	0.3	0.7	1.4	2.5	3.4	4.3

Notes

Sub-Basin D-1 Runoff Calculations

Job No.: 61148
 Project: Koinonia Ranch
 Jurisdiction: DCM
 Runoff Coefficient: Surface Type

Date: 1/28/2022 15:18
 Calcs by: WCG
 Checked by: _____
 Soil Type: B
 Urbanization: Non-Urban

Basin Land Use Characteristics

Surface	Area		Runoff Coefficient						% Imperv.
	(SF)	(Acres)	C2	C5	C10	C25	C50	C100	
Pasture/Meadow	35,624	0.82	0.02	0.08	0.15	0.25	0.3	0.35	0%
Combined	35,624	0.82	0.02	0.08	0.15	0.25	0.30	0.35	0.0%

Basin Travel Time

	Shallow Channel Ground Cover		Short Pasture/Lawns			
	$L_{max,Overland}$	300 ft	S_0 (ft/ft)	v (ft/s)	t (min)	t_{Alt} (min)
Total	256	15	-	-	-	-
Initial Time	100	5	0.050	-	10.8	N/A DCM Eq. 6-8
Shallow Channel	156	10	0.064	1.8	1.5	- DCM Eq. 6-9
Channelized			0.000	0.0	0.0	- V-Ditch
				t_c	12.3 min.	

Rainfall Intensity & Runoff

	2-Yr	5-Yr	10-Yr	25-Yr	50-Yr	100-Yr
Intensity (in/hr)	3.05	3.82	4.46	5.09	5.73	6.41
Runoff (cfs)	0.0	0.2	0.5	1.0	1.4	1.8
Release Rates (cfs/ac)	-	-	-	-	-	-
Allowed Release (cfs)	0.0	0.2	0.5	1.0	1.4	1.8

Notes

Combined Sub-Basin Runoff Calculations (DP1)

Includes Basins OSA-1 A-2 OSA-6

Job No.:	61148	Date:	1/28/2022 15:18
Project:	Koinonia Ranch	Calcs by:	WCG
Jurisdiction	DCM	Checked by:	
Runoff Coefficient	Surface Type	Soil Type	B
		Urbanization	Non-Urban

Basin Land Use Characteristics

Surface	Area		Runoff Coefficient							% Imperv.
	(SF)	(Acres)	C2	C5	C10	C25	C50	C100		
Paved	27,770	0.64	0.89	0.9	0.92	0.94	0.95	0.96	100%	
Pasture/Meadow	866,651	19.90	0.02	0.08	0.15	0.25	0.3	0.35	0%	
Roofs	8,000	0.18	0.71	0.73	0.75	0.78	0.8	0.81	90%	
Gravel	27,653	0.63	0.57	0.59	0.63	0.66	0.68	0.7	80%	
Combined	930,074	21.35	0.07	0.13	0.19	0.29	0.34	0.38	6.1%	

Basin Travel Time

	Sub-basin or Channel Type	Material Type	L (ft)	Elev. ΔZ ₀ (ft)	Q _i (cfs)	Base or Dia (ft)	Sides z:1 (ft/ft)	v (ft/s)	t (min)
Furthest Reach	OSA-1	-	366	67	-	-	-	-	7.7
Channelized-1	V-Ditch	2	2,780	150	8	0	2	4.4	10.5
Channelized-2									
Channelized-3									
Total			3,146	217					

2 = Natural, Winding, minimal vegetation/shallow grass

t_c (min) 18.2

Contributing Offsite Flows (Added to Runoff and Allowed Release, below.)

Contributing Basins/Areas

Q_{Minor} (cfs) - 5-year Storm

Q_{Major} (cfs) - 100-year Storm

Rainfall Intensity & Runoff

	2-Yr	5-Yr	10-Yr	25-Yr	50-Yr	100-Yr
Intensity (in/hr)	2.58	3.23	3.77	4.31	4.85	5.42
Site Runoff (cfs)	3.76	8.64	15.48	26.42	34.66	44.29
OffSite Runoff (cfs)	-	0.00	-	-	-	0.00
Release Rates (cfs/ac)	-	-	-	-	-	-
Allowed Release (cfs)	-	8.6	-	-	-	44.3

DCM: $I = C1 * \ln(tc) + C2$

C1	1.19	1.5	1.75	2	2.25	2.52
C2	6.035	7.583	8.847	10.111	11.375	12.735

Combined Sub-Basin Runoff Calculations (DP2)

Includes Basins OSA-1 A-2 OSA-3 OSA-4 A-5 OSA-6 A-7 OSA-8

Job No.:	61148	Date:	1/28/2022 15:18
Project:	Koinonia Ranch	Calcs by:	WCG
Jurisdiction	DCM	Checked by:	
Runoff Coefficient	Surface Type	Soil Type	B
		Urbanization	Non-Urban

Basin Land Use Characteristics

Surface	Area		Runoff Coefficient							% Imperv.
	(SF)	(Acres)	C2	C5	C10	C25	C50	C100		
Paved	31,770	0.73	0.89	0.9	0.92	0.94	0.95	0.96	100%	
Pasture/Meadow	2,411,748	55.37	0.02	0.08	0.15	0.25	0.3	0.35	0%	
Roofs	18,000	0.41	0.71	0.73	0.75	0.78	0.8	0.81	90%	
Gravel	83,482	1.92	0.57	0.59	0.63	0.66	0.68	0.7	80%	
Combined	2,545,000	58.43	0.05	0.11	0.18	0.28	0.32	0.37	4.5%	

Basin Travel Time

	Sub-basin or Channel Type	Material Type	L (ft)	Elev. ΔZ ₀ (ft)	Q _i (cfs)	Base or Dia (ft)	Sides z:1 (ft/ft)	v (ft/s)	t (min)
Furthest Reach	OSA-4	-	1,418	92	-	-	-	-	21.6
Channelized-1									
Channelized-2									
Channelized-3									
Total			1,418	92					
								t_c (min)	21.6

Contributing Offsite Flows (Added to Runoff and Allowed Release, below.)

Contributing Basins/Areas

Q _{Minor}	(cfs) - 5-year Storm
Q _{Major}	(cfs) - 100-year Storm

Rainfall Intensity & Runoff

	2-Yr	5-Yr	10-Yr	25-Yr	50-Yr	100-Yr
Intensity (in/hr)	2.38	2.98	3.47	3.97	4.46	4.99
Site Runoff (cfs)	7.48	19.39	36.42	63.93	84.52	108.64
OffSite Runoff (cfs)	-	0.00	-	-	-	0.00
Release Rates (cfs/ac)	-	-	-	-	-	-
Allowed Release (cfs)	-	19.4	-	-	-	108.6

DCM: $I = C1 * \ln(tc) + C2$

C1	1.19	1.5	1.75	2	2.25	2.52
C2	6.035	7.583	8.847	10.111	11.375	12.735

Combined Sub-Basin Runoff Calculations (OSB1+B2)

Includes Basins OSB-1 B-2

Job No.:	61148	Date:	1/28/2022 15:18
Project:	Koinonia Ranch	Calcs by:	WCG
Jurisdiction	DCM	Checked by:	
Runoff Coefficient	Surface Type	Soil Type	B
		Urbanization	Non-Urban

Basin Land Use Characteristics

Surface	Area		Runoff Coefficient						% Imperv.
	(SF)	(Acres)	C2	C5	C10	C25	C50	C100	
Pasture/Meadow	308,431	7.08	0.02	0.08	0.15	0.25	0.3	0.35	0%
Gravel	1,450	0.03	0.57	0.59	0.63	0.66	0.68	0.7	80%
Paved	500	0.01	0.89	0.9	0.92	0.94	0.95	0.96	100%
Roofs	4,000	0.09	0.71	0.73	0.75	0.78	0.8	0.81	90%
Combined	314,381	7.22	0.03	0.09	0.16	0.26	0.31	0.36	1.7%

Basin Travel Time

	Sub-basin or Channel Type	Material Type	L (ft)	Elev. ΔZ ₀ (ft)	Q _i (cfs)	Base or Dia (ft)	Sides z:1 (ft/ft)	v (ft/s)	t (min)
Furthest Reach	OSB-1	-	342	44	-	-	-	-	8.6
Channelized-1	V-Ditch	2	672	45	4	0	2	4.1	2.8
Channelized-2									
Channelized-3									
Total			1,014	89					

2 = Natural, Winding, minimal vegetation/shallow grass

t_c (min) 11.3

Contributing Offsite Flows (Added to Runoff and Allowed Release, below.)

Contributing Basins/Areas

Q_{Minor} (cfs) - 5-year Storm

Q_{Major} (cfs) - 100-year Storm

Rainfall Intensity & Runoff

	2-Yr	5-Yr	10-Yr	25-Yr	50-Yr	100-Yr
Intensity (in/hr)	3.15	3.94	4.60	5.26	5.92	6.62
Site Runoff (cfs)	0.74	2.62	5.35	9.86	13.20	17.13
OffSite Runoff (cfs)	-	0.00	-	-	-	0.00
Release Rates (cfs/ac)	-	-	-	-	-	-
Allowed Release (cfs)	-	2.6	-	-	-	17.1

DCM: $I = C1 * \ln(tc) + C2$

C1	1.19	1.5	1.75	2	2.25	2.52
C2	6.035	7.583	8.847	10.111	11.375	12.735

Design Procedure Form: Runoff Reduction

UD-BMP (Version 3.07, March 2018)

Sheet 1 of 1

Designer: _____
Company: _____
Date: January 28, 2022
Project: _____
Location: _____

SITE INFORMATION (User Input in Blue Cells)

WQCV Rainfall Depth 0.60 inches
 Depth of Average Runoff Producing Storm, d_6 = 0.43 inches (for Watersheds Outside of the Denver Region, Figure 3-1 in USDCM Vol. 3)

Area Type	UIA:RPA	UIA:RPA											
Area ID	A-2	A-5											
Downstream Design Point ID	DP2	DP2											
Downstream BMP Type	EDB	EDB											
DCIA (ft ²)	--	--											
UIA (ft ²)	29,930	35,140											
RPA (ft ²)	16,933	16,895											
SPA (ft ²)	--	--											
HSG A (%)	0%	0%											
HSG B (%)	100%	100%											
HSG C/D (%)	0%	0%											
Average Slope of RPA (ft/ft)	0.050	0.050											
UIA:RPA Interface Width (ft)	500.00	500.00											

CALCULATED RUNOFF RESULTS

Area ID	A-2	A-5											
UIA:RPA Area (ft ²)	46,863	52,035											
L / W Ratio	0.19	0.21											
UIA / Area	0.6387	0.6753											
Runoff (in)	0.00	0.00											
Runoff (ft ³)	0	1											
Runoff Reduction (ft ³)	1247	1463											

CALCULATED WQCV RESULTS

Area ID	A-2	A-5											
WQCV (ft ³)	1247	1464											
WQCV Reduction (ft ³)	1247	1463											
WQCV Reduction (%)	100%	100%											
Untreated WQCV (ft ³)	0	1											

CALCULATED DESIGN POINT RESULTS (sums results from all columns with the same Downstream Design Point ID)







Downstream Design Point ID	DP2												
DCIA (ft ²)	0												
UIA (ft ²)	65,070												
RPA (ft ²)	33,828												
SPA (ft ²)	0												
Total Area (ft ²)	98,898												
Total Impervious Area (ft ²)	65,070												
WQCV (ft ³)	2,711												
WQCV Reduction (ft ³)	2,710												
WQCV Reduction (%)	100%												
Untreated WQCV (ft ³)	1												

CALCULATED SITE RESULTS (sums results from all columns in worksheet)

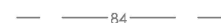

Total Area (ft ²)	98,898
Total Impervious Area (ft ²)	65,070
WQCV (ft ³)	2,711
WQCV Reduction (ft ³)	2,710
WQCV Reduction (%)	100%
Untreated WQCV (ft ³)	1

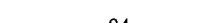
← **Okay - Meets 60% WQCV Requirement for Runoff**

LEGEND

-  PROPERTY LINE
-  EASEMENT LINE
- EXISTING**
-  5985 INDEX CONTOUR
-  84 INTERMEDIATE CONTOUR
- PROPOSED**
-  5985 INDEX CONTOUR
-  84 INTERMEDIATE CONTOUR
-  AREA BOUNDARY
-
-  AREA I.D.

SURFACE TYPES

UNCONNECTED IMPERVIOUS AREA (UIA)	
RECEIVING PERVIOUS AREA (RPA)	
EXCLUDED PER ECM I.7.1.B.5	



 (719) 635-5736	MONUMENT VALLEY ENGINEERS INC. *** ENGINEERS *** SURVEYORS *** 1903 LELARAY ST., COLORADO SPRINGS, COLORADO 80909
BMP_AREA_I.D.	

9 Hydraulic Calculations

Culvert Calculations
Ditch Flow Calculations
HY-8 Calculations

Culvert Report

Circular Culvert

Invert Elev Dn (ft)	= 7261.13
Pipe Length (ft)	= 50.71
Slope (%)	= 3.18
Invert Elev Up (ft)	= 7262.74
Rise (in)	= 30.0
Shape	= Circular
Span (in)	= 30.0
No. Barrels	= 1
n-Value	= 0.012
Culvert Type	= Circular Corrugate Metal Pipe
Culvert Entrance	= Projecting
Coeff. K,M,c,Y,k	= 0.034, 1.5, 0.0553, 0.54, 0.9

Embankment

Top Elevation (ft)	= 7266.00
Top Width (ft)	= 27.66
Crest Width (ft)	= 20.00

Calculations

Qmin (cfs)	= 0.00
Qmax (cfs)	= 120.00
Tailwater Elev (ft)	= (dc+D)/2

Highlighted

Qtotal (cfs)	= 40.00
Qpipe (cfs)	= 31.18
Qovertop (cfs)	= 8.82
Veloc Dn (ft/s)	= 6.82
Veloc Up (ft/s)	= 7.79
HGL Dn (ft)	= 7263.33
HGL Up (ft)	= 7264.64
Hw Elev (ft)	= 7266.28
Hw/D (ft)	= 1.42
Flow Regime	= Inlet Control

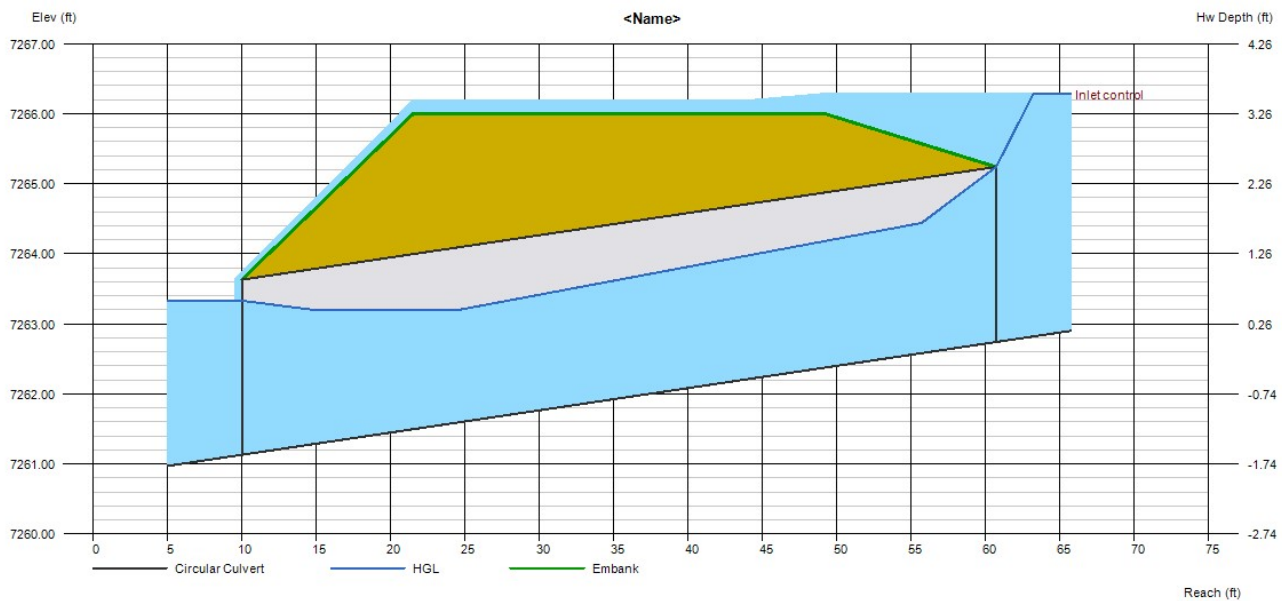

Q			Veloc		Depth	
Total	Pipe	Over	Dn	Up	Dn	Up
(cfs)	(cfs)	(cfs)	(ft/s)	(ft/s)	(in)	(in)
20.00	20.00	0.00	4.73	6.42	24.10	18.21
40.00	31.18	8.82	6.82	7.79	26.40	22.81
60.00	33.22	26.78	7.19	8.05	26.76	23.51
80.00	34.75	45.25	7.47	8.25	27.01	24.01
100.00	36.05	63.95	7.70	8.43	27.21	24.42
120.00	37.19	82.81	7.91	8.58	27.38	24.76

HGL			
Dn	Up	Hw	Hw/D
(ft)	(ft)	(ft)	
7263.14	7264.26	7265.21	0.99
7263.33	7264.64	7266.28	1.42
7263.36	7264.70	7266.58	1.54
7263.38	7264.74	7266.82	1.63
7263.40	7264.78	7267.03	1.72
7263.41	7264.80	7267.23	1.79

BOX CONDUIT FLOW (Normal & Critical Depth Computation)

MHFD-Culvert, Version 4.00 (May 2020)

Project: _____

Box ID: _____

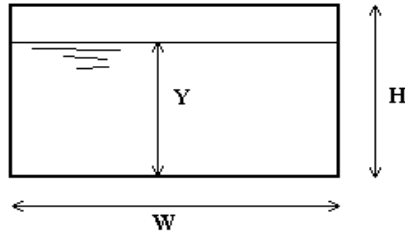

Design Information (Input)	
Box conduit invert slope	So = 0.0071 ft/ft
Box Manning's n-value	n = 0.0130
Box Width	W = 4.50 ft
Box Height	H = 1.50 ft
Design discharge	Q = 44.30 cfs
Full-flow capacity (Calculated)	
Full-flow area	Af = 6.75 sq ft
Full-flow wetted perimeter	Pf = 12.00 ft
Full-flow capacity	Qf = 44.42 cfs
Calculations of Normal Flow Condition	
Normal flow depth (<H)	Yn = 1.20 ft
Flow area	An = 5.40 sq ft
Wetted perimeter	Pn = 6.90 ft
Flow velocity	Vn = 8.20 fps
Discharge	Qn = 44.30 cfs
Percent of Full Flow	Flow = 99.7% of full flow
Normal Depth Froude Number	Fr _n = 1.32 supercritical
Calculation of Critical Flow Condition	
Critical flow depth	Yc = 1.44 ft
Critical flow area	Ac = 6.50 sq ft
Critical flow velocity	Vc = 6.82 fps
Critical Depth Froude Number	Fr _c = 1.00

CULVERT SIZING (INLET vs. OUTLET CONTROL WITH TAILWATER EFFECTS)

MHFD-Culvert, Version 4.00 (May 2020)

Project: _____

ID: _____

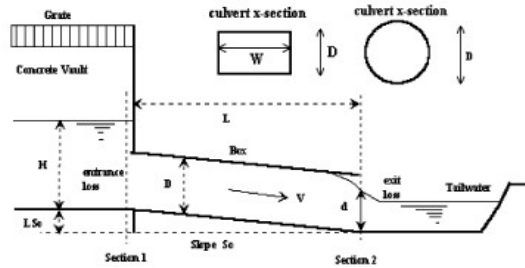

Design Information (Input):

Circular Culvert: Barrel Diameter in Inches D =
 Inlet Edge Type (Choose from pull-down list)

OR:

Box Culvert: Barrel Height (Rise) in Feet H (Rise) = ft
 Barrel Width (Span) in Feet W (Span) = ft
 Inlet Edge Type (Choose from pull-down list) Square Edge w/ 30-75 deg. Flared Wingwall

Number of Barrels # Barrels =
 Inlet Elevation at Culvert Invert Elev IN = ft
 Outlet Elevation **OR** Slope Elev OUT = ft
 Culvert Length L = ft
 Manning's Roughness n =
 Bend Loss Coefficient K_b =
 Exit Loss Coefficient K_x =

Design Information (calculated):

Entrance Loss Coefficient K_e =
 Friction Loss Coefficient K_f =
 Sum of All Loss Coefficients K_s =
 Minimum Energy Condition Coefficient KE_{low} =
 Orifice Inlet Condition Coefficient C_d =

Calculations of Culvert Capacity (output):

Backwater calculations required to obtain Outlet Control Flowrate when H_{wo} < 0.75 * Culvert Rise

Headwater Surface Elevation (ft)	Tailwater Surface Elevation (ft)	Inlet Control Equation Used	Inlet Control Flowrate (cfs)	Outlet Control Flowrate (cfs)	Controlling Culvert Flowrate (cfs)	Flow Control Used
7263.75		No Flow (WS < inlet)	0.00	0.00	0.00	N/A
7264.00		Min. Energy. Eqn.	1.71	#N/A	#N/A	#N/A
7264.25		Min. Energy. Eqn.	4.81	#N/A	#N/A	#N/A
7264.50		Min. Energy. Eqn.	8.82	#N/A	#N/A	#N/A
7264.75		Regression Eqn.	13.37	#N/A	#N/A	#N/A
7265.00		Regression Eqn.	18.62	24.84	18.62	INLET
7265.25		Regression Eqn.	24.12	29.63	24.12	INLET
7265.50		Regression Eqn.	29.36	33.93	29.36	INLET
7265.75		Regression Eqn.	34.11	37.86	34.11	INLET
7266.00		Regression Eqn.	38.37	41.50	38.37	INLET
7266.25		Regression Eqn.	42.21	44.90	42.21	INLET
7266.50		Regression Eqn.	45.71	48.29	45.71	INLET
7266.75		Regression Eqn.	48.92	51.75	48.92	INLET
7267.00		Regression Eqn.	51.92	54.99	51.92	INLET
7267.25		Regression Eqn.	54.74	58.04	54.74	INLET
7267.50		Regression Eqn.	57.41	60.95	57.41	INLET
7267.75		Regression Eqn.	59.95	63.72	59.95	INLET
7268.00		Regression Eqn.	62.41	66.38	62.41	INLET
7268.25		Regression Eqn.	64.73	68.93	64.73	INLET
7268.50		Orifice Eqn.	66.86	71.39	66.86	INLET
7268.75		Orifice Eqn.	68.92	73.77	68.92	INLET
7269.00		Orifice Eqn.	70.91	76.08	70.91	INLET
7269.25		Orifice Eqn.	72.86	78.32	72.86	INLET
7269.50		Orifice Eqn.	74.75	80.50	74.75	INLET
7269.75		Orifice Eqn.	76.61	82.62	76.61	INLET
7270.00		Orifice Eqn.	78.41	84.68	78.41	INLET
7270.25		Orifice Eqn.	80.16	86.70	80.16	INLET
7270.50		Orifice Eqn.	81.91	88.67	81.91	INLET
7270.75		Orifice Eqn.	83.61	90.60	83.61	INLET
7271.00		Orifice Eqn.	85.23	92.48	85.23	INLET

Processing Time: **00.16 Seconds**

CULVERT SIZING (INLET vs. OUTLET CONTROL WITH TAILWATER EFFECTS)

MHFD-Culvert, Version 4.00 (May 2020)

Project: _____

ID: _____

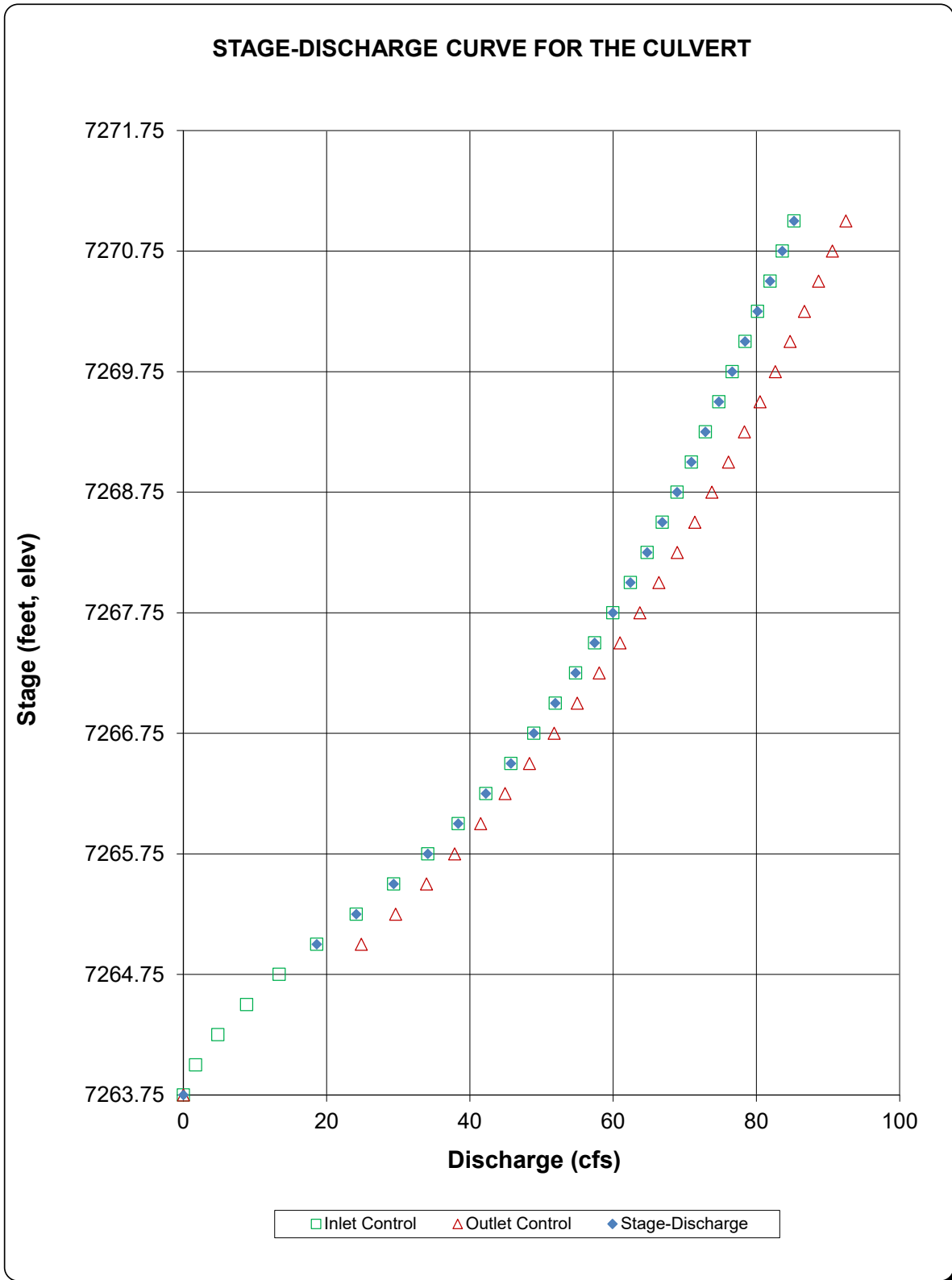

DETERMINATION OF CULVERT HEADWATER AND OUTLET PROTECTION

MHFD-Culvert, Version 4.00 (May 2020)

Project: _____
ID: _____

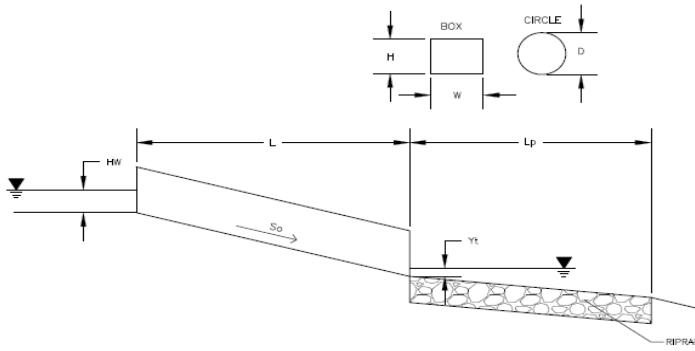

Soil Type:

Choose One:

- Sandy
 Non-Sandy

Supercritical Flow! Using Adjusted Rise to calculate protection type.

Design Information:	
Design Discharge	Q = <input style="width: 50px;" type="text" value="44"/> cfs
Circular Culvert:	
Barrel Diameter in Inches	D = <input style="width: 50px;" type="text"/>
Inlet Edge Type (Choose from pull-down list)	
OR:	
Box Culvert:	
Barrel Height (Rise) in Feet	H (Rise) = <input style="width: 50px;" type="text" value="1.5"/> ft
Barrel Width (Span) in Feet	W (Span) = <input style="width: 50px;" type="text" value="4.5"/> ft
Inlet Edge Type (Choose from pull-down list)	Square Edge w/ 30-75 deg. Flared Wingwall
Number of Barrels	# Barrels = <input style="width: 50px;" type="text" value="1"/>
Inlet Elevation	Elev IN = <input style="width: 50px;" type="text" value="7263.75"/> ft
Outlet Elevation OR Slope	Elev OUT = <input style="width: 50px;" type="text" value="7263.31"/> ft
Culvert Length	L = <input style="width: 50px;" type="text" value="87.4"/> ft
Manning's Roughness	n = <input style="width: 50px;" type="text" value="0.013"/>
Bend Loss Coefficient	k _b = <input style="width: 50px;" type="text" value="0"/>
Exit Loss Coefficient	k _x = <input style="width: 50px;" type="text" value="1"/>
Tailwater Surface Elevation	Y _t Elevation = <input style="width: 50px;" type="text"/>
Max Allowable Channel Velocity	V = <input style="width: 50px;" type="text" value="5"/> ft/s
Calculated Results:	
Culvert Cross Sectional Area Available	A = <input style="width: 50px;" type="text" value="6.75"/> ft ²
Culvert Normal Depth	Y _n = <input style="width: 50px;" type="text" value="1.35"/> ft
Culvert Critical Depth	Y _c = <input style="width: 50px;" type="text" value="1.44"/> ft
Froude Number	Fr = <input style="width: 50px;" type="text" value="1.10"/> Supercritical!
Entrance Loss Coefficient	k _e = <input style="width: 50px;" type="text" value="0.20"/>
Friction Loss Coefficient	k _f = <input style="width: 50px;" type="text" value="0.92"/>
Sum of All Loss Coefficients	k _s = <input style="width: 50px;" type="text" value="2.12"/> ft
Headwater:	
Inlet Control Headwater	HW _I = <input style="width: 50px;" type="text" value="2.63"/> ft
Outlet Control Headwater	HW _O = <input style="width: 50px;" type="text" value="2.43"/> ft
Design Headwater Elevation	HW = <input style="width: 50px;" type="text" value="7266.38"/> ft
Headwater/Diameter OR Headwater/Rise Ratio	HW/H = <input style="width: 50px;" type="text" value="1.75"/> HW/H > 1.5!
Outlet Protection:	
Flow/(Span * Rise ^{1.5})	Q/WH ^{1.5} = <input style="width: 50px;" type="text" value="5.32"/> ft ^{0.5} /s
Tailwater Surface Height	Y _t = <input style="width: 50px;" type="text" value="0.60"/> ft
Tailwater/Rise	Y _t /H = <input style="width: 50px;" type="text" value="0.40"/>
Expansion Factor	1/(2*tan(θ)) = <input style="width: 50px;" type="text" value="1.57"/>
Flow Area at Max Channel Velocity	A _t = <input style="width: 50px;" type="text" value="8.80"/> ft ²
Width of Equivalent Conduit for Multiple Barrels	W _{eq} = <input style="width: 50px;" type="text" value="-"/>
Length of Riprap Protection	L_p = <input style="width: 50px;" type="text" value="15"/> ft
Width of Riprap Protection at Downstream End	T = <input style="width: 50px;" type="text" value="15"/> ft
Adjusted Rise for Supercritical Flow	
Minimum Theoretical Riprap Size	Ha = <input style="width: 50px;" type="text" value="1.42"/> ft
Nominal Riprap Size	d ₅₀ min = <input style="width: 50px;" type="text" value="3"/> in
MHFD Riprap Type	d ₅₀ nominal = <input style="width: 50px;" type="text" value="6"/> in
	Type = <input style="width: 50px;" type="text" value="VL"/>

M.V.E., Inc.
 Date: 10/20/2021
 Project: 61148
 Koinonia Ranch

Ditch Velocities & Erosion Protection

Ditch Data:

S. Slope H 6.0
 S. Slope H 3.0
 Manning's n 0.030

Permissible Velocities by Soil Type:

40- Kettle gravelly loamy sand 3.5 fps
 41- Kettle gravelly loamy sand 3.5 fps
 71 - Pring Coarse Sandy Loam 2.5 fps

Permissible Velocities by Grass Linings:

Grass-legume mixture (0-5%) 4.0 fps
 Grass-legume mixture (5-10%) 3.0 fps

Sub-basin Designation	Road Name	Stations	Full Sub-Basin Area (Ac)	Full Sub-Basin Q ₁₀₀ (cfs)	Partial Sub-Basin Area (Ac)	Ditch Flow Q ₁₀₀ (cfs)	Max. Longit. Ditch Slope in Reach (ft/ft)	Ditch Flow Depth (ft)	Ditch Flow Area (ft ²)	Ditch Flow Velocity (ft/sec)	Permissible Velocity (ft/sec)	Ditch Protection Required?
A-2	Koinonia Court	17+32.95E - 11+00.00E	21.35	43.3	14.04	28.5	0.051	1.0	4.2	6.7	4.0	YES
A-5	Koinonia Court	17+32.95W - 11+00.00W	18.11	39.8	7.98	17.5	0.051	0.8	3.0	5.9	4.0	YES
A-2	Koinonia Court	7+50.00E - 11+00.00E	N/A	N/A	N/A	N/A	N/A	N/A	N/A	N/A	N/A	No Ditch
A-5	Koinonia Court	7+50.00w - 11+00.00W	18.1	39.8	8.4	18.5	0.040	0.9	3.4	5.4	4.0	YES
A-2	Koinonia Court	3+00.00E - 7+50.00E	21.4	43.3	19.9	40.3	0.051	1.1	5.5	7.3	3.0	YES
A-5	Koinonia Court	3+00.00W - 7+50.00W	18.1	39.8	12.6	27.7	0.051	1.0	4.2	6.7	3.0	YES
A-2	Koinonia Court	1+59.00E - 3+00.00E	21.4	43.3	20.0	40.6	0.078	1.0	4.8	8.5	3.0	YES
A-5	Koinonia Court	1+59.00W - 3+00.00W	18.1	39.8	12.7	27.9	0.078	0.9	3.6	7.8	3.0	YES

(cfs)	arge (cfs)	ion (ft)	rol Dep th (ft)	rol Dep th (ft)	pe	th (ft)	th (ft)	pth (ft)	h (ft)	city (ft/s)	ity (ft/s)
19.40 cfs	19.40 cfs	7265.17	2.43	0.561	6-FFc	1.05	1.49	1.49	0.43	6.34	6.85
108.60 cfs	32.49 cfs	7266.66	3.92	2.509	6-FFc	1.42	1.94	1.94	0.83	7.95	10.54

Culvert Barrel Data

Culvert Barrel Type Straight Culvert

Inlet Elevation (invert): 7262.74 ft,

Outlet Elevation (invert): 7261.13 ft

Culvert Length: 50.74 ft,

Culvert Slope: 0.0317

Culvert Performance Curve Plot: Culvert 1

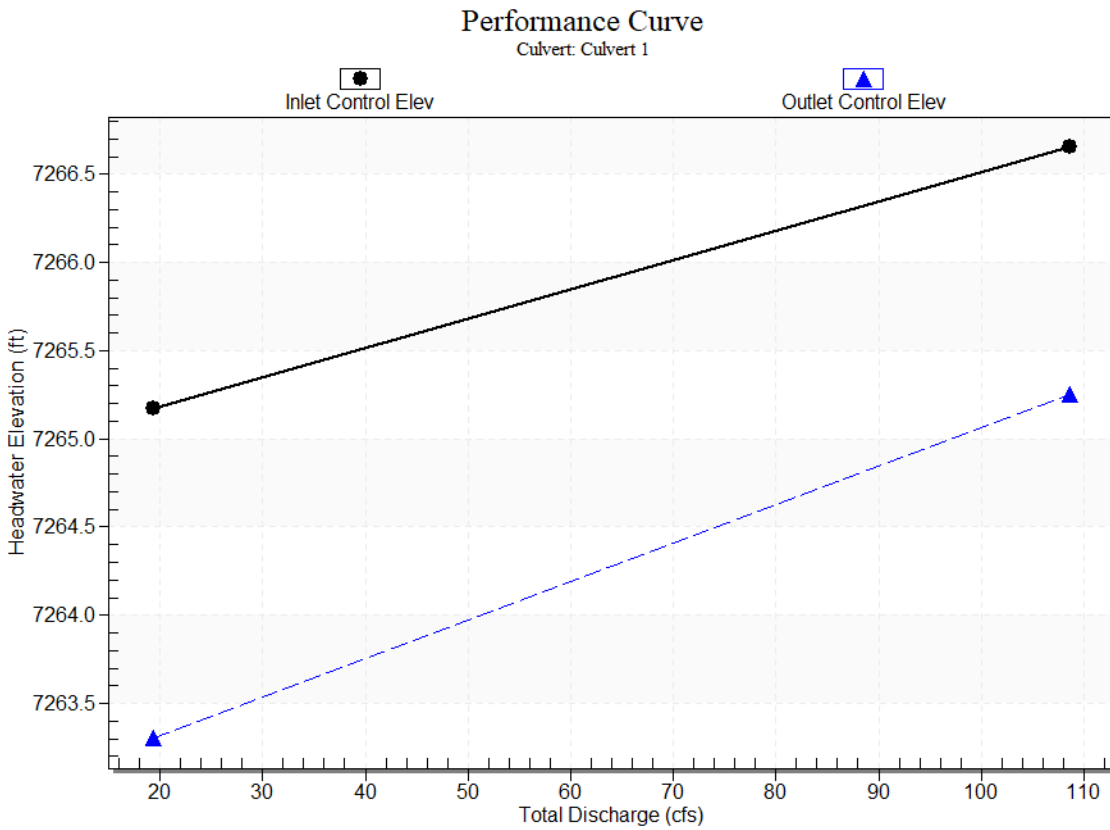

Water Surface Profile Plot for Culvert: Culvert 1

Crossing - Crossing 1, Design Discharge - 108.6 cfs
Culvert - Culvert 1, Culvert Discharge - 32.5 cfs

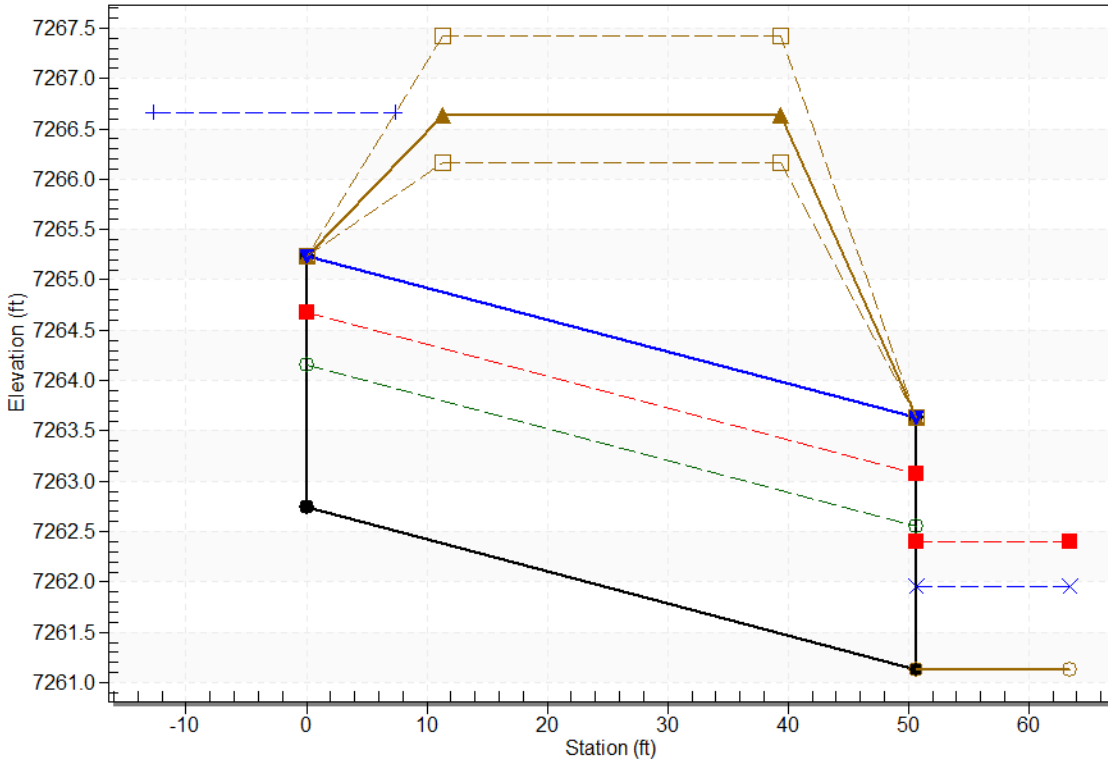

Site Data - Culvert 1

Site Data Option: Culvert Invert Data

Inlet Station: 0.00 ft

Inlet Elevation: 7262.74 ft

Outlet Station: 50.71 ft

Outlet Elevation: 7261.13 ft

Number of Barrels: 1

Culvert Data Summary - Culvert 1

Barrel Shape: Circular

Barrel Diameter: 2.50 ft

Barrel Material: Corrugated Steel

Embedment: 0.00 in

Barrel Manning's n: 0.0180

Culvert Type: Straight

Inlet Configuration: Thin Edge Projecting (Ke=0.9)

Inlet Depression: None

Tailwater Data for Crossing: Crossing 1

Table 3 - Downstream Channel Rating Curve (Crossing: Crossing 1)

Flow (cfs)	Water Surface Elev (ft)	Velocity (ft/s)	Depth (ft)	Shear (psf)	Froude Number
19.40	7261.56	0.43	6.85	5.42	2.59
108.60	7261.96	0.83	10.54	10.34	2.88

Tailwater Channel Data - Crossing 1

Tailwater Channel Option: Triangular Channel

Side Slope (H:V): 15.00 (1:1)

Channel Slope: 0.2000

Channel Manning's n: 0.0350

Channel Invert Elevation: 7261.13 ft

Roadway Data for Crossing: Crossing 1

Roadway Profile Shape: Irregular Roadway Shape (coordinates)

Irregular Roadway Cross-Section

Coord No.	Station (ft)	Elevation (ft)
0	0.00	7267.42
1	55.57	7266.77
2	92.65	7266.63
3	96.74	7266.62
4	133.93	7266.55
5	177.25	7266.30
6	218.97	7266.17
7	265.70	7266.37

Roadway Surface: Gravel

Roadway Top Width: 28.00 ft

10 Report Maps

Existing Condition Hydraulic Analysis Map (Map Pocket)
Proposed Condition Hydraulic Analysis Map (Map Pocket)

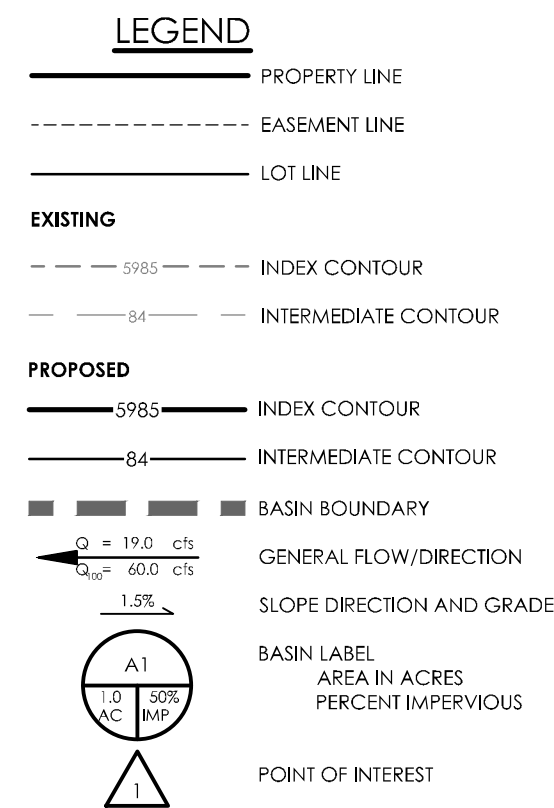

FLOODPLAIN STATEMENT

NO PORTION OF THE SUBJECT PROPERTY IS LOCATED WITHIN A FEMA DESIGNATED SPECIAL FLOOD HAZARD AREA (SFHA) AS INDICATED ON THE FLOOD INSURANCE RATE MAP (FIRM) FOR EL PASO COUNTY, COLORADO AND INCORPORATED AREAS - MAP NUMBER 08041C0527 G, EFFECTIVE DECEMBER 7, 2018.

EXISTING DRAINAGE SUMMARY TABLE					
DESIGN POINT	INCLUDED BASIN(S)	AREA (AC)	Tc (MIN.)	RUNOFF	
				Q5 (CFS)	Q100 (CFS)
	EX-OSA-1	5.47	8.1	1.9	14.3
	EX-OSA-2	12.06	21.6	3.3	21.6
	EX-OSA-3	3.90	12.0	3.1	11.2
	EX-A-4	0.97	9.5	0.3	2.4
	EX-A-5	30.09	37.7	6.2	39.0
	EX-OSA-6	5.93	16.1	2.2	12.6
DP1	EX-OSA-1, 2, 3, 6 EX-A-4, 5	58.43	21.6	17.8	106.7
	EX-OSB-1	1.66	8.6	0.6	4.3
	EX-B-2	5.55	15.1	1.6	11.5
	EX-C-1	1.70	10.4	0.6	4.1
	EX-D-1	0.82	12.3	0.2	1.8

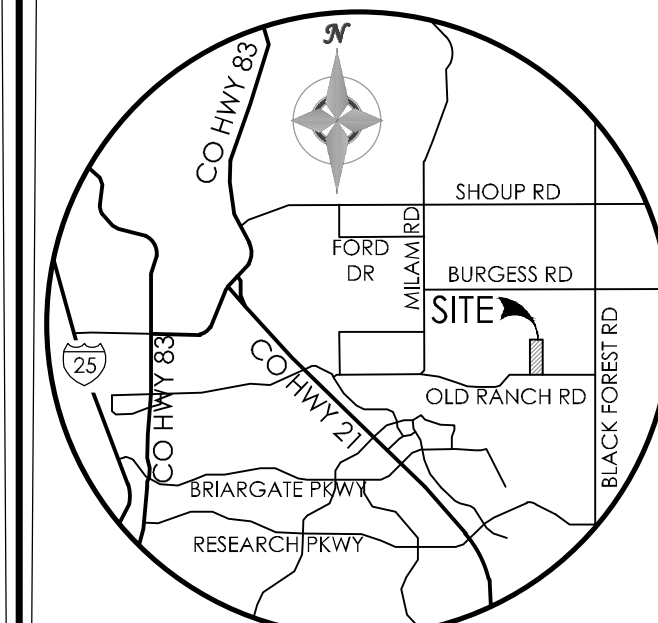
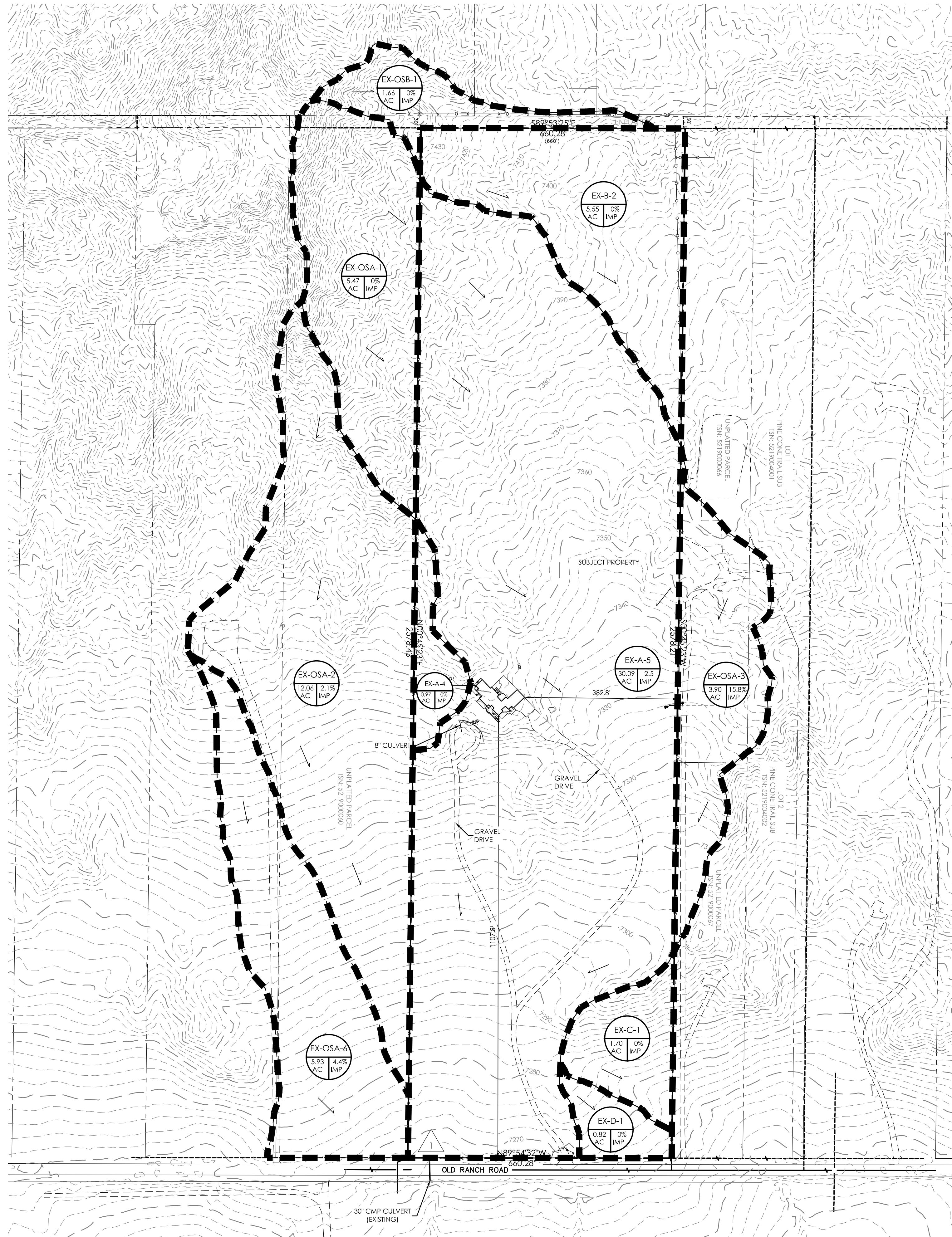

VICINITY MAP
NOT TO SCALE

BENCHMARK

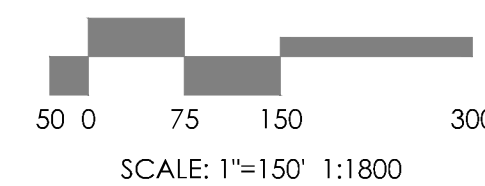
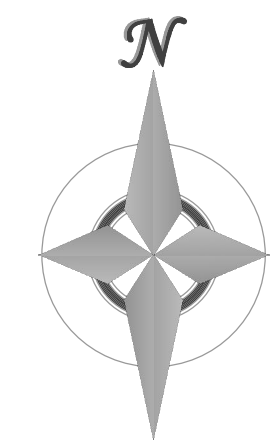

REVISIONS

DESIGNED BY _____
 DRAWN BY _____
 CHECKED BY _____
 AS-BUILT BY _____
 CHECKED BY _____

KOINONIA RANCH

EXISTING DRAINAGE

MVE PROJECT 61148
 MVE DRAWING EX-DRN

JANUARY 28, 2022
 SHEET 1 OF 1

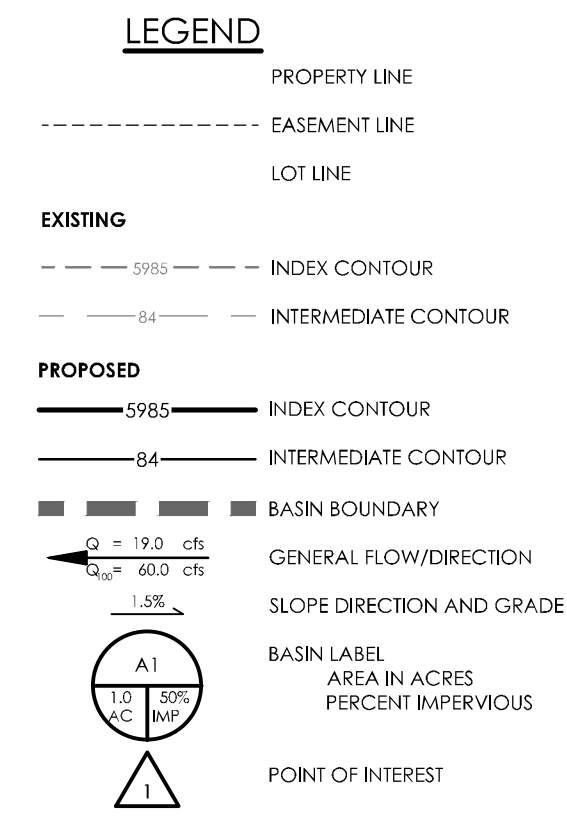

FLOODPLAIN STATEMENT

NO PORTION OF THE SUBJECT PROPERTY IS LOCATED WITHIN A FEMA DESIGNATED SPECIAL FLOOD HAZARD AREA (SFHA) AS INDICATED ON THE FLOOD INSURANCE RATE MAP (FIRM) FOR EL PASO COUNTY, COLORADO AND INCORPORATED AREAS - MAP NUMBER 08041C0527 G, EFFECTIVE DECEMBER 7, 2018.

DEVELOPED DRAINAGE SUMMARY TABLE

DESIGN POINT	INCLUDED BASIN(S)	AREA (AC)	Tc (MIN.)	RUNOFF	
				Q5 (CFS)	Q100 (CFS)
	OSA-1	3.14	7.7	1.1	8.3
	A-2	14.31	23.5	4.6	25.5
	OSA-6	3.90	12.0	3.1	11.2
DP1	OSA 1, A-2, OSA-6	21.35	18.2	8.6	44.3
	OSA-3	2.33	8.9	0.8	5.9
	OSA-4	12.06	21.6	3.3	21.6
	A-5	15.78	18.2	5.9	32.1
	A-7	0.97	9.5	0.3	2.4
	OSA-8	5.93	16.1	2.2	12.6
DP2	DP1, OSA-3, 4, 8, A-5, 7	58.43	21.6	19.4	108.6
	OSB-1	1.66	8.6	0.6	4.3
	B-2	5.55	14.9	1.9	11.9
	C-1	1.70	10.2	0.7	4.3
	D-1	0.82	12.3	0.2	1.8

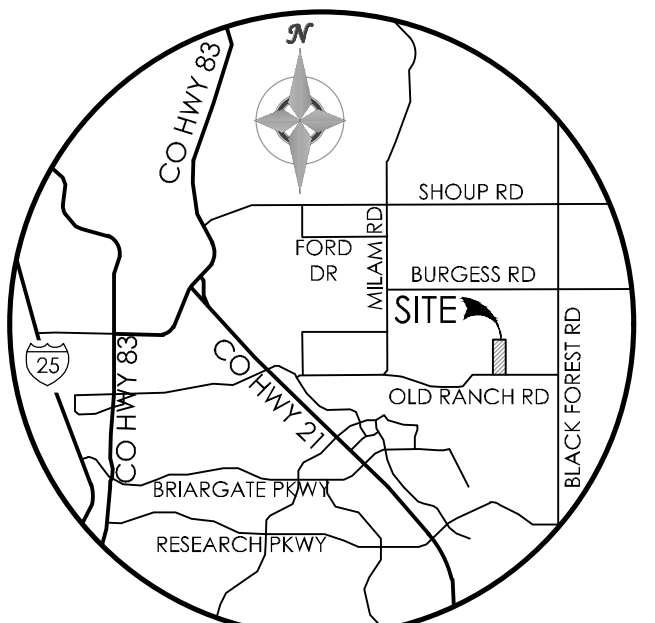
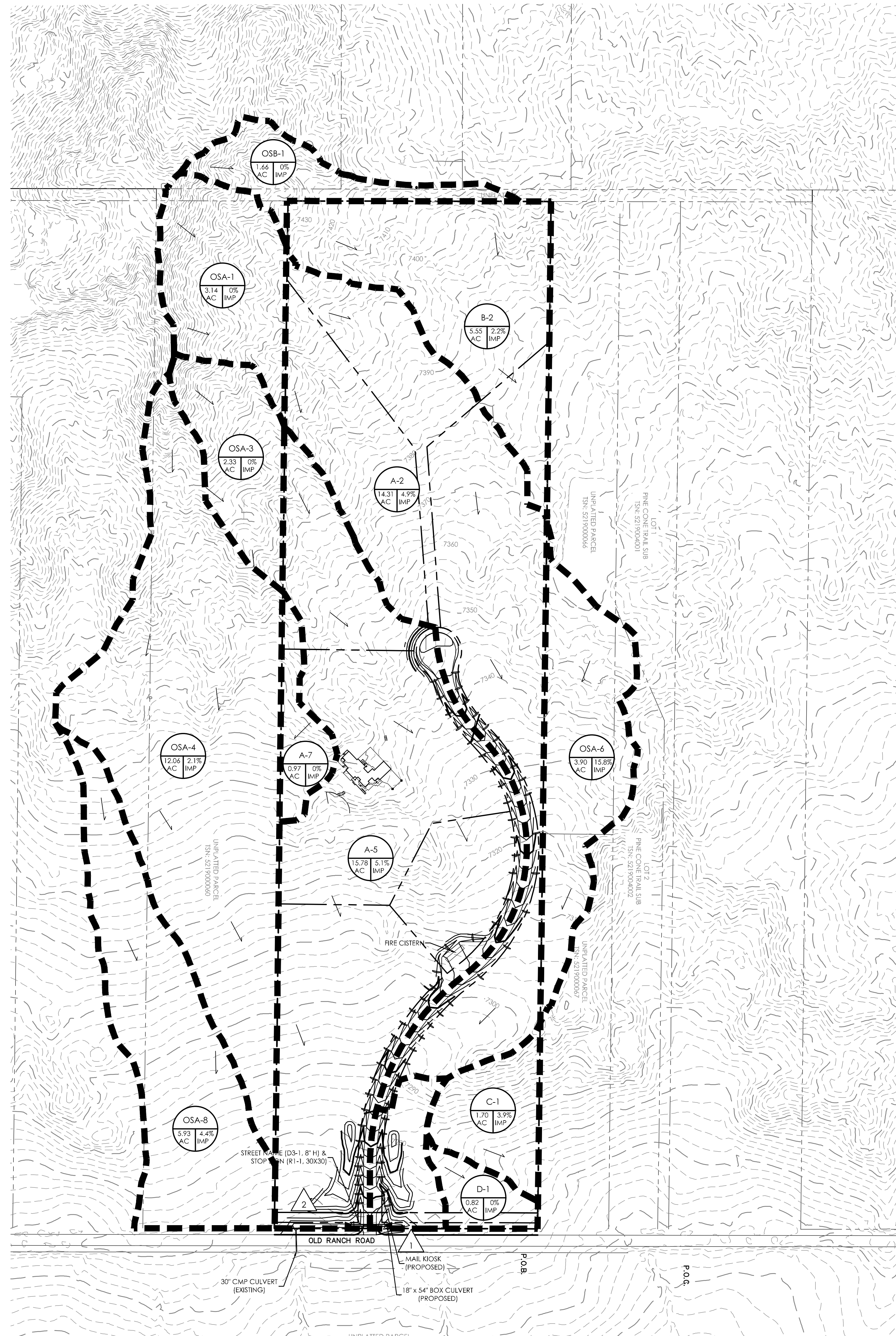

VICINITY MAP
 NOT TO SCALE

BENCHMARK X

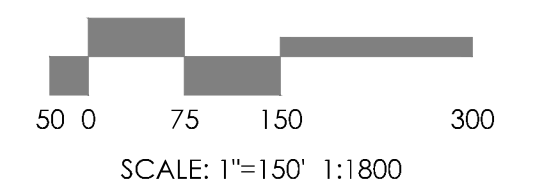
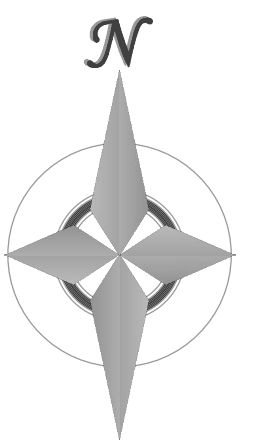

SCALE: 1"=150' 1:1800

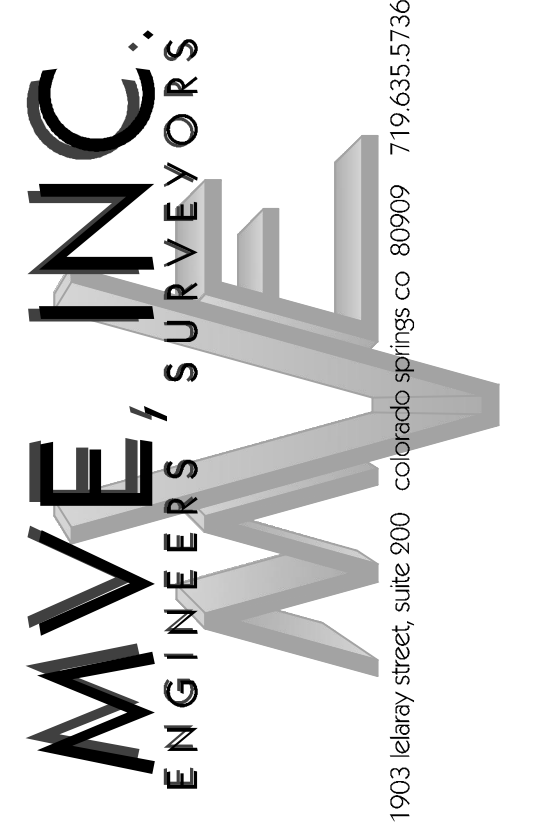

REVISIONS

DESIGNED BY _____
 DRAWN BY _____
 CHECKED BY _____
 AS-BUILT BY _____
 CHECKED BY _____

KOINONIA RANCH

PROPOSED DRAINAGE

MVE PROJECT 61148
 MVE DRAWING PP-DRN

JANUARY 28, 2022
 SHEET 1 OF 1