

INTERMEDIATE TRAFFIC IMPACT STUDY

For

Western Drive Townhomes
El Paso County, Colorado
PCD File No. P238

PPR - 24-15

Please remove. At this stage, it is no longer intermediate. Please remove through the whole report.

September 2023
Revised October 2023
Revised November 2023

Prepared for:

J. Elliott Construction LLC
P.O. Box 358
Peyton, Colorado 80831

Prepared by:



SM ROCHA, LLC
TRAFFIC AND TRANSPORTATION CONSULTANTS

8700 Turnpike Drive, Suite 240
Westminster, Colorado 80031
(303) 458-9798

6 South Tejon Street, Suite 618
Colorado Springs, Colorado 80903
(719) 203-6639

Project Manager:
Brandon Wilson, EIT
Project Engineer:
Zac Trotter, EIT

Engineer in Responsible Charge:
Fred Lantz, PE



Table of Contents

I. Introduction	1
Project Overview.....	1
Study Area Boundaries	1
Site Description.....	1
Existing and Committed Surface Transportation Network.....	5
II. Existing Traffic Conditions	6
Peak Hour Intersection Levels of Service – Existing Traffic.....	9
Existing Traffic Analysis Results	10
III. Future Traffic Conditions Without Proposed Development.....	12
Peak Hour Intersection Levels of Service – Background Traffic	17
Background Traffic Analysis Results – Year 2025	18
Background Traffic Analysis Results – Year 2043	19
IV. Proposed Project Traffic	21
Trip Generation.....	21
Adjustments to Trip Generation Rates	22
Trip Distribution.....	22
Trip Assignment.....	22
V. Future Traffic Conditions With Proposed Developments.....	24
VI. Project Impacts	29
Total Traffic Auxiliary Lane Analysis	29
Peak Hour Intersection Levels of Service – Total Traffic	29
Total Traffic Analysis Results Upon Development Build-Out	31
Pedestrian Circulation & Safety Analysis	32
VII. Conclusion	33

List of Figures

Figure 1 – Location.....3

Figure 2 – Conceptual Site Plan.....4

Figure 3 – Existing Traffic Volumes.....7

Figure 3a – Existing Traffic Intersection Geometry.....8

Figure 4 – Background Traffic Volumes – Year 2025.....13

Figure 4a – Background Traffic Intersection Geometry – Year 2025.....14

Figure 5 – Background Traffic Volumes – Year 2043.....15

Figure 5a – Background Traffic Intersection Geometry – Year 2043.....16

Figure 6 – Distribution and Site-Generated Assignment.....23

Figure 7 – Total Traffic Volumes – Year 2025.....25

Figure 7a – Total Traffic Intersection Geometry – Year 2025.....26

Figure 8 – Total Traffic Volumes – Year 2043.....27

Figure 8a – Total Traffic Intersection Geometry – Year 2043.....28

List of Tables

Table 1 – Intersection Capacity Analysis Summary – Existing Traffic.....10

Table 2 – Intersection Capacity Analysis Summary – Background Traffic – Year 2025.....17

Table 3 – Intersection Capacity Analysis Summary – Background Traffic – Year 2043.....19

Table 4 – Trip Generation Rates.....21

Table 5 – Trip Generation Summary.....22

Table 6 – Intersection Capacity Analysis Summary – Total Traffic – Year 2025.....30

Table 7 – Intersection Capacity Analysis Summary – Total Traffic – Year 2043.....31

Appendices

APPENDIX A TRAFFIC COUNT DATA
 SIGNAL TIMING INFORMATION

APPENDIX B LEVEL OF SERVICE DEFINITIONS

APPENDIX C CAPACITY WORKSHEETS

APPENDIX D INTERSECTION SIGHT DISTANCE EXHIBIT

I. Introduction

Project Overview

This Intermediate Traffic Impact Study is provided as a planning document and addresses the capacity, geometric, and control requirements associated with the development entitled Western Drive Townhomes.

This traffic impact study has been revised to address County review comments made to the October 2023 traffic study regarding the list of traffic count locations.

52 units per Letter of Intent

This proposed residential development consists of 60 townhomes. The development is located near the southeast corner of Hathaway Drive and Western Drive in El Paso County, Colorado.

Study Area Boundaries

The study area to be examined in this analysis encompasses the Hathaway Drive intersections with Galley Road, E Platte Avenue (U.S. Highway 24), Western Drive, Ford Street and the existing Bednarski Access, as well as the intersections of Western Drive with Galley Road and the existing shared Freedom Springs and Western Hills Apartments Access and includes proposed site accesses.

Figure 1 illustrates location of the site and study intersections.

Site Description

This is the site development plan, the layout should be fairly set. Please revise statement.

Land for the development is currently vacant and surrounded by a mix of residential, institutional, commercial, recreational, and industrial land uses.

The proposed development is conceptual and no specific land use density has been determined. However, for purposes of this analysis, there is assumed to be construction for a maximum of 60 townhomes as allowed within the County's RM-30 (Residential Multi-Dwelling) zoning district.

Proposed access to the development is provided at the following locations: one full-movement access onto Hathaway Drive using the existing access for Bednarski Products (referred to as Access A) and one full-movement access at the intersection of Western Drive and shared apartment access (referred to as Access B).

General site and access locations are shown on Figure 1.

A conceptual site plan, as prepared by M.V.E., Inc., is shown on Figure 2. This plan is provided for illustrative purposes only.

A **conceptual** sight distance exhibit, illustrating approximate intersection sight distance triangles, is included for reference in Appendix D. This two-dimensional exhibit does not consider the potential for landscaping, utility, nor vertical curve obstructions, and was prepared in accordance to Section 2.4.2 of the Engineering Criteria Manual (ECM)¹ and Section 9.5.3.2 of the American Association of State Highway and Transportation Officials' A Policy on Geometric Design of Highway and Streets (Green Book)² and is provided for illustrative purposes only.

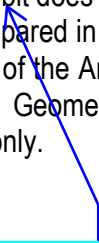

Please update exhibit as utility and landscape designs have been included with the submittal.

¹ El Paso County Engineering Criteria Manual, El Paso County, October 2020.

² A Policy on Geometric Design of Highways and Streets (7th Edition), American Association of State Highway and Transportation Officials, 2018.

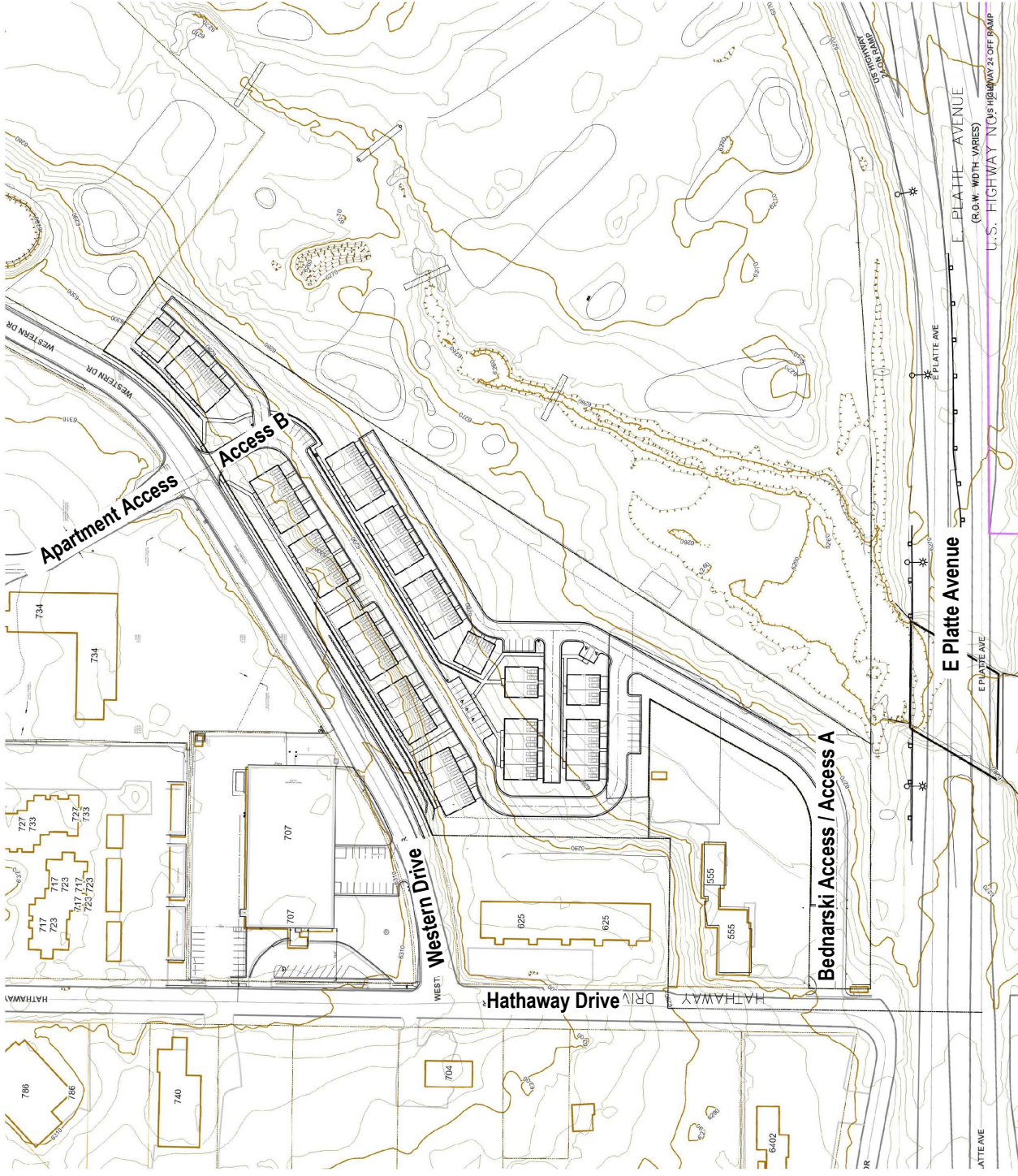

Figure 1
SITE LOCATION

WESTERN DRIVE TOWNHOMES
Intermediate Traffic Impact Study

SM ROCHA, LLC
Traffic and Transportation Consultants





WESTERN DRIVE TOWNHOMES
Intermediate Traffic Impact Study

SM ROCHA, LLC
Traffic and Transportation Consultants

Figure 2
CONCEPTUAL SITE PLAN

November 2023
Page 4

Existing and Committed Surface Transportation Network

Within the study area, Hathaway Drive and Western Drive are the primary roadways that will accommodate traffic to and from the proposed development. The secondary roadways include Galley Road and E Platte Avenue. A brief description of each roadway, based on the El Paso County 2016 Major Transportation Corridors Plan Update (MTCP)³ and ECM, is provided below:

Hathaway Drive is generally a north-south collector roadway having two through lanes (one lane in each direction) with shared turn lanes at the intersections within the study area. Hathaway Drive provides a posted speed limit of 30 MPH. Hathaway Drive ends at E Platte Avenue and continues west as Ford Street.

Western Drive is a northeast-southwest roadway having two through lanes (one lane in each direction) with shared turn lanes at the intersections within the study area. Western Drive is unclassified in the County’s MTCP. However, per Sections 2.2.4 and 2.3.2 of the County’s ECM and the roadway’s estimated right-of-way (ROW) width, Western Drive is assumed to be classified as an urban local roadway and provides a posted speed limit of 30 MPH.

Galley Road is an east-west minor arterial roadway having three lanes (one through lane in each direction with a center two-way left-turn lane) with a combination of shared and exclusive turn lanes at the intersections within the study area. Galley Road provides a posted speed limit of 30 MPH. Galley Road ends at Peterson Road and continues south as Peterson Road.

E Platte Avenue is an east-west expressway having four through lanes (two lanes in each direction) with exclusive turn lanes at the intersection within the study area. The Colorado Department of Transportation (CDOT) categorizes the adjacent segment of E Platte Avenue (U.S. Highway 24) as an Expressway, Major Bypass (E-X) and provides a posted speed limit of 55 MPH.

The study intersection of Hathaway Drive and Galley Road is signalized. All other study intersections operate under a stop-controlled condition. A stop-controlled intersection is defined as a roadway intersection where vehicle rights-of-way are controlled by one or more “STOP” signs.

Comparison of existing roadway cross-sections of the study roadways to the County’s ECM concludes that Galley Road is not built to its ultimate cross-section for accommodation of future regional transportation demands. Pursuant to Section 2.2.4 of the County’s ECM, Galley Road has the potential to be built to four through lanes (two lanes in each direction). No other regional or specific improvements for the above-described roadways are known to be planned or committed at this time.

Per the EPC 2016 Major Transportation Corridors Plan, none of the roadways listed in this area are listed projects in the 2040 roadway improvement projects.

³ El Paso County 2016 Major Transportation Corridors Plan Update, prepared by Holt & Ullevig, December 2016.

II. Existing Traffic Conditions

Morning (AM) and afternoon (PM) peak hour traffic counts were collected at the following intersections:

1. Hathaway Drive / Galley Road
2. Western Drive / Galley Road
3. Hathaway Drive / E Platte Avenue
4. Hathaway Drive / Western Drive
5. Western Drive / Apartment Access
6. Hathaway Drive / Bednarski Access
7. Hathaway Drive / Ford Street

Average daily traffic (ADT) volumes were collected over a 24-hour period on Western Drive. Counts were collected on August 23, 2023, with AM peak hour counts being collected during the period of 7:00 a.m. to 9:00 a.m. and PM peak hour counts being collected during the period of 4:00 p.m. to 6:00 p.m.

Peak hour traffic counts shown for the intersection of Hathaway Drive and Ford Street were estimated using collected counts at the E Platte Avenue and Hathaway Drive intersection and applying assumed traffic distribution characteristics.

Existing volumes and intersection geometry are shown on Figure 3 and Figure 3a, respectively. Traffic count data is included for reference in Appendix A.

Existing signal timing parameters for Hathaway Drive and Galley Road were obtained from El Paso County and used throughout this study to the best extent possible in order to remain consistent with existing signal coordination plans. County signal timing information received is included for reference in Appendix A.

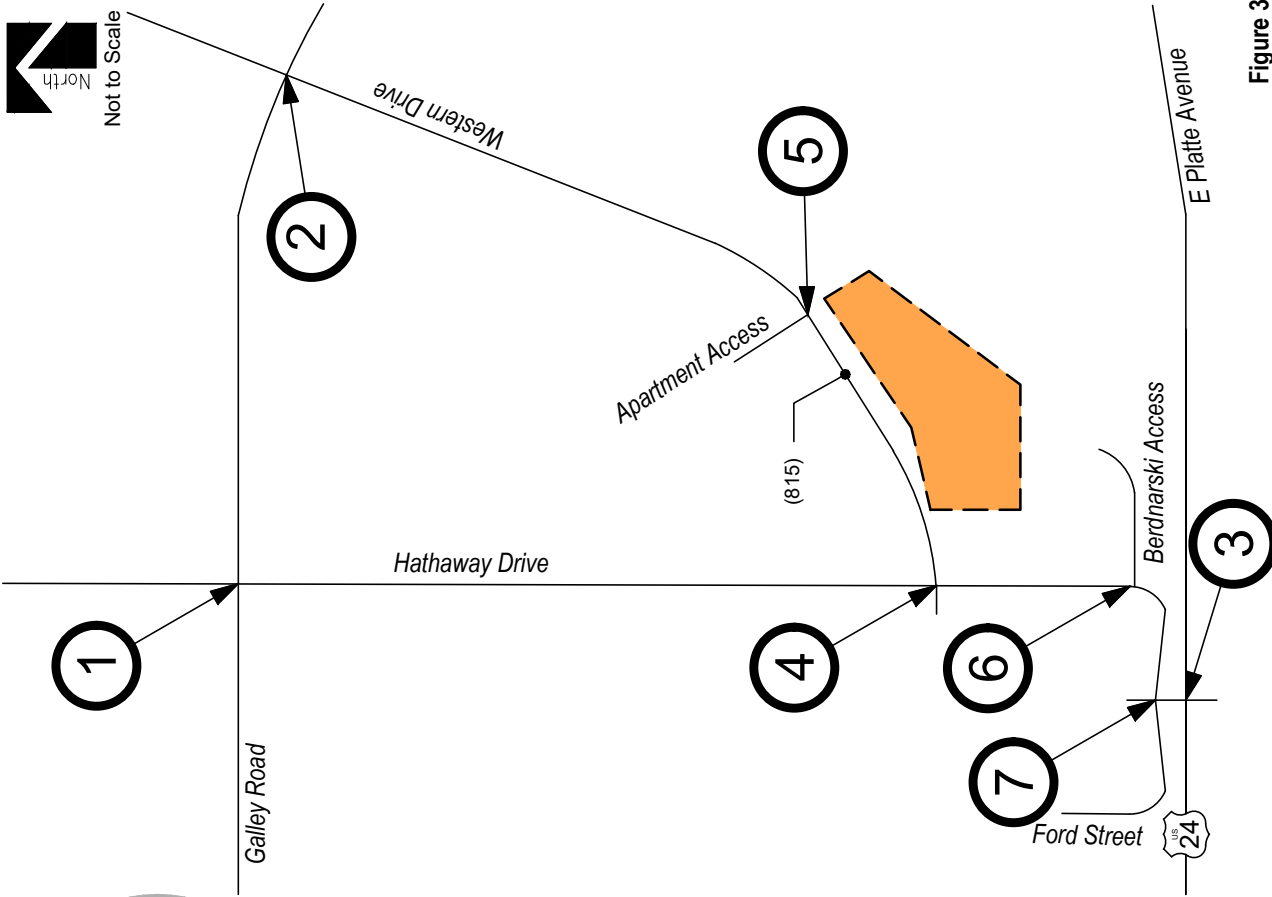
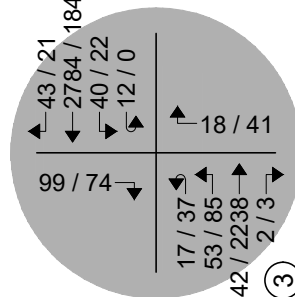
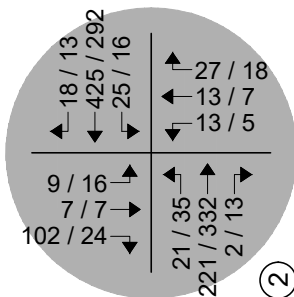
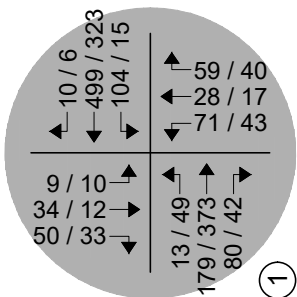
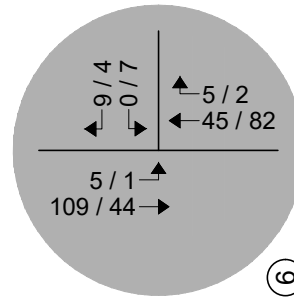
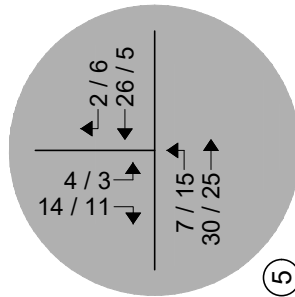
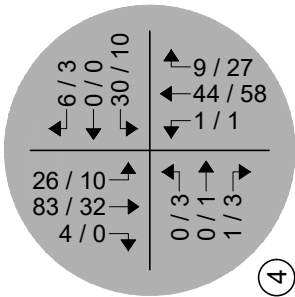
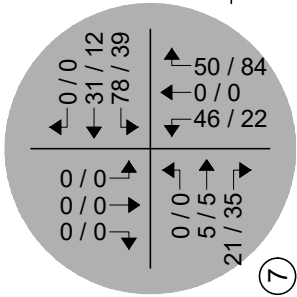

Figure 3
EXISTING TRAFFIC
 Volumes
 AM / PM Peak Hour
 (ADT) : Average Daily Traffic



LEGEND

- Study Intersection
- Volumes
- Development Site

WESTERN DRIVE TOWNHOMES
 Intermediate Traffic Impact Study



SM ROCHA, LLC
 Traffic and Transportation Consultants

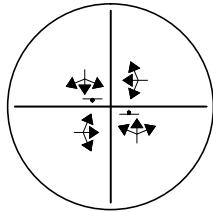
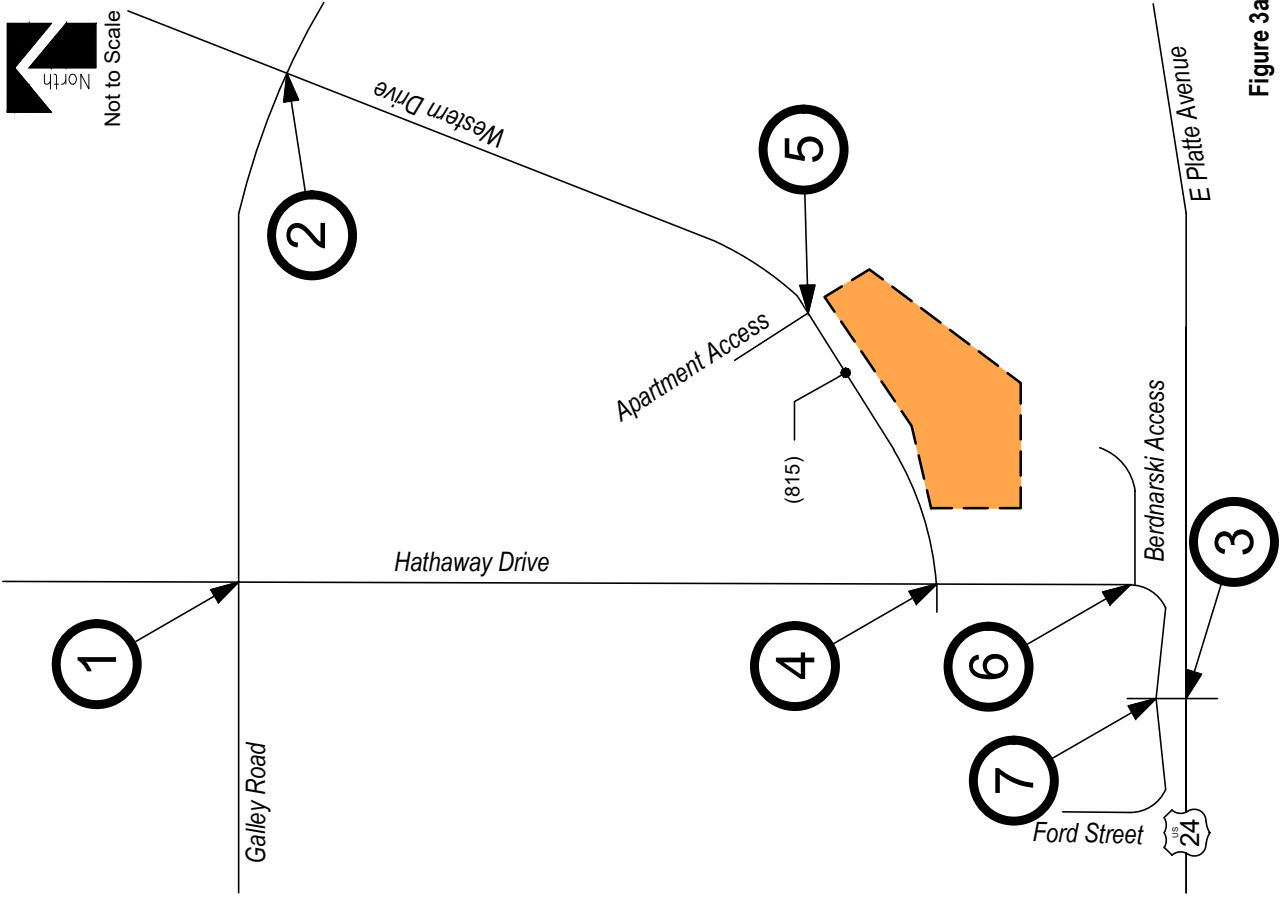

7

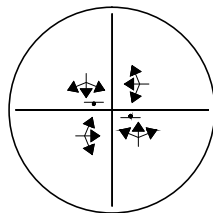

4

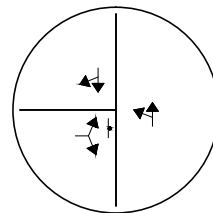

5

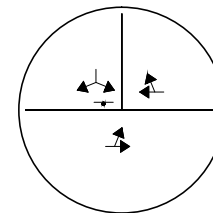

6

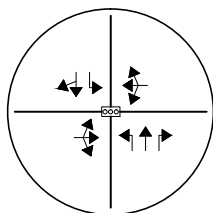

1

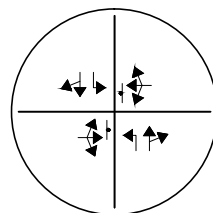

2

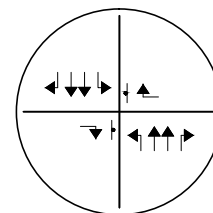

3

LEGEND



-  Study Intersection
-  Lane Geometry
-  Development Site

Figure 3a
EXISTING TRAFFIC
 Intersection Geometry
 AM / PM Peak Hour
 (ADT) : Average Daily Traffic



Peak Hour Intersection Levels of Service – Existing Traffic

The Signalized and Unsignalized Intersection Analysis techniques, as published in the Highway Capacity Manual (HCM), 6th Edition, by the Transportation Research Board and as incorporated into the SYNCHRO computer program, were used to analyze the study intersections for existing and future traffic conditions. These nationally accepted techniques allow for the determination of intersection level of service (LOS) based on the congestion and delay of each traffic movement.

Pursuant to Section B.4.1.A of the County’s ECM, the design objective of each scenario of this study shall be level of service “D”. Level of service is a method of measurement used by transportation professionals to quantify a driver’s perception of travel conditions that include travel time, number of stops, and total amount of stopped delay experienced on a roadway network. The HCM categorizes level of service into a range from “A” which indicates little, if any, vehicle delay, to “F” which indicates a level of operation considered unacceptable to most drivers. These levels of service grades with brief descriptions of the operating condition, for unsignalized and signalized intersections, are included for reference in Appendix B and have been used throughout this study.

The level of service analyses results for existing conditions are summarized in Table 1.

Intersection capacity worksheets developed for this study are provided in Appendix C.

Table 1 – Intersection Capacity Analysis Summary – Existing Traffic

INTERSECTION LANE GROUPS	LEVEL OF SERVICE	
	AM PEAK HOUR	PM PEAK HOUR
Hathaway Drive / Galley Road (Signalized)	B (11.3)	A (9.4)
Western Drive / Galley Road (Stop-Controlled)		
Eastbound Left	A	A
Westbound Left	A	A
Northbound Left, Through and Right	C	B
Southbound Left, Through and Right	B	C
Hathaway Drive / E Platte Avenue (Stop-Controlled)		
Eastbound Left	F	F
Westbound Left	E	D
Northbound Right	C	D
Southbound Right	F	D
Hathaway Drive / Western Drive (Stop-Controlled)		
Eastbound Left, Through and Right	A	A
Westbound Left, Through and Right	A	A
Northbound Left, Through and Right	A	A
Southbound Left, Through and Right	A	A
Western Drive / Apartment Access (Stop-Controlled)		
Eastbound Left and Through	A	A
Southbound Left and Right	A	A
Hathaway Drive / Bednarski Access (Stop-Controlled)		
Westbound Left and Right	A	A
Southbound Left and Through	A	A
Hathaway Drive / Ford Street (Stop-Controlled)		
Eastbound Left, Through and Right	A	A
Westbound Left, Through and Right	B	A
Northbound Left, Through and Right	A	A
Southbound Left, Through and Right	A	A

Key: Signalized Intersection: Level of Service (Control Delay in sec/veh)
 Stop-Controlled Intersection: Level of Service

Existing Traffic Analysis Results

Under existing conditions, operational analysis shows that the signalized intersection of Hathaway Drive with Galley Road has overall operations at LOS B during the morning peak traffic hour and LOS A during the afternoon peak traffic hour.

The unsignalized intersections within the study area have turn movement operations at or better than LOS C during the morning peak traffic hour and LOS D or better during the afternoon peak traffic hour.

Exceptions would include the eastbound and westbound left turn movements, as well as the southbound right turn movements, for the intersection of Hathaway Drive with E Platte Avenue. Said turning movements are shown to operate at LOS E and F during their respective peak traffic hours. The LOS E and F operations are attributed to the through traffic volume along E Platte Avenue and stop-controlled nature of the intersection.

It is to be noted that it is not uncommon for unsignalized movements to or from an arterial roadway, in urban areas, to operate with noticeable delays during peak traffic hours. It is, however, likely that turn movements will operate better than the results obtained with this HCM Two-Way Stop-Control (TWSC) level of service analysis would indicate, as the HCM analysis may not accurately account for the effect of vehicle platooning and gaps.

It is also noted that, for analysis purposes, the intersection of Hathaway Drive and Ford Street currently operates as a yield-controlled intersection, with “YIELD” signs at the eastbound and westbound approaches. However, considering how the HCM does not provide analysis for yield-controlled intersections, the intersection was analyzed as a two-way stop-controlled intersection.

III. Future Traffic Conditions Without Proposed Development

Background traffic is the traffic projected to be on area roadways without consideration of the proposed development. Background traffic includes traffic generated by development of vacant parcels in the area.

To account for projected increases in background traffic for Years 2025 and 2043, a compounded annual growth rate was determined using historical traffic data for the surrounding area provided by CDOT's Online Transportation Information System (OTIS) along the adjacent segment of E Platte Avenue, which shows a 20-year growth rate between one and two percent. Therefore, in order to provide for a conservative analysis, a growth rate of approximately two percent was applied to existing traffic volumes.

Pursuant to the non-committed area roadway improvements discussed in Section I, Year 2025 and Year 2043 background traffic conditions assume no roadway improvements to accommodate regional transportation demands. This assumption provides for a conservative analysis. Year 2043 assumes existing signal timing parameters for Hathaway Drive and Galley Road with optimized intersection splits in effort to better long-term intersection performance.

Projected background traffic volumes and intersection geometry for Year 2025 are shown on Figure 4 and Figure 4a, respectively.

Projected background traffic volumes and intersection geometry for Year 2043 are shown on Figure 5 and Figure 5a, respectively.

Internal roads will need to be private. Provide deviation request for private roadways. Include section discussing all deviations in report. (See Site development plan for additional comments)

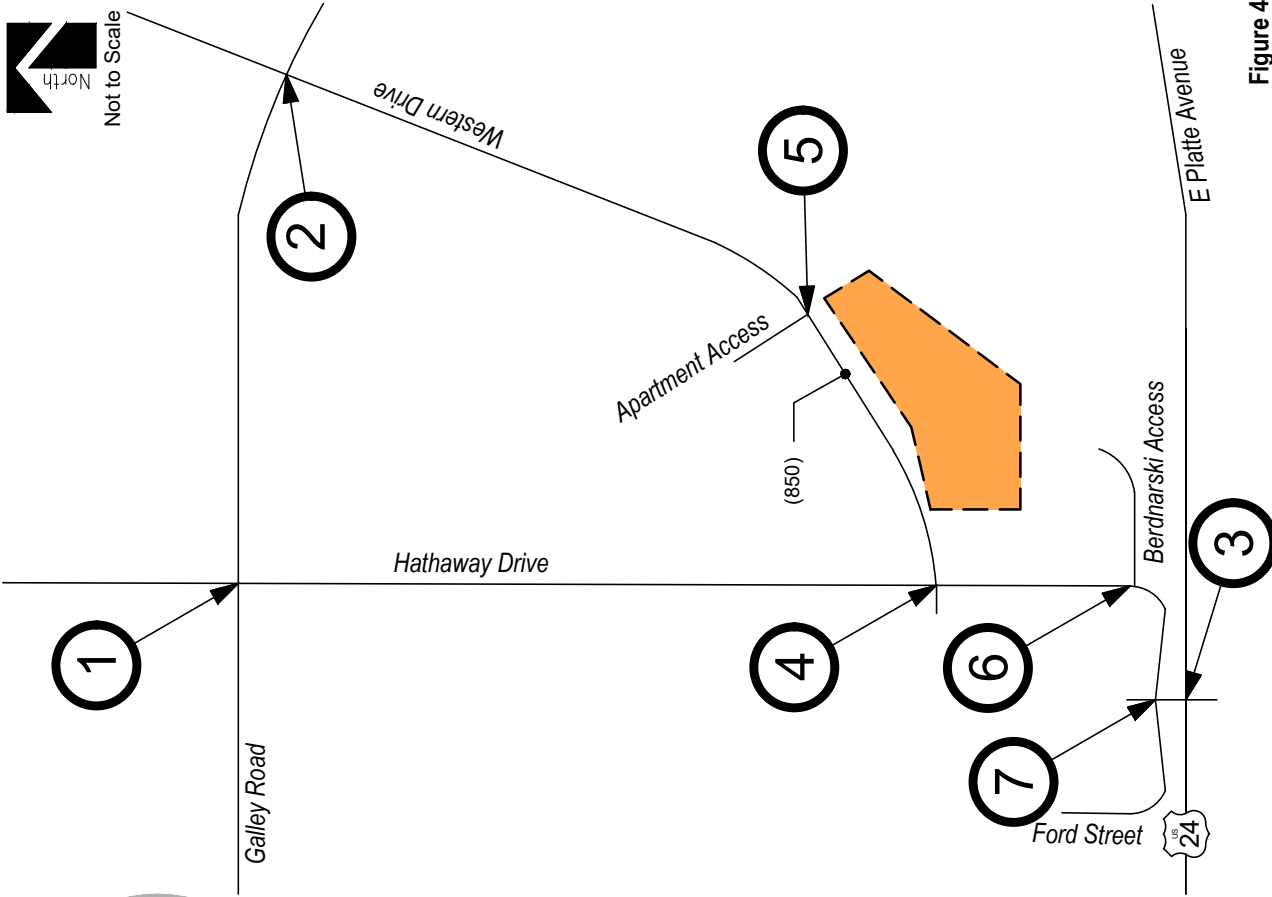
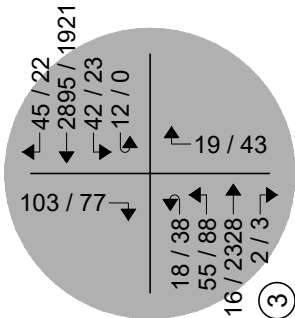
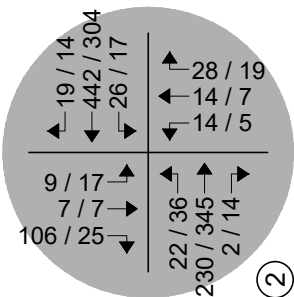
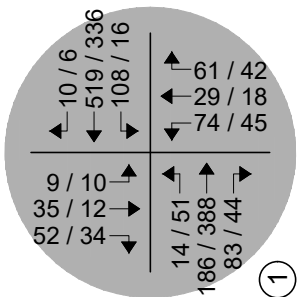
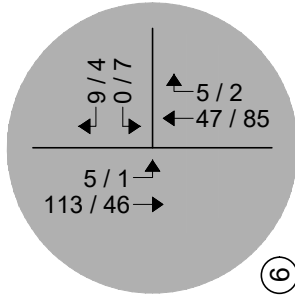
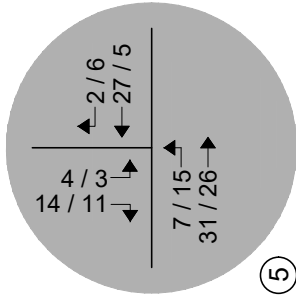
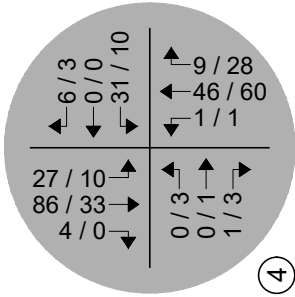
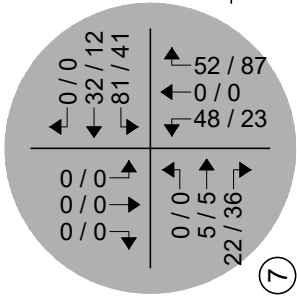
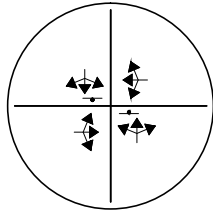
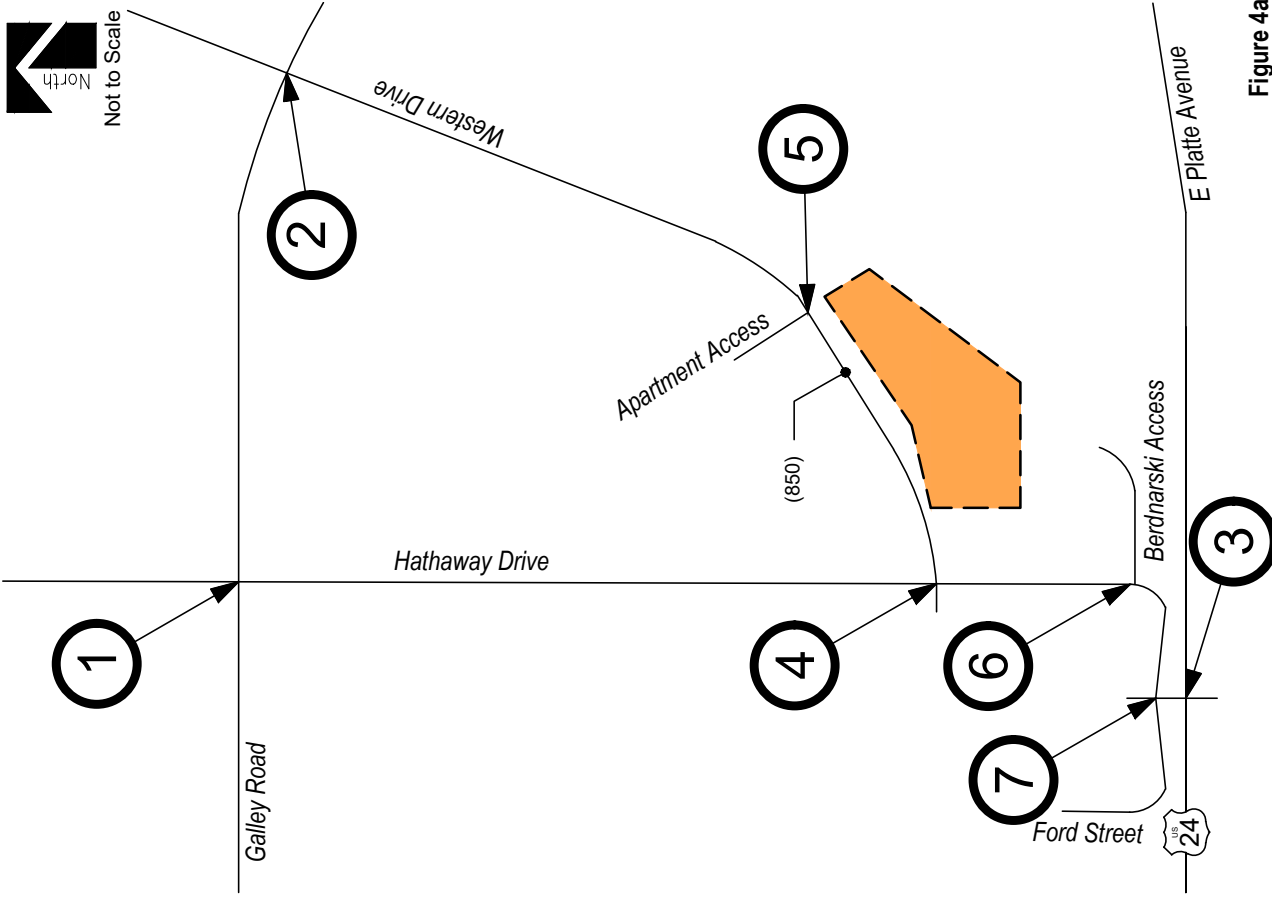

Figure 4
BACKGROUND TRAFFIC - YEAR 2025
 Volumes
 AM / PM Peak Hour
 (ADT) : Average Daily Traffic



LEGEND

- Study Intersection
- Volumes
- Development Site



7

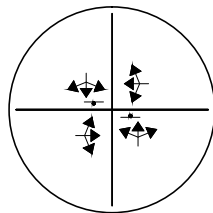

4

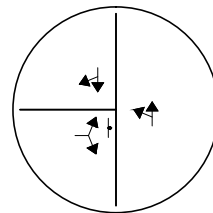

5

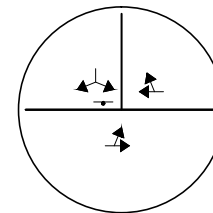

6

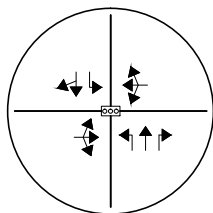

1

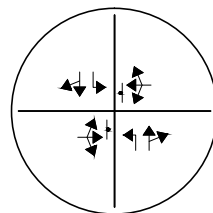

2

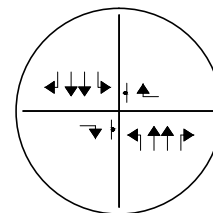

3

LEGEND



-  Study Intersection
-  Lane Geometry
-  Development Site

Figure 4a
BACKGROUND TRAFFIC - YEAR 2025
 Intersection Geometry
 AM / PM Peak Hour
 (ADT) : Average Daily Traffic

WESTERN DRIVE TOWNHOMES
 Intermediate Traffic Impact Study



SM ROCHA, LLC
 Traffic and Transportation Consultants

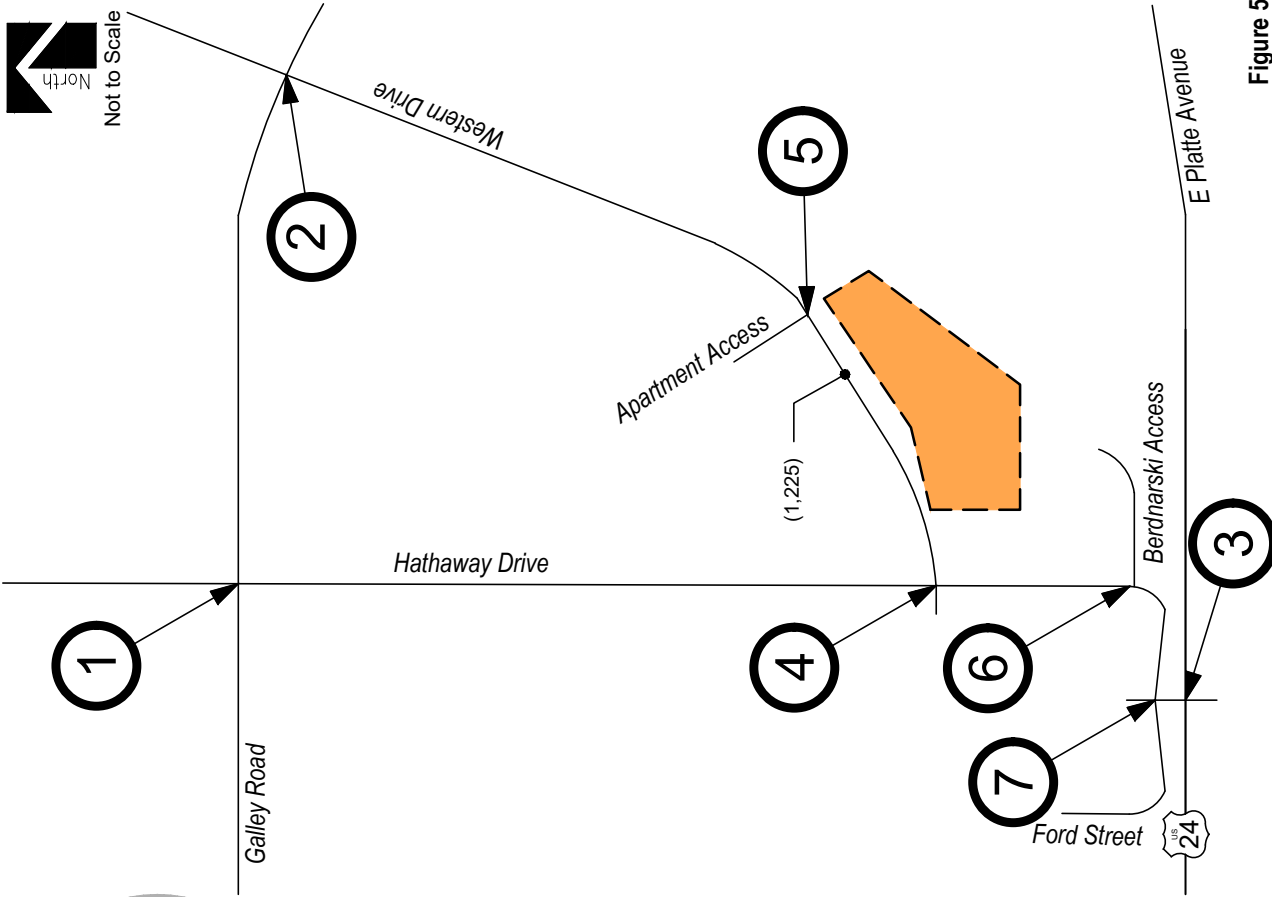
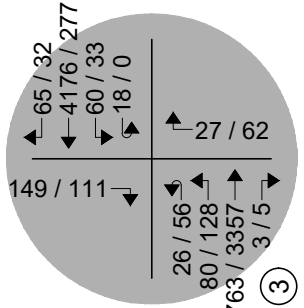
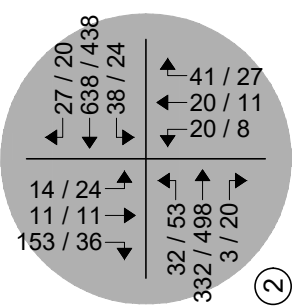
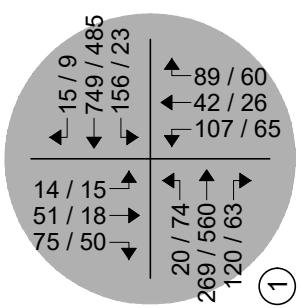
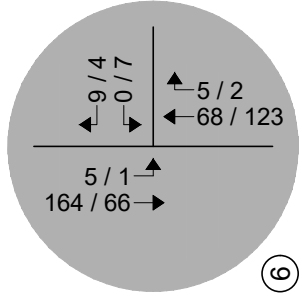
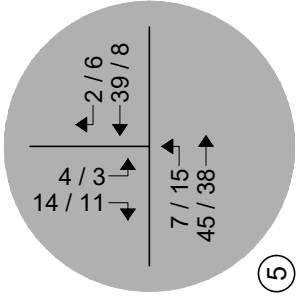
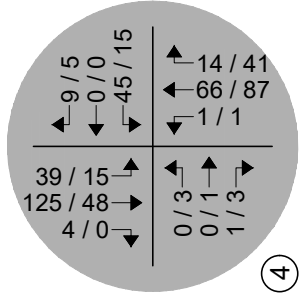
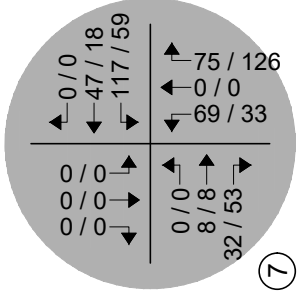

Figure 5
BACKGROUND TRAFFIC - YEAR 2043
 Volumes
 AM / PM Peak Hour
 (ADT) : Average Daily Traffic



LEGEND

- Study Intersection
- Volumes
- Development Site

WESTERN DRIVE TOWNHOMES
 Intermediate Traffic Impact Study



SM ROCHA, LLC
 Traffic and Transportation Consultants

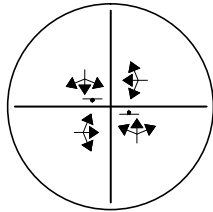
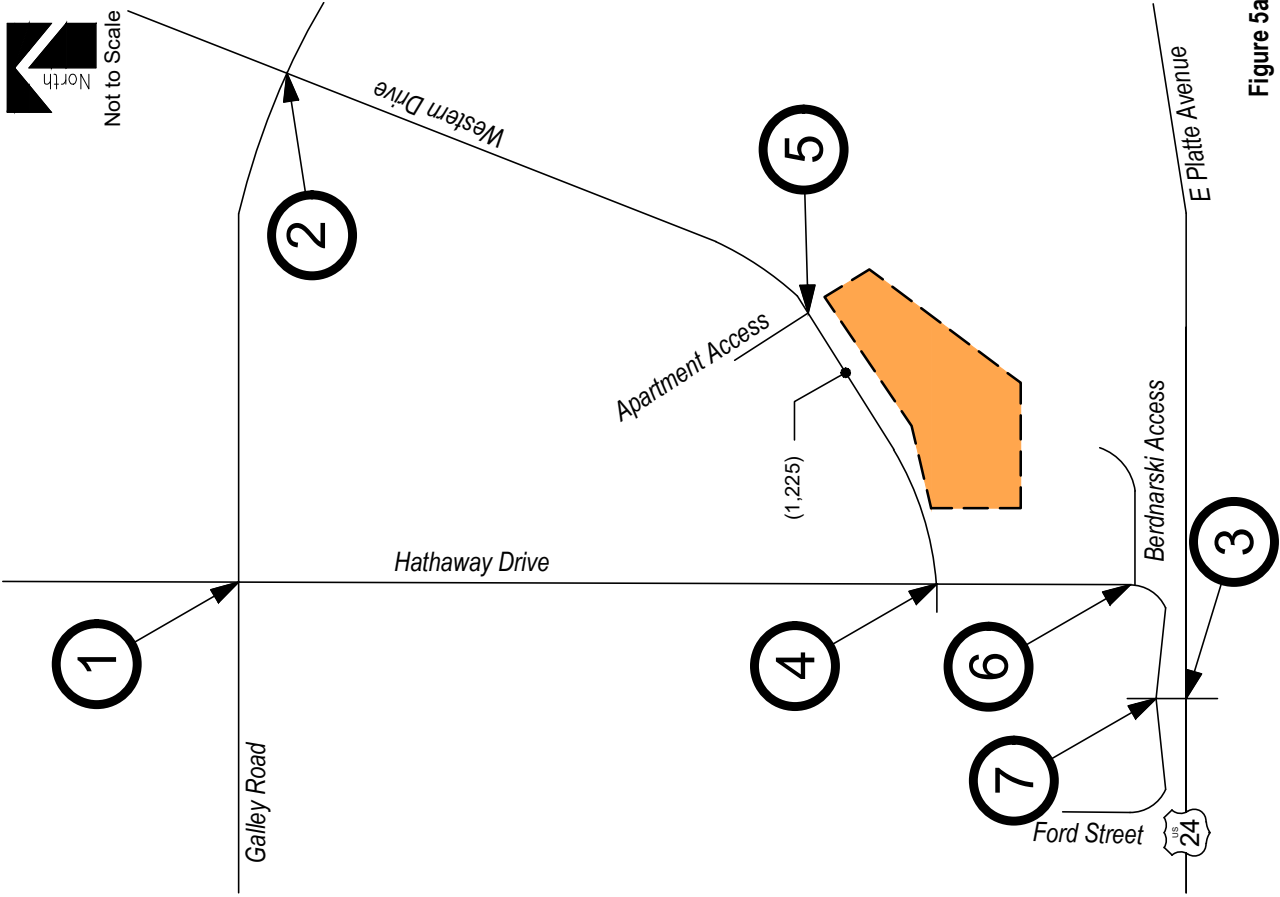

7

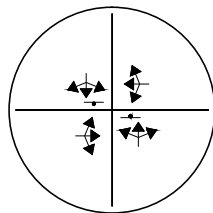

4

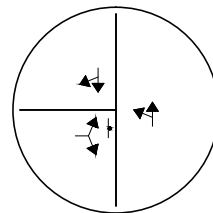

5

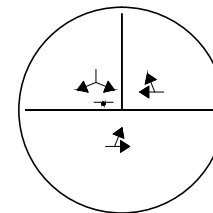

6

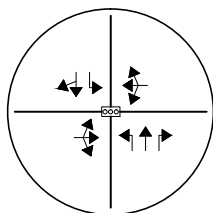

1

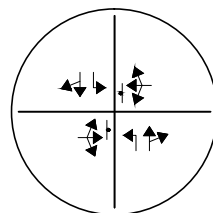

2

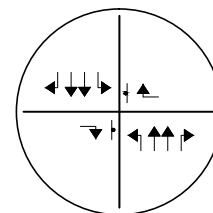

3

LEGEND



-  Study Intersection
-  Lane Geometry
-  Development Site

Figure 5a
BACKGROUND TRAFFIC - YEAR 2043
 Intersection Geometry
 AM / PM Peak Hour
 (ADT) : Average Daily Traffic

WESTERN DRIVE TOWNHOMES
 Intermediate Traffic Impact Study

SM ROCHA, LLC
 Traffic and Transportation Consultants



Peak Hour Intersection Levels of Service – Background Traffic

As with existing traffic conditions, the operations of study intersections were analyzed under background conditions, without the proposed development, using the SYNCHRO computer program.

Background traffic level of service analysis results for Year 2025 are listed in Table 2. Year 2043 operational results are summarized in Table 3.

Definitions of levels of service are given in Appendix B. Intersection capacity worksheets are provided in Appendix C.

Table 2 – Intersection Capacity Analysis Summary – Background Traffic – Year 2025

INTERSECTION LANE GROUPS	LEVEL OF SERVICE	
	AM PEAK HOUR	PM PEAK HOUR
Hathaway Drive / Galley Road (Signalized)	B (12.0)	A (9.6)
Western Drive / Galley Road (Stop-Controlled)		
Eastbound Left	A	A
Westbound Left	A	A
Northbound Left, Through and Right	C	B
Southbound Left, Through and Right	B	C
Hathaway Drive / E Platte Avenue (Stop-Controlled)		
Eastbound Left	F	F
Westbound Left	E	D
Northbound Right	C	E
Southbound Right	F	D
Hathaway Drive / Western Drive (Stop-Controlled)		
Eastbound Left, Through and Right	A	A
Westbound Left, Through and Right	B	A
Northbound Left, Through and Right	A	A
Southbound Left, Through and Right	A	A
Western Drive / Apartment Access (Stop-Controlled)		
Eastbound Left and Through	A	A
Southbound Left and Right	A	A
Hathaway Drive / Bednarski Access (Stop-Controlled)		
Westbound Left and Right	A	A
Southbound Left and Through	A	A
Hathaway Drive / Ford Street (Stop-Controlled)		
Eastbound Left, Through and Right	A	A
Westbound Left, Through and Right	A	A
Northbound Left, Through and Right	B	A
Southbound Left, Through and Right	A	A

Key: Signalized Intersection: Level of Service (Control Delay in sec/v eh)
Stop-Controlled Intersection: Level of Service

Background Traffic Analysis Results – Year 2025

Year 2025 background traffic analysis indicates that the signalized intersection of Hathaway Drive with Galley Drive has overall operations at LOS B during the AM peak traffic hour and LOS A during the PM peak traffic hour.

The unsignalized intersections within the study area have turn movement operations at or better than LOS C during the morning peak traffic hour and LOS D or better during the afternoon peak traffic hour.

Exceptions would include the eastbound and westbound left turn movements, as well as the southbound and northbound right turn movements, for the intersection of Hathaway Drive with E Platte Avenue. Said turning movements are shown to operate at LOS E and F during their respective peak traffic hours. The LOS E and F operations are attributed to the through traffic volume along E Platte Avenue and stop-controlled nature of the intersection.

It is to be noted that it is not uncommon for unsignalized movements to or from an arterial roadway, in urban areas, to operate with noticeable delays during peak traffic hours. It is, however, likely that turn movements will operate better than the results obtained with this HCM Two-Way Stop-Control (TWSC) level of service analysis would indicate, as the HCM analysis may not accurately account for the effect of vehicle platooning and gaps.

Table 3 – Intersection Capacity Analysis Summary – Background Traffic – Year 2043

INTERSECTION LANE GROUPS	LEVEL OF SERVICE	
	AM PEAK HOUR	PM PEAK HOUR
Hathaway Drive / Galley Road (Signalized)	B (18.4)	B (11.9)
Western Drive / Galley Road (Stop-Controlled)		
Eastbound Left	A	A
Westbound Left	A	A
Northbound Left, Through and Right	E	C
Southbound Left, Through and Right	D	D
Hathaway Drive / E Platte Avenue (Stop-Controlled)		
Eastbound Left	F	F
Westbound Left	F	F
Northbound Right	E	F
Southbound Right	F	F
Hathaway Drive / Western Drive (Stop-Controlled)		
Eastbound Left, Through and Right	A	A
Westbound Left, Through and Right	B	A
Northbound Left, Through and Right	A	A
Southbound Left, Through and Right	A	A
Western Drive / Apartment Access (Stop-Controlled)		
Eastbound Left and Through	A	A
Southbound Left and Right	A	A
Hathaway Drive / Bednarski Access (Stop-Controlled)		
Westbound Left and Right	A	A
Southbound Left and Through	A	A
Hathaway Drive / Ford Street (Stop-Controlled)		
Eastbound Left, Through and Right	A	A
Westbound Left, Through and Right	B	B
Northbound Left, Through and Right	A	A
Southbound Left, Through and Right	A	A

Key: Signalized Intersection: Level of Service (Control Delay in sec/v eh)
 Stop-Controlled Intersection: Level of Service

Background Traffic Analysis Results – Year 2043

By Year 2043 and without the proposed development, the signalized intersection of Hathaway Drive with Galley Road experiences LOS B operations during the AM and PM peak traffic hours.

The stop-controlled intersections of Hathaway Drive with Western Drive, Bednarski Access, and Ford Street have turning movement operations at or better than LOS B during both the morning and afternoon peak traffic hours.

The stop-controlled intersection of Western Drive with Apartment Access has turning movement operations at LOS A during both the morning and afternoon peak traffic hours.

The stop-controlled intersection of Western Drive and Galley Road projects turning movement operations at LOS D or better during the morning and afternoon peak traffic hours. Exceptions would include the northbound left, through and right turn movement which operates at LOS E during the morning peak traffic hour. The LOS E operation is attributed to the through traffic volume along Galley Road and the stop-controlled nature of the intersection.

The intersection of Hathaway Drive and E Platte Avenue has turning movement operations as LOS F and E during the morning peak traffic hour and at LOS F during the afternoon peak traffic hour. These failing operations are attributed to the through traffic volumes along E Platte Avenue and the stop-controlled nature of the intersection.

It is again to be noted that it is not uncommon for unsignalized movements to or from an arterial roadway, in urban areas, to operate with noticeable delays during peak traffic hours. It is, however, likely that turn movements will operate better than the results obtained with this HCM Two-Way Stop-Control (TWSC) level of service analysis would indicate, as the HCM analysis may not accurately account for the effect of vehicle platooning and gaps caused by upstream signals.

IV. Proposed Project Traffic

Trip Generation

Standard traffic generation characteristics compiled by the Institute of Transportation Engineers (ITE) in their report entitled Trip Generation Manual, 11th Edition, were applied to the proposed land use in order to estimate average daily traffic (ADT), AM Peak Hour, and PM Peak Hour vehicle trips. A vehicle trip is defined as a one-way vehicle movement from a point of origin to a point of destination.

The ITE land use code 215 (Single-Family Attached Housing) was used for estimating trip generation because of its conservative rates and best fit to the proposed land use description.

Revise or remove statement

Due to the conceptual nature of the proposed development, a specific density has not yet been determined. As such, the maximum allowed density of 60 dwelling units was applied in order to provide for a conservative analysis.

As actual densities or site plans within the conceptual site plan become defined over time, it is expected that traffic generation characteristics considered within this study may need to be updated by more specific traffic analyses or studies to help assess if transportation improvements are needed to successfully mitigate potential traffic impacts.

Trip generation rates used in this study are presented in Table 4.

This should be the report determining any improvements and mitigation impacts.

Table 4 – Trip Generation Rates

ITE CODE	LAND USE	UNIT	TRIP GENERATION RATES						
			24 HOUR	AM PEAK HOUR			PM PEAK HOUR		
				ENTER	EXIT	TOTAL	ENTER	EXIT	TOTAL
215	Single-Family Attached Housing	DU	7.20	0.12	0.36	0.48	0.34	0.23	0.57

Key: DU = Dwelling Units.

Note: All data and calculations above are subject to being rounded to nearest value.

Table 5 illustrates projected ADT, AM Peak Hour, and PM Peak Hour traffic volumes likely generated by the proposed development upon build-out.

Table 5 – Trip Generation Summary

ITE CODE	LAND USE	SIZE	TOTAL TRIPS GENERATED						
			24 HOUR	AM PEAK HOUR			PM PEAK HOUR		
				ENTER	EXIT	TOTAL	ENTER	EXIT	TOTAL
215	Single-Family Attached Housing	60 DU	432	7	22	29	20	14	34
<i>Total:</i>			432	7	22	29	20	14	34

Key: DU = Dwelling Units.

Note: All data and calculations above are subject to being rounded to nearest value.

Upon build-out, Table 5 illustrates that the proposed development has the potential to generate approximately 432 daily vehicle trips with 29 of those occurring during the morning peak hour and 34 during the afternoon peak hour.

Adjustments to Trip Generation Rates

A development of this type is not likely to attract trips from within area land uses nor pass-by or diverted link trips from the adjacent roadway system, therefore no trip reduction was taken in this analysis.

Trip Distribution

The overall directional distribution of site-generated traffic was determined based on the location of development site within the County, proposed and existing area land uses, allowed turning movements, and available roadway network.

Overall trip distribution patterns for the development are shown on Figure 6.

Trip Assignment

Traffic assignment is how generated and distributed vehicle trips are expected to be loaded onto the available roadway network.

Applying trip distribution patterns to site-generated traffic provides the overall site-generated trip assignments shown on Figure 6.

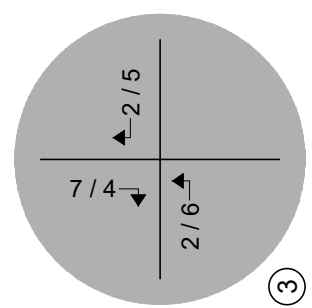
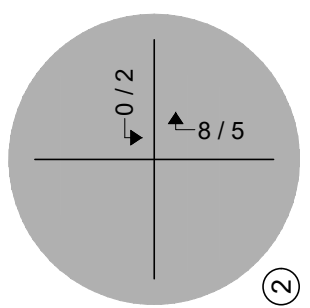
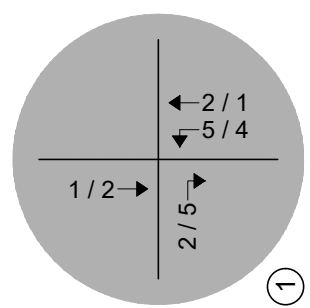
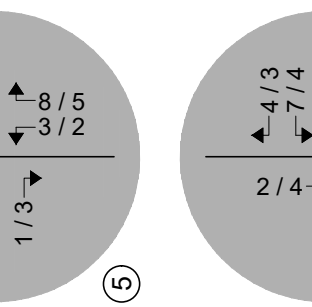
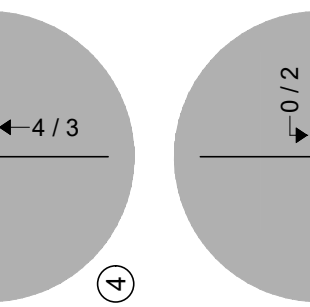
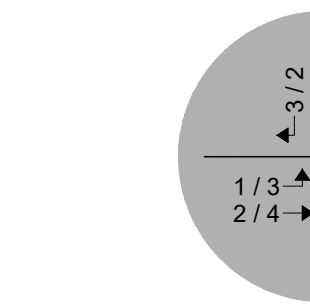
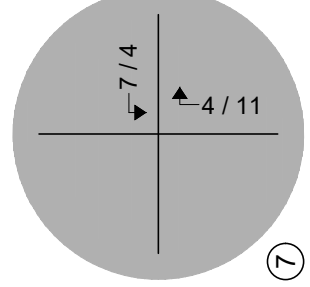
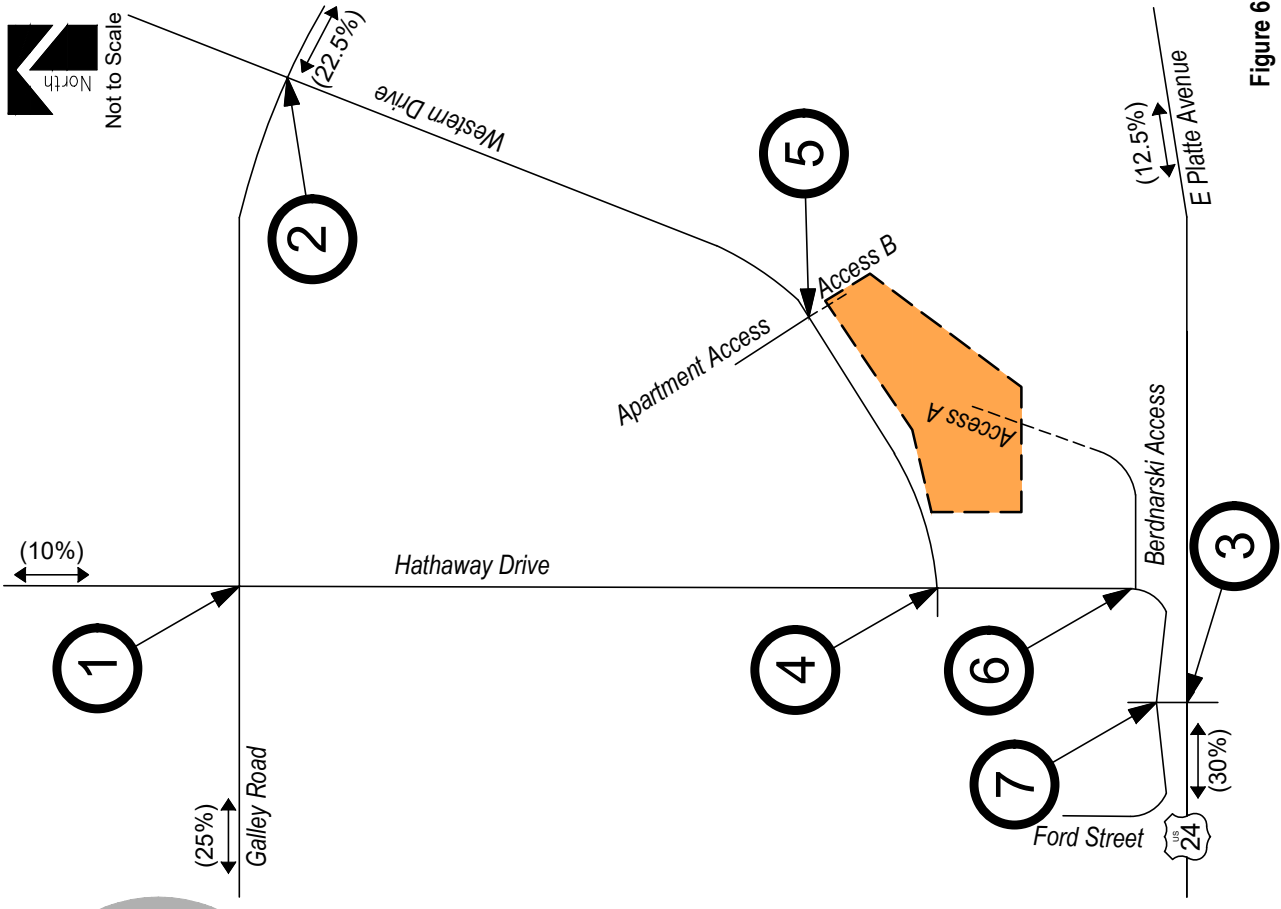

LEGEND

- Study Intersection
- Volumes
- Development Site

Figure 6
SITE DEVELOPMENT DISTRIBUTION
 (%): Overall
SITE-GENERATED
 AM / PM Peak Hour

WESTERN DRIVE TOWNHOMES
 Intermediate Traffic Impact Study

SM ROCHA, LLC
 Traffic and Transportation Consultants



V. Future Traffic Conditions With Proposed Developments

Total traffic is the traffic projected to be on area roadways with consideration of the proposed development. Total traffic includes background traffic projections for Years 2025 and 2043 with consideration of site-generated traffic. For analysis purposes, it was assumed that development construction would be completed by end of Year 2025.

Pursuant to area roadway improvement discussions provided in Section III, Year 2025 and Year 2043 total traffic conditions assume no roadway improvements to accommodate regional transportation demands. Roadway improvements associated with site development are expected to be limited to site access and frontage as required by the governing agency. This assumption provides for a conservative analysis.

Projected Year 2025 total traffic volumes and intersection geometry are shown in Figure 7 and Figure 7a, respectively.

Figure 8 and Figure 8a shows projected total traffic volumes and intersection geometry for Year 2043, respectively.

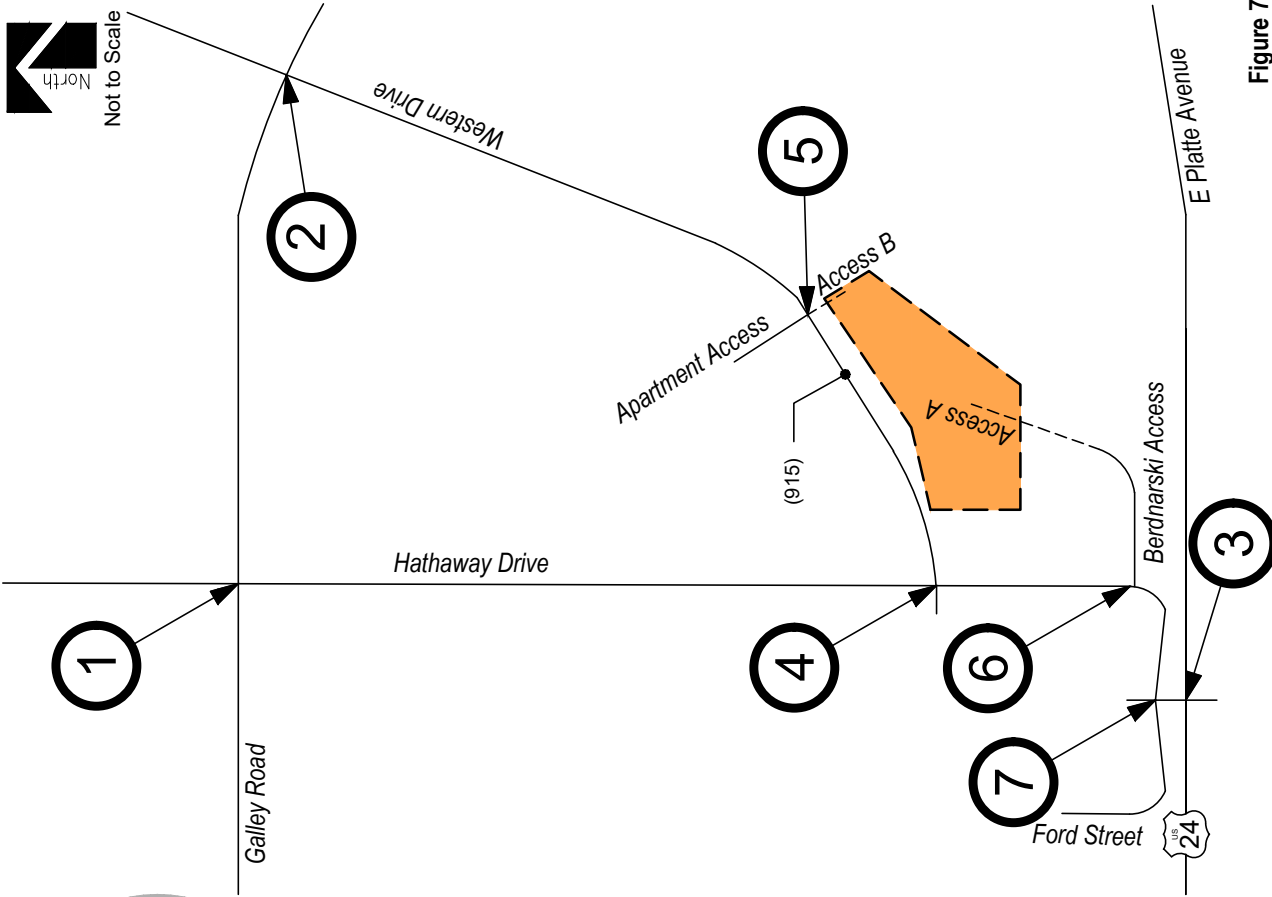
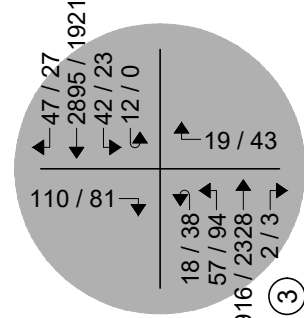
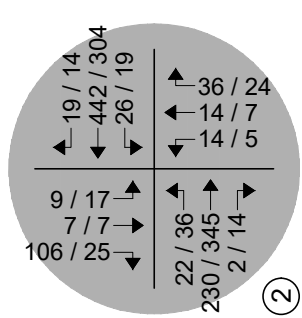
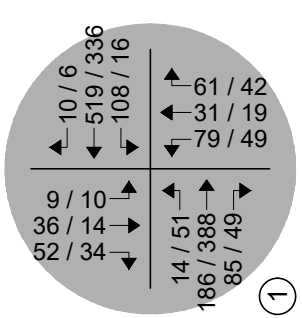
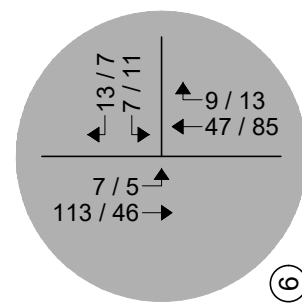
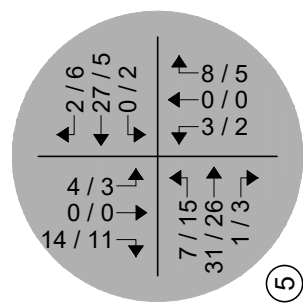
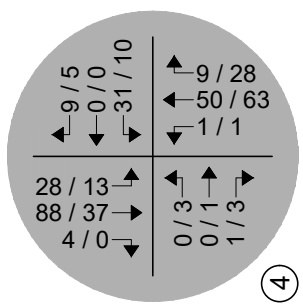
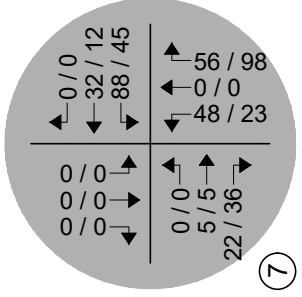

Figure 7
TOTAL TRAFFIC - YEAR 2025
 Volumes
 AM / PM Peak Hour
 (ADT) : Average Daily Traffic



LEGEND

- Study Intersection
- Volumes
- Development Site



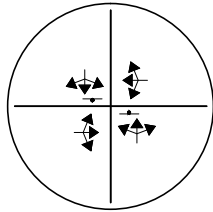
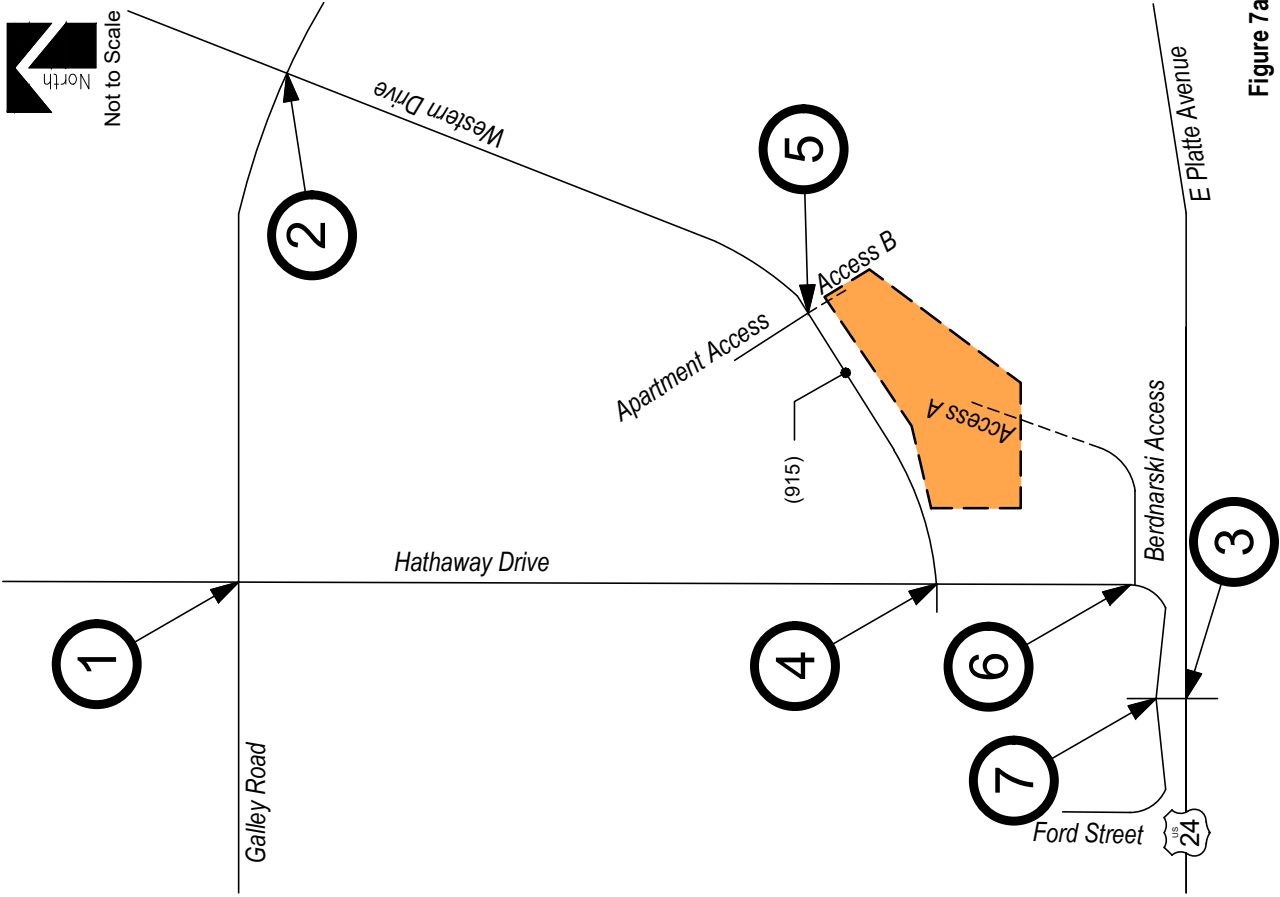

7

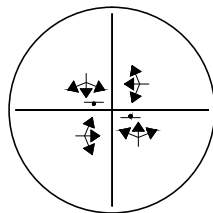

4

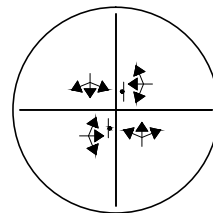

5

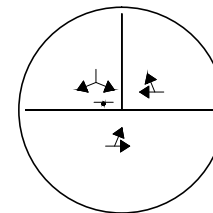

6

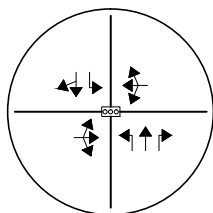

1

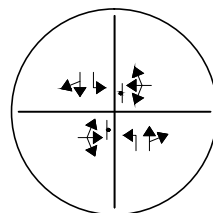

2

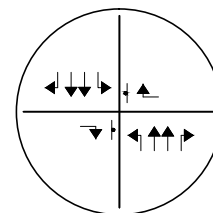

3

LEGEND



-  Study Intersection
-  Lane Geometry
-  Development Site

Figure 7a
TOTAL TRAFFIC - YEAR 2025
 Volumes & Intersection Geometry
 AM / PM Peak Hour
 (ADT) : Average Daily Traffic

WESTERN DRIVE TOWNHOMES
 Intermediate Traffic Impact Study



SM ROCHA, LLC
 Traffic and Transportation Consultants

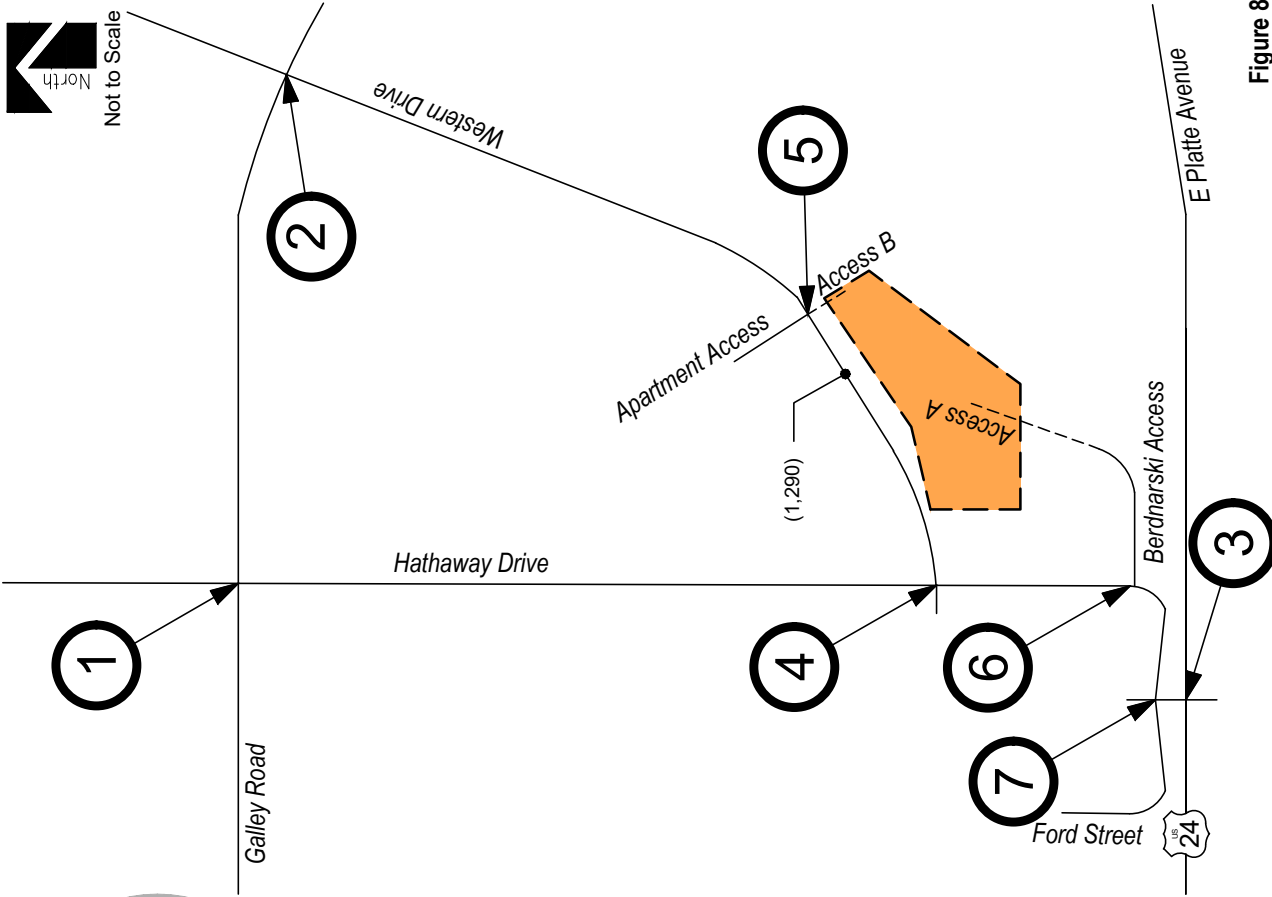
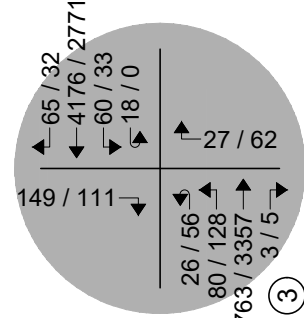
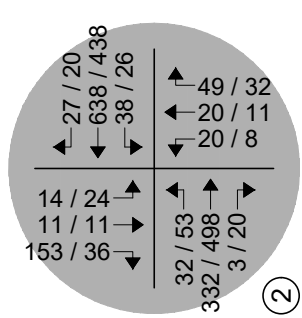
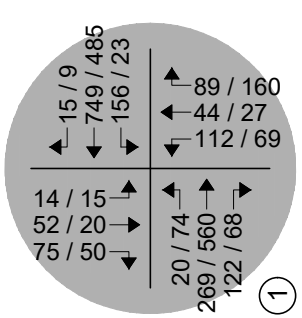
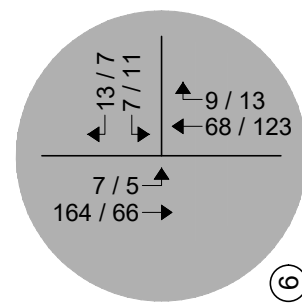
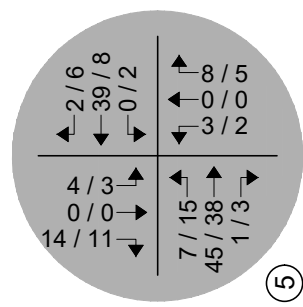
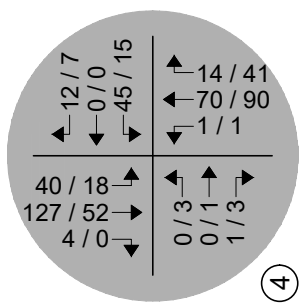
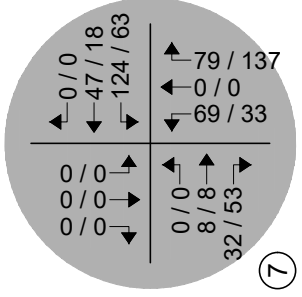

Figure 8
TOTAL TRAFFIC - YEAR 2043
 Volumes
 AM / PM Peak Hour
 (ADT) : Average Daily Traffic



LEGEND

- Study Intersection
- Volumes
- Development Site



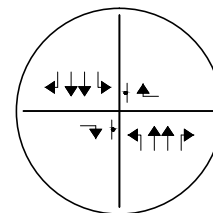
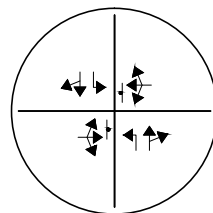
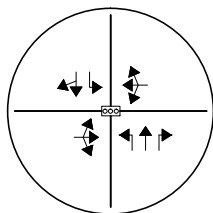
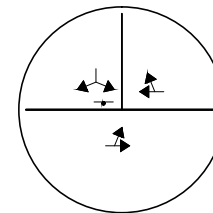
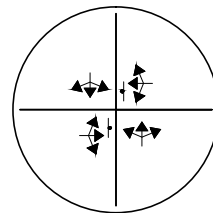
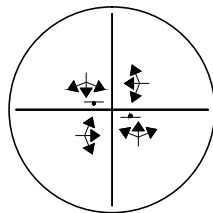
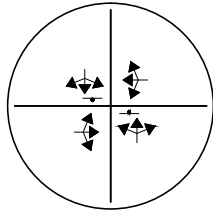
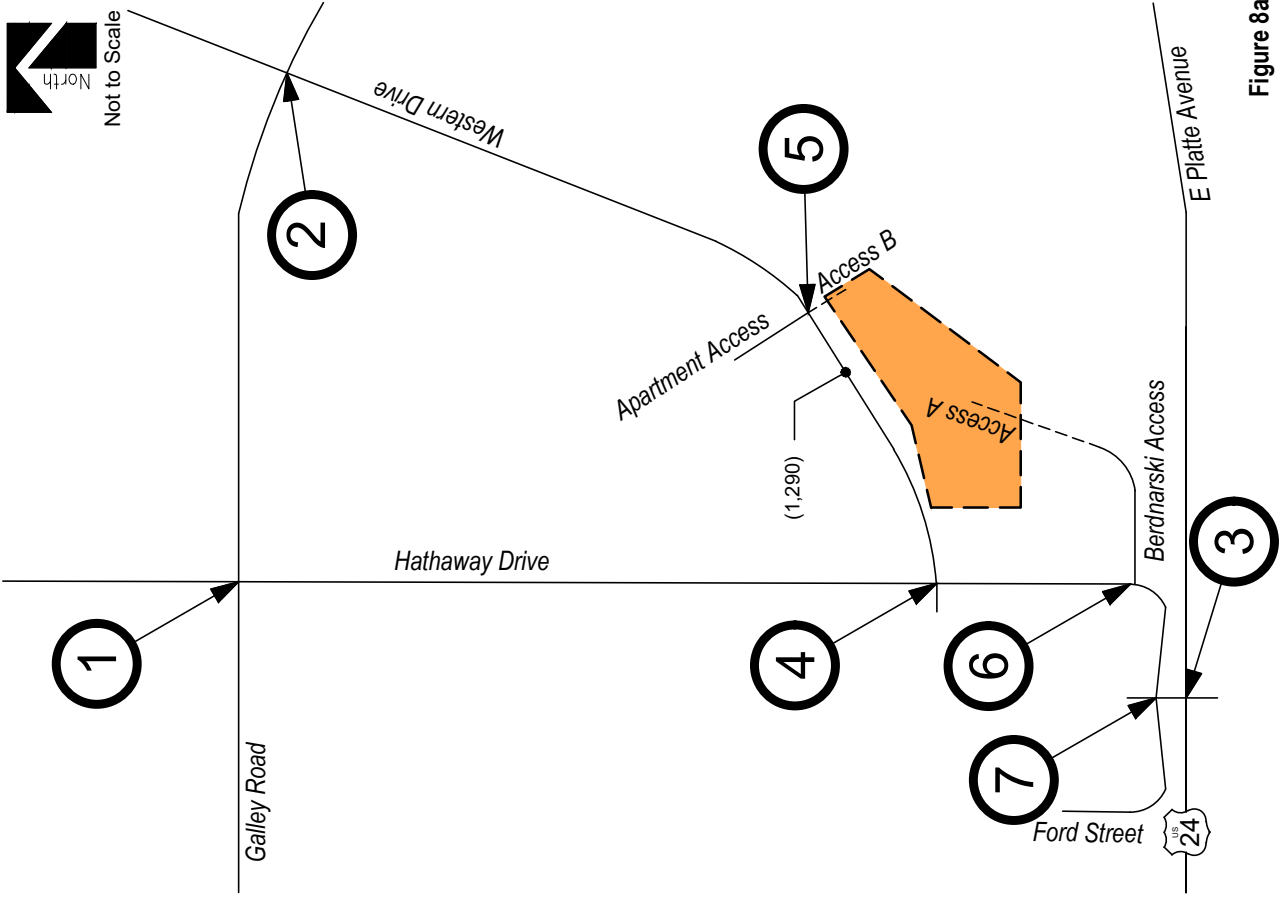

LEGEND



-  Study Intersection
-  Lane Geometry
-  Development Site

Figure 8a
TOTAL TRAFFIC - YEAR 2043
 Intersection Geometry
 AM / PM Peak Hour
 (ADT) : Average Daily Traffic

WESTERN DRIVE TOWNHOMES
 Intermediate Traffic Impact Study

SM ROCHA, LLC
 Traffic and Transportation Consultants



VI. Project Impacts

The analyses and procedures described in this study were performed in accordance with the latest (HCM) and are based upon the worst-case conditions that occur during a typical weekday upon build-out of site development and analyzed land uses. Therefore, study intersections are likely to operate with traffic conditions better than those described within this study, which represent the peak hours of weekday operations only.

Total Traffic Auxiliary Lane Analysis

Auxiliary lanes for site development accesses were based on the County's ECM.

Considering development build-out, an evaluation of auxiliary lane requirements, pursuant to Section 2.3.7.D of the County's ECM, reveals that this development does not warrant the need for right or left turn deceleration lanes along Hathaway Drive and Western Drive since ingress traffic volumes do not exceed design hourly volume thresholds. The County's ECM states that for minor arterial roadways and lower classifications, a left turn deceleration lane is required if the development's projected peak hour ingress volume exceeds 25 vehicles, and a right turn deceleration lane is required if the ingress volume exceeds 50 vehicles. The largest projected peak hour ingress volume at either site access is 13 vehicles, therefore no new turn lanes are required along Hathaway Drive and Western Drive.

Peak Hour Intersection Levels of Service – Total Traffic

As with background traffic, the operations of the study intersections were analyzed under projected total traffic conditions using the SYNCHRO computer program. Total traffic level of service analysis results for Years 2025 and 2043 are summarized in Table 6 and Table 7, respectively.

Definitions of levels of service are given in Appendix B. Intersection capacity worksheets are provided in Appendix C.

Table 6 – Intersection Capacity Analysis Summary – Total Traffic – Year 2025

INTERSECTION LANE GROUPS	LEVEL OF SERVICE	
	AM PEAK HOUR	PM PEAK HOUR
Hathaway Drive / Galley Road (Signalized)	B (12.4)	A (9.8)
Western Drive / Galley Road (Stop-Controlled)		
Eastbound Left	A	A
Westbound Left	A	A
Northbound Left, Through and Right	C	B
Southbound Left, Through and Right	B	C
Hathaway Drive / E Platte Avenue (Stop-Controlled)		
Eastbound Left	F	F
Westbound Left	E	D
Northbound Right	C	E
Southbound Right	F	D
Hathaway Drive / Western Drive (Stop-Controlled)		
Eastbound Left, Through and Right	A	A
Westbound Left, Through and Right	A	A
Northbound Left, Through and Right	A	A
Southbound Left, Through and Right	A	A
Western Drive / Apartment Access / Access B (Stop-Controlled)		
Eastbound Left, Through and Right	A	A
Westbound Left, Through and Right	A	A
Northbound Left, Through and Right	A	A
Southbound Left, Through and Right	A	A
Hathaway Drive / Bednarski Access / Access A (Stop-Controlled)		
Westbound Left and Right	A	A
Southbound Left and Through	A	A
Hathaway Drive / Ford Street (Stop-Controlled)		
Eastbound Left, Through and Right	A	A
Westbound Left, Through and Right	B	A
Northbound Left, Through and Right	A	A
Southbound Left, Through and Right	A	A

Key: Signalized Intersection: Level of Service (Control Delay in sec/veh)
 Stop-Controlled Intersection: Level of Service

Table 7 – Intersection Capacity Analysis Summary – Total Traffic – Year 2043

INTERSECTION LANE GROUPS	LEVEL OF SERVICE	
	AM PEAK HOUR	PM PEAK HOUR
Hathaway Drive / Galley Road (Signalized)	B (18.8)	B (12.1)
Western Drive / Galley Road (Stop-Controlled)		
Eastbound Left	A	A
Westbound Left	A	A
Northbound Left, Through and Right	E	C
Southbound Left, Through and Right	D	D
Hathaway Drive / E Platte Avenue (Stop-Controlled)		
Eastbound Left	F	F
Westbound Left	F	F
Northbound Right	E	F
Southbound Right	F	F
Hathaway Drive / Western Drive (Stop-Controlled)		
Eastbound Left, Through and Right	A	A
Westbound Left, Through and Right	B	A
Northbound Left, Through and Right	A	A
Southbound Left, Through and Right	A	A
Western Drive / Apartment Access / Access B (Stop-Controlled)		
Eastbound Left, Through and Right	A	A
Westbound Left, Through and Right	A	A
Northbound Left, Through and Right	A	A
Southbound Left, Through and Right	A	A
Hathaway Drive / Bednarski Access / Access A (Stop-Controlled)		
Westbound Left and Right	A	A
Southbound Left and Through	A	A
Hathaway Drive / Ford Street (Stop-Controlled)		
Eastbound Left, Through and Right	A	A
Westbound Left, Through and Right	B	B
Northbound Left, Through and Right	A	A
Southbound Left, Through and Right	A	A

Key: Signalized Intersection: Level of Service (Control Delay in sec/veh)
 Stop-Controlled Intersection: Level of Service

Total Traffic Analysis Results Upon Development Build-Out

Table 7 illustrates how, by Year 2043 and upon development build-out, the signalized intersection of Hathaway Drive and Galley Road shows an overall LOS B operation during the morning and afternoon peak traffic hour. Compared to the background traffic analysis, the traffic generated by the proposed development is not expected to significantly change the operations of the study intersection.

The stop-controlled intersections of Hathaway Drive with Western Drive, Bednarski Access, and Ford Street have turning movement operations at or better than LOS B during both the morning and afternoon peak traffic hours.

The stop-controlled intersection of Western Drive with Apartment Access has turning movement operations at LOS A during both the morning and afternoon peak traffic hours.

The stop-controlled intersection of Western Drive and Galley Road projects turning movement operations at LOS D or better during the morning and afternoon peak traffic hours. Exceptions would include the northbound left, through and right turn movement which operates at LOS E during the morning peak traffic hour. The LOS E operation is still attributed to the through traffic volume along Galley Road and the stop-controlled nature of the intersection.

The intersection of Hathaway Drive and E Platte Avenue projects turn movement operation to be LOS F and E during the morning peak traffic hour and LOS F during the afternoon peak traffic hour. The failing operations continue to be attributed to the through volumes along E Platte Avenue and the stop-controlled nature of the intersection.

As with existing and background traffic conditions, it is not uncommon for unsignalized movements to or from an arterial roadway, in urban areas, to operate with noticeable delays during peak traffic hours. It is, however, likely that turn movements will operate better than the results obtained with this HCM Two-Way Stop-Control (TWSC) level of service analysis would indicate, as the HCM analysis may not accurately account for the effect of vehicle platooning and gaps caused by upstream signals.

These intersection operations are similar to background conditions.

Pedestrian Circulation & Safety Analysis

In accordance with Section B.2.4.B of the County’s ECM, an assessment to pedestrian connectivity and safety was considered.

The proposed development would accommodate pedestrians and bicyclists with detached sidewalks along the south side of Western Drive and into the site along the borders of the proposed buildings as well as ADA parking spaces adjacent to the attached sidewalks and building entrances.

With the assumption that the site plan for the proposed development was designed per the County’s ECM, and pursuant to the Federal Highway Administration’s (FHWA) Guide for Improving Pedestrian Safety at Uncontrolled Crossing Locations⁴, pedestrian safety is not expected to be of concern. Moreover, traffic calming and pedestrian crossing treatments are not applicable, and traffic calming is not recommended for the proposed conditions.

⁴ Guide for Improving Pedestrian Safety at Uncontrolled Crossing Locations, Federal Highway Administration, July 2018.

VII. Conclusion

This Intermediate Traffic Impact Study addressed the capacity, geometric, and control requirements associated with the development entitled Western Drive Townhomes. This proposed residential development consists of 60 residential townhomes. The development is located near the southeast corner of Hathaway Drive and Western Drive in El Paso County, Colorado.

The study area examined in this analysis encompassed the Hathaway Drive intersections with Galley Road, E Platte Avenue (U.S. Highway 24), Western Drive, Ford Street and the existing Bednarski Access as well as the intersection of Western Drive with Galley Road and the existing shared Freedom Springs and Western Hills Apartments Access and includes proposed site accesses.

Analysis was conducted for critical AM Peak Hour and PM Peak Hour traffic operations for existing traffic conditions, Year 2025 and Year 2043 background traffic conditions, and Year 2025 and Year 2043 total traffic conditions.

Analysis of existing traffic conditions indicates that the signalized intersection of Galley Road with Hathaway Drive has operations at LOS B during the morning peak traffic hour and LOS A during the afternoon peak traffic hour.

Under existing conditions, operational analysis shows that the signalized intersection of Hathaway Drive with Galley Road has overall operations at LOS B during the morning peak traffic hour and LOS A during the afternoon peak traffic hour. The unsignalized intersections within the study area have turn movement operations at or better than LOS C during the morning peak traffic hour and LOS D or better during the afternoon peak traffic hour. Exceptions would include the eastbound and westbound left turn movements, as well as the southbound right turn movements, for the intersection of Hathaway Drive with E Platte Avenue. Said turning movements are shown to operate at LOS E and F during their respective peak traffic hours. The LOS E and F operations are attributed to the through traffic volume along E Platte Avenue and stop-controlled nature of the intersection.

Without the proposed development, Year 2025 background operational analysis shows that the signalized intersection of Hathaway Drive with Galley Drive has overall operations at LOS B during the AM peak traffic hour and LOS A during the PM peak traffic hour. The unsignalized intersections within the study area have turn movement operations at or better than LOS C during the morning peak traffic hour and LOS D or better during the afternoon peak traffic hour. Exceptions would include the eastbound and westbound left turn movements, as well as the southbound and northbound right turn movements, for the intersection of Hathaway Drive with E Platte Avenue. Said turning movements are shown to operate at LOS E and F during their respective peak traffic hours. The LOS E and F operations are attributed to the through traffic volume along E Platte Avenue and stop-controlled nature of the intersection. Year 2025 traffic conditions indicate that the unsignalized intersections within the study area have turn movement operations at or better than LOS C during the morning peak traffic hour and LOS D or better during the afternoon peak traffic hour.

By Year 2043 and without the proposed development, the signalized intersection of Hathaway Drive with Galley Road experiences LOS B operations during the AM and PM peak traffic hours. The stop-controlled intersections of Hathaway Drive with Western Drive, Bednarski Access, and Ford Street have turning movement operations at or better than LOS B during both the morning and afternoon peak traffic hours. The stop-controlled intersection of Western Drive with Apartment Access has turning movement operations at LOS A during both the morning and afternoon peak traffic hours. The stop-controlled intersection of Western Drive and Galley Road projects turning movement operations at LOS D or better during the morning and afternoon peak traffic hours. Exceptions would include the northbound left, through and right turn movement which operates at LOS E during the morning peak traffic hour. The LOS E operation is attributed to the through traffic volume along Galley Road and the stop-controlled nature of the intersection. The intersection of Hathaway Drive and E Platte Avenue has turning movement operations as LOS F and E during the morning peak traffic hour and at LOS F during the afternoon peak traffic hour. These failing operations are attributed to the through traffic volumes along E Platte Avenue and the stop-controlled nature of the intersection.

It is to be noted that it is not uncommon for unsignalized movements to or from an arterial roadway, in urban areas, to operate with noticeable delays during peak traffic hours. It is, however, likely that turn movements will operate better than the results obtained with this HCM Two-Way Stop-Control (TWSC) level of service analysis would indicate, as the HCM analysis may not accurately account for the effect of vehicle platooning and gaps caused by upstream signals.

Analysis of future traffic conditions indicates that the addition of site-generated traffic is expected to create no negative impact to traffic operations for the existing and surrounding roadway system. With all conservative assumptions defined in this analysis, the study intersections are projected to operate at future levels of service comparable to Year 2043 background traffic conditions. Proposed site accesses have long-term operations at LOS A during both peak traffic periods and upon build-out.

The proposed lot will be subject to fees established by the El Paso County Road Impact Fee Program per El Paso County Resolution Number 19-471. The owners do not intend to seek inclusion in any Public Improvements District. Traffic Impact Fees will be paid at time of any eventual building permit application.

APPENDIX A

Traffic Count Data Signal Timing Information

Location: 1 HATHAWAY DR & GALLEY RD AM

Date: Wednesday, August 23, 2023

Peak Hour: 07:00 AM - 08:00 AM

Peak 15-Minutes: 07:30 AM - 07:45 AM

Peak Hour - Motorized Vehicles

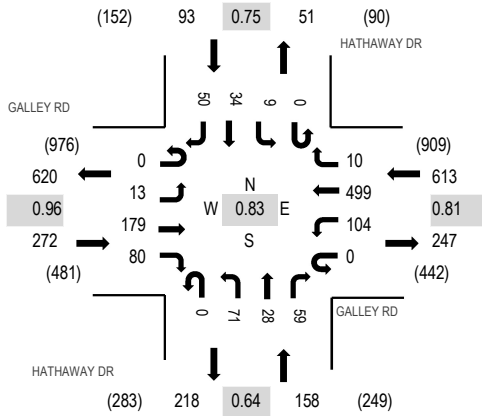

Peak Hour - Bicycles

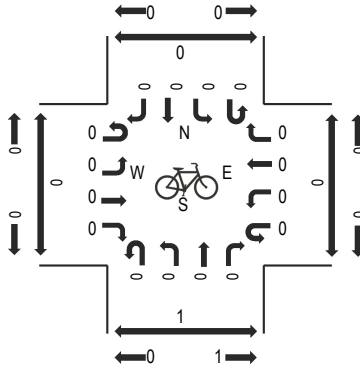

Peak Hour - Pedestrians

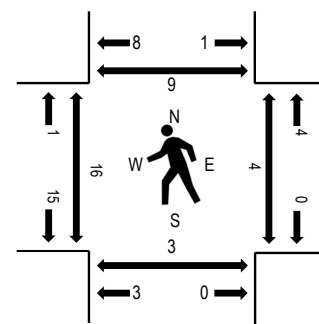

Note: Total study counts contained in parentheses.

Traffic Counts - Motorized Vehicles

Interval Start Time	GALLEY RD Eastbound				GALLEY RD Westbound				HATHAWAY DR Northbound				HATHAWAY DR Southbound				Total	Rolling Hour	Pedestrian Crossings			
	U-Turn	Left	Thru	Right	U-Turn	Left	Thru	Right	U-Turn	Left	Thru	Right	U-Turn	Left	Thru	Right			West	East	South	North
7:00 AM	0	4	54	12	0	9	104	2	0	14	4	3	0	6	3	10	225	1,136	0	0	0	0
7:15 AM	0	1	47	17	0	14	111	3	0	11	2	8	0	1	7	17	239	1,126	5	0	2	1
7:30 AM	0	3	41	27	0	55	134	1	0	19	15	16	0	1	17	13	342	1,037	7	0	0	7
7:45 AM	0	5	37	24	0	26	150	4	0	27	7	32	0	1	7	10	330	828	4	4	1	1
8:00 AM	0	4	55	10	0	9	101	0	0	15	4	10	0	0	2	5	215	655	0	0	1	1
8:15 AM	0	2	41	3	0	7	58	1	0	12	6	6	0	0	7	7	150		0	0	1	0
8:30 AM	0	8	36	5	0	1	47	1	0	12	4	6	0	1	4	8	133		0	0	0	0
8:45 AM	0	6	35	4	0	5	65	1	0	11	2	3	0	2	8	15	157		0	0	0	0
Count Total	0	33	346	102	0	126	770	13	0	121	44	84	0	12	55	85	1,791		16	4	5	10
Peak Hour	0	13	179	80	0	104	499	10	0	71	28	59	0	9	34	50	1,136		16	4	3	9

Location: 1 HATHAWAY DR & GALLEY RD PM

Date: Wednesday, August 23, 2023

Peak Hour: 04:00 PM - 05:00 PM

Peak 15-Minutes: 04:00 PM - 04:15 PM

Peak Hour - Motorized Vehicles

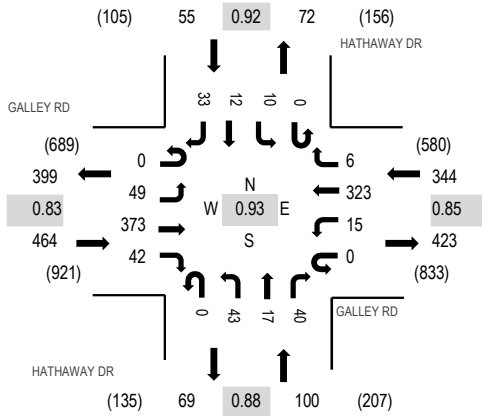

Peak Hour - Bicycles

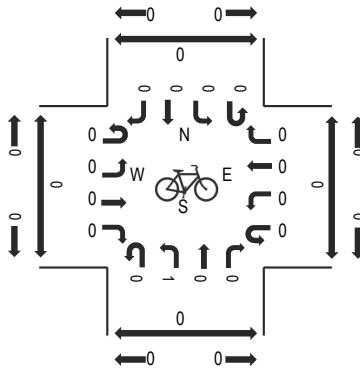

Peak Hour - Pedestrians

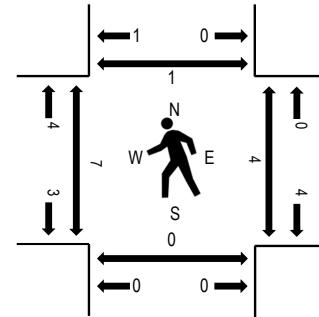

Note: Total study counts contained in parentheses.

Traffic Counts - Motorized Vehicles

Interval Start Time	GALLEY RD Eastbound				GALLEY RD Westbound				HATHAWAY DR Northbound				HATHAWAY DR Southbound				Total	Rolling Hour	Pedestrian Crossings			
	U-Turn	Left	Thru	Right	U-Turn	Left	Thru	Right	U-Turn	Left	Thru	Right	U-Turn	Left	Thru	Right			West	East	South	North
4:00 PM	0	10	101	12	0	2	95	4	0	10	6	6	0	1	3	8	258	963	1	0	0	1
4:15 PM	0	13	102	11	0	2	83	0	0	12	5	11	0	2	2	10	253	961	1	4	0	0
4:30 PM	0	15	93	8	0	6	70	1	0	16	2	10	0	5	2	6	234	903	5	0	0	0
4:45 PM	0	11	77	11	0	5	75	1	0	5	4	13	0	2	5	9	218	878	0	0	0	0
5:00 PM	0	13	121	13	0	4	54	4	0	11	6	14	0	3	5	8	256	850	1	1	0	0
5:15 PM	0	15	79	8	0	0	54	3	0	12	6	5	0	1	5	7	195		0	1	0	1
5:30 PM	0	15	87	8	0	2	61	1	0	11	4	7	0	4	3	6	209		2	0	0	0
5:45 PM	0	8	79	11	0	3	48	2	0	14	7	10	0	0	4	4	190		2	0	0	1
Count Total	0	100	739	82	0	24	540	16	0	91	40	76	0	18	29	58	1,813		12	6	0	3
Peak Hour	0	49	373	42	0	15	323	6	0	43	17	40	0	10	12	33	963		7	4	0	1

Location: 2 WESTERN DR & GALLEY RD AM

Date: Wednesday, August 23, 2023

Peak Hour: 07:15 AM - 08:15 AM

Peak 15-Minutes: 07:45 AM - 08:00 AM

Peak Hour - Motorized Vehicles

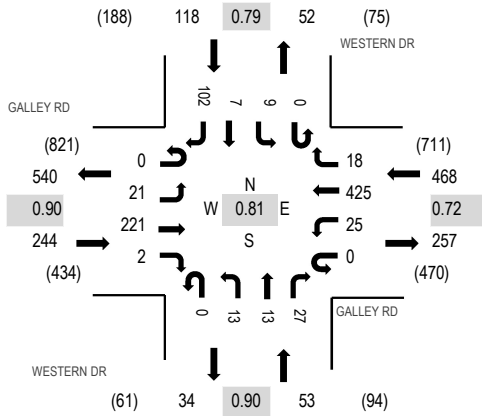

Peak Hour - Bicycles

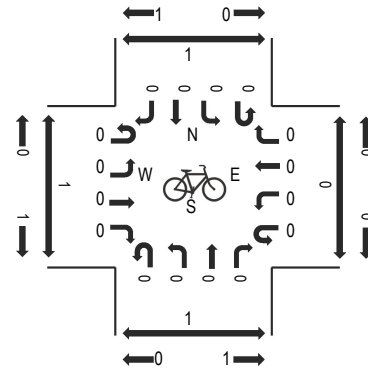

Peak Hour - Pedestrians

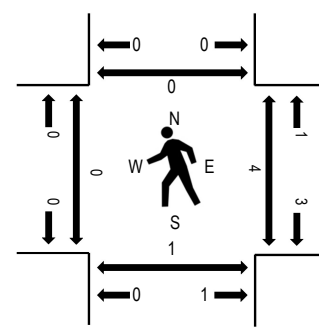

Note: Total study counts contained in parentheses.

Traffic Counts - Motorized Vehicles

Interval Start Time	GALLEY RD Eastbound				GALLEY RD Westbound				WESTERN DR Northbound				WESTERN DR Southbound				Total	Rolling Hour	Pedestrian Crossings			
	U-Turn	Left	Thru	Right	U-Turn	Left	Thru	Right	U-Turn	Left	Thru	Right	U-Turn	Left	Thru	Right			West	East	South	North
7:00 AM	0	3	59	1	0	4	75	2	0	7	0	10	0	4	0	19	184	881	0	0	0	2
7:15 AM	0	3	56	0	0	1	73	5	0	7	2	4	0	7	0	28	186	883	0	2	0	0
7:30 AM	0	8	46	1	0	4	125	4	0	1	2	11	0	0	3	35	240	821	0	2	1	0
7:45 AM	0	6	62	0	0	11	147	4	0	3	6	8	0	2	1	21	271	695	0	0	0	0
8:00 AM	0	4	57	1	0	9	80	5	0	2	3	4	0	0	3	18	186	546	0	0	0	0
8:15 AM	0	2	40	1	0	4	45	3	0	2	0	7	0	1	1	18	124		0	0	0	0
8:30 AM	0	2	44	0	0	6	40	4	0	3	1	5	0	5	1	3	114		0	0	0	0
8:45 AM	0	3	35	0	0	7	52	1	0	3	2	1	0	2	2	14	122		0	1	0	1
Count Total	0	31	399	4	0	46	637	28	0	28	16	50	0	21	11	156	1,427		0	5	1	3
Peak Hour	0	21	221	2	0	25	425	18	0	13	13	27	0	9	7	102	883		0	4	1	0

Peak Hour - Motorized Vehicles

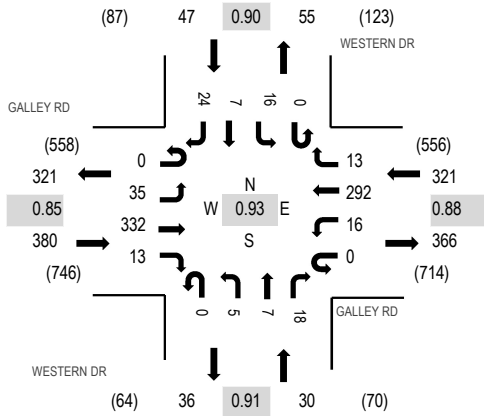

Peak Hour - Bicycles

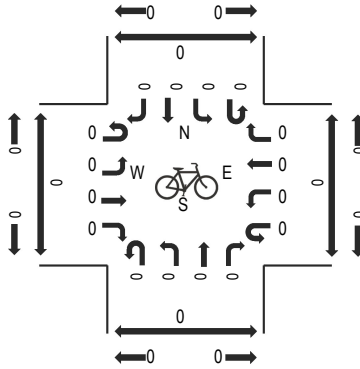

Peak Hour - Pedestrians

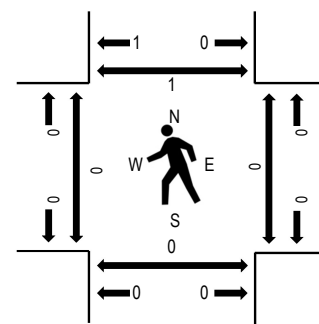

Note: Total study counts contained in parentheses.

Traffic Counts - Motorized Vehicles

Interval Start Time	GALLEY RD Eastbound				GALLEY RD Westbound				WESTERN DR Northbound				WESTERN DR Southbound				Total	Rolling Hour	Pedestrian Crossings			
	U-Turn	Left	Thru	Right	U-Turn	Left	Thru	Right	U-Turn	Left	Thru	Right	U-Turn	Left	Thru	Right			West	East	South	North
4:00 PM	0	9	84	4	0	5	83	3	0	3	3	3	0	4	4	5	210	778	0	0	0	1
4:15 PM	0	9	96	3	0	3	72	2	0	0	1	3	0	5	1	7	202	777	0	0	0	0
4:30 PM	0	10	81	4	0	5	68	7	0	1	2	6	0	3	2	8	197	739	0	0	0	0
4:45 PM	0	7	71	2	0	3	69	1	0	1	1	6	0	4	0	4	169	702	0	0	0	0
5:00 PM	0	11	106	1	0	8	61	4	0	2	3	6	0	1	1	5	209	681	0	0	0	0
5:15 PM	0	14	70	2	0	5	47	4	0	2	1	7	0	4	1	7	164		0	0	0	0
5:30 PM	0	9	76	0	0	1	44	6	0	3	1	6	0	2	0	12	160		0	1	0	0
5:45 PM	0	10	63	4	0	4	48	3	0	2	2	5	0	2	1	4	148		0	0	0	0
Count Total	0	79	647	20	0	34	492	30	0	14	14	42	0	25	10	52	1,459		0	1	0	1
Peak Hour	0	35	332	13	0	16	292	13	0	5	7	18	0	16	7	24	778		0	0	0	1



(303) 216-2439
www.alltrafficdata.net

Location: 3 HATHAWAY DR & US 24 AM
Date: Wednesday, August 23, 2023
Peak Hour: 07:00 AM - 08:00 AM
Peak 15-Minutes: 07:15 AM - 07:30 AM

Peak Hour - Motorized Vehicles

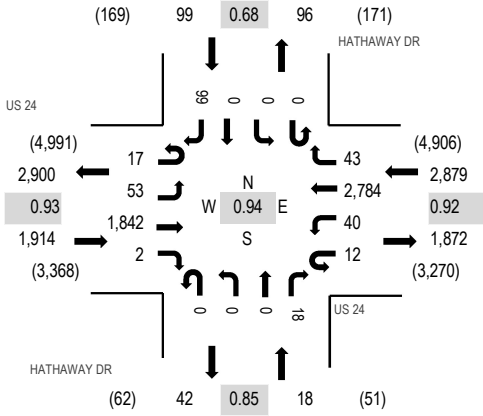

Peak Hour - Bicycles

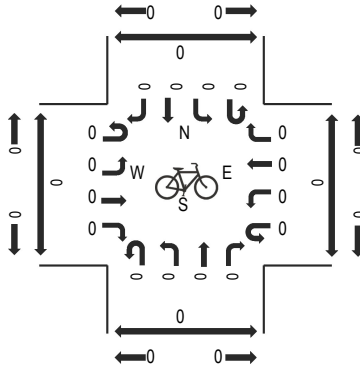

Peak Hour - Pedestrians

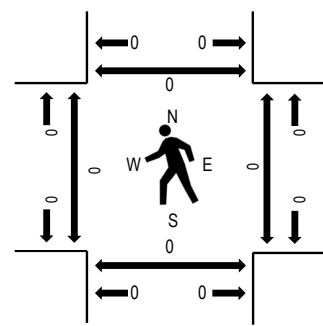

Note: Total study counts contained in parentheses.

Traffic Counts - Motorized Vehicles

Interval Start Time	US 24 Eastbound				US 24 Westbound				HATHAWAY DR Northbound				HATHAWAY DR Southbound				Total	Rolling Hour	Pedestrian Crossings			
	U-Turn	Left	Thru	Right	U-Turn	Left	Thru	Right	U-Turn	Left	Thru	Right	U-Turn	Left	Thru	Right			West	East	South	North
7:00 AM	5	14	444	0	0	10	641	7	0	0	0	3	0	0	0	19	1,143	4,910	0	0	0	0
7:15 AM	3	8	504	1	1	8	765	8	0	0	0	2	0	0	0	12	1,312	4,772	0	0	0	0
7:30 AM	2	16	491	1	6	12	700	17	0	0	0	6	0	0	0	30	1,281	4,375	0	0	0	0
7:45 AM	7	15	403	0	5	10	678	11	0	0	0	7	0	0	0	38	1,174	3,986	0	0	0	0
8:00 AM	9	13	341	0	2	7	597	9	0	0	0	9	0	0	0	18	1,005	3,584	0	0	0	0
8:15 AM	12	16	348	1	0	8	498	5	0	0	0	10	0	0	0	17	915		0	0	0	0
8:30 AM	9	13	358	0	0	4	486	1	0	0	0	8	0	0	0	13	892		0	0	0	0
8:45 AM	6	13	315	0	1	0	404	5	0	0	0	6	0	0	0	22	772		1	0	0	1
Count Total	53	108	3,204	3	15	59	4,769	63	0	0	0	51	0	0	0	169	8,494		1	0	0	1
Peak Hour	17	53	1,842	2	12	40	2,784	43	0	0	0	18	0	0	0	99	4,910		0	0	0	0

Peak Hour - Motorized Vehicles

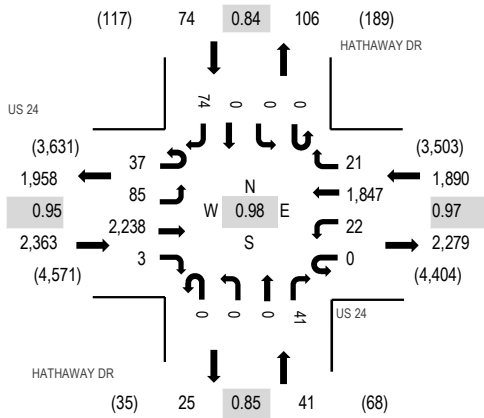

Peak Hour - Bicycles

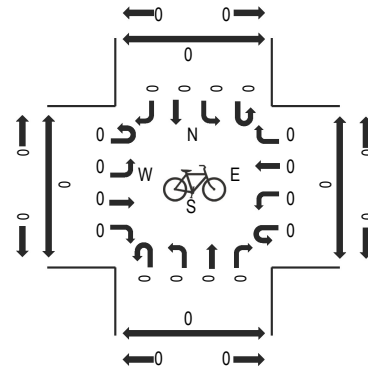

Peak Hour - Pedestrians

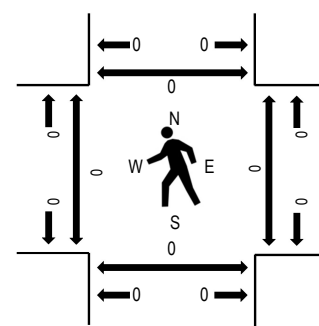

Note: Total study counts contained in parentheses.

Traffic Counts - Motorized Vehicles

Interval Start Time	US 24 Eastbound				US 24 Westbound				HATHAWAY DR Northbound				HATHAWAY DR Southbound				Total	Rolling Hour	Pedestrian Crossings			
	U-Turn	Left	Thru	Right	U-Turn	Left	Thru	Right	U-Turn	Left	Thru	Right	U-Turn	Left	Thru	Right			West	East	South	North
4:00 PM	12	18	552	0	2	2	433	9	0	0	0	12	0	0	0	19	1,059	4,316	0	0	0	0
4:15 PM	8	22	531	0	0	9	457	8	0	0	0	12	0	0	0	19	1,066	4,368	0	0	0	0
4:30 PM	8	15	598	1	0	6	461	5	0	0	0	7	0	0	0	16	1,117	4,309	0	0	0	0
4:45 PM	7	29	548	0	0	4	450	3	0	0	0	10	0	0	0	23	1,074	4,144	0	0	0	0
5:00 PM	14	19	561	2	0	3	479	5	0	0	0	12	0	0	0	16	1,111	3,943	0	0	0	0
5:15 PM	10	13	544	0	2	2	420	2	0	0	0	4	0	0	0	10	1,007		0	0	1	0
5:30 PM	14	21	520	1	0	5	373	2	0	0	0	8	0	0	0	8	952		0	0	0	0
5:45 PM	9	17	477	0	1	0	359	1	0	0	0	3	0	0	0	6	873		0	0	0	0
Count Total	82	154	4,331	4	5	31	3,432	35	0	0	0	68	0	0	0	117	8,259		0	0	1	0
Peak Hour	37	85	2,238	3	0	22	1,847	21	0	0	0	41	0	0	0	74	4,368		0	0	0	0

Peak Hour - Motorized Vehicles

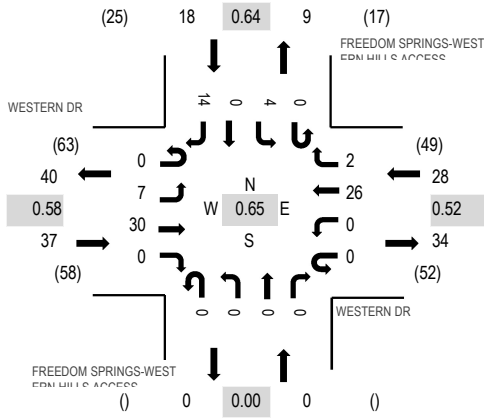

Peak Hour - Bicycles

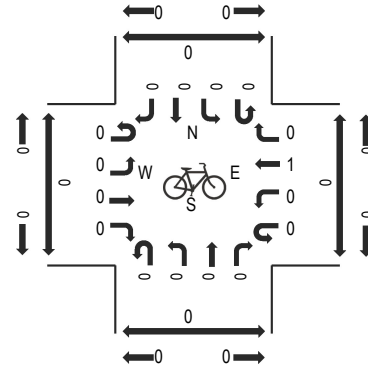

Peak Hour - Pedestrians

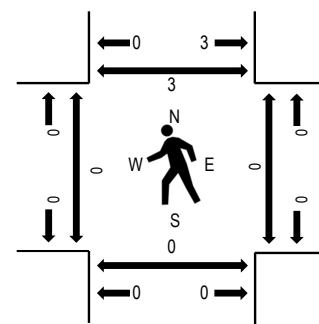

Note: Total study counts contained in parentheses.

Traffic Counts - Motorized Vehicles

Interval Start Time	WESTERN DR Eastbound				WESTERN DR Westbound				FREEDOM SPRINGS- WESTERN HILLS ACCESS Northbound				FREEDOM SPRINGS- WESTERN HILLS ACCESS Southbound				Total	Rolling Hour	Pedestrian Crossings			
	U-Turn	Left	Thru	Right	U-Turn	Left	Thru	Right	U-Turn	Left	Thru	Right	U-Turn	Left	Thru	Right			West	East	South	North
7:00 AM	0	0	4	0	0	0	4	0	0	0	0	0	0	3	0	4	15	83	0	0	0	0
7:15 AM	0	2	3	0	0	0	2	1	0	0	0	0	0	0	0	6	14	82	0	0	0	0
7:30 AM	0	0	12	0	0	0	5	0	0	0	0	0	0	1	0	4	22	76	0	0	0	1
7:45 AM	0	5	11	0	0	0	15	1	0	0	0	0	0	0	0	0	32	69	0	0	0	2
8:00 AM	0	1	2	0	0	0	8	1	0	0	0	0	0	1	0	1	14	49	0	0	0	1
8:15 AM	0	2	4	0	0	0	1	1	0	0	0	0	0	0	0	0	8		0	0	0	0
8:30 AM	0	0	8	0	0	0	3	1	0	0	0	0	0	0	0	3	15		0	0	0	1
8:45 AM	0	1	3	0	0	0	5	1	0	0	0	0	0	0	0	2	12		0	0	0	0
Count Total	0	11	47	0	0	0	43	6	0	0	0	0	0	5	0	20	132		0	0	0	5
Peak Hour	0	7	30	0	0	0	26	2	0	0	0	0	0	4	0	14	83		0	0	0	3

Peak Hour - Motorized Vehicles

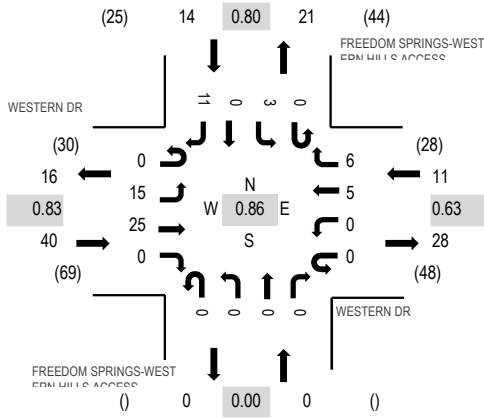

Peak Hour - Bicycles

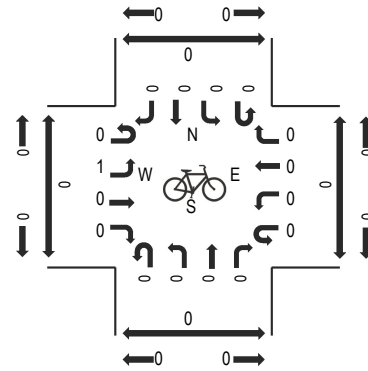

Peak Hour - Pedestrians

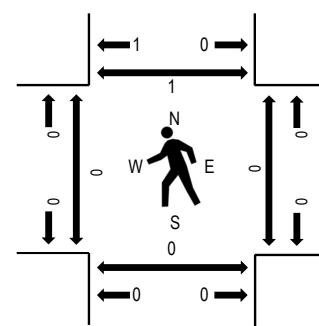

Note: Total study counts contained in parentheses.

Traffic Counts - Motorized Vehicles

Interval Start Time	WESTERN DR Eastbound				WESTERN DR Westbound				FREEDOM SPRINGS- WESTERN HILLS ACCESS Northbound				FREEDOM SPRINGS- WESTERN HILLS ACCESS Southbound				Total	Rolling Hour	Pedestrian Crossings			
	U-Turn	Left	Thru	Right	U-Turn	Left	Thru	Right	U-Turn	Left	Thru	Right	U-Turn	Left	Thru	Right			West	East	South	North
4:00 PM	0	4	3	0	0	0	6	1	0	0	0	0	0	3	0	1	18	59	0	0	0	0
4:15 PM	0	6	5	0	0	0	0	2	0	0	0	0	0	1	0	1	15	60	0	0	0	0
4:30 PM	0	1	3	0	0	0	1	2	0	0	0	0	0	1	0	4	12	62	0	0	0	0
4:45 PM	0	4	6	0	0	0	1	0	0	0	0	0	0	0	0	3	14	65	0	0	0	0
5:00 PM	0	4	8	0	0	0	1	3	0	0	0	0	0	1	0	2	19	63	0	0	0	0
5:15 PM	0	1	5	0	0	0	3	3	0	0	0	0	0	1	0	4	17		0	0	0	1
5:30 PM	0	6	6	0	0	0	0	0	0	0	0	0	0	1	0	2	15		0	0	0	0
5:45 PM	0	3	4	0	0	0	1	4	0	0	0	0	0	0	0	0	12		0	0	0	1
Count Total	0	29	40	0	0	0	13	15	0	0	0	0	0	8	0	17	122		0	0	0	2
Peak Hour	0	15	25	0	0	0	5	6	0	0	0	0	0	3	0	11	65		0	0	0	1

Peak Hour - Motorized Vehicles

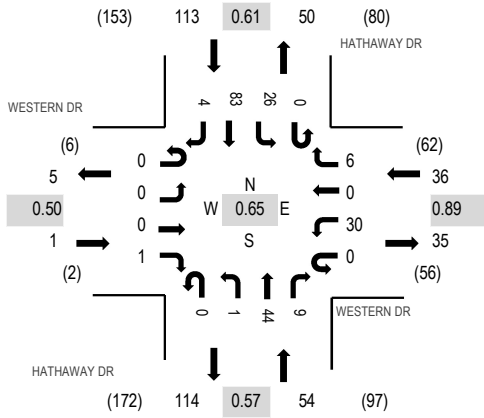

Peak Hour - Bicycles

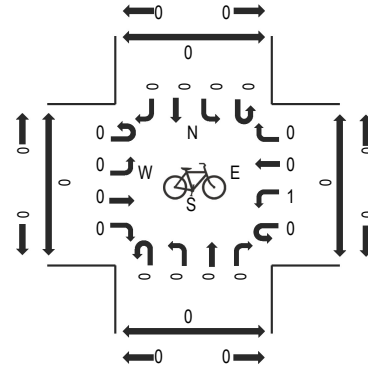

Peak Hour - Pedestrians

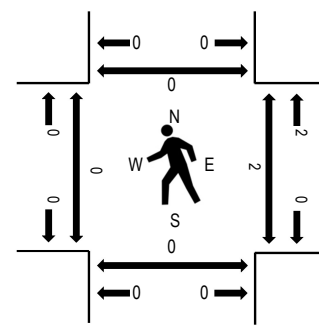

Note: Total study counts contained in parentheses.

Traffic Counts - Motorized Vehicles

Interval Start Time	WESTERN DR Eastbound				WESTERN DR Westbound				HATHAWAY DR Northbound				HATHAWAY DR Southbound				Total	Rolling Hour	Pedestrian Crossings			
	U-Turn	Left	Thru	Right	U-Turn	Left	Thru	Right	U-Turn	Left	Thru	Right	U-Turn	Left	Thru	Right			West	East	South	North
7:00 AM	0	0	0	0	0	6	0	2	0	0	8	4	0	0	15	0	35	204	0	0	0	0
7:15 AM	0	0	0	0	0	8	0	1	0	0	6	2	0	1	5	3	26	198	0	2	0	0
7:30 AM	0	0	0	0	0	6	0	3	0	0	23	1	0	13	33	0	79	202	0	0	0	0
7:45 AM	0	0	0	1	0	10	0	0	0	1	7	2	0	12	30	1	64	143	0	0	0	0
8:00 AM	0	0	0	0	0	9	0	2	0	0	7	2	0	2	7	0	29	110	0	0	0	0
8:15 AM	0	1	0	0	0	3	0	0	0	0	7	5	0	1	12	1	30		0	0	0	0
8:30 AM	0	0	0	0	0	4	0	0	0	0	4	8	0	0	4	0	20		0	0	0	0
8:45 AM	0	0	0	0	0	7	0	1	0	0	8	2	0	1	12	0	31		0	1	0	0
Count Total	0	1	0	1	0	53	0	9	0	1	70	26	0	30	118	5	314		0	3	0	0
Peak Hour	0	0	0	1	0	30	0	6	0	1	44	9	0	26	83	4	204		0	2	0	0

Location: 5 HATHAWAY DR & WESTERN DR PM

Date: Wednesday, August 23, 2023

Peak Hour: 04:15 PM - 05:15 PM

Peak 15-Minutes: 05:00 PM - 05:15 PM

Peak Hour - Motorized Vehicles

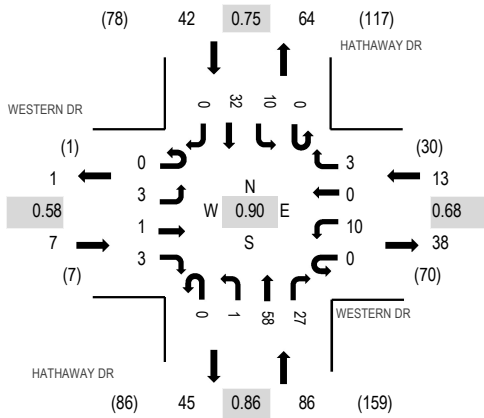

Peak Hour - Bicycles

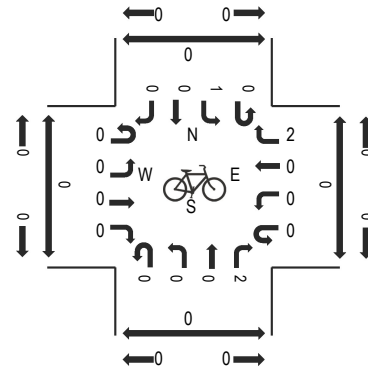

Peak Hour - Pedestrians

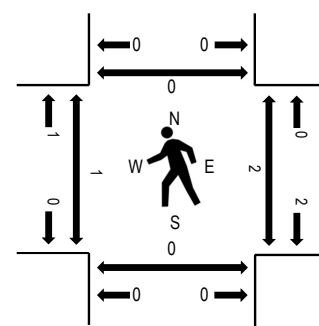

Note: Total study counts contained in parentheses.

Traffic Counts - Motorized Vehicles

Interval Start Time	WESTERN DR Eastbound				WESTERN DR Westbound				HATHAWAY DR Northbound				HATHAWAY DR Southbound				Total	Rolling Hour	Pedestrian Crossings			
	U-Turn	Left	Thru	Right	U-Turn	Left	Thru	Right	U-Turn	Left	Thru	Right	U-Turn	Left	Thru	Right			West	East	South	North
4:00 PM	0	0	0	0	0	5	0	2	0	0	13	4	0	3	8	0	35	142	0	0	0	0
4:15 PM	0	1	0	2	0	1	0	0	0	1	14	6	0	5	6	0	36	148	0	0	0	0
4:30 PM	0	2	0	1	0	4	0	1	0	0	15	4	0	0	4	0	31	139	0	2	0	0
4:45 PM	0	0	0	0	0	4	0	0	0	0	13	10	0	3	10	0	40	145	1	0	0	0
5:00 PM	0	0	1	0	0	1	0	2	0	0	16	7	0	2	12	0	41	132	0	0	0	0
5:15 PM	0	0	0	0	0	6	0	1	0	0	9	6	0	0	5	0	27		0	0	0	0
5:30 PM	0	0	0	0	0	1	0	1	0	0	15	10	0	2	8	0	37		0	0	0	0
5:45 PM	0	0	0	0	0	0	0	1	0	0	11	5	0	2	8	0	27		0	0	0	0
Count Total	0	3	1	3	0	22	0	8	0	1	106	52	0	17	61	0	274		1	2	0	0
Peak Hour	0	3	1	3	0	10	0	3	0	1	58	27	0	10	32	0	148		1	2	0	0

Peak Hour - Motorized Vehicles

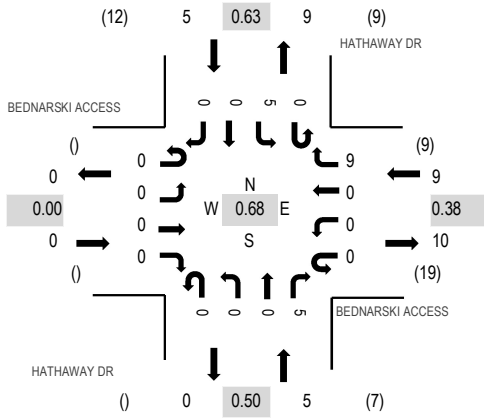

Peak Hour - Bicycles

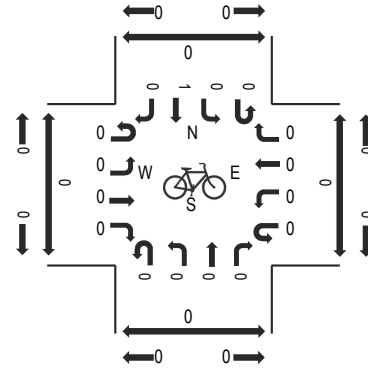

Peak Hour - Pedestrians

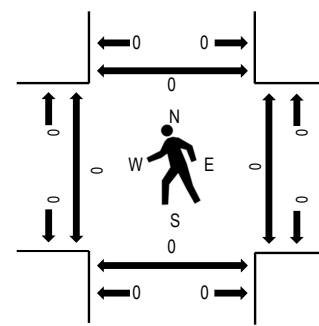

Note: Total study counts contained in parentheses.

Traffic Counts - Motorized Vehicles

Interval Start Time	BEDNARSKI ACCESS Eastbound				BEDNARSKI ACCESS Westbound				HATHAWAY DR Northbound				HATHAWAY DR Southbound				Total	Rolling Hour	Pedestrian Crossings			
	U-Turn	Left	Thru	Right	U-Turn	Left	Thru	Right	U-Turn	Left	Thru	Right	U-Turn	Left	Thru	Right			West	East	South	North
7:00 AM	0	0	0	0	0	0	0	0	0	0	0	1	0	2	0	0	3	16	0	0	0	0
7:15 AM	0	0	0	0	0	0	0	0	0	0	0	0	0	1	0	0	1	17	0	0	0	0
7:30 AM	0	0	0	0	0	0	0	0	0	0	0	1	0	4	0	0	5	18	0	0	0	0
7:45 AM	0	0	0	0	0	0	0	1	0	0	0	3	0	3	0	0	7	19	0	0	0	0
8:00 AM	0	0	0	0	0	0	0	0	0	0	0	2	0	2	0	0	4	12	0	0	0	0
8:15 AM	0	0	0	0	0	0	0	2	0	0	0	0	0	0	0	0	2		0	0	0	0
8:30 AM	0	0	0	0	0	0	0	6	0	0	0	0	0	0	0	0	6		0	0	0	0
8:45 AM	0	0	0	0	0	0	0	0	0	0	0	0	0	0	0	0	0		0	1	0	0
Count Total	0	0	0	0	0	0	0	9	0	0	0	7	0	12	0	0	28		0	1	0	0
Peak Hour	0	0	0	0	0	0	0	9	0	0	0	5	0	5	0	0	19		0	0	0	0

Peak Hour - Motorized Vehicles

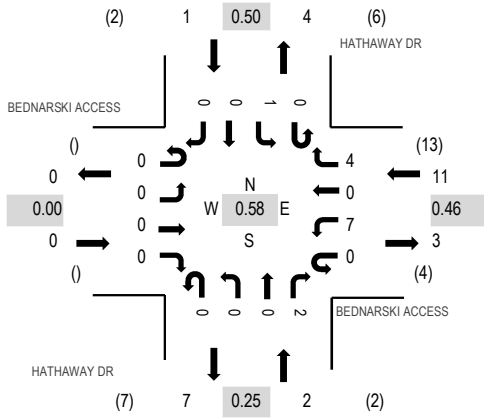

Peak Hour - Bicycles

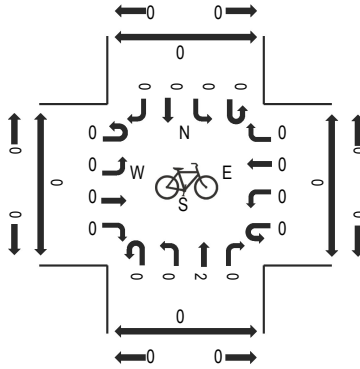

Peak Hour - Pedestrians

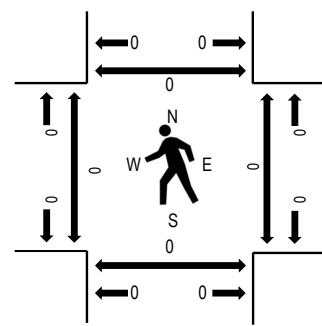

Note: Total study counts contained in parentheses.

Traffic Counts - Motorized Vehicles

Interval Start Time	BEDNARSKI ACCESS Eastbound				BEDNARSKI ACCESS Westbound				HATHAWAY DR Northbound				HATHAWAY DR Southbound				Total	Rolling Hour	Pedestrian Crossings			
	U-Turn	Left	Thru	Right	U-Turn	Left	Thru	Right	U-Turn	Left	Thru	Right	U-Turn	Left	Thru	Right			West	East	South	North
4:00 PM	0	0	0	0	0	0	0	1	0	0	0	0	0	0	0	0	1	14	0	0	0	0
4:15 PM	0	0	0	0	0	1	0	0	0	0	0	2	0	0	0	0	3	13	0	0	0	0
4:30 PM	0	0	0	0	0	3	0	3	0	0	0	0	0	0	0	0	6	11	0	0	0	0
4:45 PM	0	0	0	0	0	3	0	0	0	0	0	0	0	1	0	0	4	7	0	0	0	0
5:00 PM	0	0	0	0	0	0	0	0	0	0	0	0	0	0	0	0	0	3	0	0	0	0
5:15 PM	0	0	0	0	0	0	0	1	0	0	0	0	0	0	0	0	1		0	0	0	0
5:30 PM	0	0	0	0	0	0	0	1	0	0	0	0	0	1	0	0	2		0	0	0	0
5:45 PM	0	0	0	0	0	0	0	0	0	0	0	0	0	0	0	0	0		0	0	0	0
Count Total	0	0	0	0	0	7	0	6	0	0	0	2	0	2	0	0	17		0	0	0	0
Peak Hour	0	0	0	0	0	7	0	4	0	0	0	2	0	1	0	0	14		0	0	0	0

Start Time	23-Aug-23 Wed	EB	WB	Total
12:00 AM		4	3	7
01:00		0	1	1
02:00		4	1	5
03:00		3	1	4
04:00		2	6	8
05:00		5	15	20
06:00		15	21	36
07:00		35	36	71
08:00		21	26	47
09:00		11	21	32
10:00		31	25	56
11:00		28	25	53
12:00 PM		13	19	32
01:00		16	20	36
02:00		48	27	75
03:00		32	17	49
04:00		35	17	52
05:00		35	13	48
06:00		34	17	51
07:00		30	21	51
08:00		30	10	40
09:00		15	8	23
10:00		12	2	14
11:00		3	3	6
Total		462	355	817
Percent		56.5%	43.5%	
AM Peak	-	07:00	07:00	-
Vol.	-	35	36	-
PM Peak	-	14:00	14:00	-
Vol.	-	48	27	-
Grand Total		462	355	817
Percent		56.5%	43.5%	
ADT		ADT 817	ADT 817	AADT 817

9 + Key			C + F + Key		
FUNCTION	KEY	VALUE	FUNCTION	KEY	VALUE
Short Power Down	0	4	Page ID	0	0
Long Power Down	1	14	Reserved	1	0
EVA Delay Type	2	0	Reserved	2	0
EVB Delay Type	3	0	Reserved	3	0
EVC Delay Type	4	0	OLA Red	4	0.0
EVD Delay Type	5	0	OLB Red	5	0.0
RR Delay Type	6	0	OLC Red	6	0.0
Ped Inhibit	7	0	OLD Red	7	0.0
OLA Green	8	0.0			12345678
OLA Yellow	9	0.0	Overlap E	8	
OLB Green	A	0.0	Overlap F	9	
OLB Yellow	B	0.0	Red Rest	A	
OLC Green	C	0.0	Max Recall	B	
OLC Yellow	D	0.0	Flash Green	C	
OLD Green	E	0.0	Flash Walk	D	
OLD Yellow	F	0.0	Advance Walk	E	
			Restrictive Phase	F	

D + C + 9 + Key			D + C + B + Key		
FUNCTION	KEY	VALUE	FUNCTION	KEY	VALUE
Short Power Down	0	4	Page ID	0	1
Long Power Down	1	14	Reserved	1	0
EVA Delay Type	2	0	Reserved	2	0
EVB Delay Type	3	0	Reserved	3	0
EVC Delay Type	4	0	OLA Red	4	0.0
EVD Delay Type	5	0	OLB Red	5	0.0
RR Delay Type	6	0	OLC Red	6	0.0
Ped Inhibit	7	0	OLD Red	7	0.0
OLA Green	8	0.0			12345678
OLA Yellow	9	0.0	Overlap E	8	
OLB Green	A	0.0	Overlap F	9	
OLB Yellow	B	0.0	Red Rest	A	
OLC Green	C	0.0	Max Recall	B	
OLC Yellow	D	0.0	Flash Green	C	
OLD Green	E	0.0	Flash Walk	D	
OLD Yellow	F	0.0	Advance Walk	E	
			Restrictive Phase	F	

D + D + 9 + Key			D + D + B + Key		
FUNCTION	KEY	VALUE	FUNCTION	KEY	VALUE
Short Power Down	0	4	Page ID	0	2
Long Power Down	1	14	Reserved	1	0
EVA Delay Type	2	0	Reserved	2	0
EVB Delay Type	3	0	Reserved	3	0
EVC Delay Type	4	0	OLA Red	4	0.0
EVD Delay Type	5	0	OLB Red	5	0.0
RR Delay Type	6	0	OLC Red	6	0.0
Ped Inhibit	7	0	OLD Red	7	0.0
OLA Green	8	0.0			12345678
OLA Yellow	9	0.0	Overlap E	8	
OLB Green	A	0.0	Overlap F	9	
OLB Yellow	B	0.0	Red Rest	A	
OLC Green	C	0.0	Max Recall	B	
OLC Yellow	D	0.0	Flash Green	C	
OLD Green	E	0.0	Flash Walk	D	
OLD Yellow	F	0.0	Advance Walk	E	
			Restrictive Phase	F	

103 - Galley @ Hathaway
 Table 3 - Preempts
 12/22/2016
 8:40 AM

C + Key			E + Key		
FUNCTION	KEY	VALUE	FUNCTION	KEY	VALUE
Year	0	9	EVA Delay	0	0
Month	1	11	EVA Minimum	1	0
Day of Month	2	3	EVB Delay	2	0
		1234567	EVB Minimum	3	0
Day of Week	3	3	EVC Delay	4	0
		VALUE	EVC Minimum	5	0
Hour	4	10	EVD Delay	6	0
Minute	5	2	EVD Minimum	7	0
Second	6	10	OL Red Revert	8	0.0
Reserved	7	0	RR Delay	9	0
Triggers On In Flash	8	0	RR Clear	A	0
		12345678			12345678
Startup Yellow	9		RR Clear Phases	B	
EVA Phases	A		RR Permit	C	
EVB Phases	B		RR OL Permit	D	
EVC Phases	C		NEMA Hold Phases	E	
EVD Phases	D		Reserved	F	2
Handicap Ped	E				
Reserved	F				

103 - Galley @ Hathaway
 Table 4 - Detectors Timing
 12/22/2016
 8:41 AM

D + Col + Key			Delay				Carryover			
Detector Type			2		3		4		5	
Column No.										
KEY	CHANNEL (*)	PH	TIME	PH	TIME	PH	TIME	PH	TIME	
0	BOTH (1)	1	5.0	5	5.0	1	0.0	5	0.0	
1	UPPER (9)	1	5.0	5	5.0	1	0.0	5	0.0	
2	UPPER (2)	2	0.0	6	0.0	2	0.0	6	0.0	
3	LOWER (2)	2	0.0	6	0.0	2	0.0	6	0.0	
4	UPPER (3)	2	0.0	6	0.0	2	0.0	6	0.0	
5	LOWER (3)		0.0		0.0	2	0.0	6	0.0	
6	BOTH (4)	2	0.0	6	0.0	2*	0.0	6*	0.0	
7	BOTH (5)	3	0.0	7	0.0	3	0.0	7	0.0	
8	LOWER (9)	3	0.0	7	0.0	3	0.0	7	0.0	
9	UPPER (6)	4	5.0	8	5.0	4	0.0	8	0.0	
A	LOWER (6)	4	5.0	8	5.0	4	0.0	8	0.0	
B	UPPER (7)	4	5.0	8	5.0	4	0.0	8	0.0	
C	LOWER (7)		0.0		0.0	4	0.0	8	0.0	
D	BOTH (8)	4	5.0	8	5.0	4*	0.0	8*	0.0	
E	Reserved		0		0		0		0	
F	Reserved		0		0		0		0	

Note: * = Set Type 3 Detector

103 - Galley @ Hathaway
 Table 4 - Detectors Diagnostics
 12/22/2016
 8:41 AM

D + 9 + 4 + Key			D + 9 + 5 + Key		
FUNCTION	KEY	VALUE	FUNCTION	KEY	VALUE
Detector Fail On	0	0	DF 01 Min	0	0
Detector Fail Off	1	0	DF 02 Min	1	0
Fail Detector Backup	2	0	DF 03 Min	2	0
Max II In Delay	3	0	DF 04 Min	3	0
Max II In Carryover	4	0	DF 05 Min	4	0
Plan 9 In Delay	5	0	DF 06 Min	5	0
Plan 9 In Carryover	6	0	DF 07 Min	6	0
Plan 18 In Delay	7	0	DF 08 Min	7	0
Plan 18 In Carryover	8	0	DF 01 Max	8	0
TT Page 1 Delay	9	0	DF 02 Max	9	0
TT Page 1 Carryover	A	0	DF 03 Max	A	0
TT Page 2 Delay	B	0	DF 04 Max	B	0
TT Page 2 Carryover	C	0	DF 05 Max	C	0
NOVRAM	D	0	DF 06 Max	D	0
ACT Protocol	E	217	DF 07 Max	E	0
Release	F	0	DF 08 Max	F	0

103 - Galley @ Hathaway
 Table 6 - Coordination Functions
 12/22/2016 8:41 AM

B + 0 + Key			D + Key		
FUNCTION	KEY	VALUE	FUNCTION	KEY	VALUE
Present Plan	0	0	Floating Ped	2E	0
TOD/DOW Plan	1	0	ID Number	2F	103
Hardwire Plan	2	0	No Coord Ped Recall	3E	0
Modem Plan	3	0	Rest In Walk	3F	0
Mode (0-4)	4	0	Adv Warning EOG	4E	0
Master (0 = Off)	5	0	Adv Warning SOG	4F	0
Master Clock	6	0	RR Red Clear	5E	0
Local Clock	7	0	RR Clear Color	5F	0
Dwell Clock	8	0	Bus Delay	6D	0.0
Reserved	9	0	Bus Free T1	6E	0
Reserved	A	0	Bus Free T3	6F	0
Reserved	B	0	EV Min After Clear	7E	0
		1 2 3 4 5 6 7 8	EV Indicators	7F	0
Reserved	C		NEMA Inputs	66	0
NEMA CNA Phase	D		Reserved		0
Adv Warning Phase	E		Reserved		0
MRI Phase	F	1 4 5 8			

A + 4 + Key			A + 5 + Key			A + 6 + Key		
C1 PIN (CODE)	KEY	VALUE	C1 PIN (CODE)	KEY	VALUE	C1 PIN (CODE)	KEY	VALUE
PH2 E&C #39(11)	0	0	PH5 E&C #55(31)	0	12	PH2 PPB #67(51)	0	13
PH6 E&C #40(12)	1	31	PH1 E&C #56(32)	1	14	PH6 PPB #68(52)	1	15
PH4 E&C #41(13)	2	16	PH7 E&C #57(33)	2	51	PH4 PPB #69(53)	2	35
PH8 E&C #42(14)	3	32	PH3 E&C #58(34)	3	53	PH8 PPB #70(54)	3	36
PH2 E&C #43(15)	4	17	PH5 E&C #59(35)	4	52	EVA #71(55)	4	0
PH6 E&C #44(16)	5	33	PH1 E&C #60(36)	5	54	EVB #72(56)	5	0
PH4 E&C #45(17)	6	18	PH7 E&C #61(37)	6	0	EVC #73(57)	6	0
PH8 E&C #46(18)	7	34	PH3 E&C #62(38)	7	0	EVD #74(58)	7	0
PH2 C #47(21)	8	0	N/U	8	0	(-) #75 (61)	8	0
PH6 C #48(22)	9	0	N/U	9	0	PH2 E. #76(62)	9	0
PH4 C #49(23)	A	0	N/U	A	0	PH6 E. #77(63)	A	0
PH8 C #50(24)	B	0	N/U	B	0	PH4 E. #78(64)	B	0
PED INH. #51(25)	C	0	PH2 E&C #63(45)	C	0	PH8 E. #79(65)	C	0
RR #52(26)	D	0	PH6 E&C #64(46)	D	0	ADV. #80(66)	D	0
ADV. EN #53(27)	E	0	PH4 E&C #65(47)	E	0	FL SENCE #81(67)	E	0
(-) #54(28)	F	0	PH8 E&C #66(48)	F	0	STOP TIME #82(68)	F	0

D + A + 4 + Key			D + A + 5 + Key			D + A + 6 + Key		
C1 PIN (CODE)	KEY	VALUE	C1 PIN (CODE)	KEY	VALUE	C1 PIN (CODE)	KEY	VALUE
PH2 E&C #39(11)	0	0	PH5 E&C #55(31)	0	12	PH2 PPB #67(51)	0	13
PH6 E&C #40(12)	1	31	PH1 E&C #56(32)	1	14	PH6 PPB #68(52)	1	15
PH4 E&C #41(13)	2	16	PH7 E&C #57(33)	2	51	PH4 PPB #69(53)	2	35
PH8 E&C #42(14)	3	32	PH3 E&C #58(34)	3	53	PH8 PPB #70(54)	3	36
PH2 E&C #43(15)	4	17	PH5 E&C #59(35)	4	52	EVA #71(55)	4	0
PH6 E&C #44(16)	5	33	PH1 E&C #60(36)	5	54	EVB #72(56)	5	0
PH4 E&C #45(17)	6	18	PH7 E&C #61(37)	6	0	EVC #73(57)	6	0
PH8 E&C #46(18)	7	34	PH3 E&C #62(38)	7	0	EVD #74(58)	7	0
PH2 C #47(21)	8	0	N/U	8	0	(-) #75 (61)	8	0
PH6 C #48(22)	9	0	N/U	9	0	PH2 E. #76(62)	9	0
PH4 C #49(23)	A	0	N/U	A	0	PH6 E. #77(63)	A	0
PH8 C #50(24)	B	0	N/U	B	0	PH4 E. #78(64)	B	0
PED INH. #51(25)	C	0	PH2 E&C #63(45)	C	0	PH8 E. #79(65)	C	0
RR #52(26)	D	0	PH6 E&C #64(46)	D	0	ADV. #80(66)	D	0
ADV. EN #53(27)	E	0	PH4 E&C #65(47)	E	0	FL SENCE #81(67)	E	0
(-) #54(28)	F	0	PH8 E&C #66(48)	F	0	STOP TIME #82(68)	F	0

D + A + B + Key			D + A + C + Key			D + A + D + Key		
C1 PIN (CODE)	KEY	VALUE	C1 PIN (CODE)	KEY	VALUE	C1 PIN (CODE)	KEY	VALUE
PH2 E&C #39(11)	0	0	PH5 E&C #55(31)	0	12	PH2 PPB #67(51)	0	13
PH6 E&C #40(12)	1	31	PH1 E&C #56(32)	1	14	PH6 PPB #68(52)	1	15
PH4 E&C #41(13)	2	16	PH7 E&C #57(33)	2	51	PH4 PPB #69(53)	2	35
PH8 E&C #42(14)	3	32	PH3 E&C #58(34)	3	53	PH8 PPB #70(54)	3	36
PH2 E&C #43(15)	4	17	PH5 E&C #59(35)	4	52	EVA #71(55)	4	0
PH6 E&C #44(16)	5	33	PH1 E&C #60(36)	5	54	EVB #72(56)	5	0
PH4 E&C #45(17)	6	18	PH7 E&C #61(37)	6	0	EVC #73(57)	6	0
PH8 E&C #46(18)	7	34	PH3 E&C #62(38)	7	0	EVD #74(58)	7	0
PH2 C #47(21)	8	0	N/U	8	0	(-) #75 (61)	8	0
PH6 C #48(22)	9	0	N/U	9	0	PH2 E. #76(62)	9	0
PH4 C #49(23)	A	0	N/U	A	0	PH6 E. #77(63)	A	0
PH8 C #50(24)	B	0	N/U	B	0	PH4 E. #78(64)	B	0
PED INH. #51(25)	C	0	PH2 E&C #63(45)	C	0	PH8 E. #79(65)	C	0
RR #52(26)	D	0	PH6 E&C #64(46)	D	0	ADV. #80(66)	D	0
ADV. EN #53(27)	E	0	PH4 E&C #65(47)	E	0	FL SENCE #81(67)	E	0
(-) #54(28)	F	0	PH8 E&C #66(48)	F	0	STOP TIME #82(68)	F	0

A + 0 + Key			A + 1 + Key			A + 2 + Key			A + 3 + Key		
FUNCTION(CODE)	KEY	VALUE	FUNCTION	KEY	VALUE	FUNCTION	KEY	VALUE	FUNCTION	KEY	VALUE
04 D/W (11)	0	41	08 D/W (31)	0	46	02 Ped Yellow(51)	0	37	01 D/W (71)	0	0
04 Walk (12)	1	42	08 Walk (32)	1	48	06 Ped Yellow(52)	1	44	01 Walk (72)	1	0
04 Red (13)	2	21	08 Red (33)	2	0	04 Ped Yellow(53)	2	52	OLB Red (73)	2	66
04 Yellow (14)	3	51	08 Yellow (34)	3	0	08 Ped Yellow(54)	3	47	OLB Yellow (74)	3	67
04 Green (15)	4	22	08 Green (35)	4	0	03 Ped Yellow(55)	4	0	OLB Green (75)	4	68
03 Red (16)	5	0	07 Red (36)	5	31	01 Ped Yellow(56)	5	0	OLA Red (76)	5	63
03 Yellow (17)	6	0	07 Yellow (37)	6	54	Flash (57)	6	0	OLA Yellow (77)	6	64
03 Green (18)	7	0	07 Green (38)	7	32	Watchdog (58)	7	0	OLA Green (78)	7	65
02 D/W (21)	8	36	06 D/W (41)	8	43	03 D/W (61)	8	0	Reserved	8	0
02 Walk (22)	9	38	06 Walk (42)	9	45	03 Walk (62)	9	0	S.D.	9	0
02 Red (23)	A	13	06 Red (43)	A	26	OLD Red (63)	A	73	LTT	A	2
02 Yellow (24)	B	14	06 Yellow (44)	B	27	OLD Yellow (64)	B	74	ID (MSB)	B	0
02 Green (25)	C	15	06 Green (45)	C	28	OLD Green (65)	C	75	Group 1	C	0
01 Red (26)	D	11	05 Red (46)	D	23	OLC Red (66)	D	77	Group 2	D	0
01 Yellow (27)	E	53	05 Yellow (47)	E	24	OLC Yellow (67)	E	76	Group 3	E	0
01 Green (28)	F	12	05 Green (48)	F	25	OLC Green (68)	F	78	Group 4	F	0

D + A + 0 + Key			D + A + 1 + Key			D + A + 2 + Key			D + A + 3 + Key		
FUNCTION(CODE	KEY	VALUE	FUNCTION (CODE	KEY	VALUE	FUNCTION (CODE	KEY	VALUE	FUNCTION (CODE	KEY	VALUE
04 D/W (11)	0	41	08 D/W (31)	0	46	02 Ped Yellow(51)	0	37	01 D/W (71)	0	0
04 Walk (12)	1	42	08 Walk (32)	1	48	06 Ped Yellow(52)	1	44	01 Walk (72)	1	0
04 Red (13)	2	21	08 Red (33)	2	0	04 Ped Yellow(53)	2	52	0LB Red (73)	2	66
04 Yellow (14)	3	51	08 Yellow (34)	3	0	08 Ped Yellow(54)	3	47	0LB Yellow (74)	3	67
04 Green (15)	4	22	08 Green (35)	4	0	03 Ped Yellow(55)	4	0	0LB Green (75)	4	68
03 Red (16)	5	0	07 Red (36)	5	31	01 Ped Yellow(56)	5	0	OLA Red (76)	5	63
03 Yellow (17)	6	0	07 Yellow (37)	6	54	Flash (57)	6	0	OLA Yellow (77)	6	64
03 Green (18)	7	0	07 Green (38)	7	32	Watchdog (58)	7	0	OLA Green (78)	7	65
02 D/W (21)	8	36	06 D/W (41)	8	43	03 D/W (61)	8	0	Reserved	8	0
02 Walk (22)	9	38	06 Walk (42)	9	45	03 Walk (62)	9	0	S.D.	9	0
02 Red (23)	A	13	06 Red (43)	A	26	OLD Red (63)	A	73	LTT	A	2
02 Yellow (24)	B	14	06 Yellow (44)	B	27	OLD Yellow (64)	B	74	Preemption Timeou	B	0
02 Green (25)	C	15	06 Green (45)	C	28	OLD Green (65)	C	75	EV Minimum Greer	C	0
01 Red (26)	D	11	05 Red (46)	D	23	OLC Red (66)	D	77	EV Minimum DW	D	0
01 Yellow (27)	E	53	05 Yellow (47)	E	24	OLC Yellow (67)	E	76	E.O.G on Ring 2	E	0
01 Green (28)	F	12	05 Green (48)	F	25	OLC Green (68)	F	78	S.O.G on Ring 2	F	0

D + A + 7 + Key			D + A + 8 + Key			D + A + 9 + Key			D + A + A + Key		
FUNCTION(CODE	KEY	VALUE	FUNCTION (CODE	KEY	VALUE	FUNCTION (CODE	KEY	VALUE	FUNCTION (CODE	KEY	VALUE
04 D/W (11)	0	41	08 D/W (31)	0	46	02 Ped Yellow(51)	0	37	01 D/W (71)	0	0
04 Walk (12)	1	42	08 Walk (32)	1	48	06 Ped Yellow(52)	1	44	01 Walk (72)	1	0
04 Red (13)	2	21	08 Red (33)	2	0	04 Ped Yellow(53)	2	52	OLB Red (73)	2	66
04 Yellow (14)	3	51	08 Yellow (34)	3	0	08 Ped Yellow(54)	3	47	OLB Yellow (74)	3	67
04 Green (15)	4	22	08 Green (35)	4	0	03 Ped Yellow(55)	4	0	OLB Green (75)	4	68
03 Red (16)	5	0	07 Red (36)	5	31	01 Ped Yellow(56)	5	0	OLA Red (76)	5	63
03 Yellow (17)	6	0	07 Yellow (37)	6	54	Flash (57)	6	0	OLA Yellow (77)	6	64
03 Green (18)	7	0	07 Green (38)	7	32	Watchdog (58)	7	0	OLA Green (78)	7	65
02 D/W (21)	8	36	06 D/W (41)	8	43	03 D/W (61)	8	0	Reserved	8	0
02 Walk (22)	9	38	06 Walk (42)	9	45	03 Walk (62)	9	0	S.D.	9	0
02 Red (23)	A	13	06 Red (43)	A	26	OLD Red (63)	A	73	LTT	A	2
02 Yellow (24)	B	14	06 Yellow (44)	B	27	OLD Yellow (64)	B	74	ID (MSB)	B	0
02 Green (25)	C	15	06 Green (45)	C	28	OLD Green (65)	C	75	Group 1	C	0
01 Red (26)	D	11	05 Red (46)	D	23	OLC Red (66)	D	77	Group 2	D	0
01 Yellow (27)	E	53	05 Yellow (47)	E	24	OLC Yellow (67)	E	76	Group 3	E	0
01 Green (28)	F	12	05 Green (48)	F	25	OLC Green (68)	F	78	Group 4	F	0

103 - Galley @ Hathaway
 Table 13 - Additional Overlaps
 12/22/2016 8:41 AM

D + 9 + 0 + Key			D + 9 + 3 + Key			E + F + Key		
FUNCTION	KEY	12345678	FUNCTION	KEY	VALUE	FUNCTION	KEY	VALUE
Overlap H	0		OLH Green	0	0.0	RR Max II	0	0
Overlap J	1		OLH Yellow	1	0.0	Ped Perm Plan 1	1	0
Overlap K	2		OLH Red	2	0.0	Ped Perm Plan 2	2	0
Overlap L	3		OLJ Green	3	0.0	Ped Perm Plan 3	3	0
OLH Switchpack	4		OLJ Yellow	4	0.0	Ped Perm Plan 4	4	0
OLJ Switchpack	5		OLJ Red	5	0.0	Ped Perm Plan 5	5	0
OLK Switchpack	6		OLK Green	6	0.0	Ped Perm Plan 6	6	0
OLL Switchpack	7		OLK Yellow	7	0.0	Ped Perm Plan 7	7	0
Reserved	8		OLK Red	8	0.0	Ped Perm Plan 8	8	0
TimeKeeper (hc11)	9		OLL Green	9	0.0	Ped Perm Plan 9	9	0
All Red B4 EV	A		OLL Yellow	A	0.0	Long Power Outs	A	0
Reserved	B		OLL Red	B	0.0	Short Power Outs	B	0
Reserved	C		Spring DST	C	0	Failed Detectors	C	0
Reserved	D		Reserved	D		Max II On	D	0
Reserved	E		TR-3 GPS(6800)	E	0	Fall DST	E	0
Reserved	F		RTC Clock	F	0	Revision Level	F	17

APPENDIX B

Level of Service Definitions

The following information is referenced from the Highway Capacity Manual: A Guide for Multimodal Mobility Analysis, 6th Edition, Transportation Research Board, 2016: Chapter 19 – Signalized Intersections.

Motorized Vehicle Level of Service (LOS) for Signalized Intersections

Levels of service are defined to represent reasonable ranges in control delay.

LOS A Describes operations with a control delay of 10 s/veh or less and a volume-to-capacity ratio no greater than 1.0. This level is typically assigned when the volume-to-capacity ratio is low and either progression is exceptionally favorable or the cycle length is very short. If it is due to favorable progression, most vehicles arrive during the green indication and travel through the intersection without stopping.

LOS B Describes operations with control delay between 10 and 20 s/veh and a volume-to-capacity ratio no greater than 1.0. This level is typically assigned when the volume-to-capacity ratio is low and either progression is highly favorable or the cycle length is short. More vehicles stop than with LOS A.

LOS C Describes operations with control delay between 20 and 35 s/veh and a volume-to-capacity ratio no greater than 1.0. This level is typically assigned when progression is favorable or the cycle length is moderate. Individual *cycle failures* (i.e., one or more queued vehicles are not able to depart as a result of insufficient capacity during the cycle) may begin to appear at this level. The number of vehicles stopping is significant, although many vehicles still pass through the intersection without stopping.

LOS D Describes operations with control delay between 35 and 55 s/veh and a volume-to-capacity ratio no greater than 1.0. This level is typically assigned when the volume-to-capacity ratio is high and either progression is ineffective or the cycle length is long. Many vehicles stop and individual cycle failures are noticeable.

LOS E Describes operations with control delay between 55 and 80 s/veh and a volume-to-capacity ratio no greater than 1.0. This level is typically assigned when the volume-to-capacity ratio is high, progression is unfavorable, and the cycle length is long. Individual cycle failures are frequent.

LOS F Describes operations with control delay exceeding 80 s/veh or a volume-to-capacity ratio greater than 1.0. This level is typically assigned when the volume-to-capacity ratio is very high, progression is very poor, and the cycle length is long. Most cycles fail to clear the queue.

Control Delay (s/veh)	LOS by Volume-to-Capacity Ratio ^a	
	$v/c \leq 1.0$	$v/c > 1.0$
≤ 10	A	F
> 10 – 20	B	F
> 20 – 35	C	F
> 35 – 55	D	F
> 55 – 80	E	F
> 80	F	F

Note: ^a For approach-based and intersectionwide assessments, LOS is defined solely by control delay.

The following information is referenced from the Highway Capacity Manual: A Guide for Multimodal Mobility Analysis, 6th Edition, Transportation Research Board, 2016: Chapter 20 – Two-Way Stop-Controlled Intersections, Chapter 21 – All-Way Stop-Controlled Intersections, and Chapter 22 - Roundabouts.

Motorized Vehicle Level of Service (LOS) for Unsignalized & Roundabout Intersections

LOS is a quantitative stratification of performance measure(s) representing quality of service. Quality of service describes how well a transportation facility or service operates from a traveler’s perspective. LOS is measured on an A – F scale, with LOS A representing the best operating conditions from a traveler’s perspective.

Control Delay (s/veh)	LOS by Volume-to-Capacity Ratio ^a	
	$v/c \leq 1.0$	$v/c > 1.0$
0 – 10	A	F
> 10 – 15	B	F
> 15 – 25	C	F
> 25 – 35	D	F
> 35 – 50	E	F
> 50	F	F

Note: The LOS criteria apply to each lane on a given approach and to each approach on the minor street. LOS is not calculated for major-street approaches or for the intersection as a whole.





















^a For approaches and intersectionwide assessment, LOS is defined solely by control delay.

APPENDIX C

Capacity Worksheets

Timings
1: Hathaway Drive & Galley Road

Existing Traffic Conditions
AM Peak Hour

												
Lane Group	EBL	EBT	EBR	WBL	WBT	WBR	NBL	NBT	NBR	SBL	SBT	SBR
Lane Configurations												
Traffic Volume (vph)	13	179	80	104	499	10	71	28	59	9	34	50
Future Volume (vph)	13	179	80	104	499	10	71	28	59	9	34	50
Satd. Flow (prot)	1770	1863	1583	1770	1857	0	0	1729	0	0	1720	0
Flt Permitted	0.445			0.550				0.864			0.961	
Satd. Flow (perm)	829	1863	1583	1025	1857	0	0	1527	0	0	1661	0
Satd. Flow (RTOR)			127		2			44			54	
Lane Group Flow (vph)	14	195	87	113	553	0	0	171	0	0	101	0
Turn Type	pm+pt	NA	Perm	pm+pt	NA		Perm	NA		Perm	NA	
Protected Phases	5	2		1	6			8				4
Permitted Phases	2		2	6			8			4		
Detector Phase	5	2	2	1	6		8	8		4		4
Switch Phase												
Minimum Initial (s)	5.0	20.0	20.0	5.0	20.0		6.0	6.0		6.0	6.0	
Minimum Split (s)	10.0	26.0	26.0	10.0	26.0		11.0	11.0		11.0	11.0	
Total Split (s)	15.0	29.0	29.0	15.0	29.0		16.0	16.0		16.0	16.0	
Total Split (%)	25.0%	48.3%	48.3%	25.0%	48.3%		26.7%	26.7%		26.7%	26.7%	
Yellow Time (s)	3.0	4.0	4.0	3.0	4.0		3.0	3.0		3.0	3.0	
All-Red Time (s)	2.0	2.0	2.0	2.0	2.0		2.0	2.0		2.0	2.0	
Lost Time Adjust (s)	0.0	0.0	0.0	0.0	0.0			0.0			0.0	
Total Lost Time (s)	5.0	6.0	6.0	5.0	6.0			5.0			5.0	
Lead/Lag	Lead	Lag	Lag	Lead	Lag							
Lead-Lag Optimize?	Yes	Yes	Yes	Yes	Yes							
Recall Mode	None	C-Min	C-Min	None	Min		None	None		None	None	
Act Effct Green (s)	37.3	32.9	32.9	42.0	40.5			9.7			9.7	
Actuated g/C Ratio	0.62	0.55	0.55	0.70	0.68			0.16			0.16	
v/c Ratio	0.02	0.19	0.09	0.14	0.44			0.60			0.32	
Control Delay	4.4	11.3	1.5	4.4	9.1			26.3			14.8	
Queue Delay	0.0	0.0	0.0	0.0	0.0			0.0			0.0	
Total Delay	4.4	11.3	1.5	4.4	9.1			26.3			14.8	
LOS	A	B	A	A	A			C			B	
Approach Delay		8.1			8.3			26.3			14.8	
Approach LOS		A			A			C			B	
Queue Length 50th (ft)	1	41	0	12	84			42			15	
Queue Length 95th (ft)	6	84	12	27	246			95			50	
Internal Link Dist (ft)		635			518			1811			361	
Turn Bay Length (ft)	200		270	90								
Base Capacity (vph)	719	1021	925	846	1253			323			357	
Starvation Cap Reductn	0	0	0	0	0			0			0	
Spillback Cap Reductn	0	0	0	0	0			0			0	
Storage Cap Reductn	0	0	0	0	0			0			0	
Reduced v/c Ratio	0.02	0.19	0.09	0.13	0.44			0.53			0.28	

Intersection Summary





Cycle Length: 60
 Actuated Cycle Length: 60
 Offset: 0 (0%), Referenced to phase 2:EBTL, Start of Green
 Natural Cycle: 60
 Control Type: Actuated-Coordinated

Timings
 1: Hathaway Drive & Galley Road

Existing Traffic Conditions
 AM Peak Hour

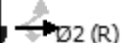
Maximum v/c Ratio: 0.60	
Intersection Signal Delay: 11.3	Intersection LOS: B
Intersection Capacity Utilization 60.0%	ICU Level of Service B
Analysis Period (min) 15	

Splits and Phases: 1: Hathaway Drive & Galley Road

 15 s	 29 s	 16 s
 15 s	 29 s	 16 s

HCM 6th TWSC
2: Western Drive & Galley Road

Existing Traffic Conditions
AM Peak Hour

Intersection												
Int Delay, s/veh	3.3											
Movement	EBL	EBT	EBR	WBL	WBT	WBR	NBL	NBT	NBR	SBL	SBT	SBR
Lane Configurations		↔			↔			↔			↔	
Traffic Vol, veh/h	21	221	2	25	425	18	13	13	27	9	7	102
Future Vol, veh/h	21	221	2	25	425	18	13	13	27	9	7	102
Conflicting Peds, #/hr	0	0	0	0	0	0	0	0	0	0	0	0
Sign Control	Free	Free	Free	Free	Free	Free	Stop	Stop	Stop	Stop	Stop	Stop
RT Channelized	-	-	None	-	-	None	-	-	None	-	-	None
Storage Length	-	-	-	-	-	-	-	-	-	-	-	-
Veh in Median Storage, #	-	0	-	-	0	-	-	0	-	-	0	-
Grade, %	-	0	-	-	0	-	-	0	-	-	0	-
Peak Hour Factor	92	92	92	92	92	92	92	92	92	92	92	92
Heavy Vehicles, %	2	2	2	2	2	2	2	2	2	2	2	2
Mvmt Flow	23	240	2	27	462	20	14	14	29	10	8	111

Major/Minor	Major1			Major2			Minor1			Minor2		
Conflicting Flow All	482	0	0	242	0	0	873	823	241	835	814	472
Stage 1	-	-	-	-	-	-	287	287	-	526	526	-
Stage 2	-	-	-	-	-	-	586	536	-	309	288	-
Critical Hdwy	4.12	-	-	4.12	-	-	7.12	6.52	6.22	7.12	6.52	6.22
Critical Hdwy Stg 1	-	-	-	-	-	-	6.12	5.52	-	6.12	5.52	-
Critical Hdwy Stg 2	-	-	-	-	-	-	6.12	5.52	-	6.12	5.52	-
Follow-up Hdwy	2.218	-	-	2.218	-	-	3.518	4.018	3.318	3.518	4.018	3.318
Pot Cap-1 Maneuver	1081	-	-	1324	-	-	271	309	798	287	312	592
Stage 1	-	-	-	-	-	-	720	674	-	535	529	-
Stage 2	-	-	-	-	-	-	496	523	-	701	674	-
Platoon blocked, %	-	-	-	-	-	-	-	-	-	-	-	-
Mov Cap-1 Maneuver	1081	-	-	1324	-	-	207	293	798	256	296	592
Mov Cap-2 Maneuver	-	-	-	-	-	-	207	293	-	256	296	-
Stage 1	-	-	-	-	-	-	702	657	-	522	514	-
Stage 2	-	-	-	-	-	-	386	508	-	644	657	-

Approach	EB			WB			NB			SB		
HCM Control Delay, s	0.7			0.4			16.3			14.4		
HCM LOS							C			B		

Minor Lane/Major Mvmt	NBLn1	EBL	EBT	EBR	WBL	WBT	WBR	SBLn1
Capacity (veh/h)	376	1081	-	-	1324	-	-	511
HCM Lane V/C Ratio	0.153	0.021	-	-	0.021	-	-	0.251
HCM Control Delay (s)	16.3	8.4	-	-	7.8	-	-	14.4
HCM Lane LOS	C	A	-	-	A	-	-	B
HCM 95th %tile Q(veh)	0.5	0.1	-	-	0.1	-	-	1

HCM 6th TWSC
3: Hathaway Drive & E Platte Avenue

Existing Traffic Conditions
AM Peak Hour

Intersection														
Int Delay, s/veh	145.5													
Movement	EBU	EBL	EBT	EBR	WBU	WBL	WBT	WBR	NBL	NBT	NBR	SBL	SBT	SBR
Lane Configurations		↔	↕	↕		↔	↕	↕			↕			↕
Traffic Vol, veh/h	17	53	1842	2	12	40	2784	43	0	0	18	0	0	99
Future Vol, veh/h	17	53	1842	2	12	40	2784	43	0	0	18	0	0	99
Conflicting Peds, #/hr	0	0	0	0	0	0	0	0	0	0	0	0	0	0
Sign Control	Free	Free	Free	Free	Free	Free	Free	Free	Stop	Stop	Stop	Stop	Stop	Stop
RT Channelized	-	-	-	None	-	-	-	Free	-	-	None	-	-	Stop
Storage Length	-	330	-	200	-	250	-	500	-	-	0	-	-	0
Veh in Median Storage, #	-	-	0	-	-	-	0	-	-	0	-	-	0	-
Grade, %	-	-	0	-	-	-	0	-	-	0	-	-	0	-
Peak Hour Factor	92	92	92	92	92	92	92	92	92	92	92	92	92	92
Heavy Vehicles, %	2	2	2	2	2	2	2	2	2	2	2	2	2	2
Mvmt Flow	18	58	2002	2	13	43	3026	47	0	0	20	0	0	108

Major/Minor	Major1		Major2		Minor1		Minor2							
Conflicting Flow All	3026	3026	0	0	2002	2004	0	0	-	-	1001	-	-	1513
Stage 1	-	-	-	-	-	-	-	-	-	-	-	-	-	-
Stage 2	-	-	-	-	-	-	-	-	-	-	-	-	-	-
Critical Hdwy	6.44	4.14	-	-	6.44	4.14	-	-	-	-	6.94	-	-	6.94
Critical Hdwy Stg 1	-	-	-	-	-	-	-	-	-	-	-	-	-	-
Critical Hdwy Stg 2	-	-	-	-	-	-	-	-	-	-	-	-	-	-
Follow-up Hdwy	2.52	2.22	-	-	2.52	2.22	-	-	-	-	3.32	-	-	3.32
Pot Cap-1 Maneuver	~ 15	110	-	-	74	282	-	0	0	0	241	0	0	109
Stage 1	-	-	-	-	-	-	-	0	0	0	-	0	0	-
Stage 2	-	-	-	-	-	-	-	0	0	0	-	0	0	-
Platoon blocked, %			-	-			-							
Mov Cap-1 Maneuver	~ 4	~ 4	-	-	163	163	-	-	-	-	241	-	-	109
Mov Cap-2 Maneuver	-	-	-	-	-	-	-	-	-	-	-	-	-	-
Stage 1	-	-	-	-	-	-	-	-	-	-	-	-	-	-
Stage 2	-	-	-	-	-	-	-	-	-	-	-	-	-	-

Approach	EB	WB	NB	SB
HCM Control Delay, s	360.7	0.7	21.3	156.3
HCM LOS			C	F

Minor Lane/Major Mvmt	NBLn1	EBL	EBT	EBR	WBL	WBT	SBLn1
Capacity (veh/h)	241	~ 4	-	-	163	-	109
HCM Lane V/C Ratio	0.081	19.022	-	-	0.347	-	0.987
HCM Control Delay (s)	21.3	9863.1	-	-	38.3	-	156.3
HCM Lane LOS	C	F	-	-	E	-	F
HCM 95th %tile Q(veh)	0.3	11.5	-	-	1.4	-	6.3

Notes
 ~: Volume exceeds capacity \$: Delay exceeds 300s +: Computation Not Defined *: All major volume in platoon

HCM 6th TWSC
4: Hathaway Drive & Western Drive

Existing Traffic Conditions
AM Peak Hour

Intersection												
Int Delay, s/veh	2.8											
Movement	EBL	EBT	EBR	WBL	WBT	WBR	NBL	NBT	NBR	SBL	SBT	SBR
Lane Configurations	↕			↕			↕			↕		
Traffic Vol, veh/h	0	0	1	30	0	6	1	44	9	26	83	4
Future Vol, veh/h	0	0	1	30	0	6	1	44	9	26	83	4
Conflicting Peds, #/hr	0	0	0	0	0	0	0	0	0	0	0	0
Sign Control	Stop	Stop	Stop	Stop	Stop	Stop	Free	Free	Free	Free	Free	Free
RT Channelized	-	-	None	-	-	None	-	-	None	-	-	None
Storage Length	-	-	-	-	-	-	-	-	-	-	-	-
Veh in Median Storage, #	-	0	-	-	0	-	-	0	-	-	0	-
Grade, %	-	0	-	-	0	-	-	0	-	-	0	-
Peak Hour Factor	92	92	92	92	92	92	92	92	92	92	92	92
Heavy Vehicles, %	2	2	2	2	2	2	2	2	2	2	2	2
Mvmt Flow	0	0	1	33	0	7	1	48	10	28	90	4

Major/Minor	Minor2		Minor1		Major1			Major2				
Conflicting Flow All	207	208	92	204	205	53	94	0	0	58	0	0
Stage 1	148	148	-	55	55	-	-	-	-	-	-	-
Stage 2	59	60	-	149	150	-	-	-	-	-	-	-
Critical Hdwy	7.12	6.52	6.22	7.12	6.52	6.22	4.12	-	-	4.12	-	-
Critical Hdwy Stg 1	6.12	5.52	-	6.12	5.52	-	-	-	-	-	-	-
Critical Hdwy Stg 2	6.12	5.52	-	6.12	5.52	-	-	-	-	-	-	-
Follow-up Hdwy	3.518	4.018	3.318	3.518	4.018	3.318	2.218	-	-	2.218	-	-
Pot Cap-1 Maneuver	751	689	965	754	691	1014	1500	-	-	1546	-	-
Stage 1	855	775	-	957	849	-	-	-	-	-	-	-
Stage 2	953	845	-	854	773	-	-	-	-	-	-	-
Platoon blocked, %	-	-	-	-	-	-	-	-	-	-	-	-
Mov Cap-1 Maneuver	734	675	965	742	677	1014	1500	-	-	1546	-	-
Mov Cap-2 Maneuver	734	675	-	742	677	-	-	-	-	-	-	-
Stage 1	854	760	-	956	848	-	-	-	-	-	-	-
Stage 2	946	844	-	837	758	-	-	-	-	-	-	-

Approach	EB		WB		NB		SB	
HCM Control Delay, s	8.7		9.9		0.1		1.7	
HCM LOS	A		A					

Minor Lane/Major Mvmt	NBL	NBT	NBR	EBLn1	WBLn1	SBL	SBT	SBR
Capacity (veh/h)	1500	-	-	965	777	1546	-	-
HCM Lane V/C Ratio	0.001	-	-	0.001	0.05	0.018	-	-
HCM Control Delay (s)	7.4	0	-	8.7	9.9	7.4	0	-
HCM Lane LOS	A	A	-	A	A	A	A	-
HCM 95th %tile Q(veh)	0	-	-	0	0.2	0.1	-	-

HCM 6th TWSC
5: Western Drive & Apartment Access

Existing Traffic Conditions
AM Peak Hour

Intersection						
Int Delay, s/veh	2.5					
Movement	EBL	EBT	WBT	WBR	SBL	SBR
Lane Configurations		↕	↕		↕	
Traffic Vol, veh/h	7	30	26	2	4	14
Future Vol, veh/h	7	30	26	2	4	14
Conflicting Peds, #/hr	0	0	0	0	0	0
Sign Control	Free	Free	Free	Free	Stop	Stop
RT Channelized	-	None	-	None	-	None
Storage Length	-	-	-	-	0	-
Veh in Median Storage, #	-	0	0	-	0	-
Grade, %	-	0	0	-	0	-
Peak Hour Factor	92	92	92	92	92	92
Heavy Vehicles, %	2	2	2	2	2	2
Mvmt Flow	8	33	28	2	4	15

Major/Minor	Major1	Major2	Minor2		
Conflicting Flow All	30	0	-	0	78 29
Stage 1	-	-	-	-	29 -
Stage 2	-	-	-	-	49 -
Critical Hdwy	4.12	-	-	-	6.42 6.22
Critical Hdwy Stg 1	-	-	-	-	5.42 -
Critical Hdwy Stg 2	-	-	-	-	5.42 -
Follow-up Hdwy	2.218	-	-	-	3.518 3.318
Pot Cap-1 Maneuver	1583	-	-	-	925 1046
Stage 1	-	-	-	-	994 -
Stage 2	-	-	-	-	973 -
Platoon blocked, %		-	-	-	
Mov Cap-1 Maneuver	1583	-	-	-	920 1046
Mov Cap-2 Maneuver	-	-	-	-	920 -
Stage 1	-	-	-	-	989 -
Stage 2	-	-	-	-	973 -

Approach	EB	WB	SB
HCM Control Delay, s	1.4	0	8.6
HCM LOS			A

Minor Lane/Major Mvmt	EBL	EBT	WBT	WBR	SBLn1
Capacity (veh/h)	1583	-	-	-	1015
HCM Lane V/C Ratio	0.005	-	-	-	0.019
HCM Control Delay (s)	7.3	0	-	-	8.6
HCM Lane LOS	A	A	-	-	A
HCM 95th %tile Q(veh)	0	-	-	-	0.1

HCM 6th TWSC
6: Hathaway Drive & Bednarski Access

Existing Traffic Conditions
AM Peak Hour

Intersection						
Int Delay, s/veh	0.6					
Movement	WBL	WBR	NBT	NBR	SBL	SBT
Lane Configurations	T		T		T	
Traffic Vol, veh/h	0	9	45	5	5	109
Future Vol, veh/h	0	9	45	5	5	109
Conflicting Peds, #/hr	0	0	0	0	0	0
Sign Control	Stop	Stop	Free	Free	Free	Free
RT Channelized	-	None	-	None	-	None
Storage Length	0	-	-	-	-	-
Veh in Median Storage, #	0	-	0	-	-	0
Grade, %	0	-	0	-	-	0
Peak Hour Factor	92	92	92	92	92	92
Heavy Vehicles, %	2	2	2	2	2	2
Mvmt Flow	0	10	49	5	5	118

Major/Minor	Minor1	Major1	Major2		
Conflicting Flow All	180	52	0	0	54
Stage 1	52	-	-	-	-
Stage 2	128	-	-	-	-
Critical Hdwy	6.42	6.22	-	-	4.12
Critical Hdwy Stg 1	5.42	-	-	-	-
Critical Hdwy Stg 2	5.42	-	-	-	-
Follow-up Hdwy	3.518	3.318	-	-	2.218
Pot Cap-1 Maneuver	810	1016	-	-	1551
Stage 1	970	-	-	-	-
Stage 2	898	-	-	-	-
Platoon blocked, %			-	-	-
Mov Cap-1 Maneuver	808	1016	-	-	1551
Mov Cap-2 Maneuver	808	-	-	-	-
Stage 1	970	-	-	-	-
Stage 2	895	-	-	-	-

Approach	WB	NB	SB
HCM Control Delay, s	8.6	0	0.3
HCM LOS	A		

Minor Lane/Major Mvmt	NBT	NBRWBLn1	SBL	SBT
Capacity (veh/h)	-	-	1016	1551
HCM Lane V/C Ratio	-	-	0.01	0.004
HCM Control Delay (s)	-	-	8.6	7.3
HCM Lane LOS	-	-	A	A
HCM 95th %tile Q(veh)	-	-	0	0

HCM 6th TWSC
7: Hathaway Drive & Ford Street

Existing Traffic Conditions
AM Peak Hour

Intersection												
Int Delay, s/veh	7.4											
Movement	EBL	EBT	EBR	WBL	WBT	WBR	NBL	NBT	NBR	SBL	SBT	SBR
Lane Configurations	↕			↕			↕			↕		
Traffic Vol, veh/h	0	5	21	78	31	0	46	0	50	0	0	0
Future Vol, veh/h	0	5	21	78	31	0	46	0	50	0	0	0
Conflicting Peds, #/hr	0	0	0	0	0	0	0	0	0	0	0	0
Sign Control	Stop	Stop	Stop	Stop	Stop	Stop	Free	Free	Free	Free	Free	Free
RT Channelized	-	-	None	-	-	None	-	-	None	-	-	None
Storage Length	-	-	-	-	-	-	-	-	-	-	-	-
Veh in Median Storage, #	-	0	-	-	0	-	-	0	-	-	0	-
Grade, %	-	0	-	-	0	-	-	0	-	-	0	-
Peak Hour Factor	92	92	92	92	92	92	92	92	92	92	92	92
Heavy Vehicles, %	2	2	2	2	2	2	2	2	2	2	2	2
Mvmt Flow	0	5	23	85	34	0	50	0	54	0	0	0





















Major/Minor	Minor2		Minor1		Major1			Major2				
Conflicting Flow All	145	155	1	142	128	27	1	0	0	54	0	0
Stage 1	1	1	-	127	127	-	-	-	-	-	-	-
Stage 2	144	154	-	15	1	-	-	-	-	-	-	-
Critical Hdwy	7.12	6.52	6.22	7.12	6.52	6.22	4.12	-	-	4.12	-	-
Critical Hdwy Stg 1	6.12	5.52	-	6.12	5.52	-	-	-	-	-	-	-
Critical Hdwy Stg 2	6.12	5.52	-	6.12	5.52	-	-	-	-	-	-	-
Follow-up Hdwy	3.518	4.018	3.318	3.518	4.018	3.318	2.218	-	-	2.218	-	-
Pot Cap-1 Maneuver	824	737	1084	828	763	1048	1622	-	-	1551	-	-
Stage 1	1022	895	-	877	791	-	-	-	-	-	-	-
Stage 2	859	770	-	1005	895	-	-	-	-	-	-	-
Platoon blocked, %	-	-	-	-	-	-	-	-	-	-	-	-
Mov Cap-1 Maneuver	776	713	1084	787	739	1048	1622	-	-	1551	-	-
Mov Cap-2 Maneuver	776	713	-	787	739	-	-	-	-	-	-	-
Stage 1	989	895	-	849	766	-	-	-	-	-	-	-
Stage 2	795	745	-	978	895	-	-	-	-	-	-	-

Approach	EB		WB		NB		SB	
HCM Control Delay, s	8.8		10.5		3.5		0	
HCM LOS	A		B					

Minor Lane/Major Mvmt	NBL	NBT	NBR	EBLn1	WBLn1	SBL	SBT	SBR
Capacity (veh/h)	1622	-	-	985	773	1551	-	-
HCM Lane V/C Ratio	0.031	-	-	0.029	0.153	-	-	-
HCM Control Delay (s)	7.3	0	-	8.8	10.5	0	-	-
HCM Lane LOS	A	A	-	A	B	A	-	-
HCM 95th %tile Q(veh)	0.1	-	-	0.1	0.5	0	-	-

Timings
1: Hathaway Drive & Galley Road

Existing Traffic Conditions
PM Peak Hour

												
Lane Group	EBL	EBT	EBR	WBL	WBT	WBR	NBL	NBT	NBR	SBL	SBT	SBR
Lane Configurations												
Traffic Volume (vph)	49	373	42	15	323	6	43	17	40	10	12	33
Future Volume (vph)	49	373	42	15	323	6	43	17	40	10	12	33
Satd. Flow (prot)	1770	1863	1583	1770	1857	0	0	1725	0	0	1696	0
Flt Permitted	0.496			0.524				0.831			0.940	
Satd. Flow (perm)	924	1863	1583	976	1857	0	0	1464	0	0	1609	0
Satd. Flow (RTOR)			127		2			43			36	
Lane Group Flow (vph)	53	405	46	16	358	0	0	108	0	0	60	0
Turn Type	pm+pt	NA	Perm	pm+pt	NA		Perm	NA		Perm	NA	
Protected Phases	5	2		1	6			8				4
Permitted Phases	2		2	6			8			4		
Detector Phase	5	2	2	1	6		8	8		4		4
Switch Phase												
Minimum Initial (s)	5.0	20.0	20.0	5.0	20.0		6.0	6.0		6.0	6.0	
Minimum Split (s)	10.0	26.0	26.0	10.0	26.0		11.0	11.0		11.0	11.0	
Total Split (s)	15.0	29.0	29.0	15.0	29.0		16.0	16.0		16.0	16.0	
Total Split (%)	25.0%	48.3%	48.3%	25.0%	48.3%		26.7%	26.7%		26.7%	26.7%	
Yellow Time (s)	3.0	4.0	4.0	3.0	4.0		3.0	3.0		3.0	3.0	
All-Red Time (s)	2.0	2.0	2.0	2.0	2.0		2.0	2.0		2.0	2.0	
Lost Time Adjust (s)	0.0	0.0	0.0	0.0	0.0			0.0			0.0	
Total Lost Time (s)	5.0	6.0	6.0	5.0	6.0			5.0			5.0	
Lead/Lag	Lead	Lag	Lag	Lead	Lag							
Lead-Lag Optimize?	Yes	Yes	Yes	Yes	Yes							
Recall Mode	None	C-Min	C-Min	None	Min		None	None		None	None	
Act Effct Green (s)	43.1	41.9	41.9	40.6	37.3			8.2			8.2	
Actuated g/C Ratio	0.72	0.70	0.70	0.68	0.62			0.14			0.14	
v/c Ratio	0.07	0.31	0.04	0.02	0.31			0.45			0.24	
Control Delay	3.7	7.1	0.1	3.8	9.9			21.6			14.5	
Queue Delay	0.0	0.0	0.0	0.0	0.0			0.0			0.0	
Total Delay	3.7	7.1	0.1	3.8	9.9			21.6			14.5	
LOS	A	A	A	A	A			C			B	
Approach Delay		6.1			9.6			21.6			14.5	
Approach LOS		A			A			C			B	
Queue Length 50th (ft)	5	47	0	1	74			22			8	
Queue Length 95th (ft)	15	165	0	7	147			59			34	
Internal Link Dist (ft)		635			518			1811			361	
Turn Bay Length (ft)	200		270	90								
Base Capacity (vph)	814	1302	1144	833	1154			303			324	
Starvation Cap Reductn	0	0	0	0	0			0			0	
Spillback Cap Reductn	0	0	0	0	0			0			0	
Storage Cap Reductn	0	0	0	0	0			0			0	
Reduced v/c Ratio	0.07	0.31	0.04	0.02	0.31			0.36			0.19	

Intersection Summary







Cycle Length: 60
 Actuated Cycle Length: 60
 Offset: 0 (0%), Referenced to phase 2:EBTL, Start of Green
 Natural Cycle: 50
 Control Type: Actuated-Coordinated

Timings
 1: Hathaway Drive & Galley Road

Existing Traffic Conditions
 PM Peak Hour

Maximum v/c Ratio: 0.45	
Intersection Signal Delay: 9.4	Intersection LOS: A
Intersection Capacity Utilization 48.8%	ICU Level of Service A
Analysis Period (min) 15	

Splits and Phases: 1: Hathaway Drive & Galley Road

 15 s	 29 s	 16 s
 15 s	 29 s	 16 s

HCM 6th TWSC
2: Western Drive & Galley Road

Existing Traffic Conditions
PM Peak Hour

Intersection												
Int Delay, s/veh	2											
Movement	EBL	EBT	EBR	WBL	WBT	WBR	NBL	NBT	NBR	SBL	SBT	SBR
Lane Configurations	↶			↷			↕			↕		
Traffic Vol, veh/h	35	332	13	16	292	13	5	7	18	16	7	24
Future Vol, veh/h	35	332	13	16	292	13	5	7	18	16	7	24
Conflicting Peds, #/hr	0	0	0	0	0	0	0	0	0	0	0	0
Sign Control	Free	Free	Free	Free	Free	Free	Stop	Stop	Stop	Stop	Stop	Stop
RT Channelized	-	-	None	-	-	None	-	-	None	-	-	None
Storage Length	-	-	-	-	-	-	-	-	-	-	-	-
Veh in Median Storage, #	-	0	-	-	0	-	-	0	-	-	0	-
Grade, %	-	0	-	-	0	-	-	0	-	-	0	-
Peak Hour Factor	92	92	92	92	92	92	92	92	92	92	92	92
Heavy Vehicles, %	2	2	2	2	2	2	2	2	2	2	2	2
Mvmt Flow	38	361	14	17	317	14	5	8	20	17	8	26

Major/Minor	Major1		Major2		Minor1		Minor2					
Conflicting Flow All	331	0	0	375	0	0	819	809	368	816	809	324
Stage 1	-	-	-	-	-	-	444	444	-	358	358	-
Stage 2	-	-	-	-	-	-	375	365	-	458	451	-
Critical Hdwy	4.12	-	-	4.12	-	-	7.12	6.52	6.22	7.12	6.52	6.22
Critical Hdwy Stg 1	-	-	-	-	-	-	6.12	5.52	-	6.12	5.52	-
Critical Hdwy Stg 2	-	-	-	-	-	-	6.12	5.52	-	6.12	5.52	-
Follow-up Hdwy	2.218	-	-	2.218	-	-	3.518	4.018	3.318	3.518	4.018	3.318
Pot Cap-1 Maneuver	1228	-	-	1183	-	-	294	314	677	296	314	717
Stage 1	-	-	-	-	-	-	593	575	-	660	628	-
Stage 2	-	-	-	-	-	-	646	623	-	583	571	-
Platoon blocked, %	-	-	-	-	-	-	-	-	-	-	-	-
Mov Cap-1 Maneuver	1228	-	-	1183	-	-	266	296	677	270	296	717
Mov Cap-2 Maneuver	-	-	-	-	-	-	266	296	-	270	296	-
Stage 1	-	-	-	-	-	-	570	553	-	634	617	-
Stage 2	-	-	-	-	-	-	604	612	-	537	549	-

Approach	EB		WB		NB		SB	
HCM Control Delay, s	0.7		0.4		13.9		15.2	
HCM LOS					B		C	

Minor Lane/Major Mvmt	NBLn1	EBL	EBT	EBR	WBL	WBT	WBR	SBLn1
Capacity (veh/h)	435	1228	-	-	1183	-	-	404
HCM Lane V/C Ratio	0.075	0.031	-	-	0.015	-	-	0.126
HCM Control Delay (s)	13.9	8	-	-	8.1	-	-	15.2
HCM Lane LOS	B	A	-	-	A	-	-	C
HCM 95th %tile Q(veh)	0.2	0.1	-	-	0	-	-	0.4

HCM 6th TWSC
3: Hathaway Drive & E Platte Avenue

Existing Traffic Conditions
PM Peak Hour

Intersection													
Int Delay, s/veh	6.3												
Movement	EBU	EBL	EBT	EBR	WBL	WBT	WBR	NBL	NBT	NBR	SBL	SBT	SBR
Lane Configurations		↔	↕	↗	↔	↕	↗			↗			↗
Traffic Vol, veh/h	37	85	2238	3	22	1847	21	0	0	41	0	0	74
Future Vol, veh/h	37	85	2238	3	22	1847	21	0	0	41	0	0	74
Conflicting Peds, #/hr	0	0	0	0	0	0	0	0	0	0	0	0	0
Sign Control	Free	Free	Free	Free	Free	Free	Free	Stop	Stop	Stop	Stop	Stop	Stop
RT Channelized	-	-	-	None	-	-	Free	-	-	None	-	-	Stop
Storage Length	-	330	-	200	250	-	500	-	-	0	-	-	0
Veh in Median Storage, #	-	-	0	-	-	0	-	-	0	-	-	0	-
Grade, %	-	-	0	-	-	0	-	-	0	-	-	0	-
Peak Hour Factor	92	92	92	92	92	92	92	92	92	92	92	92	92
Heavy Vehicles, %	2	2	2	2	2	2	2	2	2	2	2	2	2
Mvmt Flow	40	92	2433	3	24	2008	23	0	0	45	0	0	80

Major/Minor	Major1				Major2			Minor1			Minor2		
Conflicting Flow All	2008	2008	0	0	2436	0	0	-	-	1217	-	-	1004
Stage 1	-	-	-	-	-	-	-	-	-	-	-	-	-
Stage 2	-	-	-	-	-	-	-	-	-	-	-	-	-
Critical Hdwy	6.44	4.14	-	-	4.14	-	-	-	-	6.94	-	-	6.94
Critical Hdwy Stg 1	-	-	-	-	-	-	-	-	-	-	-	-	-
Critical Hdwy Stg 2	-	-	-	-	-	-	-	-	-	-	-	-	-
Follow-up Hdwy	2.52	2.22	-	-	2.22	-	-	-	-	3.32	-	-	3.32
Pot Cap-1 Maneuver	73	281	-	-	190	-	0	0	0	173	0	0	240
Stage 1	-	-	-	-	-	-	0	0	0	-	0	0	-
Stage 2	-	-	-	-	-	-	0	0	0	-	0	0	-
Platoon blocked, %			-	-			-						
Mov Cap-1 Maneuver	117	117	-	-	190	-	-	-	-	173	-	-	240
Mov Cap-2 Maneuver	-	-	-	-	-	-	-	-	-	-	-	-	-
Stage 1	-	-	-	-	-	-	-	-	-	-	-	-	-
Stage 2	-	-	-	-	-	-	-	-	-	-	-	-	-

Approach	EB	WB	NB	SB
HCM Control Delay, s	10	0.3	32.9	27.4
HCM LOS			D	D

Minor Lane/Major Mvmt	NBLn1	EBL	EBT	EBR	WBL	WBT	SBLn1
Capacity (veh/h)	173	117	-	-	190	-	240
HCM Lane V/C Ratio	0.258	1.133	-	-	0.126	-	0.335
HCM Control Delay (s)	32.9	194.5	-	-	26.7	-	27.4
HCM Lane LOS	D	F	-	-	D	-	D
HCM 95th %tile Q(veh)	1	8.1	-	-	0.4	-	1.4

HCM 6th TWSC
4: Hathaway Drive & Western Drive

Existing Traffic Conditions
PM Peak Hour

Intersection												
Int Delay, s/veh	1.8											
Movement	EBL	EBT	EBR	WBL	WBT	WBR	NBL	NBT	NBR	SBL	SBT	SBR
Lane Configurations	↕			↕			↕			↕		
Traffic Vol, veh/h	3	1	3	10	0	3	1	58	27	10	32	0
Future Vol, veh/h	3	1	3	10	0	3	1	58	27	10	32	0
Conflicting Peds, #/hr	0	0	0	0	0	0	0	0	0	0	0	0
Sign Control	Stop	Stop	Stop	Stop	Stop	Stop	Free	Free	Free	Free	Free	Free
RT Channelized	-	-	None	-	-	None	-	-	None	-	-	None
Storage Length	-	-	-	-	-	-	-	-	-	-	-	-
Veh in Median Storage, #	-	0	-	-	0	-	-	0	-	-	0	-
Grade, %	-	0	-	-	0	-	-	0	-	-	0	-
Peak Hour Factor	92	92	92	92	92	92	92	92	92	92	92	92
Heavy Vehicles, %	2	2	2	2	2	2	2	2	2	2	2	2
Mvmt Flow	3	1	3	11	0	3	1	63	29	11	35	0

Major/Minor	Minor2		Minor1		Major1			Major2				
Conflicting Flow All	138	151	35	139	137	78	35	0	0	92	0	0
Stage 1	57	57	-	80	80	-	-	-	-	-	-	-
Stage 2	81	94	-	59	57	-	-	-	-	-	-	-
Critical Hdwy	7.12	6.52	6.22	7.12	6.52	6.22	4.12	-	-	4.12	-	-
Critical Hdwy Stg 1	6.12	5.52	-	6.12	5.52	-	-	-	-	-	-	-
Critical Hdwy Stg 2	6.12	5.52	-	6.12	5.52	-	-	-	-	-	-	-
Follow-up Hdwy	3.518	4.018	3.318	3.518	4.018	3.318	2.218	-	-	2.218	-	-
Pot Cap-1 Maneuver	833	741	1038	831	754	983	1576	-	-	1503	-	-
Stage 1	955	847	-	929	828	-	-	-	-	-	-	-
Stage 2	927	817	-	953	847	-	-	-	-	-	-	-
Platoon blocked, %	-	-	-	-	-	-	-	-	-	-	-	-
Mov Cap-1 Maneuver	826	735	1038	823	748	983	1576	-	-	1503	-	-
Mov Cap-2 Maneuver	826	735	-	823	748	-	-	-	-	-	-	-
Stage 1	954	841	-	928	827	-	-	-	-	-	-	-
Stage 2	923	816	-	942	841	-	-	-	-	-	-	-

Approach	EB		WB		NB		SB	
HCM Control Delay, s	9.1		9.3		0.1		1.8	
HCM LOS	A		A					

Minor Lane/Major Mvmt	NBL	NBT	NBR	EBLn1	WBLn1	SBL	SBT	SBR
Capacity (veh/h)	1576	-	-	888	855	1503	-	-
HCM Lane V/C Ratio	0.001	-	-	0.009	0.017	0.007	-	-
HCM Control Delay (s)	7.3	0	-	9.1	9.3	7.4	0	-
HCM Lane LOS	A	A	-	A	A	A	A	-
HCM 95th %tile Q(veh)	0	-	-	0	0.1	0	-	-

HCM 6th TWSC
5: Western Drive & Apartment Access

Existing Traffic Conditions
PM Peak Hour

Intersection						
Int Delay, s/veh	3.5					
Movement	EBL	EBT	WBT	WBR	SBL	SBR
Lane Configurations		↕	↕		↕	
Traffic Vol, veh/h	15	25	5	6	3	11
Future Vol, veh/h	15	25	5	6	3	11
Conflicting Peds, #/hr	0	0	0	0	0	0
Sign Control	Free	Free	Free	Free	Stop	Stop
RT Channelized	-	None	-	None	-	None
Storage Length	-	-	-	-	0	-
Veh in Median Storage, #	-	0	0	-	0	-
Grade, %	-	0	0	-	0	-
Peak Hour Factor	92	92	92	92	92	92
Heavy Vehicles, %	2	2	2	2	2	2
Mvmt Flow	16	27	5	7	3	12

Major/Minor	Major1	Major2	Minor2		
Conflicting Flow All	12	0	-	0	68
Stage 1	-	-	-	-	9
Stage 2	-	-	-	-	59
Critical Hdwy	4.12	-	-	-	6.42
Critical Hdwy Stg 1	-	-	-	-	5.42
Critical Hdwy Stg 2	-	-	-	-	5.42
Follow-up Hdwy	2.218	-	-	-	3.518
Pot Cap-1 Maneuver	1607	-	-	-	937
Stage 1	-	-	-	-	1014
Stage 2	-	-	-	-	964
Platoon blocked, %		-	-	-	
Mov Cap-1 Maneuver	1607	-	-	-	928
Mov Cap-2 Maneuver	-	-	-	-	928
Stage 1	-	-	-	-	1004
Stage 2	-	-	-	-	964

Approach	EB	WB	SB
HCM Control Delay, s	2.7	0	8.5
HCM LOS			A

Minor Lane/Major Mvmt	EBL	EBT	WBT	WBR	SBLn1
Capacity (veh/h)	1607	-	-	-	1038
HCM Lane V/C Ratio	0.01	-	-	-	0.015
HCM Control Delay (s)	7.3	0	-	-	8.5
HCM Lane LOS	A	A	-	-	A
HCM 95th %tile Q(veh)	0	-	-	-	0

HCM 6th TWSC
6: Hathaway Drive & Bednarski Access

Existing Traffic Conditions
PM Peak Hour

Intersection						
Int Delay, s/veh	0.8					
Movement	WBL	WBR	NBT	NBR	SBL	SBT
Lane Configurations	T		T		T	
Traffic Vol, veh/h	7	4	82	2	1	44
Future Vol, veh/h	7	4	82	2	1	44
Conflicting Peds, #/hr	0	0	0	0	0	0
Sign Control	Stop	Stop	Free	Free	Free	Free
RT Channelized	-	None	-	None	-	None
Storage Length	0	-	-	-	-	-
Veh in Median Storage, #	0	-	0	-	-	0
Grade, %	0	-	0	-	-	0
Peak Hour Factor	92	92	92	92	92	92
Heavy Vehicles, %	2	2	2	2	2	2
Mvmt Flow	8	4	89	2	1	48

Major/Minor	Minor1	Major1	Major2		
Conflicting Flow All	140	90	0	0	91
Stage 1	90	-	-	-	-
Stage 2	50	-	-	-	-
Critical Hdwy	6.42	6.22	-	-	4.12
Critical Hdwy Stg 1	5.42	-	-	-	-
Critical Hdwy Stg 2	5.42	-	-	-	-
Follow-up Hdwy	3.518	3.318	-	-	2.218
Pot Cap-1 Maneuver	853	968	-	-	1504
Stage 1	934	-	-	-	-
Stage 2	972	-	-	-	-
Platoon blocked, %			-	-	-
Mov Cap-1 Maneuver	852	968	-	-	1504
Mov Cap-2 Maneuver	852	-	-	-	-
Stage 1	934	-	-	-	-
Stage 2	971	-	-	-	-

Approach	WB	NB	SB
HCM Control Delay, s	9.1	0	0.2
HCM LOS	A		

Minor Lane/Major Mvmt	NBT	NBRWBLn1	SBL	SBT
Capacity (veh/h)	-	-	891	1504
HCM Lane V/C Ratio	-	-	0.013	0.001
HCM Control Delay (s)	-	-	9.1	7.4
HCM Lane LOS	-	-	A	A
HCM 95th %tile Q(veh)	-	-	0	0

HCM 6th TWSC
7: Hathaway Drive & Ford Street

Existing Traffic Conditions
PM Peak Hour

Intersection												
Int Delay, s/veh	5.1											
Movement	EBL	EBT	EBR	WBL	WBT	WBR	NBL	NBT	NBR	SBL	SBT	SBR
Lane Configurations	↕			↕			↕			↕		
Traffic Vol, veh/h	0	5	35	39	12	0	22	0	84	0	0	0
Future Vol, veh/h	0	5	35	39	12	0	22	0	84	0	0	0
Conflicting Peds, #/hr	0	0	0	0	0	0	0	0	0	0	0	0
Sign Control	Stop	Stop	Stop	Stop	Stop	Stop	Free	Free	Free	Free	Free	Free
RT Channelized	-	-	None	-	-	None	-	-	None	-	-	None
Storage Length	-	-	-	-	-	-	-	-	-	-	-	-
Veh in Median Storage, #	-	0	-	-	0	-	-	0	-	-	0	-
Grade, %	-	0	-	-	0	-	-	0	-	-	0	-
Peak Hour Factor	92	92	92	92	92	92	92	92	92	92	92	92
Heavy Vehicles, %	2	2	2	2	2	2	2	2	2	2	2	2
Mvmt Flow	0	5	38	42	13	0	24	0	91	0	0	0





















Major/Minor	Minor2		Minor1		Major1			Major2				
Conflicting Flow All	101	140	1	117	95	46	1	0	0	91	0	0
Stage 1	1	1	-	94	94	-	-	-	-	-	-	-
Stage 2	100	139	-	23	1	-	-	-	-	-	-	-
Critical Hdwy	7.12	6.52	6.22	7.12	6.52	6.22	4.12	-	-	4.12	-	-
Critical Hdwy Stg 1	6.12	5.52	-	6.12	5.52	-	-	-	-	-	-	-
Critical Hdwy Stg 2	6.12	5.52	-	6.12	5.52	-	-	-	-	-	-	-
Follow-up Hdwy	3.518	4.018	3.318	3.518	4.018	3.318	2.218	-	-	2.218	-	-
Pot Cap-1 Maneuver	880	751	1084	859	795	1023	1622	-	-	1504	-	-
Stage 1	1022	895	-	913	817	-	-	-	-	-	-	-
Stage 2	906	782	-	995	895	-	-	-	-	-	-	-
Platoon blocked, %	-	-	-	-	-	-	-	-	-	-	-	-
Mov Cap-1 Maneuver	858	739	1084	814	782	1023	1622	-	-	1504	-	-
Mov Cap-2 Maneuver	858	739	-	814	782	-	-	-	-	-	-	-
Stage 1	1006	895	-	898	804	-	-	-	-	-	-	-
Stage 2	877	769	-	954	895	-	-	-	-	-	-	-

Approach	EB		WB		NB		SB	
HCM Control Delay, s	8.7		9.8		1.5		0	
HCM LOS	A		A					

Minor Lane/Major Mvmt	NBL	NBT	NBR	EBLn1	WBLn1	SBL	SBT	SBR
Capacity (veh/h)	1622	-	-	1024	806	1504	-	-
HCM Lane V/C Ratio	0.015	-	-	0.042	0.069	-	-	-
HCM Control Delay (s)	7.3	0	-	8.7	9.8	0	-	-
HCM Lane LOS	A	A	-	A	A	A	-	-
HCM 95th %tile Q(veh)	0	-	-	0.1	0.2	0	-	-

Timings
1: Hathaway Drive & Galley Road

Background Traffic Conditions
Year 2025 - AM Peak Hour

												
Lane Group	EBL	EBT	EBR	WBL	WBT	WBR	NBL	NBT	NBR	SBL	SBT	SBR
Lane Configurations												
Traffic Volume (vph)	14	186	83	108	519	10	74	29	61	9	35	52
Future Volume (vph)	14	186	83	108	519	10	74	29	61	9	35	52
Satd. Flow (prot)	1770	1863	1583	1770	1857	0	0	1731	0	0	1718	0
Flt Permitted	0.418			0.541				0.856			0.967	
Satd. Flow (perm)	779	1863	1583	1008	1857	0	0	1515	0	0	1670	0
Satd. Flow (RTOR)			127		2			43			57	
Lane Group Flow (vph)	15	202	90	117	575	0	0	178	0	0	105	0
Turn Type	pm+pt	NA	Perm	pm+pt	NA		Perm	NA		Perm	NA	
Protected Phases	5	2		1	6			8				4
Permitted Phases	2		2	6			8			4		
Detector Phase	5	2	2	1	6		8	8		4		4
Switch Phase												
Minimum Initial (s)	5.0	20.0	20.0	5.0	20.0		6.0	6.0		6.0	6.0	
Minimum Split (s)	10.0	26.0	26.0	10.0	26.0		11.0	11.0		11.0	11.0	
Total Split (s)	15.0	29.0	29.0	15.0	29.0		16.0	16.0		16.0	16.0	
Total Split (%)	25.0%	48.3%	48.3%	25.0%	48.3%		26.7%	26.7%		26.7%	26.7%	
Yellow Time (s)	3.0	4.0	4.0	3.0	4.0		3.0	3.0		3.0	3.0	
All-Red Time (s)	2.0	2.0	2.0	2.0	2.0		2.0	2.0		2.0	2.0	
Lost Time Adjust (s)	0.0	0.0	0.0	0.0	0.0			0.0			0.0	
Total Lost Time (s)	5.0	6.0	6.0	5.0	6.0			5.0			5.0	
Lead/Lag	Lead	Lag	Lag	Lead	Lag							
Lead-Lag Optimize?	Yes	Yes	Yes	Yes	Yes							
Recall Mode	None	C-Min	C-Min	None	Min		None	None		None	None	
Act Effct Green (s)	35.0	29.4	29.4	39.7	37.0			9.7			9.7	
Actuated g/C Ratio	0.58	0.49	0.49	0.66	0.62			0.16			0.16	
v/c Ratio	0.03	0.22	0.11	0.15	0.50			0.63			0.33	
Control Delay	4.4	11.7	1.7	4.5	10.0			27.9			14.6	
Queue Delay	0.0	0.0	0.0	0.0	0.0			0.0			0.0	
Total Delay	4.4	11.7	1.7	4.5	10.0			27.9			14.6	
LOS	A	B	A	A	A			C			B	
Approach Delay		8.4			9.1			27.9			14.6	
Approach LOS		A			A			C			B	
Queue Length 50th (ft)	2	43	0	13	91			45			15	
Queue Length 95th (ft)	6	87	13	28	260			#100			51	
Internal Link Dist (ft)		635			518			1811			361	
Turn Bay Length (ft)	200		270	90								
Base Capacity (vph)	663	912	839	799	1147			319			360	
Starvation Cap Reductn	0	0	0	0	0			0			0	
Spillback Cap Reductn	0	0	0	0	0			0			0	
Storage Cap Reductn	0	0	0	0	0			0			0	
Reduced v/c Ratio	0.02	0.22	0.11	0.15	0.50			0.56			0.29	

Intersection Summary

Cycle Length: 60
 Actuated Cycle Length: 60
 Offset: 0 (0%), Referenced to phase 2:EBTL, Start of Green
 Natural Cycle: 60
 Control Type: Actuated-Coordinated

Timings
 1: Hathaway Drive & Galley Road

Background Traffic Conditions
 Year 2025 - AM Peak Hour

Maximum v/c Ratio: 0.63
 Intersection Signal Delay: 12.0 Intersection LOS: B
 Intersection Capacity Utilization 61.4% ICU Level of Service B
 Analysis Period (min) 15
 # 95th percentile volume exceeds capacity, queue may be longer.
 Queue shown is maximum after two cycles.

Splits and Phases: 1: Hathaway Drive & Galley Road

↙ Ø1 15 s	↘ Ø2 (R) 29 s	↓ Ø4 16 s
↗ Ø5 15 s	← Ø6 29 s	↑ Ø8 16 s

HCM 6th TWSC
2: Western Drive & Galley Road

Background Traffic Conditions
Year 2025 - AM Peak Hour

Intersection												
Int Delay, s/veh	3.4											
Movement	EBL	EBT	EBR	WBL	WBT	WBR	NBL	NBT	NBR	SBL	SBT	SBR
Lane Configurations		↗			↗			↔			↔	
Traffic Vol, veh/h	22	230	2	26	442	19	14	14	28	9	7	106
Future Vol, veh/h	22	230	2	26	442	19	14	14	28	9	7	106
Conflicting Peds, #/hr	0	0	0	0	0	0	0	0	0	0	0	0
Sign Control	Free	Free	Free	Free	Free	Free	Stop	Stop	Stop	Stop	Stop	Stop
RT Channelized	-	-	None	-	-	None	-	-	None	-	-	None
Storage Length	-	-	-	-	-	-	-	-	-	-	-	-
Veh in Median Storage, #	-	0	-	-	0	-	-	0	-	-	0	-
Grade, %	-	0	-	-	0	-	-	0	-	-	0	-
Peak Hour Factor	92	92	92	92	92	92	92	92	92	92	92	92
Heavy Vehicles, %	2	2	2	2	2	2	2	2	2	2	2	2
Mvmt Flow	24	250	2	28	480	21	15	15	30	10	8	115

Major/Minor	Major1		Major2		Minor1		Minor2					
Conflicting Flow All	501	0	0	252	0	0	907	856	251	869	847	491
Stage 1	-	-	-	-	-	-	299	299	-	547	547	-
Stage 2	-	-	-	-	-	-	608	557	-	322	300	-
Critical Hdwy	4.12	-	-	4.12	-	-	7.12	6.52	6.22	7.12	6.52	6.22
Critical Hdwy Stg 1	-	-	-	-	-	-	6.12	5.52	-	6.12	5.52	-
Critical Hdwy Stg 2	-	-	-	-	-	-	6.12	5.52	-	6.12	5.52	-
Follow-up Hdwy	2.218	-	-	2.218	-	-	3.518	4.018	3.318	3.518	4.018	3.318
Pot Cap-1 Maneuver	1063	-	-	1313	-	-	257	295	788	272	299	578
Stage 1	-	-	-	-	-	-	710	666	-	521	517	-
Stage 2	-	-	-	-	-	-	483	512	-	690	666	-
Platoon blocked, %	-	-	-	-	-	-	-	-	-	-	-	-
Mov Cap-1 Maneuver	1063	-	-	1313	-	-	193	279	788	240	283	578
Mov Cap-2 Maneuver	-	-	-	-	-	-	193	279	-	240	283	-
Stage 1	-	-	-	-	-	-	692	649	-	507	501	-
Stage 2	-	-	-	-	-	-	369	497	-	631	649	-

Approach	EB		WB		NB		SB	
HCM Control Delay, s	0.7		0.4		17.3		14.9	
HCM LOS					C		B	

Minor Lane/Major Mvmt	NBLn1	EBL	EBT	EBR	WBL	WBT	WBR	SBLn1
Capacity (veh/h)	354	1063	-	-	1313	-	-	497
HCM Lane V/C Ratio	0.172	0.022	-	-	0.022	-	-	0.267
HCM Control Delay (s)	17.3	8.5	-	-	7.8	-	-	14.9
HCM Lane LOS	C	A	-	-	A	-	-	B
HCM 95th %tile Q(veh)	0.6	0.1	-	-	0.1	-	-	1.1

HCM 6th TWSC
3: Hathaway Drive & E Platte Avenue

Background Traffic Conditions
Year 2025 - AM Peak Hour

Intersection														
Int Delay, s/veh	4.8													
Movement	EBU	EBL	EBT	EBR	WBU	WBL	WBT	WBR	NBL	NBT	NBR	SBL	SBT	SBR
Lane Configurations		↔	↑↑	↗		↔	↑↑	↗			↗			↗
Traffic Vol, veh/h	18	55	1916	2	12	42	2895	45	0	0	19	0	0	103
Future Vol, veh/h	18	55	1916	2	12	42	2895	45	0	0	19	0	0	103
Conflicting Peds, #/hr	0	0	0	0	0	0	0	0	0	0	0	0	0	0
Sign Control	Free	Free	Free	Free	Free	Free	Free	Free	Stop	Stop	Stop	Stop	Stop	Stop
RT Channelized	-	-	-	None	-	-	-	Free	-	-	None	-	-	Stop
Storage Length	-	330	-	200	-	250	-	500	-	-	0	-	-	0
Veh in Median Storage, #	-	-	0	-	-	-	0	-	-	0	-	-	0	-
Grade, %	-	-	0	-	-	-	0	-	-	0	-	-	0	-
Peak Hour Factor	92	92	92	92	92	92	92	92	92	92	92	92	92	92
Heavy Vehicles, %	2	2	2	2	2	2	2	2	2	2	2	2	2	2
Mvmt Flow	20	60	2083	2	13	46	3147	49	0	0	21	0	0	112

Major/Minor	Major1		Major2		Minor1		Minor2							
Conflicting Flow All	3147	3147	0	0	2083	2085	0	0	-	-	1042	-	-	1574
Stage 1	-	-	-	-	-	-	-	-	-	-	-	-	-	-
Stage 2	-	-	-	-	-	-	-	-	-	-	-	-	-	-
Critical Hdwy	6.44	4.14	-	-	6.44	4.14	-	-	-	-	6.94	-	-	6.94
Critical Hdwy Stg 1	-	-	-	-	-	-	-	-	-	-	-	-	-	-
Critical Hdwy Stg 2	-	-	-	-	-	-	-	-	-	-	-	-	-	-
Follow-up Hdwy	2.52	2.22	-	-	2.52	2.22	-	-	-	-	3.32	-	-	3.32
Pot Cap-1 Maneuver	~ 13	99	-	-	65	262	-	0	0	0	226	0	0	~ 99
Stage 1	-	-	-	-	-	-	-	0	0	0	-	0	0	-
Stage 2	-	-	-	-	-	-	-	0	0	0	-	0	0	-
Platoon blocked, %			-	-			-							
Mov Cap-1 Maneuver	~ -9	~ -9	-	-	150	150	-	-	-	-	226	-	-	~ 99
Mov Cap-2 Maneuver	-	-	-	-	-	-	-	-	-	-	-	-	-	-
Stage 1	-	-	-	-	-	-	-	-	-	-	-	-	-	-
Stage 2	-	-	-	-	-	-	-	-	-	-	-	-	-	-

Approach	EB	WB	NB	SB
HCM Control Delay, s		0.8	22.5	210
HCM LOS			C	F

Minor Lane/Major Mvmt	NBLn1	EBL	EBT	EBR	WBL	WBT	SBLn1
Capacity (veh/h)	226	+	-	-	150	-	99
HCM Lane V/C Ratio	0.091	-	-	-	0.391	-	1.131
HCM Control Delay (s)	22.5	-	-	-	43.7	-	210
HCM Lane LOS	C	-	-	-	E	-	F
HCM 95th %tile Q(veh)	0.3	-	-	-	1.7	-	7.3

Notes
 ~: Volume exceeds capacity \$: Delay exceeds 300s +: Computation Not Defined *: All major volume in platoon

HCM 6th TWSC
4: Hathaway Drive & Western Drive

Background Traffic Conditions
Year 2025 - AM Peak Hour

Intersection												
Int Delay, s/veh	2.8											
Movement	EBL	EBT	EBR	WBL	WBT	WBR	NBL	NBT	NBR	SBL	SBT	SBR
Lane Configurations	↔			↔			↔			↔		
Traffic Vol, veh/h	0	0	1	31	0	6	1	46	9	27	86	4
Future Vol, veh/h	0	0	1	31	0	6	1	46	9	27	86	4
Conflicting Peds, #/hr	0	0	0	0	0	0	0	0	0	0	0	0
Sign Control	Stop	Stop	Stop	Stop	Stop	Stop	Free	Free	Free	Free	Free	Free
RT Channelized	-	-	None	-	-	None	-	-	None	-	-	None
Storage Length	-	-	-	-	-	-	-	-	-	-	-	-
Veh in Median Storage, #	-	0	-	-	0	-	-	0	-	-	0	-
Grade, %	-	0	-	-	0	-	-	0	-	-	0	-
Peak Hour Factor	92	92	92	92	92	92	92	92	92	92	92	92
Heavy Vehicles, %	2	2	2	2	2	2	2	2	2	2	2	2
Mvmt Flow	0	0	1	34	0	7	1	50	10	29	93	4

Major/Minor	Minor2		Minor1		Major1		Major2					
Conflicting Flow All	214	215	95	211	212	55	97	0	0	60	0	0
Stage 1	153	153	-	57	57	-	-	-	-	-	-	-
Stage 2	61	62	-	154	155	-	-	-	-	-	-	-
Critical Hdwy	7.12	6.52	6.22	7.12	6.52	6.22	4.12	-	-	4.12	-	-
Critical Hdwy Stg 1	6.12	5.52	-	6.12	5.52	-	-	-	-	-	-	-
Critical Hdwy Stg 2	6.12	5.52	-	6.12	5.52	-	-	-	-	-	-	-
Follow-up Hdwy	3.518	4.018	3.318	3.518	4.018	3.318	2.218	-	-	2.218	-	-
Pot Cap-1 Maneuver	743	683	962	746	685	1012	1496	-	-	1544	-	-
Stage 1	849	771	-	955	847	-	-	-	-	-	-	-
Stage 2	950	843	-	848	769	-	-	-	-	-	-	-
Platoon blocked, %	-	-	-	-	-	-	-	-	-	-	-	-
Mov Cap-1 Maneuver	727	669	962	733	671	1012	1496	-	-	1544	-	-
Mov Cap-2 Maneuver	727	669	-	733	671	-	-	-	-	-	-	-
Stage 1	848	756	-	954	846	-	-	-	-	-	-	-
Stage 2	943	842	-	830	754	-	-	-	-	-	-	-

Approach	EB	WB	NB	SB
HCM Control Delay, s	8.7	10	0.1	1.7
HCM LOS	A	B		

Minor Lane/Major Mvmt	NBL	NBT	NBR	EBLn1WBLn1	SBL	SBT	SBR
Capacity (veh/h)	1496	-	-	962	767	1544	-
HCM Lane V/C Ratio	0.001	-	-	0.001	0.052	0.019	-
HCM Control Delay (s)	7.4	0	-	8.7	10	7.4	0
HCM Lane LOS	A	A	-	A	B	A	A
HCM 95th %tile Q(veh)	0	-	-	0	0.2	0.1	-

HCM 6th TWSC
5: Western Drive & Apartment Access

Background Traffic Conditions
Year 2025 - AM Peak Hour

Intersection						
Int Delay, s/veh	2.4					
Movement	EBL	EBT	WBT	WBR	SBL	SBR
Lane Configurations		↕	↕		↕	
Traffic Vol, veh/h	7	31	27	2	4	14
Future Vol, veh/h	7	31	27	2	4	14
Conflicting Peds, #/hr	0	0	0	0	0	0
Sign Control	Free	Free	Free	Free	Stop	Stop
RT Channelized	-	None	-	None	-	None
Storage Length	-	-	-	-	0	-
Veh in Median Storage, #	-	0	0	-	0	-
Grade, %	-	0	0	-	0	-
Peak Hour Factor	92	92	92	92	92	92
Heavy Vehicles, %	2	2	2	2	2	2
Mvmt Flow	8	34	29	2	4	15

Major/Minor	Major1	Major2	Minor2		
Conflicting Flow All	31	0	-	0	80 30
Stage 1	-	-	-	-	30 -
Stage 2	-	-	-	-	50 -
Critical Hdwy	4.12	-	-	-	6.42 6.22
Critical Hdwy Stg 1	-	-	-	-	5.42 -
Critical Hdwy Stg 2	-	-	-	-	5.42 -
Follow-up Hdwy	2.218	-	-	-	3.518 3.318
Pot Cap-1 Maneuver	1582	-	-	-	922 1044
Stage 1	-	-	-	-	993 -
Stage 2	-	-	-	-	972 -
Platoon blocked, %		-	-	-	
Mov Cap-1 Maneuver	1582	-	-	-	917 1044
Mov Cap-2 Maneuver	-	-	-	-	917 -
Stage 1	-	-	-	-	988 -
Stage 2	-	-	-	-	972 -

Approach	EB	WB	SB
HCM Control Delay, s	1.3	0	8.6
HCM LOS			A

Minor Lane/Major Mvmt	EBL	EBT	WBT	WBR	SBLn1
Capacity (veh/h)	1582	-	-	-	1013
HCM Lane V/C Ratio	0.005	-	-	-	0.019
HCM Control Delay (s)	7.3	0	-	-	8.6
HCM Lane LOS	A	A	-	-	A
HCM 95th %tile Q(veh)	0	-	-	-	0.1

HCM 6th TWSC
6: Hathaway Drive & Bednarski Access

Background Traffic Conditions
Year 2025 - AM Peak Hour

Intersection						
Int Delay, s/veh	0.6					
Movement	WBL	WBR	NBT	NBR	SBL	SBT
Lane Configurations	T		T		T	
Traffic Vol, veh/h	0	9	47	5	5	113
Future Vol, veh/h	0	9	47	5	5	113
Conflicting Peds, #/hr	0	0	0	0	0	0
Sign Control	Stop	Stop	Free	Free	Free	Free
RT Channelized	-	None	-	None	-	None
Storage Length	0	-	-	-	-	-
Veh in Median Storage, #	0	-	0	-	-	0
Grade, %	0	-	0	-	-	0
Peak Hour Factor	92	92	92	92	92	92
Heavy Vehicles, %	2	2	2	2	2	2
Mvmt Flow	0	10	51	5	5	123

Major/Minor	Minor1	Major1	Major2		
Conflicting Flow All	187	54	0	0	56
Stage 1	54	-	-	-	-
Stage 2	133	-	-	-	-
Critical Hdwy	6.42	6.22	-	-	4.12
Critical Hdwy Stg 1	5.42	-	-	-	-
Critical Hdwy Stg 2	5.42	-	-	-	-
Follow-up Hdwy	3.518	3.318	-	-	2.218
Pot Cap-1 Maneuver	802	1013	-	-	1549
Stage 1	969	-	-	-	-
Stage 2	893	-	-	-	-
Platoon blocked, %			-	-	-
Mov Cap-1 Maneuver	800	1013	-	-	1549
Mov Cap-2 Maneuver	800	-	-	-	-
Stage 1	969	-	-	-	-
Stage 2	890	-	-	-	-

Approach	WB	NB	SB
HCM Control Delay, s	8.6	0	0.3
HCM LOS	A		

Minor Lane/Major Mvmt	NBT	NBRWBLn1	SBL	SBT
Capacity (veh/h)	-	-	1013	1549
HCM Lane V/C Ratio	-	-	0.01	0.004
HCM Control Delay (s)	-	-	8.6	7.3
HCM Lane LOS	-	-	A	A
HCM 95th %tile Q(veh)	-	-	0	0

HCM 6th TWSC
7: Hathaway Drive & Ford Street

Background Traffic Conditions
Year 2025 - AM Peak Hour

Intersection												
Int Delay, s/veh	7.4											
Movement	EBL	EBT	EBR	WBL	WBT	WBR	NBL	NBT	NBR	SBL	SBT	SBR
Lane Configurations	↕			↕			↕			↕		
Traffic Vol, veh/h	0	5	22	81	32	0	48	0	52	0	0	0
Future Vol, veh/h	0	5	22	81	32	0	48	0	52	0	0	0
Conflicting Peds, #/hr	0	0	0	0	0	0	0	0	0	0	0	0
Sign Control	Stop	Stop	Stop	Stop	Stop	Stop	Free	Free	Free	Free	Free	Free
RT Channelized	-	-	None	-	-	None	-	-	None	-	-	None
Storage Length	-	-	-	-	-	-	-	-	-	-	-	-
Veh in Median Storage, #	-	0	-	-	0	-	-	0	-	-	0	-
Grade, %	-	0	-	-	0	-	-	0	-	-	0	-
Peak Hour Factor	92	92	92	92	92	92	92	92	92	92	92	92
Heavy Vehicles, %	2	2	2	2	2	2	2	2	2	2	2	2
Mvmt Flow	0	5	24	88	35	0	52	0	57	0	0	0





















Major/Minor	Minor2		Minor1		Major1			Major2				
Conflicting Flow All	151	162	1	149	134	29	1	0	0	57	0	0
Stage 1	1	1	-	133	133	-	-	-	-	-	-	-
Stage 2	150	161	-	16	1	-	-	-	-	-	-	-
Critical Hdwy	7.12	6.52	6.22	7.12	6.52	6.22	4.12	-	-	4.12	-	-
Critical Hdwy Stg 1	6.12	5.52	-	6.12	5.52	-	-	-	-	-	-	-
Critical Hdwy Stg 2	6.12	5.52	-	6.12	5.52	-	-	-	-	-	-	-
Follow-up Hdwy	3.518	4.018	3.318	3.518	4.018	3.318	2.218	-	-	2.218	-	-
Pot Cap-1 Maneuver	816	730	1084	819	757	1046	1622	-	-	1547	-	-
Stage 1	1022	895	-	870	786	-	-	-	-	-	-	-
Stage 2	853	765	-	1004	895	-	-	-	-	-	-	-
Platoon blocked, %	-	-	-	-	-	-	-	-	-	-	-	-
Mov Cap-1 Maneuver	767	706	1084	776	732	1046	1622	-	-	1547	-	-
Mov Cap-2 Maneuver	767	706	-	776	732	-	-	-	-	-	-	-
Stage 1	988	895	-	841	760	-	-	-	-	-	-	-
Stage 2	787	740	-	976	895	-	-	-	-	-	-	-

Approach	EB		WB		NB		SB	
HCM Control Delay, s	8.8		10.6		3.5		0	
HCM LOS	A		B					

Minor Lane/Major Mvmt	NBL	NBT	NBR	EBLn1	WBLn1	SBL	SBT	SBR
Capacity (veh/h)	1622	-	-	986	763	1547	-	-
HCM Lane V/C Ratio	0.032	-	-	0.03	0.161	-	-	-
HCM Control Delay (s)	7.3	0	-	8.8	10.6	0	-	-
HCM Lane LOS	A	A	-	A	B	A	-	-
HCM 95th %tile Q(veh)	0.1	-	-	0.1	0.6	0	-	-

Timings
1: Hathaway Drive & Galley Road

Background Traffic Conditions
Year 2025 - PM Peak Hour







												
Lane Group	EBL	EBT	EBR	WBL	WBT	WBR	NBL	NBT	NBR	SBL	SBT	SBR
Lane Configurations												
Traffic Volume (vph)	51	388	44	16	336	6	45	18	42	10	12	34
Future Volume (vph)	51	388	44	16	336	6	45	18	42	10	12	34
Satd. Flow (prot)	1770	1863	1583	1770	1857	0	0	1725	0	0	1695	0
Flt Permitted	0.484			0.516				0.834			0.939	
Satd. Flow (perm)	902	1863	1583	961	1857	0	0	1470	0	0	1606	0
Satd. Flow (RTOR)			127		2			46			37	
Lane Group Flow (vph)	55	422	48	17	372	0	0	115	0	0	61	0
Turn Type	pm+pt	NA	Perm	pm+pt	NA		Perm	NA		Perm	NA	
Protected Phases	5	2		1	6			8				4
Permitted Phases	2		2	6			8			4		
Detector Phase	5	2	2	1	6		8	8		4		4
Switch Phase												
Minimum Initial (s)	5.0	20.0	20.0	5.0	20.0		6.0	6.0		6.0	6.0	
Minimum Split (s)	10.0	26.0	26.0	10.0	26.0		11.0	11.0		11.0	11.0	
Total Split (s)	15.0	29.0	29.0	15.0	29.0		16.0	16.0		16.0	16.0	
Total Split (%)	25.0%	48.3%	48.3%	25.0%	48.3%		26.7%	26.7%		26.7%	26.7%	
Yellow Time (s)	3.0	4.0	4.0	3.0	4.0		3.0	3.0		3.0	3.0	
All-Red Time (s)	2.0	2.0	2.0	2.0	2.0		2.0	2.0		2.0	2.0	
Lost Time Adjust (s)	0.0	0.0	0.0	0.0	0.0			0.0			0.0	
Total Lost Time (s)	5.0	6.0	6.0	5.0	6.0			5.0			5.0	
Lead/Lag	Lead	Lag	Lag	Lead	Lag							
Lead-Lag Optimize?	Yes	Yes	Yes	Yes	Yes							
Recall Mode	None	C-Min	C-Min	None	Min		None	None		None	None	
Act Effct Green (s)	43.0	41.8	41.8	40.5	37.1			8.3			8.3	
Actuated g/C Ratio	0.72	0.70	0.70	0.68	0.62			0.14			0.14	
v/c Ratio	0.07	0.33	0.04	0.02	0.32			0.47			0.24	
Control Delay	3.7	7.3	0.1	3.9	10.1			21.7			14.4	
Queue Delay	0.0	0.0	0.0	0.0	0.0			0.0			0.0	
Total Delay	3.7	7.3	0.1	3.9	10.1			21.7			14.4	
LOS	A	A	A	A	B			C			B	
Approach Delay		6.2			9.8			21.7			14.4	
Approach LOS		A			A			C			B	
Queue Length 50th (ft)	5	50	0	1	78			23			8	
Queue Length 95th (ft)	15	174	0	7	155			62			35	
Internal Link Dist (ft)		635			518			1811			361	
Turn Bay Length (ft)	200		270	90								
Base Capacity (vph)	800	1298	1142	822	1150			307			324	
Starvation Cap Reductn	0	0	0	0	0			0			0	
Spillback Cap Reductn	0	0	0	0	0			0			0	
Storage Cap Reductn	0	0	0	0	0			0			0	
Reduced v/c Ratio	0.07	0.33	0.04	0.02	0.32			0.37			0.19	
Intersection Summary												
Cycle Length: 60												
Actuated Cycle Length: 60												
Offset: 0 (0%), Referenced to phase 2:EBTL, Start of Green												
Natural Cycle: 50												
Control Type: Actuated-Coordinated												

Timings
 1: Hathaway Drive & Galley Road

Background Traffic Conditions
 Year 2025 - PM Peak Hour

Maximum v/c Ratio: 0.47	
Intersection Signal Delay: 9.6	Intersection LOS: A
Intersection Capacity Utilization 50.3%	ICU Level of Service A
Analysis Period (min) 15	

Splits and Phases: 1: Hathaway Drive & Galley Road

 Ø1	 Ø2 (R)	 Ø4
15 s	29 s	16 s
 Ø5	 Ø6	 Ø8
15 s	29 s	16 s

HCM 6th TWSC
2: Western Drive & Galley Road

Background Traffic Conditions
Year 2025 - PM Peak Hour

Intersection												
Int Delay, s/veh	2											
Movement	EBL	EBT	EBR	WBL	WBT	WBR	NBL	NBT	NBR	SBL	SBT	SBR
Lane Configurations		↗			↗			↔			↔	
Traffic Vol, veh/h	36	345	14	17	304	14	5	7	19	17	7	25
Future Vol, veh/h	36	345	14	17	304	14	5	7	19	17	7	25
Conflicting Peds, #/hr	0	0	0	0	0	0	0	0	0	0	0	0
Sign Control	Free	Free	Free	Free	Free	Free	Stop	Stop	Stop	Stop	Stop	Stop
RT Channelized	-	-	None	-	-	None	-	-	None	-	-	None
Storage Length	-	-	-	-	-	-	-	-	-	-	-	-
Veh in Median Storage, #	-	0	-	-	0	-	-	0	-	-	0	-
Grade, %	-	0	-	-	0	-	-	0	-	-	0	-
Peak Hour Factor	92	92	92	92	92	92	92	92	92	92	92	92
Heavy Vehicles, %	2	2	2	2	2	2	2	2	2	2	2	2
Mvmt Flow	39	375	15	18	330	15	5	8	21	18	8	27

Major/Minor	Major1		Major2		Minor1			Minor2				
Conflicting Flow All	345	0	0	390	0	0	852	842	383	849	842	338
Stage 1	-	-	-	-	-	-	461	461	-	374	374	-
Stage 2	-	-	-	-	-	-	391	381	-	475	468	-
Critical Hdwy	4.12	-	-	4.12	-	-	7.12	6.52	6.22	7.12	6.52	6.22
Critical Hdwy Stg 1	-	-	-	-	-	-	6.12	5.52	-	6.12	5.52	-
Critical Hdwy Stg 2	-	-	-	-	-	-	6.12	5.52	-	6.12	5.52	-
Follow-up Hdwy	2.218	-	-	2.218	-	-	3.518	4.018	3.318	3.518	4.018	3.318
Pot Cap-1 Maneuver	1214	-	-	1169	-	-	280	301	664	281	301	704
Stage 1	-	-	-	-	-	-	581	565	-	647	618	-
Stage 2	-	-	-	-	-	-	633	613	-	570	561	-
Platoon blocked, %		-	-		-	-						
Mov Cap-1 Maneuver	1214	-	-	1169	-	-	252	283	664	255	283	704
Mov Cap-2 Maneuver	-	-	-	-	-	-	252	283	-	255	283	-
Stage 1	-	-	-	-	-	-	557	542	-	620	606	-
Stage 2	-	-	-	-	-	-	590	601	-	522	538	-

Approach	EB		WB		NB		SB	
HCM Control Delay, s	0.7		0.4		14.2		15.8	
HCM LOS					B		C	

Minor Lane/Major Mvmt	NBLn1	EBL	EBT	EBR	WBL	WBT	WBR	SBLn1
Capacity (veh/h)	424	1214	-	-	1169	-	-	386
HCM Lane V/C Ratio	0.079	0.032	-	-	0.016	-	-	0.138
HCM Control Delay (s)	14.2	8.1	-	-	8.1	-	-	15.8
HCM Lane LOS		B	A	-	-	A	-	C
HCM 95th %tile Q(veh)	0.3	0.1	-	-	0	-	-	0.5

HCM 6th TWSC
3: Hathaway Drive & E Platte Avenue

Background Traffic Conditions
Year 2025 - PM Peak Hour

Intersection													
Int Delay, s/veh	8.6												
Movement	EBU	EBL	EBT	EBR	WBL	WBT	WBR	NBL	NBT	NBR	SBL	SBT	SBR
Lane Configurations		↔	↑↑	↗	↔	↑↑	↗			↗			↗
Traffic Vol, veh/h	38	88	2328	3	23	1921	22	0	0	43	0	0	77
Future Vol, veh/h	38	88	2328	3	23	1921	22	0	0	43	0	0	77
Conflicting Peds, #/hr	0	0	0	0	0	0	0	0	0	0	0	0	0
Sign Control	Free	Free	Free	Free	Free	Free	Free	Stop	Stop	Stop	Stop	Stop	Stop
RT Channelized	-	-	-	None	-	-	Free	-	-	None	-	-	Stop
Storage Length	-	330	-	200	250	-	500	-	-	0	-	-	0
Veh in Median Storage, #	-	-	0	-	-	0	-	-	0	-	-	0	-
Grade, %	-	-	0	-	-	0	-	-	0	-	-	0	-
Peak Hour Factor	92	92	92	92	92	92	92	92	92	92	92	92	92
Heavy Vehicles, %	2	2	2	2	2	2	2	2	2	2	2	2	2
Mvmt Flow	41	96	2530	3	25	2088	24	0	0	47	0	0	84
Major/Minor	Major1				Major2			Minor1			Minor2		
Conflicting Flow All	2088	2088	0	0	2533	0	0	-	-	1265	-	-	1044
Stage 1	-	-	-	-	-	-	-	-	-	-	-	-	-
Stage 2	-	-	-	-	-	-	-	-	-	-	-	-	-
Critical Hdwy	6.44	4.14	-	-	4.14	-	-	-	-	6.94	-	-	6.94
Critical Hdwy Stg 1	-	-	-	-	-	-	-	-	-	-	-	-	-
Critical Hdwy Stg 2	-	-	-	-	-	-	-	-	-	-	-	-	-
Follow-up Hdwy	2.52	2.22	-	-	2.22	-	-	-	-	3.32	-	-	3.32
Pot Cap-1 Maneuver	65	261	-	-	174	-	0	0	0	160	0	0	226
Stage 1	-	-	-	-	-	-	0	0	0	-	0	0	-
Stage 2	-	-	-	-	-	-	0	0	0	-	0	0	-
Platoon blocked, %			-	-			-						
Mov Cap-1 Maneuver	103	103	-	-	174	-	-	-	-	160	-	-	226
Mov Cap-2 Maneuver	-	-	-	-	-	-	-	-	-	-	-	-	-
Stage 1	-	-	-	-	-	-	-	-	-	-	-	-	-
Stage 2	-	-	-	-	-	-	-	-	-	-	-	-	-
Approach	EB				WB			NB			SB		
HCM Control Delay, s	14.1				0.3			36.5			30		
HCM LOS								E			D		
Minor Lane/Major Mvmt	NBLn1	EBL	EBT	EBR	WBL	WBT	SBLn1						
Capacity (veh/h)	160	103	-	-	174	-	226						
HCM Lane V/C Ratio	0.292	1.33	-	-	0.144	-	0.37						
HCM Control Delay (s)	36.5	275.5	-	-	29.1	-	30						
HCM Lane LOS	E	F	-	-	D	-	D						
HCM 95th %tile Q(veh)	1.1	9.6	-	-	0.5	-	1.6						

HCM 6th TWSC
4: Hathaway Drive & Western Drive

Background Traffic Conditions
Year 2025 - PM Peak Hour

Intersection												
Int Delay, s/veh	1.8											
Movement	EBL	EBT	EBR	WBL	WBT	WBR	NBL	NBT	NBR	SBL	SBT	SBR
Lane Configurations	↕			↕			↕			↕		
Traffic Vol, veh/h	3	1	3	10	0	3	1	60	28	10	33	0
Future Vol, veh/h	3	1	3	10	0	3	1	60	28	10	33	0
Conflicting Peds, #/hr	0	0	0	0	0	0	0	0	0	0	0	0
Sign Control	Stop	Stop	Stop	Stop	Stop	Stop	Free	Free	Free	Free	Free	Free
RT Channelized	-	-	None	-	-	None	-	-	None	-	-	None
Storage Length	-	-	-	-	-	-	-	-	-	-	-	-
Veh in Median Storage, #	-	0	-	-	0	-	-	0	-	-	0	-
Grade, %	-	0	-	-	0	-	-	0	-	-	0	-
Peak Hour Factor	92	92	92	92	92	92	92	92	92	92	92	92
Heavy Vehicles, %	2	2	2	2	2	2	2	2	2	2	2	2
Mvmt Flow	3	1	3	11	0	3	1	65	30	11	36	0

Major/Minor	Minor2		Minor1		Major1			Major2				
Conflicting Flow All	142	155	36	142	140	80	36	0	0	95	0	0
Stage 1	58	58	-	82	82	-	-	-	-	-	-	-
Stage 2	84	97	-	60	58	-	-	-	-	-	-	-
Critical Hdwy	7.12	6.52	6.22	7.12	6.52	6.22	4.12	-	-	4.12	-	-
Critical Hdwy Stg 1	6.12	5.52	-	6.12	5.52	-	-	-	-	-	-	-
Critical Hdwy Stg 2	6.12	5.52	-	6.12	5.52	-	-	-	-	-	-	-
Follow-up Hdwy	3.518	4.018	3.318	3.518	4.018	3.318	2.218	-	-	2.218	-	-
Pot Cap-1 Maneuver	828	737	1037	828	751	980	1575	-	-	1499	-	-
Stage 1	954	847	-	926	827	-	-	-	-	-	-	-
Stage 2	924	815	-	951	847	-	-	-	-	-	-	-
Platoon blocked, %	-	-	-	-	-	-	-	-	-	-	-	-
Mov Cap-1 Maneuver	821	731	1037	820	745	980	1575	-	-	1499	-	-
Mov Cap-2 Maneuver	821	731	-	820	745	-	-	-	-	-	-	-
Stage 1	953	841	-	925	826	-	-	-	-	-	-	-
Stage 2	920	814	-	940	841	-	-	-	-	-	-	-

Approach	EB		WB		NB		SB	
HCM Control Delay, s	9.1		9.3		0.1		1.7	
HCM LOS	A		A					

Minor Lane/Major Mvmt	NBL	NBT	NBR	EBLn1	WBLn1	SBL	SBT	SBR
Capacity (veh/h)	1575	-	-	884	852	1499	-	-
HCM Lane V/C Ratio	0.001	-	-	0.009	0.017	0.007	-	-
HCM Control Delay (s)	7.3	0	-	9.1	9.3	7.4	0	-
HCM Lane LOS	A	A	-	A	A	A	A	-
HCM 95th %tile Q(veh)	0	-	-	0	0.1	0	-	-

HCM 6th TWSC
5: Western Drive & Apartment Access

Background Traffic Conditions
Year 2025 - PM Peak Hour

Intersection						
Int Delay, s/veh	3.5					
Movement	EBL	EBT	WBT	WBR	SBL	SBR
Lane Configurations		↕	↕		↕	
Traffic Vol, veh/h	15	26	5	6	3	11
Future Vol, veh/h	15	26	5	6	3	11
Conflicting Peds, #/hr	0	0	0	0	0	0
Sign Control	Free	Free	Free	Free	Stop	Stop
RT Channelized	-	None	-	None	-	None
Storage Length	-	-	-	-	0	-
Veh in Median Storage, #	-	0	0	-	0	-
Grade, %	-	0	0	-	0	-
Peak Hour Factor	92	92	92	92	92	92
Heavy Vehicles, %	2	2	2	2	2	2
Mvmt Flow	16	28	5	7	3	12

Major/Minor	Major1	Major2	Minor2		
Conflicting Flow All	12	0	-	0	69
Stage 1	-	-	-	-	9
Stage 2	-	-	-	-	60
Critical Hdwy	4.12	-	-	-	6.42
Critical Hdwy Stg 1	-	-	-	-	5.42
Critical Hdwy Stg 2	-	-	-	-	5.42
Follow-up Hdwy	2.218	-	-	-	3.518
Pot Cap-1 Maneuver	1607	-	-	-	936
Stage 1	-	-	-	-	1014
Stage 2	-	-	-	-	963
Platoon blocked, %		-	-	-	
Mov Cap-1 Maneuver	1607	-	-	-	927
Mov Cap-2 Maneuver	-	-	-	-	927
Stage 1	-	-	-	-	1004
Stage 2	-	-	-	-	963

Approach	EB	WB	SB
HCM Control Delay, s	2.7	0	8.5
HCM LOS			A

Minor Lane/Major Mvmt	EBL	EBT	WBT	WBR	SBLn1
Capacity (veh/h)	1607	-	-	-	1038
HCM Lane V/C Ratio	0.01	-	-	-	0.015
HCM Control Delay (s)	7.3	0	-	-	8.5
HCM Lane LOS	A	A	-	-	A
HCM 95th %tile Q(veh)	0	-	-	-	0

HCM 6th TWSC
6: Hathaway Drive & Bednarski Access

Background Traffic Conditions
Year 2025 - PM Peak Hour

Intersection						
Int Delay, s/veh	0.8					
Movement	WBL	WBR	NBT	NBR	SBL	SBT
Lane Configurations	T		T		T	
Traffic Vol, veh/h	7	4	85	2	1	46
Future Vol, veh/h	7	4	85	2	1	46
Conflicting Peds, #/hr	0	0	0	0	0	0
Sign Control	Stop	Stop	Free	Free	Free	Free
RT Channelized	-	None	-	None	-	None
Storage Length	0	-	-	-	-	-
Veh in Median Storage, #	0	-	0	-	-	0
Grade, %	0	-	0	-	-	0
Peak Hour Factor	92	92	92	92	92	92
Heavy Vehicles, %	2	2	2	2	2	2
Mvmt Flow	8	4	92	2	1	50

Major/Minor	Minor1	Major1	Major2		
Conflicting Flow All	145	93	0	0	94
Stage 1	93	-	-	-	-
Stage 2	52	-	-	-	-
Critical Hdwy	6.42	6.22	-	-	4.12
Critical Hdwy Stg 1	5.42	-	-	-	-
Critical Hdwy Stg 2	5.42	-	-	-	-
Follow-up Hdwy	3.518	3.318	-	-	2.218
Pot Cap-1 Maneuver	847	964	-	-	1500
Stage 1	931	-	-	-	-
Stage 2	970	-	-	-	-
Platoon blocked, %			-	-	-
Mov Cap-1 Maneuver	846	964	-	-	1500
Mov Cap-2 Maneuver	846	-	-	-	-
Stage 1	931	-	-	-	-
Stage 2	969	-	-	-	-

Approach	WB	NB	SB
HCM Control Delay, s	9.1	0	0.2
HCM LOS	A		

Minor Lane/Major Mvmt	NBT	NBRWBLn1	SBL	SBT
Capacity (veh/h)	-	-	885	1500
HCM Lane V/C Ratio	-	-	0.014	0.001
HCM Control Delay (s)	-	-	9.1	7.4
HCM Lane LOS	-	-	A	A
HCM 95th %tile Q(veh)	-	-	0	0

HCM 6th TWSC
7: Hathaway Drive & Ford Street

Background Traffic Conditions
Year 2025 - PM Peak Hour

Intersection												
Int Delay, s/veh	5.1											
Movement	EBL	EBT	EBR	WBL	WBT	WBR	NBL	NBT	NBR	SBL	SBT	SBR
Lane Configurations	↕			↕			↕			↕		
Traffic Vol, veh/h	0	5	36	41	12	0	23	0	87	0	0	0
Future Vol, veh/h	0	5	36	41	12	0	23	0	87	0	0	0
Conflicting Peds, #/hr	0	0	0	0	0	0	0	0	0	0	0	0
Sign Control	Stop	Stop	Stop	Stop	Stop	Stop	Free	Free	Free	Free	Free	Free
RT Channelized	-	-	None	-	-	None	-	-	None	-	-	None
Storage Length	-	-	-	-	-	-	-	-	-	-	-	-
Veh in Median Storage, #	-	0	-	-	0	-	-	0	-	-	0	-
Grade, %	-	0	-	-	0	-	-	0	-	-	0	-
Peak Hour Factor	92	92	92	92	92	92	92	92	92	92	92	92
Heavy Vehicles, %	2	2	2	2	2	2	2	2	2	2	2	2
Mvmt Flow	0	5	39	45	13	0	25	0	95	0	0	0





















Major/Minor	Minor2		Minor1		Major1			Major2				
Conflicting Flow All	105	146	1	121	99	48	1	0	0	95	0	0
Stage 1	1	1	-	98	98	-	-	-	-	-	-	-
Stage 2	104	145	-	23	1	-	-	-	-	-	-	-
Critical Hdwy	7.12	6.52	6.22	7.12	6.52	6.22	4.12	-	-	4.12	-	-
Critical Hdwy Stg 1	6.12	5.52	-	6.12	5.52	-	-	-	-	-	-	-
Critical Hdwy Stg 2	6.12	5.52	-	6.12	5.52	-	-	-	-	-	-	-
Follow-up Hdwy	3.518	4.018	3.318	3.518	4.018	3.318	2.218	-	-	2.218	-	-
Pot Cap-1 Maneuver	875	745	1084	854	791	1021	1622	-	-	1499	-	-
Stage 1	1022	895	-	908	814	-	-	-	-	-	-	-
Stage 2	902	777	-	995	895	-	-	-	-	-	-	-
Platoon blocked, %	-	-	-	-	-	-	-	-	-	-	-	-
Mov Cap-1 Maneuver	853	733	1084	809	778	1021	1622	-	-	1499	-	-
Mov Cap-2 Maneuver	853	733	-	809	778	-	-	-	-	-	-	-
Stage 1	1006	895	-	893	801	-	-	-	-	-	-	-
Stage 2	873	765	-	953	895	-	-	-	-	-	-	-

Approach	EB		WB		NB		SB	
HCM Control Delay, s	8.7		9.8		1.5		0	
HCM LOS	A		A					

Minor Lane/Major Mvmt	NBL	NBT	NBR	EBLn1	WBLn1	SBL	SBT	SBR
Capacity (veh/h)	1622	-	-	1024	802	1499	-	-
HCM Lane V/C Ratio	0.015	-	-	0.044	0.072	-	-	-
HCM Control Delay (s)	7.3	0	-	8.7	9.8	0	-	-
HCM Lane LOS	A	A	-	A	A	A	-	-
HCM 95th %tile Q(veh)	0	-	-	0.1	0.2	0	-	-

Timings
1: Hathaway Drive & Galley Road

Background Traffic Conditions
Year 2043 - AM Peak Hour

												
Lane Group	EBL	EBT	EBR	WBL	WBT	WBR	NBL	NBT	NBR	SBL	SBT	SBR
Lane Configurations												
Traffic Volume (vph)	20	269	120	156	749	15	107	42	89	14	51	75
Future Volume (vph)	20	269	120	156	749	15	107	42	89	14	51	75
Satd. Flow (prot)	1770	1863	1583	1770	1857	0	0	1729	0	0	1718	0
Flt Permitted	0.168			0.526				0.794			0.951	
Satd. Flow (perm)	313	1863	1583	980	1857	0	0	1404	0	0	1642	0
Satd. Flow (RTOR)			130		2			43			82	
Lane Group Flow (vph)	22	292	130	170	830	0	0	259	0	0	152	0
Turn Type	pm+pt	NA	Perm	pm+pt	NA		Perm	NA		Perm	NA	
Protected Phases	5	2		1	6			8				4
Permitted Phases	2		2	6			8			4		
Detector Phase	5	2	2	1	6		8	8		4		4
Switch Phase												
Minimum Initial (s)	5.0	20.0	20.0	5.0	20.0		6.0	6.0		6.0	6.0	
Minimum Split (s)	10.0	26.0	26.0	10.0	26.0		11.0	11.0		11.0	11.0	
Total Split (s)	10.0	35.0	35.0	10.0	35.0		15.0	15.0		15.0	15.0	
Total Split (%)	16.7%	58.3%	58.3%	16.7%	58.3%		25.0%	25.0%		25.0%	25.0%	
Yellow Time (s)	3.0	4.0	4.0	3.0	4.0		3.0	3.0		3.0	3.0	
All-Red Time (s)	2.0	2.0	2.0	2.0	2.0		2.0	2.0		2.0	2.0	
Lost Time Adjust (s)	0.0	0.0	0.0	0.0	0.0			0.0			0.0	
Total Lost Time (s)	5.0	6.0	6.0	5.0	6.0			5.0			5.0	
Lead/Lag	Lead	Lag	Lag	Lead	Lag							
Lead-Lag Optimize?	Yes	Yes	Yes	Yes	Yes							
Recall Mode	None	C-Min	C-Min	None	Min		None	None		None	None	
Act Effct Green (s)	34.8	29.8	29.8	37.8	35.8			11.2			11.2	
Actuated g/C Ratio	0.58	0.50	0.50	0.63	0.60			0.19			0.19	
v/c Ratio	0.07	0.32	0.15	0.25	0.75			0.87			0.41	
Control Delay	4.2	10.7	2.5	5.0	16.4			53.3			15.3	
Queue Delay	0.0	0.0	0.0	0.0	0.0			0.0			0.0	
Total Delay	4.2	10.7	2.5	5.0	16.4			53.3			15.3	
LOS	A	B	A	A	B			D			B	
Approach Delay		8.0			14.5			53.3			15.3	
Approach LOS		A			B			D			B	
Queue Length 50th (ft)	2	60	0	18	156			79			22	
Queue Length 95th (ft)	8	106	22	36	#493			#210			68	
Internal Link Dist (ft)		635			518			1811			361	
Turn Bay Length (ft)	200		270	90								
Base Capacity (vph)	305	940	863	685	1107			297			374	
Starvation Cap Reductn	0	0	0	0	0			0			0	
Spillback Cap Reductn	0	0	0	0	0			0			0	
Storage Cap Reductn	0	0	0	0	0			0			0	
Reduced v/c Ratio	0.07	0.31	0.15	0.25	0.75			0.87			0.41	

Intersection Summary







Cycle Length: 60
 Actuated Cycle Length: 60
 Offset: 0 (0%), Referenced to phase 2:EBTL, Start of Green
 Natural Cycle: 70
 Control Type: Actuated-Coordinated

Timings
 1: Hathaway Drive & Galley Road

Background Traffic Conditions
 Year 2043 - AM Peak Hour

Maximum v/c Ratio: 0.87
 Intersection Signal Delay: 18.4 Intersection LOS: B
 Intersection Capacity Utilization 83.6% ICU Level of Service E
 Analysis Period (min) 15
 # 95th percentile volume exceeds capacity, queue may be longer.
 Queue shown is maximum after two cycles.

Splits and Phases: 1: Hathaway Drive & Galley Road

 Ø1	 Ø2 (R)	 Ø4
10 s	35 s	15 s
 Ø5	 Ø6	 Ø8
10 s	35 s	15 s

HCM 6th TWSC
2: Western Drive & Galley Road

Background Traffic Conditions
Year 2043 - AM Peak Hour

Intersection												
Int Delay, s/veh	7.2											
Movement	EBL	EBT	EBR	WBL	WBT	WBR	NBL	NBT	NBR	SBL	SBT	SBR
Lane Configurations	↶			↶			↷			↷		
Traffic Vol, veh/h	32	332	3	38	638	27	20	20	41	14	11	153
Future Vol, veh/h	32	332	3	38	638	27	20	20	41	14	11	153
Conflicting Peds, #/hr	0	0	0	0	0	0	0	0	0	0	0	0
Sign Control	Free	Free	Free	Free	Free	Free	Stop	Stop	Stop	Stop	Stop	Stop
RT Channelized	-	-	None	-	-	None	-	-	None	-	-	None
Storage Length	-	-	-	-	-	-	-	-	-	-	-	-
Veh in Median Storage, #	-	0	-	-	0	-	-	0	-	-	0	-
Grade, %	-	0	-	-	0	-	-	0	-	-	0	-
Peak Hour Factor	92	92	92	92	92	92	92	92	92	92	92	92
Heavy Vehicles, %	2	2	2	2	2	2	2	2	2	2	2	2
Mvmt Flow	35	361	3	41	693	29	22	22	45	15	12	166

Major/Minor	Major1		Major2		Minor1			Minor2				
Conflicting Flow All	722	0	0	364	0	0	1312	1237	363	1256	1224	708
Stage 1	-	-	-	-	-	-	433	433	-	790	790	-
Stage 2	-	-	-	-	-	-	879	804	-	466	434	-
Critical Hdwy	4.12	-	-	4.12	-	-	7.12	6.52	6.22	7.12	6.52	6.22
Critical Hdwy Stg 1	-	-	-	-	-	-	6.12	5.52	-	6.12	5.52	-
Critical Hdwy Stg 2	-	-	-	-	-	-	6.12	5.52	-	6.12	5.52	-
Follow-up Hdwy	2.218	-	-	2.218	-	-	3.518	4.018	3.318	3.518	4.018	3.318
Pot Cap-1 Maneuver	880	-	-	1195	-	-	136	176	682	148	179	435
Stage 1	-	-	-	-	-	-	601	582	-	383	402	-
Stage 2	-	-	-	-	-	-	342	396	-	577	581	-
Platoon blocked, %	-	-	-	-	-	-	-	-	-	-	-	-
Mov Cap-1 Maneuver	880	-	-	1195	-	-	73	158	682	114	160	435
Mov Cap-2 Maneuver	-	-	-	-	-	-	73	158	-	114	160	-
Stage 1	-	-	-	-	-	-	571	553	-	364	379	-
Stage 2	-	-	-	-	-	-	193	373	-	492	552	-

Approach	EB		WB		NB			SB		
HCM Control Delay, s	0.8		0.4		44.3			30.6		
HCM LOS					E			D		

Minor Lane/Major Mvmt	NBLn1	EBL	EBT	EBR	WBL	WBT	WBR	SBLn1
Capacity (veh/h)	176	880	-	-	1195	-	-	328
HCM Lane V/C Ratio	0.5	0.04	-	-	0.035	-	-	0.59
HCM Control Delay (s)	44.3	9.3	-	-	8.1	-	-	30.6
HCM Lane LOS	E	A	-	-	A	-	-	D
HCM 95th %tile Q(veh)	2.5	0.1	-	-	0.1	-	-	3.6

HCM 6th TWSC
3: Hathaway Drive & E Platte Avenue

Background Traffic Conditions
Year 2043 - AM Peak Hour

Intersection														
Int Delay, s/veh	49.3													
Movement	EBU	EBL	EBT	EBR	WBU	WBL	WBT	WBR	NBL	NBT	NBR	SBL	SBT	SBR
Lane Configurations		↔	↕	↗		↔	↕	↗			↗			↗
Traffic Vol, veh/h	26	80	2763	3	18	60	4176	65	0	0	27	0	0	149
Future Vol, veh/h	26	80	2763	3	18	60	4176	65	0	0	27	0	0	149
Conflicting Peds, #/hr	0	0	0	0	0	0	0	0	0	0	0	0	0	0
Sign Control	Free	Free	Free	Free	Free	Free	Free	Free	Stop	Stop	Stop	Stop	Stop	Stop
RT Channelized	-	-	-	None	-	-	-	Free	-	-	None	-	-	Stop
Storage Length	-	330	-	200	-	250	-	500	-	-	0	-	-	0
Veh in Median Storage, #	-	-	0	-	-	-	0	-	-	0	-	-	0	-
Grade, %	-	-	0	-	-	-	0	-	-	0	-	-	0	-
Peak Hour Factor	92	92	92	92	92	92	92	92	92	92	92	92	92	92
Heavy Vehicles, %	2	2	2	2	2	2	2	2	2	2	2	2	2	2
Mvmt Flow	28	87	3003	3	20	65	4539	71	0	0	29	0	0	162

Major/Minor	Major1		Major2		Minor1		Minor2							
Conflicting Flow All	4539	4539	0	0	3003	3006	0	0	-	-	1502	-	-	2270
Stage 1	-	-	-	-	-	-	-	-	-	-	-	-	-	-
Stage 2	-	-	-	-	-	-	-	-	-	-	-	-	-	-
Critical Hdwy	6.44	4.14	-	-	6.44	4.14	-	-	-	-	6.94	-	-	6.94
Critical Hdwy Stg 1	-	-	-	-	-	-	-	-	-	-	-	-	-	-
Critical Hdwy Stg 2	-	-	-	-	-	-	-	-	-	-	-	-	-	-
Follow-up Hdwy	2.52	2.22	-	-	2.52	2.22	-	-	-	-	3.32	-	-	3.32
Pot Cap-1 Maneuver	~ 1	~ 26	-	-	~ 16	112	-	0	0	0	111	0	0	~ 33
Stage 1	-	-	-	-	-	-	-	0	0	0	-	0	0	-
Stage 2	-	-	-	-	-	-	-	0	0	0	-	0	0	-
Platoon blocked, %			-	-			-							
Mov Cap-1 Maneuver	~-11	~-11	-	-	38	~ 38	-	-	-	-	111	-	-	~ 33
Mov Cap-2 Maneuver	-	-	-	-	-	-	-	-	-	-	-	-	-	-
Stage 1	-	-	-	-	-	-	-	-	-	-	-	-	-	-
Stage 2	-	-	-	-	-	-	-	-	-	-	-	-	-	-

Approach	EB		WB		NB		SB	
HCM Control Delay, s			14.3		48.7		\$ 2000.3	
HCM LOS					E		F	

Minor Lane/Major Mvmt	NBLn1	EBL	EBT	EBR	WBL	WBT	SBLn1
Capacity (veh/h)	111	+	-	-	~ 38	-	33
HCM Lane V/C Ratio	0.264	-	-	-	2.231	-	4.908
HCM Control Delay (s)	48.7	-	-	-	\$ 781.7	-	\$ 2000.3
HCM Lane LOS	E	-	-	-	F	-	F
HCM 95th %tile Q(veh)	1	-	-	-	9.3	-	19.3

Notes
 ~: Volume exceeds capacity \$: Delay exceeds 300s +: Computation Not Defined *: All major volume in platoon

HCM 6th TWSC
4: Hathaway Drive & Western Drive

Background Traffic Conditions
Year 2043 - AM Peak Hour

Intersection												
Int Delay, s/veh	2.9											
Movement	EBL	EBT	EBR	WBL	WBT	WBR	NBL	NBT	NBR	SBL	SBT	SBR
Lane Configurations	↕			↕			↕			↕		
Traffic Vol, veh/h	0	0	1	45	0	9	1	66	14	39	125	4
Future Vol, veh/h	0	0	1	45	0	9	1	66	14	39	125	4
Conflicting Peds, #/hr	0	0	0	0	0	0	0	0	0	0	0	0
Sign Control	Stop	Stop	Stop	Stop	Stop	Stop	Free	Free	Free	Free	Free	Free
RT Channelized	-	-	None	-	-	None	-	-	None	-	-	None
Storage Length	-	-	-	-	-	-	-	-	-	-	-	-
Veh in Median Storage, #	-	0	-	-	0	-	-	0	-	-	0	-
Grade, %	-	0	-	-	0	-	-	0	-	-	0	-
Peak Hour Factor	92	92	92	92	92	92	92	92	92	92	92	92
Heavy Vehicles, %	2	2	2	2	2	2	2	2	2	2	2	2
Mvmt Flow	0	0	1	49	0	10	1	72	15	42	136	4

Major/Minor	Minor2		Minor1		Major1		Major2					
Conflicting Flow All	309	311	138	305	306	80	140	0	0	87	0	0
Stage 1	222	222	-	82	82	-	-	-	-	-	-	-
Stage 2	87	89	-	223	224	-	-	-	-	-	-	-
Critical Hdwy	7.12	6.52	6.22	7.12	6.52	6.22	4.12	-	-	4.12	-	-
Critical Hdwy Stg 1	6.12	5.52	-	6.12	5.52	-	-	-	-	-	-	-
Critical Hdwy Stg 2	6.12	5.52	-	6.12	5.52	-	-	-	-	-	-	-
Follow-up Hdwy	3.518	4.018	3.318	3.518	4.018	3.318	2.218	-	-	2.218	-	-
Pot Cap-1 Maneuver	643	604	910	647	608	980	1443	-	-	1509	-	-
Stage 1	780	720	-	926	827	-	-	-	-	-	-	-
Stage 2	921	821	-	780	718	-	-	-	-	-	-	-
Platoon blocked, %	-	-	-	-	-	-	-	-	-	-	-	-
Mov Cap-1 Maneuver	622	585	910	631	589	980	1443	-	-	1509	-	-
Mov Cap-2 Maneuver	622	585	-	631	589	-	-	-	-	-	-	-
Stage 1	779	698	-	925	826	-	-	-	-	-	-	-
Stage 2	911	820	-	756	696	-	-	-	-	-	-	-

Approach	EB		WB		NB		SB	
HCM Control Delay, s	9		10.9		0.1		1.7	
HCM LOS	A		B					

Minor Lane/Major Mvmt	NBL	NBT	NBR	EBLn1	WBLn1	SBL	SBT	SBR
Capacity (veh/h)	1443	-	-	910	671	1509	-	-
HCM Lane V/C Ratio	0.001	-	-	0.001	0.087	0.028	-	-
HCM Control Delay (s)	7.5	0	-	9	10.9	7.5	0	-
HCM Lane LOS	A	A	-	A	B	A	A	-
HCM 95th %tile Q(veh)	0	-	-	0	0.3	0.1	-	-

HCM 6th TWSC
5: Western Drive & Apartment Access

Background Traffic Conditions
Year 2043 - AM Peak Hour

Intersection						
Int Delay, s/veh	1.9					
Movement	EBL	EBT	WBT	WBR	SBL	SBR
Lane Configurations		↕	↕		↕	
Traffic Vol, veh/h	7	45	39	2	4	14
Future Vol, veh/h	7	45	39	2	4	14
Conflicting Peds, #/hr	0	0	0	0	0	0
Sign Control	Free	Free	Free	Free	Stop	Stop
RT Channelized	-	None	-	None	-	None
Storage Length	-	-	-	-	0	-
Veh in Median Storage, #	-	0	0	-	0	-
Grade, %	-	0	0	-	0	-
Peak Hour Factor	92	92	92	92	92	92
Heavy Vehicles, %	2	2	2	2	2	2
Mvmt Flow	8	49	42	2	4	15



Major/Minor	Major1	Major2	Minor2		
Conflicting Flow All	44	0	-	0	108 43
Stage 1	-	-	-	-	43 -
Stage 2	-	-	-	-	65 -
Critical Hdwy	4.12	-	-	-	6.42 6.22
Critical Hdwy Stg 1	-	-	-	-	5.42 -
Critical Hdwy Stg 2	-	-	-	-	5.42 -
Follow-up Hdwy	2.218	-	-	-	3.518 3.318
Pot Cap-1 Maneuver	1564	-	-	-	889 1027
Stage 1	-	-	-	-	979 -
Stage 2	-	-	-	-	958 -
Platoon blocked, %		-	-	-	
Mov Cap-1 Maneuver	1564	-	-	-	885 1027
Mov Cap-2 Maneuver	-	-	-	-	885 -
Stage 1	-	-	-	-	974 -
Stage 2	-	-	-	-	958 -

Approach	EB	WB	SB
HCM Control Delay, s	1	0	8.7
HCM LOS			A

Minor Lane/Major Mvmt	EBL	EBT	WBT	WBR	SBLn1
Capacity (veh/h)	1564	-	-	-	992
HCM Lane V/C Ratio	0.005	-	-	-	0.02
HCM Control Delay (s)	7.3	0	-	-	8.7
HCM Lane LOS	A	A	-	-	A
HCM 95th %tile Q(veh)	0	-	-	-	0.1

HCM 6th TWSC
6: Hathaway Drive & Bednarski Access

Background Traffic Conditions
Year 2043 - AM Peak Hour

Intersection						
Int Delay, s/veh	0.4					
Movement	WBL	WBR	NBT	NBR	SBL	SBT
Lane Configurations						
Traffic Vol, veh/h	0	9	68	5	5	164
Future Vol, veh/h	0	9	68	5	5	164
Conflicting Peds, #/hr	0	0	0	0	0	0
Sign Control	Stop	Stop	Free	Free	Free	Free
RT Channelized	-	None	-	None	-	None
Storage Length	0	-	-	-	-	-
Veh in Median Storage, #	0	-	0	-	-	0
Grade, %	0	-	0	-	-	0
Peak Hour Factor	92	92	92	92	92	92
Heavy Vehicles, %	2	2	2	2	2	2
Mvmt Flow	0	10	74	5	5	178

Major/Minor	Minor1	Major1	Major2		
Conflicting Flow All	265	77	0	0	79
Stage 1	77	-	-	-	-
Stage 2	188	-	-	-	-
Critical Hdwy	6.42	6.22	-	-	4.12
Critical Hdwy Stg 1	5.42	-	-	-	-
Critical Hdwy Stg 2	5.42	-	-	-	-
Follow-up Hdwy	3.518	3.318	-	-	2.218
Pot Cap-1 Maneuver	724	984	-	-	1519
Stage 1	946	-	-	-	-
Stage 2	844	-	-	-	-
Platoon blocked, %			-	-	-
Mov Cap-1 Maneuver	721	984	-	-	1519
Mov Cap-2 Maneuver	721	-	-	-	-
Stage 1	946	-	-	-	-
Stage 2	841	-	-	-	-

Approach	WB	NB	SB
HCM Control Delay, s	8.7	0	0.2
HCM LOS	A		

Minor Lane/Major Mvmt	NBT	NBRWBLn1	SBL	SBT
Capacity (veh/h)	-	-	984	1519
HCM Lane V/C Ratio	-	-	0.01	0.004
HCM Control Delay (s)	-	-	8.7	7.4
HCM Lane LOS	-	-	A	A
HCM 95th %tile Q(veh)	-	-	0	0

HCM 6th TWSC
7: Hathaway Drive & Ford Street

Background Traffic Conditions
Year 2043 - AM Peak Hour

Intersection												
Int Delay, s/veh	8.2											
Movement	EBL	EBT	EBR	WBL	WBT	WBR	NBL	NBT	NBR	SBL	SBT	SBR
Lane Configurations	↕			↕			↕			↕		
Traffic Vol, veh/h	0	8	32	117	47	0	69	0	75	0	0	0
Future Vol, veh/h	0	8	32	117	47	0	69	0	75	0	0	0
Conflicting Peds, #/hr	0	0	0	0	0	0	0	0	0	0	0	0
Sign Control	Stop	Stop	Stop	Stop	Stop	Stop	Free	Free	Free	Free	Free	Free
RT Channelized	-	-	None	-	-	None	-	-	None	-	-	None
Storage Length	-	-	-	-	-	-	-	-	-	-	-	-
Veh in Median Storage, #	-	0	-	-	0	-	-	0	-	-	0	-
Grade, %	-	0	-	-	0	-	-	0	-	-	0	-
Peak Hour Factor	92	92	92	92	92	92	92	92	92	92	92	92
Heavy Vehicles, %	2	2	2	2	2	2	2	2	2	2	2	2
Mvmt Flow	0	9	35	127	51	0	75	0	82	0	0	0





















Major/Minor	Minor2		Minor1		Major1			Major2				
Conflicting Flow All	218	233	1	214	192	41	1	0	0	82	0	0
Stage 1	1	1	-	191	191	-	-	-	-	-	-	-
Stage 2	217	232	-	23	1	-	-	-	-	-	-	-
Critical Hdwy	7.12	6.52	6.22	7.12	6.52	6.22	4.12	-	-	4.12	-	-
Critical Hdwy Stg 1	6.12	5.52	-	6.12	5.52	-	-	-	-	-	-	-
Critical Hdwy Stg 2	6.12	5.52	-	6.12	5.52	-	-	-	-	-	-	-
Follow-up Hdwy	3.518	4.018	3.318	3.518	4.018	3.318	2.218	-	-	2.218	-	-
Pot Cap-1 Maneuver	738	667	1084	743	703	1030	1622	-	-	1515	-	-
Stage 1	1022	895	-	811	742	-	-	-	-	-	-	-
Stage 2	785	713	-	995	895	-	-	-	-	-	-	-
Platoon blocked, %	-	-	-	-	-	-	-	-	-	-	-	-
Mov Cap-1 Maneuver	669	634	1084	685	669	1030	1622	-	-	1515	-	-
Mov Cap-2 Maneuver	669	634	-	685	669	-	-	-	-	-	-	-
Stage 1	972	895	-	771	706	-	-	-	-	-	-	-
Stage 2	693	678	-	954	895	-	-	-	-	-	-	-

Approach	EB		WB		NB		SB	
HCM Control Delay, s	9		12.2		3.5		0	
HCM LOS	A		B					

Minor Lane/Major Mvmt	NBL	NBT	NBR	EBLn1WBLn1	SBL	SBT	SBR
Capacity (veh/h)	1622	-	-	949	680	1515	-
HCM Lane V/C Ratio	0.046	-	-	0.046	0.262	-	-
HCM Control Delay (s)	7.3	0	-	9	12.2	0	-
HCM Lane LOS	A	A	-	A	B	A	-
HCM 95th %tile Q(veh)	0.1	-	-	0.1	1	0	-

Timings
1: Hathaway Drive & Galley Road

Background Traffic Conditions
Year 2043 - PM Peak Hour

												
Lane Group	EBL	EBT	EBR	WBL	WBT	WBR	NBL	NBT	NBR	SBL	SBT	SBR
Lane Configurations												
Traffic Volume (vph)	74	560	63	23	485	9	65	26	60	15	18	50
Future Volume (vph)	74	560	63	23	485	9	65	26	60	15	18	50
Satd. Flow (prot)	1770	1863	1583	1770	1857	0	0	1725	0	0	1696	0
Flt Permitted	0.371			0.356				0.871			0.911	
Satd. Flow (perm)	691	1863	1583	663	1857	0	0	1535	0	0	1560	0
Satd. Flow (RTOR)			127		2			47			54	
Lane Group Flow (vph)	80	609	68	25	537	0	0	164	0	0	90	0
Turn Type	pm+pt	NA	Perm	pm+pt	NA		Perm	NA		Perm	NA	
Protected Phases	5	2		1	6			8				4
Permitted Phases	2		2	6			8			4		
Detector Phase	5	2	2	1	6		8	8		4	4	
Switch Phase												
Minimum Initial (s)	5.0	20.0	20.0	5.0	20.0		6.0	6.0		6.0	6.0	
Minimum Split (s)	10.0	26.0	26.0	10.0	26.0		11.0	11.0		11.0	11.0	
Total Split (s)	10.0	35.0	35.0	10.0	35.0		15.0	15.0		15.0	15.0	
Total Split (%)	16.7%	58.3%	58.3%	16.7%	58.3%		25.0%	25.0%		25.0%	25.0%	
Yellow Time (s)	3.0	4.0	4.0	3.0	4.0		3.0	3.0		3.0	3.0	
All-Red Time (s)	2.0	2.0	2.0	2.0	2.0		2.0	2.0		2.0	2.0	
Lost Time Adjust (s)	0.0	0.0	0.0	0.0	0.0			0.0			0.0	
Total Lost Time (s)	5.0	6.0	6.0	5.0	6.0			5.0			5.0	
Lead/Lag	Lead	Lag	Lag	Lead	Lag							
Lead-Lag Optimize?	Yes	Yes	Yes	Yes	Yes							
Recall Mode	None	C-Min	C-Min	None	Min		None	None		None	None	
Act Effct Green (s)	41.2	39.4	39.4	40.1	37.2			9.0			9.0	
Actuated g/C Ratio	0.69	0.66	0.66	0.67	0.62			0.15			0.15	
v/c Ratio	0.14	0.50	0.06	0.05	0.47			0.61			0.32	
Control Delay	4.3	10.5	0.6	3.9	11.3			27.1			14.8	
Queue Delay	0.0	0.0	0.0	0.0	0.0			0.0			0.0	
Total Delay	4.3	10.5	0.6	3.9	11.3			27.1			14.8	
LOS	A	B	A	A	B			C			B	
Approach Delay		9.0			11.0			27.1			14.8	
Approach LOS		A			B			C			B	
Queue Length 50th (ft)	8	95	0	2	138			39			11	
Queue Length 95th (ft)	19	261	5	8	217			91			46	
Internal Link Dist (ft)		635			518			1811			361	
Turn Bay Length (ft)	200		270	90								
Base Capacity (vph)	574	1229	1087	541	1164			299			309	
Starvation Cap Reductn	0	0	0	0	0			0			0	
Spillback Cap Reductn	0	0	0	0	0			0			0	
Storage Cap Reductn	0	0	0	0	0			0			0	
Reduced v/c Ratio	0.14	0.50	0.06	0.05	0.46			0.55			0.29	

Intersection Summary







Cycle Length: 60
 Actuated Cycle Length: 60
 Offset: 0 (0%), Referenced to phase 2:EBTL, Start of Green
 Natural Cycle: 60
 Control Type: Actuated-Coordinated

Timings
 1: Hathaway Drive & Galley Road

Background Traffic Conditions
 Year 2043 - PM Peak Hour

Maximum v/c Ratio: 0.61	
Intersection Signal Delay: 11.9	Intersection LOS: B
Intersection Capacity Utilization 62.3%	ICU Level of Service B
Analysis Period (min) 15	

Splits and Phases: 1: Hathaway Drive & Galley Road

 Ø1	 Ø2 (R)	 Ø4
10 s	35 s	15 s
 Ø5	 Ø6	 Ø8
10 s	35 s	15 s

HCM 6th TWSC
2: Western Drive & Galley Road

Background Traffic Conditions
Year 2043 - PM Peak Hour

Intersection												
Int Delay, s/veh	3.3											
Movement	EBL	EBT	EBR	WBL	WBT	WBR	NBL	NBT	NBR	SBL	SBT	SBR
Lane Configurations		↔			↔			↔			↔	
Traffic Vol, veh/h	53	498	20	24	438	20	8	11	27	24	11	36
Future Vol, veh/h	53	498	20	24	438	20	8	11	27	24	11	36
Conflicting Peds, #/hr	0	0	0	0	0	0	0	0	0	0	0	0
Sign Control	Free	Free	Free	Free	Free	Free	Stop	Stop	Stop	Stop	Stop	Stop
RT Channelized	-	-	None	-	-	None	-	-	None	-	-	None
Storage Length	-	-	-	-	-	-	-	-	-	-	-	-
Veh in Median Storage, #	-	0	-	-	0	-	-	0	-	-	0	-
Grade, %	-	0	-	-	0	-	-	0	-	-	0	-
Peak Hour Factor	92	92	92	92	92	92	92	92	92	92	92	92
Heavy Vehicles, %	2	2	2	2	2	2	2	2	2	2	2	2
Mvmt Flow	58	541	22	26	476	22	9	12	29	26	12	39

Major/Minor	Major1		Major2		Minor1			Minor2				
Conflicting Flow All	498	0	0	563	0	0	1233	1218	552	1228	1218	487
Stage 1	-	-	-	-	-	-	668	668	-	539	539	-
Stage 2	-	-	-	-	-	-	565	550	-	689	679	-
Critical Hdwy	4.12	-	-	4.12	-	-	7.12	6.52	6.22	7.12	6.52	6.22
Critical Hdwy Stg 1	-	-	-	-	-	-	6.12	5.52	-	6.12	5.52	-
Critical Hdwy Stg 2	-	-	-	-	-	-	6.12	5.52	-	6.12	5.52	-
Follow-up Hdwy	2.218	-	-	2.218	-	-	3.518	4.018	3.318	3.518	4.018	3.318
Pot Cap-1 Maneuver	1066	-	-	1008	-	-	154	181	533	155	181	581
Stage 1	-	-	-	-	-	-	448	456	-	527	522	-
Stage 2	-	-	-	-	-	-	510	516	-	436	451	-
Platoon blocked, %	-	-	-	-	-	-	-	-	-	-	-	-
Mov Cap-1 Maneuver	1066	-	-	1008	-	-	124	161	533	126	161	581
Mov Cap-2 Maneuver	-	-	-	-	-	-	124	161	-	126	161	-
Stage 1	-	-	-	-	-	-	413	420	-	485	503	-
Stage 2	-	-	-	-	-	-	448	497	-	369	415	-

Approach	EB		WB		NB			SB		
HCM Control Delay, s	0.8		0.4		22.9			29.8		
HCM LOS					C			D		

Minor Lane/Major Mvmt	NBLn1	EBL	EBT	EBR	WBL	WBT	WBR	SBLn1
Capacity (veh/h)	251	1066	-	-	1008	-	-	221
HCM Lane V/C Ratio	0.199	0.054	-	-	0.026	-	-	0.349
HCM Control Delay (s)	22.9	8.6	-	-	8.7	-	-	29.8
HCM Lane LOS	C	A	-	-	A	-	-	D
HCM 95th %tile Q(veh)	0.7	0.2	-	-	0.1	-	-	1.5

HCM 6th TWSC
3: Hathaway Drive & E Platte Avenue

Background Traffic Conditions
Year 2043 - PM Peak Hour

Intersection													
Int Delay, s/veh	6												
Movement	EBU	EBL	EBT	EBR	WBL	WBT	WBR	NBL	NBT	NBR	SBL	SBT	SBR
Lane Configurations		↔	↕	↕	↔	↕	↕	↔			↕		↕
Traffic Vol, veh/h	56	128	3357	5	33	2771	32	0	0	62	0	0	111
Future Vol, veh/h	56	128	3357	5	33	2771	32	0	0	62	0	0	111
Conflicting Peds, #/hr	0	0	0	0	0	0	0	0	0	0	0	0	0
Sign Control	Free	Free	Free	Free	Free	Free	Free	Stop	Stop	Stop	Stop	Stop	Stop
RT Channelized	-	-	-	None	-	-	Free	-	-	None	-	-	Stop
Storage Length	-	330	-	200	250	-	500	-	-	0	-	-	0
Veh in Median Storage, #	-	-	0	-	-	0	-	-	0	-	-	0	-
Grade, %	-	-	0	-	-	0	-	-	0	-	-	0	-
Peak Hour Factor	92	92	92	92	92	92	92	92	92	92	92	92	92
Heavy Vehicles, %	2	2	2	2	2	2	2	2	2	2	2	2	2
Mvmt Flow	61	139	3649	5	36	3012	35	0	0	67	0	0	121

Major/Minor	Major1				Major2			Minor1			Minor2		
Conflicting Flow All	3012	3012	0	0	3654	0	0	-	-	1825	-	-	1506
Stage 1	-	-	-	-	-	-	-	-	-	-	-	-	-
Stage 2	-	-	-	-	-	-	-	-	-	-	-	-	-
Critical Hdwy	6.44	4.14	-	-	4.14	-	-	-	-	6.94	-	-	6.94
Critical Hdwy Stg 1	-	-	-	-	-	-	-	-	-	-	-	-	-
Critical Hdwy Stg 2	-	-	-	-	-	-	-	-	-	-	-	-	-
Follow-up Hdwy	2.52	2.22	-	-	2.22	-	-	-	-	3.32	-	-	3.32
Pot Cap-1 Maneuver	~ 16	~ 112	-	-	61	-	0	0	0	~ 66	0	0	~ 110
Stage 1	-	-	-	-	-	-	0	0	0	-	0	0	-
Stage 2	-	-	-	-	-	-	0	0	0	-	0	0	-
Platoon blocked, %			-	-			-						
Mov Cap-1 Maneuver	~-7	~-7	-	-	61	-	-	-	-	~ 66	-	-	~ 110
Mov Cap-2 Maneuver	-	-	-	-	-	-	-	-	-	-	-	-	-
Stage 1	-	-	-	-	-	-	-	-	-	-	-	-	-
Stage 2	-	-	-	-	-	-	-	-	-	-	-	-	-

Approach	EB	WB	NB	SB
HCM Control Delay, s		1.5	222.7	188.5
HCM LOS			F	F

Minor Lane/Major Mvmt	NBLn1	EBL	EBT	EBR	WBL	WBT	SBLn1
Capacity (veh/h)	66	+	-	-	61	-	110
HCM Lane V/C Ratio	1.021	-	-	-	0.588	-	1.097
HCM Control Delay (s)	222.7	-	-	-	126.9	-	188.5
HCM Lane LOS	F	-	-	-	F	-	F
HCM 95th %tile Q(veh)	5.1	-	-	-	2.4	-	7.4

Notes
 ~: Volume exceeds capacity \$: Delay exceeds 300s +: Computation Not Defined *: All major volume in platoon

HCM 6th TWSC
4: Hathaway Drive & Western Drive

Background Traffic Conditions
Year 2043 - PM Peak Hour

Intersection												
Int Delay, s/veh	1.8											
Movement	EBL	EBT	EBR	WBL	WBT	WBR	NBL	NBT	NBR	SBL	SBT	SBR
Lane Configurations	↕			↕			↕			↕		
Traffic Vol, veh/h	3	1	3	15	0	5	1	87	41	15	48	0
Future Vol, veh/h	3	1	3	15	0	5	1	87	41	15	48	0
Conflicting Peds, #/hr	0	0	0	0	0	0	0	0	0	0	0	0
Sign Control	Stop	Stop	Stop	Stop	Stop	Stop	Free	Free	Free	Free	Free	Free
RT Channelized	-	-	None	-	-	None	-	-	None	-	-	None
Storage Length	-	-	-	-	-	-	-	-	-	-	-	-
Veh in Median Storage, #	-	0	-	-	0	-	-	0	-	-	0	-
Grade, %	-	0	-	-	0	-	-	0	-	-	0	-
Peak Hour Factor	92	92	92	92	92	92	92	92	92	92	92	92
Heavy Vehicles, %	2	2	2	2	2	2	2	2	2	2	2	2
Mvmt Flow	3	1	3	16	0	5	1	95	45	16	52	0

Major/Minor	Minor2		Minor1		Major1		Major2					
Conflicting Flow All	206	226	52	206	204	118	52	0	0	140	0	0
Stage 1	84	84	-	120	120	-	-	-	-	-	-	-
Stage 2	122	142	-	86	84	-	-	-	-	-	-	-
Critical Hdwy	7.12	6.52	6.22	7.12	6.52	6.22	4.12	-	-	4.12	-	-
Critical Hdwy Stg 1	6.12	5.52	-	6.12	5.52	-	-	-	-	-	-	-
Critical Hdwy Stg 2	6.12	5.52	-	6.12	5.52	-	-	-	-	-	-	-
Follow-up Hdwy	3.518	4.018	3.318	3.518	4.018	3.318	2.218	-	-	2.218	-	-
Pot Cap-1 Maneuver	752	673	1016	752	692	934	1554	-	-	1443	-	-
Stage 1	924	825	-	884	796	-	-	-	-	-	-	-
Stage 2	882	779	-	922	825	-	-	-	-	-	-	-
Platoon blocked, %	-	-	-	-	-	-	-	-	-	-	-	-
Mov Cap-1 Maneuver	741	665	1016	741	684	934	1554	-	-	1443	-	-
Mov Cap-2 Maneuver	741	665	-	741	684	-	-	-	-	-	-	-
Stage 1	923	816	-	883	795	-	-	-	-	-	-	-
Stage 2	876	778	-	908	816	-	-	-	-	-	-	-

Approach	EB		WB		NB		SB	
HCM Control Delay, s	9.4		9.7		0.1		1.8	
HCM LOS	A		A					

Minor Lane/Major Mvmt	NBL	NBT	NBR	EBLn1WBLn1	SBL	SBT	SBR
Capacity (veh/h)	1554	-	-	823	781	1443	-
HCM Lane V/C Ratio	0.001	-	-	0.009	0.028	0.011	-
HCM Control Delay (s)	7.3	0	-	9.4	9.7	7.5	0
HCM Lane LOS	A	A	-	A	A	A	A
HCM 95th %tile Q(veh)	0	-	-	0	0.1	0	-

HCM 6th TWSC
5: Western Drive & Apartment Access

Background Traffic Conditions
Year 2043 - PM Peak Hour

Intersection						
Int Delay, s/veh	2.9					
Movement	EBL	EBT	WBT	WBR	SBL	SBR
Lane Configurations		↕	↕		↕	
Traffic Vol, veh/h	15	38	8	6	3	11
Future Vol, veh/h	15	38	8	6	3	11
Conflicting Peds, #/hr	0	0	0	0	0	0
Sign Control	Free	Free	Free	Free	Stop	Stop
RT Channelized	-	None	-	None	-	None
Storage Length	-	-	-	-	0	-
Veh in Median Storage, #	-	0	0	-	0	-
Grade, %	-	0	0	-	0	-
Peak Hour Factor	92	92	92	92	92	92
Heavy Vehicles, %	2	2	2	2	2	2
Mvmt Flow	16	41	9	7	3	12

Major/Minor	Major1	Major2	Minor2		
Conflicting Flow All	16	0	-	0	86 13
Stage 1	-	-	-	-	13 -
Stage 2	-	-	-	-	73 -
Critical Hdwy	4.12	-	-	-	6.42 6.22
Critical Hdwy Stg 1	-	-	-	-	5.42 -
Critical Hdwy Stg 2	-	-	-	-	5.42 -
Follow-up Hdwy	2.218	-	-	-	3.518 3.318
Pot Cap-1 Maneuver	1602	-	-	-	915 1067
Stage 1	-	-	-	-	1010 -
Stage 2	-	-	-	-	950 -
Platoon blocked, %		-	-	-	
Mov Cap-1 Maneuver	1602	-	-	-	906 1067
Mov Cap-2 Maneuver	-	-	-	-	906 -
Stage 1	-	-	-	-	1000 -
Stage 2	-	-	-	-	950 -

Approach	EB	WB	SB
HCM Control Delay, s	2.1	0	8.6
HCM LOS			A

Minor Lane/Major Mvmt	EBL	EBT	WBT	WBR	SBLn1
Capacity (veh/h)	1602	-	-	-	1028
HCM Lane V/C Ratio	0.01	-	-	-	0.015
HCM Control Delay (s)	7.3	0	-	-	8.6
HCM Lane LOS	A	A	-	-	A
HCM 95th %tile Q(veh)	0	-	-	-	0

HCM 6th TWSC
6: Hathaway Drive & Bednarski Access

Background Traffic Conditions
Year 2043 - PM Peak Hour

Intersection						
Int Delay, s/veh	0.5					
Movement	WBL	WBR	NBT	NBR	SBL	SBT
Lane Configurations	T		T		T	
Traffic Vol, veh/h	7	4	123	2	1	66
Future Vol, veh/h	7	4	123	2	1	66
Conflicting Peds, #/hr	0	0	0	0	0	0
Sign Control	Stop	Stop	Free	Free	Free	Free
RT Channelized	-	None	-	None	-	None
Storage Length	0	-	-	-	-	-
Veh in Median Storage, #	0	-	0	-	-	0
Grade, %	0	-	0	-	-	0
Peak Hour Factor	92	92	92	92	92	92
Heavy Vehicles, %	2	2	2	2	2	2
Mvmt Flow	8	4	134	2	1	72

Major/Minor	Minor1	Major1	Major2		
Conflicting Flow All	209	135	0	0	136
Stage 1	135	-	-	-	-
Stage 2	74	-	-	-	-
Critical Hdwy	6.42	6.22	-	-	4.12
Critical Hdwy Stg 1	5.42	-	-	-	-
Critical Hdwy Stg 2	5.42	-	-	-	-
Follow-up Hdwy	3.518	3.318	-	-	2.218
Pot Cap-1 Maneuver	779	914	-	-	1448
Stage 1	891	-	-	-	-
Stage 2	949	-	-	-	-
Platoon blocked, %			-	-	-
Mov Cap-1 Maneuver	778	914	-	-	1448
Mov Cap-2 Maneuver	778	-	-	-	-
Stage 1	891	-	-	-	-
Stage 2	948	-	-	-	-

Approach	WB	NB	SB
HCM Control Delay, s	9.4	0	0.1
HCM LOS	A		

Minor Lane/Major Mvmt	NBT	NBRWBLn1	SBL	SBT
Capacity (veh/h)	-	-	823	1448
HCM Lane V/C Ratio	-	-	0.015	0.001
HCM Control Delay (s)	-	-	9.4	7.5
HCM Lane LOS	-	-	A	A
HCM 95th %tile Q(veh)	-	-	0	0

HCM 6th TWSC
7: Hathaway Drive & Ford Street

Background Traffic Conditions
Year 2043 - PM Peak Hour

Intersection												
Int Delay, s/veh	5.3											
Movement	EBL	EBT	EBR	WBL	WBT	WBR	NBL	NBT	NBR	SBL	SBT	SBR
Lane Configurations	↕			↕			↕			↕		
Traffic Vol, veh/h	0	8	53	59	18	0	33	0	126	0	0	0
Future Vol, veh/h	0	8	53	59	18	0	33	0	126	0	0	0
Conflicting Peds, #/hr	0	0	0	0	0	0	0	0	0	0	0	0
Sign Control	Stop	Stop	Stop	Stop	Stop	Stop	Free	Free	Free	Free	Free	Free
RT Channelized	-	-	None	-	-	None	-	-	None	-	-	None
Storage Length	-	-	-	-	-	-	-	-	-	-	-	-
Veh in Median Storage, #	-	0	-	-	0	-	-	0	-	-	0	-
Grade, %	-	0	-	-	0	-	-	0	-	-	0	-
Peak Hour Factor	92	92	92	92	92	92	92	92	92	92	92	92
Heavy Vehicles, %	2	2	2	2	2	2	2	2	2	2	2	2
Mvmt Flow	0	9	58	64	20	0	36	0	137	0	0	0





















Major/Minor	Minor2		Minor1		Major1			Major2				
Conflicting Flow All	152	210	1	176	142	69	1	0	0	137	0	0
Stage 1	1	1	-	141	141	-	-	-	-	-	-	-
Stage 2	151	209	-	35	1	-	-	-	-	-	-	-
Critical Hdwy	7.12	6.52	6.22	7.12	6.52	6.22	4.12	-	-	4.12	-	-
Critical Hdwy Stg 1	6.12	5.52	-	6.12	5.52	-	-	-	-	-	-	-
Critical Hdwy Stg 2	6.12	5.52	-	6.12	5.52	-	-	-	-	-	-	-
Follow-up Hdwy	3.518	4.018	3.318	3.518	4.018	3.318	2.218	-	-	2.218	-	-
Pot Cap-1 Maneuver	815	687	1084	786	749	994	1622	-	-	1447	-	-
Stage 1	1022	895	-	862	780	-	-	-	-	-	-	-
Stage 2	851	729	-	981	895	-	-	-	-	-	-	-
Platoon blocked, %	-	-	-	-	-	-	-	-	-	-	-	-
Mov Cap-1 Maneuver	784	671	1084	723	731	994	1622	-	-	1447	-	-
Mov Cap-2 Maneuver	784	671	-	723	731	-	-	-	-	-	-	-
Stage 1	997	895	-	841	761	-	-	-	-	-	-	-
Stage 2	809	712	-	920	895	-	-	-	-	-	-	-

Approach	EB	WB	NB	SB
HCM Control Delay, s	8.8	10.6	1.5	0
HCM LOS	A	B		

Minor Lane/Major Mvmt	NBL	NBT	NBR	EBLn1WBLn1	SBL	SBT	SBR
Capacity (veh/h)	1622	-	-	1003	725	1447	-
HCM Lane V/C Ratio	0.022	-	-	0.066	0.115	-	-
HCM Control Delay (s)	7.3	0	-	8.8	10.6	0	-
HCM Lane LOS	A	A	-	A	B	A	-
HCM 95th %tile Q(veh)	0.1	-	-	0.2	0.4	0	-

Timings
1: Hathaway Drive & Galley Road

Total Traffic Conditions
Year 2025 - AM Peak Hour

												
Lane Group	EBL	EBT	EBR	WBL	WBT	WBR	NBL	NBT	NBR	SBL	SBT	SBR
Lane Configurations												
Traffic Volume (vph)	14	186	85	108	519	10	79	31	61	9	36	52
Future Volume (vph)	14	186	85	108	519	10	79	31	61	9	36	52
Satd. Flow (prot)	1770	1863	1583	1770	1857	0	0	1733	0	0	1718	0
Flt Permitted	0.415			0.541				0.850			0.967	
Satd. Flow (perm)	773	1863	1583	1008	1857	0	0	1507	0	0	1670	0
Satd. Flow (RTOR)			127		2			40			57	
Lane Group Flow (vph)	15	202	92	117	575	0	0	186	0	0	106	0
Turn Type	pm+pt	NA	Perm	pm+pt	NA		Perm	NA		Perm	NA	
Protected Phases	5	2		1	6			8				4
Permitted Phases	2		2	6			8			4		
Detector Phase	5	2	2	1	6		8	8		4		4
Switch Phase												
Minimum Initial (s)	5.0	20.0	20.0	5.0	20.0		6.0	6.0		6.0	6.0	
Minimum Split (s)	10.0	26.0	26.0	10.0	26.0		11.0	11.0		11.0	11.0	
Total Split (s)	15.0	29.0	29.0	15.0	29.0		16.0	16.0		16.0	16.0	
Total Split (%)	25.0%	48.3%	48.3%	25.0%	48.3%		26.7%	26.7%		26.7%	26.7%	
Yellow Time (s)	3.0	4.0	4.0	3.0	4.0		3.0	3.0		3.0	3.0	
All-Red Time (s)	2.0	2.0	2.0	2.0	2.0		2.0	2.0		2.0	2.0	
Lost Time Adjust (s)	0.0	0.0	0.0	0.0	0.0			0.0			0.0	
Total Lost Time (s)	5.0	6.0	6.0	5.0	6.0			5.0			5.0	
Lead/Lag	Lead	Lag	Lag	Lead	Lag							
Lead-Lag Optimize?	Yes	Yes	Yes	Yes	Yes							
Recall Mode	None	C-Min	C-Min	None	Min		None	None		None	None	
Act Effct Green (s)	34.7	29.1	29.1	39.5	36.8			10.0			10.0	
Actuated g/C Ratio	0.58	0.48	0.48	0.66	0.61			0.17			0.17	
v/c Ratio	0.03	0.22	0.11	0.16	0.50			0.66			0.33	
Control Delay	4.4	11.8	1.8	4.6	10.1			29.9			14.5	
Queue Delay	0.0	0.0	0.0	0.0	0.0			0.0			0.0	
Total Delay	4.4	11.8	1.8	4.6	10.1			29.9			14.5	
LOS	A	B	A	A	B			C			B	
Approach Delay		8.5			9.2			29.9			14.5	
Approach LOS		A			A			C			B	
Queue Length 50th (ft)	2	45	0	13	94			48			15	
Queue Length 95th (ft)	6	87	14	28	260			#119			51	
Internal Link Dist (ft)		635			518			1811			361	
Turn Bay Length (ft)	200		270	90								
Base Capacity (vph)	657	904	833	795	1139			317			361	
Starvation Cap Reductn	0	0	0	0	0			0			0	
Spillback Cap Reductn	0	0	0	0	0			0			0	
Storage Cap Reductn	0	0	0	0	0			0			0	
Reduced v/c Ratio	0.02	0.22	0.11	0.15	0.50			0.59			0.29	

Intersection Summary

Cycle Length: 60
 Actuated Cycle Length: 60
 Offset: 0 (0%), Referenced to phase 2:EBTL, Start of Green
 Natural Cycle: 55
 Control Type: Actuated-Coordinated

Timings
 1: Hathaway Drive & Galley Road

Total Traffic Conditions
 Year 2025 - AM Peak Hour

Maximum v/c Ratio: 0.66

Intersection Signal Delay: 12.4

Intersection LOS: B

Intersection Capacity Utilization 61.8%







ICU Level of Service B

Analysis Period (min) 15

95th percentile volume exceeds capacity, queue may be longer.

Queue shown is maximum after two cycles.

Splits and Phases: 1: Hathaway Drive & Galley Road

 Ø1 15 s	 Ø2 (R) 29 s	 Ø4 16 s
 Ø5 15 s	 Ø6 29 s	 Ø8 16 s

HCM 6th TWSC
2: Western Drive & Galley Road

Total Traffic Conditions
Year 2025 - AM Peak Hour

Intersection												
Int Delay, s/veh	3.5											
Movement	EBL	EBT	EBR	WBL	WBT	WBR	NBL	NBT	NBR	SBL	SBT	SBR
Lane Configurations		↗			↗			↔			↔	
Traffic Vol, veh/h	22	230	2	26	442	19	14	14	36	9	7	106
Future Vol, veh/h	22	230	2	26	442	19	14	14	36	9	7	106
Conflicting Peds, #/hr	0	0	0	0	0	0	0	0	0	0	0	0
Sign Control	Free	Free	Free	Free	Free	Free	Stop	Stop	Stop	Stop	Stop	Stop
RT Channelized	-	-	None	-	-	None	-	-	None	-	-	None
Storage Length	-	-	-	-	-	-	-	-	-	-	-	-
Veh in Median Storage, #	-	0	-	-	0	-	-	0	-	-	0	-
Grade, %	-	0	-	-	0	-	-	0	-	-	0	-
Peak Hour Factor	92	92	92	92	92	92	92	92	92	92	92	92
Heavy Vehicles, %	2	2	2	2	2	2	2	2	2	2	2	2
Mvmt Flow	24	250	2	28	480	21	15	15	39	10	8	115

Major/Minor	Major1		Major2		Minor1		Minor2					
Conflicting Flow All	501	0	0	252	0	0	907	856	251	873	847	491
Stage 1	-	-	-	-	-	-	299	299	-	547	547	-
Stage 2	-	-	-	-	-	-	608	557	-	326	300	-
Critical Hdwy	4.12	-	-	4.12	-	-	7.12	6.52	6.22	7.12	6.52	6.22
Critical Hdwy Stg 1	-	-	-	-	-	-	6.12	5.52	-	6.12	5.52	-
Critical Hdwy Stg 2	-	-	-	-	-	-	6.12	5.52	-	6.12	5.52	-
Follow-up Hdwy	2.218	-	-	2.218	-	-	3.518	4.018	3.318	3.518	4.018	3.318
Pot Cap-1 Maneuver	1063	-	-	1313	-	-	257	295	788	271	299	578
Stage 1	-	-	-	-	-	-	710	666	-	521	517	-
Stage 2	-	-	-	-	-	-	483	512	-	687	666	-
Platoon blocked, %	-	-	-	-	-	-	-	-	-	-	-	-
Mov Cap-1 Maneuver	1063	-	-	1313	-	-	193	279	788	237	283	578
Mov Cap-2 Maneuver	-	-	-	-	-	-	193	279	-	237	283	-
Stage 1	-	-	-	-	-	-	692	649	-	507	501	-
Stage 2	-	-	-	-	-	-	369	497	-	621	649	-

Approach	EB		WB		NB		SB	
HCM Control Delay, s	0.7		0.4		16.6		14.9	
HCM LOS					C		B	

Minor Lane/Major Mvmt	NBLn1	EBL	EBT	EBR	WBL	WBT	WBR	SBLn1
Capacity (veh/h)	380	1063	-	-	1313	-	-	496
HCM Lane V/C Ratio	0.183	0.022	-	-	0.022	-	-	0.267
HCM Control Delay (s)	16.6	8.5	-	-	7.8	-	-	14.9
HCM Lane LOS	C	A	-	-	A	-	-	B
HCM 95th %tile Q(veh)	0.7	0.1	-	-	0.1	-	-	1.1

HCM 6th TWSC
3: Hathaway Drive & E Platte Avenue

Total Traffic Conditions
Year 2025 - AM Peak Hour

Intersection														
Int Delay, s/veh	5.7													
Movement	EBU	EBL	EBT	EBR	WBU	WBL	WBT	WBR	NBL	NBT	NBR	SBL	SBT	SBR
Lane Configurations		↔	↕	↕		↔	↕	↕			↕			↕
Traffic Vol, veh/h	18	57	1916	2	12	42	2895	47	0	0	19	0	0	110
Future Vol, veh/h	18	57	1916	2	12	42	2895	47	0	0	19	0	0	110
Conflicting Peds, #/hr	0	0	0	0	0	0	0	0	0	0	0	0	0	0
Sign Control	Free	Free	Free	Free	Free	Free	Free	Free	Stop	Stop	Stop	Stop	Stop	Stop
RT Channelized	-	-	-	None	-	-	-	Free	-	-	None	-	-	Stop
Storage Length	-	330	-	200	-	250	-	500	-	-	0	-	-	0
Veh in Median Storage, #	-	-	0	-	-	-	0	-	-	0	-	-	0	-
Grade, %	-	-	0	-	-	-	0	-	-	0	-	-	0	-
Peak Hour Factor	92	92	92	92	92	92	92	92	92	92	92	92	92	92
Heavy Vehicles, %	2	2	2	2	2	2	2	2	2	2	2	2	2	2
Mvmt Flow	20	62	2083	2	13	46	3147	51	0	0	21	0	0	120

Major/Minor	Major1		Major2		Minor1		Minor2							
Conflicting Flow All	3147	3147	0	0	2083	2085	0	0	-	-	1042	-	-	1574
Stage 1	-	-	-	-	-	-	-	-	-	-	-	-	-	-
Stage 2	-	-	-	-	-	-	-	-	-	-	-	-	-	-
Critical Hdwy	6.44	4.14	-	-	6.44	4.14	-	-	-	-	6.94	-	-	6.94
Critical Hdwy Stg 1	-	-	-	-	-	-	-	-	-	-	-	-	-	-
Critical Hdwy Stg 2	-	-	-	-	-	-	-	-	-	-	-	-	-	-
Follow-up Hdwy	2.52	2.22	-	-	2.52	2.22	-	-	-	-	3.32	-	-	3.32
Pot Cap-1 Maneuver	~ 13	99	-	-	65	262	-	0	0	0	226	0	0	~ 99
Stage 1	-	-	-	-	-	-	-	0	0	0	-	0	0	-
Stage 2	-	-	-	-	-	-	-	0	0	0	-	0	0	-
Platoon blocked, %			-	-			-							
Mov Cap-1 Maneuver	~ -9	~ -9	-	-	150	150	-	-	-	-	226	-	-	~ 99
Mov Cap-2 Maneuver	-	-	-	-	-	-	-	-	-	-	-	-	-	-
Stage 1	-	-	-	-	-	-	-	-	-	-	-	-	-	-
Stage 2	-	-	-	-	-	-	-	-	-	-	-	-	-	-

Approach	EB	WB	NB	SB
HCM Control Delay, s		0.8	22.5	236.2
HCM LOS			C	F

Minor Lane/Major Mvmt	NBLn1	EBL	EBT	EBR	WBL	WBT	SBLn1
Capacity (veh/h)	226	+	-	-	150	-	99
HCM Lane V/C Ratio	0.091	-	-	-	0.391	-	1.208
HCM Control Delay (s)	22.5	-	-	-	43.7	-	236.2
HCM Lane LOS	C	-	-	-	E	-	F
HCM 95th %tile Q(veh)	0.3	-	-	-	1.7	-	8.1

Notes
 ~: Volume exceeds capacity \$: Delay exceeds 300s +: Computation Not Defined *: All major volume in platoon

HCM 6th TWSC
4: Hathaway Drive & Western Drive

Total Traffic Conditions
Year 2025 - AM Peak Hour

Intersection												
Int Delay, s/veh	2.8											
Movement	EBL	EBT	EBR	WBL	WBT	WBR	NBL	NBT	NBR	SBL	SBT	SBR
Lane Configurations	↕			↕			↕			↕		
Traffic Vol, veh/h	0	0	1	31	0	9	1	50	9	28	88	4
Future Vol, veh/h	0	0	1	31	0	9	1	50	9	28	88	4
Conflicting Peds, #/hr	0	0	0	0	0	0	0	0	0	0	0	0
Sign Control	Stop	Stop	Stop	Stop	Stop	Stop	Free	Free	Free	Free	Free	Free
RT Channelized	-	-	None	-	-	None	-	-	None	-	-	None
Storage Length	-	-	-	-	-	-	-	-	-	-	-	-
Veh in Median Storage, #	-	0	-	-	0	-	-	0	-	-	0	-
Grade, %	-	0	-	-	0	-	-	0	-	-	0	-
Peak Hour Factor	92	92	92	92	92	92	92	92	92	92	92	92
Heavy Vehicles, %	2	2	2	2	2	2	2	2	2	2	2	2
Mvmt Flow	0	0	1	34	0	10	1	54	10	30	96	4

Major/Minor	Minor2		Minor1		Major1		Major2					
Conflicting Flow All	224	224	98	220	221	59	100	0	0	64	0	0
Stage 1	158	158	-	61	61	-	-	-	-	-	-	-
Stage 2	66	66	-	159	160	-	-	-	-	-	-	-
Critical Hdwy	7.12	6.52	6.22	7.12	6.52	6.22	4.12	-	-	4.12	-	-
Critical Hdwy Stg 1	6.12	5.52	-	6.12	5.52	-	-	-	-	-	-	-
Critical Hdwy Stg 2	6.12	5.52	-	6.12	5.52	-	-	-	-	-	-	-
Follow-up Hdwy	3.518	4.018	3.318	3.518	4.018	3.318	2.218	-	-	2.218	-	-
Pot Cap-1 Maneuver	732	675	958	736	678	1007	1493	-	-	1538	-	-
Stage 1	844	767	-	950	844	-	-	-	-	-	-	-
Stage 2	945	840	-	843	766	-	-	-	-	-	-	-
Platoon blocked, %	-	-	-	-	-	-	-	-	-	-	-	-
Mov Cap-1 Maneuver	713	660	958	723	663	1007	1493	-	-	1538	-	-
Mov Cap-2 Maneuver	713	660	-	723	663	-	-	-	-	-	-	-
Stage 1	843	751	-	949	843	-	-	-	-	-	-	-
Stage 2	935	839	-	824	750	-	-	-	-	-	-	-

Approach	EB		WB		NB		SB	
HCM Control Delay, s	8.8		9.9		0.1		1.7	
HCM LOS	A		A					

Minor Lane/Major Mvmt	NBL	NBT	NBR	EBLn1	WBLn1	SBL	SBT	SBR
Capacity (veh/h)	1493	-	-	958	772	1538	-	-
HCM Lane V/C Ratio	0.001	-	-	0.001	0.056	0.02	-	-
HCM Control Delay (s)	7.4	0	-	8.8	9.9	7.4	0	-
HCM Lane LOS	A	A	-	A	A	A	A	-
HCM 95th %tile Q(veh)	0	-	-	0	0.2	0.1	-	-

HCM 6th TWSC
5: Access B/Apartment Access & Western Drive

Total Traffic Conditions
Year 2025 - AM Peak Hour

Intersection												
Int Delay, s/veh	3.1											
Movement	EBL	EBT	EBR	WBL	WBT	WBR	NBL	NBT	NBR	SBL	SBT	SBR
Lane Configurations	↕			↕			↕			↕		
Traffic Vol, veh/h	7	31	1	0	27	2	3	0	8	4	0	14
Future Vol, veh/h	7	31	1	0	27	2	3	0	8	4	0	14
Conflicting Peds, #/hr	0	0	0	0	0	0	0	0	0	0	0	0
Sign Control	Free	Free	Free	Free	Free	Free	Stop	Stop	Stop	Stop	Stop	Stop
RT Channelized	-	-	None	-	-	None	-	-	None	-	-	None
Storage Length	-	-	-	-	-	-	-	-	-	-	-	-
Veh in Median Storage, #	-	0	-	-	0	-	-	0	-	-	0	-
Grade, %	-	0	-	-	0	-	-	0	-	-	0	-
Peak Hour Factor	92	92	92	92	92	92	92	92	92	92	92	92
Heavy Vehicles, %	2	2	2	2	2	2	2	2	2	2	2	2
Mvmt Flow	8	34	1	0	29	2	3	0	9	4	0	15

Major/Minor	Major1		Major2		Minor1		Minor2					
Conflicting Flow All	31	0	0	35	0	0	89	82	35	85	81	30
Stage 1	-	-	-	-	-	-	51	51	-	30	30	-
Stage 2	-	-	-	-	-	-	38	31	-	55	51	-
Critical Hdwy	4.12	-	-	4.12	-	-	7.12	6.52	6.22	7.12	6.52	6.22
Critical Hdwy Stg 1	-	-	-	-	-	-	6.12	5.52	-	6.12	5.52	-
Critical Hdwy Stg 2	-	-	-	-	-	-	6.12	5.52	-	6.12	5.52	-
Follow-up Hdwy	2.218	-	-	2.218	-	-	3.518	4.018	3.318	3.518	4.018	3.318
Pot Cap-1 Maneuver	1582	-	-	1576	-	-	896	808	1038	901	809	1044
Stage 1	-	-	-	-	-	-	962	852	-	987	870	-
Stage 2	-	-	-	-	-	-	977	869	-	957	852	-
Platoon blocked, %	-	-	-	-	-	-	-	-	-	-	-	-
Mov Cap-1 Maneuver	1582	-	-	1576	-	-	880	804	1038	890	805	1044
Mov Cap-2 Maneuver	-	-	-	-	-	-	880	804	-	890	805	-
Stage 1	-	-	-	-	-	-	957	848	-	982	870	-
Stage 2	-	-	-	-	-	-	963	869	-	944	848	-

Approach	EB		WB		NB		SB	
HCM Control Delay, s	1.3		0		8.7		8.7	
HCM LOS					A		A	

Minor Lane/Major Mvmt	NBLn1	EBL	EBT	EBR	WBL	WBT	WBR	SBLn1
Capacity (veh/h)	990	1582	-	-	1576	-	-	1005
HCM Lane V/C Ratio	0.012	0.005	-	-	-	-	-	0.019
HCM Control Delay (s)	8.7	7.3	0	-	0	-	-	8.7
HCM Lane LOS	A	A	A	-	A	-	-	A
HCM 95th %tile Q(veh)	0	0	-	-	0	-	-	0.1

HCM 6th TWSC
6: Hathaway Drive & Bednarski Access/ Access A

Total Traffic Conditions
Year 2025 - AM Peak Hour

Intersection						
Int Delay, s/veh	1.2					
Movement	WBL	WBR	NBT	NBR	SBL	SBT
Lane Configurations	T		T		T	
Traffic Vol, veh/h	7	13	47	9	7	113
Future Vol, veh/h	7	13	47	9	7	113
Conflicting Peds, #/hr	0	0	0	0	0	0
Sign Control	Stop	Stop	Free	Free	Free	Free
RT Channelized	-	None	-	None	-	None
Storage Length	0	-	-	-	-	-
Veh in Median Storage, #	0	-	0	-	-	0
Grade, %	0	-	0	-	-	0
Peak Hour Factor	92	92	92	92	92	92
Heavy Vehicles, %	2	2	2	2	2	2
Mvmt Flow	8	14	51	10	8	123

Major/Minor	Minor1	Major1	Major2		
Conflicting Flow All	195	56	0	0	61
Stage 1	56	-	-	-	-
Stage 2	139	-	-	-	-
Critical Hdwy	6.42	6.22	-	-	4.12
Critical Hdwy Stg 1	5.42	-	-	-	-
Critical Hdwy Stg 2	5.42	-	-	-	-
Follow-up Hdwy	3.518	3.318	-	-	2.218
Pot Cap-1 Maneuver	794	1011	-	-	1542
Stage 1	967	-	-	-	-
Stage 2	888	-	-	-	-
Platoon blocked, %			-	-	-
Mov Cap-1 Maneuver	789	1011	-	-	1542
Mov Cap-2 Maneuver	789	-	-	-	-
Stage 1	967	-	-	-	-
Stage 2	883	-	-	-	-

Approach	WB	NB	SB
HCM Control Delay, s	9	0	0.4
HCM LOS	A		

Minor Lane/Major Mvmt	NBT	NBRWBLn1	SBL	SBT
Capacity (veh/h)	-	-	920	1542
HCM Lane V/C Ratio	-	-	0.024	0.005
HCM Control Delay (s)	-	-	9	7.3
HCM Lane LOS	-	-	A	A
HCM 95th %tile Q(veh)	-	-	0.1	0

HCM 6th TWSC
7: Hathaway Drive & Ford Street

Total Traffic Conditions
Year 2025 - AM Peak Hour

Intersection												
Int Delay, s/veh	7.4											
Movement	EBL	EBT	EBR	WBL	WBT	WBR	NBL	NBT	NBR	SBL	SBT	SBR
Lane Configurations	↕			↕			↕			↕		
Traffic Vol, veh/h	0	5	22	88	32	0	48	0	56	0	0	0
Future Vol, veh/h	0	5	22	88	32	0	48	0	56	0	0	0
Conflicting Peds, #/hr	0	0	0	0	0	0	0	0	0	0	0	0
Sign Control	Stop	Stop	Stop	Stop	Stop	Stop	Free	Free	Free	Free	Free	Free
RT Channelized	-	-	None	-	-	None	-	-	None	-	-	None
Storage Length	-	-	-	-	-	-	-	-	-	-	-	-
Veh in Median Storage, #	-	0	-	-	0	-	-	0	-	-	0	-
Grade, %	-	0	-	-	0	-	-	0	-	-	0	-
Peak Hour Factor	92	92	92	92	92	92	92	92	92	92	92	92
Heavy Vehicles, %	2	2	2	2	2	2	2	2	2	2	2	2
Mvmt Flow	0	5	24	96	35	0	52	0	61	0	0	0





















Major/Minor	Minor2		Minor1		Major1			Major2				
Conflicting Flow All	153	166	1	151	136	31	1	0	0	61	0	0
Stage 1	1	1	-	135	135	-	-	-	-	-	-	-
Stage 2	152	165	-	16	1	-	-	-	-	-	-	-
Critical Hdwy	7.12	6.52	6.22	7.12	6.52	6.22	4.12	-	-	4.12	-	-
Critical Hdwy Stg 1	6.12	5.52	-	6.12	5.52	-	-	-	-	-	-	-
Critical Hdwy Stg 2	6.12	5.52	-	6.12	5.52	-	-	-	-	-	-	-
Follow-up Hdwy	3.518	4.018	3.318	3.518	4.018	3.318	2.218	-	-	2.218	-	-
Pot Cap-1 Maneuver	814	727	1084	816	755	1043	1622	-	-	1542	-	-
Stage 1	1022	895	-	868	785	-	-	-	-	-	-	-
Stage 2	850	762	-	1004	895	-	-	-	-	-	-	-
Platoon blocked, %	-	-	-	-	-	-	-	-	-	-	-	-
Mov Cap-1 Maneuver	765	703	1084	774	730	1043	1622	-	-	1542	-	-
Mov Cap-2 Maneuver	765	703	-	774	730	-	-	-	-	-	-	-
Stage 1	988	895	-	839	759	-	-	-	-	-	-	-
Stage 2	784	737	-	976	895	-	-	-	-	-	-	-

Approach	EB		WB		NB		SB	
HCM Control Delay, s	8.8		10.7		3.4		0	
HCM LOS	A		B					

Minor Lane/Major Mvmt	NBL	NBT	NBR	EBLn1	WBLn1	SBL	SBT	SBR
Capacity (veh/h)	1622	-	-	985	762	1542	-	-
HCM Lane V/C Ratio	0.032	-	-	0.03	0.171	-	-	-
HCM Control Delay (s)	7.3	0	-	8.8	10.7	0	-	-
HCM Lane LOS	A	A	-	A	B	A	-	-
HCM 95th %tile Q(veh)	0.1	-	-	0.1	0.6	0	-	-

Timings
1: Hathaway Drive & Galley Road

Total Traffic Conditions
Year 2025 - PM Peak Hour

												
Lane Group	EBL	EBT	EBR	WBL	WBT	WBR	NBL	NBT	NBR	SBL	SBT	SBR
Lane Configurations												
Traffic Volume (vph)	51	388	49	16	336	6	49	19	42	10	14	34
Future Volume (vph)	51	388	49	16	336	6	49	19	42	10	14	34
Satd. Flow (prot)	1770	1863	1583	1770	1857	0	0	1727	0	0	1700	0
Flt Permitted	0.483			0.516				0.828			0.940	
Satd. Flow (perm)	900	1863	1583	961	1857	0	0	1462	0	0	1613	0
Satd. Flow (RTOR)			127		2			46			37	
Lane Group Flow (vph)	55	422	53	17	372	0	0	120	0	0	63	0
Turn Type	pm+pt	NA	Perm	pm+pt	NA		Perm	NA		Perm	NA	
Protected Phases	5	2		1	6			8				4
Permitted Phases	2		2	6			8			4		
Detector Phase	5	2	2	1	6		8	8		4		4
Switch Phase												
Minimum Initial (s)	5.0	20.0	20.0	5.0	20.0		6.0	6.0		6.0	6.0	
Minimum Split (s)	10.0	26.0	26.0	10.0	26.0		11.0	11.0		11.0	11.0	
Total Split (s)	15.0	29.0	29.0	15.0	29.0		16.0	16.0		16.0	16.0	
Total Split (%)	25.0%	48.3%	48.3%	25.0%	48.3%		26.7%	26.7%		26.7%	26.7%	
Yellow Time (s)	3.0	4.0	4.0	3.0	4.0		3.0	3.0		3.0	3.0	
All-Red Time (s)	2.0	2.0	2.0	2.0	2.0		2.0	2.0		2.0	2.0	
Lost Time Adjust (s)	0.0	0.0	0.0	0.0	0.0			0.0			0.0	
Total Lost Time (s)	5.0	6.0	6.0	5.0	6.0			5.0			5.0	
Lead/Lag	Lead	Lag	Lag	Lead	Lag							
Lead-Lag Optimize?	Yes	Yes	Yes	Yes	Yes							
Recall Mode	None	C-Min	C-Min	None	Min		None	None		None	None	
Act Effct Green (s)	42.9	41.7	41.7	40.4	37.0			8.4			8.4	
Actuated g/C Ratio	0.72	0.70	0.70	0.67	0.62			0.14			0.14	
v/c Ratio	0.08	0.33	0.05	0.02	0.32			0.49			0.24	
Control Delay	3.8	7.3	0.1	3.9	10.2			22.4			14.6	
Queue Delay	0.0	0.0	0.0	0.0	0.0			0.0			0.0	
Total Delay	3.8	7.3	0.1	3.9	10.2			22.4			14.6	
LOS	A	A	A	A	B			C			B	
Approach Delay		6.2			9.9			22.4			14.6	
Approach LOS		A			A			C			B	
Queue Length 50th (ft)	5	51	0	1	78			25			8	
Queue Length 95th (ft)	15	174	1	7	155			65			36	
Internal Link Dist (ft)		635			518			1811			361	
Turn Bay Length (ft)	200		270	90								
Base Capacity (vph)	798	1295	1139	820	1147			305			325	
Starvation Cap Reductn	0	0	0	0	0			0			0	
Spillback Cap Reductn	0	0	0	0	0			0			0	
Storage Cap Reductn	0	0	0	0	0			0			0	
Reduced v/c Ratio	0.07	0.33	0.05	0.02	0.32			0.39			0.19	

Intersection Summary







Cycle Length: 60
 Actuated Cycle Length: 60
 Offset: 0 (0%), Referenced to phase 2:EBTL, Start of Green
 Natural Cycle: 50
 Control Type: Actuated-Coordinated

Timings
 1: Hathaway Drive & Galley Road

Total Traffic Conditions
 Year 2025 - PM Peak Hour

Maximum v/c Ratio: 0.49	
Intersection Signal Delay: 9.8	Intersection LOS: A
Intersection Capacity Utilization 50.9%	ICU Level of Service A
Analysis Period (min) 15	

Splits and Phases: 1: Hathaway Drive & Galley Road

 Ø1	 Ø2 (R)	 Ø4
15 s	29 s	16 s
 Ø5	 Ø6	 Ø8
15 s	29 s	16 s

HCM 6th TWSC
2: Western Drive & Galley Road

Total Traffic Conditions
Year 2025 - PM Peak Hour

Intersection												
Int Delay, s/veh	2.1											
Movement	EBL	EBT	EBR	WBL	WBT	WBR	NBL	NBT	NBR	SBL	SBT	SBR
Lane Configurations		↔			↔			↔			↔	
Traffic Vol, veh/h	36	345	14	19	304	14	5	7	24	17	7	25
Future Vol, veh/h	36	345	14	19	304	14	5	7	24	17	7	25
Conflicting Peds, #/hr	0	0	0	0	0	0	0	0	0	0	0	0
Sign Control	Free	Free	Free	Free	Free	Free	Stop	Stop	Stop	Stop	Stop	Stop
RT Channelized	-	-	None	-	-	None	-	-	None	-	-	None
Storage Length	-	-	-	-	-	-	-	-	-	-	-	-
Veh in Median Storage, #	-	0	-	-	0	-	-	0	-	-	0	-
Grade, %	-	0	-	-	0	-	-	0	-	-	0	-
Peak Hour Factor	92	92	92	92	92	92	92	92	92	92	92	92
Heavy Vehicles, %	2	2	2	2	2	2	2	2	2	2	2	2
Mvmt Flow	39	375	15	21	330	15	5	8	26	18	8	27

Major/Minor	Major1		Major2		Minor1			Minor2				
Conflicting Flow All	345	0	0	390	0	0	858	848	383	858	848	338
Stage 1	-	-	-	-	-	-	461	461	-	380	380	-
Stage 2	-	-	-	-	-	-	397	387	-	478	468	-
Critical Hdwy	4.12	-	-	4.12	-	-	7.12	6.52	6.22	7.12	6.52	6.22
Critical Hdwy Stg 1	-	-	-	-	-	-	6.12	5.52	-	6.12	5.52	-
Critical Hdwy Stg 2	-	-	-	-	-	-	6.12	5.52	-	6.12	5.52	-
Follow-up Hdwy	2.218	-	-	2.218	-	-	3.518	4.018	3.318	3.518	4.018	3.318
Pot Cap-1 Maneuver	1214	-	-	1169	-	-	277	298	664	277	298	704
Stage 1	-	-	-	-	-	-	581	565	-	642	614	-
Stage 2	-	-	-	-	-	-	629	610	-	568	561	-
Platoon blocked, %	-	-	-	-	-	-	-	-	-	-	-	-
Mov Cap-1 Maneuver	1214	-	-	1169	-	-	248	280	664	248	280	704
Mov Cap-2 Maneuver	-	-	-	-	-	-	248	280	-	248	280	-
Stage 1	-	-	-	-	-	-	557	542	-	616	600	-
Stage 2	-	-	-	-	-	-	584	597	-	516	538	-

Approach	EB		WB		NB			SB		
HCM Control Delay, s	0.7		0.5		13.9			16		
HCM LOS					B			C		

Minor Lane/Major Mvmt	NBLn1	EBL	EBT	EBR	WBL	WBT	WBR	SBLn1
Capacity (veh/h)	443	1214	-	-	1169	-	-	380
HCM Lane V/C Ratio	0.088	0.032	-	-	0.018	-	-	0.14
HCM Control Delay (s)	13.9	8.1	-	-	8.1	-	-	16
HCM Lane LOS	B	A	-	-	A	-	-	C
HCM 95th %tile Q(veh)	0.3	0.1	-	-	0.1	-	-	0.5

HCM 6th TWSC
3: Hathaway Drive & E Platte Avenue

Total Traffic Conditions
Year 2025 - PM Peak Hour

Intersection													
Int Delay, s/veh	9.6												
Movement	EBU	EBL	EBT	EBR	WBL	WBT	WBR	NBL	NBT	NBR	SBL	SBT	SBR
Lane Configurations		↔	↑↑	↗	↔	↑↑	↗			↗			↗
Traffic Vol, veh/h	38	94	2328	3	23	1921	27	0	0	43	0	0	81
Future Vol, veh/h	38	94	2328	3	23	1921	27	0	0	43	0	0	81
Conflicting Peds, #/hr	0	0	0	0	0	0	0	0	0	0	0	0	0
Sign Control	Free	Free	Free	Free	Free	Free	Free	Stop	Stop	Stop	Stop	Stop	Stop
RT Channelized	-	-	-	None	-	-	Free	-	-	None	-	-	Stop
Storage Length	-	330	-	200	250	-	500	-	-	0	-	-	0
Veh in Median Storage, #	-	-	0	-	-	0	-	-	0	-	-	0	-
Grade, %	-	-	0	-	-	0	-	-	0	-	-	0	-
Peak Hour Factor	92	92	92	92	92	92	92	92	92	92	92	92	92
Heavy Vehicles, %	2	2	2	2	2	2	2	2	2	2	2	2	2
Mvmt Flow	41	102	2530	3	25	2088	29	0	0	47	0	0	88

Major/Minor	Major1			Major2			Minor1			Minor2			
Conflicting Flow All	2088	2088	0	0	2533	0	0	-	-	1265	-	-	1044
Stage 1	-	-	-	-	-	-	-	-	-	-	-	-	-
Stage 2	-	-	-	-	-	-	-	-	-	-	-	-	-
Critical Hdwy	6.44	4.14	-	-	4.14	-	-	-	-	6.94	-	-	6.94
Critical Hdwy Stg 1	-	-	-	-	-	-	-	-	-	-	-	-	-
Critical Hdwy Stg 2	-	-	-	-	-	-	-	-	-	-	-	-	-
Follow-up Hdwy	2.52	2.22	-	-	2.22	-	-	-	-	3.32	-	-	3.32
Pot Cap-1 Maneuver	65	261	-	-	174	-	0	0	0	160	0	0	226
Stage 1	-	-	-	-	-	-	0	0	0	-	0	0	-
Stage 2	-	-	-	-	-	-	0	0	0	-	0	0	-
Platoon blocked, %			-	-			-	-					
Mov Cap-1 Maneuver	104	104	-	-	174	-	-	-	-	160	-	-	226
Mov Cap-2 Maneuver	-	-	-	-	-	-	-	-	-	-	-	-	-
Stage 1	-	-	-	-	-	-	-	-	-	-	-	-	-
Stage 2	-	-	-	-	-	-	-	-	-	-	-	-	-

Approach	EB	WB	NB	SB
HCM Control Delay, s	15.7	0.3	36.5	30.7
HCM LOS			E	D

Minor Lane/Major Mvmt	NBLn1	EBL	EBT	EBR	WBL	WBT	SBLn1
Capacity (veh/h)	160	104	-	-	174	-	226
HCM Lane V/C Ratio	0.292	1.38	-	-	0.144	-	0.39
HCM Control Delay (s)	36.5	292.6	-	-	29.1	-	30.7
HCM Lane LOS	E	F	-	-	D	-	D
HCM 95th %tile Q(veh)	1.1	10.2	-	-	0.5	-	1.7

HCM 6th TWSC
4: Hathaway Drive & Western Drive

Total Traffic Conditions
Year 2025 - PM Peak Hour

Intersection												
Int Delay, s/veh	1.9											
Movement	EBL	EBT	EBR	WBL	WBT	WBR	NBL	NBT	NBR	SBL	SBT	SBR
Lane Configurations	↕			↕			↕			↕		
Traffic Vol, veh/h	3	1	3	10	0	5	1	63	28	13	37	0
Future Vol, veh/h	3	1	3	10	0	5	1	63	28	13	37	0
Conflicting Peds, #/hr	0	0	0	0	0	0	0	0	0	0	0	0
Sign Control	Stop	Stop	Stop	Stop	Stop	Stop	Free	Free	Free	Free	Free	Free
RT Channelized	-	-	None	-	-	None	-	-	None	-	-	None
Storage Length	-	-	-	-	-	-	-	-	-	-	-	-
Veh in Median Storage, #	-	0	-	-	0	-	-	0	-	-	0	-
Grade, %	-	0	-	-	0	-	-	0	-	-	0	-
Peak Hour Factor	92	92	92	92	92	92	92	92	92	92	92	92
Heavy Vehicles, %	2	2	2	2	2	2	2	2	2	2	2	2
Mvmt Flow	3	1	3	11	0	5	1	68	30	14	40	0

Major/Minor	Minor2		Minor1		Major1		Major2					
Conflicting Flow All	156	168	40	155	153	83	40	0	0	98	0	0
Stage 1	68	68	-	85	85	-	-	-	-	-	-	-
Stage 2	88	100	-	70	68	-	-	-	-	-	-	-
Critical Hdwy	7.12	6.52	6.22	7.12	6.52	6.22	4.12	-	-	4.12	-	-
Critical Hdwy Stg 1	6.12	5.52	-	6.12	5.52	-	-	-	-	-	-	-
Critical Hdwy Stg 2	6.12	5.52	-	6.12	5.52	-	-	-	-	-	-	-
Follow-up Hdwy	3.518	4.018	3.318	3.518	4.018	3.318	2.218	-	-	2.218	-	-
Pot Cap-1 Maneuver	810	725	1031	812	739	976	1570	-	-	1495	-	-
Stage 1	942	838	-	923	824	-	-	-	-	-	-	-
Stage 2	920	812	-	940	838	-	-	-	-	-	-	-
Platoon blocked, %	-	-	-	-	-	-	-	-	-	-	-	-
Mov Cap-1 Maneuver	799	717	1031	801	731	976	1570	-	-	1495	-	-
Mov Cap-2 Maneuver	799	717	-	801	731	-	-	-	-	-	-	-
Stage 1	941	830	-	922	823	-	-	-	-	-	-	-
Stage 2	914	811	-	926	830	-	-	-	-	-	-	-

Approach	EB		WB		NB		SB	
HCM Control Delay, s	9.2		9.3		0.1		1.9	
HCM LOS	A		A					

Minor Lane/Major Mvmt	NBL	NBT	NBR	EBLn1	WBLn1	SBL	SBT	SBR
Capacity (veh/h)	1570	-	-	869	852	1495	-	-
HCM Lane V/C Ratio	0.001	-	-	0.009	0.019	0.009	-	-
HCM Control Delay (s)	7.3	0	-	9.2	9.3	7.4	0	-
HCM Lane LOS	A	A	-	A	A	A	A	-
HCM 95th %tile Q(veh)	0	-	-	0	0.1	0	-	-

HCM 6th TWSC
5: Access B/Apartment Access & Western Drive

Total Traffic Conditions
Year 2025 - PM Peak Hour

Intersection												
Int Delay, s/veh	3.9											
Movement	EBL	EBT	EBR	WBL	WBT	WBR	NBL	NBT	NBR	SBL	SBT	SBR
Lane Configurations	↕			↕			↕			↕		
Traffic Vol, veh/h	15	26	3	2	5	6	2	0	5	3	0	11
Future Vol, veh/h	15	26	3	2	5	6	2	0	5	3	0	11
Conflicting Peds, #/hr	0	0	0	0	0	0	0	0	0	0	0	0
Sign Control	Free	Free	Free	Free	Free	Free	Stop	Stop	Stop	Stop	Stop	Stop
RT Channelized	-	-	None	-	-	None	-	-	None	-	-	None
Storage Length	-	-	-	-	-	-	-	-	-	-	-	-
Veh in Median Storage, #	-	0	-	-	0	-	-	0	-	-	0	-
Grade, %	-	0	-	-	0	-	-	0	-	-	0	-
Peak Hour Factor	92	92	92	92	92	92	92	92	92	92	92	92
Heavy Vehicles, %	2	2	2	2	2	2	2	2	2	2	2	2
Mvmt Flow	16	28	3	2	5	7	2	0	5	3	0	12



Major/Minor	Major1		Major2		Minor1		Minor2					
Conflicting Flow All	12	0	0	31	0	0	81	78	30	77	76	9
Stage 1	-	-	-	-	-	-	62	62	-	13	13	-
Stage 2	-	-	-	-	-	-	19	16	-	64	63	-
Critical Hdwy	4.12	-	-	4.12	-	-	7.12	6.52	6.22	7.12	6.52	6.22
Critical Hdwy Stg 1	-	-	-	-	-	-	6.12	5.52	-	6.12	5.52	-
Critical Hdwy Stg 2	-	-	-	-	-	-	6.12	5.52	-	6.12	5.52	-
Follow-up Hdwy	2.218	-	-	2.218	-	-	3.518	4.018	3.318	3.518	4.018	3.318
Pot Cap-1 Maneuver	1607	-	-	1582	-	-	907	812	1044	912	814	1073
Stage 1	-	-	-	-	-	-	949	843	-	1007	885	-
Stage 2	-	-	-	-	-	-	1000	882	-	947	842	-
Platoon blocked, %	-	-	-	-	-	-	-	-	-	-	-	-
Mov Cap-1 Maneuver	1607	-	-	1582	-	-	890	803	1044	899	805	1073
Mov Cap-2 Maneuver	-	-	-	-	-	-	890	803	-	899	805	-
Stage 1	-	-	-	-	-	-	940	835	-	997	884	-
Stage 2	-	-	-	-	-	-	988	881	-	933	834	-

Approach	EB		WB		NB		SB	
HCM Control Delay, s	2.5		1.1		8.6		8.5	
HCM LOS					A		A	

Minor Lane/Major Mvmt	NBLn1	EBL	EBT	EBR	WBL	WBT	WBR	SBLn1
Capacity (veh/h)	995	1607	-	-	1582	-	-	1030
HCM Lane V/C Ratio	0.008	0.01	-	-	0.001	-	-	0.015
HCM Control Delay (s)	8.6	7.3	0	-	7.3	0	-	8.5
HCM Lane LOS	A	A	A	-	A	A	-	A
HCM 95th %tile Q(veh)	0	0	-	-	0	-	-	0

HCM 6th TWSC
6: Hathaway Drive & Bednarski Access / Access A

Total Traffic Conditions
Year 2025 - PM Peak Hour

Intersection						
Int Delay, s/veh	1.2					
Movement	WBL	WBR	NBT	NBR	SBL	SBT
Lane Configurations						
Traffic Vol, veh/h	11	7	85	13	5	46
Future Vol, veh/h	11	7	85	13	5	46
Conflicting Peds, #/hr	0	0	0	0	0	0
Sign Control	Stop	Stop	Free	Free	Free	Free
RT Channelized	-	None	-	None	-	None
Storage Length	0	-	-	-	-	-
Veh in Median Storage, #	0	-	0	-	-	0
Grade, %	0	-	0	-	-	0
Peak Hour Factor	92	92	92	92	92	92
Heavy Vehicles, %	2	2	2	2	2	2
Mvmt Flow	12	8	92	14	5	50

Major/Minor	Minor1	Major1	Major2		
Conflicting Flow All	159	99	0	0	106
Stage 1	99	-	-	-	-
Stage 2	60	-	-	-	-
Critical Hdwy	6.42	6.22	-	-	4.12
Critical Hdwy Stg 1	5.42	-	-	-	-
Critical Hdwy Stg 2	5.42	-	-	-	-
Follow-up Hdwy	3.518	3.318	-	-	2.218
Pot Cap-1 Maneuver	832	957	-	-	1485
Stage 1	925	-	-	-	-
Stage 2	963	-	-	-	-
Platoon blocked, %			-	-	-
Mov Cap-1 Maneuver	830	957	-	-	1485
Mov Cap-2 Maneuver	830	-	-	-	-
Stage 1	925	-	-	-	-
Stage 2	960	-	-	-	-

Approach	WB	NB	SB
HCM Control Delay, s	9.2	0	0.7
HCM LOS	A		

Minor Lane/Major Mvmt	NBT	NBRWBLn1	SBL	SBT
Capacity (veh/h)	-	-	875	1485
HCM Lane V/C Ratio	-	-	0.022	0.004
HCM Control Delay (s)	-	-	9.2	7.4
HCM Lane LOS	-	-	A	A
HCM 95th %tile Q(veh)	-	-	0.1	0

HCM 6th TWSC
7: Hathaway Drive & Ford Street

Total Traffic Conditions
Year 2025 - PM Peak Hour

Intersection												
Int Delay, s/veh	5											
Movement	EBL	EBT	EBR	WBL	WBT	WBR	NBL	NBT	NBR	SBL	SBT	SBR
Lane Configurations	↕			↕			↕			↕		
Traffic Vol, veh/h	0	5	36	45	12	0	23	0	98	0	0	0
Future Vol, veh/h	0	5	36	45	12	0	23	0	98	0	0	0
Conflicting Peds, #/hr	0	0	0	0	0	0	0	0	0	0	0	0
Sign Control	Stop	Stop	Stop	Stop	Stop	Stop	Free	Free	Free	Free	Free	Free
RT Channelized	-	-	None	-	-	None	-	-	None	-	-	None
Storage Length	-	-	-	-	-	-	-	-	-	-	-	-
Veh in Median Storage, #	-	0	-	-	0	-	-	0	-	-	0	-
Grade, %	-	0	-	-	0	-	-	0	-	-	0	-
Peak Hour Factor	92	92	92	92	92	92	92	92	92	92	92	92
Heavy Vehicles, %	2	2	2	2	2	2	2	2	2	2	2	2
Mvmt Flow	0	5	39	49	13	0	25	0	107	0	0	0





















Major/Minor	Minor2		Minor1		Major1			Major2				
Conflicting Flow All	111	158	1	127	105	54	1	0	0	107	0	0
Stage 1	1	1	-	104	104	-	-	-	-	-	-	-
Stage 2	110	157	-	23	1	-	-	-	-	-	-	-
Critical Hdwy	7.12	6.52	6.22	7.12	6.52	6.22	4.12	-	-	4.12	-	-
Critical Hdwy Stg 1	6.12	5.52	-	6.12	5.52	-	-	-	-	-	-	-
Critical Hdwy Stg 2	6.12	5.52	-	6.12	5.52	-	-	-	-	-	-	-
Follow-up Hdwy	3.518	4.018	3.318	3.518	4.018	3.318	2.218	-	-	2.218	-	-
Pot Cap-1 Maneuver	867	734	1084	846	785	1013	1622	-	-	1484	-	-
Stage 1	1022	895	-	902	809	-	-	-	-	-	-	-
Stage 2	895	768	-	995	895	-	-	-	-	-	-	-
Platoon blocked, %	-	-	-	-	-	-	-	-	-	-	-	-
Mov Cap-1 Maneuver	844	722	1084	800	772	1013	1622	-	-	1484	-	-
Mov Cap-2 Maneuver	844	722	-	800	772	-	-	-	-	-	-	-
Stage 1	1005	895	-	887	795	-	-	-	-	-	-	-
Stage 2	865	755	-	953	895	-	-	-	-	-	-	-

Approach	EB		WB		NB		SB	
HCM Control Delay, s	8.7		9.9		1.4		0	
HCM LOS	A		A					

Minor Lane/Major Mvmt	NBL	NBT	NBR	EBLn1	WBLn1	SBL	SBT	SBR
Capacity (veh/h)	1622	-	-	1022	794	1484	-	-
HCM Lane V/C Ratio	0.015	-	-	0.044	0.078	-	-	-
HCM Control Delay (s)	7.3	0	-	8.7	9.9	0	-	-
HCM Lane LOS	A	A	-	A	A	A	-	-
HCM 95th %tile Q(veh)	0	-	-	0.1	0.3	0	-	-

Timings
1: Hathaway Drive & Galley Road

Total Traffic Conditions
Year 2043 - AM Peak Hour

												
Lane Group	EBL	EBT	EBR	WBL	WBT	WBR	NBL	NBT	NBR	SBL	SBT	SBR
Lane Configurations												
Traffic Volume (vph)	20	269	122	156	749	15	112	44	89	14	52	75
Future Volume (vph)	20	269	122	156	749	15	112	44	89	14	52	75
Satd. Flow (prot)	1770	1863	1583	1770	1857	0	0	1732	0	0	1720	0
Flt Permitted	0.159			0.523				0.790			0.954	
Satd. Flow (perm)	296	1863	1583	974	1857	0	0	1399	0	0	1649	0
Satd. Flow (RTOR)			133		2			41			82	
Lane Group Flow (vph)	22	292	133	170	830	0	0	267	0	0	154	0
Turn Type	pm+pt	NA	Perm	pm+pt	NA		Perm	NA		Perm	NA	
Protected Phases	5	2		1	6			8				4
Permitted Phases	2		2	6			8			4		
Detector Phase	5	2	2	1	6		8	8		4		4
Switch Phase												
Minimum Initial (s)	5.0	20.0	20.0	5.0	20.0		6.0	6.0		6.0	6.0	
Minimum Split (s)	10.0	26.0	26.0	10.0	26.0		11.0	11.0		11.0	11.0	
Total Split (s)	10.0	35.0	35.0	10.0	35.0		15.0	15.0		15.0	15.0	
Total Split (%)	16.7%	58.3%	58.3%	16.7%	58.3%		25.0%	25.0%		25.0%	25.0%	
Yellow Time (s)	3.0	4.0	4.0	3.0	4.0		3.0	3.0		3.0	3.0	
All-Red Time (s)	2.0	2.0	2.0	2.0	2.0		2.0	2.0		2.0	2.0	
Lost Time Adjust (s)	0.0	0.0	0.0	0.0	0.0			0.0			0.0	
Total Lost Time (s)	5.0	6.0	6.0	5.0	6.0			5.0			5.0	
Lead/Lag	Lead	Lag	Lag	Lead	Lag							
Lead-Lag Optimize?	Yes	Yes	Yes	Yes	Yes							
Recall Mode	None	C-Min	C-Min	None	Min		None	None		None	None	
Act Effct Green (s)	34.3	29.3	29.3	37.3	35.3			11.7			11.7	
Actuated g/C Ratio	0.57	0.49	0.49	0.62	0.59			0.20			0.20	
v/c Ratio	0.07	0.32	0.16	0.25	0.76			0.87			0.40	
Control Delay	4.2	10.8	2.5	5.1	16.9			53.4			15.2	
Queue Delay	0.0	0.0	0.0	0.0	0.0			0.0			0.0	
Total Delay	4.2	10.8	2.5	5.1	16.9			53.4			15.2	
LOS	A	B	A	A	B			D			B	
Approach Delay		8.0			14.9			53.4			15.2	
Approach LOS		A			B			D			B	
Queue Length 50th (ft)	2	60	0	18	156			83			23	
Queue Length 95th (ft)	8	106	22	36	#493			#219			69	
Internal Link Dist (ft)		635			518			1811			361	
Turn Bay Length (ft)	200		270	90								
Base Capacity (vph)	294	925	852	673	1092			306			388	
Starvation Cap Reductn	0	0	0	0	0			0			0	
Spillback Cap Reductn	0	0	0	0	0			0			0	
Storage Cap Reductn	0	0	0	0	0			0			0	
Reduced v/c Ratio	0.07	0.32	0.16	0.25	0.76			0.87			0.40	
Intersection Summary												
Cycle Length: 60												
Actuated Cycle Length: 60												
Offset: 0 (0%), Referenced to phase 2:EBTL, Start of Green												
Natural Cycle: 75												
Control Type: Actuated-Coordinated												

Timings
 1: Hathaway Drive & Galley Road

Total Traffic Conditions
 Year 2043 - AM Peak Hour

Maximum v/c Ratio: 0.87

Intersection Signal Delay: 18.8

Intersection LOS: B

Intersection Capacity Utilization 84.1%







ICU Level of Service E

Analysis Period (min) 15

95th percentile volume exceeds capacity, queue may be longer.

Queue shown is maximum after two cycles.

Splits and Phases: 1: Hathaway Drive & Galley Road

 Ø1	 Ø2 (R)	 Ø4
10 s	35 s	15 s
 Ø5	 Ø6	 Ø8
10 s	35 s	15 s

HCM 6th TWSC
2: Western Drive & Galley Road

Total Traffic Conditions
Year 2043 - AM Peak Hour

Intersection												
Int Delay, s/veh	7.4											
Movement	EBL	EBT	EBR	WBL	WBT	WBR	NBL	NBT	NBR	SBL	SBT	SBR
Lane Configurations		↔			↔			↔			↔	
Traffic Vol, veh/h	32	332	3	38	638	27	20	20	49	14	11	153
Future Vol, veh/h	32	332	3	38	638	27	20	20	49	14	11	153
Conflicting Peds, #/hr	0	0	0	0	0	0	0	0	0	0	0	0
Sign Control	Free	Free	Free	Free	Free	Free	Stop	Stop	Stop	Stop	Stop	Stop
RT Channelized	-	-	None	-	-	None	-	-	None	-	-	None
Storage Length	-	-	-	-	-	-	-	-	-	-	-	-
Veh in Median Storage, #	-	0	-	-	0	-	-	0	-	-	0	-
Grade, %	-	0	-	-	0	-	-	0	-	-	0	-
Peak Hour Factor	92	92	92	92	92	92	92	92	92	92	92	92
Heavy Vehicles, %	2	2	2	2	2	2	2	2	2	2	2	2
Mvmt Flow	35	361	3	41	693	29	22	22	53	15	12	166

Major/Minor	Major1		Major2		Minor1			Minor2				
Conflicting Flow All	722	0	0	364	0	0	1312	1237	363	1260	1224	708
Stage 1	-	-	-	-	-	-	433	433	-	790	790	-
Stage 2	-	-	-	-	-	-	879	804	-	470	434	-
Critical Hdwy	4.12	-	-	4.12	-	-	7.12	6.52	6.22	7.12	6.52	6.22
Critical Hdwy Stg 1	-	-	-	-	-	-	6.12	5.52	-	6.12	5.52	-
Critical Hdwy Stg 2	-	-	-	-	-	-	6.12	5.52	-	6.12	5.52	-
Follow-up Hdwy	2.218	-	-	2.218	-	-	3.518	4.018	3.318	3.518	4.018	3.318
Pot Cap-1 Maneuver	880	-	-	1195	-	-	136	176	682	147	179	435
Stage 1	-	-	-	-	-	-	601	582	-	383	402	-
Stage 2	-	-	-	-	-	-	342	396	-	574	581	-
Platoon blocked, %	-	-	-	-	-	-	-	-	-	-	-	-
Mov Cap-1 Maneuver	880	-	-	1195	-	-	73	158	682	112	160	435
Mov Cap-2 Maneuver	-	-	-	-	-	-	73	158	-	112	160	-
Stage 1	-	-	-	-	-	-	571	553	-	364	379	-
Stage 2	-	-	-	-	-	-	193	373	-	483	552	-

Approach	EB		WB		NB			SB		
HCM Control Delay, s	0.8		0.4		42.8			31		
HCM LOS					E			D		

Minor Lane/Major Mvmt	NBLn1	EBL	EBT	EBR	WBL	WBT	WBR	SBLn1
Capacity (veh/h)	188	880	-	-	1195	-	-	326
HCM Lane V/C Ratio	0.515	0.04	-	-	0.035	-	-	0.593
HCM Control Delay (s)	42.8	9.3	-	-	8.1	-	-	31
HCM Lane LOS	E	A	-	-	A	-	-	D
HCM 95th %tile Q(veh)	2.6	0.1	-	-	0.1	-	-	3.6

HCM 6th TWSC
3: Hathaway Drive & E Platte Avenue

Total Traffic Conditions
Year 2043 - AM Peak Hour

Intersection														
Int Delay, s/veh	53.4													
Movement	EBU	EBL	EBT	EBR	WBU	WBL	WBT	WBR	NBL	NBT	NBR	SBL	SBT	SBR
Lane Configurations		↔	↕	↕		↔	↕	↕			↕			↕
Traffic Vol, veh/h	26	82	2763	3	18	60	4176	67	0	0	27	0	0	156
Future Vol, veh/h	26	82	2763	3	18	60	4176	67	0	0	27	0	0	156
Conflicting Peds, #/hr	0	0	0	0	0	0	0	0	0	0	0	0	0	0
Sign Control	Free	Free	Free	Free	Free	Free	Free	Free	Stop	Stop	Stop	Stop	Stop	Stop
RT Channelized	-	-	-	None	-	-	-	Free	-	-	None	-	-	Stop
Storage Length	-	330	-	200	-	250	-	500	-	-	0	-	-	0
Veh in Median Storage, #	-	-	0	-	-	-	0	-	-	0	-	-	0	-
Grade, %	-	-	0	-	-	-	0	-	-	0	-	-	0	-
Peak Hour Factor	92	92	92	92	92	92	92	92	92	92	92	92	92	92
Heavy Vehicles, %	2	2	2	2	2	2	2	2	2	2	2	2	2	2
Mvmt Flow	28	89	3003	3	20	65	4539	73	0	0	29	0	0	170

Major/Minor	Major1		Major2		Minor1		Minor2							
Conflicting Flow All	4539	4539	0	0	3003	3006	0	0	-	-	1502	-	-	2270
Stage 1	-	-	-	-	-	-	-	-	-	-	-	-	-	-
Stage 2	-	-	-	-	-	-	-	-	-	-	-	-	-	-
Critical Hdwy	6.44	4.14	-	-	6.44	4.14	-	-	-	-	6.94	-	-	6.94
Critical Hdwy Stg 1	-	-	-	-	-	-	-	-	-	-	-	-	-	-
Critical Hdwy Stg 2	-	-	-	-	-	-	-	-	-	-	-	-	-	-
Follow-up Hdwy	2.52	2.22	-	-	2.52	2.22	-	-	-	-	3.32	-	-	3.32
Pot Cap-1 Maneuver	~ 1	~ 26	-	-	~ 16	112	-	0	0	0	111	0	0	~ 33
Stage 1	-	-	-	-	-	-	-	0	0	0	-	0	0	-
Stage 2	-	-	-	-	-	-	-	0	0	0	-	0	0	-
Platoon blocked, %			-	-			-							
Mov Cap-1 Maneuver	~-11	~-11	-	-	38	~ 38	-	-	-	-	111	-	-	~ 33
Mov Cap-2 Maneuver	-	-	-	-	-	-	-	-	-	-	-	-	-	-
Stage 1	-	-	-	-	-	-	-	-	-	-	-	-	-	-
Stage 2	-	-	-	-	-	-	-	-	-	-	-	-	-	-

Approach	EB		WB		NB		SB	
HCM Control Delay, s			14.3		48.7		\$ 2103.2	
HCM LOS					E		F	

Minor Lane/Major Mvmt	NBLn1	EBL	EBT	EBR	WBL	WBT	SBLn1
Capacity (veh/h)	111	+	-	-	~ 38	-	33
HCM Lane V/C Ratio	0.264	-	-	-	2.231	-	5.138
HCM Control Delay (s)	48.7	-	-	-	\$ 781.7	-	\$ 2103.2
HCM Lane LOS	E	-	-	-	F	-	F
HCM 95th %tile Q(veh)	1	-	-	-	9.3	-	20.2

Notes
 ~: Volume exceeds capacity \$: Delay exceeds 300s +: Computation Not Defined *: All major volume in platoon

HCM 6th TWSC
4: Hathaway Drive & Western Drive

Total Traffic Conditions
Year 2043 - AM Peak Hour

Intersection												
Int Delay, s/veh	3											
Movement	EBL	EBT	EBR	WBL	WBT	WBR	NBL	NBT	NBR	SBL	SBT	SBR
Lane Configurations	↕			↕			↕			↕		
Traffic Vol, veh/h	0	0	1	45	0	12	1	70	14	40	127	4
Future Vol, veh/h	0	0	1	45	0	12	1	70	14	40	127	4
Conflicting Peds, #/hr	0	0	0	0	0	0	0	0	0	0	0	0
Sign Control	Stop	Stop	Stop	Stop	Stop	Stop	Free	Free	Free	Free	Free	Free
RT Channelized	-	-	None	-	-	None	-	-	None	-	-	None
Storage Length	-	-	-	-	-	-	-	-	-	-	-	-
Veh in Median Storage, #	-	0	-	-	0	-	-	0	-	-	0	-
Grade, %	-	0	-	-	0	-	-	0	-	-	0	-
Peak Hour Factor	92	92	92	92	92	92	92	92	92	92	92	92
Heavy Vehicles, %	2	2	2	2	2	2	2	2	2	2	2	2
Mvmt Flow	0	0	1	49	0	13	1	76	15	43	138	4

Major/Minor	Minor2		Minor1		Major1		Major2					
Conflicting Flow All	318	319	140	313	314	84	142	0	0	91	0	0
Stage 1	226	226	-	86	86	-	-	-	-	-	-	-
Stage 2	92	93	-	227	228	-	-	-	-	-	-	-
Critical Hdwy	7.12	6.52	6.22	7.12	6.52	6.22	4.12	-	-	4.12	-	-
Critical Hdwy Stg 1	6.12	5.52	-	6.12	5.52	-	-	-	-	-	-	-
Critical Hdwy Stg 2	6.12	5.52	-	6.12	5.52	-	-	-	-	-	-	-
Follow-up Hdwy	3.518	4.018	3.318	3.518	4.018	3.318	2.218	-	-	2.218	-	-
Pot Cap-1 Maneuver	635	598	908	640	601	975	1441	-	-	1504	-	-
Stage 1	777	717	-	922	824	-	-	-	-	-	-	-
Stage 2	915	818	-	776	715	-	-	-	-	-	-	-
Platoon blocked, %	-	-	-	-	-	-	-	-	-	-	-	-
Mov Cap-1 Maneuver	612	579	908	623	582	975	1441	-	-	1504	-	-
Mov Cap-2 Maneuver	612	579	-	623	582	-	-	-	-	-	-	-
Stage 1	776	695	-	921	823	-	-	-	-	-	-	-
Stage 2	902	817	-	751	693	-	-	-	-	-	-	-

Approach	EB		WB		NB		SB	
HCM Control Delay, s	9		10.9		0.1		1.7	
HCM LOS	A		B					

Minor Lane/Major Mvmt	NBL	NBT	NBR	EBLn1WBLn1	SBL	SBT	SBR
Capacity (veh/h)	1441	-	-	908	674	1504	-
HCM Lane V/C Ratio	0.001	-	-	0.001	0.092	0.029	-
HCM Control Delay (s)	7.5	0	-	9	10.9	7.5	0
HCM Lane LOS	A	A	-	A	B	A	A
HCM 95th %tile Q(veh)	0	-	-	0	0.3	0.1	-

HCM 6th TWSC
5: Access B/Apartment Access & Western Drive

Total Traffic Conditions
Year 2043 - AM Peak Hour

Intersection												
Int Delay, s/veh	2.5											
Movement	EBL	EBT	EBR	WBL	WBT	WBR	NBL	NBT	NBR	SBL	SBT	SBR
Lane Configurations	↕			↕			↕			↕		
Traffic Vol, veh/h	7	45	1	0	39	2	3	0	8	4	0	14
Future Vol, veh/h	7	45	1	0	39	2	3	0	8	4	0	14
Conflicting Peds, #/hr	0	0	0	0	0	0	0	0	0	0	0	0
Sign Control	Free	Free	Free	Free	Free	Free	Stop	Stop	Stop	Stop	Stop	Stop
RT Channelized	-	-	None	-	-	None	-	-	None	-	-	None
Storage Length	-	-	-	-	-	-	-	-	-	-	-	-
Veh in Median Storage, #	-	0	-	-	0	-	-	0	-	-	0	-
Grade, %	-	0	-	-	0	-	-	0	-	-	0	-
Peak Hour Factor	92	92	92	92	92	92	92	92	92	92	92	92
Heavy Vehicles, %	2	2	2	2	2	2	2	2	2	2	2	2
Mvmt Flow	8	49	1	0	42	2	3	0	9	4	0	15

Major/Minor	Major1			Major2			Minor1			Minor2		
Conflicting Flow All	44	0	0	50	0	0	117	110	50	113	109	43
Stage 1	-	-	-	-	-	-	66	66	-	43	43	-
Stage 2	-	-	-	-	-	-	51	44	-	70	66	-
Critical Hdwy	4.12	-	-	4.12	-	-	7.12	6.52	6.22	7.12	6.52	6.22
Critical Hdwy Stg 1	-	-	-	-	-	-	6.12	5.52	-	6.12	5.52	-
Critical Hdwy Stg 2	-	-	-	-	-	-	6.12	5.52	-	6.12	5.52	-
Follow-up Hdwy	2.218	-	-	2.218	-	-	3.518	4.018	3.318	3.518	4.018	3.318
Pot Cap-1 Maneuver	1564	-	-	1557	-	-	859	780	1018	864	781	1027
Stage 1	-	-	-	-	-	-	945	840	-	971	859	-
Stage 2	-	-	-	-	-	-	962	858	-	940	840	-
Platoon blocked, %	-	-	-	-	-	-	-	-	-	-	-	-
Mov Cap-1 Maneuver	1564	-	-	1557	-	-	843	776	1018	854	777	1027
Mov Cap-2 Maneuver	-	-	-	-	-	-	843	776	-	854	777	-
Stage 1	-	-	-	-	-	-	940	836	-	966	859	-
Stage 2	-	-	-	-	-	-	948	858	-	927	836	-

Approach	EB			WB			NB			SB		
HCM Control Delay, s	1			0			8.8			8.7		
HCM LOS							A			A		

Minor Lane/Major Mvmt	NBLn1	EBL	EBT	EBR	WBL	WBT	WBR	SBLn1
Capacity (veh/h)	963	1564	-	-	1557	-	-	983
HCM Lane V/C Ratio	0.012	0.005	-	-	-	-	-	0.02
HCM Control Delay (s)	8.8	7.3	0	-	0	-	-	8.7
HCM Lane LOS	A	A	A	-	A	-	-	A
HCM 95th %tile Q(veh)	0	0	-	-	0	-	-	0.1

HCM 6th TWSC
6: Hathaway Drive & Bednarski Access / Access A

Total Traffic Conditions
Year 2043 - AM Peak Hour

Intersection						
Int Delay, s/veh	0.9					
Movement	WBL	WBR	NBT	NBR	SBL	SBT
Lane Configurations	T		T		T	
Traffic Vol, veh/h	7	13	68	9	7	164
Future Vol, veh/h	7	13	68	9	7	164
Conflicting Peds, #/hr	0	0	0	0	0	0
Sign Control	Stop	Stop	Free	Free	Free	Free
RT Channelized	-	None	-	None	-	None
Storage Length	0	-	-	-	-	-
Veh in Median Storage, #	0	-	0	-	-	0
Grade, %	0	-	0	-	-	0
Peak Hour Factor	92	92	92	92	92	92
Heavy Vehicles, %	2	2	2	2	2	2
Mvmt Flow	8	14	74	10	8	178

Major/Minor	Minor1	Major1	Major2		
Conflicting Flow All	273	79	0	0	84
Stage 1	79	-	-	-	-
Stage 2	194	-	-	-	-
Critical Hdwy	6.42	6.22	-	-	4.12
Critical Hdwy Stg 1	5.42	-	-	-	-
Critical Hdwy Stg 2	5.42	-	-	-	-
Follow-up Hdwy	3.518	3.318	-	-	2.218
Pot Cap-1 Maneuver	716	981	-	-	1513
Stage 1	944	-	-	-	-
Stage 2	839	-	-	-	-
Platoon blocked, %			-	-	-
Mov Cap-1 Maneuver	712	981	-	-	1513
Mov Cap-2 Maneuver	712	-	-	-	-
Stage 1	944	-	-	-	-
Stage 2	834	-	-	-	-

Approach	WB	NB	SB
HCM Control Delay, s	9.3	0	0.3
HCM LOS	A		

Minor Lane/Major Mvmt	NBT	NBRWBLn1	SBL	SBT
Capacity (veh/h)	-	-	866	1513
HCM Lane V/C Ratio	-	-	0.025	0.005
HCM Control Delay (s)	-	-	9.3	7.4
HCM Lane LOS	-	-	A	A
HCM 95th %tile Q(veh)	-	-	0.1	0

HCM 6th TWSC
7: Hathaway Drive & Ford Street

Total Traffic Conditions
Year 2043 - AM Peak Hour

Intersection												
Int Delay, s/veh	8.2											
Movement	EBL	EBT	EBR	WBL	WBT	WBR	NBL	NBT	NBR	SBL	SBT	SBR
Lane Configurations	↕			↕			↕			↕		
Traffic Vol, veh/h	0	8	32	124	47	0	69	0	79	0	0	0
Future Vol, veh/h	0	8	32	124	47	0	69	0	79	0	0	0
Conflicting Peds, #/hr	0	0	0	0	0	0	0	0	0	0	0	0
Sign Control	Stop	Stop	Stop	Stop	Stop	Stop	Free	Free	Free	Free	Free	Free
RT Channelized	-	-	None	-	-	None	-	-	None	-	-	None
Storage Length	-	-	-	-	-	-	-	-	-	-	-	-
Veh in Median Storage, #	-	0	-	-	0	-	-	0	-	-	0	-
Grade, %	-	0	-	-	0	-	-	0	-	-	0	-
Peak Hour Factor	92	92	92	92	92	92	92	92	92	92	92	92
Heavy Vehicles, %	2	2	2	2	2	2	2	2	2	2	2	2
Mvmt Flow	0	9	35	135	51	0	75	0	86	0	0	0





















Major/Minor	Minor2		Minor1		Major1			Major2				
Conflicting Flow All	220	237	1	216	194	43	1	0	0	86	0	0
Stage 1	1	1	-	193	193	-	-	-	-	-	-	-
Stage 2	219	236	-	23	1	-	-	-	-	-	-	-
Critical Hdwy	7.12	6.52	6.22	7.12	6.52	6.22	4.12	-	-	4.12	-	-
Critical Hdwy Stg 1	6.12	5.52	-	6.12	5.52	-	-	-	-	-	-	-
Critical Hdwy Stg 2	6.12	5.52	-	6.12	5.52	-	-	-	-	-	-	-
Follow-up Hdwy	3.518	4.018	3.318	3.518	4.018	3.318	2.218	-	-	2.218	-	-
Pot Cap-1 Maneuver	736	664	1084	740	701	1027	1622	-	-	1510	-	-
Stage 1	1022	895	-	809	741	-	-	-	-	-	-	-
Stage 2	783	710	-	995	895	-	-	-	-	-	-	-
Platoon blocked, %	-	-	-	-	-	-	-	-	-	-	-	-
Mov Cap-1 Maneuver	668	631	1084	682	667	1027	1622	-	-	1510	-	-
Mov Cap-2 Maneuver	668	631	-	682	667	-	-	-	-	-	-	-
Stage 1	972	895	-	769	705	-	-	-	-	-	-	-
Stage 2	691	675	-	954	895	-	-	-	-	-	-	-

Approach	EB		WB		NB		SB	
HCM Control Delay, s	9		12.3		3.4		0	
HCM LOS	A		B					

Minor Lane/Major Mvmt	NBL	NBT	NBR	EBLn1	WBLn1	SBL	SBT	SBR
Capacity (veh/h)	1622	-	-	948	678	1510	-	-
HCM Lane V/C Ratio	0.046	-	-	0.046	0.274	-	-	-
HCM Control Delay (s)	7.3	0	-	9	12.3	0	-	-
HCM Lane LOS	A	A	-	A	B	A	-	-
HCM 95th %tile Q(veh)	0.1	-	-	0.1	1.1	0	-	-

Timings
1: Hathaway Drive & Galley Road

Total Traffic Conditions
Year 2043 - PM Peak Hour

												
Lane Group	EBL	EBT	EBR	WBL	WBT	WBR	NBL	NBT	NBR	SBL	SBT	SBR
Lane Configurations												
Traffic Volume (vph)	74	560	68	23	485	9	69	27	60	15	20	50
Future Volume (vph)	74	560	68	23	485	9	69	27	60	15	20	50
Satd. Flow (prot)	1770	1863	1583	1770	1857	0	0	1727	0	0	1700	0
Flt Permitted	0.371			0.355				0.869			0.912	
Satd. Flow (perm)	691	1863	1583	661	1857	0	0	1535	0	0	1565	0
Satd. Flow (RTOR)			127		2			45			54	
Lane Group Flow (vph)	80	609	74	25	537	0	0	169	0	0	92	0
Turn Type	pm+pt	NA	Perm	pm+pt	NA		Perm	NA		Perm	NA	
Protected Phases	5	2		1	6			8				4
Permitted Phases	2		2	6			8			4		
Detector Phase	5	2	2	1	6		8	8		4		4
Switch Phase												
Minimum Initial (s)	5.0	20.0	20.0	5.0	20.0		6.0	6.0		6.0	6.0	
Minimum Split (s)	10.0	26.0	26.0	10.0	26.0		11.0	11.0		11.0	11.0	
Total Split (s)	10.0	35.0	35.0	10.0	35.0		15.0	15.0		15.0	15.0	
Total Split (%)	16.7%	58.3%	58.3%	16.7%	58.3%		25.0%	25.0%		25.0%	25.0%	
Yellow Time (s)	3.0	4.0	4.0	3.0	4.0		3.0	3.0		3.0	3.0	
All-Red Time (s)	2.0	2.0	2.0	2.0	2.0		2.0	2.0		2.0	2.0	
Lost Time Adjust (s)	0.0	0.0	0.0	0.0	0.0			0.0			0.0	
Total Lost Time (s)	5.0	6.0	6.0	5.0	6.0			5.0			5.0	
Lead/Lag	Lead	Lag	Lag	Lead	Lag							
Lead-Lag Optimize?	Yes	Yes	Yes	Yes	Yes							
Recall Mode	None	C-Min	C-Min	None	Min		None	None		None	None	
Act Effct Green (s)	41.1	39.3	39.3	40.0	37.0			9.1			9.1	
Actuated g/C Ratio	0.68	0.66	0.66	0.67	0.62			0.15			0.15	
v/c Ratio	0.14	0.50	0.07	0.05	0.47			0.63			0.33	
Control Delay	4.3	10.6	0.8	3.9	11.4			28.2			14.9	
Queue Delay	0.0	0.0	0.0	0.0	0.0			0.0			0.0	
Total Delay	4.3	10.6	0.8	3.9	11.4			28.2			14.9	
LOS	A	B	A	A	B			C			B	
Approach Delay		9.0			11.1			28.2			14.9	
Approach LOS		A			B			C			B	
Queue Length 50th (ft)	8	97	0	3	140			41			12	
Queue Length 95th (ft)	19	261	7	8	217			#100			47	
Internal Link Dist (ft)		635			518			1811			361	
Turn Bay Length (ft)	200		270	90								
Base Capacity (vph)	573	1225	1084	539	1162			298			311	
Starvation Cap Reductn	0	0	0	0	0			0			0	
Spillback Cap Reductn	0	0	0	0	0			0			0	
Storage Cap Reductn	0	0	0	0	0			0			0	
Reduced v/c Ratio	0.14	0.50	0.07	0.05	0.46			0.57			0.30	
Intersection Summary												
Cycle Length: 60												
Actuated Cycle Length: 60												
Offset: 0 (0%), Referenced to phase 2:EBTL, Start of Green												
Natural Cycle: 60												
Control Type: Actuated-Coordinated												

Timings

1: Hathaway Drive & Galley Road

Total Traffic Conditions
Year 2043 - PM Peak Hour

Maximum v/c Ratio: 0.63

Intersection Signal Delay: 12.1

Intersection LOS: B

Intersection Capacity Utilization 62.6%







ICU Level of Service B

Analysis Period (min) 15

95th percentile volume exceeds capacity, queue may be longer.

Queue shown is maximum after two cycles.

Splits and Phases: 1: Hathaway Drive & Galley Road

 Ø1	 Ø2 (R)	 Ø4
10 s	35 s	15 s
 Ø5	 Ø6	 Ø8
10 s	35 s	15 s

HCM 6th TWSC
2: Western Drive & Galley Road

Total Traffic Conditions
Year 2043 - PM Peak Hour

Intersection												
Int Delay, s/veh	3.4											
Movement	EBL	EBT	EBR	WBL	WBT	WBR	NBL	NBT	NBR	SBL	SBT	SBR
Lane Configurations		↗			↗			↕			↕	
Traffic Vol, veh/h	53	498	20	26	438	20	8	11	32	24	11	36
Future Vol, veh/h	53	498	20	26	438	20	8	11	32	24	11	36
Conflicting Peds, #/hr	0	0	0	0	0	0	0	0	0	0	0	0
Sign Control	Free	Free	Free	Free	Free	Free	Stop	Stop	Stop	Stop	Stop	Stop
RT Channelized	-	-	None	-	-	None	-	-	None	-	-	None
Storage Length	-	-	-	-	-	-	-	-	-	-	-	-
Veh in Median Storage, #	-	0	-	-	0	-	-	0	-	-	0	-
Grade, %	-	0	-	-	0	-	-	0	-	-	0	-
Peak Hour Factor	92	92	92	92	92	92	92	92	92	92	92	92
Heavy Vehicles, %	2	2	2	2	2	2	2	2	2	2	2	2
Mvmt Flow	58	541	22	28	476	22	9	12	35	26	12	39

Major/Minor	Major1		Major2		Minor1			Minor2				
Conflicting Flow All	498	0	0	563	0	0	1237	1222	552	1235	1222	487
Stage 1	-	-	-	-	-	-	668	668	-	543	543	-
Stage 2	-	-	-	-	-	-	569	554	-	692	679	-
Critical Hdwy	4.12	-	-	4.12	-	-	7.12	6.52	6.22	7.12	6.52	6.22
Critical Hdwy Stg 1	-	-	-	-	-	-	6.12	5.52	-	6.12	5.52	-
Critical Hdwy Stg 2	-	-	-	-	-	-	6.12	5.52	-	6.12	5.52	-
Follow-up Hdwy	2.218	-	-	2.218	-	-	3.518	4.018	3.318	3.518	4.018	3.318
Pot Cap-1 Maneuver	1066	-	-	1008	-	-	153	180	533	153	180	581
Stage 1	-	-	-	-	-	-	448	456	-	524	520	-
Stage 2	-	-	-	-	-	-	507	514	-	434	451	-
Platoon blocked, %	-	-	-	-	-	-	-	-	-	-	-	-
Mov Cap-1 Maneuver	1066	-	-	1008	-	-	123	159	533	123	159	581
Mov Cap-2 Maneuver	-	-	-	-	-	-	123	159	-	123	159	-
Stage 1	-	-	-	-	-	-	413	420	-	483	500	-
Stage 2	-	-	-	-	-	-	444	494	-	363	415	-

Approach	EB		WB		NB		SB	
HCM Control Delay, s	0.8		0.5		22.3		30.3	
HCM LOS					C		D	

Minor Lane/Major Mvmt	NBLn1	EBL	EBT	EBR	WBL	WBT	WBR	SBLn1
Capacity (veh/h)	263	1066	-	-	1008	-	-	218
HCM Lane V/C Ratio	0.211	0.054	-	-	0.028	-	-	0.354
HCM Control Delay (s)	22.3	8.6	-	-	8.7	-	-	30.3
HCM Lane LOS	C	A	-	-	A	-	-	D
HCM 95th %tile Q(veh)	0.8	0.2	-	-	0.1	-	-	1.5

HCM 6th TWSC
3: Hathaway Drive & E Platte Avenue

Total Traffic Conditions
Year 2043 - PM Peak Hour

Intersection													
Int Delay, s/veh	11.1												
Movement	EBU	EBL	EBT	EBR	WBL	WBT	WBR	NBL	NBT	NBR	SBL	SBT	SBR
Lane Configurations		↔	↑↑	↗	↔	↑↑	↗			↗			↗
Traffic Vol, veh/h	56	134	3357	5	33	2771	37	0	0	62	0	0	156
Future Vol, veh/h	56	134	3357	5	33	2771	37	0	0	62	0	0	156
Conflicting Peds, #/hr	0	0	0	0	0	0	0	0	0	0	0	0	0
Sign Control	Free	Free	Free	Free	Free	Free	Free	Stop	Stop	Stop	Stop	Stop	Stop
RT Channelized	-	-	-	None	-	-	Free	-	-	None	-	-	Stop
Storage Length	-	330	-	200	250	-	500	-	-	0	-	-	0
Veh in Median Storage, #	-	-	0	-	-	0	-	-	0	-	-	0	-
Grade, %	-	-	0	-	-	0	-	-	0	-	-	0	-
Peak Hour Factor	92	92	92	92	92	92	92	92	92	92	92	92	92
Heavy Vehicles, %	2	2	2	2	2	2	2	2	2	2	2	2	2
Mvmt Flow	61	146	3649	5	36	3012	40	0	0	67	0	0	170

Major/Minor	Major1				Major2			Minor1			Minor2		
Conflicting Flow All	3012	3012	0	0	3654	0	0	-	-	1825	-	-	1506
Stage 1	-	-	-	-	-	-	-	-	-	-	-	-	-
Stage 2	-	-	-	-	-	-	-	-	-	-	-	-	-
Critical Hdwy	6.44	4.14	-	-	4.14	-	-	-	-	6.94	-	-	6.94
Critical Hdwy Stg 1	-	-	-	-	-	-	-	-	-	-	-	-	-
Critical Hdwy Stg 2	-	-	-	-	-	-	-	-	-	-	-	-	-
Follow-up Hdwy	2.52	2.22	-	-	2.22	-	-	-	-	3.32	-	-	3.32
Pot Cap-1 Maneuver	~ 16	~ 112	-	-	61	-	0	0	0	~ 66	0	0	~ 110
Stage 1	-	-	-	-	-	-	0	0	0	-	0	0	-
Stage 2	-	-	-	-	-	-	0	0	0	-	0	0	-
Platoon blocked, %			-	-			-						
Mov Cap-1 Maneuver	~ -7	~ -7	-	-	61	-	-	-	-	~ 66	-	-	~ 110
Mov Cap-2 Maneuver	-	-	-	-	-	-	-	-	-	-	-	-	-
Stage 1	-	-	-	-	-	-	-	-	-	-	-	-	-
Stage 2	-	-	-	-	-	-	-	-	-	-	-	-	-

Approach	EB	WB	NB	SB
HCM Control Delay, s		1.5	222.7	\$ 353.3
HCM LOS			F	F

Minor Lane/Major Mvmt	NBLn1	EBL	EBT	EBR	WBL	WBT	SBLn1
Capacity (veh/h)	66	+	-	-	61	-	110
HCM Lane V/C Ratio	1.021	-	-	-	0.588	-	1.542
HCM Control Delay (s)	222.7	-	-	-	126.9	-	\$ 353.3
HCM Lane LOS	F	-	-	-	F	-	F
HCM 95th %tile Q(veh)	5.1	-	-	-	2.4	-	12.5

Notes
 ~: Volume exceeds capacity \$: Delay exceeds 300s +: Computation Not Defined *: All major volume in platoon

HCM 6th TWSC
4: Hathaway Drive & Western Drive

Total Traffic Conditions
Year 2043 - PM Peak Hour

Intersection												
Int Delay, s/veh	1.9											
Movement	EBL	EBT	EBR	WBL	WBT	WBR	NBL	NBT	NBR	SBL	SBT	SBR
Lane Configurations	↕			↕			↕			↕		
Traffic Vol, veh/h	3	1	3	15	0	7	1	90	41	18	52	0
Future Vol, veh/h	3	1	3	15	0	7	1	90	41	18	52	0
Conflicting Peds, #/hr	0	0	0	0	0	0	0	0	0	0	0	0
Sign Control	Stop	Stop	Stop	Stop	Stop	Stop	Free	Free	Free	Free	Free	Free
RT Channelized	-	-	None	-	-	None	-	-	None	-	-	None
Storage Length	-	-	-	-	-	-	-	-	-	-	-	-
Veh in Median Storage, #	-	0	-	-	0	-	-	0	-	-	0	-
Grade, %	-	0	-	-	0	-	-	0	-	-	0	-
Peak Hour Factor	92	92	92	92	92	92	92	92	92	92	92	92
Heavy Vehicles, %	2	2	2	2	2	2	2	2	2	2	2	2
Mvmt Flow	3	1	3	16	0	8	1	98	45	20	57	0

Major/Minor	Minor2		Minor1		Major1		Major2					
Conflicting Flow All	224	242	57	222	220	121	57	0	0	143	0	0
Stage 1	97	97	-	123	123	-	-	-	-	-	-	-
Stage 2	127	145	-	99	97	-	-	-	-	-	-	-
Critical Hdwy	7.12	6.52	6.22	7.12	6.52	6.22	4.12	-	-	4.12	-	-
Critical Hdwy Stg 1	6.12	5.52	-	6.12	5.52	-	-	-	-	-	-	-
Critical Hdwy Stg 2	6.12	5.52	-	6.12	5.52	-	-	-	-	-	-	-
Follow-up Hdwy	3.518	4.018	3.318	3.518	4.018	3.318	2.218	-	-	2.218	-	-
Pot Cap-1 Maneuver	732	660	1009	734	678	930	1547	-	-	1440	-	-
Stage 1	910	815	-	881	794	-	-	-	-	-	-	-
Stage 2	877	777	-	907	815	-	-	-	-	-	-	-
Platoon blocked, %	-	-	-	-	-	-	-	-	-	-	-	-
Mov Cap-1 Maneuver	717	650	1009	722	668	930	1547	-	-	1440	-	-
Mov Cap-2 Maneuver	717	650	-	722	668	-	-	-	-	-	-	-
Stage 1	909	804	-	880	793	-	-	-	-	-	-	-
Stage 2	869	776	-	890	804	-	-	-	-	-	-	-

Approach	EB		WB		NB		SB	
HCM Control Delay, s	9.5		9.8		0.1		1.9	
HCM LOS	A		A					

Minor Lane/Major Mvmt	NBL	NBT	NBR	EBLn1	WBLn1	SBL	SBT	SBR
Capacity (veh/h)	1547	-	-	805	777	1440	-	-
HCM Lane V/C Ratio	0.001	-	-	0.009	0.031	0.014	-	-
HCM Control Delay (s)	7.3	0	-	9.5	9.8	7.5	0	-
HCM Lane LOS	A	A	-	A	A	A	A	-
HCM 95th %tile Q(veh)	0	-	-	0	0.1	0	-	-

HCM 6th TWSC
5: Access B/Apartment Access & Western Drive

Total Traffic Conditions
Year 2043 - PM Peak Hour

Intersection												
Int Delay, s/veh	3.2											
Movement	EBL	EBT	EBR	WBL	WBT	WBR	NBL	NBT	NBR	SBL	SBT	SBR
Lane Configurations	↕			↕			↕			↕		
Traffic Vol, veh/h	15	38	3	2	8	6	2	0	5	3	0	11
Future Vol, veh/h	15	38	3	2	8	6	2	0	5	3	0	11
Conflicting Peds, #/hr	0	0	0	0	0	0	0	0	0	0	0	0
Sign Control	Free	Free	Free	Free	Free	Free	Stop	Stop	Stop	Stop	Stop	Stop
RT Channelized	-	-	None	-	-	None	-	-	None	-	-	None
Storage Length	-	-	-	-	-	-	-	-	-	-	-	-
Veh in Median Storage, #	-	0	-	-	0	-	-	0	-	-	0	-
Grade, %	-	0	-	-	0	-	-	0	-	-	0	-
Peak Hour Factor	92	92	92	92	92	92	92	92	92	92	92	92
Heavy Vehicles, %	2	2	2	2	2	2	2	2	2	2	2	2
Mvmt Flow	16	41	3	2	9	7	2	0	5	3	0	12

Major/Minor	Major1		Major2		Minor1		Minor2					
Conflicting Flow All	16	0	0	44	0	0	98	95	43	94	93	13
Stage 1	-	-	-	-	-	-	75	75	-	17	17	-
Stage 2	-	-	-	-	-	-	23	20	-	77	76	-
Critical Hdwy	4.12	-	-	4.12	-	-	7.12	6.52	6.22	7.12	6.52	6.22
Critical Hdwy Stg 1	-	-	-	-	-	-	6.12	5.52	-	6.12	5.52	-
Critical Hdwy Stg 2	-	-	-	-	-	-	6.12	5.52	-	6.12	5.52	-
Follow-up Hdwy	2.218	-	-	2.218	-	-	3.518	4.018	3.318	3.518	4.018	3.318
Pot Cap-1 Maneuver	1602	-	-	1564	-	-	884	795	1027	889	797	1067
Stage 1	-	-	-	-	-	-	934	833	-	1002	881	-
Stage 2	-	-	-	-	-	-	995	879	-	932	832	-
Platoon blocked, %	-	-	-	-	-	-	-	-	-	-	-	-
Mov Cap-1 Maneuver	1602	-	-	1564	-	-	867	786	1027	877	788	1067
Mov Cap-2 Maneuver	-	-	-	-	-	-	867	786	-	877	788	-
Stage 1	-	-	-	-	-	-	925	825	-	992	880	-
Stage 2	-	-	-	-	-	-	983	878	-	918	824	-

Approach	EB		WB		NB		SB	
HCM Control Delay, s	1.9		0.9		8.7		8.6	
HCM LOS					A		A	

Minor Lane/Major Mvmt	NBLn1	EBL	EBT	EBR	WBL	WBT	WBR	SBLn1
Capacity (veh/h)	976	1602	-	-	1564	-	-	1020
HCM Lane V/C Ratio	0.008	0.01	-	-	0.001	-	-	0.015
HCM Control Delay (s)	8.7	7.3	0	-	7.3	0	-	8.6
HCM Lane LOS	A	A	A	-	A	A	-	A
HCM 95th %tile Q(veh)	0	0	-	-	0	-	-	0

HCM 6th TWSC
6: Hathaway Drive & Bednarski Access / Access A

Total Traffic Conditions
Year 2043 - PM Peak Hour

Intersection						
Int Delay, s/veh	0.9					
Movement	WBL	WBR	NBT	NBR	SBL	SBT
Lane Configurations						
Traffic Vol, veh/h	11	7	123	13	5	66
Future Vol, veh/h	11	7	123	13	5	66
Conflicting Peds, #/hr	0	0	0	0	0	0
Sign Control	Stop	Stop	Free	Free	Free	Free
RT Channelized	-	None	-	None	-	None
Storage Length	0	-	-	-	-	-
Veh in Median Storage, #	0	-	0	-	-	0
Grade, %	0	-	0	-	-	0
Peak Hour Factor	92	92	92	92	92	92
Heavy Vehicles, %	2	2	2	2	2	2
Mvmt Flow	12	8	134	14	5	72

Major/Minor	Minor1	Major1	Major2		
Conflicting Flow All	223	141	0	0	148
Stage 1	141	-	-	-	-
Stage 2	82	-	-	-	-
Critical Hdwy	6.42	6.22	-	-	4.12
Critical Hdwy Stg 1	5.42	-	-	-	-
Critical Hdwy Stg 2	5.42	-	-	-	-
Follow-up Hdwy	3.518	3.318	-	-	2.218
Pot Cap-1 Maneuver	765	907	-	-	1434
Stage 1	886	-	-	-	-
Stage 2	941	-	-	-	-
Platoon blocked, %			-	-	-
Mov Cap-1 Maneuver	762	907	-	-	1434
Mov Cap-2 Maneuver	762	-	-	-	-
Stage 1	886	-	-	-	-
Stage 2	937	-	-	-	-

Approach	WB	NB	SB
HCM Control Delay, s	9.5	0	0.5
HCM LOS	A		

Minor Lane/Major Mvmt	NBT	NBRWBLn1	SBL	SBT
Capacity (veh/h)	-	-	813	1434
HCM Lane V/C Ratio	-	-	0.024	0.004
HCM Control Delay (s)	-	-	9.5	7.5
HCM Lane LOS	-	-	A	A
HCM 95th %tile Q(veh)	-	-	0.1	0

HCM 6th TWSC
7: Hathaway Drive & Ford Street

Total Traffic Conditions
Year 2043 - PM Peak Hour

Intersection												
Int Delay, s/veh	5.3											
Movement	EBL	EBT	EBR	WBL	WBT	WBR	NBL	NBT	NBR	SBL	SBT	SBR
Lane Configurations	↕			↕			↕			↕		
Traffic Vol, veh/h	0	8	53	63	18	0	33	0	137	0	0	0
Future Vol, veh/h	0	8	53	63	18	0	33	0	137	0	0	0
Conflicting Peds, #/hr	0	0	0	0	0	0	0	0	0	0	0	0
Sign Control	Stop	Stop	Stop	Stop	Stop	Stop	Free	Free	Free	Free	Free	Free
RT Channelized	-	-	None	-	-	None	-	-	None	-	-	None
Storage Length	-	-	-	-	-	-	-	-	-	-	-	-
Veh in Median Storage, #	-	0	-	-	0	-	-	0	-	-	0	-
Grade, %	-	0	-	-	0	-	-	0	-	-	0	-
Peak Hour Factor	92	92	92	92	92	92	92	92	92	92	92	92
Heavy Vehicles, %	2	2	2	2	2	2	2	2	2	2	2	2
Mvmt Flow	0	9	58	68	20	0	36	0	149	0	0	0

Major/Minor	Minor2		Minor1		Major1			Major2				
Conflicting Flow All	158	222	1	182	148	75	1	0	0	149	0	0
Stage 1	1	1	-	147	147	-	-	-	-	-	-	-
Stage 2	157	221	-	35	1	-	-	-	-	-	-	-
Critical Hdwy	7.12	6.52	6.22	7.12	6.52	6.22	4.12	-	-	4.12	-	-
Critical Hdwy Stg 1	6.12	5.52	-	6.12	5.52	-	-	-	-	-	-	-
Critical Hdwy Stg 2	6.12	5.52	-	6.12	5.52	-	-	-	-	-	-	-
Follow-up Hdwy	3.518	4.018	3.318	3.518	4.018	3.318	2.218	-	-	2.218	-	-
Pot Cap-1 Maneuver	808	677	1084	779	743	986	1622	-	-	1432	-	-
Stage 1	1022	895	-	856	775	-	-	-	-	-	-	-
Stage 2	845	720	-	981	895	-	-	-	-	-	-	-
Platoon blocked, %	-	-	-	-	-	-	-	-	-	-	-	-
Mov Cap-1 Maneuver	776	660	1084	716	724	986	1622	-	-	1432	-	-
Mov Cap-2 Maneuver	776	660	-	716	724	-	-	-	-	-	-	-
Stage 1	996	895	-	835	756	-	-	-	-	-	-	-
Stage 2	803	702	-	920	895	-	-	-	-	-	-	-

Approach	EB		WB		NB		SB	
HCM Control Delay, s	8.9		10.7		1.4		0	
HCM LOS	A		B					

Minor Lane/Major Mvmt	NBL	NBT	NBR	EBLn1	WBLn1	SBL	SBT	SBR
Capacity (veh/h)	1622	-	-	1000	718	1432	-	-
HCM Lane V/C Ratio	0.022	-	-	0.066	0.123	-	-	-
HCM Control Delay (s)	7.3	0	-	8.9	10.7	0	-	-
HCM Lane LOS	A	A	-	A	B	A	-	-
HCM 95th %tile Q(veh)	0.1	-	-	0.2	0.4	0	-	-

APPENDIX D

Intersection Sight Distance Exhibit



Provide sight distance exhibit for other access location.

LEGEND

- Areas Within Site Distance Triangle That Should Avoid Obstructions

WESTERN DRIVE TOWNHOMES
 Intersection Sight Distance Exhibit

SM ROCHA, LLC
 Traffic and Transportation Consultants



October 2023

