



FINAL DRAINAGE REPORT

FALCON MEADOWS AT BENT GRASS FILING NO. 4

El Paso County, Colorado

PREPARED FOR:
Challenger Communities
8605 Explorer Dr., Suite 250
Colorado Springs, CO 80920

PREPARED BY:
Galloway & Company, Inc.
1155 Kelly Johnson Blvd., Suite 305
Colorado Springs, CO 80920

DATE:
Prepared: July 1, 2022
Revised: October 10, 2022
Revised: March 22, 2024

PCD Filing No.: SF-22-023



ENGINEER'S STATEMENT

The attached drainage plan and report were prepared under my direction and supervision and are correct to the best of my knowledge and belief. Said drainage report has been prepared according to the criteria established by the County for drainage reports and said report is in conformity with the applicable master plan of the drainage basin. I accept responsibility for any liability caused by any negligent acts, errors or omissions on my part in preparing this report.



Brady A. Shyrock, PE 38164
For and on behalf of Galloway & Company, Inc.

05/20/2024

Date



DEVELOPER'S CERTIFICATION

I, The developer, have read and will comply with all of the requirements specified in this drainage report and plan.

By: Jim Byers

05/20/24

Date

Address: Challenger Communities, LLC
8605 Explorer Dr., Suite 250
Colorado Springs, CO 80920

EL PASO COUNTY CERTIFICATION

Filed in accordance with the requirements of the Drainage Criteria Manual, Volumes 1 and 2, El Paso County Engineering Criteria Manual and Land Development Code as amended.

06/12/2024

Joshua Palmer, P.E.
County Engineer/ECM Administrator

Date

Conditions:

TABLE OF CONTENTS

I.	Purpose.....	1
II.	General Description.....	1
III.	Previous Reports	1
IV.	Drainage Criteria.....	2
V.	Historic Drainage Conditions	3
VI.	Existing Drainage Conditions	3
VII.	Four Step Process	5
	1. Employ Runoff Reduction Practices.....	5
	2. Stabilize Drainageways.....	5
	3. Provide Water Quality Capture Volume (WQCV)	6
	4. Consider Need for Industrial and Commercial BMPs	6
VIII.	Proposed Drainage Conditions.....	6
IX.	Storm Sewer System.....	9
X.	Proposed Water Quality Detention Ponds.....	9
XI.	Channel and Swales.....	10
	Swales.....	10
	Channel.....	10
XII.	Maintenance	10
XIII.	Wetlands Mitigation	10
XIV.	Floodplain Statement.....	10
XV.	Drainage/Bridge Fees and Credits/Reimbursements.....	10
XVI.	Conclusion	12
XVII.	References	12

Appendices:

- A. Exhibits and Figures
- B. Excerpts from Previous Reports
- C. Hydrologic Computations
- D. Hydraulic Computations
- E. Pond Analysis
- F. Drainage Maps

I. Purpose

The purpose of this Final Drainage Report is to identify on and offsite drainage patterns, locate and identify tributary or downstream drainage features and facilities that impact the site, and to identify which types of drainage facilities will be needed and where they will be located. This report will remain in compliance with the MDDP for the site, prepared by Galloway & Company, September 2021.

II. General Description

The Falcon Meadows at Bent Grass Filing No. 4 is approximately 10.42 acres within the Bent Grass development. It is located along the northern boundary line of the overall Bent Grass development and is bisected by the existing West Tributary of the Falcon Basin. The project is a single-family residential development of 39 lots, located in the Falcon area of El Paso County, Colorado. The site is located in the Northwest $\frac{1}{4}$ and Southwest $\frac{1}{4}$ of Section 1, Township 13S, Range 65W, of the Sixth Principal Meridian, County of El Paso, State of Colorado. The subject property is located on either side of the existing West Tributary of the Falcon Basin with the majority of the site located to the north of Bent Grass Meadows Drive, sandwiched between Bent Grass Residential Filing No. 2 (to the east) and Falcon Meadows at Bent Grass Filing Nos. 1 through 3 (to the west). 11 lots are located to the south of Bent Grass Meadows Drive and are situated to the west of the existing West Tributary of the Falcon Basin immediately adjacent to Falcon Meadows at Bent Grass Filing No. 1. A Vicinity Map is included in Appendix A.

Construction of the Falcon Meadows at Bent Grass Drainage Channel (SF-21-014) and FEMA LOMR must be completed prior to the recording of the Falcon Meadows at Bent Grass Filing No. 4 Subdivision Plat.

A Planned Unit Development Plan Amendment was approved for the site, PUD-14-002 in July 2014. An additional amendment to this PUD has also been approved (PUD-SP-205). The overall Bent Grass site consists of approximately 103.4 acres and included 309 dwelling units.

The existing soil types within the proposed site as determined by the NRCS Web Soil Survey for El Paso County Area consist of Columbine gravelly sandy loam and Blakeland loamy sand. All soils are defined as having hydrologic soil group A. See the soils map included in Appendix A.

III. Previous Reports

The proposed site has been included in multiple drainage studies in the past. The following is a composite list of the existing reports pertaining to this site analysis.

1. *Falcon Drainage Basin Planning Study*, by Matrix Design Group, September 2015.
2. *Master Development Drainage Plan – Bent Grass Residential Subdivision*, by Galloway & Company, September 2021.
3. *Master Development Drainage Plan and Preliminary Drainage Plan – Bent Grass Subdivision*, by Kiowa Engineering Corporation, December 2006.
4. *Final Drainage Report for Bent Grass Residential (Filing No. 1)*, by Classic Consulting Engineers & Surveyors, LLC, August 2014.
5. *Final Drainage Report Addendum for Bent Grass Residential (Filing No. 1)*, by Classic Consulting Engineers & Surveyors, LLC, August 2015.
6. *Master Development Drainage Plan for The Ranch*, by Classic Consulting Engineers & Surveyors, LLC, November 2018.

7. *Falcon Highlands Master Development Drainage Plan & Preliminary Drainage Report & Final Drainage Report for Filing 1*, by URS, January 2005.
8. *Final Drainage Report and Erosion Control Plan – Latigo Business Center Filing No. 1 A Re-subdivision of a Portion of Latigo Business and Research Center Filing No. 1*, by Kiowa Engineering Corporation, November 2004.
9. *Final Drainage Letter Report for Lot 1, Latigo Business Center Filing No. 1*, by Colorado Design Concepts, April 2005.
10. *Final Drainage and Erosion Control for The Meadows Filing Three Subdivision*, by LADD Engineering, July 2000.
11. *Final Drainage Report Bent Grass Residential Subdivision, Filing No. 2*, Galloway & Company, March 2020.
12. *Preliminary Drainage Report Falcon Meadows at Bent Grass*, by Galloway & Company, February 2021.
13. *Final Drainage Report for Falcon Meadows at Bent Grass Filing No. 1*, by Galloway & Company, September 2021.
14. *Final Drainage Report for Falcon Meadows at Bent Grass Filing No. 2*, by Galloway & Company, April, 2022.
15. *Final Drainage Report for Falcon Meadows at Bent Grass Filing No. 3*, by Galloway & Company, August, 2022.

IV. Drainage Criteria

Hydrology calculations were performed using the City of Colorado Springs/El Paso County Drainage Criteria Manual, as revised in November 1991 and October 1994 with County adopted Chapter 6 and Section 3.2.1 of Chapter 13 of the City of Colorado Springs/El Paso County Drainage Criteria Manual as revised in May 2014 and the El Paso County Engineering Criteria Manual (ECM) as revised in July 2019.

The drainage calculations were based on the criteria manual Figure 6-5 and IDF equations to determine the intensity and are listed in Table 1 below.

Table 1 - Precipitation Data

Return Period	One Hour Depth (in).	Intensity (in/hr)
5-year	1.50	5.17
100-year	2.52	8.68

The rational method was used to calculate peak flows as the tributary areas are less than 100 acres. The rational method has been proven to be accurate for basins of this size and is based on the following formula:

$$Q = CIA$$

Where:

- Q = Peak Discharge (cfs)
- C = Runoff Coefficient
- I = Runoff intensity (inches/hour)
- A = Drainage area (acres)

The runoff coefficients are calculated based on land use, percent imperviousness, and design storm for each basin, as shown in the drainage criteria manual (Table 6-6). Composite percent impervious and C values were calculated using the residential, streets, roofs, and lawns coefficients found in Table 6-6 of the manual.

The 100-year event was used as the major storm event for pipes and inlets. The 5-year event was used as the minor event.

The UD-Detention spreadsheet was utilized for to check the existing the water quality ponds still function with the revised tributary areas and impervious values. This spreadsheet was also utilized for the original design of the on-site water quality ponds, Pond (North) and Pond (South).

UD-Inlet was utilized to calculate both the street capacities and the inlet capacities.

StormCAD was utilized to size the storm sewer systems.

V. Historic Drainage Conditions

The site is contained fully within the Falcon Drainage Basin, more specifically the West Falcon Tributary. The site generally drains from north to south with an average slope of 2%. The rational method was used to analyze the individual basins within the site as the proposed drainage basins are less than 100 acres. The project site was studied in the Falcon Basin Drainage Basin Planning Study (DBPS) and in the Master Development and Drainage Plan (MDDP) for Bent Grass.

Per the Falcon DBPS by Matrix, the site lies within the basins, WT200, WT210, and WT220. These basins connect to channel reaches RWT202, RWT204, and RWT210. Both the RWT204 and RWT210 sections of channel currently exist and appear as a drainageway when visiting the site. Reach RWT202 appears to be a shallow overland flow through the project site. It is nearly unrecognizable through the site from a visual standpoint.

A historic basin map has been prepared for this site to analyze the historic basins as well as the offsite basins contributing to the site. Historic basins have been discussed in the Bent Grass Residential Filing No. 2 Final Drainage Report, El Paso County Project # SF-19-014. Copies of the hydrology calculations have been included in Appendix B and a copy of the historic map is included in Appendix B. Efforts have been made to comply with the recommendations set forth in the approved DBPS and MDDP.

VI. Existing Drainage Conditions

With respect to the existing/current conditions, developed conditions maps from previous studies are being utilized for Falcon Meadows at Bent Grass Filing No. 4 and will be the existing condition as Filing No. 4 begins construction. Under this scenario, it is assumed that Bent Grass Residential Filing No. 2 and Falcon Meadows at Bent Grass Filing Nos. 1, 2 and 3 are developed. The Falcon Meadows at Bent Grass Filing No. 3 proposed drainage maps are included in Appendix B and the basins are described below.

Below is a description of the basins which were developed as part of Falcon Meadows at Bent Grass Filing No. 3:

Basin EX-1 (1.19 AC, $Q_5 = 0.4$ cfs, $Q_{100} = 2.5$ cfs): is associated with the northwestern portion of the Bent Grass Residential Filing No. 2 site east of the existing channel (now the northeast portion of Falcon Meadows at Bent Grass Filing No. 4). The basin is currently undeveloped. Runoff from the basin generally flows to the southwest, into Basins EX-2 and B-1.

Basin EX-2 (1.60 AC, $Q_5 = 0.5$ cfs, $Q_{100} = 3.8$ cfs): is along the western boundary portion of the Bent Grass Residential Filing No. 2 site and is south of Basin EX-1, east of the existing channel (now the eastern portion of Falcon Meadows at Bent Grass Filing No. 4). The basin is currently undeveloped and receives flows from Basins OS-4 & OS-5. Runoff from the basin generally flows to the southeast into Basin EX-3 at **DP 5** combined with flows from **DP 1, & 2**.

Basin EX-3 (0.66 AC, $Q_5 = 0.2$ cfs, $Q_{100} = 1.6$ cfs): is along the western boundary portion of the Bent Grass Residential Filing No. 2 site south of Basin EX-2 and east of the existing channel (now southeast portion of Falcon Meadows at Bent Grass Filing No. 4). The basin currently contains an existing WQCV pond created as part of Bent Grass Residential Filing No. 2 (North Pond). This basin receives flows from **DP 5** and **DP 3**.

Basin C-1e (0.49 AC, $Q_5 = 2.3$ cfs, $Q_{100} = 4.1$ cfs): a basin that will include the east half of Henzlee Place. Runoff will flow from the R.O.W. into the existing mountable curb and gutter where it will be conveyed to **DP 12**. Flows will then enter an existing 15' at grade CDOT Type R inlet, part of Storm System B, where it will be piped to the existing north WQCV pond at **DP 13**. Bypass flows from the inlet at **DP 12** will travel to the south, then east in Bent Grass Meadows Drive to **DP 8**, an existing 20' CDOT sump Type R inlet, which releases into the existing WQCV pond in Bent Grass Residential Filing No. 2.

Basin C-5 (0.60 AC, $Q_5 = 0.3$ cfs, $Q_{100} = 1.9$ cfs): Is a basin which will encompass the existing north WQCV pond area. The stormwater within the existing north WQCV pond will be released at a controlled rate, via an outlet structure with orifice holes, into the existing channel RWT204.

Basin B-1 (6.59 AC, $Q_5 = 1.8$ cfs, $Q_{100} = 11.8$ cfs): a basin that is along the north boundary of the site and through the center of the site, encompassing the existing rerouted channel RWT202 and channel RWT204. Flows will continue south in the existing channel where they will then be conveyed through the existing twin 16' x 6' RCBC's to **DP AA**.

Basin D-4c (1.21 AC, $Q_5 = 2.4$ cfs, $Q_{100} = 5.0$ cfs): a basin that is east of Henzlee Place and south of Bent Grass Meadows Drive. It encompasses single-family residential lots, & portions of Nico Way, Jayla Trail, and Henzlee Place. Runoff will flow from each lot onto the existing public R.O.W. where existing mountable curb and gutter will convey flows to **DP 17c**, the north side of **DP 17**. Flows at **DP 17** (combined flows from **DP 17b** & **DP 17c** with bypass from **DP 18**) will then enter an existing sump CDOT Type R inlet, part of Storm System A, where it will then be piped and ultimately outfall in the existing south WQCV pond at **DP 31**. Overflow from this inlet would be to overtop the curb and then continue via an existing swale, following the same path as the existing pipe, to the east until flows are released into the existing south water quality pond.

Basin D-7 (7.65 AC, $Q_5 = 4.3$ cfs, $Q_{100} = 18.2$ cfs): a basin that is in the south end of the site, east of Bent Grass Meadows Drive & west of the existing channel. It encompasses the back half of several single-family residential lots as well as the existing south WQCV pond and an existing drainage ditch (Swale F). Runoff will flow, via sheet flow, until it enters the existing swale and is conveyed to the existing south WQCV pond or will directly flow into the existing south WQCV pond at **DP 30**.

Basin D-8 (1.69 AC, Q5 = 2.6 cfs, Q100 = 6.0 cfs): a basin that is west of the existing channel & south of Bent Grass Meadows Drive. It encompasses the back half of single-family residential lots. Runoff will flow from each lot and discharge into an existing drainage swale (Swale C). The swale will convey flows to the south, ultimately discharging into the existing south WQCV pond at **DP 32**.

Basin OS-4 (4.46 AC, Q5 = 5.6 cfs, Q100 = 14.0 cfs) is associated with The Bent Grass Residential Filing No. 2, lots 152-160, lots 163-168, Tract D, and portions of Thedford Court & Willmore Drive. Runoff from this basin flows via curb & gutter south on Thedford Court then continues flowing west along the northern curb & gutter along Willmore Drive before discharging into Basin EX-2 at **DP 1**. This basin remains unchanged.

Basin OS-5 (0.46 AC, Q5 = 1.1 cfs, Q100 = 2.3 cfs): is associated with The Bent Grass Residential Filing No. 2, lots 161 & 162 along with a portion of Silky Thread Road. Runoff from this basin generally flows to the west via curb & gutter along Silky Thread Road before discharging into Basin EX-2 at **DP 2**. This basin remains unchanged.

Basin OS-6 (1.17 AC, Q5 = 2.0 cfs, Q100 = 4.3 cfs): is associated with The Bent Grass Residential Filing No. 2, the northern halves of Lots 170-178 and a portion of the southern side of Willmore Drive. Runoff from this basin generally flows to the west via curb & gutter along Willmore Drive before discharging into Basin EX-2 at **DP 3**. This basin remains unchanged.

Basin RWT204 (38.4 AC, Q5 = 7 cfs, Q100 = 43 cfs) represents one of the larger offsite basins to the north of the proposed project. This area was studied as part of the Falcon Basin DBPS prepared by Matrix and were also part of the Bent Grass MDDP, approved September 21, 2021. There have been no changes to this basin as it is offsite and existing.

Design Point AA is the location in channel reach RWT204, where flows cross Bent Grass Meadows Drive within the existing twin 16' x 6' RCBC. The minor flows are 335.9 cfs and the major flows are 1450 cfs.

Design Point CC is the location in channel reach RWT210, where flows exit the Falcon Meadows development, including the offsite flows from RWT202, RWT204 and WT200. The minor flows are 335.9 cfs and the major flows are 1450 cfs.

VII. Four Step Process

The Four Step Process is used to minimize the adverse impacts of urbanization and is a vital component of developing a balanced, sustainable project. Below identifies the approach to the four-step process:

1. Employ Runoff Reduction Practices

The proposed development uses Low Impact Development (LID) practices to reduce runoff at the source. Rather than creating point discharges that are directly connected to impervious areas, runoff is routed through pervious areas to promote infiltration and minimize directly connected impervious areas (MDCIA). Grass buffers and swales are used where practical.

2. Stabilize Drainageways

This step implements stabilization to channels to accommodate developed flows while protecting infrastructure and controlling sediment loading from erosion in the drainageways. Erosion protection

in the form of riprap pads at all outfall points to the channel to prevent scouring of the channel from point discharges. This will be further discussed later in this report, see Section XI Channels and Swales.

3. Provide Water Quality Capture Volume (WQCV)

This step utilizes formalized water quality capture volume to slow the release of runoff from the site. The WQCV will release in no less than 40 hours. On-site water quality control volume detention ponds will provide water quality treatment prior to the runoff being released into the channel.

4. Consider Need for Industrial and Commercial BMPs

Industrial and Commercial BMP's are not applicable to this proposed site. Source control BMPs for homeowners include the use of garages as the primary area where pollutants can be stored. The single-family detached homes provide garages which can act as storage areas. The proposed development does not include outdoor storage or the potential for introduction of contaminants to the Counties' MS4, thus no targeted source control BMPs are necessary. The biggest source control BMP is public education which can be found on the El Paso County website and discuss topics such as: pet waste, car washing, lawn care, fall leaves, and snow melt and deicer.

VIII. Proposed Drainage Conditions

Three existing WQCV Detention Ponds will provide water quality treatment for the site prior to discharging the runoff directly into the West Tributary channel RWT204/RWT210.

1. Existing Pond 1 was designed and constructed with Bent Grass Residential Filing No. 2 (SF-19-014).
2. Existing Pond (South) was designed and constructed with Bent Grass Residential Filing No. 2 (SF-21-020).
3. Existing Pond (North) was designed and constructed with Falcon Meadows at Bent Grass Filing No. 2. (SF-21-034).

The project site is Single Family Residential. Runoff from the residential lots will either sheet flow or concentrate in side-yard swales and spill onto the proposed roadway. Curb and gutter will convey these flows to storm drain infrastructure and routed to existing WQCV Detention Ponds before outfalling directly into the West Tributary Channel.

The following basins are offsite basins that impact the Filing 4 site.

Basin OS-4 (4.48 AC, Q5 = 7.8 cfs, Q100 = 16.1 cfs) is associated with Bent Grass Residential Filing No. 2. Runoff from this basin sheet flows to the frontage of the residential lots to Thedford Court and then flows, via existing curb and gutter, to a proposed 5' sump CDOT Type R inlet on Willmore Drive at **DP 2**. Runoff continues to route to the south to proposed Lemon Grass Road (Flg No. 4), which will direct runoff to a proposed 15' at-grade CDOT Type R inlet at **DP 4**. Runoff is conveyed downstream via proposed 24" RCP through a proposed 5' manhole at **DP 4b**, to Design Point 5 where flows are combined with runoff generated in sub-basin A-3. Bypass flows are routed via curb & gutter to an existing 20' CDOT Type R sump inlet at DP 8. Emergency overflows will overtop the curb & gutter and be directed to Existing Pond 1.

Basin OS-5 (0.46 AC, Q5 = 1.2 cfs, Q100 = 2.5 cfs) is associated with Bent Grass Residential Filing No. 2. Runoff from this basin sheet flows to the frontage of the residential lots to Willmore Drive and then flows, via existing curb and gutter, to proposed Lemon Grass Road at **DP 1**. Runoff continues to route to

the south within proposed Lemon Grass Road (Flg No. 4), which will direct runoff to a proposed 15' at-grade CDOT Type R inlet at **DP 4**. Runoff is conveyed downstream via proposed 24" RCP through a proposed 5' manhole at **DP 4b**, to Design Point 5 where flows are combined with runoff generated in sub-basin A-3. Bypass flows are routed via curb & gutter to an existing 20' CDOT Type R sump inlet at DP 8. Emergency overflows will overtop the curb & gutter and be directed to Existing Pond 1.

Basin OS-6 (1.17 AC, Q5 = 2.2 cfs, Q100 = 4.6 cfs) is associated with Bent Grass Residential Filing No. 2. Runoff from this basin sheet flows to the frontage of the residential lots to Silky Thread Road and then flows, via existing curb and gutter, to proposed Lemon Grass Road at **DP 3**. Runoff continues to route to the south within proposed Lemon Grass Road (Flg No. 4), which will direct runoff to a proposed 15' at-grade CDOT Type R inlet at **DP 4**. Runoff is conveyed downstream via proposed 24" RCP through a proposed 5' manhole at **DP 4b**, to Design Point 5 where flows are combined with runoff generated in sub-basin A-3. Bypass flows are routed via curb & gutter to an existing 20' CDOT Type R sump inlet at DP 8. Emergency overflows will overtop the curb & gutter and be directed to Existing Pond 1.

Below is a description of the basins that encompass Falcon Meadows at Bent Grass Filing No. 4.

Basin A-1 (2.18 AC, Q5 = 4.5 cfs, Q100 = 9.3 cfs): a basin that includes residential lots and the east half of Lemon Grass Road. Runoff will flow from each lot onto the proposed public R.O.W. where proposed mountable curb and gutter will convey flows to a proposed 15' at-grade CDOT Type R inlet at **DP 4**. Runoff is conveyed downstream via proposed 24" RCP through a proposed 5' manhole at **DP 4b**, to Design Point 5 where flows are combined with runoff generated in sub-basin A-3. Bypass flows are routed via curb & gutter to an existing 20' CDOT Type R sump inlet at DP 8. Emergency overflows will overtop the curb & gutter and be directed to Existing Pond 1.

Basin A-2 (0.92 AC, Q5 = 2.1 cfs, Q100 = 4.4 cfs): a basin that includes the rear portion of residential lots along proposed Lemon Grass Road. Runoff from this basin will sheet flow directly to the West Tributary channel RWT204/RWT210. All roof drains (for lots 13-21) within this sub-basin will be directed toward Lemon Grass Road, no impervious surfaces will be allowed within the rear lot setbacks and runoff reduction will be implemented within this sub-basin. Additionally, the existing riprap lined swale will be removed and relocated. The associated lots must be reseeded and stabilized to help mitigate any unnecessary sediment spilling into the channel.

Basin A-3 (1.13 AC, Q5 = 2.1 cfs, Q100 = 4.4 cfs): a basin that includes residential lots and the west half of Lemon Grass Road. Runoff will flow from each lot onto the proposed public R.O.W. where proposed mountable curb and gutter will convey flows to a proposed 15' at-grade CDOT Type R inlet at **DP 5**. Runoff is conveyed downstream via proposed 24" RCP to Design Point 6 where flows are combined within Existing Pond 1. Bypass flows are routed via curb & gutter to an existing 20' CDOT Type R sump inlet at DP 8. Emergency overflows will overtop the curb & gutter and be directed to Existing Pond 1.

Basin A-4 (0.54 AC, Q5 = 0.0 cfs, Q100 = 0.6 cfs): a basin that includes undeveloped land and Existing Pond 1. Runoff will sheet flow directly to Existing Pond 1 at **DP 6**. This basin receives flows from **DP 5** and **DP 8**.

Basin B-1 (4.33 AC, Q5 = 0.1 cfs, Q100 = 2.8 cfs): a basin that is along the north boundary of the site and through the center of the site, encompassing the existing rerouted channel RWT202 and channel RWT204. This basin has been reduced in size from the existing condition with the development of areas immediately adjacent to the channel. Flows will continue south in the existing channel where they will then be conveyed through the existing twin 16' x 6' RCBC's to **DP AA**.

Basin C-1e (0.49 AC, Q5 = 2.2 cfs, Q100 = 3.8 cfs): a basin that includes the east half of Henzlee Place. Runoff will flow from each lot onto the proposed public R.O.W. where proposed mountable curb and gutter will convey flows to an existing 15' CDOT Type R sump inlet at **DP 12**. Runoff is conveyed downstream via existing 42" RCP to **DP 13** where flows are combined within Existing Pond North. Emergency overflows will overtop the curb & gutter and be directed to Existing Pond North. This basin remains unchanged from the existing condition.

Basin C-1g (0.87 AC, Q5 = 2.1 cfs, Q100 = 4.3 cfs): a basin that includes the front half of lots along Henzlee Place. Runoff will flow from each lot onto the proposed public R.O.W. where proposed mountable curb and gutter will convey flows to an existing 15' CDOT Type R sump inlet at **DP 12**. Runoff is conveyed downstream via existing 42" RCP to **DP 13** where flows are combined within Existing Pond North. Emergency overflows will overtop the curb & gutter and be directed to Existing Pond North.

Basin C-1h (1.12 AC, Q5 = 1.7 cfs, Q100 = 4.0 cfs): a basin that includes the rear half of lots along Henzlee Place. Runoff will flow from each lot into proposed swale A and conveyed to a proposed CDOT-Type C Inlet at **DP 19**. Flows are conveyed downstream via an existing 18" RCP to **DP 13** where flows are combined within Existing Pond North. Emergency overflows will overtop the adjacent maintenance road and be directed to Existing Pond North. Swale A is located within a tract and maintained by Bent Grass Metropolitan District.

Basin C-5 (0.51 AC, Q5 = 0.0 cfs, Q100 = 0.6 cfs): a basin that encompasses Existing Pond North. Runoff will sheet flow directly to Existing Pond North at **DP 13**. This basin receives flows from **DP 12** and **DP 19**.

Basin D-4c (3.00 AC, Q5 = 5.4 cfs, Q100 = 11.2 cfs): a basin that includes residential lots and the east half of Jayla Trail and Henzlee Place. Runoff will flow from each lot onto the proposed public R.O.W. where existing mountable curb and gutter will convey flows to an existing 15' CDOT Type R sump inlet at **DP 17**. Runoff is conveyed downstream via existing 24" RCP to **DP31** where flows outfall into existing Pond South. Emergency overflows will overtop the curb & gutter and be directed to Existing Pond South via an existing emergency overflow swale.

Basin D-7 (8.01 AC, Q5 = 1.7 cfs, Q100 = 10.0 cfs): a basin that includes the rear portion of residential lots along Linley Way and Jayla Trail, respectively. The portion of this basin impacted by proposed design for Falcon Meadows at Bent Grass Filing No. 4 will sheet flow to the rear property line, then onward directly to Existing Pond South.

Basin D-8 (1.46 AC, Q5 = 0.6 cfs, Q100 = 2.3 cfs): a basin that includes the rear portion of residential lots along Jayla Trail & Henzlee Place. Runoff will sheet flow towards the rear property line to proposed Swale C, where runoff is directed to Existing Pond South at **DP 32**. Swale C is located within a tract and will be maintained by Bent Grass Metropolitan District.

Design Point AA is the location in channel reach RWT204, where flows are conveyed under Bent Grass Meadows Drive within an existing twin 16' x 6' RCBC. The minor flows are 335.9 cfs and the major flows are 1450 cfs. The MDDP Amendment, from the HEC-HMS model, has flows of 191.8 cfs and 1075.3 cfs for the 5- and 100-year flows under proposed/future conditions analysis. The FEMA FIS report has a total flow of 1400 cfs in channel reach RWT210. Falcon Meadows at Bent Grass Filing No. 4 will not increase these flows.

Design Point 8 is the location of the existing 20' CDOT Type R curb inlet where by-pass flows are received from **DP 5a** and **DP 4a**. As shown in existing excerpts (Appendix B) the current flows at DP 8 is 10.0 cfs in the minor storm, and 22.2 cfs in the major storm. The proposed condition adds 2.8 cfs in the major storm, and 13.1 cfs in the minor storm, totaling to 12.8 cfs in the minor storm, and 35.3 cfs in the major storm. The capacity of the existing inlet is 14.4 cfs in the minor storm, and 52.7 in the major storm. Therefore, the inlet has sufficient capacity with the added bypass flow.

IX. Storm Sewer System

All development is anticipated to be urban and will include storm sewer & street inlets. Storm sewers collect storm water runoff and convey the water to existing water quality facilities prior to discharging. Storm sewer systems will be designed to the 100-year storm and checked with the 5-year storm. Inlets will be placed at sump areas and intersections where street flow is larger than street capacity. The UDFCD Inlet spreadsheet is used to determine the size of all at-grade and sump inlets. There will be 1 proposed storm system and three existing systems within the site.

The proposed storm system (Storm System A), collects flows northeast of Bent Grass Meadows Drive, over to Existing Pond 1 just west from Lemon Grass Road. These flows are routed directly to Existing Pond 1, constructed as part of Bent Grass Residential Filing No. 2. The design of the proposed system has been included in the appendix. Flows not intercepted from this area, reach the existing sump inlet at DP 8, which releases into the existing WQCV pond in Bent Grass Residential Filing No. 2. All design calculations (StormCAD, inlet design & street capacity spreadsheets, etc.) have been included in Appendix D for this system.

The inlets located within Bent Grass Meadows Drive (DP-8), Henzlee Place (DP-12), and Jayla Trail (DP-17) were all designed under the FDRs for Bent Grass Residential Filing No. 2, Falcon Meadows at Bent Grass Filing No. 3, and Falcon Meadows at Bent Grass Filing No. 2, respectively. The inlets were "rechecked" based on updated flows reaching each of these design points. The analysis of these inlets is included in Appendix D. Analysis of the existing inlets, have also been included in Appendix D, to ensure inlets still perform adequately.

The proposed inlets located within Lemon Grass Drive (DP-4 & DP-5) are 15' & 10' at-grade CDOT Type R inlets were sized appropriately to intercept flows so that the existing 20' CDOT Type R sump inlet at DP 8 has sufficient capacity for the added bypass flows. The analysis of these inlets is included in Appendix D.

X. Proposed Water Quality Detention Ponds

There are 3 facilities which provide water quality for this site. One facility was constructed under the Bent Grass Residential Filing No. 2 project and is located north of Bent Grass Meadows Drive (*Existing Pond 1*). An existing inlet at DP 8 and proposed inlets at DP 4 and DP 5 releases collected runoff into this facility. The second WQCV (*Existing Pond South*) was constructed as part of the Falcon Meadows at Bent Grass Filing No. 1 project and is situated north of the southern property line and west of the existing channel. Design Points 30, 31 and 32 are the ultimate outfalls releasing into this facility. The final WQCV facility (*Existing Pond North*) was constructed as part of Falcon Meadows at Bent Grass Filing No. 2 and is located north of Bent Grass Meadows Drive and west of the existing facility built with Bent Grass Residential Filing No. 2. Ultimate release points into this facility are DP 19 and 12. An analysis of the existing pond facilities (*Existing Pond 1, Existing Pond South, and Existing Pond North*) is included in

Appendix E to ensure they function adequately with minor revisions made to hydrology routing with this filing.

All three facilities release treated waters to the existing channel at RWT204 (north of Bent Grass Meadows Drive) or RWT210 (south of Bent Grass Meadows Drive).

Basin B-1 represents the improvements that is to be constructed as a part of CDR-21-014. Falcon Meadows at Bent Grass Drainage Channel (CDR-21-014) is a standalone stream stabilization project, and therefore falls under the Water Quality I.7.1.B.7 exclusion. These improvements will be completed prior to the recording of the Falcon Meadows at Bent Grass Filing No. 4 Final Plat. Therefore, it does not “count” towards the allowable 1 acre of area to be untreated from the site.

Basin A-2 will outfall directly into RWT204 untreated. The total area of this basin is 0.71 acres, less than the allowable 1 acre. All roof drains (for lots 13-21) within Basin A-2 will be directed toward Lemon Grass Road.

XI. Channel and Swales

Swales

Swale A and Swale C were designed for this Filing within the Falcon Meadows at Bent Grass development. Analysis has been provided in Appendix D of this report.

Channel

No channel improvements are proposed in this project. Please refer to Falcon Meadows at Bent Grass Drainage Channel (CDR-21-014) for the associated adjacent channel improvements. The channel construction as shown in (CDR-21-014) must be completed prior to the recording of Falcon Meadows at Bent Grass Filing No. 4 Final Plat.

XII. Maintenance

After completion of construction and upon the Board of County Commissioners acceptance, all public drainage facilities within easements and public Right-of-Way will be owned and maintained by El Paso County. All private drainage facilities shown on this project will be owned and maintained by Bent Grass Metropolitan District.

XIII. Wetlands Mitigation

No wetlands are located on site.

XIV. Floodplain Statement

A portion of the project site lies within Zone AE Special Flood Hazard Area as defined by the FIRM Map number 08041C0553G effective December 7, 2018. A copy of the FIRM Panel is included in Appendix A.

XV. Drainage/Bridge Fees and Credits/Reimbursements

The site lies within the Falcon Drainage Basin. The DBPS was approved in 2013 and has drainage and bridge fees associated with the basin.

The project site has a total area of 10.42 acres. The tracts account for a total of 4.05 acres, 39 residential lots are 5.73 acres and 1.04 acres of right-of-way. The following calculations for the imperviousness of this development have been computed as follows:

$$\text{Average Residential lot size: } 5.73 \text{ acres} / 39 \text{ lots} = 6,398 \text{ sf/lot}$$

$$\text{Average lot imperviousness} = 6,398 \text{ sf} \times 43\% = 2,751 \text{ sf}$$

$$\text{Average Residential imperviousness: } 2,751/6,398 = 43.0\%$$

ROW area is 100% impervious

Open Space is 0% impervious

Average imperviousness for developed area:

$$(0.43 \times 5.73) + (1.0 \times 1.04) + (0 \times 4.05) / 10.42 = 0.3363$$

$$10.42 \text{ acres} \times 33.63\% = 3.5039 \text{ Impervious Acres}$$

The following calculations are based on the 2022 Falcon Basin drainage/bridge fees:

Drainage Fees

$$\$34,117 \times 3.5039 \text{ Imp. Acres} = \underline{\$119,542.56}$$

Bridge Fees

$$\$4,687 \times 3.5039 \text{ Imp. Acres} = \underline{\$16,422.78}$$

Per discussions with El Paso County the fees will be offset by drainage improvements. The tables on the next page provide a tabular summary of previous fees and offsets for the overall Bent Grass development.

(SF-19-014) Bent Grass Residential Filing No. 2 - Final Drainage Report
FALCON DRAINAGE BASIN
2019 Original Drainage and Bridge Fees

	Impervious Area (acres) *	Fee Per Impervious Acre	=	Total Fee	- (Total Collateral from FAE	+	Remaining Fee Offset from Previous Filings) =	Remaining Fee Offset	OR	Fee Due at Platting
Drainage Fee	23.45	\$ 29,622.00	=	\$ 694,635.90	- (\$ 1,270,481.00	+	\$ -) =	\$ 575,845.10		
Bridge Fee	23.45	\$ 4,069.00	=	\$ 95,418.05	- (\$ 480,000.00	+	\$ -) =	\$ 384,581.95		

(SF-21-020) Falcon Meadows at Bent Grass Filing No. 1 - Final Drainage Report
FALCON DRAINAGE BASIN
2021 Original Drainage and Bridge Fees

	Impervious Area (acres) *	Fee Per Impervious Acre	=	Total Fee	- (Total Collateral from FAE	+	Remaining Fee Offset from Previous Filings) =	Remaining Fee Offset	OR	Fee Due at Platting
Drainage Fee	5.73	\$ 31,885.00	=	\$ 182,701.05	- (\$ -	+	\$ 575,845.10) =	\$ 393,144.05		
Bridge Fee	5.73	\$ 4,380.00	=	\$ 25,097.40	- (\$ -	+	\$ 384,581.95) =	\$ 359,484.55		

(SF-21-034) Falcon Meadows at Bent Grass Filing No. 2 - Final Drainage Report
FALCON DRAINAGE BASIN
2021 Original Drainage and Bridge Fees

	Impervious Area (acres) *	Fee Per Impervious Acre	=	Total Fee	- (Total Collateral from FAE	+	Remaining Fee Offset from Previous Filings) =	Remaining Fee Offset	OR	Fee Due at Platting
Drainage Fee	9.6	\$ 31,885.00	=	\$ 306,096.00	- (\$ -	+	\$ 393,144.05) =	\$ 87,048.05		
Bridge Fee	9.6	\$ 4,380.00	=	\$ 42,048.00	- (\$ -	+	\$ 359,484.55) =	\$ 317,436.55		

(SF-22-016) Falcon Meadows at Bent Grass Filing No. 3 - Final Drainage Report
FALCON DRAINAGE BASIN
2022 Original Drainage and Bridge Fees

	Impervious Area (acres) *	Fee Per Impervious Acre	=	Total Fee	- (Total Collateral from FAE	+	Remaining Fee Offset from Previous Filings) =	Remaining Fee Offset	OR	Fee Due at Platting
Drainage Fee	6.665	\$ 34,117.00	=	\$ 227,389.81	- (\$ -	+	\$ 87,048.05) =			\$ (140,341.76)
Bridge Fee	6.665	\$ 4,687.00	=	\$ 31,238.86	- (\$ -	+	\$ 317,436.55) =	\$ 286,197.70		

(SF-22-023) Falcon Meadows at Bent Grass Filing No. 4 - Final Drainage Report
FALCON DRAINAGE BASIN
2022 Original Drainage and Bridge Fees

	Impervious Area (acres) *	Fee Per Impervious Acre	=	Total Fee	- (Total Collateral from FAE	+	Remaining Fee Offset from Previous Filings) =	Remaining Fee Offset	OR	Fee Due at Platting
Drainage Fee	3.504	\$ 34,117.00	=	\$ 119,542.56	- (\$ -	+	\$ -) =			\$ (119,542.56)
Bridge Fee	3.504	\$ 4,687.00	=	\$ 16,422.78	- (\$ -	+	\$ 317,436.55) =	\$ 301,013.77		

Below is a cost estimate for the improvements proposed with this filing.

Item	Quantity	Unit	Unit Cost	Cost
Storm Drain Improvements				
5' CDOT Type R Inlet (Public)	1	EA	\$ 7,212.00	\$ 7,212.00
10' CDOT Type R Inlet (Public)	1	EA	\$ 9,925.00	\$ 9,925.00
15' CDOT Type R Inlet (Public)	1	EA	\$ 12,907.00	\$ 12,907.00
CDOT Type C Inlet (Private)	1	EA	\$ 6,037.00	\$ 6,037.00
15" RCP Storm Drain (Public)	195	LF	\$ 60.00	\$ 2,340.00
24" RCP Storm Drain (Public)	35	LF	\$ 98.00	\$ 3,430.00
Total				\$ 41,851.00
Contingency			10%	\$ 4,185.00
Grand Total				\$ 46,036.00
Existing Pond 1 Improvements (Private)				
24" RCP Storm Drain (Private)	53	LF	\$ 98.00	\$ 5,194.00
Trickle Channel	75	LF	\$ 15.00	\$ 1,125.00
Fence (Forebay)	46	LF	\$ 3.00	\$ 138.00
Forebay	1	EA	\$ 10,000.00	\$ 98.00
Total				\$ 6,555.00
Contingency			10%	\$ 655.00
Grand Total				\$ 7,210.00

XVI. Conclusion

The Falcon Meadows at Bent Grass Filing No. 4 Subdivision lies within the West Tributary of the Falcon Basin Area Watershed. Detention for the site is provided from three existing WQCV ponds to provide water quality for the entire tributary area. The proposed development will not have any adverse impacts to downstream developments or existing drainageways.

XVII. References

1. *City of Colorado Springs/County of El Paso Drainage Criteria Manual*, October 1991.
2. *Drainage Criteria Manual, Volume 2*, City of Colorado Springs, November 2002.
3. *Urban Storm Drainage Criteria Manual*, Urban Drainage and Flood Control District, January 2016 (with current revisions).
4. *Falcon Drainage Basin Planning Study*, by Matrix Design Group, September 2015.
5. *Master Development Drainage Plan and Preliminary Drainage Plan – Bent Grass Subdivision*, by Kiowa Engineering Corporation, December 2006.
6. *Final Drainage Report for Bent Grass Residential (Filing No. 1)*, by Classic Consulting Engineers & Surveyors, LLC, August 2014.
7. *Final Drainage Report Addendum for Bent Grass Residential (Filing No. 1)*, by Classic Consulting Engineers & Surveyors, LLC, August 2015.
8. *Master Development Drainage Plan for The Ranch*, by Classic Consulting Engineers & Surveyors, LLC, November 2018.

9. *Falcon Highlands Master Development Drainage Plan & Preliminary Drainage Report & Final Drainage Report for Filing 1*, by URS, January 2005.
10. *Final Drainage Report and Erosion Control Plan – Latigo Business Center Filing No. 1 A Re-subdivision of a Portion of Latigo Business and Research Center Filing No. 1*, by Kiowa Engineering Corporation, November 2004.
11. *Final Drainage Report for Bent Grass Residential (Filing No. 2)*, by Galloway & Company, May 2020.
12. *Preliminary Drainage Report-Falcon Meadows at Bent Grass*, by Galloway & Company, February 2021.
13. *Final Drainage Report for Falcon Meadows at Bent Grass Filing No. 1*, by Galloway & Company, September 2021.
14. *Final Drainage Report for Falcon Meadows at Bent Grass Filing No. 2*, by Galloway & Company, April, 2022.
15. *Final Drainage Report for Falcon Meadows at Bent Grass Filing No. 3*, by Galloway & Company, August, 2022.

APPENDIX A
Exhibits and Figures

Soil Map—El Paso County Area, Colorado

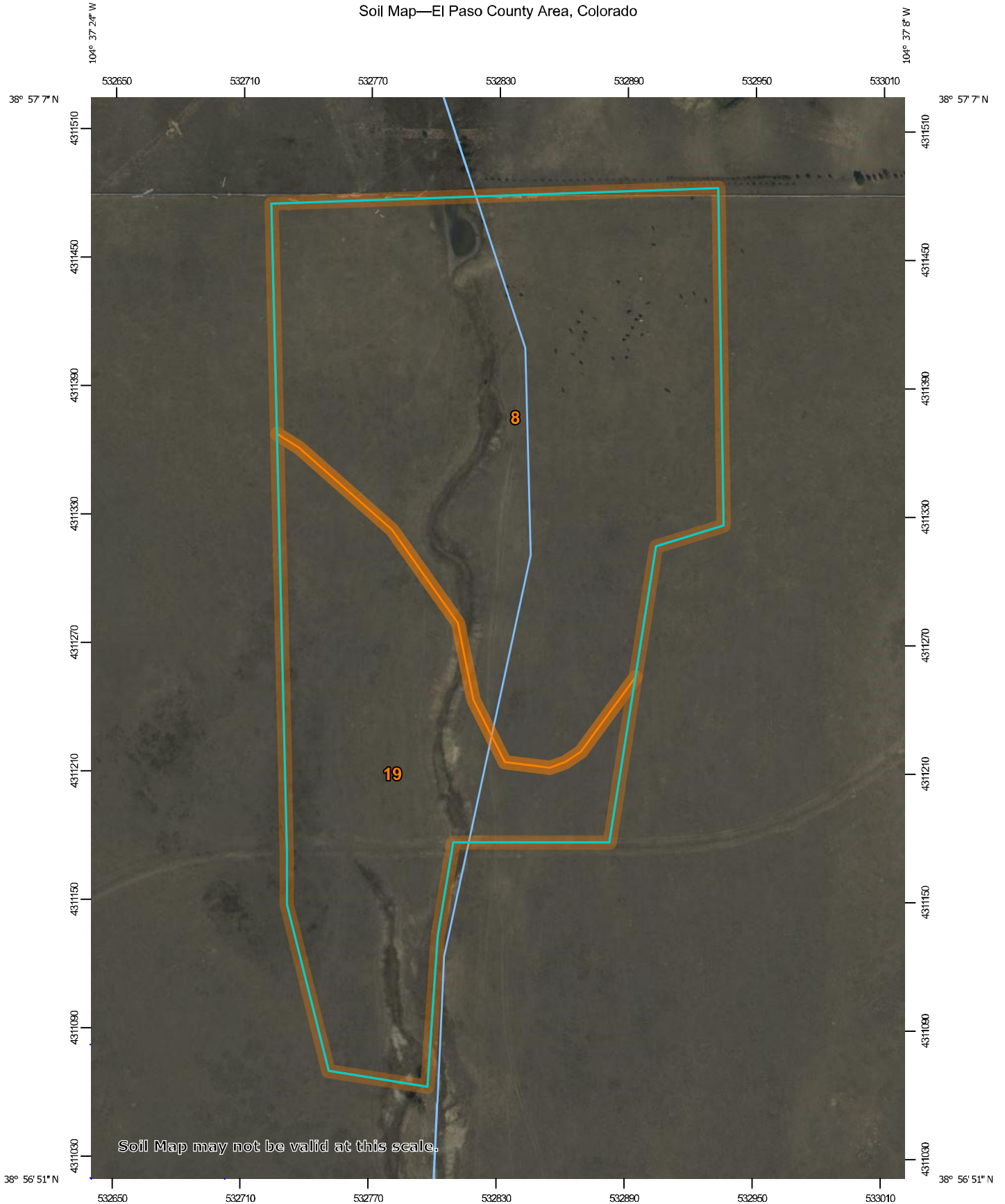

Soil Map may not be valid at this scale.

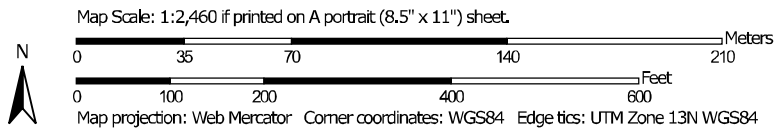

MAP LEGEND

- Area of Interest (AOI)
- Soil Map Unit Polygons
- Soil Map Unit Lines
- Soil Map Unit Points
- Special Point Features**
 - Blowout
 - Borrow Pit
 - Clay Spot
 - Closed Depression
 - Gravel Pit
 - Gravelly Spot
 - Landfill
 - Lava Flow
 - Marsh or swamp
 - Mine or Quarry
 - Miscellaneous Water
 - Perennial Water
 - Rock Outcrop
 - Saline Spot
 - Sandy Spot
 - Severely Eroded Spot
 - Sinkhole
 - Slide or Slip
 - Sodic Spot
- Water Features**
 - Streams and Canals
- Transportation**
 - Rails
 - Interstate Highways
 - US Routes
 - Major Roads
 - Local Roads
- Background**
 - Aerial Photography
- Spoil Area
- Stony Spot
- Very Stony Spot
- Wet Spot
- Other
- Special Line Features

MAP INFORMATION

The soil surveys that comprise your AOI were mapped at 1:24,000.

Warning: Soil Map may not be valid at this scale.

Enlargement of maps beyond the scale of mapping can cause misunderstanding of the detail of mapping and accuracy of soil line placement. The maps do not show the small areas of contrasting soils that could have been shown at a more detailed scale.

Please rely on the bar scale on each map sheet for map measurements.

Source of Map: Natural Resources Conservation Service
 Web Soil Survey URL:
 Coordinate System: Web Mercator (EPSG:3857)

Maps from the Web Soil Survey are based on the Web Mercator projection, which preserves direction and shape but distorts distance and area. A projection that preserves area, such as the Albers equal-area conic projection, should be used if more accurate calculations of distance or area are required.

This product is generated from the USDA-NRCS certified data as of the version date(s) listed below.

Soil Survey Area: El Paso County Area, Colorado
 Survey Area Data: Version 19, Aug 31, 2021

Soil map units are labeled (as space allows) for map scales 1:50,000 or larger.

Date(s) aerial images were photographed: Sep 11, 2018—Oct 20, 2018

The orthophoto or other base map on which the soil lines were compiled and digitized probably differs from the background imagery displayed on these maps. As a result, some minor shifting of map unit boundaries may be evident.

Map Unit Legend

Map Unit Symbol	Map Unit Name	Acres in AOI	Percent of AOI
8	Blakeland loamy sand, 1 to 9 percent slopes	10.0	63.4%
19	Columbine gravelly sandy loam, 0 to 3 percent slopes	5.8	36.6%
Totals for Area of Interest		15.8	100.0%

El Paso County Area, Colorado

8—Blakeland loamy sand, 1 to 9 percent slopes

Map Unit Setting

National map unit symbol: 369v
Elevation: 4,600 to 5,800 feet
Mean annual precipitation: 14 to 16 inches
Mean annual air temperature: 46 to 48 degrees F
Frost-free period: 125 to 145 days
Farmland classification: Not prime farmland

Map Unit Composition

Blakeland and similar soils: 98 percent
Minor components: 2 percent
Estimates are based on observations, descriptions, and transects of the mapunit.

Description of Blakeland

Setting

Landform: Hills, flats
Landform position (three-dimensional): Side slope, talf
Down-slope shape: Linear
Across-slope shape: Linear
Parent material: Alluvium derived from sedimentary rock and/or eolian deposits derived from sedimentary rock

Typical profile

A - 0 to 11 inches: loamy sand
AC - 11 to 27 inches: loamy sand
C - 27 to 60 inches: sand

Properties and qualities

Slope: 1 to 9 percent
Depth to restrictive feature: More than 80 inches
Drainage class: Somewhat excessively drained
Runoff class: Low
Capacity of the most limiting layer to transmit water (Ksat): High to very high (5.95 to 19.98 in/hr)
Depth to water table: More than 80 inches
Frequency of flooding: None
Frequency of ponding: None
Calcium carbonate, maximum content: 5 percent
Available water supply, 0 to 60 inches: Low (about 4.5 inches)

Interpretive groups

Land capability classification (irrigated): 3e
Land capability classification (nonirrigated): 6e
Hydrologic Soil Group: A
Ecological site: R049XB210CO - Sandy Foothill
Hydric soil rating: No

Minor Components

Other soils

Percent of map unit: 1 percent

Hydric soil rating: No

Pleasant

Percent of map unit: 1 percent

Landform: Depressions

Hydric soil rating: Yes

Data Source Information

Soil Survey Area: El Paso County Area, Colorado

Survey Area Data: Version 19, Aug 31, 2021

El Paso County Area, Colorado

19—Columbine gravelly sandy loam, 0 to 3 percent slopes

Map Unit Setting

National map unit symbol: 367p
Elevation: 6,500 to 7,300 feet
Mean annual precipitation: 14 to 16 inches
Mean annual air temperature: 46 to 50 degrees F
Frost-free period: 125 to 145 days
Farmland classification: Not prime farmland

Map Unit Composition

Columbine and similar soils: 97 percent
Minor components: 3 percent
Estimates are based on observations, descriptions, and transects of the mapunit.

Description of Columbine

Setting

Landform: Flood plains, fan terraces, fans
Down-slope shape: Linear
Across-slope shape: Linear
Parent material: Alluvium

Typical profile

A - 0 to 14 inches: gravelly sandy loam
C - 14 to 60 inches: very gravelly loamy sand

Properties and qualities

Slope: 0 to 3 percent
Depth to restrictive feature: More than 80 inches
Drainage class: Well drained
Runoff class: Very low
Capacity of the most limiting layer to transmit water (Ksat): High to very high (5.95 to 19.98 in/hr)
Depth to water table: More than 80 inches
Frequency of flooding: None
Frequency of ponding: None
Available water supply, 0 to 60 inches: Very low (about 2.5 inches)

Interpretive groups

Land capability classification (irrigated): 4e
Land capability classification (nonirrigated): 6e
Hydrologic Soil Group: A
Ecological site: R049XY214CO - Gravelly Foothill
Hydric soil rating: No

Minor Components

Fluvaquentic haplaquolls

Percent of map unit: 1 percent

Landform: Swales
Hydric soil rating: Yes

Other soils

Percent of map unit: 1 percent
Hydric soil rating: No

Pleasant

Percent of map unit: 1 percent
Landform: Depressions
Hydric soil rating: Yes

Data Source Information

Soil Survey Area: El Paso County Area, Colorado
Survey Area Data: Version 19, Aug 31, 2021

NOTES TO USERS

This map is for use in administering the National Flood Insurance Program. It does not necessarily identify all areas subject to flooding, particularly from local drainage sources of small size. The community map repository should be consulted for possible updated or additional flood hazard information.

To obtain more detailed information in areas where **Base Flood Elevations (BFEs)** and/or **floodways** have been determined, users are encouraged to consult the Flood Profiles and Floodway Data and/or Summary of Stillwater Elevations tables contained within the Flood Insurance Study (FIS) report that accompanies this FIRM. Users should be aware that BFEs shown on the FIRM represent rounded whole-foot elevations. These BFEs are intended for flood insurance rating purposes only and should not be used as the sole source of flood elevation information. Accordingly, flood elevation data presented in the FIS report should be utilized in conjunction with the FIRM for purposes of construction and/or floodplain management.

Coastal Base Flood Elevations shown on this map apply only landward of 0.0' North American Vertical Datum of 1988 (NAVD88). Users of this FIRM should be aware that coastal flood elevations are also provided in the Summary of Stillwater Elevations table in the Flood Insurance Study report for this jurisdiction. Elevations shown in the Summary of Stillwater Elevations table should be used for construction and/or floodplain management purposes when they are higher than the elevations shown on this FIRM.

Boundaries of the **floodways** were computed at cross sections and interpolated between cross sections. The floodways were based on hydraulic considerations with regard to requirements of the National Flood Insurance Program. Floodway widths and other pertinent floodway data are provided in the Flood Insurance Study report for this jurisdiction.

Certain areas not in Special Flood Hazard Areas may be protected by **flood control structures**. Refer to section 2.4 "Flood Protection Measures" of the Flood Insurance Study report for information on flood control structures for this jurisdiction.

The **projection** used in the preparation of this map was Universal Transverse Mercator (UTM) zone 13. The **horizontal datum** was NAD83, GRS80 spheroid. Differences in datum, spheroid, projection or UTM zones used in the production of FIRMs for adjacent jurisdictions may result in slight positional differences in map features across jurisdiction boundaries. These differences do not affect the accuracy of this FIRM.

Flood elevations on this map are referenced to the **North American Vertical Datum of 1988 (NAVD88)**. These flood elevations must be compared to structure and ground elevations referenced to the same vertical datum. For information regarding conversion between the National Geodetic Vertical Datum of 1929 and the North American Vertical Datum of 1988, visit the National Geodetic Survey website at <http://www.ngs.noaa.gov/> or contact the National Geodetic Survey at the following address:

NGS Information Services
NOAA, NINGS12
National Geodetic Survey
SSMC-3, #9202
1315 East-West Highway
Silver Spring, MD 20910-3282

To obtain current elevation, description, and/or location information for **bench marks** shown on this map, please contact the Information Services Branch of the National Geodetic Survey at (301) 713-3242 or visit its website at <http://www.ngs.noaa.gov/>.

Base Map information shown on this FIRM was provided in digital format by El Paso County, Colorado Springs Utilities, City of Fountain, Bureau of Land Management, National Oceanic and Atmospheric Administration, United States Geological Survey, and Anderson Consulting Engineers, Inc. These data are current as of 2006.

This map reflects more detailed and up-to-date **stream channel configurations and floodplain delineations** than those shown on the previous FIRM for this jurisdiction. The floodplains and floodways that were transferred from the previous FIRM may have been adjusted to conform to these new stream channel configurations. As a result, the Flood Profiles and Floodway Data tables in the Flood Insurance Study Report (which contains authoritative hydraulic data) may reflect stream channel distances that differ from what is shown on this map. The profile baselines depicted on this map represent the hydraulic modeling baselines that match the flood profiles and Floodway Data Tables if applicable, in the FIS report. As a result, the profile baselines may deviate significantly from the new base map channel representation and may appear outside of the floodplain.

Corporate limits shown on this map are based on the best data available at the time of publication. Because changes due to annexations or de-annexations may have occurred after this map was published, map users should contact appropriate community officials to verify current corporate limit locations.

Please refer to the separately printed **Map Index** for an overview map of the county showing the layout of map panels; community map repository addresses; and a Listing of Communities table containing National Flood Insurance Program dates for each community as well as a listing of the panels on which each community is located.

Contact **FEMA Map Service Center (MSC)** via the FEMA Map Information eXchange (FMIX) 1-877-336-2627 for information on available products associated with this FIRM. Available products may include previously issued Letters of Map Change, a Flood Insurance Study Report, and/or digital versions of this map. The MSC may also be reached by Fax at 1-800-358-9820 and its website at <http://www.msc.fema.gov/>.

If you have **questions about this map** or **questions concerning the National Flood Insurance Program** in general, please call 1-877-FEMA MAP (1-877-336-2627) or visit the FEMA website at <http://www.fema.gov/business/nfp>.

El Paso County Vertical Datum Offset Table	
Flooding Source	Vertical Datum Offset (ft)
REFER TO SECTION 3.3 OF THE EL PASO COUNTY FLOOD INSURANCE STUDY FOR STREAM BY STREAM VERTICAL DATUM CONVERSION INFORMATION	

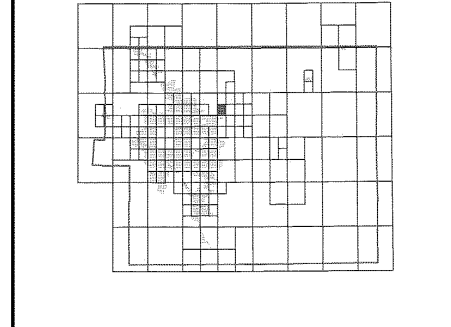

This Digital Flood Insurance Rate Map (DFIRM) was produced through a Cooperating Technical Partner (CTP) agreement between the State of Colorado Water Conservation Board (CWCB) and the Federal Emergency Management Agency (FEMA).

Additional Flood Hazard information and resources are available from local communities and the Colorado Water Conservation Board.

LEGEND

- SPECIAL FLOOD HAZARD AREAS (SFHAs) SUBJECT TO INUNDATION BY THE 1% ANNUAL CHANCE FLOOD
- ZONE A**
No Base Flood Elevations determined.
- ZONE AE**
Base Flood Elevations determined.
- ZONE AH**
Flood depths of 1 to 3 feet (usually areas of ponding); Base Flood Elevations determined.
- ZONE AO**
Flood depths of 1 to 3 feet (usually sheet flow on sloping terrain); average depths determined. For areas of alluvial fan flooding, velocities also determined.
- ZONE AR**
Special Flood Hazard Area Formerly protected from the 1% annual chance flood by a flood control system that was subsequently decertified. Zone AR indicates that the former flood control system is being restored to provide protection from the 1% annual chance or greater flood.
- ZONE A99**
Area to be protected from 1% annual chance flood by a Federal flood protection system under construction; no Base Flood Elevations determined.
- ZONE V**
Coastal flood zone with velocity hazard (wave action); no Base Flood Elevations determined.
- ZONE VE**
Coastal flood zone with velocity hazard (wave action); Base Flood Elevations determined.
- FLOODWAY AREAS IN ZONE AE**
The floodway is the channel of a stream plus any adjacent floodplain areas that must be kept free of encroachment so that the 1% annual chance flood can be carried without substantial increases in flood heights.
- OTHER FLOOD AREAS**
- ZONE X**
Areas of 0.2% annual chance flood; areas of 1% annual chance flood with average depths of less than 1 foot or with drainage areas less than 1 square mile; and areas protected by levees from 1% annual chance flood.
- OTHER AREAS**
- ZONE X**
Areas determined to be outside the 0.2% annual chance floodplain.
- ZONE D**
Areas in which flood hazards are undetermined, but possible.
- COASTAL BARRIER RESOURCES SYSTEM (CBRS) AREAS**
- OTHERWISE PROTECTED AREAS (OPAs)**
- CBRS areas and OPAs are normally located within or adjacent to Special Flood Hazard Areas.
- Floodplain boundary
- Floodway boundary
- Zone D boundary
- CBRS and OPA boundary
- Boundary dividing Special Flood Hazard Areas of different Base Flood Elevations, flood depths or flood velocities.
- Base Flood Elevation line and value; elevation in feet* (EL 987)
- Base Flood Elevation value where uniform within zone; elevation in feet*
- Cross section line
- Transect line
- Geographic coordinates referenced to the North American Datum of 1983 (NAD 83)
- 1000-meter Universal Transverse Mercator grid ticks, zone 13
- 5000-foot grid ticks: Colorado State Plane coordinate system, central zone (FIPSZONE 0502), Lambert Conformal Conic Projection
- Bench mark (see explanation in Notes to Users section of this FIRM panel)
- River Mile
- MAP REPOSITORIES
Refer to Map Repositories list on Map Index
- EFFECTIVE DATE OF COUNTYWIDE FLOOD INSURANCE RATE MAP
MARCH 17, 1997
- EFFECTIVE DATE(S) OF REVISION(S) TO THIS PANEL
DECEMBER 7, 2018 - to update corporate limits, to change Base Flood Elevations and Special Flood Hazard Areas, to update map format, to add roads and road names, and to incorporate previously issued Letters of Map Revision.

For community map repository history prior to countywide mapping, refer to the Community Map History Table located in the Flood Insurance Study report for this jurisdiction.

To determine if flood insurance is available in this community, contact your insurance agent or call the National Flood Insurance Program at 1-800-638-6620.



NFP

PANEL 0553G

FIRM

FLOOD INSURANCE RATE MAP

EL PASO COUNTY, COLORADO AND INCORPORATED AREAS

PANEL 553 OF 1300

(SEE MAP INDEX FOR FIRM PANEL LAYOUT)

CONTAINS:

COMMUNITY	NUMBER	PANEL	SUFFIX
EL PASO COUNTY	08059	553	G

Notice to User: The Map Number shown below should be used when placing map orders. The Community Number shown above should be used on insurance applications for the subject community.

MAP NUMBER 08041C0553G

MAP REVISED DECEMBER 7, 2018

Federal Emergency Management Agency

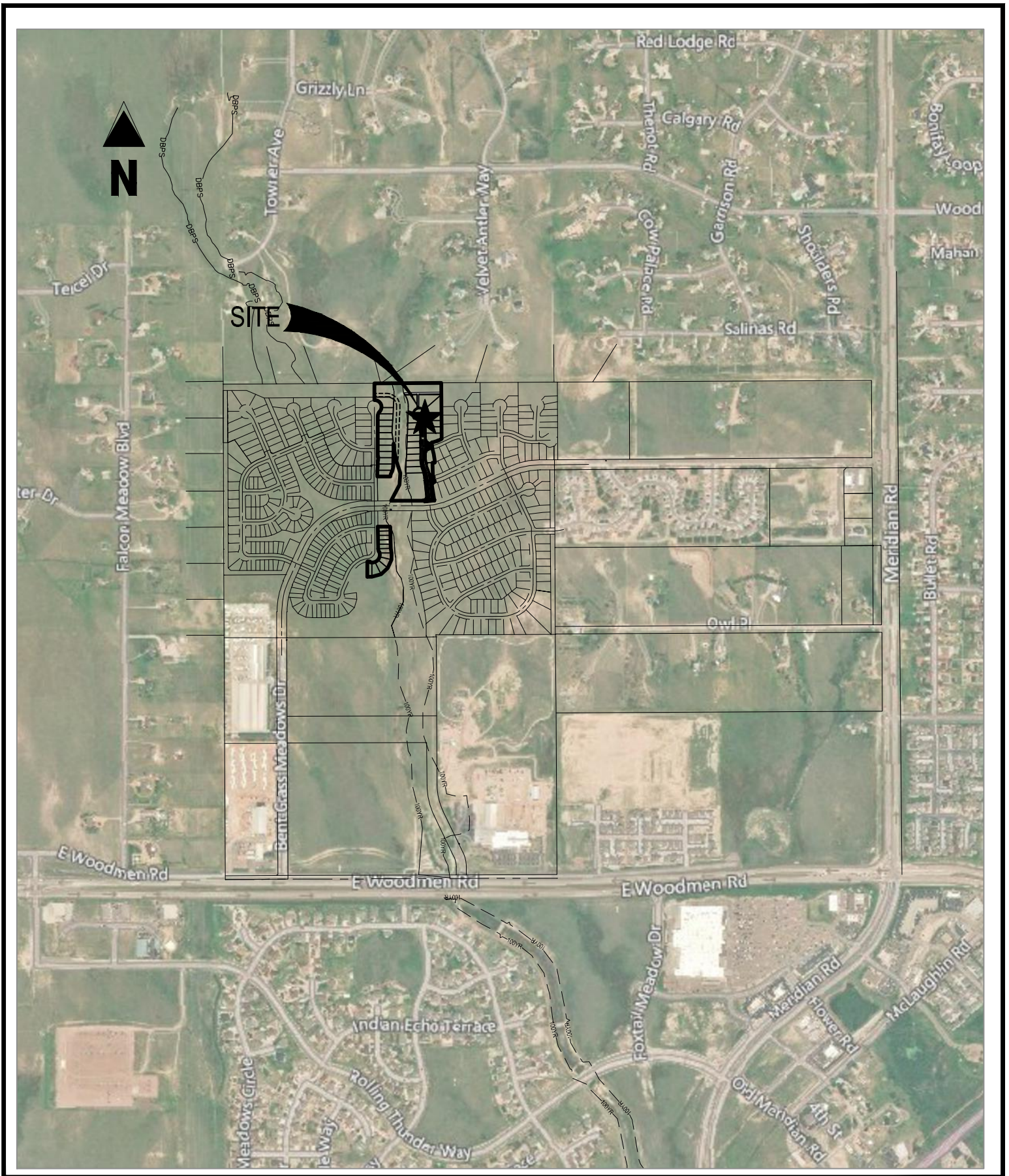

FALCON MEADOWS AT BENT GRASS
 FILING NO. 4
 BENT GRASS MEADOWS DRIVE
 SCALE: 1"=1,000'
 VICINITY MAP

Project No:	CLH000021.20
Drawn By:	TJE
Checked By:	CMD
Date:	07/08/2021

Galloway
 1155 Kelly Johnson Blvd., Suite 305
 Colorado Springs, CO 80920
 719.900.7220 • GallowayUS.com

APPENDIX B
Excerpts From Previous Reports

Historic Computations

COMPOSITE % IMPERVIOUS CALCULATIONS (EXISTING/HISTORIC CONDITIONS)

Subdivision: Falcon Meadows

Falcon Meadows at Bent Grass Filing No. 3

Location: CO, Colorado Springs

CLH020.20

TJE

CMD

12/2/20

Basin ID	Total Area (ac)	Paved Roads			Lawns			Roofs			Basins Total Weighted % Imp.
		% Imp.	Area (ac)	Weighted % Imp.	% Imp.	Area (ac)	Weighted % Imp.	% Imp.	Area (ac)	Weighted % Imp.	
OFFSITE BASINS											
WT200	192.00										10.0
OS-25	14.13	100	0.17	1.2	2	13.71	1.9	90	0.22	1.4	4.5
OS-26	5.81	100	0.00	0.0	2	5.81	2.0	90	0.00	0.0	2.0
OS-1	13.06	100	0.84	6.4	2	11.65	1.8	90	0.57	3.9	12.1
OS-2	17.81	100	2.00	11.2	2	15.18	1.7	90	0.63	3.2	16.1
OS-4	30.69	100	1.42	4.6	2	28.41	1.9	90	0.86	2.5	9.0
BENT GRASS FILING NO. 2 & BENT GRASS WEST BASINS											
A-1	5.42	100	0.16	3.0	2	5.26	1.9	90	0.00	0.0	4.9
A-2	18.00	100	0.00	0.0	2	18.00	2.0	90	0.00	0.0	2.0
A-3	19.59	100	0.00	0.0	2	19.59	2.0	90	0.00	0.0	2.0
A-4	23.81	100	0.57	2.4	2	23.12	1.9	90	0.12	0.5	4.8
B-1	32.53	100	0.00	0.0	2	32.53	2.0	90	0.00	0.0	2.0
B-2	4.51	100	0.00	0.0	2	4.51	2.0	90	0.00	0.0	2.0
B-3	16.18	100	1.00	6.2	2	15.18	1.9	90	0.00	0.0	8.1

COMPOSITE RUNOFF COEFFICIENT CALCULATIONS (EXISTING/HISTORIC CONDITIONS)

Subdivision: Falcon Meadows Falcon Meadows at Bent Grass Filing No. 3
 Location: CO, Colorado Springs CLH020.20
 TJE
 CMD
 12/2/20

Basin ID	Total Area (ac)	Hydrologic Soils Group	Paved Roads			Lawns			Roofs			Composite C ₅	Composite C ₁₀₀	
			C ₅	C ₁₀₀	Area (ac)	C ₅	C ₁₀₀	Area (ac)	C ₅	C ₁₀₀	Area (ac)			
OFFSITE BASINS														
WT200	192.00											0.20	0.44	
OS-25	14.13	A	0.90	0.96	0.17	0.09	0.36	13.71	0.73	0.81	0.22	0.11	0.37	
OS-26	5.81	A	0.90	0.96	0.00	0.09	0.36	5.81	0.73	0.81	0.00	0.09	0.36	
OS-1	13.06	A	0.90	0.96	0.84	0.09	0.36	11.65	0.73	0.81	0.57	0.17	0.42	
OS-2	17.81	A	0.90	0.96	2.00	0.09	0.36	15.18	0.73	0.81	0.63	0.20	0.44	
OS-4	30.69	A	0.90	0.96	1.42	0.09	0.36	28.41	0.73	0.81	0.86	0.15	0.40	
BENT GRASS FILING NO. 2 & BENT GRASS WEST BASINS														
A-1	5.42	A	0.90	0.96	0.16	0.09	0.36	5.26	0.73	0.81	0.00	0.11	0.38	
A-2	18.00	A	0.90	0.96	0.00	0.09	0.36	18.00	0.73	0.81	0.00	0.09	0.36	
A-3	19.59	A	0.90	0.96	0.00	0.09	0.36	19.59	0.73	0.81	0.00	0.09	0.36	
A-4	23.81	A	0.90	0.96	0.57	0.09	0.36	23.12	0.73	0.81	0.12	0.11	0.38	
B-1	32.53	A	0.90	0.96	0.00	0.09	0.36	32.53	0.73	0.81	0.00	0.09	0.36	
B-2	4.51	A	0.90	0.96	0.00	0.09	0.36	4.51	0.73	0.81	0.00	0.09	0.36	
B-3	16.18	A	0.90	0.96	1.00	0.09	0.36	15.18	0.73	0.81	0.00	0.14	0.40	

**STANDARD FORM SF-2
TIME OF CONCENTRATION
EXISTING/HISTORIC CONDITIONS**

Subdivision: Falcon Meadows
Location: CO, Colorado Springs

Project Name: Falcon Meadows at Bent Grass Filing No. 3
Project No.: CLH020.20
Calculated By: TJE
Checked By: CMD
Date: 12/2/20

SUB-BASIN						INITIAL/OVERLAND			TRAVEL TIME					T _c CHECK			FINAL T _c (MIN)
DATA						(T _i)			(T _t)					(URBANIZED BASINS)			
BASIN ID	D.A. (AC)	Hydrologic Soils Group	Impervious (%)	C5	C ₁₀₀	L (FT)	S (%)	T _i (MIN)	L (FT)	S (%)	C _v	VEL. (FPS)	T _t (MIN)	COMP. T _c (MIN)	TOTAL LENGTH (FT)	Urbanized T _c (MIN)	
OFFSITE BASINS																	
WT200	192.00	A	10.00	0.20	0.44	300	2.0	22.7	2060	2.0	15.0	2.1	16.2	38.8	2360.0	23.1	23.1
OS-25	14.13	A	4.50	0.11	0.37	300	2.5	23.1	1400	3.0	15.0	2.6	9.0	32.1	1700.0	19.4	19.4
OS-26	5.81	A	2.00	0.09	0.36	300	2.0	25.4	400	2.0	15.0	2.1	3.1	28.6	700.0	13.9	13.9
OS-1	13.06	A	12.10	0.17	0.42	300	2.5	21.7	1420	2.5	15.0	2.4	10.0	31.7	1720.0	19.6	19.6
OS-2	17.81	A	16.10	0.20	0.44	300	2.3	21.6	1370	2.3	15.0	2.3	10.0	31.7	1670.0	19.3	19.3
OS-4	30.69	A	9.00	0.15	0.40	300	2.3	22.8	2600	2.3	15.0	2.3	19.0	41.9	2900.0	26.1	26.1
BENT GRASS FILING NO. 2 & BENT GRASS WEST BASINS																	
A-1	5.42	A	4.90	0.11	0.38	300	2.5	23.0	466	2.5	15.0	2.4	3.3	26.3	766.0	14.3	14.3
A-2	18.00	A	2.00	0.09	0.36	300	2.4	23.9	1130	2.0	15.0	2.1	8.9	32.8	1430.0	17.9	17.9
A-3	19.59	A	2.00	0.09	0.36	300	2.7	23.0	760	2.7	15.0	2.5	5.1	28.1	1060.0	15.9	15.9
A-4	23.81	A	4.80	0.11	0.38	300	2.0	24.9	1500	2.0	15.0	2.1	11.8	36.7	1800.0	20.0	20.0
B-1	32.53	A	2.00	0.09	0.36	300	2.6	23.3	1100	2.6	15.0	2.4	7.6	30.9	1400.0	17.8	17.8
B-2	4.51	A	2.00	0.09	0.36	300	3.0	22.2	323	5.0	15.0	3.4	1.6	23.8	623.0	13.5	13.5
B-3	16.18	A	8.10	0.14	0.40	300	2.9	21.4	780	2.9	15.0	2.6	5.1	26.4	1080.0	16.0	16.0

NOTES:

$T_i = (0.395 * (1.1 - C_5) * (L)^{0.5}) / ((S)^{0.33})$, S in ft/ft

$T_t = L / 60V$

Velocity $V = C_v * S^{0.5}$, S in ft/ft

$T_c \text{ Check} = 10 + L / 180$

For Urbanized basins a minimum T_c of 5.0 minutes is required.

For non-urbanized basins a minimum T_c of 10.0 minutes is required

Type of Land Surface	C _v
Heavy Meadow	2.5
Tillage/field	5
Short pasture and lawns	7
Nearly bare ground	10
Grassed waterway	15
Paved areas and shallow paved swales	20

STANDARD FORM SF-3
STORM DRAINAGE SYSTEM DESIGN (EXISTING/HISTORIC CONDITIONS)
(RATIONAL METHOD PROCEDURE)

Subdivision: Falcon Meadows
Location: CO, Colorado Springs
Design Storm: 5-Year

Project Name: Falcon Meadows at Bent Grass Filing No. 3
Project No.: CLH020.20
Calculated By: TJE
Checked By: CMD
Date: 12/2/20

STREET	Design Point	DIRECT RUNOFF							TOTAL RUNOFF				STREET		PIPE			TRAVEL TIME			REMARKS
		Basin ID	Area (Ac)	Runoff Coeff.	Tc (min)	C*A (Ac)	I (in/hr)	Q (cfs)	Tc (min)	C*A (Ac)	I (in/hr)	Q (cfs)	Slope (%)	Street Flow (cfs)	Design Flow (cfs)	Slope (%)	Pipe Size (inches)	Length (ft)	Velocity (fps)	Tt (min)	
		RWT202	1574.40					46.6	7.69	1.82	14.0										From Falcon DBPS by Matrix (Existing Flows)
		RWT204	38.40					11.4	1.78	3.94	7.0										From Falcon DBPS by Matrix (Existing Flows)
		WT200	192.00					37.8	11.74	2.13	25.0										From Falcon DBPS by Matrix (Existing Flows)
		OS-25	14.13	0.11	19.4	1.55	3.13	4.9													
		OS-26	5.81	0.09	13.9	0.52	3.64	1.9													
		OS-1	13.06	0.17	19.6	2.22	3.12	6.9													
		OS-2	17.81	0.20	19.3	3.56	3.14	11.2													
		OS-4	30.69	0.15	26.1	4.60	2.69	12.4													
BENT GRASS FILING NO. 2 & BENT GRASS WEST BASINS																					
		A-1	5.42	0.11	14.3	0.60	3.60	2.2													
		A-2	18.00	0.09	17.9	1.62	3.25	5.3													
		A-3	19.59	0.09	15.9	1.76	3.43	6.0													
		A-4	23.81	0.11	20.0	2.62	3.09	8.1													
		B-1	32.53	0.09	17.8	2.93	3.27	9.6													
		B-2	4.51	0.09	13.5	0.41	3.68	1.5													
		B-3	16.18	0.14	16.0	2.27	3.42	7.8													

STANDARD FORM SF-3
STORM DRAINAGE SYSTEM DESIGN
(RATIONAL METHOD PROCEDURE)

Subdivision: Falcon Meadows
Location: CO, Colorado Springs
Design Storm: 100-Year

Project Name: Falcon Meadows at Bent Grass Filing No. 3
Project No.: CLH020.20
Calculated By: TJE
Checked By: CMD
Date: 12/2/20

STREET	Design Point	DIRECT RUNOFF							TOTAL RUNOFF				STREET		PIPE			TRAVEL TIME			REMARKS
		Basin ID	Area (Ac)	Runoff Coeff.	Tc (min)	C*A (Ac)	I (in/hr)	Q (cfs)	Tc (min)	C*A (Ac)	I (in/hr)	Q (cfs)	Slope (%)	Street Flow (cfs)	Design Flow (cfs)	Slope (%)	Pipe Size (inches)	Length (ft)	Velocity (fps)	Tt (min)	
		RWT202	1574.40					46.6	252.46	3.05	770.0										From Falcon DBPS by Matrix (Existing Flows)
		RWT204	38.40					11.4	6.51	6.61	43.0										From Falcon DBPS by Matrix (Existing Flows)
		WT200	192.00					37.8	30.73	3.58	110.0										From Falcon DBPS by Matrix (Existing Flows)
		OS-25	14.13	0.37	19.4	5.23	5.26	27.5													
		OS-26	5.81	0.36	13.9	2.09	6.10	12.7													
		OS-1	13.06	0.42	19.6	5.49	5.24	28.8													
		OS-2	17.81	0.44	19.3	7.84	5.28	41.4													
		OS-4	30.69	0.40	26.1	12.28	4.51	55.4													
BENT GRASS FILING NO. 2 & BENT GRASS WEST BASINS																					
		A-1	5.42	0.38	14.3	2.06	6.04	12.4													
		A-2	18.00	0.36	17.9	6.48	5.46	35.4													
		A-3	19.59	0.36	15.9	7.05	5.77	40.7													
		A-4	23.81	0.38	20.0	9.05	5.19	47.0													
		B-1	32.53	0.36	17.8	11.71	5.48	64.2													
		B-2	4.51	0.36	13.5	1.62	6.18	10.0													
		B-3	16.18	0.40	16.0	6.47	5.75	37.2													

Proposed Computations

COMPOSITE % IMPERVIOUS CALCULATIONS: PROPOSED

Subdivision: Falcon Meadows
 Location: CO, Colorado Springs

Project Name: Falcon Meadows at Bent Grass Filing No. 3
 Project No.: CLH000020
 Calculated By: CMV
 Checked By: SMB
 Date: 12/6/21

Basin ID	Total Area (ac)	Paved/Gravel Roads			Lawns/Undeveloped			Residential - 1/8 Acre			Residential - 1/4 Acre			Residential - 1/3 Acre			Residential - 1/2 Acre			Residential - 1 Acre			Basins Total Weighted % Imp.
		% Imp.	Area (ac)	Weighted % Imp.	% Imp.	Area (ac)	Weighted % Imp.	% Imp.	Area (ac)	Weighted % Imp.	% Imp.	Area (ac)	Weighted % Imp.	% Imp.	Area (ac)	Weighted % Imp.	% Imp.	Area (ac)	Weighted % Imp.	% Imp.	Area (ac)	Weighted % Imp.	
OFFSITE																							
OS-1	32.28	100	2.15	6.7	2	29.25	1.8	65.0	0.00	0.0	40	0.00	0.0	30	0.00	0.0	25	0.00	0.0	20	0.00	0.0	11.0
OS-2	20.07	80	0.90	3.6	2	18.62	1.9	65.0	0.00	0.0	40	0.00	0.0	30	0.00	0.0	25	0.00	0.0	20	0.00	0.0	8.0
OS-3	10.61	80	0.48	3.6	2	9.84	1.9	65.0	0.00	0.0	40	0.00	0.0	30	0.00	0.0	25	0.00	0.0	20	0.00	0.0	8.0
BENT GRASS FILING NO. 2 & FALCON MEADOWS AT BENT GRASS FILING NO. 1																							
EX-1	1.19	100	0.00	0.0	2	1.19	2.0	65.0	0.00	0.0	40	0.00	0.0	30	0.00	0.0	25	0.00	0.0	20	0.00	0.0	2.0
EX-2	1.60	100	0.00	0.0	2	1.60	2.0	65.0	0.00	0.0	40	0.00	0.0	30	0.00	0.0	25	0.00	0.0	20	0.00	0.0	2.0
EX-3	0.66	100	0.00	0.0	2	0.66	2.0	65.0	0.00	0.0	40	0.00	0.0	30	0.00	0.0	25	0.00	0.0	20	0.00	0.0	2.0
B-1	6.59	100	0.00	0.0	2	6.59	2.0	65.0	0.00	0.0	40	0.00	0.0	30	0.00	0.0	25	0.00	0.0	20	0.00	0.0	2.0
B-2	4.16	100	0.00	0.0	2	4.16	2.0	65.0	0.00	0.0	40	0.00	0.0	30	0.00	0.0	25	0.00	0.0	20	0.00	0.0	2.0
D-4a	0.98	100	0.21	21.4	2	0.00	0.0	65.0	0.77	51.1	40	0.00	0.0	30	0.00	0.0	25	0.00	0.0	20	0.00	0.0	72.5
D-4b	0.95	100	0.43	45.3	2	0.00	0.0	65.0	0.52	35.6	40	0.00	0.0	30	0.00	0.0	25	0.00	0.0	20	0.00	0.0	80.9
D-4c	1.22	100	0.43	35.2	2	0.24	0.4	65.0	0.55	29.3	40	0.00	0.0	30	0.00	0.0	25	0.00	0.0	20	0.00	0.0	64.9
D-5	1.08	100	0.22	20.4	2	0.11	0.2	65.0	0.75	45.1	40	0.00	0.0	30	0.00	0.0	25	0.00	0.0	20	0.00	0.0	65.7
D-6a	1.33	100	0.44	33.1	2	0.00	0.0	65.0	0.89	43.5	40	0.00	0.0	30	0.00	0.0	25	0.00	0.0	20	0.00	0.0	76.6
D-6b	2.69	100	0.59	21.9	2	0.00	0.0	65.0	2.10	50.7	40	0.00	0.0	30	0.00	0.0	25	0.00	0.0	20	0.00	0.0	72.6
D-7	7.65	100	0.00	0.0	2	6.22	1.6	65.0	1.43	12.2	40	0.00	0.0	30	0.00	0.0	25	0.00	0.0	20	0.00	0.0	13.8
D-8	1.69	100	0.00	0.0	2	0.11	0.1	65.0	1.58	60.8	40	0.00	0.0	30	0.00	0.0	25	0.00	0.0	20	0.00	0.0	60.9
E-1	1.71	100	0.78	45.6	2	0.23	0.3	65.0	0.00	0.0	40	0.70	16.4	30	0.00	0.0	25	0.00	0.0	20	0.00	0.0	62.3
E-2	0.68	100	0.56	82.4	2	0.12	0.4	65.0	0.00	0.0	40	0.00	0.0	30	0.00	0.0	25	0.00	0.0	20	0.00	0.0	82.8
E-3	0.78	100	0.69	88.5	2	0.09	0.2	65.0	0.00	0.0	40	0.00	0.0	30	0.00	0.0	25	0.00	0.0	20	0.00	0.0	88.7
E-4	0.91	100	0.73	80.2	2	0.18	0.4	65.0	0.00	0.0	40	0.00	0.0	30	0.00	0.0	25	0.00	0.0	20	0.00	0.0	80.6
E-5	0.89	100	0.79	88.8	2	0.10	0.2	65.0	0.00	0.0	40	0.00	0.0	30	0.00	0.0	25	0.00	0.0	20	0.00	0.0	89.0
OS-4	4.46	100	0.00	0.0	2	0.00	0.0	65.0	2.28	33.2	40	1.46	13.1	30	0.00	0.0	25	0.00	0.0	20	0.72	3.2	49.5
OS-5	0.46	100	0.00	0.0	2	0.00	0.0	65.0	0.46	65.0	40	0.00	0.0	30	0.00	0.0	25	0.00	0.0	20	0.00	0.0	65.0
OS-6	1.17	100	0.00	0.0	2	0.00	0.0	65.0	1.17	65.0	40	0.00	0.0	30	0.00	0.0	25	0.00	0.0	20	0.00	0.0	65.0
FALCON MEADOWS AT BENT GRASS FILING NO. 2																							
C-1a	0.27	100	0.15	55.6	2	0.00	0.0	65.0	0.12	28.9	40	0.00	0.0	30	0.00	0.0	25	0.00	0.0	20	0.00	0.0	84.5
C-1d	1.97	100	0.40	20.3	2	0.00	0.0	65.0	1.57	51.8	40	0.00	0.0	30	0.00	0.0	25	0.00	0.0	20	0.00	0.0	72.1
C-1e	0.49	100	0.49	100.0	2	0.00	0.0	65.0	0.00	0.0	40	0.00	0.0	30	0.00	0.0	25	0.00	0.0	20	0.00	0.0	100.0
C-3	0.18	100	0.14	77.8	2	0.02	0.3	65.0	0.02	7.6	40	0.00	0.0	30	0.00	0.0	25	0.00	0.0	20	0.00	0.0	85.7
C-4	2.67	100	0.41	15.4	2	0.84	0.6	65.0	1.41	34.3	40	0.00	0.0	30	0.00	0.0	25	0.00	0.0	20	0.00	0.0	50.3
C-5	0.60	100	0.00	0.0	2	0.60	2.0	65.0	0.00	0.0	40	0.00	0.0	30	0.00	0.0	25	0.00	0.0	20	0.00	0.0	2.0
C-6	0.94	100	0.00	0.0	2	0.65	1.4	65.0	0.29	20.1	40	0.00	0.0	30	0.00	0.0	25	0.00	0.0	20	0.00	0.0	21.5
C-7	0.52	100	0.15	29.4	2	0.00	0.0	65.0	0.37	46.3	40	0.00	0.0	30	0.00	0.0	25	0.00	0.0	20	0.00	0.0	75.7
D-9	0.72	100	0.00	0.0	2	0.46	1.3	65.0	0.26	23.5	40	0.00	0.0	30	0.00	0.0	25	0.00	0.0	20	0.00	0.0	24.8
D-1c	3.95	100	0.33	8.4	2	0.00	0.0	65.0	2.67	43.9	40	0.95	9.6	30	0.00	0.0	25	0.00	0.0	20	0.00	0.0	61.9
D-2a	0.50	100	0.33	66.0	2	0.00	0.0	65.0	0.17	22.7	40	0.00	0.0	30	0.00	0.0	25	0.00	0.0	20	0.00	0.0	88.7
D-2b	0.74	100	0.18	24.3	2	0.14	0.4	65.0	0.42	37.1	40	0.00	0.0	30	0.00	0.0	25	0.00	0.0	20	0.00	0.0	61.8
D-2c	0.31	100	0.15	50.0	2	0.00	0.0	65.0	0.16	33.5	40	0.00	0.0	30	0.00	0.0	25	0.00	0.0	20	0.00	0.0	83.5
D-2d	0.24	100	0.10	43.4	2	0.00	0.0	65.0	0.14	37.9	40	0.00	0.0	30	0.00	0.0	25	0.00	0.0	20	0.00	0.0	81.3
D-2e	1.41	100	0.41	29.3	2	0.00	0.0	65.0	1.00	46.1	40	0.00	0.0	30	0.00	0.0	25	0.00	0.0	20	0.00	0.0	75.4
D-2f	2.43	100	0.70	28.8	2	0.07	0.1	65.0	1.67	44.7	40	0.00	0.0	30	0.00	0.0	25	0.00	0.0	20	0.00	0.0	73.6
D-2g	1.81	100	0.48	26.5	2	0.57	0.6	65.0	0.76	27.3	40	0.00	0.0	30	0.00	0.0	25	0.00	0.0	20	0.00	0.0	54.4
D-2h	0.23	100	0.00	0.0	2	0.00	0.0	65.0	0.23	65.0	40	0.00	0.0	30	0.00	0.0	25	0.00	0.0	20	0.00	0.0	65.0
D-3	2.26	100	0.00	0.0	2	0.28	0.2	65.0	1.74	50.0	40	0.13	2.3	30	0.11	1.5	25	0.00	0.0	20	0.00	0.0	54.0
FALCON MEADOWS AT BENT GRASS FILING NO. 3																							
C-1b	1.77	100	0.38	21.5	2	0.10	0.1	65.0	0.75	27.5	40	0.54	12.2	30	0.00	0.0	25	0.00	0.0	20	0.00	0.0	61.3
C-1c	1.19	100	0.26	21.8	2	0.00	0.0	65.0	0.72	39.3	40	0.21	7.1	30	0.00	0.0	25	0.00	0.0	20	0.00	0.0	68.2
C-1f	0.14	100	0.09	64.3	2	0.00	0.0	65.0	0.05	23.2	40	0.00	0.0	30	0.00	0.0	25	0.00	0.0	20	0.00	0.0	87.5
C-2	1.00	100	0.27	27.0	2	0.04	0.1	65.0	0.69	44.9	40	0.00	0.0	30	0.00	0.0	25	0.00	0.0	20	0.00	0.0	72.0
D-1a	1.83	100	0.35	19.1	2	0.15	0.2	65.0	0.75	26.6	40	0.25	5.5	30	0.33	5.4	25	0.00	0.0	20	0.00	0.0	56.8
D-1b	1.19	100	0.29	24.4	2	0.00	0.0	65.0	0.39	21.3	40	0.39	13.1	30	0.12	3.0	25	0.00	0.0	20	0.00	0.0	61.8
D-1f	0.67	100	0.16	23.9	2	0.00	0.0	65.0	0.51	49.5	40	0.00	0.0	30	0.00	0.0	25	0.00	0.0	20	0.00	0.0	73.4
D-1g	0.78	100	0.13	16.7	2	0.20	0.5	65.0															

COMPOSITE RUNOFF COEFFICIENT CALCULATIONS: PROPOSED

Subdivision: Falcon Meadows
 Location: CO, Colorado Springs

Project Name: Falcon Meadows at Bent Grass Filing No. 3
 Project No.: CLH000020
 Calculated By: CMV
 Checked By: SMB
 Date: 12/6/21

Basin ID	Total Area (ac)	Paved/Gravel Roads			Lawns/Undeveloped			Residential - 1/8 Acre			Residential - 1/4 Acre			Residential - 1/3 Acre			Residential - 1/2 Acre			Residential - 1 Acre			Composite C ₅	Composite C ₁₀₀
		C ₅	C ₁₀₀	Area (ac)	C ₅	C ₁₀₀	Area (ac)	C ₅	C ₁₀₀	Area (ac)	C ₅	C ₁₀₀	Area (ac)	C ₅	C ₁₀₀	Area (ac)	C ₅	C ₁₀₀	Area (ac)	C ₅	C ₁₀₀	Area (ac)		
OFFSITE																								
OS-1	32.28	0.90	0.96	2.15	0.09	0.36	29.25	0.45	0.59	0.00	0.30	0.50	0.00	0.25	0.47	0.00	0.22	0.46	0.00	0.20	0.44	0.00	0.16	0.41
OS-2	20.07	0.90	0.96	0.90	0.09	0.36	18.62	0.45	0.59	0.00	0.30	0.50	0.00	0.25	0.47	0.00	0.22	0.46	0.00	0.20	0.44	0.00	0.14	0.40
OS-3	10.61	0.90	0.96	0.48	0.09	0.36	9.84	0.45	0.59	0.00	0.30	0.50	0.00	0.25	0.47	0.00	0.22	0.46	0.00	0.20	0.44	0.00	0.14	0.40
BENT GRASS FILING NO. 2 & FALCON MEADOWS AT BENT GRASS FILING NO. 1																								
EX-1	1.19	0.90	0.96	0.00	0.09	0.36	1.19	0.45	0.59	0.00	0.30	0.50	0.00	0.25	0.47	0.00	0.22	0.46	0.00	0.20	0.44	0.00	0.09	0.36
EX-2	1.60	0.90	0.96	0.00	0.09	0.36	1.60	0.45	0.59	0.00	0.30	0.50	0.00	0.25	0.47	0.00	0.22	0.46	0.00	0.20	0.44	0.00	0.09	0.36
EX-3	0.66	0.90	0.96	0.00	0.09	0.36	0.66	0.45	0.59	0.00	0.30	0.50	0.00	0.25	0.47	0.00	0.22	0.46	0.00	0.20	0.44	0.00	0.09	0.36
B-1	6.59	0.90	0.96	0.00	0.09	0.36	6.59	0.45	0.59	0.00	0.30	0.50	0.00	0.25	0.47	0.00	0.22	0.46	0.00	0.20	0.44	0.00	0.09	0.36
B-2	4.16	0.90	0.96	0.00	0.09	0.36	4.16	0.45	0.59	0.00	0.30	0.50	0.00	0.25	0.47	0.00	0.22	0.46	0.00	0.20	0.44	0.00	0.09	0.36
D-4a	0.98	0.90	0.96	0.21	0.09	0.36	0.00	0.45	0.59	0.77	0.30	0.50	0.00	0.25	0.47	0.00	0.22	0.46	0.00	0.20	0.44	0.00	0.55	0.67
D-4b	0.95	0.90	0.96	0.43	0.09	0.36	0.00	0.45	0.59	0.52	0.30	0.50	0.00	0.25	0.47	0.00	0.22	0.46	0.00	0.20	0.44	0.00	0.65	0.76
D-4c	1.22	0.90	0.96	0.43	0.09	0.36	0.24	0.45	0.59	0.55	0.30	0.50	0.00	0.25	0.47	0.00	0.22	0.46	0.00	0.20	0.44	0.00	0.54	0.68
D-5	1.08	0.90	0.96	0.22	0.09	0.36	0.11	0.45	0.59	0.75	0.30	0.50	0.00	0.25	0.47	0.00	0.22	0.46	0.00	0.20	0.44	0.00	0.51	0.64
D-6a	1.33	0.90	0.96	0.44	0.09	0.36	0.00	0.45	0.59	0.89	0.30	0.50	0.00	0.25	0.47	0.00	0.22	0.46	0.00	0.20	0.44	0.00	0.60	0.71
D-6b	2.69	0.90	0.96	0.59	0.09	0.36	0.00	0.45	0.59	2.10	0.30	0.50	0.00	0.25	0.47	0.00	0.22	0.46	0.00	0.20	0.44	0.00	0.55	0.67
D-7	7.65	0.90	0.96	0.00	0.09	0.36	6.22	0.45	0.59	1.43	0.30	0.50	0.00	0.25	0.47	0.00	0.22	0.46	0.00	0.20	0.44	0.00	0.16	0.40
D-8	1.69	0.90	0.96	0.00	0.09	0.36	0.11	0.45	0.59	1.58	0.30	0.50	0.00	0.25	0.47	0.00	0.22	0.46	0.00	0.20	0.44	0.00	0.43	0.58
E-1	1.71	0.90	0.96	0.78	0.09	0.36	0.23	0.45	0.59	0.00	0.30	0.50	0.70	0.25	0.47	0.00	0.22	0.46	0.00	0.20	0.44	0.00	0.55	0.69
E-2	0.68	0.90	0.96	0.56	0.09	0.36	0.12	0.45	0.59	0.00	0.30	0.50	0.00	0.25	0.47	0.00	0.22	0.46	0.00	0.20	0.44	0.00	0.76	0.85
E-3	0.78	0.90	0.96	0.69	0.09	0.36	0.09	0.45	0.59	0.00	0.30	0.50	0.00	0.25	0.47	0.00	0.22	0.46	0.00	0.20	0.44	0.00	0.81	0.89
E-4	0.91	0.90	0.96	0.73	0.09	0.36	0.18	0.45	0.59	0.00	0.30	0.50	0.00	0.25	0.47	0.00	0.22	0.46	0.00	0.20	0.44	0.00	0.74	0.84
E-5	0.89	0.90	0.96	0.79	0.09	0.36	0.10	0.45	0.59	0.00	0.30	0.50	0.00	0.25	0.47	0.00	0.22	0.46	0.00	0.20	0.44	0.00	0.81	0.89
OS-4	4.46	0.90	0.96	0.00	0.09	0.36	0.00	0.45	0.59	2.28	0.30	0.50	1.46	0.25	0.47	0.00	0.22	0.46	0.00	0.20	0.44	0.72	0.36	0.54
OS-5	0.46	0.90	0.96	0.00	0.09	0.36	0.00	0.45	0.59	0.46	0.30	0.50	0.00	0.25	0.47	0.00	0.22	0.46	0.00	0.20	0.44	0.00	0.45	0.59
OS-6	1.17	0.90	0.96	0.00	0.09	0.36	0.00	0.45	0.59	1.17	0.30	0.50	0.00	0.25	0.47	0.00	0.22	0.46	0.00	0.20	0.44	0.00	0.45	0.59
FALCON MEADOWS FILING NO. 2																								
C-1a	0.27	0.90	0.96	0.15	0.09	0.36	0.00	0.45	0.59	0.12	0.30	0.50	0.00	0.25	0.47	0.00	0.22	0.46	0.00	0.20	0.44	0.00	0.70	0.80
C-1d	1.97	0.90	0.96	0.40	0.09	0.36	0.00	0.45	0.59	1.57	0.30	0.50	0.00	0.25	0.47	0.00	0.22	0.46	0.00	0.20	0.44	0.00	0.54	0.67
C-1e	0.49	0.90	0.96	0.49	0.09	0.36	0.00	0.45	0.59	0.00	0.30	0.50	0.00	0.25	0.47	0.00	0.22	0.46	0.00	0.20	0.44	0.00	0.90	0.96
C-3	0.18	0.90	0.96	0.14	0.09	0.36	0.02	0.45	0.59	0.02	0.30	0.50	0.00	0.25	0.47	0.00	0.22	0.46	0.00	0.20	0.44	0.00	0.76	0.86
C-4	2.67	0.90	0.96	0.41	0.09	0.36	0.84	0.45	0.59	1.41	0.30	0.50	0.00	0.25	0.47	0.00	0.22	0.46	0.00	0.20	0.44	0.00	0.41	0.57
C-5	0.60	0.90	0.96	0.00	0.09	0.36	0.60	0.45	0.59	0.00	0.30	0.50	0.00	0.25	0.47	0.00	0.22	0.46	0.00	0.20	0.44	0.00	0.09	0.36
C-6	0.94	0.90	0.96	0.00	0.09	0.36	0.65	0.45	0.59	0.29	0.30	0.50	0.00	0.25	0.47	0.00	0.22	0.46	0.00	0.20	0.44	0.00	0.20	0.43
C-7	0.52	0.90	0.96	0.15	0.09	0.36	0.00	0.45	0.59	0.37	0.30	0.50	0.00	0.25	0.47	0.00	0.22	0.46	0.00	0.20	0.44	0.00	0.58	0.70
D-9	0.72	0.90	0.96	0.00	0.09	0.36	0.46	0.45	0.59	0.26	0.30	0.50	0.00	0.25	0.47	0.00	0.22	0.46	0.00	0.20	0.44	0.00	0.22	0.44
D-1c	3.95	0.90	0.96	0.33	0.09	0.36	0.00	0.45	0.59	2.67	0.30	0.50	0.95	0.25	0.47	0.00	0.22	0.46	0.00	0.20	0.44	0.00	0.45	0.60
D-2a	0.50	0.90	0.96	0.33	0.09	0.36	0.00	0.45	0.59	0.17	0.30	0.50	0.00	0.25	0.47	0.00	0.22	0.46	0.00	0.20	0.44	0.00	0.75	0.84
D-2b	0.74	0.90	0.96	0.18	0.09	0.36	0.14	0.45	0.59	0.42	0.30	0.50	0.00	0.25	0.47	0.00	0.22	0.46	0.00	0.20	0.44	0.00	0.49	0.64
D-2c	0.31	0.90	0.96	0.15	0.09	0.36	0.00	0.45	0.59	0.16	0.30	0.50	0.00	0.25	0.47	0.00	0.22	0.46	0.00	0.20	0.44	0.00	0.68	0.78
D-2d	0.24	0.90	0.96	0.10	0.09	0.36	0.00	0.45	0.59	0.14	0.30	0.50	0.00	0.25	0.47	0.00	0.22	0.46	0.00	0.20	0.44	0.00	0.65	0.76
D-2e	1.41	0.90	0.96	0.41	0.09	0.36	0.00	0.45	0.59	1.00	0.30	0.50	0.00	0.25	0.47	0.00	0.22	0.46	0.00	0.20	0.44	0.00	0.58	0.70
D-2f	2.43	0.90	0.96	0.70	0.09	0.36	0.07	0.45	0.59	1.67	0.30	0.50	0.00	0.25	0.47	0.00	0.22	0.46	0.00	0.20	0.44	0.00	0.57	0.69
D-2g	1.81	0.90	0.96	0.48	0.09	0.36	0.57	0.45	0.59	0.76	0.30	0.50	0.00	0.25	0.47	0.00	0.22	0.46	0.00	0.20	0.44	0.00	0.46	0.62
D-2h	0.23	0.90	0.96	0.00	0.09	0.36	0.00	0.45	0.59	0.23	0.30	0.50	0.00	0.25	0.47	0.00	0.22	0.46	0.00	0.20	0.44	0.00	0.45	0.59
D-3	2.26	0.90	0.96	0.00	0.09	0.36	0.28	0.45	0.59	1.74	0.30	0.50	0.13	0.25	0.47	0.11	0.22	0.46	0.00	0.20	0.44	0.00	0.39	0.55
FALCON MEADOWS FILING NO. 3																								
C-1b	1.77	0.90	0.96	0.38	0.09	0.36	0.10	0.45	0.59	0.75	0.30	0.50	0.54	0.25	0.47	0.00	0.22	0.46	0.00	0.20	0.44	0.00	0.48	0.63
C-1c	1.19	0.90	0.96	0.26	0.09	0.36	0.00	0.45	0.59	0.72	0.30	0.50	0.21	0.25	0.47	0.00	0.22	0.46	0.00	0.20	0.44	0.00	0.52	0.65
C-1f	0.14	0.90	0.96	0.09	0.09	0.36	0.00	0.45	0.59	0.05	0.30	0.50	0.00	0.25	0.47	0.00	0.22	0.46	0.00	0.20	0.44	0.00	0.74	0.83

Basin ID	Total Area (ac)	Paved/Gravel Roads			Lawns/Undeveloped			Residential - 1/8 Acre			Residential - 1/4 Acre			Residential - 1/3 Acre			Residential - 1/2 Acre			Residential - 1 Acre			Composite	Composite
		C ₅	C ₁₀₀	Area (ac)	C ₅	C ₁₀₀	Area (ac)	C ₅	C ₁₀₀	Area (ac)	C ₅	C ₁₀₀	Area (ac)	C ₅	C ₁₀₀	Area (ac)	C ₅	C ₁₀₀	Area (ac)	C ₅	C ₁₀₀	Area (ac)	C ₅	C ₁₀₀
C-2	1.00	0.90	0.96	0.27	0.09	0.36	0.04	0.45	0.59	0.69	0.30	0.50	0.00	0.25	0.47	0.00	0.22	0.46	0.00	0.20	0.44	0.00	0.56	0.68
D-1a	1.83	0.90	0.96	0.35	0.09	0.36	0.15	0.45	0.59	0.75	0.30	0.50	0.25	0.25	0.47	0.33	0.22	0.46	0.00	0.20	0.44	0.00	0.45	0.61
D-1b	1.19	0.90	0.96	0.29	0.09	0.36	0.00	0.45	0.59	0.39	0.30	0.50	0.39	0.25	0.47	0.12	0.22	0.46	0.00	0.20	0.44	0.00	0.49	0.64
D-1f	0.67	0.90	0.96	0.16	0.09	0.36	0.00	0.45	0.59	0.51	0.30	0.50	0.00	0.25	0.47	0.00	0.22	0.46	0.00	0.20	0.44	0.00	0.56	0.68
D-1g	0.78	0.90	0.96	0.13	0.09	0.36	0.20	0.45	0.59	0.34	0.30	0.50	0.00	0.25	0.47	0.00	0.22	0.46	0.00	0.20	0.44	0.00	0.37	0.51
D-1h	1.57	0.90	0.96	0.23	0.09	0.36	0.31	0.45	0.59	0.58	0.30	0.50	0.19	0.25	0.47	0.26	0.22	0.46	0.00	0.20	0.44	0.00	0.39	0.57
D-1j	0.95	0.90	0.96	0.23	0.09	0.36	0.09	0.45	0.59	0.38	0.30	0.50	0.22	0.25	0.47	0.03	0.22	0.46	0.00	0.20	0.44	0.00	0.48	0.63
D-1k	0.80	0.90	0.96	0.18	0.09	0.36	0.10	0.45	0.59	0.19	0.30	0.50	0.00	0.25	0.47	0.33	0.22	0.46	0.00	0.20	0.44	0.00	0.42	0.60
FUTURE FILINGS																								
C-1g	1.02	0.90	0.96	0.00	0.09	0.36	0.00	0.45	0.59	1.02	0.30	0.50	0.00	0.25	0.47	0.00	0.22	0.46	0.00	0.20	0.44	0.00	0.45	0.59

Lot Type Identification:	
Lot Size (SF)	Lot Size (Acre)
0 - 8,167	<= 1/8 Acre
8,168 - 12,704	1/4 Acre
12,705 - 18,149	1/3 Acre
18,150 - 32,670	1/2 Acre
32,671 - 43,560	1 Acre

NOTES:

C values are taken directly from Table 6-6 in the Colorado Springs DCM Vol. 1. CH. 6 (Referencing UDFCD 2001)

Coefficients use HSG A&B soils - Refer to "Appendix A: Exhibits and Figures" for soil map

STANDARD FORM SF-2: PROPOSED TIME OF CONCENTRATION

Subdivision: Falcon Meadows
Location: CO, Colorado Springs

Project Name: Falcon Meadows at Bent Grass Filing No. 3
Project No.: CLH000020
Calculated By: CMV
Checked By: SMB
Date: 12/6/21

SUB-BASIN					INITIAL/OVERLAND			TRAVEL TIME					Tc CHECK			FINAL
DATA					(T _i)			(T _t)					(URBANIZED BASINS)			
BASIN ID	D.A. (AC)	Impervious (%)	C ₅	C ₁₀₀	L (FT)	S (%)	T _i (MIN)	L (FT)	S (%)	C _v	VEL. (FPS)	T _t (MIN)	COMP. T _c (MIN)	TOTAL LENGTH(FT)	Urbanized T _c (MIN)	
OFFSITE																
OS-1	32.28	11.0	0.16	0.41	100	2.4	12.9	2100	2.2	15	2.2	15.7	28.6	2200.0	22.2	22.2
OS-2	20.07	8.0	0.14	0.40	100	2.3	13.3	1400	2.3	15	2.3	10.3	23.6	1500.0	18.3	18.3
OS-3	10.61	8.0	0.14	0.40	100	2.0	14.0	1500	2.0	15	2.1	11.8	25.7	1600.0	18.9	18.9
BENT GRASS FILING NO. 2 & FALCON MEADOWS AT BENT GRASS FILING NO. 1																
EX-1	1.19	2.0	0.09	0.36	300	2.7	23.0	690	2.7	15	2.5	4.7	27.7	990.0	15.5	15.5
EX-2	1.60	2.0	0.09	0.36	200	2.7	18.8	100	2.7	15	2.5	0.7	19.5	300.0	11.7	11.7
EX-3	0.66	2.0	0.09	0.36	100	5.0	10.8	30	2.7	15	2.5	0.2	11.0	130.0	10.7	10.7
B-1	6.59	2.0	0.09	0.36	90	6.4	9.5	2000	1.7	15	2.0	17.0	26.5	2090.0	21.6	21.6
B-2	4.16	2.0	0.09	0.36	160	11.0	10.5	920	1.6	15	1.9	8.1	18.6	1080.0	16.0	16.0
D-4a	0.98	72.5	0.55	0.67	100	2.3	7.6	420	1.0	20	2.0	3.5	11.1	520.0	12.9	11.1
D-4b	0.95	80.9	0.65	0.76	75	1.5	6.2	480	1.0	20	2.0	4.0	10.2	555.0	13.1	10.2
D-4c	1.22	64.9	0.54	0.68	70	0.5	10.8	690	1.0	20	2.0	5.8	16.6	760.0	14.2	14.2
D-5	1.08	65.7	0.51	0.64	10	2.0	2.7	300	1.1	20	2.1	2.4	5.1	310.0	11.7	5.1
D-6a	1.33	76.6	0.60	0.71	20	2.0	3.2	385	1.0	20	2.0	3.2	6.5	405.0	12.3	6.5
D-6b	2.69	72.6	0.55	0.67	45	2.0	5.4	870	1.0	20	2.0	7.3	12.6	915.0	15.1	12.6
D-7	7.65	13.8	0.16	0.40	200	7.5	12.4	665	1.0	15	1.5	7.4	19.8	865.0	14.8	14.8
D-8	1.69	60.9	0.43	0.58	125	3.7	8.9	600	1.0	15	1.5	6.7	15.5	725.0	14.0	14.0
E-1	1.71	62.3	0.55	0.69	25	2.0	4.0	940	1.0	20	2.0	7.8	11.8	965.0	15.4	11.8
E-2	0.68	82.8	0.76	0.85	25	2.0	2.5	665	1.6	20	2.5	4.4	6.9	690.0	13.8	6.9
E-3	0.78	88.7	0.81	0.89	25	2.0	2.1	632	1.0	20	2.0	5.3	7.4	657.0	13.7	7.4
E-4	0.91	80.6	0.74	0.84	25	2.0	2.6	913	2.0	20	2.8	5.4	8.0	938.0	15.2	8.0
E-5	0.89	89.0	0.81	0.89	25	2.0	2.1	903	2.1	20	2.9	5.2	7.3	928.0	15.2	7.3
OS-4	4.46	49.5	0.36	0.54	100	2.0	10.8	910	1.2	20	2.2	6.9	17.7	1010.0	15.6	15.6
OS-5	0.46	65.0	0.45	0.59	15	2.0	3.7	190	1.0	20	2.0	1.6	5.2	205.0	11.1	5.2
OS-6	1.17	65.0	0.45	0.59	85	0.2	18.7	430	0.9	20	1.9	3.8	22.5	515.0	12.9	12.9
FALCON MEADOWS FILING NO. 2																
C-1a	0.27	84.5	0.70	0.80	10	2.0	1.8	230	1.0	20	2.0	1.9	3.8	240.0	11.3	5.0
C-1d	1.97	72.1	0.54	0.67	100	3.8	6.6	505	0.8	20	1.8	4.6	11.2	605.0	13.4	11.2
C-1e	0.49	100.0	0.90	0.96	10	2.0	0.9	68	3.4	20	3.7	0.3	1.2	78.0	10.4	5.0
C-3	0.18	85.7	0.76	0.86	10	2.0	1.6	580	1.0	20	2.0	4.8	6.4	590.0	13.3	6.4
C-4	2.67	50.3	0.41	0.57	100	3.0	8.8	600	2.0	20	2.8	3.5	12.3	700.0	13.9	12.3
C-5	0.60	2.0	0.09	0.36	5	2.0	3.3		1.0	15	1.5	0.0	3.3	5.0	10.0	5.0
C-6	0.94	21.5	0.20	0.43	20	3.3	5.0	90	5.0	15	3.4	0.4	5.4	110.0	10.6	5.4
C-7	0.52	75.7	0.58	0.70	100	6.8	5.0	165	1.3	15	1.7	1.6	6.7	265.0	11.5	6.7

SUB-BASIN					INITIAL/OVERLAND			TRAVEL TIME					Tc CHECK			FINAL
DATA					(T _i)			(T _i)					(URBANIZED BASINS)			T _c
BASIN ID	D.A. (AC)	Impervious (%)	C ₅	C ₁₀₀	L (FT)	S (%)	T _i (MIN)	L (FT)	S (%)	C _v	VEL. (FPS)	T _i (MIN)	COMP. T _c (MIN)	TOTAL LENGTH(FT)	Urbanized T _c (MIN)	T _c (MIN)
D-9	0.72	24.8	0.22	0.44	10	2.0	4.0	250	3.6	15	2.8	1.5	5.5	260.0	11.4	5.5
D-1c	3.95	61.9	0.45	0.60	100	2.6	8.7	1900	1.3	20	2.3	13.9	22.5	2000.0	21.1	21.1
D-2a	0.50	88.7	0.75	0.84	10	2.0	1.6	495	1.3	20	2.3	3.6	5.2	505.0	12.8	5.2
D-2b	0.74	61.8	0.49	0.64	100	1.7	9.4	189	1.0	20	2.0	1.6	10.9	289.0	11.6	10.9
D-2c	0.31	83.5	0.68	0.78	5	2.0	1.4	275	1.0	20	2.0	2.3	3.7	280.0	11.6	5.0
D-2d	0.24	81.3	0.65	0.76	5	2.0	1.5	200	1.3	20	2.3	1.5	2.9	205.0	11.1	5.0
D-2e	1.41	75.4	0.58	0.70	100	1.9	7.7	340	0.8	20	1.8	3.2	10.9	440.0	12.4	10.9
D-2f	2.43	73.6	0.57	0.69	75	2.0	6.7	175	0.5	20	1.4	2.1	8.7	250.0	11.4	8.7
D-2g	1.81	54.4	0.46	0.62	35	2.0	5.5	1355	1.3	20	2.3	9.9	15.4	1390.0	17.7	15.4
D-2h	0.23	65.0	0.45	0.59	35	2.0	5.6	1355	1.3	20	2.3	9.9	15.5	1390.0	17.7	15.5
D-3	2.26	54.0	0.39	0.55	25	8.0	3.3	1960	1.0	15	1.5	21.8	25.0	1985.0	21.0	21.0
FALCON MEADOWS FILING NO. 3																
C-1b	1.77	61.3	0.48	0.63	50	12.0	3.5	570	1.7	20	2.6	3.7	7.2	620.0	13.4	7.2
C-1c	1.19	68.2	0.52	0.65	10	2.0	2.7	440	1.7	20	2.6	2.9	5.5	450.0	12.5	5.5
C-1f	0.14	87.5	0.74	0.83	60	7.0	2.7	90	1.8	20	2.7	0.6	3.2	150.0	10.8	5.0
C-2	1.00	72.0	0.56	0.68	80	2.4	6.6	360	3.4	20	3.7	1.6	8.2	440.0	12.4	8.2
D-1a	1.83	56.8	0.45	0.61	100	3.6	7.8	550	2.2	20	3.0	3.1	10.9	650.0	13.6	10.9
D-1b	1.19	61.8	0.49	0.64	100	3.9	7.1	520	2.2	20	3.0	2.9	10.0	620.0	13.4	10.0
D-1f	0.67	73.4	0.56	0.68	20	2.0	3.5	225	1.0	20	2.0	1.9	5.4	245.0	11.4	5.4
D-1g	0.78	45.5	0.37	0.51	100	2.3	10.1	395	1.0	20	2.0	3.3	13.4	495.0	12.8	12.8
D-1h	1.57	48.8	0.39	0.57	100	2.3	9.8	380	2.9	20	3.4	1.9	11.7	480.0	12.7	11.7
D-1j	0.95	60.6	0.48	0.63	75	4.4	6.0	320	2.9	20	3.4	1.6	7.6	395.0	12.2	7.6
D-1k	0.80	50.6	0.42	0.60	100	3.8	8.0	300	1.7	20	2.6	1.9	9.9	400.0	12.2	9.9
FUTURE FILINGS																
C-1g	1.02	65.0	0.45	0.59	100	6.1	6.5	375	2.4	20	3.1	2.0	8.5	475.0	12.6	8.5

NOTES:

$$T_i = (0.395 * (1.1 - C_5) * (L)^{0.5}) / ((S)^{0.33}), \text{ S in ft/ft}$$

$$T_i = L / 60V \text{ (Velocity From Fig. 501)}$$

$$\text{Velocity } V = C_v * S^{0.5}, \text{ S in ft/ft}$$

$$T_c \text{ Check} = 10 + L / 180$$

For Urbanized basins a minimum T_c of 5.0 minutes is required.

For non-urbanized basins a minimum T_c of 10.0 minutes is required

Type of Land Surface	C _v
Heavy Meadow	2.5
Tillage/field	5
Short pasture and lawns	7
Nearly bare ground	10
Grassed waterway	15
Paved areas and shallow paved swale	20

**STANDARD FORM SF-3: PROPOSED
STORM DRAINAGE SYSTEM DESIGN
(RATIONAL METHOD PROCEDURE)**

Subdivision: Falcon Meadows
 Location: CO, Colorado Springs
 Design Storm: 5-Year

Project Name: Falcon Meadows at Bent Grass Filing No. 3
 Project No.: CLH000020
 Calculated By: CMV
 Checked By: SMB
 Date: 12/6/21

STREET	Design Point	DIRECT RUNOFF							TOTAL RUNOFF				STREET		PIPE			TRAVEL TIME			REMARKS	
		Basin ID	Area (Ac)	Runoff Coeff.	Tc (min)	C* _A (Ac)	I (in/hr)	Q (cfs)	Tc (min)	C* _A (Ac)	I (in/hr)	Q (cfs)	Slope (%)	Street Flow (cfs)	Design Flow (cfs)	Slope (%)	Pipe Size (inches)	Length (ft)	Velocity (fps)	Tt (min)		
		RWT202	1574.40						46.6	120.88	1.82	220.0									From Falcon DBPS by Matrix	
		RWT204	38.40						11.37	1.78	3.94	7.0									From Falcon DBPS by Matrix	
		WT200	192.00						37.8	24.41	2.13	52.0									From Falcon DBPS by Matrix	
	21	OS-1	32.28	0.16	22.2	5.16	2.93	15.1	46.6	152.23	1.82	277.1									Flows obtained from Bent Grass Filing No. 2 FDR. Q=65.1 CFS Cumulation of northern off-site flows entering Basin B-1	
	1	OS-4	4.46	0.36	15.6	1.61	3.46	5.6					1.2	5.6			910	2.2	6.9		Flows from Basin B-1 of Bent Grass Filing No. 2 FDR into Basin EX-2	
	2	OS-5	0.46	0.45	5.2	0.21	5.10	1.1					1	1.1			190	2.0	1.6		Flows from Basin B-2 of Bent Grass Filing No. 2 FDR into Basin EX-2	
	3	OS-6	1.17	0.45	12.9	0.53	3.75	2.0					0.9	2.0			430	1.9	3.8		Flows from Basin B-3 of Bent Grass Filing No. 2 FDR into Basin EX-2	
		EX-1	1.19	0.09	15.5	0.11	3.47	0.4													Flows to Basin EX-2	
	5	EX-2	1.60	0.09	11.7	0.14	3.90	0.5	22.5	2.60	2.91	7.6									Flows to Basin EX-3	
	7	E-3	0.78	0.81	7.4	0.63	4.59	2.9														
		C-6	0.94	0.20	5.4	0.19	5.05	1.0					1	1.0			216	2.0	1.8			
	45	C-7	0.52	0.58	6.7	0.30	4.74	1.4					1	1.4			216	2.0	1.8			
		E-2	0.68	0.76	6.9	0.52	4.70	2.4	8.5	1.01	4.38	4.4									Combination of C-6, C-7, E-2	
	8	E-1	1.71	0.55	11.8	0.94	3.88	3.6	11.8	2.58	3.88	10.0									Ex Basin from Filing No. 2(East side of BGMD) Combination of C-7, E-1, E-2, E-3. Flows to Basin EX-3	
	6	EX-3	0.66	0.09	10.7	0.06	4.02	0.2	22.5	5.24	2.91	15.2									Flows to Basin B-1	
	15a	D-1g	0.78	0.37	12.8	0.29	3.76	1.1					1	1.1			57	2.0	0.5			
		D-1h	1.57	0.39	11.7	0.61	3.89	2.4														
	51	D-1j	0.95	0.48	7.6	0.46	4.55	2.1	13.2	1.36	3.71	5.0	0.9	0.0	5.0		225	1.9	2.0		Flows to existing on-grade inlet at DP51	
		D-1f	0.67	0.56	5.4	0.38	5.06	1.9														
	52	D-1k	0.80	0.42	9.9	0.34	4.14	1.4	9.9	0.72	4.14	3.0										
	53	C-1a	0.27	0.70	5.0	0.19	5.17	1.0	15.2	0.92	3.50	3.2	1.1	0.0	3.2		430	2.1	3.4		Flows to proposed on-grade inlet at DP53	
	53								15.1	2.26	3.51	7.9			7.9							Total pipe flow at DP 53
		C-1b	1.77	0.48	7.2	0.85	4.62	3.9														
	54	C-2	1.00	0.56	8.2	0.56	4.42	2.5	8.2	1.41	4.42	6.2	1	6.2			130	1.6	1.4			
	41	C-1c	1.19	0.52	5.5	0.62	5.02	3.1	9.6	2.03	4.19	8.5		0.3	8.2	1.3	30	180	2.2	1.3		On-grade inlet
									15.1	4.22	3.51	14.8			14.8							Total pipe flow at DP 41
	42	C-1f	0.14	0.74	5.0	0.10	5.17	0.5	10.9	0.17	4.00	0.7	1	0.7			185	2.0	1.5		Gutter flow to DP15	
		C-3	0.18	0.76	6.4	0.14	4.80	0.7					1	0.7			660	2.0	5.5		Gutter flow through C-4 to DP44	
	44	C-4	2.67	0.41	12.3	1.09	3.82	4.2	12.3	1.23	3.82	4.7	1	0.0	4.7	1.3	24	70	2.2	0.5	Flow into on-grade inlet at DP44	
	43	C-1d	1.97	0.54	11.2	1.06	3.96	4.2	12.5	1.23	3.80	4.7									Flow into inlet at DP15	
	15								12.5	1.23	3.80	4.7										Flow into inlet at DP15

**STANDARD FORM SF-3: PROPOSED
STORM DRAINAGE SYSTEM DESIGN
(RATIONAL METHOD PROCEDURE)**

Subdivision: Falcon Meadows
 Location: CO, Colorado Springs
 Design Storm: 5-Year

Project Name: Falcon Meadows at Bent Grass Filing No. 3
 Project No.: CLH000020
 Calculated By: CMV
 Checked By: SMB
 Date: 12/6/21

STREET	Design Point	DIRECT RUNOFF							TOTAL RUNOFF				STREET		PIPE			TRAVEL TIME			REMARKS
		Basin ID	Area (Ac)	Runoff Coeff.	Tc (min)	C* <i>A</i> (Ac)	I (in/hr)	Q (cfs)	Tc (min)	C* <i>A</i> (Ac)	I (in/hr)	Q (cfs)	Slope (%)	Street Flow (cfs)	Design Flow (cfs)	Slope (%)	Pipe Size (inches)	Length (ft)	Velocity (fps)	Tt (min)	
	25	E-5	0.89	0.81	7.3	0.72	4.60	3.3													Flow to existing inlet at DP25
	26								24.4	2.82	2.79	7.9									Flow into existing pond via Swale F at DP26
	32	D-8	1.69	0.43	14.0	0.73	3.62	2.6													Flow in Swale C (Basin D-8) into existing pond
	30	D-7	7.65	0.16	14.8	1.22	3.54	4.3													Existing Water quality pond
		B-2	4.16	0.09	16.0	0.37	3.42	1.3	26.8	20.76	2.65	55.0									Outlet to existing channel Basin B-2
	CC								46.6	186.82	1.82	340.0									

STANDARD FORM SF-3: PROPOSED
STORM DRAINAGE SYSTEM DESIGN
(RATIONAL METHOD PROCEDURE)

Subdivision: Falcon Meadows
Location: CO, Colorado Springs
Design Storm: 100-Year

Project Name: Falcon Meadows at Bent Grass Filing No. 3
Project No.: CLH000020
Calculated By: CMV
Checked By: SMB
Date: 12/6/21

STREET	Design Point	DIRECT RUNOFF							TOTAL RUNOFF				STREET		PIPE			TRAVEL TIME			REMARKS
		Basin ID	Area (Ac)	Runoff Coeff.	Tc (min)	C*A (Ac)	I (in/hr)	Q (cfs)	Tc (min)	C*A (Ac)	I (in/hr)	Q (cfs)	Slope (%)	Street Flow (cfs)	Design Flow (cfs)	Slope (%)	Pipe Size (inches)	Length (ft)	Velocity (fps)	Tt (min)	
		RWT202	1574.40						46.6	327.87	3.05	1000.0									From Falcon DBPS by Matrix
		RWT204	38.40						11.4	6.52	6.60	43.0									From Falcon DBPS by Matrix
		WT200	192.00						37.8	53.07	3.58	190.0									From Falcon DBPS by Matrix
	21	OS-1	32.28	0.41	22.2	13.23	4.92	65.1	46.6	400.69	3.05	1222.1									Flows obtained from Bent Grass Filing No. 2 FDR, Q=65.1 CFS Cumulation of northern off-site flows entering Basin B-1
	1	OS-4	4.46	0.54	15.6	2.41	5.81	14.0					1.2	14.0				910	2.2	6.9	Flows from Basin B-1 of Bent Grass Filing No. 2 FDR into Basin EX-2
	2	OS-5	0.46	0.59	5.2	0.27	8.56	2.3					1	2.3				190	2.0	1.6	Flows from Basin B-2 of Bent Grass Filing No. 2 FDR into Basin EX-2
	3	OS-6	1.17	0.59	12.9	0.69	6.30	4.3					0.9	4.3				430	1.9	3.8	Flows from Basin B-3 of Bent Grass Filing No. 2 FDR into Basin EX-2
		EX-1	1.19	0.36	15.5	0.43	5.83	2.5													Flows to Basin EX-2
	5	EX-2	1.60	0.36	11.7	0.58	6.54	3.8													Flows to Basin EX-3
	7	E-3	0.78	0.89	7.4	0.69	7.70	5.3													
		C-6	0.94	0.43	5.4	0.40	8.49	3.4					1	3.4				216	2.0	1.8	
		C-7	0.52	0.70	6.7	0.36	7.95	2.9					1	2.9				216	2.0	1.8	
	45	E-2	0.68	0.85	6.9	0.58	7.89	4.6	16.7	1.28	5.64	7.2									
		E-1	1.71	0.69	11.8	1.18	6.51	7.7	18.5	2.26	5.38	12.2									Combination of C-6, C-7, E-2 Ex Basin from Filing No. 2(East side of BGMD)
	8	EX-3	0.66	0.36	10.7	0.24	6.76	1.6	18.5	4.13	5.38	22.2									Combination of C-6, C-7, E-1, E-2, E-3. Flows to Basin EX-3
	6	D-1g	0.78	0.51	12.8	0.40	6.32	2.5					1	2.5				57	2.0	0.5	Flows to Basin B-1
	15a	D-1h	1.57	0.57	11.7	0.89	6.53	5.8													
		D-1j	0.95	0.63	7.6	0.60	7.63	4.6	13.2	1.89	6.23	11.8	0.9	1.6	10.2			225	1.9	2.0	Flows to existing on-grade inlet at DP51
		D-1f	0.67	0.68	5.4	0.46	8.49	3.9													
		D-1k	0.80	0.60	9.9	0.48	6.95	3.3													
	52	C-1a	0.27	0.80	5.0	0.22	8.68	1.9	9.9	1.19	6.95	8.3									
	53								9.9	1.41	6.95	9.8	1.1	0.8	9.0			430	2.1	3.4	Flows to proposed on-grade inlet at DP53
	53								13.2	2.93	6.23	18.3			18.3						Total pipe flow at DP 53
		C-1b	1.77	0.63	7.2	1.12	7.76	8.7													
		C-2	1.00	0.68	8.2	0.68	7.42	5.0	8.2	1.80	7.42	13.4	1	13.4				130	1.6	1.4	
	54	C-1c	1.19	0.65	5.5	0.77	8.43	6.5	13.3	2.69	6.21	16.7		4.1	12.6	1.3	30	180	2.2	1.3	Flow into existing on-grade inlet at DP41
	41								13.3	4.96	6.21	30.8			30.8						Total pipe flow at DP41
	42	C-1f	0.14	0.83	5.0	0.12	8.68	1.0	14.7	0.78	5.96	4.6	1	4.6				185	2.0	1.5	Gutter flow to DP15
		C-3	0.18	0.86	6.4	0.15	8.06	1.2					1	1.2				660	2.0	5.5	Gutter flow through C-4 to DP44
	44	C-4	2.67	0.57	12.3	1.52	6.41	9.7	12.3	1.67	6.41	10.7	1	1.1	9.6	1.3	24	70	2.2	0.5	Flow into existing on-grade inlet at DP44
	43	C-1d	1.97	0.67	11.2	1.32	6.64	8.8													Flow into inlet at DP15
	15								16.2	2.27	5.71	13.0	2	2.1	10.9			85	2.8	0.5	Flow into inlet at DP15

STANDARD FORM SF-3: PROPOSED
STORM DRAINAGE SYSTEM DESIGN
(RATIONAL METHOD PROCEDURE)

Subdivision: Falcon Meadows
Location: CO, Colorado Springs
Design Storm: 100-Year

Project Name: Falcon Meadows at Bent Grass Filing No. 3
Project No.: CLH000020
Calculated By: CMV
Checked By: SMB
Date: 12/6/21

STREET	Design Point	DIRECT RUNOFF							TOTAL RUNOFF				STREET		PIPE			TRAVEL TIME			REMARKS	
		Basin ID	Area (Ac)	Runoff Coeff.	Tc (min)	C*A (Ac)	I (in/hr)	Q (cfs)	Tc (min)	C*A (Ac)	I (in/hr)	Q (cfs)	Slope (%)	Street Flow (cfs)	Design Flow (cfs)	Slope (%)	Pipe Size (inches)	Length (ft)	Velocity (fps)	Tt (min)		
	15																				Total pipe flow at DP15	
	12	C-1e	0.49	0.96	5.0	0.47	8.68	4.1	16.2	8.37	5.71	47.8	2	0.1	4.0			85	2.8	0.5	Flow into inlet at DP12 Total pipe flow at DP12	
	19	C-1g	1.02	0.59	8.5	0.60	7.33	4.4													Flow into Pond North	
	13	C-5	0.60	0.36	5.0	0.22	8.68	1.9	16.2	9.65	5.71	55.1									North Pond Total flow to Pond North. Outfalls to Basin B-1	
	AA	B-1	6.59	0.36	21.6	2.37	4.99	11.8	46.6	421.46	3.05	1285.4									Total flow under BGMD into Basin B-2	
		D-2b	0.74	0.64	10.9	0.47	6.71	3.2														
		D-2a	0.50	0.84	5.2	0.42	8.57	3.6														
	14a	D-2c	0.31	0.78	5.0	0.24	8.68	2.1	10.9	1.13	6.71	7.6	1.3	7.6				230	2.3	1.7	Gutter flow through D-2d to DP14b	
	14b	D-2d	0.24	0.76	5.0	0.18	8.68	1.6	12.6	1.31	6.35	8.3	1.3	8.3				625	2.3	4.6	Gutter flow through D-2d to DP14b	
	14	D-2g	1.81	0.62	15.4	1.12	5.84	6.5	17.2	2.43	5.57	13.5	2.5	5.3	8.2			625	3.2	3.3	Flow into existing inlet at DP14	
	9	OS-2	20.07	0.40	18.3	8.03	5.41	43.4													Overland flow into Basin D-3. Flow obtained from Bent Grass Filing No. 2 FDR	
	10	OS-3	10.61	0.40	18.9	4.24	5.33	22.6													Offsite flow into Basin D-3. Flow obtained from Bent Grass Filing No. 2 FDR	
	11	D-3	2.26	0.55	21.0	1.24	5.06	6.3	21.0	13.51	5.06	68.4			68.4	1.0	42	100	2.0	0.8	Flows conveyed via existing ditch into proposed area inlet.	
	14e	D-2f	2.43	0.69	8.7	1.68	7.27	12.2													Flows to existing inlet at DP14e	
	14d	D-2e	1.41	0.70	10.9	0.99	6.73	6.7	10.9	2.67	6.73	18.0			18.0	1.0	42	100	2.0	0.8	Flows to existing inlet at DP14d Flows conveyed storm sewer to DP16	
		D-1a	1.83	0.61	10.9	1.12	6.73	7.5														
	16a	D-1b	1.19	0.64	10.0	0.76	6.93	5.3	10.9	1.88	6.73	12.7	1.3	12.7				1300	2.3	9.5	Gutter flow through Basin D-1c to DP16	
	16	D-1c	3.95	0.60	21.1	2.37	5.05	12.0	21.1	4.25	5.05	21.5	2.5	11.3	10.2			625	3.2	3.3	Flows to existing inlet at DP16	
	16								21.9	19.67	4.96	97.6			97.6	2.0	48	835	2.8	4.9	Combination of flows to existing inlets at DP14 and DP16. Flows to DP 17	
		D-5	1.08	0.64	5.1	0.69	8.63	6.0					1	6.0				600	2.0	5.0	Gutter flow through Basin D-6b to DP18	
		D-6b	2.69	0.67	12.6	1.80	6.35	11.4														
	18	D-6a	1.33	0.71	6.5	0.94	8.03	7.5	12.6	3.43	6.35	21.8			21.8	2.0	24	38	2.8	0.2	Flow to existing inlet. Flow out of inlet to DP17c	
	17a	D-4a	0.98	0.67	11.1	0.66	6.66	4.4					1	4.4				700	2.0	5.8	Gutter flow through Basin D-4b to DP17b	
	17b	D-4b	0.95	0.76	10.2	0.72	6.87	4.9	17.0	1.38	5.60	7.7									Gutter flow to DP17c	
	17c	D-4c	1.22	0.68	14.2	0.83	6.04	5.0	17.0	2.21	5.60	12.4			12.4	2.0	24	8	2.8	0.0	Flows from Basin B-3 of Bent Grass Filing No. 2 FDR. Flows to existing inlet at DP17c	
	17c								17.0	5.64	5.60	31.6										Total pipe flow at DP17c to DP17
	17								26.8	25.31	4.45	112.6										Storm system entering existing pond at Basin D-7
		D-9	0.72	0.44	5.5	0.32	8.44	2.7					1.5	2.7				625	2.4	4.3	Gutter flow through Basin E-4 to DP24	
		D-2h	0.23	0.59	15.5	0.14	5.83	0.8					1.5	0.8				550	2.4	3.7	Gutter flow through Basin E-4 to DP24	
	24	E-4	0.91	0.84	8.0	0.76	7.50	5.7	24.4	4.41	4.68	20.6										Flow to existing inlet at DP24

STANDARD FORM SF-3: PROPOSED
STORM DRAINAGE SYSTEM DESIGN
(RATIONAL METHOD PROCEDURE)

Subdivision: Falcon Meadows
Location: CO, Colorado Springs
Design Storm: 100-Year

Project Name: Falcon Meadows at Bent Grass Filing No. 3
Project No.: CLH000020
Calculated By: CMV
Checked By: SMB
Date: 12/6/21

STREET	Design Point	DIRECT RUNOFF							TOTAL RUNOFF				STREET		PIPE			TRAVEL TIME			REMARKS
		Basin ID	Area (Ac)	Runoff Coeff.	Tc (min)	C*A (Ac)	I (in/hr)	Q (cfs)	Tc (min)	C*A (Ac)	I (in/hr)	Q (cfs)	Slope (%)	Street Flow (cfs)	Design Flow (cfs)	Slope (%)	Pipe Size (inches)	Length (ft)	Velocity (fps)	Tt (min)	
	25	E-5	0.89	0.89	7.3	0.79	7.73	6.1													Flow to existing inlet at DP25
	26								24.4	5.20	4.68	24.3									Flow into existing pond via Swale F at DP26
	32	D-8	1.69	0.58	14.0	0.98	6.08	6.0													Flow in Swale C (Basin D-8) into existing pond
	30	D-7	7.65	0.40	14.8	3.06	5.94	18.2													Existing Water quality pond
	CC	B-2	4.16	0.36	16.0	1.50	5.75	8.6	26.8	34.55	4.45	153.7									Outlet to existing channel Basin B-2
									46.6	457.51	3.05	1395.4									

Approved Construction Drawings
(Falcon Meadows at Bent Grass Drainage Channel)

APPENDIX C
Hydrologic Computations

APPENDIX D
Hydraulic Computations

Channel Report

Swale A (Basin C-6)

Triangular

Side Slopes (z:1) = 3.00, 3.00
Total Depth (ft) = 1.50

Invert Elev (ft) = 1.00
Slope (%) = 2.00
N-Value = 0.020

Calculations

Compute by: Known Q
Known Q (cfs) = 4.00

Highlighted

Depth (ft) = 0.56
Q (cfs) = 4.000
Area (sqft) = 0.94
Velocity (ft/s) = 4.25
Wetted Perim (ft) = 3.54
Crit Depth, Y_c (ft) = 0.65
Top Width (ft) = 3.36
EGL (ft) = 0.84

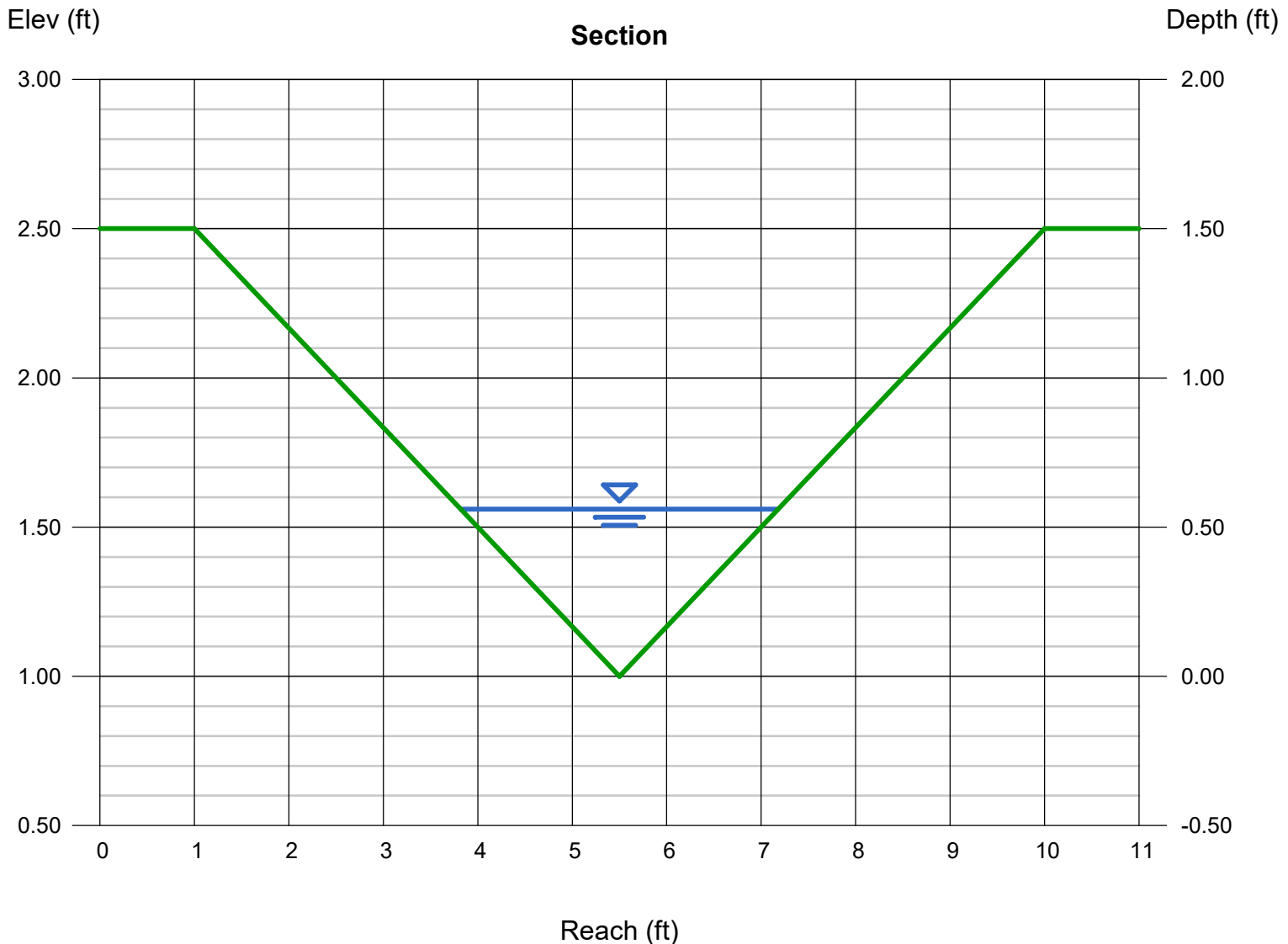

Channel Report

Swale C (Basin D-8)

Trapezoidal

Bottom Width (ft)	= 1.00
Side Slopes (z:1)	= 3.00, 3.00
Total Depth (ft)	= 1.25
Invert Elev (ft)	= 1.00
Slope (%)	= 2.00
N-Value	= 0.020

Highlighted

Depth (ft)	= 0.32
Q (cfs)	= 2.300
Area (sqft)	= 0.63
Velocity (ft/s)	= 3.67
Wetted Perim (ft)	= 3.02
Crit Depth, Yc (ft)	= 0.39
Top Width (ft)	= 2.92
EGL (ft)	= 0.53

Calculations

Compute by:	Known Q
Known Q (cfs)	= 2.30

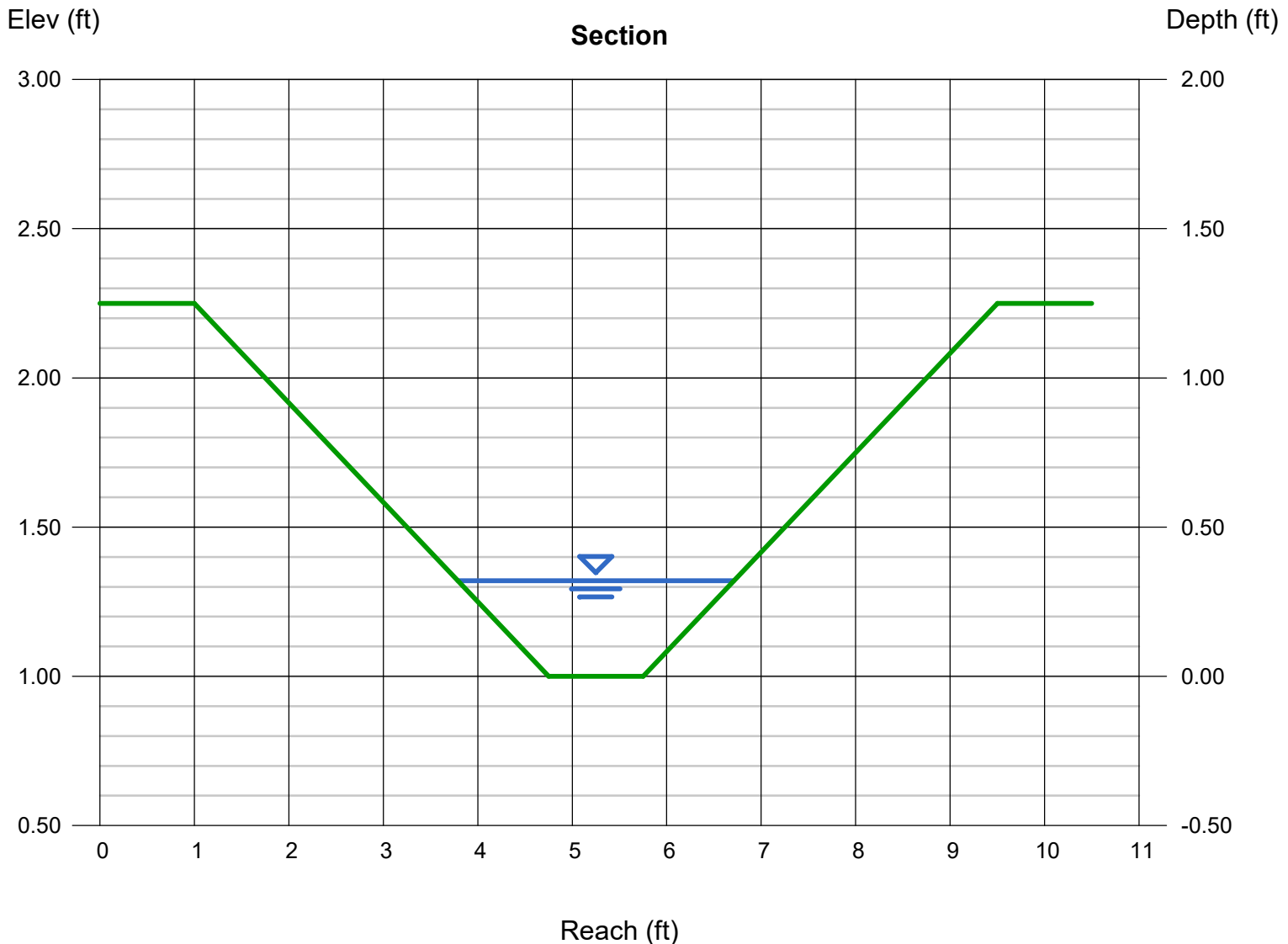

Inlets – Proposed Design

INLET MANAGEMENT

Worksheet Protected

INLET NAME	Basin A-1 (DP 4)	Basin A-3 (DP 5)	Ex Inlet BGM Drive(DP 8)
Site Type (Urban or Rural)	URBAN	URBAN	URBAN
Inlet Application (Street or Area)	STREET	STREET	STREET
Hydraulic Condition	On Grade	On Grade	In Sump
Inlet Type	CDOT Type R Curb Opening	CDOT Type R Curb Opening	CDOT Type R Curb Opening

USER-DEFINED INPUT

User-Defined Design Flows			
Minor Q_{Known} (cfs)	10.5	2.2	0.9
Major Q_{Known} (cfs)	24.2	4.4	9.1
Bypass (Carry-Over) Flow from Upstream			
Receive Bypass Flow from:	No Bypass Flow Received	No Bypass Flow Received	User-Defined
Minor Bypass Flow Received, Q_b (cfs)	0.0	0.0	0.9
Major Bypass Flow Received, Q_b (cfs)	0.0	0.0	9.1
Watershed Characteristics			
Subcatchment Area (acres)			
Percent Impervious			
NRCS Soil Type			
Watershed Profile			
Overland Slope (ft/ft)			
Overland Length (ft)			
Channel Slope (ft/ft)			
Channel Length (ft)			
Minor Storm Rainfall Input			
Design Storm Return Period, T_r (years)			
One-Hour Precipitation, P_1 (inches)			
Major Storm Rainfall Input			
Design Storm Return Period, T_r (years)			
One-Hour Precipitation, P_1 (inches)			

CALCULATED OUTPUT

Minor Total Design Peak Flow, Q (cfs)	10.5	2.2	1.8
Major Total Design Peak Flow, Q (cfs)	24.2	4.4	18.2
Minor Flow Bypassed Downstream, Q_b (cfs)	0.9	0.0	N/A
Major Flow Bypassed Downstream, Q_b (cfs)	8.9	0.1	N/A

INLET MANAGEMENT

Worksheet Protected

INLET NAME	Ex Inlet BasinC-1e(DP12)	ExInletBasinD-4c(DP 17)	Basin A-1A (DP 2)
Site Type (Urban or Rural)	URBAN	URBAN	URBAN
Inlet Application (Street or Area)	STREET	STREET	STREET
Hydraulic Condition	On Grade	In Sump	On Grade
Inlet Type	CDOT Type R Curb Opening	CDOT Type R Curb Opening	CDOT Type R Curb Opening

USER-DEFINED INPUT

User-Defined Design Flows			
Minor Q_{known} (cfs)	4.1	5.4	7.8
Major Q_{known} (cfs)	7.8	11.2	16.2
Bypass (Carry-Over) Flow from Upstream			
Receive Bypass Flow from:	No Bypass Flow Received	No Bypass Flow Received	No Bypass Flow Received
Minor Bypass Flow Received, Q_b (cfs)	0.0	0.0	
Major Bypass Flow Received, Q_b (cfs)	0.0	0.0	
Watershed Characteristics			
Subcatchment Area (acres)			
Percent Impervious			
NRCS Soil Type			
Watershed Profile			
Overland Slope (ft/ft)			
Overland Length (ft)			
Channel Slope (ft/ft)			
Channel Length (ft)			
Minor Storm Rainfall Input			
Design Storm Return Period, T_r (years)			
One-Hour Precipitation, P_1 (inches)			
Major Storm Rainfall Input			
Design Storm Return Period, T_r (years)			
One-Hour Precipitation, P_1 (inches)			

CALCULATED OUTPUT

Minor Total Design Peak Flow, Q (cfs)	4.1	5.4	7.8
Major Total Design Peak Flow, Q (cfs)	7.8	11.2	16.2
Minor Flow Bypassed Downstream, Q_b (cfs)	0.0	N/A	4.4
Major Flow Bypassed Downstream, Q_b (cfs)	0.1	N/A	11.6

ALLOWABLE CAPACITY FOR ONE-HALF OF STREET (Minor & Major Storm)

(Based on Regulated Criteria for Maximum Allowable Flow Depth and Spread)

Project: Falcon Meadows at Bent Grass Filing No. 4
 Inlet ID: Basin A-1 (DP 4)

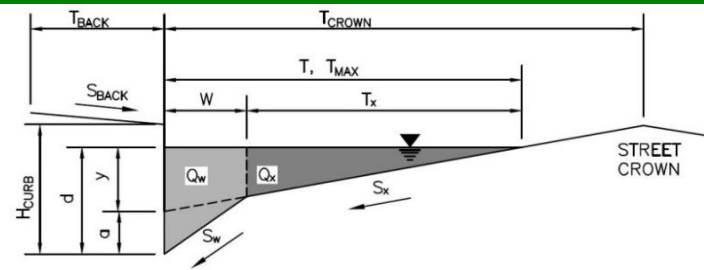

Gutter Geometry:					
Maximum Allowable Width for Spread Behind Curb	$T_{BACK} = 8.0$ ft				
Side Slope Behind Curb (leave blank for no conveyance credit behind curb)	$S_{BACK} = 0.020$ ft/ft				
Manning's Roughness Behind Curb (typically between 0.012 and 0.020)	$n_{BACK} = 0.013$				
Height of Curb at Gutter Flow Line	$H_{CURB} = 6.00$ inches				
Distance from Curb Face to Street Crown	$T_{CROWN} = 17.0$ ft				
Gutter Width	$W = 2.00$ ft				
Street Transverse Slope	$S_x = 0.020$ ft/ft				
Gutter Cross Slope (typically 2 inches over 24 inches or 0.083 ft/ft)	$S_w = 0.083$ ft/ft				
Street Longitudinal Slope - Enter 0 for sump condition	$S_o = 0.025$ ft/ft				
Manning's Roughness for Street Section (typically between 0.012 and 0.020)	$n_{STREET} = 0.016$				
Max. Allowable Spread for Minor & Major Storm	$T_{MAX} =$ <table border="1"><tr><td>Minor Storm</td><td>Major Storm</td></tr><tr><td>17.0</td><td>17.0</td></tr></table> ft	Minor Storm	Major Storm	17.0	17.0
Minor Storm	Major Storm				
17.0	17.0				
Max. Allowable Depth at Gutter Flowline for Minor & Major Storm	$d_{MAX} =$ <table border="1"><tr><td>Minor Storm</td><td>Major Storm</td></tr><tr><td>6.0</td><td>8.0</td></tr></table> inches	Minor Storm	Major Storm	6.0	8.0
Minor Storm	Major Storm				
6.0	8.0				
Allow Flow Depth at Street Crown (check box for yes, leave blank for no)	<input type="checkbox"/> <input checked="" type="checkbox"/>				
MINOR STORM Allowable Capacity is based on Spread Criterion					
MAJOR STORM Allowable Capacity is based on Depth Criterion					
Minor storm max. allowable capacity GOOD - greater than the design flow given on sheet 'Inlet Management'					
Major storm max. allowable capacity GOOD - greater than the design flow given on sheet 'Inlet Management'					
$Q_{allow} =$	<table border="1"><tr><td>Minor Storm</td><td>Major Storm</td></tr><tr><td>17.2</td><td>38.3</td></tr></table> cfs	Minor Storm	Major Storm	17.2	38.3
Minor Storm	Major Storm				
17.2	38.3				

INLET ON A CONTINUOUS GRADE

MHFD-Inlet, Version 5.01 (April 2021)

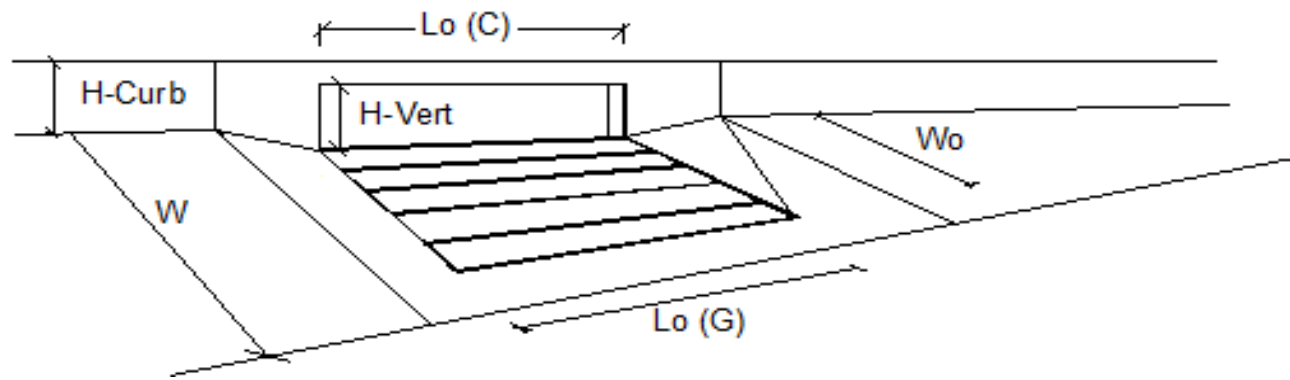

Design Information (Input)	MINOR	MAJOR	
Type of Inlet	CDOT Type R Curb Opening		
Local Depression (additional to continuous gutter depression 'a')	3.0	3.0	inches
Total Number of Units in the Inlet (Grate or Curb Opening)	1	1	
Length of a Single Unit Inlet (Grate or Curb Opening)	15.00	15.00	ft
Width of a Unit Grate (cannot be greater than W, Gutter Width)	N/A	N/A	ft
Clogging Factor for a Single Unit Grate (typical min. value = 0.5)	N/A	N/A	
Clogging Factor for a Single Unit Curb Opening (typical min. value = 0.1)	0.10	0.10	
Street Hydraulics: OK - Q < Allowable Street Capacity'			
Total Inlet Interception Capacity	Q = 9.6	15.3	cfs
Total Inlet Carry-Over Flow (flow bypassing inlet)	Q_b = 0.9	8.9	cfs
Capture Percentage = $Q_a/Q_o =$	C% = 91	63	%

Inlets – Existing Analysis

ALLOWABLE CAPACITY FOR ONE-HALF OF STREET (Minor & Major Storm)

(Based on Regulated Criteria for Maximum Allowable Flow Depth and Spread)

Project: Falcon Meadows at Bent Grass Filing No. 4
 Inlet ID: Basin A-1A (DP 2)

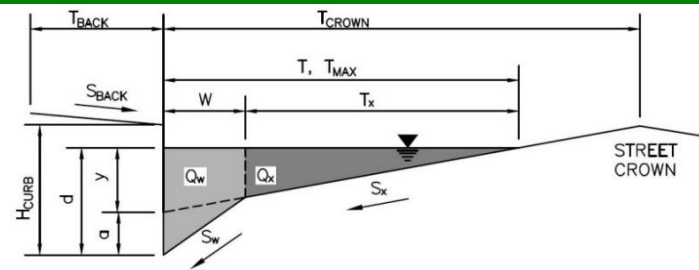

Gutter Geometry:					
Maximum Allowable Width for Spread Behind Curb	$T_{BACK} = 8.0$ ft				
Side Slope Behind Curb (leave blank for no conveyance credit behind curb)	$S_{BACK} = 0.020$ ft/ft				
Manning's Roughness Behind Curb (typically between 0.012 and 0.020)	$n_{BACK} = 0.013$				
Height of Curb at Gutter Flow Line	$H_{CURB} = 6.00$ inches				
Distance from Curb Face to Street Crown	$T_{CROWN} = 17.0$ ft				
Gutter Width	$W = 2.00$ ft				
Street Transverse Slope	$S_x = 0.020$ ft/ft				
Gutter Cross Slope (typically 2 inches over 24 inches or 0.083 ft/ft)	$S_w = 0.083$ ft/ft				
Street Longitudinal Slope - Enter 0 for sump condition	$S_o = 0.009$ ft/ft				
Manning's Roughness for Street Section (typically between 0.012 and 0.020)	$n_{STREET} = 0.016$				
Max. Allowable Spread for Minor & Major Storm	$T_{MAX} =$ <table border="1"><tr><th>Minor Storm</th><th>Major Storm</th></tr><tr><td>17.0</td><td>17.0</td></tr></table> ft	Minor Storm	Major Storm	17.0	17.0
Minor Storm	Major Storm				
17.0	17.0				
Max. Allowable Depth at Gutter Flowline for Minor & Major Storm	$d_{MAX} =$ <table border="1"><tr><th>Minor Storm</th><th>Major Storm</th></tr><tr><td>6.0</td><td>8.0</td></tr></table> inches	Minor Storm	Major Storm	6.0	8.0
Minor Storm	Major Storm				
6.0	8.0				
Allow Flow Depth at Street Crown (check box for yes, leave blank for no)	<input type="checkbox"/> <input type="checkbox"/>				
MINOR STORM Allowable Capacity is based on Spread Criterion					
MAJOR STORM Allowable Capacity is based on Spread Criterion					
Minor storm max. allowable capacity GOOD - greater than the design flow given on sheet 'Inlet Management'					
WARNING: MAJOR STORM max. allowable capacity is less than the design flow given on sheet 'Inlet Management'					
$Q_{allow} =$	<table border="1"><tr><th>Minor Storm</th><th>Major Storm</th></tr><tr><td>10.1</td><td>10.1</td></tr></table> cfs	Minor Storm	Major Storm	10.1	10.1
Minor Storm	Major Storm				
10.1	10.1				

INLET ON A CONTINUOUS GRADE

MHFD-Inlet, Version 5.01 (April 2021)

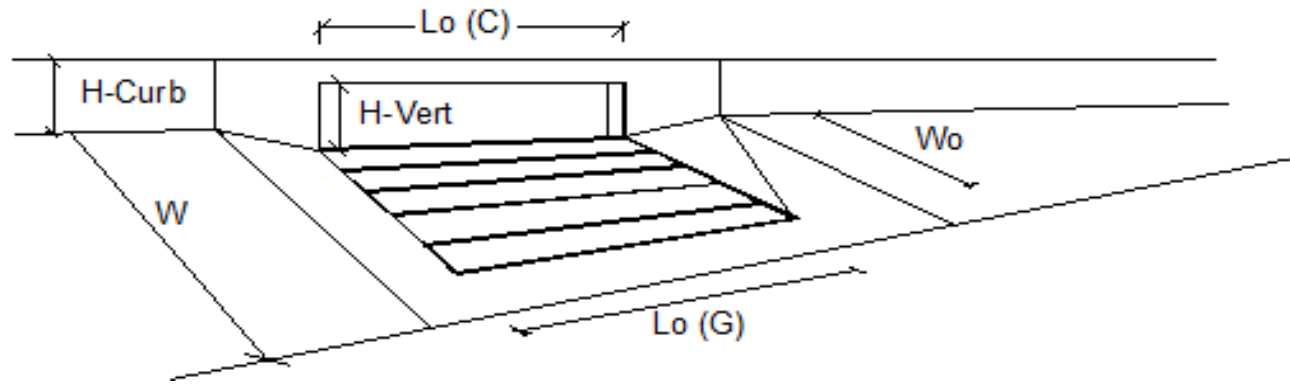

Design Information (Input)	MINOR	MAJOR	
Type of Inlet	CDOT Type R Curb Opening		
Local Depression (additional to continuous gutter depression 'a')	3.0	3.0	inches
Total Number of Units in the Inlet (Grate or Curb Opening)	1	1	
Length of a Single Unit Inlet (Grate or Curb Opening)	5.00	5.00	ft
Width of a Unit Grate (cannot be greater than W, Gutter Width)	N/A	N/A	ft
Clogging Factor for a Single Unit Grate (typical min. value = 0.5)	N/A	N/A	
Clogging Factor for a Single Unit Curb Opening (typical min. value = 0.1)	0.10	0.10	
Street Hydraulics: WARNING: Q > ALLOWABLE Q FOR MAJOR STORM			
Total Inlet Interception Capacity	3.4	4.6	cfs
Total Inlet Carry-Over Flow (flow bypassing inlet)	4.4	11.6	cfs
Capture Percentage = $Q_a/Q_o =$	44	29	%

ALLOWABLE CAPACITY FOR ONE-HALF OF STREET (Minor & Major Storm)

(Based on Regulated Criteria for Maximum Allowable Flow Depth and Spread)

Project: Falcon Meadows at Bent Grass Filing No. 4

Inlet ID: Basin A-3 (DP 5)

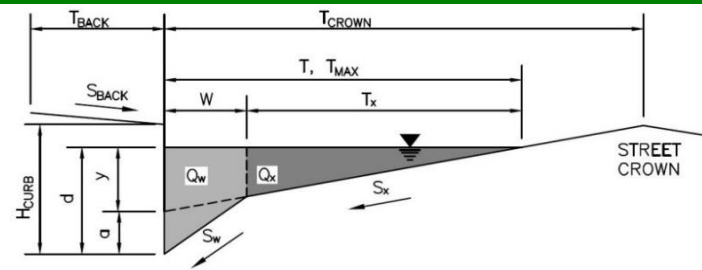

Gutter Geometry:

Maximum Allowable Width for Spread Behind Curb
 Side Slope Behind Curb (leave blank for no conveyance credit behind curb)
 Manning's Roughness Behind Curb (typically between 0.012 and 0.020)

$T_{BACK} = 8.0$ ft
 $S_{BACK} = 0.020$ ft/ft
 $n_{BACK} = 0.013$

Height of Curb at Gutter Flow Line
 Distance from Curb Face to Street Crown
 Gutter Width
 Street Transverse Slope
 Gutter Cross Slope (typically 2 inches over 24 inches or 0.083 ft/ft)
 Street Longitudinal Slope - Enter 0 for sump condition
 Manning's Roughness for Street Section (typically between 0.012 and 0.020)

$H_{CURB} = 6.00$ inches
 $T_{CROWN} = 17.0$ ft
 $W = 2.00$ ft
 $S_X = 0.020$ ft/ft
 $S_W = 0.083$ ft/ft
 $S_O = 0.025$ ft/ft
 $n_{STREET} = 0.016$

Max. Allowable Spread for Minor & Major Storm
 Max. Allowable Depth at Gutter Flowline for Minor & Major Storm
 Allow Flow Depth at Street Crown (check box for yes, leave blank for no)

	Minor Storm	Major Storm	
$T_{MAX} =$	17.0	17.0	ft
$d_{MAX} =$	6.0	8.0	inches
	<input type="checkbox"/>	<input checked="" type="checkbox"/>	

MINOR STORM Allowable Capacity is based on Spread Criterion
 MAJOR STORM Allowable Capacity is based on Depth Criterion

	Minor Storm	Major Storm	
$Q_{allow} =$	17.2	38.3	cfs

Minor storm max. allowable capacity GOOD - greater than the design flow given on sheet 'Inlet Management'
Major storm max. allowable capacity GOOD - greater than the design flow given on sheet 'Inlet Management'

INLET ON A CONTINUOUS GRADE

MHFD-Inlet, Version 5.01 (April 2021)

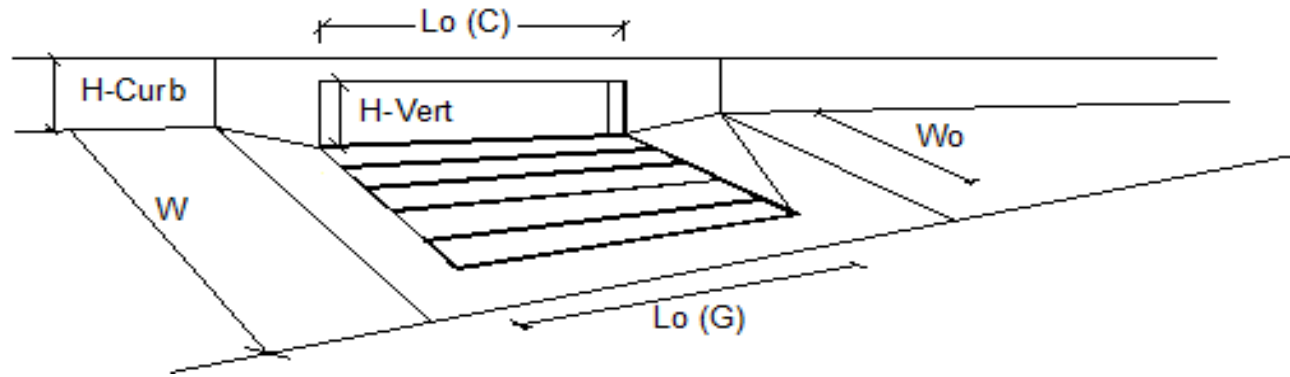

Design Information (Input)	MINOR	MAJOR	
Type of Inlet	CDOT Type R Curb Opening		
Local Depression (additional to continuous gutter depression 'a')	3.0	3.0	inches
Total Number of Units in the Inlet (Grate or Curb Opening)	1	1	
Length of a Single Unit Inlet (Grate or Curb Opening)	10.00	10.00	ft
Width of a Unit Grate (cannot be greater than W, Gutter Width)	N/A	N/A	ft
Clogging Factor for a Single Unit Grate (typical min. value = 0.5)	N/A	N/A	
Clogging Factor for a Single Unit Curb Opening (typical min. value = 0.1)	0.10	0.10	
Street Hydraulics: OK - Q < Allowable Street Capacity'			
Total Inlet Interception Capacity	2.2	4.3	cfs
Total Inlet Carry-Over Flow (flow bypassing inlet)	0.0	0.1	cfs
Capture Percentage = $Q_a/Q_o =$	100	97	%

ALLOWABLE CAPACITY FOR ONE-HALF OF STREET (Minor & Major Storm)

(Based on Regulated Criteria for Maximum Allowable Flow Depth and Spread)

Project: Falcon Meadows at Bent Grass Filing No. 4

Inlet ID: Ex Inlet BGM Drive(DP 8)

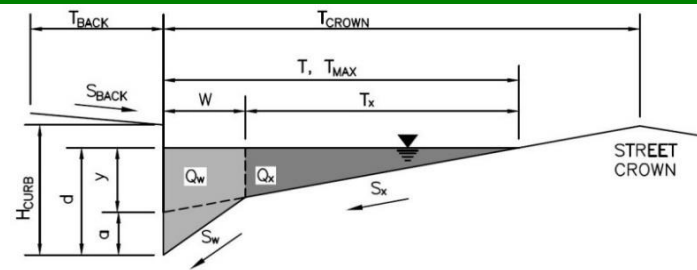

Gutter Geometry:

Maximum Allowable Width for Spread Behind Curb
 Side Slope Behind Curb (leave blank for no conveyance credit behind curb)
 Manning's Roughness Behind Curb (typically between 0.012 and 0.020)

$T_{BACK} = 14.0$ ft
 $S_{BACK} = 0.020$ ft/ft
 $n_{BACK} = 0.013$

Height of Curb at Gutter Flow Line
 Distance from Curb Face to Street Crown
 Gutter Width
 Street Transverse Slope
 Gutter Cross Slope (typically 2 inches over 24 inches or 0.083 ft/ft)
 Street Longitudinal Slope - Enter 0 for sump condition
 Manning's Roughness for Street Section (typically between 0.012 and 0.020)

$H_{CURB} = 6.00$ inches
 $T_{CROWN} = 26.0$ ft
 $W = 2.00$ ft
 $S_X = 0.020$ ft/ft
 $S_W = 0.083$ ft/ft
 $S_O = 0.000$ ft/ft
 $n_{STREET} = 0.016$

Max. Allowable Spread for Minor & Major Storm
 Max. Allowable Depth at Gutter Flowline for Minor & Major Storm
 Check boxes are not applicable in SUMP conditions

	Minor Storm	Major Storm	
$T_{MAX} =$	26.0	26.0	ft
$d_{MAX} =$	6.0	12.0	inches
	<input type="checkbox"/>	<input type="checkbox"/>	

MINOR STORM Allowable Capacity is based on Depth Criterion
 MAJOR STORM Allowable Capacity is based on Depth Criterion

$Q_{allow} =$

Minor Storm	Major Storm
SUMP	SUMP

 cfs

INLET IN A SUMP OR SAG LOCATION

MHFD-Inlet, Version 5.01 (April 2021)

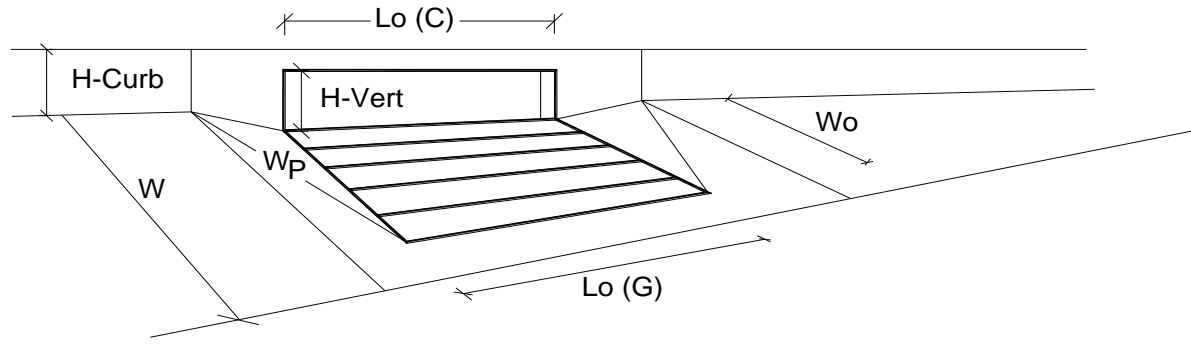

Design Information (Input)	MINOR	MAJOR	
Type of Inlet	CDOT Type R Curb Opening		
Local Depression (additional to continuous gutter depression 'a' from above)	3.00	3.00	inches
Number of Unit Inlets (Grate or Curb Opening)	2	2	
Water Depth at Flowline (outside of local depression)	6.0	12.0	inches
Grate Information			
Length of a Unit Grate	N/A	N/A	feet
Width of a Unit Grate	N/A	N/A	feet
Area Opening Ratio for a Grate (typical values 0.15-0.90)	N/A	N/A	
Clogging Factor for a Single Grate (typical value 0.50 - 0.70)	N/A	N/A	
Grate Weir Coefficient (typical value 2.15 - 3.60)	N/A	N/A	
Grate Orifice Coefficient (typical value 0.60 - 0.80)	N/A	N/A	
Curb Opening Information			
Length of a Unit Curb Opening	10.00	10.00	feet
Height of Vertical Curb Opening in Inches	6.00	6.00	inches
Height of Curb Orifice Throat in Inches	6.00	6.00	inches
Angle of Throat (see USDCM Figure ST-5)	63.40	63.40	degrees
Side Width for Depression Pan (typically the gutter width of 2 feet)	2.00	2.00	feet
Clogging Factor for a Single Curb Opening (typical value 0.10)	0.10	0.10	
Curb Opening Weir Coefficient (typical value 2.3-3.7)	3.60	3.60	
Curb Opening Orifice Coefficient (typical value 0.60 - 0.70)	0.67	0.67	
Low Head Performance Reduction (Calculated)			
Depth for Grate Midwidth	N/A	N/A	ft
Depth for Curb Opening Weir Equation	0.33	0.83	ft
Combination Inlet Performance Reduction Factor for Long Inlets	0.57	1.00	
Curb Opening Performance Reduction Factor for Long Inlets	0.79	1.00	
Grated Inlet Performance Reduction Factor for Long Inlets	N/A	N/A	
Total Inlet Interception Capacity (assumes clogged condition)			
Q_a	14.4	52.7	cfs
Q_{PEAK REQUIRED}	1.8	18.2	cfs

Inlet Capacity IS GOOD for Minor and Major Storms(>Q PEAK)

ALLOWABLE CAPACITY FOR ONE-HALF OF STREET (Minor & Major Storm)

(Based on Regulated Criteria for Maximum Allowable Flow Depth and Spread)

Project: Falcon Meadows at Bent Grass Filing No. 4

Inlet ID: Ex Inlet BasinC-1e(DP12)

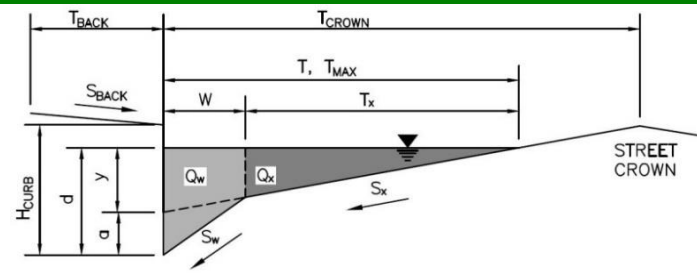

Gutter Geometry:

Maximum Allowable Width for Spread Behind Curb
 Side Slope Behind Curb (leave blank for no conveyance credit behind curb)
 Manning's Roughness Behind Curb (typically between 0.012 and 0.020)

$T_{BACK} = 8.0$ ft
 $S_{BACK} = 0.020$ ft/ft
 $n_{BACK} = 0.013$

Height of Curb at Gutter Flow Line
 Distance from Curb Face to Street Crown
 Gutter Width
 Street Transverse Slope
 Gutter Cross Slope (typically 2 inches over 24 inches or 0.083 ft/ft)
 Street Longitudinal Slope - Enter 0 for sump condition
 Manning's Roughness for Street Section (typically between 0.012 and 0.020)

$H_{CURB} = 6.00$ inches
 $T_{CROWN} = 17.0$ ft
 $W = 2.00$ ft
 $S_X = 0.020$ ft/ft
 $S_W = 0.083$ ft/ft
 $S_O = 0.030$ ft/ft
 $n_{STREET} = 0.016$

Max. Allowable Spread for Minor & Major Storm
 Max. Allowable Depth at Gutter Flowline for Minor & Major Storm
 Allow Flow Depth at Street Crown (check box for yes, leave blank for no)

	Minor Storm	Major Storm	
$T_{MAX} =$	17.0	17.0	ft
$d_{MAX} =$	6.0	12.0	inches
	<input type="checkbox"/>	<input type="checkbox"/>	

MINOR STORM Allowable Capacity is based on Depth Criterion
 MAJOR STORM Allowable Capacity is based on Spread Criterion

	Minor Storm	Major Storm	
$Q_{allow} =$	17.7	18.8	cfs

Minor storm max. allowable capacity GOOD - greater than the design flow given on sheet 'Inlet Management'
Major storm max. allowable capacity GOOD - greater than the design flow given on sheet 'Inlet Management'

INLET ON A CONTINUOUS GRADE

MHFD-Inlet, Version 5.01 (April 2021)

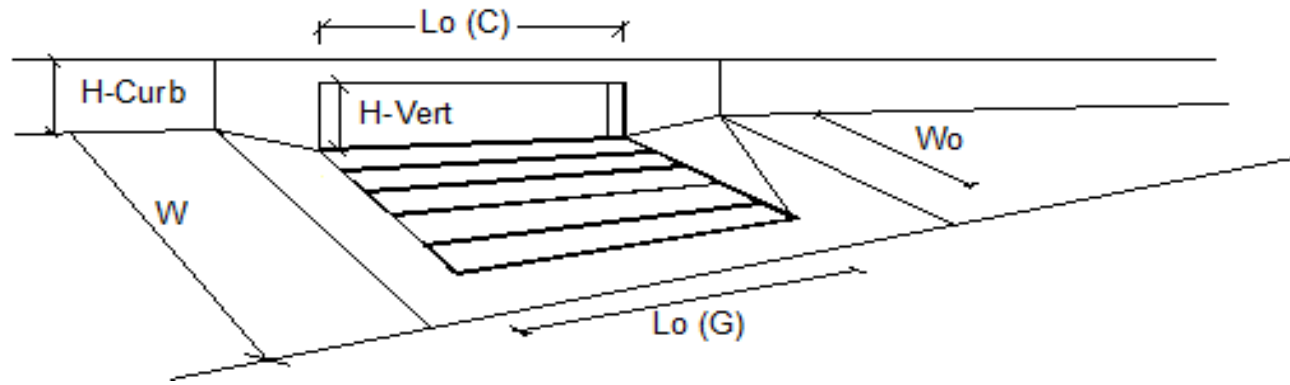

Design Information (Input)	MINOR	MAJOR	
Type of Inlet	CDOT Type R Curb Opening		
Local Depression (additional to continuous gutter depression 'a')	3.0	3.0	inches
Total Number of Units in the Inlet (Grate or Curb Opening)	1	1	
Length of a Single Unit Inlet (Grate or Curb Opening)	15.00	15.00	ft
Width of a Unit Grate (cannot be greater than W, Gutter Width)	N/A	N/A	ft
Clogging Factor for a Single Unit Grate (typical min. value = 0.5)	N/A	N/A	
Clogging Factor for a Single Unit Curb Opening (typical min. value = 0.1)	0.10	0.10	
Street Hydraulics: OK - Q < Allowable Street Capacity'			
Total Inlet Interception Capacity	4.1	7.7	cfs
Total Inlet Carry-Over Flow (flow bypassing inlet)	0.0	0.1	cfs
Capture Percentage = $Q_a/Q_o =$	100	98	%

ALLOWABLE CAPACITY FOR ONE-HALF OF STREET (Minor & Major Storm)

(Based on Regulated Criteria for Maximum Allowable Flow Depth and Spread)

Project: Falcon Meadows at Bent Grass Filing No. 4
 Inlet ID: ExInletBasinD-4c(DP 17)

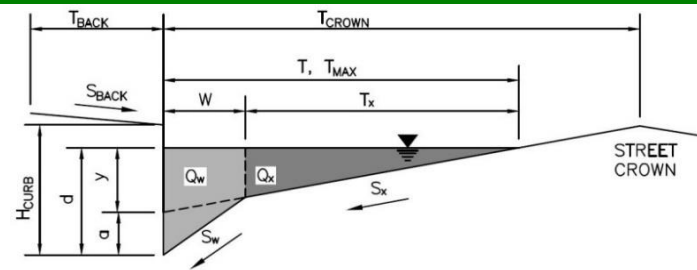

Gutter Geometry:	
Maximum Allowable Width for Spread Behind Curb	$T_{BACK} = 8.0$ ft
Side Slope Behind Curb (leave blank for no conveyance credit behind curb)	$S_{BACK} = 0.020$ ft/ft
Manning's Roughness Behind Curb (typically between 0.012 and 0.020)	$n_{BACK} = 0.013$
Height of Curb at Gutter Flow Line	$H_{CURB} = 6.00$ inches
Distance from Curb Face to Street Crown	$T_{CROWN} = 17.0$ ft
Gutter Width	$W = 2.00$ ft
Street Transverse Slope	$S_x = 0.020$ ft/ft
Gutter Cross Slope (typically 2 inches over 24 inches or 0.083 ft/ft)	$S_w = 0.083$ ft/ft
Street Longitudinal Slope - Enter 0 for sump condition	$S_o = 0.000$ ft/ft
Manning's Roughness for Street Section (typically between 0.012 and 0.020)	$n_{STREET} = 0.016$
Max. Allowable Spread for Minor & Major Storm	$T_{MAX} = \begin{matrix} \text{Minor Storm} & \text{Major Storm} \\ 17.0 & 17.0 \end{matrix}$ ft
Max. Allowable Depth at Gutter Flowline for Minor & Major Storm	$d_{MAX} = \begin{matrix} \text{Minor Storm} & \text{Major Storm} \\ 6.0 & 12.0 \end{matrix}$ inches
Check boxes are not applicable in SUMP conditions	<input type="checkbox"/> <input type="checkbox"/>
MINOR STORM Allowable Capacity is based on Depth Criterion	
MAJOR STORM Allowable Capacity is based on Depth Criterion	
$Q_{allow} =$	$\begin{matrix} \text{Minor Storm} & \text{Major Storm} \\ \text{SUMP} & \text{SUMP} \end{matrix}$ cfs

INLET IN A SUMP OR SAG LOCATION

MHFD-Inlet, Version 5.01 (April 2021)

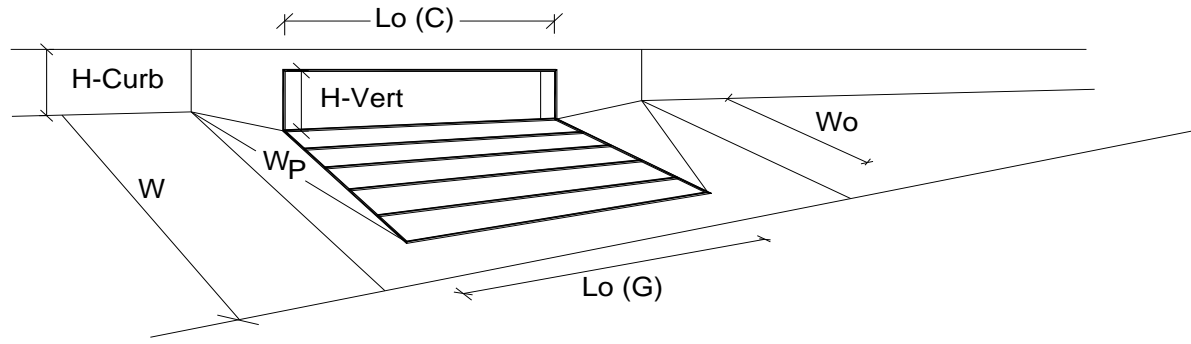

		MINOR	MAJOR	
Design Information (Input)				
Type of Inlet	<input type="text" value="CDOT Type R Curb Opening"/>			
Local Depression (additional to continuous gutter depression 'a' from above)				
Number of Unit Inlets (Grate or Curb Opening)				
Water Depth at Flowline (outside of local depression)				
Grate Information				
Length of a Unit Grate				
Width of a Unit Grate				
Area Opening Ratio for a Grate (typical values 0.15-0.90)				
Clogging Factor for a Single Grate (typical value 0.50 - 0.70)				
Grate Weir Coefficient (typical value 2.15 - 3.60)				
Grate Orifice Coefficient (typical value 0.60 - 0.80)				
Curb Opening Information				
Length of a Unit Curb Opening				
Height of Vertical Curb Opening in Inches				
Height of Curb Orifice Throat in Inches				
Angle of Throat (see USDCM Figure ST-5)				
Side Width for Depression Pan (typically the gutter width of 2 feet)				
Clogging Factor for a Single Curb Opening (typical value 0.10)				
Curb Opening Weir Coefficient (typical value 2.3-3.7)				
Curb Opening Orifice Coefficient (typical value 0.60 - 0.70)				
Low Head Performance Reduction (Calculated)				
Depth for Grate Midwidth				
Depth for Curb Opening Weir Equation				
Combination Inlet Performance Reduction Factor for Long Inlets				
Curb Opening Performance Reduction Factor for Long Inlets				
Grated Inlet Performance Reduction Factor for Long Inlets				
Total Inlet Interception Capacity (assumes clogged condition)				
Inlet Capacity IS GOOD for Minor and Major Storms(>Q PEAK)				
Type =		CDOT Type R Curb Opening		
a _{local} =	3.00	3.00	inches	
No =	1	1		
Ponding Depth =	5.6	12.0	inches	
			<input checked="" type="checkbox"/> Override Depths	
L _o (G) =	N/A	N/A	feet	
W _o =	N/A	N/A	feet	
A _{ratio} =	N/A	N/A		
C _f (G) =	N/A	N/A		
C _w (G) =	N/A	N/A		
C _o (G) =	N/A	N/A		
L _o (C) =	15.00	15.00	feet	
H _{vert} =	6.00	6.00	inches	
H _{throat} =	6.00	6.00	inches	
Theta =	63.40	63.40	degrees	
W _p =	2.00	2.00	feet	
C _f (C) =	0.10	0.10		
C _w (C) =	3.60	3.60		
C _o (C) =	0.67	0.67		
d _{Grate} =	N/A	N/A	ft	
d _{Curb} =	0.30	0.83	ft	
RF _{Combination} =	0.53	1.00		
RF _{Curb} =	0.76	1.00		
RF _{Grate} =	N/A	N/A		
Q _a =	8.0	39.1	cfs	
Q _{PEAK REQUIRED} =	5.4	11.2	cfs	

StormCAD

Falcon Meadows at Bent Grass Filing No. 4

StormCAD Schematic

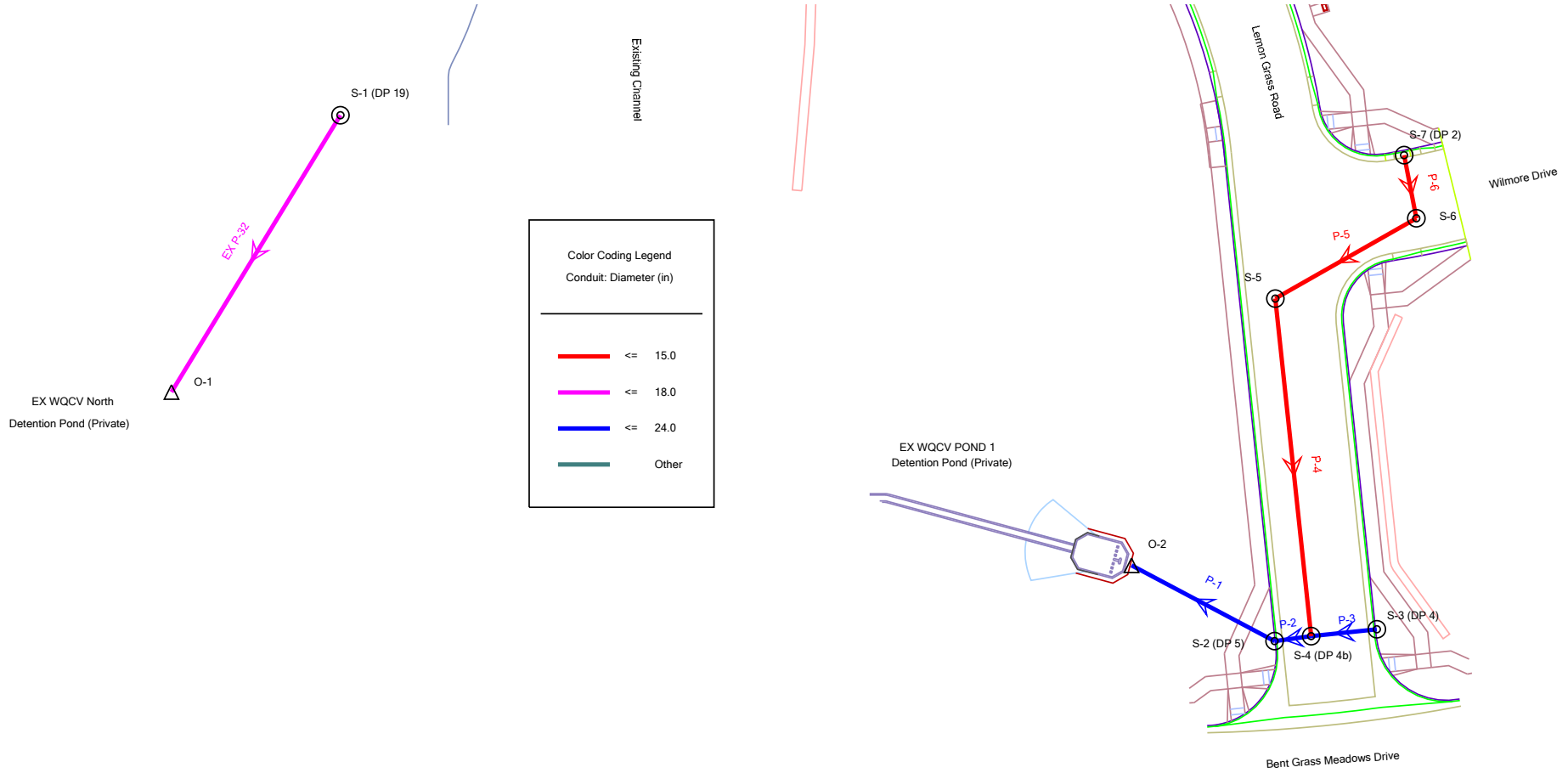

FlexTable: Conduit Table

Active Scenario: 5 YR

Label	Start Node	Stop Node	Invert (Start) (ft)	Invert (Stop) (ft)	Length (User Defined) (ft)	Slope (Calculated) (ft/ft)	Section Type	Diameter (in)	Manning's n	Material	Flow (cfs)	Velocity (ft/s)	Capacity (Full Flow) (cfs)	Hydraulic Grade Line (In) (ft)	Hydraulic Grade Line (Out) (ft)	Energy Grade Line (In) (ft)	Energy Grade Line (Out) (ft)
EX P-32	S-1 (DP 19)	O-1	6,943.93	6,942.30	38.6	0.042	Circle	18.0	0.013	Concrete	1.70	7.28	21.58	6,945.14	6,945.13	6,945.15	6,945.14
P-1	S-2 (DP 5)	O-2	6,942.26	6,940.00	53.0	0.043	Circle	24.0	0.013	Concrete	14.70	13.17	46.73	6,943.64	6,942.00	6,944.27	6,942.34
P-3	S-3 (DP 4)	S-4 (DP 4b)	6,943.34	6,942.71	27.5	0.023	Circle	24.0	0.013	Concrete	9.60	9.35	34.24	6,944.45	6,944.64	6,944.90	6,944.79
P-2	S-4 (DP 4b)	S-2 (DP 5)	6,942.61	6,942.46	7.5	0.020	Circle	24.0	0.013	Concrete	12.90	9.64	31.99	6,943.90	6,943.54	6,944.46	6,944.40
P-6	S-7 (DP 2)	S-6	6,951.76	6,950.80	24.0	0.040	Circle	15.0	0.013	Concrete	3.40	8.88	12.93	6,952.50	6,951.27	6,952.81	6,952.29
P-5	S-6	S-5	6,950.50	6,948.05	61.2	0.040	Circle	15.0	0.013	Concrete	3.40	8.88	12.93	6,951.24	6,948.49	6,951.55	6,949.71
P-4	S-5	S-4 (DP 4b)	6,947.75	6,943.46	110.2	0.039	Circle	15.0	0.013	Concrete	3.40	8.79	12.74	6,948.49	6,944.64	6,948.80	6,944.77

FlexTable: Manhole Table

Active Scenario: 5 YR

Label	Elevation (Rim) (ft)	Elevation (Invert) (ft)	Flow (Total Out) (cfs)	Headloss Coefficient (Standard)	Hydraulic Grade Line (In) (ft)	Hydraulic Grade Line (Out) (ft)
S-1 (DP 19)	6,949.32	6,943.93	1.70	0.640	6,945.15	6,945.14
S-2 (DP 5)	6,947.36	6,942.26	14.70	0.100	6,943.70	6,943.64
S-3 (DP 4)	6,947.34	6,943.34	9.60	0.050	6,944.47	6,944.45
S-4 (DP 4b)	6,947.07	6,942.61	12.90	1.320	6,944.64	6,943.90
S-5	6,953.58	6,947.75	3.40	0.640	6,948.69	6,948.49
S-6	6,955.52	6,950.50	3.40	0.640	6,951.44	6,951.24
S-7 (DP 2)	6,955.76	6,951.76	3.40	0.000	6,952.50	6,952.50

FlexTable: Outfall Table

Active Scenario: 5 YR

Label	Elevation (Ground) (ft)	Elevation (Invert) (ft)	Boundary Condition Type	Elevation (User Defined Tailwater) (ft)	Hydraulic Grade (ft)	Flow (Total Out) (cfs)
O-1	6,944.51	6,942.30	User Defined Tailwater	6,945.13	6,945.13	1.70
O-2	6,942.93	6,940.00	User Defined Tailwater	6,942.00	6,942.00	14.70

Falcon Meadows at Bent Grass Filing No. 4
Profile Report
Engineering Profile - DP 19 - O-1 (FM Filing 4 System.stsw)
Active Scenario: 5 YR

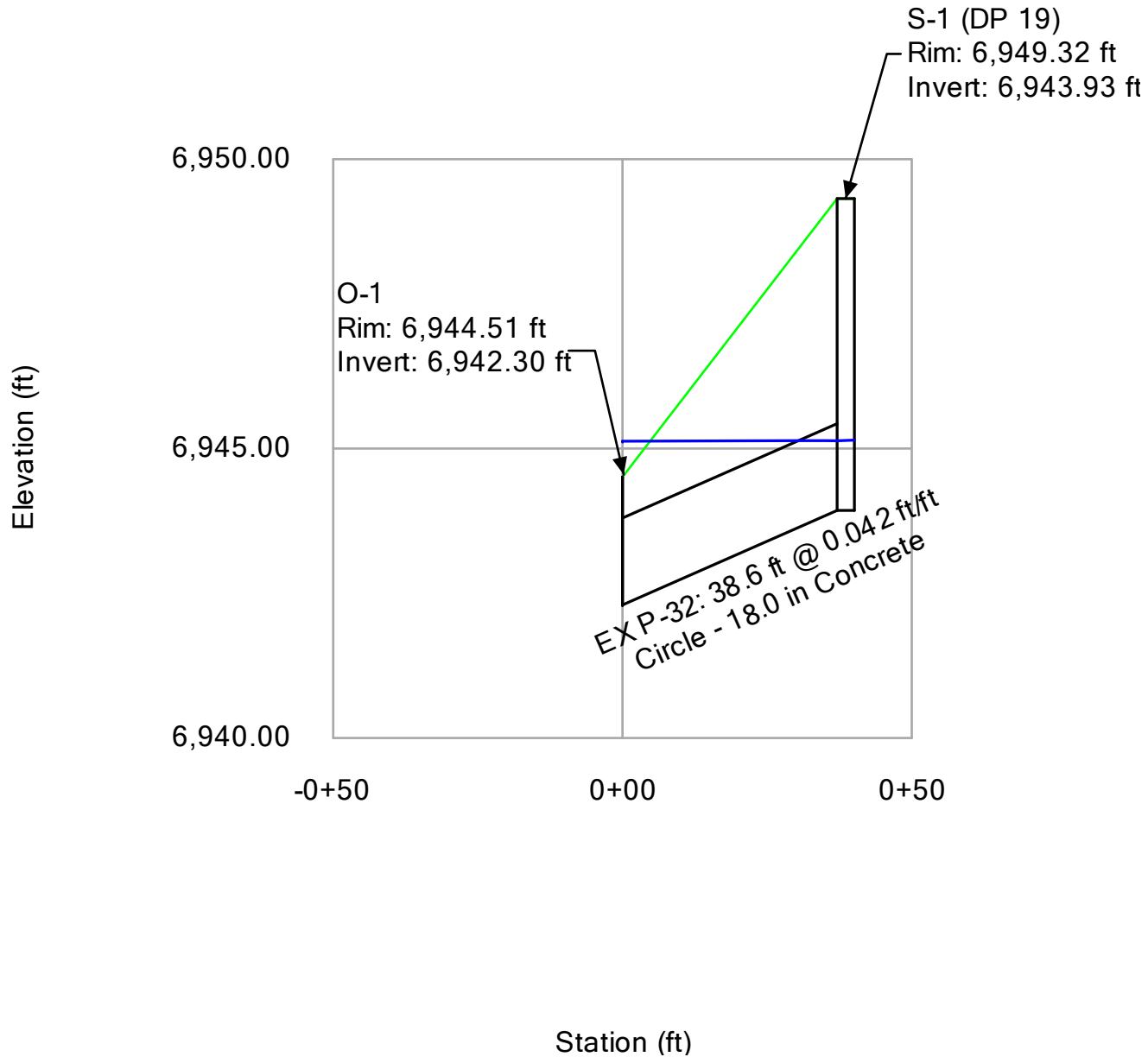

Falcon Meadows at Bent Grass Filing No. 4
Profile Report
Engineering Profile - DP 4 - O-2 (FM Filing 4 System.stsw)
Active Scenario: 5 YR

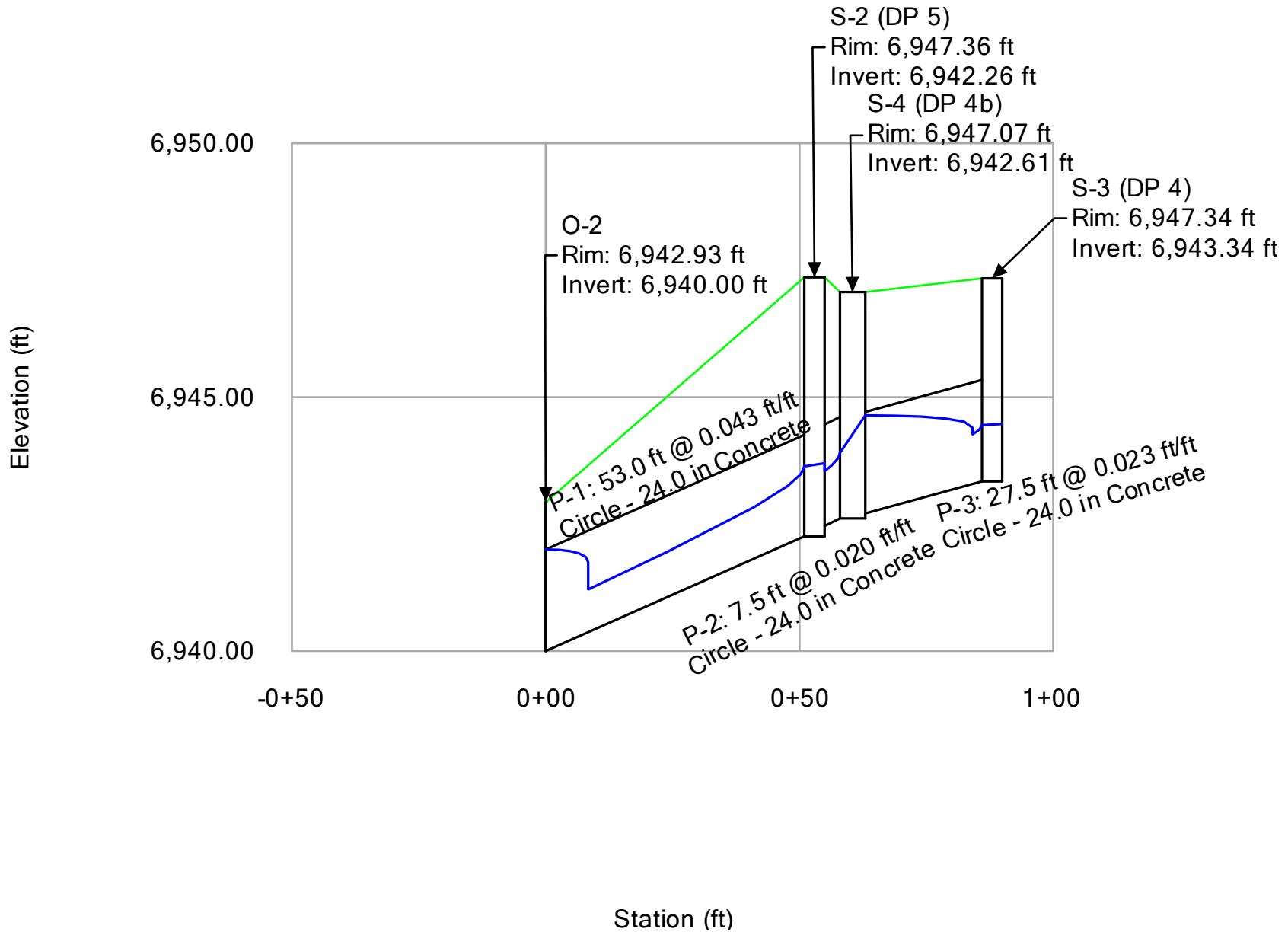

Falcon Meadows at Bent Grass Filing No. 4
Profile Report
Engineering Profile - DP4b - DP 2 (5 Year) (FM Filing 4 System.stsw)
Active Scenario: 5 YR

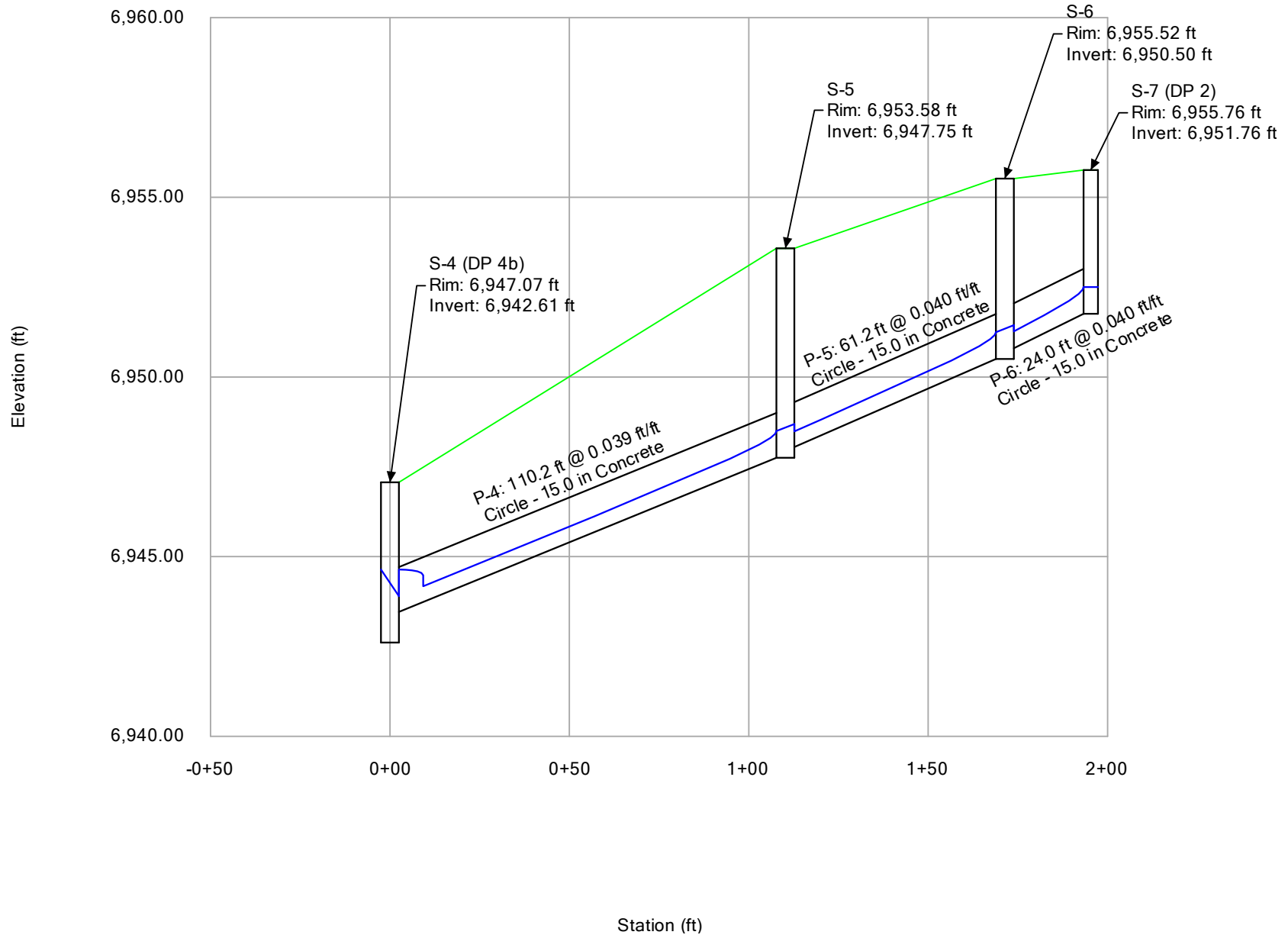

FlexTable: Conduit Table

Active Scenario: 100 YR

Label	Start Node	Stop Node	Invert (Start) (ft)	Invert (Stop) (ft)	Length (User Defined) (ft)	Slope (Calculated) (ft/ft)	Section Type	Diameter (in)	Manning's n	Material	Flow (cfs)	Velocity (ft/s)	Capacity (Full Flow) (cfs)	Hydraulic Grade Line (In) (ft)	Hydraulic Grade Line (Out) (ft)	Energy Grade Line (In) (ft)	Energy Grade Line (Out) (ft)
EX P-32	S-1 (DP 19)	O-1	6,943.93	6,942.30	38.6	0.042	Circle	18.0	0.013	Concrete	4.00	2.26	21.58	6,945.56	6,945.50	6,945.64	6,945.58
P-1	S-2 (DP 5)	O-2	6,942.26	6,940.00	53.0	0.043	Circle	24.0	0.013	Concrete	23.60	14.92	46.73	6,943.98	6,942.00	6,945.03	6,942.88
P-3	S-3 (DP 4)	S-4 (DP 4b)	6,943.34	6,942.71	27.5	0.023	Circle	24.0	0.013	Concrete	15.30	4.87	34.24	6,945.43	6,945.31	6,945.80	6,945.68
P-2	S-4 (DP 4b)	S-2 (DP 5)	6,942.61	6,942.46	7.5	0.020	Circle	24.0	0.013	Concrete	19.70	10.71	31.99	6,944.21	6,944.09	6,945.04	6,944.89
P-6	S-7 (DP 2)	S-6	6,951.76	6,950.80	24.0	0.040	Circle	15.0	0.013	Concrete	4.60	9.64	12.93	6,952.63	6,951.36	6,953.03	6,952.52
P-5	S-6	S-5	6,950.50	6,948.05	61.2	0.040	Circle	15.0	0.013	Concrete	4.60	9.64	12.93	6,951.37	6,948.57	6,951.77	6,950.00
P-4	S-5	S-4 (DP 4b)	6,947.75	6,943.46	110.2	0.039	Circle	15.0	0.013	Concrete	4.60	9.55	12.74	6,948.62	6,945.31	6,949.02	6,945.53

FlexTable: Manhole Table

Active Scenario: 100 YR

Label	Elevation (Rim) (ft)	Elevation (Invert) (ft)	Flow (Total Out) (cfs)	Headloss Coefficient (Standard)	Hydraulic Grade Line (In) (ft)	Hydraulic Grade Line (Out) (ft)
S-1 (DP 19)	6,949.32	6,943.93	4.00	0.640	6,945.61	6,945.56
S-2 (DP 5)	6,947.36	6,942.26	23.60	0.100	6,944.09	6,943.98
S-3 (DP 4)	6,947.34	6,943.34	15.30	0.050	6,945.45	6,945.43
S-4 (DP 4b)	6,947.07	6,942.61	19.70	1.320	6,945.31	6,944.21
S-5	6,953.58	6,947.75	4.60	0.640	6,948.87	6,948.62
S-6	6,955.52	6,950.50	4.60	0.640	6,951.62	6,951.37
S-7 (DP 2)	6,955.76	6,951.76	4.60	0.000	6,952.63	6,952.63

FlexTable: Outfall Table

Active Scenario: 100 YR

Label	Elevation (Ground) (ft)	Elevation (Invert) (ft)	Boundary Condition Type	Elevation (User Defined Tailwater) (ft)	Hydraulic Grade (ft)	Flow (Total Out) (cfs)
O-1	6,944.51	6,942.30	User Defined Tailwater	6,945.50	6,945.50	4.00
O-2	6,942.93	6,940.00	User Defined Tailwater	6,942.00	6,942.00	23.60

Falcon Meadows at Bent Grass Filing No. 4
Profile Report
Engineering Profile - DP 19 - O-1 (FM Filing 4 System.stsw)
Active Scenario: 100 YR

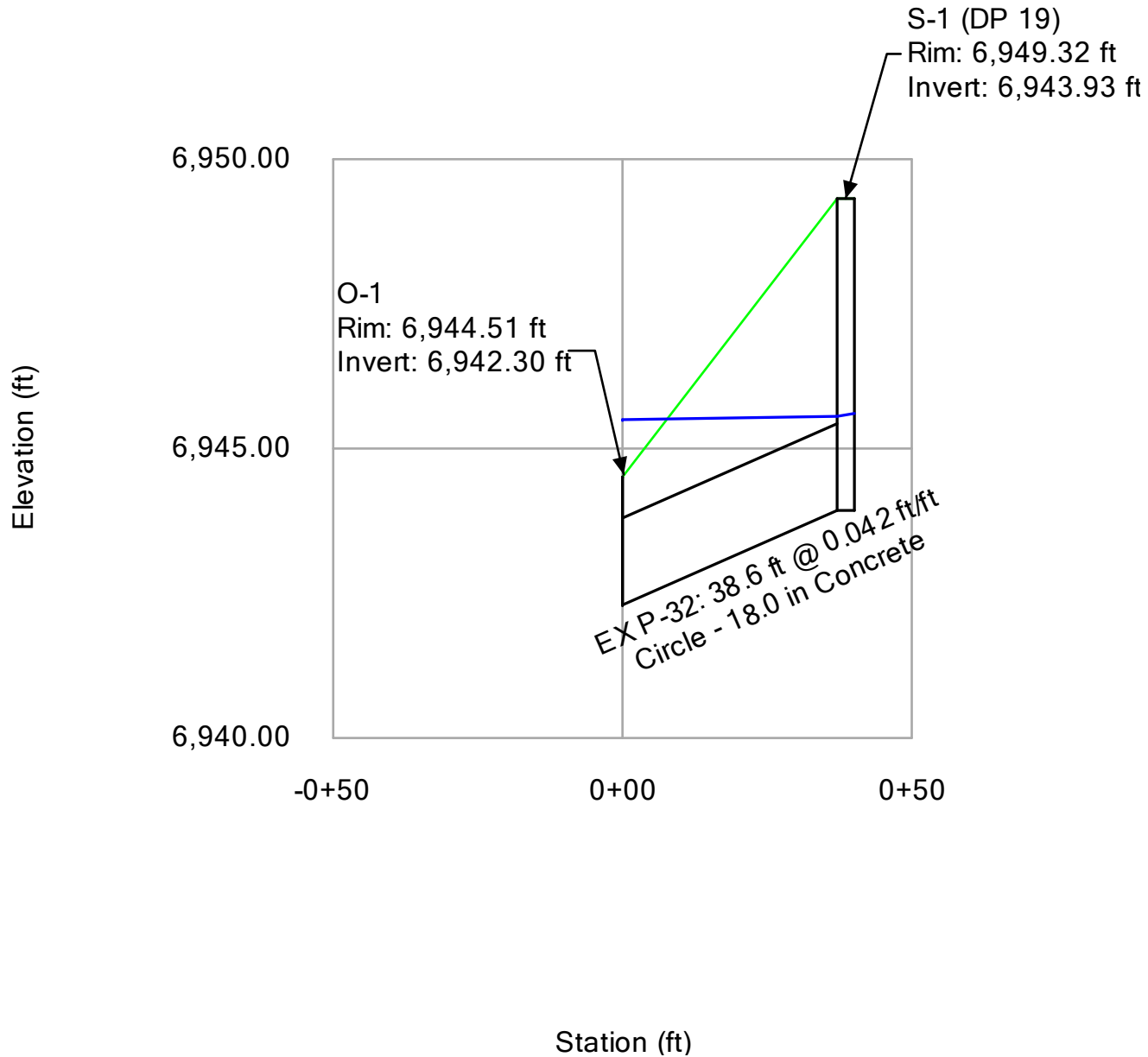

Falcon Meadows at Bent Grass Filing No. 4
Profile Report
Engineering Profile - DP 4 - O-2 (FM Filing 4 System.stsw)
Active Scenario: 100 YR

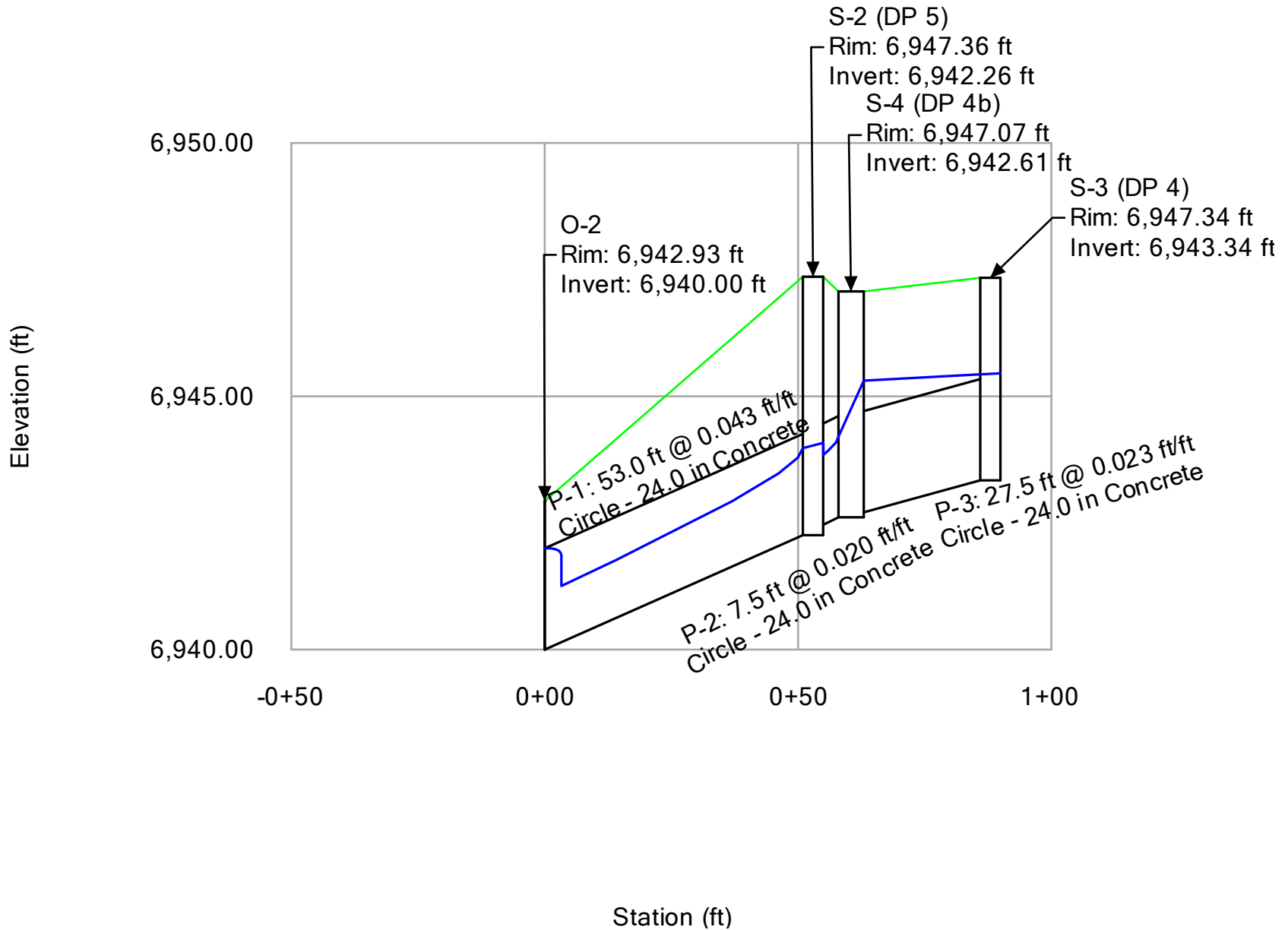

Falcon Meadows at Bent Grass Filing No. 4
Profile Report
Engineering Profile - DP4b - DP 2 (FM Filing 4 System.stsw)
Active Scenario: 100 YR

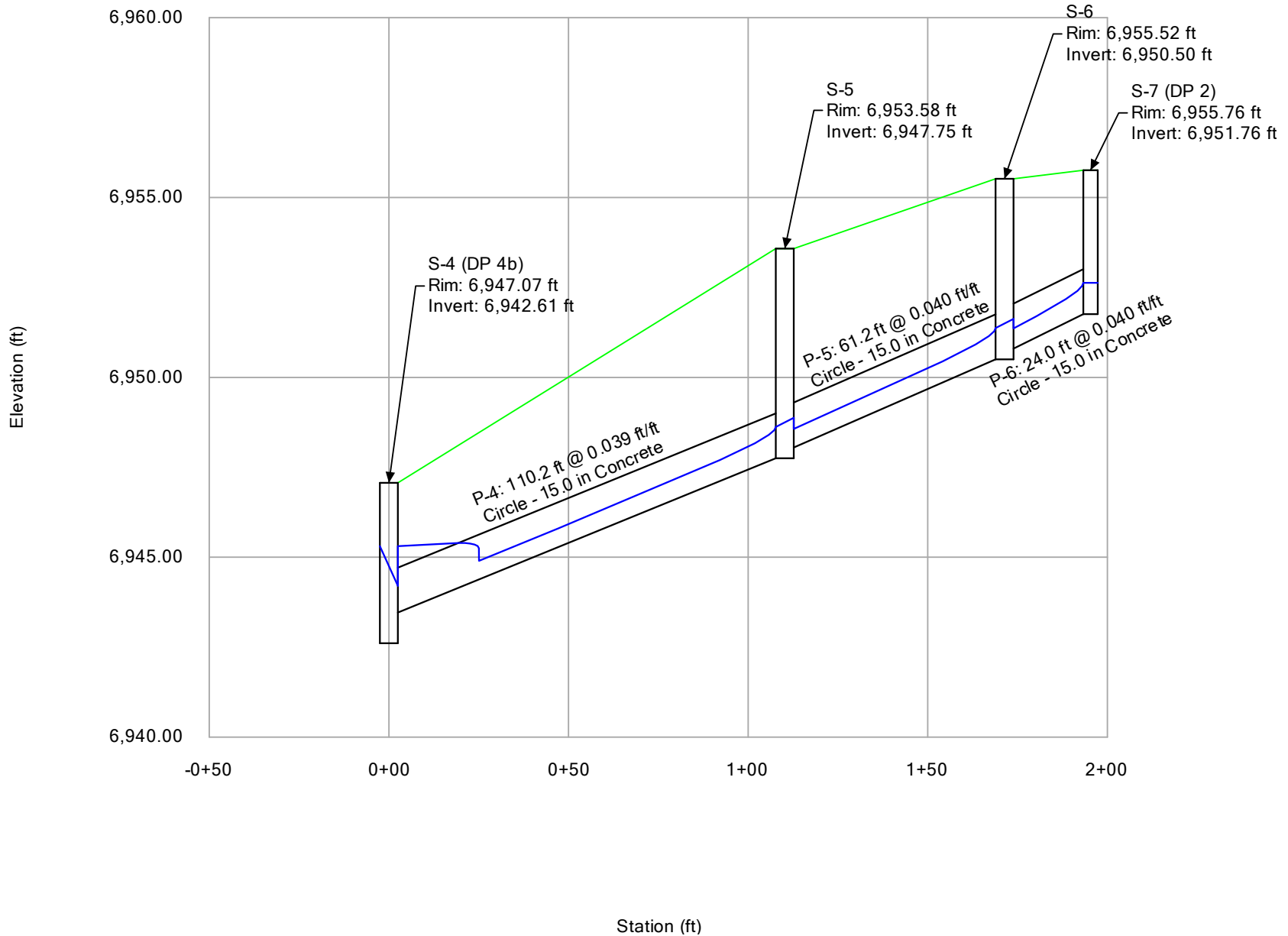

APPENDIX E
Existing Pond Analysis

DETENTION POND TRIBUTARY AREAS

Subdivision: Falcon Meadows
Location: CO, Colorado Springs

Project Name: Falcon Meadows at Bent Grass Filing No. 4
Project No.: CLH021
Calculated By: TJE
Checked By: BAS
Date: 6/29/22

Pond North (Existing)

Basin	Area	% Imp	
C-1a	0.27	84.5	(Obtained from Falcon Meadows Filing No. 3)
C-1b	1.77	61.3	(Obtained from Falcon Meadows Filing No. 3)
C-1c	1.19	68.2	(Obtained from Falcon Meadows Filing No. 3)
C-1d	1.97	72.1	(Obtained from Falcon Meadows Filing No. 3)
C-1e	0.49	100	(Obtained from Falcon Meadows Filing No. 3)
C-1f	0.14	87.5	(Obtained from Falcon Meadows Filing No. 3)
C-1g	0.87	65	
C-1h	1.12	49.3	
C-2	1	72	(Obtained from Falcon Meadows Filing No. 3)
C-3	0.18	85.7	(Obtained from Falcon Meadows Filing No. 3)
C-4	2.67	50.3	(Obtained from Falcon Meadows Filing No. 3)
C-5	0.6	2	(Obtained from Falcon Meadows Filing No. 3)
D-1f	0.67	73.4	(Obtained from Falcon Meadows Filing No. 3)
D-1g	0.78	45.5	(Obtained from Falcon Meadows Filing No. 3)
D-1h	1.57	48.8	(Obtained from Falcon Meadows Filing No. 3)
D-1j	0.95	60.6	(Obtained from Falcon Meadows Filing No. 3)
D-1k	0.8	50.6	(Obtained from Falcon Meadows Filing No. 3)
Total	17.04	59.3	

Pond South (Existing)

Basin	Area	% Imp	
D-1a	1.83	56.8	(Obtained from Falcon Meadows Filing No. 3)
D-1b	1.19	61.8	(Obtained from Falcon Meadows Filing No. 3)
D-1c	3.95	61.9	(Obtained from Falcon Meadows Filing No. 3)
D-2a	0.5	88.7	(Obtained from Falcon Meadows Filing No. 3)
D-2b	0.74	61.8	(Obtained from Falcon Meadows Filing No. 3)
D-2c	0.31	83.5	(Obtained from Falcon Meadows Filing No. 3)
D-2d	0.24	81.3	(Obtained from Falcon Meadows Filing No. 3)
D-2e	1.41	75.4	(Obtained from Falcon Meadows Filing No. 3)
D-2f	2.43	73.6	(Obtained from Falcon Meadows Filing No. 3)
D-2g	1.81	54.4	(Obtained from Falcon Meadows Filing No. 3)
D-2h	0.23	65	(Obtained from Falcon Meadows Filing No. 3)
D-3	2.26	54	(Obtained from Falcon Meadows Filing No. 3)
D-4a	0.98	72.5	(Obtained from Falcon Meadows Filing No. 3)
D-4b	0.95	80.9	(Obtained from Falcon Meadows Filing No. 3)
D-4c	3	65	
D-5	1.08	65.7	(Obtained from Falcon Meadows Filing No. 3)
D-6a	1.33	76.6	(Obtained from Falcon Meadows Filing No. 3)
D-6b	2.69	72.6	(Obtained from Falcon Meadows Filing No. 3)
D-7	8.01	13.2	
D-8	1.46	19.7	
D-9	0.72	24.8	(Obtained from Falcon Meadows Filing No. 3)
E-4	0.91	80.6	(Obtained from Falcon Meadows Filing No. 3)
E-5	0.89	89	(Obtained from Falcon Meadows Filing No. 3)
OS-2	20.07	8	(Obtained from Falcon Meadows Filing No. 3)
OS-3	10.61	8	(Obtained from Falcon Meadows Filing No. 3)
Total	69.6	33.6	

DETENTION POND TRIBUTARY AREAS

Subdivision: Falcon Meadows
Location: CO, Colorado Springs

Project Name: Falcon Meadows at Bent Grass Filing No. 4
Project No.: CLH021
Calculated By: TJE
Checked By: BAS
Date: 6/29/22

Existing Pond - Bent Grass Residential Filing No. 1

Basin	Area	% Imp
E-1	1.71	62.3
E-2	0.68	82.8
E-3	0.78	88.7
A-1 Thru A-4	7.7	46
OS-4	4.46	65
OS-5	0.46	65
OS-6	1.17	65
A-1	2.19	65
A-3	1.08	65
A-4	0.81	2
Total	21.04	56.9

(Obtained from Bent Grass Residential Subdivision Filing 2)
(Obtained from Bent Grass Residential Subdivision Filing 2)
(Obtained from Bent Grass Residential Subdivision Filing 2)
(Obtained from Bent Grass Residential Subdivision Filing 2)

DETENTION BASIN STAGE-STORAGE TABLE BUILDER

MHFD-Detention, Version 4.03 (May 2020)

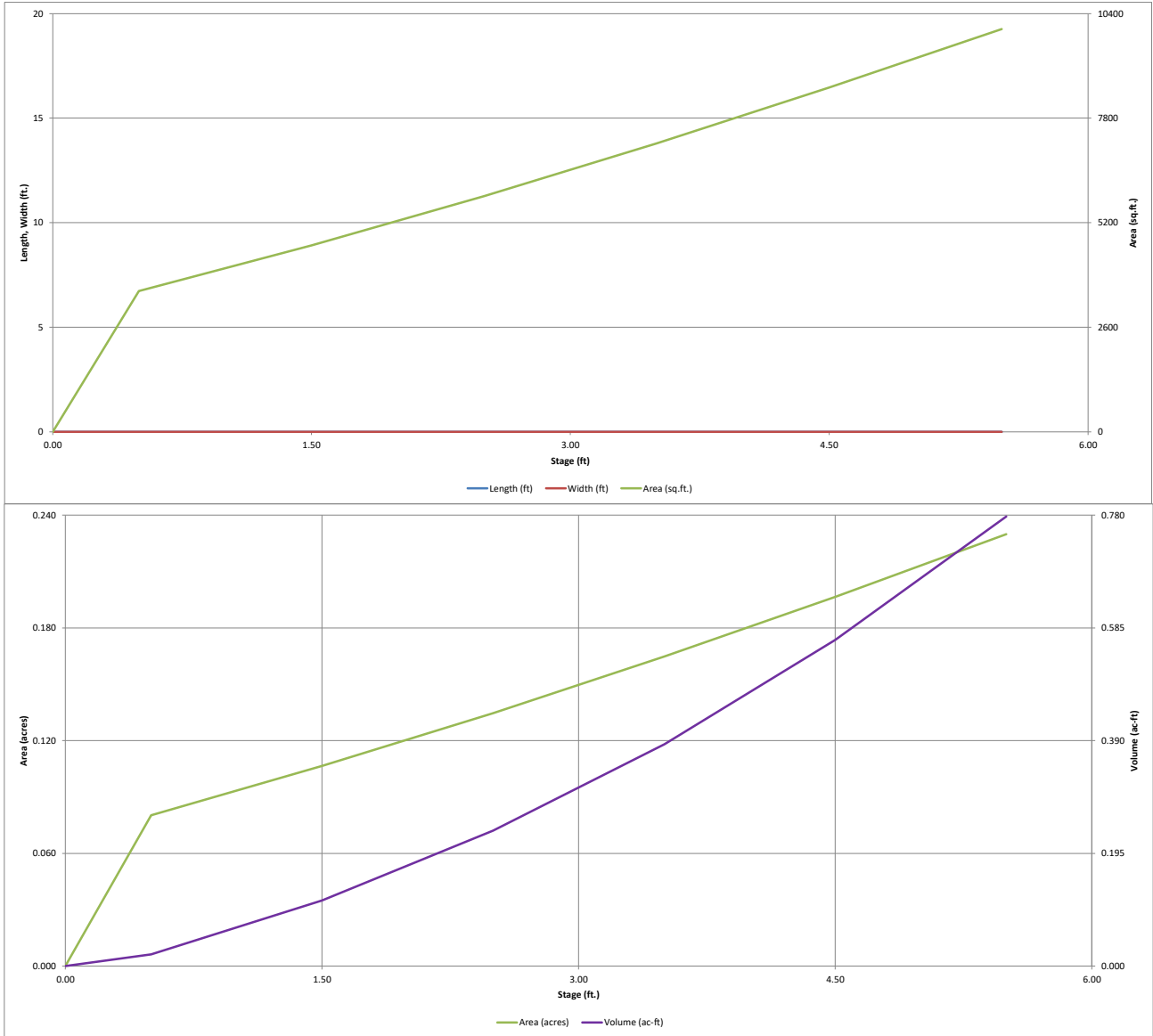

DETENTION BASIN OUTLET STRUCTURE DESIGN

MHFD-Detention, Version 4.03 (May 2020)

Project: Bent Grass Residential Filing No. 2
Basin ID: Ex WQCV Pond - North

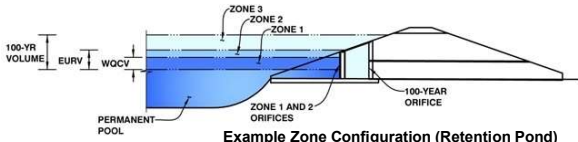

	Estimated Stage (ft)	Estimated Volume (ac-ft)	Outlet Type
Zone 1 (WQCV)	3.66	0.410	Orifice Plate
Zone 2			
Zone 3			
Total (all zones)		0.410	

User Input: Orifice at Underdrain Outlet (typically used to drain WQCV in a Filtration BMP)

Underdrain Orifice Invert Depth = ft (distance below the filtration media surface)
 Underdrain Orifice Diameter = inches

Calculated Parameters for Underdrain

Underdrain Orifice Area = ft²
 Underdrain Orifice Centroid = feet

User Input: Orifice Plate with one or more orifices or Elliptical Slot Weir (typically used to drain WQCV and/or EURV in a sedimentation BMP)

Invert of Lowest Orifice = 0.00 ft (relative to basin bottom at Stage = 0 ft)
 Depth at top of Zone using Orifice Plate = 3.10 ft (relative to basin bottom at Stage = 0 ft)
 Orifice Plate: Orifice Vertical Spacing = 12.00 inches
 Orifice Plate: Orifice Area per Row = 1.66 sq. inches (diameter = 1-7/16 inches)

Calculated Parameters for Plate

WQ Orifice Area per Row = 1.153E-02 ft²
 Elliptical Half-Width = N/A feet
 Elliptical Slot Centroid = N/A feet
 Elliptical Slot Area = N/A ft²

User Input: Stage and Total Area of Each Orifice Row (numbered from lowest to highest)

	Row 1 (required)	Row 2 (optional)	Row 3 (optional)	Row 4 (optional)	Row 5 (optional)	Row 6 (optional)	Row 7 (optional)	Row 8 (optional)
Stage of Orifice Centroid (ft)	0.00	1.00	2.00	3.00				
Orifice Area (sq. inches)	1.66	1.66	1.66					

	Row 9 (optional)	Row 10 (optional)	Row 11 (optional)	Row 12 (optional)	Row 13 (optional)	Row 14 (optional)	Row 15 (optional)	Row 16 (optional)
Stage of Orifice Centroid (ft)								
Orifice Area (sq. inches)								

User Input: Vertical Orifice (Circular or Rectangular)

Invert of Vertical Orifice = Not Selected Not Selected ft (relative to basin bottom at Stage = 0 ft)
 Depth at top of Zone using Vertical Orifice = ft (relative to basin bottom at Stage = 0 ft)
 Vertical Orifice Diameter = inches

Calculated Parameters for Vertical Orifice

Vertical Orifice Area = Not Selected Not Selected ft²
 Vertical Orifice Centroid = Not Selected Not Selected feet

User Input: Overflow Weir (Dropbox with Flat or Sloped Gate and Outlet Pipe OR Rectangular/Trapezoidal Weir (and No Outlet Pipe))

Overflow Weir Front Edge Height, Ho = Not Selected Not Selected ft (relative to basin bottom at Stage = 0 ft)
 Overflow Weir Front Edge Length = feet
 Overflow Weir Gate Slope = H:V
 Horiz. Length of Weir Sides = feet
 Overflow Gate Open Area % = %, gate open area/total area
 Debris Clogging % = %

Calculated Parameters for Overflow Weir

Height of Gate Upper Edge, H₁ = Not Selected Not Selected feet
 Overflow Weir Slope Length = feet
 Gate Open Area / 100-yr Orifice Area =
 Overflow Gate Open Area w/o Debris = ft²
 Overflow Gate Open Area w/ Debris = ft²

User Input: Outlet Pipe w/ Flow Restriction Plate (Circular Orifice, Restrictor Plate, or Rectangular Orifice)

Depth to Invert of Outlet Pipe = Not Selected Not Selected ft (distance below basin bottom at Stage = 0 ft)
 Circular Orifice Diameter = inches

Calculated Parameters for Outlet Pipe w/ Flow Restriction Plate

Outlet Orifice Area = Not Selected Not Selected ft²
 Outlet Orifice Centroid = Not Selected Not Selected feet
 Half-Central Angle of Restrictor Plate on Pipe = N/A N/A radians

User Input: Emergency Spillway (Rectangular or Trapezoidal)

Spillway Invert Stage = 3.25 ft (relative to basin bottom at Stage = 0 ft)
 Spillway Crest Length = 40.00 feet
 Spillway End Slopes = 4.00 H:V
 Freeboard above Max Water Surface = 1.00 feet

Calculated Parameters for Spillway

Spillway Design Flow Depth = 0.45 feet
 Stage at Top of Freeboard = 4.70 feet
 Basin Area at Top of Freeboard = 0.20 acres
 Basin Volume at Top of Freeboard = 0.60 acre-ft

Routed Hydrograph Results

The user can override the default CUHP hydrographs and runoff volumes by entering new values in the Inflow Hydrographs table (Columns W through AF).

	WQCV	EURV	2 Year	5 Year	10 Year	25 Year	50 Year	100 Year	500 Year
Design Storm Return Period =									
One-Hour Rainfall Depth (in) =	N/A	N/A	1.19	1.50	1.75	2.00	2.25	2.52	3.68
CUHP Runoff Volume (acre-ft) =	0.410	1.509	1.123	1.481	1.767	2.162	2.551	3.031	5.036
Inflow Hydrograph Volume (acre-ft) =	N/A	N/A	1.123	1.481	1.767	2.162	2.551	3.031	5.036
CUHP Predevelopment Peak Q (cfs) =	N/A	N/A	0.1	0.2	0.3	2.9	5.8	9.7	25.4
OPTIONAL Override Predevelopment Peak Q (cfs) =	N/A	N/A							
Predevelopment Unit Peak Flow, q (cfs/acre) =	N/A	N/A	0.01	0.01	0.02	0.14	0.28	0.46	1.21
Peak Inflow Q (cfs) =	N/A	N/A	14.5	19.1	22.7	29.6	35.7	43.1	72.1
Peak Outflow Q (cfs) =	10.4	257.5	14.0	20.8	21.4	36.4	39.5	44.9	84.6
Ratio Peak Outflow to Predevelopment Q =	N/A	N/A	N/A	90.7	66.7	12.5	6.8	4.6	3.3
Structure Controlling Flow =	Spillway	Plate	Spillway	Spillway	Spillway	Spillway	Spillway	Spillway	Spillway
Max Velocity through Gate 1 (fps) =	N/A	N/A	N/A	N/A	N/A	N/A	N/A	N/A	N/A
Max Velocity through Gate 2 (fps) =	N/A	N/A	N/A	N/A	N/A	N/A	N/A	N/A	N/A
Time to Drain 97% of Inflow Volume (hours) =	37	>120	33	31	29	26	24	22	15
Time to Drain 99% of Inflow Volume (hours) =	40	>120	40	39	38	37	36	34	29
Maximum Ponding Depth (ft) =	3.66	0.00	3.48	3.55	3.56	3.69	3.71	3.75	4.01
Area at Maximum Ponding Depth (acres) =	0.17	0.00	0.16	0.17	0.17	0.17	0.17	0.17	0.18
Maximum Volume Stored (acre-ft) =	0.410	0.000	0.380	0.392	0.392	0.414	0.419	0.426	0.470

DETENTION BASIN OUTLET STRUCTURE DESIGN

MHFD-Detention, Version 4.00 (December 2019)

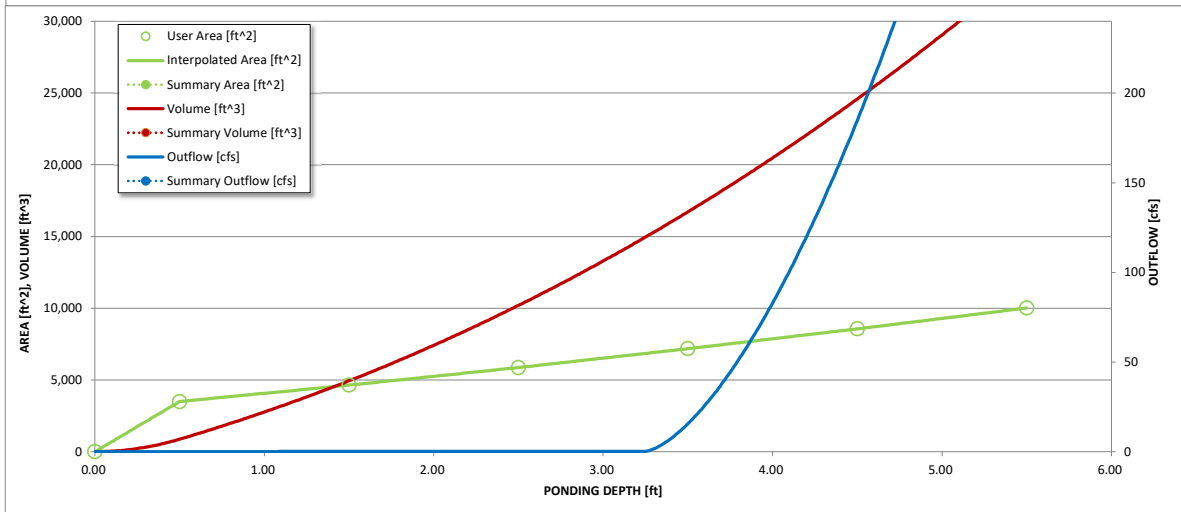
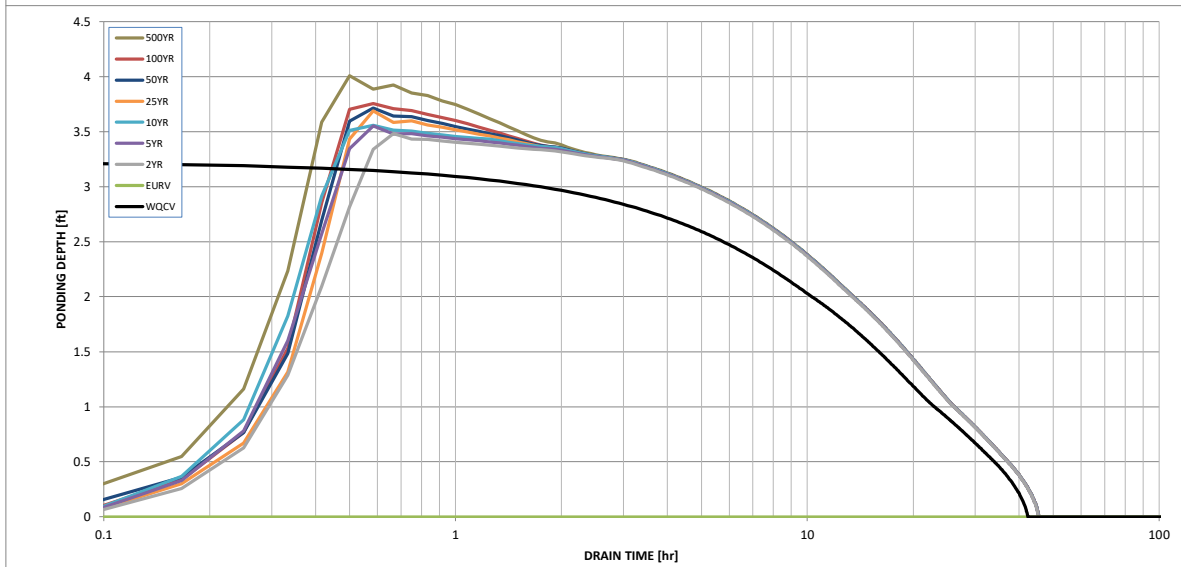
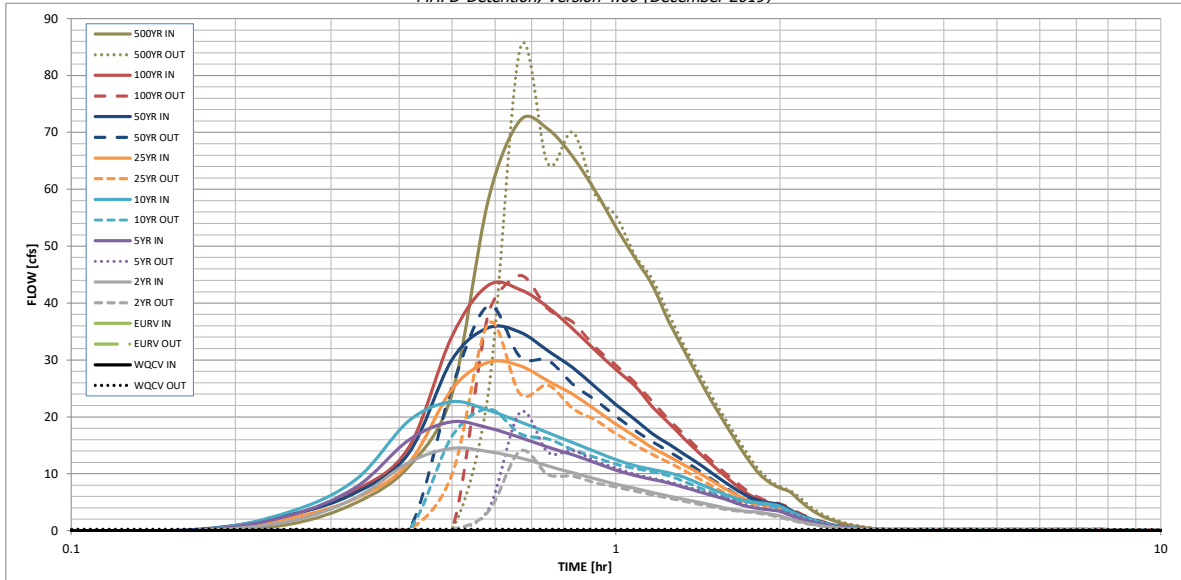

S-A-V-D Chart Axis Override	X-axis	Left Y-Axis	Right Y-Axis
minimum bound			
maximum bound			

DETENTION BASIN OUTLET STRUCTURE DESIGN

Outflow Hydrograph Workbook Filename: _____

Inflow Hydrographs

The user can override the calculated inflow hydrographs from this workbook with inflow hydrographs developed in a separate program.

Time Interval	SOURCE	CUHP	CUHP	CUHP	CUHP	CUHP	CUHP	CUHP	CUHP	CUHP
	TIME	WQCV [cfs]	EURV [cfs]	2 Year [cfs]	5 Year [cfs]	10 Year [cfs]	25 Year [cfs]	50 Year [cfs]	100 Year [cfs]	500 Year [cfs]
5.00 min	0:00:00	0.00	0.00	0.00	0.00	0.00	0.00	0.00	0.00	0.00
	0:05:00	0.00	0.00	0.00	0.00	0.00	0.00	0.00	0.00	0.00
	0:10:00	0.00	0.00	0.00	0.00	0.00	0.00	0.18	0.02	1.07
	0:15:00	0.00	0.00	1.59	2.58	3.20	2.16	2.71	2.64	4.89
	0:20:00	0.00	0.00	5.79	7.64	9.00	5.70	6.67	7.12	11.25
	0:25:00	0.00	0.00	11.99	15.90	19.26	11.89	13.60	14.62	23.96
	0:30:00	0.00	0.00	14.48	19.14	22.66	24.84	30.02	34.16	58.20
	0:35:00	0.00	0.00	13.87	18.05	21.15	29.59	35.68	43.15	72.13
	0:40:00	0.00	0.00	12.78	16.35	19.11	28.97	34.88	42.37	70.59
	0:45:00	0.00	0.00	11.37	14.69	17.22	26.34	31.61	39.27	65.71
	0:50:00	0.00	0.00	10.16	13.33	15.48	23.96	28.62	35.45	59.67
	0:55:00	0.00	0.00	9.10	11.93	13.89	21.24	25.27	31.64	53.40
	1:00:00	0.00	0.00	8.16	10.65	12.48	18.74	22.18	28.33	47.91
	1:05:00	0.00	0.00	7.45	9.67	11.42	16.59	19.53	25.43	43.13
	1:10:00	0.00	0.00	6.71	9.03	10.75	14.54	17.04	21.79	36.78
	1:15:00	0.00	0.00	6.08	8.36	10.20	13.04	15.23	18.93	31.73
	1:20:00	0.00	0.00	5.52	7.60	9.38	11.56	13.45	16.22	26.96
	1:25:00	0.00	0.00	5.00	6.88	8.32	10.20	11.82	13.79	22.69
	1:30:00	0.00	0.00	4.49	6.19	7.30	8.77	10.13	11.63	18.95
	1:35:00	0.00	0.00	4.00	5.55	6.39	7.45	8.56	9.65	15.53
	1:40:00	0.00	0.00	3.60	4.79	5.65	6.27	7.16	7.88	12.47
	1:45:00	0.00	0.00	3.36	4.22	5.18	5.30	5.99	6.40	9.93
	1:50:00	0.00	0.00	3.23	3.88	4.91	4.68	5.27	5.47	8.42
	1:55:00	0.00	0.00	2.90	3.64	4.65	4.31	4.85	4.92	7.50
	2:00:00	0.00	0.00	2.60	3.39	4.30	4.08	4.59	4.56	6.86
	2:05:00	0.00	0.00	2.10	2.74	3.48	3.28	3.69	3.62	5.40
	2:10:00	0.00	0.00	1.65	2.15	2.74	2.56	2.87	2.77	4.10
	2:15:00	0.00	0.00	1.30	1.69	2.14	2.00	2.24	2.12	3.11
	2:20:00	0.00	0.00	1.01	1.32	1.66	1.54	1.73	1.62	2.34
	2:25:00	0.00	0.00	0.78	1.02	1.28	1.19	1.33	1.24	1.80
	2:30:00	0.00	0.00	0.60	0.77	0.97	0.90	1.01	0.95	1.37
	2:35:00	0.00	0.00	0.46	0.58	0.73	0.68	0.76	0.72	1.03
	2:40:00	0.00	0.00	0.34	0.43	0.55	0.51	0.57	0.55	0.78
	2:45:00	0.00	0.00	0.25	0.32	0.41	0.39	0.43	0.41	0.59
	2:50:00	0.00	0.00	0.18	0.23	0.30	0.28	0.31	0.30	0.42
	2:55:00	0.00	0.00	0.11	0.15	0.20	0.19	0.21	0.20	0.29
	3:00:00	0.00	0.00	0.07	0.10	0.12	0.12	0.13	0.12	0.17
	3:05:00	0.00	0.00	0.03	0.05	0.06	0.06	0.07	0.07	0.09
	3:10:00	0.00	0.00	0.01	0.02	0.02	0.03	0.03	0.03	0.03
	3:15:00	0.00	0.00	0.00	0.00	0.00	0.00	0.00	0.00	0.00
	3:20:00	0.00	0.00	0.00	0.00	0.00	0.00	0.00	0.00	0.00
	3:25:00	0.00	0.00	0.00	0.00	0.00	0.00	0.00	0.00	0.00
	3:30:00	0.00	0.00	0.00	0.00	0.00	0.00	0.00	0.00	0.00
	3:35:00	0.00	0.00	0.00	0.00	0.00	0.00	0.00	0.00	0.00
	3:40:00	0.00	0.00	0.00	0.00	0.00	0.00	0.00	0.00	0.00
	3:45:00	0.00	0.00	0.00	0.00	0.00	0.00	0.00	0.00	0.00
	3:50:00	0.00	0.00	0.00	0.00	0.00	0.00	0.00	0.00	0.00
	3:55:00	0.00	0.00	0.00	0.00	0.00	0.00	0.00	0.00	0.00
	4:00:00	0.00	0.00	0.00	0.00	0.00	0.00	0.00	0.00	0.00
	4:05:00	0.00	0.00	0.00	0.00	0.00	0.00	0.00	0.00	0.00
	4:10:00	0.00	0.00	0.00	0.00	0.00	0.00	0.00	0.00	0.00
	4:15:00	0.00	0.00	0.00	0.00	0.00	0.00	0.00	0.00	0.00
	4:20:00	0.00	0.00	0.00	0.00	0.00	0.00	0.00	0.00	0.00
	4:25:00	0.00	0.00	0.00	0.00	0.00	0.00	0.00	0.00	0.00
	4:30:00	0.00	0.00	0.00	0.00	0.00	0.00	0.00	0.00	0.00
	4:35:00	0.00	0.00	0.00	0.00	0.00	0.00	0.00	0.00	0.00
	4:40:00	0.00	0.00	0.00	0.00	0.00	0.00	0.00	0.00	0.00
	4:45:00	0.00	0.00	0.00	0.00	0.00	0.00	0.00	0.00	0.00
	4:50:00	0.00	0.00	0.00	0.00	0.00	0.00	0.00	0.00	0.00
	4:55:00	0.00	0.00	0.00	0.00	0.00	0.00	0.00	0.00	0.00
	5:00:00	0.00	0.00	0.00	0.00	0.00	0.00	0.00	0.00	0.00
	5:05:00	0.00	0.00	0.00	0.00	0.00	0.00	0.00	0.00	0.00
	5:10:00	0.00	0.00	0.00	0.00	0.00	0.00	0.00	0.00	0.00
	5:15:00	0.00	0.00	0.00	0.00	0.00	0.00	0.00	0.00	0.00
	5:20:00	0.00	0.00	0.00	0.00	0.00	0.00	0.00	0.00	0.00
	5:25:00	0.00	0.00	0.00	0.00	0.00	0.00	0.00	0.00	0.00
	5:30:00	0.00	0.00	0.00	0.00	0.00	0.00	0.00	0.00	0.00
	5:35:00	0.00	0.00	0.00	0.00	0.00	0.00	0.00	0.00	0.00
	5:40:00	0.00	0.00	0.00	0.00	0.00	0.00	0.00	0.00	0.00
	5:45:00	0.00	0.00	0.00	0.00	0.00	0.00	0.00	0.00	0.00
	5:50:00	0.00	0.00	0.00	0.00	0.00	0.00	0.00	0.00	0.00
	5:55:00	0.00	0.00	0.00	0.00	0.00	0.00	0.00	0.00	0.00
	6:00:00	0.00	0.00	0.00	0.00	0.00	0.00	0.00	0.00	0.00

DETENTION BASIN STAGE-STORAGE TABLE BUILDER

MHFD-Detention, Version 4.03 (May 2020)

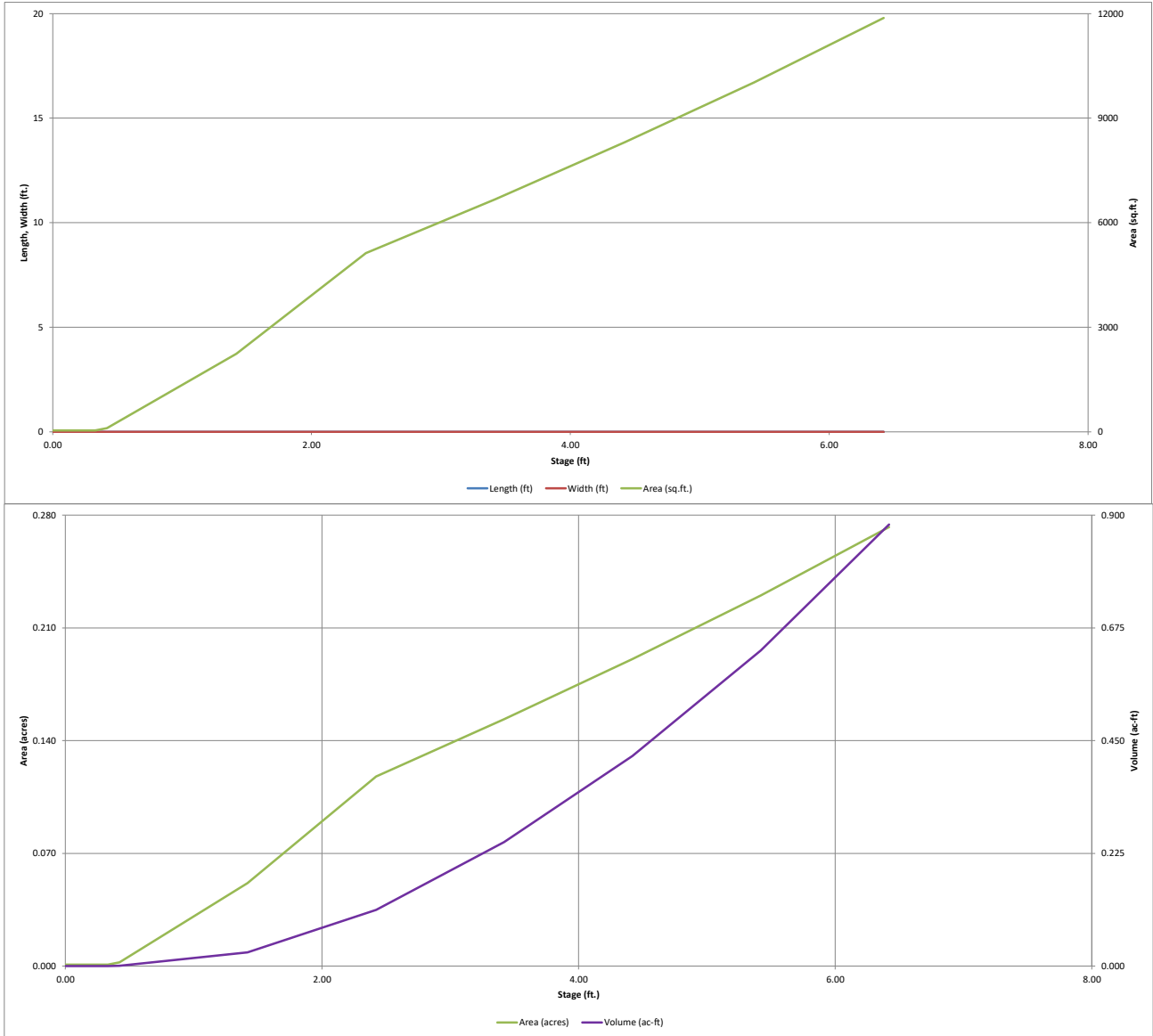

DETENTION BASIN OUTLET STRUCTURE DESIGN

MHFD-Detention, Version 4.03 (May 2020)

Project: Falcon Meadows at Bent Grass Filing No. 2
Basin ID: Existing WQCV Pond - North (Analysis)

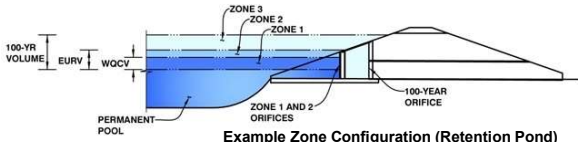

	Estimated Stage (ft)	Estimated Volume (ac-ft)	Outlet Type
Zone 1 (WQCV)	3.94	0.332	Orifice Plate
Zone 2			
Zone 3			
Total (all zones)		0.332	

User Input: Orifice at Underdrain Outlet (typically used to drain WQCV in a Filtration BMP)

Underdrain Orifice Invert Depth = ft (distance below the filtration media surface)
 Underdrain Orifice Diameter = inches

Calculated Parameters for Underdrain

Underdrain Orifice Area = ft²
 Underdrain Orifice Centroid = feet

User Input: Orifice Plate with one or more orifices or Elliptical Slot Weir (typically used to drain WQCV and/or EURV in a sedimentation BMP)

Invert of Lowest Orifice = 0.00 ft (relative to basin bottom at Stage = 0 ft)
 Depth at top of Zone using Orifice Plate = 4.07 ft (relative to basin bottom at Stage = 0 ft)
 Orifice Plate: Orifice Vertical Spacing = N/A inches
 Orifice Plate: Orifice Area per Row = 1.01 sq. inches (diameter = 1-1/8 inches)

Calculated Parameters for Plate

WQ Orifice Area per Row = 7.014E-03 ft²
 Elliptical Half-Width = N/A feet
 Elliptical Slot Centroid = N/A feet
 Elliptical Slot Area = N/A ft²

User Input: Stage and Total Area of Each Orifice Row (numbered from lowest to highest)

	Row 1 (required)	Row 2 (optional)	Row 3 (optional)	Row 4 (optional)	Row 5 (optional)	Row 6 (optional)	Row 7 (optional)	Row 8 (optional)
Stage of Orifice Centroid (ft)	0.00	1.10	2.20					
Orifice Area (sq. inches)	1.01	1.01	1.01					

	Row 9 (optional)	Row 10 (optional)	Row 11 (optional)	Row 12 (optional)	Row 13 (optional)	Row 14 (optional)	Row 15 (optional)	Row 16 (optional)
Stage of Orifice Centroid (ft)								
Orifice Area (sq. inches)								

User Input: Vertical Orifice (Circular or Rectangular)

Invert of Vertical Orifice = Not Selected Not Selected ft (relative to basin bottom at Stage = 0 ft)
 Depth at top of Zone using Vertical Orifice = ft (relative to basin bottom at Stage = 0 ft)
 Vertical Orifice Diameter = inches

Calculated Parameters for Vertical Orifice

Vertical Orifice Area = Not Selected Not Selected ft²
 Vertical Orifice Centroid = Not Selected Not Selected feet

User Input: Overflow Weir (Dropbox with Flat or Sloped Gate and Outlet Pipe OR Rectangular/Trapezoidal Weir (and No Outlet Pipe)

Overflow Weir Front Edge Height, Ho = Not Selected Not Selected ft (relative to basin bottom at Stage = 0 ft)
 Overflow Weir Front Edge Length = 6.00 feet
 Overflow Weir Gate Slope = 0.00 H:V
 Horiz. Length of Weir Sides = 3.00 feet
 Overflow Gate Open Area % = 70% %, gate open area/total area
 Debris Clogging % = 50% %

Calculated Parameters for Overflow Weir

Height of Gate Upper Edge, H₁ = Not Selected Not Selected feet
 Overflow Weir Slope Length = 3.00 feet
 Gate Open Area / 100-yr Orifice Area = 4.01
 Overflow Gate Open Area w/o Debris = 12.60 ft²
 Overflow Gate Open Area w/ Debris = 6.30 ft²

User Input: Outlet Pipe w/ Flow Restriction Plate (Circular Orifice, Restrictor Plate, or Rectangular Orifice)

Depth to Invert of Outlet Pipe = Not Selected Not Selected ft (distance below basin bottom at Stage = 0 ft)
 Circular Orifice Diameter = 24.00 inches

Calculated Parameters for Outlet Pipe w/ Flow Restriction Plate

Outlet Orifice Area = 3.14 ft²
 Outlet Orifice Centroid = 1.00 feet
 Half-Central Angle of Restrictor Plate on Pipe = N/A N/A radians

User Input: Emergency Spillway (Rectangular or Trapezoidal)

Spillway Invert Stage = 4.92 ft (relative to basin bottom at Stage = 0 ft)
 Spillway Crest Length = 25.00 feet
 Spillway End Slopes = 4.00 H:V
 Freeboard above Max Water Surface = 0.00 feet

Calculated Parameters for Spillway

Spillway Design Flow Depth = 0.66 feet
 Stage at Top of Freeboard = 5.58 feet
 Basin Area at Top of Freeboard = 0.24 acres
 Basin Volume at Top of Freeboard = 0.67 acre-ft

Routed Hydrograph Results

The user can override the default CUHP hydrographs and runoff volumes by entering new values in the Inflow Hydrographs table (Columns W through AF).

	WQCV	EURV	2 Year	5 Year	10 Year	25 Year	50 Year	100 Year	500 Year
Design Storm Return Period =									
One-Hour Rainfall Depth (in) =	N/A	N/A	1.19	1.50	1.75	2.00	2.25	2.52	3.68
CUHP Runoff Volume (acre-ft) =	0.332	1.222	0.900	1.186	1.414	1.730	2.041	2.425	4.027
Inflow Hydrograph Volume (acre-ft) =	N/A	N/A	0.900	1.186	1.414	1.730	2.041	2.425	4.027
CUHP Predevelopment Peak Q (cfs) =	N/A	N/A	0.1	0.2	0.3	3.1	6.1	10.0	25.6
OPTIONAL Override Predevelopment Peak Q (cfs) =	N/A	N/A							
Predevelopment Unit Peak Flow, q (cfs/acre) =	N/A	N/A	0.01	0.01	0.02	0.18	0.36	0.59	1.50
Peak Inflow Q (cfs) =	N/A	N/A	14.0	18.5	21.8	28.5	34.3	41.9	69.7
Peak Outflow Q (cfs) =	0.2	130.9	7.9	12.6	15.8	24.5	29.8	37.7	67.9
Ratio Peak Outflow to Predevelopment Q =	N/A	N/A	N/A	53.3	47.4	8.0	4.9	3.8	2.7
Structure Controlling Flow =	Plate	Plate	Overflow Weir 1	Overflow Weir 1	Overflow Weir 1	Overflow Weir 1	Spillway	Spillway	Spillway
Max Velocity through Gate 1 (fps) =	N/A	N/A	0.60	1.0	1.2	1.9	2.3	2.5	2.6
Max Velocity through Gate 2 (fps) =	N/A	N/A	N/A	N/A	N/A	N/A	N/A	N/A	N/A
Time to Drain 97% of Inflow Volume (hours) =	36	32	37	35	34	32	31	29	23
Time to Drain 99% of Inflow Volume (hours) =	39	36	41	40	40	39	38	37	34
Maximum Ponding Depth (ft) =	3.94	3.87	4.42	4.55	4.63	4.81	4.96	5.11	5.49
Area at Maximum Ponding Depth (acres) =	0.17	0.17	0.19	0.20	0.20	0.21	0.21	0.22	0.23
Maximum Volume Stored (acre-ft) =	0.332	0.319	0.420	0.445	0.458	0.497	0.526	0.558	0.646

DETENTION BASIN OUTLET STRUCTURE DESIGN

MHFD-Detention, Version 4.00 (December 2019)

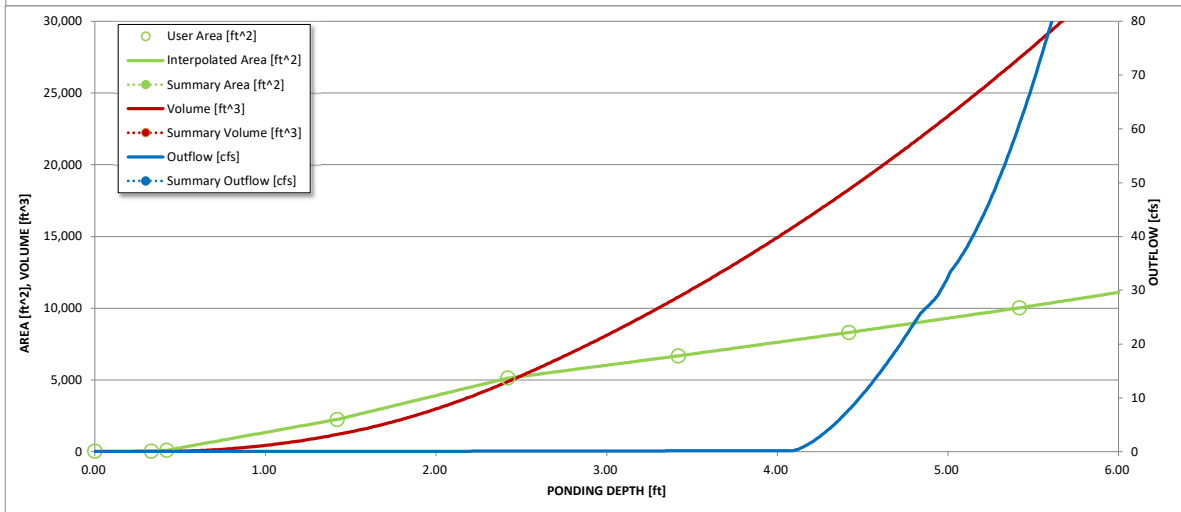
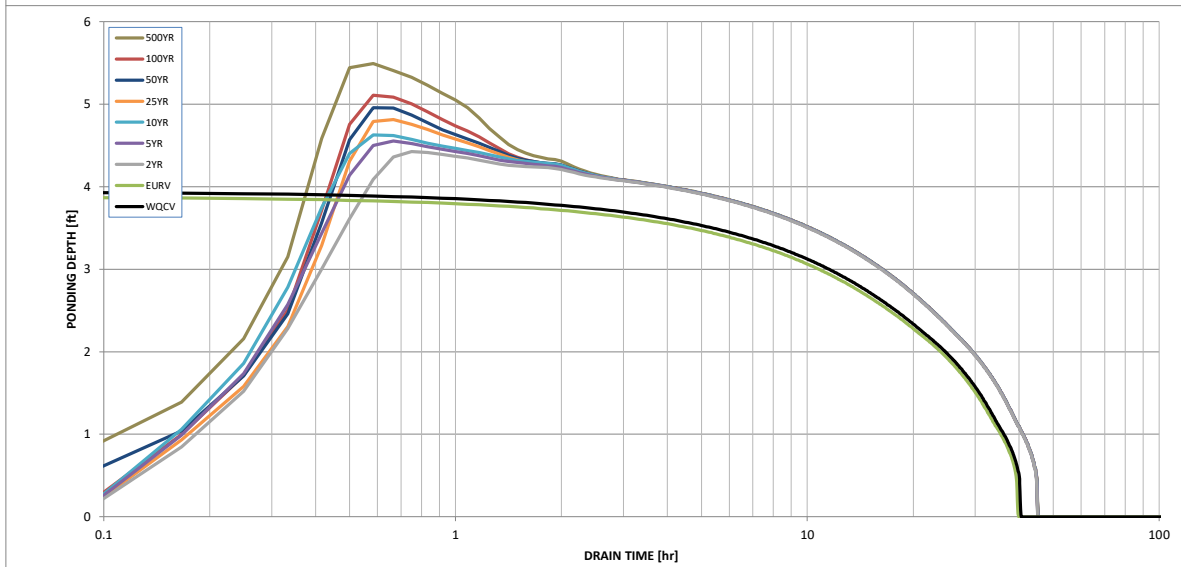
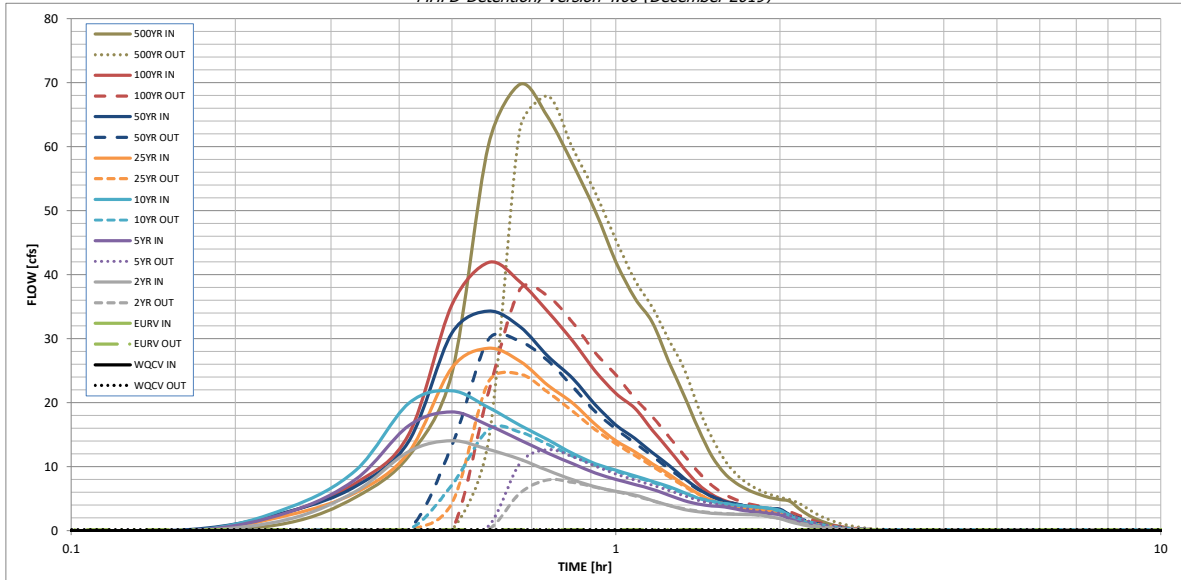

S-A-V-D Chart Axis Override	X-axis	Left Y-Axis	Right Y-Axis
minimum bound			
maximum bound			

DETENTION BASIN OUTLET STRUCTURE DESIGN

Outflow Hydrograph Workbook Filename: _____

Inflow Hydrographs

The user can override the calculated inflow hydrographs from this workbook with inflow hydrographs developed in a separate program.

Time Interval	SOURCE	CUHP	CUHP	CUHP	CUHP	CUHP	CUHP	CUHP	CUHP	CUHP	
	TIME	WQCV [cfs]	EURV [cfs]	2 Year [cfs]	5 Year [cfs]	10 Year [cfs]	25 Year [cfs]	50 Year [cfs]	100 Year [cfs]	500 Year [cfs]	
5.00 min	0:00:00	0.00	0.00	0.00	0.00	0.00	0.00	0.00	0.00	0.00	
	0:05:00	0.00	0.00	0.00	0.00	0.00	0.00	0.00	0.00	0.00	
	0:10:00	0.00	0.00	0.00	0.00	0.00	0.00	0.00	0.02	0.02	1.19
	0:15:00	0.00	0.00	1.76	2.86	3.55	2.39	2.97	2.91	2.91	5.24
	0:20:00	0.00	0.00	6.17	8.06	9.47	5.97	6.95	7.46	7.46	11.66
	0:25:00	0.00	0.00	12.37	16.41	19.89	12.25	13.97	15.03	15.03	24.62
	0:30:00	0.00	0.00	14.04	18.53	21.84	25.47	30.88	35.29	35.29	60.20
	0:35:00	0.00	0.00	12.69	16.46	19.23	28.47	34.31	41.88	41.88	69.73
	0:40:00	0.00	0.00	11.15	14.15	16.47	26.45	31.84	38.85	38.85	64.58
	0:45:00	0.00	0.00	9.39	12.11	14.18	22.72	27.24	34.22	34.22	57.27
	0:50:00	0.00	0.00	7.93	10.45	12.05	19.91	23.76	29.59	29.59	49.88
	0:55:00	0.00	0.00	6.87	9.01	10.46	16.59	19.65	24.92	24.92	42.01
	1:00:00	0.00	0.00	6.16	8.02	9.43	14.04	16.52	21.43	21.43	36.28
	1:05:00	0.00	0.00	5.57	7.22	8.56	12.29	14.38	19.10	19.10	32.54
	1:10:00	0.00	0.00	4.72	6.46	7.70	10.46	12.18	15.69	15.69	26.45
	1:15:00	0.00	0.00	3.94	5.55	6.89	8.84	10.23	12.72	12.72	21.15
	1:20:00	0.00	0.00	3.32	4.70	5.94	7.15	8.22	9.72	9.72	15.93
	1:25:00	0.00	0.00	2.93	4.15	5.07	5.77	6.56	7.25	7.25	11.64
	1:30:00	0.00	0.00	2.72	3.87	4.55	4.70	5.31	5.63	5.63	8.94
	1:35:00	0.00	0.00	2.61	3.70	4.21	4.06	4.57	4.71	4.71	7.36
	1:40:00	0.00	0.00	2.55	3.33	3.97	3.65	4.11	4.13	4.13	6.34
	1:45:00	0.00	0.00	2.51	3.04	3.79	3.38	3.80	3.74	3.74	5.65
	1:50:00	0.00	0.00	2.47	2.83	3.67	3.20	3.59	3.48	3.48	5.17
	1:55:00	0.00	0.00	2.16	2.67	3.49	3.07	3.45	3.29	3.29	4.83
	2:00:00	0.00	0.00	1.90	2.47	3.17	2.98	3.35	3.16	3.16	4.62
	2:05:00	0.00	0.00	1.42	1.85	2.36	2.23	2.50	2.36	2.36	3.43
	2:10:00	0.00	0.00	1.03	1.34	1.70	1.61	1.81	1.70	1.70	2.48
	2:15:00	0.00	0.00	0.75	0.97	1.23	1.16	1.31	1.24	1.24	1.80
	2:20:00	0.00	0.00	0.53	0.69	0.88	0.83	0.93	0.89	0.89	1.29
	2:25:00	0.00	0.00	0.37	0.47	0.61	0.58	0.65	0.62	0.62	0.90
	2:30:00	0.00	0.00	0.25	0.32	0.42	0.41	0.45	0.43	0.43	0.62
	2:35:00	0.00	0.00	0.16	0.22	0.28	0.28	0.31	0.29	0.29	0.42
	2:40:00	0.00	0.00	0.10	0.14	0.17	0.17	0.19	0.18	0.18	0.26
	2:45:00	0.00	0.00	0.05	0.07	0.09	0.09	0.10	0.10	0.10	0.14
	2:50:00	0.00	0.00	0.02	0.03	0.04	0.04	0.04	0.04	0.04	0.05
	2:55:00	0.00	0.00	0.00	0.01	0.01	0.01	0.01	0.01	0.01	0.01
	3:00:00	0.00	0.00	0.00	0.00	0.00	0.00	0.00	0.00	0.00	0.00
	3:05:00	0.00	0.00	0.00	0.00	0.00	0.00	0.00	0.00	0.00	0.00
	3:10:00	0.00	0.00	0.00	0.00	0.00	0.00	0.00	0.00	0.00	0.00
	3:15:00	0.00	0.00	0.00	0.00	0.00	0.00	0.00	0.00	0.00	0.00
	3:20:00	0.00	0.00	0.00	0.00	0.00	0.00	0.00	0.00	0.00	0.00
	3:25:00	0.00	0.00	0.00	0.00	0.00	0.00	0.00	0.00	0.00	0.00
	3:30:00	0.00	0.00	0.00	0.00	0.00	0.00	0.00	0.00	0.00	0.00
	3:35:00	0.00	0.00	0.00	0.00	0.00	0.00	0.00	0.00	0.00	0.00
	3:40:00	0.00	0.00	0.00	0.00	0.00	0.00	0.00	0.00	0.00	0.00
	3:45:00	0.00	0.00	0.00	0.00	0.00	0.00	0.00	0.00	0.00	0.00
	3:50:00	0.00	0.00	0.00	0.00	0.00	0.00	0.00	0.00	0.00	0.00
	3:55:00	0.00	0.00	0.00	0.00	0.00	0.00	0.00	0.00	0.00	0.00
	4:00:00	0.00	0.00	0.00	0.00	0.00	0.00	0.00	0.00	0.00	0.00
	4:05:00	0.00	0.00	0.00	0.00	0.00	0.00	0.00	0.00	0.00	0.00
	4:10:00	0.00	0.00	0.00	0.00	0.00	0.00	0.00	0.00	0.00	0.00
	4:15:00	0.00	0.00	0.00	0.00	0.00	0.00	0.00	0.00	0.00	0.00
	4:20:00	0.00	0.00	0.00	0.00	0.00	0.00	0.00	0.00	0.00	0.00
	4:25:00	0.00	0.00	0.00	0.00	0.00	0.00	0.00	0.00	0.00	0.00
	4:30:00	0.00	0.00	0.00	0.00	0.00	0.00	0.00	0.00	0.00	0.00
	4:35:00	0.00	0.00	0.00	0.00	0.00	0.00	0.00	0.00	0.00	0.00
	4:40:00	0.00	0.00	0.00	0.00	0.00	0.00	0.00	0.00	0.00	0.00
	4:45:00	0.00	0.00	0.00	0.00	0.00	0.00	0.00	0.00	0.00	0.00
	4:50:00	0.00	0.00	0.00	0.00	0.00	0.00	0.00	0.00	0.00	0.00
	4:55:00	0.00	0.00	0.00	0.00	0.00	0.00	0.00	0.00	0.00	0.00
5:00:00	0.00	0.00	0.00	0.00	0.00	0.00	0.00	0.00	0.00	0.00	
5:05:00	0.00	0.00	0.00	0.00	0.00	0.00	0.00	0.00	0.00	0.00	
5:10:00	0.00	0.00	0.00	0.00	0.00	0.00	0.00	0.00	0.00	0.00	
5:15:00	0.00	0.00	0.00	0.00	0.00	0.00	0.00	0.00	0.00	0.00	
5:20:00	0.00	0.00	0.00	0.00	0.00	0.00	0.00	0.00	0.00	0.00	
5:25:00	0.00	0.00	0.00	0.00	0.00	0.00	0.00	0.00	0.00	0.00	
5:30:00	0.00	0.00	0.00	0.00	0.00	0.00	0.00	0.00	0.00	0.00	
5:35:00	0.00	0.00	0.00	0.00	0.00	0.00	0.00	0.00	0.00	0.00	
5:40:00	0.00	0.00	0.00	0.00	0.00	0.00	0.00	0.00	0.00	0.00	
5:45:00	0.00	0.00	0.00	0.00	0.00	0.00	0.00	0.00	0.00	0.00	
5:50:00	0.00	0.00	0.00	0.00	0.00	0.00	0.00	0.00	0.00	0.00	
5:55:00	0.00	0.00	0.00	0.00	0.00	0.00	0.00	0.00	0.00	0.00	
6:00:00	0.00	0.00	0.00	0.00	0.00	0.00	0.00	0.00	0.00	0.00	

DETENTION BASIN STAGE-STORAGE TABLE BUILDER

MHFD-Detention, Version 4.03 (May 2020)

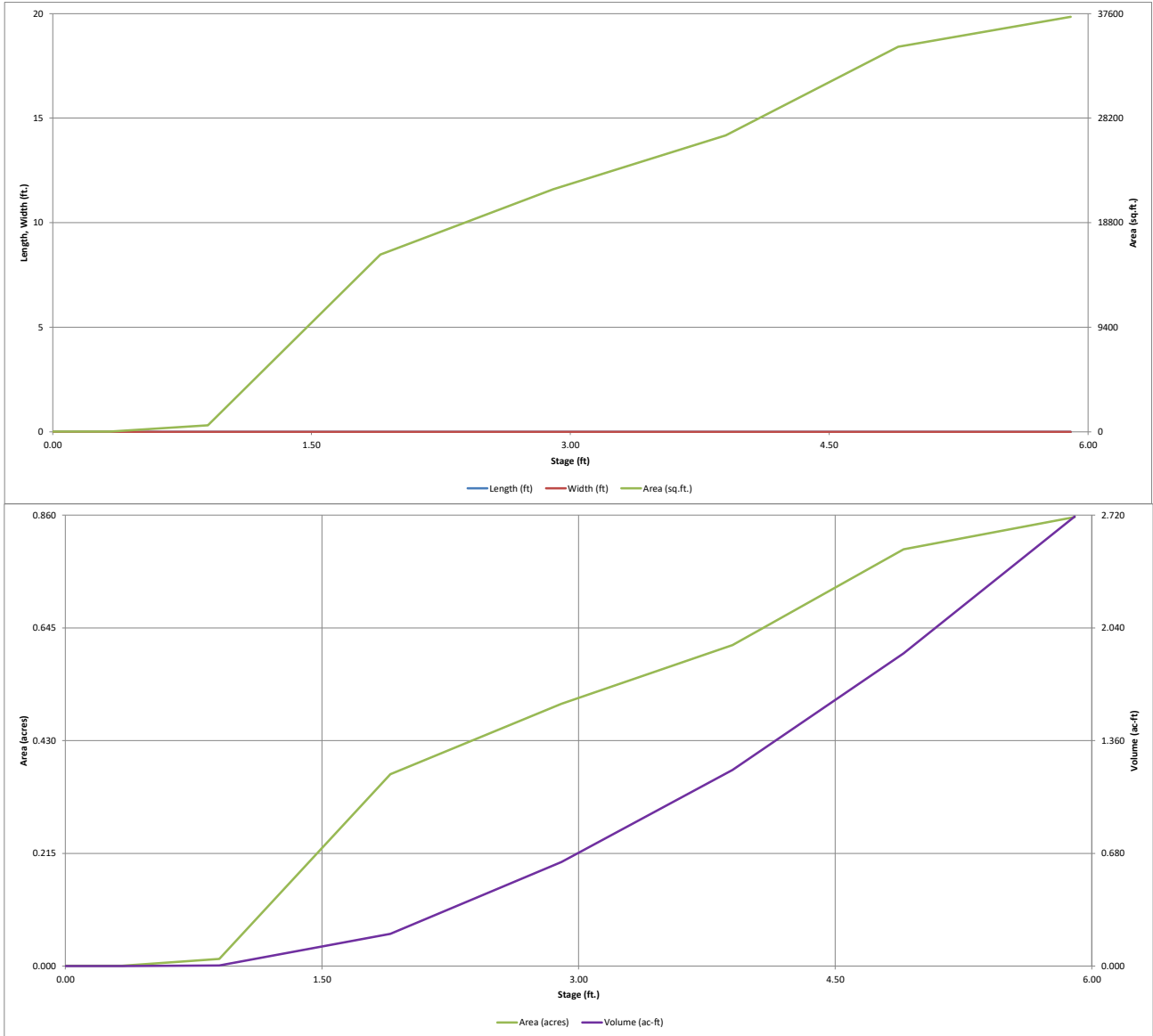

DETENTION BASIN OUTLET STRUCTURE DESIGN

MHFD-Detention, Version 4.03 (May 2020)

Project: Falcon Meadows at Bent Grass Filing No. 2

Basin ID: Existing WQCV Pond - South (Analysis)

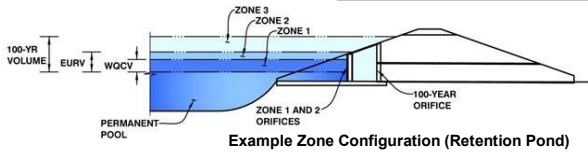

	Estimated Stage (ft)	Estimated Volume (ac-ft)	Outlet Type
Zone 1 (WQCV)	3.49	0.941	Orifice Plate
Zone 2			
Zone 3			
Total (all zones)		0.941	

User Input: Orifice at Underdrain Outlet (typically used to drain WQCV in a Filtration BMP)

Calculated Parameters for Underdrain

Underdrain Orifice Invert Depth = ft (distance below the filtration media surface)
 Underdrain Orifice Diameter = inches

Underdrain Orifice Area = ft²
 Underdrain Orifice Centroid = feet

User Input: Orifice Plate with one or more orifices or Elliptical Slot Weir (typically used to drain WQCV and/or EURV in a sedimentation BMP)

Calculated Parameters for Plate

Invert of Lowest Orifice = 0.00 ft (relative to basin bottom at Stage = 0 ft)
 Depth at top of Zone using Orifice Plate = 3.41 ft (relative to basin bottom at Stage = 0 ft)
 Orifice Plate: Orifice Vertical Spacing = N/A inches
 Orifice Plate: Orifice Area per Row = 2.41 sq. inches (diameter = 1-3/4 inches)

WQ Orifice Area per Row = 1.670E-02 ft²
 Elliptical Half-Width = N/A feet
 Elliptical Slot Centroid = N/A feet
 Elliptical Slot Area = N/A ft²

User Input: Stage and Total Area of Each Orifice Row (numbered from lowest to highest)

	Row 1 (required)	Row 2 (optional)	Row 3 (optional)	Row 4 (optional)	Row 5 (optional)	Row 6 (optional)	Row 7 (optional)	Row 8 (optional)
Stage of Orifice Centroid (ft)	0.00	1.14	2.27					
Orifice Area (sq. inches)	2.41	2.41	2.41					

	Row 9 (optional)	Row 10 (optional)	Row 11 (optional)	Row 12 (optional)	Row 13 (optional)	Row 14 (optional)	Row 15 (optional)	Row 16 (optional)
Stage of Orifice Centroid (ft)								
Orifice Area (sq. inches)								

User Input: Vertical Orifice (Circular or Rectangular)

Calculated Parameters for Vertical Orifice

Invert of Vertical Orifice = Not Selected ft (relative to basin bottom at Stage = 0 ft)
 Depth at top of Zone using Vertical Orifice = Not Selected ft (relative to basin bottom at Stage = 0 ft)
 Vertical Orifice Diameter = Not Selected inches

Vertical Orifice Area = Not Selected ft²
 Vertical Orifice Centroid = Not Selected feet

User Input: Overflow Weir (Dropbox with Flat or Sloped Grate and Outlet Pipe OR Rectangular/Trapezoidal Weir (and No Outlet Pipe))

Calculated Parameters for Overflow Weir

Overflow Weir Front Edge Height, H_o = 3.50 ft (relative to basin bottom at Stage = 0 ft)
 Overflow Weir Front Edge Length = 6.00 feet
 Overflow Weir Grate Slope = 0.00 H:V
 Horiz. Length of Weir Sides = 6.00 feet
 Overflow Grate Open Area % = 80% %, grate open area/total area
 Debris Clogging % = 50% %

Height of Grate Upper Edge, H_t = 3.50 feet
 Overflow Weir Slope Length = 6.00 feet
 Grate Open Area / 100-yr Orifice Area = 5.87
 Overflow Grate Open Area w/o Debris = 28.80 ft²
 Overflow Grate Open Area w/ Debris = 14.40 ft²

User Input: Outlet Pipe w/ Flow Restriction Plate (Circular Orifice, Restrictor Plate, or Rectangular Orifice)

Calculated Parameters for Outlet Pipe w/ Flow Restriction Plate

Depth to Invert of Outlet Pipe = 2.50 ft (distance below basin bottom at Stage = 0 ft)
 Circular Orifice Diameter = 30.00 inches

Outlet Orifice Area = 4.91 ft²
 Outlet Orifice Centroid = 1.25 feet
 Half-Central Angle of Restrictor Plate on Pipe = N/A radians

User Input: Emergency Spillway (Rectangular or Trapezoidal)

Calculated Parameters for Spillway

Spillway Invert Stage = 4.90 ft (relative to basin bottom at Stage = 0 ft)
 Spillway Crest Length = 24.00 feet
 Spillway End Slopes = 4.00 H:V
 Freeboard above Max Water Surface = 0.00 feet

Spillway Design Flow Depth = 0.93 feet
 Stage at Top of Freeboard = 5.83 feet
 Basin Area at Top of Freeboard = 0.85 acres
 Basin Volume at Top of Freeboard = 2.65 acre-ft

Routed Hydrograph Results

The user can override the default CUHP hydrographs and runoff volumes by entering new values in the Inflow Hydrographs table (Columns W through AF).

	WQCV	EURV	2 Year	5 Year	10 Year	25 Year	50 Year	100 Year	500 Year
Design Storm Return Period =									
One-Hour Rainfall Depth (in) =	N/A	N/A	1.19	1.50	1.75	2.00	2.25	2.52	3.68
CUHP Runoff Volume (acre-ft) =	0.941	2.412	1.746	2.380	2.898	4.083	5.199	6.686	12.916
Inflow Hydrograph Volume (acre-ft) =	N/A	N/A	1.746	2.380	2.898	4.083	5.199	6.686	12.916
CUHP Predevelopment Peak Q (cfs) =	N/A	N/A	0.4	0.8	1.1	10.5	21.0	35.0	91.0
OPTIONAL Override Predevelopment Peak Q (cfs) =	N/A	N/A							
Predevelopment Unit Peak Flow, q (cfs/acre) =	N/A	N/A	0.01	0.01	0.02	0.15	0.30	0.50	1.31
Peak Inflow Q (cfs) =	N/A	N/A	17.5	24.1	29.6	47.0	61.9	80.6	155.3
Peak Outflow Q (cfs) =	0.4	74.6	7.7	14.0	18.8	35.4	49.6	58.2	138.4
Ratio Peak Outflow to Predevelopment Q =	N/A	N/A	N/A	17.2	16.5	3.4	2.4	1.7	1.5
Structure Controlling Flow =	Plate	Spillway	Overflow Weir 1	Overflow Weir 1	Overflow Weir 1	Overflow Weir 1	Overflow Weir 1	Outlet Plate 1	Spillway
Max Velocity through Grate 1 (fps) =	N/A	2.12	0.26	0.5	0.6	1.2	1.7	2.0	2.2
Max Velocity through Grate 2 (fps) =	N/A	N/A	N/A	N/A	N/A	N/A	N/A	N/A	N/A
Time to Drain 97% of Inflow Volume (hours) =	46	45	48	47	45	43	40	37	26
Time to Drain 99% of Inflow Volume (hours) =	49	49	52	51	51	49	48	47	42
Maximum Ponding Depth (ft) =	3.49	5.55	3.75	3.88	3.96	4.20	4.38	4.82	5.85
Area at Maximum Ponding Depth (acres) =	0.57	0.83	0.59	0.61	0.62	0.67	0.70	0.78	0.85
Maximum Volume Stored (acre-ft) =	0.942	2.417	1.087	1.165	1.215	1.376	1.499	1.816	2.670

DETENTION BASIN OUTLET STRUCTURE DESIGN

MHFD- Detention, Version 4.00 (December 2019)

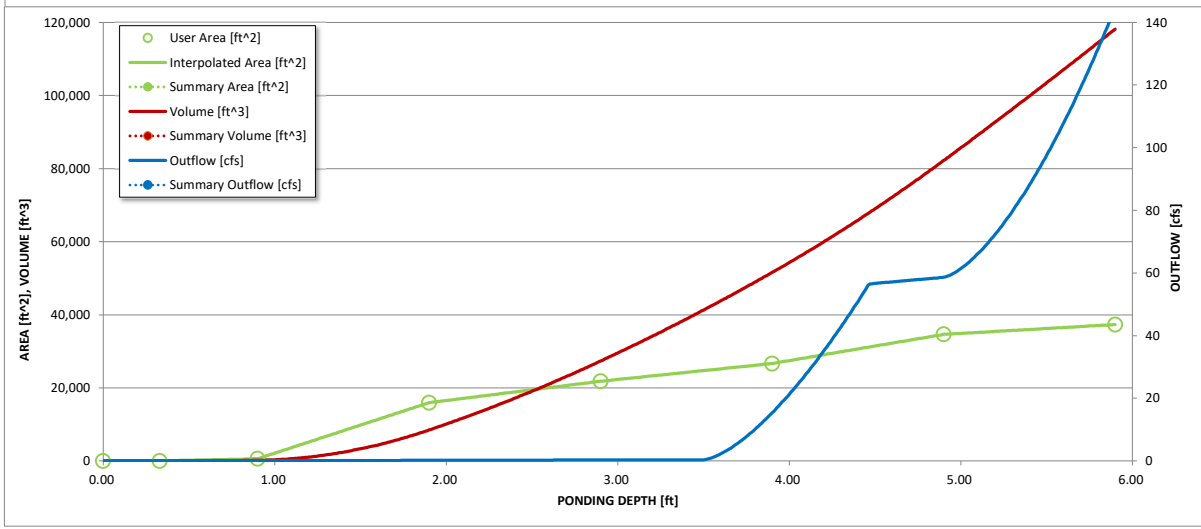
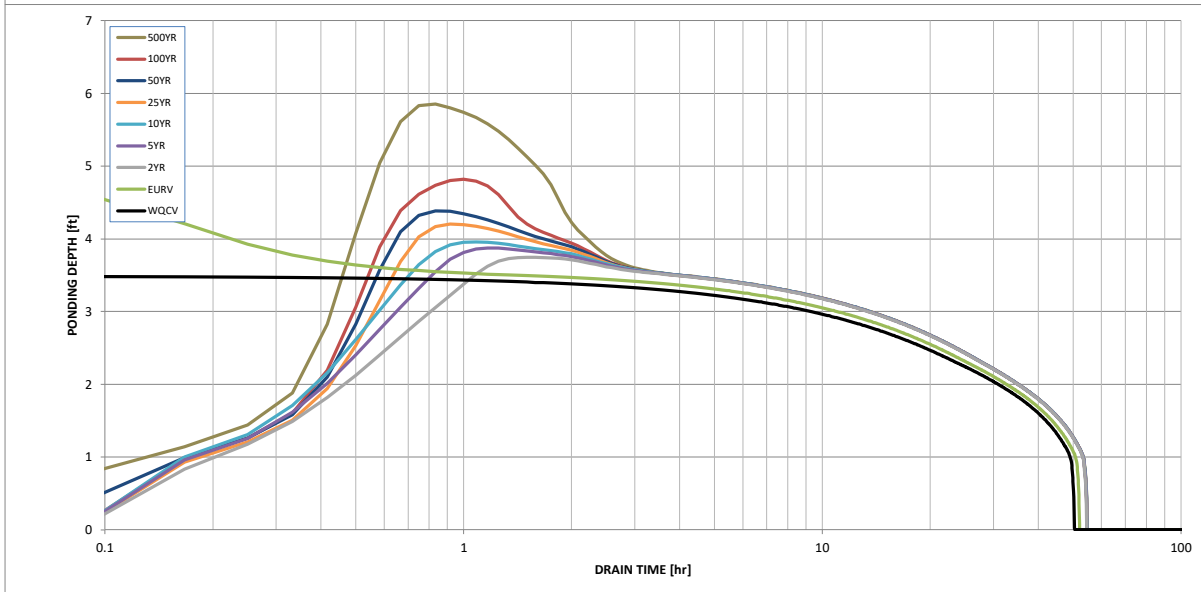
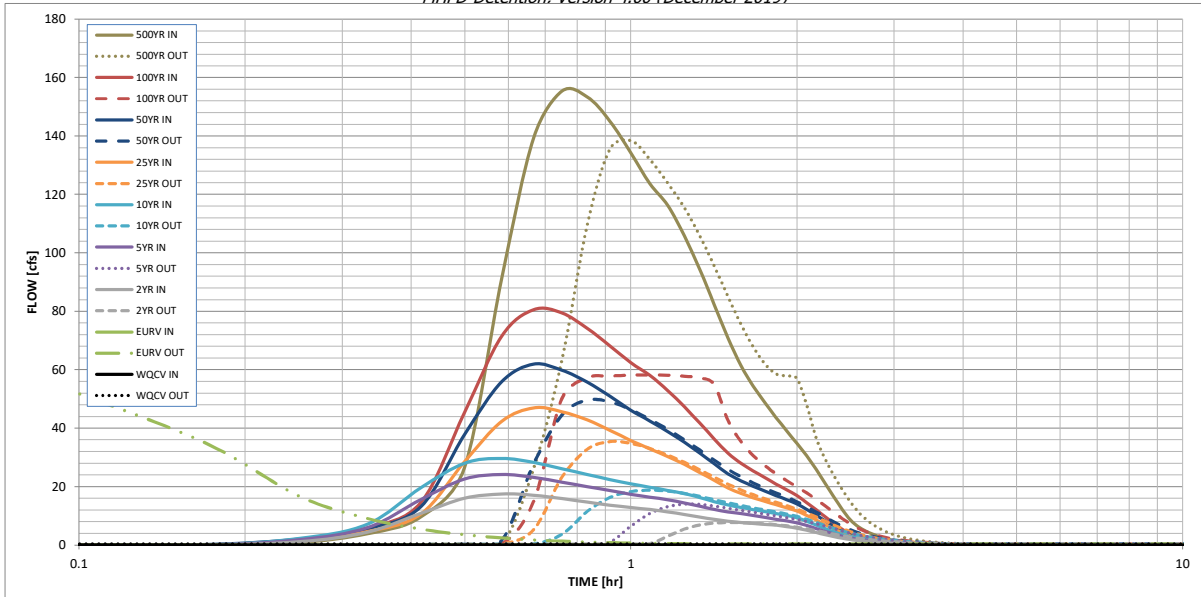

S-A-V-D Chart Axis Override	X-axis	Left Y-Axis	Right Y-Axis
minimum bound			
maximum bound			

DETENTION BASIN OUTLET STRUCTURE DESIGN

Outflow Hydrograph Workbook Filename: _____

Inflow Hydrographs

The user can override the calculated inflow hydrographs from this workbook with inflow hydrographs developed in a separate program.

Time Interval	SOURCE	CUHP	CUHP	CUHP	CUHP	CUHP	CUHP	CUHP	CUHP	CUHP
	TIME	WQCV [cfs]	EURV [cfs]	2 Year [cfs]	5 Year [cfs]	10 Year [cfs]	25 Year [cfs]	50 Year [cfs]	100 Year [cfs]	500 Year [cfs]
5.00 min	0:00:00	0.00	0.00	0.00	0.00	0.00	0.00	0.00	0.00	0.00
	0:05:00	0.00	0.00	0.00	0.00	0.00	0.00	0.00	0.00	0.00
	0:10:00	0.00	0.00	0.00	0.00	0.00	0.00	0.13	0.01	0.79
	0:15:00	0.00	0.00	1.10	1.78	2.24	1.53	1.98	1.90	3.87
	0:20:00	0.00	0.00	4.41	5.94	7.13	4.60	5.49	5.81	9.65
	0:25:00	0.00	0.00	10.85	15.61	19.66	10.61	13.20	14.60	26.52
	0:30:00	0.00	0.00	16.03	22.62	28.01	28.50	37.86	45.41	91.19
	0:35:00	0.00	0.00	17.45	24.13	29.62	42.31	55.85	71.47	139.37
	0:40:00	0.00	0.00	17.06	23.18	28.26	46.96	61.90	80.57	155.33
	0:45:00	0.00	0.00	15.88	21.50	26.13	45.64	59.83	79.44	153.41
	0:50:00	0.00	0.00	14.69	20.01	24.16	42.82	55.75	74.22	145.10
	0:55:00	0.00	0.00	13.67	18.61	22.38	39.29	50.94	68.18	134.29
	1:00:00	0.00	0.00	12.82	17.39	20.95	35.78	46.19	62.46	123.69
	1:05:00	0.00	0.00	12.15	16.40	19.79	32.95	42.45	58.03	116.21
	1:10:00	0.00	0.00	11.34	15.47	18.69	30.24	38.78	52.87	105.87
	1:15:00	0.00	0.00	10.44	14.41	17.59	27.59	35.17	47.37	94.37
	1:20:00	0.00	0.00	9.56	13.24	16.28	24.82	31.43	41.72	82.34
	1:25:00	0.00	0.00	8.77	12.14	14.83	22.13	27.81	36.28	70.90
	1:30:00	0.00	0.00	8.16	11.30	13.70	19.55	24.40	31.46	61.34
	1:35:00	0.00	0.00	7.73	10.73	12.86	17.64	21.98	27.98	54.33
	1:40:00	0.00	0.00	7.40	10.11	12.13	16.19	20.10	25.35	48.70
	1:45:00	0.00	0.00	7.08	9.45	11.45	14.94	18.47	23.02	43.67
	1:50:00	0.00	0.00	6.78	8.82	10.81	13.78	16.94	20.89	39.06
	1:55:00	0.00	0.00	6.29	8.21	10.13	12.70	15.50	18.86	34.70
	2:00:00	0.00	0.00	5.74	7.59	9.33	11.64	14.10	16.90	30.54
	2:05:00	0.00	0.00	5.02	6.67	8.14	10.16	12.21	14.52	25.86
	2:10:00	0.00	0.00	4.26	5.66	6.85	8.55	10.19	12.05	21.10
	2:15:00	0.00	0.00	3.54	4.68	5.61	6.98	8.23	9.64	16.49
	2:20:00	0.00	0.00	2.88	3.79	4.51	5.53	6.41	7.39	12.19
	2:25:00	0.00	0.00	2.30	3.02	3.58	4.23	4.78	5.35	8.56
	2:30:00	0.00	0.00	1.85	2.41	2.93	3.15	3.54	3.87	6.31
	2:35:00	0.00	0.00	1.52	2.00	2.46	2.46	2.76	2.94	4.79
	2:40:00	0.00	0.00	1.27	1.68	2.06	1.97	2.21	2.29	3.64
	2:45:00	0.00	0.00	1.06	1.40	1.72	1.60	1.78	1.79	2.75
	2:50:00	0.00	0.00	0.88	1.17	1.42	1.29	1.43	1.39	2.07
	2:55:00	0.00	0.00	0.73	0.96	1.17	1.05	1.15	1.08	1.54
	3:00:00	0.00	0.00	0.61	0.79	0.96	0.84	0.93	0.85	1.17
	3:05:00	0.00	0.00	0.50	0.65	0.79	0.69	0.76	0.69	0.95
	3:10:00	0.00	0.00	0.42	0.53	0.64	0.56	0.61	0.56	0.76
	3:15:00	0.00	0.00	0.34	0.43	0.51	0.45	0.49	0.45	0.61
	3:20:00	0.00	0.00	0.27	0.34	0.40	0.35	0.38	0.35	0.47
	3:25:00	0.00	0.00	0.21	0.26	0.31	0.27	0.29	0.27	0.35
	3:30:00	0.00	0.00	0.15	0.19	0.23	0.20	0.21	0.20	0.25
	3:35:00	0.00	0.00	0.11	0.14	0.16	0.14	0.15	0.13	0.16
	3:40:00	0.00	0.00	0.07	0.09	0.11	0.09	0.10	0.08	0.10
	3:45:00	0.00	0.00	0.04	0.06	0.06	0.05	0.05	0.05	0.05
	3:50:00	0.00	0.00	0.02	0.03	0.03	0.03	0.02	0.02	0.01
	3:55:00	0.00	0.00	0.01	0.01	0.01	0.01	0.01	0.00	0.00
	4:00:00	0.00	0.00	0.00	0.00	0.00	0.00	0.00	0.00	0.00
	4:05:00	0.00	0.00	0.00	0.00	0.00	0.00	0.00	0.00	0.00
	4:10:00	0.00	0.00	0.00	0.00	0.00	0.00	0.00	0.00	0.00
	4:15:00	0.00	0.00	0.00	0.00	0.00	0.00	0.00	0.00	0.00
	4:20:00	0.00	0.00	0.00	0.00	0.00	0.00	0.00	0.00	0.00
	4:25:00	0.00	0.00	0.00	0.00	0.00	0.00	0.00	0.00	0.00
	4:30:00	0.00	0.00	0.00	0.00	0.00	0.00	0.00	0.00	0.00
	4:35:00	0.00	0.00	0.00	0.00	0.00	0.00	0.00	0.00	0.00
	4:40:00	0.00	0.00	0.00	0.00	0.00	0.00	0.00	0.00	0.00
	4:45:00	0.00	0.00	0.00	0.00	0.00	0.00	0.00	0.00	0.00
	4:50:00	0.00	0.00	0.00	0.00	0.00	0.00	0.00	0.00	0.00
	4:55:00	0.00	0.00	0.00	0.00	0.00	0.00	0.00	0.00	0.00
	5:00:00	0.00	0.00	0.00	0.00	0.00	0.00	0.00	0.00	0.00
	5:05:00	0.00	0.00	0.00	0.00	0.00	0.00	0.00	0.00	0.00
	5:10:00	0.00	0.00	0.00	0.00	0.00	0.00	0.00	0.00	0.00
	5:15:00	0.00	0.00	0.00	0.00	0.00	0.00	0.00	0.00	0.00
	5:20:00	0.00	0.00	0.00	0.00	0.00	0.00	0.00	0.00	0.00
	5:25:00	0.00	0.00	0.00	0.00	0.00	0.00	0.00	0.00	0.00
	5:30:00	0.00	0.00	0.00	0.00	0.00	0.00	0.00	0.00	0.00
	5:35:00	0.00	0.00	0.00	0.00	0.00	0.00	0.00	0.00	0.00
	5:40:00	0.00	0.00	0.00	0.00	0.00	0.00	0.00	0.00	0.00
	5:45:00	0.00	0.00	0.00	0.00	0.00	0.00	0.00	0.00	0.00
	5:50:00	0.00	0.00	0.00	0.00	0.00	0.00	0.00	0.00	0.00
	5:55:00	0.00	0.00	0.00	0.00	0.00	0.00	0.00	0.00	0.00
	6:00:00	0.00	0.00	0.00	0.00	0.00	0.00	0.00	0.00	0.00

Site-Level Low Impact Development (LID) Design Effective Impervious Calculator LID Credit by Impervious Reduction Factor (IRF) Method

UD-BMP (Version 3.06, November 2016)

User Input		
Calculated cells		
***Design Storm: 1-Hour Rain Depth	WQCV Event	0.60
***Minor Storm: 1-Hour Rain Depth	5-Year Event	1.50
***Major Storm: 1-Hour Rain Depth	100-Year Event	2.52
Optional User Defined Storm	CUHP	
(CUHP) NOAA 1 Hour Rainfall Depth and Frequency for User Defined Storm	100-Year Event	
Max Intensity for Optional User Defined Storm		0

Designer: TJE
Company: Galloway & Company
Date: June 29, 2022
Project: Falcon Meadows at Bent Grass Filing No. 4
Location: Falcon, CO

SITE INFORMATION (USER-INPUT)

Sub-basin Identifier	A-Z																			
Receiving Pervious Area Soil Type	Loamy Sand																			
Total Area (ac., Sum of DCIA, UIA, RPA, & SPA)	0.710																			
Directly Connected Impervious Area (DCIA, acres)	0.000																			
Unconnected Impervious Area (UIA, acres)	0.090																			
Receiving Pervious Area (RPA, acres)	0.620																			
Separate Pervious Area (SPA, acres)	0.000																			
RPA Treatment Type: Conveyance (C), Volume (V), or Permeable Pavement (PP)	C																			

CALCULATED RESULTS (OUTPUT)

Total Calculated Area (ac, check against input)	0.710																			
Directly Connected Impervious Area (DCIA, %)	0.0%																			
Unconnected Impervious Area (UIA, %)	12.7%																			
Receiving Pervious Area (RPA, %)	87.3%																			
Separate Pervious Area (SPA, %)	0.0%																			
A_p (RPA / UIA)	6.889																			
I_p Check	0.130																			
f / I for WQCV Event:	3.2																			
f / I for 5-Year Event:	0.5																			
f / I for 100-Year Event:	0.4																			
f / I for Optional User Defined Storm CUHP:																				
IRF for WQCV Event:	0.28																			
IRF for 5-Year Event:	0.54																			
IRF for 100-Year Event:	0.56																			
IRF for Optional User Defined Storm CUHP:																				
Total Site Imperviousness: I_{total}	12.7%																			
Effective Imperviousness for WQCV Event:	3.6%																			
Effective Imperviousness for 5-Year Event:	6.9%																			
Effective Imperviousness for 100-Year Event:	7.1%																			
Effective Imperviousness for Optional User Defined Storm CUHP:																				

LID / EFFECTIVE IMPERVIOUSNESS CREDITS

WQCV Event CREDIT: Reduce Detention By:	67.8%	N/A	N/A	N/A	N/A	N/A	N/A	N/A	N/A	N/A	N/A	N/A	N/A	N/A	N/A	N/A	N/A	N/A	N/A	
This line only for 10-Year Event	N/A	N/A	N/A	N/A	N/A	N/A	N/A	N/A	N/A	N/A	N/A	N/A	N/A	N/A	N/A	N/A	N/A	N/A	N/A	N/A
100-Year Event CREDIT**:	51.7%	N/A	N/A	N/A	N/A	N/A	N/A	N/A	N/A	N/A	N/A	N/A	N/A	N/A	N/A	N/A	N/A	N/A	N/A	N/A
User Defined CUHP CREDIT: Reduce Detention By:																				

Total Site Imperviousness:	12.7%
Total Site Effective Imperviousness for WQCV Event:	3.6%
Total Site Effective Imperviousness for 5-Year Event:	6.9%
Total Site Effective Imperviousness for 100-Year Event:	7.1%
Total Site Effective Imperviousness for Optional User Defined Storm CUHP:	

Notes:

- * Use Green-Ampt average infiltration rate values from Table 3-3.
- ** Flood control detention volume credits based on empirical equations from Storage Chapter of USDCM.
- *** Method assumes that 1-hour rainfall depth is equivalent to 1-hour intensity for calculation purposes

APPENDIX F

Drainage Maps (Refer to Appendix B for Existing Drainage Maps)

