



LSC TRANSPORTATION CONSULTANTS, INC.  
2504 East Pikes Peak Avenue, Suite 304  
Colorado Springs, CO 80909  
(719) 633-2868  
FAX (719) 633-5430  
E-mail: [lsc@lsctrans.com](mailto:lsc@lsctrans.com)  
Website: <http://www.lsctrans.com>

Falcon Meadows at Bent Grass Filing No. 4  
Transportation Memorandum  
(LSC #S214333)  
October 7, 2022

**Traffic Engineer's Statement**

This traffic report and supporting information were prepared under my responsible charge and they comport with the standard of care. So far as is consistent with the standard of care, said report was prepared in general conformance with the criteria established by the County for traffic reports.



**Developer's Statement**

I, the Developer, have read and will comply with all commitments made on my behalf within this report.

\_\_\_\_\_

\_\_\_\_\_

Date

# Falcon Meadows at Bent Grass

## Filing No. 4

### Transportation Memorandum

Prepared for:  
Mr. Jim Byers  
VP of Community Development  
Challenger Homes  
8605 Explorer Dr, Suite 250  
Colorado Springs, CO 80920

OCTOBER 7, 2022

---

LSC Transportation Consultants  
Prepared by: Kirstin D. Ferrin, P.E.  
Reviewed by: Jeffrey C. Hodsdon, P.E.

LSC #S214333



## CONTENTS

LAND USE AND ACCESS .....	1
Land Use.....	1
Access .....	1
Sight Distance.....	2
Pedestrian Routes to Schools.....	2
EXISTING TRAFFIC CONDITIONS .....	2
TRIP GENERATION.....	3
PROJECTED SHORT-TERM ADDITIONAL TRAFFIC.....	3
SHORT-TERM TOTAL TRAFFIC .....	3
2040 TOTAL TRAFFIC.....	3
REQUIRED IMPROVEMENTS.....	4
ROADWAY CLASSIFICATIONS .....	6
ROAD IMPROVEMENT FEE PROGRAM .....	6
Enclosures:.....	6

Tables 1-2

Figures 1-7

Pages from the *Falcon Meadows at Bent Grass Updated Traffic Impact Study*  
December 11, 2020 (with updates noted)

Traffic Counts

Falcon Marketplace TIS Report Addendum



LSC TRANSPORTATION CONSULTANTS, INC.  
2504 East Pikes Peak Avenue, Suite 304  
Colorado Springs, CO 80909  
(719) 633-2868  
FAX (719) 633-5430  
E-mail: [lsc@lsctrans.com](mailto:lsc@lsctrans.com)  
Website: <http://www.lsctrans.com>

October 7, 2022

Mr. Jim Byers  
VP of Community Development  
Challenger Homes  
8605 Explorer Dr, Suite 250  
Colorado Springs, CO 80920

RE: Falcon Meadows at Bent Grass Filing No. 4  
El Paso County, CO  
Updated Transportation Memorandum  
LSC #S214333

Dear Mr. Byers,

LSC Transportation Consultants, Inc. has prepared this updated Transportation Memorandum for Falcon Meadows at Bent Grass Filing No. 4. The location of the site is shown in Figure 1. This report is intended as a site-specific, final-plat traffic report for the currently-proposed Filing 4.

LSC recently completed a traffic impact study (TIS) for the Falcon Meadows at Bent Grass PUD (PUDSP-20-005). This report was dated December 11, 2020. The land use and access currently proposed for Filing No. 4 is consistent with the land use and trip generation estimated and evaluated in that report.

Memos were also prepared for Filing 1 (dated September 28, 2021), Filing 2 (dated March 18, 2022), and Filing 3 (dated April 7, 2022).

## **LAND USE AND ACCESS**

### **Land Use**

Filing No. 4 is planned to include a total of 39 lots for single-family homes. The location of the lots to be included as part of currently-proposed Filing No. 4 was included in traffic-analysis zone (TAZ) 1 in the PUD TIS.

### **Access**

Two full-movement access points (Rowena Way and Henzilee Place) to the recently-completed section of Bent Grass Meadows Drive were approved as part of Falcon Meadows at Bent Grass

Filing No. 2. An additional access point (Lemon Grass Road) is proposed to be constructed as part of Filing No. 4. Please refer to the attached site-plan exhibit. Figure 2 shows the location of the access points.

### **Sight Distance**

Figure 3 shows a sight-distance analysis at the proposed Falcon Meadows at Bent Grass access points to Bent Grass Meadows Drive. Based on a design speed of 40 miles per hour (mph) on Bent Grass Meadows Drive and the criteria contained in Table 2-21 of the *Engineering Criteria Manual (ECM)*, the required intersection sight distance at the proposed site-access points is 445 feet. The required stopping sight distance from *ECM* Table 2-17 is also shown in the figure. The required intersection sight distance and stopping sight distance can be met at both intersections if the areas between the sight-distance lines and the curb line have low-level landscaping and are kept free of other obstructions (such as monument signs and parking areas) that would restrict the drivers' line of sight. Landscaping should be low — about 18 inches or lower in height — to the east of the passenger-vehicle lines of sight shown. Please refer to *ECM* Sections 2.3.6.G.1 and 2.

### **Pedestrian Routes to Schools**

- Woodmen and Meridian are shown as proposed bike routes on the *Major Transportation Corridors Plan (MTCP)* Non-Motorized Plan. Also shown is a proposed secondary regional trail west of the site.
- Bent Grass Meadows Drive is sufficiently wide for bicycles with the paved shoulder.
- There are developing pedestrian connections along the north side of the Woodmen North Frontage Road, Bent Grass Meadows Drive, and Meridian Park Drive. Other area sections of sidewalk/trail connections are being added as development occurs.
- Sidewalks have been added along Bent Grass Meadows Drive with the connection south to the frontage road, adjacent to the School District 49 headquarters.
- The subdivision streets will all have sidewalks to connect to the sidewalk along Bent Grass Meadows Drive.

### **EXISTING TRAFFIC CONDITIONS**

Figure 4 shows the existing morning and afternoon peak-hour traffic volumes at the intersections of Woodmen Road/Golden Sage Road and Meridian Road/Bent Grass Meadows Drive. The counts at the intersection of Woodmen Road/Golden Sage Road were counted in January 2020 and again in December 2020. The January 2020 counts were conducted prior to the completion of Bent Grass Meadows Drive between the Woodmen frontage road and Meridian Road, but before the restrictions due to the COVID-19 pandemic were put in place. Figure 4 shows the results of both the October 2018 counts and the October 2020 counts, as the more current counts were likely impacted by the COVID-19 pandemic. The traffic-count reports are attached.

## **TRIP GENERATION**

The site-generated vehicle trips were estimated using the nationally-published trip-generation rates from *Trip Generation, 11th Edition, 2021* by the Institute of Transportation Engineers (ITE). Table 1 shows the trip-generation estimates for Falcon Meadows at Bent Grass Filing No. 4.

Falcon Meadows at Bent Grass Filing No. 4 is expected to generate about 368 vehicle trips on the average weekday, with about half entering and half exiting the site during a 24-hour period. During the morning peak hour, which generally occurs for one hour between 6:30 a.m. and 8:30 a.m., about 7 vehicles would enter and 22 vehicles would exit the site. During the afternoon peak hour, which generally occurs for one hour between 4:15 p.m. and 6:15 p.m., about 24 vehicles would enter and 14 vehicles would exit the site.

## **PROJECTED SHORT-TERM ADDITIONAL TRAFFIC**

Figure 5 shows the projected additional traffic volumes at the intersections of Woodmen/Golden Sage and Meridian/Bent Grass Meadows due to Falcon Meadows at Bent Grass Filing No. 4. These volumes were calculated by applying the external trip-distribution percentages shown in Figure 7 of the PUD TIS to the trip generation shown in Table 1. Trips with destinations and/or origins within the area bound by Woodmen Road on the south and Meridian Road on the east have been assigned separately, based on the location of the future commercial and school uses within the study area.

Figure 5 also shows the projected additional traffic volumes at the intersections of Woodmen/Golden Sage and Meridian/Bent Grass Meadows due to Bent Grass Residential Filing 2 taken from the TIS dated January 24, 2020 (PCD File No. SF-1914), due to Falcon Meadows at Bent Grass Filing No. 1 taken from the September 2021 memorandum (PCD File NO. SF-2034), due to Falcon Meadows at Bent Grass Filing No. 2 taken from the March 2022 memorandum (PCD File NO. SF-2134), and due to Falcon Meadows at Bent Grass Filing No. 3 taken from the April 2022 memorandum (PCD File NO. SF-2216).

## **SHORT-TERM TOTAL TRAFFIC**

Figure 6 shows the projected short-term total traffic volumes at the intersections of Woodmen/Golden Sage and Meridian/Bent Grass Meadows. The volumes are the sum of the January 2020 traffic volumes (from Figure 4) plus the additional short-term traffic volumes (from Figure 5). Please refer to the PUD TIS for short-term total traffic volumes at the other area intersections and the short-term level of service analysis.

## **2040 TOTAL TRAFFIC**

Please refer to the PUD TIS for the 2040-total traffic volumes and level of service analysis.

## REQUIRED IMPROVEMENTS

Based on the projected short-term total traffic volumes from the PUD TIS, the classification of Bent Grass Meadows Drive as an Urban Non-Residential Collector, and the criteria contained in the *ECM*, right-turn deceleration lanes are **not** projected to be warranted on Bent Grass Meadows Drive approaching any of the Falcon Meadows at Bent Grass access points (Rowena Way, Henzlee Place, and Lemon Grass Road).

Based on the projected short-term total traffic volumes from the PUD TIS, the classification of Bent Grass Meadows Drive as an Urban Non-Residential Collector, and the criteria contained in the *ECM*, northeast-bound left-turn lanes are projected to be warranted on Bent Grass Meadows Drive approaching all of the Falcon Meadows at Bent Grass access points (Rowena Way, Henzlee Place, and Lemon Grass Road). Bent Grass Meadows Drive has been constructed with a center two-way, left-turn lane that will meet these criteria.

Please see a copy of Table 4 Roadway System Improvements from the PUD TIS with annotations added in September 2021 (as part of the Filing 1 memo), March 2022 (as part of the Filing 2 memo), April 2022 (as part of the Filing 3 memo) and June 2022 (for this memo) indicating the status of each improvement.

Regarding Improvement F, note that Bent Grass Meadows Drive has been completed between the Woodmen frontage road and Meridian Road since completion of the PUD TIS. The approved Filing 1 in Falcon Meadows at Bent Grass required construction, paving, and associated repairs to Bent Grass Meadows Drive south of the site, as deemed appropriate by the PCD Director and the County Engineer, including design and construction of an eastbound left-turn lane on Woodmen Frontage Road at Bent Grass Meadows Drive, if warranted, to meet the minimum standards of a Non-Residential Collector in accordance with the *Engineering Criteria Manual*. These road improvements may be eligible for cost recovery from adjacent developers.

Meeting were held with El Paso County PCD staff and City Traffic Engineering on March 14, 2022 and March 29, 2022 to discuss items G,H, I, and J in this table. The intersection is under city ownership/jurisdiction, however the ownership of the intersection of Golden Sage/N. Frontage Road is not clear. The city will be researching the ownership and the availability of potential additional ROW (if possible) to accommodate potential future alternative intersection options for the intersection of Golden Sage/N. Frontage Road and the approach legs to the south, east and west. It was determined that item H would not be needed at this time. Item I would likely be needed in the short term; however, it was agreed that Falcon Meadows at Bent Grass would only be required to provide escrow towards this improvement for future construction once ownership and the availability of potential additional ROW is determined.

As of the week of **June 20, 2022**, and a conversation with City Traffic staff, there are no updates to the above meeting notes. City staff indicated they would like the County to collect the escrow from this and all future Falcon Meadows at Bent Grass filings and then give the money to the City

to go towards future improvements at Golden Sage/Woodmen and Golden Sage/North Frontage Road.

Regarding Improvement G, protected/permitted phasing has been added to the intersection of Golden Sage/Woodmen. This improvement is complete.

Regarding Improvement H, the *Falcon Marketplace TIS Report Addendum* by LSC dated July 21, 2020 (PCD File No. SP-17-001/CDR-16-007) identified the trigger for the need to lengthen the current eastbound single left-turn deceleration lane on Woodmen Road approaching Golden Sage Road as when the eastbound left-turn volume is greater than 200 vehicles per hour (vph) during the afternoon peak hour. As shown in Figure 6, following buildout of Bent Grass Residential Filing No. 1 and Falcon Meadows at Bent Grass Filings Nos. 1, 2, 3 and 4, the projected volume for this movement is 222 vph during the afternoon peak hour. However, it should be noted that our understanding is that control over the intersection of Golden Sage/Woodmen has been transferred to the City of Colorado Springs as part of the Banning Lewis Ranch North Annexation (CPC A 19-00022). The outcome of a meeting with the city was that item H would not be needed at this time.

Regarding Improvement I, the *Falcon Marketplace TIS Report Addendum* by LSC dated July 21, 2020 (PCD File No. SP-17-001/CDR-16-007) identified the trigger for the need to for an exclusive southbound right-turn deceleration lane on Golden Sage Road approaching Woodmen Road as when the southbound left-turn volume is greater than 167 to 192 vph during the morning peak hour. As shown in Figure 6, following buildout of Bent Grass Residential Filing No. 1 and Falcon Meadows at Bent Grass Filings Nos. 1, 2, 3 and 4, the projected volume for this movement is 225 vph during the morning peak hour. This exceeds the estimated trigger identified that would require the construction of an exclusive southbound right-turn deceleration lane. However, recent analysis suggests that the existing laneage will accommodate Filing 4 traffic. Also note that control over the intersection of Golden Sage/Woodmen has transferred to the City of Colorado Springs as part of the Banning Lewis Ranch North Annexation (CPC A 19-00022). The outcome of meetings with the city was that escrow would be collected for improvement I for future construction once right-of-way and ownership issues are resolved.

Table 2 shows the percentage of the projected 2040 total traffic due to Falcon Meadows at Bent Grass Filing No 4 for Improvements H, I, and J. These percentages could be used to determine the pro-rata share of the cost of intersection improvements. However, it should be noted that control over the intersection of Golden Sage/Woodmen has been transferred to the City of Colorado Springs as part of the Banning Lewis Ranch North Annexation (CPC A 19-00022). Per the paragraph above, additional research is underway which will be helpful in determining a solution for Golden Sage/N. Frontage Road.



## **ROADWAY CLASSIFICATIONS**

Figure 7 shows the recommended internal street classifications.

## **ROAD IMPROVEMENT FEE PROGRAM**

Applicable fees will need to be paid to the Woodmen Road District pursuant to the agreement between El Paso County and the Woodmen Road District.

\* \* \* \* \*

Please contact me if you have any questions regarding this report.

Respectfully Submitted,

LSC TRANSPORTATION CONSULTANTS, INC.

By: Jeffrey C. Hodsdon, P.E.  
Principal

JCH/KDF:jas

Enclosures: Tables 1-2  
Figures 1-7  
Pages from the *Falcon Meadows at Bent Grass Updated Traffic Impact Study*  
December 11, 2020 (with updates noted)  
Traffic Counts  
Falcon Marketplace TIS Report Addendum

# Tables 1-2

---



**Table 1  
Trip Generation Estimate  
Falcon Meadows at Bent Grass Filing No. 4**

Land Use Code	Land Use Description	Trip Generation Units	Trip Generation Rates <sup>(1)</sup>				Total Trips Generated					
			Average Weekday Traffic	Morning Peak Hour		Afternoon Peak Hour		Average Weekday Traffic	Morning Peak Hour		Afternoon Peak Hour	
				In	Out	In	Out		In	Out	In	Out
210	Single-Family Detached Housing	39 DU <sup>(2)</sup>	9.44	0.19	0.56	0.62	0.37	368	7	22	24	14

Notes:  
(1) Source: "Trip Generation, 11th Edition, 2017" by the Institute of Transportation Engineers (ITE)  
(2) DU = dwelling unit

Source: LSC Transportation Consultants, Inc. Jun-22

**Table 2**  
**Prorata Share Contribution Calculations<sup>(1)</sup>**  
**Falcon Meadows at Bent Grass Filing No. 4**

Item	Improvement Description and Estimated Cost		AM	PM	AM + PM	
H	Lengthening of the current eastbound single left-turn deceleration lane on Woodmen approaching Golden Sage Road		Site-Generated Traffic <sup>(2)</sup> (vehicles per hour)	4	12	16
			2040 Total Traffic <sup>(2)</sup> (vehicles per hour)	319	447	766
			%	1.25%	2.68%	2.09%
	Estimated Improvement Cost:	\$ 200,000	Estimated Fair-Share Portion for this project based on calculated AM + PM percentage:	\$ 4,178		
I	Southbound exclusive right-turn lane on Golden Sage Road approaching Woodmen Road		Site-Generated Traffic <sup>(3)</sup> (vehicles per hour)	11	7	18
			2040 Total Traffic <sup>(3)</sup> (vehicles per hour)	392	391	783
			%	2.81%	1.79%	2.30%
	Estimated Improvement Cost:	\$ 100,000	Estimated Fair-Share Portion for this project based on calculated AM + PM percentage:	\$ 2,299		
J	Signalization of Golden Sage Road/Woodmen Frontage Road or reconstruction as a modern roundabout; Future additional laneage may be necessary at this intersection to accommodate vehicle queues and for traffic operations.		Site-Generated Traffic <sup>(4)</sup> (vehicles per hour)	15	19	34
			2040 Total Traffic <sup>(4)</sup> (vehicles per hour)	979	1183	2162
			%	1.53%	1.61%	1.57%
	Estimated Improvement Cost:	\$ 350,000	Estimated Fair-Share Portion for this project based on calculated AM + PM percentage:	\$ 5,504		

Notes:

(1) The improvements and fair shares are to be verified with an updated traffic impact analysis or memorandum as appropriate with each final plat in the Falcon Meadows at Bent Grass development. An escrow agreement, including a financial assurance estimate for the intersection improvements, as approved by the Planning and Community Development Department Director and the County Attorney's Office shall be completed and escrow deposited with each final plat for the respective improvements within the County's jurisdiction. It should be noted that our understanding is that control over the intersection of Golden Sage/Woodmen is being transferred to the City of Colorado Springs as part of the Banning Lewis Ranch North Annexation (CPC A 19-00022).

(2) Eastbound left-turn volume at the intersection of Woodmen/Golden Sage

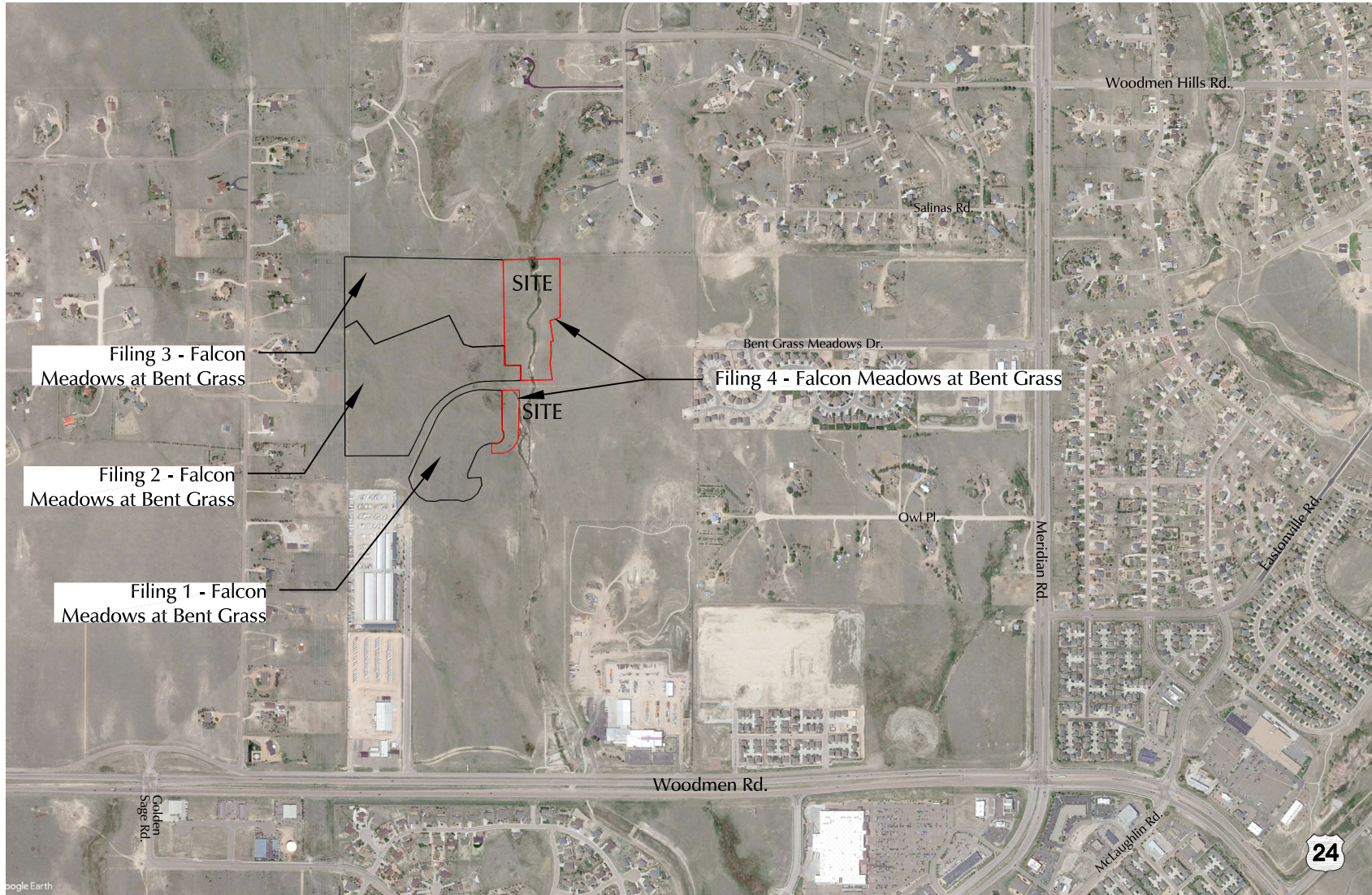
(3) Southbound right-turn volume at the intersection of Woodmen/Golden Sage

(4) Sum of all traffic volumes at the intersection of Golden Sage/Woodmen frontage road

# Figures 1-7

---






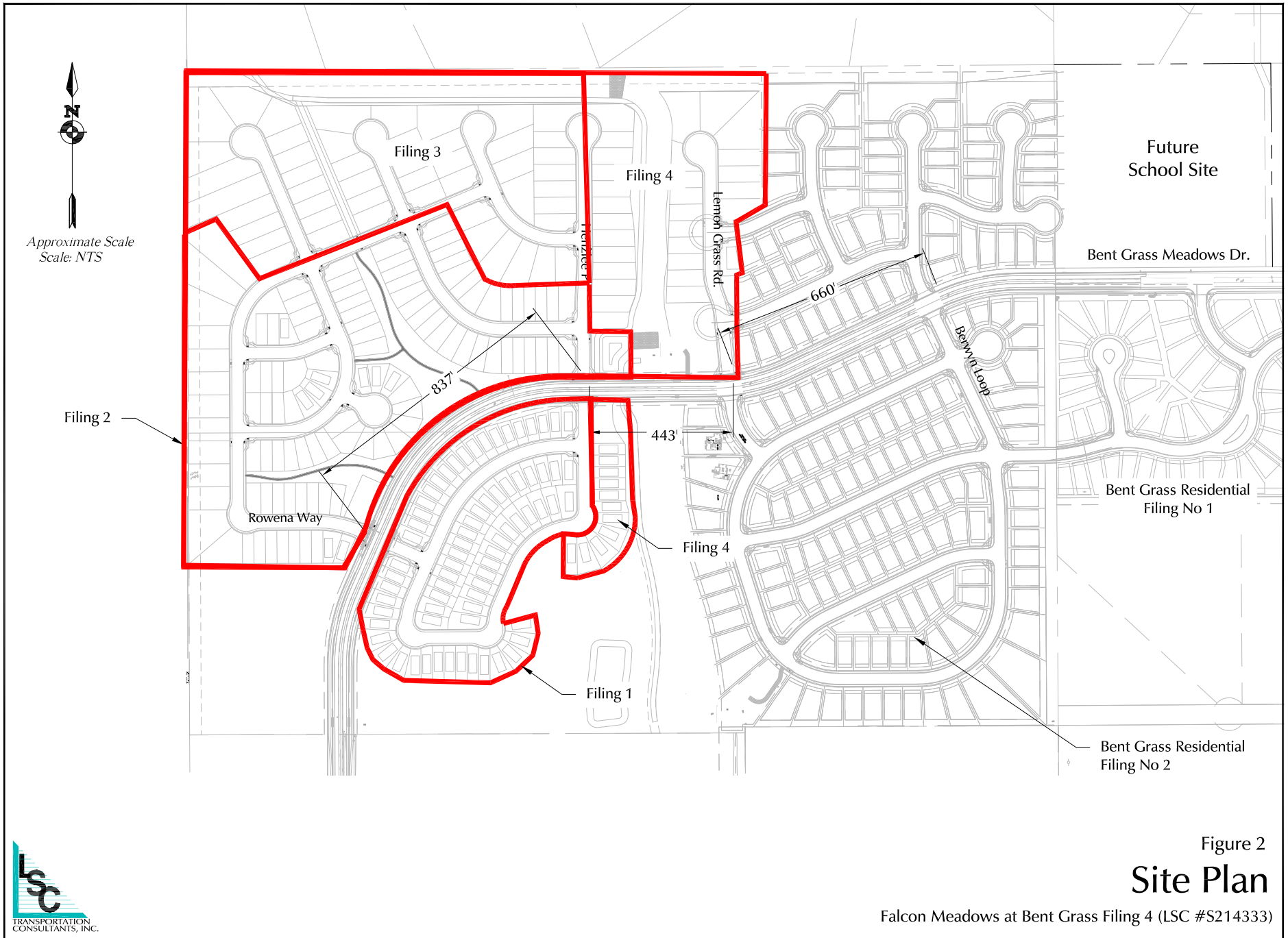
  
 Approximate Scale  
 Scale: 1" = 1,200'

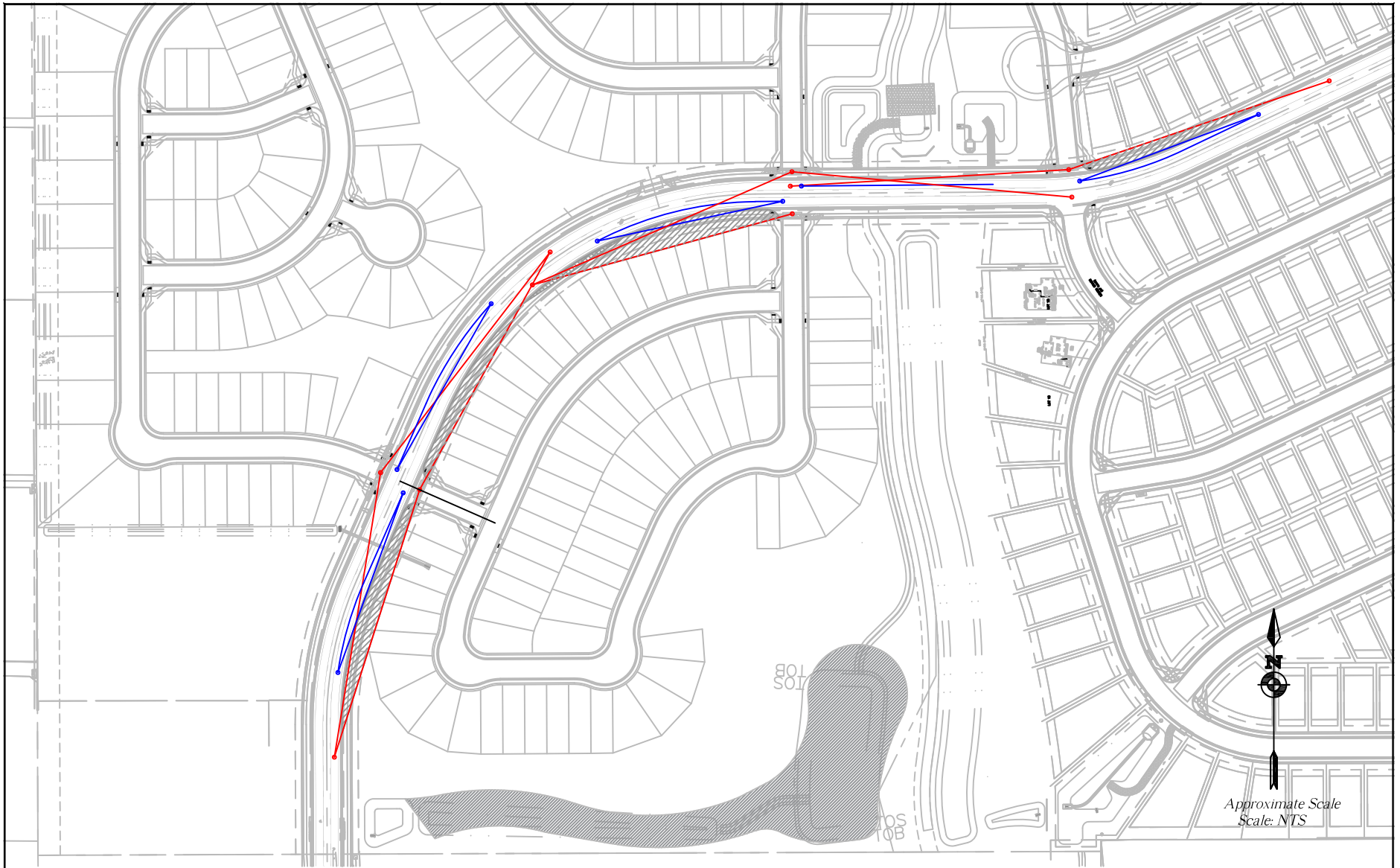
Figure 1

# Vicinity Map

Falcon Meadows at Bent Grass Filing 4 (LSC #S214333)







Approximate Scale  
Scale: NTS

LEGEND:

- = ECM Required Intersection Sight Distance (445' based on design speed of 40mph from Table 2-21)
- ←←← = ECM Required Stopping Sight Distance Travel Path (305' based on design speed of 40mph from Table 2-17)
- = Stopping Sight Distance Sight Line
- = Area must be kept clear of obstructions to intersection distance line of sight.

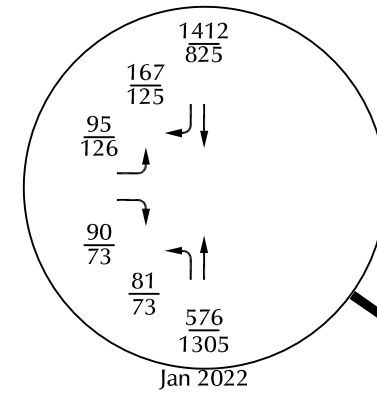


Figure 3  
**Sight Distance**

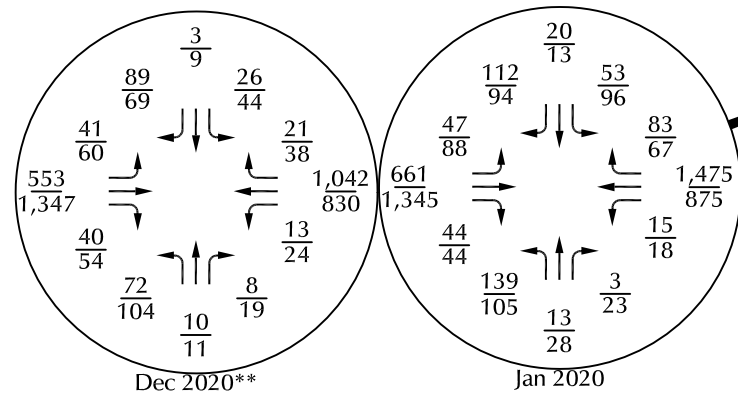
Falcon Meadows at Bent Grass Filing 4 (LSC #S214333)



\*\*The January 2020 counts were conducted prior to the completion of Bent Grass Meadows Drive between the Woodmen frontage road and Meridian Ranch, but before impacts of the COVID-19 pandemic. The December 2020 counts were conducted following the completion of Bent Grass Meadows Drive between the Woodmen frontage road and Meridian Ranch, but during the COVID-19 pandemic.



Approximate Scale  
Scale: 1" = 1,200'



LEGEND:

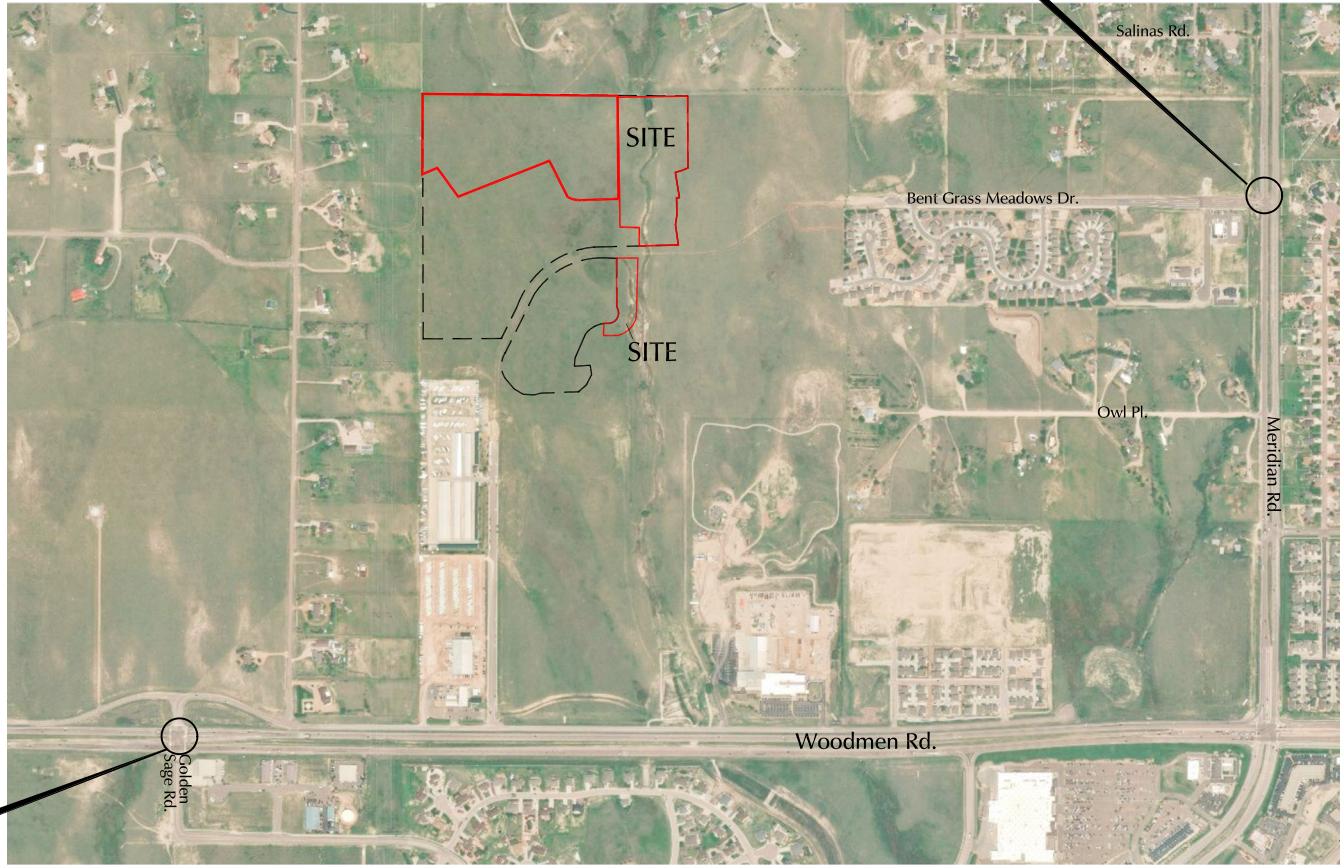
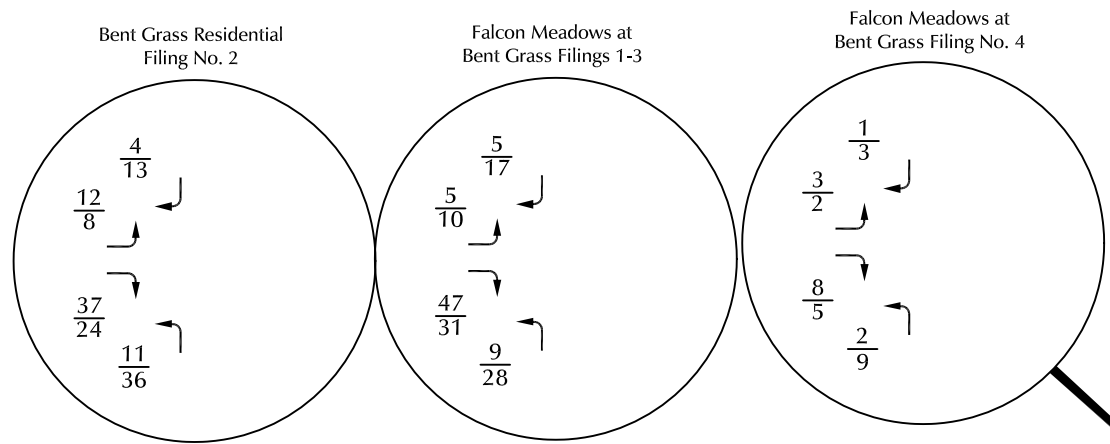
$\frac{XX}{XX}$  = AM Weekday Peak-Hour Traffic (vehicles per hour)  
 $\frac{XX}{XX}$  = PM Weekday Peak-Hour Traffic (vehicles per hour)

X,XXX= Average Daily Traffic (vehicles per day)

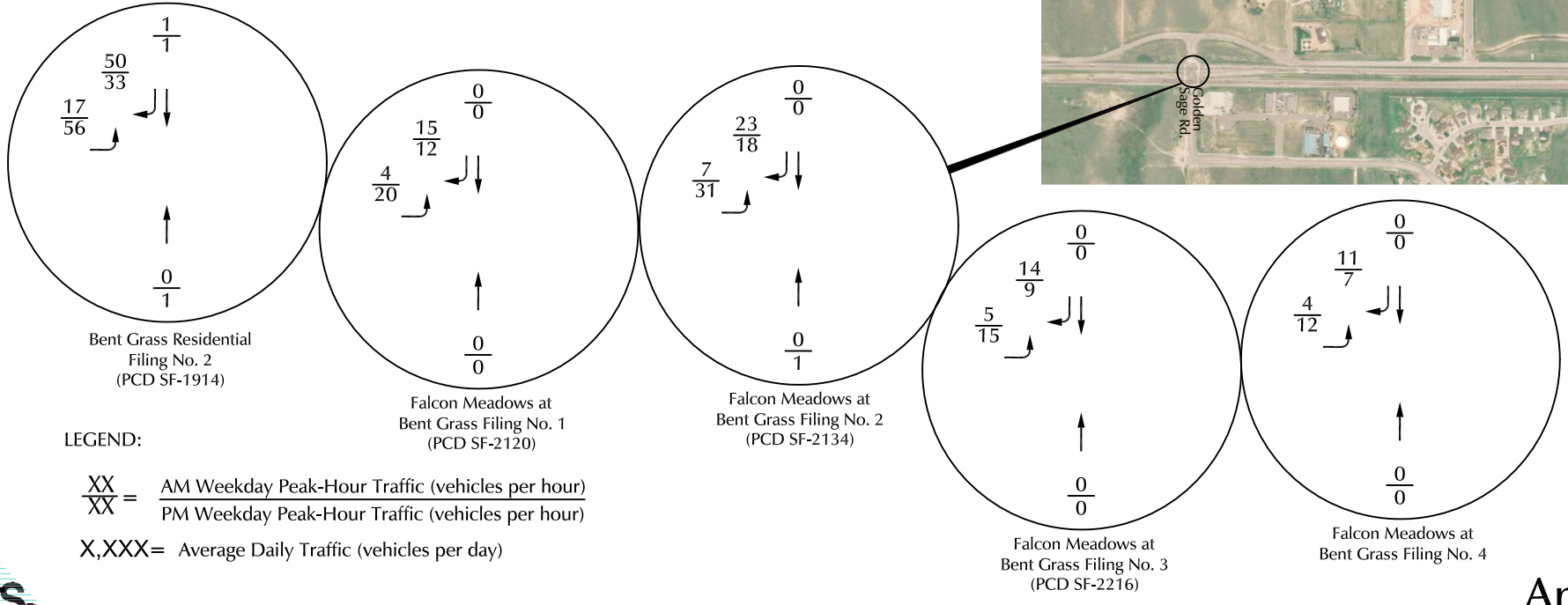


Figure 4  
Existing Traffic

Falcon Meadows at Bent Grass Filing 4 (LSC #S214333)



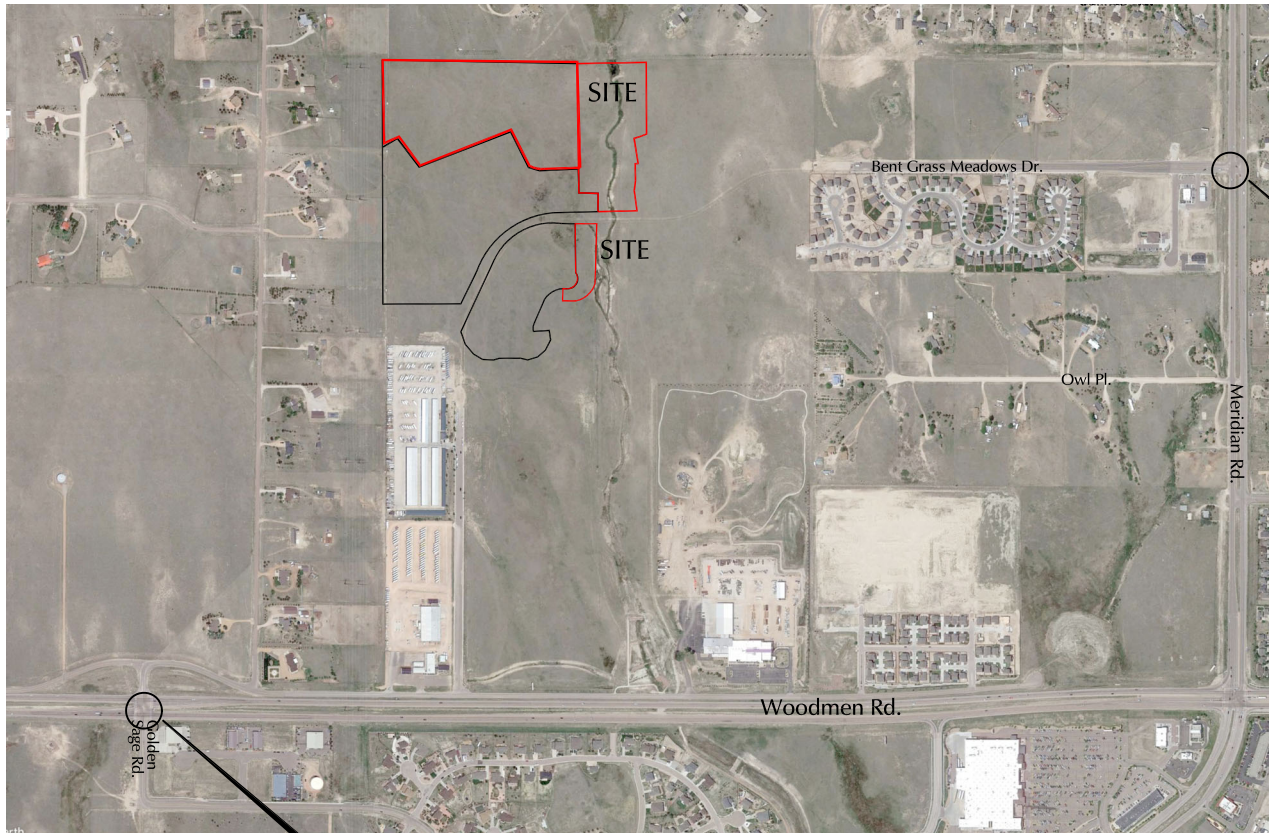
Approximate Scale  
Scale: 1" = 1,200'



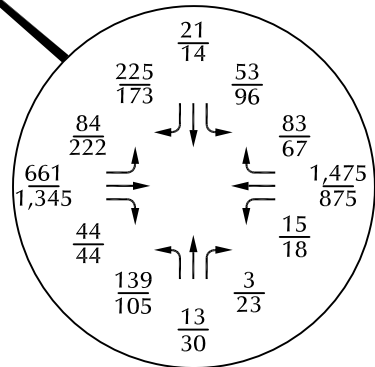
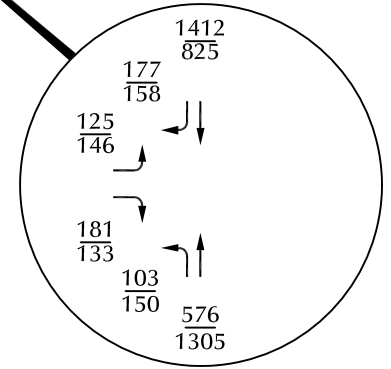
LEGEND:  
 $\frac{XX}{XX}$  = AM Weekday Peak-Hour Traffic (vehicles per hour)  
 $\frac{XX}{XX}$  = PM Weekday Peak-Hour Traffic (vehicles per hour)  
 X,XXX= Average Daily Traffic (vehicles per day)



Figure 5  
**Anticipated Additional Short-Term Traffic Volumes**  
 Falcon Meadows at Bent Grass Filing 4 (LSC #S214333)



Approximate Scale  
NTS



\*The short-term total traffic volumes are the sum of the January 2020 volumes from Figure 4 plus the anticipated additional short-term traffic volumes from Figure 5.



LEGEND:

$\frac{XX}{XX}$  = AM Weekday Peak-Hour Traffic (vehicles per hour)  
 $\frac{XX}{XX}$  = PM Weekday Peak-Hour Traffic (vehicles per hour)

Figure 6  
**Short-Term Total\* Traffic**  
 Falcon Meadows at Bent Grass Filing 4 (LSC #S214333)

# Additional Attachments

---

Pages from the *Falcon Meadows at Bent Grass Updated Traffic Impact Study* December 11, 2020 (with updates noted)



Taken from the *Falcon Meadows at Bent Grass Updated Traffic Impact Study* December 11, 2020 with Updates added in July 2021 and September 2021 and December 2021

Updated for Fil 2 March 2022.

Updated for Fil 3 April 2022.

Updated for Fil 4 June 2022

**Table 4  
Roadway System Improvements  
Falcon Meadows at Bent Grass**

Description	Trigger	Timing	Responsibility
<b>Meridian Road/Bent Grass Meadows Road</b>			
A Signalize Meridian/Bent Grass Meadows	Remove existing stop-sign and replace with traffic signal control.	When warrant(s) are met -- 2 of the 3 conditions of the "Crash Experience" warrant are currently met. The current number of reported crashes (susceptible to correction with a signal) exceeds the threshold as do the associated traffic volume thresholds.	Bent Grass Metro District
B Right-turn acceleration lane on Meridian at Bent Grass Meadows	ECM criteria indicates the acceleration lane would need to be 960 feet long plus a 222-foot taper based on the design speed of 60 mph. Note that Owl Lane is located approximately 925 feet south of Bent Grass Meadows Drive. Therefore, the lane would be a continuous acceleration/deceleration lane between Bent Grass Meadows Drive and Owl Lane.	ECM criteria has been exceeded. A deviation was previously approved waiving this requirement with the development of Bent Grass Residential Filing 1 and Bent Grass East Commercial Filing 2A. Additional development will either require the submittal and approval of a new deviation or construction of this improvement. (Notes: The installation of the traffic signal will regularly stop southbound traffic allowing eastbound right turns to enter southbound Meridian Road without an acceleration lane. The LOS analysis indicates significant improvement of the LOS with the signal. The crash data does not indicate a safety issue with the current eastbound right movement without the accel lane. Several costly improvements may be needed to build the accel lane -- including burying the overhead power lines south to Owl Place, reconstructing the ditch section along the west side of Meridian Road, and reworking the radius at Meridian Road. This intersection is similar to the Meridian/Woodmen Hills, Meridian/Stapleton, and Meridian/Londonderry intersections to the north in that [for "to the extent that"] southbound right acceleration lanes have not been added. If the County ultimately wants a raised right-turn island on this southwest corner of the Bent Grass Meadows/Meridian Road intersection in conjunction with an accel lane, this would likely need to be accomplished later with the overall widening of Bent Grass Meadows just west of Meridian Road.	Bent Grass Metro District
<b>Bent Grass Meadows Dr</b>			
C Construct Bent Grass Meadows Drive between the existing sections located north of the Woodmen frontage road and west of Meridian Road	Construct Bent Grass Meadows Drive as a Non-Residential Collector	With any development west of Bent Grass Residential Filing No. 1	Bent Grass Metro District
D Restrict westbound left-turn at 7-Eleven access	This first final plat (Filing 1) in Falcon Meadows at Bent Grass shall require construction, paving and associated repairs to Bent Grass Meadows Drive south of the site, as deemed appropriate by the PCD Director and the County Engineer, including design and construction of an eastbound left turn lane on Woodmen Frontage Road at Bent Grass Meadows Drive if warranted, to meet the minimum standards of a Non-Residential Collector in accordance with the Engineering Criteria Manual. These road improvements may be eligible for cost recovery from adjacent developers.	With 50% percent development of the remaining Eastwood expansion	Bent Grass Metro District
E Close 7-Eleven Access	Remove the existing curb cut.	With 50% percent development of the remaining Eastwood expansion	Bent Grass Metro District
<b>Woodmen frontage road/Bent Grass Meadows Dr</b>			
F Eastbound left-turn lane on Woodmen frontage road approaching Bent Grass Meadows Dr.	ECM criteria indicates the left-turn lane would need to be 315 feet long (155 feet of deceleration length plus 160 feet of storage length) plus a 160-foot taper based on the design speed of 40 mph.	When the eastbound left-turn volume exceeds 25 vehicles per hour	Bent Grass Metro District
<b>Woodmen/Golden Sage</b>			
G Add protected/permitted phasing for left-turn movements	Prepare a traffic signal modification plan and furnish/install new traffic signal heads for protected-permissive phasing and other necessary hardware, software needed to implement this phase; modify existing signal timing plan.	--Prior to the opening of the Bent Grass Meadows Boulevard to the public, signal modification plans should be prepared, and coordination with EPC DPW (and possibly the City of Colorado Springs) will be a necessary step(s) toward future implementation of this left turn phase. Steps should be taken such that the phase can be implemented shortly after it has been determined that it should be implemented. This determination would be made by monitoring the traffic volumes and operations once Bent Grass Meadows Drive connection is opened to traffic to determine if the phase should be added at that time.	Applicant. These road improvements may be eligible for cost recovery from adjacent developers.
H Lengthening of the current eastbound single left-turn deceleration lane on Woodmen approaching Golden Sage Road	Provide a 240-foot transition taper (20:1 taper ratio), 290 feet of deceleration distance plus sufficient vehicle stacking distance. CURRENT: 175-foot taper plus a 465-foot left-turn lane which translates to a 175-foot taper, 290-foot deceleration distance, and 175 feet of stacking distance. SHORT TERM: Adequate stacking is available in the current turn lane - calculated queue length 204 feet. LONG TERM: Lengthen single left-turn lane and/or future implementation of dual left-turn lanes (if capacity needs dictate). If a dual left is implemented in the future, consideration will need to be given to the configuration on Golden Sage and at the Golden Sage/Woodmen Frontage Road intersection to receive the dual left-turn movement.	The estimated "trigger" of 40 PM peak hour eastbound left turns above the estimated short term total volume (from Figure 16a of the TIS) approximately translates to an additional 589 directional ADT for residential trips making this turning movement (based on the ITE single family trip ratio). This estimated threshold may be reached with a combination of site-generated trips and background trips.	Bent Grass Metro District* - pro-rata share (based on total traffic volumes) of the cost of the improvement. (1)Note: Other potential responsibility for participation: In addition to the yet-to-be developed properties within the Bent Grass Metro District service area and the Falcon Marketplace development, other future developers of currently vacant lane within the "travel shed" of the north leg (and potentially the south leg) of the Golden Sage/Woodmen and Golden Sage/Woodmen N. Frontage Road intersection may also be assigned as responsible participants in future or completed (if a cost recovery agreement is put in place) traffic/roadway improvements.
I Southbound exclusive right-turn lane on Golden Sage Road approaching Woodmen Road	A continuous right-turn lane within the 150 feet between the Woodmen Frontage Road and Woodmen Road	The estimated "trigger" of 5-30 AM peak hour southbound right turns above the estimated short term total volume (from Figure 16a of the Falcon Marketplace TIS) approximately translates to an additional 85-510 directional ADT for residential trips making this turning movement (based on the ITE single family trip ratio). This estimated threshold may be reached with a combination of site-generated trips and background trips.	Bent Grass Metro District - pro-rata share (based on total traffic volumes) of the cost of the improvement. (1)Note: Other potential responsibility for participation: In addition to the yet-to-be developed properties within the Bent Grass Metro District service area and the Falcon Marketplace development, other future developers of currently vacant lane within the "travel shed" of the north leg (and potentially the south leg) of the Golden Sage/Woodmen and Golden Sage/Woodmen N. Frontage Road intersection may also be assigned as responsible participants in future or completed (if a cost recovery agreement is put in place) traffic/roadway improvements.
J Signalization of Golden Sage Road/Woodmen Frontage Road or reconstruction as a modern roundabout; Future additional laneage may be necessary at this intersection to accommodate vehicle queues and for traffic operations.	Remove existing stop-signs and replace with traffic signal control or reconstruct as modern roundabout	If/when needed to maintain acceptable level of service/traffic operations and/or to control vehicle queues. Fair-share participation by the development or the district on behalf of the district members.	Bent Grass Metro District* - pro-rata share (based on total traffic volumes) of the cost of the improvement. (1)Note: Other potential responsibility for participation: In addition to the yet-to-be developed properties within the Bent Grass Metro District service area and the Falcon Marketplace development, other future developers of currently vacant lane within the "travel shed" of the north leg (and potentially the south leg) of the Golden Sage/Woodmen and Golden Sage/Woodmen N. Frontage Road intersection may also be assigned as responsible participants in future or completed (if a cost recovery agreement is put in place) traffic/roadway improvements.
<p>*Note: It is our understanding that the specifics of the district participation will need to be included in the SIA/revise development agreement to be completed and finalized prior to the development of lots beyond the initial 49 lots. If for some reason the District is unable or unwilling to participate, or if determination by the district is delayed, the applicant would be responsible. In this case, an escrow agreement between the applicant and the County would be prepared and finalized. We understand that staff would like for that the applicant to understand the estimated/approximate costs associated with their fair share of future improvements at Golden Sage/Woodmen. LSC will provide preliminary fair share cost estimates utilizing available information from the Falcon Marketplace SIA. This will be provided by March 31st to the applicant and staff.</p>			

(1) See Table 5 for pro-rata percentage calculations  
Source: LSC Transportation Consultants, Inc. (December 2020)

(2) April 2022 Note: Meetings were held with El Paso County PCD staff and City Traffic Engineering on March 14, 2022 and March 29, 2022 to discuss items G,H, I, and J in this table. The intersection is under city ownership/jurisdiction, however the ownership of the intersection of Golden Sage/N. Frontage Road is not clear. The city will be researching the ownership and the availability of potential additional ROW (if possible) to accommodate potential future alternative intersection options for the intersection of Golden Sage/N. Frontage Road and the approach legs to the south, east and west. Item G has been completed. Item H would not be needed at this time. Item I will likely be needed in the short term, however only an escrow will be required with Filing 3, as the research of the Golden Sage/N. Frontage Road is ongoing. LSC talked with City Traffic staff the week of June 20th and at this time, there are no updates to this information (6/27/2022).

(3) See attached *Falcon Marketplace TIS Report Addendum* dated July 21, 2020 (PCD File Nos. SP-07-001 and CDR-16-007).

# Traffic Counts

---



# LSC Transportation Consultants, Inc.

2504 E Pikes Peak Ave, Suite 304  
 Colorado Springs, CO 80909  
 719-633-2868

File Name : Meridian Rd - Bent Grass Meadows AM 1-22 with light  
 Site Code : S215050  
 Start Date : 1/11/2022  
 Page No : 1

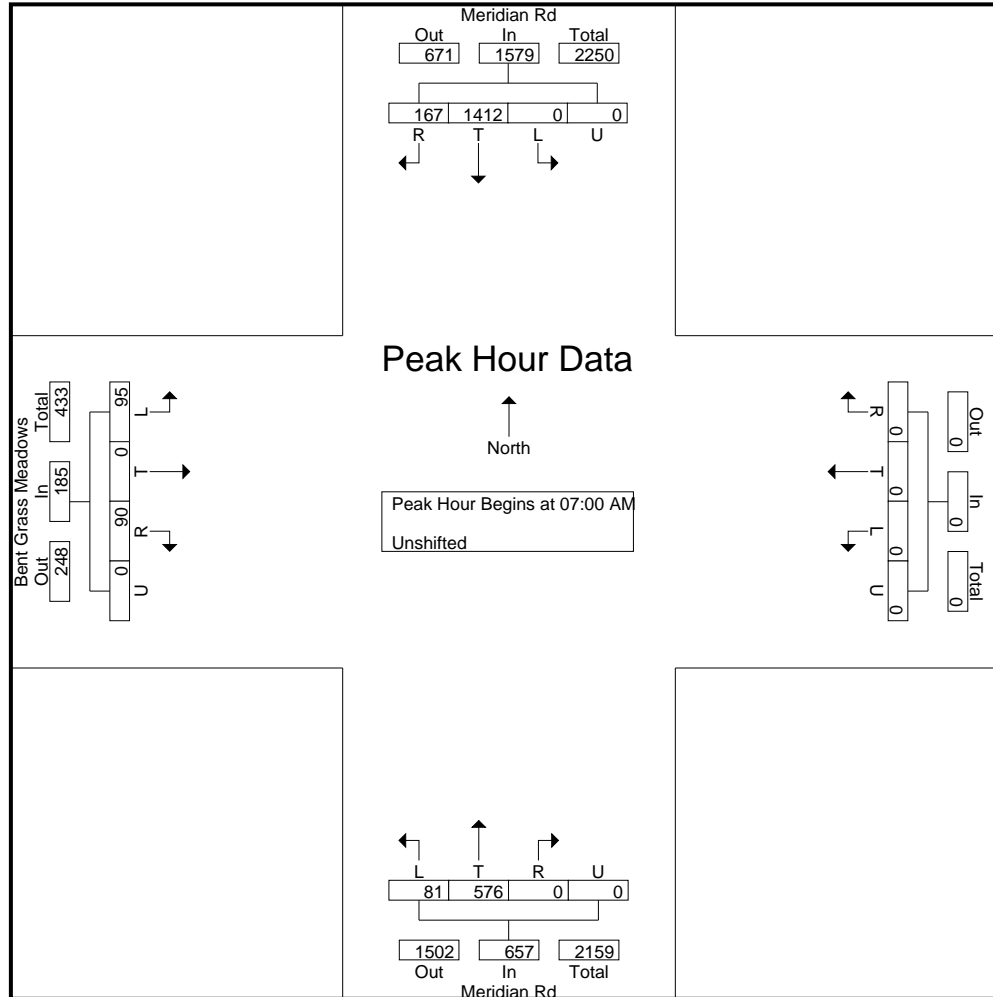
### Groups Printed- Unshifted

Start Time	Meridian Rd Southbound					Westbound					Meridian Rd Northbound					Bent Grass Meadows Eastbound					Int. Total
	L	T	R	U	App. Total	L	T	R	U	App. Total	L	T	R	U	App. Total	L	T	R	U	App. Total	
06:30 AM	0	296	27	0	323	0	0	0	0	0	10	58	0	0	68	17	0	13	0	30	421
06:45 AM	0	276	29	0	305	0	0	0	0	0	11	83	0	0	94	11	0	28	0	39	438
Total	0	572	56	0	628	0	0	0	0	0	21	141	0	0	162	28	0	41	0	69	859
07:00 AM	0	354	32	0	386	0	0	0	0	0	14	105	0	0	119	17	0	24	0	41	546
07:15 AM	0	398	32	0	430	0	0	0	0	0	20	154	0	0	174	28	0	21	0	49	653
07:30 AM	0	350	41	0	391	0	0	0	0	0	23	169	0	0	192	29	0	25	0	54	637
07:45 AM	0	310	62	0	372	0	0	0	0	0	24	148	0	0	172	21	0	20	0	41	585
Total	0	1412	167	0	1579	0	0	0	0	0	81	576	0	0	657	95	0	90	0	185	2421
08:00 AM	0	239	22	0	261	0	0	0	0	0	16	168	0	0	184	19	0	23	0	42	487
08:15 AM	0	244	43	0	287	0	0	0	0	0	9	152	0	0	161	24	0	12	0	36	484
Grand Total	0	2467	288	0	2755	0	0	0	0	0	127	1037	0	0	1164	166	0	166	0	332	4251
Apprch %	0	89.5	10.5	0		0	0	0	0	0	10.9	89.1	0	0		50	0	50	0		
Total %	0	58	6.8	0	64.8	0	0	0	0	0	3	24.4	0	0	27.4	3.9	0	3.9	0	7.8	

# LSC Transportation Consultants, Inc.

2504 E Pikes Peak Ave, Suite 304  
 Colorado Springs, CO 80909  
 719-633-2868

File Name : Meridian Rd - Bent Grass Meadows AM 1-22 with light  
 Site Code : S215050  
 Start Date : 1/11/2022  
 Page No : 3





# LSC Transportation Consultants, Inc.

2504 E Pikes Peak Ave, Suite 304  
 Colorado Springs, CO 80909  
 719-633-2868

File Name : Meridian Rd - Bent Grass Meadows PM 1-22 with light  
 Site Code : S215050  
 Start Date : 1/11/2022  
 Page No : 1

### Groups Printed- Unshifted

Start Time	Meridian Rd Southbound					Westbound					Meridian Rd Northbound					Bent Grass Meadows Eastbound					Int. Total
	L	T	R	U	App. Total	L	T	R	U	App. Total	L	T	R	U	App. Total	L	T	R	U	App. Total	
04:00 PM	0	260	36	0	296	0	0	0	0	0	16	308	0	0	324	33	0	17	0	50	670
04:15 PM	0	217	32	0	249	0	0	0	0	0	16	324	0	1	341	26	0	15	0	41	631
04:30 PM	0	185	43	0	228	0	0	0	0	0	17	291	0	0	308	33	0	21	0	54	590
04:45 PM	0	201	21	0	222	0	0	0	0	0	18	345	0	0	363	33	0	13	0	46	631
Total	0	863	132	0	995	0	0	0	0	0	67	1268	0	1	1336	125	0	66	0	191	2522
05:00 PM	0	222	29	0	251	0	0	0	0	0	22	345	0	0	367	34	0	24	0	58	676
05:15 PM	0	181	22	0	203	0	0	0	0	0	11	340	0	0	351	20	0	30	0	50	604
05:30 PM	0	197	13	1	211	0	0	0	0	0	14	337	0	0	351	28	0	23	0	51	613
05:45 PM	0	164	20	0	184	0	0	0	0	0	19	296	0	0	315	18	0	19	0	37	536
Total	0	764	84	1	849	0	0	0	0	0	66	1318	0	0	1384	100	0	96	0	196	2429
Grand Total	0	1627	216	1	1844	0	0	0	0	0	133	2586	0	1	2720	225	0	162	0	387	4951
Apprch %	0	88.2	11.7	0.1		0	0	0	0		4.9	95.1	0	0		58.1	0	41.9	0		
Total %	0	32.9	4.4	0	37.2	0	0	0	0	0	2.7	52.2	0	0	54.9	4.5	0	3.3	0	7.8	

# LSC Transportation Consultants, Inc.

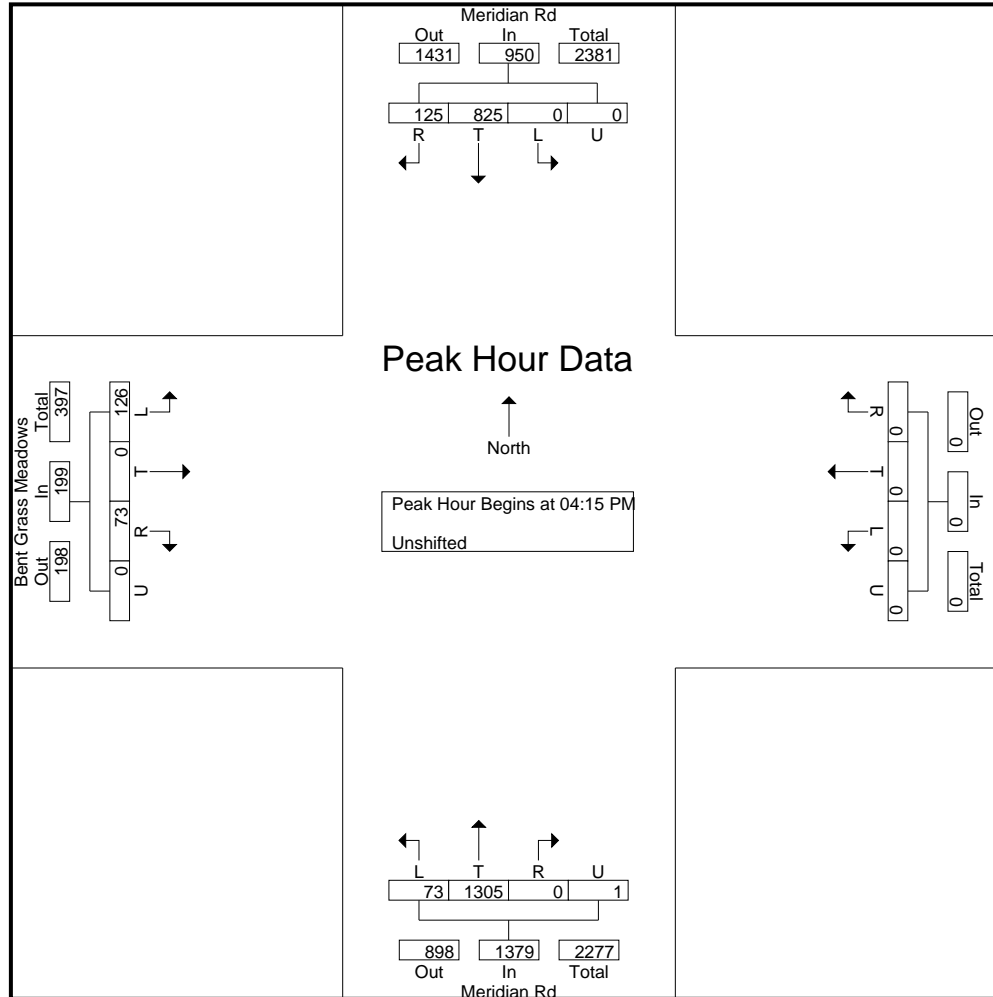
2504 E Pikes Peak Ave, Suite 304  
 Colorado Springs, CO 80909  
 719-633-2868

File Name : Meridian Rd - Bent Grass Meadows PM 1-22 with light

Site Code : S215050

Start Date : 1/11/2022

Page No : 3



# LSC Transportation Consultants, Inc.

2504 E Pikes Peak Ave, Suite 304  
Colorado Springs, CO 80909

719-633-2868

File Name : Golden Sage Rd - Woodmen Rd AM 1-20

Site Code : 00194460

Start Date : 1/21/2020

Page No : 1

### Groups Printed- Unshifted

Start Time	Golden Sage Rd Southbound					Woodmen Rd Westbound					Golden Sage Rd Northbound					Woodmen Rd Eastbound					Int. Total
	Left	Through	Right	Peds	App. Total	Left	Through	Right	Peds	App. Total	Left	Through	Right	Peds	App. Total	Left	Through	Right	Peds	App. Total	
06:30 AM	5	1	25	0	31	0	195	48	1	244	20	2	0	0	22	10	107	0	0	117	414
06:45 AM	12	5	28	0	45	4	355	30	0	389	24	4	0	0	28	14	151	9	0	174	636
Total	17	6	53	0	76	4	550	78	1	633	44	6	0	0	50	24	258	9	0	291	1050
07:00 AM	17	7	29	0	53	2	340	25	0	367	42	2	1	0	45	13	158	13	0	184	649
07:15 AM	8	4	30	0	42	3	424	16	0	443	44	3	1	0	48	12	171	11	0	194	727
07:30 AM	16	4	25	1	46	6	356	12	0	374	29	4	1	0	34	8	181	11	0	200	654
07:45 AM	7	1	7	0	15	2	293	17	0	312	13	5	0	0	18	16	209	20	0	245	590
Total	48	16	91	1	156	13	1413	70	0	1496	128	14	3	0	145	49	719	55	0	823	2620
08:00 AM	9	1	14	0	24	3	239	12	1	255	18	0	0	0	18	16	165	13	1	195	492
08:15 AM	13	2	12	0	27	2	267	19	1	289	18	3	2	0	23	28	142	6	1	177	516
Grand Total	87	25	170	1	283	22	2469	179	3	2673	208	23	5	0	236	117	1284	83	2	1486	4678
Apprch %	30.7	8.8	60.1	0.4		0.8	92.4	6.7	0.1		88.1	9.7	2.1	0		7.9	86.4	5.6	0.1		
Total %	1.9	0.5	3.6	0	6	0.5	52.8	3.8	0.1	57.1	4.4	0.5	0.1	0	5	2.5	27.4	1.8	0	31.8	

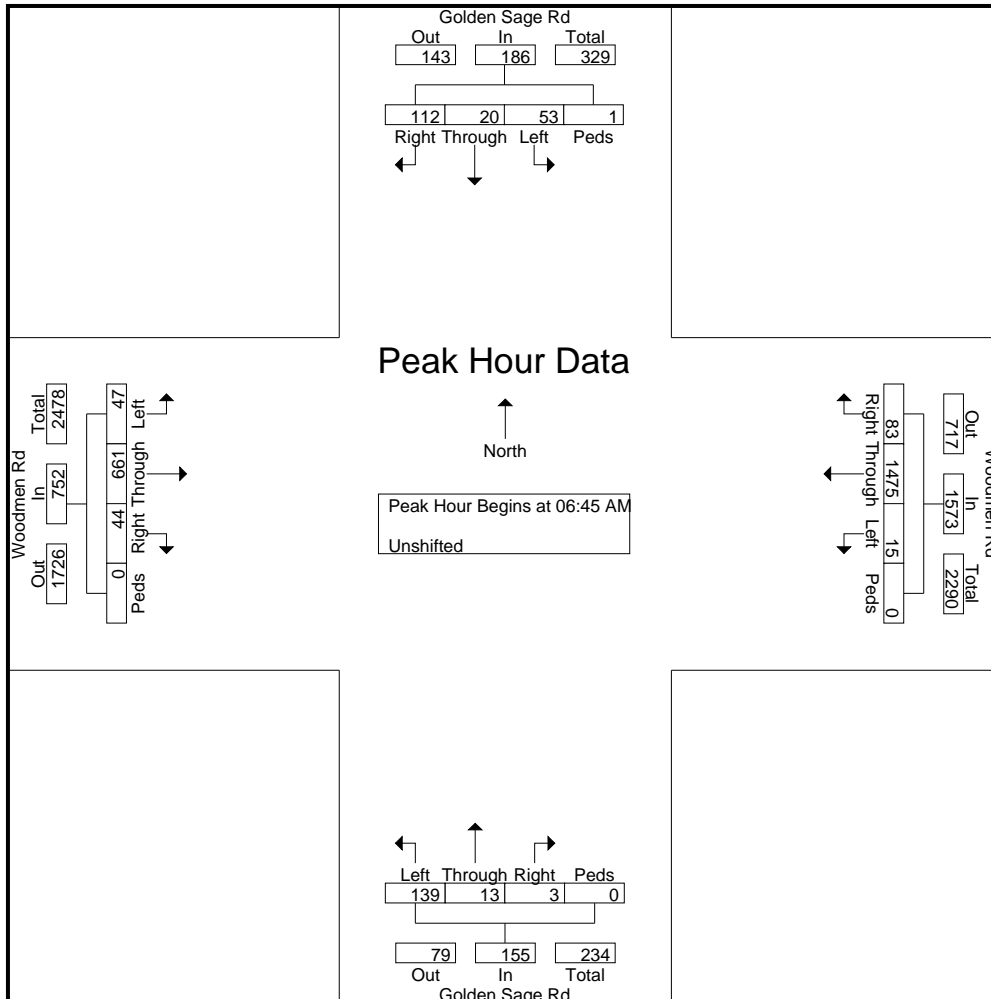
# LSC Transportation Consultants, Inc.

2504 E Pikes Peak Ave, Suite 304  
 Colorado Springs, CO 80909

719-633-2868

File Name : Golden Sage Rd - Woodmen Rd AM 1-20  
 Site Code : 00194460  
 Start Date : 1/21/2020  
 Page No : 2

Start Time	Golden Sage Rd Southbound					Woodmen Rd Westbound					Golden Sage Rd Northbound					Woodmen Rd Eastbound					Int. Total
	Left	Through	Right	Peds	App. Total	Left	Through	Right	Peds	App. Total	Left	Through	Right	Peds	App. Total	Left	Through	Right	Peds	App. Total	
<b>Peak Hour Analysis From 6:30:00 AM to 8:15:00 AM - Peak 1 of 1</b>																					
Peak Hour for Entire Intersection Begins at 6:45:00 AM																					
6:45:00 AM	12	5	28	0	45	4	355	30	0	389	24	4	0	0	28	14	151	9	0	174	636
7:00:00 AM	17	7	29	0	53	2	340	25	0	367	42	2	1	0	45	13	158	13	0	184	649
7:15:00 AM	8	4	30	0	42	3	424	16	0	443	44	3	1	0	48	12	171	11	0	194	727
7:30:00 AM	16	4	25	1	46	6	356	12	0	374	29	4	1	0	34	8	181	11	0	200	654
Total Volume	53	20	112	1	186	15	1475	83	0	1573	139	13	3	0	155	47	661	44	0	752	2666
% App. Total	28.5	10.8	60.2	0.5		1	93.8	5.3	0		89.7	8.4	1.9	0		6.2	87.9	5.9	0		
PHF	.779	.714	.933	.250	.877	.625	.870	.692	.000	.888	.790	.813	.750	.000	.807	.839	.913	.846	.000	.940	.917



# LSC Transportation Consultants, Inc.

2504 E Pikes Peak Ave, Suite 304  
Colorado Springs, CO 80909

719-633-2868

File Name : Golden Sage Rd - Woodmen Rd PM 1-20

Site Code : 00194460

Start Date : 1/21/2020

Page No : 1

### Groups Printed- Unshifted

Start Time	Golden Sage Rd Southbound					Woodmen Rd Westbound					Golden Sage Rd Northbound					Woodmen Rd Eastbound					Int. Total
	Left	Through	Right	Peds	App. Total	Left	Through	Right	Peds	App. Total	Left	Through	Right	Peds	App. Total	Left	Through	Right	Peds	App. Total	
04:00 PM	17	2	26	0	45	7	205	16	0	228	23	9	5	0	37	21	272	23	2	318	628
04:15 PM	7	1	22	0	30	5	241	26	0	272	26	5	6	0	37	28	325	12	1	366	705
04:30 PM	21	4	24	0	49	1	241	20	1	263	26	8	4	0	38	24	313	3	1	341	691
04:45 PM	29	3	19	2	53	1	202	24	0	227	16	4	0	0	20	18	341	10	1	370	670
Total	74	10	91	2	177	14	889	86	1	990	91	26	15	0	132	91	1251	48	5	1395	2694
05:00 PM	18	1	27	0	46	2	254	11	2	269	27	7	1	0	35	19	328	11	0	358	708
05:15 PM	7	2	6	0	15	8	192	9	1	210	32	10	12	0	54	23	340	17	0	380	659
05:30 PM	42	7	42	1	92	7	227	23	0	257	30	7	10	0	47	28	336	6	0	370	766
05:45 PM	21	1	18	0	40	1	180	12	1	194	19	5	5	0	29	18	326	9	0	353	616
Total	88	11	93	1	193	18	853	55	4	930	108	29	28	0	165	88	1330	43	0	1461	2749
Grand Total	162	21	184	3	370	32	1742	141	5	1920	199	55	43	0	297	179	2581	91	5	2856	5443
Apprch %	43.8	5.7	49.7	0.8		1.7	90.7	7.3	0.3		67	18.5	14.5	0		6.3	90.4	3.2	0.2		
Total %	3	0.4	3.4	0.1	6.8	0.6	32	2.6	0.1	35.3	3.7	1	0.8	0	5.5	3.3	47.4	1.7	0.1	52.5	

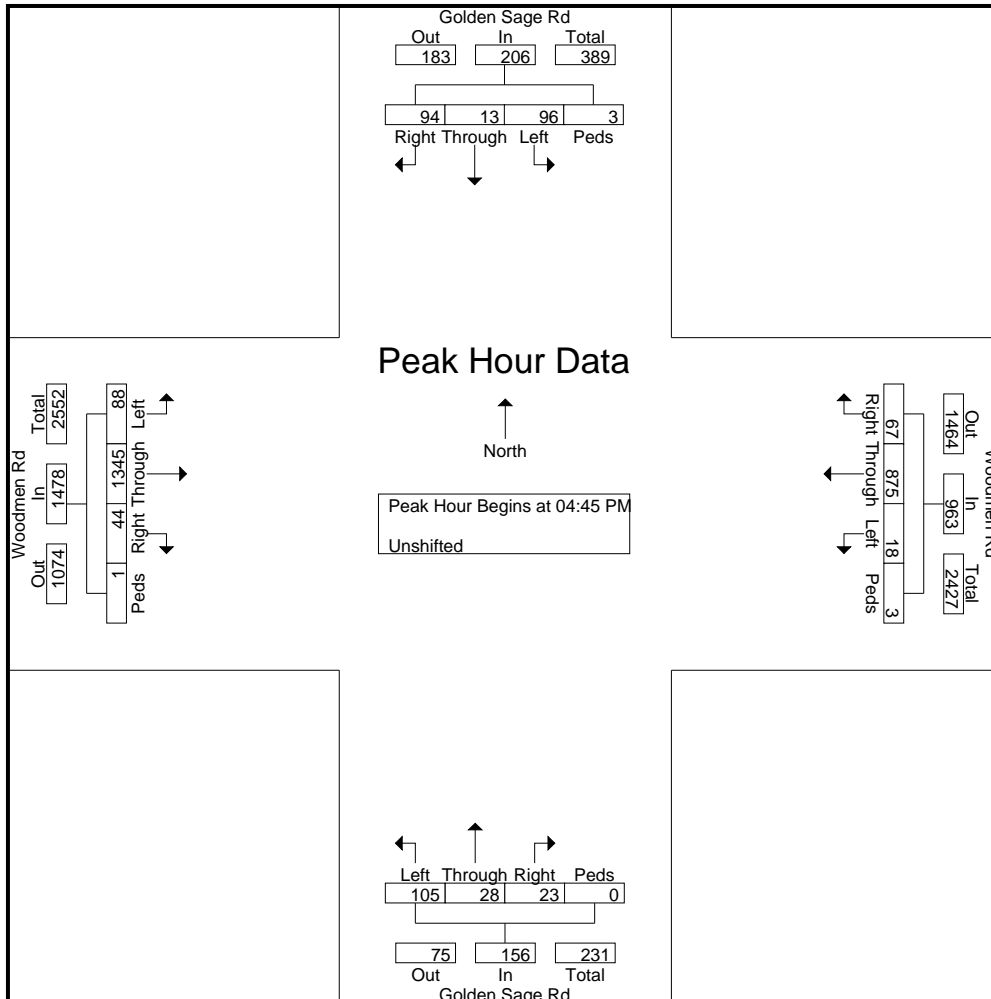
# LSC Transportation Consultants, Inc.

2504 E Pikes Peak Ave, Suite 304  
 Colorado Springs, CO 80909

719-633-2868

File Name : Golden Sage Rd - Woodmen Rd PM 1-20  
 Site Code : 00194460  
 Start Date : 1/21/2020  
 Page No : 2

Start Time	Golden Sage Rd Southbound					Woodmen Rd Westbound					Golden Sage Rd Northbound					Woodmen Rd Eastbound					Int. Total
	Left	Through	Right	Peds	App. Total	Left	Through	Right	Peds	App. Total	Left	Through	Right	Peds	App. Total	Left	Through	Right	Peds	App. Total	
<b>Peak Hour Analysis From 4:00:00 PM to 5:45:00 PM - Peak 1 of 1</b>																					
Peak Hour for Entire Intersection Begins at 4:45:00 PM																					
4:45:00 PM	29	3	19	2	53	1	202	24	0	227	16	4	0	0	20	18	341	10	1	370	670
5:00:00 PM	18	1	27	0	46	2	254	11	2	269	27	7	1	0	35	19	328	11	0	358	708
5:15:00 PM	7	2	6	0	15	8	192	9	1	210	32	10	12	0	54	23	340	17	0	380	659
5:30:00 PM	42	7	42	1	92	7	227	23	0	257	30	7	10	0	47	28	336	6	0	370	766
Total Volume	96	13	94	3	206	18	875	67	3	963	105	28	23	0	156	88	1345	44	1	1478	2803
% App. Total	46.6	6.3	45.6	1.5		1.9	90.9	7	0.3		67.3	17.9	14.7	0		6	91	3	0.1		
PHF	.571	.464	.560	.375	.560	.563	.861	.698	.375	.895	.820	.700	.479	.000	.722	.786	.986	.647	.250	.972	.915



# LSC Transportation Consultants, Inc.

2504 E Pikes Peak Ave, Suite 304  
Colorado Springs, CO 80909

File Name : Golden Sage Rd - Woodmen Rd AM  
Site Code : 00194460  
Start Date : 12/8/2020  
Page No : 1

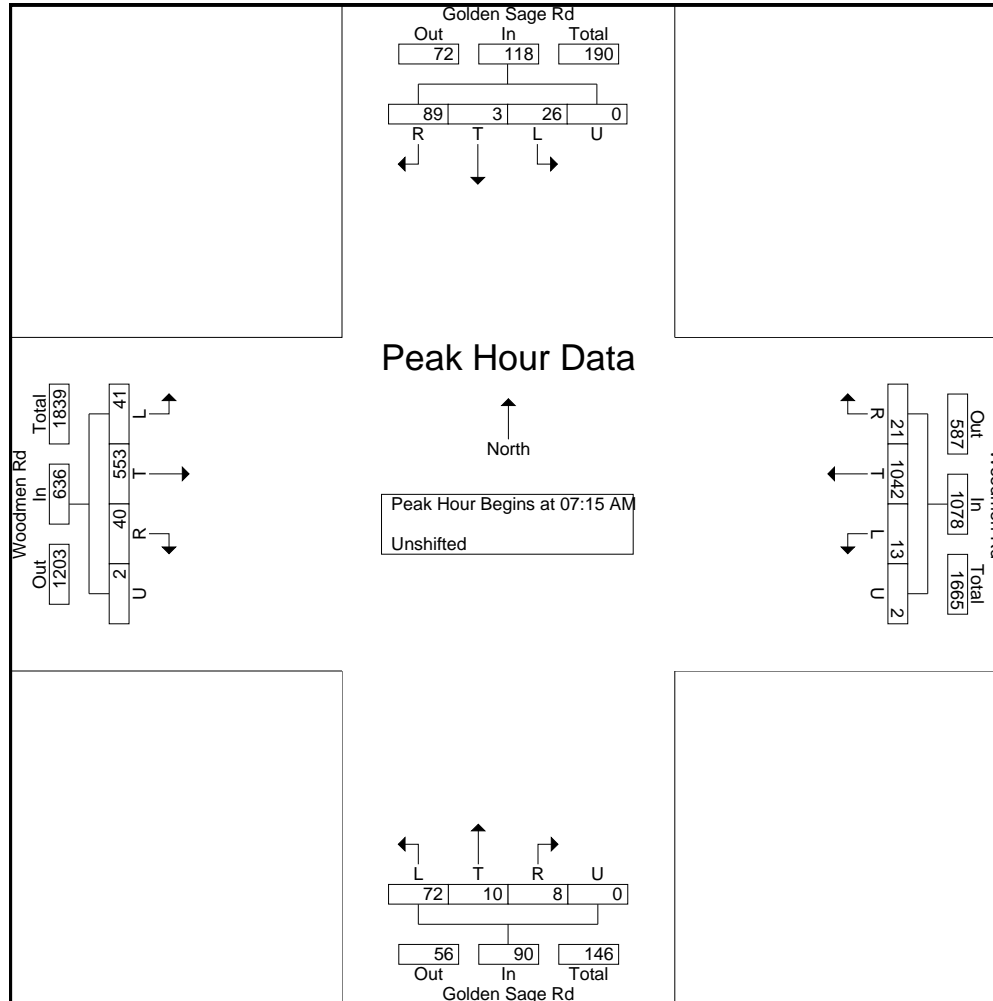
### Groups Printed- Unshifted

Start Time	Golden Sage Rd Southbound					Woodmen Rd Westbound					Golden Sage Rd Northbound					Woodmen Rd Eastbound					Int. Total
	L	T	R	U	App. Total	L	T	R	U	App. Total	L	T	R	U	App. Total	L	T	R	U	App. Total	
07:00 AM	17	1	13	0	31	1	242	5	0	248	13	4	0	0	17	7	127	6	0	140	436
07:15 AM	8	0	20	0	28	4	289	7	0	300	20	2	1	0	23	7	138	4	0	149	500
07:30 AM	8	2	30	0	40	3	318	7	0	328	29	3	2	0	34	10	138	11	1	160	562
07:45 AM	7	0	21	0	28	4	211	3	0	218	11	2	2	0	15	8	133	17	0	158	419
Total	40	3	84	0	127	12	1060	22	0	1094	73	11	5	0	89	32	536	38	1	607	1917
08:00 AM	3	1	18	0	22	2	224	4	2	232	12	3	3	0	18	16	144	8	1	169	441
08:15 AM	10	2	23	0	35	3	210	6	0	219	14	2	3	0	19	18	165	4	0	187	460
08:30 AM	6	0	22	0	28	1	247	6	0	254	16	0	1	0	17	7	161	9	0	177	476
08:45 AM	10	3	12	0	25	3	170	8	0	181	19	2	0	0	21	12	142	14	0	168	395
Total	29	6	75	0	110	9	851	24	2	886	61	7	7	0	75	53	612	35	1	701	1772
Grand Total	69	9	159	0	237	21	1911	46	2	1980	134	18	12	0	164	85	1148	73	2	1308	3689
Apprch %	29.1	3.8	67.1	0		1.1	96.5	2.3	0.1		81.7	11	7.3	0		6.5	87.8	5.6	0.2		
Total %	1.9	0.2	4.3	0	6.4	0.6	51.8	1.2	0.1	53.7	3.6	0.5	0.3	0	4.4	2.3	31.1	2	0.1	35.5	

# LSC Transportation Consultants, Inc.

2504 E Pikes Peak Ave, Suite 304  
 Colorado Springs, CO 80909

File Name : Golden Sage Rd - Woodmen Rd AM  
 Site Code : 00194460  
 Start Date : 12/8/2020  
 Page No : 3





# LSC Transportation Consultants, Inc.

2504 E Pikes Peak Ave, Suite 304  
Colorado Springs, CO 80909

File Name : Golden Sage Rd - Woodmen Rd PM  
Site Code : 00194460  
Start Date : 12/3/2020  
Page No : 1

### Groups Printed- Unshifted

Start Time	Golden Sage Rd Southbound					Woodmen Rd Westbound					Golden Sage Rd Northbound					Woodmen Rd Eastbound					Int. Total
	L	T	R	U	App. Total	L	T	R	U	App. Total	L	T	R	U	App. Total	L	T	R	U	App. Total	
04:00 PM	23	0	12	0	35	8	260	13	0	281	18	3	7	0	28	13	279	30	1	323	667
04:15 PM	13	1	15	0	29	4	220	8	0	232	16	2	4	0	22	16	332	19	0	367	650
04:30 PM	15	1	17	0	33	1	245	10	0	256	14	4	2	0	20	14	316	16	0	346	655
04:45 PM	11	0	13	0	24	2	223	12	2	239	21	2	3	0	26	10	335	8	1	354	643
Total	62	2	57	0	121	15	948	43	2	1008	69	11	16	0	96	53	1262	73	2	1390	2615
05:00 PM	9	3	16	0	28	2	225	8	0	235	27	3	2	0	32	15	336	17	0	368	663
05:15 PM	7	4	12	0	23	5	190	13	2	210	32	4	11	0	47	18	325	19	0	362	642
05:30 PM	17	2	28	0	47	15	192	5	0	212	24	2	3	0	29	17	378	10	0	405	693
05:45 PM	10	2	5	0	17	3	145	9	1	158	12	4	2	0	18	15	278	16	1	310	503
Total	43	11	61	0	115	25	752	35	3	815	95	13	18	0	126	65	1317	62	1	1445	2501
Grand Total	105	13	118	0	236	40	1700	78	5	1823	164	24	34	0	222	118	2579	135	3	2835	5116
Apprch %	44.5	5.5	50	0		2.2	93.3	4.3	0.3		73.9	10.8	15.3	0		4.2	91	4.8	0.1		
Total %	2.1	0.3	2.3	0	4.6	0.8	33.2	1.5	0.1	35.6	3.2	0.5	0.7	0	4.3	2.3	50.4	2.6	0.1	55.4	

# LSC Transportation Consultants, Inc.

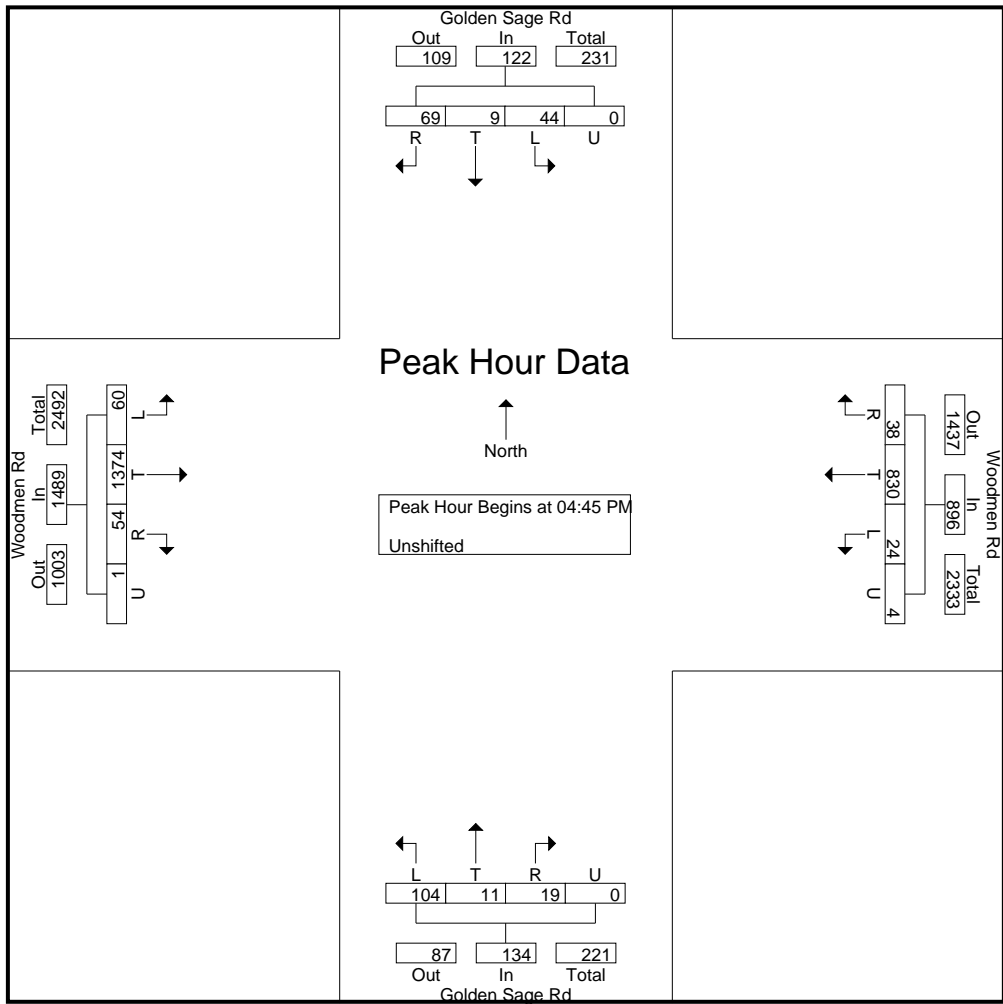
2504 E Pikes Peak Ave, Suite 304  
 Colorado Springs, CO 80909

File Name : Golden Sage Rd - Woodmen Rd PM

Site Code : 00194460

Start Date : 12/3/2020

Page No : 3



# Additional Attachments

Falcon Marketplace TIS Report Addendum





LSC TRANSPORTATION CONSULTANTS, INC.  
2504 East Pikes Peak Avenue, Suite 304  
Colorado Springs, CO 80909  
(719) 633-2868  
FAX (719) 633-5430  
E-mail: [lsc@lsctrans.com](mailto:lsc@lsctrans.com)  
Website: <http://www.lsctrans.com>

## MEMORANDUM

---

DATE: July 21, 2020

TO: Kari Parsons – El Paso County Planning & Community Development

FROM: Jeff Hodsdon

SUBJECT: Falcon Marketplace  
TIS Report Addendum  
LSC #164350  
PCD#: SP-17-001 and CDR-16-007

---

LSC has prepared this addendum to the Traffic Impact Study (TIS) report for Falcon Marketplace dated October 23, 2017 (**September 5, 2018 revision**). For reference, the EPC PCD File numbers for that report are SP-17-001 and CDR-16-007.

This addendum memo has been prepared to address final plat/construction drawing comments. Also, please refer to the attached itemized responses to comments.

### **Meridian/Eastonville Intersection**

#### Southbound Left-Turn Phasing

The level of service and queuing analysis sheets for this intersection have been updated to reflect **protected-only southbound left-turn phasing** at this intersection. The revised analysis sheets are attached. The 2018 TIS report showed protected-permissive left-turn phasing. This change has been made in response to the comments regarding the negatively offset alignment of the southbound left-turn lane.

The results show similar results to the original TIS report, except for the southbound left turn individual movement level of service. This turning movement would have a higher average vehicular delay with protected-only phasing, but would operate acceptably. The movement would be below capacity.

### Westbound Approach Lane Configuration

The attached analysis sheets also show the levels of service and queues for the westbound approach at this intersection. For this approach, there are essentially no changes to the assumptions from the 2018 TIS report, as a westbound single left turn and protected-permissive left-turn phasing have been assumed. Please refer to the plans prepared by Drexel Barrell for details on the improvements on this approach and leg of the intersection, including the detailed striping/pavement markings. The projected queues are projected to periodically back through the intersection of Eastonville/Bullet, due to the close spacing from Meridian Road. LSC recommends the addition of signs and potentially pavement markings indicating “DO NOT BLOCK INTERSECTION” on the westbound approach to Eastonville/Bullet.

### Updated Figures and Tables

Please refer to the attached **updates** to the following figures and tables from the original report:

- Figure 18c – Level of Service
- Table 4 – Level of Service
- Table 6 – Queuing
- Table 7b – Improvements

### Updated Level of Service and Queuing Analysis Sheets (attached)

- Revised applicable LOS sheets for the Meridian/Eastonville intersection
- Revised applicable queuing analysis sheets for the Meridian/Eastonville intersection

# Figures

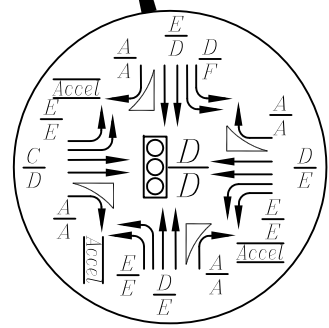
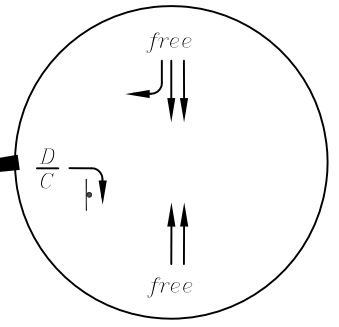
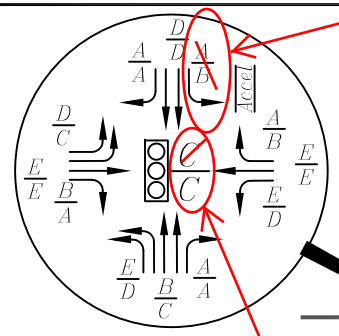
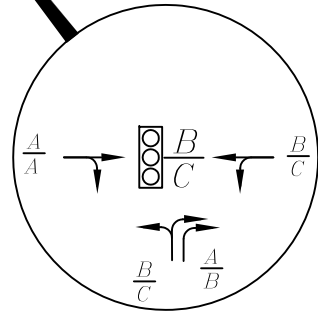
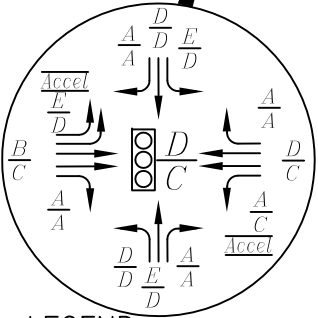
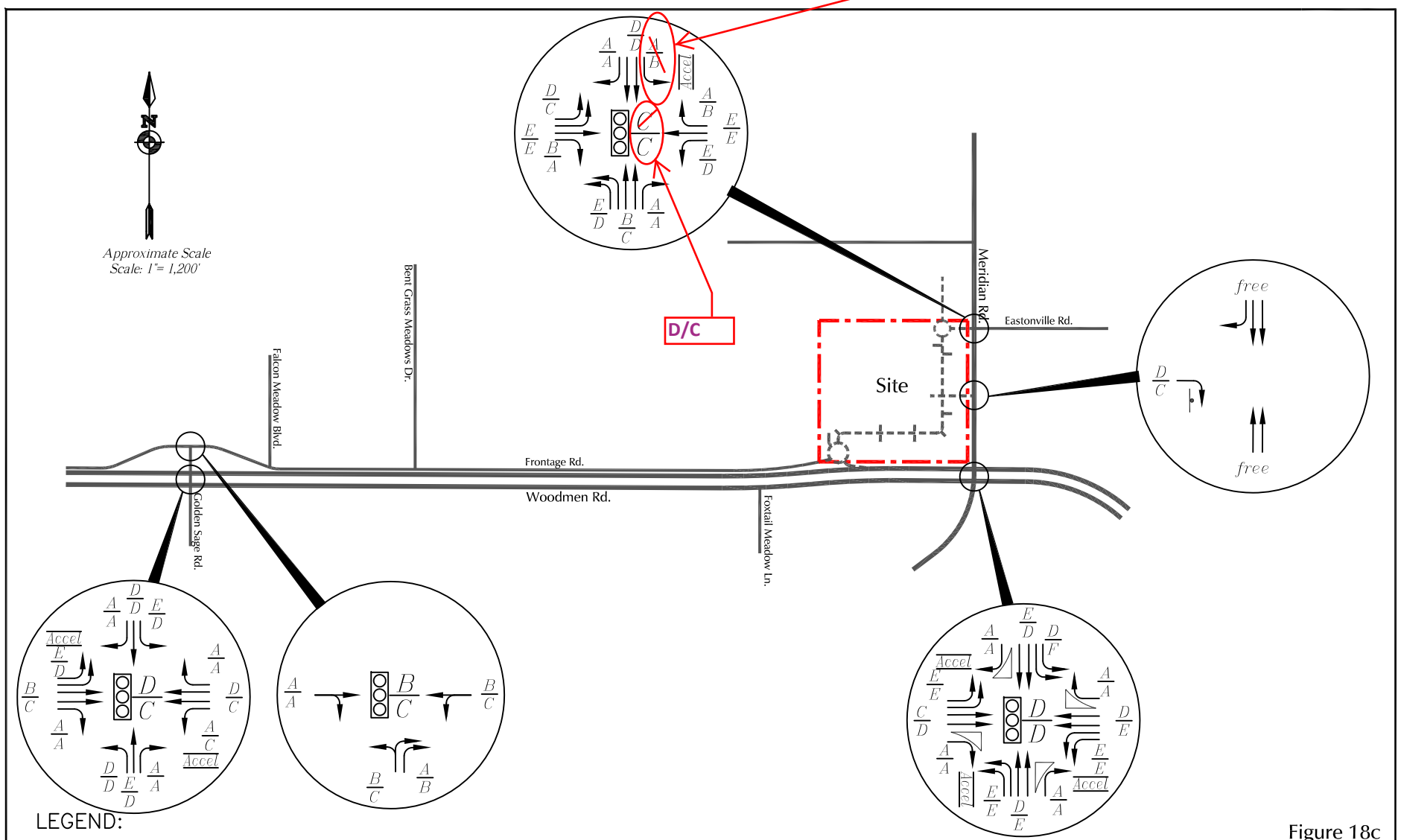
---

Figure 18c – Level of Service

E/E

D/C

Approximate Scale  
Scale: 1" = 1,200'



LEGEND:

- ⊥ = Stop Sign
- ⊞ = Traffic Signal
- $\frac{A}{A}$  = AM Individual Movement Peak-Hour Level of Service
- $\frac{B}{B}$  = PM Individual Movement Peak-Hour Level of Service
- $\frac{C}{C}$  = AM Entire Intersection Peak-Hour Level of Service
- $\frac{D}{D}$  = PM Entire Intersection Peak-Hour Level of Service

Figure 18c

# Year 2040 Total Lane Geometry, Traffic Control and Levels of Service With Proposed Right-In Access

Falcon Marketplace (LSC #164350)

# Tables

---

Table 4 – Level of Service

Table 6 – Queuing

Table 7b – Improvements



**Table 4**  
**2040 Projected Total Traffic Level of Service E and F Movements**  
**Falcon Marketplace**

Intersection Movement	AM				PM			
	Volume	LOS	Delay	V/C	Volume	LOS	Delay	V/C
<b>Scenario: Without Proposed Right-in Access to Woodmen Road</b>								
<b>Woodmen Road/Meridian Road</b>								
Eastbound Left	468	E	70.1	0.90	775	E	73.7	0.98
Westbound Left	150	E	55.1	0.46	225	E	60.2	0.64
Westbound Through	804	D	48.1	0.83	561	E	58.8	0.84
Northbound Left	250	E	61.4	0.69	350	D	54.9	0.69
Northbound Through	422	D	38.6	0.46	1008	F*	103.4	1.10*
Southbound Left	294	D	54.1	0.63	483	F	80.5	0.96
Southbound Through	941	D	54.4	0.92	704	D	48.1	0.77
<b>Overall</b>	<b>---</b>	<b>D</b>	<b>37.4</b>	<b>---</b>	<b>---</b>	<b>D</b>	<b>53.2</b>	<b>---</b>
<b>Eastonville Road/Meridian Road</b>								
Eastbound Through	73	E	54.9	0.45	197	E	56.1	0.68
Westbound Left	250	E	61.8	0.82	200	D	47.0	0.72
Westbound Through	113	E	55.9	0.50	136	E	55.7	0.57
Northbound Left	387	E	70.3	0.87	644	F*	106.7	1.09*
<b>Overall</b>	<b>---</b>	<b>D</b>	<b>38.2</b>	<b>---</b>	<b>---</b>	<b>D</b>	<b>40.0</b>	<b>---</b>
<b>Woodmen Road/Golden Sage Rd</b>								
Eastbound Left	422	E	79.2	0.94	404	D	50.3	0.72
Northbound Through	19	E	56.4	0.17	39	D	52.8	0.26
Southbound Left	251	E	63.9	0.73	191	D	53.2	0.69
Southbound Through	21	D	52.7	0.15	26	D	53.1	0.19
<b>Overall</b>	<b>---</b>	<b>D</b>	<b>38.6</b>	<b>---</b>	<b>---</b>	<b>C</b>	<b>24.6</b>	<b>---</b>
<b>Scenario: With Proposed Right-in Access to Woodmen Road</b>								
<b>Woodmen Road/Meridian Road</b>								
Eastbound Left	472	E	74.5	0.92	785	E	78.0	1.00
Westbound Left	150	E	55.7	0.47	225	E	60.4	0.64
Westbound Through	884	D	53.5	0.90	665	E	77.9	0.98
Northbound Left	328	E	78.3	0.89	465	E	60.4	0.82
Northbound Through	344	D	37.5	0.37	893	E	69.7	0.98
Southbound Left	294	D	54.9	0.64	483	F	81.7	0.96
Southbound Through	941	E	55.9	0.93	704	D	53.0	0.83
<b>Overall</b>	<b>---</b>	<b>D</b>	<b>40.3</b>	<b>---</b>	<b>---</b>	<b>D</b>	<b>50.8</b>	<b>---</b>
<b>Eastonville Road/Meridian Road</b>								
Eastbound Through	73	E	59.3	0.45	197	E	55.6	0.67
Westbound Left	250	E	61.4	0.82	200	D	46.3	0.71
Westbound Through	113	E	55.8	0.50	136	E	55.6	0.56
Northbound Left	222	E	62.5	0.69	415	D	54.5	0.76
<b>Southbound Left</b>	<b>100</b>	<b>E</b>	<b>68.5</b>	<b>0.63</b>	<b>100</b>	<b>E</b>	<b>56.1</b>	<b>0.50</b>
<b>Overall</b>	<b>---</b>	<b>D</b>	<b>36.4</b>	<b>---</b>	<b>---</b>	<b>C</b>	<b>34.4</b>	<b>---</b>
<b>Woodmen Road/Golden Sage Rd</b>								
Eastbound Left	418	E	77.7	0.93	394	D	50.1	0.71
Northbound Through	19	E	56.4	0.17	39	D	52.9	0.26
Southbound Left	251	E	63.9	0.73	191	D	53.5	0.70
Southbound Through	21	D	52.7	0.15	26	D	53.2	0.19
<b>Overall</b>	<b>---</b>	<b>D</b>	<b>39.4</b>	<b>---</b>	<b>---</b>	<b>C</b>	<b>24.7</b>	<b>---</b>
Notes:								
* Volume exceeds capacity - queuing analysis indicates queues will overspill the left turn lane into the adjacent through lane.								
<b>7/20/20 - Noted: Updated the Meridian/Eastonville intersection for the Scenario WITH the right-in</b>								
Source: LSC Transportation Consultants, Inc.								<b>rev. 7/20/20</b>

**Table 6  
Projected Queue Lengths  
Falcon Marketplace**

Intersection Movement	Lane Length	Projected Queue Lengths						Lane Length	Projected Queue Lengths			
		Short-Term							2040 Total Traffic			
		Background Traffic		Total Traffic					Without Right-In		With Right-In	
		Without Right-In	With Right-In	Without Right-In	With Right-In	Without Right-In	With Right-In		Without Right-In	With Right-In		
		AM	PM	AM	PM	AM	PM	AM	PM	AM	PM	
<b>Eastonville Road/Meridian Road</b>												
Northbound Left	425'	58	59	357	415	128	174	425'	259	430 <sup>(1)</sup>	148	236
Southbound Left	375							375			475 <sup>(2)</sup>	207
Westbound Left	105'							105'			204 <sup>(3)</sup>	196 <sup>(3)</sup>
Westbound Thru	220'(4)							220 <sup>(4)</sup>			292'	334'
<b>Woodmen Road/Meridian Road</b>												
Eastbound Left	500' dual section + 215' (single)	168	361	193	368	173	443	Modeled with sufficient length to determine needed length	382	865 <sup>(5)</sup>	358	840
Westbound Left	435'	108	160	112	150	120	146	435'	129	177	217	318
Northbound Left	Modeled with sufficient length to determine needed length	142	140	139	163	162	220	Modeled with sufficient length to determine needed length	217	392	281	346
	315' dual section +145' Single	161	176	167	176	196	275	(400' dual section + 360' single)	243	929	307	391
Southbound Left	475'	147	137	151	152	184	202	475'	171	407	170	440
<b>Woodmen Road/Golden Sage Road</b>												
Eastbound Left	465'	90	107	122	149	108	145	465'	421	297	437	238

Notes:

(1) Projected queue exceeds future available storage length/capacity. The queue is projected to extend beyond the storage length about 21% of the time.

(2) The 375' of lane will be sufficient to accommodate the projected 100 vph; The queue reports reflect 34% upstream block time during the morning peak hour and 2% during the afternoon peak hour. The reported 475' max queue during the morning peak includes left turning vehicles in the through lane queue upstream of the start of the left turn lane.

(3) The queue for the WB Thru includes WB Left turning vehicles as well due to the reported 39 (am)/22 (pm) percent storage block time percentages.

(4) The westbound through lane stacking distance between the Meridian and Bullet intersections;

(5) Queue length shown assumes the queue for the northbound left-turn at Eastonville/Meridian does not impede eastbound left-turning vehicles from turning onto Meridian Road from Woodmen Road.

Source: LSC Transportation Consultants, Inc.

Yellow Highlighted items added: 2-22-2020

Table 7b - Updated Falcon Marketplace Roadway Improvements With Proposed Right-In Access to Woodmen Road					
Item #	Improvement	Timing	MORE DETAILED TIMING	ADT that will warrant/TRIGGER the Improvement	Responsibility
Countywide Road Impact Fee Program Fees and Taxes					
1	Woodmen Road Metropolitan District fees and taxes to be paid in lieu of Countywide Road Impact Fee Program fees and taxes. Woodmen Road has already been completed, but this project is joining the district.	District fees payable at platting	WITH PLAT & EACH BUILDING PERMIT	BASED ON WOODMEN ROAD DISTRICT REQUIREMENTS	Falcon Marketplace
Meridian/Eastonville and Meridian Right-In/Right-Out Intersections					
2	Signalization of Meridian Road/Eastonville Road intersection.	Design and installation with the development of Falcon Marketplace once allowed by El Paso County.	PHASE 1	TRIGGER FOR INSTALL IS ONCE WARRANTS ARE MET - HOWEVER, IF NOT ALLOWED TO INSTALL W/PHASE 1, EPC WILL REQUIRE ESCROW FOR FULL AMOUNT W PHASE 1	Falcon Marketplace
3	Reconstruction of the Meridian center median south of Eastonville Road to achieve major street left-turn sight distance for the option of northbound/southbound protected/permissive left-turn signal phasing with interim single left-turn lanes northbound and southbound and to accommodate future northbound dual left-turn lanes if needed in the future. This lane should be 425 feet long plus a 200-foot taper. The taper would be back-to-back with the southbound dual left-turn taper.	Design and installation with the development of Falcon Marketplace.	PHASE 1	PLANNED TO BE COMPLETED WITH PHASE 1	Falcon Marketplace
4	Southbound right-turn deceleration lane on Meridian Road approaching Eastonville Road. This lane should be 235 feet long plus a 200-foot taper.	Design and installation with the development of Falcon Marketplace.	PHASE 1	PLANNED TO BE COMPLETED WITH PHASE 1	Falcon Marketplace
5	Design and construction of continuous southbound right-turn lanes and shoulder/bike lane on Meridian Road from Eastonville Road south to the proposed right-in/right-out and from the right-in/right-out south to Woodmen Road. (Note: Also please refer to related item #16 below.)	Design and installation with the development of Falcon Marketplace.	PHASE 1	PLANNED TO BE COMPLETED WITH PHASE 1	Falcon Marketplace
6	Widening of Eastonville Road east of Meridian Road to add a westbound through lane and add width as feasible between the westbound left-turn lane and the westbound through lane due to the proposed dual left-turn lanes on the west side of the intersection. This added width would allow for through lane alignment (with an acceptable offset across the intersection).	Design and installation with the development of Falcon Marketplace. Extent of this off-site improvement may be limited by available right-of-way and/or other existing constraints.	PHASE 1	PLANNED TO BE COMPLETED WITH PHASE 1	Falcon Marketplace
6a (7/21/20)	Add signs and potentially pavement markings indicating "DO NOT BLOCK INTERSECTION" on the westbound approach to Eastonville/Bullet (just east of the Meridian/Eastonville intersection)	Design and installation with the development of Falcon Marketplace.	PHASE 1	PLANNED TO BE COMPLETED WITH PHASE 1	Falcon Marketplace
7	Design and construction of the proposed extension of Eastonville Road between Meridian and the proposed roundabout.	Design and installation with the development of Falcon Marketplace.	PHASE 1	PLANNED TO BE COMPLETED WITH PHASE 1	Falcon Marketplace
On-Site Improvements					
8	Design and construction of the public street connection through the site (Falcon Market Place).	Design and installation with the development of Falcon Marketplace.	PHASE 1	PLANNED TO BE COMPLETED WITH PHASE 1	Falcon Marketplace
9	Design and construction of the proposed roundabout on-site west of the Meridian/Eastonville intersection. This would include a "stub" to the north for the anticipated future street connection north to Bent Grass Meadows Drive.	Design and installation with the development of Falcon Marketplace.	PHASE 1	PLANNED TO BE COMPLETED WITH PHASE 1	Falcon Marketplace
10	Design and construction of the proposed roundabout on-site at the east terminus of the Woodmen Frontage Road.	Design and installation with the development of Falcon Marketplace.	PHASE 1	PLANNED TO BE COMPLETED WITH PHASE 1	Falcon Marketplace
Woodmen/Meridian Intersection					
11	Extend existing westbound right-turn acceleration lane on Woodmen Road at Meridian Road to provide a continuous right-turn lane between Meridian Road and the proposed right-in-only access.	Design and installation with the development of Falcon Marketplace.	PHASE 1	PLANNED TO BE COMPLETED WITH PHASE 1	Falcon Marketplace
12	Lengthening of Woodmen eastbound dual left-turn lanes. Lengthening of eastbound left-turn lanes and potential further future lengthening to provide a 240-foot lane transition taper, 290 feet of deceleration distance plus sufficient vehicle stacking distance. CURRENT lane length: 500 feet of dual left-turn lane and 425-foot taper. Of this taper, 215 feet is full-width "decel" distance. Remaining 20 feet of the required 235-foot decel distance occurs in the first 20 feet of the 500-foot dual left-turn lanes. The remainder of the dual left-turn lanes is stacking distance - 480 feet. SHORT TERM: Based on the short-term analysis, the existing lane provides sufficient stacking distance. LONG TERM: This lane will likely need to be extended to provide a total of 840 feet of dual left storage distance plus 235 feet of deceleration length plus a 200-foot taper.	Future extension of existing dual left-turn lanes once traffic queues regularly extend beyond the 480-foot stacking distance.	PAYMENT WITH DEVELOPMENT PLAN FOR EACH INDIVIDUAL LOT; WITH REGARDS TO THE TIMING OF THE IMPROVEMENT: "once traffic queues regularly extend beyond the 480-foot stacking distance." This is estimated to be approximately 65 PM peak hour eastbound left turns above the estimated short term total volume from Figure 16a of the TIS. Note: Short term total volumes assume the Meridian extension to Highway 24 to be open.	PAYMENT OF PRO RATA SHARE WITH EACH LOT DEVELOPMENT PLAN; The estimated "trigger" of 65 PM peak hour eastbound left turns above the estimated short term total volume (from Figure 16a of the TIS) approximately translates to an additional 957 directional ADT for residential trips (based on the ITE single family trip ratio). This estimated threshold may be reached with a combination of Falcon Marketplace trips and background trips. Falcon Marketplace daily trip to afternoon peak hour trip ratio is about 23:1 but would need to be adjusted for passby trips.	Falcon Marketplace will pay its pro-rata share by (based on total traffic volumes) of the cost of the improvements. The payment amount will be determined on an individual-lot basis in the form of an escrow amount payable at the time of site development plan for each individual lot.
13	Meridian northbound dual left-turn lanes: Lengthening of northbound left-turn lanes and potential further future lengthening to provide a 200-foot lane transition taper, 235 feet of deceleration distance plus sufficient vehicle stacking distance. CURRENT lane configuration: 315 feet of dual left-turn lane length, 145 feet of single left-turn lane length and a 150-foot lane transition taper from the through lane to the single left-turn lane. This provides a 150-foot taper, 235 feet of deceleration distance, and 225 feet of dual left stacking. SHORT TERM: The 315-foot dual left-turn lanes would accommodate the projected short-term queues. The deceleration distance (235 feet) plus a 200-foot taper will need to be provided south of the end of the existing 315-foot dual left stacking lanes. For the deceleration distance, 235 feet of at least single-lane width for deceleration length would flare to the north to connect to the existing dual lane width to the north. South of the deceleration portion of the lane, a standard 200-foot taper will need to be added in the median. These modifications will involve median reconstruction and restriping south of the existing dual left-turn lanes. This would result in a 200-foot taper, 235-foot deceleration distance, and 315 feet of dual left-turn stacking.	With the development of Falcon Marketplace, extend the northbound left-turn lane as described in the column to the left and as shown in Figure 25.	PHASE 1	PLANNED TO BE COMPLETED WITH PHASE 1	Short Term - Falcon Marketplace
14	Meridian northbound dual left-turn lanes. LONG TERM: Potentially, additional growth in the Falcon Area and east along Falcon Highway will add left-turning traffic demand. Long-term analysis indicates the potential future need for 400 feet of stacking distance plus the 235 feet of deceleration distance and the 200-foot taper.	Future (if necessary -- Add additional lane length beyond #13 to provide additional stacking //when needed (as shown in Figure 26).			By other future developments impacting this turn lane. Potential for fee program credit for improvements completed as this is a regional intersection.
Golden Sage Intersections					
15	Directional wayfinding sign(s) on eastbound Woodmen Road upstream of Golden Sage - notifying/reminding eastbound motorists of the option to enter Falcon Marketplace via the Woodmen Frontage Road.	Design and installation with the development of Falcon Marketplace.	PHASE 1	PLANNED TO BE COMPLETED WITH PHASE 1	Falcon Marketplace
16	Lengthening of the current eastbound single left-turn deceleration lane on Woodmen approaching Golden Sage Road to provide a 240-foot transition taper (20:1 taper ratio), 290 feet of deceleration distance plus sufficient vehicle stacking distance. CURRENT: 175-foot taper plus a 465-foot left-turn lane which translates to a 175-foot taper, 290-foot deceleration distance, and 175 feet of stacking distance. SHORT TERM: Adequate stacking is available in the current turn lane - calculated queue length 141 feet. LONG TERM: Lengthen single left-turn lane and/or future implementation of dual left-turn lanes (if capacity needs dictate) to maintain 290 feet of deceleration length, a 240-foot lane taper (20:1 taper ratio) plus provide sufficient vehicle stacking length - model indicates 471 feet of dual left stacking distance based on morning peak-hour projected volumes. If a dual left is implemented in the future, consideration will need to be given to the configuration on Golden Sage and at the Golden Sage/Woodmen Frontage Road intersection to receive the dual left-turn movement.	Short Term: The existing lane is adequate based on the short-term analysis. Long Term: Future with additional development served by the north frontage road - extension of existing single left-turn lane and potentially widening in the median to provide dual left-turn lanes to provide additional vehicle stacking distance as described in the column to the left.	PAYMENT WITH DEVELOPMENT PLAN FOR EACH INDIVIDUAL LOT; WITH REGARDS TO THE TIMING OF THE IMPROVEMENT: AS NEEDED TO MAINTAIN ADEQUATE LEVEL OF SERVICE AND VEHICLE STACKING DISTANCE. " This is estimated to be when the eastbound left turn turning volume reaches approximately 200 vehicles per hour during the PM peak. This translates to about 40 vehicles per hour over the estimated short term total volume from Figure 16a of the TIS. Note: Short term total volumes assume the Meridian extension to Highway 24 to be open.	PAYMENT OF PRO RATA SHARE WITH EACH LOT DEVELOPMENT PLAN; The estimated "trigger" of 40 PM peak hour eastbound left turns above the estimated short term total volume (from Figure 16a of the TIS) approximately translates to and additional 589 directional ADT for residential trips making this turning movement (based on the ITE single family trip ratio). This estimated threshold may be reached with a combination of Falcon Marketplace trips and background trips. Falcon Marketplace daily trip to afternoon peak hour trip ratio is about 23:1 but would need to be adjusted for passby trips.	Falcon Marketplace will pay its pro-rata share by (based on total traffic volumes) of the cost of the improvements. The payment amount will be determined on an individual-lot basis in the form of an escrow amount payable at the time of site development plan for each individual lot.
16a (7/21/20)	Add protected/permitted phasing for left-turn movements	Prepare a traffic signal modification plan and furnish/install new traffic signal heads for protected-permissive phasing and other necessary hardware, software needed to implement this phase; modify existing signal timing plan.	If/when needed to maintain acceptable level of service/traffic operations and/or to control vehicle queues. .	--Prior to the opening of the Bent Grass Meadows Boulevard to the public, signal modification plans should be prepared, and coordination with EPC DPW (and possibly the City of Colorado Springs) will be a necessary step(s) toward future implementation of this left turn phase. Steps should be taken such that the phase can be implemented shortly after it has been determined that it should be implemented. This determination would be made by monitoring the traffic volumes and operations once Bent Grass Meadows Drive connection is opened to traffic to determine if the phase should be added at that time.	Falcon Marketplace will pay its pro-rata share by (based on total traffic volumes) of the cost of the improvements. The payment amount will be determined on an individual-lot basis in the form of an escrow amount payable at the time of site development plan for each individual lot.
17	Southbound exclusive right-turn lane on Golden Sage Road approaching Woodmen Road (a continuous right-turn lane within the 150 feet between the Woodmen Frontage Road and Woodmen Road).	If/when needed to maintain acceptable level of service/traffic operations and/or to control vehicle queues.	PAYMENT WITH DEVELOPMENT PLAN FOR EACH INDIVIDUAL LOT; WITH REGARDS TO THE TIMING OF THE IMPROVEMENT: AS NEEDED TO MAINTAIN ADEQUATE LEVEL OF SERVICE AND VEHICLE STACKING DISTANCE. " A preliminary trigger could be a southbound right turn volume of about 150-175 vehicles per hour. This translates to about 5 to 30 vehicles per hour over the projected short term volume from Figure 16a of the TIS. This may be conservative due to the westbound right turn acceleration lane on Woodmen Road. Additional study may indicate a higher threshold based on empirical data collection and analysis.	PAYMENT OF PRO RATA SHARE WITH EACH LOT DEVELOPMENT PLAN; The estimated "trigger" of 5-30 AM peak hour southbound right turns above the estimated short term total volume (from Figure 16a of the TIS) approximately translates to an additional 85-810 directional ADT for residential trips making this turning movement (based on the ITE single family trip ratio). This estimated threshold may be reached with a combination of Falcon Marketplace trips and background trips. Falcon Marketplace daily trip to afternoon peak hour trip ratio is about 45:1 but would need to be adjusted for passby trips.	Falcon Marketplace will pay its pro-rata share by (based on total traffic volumes) of the cost of the improvements. The payment amount will be determined on an individual-lot basis in the form of an escrow amount payable at the time of site development plan for each individual lot.
18	Signalization of Golden Sage Road/Woodmen Frontage Road or reconstruction as a modern roundabout; Future additional laneage may be necessary at this intersection to accommodate vehicle queues and for traffic operations.	Please refer to the attached sheet.	Please refer to the attached sheet.	PAYMENT OF PRO RATA SIGNAL ESCROW WITH EACH LOT DEVELOPMENT PLAN;	Falcon Marketplace will pay its pro-rata share by (based on total traffic volumes) of the cost of the improvements. The payment amount will be determined on an individual-lot basis in the form of an escrow amount payable at the time of site development plan for each individual lot.

# Revised Applicable Level of Service Sheets

---

Meridian/Eastonville intersection



Timings  
2: Meridian Rd & Eastonville Rd

2040 Total Traffic WITH Right-in Access  
AM Peak Hour

Lane Group	EBL	EBT	EBR	WBL	WBT	WBR	NBL	NBT	NBR	SBL	SBT	SBR
Lane Configurations												
Traffic Volume (vph)	122	73	138	250	113	125	222	596	150	100	1807	86
Future Volume (vph)	122	73	138	250	113	125	222	596	150	100	1807	86
Turn Type	pm+pt	NA	Perm	pm+pt	NA	Perm	Prot	NA	Perm	Prot	NA	Perm
Protected Phases	7	4		3	8		5	2		1	6	
Permitted Phases	4		4	8		8			2			6
Detector Phase	7	4	4	3	8	8	5	2	2	1	6	6
Switch Phase												
Minimum Initial (s)	5.0	5.0	5.0	5.0	5.0	5.0	5.0	5.0	5.0	5.0	5.0	5.0
Minimum Split (s)	10.0	11.5	11.5	10.0	11.5	11.5	10.0	11.5	11.5	10.0	11.5	11.5
Total Split (s)	15.0	17.0	17.0	18.0	20.0	20.0	16.0	69.0	69.0	16.0	69.0	69.0
Total Split (%)	12.5%	14.2%	14.2%	15.0%	16.7%	16.7%	13.3%	57.5%	57.5%	13.3%	57.5%	57.5%
Yellow Time (s)	3.0	3.0	3.0	3.0	3.0	3.0	3.0	4.5	4.5	3.0	4.5	4.5
All-Red Time (s)	2.0	2.0	2.0	2.0	2.0	2.0	2.0	2.0	2.0	2.0	2.0	2.0
Lost Time Adjust (s)	-1.0	-1.0	-1.0	-1.0	-1.0	-1.0	-1.0	-1.0	-1.0	-1.0	-1.0	-1.0
Total Lost Time (s)	4.0	4.0	4.0	4.0	4.0	4.0	4.0	5.5	5.5	4.0	5.5	5.5
Lead/Lag	Lead	Lag	Lag	Lead	Lag	Lag	Lead	Lag	Lag	Lead	Lag	Lag
Lead-Lag Optimize?	Yes	Yes	Yes	Yes	Yes	Yes	Yes	Yes	Yes	Yes	Yes	Yes
Recall Mode	None	None	None	None	None	None	None	Min	Min	None	Min	Min
Act Effct Green (s)	20.4	10.8	10.8	28.4	15.1	15.1	11.7	64.1	64.1	11.1	63.5	63.5
Actuated g/C Ratio	0.17	0.09	0.09	0.24	0.13	0.13	0.10	0.55	0.55	0.09	0.54	0.54
v/c Ratio	0.25	0.45	0.53	0.82	0.50	0.42	0.69	0.32	0.17	0.63	0.96	0.10
Control Delay	36.3	59.3	15.3	61.4	55.8	12.2	62.5	15.6	2.6	68.5	40.3	2.0
Queue Delay	0.0	0.0	0.0	0.0	0.0	0.0	0.0	0.0	0.0	0.0	0.0	0.0
Total Delay	36.3	59.3	15.3	61.4	55.8	12.2	62.5	15.6	2.6	68.5	40.3	2.0
LOS	D	E	B	E	E	B	E	B	A	E	D	A
Approach Delay		32.7			47.5			24.5			40.1	
Approach LOS		C			D			C			D	

Intersection Summary

Cycle Length: 120  
 Actuated Cycle Length: 117.5  
 Natural Cycle: 90  
 Control Type: Actuated-Uncoordinated  
 Maximum v/c Ratio: 0.96  
 Intersection Signal Delay: 36.4  
 Intersection LOS: D  
 Intersection Capacity Utilization 88.1%  
 ICU Level of Service E  
 Analysis Period (min) 15

Splits and Phases: 2: Meridian Rd & Eastonville Rd



Timings  
2: Meridian Rd & Eastonville Rd

2040 Total Traffic WITH Right-in Access  
PM Peak Hour

Lane Group	EBL	EBT	EBR	WBL	WBT	WBR	NBL	NBT	NBR	SBL	SBT	SBR
Lane Configurations												
Traffic Volume (vph)	339	197	228	200	136	225	415	1246	250	100	1203	134
Future Volume (vph)	339	197	228	200	136	225	415	1246	250	100	1203	134
Turn Type	pm+pt	NA	Perm	pm+pt	NA	Perm	Prot	NA	Perm	Prot	NA	Perm
Protected Phases	7	4		3	8		5	2		1	6	
Permitted Phases	4		4	8		8			2			6
Detector Phase	7	4	4	3	8	8	5	2	2	1	6	6
Switch Phase												
Minimum Initial (s)	5.0	5.0	5.0	5.0	5.0	5.0	5.0	5.0	5.0	5.0	5.0	5.0
Minimum Split (s)	10.0	10.0	10.0	10.0	10.0	10.0	10.0	11.5	11.5	10.0	11.5	11.5
Total Split (s)	21.0	27.0	27.0	16.0	22.0	22.0	24.0	54.0	54.0	23.0	53.0	53.0
Total Split (%)	17.5%	22.5%	22.5%	13.3%	18.3%	18.3%	20.0%	45.0%	45.0%	19.2%	44.2%	44.2%
Yellow Time (s)	3.0	3.0	3.0	3.0	3.0	3.0	3.0	4.5	4.5	3.0	4.5	4.5
All-Red Time (s)	2.0	2.0	2.0	2.0	2.0	2.0	2.0	2.0	2.0	2.0	2.0	2.0
Lost Time Adjust (s)	-1.0	-1.0	-1.0	-1.0	-1.0	-1.0	-1.0	-1.0	-1.0	-1.0	-1.0	-1.0
Total Lost Time (s)	4.0	4.0	4.0	4.0	4.0	4.0	4.0	5.5	5.5	4.0	5.5	5.5
Lead/Lag	Lead	Lag	Lag	Lead	Lag	Lag	Lead	Lag	Lag	Lead	Lag	Lag
Lead-Lag Optimize?	Yes	Yes	Yes	Yes	Yes	Yes	Yes	Yes	Yes	Yes	Yes	Yes
Recall Mode	None	None	None	None	None	None	None	Min	Min	None	Min	Min
Act Effct Green (s)	33.0	18.3	18.3	26.8	15.1	15.1	18.5	49.5	49.5	13.0	44.0	44.0
Actuated g/C Ratio	0.30	0.17	0.17	0.24	0.14	0.14	0.17	0.45	0.45	0.12	0.40	0.40
v/c Ratio	0.51	0.67	0.52	0.71	0.56	0.56	0.76	0.80	0.31	0.50	0.87	0.20
Control Delay	32.8	55.6	9.6	46.3	55.6	11.5	54.5	32.0	3.7	56.1	39.1	6.7
Queue Delay	0.0	0.0	0.0	0.0	0.0	0.0	0.0	0.0	0.0	0.0	0.0	0.0
Total Delay	32.8	55.6	9.6	46.3	55.6	11.5	54.5	32.0	3.7	56.1	39.1	6.7
LOS	C	E	A	D	E	B	D	C	A	E	D	A
Approach Delay		31.8			34.6			33.2			37.2	
Approach LOS		C			C			C			D	

Intersection Summary

Cycle Length: 120  
 Actuated Cycle Length: 110.4  
 Natural Cycle: 70  
 Control Type: Actuated-Uncoordinated  
 Maximum v/c Ratio: 0.87  
 Intersection Signal Delay: 34.4  
 Intersection LOS: C  
 Intersection Capacity Utilization 81.1%  
 ICU Level of Service D  
 Analysis Period (min) 15

Splits and Phases: 2: Meridian Rd & Eastonville Rd



# Revised Applicable Queuing Analysis Sheets

---

Meridian/Eastonville intersection



Queuing and Blocking Report

Intersection: 2: Meridian Rd & Eastonville Rd

Movement	EB	EB	EB	EB	WB	WB	WB	NB	NB	NB	NB	NB	
Directions Served	L	L	T	R	L	T	R	L	L	T	T	R	
Maximum Queue (ft)	144	89	132	137	204	412	208	147	152	170	168	78	
Average Queue (ft)	77	12	61	49	158	158	56	76	88	66	80	18	
95th Queue (ft)	129	47	113	97	226	339	173	132	142	161	168	49	
Link Distance (ft)	261	261	261	261		796				444	444		
Upstream Blk Time (%)													
Queuing Penalty (veh)													
Storage Bay Dist (ft)					105		200	425	425				525
Storage Blk Time (%)					39		6						
Queuing Penalty (veh)					93		23						

Intersection: 2: Meridian Rd & Eastonville Rd

Movement	SB	SB	SB	SB
Directions Served	L	T	T	R
Maximum Queue (ft)	475	1402	1422	1401
Average Queue (ft)	197	1075	1145	563
95th Queue (ft)	500	1638	1635	1636
Link Distance (ft)		1380	1380	1380
Upstream Blk Time (%)		12	29	15
Queuing Penalty (veh)		0	0	0
Storage Bay Dist (ft)	375			
Storage Blk Time (%)	0	34		
Queuing Penalty (veh)	0	34		



Queuing and Blocking Report

Intersection: 2: Meridian Rd & Eastonville Rd

Movement	EB	EB	EB	EB	WB	WB	WB	NB	NB	NB	NB	NB
Directions Served	L	L	T	R	L	T	R	L	L	T	T	R
Maximum Queue (ft)	244	178	251	179	196	355	217	218	272	411	415	118
Average Queue (ft)	156	84	130	71	119	124	59	125	141	218	231	45
95th Queue (ft)	228	178	211	130	195	286	160	195	219	377	385	96
Link Distance (ft)	261	261	261	261		796				444	444	
Upstream Blk Time (%)	0		0							0	0	
Queuing Penalty (veh)	0		0							0	0	
Storage Bay Dist (ft)					105		200	425	425			525
Storage Blk Time (%)					22	12				0	0	
Queuing Penalty (veh)					82	50				0	0	

Intersection: 2: Meridian Rd & Eastonville Rd

Movement	SB	SB	SB	SB
Directions Served	L	T	T	R
Maximum Queue (ft)	207	448	481	90
Average Queue (ft)	76	297	310	38
95th Queue (ft)	150	429	446	69
Link Distance (ft)		1380	1380	1380
Upstream Blk Time (%)				
Queuing Penalty (veh)				
Storage Bay Dist (ft)	375			
Storage Blk Time (%)	0	2		
Queuing Penalty (veh)	0	2		