

WOODMOOR WSD WELL NO. 22 EL PASO COUNTY, COLORADO SWMP, GRADING AND EROSION CONTROL PLAN

CONTACTS

<p>OWNER: WOODMOOR WATER AND SANITATION DISTRICT NO. 1 1845 WOODMOOR DRIVE MONUMENT, CO 80132</p>	<p>JESSIE SHAFFER (719) 488-2525 JESSIES@WOODMOORWATER.COM</p>
<p>ENVRO/CIVIL ENGINEER: JVA, INC 1319 SPRUCE STREET BOULDER, CO 80302</p>	<p>JOSH MCGIBBON, P.E. (303) 444-1951 J.MCGIBBON@JVAJVA.COM</p>
<p>STRUCTURAL ENGINEER: JVA, INC 1319 SPRUCE STREET BOULDER, CO 80302</p>	<p>ADAM TEUNISSEN, P.E. (303) 444-1951 ATEUNISSEN@JVAJVA.COM</p>
<p>ELECTRICAL ENGINEER: BROWNS HILL ENGINEERING AND CONTROLS, LLC 8119 SHAFFER PARKWAY, UNIT C LITTLETON, CO 80127</p>	<p>TED WILLE, P.E. (720) 344-7771 TWILLE@BROWNSHILLENG.COM</p>



JVA, Inc. 1319 Spruce Street
Boulder, CO 80302 303.444.1951
www.jvajva.com
Boulder • Fort Collins • Winter Park
Glenwood Springs • Denver

DRAWING INDEX

SHEET NO.	TITLE
GO.0	COVER SHEET
GO.1	LEGEND, NOTES AND ABBREVIATIONS
CE1.1	GRADING AND EROSION CONTROL PLAN
CE1.2	SWMP AND GEC NOTES
CE1.3	EROSION CONTROL DETAILS
CE1.4	EROSION CONTROL DETAILS

APRIL 2022

PREPARED UNDER THE SUPERVISION OF

JVA, Inc.

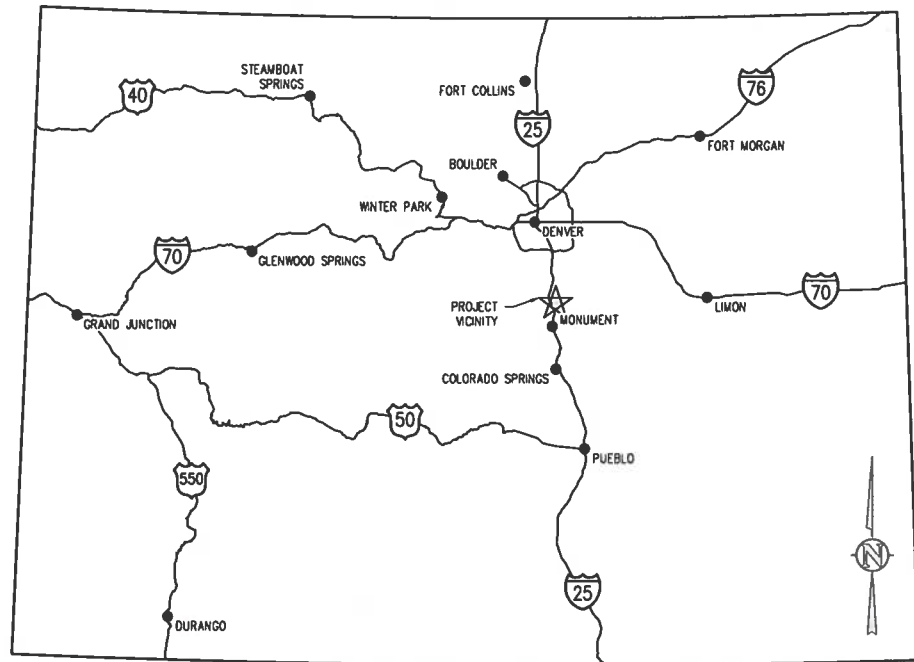

VICINITY MAP
NTS



PROJECT LOCATION MAP
NTS

ENGINEER'S STATEMENT:

THIS GRADING AND EROSION CONTROL PLAN WAS PREPARED UNDER MY DIRECTION AND SUPERVISION AND IS CORRECT TO THE BEST OF MY KNOWLEDGE AND BELIEF. SAID PLAN HAS BEEN PREPARED ACCORDING TO THE CRITERIA ESTABLISHED BY THE COUNTY FOR GRADING AND EROSION CONTROL PLANS. I ACCEPT RESPONSIBILITY FOR ANY LIABILITY CAUSED BY MY NEGLIGENCE, ACTS, ERRORS OR OMISSIONS ON MY PART IN PREPARING THIS PLAN.

ENGINEER OF RECORD SIGNATURE: _____ DATE: 4/11/2022

OWNER'S STATEMENT:

I, THE OWNER/DEVELOPER HAVE READ AND WILL COMPLY WITH THE REQUIREMENTS OF THE GRADING AND EROSION CONTROL PLAN.

OWNER SIGNATURE: *Jessie Shaffer* DATE: 4/11/22

EL PASO COUNTY:

COUNTY PLAN REVIEW IS PROVIDED ONLY FOR GENERAL CONFORMANCE WITH THE COUNTY DESIGN CRITERIA. THE COUNTY IS NOT RESPONSIBLE FOR THE ACCURACY AND ADEQUACY OF THE DESIGN, DIMENSIONS, AND/OR ELEVATIONS WHICH SHALL BE CONFIRMED AT THE JOB SITE. THE COUNTY THROUGH THE APPROVAL OF THIS DOCUMENT ASSUMES NO RESPONSIBILITY FOR COMPLETENESS AND/OR ACCURACY OF THIS DOCUMENT.

FILED IN ACCORDANCE WITH THE REQUIREMENTS OF THE EL PASO COUNTY LAND DEVELOPMENT CODE. DRAINAGE CRITERIA MANUAL VOLUMES 1 AND 2, AND ENGINEERING CRITERIA MANUAL, AS AMENDED.

IN ACCORDANCE WITH EGM SECTION 1.12, THESE CONSTRUCTION DOCUMENTS WILL BE VALID FOR CONSTRUCTION FOR A PERIOD OF 2 YEARS FROM THE DATE SIGNED BY THE EL PASO COUNTY ENGINEER. IF CONSTRUCTION HAS NOT STARTED WITHIN THOSE 2 YEARS, THE PLANS WILL NEED TO BE RESUBMITTED FOR APPROVAL, INCLUDING PAYMENT OF REVIEW FEES AT THE PLANNING AND COMMUNITY DEVELOPMENT DIRECTOR'S DISCRETION.

Jennifer Irvine, P.E. _____ DATE _____
 County Engineer/ECM Administrator

16: 1051.06 - Well 22 (Woodmoor) El Paso County Permit(1051.06) - GEC - CIV - IJA.dwg, 4/08/2022, 1:51 PM, JI

ABBREVIATIONS

AASHTO	AMERICAN ASSOC. OF STATE HIGHWAY AND TRANSPORTATION OFFICIALS	INCL	INCLUDED
ABAN	ABANDON	ID	INSIDE DIAMETER
AC	ASPHALTIC CONCRETE PAVING	IN	INLET
ADDL	ADDITIONAL	INSUL	INSULATION
ADDM	ADDENDUM	INV	INVERT
ADJ	ADJUSTABLE	IRR	IRRIGATION
AL	ALUMINUM	JTS	JOINTS
ALT	ALTERNATE	KO	KNOCKOUT
AMT	AMOUNT	KPL	KICK PLATE
APPROX	APPROXIMATE	KWY	KEYWAY
ARCH	ARCHITECT(URAL)	L	LEFT OR LITER
ARV	AIR RELIEF VALVE	LSCAPE	LANDSCAPE(NG)
ASTM	AMERICAN SOCIETY FOR TESTING AND MATERIALS	LF	LINEAR FOOT
ASPH	ASPHALT	LP	LOW POINT OR LIGHT POLE
ASSY	ASSEMBLY	LT	LIGHT
ASYM	ASYMMETRICAL	LWL	LOW WATER LEVEL
AUTO	AUTOMATIC	MAINT	MAINTENANCE
AVG	AVERAGE	MAN	MAN
AWWA	AMERICAN WATER WORKS ASSOC.	MATL	MATERIAL
BC	BACK OF CURB	MAX	MAXIMUM
BFV	BUTTERFLY VALVE	MECH	MATCH EXISTING
BG	FINISHED GRADE ADJACENT TO BOTTOM OF WALL	MFR	MECHANICAL MANUFACTURER
BLDG	BUILDING	MH	MANHOLE
BLK	BLOCK	MIN	MINIMUM
BM	BENCH MARK	MISC	MISCELLANEOUS
BMP	BEST MANAGEMENT PRACTICE	MJ	MECHANICAL JOINT
BS	BACKSIGHT	N	NORTH
BOS	BOTTOM OF STEP	NA	NOT APPLICABLE
BOT	BOTTOM	NIC	NOT IN CONTRACT
BMT	BASEMENT	NPT	NATIONAL PIPE THREAD
BVCE	BEGIN VERTICAL CURVE ELEVATION	NTS	NOT TO SCALE
BVCS	BEGIN VERTICAL CURVE STATION	OC	ON CENTER
BW	BOTTOM OF WALL	OD	OUTSIDE DIAMETER
CB	CATCH BASIN	OPP	OPPOSITE
CCW	COUNTER CLOCKWISE	OPT	OPTIONAL
CDOT	COLORADO DEPARTMENT OF TRANSPORTATION	PC	POINT OF CURVATURE
CIP	CAST IRON PIPE	PCO	PRESSURE CLEAN OUT
CJ	CONSTRUCTION JOINT	PCR	POINT OF CURVE RETURN
CL	CENTER LINE OR CHAIN LINK	PI	POINT OF INTERSECTION
CLR	CLEAR	PVI	POINT OF VERTICAL INTERSECTION
CMP	CORRUGATED METAL PIPE	PL	PROPERTY LINE
CMU	CONCRETE MASONRY UNIT	PE	POLYETHYLENE
CO	CLEANOUT	PREFAB	PREFABRICATED
CONC	CONCRETE	PRELIM	PRELIMINARY
CONST	CONSTRUCTION	PREP	PREPARATION
CONT	CONTINUOUS(ATION)	PROP	PROPOSED
COR	CORNER	PRV	PRESSURE REDUCING VALVE OR PRESSURE RELIEF VALVE
CR	CONCENTRIC REDUCER	PSF	POUNDS PER SQUARE FOOT
CTR	CENTER	PSI	POUNDS PER SQUARE INCH
CY	CUBIC YARDS	PT	POINT OF TANGENCY
DEMO	DEMOLITION	PV	PLUG VALVE
DIA	DIAMETER	PVC	POLYVINYL CHLORIDE OR POINT OF VERTICAL CURVATURE
DIAG	DIAGONAL	PVMT	PAVEMENT
DIP	DUCTILE IRON PIPE	QTY	QUANTITY
DOM	DOMESTIC	R	RIGHT
DN	DOWN	RAD	RADIUS
DR	DRAIN	RCP	REINFORCED CONCRETE PIPE
DWG	DRAWING	RD	ROOF DRAIN
DWL	DOWEL	RE	REFERENCE
E	EAST	RECT	RECTANGULAR
EA	EACH	REINF	REINFORCE (D) (ING) (MENT)
ECC	ECCENTRIC	REQD	REQUIRED
EJ	EXPANSION JT	ROW	RIGHT OF WAY
EL	ELEVATION	SAN	SANITARY
ELB	ELBOW	SD	STORM DRAIN
ELEC	ELECTRICAL	SECT	SECTION
ENGR	ENGINEER	SPD	STANDARD PROCTOR DENSITY
EOP	EDGE OF PAVEMENT	SPEC	SPECIFICATION
EQ	EQUAL	SQ	SQUARE
EQUIP	EQUIPMENT	SQ IN	SQUARE INCH
EQUIV	EQUIVALENT	SQ FT	SQUARE FOOT
ESMT	EASEMENT	SQ YD	SQUARE YARD
EST	ESTIMATE	SS	SANITARY SEWER
EVCE	END VERTICAL CURVE ELEVATION	SST	STAINLESS STEEL
EVCS	END VERTICAL CURVE STATION	STA	STATION
EW	EACH WAY	STD	STANDARD
EXP	EXPANSION JOINT	STL	STEEL
EXIST	EXISTING	STRUCT	STRUCTURAL
FND	FOUNDATION	SVC	SERVICE
FES	FLARED END SECTION	SWMP	STORMWATER MANAGEMENT PLAN
FF	FINISH FLOOR	SYM	SYMMETRICAL
FG	FINISH GRADE	TB	THRUST BLOCK
FH	FIRE HYDRANT	TBC	TOP BACK OF CURB
FL	FLOW LINE	TBM	TEMPORARY BENCH MARK
FN	FENCE	TEMP	TEMPORARY
FOC	FACE OF CONCRETE	TG	FINISHED GRADE ADJACENT TO TOP OF WALL
FPM	FEET PER MINUTE	THK	THICK
FPS	FEET PER SECOND	TOB	TOP OF BANK
FT	FEET	TOC	TOP OF CONCRETE OR TOP OF CURB
FTG	FOOTING OR FITTING	TOS	TOP OF STEP
G	GAS	TOT	TOTAL
GA	GAUGE	TW	TOP OF WALL OR CAP OF WALL
GAL	GALLON	TYP	TYPICAL
GALV	GALVANIZED	UBC	UNIFORM BUILDING CODE
GCO	GRADE CLEANOUT	UGE	UNDERGROUND ELECTRIC
GIP	GALVANIZED IRON PIPE	UTIL	UTILITY
GND	GROUND	VERT	VERTICAL
GPD	GALLONS PER DAY	VC	POINT OF VERTICAL CURVATURE
GPM	GALLONS PER MINUTE	VCP	VITRIFIED CLAY PIPE
GR	GRATE	W	WIDE OR WIDTH
GRG	GRATING	W/	WITH
GSP	GALVANIZED STEEL PIPE	W/O	WITHOUT
GV	GATE VALVE	WQCV	WATER QUALITY CONTROL VOLUME
H	HIGH	WSE	WATER SURFACE ELEVATION
HB	HOSE BIB	WW	WASTEWATER
HE	HORIZONTAL ELLIPTICAL	X	SECT CROSS SECTION
HDWL	HEADWALL	XFMR	ELECTRICAL TRANSFORMER
HNDRL	HAND RAIL	YH	YARD HYDRANT
HORIZ	HORIZONTAL		
HP	HIGH POINT		
HR	HOUR		
HVAC	HEATING, VENTILATION, AIR CONDITIONING		
HWY	HIGHWAY		
HWL	HIGH WATER LINE		
HYD	HYDRANT		

DESIGN LEGEND

	BENCHMARK		FENCE
	MANHOLE		FLOW LINE OF DITCH OR WASH
	FLARED END SECTION W/ RIPRAP		SLOPE ARROW
	TEE W/ THRUST BLOCK		PROPOSED SPOT ELEVATION
	BEND W/ THRUST BLOCK		EXIST SPOT ELEVATION
	END CAP W/ THRUST BLOCK		EXIST INDEX CONTOUR
	GATE VALVE		EXIST INTERMEDIATE CONTOUR
	REDUCER/INCRASER		PROPOSED INDEX CONTOUR
	WATER METER		PROPOSED INTERMEDIATE CONTOUR
	FIRE HYDRANT		GRAVEL
	STORM - 12" AND SMALLER		PROPOSED BUILDING
	STORM - LARGER THAN 12"		LIMITS OF WORK
	ROOF DRAIN		EASEMENT LINE
	TRENCH DRAIN		PROPERTY LINE
	UNDERDRAIN		ADJACENT PROPERTY LINE/ROW
	SANITARY SEWER		MATCHLINE
	FORCE MAIN		
	WATER		
	NON POTABLE WATER		
	POTABLE WATER		
	IRRIGATION		
	IRRIGATION - LARGER THAN 12"		
	CABLE TV		
	DRAIN		
	ELECTRIC		
	UNDERGROUND ELECTRIC		
	OVERHEAD ELECTRIC		
	TELEPHONE		
	FIBER OPTIC		
	FUEL		
	GAS		
	PVC PIPE (MISC)		



GENERAL NOTES

- ALL MATERIALS AND WORKMANSHIP SHALL BE IN CONFORMANCE WITH THE LATEST STANDARDS AND SPECIFICATIONS OF EL PASO COUNTY, COLORADO, WOODMOOR WATER AND SANITATION DISTRICT, COLORADO DEPARTMENT OF TRANSPORTATION, TRI-LAKES MONUMENT FIRE PROTECTION DISTRICT REQUIREMENTS, AND APPLICABLE STATE AND LOCAL STANDARDS AND SPECIFICATIONS. THE CONTRACTOR SHALL HAVE IN POSSESSION AT THE JOB SITE AT ALL TIMES ONE (1) SIGNED COPY OF APPROVED PLANS, STANDARDS AND SPECIFICATIONS. CONTRACTOR SHALL CONSTRUCT AND MAINTAIN EMERGENCY ACCESS ROUTES TO THE SITE AND STRUCTURE AT ALL TIMES PER THE APPLICABLE TRI-LAKES MONUMENT FIRE PROTECTION DISTRICT REQUIREMENTS. THE CONTRACTOR SHALL OBTAIN WRITTEN APPROVAL FOR ANY VARIANCE TO THE ABOVE DOCUMENTS. NOTIFY ENGINEER OF ANY CONFLICTING STANDARDS OR SPECIFICATIONS. IN THE EVENT OF ANY CONFLICTING STANDARD OR SPECIFICATION, THE MORE STRINGENT OR HIGHER QUALITY STANDARD, DETAIL OR SPECIFICATION SHALL APPLY.
- THE CONTRACTOR SHALL OBTAIN, AT HIS OWN EXPENSE, ALL APPLICABLE CODES, LICENSES, STANDARD SPECIFICATIONS, PERMITS, BONDS, ETC., WHICH ARE NECESSARY TO PERFORM THE PROPOSED WORK, INCLUDING, BUT NOT LIMITED TO A LOCAL AND STATE GROUNDWATER DISCHARGE AND COLORADO DEPARTMENT OF HEALTH AND ENVIRONMENT (CDPHE) STORMWATER DISCHARGE PERMIT ASSOCIATED WITH CONSTRUCTION ACTIVITY.
- THE CONTRACTOR SHALL BE RESPONSIBLE FOR NOTIFYING THE REQUIRED PARTY (OWNER AND ENGINEER) AT LEAST 48 HOURS PRIOR TO START OF ANY CONSTRUCTION, PRIOR TO BACKFILLING, AND AS REQUIRED BY JURISDICTIONAL AUTHORITY AND/OR PROJECT SPECIFICATIONS. THE CONTRACTOR SHALL CONTINUE WITH NOTIFICATIONS THROUGHOUT THE PROJECT AS REQUIRED BY THE STANDARDS AND SPECIFICATIONS.
- THE LOCATIONS OF EXISTING UTILITIES ARE SHOWN IN THE APPROXIMATE LOCATION BASED ON INFORMATION BY OTHERS. NOT ALL UTILITIES MAY BE SHOWN. THE CONTRACTOR SHALL DETERMINE THE EXACT SIZE, LOCATION AND TYPE OF ALL EXISTING UTILITIES WHETHER SHOWN OR NOT BEFORE COMMENCING WORK. THE ENGINEER AND/OR OWNER ASSUMES NO RESPONSIBILITY FOR THE ACCURACY OR COMPLETENESS SHOWN ON PLANS. THE CONTRACTOR SHALL BE FULLY AND SOLELY RESPONSIBLE FOR ANY AND ALL DAMAGES AND COSTS WHICH MIGHT OCCUR BY THE CONTRACTOR'S FAILURE TO EXACTLY LOCATE AND PRESERVE ANY AND ALL UTILITIES. THE CONTRACTOR SHALL NOTIFY ALL PUBLIC AND PRIVATE UTILITY COMPANIES AND DETERMINE THE LOCATION OF ALL EXISTING UTILITIES PRIOR TO PROCEEDING WITH GRADING AND CONSTRUCTION. ALL WORK PERFORMED IN THE AREA OF UTILITIES SHALL BE PERFORMED AND INSPECTED ACCORDING TO THE REQUIREMENTS OF THE UTILITY OWNER. LIKEWISE, THE CONTRACTOR SHALL BE RESPONSIBLE FOR LOCATING AND MAPPING ANY EXISTING UTILITY (INCLUDING DEPTH) WHICH MAY CONFLICT WITH THE PROPOSED CONSTRUCTION, AND FOR RELOCATING ENCOUNTERED UTILITIES AS DIRECTED BY THE ENGINEER. CONTRACTOR SHALL CONTACT AND RECEIVE APPROVAL FROM UTILITY OWNER AND ENGINEER BEFORE RELOCATING ANY ENCOUNTERED UTILITIES. CONTRACTOR RESPONSIBLE FOR SERVICE CONNECTIONS, AND RELOCATING AND RECONNECTING AFFECTED UTILITIES AS COORDINATED WITH UTILITY OWNER AND/OR ENGINEER, INCLUDING NON-MUNICIPAL UTILITIES (TELEPHONE, GAS, CABLE, ETC., WHICH SHALL BE COORDINATED WITH THE UTILITY OWNER). THE CONTRACTOR SHALL IMMEDIATELY CONTACT ENGINEER UPON DISCOVERY OF A UTILITY DISCREPANCY OR CONFLICT. AT LEAST 48 HOURS PRIOR TO CONSTRUCTION, THE CONTRACTOR SHALL NOTIFY THE UTILITY NOTIFICATION CENTER OF COLORADO (1-800-922-1987, WWW.UNCC.ORG). SEE SURVEY UTILITY LOCATION INFORMATION BELOW.
- THE CONTRACTOR SHALL BE SOLELY AND COMPLETELY RESPONSIBLE FOR CONDITIONS AT AND ADJACENT TO THE JOB SITE, INCLUDING SAFETY OF ALL PERSONS AND PROPERTY DURING THE PERFORMANCE OF THE WORK. THE CONTRACTOR SHALL PREPARE A TRAFFIC CONTROL PLAN FOR OWNER AND/OR CITY APPROVAL AND PROVIDE ALL LIGHTS, SIGNS, BARRICADES, FENCING, FLAGMEN OR OTHER DEVICES NECESSARY TO PROVIDE FOR PUBLIC SAFETY. THIS REQUIREMENT SHALL APPLY CONTINUOUSLY AND NOT BE LIMITED TO NORMAL WORKING HOURS. THE CONTRACTOR AGREES TO COMPLY WITH THE PROVISIONS OF THE TRAFFIC CONTROL PLAN AND THE LATEST EDITION OF THE "MANUAL ON UNIFORM TRAFFIC CONTROL DEVICES," PART VI, FOR CONSTRUCTION SIGNAGE AND TRAFFIC CONTROL. ALL TEMPORARY AND PERMANENT TRAFFIC SIGNS SHALL COMPLY TO THE MANUAL ON UNIFORM TRAFFIC CONTROL DEVICES (MUTCD) WITH REGARD TO SIGN SHAPE, COLOR, SIZE, LETTERING, ETC. UNLESS OTHERWISE SPECIFIED. IF APPLICABLE, PART NUMBERS ON SIGNAGE DETAILS REFER TO MUTCD SIGN NUMBERS.
- THE CONTRACTOR SHALL BE RESPONSIBLE FOR REMOVING ANY GROUNDWATER ENCOUNTERED DURING THE CONSTRUCTION OF ANY PORTION OF THIS PROJECT. GROUNDWATER SHALL BE PUMPED, PIPED, REMOVED AND DISPOSED OF IN A MANNER WHICH DOES NOT CAUSE FLOODING OF EXISTING STREETS NOR EROSION ON ADJUTING PROPERTIES IN ORDER TO CONSTRUCT THE IMPROVEMENTS SHOWN ON THESE PLANS. GROUNDWATER TO BE PUMPED SHALL BE TESTED, PERMITTED, AND PUMPED PER THE STATE OF COLORADO AND LOCAL GROUNDWATER DISCHARGING PERMIT REQUIREMENTS.
- ANY EXISTING MONITORING WELLS, CLEANOUTS, VALVE BOXES, ETC. TO BE PROTECTED AND TO REMAIN IN SERVICE. IF FEATURES EXIST, EXTEND OR LOWER TO FINAL SURFACE WITH LIKE KIND CAP WITH STANDARD CAST ACCESS LID WITH SAME MARKINGS.
- ALL SURPLUS MATERIALS, TOOLS, AND TEMPORARY STRUCTURES, FURNISHED BY THE CONTRACTOR, SHALL BE REMOVED FROM THE PROJECT SITE BY THE CONTRACTOR. ALL DEBRIS AND RUBBISH CAUSED BY THE OPERATIONS OF THE CONTRACTOR SHALL BE REMOVED, AND THE AREA OCCUPIED DURING CONSTRUCTION ACTIVITIES SHALL BE RESTORED TO ITS ORIGINAL CONDITION, WITHIN 48 HOURS OF PROJECT COMPLETION, UNLESS OTHERWISE DIRECTED BY THE MUNICIPALITY OR OWNER'S REPRESENTATIVE.
- THE CONTRACTOR IS REQUIRED TO PROVIDE AND MAINTAIN EROSION AND SEDIMENT CONTROL MEASURES IN ACCORDANCE WITH THE LOCAL JURISDICTION, THE STATE OF COLORADO, THE M-STANDARD PLANS OF THE COLORADO DEPARTMENT OF TRANSPORTATION, AND THE APPROVED EROSION CONTROL PLAN. JURISDICTIONAL AUTHORITY MAY REQUIRE THE CONTRACTOR TO PROVIDE ADDITIONAL EROSION CONTROL MEASURES AT THE CONTRACTOR'S EXPENSE DUE TO UNFORESEEN EROSION PROBLEMS OR IF THE PLANS DO NOT FUNCTION AS INTENDED. THE CONTRACTOR IS RESPONSIBLE FOR PROHIBITING SILT AND DEBRIS LADEN RUNOFF FROM LEAVING THE SITE, AND FOR KEEPING ALL PUBLIC AREAS FREE OF MUD AND DEBRIS. THE CONTRACTOR IS RESPONSIBLE FOR RE-ESTABLISHING FINAL GRADES AND FOR REMOVING ACCUMULATED SEDIMENTATION FROM ALL AREAS INCLUDING SWALES AND DETENTION/WATER QUALITY AREAS. CONTRACTOR SHALL REMOVE TEMPORARY EROSION CONTROL MEASURES AND REPAIR AREAS AS REQUIRED AFTER VEGETATION IS ESTABLISHED AND ACCEPTED BY OWNER AND MUNICIPALITY.
- PROTECT ALL TREES AND VEGETATION. PLACE CONSTRUCTION FENCING AT DRIP LINE OF TREES AND PLANTS NEAR THE WORK ZONE. DEEP WATER TREES WEEKLY. HAND EXCAVATION REQUIRED AT ROOT ZONES WHERE PROPOSED PAVING OR UTILITY WORK IS WITHIN DRIFLINE OF TREES.

DETAIL TITLE

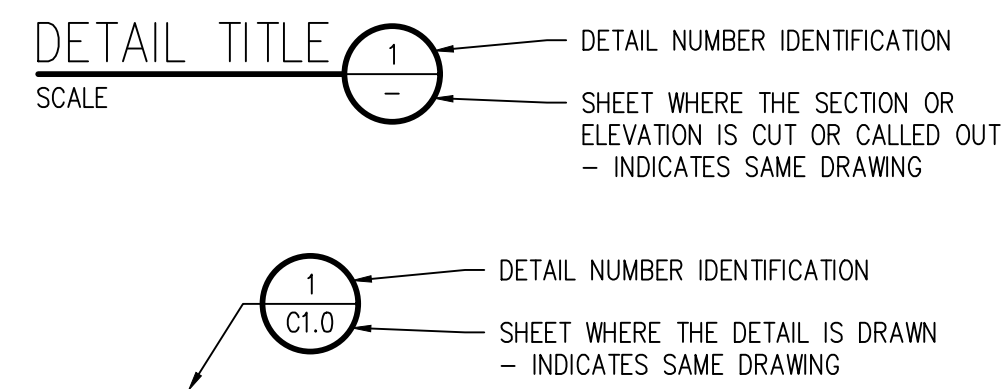

SECTION CALLOUT

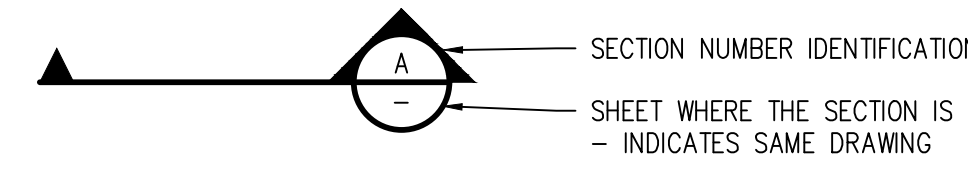

DETAIL MARKER

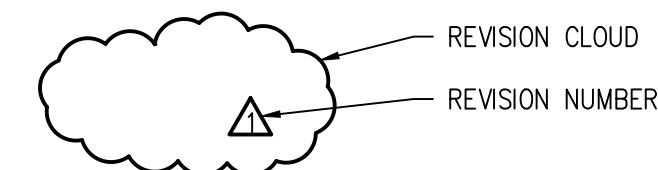

JVA CONSULTING ENGINEERS
 JVA, Inc. 1319 Spruce Street
 Boulder, CO 80502 303.444.1951
 www.jvaja.com
 Boulder • Fort Collins • Winter Park
 Glenwood Springs • Denver

REVISION DESCRIPTION
NO. DATE DESD OWN



DESIGNED BY:	MHT/JGJ
DRAWN BY:	JGJ
CHECKED BY:	KJC
JOB #:	1051.9e
DATE:	MARCH 2022
© JVA, INC.	

WOODMOOR WSD NO. 1
 WELL NO. 22
 EL PASO COUNTY, COLORADO
 LEGEND, NOTES AND ABBREVIATIONS

SHEET NO.
G0.1

N:\1051.9e - Well 22\Drawings\El Paso County Permits\1051.9e - GEC - CWP-LMA.dwg, 4/08/2022 - 1:51 PM, [G]

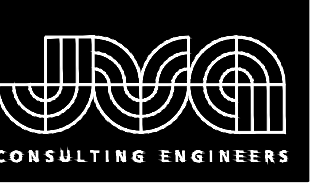

JVA, Inc. 1319 Spruce Street
 Boulder, CO 80302 303.444.1951
 www.jvajva.com
 Boulder • Fort Collins • Winter Park
 Glenwood Springs • Denver

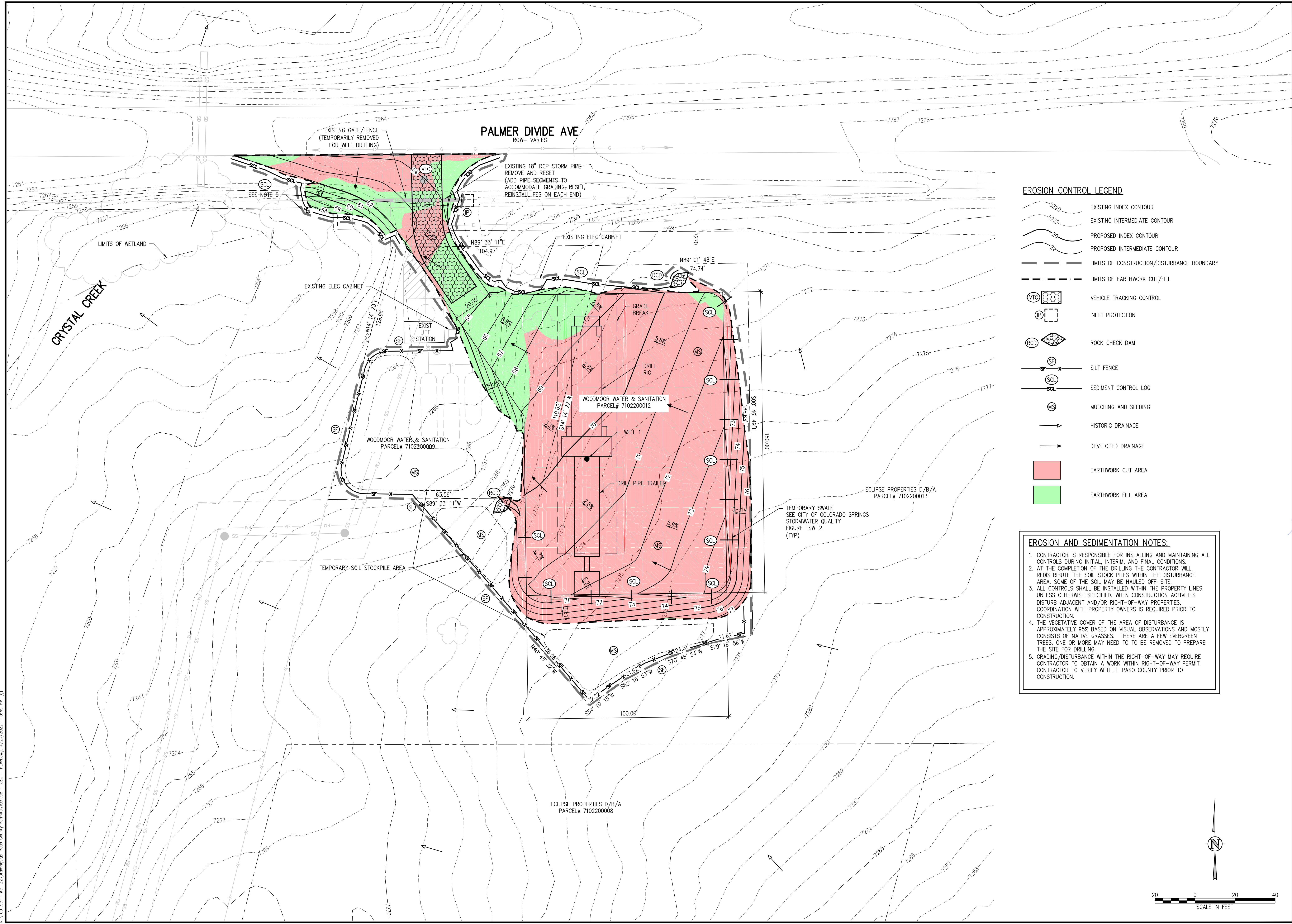

EROSION CONTROL LEGEND

	EXISTING INDEX CONTOUR
	EXISTING INTERMEDIATE CONTOUR
	PROPOSED INDEX CONTOUR
	PROPOSED INTERMEDIATE CONTOUR
	LIMITS OF CONSTRUCTION/DISTURBANCE BOUNDARY
	LIMITS OF EARTHWORK CUT/FILL
	VEHICLE TRACKING CONTROL
	INLET PROTECTION
	ROCK CHECK DAM
	SILT FENCE
	SEDIMENT CONTROL LOG
	MULCHING AND SEEDING
	HISTORIC DRAINAGE
	DEVELOPED DRAINAGE
	EARTHWORK CUT AREA
	EARTHWORK FILL AREA

EROSION AND SEDIMENTATION NOTES:

- CONTRACTOR IS RESPONSIBLE FOR INSTALLING AND MAINTAINING ALL CONTROLS DURING INITIAL, INTERIM, AND FINAL CONDITIONS.
- AT THE COMPLETION OF THE DRILLING THE CONTRACTOR WILL REDISTRIBUTE THE SOIL STOCK PILES WITHIN THE DISTURBANCE AREA. SOME OF THE SOIL MAY BE HAULED OFF-SITE.
- ALL CONTROLS SHALL BE INSTALLED WITHIN THE PROPERTY LINES UNLESS OTHERWISE SPECIFIED. WHEN CONSTRUCTION ACTIVITIES DISTURB ADJACENT AND/OR RIGHT-OF-WAY PROPERTIES, COORDINATION WITH PROPERTY OWNERS IS REQUIRED PRIOR TO CONSTRUCTION.
- THE VEGETATIVE COVER OF THE AREA OF DISTURBANCE IS APPROXIMATELY 95% BASED ON VISUAL OBSERVATIONS AND MOSTLY CONSISTS OF NATIVE GRASSES. THERE ARE A FEW EVERGREEN TREES, ONE OR MORE MAY NEED TO BE REMOVED TO PREPARE THE SITE FOR DRILLING.
- GRADING/DISTURBANCE WITHIN THE RIGHT-OF-WAY MAY REQUIRE CONTRACTOR TO OBTAIN A WORK WITHIN RIGHT-OF-WAY PERMIT. CONTRACTOR TO VERIFY WITH EL PASO COUNTY PRIOR TO CONSTRUCTION.

N:\1051.9e - Well 22\Drawings\El Paso County Permits\1051.9e - GEC - PLAN.dwg, 4/20/2022 - 3:49 PM, R1

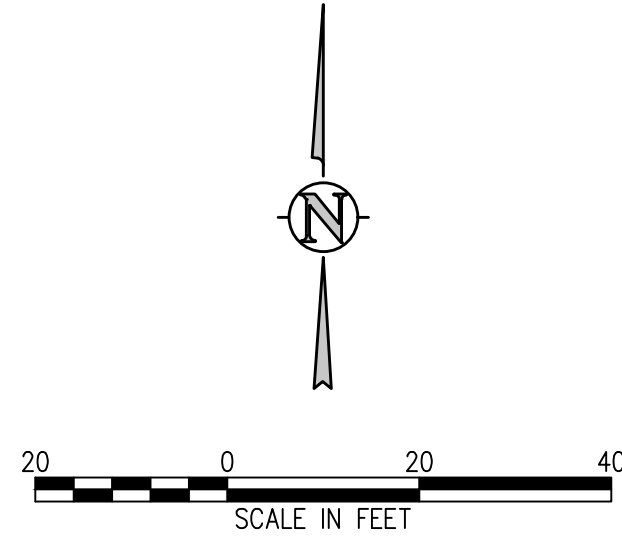

DESIGNED BY:	MHT/JGJ
DRAWN BY:	MHT/JGJ
CHECKED BY:	KJC
JOB #:	1051.9e
DATE:	MARCH 2022
© JVA, INC.	
WOODMOOR WSD NO. 1 WELL NO. 22 EL PASO COUNTY, COLORADO	GRADING AND EROSION CONTROL PLAN
SHEET NO.	CE1.1

STORMWATER MANAGEMENT PLAN (SWMP)

THIS STORMWATER MANAGEMENT PLAN IS TO BE RETAINED AND MAINTAINED ONSITE INCLUDING FINAL LANDSCAPING PLANS AND ANY OTHER EROSION CONTROL DOCUMENTATION. A SWMP ADMINISTRATOR WILL BE DESIGNATED BY THE CONTRACTOR AND IS RESPONSIBLE FOR DEVELOPING, IMPLEMENTING, MAINTAINING, AND REVISING THIS SWMP. THIS SWMP SHOULD BE VIEWED AS A LIVING DOCUMENT THAT IS CONTINUOUSLY BEING REVIEWED AND MODIFIED AS A PART OF THE OVERALL PROCESS OF EVALUATING AND MANAGING STORMWATER QUALITY ISSUES AT THE SITE. THE QUALIFIED STORMWATER MANAGER (QSM) SHALL AMEND THE SWMP WHEN THERE IS A CHANGE IN DESIGN, CONSTRUCTION, O&M OF THE SITE WHICH WOULD REQUIRE THE IMPLEMENTATION OF NEW OR REVISED BMPs OR IF THE SWMP PROVES TO BE INEFFECTIVE IN ACHIEVING THE GENERAL OBJECTIVES OF CONTROLLING POLLUTANTS IN STORMWATER DISCHARGES ASSOCIATED WITH CONSTRUCTION ACTIVITY OR WHEN BMPs ARE NO LONGER NECESSARY AND ARE REMOVED. THE QSM IS THE CONTACT FOR ALL SWMP-RELATED ISSUES AND IS RESPONSIBLE FOR ITS ACCURACY, COMPLETENESS, AND IMPLEMENTATION. THE FOLLOWING HAS BEEN DESIGNATED AS THE SWMP ADMINISTRATOR FOR THIS PROJECT:

NAME: _____

CONTACT INFO: _____

THE SITE IS LOCATED AT 1755 COUNTY LINE ROAD IN MONUMENT, COLORADO. THE WOODMOOR WATER & SANITATION DISTRICT NO. 1 (WMSD) PROPOSES TO BUILD A NEW GROUNDWATER WELL (REFERRED TO AS WELL NO. 22) ON THEIR PROPERTY. WMSD OWNS THE 0.3-ACRE CRYSTAL CREEK LIFT STATION PROPERTY (PARCEL 7102200009) AND THE ADJACENT 0.5-ACRE UNDEVELOPED PROPERTY (PARCEL 7102200012) SOUTHWEST OF THE INTERSECTION OF COUNTY LINE ROAD (HIGHWAY 404) AND DOWNWOOD DRIVE. BOTH PARCELS ARE LOCATED IN THE NORTHWEST QUARTER OF SECTION 2, TOWNSHIP 11 SOUTH, RANGE 67 WEST OF THE 6TH P.M., COUNTY OF EL PASO, STATE OF COLORADO. THE LIFT STATION PROPERTY IS ZONED AT C-1, POLITICAL SUBDIVISION. THE PROPOSED WELL NO. 22 SITE IS ON THE 0.5-ACRE UNDEVELOPED PARCEL, WHICH IS CURRENTLY ZONED AS RS-2000, RESIDENTIAL SUBURBAN. THIS PROJECT DOES NOT RELY ON CONTROL MEASURES OWNED OR OPERATED BY ANOTHER ENTITY THEN THE WMSD. THE LIMITS OF THE WORK AREA HAS BEEN CALCULATED AT 0.8-ACRE. NO DRILLING ACTIVITIES SHALL OCCUR OUTSIDE OF THE LIMITS OF WORK SHOWN ON THE GRADING AND EROSION CONTROL PLAN. THE SITE WILL NOT BE ACCESSED FROM THE NORTH SIDE OF THESE PROPERTIES AT THE EXISTING CRYSTAL CREEK LIFT STATION ACCESS DRIVE. THEREFORE, NO NEW ACCESS DRIVES WILL BE CREATED AND THE SITE WILL NOT REQUIRE ANY STREAM CROSSINGS. THE SEQUENCE OF CONSTRUCTION STARTS IS AS FOLLOWS:

PHASE	ESTIMATED	ACTUAL
MOBILIZE TO SITE	APRIL, 2022	_____
INSTALL TEMPORARY EROSION CONTROL	APRIL, 2022	_____
GRADING OF PAD SITE	APRIL, 2022	_____
DRILLING ACTIVITY	APRIL, 2022	_____
SITE RESTORATION AND SEEDING	MAY, 2022	_____

THE EXISTING SITE CONSISTS OF DEVELOPED LAND AND NATIVE GRASSLAND, AND IS APPROXIMATELY 95% COVERED WITH VEGETATIVE GROUND COVER. THE ESTIMATED HISTORIC AND DEVELOPED RUNOFF COEFFICIENTS ARE 0.25 AND 0.25, RESPECTIVELY. ONCE THE DRILLING HAS BEEN COMPLETED THE SITE WILL BE GRADED TO A SIMILAR PRE-DRILLING CONDITION AND SEEDED. THEREFORE, THE EXISTING AND DEVELOPED RUNOFF COEFFICIENTS SHOULD BE THE SAME ONCE THE SEEDED VEGETATION FULLY DEVELOPS. A DRAINAGE REPORT WAS NOT DEEMED NECESSARY FOR THIS TEMPORARY DRILLING ACTIVITY. ACCORDING TO THE USDA WEB SOIL SURVEY, THE SOILS IN THIS AREA ARE PRIMARILY CLASSIFIED AS SANDY LOAM. THEREFORE, SOIL EROSION POTENTIAL IS ANTICIPATED TO BE FAIRLY HIGH.

OFFSITE RUNOFF FLOWS ONTO THE PROPERTY ARE GENERALLY FROM THE SOUTHWEST. ONSITE FLOWS ALSO TYPICALLY FLOW FROM THE SOUTHWEST. THE MAJOR POTENTIAL POLLUTANT SOURCE FROM THE SITE IS EXPECTED TO BE FROM THE EXPOSURE OF SOIL DURING THE EXTENT OF THE DRILLING OPERATIONS. DRAINAGE SWALES HAVE BEEN ADDED ON THE SOUTH AND EAST SIDES OF THE DRILL PAD TO CAPTURE AND CONVEY OFF-SITE STORM RUNOFF AROUND THE DRILLING OPERATIONS. VARIOUS PROVEN TEMPORARY EROSION CONTROL BEST MANAGEMENT PRACTICES (BMPs) WILL BE PLACED ON SITE DURING THE DRILLING OF WELL NO. 22. A PERMANENT DETENTION FACILITY WILL NOT BE REQUIRED. STORMWATER IS DISCHARGED FROM THIS SITE TO CRYSTAL CREEK.

THE CONTRACTOR SHALL BE RESPONSIBLE FOR THE REMOVAL OF ALL WASTES FROM CONSTRUCTION SITES FOR DISPOSAL IN ACCORDANCE WITH LOCAL AND STATE REGULATORY REQUIREMENTS. NO CONSTRUCTION DEBRIS, TREE SLASH, BUILDING MATERIAL WASTES, OR UNUSED BUILDING MATERIALS SHALL BE BURIED, DUMPED, OR DISCHARGED AT THE SITE.

OTHER POTENTIAL TEMPORARY POLLUTION SOURCES WOULD BE FROM THE NORMAL DRILLING ACTIVITY SUCH AS VEHICLE TRAFFIC ACCESSING AND LEAVING THE SITE, VEHICLE FUELING, STORAGE OF MATERIALS, AND LOADING/ UNLOADING AREAS. THESE ACTIVITIES WILL BE CONTAINED WITHIN THE DESIGNATED LIMITS OF WORK, OR DO NOT EXIST AT THIS SITE. PORTABLE TOILETS WILL BE LOCATED A MINIMUM OF 10FT FROM STORMWATER INLETS AND SOFT FROM STATE WATERS. THEY WILL BE SECURED AT ALL FOUR CORNERS TO PREVENT OVERTURNING AND CLEANED ON A WEEKLY BASIS. THEY WILL BE INSPECTED DAILY FOR SPILLS.

THERE WILL BE NO OTHER NON-STORMWATER DISCHARGED FROM THE SITE.

BEST MANAGEMENT PRACTICES FOR STORMWATER MANAGEMENT

NON STRUCTURAL BMPs WILL BE IMPLEMENTED TO THE MAXIMUM EXTENT POSSIBLE. THE UTILIZATION OF NON STRUCTURAL BMPs WILL BE AN ONGOING PROCESS DIRECTED AT PREVENTING EROSION. THE NON STRUCTURAL BMPs WILL RECEIVE CONTINUOUS EMPHASIS THROUGHOUT CONSTRUCTION BECAUSE THEY AVERT PROBLEMS BEFORE THEY OCCUR AND REDUCE THE NEED FOR STRUCTURAL BMPs. NON STRUCTURAL BMPs WILL CONSIST PRIMARILY OF PRESERVATION OF EXISTING MATURE VEGETATION AND TREES, PLANNING AND SCHEDULING CONSTRUCTION ACTIVITIES AIMED AT ACHIEVING THE GOAL OF MINIMIZING EROSION. FURTHERMORE, CONSTRUCTION PERSONNEL WILL BE INSTRUCTED AND SUPERVISED IN CONSTRUCTION METHODS CONSISTENT WITH EROSION PREVENTION PRACTICES.

PLANNED STRUCTURAL BMPs FOR EROSION AND SEDIMENT CONTROL ARE SHOWN ON THE EROSION AND SEDIMENTATION CONTROL PLAN. IMPLEMENTING THESE MEASURES SHOULD MINIMIZE NUISANCE SILT AND SEDIMENTATION EXITING THE SITE AND PREVENT CLOGGING EXISTING STORM SEWERS.

APPLICATION OF THESE BMPs FOR STORMWATER MANAGEMENT ARE FOR CONSTRUCTION PERIODS AND ARE CONSIDERED TEMPORARY. POST-DEVELOPMENT STORMWATER MANAGEMENT IS PROVIDED THROUGH GRADING AND SEEDING STABILIZATION.

CONCRETE WASHOUT AREA (CWA).

CONCRETE IS NOT EXPECTED TO BE USED FOR THIS DRILLING OPERATION AND THEREFORE A CONCRETE BATCH PLANT OR CONCRETE WASHOUT ARE WILL NOT BE NECESSARY.

VEHICLE TRACKING CONTROL (VTC).

A STABILIZED CONSTRUCTION ENTRANCE WILL BE PROVIDED AT COUNTY LINE ROAD (ALSO REFERRED TO COUNTY ROAD 404 OR PALMER DIVIDE AVE). THE CONSTRUCTION ACCESS AND PARKING WILL BE GRADED AND COVERED WITH A CRUSHED STONE BASE COURSE DURING CONSTRUCTION. THE VEHICLE TRACKING CONTROL WILL BE RELOCATED WITH THE CONSTRUCTION ACCESS AS NECESSARY. THE CONTRACTOR SHALL TAKE THE NECESSARY MEASURES TO CLEAN ANY DEBRIS TRACKED ONTO COUNTY LINE ROAD. THIS WILL INCLUDE, BUT IS NOT LIMITED TO, MANUAL SWEEPING OR MOTORIZED STREET SWEEPERS.

SILT FENCING (SF) AND SEDIMENT CONTROL LOGS (SCL).

SILT FENCING AND SEDIMENT CONTROL LOGS SHALL BE INSTALLED WITH RESPECT TO PROPOSED DRAINAGE PATTERNS. SILT FENCE AND SEDIMENT CONTROL LOGS SHALL BE CONSTRUCTED ALONG THE PORTIONS OF THE PERIMETER THE PROPOSED LIMITS OF WORK AND AROUND TEMPORARY SOIL STOCKPILES. THE CONTRACTOR IS EXPECTED TO CONSTRUCT TEMPORARY DRAINAGE SWALES ALONG THE PERIMETER OF THE DRILLING PAD, AS SHOWN ON THE GEC PLAN. SEDIMENT CONTROL LOGS WILL BE PLACED AT INTERVALS PERPENDICULAR TO THE SWALES SO AS NOT TO EXCEED A MAXIMUM OF 6 INCHES OF VERTICAL HEIGHT TO THE NEXT SEDIMENT CONTROL LOG UPHILL OR DOWNHILL. THE SILT FENCING AND SEDIMENT CONTROL LOGS SHALL BE INSTALLED AT THE DOWNHILL SIDE OF THE EXISTING SLOPES ACROSS THE SITE AND AT ALL POINT DISCHARGE AREAS WHETHER SHOWN OR NOT. SILT FENCE AND SEDIMENT CONTROL LOGS SHALL BE MAINTAINED AS NEEDED THROUGHOUT THE CONSTRUCTION PROCESS. THE TEMPORARY SILT FENCE AND SEDIMENT CONTROL LOGS WILL REMAIN UNTIL THE STORM SEWER STRUCTURES ARE COMPLETED AND GROUND COVER IS EFFECTIVE.

INLET PROTECTION (IP).

THE INLET PROTECTION WILL BE INSTALLED AT THE EXISTING 18" REINFORCED CONCRETE PIPE LOCATED AT THE EXISTING ENTRANCE TO THE CRYSTAL CREEK LIFT STATION. A TEMPORARY INLET SEDIMENT TRAP WILL BE CONSTRUCTED AROUND THE EXISTING FLARED END SECTION LOCATED ON THE EAST SIDE OF THE SAID ENTRANCE.

ROCK CHECK DAMS (RCD).

ROCK CHECK DAMS WILL BE INSTALLED AS SHOWN ON THE GEC PLAN. THEY HAVE BEEN PLACED AT THE OUTFALL OF THE PROPOSED TEMPORARY DRAINAGE SWALES CONSTRUCTED ALONG THE PERIMETER OF THE DRILLING PAD. THE ROCK CHECK DAMS WILL BE REMOVED AS PART OF THE FINAL GRADING AND SEEDING OF THE SITE OCCURS.

TEMPORARY SOIL STOCKPILES.

TEMPORARY SOIL STOCKPILES WILL BE ESTABLISHED IN OPEN AREA WITHIN THE WMSD PROPERTY AS SHOWN ON GEC PLAN. SOME OR ALL OF THIS SOIL WILL BE PLACED BACK ONTO THE GRADED DISTURBANCE AREA ONCE THE DRILLING IS COMPLETE. ANY SOIL NOT USED FOR THE POST DRILLING GRADING WILL BE HAUL AWAY FROM THE SITE.

DUST CONTROL MEASURES.

DISTURBED AREAS NOT YET READY TO BE SEEDED OR OTHERWISE STABILIZED SHALL BE WATERED, OR RIPPED AS NECESSARY TO PRECLUDE VISIBLE DUST EMISSIONS.

ITEMS ARE SCHEDULED TO BE IMPLEMENTED ACCORDING TO THE CONSTRUCTION SCHEDULE. AS WORK PROCEEDS, IMPLEMENTATION OF INDIVIDUAL BMPs IS TO COINCIDE WITH THE CONSTRUCTION THEREBY MINIMIZING THE EXPOSURE OF UNPROTECTED AREAS. THE SILT FENCE, INLET PROTECTION (FOR EXISTING INLETS), AND GRAVELING OF THE CONSTRUCTION ENTRANCE WILL BE PERFORMED WHEN THE GRADING BEGINS. THE INLET PROTECTION WILL BE INSTALLED AS THE STORM SEWER STRUCTURES ARE CONSTRUCTED. THE STRUCTURAL BMPs THAT DO NOT BECOME PART OF THE PERMANENT STORMWATER MANAGEMENT PLAN ARE TO BE REMOVED, AS THE PERMANENT GROUND COVER INSTALLATIONS ARE COMPLETED. FUGITIVE DUST EMISSIONS RESULTING FROM GRADING ACTIVITIES AND/OR WIND SHALL BE CONTROLLED USING THE BEST AVAILABLE CONTROL TECHNOLOGY AS DEFINED BY THE COLORADO DEPARTMENT OF HEALTH AT THE TIME OF GRADING. THE STRUCTURAL BMPs ARE TO BE REMOVED, AS THE PERMANENT VEGETATION INSTALLATION IS COMPLETED.

THE EROSION AND SEDIMENT CONTROL PLAN MAY BE MODIFIED BY THE OWNER'S ENGINEER, COUNTY ENGINEERING INSPECTORS, OR MUNICIPALITY, OR ITS AUTHORIZED REPRESENTATIVE AS FIELD CONDITIONS WARRANT.

PERMANENT STABILIZATION MEASURES:

NATIVE PERENNIAL SEEDING WILL BE ESTABLISHED AFTER FINAL GRADING OF THE SITE IS COMPLETED.

MATERIALS AND SPILL PREVENTION:

THE CONTRACTOR WILL STORE CONSTRUCTION MATERIALS AND EQUIPMENT IN CONFINED AREAS ON SITE FROM WHICH RUNOFF WILL BE CONTAINED AND FILTERED. MATERIALS WILL BE STORED OFF THE GROUND AND PROTECTED FROM THE WEATHER BY A COVER OR STORED IN A CONTAINER SUCH AS A VAN OR TRAILER. AN EARTHEN DIKE WILL BE CONSTRUCTED AROUND THE PERIMETER OF THE FUEL STORAGE AREA TO PREVENT MATERIALS FROM CONTACT WITH SURFACE RUNOFF. EQUIPMENT MAINTENANCE WILL BE PERFORMED IN A DESIGNATED AREA AND STANDARD MAINTENANCE PROCEDURES, SUCH AS THE USE OF DRIP PANS, WILL BE USED TO CONTAIN PETROLEUM PRODUCTS.

INSPECTION AND MAINTENANCE:

THE EROSION CONTROL MEASURES WILL BE INSPECTED DAILY DURING DRILLING OPERATIONS BY THE CONTRACTOR AND AFTER EACH RAIN EVENT. ALL INSPECTIONS SHALL BE DOCUMENTED AND SHALL INCLUDE THE DATE OF INSPECTION, ANY INCIDENCE OF NON-COMPLIANCE, SIGNED CERTIFICATION THAT THE SITE IS IN COMPLIANCE, AND ANY NOTES, DRAWINGS, MAPS, ETC. PERTAINING TO REPAIRS. COPIES OF ALL DOCUMENTATION SHALL BE DISTRIBUTED TO MUNICIPALITIES AND OWNER ON A REGULAR BASIS AS SPECIFIED BY OWNER. SILT FENCE AND EROSION CONTROL LOGS WILL BE CHECKED FOR UNDERMINING AND BYPASS AND REPAIRS OR EXPANDED AS NEEDED. SEDIMENT SHOULD BE REMOVED FROM INLET FILTERS AND SILT FENCING BEFORE ONE HALF OF THE DESIGN DEPTH HAS BEEN FILLED. SEDIMENTS DEPOSITED IN THE PUBLIC RIGHTS-OF-WAY WILL BE REMOVED IMMEDIATELY. THE TEMPORARY VEGETATION OF BARE SOILS WILL BE CHECKED REGULARLY AND AREAS WHERE IT IS LOST OR DAMAGED WILL BE RESEEDED. AT MINIMUM THE CONTRACTOR OR HIS AGENT SHALL INSPECT ALL BMPs EVERY 14 DAYS AND AFTER SIGNIFICANT PRECIPITATION OR SNOWMELT EVENTS. INSTALLATIONS AND MODIFICATIONS AS REQUIRED BY THE COUNTY WILL BE IMPLEMENTED WITHIN 48 HOURS OF NOTIFICATION. CONTRACTOR SHALL REMOVE TEMPORARY EROSION CONTROL MEASURES AND REPAIR AREAS AS REQUIRED AFTER VEGETATION IS ESTABLISHED AND ACCEPTED BY OWNER AND MUNICIPALITY.

FINAL STABILIZATION AND LONG-TERM STORMWATER QUALITY:

FINAL STABILIZATION IS REACHED WHEN ALL SOIL DISTURBING ACTIVITIES AT THE SITE HAVE BEEN COMPLETED, AND UNIFORM VEGETATIVE COVER HAS BEEN ESTABLISHED WITH A DENSITY OF AT LEAST 70% OR PRE-DISTURBANCE LEVELS OR EQUIVALENT PERMANENT, PHYSICAL EROSION REDUCTION METHODS HAVE BEEN EMPLOYED. FINAL STABILIZATION WILL BE ACHIEVED BY GRADING AND NATIVE SEEDING. CONTRACTOR SHALL BE RESPONSIBLE FOR FINAL STABILIZATION REGARDLESS OF ACCEPTANCE BY OWNER OF THE CONTRACTOR ITEM.

STANDARD NOTES FOR EL PASO COUNTY GRADING AND EROSION CONTROL PLANS

- STORMWATER DISCHARGES FROM CONSTRUCTION SITES SHALL NOT CAUSE OR THREATEN TO CAUSE POLLUTION, CONTAMINATION, OR DEGRADATION OF STATE WATERS. ALL WORK AND EARTH DISTURBANCE SHALL BE DONE IN A MANNER THAT MINIMIZES POLLUTION OF ANY ON-SITE OR OFFSITE WATERS, INCLUDING WETLANDS.
- NOTWITHSTANDING ANYTHING DEPICTED IN THESE PLANS IN WORDS OR GRAPHIC REPRESENTATION, ALL DESIGN AND CONSTRUCTION RELATED TO ROADS, STORM DRAINAGE AND EROSION CONTROL SHALL CONFORM TO THE STANDARDS AND REQUIREMENTS OF THE MOST RECENT VERSION OF THE RELEVANT ADOPTED EL PASO COUNTY STANDARDS, INCLUDING THE LAND DEVELOPMENT CODE, THE ENGINEERING CRITERIA MANUAL, THE DRAINAGE CRITERIA MANUAL, AND THE DRAINAGE CRITERIA MANUAL VOLUME 2. ANY DEVIATIONS TO REGULATIONS AND STANDARDS MUST BE REQUESTED, AND APPROVED, IN WRITING.
- A SEPARATE STORMWATER MANAGEMENT PLAN (SWMP) FOR THIS PROJECT SHALL BE COMPLETED AND AN EROSION AND STORMWATER QUALITY CONTROL PERMIT (ESQCP) ISSUED PRIOR TO COMMENCING CONSTRUCTION. DURING CONSTRUCTION THE SWMP IS THE RESPONSIBILITY OF THE DESIGNATED QUALIFIED STORMWATER MANAGER OR CERTIFIED EROSION CONTROL INSPECTOR AND SHALL BE LOCATED ON SITE AT ALL TIMES DURING CONSTRUCTION AND SHALL BE KEPT UP TO DATE WITH WORK PROGRESS AND CHANGES IN THE FIELD.
- ALL TEMPORARY SEDIMENT AND EROSION CONTROL MEASURES SHALL BE MAINTAINED AND REMAIN IN EFFECTIVE OPERATING CONDITION UNTIL PERMANENT SOIL EROSION CONTROL MEASURES ARE IMPLEMENTED AND FINAL STABILIZATION IS ESTABLISHED. ALL PERSONS ENGAGED IN LAND DISTURBANCE ACTIVITIES SHALL ASSESS THE ADEQUACY OF CONTROL MEASURES AT THE SITE AND IDENTIFY IF CHANGES TO THOSE CONTROL MEASURES IS NEEDED TO ENSURE THE CONTINUED EFFECTIVE PERFORMANCE OF THE CONTROL MEASURES. ALL CHANGES TO TEMPORARY SEDIMENT AND EROSION CONTROL MEASURES MUST BE INCORPORATED INTO THE STORMWATER MANAGEMENT PLAN PRIOR TO IMPLEMENTATION.
- TEMPORARY STABILIZATION SHALL BE IMPLEMENTED ON DISTURBED AREAS AND STOCKPILES WHERE GROUND DISTURBING CONSTRUCTION ACTIVITY HAS PERMANENTLY CEASED OR TEMPORARILY CEASED FOR LONGER THAN 14 DAYS. AN AREA THAT IS GOING TO REMAIN IN AN INTERIM STATE FOR MORE THAN 60 DAYS SHALL ALSO BE STABILIZED.
- FINAL STABILIZATION MUST BE IMPLEMENTED AT ALL APPLICABLE CONSTRUCTION SITES. FINAL STABILIZATION IS ACHIEVED WHEN ALL GROUND DISTURBING ACTIVITIES ARE COMPLETE AND ALL DISTURBED AREAS EITHER HAVE A UNIFORM VEGETATIVE COVER WITH INDIVIDUAL PLANT DENSITY OF 70 PERCENT OF PRE-DISTURBANCE LEVELS ESTABLISHED OR EQUIVALENT PERMANENT ALTERNATIVE STABILIZATION METHOD IS IMPLEMENTED. ALL TEMPORARY SEDIMENT AND EROSION CONTROL MEASURES SHALL BE REMOVED UPON FINAL STABILIZATION AND BEFORE PERMIT CLOSURE.
- ALL PERMANENT STORMWATER MANAGEMENT FACILITIES SHALL BE INSTALLED AS DEFINED IN THE APPROVED PLANS. ANY PROPOSED CHANGES THAT EFFECT THE HYDROLOGY OR HYDRAULICS OF A PERMANENT STORMWATER MANAGEMENT STRUCTURES MUST BE APPROVED BY THE ECM ADMINISTRATOR PRIOR TO IMPLEMENTATION.
- ANY EARTH DISTURBANCE SHALL BE CONDUCTED IN SUCH A MANNER SO AS TO EFFECTIVELY MINIMIZE ACCELERATED SOIL EROSION AND RESULTING SEDIMENTATION. ALL DISTURBANCES SHALL BE DESIGNED, CONSTRUCTED, AND COMPLETED SO THAT THE EXPOSED AREA OF ANY DISTURBED LAND SHALL BE LIMITED TO THE SHORTEST PRACTICAL PERIOD OF TIME. PRE-EXISTING VEGETATION SHALL BE PROTECTED AND MAINTAINED WITHIN 50 HORIZONTAL FEET OF A WATERS OF THE STATE, UNLESS INFEASIBLE.
- COMPACTION OF SOIL MUST BE PREVENTED IN AREAS DESIGNATED FOR INFILTRATION CONTROL MEASURES OR WHERE FINAL STABILIZATION WILL BE ACHIEVED BY VEGETATIVE COVER. AREAS DESIGNATED FOR INFILTRATION CONTROL SHALL ALSO BE PROTECTED FROM SEDIMENTATION DURING CONSTRUCTION UNTIL FINAL STABILIZATION IS ACHIEVED.
- ANY TEMPORARY OR PERMANENT FACILITY DESIGNED AND CONSTRUCTED FOR THE CONVEYANCE OF STORMWATER AROUND, THROUGH, OR FROM THE EARTH DISTURBANCE AREA SHALL BE A STABILIZED CONVEYANCE DESIGNED TO MINIMIZE EROSION AND THE DISCHARGE OF SEDIMENT OFF SITE.
- CONCRETE WASH WATER SHALL BE CONTAINED AND DISPOSED OF IN ACCORDANCE WITH THE SWMP. NO WASH WATER SHALL BE DISCHARGED TO OR ALLOWED TO RUNOFF TO STATE WATERS, INCLUDING ANY SURFACE OR SUBSURFACE STORM DRAINAGE SYSTEM OR FACILITIES. CONCRETE WASHOUT SHALL NOT BE LOCATED IN AN AREA WHERE SHALLOW GROUNDWATER MAY BE PRESENT, OR WITHIN 50 FEET OF A SURFACE WATER BODY.
- DEWATERING OPERATIONS: UNCONTAMINATED GROUND WATER MAY BE DISCHARGED ON SITE, BUT MAY NOT LEAVE THE SITE IN THE FORM OF SURFACE RUNOFF.
- EROSION CONTROL BLANKETING IS TO BE USED ON SLOPES STEEPER THAN 3:1.
- CONTRACTOR SHALL BE RESPONSIBLE FOR THE REMOVAL OF ALL WASTES FROM CONSTRUCTION SITES FOR DISPOSAL IN ACCORDANCE WITH LOCAL AND STATE REGULATORY REQUIREMENTS. NO CONSTRUCTION DEBRIS, TREE SLASH, BUILDING MATERIAL WASTES, OR UNUSED BUILDING MATERIALS SHALL BE BURIED, DUMPED, OR DISCHARGED AT THE SITE.
- WASTE MATERIALS SHALL NOT BE TEMPORARILY PLACED OR STORED IN THE STREET, ALLEY, OR OTHER PUBLIC WAY, UNLESS IN ACCORDANCE WITH AN APPROVED TRAFFIC CONTROL PLAN. CONTROL MEASURES MAY BE REQUIRED BY EL PASO COUNTY ENGINEERING IF DEEMED NECESSARY, BASED ON SPECIFIC CONDITIONS AND CIRCUMSTANCES.
- TRACKING OF SOILS AND CONSTRUCTION DEBRIS OFF-SITE SHALL BE MINIMIZED. MATERIALS TRACKED OFF-SITE SHALL BE CLEANED UP AND PROPERLY DISPOSED OF IMMEDIATELY.
- THE OWNER, SITE DEVELOPER, CONTRACTOR, AND/OR THEIR AUTHORIZED AGENTS SHALL BE RESPONSIBLE FOR THE REMOVAL OF ALL CONSTRUCTION DEBRIS, DIRT, TRASH, ROCK, SEDIMENT, AND SAND THAT MAY ACCUMULATE IN THE STORM SEWER OR OTHER DRAINAGE CONVEYANCE SYSTEM AND STORMWATER APPURTENANCES AS A RESULT OF SITE DEVELOPMENT.
- THE QUANTITY OF MATERIALS STORED ON THE PROJECT SITE SHALL BE LIMITED, AS MUCH AS PRACTICAL, TO THAT QUANTITY REQUIRED TO PERFORM THE WORK IN AN ORDERLY SEQUENCE. ALL MATERIALS STORED ON-SITE SHALL BE STORED IN A NEAT, ORDERLY MANNER, IN THEIR ORIGINAL CONTAINERS, WITH ORIGINAL MANUFACTURER'S LABELS.
- NO CHEMICALS ARE TO BE USED BY THE CONTRACTOR, WHICH HAVE THE POTENTIAL TO BE RELEASED IN STORMWATER UNLESS PERMISSION FOR THE USE OF A SPECIFIC CHEMICAL IS GRANTED IN WRITING BY THE ECM ADMINISTRATOR. IN GRANTING THE USE OF SUCH CHEMICALS, SPECIAL CONDITIONS AND MONITORING MAY BE REQUIRED.
- BULK STORAGE OF PETROLEUM PRODUCTS OR OTHER LIQUID CHEMICALS IN EXCESS OF 55 GALLONS SHALL HAVE ADEQUATE SECONDARY CONTAINMENT PROTECTION TO CONTAIN ALL SPILLS AND PREVENT ANY SPILLED MATERIAL FROM ENTERING STATE WATERS, INCLUDING ANY SURFACE OR SUBSURFACE STORM DRAINAGE SYSTEM OR FACILITIES.
- NO PERSON SHALL CAUSE THE IMPEDIMENT OF STORMWATER FLOW IN THE CURB AND GUTTER OR DITCH EXCEPT WITH APPROVED SEDIMENT CONTROL MEASURES.
- INDIVIDUALS SHALL COMPLY WITH THE "COLORADO WATER QUALITY CONTROL ACT" (TITLE 25, ARTICLE 8, CRS), AND THE "CLEAN WATER ACT" (33 USC 1344), IN ADDITION TO THE REQUIREMENTS INCLUDED IN THE DCM VOLUME II AND THE ECM APPENDIX I. ALL APPROPRIATE PERMITS MUST BE OBTAINED BY THE CONTRACTOR PRIOR TO CONSTRUCTION (NPDES, FLOODPLAIN, 404, FUGITIVE DUST, ETC.). IN THE EVENT OF CONFLICTS BETWEEN THESE REQUIREMENTS AND LAWS, RULES, OR REGULATIONS OF OTHER FEDERAL, STATE, OR COUNTY AGENCIES, THE MORE RESTRICTIVE LAWS, RULES, OR REGULATIONS SHALL APPLY.
- ALL CONSTRUCTION TRAFFIC MUST ENTER/EXIT THE SITE AT APPROVED CONSTRUCTION ACCESS POINTS.
- PRIOR TO ACTUAL CONSTRUCTION THE PERMITEE SHALL VERIFY THE LOCATION OF EXISTING UTILITIES.
- A WATER SOURCE SHALL BE AVAILABLE ON SITE DURING EARTHWORK OPERATIONS AND UTILIZED AS REQUIRED TO MINIMIZE DUST FROM EARTHWORK EQUIPMENT AND WIND.

EL PASO COUNTY SELF-MONITORING INSPECTIONS

THE PERMIT HOLDER OR AUTHORIZED AGENT SHALL CONDUCT SELF-MONITORING INSPECTIONS. THE PURPOSE OF SELF-MONITORING INSPECTIONS IS FOR THE PERMIT HOLDER TO ENSURE THAT ALL BMPs ARE INSTALLED ACCORDING TO APPROVED PLANS, THE BMPs ARE ADEQUATE AND ARE BEING PROPERLY MAINTAINED, THE SWMP IS UPDATED TO REFLECT CURRENT CONDITIONS, AND ONLY ALLOWABLE DISCHARGES ARE OCCURRING OFF THE SITE. THE PERSON PERFORMING THE INSPECTIONS MAY BE ON THE PERMIT HOLDER'S STAFF OR A CONTRACTED THIRD PARTY. THE INDIVIDUAL PERFORMING THE SELF-MONITORING INSPECTIONS SHALL BE A QUALIFIED STORMWATER MANAGER, WHICH IS AN INDIVIDUAL KNOWLEDGEABLE IN THE PRINCIPLES AND PRACTICES OF EROSION AND POLLUTION PREVENTION AND WITH THE SKILLS TO ASSESS CONDITIONS AT CONSTRUCTION SITES THAT COULD IMPACT STORMWATER QUALITY AND THE EFFECTIVENESS OF STORMWATER CONTROLS IMPLEMENTED TO MEET STORMWATER PERMITTING REQUIREMENTS. EXAMPLES OF A QUALIFIED STORMWATER MANAGER INCLUDE A REGISTERED PROFESSIONAL ENGINEER OR AN EROSION CONTROL INSPECTOR CERTIFIED IN A REGIONALLY RECOGNIZED EROSION AND SEDIMENT CONTROL INSPECTION TRAINING PROGRAM. THE PERSON PERFORMING INSPECTIONS SHOULD BE A PERSON WITH AUTHORITY TO EXPEND PROJECT DOLLARS ON EROSION AND STORMWATER QUALITY CONTROL. THERE ARE TWO TYPES OF SELF-MONITORING INSPECTIONS ALLOWED IN EL PASO COUNTY: ROUTINE SELF-MONITORING AND OPERATOR COMPLIANCE INSPECTIONS. THE PERMIT HOLDER OR AUTHORIZED REPRESENTATIVE MAY REQUEST AN ALTERNATIVE TO THE 14 DAY ROUTINE SELF-MONITORING INSPECTION CYCLE DISCUSSED ABOVE. SELF-MONITORING INSPECTIONS OF STORMWATER BEST MANAGEMENT PRACTICES MAY BE REQUESTED FOR AT LEAST ONCE EVERY MONTH (I.E., 30 DAYS) FOR PERMITTED CONSTRUCTION SITES WHEN:

- ALL CONSTRUCTION ACTIVITY IS COMPLETED EXCEPT FINAL STABILIZATION BECAUSE PLANTED VEGETATIVE COVER HAS NOT YET BECOME ESTABLISHED;
- ALL ACTIVITIES FOR FINAL STABILIZATION HAVE BEEN COMPLETED WITH THE EXCEPTION OF SEED APPLICATION WHICH MAY NOT HAVE OCCURRED DUE TO SEASONAL CONDITIONS OR THE NECESSITY TO REAPPLY ADDITIONAL SEED TO AUGMENT PREVIOUS EFFORTS; AND
- THE SWMP HAS BEEN UPDATED TO LOCATE THOSE AREAS SUBJECT TO THE REDUCED INSPECTION FREQUENCY. ROUTINE SELF-MONITORING INSPECTIONS AFTER PRECIPITATION EVENTS ARE NOT REQUIRED DURING AN APPROVED 30 DAY INSPECTION CYCLE.

- ROUTINE SELF-MONITORING INSPECTIONS. THE ROUTINE SELF-MONITORING INSPECTIONS ARE TO BE PERFORMED AND DOCUMENTED AT LEAST ONCE EVERY 7 CALENDAR DAYS, OR AT LEAST ONCE EVERY 14 CALENDARS, IF POST-STORM EVENT INSPECTIONS ARE CONDUCTED WITHIN 24 HOURS AFTER THE END OF A PRECIPITATION OR SNOWMELT EVENT. POST-STORM INSPECTIONS MAY BE USED TO FULFILL THE 14 DAY INSPECTION REQUIREMENT. IN ADDITION TO THE BI-WEEKLY INSPECTIONS THE OWNER OR REPRESENTATIVE SHALL PERFORM POST-STORM INSPECTIONS OF ALL BMPs AFTER ANY PRECIPITATION OR SNOWMELT EVENT THAT CAUSES SURFACE EROSION TO ENSURE THAT THE BMPs HAVE OPERATED AS DESIGNED, TO DETERMINE IF MAINTENANCE IS NEEDED, AND TO LOCATE AND CLEAN UP ANY AREAS WHERE MATERIALS MAY HAVE RUN OFF SITE. FOR THOSE CHOOSING TO UTILIZE A 14-DAY AND POST-STORM INSPECTION FREQUENCY, IF NO CONSTRUCTION ACTIVITIES WILL OCCUR FOLLOWING A STORM EVENT, POST-STORM INSPECTION MUST BE CONDUCTED PRIOR TO RESUMING CONSTRUCTION ACTIVITIES BUT NO LATER THAN 72 HOURS FOLLOWING A STORM EVENT. THE DELAY OF ANY POST-STORM INSPECTION MUST BE DOCUMENTED IN THE INSPECTION RECORDS INCLUDED IN THE SWMP.

THE OWNER OR HIS REPRESENTATIVE WILL RECORD THE RESULTS OF ALL INSPECTIONS BY COMPLETING AN INSPECTION REPORT OR SIMILAR INSPECTION CHECKLIST INCLUDED IN THE SWMP. COMPLETED INSPECTION REPORTS SHALL BE KEPT ON SITE AND AVAILABLE TO ANY CONSTRUCTION INSPECTORS. THE COUNTY MAY REQUIRE THE SUBMISSION OF THESE INSPECTION REPORTS ON A SITE-SPECIFIC BASIS.

- OPERATOR COMPLIANCE INSPECTION. WHEN A COMPLIANCE INSPECTION CONDUCTED BY A COUNTY STORMWATER INSPECTOR DOCUMENTS THE FAILURE TO IMPLEMENT CONTROL MEASURES OR IMPLEMENTATION OF INADEQUATE CONTROL MEASURES, THE COUNTY STORMWATER INSPECTOR MAY REQUIRE THE ESQCP OWNER OR THEIR REPRESENTATIVE TO INSPECT AND PROVIDE A REPORT TO THE COUNTY THAT THE CONTROL MEASURES HAVE BEEN IMPLEMENTED OR CORRECTED. THE OWNER OR THE REPRESENTATIVE MUST INCLUDE DATE AND TIME STAMPED PHOTOGRAPHS OF THE NEW, ADEQUATE CONTROL MEASURES.

MULCHING AND SEEDING NOTES FOR EL PASO COUNTY

- ALL DISTURBED AREAS MUST BE MULCHED WITHIN 21 DAY AFTER FINAL GRADE AND SEEDED AREAS ARE TO BE MULCHED WITH 24 HOURS AFTER SEEDING.
- MATERIAL USED FOR MULCH CAN BUT NOT BE CLEAN, WET, AND SEED-FREE LONG STEMMED FERTILIZER OR TRUCKED TO FULFILL THE 14 DAY INSPECTION REQUIREMENT. IN ADDITION TO THE BI-WEEKLY INSPECTIONS THE OWNER OR REPRESENTATIVE SHALL PERFORM POST-STORM INSPECTIONS OF ALL BMPs AFTER ANY PRECIPITATION OR SNOWMELT EVENT THAT CAUSES SURFACE EROSION TO ENSURE THAT THE BMPs HAVE OPERATED AS DESIGNED, TO DETERMINE IF MAINTENANCE IS NEEDED, AND TO LOCATE AND CLEAN UP ANY AREAS WHERE MATERIALS MAY HAVE RUN OFF SITE. FOR THOSE CHOOSING TO UTILIZE A 14-DAY AND POST-STORM INSPECTION FREQUENCY, IF NO CONSTRUCTION ACTIVITIES WILL OCCUR FOLLOWING A STORM EVENT, POST-STORM INSPECTION MUST BE CONDUCTED PRIOR TO RESUMING CONSTRUCTION ACTIVITIES BUT NO LATER THAN 72 HOURS FOLLOWING A STORM EVENT. THE DELAY OF ANY POST-STORM INSPECTION MUST BE DOCUMENTED IN THE INSPECTION RECORDS INCLUDED IN THE SWMP.
- HYDRAULIC MULCHING MATERIAL SHALL CONSIST OF VIRGIN WOOD FIBER MANUFACTURED FORM CLEAN WHOLE WOOD CHIPS. WOOD CHIPS CANNOT CONTAIN ANY GROWTH OR GERMINATION INHIBITORS OR BE PRODUCED FROM RECYCLED WATER. GRAVEL CAN ALSO BE USED.
- MULCH IS TO BE APPLIED EVENLY AT THE RATE OF 2 TONS PER ACRE.
- MULCH TO BE ANCHORED EITHER BY CRIMPING (TUCKING MULCH FIBERS 4 INCHES INTO THE SOIL), USING NETTING (USED IN SMALL AREAS WITH STEEP SLOPES), OR WITH TACKIFIER.
- HYDRAULIC MULCHING AND TACKIFIERS ARE NOT TO BE USED IN THE PRESENCE OF FREE SURFACE WATER.

EL PASO COUNTY CONSERVATION DISTRICT SHOTGUN MIX

COMMON NAME	RECOMMENDED VARIETY	% OF SEED MIX	PLS PER ACRE
Bluestem, Big Native	Kaw, Bison, Champ	20.0 %	1.08
Little Bluestem Native	Schizachyrium scoparium	10.0%	.12
Green Needlegrass Native	Lodorm	10.0%	.48
Wheatgrass, Western Native	Arriba, Barton	20.0%	1.60
Gramma, Sidecoats Native	Vaughn, Butte, El Reno, Niner	10.0%	.46
Switchgrass Native	Blackwell, Greenville	10%	.20
Prairie Sandreed Native	Goshen, Pronghorn	10.0%	.32
Yellow Indiangrass Native	Cheyenne, Holt, Llano	10.0%	.51

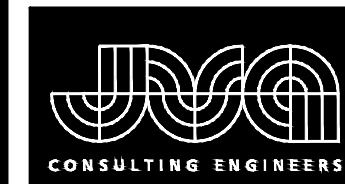

JVA, Inc. 1319 Spruce Street
Boulder, CO 80502 303.444.1951
www.jvajva.com
Boulder • Fort Collins • Winter Park
Blender Woods • Denver

REVISION DESCRIPTION

DWYN

DATE

NO.

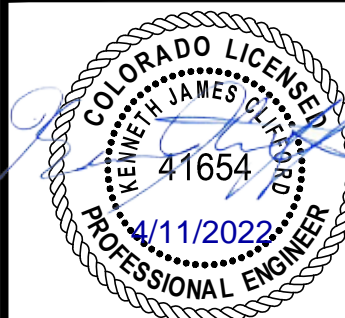

DESIGNED BY: MHT/JGJ
DRAWN BY: MHT/JGJ
CHECKED BY: KJC
JOB #: 1051.9e
DATE: MARCH 2022
© JVA, INC.

WOODMOOR WSD NO. 1
WELL NO. 22
EL PASO COUNTY, COLORADO
SWMP AND GEC NOTES

SHEET NO.

CE1.2

Vehicle Tracking Control (VTC) SM-4

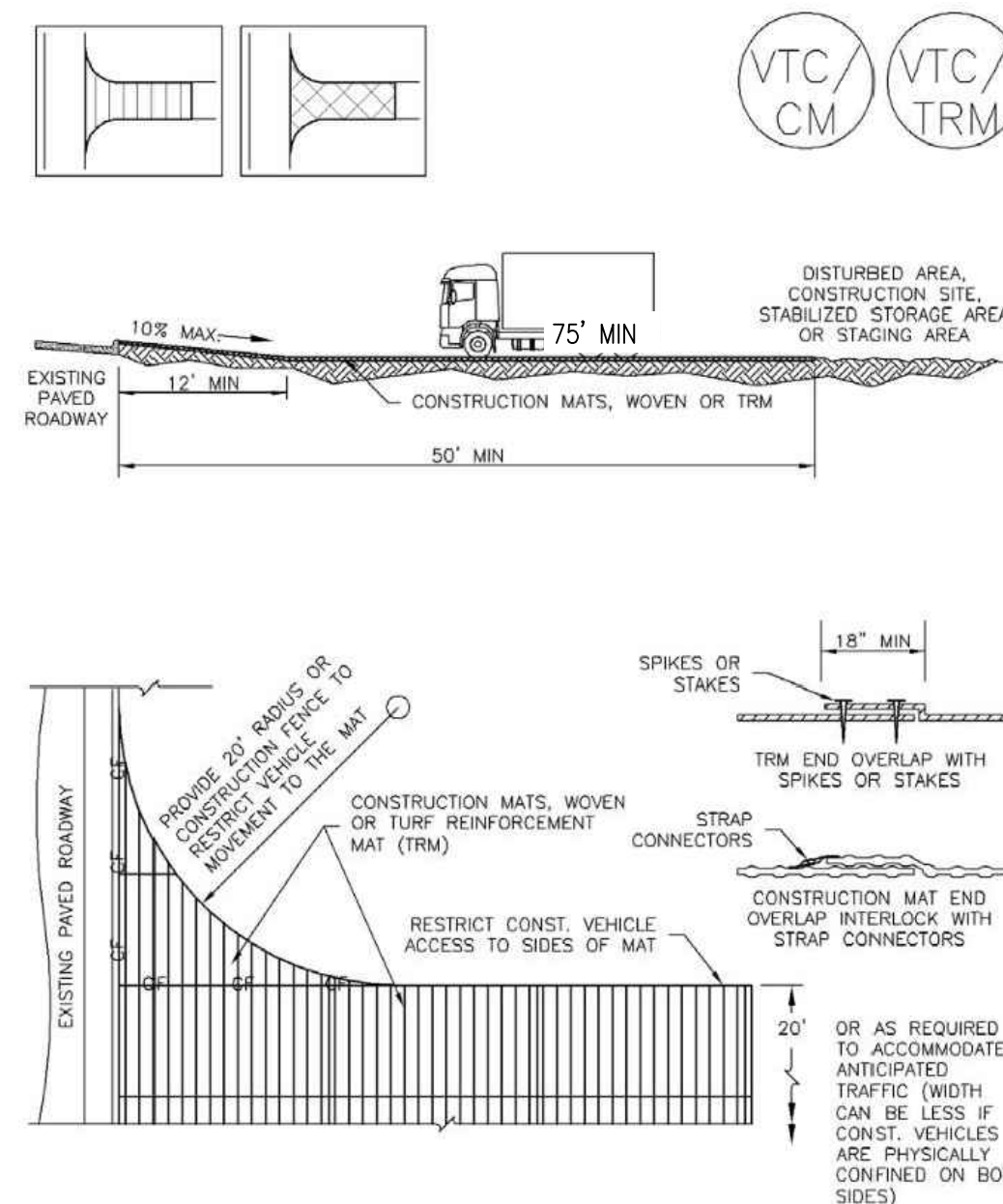

VTC-3. VEHICLE TRACKING CONTROL W/ CONSTRUCTION MAT OR TURF REINFORCEMENT MAT (TRM)

November 2010 Urban Drainage and Flood Control District Urban Storm Drainage Criteria Manual Volume 3 VTC-5

SC-2 Sediment Control Log (SCL)

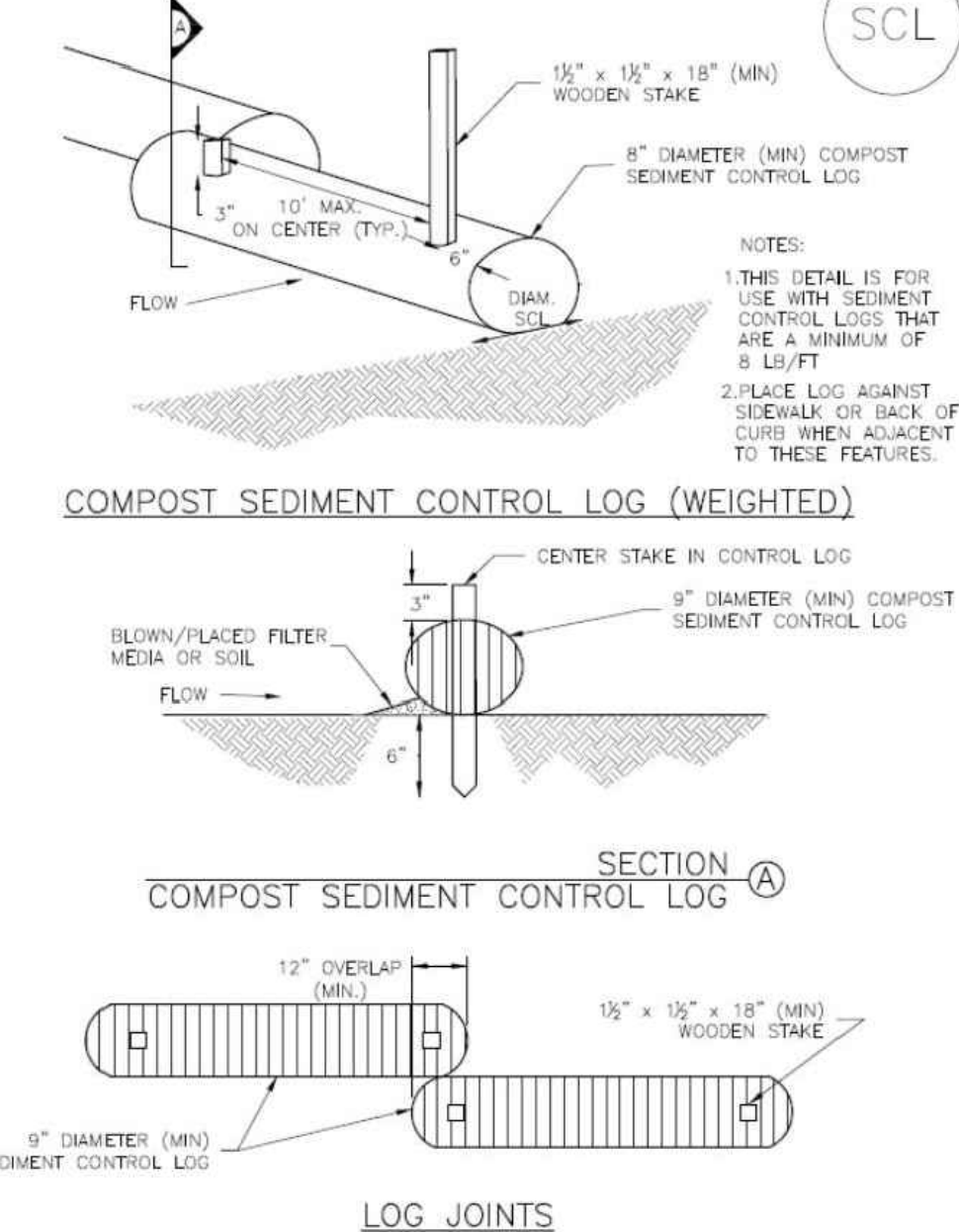

SCL-2. COMPOST SEDIMENT CONTROL LOG (WEIGHTED)

SC-4 Urban Drainage and Flood Control District Urban Storm Drainage Criteria Manual Volume 3 November 2015

Silt Fence (SF) SC-1

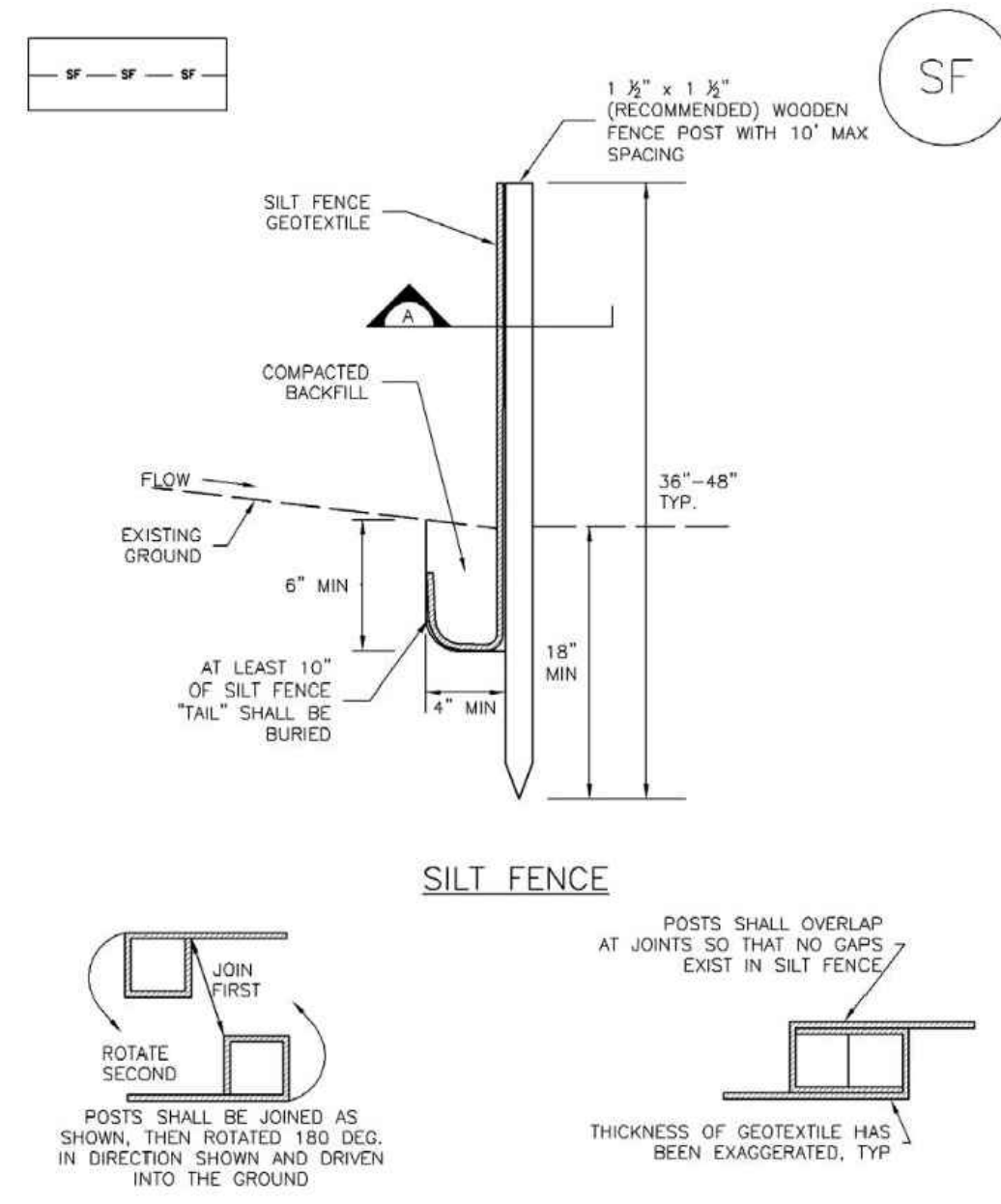

SF-1. SILT FENCE

November 2010 Urban Drainage and Flood Control District Urban Storm Drainage Criteria Manual Volume 3 SF-3

Check Dams (CD) EC-12

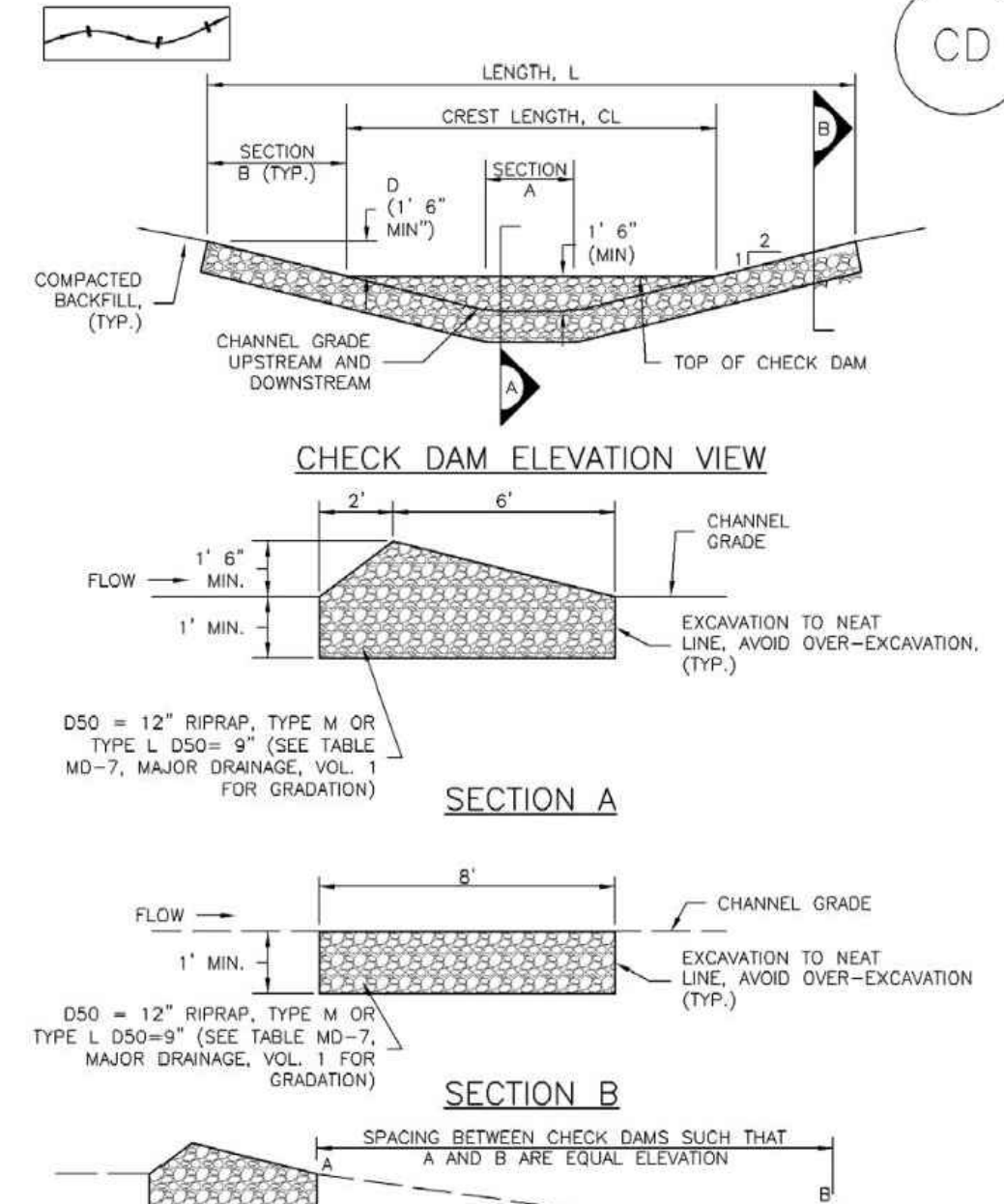

CD-1. CHECK DAM

November 2010 Urban Drainage and Flood Control District Urban Storm Drainage Criteria Manual Volume 3 CD-3

SM-4 Vehicle Tracking Control (VTC)

STABILIZED CONSTRUCTION ENTRANCE/EXIT INSTALLATION NOTES

- SEE PLAN VIEW FOR:
 - LOCATION OF CONSTRUCTION ENTRANCE(S)/EXIT(S).
 - TYPE OF CONSTRUCTION ENTRANCE(S)/EXIT(S) (WITH/WITHOUT WHEEL WASH, CONSTRUCTION MAT OR TRM).
- CONSTRUCTION MAT OR TRM STABILIZED CONSTRUCTION ENTRANCES ARE ONLY TO BE USED ON SHORT DURATION PROJECTS (TYPICALLY RANGING FROM A WEEK TO A MONTH) WHERE THERE WILL BE LIMITED VEHICULAR ACCESS.
- A STABILIZED CONSTRUCTION ENTRANCE/EXIT SHALL BE LOCATED AT ALL ACCESS POINTS WHERE VEHICLES ACCESS THE CONSTRUCTION SITE FROM PAVED RIGHT-OF-WAYS.
- STABILIZED CONSTRUCTION ENTRANCE/EXIT SHALL BE INSTALLED PRIOR TO ANY LAND DISTURBING ACTIVITIES.
- A NON-WOVEN GEOTEXTILE FABRIC SHALL BE PLACED UNDER THE STABILIZED CONSTRUCTION ENTRANCE/EXIT PRIOR TO THE PLACEMENT OF ROCK.
- UNLESS OTHERWISE SPECIFIED BY LOCAL JURISDICTION, ROCK SHALL CONSIST OF DOT SECT. #703, AASHTO #3 COARSE AGGREGATE OR 6" (MINUS) ROCK.

STABILIZED CONSTRUCTION ENTRANCE/EXIT MAINTENANCE NOTES

- INSPECT BMPs EACH WORKDAY, AND MAINTAIN THEM IN EFFECTIVE OPERATING CONDITION. MAINTENANCE OF BMPs SHOULD BE PROACTIVE, NOT REACTIVE. INSPECT BMPs AS SOON AS POSSIBLE (AND ALWAYS WITHIN 24 HOURS) FOLLOWING A STORM THAT CAUSES SURFACE EROSION, AND PERFORM NECESSARY MAINTENANCE.
- FREQUENT OBSERVATIONS AND MAINTENANCE ARE NECESSARY TO MAINTAIN BMPs IN EFFECTIVE OPERATING CONDITION. INSPECTIONS AND CORRECTIVE MEASURES SHOULD BE DOCUMENTED THOROUGHLY.
- WHERE BMPs HAVE FAILED, REPAIR OR REPLACEMENT SHOULD BE INITIATED UPON DISCOVERY OF THE FAILURE.
- ROCK SHALL BE REPLACED OR REGRADED AS NECESSARY TO THE STABILIZED ENTRANCE/EXIT TO MAINTAIN A CONSISTENT DEPTH.
- SEDIMENT TRACKED ONTO PAVED ROADS IS TO BE REMOVED THROUGHOUT THE DAY AND AT THE END OF THE DAY BY SHOVELING OR SWEEPING. SEDIMENT MAY NOT BE WASHED DOWN STORM SEWER DRAINS.

NOTE: MANY JURISDICTIONS HAVE BMP DETAILS THAT VARY FROM UDFCD STANDARD DETAILS. CONSULT WITH LOCAL JURISDICTIONS AS TO WHICH DETAIL SHOULD BE USED WHEN DIFFERENCES ARE NOTED.

(DETAILS ADAPTED FROM CITY OF BROOMFIELD, COLORADO, NOT AVAILABLE IN AUTOCAD)

VTC-6 Urban Drainage and Flood Control District Urban Storm Drainage Criteria Manual Volume 3 November 2010

SC-2 Sediment Control Log (SCL)

SEDIMENT CONTROL LOG INSTALLATION NOTES

- SEE PLAN VIEW FOR LOCATION AND LENGTH OF SEDIMENT CONTROL LOGS.
- SEDIMENT CONTROL LOGS THAT ACT AS A PERIMETER CONTROL SHALL BE INSTALLED PRIOR TO ANY UPGRADE/IMPROVEMENT OF LAND-DISTURBING ACTIVITIES.
- SEDIMENT CONTROL LOGS SHALL CONSIST OF STRAW, COMPOST, EXCELSIOR OR COCONUT FIBER, AND SHALL BE FREE OF ANY NOXIOUS WEED SEEDS OR DEFECTS INCLUDING RIPS, HOLES AND OBVIOUS WEAR.
- SEDIMENT CONTROL LOGS MAY BE USED AS SMALL CHECK DAMS IN DITCHES AND SWALES; HOWEVER, THEY SHOULD NOT BE USED IN PERENNIAL STREAMS.
- IT IS RECOMMENDED THAT SEDIMENT CONTROL LOGS BE TRENCHED INTO THE GROUND TO A DEPTH OF APPROXIMATELY 1/3 OF THE DIAMETER OF THE LOG. IF TRENCHING TO THIS DEPTH IS NOT FEASIBLE AND/OR DESIRABLE (SHORT TERM INSTALLATION WITH DESIRE NOT TO DAMAGE LANDSCAPE) A LESSER TRENCHING DEPTH MAY BE ACCEPTABLE WITH MORE ROBUST STAKING. COMPOST LOGS THAT ARE 8 LB/FT DO NOT NEED TO BE TRENCHED.
- THE UPHILL SIDE OF THE SEDIMENT CONTROL LOG SHALL BE BACKFILLED WITH SOIL OR FILTER MATERIAL THAT IS FREE OF ROCKS AND DEBRIS. THE SOIL SHALL BE TIGHTLY COMPACTED INTO THE SHAPE OF A RIGHT TRIANGLE USING A SHOVEL OR WEIGHTED LAWN ROLLER OR BLOWN IN PLACE.
- FOLLOW MANUFACTURERS' GUIDANCE FOR STAKING. IF MANUFACTURERS' INSTRUCTIONS DO NOT SPECIFY SPACING, STAKES SHALL BE PLACED ON 4' CENTERS AND EMBEDDED A MINIMUM OF 6" INTO THE GROUND. 3" OF THE STAKE SHALL PROTRUDE FROM THE TOP OF THE LOG. STAKES THAT ARE BROKEN PRIOR TO INSTALLATION SHALL BE REPLACED. COMPOST LOGS SHOULD BE STAKED 10' ON CENTER.

SEDIMENT CONTROL LOG MAINTENANCE NOTES

- INSPECT BMPs EACH WORKDAY, AND MAINTAIN THEM IN EFFECTIVE OPERATING CONDITION. MAINTENANCE OF BMPs SHOULD BE PROACTIVE, NOT REACTIVE. INSPECT BMPs AS SOON AS POSSIBLE (AND ALWAYS WITHIN 24 HOURS) FOLLOWING A STORM THAT CAUSES SURFACE EROSION, AND PERFORM NECESSARY MAINTENANCE.
- FREQUENT OBSERVATIONS AND MAINTENANCE ARE NECESSARY TO MAINTAIN BMPs IN EFFECTIVE OPERATING CONDITION. INSPECTIONS AND CORRECTIVE MEASURES SHOULD BE DOCUMENTED THOROUGHLY.
- WHERE BMPs HAVE FAILED, REPAIR OR REPLACEMENT SHOULD BE INITIATED UPON DISCOVERY OF THE FAILURE.
- SEDIMENT ACCUMULATED UPSTREAM OF SEDIMENT CONTROL LOG SHALL BE REMOVED AS NEEDED TO MAINTAIN FUNCTIONALITY OF THE BMP, TYPICALLY WHEN DEPTH OF ACCUMULATED SEDIMENTS IS APPROXIMATELY 1/2 OF THE HEIGHT OF THE SEDIMENT CONTROL LOG.
- SEDIMENT CONTROL LOG SHALL BE REMOVED AT THE END OF CONSTRUCTION/COMPOST FROM COMPOST LOGS MAY BE LEFT IN PLACE AS LONG AS BAGS ARE REMOVED AND THE AREA SEEDED. IF DISTURBED AREAS EXIST AFTER REMOVAL, THEY SHALL BE COVERED WITH TOP SOIL, SEEDED AND MULCHED OR OTHERWISE STABILIZED IN A MANNER APPROVED BY THE LOCAL JURISDICTION.

(DETAILS ADAPTED FROM TOWN OF PARKER, COLORADO, JOFFERSON COUNTY, COLORADO, DOUGLAS COUNTY, COLORADO, AND CITY OF AURORA, COLORADO, NOT AVAILABLE IN AUTOCAD)

NOTE: MANY JURISDICTIONS HAVE BMP DETAILS THAT VARY FROM UDFCD STANDARD DETAILS. CONSULT WITH LOCAL JURISDICTIONS AS TO WHICH DETAIL SHOULD BE USED WHEN DIFFERENCES ARE NOTED.

SCL-6 Urban Drainage and Flood Control District Urban Storm Drainage Criteria Manual Volume 3 November 2015

SC-1 Silt Fence (SF)

SILT FENCE INSTALLATION NOTES

- SILT FENCE MUST BE PLACED AWAY FROM THE TOE OF THE SLOPE TO ALLOW FOR WATER PONDING. SILT FENCE AT THE TOE OF A SLOPE SHOULD BE INSTALLED IN A FLAT LOCATION AT LEAST SEVERAL FEET (2-5 FT) FROM THE TOE OF THE SLOPE TO ALLOW ROOM FOR PONDING AND DEPOSITION.
- A UNIFORM 6" x 4" ANCHOR TRENCH SHALL BE EXCAVATED USING TRENCHER OR SILT FENCE INSTALLATION DEVICE. NO ROAD GRADERS, BACKHOES, OR SIMILAR EQUIPMENT SHALL BE USED.
- COMPACT ANCHOR TRENCH BY HAND WITH A "JUMPING JACK" OR BY WHEEL ROLLING. COMPACTATION SHALL BE SUCH THAT SILT FENCE RESISTS BEING PULLED OUT OF ANCHOR TRENCH BY HAND.
- SILT FENCE SHALL BE PULLED TIGHT AS IT IS ANCHORED TO THE STAKES. THERE SHOULD BE NO NOTICEABLE SAG BETWEEN STAKES AFTER IT HAS BEEN ANCHORED TO THE STAKES.
- SILT FENCE FABRIC SHALL BE ANCHORED TO THE STAKES USING 1" HEAVY DUTY STAPLES OR NAILS WITH 1" HEADS. STAPLES AND NAILS SHOULD BE PLACED 3" ALONG THE FABRIC DOWN THE STAKE.
- AT THE END OF A RUN OF SILT FENCE ALONG A CONTOUR, THE SILT FENCE SHOULD BE TURNED PERPENDICULAR TO THE CONTOUR TO CREATE A "J-HOOK." THE "J-HOOK" EXTENDING PERPENDICULAR TO THE CONTOUR SHOULD BE OF SUFFICIENT LENGTH TO KEEP RUNOFF FROM FLOWING AROUND THE END OF THE SILT FENCE (TYPICALLY 10' - 20').
- SILT FENCE SHALL BE INSTALLED PRIOR TO ANY LAND DISTURBING ACTIVITIES.

SILT FENCE MAINTENANCE NOTES

- INSPECT BMPs EACH WORKDAY, AND MAINTAIN THEM IN EFFECTIVE OPERATING CONDITION. MAINTENANCE OF BMPs SHOULD BE PROACTIVE, NOT REACTIVE. INSPECT BMPs AS SOON AS POSSIBLE (AND ALWAYS WITHIN 24 HOURS) FOLLOWING A STORM THAT CAUSES SURFACE EROSION, AND PERFORM NECESSARY MAINTENANCE.
- FREQUENT OBSERVATIONS AND MAINTENANCE ARE NECESSARY TO MAINTAIN BMPs IN EFFECTIVE OPERATING CONDITION. INSPECTIONS AND CORRECTIVE MEASURES SHOULD BE DOCUMENTED THOROUGHLY.
- WHERE BMPs HAVE FAILED, REPAIR OR REPLACEMENT SHOULD BE INITIATED UPON DISCOVERY OF THE FAILURE.
- SEDIMENT ACCUMULATED UPSTREAM OF THE SILT FENCE SHALL BE REMOVED AS NEEDED TO MAINTAIN THE FUNCTIONALITY OF THE BMP, TYPICALLY WHEN DEPTH OF ACCUMULATED SEDIMENTS IS APPROXIMATELY 1/2.
- REPAIR OR REPLACE SILT FENCE WHEN THERE ARE SIGNS OF WEAR, SUCH AS SAGGING, TEARING, OR COLLAPSE.
- SILT FENCE IS TO REMAIN IN PLACE UNTIL THE UPSTREAM DISTURBED AREA IS STABILIZED AND APPROVED BY THE LOCAL JURISDICTION, OR IS REPLACED BY AN EQUIVALENT PERIMETER SEDIMENT CONTROL BMP.
- WHEN SILT FENCE IS REMOVED, ALL DISTURBED AREAS SHALL BE COVERED WITH TOPSOIL, SEEDED AND MULCHED OR OTHERWISE STABILIZED AS APPROVED BY LOCAL JURISDICTION.

(DETAILS ADAPTED FROM TOWN OF PARKER, COLORADO AND CITY OF AURORA, NOT AVAILABLE IN AUTOCAD)

NOTE: MANY JURISDICTIONS HAVE BMP DETAILS THAT VARY FROM UDFCD STANDARD DETAILS. CONSULT WITH LOCAL JURISDICTIONS AS TO WHICH DETAIL SHOULD BE USED WHEN DIFFERENCES ARE NOTED.

SF-4 Urban Drainage and Flood Control District Urban Storm Drainage Criteria Manual Volume 3 November 2010

EC-12 Check Dams (CD)

CHECK DAM INSTALLATION NOTES

- SEE PLAN VIEW FOR:
 - LOCATION OF CHECK DAMS.
 - CHECK DAM TYPE (CHECK DAM OR REINFORCED CHECK DAM).
 - LENGTH (L), CREST LENGTH (CL), AND DEPTH (D).
- CHECK DAMS INDICATED ON INITIAL SBMP SHALL BE INSTALLED AFTER CONSTRUCTION FINISH, BUT PRIOR TO ANY UPSTREAM LAND DISTURBING ACTIVITIES.
- RRIPAP UTILIZED FOR CHECK DAMS SHOULD BE OF APPROPRIATE SIZE FOR THE APPLICATION. TYPICAL TYPES OF RRIPAP USED FOR CHECK DAMS ARE TYPE M (D50 12") OR TYPE L (D50 9").
- RRIPAP PAD SHALL BE TRENCHED INTO THE GROUND A MINIMUM OF 1'.
- THE ENDS OF THE CHECK DAM SHALL BE A MINIMUM OF 1' 6" HIGHER THAN THE CENTER OF THE CHECK DAM.

CHECK DAM MAINTENANCE NOTES

- INSPECT BMPs EACH WORKDAY, AND MAINTAIN THEM IN EFFECTIVE OPERATING CONDITION. MAINTENANCE OF BMPs SHOULD BE PROACTIVE, NOT REACTIVE. INSPECT BMPs AS SOON AS POSSIBLE (AND ALWAYS WITHIN 24 HOURS) FOLLOWING A STORM THAT CAUSES SURFACE EROSION, AND PERFORM NECESSARY MAINTENANCE.
- FREQUENT OBSERVATIONS AND MAINTENANCE ARE NECESSARY TO MAINTAIN BMPs IN EFFECTIVE OPERATING CONDITION. INSPECTIONS AND CORRECTIVE MEASURES SHOULD BE DOCUMENTED THOROUGHLY.
- WHERE BMPs HAVE FAILED, REPAIR OR REPLACEMENT SHOULD BE INITIATED UPON DISCOVERY OF THE FAILURE.
- SEDIMENT ACCUMULATED UPSTREAM OF THE CHECK DAMS SHALL BE REMOVED WHEN THE SEDIMENT DEPTH IS WITHIN 1/2 OF THE HEIGHT OF THE CREST.
- CHECK DAMS ARE TO REMAIN IN PLACE UNTIL THE UPSTREAM DISTURBED AREA IS STABILIZED AND APPROVED BY THE LOCAL JURISDICTION.
- WHEN CHECK DAMS ARE REMOVED, EXCAVATIONS SHALL BE FILLED WITH SUITABLE COMPACTED BACKFILL. DISTURBED AREA SHALL BE SEEDED AND MULCHED AND COVERED WITH GEOTEXTILE OR OTHERWISE STABILIZED IN A MANNER APPROVED BY THE LOCAL JURISDICTION.

(DETAILS ADAPTED FROM DOUGLAS COUNTY, COLORADO, NOT AVAILABLE IN AUTOCAD)

NOTE: MANY JURISDICTIONS HAVE BMP DETAILS THAT VARY FROM UDFCD STANDARD DETAILS. CONSULT WITH LOCAL JURISDICTIONS AS TO WHICH DETAIL SHOULD BE USED WHEN DIFFERENCES ARE NOTED.

CD-4 Urban Drainage and Flood Control District Urban Storm Drainage Criteria Manual Volume 3 November 2010

NO. DATE DESIGNED BY
 REVISION DESCRIPTION
 DWN



DESIGNED BY: MHT/JGJ
 DRAWN BY: MHT/JGJ
 CHECKED BY: KJC
 JOB #: 1051.9e
 DATE: MARCH 2022
 © JVA, INC.

WOODMOOR WSD NO. 1
 WELL NO. 22
 EL PASO COUNTY, COLORADO
 EROSION CONTROL DETAILS

Stockpile Management (SP)

MM-2

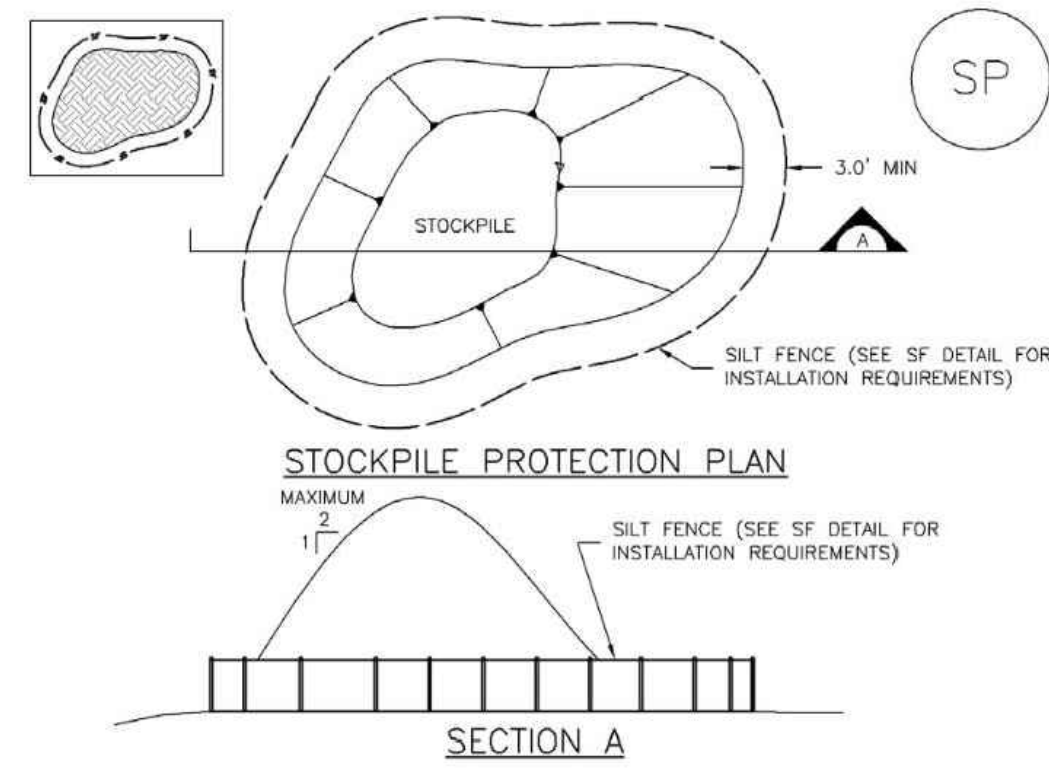

SP-1. STOCKPILE PROTECTION

STOCKPILE PROTECTION INSTALLATION NOTES

- SEE PLAN VIEW FOR:
 - LOCATION OF STOCKPILES.
 - TYPE OF STOCKPILE PROTECTION.
- INSTALL PERIMETER CONTROLS IN ACCORDANCE WITH THEIR RESPECTIVE DESIGN DETAILS. SILT FENCE IS SHOWN IN THE STOCKPILE PROTECTION DETAILS; HOWEVER, OTHER TYPES OF PERIMETER CONTROLS INCLUDING SEDIMENT CONTROL LOGS OR ROCK SOCKS MAY BE SUITABLE IN SOME CIRCUMSTANCES. CONSIDERATIONS FOR DETERMINING THE APPROPRIATE TYPE OF PERIMETER CONTROL FOR A STOCKPILE INCLUDE WHETHER THE STOCKPILE IS LOCATED ON A PERVIOUS OR IMPERVIOUS SURFACE, THE RELATIVE HEIGHTS OF THE PERIMETER CONTROL AND STOCKPILE, THE ABILITY OF THE PERIMETER CONTROL TO CONTAIN THE STOCKPILE WITHOUT FAILING IN THE EVENT THAT MATERIAL FROM THE STOCKPILE SHIFTS OR SLUMPS AGAINST THE PERIMETER, AND OTHER FACTORS.
- STABILIZE THE STOCKPILE SURFACE WITH SURFACE ROUGHENING, TEMPORARY SEEDING AND MULCHING, EROSION CONTROL BLANKETS, OR SOIL BINDERS. SOILS STOCKPILED FOR AN EXTENDED PERIOD (TYPICALLY FOR MORE THAN 60 DAYS) SHOULD BE SEEDED AND MULCHED WITH A TEMPORARY GRASS COVER ONCE THE STOCKPILE IS PLACED (TYPICALLY WITHIN 14 DAYS). USE OF MULCH ONLY OR A SOIL BINDER IS ACCEPTABLE IF THE STOCKPILE WILL BE IN PLACE FOR A MORE LIMITED TIME PERIOD (TYPICALLY 30-60 DAYS).
- FOR TEMPORARY STOCKPILES ON THE INTERIOR PORTION OF A CONSTRUCTION SITE, WHERE OTHER DOWNGRADIENT CONTROLS, INCLUDING PERIMETER CONTROL, ARE IN PLACE, STOCKPILE PERIMETER CONTROLS MAY NOT BE REQUIRED.

November 2010 Urban Drainage and Flood Control District
 Urban Storm Drainage Criteria Manual Volume 3 SP-3

Inlet Protection (IP)

SC-6

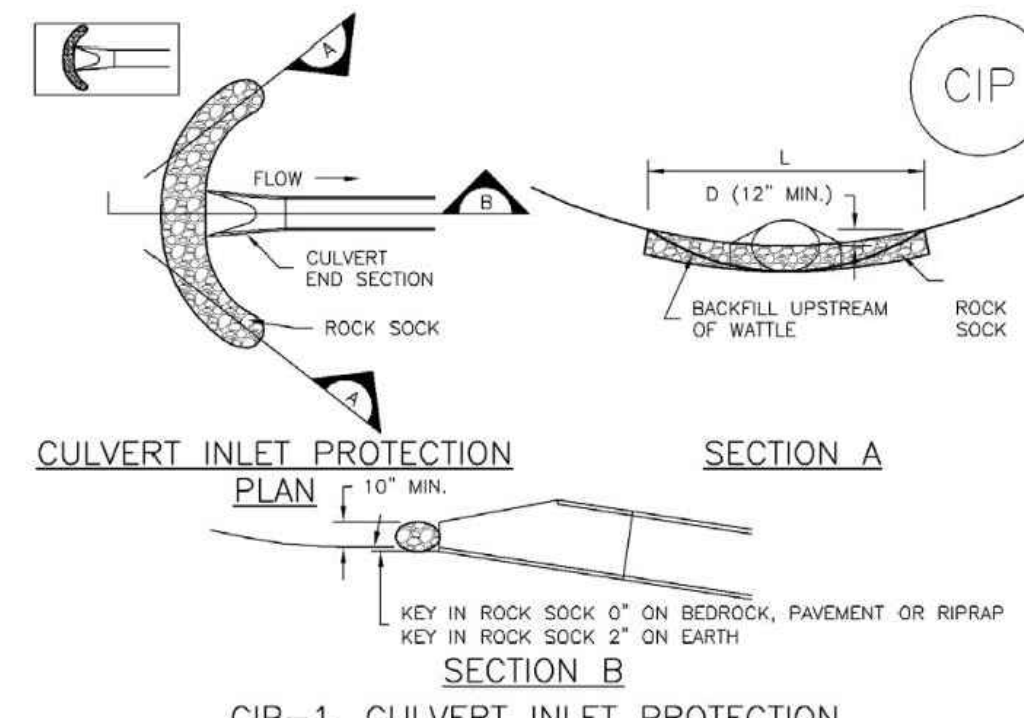

CIP-1. CULVERT INLET PROTECTION

CULVERT INLET PROTECTION INSTALLATION NOTES

- SEE PLAN VIEW FOR:
 - LOCATION OF CULVERT INLET PROTECTION.
 - SEE ROCK SOCK DESIGN DETAIL FOR ROCK GRADATION REQUIREMENTS AND JOINTING DETAIL.
 - SEE ROCK SOCK DESIGN DETAIL FOR ROCK GRADATION REQUIREMENTS AND JOINTING DETAIL.
- CULVERT INLET PROTECTION MAINTENANCE NOTES**
- INSPECT BMPs EACH WORKDAY, AND MAINTAIN THEM IN EFFECTIVE OPERATING CONDITION. MAINTENANCE OF BMPs SHOULD BE PROACTIVE, NOT REACTIVE. INSPECT BMPs AS SOON AS POSSIBLE (AND ALWAYS WITHIN 24 HOURS) FOLLOWING A STORM THAT CAUSES SURFACE EROSION, AND PERFORM NECESSARY MAINTENANCE.
 - FREQUENT OBSERVATIONS AND MAINTENANCE ARE NECESSARY TO MAINTAIN BMPs IN EFFECTIVE OPERATING CONDITION. INSPECTIONS AND CORRECTIVE MEASURES SHOULD BE DOCUMENTED THOROUGHLY.
 - WHERE BMPs HAVE FAILED, REPAIR OR REPLACEMENT SHOULD BE INITIATED UPON DISCOVERY OF THE FAILURE.
 - SEDIMENT ACCUMULATED UPSTREAM OF THE CULVERT SHALL BE REMOVED WHEN THE SEDIMENT DEPTH IS 1/2 THE HEIGHT OF THE ROCK SOCK.
 - CULVERT INLET PROTECTION SHALL REMAIN IN PLACE UNTIL THE UPSTREAM DISTURBED AREA IS PERMANENTLY STABILIZED AND APPROVED BY THE LOCAL JURISDICTION.
- (DETAILS ADAPTED FROM AURORA, COLORADO, NOT AVAILABLE IN AUTOCAD)
- NOTE: MANY JURISDICTIONS HAVE BMP DETAILS THAT VARY FROM UDFCD STANDARD DETAILS. CONSULT WITH LOCAL JURISDICTIONS AS TO WHICH DETAIL SHOULD BE USED WHEN DIFFERENCES ARE NOTED.

August 2013 Urban Drainage and Flood Control District
 Urban Storm Drainage Criteria Manual Volume 3 IP-7

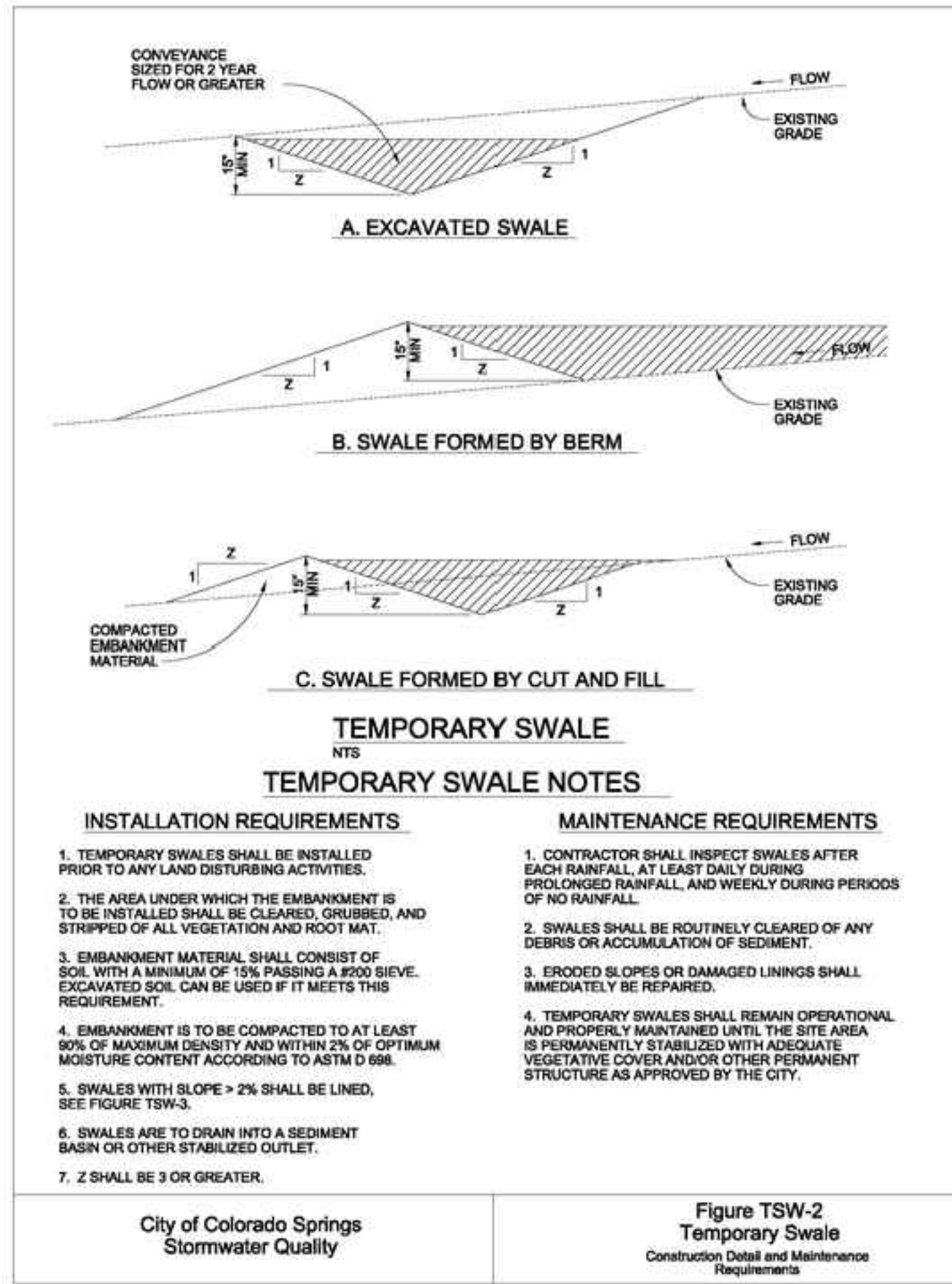

TEMPORARY SWALE NOTES

- | INSTALLATION REQUIREMENTS | MAINTENANCE REQUIREMENTS |
|---|---|
| 1. TEMPORARY SWALES SHALL BE INSTALLED PRIOR TO ANY LAND DISTURBING ACTIVITIES. | 1. CONTRACTOR SHALL INSPECT SWALES AFTER EACH RAINFALL AT LEAST DAILY DURING PROLONGED RAINFALL, AND WEEKLY DURING PERIODS OF NO RAINFALL. |
| 2. THE AREA UNDER WHICH THE EMBANKMENT IS TO BE INSTALLED SHALL BE CLEARED, GRUBBED, AND STRIPPED OF ALL VEGETATION AND ROOT MAT. | 2. SWALES SHALL BE ROUTINELY CLEARED OF ANY DEBRIS OR ACCUMULATION OF SEDIMENT. |
| 3. EMBANKMENT MATERIAL SHALL CONSIST OF SOIL WITH A MINIMUM OF 15% PASSING A #200 SIEVE. EXCAVATED SOIL CAN BE USED IF IT MEETS THIS REQUIREMENT. | 3. ERODED SLOPES OR DAMAGED LININGS SHALL IMMEDIATELY BE REPAIRED. |
| 4. EMBANKMENT IS TO BE COMPACTED TO AT LEAST 90% OF MAXIMUM DENSITY AND WITHIN 2% OF OPTIMUM MOISTURE CONTENT ACCORDING TO ASTM D 698. | 4. TEMPORARY SWALES SHALL REMAIN OPERATIONAL AND PROPERLY MAINTAINED UNTIL THE SITE AREA IS PERMANENTLY STABILIZED WITH ADEQUATE VEGETATIVE COVER AND/OR OTHER PERMANENT STRUCTURE AS APPROVED BY THE CITY. |
| 5. SWALES WITH SLOPE > 2% SHALL BE LINED, SEE FIGURE TSW-3. | |
| 6. SWALES ARE TO DRAIN INTO A SEDIMENT BASIN OR OTHER STABILIZED OUTLET. | |
| 7. Z SHALL BE 3 OR GREATER. | |

City of Colorado Springs
 Stormwater Quality

Figure TSW-2
 Temporary Swale
 Construction Detail and Maintenance Requirements

Stockpile Management (SM)

Inlet Protection (IP)

- STOCKPILE PROTECTION MAINTENANCE NOTES**
- INSPECT BMPs EACH WORKDAY, AND MAINTAIN THEM IN EFFECTIVE OPERATING CONDITION. MAINTENANCE OF BMPs SHOULD BE PROACTIVE, NOT REACTIVE. INSPECT BMPs AS SOON AS POSSIBLE (AND ALWAYS WITHIN 24 HOURS) FOLLOWING A STORM THAT CAUSES SURFACE EROSION, AND PERFORM NECESSARY MAINTENANCE.
 - FREQUENT OBSERVATIONS AND MAINTENANCE ARE NECESSARY TO MAINTAIN BMPs IN EFFECTIVE OPERATING CONDITION. INSPECTIONS AND CORRECTIVE MEASURES SHOULD BE DOCUMENTED THOROUGHLY.
 - WHERE BMPs HAVE FAILED, REPAIR OR REPLACEMENT SHOULD BE INITIATED UPON DISCOVERY OF THE FAILURE.
- STOCKPILE PROTECTION MAINTENANCE NOTES**
- IF PERIMETER PROTECTION MUST BE MOVED TO ACCESS SOIL STOCKPILE, REPLACE PERIMETER CONTROLS BY THE END OF THE WORKDAY.
 - STOCKPILE PERIMETER CONTROLS CAN BE REMOVED ONCE ALL THE MATERIAL FROM THE STOCKPILE HAS BEEN USED.
- (DETAILS ADAPTED FROM PARKER, COLORADO, NOT AVAILABLE IN AUTOCAD)
- NOTE: MANY JURISDICTIONS HAVE BMP DETAILS THAT VARY FROM UDFCD STANDARD DETAILS. CONSULT WITH LOCAL JURISDICTIONS AS TO WHICH DETAIL SHOULD BE USED WHEN DIFFERENCES ARE NOTED.

SP-4 Urban Drainage and Flood Control District
 Urban Storm Drainage Criteria Manual Volume 3 November 2010

- GENERAL INLET PROTECTION INSTALLATION NOTES**
- SEE PLAN VIEW FOR:
 - LOCATION OF INLET PROTECTION.
 - TYPE OF INLET PROTECTION (IP-1, IP-2, IP-3, IP-4, IP-5, IP-6)
 - INLET PROTECTION SHALL BE INSTALLED PROMPTLY AFTER INLET CONSTRUCTION OR PAVING IS COMPLETE (TYPICALLY WITHIN 48 HOURS), IF A RAINFALL/RUNOFF EVENT IS FORECAST, INSTALL INLET PROTECTION PRIOR TO ONSET OF EVENT.
 - MANY JURISDICTIONS HAVE BMP DETAILS THAT VARY FROM UDFCD STANDARD DETAILS. CONSULT WITH LOCAL JURISDICTIONS AS TO WHICH DETAIL SHOULD BE USED WHEN DIFFERENCES ARE NOTED.
- INLET PROTECTION MAINTENANCE NOTES**
- INSPECT BMPs EACH WORKDAY, AND MAINTAIN THEM IN EFFECTIVE OPERATING CONDITION. MAINTENANCE OF BMPs SHOULD BE PROACTIVE, NOT REACTIVE. INSPECT BMPs AS SOON AS POSSIBLE (AND ALWAYS WITHIN 24 HOURS) FOLLOWING A STORM THAT CAUSES SURFACE EROSION, AND PERFORM NECESSARY MAINTENANCE.
 - FREQUENT OBSERVATIONS AND MAINTENANCE ARE NECESSARY TO MAINTAIN BMPs IN EFFECTIVE OPERATING CONDITION. INSPECTIONS AND CORRECTIVE MEASURES SHOULD BE DOCUMENTED THOROUGHLY.
 - WHERE BMPs HAVE FAILED, REPAIR OR REPLACEMENT SHOULD BE INITIATED UPON DISCOVERY OF THE FAILURE.
 - SEDIMENT ACCUMULATED UPSTREAM OF INLET PROTECTION SHALL BE REMOVED AS NECESSARY TO MAINTAIN BMP EFFECTIVENESS, TYPICALLY WHEN STORAGE VOLUME REACHES SIZE OF CAPACITY, A DEPTH OF 6" WHEN SILT FENCE IS USED, OR 1/2 OF THE HEIGHT FOR STRAW BALES.
 - INLET PROTECTION IS TO REMAIN IN PLACE UNTIL THE UPSTREAM DISTURBED AREA IS PERMANENTLY STABILIZED, UNLESS THE LOCAL JURISDICTION APPROVES EARLIER REMOVAL OF INLET PROTECTION IN STREETS.
 - WHEN INLET PROTECTION AT AREA INLETS IS REMOVED, THE DISTURBED AREA SHALL BE COVERED WITH TOP SOIL, SEEDED AND MULCHED, OR OTHERWISE STABILIZED IN A MANNER APPROVED BY THE LOCAL JURISDICTION.
- (DETAIL ADAPTED FROM TOWN OF PARKER, COLORADO AND CITY OF AURORA, COLORADO, NOT AVAILABLE IN AUTOCAD)
- NOTE: MANY JURISDICTIONS HAVE BMP DETAILS THAT VARY FROM UDFCD STANDARD DETAILS. CONSULT WITH LOCAL JURISDICTIONS AS TO WHICH DETAIL SHOULD BE USED WHEN DIFFERENCES ARE NOTED.
- NOTE: THE DETAILS INCLUDED WITH THIS FACT SHEET SHOW COMMONLY USED, CONVENTIONAL METHODS OF INLET PROTECTION IN THE DENVER METROPOLITAN AREA. THERE ARE MANY PROPRIETARY INLET PROTECTION METHODS ON THE MARKET. UDFCD NEITHER ENDORSES NOR DISCOURAGES USE OF PROPRIETARY INLET PROTECTION. HOWEVER, IN THE EVENT PROPRIETARY METHODS ARE USED, THE APPROPRIATE DETAIL FROM THE MANUFACTURER MUST BE INCLUDED IN THE SWMP AND THE BMP MUST BE INSTALLED AND MAINTAINED AS SHOWN IN THE MANUFACTURER'S DETAILS.
- NOTE: SOME MUNICIPALITIES DISCOURAGE OR PROHIBIT THE USE OF STRAW BALES FOR INLET PROTECTION. CHECK WITH LOCAL JURISDICTION TO DETERMINE IF STRAW BALE INLET PROTECTION IS ACCEPTABLE.

IP-8 Urban Drainage and Flood Control District
 Urban Storm Drainage Criteria Manual Volume 3 August 2013

REVISION DESCRIPTION
 NO. DATE DESIGNED BY

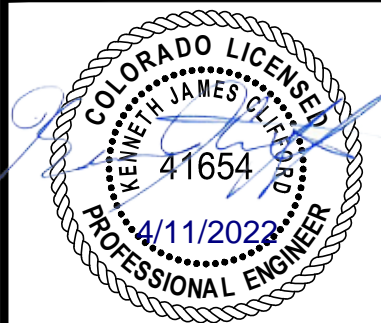

DESIGNED BY: MHT/JGJ
 DRAWN BY: MHT/JGJ
 CHECKED BY: KJC
 JOB #: 1051.9e
 DATE: MARCH 2022
 © JVA, INC.

WOODMOOR WSD NO. 1
 WELL NO. 22
 EL PASO COUNTY, COLORADO
 EROSION CONTROL DETAILS

SHEET NO.
CE1.4