



LSC TRANSPORTATION CONSULTANTS, INC.
2504 East Pikes Peak Avenue, Suite 304
Colorado Springs, CO 80909
(719) 633-2868
FAX (719) 633-5430
E-mail: lsc@lsctrans.com
Website: <http://www.lsctrans.com>

Retreat at TimberRidge Filing No. 3
Traffic Technical Memorandum
SF2241
(LSC #S224350)
September 28, 2023

Traffic Engineer's Statement

This traffic report and supporting information were prepared under my responsible charge and they comport with the standard of care. So far as is consistent with the standard of care, said report was prepared in general conformance with the criteria established by the County for traffic reports.

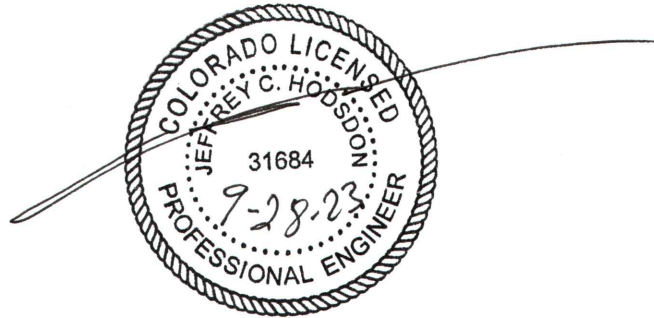

Developer's Statement

I, the Developer, have read and will comply with all commitments made on my behalf within this report.

Date

Retreat at TimberRidge Filing No. 3

Traffic Technical Memorandum

Prepared for:

Loren J. Moreland
Vice President / Project Manager
Classic Homes
6385 Corporate Drive, Suite 200

SEPTEMBER 28, 2023

LSC Transportation Consultants
Prepared by: Kirstin D. Ferrin, P.E.
Reviewed by: Jeffrey C. Hodsdon, P.E.

LSC #S224350

PCD File No.: SF2241



CONTENTS

REPORT CONTENTS 1

LAND USE AND ACCESS 2

 Current Status of Other Subdivisions Shown on the Approved PUD Plan 2

 Currently-Proposed Filing No. 3 3

 Sight Distance Analysis 3

 Pedestrian and Bicycle Access 4

EXISTING ROAD AND TRAFFIC CONDITIONS 4

 Existing Traffic Volumes 5

LEVEL OF SERVICE ANALYSIS 5

BACKGROUND (BASELINE) CONDITIONS 6

TRIP GENERATION 6

TRIP DISTRIBUTION AND ASSIGNMENT 7

TOTAL TRAFFIC 7

LEVEL OF SERVICE 7

SUBDIVISION STREET CLASSIFICATIONS 8

ROADWAY IMPROVEMENTS 8

ROADWAY IMPROVEMENT FEE PROGRAM 9

Enclosures: 9

 Tables 2-3

 Figures 1-13

 Traffic Count Reports

 Level of Service Reports

 MTCP Maps

 Retreat at TimberRidge Filing No. 3 Construction Plans



LSC TRANSPORTATION CONSULTANTS, INC.
2504 East Pikes Peak Avenue, Suite 304
Colorado Springs, CO 80909
(719) 633-2868
FAX (719) 633-5430
E-mail: lsc@lsctrans.com
Website: <http://www.lsctrans.com>

September 28, 2023

Loren J. Moreland
Vice President / Project Manager
Classic Homes
6385 Corporate Drive, Suite 200
Colorado Springs, CO

RE: Retreat at TimberRidge Filing No. 3
El Paso County, CO
Traffic Technical Memorandum
LSC #S224350

Dear Mr. Moreland:

LSC Transportation Consultants, Inc. has prepared this traffic technical memorandum for the Retreat at TimberRidge Filing No. 3. As shown in Figure 1, The Retreat at TimberRidge is located generally east of Vollmer Road and south of Arroya Lane in El Paso County, Colorado. LSC prepared a traffic impact study (TIS) for the entire Retreat at TimberRidge PUD development plan dated January 25, 2018 and a transportation memorandum that addressed phasing of that development dated April 5, 2018. LSC also completed a traffic technical memorandum for Filing No. 1 dated April 3, 2020 and for Filing No. 2 dated October 4, 2021. The lot and street plan has not changed since completion of those reports. This memorandum is intended as a site-specific, final-plat traffic report for the currently-proposed Filing No. 3.

REPORT CONTENTS

This report presents:

- A description of Retreat at TimberRidge filings that are approved and under construction, currently proposed, and planned for the future;
- The current status of other subdivisions shown on the approved PUD plan;
- The existing roadway and traffic conditions in the site's vicinity, including the roadway widths, surface conditions, lane geometries, traffic controls, and posted speed limits;
- Existing (2022) traffic-volume data;
- Projections of short-term and long-term background traffic volumes at the intersections of Vollmer Road/Poco Road and Vollmer Road/Arroya Lane;

- The projected average weekday and peak-hour vehicle trips to be generated by the Retreat at TimberRidge Filing No. 3;
- The assignment of the Filing No. 3 projected trips to the intersections of Vollmer Road/Poco Road and Vollmer Road/Arroya Lane;
- The projected short-term and long-term level of service at the intersections of Vollmer Road/Poco Road and Vollmer Road/Arroya Lane;
- The recommended street classifications for the internal streets within the currently-proposed Retreat at TimberRidge Filing No. 3;
- Improvements needed with Retreat at TimberRidge Filing No. 3; and
- The project's obligation to the County roadway improvement fee program.

LAND USE AND ACCESS

The Retreat at TimberRidge Preliminary Plan area includes the 203 lots for single-family homes located east of Vollmer Road and two lots for single-family homes located west of Vollmer Road and south of Arroya Lane. Figure 2 shows the location of the approved Retreat at TimberRidge Filing Nos. 1 and 2, the approved Timber Ridge West the currently proposed Retreat at TimberRidge Filing No. 3, and future filings. The April 2018 transportation memorandum included analysis of the preliminary plan by phase. Figure 1 from that report shows the phasing plan. No changes have been made to the PUD plan since completion of that memorandum. The current status of subdivisions is discussed below.

Current Status of Other Subdivisions Shown on the Approved PUD Plan

The Retreat at TimberRidge Filing No. 1 is approved and currently under construction. Filing 1 includes 70 lots for single-family homes. The location of the lots within this filing includes 11 of the 13 lots assumed in the **Preliminary Plan Phase 2 plan** and the 59 lots assumed in **Preliminary Plan Phase 3 plan** in the April 2018 transportation memorandum. Poco Road has been constructed east of Vollmer Road to provide access for Filing 1. The proposed easternmost north/south street segment connecting to Arroya Lane has been constructed as a gravel road to provide an interim secondary emergency access. No improvements are planned to Arroya Lane as part of the approved Retreat at TimberRidge Filing No. 1.

The Retreat at TimberRidge Filing No. 2 is approved and currently under construction. This filing includes 90 lots for single-family homes. The location of the lots within this filing includes 6 of the 33 lots assumed in the **Preliminary Plan Phase 4**, 12 of the 15 lots assumed in the **Preliminary Plan Phase 5**, and 72 of the 75 lots assumed in the **Preliminary Plan Phase 6**. No changes are proposed to the Filing 1 access plan with Filing 2.

The TimberRidge Estates Filing No. 1 (different from "Retreat at TimberRidge" Filing No. 1) was under review by El Paso County. However, it has now been withdrawn. This filing planned 10 lots for single-family homes located east of Vollmer Road and north of Arroya Lane with access to Arroya Lane only. These 10 lots remain part of the approved PUD plan and are shown as part of

Phase 1 of the Preliminary Plan. With the withdrawal of the subdivision plat, although part of Phase 1 of the Preliminary Plan, there is now no current plan to develop these lots in the short term.

Figure 2 shows the location of the Timber Ridge West filing on the west side of Vollmer Road. The April 2018 transportation memorandum assumed this area would be developed with nine lots for single-family homes with access to Vollmer Road aligning with Arroya Lane as part of a future preliminary plan. The approved Timber Ridge West filing includes 3 lots. Access for Lots 1 and 2 was approved at a shared location south of Arroya Lane and an existing home on Lot 3 has access to Vollmer Road north of Arroya Lane.

Currently-Proposed Filing No. 3

The Retreat at TimberRidge Filing No. 3 is currently proposed to include 33 lots for single-family homes. The location of the lots within this filing includes 27 of the 33 lots assumed in the **Preliminary Plan Phase 4**, 3 of the 15 lots assumed in the **Preliminary Plan Phase 5**, and 3 of the 75 lots assumed in the **Preliminary Plan Phase 6**.

Arroya Lane is planned to be improved to a Rural Collector cross section as part of the currently-proposed Filing No. 3. The intersection of Vollmer/Arroya is planned to be realigned so that Arroya intersects Vollmer at a right angle. The planned improvements at this intersection also include widening the shoulder on the east side of Vollmer Road approaching Arroya Lane. The easternmost north/south street segments connecting to Arroya Lane that were constructed as gravel roads to provide an interim secondary emergency access for Filing Nos. 1 and 2 will be paved and improved to their final cross sections as part of the currently-proposed Filing No. 3. Aspen Valley Road will also be extended north to Arroya Lane as part of this filing. Figure 2 shows the proposed intersection spacing to Arroya Lane.

Sight Distance Analysis

Figure 3 shows a sight-distance analysis at the realigned intersection of Vollmer/Arroya. Based on a design speed of 60 miles per hour (mph) and the criteria contained in Table 2-21 of the El Paso County *Engineering Criteria Manual (ECM)*, the required intersection sight distance at this intersection is calculated to be 665 feet. Based on the criteria contained in Table 2-17 of the *ECM*, the required stopping sight distance approaching this intersection is 570 feet. As shown in Figure 3, the future intersection analyzed will meet the criteria.

Figure 4 shows a sight-distance analysis at the proposed access points to Arroya Lane. Based on a design speed of 40 mph and the criteria contained in Table 2-21 of the *ECM*, the required intersection sight distance at the future intersections is 445 feet. Based on the criteria contained in Table 2-17 of the *ECM*, the required stopping sight distance approaching these intersections is 305 feet. As shown in Figure 4, the future intersections analyzed will meet the criteria.

Pedestrian and Bicycle Access

Delete "School"



There are no existing schools within two miles of the site. However, there are planned future school sites within the Sterling Ranch Master Plan area south of Briargate Parkway. There are planned sidewalks on Vollmer Road south of Poco Road and Briargate Parkway. School pedestrian crossings will be needed on the east side of the intersection of Briargate Parkway/Vollmer Road.

EXISTING ROAD AND TRAFFIC CONDITIONS

The adjacent streets are shown in Figure 1 and are described below. Copies of the *2016 El Paso County Major Transportation Corridors Plan (MTCP)*, *2040 Roadway Plan*, and *2016 MTCP 2060 Corridor Preservation Plan* with the site location identified on each of them have been attached to this report.

Vollmer Road is currently a five-lane urban street within the City of Colorado Springs limits between Black Forest Road and Cowpoke Road; and a two-lane, rural, paved roadway north of Cowpoke Road extending to north of Hodgen Road. In the southbound direction, Vollmer Road has a posted speed limit of 45 mph. South of Cowpoke Road, Vollmer Road has a 40-mph posted speed limit. The *2040 El Paso County MTCP* and the Sterling Ranch master traffic study show Vollmer Road as a four-lane Urban Minor Arterial adjacent to the site. Vollmer Road is planned to transition to a 2-lane Rural Minor Arterial north of Poco Road. Vollmer Road is planned to be improved to a four-lane Urban Minor Arterial Cross section between Sam Bass Drive and Poco Road by May 2024.

Marksheffel Road is a Principal Arterial extending north from the City of Fountain to Woodmen Road. Marksheffel Road is planned to ultimately be widened to six lanes and extended north and west from Woodmen Road to connect to Research Parkway at Black Forest Road. Marksheffel Road is shown as a four-lane Principal Arterial between Woodmen Road and Vollmer Road on the El Paso County MTCP. The City of Colorado Springs intends to take ownership and maintenance of Marksheffel Road when it is constructed from Vollmer to the east and south to where it will connect to the segment constructed north of Woodmen Road in the City.

The section of Marksheffel Road adjacent to Sterling Ranch is planned to be constructed on 107 feet of right-of-way to the City's required cross section(s) and criteria. The section of Marksheffel Road between Sterling Ranch Road and Vollmer Road will be constructed in the very short-term future and the section of Marksheffel Road southeast of Sterling Ranch Road (to connect to the segment recently constructed) will be completed in the short term and will open the connection to Woodmen Road. Marksheffel will be constructed as a four-lane roadway to the previously agreed upon cross section.

Briargate Parkway is a six-lane, Principal Arterial that extends east from Interstate 25 (I-25) to Grand Lawn Circle (about one-half mile east of Powers Boulevard). Briargate Parkway/Stapleton Road is planned ultimately to extend to Towner Drive. The section of Briargate Parkway between

Vollmer Road and the first Sterling Ranch access (Wheatland Drive) is planned to be constructed to its full section by the end of 2023 and the section from Wheatland Drive to Sterling Ranch Road is planned to be constructed to its full cross section by spring 2024.

Poco Road is an existing gravel road which extends east for about three quarters of a mile from Lochwinnoch Lane to Vollmer Road. Poco Road has recently been constructed east of Vollmer Road as an Urban Local Road to serve the Retreat at TimberRidge Filing No. 1 (PCD-SF-19-009). Poco Road and Arroya Lane provide two points of access to the Retreat at TimberRidge development.

Existing Traffic Volumes

Figure 5 shows the existing (2022) peak-hour traffic volumes at the intersections of Poco/Vollmer and Arroya/Vollmer. The traffic volumes were based on traffic counts conducted by LSC in May and June 2022. At the time the traffic counts were conducted, only a few homes within the Retreat at TimberRidge were occupied. However, heavy construction activity was observed on the east leg of this intersection. The traffic count sheets are attached.

LEVEL OF SERVICE ANALYSIS

Level of service (LOS) is a quantitative measure of the level of congestion or delay at an intersection. Level of service is indicated on a scale from "A" to "F." LOS A represents control delay of less than 10 seconds for unsignalized intersections. LOS F represents control delay of more than 50 seconds for unsignalized intersections. Table 1 shows the level of service delay ranges.

Table 1: Intersection Levels of Service Delay Ranges

Level of Service	Signalized Intersections	Unsignalized Intersections
	Average Control Delay (seconds per vehicle)	Average Control Delay (seconds per vehicle) ⁽¹⁾
A	10.0 sec or less	10.0 sec or less
B	10.1-20.0 sec	10.1-15.0 sec
C	20.1-35.0 sec	15.1-25.0 sec
D	35.1-55.0 sec	25.1-35.0 sec
E	55.1-80.0 sec	35.1-50.0 sec
F	80.1 sec or more	50.1 sec or more

(1) For unsignalized intersections, if V/C ratio is greater than 1.0 the level of service is LOS F, regardless of the projected average control delay per vehicle.

The intersections of Poco/Vollmer and Arroya/Vollmer have been analyzed to determine the existing intersection levels of service. The analysis was based on the unsignalized-intersection analysis procedures from the *Highway Capacity Manual, 6th Edition*. Figure 5 shows the level of service analysis results. The level of service reports are attached.

All movements at the intersections of Poco/Vollmer and Arroya/Vollmer are currently operating at LOS B or better during the peak hours.

BACKGROUND (BASELINE) CONDITIONS

Background traffic is the traffic estimated to be on the adjacent roadways and at adjacent intersections without the proposed development's trip generation of site-generated traffic volumes. Background traffic includes the through traffic and the traffic generated by nearby developments but assumes zero traffic generated by Retreat at TimberRidge Filing No. 3.

Figure 6 shows the projected short-term background traffic volumes at the key area intersections. The short-term background traffic includes the existing traffic volumes (from Figure 5 with the traffic on the east leg of the intersection of Vollmer/Poco removed as most of it was observed to be construction related), plus increases in through traffic due to regional growth, plus traffic estimated to be generated by buildout of the Homestead at Sterling Ranch Filing 2, Branding Iron at Sterling Ranch Filing 2, Sterling Ranch Filing No. 2, Sterling Ranch Phase 2, Homestead North Filings 1 through 3 located southeast of the intersection of Vollmer/Poco, and the Retreat at TimberRidge Filing Nos. 1 and 2. The short-term background volumes assume Aspen Valley Road and Hawks Hill Court have been constructed north to Arroya Lane.

Figure 7 shows the projected 2043 background traffic volumes at the key area intersections. 2043 background traffic-volume estimates were based on 2040 volume projections in the *El Paso County MTCP* and previous work completed in the area by LSC. The 2043 background traffic volumes assume buildout of the land uses and street network within the Sterling Ranch Master Plan area, the Jaynes development located west of Vollmer Road, and future phases of the Retreat at TimberRidge.

TRIP GENERATION

The Retreat at TimberRidge Filing No. 3 site-generated vehicle trips have been estimated using the nationally published trip-generation rates from *Trip Generation, 11th Edition, 2021* by the Institute of Transportation Engineers (ITE). Table 2 (attached) shows the trip-generation estimates for Filing No. 3. Table 2 also shows estimates of the traffic expected to be generated by the approved Retreat at TimberRidge Filing Nos. 1 and 2 and by future Retreat at TimberRidge filings. The total trips generated by the Retreat at TimberRidge at buildout is consistent with the estimate shown in Table 1 of *The Retreat at TimberRidge Preliminary Plan Transportation Memorandum* dated April 5, 2018.

The Retreat at TimberRidge Filing No. 3 is expected to generate 311 vehicle trips on the average weekday, with about half entering and half exiting the site during a 24-hour period. During the morning peak hour, which generally occurs for one hour between 6:30 and 8:30 a.m., about 6 vehicles would enter and 17 vehicles would exit the site. During the afternoon peak hour, which generally occurs for one hour between 4:15 and 6:15 p.m., about 20 vehicles would enter and 11 vehicles would exit the site.

TRIP DISTRIBUTION AND ASSIGNMENT

The directional distribution of the site-generated traffic volumes on the street and roadway system serving the site is one of the most important factors in determining the site's traffic impacts. The specific short-term and long-term distribution estimates are shown in Figure 8. The directional-distribution estimates are based on the following factors: the location of the site with respect to the Colorado Springs metropolitan area, the planned access system for the site, the street and roadway system serving the site, the land uses proposed for the site, and the distribution of existing traffic volumes. The short-term distribution estimate assumes only the short section of Briargate Parkway between Vollmer Road and Wheatland Drive has been constructed in the vicinity of the site and the long-term distribution estimate assumes full buildout of the future roadway network in the vicinity of the site.

When the distribution percentages (from Figure 8) are applied to the trip-generation estimates (from Table 2), the resulting site-generated traffic volumes can be determined. Figures 9 and 10 show the short-term and long-term site-generated traffic-volume estimates for the Retreat at TimberRidge Filing 3, respectively.

TOTAL TRAFFIC

Figure 11 shows the projected short-term total traffic volumes at the intersections of Vollmer Road/Poco Road and Vollmer Road/Arroya Lane. The short-term total traffic volumes are the sum of the short-term site-generated traffic volumes (from Figure 9) plus the short-term background traffic volumes (from Figure 6).

Figure 12 shows the projected 2043 total traffic volumes at the intersection of Vollmer Road/Poco Road. The 2043 total traffic volumes are the sum of the long-term site-generated traffic volumes (from Figure 10) plus the 2043 background traffic volumes (from Figure 7).

LEVEL OF SERVICE

The intersections of Vollmer Road/Poco Road and Vollmer Road/Arroya Lane were analyzed using the unsignalized method of analysis procedures outlined in the *Highway Capacity Manual, 6th Edition* by the Transportation Research Board. The results of the analysis are shown in Figures 6, 7, 11, and 12.

All movements at the stop-sign-controlled intersections of Vollmer Road/Poco Road and Vollmer Road/Arroya Lane are projected to operate at an acceptable level of service (LOS D or better) during the peak hours through 2043.

SUBDIVISION STREET CLASSIFICATIONS

Figure 13 shows the recommended street classifications for the internal streets within the Retreat at TimberRidge plan.

ROADWAY IMPROVEMENTS

The April 2018 memorandum contained a summary of needed improvements for the entire TimberRidge PUD plan by phase. Table 3 is an updated version of that table based on the information from traffic studies recently completed in the area, including the *Sterling Ranch Sketch Plan Amendment Master Traffic Impact Study*, dated March 17, 2023 ([PCD File Number SKP-22-004](#)). The approved Retreat at TimberRidge Filing Nos. 1 and 2, and the currently-proposed Retreat at TimberRidge Filing No. 3 include 193 of the 195 lots identified in that memorandum as Phases 2 through 6. TimberRidge Filing Nos 1 through 3 do not include the two lots located west of Vollmer Road (now included as part of the approved West Timber Ridge), nor the 10 lots shown as Preliminary Plan Phase 1.

The improvements specially needed with the Retreat at Timber Ridge Filing No. 3 have been repeated below.

- Update Arroya Lane to a Rural Collector cross section. Arroya Lane could potentially need to be upgraded to an Urban cross section with curb and gutters if significant changes are made to the Sterling Ranch Sketch Plan located east of the Retreat at TimberRidge. The currently approved Sterling Ranch Master TIS assumes five-acre lots on the parcel adjacent to Arroya Lane. The previously approved Master TIS assumed Sterling Ranch Road would be constructed between Marksheffel Road and Arroya Lane. Sterling Ranch Road is now planned to terminate north of Briargate Parkway within the Sterling Ranch Sketch Plan area. A circuitous connection to Arroya Lane will be provided via a local street network. Arroya Lane will likely only need to be upgraded to an Urban standard if the density for the Sterling Ranch parcels adjacent to Arroya Lane are significantly increased or if Sterling Ranch Road is constructed to provide a direct connection to Arroya Lane.
- Realign Arroya Lane at the intersection of Vollmer Road so Arroya intersects Vollmer at a right angle and improve the shoulders on the east side of Vollmer Road approaching the intersection per the attached Retreat at TimberRidge Filing No. 3 Construction Plans.
- Based on the criteria contained in the El Paso County *Engineering Criteria Manual (ECM)* and the projected 2043 total traffic volumes shown in Figure 12, a southbound left-turn lane is **not** projected to be required on Vollmer Road approaching Arroya Lane.

ROADWAY IMPROVEMENT FEE PROGRAM

This project will be required to participate in the El Paso County Road Improvement Fee Program. The Retreat at TimberRidge Filing No. 3 will join the ten-mil PID. The 2019 ten-mil PID building permit fee portion associated with this option is \$1,221 per single-family dwelling unit. Based on 33 lots, the total building permit fee would be \$40,293.

* * * * *

Please contact me if you have any questions regarding this report.

Respectfully Submitted,

LSC TRANSPORTATION CONSULTANTS, INC.

By: Jeffrey C. Hodsdon, P.E.
Principal

JCH/KDF:jas

Enclosures: Tables 2-3
Figures 1-13
Traffic Count Reports
Level of Service Reports
MTCP Maps
Retreat at TimberRidge Filing No. 3 Construction Plans

Tables



**Table 3
Roadway Improvements
Retreat at TimberRidge Filing No. 3
Preliminary Plan**

Improvement	Timing	Responsibility ⁽¹⁾
Upgrade Arroya Lane to a Rural Collector cross section	With the Retreat at TimberRidge Filing No. 3	The Retreat at TimberRidge
Realign Arroya Lane at the intersection of Vollmer Road/Arroya Lane so Arroya intersects Vollmer at a right angle	With the Retreat at TimberRidge Filing No. 3	The Retreat at Timber Ridge
Extend Poco Road to the east including the creek crossing	This improvement has been completed	
Construct a gravel road to provide secondary emergency access to Arroya Lane	This improvement has been completed	
Replace the secondary emergency access gravel road with subdivision streets	With the Retreat at TimberRidge Filing No. 3	The Retreat at TimberRidge
Construct a northbound right-turn deceleration lane on Vollmer Road approaching Poco Road.	This improvement has been completed	
Potential improvement: Southbound left-turn lane on Vollmer Road at Arroya Lane	Evaluation with final plats. [Not anticipated to be needed with the currently proposed Filing No. 3] <i>Although the long term anticipated traffic counts do not warrant it, the County Engineer may require a southbound left-turn lane at Arroya based on unanticipated traffic patterns.</i> [from Staff Comments].	The Retreat at Timber Ridge and/or possible-but-not-currently-anticipated-future development with access via Arroya Lane
Improve the shoulders on the east side of Vollmer Road approaching Arroya Lane per the attached Retreat at TimberRidge Filing No. 3 Construction Plans.	With the Retreat at TimberRidge Filing No. 3	The Retreat at TimberRidge
As shown on the County MTCP: Vollmer Road upgrade between Poco Road and Shoup Road to a county-standard, two-lane Rural Minor Arterial.	Traffic volume estimates indicate this improvement will not be needed in the short term horizon. The 2040 MTCP indicates the Vollmer project will be needed by 2040. The 2040 MTCP shows the Vollmer upgrade "project" as Project ID U-12.	The Retreat at Timber Ridge will dedicate right-of-way to accommodate the future upgrade to Rural Minor Arterial standards (As shown in the MTCP and the Fee Study); The applicant will be required to participate in the County Road Impact Fee program.
Upgrade Vollmer Road between future Stapleton Drive and Poco Road to an Urban Minor Arterial cross section (five lanes)	This improvement is planned to be completed by May 2024	
Upgrade Vollmer Road generally between the south boundary of Sterling Ranch and future Briargate Parkway to an Urban Minor Arterial cross section (five lanes)	Designed MTCP Project ID C-13	Sterling Ranch Metro District
Upgrade Vollmer Road generally between Cowpoke Road and the south boundary of Sterling Ranch to an Urban Minor Arterial cross section (five lanes)	Designed MTCP Project ID C-13	Woodmen Heights Metro District
Construct section of Briargate Parkway between Vollmer Road and the first Sterling Ranch access point (Wheatland Drive)	This improvement is planned to be completed by the end of 2023	
Construct a northbound right-turn deceleration lane on Vollmer Road approaching Briargate Parkway	This improvement is planned to be completed by May 2024	
Construct Briargate Parkway (four-lane Principal Arterial) between Black Forest Road and Vollmer Road.	Future - TBD TBD with PPRTA ⁽²⁾ Corridor Study	TBD with PPRTA ⁽²⁾ Corridor Study MTCP Project N-5
Construct Stapleton Drive between Vollmer Road and Towner	Future TBD with PPRTA ⁽²⁾ Corridor Study	TBD with PPRTA ⁽²⁾ Corridor Study MTCP Project N-5
Southbound left-turn lanes on Vollmer Road approaching Burgess Road ⁽³⁾	Existing Deficiency	Existing Deficiency - Others (This development will not add volume to this turning movement.)
Northbound left-turn lane at Burgess/Vollmer ⁽³⁾	Projections indicate after 2020 but prior to 2040 the turning volume threshold warranting the turn lane (25 northbound left turns per hour) would be exceeded.	Based on the PUD plan (which the existing Filings 1 and 2 and the currently proposed Filing No 3 are consistent with), the afternoon peak-hour traffic impact from the Retreat at TimberRidge PUD on the northbound approach to this intersection is projected to be below 10 percent. The site volume on the roadway link (both directions of travel) south of the intersection is more than 10 percent, however the turn lane thresholds are shown to be exceeded on the northbound approach during the afternoon peak hour when the impact of this project is below 10 percent on this approach. This project will be participating in the Fee Program and the MTCP Project ID is U-12.
Northbound right-turn lane at Burgess/Vollmer ⁽³⁾	Projections indicate by 2020 the turning volume threshold warranting the turn lane (50 northbound right turns per hour) would be exceeded.	Based on the PUD plan (which the existing Filings 1 and 2 and the currently proposed Filing No 3 are consistent with), the afternoon peak-hour traffic impact from this project on the northbound approach to this intersection is projected to be below 10 percent. The site volume on the roadway link (both directions of travel) south of the intersection is more than 10 percent, however the turn lane thresholds are shown to be exceeded on the northbound approach during the afternoon peak hour when the impact of this project is below 10 percent on this approach. This project will be participating in the Fee Program and the MTCP Project ID is U-12.
Future traffic signal at Briargate/Vollmer ⁽³⁾	Once warrants are met; analysis to be included with final plat traffic reports; projections indicate by 2043 the intersection would be signalized.	Escrow a fair-share amount toward the cost the signal (to be determined with final plats). Once the signal is constructed, a portion of the escrow amount used to fund the installation of the signal may have become creditable under the Fee Program (if this signal is added to the fee program list of signals eligible for credit (County signals not currently programmed in Fee Program).

Notes:
(1) Preliminary concept of responsibility; the actual construction responsibility would be determined through subdivision applications and cost recovery if applicable agreements.
(2) PPRTA = Pikes Peak Rural Transportation Authority.
(3) This improvement will not be needed if the intersect of Burgess/Vollmer is reconstructed as a modern roundabout as shown in the Sterling Ranch Sketch Plan Amendment Master Traffic Impact Study dated March 17, 2023 (SKP224)

Source: LSC Transportation Consultants, Inc. Sep-23

Figures



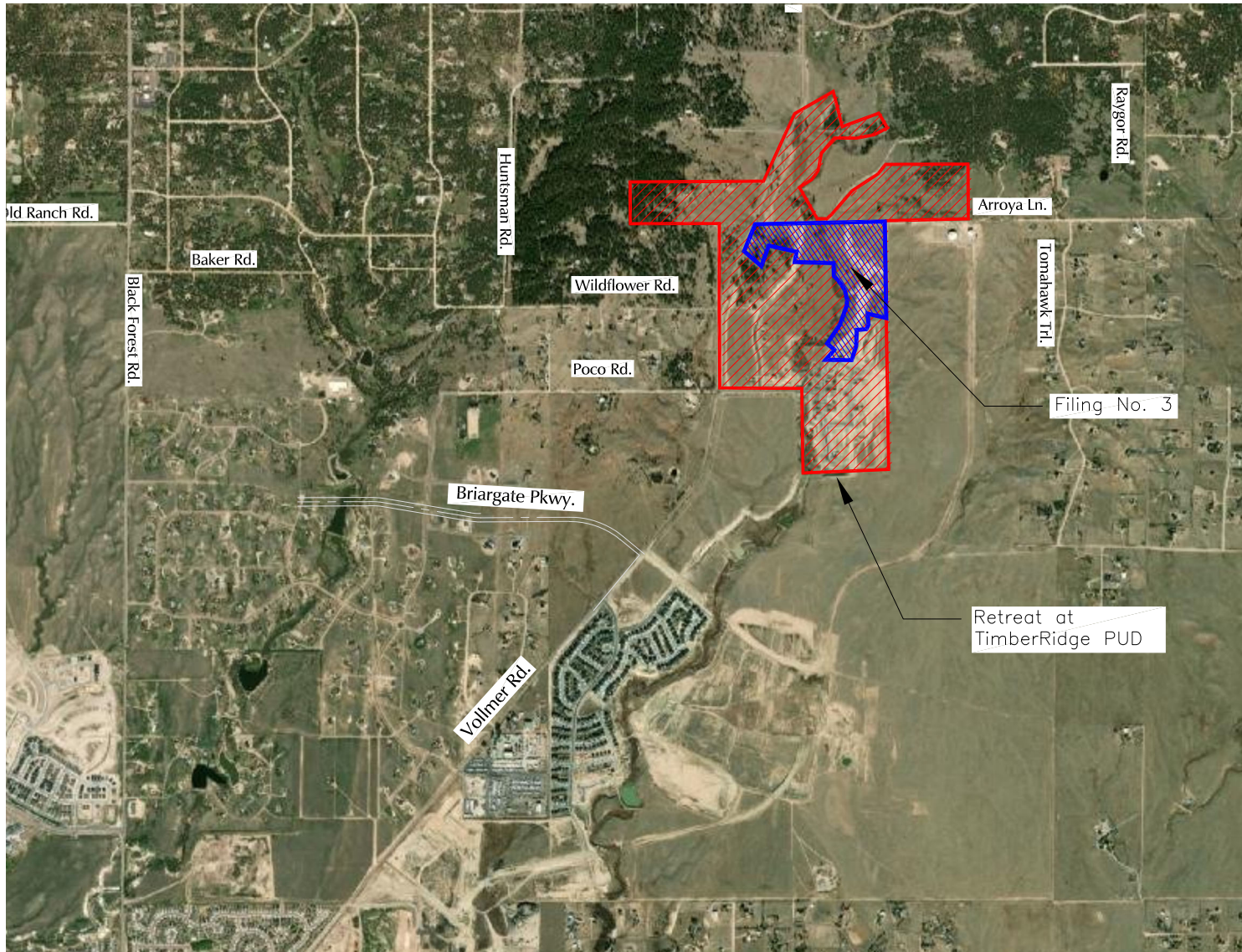

Approximate Scale
Scale: 1" = 2,500'

Figure 1
Vicinity
Map

Retreat at TimberRidge Filing 3 (LSC #S224350)

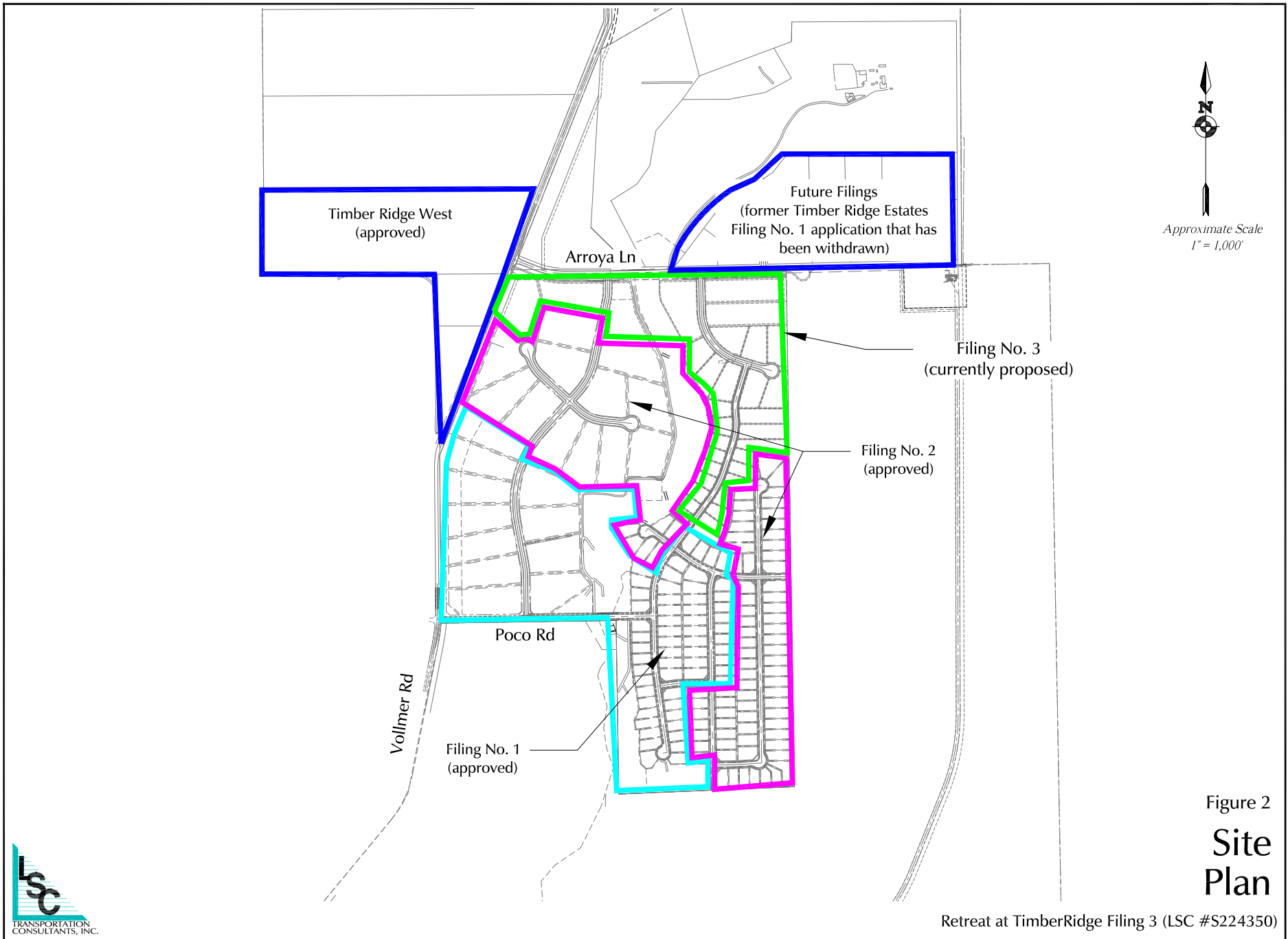
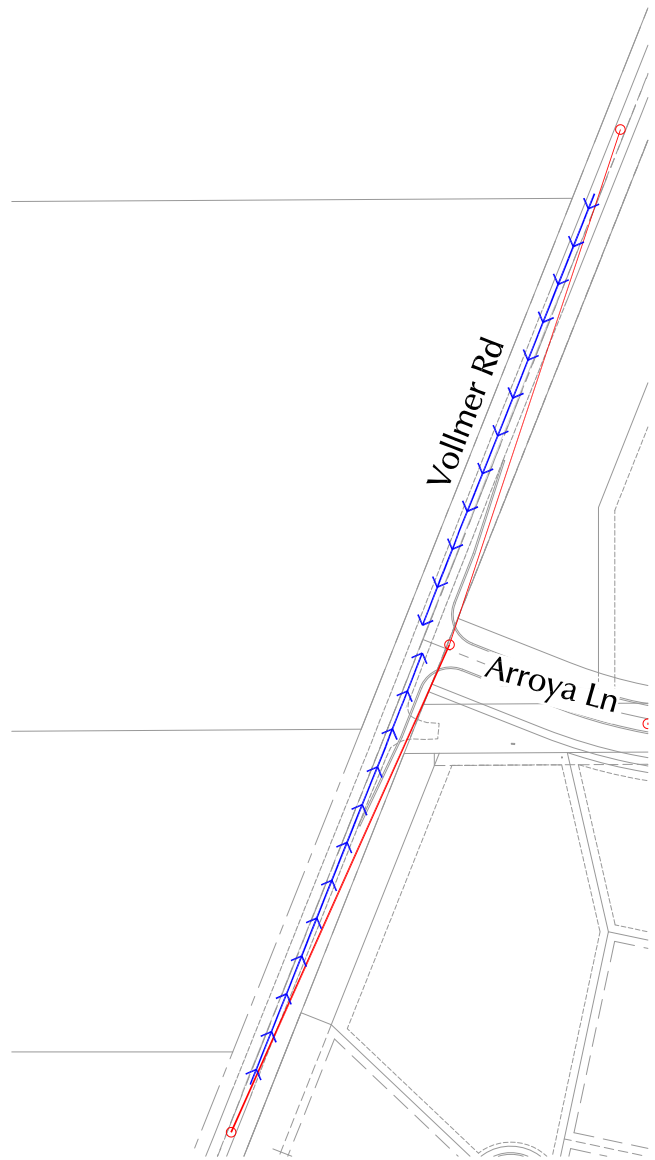
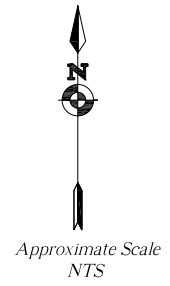

Figure 2
Site Plan

Retreat at TimberRidge Filing 3 (LSC #S224350)









- LEGEND:
-  = ECM Required Intersection Sight Distance (665' based on a design speed of 60mph from Table 2-21)
 -  = ECM Required Stopping Sight Distance (570' (calculated) based on a design speed of 60mph from Table 2-17)

Figure 3
Sight Distance Analysis
Vollmer/Arroya

Retreat at TimberRidge Filing 3 (LSC #S224350)



LEGEND:

-  = ECM Required Intersection Sight Distance (445' based on a design speed of 40mph from Table 2-21)
-  = ECM Required Stopping Sight Distance (305' based on a design speed of 40mph from Table 2-17)

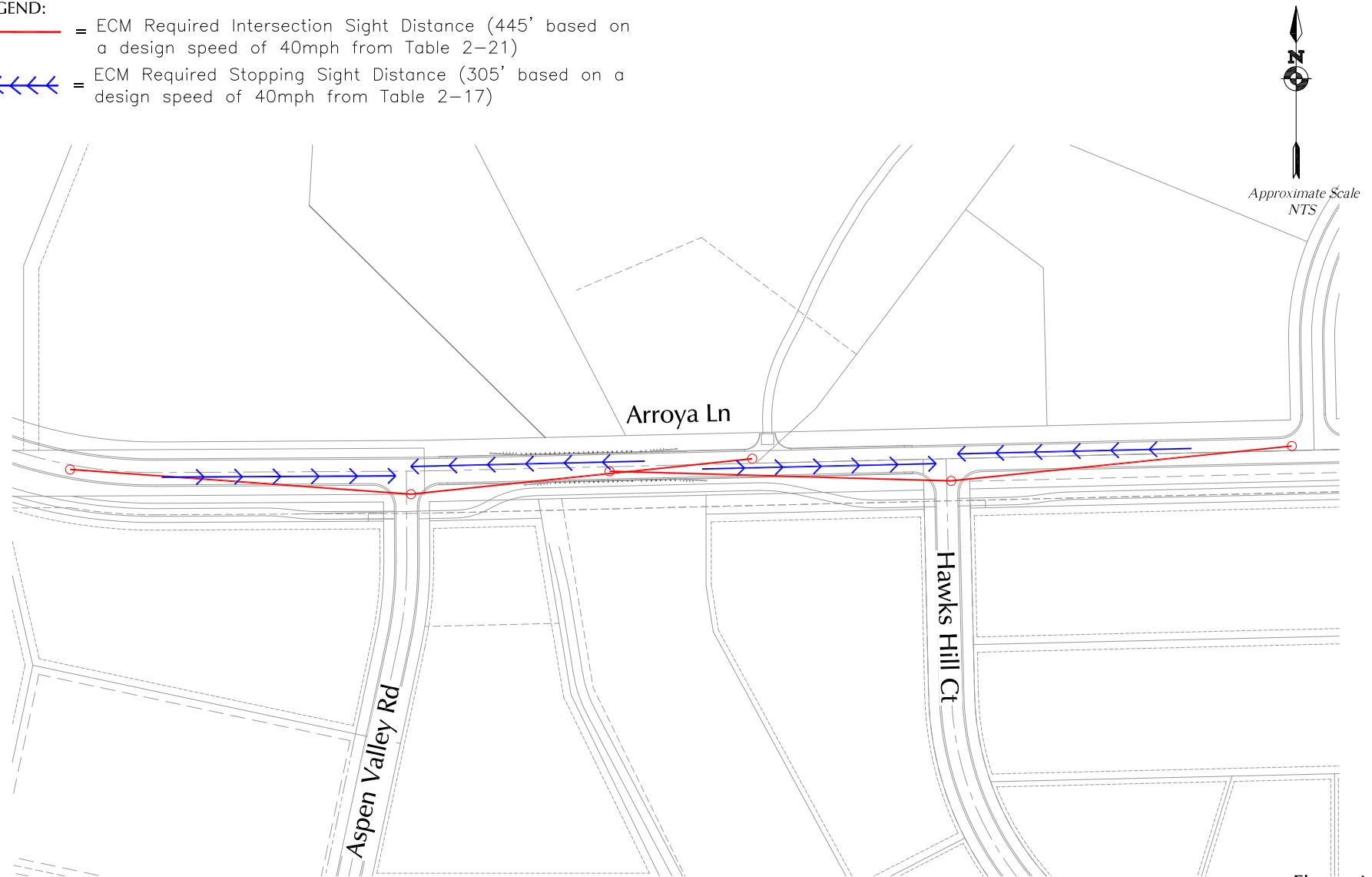
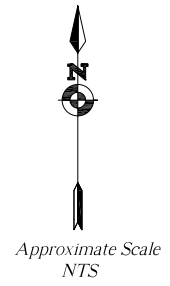
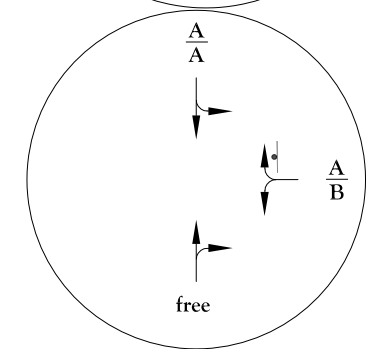
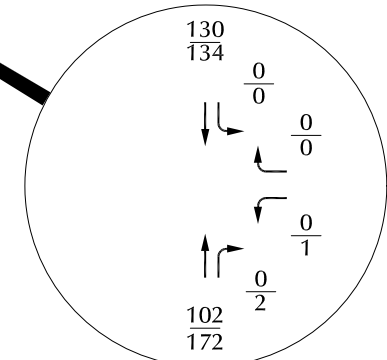
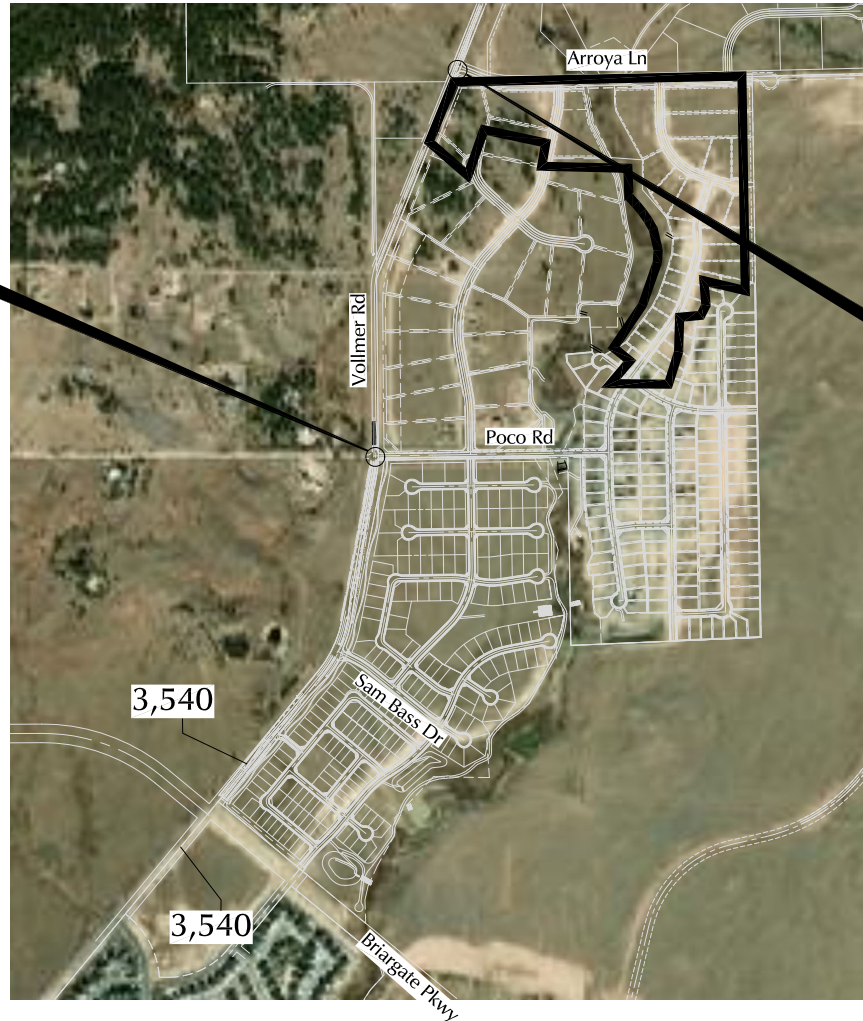
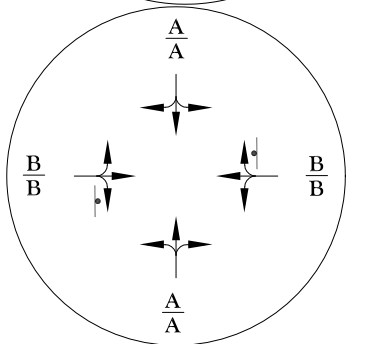
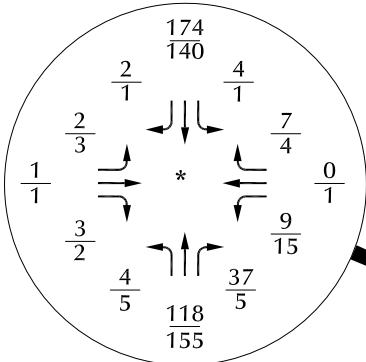

Figure 4

Sight Distance Analysis - Arroya Access Points

Retreat at TimberRidge Filing 3 (LSC #S224350)



LEGEND:

$\frac{XX}{XX}$ = AM Weekday Peak-Hour Traffic (vehicles per hour) / PM Weekday Peak-Hour Traffic (vehicles per hour) Based on counts by LSC May/June 2022

XXX = Average Weekday Traffic (vehicles per day) Estimate by LSC



*Note: Traffic on the east leg is primarily construction related traffic

Figure 5

Existing Traffic

Retreat at TimberRidge Filing 3 (LSC #S224350)

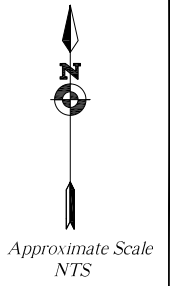
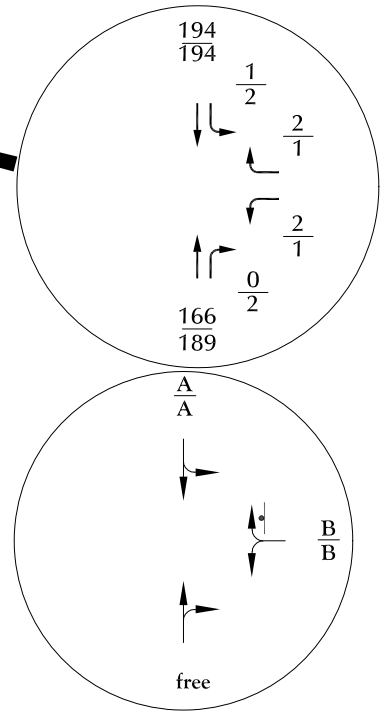
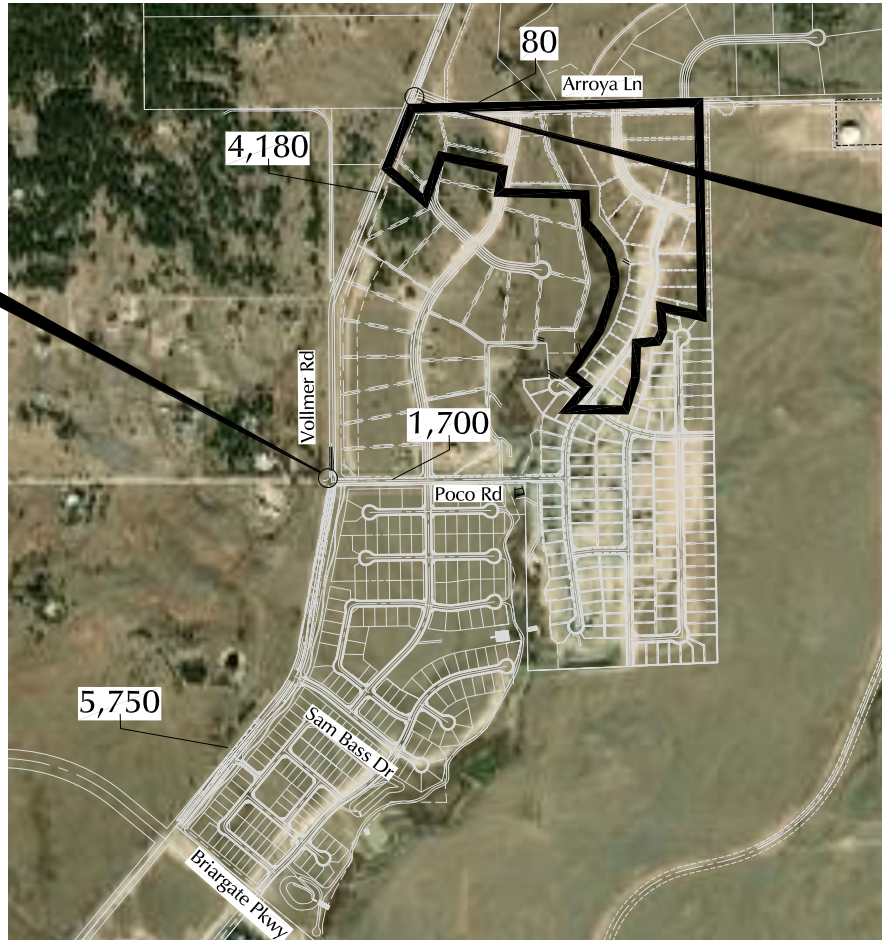
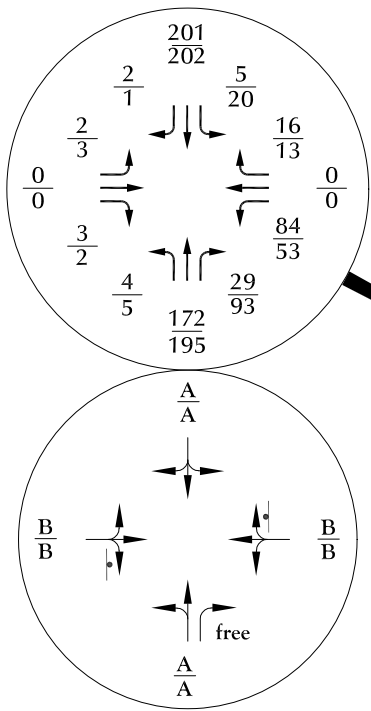

LEGEND:

- \downarrow = Stop Sign
- $\frac{XX}{XX}$ = AM Weekday Peak-Hour Traffic (vehicles per hour)
PM Weekday Peak-Hour Traffic (vehicles per hour)
- XXX = Average Weekday Traffic (vehicles per day)
- $\frac{A}{B}$ = AM Individual Movement Peak-Hour Level of Service
PM Individual Movement Peak-Hour Level of Service
- $\frac{C}{D}$ = AM Entire Intersection Peak-Hour Level of Service
PM Entire Intersection Peak-Hour Level of Service



Figure 6
Short-Term Background Conditions
 Retreat at TimberRidge Filing 3 (LSC #S224350)

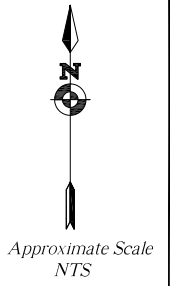
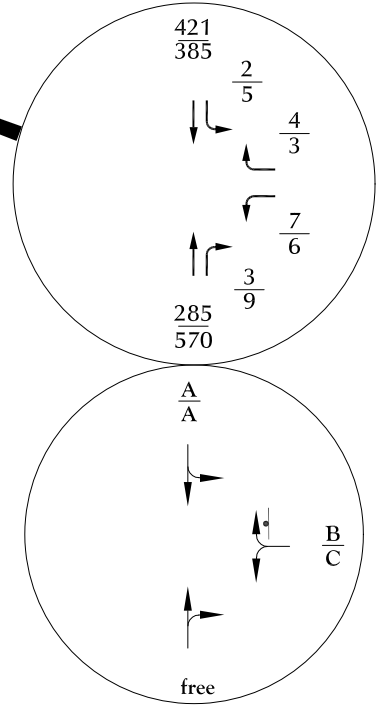
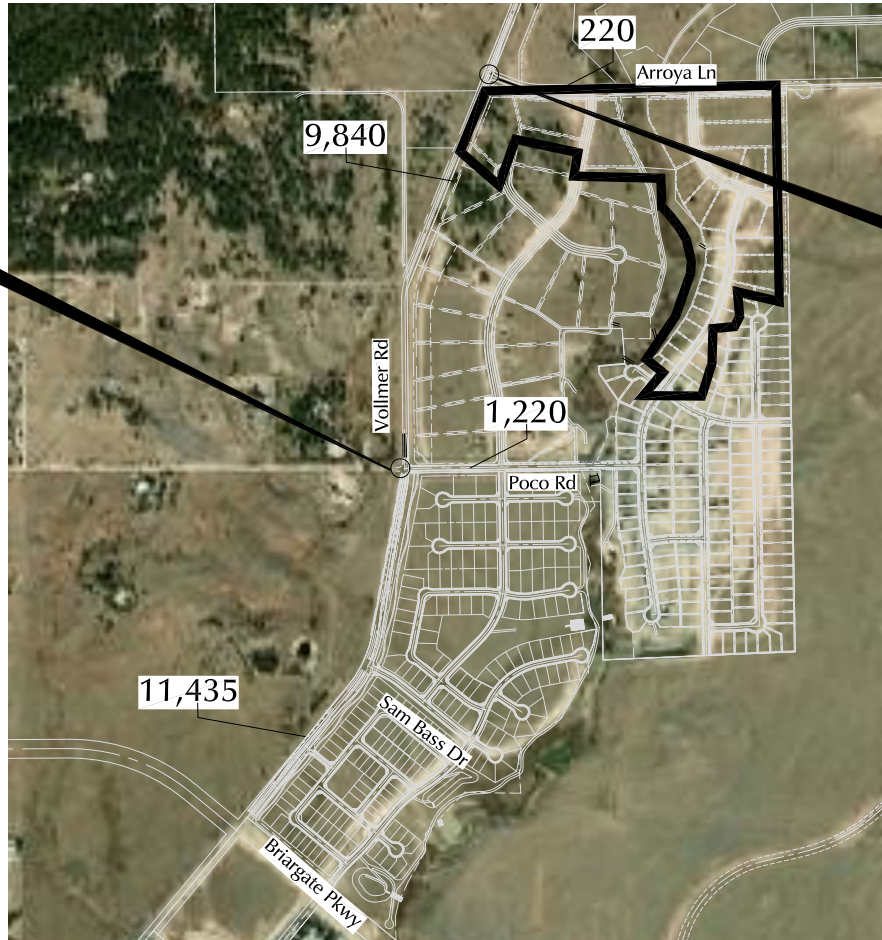
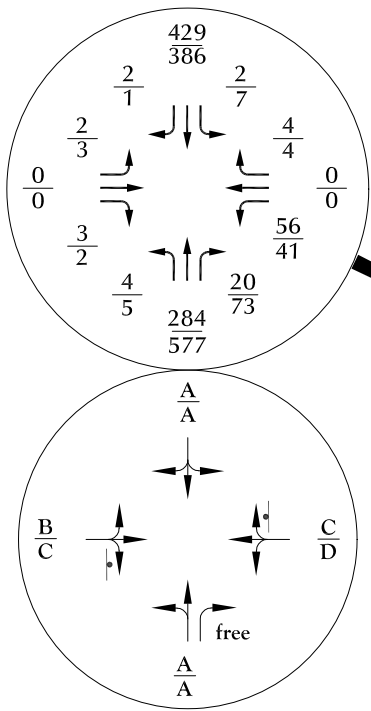

LEGEND:

- ⊥ = Stop Sign [●●] = Traffic Signal
- $\frac{XX}{XX}$ = AM Weekday Peak-Hour Traffic (vehicles per hour)
 PM Weekday Peak-Hour Traffic (vehicles per hour)
- XXX = Average Weekday Traffic (vehicles per day)
- $\frac{A}{B}$ = AM Individual Movement Peak-Hour Level of Service
 PM Individual Movement Peak-Hour Level of Service
- $\frac{C}{D}$ = AM Entire Intersection Peak-Hour Level of Service
 PM Entire Intersection Peak-Hour Level of Service



Figure 7
2043 Background Conditions
 Retreat at TimberRidge Filing 3 (LSC #S224350)



Approximate Scale
Scale: 1" = 3,000'

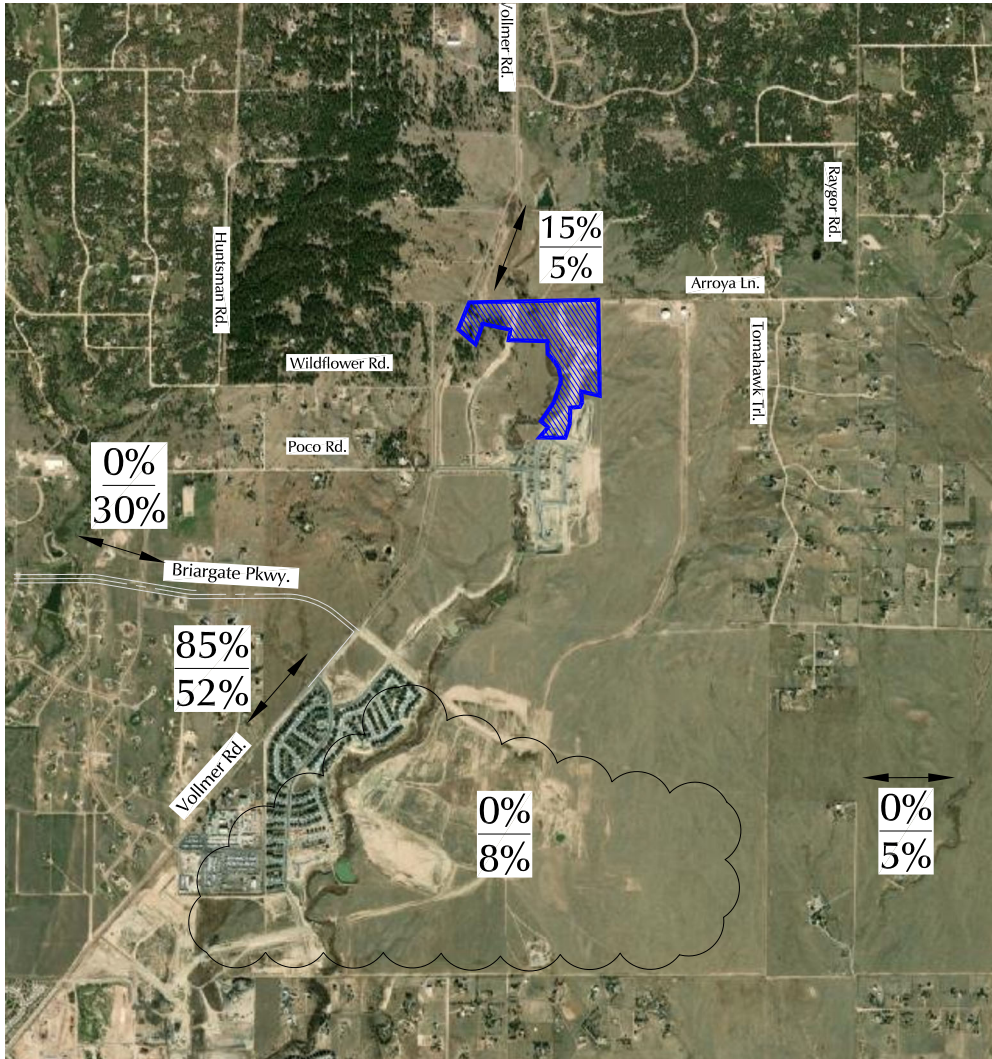

LEGEND:

$$\frac{XX\%}{XX\%} = \frac{\text{Short-Term Percent Directional Distribution}}{\text{Long-Term Percent Directional Distribution}}$$

Figure 8

Directional Distribution of Site-Generated Traffic

Retreat at TimberRidge Filing 3 (LSC #S224350)





Approximate Scale
NTS

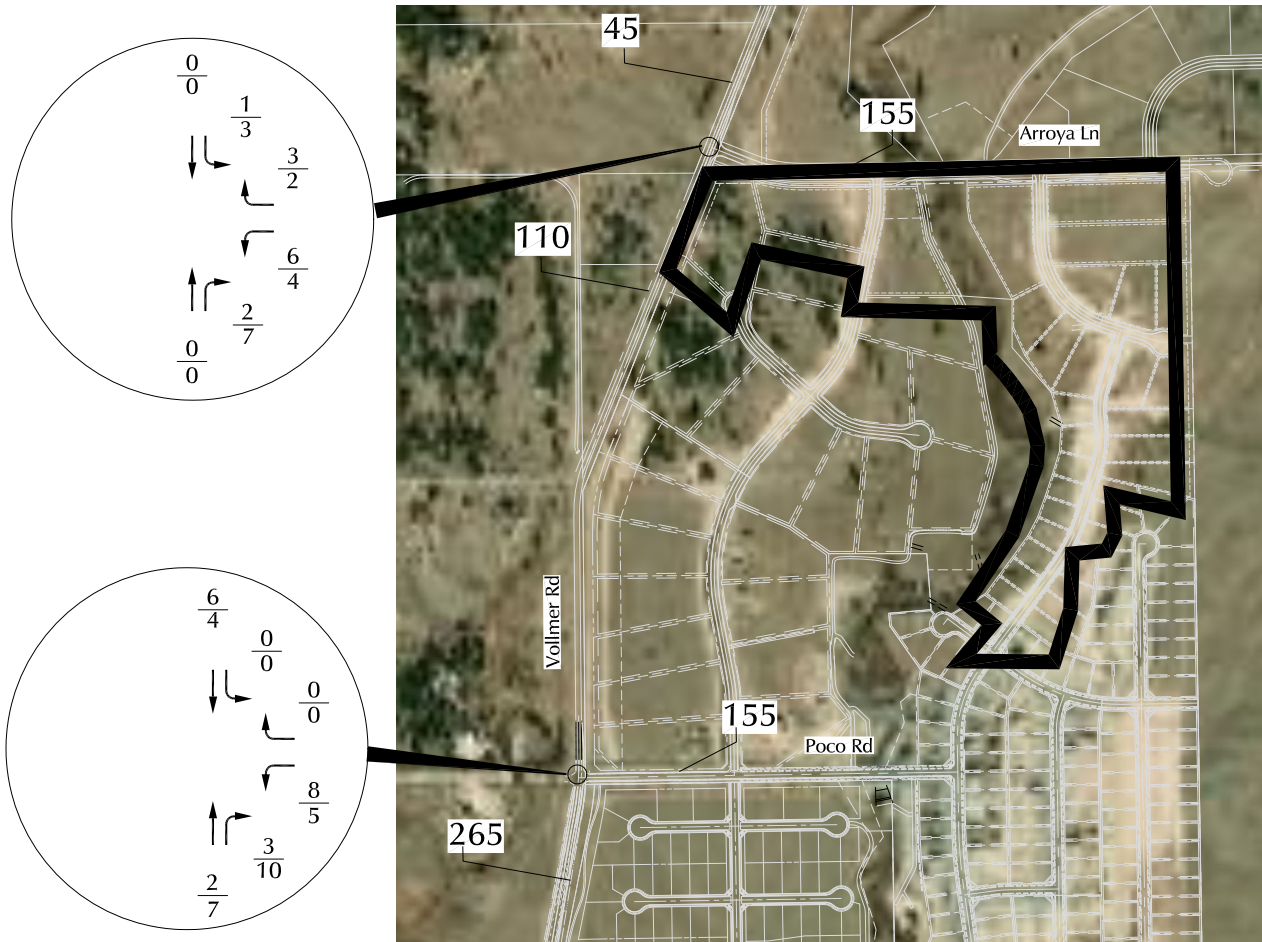

LEGEND:

$\frac{XX}{XX}$ = AM Weekday Peak-Hour Traffic (vehicles per hour)
 $\frac{XX}{XX}$ = PM Weekday Peak-Hour Traffic (vehicles per hour)

XXX = Average Weekday Traffic (vehicles per day)

Figure 9
Short-Term Assignment of
Filing No. 3 Site-Generated Traffic

Retreat at TimberRidge Filing 3 (LSC #S224350)

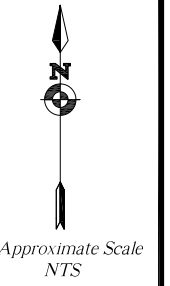
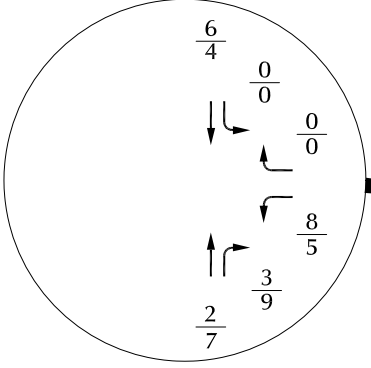
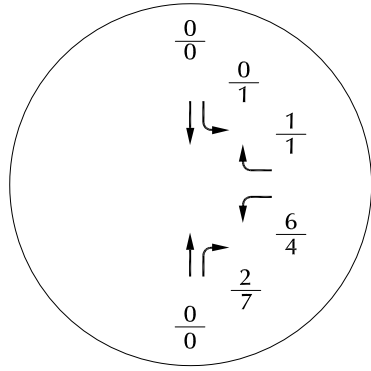



LEGEND:
 $\frac{XX}{XX}$ = AM Weekday Peak-Hour Traffic (vehicles per hour)
 $\frac{XX}{XX}$ = PM Weekday Peak-Hour Traffic (vehicles per hour)
 XXX = Average Weekday Traffic (vehicles per day)

Figure 10
**Long-Term Assignment of
 Filing No. 3 Site-Generated Traffic**
 Retreat at TimberRidge Filing 3 (LSC #S224350)

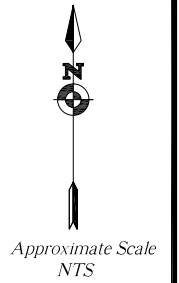
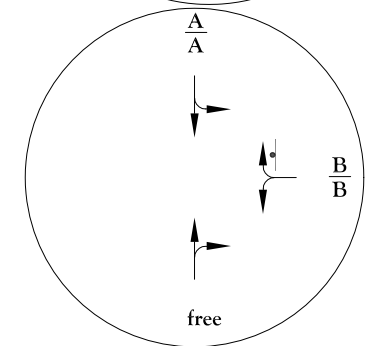
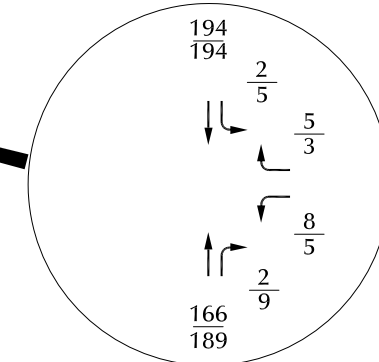
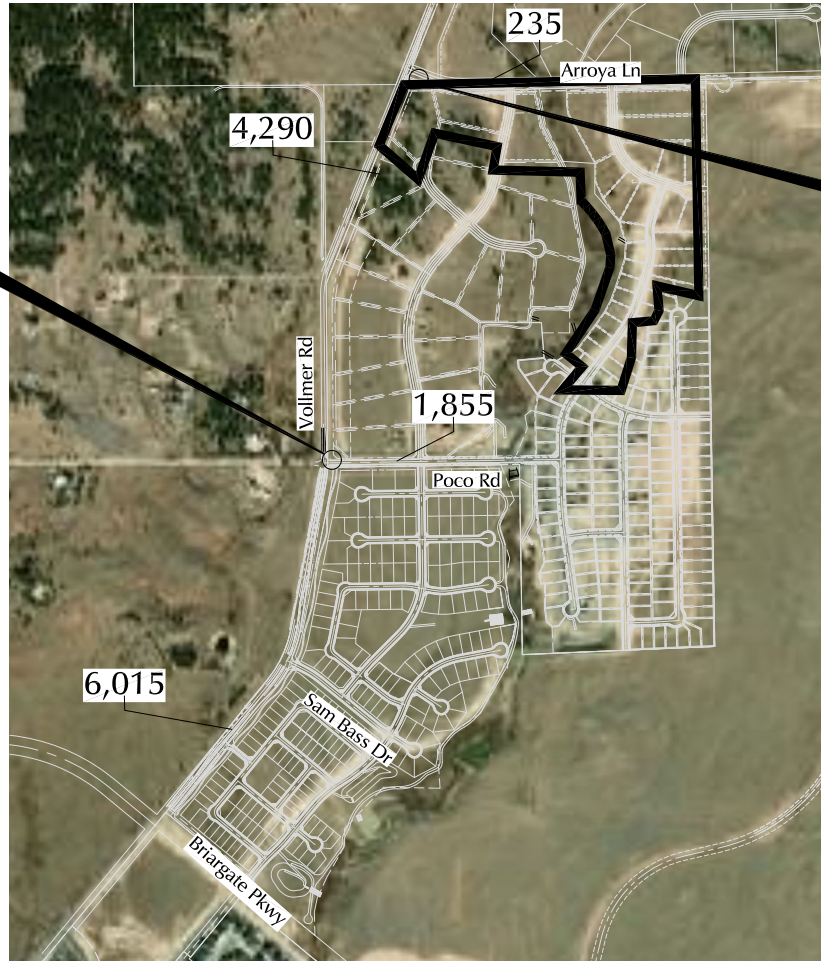
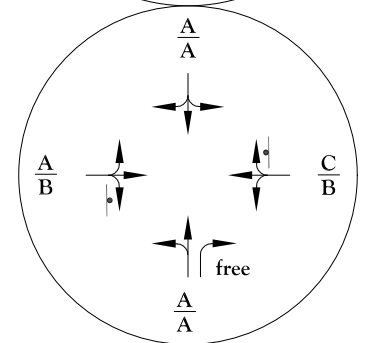
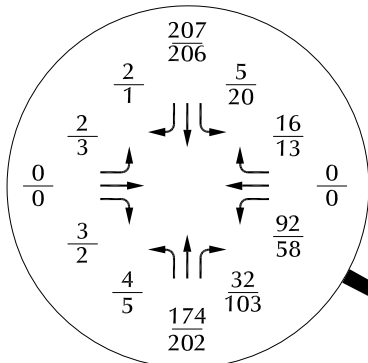



LEGEND:

 = Stop Sign  = Traffic Signal

$\frac{XX}{XX}$ = AM Weekday Peak-Hour Traffic (vehicles per hour)
 PM Weekday Peak-Hour Traffic (vehicles per hour)

XXX = Average Weekday Traffic (vehicles per day)

$\frac{A}{B}$ = AM Individual Movement Peak-Hour Level of Service
 PM Individual Movement Peak-Hour Level of Service

$\frac{C}{D}$ = AM Entire Intersection Peak-Hour Level of Service
 PM Entire Intersection Peak-Hour Level of Service



Approximate Scale
NTS

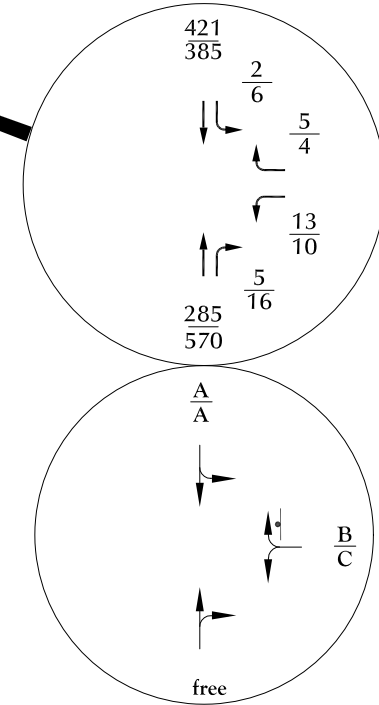
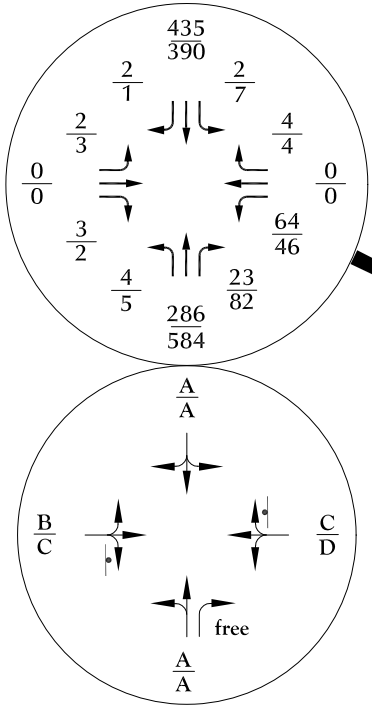

LEGEND:

⊥ = Stop Sign [] = Traffic Signal

$\frac{XX}{XX}$ = AM Weekday Peak-Hour Traffic (vehicles per hour)
 PM Weekday Peak-Hour Traffic (vehicles per hour)

XXX = Average Weekday Traffic (vehicles per day)

$\frac{A}{A}$ = AM Individual Movement Peak-Hour Level of Service

$\frac{B}{B}$ = PM Individual Movement Peak-Hour Level of Service

$\frac{C}{C}$ = AM Entire Intersection Peak-Hour Level of Service

$\frac{D}{D}$ = PM Entire Intersection Peak-Hour Level of Service



Figure 12
2043 Total Conditions

Retreat at TimberRidge Filing 3 (LSC #S224350)



Figure 13

Recommended Classification

Retreat at TimberRidge Filing 3 (LSC #S224350)



Traffic Counts



LSC Transportation Consultants, Inc.

2504 E. Pikes Peak Ave, Suite 304
 Colorado Springs, CO 80909
 719-633-2868

File Name : Vollmer rd - POCO rd Am
 Site Code : S224250
 Start Date : 5/11/2022
 Page No : 1

Groups Printed- Unshifted

Start Time	Vollmer Rd Southbound					Poco Rd Westbound					Vollmer Rd Northbound					Poco Rd Eastbound					Int. Total
	Right	Thru	Left	Peds	App. Total	Right	Thru	Left	Peds	App. Total	Right	Thru	Left	Peds	App. Total	Right	Thru	Left	Peds	App. Total	
06:30	0	38	0	0	38	0	0	1	0	1	6	20	0	0	26	1	0	1	0	2	67
06:45	0	34	0	0	34	0	0	0	0	0	12	16	0	0	28	0	0	0	0	0	62
Total	0	72	0	0	72	0	0	1	0	1	18	36	0	0	54	1	0	1	0	2	129
07:00	1	28	1	0	30	0	0	2	0	2	8	15	0	0	23	0	0	1	0	1	56
07:15	0	38	0	0	38	0	0	3	0	3	2	24	3	0	29	0	1	1	0	2	72
07:30	2	64	1	0	67	3	0	3	0	6	8	19	0	0	27	3	0	0	0	3	103
07:45	0	41	2	0	43	0	0	2	0	2	13	39	0	0	52	0	0	0	0	0	97
Total	3	171	4	0	178	3	0	10	0	13	31	97	3	0	131	3	1	2	0	6	328
08:00	0	31	1	0	32	4	0	1	0	5	14	36	1	0	51	0	0	1	0	1	89
08:15	0	20	0	0	20	2	0	7	0	9	7	24	2	0	33	0	0	0	0	0	62
Grand Total	3	294	5	0	302	9	0	19	0	28	70	193	6	0	269	4	1	4	0	9	608
Apprch %	1	97.4	1.7	0		32.1	0	67.9	0		26	71.7	2.2	0		44.4	11.1	44.4	0		
Total %	0.5	48.4	0.8	0	49.7	1.5	0	3.1	0	4.6	11.5	31.7	1	0	44.2	0.7	0.2	0.7	0	1.5	

LSC Transportation Consultants, Inc.

2504 E. Pikes Peak Ave, Suite 304
 Colorado Springs, CO 80909
 719-633-2868

File Name : Vollmer rd - POCO rd Am

Site Code : S224250

Start Date : 5/11/2022

Page No : 2

Start Time	Vollmer Rd Southbound					Poco Rd Westbound					Vollmer Rd Northbound					Poco Rd Eastbound					Int. Total
	Right	Thru	Left	Peds	App. Total	Right	Thru	Left	Peds	App. Total	Right	Thru	Left	Peds	App. Total	Right	Thru	Left	Peds	App. Total	
Peak Hour Analysis From 6:30:00 AM to 8:15:00 AM - Peak 1 of 1																					
Peak Hour for Entire Intersection Begins at 7:15:00 AM																					
7:15:00 AM	0	38	0	0	38	0	0	3	0	3	2	24	3	0	29	0	1	1	0	2	72
7:30:00 AM	2	64	1	0	67	3	0	3	0	6	8	19	0	0	27	3	0	0	0	3	103
7:45:00 AM	0	41	2	0	43	0	0	2	0	2	13	39	0	0	52	0	0	0	0	0	97
8:00:00 AM	0	31	1	0	32	4	0	1	0	5	14	36	1	0	51	0	0	1	0	1	89
Total Volume	2	174	4	0	180	7	0	9	0	16	37	118	4	0	159	3	1	2	0	6	361
% App. Total	1.1	96.7	2.2	0		43.8	0	56.2	0		23.3	74.2	2.5	0		50	16.7	33.3	0		
PHF	.250	.680	.500	.000	.672	.438	.000	.750	.000	.667	.661	.756	.333	.000	.764	.250	.250	.500	.000	.500	.876

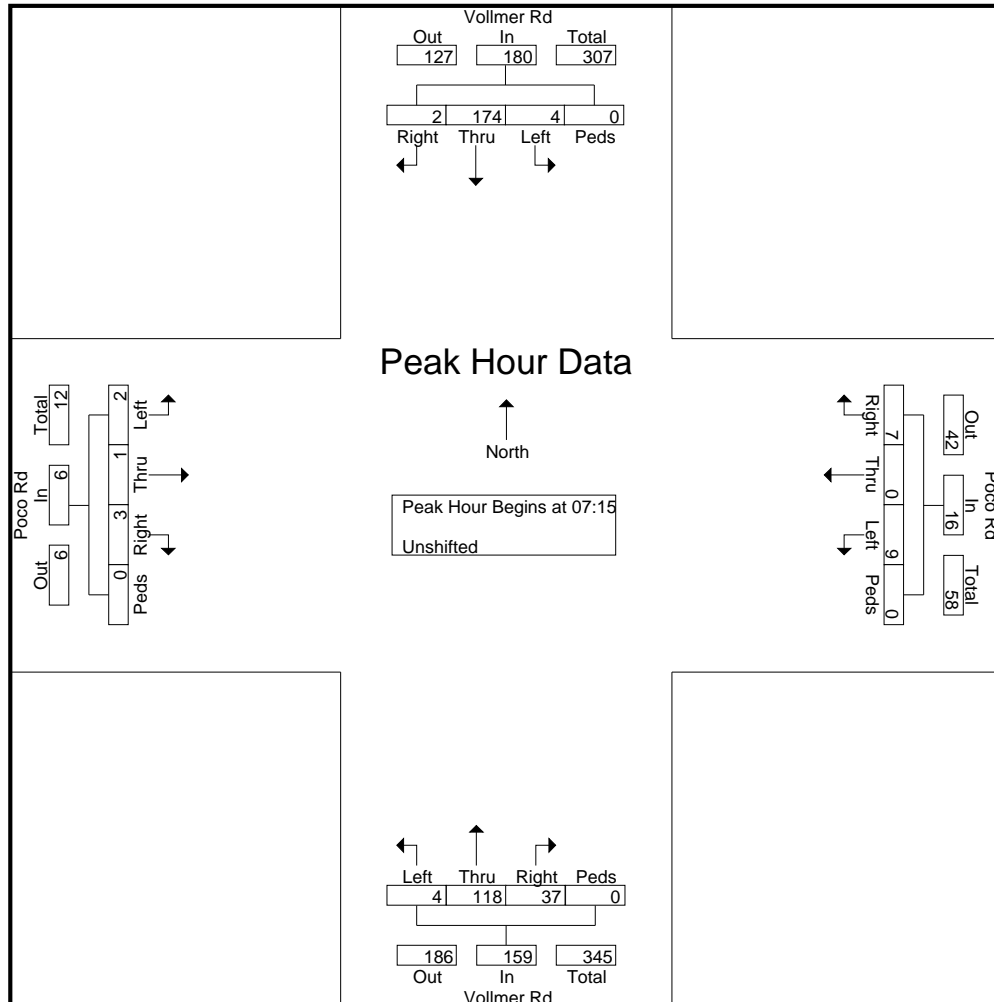

LSC Transportation Consultants, Inc.

2504 E. Pikes Peak Ave, Suite 304
 Colorado Springs, CO 80909
 719-633-2868

File Name : Vollmer Rd - POCO Rd PM Construction

Site Code : S224250

Start Date : 5/11/2022

Page No : 1

Groups Printed- Unshifted

Start Time	Poco Rd Southbound					Vollmer Rd Westbound					Poco Rd Northbound					Vollmer Rd Eastbound					Int. Total
	Right	Thru	Left	Peds	App. Total	Right	Thru	Left	Peds	App. Total	Right	Thru	Left	Peds	App. Total	Right	Thru	Left	Peds	App. Total	
16:00	1	35	6	0	42	0	0	6	0	6	1	32	0	0	33	1	1	1	0	3	84
16:15	1	29	0	0	30	0	0	2	0	2	1	43	0	0	44	0	0	0	0	0	76
16:30	0	40	0	0	40	4	0	5	0	9	0	41	3	0	44	0	1	1	0	2	95
16:45	0	36	0	0	36	0	1	6	0	7	2	30	0	0	32	0	0	1	0	1	76
Total	2	140	6	0	148	4	1	19	0	24	4	146	3	0	153	1	2	3	0	6	331
17:00	0	33	1	0	34	0	0	1	0	1	1	45	0	0	46	0	0	0	0	0	81
17:15	1	31	0	0	32	0	0	3	0	3	2	39	2	0	43	2	0	1	0	3	81
17:30	0	37	0	0	37	0	0	6	0	6	2	37	0	0	39	1	0	0	0	1	83
17:45	0	34	0	0	34	0	0	1	0	1	1	35	1	0	37	0	0	0	0	0	72
Total	1	135	1	0	137	0	0	11	0	11	6	156	3	0	165	3	0	1	0	4	317
Grand Total	3	275	7	0	285	4	1	30	0	35	10	302	6	0	318	4	2	4	0	10	648
Apprch %	1.1	96.5	2.5	0		11.4	2.9	85.7	0		3.1	95	1.9	0		40	20	40	0		
Total %	0.5	42.4	1.1	0	44	0.6	0.2	4.6	0	5.4	1.5	46.6	0.9	0	49.1	0.6	0.3	0.6	0	1.5	

LSC Transportation Consultants, Inc.

2504 E. Pikes Peak Ave, Suite 304
 Colorado Springs, CO 80909
 719-633-2868

File Name : Vollmer Rd - POCO Rd PM Construction

Site Code : S224250

Start Date : 5/11/2022

Page No : 3

Start Time	Poco Rd Southbound					Vollmer Rd Westbound					Poco Rd Northbound					Vollmer Rd Eastbound					Int. Total
	Right	Thru	Left	Peds	App. Total	Right	Thru	Left	Peds	App. Total	Right	Thru	Left	Peds	App. Total	Right	Thru	Left	Peds	App. Total	
Peak Hour Analysis From 4:00:00 PM to 5:45:00 PM - Peak 1 of 1																					
Peak Hour for Each Approach Begins at:																					
	4:00:00 PM					4:00:00 PM					4:15:00 PM					4:00:00 PM					
+0 mins.	1	35	6	0	42	0	0	6	0	6	1	43	0	0	44	1	1	1	0	3	
+5 mins.	1	29	0	0	30	0	0	2	0	2	0	41	3	0	44	0	0	0	0	0	
+10 mins.	0	40	0	0	40	4	0	5	0	9	2	30	0	0	32	0	1	1	1	2	
+15 mins.	0	36	0	0	36	0	1	6	0	7	1	45	0	0	46	0	0	1	0	1	
Total Volume	2	140	6	0	148	4	1	19	0	24	4	159	3	0	166	1	2	3	0	6	
% App. Total	1.4	94.6	4.1	0		16.7	4.2	79.2	0		2.4	95.8	1.8	0		16.7	33.3	50	0		
PHF	.500	.875	.250	.000	.881	.250	.250	.792	.000	.667	.500	.883	.250	.000	.902	.250	.500	.750	.000	.500	

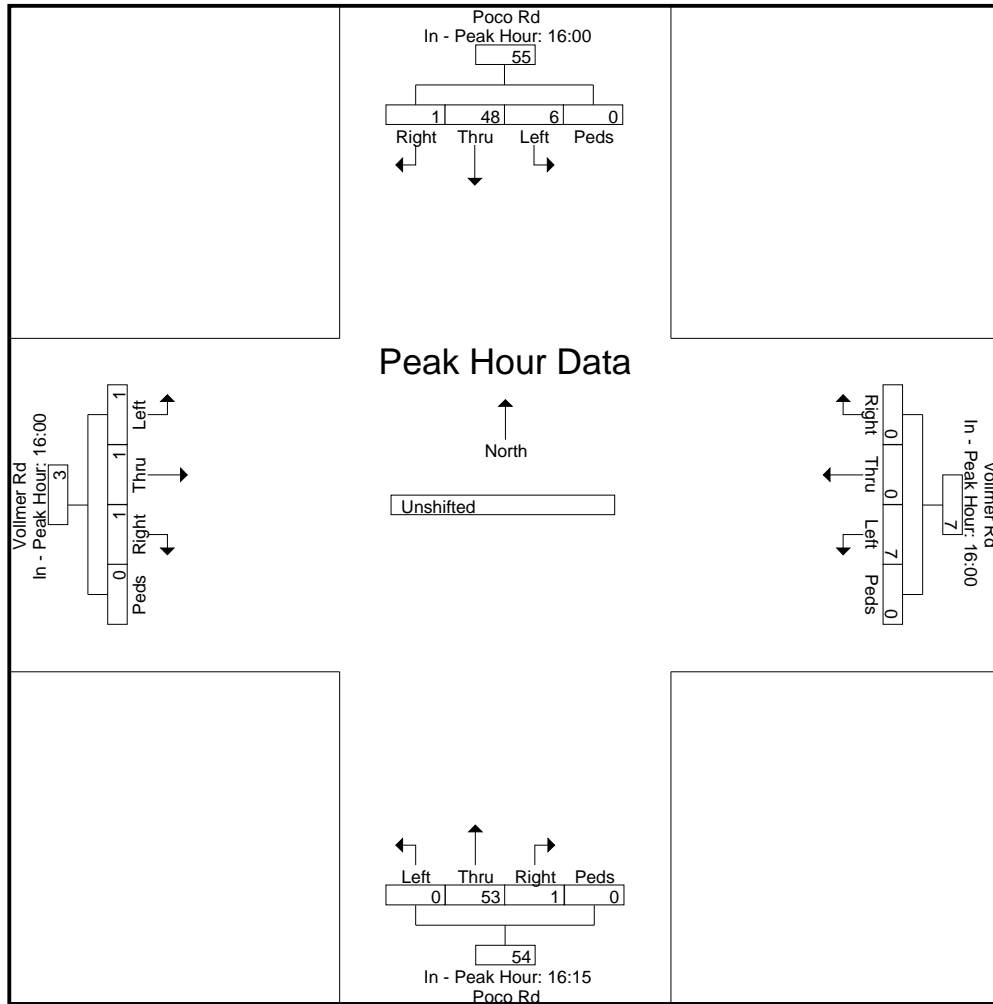

LSC Transportation Consultants, Inc.

2504 E. Pikes Peak Ave, Suite 304
 Colorado Springs, CO 80909
 719-633-2868

File Name : Vollmer Rd - Arroya Ln AM

Site Code : S224350

Start Date : 6/8/2022

Page No : 1

Groups Printed- Unshifted

Start Time	Vollmer Rd Southbound					Arroya Ln Westbound					Vollmer Rd Northbound					Eastbound					Int. Total	
	Right	Thru	Left	Peds	App. Total	Right	Thru	Left	Peds	App. Total	Right	Thru	Left	Peds	App. Total	Right	Thru	Left	Peds	App. Total		
06:30	0	29	0	0	29	0	0	0	0	0	0	10	0	0	10	0	0	0	0	0	0	39
06:45	0	24	0	0	24	0	0	0	0	0	0	10	0	0	10	0	0	0	0	0	0	34
Total	0	53	0	0	53	0	0	0	0	0	0	20	0	0	20	0	0	0	0	0	0	73
07:00	0	26	0	0	26	0	0	0	0	0	0	19	0	0	19	0	0	0	0	0	0	45
07:15	0	33	0	0	33	0	0	0	0	0	0	25	0	0	25	0	0	0	0	0	0	58
07:30	0	41	0	0	41	0	0	0	0	0	0	32	0	0	32	0	0	0	0	0	0	73
07:45	0	24	0	0	24	0	0	0	0	0	0	18	0	0	18	0	0	0	0	0	0	42
Total	0	124	0	0	124	0	0	0	0	0	0	94	0	0	94	0	0	0	0	0	0	218
08:00	0	32	0	0	32	0	0	0	0	0	0	27	0	0	27	0	0	0	0	0	0	59
08:15	0	31	0	0	31	0	0	0	0	0	0	22	0	0	22	0	0	0	0	0	0	53
Grand Total	0	240	0	0	240	0	0	0	0	0	0	163	0	0	163	0	0	0	0	0	0	403
Apprch %	0	100	0	0		0	0	0	0		0	100	0	0		0	0	0	0			
Total %	0	59.6	0	0	59.6	0	0	0	0	0	0	40.4	0	0	40.4	0	0	0	0	0	0	

LSC Transportation Consultants, Inc.

2504 E. Pikes Peak Ave, Suite 304
 Colorado Springs, CO 80909
 719-633-2868

File Name : Vollmer Rd - Arroya Ln PM

Site Code : S224350

Start Date : 6/8/2022

Page No : 1

Groups Printed- Unshifted

Start Time	Vollmer Rd Southbound					Arroya Ln Westbound					Vollmer Rd Northbound					Eastbound					Int. Total
	Right	Thru	Left	Peds	App. Total	Right	Thru	Left	Peds	App. Total	Right	Thru	Left	Peds	App. Total	Right	Thru	Left	Peds	App. Total	
16:00	0	27	0	0	27	2	0	0	0	2	0	36	0	0	36	0	0	0	0	0	65
16:15	0	28	0	0	28	0	0	0	0	0	1	45	0	0	46	0	0	0	0	0	74
16:30	0	32	0	0	32	0	0	1	0	1	0	36	0	0	36	0	0	0	0	0	69
16:45	0	31	0	0	31	0	0	0	0	0	0	46	0	0	46	0	0	0	0	0	77
Total	0	118	0	0	118	2	0	1	0	3	1	163	0	0	164	0	0	0	0	0	285
17:00	0	45	0	0	45	0	0	0	0	0	0	40	0	0	40	0	0	0	0	0	85
17:15	0	25	0	0	25	0	0	1	0	1	2	47	0	0	49	0	0	0	0	0	75
17:30	0	33	0	0	33	0	0	0	0	0	0	39	0	0	39	0	0	0	0	0	72
17:45	0	18	0	0	18	1	0	0	0	1	0	35	0	0	35	0	0	0	0	0	54
Total	0	121	0	0	121	1	0	1	0	2	2	161	0	0	163	0	0	0	0	0	286
Grand Total	0	239	0	0	239	3	0	2	0	5	3	324	0	0	327	0	0	0	0	0	571
Apprch %	0	100	0	0		60	0	40	0		0.9	99.1	0	0		0	0	0	0		
Total %	0	41.9	0	0	41.9	0.5	0	0.4	0	0.9	0.5	56.7	0	0	57.3	0	0	0	0	0	

Levels of Service



Intersection												
Int Delay, s/veh	1											
Movement	EBL	EBT	EBR	WBL	WBT	WBR	NBL	NBT	NBR	SBL	SBT	SBR
Lane Configurations		↕			↕			↕	↕		↕	
Traffic Vol, veh/h	2	1	3	9	0	7	4	118	37	4	174	2
Future Vol, veh/h	2	1	3	9	0	7	4	118	37	4	174	2
Conflicting Peds, #/hr	0	0	0	0	0	0	0	0	0	0	0	0
Sign Control	Stop	Stop	Stop	Stop	Stop	Stop	Free	Free	Free	Free	Free	Free
RT Channelized	-	-	None	-	-	None	-	-	None	-	-	None
Storage Length	-	-	-	-	-	-	-	-	-	-	-	-
Veh in Median Storage, #	-	0	-	-	0	-	-	0	-	-	0	-
Grade, %	-	0	-	-	0	-	-	0	-	-	0	-
Peak Hour Factor	50	50	50	67	67	67	87	87	87	67	67	67
Heavy Vehicles, %	2	2	2	2	2	2	2	2	2	2	2	2
Mvmt Flow	4	2	6	13	0	10	5	136	43	6	260	3

Major/Minor	Minor2		Minor1		Major1		Major2					
Conflicting Flow All	447	463	262	424	421	136	263	0	0	179	0	0
Stage 1	274	274	-	146	146	-	-	-	-	-	-	-
Stage 2	173	189	-	278	275	-	-	-	-	-	-	-
Critical Hdwy	7.12	6.52	6.22	7.12	6.52	6.22	4.12	-	-	4.12	-	-
Critical Hdwy Stg 1	6.12	5.52	-	6.12	5.52	-	-	-	-	-	-	-
Critical Hdwy Stg 2	6.12	5.52	-	6.12	5.52	-	-	-	-	-	-	-
Follow-up Hdwy	3.518	4.018	3.318	3.518	4.018	3.318	2.218	-	-	2.218	-	-
Pot Cap-1 Maneuver	522	496	777	540	524	913	1301	-	-	1397	-	-
Stage 1	732	683	-	857	776	-	-	-	-	-	-	-
Stage 2	829	744	-	728	683	-	-	-	-	-	-	-
Platoon blocked, %								-	-	-	-	-
Mov Cap-1 Maneuver	513	492	777	530	519	913	1301	-	-	1397	-	-
Mov Cap-2 Maneuver	513	492	-	530	519	-	-	-	-	-	-	-
Stage 1	729	680	-	854	773	-	-	-	-	-	-	-
Stage 2	816	741	-	717	680	-	-	-	-	-	-	-

Approach	EB		WB		NB		SB	
HCM Control Delay, s	11		10.8		0.2		0.2	
HCM LOS	B		B					

Minor Lane/Major Mvmt	NBL	NBT	NBR	EBLn1	WBLn1	SBL	SBT	SBR
Capacity (veh/h)	1301	-	-	613	649	1397	-	-
HCM Lane V/C Ratio	0.004	-	-	0.02	0.037	0.004	-	-
HCM Control Delay (s)	7.8	0	-	11	10.8	7.6	0	-
HCM Lane LOS	A	A	-	B	B	A	A	-
HCM 95th %tile Q(veh)	0	-	-	0.1	0.1	0	-	-

Intersection						
Int Delay, s/veh	0					
Movement	WBL	WBR	NBT	NBR	SBL	SBT
Lane Configurations						
Traffic Vol, veh/h	0	0	102	0	0	130
Future Vol, veh/h	0	0	102	0	0	130
Conflicting Peds, #/hr	0	0	0	0	0	0
Sign Control	Stop	Stop	Free	Free	Free	Free
RT Channelized	-	None	-	None	-	None
Storage Length	0	-	-	-	-	-
Veh in Median Storage, #	0	-	0	-	-	0
Grade, %	0	-	0	-	-	0
Peak Hour Factor	85	85	80	80	79	79
Heavy Vehicles, %	2	2	2	2	2	2
Mvmt Flow	0	0	128	0	0	165

Major/Minor	Minor1	Major1	Major2		
Conflicting Flow All	293	128	0	0	128
Stage 1	128	-	-	-	-
Stage 2	165	-	-	-	-
Critical Hdwy	6.42	6.22	-	-	4.12
Critical Hdwy Stg 1	5.42	-	-	-	-
Critical Hdwy Stg 2	5.42	-	-	-	-
Follow-up Hdwy	3.518	3.318	-	-	2.218
Pot Cap-1 Maneuver	698	922	-	-	1458
Stage 1	898	-	-	-	-
Stage 2	864	-	-	-	-
Platoon blocked, %			-	-	-
Mov Cap-1 Maneuver	698	922	-	-	1458
Mov Cap-2 Maneuver	698	-	-	-	-
Stage 1	898	-	-	-	-
Stage 2	864	-	-	-	-

Approach	WB	NB	SB
HCM Control Delay, s	0	0	0
HCM LOS	A		

Minor Lane/Major Mvmt	NBT	NBRWBLn1	SBL	SBT
Capacity (veh/h)	-	-	-	1458
HCM Lane V/C Ratio	-	-	-	-
HCM Control Delay (s)	-	-	0	0
HCM Lane LOS	-	-	A	A
HCM 95th %tile Q(veh)	-	-	-	0

Intersection												
Int Delay, s/veh	1.3											
Movement	EBL	EBT	EBR	WBL	WBT	WBR	NBL	NBT	NBR	SBL	SBT	SBR
Lane Configurations		↕			↕			↕	↕		↕	
Traffic Vol, veh/h	3	1	2	15	1	4	5	155	5	1	140	1
Future Vol, veh/h	3	1	2	15	1	4	5	155	5	1	140	1
Conflicting Peds, #/hr	0	0	0	0	0	0	0	0	0	0	0	0
Sign Control	Stop	Stop	Stop	Stop	Stop	Stop	Free	Free	Free	Free	Free	Free
RT Channelized	-	-	None	-	-	None	-	-	None	-	-	None
Storage Length	-	-	-	-	-	-	-	-	-	-	-	-
Veh in Median Storage, #	-	0	-	-	0	-	-	0	-	-	0	-
Grade, %	-	0	-	-	0	-	-	0	-	-	0	-
Peak Hour Factor	78	78	78	56	56	56	87	87	87	89	89	89
Heavy Vehicles, %	2	2	2	2	2	2	2	2	2	2	2	2
Mvmt Flow	4	1	3	27	2	7	6	178	6	1	157	1

Major/Minor	Minor2		Minor1		Major1		Major2					
Conflicting Flow All	358	356	158	352	350	178	158	0	0	184	0	0
Stage 1	160	160	-	190	190	-	-	-	-	-	-	-
Stage 2	198	196	-	162	160	-	-	-	-	-	-	-
Critical Hdwy	7.12	6.52	6.22	7.12	6.52	6.22	4.12	-	-	4.12	-	-
Critical Hdwy Stg 1	6.12	5.52	-	6.12	5.52	-	-	-	-	-	-	-
Critical Hdwy Stg 2	6.12	5.52	-	6.12	5.52	-	-	-	-	-	-	-
Follow-up Hdwy	3.518	4.018	3.318	3.518	4.018	3.318	2.218	-	-	2.218	-	-
Pot Cap-1 Maneuver	597	570	887	603	574	865	1422	-	-	1391	-	-
Stage 1	842	766	-	812	743	-	-	-	-	-	-	-
Stage 2	804	739	-	840	766	-	-	-	-	-	-	-
Platoon blocked, %								-	-	-	-	-
Mov Cap-1 Maneuver	588	567	887	598	571	865	1422	-	-	1391	-	-
Mov Cap-2 Maneuver	588	567	-	598	571	-	-	-	-	-	-	-
Stage 1	838	765	-	808	739	-	-	-	-	-	-	-
Stage 2	791	735	-	835	765	-	-	-	-	-	-	-

Approach	EB		WB		NB		SB	
HCM Control Delay, s	10.5		11		0.2		0.1	
HCM LOS	B		B					

Minor Lane/Major Mvmt	NBL	NBT	NBR	EBLn1	WBLn1	SBL	SBT	SBR
Capacity (veh/h)	1422	-	-	658	636	1391	-	-
HCM Lane V/C Ratio	0.004	-	-	0.012	0.056	0.001	-	-
HCM Control Delay (s)	7.5	0	-	10.5	11	7.6	0	-
HCM Lane LOS	A	A	-	B	B	A	A	-
HCM 95th %tile Q(veh)	0	-	-	0	0.2	0	-	-

Intersection						
Int Delay, s/veh	0					
Movement	WBL	WBR	NBT	NBR	SBL	SBT
Lane Configurations						
Traffic Vol, veh/h	1	0	172	2	0	134
Future Vol, veh/h	1	0	172	2	0	134
Conflicting Peds, #/hr	0	0	0	0	0	0
Sign Control	Stop	Stop	Free	Free	Free	Free
RT Channelized	-	None	-	None	-	None
Storage Length	0	-	-	-	-	-
Veh in Median Storage, #	0	-	0	-	-	0
Grade, %	0	-	0	-	-	0
Peak Hour Factor	85	85	87	87	74	74
Heavy Vehicles, %	2	2	2	2	2	2
Mvmt Flow	1	0	198	2	0	181

Major/Minor	Minor1	Major1	Major2		
Conflicting Flow All	380	199	0	0	200
Stage 1	199	-	-	-	-
Stage 2	181	-	-	-	-
Critical Hdwy	6.42	6.22	-	-	4.12
Critical Hdwy Stg 1	5.42	-	-	-	-
Critical Hdwy Stg 2	5.42	-	-	-	-
Follow-up Hdwy	3.518	3.318	-	-	2.218
Pot Cap-1 Maneuver	622	842	-	-	1372
Stage 1	835	-	-	-	-
Stage 2	850	-	-	-	-
Platoon blocked, %			-	-	-
Mov Cap-1 Maneuver	622	842	-	-	1372
Mov Cap-2 Maneuver	622	-	-	-	-
Stage 1	835	-	-	-	-
Stage 2	850	-	-	-	-

Approach	WB	NB	SB
HCM Control Delay, s	10.8	0	0
HCM LOS	B		

Minor Lane/Major Mvmt	NBT	NBRWBLn1	SBL	SBT
Capacity (veh/h)	-	-	622	1372
HCM Lane V/C Ratio	-	-	0.002	-
HCM Control Delay (s)	-	-	10.8	0
HCM Lane LOS	-	-	B	A
HCM 95th %tile Q(veh)	-	-	0	0

Intersection												
Int Delay, s/veh	2.9											
Movement	EBL	EBT	EBR	WBL	WBT	WBR	NBL	NBT	NBR	SBL	SBT	SBR
Lane Configurations		↕			↕			↕	↕		↕	
Traffic Vol, veh/h	2	0	3	84	0	16	4	172	29	5	201	2
Future Vol, veh/h	2	0	3	84	0	16	4	172	29	5	201	2
Conflicting Peds, #/hr	0	0	0	0	0	0	0	0	0	0	0	0
Sign Control	Stop	Stop	Stop	Stop	Stop	Stop	Free	Free	Free	Free	Free	Free
RT Channelized	-	-	None	-	-	None	-	-	None	-	-	None
Storage Length	-	-	-	-	-	-	-	-	-	-	-	-
Veh in Median Storage, #	-	0	-	-	0	-	-	0	-	-	0	-
Grade, %	-	0	-	-	0	-	-	0	-	-	0	-
Peak Hour Factor	50	50	50	85	85	85	87	87	87	67	67	67
Heavy Vehicles, %	2	2	2	2	2	2	2	2	2	2	2	2
Mvmt Flow	4	0	6	99	0	19	5	198	33	7	300	3

Major/Minor	Minor2		Minor1		Major1		Major2					
Conflicting Flow All	550	557	302	527	525	198	303	0	0	231	0	0
Stage 1	316	316	-	208	208	-	-	-	-	-	-	-
Stage 2	234	241	-	319	317	-	-	-	-	-	-	-
Critical Hdwy	7.12	6.52	6.22	7.12	6.52	6.22	4.12	-	-	4.12	-	-
Critical Hdwy Stg 1	6.12	5.52	-	6.12	5.52	-	-	-	-	-	-	-
Critical Hdwy Stg 2	6.12	5.52	-	6.12	5.52	-	-	-	-	-	-	-
Follow-up Hdwy	3.518	4.018	3.318	3.518	4.018	3.318	2.218	-	-	2.218	-	-
Pot Cap-1 Maneuver	446	439	738	462	458	843	1258	-	-	1337	-	-
Stage 1	695	655	-	794	730	-	-	-	-	-	-	-
Stage 2	769	706	-	693	654	-	-	-	-	-	-	-
Platoon blocked, %								-	-	-	-	-
Mov Cap-1 Maneuver	432	434	738	455	453	843	1258	-	-	1337	-	-
Mov Cap-2 Maneuver	432	434	-	455	453	-	-	-	-	-	-	-
Stage 1	692	651	-	790	726	-	-	-	-	-	-	-
Stage 2	748	702	-	683	650	-	-	-	-	-	-	-

Approach	EB		WB		NB		SB	
HCM Control Delay, s	11.4		14.6		0.2		0.2	
HCM LOS	B		B					

Minor Lane/Major Mvmt	NBL	NBT	NBR	EBLn1	WBLn1	SBL	SBT	SBR
Capacity (veh/h)	1258	-	-	575	491	1337	-	-
HCM Lane V/C Ratio	0.004	-	-	0.017	0.24	0.006	-	-
HCM Control Delay (s)	7.9	0	-	11.4	14.6	7.7	0	-
HCM Lane LOS	A	A	-	B	B	A	A	-
HCM 95th %tile Q(veh)	0	-	-	0.1	0.9	0	-	-

Intersection						
Int Delay, s/veh	0.1					
Movement	WBL	WBR	NBT	NBR	SBL	SBT
Lane Configurations	W	W	T	T	T	T
Traffic Vol, veh/h	2	2	166	0	1	194
Future Vol, veh/h	2	2	166	0	1	194
Conflicting Peds, #/hr	0	0	0	0	0	0
Sign Control	Stop	Stop	Free	Free	Free	Free
RT Channelized	-	None	-	None	-	None
Storage Length	0	-	-	-	-	-
Veh in Median Storage, #	0	-	0	-	-	0
Grade, %	0	-	0	-	-	0
Peak Hour Factor	85	85	87	87	67	67
Heavy Vehicles, %	2	2	2	2	2	2
Mvmt Flow	2	2	191	0	1	290

Major/Minor	Minor1	Major1	Major2			
Conflicting Flow All	483	191	0	0	191	0
Stage 1	191	-	-	-	-	-
Stage 2	292	-	-	-	-	-
Critical Hdwy	6.42	6.22	-	-	4.12	-
Critical Hdwy Stg 1	5.42	-	-	-	-	-
Critical Hdwy Stg 2	5.42	-	-	-	-	-
Follow-up Hdwy	3.518	3.318	-	-	2.218	-
Pot Cap-1 Maneuver	542	851	-	-	1383	-
Stage 1	841	-	-	-	-	-
Stage 2	758	-	-	-	-	-
Platoon blocked, %			-	-	-	-
Mov Cap-1 Maneuver	541	851	-	-	1383	-
Mov Cap-2 Maneuver	541	-	-	-	-	-
Stage 1	841	-	-	-	-	-
Stage 2	757	-	-	-	-	-

Approach	WB	NB	SB
HCM Control Delay, s	10.5	0	0
HCM LOS	B		

Minor Lane/Major Mvmt	NBT	NBRWBLn1	SBL	SBT
Capacity (veh/h)	-	-	661	1383
HCM Lane V/C Ratio	-	-	0.007	0.001
HCM Control Delay (s)	-	-	10.5	7.6
HCM Lane LOS	-	-	B	A
HCM 95th %tile Q(veh)	-	-	0	0

Intersection												
Int Delay, s/veh	2											
Movement	EBL	EBT	EBR	WBL	WBT	WBR	NBL	NBT	NBR	SBL	SBT	SBR
Lane Configurations		↕			↕			↕	↕		↕	
Traffic Vol, veh/h	3	0	2	53	0	13	5	195	93	20	202	1
Future Vol, veh/h	3	0	2	53	0	13	5	195	93	20	202	1
Conflicting Peds, #/hr	0	0	0	0	0	0	0	0	0	0	0	0
Sign Control	Stop	Stop	Stop	Stop	Stop	Stop	Free	Free	Free	Free	Free	Free
RT Channelized	-	-	None	-	-	None	-	-	None	-	-	None
Storage Length	-	-	-	-	-	-	-	-	-	-	-	-
Veh in Median Storage, #	-	0	-	-	0	-	-	0	-	-	0	-
Grade, %	-	0	-	-	0	-	-	0	-	-	0	-
Peak Hour Factor	78	78	78	85	85	85	87	87	87	89	89	89
Heavy Vehicles, %	2	2	2	2	2	2	2	2	2	2	2	2
Mvmt Flow	4	0	3	62	0	15	6	224	107	22	227	1

Major/Minor	Minor2		Minor1		Major1		Major2					
Conflicting Flow All	569	615	228	509	508	224	228	0	0	331	0	0
Stage 1	272	272	-	236	236	-	-	-	-	-	-	-
Stage 2	297	343	-	273	272	-	-	-	-	-	-	-
Critical Hdwy	7.12	6.52	6.22	7.12	6.52	6.22	4.12	-	-	4.12	-	-
Critical Hdwy Stg 1	6.12	5.52	-	6.12	5.52	-	-	-	-	-	-	-
Critical Hdwy Stg 2	6.12	5.52	-	6.12	5.52	-	-	-	-	-	-	-
Follow-up Hdwy	3.518	4.018	3.318	3.518	4.018	3.318	2.218	-	-	2.218	-	-
Pot Cap-1 Maneuver	433	407	811	475	468	815	1340	-	-	1228	-	-
Stage 1	734	685	-	767	710	-	-	-	-	-	-	-
Stage 2	712	637	-	733	685	-	-	-	-	-	-	-
Platoon blocked, %								-	-	-	-	-
Mov Cap-1 Maneuver	416	396	811	464	455	815	1340	-	-	1228	-	-
Mov Cap-2 Maneuver	416	396	-	464	455	-	-	-	-	-	-	-
Stage 1	730	671	-	762	706	-	-	-	-	-	-	-
Stage 2	694	633	-	715	671	-	-	-	-	-	-	-

Approach	EB		WB		NB		SB	
HCM Control Delay, s	12.1		13.4		0.1		0.7	
HCM LOS	B		B					

Minor Lane/Major Mvmt	NBL	NBT	NBR	EBLn1	WBLn1	SBL	SBT	SBR
Capacity (veh/h)	1340	-	-	517	507	1228	-	-
HCM Lane V/C Ratio	0.004	-	-	0.012	0.153	0.018	-	-
HCM Control Delay (s)	7.7	0	-	12.1	13.4	8	0	-
HCM Lane LOS	A	A	-	B	B	A	A	-
HCM 95th %tile Q(veh)	0	-	-	0	0.5	0.1	-	-

Intersection						
Int Delay, s/veh	0.1					
Movement	WBL	WBR	NBT	NBR	SBL	SBT
Lane Configurations						
Traffic Vol, veh/h	1	1	189	2	2	194
Future Vol, veh/h	1	1	189	2	2	194
Conflicting Peds, #/hr	0	0	0	0	0	0
Sign Control	Stop	Stop	Free	Free	Free	Free
RT Channelized	-	None	-	None	-	None
Storage Length	0	-	-	-	-	-
Veh in Median Storage, #	0	-	0	-	-	0
Grade, %	0	-	0	-	-	0
Peak Hour Factor	85	85	87	87	89	89
Heavy Vehicles, %	2	2	2	2	2	2
Mvmt Flow	1	1	217	2	2	218

Major/Minor	Minor1	Major1	Major2		
Conflicting Flow All	440	218	0	0	219
Stage 1	218	-	-	-	-
Stage 2	222	-	-	-	-
Critical Hdwy	6.42	6.22	-	-	4.12
Critical Hdwy Stg 1	5.42	-	-	-	-
Critical Hdwy Stg 2	5.42	-	-	-	-
Follow-up Hdwy	3.518	3.318	-	-	2.218
Pot Cap-1 Maneuver	574	822	-	-	1350
Stage 1	818	-	-	-	-
Stage 2	815	-	-	-	-
Platoon blocked, %			-	-	-
Mov Cap-1 Maneuver	573	822	-	-	1350
Mov Cap-2 Maneuver	573	-	-	-	-
Stage 1	818	-	-	-	-
Stage 2	813	-	-	-	-

Approach	WB	NB	SB
HCM Control Delay, s	10.4	0	0.1
HCM LOS	B		

Minor Lane/Major Mvmt	NBT	NBRWBLn1	SBL	SBT
Capacity (veh/h)	-	-	675	1350
HCM Lane V/C Ratio	-	-	0.003	0.002
HCM Control Delay (s)	-	-	10.4	7.7
HCM Lane LOS	-	-	B	A
HCM 95th %tile Q(veh)	-	-	0	0

Intersection												
Int Delay, s/veh	3.1											
Movement	EBL	EBT	EBR	WBL	WBT	WBR	NBL	NBT	NBR	SBL	SBT	SBR
Lane Configurations		↕			↕			↕	↕		↕	
Traffic Vol, veh/h	2	0	3	92	0	16	4	174	32	5	207	2
Future Vol, veh/h	2	0	3	92	0	16	4	174	32	5	207	2
Conflicting Peds, #/hr	0	0	0	0	0	0	0	0	0	0	0	0
Sign Control	Stop	Stop	Stop	Stop	Stop	Stop	Free	Free	Free	Free	Free	Free
RT Channelized	-	-	None	-	-	None	-	-	None	-	-	None
Storage Length	-	-	-	-	-	-	-	-	-	-	-	-
Veh in Median Storage, #	-	0	-	-	0	-	-	0	-	-	0	-
Grade, %	-	0	-	-	0	-	-	0	-	-	0	-
Peak Hour Factor	50	50	50	85	85	85	87	87	87	67	67	67
Heavy Vehicles, %	2	2	2	2	2	2	2	2	2	2	2	2
Mvmt Flow	4	0	6	108	0	19	5	200	37	7	309	3

Major/Minor	Minor2		Minor1		Major1		Major2					
Conflicting Flow All	563	572	311	538	536	200	312	0	0	237	0	0
Stage 1	325	325	-	210	210	-	-	-	-	-	-	-
Stage 2	238	247	-	328	326	-	-	-	-	-	-	-
Critical Hdwy	7.12	6.52	6.22	7.12	6.52	6.22	4.12	-	-	4.12	-	-
Critical Hdwy Stg 1	6.12	5.52	-	6.12	5.52	-	-	-	-	-	-	-
Critical Hdwy Stg 2	6.12	5.52	-	6.12	5.52	-	-	-	-	-	-	-
Follow-up Hdwy	3.518	4.018	3.318	3.518	4.018	3.318	2.218	-	-	2.218	-	-
Pot Cap-1 Maneuver	437	430	729	454	451	841	1248	-	-	1330	-	-
Stage 1	687	649	-	792	728	-	-	-	-	-	-	-
Stage 2	765	702	-	685	648	-	-	-	-	-	-	-
Platoon blocked, %								-	-	-	-	-
Mov Cap-1 Maneuver	423	425	729	446	446	841	1248	-	-	1330	-	-
Mov Cap-2 Maneuver	423	425	-	446	446	-	-	-	-	-	-	-
Stage 1	684	645	-	788	724	-	-	-	-	-	-	-
Stage 2	744	698	-	675	644	-	-	-	-	-	-	-

Approach	EB		WB		NB		SB	
HCM Control Delay, s	11.5		15.2		0.2		0.2	
HCM LOS	B		C					

Minor Lane/Major Mvmt	NBL	NBT	NBR	EBLn1	WBLn1	SBL	SBT	SBR
Capacity (veh/h)	1248	-	-	565	479	1330	-	-
HCM Lane V/C Ratio	0.004	-	-	0.018	0.265	0.006	-	-
HCM Control Delay (s)	7.9	0	-	11.5	15.2	7.7	0	-
HCM Lane LOS	A	A	-	B	C	A	A	-
HCM 95th %tile Q(veh)	0	-	-	0.1	1.1	0	-	-

Intersection						
Int Delay, s/veh	0.4					
Movement	WBL	WBR	NBT	NBR	SBL	SBT
Lane Configurations						
Traffic Vol, veh/h	8	5	166	2	2	194
Future Vol, veh/h	8	5	166	2	2	194
Conflicting Peds, #/hr	0	0	0	0	0	0
Sign Control	Stop	Stop	Free	Free	Free	Free
RT Channelized	-	None	-	None	-	None
Storage Length	0	-	-	-	-	-
Veh in Median Storage, #	0	-	0	-	-	0
Grade, %	0	-	0	-	-	0
Peak Hour Factor	85	85	87	87	67	67
Heavy Vehicles, %	2	2	2	2	2	2
Mvmt Flow	9	6	191	2	3	290

Major/Minor	Minor1	Major1	Major2		
Conflicting Flow All	488	192	0	0	193
Stage 1	192	-	-	-	-
Stage 2	296	-	-	-	-
Critical Hdwy	6.42	6.22	-	-	4.12
Critical Hdwy Stg 1	5.42	-	-	-	-
Critical Hdwy Stg 2	5.42	-	-	-	-
Follow-up Hdwy	3.518	3.318	-	-	2.218
Pot Cap-1 Maneuver	539	850	-	-	1380
Stage 1	841	-	-	-	-
Stage 2	755	-	-	-	-
Platoon blocked, %			-	-	-
Mov Cap-1 Maneuver	537	850	-	-	1380
Mov Cap-2 Maneuver	537	-	-	-	-
Stage 1	841	-	-	-	-
Stage 2	753	-	-	-	-

Approach	WB	NB	SB
HCM Control Delay, s	10.9	0	0.1
HCM LOS	B		

Minor Lane/Major Mvmt	NBT	NBRWBLn1	SBL	SBT
Capacity (veh/h)	-	-	626	1380
HCM Lane V/C Ratio	-	-	0.024	0.002
HCM Control Delay (s)	-	-	10.9	7.6
HCM Lane LOS	-	-	B	A
HCM 95th %tile Q(veh)	-	-	0.1	0

Intersection												
Int Delay, s/veh	2.1											
Movement	EBL	EBT	EBR	WBL	WBT	WBR	NBL	NBT	NBR	SBL	SBT	SBR
Lane Configurations		↕			↕			↕	↕		↕	
Traffic Vol, veh/h	3	0	2	58	0	13	5	202	103	20	206	1
Future Vol, veh/h	3	0	2	58	0	13	5	202	103	20	206	1
Conflicting Peds, #/hr	0	0	0	0	0	0	0	0	0	0	0	0
Sign Control	Stop	Stop	Stop	Stop	Stop	Stop	Free	Free	Free	Free	Free	Free
RT Channelized	-	-	None	-	-	None	-	-	None	-	-	None
Storage Length	-	-	-	-	-	-	-	-	-	-	-	-
Veh in Median Storage, #	-	0	-	-	0	-	-	0	-	-	0	-
Grade, %	-	0	-	-	0	-	-	0	-	-	0	-
Peak Hour Factor	78	78	78	85	85	85	87	87	87	89	89	89
Heavy Vehicles, %	2	2	2	2	2	2	2	2	2	2	2	2
Mvmt Flow	4	0	3	68	0	15	6	232	118	22	231	1

Major/Minor	Minor2		Minor1		Major1		Major2					
Conflicting Flow All	587	638	232	521	520	232	232	0	0	350	0	0
Stage 1	276	276	-	244	244	-	-	-	-	-	-	-
Stage 2	311	362	-	277	276	-	-	-	-	-	-	-
Critical Hdwy	7.12	6.52	6.22	7.12	6.52	6.22	4.12	-	-	4.12	-	-
Critical Hdwy Stg 1	6.12	5.52	-	6.12	5.52	-	-	-	-	-	-	-
Critical Hdwy Stg 2	6.12	5.52	-	6.12	5.52	-	-	-	-	-	-	-
Follow-up Hdwy	3.518	4.018	3.318	3.518	4.018	3.318	2.218	-	-	2.218	-	-
Pot Cap-1 Maneuver	421	394	807	466	461	807	1336	-	-	1209	-	-
Stage 1	730	682	-	760	704	-	-	-	-	-	-	-
Stage 2	699	625	-	729	682	-	-	-	-	-	-	-
Platoon blocked, %								-	-	-	-	-
Mov Cap-1 Maneuver	405	383	807	455	449	807	1336	-	-	1209	-	-
Mov Cap-2 Maneuver	405	383	-	455	449	-	-	-	-	-	-	-
Stage 1	726	668	-	755	700	-	-	-	-	-	-	-
Stage 2	682	621	-	711	668	-	-	-	-	-	-	-

Approach	EB	WB	NB	SB
HCM Control Delay, s	12.2	13.8	0.1	0.7
HCM LOS	B	B		

Minor Lane/Major Mvmt	NBL	NBT	NBR	EBLn1	WBLn1	SBL	SBT	SBR
Capacity (veh/h)	1336	-	-	506	494	1209	-	-
HCM Lane V/C Ratio	0.004	-	-	0.013	0.169	0.019	-	-
HCM Control Delay (s)	7.7	0	-	12.2	13.8	8	0	-
HCM Lane LOS	A	A	-	B	B	A	A	-
HCM 95th %tile Q(veh)	0	-	-	0	0.6	0.1	-	-

Intersection						
Int Delay, s/veh	0.3					
Movement	WBL	WBR	NBT	NBR	SBL	SBT
Lane Configurations						
Traffic Vol, veh/h	5	3	189	9	5	194
Future Vol, veh/h	5	3	189	9	5	194
Conflicting Peds, #/hr	0	0	0	0	0	0
Sign Control	Stop	Stop	Free	Free	Free	Free
RT Channelized	-	None	-	None	-	None
Storage Length	0	-	-	-	-	-
Veh in Median Storage, #	0	-	0	-	-	0
Grade, %	0	-	0	-	-	0
Peak Hour Factor	85	85	87	87	89	89
Heavy Vehicles, %	2	2	2	2	2	2
Mvmt Flow	6	4	217	10	6	218

Major/Minor	Minor1	Major1	Major2			
Conflicting Flow All	452	222	0	0	227	0
Stage 1	222	-	-	-	-	-
Stage 2	230	-	-	-	-	-
Critical Hdwy	6.42	6.22	-	-	4.12	-
Critical Hdwy Stg 1	5.42	-	-	-	-	-
Critical Hdwy Stg 2	5.42	-	-	-	-	-
Follow-up Hdwy	3.518	3.318	-	-	2.218	-
Pot Cap-1 Maneuver	565	818	-	-	1341	-
Stage 1	815	-	-	-	-	-
Stage 2	808	-	-	-	-	-
Platoon blocked, %			-	-		-
Mov Cap-1 Maneuver	562	818	-	-	1341	-
Mov Cap-2 Maneuver	562	-	-	-	-	-
Stage 1	815	-	-	-	-	-
Stage 2	804	-	-	-	-	-

Approach	WB	NB	SB
HCM Control Delay, s	10.7	0	0.2
HCM LOS	B		

Minor Lane/Major Mvmt	NBT	NBRWBLn1	SBL	SBT
Capacity (veh/h)	-	-	637	1341
HCM Lane V/C Ratio	-	-	0.015	0.004
HCM Control Delay (s)	-	-	10.7	7.7
HCM Lane LOS	-	-	B	A
HCM 95th %tile Q(veh)	-	-	0	0

Intersection												
Int Delay, s/veh	1.6											
Movement	EBL	EBT	EBR	WBL	WBT	WBR	NBL	NBT	NBR	SBL	SBT	SBR
Lane Configurations		↕			↕			↕	↕		↕	
Traffic Vol, veh/h	2	0	3	56	0	4	4	284	20	2	429	2
Future Vol, veh/h	2	0	3	56	0	4	4	284	20	2	429	2
Conflicting Peds, #/hr	0	0	0	0	0	0	0	0	0	0	0	0
Sign Control	Stop	Stop	Stop	Stop	Stop	Stop	Free	Free	Free	Free	Free	Free
RT Channelized	-	-	None	-	-	None	-	-	None	-	-	None
Storage Length	-	-	-	-	-	-	-	-	-	-	-	-
Veh in Median Storage, #	-	0	-	-	0	-	-	0	-	-	0	-
Grade, %	-	0	-	-	0	-	-	0	-	-	0	-
Peak Hour Factor	92	92	92	92	92	92	92	92	92	92	92	92
Heavy Vehicles, %	2	2	2	2	2	2	2	2	2	2	2	2
Mvmt Flow	2	0	3	61	0	4	4	309	22	2	466	2

Major/Minor	Minor2		Minor1		Major1		Major2					
Conflicting Flow All	801	810	467	790	789	309	468	0	0	331	0	0
Stage 1	471	471	-	317	317	-	-	-	-	-	-	-
Stage 2	330	339	-	473	472	-	-	-	-	-	-	-
Critical Hdwy	7.12	6.52	6.22	7.12	6.52	6.22	4.12	-	-	4.12	-	-
Critical Hdwy Stg 1	6.12	5.52	-	6.12	5.52	-	-	-	-	-	-	-
Critical Hdwy Stg 2	6.12	5.52	-	6.12	5.52	-	-	-	-	-	-	-
Follow-up Hdwy	3.518	4.018	3.318	3.518	4.018	3.318	2.218	-	-	2.218	-	-
Pot Cap-1 Maneuver	303	314	596	308	323	731	1094	-	-	1228	-	-
Stage 1	573	560	-	694	654	-	-	-	-	-	-	-
Stage 2	683	640	-	572	559	-	-	-	-	-	-	-
Platoon blocked, %								-	-	-	-	-
Mov Cap-1 Maneuver	300	312	596	305	321	731	1094	-	-	1228	-	-
Mov Cap-2 Maneuver	300	312	-	305	321	-	-	-	-	-	-	-
Stage 1	571	559	-	691	651	-	-	-	-	-	-	-
Stage 2	676	637	-	568	558	-	-	-	-	-	-	-

Approach	EB	WB	NB	SB
HCM Control Delay, s	13.5	19.3	0.1	0
HCM LOS	B	C		

Minor Lane/Major Mvmt	NBL	NBT	NBR	EBLn1	WBLn1	SBL	SBT	SBR
Capacity (veh/h)	1094	-	-	427	317	1228	-	-
HCM Lane V/C Ratio	0.004	-	-	0.013	0.206	0.002	-	-
HCM Control Delay (s)	8.3	0	-	13.5	19.3	7.9	0	-
HCM Lane LOS	A	A	-	B	C	A	A	-
HCM 95th %tile Q(veh)	0	-	-	0	0.8	0	-	-

Intersection						
Int Delay, s/veh	0.2					
Movement	WBL	WBR	NBT	NBR	SBL	SBT
Lane Configurations						
Traffic Vol, veh/h	7	4	285	3	2	421
Future Vol, veh/h	7	4	285	3	2	421
Conflicting Peds, #/hr	0	0	0	0	0	0
Sign Control	Stop	Stop	Free	Free	Free	Free
RT Channelized	-	None	-	None	-	None
Storage Length	0	-	-	-	-	-
Veh in Median Storage, #	0	-	0	-	-	0
Grade, %	0	-	0	-	-	0
Peak Hour Factor	92	92	92	92	92	92
Heavy Vehicles, %	2	2	2	2	2	2
Mvmt Flow	8	4	310	3	2	458

Major/Minor	Minor1	Major1	Major2		
Conflicting Flow All	774	312	0	0	313
Stage 1	312	-	-	-	-
Stage 2	462	-	-	-	-
Critical Hdwy	6.42	6.22	-	-	4.12
Critical Hdwy Stg 1	5.42	-	-	-	-
Critical Hdwy Stg 2	5.42	-	-	-	-
Follow-up Hdwy	3.518	3.318	-	-	2.218
Pot Cap-1 Maneuver	367	728	-	-	1247
Stage 1	742	-	-	-	-
Stage 2	634	-	-	-	-
Platoon blocked, %			-	-	-
Mov Cap-1 Maneuver	366	728	-	-	1247
Mov Cap-2 Maneuver	366	-	-	-	-
Stage 1	742	-	-	-	-
Stage 2	633	-	-	-	-

Approach	WB	NB	SB
HCM Control Delay, s	13.3	0	0
HCM LOS	B		

Minor Lane/Major Mvmt	NBT	NBRWBLn1	SBL	SBT
Capacity (veh/h)	-	-	447	1247
HCM Lane V/C Ratio	-	-	0.027	0.002
HCM Control Delay (s)	-	-	13.3	7.9
HCM Lane LOS	-	-	B	A
HCM 95th %tile Q(veh)	-	-	0.1	0

Intersection												
Int Delay, s/veh	1.4											
Movement	EBL	EBT	EBR	WBL	WBT	WBR	NBL	NBT	NBR	SBL	SBT	SBR
Lane Configurations		↕			↕			↕	↕		↕	
Traffic Vol, veh/h	3	0	2	41	0	4	5	577	73	7	386	1
Future Vol, veh/h	3	0	2	41	0	4	5	577	73	7	386	1
Conflicting Peds, #/hr	0	0	0	0	0	0	0	0	0	0	0	0
Sign Control	Stop	Stop	Stop	Stop	Stop	Stop	Free	Free	Free	Free	Free	Free
RT Channelized	-	-	None	-	-	None	-	-	None	-	-	None
Storage Length	-	-	-	-	-	-	-	-	-	-	-	-
Veh in Median Storage, #	-	0	-	-	0	-	-	0	-	-	0	-
Grade, %	-	0	-	-	0	-	-	0	-	-	0	-
Peak Hour Factor	92	92	92	92	92	92	92	92	92	92	92	92
Heavy Vehicles, %	2	2	2	2	2	2	2	2	2	2	2	2
Mvmt Flow	3	0	2	45	0	4	5	627	79	8	420	1

Major/Minor	Minor2		Minor1		Major1		Major2					
Conflicting Flow All	1116	1153	421	1075	1074	627	421	0	0	706	0	0
Stage 1	437	437	-	637	637	-	-	-	-	-	-	-
Stage 2	679	716	-	438	437	-	-	-	-	-	-	-
Critical Hdwy	7.12	6.52	6.22	7.12	6.52	6.22	4.12	-	-	4.12	-	-
Critical Hdwy Stg 1	6.12	5.52	-	6.12	5.52	-	-	-	-	-	-	-
Critical Hdwy Stg 2	6.12	5.52	-	6.12	5.52	-	-	-	-	-	-	-
Follow-up Hdwy	3.518	4.018	3.318	3.518	4.018	3.318	2.218	-	-	2.218	-	-
Pot Cap-1 Maneuver	185	197	632	197	220	484	1138	-	-	892	-	-
Stage 1	598	579	-	465	471	-	-	-	-	-	-	-
Stage 2	441	434	-	597	579	-	-	-	-	-	-	-
Platoon blocked, %								-	-	-	-	-
Mov Cap-1 Maneuver	181	193	632	193	216	484	1138	-	-	892	-	-
Mov Cap-2 Maneuver	181	193	-	193	216	-	-	-	-	-	-	-
Stage 1	594	572	-	462	468	-	-	-	-	-	-	-
Stage 2	434	431	-	588	572	-	-	-	-	-	-	-

Approach	EB		WB		NB		SB	
HCM Control Delay, s	19.5		28.1		0.1		0.2	
HCM LOS	C		D					

Minor Lane/Major Mvmt	NBL	NBT	NBR	EBLn1	WBLn1	SBL	SBT	SBR
Capacity (veh/h)	1138	-	-	253	204	892	-	-
HCM Lane V/C Ratio	0.005	-	-	0.021	0.24	0.009	-	-
HCM Control Delay (s)	8.2	0	-	19.5	28.1	9.1	0	-
HCM Lane LOS	A	A	-	C	D	A	A	-
HCM 95th %tile Q(veh)	0	-	-	0.1	0.9	0	-	-

Intersection						
Int Delay, s/veh	0.2					
Movement	WBL	WBR	NBT	NBR	SBL	SBT
Lane Configurations						
Traffic Vol, veh/h	6	3	570	9	5	385
Future Vol, veh/h	6	3	570	9	5	385
Conflicting Peds, #/hr	0	0	0	0	0	0
Sign Control	Stop	Stop	Free	Free	Free	Free
RT Channelized	-	None	-	None	-	None
Storage Length	0	-	-	-	-	-
Veh in Median Storage, #	0	-	0	-	-	0
Grade, %	0	-	0	-	-	0
Peak Hour Factor	92	92	92	92	92	92
Heavy Vehicles, %	2	2	2	2	2	2
Mvmt Flow	7	3	620	10	5	418

Major/Minor	Minor1	Major1	Major2			
Conflicting Flow All	1053	625	0	0	630	0
Stage 1	625	-	-	-	-	-
Stage 2	428	-	-	-	-	-
Critical Hdwy	6.42	6.22	-	-	4.12	-
Critical Hdwy Stg 1	5.42	-	-	-	-	-
Critical Hdwy Stg 2	5.42	-	-	-	-	-
Follow-up Hdwy	3.518	3.318	-	-	2.218	-
Pot Cap-1 Maneuver	251	485	-	-	952	-
Stage 1	534	-	-	-	-	-
Stage 2	657	-	-	-	-	-
Platoon blocked, %			-	-		
Mov Cap-1 Maneuver	249	485	-	-	952	-
Mov Cap-2 Maneuver	249	-	-	-	-	-
Stage 1	534	-	-	-	-	-
Stage 2	652	-	-	-	-	-

Approach	WB	NB	SB
HCM Control Delay, s	17.5	0	0.1
HCM LOS	C		

Minor Lane/Major Mvmt	NBT	NBRWBLn1	SBL	SBT
Capacity (veh/h)	-	-	297	952
HCM Lane V/C Ratio	-	-	0.033	0.006
HCM Control Delay (s)	-	-	17.5	8.8
HCM Lane LOS	-	-	C	A
HCM 95th %tile Q(veh)	-	-	0.1	0

Intersection												
Int Delay, s/veh	1.8											
Movement	EBL	EBT	EBR	WBL	WBT	WBR	NBL	NBT	NBR	SBL	SBT	SBR
Lane Configurations		↕			↕			↕	↕		↕	
Traffic Vol, veh/h	2	0	3	64	0	4	4	286	23	2	435	2
Future Vol, veh/h	2	0	3	64	0	4	4	286	23	2	435	2
Conflicting Peds, #/hr	0	0	0	0	0	0	0	0	0	0	0	0
Sign Control	Stop	Stop	Stop	Stop	Stop	Stop	Free	Free	Free	Free	Free	Free
RT Channelized	-	-	None	-	-	None	-	-	None	-	-	None
Storage Length	-	-	-	-	-	-	-	-	-	-	-	-
Veh in Median Storage, #	-	0	-	-	0	-	-	0	-	-	0	-
Grade, %	-	0	-	-	0	-	-	0	-	-	0	-
Peak Hour Factor	92	92	92	92	92	92	92	92	92	92	92	92
Heavy Vehicles, %	2	2	2	2	2	2	2	2	2	2	2	2
Mvmt Flow	2	0	3	70	0	4	4	311	25	2	473	2

Major/Minor	Minor2		Minor1		Major1		Major2					
Conflicting Flow All	812	822	474	799	798	311	475	0	0	336	0	0
Stage 1	478	478	-	319	319	-	-	-	-	-	-	-
Stage 2	334	344	-	480	479	-	-	-	-	-	-	-
Critical Hdwy	7.12	6.52	6.22	7.12	6.52	6.22	4.12	-	-	4.12	-	-
Critical Hdwy Stg 1	6.12	5.52	-	6.12	5.52	-	-	-	-	-	-	-
Critical Hdwy Stg 2	6.12	5.52	-	6.12	5.52	-	-	-	-	-	-	-
Follow-up Hdwy	3.518	4.018	3.318	3.518	4.018	3.318	2.218	-	-	2.218	-	-
Pot Cap-1 Maneuver	298	309	590	304	319	729	1087	-	-	1223	-	-
Stage 1	568	556	-	693	653	-	-	-	-	-	-	-
Stage 2	680	637	-	567	555	-	-	-	-	-	-	-
Platoon blocked, %								-	-	-	-	-
Mov Cap-1 Maneuver	295	307	590	301	317	729	1087	-	-	1223	-	-
Mov Cap-2 Maneuver	295	307	-	301	317	-	-	-	-	-	-	-
Stage 1	565	555	-	690	650	-	-	-	-	-	-	-
Stage 2	673	634	-	563	554	-	-	-	-	-	-	-

Approach	EB		WB		NB		SB	
HCM Control Delay, s	13.7		20.1		0.1		0	
HCM LOS	B		C					

Minor Lane/Major Mvmt	NBL	NBT	NBR	EBLn1	WBLn1	SBL	SBT	SBR
Capacity (veh/h)	1087	-	-	421	312	1223	-	-
HCM Lane V/C Ratio	0.004	-	-	0.013	0.237	0.002	-	-
HCM Control Delay (s)	8.3	0	-	13.7	20.1	7.9	0	-
HCM Lane LOS	A	A	-	B	C	A	A	-
HCM 95th %tile Q(veh)	0	-	-	0	0.9	0	-	-

Intersection						
Int Delay, s/veh	0.3					
Movement	WBL	WBR	NBT	NBR	SBL	SBT
Lane Configurations						
Traffic Vol, veh/h	13	5	285	5	2	421
Future Vol, veh/h	13	5	285	5	2	421
Conflicting Peds, #/hr	0	0	0	0	0	0
Sign Control	Stop	Stop	Free	Free	Free	Free
RT Channelized	-	None	-	None	-	None
Storage Length	0	-	-	-	-	-
Veh in Median Storage, #	0	-	0	-	-	0
Grade, %	0	-	0	-	-	0
Peak Hour Factor	92	92	92	92	92	92
Heavy Vehicles, %	2	2	2	2	2	2
Mvmt Flow	14	5	310	5	2	458

Major/Minor	Minor1	Major1	Major2		
Conflicting Flow All	775	313	0	0	315
Stage 1	313	-	-	-	-
Stage 2	462	-	-	-	-
Critical Hdwy	6.42	6.22	-	-	4.12
Critical Hdwy Stg 1	5.42	-	-	-	-
Critical Hdwy Stg 2	5.42	-	-	-	-
Follow-up Hdwy	3.518	3.318	-	-	2.218
Pot Cap-1 Maneuver	366	727	-	-	1245
Stage 1	741	-	-	-	-
Stage 2	634	-	-	-	-
Platoon blocked, %			-	-	-
Mov Cap-1 Maneuver	365	727	-	-	1245
Mov Cap-2 Maneuver	365	-	-	-	-
Stage 1	741	-	-	-	-
Stage 2	633	-	-	-	-

Approach	WB	NB	SB
HCM Control Delay, s	13.9	0	0
HCM LOS	B		

Minor Lane/Major Mvmt	NBT	NBRWBLn1	SBL	SBT
Capacity (veh/h)	-	-	424	1245
HCM Lane V/C Ratio	-	-	0.046	0.002
HCM Control Delay (s)	-	-	13.9	7.9
HCM Lane LOS	-	-	B	A
HCM 95th %tile Q(veh)	-	-	0.1	0

Intersection												
Int Delay, s/veh	1.5											
Movement	EBL	EBT	EBR	WBL	WBT	WBR	NBL	NBT	NBR	SBL	SBT	SBR
Lane Configurations		↕			↕			↕	↕		↕	
Traffic Vol, veh/h	3	0	2	46	0	4	5	584	82	7	390	1
Future Vol, veh/h	3	0	2	46	0	4	5	584	82	7	390	1
Conflicting Peds, #/hr	0	0	0	0	0	0	0	0	0	0	0	0
Sign Control	Stop	Stop	Stop	Stop	Stop	Stop	Free	Free	Free	Free	Free	Free
RT Channelized	-	-	None	-	-	None	-	-	None	-	-	None
Storage Length	-	-	-	-	-	-	-	-	-	-	-	-
Veh in Median Storage, #	-	0	-	-	0	-	-	0	-	-	0	-
Grade, %	-	0	-	-	0	-	-	0	-	-	0	-
Peak Hour Factor	92	92	92	92	92	92	92	92	92	92	92	92
Heavy Vehicles, %	2	2	2	2	2	2	2	2	2	2	2	2
Mvmt Flow	3	0	2	50	0	4	5	635	89	8	424	1

Major/Minor	Minor2		Minor1		Major1		Major2					
Conflicting Flow All	1133	1175	425	1087	1086	635	425	0	0	724	0	0
Stage 1	441	441	-	645	645	-	-	-	-	-	-	-
Stage 2	692	734	-	442	441	-	-	-	-	-	-	-
Critical Hdwy	7.12	6.52	6.22	7.12	6.52	6.22	4.12	-	-	4.12	-	-
Critical Hdwy Stg 1	6.12	5.52	-	6.12	5.52	-	-	-	-	-	-	-
Critical Hdwy Stg 2	6.12	5.52	-	6.12	5.52	-	-	-	-	-	-	-
Follow-up Hdwy	3.518	4.018	3.318	3.518	4.018	3.318	2.218	-	-	2.218	-	-
Pot Cap-1 Maneuver	180	192	629	194	216	478	1134	-	-	879	-	-
Stage 1	595	577	-	461	467	-	-	-	-	-	-	-
Stage 2	434	426	-	594	577	-	-	-	-	-	-	-
Platoon blocked, %								-	-	-	-	-
Mov Cap-1 Maneuver	176	188	629	191	212	478	1134	-	-	879	-	-
Mov Cap-2 Maneuver	176	188	-	191	212	-	-	-	-	-	-	-
Stage 1	591	570	-	458	464	-	-	-	-	-	-	-
Stage 2	427	423	-	585	570	-	-	-	-	-	-	-

Approach	EB		WB		NB		SB	
HCM Control Delay, s	19.9		29.4		0.1		0.2	
HCM LOS	C		D					

Minor Lane/Major Mvmt	NBL	NBT	NBR	EBLn1	WBLn1	SBL	SBT	SBR
Capacity (veh/h)	1134	-	-	247	201	879	-	-
HCM Lane V/C Ratio	0.005	-	-	0.022	0.27	0.009	-	-
HCM Control Delay (s)	8.2	0	-	19.9	29.4	9.1	0	-
HCM Lane LOS	A	A	-	C	D	A	A	-
HCM 95th %tile Q(veh)	0	-	-	0.1	1.1	0	-	-

Intersection						
Int Delay, s/veh	0.3					
Movement	WBL	WBR	NBT	NBR	SBL	SBT
Lane Configurations	W		T			T
Traffic Vol, veh/h	10	4	570	16	6	385
Future Vol, veh/h	10	4	570	16	6	385
Conflicting Peds, #/hr	0	0	0	0	0	0
Sign Control	Stop	Stop	Free	Free	Free	Free
RT Channelized	-	None	-	None	-	None
Storage Length	0	-	-	-	-	-
Veh in Median Storage, #	0	-	0	-	-	0
Grade, %	0	-	0	-	-	0
Peak Hour Factor	92	92	92	92	92	92
Heavy Vehicles, %	2	2	2	2	2	2
Mvmt Flow	11	4	620	17	7	418

Major/Minor	Minor1	Major1	Major2		
Conflicting Flow All	1061	629	0	0	637
Stage 1	629	-	-	-	-
Stage 2	432	-	-	-	-
Critical Hdwy	6.42	6.22	-	-	4.12
Critical Hdwy Stg 1	5.42	-	-	-	-
Critical Hdwy Stg 2	5.42	-	-	-	-
Follow-up Hdwy	3.518	3.318	-	-	2.218
Pot Cap-1 Maneuver	248	482	-	-	947
Stage 1	531	-	-	-	-
Stage 2	655	-	-	-	-
Platoon blocked, %			-	-	-
Mov Cap-1 Maneuver	246	482	-	-	947
Mov Cap-2 Maneuver	246	-	-	-	-
Stage 1	531	-	-	-	-
Stage 2	648	-	-	-	-

Approach	WB	NB	SB
HCM Control Delay, s	18.3	0	0.1
HCM LOS	C		

Minor Lane/Major Mvmt	NBT	NBRWBLn1	SBL	SBT
Capacity (veh/h)	-	-	286	947
HCM Lane V/C Ratio	-	-	0.053	0.007
HCM Control Delay (s)	-	-	18.3	8.8
HCM Lane LOS	-	-	C	A
HCM 95th %tile Q(veh)	-	-	0.2	0

MTCP Maps



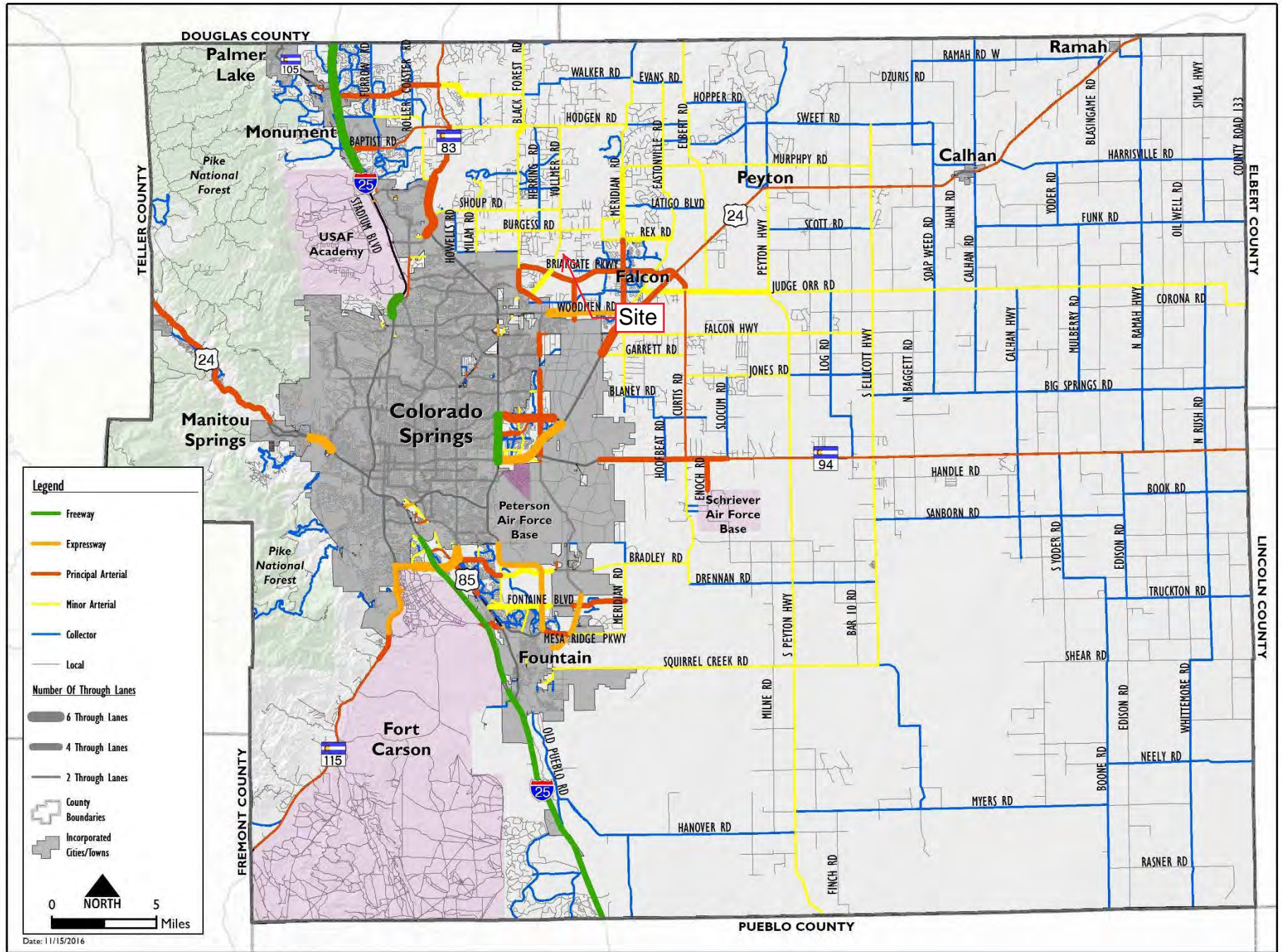

Map 14: 2040 Roadway Plan (Classification and Lanes)

Retreat at TimberRidge Filing No. 3 Construction Plans



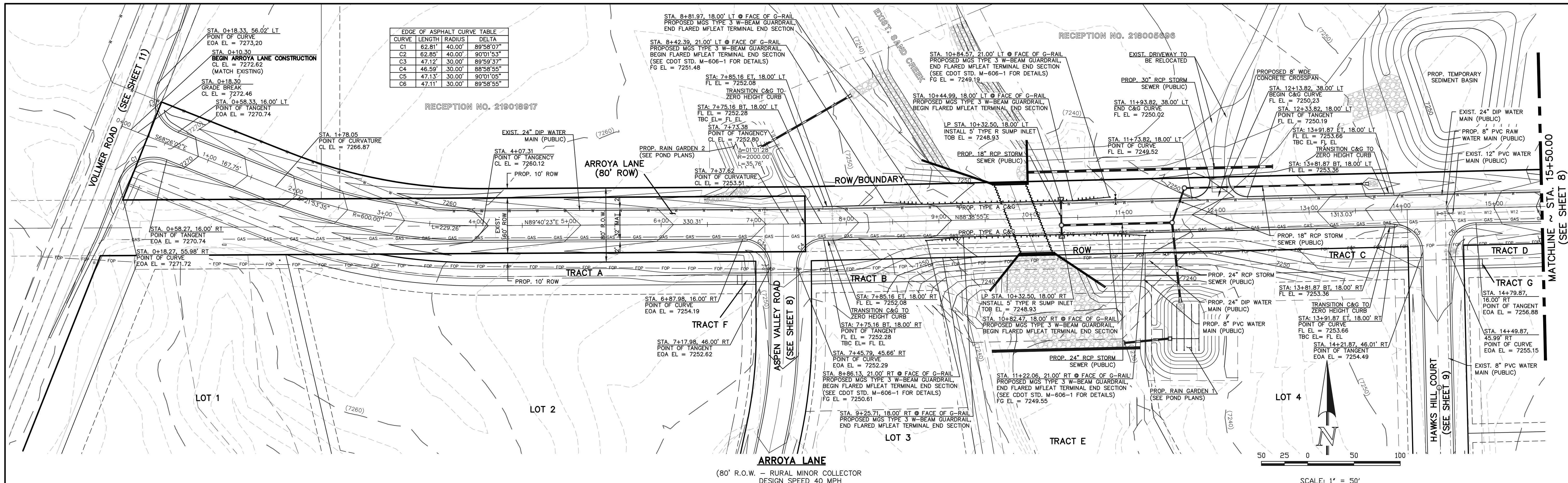

EDGE OF ASPHALT CURVE TABLE			
CURVE	LENGTH	RADIUS	DELTA
C1	62.81'	40.00'	89°58'07"
C2	62.85'	40.00'	90°01'53"
C3	47.12'	30.00'	89°58'37"
C4	46.59'	30.00'	88°58'55"
C5	47.13'	30.00'	90°01'05"
C6	47.11'	30.00'	89°58'55"

ARROYA LANE
 (80' R.O.W. - RURAL MINOR COLLECTOR
 DESIGN SPEED 40 MPH)

SCALE: 1" = 50'

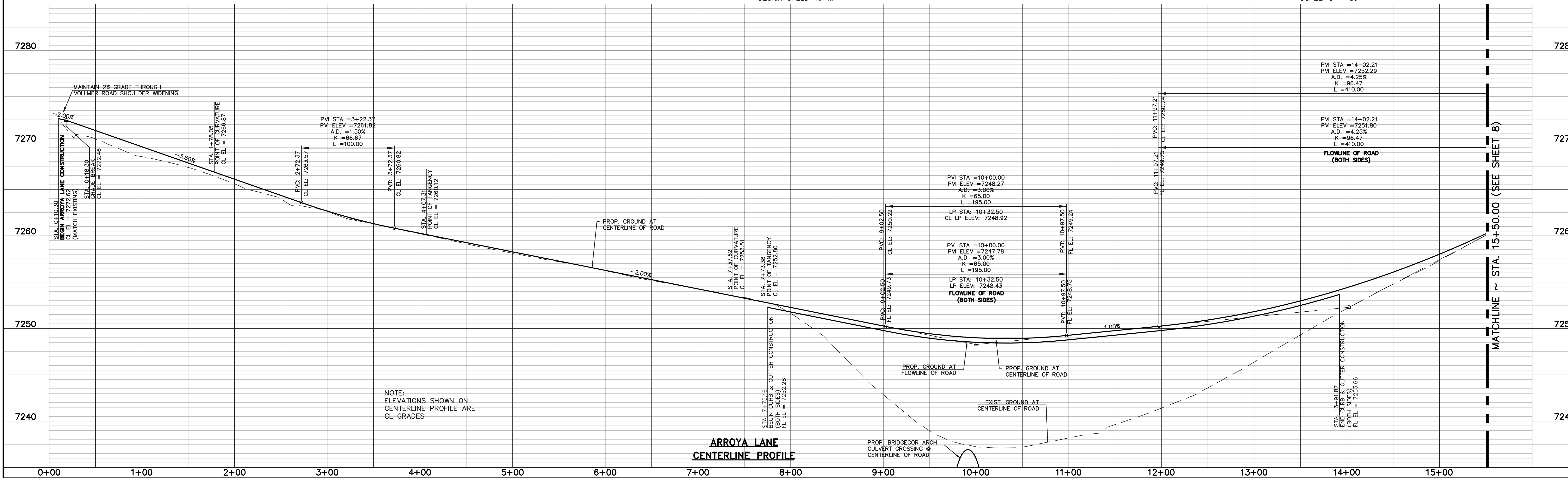

ARROYA LANE CENTERLINE PROFILE

NOTE:
 ELEVATIONS SHOWN ON
 CENTERLINE PROFILE ARE
 CL GRADES

<p>48 HOURS BEFORE YOU DIG, CALL UTILITY LOCATORS 811 UTILITY NOTIFICATION CENTER OF COLORADO IT'S THE LAW</p> <p>THE LOCATIONS OF EXISTING UNDERGROUND UTILITIES ARE SHOWN IN AN APPROXIMATE WAY ONLY. THE CONTRACTOR SHALL DETERMINE THE EXACT LOCATION OF ALL EXISTING UTILITIES BEFORE COMMENCING WORK. THE CONTRACTOR SHALL BE FULLY RESPONSIBLE FOR ANY AND ALL DAMAGES WHICH MIGHT BE CAUSED BY HIS FAILURE TO EXACTLY LOCATE AND PRESERVE ANY AND ALL UNDERGROUND UTILITIES.</p>	<p>NO. REVISION</p> <p>1 REVISED PER EPC COMMENTS</p>	<p>DATE</p> <p>3-07-23</p>	<p>REVIEW:</p> <p>PREPARED UNDER MY DIRECT SUPERVISION FOR AND ON BEHALF OF CLASSIC CONSULTING ENGINEERS AND SURVEYORS, LLC</p> <p>MARC A. WHORTON, COLORADO P.E. #37155</p>	<p>RETREAT AT TIMBERIDGE FILING NO. 3 CONSTRUCTION PLANS STREET IMPROVEMENT PLANS ARROYA LANE</p> <p>DESIGNED BY PRA SCALE DATE 11-22-2022 DRAWN BY PRA (H) 1" = 50' SHEET 7 OF 24 CHECKED BY (V) 1" = 5' JOB NO. 1185.30</p>
	<p>CLASSIC CONSULTING</p> <p>619 N. Cascade Avenue, Suite 200 (719) 785-0790 Colorado Springs, Colorado 80903 (719) 785-0799 (Fax)</p>			

V:\118530\DRAWINGS\CONSTRUCT\DRAWING-118530-9-01.dwg, 3/7/2023 2:42:02 PM, 1/1

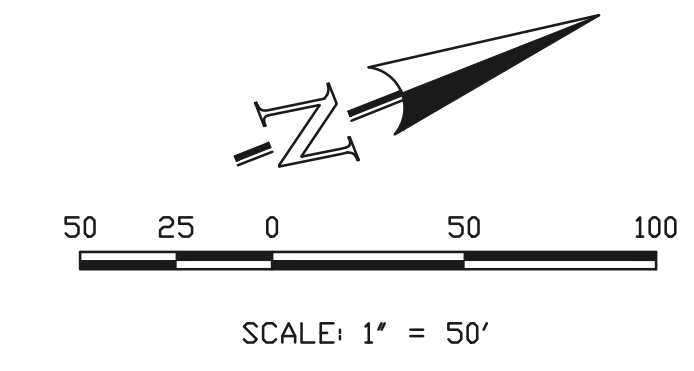
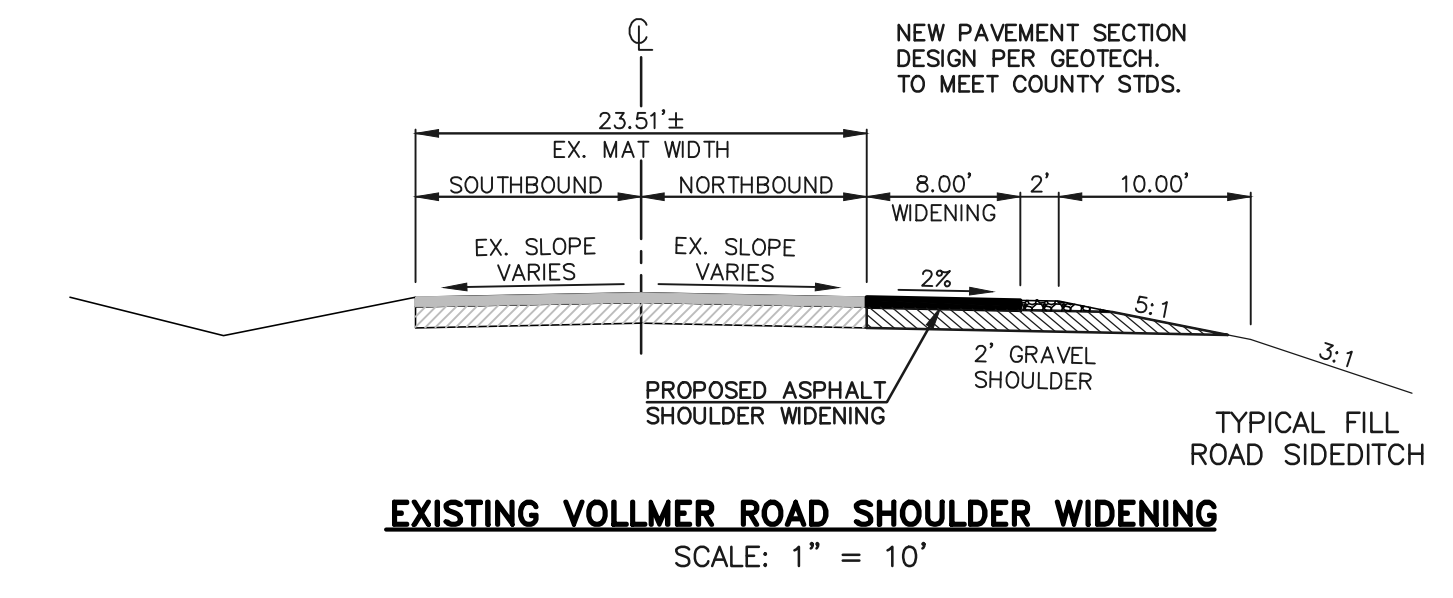
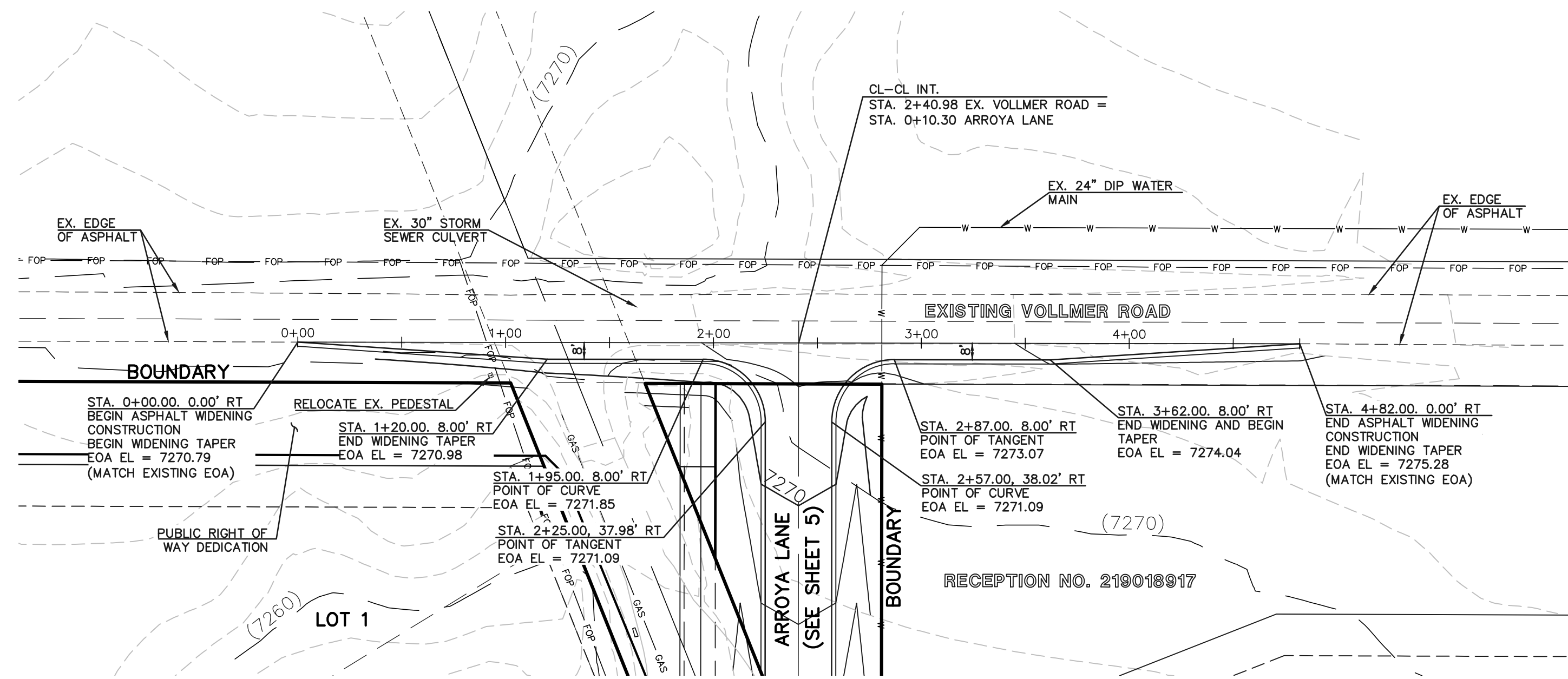

EXISTING VOLLMER ROAD
(R.O.W. VARIES- RURAL MINOR ARTERIAL)
POSTED SPEED 45 MPH

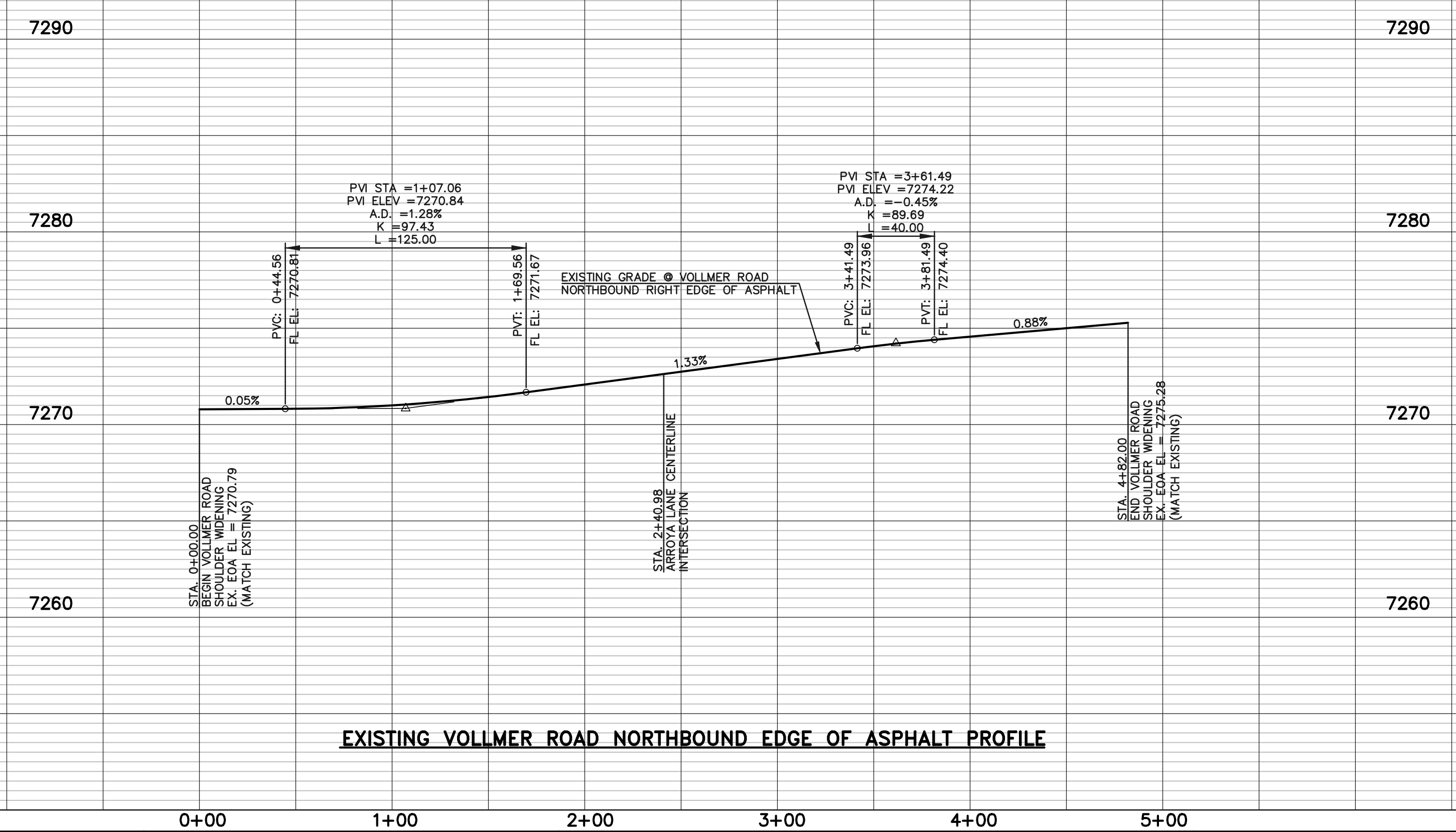

EXISTING VOLLMER ROAD NORTHBOUND EDGE OF ASPHALT PROFILE

0+00 1+00 2+00 3+00 4+00 5+00

<p>48 HOURS BEFORE YOU DIG, CALL UTILITY LOCATORS 811 UTILITY NOTIFICATION CENTER OF COLORADO IT'S THE LAW</p> <p>THE LOCATIONS OF EXISTING UNDERGROUND UTILITIES ARE SHOWN IN AN APPROXIMATE WAY ONLY. THE CONTRACTOR SHALL DETERMINE THE EXACT LOCATION OF ALL EXISTING UTILITIES BEFORE COMMENCING WORK. THE CONTRACTOR SHALL BE FULLY RESPONSIBLE FOR ANY AND ALL DAMAGES WHICH MIGHT BE CAUSED BY HIS FAILURE TO EXACTLY LOCATE AND PRESERVE ANY AND ALL UNDERGROUND UTILITIES.</p>	<table border="1" style="width:100%; border-collapse: collapse;"> <thead> <tr> <th>NO.</th> <th>REVISION</th> <th>DATE</th> </tr> </thead> <tbody> <tr><td> </td><td> </td><td> </td></tr> <tr><td> </td><td> </td><td> </td></tr> <tr><td> </td><td> </td><td> </td></tr> </tbody> </table>	NO.	REVISION	DATE										<p>REVIEW:</p> <p>PREPARED UNDER MY DIRECT SUPERVISION FOR AND ON BEHALF OF CLASSIC CONSULTING ENGINEERS AND SURVEYORS, LLC</p> <p>MARC A. WHORTON, COLORADO P.E. #37155 DATE</p>		<p>RETREAT AT TIMBERRIDGE FILING NO. 3 CONSTRUCTION PLANS STREET IMPROVEMENT PLANS VOLLMER ROAD EAST SHOULDER WIDENING</p> <table border="1" style="width:100%; border-collapse: collapse;"> <tr> <td>DESIGNED BY</td> <td>PRA</td> <td>SCALE</td> <td>DATE</td> <td>11-22-2022</td> </tr> <tr> <td>DRAWN BY</td> <td>PRA</td> <td>(H) 1"= 50'</td> <td>SHEET</td> <td>9 OF 19</td> </tr> <tr> <td>CHECKED BY</td> <td>(V) 1"= 5'</td> <td>JOB NO.</td> <td colspan="2">1185.30</td> </tr> </table>	DESIGNED BY	PRA	SCALE	DATE	11-22-2022	DRAWN BY	PRA	(H) 1"= 50'	SHEET	9 OF 19	CHECKED BY	(V) 1"= 5'	JOB NO.	1185.30	
NO.	REVISION	DATE																													
DESIGNED BY	PRA	SCALE	DATE	11-22-2022																											
DRAWN BY	PRA	(H) 1"= 50'	SHEET	9 OF 19																											
CHECKED BY	(V) 1"= 5'	JOB NO.	1185.30																												

V2_TIS.pdf Markup Summary

Callout (1)

ite. However, there are plann
south of Briargate Parkway. 1
nd Briargate Parkway. School p
ing of Briargate Parkway/Alle

Subject: Callout
Page Label: 7
Author: CDurham
Date: 10/24/2023 9:14:41 AM
Status:
Color: 
Layer:
Space:

Delete "School"