



**ENTECH**  
ENGINEERING, INC.

505 ELKTON DRIVE  
COLORADO SPRINGS, CO 80907  
PHONE (719) 531-5599  
FAX (719) 531-5238

**SOIL, GEOLOGY, GEOLOGIC HAZARD,  
AND WASTEWATER STUDY,  
HODGEN ROAD SUBDIVISION  
PARCEL NO. 51990-01-009  
NORTHWEST OF HODGEN ROAD  
AND BLACK FOREST ROAD  
EL PASO COUNTY, COLORADO**

Prepared for

**Savage Development, Inc.**  
8605 Explorer Drive  
Colorado Springs, Colorado 80920

Attn: Jordan Savage

April 20, 2018  
Revised February 1, 2019

Respectfully Submitted,

ENTECH ENGINEERING, INC.

Logan L. Langford.  
Geologist

Kristen A. Andrew-Hoeser, P.G.  
Engineering Geologist

LLL/nc

Encl.

Entech Job No. 180368  
AAprojects/2018/180368 countysoil/geo/ww

Reviewed by:

Joseph C. Gooden, P.E.  
President



**TABLE OF CONTENTS**

1.0 SUMMARY..... 1  
2.0 GENERAL SITE CONDITIONS AND PROJECT DESCRIPTION.....2  
3.0 SCOPE OF THE REPORT .....2  
4.0 FIELD INVESTIGATION .....3  
5.0 SOIL, GEOLOGY AND ENGINEERING GEOLOGY.....3  
    5.1 General Geology.....3  
    5.2 Soil Conservation Survey.....4  
    5.3 Site Stratigraphy.....4  
    5.4 Soil Conditions .....5  
    5.5 Groundwater .....6  
6.0 ENGINEERING GEOLOGY – IDENTIFICATION AND MITIGATION OF GEOLOGIC HAZARDS.....7  
    6.1 Relevance of Geologic Conditions to Land Use Planning..... 10  
7.0 ON-SITE DISPOSAL OF WASTEWATER..... 12  
8.0 ECONOMIC MINERAL RESOURCES..... 13  
9.0 EROSION CONTROL ..... 14  
10.0 CLOSURE ..... 15  
BIBLIOGRAPHY..... 16

**TABLES**

- Table 1: Summary of Laboratory Test Results
- Table 2: Summary of Tactile Test Pits Results

**FIGURES**

- Figure 1: Vicinity Map
- Figure 2: USGS Map
- Figure 3: Development Plan/Testing Location Map
- Figure 4: Soil Survey Map
- Figure 5: Black Forest Quadrangle Geology Map
- Figure 6: Geology Map/Engineering Geology
- Figure 7: Floodplain Map
- Figure 8: Typical Perimeter Drain Details
- Figure 9: Septic Suitability Map

- APPENDIX A: Site Photographs
- APPENDIX B: Test Boring Logs and Test Pit Logs
- APPENDIX C: Laboratory Test Results
- APPENDIX D: Soil Survey Descriptions

## **1.0 SUMMARY**

### ***Project Location***

The project lies in a portion of the SW $\frac{1}{4}$  of the SE $\frac{1}{4}$  of Section 19, Township 11 South, Range 65 West of the 6<sup>th</sup> Principal Meridian in El Paso County, Colorado. The site is located approximately 8 miles southeast of Monument, Colorado, northwest of Hodgen Road and Black Forest Road.

### ***Project Description***

Total acreage involved in the project is approximately 39.4 acres. The proposed site development consists of seven single-family rural residential lots. The development will utilize individual wells and on-site wastewater treatment systems.

### ***Scope of Report***

This report presents the results of our geologic evaluation, treatment of engineering geologic hazard study and wastewater study for individual on-site wastewater treatment systems.

### ***Land Use and Engineering Geology***

This site was found to be suitable for the proposed development. Areas were encountered where the geologic conditions will impose some constraints on development and land use. These include areas of artificial fill, expansive soils, potentially unstable slopes, floodplain, potentially seasonal shallow groundwater, and shallow groundwater areas. Based on the proposed development plan, it appears that these areas will have some impact on the development. These conditions will be discussed in greater detail in the report.

In general, it is our opinion that the development can be achieved if the observed geologic conditions on site are either avoided or properly mitigated. All recommendations are subject to the limitations discussed in the report.

## **2.0 GENERAL SITE CONDITIONS AND PROJECT DESCRIPTION**

The site is located in a portion of the SW¼ of the SE¼ of Section 19, Township 11 South, Range 65 West of the 6<sup>th</sup> Principal Meridian in El Paso County, Colorado. The site is located approximately 8 miles southeast of Monument, Colorado, northwest of Hodgen Road and Black Forest Road. The location of the site is as shown on the Vicinity Map, Figure 1.

The topography of the site consists of rolling hills that vary from gradually to moderately sloping generally to the southeast and northwest. A tributary of the East Fork of Cherry Creek bisects the site. Steep slopes are located along the drainage, and potentially unstable slopes are located in the southeast portion of the site along a cut bank of the drainage. The drainages on site flow in northeasterly direction through the southeastern portion of the site. Water was not observed in the drainages at the time of this investigation. The site boundaries are indicated on the USGS Map, Figure 2. Previous land uses have included grazing and pasture land. The site contains primarily field grasses and weeds. Site photographs, taken March 10, 2018, are included in Appendix A.

Total acreage involved in the proposed development is approximately 39.4 acres. Seven single-family rural residential lots are proposed. The proposed lots are approximately 5 acres each. The area will be serviced by individual wells and on-site wastewater treatment systems. The proposed Development Plan/Testing Location Map is presented in Figure 3.

## **3.0 SCOPE OF THE REPORT**

The scope of the report will include the following:

- A general geologic analysis utilizing published geologic data. Detailed site-specific mapping will be conducted to obtain general information in respect to major geographic and geologic features, geologic descriptions and their effects on the development of the property.
- The site will be evaluated for individual on-site wastewater treatment systems in accordance with El Paso Land Development Code.

## **4.0 FIELD INVESTIGATION**

Our field investigation consisted of the preparation of a geologic map of any bedrock features and significant surficial deposits. The Natural Resource Conservation Service (NRCS), previously the Soil Conservation Service (SCS) survey was also reviewed to evaluate the site. The position of mappable units within the subject property are shown on the Geologic Map. Our mapping procedures involved both field reconnaissance and measurements and air photo reconnaissance and interpretation. The same mapping procedures have also been utilized to produce the Geology/Engineering Geology Map which identified pertinent geologic conditions affecting development. The field mapping was performed by personnel of Entech Engineering, Inc. on March 10, 2018.

Two (2) test borings, and three (3) tactile test pits were performed on the site to determine general suitability of the site for the use of on-site wastewater treatment systems. The locations of the test borings, and test pits are indicated on the Development Plan/Testing Location Map, Figure 3. The Test Boring and Test Pit Logs are presented in Appendix B. Results of this testing will be discussed later in this report.

Laboratory testing was also performed on some of the soils to classify and determine the soils engineering characteristics. Laboratory tests included grain-size analysis, ASTM D-422, and Atterberg Limits, ASTM D-4318. Results of the laboratory testing are included in Appendix C. A Summary of Laboratory Test Results is presented in Table 1.

## **5.0 SOIL, GEOLOGY AND ENGINEERING GEOLOGY**

### ***5.1 General Geology***

Physiographically, the site lies in the western portion of the Great Plains Physiographic Province north of the Palmer Divide. Approximately 11 miles to the west is a major structural feature known as the Rampart Range Fault. This fault marks the boundary between the Great Plains Physiographic Province and the Southern Rocky Mountain Province. The site exists within the southeastern edge of a large structural feature known as the Denver Basin. Bedrock in the area

tends to be very gently dipping in a northwesterly direction (Reference 1). The rocks in the area of the site are sedimentary in nature and typically Tertiary to Upper Cretaceous in age. The bedrock underlying the site consists of the Dawson Arkose Formation. Overlying this formation are unconsolidated deposits of residual soils, man-made, and alluvial soils of the Quaternary Age. The residual soils are produced by the in-situ action of weathering of the bedrock on site. The alluvial soils were deposited by water in the major drainage on the site and as stream terraces on some of the ridge lines. Man-made soils exist as earthen dams and erosion berms. The site's stratigraphy will be discussed in more detail in Section 5.3.

### **5.2 Soil Conservation Survey**

The Natural Resource Conservation Service (Reference 2), previously the Soil Conservation Service (Reference 3) has mapped two soil types on the site (Figure 4). In general, they vary from sandy loam to sandy clay loam. The soils are described as follows:

<u>Type</u>	<u>Description</u>
67	Peyton Sandy Loam, 5-9% slopes
68	Peyton-Pring Complex, 3-8% slopes

Complete descriptions of each soil type are presented in Appendix D. The soils have generally been described to typically have moderate to moderately rapid permeabilities. Roads may need to be designed to minimize frost-heave potential. Possible hazards with soil erosion are present on the site. The erosion potential can be controlled with vegetation. The majority of the soils have been described to have moderate erosion hazards.

### **5.3 Site Stratigraphy**

The Black Forest Quadrangle Geology Map showing the site is presented in Figure 5 (Reference 4). The Geology Map prepared for the site is presented in Figure 6. Four mappable units were identified on this site which are described as follows:

**Qal Recent Alluvium of Holocene Age:** These are recent deposits that have been deposited along the drainage that exists on-site. These materials typically consist of

- silty to clayey sands and sandy clays. Some of these alluviums contain highly organic soils.
- Qaf**      **Recent Artificial Fill of Holocene Age:** These are man-made fill deposits associated with erosion berms and earthen dams on-site.
- Qt<sub>1</sub>**      **Terrace Alluvium One of Holocene and Late Pleistocene Age:** These materials consist of water-deposited stream terrace deposits. They typically consist of silty to clayey sands with gravelly lenses.
- Qc/Tkd**      **Colluvium of Quaternary Age overlying Dawson Formation of Tertiary to Cretaceous Age:** The Dawson Formation typically consists of arkosic sandstone with interbedded fine-grained sandstone, siltstone and claystone. Overlying this formation is a variable layer of residual soil. The residual soils were derived from the in-situ weathering of the bedrock materials on-site. These soils consisted of silty to clayey sands, sandy clays and sandy silts.

The soils listed above were mapped from site-specific mapping, the *Geologic Map of the Black Forest Quadrangle* distributed by the Colorado Geological Survey in 2003 (Reference 4), the *Geologic Map of the Colorado Springs-Castle Rock Area*, distributed by the US Geological Survey in 1979 (Reference 5), and the *Geologic Map of the Denver 1<sup>o</sup> x 2<sup>o</sup> Quadrangle*, distributed by the US Geological Survey in 1981 (Reference 6). The Test Pits and Profile Holes were also used in evaluating the site and are included in Appendix B. The Geology Map prepared for the site is presented in Figure 6.

#### **5.4 Soil Conditions**

The soils encountered in the Test Borings can be grouped into three general soil and rock types. The Test Boring soils were classified using the Unified Soil Classification System (USCS). The soils encountered in the Test Pits can be grouped into three general soil types. The test pit soils were classified using the USDA Textural Soil Classification.

Soil Type 1 is a silty sand (SM). This material was encountered in both of the test borings and in Test Pit No. 3. The sand was encountered at depths ranging from the existing surface to 10 feet

bgs and extended to the termination of the boring (20 feet). These soils were encountered at medium dense states and at moist conditions. Samples tested had 12 to 20 percent of the soil sized particles passing the No. 200 Sieve.

Soil Type 2 is a sandy clay (CL). This material was encountered in Test Boring No. 1 and in Test Pit Nos. 1 and 2. The clays were encountered at the existing surface grade and extended to depths up to 10 feet bgs. The clays were encountered at firm to stiff consistencies and moist conditions. Samples tested had 51 to 83 percent of the soil sized particles passing the No. 200 sieve. FHA Swell Testing on a sample of clayey sand resulted in an expansion pressure of 540 psf. Swell/Consolidation Testing resulted in a volume change of 1.1 percent. These test results indicated the clay exhibits a low to moderate expansion potential.

Soil Type 3 is a sandy claystone/sandstone (CL, SM-SW, SM, SC). This material was encountered Test Boring No. 2 at 18 feet bgs and extended to the termination of the boring (20 feet). The claystone was encountered at hard consistencies and moist conditions. Samples tested had 54 percent of the soil sized particles passing the No. 200 sieve. The sandstones are typically non-expansive, however; expansive clayey sandstone and claystone are common in the area.

The Test Boring Logs and Test Pit Logs are presented in Appendix B. Laboratory Test Results are presented in Appendix C. A Summary of Laboratory Test Results is presented in Table 1.

### ***5.5 Groundwater***

Groundwater was not encountered in the Test Borings which were drilled to 20 feet. Areas of seasonal shallow groundwater have been mapped in low-lying areas and in the drainage on-site. These areas are discussed in the following section. Fluctuation in groundwater conditions may occur due to variations in rainfall and other factors not readily apparent at this time.

It should be noted that in the sandy materials on site, some groundwater conditions might be encountered due to the variability in the soil profile. Isolated sand and gravel layers within the soils, sometimes only a few feet in thickness and width, can carry water in the subsurface. Groundwater may also flow on top of the underlying bedrock. Builders and planners should be cognizant of the potential for the occurrence of such subsurface water features during



construction on-site and deal with each individual problem as necessary at the time of construction.

## 6.0 ENGINEERING GEOLOGY – IDENTIFICATION AND MITIGATION OF GEOLOGIC HAZARDS

As mentioned previously, detailed mapping has been performed on this site to produce an Geology/Engineering Geology Map (Figure 6). This map shows the location of various geologic conditions of which the developers should be cognizant during the planning, design and construction stages of the project. These hazards and the recommended mitigation techniques are as follows:

### Artificial Fill

These are man-made fill deposits associated with an earthen dam and erosion berms on-site.

Mitigation: The small erosion berms can easily be removed or penetrated by foundations. The earthen dam is located in the floodplain area and can be avoided by the development. Should any uncontrolled fill be encountered beneath foundations, removal and recompaction at 95% of its maximum Modified Proctor Dry Density, ASTM D-1557 will be required.

### Expansive Soils

Expansive soils were encountered in the test borings drilled and test pits excavated on-site. Expansive claystone is commonly encountered within the Dawson Formation. These occurrences are typically sporadic; therefore, none have been indicated on the maps. These expansive soils, if encountered beneath foundations, can cause differential movement in the structure foundation. These occurrences should be identified and mitigated on an individual basis.

Mitigation: Should expansive soils be encountered beneath the foundation, mitigation will be necessary. Mitigation of expansive soils will require special foundation design. Overexcavation and replacement with non-expansive soils at a minimum of 95% of its maximum Modified Proctor Dry Density, ASTM D-1557 is a suitable mitigation, which is common in the area. Another alternative in areas of highly expansive soils is the use of drilled pier foundation systems. Typical minimum pier depths are on the order of 20 feet or more and require penetration into the bedrock material a minimum of 4 to 6 feet, depending upon building loads. Floor slabs on expansive soils should be expected to experience movement. Overexcavation and replacement has been successful in minimizing slab movements. The use of structural floors should be considered for

basement construction on highly expansive clays. Final recommendations should be determined after additional investigation of each building site.

Slope Stability and Landslide Hazard

The majority of the slopes in the building areas on site are gently to moderately sloping and do not exhibit any past or potential unstable slopes or landslides. However, the steeply sloping areas along the drainage in the southeastern portion of the site have been identified as potentially unstable slopes. These areas are identified on the Geology/Engineering Geology Map, Figure 6. The recommendations for these areas are as follows:

- Potentially Unstable Slope Area

The area identified with this hazard is located along the southeastern side of the drainage where a cut bank of the tributary has created an unstable slope. The slope is located in portions of Lots 4, 5, and 6. These slopes are considered stable in their present condition; however, considerable care must be exercised in these areas not to create a condition which would tend to activate instability.

Mitigation: Building should be avoided in these areas. The lot most significantly affected by potentially unstable slope is Lot 4. The structure on this lot should be set back a minimum of 40 feet from the crest of this slope. There is sufficient room on the lot to avoid this hazard. Proper control of drainage at both the surface above the slope and the subsurface is extremely important. Areas of ponded water at the surface should be avoided. Utility trenches, basement excavations and other subsurface features should not be permitted to become water traps which may promote saturation of the subsurface materials. Drainage should not be permitted over the potentially unstable slope but directed in a non-erosive manner away from the slope. Irrigation above these slopes should be kept to a minimum to prevent saturation of the subsurface soils. The use of xeriscope landscaping utilizing native plantings is recommended to reduce the need for irrigation.

Floodplain and Seasonal Shallow Groundwater Areas

Portions of the site are mapped within a floodplain zone according to the FEMA Map No. 08041CO325F, dated March 17, 1997 (Figure 7, Reference 7). Additionally, areas of seasonal shallow groundwater were observed across the site. In these areas, we would anticipate the potential for periodically high subsurface moisture conditions and frost heave potential. These areas lie within low-lying areas along the drainage in the southeastern portion of the site and in the low-lying areas across the site. Water was not observed in any of the drainages at the time of our site investigation. These areas can likely be avoided or properly mitigated by development. The floodplain should be avoided by construction unless site-specific floodplain determination and drainage studies are performed. The potential exists for high groundwater levels during high moisture periods and should structures encroach on these areas the following precautions should be followed.

Mitigation: Foundations must have a minimum 30-inch depth for frost protection. In areas where high subsurface moisture conditions are anticipated periodically, subsurface perimeter drains are recommended to help prevent the intrusion of water into areas below grade. Typical drain details are presented in Figure 8. The minor drainage swales on Lots 1 and 7 can be avoided or regraded. The main drainage that bisects the site can be avoided. Any grading in these areas should be done to direct surface flow around construction to avoid areas of ponded water. Finished floors must be located at least one foot above floodplain levels. Specific drainage studies and exact floodplain locations are beyond the scope of this report.

***6.1 Relevance of Geologic Conditions to Land Use Planning***

We understand that the development will be rural residential. It is our opinion that the existing geologic and engineering geologic conditions will impose some constraints on the proposed development and construction. The most significant problems affecting development will be those associated with the drainages on site that can be avoided or properly mitigated during construction on each lot. Other hazards on site may be satisfactorily mitigated through proper engineering design and construction practices or avoidance.

The upper materials are typically at medium dense states and firm consistencies. The granular soils encountered in the upper soil profiles of the test borings and test pits should provide good

support for foundations. Expansive soils, although sporadic, were encountered. Expansive clayey sandstone and claystone are common in the Dawson Formation, and may require mitigation. Foundations anticipated for the site are standard spread footings possibly in conjunction with overexcavation in areas of expansive soils or loose soils. Areas containing arkosic sandstone will have high allowable bearing conditions. Expansive layers may also be encountered in the soil and bedrock on this site. Areas of expansive soils encountered on site are sporadic; therefore, none have been indicated on the maps. Expansive soils, if encountered, will require special foundation design and/or overexcavation. These soils will not prohibit development.

A potentially unstable slope exists in the southeastern portion of the site where the stream has eroded a cut bank. This mostly affects Lot 4. A 40-foot building setback from the crest of the slope is recommended. Septic fields should not be located within the building setback as well. It appears there is sufficient room on the lot to avoid the potentially unstable slope.

Areas of seasonal shallow groundwater and potentially seasonal shallow groundwater were encountered on site. Additionally, portions of the site have been mapped in a floodplain zone. Water was not observed in the drainages on-site during our site investigation. Due to the size of the lots and the proposed development, these areas can be avoided by construction on the residential lots. The minor drainage swales on Lots 1 and 7 can be avoided or regraded. Structures should not block drainages. Any site grading should be done in such a manner as to not create areas of ponded water around structures or septic fields. Septic fields should not be located in drainage areas due to the potential for periodic high groundwater conditions.

In summary, development of the site can be achieved if the items mentioned above are mitigated. These items can be mitigated through proper design and construction or through avoidance. Investigation on each lot is recommended prior to construction.

## **7.0 ON-SITE WASTEWATER TREATMENT**

The site was evaluated for individual and commercial on-site wastewater treatment systems in accordance with El Paso Land Development Code. Three (3) tactile test pits were performed on the property. The test pits were located in potential locations of future systems. The approximate locations of the percolation tests are indicated on Figure 3, on the Geology/Engineering Geology Map, Figure 6, and on the Septic Suitability Map, Figure 9. A table showing the results of the Tactile Test Pits is presented in Table 2. Test Pit Logs are included in Appendix B..

The Natural Resource Conservation Service (Reference 2), previously the Soil Conservation Service (Reference 3) has been mapped with four soil descriptions. The Soil Survey Map (Reference 2) is presented in Figure 4, and the Soil Survey Descriptions are presented in Appendix D. The soils are described as having moderate to moderately rapid percolation rates.

Soils encountered in the tactile test pits consisted of loamy sand, sandy clay loam and sandy clay. Bedrock was not encountered in the test pits which were excavated to 8 feet. The limiting layers encountered in the test pits are the sandy loam (Soil Type 2), and sandy clay (Soil Type 4) which corresponds to LTAR values of 0.60 to 0.20 gallons per day per square foot. The conditions encountered in the Test Pit Nos. 1 and 2 will require a designed system. Additional investigation may identify areas where suitable for conventional systems could be used.

In summary, it is our opinion the site is suitable for individual on-site wastewater treatment systems (OWTS) and that contamination of surface and subsurface water resources should not occur provided the OWTS sites are evaluated and installed according to El Paso County and State Guidelines and properly maintained. Based on the testing performed as part of this investigation designed systems will likely be required for the majority of the lots. A Septic Suitability Map is presented in Figure 9. Possible locations for a house, a water well, and two OWTS sites are indicated on Figure 9. Areas where OWTS sites are not recommended are indicated on Figure 9. Individual soil testing is required on each lot prior to construction. Absorption fields must be located a minimum of 100 feet from any well, including those on adjacent properties. Absorption fields must also be located a minimum of 50 feet from any drainages, floodplains or ponded areas and 25 feet from dry gulches.

## 8.0 ECONOMIC MINERAL RESOURCES

Some of the sandy materials on-site could be considered a low-grade sand resource. According to the *El Paso County Aggregate Resource Evaluation Map* (Reference 8), the area is not mapped with any aggregate deposits. According to the *Atlas of Sand, Gravel and Quarry Aggregate Resources, Colorado Front Range Counties* distributed by the Colorado Geological Survey (Reference 9), areas of the site are not mapped with any resources. According to the *Evaluation of Mineral and Mineral Fuel Potential* (Reference 10), the area of the site has been mapped as "Fair" for industrial minerals. However, considering the silty to clayey nature of much of these materials and abundance of similar materials through the region and the close proximity to developed land, they would be considered to have little significance as an economic resource.

According to the *Evaluation of Mineral and Mineral Fuel Potential of El Paso County State Mineral Lands* (Reference 10), the site is mapped within the Denver Basin Coal Region. However, the area of the site has been mapped as "Poor" for coal resources. No active or inactive mines have been mapped in the area of the site. No metallic mineral resources have been mapped on the site (Reference 10).

The site has been mapped as "Fair" for oil and gas resources (Reference 10). No oil or gas fields have been discovered in the area of the site. The sedimentary rocks in the area may lack the geologic structure for trapping oil or gas; therefore, it may not be considered a significant resource. Hydraulic fracturing is a new method that is being used to extract oil and gas from rocks. It utilizes pressurized fluid to extract oil and gas from rocks that would not normally be productive. The area of the site has not been explored to determine if the rocks underlying the site would be commercially viable utilizing hydraulic fracturing. The practice of hydraulic fracturing has come under review due to concerns about environmental impacts, health and safety.

## **9.0 EROSION CONTROL**

The soil types observed on the site are mildly to highly susceptible to wind erosion, and moderately to highly susceptible to water erosion. A minor wind erosion and dust problem may be created for a short time during and immediately after construction. Should the problem be considered severe enough during this time, watering of the cut areas or the use of chemical palliative may be required to control dust. However, once construction has been completed and vegetation re-established, the potential for wind erosion should be considerably reduced.

With regard to water erosion, loosely compacted soils will be the most susceptible to water erosion, residually weathered soils and weathered bedrock materials become increasingly less susceptible to water erosion. For the typical soils observed on site, allowable velocities or unvegetated and unlined earth channels would be on the order of 3 to 4 feet/second, depending upon the sediment load carried by the water. Permissible velocities may be increased through the use of vegetation to something on the order of 4 to 7 feet/second, depending upon the type of vegetation established. Should the anticipated velocities exceed these values, some form of channel lining material may be required to reduce erosion potential. These might consist of some of the synthetic channel lining materials on the market or conventional riprap. In cases where ditch-lining materials are still insufficient to control erosion, small check dams or sediment traps may be required. The check dams will serve to reduce flow velocities, as well as provide small traps for containing sediment. The determination of the amount, location and placement of ditch linings, check dams and of the special erosion control features should be performed by or in conjunction with the drainage engineer who is more familiar with the flow quantities and velocities.

Cut and fill slope areas will be subjected primarily to sheetwash and rill erosion. Unchecked rill erosion can eventually lead to concentrated flows of water and gully erosion. The best means to combat this type of erosion is, where possible, the adequate re-vegetation of cut and fill slopes. Cut and fill slopes having gradients more than three (3) horizontal to one (1) vertical become increasingly more difficult to revegetate successfully. Therefore, recommendations pertaining to the vegetation of the cut and fill slopes may require input from a qualified landscape architect and/or the Soil Conservation Service.



## **10.0 CLOSURE**

It is our opinion that the existing geologic engineering and geologic conditions will impose some minor constraints on development and construction of the site. The majority of these conditions can be avoided by construction. Others can be mitigated through proper engineering design and construction practices. The proposed development and use is consistent with anticipated geologic and engineering geologic conditions.

It should be pointed out that because of the nature of data obtained by random sampling of such variable and non-homogeneous materials as soil and rock, it is important that we be informed of any differences observed between surface and subsurface conditions encountered in construction and those assumed in the body of this report. Individual investigations for building sites and septic systems will be required prior to construction. Construction and design personnel should be made familiar with the contents of this report. Reporting such discrepancies to Entech Engineering, Inc. soon after they are discovered would be greatly appreciated and could possibly help avoid construction and development problems.

This report has been prepared for Savage Development, Inc. for application to the proposed project in accordance with generally accepted geologic soil and engineering practices. No other warranty expressed or implied is made.

We trust that this report has provided you with all the information that you required. Should you require additional information, please do not hesitate to contact Entech Engineering, Inc.

## **BIBLIOGRAPHY**

1. Bryant, Bruce; McGrew, Laura W, and Wabus, Reinhard A. 1981. *Geologic Structure Map of the Denver 1° x 2° Quadrangle, North-Central Colorado*. Sheet 2. U.S. Geologic Survey. Map I-1163.
2. Natural Resource Conservation Service, September 23, 2016. *Web Soil Survey*. United States Department Agriculture, <http://websoilsurvey.sc.egov.usda.gov/App/HomePage.htm>.
3. United States Department of Agriculture Soil Conservation Service. June 1981. *Soil Survey of El Paso County Area, Colorado*.
4. Thorson, Jon P. and Madole, Richard F., 2003. *Geologic Map of the Black Forest Quadrangle, El Paso County, Colorado*. Colorado Geological Survey. Open-File Report 03-6.
5. Trimble, Donald E. and Machette, Michael N. 1979. *Geologic Map of the Colorado Springs-Castle Rock Area, Front Range Urban Corridor, Colorado*. USGS, Map I-857-F.
6. Bryant, Bruce; McGrew, Laura W. and Wobus, Reinhard A. 1981. *Geologic Map of the Denver 1° x 2° Quadrangle, North-Central Colorado*. U.S. Geologic Survey. Map 1-1163.
7. Federal Emergency Management Agency. March 17, 1997. *Flood Insurance Rate Maps for the City of Colorado Springs, Colorado*. Map Number 08041CO325F
8. El Paso County Planning Development. December 1995. *El Paso County Aggregate Resource Evaluation Maps*.
9. Schwochow, S.D.; Shroba, R.R. and Wicklein, P.C. 1974. *Atlas of Sand, Gravel, and Quarry Aggregate Resources, Colorado Front Range Counties*. Colorado Geological Survey. Special Publication 5-B.
10. Keller, John W.; TerBest, Harry and Garrison, Rachel E. 2003. *Evaluation of Mineral and Mineral Fuel Potential of El Paso County State Mineral Lands Administered by the Colorado State Land Board*. Colorado Geological Survey. Open-File Report 03-07.

## **TABLES**

**TABLE 1**  
**SUMMARY OF LABORATORY TEST RESULTS**

CLIENT SAVAGE DEVELOPMENT  
 PROJECT HODGEN & BLACK FOREST  
 JOB NO. 180368

SOIL TYPE	TEST BORING NO.	DEPTH (FT)	WATER (%)	DRY DENSITY (PCF)	PASSING NO. 200 SIEVE (%)	LIQUID LIMIT (%)	PLASTIC INDEX (%)	SULFATE (WT %)	FHA SWELL (PSF)	SWELL/CONSOL (%)	UNIFIED CLASSIFICATION	SOIL DESCRIPTION
1	2	5			19.8						SM	SAND, SILTY
2	1	10	10.8	115.3	51.0					1.1	CL	CLAY, VERY SANDY
2	1	2-3			80.6			540			CL	CLAY, SANDY
3	2	20			53.6						CL	CLAYSTONE, VERY SANDY

**Table 2: Summary Tactile Test Pit Results**

<b>Test Pit No.</b>	<b>USDA Soil Type</b>	<b>LTAR Value</b>	<b>Depth to Bedrock (ft.)</b>	<b>Depth to Seasonally Occurring Groundwater (ft.)</b>
1	4*	0.15*	N/A	N/A
2	4*	0.15*	N/A	N/A
3	2	0.60	N/A	N/A

\*- Conditions that will require an engineered OWTS

## FIGURES





**ENTECH**  
**ENGINEERING, INC.**  
505 ELKTON DRIVE  
 COLORADO SPRINGS, CO. 80907 (719) 531-5399

**VICINITY MAP**  
**HODGEN ROAD SUBDIVISION**  
**HODGEN ROAD AND BLACK FOREST ROAD**  
**EL PASO COUNTY, CO.**  
**FOR: SAVAGE DEVELOPMENT, INC.**

DRAWN: <b>LLL</b>	DATE: <b>4/11/18</b>	CHECKED:	DATE:
----------------------	-------------------------	----------	-------

JOB NO.:  
**180368**

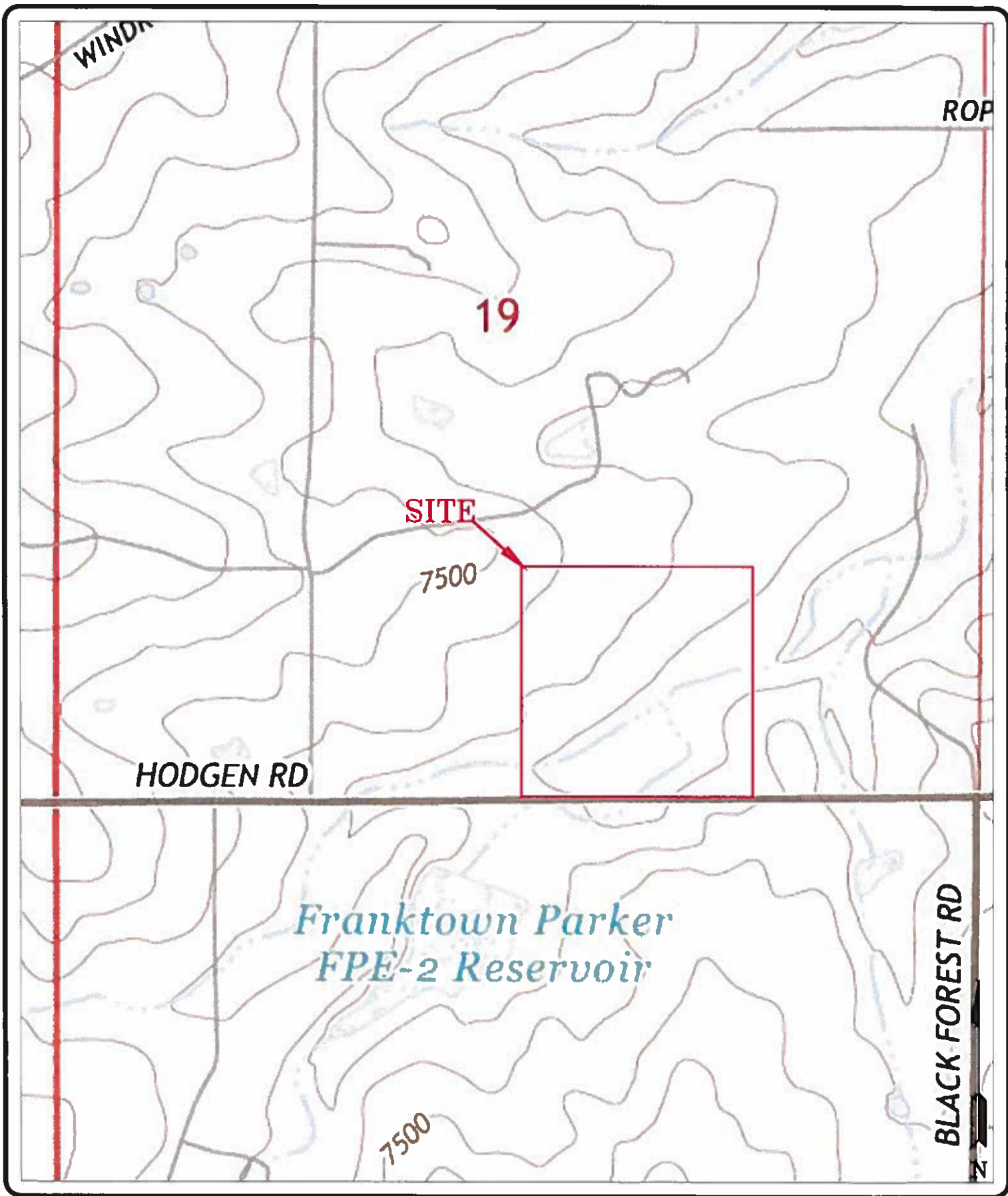
FIG NO.:  
**1**



**ENTECH**  
ENGINEERING, INC.  
525 ELKTON DRIVE  
COLORADO SPRINGS, CO. 80907 (719) 531-5299

USGS MAP  
HODGEN ROAD SUBDIVISION  
HODGEN ROAD AND BLACK FOREST ROAD  
EL PASO COUNTY, CO.  
FOR: SAVAGE DEVELOPMENT, INC.

DRAWN:  
LLL

DATE:  
4/11/18

CHECKED:



DATE:

JOB NO.:  
180368

FIG NO.:  
2

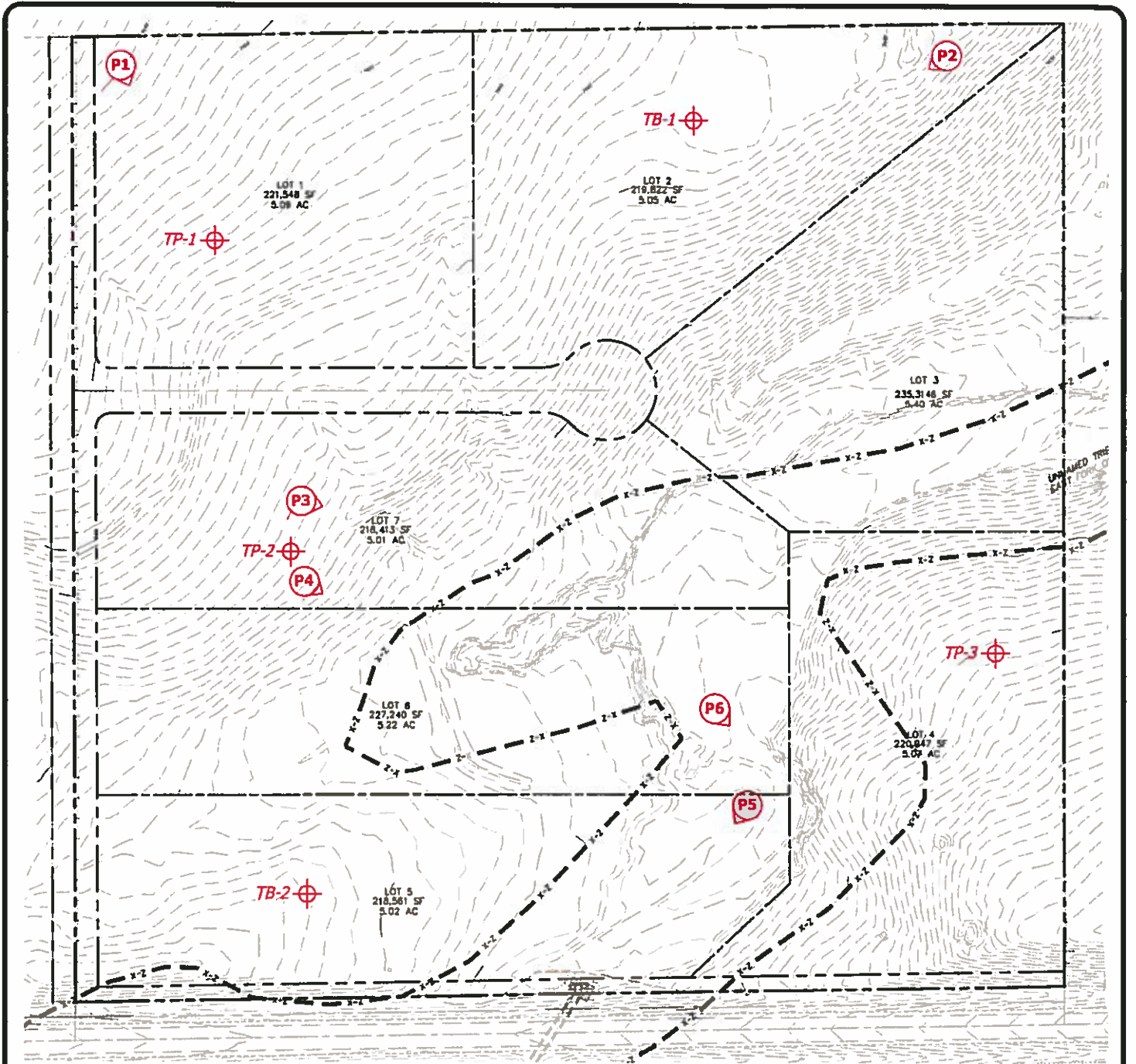



-  TB- APPROXIMATE TEST BORING LOCATION AND NUMBER
-  TP- APPROXIMATE TEST PIT LOCATION AND NUMBER
-  - APPROXIMATE TEST PIT LOCATION AND NUMBER



**ENTECH**  
**ENGINEERING, INC.**  
 505 ELKTON DRIVE  
 COLORADO SPRINGS, CO. 80907 (719) 531-3599

**SITE PLAN/TESTING LOCATION MAP**  
**HODGEN ROAD SUBDIVISION**  
**HODGEN ROAD AND BLACK FOREST ROAD**  
**EL PASO COUNTY, CO.**  
**FOR: SAVAGE DEVELOPMENT, INC.**

DRAWN:  
 LLL

DATE:  
 4/11/18

CHECKED:

DATE:

JOB NO:  
 180368

FIG NO:  
 3



67

68



**ENTECH**  
**ENGINEERING, INC.**  
505 ELKTON DRIVE  
 COLORADO SPRINGS, CO. 80907 (719) 531-5299

**SCS MAP**  
**HODGEN ROAD SUBDIVISION**  
**HODGEN ROAD AND BLACK FOREST ROAD**  
**EL PASO COUNTY, CO.**  
**FOR: SAVAGE DEVELOPMENT, INC.**

<b>DRAWN:</b> LLL	<b>DATE:</b> 4/11/18	<b>CHECKED:</b>	<b>DATE:</b>
----------------------	-------------------------	-----------------	--------------

**JOB NO.:**  
**180368**  
**FIG NO.:**  
 4



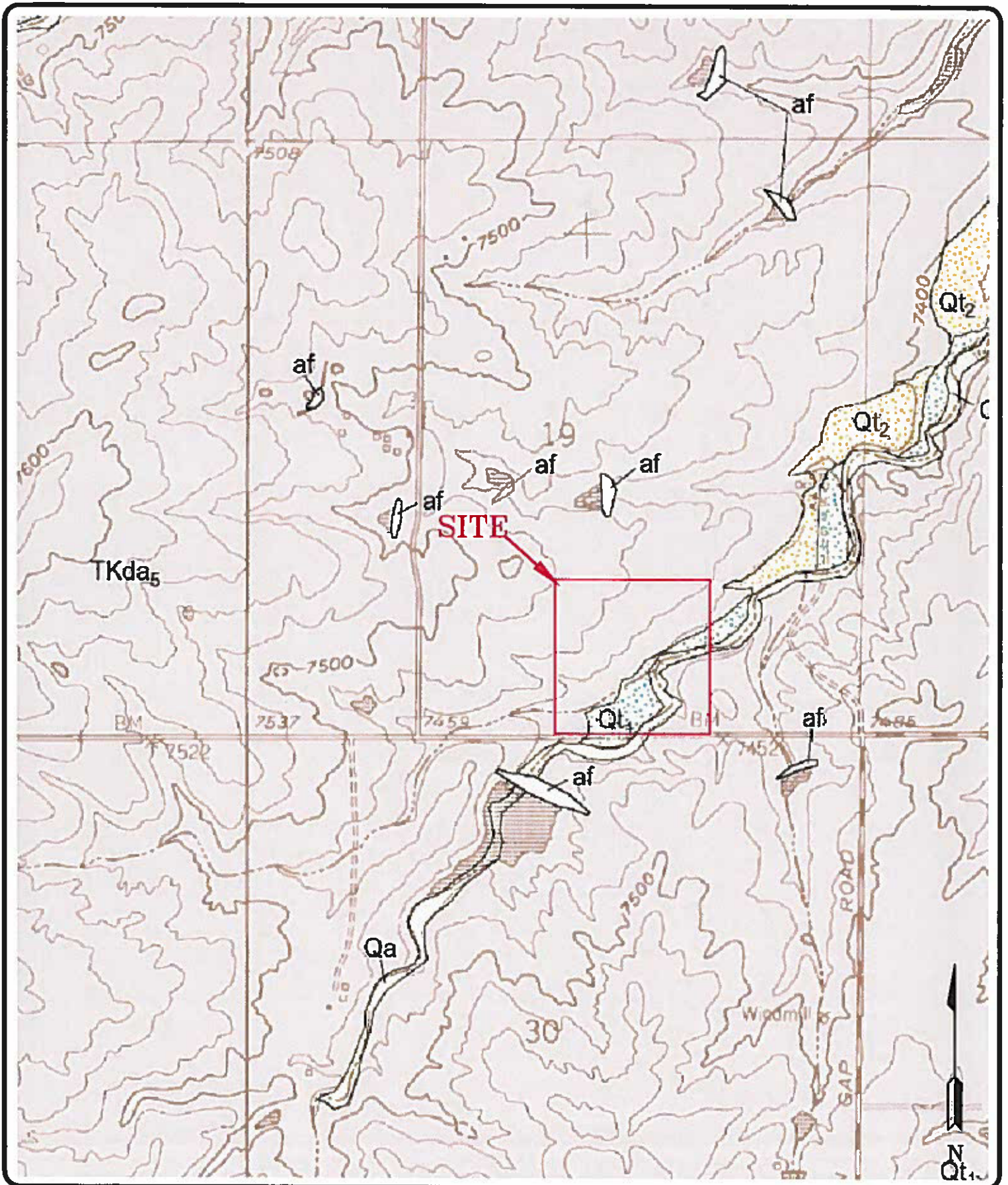

**ENTECH**  
ENGINEERING, INC.  
585 ELKTON DRIVE  
COLORADO SPRINGS, CO. 80907 (719) 521-3399

**BLACK FOREST QUADRANGLE GEOLOGIC MAP**  
HODGEN ROAD SUBDIVISION  
HODGEN ROAD AND BLACK FOREST ROAD  
EL PASO COUNTY, CO.  
FOR: SAVAGE DEVELOPMENT, INC.

DRAWN: LLL	DATE: 4/11/18	CHECKED:	DATE:
---------------	------------------	----------	-------

JOB NO.:  
**180368**

FIG NO.:  
**5**



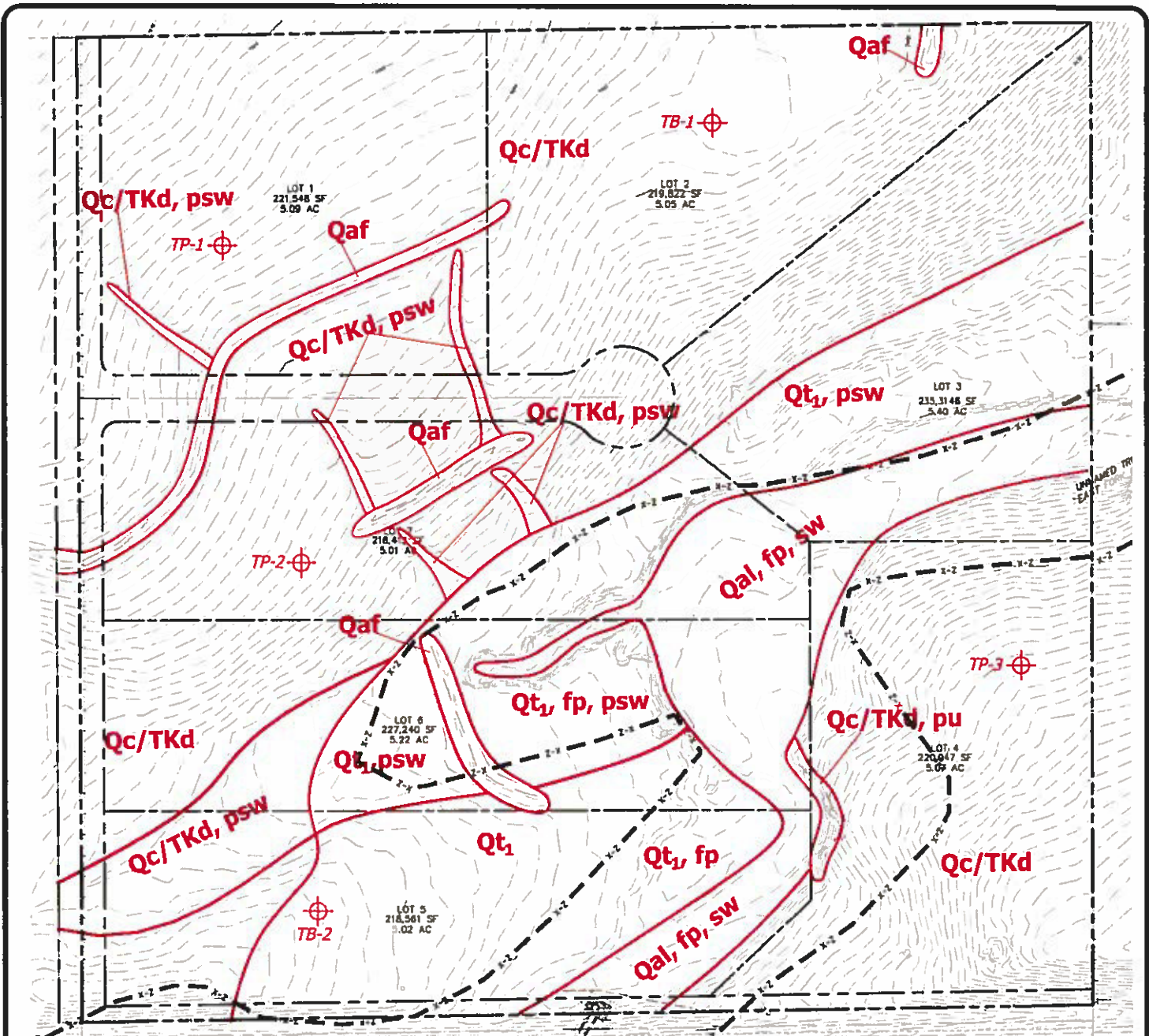

**LEGEND:**

- Qal - Recent Alluvium of Holocene Age:  
recent water deposits
- Qaf - Artificial Fill of Holocene Age:  
man-made fill deposits
- Qt<sub>1</sub> - Terrace Alluvium One of Holocene and Late Pleistocene Age:  
water deposited stream terrace deposits
- Qc/TKda - Colluvium of Quaternary Age overlying Dawson Formation of Tertiary to Cretaceous Age:  
sheetwash and residual soils deposits overlying arkosic sandstone with interbedded fine-grained sandstone, siltstone and claystone
  
- fp - floodplain
- psw - potentially seasonal shallow groundwater area
- pu - potentially unstable slope
- sw - seasonal shallow groundwater area



**ENTECH**  
ENGINEERING, INC.  
505 ELKTON DRIVE  
COLORADO SPRINGS, CO. 80907 (719) 531-2399

**GEOLOGY MAP**  
**HODGEN ROAD SUBDIVISION**  
**HODGEN ROAD AND BLACK FOREST ROAD**  
**EL PASO COUNTY, CO.**  
**FOR: SAVAGE DEVELOPMENT, INC.**

DRAWN: LLL	DATE: 4/18/18	CHECKED:	DATE:
---------------	------------------	----------	-------

JOB NO.:  
**180368**

FIG NO.:  
**6**

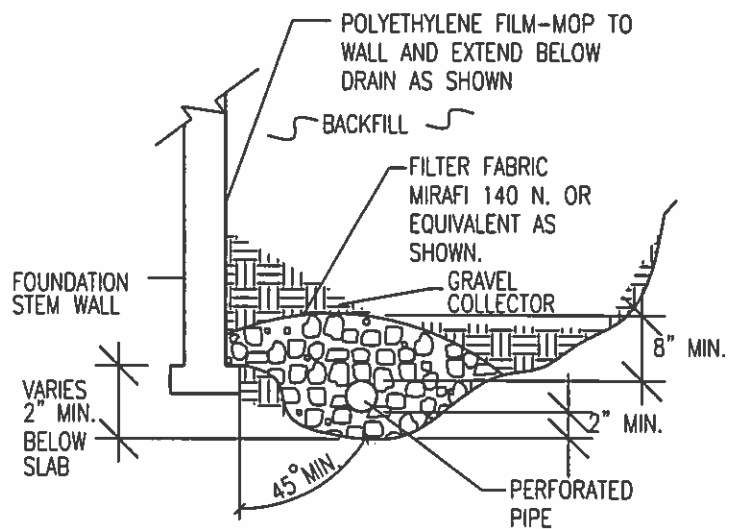
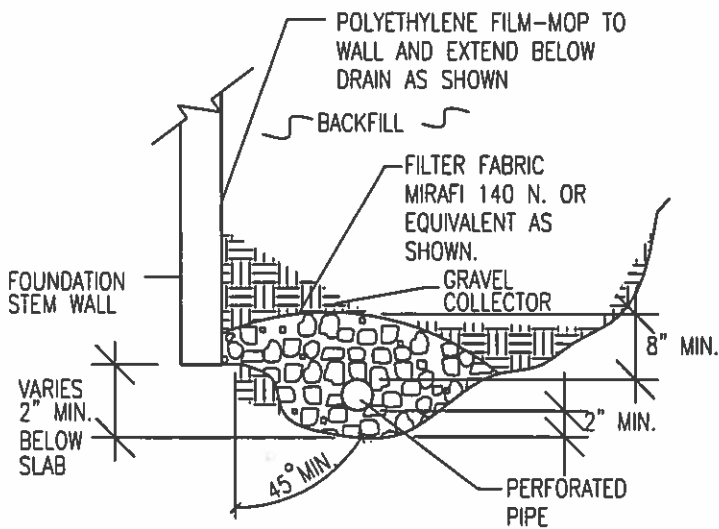

NOTES:

-GRAVEL SIZE IS RELATED TO DIAMETER OF PIPE PERFORATIONS-85% GRAVEL GREATER THAN 2x PERFORATION DIAMETER.

-PIPE DIAMETER DEPENDS UPON EXPECTED SEEPAGE. 4-INCH DIAMETER IS MOST OFTEN USED.

-ALL PIPE SHALL BE PERFORATED PLASTIC. THE DISCHARGE PORTION OF THE PIPE SHOULD BE NON-PERFORATED PIPE.

-FLEXIBLE PIPE MAY BE USED UP TO 8 FEET IN DEPTH, IF SUCH PIPE IS DESIGNED TO WITHSTAND THE PRESSURES. RIGID PLASTIC PIPE WOULD OTHERWISE BE REQUIRED.

-MINIMUM GRADE FOR DRAIN PIPE TO BE 1% OR 3 INCHES OF FALL IN 25 FEET.

-DRAIN TO BE PROVIDED WITH A FREE GRAVITY OUTFALL, IF POSSIBLE. A SUMP AND PUMP MAY BE USED IF GRAVITY OUT FALL IS NOT AVAILABLE.



**ENTECH**  
ENGINEERING, INC.  
505 ELKTON DRIVE  
COLORADO SPRINGS, CO. 80907 (719) 531-5399

*PERIMETER DRAIN DETAIL*

DRAWN:

DATE DRAWN:

DESIGNED BY:

CHECKED:

DS

LLL

JOB NO.:

180368

FIG. NO.:

8

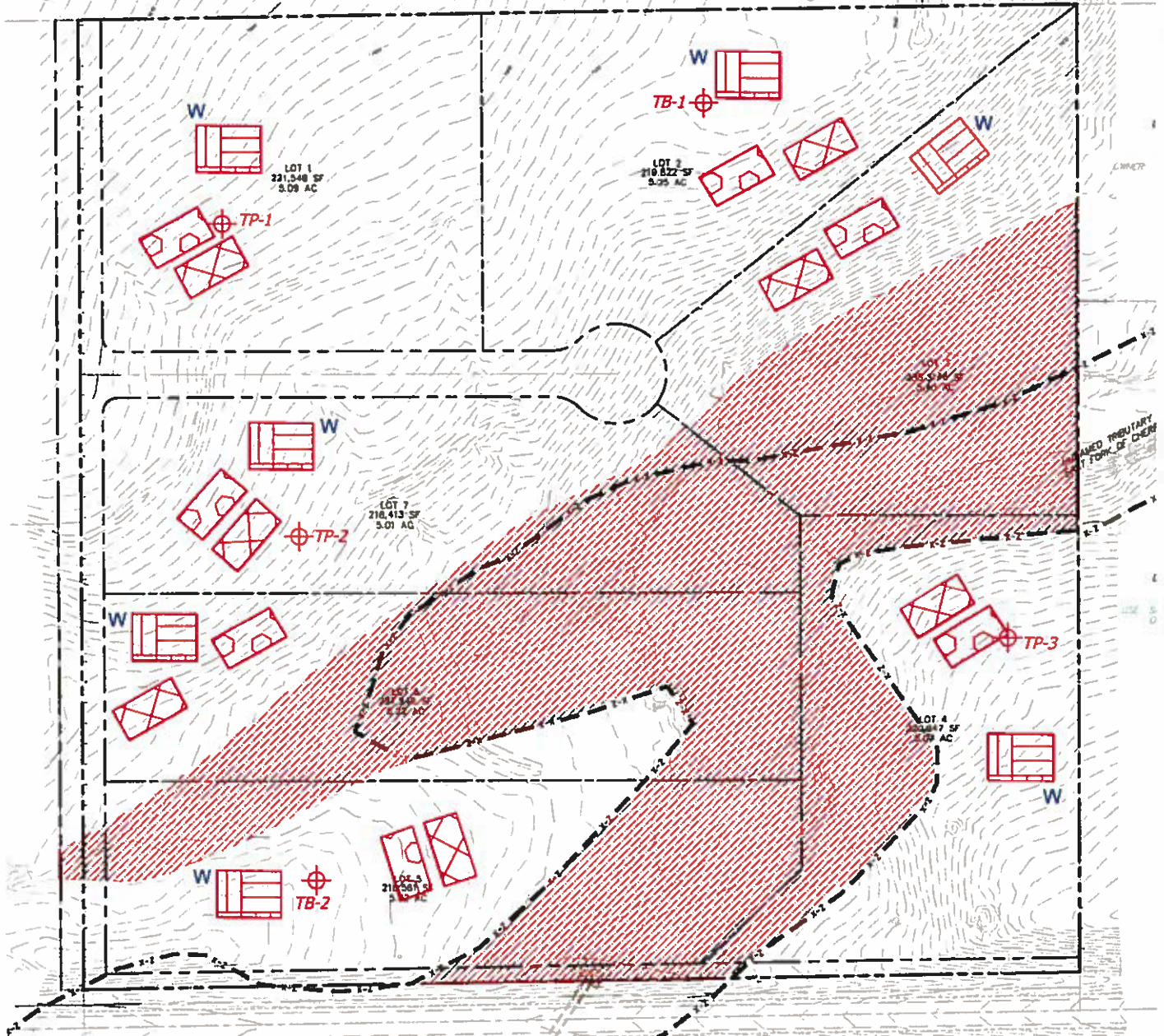

**LEGEND:**



- POSSIBLE OWTS LOCATIONS



- POSSIBLE OWTS ALTERNATE LOCATIONS



- POSSIBLE HOUSE LOCATIONS



\*- WATER WELLS MUST BE A MINIMUM OF 100 FT FROM OWTS ABSORPTION FIELDS



- AREAS WHERE OWTS ARE NOT RECOMMENDED



**ENTECH**  
ENGINEERING, INC.  
355 ELKTON DRIVE  
COLORADO SPRINGS, CO. 80907 (719) 531-5399

SEPTIC SUITABILITY MAP  
HODGEN ROAD SUBDIVISION  
HODGEN ROAD AND BLACK FOREST ROAD  
EL PASO COUNTY, CO.  
FOR: SAVAGE DEVELOPMENT, INC.

DRAWN:  
LLL

DATE:  
4/18/18

CHECKED:

DATE:

JOB NO.:  
180368

FIG NO.:  
9

## **APPENDIX A: Site Photographs**



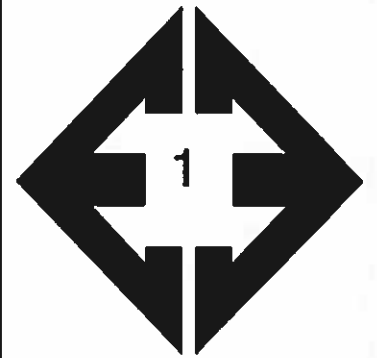

**Looking southeast  
from the northwestern  
portion of the site.**

March 10, 2018

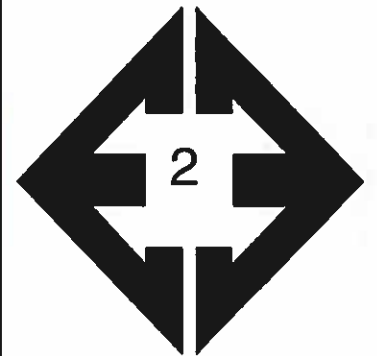

**Looking west from the  
northeastern portion of  
the site.**

March 10, 2018





**Looking east from the western portion of the site.**

March 10, 2018

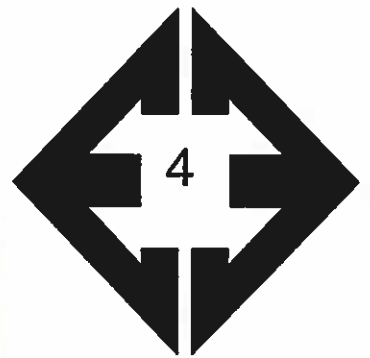

**Looking southeast from the western portion of the site.**

March 10, 2018

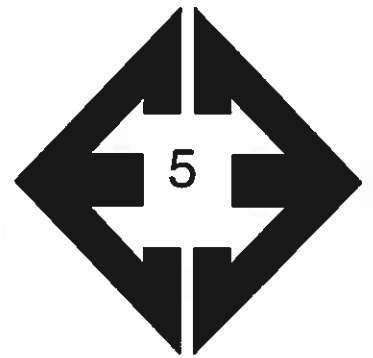

**Looking southwest  
from the southeastern  
portion of the site.**

March 10, 2018

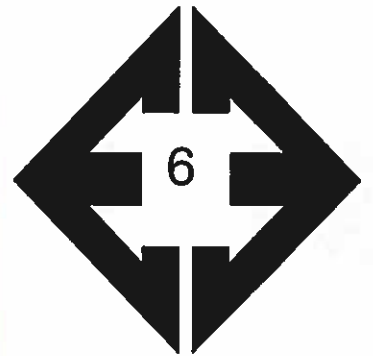

**Looking southeast  
towards the potentially  
unstable slope on Lot  
4.**

March 10, 2018

## **APPENDIX B: Test Boring Logs and Test Pit Logs**

TEST BORING NO. 1  
 DATE DRILLED 3/12/2018  
 Job # 180368

TEST BORING NO. 2  
 DATE DRILLED 3/12/2018  
 CLIENT SAVAGE DEVELOPMENT  
 LOCATION HODGEN & BLACK FOREST

REMARKS	Depth (ft)	Symbol	Samples	Blows per foot	Watercontent %	Soil Type	REMARKS	Depth (ft)	Symbol	Samples	Blows per foot	Watercontent %	Soil Type
DRY TO 20', 3/14/18 CLAY, SANDY TO VERY SANDY, TAN, FIRM TO STIFF, MOIST	5			12	7.9	2	DRY TO 20', 3/14/18 SAND, SILTY, FINE TO COARSE GRAINED, TAN, MEDIUM DENSE, MOIST	5			22	4.3	1
	5			12	8.3	2		5			21	7.7	1
	10			17	7.5	2		10			20	10.5	1
SAND, SILTY, FINE TO COARSE GRAINED, TAN TO BROWN, MEDIUM DENSE, MOIST	15			19	4.5	1		15			24	13.3	1
	20			21	8.3	1	CLAYSTONE, VERY SANDY, GRAY BROWN, HARD, MOIST	20			50 10"	13.7	3



**ENTECH**  
 ENGINEERING, INC.  
 505 ELKTON DRIVE  
 COLORADO SPRINGS, COLORADO 80907

TEST BORING LOG

DRAWN:

DATE:

CHECKED:

DATE:

LL

4/12/18





















JOB NO.:  
180368

FIG NO.:

B-1

TEST PIT NO. 1  
 DATE EXCAVATED 3/10/2018  
 Job # 180368

TEST PIT NO. 2  
 DATE EXCAVATED 3/10/2018  
 CLIENT SAVAGE DEVELOPMENT  
 LOCATION HODGEN ROAD & BLACK FOREST ROAD

REMARKS	Depth (ft)	Symbol	Samples	Soil Structure Shape	Soil Structure Grade	USDA Soil Type	REMARKS	Depth (ft)	Symbol	Samples	Soil Structure Shape	Soil Structure Grade	USDA Soil Type
topsoil sandy clay loam, brown	1						topsoil sandy clay, brown	1					
sandy clay loam, light brown	2			bl	m	3	sandy clay, light brown	2			bl	m	4
sandy clay, tan	3			bl	m	4		3					
	4						sandy clay loam, tan	4			bl	m	3
	5							5					
	6							6					
	7							7					
	8							8					
	9							9					
	10							10					

Soil Structure Shape  
 granular - gr  
 platy - pl  
 blocky - bl  
 prismatic - pr  
 single grain - sg  
 massive - ma

Soil Structure Grade  
 weak - w  
 moderate - m  
 strong - s  
 loose - l



**ENTECH**  
**ENGINEERING, INC.**

505 ELKTON DRIVE  
 COLORADO SPRINGS, COLORADO 80907

**TEST PIT LOG**

DRAWN:	DATE:	CHECKED:	DATE:
		LLL	4/12/18

JOB NO.:  
 180368  
 FIG NO.:  
 B-2

TEST PIT NO. 3  
 DATE EXCAVATED 3/10/2018  
 Job # 180368

CLIENT LOCATION SAVAGE DEVELOPMENT  
 HODGEN ROAD & BLACK FOREST ROAD

REMARKS	Depth (ft)	Symbol	Samples	Soil Structure Shape	Soil Structure Grade	USDA Soil Type	REMARKS	Depth (ft)	Symbol	Samples	Soil Structure Shape	Soil Structure Grade	USDA Soil Type
topsoil loamy sand, brown	1							1					
sandy loam, fine to medium grained, tan	2			gr	m	2		2					
	3							3					
loamy sand, fine to coarse grained, tan	4			sg		1		4					
	5							5					
	6							6					
	7							7					
	8							8					
	9							9					
	10							10					

Soil Structure Shape

- granular - gr
- platy - pl
- blocky - bl
- prismatic - pr
- single grain - sg
- massive - ma

Soil Structure Grade

- weak - w
- moderate - m
- strong - s
- loose - l



**ENTECH**  
**ENGINEERING, INC.**

505 ELKTON DRIVE  
 COLORADO SPRINGS, COLORADO 80907

TEST PIT LOG

DRAWN:	DATE:	CHECKED:	DATE:
		LLL	4/12/18

JOB NO.:  
 180368  
 FIG NO.:  
 B-3

## **APPENDIX C: Laboratory Test Results**



BORING NO.	2	UNIFIED CLASSIFICATION	SM	TEST BY	BL
DEPTH(ft)	5	SOIL TYPE	#1	JOB NO.	180368
CLIENT	SAVAGE DEVELOPMENT				
PROJECT	HODGEN & BLACK FOREST				

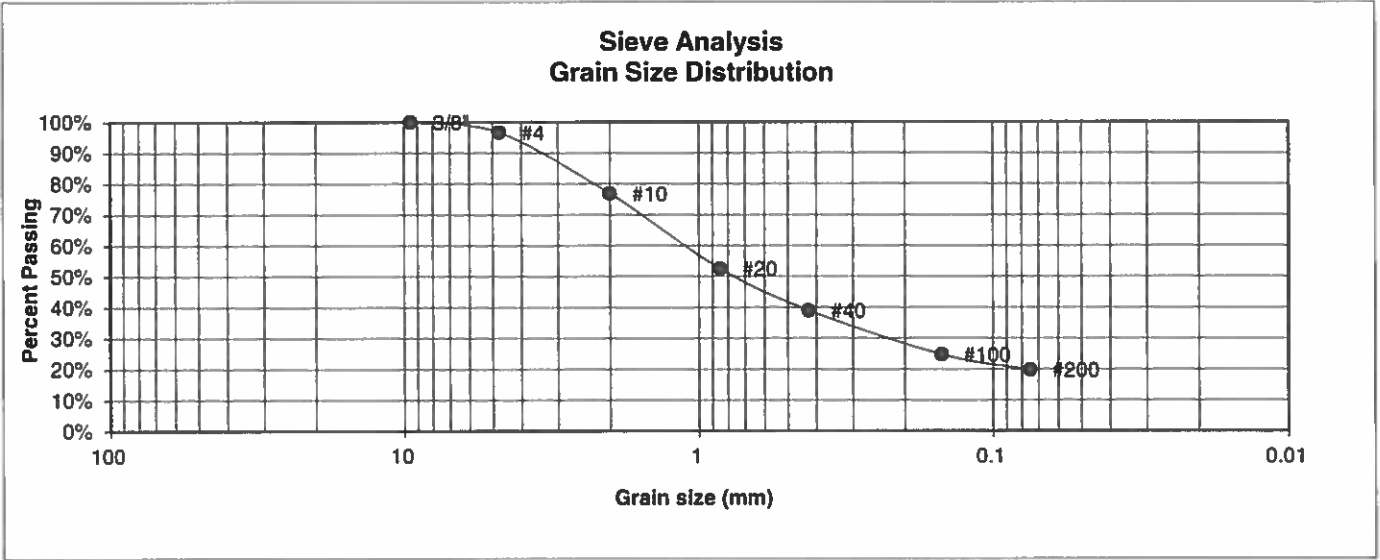

U.S. Sieve #	Percent Finer
3"	
1 1/2"	
3/4"	
1/2"	
3/8"	100.0%
4	96.7%
10	76.9%
20	52.6%
40	39.0%
100	24.7%
200	19.8%

**Atterberg Limits**  
 Plastic Limit  
 Liquid Limit  
 Plastic Index

**Swell**  
 Moisture at start  
 Moisture at finish  
 Moisture increase  
 Initial dry density (pcf)  
 Swell (psf)



**ENTECH  
ENGINEERING, INC.**

505 ELKTON DRIVE  
COLORADO SPRINGS, COLORADO 80907

**LABORATORY TEST  
RESULTS**

DRAWN:	DATE:	CHECKED: <i>[Signature]</i>	DATE: 3/19/18
--------	-------	-----------------------------	---------------

JOB NO.:  
180368

FIG NO.:  
C-1



BORING NO.	TP-3	UNIFIED CLASSIFICATION	SM-SW	TEST BY	BL
DEPTH(ft)	5-6	AASHTO CLASSIFICATION		JOB NO.	180368
CLIENT	SAVAGE DEVELOPMENT				
PROJECT	HODGEN & BLACK FOREST				

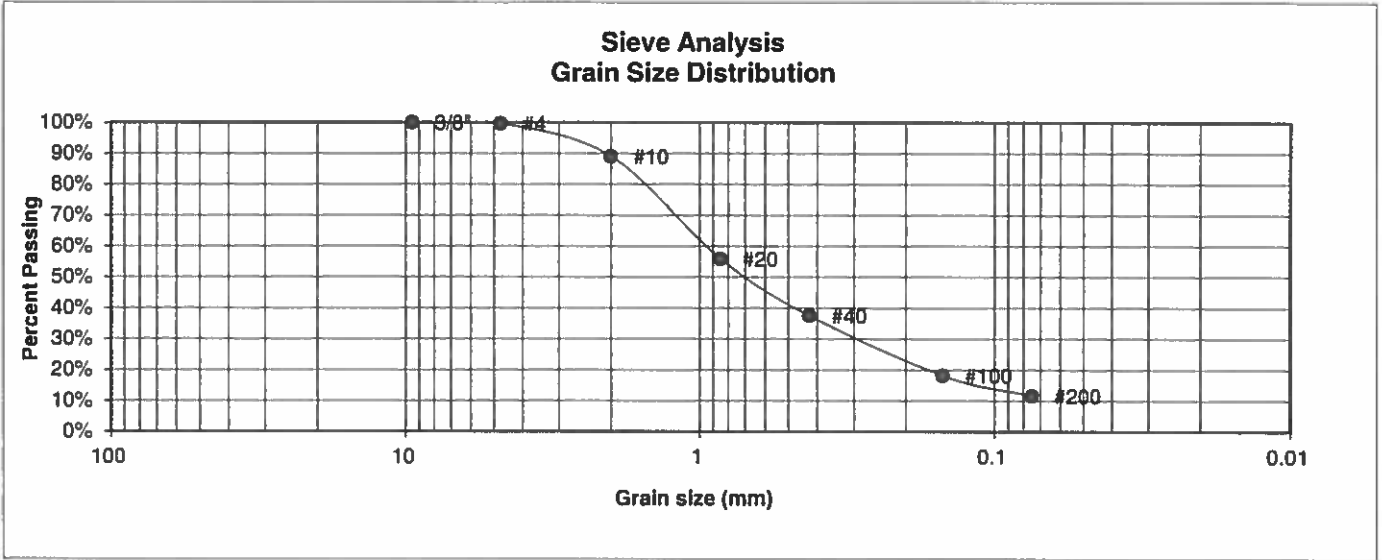

U.S. Sieve #	Percent Finer
3"	
1 1/2"	
3/4"	
1/2"	
3/8"	100.0%
4	99.7%
10	89.0%
20	55.9%
40	37.6%
100	18.2%
200	11.6%

Atterberg  
Limits  
Plastic Limit  
Liquid Limit  
Plastic Index

Swell  
Moisture at start  
Moisture at finish  
Moisture increase  
Initial dry density (pcf)  
Swell (psf)



**ENTECH**  
ENGINEERING, INC.  
505 ELKTON DRIVE  
COLORADO SPRINGS, COLORADO 80907

LABORATORY TEST RESULTS

DRAWN	DATE	CHECKED: <i>h</i>	DATE: 3/19/18
-------	------	-------------------	---------------

JOB NO.:  
180368

FIG NO.:  
C-2

BORING NO.	1	UNIFIED CLASSIFICATION	CL	TEST BY	BL
DEPTH(ft)	10	SOIL TYPE	#2	JOB NO.	180368
CLIENT	SAVAGE DEVELOPMENT				
PROJECT	HODGEN & BLACK FOREST				

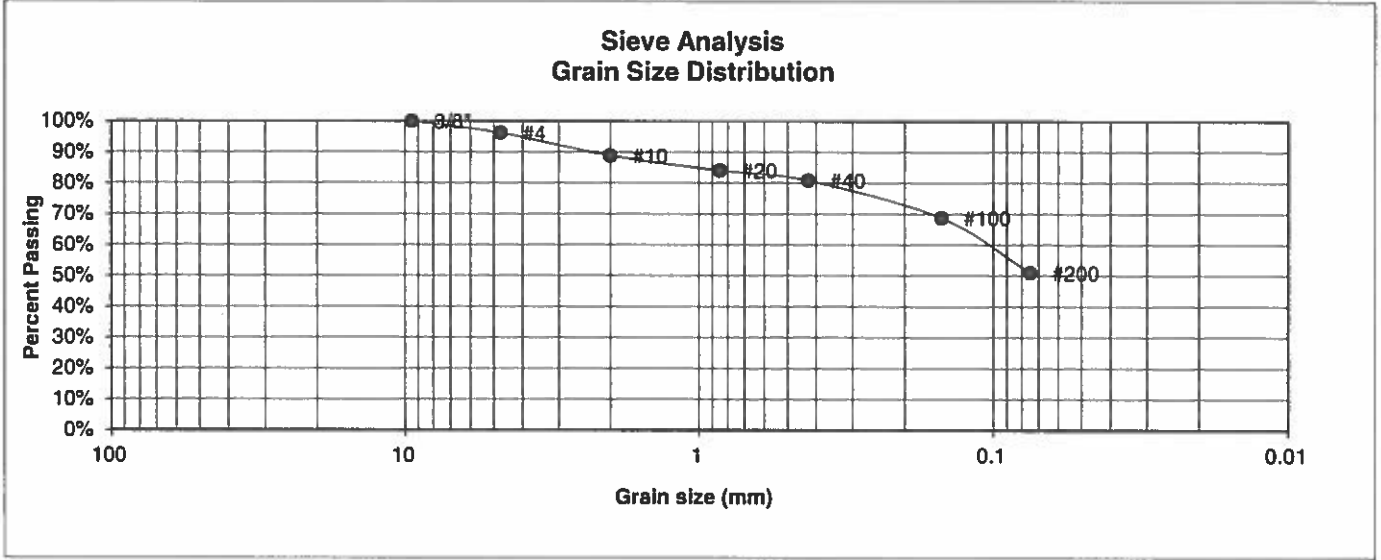

U.S. Sieve #	Percent Finer
3"	
1 1/2"	
3/4"	
1/2"	
3/8"	100.0%
4	96.1%
10	88.8%
20	84.0%
40	80.8%
100	68.7%
200	51.0%

**Atterberg Limits**  
 Plastic Limit  
 Liquid Limit  
 Plastic Index

**Swell**  
 Moisture at start  
 Moisture at finish  
 Moisture increase  
 Initial dry density (pcf)  
 Swell (psf)



**ENTECH  
ENGINEERING, INC.**

505 ELKTON DRIVE  
COLORADO SPRINGS, COLORADO 80907

**LABORATORY TEST  
RESULTS**

DRAWN:	DATE:	CHECKED:	DATE:
		<i>ln</i>	3/19/18

JOB NO.:  
180368

FIG NO.:  
L-3

BORING NO.	1	UNIFIED CLASSIFICATION	CL	TEST BY	BL
DEPTH(ft)	2-3	SOIL TYPE	#2	JOB NO.	180368
CLIENT	SAVAGE DEVELOPMENT				
PROJECT	HODGEN & BLACK FOREST				

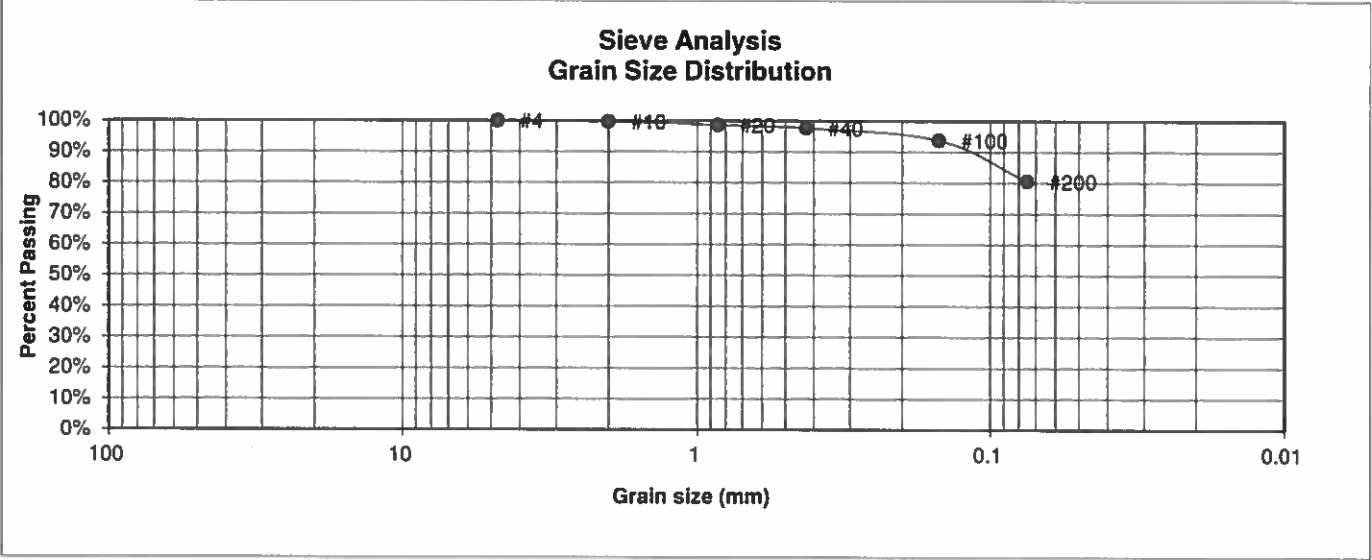

U.S. Sieve #	Percent Finer
3"	
1 1/2"	
3/4"	
1/2"	
3/8"	
4	100.0%
10	99.7%
20	98.7%
40	97.7%
100	93.8%
200	80.6%

**Atterberg Limits**  
 Plastic Limit  
 Liquid Limit  
 Plastic Index

<b>Swell</b>	
Moisture at start	15.5%
Moisture at finish	20.3%
Moisture increase	4.8%
Initial dry density (pcf)	99
Swell (psf)	540



**ENTECH  
ENGINEERING, INC.**

505 ELKTON DRIVE  
COLORADO SPRINGS, COLORADO 80907

**LABORATORY TEST  
RESULTS**

DRAWN

DATE

CHECKED: *h*

DATE: 3/19/18

JOB NO.:  
180368

FIG NO.:

C-4

BORING NO.	TP-1	UNIFIED CLASSIFICATION	CL	TEST BY	BL
DEPTH(ft)	2-3	AASHTO CLASSIFICATION		JOB NO.	180368
CLIENT	SAVAGE DEVELOPMENT				
PROJECT	HODGEN & BLACK FOREST				

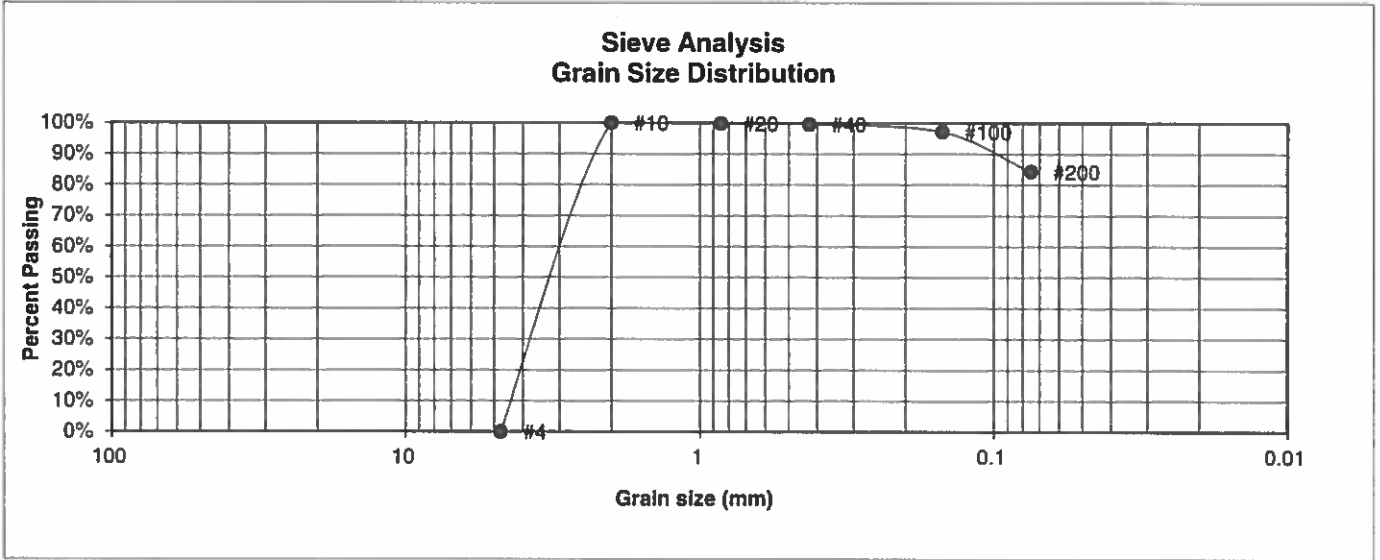

U.S. Sieve #	Percent Finer
3"	
1 1/2"	
3/4"	
1/2"	
3/8"	
4	
10	100.0%
20	99.8%
40	99.6%
100	97.2%
200	84.3%

**Atterberg Limits**  
 Plastic Limit  
 Liquid Limit  
 Plastic Index

**Swell**  
 Moisture at start  
 Moisture at finish  
 Moisture increase  
 Initial dry density (pcf)  
 Swell (psf)



**ENTECH  
ENGINEERING, INC.**

505 ELKTON DRIVE  
COLORADO SPRINGS, COLORADO 80907

**LABORATORY TEST  
RESULTS**

DRAWN:	DATE:	CHECKED: <i>W</i>	DATE: 3/19/10
--------	-------	-------------------	---------------

JOB NO.:  
180368

FIG NO.:  
L-5

BORING NO.	TP-2	UNIFIED CLASSIFICATION	CL	TEST BY	BL
DEPTH(ft)	5-6	AASHTO CLASSIFICATION		JOB NO.	180368
CLIENT	SAVAGE DEVELOPMENT				
PROJECT	HODGEN & BLACK FOREST				

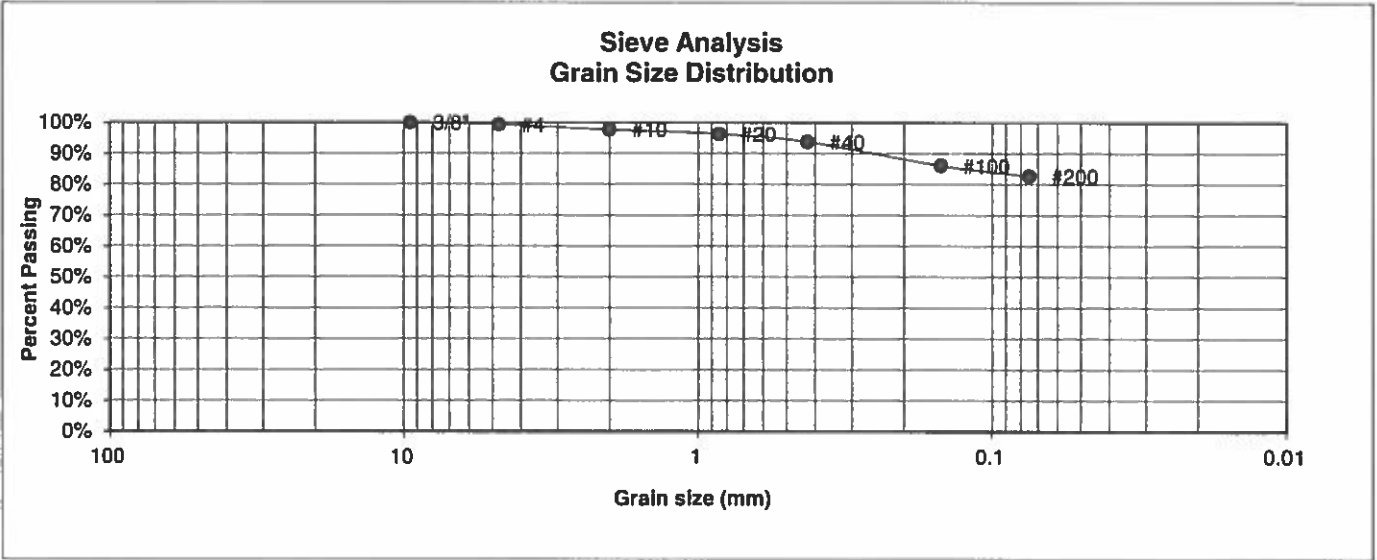

U.S. Sieve #	Percent Finer
3"	
1 1/2"	
3/4"	
1/2"	
3/8"	100.0%
4	99.3%
10	97.7%
20	96.3%
40	93.7%
100	86.1%
200	82.7%

Atterberg Limits  
 Plastic Limit  
 Liquid Limit  
 Plastic Index

Swell  
 Moisture at start  
 Moisture at finish  
 Moisture increase  
 Initial dry density (pcf)  
 Swell (psf)



**ENTECH**  
**ENGINEERING, INC.**

505 ELKTON DRIVE  
 COLORADO SPRINGS, COLORADO 80907

**LABORATORY TEST RESULTS**

DRAWN	DATE	CHECKED	DATE
		<i>[Signature]</i>	3/19/18

JOB NO.:  
180368

FIG NO.:  
C-6

BORING NO.	2	UNIFIED CLASSIFICATION	CL	TEST BY	BL
DEPTH(ft)	20	SOIL TYPE	#3	JOB NO.	180368
CLIENT	SAVAGE DEVELOPMENT				
PROJECT	HODGEN & BLACK FOREST				

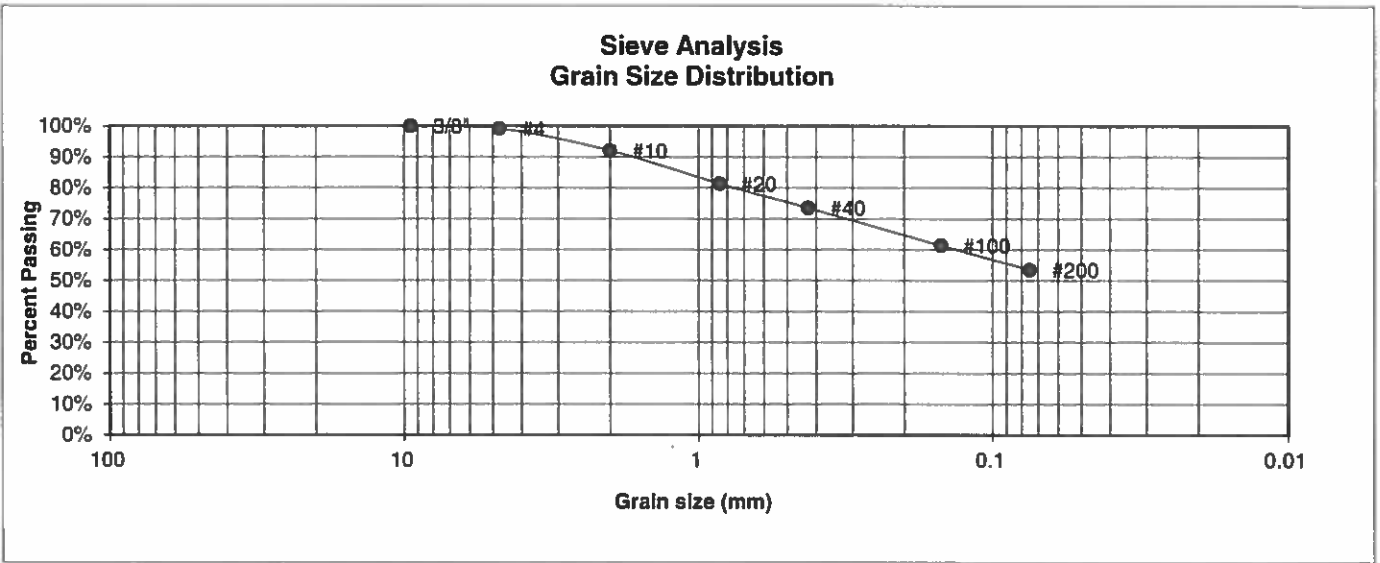

U.S. Sieve #	Percent Finer
3"	
1 1/2"	
3/4"	
1/2"	
3/8"	100.0%
4	99.2%
10	92.0%
20	81.4%
40	73.5%
100	61.4%
200	53.6%

**Atterberg Limits**  
 Plastic Limit  
 Liquid Limit  
 Plastic Index

**Swell**  
 Moisture at start  
 Moisture at finish  
 Moisture increase  
 Initial dry density (pcf)  
 Swell (psf)



**ENTECH  
ENGINEERING, INC.**

505 ELKTON DRIVE  
COLORADO SPRINGS, COLORADO 80907

**LABORATORY TEST  
RESULTS**

DRAWN:	DATE:	CHECKED: <i>h</i>	DATE: 3/19/18
--------	-------	-------------------	---------------

JOB NO.:  
180368

FIG NO.:

C-7

**CONSOLIDATION TEST RESULTS**

SAMPLE FROM:	1	DEPTH(ft)	10
DESCRIPTION	CL	SOIL TYPE	2
NATURAL UNIT DRY WEIGHT (PCF)			115
NATURAL MOISTURE CONTENT			10.8%
SWELL/CONSOLIDATION (%)			1.1%

JOB NO. 180368  
 CLIENT SAVAGE DEVELOPMENT  
 PROJECT HODGEN & BLACK FOREST

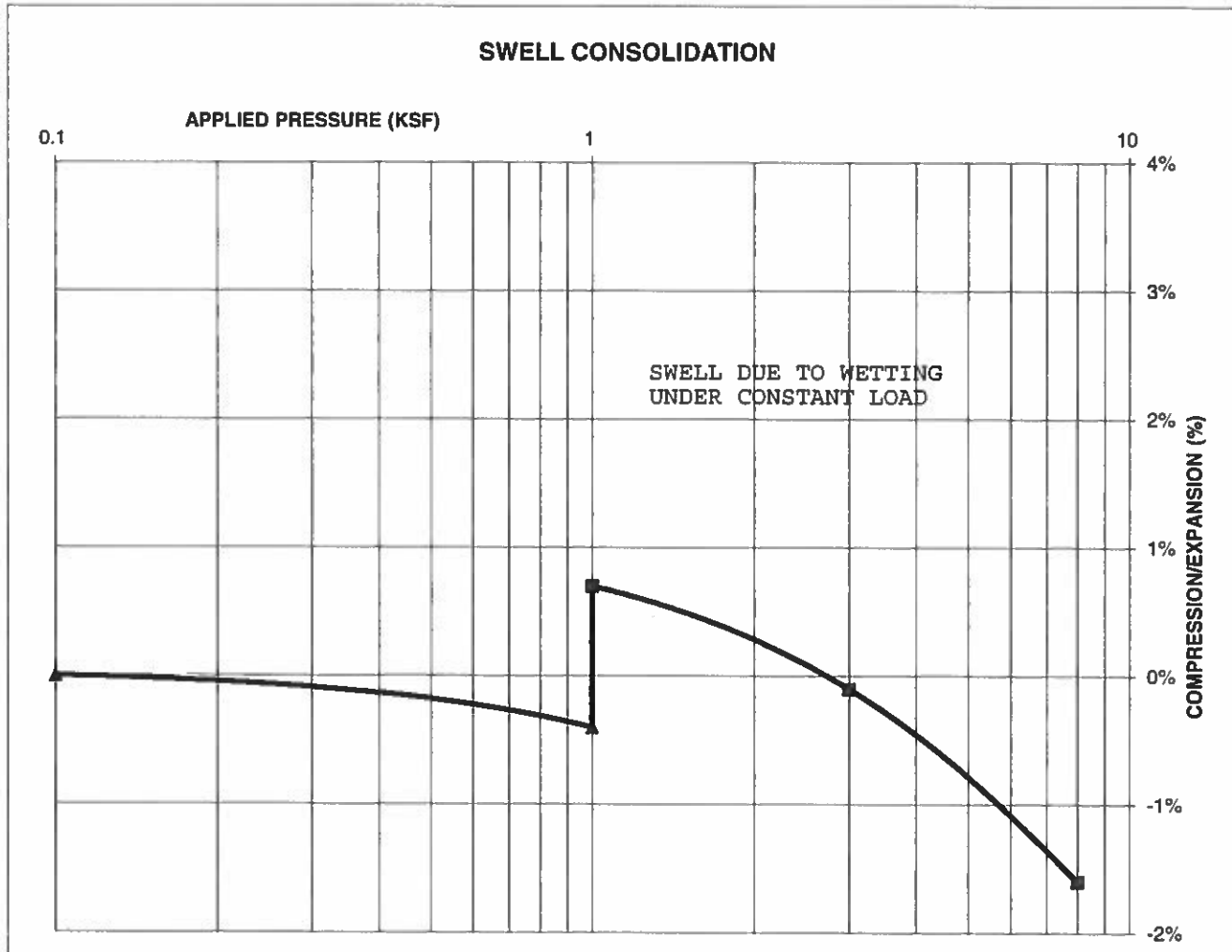

**ENTECH**  
 ENGINEERING, INC.  
 505 ELKTON DRIVE  
 COLORADO SPRINGS, COLORADO 80907

**SWELL CONSOLIDATION  
 TEST RESULTS**

DRAWN:

DATE:

CHECKED: *h*

DATE: 3/19/18

JOB NO.:  
 180368

FIG NO.:  
 C-8

## **APPENDIX D: Soil Survey Descriptions**



## El Paso County Area, Colorado

### 67—Peyton sandy loam, 5 to 9 percent slopes

#### Map Unit Setting

*National map unit symbol:* 369d  
*Elevation:* 6,800 to 7,600 feet  
*Mean annual air temperature:* 43 to 45 degrees F  
*Frost-free period:* 115 to 125 days  
*Farmland classification:* Not prime farmland

#### Map Unit Composition

*Peyton and similar soils:* 85 percent  
*Estimates are based on observations, descriptions, and transects of the mapunit.*

#### Description of Peyton

##### Setting

*Landform:* Hills  
*Landform position (three-dimensional):* Side slope  
*Down-slope shape:* Linear  
*Across-slope shape:* Linear  
*Parent material:* Arkosic alluvium derived from sedimentary rock and/or arkosic residuum weathered from sedimentary rock

##### Typical profile

*A - 0 to 12 inches:* sandy loam  
*Bt - 12 to 25 inches:* sandy clay loam  
*BC - 25 to 35 inches:* sandy loam  
*C - 35 to 60 inches:* sandy loam

##### Properties and qualities

*Slope:* 5 to 9 percent  
*Depth to restrictive feature:* More than 80 inches  
*Natural drainage class:* Well drained  
*Runoff class:* Medium  
*Capacity of the most limiting layer to transmit water (Ksat):*  
Moderately high (0.20 to 0.60 in/hr)  
*Depth to water table:* More than 80 inches  
*Frequency of flooding:* None  
*Frequency of ponding:* None  
*Available water storage in profile:* Moderate (about 7.3 inches)

##### Interpretive groups

*Land capability classification (irrigated):* None specified  
*Land capability classification (nonirrigated):* 4e  
*Hydrologic Soil Group:* B  
*Ecological site:* Sandy Divide (R049BY216CO)  
*Hydric soil rating:* No

### **Minor Components**

#### **Other soils**

*Percent of map unit:*  
*Hydric soil rating:* No

#### **Pleasant**

*Percent of map unit:*  
*Landform:* Depressions  
*Hydric soil rating:* Yes

## **Data Source Information**

Soil Survey Area: El Paso County Area, Colorado  
Survey Area Data: Version 15, Oct 10, 2017

## El Paso County Area, Colorado

### 68—Peyton-Pring complex, 3 to 8 percent slopes

#### Map Unit Setting

*National map unit symbol:* 369f

*Elevation:* 6,800 to 7,600 feet

*Farmland classification:* Not prime farmland

#### Map Unit Composition

*Peyton and similar soils:* 40 percent

*Pring and similar soils:* 30 percent

*Estimates are based on observations, descriptions, and transects of the mapunit.*

#### Description of Peyton

##### Setting

*Landform:* Hills

*Landform position (three-dimensional):* Side slope

*Down-slope shape:* Linear

*Across-slope shape:* Linear

*Parent material:* Arkosic alluvium derived from sedimentary rock and/or arkosic residuum weathered from sedimentary rock

##### Typical profile

*A - 0 to 12 inches:* sandy loam

*Bt - 12 to 25 inches:* sandy clay loam

*BC - 25 to 35 inches:* sandy loam

*C - 35 to 60 inches:* sandy loam

##### Properties and qualities

*Slope:* 3 to 5 percent

*Depth to restrictive feature:* More than 80 inches

*Natural drainage class:* Well drained

*Runoff class:* Low

*Capacity of the most limiting layer to transmit water (Ksat):*

Moderately high (0.20 to 0.60 in/hr)

*Depth to water table:* More than 80 inches

*Frequency of flooding:* None

*Frequency of ponding:* None

*Available water storage in profile:* Moderate (about 7.3 inches)

##### Interpretive groups

*Land capability classification (irrigated):* None specified

*Land capability classification (nonirrigated):* 4c

*Hydrologic Soil Group:* B

*Ecological site:* Sandy Divide (R049BY216CO)

*Hydric soil rating:* No

## Description of Pring

### Setting

*Landform:* Hills

*Landform position (three-dimensional):* Side slope

*Down-slope shape:* Linear

*Across-slope shape:* Linear

*Parent material:* Arkosic alluvium derived from sedimentary rock

### Typical profile

*A - 0 to 14 inches:* coarse sandy loam

*C - 14 to 60 inches:* gravelly sandy loam

### Properties and qualities

*Slope:* 3 to 8 percent

*Depth to restrictive feature:* More than 80 inches

*Natural drainage class:* Well drained

*Runoff class:* Low

*Capacity of the most limiting layer to transmit water (Ksat):* High  
(2.00 to 6.00 in/hr)

*Depth to water table:* More than 80 inches

*Frequency of flooding:* None

*Frequency of ponding:* None

*Available water storage in profile:* Low (about 6.0 inches)

### Interpretive groups

*Land capability classification (irrigated):* None specified

*Land capability classification (nonirrigated):* 3e

*Hydrologic Soil Group:* B

*Ecological site:* Loamy Park (R048AY222CO)

*Hydric soil rating:* No

## Minor Components

### Other soils

*Percent of map unit:*

*Hydric soil rating:* No

### Pleasant

*Percent of map unit:*

*Landform:* Depressions

*Hydric soil rating:* Yes

## Data Source Information

Soil Survey Area: El Paso County Area, Colorado

Survey Area Data: Version 15, Oct 10, 2017