



Master Development Drainage Plan and
Preliminary Drainage Report

Peerless Farms
16975 Falcon Hwy
Peyton, CO 80831

Prepared for (Owner):
Robert S Williams
4075 Golf Club Dr.
Colorado Springs CO, 80922
Contact: Robert S Williams
(460) 438-1874

Prepared by:
Kimley-Horn and Associates, Inc.
2 North Nevada Avenue, Suite 900
Colorado Springs, Colorado 80903
Contact: Mitchell Hess, P.E.
(719) 453-0180

Project #: 19611400

PCD File No. SP-21-7

Prepared: November 13th, 2023

Kimley»Horn



Master Development Drainage Plan and Preliminary Drainage Report
Peerless Farms – El Paso County, Colorado

CERTIFICATION

ENGINEERS STATEMENT

The attached drainage plan and report were prepared under my direction and supervision and are correct to the best of my knowledge and belief. Said drainage report has been prepared according to the criteria established by the County for drainage reports and said report is in conformity with the applicable master plan of the drainage basin. I accept responsibility for any liability caused by any negligent acts, errors or omissions on my part in preparing this report.

SIGNATURE (Affix Seal): _____
Mitchell Hess, Colorado P.E. No. 53916



DEVELOPER'S STATEMENT

I, the owner/developer have read and will comply with all of the requirements specified in this drainage report and plan.
Robert Williams

DocuSigned by:
Name of Developer: Robert Williams Date: 1/4/24
AF42CBD1A97948D...

Authorized Signature: Robert Williams Date: _____

Printed Name: owner

Title: 16975 Falcon Hwy
Peyton, CO 80831

Address: _____

EL PASO COUNTY

Filed in accordance with the requirements of the Drainage Criteria Manual, Volumes 1 and 2, El Paso County Engineering Criteria Manual and Land Development Code as amended.

Joshua Palmer, P.E.
County Engineer / ECM Administrator

_____ Date

Conditions:

Master Development Drainage Plan and Preliminary Drainage Report
Peerless Farms – El Paso County, Colorado

TABLE OF CONTENTS

CERTIFICATION	1
ENGINEERS STATEMENT	1
DEVELOPER’S STATEMENT	1
EL PASO COUNTY.....	1
INTRODUCTION	4
PURPOSE AND SCOPE OF STUDY.....	4
GENERAL PROJECT DESCRIPTION	4
PROJECT CHARACTERISTICS	4
DRAINAGE BASIN PLANNING STUDY INFRASTRUCTURE AND ANALYSIS	5
SOILS CONDITIONS	5
DRAINAGE DESIGN CRITERIA.....	5
REGULATIONS	5
DEVELOPMENT DESIGN CRITERIA REFERENCE AND CONSTRAINTS	5
HYDROLOGIC CRITERIA.....	5
HYDRAULIC CRITERIA	5
VARIANCES FROM CRITERIA	6
EXISTING DRAINAGE CONDITIONS	6
EXISTING DRAINAGE BASIN	6
<i>Sub-Basin EX1</i>	6
<i>Sub-Basin EX2</i>	6
<i>Sub-Basin EX3</i>	6
<i>Sub-Basin EX3B</i>	6
<i>Sub-Basin T3-02</i>	6
<i>Sub-Basin T4</i>	7
<i>Sagecreek South Drainage</i>	7
PROPOSED DRAINAGE CONDITIONS.....	7
<i>Sub-Basin 1</i>	7
<i>Sub-Basin 2</i>	7
<i>Sub-Basin 3</i>	8
<i>Sub-Basin 4</i>	8
<i>Sub-Basin 5</i>	8
<i>Sub-Basin 6</i>	8
<i>Sub-Basin 7</i>	8
<i>Sub-Basin 8</i>	8
<i>Sub-Basin EX3</i>	9
<i>Sub-Basin EX3B</i>	9
<i>Sub-Basin T3-02</i>	9
<i>Sub-Basin T4</i>	9
<i>Sagecreek South Drainage</i>	9
PUBLIC ROADWAY AND PRIVATE DRIVEWAY DITCHES	9
PUBLIC ROADWAY AND PRIVATE DRIVEWAY CULVERTS	10
CONFORMANCE WITH THE DBPS	10
EMERGENCY OVERFLOW ROUTING	10
HYDRAULIC ANALYSIS METHODOLOGY.....	10
<i>Four-Step Process</i>	10

Master Development Drainage Plan and Preliminary Drainage Report
Peerless Farms – El Paso County, Colorado

WATER QUALITY AND DETENTION REQUIREMENTS	12
EROSION CONTROL PLAN	13
FLOODPLAIN STATEMENT	13
FEES DEVELOPMENT	13
APPLICABLE FEES.....	13
CONSTRUCTION COST OPINION.....	13
MAINTENANCE AND OPERATIONS.....	13
GROUNDWATER CONSIDERATIONS	14
SUMMARY	14
COMPLIANCE WITH STANDARDS.....	14
REFERENCES	15
APPENDIX	16
APPENDIX A – VICINITY MAP	
APPENDIX B – SOILS MAP AND FEMA FIRM PANEL	
APPENDIX C – HYDROLOGIC CALCULATIONS	
APPENDIX D – HYDRAULIC CALCULATIONS	
APPENDIX E – EOPCC AND TEMPORARY SEDIMENT BASIN STANDARD DETAIL	
APPENDIX F – UNNAMED DRAINAGEWAY PHOTOGRAPHS	
APPENDIX G – EXCERPTS FROM THE DBPS	
APPENDIX H – DRAINAGE EXHIBITS	

INTRODUCTION

PURPOSE AND SCOPE OF STUDY

The purpose of this final drainage report is to outline the drainage facilities for 16975 Falcon Hwy Peyton, CO (the “Property”), El Paso County, Colorado (the “County”). This final drainage report identifies drainage patterns and infrastructure for the Site and proposes to safely route storm water to adequate outfalls. The Property is 40 acres in size.

The Property is located in the Haegler Ranch major drainage basin and is tributary to Black Squirrel Creek. The Site is discussed in the *Haegler Ranch Basin Drainage Basin Planning Study*, dated May 2009 and prepared by URS (“DBPS”).

GENERAL PROJECT DESCRIPTION

The project improvements consist of the construction of a single public road (60’ ROW), two private driveways, and private utilities (the “Project”) within the Property (the “Site”). The Project will be processed through El Paso County.

The Project is located in a portion of the northwest quarter of Section 13, Township 13 south, Range 64 west of the 6th P.M., County of El Paso, State of Colorado (see Vicinity Map in Appendix A). More specifically, the site is located at 16975 Falcon Hwy Peyton, CO 80831. The Property is bound by Falcon Hwy to the north, privately owned pastures to the west and south, and Sagecreek South Filing No. 1 to the east. The Property is mostly vacant but contains two single family houses, one large barn and some small chicken coops and sheds. The Site is to be replatted as 7 individual lots approximately 5-6 acres each with two private driveways connected to a public access road branching from Falcon Hwy. Stormwater will ultimately outfall to Black Squirrel Creek after initially discharging into an unnamed vegetated creek along the western portion of the Property.

A field survey was completed by Centennial Surveying, dated January 2021, and is the basis for design for the drainage improvements.

PROJECT CHARACTERISTICS

The Project Site is 40 acres in size. The Project involves the construction of a public road with two private driveways, roadside ditches, and culverts. The Site will be subdivided into large-lot residential lots for future single-family residences. The proposed impervious area consists of 0.66 acres for the public/paved roadway in addition to any future single-family residences constructed as part of the development.

The existing Project Site generally slopes from east to west as well as from the southeast to the north at grades of approximately 1.5 – 3.5%. The historical drainage patterns will be generally maintained. The Site consists of two single-family homes, a large barn and some small chicken coops and sheds. The Site does not have any existing stormwater infrastructure with the exception of a 24” culvert beneath Falcon Highway that allows the unnamed drainageway to drain from the north side of Falcon Highway to the Site.

DRAINAGE BASIN PLANNING STUDY INFRASTRUCTURE AND ANALYSIS

The Project Site is contained within the Haegler Ranch Basin and is discussed within the DBPS. Haegler Ranch Drainage Basin consists of 16.6 square miles in unincorporated El Paso County. The basin mostly consists of residential lots greater than 2-acres in size and large agricultural parcels. According to the DBPS, "...the subregional detention alternative is preferred and recommended for implementation" as the drainage basin continues to develop and more dense zoning uses are developed. The DBPS does not recommend that a subregional detention basin be constructed on the subject Site. The DBPS recommends that the existing storm drain culvert that is beneath Falcon Highway which discharges stormwater onto the property be upsized to a 66" RCP Culvert. As no improvements are proposed for Falcon Highway, this culvert will not be upsized as part of this Project.

SOILS CONDITIONS

NRCS soil data is available for this Site and it has been noted that onsite soils are primarily USCS Type A. The NRCS Soils map has been provided in Appendix B.

DRAINAGE DESIGN CRITERIA***REGULATIONS***

The proposed development does not propose any deviations from The City of Colorado Springs/El Paso County Drainage Criteria Manual, dated October 12, 1994 or any subsequent revisions.

DEVELOPMENT DESIGN CRITERIA REFERENCE AND CONSTRAINTS

The custom Flood Insurance Rate Map (FIRM) map listed in Appendix B shows the western portion of the Site to be located inside the 100-year flood plain. The proposed private storm facilities follow The City of Colorado Springs/El Paso County Drainage Criteria Manual (the "CRITERIA"), El Paso County Engineering Criteria Manual (the "ECM"), and the Urban Storm Drainage Criteria Manual (the "MANUAL"). Site drainage is not significantly impacted by constraints such as utilities or existing development. Further detail regarding onsite drainage patterns has been provided in the Proposed Drainage Conditions Section.

HYDROLOGIC CRITERIA

The 5-year and 100-year design storm events were used in determining rainfall and runoff for the proposed drainage system per Chapter 6 of the CRITERIA. Table 6-2 of the CRITERIA is the source for rainfall data for the 5-year and 100-year design storm events. Design runoff was calculated using the Rational Method for developed conditions as established in the CRITERIA and MANUAL. Runoff coefficients for the proposed development were determined using Table 6-6 of the CRITERIA by calculating weighted impervious values for each specific site sub-basin.

HYDRAULIC CRITERIA

The proposed drainage facilities are designed in accordance with the CRITERIA and MANUAL. Floodplain identification was determined using a custom FIRMette map by FEMA and information provided in the CRITERIA. Results of hydraulic calculations are summarized in Appendix D.

VARIANCES FROM CRITERIA

Due to existing grades and to match the historical flows presented at the Site, some drainage will be directed back to the county ROW. This is an existing condition. Besides this condition, no variances from the CRITERIA have been proposed for this development.

EXISTING DRAINAGE CONDITIONS

EXISTING DRAINAGE BASIN

Sub-Basin EX1

Sub-basin EX1 is 35.36 acres with a basin impervious value of 2% and consists of agricultural fields, gravel driveways, single-family residences and multiple agricultural barns and sheds. The existing runoff within this sub-basin drains directly to the unnamed drainageway. Runoff during the 5-year and 100-year storm events is anticipated to be 5.99 and 38.94 cfs respectively. The total 100-year storm event direct runoff value (5-year values are unknown for T3-02 and T4), inclusive of the upstream Sub-Basins EX3, EX3B, EX2, T3-02 and T4 is 1,097.15 cfs. Refer to the Existing Drainage Map for the location of the design points associated with the upstream sub-basins.

Sub-Basin EX2

Sub-basin EX2 is 4.64 acres with a basin impervious value of 4% and consists of agricultural fields, gravel driveways and a portion of an agricultural barn. The existing runoff within this sub-basin drains to an existing roadside ditch within Sub-Basin EX3 before flowing into the unnamed drainageway. Runoff during the 5-year and 100-year storm events is anticipated to be 1.03 and 6.07 cfs respectively.

Sub-Basin EX3

Sub-Basin EX3 consists of a portion of the northern property frontage within the ROW that drains to the property. Sub-Basin EX3 is 2.63 acres with a basin impervious value of 27% and 5-year and 100-year storm event direct runoff values of 2.18 and 7.47 cfs respectively. Total 5-year and 100-year storm event direct runoff values, inclusive of the upstream Sub-Basins EX2 and EX3B (Design Point EX2 and EX3B flows), are 5.35 and 28.21 cfs respectively.

Sub-Basin EX3B

Sub-Basin EX3B is an offsite sub-basin which consists of the south half of Falcon Highway and the west half of Peerless Farms Road adjacent to Lot 1 of Sagecreek South Filing No. 1 as well as all of Lot 1. Stormwater runoff within Sub-Basin EX3B flows into the Falcon Highway ROW before flowing west to Sub-Basin EX3. Sub-Basin EX3B is 5.97 acres with a basin impervious value of 9% and 5-year and 100-year storm event direct runoff values of 2.14 and 14.67 cfs respectively.

Sub-Basin T3-02

Sub-Basin T3-02 consists of a named tributary discussed in the DBPS and is made up of Sub-Basins HR0290 and HR0300. Sub-Basin T3-02 is 289 acres in size and consists of agricultural/vacant land and large-lot single-family residential properties. A sub-basin impervious value was not identified in the DBPS for this area, but the 100-year storm event direct runoff was

Master Development Drainage Plan and Preliminary Drainage Report
Peerless Farms – El Paso County, Colorado

found to be 460 cfs. Stormwater runoff within Sub-Basin T3-02 will continue to follow its historical path.

Sub-Basin T4

Sub-Basin T4 consists of a named tributary discussed in the DBPS and is made up of Sub-Basins HR0260, HR0270 and HR0280. Sub-Basin T4 is 350 acres in size and consists of agricultural/vacant land and large-lot single-family residential properties. A sub-basin impervious value was not identified in the DBPS for this area, but the 100-year storm event direct runoff was found to be 570 cfs. Stormwater runoff within Sub-Basin T4 will continue to follow its historical path.

Sagecreek South Drainage

As part of the Project drainage design, the Sagecreek South Drainage Final Drainage Report was reviewed and an onsite field visit was conducted. To the best of our knowledge, it appears that when the Sagecreek South Subdivision was constructed, grading at the western fence line/property line was done such that stormwater is not anticipated to drain directly from the Sagecreek South residential lots directly onto the Peerless Farms Property. Instead, stormwater runoff is anticipated to flow north to the Falcon Highway roadside ditch. A portion of these flows will enter Sub-Basin EX3 and eventually will flow onto the Peerless Farms Property. This Sagecreek South Subdivision related sub-Basin has been identified as Sub-Basin EX3B. The remaining flows from Sagecreek South Subdivision flow east or south, away from the Site. This drainage condition will remain the same in the proposed drainage condition, except a proposed stormwater culvert will be installed as part of the proposed extension of Sagecreek Road in order for flows to continue to follow their historic path.

PROPOSED DRAINAGE CONDITIONS

The developed runoff from the Project will generally be collected by means of roadside ditches located adjacent to the proposed public road and private gravel driveways. The runoff collected in the roadside ditches will be conveyed to the unnamed drainageway, following historical runoff patterns. The Property has been divided into 8 on-site sub-basins, Sub-Basins 1 - 8 and 3 off-site sub-basins, Sub-Basin EX3, Sub-Basin T3-02 and Sub-Basin T4. The proposed conditions map is provided in Appendix H.

Sub-Basin 1

Sub-basin 1 is 19.97 acres with a basin impervious value of 10% and consists of the unnamed drainageway as well as future single-family residential lots. The runoff developed within this sub-basin drains directly to the unnamed drainageway. Developed runoff during the 5-year and 100-year storm events will be 6.21 and 27.04 cfs respectively. Stormwater runoff within Sub-Basin 1 will continue to generally follow its historical path. The total 100-year storm event direct runoff value (5-year values are unknown for T3-02 and T4), inclusive of the upstream Sub-Basins 2 – 8, EX3, EX3B, T3-02 and T4 is 1,115.63 cfs. Refer to the Proposed Drainage Map for the location of the design points associated with the upstream sub-basins.

Sub-Basin 2

Sub-basin 2 is 1.78 acres with a basin impervious value of 17% and consists primarily of a portion of a gravel driveway and driveway drainage ditch. Sub-Basin 2 also includes a small portion of the proposed public road. The runoff developed within this sub-basin will be collected within a proposed driveway ditch before flowing into the unnamed drainageway. Developed runoff during the 5-year and 100-year storm events will be 0.87 and 3.24 cfs respectively. Stormwater runoff within Sub-Basin 2 will continue to generally follow its historical path. Total 5-year and 100-year

Master Development Drainage Plan and Preliminary Drainage Report
Peerless Farms – El Paso County, Colorado

storm event direct runoff values, inclusive of the upstream Sub-Basin 3 (Design Point 3 flows), are 1.73 and 5.72 cfs respectively.

Sub-Basin 3

Sub-basin 3 is 0.78 acres with a basin impervious value of 31% and consists primarily of a portion of a gravel driveway and driveway drainage ditch. Sub-Basin 3 also includes a small portion of the proposed public road. The runoff developed within this sub-basin will be collected within a proposed driveway ditch before flowing into a drainage ditch within Sub-Basin 2 and being routed to the unnamed drainageway. Developed runoff during the 5-year and 100-year storm events will be 0.86 and 2.48 cfs respectively. Stormwater runoff within Sub-Basin 3 will continue to generally follow its historical path.

Sub-Basin 4

Sub-basin 4 is 0.42 acres with a basin impervious value of 57% and consists of a portion of the proposed public road. The runoff developed within this sub-basin will be collected within a proposed roadside ditch before flowing into a driveway ditch within Sub-Basin 6 and being routed to the unnamed drainageway. Developed runoff during the 5-year and 100-year storm events will be 1.03 and 2.21 cfs respectively. Stormwater runoff within Sub-Basin 4 will continue to generally follow its historical path.

Sub-Basin 5

Sub-basin 5 is 0.85 acres with a basin impervious value of 40% and consists of a portion of the proposed public road, a portion of a gravel driveway and a driveway ditch. The runoff developed within this sub-basin will be collected within proposed roadside and driveway ditches before flowing into a drainage ditch within Sub-Basin 6 and being routed to the unnamed drainageway. Developed runoff during the 5-year and 100-year storm events will be 1.12 and 2.84 cfs respectively. Stormwater runoff within Sub-Basin 5 will continue to generally follow its historical path.

Sub-Basin 6

Sub-basin 6 is 5.55 acres with a basin impervious value of 13% and consists of a portion of a gravel driveway, a driveway ditch and future single-family lots. The runoff developed within this sub-basin will be collected within proposed roadside and driveway ditches before flowing into the unnamed drainageway. Developed runoff during the 5-year and 100-year storm events will be 2.32 and 9.26 cfs respectively. Stormwater runoff within Sub-Basin 6 will continue to generally follow its historical path. Total 5-year and 100-year storm event direct runoff values, inclusive of the upstream Sub-Basins 4 and 5 (Design Point 4 and 5 flows), are 4.47 and 14.31 cfs respectively.

Sub-Basin 7

Sub-basin 7 is 1.57 acres with a basin impervious value of 6% and consists of a portion of the proposed public road, roadside ditches and a future single-family lot. The runoff developed within this sub-basin will be collected within an existing roadside ditch within Sub-Basin EX3 before flowing into the unnamed drainageway. Developed runoff during the 5-year and 100-year storm events will be 0.54 and 2.77 cfs respectively. Stormwater runoff within Sub-Basin 7 will continue to follow its historical path.

Sub-Basin 8

Sub-basin 8 is 9.09 acres with a basin impervious value of 10% and consists of future single-family residential lots. The runoff developed within this sub-basin drains directly to the unnamed

Master Development Drainage Plan and Preliminary Drainage Report
Peerless Farms – El Paso County, Colorado

drainageway. Developed runoff during the 5-year and 100-year storm events will be 3.14 and 13.65 cfs respectively. Stormwater runoff within Sub-Basin 8 will continue to generally follow its historical path.

Sub-Basin EX3

Sub-Basin EX3 consists of a portion of the northern property frontage within the ROW that drains to the property. Sub-Basin EX3 is 2.63 acres with a basin impervious value of 27% and 5-year and 100-year storm event direct runoff values of 2.18 and 7.47 cfs respectively. Stormwater runoff within Sub-Basin EX3 will continue to follow its historical path. Total 5-year and 100-year storm event direct runoff values, inclusive of the upstream Sub-Basin 7 and EX3B (Design Point 7 and EX3B flows), are 4.86 and 24.91 cfs respectively. Total flows within Sub-Basin EX3 will decline in the proposed condition due to less of the onsite flows flowing directly to Sub-Basin EX3.

Sub-Basin EX3B

Sub-Basin EX3B is an offsite sub-basin which consists of the south half of Falcon Highway and the west half of Peerless Farms Road adjacent to Lot 1 of Sagecreek South Filing No. 1 as well as all of Lot 1. Stormwater runoff within Sub-Basin EX3B flows into the Falcon Highway ROW before flowing west to Sub-Basin EX3. Sub-Basin EX3B is 5.97 acres with a basin impervious value of 9% and 5-year and 100-year storm event direct runoff values of 2.14 and 14.67 cfs respectively.

Sub-Basin T3-02

Sub-Basin T3-02 consists of a named tributary discussed in the DBPS and is made up of Sub-Basins HR0290 and HR0300. Sub-Basin T3-02 is 289 acres in size and consists of agricultural/vacant land and large-lot single-family residential properties. A sub-basin impervious value was not identified in the DBPS for this area, but the 100-year storm event direct runoff was found to be 460 cfs. Stormwater runoff within Sub-Basin T3-02 will continue to follow its historical path.

Sub-Basin T4

Sub-Basin T4 consists of a named tributary discussed in the DBPS and is made up of Sub-Basins HR0260, HR0270 and HR0280. Sub-Basin T4 is 350 acres in size and consists of agricultural/vacant land and large-lot single-family residential properties. A sub-basin impervious value was not identified in the DBPS for this area, but the 100-year storm event direct runoff was found to be 570 cfs. Stormwater runoff within Sub-Basin T4 will continue to follow its historical path.

Sagecreek South Drainage

As part of the Project drainage design, the Sagecreek South Drainage Final Drainage Report was reviewed and an onsite field visit was conducted. To the best of our knowledge, it appears that when the Sagecreek South Subdivision was constructed, final grading restrict stormwater flows from draining from the Sagecreek South Subdivision lots to the Peerless Farms lot.

PUBLIC ROADWAY AND PRIVATE DRIVEWAY DITCHES

Ditches have been proposed adjacent to the proposed public roadway and the proposed private gravel driveways. Ditches will be constructed to meet the requirements of El Paso County Standard Detail SD_2-11. Ditches are considered roadside ditches and per Section 3.3.4 of the ECM, are not considered drainage ditches and therefore are not required to meet open channel standards. Ditch calculations for each applicable Sub-Basin have been included in Appendix D. Based on ditch slopes between 0.5% and 5% as well as mean ditch velocities varying between

Master Development Drainage Plan and Preliminary Drainage Report
Peerless Farms – El Paso County, Colorado

2.87 and 4.48 ft/s, ditches will be seeded/lined with either Bermudagrass, Reed Canary Grass or Tall Fescue Grass.

PUBLIC ROADWAY AND PRIVATE DRIVEWAY CULVERTS

Reinforced Concrete Pipes (RCP) and Concrete Flared-End Sections (FES) have been proposed as necessary where proposed public roadway or private gravel driveways intersect with roadside ditches. Culvert calculations have been included in Appendix D. Culverts range in size from 18-inches to 24-inches depending on the proposed stormwater runoff that will pass through the culvert in the 100-year storm event. Riprap will be provided at both ends of culverts. Riprap has been sized for the culvert with the highest flows and this size and type of riprap will be used on both ends of each culvert (18" thick Type L Riprap D50 = 9"). Riprap calculations have been included in Appendix D and a standard culvert detail for the riprap has been included on the Grading and Erosion Control Plans.

CONFORMANCE WITH THE DBPS

The proposed Project includes single-family lots which are all greater than 5-acres in size. The proposed Site imperviousness for the Project, inclusive of the proposed public road) is 12%. Individual lots will be limited to up to 10% imperviousness. The 5-year and 100-year storm event direct runoff for the site will be 16.08 and 63.49 cfs respectively. The proposed development is in general conformance with the DBPS and will not negatively affect downstream drainage.

EMERGENCY OVERFLOW ROUTING

All overflow routing will be directed to the existing unnamed drainageway that is located on the western side of the site. This flow path matches the historical stormwater runoff path.

HYDRAULIC ANALYSIS METHODOLOGY

The proposed drainage facilities were designed in accordance with the CRITERIA and MANUAL. Floodplain identification was determined using a custom FIRMette map by FEMA and information provided in the CRITERIA. Apart from road culverts, no underground storm drain pipes are proposed for the development. Culvert sizing calculations were computed using Flow master and are included in Appendix D. There are no proposed variances from the City of Colorado Springs/El Paso County Criteria for the proposed development.

No inlets have been proposed as part of the Project. Stormwater runoff will be routed above ground through roadside ditches and culverts beneath the public roadway and private driveways.

Four-Step Process

The Site was designed in accordance with the four-step process to minimize adverse impacts of urbanization, as outlined in Section I.7.2 BMP Selection of the CRITERIA. The four-step process per the CRITERIA provides guidance and requirements for the selection of siting of structural Best Management Practices (BMPs) for new development and significant redevelopment.

Step 1: Employ Runoff Reduction Practices

Currently the site is mostly vacant land. Development of the site will increase current runoff conditions due to increased imperviousness values. The increase in impervious area is minimal though due to the Site size of 40-acres and the proposed large residential lot sizes.

As discussed in Section I.7.1B of Appendix I of the ECM, water-quality facilities are not required for the Project as the development consists of 5-acre residential lots. Water quality treatment will be provided for the Proposed Public ROW through means of runoff

Master Development Drainage Plan and Preliminary Drainage Report
Peerless Farms – El Paso County, Colorado

reduction. Stormwater within the Public ROW will drain to vegetated roadside ditches which will promote stormwater infiltration. A 94% WQVC reduction will be achieved to accomplish the requirements of the 60% Runoff Reduction Standard as outlined by the County's MS4. Calculations showing the runoff reduction amounts have been included in Appendix C.

The Site was designed to conserve as much of the existing vegetation as possible and to minimize the extent of paved areas. Additionally, the Site was designed to eliminate underground storm drains and storm drain culverts will only be used to route water beneath the public road and private driveways, allowing more opportunities for stormwater to infiltrate into the ground.

Step 2: Stabilize Drainageways

An existing unnamed drainageway flows through the western portion of the Site. During a Site visit, it was found that the drainageway is currently well-stabilized and extremely vegetated. Site visit photos of the drainageway have been included in Appendix F. As the drainageway is currently stable and the development of the large-lot subdivision will only minimally increase the stormwater runoff it has been determined that leaving the unnamed drainageway as-is, currently stabilized and vegetated, will allow the channel to remain stabilized. As discussed in the DBPS, "The disturbance of the native vegetation and failure to properly revegetate areas impacted by site development, utility, roadway and landscape construction activities have in some cases negatively affected downstream areas." Furthermore, as noted in Chapter 1, Section 1.4 of the CRITERIA, "Natural channel systems, primarily the designated Major Drainageways and Primary outfalls, serve to store flood waters, enhance water quality, provide for ground water recharge and preserve riparian corridors. The use of historical channels to convey storm water runoff from developed and developing areas is acceptable. However, if historical storm water flows are increased, or if historical channels are unstable in their natural conditions, these channels must be adequately stabilized to prevent excessive erosion." Additionally, Chapter 2, Section 2.2 of the CRITERIA states, "A stable natural channel reaches 'equilibrium' over many years. Therefore, channel modifications should be minimal." Because the existing drainageway is properly stabilized, it is felt that attempts to change the natural channel may lead to destabilization of the drainageway and therefore, no changes to the unnamed drainageway, with the exception of stabilization at the location of the proposed ditches, are recommended.

The proposed Project involves construction of roadside ditches which will discharge into the unnamed drainageway. To reduce the opportunity for erosion where the ditches outfall, riprap will be added to dissipate energy from stormwater runoff.

Step 3: Provide Water Quality Capture Volume (WQCV)

The proposed Project development includes large-lot single-family lots which include minimal impervious areas. The single-family lots will be restricted to a maximum impervious value of 10% per lot. Lots 2, 6 and 7 include private/shared gravel driveways which will count towards the 10% maximum impervious allotment of those lots. As all of the lots are built out with future impervious coverings such as houses, out-buildings, driveways, sidewalks and patios, impervious values for each lot will be considered up to a maximum of 10% for each lot. As discussed above in Step 1, the residential lots are exempt from WQCV requirements and the Public ROW will meet County MS4 requirements by using runoff reduction methods which will meet the 60% runoff reduction standard.

Step 4: Consider Need for Industrial and Commercial BMPs

The proposed Project consists of a single-family subdivision. No industrial and commercial uses or developments are anticipated as part of the proposed development.

Master Development Drainage Plan and Preliminary Drainage Report
Peerless Farms – El Paso County, Colorado

WATER QUALITY AND DETENTION REQUIREMENTS

The proposed Project development includes large-lot single-family lots which include minimal impervious areas. As discussed above in Step 1 of the Four-Step Process, the residential lots are exempt from WQCV requirements and the Public ROW will meet County MS4 requirements by using runoff reduction methods which will meet the 60% runoff reduction standard.

The Project does not include a proposed detention pond for this development. Large-Lot Residential Developments, especially those in excess of 5-acre lots, do not increase post-development stormwater flows as substantially as smaller-lot residential and non-residential developments. Stormwater flows collected from this development will drain to the existing unnamed drainageway. As documented in the DBPS, the unnamed drainageway is made up of the combination of the T3-02 and T4 Tributaries which both cross Falcon Highway using corrugated metal pipes known as Facility Numbers 609 and 610. The proposed 100-year flows for these tributaries at these locations are 460 cfs and 570 cfs respectively. Therefore, the unnamed drainageway is expected to have proposed 100-year storm event flows of 1,030 cfs.

The Project currently contributes 7.02 cfs and 45.01 cfs to the unnamed drainageway during the 5-year and 100-year storm events respectively, and it is proposed that 16.08 cfs and 63.49 cfs will discharge to the unnamed drainageway in the redeveloped condition and during the 5-year and 100-year storm events respectively. During a 100-year storm event, the existing stormwater flows for the Site account for 4.37% of the total flows in the unnamed drainageway (45.01 cfs of 1,030 cfs). During a 100-year storm event, the proposed stormwater flows for the Site will account for 6.16% of the total flows in the unnamed drainageway (63.49 cfs of 1,030 cfs) which results in an increase of only 1.79%.

Because the unnamed drainageway flows directly through the Site, it is advantageous to allow stormwater from the Project to flow directly and undetained into the unnamed drainage as the Project stormwater peak flows can enter the unnamed drainageway and flow downstream before the peak flows from the off-site upstream drainage basins can arrive at this area of the drainage basin. There are five upstream drainage sub-basins identified in the DBPS. They are identified as HR0260, HR0270, HR0280, HR0290 and HR0300, with the lower numbered sub-basins located further from the Site. The lag times associated with each of these sub-basins are 11, 23, 42, 17 and 31 minutes respectively. The three proposed sub-basins for the Project which contribute the largest peak flows are also the three sub-basins with the longest time of concentrations. Each of these sub-basins, 1, 6 and 8 also drain directly into the unnamed drainageway. Their time of concentrations are 39.28, 29.41 and 33.25 minutes respectively. Based on these time of concentrations being less than the longest lag time identified for the upstream DBPS sub-basins and the fact that the lag times identified above do not account for channel flow times for the stormwater to arrive at the Site, it has been concluded that not detaining stormwater flows for this Project will allow the peak stormwater flows to beat the peak stormwater flows from the overall drainage basin. Conversely, detaining stormwater flows on-site in a private extended detention basin, would negatively impact the channel as peak flows would be released at a later time which could coincide with the peak flows in the channel, allowing higher volumes and velocities in the unnamed drainageway.

Due to the minimal increase of stormwater flows caused by the redevelopment, the large 5-acre and larger residential lot configuration, the recommendations of the DBPS for regional detention ponds as opposed to private onsite detention, the negligible impact to the overall flows within the unnamed drainageway and the ability of the peak stormwater flows from the Site to beat the peak flows in the unnamed drainageway, no stormwater detention has been proposed for this Project.

Master Development Drainage Plan and Preliminary Drainage Report
Peerless Farms – El Paso County, Colorado

EROSION CONTROL PLAN

Erosion Control Plans will be submitted separately as a standalone construction document. During construction temporary control measures will be installed to reduce erosion onsite. The temporary controls are anticipated to consist, at a minimum, of silt fencing, vehicle tracking control, ditches, check dams, culvert protection, erosion control blankets, seeding and mulching and temporary sediment basins.

As part of the construction associated with this subdivision, two temporary sediment basins will be constructed to meet County MS4 and State requirements. Although the sediment basins will be temporary erosion controls, permanent ditches will be constructed which will route stormwater to the temporary sediment basins during construction and to the unnamed drainageway post-construction. The temporary sediment basins will be sized according to El Paso County Standard Detail 900-TSB-2. This standard detail has been included in Appendix E. Final sizing for the temporary sediment basins will be included in the Grading and Erosion Control Plans and Stormwater Management Plan.

FLOODPLAIN STATEMENT

The western portion of the Site is within Area AE, special flood hazard areas with base flood elevations and Zone X, 0.2% annual chance flood hazard, areas of 1% annual chance flood with average depth less than one foot or with drainage areas of less than one square mile.

The remaining portion of the Site is located outside of the 100-year floodplain as determined by the custom FIRMetMap created on April 20, 2021 and contained with Appendix B.

FEES DEVELOPMENT

APPLICABLE FEES

Drainage and Bridge Fees are required to be paid at the time of Final Plat recording for the Project. The Site is within the Haeger Drainage Basin. Drainage Fees are based on the number of impervious acres for the development. The 2023 Drainage and Bridge Fees are \$12,985 and \$1,916, respective, per impervious acre.

Total Acreage (40-acres) x Total Development (inclusive of Prop. Public ROW) Impervious Value (12%) = Impervious Acres (4.8)

Drainage Basins Fees = 4.8-acres x (\$12,985 + \$1,916) = \$71,524.80

25% Reduction for 5-acre lots

Final Fee = 0.75 x \$71,524.80 = **\$53,643.60**

CONSTRUCTION COST OPINION

An opinion of probable construction cost for the construction of the private drainage facilities for the Project has been included in Appendix E. There are no public drainage ponds or permanent control measures proposed as part of the Project.

MAINTENANCE AND OPERATIONS

No detention has been proposed as part of this Project. The public roadside ditches and culverts within the proposed Public ROW which provide water quality treatment will be maintained by El

Master Development Drainage Plan and Preliminary Drainage Report
Peerless Farms – El Paso County, Colorado

Paso County, upon acceptance. Other proposed ditches, swales and culverts located outside of the proposed Public ROW will be maintained by property owners of the development. Easements will be provided over the shared driveways and ditches to allow all property owners the ability to access and maintain ditches and culverts as needed.

GROUNDWATER CONSIDERATIONS

A Geotechnical Evaluation by RMG and dated 4/14/2021 was performed for the Site. According to the Geotechnical Evaluation, "Groundwater was encountered in all three test borings at depths ranging from between 11.0 feet to 18.0 feet below the existing ground surface at the time of boring. When checked five days subsequent to drilling, groundwater was encountered at depths ranging between 4.0 feet to 18.6 feet. Groundwater levels are anticipated to have sufficient separation from the bottom of proposed crawlspace and basement foundation components on Lots 2, 4, 6 and 7. Due to the shallow groundwater conditions encountered near the unnamed intermittent creek, the use of basements on Lots 1 and 5 may be limited. Groundwater conditions should be considered in the site-specific soils investigations and OWTS designs."

SUMMARY

COMPLIANCE WITH STANDARDS

The drainage design presented within this report for the Peerless Farms Large-Lot Single-Family Development conforms to the City of Colorado Springs/El Paso County Storm Drainage Criteria and the Urban Drainage and Flood Control District Manual. Additionally, the Site runoff and private storm sewer facilities will not adversely affect the downstream and surrounding developments or waterways. This report and its findings are consistent with the drainage requirements documented in the DBPS. During construction at the Site, erosion control measures will be implemented as briefly discussed in the Erosion Control Plan Section above and as further detailed in the Grading and Erosion Control Plans and Stormwater Management Plan. The total anticipated project disturbance area for this Project as part of the proposed public road and site infrastructure is 7.3 acres.

Master Development Drainage Plan and Preliminary Drainage Report
Peerless Farms – El Paso County, Colorado

REFERENCES

1. The City of Colorado Springs Drainage Criteria Manual, May 2014
2. El Paso County Drainage Criteria Manual, Vol. 1 and 2, October 1994
3. Urban Drainage and Flood Control District Drainage Criteria Manual (UDFCDCM), Vol. 1, prepared by Wright-McLaughlin Engineers, June 2001, with latest revisions.
4. Flood Insurance Rate Map, El Paso County, Colorado and Incorporated Areas, Map Number 08041C0553G, Effective Date December 7, 2018, prepared by the Federal Emergency Management Agency (FEMA).
5. Haegler Ranch Basin Drainage Basin Planning Study. Prepared by URS, May 2009.
6. Geotechnical Evaluation prepared by RMG. April 14, 2021.

Master Development Drainage Plan and Preliminary Drainage Report
Peerless Farms – El Paso County, Colorado

APPENDIX

Master Development Drainage Plan and Preliminary Drainage Report
Peerless Farms – El Paso County, Colorado

APPENDIX A - VICINITY MAP

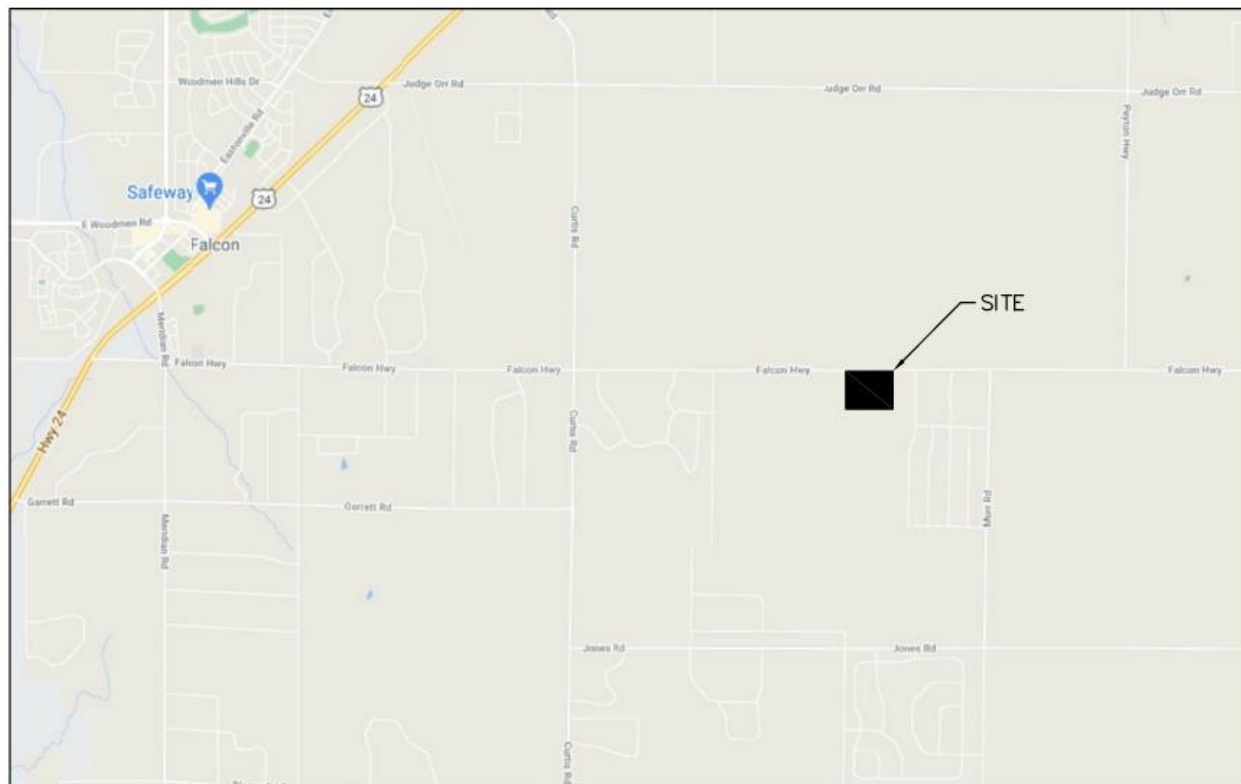

Master Development Drainage Plan and Preliminary Drainage Report
Peerless Farms – El Paso County, Colorado

APPENDIX B - SOILS MAP AND FEMA FIRM PANEL



A product of the National Cooperative Soil Survey, a joint effort of the United States Department of Agriculture and other Federal agencies, State agencies including the Agricultural Experiment Stations, and local participants

Custom Soil Resource Report for El Paso County Area, Colorado

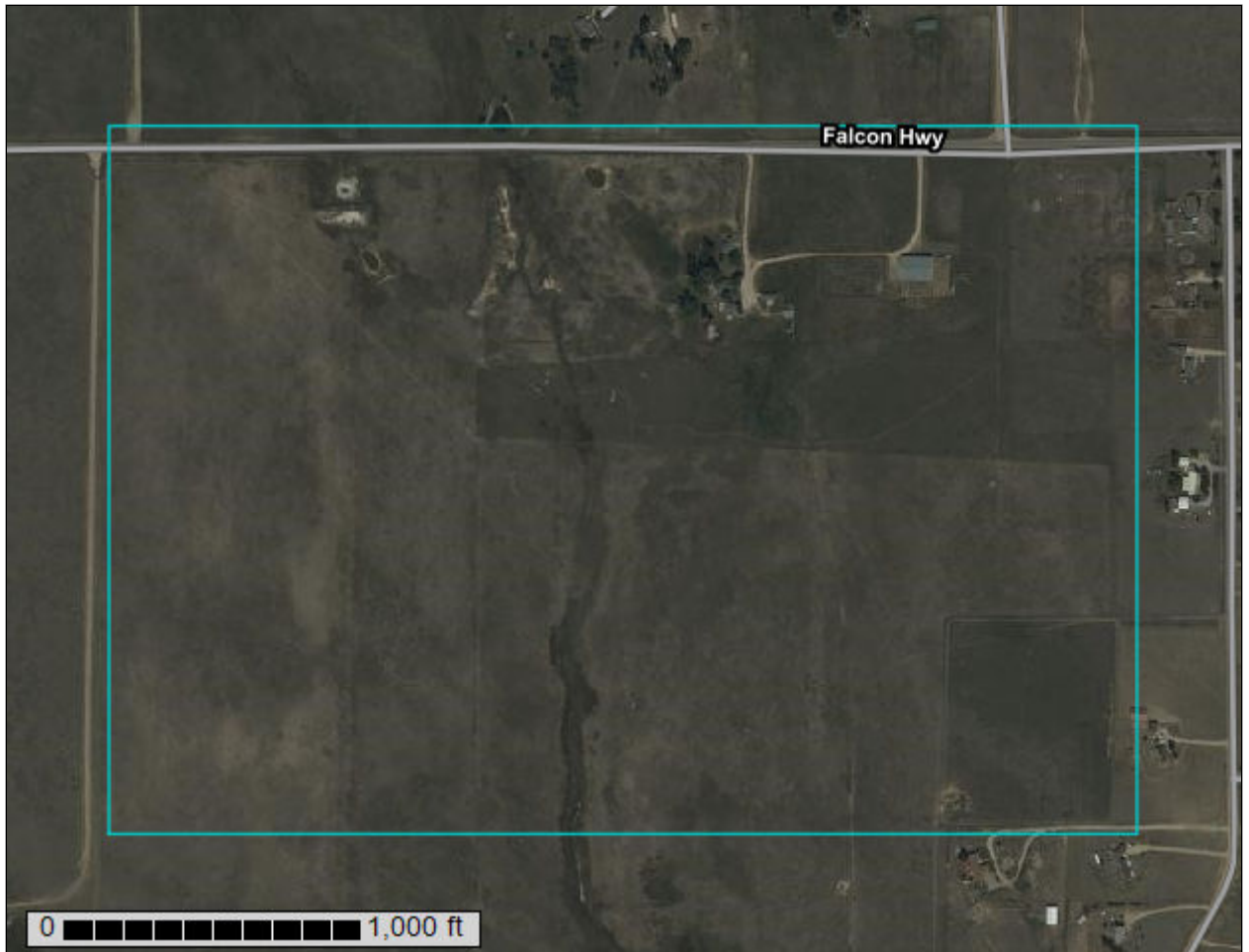

Preface

Soil surveys contain information that affects land use planning in survey areas. They highlight soil limitations that affect various land uses and provide information about the properties of the soils in the survey areas. Soil surveys are designed for many different users, including farmers, ranchers, foresters, agronomists, urban planners, community officials, engineers, developers, builders, and home buyers. Also, conservationists, teachers, students, and specialists in recreation, waste disposal, and pollution control can use the surveys to help them understand, protect, or enhance the environment.

Various land use regulations of Federal, State, and local governments may impose special restrictions on land use or land treatment. Soil surveys identify soil properties that are used in making various land use or land treatment decisions. The information is intended to help the land users identify and reduce the effects of soil limitations on various land uses. The landowner or user is responsible for identifying and complying with existing laws and regulations.

Although soil survey information can be used for general farm, local, and wider area planning, onsite investigation is needed to supplement this information in some cases. Examples include soil quality assessments (<http://www.nrcs.usda.gov/wps/portal/nrcs/main/soils/health/>) and certain conservation and engineering applications. For more detailed information, contact your local USDA Service Center (<https://offices.sc.egov.usda.gov/locator/app?agency=nrcs>) or your NRCS State Soil Scientist (http://www.nrcs.usda.gov/wps/portal/nrcs/detail/soils/contactus/?cid=nrcs142p2_053951).

Great differences in soil properties can occur within short distances. Some soils are seasonally wet or subject to flooding. Some are too unstable to be used as a foundation for buildings or roads. Clayey or wet soils are poorly suited to use as septic tank absorption fields. A high water table makes a soil poorly suited to basements or underground installations.

The National Cooperative Soil Survey is a joint effort of the United States Department of Agriculture and other Federal agencies, State agencies including the Agricultural Experiment Stations, and local agencies. The Natural Resources Conservation Service (NRCS) has leadership for the Federal part of the National Cooperative Soil Survey.

Information about soils is updated periodically. Updated information is available through the NRCS Web Soil Survey, the site for official soil survey information.

The U.S. Department of Agriculture (USDA) prohibits discrimination in all its programs and activities on the basis of race, color, national origin, age, disability, and where applicable, sex, marital status, familial status, parental status, religion, sexual orientation, genetic information, political beliefs, reprisal, or because all or a part of an individual's income is derived from any public assistance program. (Not all prohibited bases apply to all programs.) Persons with disabilities who require

alternative means for communication of program information (Braille, large print, audiotape, etc.) should contact USDA's TARGET Center at (202) 720-2600 (voice and TDD). To file a complaint of discrimination, write to USDA, Director, Office of Civil Rights, 1400 Independence Avenue, S.W., Washington, D.C. 20250-9410 or call (800) 795-3272 (voice) or (202) 720-6382 (TDD). USDA is an equal opportunity provider and employer.

Contents

Preface	2
How Soil Surveys Are Made	5
Soil Map	8
Soil Map.....	9
Legend.....	10
Map Unit Legend.....	11
Map Unit Descriptions.....	11
El Paso County Area, Colorado.....	13
8—Blakeland loamy sand, 1 to 9 percent slopes.....	13
9—Blakeland-Fluvaquentic Haplaquolls.....	14
95—Truckton loamy sand, 1 to 9 percent slopes.....	16
Soil Information for All Uses	18
Soil Properties and Qualities.....	18
Soil Erosion Factors.....	18
K Factor, Whole Soil.....	18
Wind Erodibility Group.....	21
Soil Qualities and Features.....	24
Hydrologic Soil Group.....	24
References	29

How Soil Surveys Are Made

Soil surveys are made to provide information about the soils and miscellaneous areas in a specific area. They include a description of the soils and miscellaneous areas and their location on the landscape and tables that show soil properties and limitations affecting various uses. Soil scientists observed the steepness, length, and shape of the slopes; the general pattern of drainage; the kinds of crops and native plants; and the kinds of bedrock. They observed and described many soil profiles. A soil profile is the sequence of natural layers, or horizons, in a soil. The profile extends from the surface down into the unconsolidated material in which the soil formed or from the surface down to bedrock. The unconsolidated material is devoid of roots and other living organisms and has not been changed by other biological activity.

Currently, soils are mapped according to the boundaries of major land resource areas (MLRAs). MLRAs are geographically associated land resource units that share common characteristics related to physiography, geology, climate, water resources, soils, biological resources, and land uses (USDA, 2006). Soil survey areas typically consist of parts of one or more MLRA.

The soils and miscellaneous areas in a survey area occur in an orderly pattern that is related to the geology, landforms, relief, climate, and natural vegetation of the area. Each kind of soil and miscellaneous area is associated with a particular kind of landform or with a segment of the landform. By observing the soils and miscellaneous areas in the survey area and relating their position to specific segments of the landform, a soil scientist develops a concept, or model, of how they were formed. Thus, during mapping, this model enables the soil scientist to predict with a considerable degree of accuracy the kind of soil or miscellaneous area at a specific location on the landscape.

Commonly, individual soils on the landscape merge into one another as their characteristics gradually change. To construct an accurate soil map, however, soil scientists must determine the boundaries between the soils. They can observe only a limited number of soil profiles. Nevertheless, these observations, supplemented by an understanding of the soil-vegetation-landscape relationship, are sufficient to verify predictions of the kinds of soil in an area and to determine the boundaries.

Soil scientists recorded the characteristics of the soil profiles that they studied. They noted soil color, texture, size and shape of soil aggregates, kind and amount of rock fragments, distribution of plant roots, reaction, and other features that enable them to identify soils. After describing the soils in the survey area and determining their properties, the soil scientists assigned the soils to taxonomic classes (units). Taxonomic classes are concepts. Each taxonomic class has a set of soil characteristics with precisely defined limits. The classes are used as a basis for comparison to classify soils systematically. Soil taxonomy, the system of taxonomic classification used in the United States, is based mainly on the kind and character of soil properties and the arrangement of horizons within the profile. After the soil

Custom Soil Resource Report

scientists classified and named the soils in the survey area, they compared the individual soils with similar soils in the same taxonomic class in other areas so that they could confirm data and assemble additional data based on experience and research.

The objective of soil mapping is not to delineate pure map unit components; the objective is to separate the landscape into landforms or landform segments that have similar use and management requirements. Each map unit is defined by a unique combination of soil components and/or miscellaneous areas in predictable proportions. Some components may be highly contrasting to the other components of the map unit. The presence of minor components in a map unit in no way diminishes the usefulness or accuracy of the data. The delineation of such landforms and landform segments on the map provides sufficient information for the development of resource plans. If intensive use of small areas is planned, onsite investigation is needed to define and locate the soils and miscellaneous areas.

Soil scientists make many field observations in the process of producing a soil map. The frequency of observation is dependent upon several factors, including scale of mapping, intensity of mapping, design of map units, complexity of the landscape, and experience of the soil scientist. Observations are made to test and refine the soil-landscape model and predictions and to verify the classification of the soils at specific locations. Once the soil-landscape model is refined, a significantly smaller number of measurements of individual soil properties are made and recorded. These measurements may include field measurements, such as those for color, depth to bedrock, and texture, and laboratory measurements, such as those for content of sand, silt, clay, salt, and other components. Properties of each soil typically vary from one point to another across the landscape.

Observations for map unit components are aggregated to develop ranges of characteristics for the components. The aggregated values are presented. Direct measurements do not exist for every property presented for every map unit component. Values for some properties are estimated from combinations of other properties.

While a soil survey is in progress, samples of some of the soils in the area generally are collected for laboratory analyses and for engineering tests. Soil scientists interpret the data from these analyses and tests as well as the field-observed characteristics and the soil properties to determine the expected behavior of the soils under different uses. Interpretations for all of the soils are field tested through observation of the soils in different uses and under different levels of management. Some interpretations are modified to fit local conditions, and some new interpretations are developed to meet local needs. Data are assembled from other sources, such as research information, production records, and field experience of specialists. For example, data on crop yields under defined levels of management are assembled from farm records and from field or plot experiments on the same kinds of soil.

Predictions about soil behavior are based not only on soil properties but also on such variables as climate and biological activity. Soil conditions are predictable over long periods of time, but they are not predictable from year to year. For example, soil scientists can predict with a fairly high degree of accuracy that a given soil will have a high water table within certain depths in most years, but they cannot predict that a high water table will always be at a specific level in the soil on a specific date.

After soil scientists located and identified the significant natural bodies of soil in the survey area, they drew the boundaries of these bodies on aerial photographs and

Custom Soil Resource Report

identified each as a specific map unit. Aerial photographs show trees, buildings, fields, roads, and rivers, all of which help in locating boundaries accurately.

Soil Map

The soil map section includes the soil map for the defined area of interest, a list of soil map units on the map and extent of each map unit, and cartographic symbols displayed on the map. Also presented are various metadata about data used to produce the map, and a description of each soil map unit.

Custom Soil Resource Report Soil Map

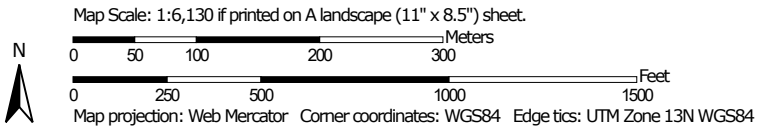

Custom Soil Resource Report

MAP LEGEND

Area of Interest (AOI)

 Area of Interest (AOI)

Soils

 Soil Map Unit Polygons

 Soil Map Unit Lines

 Soil Map Unit Points

Special Point Features

 Blowout

 Borrow Pit

 Clay Spot

 Closed Depression

 Gravel Pit

 Gravelly Spot

 Landfill

 Lava Flow

 Marsh or swamp

 Mine or Quarry

 Miscellaneous Water

 Perennial Water

 Rock Outcrop

 Saline Spot

 Sandy Spot

 Severely Eroded Spot

 Sinkhole

 Slide or Slip

 Sodic Spot

 Spoil Area

 Stony Spot

 Very Stony Spot

 Wet Spot

 Other

 Special Line Features

Water Features

 Streams and Canals

Transportation

 Rails

 Interstate Highways

 US Routes

 Major Roads

 Local Roads

Background

 Aerial Photography

MAP INFORMATION

The soil surveys that comprise your AOI were mapped at 1:24,000.

Warning: Soil Map may not be valid at this scale.

Enlargement of maps beyond the scale of mapping can cause misunderstanding of the detail of mapping and accuracy of soil line placement. The maps do not show the small areas of contrasting soils that could have been shown at a more detailed scale.

Please rely on the bar scale on each map sheet for map measurements.

Source of Map: Natural Resources Conservation Service
 Web Soil Survey URL:
 Coordinate System: Web Mercator (EPSG:3857)

Maps from the Web Soil Survey are based on the Web Mercator projection, which preserves direction and shape but distorts distance and area. A projection that preserves area, such as the Albers equal-area conic projection, should be used if more accurate calculations of distance or area are required.

This product is generated from the USDA-NRCS certified data as of the version date(s) listed below.

Soil Survey Area: El Paso County Area, Colorado
 Survey Area Data: Version 18, Jun 5, 2020

Soil map units are labeled (as space allows) for map scales 1:50,000 or larger.

Date(s) aerial images were photographed: Sep 11, 2018—Oct 20, 2018

The orthophoto or other base map on which the soil lines were compiled and digitized probably differs from the background imagery displayed on these maps. As a result, some minor shifting of map unit boundaries may be evident.

Custom Soil Resource Report

Map Unit Legend

Map Unit Symbol	Map Unit Name	Acres in AOI	Percent of AOI
8	Blakeland loamy sand, 1 to 9 percent slopes	13.9	7.4%
9	Blakeland-Fluvaquentic Haplaquolls	75.0	39.7%
95	Truckton loamy sand, 1 to 9 percent slopes	99.9	52.9%
Totals for Area of Interest		188.9	100.0%

Map Unit Descriptions

The map units delineated on the detailed soil maps in a soil survey represent the soils or miscellaneous areas in the survey area. The map unit descriptions, along with the maps, can be used to determine the composition and properties of a unit.

A map unit delineation on a soil map represents an area dominated by one or more major kinds of soil or miscellaneous areas. A map unit is identified and named according to the taxonomic classification of the dominant soils. Within a taxonomic class there are precisely defined limits for the properties of the soils. On the landscape, however, the soils are natural phenomena, and they have the characteristic variability of all natural phenomena. Thus, the range of some observed properties may extend beyond the limits defined for a taxonomic class. Areas of soils of a single taxonomic class rarely, if ever, can be mapped without including areas of other taxonomic classes. Consequently, every map unit is made up of the soils or miscellaneous areas for which it is named and some minor components that belong to taxonomic classes other than those of the major soils.

Most minor soils have properties similar to those of the dominant soil or soils in the map unit, and thus they do not affect use and management. These are called noncontrasting, or similar, components. They may or may not be mentioned in a particular map unit description. Other minor components, however, have properties and behavioral characteristics divergent enough to affect use or to require different management. These are called contrasting, or dissimilar, components. They generally are in small areas and could not be mapped separately because of the scale used. Some small areas of strongly contrasting soils or miscellaneous areas are identified by a special symbol on the maps. If included in the database for a given area, the contrasting minor components are identified in the map unit descriptions along with some characteristics of each. A few areas of minor components may not have been observed, and consequently they are not mentioned in the descriptions, especially where the pattern was so complex that it was impractical to make enough observations to identify all the soils and miscellaneous areas on the landscape.

The presence of minor components in a map unit in no way diminishes the usefulness or accuracy of the data. The objective of mapping is not to delineate pure taxonomic classes but rather to separate the landscape into landforms or

Custom Soil Resource Report

landform segments that have similar use and management requirements. The delineation of such segments on the map provides sufficient information for the development of resource plans. If intensive use of small areas is planned, however, onsite investigation is needed to define and locate the soils and miscellaneous areas.

An identifying symbol precedes the map unit name in the map unit descriptions. Each description includes general facts about the unit and gives important soil properties and qualities.

Soils that have profiles that are almost alike make up a *soil series*. Except for differences in texture of the surface layer, all the soils of a series have major horizons that are similar in composition, thickness, and arrangement.

Soils of one series can differ in texture of the surface layer, slope, stoniness, salinity, degree of erosion, and other characteristics that affect their use. On the basis of such differences, a soil series is divided into *soil phases*. Most of the areas shown on the detailed soil maps are phases of soil series. The name of a soil phase commonly indicates a feature that affects use or management. For example, Alpha silt loam, 0 to 2 percent slopes, is a phase of the Alpha series.

Some map units are made up of two or more major soils or miscellaneous areas. These map units are complexes, associations, or undifferentiated groups.

A *complex* consists of two or more soils or miscellaneous areas in such an intricate pattern or in such small areas that they cannot be shown separately on the maps. The pattern and proportion of the soils or miscellaneous areas are somewhat similar in all areas. Alpha-Beta complex, 0 to 6 percent slopes, is an example.

An *association* is made up of two or more geographically associated soils or miscellaneous areas that are shown as one unit on the maps. Because of present or anticipated uses of the map units in the survey area, it was not considered practical or necessary to map the soils or miscellaneous areas separately. The pattern and relative proportion of the soils or miscellaneous areas are somewhat similar. Alpha-Beta association, 0 to 2 percent slopes, is an example.

An *undifferentiated group* is made up of two or more soils or miscellaneous areas that could be mapped individually but are mapped as one unit because similar interpretations can be made for use and management. The pattern and proportion of the soils or miscellaneous areas in a mapped area are not uniform. An area can be made up of only one of the major soils or miscellaneous areas, or it can be made up of all of them. Alpha and Beta soils, 0 to 2 percent slopes, is an example.

Some surveys include *miscellaneous areas*. Such areas have little or no soil material and support little or no vegetation. Rock outcrop is an example.

Custom Soil Resource Report

El Paso County Area, Colorado

8—Blakeland loamy sand, 1 to 9 percent slopes

Map Unit Setting

National map unit symbol: 369v
Elevation: 4,600 to 5,800 feet
Mean annual precipitation: 14 to 16 inches
Mean annual air temperature: 46 to 48 degrees F
Frost-free period: 125 to 145 days
Farmland classification: Not prime farmland

Map Unit Composition

Blakeland and similar soils: 98 percent
Minor components: 2 percent
Estimates are based on observations, descriptions, and transects of the mapunit.

Description of Blakeland

Setting

Landform: Hills, flats
Landform position (three-dimensional): Side slope, talf
Down-slope shape: Linear
Across-slope shape: Linear
Parent material: Alluvium derived from sedimentary rock and/or eolian deposits derived from sedimentary rock

Typical profile

A - 0 to 11 inches: loamy sand
AC - 11 to 27 inches: loamy sand
C - 27 to 60 inches: sand

Properties and qualities

Slope: 1 to 9 percent
Depth to restrictive feature: More than 80 inches
Drainage class: Somewhat excessively drained
Runoff class: Low
Capacity of the most limiting layer to transmit water (Ksat): High to very high (5.95 to 19.98 in/hr)
Depth to water table: More than 80 inches
Frequency of flooding: None
Frequency of ponding: None
Calcium carbonate, maximum content: 5 percent
Available water capacity: Low (about 4.5 inches)

Interpretive groups

Land capability classification (irrigated): 3e
Land capability classification (nonirrigated): 6e
Hydrologic Soil Group: A
Ecological site: R049XB210CO - Sandy Foothill
Hydric soil rating: No

Minor Components

Pleasant

Percent of map unit: 1 percent

Custom Soil Resource Report

Landform: Depressions
Hydric soil rating: Yes

Other soils

Percent of map unit: 1 percent
Hydric soil rating: No

9—Blakeland-Fluvaquentic Haplaquolls

Map Unit Setting

National map unit symbol: 36b6
Elevation: 3,500 to 5,800 feet
Mean annual precipitation: 13 to 17 inches
Mean annual air temperature: 46 to 55 degrees F
Frost-free period: 110 to 165 days
Farmland classification: Not prime farmland

Map Unit Composition

Blakeland and similar soils: 60 percent
Fluvaquentic haplaquolls and similar soils: 38 percent
Minor components: 2 percent
Estimates are based on observations, descriptions, and transects of the mapunit.

Description of Blakeland

Setting

Landform: Hills, flats
Landform position (three-dimensional): Side slope, talf
Down-slope shape: Linear
Across-slope shape: Linear
Parent material: Sandy alluvium derived from arkose and/or eolian deposits
derived from arkose

Typical profile

A - 0 to 11 inches: loamy sand
AC - 11 to 27 inches: loamy sand
C - 27 to 60 inches: sand

Properties and qualities

Slope: 1 to 9 percent
Depth to restrictive feature: More than 80 inches
Drainage class: Somewhat excessively drained
Runoff class: Low
Capacity of the most limiting layer to transmit water (Ksat): High to very high (5.95 to 19.98 in/hr)
Depth to water table: More than 80 inches
Frequency of flooding: None
Frequency of ponding: None
Calcium carbonate, maximum content: 5 percent
Available water capacity: Low (about 4.5 inches)

Custom Soil Resource Report

Interpretive groups

Land capability classification (irrigated): 3e
Land capability classification (nonirrigated): 6e
Hydrologic Soil Group: A
Ecological site: R049XB210CO - Sandy Foothill
Hydric soil rating: No

Description of Fluvaquentic Haplaquolls

Setting

Landform: Swales
Down-slope shape: Linear
Across-slope shape: Linear
Parent material: Alluvium

Typical profile

H1 - 0 to 12 inches: variable

Properties and qualities

Slope: 1 to 2 percent
Depth to restrictive feature: More than 80 inches
Drainage class: Poorly drained
Runoff class: Very high
Capacity of the most limiting layer to transmit water (Ksat): Moderately high to high
(0.20 to 6.00 in/hr)
Depth to water table: About 0 to 24 inches
Frequency of flooding: Occasional
Frequency of ponding: None
Maximum salinity: Nonsaline to slightly saline (0.0 to 4.0 mmhos/cm)

Interpretive groups

Land capability classification (irrigated): 6w
Land capability classification (nonirrigated): 6w
Hydrologic Soil Group: D
Hydric soil rating: Yes

Minor Components

Other soils

Percent of map unit: 1 percent
Hydric soil rating: No

Pleasant

Percent of map unit: 1 percent
Landform: Depressions
Hydric soil rating: Yes

Custom Soil Resource Report

95—Truckton loamy sand, 1 to 9 percent slopes

Map Unit Setting

National map unit symbol: 36bd
Elevation: 6,000 to 7,000 feet
Mean annual precipitation: 14 to 16 inches
Mean annual air temperature: 46 to 50 degrees F
Frost-free period: 125 to 145 days
Farmland classification: Not prime farmland

Map Unit Composition

Truckton and similar soils: 95 percent
Minor components: 5 percent
Estimates are based on observations, descriptions, and transects of the mapunit.

Description of Truckton

Setting

Landform: Hills, flats
Landform position (three-dimensional): Side slope, talf
Down-slope shape: Linear
Across-slope shape: Linear
Parent material: Arkosic alluvium derived from sedimentary rock and/or arkosic residuum weathered from sedimentary rock

Typical profile

A - 0 to 8 inches: loamy sand
Bt - 8 to 24 inches: sandy loam
C - 24 to 60 inches: coarse sandy loam

Properties and qualities

Slope: 1 to 9 percent
Depth to restrictive feature: More than 80 inches
Drainage class: Well drained
Runoff class: Low
Capacity of the most limiting layer to transmit water (Ksat): High (1.98 to 6.00 in/hr)
Depth to water table: More than 80 inches
Frequency of flooding: None
Frequency of ponding: None
Available water capacity: Low (about 5.4 inches)

Interpretive groups

Land capability classification (irrigated): 4e
Land capability classification (nonirrigated): 6e
Hydrologic Soil Group: A
Ecological site: R049XB210CO - Sandy Foothill
Hydric soil rating: No

Custom Soil Resource Report

Minor Components

Other soils

Percent of map unit: 4 percent

Hydric soil rating: No

Pleasant

Percent of map unit: 1 percent

Landform: Depressions

Hydric soil rating: Yes

Soil Information for All Uses

Soil Properties and Qualities

The Soil Properties and Qualities section includes various soil properties and qualities displayed as thematic maps with a summary table for the soil map units in the selected area of interest. A single value or rating for each map unit is generated by aggregating the interpretive ratings of individual map unit components. This aggregation process is defined for each property or quality.

Soil Erosion Factors

Soil Erosion Factors are soil properties and interpretations used in evaluating the soil for potential erosion. Example soil erosion factors can include K factor for the whole soil or on a rock free basis, T factor, wind erodibility group and wind erodibility index.

K Factor, Whole Soil

Erosion factor K indicates the susceptibility of a soil to sheet and rill erosion by water. Factor K is one of six factors used in the Universal Soil Loss Equation (USLE) and the Revised Universal Soil Loss Equation (RUSLE) to predict the average annual rate of soil loss by sheet and rill erosion in tons per acre per year. The estimates are based primarily on percentage of silt, sand, and organic matter and on soil structure and saturated hydraulic conductivity (Ksat). Values of K range from 0.02 to 0.69. Other factors being equal, the higher the value, the more susceptible the soil is to sheet and rill erosion by water.

"Erosion factor Kw (whole soil)" indicates the erodibility of the whole soil. The estimates are modified by the presence of rock fragments.

Factor K does not apply to organic horizons and is not reported for those layers.

Custom Soil Resource Report Map—K Factor, Whole Soil

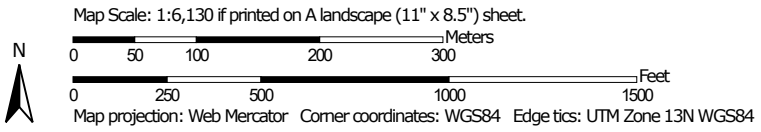
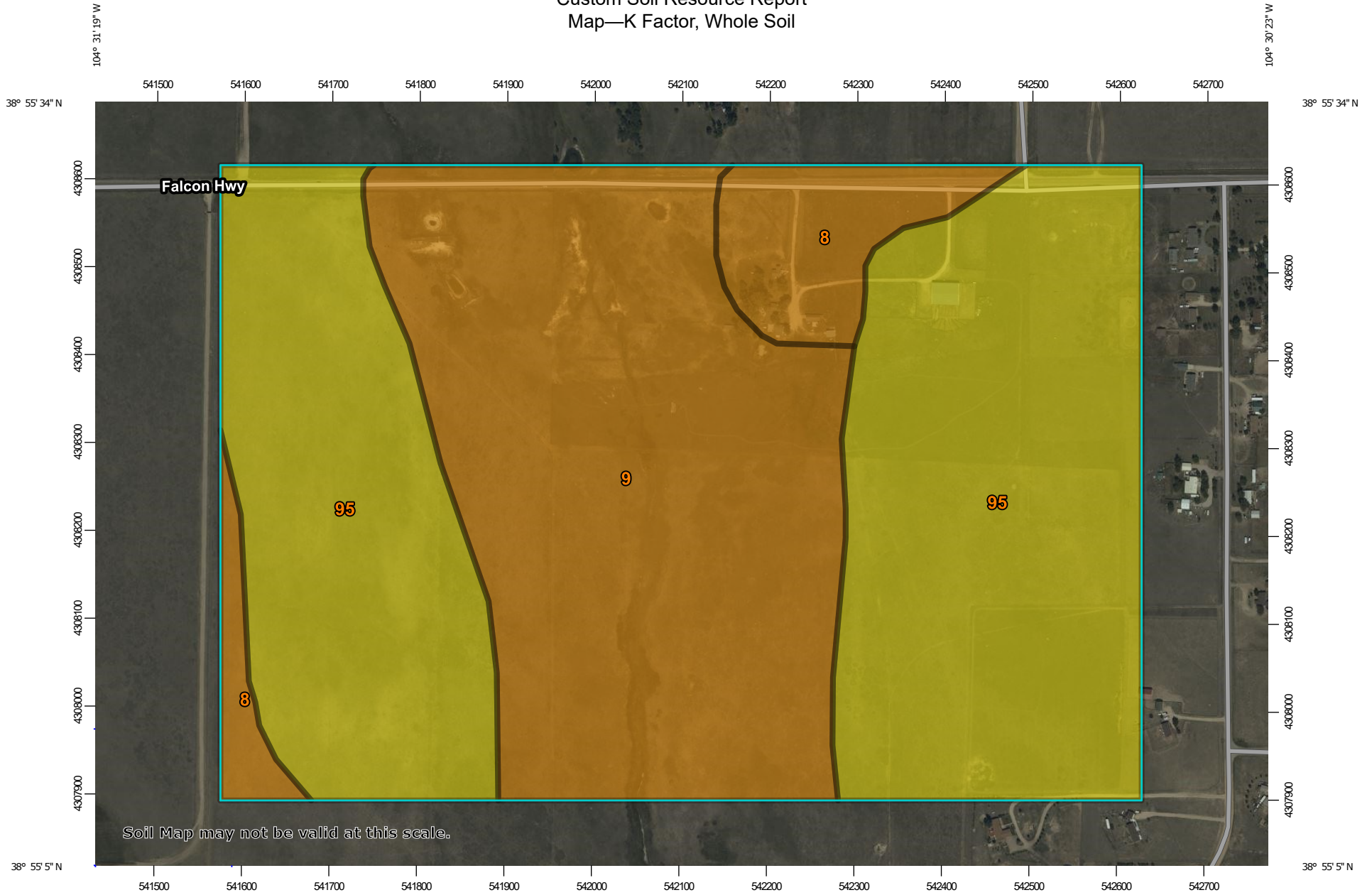

Custom Soil Resource Report















MAP LEGEND

Area of Interest (AOI)







 Area of Interest (AOI)









Soils

Soil Rating Polygons















-  .02
-  .05
-  .10
-  .15
-  .17
-  .20
-  .24
-  .28
-  .32
-  .37
-  .43
-  .49
-  .55
-  .64
-  Not rated or not available

Soil Rating Lines







-  .02
-  .05
-  .10
-  .15
-  .17
-  .20

-  .24
-  .28
-  .32
-  .37
-  .43
-  .49
-  .55
-  .64
-  Not rated or not available

Soil Rating Points

-  .02
-  .05
-  .10
-  .15
-  .17
-  .20
-  .24
-  .28
-  .32
-  .37
-  .43
-  .49
-  .55
-  .64
-  Not rated or not available

Water Features

-  Streams and Canals
- Transportation**
-  Rails
-  Interstate Highways
-  US Routes
-  Major Roads
-  Local Roads
- Background**
-  Aerial Photography

MAP INFORMATION

The soil surveys that comprise your AOI were mapped at 1:24,000.

Warning: Soil Map may not be valid at this scale.

Enlargement of maps beyond the scale of mapping can cause misunderstanding of the detail of mapping and accuracy of soil line placement. The maps do not show the small areas of contrasting soils that could have been shown at a more detailed scale.

Please rely on the bar scale on each map sheet for map measurements.

Source of Map: Natural Resources Conservation Service
 Web Soil Survey URL:
 Coordinate System: Web Mercator (EPSG:3857)

Maps from the Web Soil Survey are based on the Web Mercator projection, which preserves direction and shape but distorts distance and area. A projection that preserves area, such as the Albers equal-area conic projection, should be used if more accurate calculations of distance or area are required.

This product is generated from the USDA-NRCS certified data as of the version date(s) listed below.

Soil Survey Area: El Paso County Area, Colorado
 Survey Area Data: Version 18, Jun 5, 2020

Soil map units are labeled (as space allows) for map scales 1:50,000 or larger.

Date(s) aerial images were photographed: Sep 11, 2018—Oct 20, 2018

The orthophoto or other base map on which the soil lines were compiled and digitized probably differs from the background imagery displayed on these maps. As a result, some minor shifting of map unit boundaries may be evident.

Custom Soil Resource Report

Table—K Factor, Whole Soil

Map unit symbol	Map unit name	Rating	Acres in AOI	Percent of AOI
8	Blakeland loamy sand, 1 to 9 percent slopes	.10	13.9	7.4%
9	Blakeland-Fluvaquentic Haplaquolls	.10	75.0	39.7%
95	Truckton loamy sand, 1 to 9 percent slopes	.17	99.9	52.9%
Totals for Area of Interest			188.9	100.0%

Rating Options—K Factor, Whole Soil

Aggregation Method: Dominant Condition

Component Percent Cutoff: None Specified

Tie-break Rule: Higher

Layer Options (Horizon Aggregation Method): Surface Layer (Not applicable)

Wind Erodibility Group

A wind erodibility group (WEG) consists of soils that have similar properties affecting their susceptibility to wind erosion in cultivated areas. The soils assigned to group 1 are the most susceptible to wind erosion, and those assigned to group 8 are the least susceptible.

Custom Soil Resource Report Map—Wind Erodibility Group

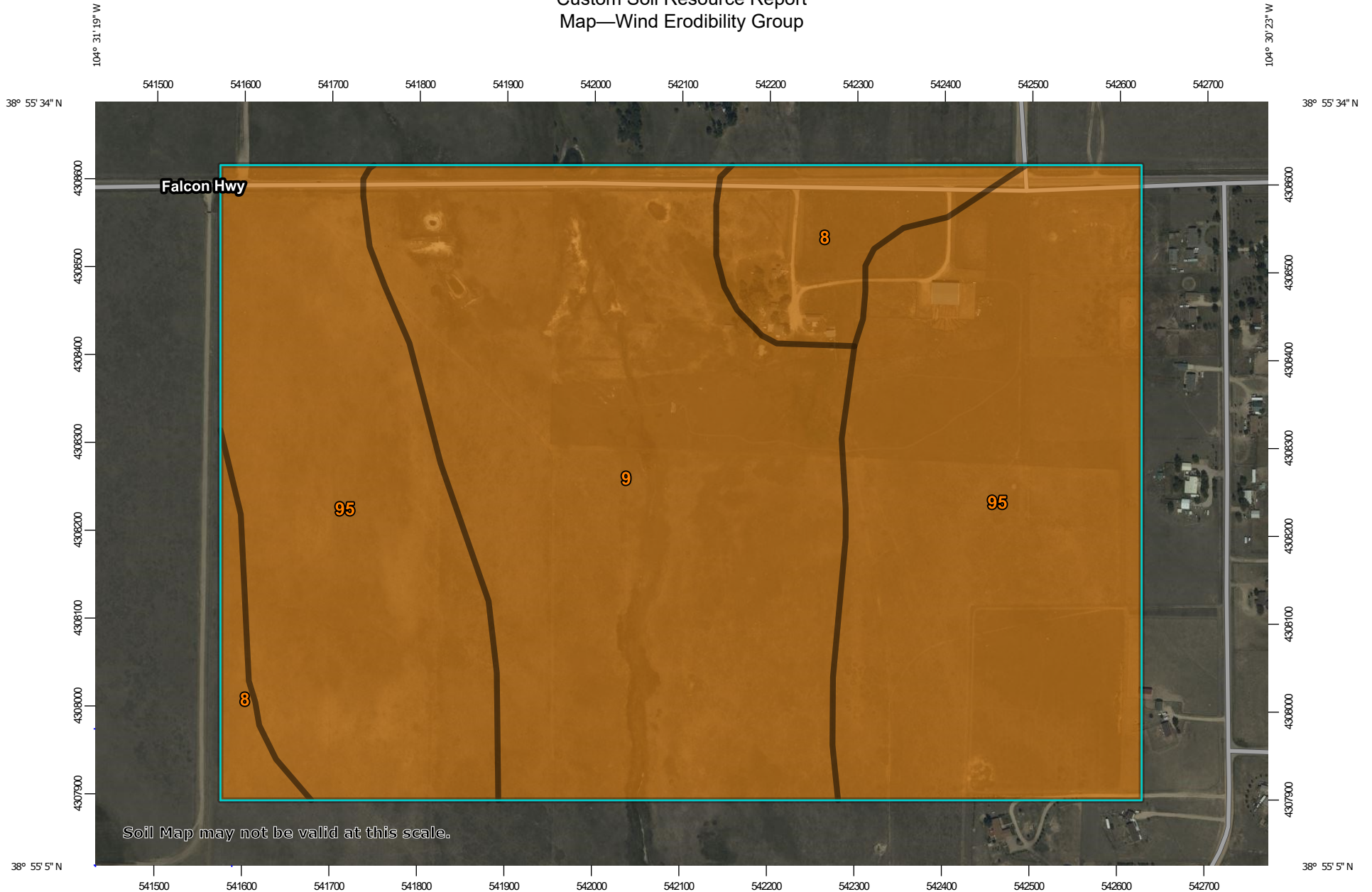



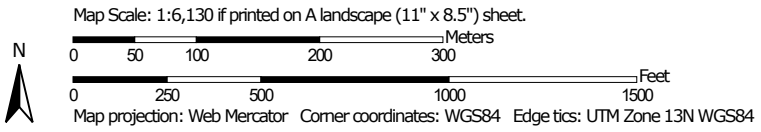



































Soil Map may not be valid at this scale.



Custom Soil Resource Report

MAP LEGEND

Area of Interest (AOI)		 1
 Area of Interest (AOI)		 2
Soils		 3
Soil Rating Polygons		 4
 1		 4L
 2		 5
 3		 6
 4		 7
 4L		 8
 5		 Not rated or not available
 6		
 7		Water Features
 8		 Streams and Canals
 Not rated or not available		Transportation
Soil Rating Lines		 Rails
 1		 Interstate Highways
 2		 US Routes
 3		 Major Roads
 4		 Local Roads
 4L		Background
 5		 Aerial Photography
 6		
 7		
 8		
 Not rated or not available		
Soil Rating Points		

MAP INFORMATION

The soil surveys that comprise your AOI were mapped at 1:24,000.

Warning: Soil Map may not be valid at this scale.

Enlargement of maps beyond the scale of mapping can cause misunderstanding of the detail of mapping and accuracy of soil line placement. The maps do not show the small areas of contrasting soils that could have been shown at a more detailed scale.

Please rely on the bar scale on each map sheet for map measurements.

Source of Map: Natural Resources Conservation Service
 Web Soil Survey URL:
 Coordinate System: Web Mercator (EPSG:3857)

Maps from the Web Soil Survey are based on the Web Mercator projection, which preserves direction and shape but distorts distance and area. A projection that preserves area, such as the Albers equal-area conic projection, should be used if more accurate calculations of distance or area are required.

This product is generated from the USDA-NRCS certified data as of the version date(s) listed below.

Soil Survey Area: El Paso County Area, Colorado
 Survey Area Data: Version 18, Jun 5, 2020

Soil map units are labeled (as space allows) for map scales 1:50,000 or larger.

Date(s) aerial images were photographed: Sep 11, 2018—Oct 20, 2018

The orthophoto or other base map on which the soil lines were compiled and digitized probably differs from the background imagery displayed on these maps. As a result, some minor shifting of map unit boundaries may be evident.

Custom Soil Resource Report

Table—Wind Erodibility Group

Map unit symbol	Map unit name	Rating	Acres in AOI	Percent of AOI
8	Blakeland loamy sand, 1 to 9 percent slopes	2	13.9	7.4%
9	Blakeland-Fluvaquentic Haplaquolls	2	75.0	39.7%
95	Truckton loamy sand, 1 to 9 percent slopes	2	99.9	52.9%
Totals for Area of Interest			188.9	100.0%

Rating Options—Wind Erodibility Group

Aggregation Method: Dominant Condition

Component Percent Cutoff: None Specified

Tie-break Rule: Lower

Soil Qualities and Features

Soil qualities are behavior and performance attributes that are not directly measured, but are inferred from observations of dynamic conditions and from soil properties. Example soil qualities include natural drainage, and frost action. Soil features are attributes that are not directly part of the soil. Example soil features include slope and depth to restrictive layer. These features can greatly impact the use and management of the soil.

Hydrologic Soil Group

Hydrologic soil groups are based on estimates of runoff potential. Soils are assigned to one of four groups according to the rate of water infiltration when the soils are not protected by vegetation, are thoroughly wet, and receive precipitation from long-duration storms.

The soils in the United States are assigned to four groups (A, B, C, and D) and three dual classes (A/D, B/D, and C/D). The groups are defined as follows:

Group A. Soils having a high infiltration rate (low runoff potential) when thoroughly wet. These consist mainly of deep, well drained to excessively drained sands or gravelly sands. These soils have a high rate of water transmission.

Group B. Soils having a moderate infiltration rate when thoroughly wet. These consist chiefly of moderately deep or deep, moderately well drained or well drained

Custom Soil Resource Report

soils that have moderately fine texture to moderately coarse texture. These soils have a moderate rate of water transmission.

Group C. Soils having a slow infiltration rate when thoroughly wet. These consist chiefly of soils having a layer that impedes the downward movement of water or soils of moderately fine texture or fine texture. These soils have a slow rate of water transmission.

Group D. Soils having a very slow infiltration rate (high runoff potential) when thoroughly wet. These consist chiefly of clays that have a high shrink-swell potential, soils that have a high water table, soils that have a claypan or clay layer at or near the surface, and soils that are shallow over nearly impervious material. These soils have a very slow rate of water transmission.

If a soil is assigned to a dual hydrologic group (A/D, B/D, or C/D), the first letter is for drained areas and the second is for undrained areas. Only the soils that in their natural condition are in group D are assigned to dual classes.

Custom Soil Resource Report Map—Hydrologic Soil Group

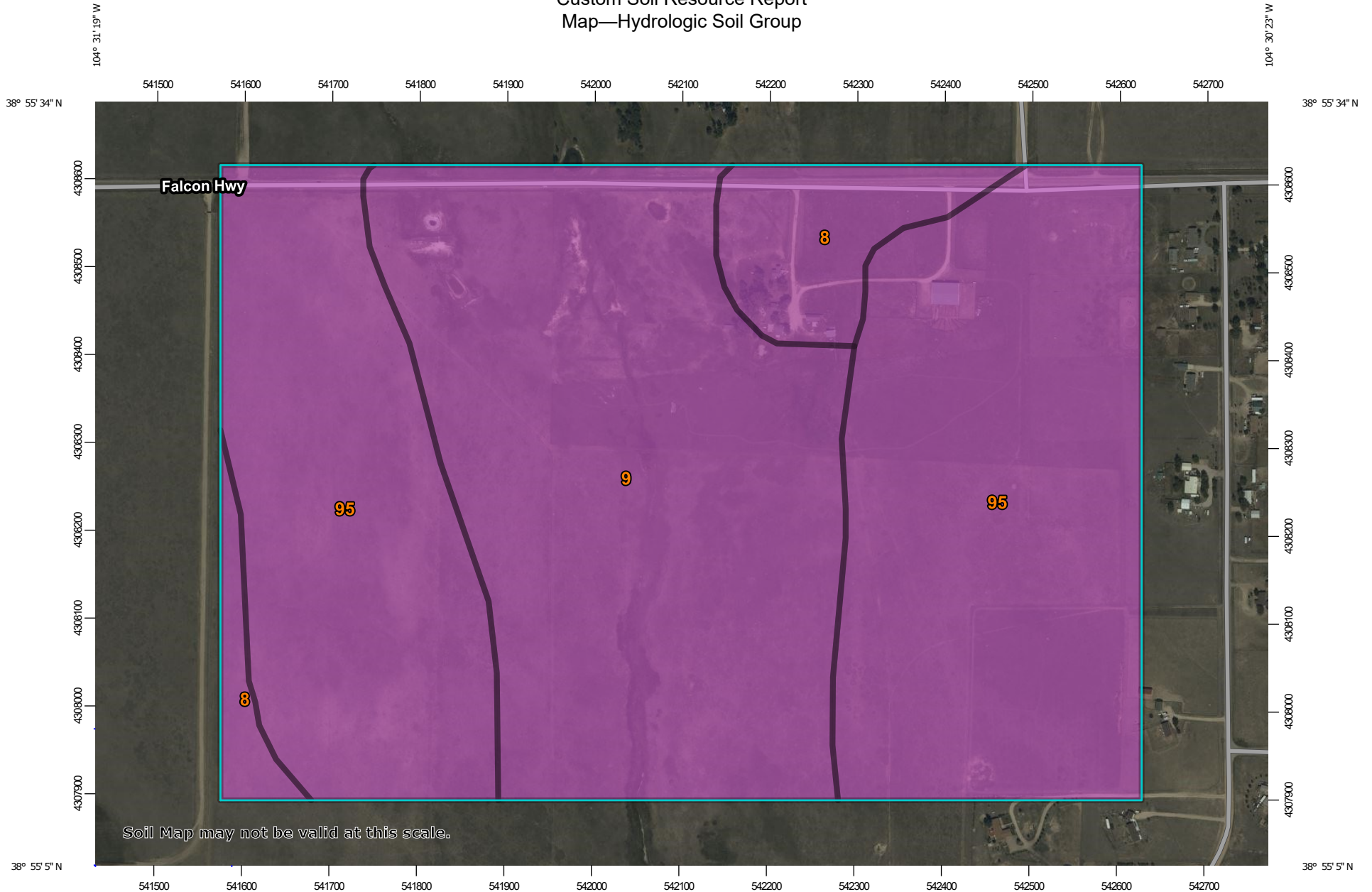

Map Scale: 1:6,130 if printed on A landscape (11" x 8.5") sheet.

0 50 100 200 300 Meters

0 250 500 1000 1500 Feet

Map projection: Web Mercator Corner coordinates: WGS84 Edge tics: UTM Zone 13N WGS84

Custom Soil Resource Report

MAP LEGEND

Area of Interest (AOI)









 Area of Interest (AOI)

Soils

Soil Rating Polygons





-  A
-  A/D
-  B
-  B/D
-  C
-  C/D
-  D
-  Not rated or not available

Soil Rating Lines

-  A
-  A/D
-  B
-  B/D
-  C
-  C/D
-  D
-  Not rated or not available

Soil Rating Points





-  A
-  A/D
-  B
-  B/D

-  C
-  C/D
-  D
-  Not rated or not available

Water Features

 Streams and Canals

Transportation

-  Rails
-  Interstate Highways
-  US Routes
-  Major Roads
-  Local Roads

Background

 Aerial Photography

MAP INFORMATION

The soil surveys that comprise your AOI were mapped at 1:24,000.

Warning: Soil Map may not be valid at this scale.

Enlargement of maps beyond the scale of mapping can cause misunderstanding of the detail of mapping and accuracy of soil line placement. The maps do not show the small areas of contrasting soils that could have been shown at a more detailed scale.

Please rely on the bar scale on each map sheet for map measurements.

Source of Map: Natural Resources Conservation Service
 Web Soil Survey URL:
 Coordinate System: Web Mercator (EPSG:3857)

Maps from the Web Soil Survey are based on the Web Mercator projection, which preserves direction and shape but distorts distance and area. A projection that preserves area, such as the Albers equal-area conic projection, should be used if more accurate calculations of distance or area are required.

This product is generated from the USDA-NRCS certified data as of the version date(s) listed below.

Soil Survey Area: El Paso County Area, Colorado
 Survey Area Data: Version 18, Jun 5, 2020

Soil map units are labeled (as space allows) for map scales 1:50,000 or larger.

Date(s) aerial images were photographed: Sep 11, 2018—Oct 20, 2018

The orthophoto or other base map on which the soil lines were compiled and digitized probably differs from the background imagery displayed on these maps. As a result, some minor shifting of map unit boundaries may be evident.

Custom Soil Resource Report

Table—Hydrologic Soil Group

Map unit symbol	Map unit name	Rating	Acres in AOI	Percent of AOI
8	Blakeland loamy sand, 1 to 9 percent slopes	A	13.9	7.4%
9	Blakeland-Fluvaquentic Haplaquolls	A	75.0	39.7%
95	Truckton loamy sand, 1 to 9 percent slopes	A	99.9	52.9%
Totals for Area of Interest			188.9	100.0%

Rating Options—Hydrologic Soil Group

Aggregation Method: Dominant Condition

Component Percent Cutoff: None Specified

Tie-break Rule: Higher

References

- American Association of State Highway and Transportation Officials (AASHTO). 2004. Standard specifications for transportation materials and methods of sampling and testing. 24th edition.
- American Society for Testing and Materials (ASTM). 2005. Standard classification of soils for engineering purposes. ASTM Standard D2487-00.
- Cowardin, L.M., V. Carter, F.C. Golet, and E.T. LaRoe. 1979. Classification of wetlands and deep-water habitats of the United States. U.S. Fish and Wildlife Service FWS/OBS-79/31.
- Federal Register. July 13, 1994. Changes in hydric soils of the United States.
- Federal Register. September 18, 2002. Hydric soils of the United States.
- Hurt, G.W., and L.M. Vasilas, editors. Version 6.0, 2006. Field indicators of hydric soils in the United States.
- National Research Council. 1995. Wetlands: Characteristics and boundaries.
- Soil Survey Division Staff. 1993. Soil survey manual. Soil Conservation Service. U.S. Department of Agriculture Handbook 18. http://www.nrcs.usda.gov/wps/portal/nrcs/detail/national/soils/?cid=nrcs142p2_054262
- Soil Survey Staff. 1999. Soil taxonomy: A basic system of soil classification for making and interpreting soil surveys. 2nd edition. Natural Resources Conservation Service, U.S. Department of Agriculture Handbook 436. http://www.nrcs.usda.gov/wps/portal/nrcs/detail/national/soils/?cid=nrcs142p2_053577
- Soil Survey Staff. 2010. Keys to soil taxonomy. 11th edition. U.S. Department of Agriculture, Natural Resources Conservation Service. http://www.nrcs.usda.gov/wps/portal/nrcs/detail/national/soils/?cid=nrcs142p2_053580
- Tiner, R.W., Jr. 1985. Wetlands of Delaware. U.S. Fish and Wildlife Service and Delaware Department of Natural Resources and Environmental Control, Wetlands Section.
- United States Army Corps of Engineers, Environmental Laboratory. 1987. Corps of Engineers wetlands delineation manual. Waterways Experiment Station Technical Report Y-87-1.
- United States Department of Agriculture, Natural Resources Conservation Service. National forestry manual. http://www.nrcs.usda.gov/wps/portal/nrcs/detail/soils/home/?cid=nrcs142p2_053374
- United States Department of Agriculture, Natural Resources Conservation Service. National range and pasture handbook. <http://www.nrcs.usda.gov/wps/portal/nrcs/detail/national/landuse/rangepasture/?cid=stelprdb1043084>

Custom Soil Resource Report

United States Department of Agriculture, Natural Resources Conservation Service. National soil survey handbook, title 430-VI. http://www.nrcs.usda.gov/wps/portal/nrcs/detail/soils/scientists/?cid=nrcs142p2_054242

United States Department of Agriculture, Natural Resources Conservation Service. 2006. Land resource regions and major land resource areas of the United States, the Caribbean, and the Pacific Basin. U.S. Department of Agriculture Handbook 296. http://www.nrcs.usda.gov/wps/portal/nrcs/detail/national/soils/?cid=nrcs142p2_053624

United States Department of Agriculture, Soil Conservation Service. 1961. Land capability classification. U.S. Department of Agriculture Handbook 210. http://www.nrcs.usda.gov/Internet/FSE_DOCUMENTS/nrcs142p2_052290.pdf

National Flood Hazard Layer FIRMette



104°31'16"W 38°55'35"N

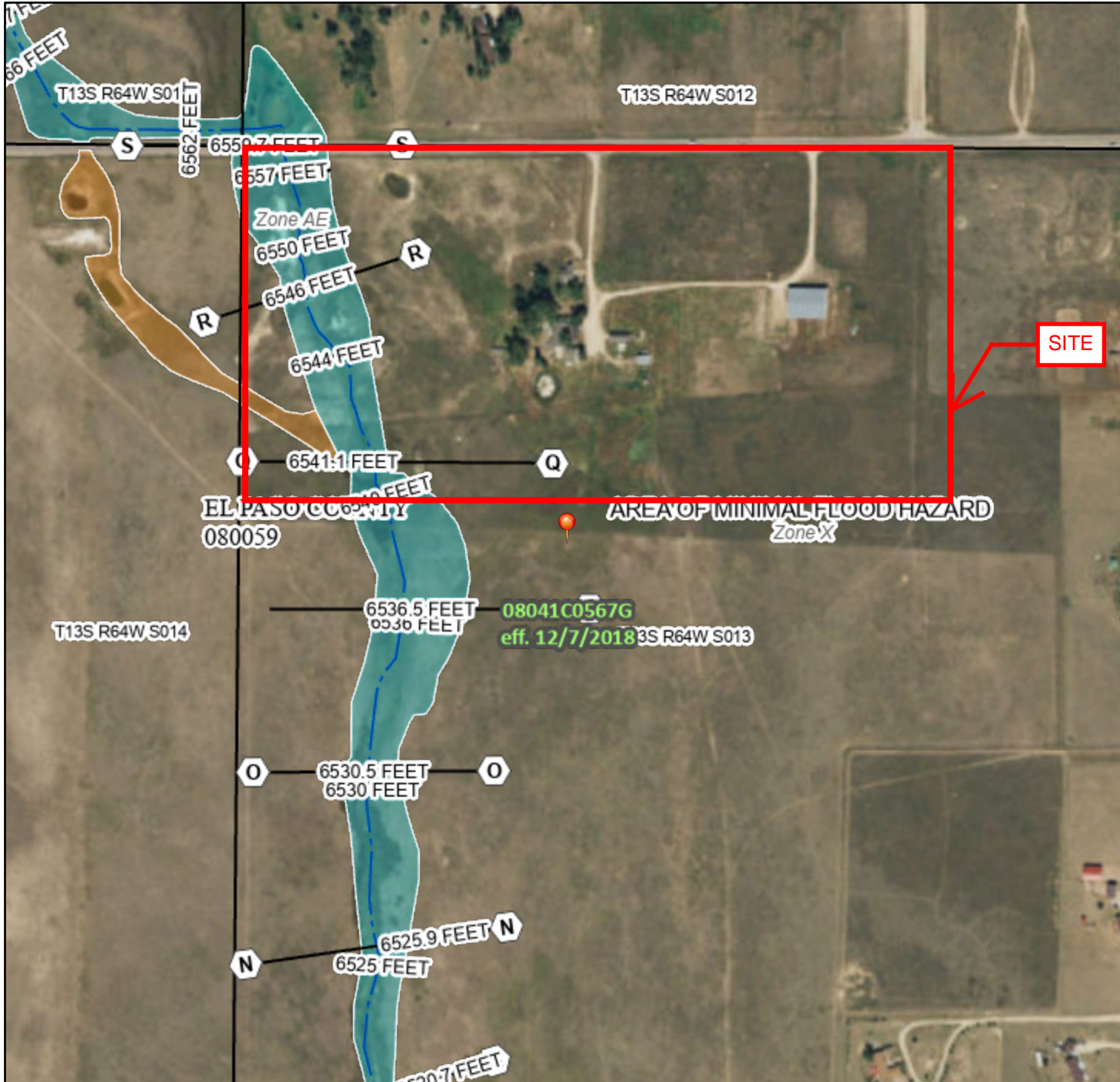

Basemap: USGS National Map: Orthoimagery: Data refreshed October, 2020

Legend

SEE FIS REPORT FOR DETAILED LEGEND AND INDEX MAP FOR FIRM PANEL LAYOUT

SPECIAL FLOOD HAZARD AREAS		Without Base Flood Elevation (BFE) <i>Zone A, V, A99</i>
		With BFE or Depth <i>Zone AE, AO, AH, VE, AR</i>
		Regulatory Floodway
OTHER AREAS OF FLOOD HAZARD		0.2% Annual Chance Flood Hazard, Areas of 1% annual chance flood with average depth less than one foot or with drainage areas of less than one square mile <i>Zone X</i>
		Future Conditions 1% Annual Chance Flood Hazard <i>Zone X</i>
		Area with Reduced Flood Risk due to Levee. See Notes. <i>Zone X</i>
		Area with Flood Risk due to Levee <i>Zone D</i>
OTHER AREAS		NO SCREEN Area of Minimal Flood Hazard <i>Zone X</i>
		Effective LOMRs
		Area of Undetermined Flood Hazard <i>Zone D</i>
GENERAL STRUCTURES		Channel, Culvert, or Storm Sewer
		Levee, Dike, or Floodwall
OTHER FEATURES		20.2 Cross Sections with 1% Annual Chance
		17.5 Water Surface Elevation
		Coastal Transect
		Base Flood Elevation Line (BFE)
		Limit of Study
		Jurisdiction Boundary
		Coastal Transect Baseline
		Profile Baseline
		Hydrographic Feature
MAP PANELS		Digital Data Available
		No Digital Data Available
		Unmapped



The pin displayed on the map is an approximate point selected by the user and does not represent an authoritative property location.

This map complies with FEMA's standards for the use of digital flood maps if it is not void as described below. The basemap shown complies with FEMA's basemap accuracy standards

The flood hazard information is derived directly from the authoritative NFHL web services provided by FEMA. This map was exported on 4/20/2021 at 4:13 PM and does not reflect changes or amendments subsequent to this date and time. The NFHL and effective information may change or become superseded by new data over time.

This map image is void if the one or more of the following map elements do not appear: basemap imagery, flood zone labels, legend, scale bar, map creation date, community identifiers, FIRM panel number, and FIRM effective date. Map images for unmapped and unmodernized areas cannot be used for regulatory purposes.

Master Development Drainage Plan and Preliminary Drainage Report
Peerless Farms – El Paso County, Colorado

APPENDIX C - HYDROLOGIC CALCULATIONS

DESIGN BASIN		DESIGN POINT	Roof <u>AREA</u> (AC)	Landscape <u>AREA</u> (AC)	Pavement <u>AREA</u> (AC)	Gravel <u>AREA</u> (AC)	TOTAL AREA (AC)	C(2)	C(5)	C(10)	C(100)	Imp %
On-Site Basins												
EX1	EX1		0.26	34.58	0.06	0.46	35.36	0.03	0.09	0.16	0.36	2%
EX2	EX2		0.09	4.45	0.00	0.10	4.64	0.05	0.10	0.17	0.37	4%
BASIN SUBTOTAL			0.35	39.03	0.06	0.56	40.00	0.04	0.09	0.16	0.36	2%
			1%	98%	0%	1%	100%					
Off-Site Basins												
EX3	EX3		0.00	1.93	0.70	0.00	2.63	0.25	0.30	0.35	0.51	27%
EX3B	EX3B		0.13	5.40	0.44	0.00	5.97	0.10	0.15	0.22	0.40	9%
T3-02	T3		-	-	-	-	289	-	-	-	-	-
T4	T4		-	-	-	-	350	-	-	-	-	-

*Acreages and Q100 values for T3-02 and T4 were taken from the DBPS. Other values are not available.



EXISTING Time of Concentration

PROJECT NAME: Peerless Farms
 PROJECT NUMBER: 196114000
 CALCULATED BY: MOH
 CHECKED BY: MOH

DATE: 11/13/2023

SUB-BASIN DATA			INITIAL TIME (T _i)			TRAVEL TIME (T _t)					T _c CHECK (URBANIZED BASINS)				FINAL T _c	
DESIGN BASIN (1)	AREA Ac (2)	C5 (3)	LENGTH Ft (4)	SLOPE % (5)	T _i Min. (6)	LENGTH Ft. (7)	SLOPE % (8)	C _v (9)	VEL fps (11)	T _t Min. (12)	COMP. t _c (13)	TOTAL LENGTH (14)	TOTAL SLOPE (15)	TOTAL IMP. (16)	T _c Min. (17)	Min.
On-Site Basins																
EX1	35.36	0.093	300	1.6%	27.3	1,618	3.4%	2.5	0.5	58.5	85.8	1918	3.1%	2%	45.2	45.2
EX2	5	0.104	300	2.8%	22.4	569	1.9%	2.5	0.3	27.5	50.0	869	2.2%	4%	35.7	35.7
Off-Site Basins																
EX3	2.63	0.30	40	2.5%	6.9	1,500	1.9%	20.0	2.8	9.1	15.9	1540	1.9%	27%	36.1	15.9
EX3B	5.97	0.15	20	2.0%	6.2	1,034	1.5%	20.0	2.4	7.0	13.2	1054	1.5%	9%	38.3	13.2
T3-02	289	-	-	-	-	-	-	-	-	-	-	-	-	-	-	-
T4	350	-	-	-	-	-	-	-	-	-	-	-	-	-	-	-
$t_i = \frac{0.395(1.1 - C_s)\sqrt{L_i}}{S_o^{0.333}} \quad t_i = \frac{L_i}{60K\sqrt{S_o}} = \frac{L_i}{60V_i} \quad t_i = (26 - 17i) + \frac{L_i}{60(14i + 9)\sqrt{S_i}}$																

*Acreages and Q100 values for T3-02 and T4 were taken from the DBPS. Other values are not available.



EXISTING
STORM DRAINAGE DESIGN - RATIONAL METHOD 5 YEAR EVENT

PROJECT NAME: Peerless Farms
 PROJECT NUMBER: 1.96E+08
 CALCULATED BY: MOH
 CHECKED BY: MOH

P₁ (1-Hour Rainfall) = **1.5**

DATE: 11/13/2023

STORM LINE	DESIGN POINT	DIRECT RUNOFF							
		DESIGN BASIN	AREA (AC)	RUNOFF COEFF	t _c (min)	C*A (ac)	I (in/hr)	Q (cfs)	
(1)	(2)	(3)	(4)	(5)	(6)	(7)	(8)	(9)	
On-Site Basins									
	EX1	EX1	35.36	0.09	45.23	3.28	1.83	5.99	
	EX2	EX2	4.64	0.10	35.66	0.48	2.12	1.03	
Off-Site Basins									
	EX3	EX3	2.63	0.25	15.93	0.66	3.31	2.18	
	EX3B	EX3B	5.97	0.10	13.19	0.59	3.61	2.14	
	T3	T3-02	289	-	-	-	-	-	
	T4	T4	350	-	-	-	-	-	

*Acreages and Q100 values for T3-02 and T4 were taken from the DBPS. Other values are not available.



EXISTING
STORM DRAINAGE DESIGN - RATIONAL METHOD 100 YEAR EVENT

PROJECT NAME: Peerless Farms
 PROJECT NUMBER: 1.96E+08
 CALCULATED BY: MOH
 CHECKED BY: MOH

DATE: 11/13/2023

P_1 (1-Hour Rainfall) = **2.52**

STORM LINE	DESIGN POINT	DIRECT RUNOFF							
		DESIGN BASIN	AREA (AC)	RUNOFF COEFF	t_c (min)	C*A(ac)	I (in/hr)	Q (cfs)	
(1)	(2)	(3)	(4)	(5)	(6)	(7)	(8)	(9)	
On-Site Basins									
	EX1	EX1	35.36	0.36	45.23	12.69	3.07	38.94	
	EX2	EX2	4.64	0.37	35.66	1.70	3.56	6.07	
Off-Site Basins									
	EX3	EX3	2.63	0.51	15.93	1.34	5.56	7.47	
	EX3B	EX3B	5.97	0.40	13.19	2.42	6.07	14.67	
	T3	T3-02	289	-	-	-	-	460	
	T4	T4	350	-	-	-	-	570	

*Acreages and Q100 values for T3-02 and T4 were taken from the DBPS. Other values are not available.



PROJECT NAME: Peerless Farms
 PROJECT NUMBER: 196114000
 CALCULATED BY: MOH
 CHECKED BY: MOH

DATE: 11/13/2023

EXISTING RATIONAL CALCULATIONS SUMMARY

DESIGN POINT	TRIBUTARY BASINS	TRIBUTARY AREA (AC)	IMPERVIOUSNESS %	PEAK FLOWS (CFS)	
				Q5	Q100
On-Site Basins					
EX1	EX1	35.36	2%	5.99	38.94
EX2	EX2	4.64	4%	1.03	6.07
TOTAL		40.00	2%	7.02	45.01
Off-Site Basins					
EX3	EX3	2.63	27%	2.18	7.47
EX3B	EX3B	5.97	9%	2.14	14.67
T3-02	T3-02	289.00	-	-	460
T4	T4	350.00	-	-	570
TOTAL		647.60	-	-	1052.14

*Acreages and Q100 values for T3-02 and T4 were taken from the DBPS. Other values are not available.



**PROPOSED
RUNOFF COEFFICIENTS - IMPERVIOUS CALCULATION**

PROJECT NAME: Peerless Farms
PROJECT NUMBER: 196114000
CALCULATED BY: MOH
CHECKED BY: MOH

DATE: 11/13/2023

SOIL:

LAND USE:	Roof AREA	Landscape AREA	Pavement AREA	Gravel AREA
2-YEAR COEFF.	0.71	0.02	0.89	0.57
5-YEAR COEFF.	0.73	0.08	0.90	0.59
10-YEAR COEFF.	0.75	0.15	0.92	0.63
100-YEAR COEFF.	0.81	0.35	0.96	0.70
IMPERVIOUS %	90%	0%	100%	80%

DESIGN BASIN	DESIGN POINT	Roof AREA (AC)	Landscape AREA (AC)	Pavement AREA (AC)	Gravel AREA (AC)	TOTAL AREA (AC)	C(2)	C(5)	C(10)	C(100)	Imp %
On-Site Basins											
1	1	2.30	17.64	0.00	0.03	19.97	0.10	0.16	0.22	0.40	10%
2	2	0.00	1.43	0.09	0.26	1.78	0.14	0.20	0.26	0.43	17%
3	3	0.00	0.49	0.04	0.26	0.78	0.24	0.29	0.35	0.50	31%
4	4	0.00	0.18	0.24	0.00	0.42	0.51	0.55	0.59	0.70	57%
5	5	0.00	0.47	0.16	0.22	0.85	0.33	0.37	0.42	0.56	40%
6	6	0.56	4.70	0.06	0.23	5.55	0.12	0.18	0.24	0.42	13%
7	7	0.00	1.48	0.09	0.00	1.57	0.07	0.13	0.19	0.38	6%
8	8	1.00	8.03	0.03	0.03	9.09	0.10	0.16	0.22	0.40	10%
BASIN SUBTOTAL		3.86	34.42	0.71	1.02	40.00	0.12	0.17	0.23	0.41	12%
Off-Site Basins											
EX3	EX3	0.00	1.93	0.70	0.00	2.63	0.25	0.30	0.35	0.51	27%
EX3B	EX3B	0.13	5.40	0.44	0.00	5.97	0.10	0.15	0.22	0.40	9%
T3-02	T3	-	-	-	-	289	-	-	-	-	-
T4	T4	-	-	-	-	350	-	-	-	-	-

*Acreages and Q100 values for T3-02 and T4 were taken from the DBPS. Other values are not available.



PROPOSED Time of Concentration

PROJECT NAME: Peerless Farms
 PROJECT NUMBER: 196114000
 CALCULATED BY: MOH
 CHECKED BY: MOH

DATE: 11/13/2023

SUB-BASIN DATA			INITIAL TIME (T _i)			TRAVEL TIME (T _t)					T _c CHECK (URBANIZED BASINS)				FINAL T _c	
DESIGN BASIN (1)	AREA Ac (2)	C5 (3)	LENGTH Ft (4)	SLOPE % (5)	T _i Min. (6)	LENGTH Ft. (7)	SLOPE % (8)	C _v (9)	VEL fps (11)	T _t Min. (12)	COMP. tc (13)	TOTAL LENGTH (14)	TOTAL SLOPE (15)	TOTAL IMP. (16)	T _c Min. (17)	Min.
On-Site Basins																
1	19.97	0.16	300	6.0%	16.5	1,090	1.1%	5.0	0.5	34.6	51.1	1390	2.2%	10%	39.3	39.3
2	1.78	0.20	300	2.5%	21.1	1,243	3.2%	20.0	3.6	5.8	26.9	1543	3.1%	17%	36.1	26.9
3	0.78	0.29	61	5.0%	6.8	981	2.9%	20.0	3.4	4.8	11.6	1042	3.0%	31%	28.2	11.6
4	0.42	0.55	61	5.0%	4.6	477	1.7%	20.0	2.6	3.0	7.7	538	2.1%	57%	20.0	7.7
5	0.85	0.37	61	5.0%	6.1	1,056	1.5%	20.0	2.4	7.2	13.3	1117	1.7%	40%	29.1	13.3
6	5.55	0.18	300	2.0%	23.3	1,036	2.0%	20.0	2.8	6.1	29.4	1336	2.0%	13%	38.2	29.4
7	1.57	0.13	260	2.0%	22.9	5	3.0%	5.0	0.9	0.1	23.0	265	2.0%	6%	28.2	23.0
8	9.09	0.16	300	4.6%	18.0	958	4.4%	5.0	1.0	15.2	33.3	1258	4.4%	10%	33.7	33.3
Off-Site Basins																
EX3	2.63	0.30	40	2.5%	6.9	1,500	1.9%	20.0	2.8	9.1	15.9	1540	1.9%	27%	36.1	15.9
EX3B	5.97	0.15	20	2.0%	6.2	1,034	1.5%	20.0	2.4	7.0	13.2	1054	1.5%	9%	38.3	13.2
T3-02	289	-	-	-	-	-	-	-	-	-	-	-	-	-	-	-
T4	350	-	-	-	-	-	-	-	-	-	-	-	-	-	-	-

$$t_i = \frac{0.395(1.1 - C_s)\sqrt{L_i}}{S_o^{0.33}}$$

$$t_t = \frac{L_t}{60K\sqrt{S_o}} = \frac{L_t}{60V_t}$$

$$t_c = (26 - 17i) + \frac{L_t}{60(14i + 9)\sqrt{S_o}}$$

*Acreages and Q100 values for T3-02 and T4 were taken from the DBPS. Other values are not available.



**PROPOSED
STORM DRAINAGE DESIGN - RATIONAL METHOD 5 YEAR EVENT**

DATE: 11/13/2023

PROJECT NAME: Peerless Farms
PROJECT NUMBER: 1.96E+08
CALCULATED BY: MOH
CHECKED BY: MOH

P₁ (1-Hour Rainfall) = **1.5**

STORM LINE	DESIGN POINT	DIRECT RUNOFF							
		DESIGN BASIN	AREA (AC)	RUNOFF COEFF	t _c (min)	C*A(ac)	I (in/hr)	Q (cfs)	
(1)	(2)	(3)	(4)	(5)	(6)	(7)	(8)	(9)	
On-Site Basins									
	1	1	19.97	0.16	39.28	3.11	2.00	6.21	
	2	2	1.78	0.20	26.92	0.35	2.51	0.87	
	3	3	0.78	0.29	11.60	0.23	3.82	0.86	
	4	4	0.42	0.55	7.69	0.23	4.47	1.03	
	5	5	0.85	0.37	13.32	0.31	3.60	1.12	
	6	6	5.55	0.18	29.41	0.97	2.38	2.32	
	7	7	1.57	0.13	22.96	0.20	2.74	0.54	
	8	8	9.09	0.16	33.25	1.42	2.21	3.14	
Off-Site Basins									
	EX3	EX3	2.63	0.25	15.93	0.66	3.31	2.18	
	EX3B	EX3B	5.97	0.10	13.19	0.59	3.61	2.14	
	T3	T3-02	289	-	-	-	-	-	
	T4	T4	350	-	-	-	-	-	

*Acreages and Q100 values for T3-02 and T4 were taken from the DBPS. Other values are not available.



**PROPOSED
STORM DRAINAGE DESIGN - RATIONAL METHOD 100 YEAR EVENT**

PROJECT NAME: Peerless Farms
 PROJECT NUMBER: 1.96E+08
 CALCULATED BY: MOH
 CHECKED BY: MOH

P_1 (1-Hour Rainfall) = **2.52**

DATE: 11/13/2023

STORM LINE	DESIGN POINT	DIRECT RUNOFF							
		DESIGN BASIN	AREA (AC)	RUNOFF COEFF	t_c (min)	C*A (ac)	I (in/hr)	Q (cfs)	
(1)	(2)	(3)	(4)	(5)	(6)	(7)	(8)	(9)	
On-Site Basins									
	1	1	19.97	0.40	39.28	8.06	3.36	27.04	
	2	2	1.78	0.43	26.92	0.77	4.21	3.24	
	3	3	0.78	0.50	11.60	0.39	6.42	2.48	
	4	4	0.42	0.70	7.69	0.29	7.51	2.21	
	5	5	0.85	0.56	13.32	0.47	6.04	2.84	
	6	6	5.55	0.42	29.41	2.32	4.00	9.26	
	7	7	1.57	0.38	22.96	0.60	4.60	2.77	
	8	8	9.09	0.40	33.25	3.67	3.72	13.65	
Off-Site Basins									
	EX3	EX3	2.63	0.51	15.93	1.34	5.56	7.47	
	EX3B	EX3B	5.97	0.40	13.19	2.42	6.07	14.67	
	T3	T3-02	289	-	-	-	-	460	
	T4	T4	350	-	-	-	-	570	

*Acreages and Q100 values for T3-02 and T4 were taken from the DBPS. Other values are not available.



PROJECT NAME: Peerless Farms
 PROJECT NUMBER: 196114000
 CALCULATED BY: MOH
 CHECKED BY: MOH

DATE: 11/13/2023

PROPOSED RATIONAL CALCULATIONS SUMMARY

DESIGN POINT	TRIBUTARY BASINS	TRIBUTARY AREA (AC)	IMPERVIOUSNESS %	PEAK FLOWS (CFS)	
				Q5	Q100
On-Site Basins					
1	1	19.97	10%	6.21	27.04
2	2	1.78	17%	0.87	3.24
3	3	0.78	31%	0.86	2.48
4	4	0.42	57%	1.03	2.21
5	5	0.85	40%	1.12	2.84
6	6	5.55	13%	2.32	9.26
7	7	1.57	6%	0.54	2.77
8	8	9.09	10%	3.14	13.65
TOTAL		30.91	12%	16.08	63.49
Off-Site Basins					
EX3	EX3	2.63	27%	2.18	7.47
EX3B	EX3B	5.97	9%	2.14	14.67
T3-02	T3-02	289	-	-	460
T4	T4	350	-	-	570
TOTAL		647.60	-	-	1052.14

*Acreages and Q100 values for T3-02 and T4 were taken from the DBPS. Other values are not available.

Design Procedure Form: Runoff Reduction

UD-BMP (Version 3.07, March 2018)

Sheet 1 of 1

Designer: Mitchell Hess
 Company: Kimley-Horn
 Date: October 7, 2023
 Project: Peerless Farms
 Location: Proposed Public ROW

SITE INFORMATION (User Input in Blue Cells)

WQCV Rainfall Depth = 0.60 inches
 Depth of Average Runoff Producing Storm, d_e = 0.43 inches (for Watersheds Outside of the Denver Region, Figure 3-1 in USDCM Vol. 3)

Area Type	UIA:RPA	UIA:RPA	UIA:RPA	UIA:RPA	UIA:RPA	UIA:RPA	UIA:RPA	SPA	UIA:RPA		
Area ID	A	B	C1	D	E	F	G	H	C2		
Downstream Design Point ID	A	B	C1	D	E	F	G	H	C2		
Downstream BMP Type	None	None	None	None	None	None	None	None	None		
DCIA (ft ²)	--	--	--	--	--	--	--	--	--		
UIA (ft ²)	1,903	1,903	8,495	2,144	6,606	3,553	999	--	1,940		
RPA (ft ²)	1,189	1,190	3,770	1,093	3,013	538	122	--	1,212		
SPA (ft ²)	--	--	--	--	--	--	--	5,523	--		
HSG A (%)	100%	100%	100%	100%	100%	100%	100%	100%	100%		
HSG B (%)	0%	0%	0%	0%	0%	0%	0%	0%	0%		
HSG C/D (%)	0%	0%	0%	0%	0%	0%	0%	0%	0%		
Average Slope of RPA (ft/ft)	0.330	0.330	0.330	0.330	0.330	0.330	0.330	--	0.330		
UIA:RPA Interface Width (ft)	119.00	119.00	424.00	118.00	314.00	125.00	19.00	--	121.00		

CALCULATED RUNOFF RESULTS

Area ID	A	B	C1	D	E	F	G	H	C2		
UIA:RPA Area (ft ²)	3,092	3,093	12,265	3,237	9,619	4,091	1,121	--	3,152		
L / W Ratio	0.22	0.22	0.07	0.23	0.10	0.26	3.11	--	0.22		
UIA / Area	0.6155	0.6153	0.6926	0.6623	0.6868	0.8685	0.8912	--	0.6155		
Runoff (in)	0.00	0.00	0.00	0.00	0.00	0.15	0.20	0.00	0.00		
Runoff (ft ³)	0	0	0	0	0	52	18	0	0		
Runoff Reduction (ft ³)	79	79	354	89	275	96	23	276	81		

CALCULATED WQCV RESULTS

Area ID	A	B	C1	D	E	F	G	H	C2		
WQCV (ft ³)	79	79	354	89	275	148	42	0	81		
WQCV Reduction (ft ³)	79	79	354	89	275	96	23	0	81		
WQCV Reduction (%)	100%	100%	100%	100%	100%	65%	56%	0%	100%		
Untreated WQCV (ft ³)	0	0	0	0	0	52	18	0	0		

CALCULATED DESIGN POINT RESULTS (sums results from all columns with the same Downstream Design Point ID)

Downstream Design Point ID	A	B	C1	D	E	F	G	H	C2		
DCIA (ft ²)	0	0	0	0	0	0	0	0	0		
UIA (ft ²)	1,903	1,903	8,495	2,144	6,606	3,553	999	0	1,940		
RPA (ft ²)	1,189	1,190	3,770	1,093	3,013	538	122	0	1,212		
SPA (ft ²)	0	0	0	0	0	0	0	5,523	0		
Total Area (ft ²)	3,092	3,093	12,265	3,237	9,619	4,091	1,121	5,523	3,152		
Total Impervious Area (ft ²)	1,903	1,903	8,495	2,144	6,606	3,553	999	0	1,940		
WQCV (ft ³)	79	79	354	89	275	148	42	0	81		
WQCV Reduction (ft ³)	79	79	354	89	275	96	23	0	81		
WQCV Reduction (%)	100%	100%	100%	100%	100%	65%	56%	0%	100%		
Untreated WQCV (ft ³)	0	0	0	0	0	52	18	0	0		

CALCULATED SITE RESULTS (sums results from all columns in worksheet)

Total Area (ft ²)	45,193
Total Impervious Area (ft ²)	27,543
WQCV (ft ³)	1,148
WQCV Reduction (ft ³)	1,077
WQCV Reduction (%)	94%
Untreated WQCV (ft ³)	71

Master Development Drainage Plan and Preliminary Drainage Report
Peerless Farms – El Paso County, Colorado

APPENDIX D - HYDRAULIC CALCULATIONS

Worksheet for Culvert 1

Project Description	
Friction Method	Manning Formula
Solve For	Normal Depth
Input Data	
Roughness Coefficient	0.013
Channel Slope	0.005 ft/ft
Diameter	18.0 in
Discharge	2.21 cfs
Results	
Normal Depth	6.7 in
Flow Area	0.6 ft ²
Wetted Perimeter	2.0 ft
Hydraulic Radius	3.7 in
Top Width	1.45 ft
Critical Depth	6.7 in
Percent Full	37.4 %
Critical Slope	0.005 ft/ft
Velocity	3.67 ft/s
Velocity Head	0.21 ft
Specific Energy	0.77 ft
Froude Number	1.003
Maximum Discharge	7.99 cfs
Discharge Full	7.43 cfs
Slope Full	0.000 ft/ft
Flow Type	Supercritical
GVF Input Data	
Downstream Depth	0.0 in
Length	0.0 ft
Number Of Steps	0
GVF Output Data	
Upstream Depth	0.0 in
Profile Description	N/A
Profile Headloss	0.00 ft
Average End Depth Over Rise	0.0 %
Normal Depth Over Rise	37.4 %
Downstream Velocity	Infinity ft/s
Upstream Velocity	Infinity ft/s
Normal Depth	6.7 in
Critical Depth	6.7 in
Channel Slope	0.005 ft/ft
Critical Slope	0.005 ft/ft

Worksheet for Culvert 1

Notes:

Flows from Sub-Basin 4.

Worksheet for Culvert 2

Project Description	
Friction Method	Manning Formula
Solve For	Normal Depth
Input Data	
Roughness Coefficient	0.013
Channel Slope	0.005 ft/ft
Diameter	18.0 in
Discharge	2.84 cfs
Results	
Normal Depth	7.7 in
Flow Area	0.7 ft ²
Wetted Perimeter	2.1 ft
Hydraulic Radius	4.1 in
Top Width	1.48 ft
Critical Depth	7.7 in
Percent Full	42.9 %
Critical Slope	0.005 ft/ft
Velocity	3.92 ft/s
Velocity Head	0.24 ft
Specific Energy	0.88 ft
Froude Number	0.991
Maximum Discharge	7.99 cfs
Discharge Full	7.43 cfs
Slope Full	0.001 ft/ft
Flow Type	Subcritical
GVF Input Data	
Downstream Depth	0.0 in
Length	0.0 ft
Number Of Steps	0
GVF Output Data	
Upstream Depth	0.0 in
Profile Description	N/A
Profile Headloss	0.00 ft
Average End Depth Over Rise	0.0 %
Normal Depth Over Rise	55.2 %
Downstream Velocity	Infinity ft/s
Upstream Velocity	Infinity ft/s
Normal Depth	7.7 in
Critical Depth	7.7 in
Channel Slope	0.005 ft/ft
Critical Slope	0.005 ft/ft

Worksheet for Culvert 2

Notes:

Flows from Sub-Basin 5.

Worksheet for Culvert 3

Project Description	
Friction Method	Manning Formula
Solve For	Normal Depth
Input Data	
Roughness Coefficient	0.013
Channel Slope	0.005 ft/ft
Diameter	24.0 in
Discharge	14.31 cfs
Results	
Normal Depth	17.7 in
Flow Area	2.5 ft ²
Wetted Perimeter	4.1 ft
Hydraulic Radius	7.2 in
Top Width	1.76 ft
Critical Depth	16.4 in
Percent Full	73.8 %
Critical Slope	0.006 ft/ft
Velocity	5.76 ft/s
Velocity Head	0.52 ft
Specific Energy	1.99 ft
Froude Number	0.854
Maximum Discharge	17.21 cfs
Discharge Full	16.00 cfs
Slope Full	0.004 ft/ft
Flow Type	Subcritical
GVF Input Data	
Downstream Depth	0.0 in
Length	0.0 ft
Number Of Steps	0
GVF Output Data	
Upstream Depth	0.0 in
Profile Description	N/A
Profile Headloss	0.00 ft
Average End Depth Over Rise	0.0 %
Normal Depth Over Rise	55.2 %
Downstream Velocity	Infinity ft/s
Upstream Velocity	Infinity ft/s
Normal Depth	17.7 in
Critical Depth	16.4 in
Channel Slope	0.005 ft/ft
Critical Slope	0.006 ft/ft

Worksheet for Culvert 3

Notes:

Flows from Sub-Basin 4, 5, and 6.

Worksheet for Culvert 4

Project Description	
Friction Method	Manning Formula
Solve For	Normal Depth
Input Data	
Roughness Coefficient	0.013
Channel Slope	0.005 ft/ft
Diameter	18.0 in
Discharge	2.48 cfs
Results	
Normal Depth	7.2 in
Flow Area	0.7 ft ²
Wetted Perimeter	2.0 ft
Hydraulic Radius	3.8 in
Top Width	1.47 ft
Critical Depth	7.2 in
Percent Full	39.8 %
Critical Slope	0.005 ft/ft
Velocity	3.78 ft/s
Velocity Head	0.22 ft
Specific Energy	0.82 ft
Froude Number	0.998
Maximum Discharge	7.99 cfs
Discharge Full	7.43 cfs
Slope Full	0.001 ft/ft
Flow Type	Subcritical
GVF Input Data	
Downstream Depth	0.0 in
Length	0.0 ft
Number Of Steps	0
GVF Output Data	
Upstream Depth	0.0 in
Profile Description	N/A
Profile Headloss	0.00 ft
Average End Depth Over Rise	0.0 %
Normal Depth Over Rise	55.2 %
Downstream Velocity	Infinity ft/s
Upstream Velocity	Infinity ft/s
Normal Depth	7.2 in
Critical Depth	7.2 in
Channel Slope	0.005 ft/ft
Critical Slope	0.005 ft/ft

Worksheet for Culvert 4

Notes:

Flows from Sub-Basin 3

Worksheet for Culvert 5

Project Description	
Friction Method	Manning Formula
Solve For	Normal Depth
Input Data	
Roughness Coefficient	0.013
Channel Slope	0.005 ft/ft
Diameter	24.0 in
Discharge	14.67 cfs
Results	
Normal Depth	18.1 in
Flow Area	2.5 ft ²
Wetted Perimeter	4.2 ft
Hydraulic Radius	7.2 in
Top Width	1.72 ft
Critical Depth	16.6 in
Percent Full	75.4 %
Critical Slope	0.006 ft/ft
Velocity	5.78 ft/s
Velocity Head	0.52 ft
Specific Energy	2.03 ft
Froude Number	0.839
Maximum Discharge	17.21 cfs
Discharge Full	16.00 cfs
Slope Full	0.004 ft/ft
Flow Type	Subcritical
GVF Input Data	
Downstream Depth	0.0 in
Length	0.0 ft
Number Of Steps	0
GVF Output Data	
Upstream Depth	0.0 in
Profile Description	N/A
Profile Headloss	0.00 ft
Average End Depth Over Rise	0.0 %
Normal Depth Over Rise	55.2 %
Downstream Velocity	Infinity ft/s
Upstream Velocity	Infinity ft/s
Normal Depth	18.1 in
Critical Depth	16.6 in
Channel Slope	0.005 ft/ft
Critical Slope	0.006 ft/ft

Worksheet for Culvert 5

Notes:

Flows from Sub-Basin EX3B

Worksheet for Sub-Basin 2 - Ditch

Project Description	
Friction Method	Manning Formula
Solve For	Normal Depth
Input Data	
Roughness Coefficient	0.030
Channel Slope	0.025 ft/ft
Left Side Slope	4.000 H:V
Right Side Slope	4.000 H:V
Discharge	5.72 cfs
Results	
Normal Depth	7.6 in
Flow Area	1.6 ft ²
Wetted Perimeter	5.2 ft
Hydraulic Radius	3.7 in
Top Width	5.07 ft
Critical Depth	7.9 in
Critical Slope	0.020 ft/ft
Velocity	3.57 ft/s
Velocity Head	0.20 ft
Specific Energy	0.83 ft
Froude Number	1.117
Flow Type	Supercritical
GVF Input Data	
Downstream Depth	0.0 in
Length	0.0 ft
Number Of Steps	0
GVF Output Data	
Upstream Depth	0.0 in
Profile Description	N/A
Profile Headloss	0.00 ft
Downstream Velocity	Infinity ft/s
Upstream Velocity	Infinity ft/s
Normal Depth	7.6 in
Critical Depth	7.9 in
Channel Slope	0.025 ft/ft
Critical Slope	0.020 ft/ft

Worksheet for Sub-Basin 2 - Ditch

Notes:

Flows from Sub-Basin 2 and 3.

Worksheet for Sub-Basin 3 - Ditch

Project Description	
Friction Method	Manning Formula
Solve For	Normal Depth
Input Data	
Roughness Coefficient	0.030
Channel Slope	0.025 ft/ft
Left Side Slope	4.000 H:V
Right Side Slope	4.000 H:V
Discharge	2.48 cfs
Results	
Normal Depth	5.6 in
Flow Area	0.9 ft ²
Wetted Perimeter	3.8 ft
Hydraulic Radius	2.7 in
Top Width	3.70 ft
Critical Depth	5.7 in
Critical Slope	0.022 ft/ft
Velocity	2.89 ft/s
Velocity Head	0.13 ft
Specific Energy	0.59 ft
Froude Number	1.060
Flow Type	Supercritical
GVF Input Data	
Downstream Depth	0.0 in
Length	0.0 ft
Number Of Steps	0
GVF Output Data	
Upstream Depth	0.0 in
Profile Description	N/A
Profile Headloss	0.00 ft
Downstream Velocity	Infinity ft/s
Upstream Velocity	Infinity ft/s
Normal Depth	5.6 in
Critical Depth	5.7 in
Channel Slope	0.025 ft/ft
Critical Slope	0.022 ft/ft

Worksheet for Sub-Basin 3 - Ditch

Notes:

Flows from Sub-Basin 3.

Worksheet for Sub-Basin 4 - Ditch

Project Description	
Friction Method	Manning Formula
Solve For	Normal Depth
Input Data	
Roughness Coefficient	0.030
Channel Slope	0.025 ft/ft
Left Side Slope	4.000 H:V
Right Side Slope	3.260 H:V
Discharge	2.21 cfs
Results	
Normal Depth	5.5 in
Flow Area	0.8 ft ²
Wetted Perimeter	3.5 ft
Hydraulic Radius	2.7 in
Top Width	3.34 ft
Critical Depth	5.6 in
Critical Slope	0.022 ft/ft
Velocity	2.87 ft/s
Velocity Head	0.13 ft
Specific Energy	0.59 ft
Froude Number	1.055
Flow Type	Supercritical
GVF Input Data	
Downstream Depth	0.0 in
Length	0.0 ft
Number Of Steps	0
GVF Output Data	
Upstream Depth	0.0 in
Profile Description	N/A
Profile Headloss	0.00 ft
Downstream Velocity	Infinity ft/s
Upstream Velocity	Infinity ft/s
Normal Depth	5.5 in
Critical Depth	5.6 in
Channel Slope	0.025 ft/ft
Critical Slope	0.022 ft/ft

Worksheet for Sub-Basin 4 - Ditch

Notes:

Flows from Sub-Basin 4.

Worksheet for Sub-Basin 5 - Ditch

Project Description	
Friction Method	Manning Formula
Solve For	Normal Depth
Input Data	
Roughness Coefficient	0.030
Channel Slope	0.025 ft/ft
Left Side Slope	4.000 H:V
Right Side Slope	4.000 H:V
Discharge	2.84 cfs
Results	
Normal Depth	5.8 in
Flow Area	0.9 ft ²
Wetted Perimeter	4.0 ft
Hydraulic Radius	2.8 in
Top Width	3.90 ft
Critical Depth	6.0 in
Critical Slope	0.022 ft/ft
Velocity	2.99 ft/s
Velocity Head	0.14 ft
Specific Energy	0.63 ft
Froude Number	1.069
Flow Type	Supercritical
GVF Input Data	
Downstream Depth	0.0 in
Length	0.0 ft
Number Of Steps	0
GVF Output Data	
Upstream Depth	0.0 in
Profile Description	N/A
Profile Headloss	0.00 ft
Downstream Velocity	Infinity ft/s
Upstream Velocity	Infinity ft/s
Normal Depth	5.8 in
Critical Depth	6.0 in
Channel Slope	0.025 ft/ft
Critical Slope	0.022 ft/ft

Worksheet for Sub-Basin 5 - Ditch

Notes:

Flows from Sub-Basin 5.

Worksheet for Sub-Basin 6 - Ditch

Project Description	
Friction Method	Manning Formula
Solve For	Normal Depth
Input Data	
Roughness Coefficient	0.030
Channel Slope	0.025 ft/ft
Left Side Slope	4.000 H:V
Right Side Slope	4.000 H:V
Discharge	14.31 cfs
Results	
Normal Depth	10.7 in
Flow Area	3.2 ft ²
Wetted Perimeter	7.4 ft
Hydraulic Radius	5.2 in
Top Width	7.15 ft
Critical Depth	11.5 in
Critical Slope	0.017 ft/ft
Velocity	4.48 ft/s
Velocity Head	0.31 ft
Specific Energy	1.21 ft
Froude Number	1.182
Flow Type	Supercritical
GVF Input Data	
Downstream Depth	0.0 in
Length	0.0 ft
Number Of Steps	0
GVF Output Data	
Upstream Depth	0.0 in
Profile Description	N/A
Profile Headloss	0.00 ft
Downstream Velocity	Infinity ft/s
Upstream Velocity	Infinity ft/s
Normal Depth	10.7 in
Critical Depth	11.5 in
Channel Slope	0.025 ft/ft
Critical Slope	0.017 ft/ft

Worksheet for Sub-Basin 6 - Ditch

Notes:

Flows from Sub-Basin 4, 5 and 6.

Worksheet for Sub-Basin 7 - Ditch

Project Description	
Friction Method	Manning Formula
Solve For	Normal Depth
Input Data	
Roughness Coefficient	0.030
Channel Slope	0.025 ft/ft
Left Side Slope	4.000 H:V
Right Side Slope	4.000 H:V
Discharge	2.77 cfs
Results	
Normal Depth	5.8 in
Flow Area	0.9 ft ²
Wetted Perimeter	4.0 ft
Hydraulic Radius	2.8 in
Top Width	3.86 ft
Critical Depth	5.9 in
Critical Slope	0.022 ft/ft
Velocity	2.97 ft/s
Velocity Head	0.14 ft
Specific Energy	0.62 ft
Froude Number	1.068
Flow Type	Supercritical
GVF Input Data	
Downstream Depth	0.0 in
Length	0.0 ft
Number Of Steps	0
GVF Output Data	
Upstream Depth	0.0 in
Profile Description	N/A
Profile Headloss	0.00 ft
Downstream Velocity	Infinity ft/s
Upstream Velocity	Infinity ft/s
Normal Depth	5.8 in
Critical Depth	5.9 in
Channel Slope	0.025 ft/ft
Critical Slope	0.022 ft/ft

Worksheet for Sub-Basin 7 - Ditch

Notes:

Flows from Sub-Basin 7.

Rip-Rap Calculation

Culvert 100-Year Outflow

Riprap Apron N4.1

Applicable Equations:

$L_p = (1/2 \tan \theta)(A_i Y_i - D)$	Equation 9-11 per USDCM
$A_t = Q/V$	Equation 9-12 per USDCM
$\theta = \tan^{-1}(1/(2 * \text{Expansion Factor}))$	Equation 9-13 per USDCM
$W = 2(L_p \tan \theta) + D$	Equation 9-14 per USDCM
$T = 2D_{50}$	Equation 9-15 per USDCM

Assumptions

Input parameters:

Description	Variable	Input	Unit
Width of the conduit (use diameter for circular conduits),	D:	2.00	ft
HGL Elevation		6567.93	ft
Invert Elevation		6566.45	ft
Tailwater depth (ft),	Y_i :	0.89	ft
Expansion angle of the culvert flow	θ :	0.09	radians
Design discharge (cfs)*	Q:	14.31	cfs
Froude Number	F_r	0.85	Subcritical
Unitless Variables for Tables:			
	For Figure 9-35 $Q/D^{2.5}$	2.53	
	For Figure 9-35 Y_i/D	0.45	
	For Figure 9-38 $Q/D^{1.5}$	5.06	
	For Figure 9-38 Y_i/D	0.45	
Allowable non-eroding velocity in the downstream channel (ft/sec)	V:	7	ft/sec
Expansion Factor (Figure 9-35), $1/(2 \tan(\theta))$		5.85	

Solve for:

Description	Variable	Output	Unit
1. Required area of flow at allowable velocity (ft ²)	A_i :	2.04	ft ²
2. Length of Protection	L_p :	1.71	ft
	$L_p < 3D$?	Yes	
	$L_p > 10D$?	No	
	$L_p > 10D$ & $F_r > 6$?	No	
	L_{pmin} :	6.00	ft
3. Width of downstream riprap protection	W:	3.00	ft
4. Rip Rap Type (Figure 9-38)	-	L	
5. Rip Rap Size (Figure 8-34)	D_{50} :	9	inches

Rip Rap Summary

Length	L_p	6.00	ft
Width	W_{min}	3.00	ft
Size	D_{50}	9	inches
Type	-	L	
Thickness	T	18	inches

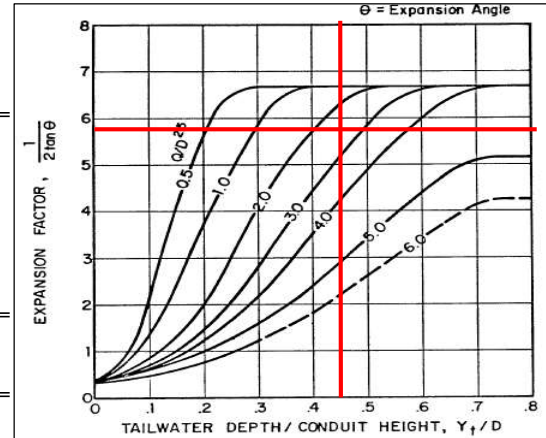
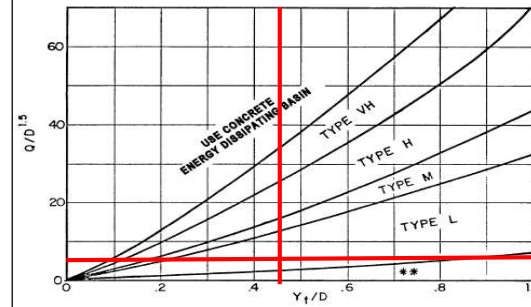

Figure 9-35. Expansion factor for circular conduits



Use D_a instead of D whenever flow is supercritical in the barrel.
 ** Use Type L for a distance of $3D$ downstream.

Figure 9-38. Riprap erosion protection at circular conduit outlet (valid for $Q/D_{2.5} \leq 6.0$)

RIPRAP DESIGNATION	% SMALLER THAN GIVEN SIZE BY WEIGHT	INTERMEDIATE ROCK DIMENSION (INCHES)	D_{50}^* (INCHES)
TYPE VL	70 - 100	12	6
	50 - 70	9	
	35 - 50	6	
	2 - 10	2	
TYPE L	70 - 100	15	9
	50 - 70	12	
	35 - 50	9	
	2 - 10	3	
TYPE M	70 - 100	21	12
	50 - 70	18	
	35 - 50	12	
	2 - 10	4	
TYPE H	70 - 100	30	18
	50 - 70	24	
	35 - 50	18	
	2 - 10	6	

* D_{50} = MEAN ROCK SIZE

Figure 8-34. Riprap and soil riprap placement and gradation (part 1 of 3)

Master Development Drainage Plan and Preliminary Drainage Report
Peerless Farms – El Paso County, Colorado

APPENDIX E – EOPCC AND TEMPORARY SEDIMENT BASIN STANDARD DETAIL



Kimley-Horn & Associates, Inc.

Opinion of Probable Construction Cost

Client: Robert S. Williams	Date: 10/9/2023
Project: Peerless Farms, El Paso County, CO	Prepared By: MH
KHA No.: 196114000	Checked By:

Sheet: 1 of 1

This OPC is not intended for basing financial decisions, or securing funding. Review all notes and assumptions. Since Kimley-Horn & Associates, Inc. has no control over the cost of labor, materials, equipment, or services furnished by others, or over methods of determining price, or over competitive bidding or market conditions, any and all opinions as to the cost herein, including but not limited to opinions as to the costs of construction materials, shall be made on the basis of experience and best available data. Kimley-Horn & Associates, Inc. cannot and does not guarantee that proposals, bids, or actual costs will not vary from the opinions on costs shown herein. The total costs and other numbers in this Opinion of Probable Cost have been rounded.

Item No.	Item Description	Quantity	Unit	Unit Price	Item Cost
Private Storm Sewer (Non-Reimbursible)					
1	18" RCP Storm Pipe	90	LF	\$76.00	\$6,840
2	24" RCP Storm Pipe	65	LF	\$91.00	\$5,915
3	18" FES	6	EA	\$456.00	\$2,736
4	24" FES	4	EA	\$546.00	\$2,184
5	Riprap, d50 9"	16	Ton	\$97.00	\$1,552
Subtotal:					\$19,227
Contingency (%,+/-)				10%	\$1,923
Project Total:					\$21,150

Basis for Cost Projection:

- No Design Completed
 Preliminary Design
 Final Design

Design Engineer:



Mitchell O. Hess
Registered Professional Engineer, State of Colorado No. 53916

TEMPORARY SEDIMENT BASIN

TSB



1.0 DESCRIPTION

- Temporary sediment basins are small impoundments of water with a small outlet structure built on a construction site.

2.0 PURPOSE

- Used to capture and slowly release runoff prior to discharge from a construction site to allow sediment to settle out.

3.0 IMPLEMENTATION

- Temporary sediment basins for drainage areas larger than 15 acres must be individually designed by engineer.
- Erosion and other sediment controls should be implemented upstream of temporary sediment basins.

4.0 TIMING

- Install prior to upstream land disturbance.
- Remove temporary sediment basin after upstream area has been stabilized. Permanently stabilize area after basin has been removed.

5.0 MAINTENANCE

- Remove sediment from basin as needed to maintain the effectiveness of the temporary sediment basin. This is typically when sediment depth reaches one foot.
- Inspect sediment basin embankments for stability and seepage.
- Inspect the inlet and outlet of the basin, repair damage, and remove debris.

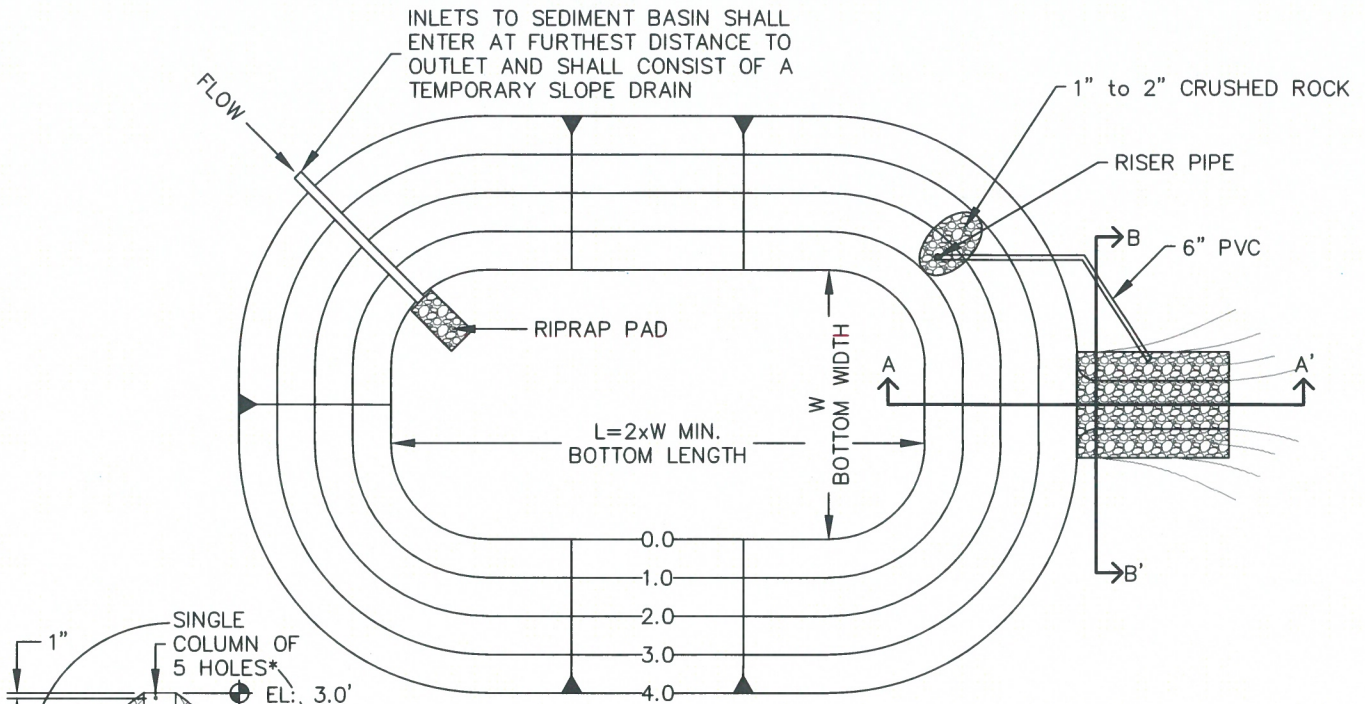

SEDIMENT BASIN PLAN

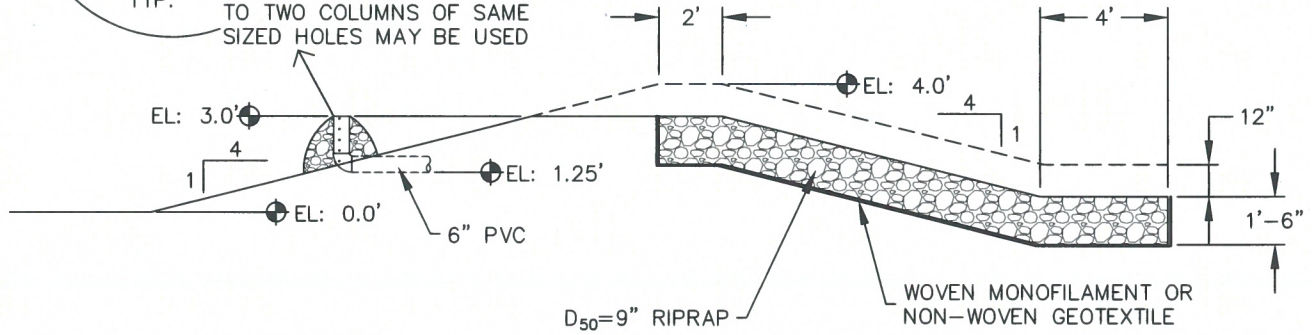
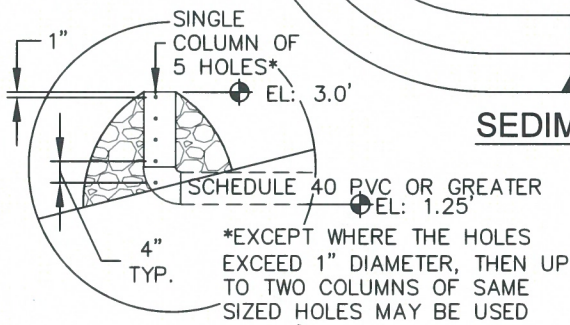

SECTION A-A'

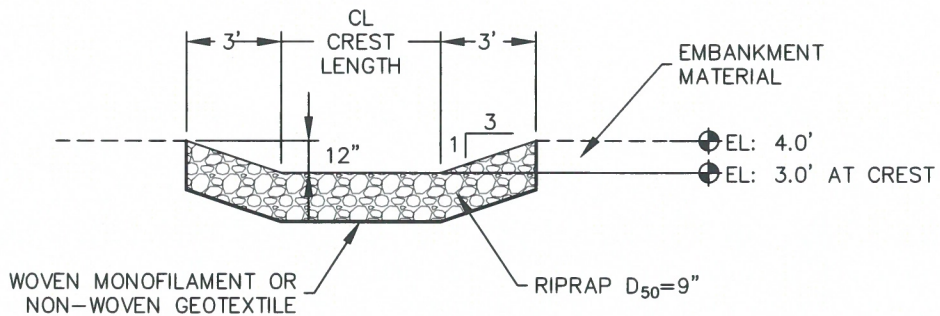

SECTION B-B'



TEMPORARY SEDIMENT BASIN		
APPROVED: 		
SWENT MANAGER		
ISSUED: 10/7/19	REVISED: 8/19/2020	DRAWING NO. 900-TSB-1

TABLE SB-1, SIZING INFORMATION FOR STANDARD SEDIMENT BASIN

UPSTREAM DRAINAGE AREA (ROUNDED TO NEAREST ACRE), (AC)	BASIN BOTTOM WIDTH (W), (FT)	SPILLWAY CREST LENGTH (CL), (FT)	HOLE DIAMETER (HD), (IN)
1	12½"	2	9/32
2	21	3	13/16
3	28	5	½
4	33½	6	9/16
5	38½	8	2½/32
6	43	9	2½/32
7	47¼	11	25/32
8	51	12	27/32
9	55	13	7/8
10	58¼	15	15/16
11	61	16	3½/32
12	64	18	1
13	67½	19	1¼/6
14	70½	21	1½/8
15	73¼	22	1¾/6

INSTALLATION NOTES

- FOR STANDARD BASIN, BOTTOM DIMENSION MAY BE MODIFIED AS LONG AS BOTTOM AREA IS NOT REDUCED.
- EMBANKMENT MATERIAL SHALL CONSIST OF SOIL FREE OF DEBRIS, ORGANIC MATERIAL, AND ROCKS OR CONCRETE GREATER THAN 3 INCHES, AND SHALL HAVE A MINIMUM OF 15 PERCENT BY WEIGHT PASSING THE No. 200 SIEVE
- EMBANKMENT MATERIAL SHALL BE COMPACTED TO AT LEAST 95 PERCENT OF MAXIMUM DENSITY IN ACCORDANCE WITH ASTM D-698.
- PIPE SCHEDULE 40 OR GREATER SHALL BE USED.
- THE DETAILS SHOWN ON THESE SHEETS PERTAIN TO STANDARD SEDIMENT BASIN(S) FOR DRAINAGE AREAS LESS THAN 15 ACRES. SEE CONSTRUCTION DRAWINGS FOR EMBANKMENT, STORAGE VOLUME, SPILLWAY, OUTLET, AND OUTLET PROTECTION DETAILS FOR ANY SEDIMENT BASIN(S) THAT HAVE BEEN INDIVIDUALLY DESIGNED FOR DRAINAGE AREAS LARGER THAN 15 ACRES. DESIGN CALCULATIONS MUST BE APPROVED PRIOR TO IMPLEMENTATION.

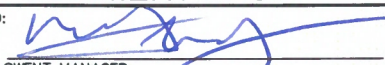
MAINTENANCE NOTES

- FREQUENT OBSERVATIONS AND MAINTENANCE ARE NECESSARY TO MAINTAIN CONTROL MEASURES IN EFFECTIVE OPERATING CONDITION. INSPECTIONS AND CORRECTIVE MEASURES SHOULD BE DOCUMENTED THOROUGHLY.
- SEDIMENT ACCUMULATED IN BASIN SHALL BE REMOVED AS NEEDED TO MAINTAIN CONTROL MEASURE EFFECTIVENESS, TYPICALLY WHEN SEDIMENT DEPTH REACHES ONE FOOT (I.E. TWO FEET BELOW SPILLWAY CREST).
- SEDIMENT BASINS ARE TO REMAIN IN PLACE UNTIL THE UPSTREAM DISTURBED AREA IS PERMANENTLY STABILIZED.
- PERMANENTLY STABILIZE AREA AFTER SEDIMENT BASIN REMOVAL.



TEMPORARY SEDIMENT BASIN		
APPROVED: 		
SWENT MANAGER		
ISSUED: 10/7/19	REVISED: 8/19/2020	DRAWING NO. 900-TSB-2

Master Development Drainage Plan and Preliminary Drainage Report
Peerless Farms – El Paso County, Colorado

APPENDIX F – UNNAMED DRAINAGEWAY PHOTOGRAPHS

Master Development Drainage Plan and Preliminary Drainage Report
Peerless Farms – El Paso County, Colorado



Figure 1: Storm Drain Culver Beneath Falcon Highway



Figure 2: Looking East Towards the Unnamed Drainageway

Master Development Drainage Plan and Preliminary Drainage Report
Peerless Farms – El Paso County, Colorado



Figure 3: Looking East Towards the Unnamed Drainageway



Figure 4: Looking North Towards Falcon Highway

Master Development Drainage Plan and Preliminary Drainage Report
Peerless Farms – El Paso County, Colorado



Figure 5: Looking Southeast at the Unnamed Drainageway



Figure 6: Unnamed Drainageway

Master Development Drainage Plan and Preliminary Drainage Report
Peerless Farms – El Paso County, Colorado



Figure 7: Looking North at the Unnamed Drainageway



Figure 8: Looking East at the Unnamed Drainageway at the South End of the Site

Master Development Drainage Plan and Preliminary Drainage Report
Peerless Farms – El Paso County, Colorado

APPENDIX G – EXCERPTS FROM DBPS

Table 6-5 Regional Detention Pond Summary

Pond	Volume (AF)	Peak Inflow (cfs)		Peak Outflow (cfs)	
		2-yr	100-yr	2-yr	100-yr
RG-01	9.02	100	320	11	63
RG-02	170	600	4800	150	2200
RG-03	0.04	3	70	2	9
RG-04	1.07	19	140	1	55
RG-05	0.03	12	120	11	3

For the 100-year peak flow, flood impacts downstream from the regional detention pond will not increase.

6.3.1.1. Channels

Channels upstream of the regional detention ponds need to be sized for the future undetained 100-year peak flow rates from development, while culverts and channels downstream of regional ponds are sized for the existing 100-year peak flow rates. Proposed channel improvements along the corresponding reaches are summarized in Table 6-6.

Table 6-6 Channel Designs for Regional Detention Alternative

Channel	Existing 100-yr Flow (cfs)	Proposed 100-yr Flow (cfs)	Design Flow (cfs)	Channel Length (ft)	Material
Main Stem (MS-04)	1700	3400	3500	7140	Riprap
Main Stem (MS-05)	1500	3000	3000	11100	Grass
Main Stem (MS-06)	590	890	900	7330	Grass
Main Stem (MS-06)	660	930	1000	3170	Grass
Main Stem (MS-06)	720	1500	1500	4450	Grass
Main Stem (MS-06)	750	1600	2000	3330	Grass
Tributary 3 (T3-01)	720	1500	1500	10710	Grass
Tributary 4 (T4)	200	570	600	1840	Grass
Tributary 5 (T5)	150	240	300	930	Grass
Tributary 5 (T5)	270	410	500	7770	Grass
Tributary 6 (T6)	200	440	500	4270	Grass
Tributary 6 (T6)	240	570	600	3940	Grass

6.3.1.2. Culverts

As with the channels, culverts upstream of a regional detention pond need to be sized for the future undetained 100-year peak flow rates, while culverts and channels downstream are sized for the existing 100-year peak flow rates. Proposed culvert improvements along the corresponding reaches are summarized in Table 6-7 for the Regional Detention Alternative.

Table 6-7 Culvert Designs for Regional Detention

Facility Number	Road Crossing	Channel	Existing Size	Proposed 100-yr Flow (cfs)	Deficiency	Necessary Facility for Proposed 100-year Flow
405	Murr Road	Main Stem (MS-04)	66" RCP	3,400	Overtops	6-10'X6' RCBs
507	Peerless Farms Road	Tributary 3 (T3-01)	60" CMP	1200	Overtops	2-10'X6' RCBs
609	Falcon Highway	Tributary 3 (T3-02)	18" CMP	460	Overtops	2-66" RCPs
610	Falcon Highway	Tributary 4 (T4)	24" CMP	570	Overtops	2-72" RCPs
612	Falcon Highway	Tributary 5 (T5)	24" CMP	240	Overtops	72" RCP
628	Falcon Highway	Main Stem (MS-05)	2-60" CMPs	2,200	Overtops	4-10'X6' RCBs
702	Curtis Road	Tributary 6 (T6)	36" CMP	140	Overtops	60" RCP
703	Curtis Road	Main Stem (MS-06)	24" CMP	890	Overtops	2-8'X6' RCBs
704	Judge Orr Road	Main Stem (MS-06)	Blocked Culvert	830	Overtops	2-8'X6' RCBs
1001	Future Pastura Street	Main Stem (MS-06)	N/A	930	Future Road	2-8'X6' RCBs
1002	Future Arroyo Hondo Blvd. N.	Main Stem (MS-06)	N/A	930	Future Road	2-8'X6' RCBs
1003	Future Arroyo Hondo Blvd. S.	Main Stem (MS-06)	N/A	1500	Future Road	3-8'X6' RCBs
1004	Future Pastura Street	Tributary 6 (T6)	N/A	440	Future Road	2-66" RCPs
1005	Future El Vado Road	Tributary 6 (T6)	N/A	440	Future Road	2-66" RCPs
1006	Future Socorro Trail	Tributary 6 (T6)	N/A	440	Future Road	2-66" RCPs

Note: Changes recommended to other culverts under existing conditions still apply

6.3.2. Subregional Detention

For this alternative, subregional detention ponds are located and sized to address development as it will occur. Locations of proposed subregional detention ponds are shown in Figure 6-2 and are summarized in Table 6-8. A connectivity diagram for the sub-regional HEC-HMS model is shown in Figure 6-3.

Master Development Drainage Plan and Preliminary Drainage Report
Peerless Farms – El Paso County, Colorado

APPENDIX H – DRAINAGE EXHIBITS

K:\COS_LA\196114000 - Peerless Farms\CADD\Exhibits\Existing Drainage Map.dwg

LEGEND

- SITE PROPERTY LINE
- 10- EXISTING MAJOR CONTOURS
- 11- EXISTING MINOR CONTOURS
- DRAINAGE BASIN BOUNDARY
- EXISTING STORM SEWER CULVERT
- A = BASIN DESIGNATION
B = AREA IN ACRES
C = 5-YR RUNOFF COEFFICIENT
D = 100-YR RUNOFF COEFFICIENT
- # = DESIGN POINT DESIGNATION
- X.XXX% EXISTING GRADE SLOPE / FLOW DIRECTION

NOTES:
 1. OFF-SITE SUB-BASINS T3-02 AND T4 ARE TRIBUTARY AREAS TO THE UNNAMED DRAINAGEWAY WHICH ARE DOCUMENTED IN THE HAEGLER RANCH DBPS. 5 AND 100-YR RUNOFF COEFFICIENTS ARE UNKNOWN FOR THESE AREAS, BUT 100-YEAR FLOWS FOR T3-02 AND T4 AFTER FULL BUILD-OUT OF THE DRAINAGE BASIN ARE EXPECTED TO BE 460 CFS AND 570 CFS, RESPECTIVELY (REFER TO TABLE 6-7 FROM THE DBPS).

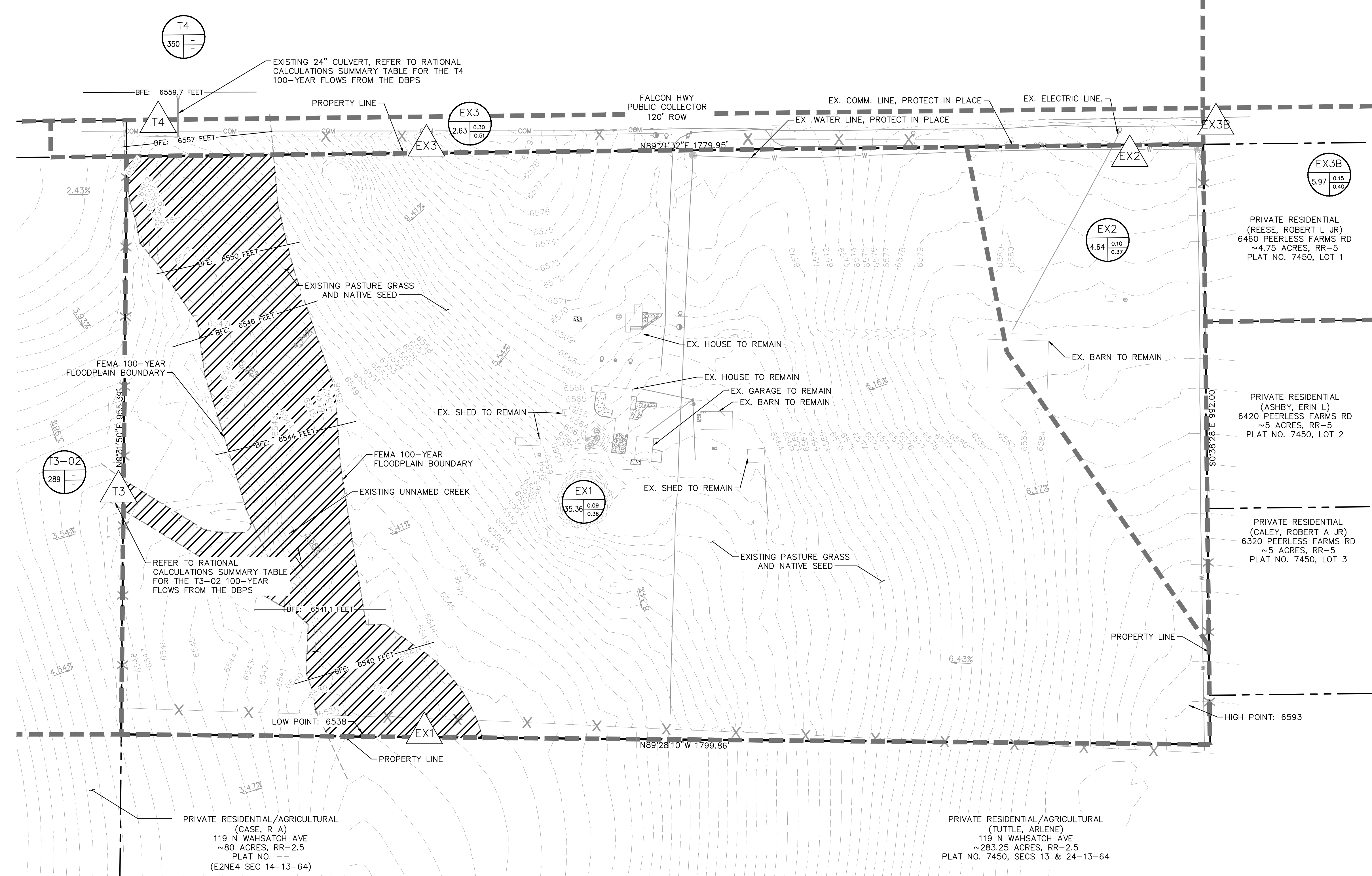

EXISTING RATIONAL CALCULATIONS SUMMARY					
DESIGN POINT	TRIBUTARY BASINS	TRIBUTARY AREA (AC)	IMPERVIOUSNESS %	PEAK FLOWS (CFS)	
				Q5	Q100
On-Site Basins					
EX1	EX1	35.36	2%	5.90	38.94
EX2	EX2	4.64	4%	1.03	6.97
TOTAL		40.00	2%	7.02	45.01
Off-Site Basins					
EX3	EX3	2.63	27%	2.18	7.47
EX3B	EX3B	5.97	9%	2.14	14.97
T3-02	T3-02	289.00	-	-	460
T4	T4	350.00	-	-	570
TOTAL		647.60	-	-	1652.14

*Acreages and Q100 values for T3-02 and T4 were taken from the DBPS. Other values are not available.

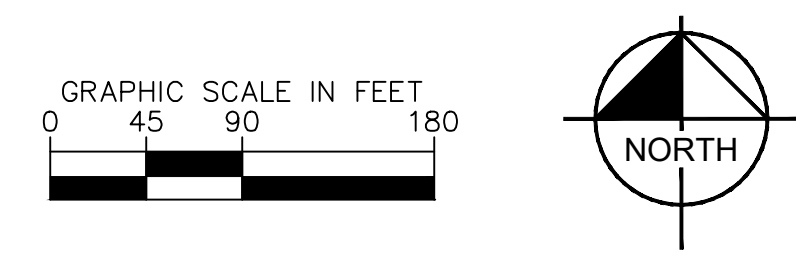

EXISTING DRAINAGE MAP
 PEERLESS FARMS
 11/13/2023

© 2023 KIMLEY-HORN AND ASSOCIATES, INC.
 2 N NEVADA AVE., SUITE 900, COLORADO SPRINGS, 80903
 PHONE: 719-453-0180

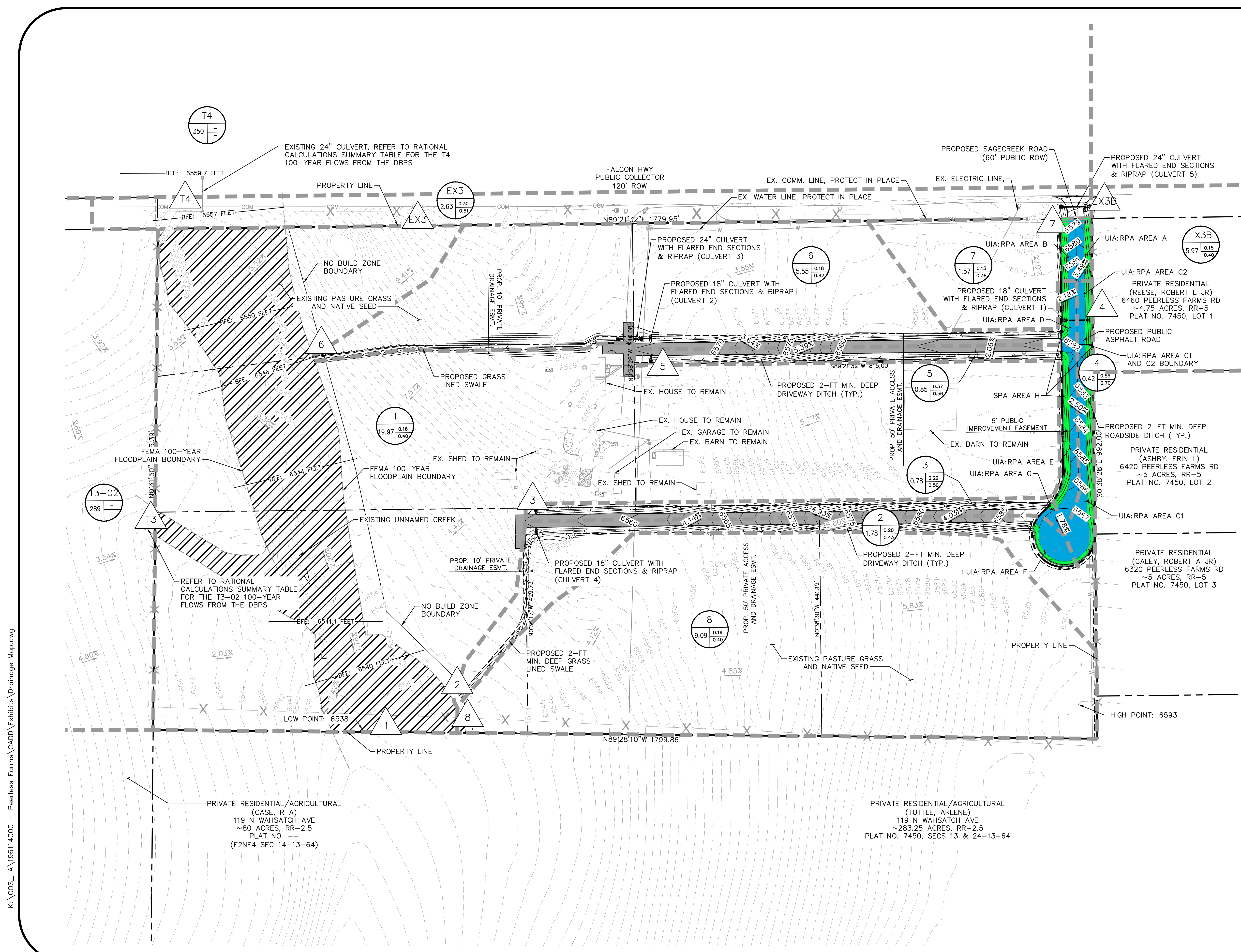

LEGEND

- SITE PROPERTY LINE
- PROPOSED MAJOR CONTOURS
- PROPOSED MINOR CONTOURS
- EXISTING MAJOR CONTOURS
- EXISTING MINOR CONTOURS
- DRAINAGE BASIN BOUNDARY
- PROPOSED STORM SEWER CULVERT
- EXISTING STORM SEWER CULVERT
- PROPOSED PRIVATE GRAVEL DRIVEWAY
- PROPOSED UNCONNECTED IMPERVIOUS AREA
- PROPOSED RECEIVING PERVIOUS AREA
- PROPOSED SEPARATE PERVIOUS AREA
- A = BASIN DESIGNATION
B = AREA IN ACRES
C = 5-YR RUNOFF COEFFICIENT
D = 100-YR RUNOFF COEFFICIENT
- # = DESIGN POINT DESIGNATION
- X.XX% EXISTING GRADE SLOPE / FLOW DIRECTION
- X.XX% PROPOSED GRADE SLOPE / FLOW DIRECTION

- NOTES:
- OFF-SITE SUB-BASINS T3-02 AND T4 ARE TRIBUTARY AREAS TO THE UNNAMED DRAINAGEWAY WHICH ARE DOCUMENTED IN THE HAEGLER RANCH DBPS. 5 AND 100-YR RUNOFF COEFFICIENTS ARE UNKNOWN FOR THESE AREAS, BUT 100-YEAR FLOWS FOR T3-02 AND T4 AFTER FULL BUILD-OUT OF THE DRAINAGE BASIN ARE EXPECTED TO BE 460 CFS AND 570 CFS, RESPECTIVELY (REFER TO TABLE 6-7 FROM THE DBPS).
 - REFERENCE GRADING AND EROSION CONTROL PLANS FOR RIPRAP PLACEMENT AND SIZING DETAIL (SHEET C2.2)

PROPOSED RATIONAL CALCULATIONS SUMMARY					
DESIGN POINT	TRIBUTARY BASINS	TRIBUTARY AREA (AC)	IMPERVIOUSNESS %	PEAK FLOWS (CFS)	
				Q5	Q100
On-Site Basins					
1	1	19.97	10%	0.21	27.04
2	2	1.78	17%	0.87	3.24
3	1	0.78	31%	0.86	2.48
4	4	0.42	67%	1.03	2.21
5	5	0.85	40%	1.12	2.84
6	6	5.55	13%	2.32	9.26
7	7	1.57	6%	0.54	2.77
8	8	9.09	10%	3.14	13.85
TOTAL		30.91	12%	16.08	63.49
Off-Site Basins					
EX3	EX3	2.63	27%	1.18	7.47
EX3B	EX3B	5.97	9%	2.14	14.67
T3-02	T3-02	289	-	-	460
T4	T4	690	-	-	570
TOTAL		647.69	-	-	1052.14

*Acreages and Q100 values for T3-02 and T4 were taken from the DBPS. Other values are not available.

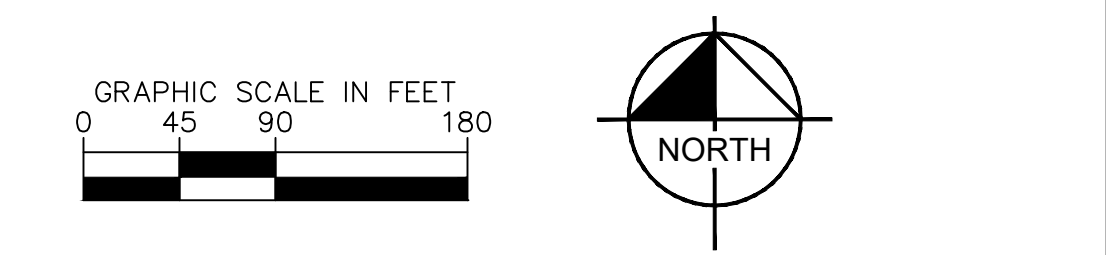

PROPOSED DRAINAGE MAP
PEERLESS FARMS
11/13/2023

© 2023 KIMLEY-HORN AND ASSOCIATES, INC.
2 N NEVADA AVE., SUITE 900, COLORADO SPRINGS, 80903
PHONE: 719-453-0180

K:\COS_LA\196114000 - Peerless Farms\CADD\Exhibits\Drainage Map.dwg