

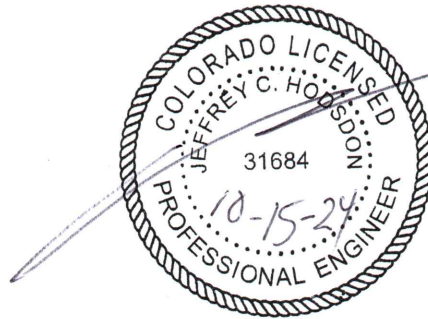


LSC TRANSPORTATION CONSULTANTS, INC.  
2504 East Pikes Peak Avenue, Suite 304  
Colorado Springs, CO 80909  
(719) 633-2868  
FAX (719) 633-5430  
E-mail: [lsc@lsctrans.com](mailto:lsc@lsctrans.com)  
Website: <http://www.lsctrans.com>

**Sterling Ranch East Filing No. 3**  
**Traffic Impact Study**  
(LSC #S244290)  
October 15, 2024

**Traffic Engineer's Statement**

This traffic report and supporting information were prepared under my responsible charge and they comport with the standard of care. So far as is consistent with the standard of care, said report was prepared in general conformance with the criteria established by the County for traffic reports.



**Developer's Statement**

I, the Developer, have read and will comply with all commitments made on my behalf within this report.

\_\_\_\_\_

\_\_\_\_\_

Date

# **Sterling Ranch East Filing No. 3**

## **Traffic Impact Study**

Prepared for:

Loren J. Moreland

Vice President/ Project Manager

Classic SRJ

2138 Flying Horse Club Drive

Colorado Springs, CO 80921

OCTOBER 15, 2024

---

LSC Transportation Consultants

Prepared by: Kirstin D. Ferrin, P.E.

Reviewed by: Jeffrey C. Hodsdon, P.E.

LSC #S244290

**CONTENTS**

REPORT CONTENTS ..... 1

RECENT TRAFFIC REPORTS ..... 2

STUDY AREA ..... 2

    Land Use..... 2

    Pedestrian Plan ..... 2

    Proposed Access Points..... 3

    Sight Distance Analysis..... 3

REPORT SCENARIOS ..... 3

    Short-Term Scenario ..... 3

    Long-Term Scenario ..... 4

EXISTING ROAD AND TRAFFIC CONDITIONS ..... 4

    Existing Traffic Volumes ..... 5

    Existing Levels of Service ..... 5

    Safety and Accident Analysis..... 6

BASELINE CONDITIONS ..... 6

    Short-Term Scenario Baseline Conditions ..... 7

    Long-Term Scenario Baseline Conditions ..... 7

TRIP GENERATION ..... 7

TRIP DISTRIBUTION AND ASSIGNMENT..... 8

TOTAL TRAFFIC..... 8

    Short-Term Total Traffic ..... 8

    2045 Total Traffic ..... 8

PRELIMINARY SIGNAL-WARRANT-THRESHOLD ANALYSIS (AM AND PM PEAK HOURS) –  
MARKSHEFFEL ROAD/VOLLMER ROAD AND MARKSHEFFEL ROAD/STERLING RANCH ROAD ..... 9

LEVEL OF SERVICE ANALYSIS ..... 10

    Intersection #4: Vollmer Road/Briargate Parkway ..... 10

    Intersection #5: Briargate Parkway/Sterling Ranch Road..... 10

    Intersection #12: Marksheffel Road/Vollmer Road ..... 10

    Intersection #13: Marksheffel Road/Sterling Ranch Road..... 11

    Intersection #303 Sterling Ranch Road/Lubbock Trail..... 11

    Intersection #304 Sterling Ranch Road/Westmont Drive..... 11

Intersection #305 Sterling Ranch Road/Lake Tahoe Drive.....	11
ROADWAY FUNCTIONAL CLASSIFICATIONS AND LANEAGE.....	12
DEVIATION REQUESTS.....	12
AREA MTCP 2050 ROADWAY IMPROVEMENT PROJECTS.....	12
ESCROW ANALYSIS.....	12
TRANSPORTATION IMPROVEMENT FEE PROGRAM AND CREDIT AGREEMENTS.....	12
CONCLUSIONS AND RECOMMENDATIONS .....	13
Trip Generation.....	13
Level of Service .....	13
Recommended Improvements.....	13
Escrow Analysis.....	14
Enclosures: .....	15
Tables 2-6	
Figures 1-14	
Traffic Count Reports	
Level of Service Reports	
Appendix Table 1	
MTCP Maps	
Crash History	





LSC TRANSPORTATION CONSULTANTS, INC.  
2504 East Pikes Peak Avenue, Suite 304  
Colorado Springs, CO 80909  
(719) 633-2868  
FAX (719) 633-5430  
E-mail: [lsc@lsctrans.com](mailto:lsc@lsctrans.com)  
Website: <http://www.lsctrans.com>

October 15, 2024

Loren J. Moreland  
Vice President/ Project Manager  
Classic SRJ  
2138 Flying Horse Club Drive  
Colorado Springs, CO 80921

RE: Sterling Ranch East Filing No. 3  
Traffic Impact Study  
El Paso County, Colorado  
LSC #S244290

Dear Mr. Moreland:

LSC Transportation Consultants, Inc. has prepared this Traffic Impact Study for the proposed Sterling Ranch Filing No. 3 final plat. As shown in Figure 1, the site is located east of the future Sterling Ranch Road and about one-half mile south of the future Briargate Parkway in El Paso County, Colorado. LSC prepared a traffic impact study (TIS) for the Sterling Ranch East Rezoning and Preliminary Plan ([SP224](#)) that included trips by the currently-proposed filings. This report is intended as a site-specific, final plat traffic report for Sterling Ranch East Filing No. 3.

## REPORT CONTENTS

The preparation of this report included the following:

- A list of previous Sterling Ranch traffic reports and the context of this project;
- The existing roadway and traffic conditions in the site's vicinity including the roadway widths, surface conditions, lane geometries, traffic controls, and posted speed limits;
- A summary of the proposed land use and access plan;
- Existing traffic-volume data;
- Estimates of projected short-term and long-term baseline traffic volumes;
- The projected average weekday and peak-hour vehicle trips to be generated by the proposed future development within the preliminary plan area;
- The assignment of the projected preliminary-plan site-generated traffic volumes to the area roadways;
- The projected short-term and long-term total traffic volumes on the area roadways;
- The projected levels of service at the key intersections within the study area;
- Signal-warrant threshold analysis;

- The recommended street classifications;
- Findings and recommendations for study-area roadways and intersections, including number of lanes, auxiliary turn lanes, intersection traffic control, etc.; and
- The project's obligation to the County roadway improvement fee program.

## **RECENT TRAFFIC REPORTS**

LSC prepared a previous master traffic impact study (MTIS) for the entire Sterling Ranch development, dated March 17, 2023. LSC also prepared a technical memorandum for the Sterling Ranch Amendment #3 (dated January 17, 2024) and for Sterling Ranch Amendment #4 (dated September 13, 2024). Appendix Table 1, which includes a list of other traffic studies within Sterling Ranch and in the vicinity of area of study completed within the past five years (that LSC is aware of), is attached for reference.

El Paso County is currently studying the Briargate Stapleton Corridor as part of a Pikes Peak Rural Transportation Authority (PPRTA) study. A draft version of the *Briargate-Stapleton Corridor Study* by Wilson & Company was published December 9, 2021.

## **STUDY AREA**

Figure 1 shows the location of Sterling Ranch East Filing No. 3 relative to the overall Sterling Ranch Sketch Plan Area. As shown in Figure 1, the site is located generally in the middle of the Sketch Plan Area east of Sterling Ranch Road and about one-half mile south of Briargate Parkway.

## **Land Use**

Figure 2 shows the proposed Sterling Ranch Filing No. 3. The site is planned to be developed with 187 residential dwelling units.

## **Pedestrian Plan**

Detached sidewalks will be provided along Sterling Ranch Road. The multi-use paved shoulder on Sterling Ranch Road will accommodate bicycles. Attached 5-foot-wide concrete sidewalks are planned on all of the local streets within and adjacent to Sterling Ranch East Filing No. 3.

There are no existing schools within two miles of the site. However, there are multiple future school sites in the area, including a future K-8 school site northwest of the site (south of Briargate Parkway and west of Sterling Ranch Road) and an elementary school site just west of the site. No information or plans are available for the school sites and separate site-specific traffic impact studies including pedestrian plans will be required to be approved prior to school-site development.

### **Proposed Access Points**

Figure 3 shows the roadway connections that are planned to be constructed in the short term. As shown in Figure 3, in the short term, Briargate Parkway is planned to be constructed to its final cross section between Vollmer Road and Sterling Ranch Road, Marksheffel Road is planned to be completed between Vollmer Road and Woodmen Road, and Sterling Ranch Road is planned to be constructed from Marksheffel Road to the northern boundary of Sterling Ranch East Filing No. 6 (currently under review).

Figure 2 shows the proposed access plan. Two full-movement access points are proposed to Sterling Ranch Road (Non-Residential Collector). The proposed spacing is greater than the 330-foot minimum intersection spacing for Urban Non-Residential Collectors when intersecting local roadways, per criteria contained in Table 2-7 of the *El Paso County Engineering Criteria Manual (ECM)*. An additional full-movement access point is proposed to Lake Tahoe Drive (Urban Local). The proposed spacing is greater than the 175-foot minimum intersection spacing for Urban Local.

### **Sight Distance Analysis**

Figure 4a shows the intersection sight-distance analysis at the intersections of Sterling Ranch Road (Urban Minor Collector)/Lubbock Trail (Urban Local) and Sterling Ranch Road (Urban Minor Collector)/Westmont (Urban Minor Collector) Based on a design speed of 40 miles per hour (mph) and the criteria contained in Table 2-21 of the *ECM*, the required intersection sight distance at these intersections is 445 feet. As shown in Figure 4a, the intersection sight distance can be met at all three intersections.

Figure 4b shows the stopping sight-distance analysis at the intersection of Lake Tahoe Drive (Urban Local)/Bentonville Way (Urban Local). Intersection sight-distance analysis was not analyzed for this intersection as guidance from the *Colorado Department of Transportation 2018 Roadway Design Guide* and *A Policy on Geometric Design of Highway and Street, 7th Edition* published by AASHTO indicate that intersection sight distance is not applicable to local urban/residential streets. Based on a design speed of 25 miles per hour (mph) and the criteria contained in Table 2-17 of the *Engineering Criteria Manual (ECM)*, the required stopping sight distance at this intersection is 155 feet. As shown in Figure 5, the stopping sight distance can be met.

As shown in Figure 4c, the stopping sight distance can be met at all of the proposed access points.

## **REPORT SCENARIOS**

### **Short-Term Scenario**

The short-term scenario includes the roadway segments to be added in the short term only, as shown in Figure 3. This scenario includes the Sterling Ranch East Filing No. 3 area (“the site”) as well as traffic to be generated in the short term by buildout of Homestead at Sterling Ranch,

Branding Iron at Sterling Ranch, Sterling Ranch Filings 2-4, Copper Chase at Sterling Ranch, Homestead North at Sterling Ranch Filings 1-3, the Retreat at TimberRidge Filings 1-4, the planned FourSquare at Sterling Ranch East development, the approved filings within Sterling Ranch East Preliminary Plan 1 (Sterling Ranch East Filings 1 and 2), Sterling Ranch East Filings 5 and 6, and the Villages at Sterling Ranch East. See Appendix Table 1 for the PCD file numbers associated with the above-mentioned projects.

Note that the short-term scenario assumes no traffic due to future anticipated land uses within Sterling Ranch East Preliminary Plan 1 beyond the approved Sterling Ranch East Filings 1 and 2 and the currently-proposed Sterling Ranch East Filing No. 3, including the residential areas east of Sterling Ranch Road and north of Idaho Falls Drive and the future school sites. Trips projected from these other short-term developments outside of the Sterling Ranch East Filing No. 3 boundary are included as short-term “background traffic” in this report.

### **Long-Term Scenario**

The long-term scenario is essentially the same as the 2045 long-term scenario contained in the LSC September 13, 2024 Master TIS Addendum with additional detail added for this application. The study area of this report is more focused than the Sketch Plan. It includes updated analysis of the Arterial/Arterial and Arterial/Collector intersections adjacent to the existing, approved, and currently-proposed preliminary plan areas within the Sterling Ranch Sketch Plan Area Briargate Parkway/Vollmer Road [#4], Briargate Parkway/Sterling Ranch Road [#5], Research Parkway/Marksheffel Road/Vollmer Road [#12], and Marksheffel Road/Sterling Ranch Road [#13], and new analysis of three intersections to Sterling Ranch Road (Lubbock [#303], Westmont [#304] and Lake Tahoe [#305]).

### **EXISTING ROAD AND TRAFFIC CONDITIONS**

The adjacent streets are shown in Figure 1 and are described below. Excerpts from the 2024 *El Paso County Major Transportation Corridors Plan (MTCP) 2045 Roadway Functional Classifications (Figure 22) and 2065 Corridor Preservation Plan (Figure 39)* with the site location identified on them have been attached to this report. The *2045 and 2065 Through Lane Requirements* (Figures 23 and 40, respectively) are also reflected in this report.

**Vollmer Road** is currently a five-lane urban street within the City of Colorado Springs limits between Black Forest Road and Cowpoke Road and a two-lane, rural, paved roadway north of Cowpoke Road extending to north of Hodgen Road. In the southbound direction, Vollmer Road has a posted speed limit of 45 mph. South of Cowpoke Road, Vollmer Road has a 40-mph posted speed limit. Note: The new *Connect COS* City of Colorado Springs transportation plan shows Vollmer as a Principal Arterial. The 2024 *MTCP* shows Vollmer Road as an Urban – Major Collector in the vicinity of the site. The South Vollmer Road improvements ([CDR2116](#)) which will provide two through lanes in each direction on Vollmer Road in the vicinity of Marksheffel Road, are currently under construction and are anticipated to be completed in the near term.

The North Vollmer Road improvements ([CDR217](#)), which will provide two through lanes in each direction on Vollmer Road in the vicinity of Briargate Parkway, are currently under construction and are anticipated to be completed in the near term.

**Marksheffel Road** is a Principal Arterial extending north from the City of Fountain to Woodmen Road. Marksheffel Road is planned to ultimately be widened to six lanes and extended north and west from Woodmen Road to connect to Research Parkway at Black Forest Road. The City of Colorado Springs has taken ownership and maintenance of Marksheffel Road..

The section of Marksheffel Road adjacent to Sterling Ranch has been or is planned to be constructed on 107 feet of right-of-way to the City's required cross section(s) and criteria. The section of Marksheffel Road between Sterling Ranch Road and Vollmer Road has recently been completed and the section of Marksheffel Road southeast of Sterling Ranch Road (to connect to the segment recently constructed) will be completed in the short term and will open the connection to Woodmen Road.

**Briargate Parkway** is a Principal Arterial that extends east from I-25 to Grand Lawn Circle (about one-half mile east of Powers Boulevard). Briargate Parkway is planned ultimately to extend to Towner Drive. The segment of Briargate Parkway between Vollmer Road and Sterling Ranch Road is planned to be constructed to its full 4-lane cross section in the very short term.

**Sterling Ranch Road** is an Urban Major Collector shown extending through the Sterling Ranch development between Marksheffel Road and the north end of the Sketch Plan area (just south of Arroya Road). Sterling Ranch Road has been constructed between Marksheffel Road and Dines Boulevard and will be constructed north to Briargate Parkway in the short term with the Sterling Ranch East Phase 1 Preliminary Plan.

### **Existing Traffic Volumes**

Figure 5 shows the existing average weekday and peak-hour traffic volumes at the intersection of Marksheffel/Vollmer. The peak-hour traffic volumes shown are based on manual turning-movement counts by LSC Transportation Consultants in April 2024. The average weekday traffic volumes on Vollmer Road north of Marksheffel Road shown in Figure 5 are based on machine counts by LSC in April 2024. The traffic-count sheets are attached.

### **Existing Levels of Service**

Level of service (LOS) is a quantitative measure of the level of congestion or delay at an intersection. Level of service is indicated on a scale from "A" to "F." LOS A represents control delay of less than 10 seconds for unsignalized intersections. LOS F represents control delay of more than 50 seconds for unsignalized intersections. Table 1 shows the level of service delay ranges.

**Table 1: Intersection Levels of Service Delay Ranges**

Level of Service	Signalized Intersections	Unsignalized Intersections
	Average Control Delay (seconds per vehicle)	Average Control Delay (seconds per vehicle) <sup>(1)</sup>
A	10.0 sec or less	10.0 sec or less
B	10.1-20.0 sec	10.1-15.0 sec
C	20.1-35.0 sec	15.1-25.0 sec
D	35.1-55.0 sec	25.1-35.0 sec
E	55.1-80.0 sec	35.1-50.0 sec
F	80.1 sec or more	50.1 sec or more

(1) For unsignalized intersections, if V/C ratio is greater than 1.0 the level of service is LOS F, regardless of the projected average control delay per vehicle.

The intersection of Marksheffel Road/Volmer Road has been analyzed based on the unsignalized-intersection analysis procedures from the *Highway Capacity Manual, 6th Edition* by the Transportation Research Board. The results of the analysis are shown in Figure 5.

All movements at the stop-sign-controlled intersection of Marksheffel/Vollmer are currently operating at LOS B or better during the peak hours.

**Safety and Accident Analysis**

The Colorado State Patrol (CSP) provided LSC with crash history data for Vollmer Road between Tahiti Drive and Burgess Road from September 2019 through September 2022. During the reported time period, there were twelve reported crashes. Of the twelve reports, ten were single-vehicle non-intersection-related crashes on Vollmer Road. One crash involved a southbound vehicle that turned right onto Poco Road and crashed into several cars parked on Poco Road partially in the lane. The only intersection-related crash occurred in June 2022. A vehicle heading northbound on Vollmer Road was slowing to turn left at Lochwinnoch Road and the vehicle behind them attempted to pass on the left side. The crash history data has been attached.

**BASELINE CONDITIONS**

Baseline traffic is the traffic estimated to be on the adjacent roadways and at adjacent intersections without the proposed development’s trip generation of site-generated traffic volumes. Baseline traffic (for a specified horizon year) includes the through traffic and the traffic generated by nearby developments (existing and planned, including traffic generated by existing and planned developments within the greater Sterling Ranch overall development) but assumes

zero traffic generated by land uses within the site (the Sterling Ranch East Filing No. 3 boundary area).

### **Short-Term Scenario Baseline Conditions**

Please refer to the description of the short-term scenario above. Figures 6a and 6b show the projected volumes for the short-term baseline scenario. Note that the short-term baseline scenario assumes only the approved filings within Sterling Ranch East Preliminary Plan 1 (Filing Nos 1 and 2), Sterling Ranch East Filings 5 and 6, and the Villages at Sterling Ranch East have been constructed in the short-term. No traffic due to future anticipated land uses within Sterling Ranch East Preliminary Plan 1 beyond Filings 1 and 2, including the residential area north of Idaho Falls Drive and the future school sites, are included in the volumes shown in Figures 6a and 6b.

Figure 6c shows the lane geometry, traffic control, and level of service at the key area intersections, based on the short-term scenario baseline volumes.

### **Long-Term Scenario Baseline Conditions**

Figure 7a shows the projected 2045 baseline daily traffic volumes on key street segments at the key area intersections and Figure 7b shows the projected 2045 peak-hour baseline traffic volumes at the key area intersections. These volumes assume buildout of the area street network, including the completion of Marksheffel Road between Vollmer Road and Black Forest Road, Briargate Parkway between Meridian Road and Black Forest Road, and Sterling Ranch Road between Marksheffel Road and Briargate Parkway.

The 2045 baseline traffic volumes are estimates by LSC, based on the traffic projections in the LSC September 13, 2024 Master TIS Addendum. The 2045 baseline daily traffic volumes assume buildout of the land uses within the Sterling Ranch Master Plan that are not included in the Sterling Ranch Filing No. 3 area, including the preliminary estimates of future traffic to be generated by the Sterling Ranch school sites. The estimates of future school trip generation and traffic volumes at intersections are only preliminary estimates because no school site plans/student enrollment numbers etc. are available.

Figure 7c shows the lane geometry, traffic control, and level of service at the key area intersections, based on the 2045 baseline volumes.

### **TRIP GENERATION**

The site-generated vehicle trips were estimated using the nationally-published trip-generation rates from *Trip Generation, 11th Edition, 2021* by the Institute of Transportation Engineers (ITE). Table 2 shows the trip-generation estimates.

Sterling Ranch East Filing No. 3 is projected to generate about 1,763 new external vehicle trips on the average weekday, with about half entering and half exiting the site during a 24-hour period. During the morning peak hour, which generally occurs for one hour between 6:30 and 8:30 a.m., about 33 vehicles would enter and 98 vehicles would exit the site. During the afternoon peak hour, which generally occurs for one hour between 4:15 and 6:15 p.m., about 111 vehicles would enter and 65 vehicles would exit the site.

## **TRIP DISTRIBUTION AND ASSIGNMENT**

The directional distribution of the site-generated traffic volumes on the street and roadway system serving the site is an important factor in determining the site's traffic impacts. The distribution estimates for short-term and long-term residential-related traffic are shown in Figure 8. The short-term directional-distribution estimate assumes the short-term roadway network shown in Figure 3 only and the long-term directional-distribution estimate assumes buildout of the roadway network. The directional-distribution estimates are based, in part, on the estimates contained in the sketch plan MTIS report. Factors include: the location of the site with respect to the Colorado Springs metropolitan area, the planned access system for the site, the street and roadway system serving the site, and the land uses proposed for the site.

When the distribution percentages (from Figure 8) are applied to the new, external trip-generation estimates (from Table 2), the resulting site-generated traffic volumes can be determined. Figures 9a and 9b show the short-term site-generated traffic volumes. These volumes assume only the street network shown in Figure 3. Figures 10a and 10b show the long-term residential site-generated traffic volumes, assuming buildout of the area roadway network.

## **TOTAL TRAFFIC**

### **Short-Term Total Traffic**

Figure 11a shows the projected short-term total daily traffic volumes on key street segments and Figure 11b shows the projected short-term-total peak-hour traffic volumes at the key study-area intersections. These volumes are the sum of the short-term-baseline traffic volumes (from Figures 6a and 6b) and the short-term site-generated traffic volumes (from Figures 9a and 9b).

Figure 11c shows the level of service analysis results for the key area intersections based on the projected short-term total volumes. The figure also shows the general intersection lane geometry and intersection traffic control used in the analysis.

### **2045 Total Traffic**

Figure 12a shows the projected 2045 total daily traffic volumes on key street segments and Figure 12b shows the projected 2045 total peak-hour traffic volumes at the key study-area



intersections. These volumes are the sum of the 2045 baseline traffic volumes (from Figures 7a and 7b) and the long-term site-generated traffic volumes (from Figures 10a and 10b).

Figure 12c shows the level of service analysis results for the key area intersections, based on the projected 2045 total volumes. The figure also shows the general intersection lane geometry and intersection traffic control used in the analysis.

**PRELIMINARY SIGNAL-WARRANT-THRESHOLD ANALYSIS (AM AND PM PEAK HOURS) – MARKSHEFFEL ROAD/VOLLMER ROAD AND MARKSHEFFEL ROAD/STERLING RANCH ROAD**

The intersections of Marksheffel/Vollmer and Marksheffel/Sterling Ranch were analyzed to determine if the thresholds for Four-Hour and/or Eight-Hour Vehicular-Volume Traffic-Signal Warrant thresholds would be reached or exceeded, based on the projected short-term peak-hour traffic volumes only. In order for an Eight-Hour Vehicular-Volume Traffic-Signal Warrant to be satisfied, the volume threshold would need to be met for six additional hours of the day and in order for a Four-Hour Vehicular Volume Traffic Signal Warrant to be satisfied, the volume threshold would need to be met for two additional hours of the day. For example, the four-hour warrant would be satisfied with the volume thresholds met for one hour in the morning, two hours (instead of the one-hour peak) during the afternoon peak period, and an hour during the mid-afternoon.

This “cursory”/planning-level analysis has been provided at the Preliminary Plan level to identify intersections which may need to be signalized in the short-term future. Detailed analysis of all applicable signal warrants should be evaluated with each filing submitted. The satisfaction of warrants does not indicate that a signal must be installed. The decision to require a signal to be installed rests with the County.

Table 3 shows the results of the analysis for the intersection of Marksheffel/Vollmer. Based on the projected short-term background and total traffic volumes, only three of the hours analyzed are projected to meet the criteria for an Eight-Hour Vehicular-Volume Warrant and none of the hours analyzed are projected to meet the criteria for a Four-Hour Vehicular-Volume Traffic-Signal Warrant. This analysis indicates that traffic-signal warrant(s) may not be met in the short-term. Detailed analysis should be provided with each future filing within Sterling Ranch.

Table 4 shows the results of the analysis for the intersection of Marksheffel/Sterling Ranch. Based on the projected short-term total traffic volumes, eight hours analyzed are projected to meet the criteria for a Four-Hour Vehicular Volume Warrant. However, only six of the hours analyzed are projected to meet the criteria for an Eight-Hour Vehicular-Volume Traffic-Signal Warrant. This analysis indicates that traffic-signal warrant(s) may be met in the short-term. Detailed analysis should be provided with each future filing within Sterling Ranch.

## **LEVEL OF SERVICE ANALYSIS**

The key area future signalized intersections have been analyzed to determine the projected intersection levels of service for short-term and 2045 baseline and total traffic scenarios for the morning and afternoon peak-hour periods using Synchro. The key area future stop-sign-controlled intersections have been analyzed based on the unsignalized-intersection analysis procedures from the *Highway Capacity Manual 6th Edition*. Figures 6c, 7c, 11c, and 12c show the level of service analysis results. The level of service reports are attached.

### **Intersection #4: Vollmer Road/Briargate Parkway**

The section of Briargate Parkway between Vollmer Road and Sterling Ranch Road is planned to be constructed to its final cross section in the short term. The intersection of Vollmer/Briargate could operate at a satisfactory level of service (LOS C or better) in the short term as a stop-sign-controlled intersection.

By 2045, it was assumed Briargate Parkway would be extended west to Black Forest Road and East to Towner Avenue and that the intersection of Vollmer/Briargate will be converted to traffic-signal control. The intersection of Vollmer/Briargate is projected to operate at an overall LOS C during the peak hours as a signalized intersection, based on the projected 2045 total traffic volumes shown in Figure 12b and the lane geometry shown in Figure 12c.

### **Intersection #5: Briargate Parkway/Sterling Ranch Road**

The section of Briargate Parkway between Vollmer Road and Sterling Ranch Road is planned to be constructed to its final cross section in the short term. The intersection of Briargate/Sterling Ranch is projected to operate at LOS B or better for all movements in the short term as a stop-sign-controlled intersection.

By 2045, it was assumed Briargate Parkway would be extended west to Black Forest Road and East to Towner Avenue and that the intersection of Briargate/Sterling Ranch will be converted to traffic-signal control. The intersection of Briargate/Sterling Ranch is projected to operate at an overall LOS C during the peak hours as a signalized intersection, based on the projected 2045 total traffic volumes shown in Figure 12b and the lane geometry shown in Figure 12c.

### **Intersection #12: Marksheffel Road/Vollmer Road**

Marksheffel Road has been recently constructed between Vollmer Road and Sterling Ranch Road. Based on the projected short-term total traffic volumes, the westbound left-turn movement is projected to operate at LOS E during the morning peak hour and LOS F during the afternoon peak hour. This intersection is planned as a future signalized intersection. However, traffic-signal warrant(s) may not be met in the short term. It is not uncommon for the minor movements at a

stop-sign-controlled intersection to operate at LOS E or F as the traffic volumes approach the levels needed to meet vehicular-volume traffic-signal warrants.

By 2045, it was assumed that Marksheffel Road would be constructed west to Briargate Parkway and that the intersection of Marksheffel/Vollmer will be converted to traffic-signal control. The intersection of Marksheffel/Vollmer is projected to operate at an overall LOS C or better during the peak hours as a signalized intersection, based on the projected 2045 total traffic volumes shown in Figure 12b and the lane geometry shown in Figure 12c. An escrow analysis for these improvements may need to be provided with the final plat.

### **Intersection #13: Marksheffel Road/Sterling Ranch Road**

Marksheffel Road was recently constructed between Sterling Ranch Road and Vollmer Road and the section southeast of Sterling Ranch Road (to connect to the segment recently constructed) will be completed in the short term and will open the connection to Woodmen Road. Based on the projected short-term total traffic volumes, the southbound left-turn movement is projected to operate at LOS F during the morning and afternoon peak hours if it remains stop-sign controlled. This intersection is planned as a future signalized intersection. However, traffic-signal warrant(s) may not be met in the short term. It is not uncommon for the minor movements at a stop-sign-controlled intersection to operate at LOS E or F as the traffic volumes approach the levels needed to meet vehicular-volume traffic-signal warrants. If this intersection is converted to signal control, it is projected to operate at an overall LOS C or better during the peak hours through 2045. An escrow analysis for these improvements may need to be provided with the final plat.

### **Intersection #303 Sterling Ranch Road/Lubbock Trail**

The intersection of Sterling Ranch/Lubbock is projected to operate at LOS D or better for all movements as a stop-sign-controlled intersection, based on the projected short-term and 2045 total traffic volumes.

### **Intersection #304 Sterling Ranch Road/Westmont Drive**

The intersection of Sterling Ranch/Westmont is projected to operate at LOS C or better for all movements as a stop-sign-controlled intersection, based on the projected short-term and 2045 total traffic volumes.

### **Intersection #305 Sterling Ranch Road/Lake Tahoe Drive**

The intersection of Sterling Ranch/Lake Tahoe is projected to operate at LOS C or better for all movements as a stop-sign-controlled intersection, based on the projected short-term and 2045 total traffic volumes.

## **ROADWAY FUNCTIONAL CLASSIFICATIONS AND LANEAGE**

Figure 13 shows the recommended functional classifications and number of through lanes for the streets in the study area.

## **DEVIATION REQUESTS**

No deviations to the criteria contained in *Land Development Code (LDC)* and the *El Paso County Engineering Criteria Manual (ECM)* are planned to be submitted as part of this application.

## **AREA MTCP 2050 ROADWAY IMPROVEMENT PROJECTS**

The *El Paso County 2024 Major Transportation Corridors Plan Update* identified the following roadway improvement projects within the study area:

- 158: Vollmer Road from Marksheffel Road to Burgess Road as an Urban Major Collector I
- 166: Stapleton Drive from west of Vollmer Road to Towner Avenue as a 4-Lane Urban Principal Arterial
- 329: Stapleton Drive/Briargate Parkway: from Black Forest Road to west of Vollmer Road and a 4-Lane Urban Principal Arterial

## **ESCROW ANALYSIS**

- Escrow for proportionate shares of the cost of some future roadway improvements may be required.

## **TRANSPORTATION IMPROVEMENT FEE PROGRAM AND CREDIT AGREEMENTS**

The applicant will be required to participate in the Countywide Transportation Improvement Fee Program. These projects will annex into the 5 mil PID, which has a per-lot upfront building permit fee of \$2,527 per single-family dwelling unit. The total building permit fee amount for the 187 residential dwelling units would be \$472,549. Note: This is based on the current rate, which is subject to change. El Paso County updates this rate periodically.

A road-fee credit agreement, development agreement, and Subdivision Improvements Agreement will be required to address developer's road-fee credits for construction of Vollmer Road. Additional credit agreements will be needed with each phase of construction to account for reimbursement of costs for the additional lanes and major intersection improvements.

## CONCLUSIONS AND RECOMMENDATIONS

### Trip Generation

- Sterling Ranch East Filing No. 3 is projected to generate about 1,763 new external vehicle trips on the average weekday, with about half entering and half exiting the site during a 24-hour period. During the morning peak hour, which generally occurs for one hour between 6:30 and 8:30 a.m., about 33 vehicles would enter and 98 vehicles would exit the site. During the afternoon peak hour, which generally occurs for one hour between 4:15 and 6:15 p.m., about 111 vehicles would enter and 65 vehicles would exit the site.

### Level of Service

- The intersections of Vollmer/Briargate and Briargate/Sterling Ranch are projected to operate at a satisfactory level of service as stop-sign-controlled intersections in the short-term future. By 2045, these intersections will likely need to be converted to traffic-signal control. As signalized intersections, all movements are projected to operate at LOS D or better during the peak hours, based on the projected 2045 total traffic volumes.
- Some of the movements at the intersections of Marksheffel Road/Vollmer Road and Marksheffel Road/Sterling Ranch Road are projected to operate at LOS E or LOS F during the peak hours, if they remain stop-sign controlled in the short-term future. Once signalized, all movements at these intersections are projected to operate at LOS D or better, based on the projected short-term and 2045 total traffic volumes. Escrow for these future traffic signals may need to be provided with this final plat.
- The intersections of Sterling Ranch/Lubbock, Sterling Ranch/Westmont, and Sterling Ranch/Lake Tahoe are projected to operate at a satisfactory level of service as stop-sign-controlled intersections.

### Recommended Improvements

- Table 5 shows detailed **intersection** improvements needed with Sterling Ranch Filing No. 3. The recommended improvements are based on the short-term and 2045 total traffic volumes shown in Figures 12c and the criteria contained in the El Paso County *Engineering Criteria Manual (ECM)*. The following auxiliary lanes will be required with the currently-proposed Sterling Ranch East Filing No. 3:
  - A northeast-bound right-turn deceleration lane on Sterling Ranch Road approaching Lubock trail. This lane should be 155 feet long plus a 160-foot taper.
  - A southwest-bound left-turn lane on Sterling Ranch Road approaching Lubock Trail. A center painted median is part of the standard Urban Minor Collector cross section.

- A northeast-bound right-turn deceleration lane on Sterling Ranch Road approaching Westmont Drive. This lane should be 155 feet long plus a 160-foot taper.
- A southwest-bound left-turn lane on Sterling Ranch Road approaching Westmont Drive. A center painted median is part of the standard Urban Minor Collector cross section.
- Table 6 shows a list of the **roadway segment** improvements in the vicinity of the site. Please see Figure 14 for a map of the key street segment locations. These recommendations are consistent with the LSC Sketch Plan TIS report.
- Figure 13 shows the recommended functional classifications and number of through lanes for the streets in the study area.
- Notes regarding the adjacent school site: The school site plan, layout, circulation, bus and parent drop-off and pick-up loop configurations are unknown at this time for the school site just west of the currently-proposed Sterling Ranch East Filing 3. School districts generally prefer to separate bus traffic from parent drop-off/pick-up traffic, so with a future school site-development plan, there is the potential for the school to show a dedicated school access to Sterling Ranch Road, while also utilizing Lubock Drive for some component of school operations/access/circulation. Lubock Drive is proposed as an Urban Local street with this plat and that functional classification will not need to change — the street length is very short and will only serve adjacent parcels. The future school site-development plan, in order to meet the needs of school circulation and operations, **may** show future modifications to the west edge of Lubock Drive (street widening, the addition of school driveway(s), etc.) and/or the corner radii at the Lubock/Sterling Ranch Road intersection.

### Escrow Analysis

Escrow for proportionate shares of the cost of some future roadway improvements may be required.

\* \* \* \* \*

Please contact me if you have any questions regarding this report.

Sincerely,

LSC TRANSPORTATION CONSULTANTS, INC.

By Jeffrey C. Hodsdon, P.E.  
Principal

JCH/KDF:jas

Enclosures: Tables 2-6  
Figures 1-14  
Traffic Count Reports  
Level of Service Reports  
Appendix Table 1  
MTCP Maps  
Crash History

# Tables 2-6





**Table 2**  
**Trip Generation Estimate**  
Sterling Ranch East Filing No. 3

ITE Code	ITE Land Use	Quantity	Unit	Daily	Trip Generation Rates <sup>(1)</sup>				Total Trips Generated				
					AM Peak Hour		PM Peak Hour		Daily	AM Peak Hour		PM Peak Hour	
					In	Out	In	Out		In	Out	In	Out
210	Single-Family Detached Housing	187	DU	9.43	0.18	0.53	0.59	0.35	1,763	33	98	111	65

Notes:

(1) Source: "Trip Generation, 11th Edition, 2021" by the Institute of Transportation Engineers (ITE)

(2) DU = Dwelling Unit

Source: LSC Transportation Consultants, Inc.

Oct-24

**Table 3**  
**Traffic Signal Warrant Analysis**  
Marksheffel Road/Vollmer Road

Warrant Analysis <sup>(1)</sup>																		
Warrant 1: Eight-Hour Vehicular-Volume Evaluation											Warrant 2: Four-Hour Vehicular-Volume Evaluation							
Warrant Thresholds											Warrant Threshold Met?				Short-Term Background		Short-Term Total	
Hour	Short-Term Background Traffic		Sterling Ranch East Filing 3 Generated Traffic		Short-Term Total Traffic		Warrant Thresholds				Short-Term Background		Short-Term Total		Warrant Threshold Minimum	Warrant Threshold Met? WB	Warrant Threshold Minimum	Warrant Threshold Met? WB
	Major <sup>(2)</sup> Vollmer	Minor <sup>(2)</sup> Marksheffel	Major	Minor	Major	Minor	Condition A		Condition B		Condition	Condition	Condition	Condition				
							Major	Minor	Major	Minor	A	B	A	B				
<b>Short-Term Total Traffic<sup>(4)</sup></b>																		
12-1 AM	43	3	0	0	43	3	600	150	900	75	No	No	No	No	Low Volume	No	Low Volume	No
1-2 AM	18	3	0	0	18	3	600	150	900	75	No	No	No	No	Low Volume	No	Low Volume	No
2-3 AM	13	0	0	0	13	0	600	150	900	75	No	No	No	No	Low Volume	No	Low Volume	No
3-4 AM	25	3	0	0	25	3	600	150	900	75	No	No	No	No	Low Volume	No	Low Volume	No
4-5 AM	50	13	0	0	50	13	600	150	900	75	No	No	No	No	Low Volume	No	Low Volume	No
5-6 AM	112	32	0	0	112	32	600	150	900	75	No	No	No	No	Low Volume	No	Low Volume	No
6-7 AM	415	94	1	1	416	95	600	150	900	75	No	No	No	No	383	No	382	No
7-8 AM	854	162	1	2	855	164	600	150	900	75	Yes	No	Yes	No	187	No	186	No
8-9 AM	749	137	1	2	750	139	600	150	900	75	No	No	No	No	226	No	225	No
9-10 AM	617	86	1	1	618	87	600	150	900	75	No	No	No	No	283	No	283	No
10-11 AM	635	86	1	1	636	87	600	150	900	75	No	No	No	No	276	No	276	No
11-12 PM	792	81	2	1	794	82	600	150	900	75	No	No	No	No	204	No	203	No
12-1 PM	701	87	2	1	703	88	600	150	900	75	No	No	No	No	250	No	249	No
1-2 PM	717	92	2	2	719	94	600	150	900	75	No	No	No	No	242	No	241	No
2-3 PM	811	97	2	2	813	99	600	150	900	75	No	No	No	No	197	No	197	No
3-4 PM	908	94	2	2	910	96	600	150	900	75	No	Yes	No	Yes	173	No	173	No
4-5 PM	1026	117	3	2	1029	119	600	150	900	75	No	Yes	No	Yes	142	No	141	No
5-6 PM	981	115	3	2	984	117	600	150	900	75	No	Yes	No	Yes	155	No	154	No
6-7 PM	598	92	2	2	600	94	600	150	900	75	No	No	No	No	291	No	290	No
7-8 PM	517	67	2	1	519	68	600	150	900	75	No	No	No	No	332	No	331	No
8-9 PM	409	48	2	1	411	49	600	150	900	75	No	No	No	No	386	No	385	No
9-10 PM	267	37	1	1	268	38	600	150	900	75	No	No	No	No	Low Volume	No	Low Volume	No
10-11 PM	140	17	1	0	141	17	600	150	900	75	No	No	No	No	Low Volume	No	Low Volume	No
11-12 AM	62	11	0	0	62	11	600	150	900	75	No	No	No	No	Low Volume	No	Low Volume	No
<b>Numbers of Hours the Warrant Thresholds Are Met</b>											1	3	1	3				
<b>Warrant Met?</b>											No		No					

Notes:  
(1) Thresholds are based on 2 or more lanes on the major approach and 1 lane on the minor approach (Warrant evaluation assuming the westbound left turn only for the minor street)  
(2) The major-street traffic includes all movements (left, through, and right)  
(3) The minor-street traffic includes only the left turns from the minor street  
(5) Off-peak-hour traffic volumes are based on the projected peak-hour traffic volumes, 72-hour machine counts conducted on Vollmer Road in April 2024 and vehicle time-of-day distribution data for single-family residential published by the Institute of Transportation Engineers

**Table 4**  
**Traffic Signal Warrant Analysis**  
Marksheffel Road/Sterling Ranch Road

Warrant Analysis <sup>(1)</sup>																		
Warrant 1: Eight-Hour Vehicular-Volume Evaluation												Warrant 2: Four-Hour Vehicular-Volume Evaluation						
Hour	Short-Term Background Traffic		Sterling Ranch East Filing No. 3 Generated Traffic		Short-Term Total Traffic		Warrant Thresholds				Warrant Threshold Met?		Short-Term Background		Short-Term Total			
	Major <sup>(2)</sup> Marksheffel	Minor <sup>(3)</sup> Sterling Ranch	Major Marksheffel	Minor Sterling Ranch	Major Marksheffel	Minor Sterling Ranch	Condition A		Condition B		Condition A	Condition B	Condition A	Condition B	Warrant Threshold Minimum	Warrant Threshold Met?	Warrant Threshold Minimum	Warrant Threshold Met?
							Major	Minor	Major	Minor								
													Condition A	Condition B	Condition A	Condition B		
												Major	Minor	Major	Minor			
<b>Short-Term Total Traffic<sup>(4)</sup></b>																		
12-1 AM	37	10	5	2	42	12	600	150	900	75	No	No	No	No	Low Volume	No	Low Volume	No
1-2 AM	15	10	2	2	17	12	600	150	900	75	No	No	No	No	Low Volume	No	Low Volume	No
2-3 AM	13	0	2	0	15	0	600	150	900	75	No	No	No	No	Low Volume	No	Low Volume	No
3-4 AM	17	10	2	2	19	12	600	150	900	75	No	No	No	No	Low Volume	No	Low Volume	No
4-5 AM	30	39	3	7	33	46	600	150	900	75	No	No	No	No	Low Volume	No	Low Volume	No
5-6 AM	57	97	5	17	62	114	600	150	900	75	No	No	No	No	Low Volume	No	Low Volume	No
6-7 AM	200	285	16	51	216	336	600	150	900	75	No	No	No	No	Low Volume	No	Low Volume	No
7-8 AM	403	493	31	88	434	581	600	150	900	75	No	No	No	No	389	Yes	373	Yes
8-9 AM	403	416	36	74	439	490	600	150	900	75	No	No	No	No	389	Yes	371	Yes
9-10 AM	336	261	31	47	367	308	600	150	900	75	No	No	No	No	Low Volume	No	Low Volume	No
10-11 AM	388	261	40	47	428	308	600	150	900	75	No	No	No	No	Low Volume	No	376	No
11-12 PM	493	247	53	44	546	291	600	150	900	75	No	No	No	No	344	No	317	No
12-1 PM	543	244	54	43	597	287	600	150	900	75	No	No	No	No	319	No	292	No
1-2 PM	578	257	59	46	637	303	600	150	900	75	No	No	Yes	No	301	No	275	Yes
2-3 PM	664	270	68	48	732	318	600	150	900	75	Yes	No	Yes	No	264	Yes	234	Yes
3-4 PM	782	262	82	46	864	308	600	150	900	75	Yes	No	Yes	No	209	Yes	184	Yes
4-5 PM	932	327	102	58	1034	385	600	150	900	75	Yes	Yes	Yes	Yes	167	Yes	140	Yes
5-6 PM	904	323	100	57	1004	380	600	150	900	75	Yes	Yes	Yes	Yes	174	Yes	149	Yes
6-7 PM	682	257	83	46	765	303	600	150	900	75	Yes	No	Yes	No	257	No	218	Yes
7-8 PM	520	187	60	33	580	220	600	150	900	75	No	No	No	No	330	No	300	No
8-9 PM	490	135	61	24	551	159	600	150	900	75	No	No	No	No	345	No	315	No
9-10 PM	341	105	43	19	384	124	600	150	900	75	No	No	No	No	Low Volume	No	Low Volume	No
10-11 PM	170	48	22	9	192	57	600	150	900	75	No	No	No	No	Low Volume	No	Low Volume	No
11-12 AM	94	31	12	5	106	36	600	150	900	75	No	No	No	No	Low Volume	No	Low Volume	No
<b>Numbers of Hours the Warrant Thresholds Are Met</b>												5	2	6	2			
<b>Warrant Met?</b>												No		No		Yes	Yes	

Notes:  
 (1) Thresholds are based on 2 or more lanes on the major approach and 1 lane on the minor approach (Warrant evaluation assuming the southbound left turn only for the minor street)  
 (2) The major-street traffic includes all movements (left, through, and right)  
 (3) The minor-street traffic includes only the left turns from the minor street  
 (4) Off-peak-hour traffic volumes are based on the projected peak-hour traffic volumes, 72-hour machine counts conducted on Vollmer Road in April 2024 and vehicle time-of-day distribution data for single-family residential published by the Institute of Transportation Engineers  
 Source: LSC Transportation Consultants, Inc.

**Table 5  
Sterling Ranch East Filing No. 3  
Intersection Improvements**

Item #	Improvement	Trigger	Timing	Responsibility
<b>1) Burgess Road/Vollmer Road</b>				
1	Plan for roundabout as ultimate traffic control in the future depending on intersection conditions - grades, available ROW, etc.	When the LOS degrades below LOS F	Long Term	This intersection may be an eligible intersection under the fee impact program
<b>5) Briargate Parkway/Sterling Ranch Road</b>				
2	Construct an eastbound left-turn lane on Briargate Parkway approaching Sterling Ranch Road. The lane should be 435' long plus a 200' taper.	eastbound left-turn volume > 10 vph	With Sterling Ranch East Filing 1	Sterling Ranch
3	Construct an eastbound right-turn deceleration lane on Briargate Parkway approaching Sterling Ranch Road. The lane should be 235' long plus a 200' taper.	eastbound right-turn volume > 25 vph	With Sterling Ranch East Filing 1	Sterling Ranch
4	Construct a northbound to eastbound right-turn acceleration lane on Briargate Parkway at Sterling Ranch Road. The lane should be 580' long plus a 180' taper.	northbound right-turn volume > 50 vph	With Sterling Ranch East Filing No. 6	Sterling Ranch
5	Construct a westbound left-turn lane on Briargate Parkway approaching Sterling Ranch Road. The lane should be 285' long plus a 200' taper.	westbound left-turn volume > 10 vph	With Sterling Ranch East Filing No. 6	Sterling Ranch
6	Construct an eastbound right-turn deceleration lane on Briargate Parkway approaching Sterling Ranch Road. The lane should be 235' long plus a 200' taper.	eastbound right-turn volume > 25 vph	With Sterling Ranch East Filing No. 6	Sterling Ranch
7	Construct a southbound to westbound right-turn acceleration lane on Briargate Parkway at Sterling Ranch Road. The lane should be 580' long plus a 180' taper.	southbound right-turn volume > 50 vph	With Sterling Ranch East Filing 2	Sterling Ranch
7	Provide interim stop-sign control with a stop sign on the eastbound approach	with construction of the intersection	With Sterling Ranch East Filing 2	Sterling Ranch
8	Signalization of the intersection	If and when warrants are met. The decision on timing of traffic signal installation rests with El Paso County Public Works.	Long Term (note: to be analyzed at the time of development of the school at which point a determination would be made regarding the intersection traffic control beyond TWSC)	Sterling Ranch or potentially the school district
<b>12) Marksheffel Road/Vollmer Road</b>				
9	Signalization of the intersection	Once warrants are met. The decision on timing of traffic signal installation rests with El Paso County Public Works.	Not Anticipated With Sterling Ranch Filing No. 3	This intersection may be an eligible intersection under the fee impact program
<b>13) Marksheffel Road/Sterling Ranch Road</b>				
10	Signalization of the intersection	Once warrants are met. The decision on timing of traffic signal installation rests with The City of Colorado Springs.	A Four-Hour Vehicular Volume Traffic Signal Warrant is Anticipated to be met with Sterling Ranch East Filing No. 6	SRMD#3
<b>303) Sterling Ranch Road/Lubbock Trail</b>				
11	Construct an westbound left-turn lane on Sterling Ranch Road approaching Lubbock Trail. The lane should be 205' long plus a 160' taper.	westbound left-turn volume > 25 vph	A center painter median is part of the standard Urban Minor Collector cross section	Sterling Ranch
12	Construct an eastbound right-turn deceleration lane on Sterling Ranch Road approaching Lubbock Trail. The lane should be 155' long plus a 160' taper.	eastbound right-turn volume > 50 vph	With Sterling Ranch East Filing 3	Sterling Ranch
<b>304) Sterling Ranch Road/Westmont Drive</b>				
13	Construct an westbound left-turn lane on Sterling Ranch Road approaching Westmont Drive. The lane should be 205' long plus a 160' taper.	westbound left-turn volume > 25 vph	A center painter median is part of the standard Urban Minor Collector cross section	Sterling Ranch
14	Construct an eastbound right-turn deceleration lane on Sterling Ranch Road approaching Westmont Drive. The lane should be 155' long plus a 160' taper.	eastbound right-turn volume > 50 vph	With Sterling Ranch East Filing 3	Sterling Ranch
<b>305) Sterling Ranch Road/Lake Tahoe Drive</b>				
15	Construct a southeastbound left-turn lane on Sterling Ranch Road approaching Lake Tahoe Drive. The lane should be 305' long plus a 160' taper.	southbound left-turn volume > 25 vph	With the construction of Sterling Ranch Parkway north of Banning Lewis Parkway	Sterling Ranch
16	Construct a northwestbound right-turn deceleration lane on Sterling Ranch Road approaching Lake Tahoe Drive. The lane should be 155' long plus a 160' taper.	northboundbound right-turn volume > 50 vph	With Sterling Ranch East Filing 5	Sterling Ranch

Source: LSC Transportation Consultants, Inc. (October 2024)

**Table 6**

**Roadway Segment Improvements**

**Sterling Ranch East Filing No. 3**

**(Page 1 of 2)**

Segment ID <sup>(1)</sup> (See Figure 14 for map)	Improvement Description	Timing	Design ADT (vpd)	Projected 2045 ADT (vpd)	Responsibility
V1 (Short-Term) Northbound	UPDATE (November 2023): It is our understanding that a meeting(s) with JR Engineering/the applicant, City staff and County staff were held, that a short-term/interim improvement to segment V1 will not be required. The original LSC recommendation for this segment was for restriping. However, City staff indicated that the striped bike lane in the southbound direction needs to remain.	Updated November 2023 - It is our understanding that following a meeting with the City of Colorado Springs and El Paso County, a V1 interim shoulder improvement will no longer be required.	5,500 (Directional northbound)	15,690	N/A
V1 (Short-Term) Southbound			10,000 (Directional southbound)		
V1	Improve Vollmer Road between Dry Needle Place and the Sterling Ranch south boundary to a standard 4-Lane Urban Minor Arterial Cross Section (Add a second northbound through lane and painted center median) <sup>(2)</sup> 8/22/2024 Note: the 2024 MTCP shows Vollmer Road as an Urban – Major Collector	Intermediate-Term Future	20,000		Updated November 2023 Adjacent parcel owner which could potentially include: <ul style="list-style-type: none"> <li>“Pioneer Landscape Center Parcel” (5300000742) (redevelopment is unlikely in the foreseeable future)</li> <li>“Schmidt Parcel” west of Vollmer Rd (5200000571)</li> <li>The triangular parcels southeast of Vollmer/Marksheffel (5232400001 and 5232400003)</li> </ul>
V2	Improve Vollmer Road between the Sterling Ranch south boundary to Lochwinnoch Lane/Sterling property boundary to a standard 4-Lane Urban Minor Arterial Cross Section <sup>(2)</sup> 8/22/2024 Note: the 2024 MTCP shows Vollmer Road as an Urban – Major Collector	<b>Updated September 2024: Complete</b>	20,000 (Note: Existing Capacity 8,000 <sup>(3)</sup> )	17,115	Sterling Ranch
V3	<b>Short Term:</b> Improve Vollmer Road from Lochwinnoch Lane to Sterling Ranch boundary (northeast of Glider Loop) to provide 36’ of pavement (existing pavement 1 approx. 23.38’) and stripe for one through lane and plus a 6’ paved, striped outside shoulder in each direction <sup>(2)</sup>	<b>Updated November 2023 – Future as required due to net increase traffic demand. The construction documents have been approved.</b>	11,000 (Note: Existing Capacity 8,000)	17,015	Sterling Ranch
	<b>Long Term:</b> Improve Vollmer Road from Lochwinnoch Lane to Sterling Ranch boundary (northeast of Glider Loop) to a standard 4-Lane Urban Minor Arterial Cross Section <sup>(2)</sup> 8/22/2024 Note: the 2024 MTCP shows Vollmer Road as an Urban – Major Collector	Long-Term Future	20,000		
V4	Improve Vollmer Road from Sterling Ranch boundary (northeast of Glider Loop) to Briargate Parkway to a standard 4-Lane Urban Minor Arterial Cross Section <sup>(2)</sup> Update November 2023 - with transition section to the existing two-lane section to the south as shown on the Vollmer North CDs. Improvements consist of curb and gutter on west side (as most of the east side is already built) and repaving.	<b>Updated September 2024: Complete</b>	20,000	16,155	Sterling Ranch
V5	Improve Vollmer Road from Briargate Parkway to Jane Kirkham Drive to a standard 4-Lane Urban Minor Arterial Cross Section <sup>(2)</sup> 8/22/2024 Note: the 2024 MTCP shows Vollmer Road as an Urban – Major Collector	<b>Updated September 2024: Complete</b>	20,000	11,505	Sterling Ranch
V6	Improve Vollmer Road from Jane Kirkham Drive to Sam Bass Drive to a standard 4-Lane Urban Minor Arterial Cross Section <sup>(2)</sup> 8/22/2024 Note: the 2024 MTCP shows Vollmer Road as an Urban – Major Collector	<b>Updated September 2024: Complete</b>	20,000	11,245	Sterling Ranch
V7	Improve Vollmer Road between Sam Bass Drive and Poco Road to a 4-lane Urban Minor Arterial but with necessary lane transitions, redirect tapers, etc. south of Poco to adequately transition between the 4-Lane Urban Minor Arterial Cross Section and the 2-Lane Rural Arterial Cross Section north of Poco Road. 8/22/2024 Note: the 2024 MTCP shows Vollmer Road as an Urban – Major Collector	<b>Updated September 2024: Complete</b>	20,000	11,010	Sterling Ranch
V8	Improve Vollmer Road from Poco Road to Burgess Road to a 2-Lane Urban – Major Collector Cross Section <sup>(2)</sup>	Long-Term Future	20,000	11,395	El Paso County

**Part 1/2 of this table (see Part 2 on next page)**

**Notes:**

(1) See Figure 14

(2) Adequate transition/redirect tapers would be needed between the various cross sections on Vollmer Road. Based on the criteria contained in Table 2-29 of the *El Paso Engineering Criteria Manual* an appropriate taper ratio for a roadway with a design speed of 40 miles per hour is 20:1

(3) Source: Table 20 Road Impact Fee Study Updated November 16, 2016

Source: LSC Transportation Consultants, Inc. (October 2024)

**Table 6**

**Roadway Segment Improvements**

**Sterling Ranch East Filing No. 6 Rezone and Preliminary Plat**

(Page 2 of 2)

Segment ID <sup>(1)</sup> (See Figure 14 for map)	Improvement Description	Timing	Design ADT (vpd)	Projected 2045 ADT (vpd)	Responsibility
SR1	Construct Sterling Ranch Road as an Urban Major Collector from Marksheffel Road to Dines Boulevard	<u>Completed</u>	20,000	14,480	Sterling Ranch
SR2	Construct Sterling Ranch Road as an Urban Major Collector from Dines Boulevard to Briargate Parkway	<b>Short-Term - with SRE Preliminary Plan 1</b>	20,000	9,815	Sterling Ranch
SR3	Construct Sterling Ranch Road as an Urban Minor Collector from Briargate Parkway to Vancouver Street	<b>Short-Term - with SRE Preliminary Plan 1</b>	10,000	7,850	Sterling Ranch
SR4	Construct Sterling Ranch Road from Vancouver Street north to ultimate north terminus	Long-Term Future	10,000	4,330	Sterling Ranch
M1	Construct Marksheffel Road as an Urban Principal Arterial to City of Colorado Springs standards in 107' of right-of-way between Vollmer Road and Sterling Ranch Road	<u>Completed</u>	40,000	23,015	Sterling Ranch
M2	Construct Marksheffel Road as an Urban Principal Arterial to City of Colorado Springs standards in 107' of right-of-way between Sterling Ranch Road and the south boundary of the Sterling Ranch Master Plan Area. <b>NOTE: With the completion of this improvement, the connection between Vollmer Road and Woodmen Road will be completed</b>	To be completed in 2024	40,000	28,220	Sterling Ranch
M3	Construct Marksheffel Road between the south boundary of the Sterling Ranch Master Plan Area and Woodmen Road (Note this segment is located within the City of Colorado Springs)	<u>Completed</u> (by Others)	40,000	24,525	Others (Completed)
M4	Construct Marksheffel Road between Black Forest Road and Vollmer Road	Long-Term Future	40,000	27,910	Others
B1	Construct the full section of Briargate Parkway (4-Lane Principal Arterial) between Vollmer Road and Wheatland Drive	<u>Completed</u>	40,000	24,745	Sterling Ranch
B2	Construct Briargate Parkway ( <b>full section</b> ) as a 4-Lane Principal Arterial between Wheatland Drive and Sterling Ranch Road	<b>Updated September 2024: In Progress Anticipated Completion Fall 2024</b>	40,000	24,190	Sterling Ranch
B3	Construct Briargate Parkway as a 4-Lane Principal Arterial between Sterling Ranch Road and Banning Lewis Parkway	Intermediate Term	40,000	21,680	Sterling Ranch
B4	Construct Stapleton Road as a 4-Lane Principal Arterial between Banning Lewis Parkway and Meridian Road (including upgrade of existing rural two-lane segment between Towner and Meridian)	Long-Term Future	40,000	17,945	Others
B5	Construct Briargate Parkway as a 4-Lane Principal Arterial between its current terminus and Black Forest Road and between Black Forest Road and Vollmer Road	Long-Term Future	40,000	24,340	Others
BL1	Construct Banning Lewis Parkway as a 4-Lane Principal Arterial between the south Sterling Ranch boundary and Briargate Pkwy	Long-Term Future	40,000	20,320	Future - TBD with the future preliminary plan for that area - potentially, financial assurances for half-section, west-side half-section or full-section w/ cost recover may be required
BL2	Construct Banning Lewis Parkway as a 4-Lane Principal Arterial between Woodmen Road and the south Sterling Ranch boundary (Note this segment will be located within the City of Colorado Springs)	Long-Term Future	40,000	28,480	Others
W1	Widen Woodmen Road from 4-lane to 6-lane section from Powers Boulevard to US 24	Long-Term Future	72,000	66,690	Others

**Part 2/2 of this table**

**Notes:**

- (1) See Figure 14
- (2) Adequate transition/redirect tapers would be needed between the various cross sections on Vollmer Road. Based on the criteria contained in Table 2-29 of the *El Paso Engineering Criteria Manual*, an appropriate taper ratio for a roadway with a design speed of 40 miles per hour is 20:1
- (3) Source: Table 20 *Road Impact Fee Study Updated* November 16, 2016

Source: LSC Transportation Consultants, Inc. (October 2024)





Not to scale

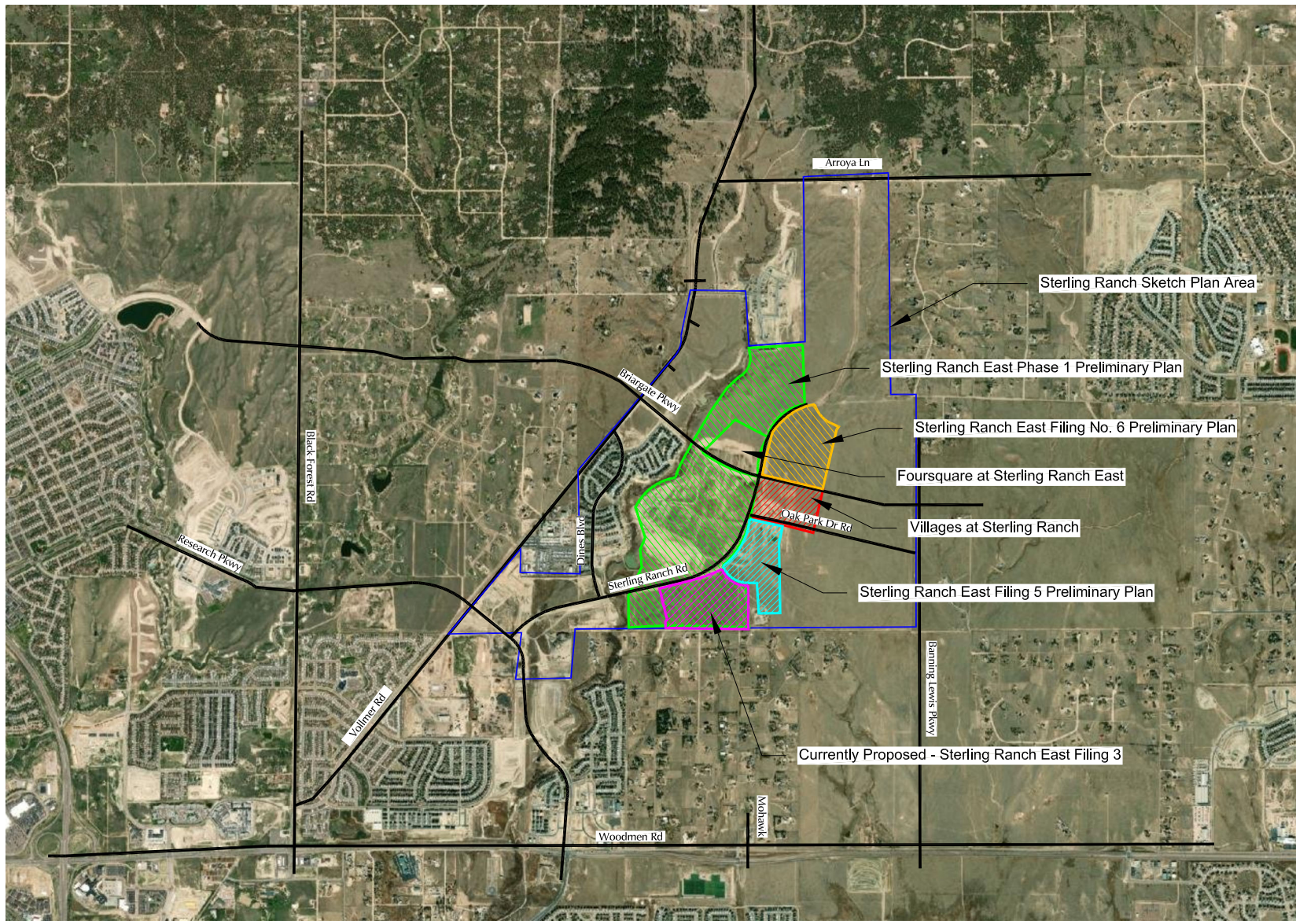


Figure 1

# Vicinity Map

Sterling Ranch East Filing No. 3 (LSC# S244270)





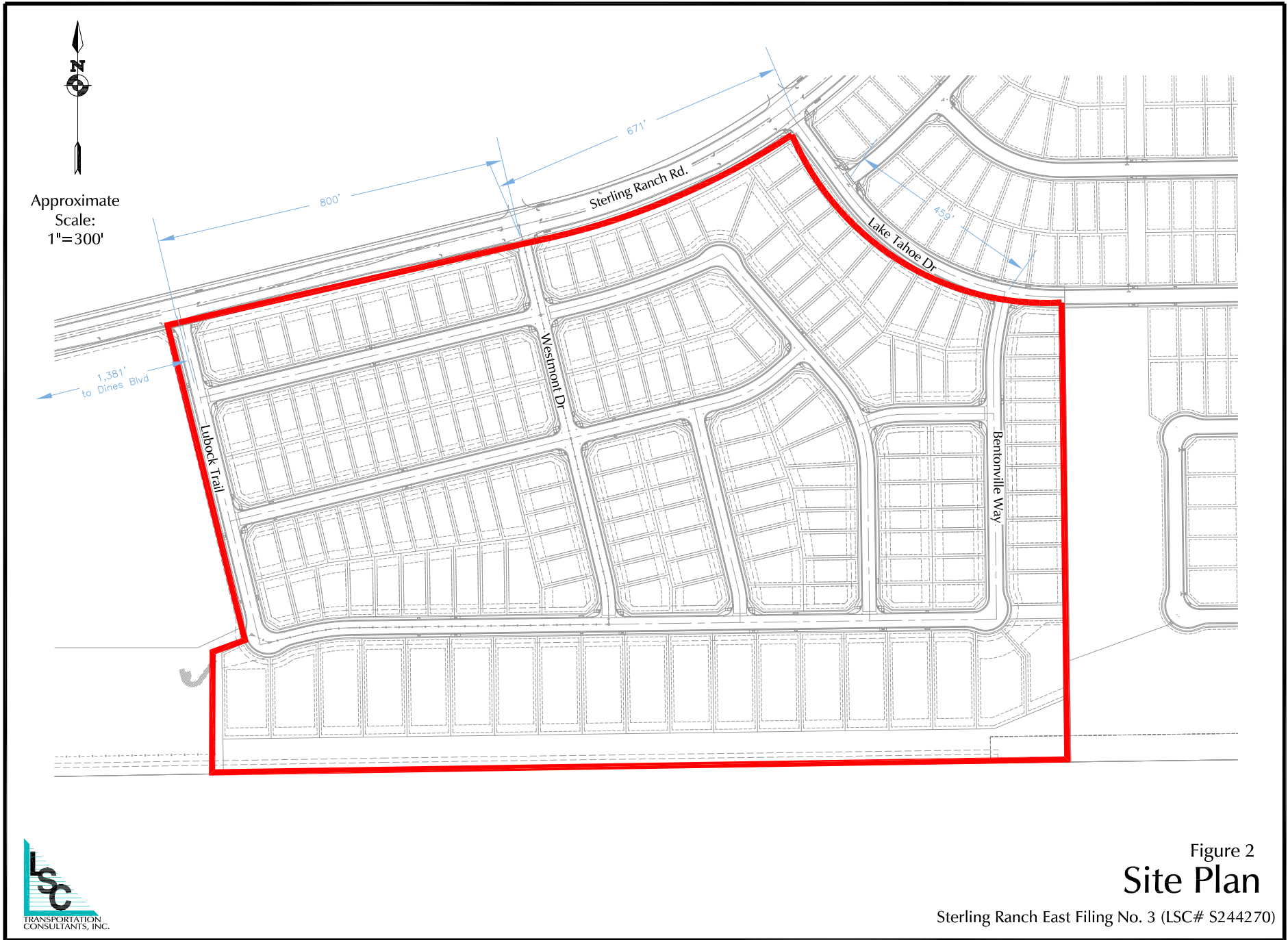


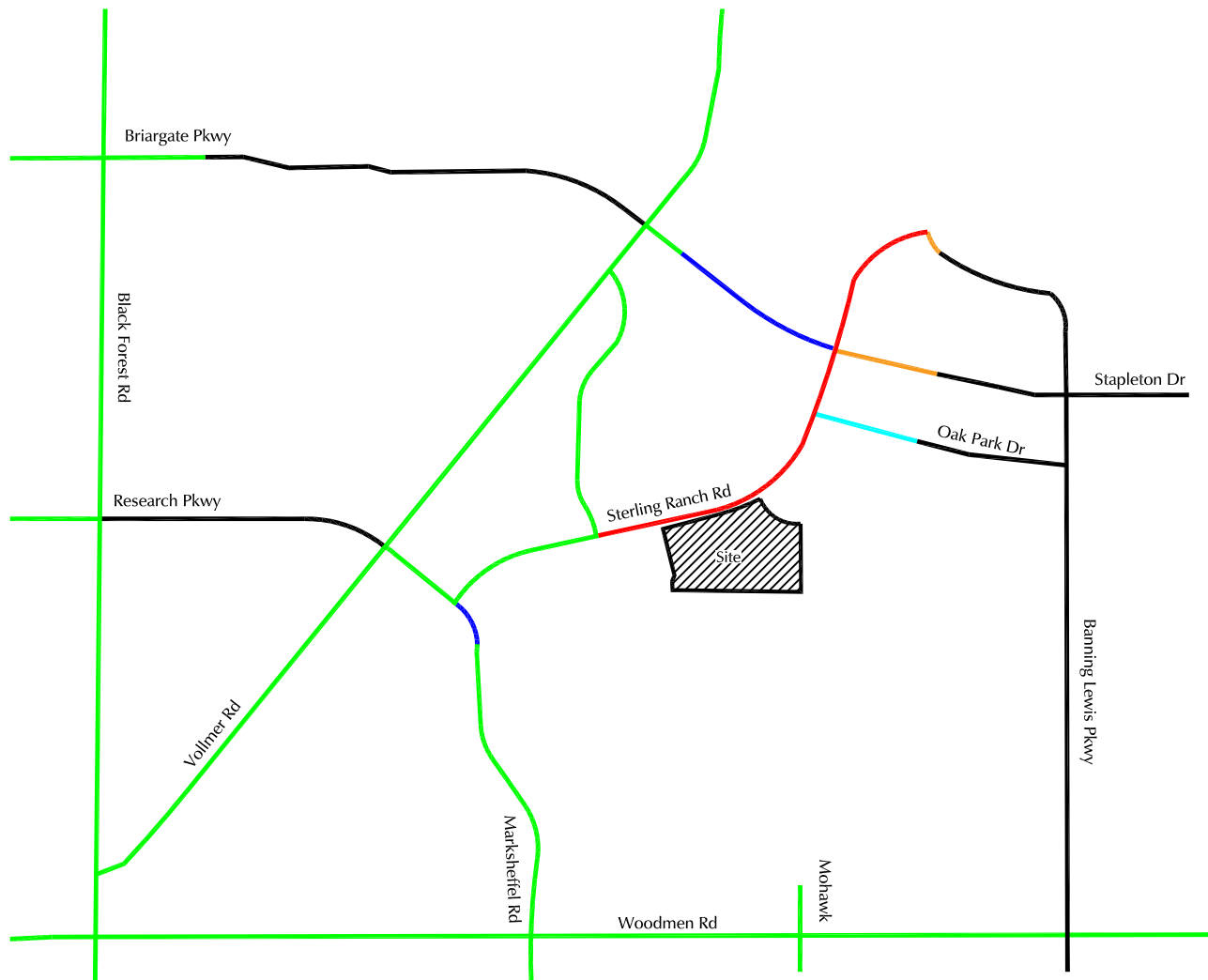
Figure 2  
Site Plan

Sterling Ranch East Filing No. 3 (LSC# S244270)





Not to scale



- Roadway connection planned with Sterling Ranch East Fil. No. 6
- Roadway connection planned with Sterling Ranch East Preliminary Plan 1
- Roadway connection planned with Villages at Sterling Ranch
- Roadway connection planned to be completed in 2024
- Existing Roadway
- Future Roadway

## Short-Term Roadway Connections

Figure 3

Sterling Ranch East Filing No. 3 (LSC# S244270)



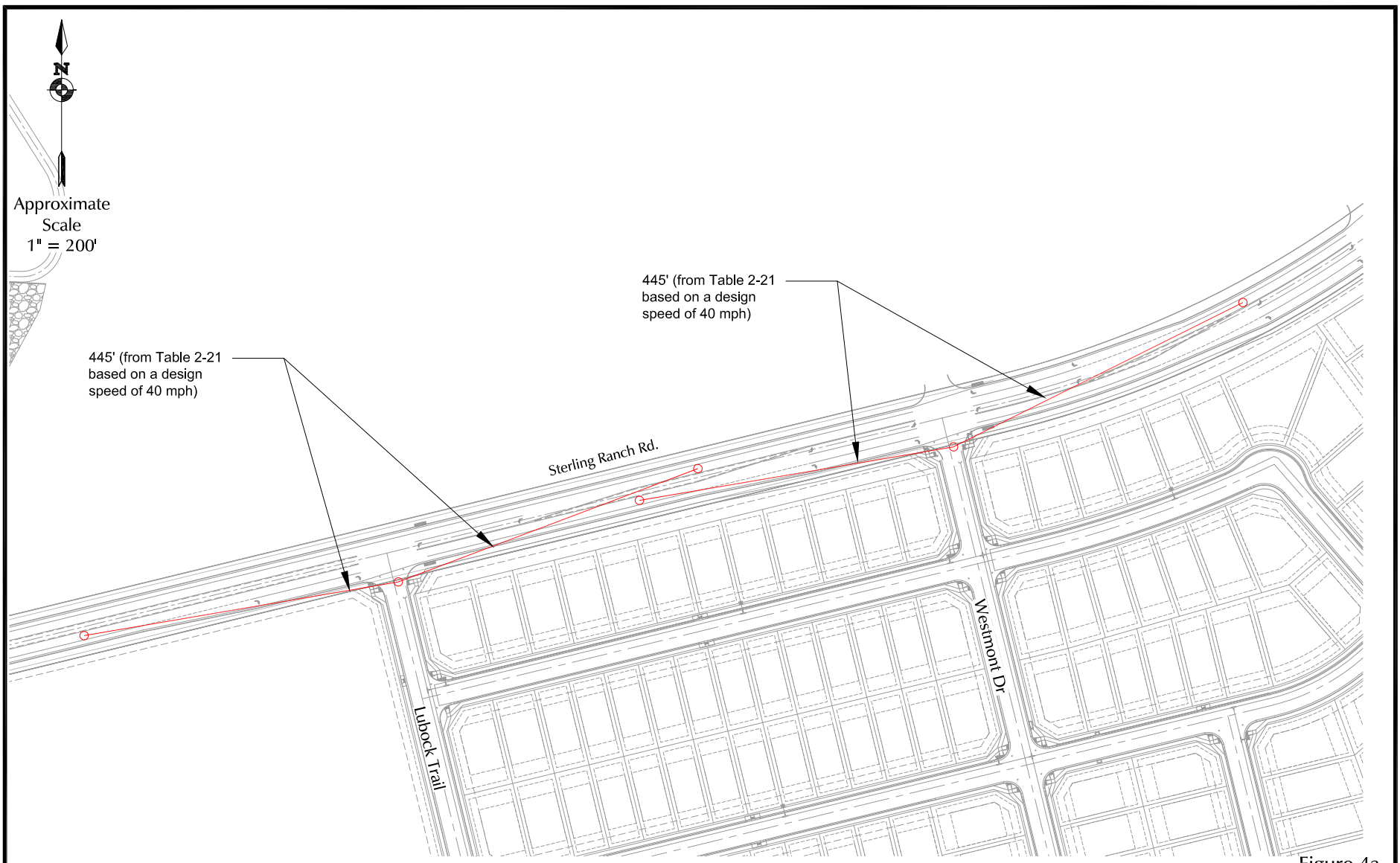


Figure 4a

LEGEND:

— ECM Required Intersection Sight Distance

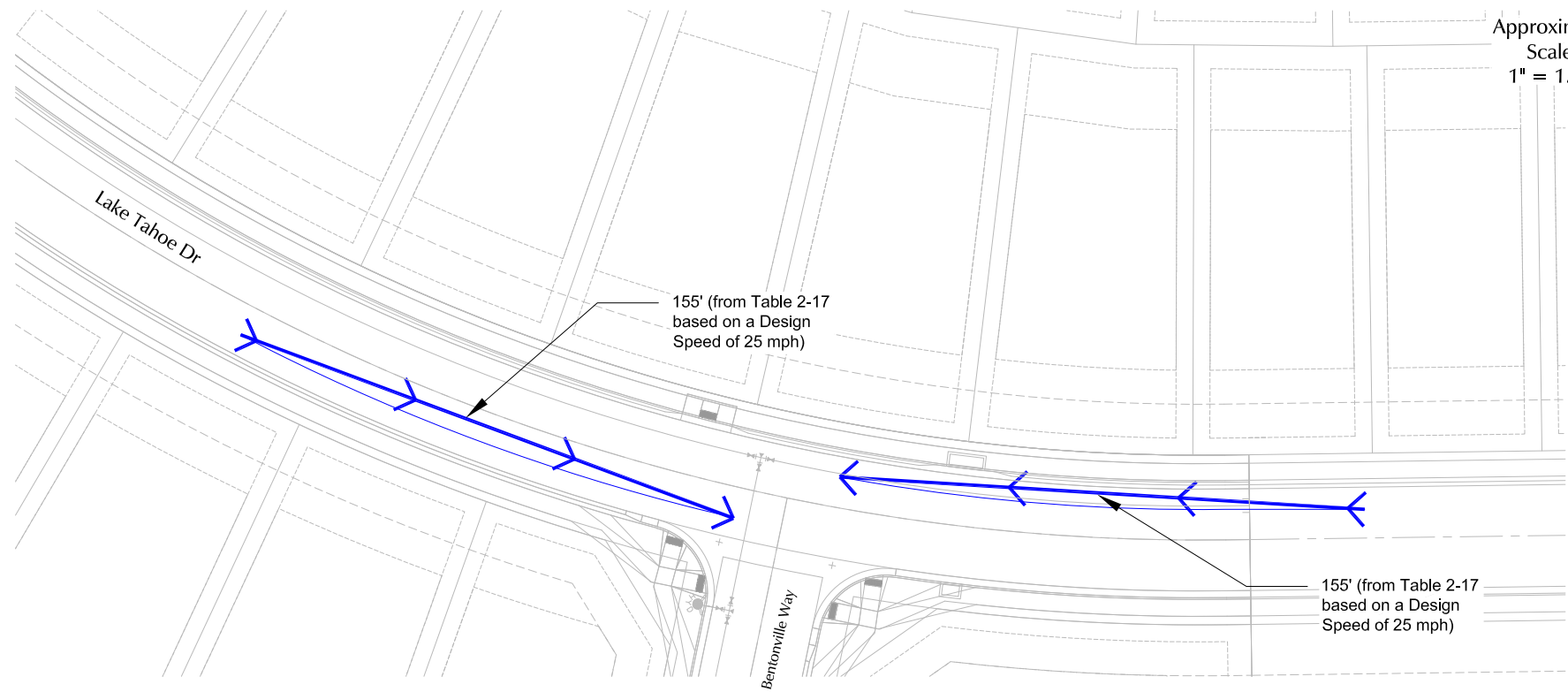
# Sight Distance Analysis- Sterling Ranch Road

Sterling Ranch East Filing No. 3 (LSC# S244270)





Approximate  
Scale  
1" = 150'

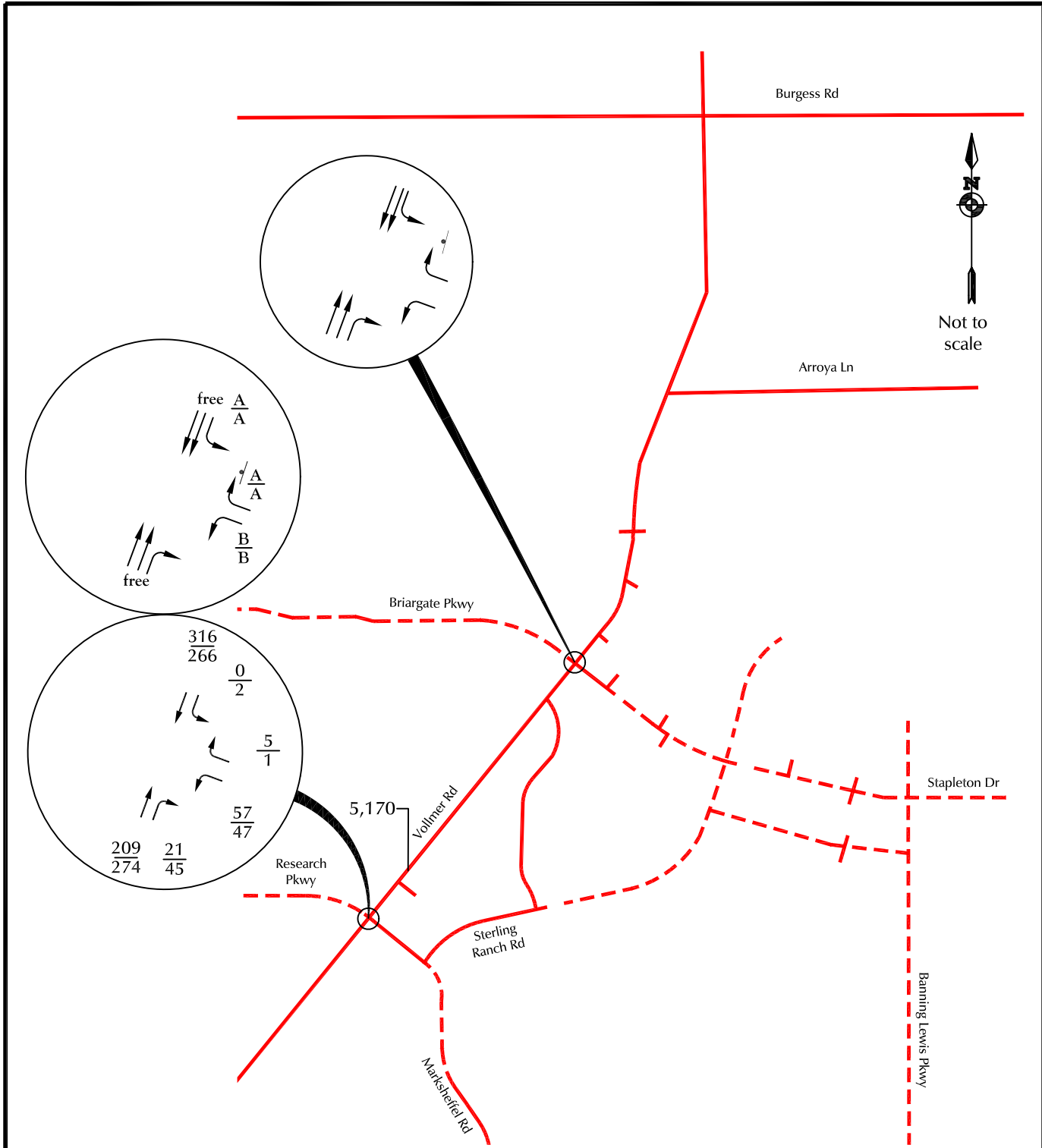


— ECM Required Stopping Sight Distance

Figure 4b  
Sight Distance Analysis  
Lake Tahoe Drive

Sterling Ranch East Filing No. 3 (LSC# S244270)





LEGEND:  $\frac{XX}{XX} = \frac{\text{AM Peak-Hour Traffic (veh/hr)}}{\text{PM Peak-Hour Traffic (veh/hr)}}$  Counts by LSC April 2024

XXX = Average Weekday Traffic (vehicles per day)(AWT) Based on counts by LSC April 2024

$\frac{A}{B} = \frac{\text{AM Individual Movement Peak-Hour Level of Service}}{\text{PM Individual Movement Peak-Hour Level of Service}}$

⊥ = Stop Sign    ⊳ = Yield Sign

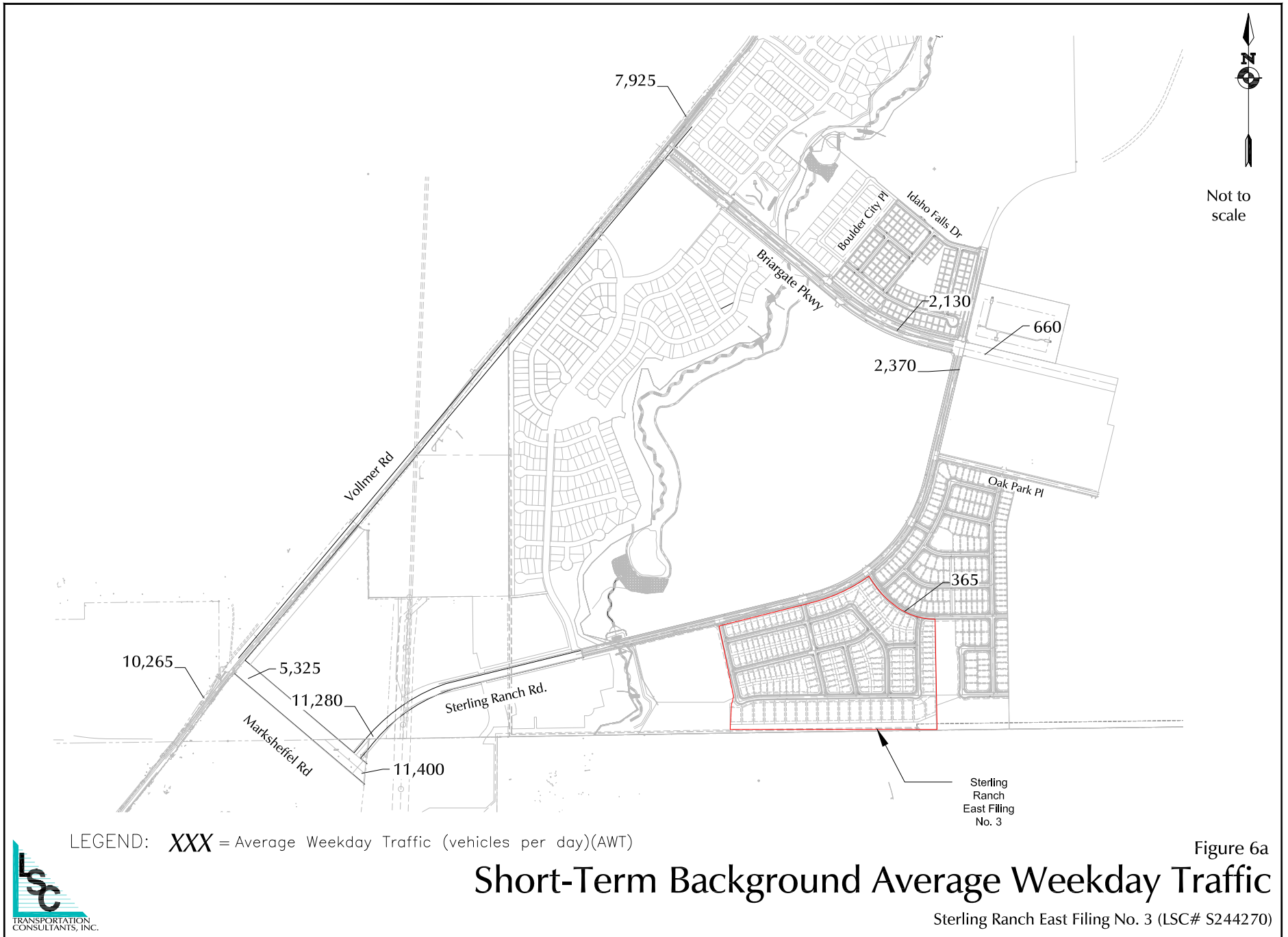
— Existing Roadway  
 - - - Future Roadway

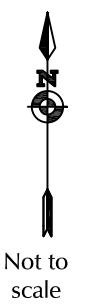
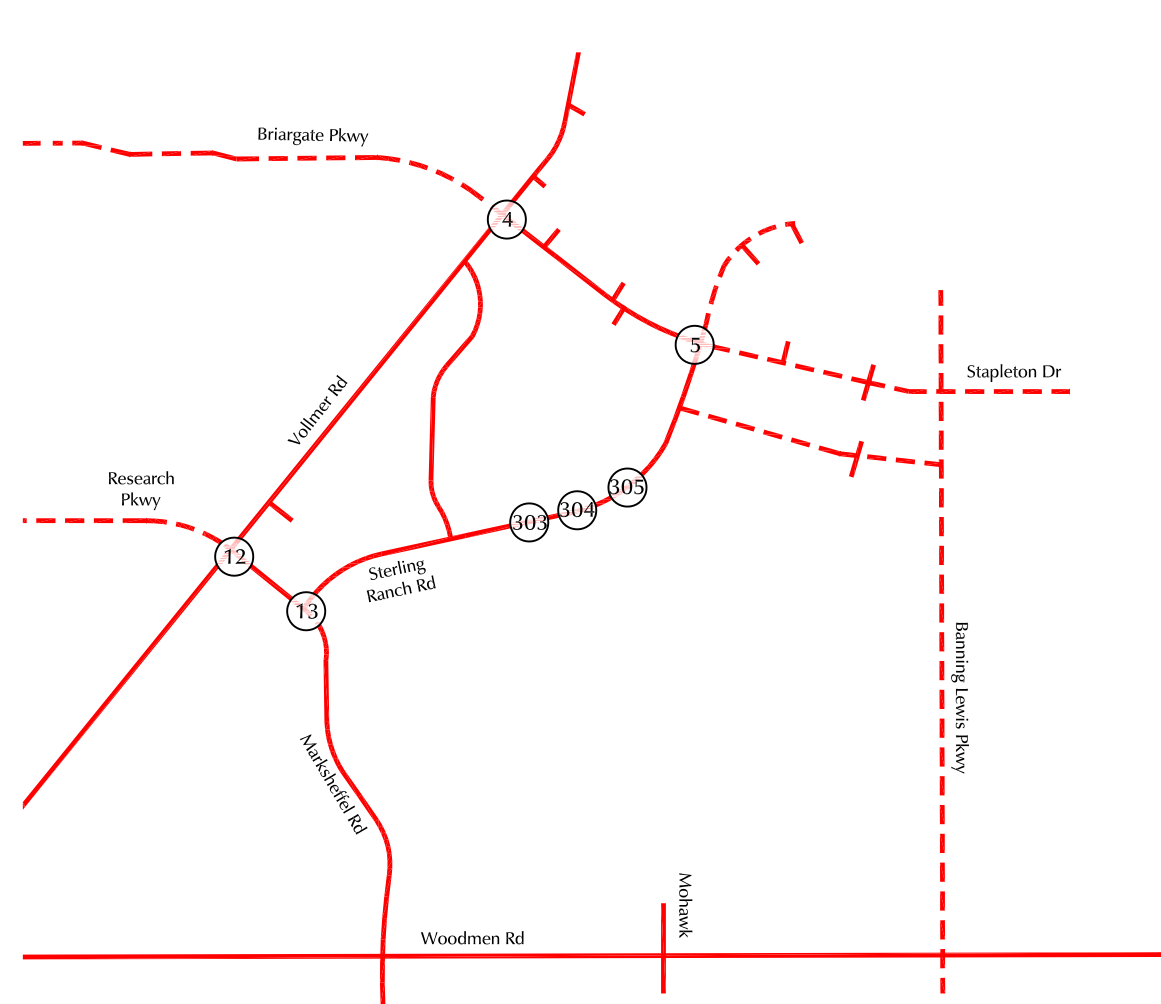
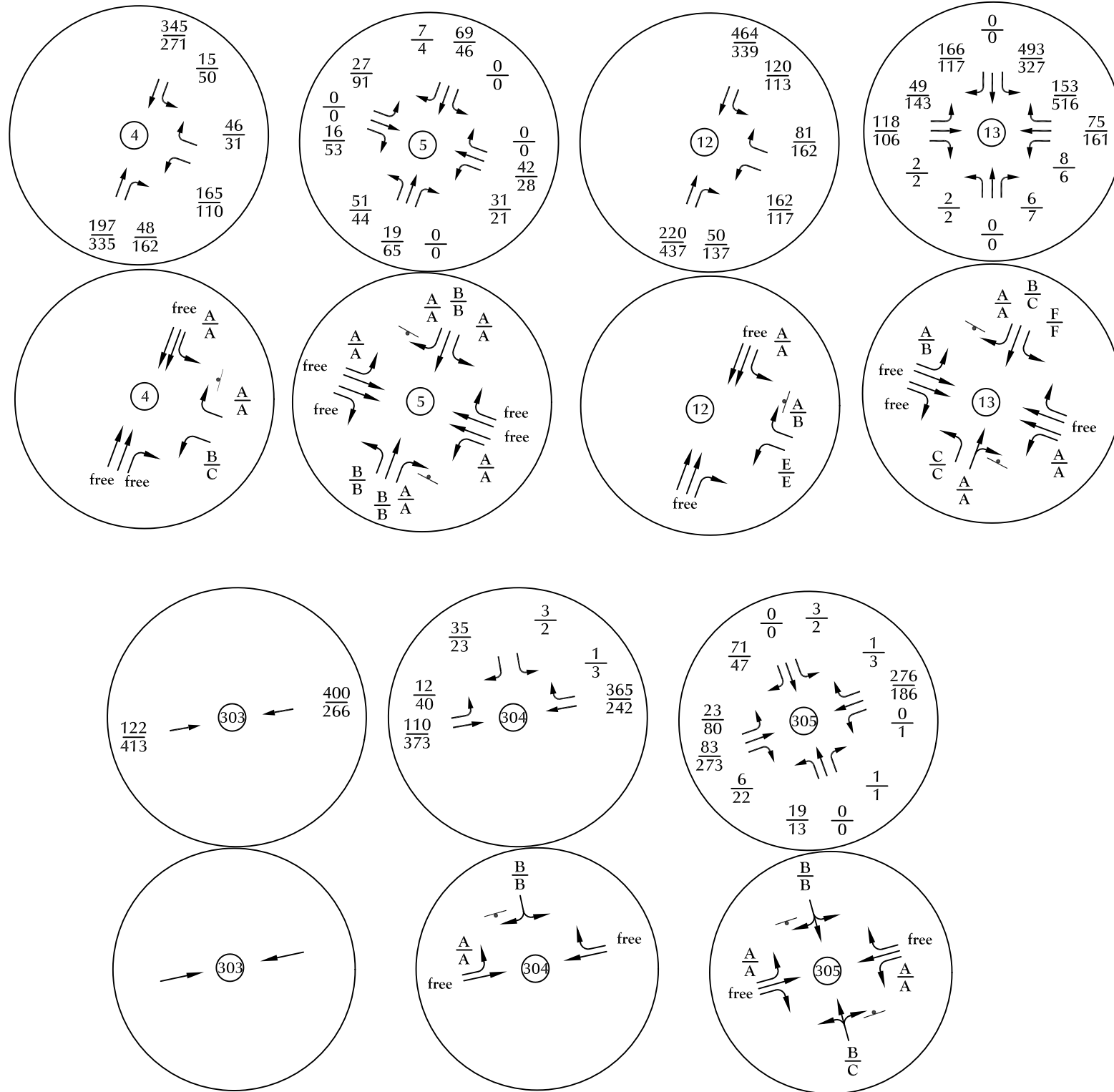
Figure 5

# Existing Peak-Hour Conditions

Sterling Ranch East Filing No. 3 (LSC# S244270)







LEGEND:  $\frac{XX}{XX}$  = AM Peak-Hour Traffic (veh/hr)  
 $\frac{XX}{XX}$  = PM Peak-Hour Traffic (veh/hr)

$\frac{A}{B}$  = AM Individual Movement Peak-Hour Level of Service  
 $\frac{A}{B}$  = PM Individual Movement Peak-Hour Level of Service  
 $\frac{C}{D}$  = AM Entire Intersection Peak-Hour Level of Service  
 $\frac{C}{D}$  = PM Entire Intersection Peak-Hour Level of Service

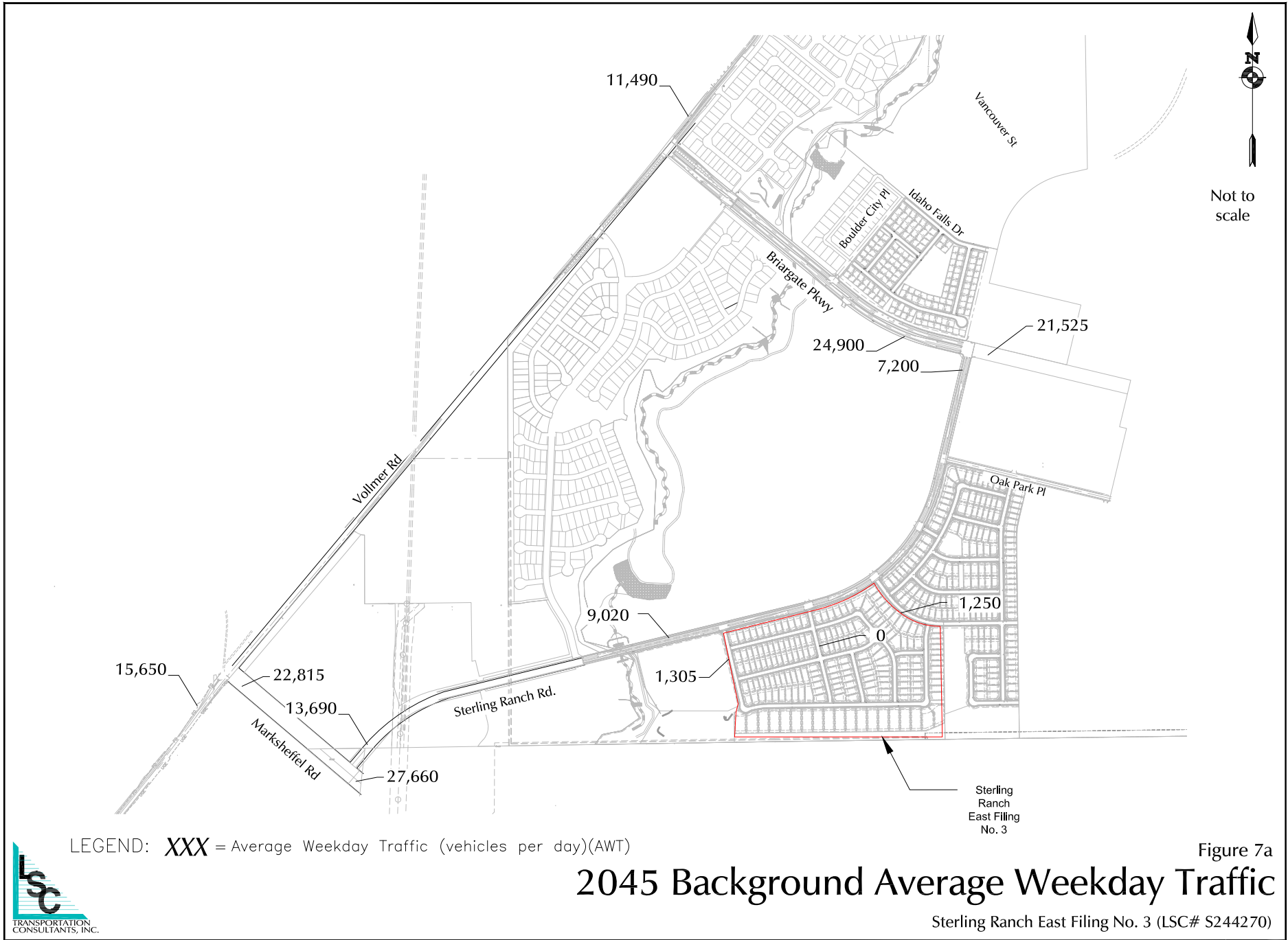
= Yield Sign  
 = Stop Sign  
 = Traffic Signal

Existing Roadway  
 Future Roadway

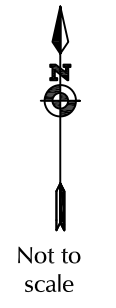
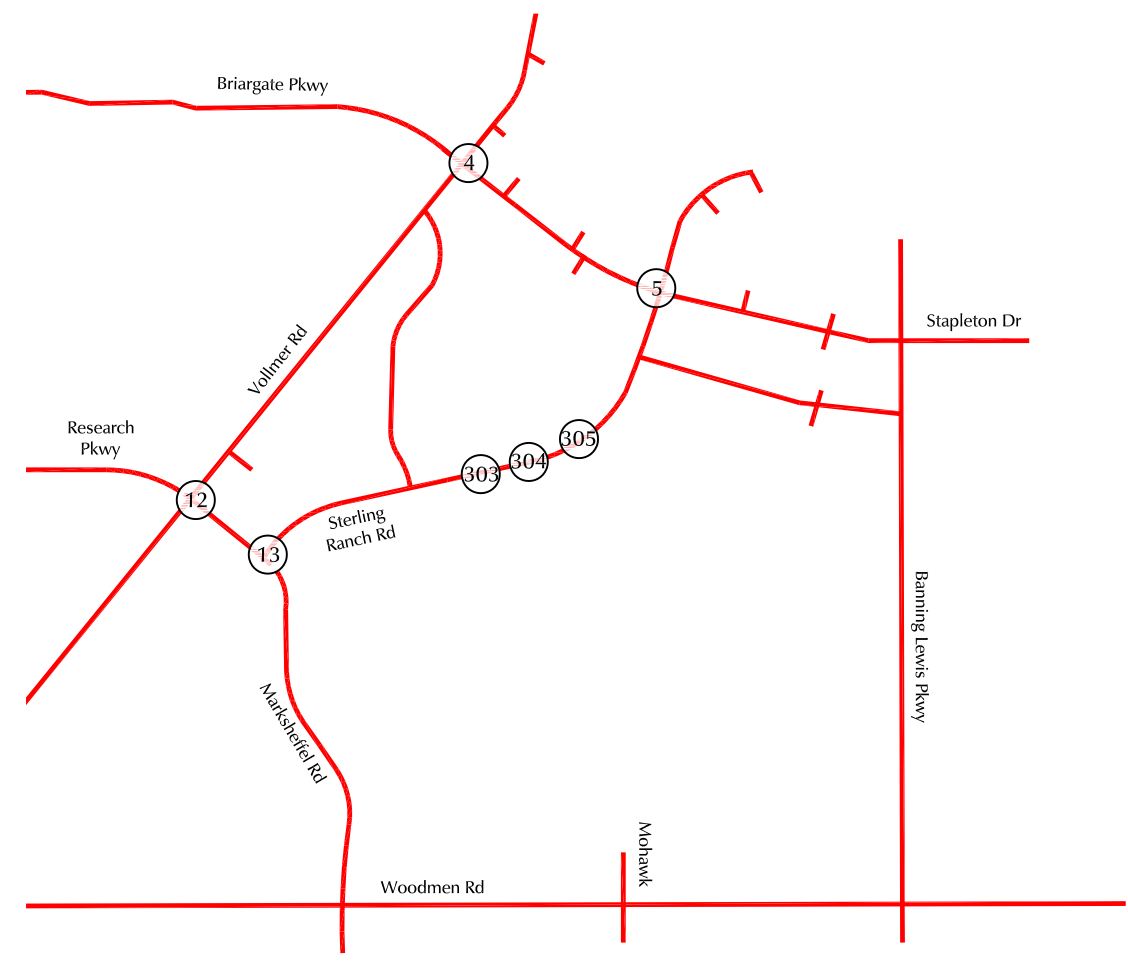
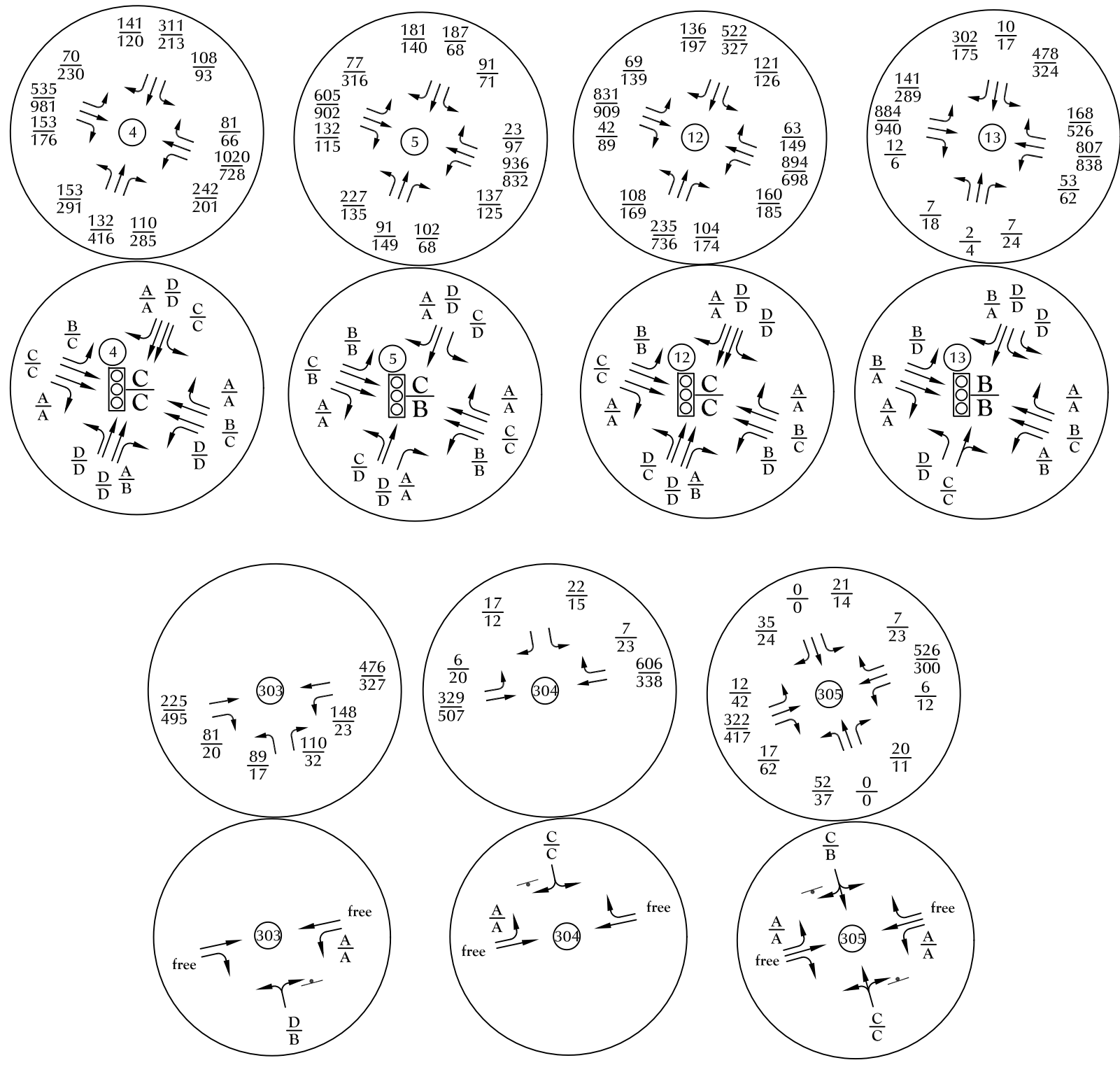


# Short-Term Background Traffic Conditions

Figure 6b  
 Sterling Ranch East Filing No. 3 (LSC# S244270)







LEGEND:  $\frac{XX}{XX}$  = AM Peak-Hour Traffic (veh/hr)  
 $\frac{XX}{XX}$  = PM Peak-Hour Traffic (veh/hr)

$\frac{A}{B}$  = AM Individual Movement Peak-Hour Level of Service  
 PM Individual Movement Peak-Hour Level of Service  
 $\frac{C}{D}$  = AM Entire Intersection Peak-Hour Level of Service  
 PM Entire Intersection Peak-Hour Level of Service

= Yield Sign  
 = Stop Sign  
 = Traffic Signal

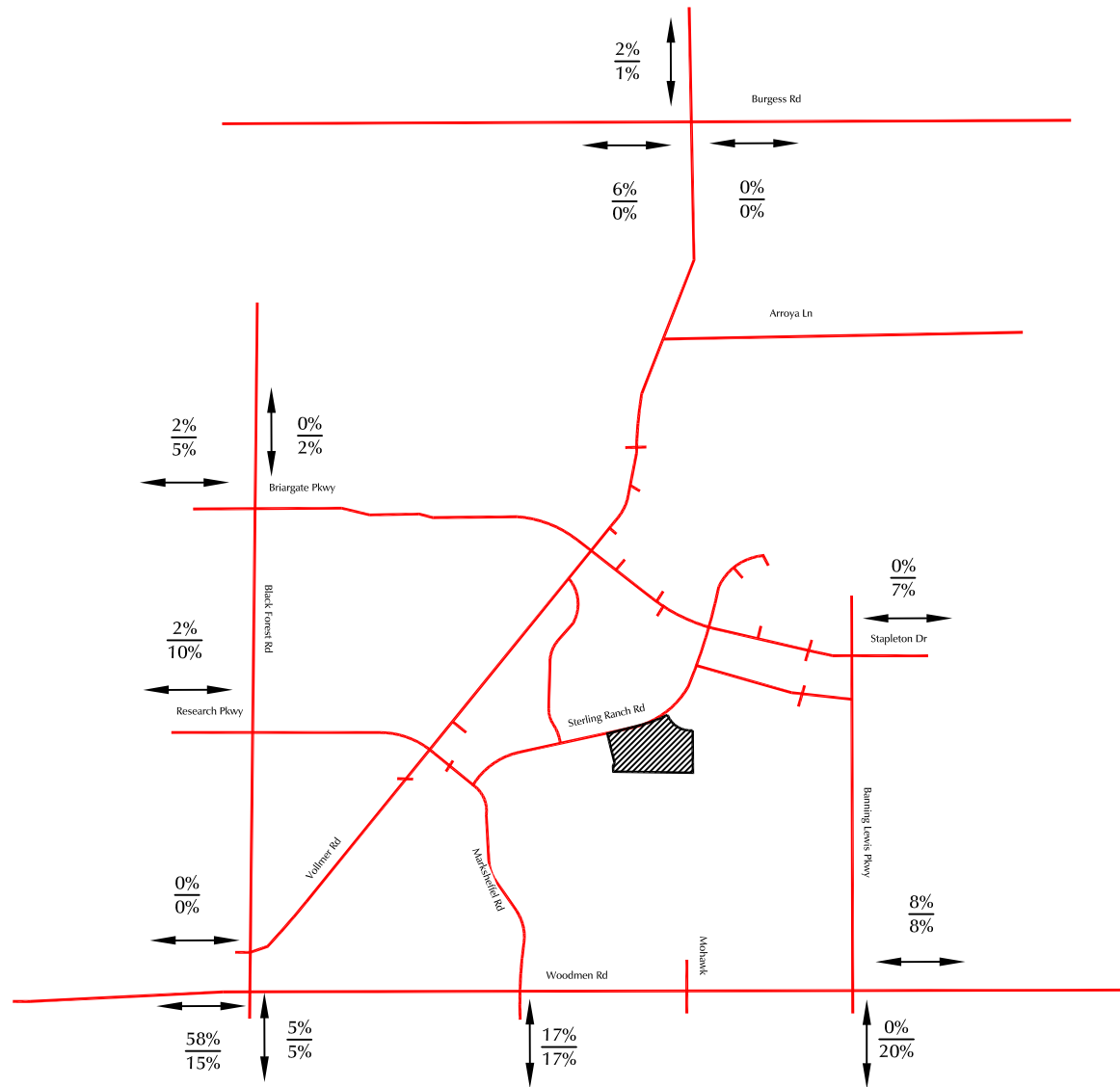


Figure 7b  
 2045 Background Traffic  
 Sterling Ranch East Filing No. 3 (LSC# S244270)

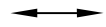




Not to scale



LEGEND:



XX%  
XX%

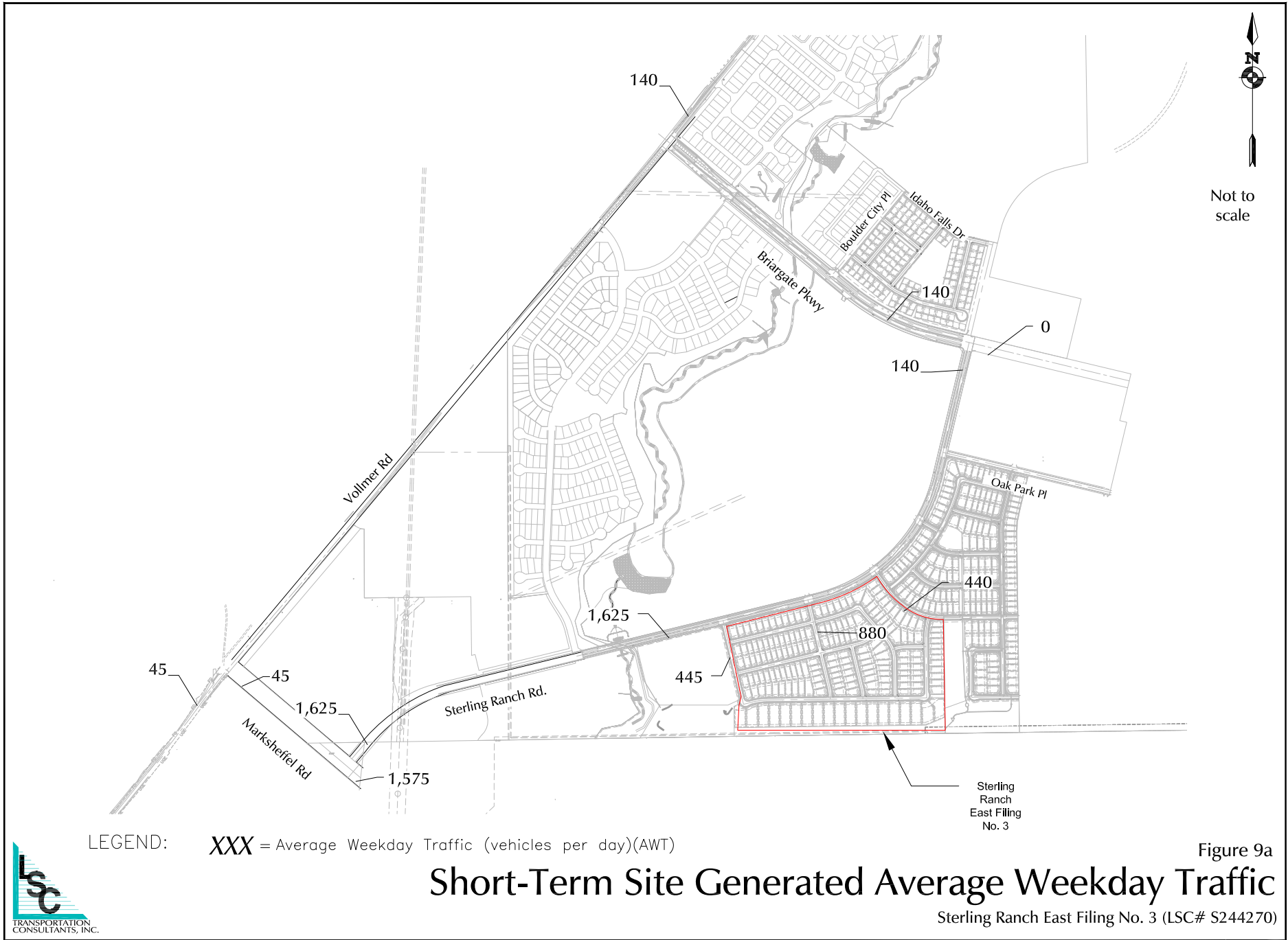
= Percent of Short-Term Trips  
Percent of Buildout Long-Term Trips

# Estimated Directional Distribution of Site-Generated Trips

Figure 8

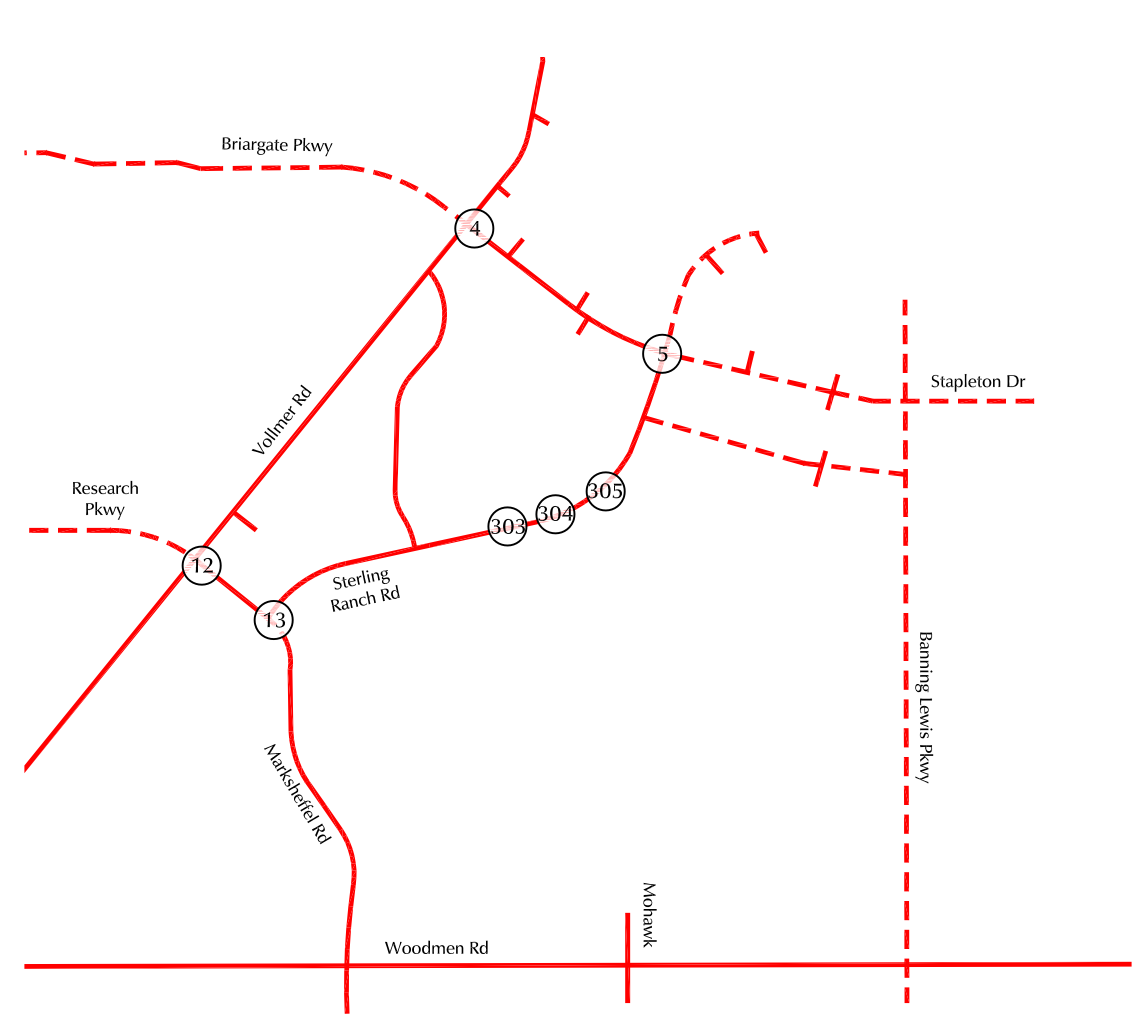
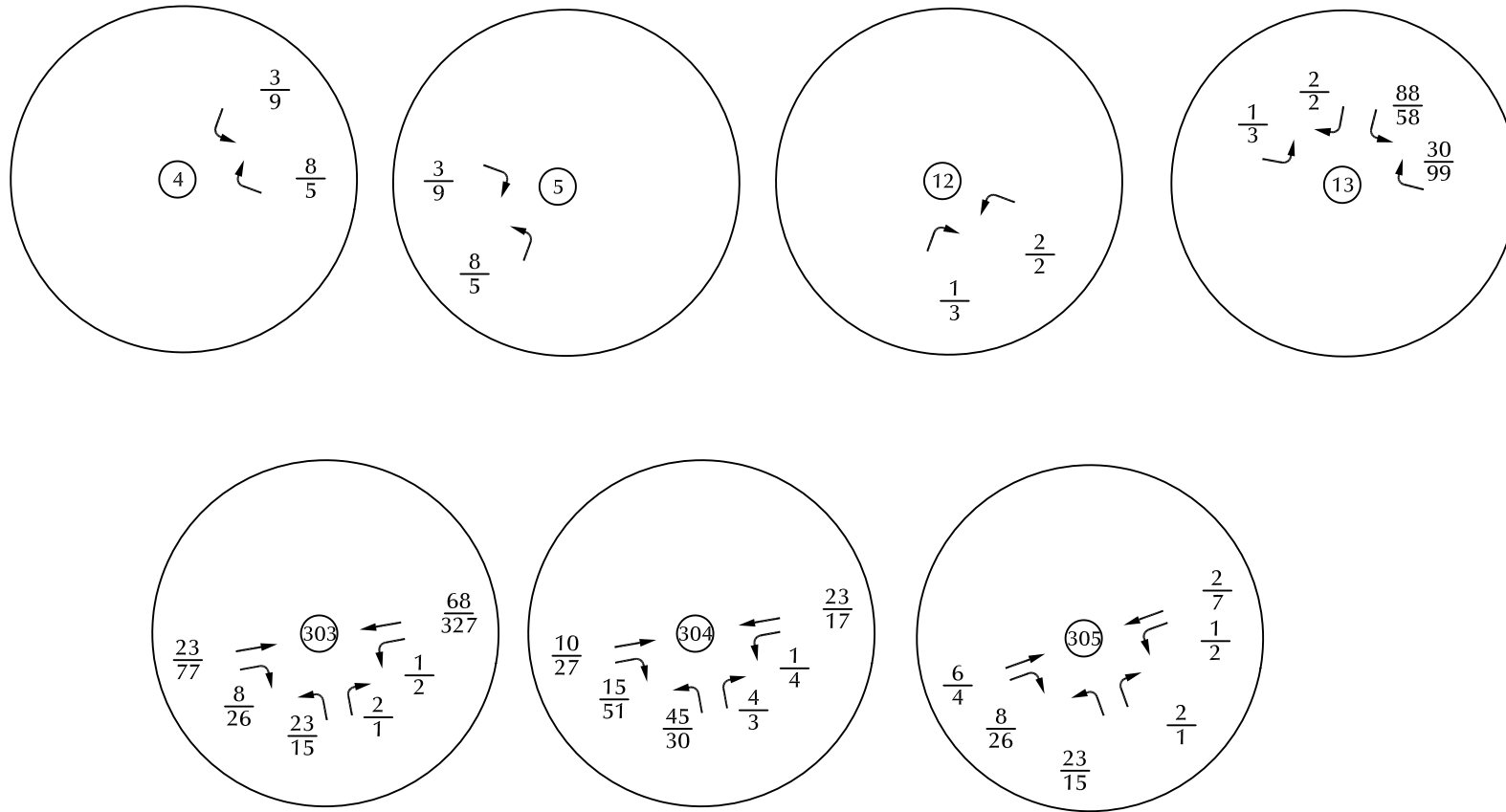
Sterling Ranch East Filing No. 3 (LSC# S244270)





Not to scale



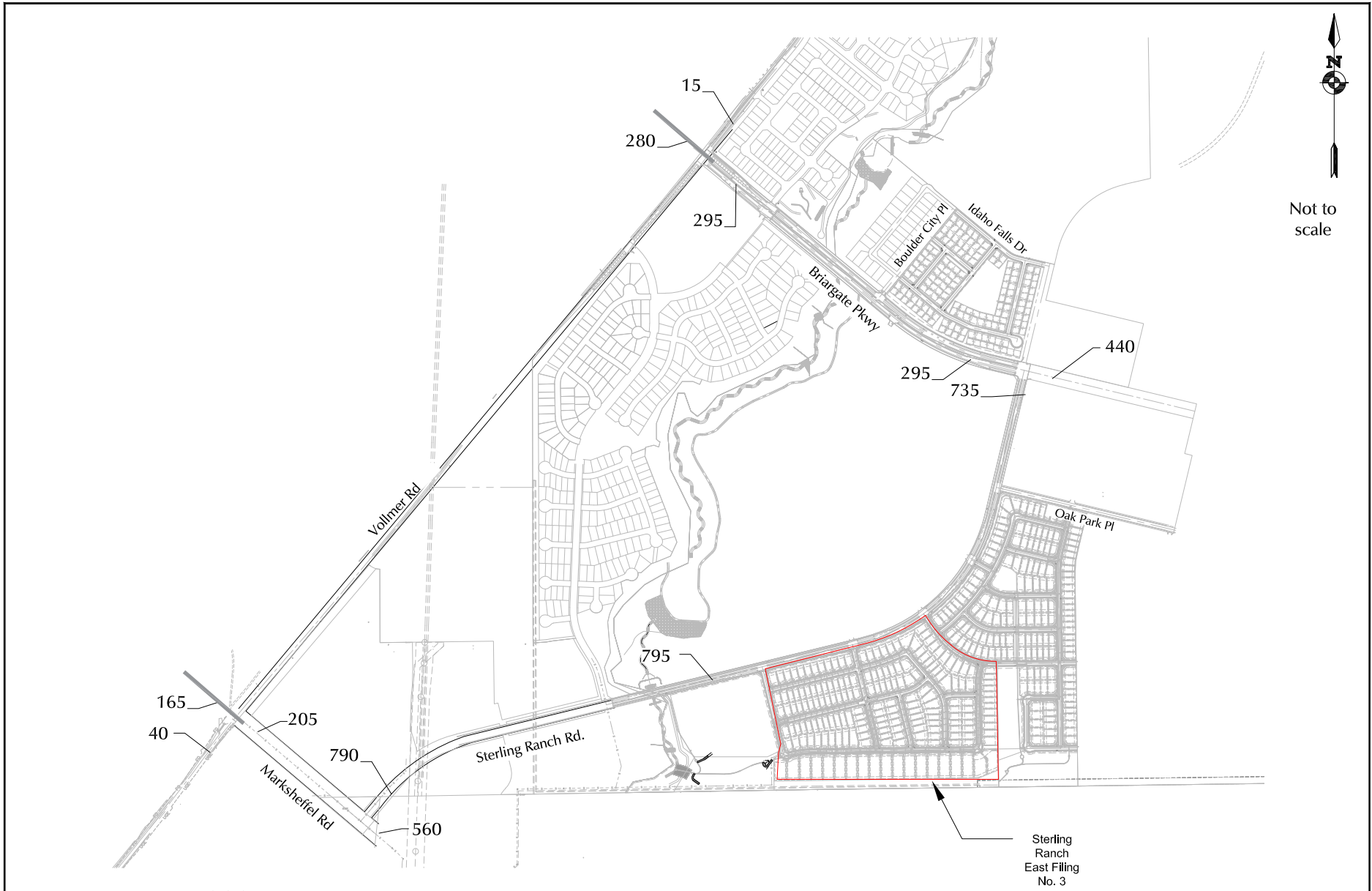


LEGEND:  $\frac{XX}{XX} = \frac{\text{AM Peak-Hour Traffic (veh/hr)}}{\text{PM Peak-Hour Traffic (veh/hr)}}$

— Existing Roadway  
 - - - Future Roadway



Figure 9b  
 Short-Term Site-Generated Traffic  
 Sterling Ranch East Filing No. 3 (LSC# S244270)



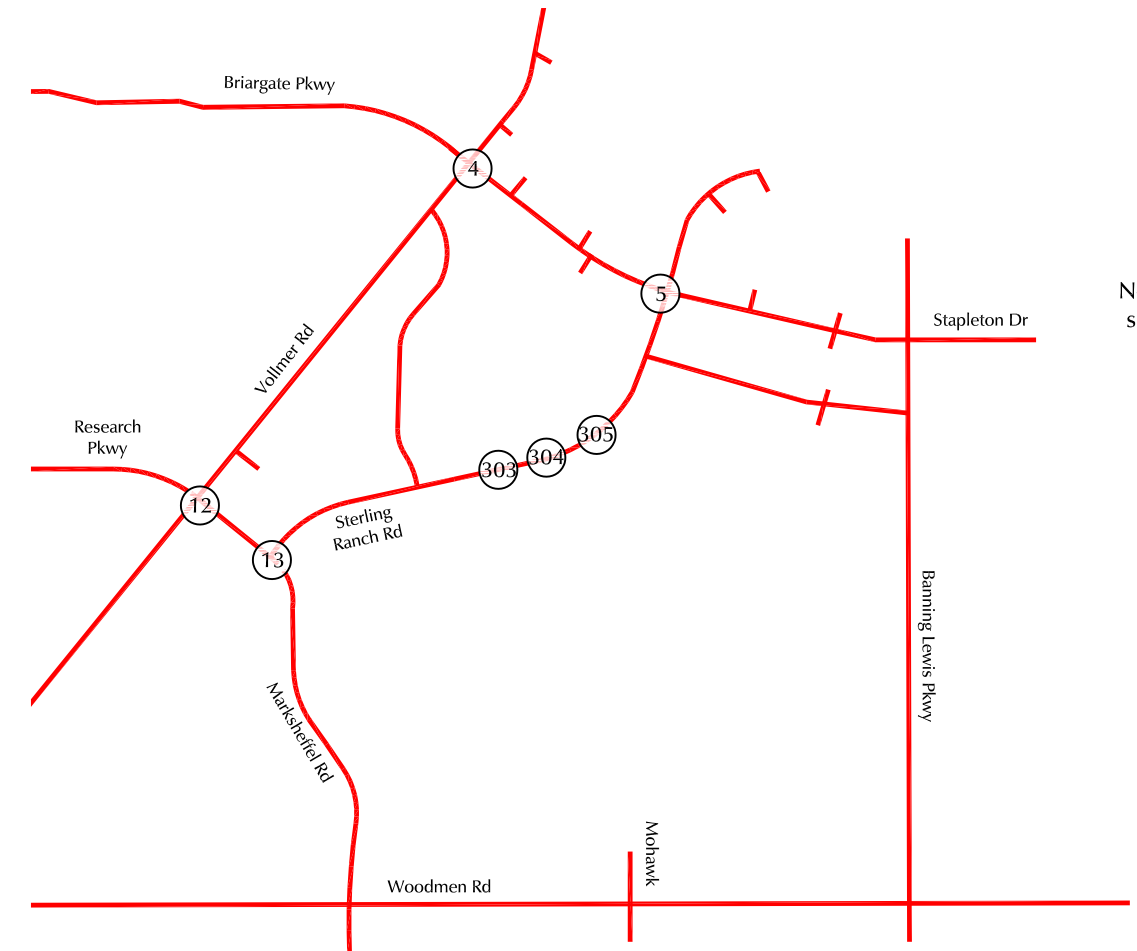
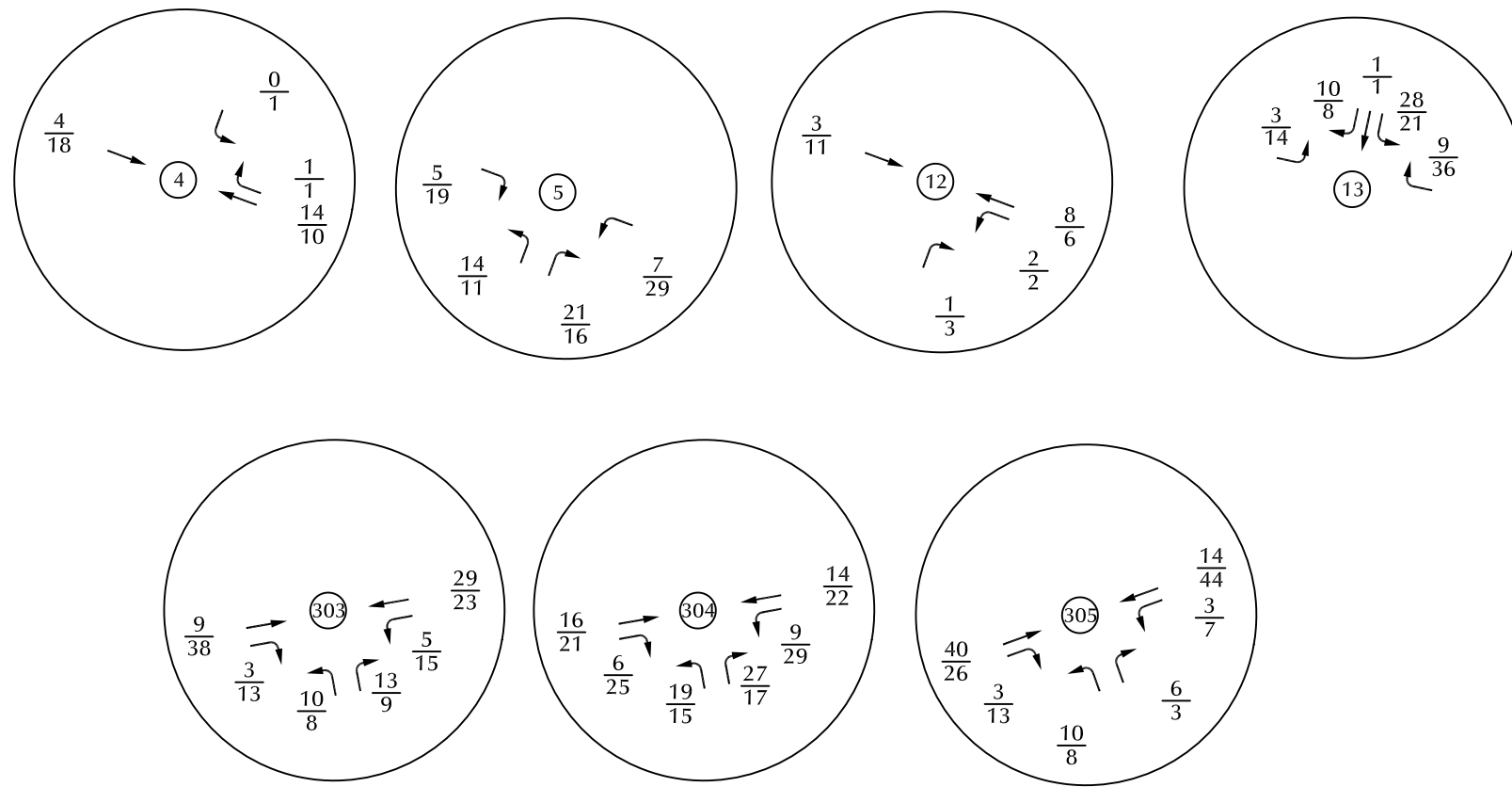
LEGEND: **XXX** = Average Weekday Traffic (vehicles per day)(AWT)

# Long-Term Site-Generated Average Weekday Traffic

Sterling Ranch East Filing No. 3 (LSC# S244270)



Figure 10a

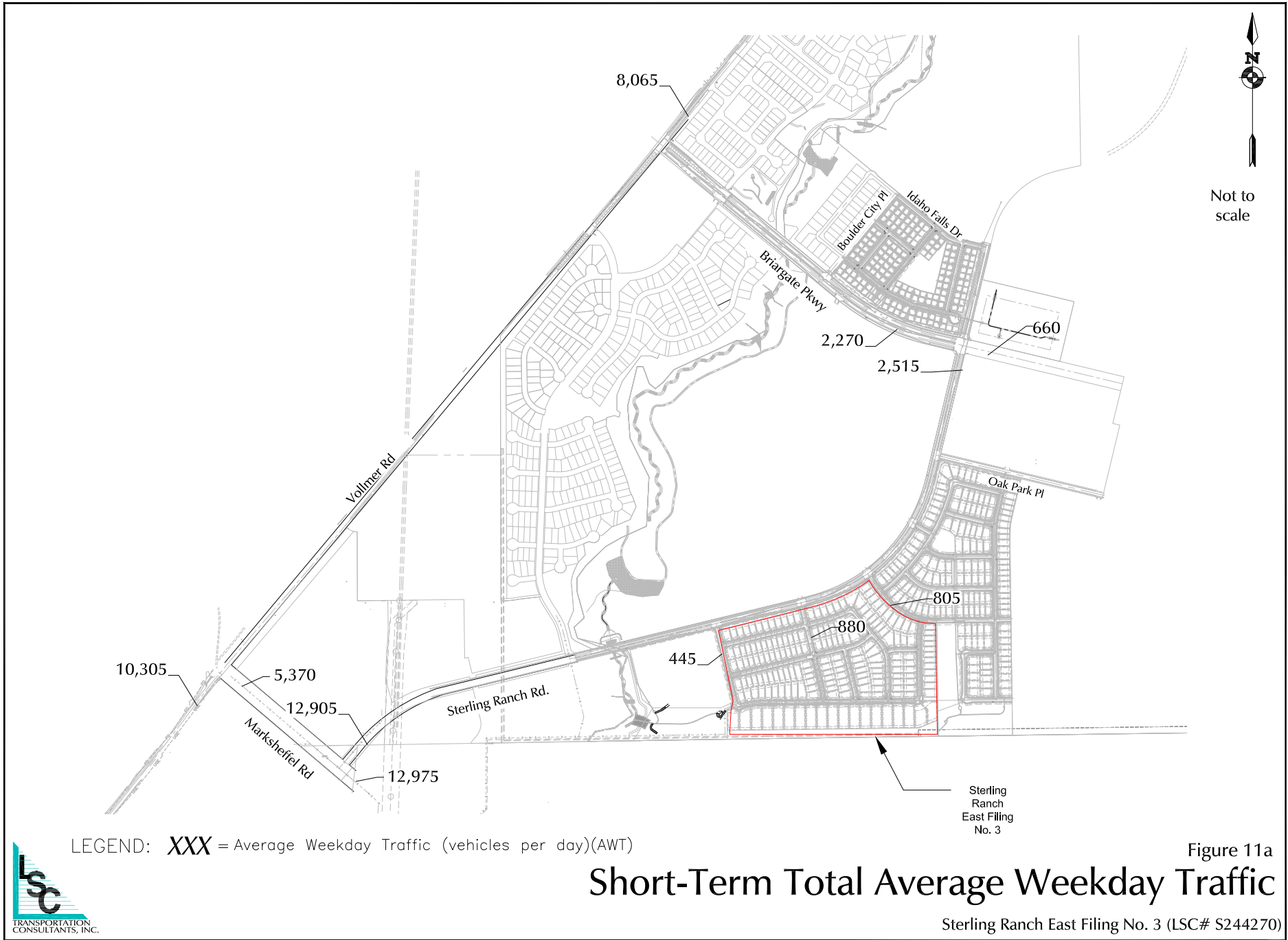


LEGEND:  $\frac{XX}{XX} = \frac{\text{AM Peak-Hour Traffic (veh/hr)}}{\text{PM Peak-Hour Traffic (veh/hr)}}$



Figure 10b  
Long-Term Site-Generated Traffic

Sterling Ranch East Filing No. 3 (LSC# S244270)

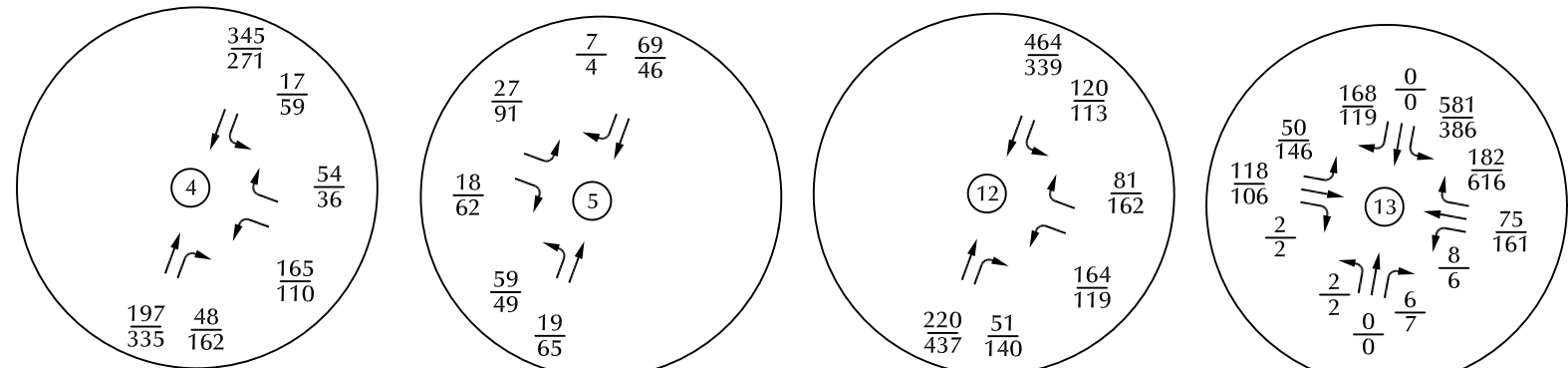


Not to scale

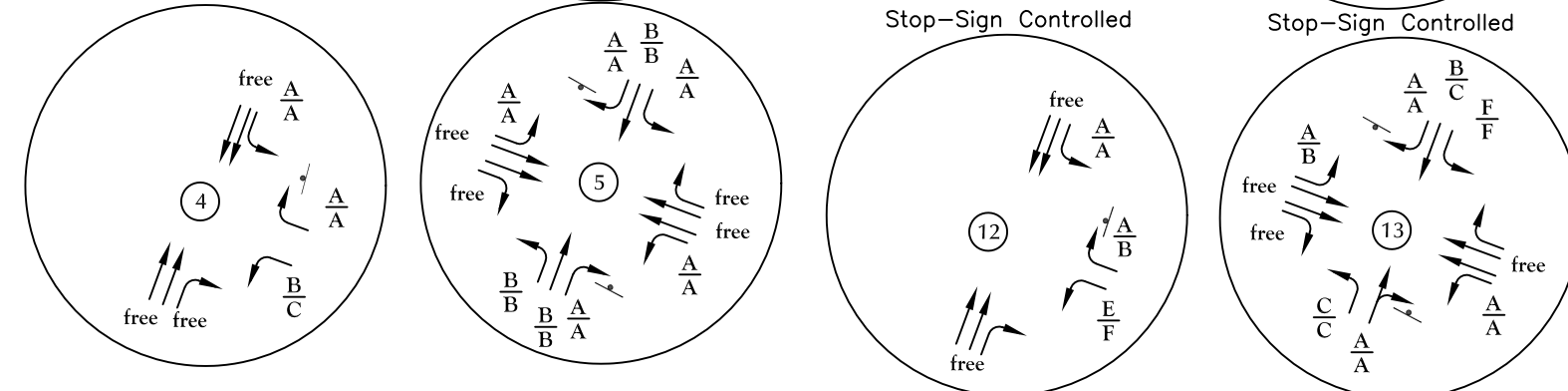


Figure 11a  
**Short-Term Total Average Weekday Traffic**

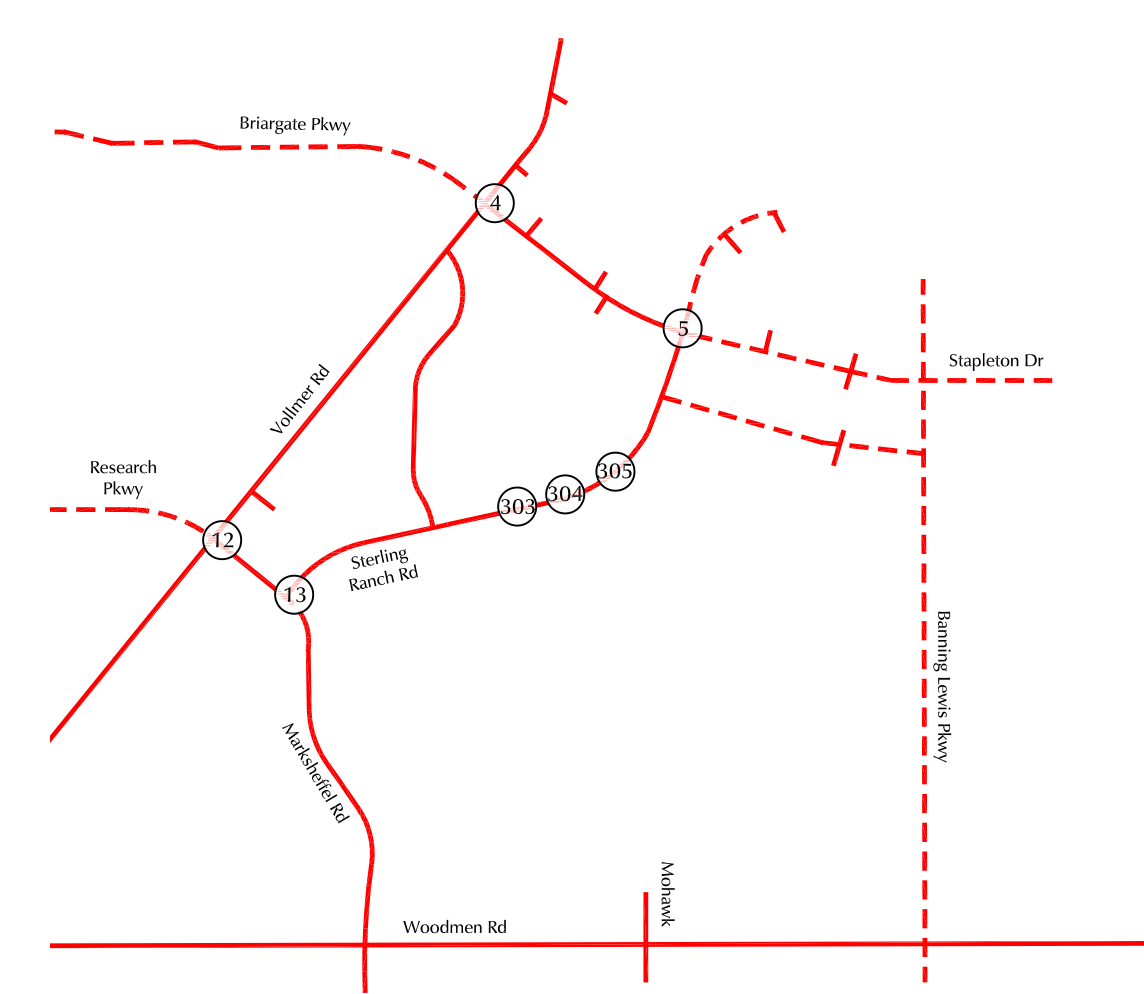
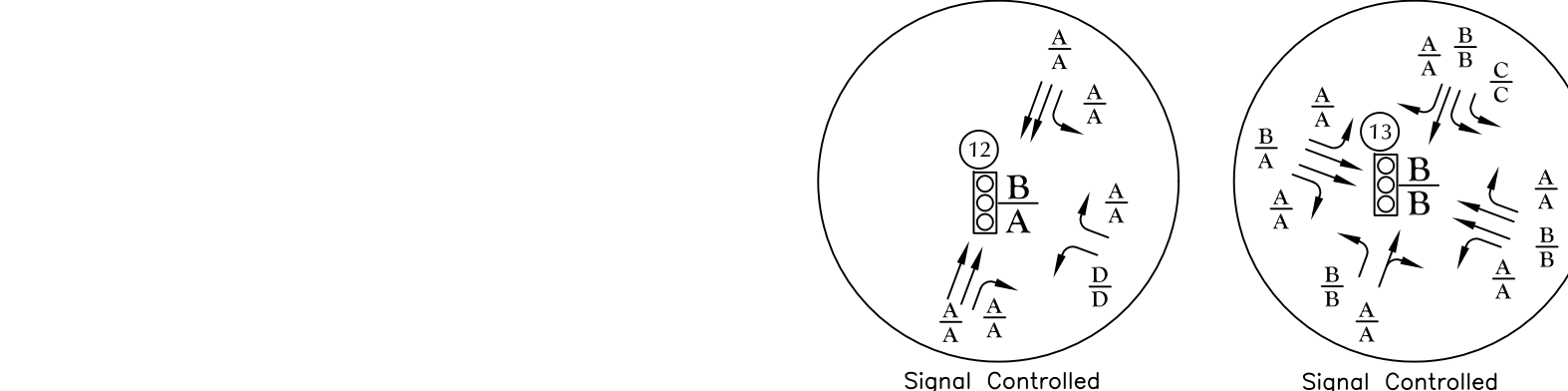
Sterling Ranch East Filing No. 3 (LSC# S244270)



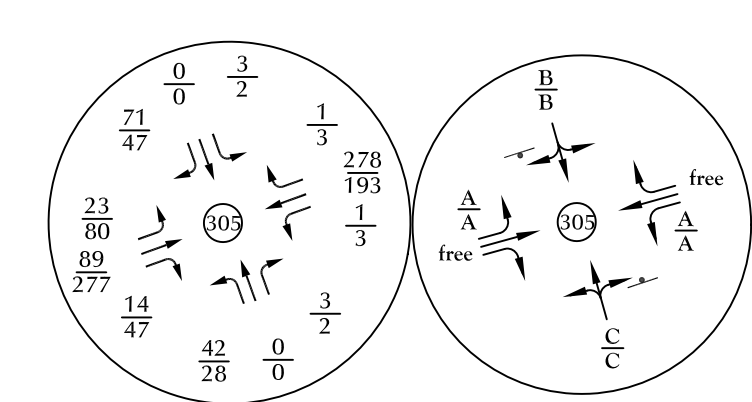
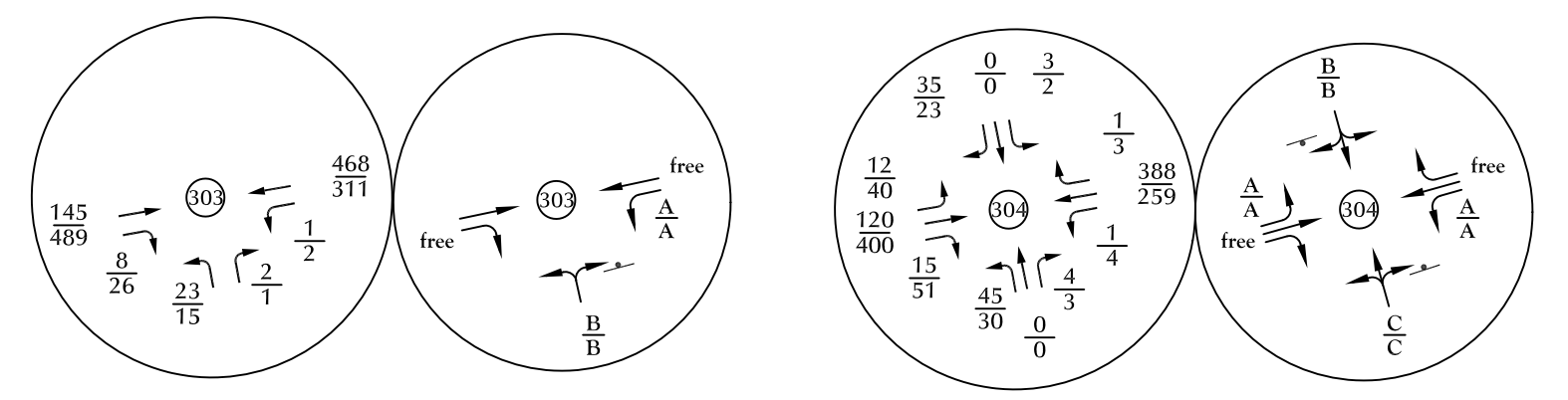
Stop-Sign Controlled      Stop-Sign Controlled



Signal Controlled      Signal Controlled



North arrow and 'Not to scale' text.



LEGEND:  $\frac{XX}{XX}$  = AM Peak-Hour Traffic (veh/hr) / PM Peak-Hour Traffic (veh/hr)

$\frac{A}{B}$  = AM Individual Movement Peak-Hour Level of Service / PM Individual Movement Peak-Hour Level of Service  
 $\frac{C}{D}$  = AM Entire Intersection Peak-Hour Level of Service / PM Entire Intersection Peak-Hour Level of Service

Yield Sign  
 Stop Sign  
 Traffic Signal



Figure 11b  
**Short-Term Total Traffic Conditions**  
 Sterling Ranch East Filing No. 3 (LSC# S244270)



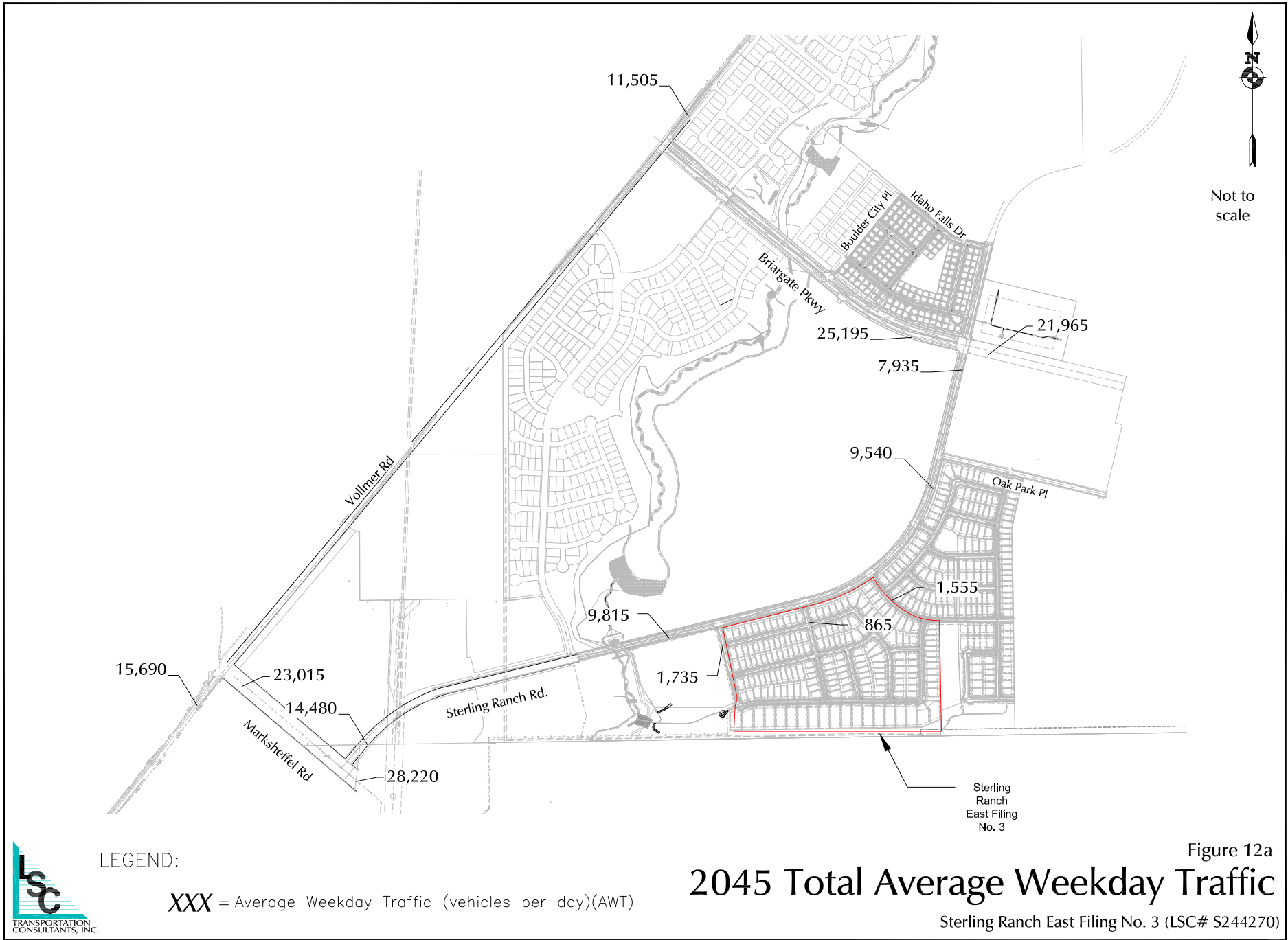


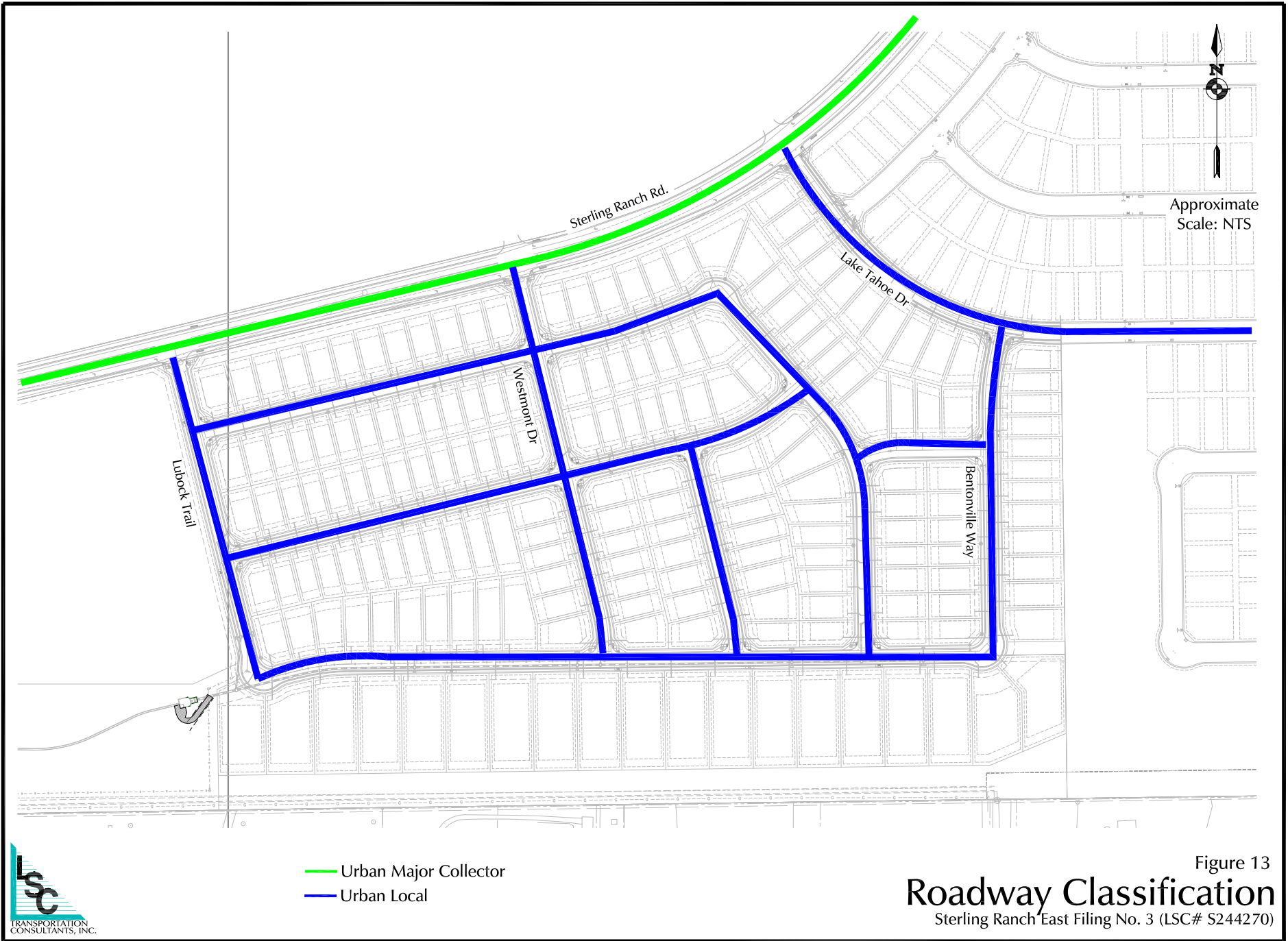
Figure 12a  
**2045 Total Average Weekday Traffic**

Sterling Ranch East Filing No. 3 (LSC# S244270)



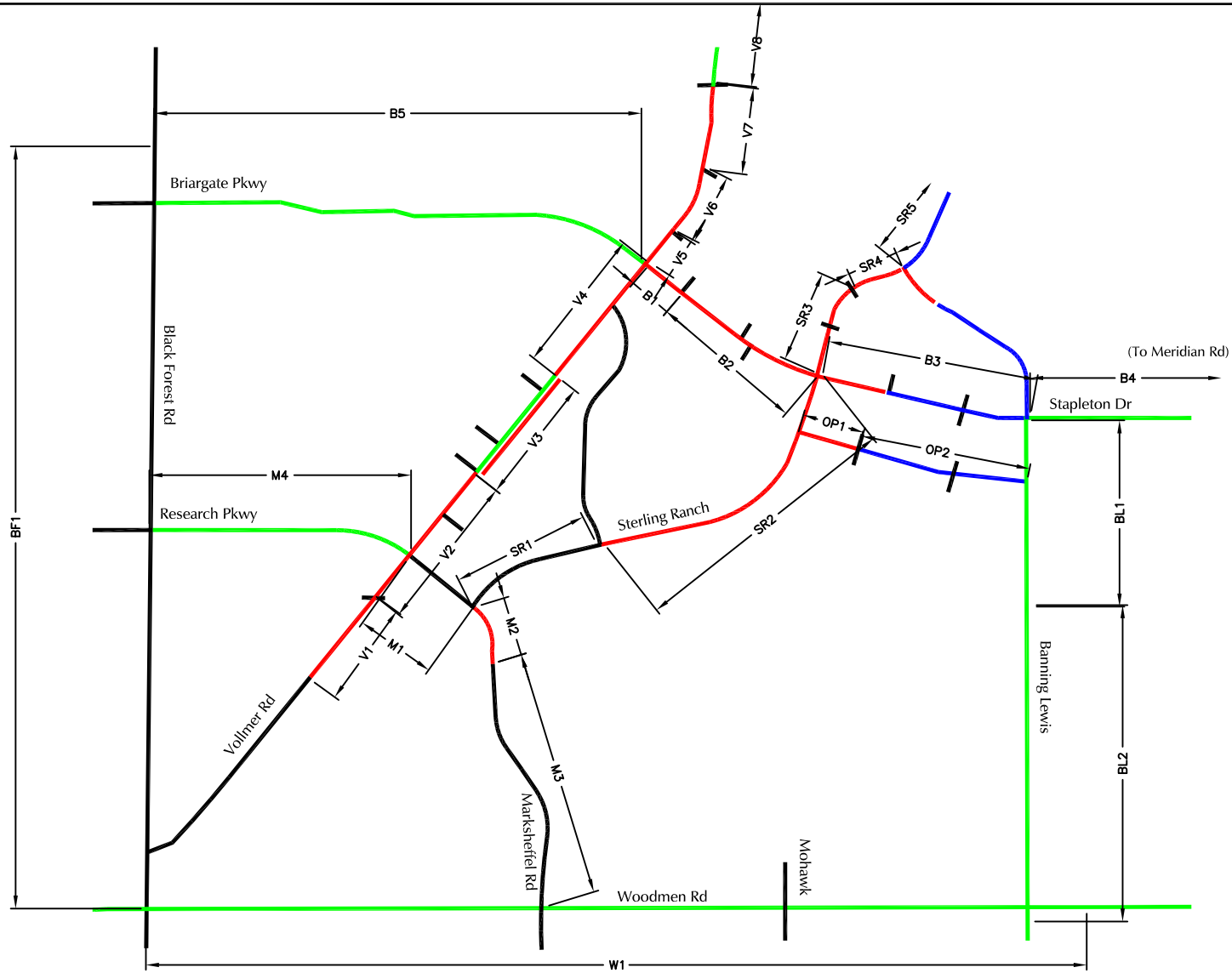








Not to scale



V1, B4, SR3, etc - Segment Identifier\*

- Short-Term
- Intermediate-Term
- Long-Term

\*See Table 6 for recommended roadway segment improvements for each segment.

# Roadway Improvement Segments\*

Figure 14

Sterling Ranch East Filing No. 3 (LSC# S244270)



# Figures 1-14

---



# Traffic Counts

---



# LSC Transportation Consultants, Inc.

2504 E. Pikes Peak Ave, Suite 304  
 Colorado Springs, CO 80909  
 719-633-2868

File Name : Vollmer Rd - Burgess Rd AM 3-6-24

Site Code : S224580

Start Date : 3/6/2024

Page No : 1

Start Time	Vollmer Rd Southbound					Burgess Rd Westbound					Vollmer Rd Northbound					Burgess Rd Eastbound					Int. Total
	Right	Thru	Left	Peds	App. Total	Right	Thru	Left	Peds	App. Total	Right	Thru	Left	Peds	App. Total	Right	Thru	Left	Peds	App. Total	
06:30	1	7	0	0	8	10	16	3	0	29	1	2	0	0	3	0	0	0	0	0	40
06:35	0	5	3	0	8	4	16	5	0	25	0	1	0	0	1	3	3	0	0	6	40
06:40	1	5	0	0	6	4	12	1	0	17	1	5	0	0	6	0	6	0	0	6	35
06:45	0	0	3	0	3	5	19	4	0	28	3	2	0	0	5	1	4	1	0	6	42
06:50	1	2	1	0	4	9	13	5	0	27	0	2	0	0	2	0	2	0	0	2	35
06:55	4	2	2	0	8	4	10	8	0	22	2	0	2	0	4	0	4	0	0	4	38
<b>Total</b>	<b>7</b>	<b>21</b>	<b>9</b>	<b>0</b>	<b>37</b>	<b>36</b>	<b>86</b>	<b>26</b>	<b>0</b>	<b>148</b>	<b>7</b>	<b>12</b>	<b>2</b>	<b>0</b>	<b>21</b>	<b>4</b>	<b>19</b>	<b>1</b>	<b>0</b>	<b>24</b>	<b>230</b>
07:00	0	0	1	0	1	11	30	4	0	45	2	3	3	0	8	1	4	0	0	5	59
07:05	2	1	0	0	3	7	25	4	0	36	2	8	2	0	12	0	4	0	0	4	55
07:10	1	15	2	0	18	9	27	5	0	41	2	3	1	0	6	1	3	0	0	4	69
07:15	2	1	1	0	4	5	27	7	0	39	1	5	2	0	8	0	2	0	0	2	53
07:20	1	5	3	0	9	14	17	2	0	33	1	7	1	0	9	1	5	1	0	7	58
07:25	2	5	6	0	13	12	19	5	0	36	2	2	0	0	4	0	3	0	0	3	56
07:30	2	1	1	0	4	10	28	5	0	43	2	2	1	0	5	0	6	0	0	6	58
07:35	2	12	0	0	14	7	22	9	0	38	4	4	0	0	8	0	6	1	0	7	67
07:40	4	5	3	0	12	6	28	9	0	43	5	2	1	0	8	2	5	1	0	8	71
07:45	1	4	3	0	8	14	28	8	0	50	1	1	3	0	5	1	7	0	0	8	71
07:50	3	8	5	0	16	8	12	9	0	29	2	3	1	0	6	1	5	1	0	7	58
07:55	2	1	3	0	6	7	23	4	0	34	7	5	1	0	13	2	5	0	0	7	60
<b>Total</b>	<b>22</b>	<b>58</b>	<b>28</b>	<b>0</b>	<b>108</b>	<b>110</b>	<b>286</b>	<b>71</b>	<b>0</b>	<b>467</b>	<b>31</b>	<b>45</b>	<b>16</b>	<b>0</b>	<b>92</b>	<b>9</b>	<b>55</b>	<b>4</b>	<b>0</b>	<b>68</b>	<b>735</b>
08:00	2	1	0	0	3	3	16	1	0	20	4	4	1	0	9	3	11	2	0	16	48
08:05	1	7	1	0	9	7	17	0	0	24	5	6	0	0	11	1	1	2	0	4	48
08:10	1	6	3	0	10	6	18	3	0	27	2	3	3	0	8	0	4	0	0	4	49
08:15	3	3	0	0	6	8	10	2	0	20	2	3	1	0	6	0	1	1	0	2	34
08:20	3	9	4	0	16	5	19	4	0	28	3	7	1	0	11	1	3	3	0	7	62
08:25	4	7	5	0	16	4	8	2	0	14	3	6	1	0	10	1	4	3	0	8	48
<b>Grand Total</b>	<b>43</b>	<b>112</b>	<b>50</b>	<b>0</b>	<b>205</b>	<b>179</b>	<b>460</b>	<b>109</b>	<b>0</b>	<b>748</b>	<b>57</b>	<b>86</b>	<b>25</b>	<b>0</b>	<b>168</b>	<b>19</b>	<b>98</b>	<b>16</b>	<b>0</b>	<b>133</b>	<b>1254</b>
<b>Apprch %</b>	<b>21</b>	<b>54.6</b>	<b>24.4</b>	<b>0</b>		<b>23.9</b>	<b>61.5</b>	<b>14.6</b>	<b>0</b>		<b>33.9</b>	<b>51.2</b>	<b>14.9</b>	<b>0</b>		<b>14.3</b>	<b>73.7</b>	<b>12</b>	<b>0</b>		
<b>Total %</b>	<b>3.4</b>	<b>8.9</b>	<b>4</b>	<b>0</b>	<b>16.3</b>	<b>14.3</b>	<b>36.7</b>	<b>8.7</b>	<b>0</b>	<b>59.6</b>	<b>4.5</b>	<b>6.9</b>	<b>2</b>	<b>0</b>	<b>13.4</b>	<b>1.5</b>	<b>7.8</b>	<b>1.3</b>	<b>0</b>	<b>10.6</b>	

# LSC Transportation Consultants, Inc.

2504 E. Pikes Peak Ave, Suite 304  
 Colorado Springs, CO 80909  
 719-633-2868

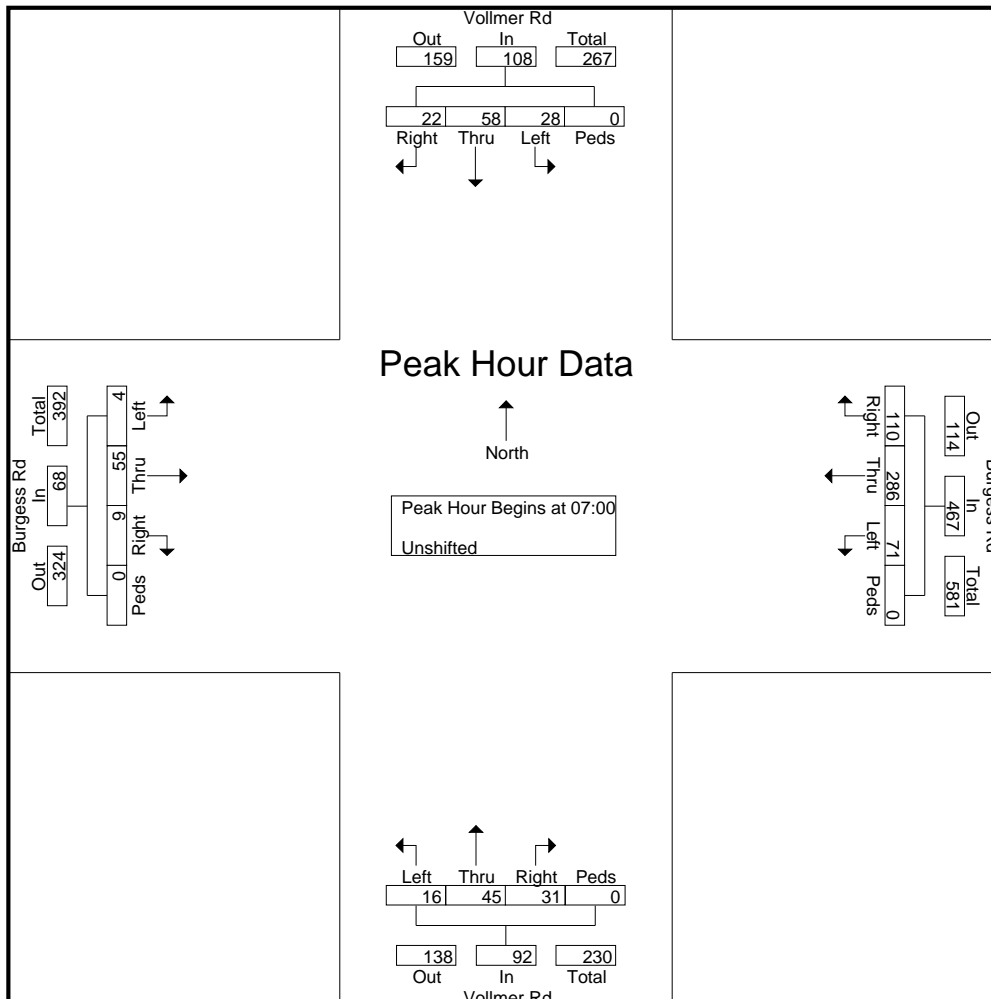
File Name : Vollmer Rd - Burgess Rd AM 3-6-24

Site Code : S224580

Start Date : 3/6/2024

Page No : 2

Start Time	Vollmer Rd Southbound					Burgess Rd Westbound					Vollmer Rd Northbound					Burgess Rd Eastbound					Int. Total
	Right	Thru	Left	Peds	App. Total	Right	Thru	Left	Peds	App. Total	Right	Thru	Left	Peds	App. Total	Right	Thru	Left	Peds	App. Total	
Peak Hour Analysis From 06:30 to 08:25 - Peak 1 of 1																					
Peak Hour for Entire Intersection Begins at 07:00																					
07:00	0	0	1	0	1	11	<b>30</b>	4	0	45	2	3	<b>3</b>	0	8	1	4	0	0	5	59
07:05	2	1	0	0	3	7	25	4	0	36	2	<b>8</b>	2	0	12	0	4	0	0	4	55
07:10	1	<b>15</b>	2	0	<b>18</b>	9	27	5	0	41	2	3	1	0	6	1	3	0	0	4	69
07:15	2	1	1	0	4	5	27	7	0	39	1	5	2	0	8	0	2	0	0	2	53
07:20	1	5	3	0	9	<b>14</b>	17	2	0	33	1	7	1	0	9	1	5	<b>1</b>	0	7	58
07:25	2	5	<b>6</b>	0	13	12	19	5	0	36	2	2	0	0	4	0	3	0	0	3	56
07:30	2	1	1	0	4	10	28	5	0	43	2	2	1	0	5	0	6	0	0	6	58
07:35	2	12	0	0	14	7	22	<b>9</b>	0	38	4	4	0	0	8	0	6	1	0	7	67
07:40	<b>4</b>	5	3	0	12	6	28	9	0	43	5	2	1	0	8	<b>2</b>	5	1	0	<b>8</b>	<b>71</b>
07:45	1	4	3	0	8	14	28	8	0	<b>50</b>	1	1	3	0	5	1	<b>7</b>	0	0	8	71
07:50	3	8	5	0	16	8	12	9	0	29	2	3	1	0	6	1	5	1	0	7	58
07:55	2	1	3	0	6	7	23	4	0	34	<b>7</b>	5	1	0	<b>13</b>	2	5	0	0	7	60
Total Volume	22	58	28	0	108	110	286	71	0	467	31	45	16	0	92	9	55	4	0	68	735
% App. Total	20.4	53.7	25.9	0		23.6	61.2	15.2	0		33.7	48.9	17.4	0		13.2	80.9	5.9	0		
PHF	.458	.322	.389	.000	.500	.655	.794	.657	.000	.778	.369	.469	.444	.000	.590	.375	.655	.333	.000	.708	.863



# LSC Transportation Consultants, Inc.

2504 E. Pikes Peak Ave, Suite 304  
 Colorado Springs, CO 80909  
 719-633-2868

File Name : Vollmer Rd - Burgess Rd PM 3-5-24

Site Code : S224580

Start Date : 3/5/2024

Page No : 1

Start Time	Vollmer Rd Southbound					Burgess Rd Westbound					Vollmer Rd Northbound					Burgess Rd Eastbound					Int. Total
	Right	Thru	Left	Peds	App. Total	Right	Thru	Left	Peds	App. Total	Right	Thru	Left	Peds	App. Total	Right	Thru	Left	Peds	App. Total	
16:00	1	8	13	0	22	4	8	4	0	16	4	1	2	0	7	5	15	1	0	21	66
16:05	3	4	6	0	13	4	9	2	0	15	9	5	1	0	15	4	19	1	0	24	67
16:10	1	4	9	0	14	7	7	3	0	17	6	3	2	0	11	1	12	2	0	15	57
16:15	0	6	13	0	19	4	5	1	0	10	3	7	3	0	13	1	18	4	0	23	65
16:20	3	8	8	0	19	2	13	5	0	20	4	8	1	0	13	0	21	1	0	22	74
16:25	1	9	17	0	27	3	9	1	0	13	5	7	1	0	13	2	17	0	0	19	72
16:30	0	7	6	0	13	5	8	0	0	13	5	3	1	0	9	0	19	1	0	20	55
16:35	4	4	11	0	19	4	7	3	0	14	2	6	2	0	10	0	19	1	0	20	63
16:40	1	4	7	0	12	2	11	1	0	14	5	6	0	0	11	1	25	0	0	26	63
16:45	0	6	5	0	11	1	9	2	0	12	8	9	0	0	17	2	19	0	0	21	61
16:50	0	5	14	0	19	4	12	6	0	22	6	8	0	0	14	1	22	1	0	24	79
16:55	2	2	9	0	13	2	8	0	0	10	4	8	1	0	13	1	14	0	0	15	51
<b>Total</b>	<b>16</b>	<b>67</b>	<b>118</b>	<b>0</b>	<b>201</b>	<b>42</b>	<b>106</b>	<b>28</b>	<b>0</b>	<b>176</b>	<b>61</b>	<b>71</b>	<b>14</b>	<b>0</b>	<b>146</b>	<b>18</b>	<b>220</b>	<b>12</b>	<b>0</b>	<b>250</b>	<b>773</b>
17:00	1	2	4	0	7	3	7	2	0	12	1	4	2	0	7	1	17	1	0	19	45
17:05	0	8	11	0	19	4	4	0	0	8	2	5	0	0	7	2	16	1	0	19	53
17:10	3	2	5	0	10	2	13	6	0	21	4	2	0	0	6	0	11	0	0	11	48
17:15	1	4	8	0	13	2	9	3	0	14	10	8	0	0	18	4	14	0	0	18	63
17:20	0	4	8	0	12	7	13	3	0	23	4	2	1	0	7	3	36	1	0	40	82
17:25	0	3	6	0	9	1	7	3	0	11	2	4	1	0	7	2	15	3	0	20	47
17:30	0	2	8	0	10	5	7	1	0	13	8	4	0	0	12	1	15	2	0	18	53
17:35	3	4	13	0	20	9	9	1	0	19	6	4	2	0	12	0	21	1	0	22	73
17:40	1	4	11	0	16	4	5	1	0	10	3	5	0	0	8	0	18	1	0	19	53
17:45	1	0	8	0	9	2	3	0	0	5	4	1	0	0	5	0	13	2	0	15	34
17:50	1	3	6	0	10	2	4	1	0	7	5	2	0	0	7	2	15	1	0	18	42
17:55	2	3	4	0	9	3	3	4	0	10	5	2	1	0	8	1	15	2	0	18	45
<b>Total</b>	<b>13</b>	<b>39</b>	<b>92</b>	<b>0</b>	<b>144</b>	<b>44</b>	<b>84</b>	<b>25</b>	<b>0</b>	<b>153</b>	<b>54</b>	<b>43</b>	<b>7</b>	<b>0</b>	<b>104</b>	<b>16</b>	<b>206</b>	<b>15</b>	<b>0</b>	<b>237</b>	<b>638</b>
<b>Grand Total</b>	<b>29</b>	<b>106</b>	<b>210</b>	<b>0</b>	<b>345</b>	<b>86</b>	<b>190</b>	<b>53</b>	<b>0</b>	<b>329</b>	<b>115</b>	<b>114</b>	<b>21</b>	<b>0</b>	<b>250</b>	<b>34</b>	<b>426</b>	<b>27</b>	<b>0</b>	<b>487</b>	<b>1411</b>
<b>Apprch %</b>	<b>8.4</b>	<b>30.7</b>	<b>60.9</b>	<b>0</b>		<b>26.1</b>	<b>57.8</b>	<b>16.1</b>	<b>0</b>		<b>46</b>	<b>45.6</b>	<b>8.4</b>	<b>0</b>		<b>7</b>	<b>87.5</b>	<b>5.5</b>	<b>0</b>		
<b>Total %</b>	<b>2.1</b>	<b>7.5</b>	<b>14.9</b>	<b>0</b>	<b>24.5</b>	<b>6.1</b>	<b>13.5</b>	<b>3.8</b>	<b>0</b>	<b>23.3</b>	<b>8.2</b>	<b>8.1</b>	<b>1.5</b>	<b>0</b>	<b>17.7</b>	<b>2.4</b>	<b>30.2</b>	<b>1.9</b>	<b>0</b>	<b>34.5</b>	



# LSC Transportation Consultants, Inc.

2504 E. Pikes Peak Ave, Suite 304  
 Colorado Springs, CO 80909  
 719-633-2868

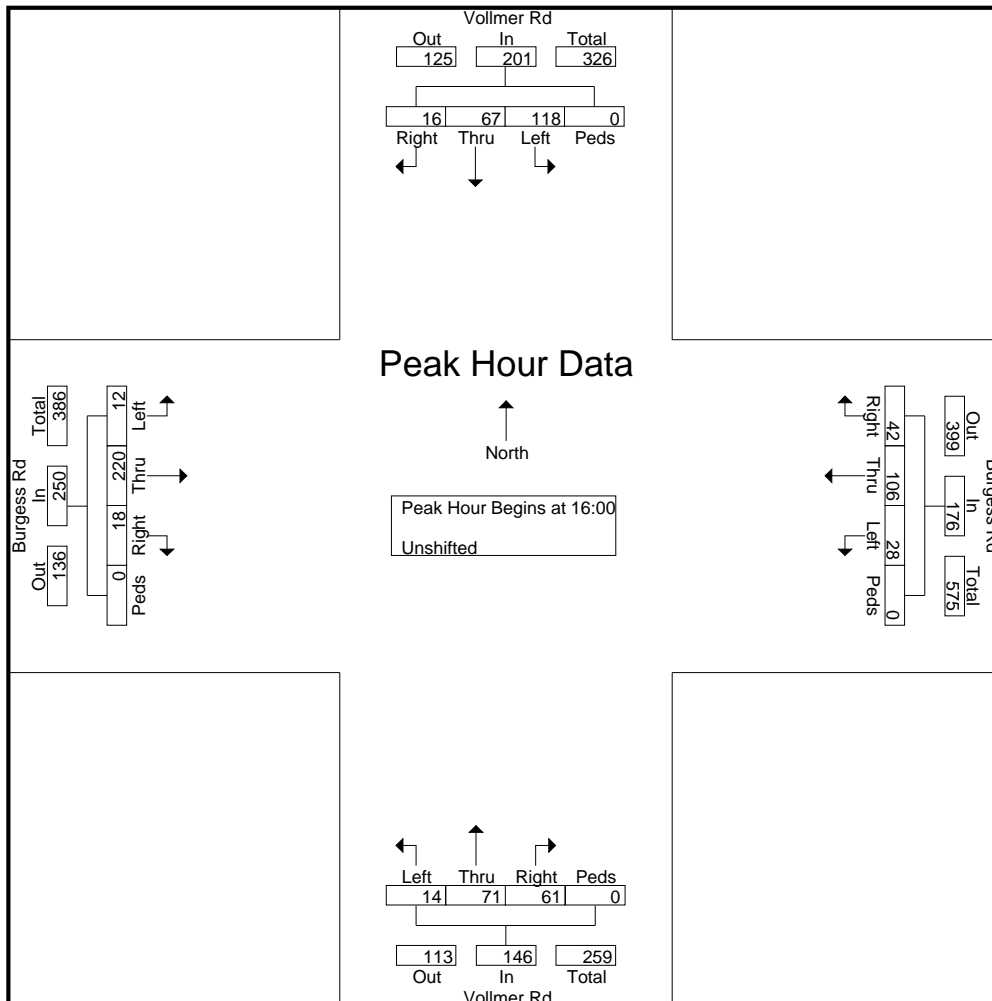
File Name : Vollmer Rd - Burgess Rd PM 3-5-24

Site Code : S224580

Start Date : 3/5/2024

Page No : 2

Start Time	Vollmer Rd Southbound					Burgess Rd Westbound					Vollmer Rd Northbound					Burgess Rd Eastbound					Int. Total
	Right	Thru	Left	Peds	App. Total	Right	Thru	Left	Peds	App. Total	Right	Thru	Left	Peds	App. Total	Right	Thru	Left	Peds	App. Total	
Peak Hour Analysis From 16:00 to 17:55 - Peak 1 of 1																					
Peak Hour for Entire Intersection Begins at 16:00																					
16:00	1	8	13	0	22	4	8	4	0	16	4	1	2	0	7	5	15	1	0	21	66
16:05	3	4	6	0	13	4	9	2	0	15	9	5	1	0	15	4	19	1	0	24	67
16:10	1	4	9	0	14	7	7	3	0	17	6	3	2	0	11	1	12	2	0	15	57
16:15	0	6	13	0	19	4	5	1	0	10	3	7	3	0	13	1	18	4	0	23	65
16:20	3	8	8	0	19	2	13	5	0	20	4	8	1	0	13	0	21	1	0	22	74
16:25	1	9	17	0	27	3	9	1	0	13	5	7	1	0	13	2	17	0	0	19	72
16:30	0	7	6	0	13	5	8	0	0	13	5	3	1	0	9	0	19	1	0	20	55
16:35	4	4	11	0	19	4	7	3	0	14	2	6	2	0	10	0	19	1	0	20	63
16:40	1	4	7	0	12	2	11	1	0	14	5	6	0	0	11	1	25	0	0	26	63
16:45	0	6	5	0	11	1	9	2	0	12	8	9	0	0	17	2	19	0	0	21	61
16:50	0	5	14	0	19	4	12	6	0	22	6	8	0	0	14	1	22	1	0	24	79
16:55	2	2	9	0	13	2	8	0	0	10	4	8	1	0	13	1	14	0	0	15	51
Total Volume	16	67	118	0	201	42	106	28	0	176	61	71	14	0	146	18	220	12	0	250	773
% App. Total	8	33.3	58.7	0		23.9	60.2	15.9	0		41.8	48.6	9.6	0		7.2	88	4.8	0		
PHF	.333	.620	.578	.000	.620	.500	.679	.389	.000	.667	.565	.657	.389	.000	.716	.300	.733	.250	.000	.801	.815





# LSC Transportation Consultants, Inc.

2504 E. Pikes Peak Ave, Suite 304  
 Colorado Springs, CO 80909  
 719-633-2868

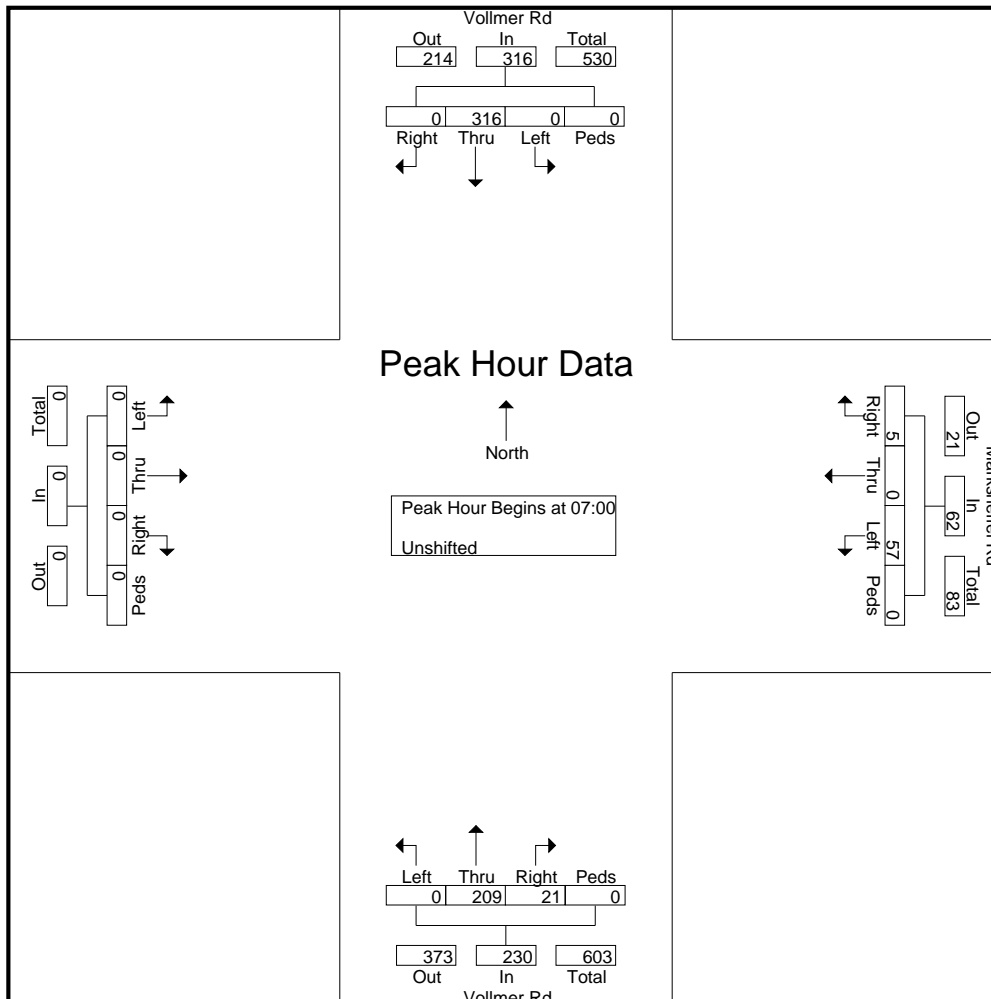
File Name : Vollmer Rd - Marksheffel Rd AM

Site Code : S224580

Start Date : 4/4/2024

Page No : 2

Start Time	Vollmer Rd Southbound					Marksheffel Rd Westbound					Vollmer Rd Northbound					Eastbound					Int. Total
	Right	Thru	Left	Peds	App. Total	Right	Thru	Left	Peds	App. Total	Right	Thru	Left	Peds	App. Total	Right	Thru	Left	Peds	App. Total	
Peak Hour Analysis From 06:30 to 08:25 - Peak 1 of 1																					
Peak Hour for Entire Intersection Begins at 07:00																					
07:00	0	20	0	0	20	1	0	6	0	7	2	16	0	0	18	0	0	0	0	0	45
07:05	0	28	0	0	28	1	0	5	0	6	5	17	0	0	22	0	0	0	0	0	56
07:10	0	25	0	0	25	1	0	4	0	5	1	20	0	0	21	0	0	0	0	0	51
07:15	0	22	0	0	22	0	0	5	0	5	1	11	0	0	12	0	0	0	0	0	39
07:20	0	37	0	0	37	0	0	4	0	4	0	12	0	0	12	0	0	0	0	0	53
07:25	0	32	0	0	32	0	0	4	0	4	0	13	0	0	13	0	0	0	0	0	49
07:30	0	28	0	0	28	0	0	6	0	6	0	17	0	0	17	0	0	0	0	0	51
07:35	0	31	0	0	31	1	0	3	0	4	0	16	0	0	16	0	0	0	0	0	51
07:40	0	23	0	0	23	1	0	4	0	5	2	22	0	0	24	0	0	0	0	0	52
07:45	0	22	0	0	22	0	0	9	0	9	1	19	0	0	20	0	0	0	0	0	51
07:50	0	27	0	0	27	0	0	5	0	5	4	16	0	0	20	0	0	0	0	0	52
07:55	0	21	0	0	21	0	0	2	0	2	5	30	0	0	35	0	0	0	0	0	58
Total Volume	0	316	0	0	316	5	0	57	0	62	21	209	0	0	230	0	0	0	0	0	608
% App. Total	0	100	0	0		8.1	0	91.9	0		9.1	90.9	0	0		0	0	0	0		
PHF	.000	.712	.000	.000	.712	.417	.000	.528	.000	.574	.350	.581	.000	.000	.548	.000	.000	.000	.000	.000	.874



# LSC Transportation Consultants, Inc.

2504 E. Pikes Peak Ave, Suite 304  
 Colorado Springs, CO 80909  
 719-633-2868

File Name : Vollmer Rd - Marksheffel Rd PM

Site Code : S224580

Start Date : 4/4/2024

Page No : 1

Start Time	Vollmer Rd Southbound					Marksheffel Rd Westbound					Vollmer Rd Northbound					Eastbound					Int. Total
	Right	Thru	Left	Peds	App. Total	Right	Thru	Left	Peds	App. Total	Right	Thru	Left	Peds	App. Total	Right	Thru	Left	Peds	App. Total	
16:00	0	26	0	0	26	0	0	0	0	0	1	22	0	0	23	0	0	0	0	0	49
16:05	0	20	0	0	20	0	0	1	0	1	3	25	0	0	28	0	0	0	0	0	49
16:10	0	21	0	0	21	0	0	4	0	4	6	23	0	0	29	0	0	0	0	0	54
16:15	0	21	1	0	22	0	0	4	0	4	4	24	0	0	28	0	0	0	0	0	54
16:20	0	16	0	0	16	1	0	1	0	2	2	26	0	0	28	0	0	0	0	0	46
16:25	0	26	0	0	26	0	0	6	0	6	2	13	0	0	15	0	0	0	0	0	47
16:30	0	24	0	0	24	0	0	3	0	3	3	22	0	0	25	0	0	0	0	0	52
16:35	0	19	0	0	19	0	0	2	0	2	1	29	0	0	30	0	0	0	0	0	51
16:40	0	23	0	0	23	0	0	3	0	3	4	23	0	0	27	0	0	0	0	0	53
16:45	0	22	1	0	23	0	0	6	0	6	6	22	0	0	28	0	0	0	0	0	57
16:50	0	24	0	0	24	0	0	3	0	3	5	26	0	0	31	0	0	0	0	0	58
16:55	0	18	0	0	18	0	0	5	0	5	2	24	0	0	26	0	0	0	0	0	49
Total	0	260	2	0	262	1	0	38	0	39	39	279	0	0	318	0	0	0	0	0	619
17:00	0	29	0	0	29	0	0	6	0	6	3	20	0	0	23	0	0	0	0	0	58
17:05	0	23	0	0	23	0	0	4	0	4	7	22	0	0	29	0	0	0	0	0	56
17:10	0	8	1	0	9	0	0	1	0	1	4	17	0	0	21	0	0	0	0	0	31
17:15	0	19	0	0	19	0	0	4	0	4	4	16	0	0	20	0	0	0	0	0	43
17:20	0	30	0	0	30	0	0	1	0	1	5	14	0	0	19	0	0	0	0	0	50
17:25	0	16	0	0	16	0	0	2	0	2	3	26	0	0	29	0	0	0	0	0	47
17:30	0	14	0	0	14	0	0	0	0	0	0	18	0	0	18	0	0	0	0	0	32
17:35	0	18	0	0	18	0	0	3	0	3	4	27	0	0	31	0	0	0	0	0	52
17:40	0	17	0	0	17	0	0	4	0	4	3	14	0	0	17	0	0	0	0	0	38
17:45	0	16	0	0	16	0	0	3	0	3	9	19	0	0	28	0	0	0	0	0	47
17:50	0	14	0	0	14	0	0	3	0	3	2	22	0	0	24	0	0	0	0	0	41
17:55	0	17	0	0	17	0	0	3	0	3	3	27	0	0	30	0	0	0	0	0	50
Total	0	221	1	0	222	0	0	34	0	34	47	242	0	0	289	0	0	0	0	0	545
Grand Total	0	481	3	0	484	1	0	72	0	73	86	521	0	0	607	0	0	0	0	0	1164
Apprch %	0	99.4	0.6	0		1.4	0	98.6	0		14.2	85.8	0	0		0	0	0	0		
Total %	0	41.3	0.3	0	41.6	0.1	0	6.2	0	6.3	7.4	44.8	0	0	52.1	0	0	0	0	0	

# LSC Transportation Consultants, Inc.

2504 E. Pikes Peak Ave, Suite 304  
 Colorado Springs, CO 80909  
 719-633-2868

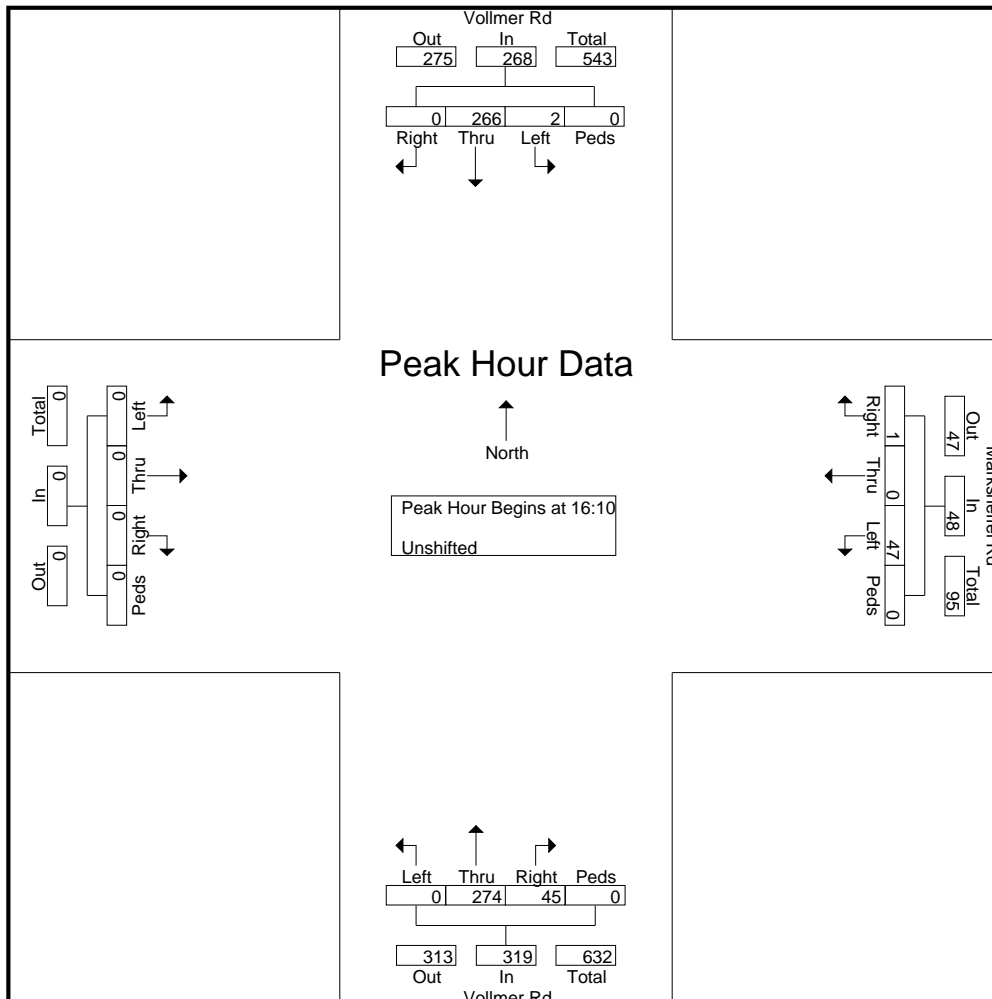
File Name : Vollmer Rd - Marksheffel Rd PM

Site Code : S224580

Start Date : 4/4/2024

Page No : 2

Start Time	Vollmer Rd Southbound					Marksheffel Rd Westbound					Vollmer Rd Northbound					Eastbound					Int. Total
	Right	Thru	Left	Peds	App. Total	Right	Thru	Left	Peds	App. Total	Right	Thru	Left	Peds	App. Total	Right	Thru	Left	Peds	App. Total	
Peak Hour Analysis From 16:00 to 17:55 - Peak 1 of 1																					
Peak Hour for Entire Intersection Begins at 16:10																					
16:10	0	21	0	0	21	0	0	4	0	4	6	23	0	0	29	0	0	0	0	0	54
16:15	0	21	1	0	22	0	0	4	0	4	4	24	0	0	28	0	0	0	0	0	54
16:20	0	16	0	0	16	1	0	1	0	2	2	26	0	0	28	0	0	0	0	0	46
16:25	0	26	0	0	26	0	0	6	0	6	2	13	0	0	15	0	0	0	0	0	47
16:30	0	24	0	0	24	0	0	3	0	3	3	22	0	0	25	0	0	0	0	0	52
16:35	0	19	0	0	19	0	0	2	0	2	1	29	0	0	30	0	0	0	0	0	51
16:40	0	23	0	0	23	0	0	3	0	3	4	23	0	0	27	0	0	0	0	0	53
16:45	0	22	1	0	23	0	0	6	0	6	6	22	0	0	28	0	0	0	0	0	57
16:50	0	24	0	0	24	0	0	3	0	3	5	26	0	0	31	0	0	0	0	0	58
16:55	0	18	0	0	18	0	0	5	0	5	2	24	0	0	26	0	0	0	0	0	49
17:00	0	29	0	0	29	0	0	6	0	6	3	20	0	0	23	0	0	0	0	0	58
17:05	0	23	0	0	23	0	0	4	0	4	7	22	0	0	29	0	0	0	0	0	56
Total Volume	0	266	2	0	268	1	0	47	0	48	45	274	0	0	319	0	0	0	0	0	635
% App. Total	0	99.3	0.7	0		2.1	0	97.9	0		14.1	85.9	0	0		0	0	0	0		
PHF	.000	.764	.167	.000	.770	.083	.000	.653	.000	.667	.536	.787	.000	.000	.858	.000	.000	.000	.000	.000	.912



Vollmer Road North of Marksheffel Road

Site Code: 00244080

Station ID:

Location 1:

Location 2:

Location 3:

Location 4:

Comment 1:

Comment 2:

Comment 3:

Comment 4:

Latitude: 0.000000

Longitude: 0.000000

4/2/2024	NB	SB	Total
Time			
12:00 AM	*	*	0
1:00	*	*	0
2:00	*	*	0
3:00	*	*	0
4:00	*	*	0
5:00	*	*	0
6:00	*	*	0
7:00	*	*	0
8:00	*	*	0
9:00	*	*	0
10:00	*	*	0
11:00	*	*	0
12:00 PM	*	*	0
1:00	*	*	0
2:00	*	*	0
3:00	197	159	356
4:00	232	174	406
5:00	208	173	381
6:00	175	107	282
7:00	116	83	199
8:00	91	32	123
9:00	61	20	81
10:00	43	10	53
11:00	13	2	15
Total	1136	760	1896
Percent	59.9%	40.1%	
AM Peak			
Volume			
PM Peak	4:00	4:00	4:00
Volume	232	174	406

Vollmer Road North of Marksheffel Road

Site Code: 00244080

Station ID:

Location 1:

Location 2:

Location 3:

Location 4:

Comment 1:

Comment 2:

Comment 3:

Comment 4:

Latitude: 0.000000

Longitude: 0.000000

4/3/2024	NB	SB	Total
Time			
12:00 AM	7	2	9
1:00	1	5	6
2:00	1	2	3
3:00	5	9	14
4:00	8	20	28
5:00	13	51	64
6:00	88	149	237
7:00	164	333	497
8:00	182	209	391
9:00	141	184	325
10:00	127	159	286
11:00	143	192	335
12:00 PM	132	161	293
1:00	147	154	301
2:00	186	173	359
3:00	215	189	404
4:00	223	195	418
5:00	206	238	444
6:00	196	122	318
7:00	139	73	212
8:00	119	43	162
9:00	71	24	95
10:00	32	10	42
11:00	13	6	19
Total	2559	2703	5262
Percent	48.6%	51.4%	
AM Peak	8:00	7:00	7:00
Volume	182	333	497
PM Peak	4:00	5:00	5:00
Volume	223	238	444

Vollmer Road North of Marksheffel Road

Site Code: 00244080

Station ID:

Location 1:

Location 2:

Location 3:

Location 4:

Comment 1:

Comment 2:

Comment 3:

Comment 4:

Latitude: 0.000000

Longitude: 0.000000

4/4/2024	NB	SB	Total
Time			
12:00 AM	9	5	14
1:00	3	1	4
2:00	1	0	1
3:00	3	4	7
4:00	4	15	19
5:00	10	45	55
6:00	78	152	230
7:00	169	302	471
8:00	191	210	401
9:00	144	171	315
10:00	136	165	301
11:00	197	191	388
12:00 PM	174	175	349
1:00	168	178	346
2:00	173	194	367
3:00	227	201	428
4:00	250	231	481
5:00	218	198	416
6:00	34	19	53
7:00	*	*	0
8:00	*	*	0
9:00	*	*	0
10:00	*	*	0
11:00	*	*	0
Total	2189	2457	4646
Percent	47.1%	52.9%	
AM Peak	11:00	7:00	7:00
Volume	197	302	471
PM Peak	4:00	4:00	4:00
Volume	250	231	481
Grand Total	5884	5920	11804
Percent	49.8%	50.2%	
ADT		ADT: 5,172	AADT: 5,172



# Level of Service Reports

---



Intersection						
Int Delay, s/veh	1.3					
Movement	WBL	WBR	NBT	NBR	SBL	SBT
Lane Configurations	↘	↗	↑↑	↗	↘	↑↑
Traffic Vol, veh/h	57	5	209	21	0	316
Future Vol, veh/h	57	5	209	21	0	316
Conflicting Peds, #/hr	0	0	0	0	0	0
Sign Control	Stop	Stop	Free	Free	Free	Free
RT Channelized	-	None	-	None	-	None
Storage Length	300	-	-	155	300	-
Veh in Median Storage, #	0	-	0	-	-	0
Grade, %	0	-	0	-	-	0
Peak Hour Factor	78	78	77	77	87	87
Heavy Vehicles, %	2	2	2	2	2	2
Mvmt Flow	73	6	271	27	0	363

Major/Minor	Minor1	Major1	Major2		
Conflicting Flow All	453	136	0	0	298
Stage 1	271	-	-	-	-
Stage 2	182	-	-	-	-
Critical Hdwy	6.84	6.94	-	-	4.14
Critical Hdwy Stg 1	5.84	-	-	-	-
Critical Hdwy Stg 2	5.84	-	-	-	-
Follow-up Hdwy	3.52	3.32	-	-	2.22
Pot Cap-1 Maneuver	535	888	-	-	1260
Stage 1	750	-	-	-	-
Stage 2	831	-	-	-	-
Platoon blocked, %			-	-	-
Mov Cap-1 Maneuver	535	888	-	-	1260
Mov Cap-2 Maneuver	535	-	-	-	-
Stage 1	750	-	-	-	-
Stage 2	831	-	-	-	-

Approach	WB	NB	SB
HCM Control Delay, s	12.5	0	0
HCM LOS	B		

Minor Lane/Major Mvmt	NBT	NBR	WBLn1	WBLn2	SBL	SBT
Capacity (veh/h)	-	-	535	888	1260	-
HCM Lane V/C Ratio	-	-	0.137	0.007	-	-
HCM Control Delay (s)	-	-	12.8	9.1	0	-
HCM Lane LOS	-	-	B	A	A	-
HCM 95th %tile Q(veh)	-	-	0.5	0	0	-

Intersection						
Int Delay, s/veh	1.2					
Movement	WBL	WBR	NBT	NBR	SBL	SBT
Lane Configurations						
Traffic Vol, veh/h	47	1	274	45	2	266
Future Vol, veh/h	47	1	274	45	2	266
Conflicting Peds, #/hr	0	0	0	0	0	0
Sign Control	Stop	Stop	Free	Free	Free	Free
RT Channelized	-	None	-	None	-	None
Storage Length	300	-	-	155	300	-
Veh in Median Storage, #	0	-	0	-	-	0
Grade, %	0	-	0	-	-	0
Peak Hour Factor	78	78	93	96	96	96
Heavy Vehicles, %	2	2	2	2	2	2
Mvmt Flow	60	1	295	47	2	277

Major/Minor	Minor1	Major1	Major2		
Conflicting Flow All	438	148	0	0	342
Stage 1	295	-	-	-	-
Stage 2	143	-	-	-	-
Critical Hdwy	6.84	6.94	-	-	4.14
Critical Hdwy Stg 1	5.84	-	-	-	-
Critical Hdwy Stg 2	5.84	-	-	-	-
Follow-up Hdwy	3.52	3.32	-	-	2.22
Pot Cap-1 Maneuver	547	872	-	-	1214
Stage 1	730	-	-	-	-
Stage 2	869	-	-	-	-
Platoon blocked, %			-	-	-
Mov Cap-1 Maneuver	546	872	-	-	1214
Mov Cap-2 Maneuver	546	-	-	-	-
Stage 1	730	-	-	-	-
Stage 2	867	-	-	-	-

Approach	WB	NB	SB
HCM Control Delay, s	12.3	0	0.1
HCM LOS	B		

Minor Lane/Major Mvmt	NBT	NBRWBLn1	WBLn2	SBL	SBT
Capacity (veh/h)	-	-	546	872	1214
HCM Lane V/C Ratio	-	-	0.11	0.001	0.002
HCM Control Delay (s)	-	-	12.4	9.1	8
HCM Lane LOS	-	-	B	A	A
HCM 95th %tile Q(veh)	-	-	0.4	0	0

Intersection						
Int Delay, s/veh	3.5					
Movement	WBL	WBR	NBT	NBR	SBL	SBT
Lane Configurations	↘	↗	↕↕	↗	↘	↕↕
Traffic Vol, veh/h	165	46	197	48	15	345
Future Vol, veh/h	165	46	197	48	15	345
Conflicting Peds, #/hr	0	0	0	0	0	0
Sign Control	Stop	Stop	Free	Free	Free	Free
RT Channelized	-	None	-	None	-	None
Storage Length	485	-	-	235	385	-
Veh in Median Storage, #	0	-	0	-	-	0
Grade, %	0	-	0	-	-	0
Peak Hour Factor	85	85	85	85	85	85
Heavy Vehicles, %	2	2	2	2	2	2
Mvmt Flow	194	54	232	56	18	406

Major/Minor	Minor1	Major1	Major2		
Conflicting Flow All	471	116	0	0	288
Stage 1	232	-	-	-	-
Stage 2	239	-	-	-	-
Critical Hdwy	6.84	6.94	-	-	4.14
Critical Hdwy Stg 1	5.84	-	-	-	-
Critical Hdwy Stg 2	5.84	-	-	-	-
Follow-up Hdwy	3.52	3.32	-	-	2.22
Pot Cap-1 Maneuver	522	914	-	-	1271
Stage 1	785	-	-	-	-
Stage 2	778	-	-	-	-
Platoon blocked, %			-	-	-
Mov Cap-1 Maneuver	515	914	-	-	1271
Mov Cap-2 Maneuver	589	-	-	-	-
Stage 1	785	-	-	-	-
Stage 2	767	-	-	-	-

Approach	WB	NB	SB
HCM Control Delay, s	13	0	0.3
HCM LOS	B		

Minor Lane/Major Mvmt	NBT	NBRWBLn1	WBLn2	SBL	SBT
Capacity (veh/h)	-	-	589	914	1271
HCM Lane V/C Ratio	-	-	0.33	0.059	0.014
HCM Control Delay (s)	-	-	14.1	9.2	7.9
HCM Lane LOS	-	-	B	A	A
HCM 95th %tile Q(veh)	-	-	1.4	0.2	0

Intersection												
Int Delay, s/veh	7.7											
Movement	EBL	EBT	EBR	WBL	WBT	WBR	NBL	NBT	NBR	SBL	SBT	SBR
Lane Configurations	↘	↑↑	↗	↘	↑↑	↗	↘	↑	↗	↘	↑	↗
Traffic Vol, veh/h	27	0	16	31	42	0	51	19	0	0	69	7
Future Vol, veh/h	27	0	16	31	42	0	51	19	0	0	69	7
Conflicting Peds, #/hr	0	0	0	0	0	0	0	0	0	0	0	0
Sign Control	Free	Free	Free	Free	Free	Free	Stop	Stop	Stop	Stop	Stop	Stop
RT Channelized	-	-	None	-	-	None	-	-	None	-	-	None
Storage Length	535	-	200	200	-	200	410	-	155	235	-	155
Veh in Median Storage, #	-	0	-	-	0	-	-	0	-	-	0	-
Grade, %	-	0	-	-	0	-	-	0	-	-	0	-
Peak Hour Factor	85	85	85	85	85	85	85	85	85	85	85	85
Heavy Vehicles, %	2	2	2	2	2	2	2	2	2	2	2	2
Mvmt Flow	32	0	19	36	49	0	60	22	0	0	81	8

Major/Minor	Major1			Major2			Minor1			Minor2		
Conflicting Flow All	49	0	0	19	0	0	201	185	0	196	204	25
Stage 1	-	-	-	-	-	-	64	64	-	121	121	-
Stage 2	-	-	-	-	-	-	137	121	-	75	83	-
Critical Hdwy	4.14	-	-	4.14	-	-	7.54	6.54	6.94	7.54	6.54	6.94
Critical Hdwy Stg 1	-	-	-	-	-	-	6.54	5.54	-	6.54	5.54	-
Critical Hdwy Stg 2	-	-	-	-	-	-	6.54	5.54	-	6.54	5.54	-
Follow-up Hdwy	2.22	-	-	2.22	-	-	3.52	4.02	3.32	3.52	4.02	3.32
Pot Cap-1 Maneuver	1556	-	-	1596	-	-	739	708	-	745	691	1045
Stage 1	-	-	-	-	-	-	939	841	-	870	795	-
Stage 2	-	-	-	-	-	-	852	795	-	926	825	-
Platoon blocked, %	-	-	-	-	-	-	-	-	-	-	-	-
Mov Cap-1 Maneuver	1556	-	-	1596	-	-	643	677	-	-	661	1045
Mov Cap-2 Maneuver	-	-	-	-	-	-	643	677	-	-	661	-
Stage 1	-	-	-	-	-	-	919	823	-	852	777	-
Stage 2	-	-	-	-	-	-	740	777	-	882	808	-

Approach	EB			WB			NB			SB		
HCM Control Delay, s	4.6			3.1			11			11		
HCM LOS							B			B		

Minor Lane/Major Mvmt	NBLn1	NBLn2	NBLn3	EBL	EBT	EBR	WBL	WBT	WBR	SBLn1	SBLn2	SBLn3
Capacity (veh/h)	643	677	-	1556	-	-	1596	-	-	-	661	1045
HCM Lane V/C Ratio	0.093	0.033	-	0.02	-	-	0.023	-	-	-	0.123	0.008
HCM Control Delay (s)	11.2	10.5	0	7.4	-	-	7.3	-	-	0	11.2	8.5
HCM Lane LOS	B	B	A	A	-	-	A	-	-	A	B	A
HCM 95th %tile Q(veh)	0.3	0.1	-	0.1	-	-	0.1	-	-	-	0.4	0

Intersection						
Int Delay, s/veh	7.7					
Movement	WBL	WBR	NBT	NBR	SBL	SBT
Lane Configurations	↘	↗	↑↑	↗	↘	↑↑
Traffic Vol, veh/h	162	81	220	50	120	464
Future Vol, veh/h	162	81	220	50	120	464
Conflicting Peds, #/hr	0	0	0	0	0	0
Sign Control	Stop	Stop	Free	Free	Free	Free
RT Channelized	-	None	-	None	-	None
Storage Length	300	-	-	155	300	-
Veh in Median Storage, #	0	-	0	-	-	0
Grade, %	0	-	0	-	-	0
Peak Hour Factor	85	85	85	85	85	85
Heavy Vehicles, %	2	2	2	2	2	2
Mvmt Flow	191	95	259	59	141	546

Major/Minor	Minor1	Major1	Major2			
Conflicting Flow All	814	130	0	0	318	0
Stage 1	259	-	-	-	-	-
Stage 2	555	-	-	-	-	-
Critical Hdwy	6.84	6.94	-	-	4.14	-
Critical Hdwy Stg 1	5.84	-	-	-	-	-
Critical Hdwy Stg 2	5.84	-	-	-	-	-
Follow-up Hdwy	3.52	3.32	-	-	2.22	-
Pot Cap-1 Maneuver	316	896	-	-	1239	-
Stage 1	761	-	-	-	-	-
Stage 2	539	-	-	-	-	-
Platoon blocked, %			-	-	-	-
Mov Cap-1 Maneuver	280	896	-	-	1239	-
Mov Cap-2 Maneuver	280	-	-	-	-	-
Stage 1	761	-	-	-	-	-
Stage 2	478	-	-	-	-	-

Approach	WB	NB	SB
HCM Control Delay, s	30.8	0	1.7
HCM LOS	D		

Minor Lane/Major Mvmt	NBT	NBR	WBLn1	WBLn2	SBL	SBT
Capacity (veh/h)	-	-	280	896	1239	-
HCM Lane V/C Ratio	-	-	0.681	0.106	0.114	-
HCM Control Delay (s)	-	-	41.4	9.5	8.3	-
HCM Lane LOS	-	-	E	A	A	-
HCM 95th %tile Q(veh)	-	-	4.5	0.4	0.4	-

Intersection												
Int Delay, s/veh	26											
Movement	EBL	EBT	EBR	WBL	WBT	WBR	NBL	NBT	NBR	SBL	SBT	SBR
Lane Configurations	↙	↑↑	↗	↙	↑↑	↗	↙	↗		↙	↑	↗
Traffic Vol, veh/h	49	118	2	8	75	153	2	0	6	493	1	166
Future Vol, veh/h	49	118	2	8	75	153	2	0	6	493	1	166
Conflicting Peds, #/hr	0	0	0	0	0	0	0	0	0	0	0	0
Sign Control	Free	Free	Free	Free	Free	Free	Stop	Stop	Stop	Stop	Stop	Stop
RT Channelized	-	-	None	-	-	None	-	-	None	-	-	None
Storage Length	300	-	200	250	-	205	0	-	-	155	-	0
Veh in Median Storage, #	-	0	-	-	0	-	-	0	-	-	0	-
Grade, %	-	0	-	-	0	-	-	0	-	-	0	-
Peak Hour Factor	85	85	85	85	85	85	85	85	85	85	85	85
Heavy Vehicles, %	2	2	70	70	2	2	88	2	88	2	2	2
Mvmt Flow	58	139	2	9	88	180	2	0	7	580	1	195

Major/Minor	Major1			Major2			Minor1			Minor2		
Conflicting Flow All	268	0	0	141	0	0	318	541	70	292	363	44
Stage 1	-	-	-	-	-	-	255	255	-	106	106	-
Stage 2	-	-	-	-	-	-	63	286	-	186	257	-
Critical Hdwy	4.14	-	-	5.5	-	-	9.26	6.54	8.66	7.54	6.54	6.94
Critical Hdwy Stg 1	-	-	-	-	-	-	8.26	5.54	-	6.54	5.54	-
Critical Hdwy Stg 2	-	-	-	-	-	-	8.26	5.54	-	6.54	5.54	-
Follow-up Hdwy	2.22	-	-	2.9	-	-	4.38	4.02	4.18	3.52	4.02	3.32
Pot Cap-1 Maneuver	1293	-	-	1059	-	-	437	447	758	638	563	1017
Stage 1	-	-	-	-	-	-	533	695	-	888	807	-
Stage 2	-	-	-	-	-	-	739	674	-	798	694	-
Platoon blocked, %		-	-		-	-						
Mov Cap-1 Maneuver	1293	-	-	1059	-	-	338	423	758	607	533	1017
Mov Cap-2 Maneuver	-	-	-	-	-	-	338	423	-	607	533	-
Stage 1	-	-	-	-	-	-	509	664	-	848	801	-
Stage 2	-	-	-	-	-	-	591	669	-	755	663	-

Approach	EB			WB			NB			SB		
HCM Control Delay, s	2.3			0.3			11.3			41.5		
HCM LOS							B			E		

Minor Lane/Major Mvmt	NBLn1	NBLn2	EBL	EBT	EBR	WBL	WBT	WBR	SBLn1	SBLn2	SBLn3
Capacity (veh/h)	338	758	1293	-	-	1059	-	-	607	533	1017
HCM Lane V/C Ratio	0.007	0.009	0.045	-	-	0.009	-	-	0.956	0.002	0.192
HCM Control Delay (s)	15.7	9.8	7.9	-	-	8.4	-	-	52.4	11.8	9.4
HCM Lane LOS		C	A	A	-	A	-	-	F	B	A
HCM 95th %tile Q(veh)	0	0	0.1	-	-	0	-	-	13.2	0	0.7

Intersection												
Int Delay, s/veh	1											
Movement	EBL	EBT	EBR	WBL	WBT	WBR	NBL	NBT	NBR	SBL	SBT	SBR
Lane Configurations	↘	↗	↘	↘	↗	↘		↔			↔	
Traffic Vol, veh/h	12	110	0	0	365	1	0	0	0	3	0	35
Future Vol, veh/h	12	110	0	0	365	1	0	0	0	3	0	35
Conflicting Peds, #/hr	0	0	0	0	0	0	0	0	0	0	0	0
Sign Control	Free	Free	Free	Free	Free	Free	Stop	Stop	Stop	Stop	Stop	Stop
RT Channelized	-	-	None	-	-	None	-	-	None	-	-	None
Storage Length	205	-	155	205	-	155	-	-	-	-	-	-
Veh in Median Storage, #	-	0	-	-	0	-	-	0	-	-	0	-
Grade, %	-	0	-	-	0	-	-	0	-	-	0	-
Peak Hour Factor	85	85	85	85	85	85	85	85	85	85	85	85
Heavy Vehicles, %	2	2	2	2	2	2	2	2	2	2	2	2
Mvmt Flow	14	129	0	0	429	1	0	0	0	4	0	41

Major/Minor	Major1			Major2			Minor1			Minor2		
Conflicting Flow All	430	0	0	129	0	0	607	587	129	586	586	429
Stage 1	-	-	-	-	-	-	157	157	-	429	429	-
Stage 2	-	-	-	-	-	-	450	430	-	157	157	-
Critical Hdwy	4.12	-	-	4.12	-	-	7.12	6.52	6.22	7.12	6.52	6.22
Critical Hdwy Stg 1	-	-	-	-	-	-	6.12	5.52	-	6.12	5.52	-
Critical Hdwy Stg 2	-	-	-	-	-	-	6.12	5.52	-	6.12	5.52	-
Follow-up Hdwy	2.218	-	-	2.218	-	-	3.518	4.018	3.318	3.518	4.018	3.318
Pot Cap-1 Maneuver	1129	-	-	1457	-	-	408	422	921	422	422	626
Stage 1	-	-	-	-	-	-	845	768	-	604	584	-
Stage 2	-	-	-	-	-	-	589	583	-	845	768	-
Platoon blocked, %		-	-		-	-						
Mov Cap-1 Maneuver	1129	-	-	1457	-	-	377	417	921	418	417	626
Mov Cap-2 Maneuver	-	-	-	-	-	-	377	417	-	418	417	-
Stage 1	-	-	-	-	-	-	835	759	-	597	584	-
Stage 2	-	-	-	-	-	-	550	583	-	835	759	-

Approach	EB	WB	NB	SB
HCM Control Delay, s	0.8	0	0	11.5
HCM LOS			A	B

Minor Lane/Major Mvmt	NBLn1	EBL	EBT	EBR	WBL	WBT	WBR	SBLn1
Capacity (veh/h)	-	1129	-	-	1457	-	-	602
HCM Lane V/C Ratio	-	0.013	-	-	-	-	-	0.074
HCM Control Delay (s)		0	8.2	-	-	0	-	11.5
HCM Lane LOS		A	A	-	-	A	-	B
HCM 95th %tile Q(veh)		-	0	-	-	0	-	0.2



Intersection												
Int Delay, s/veh	2.6											
Movement	EBL	EBT	EBR	WBL	WBT	WBR	NBL	NBT	NBR	SBL	SBT	SBR
Lane Configurations	↖	↑	↗	↖	↑	↗		↕			↕	
Traffic Vol, veh/h	23	83	6	0	276	1	19	0	1	3	0	71
Future Vol, veh/h	23	83	6	0	276	1	19	0	1	3	0	71
Conflicting Peds, #/hr	0	0	0	0	0	0	0	0	0	0	0	0
Sign Control	Free	Free	Free	Free	Free	Free	Stop	Stop	Stop	Stop	Stop	Stop
RT Channelized	-	-	None	-	-	None	-	-	None	-	-	None
Storage Length	305	-	255	305	-	155	-	-	-	-	-	-
Veh in Median Storage, #	-	0	-	-	0	-	-	0	-	-	0	-
Grade, %	-	0	-	-	0	-	-	0	-	-	0	-
Peak Hour Factor	85	85	85	85	85	85	85	85	85	85	85	85
Heavy Vehicles, %	2	2	2	2	2	2	2	2	2	2	2	2
Mvmt Flow	27	98	7	0	325	1	22	0	1	4	0	84

Major/Minor	Major1			Major2			Minor1			Minor2		
Conflicting Flow All	326	0	0	105	0	0	520	478	98	481	484	325
Stage 1	-	-	-	-	-	-	152	152	-	325	325	-
Stage 2	-	-	-	-	-	-	368	326	-	156	159	-
Critical Hdwy	4.12	-	-	4.12	-	-	7.12	6.52	6.22	7.12	6.52	6.22
Critical Hdwy Stg 1	-	-	-	-	-	-	6.12	5.52	-	6.12	5.52	-
Critical Hdwy Stg 2	-	-	-	-	-	-	6.12	5.52	-	6.12	5.52	-
Follow-up Hdwy	2.218	-	-	2.218	-	-	3.518	4.018	3.318	3.518	4.018	3.318
Pot Cap-1 Maneuver	1234	-	-	1486	-	-	467	486	958	495	483	716
Stage 1	-	-	-	-	-	-	850	772	-	687	649	-
Stage 2	-	-	-	-	-	-	652	648	-	846	766	-
Platoon blocked, %	-	-	-	-	-	-	-	-	-	-	-	-
Mov Cap-1 Maneuver	1234	-	-	1486	-	-	406	475	958	486	472	716
Mov Cap-2 Maneuver	-	-	-	-	-	-	406	475	-	486	472	-
Stage 1	-	-	-	-	-	-	831	755	-	672	649	-
Stage 2	-	-	-	-	-	-	576	648	-	826	749	-

Approach	EB			WB			NB			SB		
HCM Control Delay, s	1.6			0			14.1			10.8		
HCM LOS							B			B		

Minor Lane/Major Mvmt	NBLn1	EBL	EBT	EBR	WBL	WBT	WBR	SBLn1
Capacity (veh/h)	418	1234	-	-	1486	-	-	703
HCM Lane V/C Ratio	0.056	0.022	-	-	-	-	-	0.124
HCM Control Delay (s)	14.1	8	-	-	0	-	-	10.8
HCM Lane LOS	B	A	-	-	A	-	-	B
HCM 95th %tile Q(veh)	0.2	0.1	-	-	0	-	-	0.4

Intersection						
Int Delay, s/veh	2.5					
Movement	WBL	WBR	NBT	NBR	SBL	SBT
Lane Configurations	↘	↗	↑↑	↗	↘	↑↑
Traffic Vol, veh/h	110	31	335	162	50	271
Future Vol, veh/h	110	31	335	162	50	271
Conflicting Peds, #/hr	0	0	0	0	0	0
Sign Control	Stop	Stop	Free	Free	Free	Free
RT Channelized	-	None	-	None	-	None
Storage Length	485	-	-	235	385	-
Veh in Median Storage, #	0	-	0	-	-	0
Grade, %	0	-	0	-	-	0
Peak Hour Factor	85	85	85	85	85	85
Heavy Vehicles, %	2	2	2	2	2	2
Mvmt Flow	129	36	394	191	59	319

Major/Minor	Minor1	Major1	Major2		
Conflicting Flow All	672	197	0	0	585
Stage 1	394	-	-	-	-
Stage 2	278	-	-	-	-
Critical Hdwy	6.84	6.94	-	-	4.14
Critical Hdwy Stg 1	5.84	-	-	-	-
Critical Hdwy Stg 2	5.84	-	-	-	-
Follow-up Hdwy	3.52	3.32	-	-	2.22
Pot Cap-1 Maneuver	389	811	-	-	986
Stage 1	650	-	-	-	-
Stage 2	744	-	-	-	-
Platoon blocked, %			-	-	-
Mov Cap-1 Maneuver	366	811	-	-	986
Mov Cap-2 Maneuver	474	-	-	-	-
Stage 1	650	-	-	-	-
Stage 2	699	-	-	-	-

Approach	WB	NB	SB
HCM Control Delay, s	14.1	0	1.4
HCM LOS	B		

Minor Lane/Major Mvmt	NBT	NBRWBLn1	WBLn2	SBL	SBT
Capacity (veh/h)	-	-	474	811	986
HCM Lane V/C Ratio	-	-	0.273	0.045	0.06
HCM Control Delay (s)	-	-	15.4	9.6	8.9
HCM Lane LOS	-	-	C	A	A
HCM 95th %tile Q(veh)	-	-	1.1	0.1	0.2

Intersection												
Int Delay, s/veh	8											
Movement	EBL	EBT	EBR	WBL	WBT	WBR	NBL	NBT	NBR	SBL	SBT	SBR
Lane Configurations	↘	↑↑	↗	↘	↑↑	↗	↘	↑	↗	↘	↑	↗
Traffic Vol, veh/h	91	0	53	21	28	0	44	65	0	0	46	4
Future Vol, veh/h	91	0	53	21	28	0	44	65	0	0	46	4
Conflicting Peds, #/hr	0	0	0	0	0	0	0	0	0	0	0	0
Sign Control	Free	Free	Free	Free	Free	Free	Stop	Stop	Stop	Stop	Stop	Stop
RT Channelized	-	-	None	-	-	None	-	-	None	-	-	None
Storage Length	535	-	200	200	-	200	410	-	155	235	-	155
Veh in Median Storage, #	-	0	-	-	0	-	-	0	-	-	0	-
Grade, %	-	0	-	-	0	-	-	0	-	-	0	-
Peak Hour Factor	85	85	85	85	85	85	85	85	85	85	85	85
Heavy Vehicles, %	2	2	2	2	2	2	2	2	2	2	2	2
Mvmt Flow	107	0	62	25	33	0	52	76	0	0	54	5

Major/Minor	Major1		Major2		Minor1		Minor2					
Conflicting Flow All	33	0	0	62	0	0	308	297	0	335	359	17
Stage 1	-	-	-	-	-	-	214	214	-	83	83	-
Stage 2	-	-	-	-	-	-	94	83	-	252	276	-
Critical Hdwy	4.14	-	-	4.14	-	-	7.54	6.54	6.94	7.54	6.54	6.94
Critical Hdwy Stg 1	-	-	-	-	-	-	6.54	5.54	-	6.54	5.54	-
Critical Hdwy Stg 2	-	-	-	-	-	-	6.54	5.54	-	6.54	5.54	-
Follow-up Hdwy	2.22	-	-	2.22	-	-	3.52	4.02	3.32	3.52	4.02	3.32
Pot Cap-1 Maneuver	1577	-	-	1539	-	-	621	613	-	595	566	1058
Stage 1	-	-	-	-	-	-	768	724	-	916	825	-
Stage 2	-	-	-	-	-	-	902	825	-	730	680	-
Platoon blocked, %	-	-	-	-	-	-	-	-	-	-	-	-
Mov Cap-1 Maneuver	1577	-	-	1539	-	-	533	562	-	-	519	1058
Mov Cap-2 Maneuver	-	-	-	-	-	-	533	562	-	-	519	-
Stage 1	-	-	-	-	-	-	716	675	-	854	812	-
Stage 2	-	-	-	-	-	-	825	812	-	603	634	-

Approach	EB	WB	NB	SB
HCM Control Delay, s	4.7	3.2	12.4	12.4
HCM LOS			B	B

Minor Lane/Major Mvmt	NBLn1	NBLn2	NBLn3	EBL	EBT	EBR	WBL	WBT	WBR	SBLn1	SBLn2	SBLn3
Capacity (veh/h)	533	562	-	1577	-	-	1539	-	-	-	-	519 1058
HCM Lane V/C Ratio	0.097	0.136	-	0.068	-	-	0.016	-	-	-	-	0.104 0.004
HCM Control Delay (s)	12.5	12.4	0	7.4	-	-	7.4	-	-	0	12.7	8.4
HCM Lane LOS	B	B	A	A	-	-	A	-	-	A	B	A
HCM 95th %tile Q(veh)	0.3	0.5	-	0.2	-	-	0	-	-	-	0.3	0

Intersection						
Int Delay, s/veh	6.7					
Movement	WBL	WBR	NBT	NBR	SBL	SBT
Lane Configurations						
Traffic Vol, veh/h	117	162	437	137	113	339
Future Vol, veh/h	117	162	437	137	113	339
Conflicting Peds, #/hr	0	0	0	0	0	0
Sign Control	Stop	Stop	Free	Free	Free	Free
RT Channelized	-	None	-	None	-	None
Storage Length	300	-	-	155	300	-
Veh in Median Storage, #	0	-	0	-	-	0
Grade, %	0	-	0	-	-	0
Peak Hour Factor	85	85	85	85	85	85
Heavy Vehicles, %	2	2	2	2	2	2
Mvmt Flow	138	191	514	161	133	399

Major/Minor	Minor1	Major1	Major2		
Conflicting Flow All	980	257	0	0	675
Stage 1	514	-	-	-	-
Stage 2	466	-	-	-	-
Critical Hdwy	6.84	6.94	-	-	4.14
Critical Hdwy Stg 1	5.84	-	-	-	-
Critical Hdwy Stg 2	5.84	-	-	-	-
Follow-up Hdwy	3.52	3.32	-	-	2.22
Pot Cap-1 Maneuver	247	742	-	-	912
Stage 1	565	-	-	-	-
Stage 2	598	-	-	-	-
Platoon blocked, %			-	-	-
Mov Cap-1 Maneuver	211	742	-	-	912
Mov Cap-2 Maneuver	211	-	-	-	-
Stage 1	565	-	-	-	-
Stage 2	511	-	-	-	-

Approach	WB	NB	SB
HCM Control Delay, s	27.4	0	2.4
HCM LOS	D		

Minor Lane/Major Mvmt	NBT	NBR	WBLn1	WBLn2	SBL	SBT
Capacity (veh/h)	-	-	211	742	912	-
HCM Lane V/C Ratio	-	-	0.652	0.257	0.146	-
HCM Control Delay (s)	-	-	49.3	11.5	9.6	-
HCM Lane LOS	-	-	E	B	A	-
HCM 95th %tile Q(veh)	-	-	3.9	1	0.5	-

Intersection												
Int Delay, s/veh	38.6											
Movement	EBL	EBT	EBR	WBL	WBT	WBR	NBL	NBT	NBR	SBL	SBT	SBR
Lane Configurations	↘	↑↑	↗	↘	↑↑	↗	↘	↗	↘	↘	↑	↗
Traffic Vol, veh/h	143	106	2	6	161	516	2	0	7	327	1	117
Future Vol, veh/h	143	106	2	6	161	516	2	0	7	327	1	117
Conflicting Peds, #/hr	0	0	0	0	0	0	0	0	0	0	0	0
Sign Control	Free	Free	Free	Free	Free	Free	Stop	Stop	Stop	Stop	Stop	Stop
RT Channelized	-	-	None	-	-	None	-	-	None	-	-	None
Storage Length	300	-	200	250	-	205	0	-	-	155	-	0
Veh in Median Storage, #	-	0	-	-	0	-	-	0	-	-	0	-
Grade, %	-	0	-	-	0	-	-	0	-	-	0	-
Peak Hour Factor	85	85	85	85	85	85	85	85	85	85	85	85
Heavy Vehicles, %	2	2	88	88	2	2	78	2	78	2	2	2
Mvmt Flow	168	125	2	7	189	607	2	0	8	385	1	138

Major/Minor	Major1			Major2			Minor1			Minor2		
Conflicting Flow All	796	0	0	127	0	0	570	1271	63	602	666	95
Stage 1	-	-	-	-	-	-	461	461	-	203	203	-
Stage 2	-	-	-	-	-	-	109	810	-	399	463	-
Critical Hdwy	4.14	-	-	5.86	-	-	9.06	6.54	8.46	7.54	6.54	6.94
Critical Hdwy Stg 1	-	-	-	-	-	-	8.06	5.54	-	6.54	5.54	-
Critical Hdwy Stg 2	-	-	-	-	-	-	8.06	5.54	-	6.54	5.54	-
Follow-up Hdwy	2.22	-	-	3.08	-	-	4.28	4.02	4.08	3.52	4.02	3.32
Pot Cap-1 Maneuver	822	-	-	1003	-	-	276	167	788	~ 383	379	943
Stage 1	-	-	-	-	-	-	389	564	-	780	732	-
Stage 2	-	-	-	-	-	-	703	391	-	598	562	-
Platoon blocked, %	-	-	-	-	-	-	-	-	-	-	-	-
Mov Cap-1 Maneuver	822	-	-	1003	-	-	197	132	788	~ 318	299	943
Mov Cap-2 Maneuver	-	-	-	-	-	-	197	132	-	~ 318	299	-
Stage 1	-	-	-	-	-	-	310	449	-	621	727	-
Stage 2	-	-	-	-	-	-	595	388	-	471	447	-

Approach	EB			WB			NB			SB		
HCM Control Delay, s	6			0.1			12.7			116.5		
HCM LOS							B			F		

Minor Lane/Major Mvmt	NBLn1	NBLn2	EBL	EBT	EBR	WBL	WBT	WBR	SBLn1	SBLn2	SBLn3
Capacity (veh/h)	197	788	822	-	-	1003	-	-	318	299	943
HCM Lane V/C Ratio	0.012	0.01	0.205	-	-	0.007	-	-	1.21	0.004	0.146
HCM Control Delay (s)	23.5	9.6	10.5	-	-	8.6	-	-	155.1	17.1	9.5
HCM Lane LOS	C	A	B	-	-	A	-	-	F	C	A
HCM 95th %tile Q(veh)	0	0	0.8	-	-	0	-	-	16.9	0	0.5

Notes  
 ~: Volume exceeds capacity    \$: Delay exceeds 300s    +: Computation Not Defined    \*: All major volume in platoon

Intersection												
Int Delay, s/veh	0.9											
Movement	EBL	EBT	EBR	WBL	WBT	WBR	NBL	NBT	NBR	SBL	SBT	SBR
Lane Configurations	↘	↑	↗	↘	↑	↗		↔			↔	
Traffic Vol, veh/h	40	373	0	0	242	3	0	0	0	2	0	23
Future Vol, veh/h	40	373	0	0	242	3	0	0	0	2	0	23
Conflicting Peds, #/hr	0	0	0	0	0	0	0	0	0	0	0	0
Sign Control	Free	Free	Free	Free	Free	Free	Stop	Stop	Stop	Stop	Stop	Stop
RT Channelized	-	-	None	-	-	None	-	-	None	-	-	None
Storage Length	205	-	155	205	-	155	-	-	-	-	-	-
Veh in Median Storage, #	-	0	-	-	0	-	-	0	-	-	0	-
Grade, %	-	0	-	-	0	-	-	0	-	-	0	-
Peak Hour Factor	85	85	85	85	85	85	85	85	85	85	85	85
Heavy Vehicles, %	2	2	2	2	2	2	2	2	2	2	2	2
Mvmt Flow	47	439	0	0	285	4	0	0	0	2	0	27

Major/Minor	Major1			Major2			Minor1			Minor2		
Conflicting Flow All	289	0	0	439	0	0	834	822	439	818	818	285
Stage 1	-	-	-	-	-	-	533	533	-	285	285	-
Stage 2	-	-	-	-	-	-	301	289	-	533	533	-
Critical Hdwy	4.12	-	-	4.12	-	-	7.12	6.52	6.22	7.12	6.52	6.22
Critical Hdwy Stg 1	-	-	-	-	-	-	6.12	5.52	-	6.12	5.52	-
Critical Hdwy Stg 2	-	-	-	-	-	-	6.12	5.52	-	6.12	5.52	-
Follow-up Hdwy	2.218	-	-	2.218	-	-	3.518	4.018	3.318	3.518	4.018	3.318
Pot Cap-1 Maneuver	1273	-	-	1121	-	-	288	309	618	295	311	754
Stage 1	-	-	-	-	-	-	531	525	-	722	676	-
Stage 2	-	-	-	-	-	-	708	673	-	531	525	-
Platoon blocked, %		-	-		-	-						
Mov Cap-1 Maneuver	1273	-	-	1121	-	-	270	298	618	287	299	754
Mov Cap-2 Maneuver	-	-	-	-	-	-	270	298	-	287	299	-
Stage 1	-	-	-	-	-	-	511	506	-	695	676	-
Stage 2	-	-	-	-	-	-	683	673	-	511	506	-

Approach	EB			WB			NB			SB		
HCM Control Delay, s	0.8			0			0			10.6		
HCM LOS							A			B		

Minor Lane/Major Mvmt	NBLn1	EBL	EBT	EBR	WBL	WBT	WBR	SBLn1
Capacity (veh/h)	-	1273	-	-	1121	-	-	667
HCM Lane V/C Ratio	-	0.037	-	-	-	-	-	0.044
HCM Control Delay (s)		0	7.9	-	-	0	-	10.6
HCM Lane LOS		A	A	-	-	A	-	B
HCM 95th %tile Q(veh)	-	0.1	-	-	0	-	-	0.1

Intersection												
Int Delay, s/veh	2.2											
Movement	EBL	EBT	EBR	WBL	WBT	WBR	NBL	NBT	NBR	SBL	SBT	SBR
Lane Configurations	↘	↑	↗	↘	↑	↗		↔			↔	
Traffic Vol, veh/h	80	273	22	1	186	3	13	0	1	2	0	47
Future Vol, veh/h	80	273	22	1	186	3	13	0	1	2	0	47
Conflicting Peds, #/hr	0	0	0	0	0	0	0	0	0	0	0	0
Sign Control	Free	Free	Free	Free	Free	Free	Stop	Stop	Stop	Stop	Stop	Stop
RT Channelized	-	-	None	-	-	None	-	-	None	-	-	None
Storage Length	305	-	255	305	-	155	-	-	-	-	-	-
Veh in Median Storage, #	-	0	-	-	0	-	-	0	-	-	0	-
Grade, %	-	0	-	-	0	-	-	0	-	-	0	-
Peak Hour Factor	85	85	85	85	85	85	85	85	85	85	85	85
Heavy Vehicles, %	2	2	2	2	2	2	2	2	2	2	2	2
Mvmt Flow	94	321	26	1	219	4	15	0	1	2	0	55

Major/Minor	Major1			Major2			Minor1			Minor2		
Conflicting Flow All	223	0	0	347	0	0	760	734	321	744	756	219
Stage 1	-	-	-	-	-	-	509	509	-	221	221	-
Stage 2	-	-	-	-	-	-	251	225	-	523	535	-
Critical Hdwy	4.12	-	-	4.12	-	-	7.12	6.52	6.22	7.12	6.52	6.22
Critical Hdwy Stg 1	-	-	-	-	-	-	6.12	5.52	-	6.12	5.52	-
Critical Hdwy Stg 2	-	-	-	-	-	-	6.12	5.52	-	6.12	5.52	-
Follow-up Hdwy	2.218	-	-	2.218	-	-	3.518	4.018	3.318	3.518	4.018	3.318
Pot Cap-1 Maneuver	1346	-	-	1212	-	-	323	347	720	331	337	821
Stage 1	-	-	-	-	-	-	547	538	-	781	720	-
Stage 2	-	-	-	-	-	-	753	718	-	537	524	-
Platoon blocked, %	-	-	-	-	-	-	-	-	-	-	-	-
Mov Cap-1 Maneuver	1346	-	-	1212	-	-	285	322	720	312	313	821
Mov Cap-2 Maneuver	-	-	-	-	-	-	285	322	-	312	313	-
Stage 1	-	-	-	-	-	-	509	500	-	726	719	-
Stage 2	-	-	-	-	-	-	702	717	-	499	487	-

Approach	EB			WB			NB			SB		
HCM Control Delay, s	1.7			0			17.8			10.1		
HCM LOS							C			B		

Minor Lane/Major Mvmt	NBLn1	EBL	EBT	EBR	WBL	WBT	WBR	SBLn1
Capacity (veh/h)	298	1346	-	-	1212	-	-	770
HCM Lane V/C Ratio	0.055	0.07	-	-	0.001	-	-	0.075
HCM Control Delay (s)	17.8	7.9	-	-	8	-	-	10.1
HCM Lane LOS	C	A	-	-	A	-	-	B
HCM 95th %tile Q(veh)	0.2	0.2	-	-	0	-	-	0.2

Intersection						
Int Delay, s/veh	3.6					
Movement	WBL	WBR	NBT	NBR	SBL	SBT
Lane Configurations	↘	↗	↕↕	↗	↘	↕↕
Traffic Vol, veh/h	165	54	197	48	17	345
Future Vol, veh/h	165	54	197	48	17	345
Conflicting Peds, #/hr	0	0	0	0	0	0
Sign Control	Stop	Stop	Free	Free	Free	Free
RT Channelized	-	None	-	None	-	None
Storage Length	485	-	-	235	385	-
Veh in Median Storage, #	0	-	0	-	-	0
Grade, %	0	-	0	-	-	0
Peak Hour Factor	85	85	85	85	85	85
Heavy Vehicles, %	2	2	2	2	2	2
Mvmt Flow	194	64	232	56	20	406

Major/Minor	Minor1	Major1	Major2		
Conflicting Flow All	475	116	0	0	288
Stage 1	232	-	-	-	-
Stage 2	243	-	-	-	-
Critical Hdwy	6.84	6.94	-	-	4.14
Critical Hdwy Stg 1	5.84	-	-	-	-
Critical Hdwy Stg 2	5.84	-	-	-	-
Follow-up Hdwy	3.52	3.32	-	-	2.22
Pot Cap-1 Maneuver	519	914	-	-	1271
Stage 1	785	-	-	-	-
Stage 2	775	-	-	-	-
Platoon blocked, %			-	-	-
Mov Cap-1 Maneuver	511	914	-	-	1271
Mov Cap-2 Maneuver	586	-	-	-	-
Stage 1	785	-	-	-	-
Stage 2	763	-	-	-	-

Approach	WB	NB	SB
HCM Control Delay, s	13	0	0.4
HCM LOS	B		

Minor Lane/Major Mvmt	NBT	NBRWBLn1	WBLn2	SBL	SBT
Capacity (veh/h)	-	-	586	914	1271
HCM Lane V/C Ratio	-	-	0.331	0.07	0.016
HCM Control Delay (s)	-	-	14.2	9.2	7.9
HCM Lane LOS	-	-	B	A	A
HCM 95th %tile Q(veh)	-	-	1.4	0.2	0



Intersection												
Int Delay, s/veh	7.8											
Movement	EBL	EBT	EBR	WBL	WBT	WBR	NBL	NBT	NBR	SBL	SBT	SBR
Lane Configurations	↘	↑↑	↗	↘	↑↑	↗	↘	↑	↗	↘	↑	↗
Traffic Vol, veh/h	27	0	18	31	42	0	59	19	0	0	69	7
Future Vol, veh/h	27	0	18	31	42	0	59	19	0	0	69	7
Conflicting Peds, #/hr	0	0	0	0	0	0	0	0	0	0	0	0
Sign Control	Free	Free	Free	Free	Free	Free	Stop	Stop	Stop	Stop	Stop	Stop
RT Channelized	-	-	None	-	-	None	-	-	None	-	-	None
Storage Length	535	-	200	200	-	200	410	-	155	235	-	155
Veh in Median Storage, #	-	0	-	-	0	-	-	0	-	-	0	-
Grade, %	-	0	-	-	0	-	-	0	-	-	0	-
Peak Hour Factor	85	85	85	85	85	85	85	85	85	85	85	85
Heavy Vehicles, %	2	2	2	2	2	2	2	2	2	2	2	2
Mvmt Flow	32	0	21	36	49	0	69	22	0	0	81	8

Major/Minor	Major1			Major2			Minor1			Minor2		
Conflicting Flow All	49	0	0	21	0	0	201	185	0	196	206	25
Stage 1	-	-	-	-	-	-	64	64	-	121	121	-
Stage 2	-	-	-	-	-	-	137	121	-	75	85	-
Critical Hdwy	4.14	-	-	4.14	-	-	7.54	6.54	6.94	7.54	6.54	6.94
Critical Hdwy Stg 1	-	-	-	-	-	-	6.54	5.54	-	6.54	5.54	-
Critical Hdwy Stg 2	-	-	-	-	-	-	6.54	5.54	-	6.54	5.54	-
Follow-up Hdwy	2.22	-	-	2.22	-	-	3.52	4.02	3.32	3.52	4.02	3.32
Pot Cap-1 Maneuver	1556	-	-	1593	-	-	739	708	-	745	690	1045
Stage 1	-	-	-	-	-	-	939	841	-	870	795	-
Stage 2	-	-	-	-	-	-	852	795	-	926	824	-
Platoon blocked, %	-	-	-	-	-	-	-	-	-	-	-	-
Mov Cap-1 Maneuver	1556	-	-	1593	-	-	643	677	-	-	660	1045
Mov Cap-2 Maneuver	-	-	-	-	-	-	643	677	-	-	660	-
Stage 1	-	-	-	-	-	-	919	823	-	852	777	-
Stage 2	-	-	-	-	-	-	740	777	-	882	807	-

Approach	EB			WB			NB			SB		
HCM Control Delay, s	4.4			3.1			11.1			11		
HCM LOS							B			B		

Minor Lane/Major Mvmt	NBLn1	NBLn2	NBLn3	EBL	EBT	EBR	WBL	WBT	WBR	SBLn1	SBLn2	SBLn3
Capacity (veh/h)	643	677	-	1556	-	-	1593	-	-	-	660	1045
HCM Lane V/C Ratio	0.108	0.033	-	0.02	-	-	0.023	-	-	-	0.123	0.008
HCM Control Delay (s)	11.3	10.5	0	7.4	-	-	7.3	-	-	0	11.2	8.5
HCM Lane LOS	B	B	A	A	-	-	A	-	-	A	B	A
HCM 95th %tile Q(veh)	0.4	0.1	-	0.1	-	-	0.1	-	-	-	0.4	0

Intersection						
Int Delay, s/veh	7.9					
Movement	WBL	WBR	NBT	NBR	SBL	SBT
Lane Configurations	↘	↗	↑↑	↗	↘	↑↑
Traffic Vol, veh/h	164	81	220	51	120	464
Future Vol, veh/h	164	81	220	51	120	464
Conflicting Peds, #/hr	0	0	0	0	0	0
Sign Control	Stop	Stop	Free	Free	Free	Free
RT Channelized	-	None	-	None	-	None
Storage Length	300	-	-	155	300	-
Veh in Median Storage, #	0	-	0	-	-	0
Grade, %	0	-	0	-	-	0
Peak Hour Factor	85	85	85	85	85	85
Heavy Vehicles, %	2	2	2	2	2	2
Mvmt Flow	193	95	259	60	141	546

Major/Minor	Minor1	Major1	Major2		
Conflicting Flow All	814	130	0	0	319
Stage 1	259	-	-	-	-
Stage 2	555	-	-	-	-
Critical Hdwy	6.84	6.94	-	-	4.14
Critical Hdwy Stg 1	5.84	-	-	-	-
Critical Hdwy Stg 2	5.84	-	-	-	-
Follow-up Hdwy	3.52	3.32	-	-	2.22
Pot Cap-1 Maneuver	316	896	-	-	1238
Stage 1	761	-	-	-	-
Stage 2	539	-	-	-	-
Platoon blocked, %			-	-	-
Mov Cap-1 Maneuver	280	896	-	-	1238
Mov Cap-2 Maneuver	280	-	-	-	-
Stage 1	761	-	-	-	-
Stage 2	478	-	-	-	-

Approach	WB	NB	SB
HCM Control Delay, s	31.3	0	1.7
HCM LOS	D		

Minor Lane/Major Mvmt	NBT	NBRWBLn1	WBLn2	SBL	SBT
Capacity (veh/h)	-	-	280	896	1238
HCM Lane V/C Ratio	-	-	0.689	0.106	0.114
HCM Control Delay (s)	-	-	42.1	9.5	8.3
HCM Lane LOS	-	-	E	A	A
HCM 95th %tile Q(veh)	-	-	4.7	0.4	0.4

Timings  
12: Vollmer Rd & Marksheffel Rd

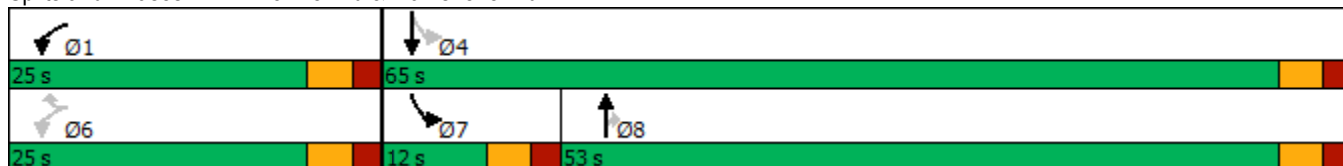
Short-Term Total Traffic  
AM Peak Hour

Lane Group	WBL	WBR	NBT	NBR	SBL	SBT
Lane Configurations						
Traffic Volume (vph)	164	81	220	51	120	464
Future Volume (vph)	164	81	220	51	120	464
Turn Type	pm+pt	Perm	NA	Perm	pm+pt	NA
Protected Phases	1		8		7	4
Permitted Phases	6	6		8	4	
Detector Phase	1	6	8	8	7	4
Switch Phase						
Minimum Initial (s)	5.0	5.0	15.0	15.0	5.0	15.0
Minimum Split (s)	10.0	10.0	20.0	20.0	10.0	20.0
Total Split (s)	25.0	25.0	53.0	53.0	12.0	65.0
Total Split (%)	27.8%	27.8%	58.9%	58.9%	13.3%	72.2%
Yellow Time (s)	3.0	3.0	3.0	3.0	3.0	3.0
All-Red Time (s)	2.0	2.0	2.0	2.0	2.0	2.0
Lost Time Adjust (s)	0.0	0.0	0.0	0.0	0.0	0.0
Total Lost Time (s)	5.0	5.0	5.0	5.0	5.0	5.0
Lead/Lag			Lag	Lag	Lead	
Lead-Lag Optimize?			Yes	Yes	Yes	
Recall Mode	None	Min	Max	Max	None	Max
Act Effct Green (s)	14.1	14.1	48.4	48.4	60.1	60.1
Actuated g/C Ratio	0.17	0.17	0.57	0.57	0.71	0.71
v/c Ratio	0.65	0.28	0.13	0.06	0.18	0.22
Control Delay	43.5	8.9	9.1	3.0	5.0	4.7
Queue Delay	0.0	0.0	0.0	0.0	0.0	0.0
Total Delay	43.5	8.9	9.1	3.0	5.0	4.7
LOS	D	A	A	A	A	A
Approach Delay	32.1		8.0			4.8
Approach LOS	C		A			A

Intersection Summary

Cycle Length: 90  
 Actuated Cycle Length: 84.2  
 Natural Cycle: 40  
 Control Type: Semi Act-Uncoord  
 Maximum v/c Ratio: 0.65  
 Intersection Signal Delay: 11.6  
 Intersection Capacity Utilization 40.7%  
 Analysis Period (min) 15  
 Intersection LOS: B  
 ICU Level of Service A

Splits and Phases: 12: Vollmer Rd & Marksheffel Rd



Intersection												
Int Delay, s/veh	52											
Movement	EBL	EBT	EBR	WBL	WBT	WBR	NBL	NBT	NBR	SBL	SBT	SBR
Lane Configurations	↘	↑↑	↗	↘	↑↑	↗	↘	↗		↘	↑	↗
Traffic Vol, veh/h	50	118	2	8	75	182	2	0	6	581	1	168
Future Vol, veh/h	50	118	2	8	75	182	2	0	6	581	1	168
Conflicting Peds, #/hr	0	0	0	0	0	0	0	0	0	0	0	0
Sign Control	Free	Free	Free	Free	Free	Free	Stop	Stop	Stop	Stop	Stop	Stop
RT Channelized	-	-	None	-	-	None	-	-	None	-	-	None
Storage Length	300	-	200	250	-	205	0	-	-	155	-	0
Veh in Median Storage, #	-	0	-	-	0	-	-	0	-	-	0	-
Grade, %	-	0	-	-	0	-	-	0	-	-	0	-
Peak Hour Factor	85	85	85	85	85	85	85	85	85	85	85	85
Heavy Vehicles, %	2	2	70	70	2	2	88	2	88	2	2	2
Mvmt Flow	59	139	2	9	88	214	2	0	7	684	1	198

Major/Minor	Major1			Major2			Minor1			Minor2		
Conflicting Flow All	302	0	0	141	0	0	320	577	70	294	365	44
Stage 1	-	-	-	-	-	-	257	257	-	106	106	-
Stage 2	-	-	-	-	-	-	63	320	-	188	259	-
Critical Hdwy	4.14	-	-	5.5	-	-	9.26	6.54	8.66	7.54	6.54	6.94
Critical Hdwy Stg 1	-	-	-	-	-	-	8.26	5.54	-	6.54	5.54	-
Critical Hdwy Stg 2	-	-	-	-	-	-	8.26	5.54	-	6.54	5.54	-
Follow-up Hdwy	2.22	-	-	2.9	-	-	4.38	4.02	4.18	3.52	4.02	3.32
Pot Cap-1 Maneuver	1256	-	-	1059	-	-	436	426	758	~ 636	562	1017
Stage 1	-	-	-	-	-	-	531	694	-	888	807	-
Stage 2	-	-	-	-	-	-	739	651	-	796	692	-
Platoon blocked, %	-	-	-	-	-	-	-	-	-	-	-	-
Mov Cap-1 Maneuver	1256	-	-	1059	-	-	336	403	758	~ 604	531	1017
Mov Cap-2 Maneuver	-	-	-	-	-	-	336	403	-	~ 604	531	-
Stage 1	-	-	-	-	-	-	506	661	-	846	801	-
Stage 2	-	-	-	-	-	-	589	646	-	752	659	-

Approach	EB			WB			NB			SB		
HCM Control Delay, s	2.4			0.3			11.3			82		
HCM LOS							B			F		

Minor Lane/Major Mvmt	NBLn1	NBLn2	EBL	EBT	EBR	WBL	WBT	WBR	SBLn1	SBLn2	SBLn3
Capacity (veh/h)	336	758	1256	-	-	1059	-	-	604	531	1017
HCM Lane V/C Ratio	0.007	0.009	0.047	-	-	0.009	-	-	1.132	0.002	0.194
HCM Control Delay (s)	15.8	9.8	8	-	-	8.4	-	-	103.1	11.8	9.4
HCM Lane LOS		C	A	A	-	A	-	-	F	B	A
HCM 95th %tile Q(veh)		0	0	0.1	-	0	-	-	21.7	0	0.7

Notes  
 ~: Volume exceeds capacity    \$: Delay exceeds 300s    +: Computation Not Defined    \*: All major volume in platoon

Timings  
13: Sterling Ranch Rd & Marksheffel Rd

Short-Term Total Traffic  
AM Peak Hour

Lane Group	EBL	EBT	EBR	WBL	WBT	WBR	NBL	NBT	SBL	SBT	SBR	
Lane Configurations												
Traffic Volume (vph)	50	118	2	8	75	182	2	0	581	1	168	
Future Volume (vph)	50	118	2	8	75	182	2	0	581	1	168	
Turn Type	pm+pt	NA	Perm	pm+pt	NA	Perm	pm+pt	NA	Prot	NA	Perm	
Protected Phases	5	2		1	6		3	8	7	4		
Permitted Phases	2		2	6		6	8				4	
Detector Phase	5	2	2	1	6	6	3	8	7	4	4	
Switch Phase												
Minimum Initial (s)	5.0	15.0	15.0	5.0	15.0	15.0	5.0	10.0	5.0	10.0	10.0	
Minimum Split (s)	10.0	23.0	23.0	10.0	23.0	23.0	10.0	23.0	10.0	23.0	23.0	
Total Split (s)	10.0	40.0	40.0	10.0	40.0	40.0	10.0	25.0	15.0	30.0	30.0	
Total Split (%)	11.1%	44.4%	44.4%	11.1%	44.4%	44.4%	11.1%	27.8%	16.7%	33.3%	33.3%	
Yellow Time (s)	3.0	3.0	3.0	3.0	3.0	3.0	3.0	3.0	3.0	3.0	3.0	
All-Red Time (s)	2.0	2.0	2.0	2.0	2.0	2.0	2.0	2.0	2.0	2.0	2.0	
Lost Time Adjust (s)	0.0	0.0	0.0	0.0	0.0	0.0	0.0	0.0	0.0	0.0	0.0	
Total Lost Time (s)	5.0	5.0	5.0	5.0	5.0	5.0	5.0	5.0	5.0	5.0	5.0	
Lead/Lag	Lead	Lag	Lag	Lead	Lag	Lag	Lead	Lag	Lead	Lag	Lag	
Lead-Lag Optimize?	Yes	Yes	Yes	Yes	Yes	Yes	Yes	Yes	Yes	Yes	Yes	
Recall Mode	None	Min	Min	None	Min	Min	None	None	None	None	None	
Act Effct Green (s)	18.3	17.6	17.6	17.3	15.7	15.7	6.6	10.5	10.5	11.2	11.2	
Actuated g/C Ratio	0.44	0.42	0.42	0.41	0.37	0.37	0.16	0.25	0.25	0.27	0.27	
v/c Ratio	0.10	0.09	0.00	0.03	0.07	0.30	0.01	0.01	0.80	0.00	0.35	
Control Delay	8.2	10.4	0.0	8.4	12.2	4.4	13.5	0.0	28.6	15.0	5.4	
Queue Delay	0.0	0.0	0.0	0.0	0.0	0.0	0.0	0.0	0.0	0.0	0.0	
Total Delay	8.2	10.4	0.0	8.4	12.2	4.4	13.5	0.0	28.6	15.0	5.4	
LOS	A	B	A	A	B	A	B	A	C	B	A	
Approach Delay		9.6			6.7			3.0		23.4		
Approach LOS		A			A			A		C		

Intersection Summary

Cycle Length: 90

Actuated Cycle Length: 42

Natural Cycle: 75

Control Type: Actuated-Uncoordinated

Maximum v/c Ratio: 0.80

Intersection Signal Delay: 17.6

Intersection LOS: B

Intersection Capacity Utilization 44.1%

ICU Level of Service A

Analysis Period (min) 15

Splits and Phases: 13: Sterling Ranch Rd & Marksheffel Rd



Intersection						
Int Delay, s/veh	0.5					
Movement	EBT	EBR	WBL	WBT	NBL	NBR
Lane Configurations	↑	↗	↖	↑	↘	↙
Traffic Vol, veh/h	145	8	1	468	23	2
Future Vol, veh/h	145	8	1	468	23	2
Conflicting Peds, #/hr	0	0	0	0	0	0
Sign Control	Free	Free	Free	Free	Stop	Stop
RT Channelized	-	None	-	None	-	None
Storage Length	-	155	205	-	0	-
Veh in Median Storage, #	0	-	-	0	0	-
Grade, %	0	-	-	0	0	-
Peak Hour Factor	85	85	85	85	85	85
Heavy Vehicles, %	2	2	2	2	2	2
Mvmt Flow	171	9	1	551	27	2

Major/Minor	Major1	Major2	Minor1			
Conflicting Flow All	0	0	180	0	724	171
Stage 1	-	-	-	-	171	-
Stage 2	-	-	-	-	553	-
Critical Hdwy	-	-	4.12	-	6.42	6.22
Critical Hdwy Stg 1	-	-	-	-	5.42	-
Critical Hdwy Stg 2	-	-	-	-	5.42	-
Follow-up Hdwy	-	-	2.218	-	3.518	3.318
Pot Cap-1 Maneuver	-	-	1396	-	393	873
Stage 1	-	-	-	-	859	-
Stage 2	-	-	-	-	576	-
Platoon blocked, %	-	-	-	-	-	-
Mov Cap-1 Maneuver	-	-	1396	-	393	873
Mov Cap-2 Maneuver	-	-	-	-	478	-
Stage 1	-	-	-	-	859	-
Stage 2	-	-	-	-	575	-

Approach	EB	WB	NB
HCM Control Delay, s	0	0	12.7
HCM LOS			B

Minor Lane/Major Mvmt	NBLn1	EBT	EBR	WBL	WBT
Capacity (veh/h)	496	-	-	1396	-
HCM Lane V/C Ratio	0.059	-	-	0.001	-
HCM Control Delay (s)	12.7	-	-	7.6	-
HCM Lane LOS	B	-	-	A	-
HCM 95th %tile Q(veh)	0.2	-	-	0	-

Intersection												
Int Delay, s/veh	2.2											
Movement	EBL	EBT	EBR	WBL	WBT	WBR	NBL	NBT	NBR	SBL	SBT	SBR
Lane Configurations	↙	↑	↗	↙	↑	↗		↕			↕	
Traffic Vol, veh/h	12	120	15	1	388	1	45	0	4	3	0	35
Future Vol, veh/h	12	120	15	1	388	1	45	0	4	3	0	35
Conflicting Peds, #/hr	0	0	0	0	0	0	0	0	0	0	0	0
Sign Control	Free	Free	Free	Free	Free	Free	Stop	Stop	Stop	Stop	Stop	Stop
RT Channelized	-	-	None	-	-	None	-	-	None	-	-	None
Storage Length	205	-	155	205	-	155	-	-	-	-	-	-
Veh in Median Storage, #	-	0	-	-	0	-	-	0	-	-	0	-
Grade, %	-	0	-	-	0	-	-	0	-	-	0	-
Peak Hour Factor	85	85	85	85	85	85	85	85	85	85	85	85
Heavy Vehicles, %	2	2	2	2	2	2	2	2	2	2	2	2
Mvmt Flow	14	141	18	1	456	1	53	0	5	4	0	41

Major/Minor	Major1			Major2			Minor1			Minor2		
Conflicting Flow All	457	0	0	159	0	0	648	628	141	639	645	456
Stage 1	-	-	-	-	-	-	169	169	-	458	458	-
Stage 2	-	-	-	-	-	-	479	459	-	181	187	-
Critical Hdwy	4.12	-	-	4.12	-	-	7.12	6.52	6.22	7.12	6.52	6.22
Critical Hdwy Stg 1	-	-	-	-	-	-	6.12	5.52	-	6.12	5.52	-
Critical Hdwy Stg 2	-	-	-	-	-	-	6.12	5.52	-	6.12	5.52	-
Follow-up Hdwy	2.218	-	-	2.218	-	-	3.518	4.018	3.318	3.518	4.018	3.318
Pot Cap-1 Maneuver	1104	-	-	1420	-	-	383	400	907	389	391	604
Stage 1	-	-	-	-	-	-	833	759	-	583	567	-
Stage 2	-	-	-	-	-	-	568	566	-	821	745	-
Platoon blocked, %		-	-	-	-	-						
Mov Cap-1 Maneuver	1104	-	-	1420	-	-	353	394	907	383	386	604
Mov Cap-2 Maneuver	-	-	-	-	-	-	353	394	-	383	386	-
Stage 1	-	-	-	-	-	-	822	749	-	575	566	-
Stage 2	-	-	-	-	-	-	529	565	-	806	735	-

Approach	EB	WB	NB	SB
HCM Control Delay, s	0.7	0	16.4	11.8
HCM LOS			C	B

Minor Lane/Major Mvmt	NBLn1	EBL	EBT	EBR	WBL	WBT	WBR	SBLn1
Capacity (veh/h)	372	1104	-	-	1420	-	-	578
HCM Lane V/C Ratio	0.155	0.013	-	-	0.001	-	-	0.077
HCM Control Delay (s)	16.4	8.3	-	-	7.5	-	-	11.8
HCM Lane LOS	C	A	-	-	A	-	-	B
HCM 95th %tile Q(veh)	0.5	0	-	-	0	-	-	0.3

Intersection												
Int Delay, s/veh	3.2											
Movement	EBL	EBT	EBR	WBL	WBT	WBR	NBL	NBT	NBR	SBL	SBT	SBR
Lane Configurations	↖	↑	↗	↖	↑	↗		↕			↕	
Traffic Vol, veh/h	23	89	14	1	278	1	42	0	3	3	0	71
Future Vol, veh/h	23	89	14	1	278	1	42	0	3	3	0	71
Conflicting Peds, #/hr	0	0	0	0	0	0	0	0	0	0	0	0
Sign Control	Free	Free	Free	Free	Free	Free	Stop	Stop	Stop	Stop	Stop	Stop
RT Channelized	-	-	None	-	-	None	-	-	None	-	-	None
Storage Length	305	-	255	305	-	155	-	-	-	-	-	-
Veh in Median Storage, #	-	0	-	-	0	-	-	0	-	-	0	-
Grade, %	-	0	-	-	0	-	-	0	-	-	0	-
Peak Hour Factor	85	85	85	85	85	85	85	85	85	85	85	85
Heavy Vehicles, %	2	2	2	2	2	2	2	2	2	2	2	2
Mvmt Flow	27	105	16	1	327	1	49	0	4	4	0	84

Major/Minor	Major1			Major2			Minor1			Minor2		
Conflicting Flow All	328	0	0	121	0	0	531	489	105	498	504	327
Stage 1	-	-	-	-	-	-	159	159	-	329	329	-
Stage 2	-	-	-	-	-	-	372	330	-	169	175	-
Critical Hdwy	4.12	-	-	4.12	-	-	7.12	6.52	6.22	7.12	6.52	6.22
Critical Hdwy Stg 1	-	-	-	-	-	-	6.12	5.52	-	6.12	5.52	-
Critical Hdwy Stg 2	-	-	-	-	-	-	6.12	5.52	-	6.12	5.52	-
Follow-up Hdwy	2.218	-	-	2.218	-	-	3.518	4.018	3.318	3.518	4.018	3.318
Pot Cap-1 Maneuver	1232	-	-	1467	-	-	459	480	949	483	470	714
Stage 1	-	-	-	-	-	-	843	766	-	684	646	-
Stage 2	-	-	-	-	-	-	648	646	-	833	754	-
Platoon blocked, %	-	-	-	-	-	-	-	-	-	-	-	-
Mov Cap-1 Maneuver	1232	-	-	1467	-	-	398	469	949	473	459	714
Mov Cap-2 Maneuver	-	-	-	-	-	-	398	469	-	473	459	-
Stage 1	-	-	-	-	-	-	824	749	-	669	645	-
Stage 2	-	-	-	-	-	-	572	645	-	812	737	-

Approach	EB	WB	NB	SB
HCM Control Delay, s	1.5	0	15	10.9
HCM LOS			C	B

Minor Lane/Major Mvmt	NBLn1	EBL	EBT	EBR	WBL	WBT	WBR	SBLn1
Capacity (veh/h)	414	1232	-	-	1467	-	-	700
HCM Lane V/C Ratio	0.128	0.022	-	-	0.001	-	-	0.124
HCM Control Delay (s)	15	8	-	-	7.5	-	-	10.9
HCM Lane LOS	C	A	-	-	A	-	-	B
HCM 95th %tile Q(veh)	0.4	0.1	-	-	0	-	-	0.4



Intersection						
Int Delay, s/veh	2.7					
Movement	WBL	WBR	NBT	NBR	SBL	SBT
Lane Configurations	↘	↗	↕↕	↗	↘	↕↕
Traffic Vol, veh/h	110	36	335	162	59	271
Future Vol, veh/h	110	36	335	162	59	271
Conflicting Peds, #/hr	0	0	0	0	0	0
Sign Control	Stop	Stop	Free	Free	Free	Free
RT Channelized	-	None	-	None	-	None
Storage Length	485	-	-	235	385	-
Veh in Median Storage, #	0	-	0	-	-	0
Grade, %	0	-	0	-	-	0
Peak Hour Factor	85	85	85	85	85	85
Heavy Vehicles, %	2	2	2	2	2	2
Mvmt Flow	129	42	394	191	69	319

Major/Minor	Minor1	Major1	Major2		
Conflicting Flow All	692	197	0	0	585
Stage 1	394	-	-	-	-
Stage 2	298	-	-	-	-
Critical Hdwy	6.84	6.94	-	-	4.14
Critical Hdwy Stg 1	5.84	-	-	-	-
Critical Hdwy Stg 2	5.84	-	-	-	-
Follow-up Hdwy	3.52	3.32	-	-	2.22
Pot Cap-1 Maneuver	378	811	-	-	986
Stage 1	650	-	-	-	-
Stage 2	727	-	-	-	-
Platoon blocked, %			-	-	-
Mov Cap-1 Maneuver	352	811	-	-	986
Mov Cap-2 Maneuver	463	-	-	-	-
Stage 1	650	-	-	-	-
Stage 2	676	-	-	-	-

Approach	WB	NB	SB
HCM Control Delay, s	14.3	0	1.6
HCM LOS	B		

Minor Lane/Major Mvmt	NBT	NBRWBLn1	WBLn2	SBL	SBT
Capacity (veh/h)	-	-	463	811	986
HCM Lane V/C Ratio	-	-	0.28	0.052	0.07
HCM Control Delay (s)	-	-	15.8	9.7	8.9
HCM Lane LOS	-	-	C	A	A
HCM 95th %tile Q(veh)	-	-	1.1	0.2	0.2

Intersection												
Int Delay, s/veh	7.9											
Movement	EBL	EBT	EBR	WBL	WBT	WBR	NBL	NBT	NBR	SBL	SBT	SBR
Lane Configurations	↘	↑↑	↗	↘	↑↑	↗	↘	↑	↗	↘	↑	↗
Traffic Vol, veh/h	91	0	62	21	28	0	49	65	0	0	46	4
Future Vol, veh/h	91	0	62	21	28	0	49	65	0	0	46	4
Conflicting Peds, #/hr	0	0	0	0	0	0	0	0	0	0	0	0
Sign Control	Free	Free	Free	Free	Free	Free	Stop	Stop	Stop	Stop	Stop	Stop
RT Channelized	-	-	None	-	-	None	-	-	None	-	-	None
Storage Length	535	-	200	200	-	200	410	-	155	235	-	155
Veh in Median Storage, #	-	0	-	-	0	-	-	0	-	-	0	-
Grade, %	-	0	-	-	0	-	-	0	-	-	0	-
Peak Hour Factor	85	85	85	85	85	85	85	85	85	85	85	85
Heavy Vehicles, %	2	2	2	2	2	2	2	2	2	2	2	2
Mvmt Flow	107	0	73	25	33	0	58	76	0	0	54	5

Major/Minor	Major1		Major2		Minor1		Minor2					
Conflicting Flow All	33	0	0	73	0	0	308	297	0	335	370	17
Stage 1	-	-	-	-	-	-	214	214	-	83	83	-
Stage 2	-	-	-	-	-	-	94	83	-	252	287	-
Critical Hdwy	4.14	-	-	4.14	-	-	7.54	6.54	6.94	7.54	6.54	6.94
Critical Hdwy Stg 1	-	-	-	-	-	-	6.54	5.54	-	6.54	5.54	-
Critical Hdwy Stg 2	-	-	-	-	-	-	6.54	5.54	-	6.54	5.54	-
Follow-up Hdwy	2.22	-	-	2.22	-	-	3.52	4.02	3.32	3.52	4.02	3.32
Pot Cap-1 Maneuver	1577	-	-	1525	-	-	621	613	-	595	558	1058
Stage 1	-	-	-	-	-	-	768	724	-	916	825	-
Stage 2	-	-	-	-	-	-	902	825	-	730	673	-
Platoon blocked, %	-	-	-	-	-	-	-	-	-	-	-	-
Mov Cap-1 Maneuver	1577	-	-	1525	-	-	533	562	-	-	512	1058
Mov Cap-2 Maneuver	-	-	-	-	-	-	533	562	-	-	512	-
Stage 1	-	-	-	-	-	-	716	675	-	854	812	-
Stage 2	-	-	-	-	-	-	824	812	-	603	627	-

Approach	EB		WB		NB		SB	
HCM Control Delay, s	4.4		3.2		12.5		12.5	
HCM LOS					B		B	

Minor Lane/Major Mvmt	NBLn1	NBLn2	NBLn3	EBL	EBT	EBR	WBL	WBT	WBR	SBLn1	SBLn2	SBLn3
Capacity (veh/h)	533	562	-	1577	-	-	1525	-	-	-	512	1058
HCM Lane V/C Ratio	0.108	0.136	-	0.068	-	-	0.016	-	-	-	0.106	0.004
HCM Control Delay (s)	12.6	12.4	0	7.4	-	-	7.4	-	-	0	12.9	8.4
HCM Lane LOS	B	B	A	A	-	-	A	-	-	A	B	A
HCM 95th %tile Q(veh)	0.4	0.5	-	0.2	-	-	0	-	-	-	0.4	0

Intersection						
Int Delay, s/veh	6.8					
Movement	WBL	WBR	NBT	NBR	SBL	SBT
Lane Configurations						
Traffic Vol, veh/h	119	162	437	140	113	339
Future Vol, veh/h	119	162	437	140	113	339
Conflicting Peds, #/hr	0	0	0	0	0	0
Sign Control	Stop	Stop	Free	Free	Free	Free
RT Channelized	-	None	-	None	-	None
Storage Length	300	-	-	155	300	-
Veh in Median Storage, #	0	-	0	-	-	0
Grade, %	0	-	0	-	-	0
Peak Hour Factor	85	85	85	85	85	85
Heavy Vehicles, %	2	2	2	2	2	2
Mvmt Flow	140	191	514	165	133	399

Major/Minor	Minor1	Major1	Major2			
Conflicting Flow All	980	257	0	0	679	0
Stage 1	514	-	-	-	-	-
Stage 2	466	-	-	-	-	-
Critical Hdwy	6.84	6.94	-	-	4.14	-
Critical Hdwy Stg 1	5.84	-	-	-	-	-
Critical Hdwy Stg 2	5.84	-	-	-	-	-
Follow-up Hdwy	3.52	3.32	-	-	2.22	-
Pot Cap-1 Maneuver	247	742	-	-	909	-
Stage 1	565	-	-	-	-	-
Stage 2	598	-	-	-	-	-
Platoon blocked, %			-	-		-
Mov Cap-1 Maneuver	211	742	-	-	909	-
Mov Cap-2 Maneuver	211	-	-	-	-	-
Stage 1	565	-	-	-	-	-
Stage 2	511	-	-	-	-	-

Approach	WB	NB	SB
HCM Control Delay, s	28	0	2.4
HCM LOS	D		

Minor Lane/Major Mvmt	NBT	NBR	WBLn1	WBLn2	SBL	SBT
Capacity (veh/h)	-	-	211	742	909	-
HCM Lane V/C Ratio	-	-	0.664	0.257	0.146	-
HCM Control Delay (s)	-	-	50.4	11.5	9.6	-
HCM Lane LOS	-	-	F	B	A	-
HCM 95th %tile Q(veh)	-	-	4.1	1	0.5	-

Timings  
12: Vollmer Rd & Marksheffel Rd

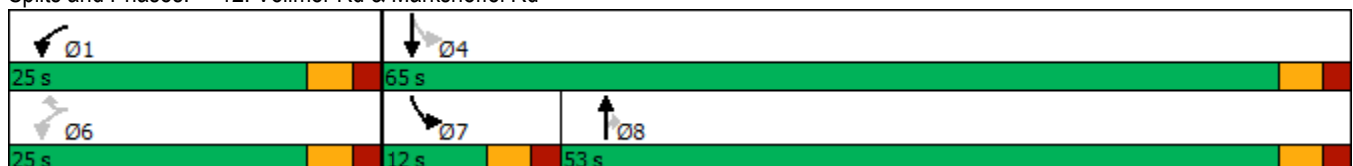
Short-Term Total Traffic  
PM Peak Hour

Lane Group	WBL	WBR	NBT	NBR	SBL	SBT
Lane Configurations						
Traffic Volume (vph)	119	162	437	140	113	339
Future Volume (vph)	119	162	437	140	113	339
Turn Type	pm+pt	Perm	NA	Perm	pm+pt	NA
Protected Phases	1		8		7	4
Permitted Phases	6	6		8	4	
Detector Phase	1	6	8	8	7	4
Switch Phase						
Minimum Initial (s)	5.0	5.0	15.0	15.0	5.0	15.0
Minimum Split (s)	10.0	10.0	20.0	20.0	10.0	20.0
Total Split (s)	25.0	25.0	53.0	53.0	12.0	65.0
Total Split (%)	27.8%	27.8%	58.9%	58.9%	13.3%	72.2%
Yellow Time (s)	3.0	3.0	3.0	3.0	3.0	3.0
All-Red Time (s)	2.0	2.0	2.0	2.0	2.0	2.0
Lost Time Adjust (s)	0.0	0.0	0.0	0.0	0.0	0.0
Total Lost Time (s)	5.0	5.0	5.0	5.0	5.0	5.0
Lead/Lag			Lag	Lag	Lead	
Lead-Lag Optimize?			Yes	Yes	Yes	
Recall Mode	None	Min	Max	Max	Max	None
Act Effct Green (s)	11.5	11.5	48.1	48.1	60.1	60.1
Actuated g/C Ratio	0.14	0.14	0.59	0.59	0.74	0.74
v/c Ratio	0.56	0.49	0.25	0.17	0.20	0.15
Control Delay	41.6	9.7	8.8	1.9	4.3	3.7
Queue Delay	0.0	0.0	0.0	0.0	0.0	0.0
Total Delay	41.6	9.7	8.8	1.9	4.3	3.7
LOS	D	A	A	A	A	A
Approach Delay	23.2		7.2			3.8
Approach LOS	C		A			A

Intersection Summary

Cycle Length: 90	
Actuated Cycle Length: 81.6	
Natural Cycle: 40	
Control Type: Semi Act-Uncoord	
Maximum v/c Ratio: 0.56	
Intersection Signal Delay: 9.5	Intersection LOS: A
Intersection Capacity Utilization 37.9%	ICU Level of Service A
Analysis Period (min) 15	

Splits and Phases: 12: Vollmer Rd & Marksheffel Rd



Intersection												
Int Delay, s/veh	68.1											
Movement	EBL	EBT	EBR	WBL	WBT	WBR	NBL	NBT	NBR	SBL	SBT	SBR
Lane Configurations	↘	↑↑	↗	↘	↑↑	↗	↘	↗	↘	↘	↑	↗
Traffic Vol, veh/h	146	106	2	6	161	616	2	0	7	386	1	119
Future Vol, veh/h	146	106	2	6	161	616	2	0	7	386	1	119
Conflicting Peds, #/hr	0	0	0	0	0	0	0	0	0	0	0	0
Sign Control	Free	Free	Free	Free	Free	Free	Stop	Stop	Stop	Stop	Stop	Stop
RT Channelized	-	-	None	-	-	None	-	-	None	-	-	None
Storage Length	300	-	200	250	-	205	0	-	-	155	-	0
Veh in Median Storage, #	-	0	-	-	0	-	-	0	-	-	0	-
Grade, %	-	0	-	-	0	-	-	0	-	-	0	-
Peak Hour Factor	85	85	85	85	85	85	85	85	85	85	85	85
Heavy Vehicles, %	2	2	88	88	2	2	78	2	78	2	2	2
Mvmt Flow	172	125	2	7	189	725	2	0	8	454	1	140

Major/Minor	Major1			Major2			Minor1			Minor2		
Conflicting Flow All	914	0	0	127	0	0	578	1397	63	610	674	95
Stage 1	-	-	-	-	-	-	469	469	-	203	203	-
Stage 2	-	-	-	-	-	-	109	928	-	407	471	-
Critical Hdwy	4.14	-	-	5.86	-	-	9.06	6.54	8.46	7.54	6.54	6.94
Critical Hdwy Stg 1	-	-	-	-	-	-	8.06	5.54	-	6.54	5.54	-
Critical Hdwy Stg 2	-	-	-	-	-	-	8.06	5.54	-	6.54	5.54	-
Follow-up Hdwy	2.22	-	-	3.08	-	-	4.28	4.02	4.08	3.52	4.02	3.32
Pot Cap-1 Maneuver	742	-	-	1003	-	-	272	140	788	~ 378	375	943
Stage 1	-	-	-	-	-	-	384	559	-	780	732	-
Stage 2	-	-	-	-	-	-	703	345	-	592	558	-
Platoon blocked, %	-	-	-	-	-	-	-	-	-	-	-	-
Mov Cap-1 Maneuver	742	-	-	1003	-	-	189	107	788	~ 306	286	943
Mov Cap-2 Maneuver	-	-	-	-	-	-	189	107	-	~ 306	286	-
Stage 1	-	-	-	-	-	-	295	429	-	599	727	-
Stage 2	-	-	-	-	-	-	593	343	-	~ 450	429	-

Approach	EB			WB			NB			SB		
HCM Control Delay, s	6.5			0.1			12.9			205.3		
HCM LOS							B			F		

Minor Lane/Major Mvmt	NBLn1	NBLn2	EBL	EBT	EBR	WBL	WBT	WBR	SBLn1	SBLn2	SBLn3
Capacity (veh/h)	189	788	742	-	-	1003	-	-	306	286	943
HCM Lane V/C Ratio	0.012	0.01	0.231	-	-	0.007	-	-	1.484	0.004	0.148
HCM Control Delay (s)	24.3	9.6	11.3	-	-	8.6	-	-	266.1	17.6	9.5
HCM Lane LOS		C	A	B	-	-	A	-	F	C	A
HCM 95th %tile Q(veh)		0	0	0.9	-	-	0	-	25.3	0	0.5

Notes  
 ~: Volume exceeds capacity    \$: Delay exceeds 300s    +: Computation Not Defined    \*: All major volume in platoon

Timings  
13: Sterling Ranch Rd & Marksheffel Rd

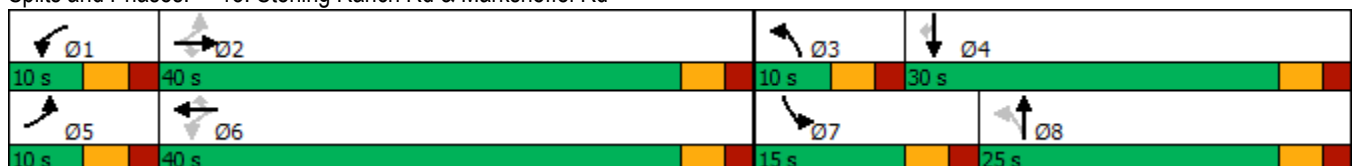
Short-Term Total Traffic  
PM Peak Hour

Lane Group	EBL	EBT	EBR	WBL	WBT	WBR	NBL	NBT	SBL	SBT	SBR
Lane Configurations											
Traffic Volume (vph)	146	106	2	6	161	616	2	0	386	1	119
Future Volume (vph)	146	106	2	6	161	616	2	0	386	1	119
Turn Type	pm+pt	NA	Perm	pm+pt	NA	Perm	pm+pt	NA	Prot	NA	Perm
Protected Phases	5	2		1	6		3	8	7	4	
Permitted Phases	2		2	6		6	8				4
Detector Phase	5	2	2	1	6	6	3	8	7	4	4
Switch Phase											
Minimum Initial (s)	5.0	15.0	15.0	5.0	15.0	15.0	5.0	10.0	5.0	10.0	10.0
Minimum Split (s)	10.0	23.0	23.0	10.0	23.0	23.0	10.0	23.0	10.0	23.0	23.0
Total Split (s)	10.0	40.0	40.0	10.0	40.0	40.0	10.0	25.0	15.0	30.0	30.0
Total Split (%)	11.1%	44.4%	44.4%	11.1%	44.4%	44.4%	11.1%	27.8%	16.7%	33.3%	33.3%
Yellow Time (s)	3.0	3.0	3.0	3.0	3.0	3.0	3.0	3.0	3.0	3.0	3.0
All-Red Time (s)	2.0	2.0	2.0	2.0	2.0	2.0	2.0	2.0	2.0	2.0	2.0
Lost Time Adjust (s)	0.0	0.0	0.0	0.0	0.0	0.0	0.0	0.0	0.0	0.0	0.0
Total Lost Time (s)	5.0	5.0	5.0	5.0	5.0	5.0	5.0	5.0	5.0	5.0	5.0
Lead/Lag	Lead	Lag	Lag	Lead	Lag	Lag	Lead	Lag	Lead	Lag	Lag
Lead-Lag Optimize?	Yes	Yes	Yes	Yes	Yes	Yes	Yes	Yes	Yes	Yes	Yes
Recall Mode	None	Min	Min	None	Min	Min	None	None	None	None	None
Act Effct Green (s)	26.8	26.1	26.1	22.3	17.2	17.2	6.6	10.3	10.3	11.0	11.0
Actuated g/C Ratio	0.53	0.52	0.52	0.44	0.34	0.34	0.13	0.20	0.20	0.22	0.22
v/c Ratio	0.29	0.07	0.00	0.02	0.16	0.71	0.02	0.01	0.64	0.00	0.30
Control Delay	8.5	8.6	0.0	7.2	12.5	6.0	17.0	0.0	26.7	19.0	6.5
Queue Delay	0.0	0.0	0.0	0.0	0.0	0.0	0.0	0.0	0.0	0.0	0.0
Total Delay	8.5	8.6	0.0	7.2	12.5	6.0	17.0	0.0	26.7	19.0	6.5
LOS	A	A	A	A	B	A	B	A	C	B	A
Approach Delay		8.5			7.4			3.4		21.9	
Approach LOS		A			A			A		C	

Intersection Summary

Cycle Length: 90  
 Actuated Cycle Length: 50.3  
 Natural Cycle: 70  
 Control Type: Actuated-Uncoordinated  
 Maximum v/c Ratio: 0.71  
 Intersection Signal Delay: 12.3  
 Intersection LOS: B  
 Intersection Capacity Utilization 67.1%  
 ICU Level of Service C  
 Analysis Period (min) 15

Splits and Phases: 13: Sterling Ranch Rd & Marksheffel Rd



Intersection						
Int Delay, s/veh	0.3					
Movement	EBT	EBR	WBL	WBT	NBL	NBR
Lane Configurations	↑	↗	↖	↑	↘	↙
Traffic Vol, veh/h	489	26	2	311	15	1
Future Vol, veh/h	489	26	2	311	15	1
Conflicting Peds, #/hr	0	0	0	0	0	0
Sign Control	Free	Free	Free	Free	Stop	Stop
RT Channelized	-	None	-	None	-	None
Storage Length	-	155	205	-	0	-
Veh in Median Storage, #	0	-	-	0	0	-
Grade, %	0	-	-	0	0	-
Peak Hour Factor	85	85	85	85	85	85
Heavy Vehicles, %	2	2	2	2	2	2
Mvmt Flow	575	31	2	366	18	1

Major/Minor	Major1	Major2	Minor1		
Conflicting Flow All	0	0	606	0	945
Stage 1	-	-	-	-	575
Stage 2	-	-	-	-	370
Critical Hdwy	-	-	4.12	-	6.42
Critical Hdwy Stg 1	-	-	-	-	5.42
Critical Hdwy Stg 2	-	-	-	-	5.42
Follow-up Hdwy	-	-	2.218	-	3.518
Pot Cap-1 Maneuver	-	-	972	-	291
Stage 1	-	-	-	-	563
Stage 2	-	-	-	-	699
Platoon blocked, %	-	-	-	-	-
Mov Cap-1 Maneuver	-	-	972	-	290
Mov Cap-2 Maneuver	-	-	-	-	414
Stage 1	-	-	-	-	563
Stage 2	-	-	-	-	698

Approach	EB	WB	NB
HCM Control Delay, s	0	0.1	14
HCM LOS			B

Minor Lane/Major Mvmt	NBLn1	EBT	EBR	WBL	WBT
Capacity (veh/h)	419	-	-	972	-
HCM Lane V/C Ratio	0.045	-	-	0.002	-
HCM Control Delay (s)	14	-	-	8.7	-
HCM Lane LOS	B	-	-	A	-
HCM 95th %tile Q(veh)	0.1	-	-	0	-

Intersection												
Int Delay, s/veh	1.7											
Movement	EBL	EBT	EBR	WBL	WBT	WBR	NBL	NBT	NBR	SBL	SBT	SBR
Lane Configurations												
Traffic Vol, veh/h	40	400	51	4	259	3	30	0	3	2	0	23
Future Vol, veh/h	40	400	51	4	259	3	30	0	3	2	0	23
Conflicting Peds, #/hr	0	0	0	0	0	0	0	0	0	0	0	0
Sign Control	Free	Free	Free	Free	Free	Free	Stop	Stop	Stop	Stop	Stop	Stop
RT Channelized	-	-	None	-	-	None	-	-	None	-	-	None
Storage Length	205	-	155	205	-	155	-	-	-	-	-	-
Veh in Median Storage, #	-	0	-	-	0	-	-	0	-	-	0	-
Grade, %	-	0	-	-	0	-	-	0	-	-	0	-
Peak Hour Factor	85	85	85	85	85	85	85	85	85	85	85	85
Heavy Vehicles, %	2	2	2	2	2	2	2	2	2	2	2	2
Mvmt Flow	47	471	60	5	305	4	35	0	4	2	0	27

Major/Minor	Major1			Major2			Minor1			Minor2		
Conflicting Flow All	309	0	0	531	0	0	896	884	471	912	940	305
Stage 1	-	-	-	-	-	-	565	565	-	315	315	-
Stage 2	-	-	-	-	-	-	331	319	-	597	625	-
Critical Hdwy	4.12	-	-	4.12	-	-	7.12	6.52	6.22	7.12	6.52	6.22
Critical Hdwy Stg 1	-	-	-	-	-	-	6.12	5.52	-	6.12	5.52	-
Critical Hdwy Stg 2	-	-	-	-	-	-	6.12	5.52	-	6.12	5.52	-
Follow-up Hdwy	2.218	-	-	2.218	-	-	3.518	4.018	3.318	3.518	4.018	3.318
Pot Cap-1 Maneuver	1252	-	-	1036	-	-	261	284	593	255	264	735
Stage 1	-	-	-	-	-	-	510	508	-	696	656	-
Stage 2	-	-	-	-	-	-	682	653	-	490	477	-
Platoon blocked, %	-	-	-	-	-	-	-	-	-	-	-	-
Mov Cap-1 Maneuver	1252	-	-	1036	-	-	243	272	593	245	253	735
Mov Cap-2 Maneuver	-	-	-	-	-	-	243	272	-	245	253	-
Stage 1	-	-	-	-	-	-	491	489	-	670	653	-
Stage 2	-	-	-	-	-	-	654	650	-	469	459	-

Approach	EB			WB			NB			SB		
HCM Control Delay, s	0.7			0.1			21.5			11		
HCM LOS							C			B		

Minor Lane/Major Mvmt	NBLn1	EBL	EBT	EBR	WBL	WBT	WBR	SBLn1
Capacity (veh/h)	257	1252	-	-	1036	-	-	634
HCM Lane V/C Ratio	0.151	0.038	-	-	0.005	-	-	0.046
HCM Control Delay (s)	21.5	8	-	-	8.5	-	-	11
HCM Lane LOS	C	A	-	-	A	-	-	B
HCM 95th %tile Q(veh)	0.5	0.1	-	-	0	-	-	0.1



Intersection												
Int Delay, s/veh	2.6											
Movement	EBL	EBT	EBR	WBL	WBT	WBR	NBL	NBT	NBR	SBL	SBT	SBR
Lane Configurations	↖	↗	↖	↖	↗	↖		↔			↔	
Traffic Vol, veh/h	80	277	47	3	193	3	28	0	2	2	0	47
Future Vol, veh/h	80	277	47	3	193	3	28	0	2	2	0	47
Conflicting Peds, #/hr	0	0	0	0	0	0	0	0	0	0	0	0
Sign Control	Free	Free	Free	Free	Free	Free	Stop	Stop	Stop	Stop	Stop	Stop
RT Channelized	-	-	None	-	-	None	-	-	None	-	-	None
Storage Length	305	-	255	305	-	155	-	-	-	-	-	-
Veh in Median Storage, #	-	0	-	-	0	-	-	0	-	-	0	-
Grade, %	-	0	-	-	0	-	-	0	-	-	0	-
Peak Hour Factor	85	85	85	85	85	85	85	85	85	85	85	85
Heavy Vehicles, %	2	2	2	2	2	2	2	2	2	2	2	2
Mvmt Flow	94	326	55	4	227	4	33	0	2	2	0	55

Major/Minor	Major1			Major2			Minor1			Minor2		
Conflicting Flow All	231	0	0	381	0	0	779	753	326	778	804	227
Stage 1	-	-	-	-	-	-	514	514	-	235	235	-
Stage 2	-	-	-	-	-	-	265	239	-	543	569	-
Critical Hdwy	4.12	-	-	4.12	-	-	7.12	6.52	6.22	7.12	6.52	6.22
Critical Hdwy Stg 1	-	-	-	-	-	-	6.12	5.52	-	6.12	5.52	-
Critical Hdwy Stg 2	-	-	-	-	-	-	6.12	5.52	-	6.12	5.52	-
Follow-up Hdwy	2.218	-	-	2.218	-	-	3.518	4.018	3.318	3.518	4.018	3.318
Pot Cap-1 Maneuver	1337	-	-	1177	-	-	313	339	715	314	316	812
Stage 1	-	-	-	-	-	-	543	535	-	768	710	-
Stage 2	-	-	-	-	-	-	740	708	-	524	506	-
Platoon blocked, %	-	-	-	-	-	-	-	-	-	-	-	-
Mov Cap-1 Maneuver	1337	-	-	1177	-	-	275	314	715	295	293	812
Mov Cap-2 Maneuver	-	-	-	-	-	-	275	314	-	295	293	-
Stage 1	-	-	-	-	-	-	505	498	-	714	708	-
Stage 2	-	-	-	-	-	-	687	706	-	486	471	-

Approach	EB			WB			NB			SB		
HCM Control Delay, s	1.6			0.1			19.3			10.1		
HCM LOS							C			B		

Minor Lane/Major Mvmt	NBLn1	EBL	EBT	EBR	WBL	WBT	WBR	SBLn1
Capacity (veh/h)	287	1337	-	-	1177	-	-	758
HCM Lane V/C Ratio	0.123	0.07	-	-	0.003	-	-	0.076
HCM Control Delay (s)	19.3	7.9	-	-	8.1	-	-	10.1
HCM Lane LOS	C	A	-	-	A	-	-	B
HCM 95th %tile Q(veh)	0.4	0.2	-	-	0	-	-	0.2

Timings  
4: Vollmer Rd & Briargate Pkwy

2045 Background Traffic  
AM Peak Hour

Lane Group	EBL	EBT	EBR	WBL	WBT	WBR	NBL	NBT	NBR	SBL	SBT	SBR
Lane Configurations												
Traffic Volume (vph)	70	535	153	242	1020	81	153	132	110	108	311	141
Future Volume (vph)	70	535	153	242	1020	81	153	132	110	108	311	141
Turn Type	pm+pt	NA	Perm	Prot	NA	Perm	pm+pt	NA	Perm	pm+pt	NA	Perm
Protected Phases	5	2		1	6		3	8		7	4	
Permitted Phases	2		2			6	8		8	4		4
Detector Phase	5	2	2	1	6	6	3	8	8	7	4	4
Switch Phase												
Minimum Initial (s)	5.0	15.0	15.0	15.0	15.0	15.0	5.0	5.0	5.0	5.0	5.0	5.0
Minimum Split (s)	10.0	20.0	20.0	20.0	20.0	20.0	10.0	10.0	10.0	10.0	10.0	10.0
Total Split (s)	12.0	57.0	57.0	20.0	65.0	65.0	17.0	28.0	28.0	15.0	26.0	26.0
Total Split (%)	10.0%	47.5%	47.5%	16.7%	54.2%	54.2%	14.2%	23.3%	23.3%	12.5%	21.7%	21.7%
Yellow Time (s)	3.0	3.0	3.0	3.0	3.0	3.0	3.0	3.0	3.0	3.0	3.0	3.0
All-Red Time (s)	2.0	2.0	2.0	2.0	2.0	2.0	2.0	2.0	2.0	2.0	2.0	2.0
Lost Time Adjust (s)	0.0	0.0	0.0	0.0	0.0	0.0	0.0	0.0	0.0	0.0	0.0	0.0
Total Lost Time (s)	5.0	5.0	5.0	5.0	5.0	5.0	5.0	5.0	5.0	5.0	5.0	5.0
Lead/Lag	Lead	Lag	Lag	Lead	Lag	Lag	Lead	Lag	Lag	Lead	Lag	Lag
Lead-Lag Optimize?	Yes	Yes	Yes	Yes	Yes	Yes	Yes	Yes	Yes	Yes	Yes	Yes
Recall Mode	None	Max	Max	None	Max	Max	None	None	None	None	None	None
Act Effct Green (s)	58.8	52.1	52.1	15.0	62.8	62.8	29.3	18.0	18.0	25.4	16.0	16.0
Actuated g/C Ratio	0.51	0.46	0.46	0.13	0.55	0.55	0.26	0.16	0.16	0.22	0.14	0.14
v/c Ratio	0.26	0.34	0.20	0.57	0.55	0.09	0.60	0.24	0.31	0.36	0.66	0.42
Control Delay	12.3	21.4	3.7	52.9	19.5	1.8	42.1	43.2	4.7	34.7	53.4	9.8
Queue Delay	0.0	0.0	0.0	0.0	0.0	0.0	0.0	0.0	0.0	0.0	0.0	0.0
Total Delay	12.3	21.4	3.7	52.9	19.5	1.8	42.1	43.2	4.7	34.7	53.4	9.8
LOS	B	C	A	D	B	A	D	D	A	C	D	A
Approach Delay		16.9			24.5			31.9			38.8	
Approach LOS		B			C			C			D	

Intersection Summary

Cycle Length: 120  
 Actuated Cycle Length: 114.5  
 Natural Cycle: 60  
 Control Type: Actuated-Uncoordinated  
 Maximum v/c Ratio: 0.66  
 Intersection Signal Delay: 26.2  
 Intersection LOS: C  
 Intersection Capacity Utilization 66.1%  
 ICU Level of Service C  
 Analysis Period (min) 15

Splits and Phases: 4: Vollmer Rd & Briargate Pkwy



Timings  
5: Sterling Ranch Rd & Briargate Pkwy

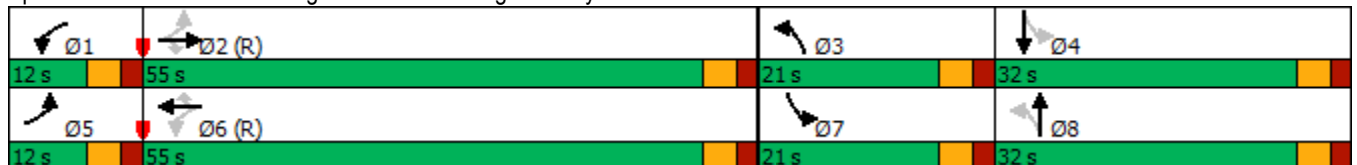
2045 Background Traffic  
AM Peak Hour

Lane Group	EBL	EBT	EBR	WBL	WBT	WBR	NBL	NBT	NBR	SBL	SBT	SBR
Lane Configurations												
Traffic Volume (vph)	77	605	132	137	936	23	227	91	102	91	187	181
Future Volume (vph)	77	605	132	137	936	23	227	91	102	91	187	181
Turn Type	pm+pt	NA	Perm	pm+pt	NA	Perm	pm+pt	NA	Free	pm+pt	NA	Free
Protected Phases	5	2		1	6		3	8		7	4	
Permitted Phases	2		2	6		6	8		Free	4		Free
Detector Phase	5	2	2	1	6	6	3	8		7	4	
Switch Phase												
Minimum Initial (s)	5.0	5.0	5.0	5.0	5.0	5.0	5.0	20.0		5.0	20.0	
Minimum Split (s)	10.0	10.0	10.0	10.0	10.0	10.0	10.0	25.0		10.0	25.0	
Total Split (s)	12.0	55.0	55.0	12.0	55.0	55.0	21.0	32.0		21.0	32.0	
Total Split (%)	10.0%	45.8%	45.8%	10.0%	45.8%	45.8%	17.5%	26.7%		17.5%	26.7%	
Yellow Time (s)	3.0	3.0	3.0	3.0	3.0	3.0	3.0	3.0		3.0	3.0	
All-Red Time (s)	2.0	2.0	2.0	2.0	2.0	2.0	2.0	2.0		2.0	2.0	
Lost Time Adjust (s)	0.0	0.0	0.0	0.0	0.0	0.0	0.0	0.0		0.0	0.0	
Total Lost Time (s)	5.0	5.0	5.0	5.0	5.0	5.0	5.0	5.0		5.0	5.0	
Lead/Lag	Lead	Lag	Lag	Lead	Lag	Lag	Lead	Lag		Lead	Lag	
Lead-Lag Optimize?	Yes	Yes	Yes	Yes	Yes	Yes	Yes	Yes		Yes	Yes	
Recall Mode	None	C-Max	C-Max	None	C-Max	C-Max	None	Max		None	Max	
Act Effct Green (s)	56.8	50.0	50.0	58.0	52.4	52.4	47.5	33.3	120.0	37.9	28.3	120.0
Actuated g/C Ratio	0.47	0.42	0.42	0.48	0.44	0.44	0.40	0.28	1.00	0.32	0.24	1.00
v/c Ratio	0.35	0.43	0.19	0.41	0.64	0.03	0.56	0.19	0.07	0.21	0.45	0.12
Control Delay	19.3	26.1	4.2	19.5	29.4	0.1	30.6	35.1	0.1	24.7	43.6	0.2
Queue Delay	0.0	0.0	0.0	0.0	0.0	0.0	0.0	0.0	0.0	0.0	0.0	0.0
Total Delay	19.3	26.1	4.2	19.5	29.4	0.1	30.6	35.1	0.1	24.7	43.6	0.2
LOS	B	C	A	B	C	A	C	D	A	C	D	A
Approach Delay		21.9			27.5			24.2			22.7	
Approach LOS		C			C			C			C	

Intersection Summary

Cycle Length: 120  
 Actuated Cycle Length: 120  
 Offset: 63 (53%), Referenced to phase 2:EBTL and 6:WBTL, Start of Green  
 Natural Cycle: 70  
 Control Type: Actuated-Coordinated  
 Maximum v/c Ratio: 0.64  
 Intersection Signal Delay: 24.6  
 Intersection LOS: C  
 Intersection Capacity Utilization 76.0%  
 ICU Level of Service D  
 Analysis Period (min) 15

Splits and Phases: 5: Sterling Ranch Rd & Briargate Pkwy



Timings  
12: Vollmer Rd & Marksheffel Rd

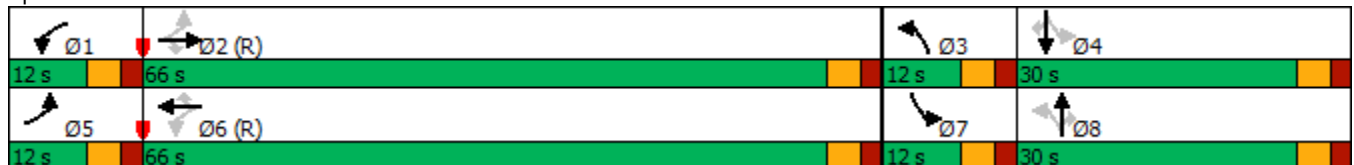
2045 Background Traffic  
AM Peak Hour

Lane Group	EBL	EBT	EBR	WBL	WBT	WBR	NBL	NBT	NBR	SBL	SBT	SBR
Lane Configurations												
Traffic Volume (vph)	69	831	42	160	894	63	108	235	104	121	522	136
Future Volume (vph)	69	831	42	160	894	63	108	235	104	121	522	136
Turn Type	pm+pt	NA	Perm	pm+pt	NA	Perm	pm+pt	NA	Perm	pm+pt	NA	Perm
Protected Phases	5	2		1	6		3	8		7	4	
Permitted Phases	2		2	6		6	8		8	4		4
Detector Phase	5	2	2	1	6	6	3	8	8	7	4	4
Switch Phase												
Minimum Initial (s)	5.0	5.0	5.0	5.0	5.0	5.0	5.0	10.0	10.0	5.0	10.0	10.0
Minimum Split (s)	10.0	23.0	23.0	10.0	23.0	23.0	10.0	23.0	23.0	10.0	23.0	23.0
Total Split (s)	12.0	66.0	66.0	12.0	66.0	66.0	12.0	30.0	30.0	12.0	30.0	30.0
Total Split (%)	10.0%	55.0%	55.0%	10.0%	55.0%	55.0%	10.0%	25.0%	25.0%	10.0%	25.0%	25.0%
Yellow Time (s)	3.0	3.0	3.0	3.0	3.0	3.0	3.0	3.0	3.0	3.0	3.0	3.0
All-Red Time (s)	2.0	2.0	2.0	2.0	2.0	2.0	2.0	2.0	2.0	2.0	2.0	2.0
Lost Time Adjust (s)	0.0	0.0	0.0	0.0	0.0	0.0	0.0	0.0	0.0	0.0	0.0	0.0
Total Lost Time (s)	5.0	5.0	5.0	5.0	5.0	5.0	5.0	5.0	5.0	5.0	5.0	5.0
Lead/Lag	Lead	Lag	Lag	Lead	Lag	Lag	Lead	Lag	Lag	Lead	Lag	Lag
Lead-Lag Optimize?	Yes	Yes	Yes	Yes	Yes	Yes	Yes	Yes	Yes	Yes	Yes	Yes
Recall Mode	None	C-Max	C-Max	None	C-Max	C-Max	None	Max	Max	None	Max	Max
Act Effct Green (s)	67.7	61.0	61.0	69.0	63.4	63.4	32.0	25.0	25.0	32.0	25.0	25.0
Actuated g/C Ratio	0.56	0.51	0.51	0.58	0.53	0.53	0.27	0.21	0.21	0.27	0.21	0.21
v/c Ratio	0.23	0.49	0.05	0.51	0.50	0.07	0.62	0.34	0.26	0.41	0.74	0.33
Control Delay	11.6	20.4	0.1	15.7	11.1	0.3	47.1	41.9	8.9	36.2	51.6	9.9
Queue Delay	0.0	0.0	0.0	0.0	0.0	0.0	0.0	0.0	0.0	0.0	0.0	0.0
Total Delay	11.6	20.4	0.1	15.7	11.1	0.3	47.1	41.9	8.9	36.2	51.6	9.9
LOS	B	C	A	B	B	A	D	D	A	D	D	A
Approach Delay		18.9			11.2			35.5			41.9	
Approach LOS		B			B			D			D	

Intersection Summary

Cycle Length: 120  
 Actuated Cycle Length: 120  
 Offset: 0 (0%), Referenced to phase 2:EBTL and 6:WBTL, Start of Green  
 Natural Cycle: 70  
 Control Type: Actuated-Coordinated  
 Maximum v/c Ratio: 0.74  
 Intersection Signal Delay: 24.0  
 Intersection LOS: C  
 Intersection Capacity Utilization 68.9%  
 ICU Level of Service C  
 Analysis Period (min) 15

Splits and Phases: 12: Vollmer Rd & Marksheffel Rd



Timings  
13: Sterling Ranch Rd & Marksheffel Rd

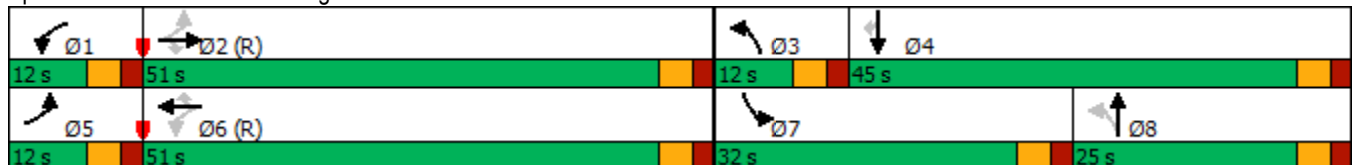
2045 Background Traffic  
AM Peak Hour

Lane Group	EBL	EBT	EBR	WBL	WBT	WBR	NBL	NBT	SBL	SBT	SBR	
Lane Configurations												
Traffic Volume (vph)	141	884	12	53	807	168	7	2	478	10	302	
Future Volume (vph)	141	884	12	53	807	168	7	2	478	10	302	
Turn Type	pm+pt	NA	Perm	pm+pt	NA	Perm	pm+pt	NA	Prot	NA	Perm	
Protected Phases	5	2		1	6		3	8	7	4		
Permitted Phases	2		2	6		6	8				4	
Detector Phase	5	2	2	1	6	6	3	8	7	4	4	
Switch Phase												
Minimum Initial (s)	5.0	15.0	15.0	5.0	15.0	15.0	5.0	10.0	20.0	10.0	10.0	
Minimum Split (s)	10.0	20.0	20.0	10.0	20.0	20.0	10.0	15.0	25.0	20.0	20.0	
Total Split (s)	12.0	51.0	51.0	12.0	51.0	51.0	12.0	25.0	32.0	45.0	45.0	
Total Split (%)	10.0%	42.5%	42.5%	10.0%	42.5%	42.5%	10.0%	20.8%	26.7%	37.5%	37.5%	
Yellow Time (s)	3.0	3.0	3.0	3.0	3.0	3.0	3.0	3.0	3.0	3.0	3.0	
All-Red Time (s)	2.0	2.0	2.0	2.0	2.0	2.0	2.0	2.0	2.0	2.0	2.0	
Lost Time Adjust (s)	0.0	0.0	0.0	0.0	0.0	0.0	0.0	0.0	0.0	0.0	0.0	
Total Lost Time (s)	5.0	5.0	5.0	5.0	5.0	5.0	5.0	5.0	5.0	5.0	5.0	
Lead/Lag	Lead	Lag	Lag	Lead	Lag	Lag	Lead	Lag	Lead	Lag	Lag	
Lead-Lag Optimize?	Yes	Yes	Yes	Yes	Yes	Yes	Yes	Yes	Yes	Yes	Yes	
Recall Mode	None	C-Max	C-Max	None	C-Max	C-Max	None	None	None	None	None	
Act Effct Green (s)	82.0	74.3	74.3	76.7	69.9	69.9	8.0	10.0	23.0	23.7	23.7	
Actuated g/C Ratio	0.68	0.62	0.62	0.64	0.58	0.58	0.07	0.08	0.19	0.20	0.20	
v/c Ratio	0.35	0.43	0.01	0.15	0.41	0.18	0.06	0.06	0.76	0.03	0.58	
Control Delay	12.0	11.5	0.0	8.7	16.4	3.2	41.1	33.0	54.0	36.5	10.6	
Queue Delay	0.0	0.0	0.0	0.0	0.0	0.0	0.0	0.0	0.0	0.0	0.0	
Total Delay	12.0	11.5	0.0	8.7	16.4	3.2	41.1	33.0	54.0	36.5	10.6	
LOS	B	B	A	A	B	A	D	C	D	D	B	
Approach Delay		11.4			13.8			36.6		37.2		
Approach LOS		B			B			D		D		

Intersection Summary

Cycle Length: 120  
 Actuated Cycle Length: 120  
 Offset: 0 (0%), Referenced to phase 2:EBTL and 6:WBTL, Start of Green  
 Natural Cycle: 75  
 Control Type: Actuated-Coordinated  
 Maximum v/c Ratio: 0.76  
 Intersection Signal Delay: 19.5  
 Intersection LOS: B  
 Intersection Capacity Utilization 62.9%  
 ICU Level of Service B  
 Analysis Period (min) 15

Splits and Phases: 13: Sterling Ranch Rd & Marksheffel Rd



Intersection						
Int Delay, s/veh	6.4					
Movement	EBT	EBR	WBL	WBT	NBL	NBR
Lane Configurations	↑	↗	↘	↑	↘	↗
Traffic Vol, veh/h	225	81	148	476	89	110
Future Vol, veh/h	225	81	148	476	89	110
Conflicting Peds, #/hr	0	0	0	0	0	0
Sign Control	Free	Free	Free	Free	Stop	Stop
RT Channelized	-	None	-	None	-	None
Storage Length	-	155	205	-	0	-
Veh in Median Storage, #	0	-	-	0	0	-
Grade, %	0	-	-	0	0	-
Peak Hour Factor	95	75	75	95	75	75
Heavy Vehicles, %	2	2	2	2	2	2
Mvmt Flow	237	108	197	501	119	147

Major/Minor	Major1	Major2	Minor1		
Conflicting Flow All	0	0	345	0	1132 237
Stage 1	-	-	-	-	237 -
Stage 2	-	-	-	-	895 -
Critical Hdwy	-	-	4.12	-	6.42 6.22
Critical Hdwy Stg 1	-	-	-	-	5.42 -
Critical Hdwy Stg 2	-	-	-	-	5.42 -
Follow-up Hdwy	-	-	2.218	-	3.518 3.318
Pot Cap-1 Maneuver	-	-	1214	-	225 802
Stage 1	-	-	-	-	802 -
Stage 2	-	-	-	-	399 -
Platoon blocked, %	-	-	-	-	-
Mov Cap-1 Maneuver	-	-	1214	-	189 802
Mov Cap-2 Maneuver	-	-	-	-	280 -
Stage 1	-	-	-	-	802 -
Stage 2	-	-	-	-	334 -

Approach	EB	WB	NB
HCM Control Delay, s	0	2.4	25.2
HCM LOS			D

Minor Lane/Major Mvmt	NBLn1	EBT	EBR	WBL	WBT
Capacity (veh/h)	437	-	-	1214	-
HCM Lane V/C Ratio	0.607	-	-	0.163	-
HCM Control Delay (s)	25.2	-	-	8.5	-
HCM Lane LOS	D	-	-	A	-
HCM 95th %tile Q(veh)	3.9	-	-	0.6	-

Intersection												
Int Delay, s/veh	0.8											
Movement	EBL	EBT	EBR	WBL	WBT	WBR	NBL	NBT	NBR	SBL	SBT	SBR
Lane Configurations	↙	↑	↗	↙	↑	↗		↕			↕	
Traffic Vol, veh/h	6	329	0	0	606	7	0	0	0	22	0	17
Future Vol, veh/h	6	329	0	0	606	7	0	0	0	22	0	17
Conflicting Peds, #/hr	0	0	0	0	0	0	0	0	0	0	0	0
Sign Control	Free	Free	Free	Free	Free	Free	Stop	Stop	Stop	Stop	Stop	Stop
RT Channelized	-	-	None	-	-	None	-	-	None	-	-	None
Storage Length	205	-	155	205	-	155	-	-	-	-	-	-
Veh in Median Storage, #	-	0	-	-	0	-	-	0	-	-	0	-
Grade, %	-	0	-	-	0	-	-	0	-	-	0	-
Peak Hour Factor	95	95	95	95	95	95	95	95	95	95	95	95
Heavy Vehicles, %	2	2	2	2	2	2	2	2	2	2	2	2
Mvmt Flow	6	346	0	0	638	7	0	0	0	23	0	18

Major/Minor	Major1			Major2			Minor1			Minor2		
Conflicting Flow All	645	0	0	346	0	0	1009	1003	346	996	996	638
Stage 1	-	-	-	-	-	-	358	358	-	638	638	-
Stage 2	-	-	-	-	-	-	651	645	-	358	358	-
Critical Hdwy	4.12	-	-	4.12	-	-	7.12	6.52	6.22	7.12	6.52	6.22
Critical Hdwy Stg 1	-	-	-	-	-	-	6.12	5.52	-	6.12	5.52	-
Critical Hdwy Stg 2	-	-	-	-	-	-	6.12	5.52	-	6.12	5.52	-
Follow-up Hdwy	2.218	-	-	2.218	-	-	3.518	4.018	3.318	3.518	4.018	3.318
Pot Cap-1 Maneuver	940	-	-	1213	-	-	219	242	697	223	244	477
Stage 1	-	-	-	-	-	-	660	628	-	465	471	-
Stage 2	-	-	-	-	-	-	457	467	-	660	628	-
Platoon blocked, %		-	-		-	-						
Mov Cap-1 Maneuver	940	-	-	1213	-	-	210	241	697	222	243	477
Mov Cap-2 Maneuver	-	-	-	-	-	-	210	241	-	222	243	-
Stage 1	-	-	-	-	-	-	656	624	-	462	471	-
Stage 2	-	-	-	-	-	-	440	467	-	656	624	-

Approach	EB	WB	NB	SB
HCM Control Delay, s	0.2	0	0	19.5
HCM LOS			A	C

Minor Lane/Major Mvmt	NBLn1	EBL	EBT	EBR	WBL	WBT	WBR	SBLn1
Capacity (veh/h)	-	940	-	-	1213	-	-	289
HCM Lane V/C Ratio	-	0.007	-	-	-	-	-	0.142
HCM Control Delay (s)		0	8.9	-	-	0	-	19.5
HCM Lane LOS		A	A	-	-	A	-	C
HCM 95th %tile Q(veh)	-	0	-	-	0	-	-	0.5

Intersection												
Int Delay, s/veh	2.8											
Movement	EBL	EBT	EBR	WBL	WBT	WBR	NBL	NBT	NBR	SBL	SBT	SBR
Lane Configurations	↙	↑	↗	↙	↑	↗		↕			↕	
Traffic Vol, veh/h	12	322	17	6	526	7	52	0	20	21	0	35
Future Vol, veh/h	12	322	17	6	526	7	52	0	20	21	0	35
Conflicting Peds, #/hr	0	0	0	0	0	0	0	0	0	0	0	0
Sign Control	Free	Free	Free	Free	Free	Free	Stop	Stop	Stop	Stop	Stop	Stop
RT Channelized	-	-	None	-	-	None	-	-	None	-	-	None
Storage Length	305	-	155	305	-	155	-	-	-	-	-	-
Veh in Median Storage, #	-	0	-	-	0	-	-	0	-	-	0	-
Grade, %	-	0	-	-	0	-	-	0	-	-	0	-
Peak Hour Factor	95	95	95	95	95	95	95	95	95	95	95	95
Heavy Vehicles, %	2	2	2	2	2	2	2	2	2	2	2	2
Mvmt Flow	13	339	18	6	554	7	55	0	21	22	0	37

Major/Minor	Major1		Major2		Minor1			Minor2				
Conflicting Flow All	561	0	0	357	0	0	953	938	339	951	949	554
Stage 1	-	-	-	-	-	-	365	365	-	566	566	-
Stage 2	-	-	-	-	-	-	588	573	-	385	383	-
Critical Hdwy	4.12	-	-	4.12	-	-	7.12	6.52	6.22	7.12	6.52	6.22
Critical Hdwy Stg 1	-	-	-	-	-	-	6.12	5.52	-	6.12	5.52	-
Critical Hdwy Stg 2	-	-	-	-	-	-	6.12	5.52	-	6.12	5.52	-
Follow-up Hdwy	2.218	-	-	2.218	-	-	3.518	4.018	3.318	3.518	4.018	3.318
Pot Cap-1 Maneuver	1010	-	-	1202	-	-	239	264	703	240	260	532
Stage 1	-	-	-	-	-	-	654	623	-	509	507	-
Stage 2	-	-	-	-	-	-	495	504	-	638	612	-
Platoon blocked, %		-	-		-	-						
Mov Cap-1 Maneuver	1010	-	-	1202	-	-	219	259	703	230	255	532
Mov Cap-2 Maneuver	-	-	-	-	-	-	219	259	-	230	255	-
Stage 1	-	-	-	-	-	-	645	615	-	502	504	-
Stage 2	-	-	-	-	-	-	458	501	-	611	604	-

Approach	EB	WB	NB	SB
HCM Control Delay, s	0.3	0.1	23.4	17.1
HCM LOS			C	C

Minor Lane/Major Mvmt	NBLn1	EBL	EBT	EBR	WBL	WBT	WBR	SBLn1
Capacity (veh/h)	271	1010	-	-	1202	-	-	356
HCM Lane V/C Ratio	0.28	0.013	-	-	0.005	-	-	0.166
HCM Control Delay (s)	23.4	8.6	-	-	8	-	-	17.1
HCM Lane LOS	C	A	-	-	A	-	-	C
HCM 95th %tile Q(veh)	1.1	0	-	-	0	-	-	0.6



Timings  
4: Vollmer Rd & Briargate Pkwy

2045 Background Traffic  
PM Peak Hour

Lane Group	EBL	EBT	EBR	WBL	WBT	WBR	NBL	NBT	NBR	SBL	SBT	SBR
Lane Configurations												
Traffic Volume (vph)	230	981	176	201	728	66	291	416	285	93	212	120
Future Volume (vph)	230	981	176	201	728	66	291	416	285	93	212	120
Turn Type	pm+pt	NA	Perm	Prot	NA	Perm	pm+pt	NA	Perm	pm+pt	NA	Perm
Protected Phases	5	2		1	6		3	8		7	4	
Permitted Phases	2		2			6	8		8	4		4
Detector Phase	5	2	2	1	6	6	3	8	8	7	4	4
Switch Phase												
Minimum Initial (s)	5.0	15.0	15.0	15.0	15.0	15.0	8.0	5.0	5.0	5.0	5.0	5.0
Minimum Split (s)	10.0	20.0	20.0	20.0	20.0	20.0	13.0	10.0	10.0	10.0	10.0	10.0
Total Split (s)	12.0	53.0	53.0	20.0	61.0	61.0	22.0	28.0	28.0	19.0	25.0	25.0
Total Split (%)	10.0%	44.2%	44.2%	16.7%	50.8%	50.8%	18.3%	23.3%	23.3%	15.8%	20.8%	20.8%
Yellow Time (s)	3.0	3.0	3.0	3.0	3.0	3.0	3.0	3.0	3.0	3.0	3.0	3.0
All-Red Time (s)	2.0	2.0	2.0	2.0	2.0	2.0	2.0	2.0	2.0	2.0	2.0	2.0
Lost Time Adjust (s)	0.0	0.0	0.0	0.0	0.0	0.0	0.0	0.0	0.0	0.0	0.0	0.0
Total Lost Time (s)	5.0	5.0	5.0	5.0	5.0	5.0	5.0	5.0	5.0	5.0	5.0	5.0
Lead/Lag	Lead	Lag	Lag	Lead	Lag	Lag	Lead	Lag	Lag	Lead	Lag	Lag
Lead-Lag Optimize?	Yes	Yes	Yes	Yes	Yes	Yes	Yes	Yes	Yes	Yes	Yes	Yes
Recall Mode	None	Max	Max	None	Max	Max	None	None	None	None	None	None
Act Effct Green (s)	55.1	48.1	48.1	15.0	56.1	56.1	35.2	20.4	20.4	24.1	14.0	14.0
Actuated g/C Ratio	0.48	0.42	0.42	0.13	0.49	0.49	0.31	0.18	0.18	0.21	0.12	0.12
v/c Ratio	0.65	0.67	0.24	0.47	0.44	0.08	0.81	0.67	0.58	0.38	0.51	0.38
Control Delay	24.6	29.8	4.2	50.3	20.2	1.1	50.9	49.4	10.6	32.9	50.7	7.1
Queue Delay	0.0	0.0	0.0	0.0	0.0	0.0	0.0	0.0	0.0	0.0	0.0	0.0
Total Delay	24.6	29.8	4.2	50.3	20.2	1.1	50.9	49.4	10.6	32.9	50.7	7.1
LOS	C	C	A	D	C	A	D	D	B	C	D	A
Approach Delay		25.6			25.0			38.6			34.5	
Approach LOS		C			C			D			C	

Intersection Summary

Cycle Length: 120  
 Actuated Cycle Length: 113.7  
 Natural Cycle: 75  
 Control Type: Actuated-Uncoordinated  
 Maximum v/c Ratio: 0.81  
 Intersection Signal Delay: 29.8  
 Intersection LOS: C  
 Intersection Capacity Utilization 78.3%  
 ICU Level of Service D  
 Analysis Period (min) 15

Splits and Phases: 4: Vollmer Rd & Briargate Pkwy





Timings  
12: Vollmer Rd & Marksheffel Rd

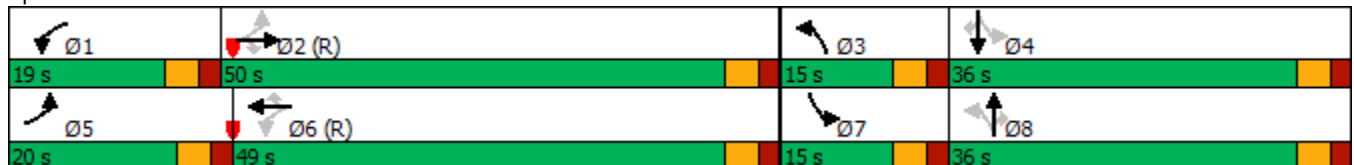
2045 Background Traffic  
PM Peak Hour

Lane Group	EBL	EBT	EBR	WBL	WBT	WBR	NBL	NBT	NBR	SBL	SBT	SBR
Lane Configurations												
Traffic Volume (vph)	139	909	89	185	698	149	169	736	174	126	327	197
Future Volume (vph)	139	909	89	185	698	149	169	736	174	126	327	197
Turn Type	pm+pt	NA	Perm	pm+pt	NA	Perm	pm+pt	NA	Perm	pm+pt	NA	Perm
Protected Phases	5	2		1	6		3	8		7	4	
Permitted Phases	2		2	6		6	8		8	4		4
Detector Phase	5	2	2	1	6	6	3	8	8	7	4	4
Switch Phase												
Minimum Initial (s)	5.0	5.0	5.0	5.0	5.0	5.0	5.0	10.0	10.0	5.0	10.0	10.0
Minimum Split (s)	10.0	23.0	23.0	10.0	23.0	23.0	10.0	23.0	23.0	10.0	23.0	23.0
Total Split (s)	20.0	50.0	50.0	19.0	49.0	49.0	15.0	36.0	36.0	15.0	36.0	36.0
Total Split (%)	16.7%	41.7%	41.7%	15.8%	40.8%	40.8%	12.5%	30.0%	30.0%	12.5%	30.0%	30.0%
Yellow Time (s)	3.0	3.0	3.0	3.0	3.0	3.0	3.0	3.0	3.0	3.0	3.0	3.0
All-Red Time (s)	2.0	2.0	2.0	2.0	2.0	2.0	2.0	2.0	2.0	2.0	2.0	2.0
Lost Time Adjust (s)	0.0	0.0	0.0	0.0	0.0	0.0	0.0	0.0	0.0	0.0	0.0	0.0
Total Lost Time (s)	5.0	5.0	5.0	5.0	5.0	5.0	5.0	5.0	5.0	5.0	5.0	5.0
Lead/Lag	Lead	Lag	Lag	Lead	Lag	Lag	Lead	Lag	Lag	Lead	Lag	Lag
Lead-Lag Optimize?	Yes	Yes	Yes	Yes	Yes	Yes	Yes	Yes	Yes	Yes	Yes	Yes
Recall Mode	None	C-Max	C-Max	None	C-Max	C-Max	None	Max	Max	None	Max	Max
Act Effct Green (s)	57.6	47.0	47.0	60.4	48.4	48.4	41.3	31.4	31.4	40.7	31.2	31.2
Actuated g/C Ratio	0.48	0.39	0.39	0.50	0.40	0.40	0.34	0.26	0.26	0.34	0.26	0.26
v/c Ratio	0.42	0.69	0.14	0.68	0.51	0.22	0.49	0.84	0.36	0.66	0.37	0.37
Control Delay	18.3	34.0	3.8	47.6	22.1	5.2	31.0	51.2	13.8	41.5	37.9	6.7
Queue Delay	0.0	0.0	0.0	0.0	0.0	0.0	0.0	0.0	0.0	0.0	0.0	0.0
Total Delay	18.3	34.0	3.8	47.6	22.1	5.2	31.0	51.2	13.8	41.5	37.9	6.7
LOS	B	C	A	D	C	A	C	D	B	D	D	A
Approach Delay		29.7			24.2			42.0			29.1	
Approach LOS		C			C			D			C	

Intersection Summary

Cycle Length: 120  
 Actuated Cycle Length: 120  
 Offset: 0 (0%), Referenced to phase 2:EBTL and 6:WBTL, Start of Green  
 Natural Cycle: 70  
 Control Type: Actuated-Coordinated  
 Maximum v/c Ratio: 0.84  
 Intersection Signal Delay: 31.6  
 Intersection LOS: C  
 Intersection Capacity Utilization 79.4%  
 ICU Level of Service D  
 Analysis Period (min) 15

Splits and Phases: 12: Vollmer Rd & Marksheffel Rd



Timings  
13: Sterling Ranch Rd & Marksheffel Rd

2045 Background Traffic  
PM Peak Hour

Lane Group	EBL	EBT	EBR	WBL	WBT	WBR	NBL	NBT	SBL	SBT	SBR	
Lane Configurations												
Traffic Volume (vph)	289	940	6	62	838	526	18	4	324	17	175	
Future Volume (vph)	289	940	6	62	838	526	18	4	324	17	175	
Turn Type	pm+pt	NA	Perm	pm+pt	NA	Perm	pm+pt	NA	Prot	NA	Perm	
Protected Phases	5	2		1	6		3	8	7	4		
Permitted Phases	2		2	6		6	8				4	
Detector Phase	5	2	2	1	6	6	3	8	7	4	4	
Switch Phase												
Minimum Initial (s)	5.0	15.0	15.0	5.0	15.0	15.0	5.0	10.0	20.0	10.0	10.0	
Minimum Split (s)	10.0	20.0	20.0	10.0	20.0	20.0	10.0	15.0	25.0	20.0	20.0	
Total Split (s)	20.0	68.0	68.0	12.0	60.0	60.0	10.0	15.0	25.0	30.0	30.0	
Total Split (%)	16.7%	56.7%	56.7%	10.0%	50.0%	50.0%	8.3%	12.5%	20.8%	25.0%	25.0%	
Yellow Time (s)	3.0	3.0	3.0	3.0	3.0	3.0	3.0	3.0	3.0	3.0	3.0	
All-Red Time (s)	2.0	2.0	2.0	2.0	2.0	2.0	2.0	2.0	2.0	2.0	2.0	
Lost Time Adjust (s)	0.0	0.0	0.0	0.0	0.0	0.0	0.0	0.0	0.0	0.0	0.0	
Total Lost Time (s)	5.0	5.0	5.0	5.0	5.0	5.0	5.0	5.0	5.0	5.0	5.0	
Lead/Lag	Lead	Lag	Lag	Lead	Lag	Lag	Lead	Lag	Lead	Lag	Lag	
Lead-Lag Optimize?	Yes	Yes	Yes	Yes	Yes	Yes	Yes	Yes	Yes	Yes	Yes	
Recall Mode	None	C-Max	C-Max	None	C-Max	C-Max	None	None	None	None	None	
Act Effct Green (s)	80.9	71.6	71.6	69.6	63.0	63.0	11.0	10.0	20.0	25.0	25.0	
Actuated g/C Ratio	0.67	0.60	0.60	0.58	0.52	0.52	0.09	0.08	0.17	0.21	0.21	
v/c Ratio	0.72	0.47	0.01	0.19	0.47	0.51	0.13	0.18	0.60	0.05	0.39	
Control Delay	37.4	9.7	0.0	10.2	20.7	3.4	35.7	24.2	51.2	37.5	8.2	
Queue Delay	0.0	0.0	0.0	0.0	0.0	0.0	0.0	0.0	0.0	0.0	0.0	
Total Delay	37.4	9.7	0.0	10.2	20.7	3.4	35.7	24.2	51.2	37.5	8.2	
LOS	D	A	A	B	C	A	D	C	D	D	A	
Approach Delay		16.1			13.9			28.8		36.1		
Approach LOS		B			B			C		D		

Intersection Summary

Cycle Length: 120  
 Actuated Cycle Length: 120  
 Offset: 0 (0%), Referenced to phase 2:EBTL and 6:WBTL, Start of Green  
 Natural Cycle: 80  
 Control Type: Actuated-Coordinated  
 Maximum v/c Ratio: 0.72  
 Intersection Signal Delay: 18.5  
 Intersection LOS: B  
 Intersection Capacity Utilization 69.4%  
 ICU Level of Service C  
 Analysis Period (min) 15

Splits and Phases: 13: Sterling Ranch Rd & Marksheffel Rd



Intersection						
Int Delay, s/veh	0.9					
Movement	EBT	EBR	WBL	WBT	NBL	NBR
Lane Configurations	↑	↗	↖	↑	↘	↙
Traffic Vol, veh/h	495	20	23	327	17	32
Future Vol, veh/h	495	20	23	327	17	32
Conflicting Peds, #/hr	0	0	0	0	0	0
Sign Control	Free	Free	Free	Free	Stop	Stop
RT Channelized	-	None	-	None	-	None
Storage Length	-	155	205	-	0	-
Veh in Median Storage, #	0	-	-	0	0	-
Grade, %	0	-	-	0	0	-
Peak Hour Factor	95	95	95	95	95	95
Heavy Vehicles, %	2	2	2	2	2	2
Mvmt Flow	521	21	24	344	18	34

Major/Minor	Major1	Major2	Minor1		
Conflicting Flow All	0	0	542	0	913
Stage 1	-	-	-	-	521
Stage 2	-	-	-	-	392
Critical Hdwy	-	-	4.12	-	6.42
Critical Hdwy Stg 1	-	-	-	-	5.42
Critical Hdwy Stg 2	-	-	-	-	5.42
Follow-up Hdwy	-	-	2.218	-	3.518
Pot Cap-1 Maneuver	-	-	1027	-	304
Stage 1	-	-	-	-	596
Stage 2	-	-	-	-	683
Platoon blocked, %	-	-	-	-	-
Mov Cap-1 Maneuver	-	-	1027	-	297
Mov Cap-2 Maneuver	-	-	-	-	422
Stage 1	-	-	-	-	596
Stage 2	-	-	-	-	667

Approach	EB	WB	NB
HCM Control Delay, s	0	0.6	13
HCM LOS			B

Minor Lane/Major Mvmt	NBLn1	EBT	EBR	WBL	WBT
Capacity (veh/h)	500	-	-	1027	-
HCM Lane V/C Ratio	0.103	-	-	0.024	-
HCM Control Delay (s)	13	-	-	8.6	-
HCM Lane LOS	B	-	-	A	-
HCM 95th %tile Q(veh)	0.3	-	-	0.1	-

Intersection												
Int Delay, s/veh	0.7											
Movement	EBL	EBT	EBR	WBL	WBT	WBR	NBL	NBT	NBR	SBL	SBT	SBR
Lane Configurations	↘	↗	↘	↘	↗	↘		↔			↔	
Traffic Vol, veh/h	20	507	0	0	338	23	0	0	0	15	0	12
Future Vol, veh/h	20	507	0	0	338	23	0	0	0	15	0	12
Conflicting Peds, #/hr	0	0	0	0	0	0	0	0	0	0	0	0
Sign Control	Free	Free	Free	Free	Free	Free	Stop	Stop	Stop	Stop	Stop	Stop
RT Channelized	-	-	None	-	-	None	-	-	None	-	-	None
Storage Length	205	-	155	205	-	155	-	-	-	-	-	-
Veh in Median Storage, #	-	0	-	-	0	-	-	0	-	-	0	-
Grade, %	-	0	-	-	0	-	-	0	-	-	0	-
Peak Hour Factor	95	95	95	95	95	95	95	95	95	95	95	95
Heavy Vehicles, %	2	2	2	2	2	2	2	2	2	2	2	2
Mvmt Flow	21	534	0	0	356	24	0	0	0	16	0	13

Major/Minor	Major1			Major2			Minor1			Minor2		
Conflicting Flow All	380	0	0	534	0	0	951	956	534	932	932	356
Stage 1	-	-	-	-	-	-	576	576	-	356	356	-
Stage 2	-	-	-	-	-	-	375	380	-	576	576	-
Critical Hdwy	4.12	-	-	4.12	-	-	7.12	6.52	6.22	7.12	6.52	6.22
Critical Hdwy Stg 1	-	-	-	-	-	-	6.12	5.52	-	6.12	5.52	-
Critical Hdwy Stg 2	-	-	-	-	-	-	6.12	5.52	-	6.12	5.52	-
Follow-up Hdwy	2.218	-	-	2.218	-	-	3.518	4.018	3.318	3.518	4.018	3.318
Pot Cap-1 Maneuver	1178	-	-	1034	-	-	240	258	546	247	266	688
Stage 1	-	-	-	-	-	-	503	502	-	661	629	-
Stage 2	-	-	-	-	-	-	646	614	-	503	502	-
Platoon blocked, %	-	-	-	-	-	-	-	-	-	-	-	-
Mov Cap-1 Maneuver	1178	-	-	1034	-	-	232	253	546	244	261	688
Mov Cap-2 Maneuver	-	-	-	-	-	-	232	253	-	244	261	-
Stage 1	-	-	-	-	-	-	494	493	-	649	629	-
Stage 2	-	-	-	-	-	-	634	614	-	494	493	-

Approach	EB	WB	NB	SB
HCM Control Delay, s	0.3	0	0	16.5
HCM LOS			A	C

Minor Lane/Major Mvmt	NBLn1	EBL	EBT	EBR	WBL	WBT	WBR	SBLn1
Capacity (veh/h)	-	1178	-	-	1034	-	-	342
HCM Lane V/C Ratio	-	0.018	-	-	-	-	-	0.083
HCM Control Delay (s)		0	8.1	-	-	0	-	16.5
HCM Lane LOS		A	A	-	-	A	-	C
HCM 95th %tile Q(veh)	-	0.1	-	-	0	-	-	0.3

Intersection												
Int Delay, s/veh	2.1											
Movement	EBL	EBT	EBR	WBL	WBT	WBR	NBL	NBT	NBR	SBL	SBT	SBR
Lane Configurations												
Traffic Vol, veh/h	42	417	62	12	300	23	37	0	11	14	0	24
Future Vol, veh/h	42	417	62	12	300	23	37	0	11	14	0	24
Conflicting Peds, #/hr	0	0	0	0	0	0	0	0	0	0	0	0
Sign Control	Free	Free	Free	Free	Free	Free	Stop	Stop	Stop	Stop	Stop	Stop
RT Channelized	-	-	None	-	-	None	-	-	None	-	-	None
Storage Length	305	-	155	305	-	155	-	-	-	-	-	-
Veh in Median Storage, #	-	0	-	-	0	-	-	0	-	-	0	-
Grade, %	-	0	-	-	0	-	-	0	-	-	0	-
Peak Hour Factor	95	95	95	95	95	95	95	95	95	95	95	95
Heavy Vehicles, %	2	2	2	2	2	2	2	2	2	2	2	2
Mvmt Flow	44	439	65	13	316	24	39	0	12	15	0	25

Major/Minor	Major1			Major2			Minor1			Minor2		
Conflicting Flow All	340	0	0	504	0	0	894	893	439	908	934	316
Stage 1	-	-	-	-	-	-	527	527	-	342	342	-
Stage 2	-	-	-	-	-	-	367	366	-	566	592	-
Critical Hdwy	4.12	-	-	4.12	-	-	7.12	6.52	6.22	7.12	6.52	6.22
Critical Hdwy Stg 1	-	-	-	-	-	-	6.12	5.52	-	6.12	5.52	-
Critical Hdwy Stg 2	-	-	-	-	-	-	6.12	5.52	-	6.12	5.52	-
Follow-up Hdwy	2.218	-	-	2.218	-	-	3.518	4.018	3.318	3.518	4.018	3.318
Pot Cap-1 Maneuver	1219	-	-	1061	-	-	262	281	618	256	266	724
Stage 1	-	-	-	-	-	-	535	528	-	673	638	-
Stage 2	-	-	-	-	-	-	653	623	-	509	494	-
Platoon blocked, %		-	-		-	-						
Mov Cap-1 Maneuver	1219	-	-	1061	-	-	244	268	618	242	253	724
Mov Cap-2 Maneuver	-	-	-	-	-	-	244	268	-	242	253	-
Stage 1	-	-	-	-	-	-	516	509	-	649	630	-
Stage 2	-	-	-	-	-	-	622	616	-	481	476	-

Approach	EB			WB			NB			SB		
HCM Control Delay, s	0.7			0.3			20.5			14.5		
HCM LOS							C			B		

Minor Lane/Major Mvmt	NBLn1	EBL	EBT	EBR	WBL	WBT	WBR	SBLn1
Capacity (veh/h)	283	1219	-	-	1061	-	-	418
HCM Lane V/C Ratio	0.179	0.036	-	-	0.012	-	-	0.096
HCM Control Delay (s)	20.5	8.1	-	-	8.4	-	-	14.5
HCM Lane LOS	C	A	-	-	A	-	-	B
HCM 95th %tile Q(veh)	0.6	0.1	-	-	0	-	-	0.3

Timings  
4: Vollmer Rd & Briargate Pkwy

2045 Total Traffic  
AM Peak Hour

Lane Group	EBL	EBT	EBR	WBL	WBT	WBR	NBL	NBT	NBR	SBL	SBT	SBR
Lane Configurations												
Traffic Volume (vph)	70	540	153	242	1034	81	153	132	110	109	311	141
Future Volume (vph)	70	540	153	242	1034	81	153	132	110	109	311	141
Turn Type	pm+pt	NA	Perm	Prot	NA	Perm	pm+pt	NA	Perm	pm+pt	NA	Perm
Protected Phases	5	2		1	6		3	8		7	4	
Permitted Phases	2		2			6	8		8	4		4
Detector Phase	5	2	2	1	6	6	3	8	8	7	4	4
Switch Phase												
Minimum Initial (s)	5.0	15.0	15.0	15.0	15.0	15.0	5.0	5.0	5.0	5.0	5.0	5.0
Minimum Split (s)	10.0	20.0	20.0	20.0	20.0	20.0	10.0	10.0	10.0	10.0	10.0	10.0
Total Split (s)	12.0	57.0	57.0	20.0	65.0	65.0	17.0	28.0	28.0	15.0	26.0	26.0
Total Split (%)	10.0%	47.5%	47.5%	16.7%	54.2%	54.2%	14.2%	23.3%	23.3%	12.5%	21.7%	21.7%
Yellow Time (s)	3.0	3.0	3.0	3.0	3.0	3.0	3.0	3.0	3.0	3.0	3.0	3.0
All-Red Time (s)	2.0	2.0	2.0	2.0	2.0	2.0	2.0	2.0	2.0	2.0	2.0	2.0
Lost Time Adjust (s)	0.0	0.0	0.0	0.0	0.0	0.0	0.0	0.0	0.0	0.0	0.0	0.0
Total Lost Time (s)	5.0	5.0	5.0	5.0	5.0	5.0	5.0	5.0	5.0	5.0	5.0	5.0
Lead/Lag	Lead	Lag	Lag	Lead	Lag	Lag	Lead	Lag	Lag	Lead	Lag	Lag
Lead-Lag Optimize?	Yes	Yes	Yes	Yes	Yes	Yes	Yes	Yes	Yes	Yes	Yes	Yes
Recall Mode	None	Max	Max	None	Max	Max	None	None	None	None	None	None
Act Effct Green (s)	58.8	52.1	52.1	15.0	62.8	62.8	29.3	18.0	18.0	25.4	16.0	16.0
Actuated g/C Ratio	0.51	0.46	0.46	0.13	0.55	0.55	0.26	0.16	0.16	0.22	0.14	0.14
v/c Ratio	0.26	0.34	0.20	0.57	0.56	0.09	0.60	0.24	0.31	0.36	0.66	0.42
Control Delay	12.4	21.5	3.7	52.9	19.7	1.8	42.0	43.2	4.7	34.7	53.4	9.8
Queue Delay	0.0	0.0	0.0	0.0	0.0	0.0	0.0	0.0	0.0	0.0	0.0	0.0
Total Delay	12.4	21.5	3.7	52.9	19.7	1.8	42.0	43.2	4.7	34.7	53.4	9.8
LOS	B	C	A	D	B	A	D	D	A	C	D	A
Approach Delay		17.0			24.5			31.9			38.8	
Approach LOS		B			C			C			D	

Intersection Summary

Cycle Length: 120  
 Actuated Cycle Length: 114.5  
 Natural Cycle: 60  
 Control Type: Actuated-Uncoordinated  
 Maximum v/c Ratio: 0.66  
 Intersection Signal Delay: 26.2  
 Intersection LOS: C  
 Intersection Capacity Utilization 66.5%  
 ICU Level of Service C  
 Analysis Period (min) 15

Splits and Phases: 4: Vollmer Rd & Briargate Pkwy







Timings  
12: Vollmer Rd & Marksheffel Rd

2045 Total Traffic  
AM Peak Hour

Lane Group	EBL	EBT	EBR	WBL	WBT	WBR	NBL	NBT	NBR	SBL	SBT	SBR
Lane Configurations												
Traffic Volume (vph)	69	834	42	162	902	63	108	235	104	121	522	136
Future Volume (vph)	69	834	42	162	902	63	108	235	104	121	522	136
Turn Type	pm+pt	NA	Perm	pm+pt	NA	Perm	pm+pt	NA	Perm	pm+pt	NA	Perm
Protected Phases	5	2		1	6		3	8		7	4	
Permitted Phases	2		2	6		6	8		8	4		4
Detector Phase	5	2	2	1	6	6	3	8	8	7	4	4
Switch Phase												
Minimum Initial (s)	5.0	5.0	5.0	5.0	5.0	5.0	5.0	10.0	10.0	5.0	10.0	10.0
Minimum Split (s)	10.0	23.0	23.0	10.0	23.0	23.0	10.0	23.0	23.0	10.0	23.0	23.0
Total Split (s)	12.0	66.0	66.0	12.0	66.0	66.0	12.0	30.0	30.0	12.0	30.0	30.0
Total Split (%)	10.0%	55.0%	55.0%	10.0%	55.0%	55.0%	10.0%	25.0%	25.0%	10.0%	25.0%	25.0%
Yellow Time (s)	3.0	3.0	3.0	3.0	3.0	3.0	3.0	3.0	3.0	3.0	3.0	3.0
All-Red Time (s)	2.0	2.0	2.0	2.0	2.0	2.0	2.0	2.0	2.0	2.0	2.0	2.0
Lost Time Adjust (s)	0.0	0.0	0.0	0.0	0.0	0.0	0.0	0.0	0.0	0.0	0.0	0.0
Total Lost Time (s)	5.0	5.0	5.0	5.0	5.0	5.0	5.0	5.0	5.0	5.0	5.0	5.0
Lead/Lag	Lead	Lag	Lag	Lead	Lag	Lag	Lead	Lag	Lag	Lead	Lag	Lag
Lead-Lag Optimize?	Yes	Yes	Yes	Yes	Yes	Yes	Yes	Yes	Yes	Yes	Yes	Yes
Recall Mode	None	C-Max	C-Max	None	C-Max	C-Max	None	Max	Max	None	Max	Max
Act Effct Green (s)	67.7	61.0	61.0	69.0	63.4	63.4	32.0	25.0	25.0	32.0	25.0	25.0
Actuated g/C Ratio	0.56	0.51	0.51	0.58	0.53	0.53	0.27	0.21	0.21	0.27	0.21	0.21
v/c Ratio	0.23	0.49	0.05	0.52	0.51	0.07	0.62	0.34	0.26	0.41	0.74	0.33
Control Delay	11.6	20.5	0.1	16.4	11.1	0.3	47.1	41.9	8.9	36.2	51.6	9.9
Queue Delay	0.0	0.0	0.0	0.0	0.0	0.0	0.0	0.0	0.0	0.0	0.0	0.0
Total Delay	11.6	20.5	0.1	16.4	11.1	0.3	47.1	41.9	8.9	36.2	51.6	9.9
LOS	B	C	A	B	B	A	D	D	A	D	D	A
Approach Delay		18.9			11.3			35.5			41.9	
Approach LOS		B			B			D			D	

Intersection Summary

Cycle Length: 120  
 Actuated Cycle Length: 120  
 Offset: 0 (0%), Referenced to phase 2:EBTL and 6:WBTL, Start of Green  
 Natural Cycle: 70  
 Control Type: Actuated-Coordinated  
 Maximum v/c Ratio: 0.74  
 Intersection Signal Delay: 24.0  
 Intersection LOS: C  
 Intersection Capacity Utilization 69.1%  
 ICU Level of Service C  
 Analysis Period (min) 15

Splits and Phases: 12: Vollmer Rd & Marksheffel Rd



Timings  
13: Sterling Ranch Rd & Marksheffel Rd

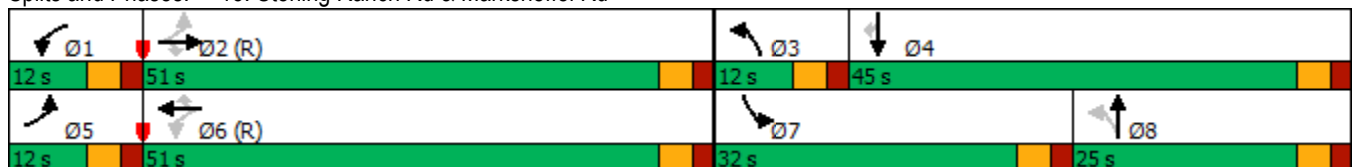
2045 Total Traffic  
AM Peak Hour

Lane Group	EBL	EBT	EBR	WBL	WBT	WBR	NBL	NBT	SBL	SBT	SBR	
Lane Configurations												
Traffic Volume (vph)	144	884	12	53	807	177	7	2	506	10	312	
Future Volume (vph)	144	884	12	53	807	177	7	2	506	10	312	
Turn Type	pm+pt	NA	Perm	pm+pt	NA	Perm	pm+pt	NA	Prot	NA	Perm	
Protected Phases	5	2		1	6		3	8	7	4		
Permitted Phases	2		2	6		6	8				4	
Detector Phase	5	2	2	1	6	6	3	8	7	4	4	
Switch Phase												
Minimum Initial (s)	5.0	15.0	15.0	5.0	15.0	15.0	5.0	10.0	20.0	10.0	10.0	
Minimum Split (s)	10.0	20.0	20.0	10.0	20.0	20.0	10.0	15.0	25.0	20.0	20.0	
Total Split (s)	12.0	51.0	51.0	12.0	51.0	51.0	12.0	25.0	32.0	45.0	45.0	
Total Split (%)	10.0%	42.5%	42.5%	10.0%	42.5%	42.5%	10.0%	20.8%	26.7%	37.5%	37.5%	
Yellow Time (s)	3.0	3.0	3.0	3.0	3.0	3.0	3.0	3.0	3.0	3.0	3.0	
All-Red Time (s)	2.0	2.0	2.0	2.0	2.0	2.0	2.0	2.0	2.0	2.0	2.0	
Lost Time Adjust (s)	0.0	0.0	0.0	0.0	0.0	0.0	0.0	0.0	0.0	0.0	0.0	
Total Lost Time (s)	5.0	5.0	5.0	5.0	5.0	5.0	5.0	5.0	5.0	5.0	5.0	
Lead/Lag	Lead	Lag	Lag	Lead	Lag	Lag	Lead	Lag	Lead	Lag	Lag	
Lead-Lag Optimize?	Yes	Yes	Yes	Yes	Yes	Yes	Yes	Yes	Yes	Yes	Yes	
Recall Mode	None	C-Max	C-Max	None	C-Max	C-Max	None	None	None	None	None	
Act Effct Green (s)	81.6	73.6	73.6	76.0	69.1	69.1	8.0	10.0	23.6	24.3	24.3	
Actuated g/C Ratio	0.68	0.61	0.61	0.63	0.58	0.58	0.07	0.08	0.20	0.20	0.20	
v/c Ratio	0.36	0.43	0.01	0.15	0.42	0.19	0.06	0.06	0.79	0.03	0.59	
Control Delay	12.9	11.8	0.0	8.9	16.8	3.2	41.1	33.0	54.8	36.1	11.3	
Queue Delay	0.0	0.0	0.0	0.0	0.0	0.0	0.0	0.0	0.0	0.0	0.0	
Total Delay	12.9	11.8	0.0	8.9	16.8	3.2	41.1	33.0	54.8	36.1	11.3	
LOS	B	B	A	A	B	A	D	C	D	D	B	
Approach Delay		11.8			14.1			36.6		38.2		
Approach LOS		B			B			D		D		

Intersection Summary

Cycle Length: 120  
 Actuated Cycle Length: 120  
 Offset: 0 (0%), Referenced to phase 2:EBTL and 6:WBTL, Start of Green  
 Natural Cycle: 75  
 Control Type: Actuated-Coordinated  
 Maximum v/c Ratio: 0.79  
 Intersection Signal Delay: 20.2  
 Intersection LOS: C  
 Intersection Capacity Utilization 63.9%  
 ICU Level of Service B  
 Analysis Period (min) 15

Splits and Phases: 13: Sterling Ranch Rd & Marksheffel Rd



Intersection						
Int Delay, s/veh	8					
Movement	EBT	EBR	WBL	WBT	NBL	NBR
Lane Configurations	↑	↗	↖	↑	↘	↙
Traffic Vol, veh/h	234	84	152	505	99	123
Future Vol, veh/h	234	84	152	505	99	123
Conflicting Peds, #/hr	0	0	0	0	0	0
Sign Control	Free	Free	Free	Free	Stop	Stop
RT Channelized	-	None	-	None	-	None
Storage Length	-	155	205	-	0	-
Veh in Median Storage, #	0	-	-	0	0	-
Grade, %	0	-	-	0	0	-
Peak Hour Factor	95	75	75	95	75	75
Heavy Vehicles, %	2	2	2	2	2	2
Mvmt Flow	246	112	203	532	132	164

Major/Minor	Major1	Major2	Minor1		
Conflicting Flow All	0	0	358	0	1184 246
Stage 1	-	-	-	-	246 -
Stage 2	-	-	-	-	938 -
Critical Hdwy	-	-	4.12	-	6.42 6.22
Critical Hdwy Stg 1	-	-	-	-	5.42 -
Critical Hdwy Stg 2	-	-	-	-	5.42 -
Follow-up Hdwy	-	-	2.218	-	3.518 3.318
Pot Cap-1 Maneuver	-	-	1201	-	209 793
Stage 1	-	-	-	-	795 -
Stage 2	-	-	-	-	381 -
Platoon blocked, %	-	-	-	-	-
Mov Cap-1 Maneuver	-	-	1201	-	174 793
Mov Cap-2 Maneuver	-	-	-	-	265 -
Stage 1	-	-	-	-	795 -
Stage 2	-	-	-	-	317 -

Approach	EB	WB	NB
HCM Control Delay, s	0	2.4	31.6
HCM LOS			D

Minor Lane/Major Mvmt	NBLn1	EBT	EBR	WBL	WBT
Capacity (veh/h)	420	-	-	1201	-
HCM Lane V/C Ratio	0.705	-	-	0.169	-
HCM Control Delay (s)	31.6	-	-	8.6	-
HCM Lane LOS	D	-	-	A	-
HCM 95th %tile Q(veh)	5.3	-	-	0.6	-

Intersection												
Int Delay, s/veh	1.6											
Movement	EBL	EBT	EBR	WBL	WBT	WBR	NBL	NBT	NBR	SBL	SBT	SBR
Lane Configurations	↙	↑	↗	↙	↑	↗		↕			↕	
Traffic Vol, veh/h	6	345	6	9	620	7	19	0	27	22	0	17
Future Vol, veh/h	6	345	6	9	620	7	19	0	27	22	0	17
Conflicting Peds, #/hr	0	0	0	0	0	0	0	0	0	0	0	0
Sign Control	Free	Free	Free	Free	Free	Free	Stop	Stop	Stop	Stop	Stop	Stop
RT Channelized	-	-	None	-	-	None	-	-	None	-	-	None
Storage Length	205	-	155	205	-	155	-	-	-	-	-	-
Veh in Median Storage, #	-	0	-	-	0	-	-	0	-	-	0	-
Grade, %	-	0	-	-	0	-	-	0	-	-	0	-
Peak Hour Factor	95	95	95	95	95	95	95	95	95	95	95	95
Heavy Vehicles, %	2	2	2	2	2	2	2	2	2	2	2	2
Mvmt Flow	6	363	6	9	653	7	20	0	28	23	0	18

Major/Minor	Major1			Major2			Minor1			Minor2		
Conflicting Flow All	660	0	0	369	0	0	1059	1053	363	1063	1052	653
Stage 1	-	-	-	-	-	-	375	375	-	671	671	-
Stage 2	-	-	-	-	-	-	684	678	-	392	381	-
Critical Hdwy	4.12	-	-	4.12	-	-	7.12	6.52	6.22	7.12	6.52	6.22
Critical Hdwy Stg 1	-	-	-	-	-	-	6.12	5.52	-	6.12	5.52	-
Critical Hdwy Stg 2	-	-	-	-	-	-	6.12	5.52	-	6.12	5.52	-
Follow-up Hdwy	2.218	-	-	2.218	-	-	3.518	4.018	3.318	3.518	4.018	3.318
Pot Cap-1 Maneuver	928	-	-	1190	-	-	202	226	682	201	227	467
Stage 1	-	-	-	-	-	-	646	617	-	446	455	-
Stage 2	-	-	-	-	-	-	439	452	-	633	613	-
Platoon blocked, %		-	-		-	-						
Mov Cap-1 Maneuver	928	-	-	1190	-	-	192	223	682	191	224	467
Mov Cap-2 Maneuver	-	-	-	-	-	-	192	223	-	191	224	-
Stage 1	-	-	-	-	-	-	642	613	-	443	451	-
Stage 2	-	-	-	-	-	-	419	448	-	603	609	-

Approach	EB			WB			NB			SB		
HCM Control Delay, s	0.1			0.1			17.7			21.7		
HCM LOS							C			C		

Minor Lane/Major Mvmt	NBLn1	EBL	EBT	EBR	WBL	WBT	WBR	SBLn1
Capacity (veh/h)	332	928	-	-	1190	-	-	257
HCM Lane V/C Ratio	0.146	0.007	-	-	0.008	-	-	0.16
HCM Control Delay (s)	17.7	8.9	-	-	8	-	-	21.7
HCM Lane LOS	C	A	-	-	A	-	-	C
HCM 95th %tile Q(veh)	0.5	0	-	-	0	-	-	0.6

Intersection												
Int Delay, s/veh	3.3											
Movement	EBL	EBT	EBR	WBL	WBT	WBR	NBL	NBT	NBR	SBL	SBT	SBR
Lane Configurations	↖	↑	↗	↖	↑	↗		↕			↕	
Traffic Vol, veh/h	12	362	20	8	540	7	61	0	26	21	0	35
Future Vol, veh/h	12	362	20	8	540	7	61	0	26	21	0	35
Conflicting Peds, #/hr	0	0	0	0	0	0	0	0	0	0	0	0
Sign Control	Free	Free	Free	Free	Free	Free	Stop	Stop	Stop	Stop	Stop	Stop
RT Channelized	-	-	None	-	-	None	-	-	None	-	-	None
Storage Length	305	-	155	305	-	155	-	-	-	-	-	-
Veh in Median Storage, #	-	0	-	-	0	-	-	0	-	-	0	-
Grade, %	-	0	-	-	0	-	-	0	-	-	0	-
Peak Hour Factor	95	95	95	95	95	95	95	95	95	95	95	95
Heavy Vehicles, %	2	2	2	2	2	2	2	2	2	2	2	2
Mvmt Flow	13	381	21	8	568	7	64	0	27	22	0	37

Major/Minor	Major1			Major2			Minor1			Minor2		
Conflicting Flow All	575	0	0	402	0	0	1013	998	381	1015	1012	568
Stage 1	-	-	-	-	-	-	407	407	-	584	584	-
Stage 2	-	-	-	-	-	-	606	591	-	431	428	-
Critical Hdwy	4.12	-	-	4.12	-	-	7.12	6.52	6.22	7.12	6.52	6.22
Critical Hdwy Stg 1	-	-	-	-	-	-	6.12	5.52	-	6.12	5.52	-
Critical Hdwy Stg 2	-	-	-	-	-	-	6.12	5.52	-	6.12	5.52	-
Follow-up Hdwy	2.218	-	-	2.218	-	-	3.518	4.018	3.318	3.518	4.018	3.318
Pot Cap-1 Maneuver	998	-	-	1157	-	-	217	244	666	217	239	522
Stage 1	-	-	-	-	-	-	621	597	-	498	498	-
Stage 2	-	-	-	-	-	-	484	494	-	603	585	-
Platoon blocked, %		-	-		-	-						
Mov Cap-1 Maneuver	998	-	-	1157	-	-	199	239	666	205	234	522
Mov Cap-2 Maneuver	-	-	-	-	-	-	199	239	-	205	234	-
Stage 1	-	-	-	-	-	-	613	589	-	492	495	-
Stage 2	-	-	-	-	-	-	447	491	-	571	577	-

Approach	EB	WB	NB	SB
HCM Control Delay, s	0.3	0.1	27.2	18.3
HCM LOS			D	C

Minor Lane/Major Mvmt	NBLn1	EBL	EBT	EBR	WBL	WBT	WBR	SBLn1
Capacity (veh/h)	252	998	-	-	1157	-	-	330
HCM Lane V/C Ratio	0.363	0.013	-	-	0.007	-	-	0.179
HCM Control Delay (s)	27.2	8.7	-	-	8.1	-	-	18.3
HCM Lane LOS	D	A	-	-	A	-	-	C
HCM 95th %tile Q(veh)	1.6	0	-	-	0	-	-	0.6

Timings  
4: Vollmer Rd & Briargate Pkwy

2045 Total Traffic  
PM Peak Hour

Lane Group	EBL	EBT	EBR	WBL	WBT	WBR	NBL	NBT	NBR	SBL	SBT	SBR
Lane Configurations												
Traffic Volume (vph)	230	999	176	201	738	67	291	416	285	95	212	120
Future Volume (vph)	230	999	176	201	738	67	291	416	285	95	212	120
Turn Type	pm+pt	NA	Perm	Prot	NA	Perm	pm+pt	NA	Perm	pm+pt	NA	Perm
Protected Phases	5	2		1	6		3	8		7	4	
Permitted Phases	2		2			6	8		8	4		4
Detector Phase	5	2	2	1	6	6	3	8	8	7	4	4
Switch Phase												
Minimum Initial (s)	5.0	15.0	15.0	15.0	15.0	15.0	8.0	5.0	5.0	5.0	5.0	5.0
Minimum Split (s)	10.0	20.0	20.0	20.0	20.0	20.0	13.0	10.0	10.0	10.0	10.0	10.0
Total Split (s)	12.0	53.0	53.0	20.0	61.0	61.0	22.0	28.0	28.0	19.0	25.0	25.0
Total Split (%)	10.0%	44.2%	44.2%	16.7%	50.8%	50.8%	18.3%	23.3%	23.3%	15.8%	20.8%	20.8%
Yellow Time (s)	3.0	3.0	3.0	3.0	3.0	3.0	3.0	3.0	3.0	3.0	3.0	3.0
All-Red Time (s)	2.0	2.0	2.0	2.0	2.0	2.0	2.0	2.0	2.0	2.0	2.0	2.0
Lost Time Adjust (s)	0.0	0.0	0.0	0.0	0.0	0.0	0.0	0.0	0.0	0.0	0.0	0.0
Total Lost Time (s)	5.0	5.0	5.0	5.0	5.0	5.0	5.0	5.0	5.0	5.0	5.0	5.0
Lead/Lag	Lead	Lag	Lag	Lead	Lag	Lag	Lead	Lag	Lag	Lead	Lag	Lag
Lead-Lag Optimize?	Yes	Yes	Yes	Yes	Yes	Yes	Yes	Yes	Yes	Yes	Yes	Yes
Recall Mode	None	Max	Max	None	Max	Max	None	None	None	None	None	None
Act Effct Green (s)	55.1	48.1	48.1	15.0	56.1	56.1	35.3	20.4	20.4	24.3	14.1	14.1
Actuated g/C Ratio	0.48	0.42	0.42	0.13	0.49	0.49	0.31	0.18	0.18	0.21	0.12	0.12
v/c Ratio	0.66	0.68	0.24	0.47	0.45	0.09	0.81	0.67	0.58	0.39	0.51	0.38
Control Delay	25.2	30.2	4.5	50.4	20.4	1.2	50.9	49.5	11.0	33.0	50.6	7.0
Queue Delay	0.0	0.0	0.0	0.0	0.0	0.0	0.0	0.0	0.0	0.0	0.0	0.0
Total Delay	25.2	30.2	4.5	50.4	20.4	1.2	50.9	49.5	11.0	33.0	50.6	7.0
LOS	C	C	A	D	C	A	D	D	B	C	D	A
Approach Delay		26.1			25.1			38.7			34.4	
Approach LOS		C			C			D			C	

Intersection Summary

Cycle Length: 120  
 Actuated Cycle Length: 113.8  
 Natural Cycle: 80  
 Control Type: Actuated-Uncoordinated  
 Maximum v/c Ratio: 0.81  
 Intersection Signal Delay: 30.0  
 Intersection LOS: C  
 Intersection Capacity Utilization 78.8%  
 ICU Level of Service D  
 Analysis Period (min) 15

Splits and Phases: 4: Vollmer Rd & Briargate Pkwy







Timings  
12: Vollmer Rd & Marksheffel Rd

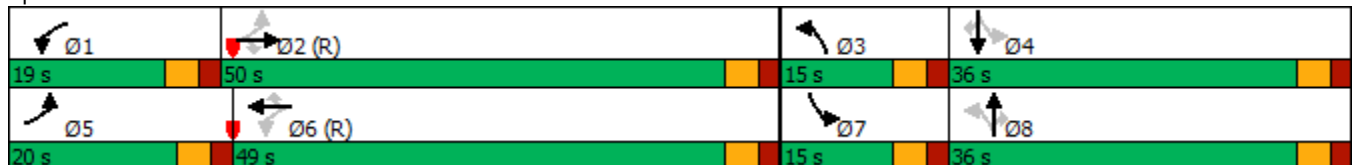
2045 Total Traffic  
PM Peak Hour

Lane Group	EBL	EBT	EBR	WBL	WBT	WBR	NBL	NBT	NBR	SBL	SBT	SBR
Lane Configurations												
Traffic Volume (vph)	139	919	89	186	704	149	169	736	176	126	327	197
Future Volume (vph)	139	919	89	186	704	149	169	736	176	126	327	197
Turn Type	pm+pt	NA	Perm	pm+pt	NA	Perm	pm+pt	NA	Perm	pm+pt	NA	Perm
Protected Phases	5	2		1	6		3	8		7	4	
Permitted Phases	2		2	6		6	8		8	4		4
Detector Phase	5	2	2	1	6	6	3	8	8	7	4	4
Switch Phase												
Minimum Initial (s)	5.0	5.0	5.0	5.0	5.0	5.0	5.0	10.0	10.0	5.0	10.0	10.0
Minimum Split (s)	10.0	23.0	23.0	10.0	23.0	23.0	10.0	23.0	23.0	10.0	23.0	23.0
Total Split (s)	20.0	50.0	50.0	19.0	49.0	49.0	15.0	36.0	36.0	15.0	36.0	36.0
Total Split (%)	16.7%	41.7%	41.7%	15.8%	40.8%	40.8%	12.5%	30.0%	30.0%	12.5%	30.0%	30.0%
Yellow Time (s)	3.0	3.0	3.0	3.0	3.0	3.0	3.0	3.0	3.0	3.0	3.0	3.0
All-Red Time (s)	2.0	2.0	2.0	2.0	2.0	2.0	2.0	2.0	2.0	2.0	2.0	2.0
Lost Time Adjust (s)	0.0	0.0	0.0	0.0	0.0	0.0	0.0	0.0	0.0	0.0	0.0	0.0
Total Lost Time (s)	5.0	5.0	5.0	5.0	5.0	5.0	5.0	5.0	5.0	5.0	5.0	5.0
Lead/Lag	Lead	Lag	Lag	Lead	Lag	Lag	Lead	Lag	Lag	Lead	Lag	Lag
Lead-Lag Optimize?	Yes	Yes	Yes	Yes	Yes	Yes	Yes	Yes	Yes	Yes	Yes	Yes
Recall Mode	None	C-Max	C-Max	None	C-Max	C-Max	None	Max	Max	None	Max	Max
Act Effct Green (s)	57.6	47.0	47.0	60.4	48.4	48.4	41.3	31.4	31.4	40.7	31.2	31.2
Actuated g/C Ratio	0.48	0.39	0.39	0.50	0.40	0.40	0.34	0.26	0.26	0.34	0.26	0.26
v/c Ratio	0.42	0.70	0.14	0.69	0.52	0.22	0.49	0.84	0.36	0.66	0.37	0.37
Control Delay	18.4	34.2	3.8	48.7	22.1	5.3	31.0	51.2	13.9	41.5	37.9	6.7
Queue Delay	0.0	0.0	0.0	0.0	0.0	0.0	0.0	0.0	0.0	0.0	0.0	0.0
Total Delay	18.4	34.2	3.8	48.7	22.1	5.3	31.0	51.2	13.9	41.5	37.9	6.7
LOS	B	C	A	D	C	A	C	D	B	D	D	A
Approach Delay		29.9			24.5			42.0			29.1	
Approach LOS		C			C			D			C	

Intersection Summary

Cycle Length: 120  
 Actuated Cycle Length: 120  
 Offset: 0 (0%), Referenced to phase 2:EBTL and 6:WBTL, Start of Green  
 Natural Cycle: 70  
 Control Type: Actuated-Coordinated  
 Maximum v/c Ratio: 0.84  
 Intersection Signal Delay: 31.7  
 Intersection LOS: C  
 Intersection Capacity Utilization 79.7%  
 ICU Level of Service D  
 Analysis Period (min) 15

Splits and Phases: 12: Vollmer Rd & Marksheffel Rd



Timings  
13: Sterling Ranch Rd & Marksheffel Rd

2045 Total Traffic  
PM Peak Hour

Lane Group	EBL	EBT	EBR	WBL	WBT	WBR	NBL	NBT	SBL	SBT	SBR
Lane Configurations											
Traffic Volume (vph)	303	940	6	62	838	562	18	4	345	18	183
Future Volume (vph)	303	940	6	62	838	562	18	4	345	18	183
Turn Type	pm+pt	NA	Perm	pm+pt	NA	Perm	pm+pt	NA	Prot	NA	Perm
Protected Phases	5	2		1	6		3	8	7	4	
Permitted Phases	2		2	6		6	8				4
Detector Phase	5	2	2	1	6	6	3	8	7	4	4
Switch Phase											
Minimum Initial (s)	5.0	15.0	15.0	5.0	15.0	15.0	5.0	10.0	20.0	10.0	10.0
Minimum Split (s)	10.0	20.0	20.0	10.0	20.0	20.0	10.0	15.0	25.0	20.0	20.0
Total Split (s)	20.0	68.0	68.0	12.0	60.0	60.0	10.0	15.0	25.0	30.0	30.0
Total Split (%)	16.7%	56.7%	56.7%	10.0%	50.0%	50.0%	8.3%	12.5%	20.8%	25.0%	25.0%
Yellow Time (s)	3.0	3.0	3.0	3.0	3.0	3.0	3.0	3.0	3.0	3.0	3.0
All-Red Time (s)	2.0	2.0	2.0	2.0	2.0	2.0	2.0	2.0	2.0	2.0	2.0
Lost Time Adjust (s)	0.0	0.0	0.0	0.0	0.0	0.0	0.0	0.0	0.0	0.0	0.0
Total Lost Time (s)	5.0	5.0	5.0	5.0	5.0	5.0	5.0	5.0	5.0	5.0	5.0
Lead/Lag	Lead	Lag	Lag	Lead	Lag	Lag	Lead	Lag	Lead	Lag	Lag
Lead-Lag Optimize?	Yes	Yes	Yes	Yes	Yes	Yes	Yes	Yes	Yes	Yes	Yes
Recall Mode	None	C-Max	C-Max	None	C-Max	C-Max	None	None	None	None	None
Act Effct Green (s)	81.0	71.6	71.6	69.3	62.7	62.7	11.0	10.0	20.0	25.0	25.0
Actuated g/C Ratio	0.68	0.60	0.60	0.58	0.52	0.52	0.09	0.08	0.17	0.21	0.21
v/c Ratio	0.75	0.47	0.01	0.19	0.48	0.53	0.13	0.18	0.63	0.05	0.40
Control Delay	39.9	9.8	0.0	10.2	20.8	3.5	35.7	24.2	52.3	37.5	8.2
Queue Delay	0.0	0.0	0.0	0.0	0.0	0.0	0.0	0.0	0.0	0.0	0.0
Total Delay	39.9	9.8	0.0	10.2	20.8	3.5	35.7	24.2	52.3	37.5	8.2
LOS	D	A	A	B	C	A	D	C	D	D	A
Approach Delay		17.0			13.7			28.8		37.0	
Approach LOS		B			B			C		D	

Intersection Summary

Cycle Length: 120  
 Actuated Cycle Length: 120  
 Offset: 0 (0%), Referenced to phase 2:EBTL and 6:WBTL, Start of Green  
 Natural Cycle: 90  
 Control Type: Actuated-Coordinated  
 Maximum v/c Ratio: 0.75  
 Intersection Signal Delay: 19.0  
 Intersection LOS: B  
 Intersection Capacity Utilization 72.4%  
 ICU Level of Service C  
 Analysis Period (min) 15

Splits and Phases: 13: Sterling Ranch Rd & Marksheffel Rd



Intersection						
Int Delay, s/veh	1.3					
Movement	EBT	EBR	WBL	WBT	NBL	NBR
Lane Configurations	↑	↗	↘	↑	↘	↗
Traffic Vol, veh/h	533	33	38	349	25	41
Future Vol, veh/h	533	33	38	349	25	41
Conflicting Peds, #/hr	0	0	0	0	0	0
Sign Control	Free	Free	Free	Free	Stop	Stop
RT Channelized	-	None	-	None	-	None
Storage Length	-	155	205	-	0	-
Veh in Median Storage, #	0	-	-	0	0	-
Grade, %	0	-	-	0	0	-
Peak Hour Factor	95	95	95	95	95	95
Heavy Vehicles, %	2	2	2	2	2	2
Mvmt Flow	561	35	40	367	26	43

Major/Minor	Major1	Major2	Minor1		
Conflicting Flow All	0	0	596	0	1008 561
Stage 1	-	-	-	-	561 -
Stage 2	-	-	-	-	447 -
Critical Hdwy	-	-	4.12	-	6.42 6.22
Critical Hdwy Stg 1	-	-	-	-	5.42 -
Critical Hdwy Stg 2	-	-	-	-	5.42 -
Follow-up Hdwy	-	-	2.218	-	3.518 3.318
Pot Cap-1 Maneuver	-	-	980	-	267 527
Stage 1	-	-	-	-	571 -
Stage 2	-	-	-	-	644 -
Platoon blocked, %	-	-	-	-	-
Mov Cap-1 Maneuver	-	-	980	-	256 527
Mov Cap-2 Maneuver	-	-	-	-	387 -
Stage 1	-	-	-	-	571 -
Stage 2	-	-	-	-	618 -

Approach	EB	WB	NB
HCM Control Delay, s	0	0.9	14.1
HCM LOS			B

Minor Lane/Major Mvmt	NBLn1	EBT	EBR	WBL	WBT
Capacity (veh/h)	463	-	-	980	-
HCM Lane V/C Ratio	0.15	-	-	0.041	-
HCM Control Delay (s)	14.1	-	-	8.8	-
HCM Lane LOS	B	-	-	A	-
HCM 95th %tile Q(veh)	0.5	-	-	0.1	-

Intersection												
Int Delay, s/veh	1.5											
Movement	EBL	EBT	EBR	WBL	WBT	WBR	NBL	NBT	NBR	SBL	SBT	SBR
Lane Configurations	↘	↗	↗	↘	↗	↘		↔			↔	
Traffic Vol, veh/h	20	528	25	29	361	23	15	0	17	15	0	12
Future Vol, veh/h	20	528	25	29	361	23	15	0	17	15	0	12
Conflicting Peds, #/hr	0	0	0	0	0	0	0	0	0	0	0	0
Sign Control	Free	Free	Free	Free	Free	Free	Stop	Stop	Stop	Stop	Stop	Stop
RT Channelized	-	-	None	-	-	None	-	-	None	-	-	None
Storage Length	205	-	155	205	-	155	-	-	-	-	-	-
Veh in Median Storage, #	-	0	-	-	0	-	-	0	-	-	0	-
Grade, %	-	0	-	-	0	-	-	0	-	-	0	-
Peak Hour Factor	95	95	95	95	95	95	95	95	95	95	95	95
Heavy Vehicles, %	2	2	2	2	2	2	2	2	2	2	2	2
Mvmt Flow	21	556	26	31	380	24	16	0	18	16	0	13

Major/Minor	Major1			Major2			Minor1			Minor2		
Conflicting Flow All	404	0	0	582	0	0	1059	1064	556	1062	1066	380
Stage 1	-	-	-	-	-	-	598	598	-	442	442	-
Stage 2	-	-	-	-	-	-	461	466	-	620	624	-
Critical Hdwy	4.12	-	-	4.12	-	-	7.12	6.52	6.22	7.12	6.52	6.22
Critical Hdwy Stg 1	-	-	-	-	-	-	6.12	5.52	-	6.12	5.52	-
Critical Hdwy Stg 2	-	-	-	-	-	-	6.12	5.52	-	6.12	5.52	-
Follow-up Hdwy	2.218	-	-	2.218	-	-	3.518	4.018	3.318	3.518	4.018	3.318
Pot Cap-1 Maneuver	1155	-	-	992	-	-	202	223	531	201	222	667
Stage 1	-	-	-	-	-	-	489	491	-	594	576	-
Stage 2	-	-	-	-	-	-	581	562	-	476	478	-
Platoon blocked, %		-	-	-	-	-						
Mov Cap-1 Maneuver	1155	-	-	992	-	-	191	212	531	187	211	667
Mov Cap-2 Maneuver	-	-	-	-	-	-	191	212	-	187	211	-
Stage 1	-	-	-	-	-	-	480	482	-	583	558	-
Stage 2	-	-	-	-	-	-	552	545	-	452	469	-

Approach	EB			WB			NB			SB		
HCM Control Delay, s	0.3			0.6			19.1			19.6		
HCM LOS							C			C		

Minor Lane/Major Mvmt	NBLn1	EBL	EBT	EBR	WBL	WBT	WBR	SBLn1
Capacity (veh/h)	289	1155	-	-	992	-	-	275
HCM Lane V/C Ratio	0.117	0.018	-	-	0.031	-	-	0.103
HCM Control Delay (s)	19.1	8.2	-	-	8.7	-	-	19.6
HCM Lane LOS	C	A	-	-	A	-	-	C
HCM 95th %tile Q(veh)	0.4	0.1	-	-	0.1	-	-	0.3

Intersection												
Int Delay, s/veh	2.4											
Movement	EBL	EBT	EBR	WBL	WBT	WBR	NBL	NBT	NBR	SBL	SBT	SBR
Lane Configurations												
Traffic Vol, veh/h	42	442	75	20	344	23	45	0	14	14	0	24
Future Vol, veh/h	42	442	75	20	344	23	45	0	14	14	0	24
Conflicting Peds, #/hr	0	0	0	0	0	0	0	0	0	0	0	0
Sign Control	Free	Free	Free	Free	Free	Free	Stop	Stop	Stop	Stop	Stop	Stop
RT Channelized	-	-	None	-	-	None	-	-	None	-	-	None
Storage Length	305	-	155	305	-	155	-	-	-	-	-	-
Veh in Median Storage, #	-	0	-	-	0	-	-	0	-	-	0	-
Grade, %	-	0	-	-	0	-	-	0	-	-	0	-
Peak Hour Factor	95	95	95	95	95	95	95	95	95	95	95	95
Heavy Vehicles, %	2	2	2	2	2	2	2	2	2	2	2	2
Mvmt Flow	44	465	79	21	362	24	47	0	15	15	0	25

Major/Minor	Major1			Major2			Minor1			Minor2		
Conflicting Flow All	386	0	0	544	0	0	982	981	465	1004	1036	362
Stage 1	-	-	-	-	-	-	553	553	-	404	404	-
Stage 2	-	-	-	-	-	-	429	428	-	600	632	-
Critical Hdwy	4.12	-	-	4.12	-	-	7.12	6.52	6.22	7.12	6.52	6.22
Critical Hdwy Stg 1	-	-	-	-	-	-	6.12	5.52	-	6.12	5.52	-
Critical Hdwy Stg 2	-	-	-	-	-	-	6.12	5.52	-	6.12	5.52	-
Follow-up Hdwy	2.218	-	-	2.218	-	-	3.518	4.018	3.318	3.518	4.018	3.318
Pot Cap-1 Maneuver	1172	-	-	1025	-	-	228	249	597	220	232	683
Stage 1	-	-	-	-	-	-	517	514	-	623	599	-
Stage 2	-	-	-	-	-	-	604	585	-	488	474	-
Platoon blocked, %		-	-	-	-	-						
Mov Cap-1 Maneuver	1172	-	-	1025	-	-	210	235	597	205	219	683
Mov Cap-2 Maneuver	-	-	-	-	-	-	210	235	-	205	219	-
Stage 1	-	-	-	-	-	-	497	494	-	599	587	-
Stage 2	-	-	-	-	-	-	570	573	-	458	456	-

Approach	EB			WB			NB			SB		
HCM Control Delay, s	0.6			0.4			24.3			16		
HCM LOS							C			C		

Minor Lane/Major Mvmt	NBLn1	EBL	EBT	EBR	WBL	WBT	WBR	SBLn1
Capacity (veh/h)	248	1172	-	-	1025	-	-	367
HCM Lane V/C Ratio	0.25	0.038	-	-	0.021	-	-	0.109
HCM Control Delay (s)	24.3	8.2	-	-	8.6	-	-	16
HCM Lane LOS	C	A	-	-	A	-	-	C
HCM 95th %tile Q(veh)	1	0.1	-	-	0.1	-	-	0.4

# Appendix Table 1



**Appendix Table 1  
Area Traffic Impact Studies  
Sterling Ranch East Filing No. 3**

<b>Study</b>	<b>PCD File No<sup>(1)</sup></b>	<b>Consultant</b>	<b>Date</b>
<b>Sterling Ranch Reports</b>			
Sterling Ranch Updated Traffic Impact Analysis	<a href="#">SKP07007</a>	LSC Transportation Consultants, Inc	June 5, 2008
Sterling Ranch Phase 1 Traffic Impact Study	<a href="#">P151</a>	LSC Transportation Consultants, Inc	March 16, 2015
Sterling Ranch Phases 1-3 Transportation Memorandum	<a href="#">SP1415</a>	LSC Transportation Consultants, Inc	October 2, 2017
Branding Iron at Sterling Ranch Filing No. 1 and Homestead at Sterling Ranch Filing No. 1 Transportation Memorandum	<a href="#">SF1724</a> <a href="#">SF1725</a>	LSC Transportation Consultants, Inc	December 19, 2017
Sterling Ranch Filing No. 2 Transportation Memorandum	<a href="#">SF1820</a>	LSC Transportation Consultants, Inc	April 3, 2018
Sterling Ranch Phase 2 Preliminary Plan Traffic Impact Study	<a href="#">SP203</a>	LSC Transportation Consultants, Inc	December 20, 2018
Homestead at Sterling Ranch Filing No. 2 Transportation Memorandum	<a href="#">SF194</a>	LSC Transportation Consultants, Inc	March 3, 2020
Branding Iron at Sterling Ranch Filing No. 2 Transportation Memorandum	<a href="#">SF1918</a>	LSC Transportation Consultants, Inc	May 6, 2020
Sterling Ranch Filing No. 2 and Phase 2 Traffic Impact Study	<a href="#">SF2015</a> <a href="#">SP191</a>	LSC Transportation Consultants, Inc	June 23, 2021
Sterling Ranch Filing No. 3 Transportation Memorandum	<a href="#">SF2132</a>	LSC Transportation Consultants, Inc	April 19, 2022
Homestead North Phase 1 Updated Transportation Memorandum	<a href="#">SP208</a>	LSC Transportation Consultants, Inc	January 11, 2022
Homestead North Filing No. 1 Traffic Technical Memorandum	<a href="#">SF2213</a>	LSC Transportation Consultants, Inc	February 2, 2022
Homestead North Filing No. 2 Traffic Technical Memorandum	<a href="#">SF2218</a>	LSC Transportation Consultants, Inc	April 15, 2022
Homestead North Filing 3 Traffic Impact Study	<a href="#">SF2229</a>	LSC Transportation Consultants, Inc	June 17, 2022
The Villages at Sterling Ranch East Preliminary Plan/Traffic Generation Analysis	<a href="#">PUDSP226</a>	SM Rocha, LLC	July 1, 2022
Sterling Ranch Sketch Plan Amendment Master Traffic Impact Study	<a href="#">SKP224</a>	LSC Transportation Consultants, Inc	March 17, 2023
Sterling Ranch East - Rezoning & Preliminary Plan Traffic Impact Study	<a href="#">SP-22-004, P-22-012, P-22-013</a>	LSC Transportation Consultants, Inc	March 17, 2023 <sup>(2)</sup>
Sterling Ranch East Filing Nos 1 & 2 Traffic Technical Memorandum	<a href="#">SF2235</a> <a href="#">SF2237</a>	LSC Transportation Consultants, Inc	February 10, 2023
Sterling Ranch Filing No. 4 Transportation Memorandum	<a href="#">SF2230</a>	LSC Transportation Consultants, Inc	February 21, 2023
Foursquare at Sterling Ranch East Transportation Memorandum	<a href="#">SF2236</a>	LSC Transportation Consultants, Inc	April 20, 2023
Copper Chase at Sterling Ranch Traffic Impact Study	<a href="#">PUDSP222</a>	LSC Transportation Consultants, Inc	April 28, 2023
Sterling Ranch Filing No. 5 Traffic Impact Study	<a href="#">PUDSP-23-002</a>	LSC Transportation Consultants, Inc	November 15, 2023
Sterling Ranch Sketch Plan 2023 Amendment & Rezone Traffic Technical Memorandum	<a href="#">SKP235, P239, P2311</a>	LSC Transportation Consultants, Inc	January 17, 2024
Sterling Ranch East - Filing 5 Rezone & Preliminary Plan Traffic Impact Study	<a href="#">P237 &amp; SP235</a>	LSC Transportation Consultants, Inc	January 15, 2024
Villages at Sterling Ranch Traffic Impact Study	<a href="#">PUDSP226</a>	LSC Transportation Consultants, Inc	August 21, 2024
Sterling Ranch East - Filing 7 Rezone & Sterling Ranch Sketch Plan Amendment #4 Master Traffic Impact Addendum/Technical		LSC Transportation Consultants, Inc	September 13, 2024
Sterling Ranch East - Filing 6 Rezone & Preliminary Plan Traffic Impact Study	<a href="#">P237 &amp; SP235</a>	LSC Transportation Consultants, Inc	January 15, 2024
		LSC Transportation Consultants, Inc	September 27, 2024
<b>Retreat at TimberRidge Reports</b>			
The Retreat at TimberRidge Traffic Impact Analysis	<a href="#">PUD173</a>	LSC Transportation Consultants, Inc	January 25, 2018
The Retreat at TimberRidge Preliminary Plan Traffic Technical Memorandum	<a href="#">SP182</a>	LSC Transportation Consultants, Inc	June 29, 2018
The Retreat at TimberRidge Filing No. 1 Traffic Technical Memorandum	<a href="#">SF199</a>	LSC Transportation Consultants, Inc	April 3, 2020
The Retreat at TimberRidge Filing No. 2 Updated Traffic Technical Memorandum	<a href="#">SF2121</a>	LSC Transportation Consultants, Inc	October 4, 2021
The Retreat at TimberRidge Filing No. 3 Traffic Technical Memorandum	<a href="#">SF2241</a>	LSC Transportation Consultants, Inc	November 15, 2023
The Retreat at TimberRidge Filing No. 4 Traffic Technical Memorandum	<a href="#">SF1827</a>	LSC Transportation Consultants, Inc	February 21, 2024
<b>Other Area Reports</b>			
Wolf Ranch School Site Traffic Impact Study	<a href="#">OAR1720</a>	Matrix Design Group, Inc.	5-May-17
The Ranch Sketch Plan Traffic Impact Analysis	<a href="#">SKP186</a>	LSC Transportation Consultants, Inc	July 9, 2019
Lodge III Traffic Impact Study	<a href="#">OAR</a>	LSC Transportation Consultants, Inc	December 13, 2019
Continental 613 Traffic Impact Study	<a href="#">OAR2177</a>	LSC Transportation Consultants, Inc	July 16, 2021
Solace at Black Forest Traffic Impact and Access Analysis	<a href="#">OAR2134</a>	LSC Transportation Consultants, Inc	August 13, 2021
Traffic Impact Study Addendum for Percheron	<a href="#">OAR2173</a>	SM Rocha, LLC	October, 2021
Woodmen East Commercial Center Traffic Impact Analysis	<a href="#">OAR2191</a>	LSC Transportation Consultants, Inc	December 8, 2021
Traffic Impact Study for Jaynes Property	<a href="#">SKP225</a>	SM Rocha, LLC	May, 2022
Briargate-Stapleton Corridor Study (DRAFT)	<a href="#">briargate-stapleton.com</a>	Wilson & Company	December 9, 2021
Sterling Recycling Facility Transportation Memorandum	<a href="#">PPR2341</a>	LSC Transportation Consultants, Inc	August 24, 2023
Notes:			
(1) Follow the links listed below to obtain the most recent version of each listed study. To obtain a copy of the version of each study used in preparing this report please contact LSC Transportation Consultants, Inc.			
Source: LSC Transportation Consultants, Inc.			

# MTCP Maps

---





Figure 22. 2045 Roadway Functional Classifications

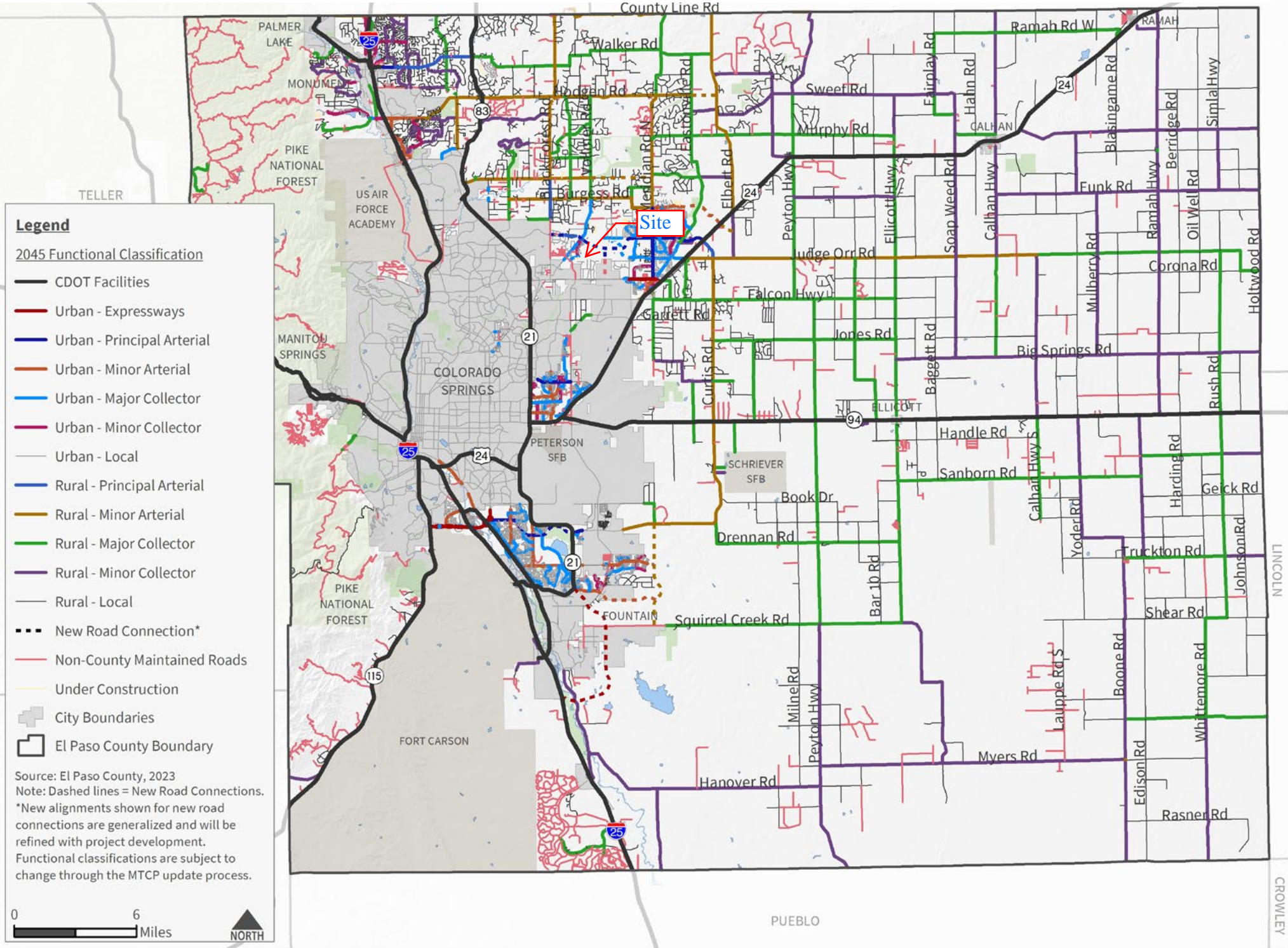
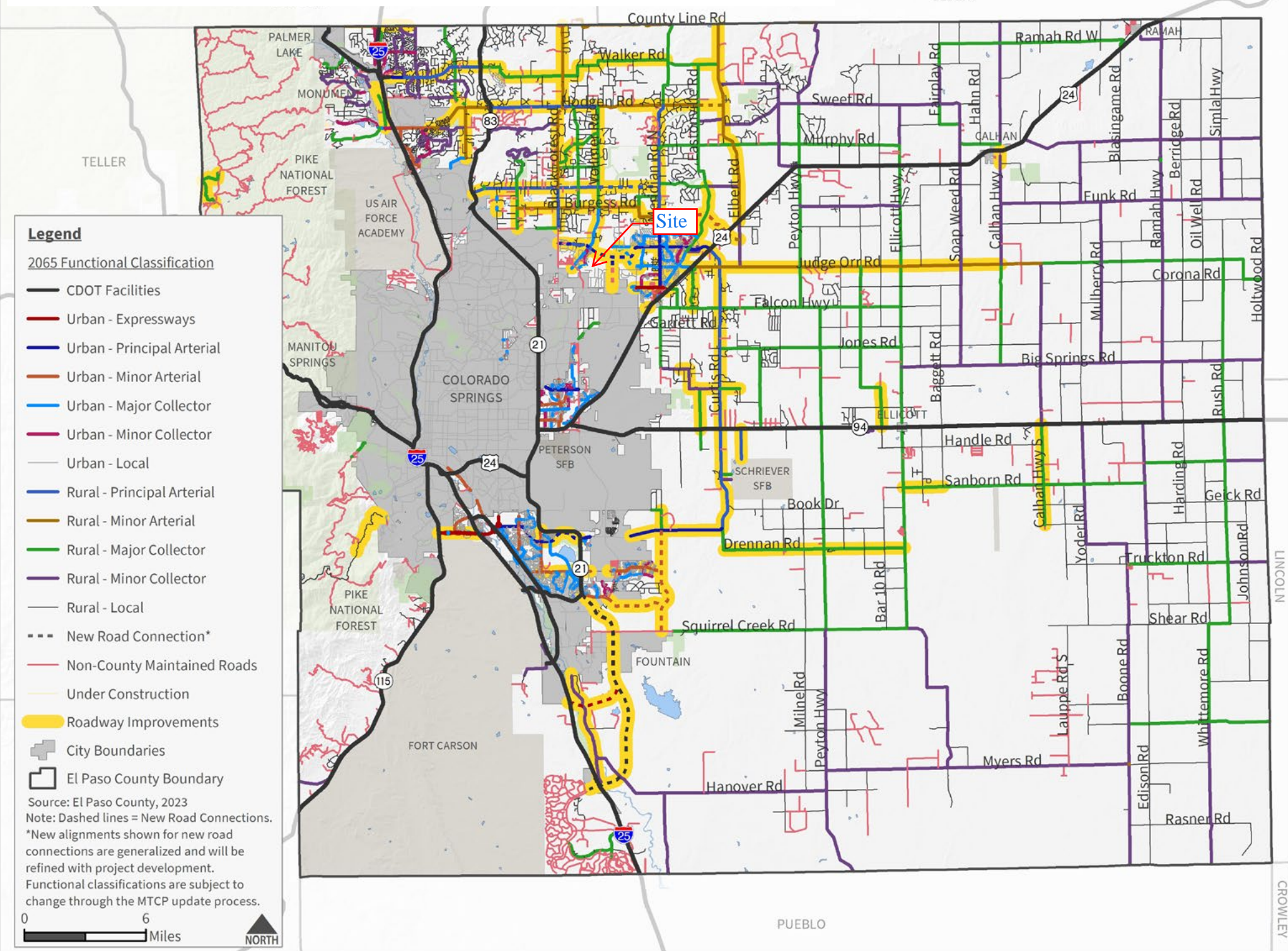




Figure 39. 2065 Corridor Preservation Plan



# Crash History

---



AccidentDate	TotalVehicles	ReferencePointName	ReferencePointAtName	AccidentNarrative
2019-09-29	1	VOLLMER RD	GLIDER LP	Vehicle # 1 was traveling northbound Vollmer Road .8 miles north of Glider Loop. Vehicle # 1's right side tires dropped off the right side of the roadway as it entered a sharp left curve. Vehicle #1 lost control on the roadway for approximately 131' before it traveled approximately 100' off the right side of the roadway. Vehicle # 1 collided its rear with a barbed-wire fence. Vehicle # 1 was moved prior to investigation.
2019-10-01	1	VOLLMER RD	S POCO RD	Vehicle #1 was northbound on Vollmer Road in a left hand curve. Vehicle #1 ran off the right side of the road for 107.3'. Vehicle over corrected, reentered the roadway, spinning counter clockwise. Vehicle #1 was out of control for 98.5'. Vehicle #1 ran off the left side of the road for 99.8', rolling 1 1/2 times. Vehicle #1 came to rest on its top facing west.
2019-11-14	1	VOLLMER RD	GLIDER PL	Vehicle 1 was southbound on Vollmer Road south of Burgess Road. Vehicle 1 was travelling in excessive speed, when it failed to negotiate a right hand bend in the roadway. Vehicle left heavy left side tire skids marks for 115.8 feet in the northbound lane, afterwhich it traveled for 59.4 across the southbound lane. Vehicle 1 ran off the right side of the road for 130.9 feet where it began to overturn, airborne for 20.7 feet, colliding with the ground, traveled another 25.9 feet and rolled another 52.2 feet where it came to final rest facing east on its right side 23.9 feet from the west road edge.
2020-04-23	1	VOLLMER RD	WILDFLOWER RD	Vehicle #1 was traveling south on Vollmer Rd approaching Wildflower Rd. Vehicle #1 failed to navigate the slight left curve in the roadway at which point it ran off the right side of the road. Vehicle #1 crashed through the fence on the right side of the road, traveled southwest into the yard of 8455 Wildflower Rd, rolled, crashed into a well, and came to rest on its wheels facing south.
2020-05-26	1	VOLLMER	WILD FLOWER	Vehicle #1 was southbound on Vollmer. Driver of vehicle #1 lost control and went off the right side of the road and overturned. Vehicle #1 was moved prior to investigation.
2020-07-25	1	VOLLMER RD	POCO RD	Vehicle 1 was traveling in an easterly direction on Vollmer Road approaching a left curve. Vehicle 1 drove on the wrong side of the road to avoid a deceased raccoon in the middle of its lane. Vehicle 1 returned to its lane while navigating the curve. Vehicle 1's right tires dropped off the right edge of the road. Driver 1 pulled the wheel to the left causing Vehicle 1 to spin out of control. Driver 1 overcorrected to the right and the vehicle rolled 3/4 times off the right side of the road. Vehicle 1 came to final rest on top of a fence facing south on its right side.
2021-03-24	1	VOLLMER RD	POCO RD	Vehicle #1 was southbound on Vollmer Road just south of Poco Road. Vehicle #1 lost control on the icy covered roadway and slid off of the west edge of the roadway for approximately 50 feet while rotating 1/4 times clockwise. Vehicle #1 then collided with a barbed wire fence approximately 15 feet west of the road edge and overturned 1/4 times onto it's left. Vehicle #1 came to final rest on its left side, approximately 15 feet west of the road edge facing west.
2021-09-13	3	VOLLMER RD	POCO RD	Vehicle #1 was traveling southbound on Vollmer Road. Vehicle #2 was parked on Poco Road, facing east, just west of the intersection of Vollmer Rd. and Poco Rd. Vehicle #2 was partially in the lane and partially on what would be a shoulder, as the entire road is dirt. Vehicle #3 was parked likewise, behind vehicle #2. Vehicle #1 made a right hand turn, to travel westbound on Poco Rd. The left front of vehicle #1 crashed into the left front of vehicle #2. Vehicle #2, being on dirt, slid backwards into the front of vehicle #3. Both vehicles #2 and #3 were unoccupied. Vehicle #1 pulled through and pulled over further down Poco Road to a safe location.
2021-11-11	1	VOLLMER RD	POCO RD	Vehicle #1 was travelling northbound on Vollmer Rd approaching Poco Rd. Vehicle #1 failed to negotiate a curve to the left and travelled off the right side of the road. Vehicle #1 overcorrected to the left, travelled across both lanes of traffic, and drove off the left side of the road. Vehicle #1 rotated counter-clockwise and hit a trip point in the soft dirt. Vehicle #1 rolled 1 and 3/4 times, coming to rest on its left side facing southwest approximately 30 feet off the road. The driver of the vehicle was ejected out of the passenger window during the rollover and came to rest in the field approximately 50 feet northwest of the vehicle.
2022-04-07	1	VOLLMER RD	WILDFLOWER RD	Vehicle 1 was traveling southbound on Vollmer Rd approaching the intersection of Wildflower Rd. Vehicle 1 failed to negotiate a curve and drove off the right side of the roadway at the intersection of Wildflower Rd. Vehicle 1 drove approximately 19 feet off of the right side of the roadway impacting an embankment and came to final rest 85 feet south of Wildflower Rd on the southwest side of the intersection facing south.
2022-06-19	2	VOLLMER RD	LOCHWINNOCH LN	VEHICLE 1 WAS NORTHBOUND ON VOLLMER ROAD. VEHICLE 2 WAS NORTHBOUND ON VOLLMER ROAD, IN FRONT OF VEHICLE 1. VEHICLE 2 BEGAN TO SLOW TO MAKE A LEFT TURN ONTO LOCHWINNOCH ROAD. VEHICLE 1 ATTEMPTED TO PASS VEHICLE 2 ON THE LEFT SIDE IN A MARKED NO PASSING ZONE. VEHICLE 2 BEGAN TO MAKE THE LEFT TURN WHERE VEHICLE 2 WAS STRUCK IN THE FRONT DRIVERS SIDE, BY THE FRONT PASSENGER SIDE OF VEHICLE 1. THE COLLISION OCCURRED WITHIN THE SOUTHBOUND LANE OF VOLLMER ROAD. VEHICLE 1 THEN ROTATED 1/2 TIME CLOCKWISE ACROSS THE NORTHBOUND LANE. VEHICLE 1 THEN DROVE OFF THE NORTHBOUND SIDE OF THE ROAD AND OVERTURNED 1/2 TIME, COMING TO FINAL REST ON ITS ROOF FACING SOUTH. VEHICLE 2 CAME TO A CONTROLLED FINAL REST ON LOCHWINNOCH LN.
2022-07-03	1	VOLLMER RD	POCO RD	Motorcycle was traveling on Vollmer Rd headed northbound. Motorcycle traveled off the right side of the road. Motorcycle lost control and rolled multiple times, the rider was ejected. Motorcycle came to rest on the left side. Rider came to rest on his back.