



**MVE, INC.**  
ENGINEERS SURVEYORS

1903 kelaray street, suite 200  
colorado springs, co 80909  
719.635.5736

# Final Drainage Report

**Misfit Crew  
Estates**

**Project No. 61160**

**October 16, 2024**

PCD File No. SF2417

# Final Drainage Report

for

**Misfit Crew Estates**

**Project No. 61160**

**October 16, 2024**

prepared for

**Mark McDonald**

5775 Mountain Shadow View  
Colorado Springs, CO 80908

prepared by

**MVE, Inc.**

1903 Lelaray Street, Suite 200  
Colorado Springs, CO 80909  
719.635.5736

Copyright © MVE, Inc., 2024

61160-Misfit Crew Estates-FDR.odt

# Statements and Acknowledgments

## Engineer's Statement

The attached drainage plan and report were prepared under my direction and supervision and are correct to the best of my knowledge and belief. Said drainage report has been prepared according to the criteria established by El Paso County for drainage reports and said report is in conformity with the applicable master plan of the drainage basin. I accept responsibility for any liability caused by any negligent acts, errors or omissions on my part in preparing this report.

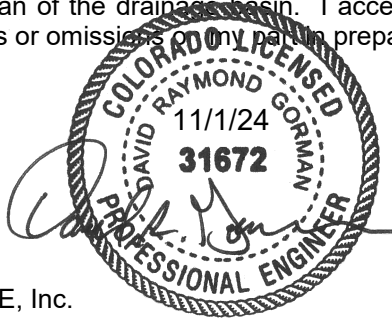

David R. Gorman, P.E.  
Colorado No. 31672  
For and on Behalf of MVE, Inc.

## Developer's Statement

I, the owner/developer have read and will comply with all of the requirements specified in this drainage report and plan.

Mark E. McDonald  
Mark McDonald  
Owner  
5775 Mountain Shadow View  
Colorado Springs, CO 80908

11/01/2024  
Date

## El Paso County

Filed in accordance with the requirements of the Drainage Criteria Manual, Volumes 1 and 2, El Paso County Engineering Criteria Manual and Land Development Code as amended.

\_\_\_\_\_  
Joshua Palmer, P.E.  
County Engineer / ECM Administrator

\_\_\_\_\_  
Date

Conditions:

# Contents

Statements and Acknowledgments.....	iii
Contents.....	v
Final Drainage Report.....	1
<b>1 General Location and Description.....</b>	<b>1</b>
1.1 Location.....	1
1.2 Description of Property.....	1
<b>2 Drainage Basins and Sub-Basins.....</b>	<b>2</b>
2.1 Major Basin Descriptions.....	2
2.2 Sub-Basin Description.....	2
<b>3 Drainage Design Criteria.....</b>	<b>2</b>
3.1 Development Criteria Reference.....	2
3.2 Previous Drainage Studies.....	3
3.3 Hydrologic Criteria.....	3
<b>4 Drainage Facility Design.....</b>	<b>3</b>
4.1 General Concept.....	3
4.2 Existing / Developed Hydrologic Conditions.....	3
4.3 Erosion Control.....	4
4.4 Four Step Process.....	4
<b>5 Drainage and Bridge Fees.....</b>	<b>5</b>
<b>6 Conclusion.....</b>	<b>5</b>

References.....	7
Appendices.....	9
<b>1 General Maps and Supporting Data.....</b>	<b>9</b>
<b>2 Hydrologic Calculations.....</b>	<b>10</b>
<b>3 Hydraulic Calculations.....</b>	<b>11</b>
<b>4 Report Maps.....</b>	<b>41</b>

# Final Drainage Report

The purpose of this Final Drainage Report is to identify drainage patterns and quantities within and affecting the proposed Misfit Crew Estates site. The development project is a residential subdivision with 5.0± acre lots. The report will identify specific solutions to drainage concerns on-site and off-site resulting from the proposed project. The report and included maps present results of hydrologic and drainage facilities analyses. The report will discuss the recommended drainage improvements to the site and identify drainage requirements relative to the proposed project. This report has been prepared and submitted in accordance with the requirements of the El Paso County development approval process. An Appendix is included with this report with pertinent calculations and graphs used in the drainage analyses and design.

## 1 General Location and Description

### 1.1 Location

The proposed Misfit Crew Estates site is located within the east half of Section 24, Township 11 South, Range 66 West of the 6th principal meridian in El Paso County, Colorado. The 36.05± acre site is situated on the north side of Hodgen Road, at the end of Mountain Shadow View, a private gravel drive, ending at the east edge of the site. The parcel (Zone RR-5) contains a single family residence and out buildings. The El Paso County Assessor's Schedule Number for the site is 6124000013. A **Vicinity Map** is included in the **Appendix**. The site is located in El Paso County's East Cherry Creek Drainage Basin.

### 1.2 Description of Property

The Misfit Crew Estates site 36.05± acres and is zoned RR-5 (Residential Rural (5 Acres)). The property contains a single-family residence with an existing gravel driveway and several out buildings. The proposed Misfit Crew Estates includes 3 rural residential lots.

The ground cover, which is in fair condition, consists of native grasses. The tree coverage is sporadic and located only around the residence.

The existing site topography slopes to the southeast with grades that range from 2% to 10%.

There are two major drainage ways in the Misfit Crew Estates site. For the north 4± acres, all storm runoff flows drain east off of the site. For the central 21± acres, all storm runoff flows drain southeast through a livestock pond and then southeast off of the site. For the south 11± acres, all storm runoff flows drain southeast off of the site. There is no storm drain system in the surrounding area. The site is located in El Paso County's East Cherry Creek Drainage Basin. The flows from the site flow southeast and eventually enter a tributary of East Cherry Creek.

According to the National Resource Conservation Service, there are two (2) soil types in the Misfit Crew Estates site. Peyton sandy loam (map unit 67) makes up about 78% of the soil on the site. The soil is deep and well drained. Permeability is moderate, surface runoff is medium, and the hazard of erosion is moderate. Peyton sandy loam is classified as being part of Hydrologic Soil Group B.

The other soil type located on the site is Cruckton sandy loam (map unit 21) which makes up the remaining 22% of the soil on the site. The soil is deep and well drained. Permeability is moderately rapid, surface runoff is slow to medium, and the hazard of erosion is moderate. Cruckton sandy loam is classified as being part of Hydrologic Soil Group B.

A portion of the Soil Map and data tables from the National Cooperative Soil Survey and relevant Official Soil Series Descriptions (OSD) are included in the **Appendix**.<sup>1 2</sup>

## 2 Drainage Basins and Sub-Basins

### 2.1 Major Basin Descriptions

The Misfit Crew Estates site is located in the East Cherry Creek Drainage Basin (CYCY0200).

The current Flood Insurance Study of the region includes Flood Insurance Rate Maps (FIRM), effective on December 7, 2018.<sup>3</sup> The proposed subdivision is included in the Community Panel Numbered 08041C0305 G of the Flood Insurance Rate Maps for the El Paso County. No part of the site is shown to be included in a 100-year flood hazard area as determined by FEMA. A portion of the current FEMA Flood Insurance Rate Maps with the site delineated is included in the **Appendix**.

### 2.2 Sub-Basin Description

The existing and developed drainage patterns of the Misfit Crew Estates project are described by three (3) on-site drainage basins and one (1) offsite basin along with two (2) points of off-site flows as detailed in the Final Drainage Report for Longview Estates. All of these basins are previously undisturbed or developed to a degree as described below. All existing basin delineations and data are depicted on the attached **Drainage Map**.

#### 2.2.1 Existing / Developed Drainage Patterns (Off-Site)

Existing off-site Design Point DP8 is located west of the site at the north edge, being the pond outfall from an adjacent detention pond in Longview Estates, the outfall drains east onto the site. This flow enters the onsite sub-basin A1 and continues through the site.

Existing off-site sub-basin OS-B1 represents the off-site that combine with sub-basin B2 to travel southeast through the site to an existing livestock pond, then continues southeast off the site.

Existing off-site Design Point DP10 is located west of the site at the south edge, being the pond outfall from an adjacent detention pond in Longview Estates, the outfall drains east onto the site. This flow enters the onsite sub-basin C1 and continues through the site to a depression along the north side of Hodgen Road where it enters an existing 42" RCP and goes under Hodgen Road.

## 3 Drainage Design Criteria

### 3.1 Development Criteria Reference

This Final Drainage Report for Misfit Crew Estates has been prepared according to the report guidelines presented in the latest edition of *El Paso County Drainage Criteria Manual* (DCM)<sup>4</sup>. The County has also adopted portions of the City of Colorado Springs Drainage Criteria Manual Volumes 1 and 2, especially concerning the calculation of rainfall runoff flow rates.<sup>5 6</sup> The hydrologic analysis is based on a collection of data from the DCM, the NRCS Web Soil Survey<sup>7</sup>, and existing topographic data by Polaris.

---

1 WSS  
 2 OSD  
 3 FIRM  
 4 DCM Section 4.3 and Section 4.4  
 5 CS DCM Vol 1  
 6 CS DCM Vol 2  
 7 WSS

### 3.2 Previous Drainage Studies

Longview Estates to the west was studied and the Final Drainage Report for Longview Estates by M.V.E., Inc, dated October 30, 2002 was used in the preparation of this report. Developed drainage basins from Longview Estates drain directly onto this site and the flows stated in the drainage report were used as off-site flows. A copy of this reports Drainage Map is included in the **Appendix**.

The existing 42" RCP under Hodgen Road, that is the nearest downstream facility to this site, was designed in the Final Drainage Report for Hodgen Road (State Highway 83 to Black Forest Road) by URS, dated December 8, 2009. Excerpts from this report and the culvert construction drawings are included in the **Appendix**.

### 3.3 Hydrologic Criteria

For this Final Drainage Report, the Rational Method as described in the *Drainage Criteria Manual* has been used for all Storm Runoff calculations, as the development and all sub-basins are less than 130 acres in area. "Colorado Springs Rainfall Intensity Duration Frequency" curves, Figure 6-5 in the DCM, was used to obtain the design rainfall values; a copy is included in the **Appendix**. The "Overland (Initial) Flow Equation" (Eq. 6-8) in the DCM, and Manning's equation with estimated depths were used in time of concentration calculations. "Runoff Coefficients for Rational Method", Table 6-6 in the DCM, was utilized as a guide in estimating runoff coefficient and Percent Impervious values; a copy is included in the **Appendix**. Peak runoff discharges were calculated for each drainage sub-basin for both the 5-year storm event and the 100-year storm event with the Rational Method formula, (Eq. 6-5) in the DCM.<sup>8</sup>

## 4 Drainage Facility Design

### 4.1 General Concept

The intent of the drainage concept presented in this Final Drainage Report is to allow for the development of the three lots while maintaining the existing drainage patterns on the site. Major and minor storm flows will continue to be safely conveyed through the site and downstream.

The existing and proposed drainage hydrologic conditions are described in more detail below. Input data and results for all calculations are included in the **Appendix**. A Drainage map for the hydrology are also included in the **Appendix**.

### 4.2 Existing / Developed Hydrologic Conditions

The Misfit Crew Estates site includes four (4) sub-basins, three (3) on site and one (1) off site as well as two (2) design points taken from the Final Drainage Report for Longview Estates. The site generally drains southeast. The sub-basins are described in more detail below.

Sub-basin A1, located at the very north end of the site, is 3.89± acres in area and accepts the flows from off-site Design Point DP8. Sub-basin A1 contains meadow/pasture and a portion of the roof of a barn, and is expected to remain as is. Peak storm runoff rates are  $Q_5 = 1.0$  cfs and  $Q_{100} = 7.0$  cfs (existing flows) with no change to the developed flows which drain east to DP1. These flows continue to drain generally via sheet flow to the east into the adjacent properties. The combined peak storm runoff rates flowing to DP1 are  $Q_5 = 7.3$  cfs and  $Q_{100} = 21.7$  cfs (existing / developed flows) which flow east through adjacent properties. There is no change to this sub-basin from existing to developed.

Existing offsite sub-basin OS-B1, located on the central west side of the site, is 1.22± acres in area. Sub-basin OS-B1 contains a meadow/pasture area of an existing developed residential lot in Longview Estates. Peak storm runoff rates are  $Q_5 = 0.3$  cfs and  $Q_{100} = 2.3$  cfs (existing / developed flows) which drain on-site to the southeast. These flows continue southeast through sub-basin B2.

---

8 DCM



Unresolved Comment from Review 1:  
Indicate what happens to flows at DP2 when they exit site. Swale, sheetflow, etc???

Sub-basin B2 located in approximately the middle half of the site, is 20.92± acres in area. Sub-basin B2 contains a single family residence, gravel drive, several out buildings and a livestock pond. This sub-basin is expected to remain as is. Peak storm runoff rates are  $Q_5 = 4.8$  cfs and  $Q_{100} = 33.4$  cfs (existing / developed flows) which drain southeast into the livestock pond where it collects and infiltrates. No clearly defined spillway or outlet exist for this structure. The State Dam Safety Engineer has directed that any future grading or improvements to this structure shall include the construction of an adequate spillway and outlet. There are no planned improvements to the pond at this time. The combined peak storm runoff rates from OS-B1 and sub-basin B2 flowing to DP2 are  $Q_5 = 5.0$  cfs and  $Q_{100} = 34.9$  cfs (existing / developed flows) which flow southeast to the edge of proposed lot 1 where a new driveway will be constructed with an 18" CMP culvert under the drive. The culvert is sized to accept the 5 year flows and the 100 year flows will overtop the driveway by 25 CFS (under 3" in depth).

Sub-basin C1, located at south end of the site, is 11.01± acres in area and accepts the flows from off-site Design Point DP10. Sub-basin C1 currently contains meadow/pasture and is the proposed location of lots 2 and 3. Sub-basin C1's peak storm runoff rates are  $Q_5 = 2.6$  cfs and  $Q_{100} = 19.0$  cfs (existing flows) and  $Q_5 = 3.3$  cfs and  $Q_{100} = 20.8$  cfs (developed flows). The developed flows assume a land use of 5 Acre lots with a percent imperviousness of 7.0%. A no-build / drainage easement is proposed for the existing swale through sub-basin C1. The swale is well vegetated and shows no signs of erosion. Calculations to determine the depth of flows and velocity of this swale are included in the **Appendix**. These flows, combined with those from off-site DP10 drain southeast to DP3, which flows southeast via an existing swale onto the adjacent property to a localized depression containing an existing 42" RCP that flows under Hodgen Road. Calculations for the existing swale and the 42" RCP are included in the Appendix. The combined peak storm runoff rates flowing to DP3 are  $Q_5 = 24.7$  cfs and  $Q_{100} = 72.3$  cfs (existing flows) and  $Q_5 = 25.4$  cfs and  $Q_{100} = 74.1$  cfs (developed flows). This is an increase of  $Q_5 = 1.7$  cfs (2.75%) and  $Q_{100} = 1.8$  cfs (2.43%).

The existing 42" RCP lying approximately 250 feet downstream of DP3 was designed using 100 year discharge of 100.9 cfs. This culvert was recalculated using 102.7 cfs (the increase in flows from existing to developed) and found to be capable of handling the minor increase in flows from this development. The culvert appears to be in stable condition with no signs of erosion at the downstream end. Outlet protection was provided and is in satisfactory condition. Excerpts from the URS drainage report showing the culvert calculations along with updated calculations for this culvert are included in the **Appendix**.

### 4.3 Erosion Control

There is no public infrastructure construction or overlot grading associated with the required control measures (CM's) for the individual lot home construction will BESQCP for each lot at time of building permit. The velocity of the swale at DP3 ( and the velocity of the swale at developed basin C1 is 4.48 FPS. These velocities FPS discussed in the associated soils and geology report and will not need stabiliz

Please include statement about detention not being required because of the minimal increase in flows and the large lot acreage.

### 4.4 Four Step Process

The El Paso County Engineering Criteria Manual (Appendix I, Section I.7.2 ) requires the consideration of a "Four Step Process for receiving water protection that focuses on reducing runoff volumes, treating the water quality capture volume (WQCV), stabilizing drainageways, and implementing long term source controls". The Four Step Process is incorporated in this project and the elements are discussed below.

The entire site consists of 5-acre single family residential lots which are excluded from Post Construction Stormwater Management requirements by ECM 1.7.1.B.5 due to the low development density as 5-acre lots. There is a 10' wide public roadway being dedicated to El Paso County. The site is not subject to Post Construction Stormwater Treatment requirements.

1) Runoff Reduction Practices are employed in this project. Impervious surfaces have been reduced as much as practically possible. There is only minimal concrete or other hard surfaces proposed.

Minimized Directly Connected Impervious Areas (MDCIA) is employed on the project because runoff passes through an open space meadow area before leaving the site.

2) There are no drainage paths on the site that are required to be stabilized as they are well vegetated with no visual erosion.

3) The project contains no potentially hazardous uses. The site is exempted from the use of WQCV CMs by ECM 1.7.1.B.5 by virtue of the large lot rural residential nature of the site having percent imperviousness of less than 10%.

4) The rural residential lot is not anticipated to contain storage of potentially harmful substances or use of potentially harmful substances. No site specific or other source control CMs are required.

## **5 Drainage and Bridge Fees**

The subdivision is located within the East Cherry Creek Drainage Basin, El Paso Basin Number CYCY0200, which which has no DBPS. There are no fees associated with this basin.

## **6 Conclusion**

This Final Drainage Report presents existing and proposed drainage conditions for the proposed Misfit Crew Estates project. The development will have negligible and inconsequential effects on the existing site drainage and drainage conditions downstream. The site is exempted from the use of WQCV CMs by ECM 1.7.1.B.5 by virtue of the large lot rural residential nature of the site having percent imperviousness of less than 10%. The entire site is consists of 5-acre single family residential lots which are excluded from Post Construction Stormwater Management requirements due to the low development density as 5-acre lots. The site is not subject to Post Construction Stormwater Treatment requirements. With such a negligible increase in stormwater flows from the site, detention will not be necessary for the proposed development and will not be provided. The proposed project will not, with respect to stormwater runoff, negatively impact the adjacent properties and downstream properties.

# References

*NRCS Web Soil Survey.* United States Department of Agriculture, Natural Resources Conservation Service ("<http://websoilsurvey.nrcs.usda.gov/app/WebSoilSurvey.aspx>", accessed March, 2018).

*NRCS Official Soil Series Descriptions.* United States Department of Agriculture, Natural Resources Conservation Service ("<http://soils.usda.gov/technical/classification/osd/index.html>", accessed March, 2018).

*Flood Insurance Rate Map.* Federal Emergency Management Agency, National Flood Insurance Program (Washington D.C.: FEMA, December 7, 2018).

*NCSS Web Soil Survey.* United States Department of Agriculture, Natural Resources Conservation Service ("<http://websoilsurvey.nrcs.usda.gov/app/WebSoilSurvey.aspx>", accessed May, 2017).

*Drainage Criteria Manual Volume 2, Stormwater Quality Policies, Procedures and Best Management Practices (BMPs).* City of Colorado Spring Engineering Division (Colorado Springs: , May 2014).

*City of Colorado Springs Drainage Criteria Manual, Volume 1.* City of Colorado Springs Engineering Division Staff, Matrix Design Group/Wright Water Engineers (Colorado Springs: , May 2014).

*City of Colorado Springs/El Paso County Drainage Criteria Manual.* City of Colorado Springs, Department of Public Works, Engineering Division; HDR Infrastructure, Inc.; El Paso County, Department of Public Works, Engineering Division (Colorado Springs: City of Colorado Springs, Revised November 1991).

*City of Colorado Springs Drainage Criteria Manual Volume 1.* City of Colorado Springs Engineering Division with Matrix Design Group and Wright Water Engineers (Colorado Springs, Colorado: , May 2014).

# | Appendices

## **1 General Maps and Supporting Data**

- Vicinity Map
- Portions of Flood Insurance Rate Map
- NRCS Soil Map and Tables
- SCS Soil Type Descriptions
- Hydrologic Soil Group Map and Tables
- Livestock Watertank Application

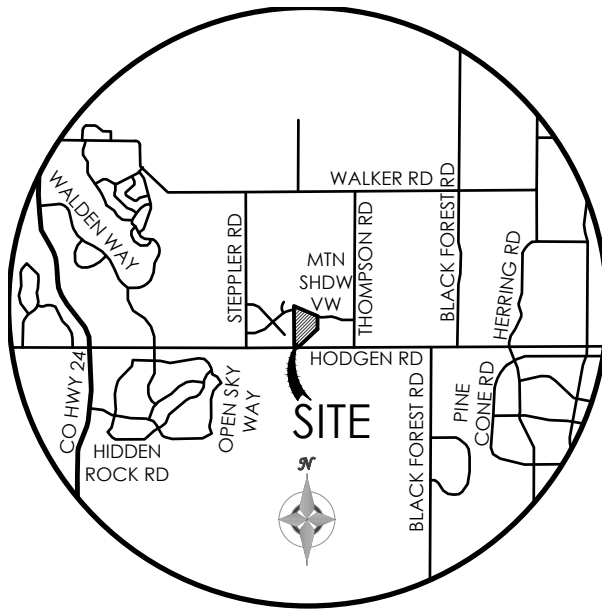

**VICINITY MAP**

NOT TO SCALE

# National Flood Hazard Layer FIRMMette



104°43'39"W 39°4'41"N

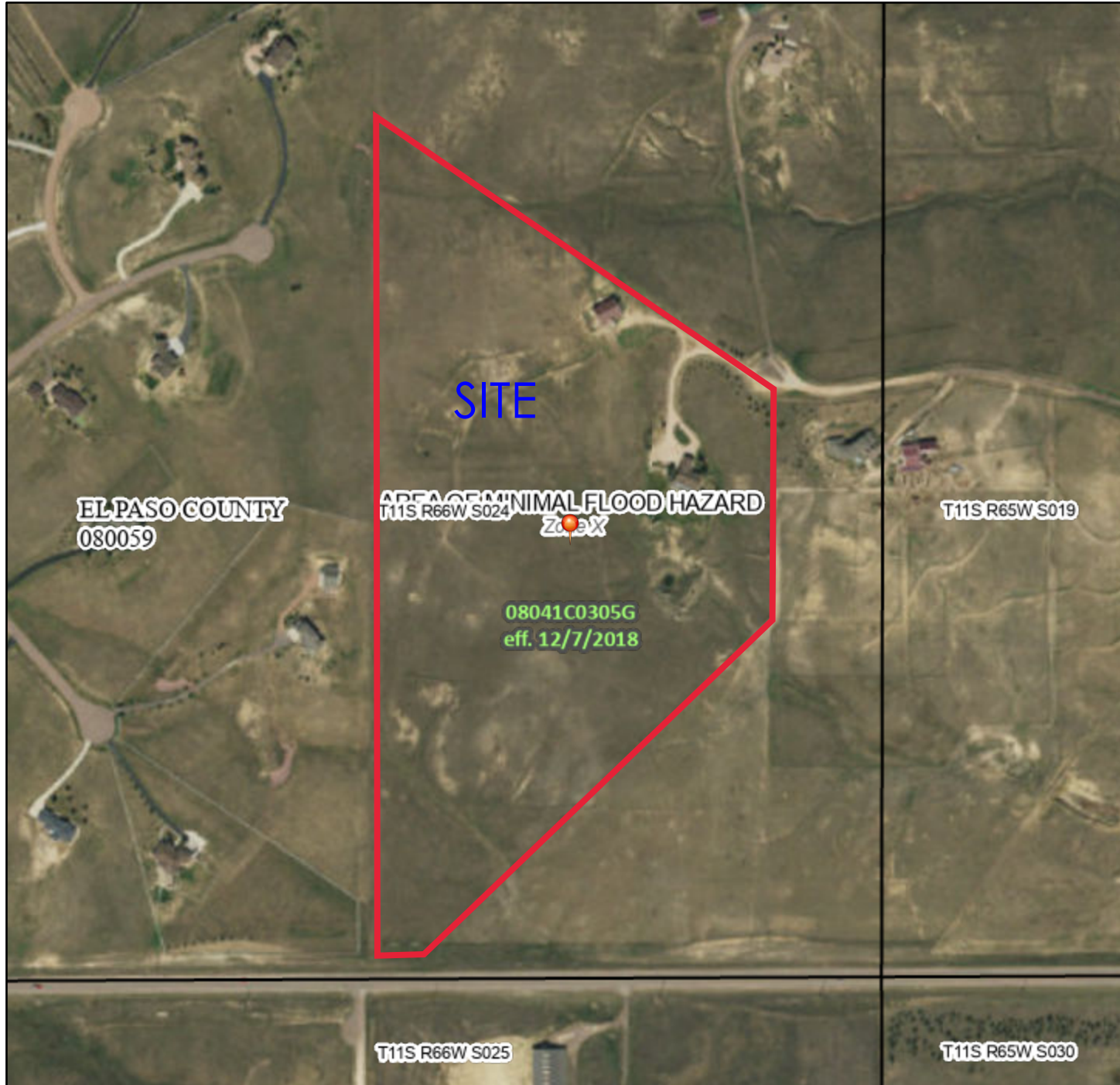

## Legend

SEE FIS REPORT FOR DETAILED LEGEND AND INDEX MAP FOR FIRM PANEL LAYOUT

- |                                    |  |  |
|------------------------------------|--|--|
| <b>SPECIAL FLOOD HAZARD AREAS</b>  |  | Without Base Flood Elevation (BFE)<br><i>Zone A, V, A99</i>  |
|                                    |  | With BFE or Depth <i>Zone AE, AO, AH, VE, AR</i>   |
|                                    |  | Regulatory Floodway  |
| <b>OTHER AREAS OF FLOOD HAZARD</b> |  | 0.2% Annual Chance Flood Hazard, Areas of 1% annual chance flood with average depth less than one foot or with drainage areas of less than one square mile <i>Zone X</i> |
|                                    |  | Future Conditions 1% Annual Chance Flood Hazard <i>Zone X</i>  |
|                                    |  | Area with Reduced Flood Risk due to Levee. See Notes. <i>Zone X</i>  |
|                                    |  | Area with Flood Risk due to Levee <i>Zone D</i>  |
| <b>OTHER AREAS</b>                 |  | NO SCREEN Area of Minimal Flood Hazard <i>Zone X</i>   |
|                                    |  | Effective LOMRs  |
| <b>GENERAL STRUCTURES</b>          |  | Area of Undetermined Flood Hazard <i>Zone D</i>  |
|                                    |  | Channel, Culvert, or Storm Sewer   |
|                                    |  | Levee, Dike, or Floodwall  |
| <b>OTHER FEATURES</b>              |  | 20.2 Cross Sections with 1% Annual Chance  |
|                                    |  | 17.5 Water Surface Elevation   |
|                                    |  | Coastal Transect   |
|                                    |  | Base Flood Elevation Line (BFE)  |
|                                    |  | Limit of Study   |
| <b>MAP PANELS</b>                  |  | Jurisdiction Boundary  |
|                                    |  | Coastal Transect Baseline  |
|                                    |  | Profile Baseline   |
|                                    |  | Hydrographic Feature   |
|                                    |  | Digital Data Available   |
|                                    |  | No Digital Data Available  |
|                                    |  | Unmapped   |
|                                    |  | The pin displayed on the map is an approximate point selected by the user and does not represent an authoritative property location.                                     |

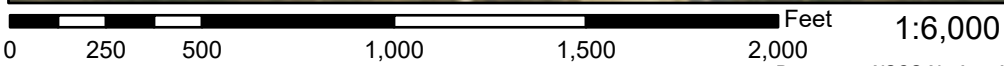

104°43'12"W 39°4'13"N

Basemap: USGS National Map: Orthoimagery: Data refreshed October, 2020

This map complies with FEMA's standards for the use of digital flood maps if it is not void as described below. The basemap shown complies with FEMA's basemap accuracy standards

The flood hazard information is derived directly from the authoritative NFHL web services provided by FEMA. This map was exported on 5/25/2021 at 5:59 PM and does not reflect changes or amendments subsequent to this date and time. The NFHL and effective information may change or become superseded by new data over time.

This map image is void if the one or more of the following map elements do not appear: basemap imagery, flood zone labels, legend, scale bar, map creation date, community identifiers, FIRM panel number, and FIRM effective date. Map images for unmapped and unmodernized areas cannot be used for regulatory purposes.

# Custom Soil Resource Report for El Paso County Area, Colorado



# Preface

---

Soil surveys contain information that affects land use planning in survey areas. They highlight soil limitations that affect various land uses and provide information about the properties of the soils in the survey areas. Soil surveys are designed for many different users, including farmers, ranchers, foresters, agronomists, urban planners, community officials, engineers, developers, builders, and home buyers. Also, conservationists, teachers, students, and specialists in recreation, waste disposal, and pollution control can use the surveys to help them understand, protect, or enhance the environment.

Various land use regulations of Federal, State, and local governments may impose special restrictions on land use or land treatment. Soil surveys identify soil properties that are used in making various land use or land treatment decisions. The information is intended to help the land users identify and reduce the effects of soil limitations on various land uses. The landowner or user is responsible for identifying and complying with existing laws and regulations.

Although soil survey information can be used for general farm, local, and wider area planning, onsite investigation is needed to supplement this information in some cases. Examples include soil quality assessments (<http://www.nrcs.usda.gov/wps/portal/nrcs/main/soils/health/>) and certain conservation and engineering applications. For more detailed information, contact your local USDA Service Center (<https://offices.sc.egov.usda.gov/locator/app?agency=nrcs>) or your NRCS State Soil Scientist ([http://www.nrcs.usda.gov/wps/portal/nrcs/detail/soils/contactus/?cid=nrcs142p2\\_053951](http://www.nrcs.usda.gov/wps/portal/nrcs/detail/soils/contactus/?cid=nrcs142p2_053951)).

Great differences in soil properties can occur within short distances. Some soils are seasonally wet or subject to flooding. Some are too unstable to be used as a foundation for buildings or roads. Clayey or wet soils are poorly suited to use as septic tank absorption fields. A high water table makes a soil poorly suited to basements or underground installations.

The National Cooperative Soil Survey is a joint effort of the United States Department of Agriculture and other Federal agencies, State agencies including the Agricultural Experiment Stations, and local agencies. The Natural Resources Conservation Service (NRCS) has leadership for the Federal part of the National Cooperative Soil Survey.

Information about soils is updated periodically. Updated information is available through the NRCS Web Soil Survey, the site for official soil survey information.

The U.S. Department of Agriculture (USDA) prohibits discrimination in all its programs and activities on the basis of race, color, national origin, age, disability, and where applicable, sex, marital status, familial status, parental status, religion, sexual orientation, genetic information, political beliefs, reprisal, or because all or a part of an individual's income is derived from any public assistance program. (Not all prohibited bases apply to all programs.) Persons with disabilities who require



alternative means for communication of program information (Braille, large print, audiotape, etc.) should contact USDA's TARGET Center at (202) 720-2600 (voice and TDD). To file a complaint of discrimination, write to USDA, Director, Office of Civil Rights, 1400 Independence Avenue, S.W., Washington, D.C. 20250-9410 or call (800) 795-3272 (voice) or (202) 720-6382 (TDD). USDA is an equal opportunity provider and employer.

# Contents

---

<b>Preface</b> .....	2
<b>How Soil Surveys Are Made</b> .....	5
<b>Soil Map</b> .....	8
Soil Map.....	9
Legend.....	10
Map Unit Legend.....	11
Map Unit Descriptions.....	11
El Paso County Area, Colorado.....	13
21—Cruickton sandy loam, 1 to 9 percent slopes.....	13
67—Peyton sandy loam, 5 to 9 percent slopes.....	14
<b>References</b> .....	16

# How Soil Surveys Are Made

---

Soil surveys are made to provide information about the soils and miscellaneous areas in a specific area. They include a description of the soils and miscellaneous areas and their location on the landscape and tables that show soil properties and limitations affecting various uses. Soil scientists observed the steepness, length, and shape of the slopes; the general pattern of drainage; the kinds of crops and native plants; and the kinds of bedrock. They observed and described many soil profiles. A soil profile is the sequence of natural layers, or horizons, in a soil. The profile extends from the surface down into the unconsolidated material in which the soil formed or from the surface down to bedrock. The unconsolidated material is devoid of roots and other living organisms and has not been changed by other biological activity.

Currently, soils are mapped according to the boundaries of major land resource areas (MLRAs). MLRAs are geographically associated land resource units that share common characteristics related to physiography, geology, climate, water resources, soils, biological resources, and land uses (USDA, 2006). Soil survey areas typically consist of parts of one or more MLRA.

The soils and miscellaneous areas in a survey area occur in an orderly pattern that is related to the geology, landforms, relief, climate, and natural vegetation of the area. Each kind of soil and miscellaneous area is associated with a particular kind of landform or with a segment of the landform. By observing the soils and miscellaneous areas in the survey area and relating their position to specific segments of the landform, a soil scientist develops a concept, or model, of how they were formed. Thus, during mapping, this model enables the soil scientist to predict with a considerable degree of accuracy the kind of soil or miscellaneous area at a specific location on the landscape.

Commonly, individual soils on the landscape merge into one another as their characteristics gradually change. To construct an accurate soil map, however, soil scientists must determine the boundaries between the soils. They can observe only a limited number of soil profiles. Nevertheless, these observations, supplemented by an understanding of the soil-vegetation-landscape relationship, are sufficient to verify predictions of the kinds of soil in an area and to determine the boundaries.

Soil scientists recorded the characteristics of the soil profiles that they studied. They noted soil color, texture, size and shape of soil aggregates, kind and amount of rock fragments, distribution of plant roots, reaction, and other features that enable them to identify soils. After describing the soils in the survey area and determining their properties, the soil scientists assigned the soils to taxonomic classes (units). Taxonomic classes are concepts. Each taxonomic class has a set of soil characteristics with precisely defined limits. The classes are used as a basis for comparison to classify soils systematically. Soil taxonomy, the system of taxonomic classification used in the United States, is based mainly on the kind and character of soil properties and the arrangement of horizons within the profile. After the soil

## Custom Soil Resource Report

scientists classified and named the soils in the survey area, they compared the individual soils with similar soils in the same taxonomic class in other areas so that they could confirm data and assemble additional data based on experience and research.

The objective of soil mapping is not to delineate pure map unit components; the objective is to separate the landscape into landforms or landform segments that have similar use and management requirements. Each map unit is defined by a unique combination of soil components and/or miscellaneous areas in predictable proportions. Some components may be highly contrasting to the other components of the map unit. The presence of minor components in a map unit in no way diminishes the usefulness or accuracy of the data. The delineation of such landforms and landform segments on the map provides sufficient information for the development of resource plans. If intensive use of small areas is planned, onsite investigation is needed to define and locate the soils and miscellaneous areas.

Soil scientists make many field observations in the process of producing a soil map. The frequency of observation is dependent upon several factors, including scale of mapping, intensity of mapping, design of map units, complexity of the landscape, and experience of the soil scientist. Observations are made to test and refine the soil-landscape model and predictions and to verify the classification of the soils at specific locations. Once the soil-landscape model is refined, a significantly smaller number of measurements of individual soil properties are made and recorded. These measurements may include field measurements, such as those for color, depth to bedrock, and texture, and laboratory measurements, such as those for content of sand, silt, clay, salt, and other components. Properties of each soil typically vary from one point to another across the landscape.

Observations for map unit components are aggregated to develop ranges of characteristics for the components. The aggregated values are presented. Direct measurements do not exist for every property presented for every map unit component. Values for some properties are estimated from combinations of other properties.

While a soil survey is in progress, samples of some of the soils in the area generally are collected for laboratory analyses and for engineering tests. Soil scientists interpret the data from these analyses and tests as well as the field-observed characteristics and the soil properties to determine the expected behavior of the soils under different uses. Interpretations for all of the soils are field tested through observation of the soils in different uses and under different levels of management. Some interpretations are modified to fit local conditions, and some new interpretations are developed to meet local needs. Data are assembled from other sources, such as research information, production records, and field experience of specialists. For example, data on crop yields under defined levels of management are assembled from farm records and from field or plot experiments on the same kinds of soil.

Predictions about soil behavior are based not only on soil properties but also on such variables as climate and biological activity. Soil conditions are predictable over long periods of time, but they are not predictable from year to year. For example, soil scientists can predict with a fairly high degree of accuracy that a given soil will have a high water table within certain depths in most years, but they cannot predict that a high water table will always be at a specific level in the soil on a specific date.

After soil scientists located and identified the significant natural bodies of soil in the survey area, they drew the boundaries of these bodies on aerial photographs and

## Custom Soil Resource Report

identified each as a specific map unit. Aerial photographs show trees, buildings, fields, roads, and rivers, all of which help in locating boundaries accurately.

# Soil Map

---

The soil map section includes the soil map for the defined area of interest, a list of soil map units on the map and extent of each map unit, and cartographic symbols displayed on the map. Also presented are various metadata about data used to produce the map, and a description of each soil map unit.

# Custom Soil Resource Report Soil Map

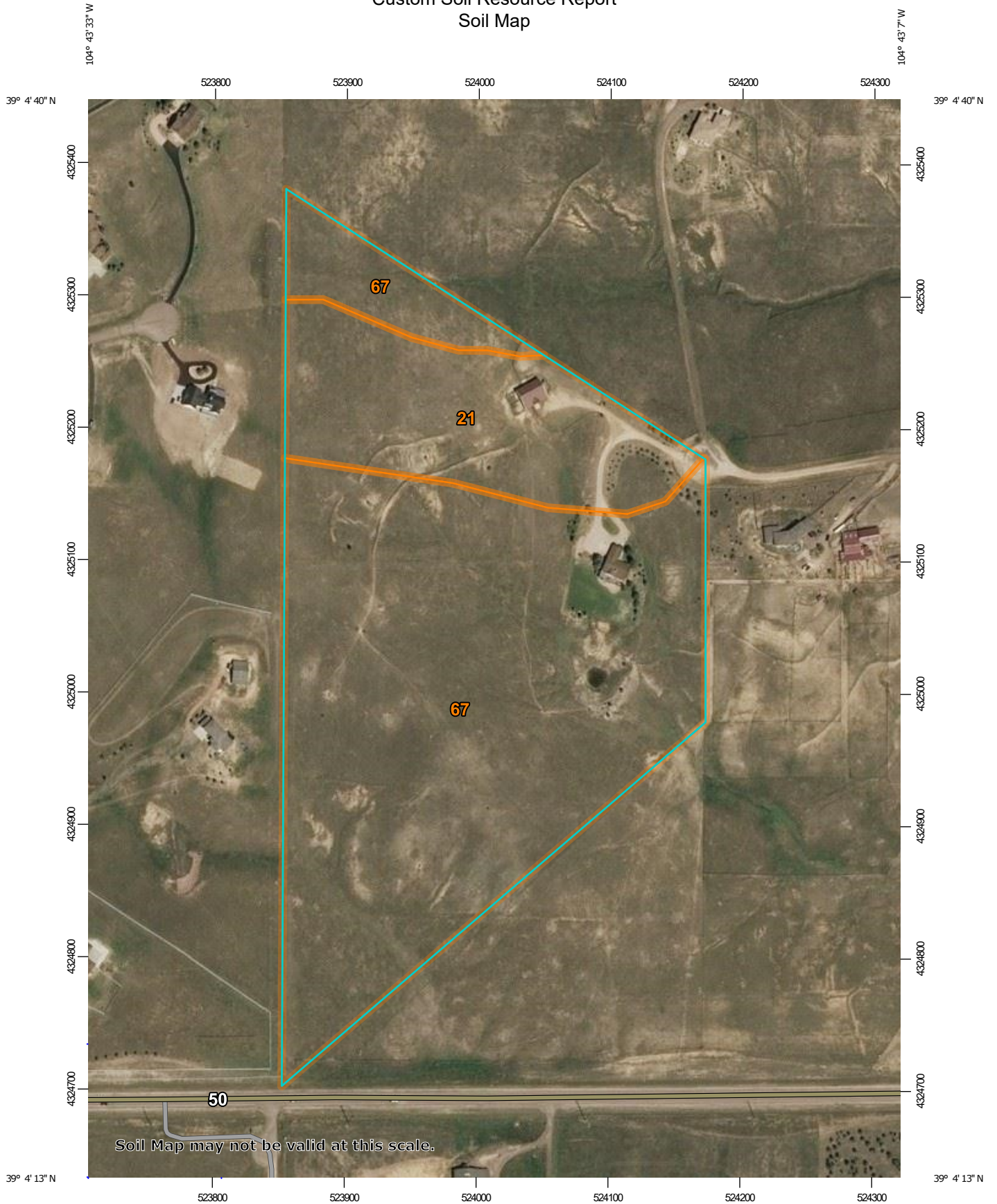

Soil Map may not be valid at this scale.

Map Scale: 1:3,970 if printed on A portrait (8.5" x 11") sheet.

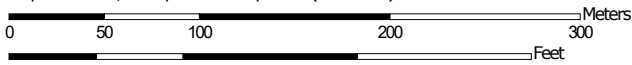

Map projection: Web Mercator Corner coordinates: WGS84 Edge tics: UTM Zone 13N WGS84

### MAP LEGEND

**Area of Interest (AOI)**

 Area of Interest (AOI)

**Soils**

 Soil Map Unit Polygons

 Soil Map Unit Lines

 Soil Map Unit Points

**Special Point Features**





-  Blowout
-  Borrow Pit
-  Clay Spot
-  Closed Depression
-  Gravel Pit
-  Gravelly Spot
-  Landfill
-  Lava Flow
-  Marsh or swamp
-  Mine or Quarry
-  Miscellaneous Water
-  Perennial Water
-  Rock Outcrop
-  Saline Spot
-  Sandy Spot
-  Severely Eroded Spot
-  Sinkhole
-  Slide or Slip
-  Sodic Spot

-  Spoil Area
-  Stony Spot
-  Very Stony Spot
-  Wet Spot
-  Other
-  Special Line Features

**Water Features**

 Streams and Canals

**Transportation**

-  Rails
-  Interstate Highways
-  US Routes
-  Major Roads
-  Local Roads

**Background**

 Aerial Photography

### MAP INFORMATION

The soil surveys that comprise your AOI were mapped at 1:24,000.

Warning: Soil Map may not be valid at this scale.

Enlargement of maps beyond the scale of mapping can cause misunderstanding of the detail of mapping and accuracy of soil line placement. The maps do not show the small areas of contrasting soils that could have been shown at a more detailed scale.

Please rely on the bar scale on each map sheet for map measurements.

Source of Map: Natural Resources Conservation Service  
 Web Soil Survey URL:  
 Coordinate System: Web Mercator (EPSG:3857)

Maps from the Web Soil Survey are based on the Web Mercator projection, which preserves direction and shape but distorts distance and area. A projection that preserves area, such as the Albers equal-area conic projection, should be used if more accurate calculations of distance or area are required.

This product is generated from the USDA-NRCS certified data as of the version date(s) listed below.

Soil Survey Area: El Paso County Area, Colorado  
 Survey Area Data: Version 18, Jun 5, 2020

Soil map units are labeled (as space allows) for map scales 1:50,000 or larger.

Date(s) aerial images were photographed: Sep 8, 2018—May 26, 2019

The orthophoto or other base map on which the soil lines were compiled and digitized probably differs from the background imagery displayed on these maps. As a result, some minor shifting of map unit boundaries may be evident.



## Map Unit Legend

Map Unit Symbol	Map Unit Name	Acres in AOI	Percent of AOI
21	Cruckton sandy loam, 1 to 9 percent slopes	7.6	21.9%
67	Peyton sandy loam, 5 to 9 percent slopes	27.1	78.1%
<b>Totals for Area of Interest</b>		<b>34.7</b>	<b>100.0%</b>

## Map Unit Descriptions

The map units delineated on the detailed soil maps in a soil survey represent the soils or miscellaneous areas in the survey area. The map unit descriptions, along with the maps, can be used to determine the composition and properties of a unit.

A map unit delineation on a soil map represents an area dominated by one or more major kinds of soil or miscellaneous areas. A map unit is identified and named according to the taxonomic classification of the dominant soils. Within a taxonomic class there are precisely defined limits for the properties of the soils. On the landscape, however, the soils are natural phenomena, and they have the characteristic variability of all natural phenomena. Thus, the range of some observed properties may extend beyond the limits defined for a taxonomic class. Areas of soils of a single taxonomic class rarely, if ever, can be mapped without including areas of other taxonomic classes. Consequently, every map unit is made up of the soils or miscellaneous areas for which it is named and some minor components that belong to taxonomic classes other than those of the major soils.

Most minor soils have properties similar to those of the dominant soil or soils in the map unit, and thus they do not affect use and management. These are called noncontrasting, or similar, components. They may or may not be mentioned in a particular map unit description. Other minor components, however, have properties and behavioral characteristics divergent enough to affect use or to require different management. These are called contrasting, or dissimilar, components. They generally are in small areas and could not be mapped separately because of the scale used. Some small areas of strongly contrasting soils or miscellaneous areas are identified by a special symbol on the maps. If included in the database for a given area, the contrasting minor components are identified in the map unit descriptions along with some characteristics of each. A few areas of minor components may not have been observed, and consequently they are not mentioned in the descriptions, especially where the pattern was so complex that it was impractical to make enough observations to identify all the soils and miscellaneous areas on the landscape.

The presence of minor components in a map unit in no way diminishes the usefulness or accuracy of the data. The objective of mapping is not to delineate pure taxonomic classes but rather to separate the landscape into landforms or landform segments that have similar use and management requirements. The delineation of such segments on the map provides sufficient information for the development of resource plans. If intensive use of small areas is planned, however,

## Custom Soil Resource Report

onsite investigation is needed to define and locate the soils and miscellaneous areas.

An identifying symbol precedes the map unit name in the map unit descriptions. Each description includes general facts about the unit and gives important soil properties and qualities.

Soils that have profiles that are almost alike make up a *soil series*. Except for differences in texture of the surface layer, all the soils of a series have major horizons that are similar in composition, thickness, and arrangement.

Soils of one series can differ in texture of the surface layer, slope, stoniness, salinity, degree of erosion, and other characteristics that affect their use. On the basis of such differences, a soil series is divided into *soil phases*. Most of the areas shown on the detailed soil maps are phases of soil series. The name of a soil phase commonly indicates a feature that affects use or management. For example, Alpha silt loam, 0 to 2 percent slopes, is a phase of the Alpha series.

Some map units are made up of two or more major soils or miscellaneous areas. These map units are complexes, associations, or undifferentiated groups.

A *complex* consists of two or more soils or miscellaneous areas in such an intricate pattern or in such small areas that they cannot be shown separately on the maps. The pattern and proportion of the soils or miscellaneous areas are somewhat similar in all areas. Alpha-Beta complex, 0 to 6 percent slopes, is an example.

An *association* is made up of two or more geographically associated soils or miscellaneous areas that are shown as one unit on the maps. Because of present or anticipated uses of the map units in the survey area, it was not considered practical or necessary to map the soils or miscellaneous areas separately. The pattern and relative proportion of the soils or miscellaneous areas are somewhat similar. Alpha-Beta association, 0 to 2 percent slopes, is an example.

An *undifferentiated group* is made up of two or more soils or miscellaneous areas that could be mapped individually but are mapped as one unit because similar interpretations can be made for use and management. The pattern and proportion of the soils or miscellaneous areas in a mapped area are not uniform. An area can be made up of only one of the major soils or miscellaneous areas, or it can be made up of all of them. Alpha and Beta soils, 0 to 2 percent slopes, is an example.

Some surveys include *miscellaneous areas*. Such areas have little or no soil material and support little or no vegetation. Rock outcrop is an example.

## El Paso County Area, Colorado

### 21—Cruckton sandy loam, 1 to 9 percent slopes

#### Map Unit Setting

*National map unit symbol:* 367s  
*Elevation:* 7,200 to 7,600 feet  
*Mean annual precipitation:* 16 to 18 inches  
*Mean annual air temperature:* 42 to 46 degrees F  
*Frost-free period:* 110 to 120 days  
*Farmland classification:* Not prime farmland

#### Map Unit Composition

*Cruckton and similar soils:* 85 percent  
*Estimates are based on observations, descriptions, and transects of the mapunit.*

#### Description of Cruckton

##### Setting

*Landform:* Flats, hills  
*Landform position (three-dimensional):* Side slope, talf  
*Down-slope shape:* Linear  
*Across-slope shape:* Linear  
*Parent material:* Alluvium derived from arkose

##### Typical profile

*A - 0 to 11 inches:* sandy loam  
*Bt - 11 to 28 inches:* sandy loam  
*C - 28 to 60 inches:* loamy coarse sand

##### Properties and qualities

*Slope:* 1 to 9 percent  
*Depth to restrictive feature:* More than 80 inches  
*Drainage class:* Well drained  
*Runoff class:* Medium  
*Capacity of the most limiting layer to transmit water (Ksat):* Moderately high to high  
(0.60 to 2.00 in/hr)  
*Depth to water table:* More than 80 inches  
*Frequency of flooding:* None  
*Frequency of ponding:* None  
*Available water capacity:* Low (about 5.9 inches)

##### Interpretive groups

*Land capability classification (irrigated):* None specified  
*Land capability classification (nonirrigated):* 4e  
*Hydrologic Soil Group:* B  
*Ecological site:* R049XB216CO - Sandy Divide  
*Hydric soil rating:* No

#### Minor Components

##### Other soils

*Percent of map unit:*  
*Hydric soil rating:* No

## 67—Peyton sandy loam, 5 to 9 percent slopes

### Map Unit Setting

*National map unit symbol:* 369d  
*Elevation:* 6,800 to 7,600 feet  
*Mean annual air temperature:* 43 to 45 degrees F  
*Frost-free period:* 115 to 125 days  
*Farmland classification:* Not prime farmland

### Map Unit Composition

*Peyton and similar soils:* 85 percent  
*Estimates are based on observations, descriptions, and transects of the mapunit.*

### Description of Peyton

#### Setting

*Landform:* Hills  
*Landform position (three-dimensional):* Side slope  
*Down-slope shape:* Linear  
*Across-slope shape:* Linear  
*Parent material:* Arkosic alluvium derived from sedimentary rock and/or arkosic residuum weathered from sedimentary rock

#### Typical profile

*A - 0 to 12 inches:* sandy loam  
*Bt - 12 to 25 inches:* sandy clay loam  
*BC - 25 to 35 inches:* sandy loam  
*C - 35 to 60 inches:* sandy loam

#### Properties and qualities

*Slope:* 5 to 9 percent  
*Depth to restrictive feature:* More than 80 inches  
*Drainage class:* Well drained  
*Runoff class:* Medium  
*Capacity of the most limiting layer to transmit water (Ksat):* Moderately high (0.20 to 0.60 in/hr)  
*Depth to water table:* More than 80 inches  
*Frequency of flooding:* None  
*Frequency of ponding:* None  
*Available water capacity:* Moderate (about 7.3 inches)

#### Interpretive groups

*Land capability classification (irrigated):* None specified  
*Land capability classification (nonirrigated):* 4e  
*Hydrologic Soil Group:* B  
*Ecological site:* R049XB216CO - Sandy Divide  
*Hydric soil rating:* No

**Minor Components**

**Pleasant**

*Percent of map unit:*

*Landform:* Depressions

*Hydric soil rating:* Yes

**Other soils**

*Percent of map unit:*

*Hydric soil rating:* No

# References

---

- American Association of State Highway and Transportation Officials (AASHTO). 2004. Standard specifications for transportation materials and methods of sampling and testing. 24th edition.
- American Society for Testing and Materials (ASTM). 2005. Standard classification of soils for engineering purposes. ASTM Standard D2487-00.
- Cowardin, L.M., V. Carter, F.C. Golet, and E.T. LaRoe. 1979. Classification of wetlands and deep-water habitats of the United States. U.S. Fish and Wildlife Service FWS/OBS-79/31.
- Federal Register. July 13, 1994. Changes in hydric soils of the United States.
- Federal Register. September 18, 2002. Hydric soils of the United States.
- Hurt, G.W., and L.M. Vasilas, editors. Version 6.0, 2006. Field indicators of hydric soils in the United States.
- National Research Council. 1995. Wetlands: Characteristics and boundaries.
- Soil Survey Division Staff. 1993. Soil survey manual. Soil Conservation Service. U.S. Department of Agriculture Handbook 18. [http://www.nrcs.usda.gov/wps/portal/nrcs/detail/national/soils/?cid=nrcs142p2\\_054262](http://www.nrcs.usda.gov/wps/portal/nrcs/detail/national/soils/?cid=nrcs142p2_054262)
- Soil Survey Staff. 1999. Soil taxonomy: A basic system of soil classification for making and interpreting soil surveys. 2nd edition. Natural Resources Conservation Service, U.S. Department of Agriculture Handbook 436. [http://www.nrcs.usda.gov/wps/portal/nrcs/detail/national/soils/?cid=nrcs142p2\\_053577](http://www.nrcs.usda.gov/wps/portal/nrcs/detail/national/soils/?cid=nrcs142p2_053577)
- Soil Survey Staff. 2010. Keys to soil taxonomy. 11th edition. U.S. Department of Agriculture, Natural Resources Conservation Service. [http://www.nrcs.usda.gov/wps/portal/nrcs/detail/national/soils/?cid=nrcs142p2\\_053580](http://www.nrcs.usda.gov/wps/portal/nrcs/detail/national/soils/?cid=nrcs142p2_053580)
- Tiner, R.W., Jr. 1985. Wetlands of Delaware. U.S. Fish and Wildlife Service and Delaware Department of Natural Resources and Environmental Control, Wetlands Section.
- United States Army Corps of Engineers, Environmental Laboratory. 1987. Corps of Engineers wetlands delineation manual. Waterways Experiment Station Technical Report Y-87-1.
- United States Department of Agriculture, Natural Resources Conservation Service. National forestry manual. [http://www.nrcs.usda.gov/wps/portal/nrcs/detail/soils/home/?cid=nrcs142p2\\_053374](http://www.nrcs.usda.gov/wps/portal/nrcs/detail/soils/home/?cid=nrcs142p2_053374)
- United States Department of Agriculture, Natural Resources Conservation Service. National range and pasture handbook. <http://www.nrcs.usda.gov/wps/portal/nrcs/detail/national/landuse/rangepasture/?cid=stelprdb1043084>

## Custom Soil Resource Report

United States Department of Agriculture, Natural Resources Conservation Service. National soil survey handbook, title 430-VI. [http://www.nrcs.usda.gov/wps/portal/nrcs/detail/soils/scientists/?cid=nrcs142p2\\_054242](http://www.nrcs.usda.gov/wps/portal/nrcs/detail/soils/scientists/?cid=nrcs142p2_054242)

United States Department of Agriculture, Natural Resources Conservation Service. 2006. Land resource regions and major land resource areas of the United States, the Caribbean, and the Pacific Basin. U.S. Department of Agriculture Handbook 296. [http://www.nrcs.usda.gov/wps/portal/nrcs/detail/national/soils/?cid=nrcs142p2\\_053624](http://www.nrcs.usda.gov/wps/portal/nrcs/detail/national/soils/?cid=nrcs142p2_053624)

United States Department of Agriculture, Soil Conservation Service. 1961. Land capability classification. U.S. Department of Agriculture Handbook 210. [http://www.nrcs.usda.gov/Internet/FSE\\_DOCUMENTS/nrcs142p2\\_052290.pdf](http://www.nrcs.usda.gov/Internet/FSE_DOCUMENTS/nrcs142p2_052290.pdf)

The main limitations of this complex for urban development are high frost action potential, moderate shrink-swell potential, the presence of stones and rock outcrop, and steep slopes. This complex requires special site or building designs because of the shrink-swell potential. Special designs are also needed when building on the steeper slopes. The roads and streets must have adequate cut-slope grade and be provided with drains to control surface runoff and keep soil losses to a minimum. Frost action is also a potential problem for the design of roads and streets. Capability subclass VIIe.

**21—Cruckton sandy loam, 1 to 9 percent slopes.** This deep, well drained soil formed in arkosic sandy loam deposits on uplands. Elevation ranges from 7,200 to 7,600 feet. The average annual precipitation is about 17 inches, the average annual air temperature is about 43 degrees F, and the average frost-free period is about 115 days.

Typically, the surface layer is dark grayish brown sandy loam about 4 inches thick. The subsoil is grayish brown sandy loam about 24 inches thick. The substratum is pale brown loamy coarse sand.

Included with this soil in mapping are small areas of Peyton sandy loam, 1 to 5 percent slopes, Peyton sandy loam, 5 to 9 percent slopes, and Pring coarse sandy loam, 3 to 8 percent slopes.

Permeability of this Cruckton soil is moderately rapid. Effective rooting depth is 60 inches or more. Available water capacity is moderate to high. Surface runoff is slow to medium, and the hazard of erosion is moderate. In places runoff from snowmelt in spring causes rills and small gullies to form in cultivated fields.

Most of this soil is in native grass that is used for grazing livestock. A small acreage on some of the more gentle slopes is used for small grain and corn for silage.

Native vegetation is mainly mountain muhly, bluestem, mountain brome, needleandthread, and blue grama. The soil is subject to invasion by Kentucky bluegrass and Gambel oak. Noticeable forbs are hairy goldenrod, geranium, milkvetch, low larkspur, fringed sage, and buckwheat.

Proper location of livestock watering facilities helps to control grazing. Timely deferment of grazing is needed to protect the plant cover.

Windbreaks and environmental plantings are generally suited to this soil. Soil blowing is the main limitation to the establishment of trees and shrubs. This limitation can be overcome by cultivating only in the tree rows and leaving a strip of vegetation between the rows. Supplemental irrigation may be needed when planting and during dry periods. Trees that are best suited and have good survival are Rocky Mountain juniper, eastern redcedar, ponderosa pine, Siberian elm, Russian-olive, and hackberry. Shrubs that are best suited are skunkbush sumac, lilac, and Siberian peashrub.

This soil is suited to wildlife habitat. It is best suited to habitat for openland and rangeland wildlife. Rangeland wildlife, such as pronghorn antelope, can be encouraged by developing livestock watering facilities, properly managing livestock grazing, and reseeding range where needed.

This soil has good potential for use as homesites. Special design of roads and streets is needed because of frost action. Installation of drains helps to control surface runoff and keeps soil losses to a minimum. Capability subclass VIe.

**22—Cushman loam, 1 to 5 percent slopes.** This moderately deep, well drained soil formed in calcareous loamy material derived from weakly consolidated beds of sandstone and shale on uplands. Elevation ranges from 6,000 to 6,500 feet. The average annual precipitation is about 15 inches, the average annual air temperature is about 47 degrees F, and the average frost-free period is about 135 days.

Typically, the surface layer is grayish brown loam about 5 inches thick. The subsoil is brown sandy clay loam about 18 inches thick. The substratum is grayish brown fine sandy loam about 7 inches thick. Interbedded sandstone and shale are at a depth of 30 inches.

Included with this soil in mapping are small areas of Bresser sandy loam, 0 to 3 percent slopes; Kutch clay loam, 3 to 5 percent slopes; and Louviers silty clay loam, 3 to 18 percent slopes.

Permeability of this Cushman soil is moderate. Effective rooting depth is 20 to 40 inches. Available water capacity is low to moderate. Surface runoff is medium, and the hazard of erosion is moderate.

This soil is suitable for cultivation and is generally used for this purpose. Winter wheat is the main crop, and this is followed by a year of summer fallow because of limited precipitation. Feed grains such as millet and sorghum may be substituted for wheat in some years. Crop residue management and minimum tillage are the practices needed to protect this soil. The soil has a high producing potential, but production is reduced by low precipitation.

This soil is well suited to the production of native vegetation suitable for grazing. Native vegetation consists of western wheatgrass, needlegrasses, big bluestem, side-oats grama, blue grama, and native bluegrasses.

If the range has deteriorated, blue grama, junegrass, and native bluegrasses increase. Sleepygrass and annuals replace these grasses if the range is seriously deteriorated. Proper range management and proper location of livestock watering facilities are essential to help maintain the more desirable plants on this soil. Seeding is a good practice if the range is in poor condition. Seeding of the native vegetation is desirable, but the range can also be seeded with tame species of grasses such as Nordan crested wheatgrass, Russian wildrye, pubescent wheatgrass, or intermediate wheatgrass.

Windbreaks and environmental plantings are generally not suited to this soil. Onsite investigation is needed to determine if plantings are feasible.

This soil is suited to wildlife habitat. It is best suited to habitat for openland and rangeland wildlife. In cropland areas, habitat favorable for ring-necked pheasant, mourning dove, and many nongame species can be developed by establishing areas for nesting and escape cover. For pheasant, the provision of undisturbed nesting cover is



support a load and potential frost action on roads and streets. Roads and buildings can be designed to overcome these limitations. Capability subclass IVe.

**67—Peyton sandy loam, 5 to 9 percent slopes.** This deep, noncalcareous, well drained soil formed in alluvium and residuum derived from weathered arkosic sedimentary rock on uplands. Elevation ranges from 6,800 to 7,600 feet.

Typically, the surface layer is grayish brown sandy loam about 12 inches thick. The subsoil, about 23 inches thick, is pale brown sandy clay loam in the upper 13 inches and pale brown sandy loam in the lower 10 inches. The substratum is pale brown sandy loam to a depth of 60 inches.

Included with this soil in mapping are small areas of Holderness loam, 5 to 8 percent slopes; Pring coarse sandy loam, 3 to 8 percent slopes; and Tomah-Crowfoot loamy sands, 3 to 8 percent slopes.

Permeability of this soil is moderate. Effective rooting depth is 60 inches or more. Available water capacity is high. Surface runoff is medium, and the hazard of erosion is moderate. Gullies and rills are common.

Most of the acreage of this Peyton soil is used as rangeland. Some areas are used for wheat and oats. Stubble mulching or other crop residue management practices are needed to control water erosion. Wildlife habitat is also an important use.

This soil is well suited to the production of native vegetation suitable for grazing. The native vegetation is mainly mountain muhly, bluestem, mountain brome, needleandthread, and blue grama. This soil is subject to invasion by Kentucky bluegrass and Gambel oak. Minor amounts of forbs such as hairy goldenrod, geranium, milkvetch, low larkspur, fringed sage, and buckwheat are in the stand.

Proper location of livestock watering facilities helps to control grazing. Timely deferment of grazing is needed to protect the plant cover.

Windbreaks and environmental plantings generally are suited to this soil. Soil blowing is the main limitation to the establishment of trees and shrubs. This limitation can be overcome by cultivating only in the tree rows and leaving a strip of vegetation between the rows. Supplemental irrigation may be necessary when planting and during dry periods. Trees that are best suited and have good survival are Rocky Mountain juniper, eastern redcedar, ponderosa pine, Siberian elm, Russian-olive, and hackberry. Shrubs that are best suited are skunkbush sumac, lilac, and Siberian peashrub.

This soil is suited to habitat for openland and rangeland wildlife. Rangeland wildlife, such as pronghorn antelope, can be encouraged by developing livestock watering facilities, properly managing livestock grazing, and reseeding range where needed.

This soil has good potential for homesites. The main limitation is the limited ability to support a load and potential frost action. Buildings and roads can be designed to overcome these limitations. Capability subclass IVe.

**68—Peyton-Pring complex, 3 to 8 percent slopes.** These gently sloping to moderately sloping soils are on valley side slopes and on uplands. Elevation ranges from 6,800 to 7,600 feet. The average annual precipitation is about 17 inches, the average annual air temperature is about 43 degrees F, and the average frost-free period is about 120 days.

The Peyton soil makes up about 40 percent of the complex, the Pring soil about 30 percent, and other soils about 30 percent.

Included with these soils in mapping are areas of Holderness loam, 1 to 5 percent slopes; Holderness loam, 5 to 8 percent slopes; and Tomah-Crowfoot loamy sands, 3 to 8 percent slopes. In some places arkosic beds of sandstone and shale are at a depth of 0 to 40 inches.

The Peyton soil is commonly on the less sloping part of the landscape. It is deep, noncalcareous, and well drained. It formed in alluvium and residuum derived from weathered arkosic sedimentary rock. Typically, the surface layer is grayish brown sandy loam about 12 inches thick. The subsoil, about 23 inches thick, is pale brown sandy clay loam in the upper 13 inches and pale brown sandy loam in the lower 10 inches. The substratum is pale brown sandy loam to a depth of 60 inches or more.

Permeability of the Peyton soil is moderate. Effective rooting depth is 60 inches or more. Available water capacity is high. Surface runoff is medium, and the hazard of erosion is moderate.

The Pring soil is deep, noncalcareous, and well drained. It formed in sandy sediment derived from weathered arkosic sedimentary rock. Typically, the surface layer is dark grayish brown coarse sandy loam about 4 inches thick. The substratum is dark grayish brown coarse sandy loam about 10 inches thick over pale brown gravelly sandy loam that extends to a depth of 60 inches or more.

Permeability of the Pring soil is rapid. Effective rooting depth is 60 inches or more. Available water capacity is moderate. Surface runoff is medium, and the hazard of erosion is moderate.

These soils are used as rangeland, for wildlife habitat, and for homesites.

These soils are well suited to the production of native vegetation suitable for grazing. The dominant native species are mountain muhly, bluestem, needleandthread, and blue grama. These soils are subject to invasion of Kentucky bluegrass and Gambel oak. Common forbs are hairy goldenrod, geranium, milkvetch, low larkspur, fringed sage, and buckwheat.

Properly locating livestock watering facilities helps to control grazing. Timely deferment of grazing is needed to protect the plant cover.

Windbreaks and environmental plantings generally are suited to these soils. Soil blowing is the main limitation to the establishment of trees and shrubs. This limitation can be overcome by cultivating only in the tree rows and leaving a strip of vegetation between the rows. Supplemental irrigation may be needed when planting and during dry periods. Trees that are best suited and have good

2965

2965

Wilbur Thompson

**STATE OF COLORADO**

**DEPARTMENT OF WATER RESOURCES**

**Office of State Engineer**

**Standard Plans, Drawings**

**and**

**SPECIFICATIONS**

**Including**

**RULES AND REGULATIONS**

**Pertaining to**

**THE FILING OF APPLICATIONS**

**for**

**THE APPROVAL**

**of**

**LIVESTOCK WATER TANKS**

**PURSUANT TO H.B. No. 750**

**SESSION LAWS OF 1941**

**DENVER, COLORADO, MAY 1, 1941**



# APPLICATION FOR APPROVAL OF LIVESTOCK WATER TANK

This application and Statement is made in conformity with provisions of the Livestock Water Tank Act of Colorado.

This application must be accompanied by a filing fee of one dollar, payable to the State Engineer of Colorado.

2965

Name of Owner Wilbur Thompson Motor Route #3 Colorado Springs Colo. P. O. Address

Location of Tank SW 1/4 SE 1/4 Section 24, Township 11 So, Range 66 W. 6th PM

Name of water course on which tank is located None

Is water course normally dry Yes

Approximate area of drainage basin above tank 60 acres.

Nature of vegetative cover over drainage basin above tank Grassland

Character of topography of drainage basin (steep, medium or flat) Medium

Character of surface formation of drainage basin (rock, rocky soil, or soil) Soil

Approximate elevation of drainage basin above sea level 7800 feet.

Is water course subject to floods at times Yes

Height of top of dam above bottom of water course 10.0 feet.

Height of bottom of spillway above bottom of water course 7.0 feet.

Approximate capacity of tank 1.0 0/0 acre feet.

Location of spillway with respect to dam Around end

Bottom width of spillway at narrowest point 30.0 feet.

Distance of lower end of spillway below dam 50.0 feet.

Kind of formations in which spillway is located (rock, shale, clay, earth or mixture of soil and rock) Earth

Width of top of dam 8.0 feet.

Length of top of dam 141.0 feet.

Slope of upstream face of dam 3:1

Slope of downstream face of dam 2:1

Nature of riprap or other protection to be placed over water face of dam To be seeded to grass

Is the reservoir to be provided with an outlet pipe No.

If so, give kind and size of pipe

Give location by section, township and range, and size of every other stock tank now constructed in drainage basin in which this tank will be located No other dams in this drainage area

NOTE—Remainder of statements to be furnished by State Engineer's office.

Date of receipt of application by State Engineer NOV 29 1946, 19

Date of notice from applicant of completion of tank Oct. 25, 19 46.

Tank or site inspected by \_\_\_\_\_, 19

Recommendation of Inspector \_\_\_\_\_

Date of return of plans and specifications to applicant for correction or revision \_\_\_\_\_

Reasons therefor \_\_\_\_\_

Filing Fee Paid NOV 29 1946, 19

Application approved this 28th day of AUGUST, 1947.

Number assigned this stock tank is \_\_\_\_\_

By G. G. Brundage State Engineer Deputy

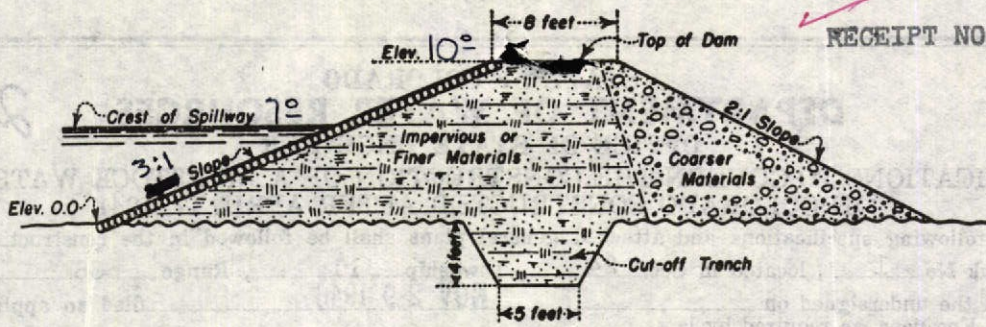

MAXIMUM CROSS-SECTION OF DAM

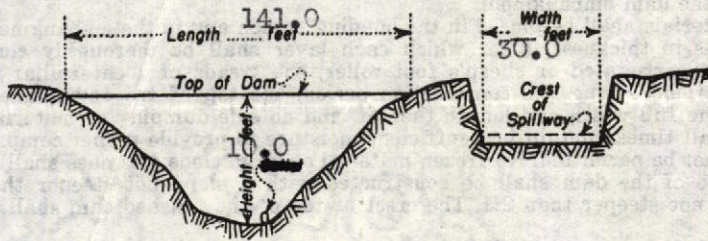

CROSS-SECTION OF DAM SITE AND SPILLWAY

Show length and height of dam and width of spillway on drawing

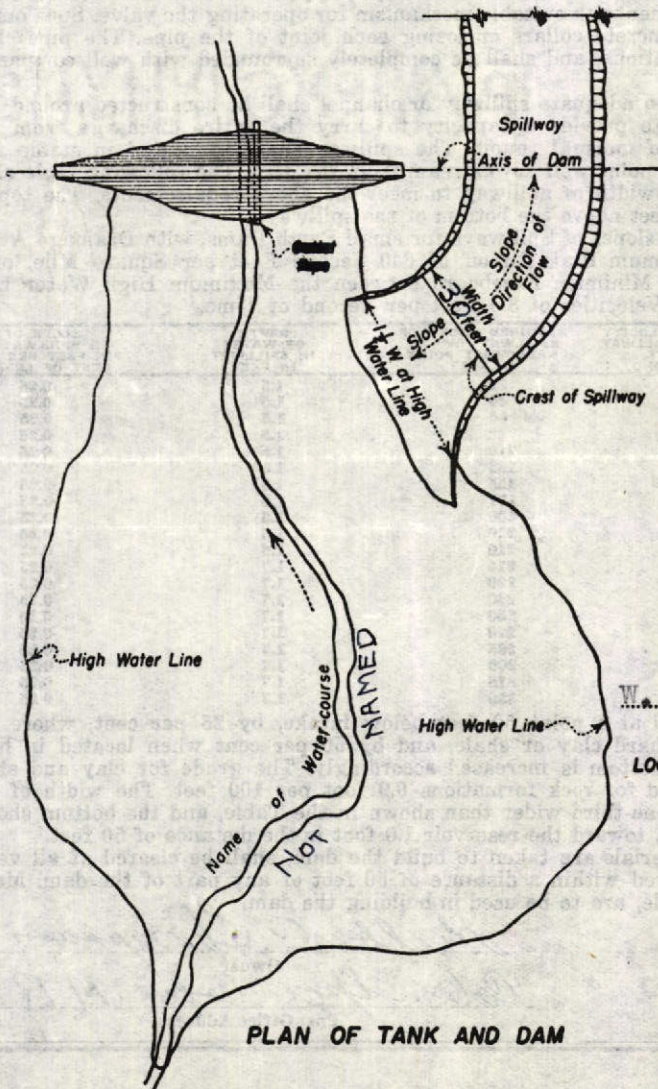

PLAN OF TANK AND DAM

STATEMENT BY OWNER

Know all men by these presents: That the undersigned Wilbur Thompson whose postoffice address is M. Rt. 3 Colo. Spgs. has caused to be located this Stock Water Tank, the essential features of which are shown by this map and plans, which together with the accompanying application and statements are hereby filed with the State Engineer pursuant to the provisions of law.

First: Height of dam above bottom of water-course is 10.0 feet.

Second: Height of spillway above bottom of water-course is 7.0 feet.

Third: Total capacity of said Stock Water Tank is 10 acre feet.

Fourth: The source of supply for said Stock Water Tank is (name of stream) None

Fifth: Filing of this map and accompanying statements with the State Engineer was made on the 29th day of November, 1947.

Wilbur C. Thompson  
Owner

MAP AND PLANS

FOR

W. Thompson STOCK WATER TANK AND DAM

LOCATED IN SECTION 24 TWP. 11<sup>5</sup> RANGE 66 W OF 6<sup>th</sup> P.M.

El Paso COUNTY

DRAINAGE AREA ABOVE DAM 60 ACRES

Approved this 28<sup>th</sup> day of AUGUST, 1947

State Engineer  
By [Signature]  
Deputy

RECEIPT NO. 2965

2965

**STATE OF COLORADO**  
**DEPARTMENT OF WATER RESOURCES**  
**OFFICE OF STATE ENGINEER**

**SPECIFICATIONS TO GOVERN THE CONSTRUCTION OF A LIVESTOCK WATER TANK  
 IN COLORADO CONSTRUCTED AFTER APRIL 17, 1941**

The following specifications and attached general plans shall be followed in the construction of stock water tank No. 1, located in Sec. 24, Township 11, Range 66, for which the undersigned on NOV 29 1946 filed an application with the State Engineer, as required by law.

**Preparation of Foundation for Dam**—All vegetable matter of every description, including roots to a depth of two feet, shall be removed from the entire area upon which the dam will rest, following which the top six-inch layer of soil, together with boggy or unstable materials shall be removed and deposited outside the toes of the dam. The banks of the stream channel shall be dressed to a slope of about 1½:1. A bonding trench, with sloping sides and a bottom width of not less than 5 feet and depth of 4 feet, shall then be excavated beneath the center line of the dam the full length thereof, which trench shall be refilled with the most impervious materials available. The foundation of the dam shall then be lightly plowed lengthwise of the dam, to provide proper contact between the foundation and the dam embankment.

**Placing of Dam Embankment**—The materials shall be placed in the bonding trench and in the embankment of the dam in layers not exceeding 6 inches in thickness, after which each layer shall be thoroughly compacted by a heavily loaded disc cultivator, a corrugated or sheep's foot roller, the treads of a caterpillar or trucks, or by livestock used in the construction. During the construction period, the top of the embankment shall be maintained as a horizontal plane the full width and length thereof, and no side dumping of materials shall be permitted. The materials shall at all times contain just sufficient moisture to provide proper compaction. Puddling of material with water shall not be permitted. No frozen material or large clods or stones shall be incorporated in the dam. The upstream face of the dam shall be constructed with a slope not steeper than 2½:1, and the downstream face on a slope not steeper than 2:1. The crest or top of the finished dam shall be not less than 8 feet in width.

The upstream two-thirds of the dam shall be constructed of the most impervious materials, such as clay loam, or a mixture of clay and sand, and the downstream one third of more pervious material, such as sand or gravel. The upstream face of the dam shall be adequately protected against wave action by stone riprap, or other suitable materials.

**Outlet**—Should the state engineer so require, there shall be located beneath the dam a galvanized, corrugated steel pipe of No. 14 gauge and not less than 8 inches in diameter, equipped with a suitable control valve attached to the upstream end of the pipe, together with suitable mechanism for operating the valve. Such outlet pipe, when required, shall be provided with concrete collars enclosing each joint of the pipe. The pipe shall be placed in a trench bottomed in stable formations, and shall be completely surrounded with well compacted impervious materials.

**Spillway**—For the protection of the dam, an adequate spillway or channel shall be constructed around one or both ends of the dam, of sufficient width to provide a capacity to carry the entire discharge from the drainage basin above the dam during periods of unusual runoff. The spillway shall be located in stable formations not easily eroded, and shall extend to a point well downstream from the dam. The following table shall be used to determine the necessary depth and width of spillway to meet the above requirements. The top of the dam at all points shall be not less than 4 feet above the bottom of the spillway.

Table Showing Required Freeboard, Widths and slopes of Spillways for small Earth Dams, with Drainage Areas above the Same as Shown, Based upon a maximum Peak Runoff of 640 Second Feet per Square Mile, or 1 Second Foot per Acre, with an Allowance of a Minimum Freeboard between the Maximum High Water Line and Top of Dam, of 2.3 Feet, and Maximum Velocities of 3.5 Feet per Second of Time.

AREA OF DRAINAGE BASIN ABOVE DAM IN ACRES	PEAK RUNOFF IN CU. FT. PER SECOND	ASSUMED VELOCITY THROUGH SPILLWAY IN FEET PER SECOND	REQUIRED WIDTH OF SPILLWAY "W" AT NARROWEST POINT IN FEET	DEPTH OF WATER IN SPILLWAY IN FEET	SLOPE OF SPILLWAY IN FEET PER 100 FEET OF LENGTH
100	100	3.0	22	1.5	0.25
200	200	3.0	44	1.5	0.25
300	300	3.0	66	1.5	0.25
400	400	3.0	88	1.5	0.25
500	500	3.0	110	1.5	0.25
600	600	3.0	133	1.5	0.25
700	700	3.0	155	1.5	0.25
800	800	3.0	177	1.5	0.25
900	900	3.0	200	1.5	0.25
1000	1000	3.0	220	1.5	0.25
1100	1100	3.0	240	1.6	0.25
1200	1200	3.2	260	1.7	0.25
1300	1300	3.3	280	1.7	0.25
1400	1400	3.4	300	1.7	0.25
1500	1500	3.4	320	1.7	0.25
1600	1600	3.5	340	1.7	0.25
1700	1700	3.5	360	1.7	0.25
1800	1800	3.5	380	1.7	0.25
1900	1900	3.5	400	1.7	0.25
2000	2000	3.5	420	1.7	0.25

The above spillway widths may be reduced at a point 50 feet below intake, by 25 per cent, where the spillway is located the full length thereof in hard clay or shale, and by 50 per cent when located in hard rock formations, if the slope or grade of the bottom is increased accordingly. The grade for clay and shale formations should be 0.30 foot per 100 feet, and for rock formations 0.9 foot per 100 feet. The width of the entrance to the spillway must in all cases be one-third wider than shown in the Table, and the bottom should slope from the lower end of the funnel section, toward the reservoir 1.0 foot in the distance of 50 feet.

**Borrow Pits**—Borrow pits, from which materials are taken to build the dam, shall be cleared of all vegetable matter, and no material shall be borrowed within a distance of 50 feet of any part of the dam. Materials excavated from the spillway, when suitable, are to be used in building the dam.

Date X Nov. 25 1946  
 NOV 29 1946

X Milton C. Thompson  
 Owner  
Colo. Spgs Colo. M R #3  
 Post Office Address

## **2 Hydrologic Calculations**

Runoff Coefficients and Percent Imperviousness Table 6-6

Colorado Springs Rainfall Intensity Duration Frequency Table 6-5

Hydrologic Calculations Summary Form SF-1 for Existing & Developed Conditions

Hydrologic Calculations Summary 5-yr Form SF-2 for Existing & Developed Conditions

Hydrologic Calculations Summary 100-yr Form SF-2 for Existing & Developed Conditions

**Table 6-6. Runoff Coefficients for Rational Method**  
(Source: UDFCD 2001)

Land Use or Surface Characteristics	Percent Impervious	Runoff Coefficients											
		2-year		5-year		10-year		25-year		50-year		100-year	
		HSG A&B	HSG C&D	HSG A&B	HSG C&D	HSG A&B	HSG C&D	HSG A&B	HSG C&D	HSG A&B	HSG C&D	HSG A&B	HSG C&D
<b>Business</b>													
Commercial Areas	95	0.79	0.80	0.81	0.82	0.83	0.84	0.85	0.87	0.87	0.88	0.88	0.89
Neighborhood Areas	70	0.45	0.49	0.49	0.53	0.53	0.57	0.58	0.62	0.60	0.65	0.62	0.68
<b>Residential</b>													
1/8 Acre or less	65	0.41	0.45	0.45	0.49	0.49	0.54	0.54	0.59	0.57	0.62	0.59	0.65
1/4 Acre	40	0.23	0.28	0.30	0.35	0.36	0.42	0.42	0.50	0.46	0.54	0.50	0.58
1/3 Acre	30	0.18	0.22	0.25	0.30	0.32	0.38	0.39	0.47	0.43	0.52	0.47	0.57
1/2 Acre	25	0.15	0.20	0.22	0.28	0.30	0.36	0.37	0.46	0.41	0.51	0.46	0.56
1 Acre	20	0.12	0.17	0.20	0.26	0.27	0.34	0.35	0.44	0.40	0.50	0.44	0.55
<b>Industrial</b>													
Light Areas	80	0.57	0.60	0.59	0.63	0.63	0.66	0.66	0.70	0.68	0.72	0.70	0.74
Heavy Areas	90	0.71	0.73	0.73	0.75	0.75	0.77	0.78	0.80	0.80	0.82	0.81	0.83
<b>Parks and Cemeteries</b>													
Parks and Cemeteries	7	0.05	0.09	0.12	0.19	0.20	0.29	0.30	0.40	0.34	0.46	0.39	0.52
Playgrounds	13	0.07	0.13	0.16	0.23	0.24	0.31	0.32	0.42	0.37	0.48	0.41	0.54
Railroad Yard Areas	40	0.23	0.28	0.30	0.35	0.36	0.42	0.42	0.50	0.46	0.54	0.50	0.58
<b>Undeveloped Areas</b>													
Historic Flow Analysis-- Greenbelts, Agriculture	2	0.03	0.05	0.09	0.16	0.17	0.26	0.26	0.38	0.31	0.45	0.36	0.51
Pasture/Meadow	0	0.02	0.04	0.08	0.15	0.15	0.25	0.25	0.37	0.30	0.44	0.35	0.50
Forest	0	0.02	0.04	0.08	0.15	0.15	0.25	0.25	0.37	0.30	0.44	0.35	0.50
Exposed Rock	100	0.89	0.89	0.90	0.90	0.92	0.92	0.94	0.94	0.95	0.95	0.96	0.96
Offsite Flow Analysis (when landuse is undefined)	45	0.26	0.31	0.32	0.37	0.38	0.44	0.44	0.51	0.48	0.55	0.51	0.59
<b>Streets</b>													
Paved	100	0.89	0.89	0.90	0.90	0.92	0.92	0.94	0.94	0.95	0.95	0.96	0.96
Gravel	80	0.57	0.60	0.59	0.63	0.63	0.66	0.66	0.70	0.68	0.72	0.70	0.74
<b>Drive and Walks</b>													
Drive and Walks	100	0.89	0.89	0.90	0.90	0.92	0.92	0.94	0.94	0.95	0.95	0.96	0.96
<b>Roofs</b>													
Roofs	90	0.71	0.73	0.73	0.75	0.75	0.77	0.78	0.80	0.80	0.82	0.81	0.83
<b>Lawns</b>													
Lawns	0	0.02	0.04	0.08	0.15	0.15	0.25	0.25	0.37	0.30	0.44	0.35	0.50

Figure 6-5. Colorado Springs Rainfall Intensity Duration Frequency

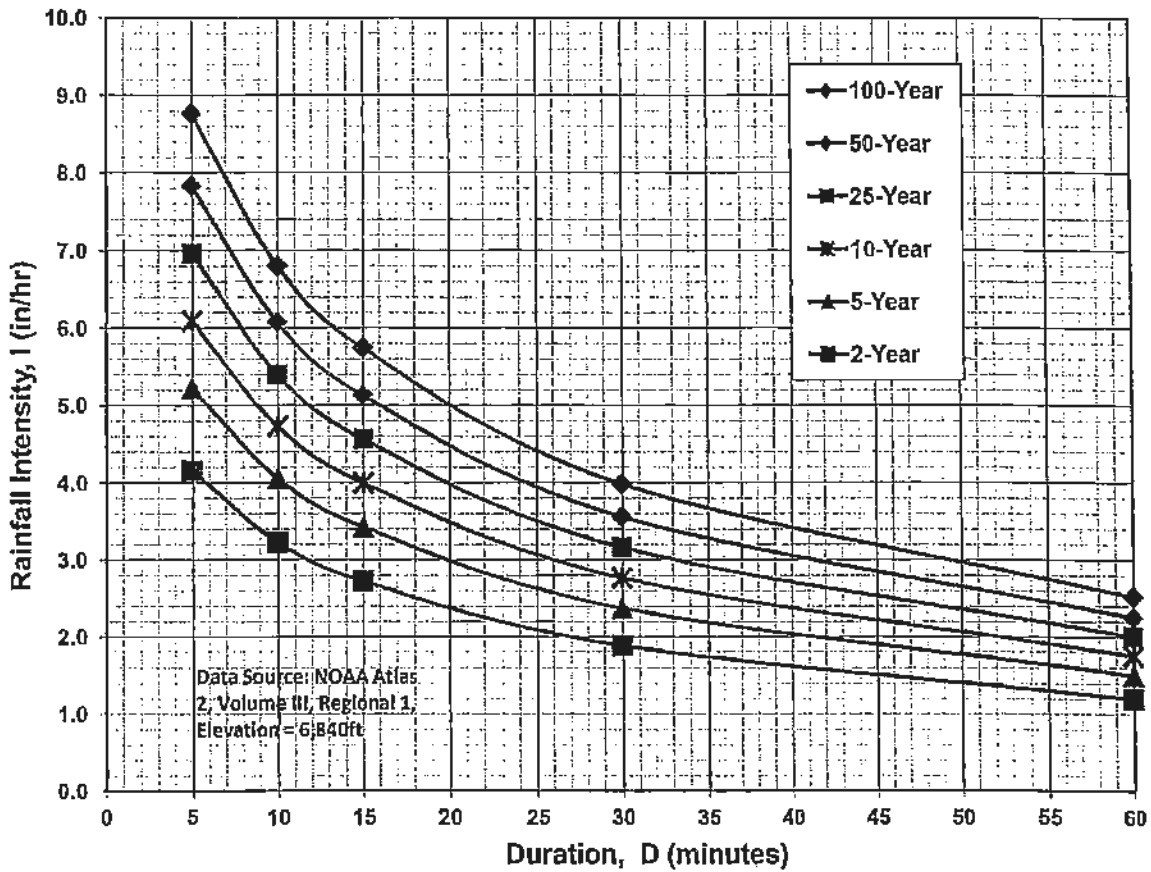

**IDF Equations**

$$I_{100} = -2.52 \ln(D) + 12.735$$

$$I_{50} = -2.25 \ln(D) + 11.375$$

$$I_{25} = -2.00 \ln(D) + 10.111$$

$$I_{10} = -1.75 \ln(D) + 8.847$$

$$I_5 = -1.50 \ln(D) + 7.583$$

$$I_2 = -1.19 \ln(D) + 6.035$$

Note: Values calculated by equations may not precisely duplicate values read from figure.



Job No.: **61160**  
 Project: **Misfit Crew Estates**  
 Design Storm: **5-Year Storm (20% Probability)**  
 Jurisdiction: **DCM**

Date: **9/27/2024 13:28**  
 Calcs By: **TJW**  
 Checked By: \_\_\_\_\_

**Sub-Basin and Combined Flows** (Modified from Standard Form SF-2)

DP	Sub-Basin	Area (Acres)	C5	Direct Runoff				Combined Runoff				Streetflow			Pipe Flow				Travel Time		
				t <sub>c</sub> (min)	CA (Acres)	I5 (in/hr)	Q5 (cfs)	t <sub>c</sub> (min)	CA (Acres)	I5 (in/hr)	Q5 (cfs)	Slope (%)	Length (ft)	Q (cfs)	Q (cfs)	Slope (%)	Mnngs n	Length (ft)	D <sub>Pipe</sub> (in)	Length (ft)	v <sub>0sc</sub> (ft/s)
DP1	A1	3.89	0.08	20.4	0.32	3.06	0.99	20.4	0.32	3.06	7.3										
	OS-B1	3.89	0.08																		
DP2	B2	1.22	0.08	18.8	0.10	3.19	0.31	26.7	1.87	2.66	5.0										
	EX-C1	20.92	0.08	26.1	1.78	2.69	4.77														
EX-DP3		22.14	0.08	22.1	0.88	2.94	2.59	22.1	0.88	2.94	24.7										
PP-DP3	PP-C1	11.01	0.08	21.8	1.10	2.96	3.26	21.8	1.10	2.96	25.4										

Unresolved from Review 1: DP should include flow from DP8

Unresolved from Review 1: DP should include flow from DP10

DCM:  $I = C1 * \ln(tc) + C2$   
 C1: 1.5  
 C1: 7.583

Job No.: **61160**  
 Project: **Misfit Crew Estates**  
 Design Storm: **100-Year Storm (1% Probability)**  
 Jurisdiction: **DCM**

Date: **9/27/2024 13:28**  
 Calcs By: **TJW**  
 Checked By: \_\_\_\_\_

**Sub-Basin and Combined Flows** (Modified from Standard Form SF-2)

DP	Sub-Basin	Area (Acres)	C100	Direct Runoff				Combined Runoff				Streetflow			Pipe Flow				Travel Time		
				t <sub>c</sub> (min)	CA (Acres)	I100 (in/hr)	Q100 (cfs)	t <sub>c</sub> (min)	CA (Acres)	I100 (in/hr)	Q100 (cfs)	Slope (%)	Length (ft)	Q (cfs)	Q (cfs)	Slope (%)	Mnngs n	Length (ft)	D <sub>Pipe</sub> (in)	Length (ft)	v <sub>0sc</sub> (ft/s)
DP1	A1	3.89	0.35	20.4	1.37	5.13	7.03	20.4	1.37	5.13	21.7										
		3.89	0.35																		
DP2	OS-B1	1.22	0.35	18.8	0.43	5.35	2.28	26.7	7.82	4.46	34.9										
	B2	20.92	0.35	26.1	7.40	4.51	33.36														
EX-DP3	EX-C1	11.01	0.35	22.1	3.86	4.94	19.04	22.1	3.86	4.94	72.3										
PP-DP3	PP-C1	11.01	0.38	21.8	4.19	4.97	20.82	21.8	4.19	4.97	74.1										
		11.01	0.38																		

DCM:  $I = C1 * \ln(tc) + C2$   
 C1: 2.52  
 C1: 12.735

## Sub-Basin Ex-A1 Runoff Calculations

Job No.: 61160  
 Project: Misfit Crew Estates  
 Jurisdiction: DCM  
 Runoff Coefficient: Surface Type

Date: 9/27/2024 13:28  
 Calcs by: TJW  
 Checked by: \_\_\_\_\_  
 Soil Type: B  
 Urbanization: Non-Urban

### Basin Land Use Characteristics

Surface	Area		Runoff Coefficient						% Imperv.
	(SF)	(Acres)	C2	C5	C10	C25	C50	C100	
Pasture/Meadow	168,736	3.87	0.02	0.08	0.15	0.25	0.3	0.35	0%
Paved			0.89	0.9	0.92	0.94	0.95	0.96	100%
Roofs	789	0.02	0.71	0.73	0.75	0.78	0.8	0.81	90%
<b>Combined</b>	<b>169,525</b>	<b>3.89</b>	<b>0.02</b>	<b>0.08</b>	<b>0.15</b>	<b>0.25</b>	<b>0.30</b>	<b>0.35</b>	<b>0.4%</b>

169525

### Basin Travel Time

	Shallow Channel Ground Cover		Short Pasture/Lawns			
	$L_{max,Overland}$	ft	$C_v$			
	L (ft)	$\Delta Z_0$ (ft)	$S_0$ (ft/ft)	v (ft/s)	t (min)	$t_{Alt}$ (min)
Total	500	26	-	-	-	-
Initial Time	300	16	0.053	-	18.3	N/A DCM Eq. 6-8
Shallow Channel	200	10	0.050	1.6	2.1	- DCM Eq. 6-9
Channelized			0.000	0.0	0.0	- V-Ditch
				$t_c$	<b>20.4 min.</b>	

### Rainfall Intensity & Runoff

	2-Yr	5-Yr	10-Yr	25-Yr	50-Yr	100-Yr
<b>Intensity (in/hr)</b>	2.44	3.06	3.57	4.08	4.59	5.13
<b>Runoff (cfs)</b>	0.2	1.0	2.1	4.0	5.4	7.0
<b>Release Rates (cfs/ac)</b>	-	-	-	-	-	-
<b>Allowed Release (cfs)</b>	0.2	1.0	2.1	4.0	5.4	7.0

DCM:  $I = C1 * \ln(tc) + C2$

C1	1.19	1.5	1.75	2	2.25	2.52
C2	6.035	7.583	8.847	10.111	11.375	12.735

### Notes

# Combined Sub-Basin Runoff Calculations - DP1

Includes Basins A1

Job No.:	<b>61160</b>	Date:	<b>9/27/2024 13:28</b>
Project:	<b>Misfit Crew Estates</b>	Calcs by:	<b>TJW</b>
Jurisdiction	<b>DCM</b>	Checked by:	
Runoff Coefficient	<b>Surface Type</b>	Soil Type	<b>B</b>
		Urbanization	<b>Non-Urban</b>

## Basin Land Use Characteristics

Surface	Area		Runoff Coefficient						% Imperv.
	(SF)	(Acres)	C2	C5	C10	C25	C50	C100	
Pasture/Meadow	168,736	3.87	0.02	0.08	0.15	0.25	0.3	0.35	0%
Paved	-	0.00	0.89	0.9	0.92	0.94	0.95	0.96	100%
Roofs	789	0.02	0.71	0.73	0.75	0.78	0.8	0.81	90%
<b>Combined</b>	<b>169,525</b>	<b>3.89</b>	<b>0.02</b>	<b>0.08</b>	<b>0.15</b>	<b>0.25</b>	<b>0.30</b>	<b>0.35</b>	<b>0.4%</b>

## Basin Travel Time

	Sub-basin or Channel Type	Material Type	L (ft)	Elev. ΔZ <sub>0</sub> (ft)	Q <sub>i</sub> (cfs)	Base or Dia (ft)	Sides z:1 (ft/ft)	v (ft/s)	t (min)
Furthest Reach	A1	-	500	26	-	-	-	-	20.4
Channelized-1									
Channelized-2									
Channelized-3									
<b>Total</b>			<b>500</b>	<b>26</b>					
								<b>t<sub>c</sub> (min)</b>	<b>20.4</b>

## Contributing Offsite Flows (Added to Runoff and Allowed Release, below.)

Contributing Basins/Areas Off-Site DP8

Q<sub>Minor</sub> 6.3 (cfs) - 5-year Storm

Q<sub>Major</sub> 14.7 (cfs) - 100-year Storm

## Rainfall Intensity & Runoff

	2-Yr	5-Yr	10-Yr	25-Yr	50-Yr	100-Yr
<b>Intensity (in/hr)</b>	2.44	3.06	3.57	4.08	4.59	5.13
<b>Site Runoff (cfs)</b>	0.22	<b>0.99</b>	2.12	4.01	5.40	<b>7.03</b>
<b>OffSite Runoff (cfs)</b>	-	<b>6.30</b>	-	-	-	<b>14.70</b>
<b>Release Rates (cfs/ac)</b>	-	-	-	-	-	-
<b>Allowed Release (cfs)</b>	-	<b>7.3</b>	-	-	-	<b>21.7</b>

DCM:  $I = C1 * \ln(tc) + C2$

C1	1.19	1.5	1.75	2	2.25	2.52
C2	6.035	7.583	8.847	10.111	11.375	12.735

## Notes

Runoff from Offsite basins have been assumed constant, despite additional times of concentration.

## Sub-Basin OS-B1 Runoff Calculations

Job No.: 61160  
 Project: Misfit Crew Estates  
 Jurisdiction: DCM  
 Runoff Coefficient: Surface Type

Date: 9/27/2024 13:28  
 Calcs by: TJW  
 Checked by: \_\_\_\_\_  
 Soil Type: B  
 Urbanization: Non-Urban

### Basin Land Use Characteristics

Surface	Area		Runoff Coefficient						% Imperv.
	(SF)	(Acres)	C2	C5	C10	C25	C50	C100	
Pasture/Meadow	53,170	1.22	0.02	0.08	0.15	0.25	0.3	0.35	0%
Paved			0.89	0.9	0.92	0.94	0.95	0.96	100%
Roofs			0.71	0.73	0.75	0.78	0.8	0.81	90%
<b>Combined</b>	<b>53,170</b>	<b>1.22</b>	<b>0.02</b>	<b>0.08</b>	<b>0.15</b>	<b>0.25</b>	<b>0.30</b>	<b>0.35</b>	<b>0.0%</b>

53170

### Basin Travel Time

	Shallow Channel Ground Cover		Short Pasture/Lawns			
	$L_{max,Overland}$				$C_v$	
	L (ft)	$\Delta Z_0$ (ft)	$S_0$ (ft/ft)	$v$ (ft/s)	t (min)	$t_{Alt}$ (min)
Total	300	15	-	-	-	-
Initial Time	300	15	0.050	-	18.8	N/A DCM Eq. 6-8
Shallow Channel			0.000	0.0	0.0	- DCM Eq. 6-9
Channelized			0.000	0.0	0.0	- V-Ditch
				$t_c$	<b>18.8 min.</b>	

### Rainfall Intensity & Runoff

	2-Yr	5-Yr	10-Yr	25-Yr	50-Yr	100-Yr
Intensity (in/hr)	2.55	3.19	3.72	4.25	4.78	5.35
Runoff (cfs)	0.1	<b>0.3</b>	0.7	1.3	1.8	<b>2.3</b>
Release Rates (cfs/ac)	-	-	-	-	-	-
Allowed Release (cfs)	0.1	<b>0.3</b>	0.7	1.3	1.8	<b>2.3</b>

DCM:  $I = C1 * \ln(tc) + C2$

C1	1.19	1.5	1.75	2	2.25	2.52
C2	6.035	7.583	8.847	10.111	11.375	12.735

### Notes

## Sub-Basin B2 Runoff Calculations

Job No.: 61160  
 Project: Misfit Crew Estates  
 Jurisdiction: DCM  
 Runoff Coefficient: Surface Type

Date: 9/27/2024 13:28  
 Calcs by: TJW  
 Checked by: \_\_\_\_\_  
 Soil Type: B  
 Urbanization: Non-Urban

### Basin Land Use Characteristics

Surface	Area		Runoff Coefficient						% Imperv.
	(SF)	(Acres)	C2	C5	C10	C25	C50	C100	
Pasture/Meadow	904,717	20.77	0.02	0.08	0.15	0.25	0.3	0.35	0%
Paved	1,000	0.02	0.89	0.9	0.92	0.94	0.95	0.96	100%
Roofs	5,621	0.13	0.71	0.73	0.75	0.78	0.8	0.81	90%
<b>Combined</b>	<b>911,338</b>	<b>20.92</b>	<b>0.03</b>	<b>0.08</b>	<b>0.15</b>	<b>0.25</b>	<b>0.30</b>	<b>0.35</b>	<b>0.7%</b>

911338

### Basin Travel Time

	Shallow Channel Ground Cover		Short Pasture/Lawns			
	$L_{max,Overland}$	$\Delta Z_0$ (ft)	$S_0$ (ft/ft)	$v$ (ft/s)	$t$ (min)	$t_{Alt}$ (min)
	300 ft	78	-	-	-	-
Total	1,200	78	-	-	-	-
Initial Time	300	17	0.057	-	17.9	N/A DCM Eq. 6-8
Shallow Channel	900	61	0.068	1.8	8.2	- DCM Eq. 6-9
Channelized			0.000	0.0	0.0	- V-Ditch
				$t_c$	<b>26.1 min.</b>	

### Rainfall Intensity & Runoff

	2-Yr	5-Yr	10-Yr	25-Yr	50-Yr	100-Yr
<b>Intensity (in/hr)</b>	2.15	2.69	3.14	3.58	4.03	4.51
<b>Runoff (cfs)</b>	1.1	4.8	10.1	19.0	25.6	33.4
<b>Release Rates (cfs/ac)</b>	-	-	-	-	-	-
<b>Allowed Release (cfs)</b>	1.1	4.8	10.1	19.0	25.6	33.4

DCM:  $I = C1 * \ln(tc) + C2$

C1	1.19	1.5	1.75	2	2.25	2.52
C2	6.035	7.583	8.847	10.111	11.375	12.735

### Notes

## Combined Sub-Basin Runoff Calculations - DP2

Includes Basins OS-B1 B2

Job No.:	<b>61160</b>	Date:	<b>9/27/2024 13:28</b>
Project:	<b>Misfit Crew Estates</b>	Calcs by:	<b>TJW</b>
Jurisdiction	<b>DCM</b>	Checked by:	
Runoff Coefficient	<b>Surface Type</b>	Soil Type	<b>B</b>
		Urbanization	<b>Non-Urban</b>

### Basin Land Use Characteristics

Surface	Area		Runoff Coefficient						% Imperv.
	(SF)	(Acres)	C2	C5	C10	C25	C50	C100	
Pasture/Meadow	957,887	21.99	0.02	0.08	0.15	0.25	0.3	0.35	0%
Paved	1,000	0.02	0.89	0.9	0.92	0.94	0.95	0.96	100%
Roofs	5,621	0.13	0.71	0.73	0.75	0.78	0.8	0.81	90%
<b>Combined</b>	<b>964,508</b>	<b>22.14</b>	<b>0.02</b>	<b>0.08</b>	<b>0.15</b>	<b>0.25</b>	<b>0.30</b>	<b>0.35</b>	<b>0.6%</b>

### Basin Travel Time

	Sub-basin or Channel Type	Material Type	L (ft)	Elev. $\Delta Z_0$ (ft)	$Q_i$ (cfs)	Base or Dia (ft)	Sides z:1 (ft/ft)	v (ft/s)	t (min)
Furthest Reach	OS-B1	-	300	15	-	-	-	-	18.8
Channelized-1	Trap Ditch	2	1,200	78	2	2	2	2.5	8.0
Channelized-2									
Channelized-3									
Total			1,500	93					

2 = Natural, Winding, minimal vegetation/shallow grass

$t_c$  (min) **26.7**

### Contributing Offsite Flows (Added to Runoff and Allowed Release, below.)

Contributing Basins/Areas

$Q_{Minor}$	(cfs) - 5-year Storm
$Q_{Major}$	(cfs) - 100-year Storm

### Rainfall Intensity & Runoff

	2-Yr	5-Yr	10-Yr	25-Yr	50-Yr	100-Yr
<b>Intensity (in/hr)</b>	2.13	2.66	3.10	3.54	3.98	4.46
<b>Site Runoff (cfs)</b>	1.17	<b>4.98</b>	10.58	19.90	26.78	<b>34.87</b>
<b>OffSite Runoff (cfs)</b>	-	<b>0.00</b>	-	-	-	<b>0.00</b>
<b>Release Rates (cfs/ac)</b>	-	-	-	-	-	-
<b>Allowed Release (cfs)</b>	-	<b>5.0</b>	-	-	-	<b>34.9</b>

DCM:  $I = C1 * \ln(tc) + C2$

C1	1.19	1.5	1.75	2	2.25	2.52
C2	6.035	7.583	8.847	10.111	11.375	12.735

### Notes

Runoff from Offsite basins have been assumed constant, despite additional times of concentration.

## Sub-Basin EX-C1 Runoff Calculations

Job No.: 61160  
 Project: Misfit Crew Estates  
 Jurisdiction: DCM  
 Runoff Coefficient: Surface Type

Date: 9/27/2024 13:28  
 Calcs by: TJW  
 Checked by: \_\_\_\_\_  
 Soil Type: B  
 Urbanization: Non-Urban

### Basin Land Use Characteristics

Surface	Area		Runoff Coefficient						% Imperv.
	(SF)	(Acres)	C2	C5	C10	C25	C50	C100	
Pasture/Meadow	479,797	11.01	0.02	0.08	0.15	0.25	0.3	0.35	0%
Paved			0.89	0.9	0.92	0.94	0.95	0.96	100%
Roofs			0.71	0.73	0.75	0.78	0.8	0.81	90%
<b>Combined</b>	<b>479,797</b>	<b>11.01</b>	<b>0.02</b>	<b>0.08</b>	<b>0.15</b>	<b>0.25</b>	<b>0.30</b>	<b>0.35</b>	<b>0.0%</b>

### Basin Travel Time

	Shallow Channel Ground Cover		Short Pasture/Lawns			
	$L_{max,Overland}$	$\Delta Z_0$ (ft)	$S_0$ (ft/ft)	$v$ (ft/s)	$t$ (min)	$t_{Alt}$ (min)
	300	54	-	-	-	-
Total	1,110	26	0.087	-	15.6	N/A DCM Eq. 6-8
Initial Time	300	18	0.044	1.5	4.7	- DCM Eq. 6-9
Shallow Channel	410	10	0.025	3.8	1.8	- Trap Ditch
Channelized	400					
				$t_c$	<b>22.1 min.</b>	

### Rainfall Intensity & Runoff

	2-Yr	5-Yr	10-Yr	25-Yr	50-Yr	100-Yr
Intensity (in/hr)	2.35	2.94	3.43	3.92	4.41	4.94
Runoff (cfs)	0.5	<b>2.6</b>	5.7	10.8	14.6	<b>19.0</b>
Release Rates (cfs/ac)	-	-	-	-	-	-
Allowed Release (cfs)	0.5	<b>2.6</b>	5.7	10.8	14.6	<b>19.0</b>

DCM:  $I = C1 * \ln(tc) + C2$

C1	1.19	1.5	1.75	2	2.25	2.52
C2	6.035	7.583	8.847	10.111	11.375	12.735

### Notes



## Sub-Basin PP-C1 Runoff Calculations

Job No.: 61160  
 Project: Misfit Crew Estates  
 Jurisdiction: DCM  
 Runoff Coefficient: Surface Type

Date: 9/27/2024 13:28  
 Calcs by: TJW  
 Checked by: \_\_\_\_\_  
 Soil Type: B  
 Urbanization: Non-Urban

### Basin Land Use Characteristics

Surface	Area		Runoff Coefficient						% Imperv.
	(SF)	(Acres)	C2	C5	C10	C25	C50	C100	
Pasture/Meadow			0.02	0.08	0.15	0.25	0.3	0.35	0%
Paved			0.89	0.9	0.92	0.94	0.95	0.96	100%
Roofs			0.71	0.73	0.75	0.78	0.8	0.81	90%
5 Acre	479,797	11.01	0.06	0.1	0.2	0.29	0.34	0.38	7%
<b>Combined</b>	<b>479,797</b>	<b>11.01</b>	<b>0.06</b>	<b>0.10</b>	<b>0.20</b>	<b>0.29</b>	<b>0.34</b>	<b>0.38</b>	<b>7.0%</b>

### Basin Travel Time

	Shallow Channel Ground Cover		Short Pasture/Lawns			
	$L_{max,Overland}$	300 ft			$C_v$	7
	L (ft)	$\Delta Z_0$ (ft)	$S_0$ (ft/ft)	v (ft/s)	t (min)	$t_{Alt}$ (min)
Total	1,110	54	-	-	-	-
Initial Time	300	26	0.087	-	15.3	N/A DCM Eq. 6-8
Shallow Channel	410	18	0.044	1.5	4.7	- DCM Eq. 6-9
Channelized	400	10	0.025	3.8	1.8	- Trap Ditch
				$t_c$	<b>21.8 min.</b>	

### Rainfall Intensity & Runoff

	2-Yr	5-Yr	10-Yr	25-Yr	50-Yr	100-Yr
<b>Intensity (in/hr)</b>	2.37	2.96	3.46	3.95	4.45	4.97
<b>Runoff (cfs)</b>	1.6	<b>3.3</b>	7.6	12.6	16.6	<b>20.8</b>
<b>Release Rates (cfs/ac)</b>	-	-	-	-	-	-
<b>Allowed Release (cfs)</b>	1.6	<b>3.3</b>	7.6	12.6	16.6	<b>20.8</b>

DCM:  $I = C1 * \ln(tc) + C2$

C1	1.19	1.5	1.75	2	2.25	2.52
C2	6.035	7.583	8.847	10.111	11.375	12.735

### Notes

## Combined Sub-Basin Runoff Calculations - EX-DP3

Includes Basins EX-C1

Job No.:	<b>61160</b>	Date:	<b>9/27/2024 13:28</b>
Project:	<b>Misfit Crew Estates</b>	Calcs by:	<b>TJW</b>
Jurisdiction	<b>DCM</b>	Checked by:	
Runoff Coefficient	<b>Surface Type</b>	Soil Type	<b>B</b>
		Urbanization	<b>Non-Urban</b>

### Basin Land Use Characteristics

Surface	Area		Runoff Coefficient						% Imperv.
	(SF)	(Acres)	C2	C5	C10	C25	C50	C100	
Pasture/Meadow	479,797	11.01	0.02	0.08	0.15	0.25	0.3	0.35	0%
Paved	-	0.00	0.89	0.9	0.92	0.94	0.95	0.96	100%
Roofs	-	0.00	0.71	0.73	0.75	0.78	0.8	0.81	90%
5 Acre	-	0.00	0.06	0.1	0.2	0.29	0.34	0.38	7%
<b>Combined</b>	<b>479,797</b>	<b>11.01</b>	<b>0.02</b>	<b>0.08</b>	<b>0.15</b>	<b>0.25</b>	<b>0.30</b>	<b>0.35</b>	<b>0.0%</b>

### Basin Travel Time

	Sub-basin or Channel Type	Material Type	L (ft)	Elev. $\Delta Z_0$ (ft)	$Q_i$ (cfs)	Base or Dia (ft)	Sides z:1 (ft/ft)	v (ft/s)	t (min)
Furthest Reach	EX-C1	-	1,110	54	-	-	-	-	22.1
Channelized-1									
Channelized-2									
Channelized-3									
Total			1,110	54					
								$t_c$ (min)	22.1

### Contributing Offsite Flows (Added to Runoff and Allowed Release, below.)

Contributing Basins/Areas Off-Site DP10

$Q_{Minor}$  22.1 (cfs) - 5-year Storm

$Q_{Major}$  53.3 (cfs) - 100-year Storm

### Rainfall Intensity & Runoff

	2-Yr	5-Yr	10-Yr	25-Yr	50-Yr	100-Yr
<b>Intensity (in/hr)</b>	2.35	2.94	3.43	3.92	4.41	4.94
<b>Site Runoff (cfs)</b>	0.52	<b>2.59</b>	5.67	10.80	14.59	<b>19.04</b>
<b>OffSite Runoff (cfs)</b>	-	<b>22.10</b>	-	-	-	<b>53.30</b>
<b>Release Rates (cfs/ac)</b>	-	-	-	-	-	-
<b>Allowed Release (cfs)</b>	-	<b>24.7</b>	-	-	-	<b>72.3</b>

DCM:  $I = C1 * \ln(tc) + C2$

C1	1.19	1.5	1.75	2	2.25	2.52
C2	6.035	7.583	8.847	10.111	11.375	12.735

### Notes

Runoff from Offsite basins have been assumed constant, despite additional times of concentration.

## Combined Sub-Basin Runoff Calculations - PP-DP3

Includes Basins PP-C1

Job No.:	<b>61160</b>	Date:	<b>9/27/2024 13:28</b>
Project:	<b>Misfit Crew Estates</b>	Calcs by:	<b>TJW</b>
Jurisdiction	<b>DCM</b>	Checked by:	
Runoff Coefficient	<b>Surface Type</b>	Soil Type	<b>B</b>
		Urbanization	<b>Non-Urban</b>

### Basin Land Use Characteristics

Surface	Area		Runoff Coefficient						% Imperv.
	(SF)	(Acres)	C2	C5	C10	C25	C50	C100	
Pasture/Meadow	-	0.00	0.02	0.08	0.15	0.25	0.3	0.35	0%
Paved	-	0.00	0.89	0.9	0.92	0.94	0.95	0.96	100%
Roofs	-	0.00	0.71	0.73	0.75	0.78	0.8	0.81	90%
5 Acre	479,797	11.01	0.06	0.1	0.2	0.29	0.34	0.38	7%
<b>Combined</b>	<b>479,797</b>	<b>11.01</b>	<b>0.06</b>	<b>0.10</b>	<b>0.20</b>	<b>0.29</b>	<b>0.34</b>	<b>0.38</b>	<b>7.0%</b>

### Basin Travel Time

	Sub-basin or Channel Type	Material Type	L (ft)	Elev. $\Delta Z_0$ (ft)	$Q_i$ (cfs)	Base or Dia (ft)	Sides z:1 (ft/ft)	v (ft/s)	t (min)
Furthest Reach	PP-C1	-	1,110	54	-	-	-	-	21.8
Channelized-1									
Channelized-2									
Channelized-3									
Total			1,110	54					
								$t_c$ (min)	<b>21.8</b>

### Contributing Offsite Flows (Added to Runoff and Allowed Release, below.)

Contributing Basins/Areas	Off-Site DP10
$Q_{Minor}$	22.1 (cfs) - 5-year Storm
$Q_{Major}$	53.3 (cfs) - 100-year Storm

### Rainfall Intensity & Runoff

	2-Yr	5-Yr	10-Yr	25-Yr	50-Yr	100-Yr
<b>Intensity (in/hr)</b>	2.37	2.96	3.46	3.95	4.45	4.97
<b>Site Runoff (cfs)</b>	1.57	<b>3.26</b>	7.62	12.62	16.65	<b>20.82</b>
<b>OffSite Runoff (cfs)</b>	-	<b>22.10</b>	-	-	-	<b>53.30</b>
<b>Release Rates (cfs/ac)</b>	-	-	-	-	-	-
<b>Allowed Release (cfs)</b>	-	<b>25.4</b>	-	-	-	<b>74.1</b>

DCM:  $I = C1 * \ln(tc) + C2$

C1	1.19	1.5	1.75	2	2.25	2.52
C2	6.035	7.583	8.847	10.111	11.375	12.735

### Notes

Runoff from Offsite basins have been assumed constant, despite additional times of concentration.

### **3 Hydraulic Calculations**

Drainage Map for Longview Estates  
Excerpts from URS Drainage Report  
Culvert Calculations  
Swale (Channel) Calculations

# DRAINAGE MAP

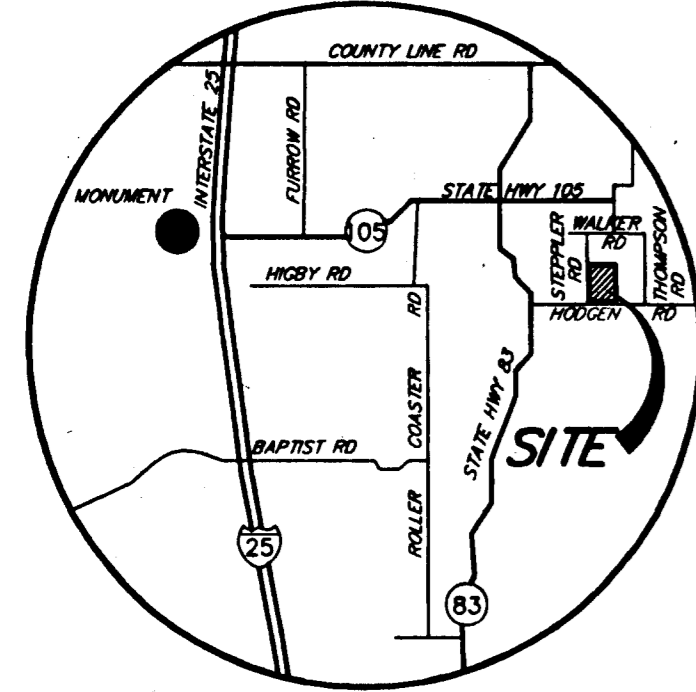

VICINITY MAP  
NTS



SCALE

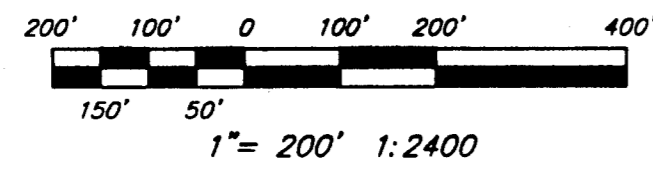

## LEGEND

- DRAINAGE BASIN BOUNDARY
- DRAINAGE BASIN DESIGNATION  
DRAINAGE BASIN AREA
- DESIGN POINT DESIGNATION
- FLOW DIRECTION
- Tc PATHWAY
- PROPOSED CULVERT
- EXISTING INDEX CONTOUR
- EXISTING INTERMEDIATE CONTOUR
- PROPOSED INDEX CONTOUR
- PROPOSED INTERMEDIATE CONTOUR

DESIGN POINT HYDROLOGIC DATA										
DP DESIGN POINT	EXISTING			DP DESIGN POINT	DEVELOPED			WITH DETENTION		STRUCTURE
	DRAINAGE AREA (AC)	Q5 (CFS)	Q100 (CFS)		DRAINAGE AREA (AC)	Q5 (CFS)	Q100 (CFS)	Q5 (CFS)	Q100 (CFS)	
OS1a	40±	---	59±	OS1a	40±	---	59±	---	---	
OS1b	9±	---	17±	OS1b	9±	---	17±	---	---	24" CULVERT
OS1	124.3	82.7	197.6	OS1	126.5	84.4	201.6	---	---	(2) 60" CULVERTS
1	132.0	88.2	211.2	1b	5.1	3.3	12.4	3.2	12.0	24" CULVERT
2	160.7	106.9	256.9	1	133.4	88.3	214.7	---	---	
3	172.3	114.9	276.6	2b	2.2	2.1	5.0	1.8	3.8	18" CULVERT
4	14.1	9.6	23.6	2	160.6	111.1	267.7	54.7	129.5	DETENTION POND
5	2.5	1.8	4.5	3a	167.0	54.7	130.4	51.8	125.8	60" CULVERT
6	23.7	16.3	40.0	3	174.3	51.8	125.8	---	---	
7	3.9	2.8	7.0	4a	5.5	5.0	11.7	2.6	6.2	DETENTION POND
8	8.5	6.2	15.2	4	12.9	8.5	19.7	---	---	
9	37.0	25.8	63.2	5	2.5	2.5	5.9	---	---	
10	44.4	31.2	76.4	6a	2.8	2.7	6.3	2.7	6.2	24" CULVERT
11	25.1	17.3	42.3	6	23.0	21.9	51.4	16.1	38.8	DETENTION POND
				7	3.9	3.9	9.2	1.6	2.8	DETENTION POND
				8	9.2	9.0	21.1	6.3	14.7	DETENTION POND
				9a	4.1	4.0	9.5	3.9	9.2	24" CULVERT
				9b	12.9	12.4	29.8	4.9	25.2	DETENTION POND
				9	36.2	24.7	70.7	18.7	45.7	DETENTION POND
				10	43.6	22.1	53.3	---	---	
				11	25.1	22.8	53.6	17.9	34.5	30" CULVERT

## NOTES

- INDIVIDUAL LOT OWNERS WILL BE RESPONSIBLE FOR CONSTRUCTING POSITIVE DRAINAGE AWAY FROM ALL STRUCTURES.
- INDIVIDUAL LOT OWNERS WILL BE RESPONSIBLE FOR PLACING DRIVEWAY CULVERTS. EL PASO COUNTY D.O.T. IS REQUIRED TO BE CONTACTED FOR A DRIVEWAY PERMIT. MINIMUM DRIVEWAY CULVERTS SIZE SHALL BE 18" DIAMETER.

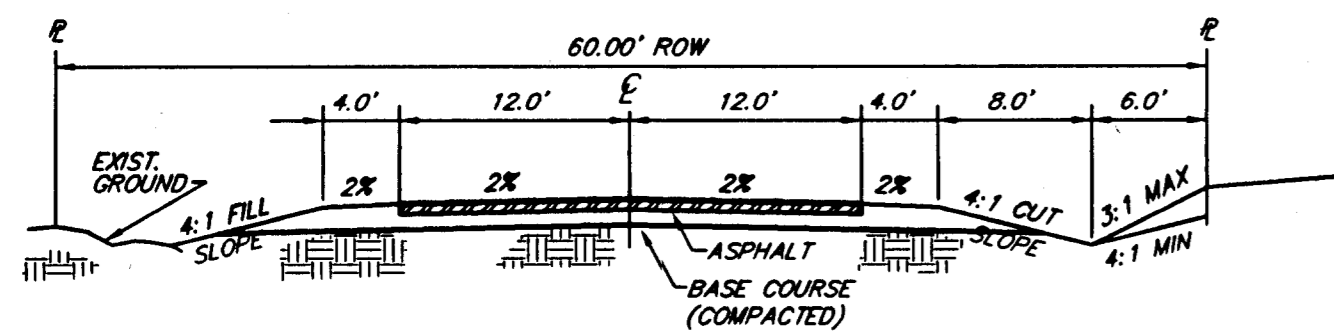

TYPICAL ROAD SECTION  
NTS

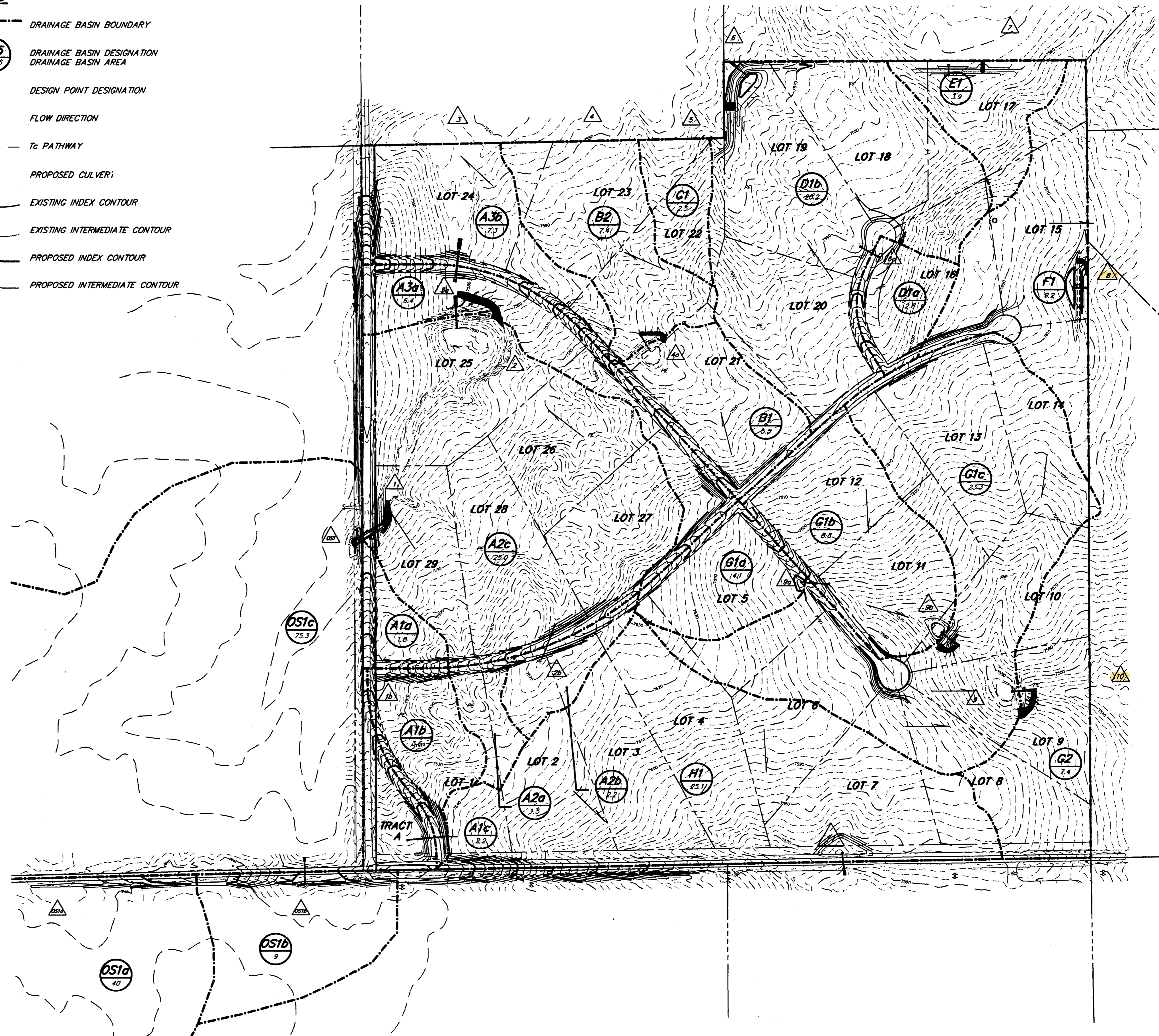

DEVELOPED CONDITION

PROJECT: LONGVIEW ESTATES

TITLE: DRAINAGE MAP - DEVELOPED CONDITION

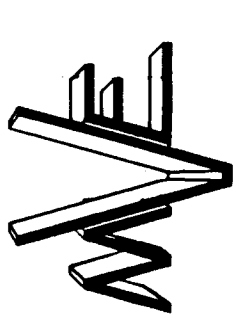

MONUMENT VALLEY  
ENGINEERS INC.  
ENGINEERS & SURVEYORS  
1903 LELARAY STREET  
COLORADO SPRINGS, COLORADO 80909  
PHONE (719) 635-5736

DISK NO.  
XREFS  
Exbase  
Subdiv  
Legend  
PROJ. NO. 60703  
DRAWN: BDK  
ENGINEER: CCC  
CHECKED:  
SCALE: 1" = 200'  
DATE: 10-31-2002  
REVISIONS:  
NO.: DATE: ITEM

SHEET  
2 OF 2  
DRAWING NO.  
60703010

URS

***FINAL DRAINAGE REPORT  
Hodgen Road  
State Highway 83 to Black Forest Road***

***December 8, 2009***

Submitted to



El Paso County Public Services Department – Transportation Division  
&  
Pikes Peak Rural Transportation Authority  
Prepared by

**URS**

URS Corporation  
9960 Federal Drive, Suite 300  
Colorado Springs, CO 80921

URS Project No. 21711554

# Culvert Analysis Report

## P Cu 121+51

Analysis Component			
Storm Event	Design	Discharge	100.90 cfs
Peak Discharge Method: User-Specified			
Design Discharge	100.90 cfs	Check Discharge	49.60 cfs
Tailwater properties: Trapezoidal Channel			
Tailwater conditions for Design Storm.			
Discharge	100.90 cfs	Bottom Elevation	7,519.00 ft
Depth	0.45 ft	Velocity	4.11 ft/s

Name	Description	Discharge	HW Elev.	Velocity
Culvert-1	1-42 inch Circular	100.90 cfs	7,528.27 ft	15.62 ft/s
Weir	Not Considered	N/A	N/A	N/A

# Culvert Analysis Report

## P Cu 121+51

Component: Culvert-1

Culvert Summary			
Computed Headwater Elevation	7,528.27 ft	Discharge	100.90 cfs
Inlet Control HW Elev.	7,528.27 ft	Tailwater Elevation	7,519.45 ft
Outlet Control HW Elev.	7,528.17 ft	Control Type	Inlet Control
Headwater Depth/Height	1.58		

Grades			
Upstream Invert	7,522.73 ft	Downstream Invert	7,519.24 ft
Length	164.00 ft	Constructed Slope	0.021280 ft/ft

Hydraulic Profile			
Profile	S2	Depth, Downstream	2.23 ft
Slope Type	Steep	Normal Depth	2.13 ft
Flow Regime	Supercritical	Critical Depth	3.08 ft
Velocity Downstream	15.62 ft/s	Critical Slope	0.009054 ft/ft

Section			
Section Shape	Circular	Mannings Coefficient	0.013
Section Material	Concrete	Span	3.50 ft
Section Size	42 inch	Rise	3.50 ft
Number Sections	1		

Outlet Control Properties			
Outlet Control HW Elev.	7,528.17 ft	Upstream Velocity Head	1.97 ft
Ke	0.20	Entrance Loss	0.39 ft

Inlet Control Properties			
Inlet Control HW Elev.	7,528.27 ft	Flow Control	Submerged
Inlet Type	Beveled ring, 33.7° bevels	Area Full	9.6 ft <sup>2</sup>
K	0.00180	HDS 5 Chart	3
M	2.50000	HDS 5 Scale	B
C	0.02430	Equation Form	1
Y	0.83000		



Oversight / NHS

FHWA REGION VIII OVERSIGHT?  NO  YES

NATIONAL HIGHWAY SYSTEM?  NO  YES

# EL PASO COUNTY PUBLIC SERVICES DEPARTMENT TRANSPORTATION DIVISION

PLAN OF PROPOSED

## HODGEN ROAD CORRIDOR IMPROVEMENTS PHASE 1 - SH 83 TO BLACK FOREST ROAD

### CONSTRUCTION BID PLANS SEPTEMBER 1, 2010

Related Projects:

P. E. UNDER PROJECT:  
PROJECT NUMBER:  
PROJECT CODE:

R.O.W. Projects:  
R.O.W. Project Description



EL PASO COUNTY PROJECT #75173



PPRTA PROJECT #06-00005

BEGIN PROJECT  
HODGEN ROAD  
STA 10+32.56

END PROJECT  
HODGEN ROAD  
STA 210+50.00

#### TABULATION OF LENGTH

BEGIN PROJECT STA 10+32.56	
END PROJECT STA 210+50.00	20,017.44 FT (3.79 MI)

#### DESIGN DATA

DESIGN SPEED	60 MPH
MINIMUM RADIUS	1505'
MAXIMUM SUPERELEVATION RATE	4%
MAXIMUM GRADE	8%

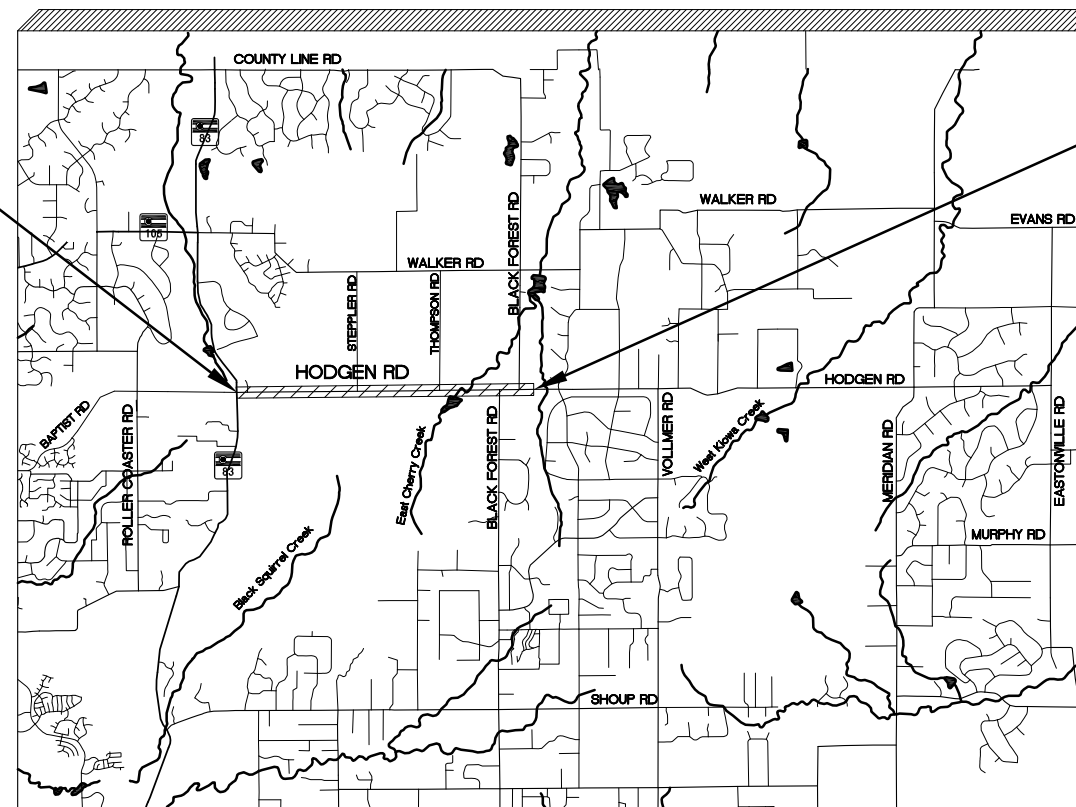

LOCATION MAP

#### INDEX OF SHEETS

1	TITLE SHEET	
2	STANDARD PLANS LIST	
3	GENERAL NOTES	
4	SUMMARY OF QUANTITIES	
5	to 12	TABULATION OF QUANTITIES
13	KEY MAP & LEGEND	
14	to 20	TYPICAL SECTIONS
21	to 22	GEOMETRIC LAYOUT
23	to 27	SURVEY CONTROL DIAGRAM
28	SURVEY TABULATION	
29	to 43	REMOVALS AND RESET
44	to 59	UTILITY PLAN
60	to 60	POTHOLE INFO
61	UTILITY CONFLICTS	
62	to 76	ROADWAY PLAN & PROFILE
77	to 80	APPROACH ROAD PLAN & PROFILE
81	to 86	DRIVEWAY PLAN & PROFILE
87	to 90	SWMP AND EROSION CONTROL NOTES
91	to 105	DRAINAGE AND EROSION CONTROL PLAN
106	to 112	DRAINAGE PROFILES AND DETAILS
113	to 116	CONSTRUCTION PHASING
117	to 131	SIGNING AND STRIPING PLAN
132	to 133	RETAINING WALL
134	to 137	EXPLORATORY BORINGS

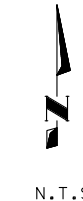

*As-Constructed*

*Ted J. Wilson*  
WILSON & COMPANY

*1-6-12*  
DATE



9960 FEDERAL DRIVE, SUITE 300  
COLORADO SPRINGS, CO. 80921  
PHONE (719) 531-0001  
FAX (719) 531-0007

CALL UTILITY NOTIFICATION  
 CENTER OF COLORADO  
 1-800-922-1987  
 CALL 3 BUSINESS DAYS IN ADVANCE  
 BEFORE YOU DIG, GRADE OR EXCAVATE  
 FOR THE MARKING OF UNDERGROUND  
 MEMBER UTILITIES.

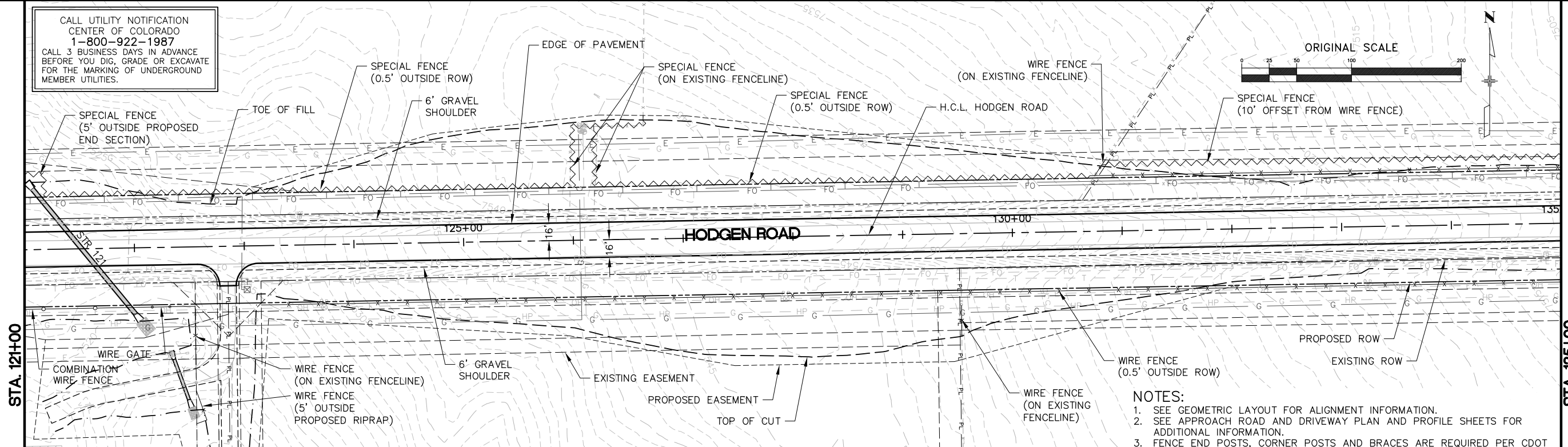

- NOTES:**
- SEE GEOMETRIC LAYOUT FOR ALIGNMENT INFORMATION.
  - SEE APPROACH ROAD AND DRIVEWAY PLAN AND PROFILE SHEETS FOR ADDITIONAL INFORMATION.
  - FENCE END POSTS, CORNER POSTS AND BRACES ARE REQUIRED PER CDOT M&S STANDARD PLAN M-607-1 AND WILL NOT BE PAID FOR SEPARATELY, BUT INCLUDED IN THE COST OF FENCE.
  - WIRE GATES SHALL BE CONSTRUCTED PER CDOT M&S STANDARD PLAN M-607-1 AND WILL NOT BE PAID FOR SEPARATELY, BUT INCLUDED IN THE COST OF FENCE.

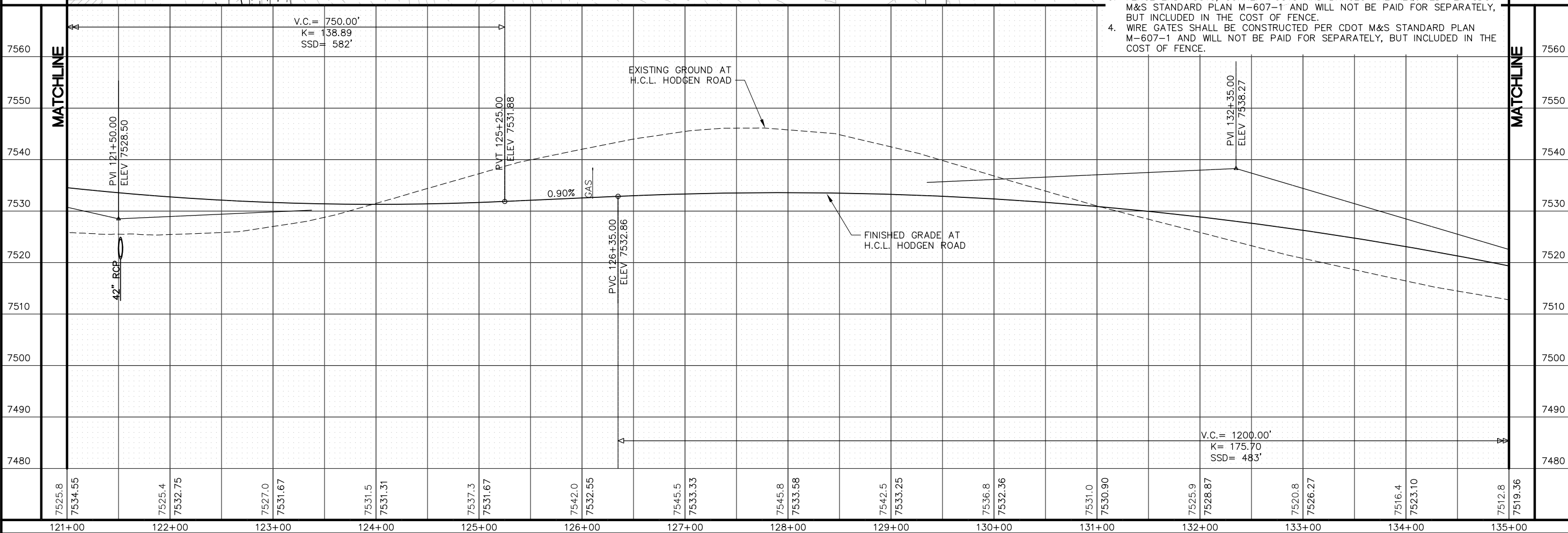

**Computer File Information**

URS File Location: s031w2kfile1\projects\21711554
Last Modification Date: 31-Aug-10 Operator: MPR
Mapped Path: p:\roadway\sheets
Drawing File Name: rdp-Hodgen.dwg
Acad. Ver. 2006 11x17 Scale: 1"=100'H: 20'V Units: Feet

**Index of Revisions**

(R-)	
(R-)	
(R-)	
(R-)	
(R-)	

**EL PASO COUNTY**  
 DEPARTMENT OF TRANSPORTATION  
 EPC #75173

**PPRTA**  
 PPRTA #06-00005

**URS**  
 9960 FEDERAL DRIVE  
 SUITE 300  
 COLORADO SPRINGS, CO 80921  
 (719) 531-0001

**HODGEN ROAD CORRIDOR IMPROVEMENTS**      JN: 21711554

**ROADWAY PLAN AND PROFILE**

**STA. 121+00 TO STA. 135+00**

Roadway: 9 of 15  
 Sheet Number 70

P:\Roadway\Sheets\rdpp-Hodgen.dwg, 121-135(9), 8/31/2010 12:55:41 PM, michael\_ryan

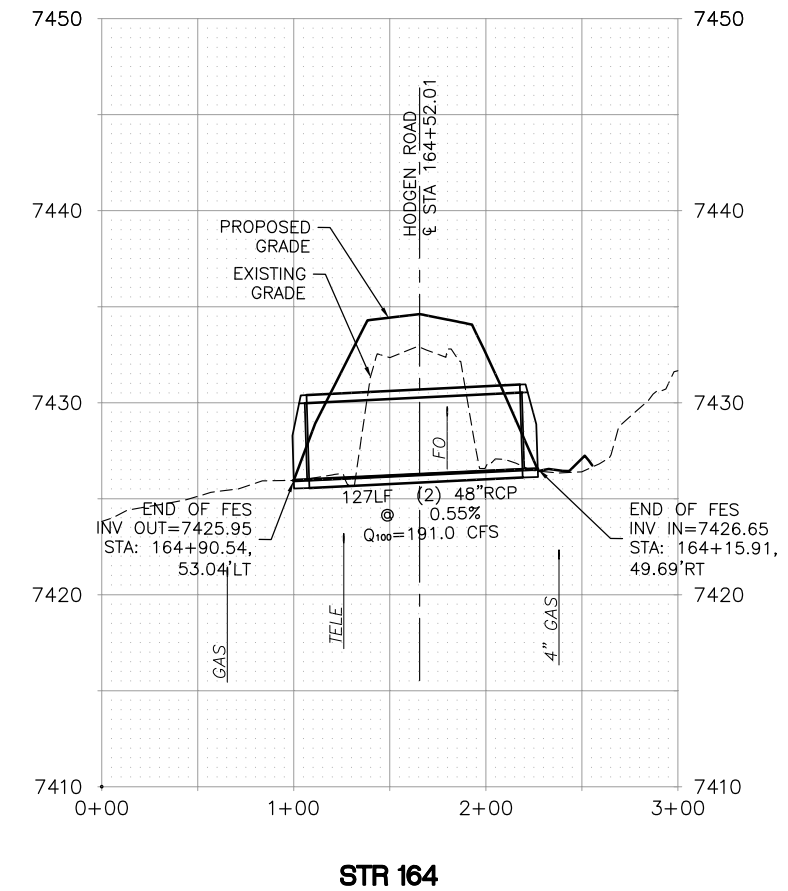
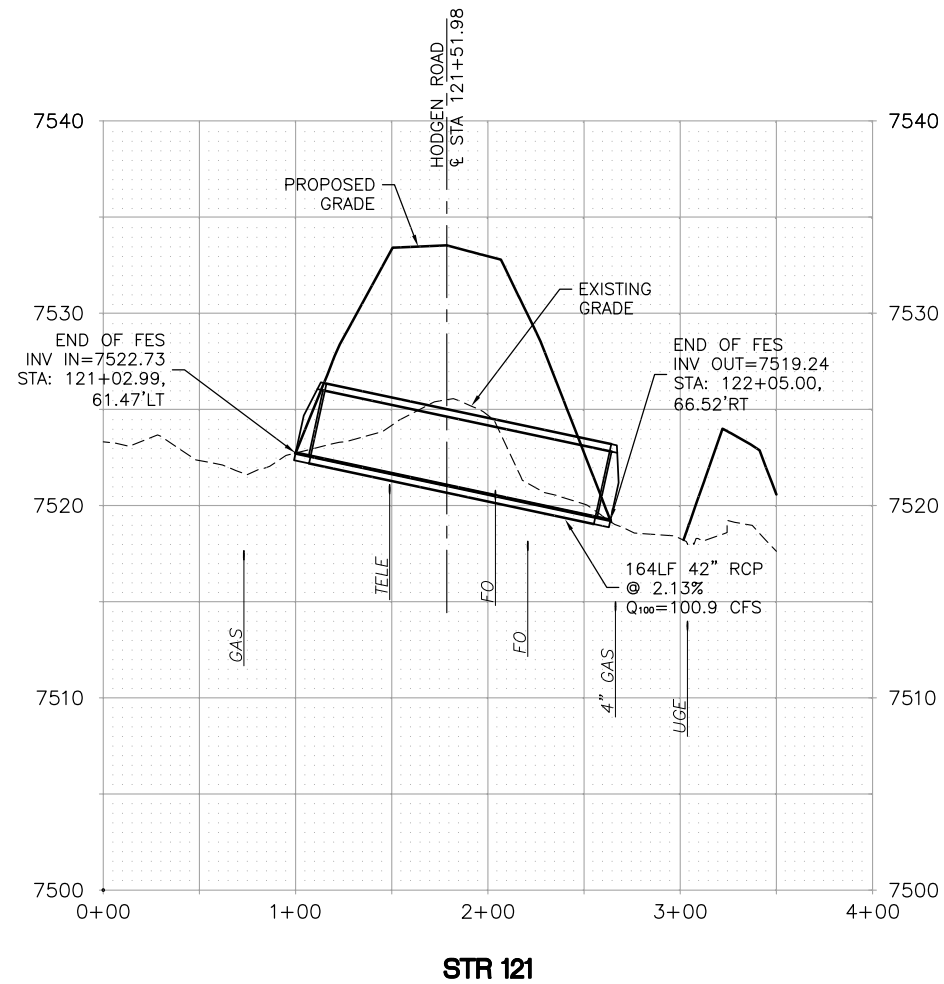

**NOTE:**

- PIPES LENGTHS LISTED INCLUDE LENGTH OF FLARED END SECTIONS.

**Computer File Information**

URS File Location: s031w2kfile1\projects\21711554	(R-)
Last Modification Date: 31-Aug-10 Operator: MPR	(R-)
Mapped Path: p:\hydraulics\sheets	(R-)
Drawing File Name: drpr-culverts.dwg	(R-)
Acad. Ver. 2006 11x17 Scale: 1"=100H, 10'V Units: Feet	(R-)

**Index of Revisions**



EPC #75173



PPRTA #06-00005



9960 FEDERAL DRIVE  
SUITE 300  
COLORADO SPRINGS, CO 80921  
(719) 531-0001

**HODGEN ROAD CORRIDOR IMPROVEMENTS**

**DRAINAGE PROFILES**

STA. 121+00 TO STA. 165+00

JN: 21711554

Drain. Profiles: 4 of 6

Sheet Number 109

# Culvert Report

## Sub-Basin B2 Driveway Culvert - 5 yr

Invert Elev Dn (ft)	=	100.00
Pipe Length (ft)	=	30.00
Slope (%)	=	2.00
Invert Elev Up (ft)	=	100.60
Rise (in)	=	18.0
Shape	=	Circular
Span (in)	=	18.0
No. Barrels	=	1
n-Value	=	0.023
Culvert Type	=	Circular Corrugate Metal Pipe
Culvert Entrance	=	Mitered to slope (C)
Coeff. K,M,c,Y,k	=	0.021, 1.33, 0.0463, 0.75, 0.7

### Embankment

Top Elevation (ft)	=	103.00
Top Width (ft)	=	20.00
Crest Width (ft)	=	70.00

### Calculations

Qmin (cfs)	=	5.00
Qmax (cfs)	=	5.00
Tailwater Elev (ft)	=	(dc+D)/2

### Highlighted

Qtotal (cfs)	=	5.00
Qpipe (cfs)	=	5.00
Qovertop (cfs)	=	0.00
Veloc Dn (ft/s)	=	3.35
Veloc Up (ft/s)	=	4.77
HGL Dn (ft)	=	101.18
HGL Up (ft)	=	101.46
Hw Elev (ft)	=	101.93
Hw/D (ft)	=	0.89
Flow Regime	=	Inlet Control

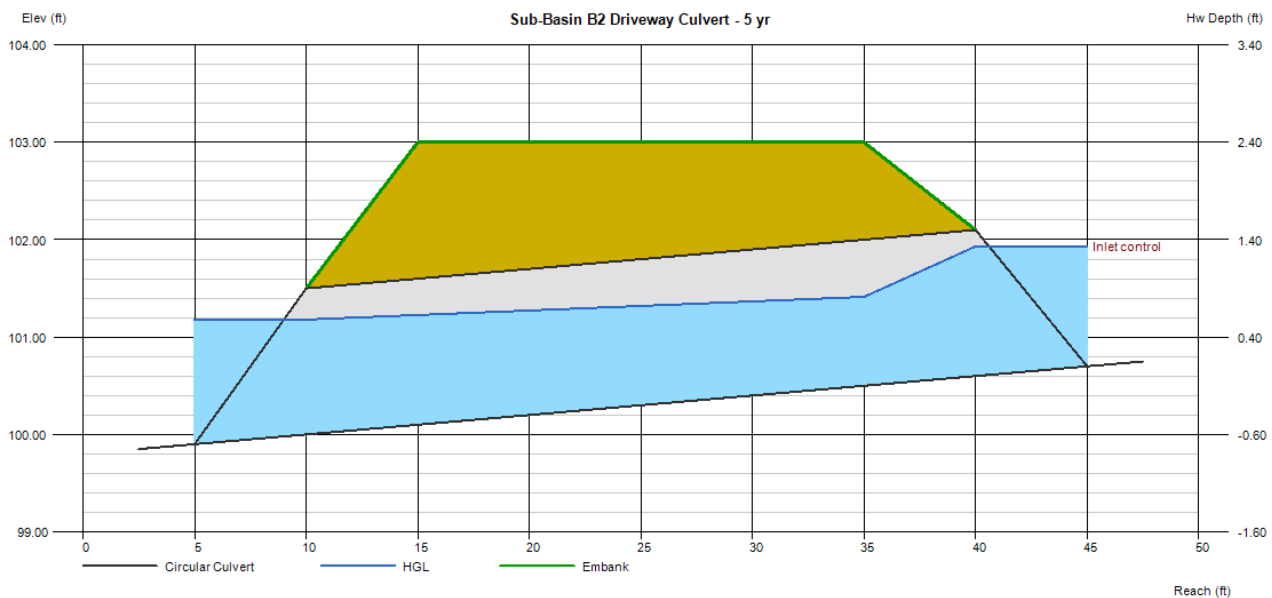

# Culvert Report

## Sub-Basin B2 Driveway Culvert - 100 yr

Invert Elev Dn (ft)	=	100.00
Pipe Length (ft)	=	30.00
Slope (%)	=	2.00
Invert Elev Up (ft)	=	100.60
Rise (in)	=	18.0
Shape	=	Circular
Span (in)	=	18.0
No. Barrels	=	1
n-Value	=	0.023
Culvert Type	=	Circular Corrugate Metal Pipe
Culvert Entrance	=	Mitered to slope (C)
Coeff. K,M,c,Y,k	=	0.021, 1.33, 0.0463, 0.75, 0.7

<b>Embankment</b>	
Top Elevation (ft)	= 103.00
Top Width (ft)	= 20.00
Crest Width (ft)	= 70.00

<b>Calculations</b>	
Qmin (cfs)	= 34.90
Qmax (cfs)	= 34.90
Tailwater Elev (ft)	= (dc+D)/2

<b>Highlighted</b>	
Qtotal (cfs)	= 34.90
Qpipe (cfs)	= 9.94
Qovertop (cfs)	= 24.96
Veloc Dn (ft/s)	= 5.91
Veloc Up (ft/s)	= 5.63
HGL Dn (ft)	= 101.36
HGL Up (ft)	= 102.20
Hw Elev (ft)	= 103.21
Hw/D (ft)	= 1.74
Flow Regime	= Inlet Control

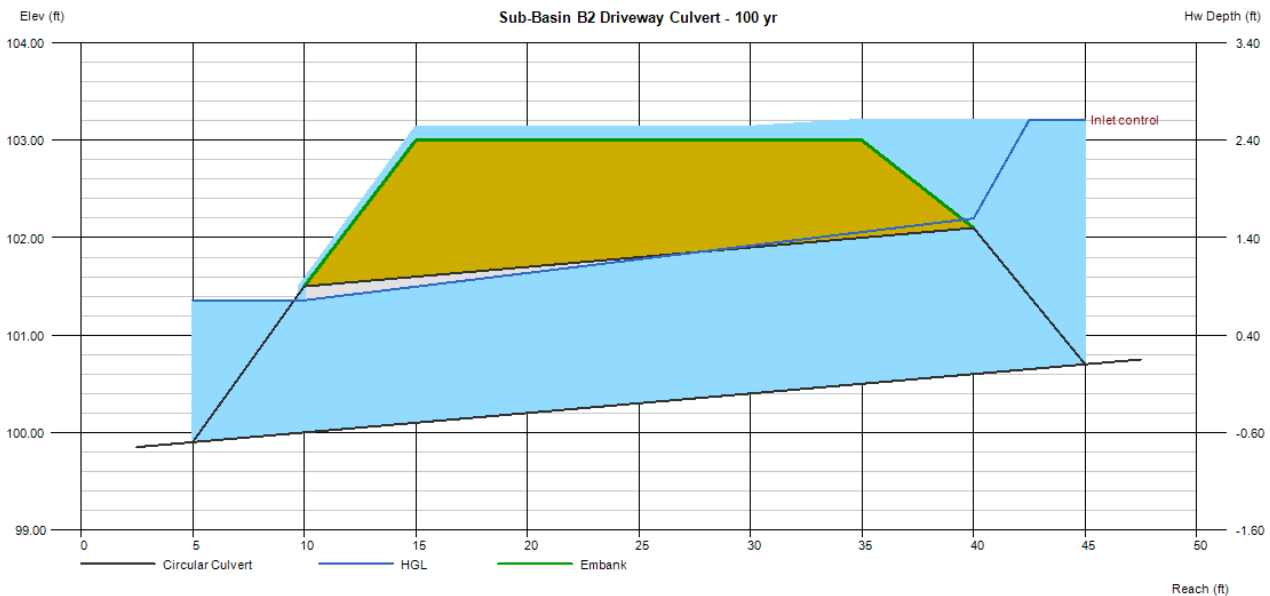

## Determination of Culvert Headwater and Outlet Protection

Project: **61160 - Misfit Crew Estates**

Basin ID: **Driveway Culvert Outlet Protection - 9.94 cfs 100 yr Pipe Flow**

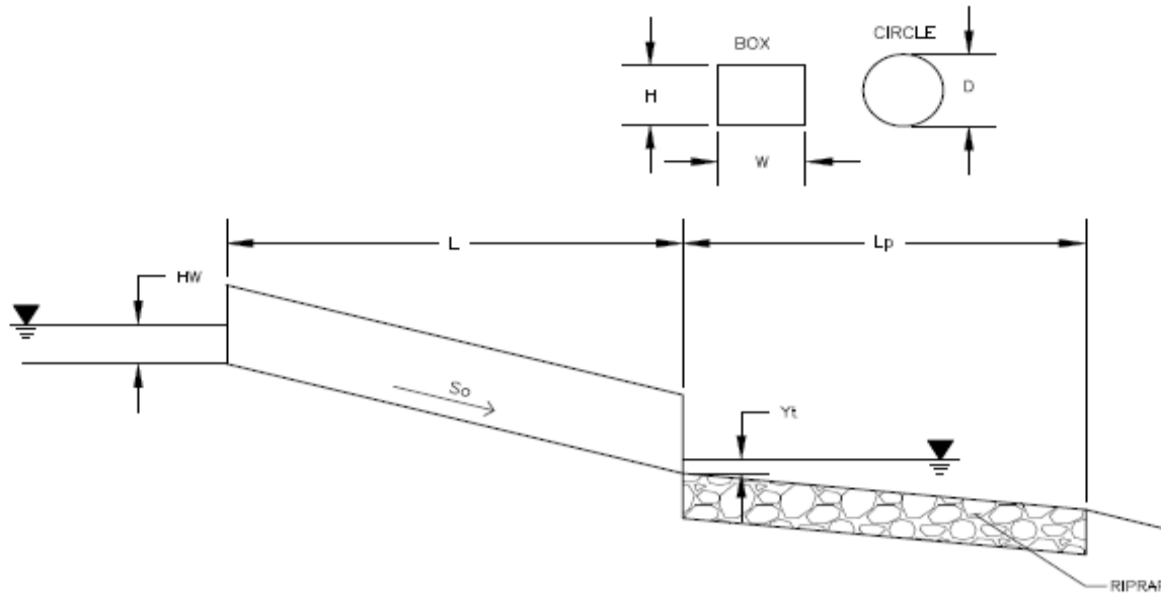

Soil Type:

Choose One:

Sandy

Non-Sandy

Supercritical Flow! Using Da to calculate protection type.

### Design Information (Input):

Design Discharge	Q = <input type="text" value="9.94"/> cfs
<b>Circular Culvert:</b>	
Barrel Diameter in Inches	D = <input type="text" value="18"/> inches
Inlet Edge Type (Choose from pull-down list)	<input type="text" value="1.5 : 1 Beveled Edge"/> ▼
<b>Box Culvert:</b>	<b>OR</b>
Barrel Height (Rise) in Feet	Height (Rise) = <input type="text"/> ft
Barrel Width (Span) in Feet	Width (Span) = <input type="text"/> ft
Inlet Edge Type (Choose from pull-down list)	<input type="text"/> ▼
Number of Barrels	No = <input type="text" value="1"/>
Inlet Elevation	Elev IN = <input type="text" value="100.6"/> ft
Outlet Elevation <b>OR</b> Slope	Elev OUT = <input type="text" value="2"/> ft
Culvert Length	L = <input type="text" value="30"/> ft
Manning's Roughness	n = <input type="text" value="0.023"/>
Bend Loss Coefficient	k <sub>b</sub> = <input type="text" value="0"/>
Exit Loss Coefficient	k <sub>x</sub> = <input type="text" value="1"/>
Tailwater Surface Elevation	Elev Y <sub>t</sub> = <input type="text"/>
Max Allowable Channel Velocity	V = <input type="text" value="5"/> ft/s

### Required Protection (Output):

Tailwater Surface Height	Y <sub>t</sub> = <input type="text" value="0.60"/> ft
Flow Area at Max Channel Velocity	A <sub>t</sub> = <input type="text" value="1.99"/> ft <sup>2</sup>
Culvert Cross Sectional Area Available	A = <input type="text" value="1.77"/> ft <sup>2</sup>
Entrance Loss Coefficient	k <sub>e</sub> = <input type="text" value="0.20"/>
Friction Loss Coefficient	k <sub>f</sub> = <input type="text" value="1.70"/>
Sum of All Losses Coefficients	k <sub>s</sub> = <input type="text" value="2.90"/> ft
Culvert Normal Depth	Y <sub>n</sub> = <input type="text" value="0.31"/> ft
Culvert Critical Depth	Y <sub>c</sub> = <input type="text" value="1.22"/> ft
Tailwater Depth for Design	d = <input type="text" value="1.36"/> ft
Adjusted Diameter <b>OR</b> Adjusted Rise	D <sub>a</sub> = <input type="text" value="0.90"/> ft
Expansion Factor	1/(2*tan(θ)) = <input type="text" value="6.57"/>
Flow/Diameter <sup>2.5</sup> <b>OR</b> Flow/(Span * Rise <sup>1.5</sup> )	Q/D <sup>2.5</sup> = <input type="text" value="3.61"/> ft <sup>0.5</sup> /s
Froude Number	Fr = <input type="text" value="14.48"/> <span style="color: red;">Supercritical!</span>
Tailwater/Adjusted Diameter <b>OR</b> Tailwater/Adjusted Rise	Y <sub>t</sub> /D = <input type="text" value="0.66"/>
Inlet Control Headwater	HW <sub>i</sub> = <input type="text" value="0.87"/> ft
Outlet Control Headwater	HW <sub>o</sub> = <input type="text" value="-95.82"/>
<b>Design Headwater Elevation</b>	<b>HW = <input type="text" value="101.47"/> ft</b>
<b>Headwater/Diameter <b>OR</b> Headwater/Rise Ratio</b>	<b>HW/D = <input type="text" value="0.58"/></b>
Minimum Theoretical Riprap Size	d <sub>50</sub> = <input type="text" value="5"/> in
Nominal Riprap Size	d <sub>50</sub> = <input type="text" value="6"/> in
<b>UDFCD Riprap Type</b>	<b>Type = <input type="text" value="VL"/></b>
<b>Length of Protection</b>	<b>L<sub>p</sub> = <input type="text" value="12"/> ft</b>
<b>Width of Protection</b>	<b>T = <input type="text" value="4"/> ft</b>

# Culvert Report

## Existing 42in RCP Under Hodgen Road w/ Developed 100 yr Flows

Invert Elev Dn (ft)	= 7519.24
Pipe Length (ft)	= 164.00
Slope (%)	= 2.13
Invert Elev Up (ft)	= 7522.73
Rise (in)	= 42.0
Shape	= Circular
Span (in)	= 42.0
No. Barrels	= 1
n-Value	= 0.013
Culvert Type	= Circular Concrete
Culvert Entrance	= Groove end projecting (C)
Coeff. K,M,c,Y,k	= 0.0045, 2, 0.0317, 0.69, 0.2

<b>Embankment</b>	
Top Elevation (ft)	= 7533.50
Top Width (ft)	= 55.00
Crest Width (ft)	= 0.00

<b>Calculations</b>	
Qmin (cfs)	= 102.70
Qmax (cfs)	= 102.70
Tailwater Elev (ft)	= (dc+D)/2

<b>Highlighted</b>	
Qtotal (cfs)	= 102.70
Qpipe (cfs)	= 102.70
Qovertop (cfs)	= 0.00
Veloc Dn (ft/s)	= 10.93
Veloc Up (ft/s)	= 11.41
HGL Dn (ft)	= 7522.54
HGL Up (ft)	= 7525.83
Hw Elev (ft)	= 7528.72
Hw/D (ft)	= 1.71
Flow Regime	= Inlet Control

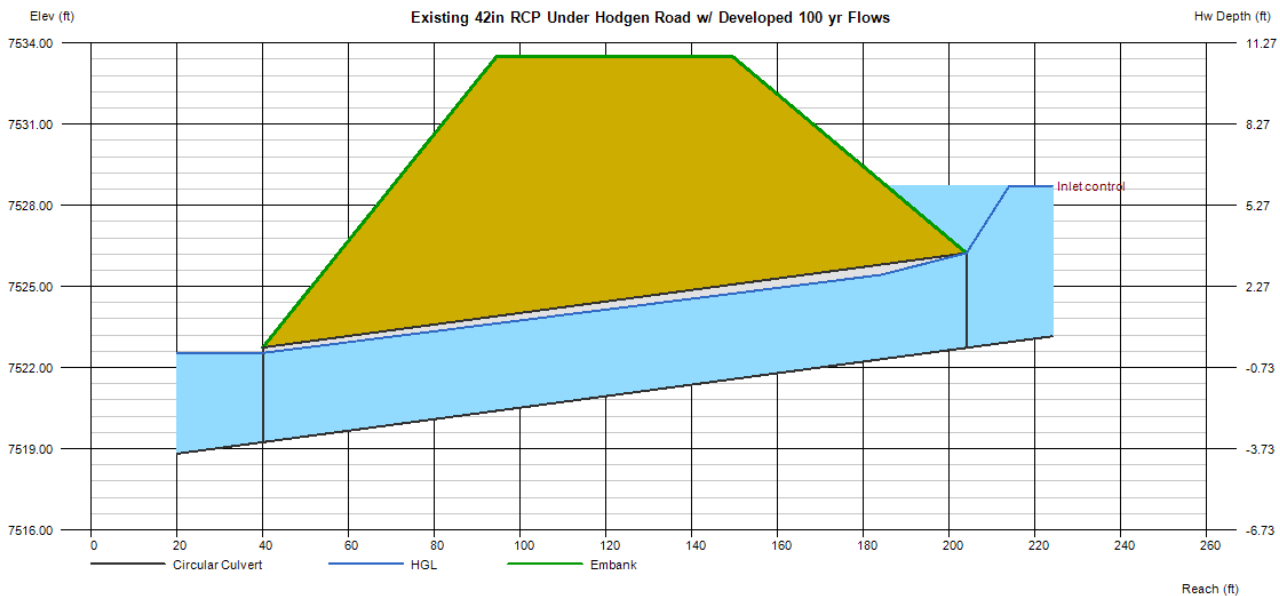

# Channel Report

## Developed Basin C1 Channel 100 yr - 74.1 cfs

### Trapezoidal

Bottom Width (ft)	= 5.00
Side Slopes (z:1)	= 10.00, 10.00
Total Depth (ft)	= 4.00
Invert Elev (ft)	= 100.00
Slope (%)	= 3.50
N-Value	= 0.045

### Highlighted

Depth (ft)	= 1.06
Q (cfs)	= 74.10
Area (sqft)	= 16.54
Velocity (ft/s)	= 4.48
Wetted Perim (ft)	= 26.31
Crit Depth, Yc (ft)	= 1.06
Top Width (ft)	= 26.20
EGL (ft)	= 1.37

### Calculations

Compute by:	Known Q
Known Q (cfs)	= 74.10

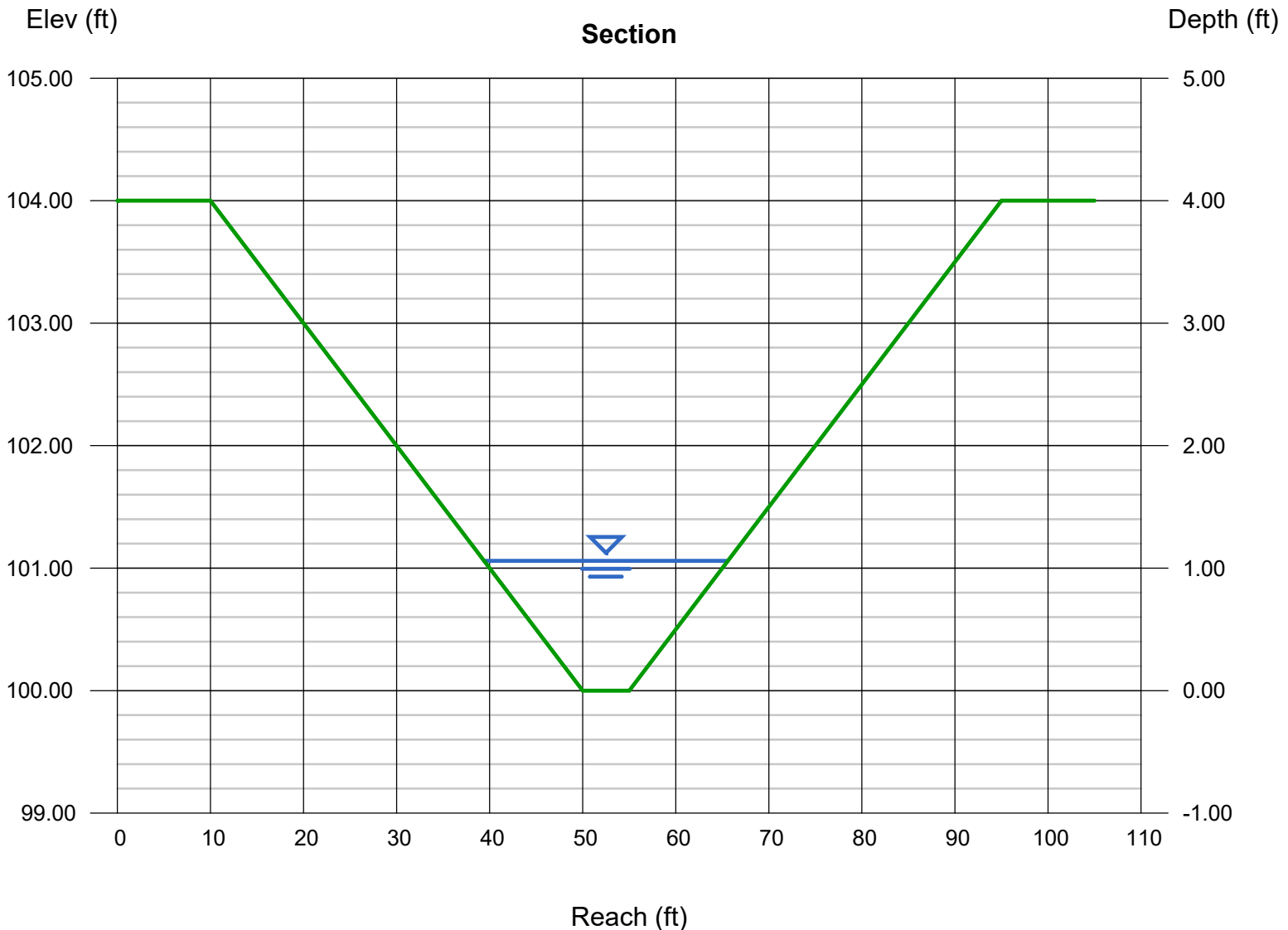



# Channel Report

## Downstream of DP3 100 yr - 74.1 cfs

### Trapezoidal

Bottom Width (ft)	= 20.00
Side Slopes (z:1)	= 10.00, 10.00
Total Depth (ft)	= 4.00
Invert Elev (ft)	= 100.00
Slope (%)	= 3.50
N-Value	= 0.045

### Highlighted

Depth (ft)	= 0.68
Q (cfs)	= 74.10
Area (sqft)	= 18.22
Velocity (ft/s)	= 4.07
Wetted Perim (ft)	= 33.67
Crit Depth, Yc (ft)	= 0.67
Top Width (ft)	= 33.60
EGL (ft)	= 0.94

### Calculations

Compute by:	Known Q
Known Q (cfs)	= 74.10

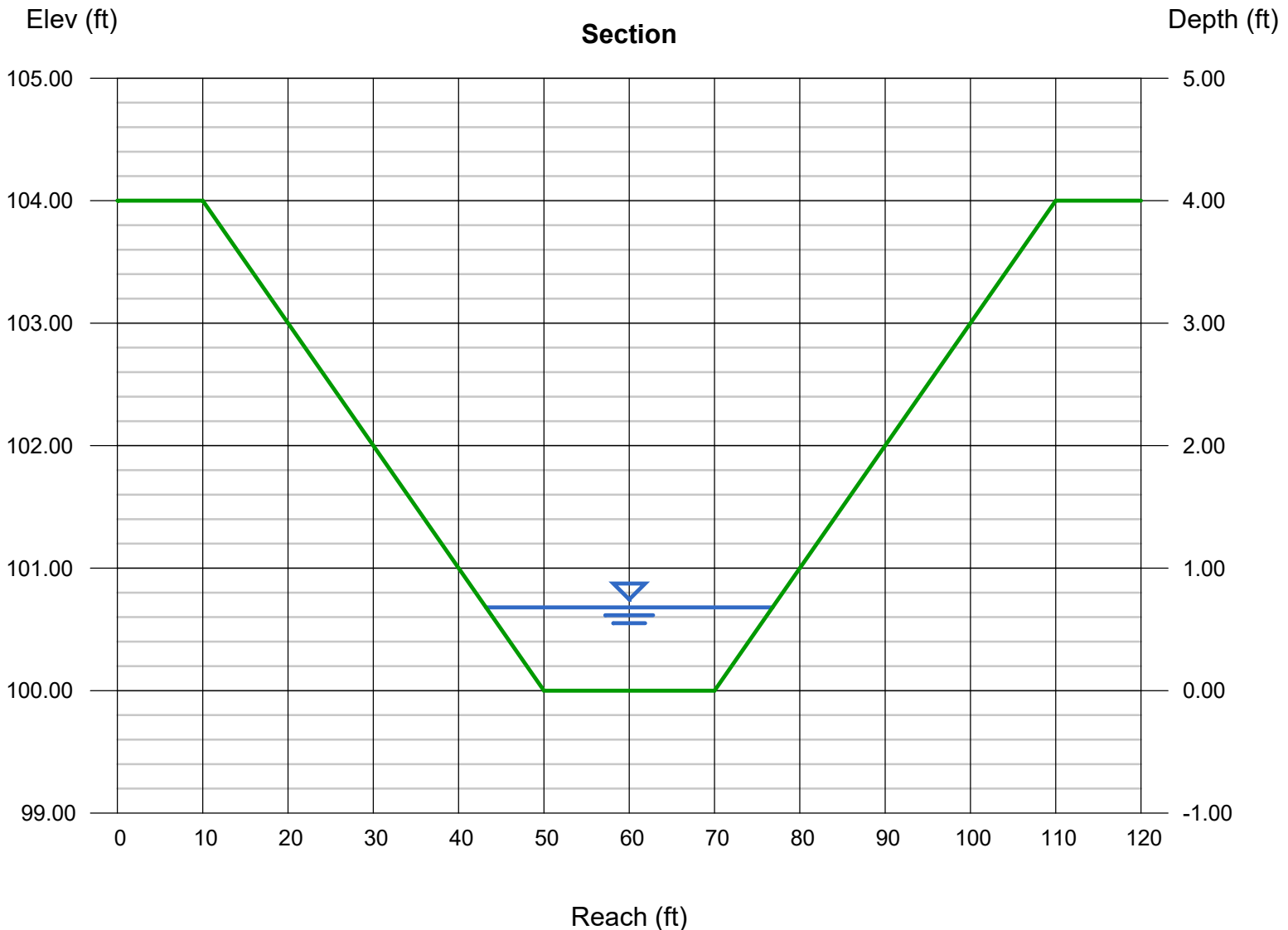

## **4 Report Maps**

Existing Condition Hydraulic Analysis Map (Map Pocket)  
Proposed Condition Hydraulic Analysis Map (Map Pocket)



**LEGEND**

PROPERTY LINE  
EASEMENT LINE  
LOT LINE

**EXISTING**

INDEX CONTOUR  
INTERMEDIATE CONTOUR

**PROPOSED**

INDEX CONTOUR  
INTERMEDIATE CONTOUR

BASIN BOUNDARY

FLOW AMOUNTS  
SLOPE DIRECTION AND GRADE

BASIN LABEL  
AREA IN ACRES  
PERCENT IMPERVIOUS

DESIGN POINT

TIME OF CONCENTRATION  
FLOW DIRECTION

**FLOODPLAIN STATEMENT**

ACCORDING TO FEMA FLOOD INSURANCE RATE MAP COMMUNITY PANEL NO. 08041CO285 G, DATED DECEMBER 7, 2018, THE PROPERTY IS LOCATED IN ZONE "X". (AREAS DETERMINED TO BE OUTSIDE THE 500-YEAR FLOODPLAIN).

**EXISTING DRAINAGE SUMMARY TABLE**

DESIGN POINTS	INCLUDED BASINS	AREA (AC)	Tc (MIN.)	RUNOFF		METHOD
				Q5 (CFS)	Q100 (CFS)	
	EX-A1	3.89	20.4	1.0	7.0	RATIONAL
DP1	LV DP8, EX-A1			7.3	21.7	RATIONAL
	OS-B1	1.22	18.8	0.3	2.3	RATIONAL
	B2	20.92	26.1	4.8	33.4	RATIONAL
DP2	OS-B1, B2	22.14	26.7	5.0	34.9	RATIONAL
	EX-C1	11.01	22.1	2.6	19.0	RATIONAL
DP3	LV DP10, EX-C1			24.7	72.3	RATIONAL

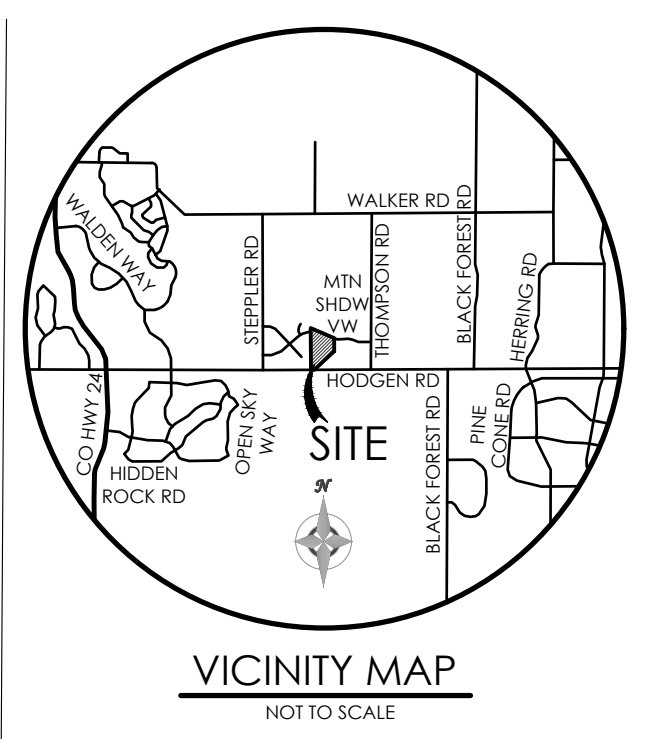

BENCHMARK

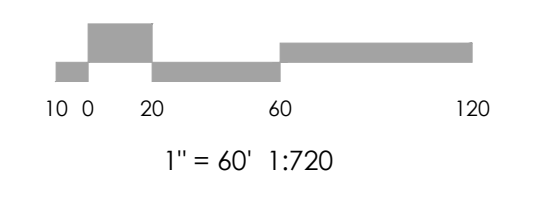
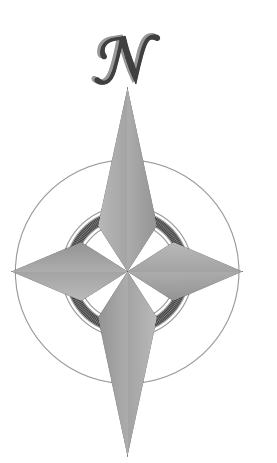

**MVE, INC.**  
ENGINEERS & SURVEYORS

1903 Idamay Street, Suite 200 Colorado Springs CO 80909 719.635.5736

REVISIONS

DESIGNED BY \_\_\_\_\_  
DRAWN BY \_\_\_\_\_  
CHECKED BY \_\_\_\_\_  
AS-BUILT BY \_\_\_\_\_  
CHECKED BY \_\_\_\_\_

MIISFIT CREW  
ESTATES

**DRAINAGE REPORT**

**EX. DRAINAGE MAP**

MVE PROJECT 61160  
MVE DRAWING DRAIN-PP

**MAY 21, 2024**  
SHEET 1 OF 1

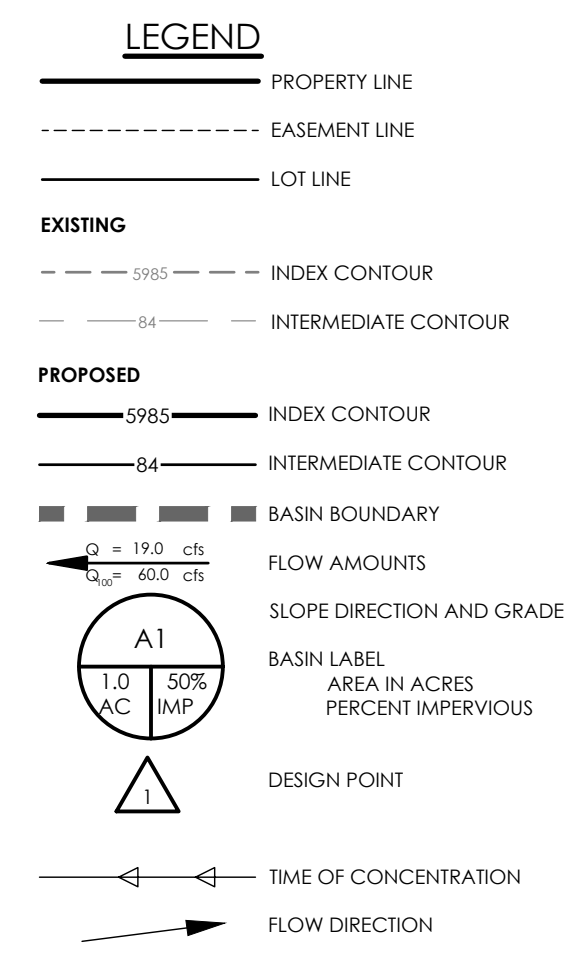

**FLOODPLAIN STATEMENT**

ACCORDING TO FEMA FLOOD INSURANCE RATE MAP COMMUNITY PANEL NO. 08041CO285 G, DATED DECEMBER 7, 2018, THE PROPERTY IS LOCATED IN ZONE "X". (AREAS DETERMINED TO BE OUTSIDE THE 500-YEAR FLOODPLAIN).

**PROPOSED DRAINAGE SUMMARY TABLE**

DESIGN POINTS	INCLUDED BASINS	AREA (AC)	Tc (MIN.)	RUNOFF		METHOD
				Q5 (CFS)	Q100 (CFS)	
	EX-A1	3.89	20.4	1.0	7.0	RATIONAL
DP1	LV DP8, EX-A1			7.3	21.7	RATIONAL
	OS-B1	1.22	18.8	0.3	2.3	RATIONAL
	B2	20.92	26.1	4.8	33.4	RATIONAL
DP2	OS-B1, B2	22.14	26.7	5.0	34.9	RATIONAL
	PP-C1	11.01	21.8	3.3	20.8	RATIONAL
DP3	LV DP10, PP-C1			25.4	74.1	RATIONAL

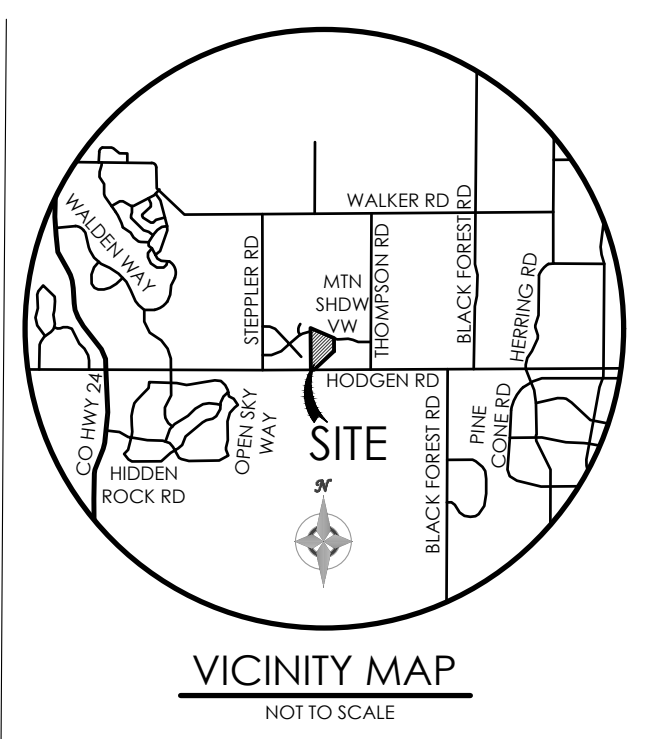

BENCHMARK

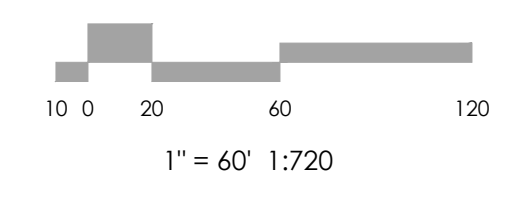
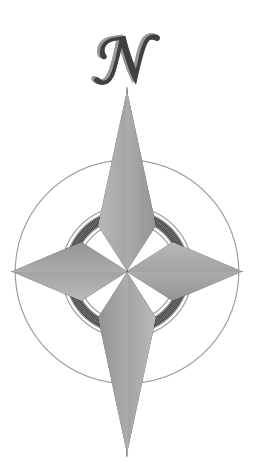

REVISIONS

DESIGNED BY \_\_\_\_\_  
 DRAWN BY \_\_\_\_\_  
 CHECKED BY \_\_\_\_\_  
 AS-BUILTS BY \_\_\_\_\_  
 CHECKED BY \_\_\_\_\_

MIISFIT CREW  
ESTATES

DRAINAGE REPORT

PROP. DRAINAGE MAP

MVE PROJECT 61160  
MVE DRAWING DRAIN-PP

MAY 21, 2024  
SHEET 1 OF 1