



Item Numbers refer to SWMP Checklist

# STORMWATER MANAGEMENT PLAN FOR TAMLIN ROAD RV STORAGE

**Prepared For:**

**C&M Properties, LLC**  
12748 Barossa Valley Road  
Colorado Springs, CO 80921  
(719) 210-9460  
Contact: Edward McDonald

**Prepared By:**

**JR Engineering, LLC**  
5475 Tech Center Drive, Suite 235  
Colorado Springs, Colorado 80919  
(303) 267-6240  
Contact: Mike Bramlett

**JR Project No. 25134.00**

**January, 2020**

**El Paso County PCD File No.:**  
PPR1945

Item 1. Add Qualified Stormwater Manager and Contractor information to cover/title sheet. If unknown, add a placeholder to be updated prior to the pre-construction meeting:

**QUALIFIED STORMWATER MANAGER**

Name: \_\_\_\_\_  
Company: \_\_\_\_\_  
Address: \_\_\_\_\_

**CONTRACTOR**

Name: \_\_\_\_\_  
Company: \_\_\_\_\_  
Address: \_\_\_\_\_

ENGINEER'S CERTIFICATION

I hereby certify that this Stormwater Management Plan for Tamlin Road RV Storage was prepared under my direct supervision in accordance with the provisions of the Colorado Water Quality Control Act, and the El Paso County Drainage Criteria Manual. JR Engineering does not and will not assume liability for the implementation of the methods, requirements, and standards set forth in this report.

---

Mike Bramlett, P.E.  
Registered Professional Engineer  
State of Colorado No. 32314  
For and on behalf of JR Engineering, LLC.

# TABLE OF CONTENTS

1.	Applicant / Contact Information .....	1
2.	Site Description and Location.....	1
3.	Proposed Sequence of Major Activities .....	2
4.	BMPs for Stormwater Pollution Prevention .....	2
5.	Final Stabilization and Long-Term Stormwater Management.....	5
6.	Inspection and Maintenance.....	6

## **Appendices**

- A. Vicinity Map
- B. Soils Map
- C. GEC Plans and Details
- D. SWMP Checklist

**1. Applicant / Contact Information**

**Owner/Developer:** C&M Properties, LLC  
Attn: Edward McDonald  
12748 Barossa Valley Road  
Colorado Springs, CO 80921  
(719) 210-9460

**Engineer:** JR Engineering, LLC  
5475 Tech Center Drive, Suite 235  
Colorado Springs, CO 80919  
Attn: Mike Bramlett (303) 267-6240  
[mbramlett@jrengineering.com](mailto:mbramlett@jrengineering.com)

Change to "Qualified Stormwater Manager" (typ.)

**SWMP Administrator:** Contractor

**Contractor:** To Be Determined

**2. Site Description and Location**

Tamlin Road Storage Yard, known as ‘the site’ from herein, is currently vacant land located in a portion of Section 20, Township 13 South, Range 65 West of the Sixth Principal Meridian in unincorporated El Paso County, Colorado. The site is located northeast of the Tamlin Road and Marksheffel Road intersection. The site is bound by Tamlin Road to the west and north, vacant land owned by Norwood to the east and south. Stetson Hills Filing No. 3 and 4 is located adjacent to the site on the west side of Marksheffel Road. A vicinity map has been presented in Appendix A.

Sand Creek East Fork tributary is located approximately ¼ mile east of the site. The ultimate outfall of this drainageway is Fountain Creek. However, there are no existing stormwater facilities located on site. Additionally, no streams cross the project site.

The site is approximately 16.5 acres and is covered with sparse trees and native vegetation. There are no existing structures on the site. An existing dirt road proceeds southeast from Tamlin Road through the site to service an existing water tank, located south of the site. In the developed condition, the site will be gravel drive aisles, parking stalls and a full spectrum water quality and detention pond. In the future condition, the site may be paved and therefore all stormwater facilities are sized for the future condition.

Site details:

- a. Estimated area to undergo disturbance: 10.9 acres (Total Area = 16.5 acres)
- b. Soil erosion potential and potential impacts upon discharge: The site is comprised solely of Truckton sandy loam, which is classified as a Type A soil by the NRCS. Group A soils exhibit a high infiltration rate when thoroughly wet and consist chiefly of deep, well drained to excessively drained gravelly sands. These soils

Item 9. Include method used to determine ground cover (i.e., visual, aerial inspection)

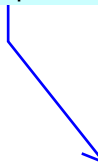

Item 13. Add a bullet for waste disposal (onsite trash).

have a high rate of water transmission. A NRCS soil survey map is presented in Appendix B. Eroded soil may adversely impact downstream drainageways. BMPs will be installed and maintained to mitigate adverse impacts due to soil erosion.

- c. Existing vegetation: Native meadow grasses (approximately 99% coverage).
- d. Location and description of potential pollution sources: Potential sources of pollution include: onsite vehicle fueling, portable toilets, and temporary stock pile. The locations of these sources are shown in the GEC plans in Appendix C or will be determined by the contractor.
- e. Spill prevention and pollution controls for dedicated batch plants: Not applicable for this site since there will be no dedicated batch plants.
- f. Location and description of anticipated non-stormwater components of discharge: A potential source of non-stormwater discharge could be the irrigation of permanent seeding (PS). Irrigation will be kept at a rate so as to not create runoff.
- g. Ultimate receiving waters: There is a ridge that divides the drainage patterns on the site. Roughly 6.5 acres drains southwest with slopes between 3-10% while the remaining 10 acres drains northeast with slopes up to 8%. Both onsite drainage basins ultimately discharge to Fountain Creek.

**3. Proposed Sequence of Major Activities**

The project will follow standard construction sequences for construction, i.e., clearing and grubbing, over excavation, overlot grading, utility installation, and street paving.

The contractor will be responsible for implementing and maintaining the erosion and sediment control measures described in this document and the accompanying design drawings. The contractor may designate these tasks to certain subcontractors as they see fit, but the ultimate responsibility for implementing these controls and their proposed function at each phase of the project remains with the contractor.

The order of major activities (with estimated completion dates) will be as follows:

- 1. Install VTC and other perimeter soil erosion control measures (March 2020).
- 2. Clear and rough grade for improvements (March 2020).
- 3. Excavate and install improvements including underground piping and drainage structures (March 2020).
- 4. Fine grading and placement of gravel drive aisles (April 2020).
- 5. Install landscaping (August 2020).
- 6. Clean up and final stabilization (August 2020).

Item 6. update schedule



**4. BMPs for Stormwater Pollution Prevention**

See GEC plans in Appendix C for BMP locations and detail sheets.

- a. Erosion and Sediment Controls
  - i. Structural BMPs:
    - 1. Sediment basins (SBs) to collect runoff before it enters receiving waters

Item 5. Add a note stating that BMP Phasing is shown on GEC Plans

2. Silt fence (SF) along downstream limits of disturbed areas to filter sediment from runoff
  3. Stabilized staging area (SSA) near site entrance to consolidate construction equipment in a stabilized location
  4. Construction marker (CM) to identify limits of construction (LOC)
  5. Vehicle tracking control (VTC) at site entrance to prevent sediment from leaving the site via vehicle tires
  6. Temporary stock pile (TSP) to consolidate materials such as topsoil in a controlled area bounded by silt fence
  7. Erosion control blanket (ECB) placed on any slopes of 3:1 or greater, including the sides of sediment basins
  8. Inlet protection (IP) around pipe entrances
  9. Outlet protection (OP) at pipe outlets
- ii. Non-structural BMPs:
    1. Mulching (MU) to stabilize soils and promote seed growth
    2. Permanent seeding (PS) to stabilize disturbed areas
- b. Materials Handling and Spill Prevention
    - i. General Materials Handling Practices:
      1. Potential pollutants shall be stored and used in a manner consistent with the manufacturer's instructions in a secure location. To the extent practical, material storage areas should not be located near storm drain inlets and should be equipped with covers, roofs, or secondary containment as required to prevent storm water from contacting stored materials. Chemicals that are not compatible shall be stored in segregated areas so that spilled materials cannot combine and react.
      2. Disposal of materials shall be in accordance with the manufacturer's instructions and applicable local, state, and federal regulations.
      3. Materials no longer required for construction shall be removed from the site as soon as possible.
      4. Adequate garbage, construction waste, and sanitary waste handling and disposal facilities shall be provided as necessary to keep the site clear of obstruction and BMPs clear and functional.
    - ii. Specific Materials Handling Practices
      1. All pollutants, including waste materials and demolition debris, that occur onsite during construction shall be handled in a way that does not contaminate storm water.
      2. All chemicals including liquid products, petroleum products, water treatment chemicals, and wastes stored onsite shall be covered and protected from vandalism.
      3. Maintenance, fueling, and repair of all equipment and vehicles involving oil changes, hydraulic system drain down, degreasing operations, fuel tank drain down and removal, and other activities which may result in the accidental release of contaminants, shall be conducted under cover during wet weather and on an impervious surface to prevent release of contaminants onto the ground.

conducted under cover during wet weather and on an impervious surface to prevent release of contaminants onto the ground. Materials spilled during maintenance operations shall be cleaned up immediately and properly disposed of.

4. Wheel wash water shall be settled and discharged onsite by infiltration.
5. Application of agricultural chemicals, including fertilizers and pesticides, shall be conducted in a manner and at application rates that will not result in loss of chemical to storm water runoff. Follow manufacturer's recommendations for application rates and procedures.
6. pH-modifying sources shall be managed to prevent contamination of runoff and storm water collected onsite. The most common sources of pH-modifying materials are bulk cement, cement kiln dust (CKD), fly ash, new concrete washing and curing waters, waste streams generated from concrete grinding and sawing, exposed aggregate processes, and concrete pumping and mixer washout waters.

iii. Spill Prevention and Response Procedures

1. The primary objective in responding to a spill is to quickly contain the material(s) and prevent or minimize their migration into storm water runoff and conveyance systems. If the release has impacted onsite storm water, it is critical to contain the released materials onsite and prevent their release into receiving waters.
2. Spill Response Procedures:
  - a. Notify site superintendent immediately when a spill, or the threat of a spill, is observed. The superintendent shall assess the situation and determine the appropriate response.
  - b. If spills represent an imminent threat of escaping onsite facilities and entering the receiving waters, site personnel shall respond immediately to contain the release and notify the superintendent after the situation has stabilized.
  - c. The site superintendent, or his/her designee, shall be responsible for completing a spill reporting form and for reporting the spill to the appropriate agency.
  - d. Spill response equipment shall be inspected and maintained as necessary to replace any materials used in spill response activities.
3. Spill kits shall be on-hand at all fueling sites. Spill kit location(s) shall be reported to the SWMP administrator.
4. Absorbent materials shall be on-hand at all fueling areas for use in containing inadvertent spills. Containers shall be on-hand at all fueling sites for disposal of used absorbents.
5. Recommended components of spill kits include the following:
  - a. Oil absorbent pads (one bale)
  - b. Oil absorbent booms (40 feet)

Since you will not have a concrete washout onsite, remove this section of text

- c. 55-gallon drums (2)
- d. 9-mil plastic bags (10)
- e. Personal protective equipment including gloves and goggles
- 6. Concrete wash water: ~~unless confined in a pre-defined, bermed containment area,~~ the cleaning of concrete truck delivery chutes is prohibited at the job site.
- 7. Notification procedures:
  - a. In the event of an accident or spill, the SWMP administrator shall be notified.
  - b. Depending on the nature of the spill material involved, the Colorado Department of Public Health and Environment (24-hour spill reporting line: 887-518-5608), downstream water users, or other agencies may also need to be notified.
  - c. Any spill of oil which 1) violates water quality standards, 2) produces a “sheen” on a surface water, or 3) causes a sludge or emulsion, or any hazardous substance release, or hazardous waste release which exceeds the reportable quantity, must be reported immediately by telephone to the National Response Center Hotline at (800) 424-8802.

## **5. Final Stabilization and Long-Term Stormwater Management**

- a. Permanent seeding will be provided to achieve long-term stabilization of the site.
- b. Seed Mix: “Foothills” or approved equal.
- c. Seeding Application Rate: Drill seed 0.25” to 0.5” into the soil. In small areas not accessible to a drill, hand broadcast at double the rate and rake 0.25” to 0.5” into the soil. Apply seed at the following rates:
  - i. Dryland: 20-25 lbs/acre
  - ii. Irrigated: 40 lbs/acre
- d. Soil stabilization Practices:
  - i. Mulching Application: Apply 1-1/2 tons of certified weed free hay per acre mechanically crimped into the soil in combination with an organic mulch tackifier. On slopes and ditches requiring a blanket, the blanket shall be placed in lieu of much and mulch tackifier.
- e. Soil Conditioning and Fertilization Requirements:
  - i. Soil conditioner, organic amendment shall be applied to all seeded areas at 3 CY / 1000 SF.
  - ii. Fertilizer shall consist of 90% fungal biomass (mycelium) and 10% potassium-magnesia with a grade of 6-1-3 or approved equal. Fertilizer shall be applied as recommended by seed supplier.
- f. Final stabilization is reached when all soil-disturbing activities at the site have been completed, and uniform vegetative cover has been established with an individual plan density of at least 70 percent of pre-disturbance levels, or equivalent permanent, physical erosion reduction methods have been employed.
- g. Long term stormwater management will be provided in a single, full spectrum water quality and detention pond. The pond will discharge to the east to follow



Item 26. Add a note stating that this project does not rely on control measures owned or operated by another entity.

historic drainage patterns and will release at less than historic rates for the site.

## **6. Inspection and Maintenance**

- a. Inspection Schedules:
  - i. The contractor shall inspect BMPs once every 14 days at a minimum, and immediately (within 24 hours) after any precipitation or snowmelt event that causes surface erosion (i.e. that results in storm water running across the ground), to ensure that BMPs are maintained in effective operating condition.
- b. Inspection Procedures:
  - i. Site Inspection / Observation Items:
    1. Construction site perimeter and discharge points
    2. All disturbed areas
    3. Areas used for material / waste storage that are exposed to precipitation
    4. Other areas having a significant potential for storm water pollution, such as demolition areas or concrete washout areas, or locations where vehicles enter or leave the site
    5. Erosion and sediment control measures identified in the SWMP
    6. Any other structural BMPs that may require maintenance, such as secondary containment around fuel tanks, or the conditions of spill response kits.
  - ii. Inspection Requirements:
    1. Determine if there is any evidence of, or potential for, pollutants entering the receiving waters.
    2. Review BMPs to determine if they still meet design and operational criteria in the SWMP, and if they continue to adequately control pollutants at the site.
    3. Upgrade and/or revise any BMPs not operating in accordance with the SWMP and update the SWMP to reflect any revisions.
  - iii. BMP Maintenance / Replacement and Failed BMPs:
    1. The contractor shall remove sediment that has been collected by perimeter controls, such as silt fence and inlet protection, on a regular basis to prevent failure of BMPs, and remove potential of sediment from being discharged from the site in the event of BMP failure.
    2. Removed sediment must be moved to an appropriate location where it will not become an additional pollutant source, and should never be placed in ditches or streams.
    3. The contractor shall update the GEC as required with any new BMPs added during the construction period.
    4. The contractor shall address BMPs that have failed or have the potential to fail without maintenance or modifications, as soon as possible, immediately in most cases, to prevent discharge of pollutants.

- iv. Record Keeping and Documenting Inspections:
  - 1. The contractor shall maintain records of all inspection reports, including signed inspection logs, at the project site.
  - 2. The permittee shall document inspection results and maintain a record of the results for a period of 3 years following expiration or inactivation of permit coverage.
  - 3. Site inspection records shall include the following:
    - a. Inspection date
    - b. Name and title of personnel making the inspection
    - c. Location of discharges of sediment or other pollutants from the site
    - d. Location(s) of BMPs in need of maintenance
    - e. Location(s) of BMPs that failed to operate as designed or proved inadequate for a particular location
    - f. Location(s) where additional BMPs are needed that were not in place at the time of inspection
    - g. Deviations from the minimum inspection schedule

Item 21. Add text stating that the SWMP should be viewed as a “living document” that is continuously being reviewed and modified as a part of the overall process of evaluating and managing stormwater quality issues at the site. The Qualified Stormwater Manager shall amend the SWMP when there is a change in design, construction, operation or maintenance of the site which would require the implementation of new or revised BMPs or if the SWMP proves to be ineffective in achieving the general objectives of controlling pollutants in stormwater discharges associated with construction activity or when BMPs are no longer necessary and are removed.

## **APPENDIX A – VICINITY MAP**

---

X:\2510000.all\2513400\Drawings\Blocks\Vicinity Map.dwg, VIC. MAP, 6/14/2019 9:14:38 AM, CS

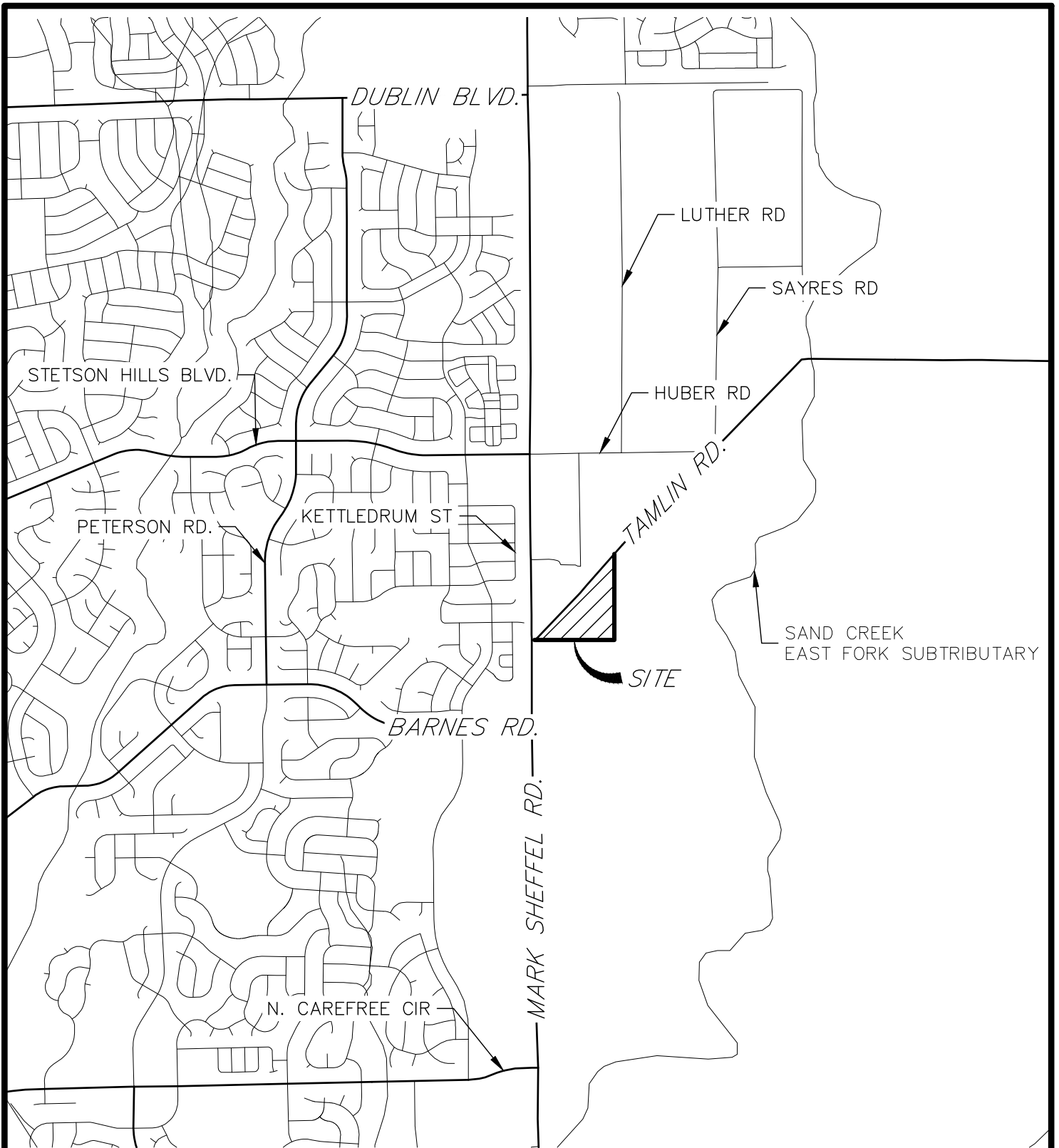

2000 1000 0 2000



ORIGINAL SCALE: 1" = 2000'

VICINITY MAP  
 TAMLIN ROAD STORAGE YARD  
 2513400  
 06/14/19  
 SHEET 1 OF 1



Centennial 303-740-9393 • Colorado Springs 719-593-2593  
 Fort Collins 970-491-9888 • www.jrengineering.com

## **APPENDIX B – SOILS MAP**

---

Hydrologic Soil Group—El Paso County Area, Colorado

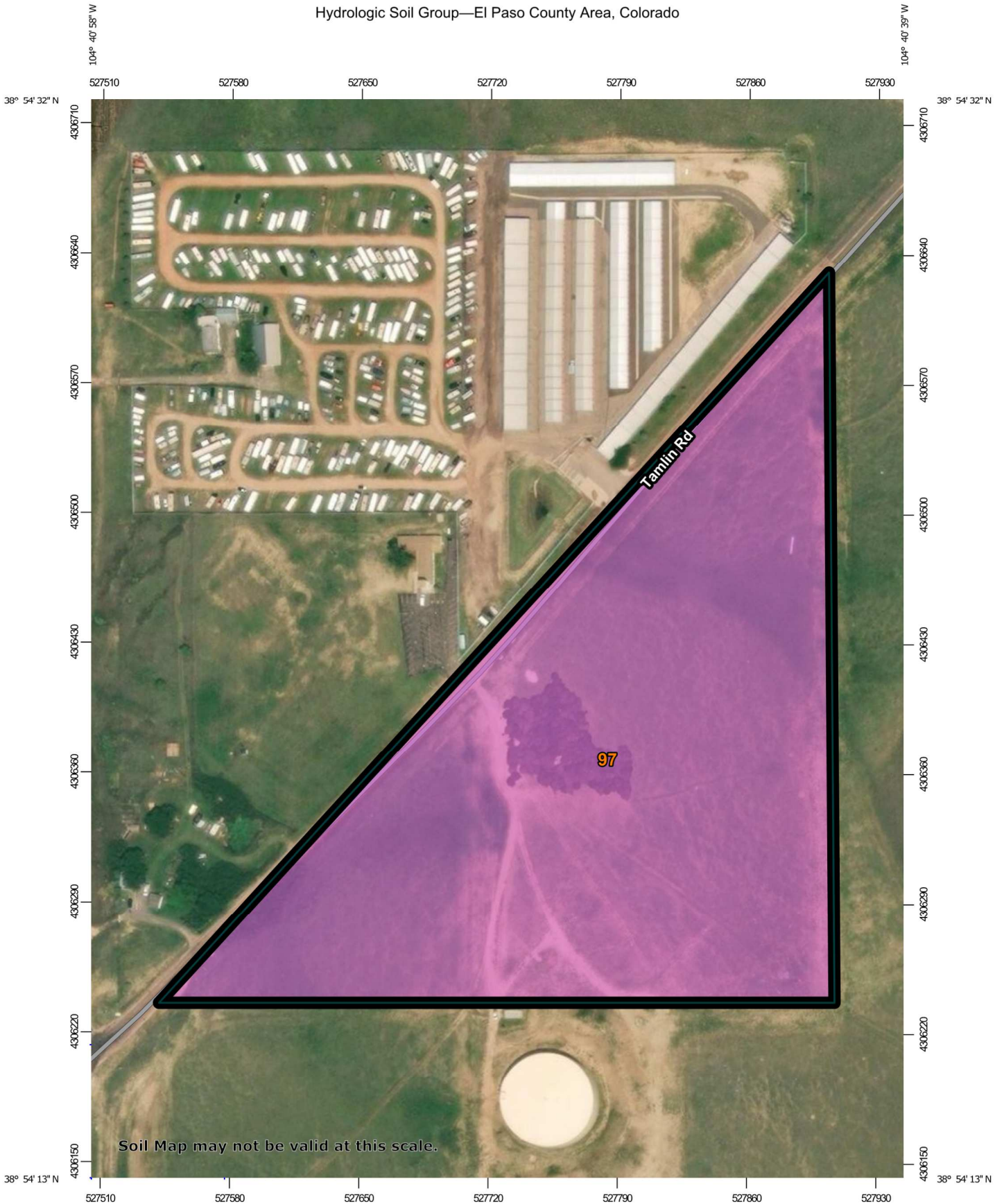

Soil Map may not be valid at this scale.

Map Scale: 1:2,840 if printed on A portrait (8.5" x 11") sheet.

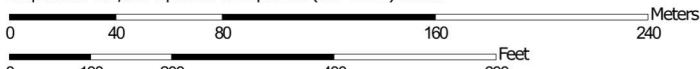

Map projection: Web Mercator Corner coordinates: WGS84 Edge tics: UTM Zone 13N WGS84



## MAP LEGEND

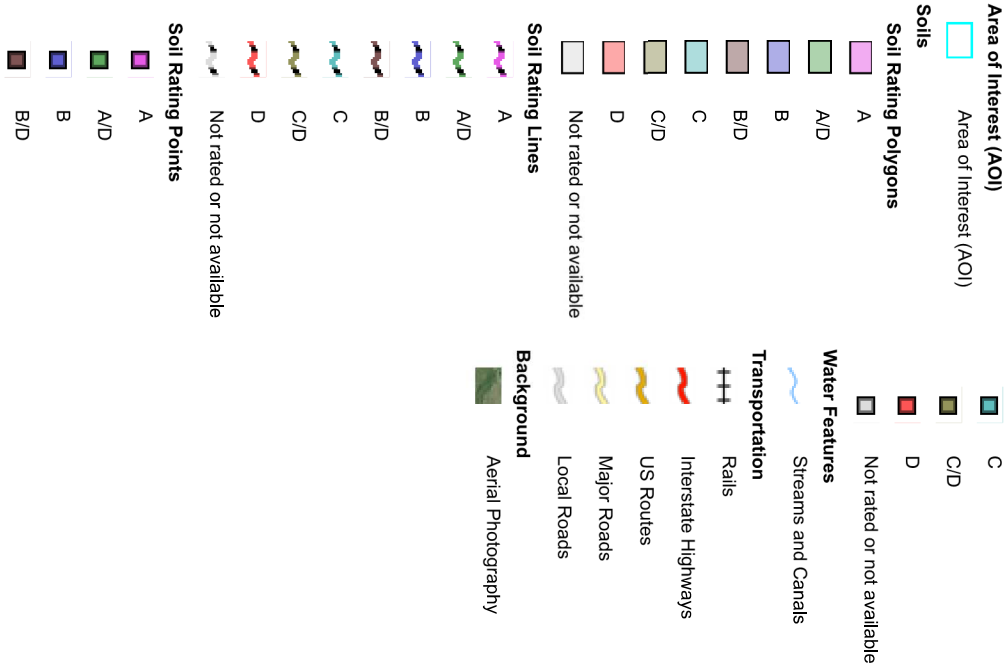

## MAP INFORMATION

The soil surveys that comprise your AOI were mapped at 1:24,000.

**Warning:** Soil Map may not be valid at this scale.

Enlargement of maps beyond the scale of mapping can cause misunderstanding of the detail of mapping and accuracy of soil line placement. The maps do not show the small areas of contrasting soils that could have been shown at a more detailed scale.

Please rely on the bar scale on each map sheet for map measurements.

Source of Map: Natural Resources Conservation Service  
 Web Soil Survey URL:  
 Coordinate System: Web Mercator (EPSG:3857)

Maps from the Web Soil Survey are based on the Web Mercator projection, which preserves direction and shape but distorts distance and area. A projection that preserves area, such as the Albers equal-area conic projection, should be used if more accurate calculations of distance or area are required.

This product is generated from the USDA-NRCS certified data as of the version date(s) listed below.

Soil Survey Area: El Paso County Area, Colorado  
 Survey Area Data: Version 16, Sep 10, 2018

Soil map units are labeled (as space allows) for map scales 1:50,000 or larger.

Date(s) aerial images were photographed: Apr 15, 2011—Aug 17, 2017

The orthophoto or other base map on which the soil lines were compiled and digitized probably differs from the background imagery displayed on these maps. As a result, some minor shifting of map unit boundaries may be evident.

## Hydrologic Soil Group

Map unit symbol	Map unit name	Rating	Acres in AOI	Percent of AOI
97	Truckton sandy loam, 3 to 9 percent slopes	A	17.9	100.0%
<b>Totals for Area of Interest</b>			<b>17.9</b>	<b>100.0%</b>

### Description

Hydrologic soil groups are based on estimates of runoff potential. Soils are assigned to one of four groups according to the rate of water infiltration when the soils are not protected by vegetation, are thoroughly wet, and receive precipitation from long-duration storms.

The soils in the United States are assigned to four groups (A, B, C, and D) and three dual classes (A/D, B/D, and C/D). The groups are defined as follows:

Group A. Soils having a high infiltration rate (low runoff potential) when thoroughly wet. These consist mainly of deep, well drained to excessively drained sands or gravelly sands. These soils have a high rate of water transmission.

Group B. Soils having a moderate infiltration rate when thoroughly wet. These consist chiefly of moderately deep or deep, moderately well drained or well drained soils that have moderately fine texture to moderately coarse texture. These soils have a moderate rate of water transmission.

Group C. Soils having a slow infiltration rate when thoroughly wet. These consist chiefly of soils having a layer that impedes the downward movement of water or soils of moderately fine texture or fine texture. These soils have a slow rate of water transmission.

Group D. Soils having a very slow infiltration rate (high runoff potential) when thoroughly wet. These consist chiefly of clays that have a high shrink-swell potential, soils that have a high water table, soils that have a claypan or clay layer at or near the surface, and soils that are shallow over nearly impervious material. These soils have a very slow rate of water transmission.

If a soil is assigned to a dual hydrologic group (A/D, B/D, or C/D), the first letter is for drained areas and the second is for undrained areas. Only the soils that in their natural condition are in group D are assigned to dual classes.

### Rating Options

*Aggregation Method: Dominant Condition*

*Component Percent Cutoff: None Specified*



## **APPENDIX C – GEC PLANS AND DETAILS**

---

**GRADING AND EROSION CONTROL STANDARD NOTES**

- 1. STORMWATER DISCHARGES FROM CONSTRUCTION SITES SHALL NOT CAUSE OR CONTRIBUTE TO CHAIN POLLUTION, CONTAMINATION OR DEGRADATION OF STATE WATERS. ALL WATERS AND EARTH DISTURBANCE SHALL BE DONE IN A MANNER THAT WILL PROTECT THE QUALITY OF STATE WATERS, INCLUDING DELIVERING.
- 2. CONSTRUCTION RELATED TO ROADS, STREET REPAIRS AND EROSION CONTROL SHALL CONFORM TO THE STANDARDS AND REGULATIONS OF THE COLORADO DEPARTMENT OF TRANSPORTATION AND PUBLIC WORKS, INCLUDING DELIVERING, AND THE COLORADO DEPARTMENT OF TRANSPORTATION AND PUBLIC WORKS, INCLUDING DELIVERING, AND THE COLORADO DEPARTMENT OF TRANSPORTATION AND PUBLIC WORKS, INCLUDING DELIVERING.
- 3. SEPARATE STORMWATER MANAGEMENT PLAN (SWMP) FOR THIS PROJECT SHALL BE COMPLETED AND IN PERSON, AND APPROVED BY THE COLORADO DEPARTMENT OF TRANSPORTATION AND PUBLIC WORKS, INCLUDING DELIVERING, AND THE COLORADO DEPARTMENT OF TRANSPORTATION AND PUBLIC WORKS, INCLUDING DELIVERING.
- 4. THE SWMP SHALL BE LOCATED ON SITE AT ALL TIMES DURING CONSTRUCTION AND SHALL BE KEPT UP TO DATE WITH WORK PROGRESS AND CHANGES IN THE FIELD.
- 5. THE SWMP SHALL BE KEPT ON SITE AT ALL TIMES DURING CONSTRUCTION AND SHALL BE KEPT UP TO DATE WITH WORK PROGRESS AND CHANGES IN THE FIELD.
- 6. ALL TEMPORARY STORMWATER MANAGEMENT MEASURES SHALL BE MAINTAINED AND MONITORED AT ALL TIMES DURING CONSTRUCTION. ALL TEMPORARY STORMWATER MANAGEMENT MEASURES SHALL BE MAINTAINED AND MONITORED AT ALL TIMES DURING CONSTRUCTION.
- 7. ALL TEMPORARY STORMWATER MANAGEMENT MEASURES SHALL BE MAINTAINED AND MONITORED AT ALL TIMES DURING CONSTRUCTION.
- 8. ALL TEMPORARY STORMWATER MANAGEMENT MEASURES SHALL BE MAINTAINED AND MONITORED AT ALL TIMES DURING CONSTRUCTION.
- 9. ALL TEMPORARY STORMWATER MANAGEMENT MEASURES SHALL BE MAINTAINED AND MONITORED AT ALL TIMES DURING CONSTRUCTION.
- 10. ALL TEMPORARY STORMWATER MANAGEMENT MEASURES SHALL BE MAINTAINED AND MONITORED AT ALL TIMES DURING CONSTRUCTION.
- 11. ALL TEMPORARY STORMWATER MANAGEMENT MEASURES SHALL BE MAINTAINED AND MONITORED AT ALL TIMES DURING CONSTRUCTION.
- 12. ALL TEMPORARY STORMWATER MANAGEMENT MEASURES SHALL BE MAINTAINED AND MONITORED AT ALL TIMES DURING CONSTRUCTION.
- 13. ALL TEMPORARY STORMWATER MANAGEMENT MEASURES SHALL BE MAINTAINED AND MONITORED AT ALL TIMES DURING CONSTRUCTION.
- 14. ALL TEMPORARY STORMWATER MANAGEMENT MEASURES SHALL BE MAINTAINED AND MONITORED AT ALL TIMES DURING CONSTRUCTION.
- 15. ALL TEMPORARY STORMWATER MANAGEMENT MEASURES SHALL BE MAINTAINED AND MONITORED AT ALL TIMES DURING CONSTRUCTION.
- 16. ALL TEMPORARY STORMWATER MANAGEMENT MEASURES SHALL BE MAINTAINED AND MONITORED AT ALL TIMES DURING CONSTRUCTION.
- 17. ALL TEMPORARY STORMWATER MANAGEMENT MEASURES SHALL BE MAINTAINED AND MONITORED AT ALL TIMES DURING CONSTRUCTION.
- 18. ALL TEMPORARY STORMWATER MANAGEMENT MEASURES SHALL BE MAINTAINED AND MONITORED AT ALL TIMES DURING CONSTRUCTION.
- 19. ALL TEMPORARY STORMWATER MANAGEMENT MEASURES SHALL BE MAINTAINED AND MONITORED AT ALL TIMES DURING CONSTRUCTION.
- 20. ALL TEMPORARY STORMWATER MANAGEMENT MEASURES SHALL BE MAINTAINED AND MONITORED AT ALL TIMES DURING CONSTRUCTION.
- 21. ALL TEMPORARY STORMWATER MANAGEMENT MEASURES SHALL BE MAINTAINED AND MONITORED AT ALL TIMES DURING CONSTRUCTION.
- 22. ALL TEMPORARY STORMWATER MANAGEMENT MEASURES SHALL BE MAINTAINED AND MONITORED AT ALL TIMES DURING CONSTRUCTION.
- 23. ALL TEMPORARY STORMWATER MANAGEMENT MEASURES SHALL BE MAINTAINED AND MONITORED AT ALL TIMES DURING CONSTRUCTION.
- 24. ALL TEMPORARY STORMWATER MANAGEMENT MEASURES SHALL BE MAINTAINED AND MONITORED AT ALL TIMES DURING CONSTRUCTION.
- 25. ALL TEMPORARY STORMWATER MANAGEMENT MEASURES SHALL BE MAINTAINED AND MONITORED AT ALL TIMES DURING CONSTRUCTION.
- 26. ALL TEMPORARY STORMWATER MANAGEMENT MEASURES SHALL BE MAINTAINED AND MONITORED AT ALL TIMES DURING CONSTRUCTION.
- 27. ALL TEMPORARY STORMWATER MANAGEMENT MEASURES SHALL BE MAINTAINED AND MONITORED AT ALL TIMES DURING CONSTRUCTION.
- 28. ALL TEMPORARY STORMWATER MANAGEMENT MEASURES SHALL BE MAINTAINED AND MONITORED AT ALL TIMES DURING CONSTRUCTION.

**TAMLIN ROAD RV STORAGE**  
5080 TAMLIN ROAD  
EL PASO COUNTY, COLORADO  
**GRADING AND EROSION CONTROL PLANS (W/ POND DETAILS)**  
LOCATED IN SECTION 21, TOWNSHIP 13S, RANGE 65W OF THE 6TH P.M., EL PASO COUNTY, COLORADO

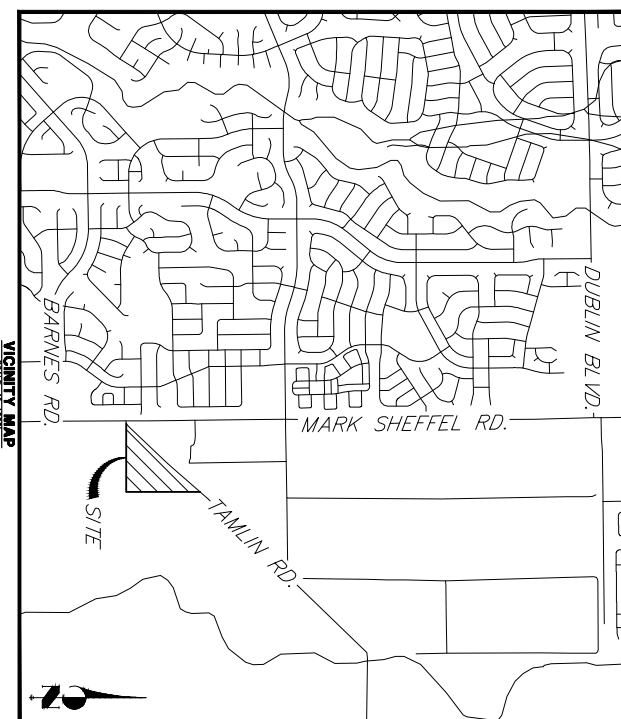

**STANDARD NOTES FOR EL PASO COUNTY CONSTRUCTION PLANS**

- 1. ALL GRADING AND EROSION CONTROL MEASURES SHALL BE DONE IN ACCORDANCE WITH THE CITY OF COLORADO MANUAL.
- 2. THE CONSTRUCTION SHALL BE DONE IN ACCORDANCE WITH THE CITY OF COLORADO MANUAL.
- 3. THE CONSTRUCTION SHALL BE DONE IN ACCORDANCE WITH THE CITY OF COLORADO MANUAL.
- 4. THE CONSTRUCTION SHALL BE DONE IN ACCORDANCE WITH THE CITY OF COLORADO MANUAL.
- 5. THE CONSTRUCTION SHALL BE DONE IN ACCORDANCE WITH THE CITY OF COLORADO MANUAL.
- 6. THE CONSTRUCTION SHALL BE DONE IN ACCORDANCE WITH THE CITY OF COLORADO MANUAL.
- 7. THE CONSTRUCTION SHALL BE DONE IN ACCORDANCE WITH THE CITY OF COLORADO MANUAL.
- 8. THE CONSTRUCTION SHALL BE DONE IN ACCORDANCE WITH THE CITY OF COLORADO MANUAL.
- 9. THE CONSTRUCTION SHALL BE DONE IN ACCORDANCE WITH THE CITY OF COLORADO MANUAL.
- 10. THE CONSTRUCTION SHALL BE DONE IN ACCORDANCE WITH THE CITY OF COLORADO MANUAL.
- 11. THE CONSTRUCTION SHALL BE DONE IN ACCORDANCE WITH THE CITY OF COLORADO MANUAL.
- 12. THE CONSTRUCTION SHALL BE DONE IN ACCORDANCE WITH THE CITY OF COLORADO MANUAL.
- 13. THE CONSTRUCTION SHALL BE DONE IN ACCORDANCE WITH THE CITY OF COLORADO MANUAL.
- 14. THE CONSTRUCTION SHALL BE DONE IN ACCORDANCE WITH THE CITY OF COLORADO MANUAL.
- 15. THE CONSTRUCTION SHALL BE DONE IN ACCORDANCE WITH THE CITY OF COLORADO MANUAL.
- 16. THE CONSTRUCTION SHALL BE DONE IN ACCORDANCE WITH THE CITY OF COLORADO MANUAL.
- 17. THE CONSTRUCTION SHALL BE DONE IN ACCORDANCE WITH THE CITY OF COLORADO MANUAL.
- 18. THE CONSTRUCTION SHALL BE DONE IN ACCORDANCE WITH THE CITY OF COLORADO MANUAL.
- 19. THE CONSTRUCTION SHALL BE DONE IN ACCORDANCE WITH THE CITY OF COLORADO MANUAL.
- 20. THE CONSTRUCTION SHALL BE DONE IN ACCORDANCE WITH THE CITY OF COLORADO MANUAL.
- 21. THE CONSTRUCTION SHALL BE DONE IN ACCORDANCE WITH THE CITY OF COLORADO MANUAL.
- 22. THE CONSTRUCTION SHALL BE DONE IN ACCORDANCE WITH THE CITY OF COLORADO MANUAL.
- 23. THE CONSTRUCTION SHALL BE DONE IN ACCORDANCE WITH THE CITY OF COLORADO MANUAL.
- 24. THE CONSTRUCTION SHALL BE DONE IN ACCORDANCE WITH THE CITY OF COLORADO MANUAL.
- 25. THE CONSTRUCTION SHALL BE DONE IN ACCORDANCE WITH THE CITY OF COLORADO MANUAL.
- 26. THE CONSTRUCTION SHALL BE DONE IN ACCORDANCE WITH THE CITY OF COLORADO MANUAL.
- 27. THE CONSTRUCTION SHALL BE DONE IN ACCORDANCE WITH THE CITY OF COLORADO MANUAL.
- 28. THE CONSTRUCTION SHALL BE DONE IN ACCORDANCE WITH THE CITY OF COLORADO MANUAL.

**CONTACTS:**  
C&M PROPERTIES, LLC  
12748 BAROSSA VALLEY ROAD  
COLORADO SPRINGS, CO 80921  
P- (719)-215-9480  
F- (719)-215-9480

**ENGINEER/SUPERVISOR:**  
JR ENGINEERING, LLC  
ATTN: MIKE A. BRUNETTI  
12748 BAROSSA VALLEY ROAD  
COLORADO SPRINGS, CO 80921  
P- (719)-215-9480  
F- (719)-215-9480

**PREPARED FOR:**  
C&M PROPERTIES, LLC  
12748 BAROSSA VALLEY ROAD  
COLORADO SPRINGS, CO 80921  
EDWARD WOODLAND  
719-210-9480

UNTIL SUCH TIME AS THESE DRAWINGS ARE APPROVED BY THE APPROPRIATE REVIEWING AGENCIES, OR ENGINEERING APPROVES THEIR USE, ONLY FOR THE PURPOSES DESIGNATED BY WRITTEN AUTHORIZATION.

**SHEET INDEX**

1	CONTRACT SHEET
2	GRADING AND EROSION CONTROL PLAN
3	CONTRACT SHEET
4	CONTRACT SHEET
5	CONTRACT SHEET
6	CONTRACT SHEET
7	CONTRACT SHEET
8	CONTRACT SHEET
9	CONTRACT SHEET
10	CONTRACT SHEET

**BENCHMARK:**  
TBM BY BOUNDARY SURVEY.

**BASIS OF BEARINGS:**  
TBM BY BOUNDARY SURVEY.

**ENGINEER'S STATEMENT:**  
THE GRADING AND EROSION CONTROL PLAN WAS PREPARED UNDER MY DIRECT SUPERVISION AND IS CORRECT TO THE BEST OF MY KNOWLEDGE AND BELIEF. I ACCEPT RESPONSIBILITY FOR ANY LIABILITY IN CONNECTION WITH THESE PLANS.

**OWNER/DEVELOPER STATEMENT:**  
I, THE OWNER/DEVELOPER, HAVE READ AND WILL COMPLY WITH THE REQUIREMENTS OF THE GRADING AND EROSION CONTROL PLAN.

**ENGINEER'S STATEMENT:**  
THESE DETAIL PLANS AND SPECIFICATIONS WERE PREPARED UNDER MY DIRECT SUPERVISION AND I AM CORRECT TO THE BEST OF MY KNOWLEDGE AND BELIEF. I ACCEPT RESPONSIBILITY FOR ANY LIABILITY IN CONNECTION WITH THESE PLANS.

NO.	REVISION	DATE	BY
1		01/17/20	NOJ
2		01/17/20	NOJ

**OWNER/DEVELOPER STATEMENT:**  
I, THE OWNER/DEVELOPER, HAVE READ AND WILL COMPLY WITH THE REQUIREMENTS OF THE GRADING AND EROSION CONTROL PLAN.

**ENGINEER'S STATEMENT:**  
THESE DETAIL PLANS AND SPECIFICATIONS WERE PREPARED UNDER MY DIRECT SUPERVISION AND I AM CORRECT TO THE BEST OF MY KNOWLEDGE AND BELIEF. I ACCEPT RESPONSIBILITY FOR ANY LIABILITY IN CONNECTION WITH THESE PLANS.

EDWARD WOODLAND 12748 BAROSSA VALLEY ROAD COLORADO SPRINGS, CO 80921	DATE
MIKE A. BRUNETTI, P.E. 12748 BAROSSA VALLEY ROAD COLORADO SPRINGS, CO 80921	DATE

PCD FILE NO.: PPR1945

TAMLIN ROAD RV STORAGE GRADING AND EROSION CONTROL PLANS (W/ POND DETAILS)	H-SCALE 1"=1000'	No. 1	DATE 01/17/20	BY NOJ
COVER SHEET	V-SCALE N/A	DATE 01/17/20	DESIGNED BY NOJ	DRAWN BY NOJ
SHEET 1 OF 10	108 NO. 2513400	CHECKED BY		

**LAYER LINETYPE LEGEND**

	EXISTING	PROPOSED
PHASE LINE		
MATCH LINE		
BOUNDARY LINE		
PROPERTY LINE		
EXHIBIT LINE		
RIGHT OF WAY		
R.O.W. A LINE		
CENTERLINE		
CITY LIMITS		
WIRE FENCE		
CHAIN LINK FENCE		
WOOD FENCE		
MASSIVE FENCE		
CONC. BARRIER		
CABLE TV		
ELECTRIC		
FIBER OPTIC		
GAS MAIN		
IRRIGATION MAIN		
OIL/THERMO MAIN		
OVERHEAD UTILITY		
SANITARY SEWER		
STORM DRAIN		
TELEPHONE		
RAIN WATER LINE		
SMALL/INTERM. FLOWING		
DIVERSION DITCH		
MOON DRAINAGE BASIN		
TOP OF SLOPE		
TOE OF SLOPE		
EDGE OF WATER		
INDEX CONTOUR		
INTERMEDIATE CONTOUR		
DEPRESSION CONTOUR (INDEX)		
DEPRESSION CONTOUR (INDEX)		
TOP OF DIRT		
TOP OF FINISH		
CUT THICK		
100 YEAR FLOODPLAIN		
500 YEAR FLOODPLAIN		
FLOODWAY		
BASE FLOOD ELEVATION		
EDGE OF MEADOWS		
STONE WALL		

**UTILITIES LEGEND**

	EXISTING	PROPOSED
STORM SEWER		
MANHOLE		
STORM INLET		
AREA INLET - SQUARE		
AREA INLET - ROUND		
FLUMED END SECTION		
BRIRAP		
SANITARY SEWER		
LINE MARKER		
SERVICE MARKER		
CLEAN-OUT		
MANHOLE W/ DIRECTIONAL		
FLY ARMOR		
WATER LINE		
LINE MARKER		
SERVICE MARKER		
FIRE HYDRANT		
FIRE CONNECTION		
BLIND		
BLOW-OFF VALVE		
WELL		
VALVE		
VALVE ASSEMBLY		
THRUST BLOCK		
CROSS		
PLUG W/ THRUST BLOCK		
TE		
REVERSE ANCHOR		
ANODE		
AIR & VACUUM		
VALVE ASSEMBLY		
BLOW-OFF ASSEMBLY		
GAS LINE		
VALVE		
SERVICE MARKER		
VALVE		
PLUG		
TE		
DRY UTILITIES		
CABLE TELEVISION PEDESTAL		
ELECTRIC MARKER		
ELECTRIC SERVICE MARKER		
ELECTRICAL PEDESTAL		
ELECTRICAL METERS		
ELECTRICAL METER		
TELEPHONE MARKER		
IRRIGATION PEDESTAL		
TELEPHONE PEDESTAL		
TELEPHONE MARKER		
UTILITY POLE		
UTILITY ANCHOR		
CLAY POLE		
MISC. UTILITIES		
WANT PILE		
TEST HOLE DESIGNATOR		

**ENGINEER'S STATEMENT**  
 PREPARED UNDER MY DIRECT SUPERVISION AND UNDER MY CLOSE PERSONAL SUPERVISION AND CONTROL.  
 I AM A LICENSED PROFESSIONAL ENGINEER IN THE STATE OF COLORADO.  
 I AM THE DESIGNER OF THE ABOVE WORK.  
 I AM NOT PROVIDING ANY GUARANTEE OR WARRANTY FOR THE WORK.  
 I AM NOT PROVIDING ANY GUARANTEE OR WARRANTY FOR THE WORK.  
 I AM NOT PROVIDING ANY GUARANTEE OR WARRANTY FOR THE WORK.

DATE	01/17/20
DESIGNED BY	NQJ
DRAWN BY	NQJ
CHECKED BY	

NO.	REVISION	BY	DATE



PREPARED FOR  
**C&M PROPERTIES, LLC**  
 12748 BAROSSA VALLEY ROAD  
 COLORADO SPRINGS, CO 80921  
 EDWARD McDONALD  
 719-210-9480

UNTIL SUCH TIME AS THESE DRAWINGS ARE APPROVED BY THE APPROPRIATE REVIEWING AGENCIES, OR ENGINEERING APPROVES THEIR USE, ONLY FOR THE PURPOSES DESIGNATED BY WRITTEN AUTHORIZATION.



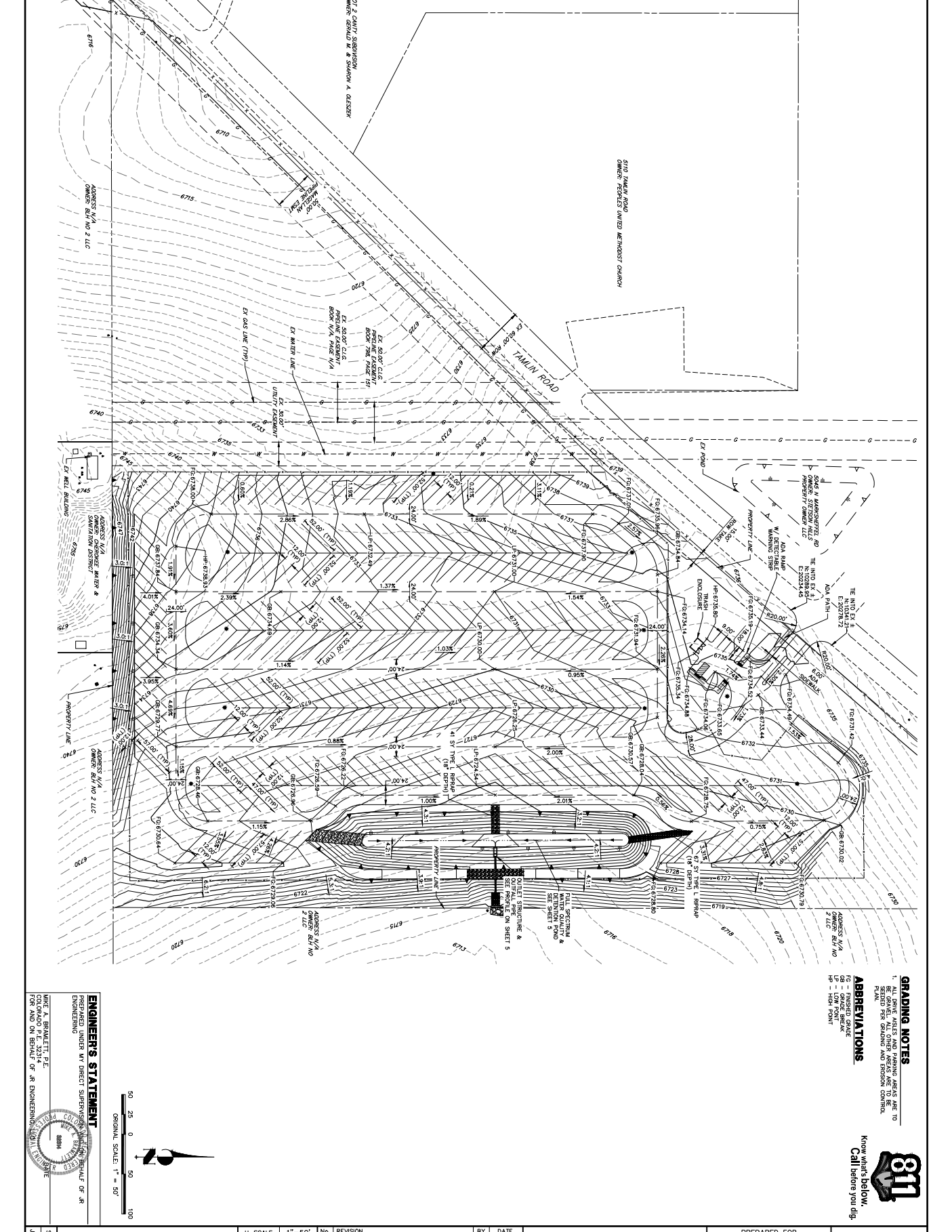

- GRADING NOTES**
1. ALL GRADE EASES AND PARKING AREAS ARE TO BE STUDIED FOR GRADING AND EROSION CONTROL PLAN.
- ABBREVIATIONS**
- FG - FINISHED GRADE
  - GP - GRADE BREAK
  - HP - HIGH POINT



**ENGINEER'S STATEMENT**  
 PREPARED UNDER MY DIRECT SUPERVISION AND AS A RESULT OF MY OWN EXAMINATION AND SURVEYING.  
 WAKE A. BRALLETI, P.E.  
 COLORADO P.E. 32314  
 CIVIL AND ENVIRONMENTAL ENGINEERING  
 JR ENGINEERING



TAMLIN ROAD RV STORAGE  
 SHEET 4 OF 10  
 JOB NO. 25134.00

H-SCALE	1"=50'
V-SCALE	N/A
DATE	01/17/20
DESIGNED BY	DRC
DRAWN BY	NQJ
CHECKED BY	

No.	REVISION	BY	DATE



PREPARED FOR  
 C&M PROPERTIES, LLC  
 12748 BAROSSA VALLEY ROAD  
 COLORADO SPRINGS, CO 80921  
 EDWARD McDONALD  
 719-210-9480

UNTIL SUCH TIME AS THESE DRAWINGS ARE APPROVED BY THE APPROPRIATE REVIEWING AGENCIES OR ENGINEERING APPROVES THEIR USE ONLY FOR THE PURPOSES DESIGNATED BY WRITTEN AUTHORIZATION.

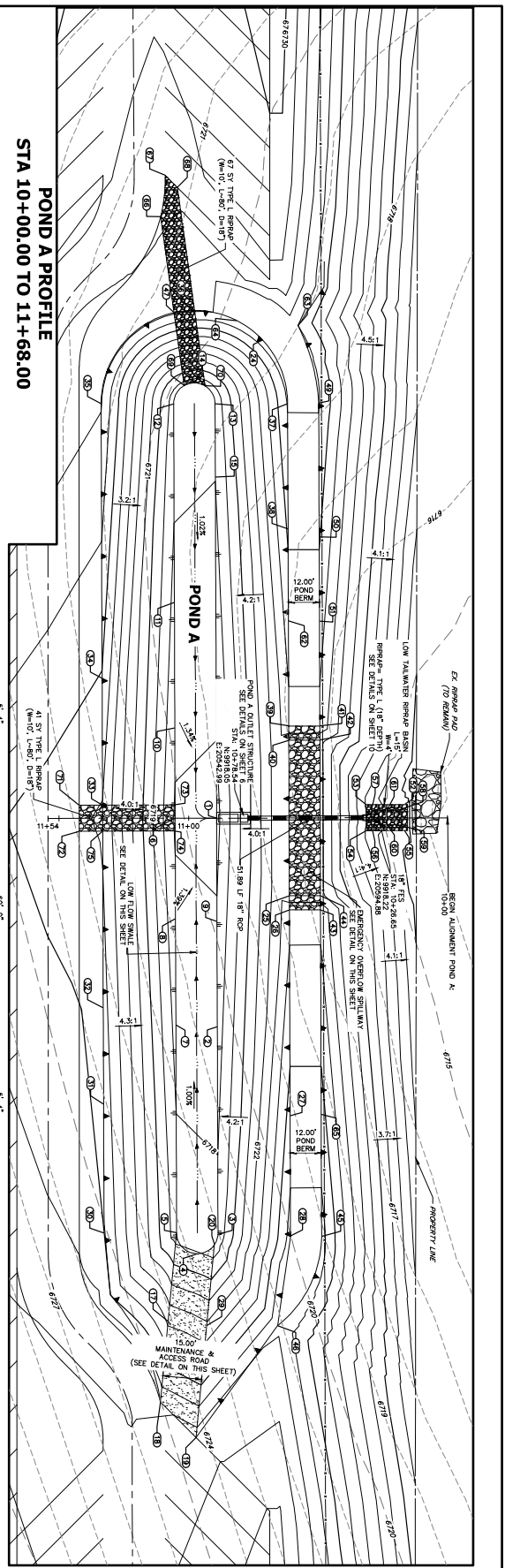

POND A PROFILE  
STA 10+00.00 TO 11+68.00

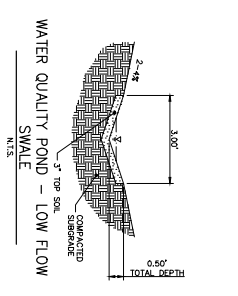
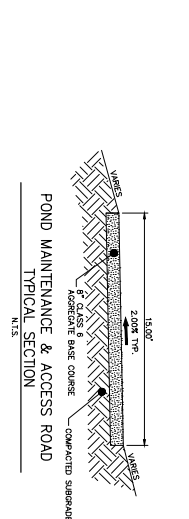
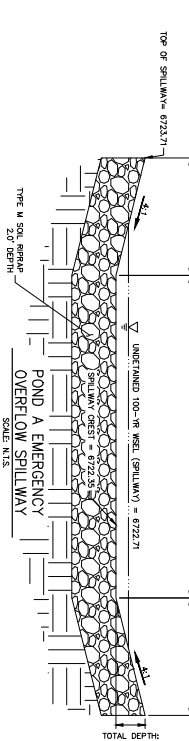
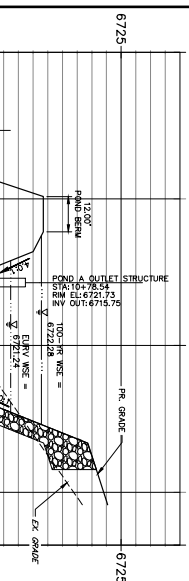

ID NO.	DESCRIPTION	NORTHING/EASTING	ELEVATION
1	OUTLET STRUCTURE	N:8918.05	6716.70
2	TOP OF SLOPE	N:8927.42	6717.50
3	TOP OF SLOPE	N:8927.40	6718.21
4	TOP OF SLOPE	N:8925.88	6718.69
5	WANT. & ACCESS ROAD/TOP OF SLOPE	N:8925.01	6718.46
6	TOP OF SLOPE/ASHP	N:8918.03	6718.86
7	TOP OF SLOPE	E:20018.61	6717.86
8	TOP OF SLOPE	E:20018.46	6717.25

ID NO.	DESCRIPTION	NORTHING/EASTING	ELEVATION	ID NO.	DESCRIPTION	NORTHING/EASTING	ELEVATION
10	TOP OF SLOPE	N:8926.28	6717.21	34	TOP OF SLOPE	N:8921.77	6724.84
11	TOP OF SLOPE	E:20016.42	6717.69	35	TOP OF SLOPE	E:20048.75	6721.66
12	TOP OF SLOPE	N:10078.00	6718.46	36	TOP OF SLOPE/ASHP	N:10114.03	6721.13
13	TOP OF SLOPE	E:20031.15	6718.30	37	TOP OF SLOPE	E:20053.94	6726.07
14	TOP OF SLOPE	N:10066.03	6718.51	38	TOP OF SLOPE	N:10029.83	6723.15
15	TOP OF SLOPE	N:10064.95	6718.02	39	TOP OF POND/REGION SPILLWAY	E:20051.35	6723.71
16	TOP OF SLOPE	N:9984.08	6717.18	40	SPILLWAY CREST	E:20061.22	6723.25
17	WANT. & ACCESS ROAD	N:9733.32	6717.79	41	TOP OF POND/REGION SPILLWAY	E:20051.35	6723.71
18	WANT. & ACCESS ROAD	N:9733.32	6717.79	42	SPILLWAY CREST	E:20051.35	6723.71
19	WANT. & ACCESS ROAD	N:9733.32	6717.79	43	TOP OF POND/REGION SPILLWAY	E:20051.35	6723.71
20	WANT. & ACCESS ROAD/TOP OF SLOPE	N:9733.32	6717.79	44	SPILLWAY CREST	E:20051.35	6723.71
21	SPILLWAY CREST	N:9733.32	6717.79	45	TOP OF SLOPE	N:9733.32	6723.71
22	TOP OF SLOPE	N:9733.32	6717.79	46	TOP OF SLOPE	N:9733.32	6723.71
23	TOP OF SLOPE	N:9733.32	6717.79	47	TOP OF SLOPE/ASHP	N:10113.16	6723.15
24	TOP OF SLOPE	N:9733.32	6717.79	48	TOP OF SLOPE/ASHP	E:20053.94	6726.07
25	TOP OF SLOPE	N:9733.32	6717.79	49	TOP OF SLOPE/ASHP	E:20071.75	6726.07
26	TOP OF SLOPE	N:9733.32	6717.79	50	TOP OF SLOPE/ASHP	E:20071.75	6726.07
27	TOP OF SLOPE	N:9733.32	6717.79	51	TOP OF SLOPE	E:20071.75	6726.07
28	TOP OF SLOPE	N:9733.32	6717.79	52	TOP OF SLOPE	E:20071.75	6726.07
29	TOP OF SLOPE	N:9733.32	6717.79	53	TOP OF SLOPE	E:20071.75	6726.07
30	TOP OF SLOPE	N:9733.32	6717.79	54	TOP OF SLOPE	E:20071.75	6726.07
31	TOP OF SLOPE	N:9733.32	6717.79	55	TOP OF SLOPE	E:20071.75	6726.07
32	TOP OF SLOPE/ASHP	N:9833.27	6723.96	56	DISSEMINATOR	E:20096.13	6714.42
33	TOP OF SLOPE/ASHP	E:20096.13	6723.96	57	DISSEMINATOR	E:20096.13	6714.42
				58	DISSEMINATOR	E:20096.13	6714.42
				59	DISSEMINATOR	E:20096.13	6714.42
				60	DISSEMINATOR	E:20096.13	6714.42
				61	DISSEMINATOR	E:20096.13	6714.42
				62	DISSEMINATOR	E:20096.13	6714.42
				63	DISSEMINATOR	E:20096.13	6714.42
				64	DISSEMINATOR	E:20096.13	6714.42
				65	DISSEMINATOR	E:20096.13	6714.42
				66	DISSEMINATOR	E:20096.13	6714.42
				67	DISSEMINATOR	E:20096.13	6714.42
				68	DISSEMINATOR	E:20096.13	6714.42
				69	DISSEMINATOR	E:20096.13	6714.42
				70	DISSEMINATOR	E:20096.13	6714.42
				71	DISSEMINATOR	E:20096.13	6714.42
				72	DISSEMINATOR	E:20096.13	6714.42
				73	DISSEMINATOR	E:20096.13	6714.42
				74	DISSEMINATOR	E:20096.13	6714.42
				75	DISSEMINATOR	E:20096.13	6714.42

Know what's below. Call before you dig.

811

ENGINEER'S STATEMENT

PREPARED UNDER MY DIRECT SUPERVISION AND TO THE BEST OF MY KNOWLEDGE AND BELIEF, THE INFORMATION CONTAINED HEREIN IS TRUE AND CORRECT.

DATE: 01/17/20

SCALE: 1" = 2'

DESIGNED BY: NQJ

DRAWN BY: NQJ

CHECKED BY:

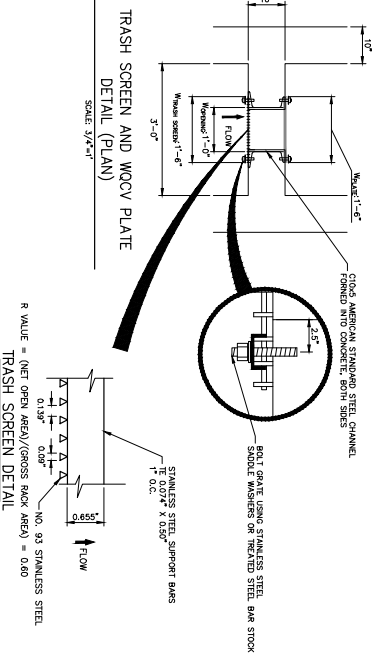
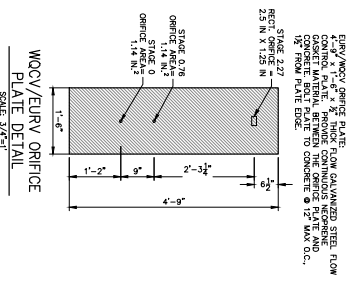
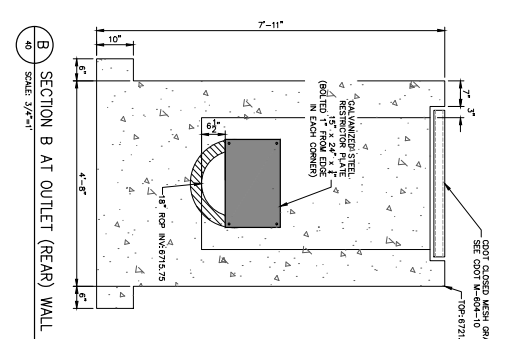
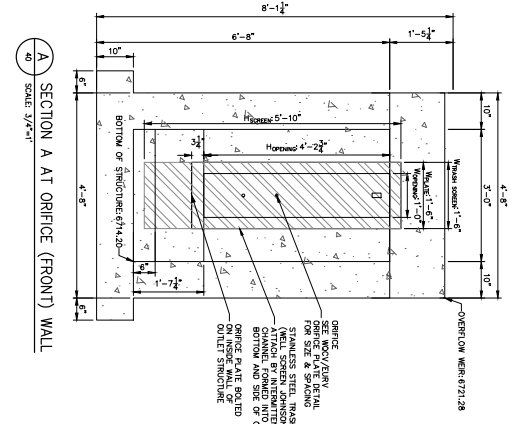
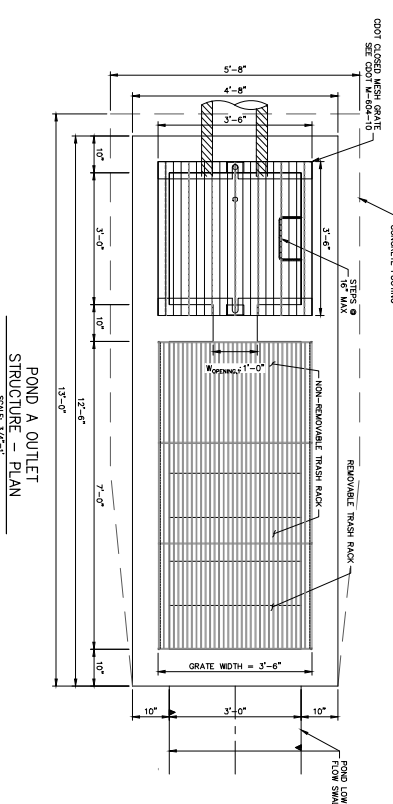
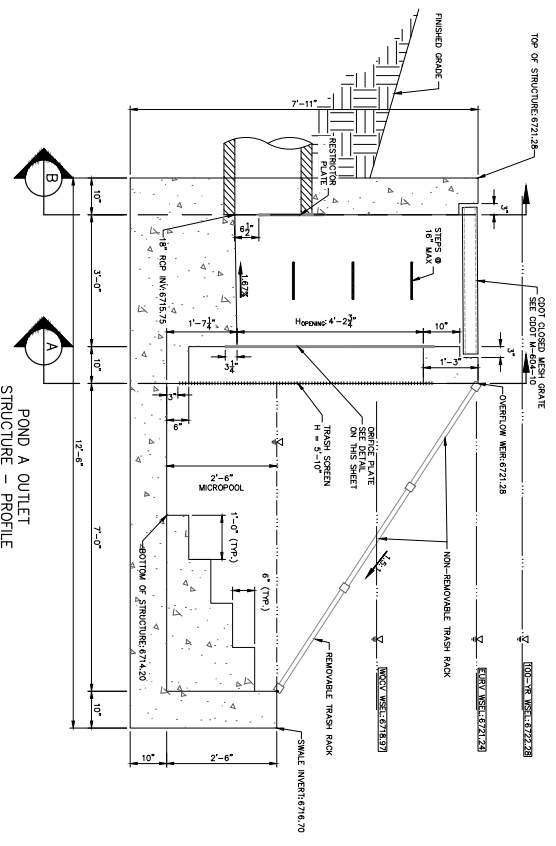

**ENGINEER'S STATEMENT**  
 PREPARED UNDER MY DIRECT SUPERVISION AND AS A PROFESSIONAL ENGINEER, I CERTIFY THAT THE DESIGN AND CONSTRUCTION OF THIS PROJECT IS IN ACCORDANCE WITH ALL APPLICABLE CODES AND REGULATIONS.  
 WAKE A. BRADLEY, P.E.  
 COLORADO P.E. 33314  
 303-441-8888  
 JR ENGINEERING

SHEET 6 OF 10 JOB NO. 25134.00	TAMLIN ROAD RV STORAGE	H-SCALE 3/4" = 1'	No. REVISION	BY	DATE	PREPARED FOR <b>C&amp;M PROPERTIES, LLC</b> 12748 BAROSSA VALLEY ROAD COLORADO SPRINGS, CO 80921 EDWARD McDONALD 719-210-9480	UNTIL SUCH TIME AS THESE DRAWINGS ARE APPROVED BY THE APPROPRIATE REVIEWING AGENCIES OR ENGINEERING APPROVES THEIR USE ONLY FOR THE PURPOSES DESIGNATED BY WRITTEN AUTHORIZATION.
	POND A OUTLET STRUCTURE	V-SCALE 3/4" = 1'	DATE 01/17/20	DESIGNED BY NQJ	DRAWN BY NQJ		
	CHECKED BY	DATE	DATE	DATE	DATE		
	CHECKED BY	DATE	DATE	DATE	DATE		

**JR ENGINEERING**  
 A Wehrman Company  
 Centennial 303-740-9393 • Colorado Springs 719-593-2593  
 Fort Collins 970-491-8888 • www.jrengineering.com

**Vehicle Tracking Control (VTC) SM-4**

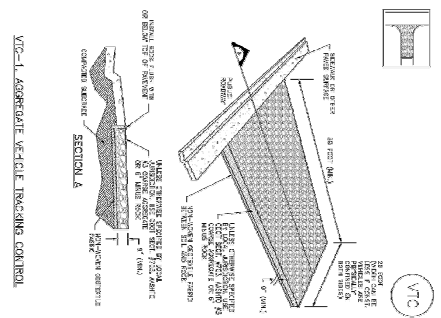

Vehicle Tracking Control (VTC) SM-4  
 1/20/2021 11:50:38 AM: 2/3  
 Title: Detail Grading Detail Design and Erosion Control Sheet 151400101 Job: DTN: 1/20/2021 11:50:38 AM: 2/3

**Vehicle Tracking Control (VTC) SM-4**

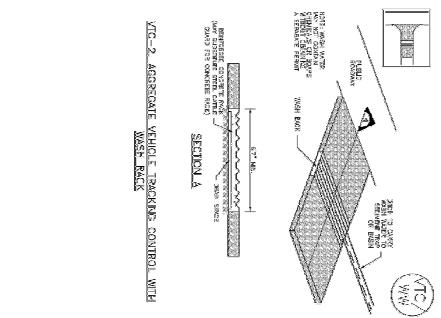

Vehicle Tracking Control (VTC) SM-4  
 1/20/2021 11:50:38 AM: 2/3  
 Title: Detail Grading Detail Design and Erosion Control Sheet 151400101 Job: DTN: 1/20/2021 11:50:38 AM: 2/3

**Vehicle Tracking Control (VTC) SM-4**

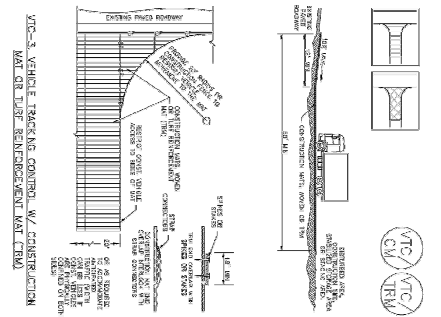

Vehicle Tracking Control (VTC) SM-4  
 1/20/2021 11:50:38 AM: 2/3  
 Title: Detail Grading Detail Design and Erosion Control Sheet 151400101 Job: DTN: 1/20/2021 11:50:38 AM: 2/3

**Vehicle Tracking Control (VTC) SM-4**

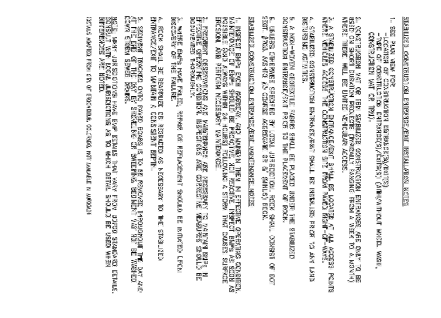

Vehicle Tracking Control (VTC) SM-4  
 1/20/2021 11:50:38 AM: 2/3  
 Title: Detail Grading Detail Design and Erosion Control Sheet 151400101 Job: DTN: 1/20/2021 11:50:38 AM: 2/3

**Stabilized Stepping Area (SSA) SM-6**

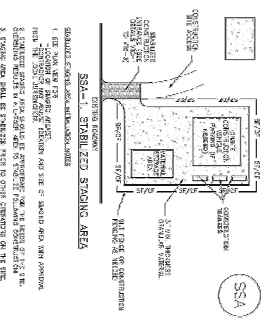

Stabilized Stepping Area (SSA) SM-6  
 1/20/2021 11:50:38 AM: 2/3  
 Title: Detail Grading Detail Design and Erosion Control Sheet 151400101 Job: DTN: 1/20/2021 11:50:38 AM: 2/3

**Stabilized Stepping Area (SSA) SM-6**

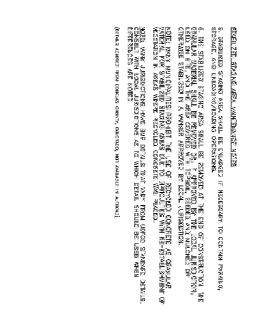

Stabilized Stepping Area (SSA) SM-6  
 1/20/2021 11:50:38 AM: 2/3  
 Title: Detail Grading Detail Design and Erosion Control Sheet 151400101 Job: DTN: 1/20/2021 11:50:38 AM: 2/3

**Silt Fence (SF) SC-1**

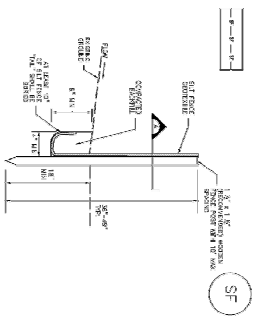

Silt Fence (SF) SC-1  
 1/20/2021 11:50:38 AM: 2/3  
 Title: Detail Grading Detail Design and Erosion Control Sheet 151400101 Job: DTN: 1/20/2021 11:50:38 AM: 2/3

**Silt Fence (SF) SC-1**

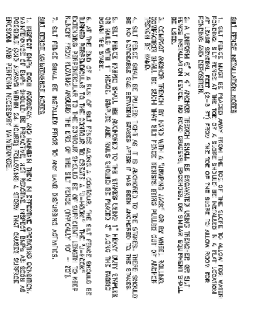

Silt Fence (SF) SC-1  
 1/20/2021 11:50:38 AM: 2/3  
 Title: Detail Grading Detail Design and Erosion Control Sheet 151400101 Job: DTN: 1/20/2021 11:50:38 AM: 2/3

1. THE DRAWING IS THE PROPERTY OF JR ENGINEERING, INC. AND IS NOT TO BE REPRODUCED OR TRANSMITTED IN ANY FORM OR BY ANY MEANS, ELECTRONIC OR MECHANICAL, INCLUDING PHOTOCOPYING, RECORDING, OR BY ANY INFORMATION STORAGE AND RETRIEVAL SYSTEM, WITHOUT THE WRITTEN PERMISSION OF JR ENGINEERING, INC.

2. THE DRAWING IS THE PROPERTY OF JR ENGINEERING, INC. AND IS NOT TO BE REPRODUCED OR TRANSMITTED IN ANY FORM OR BY ANY MEANS, ELECTRONIC OR MECHANICAL, INCLUDING PHOTOCOPYING, RECORDING, OR BY ANY INFORMATION STORAGE AND RETRIEVAL SYSTEM, WITHOUT THE WRITTEN PERMISSION OF JR ENGINEERING, INC.

3. THE DRAWING IS THE PROPERTY OF JR ENGINEERING, INC. AND IS NOT TO BE REPRODUCED OR TRANSMITTED IN ANY FORM OR BY ANY MEANS, ELECTRONIC OR MECHANICAL, INCLUDING PHOTOCOPYING, RECORDING, OR BY ANY INFORMATION STORAGE AND RETRIEVAL SYSTEM, WITHOUT THE WRITTEN PERMISSION OF JR ENGINEERING, INC.

4. THE DRAWING IS THE PROPERTY OF JR ENGINEERING, INC. AND IS NOT TO BE REPRODUCED OR TRANSMITTED IN ANY FORM OR BY ANY MEANS, ELECTRONIC OR MECHANICAL, INCLUDING PHOTOCOPYING, RECORDING, OR BY ANY INFORMATION STORAGE AND RETRIEVAL SYSTEM, WITHOUT THE WRITTEN PERMISSION OF JR ENGINEERING, INC.

5. THE DRAWING IS THE PROPERTY OF JR ENGINEERING, INC. AND IS NOT TO BE REPRODUCED OR TRANSMITTED IN ANY FORM OR BY ANY MEANS, ELECTRONIC OR MECHANICAL, INCLUDING PHOTOCOPYING, RECORDING, OR BY ANY INFORMATION STORAGE AND RETRIEVAL SYSTEM, WITHOUT THE WRITTEN PERMISSION OF JR ENGINEERING, INC.

1. THE DRAWING IS THE PROPERTY OF JR ENGINEERING, INC. AND IS NOT TO BE REPRODUCED OR TRANSMITTED IN ANY FORM OR BY ANY MEANS, ELECTRONIC OR MECHANICAL, INCLUDING PHOTOCOPYING, RECORDING, OR BY ANY INFORMATION STORAGE AND RETRIEVAL SYSTEM, WITHOUT THE WRITTEN PERMISSION OF JR ENGINEERING, INC.

2. THE DRAWING IS THE PROPERTY OF JR ENGINEERING, INC. AND IS NOT TO BE REPRODUCED OR TRANSMITTED IN ANY FORM OR BY ANY MEANS, ELECTRONIC OR MECHANICAL, INCLUDING PHOTOCOPYING, RECORDING, OR BY ANY INFORMATION STORAGE AND RETRIEVAL SYSTEM, WITHOUT THE WRITTEN PERMISSION OF JR ENGINEERING, INC.

3. THE DRAWING IS THE PROPERTY OF JR ENGINEERING, INC. AND IS NOT TO BE REPRODUCED OR TRANSMITTED IN ANY FORM OR BY ANY MEANS, ELECTRONIC OR MECHANICAL, INCLUDING PHOTOCOPYING, RECORDING, OR BY ANY INFORMATION STORAGE AND RETRIEVAL SYSTEM, WITHOUT THE WRITTEN PERMISSION OF JR ENGINEERING, INC.

4. THE DRAWING IS THE PROPERTY OF JR ENGINEERING, INC. AND IS NOT TO BE REPRODUCED OR TRANSMITTED IN ANY FORM OR BY ANY MEANS, ELECTRONIC OR MECHANICAL, INCLUDING PHOTOCOPYING, RECORDING, OR BY ANY INFORMATION STORAGE AND RETRIEVAL SYSTEM, WITHOUT THE WRITTEN PERMISSION OF JR ENGINEERING, INC.

5. THE DRAWING IS THE PROPERTY OF JR ENGINEERING, INC. AND IS NOT TO BE REPRODUCED OR TRANSMITTED IN ANY FORM OR BY ANY MEANS, ELECTRONIC OR MECHANICAL, INCLUDING PHOTOCOPYING, RECORDING, OR BY ANY INFORMATION STORAGE AND RETRIEVAL SYSTEM, WITHOUT THE WRITTEN PERMISSION OF JR ENGINEERING, INC.

1. THE DRAWING IS THE PROPERTY OF JR ENGINEERING, INC. AND IS NOT TO BE REPRODUCED OR TRANSMITTED IN ANY FORM OR BY ANY MEANS, ELECTRONIC OR MECHANICAL, INCLUDING PHOTOCOPYING, RECORDING, OR BY ANY INFORMATION STORAGE AND RETRIEVAL SYSTEM, WITHOUT THE WRITTEN PERMISSION OF JR ENGINEERING, INC.

2. THE DRAWING IS THE PROPERTY OF JR ENGINEERING, INC. AND IS NOT TO BE REPRODUCED OR TRANSMITTED IN ANY FORM OR BY ANY MEANS, ELECTRONIC OR MECHANICAL, INCLUDING PHOTOCOPYING, RECORDING, OR BY ANY INFORMATION STORAGE AND RETRIEVAL SYSTEM, WITHOUT THE WRITTEN PERMISSION OF JR ENGINEERING, INC.

3. THE DRAWING IS THE PROPERTY OF JR ENGINEERING, INC. AND IS NOT TO BE REPRODUCED OR TRANSMITTED IN ANY FORM OR BY ANY MEANS, ELECTRONIC OR MECHANICAL, INCLUDING PHOTOCOPYING, RECORDING, OR BY ANY INFORMATION STORAGE AND RETRIEVAL SYSTEM, WITHOUT THE WRITTEN PERMISSION OF JR ENGINEERING, INC.

4. THE DRAWING IS THE PROPERTY OF JR ENGINEERING, INC. AND IS NOT TO BE REPRODUCED OR TRANSMITTED IN ANY FORM OR BY ANY MEANS, ELECTRONIC OR MECHANICAL, INCLUDING PHOTOCOPYING, RECORDING, OR BY ANY INFORMATION STORAGE AND RETRIEVAL SYSTEM, WITHOUT THE WRITTEN PERMISSION OF JR ENGINEERING, INC.

5. THE DRAWING IS THE PROPERTY OF JR ENGINEERING, INC. AND IS NOT TO BE REPRODUCED OR TRANSMITTED IN ANY FORM OR BY ANY MEANS, ELECTRONIC OR MECHANICAL, INCLUDING PHOTOCOPYING, RECORDING, OR BY ANY INFORMATION STORAGE AND RETRIEVAL SYSTEM, WITHOUT THE WRITTEN PERMISSION OF JR ENGINEERING, INC.

1. THE DRAWING IS THE PROPERTY OF JR ENGINEERING, INC. AND IS NOT TO BE REPRODUCED OR TRANSMITTED IN ANY FORM OR BY ANY MEANS, ELECTRONIC OR MECHANICAL, INCLUDING PHOTOCOPYING, RECORDING, OR BY ANY INFORMATION STORAGE AND RETRIEVAL SYSTEM, WITHOUT THE WRITTEN PERMISSION OF JR ENGINEERING, INC.

2. THE DRAWING IS THE PROPERTY OF JR ENGINEERING, INC. AND IS NOT TO BE REPRODUCED OR TRANSMITTED IN ANY FORM OR BY ANY MEANS, ELECTRONIC OR MECHANICAL, INCLUDING PHOTOCOPYING, RECORDING, OR BY ANY INFORMATION STORAGE AND RETRIEVAL SYSTEM, WITHOUT THE WRITTEN PERMISSION OF JR ENGINEERING, INC.

3. THE DRAWING IS THE PROPERTY OF JR ENGINEERING, INC. AND IS NOT TO BE REPRODUCED OR TRANSMITTED IN ANY FORM OR BY ANY MEANS, ELECTRONIC OR MECHANICAL, INCLUDING PHOTOCOPYING, RECORDING, OR BY ANY INFORMATION STORAGE AND RETRIEVAL SYSTEM, WITHOUT THE WRITTEN PERMISSION OF JR ENGINEERING, INC.

4. THE DRAWING IS THE PROPERTY OF JR ENGINEERING, INC. AND IS NOT TO BE REPRODUCED OR TRANSMITTED IN ANY FORM OR BY ANY MEANS, ELECTRONIC OR MECHANICAL, INCLUDING PHOTOCOPYING, RECORDING, OR BY ANY INFORMATION STORAGE AND RETRIEVAL SYSTEM, WITHOUT THE WRITTEN PERMISSION OF JR ENGINEERING, INC.

5. THE DRAWING IS THE PROPERTY OF JR ENGINEERING, INC. AND IS NOT TO BE REPRODUCED OR TRANSMITTED IN ANY FORM OR BY ANY MEANS, ELECTRONIC OR MECHANICAL, INCLUDING PHOTOCOPYING, RECORDING, OR BY ANY INFORMATION STORAGE AND RETRIEVAL SYSTEM, WITHOUT THE WRITTEN PERMISSION OF JR ENGINEERING, INC.

**ENGINEER'S STATEMENT**  
 STANDARD DETAILS SHOWN WERE REVIEWED AND FOUND TO BE APPROPRIATE FOR THIS PROJECT.  
 WAKE A. BRADLEY, P.E.  
 COLORADO P.E. 32314  
 CIVIL AND ENVIRONMENTAL ENGINEERING  
 JR ENGINEERING, INC.

NO.	REVISION	DATE	BY

**JR ENGINEERING**  
 A Westlin Company  
 Centennial 303-740-9383 • Colorado Springs 703-693-2593  
 Fort Collins 970-491-8888 • www.jrengineering.com

PREPARED FOR  
**C&M PROPERTIES, LLC**  
 12748 BAROSSA VALLEY ROAD  
 COLORADO SPRINGS, CO 80921  
 EDWARD McDONALD  
 719-210-9480

UNTIL SUCH TIME AS THESE DRAWINGS ARE APPROVED BY THE APPROPRIATE REVIEWING AGENCIES, THE ENGINEERING APPROVES THEIR USE ONLY FOR THE PURPOSES DESIGNATED BY WRITTEN AUTHORIZATION.





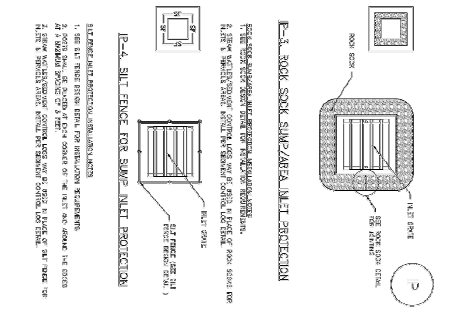

### Temporary and Permanent Seeding (TSP/PS)

TABLE 1.3.00" SQUARE SQUARE MESH NET PROTECTION

Quantity (Linear Feet)	Unit Price	Amount	Material
2,000.00	0.33	660.00	3.00" SQUARE SQUARE MESH NET PROTECTION
1,000.00	0.33	330.00	3.00" SQUARE SQUARE MESH NET PROTECTION
500.00	0.33	165.00	3.00" SQUARE SQUARE MESH NET PROTECTION

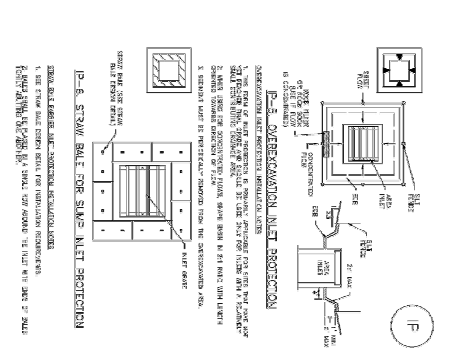

### Temporary and Permanent Seeding (TSP/PS)

TABLE 1.3.00" SQUARE SQUARE MESH NET PROTECTION

Quantity (Linear Feet)	Unit Price	Amount	Material
2,000.00	0.33	660.00	3.00" SQUARE SQUARE MESH NET PROTECTION
1,000.00	0.33	330.00	3.00" SQUARE SQUARE MESH NET PROTECTION
500.00	0.33	165.00	3.00" SQUARE SQUARE MESH NET PROTECTION

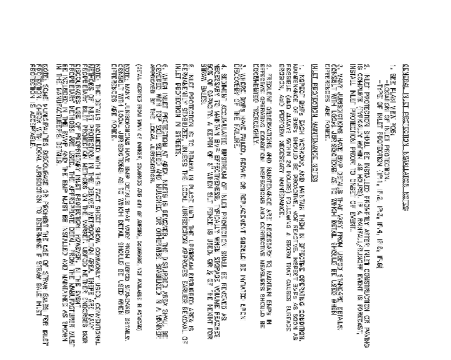

### Temporary and Permanent Seeding (TSP/PS)

TABLE 1.3.00" SQUARE SQUARE MESH NET PROTECTION

Quantity (Linear Feet)	Unit Price	Amount	Material
2,000.00	0.33	660.00	3.00" SQUARE SQUARE MESH NET PROTECTION
1,000.00	0.33	330.00	3.00" SQUARE SQUARE MESH NET PROTECTION
500.00	0.33	165.00	3.00" SQUARE SQUARE MESH NET PROTECTION

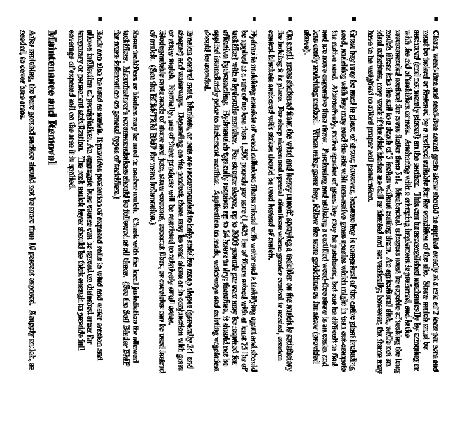

### Temporary and Permanent Seeding (TSP/PS)

TABLE 1.3.00" SQUARE SQUARE MESH NET PROTECTION

Quantity (Linear Feet)	Unit Price	Amount	Material
2,000.00	0.33	660.00	3.00" SQUARE SQUARE MESH NET PROTECTION
1,000.00	0.33	330.00	3.00" SQUARE SQUARE MESH NET PROTECTION
500.00	0.33	165.00	3.00" SQUARE SQUARE MESH NET PROTECTION

Standard details shown were reviewed and approved by the Engineer. The Engineer does not warrant that the drawings are free of errors or omissions. The Engineer shall not be responsible for any errors or omissions on the part of the contractor. The contractor shall be responsible for obtaining all necessary permits and licenses. The contractor shall be responsible for obtaining all necessary approvals from the appropriate authorities. The contractor shall be responsible for obtaining all necessary approvals from the appropriate authorities. The contractor shall be responsible for obtaining all necessary approvals from the appropriate authorities.

**ENGINEER'S STATEMENT**

STANDARD DETAILS SHOWN WERE REVIEWED AND APPROVED BY THE ENGINEER.

DATE: 01/17/20  
 BY: [Signature]  
 TITLE: [Title]

DATE: 01/17/20  
 BY: [Signature]  
 TITLE: [Title]

DATE: 01/17/20  
 BY: [Signature]  
 TITLE: [Title]

DATE: 01/17/20  
 BY: [Signature]  
 TITLE: [Title]

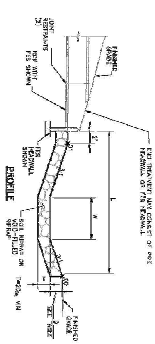
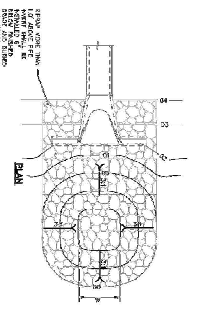

ITEM	QTY	UNIT	PRICE	TOTAL
1. 48\"/>				

Figure 10. Storm sewer structure details

6.12 Talmil Road and Talmil Creek, Talmil Road, Colorado Springs, Colorado  
 Urban Storm Sewerage System, Station 1+00.00 to 1+10.00

**ENGINEER'S STATEMENT**

STANDARD DETAILS SHOWN WERE REVIEWED FOR CONFORMANCE TO THEIR APPLICATION ON THIS PROJECT.  
 MIKE A. BRADLETT, P.E.  
 COLORADO P.E. 32314  
 IN CHARGE OF JR ENGINEERING



JOB NO. 25134.00	TAMLIN ROAD RV STORAGE	H-SCALE	N/A	No. REVISION	BY	DATE	PREPARED FOR C&M PROPERTIES, LLC 12748 BAROSSA VALLEY ROAD COLORADO SPRINGS, CO 80921 EDWARD McDONALD 719-210-9480	UNTIL SUCH TIME AS THESE DRAWINGS ARE APPROVED BY THE APPROPRIATE REVIEWING AGENCIES, JR ENGINEERING APPROVES THEIR USE ONLY FOR THE PURPOSES DESIGNATED BY WRITTEN AUTHORIZATION.
	STORM SEWER DETAILS	V-SCALE	N/A					
SHEET 10 OF 10	DESIGNED BY	DATE	01/17/20					
	DRAWN BY		NQJ					
	CHECKED BY							



## **APPENDIX D – SWMP CHECKLIST**

---

All Items in the SWMP Checklist must be addressed. If not applicable, explain in SWMP text and check box on SWMP Checklist. Do not use "N/A" on SWMP Checklist.

✓ Satisfies criteria  
 X Needs to be addressed



2880 International Circle, Suite 110  
 Colorado Springs, CO 80910  
 Phone 719-520-6300  
 Fax 719-520-6695  
 www.elpasoco.com

**EL PASO COUNTY PLANNING AND  
 COMMUNITY DEVELOPMENT  
 DEPARTMENT**

**STORMWATER MANAGEMENT PLAN CHECKLIST**  
 Upload SWMP Checklist separately from SWMP

Revised: July 2019

		Applicant	PCD
<b>1. STORMWATER MANAGEMENT PLAN (SWMP)</b>			
1	Applicant (owner/designated operator), SWMP Preparer, Qualified Stormwater Manager, and Contractor Information. (On cover/title sheet)	X	X
2	Table of Contents	X	✓
3	Site description and location to include: vicinity map with nearest street/crossroads description.	X	✓
4	Narrative description of construction activities proposed (e.g., may include clearing and grubbing, temporary stabilization, road grading, utility / storm installation, final grading, final stabilization, and removal of temporary control measures)	X	✓
5	Phasing plan – may require separate drawings indicating initial, interim, and final site phases for larger projects. Provide "living maps" that can be revised in the field as conditions dictate.	N/A	X
6	Proposed sequence for major activities: Provide a construction schedule of anticipated starting and completion dates for each stage of land-disturbing activity depicting conservation measures anticipated, including the expected date on which the final stabilization will be completed.	X	X
7	Estimates of the total site area and area to undergo disturbance; current area of disturbance must be updated on the SWMP as changes occur.	X	✓
8	Soil erosion potential and impacts on discharge that includes a summary of the data used to determine soil erosion potential		✓
9	A description of existing vegetation at the site and percent ground cover and method used to determine ground cover	X	X
10	Location and description of all potential pollution sources including but not limited to: disturbed and stored soils; vehicle tracking; management of contaminated soils; loading and unloading operations; outdoor storage of materials; vehicle and equipment maintenance and fueling; significant dust generating process; routine maintenance activities involving fertilizers, pesticides, herbicides, detergents, fuels, solvents, oils, etc.; on-site waste management; concrete truck/equipment washing; dedicated asphalt, concrete batch plants and masonry mixing stations; non-industrial waste such as trash and portable toilets	X	✓
11	Material handling to include spill prevention and response plan and procedures.	X	✓
12	Spill prevention and pollution controls for dedicated batch plants	X	✓
13	Other SW pollutant control measures to include waste disposal and off site soil tracking	X	X
14	Location and description of any anticipated allowable non-stormwater discharge (ground water, springs, irrigation, discharge covered by CDPHE Low Risk Guidance, etc.)	N/A	✓
15	Name(s) of ultimate receiving waters; size, type and location of stormwater outfall or storm sewer system discharge	X	✓
16	Description of all stream crossings located within the project area or statement that no streams cross the project area	X	✓



2880 International Circle, Suite 110  
 Colorado Springs, CO 80910  
 Phone 719-520-6300  
 Fax 719-520-6695  
 www.elpasoco.com

**EL PASO COUNTY PLANNING AND  
 COMMUNITY DEVELOPMENT  
 DEPARTMENT**

**STORMWATER MANAGEMENT PLAN CHECKLIST**

Revised: July 2019		Applicant	PCD
17	SWMP Map to include: <b>Reviewed Grading and Erosion Control Plan_v2</b>		
17a	construction site boundaries	X	X
17b	flow arrows to depict stormwater flow directions	X	✓
17c	all areas of disturbance	X	✓
17d	areas of cut and fill	X	✓
17e	areas used for storage of building materials, soils (stockpiles) or wastes	X	✓
17f	location of any dedicated asphalt / concrete batch plants	X	X
17g	location of all structural control measures	X	✓
17h	location of all non-structural control measures	X	✓
17i	springs, streams, wetlands and other surface waters, including areas that require maintenance of pre-existing vegetation within 50 feet of a receiving water	N/A	X
18	Narrative description of all structural control measures to be used. Modifications to EPC standard control measures must meet or exceed County-approved details.	X	✓
19	Description of all non-structural control measures to be used including seeding, mulching, protection of existing vegetation, site watering, sod placement, etc.	X	✓
20	Technical drawing details for all control measure installation and maintenance; custom or other jurisdiction's details used must meet or exceed EPC standards	X	X
21	<b>Procedure describing how the SWMP is to be revised</b>	X	X
22	Description of Final Stabilization and Long-term Stormwater Quality (describe nonstructural and structural measures to control SW pollutants after construction operations have been completed, including detention, water quality control measure etc.)	X	✓
23	Specification that final vegetative cover density is to be 70% of pre-disturbed levels	X	✓
24	Outline of permit holder inspection procedures to install, maintain, and effectively operate control measures to manage erosion and sediment	X	✓
25	Record keeping procedures identified to include signature on inspection logs and location of SWMP records on-site	X	✓
26	If this project relies on control measures owned or operated by another entity, a documented agreement must be included in the SWMP that identifies location, installation and design specifications, and maintenance requirements and responsibility of the control measure(s).	N/A	X
<b>Please note: all items above must be addressed. If not applicable, explain why, simply identifying "not applicable" will not satisfy CDPHE requirement of explanation.</b>			
<b>2. ADDITIONAL REPORTS/PERMITS/DOCUMENTS</b>			
a	Grading and Erosion Control Plan (signed)	X	
b	Erosion and Stormwater Quality Control Permit (ESQCP) (signed)	X	
<b>3. Applicant Comments:</b>			
a	Phasing plan – may require separate drawings indicating initial, interim, and final site phases for larger projects. Provide "living maps" that can be revised in the field as conditions dictate. -JR RESPONSE: THE SITE DOES NOT REQUIRE A PHASED PLAN. <b>State BMP Phasing is shown on GEC in SWMP text.</b> Location and description of any anticipated allowable non-stormwater discharge (ground water, springs, irrigation, discharge covered by CDPHE Low Risk Guidance, etc.) - JR RESPONSE: NO NON-STORMWATER DISCHARGES ANTICIPATED. <b>This is stated in the SWMP text. Item 14 has been adequately addressed.</b>		



2880 International Circle, Suite 110  
 Colorado Springs, CO 80910  
 Phone 719-520-6300  
 Fax 719-520-6695  
 www.elpasoco.com

**EL PASO COUNTY PLANNING AND  
 COMMUNITY DEVELOPMENT  
 DEPARTMENT**

**STORMWATER MANAGEMENT PLAN CHECKLIST**

Revised: July 2019

		Applicant	PCD
b	<p>springs, streams, wetlands and other surface waters, including areas that require maintenance of pre-existing vegetation within 50 feet of a receiving water. - JR RESPONSE: NO EXISTING SPRINGS, STREAMS WETLANDS OR OTHER SURFACE WATERS ON OR NEAR THE SITE.  <b>Add a note to the GEC stating this</b></p>		
c	<p>If this project relies on control measures owned or operated by another entity, a documented agreement must be included in the SWMP that identifies location, installation and design specifications, and maintenance requirements and responsibility of the control measure(s). - JR RESPONSE: NO CONTROL MEASURES BEING UTILIZED THAT ARE OWNED BY OTHERS.  <b>Add a note to the SWMP text stating this</b></p>		
<b>4. Checklist Review Certifications:</b>			
a	<p>Engineer of Record:            The Stormwater Management Plan was prepared under my direction and supervision and is correct to the best of my knowledge and belief. Said Plan has been prepared according to the criteria established by the County and State for Stormwater Management Plans.</p> <p>_____ Date _____            Engineer of Record Signature</p>	<b>X</b>	
b	<p>Review Engineer:            The Stormwater Management Plan was reviewed and found to meet the checklist requirements except where otherwise noted or allowed by an approved deviation request.</p> <p>_____ Date _____            Review Engineer</p>		



2880 International Circle, Suite 110  
 Colorado Springs, CO 80910  
 Phone 719-520-6300  
 Fax 719-520-6695  
 www.elpasoco.com

**EL PASO COUNTY PLANNING AND  
 COMMUNITY DEVELOPMENT  
 DEPARTMENT**

**GRADING AND EROSION CONTROL PLAN CHECKLIST**

Revised: July 2019

		Applicant	PCD
<b>1. GRADING AND EROSION CONTROL PLAN</b>			
a	Vicinity map.	X	
b	Adjacent city/town/jurisdictional boundaries, subdivision names, and property parcel numbers labeled.	X	
c	North arrow and acceptable scale (1"=20' to 1"=100').	X	
d	Legend for all symbols used in the plan.	X	
e	Existing and proposed property lines. Proposed subdivision boundary for subdivision projects.	X	
f	All existing structures.	X	
g	All existing utilities.	X	
h	Construction site boundaries.	X	
i	Existing vegetation (notes are acceptable in cases where there is no notable vegetation, only grasses/weeds, or site has already been stripped).	X	
j	FEMA 100-yr floodplain.	N/A	
k	Existing and proposed water courses including springs, streams, wetlands, detention ponds, stormwater quality structures, roadside ditches, irrigation ditches and other water surfaces. Show maintenance of pre-existing vegetation within 50 feet of a receiving water.	X	
l	Existing and proposed contours 2 feet or less (except for hillside).	X	
m	Limits of disturbance delineating all anticipated areas of soil disturbance.	X	
n	Identify and protect areas outside of the construction site boundary with existing fencing, construction fencing or other methods as appropriate.	X	
o	Offsite grading clearly shown and called out.	N/A	
p	Areas of cut and fill identified.	X	
q	Conclusions from soils/geotechnical report and geologic hazards report incorporated in grading design (slopes, embankments, materials, mitigation, etc.)	X	
r	Proposed slopes steeper than 3:1 with top and toe of slope delineated. Erosion control blanketing or other protective covering required.	X	
s	Stormwater flow direction arrows.	X	
t	Location of any dedicated asphalt / concrete batch plants.	X	
u	Areas used for staging, storage of building materials, soils (stockpiles) or wastes. The use of construction office trailers requires PCD permitting.	X	
v	All proposed temporary construction control measures, structural and non-structural. Temporary construction control measures shall be identified by phase of implementation to include "initial," "interim," and "final" or shown on separate phased maps identifying each phase.	X	
w	Vehicle tracking provided at all construction entrances/exits. Construction fencing, barricades, and/or signage provided at access points not to be used for construction.	X	
x	Temporary sediment ponds provided for disturbed drainage areas greater than 1 acre.	X	
y	Dewatering operations to include locations of diversion, pump and discharge(s) as anticipated at time of design.	N/A	
z	All proposed temporary construction control measure details. Custom or other jurisdiction's details used must meet or exceed EPC standards.	X	
aa	Any offsite stormwater control measure proposed for use by the project and not under the direct control or ownership of the Owner or Operator.	N/A	





2880 International Circle, Suite 110  
 Colorado Springs, CO 80910  
 Phone 719-520-6300  
 Fax 719-520-6695  
 www.elpasoco.com

**EL PASO COUNTY PLANNING AND  
 COMMUNITY DEVELOPMENT  
 DEPARTMENT**

**GRADING AND EROSION CONTROL PLAN CHECKLIST**

Revised: July 2019

		Applicant	PCD
bb	Existing and proposed permanent storm water management facilities, including areas proposed for stormwater infiltration or subsurface detention.	<b>X</b>	
cc	Existing and proposed easements (permanent and construction) including required off site easements.	<b>X</b>	
dd	Retaining walls (not to be located in County ROW unless approved via license agreement). Design by P.E. and building permit from Regional Building Department required for walls greater than or equal to 4 feet in height, series of walls, or walls supporting a surcharge.	<b>N/A</b>	
ee	Plan certified by a Colorado Registered P.E., with EPC standard signature blocks for Engineer, Owner and EPC.	<b>X</b>	
ff	<p>Engineer's Statement (for standalone GEC Plan):            This Grading and Erosion Control Plan was prepared under my direction and supervision and is correct to the best of my knowledge and belief. Said Plan has been prepared according to the criteria established by the County for Grading and Erosion Control Plans. I accept responsibility for any liability caused by any negligent acts, errors or omissions on my part in preparing this plan.</p> <p>_____ Date _____            Engineer of Record Signature</p>	<b>X</b>	
gg	<p>Engineer's Statement (for GEC Plan within Construction Drawing set):            These detailed plans and specifications were prepared under my direction and supervision. Said plans and specifications have been prepared according to the criteria established by the County for detailed roadway, drainage, grading and erosion control plans and specifications, and said plans and specifications are in conformity with applicable master drainage plans and master transportation plans. Said plans and specifications meet the purposes for which the particular roadway and drainage facilities are designed and are correct to the best of my knowledge and belief. I accept responsibility for any liability caused by any negligent acts, errors or omissions on my part in preparation of these detailed plans and specifications.</p> <p>_____ Date _____            Engineer of Record Signature</p>		
hh	<p>Owner's Statement (for standalone GEC Plan):            I, the owner/developer have read and will comply with the requirements of the Grading and Erosion Control Plan.</p> <p>_____ Date _____            Owner Signature</p>	<b>X</b>	
ii	<p>Owner's Statement (for GEC Plan within Construction Drawing set):            I, the owner/developer have read and will comply with the requirements of the grading and erosion control plan and all of the requirements specified in these detailed plans and specifications.</p> <p>_____ Date _____            Owner Signature</p>		



2880 International Circle, Suite 110  
 Colorado Springs, CO 80910  
 Phone 719-520-6300  
 Fax 719-520-6695  
 www.elpasoco.com

**EL PASO COUNTY PLANNING AND  
 COMMUNITY DEVELOPMENT  
 DEPARTMENT**

**GRADING AND EROSION CONTROL PLAN CHECKLIST**

Revised: July 2019

		Applicant	PCD
jj	<p>El Paso County (standalone GEC Plan):            County plan review is provided only for general conformance with County Design Criteria. The County is not responsible for the accuracy and adequacy of the design, dimensions, and/ or elevations which shall be confirmed at the job site. The County through the approval of this document assumes no responsibility for completeness and/ or accuracy of this document.            Filed in accordance with the requirements of the El Paso County Land Development Code, Drainage Criteria Manual Volumes 1 and 2, and Engineering Criteria Manual, as amended.</p>		
	<p>In accordance with ECM Section 1.12, these construction documents will be valid for construction for a period of 2 years from the date signed by the El Paso County Engineer. If construction has not started within those 2 years, the plans will need to be resubmitted for approval, including payment of review fees at the Planning and Community Development Director's discretion.</p> <p>_____ Date</p> <p>County Engineer/ECM Administrator</p>		
<b>2. ADDITIONAL REPORTS/PERMITS/DOCUMENTS</b>			
a	Soils report / geotechnical investigation as appropriate for grading/utilities/drainage/road construction.		
b	Use Agreement/easement between the Owner or Operator and other third party for use of all offsite grading or stormwater control measures, used by the owner or operator but not under their direct control or ownership.		
c	Floodplain Development Permit		
d	USACE 404/wetlands permit/mitigation plan		
e	FEMA CLOMR		
f	State Engineer's permit/Notice Of Intent to Construct		
g	Stormwater Management Plan (SWMP)		
h	Financial Assurance Estimate (FAE) (signed)		
i	Erosion and Stormwater Quality Control Permit (ESQCP) (signed)		
j	Pre-Development Site Grading Acknowledgement and Right of Access Form (signed)		
k	Conditions of Approval met?		



2880 International Circle, Suite 110  
 Colorado Springs, CO 80910  
 Phone 719-520-6300  
 Fax 719-520-6695  
 www.elpasoco.com

**EL PASO COUNTY PLANNING AND  
 COMMUNITY DEVELOPMENT  
 DEPARTMENT**

**GRADING AND EROSION CONTROL PLAN CHECKLIST**

Revised: July 2019

		Applicant	PCD
<b>3. STANDARD NOTES FOR EL PASO COUNTY GRADING AND EROSION CONTROL PLANS</b>			
1	Stormwater discharges from construction sites shall not cause or threaten to cause pollution, contamination, or degradation of State Waters. All work and earth disturbance shall be done in a manner that minimizes pollution of any on-site or off-site waters, including wetlands.	X	
2	Notwithstanding anything depicted in these plans in words or graphic representation, all design and construction related to roads, storm drainage and erosion control shall conform to the standards and requirements of the most recent version of the relevant adopted El Paso County standards, including the Land Development Code, the Engineering Criteria Manual, the Drainage Criteria Manual, and the Drainage Criteria Manual Volume 2. Any deviations from regulations and standards must be requested, and approved, in writing.	X	
3	A separate Stormwater Management Plan (SMWP) for this project shall be completed and an Erosion and Stormwater Quality Control Permit (ESQCP) issued prior to commencing construction. Management of the SWMP during construction is the responsibility of the designated Qualified Stormwater Manager or Certified Erosion Control Inspector. The SWMP shall be located on site at all times during construction and shall be kept up to date with work progress and changes in the field.	X	
4	Once the ESQCP is approved and a "Notice to Proceed" has been issued, the contractor may install the initial stage erosion and sediment control measures as indicated on the approved GEC. A Preconstruction Meeting between the contractor, engineer, and El Paso County will be held prior to any construction. It is the responsibility of the applicant to coordinate the meeting time and place with County staff.	X	
5	Control measures must be installed prior to commencement of activities that could contribute pollutants to stormwater. control measures for all slopes, channels, ditches, and disturbed land areas shall be installed immediately upon completion of the disturbance.	X	
6	All temporary sediment and erosion control measures shall be maintained and remain in effective operating condition until permanent soil erosion control measures are implemented and final stabilization is established. All persons engaged in land disturbance activities shall assess the adequacy of control measures at the site and identify if changes to those control measures are needed to ensure the continued effective performance of the control measures. All changes to temporary sediment and erosion control measures must be incorporated into the Stormwater Management Plan.	X	
7	Temporary stabilization shall be implemented on disturbed areas and stockpiles where ground disturbing construction activity has permanently ceased or temporarily ceased for longer than 14 days.	X	
8	Final stabilization must be implemented at all applicable construction sites. Final stabilization is achieved when all ground disturbing activities are complete and all disturbed areas either have a uniform vegetative cover with individual plant density of 70 percent of pre-disturbance levels established or equivalent permanent alternative stabilization method is implemented. All temporary sediment and erosion control measures shall be removed upon final stabilization and before permit closure.	X	
9	All permanent stormwater management facilities shall be installed as designed in the approved plans. Any proposed changes that effect the design or function of permanent stormwater management structures must be approved by the ECM Administrator prior to implementation.	X	
10	Earth disturbances shall be conducted in such a manner so as to effectively minimize accelerated soil erosion and resulting sedimentation. All disturbances shall be designed, constructed, and completed so that the exposed area of any disturbed land shall be limited to the shortest practical period of time. Pre-existing vegetation shall be protected and maintained within 50 horizontal feet of a waters of the state unless shown to be infeasible and specifically requested and approved.	X	



2880 International Circle, Suite 110  
 Colorado Springs, CO 80910  
 Phone 719-520-6300  
 Fax 719-520-6695  
 www.elpasoco.com

**EL PASO COUNTY PLANNING AND  
 COMMUNITY DEVELOPMENT  
 DEPARTMENT**

**GRADING AND EROSION CONTROL PLAN CHECKLIST**

Revised: July 2019

		Applicant	PCD
11	Compaction of soil must be prevented in areas designated for infiltration control measures or where final stabilization will be achieved by vegetative cover. Areas designated for infiltration control measures shall also be protected from sedimentation during construction until final stabilization is achieved. If compaction prevention is not feasible due to site constraints, all areas designated for infiltration and vegetation control measures must be loosened prior to installation of the control measure(s).	X	
12	Any temporary or permanent facility designed and constructed for the conveyance of stormwater around, through, or from the earth disturbance area shall be a stabilized conveyance designed to minimize erosion and the discharge of sediment off site.	X	
13	Concrete wash water shall be contained and disposed of in accordance with the SWMP. No wash water shall be discharged to or allowed to enter State Waters, including any surface or subsurface storm drainage system or facilities. Concrete washouts shall not be located in an area where shallow groundwater may be present, or within 50 feet of a surface water body, creek or stream.	X	
14	During dewatering operations of uncontaminated ground water may be discharged on site, but shall not leave the site in the form of surface runoff unless an approved State dewatering permit is in place.	X	
15	Erosion control blanketing or other protective covering shall be used on slopes steeper than 3:1.	X	
16	Contractor shall be responsible for the removal of all wastes from the construction site for disposal in accordance with local and State regulatory requirements. No construction debris, tree slash, building material wastes or unused building materials shall be buried, dumped, or discharged at the site.	X	
17	Waste materials shall not be temporarily placed or stored in the street, alley, or other public way, unless in accordance with an approved Traffic Control Plan. control measures may be required by El Paso County Engineering if deemed necessary, based on specific conditions and circumstances.	X	
18	Tracking of soils and construction debris off-site shall be minimized. Materials tracked off-site shall be cleaned up and properly disposed of immediately.	X	
19	The owner/developer shall be responsible for the removal of all construction debris, dirt, trash, rock, sediment, soil, and sand that may accumulate in roads, storm drains and other drainage conveyance systems and stormwater appurtenances as a result of site development.	X	
20	The quantity of materials stored on the project site shall be limited, as much as practical, to that quantity required to perform the work in an orderly sequence. All materials stored on-site shall be stored in a neat, orderly manner, in their original containers, with original manufacturer's labels.	X	
21	No chemical(s) having the potential to be released in stormwater are to be stored or used onsite unless permission for the use of such chemical(s) is granted in writing by the ECM Administrator. In granting approval for the use of such chemical(s), special conditions and monitoring may be required.	X	
22	Bulk storage of allowed petroleum products or other allowed liquid chemicals in excess of 55 gallons shall require adequate secondary containment protection to contain all spills onsite and to prevent any spilled materials from entering State Waters, any surface or subsurface storm drainage system or other facilities.	X	
23	No person shall cause the impediment of stormwater flow in the curb and gutter or ditch except with approved sediment control measures.	X	



2880 International Circle, Suite 110  
 Colorado Springs, CO 80910  
 Phone 719-520-6300  
 Fax 719-520-6695  
 www.elpasoco.com

**EL PASO COUNTY PLANNING AND  
 COMMUNITY DEVELOPMENT  
 DEPARTMENT**

**GRADING AND EROSION CONTROL PLAN CHECKLIST**

Revised: July 2019

		Applicant	PCD
24	Owner/developer and their agents shall comply with the "Colorado Water Quality Control Act" (Title 25, Article 8, CRS), and the "Clean Water Act" (33 USC 1344), in addition to the requirements of the Land Development Code, DCM Volume II and the ECM Appendix I. All appropriate permits must be obtained by the contractor prior to construction (1041, NPDES, Floodplain, 404, fugitive dust, etc.). In the event of conflicts between these requirements and other laws, rules, or regulations of other Federal, State, local, or County agencies, the most restrictive laws, rules, or regulations shall apply.	X	
25	All construction traffic must enter/exit the site only at approved construction access points.	X	
26	Prior to construction the permittee shall verify the location of existing utilities.	X	
27	A water source shall be available on site during earthwork operations and shall be utilized as required to minimize dust from earthwork equipment and wind.	X	
28	The soils report for this site has been prepared by _____ and shall be considered a part of these plans.	X	
29	At least ten (10) days prior to the anticipated start of construction, for projects that will disturb one (1) acre or more, the owner or operator of construction activity shall submit a permit application for stormwater discharge to the Colorado Department of Public Health and Environment, Water Quality Division. The application contains certification of completion of a stormwater management plan (SWMP), of which this Grading and Erosion Control Plan may be a part. For information or application materials contact:  Colorado Department of Public Health and Environment Water Quality Control Division WQCD – Permits 4300 Cherry Creek Drive South Denver, CO 80246-1530 Attn: Permits Unit	X	
a	FEMA 100-yr floodplain. - JR RESPONSE: NO FLOODPLAIN WITHIN VICINITY OF SITE.  Offsite grading clearly shown and called out. - JR RESPONSE: NO OFFSITE GRADING PROPOSED  Dewatering operations to include locations of diversion, pump and discharge(s) as anticipated at time of design. - JR RESPONSE: NO DEWATERING OPERATIONS ANTICIPATED ON SITE.		
b	Any offsite stormwater control measure proposed for use by the project and not under the direct control or ownership of the Owner or Operator. - JR RESPONSE: NO UTILIZATION OF OFFSITE STORMWATER CONTROL MEASURES.  Retaining walls (not to be located in County ROW unless approved via license agreement). Design by P.E. and building permit from Regional Building Department required for walls greater than or equal to 4 feet in height, series of walls, or walls supporting a surcharge. - JR RESPONSE: NO RETAINING WALLS PROPOSED.		
c			



2880 International Circle, Suite 110  
 Colorado Springs, CO 80910  
 Phone 719-520-6300  
 Fax 719-520-6695  
 www.elpasoco.com

**EL PASO COUNTY PLANNING AND  
 COMMUNITY DEVELOPMENT  
 DEPARTMENT**

**GRADING AND EROSION CONTROL PLAN CHECKLIST**

Revised: July 2019

		Applicant	PCD
<b>5. Checklist Review Certifications:</b>			
a	<p>Engineer of Record:            The Grading and Erosion Control Plan was prepared under my direction and supervision and is complete and correct to the best of my knowledge and belief. Said Plan has been prepared according to the criteria established by the County for Grading and Erosion Control Plans.</p> <p>_____ Date _____</p> <p>Engineer of Record Signature</p>	<b>X</b>	
b	<p>Review Engineer:            The Grading and Erosion Control Plan was reviewed and found to meet the checklist requirements except where otherwise noted or allowed by an approved deviation request.</p> <p>_____ Date _____</p> <p>Review Engineer</p>		