

# Drainage Report

17115 GOSHAWK ROAD  
COLORADO SPRINGS, CO 80908  
EL PASO COUNTY

PREPARED FOR: MR. ARVIN LOUDERMILK  
17115 GOSHAWK ROAD  
COLORADO SPRINGS, CO 80908

January 17, 2019

Prepared by  
**Richard Lyon, P.E.**  
Rocky Mountain Group  
2910 Austin Bluffs Parkway | Colorado Springs, CO 80918



Engineering Documents  
Reviewed By:  
*Daniel Torres*  
*danieltorres@elpasoco.com*  
EPC Planning & Community  
Development Department

Add PCD File No. MS192

Drainage Report Statements

**1. Engineer's Statement:**

This report and plan for the preliminary drainage design of the Loudermilk Minor Subdivision was prepared by me (or under my direct supervision) in accordance with the provisions of El Paso County Drainage Design and Technical Criteria for the owners thereof. I understand that El Paso County does not and will not assume liability for drainage facilities designed by other :

*[Handwritten Signature]*

53921

Richard D. Lyon

Colorado P.E. No.



**2. Developer's Statement:**

I, the developer have read and will comply with all of the requirements specified in this drainage report and plan.

LOUDERMILK LIVING TRUST

Business Name

By: ARVIN LOUDERMILK

Title: TRUSTEE

Address: 17115 E. GOSHAWK RD

80908

*[Handwritten Signature]*

**3. EL PASO COUNTY:**

Filed in accordance with the requirements of the Drainage Criteria Manual, Volumes 1 and 2, El Paso County Engineering Criteria Manual and Land Development Code as amended.

---

Jennifer Irvine, P.E.  
County Engineer / ECM Administrator

---

Date

Conditions:

## Table of Contents

I.	General Location and Description .....	1
A.	Location .....	1
B.	Description of Property .....	1
II.	Existing and Proposed Drainage Basins and Subbasins .....	2
A.	Major Basin Description .....	2
B.	Existing Subbasin Descriptions .....	2
C.	Proposed Subbasin Descriptions .....	3
III.	Drainage Design Criteria .....	4
A.	Development Criteria Reference .....	4
B.	Hydrologic Criteria .....	5
IV.	Drainage Facility Design .....	6
A.	General Concept .....	6
B.	Specific Details .....	6
V.	Drawings .....	7
A.	General Location Map .....	7
B.	Drainage Plan .....	7

## Appendices

Appendix A – General Location Map, Assessor Maps, Survey/Plat Maps

Appendix B –FEMA Floodplain Map

Appendix C – USDA Soils Map

Appendix D – Drainage Plan Exhibits including Elevations Exhibit, Existing Subbasins, and Proposed Subbasins

Appendix E – Hydrologic and Hydraulic Calculations

## **I. General Location and Description**

### **A. Location**

The project addresses of 17115 Goshawk Road East and 0 Goshawk Road East are located in Colorado Springs in El Paso County, Colorado. The township, range, and section code is S23 T11S R65W includes the two parcels owned by Loudermilk Living Trust and are schedule numbers 5123000014 and 5123000013, as shown in Appendix A. The parcels are approximately a half of a mile north of Hodgen Road, 1.25 miles west of North Meridian Road, and within 3.5 miles of the northern county border. The parcels are a quarter of a mile northwest of the West Kiowa Creek and are divided at an easement for overhead electric lines running north and south. Drainage and utilities easements are shown on the survey plat provided in the Appendix A. The property and the subdivisions in the vicinity flow to the Kiowa Creek watershed and are nearest the Kiowa Creek Watershed 1-N-10 Reservoir. The nearby platted developments include sections of Sec. 23-11-65 and Meridian Ranch to the east.

### **B. Description of Property**

The properties are approximately 19.87 acres with 17115 Goshawk Road East accounting for 15.96 acres and 0 Goshawk Road East accounting for 4.04 acres. The vast majority of the parcels consist of vegetation, shrubbery, and fields. Existing development currently consists of a single family residence with various detached structures including a garage, two sheds, and a pool building currently under construction at 17115 Goshawk Road East. There is no existing or proposed development on the east parcel. A vicinity map, survey maps with the legal description of the parcel and topography is provided in Appendix A.

The developed property contains an existing 990 lineal foot gravel driveway from Goshawk Road East which terminates to the existing shed. The existing structures and their approximate roof areas are as follows: single family residence of 4,445 square feet; pool building additions of 2,612 square feet; detached garage of 1,632 square feet; shed 1 of 1,618 square feet; shed 2 of 584 square feet; and a barn of 2,024 square feet.

The Owners plan to build a single-family residence following the subdivision of the west parcel into a separate lot. As such, a minor subdivision is required by El Paso County prior to obtaining a building permit.

The general ground cover consists of tall grasses and weeds with landscaping around the existing single family residence. Deciduous trees and vegetation are denser near the western portion of the property. The general topography consists of natural flat areas nearing 1 percent slope to areas of drainage ways at 25 percent slopes from north to south. Field areas make up about two-thirds of the parcel and are generally within 10 percent slope. The other third of the parcel consists of sloped landscape to depressions that convey storm water to the West Kiowa Creek and are generally sloped from 10 to 25 percent. The overall elevation difference from the highest point in the northwest corner of the property to the lowest point about 400 feet east of the southwest property corner is about 36 feet.

The soil conditions are described in a Geology and Soils Report prepared by RMG-Rocky Mountain Group and are described as well-draining to high-draining sandy loam soils. Additionally, a USDA soil survey map is provided in Appendix C for reference.

The properties consists of some major drainage ways that ultimately drain to the West Kiowa Creek drainage way. The on-site major drainage ways consist of elevation depressions that flow from north to south. The existing development contains a gravel roadway that crosses through a drainage way and a stand pipe connected to a culvert pipe is currently installed for conveyance. A culvert pipe is proposed to replace the stand pipe for the proposed minor subdivision. There are no known irrigation facilities or utilities and other encumbrances in respect to drainage patterns on the site.

Further sections will refer to the two parcels as a combined 19.87 acre property as it was analyzed in engineering exhibits and calculations.

## II. Existing and Proposed Drainage Basins and Subbasins

### A. Major Basin Description

The parcel falls within the southeast region of FEMA Floodplain Map Number 08041C0310G dated December 7, 2018 showing a designation of Zone X, an area of minimal flood hazard. The map is provided in Appendix B. The major basin that the parcel falls within sheet flows from the north to the south to the West Kiowa Creek drainage way. There are no identified nearby irrigation facilities or other obstruction which could influence or be included by the local drainage.

### B. Existing Subbasin Descriptions

The existing subbasins are delineated according to major drainage ways as determined by the natural topography of the land and any drainage infrastructure. The Loudermilk parcel plus the additional 4.04 acre parcel to the east (schedule no. 5123000013) was delineated into five subbasins and are described as follows:

**Subbasin EX-1** is the 5.87 acre subbasin consisting of the area north of the gravel roadway to the existing single-family residence that flows into the existing stand pipe and culvert under the gravel roadway. The subbasin contains impervious area due to existing gravel roadways, a single-family residence with addition, and various hardscape and detached buildings. The vast majority of the subbasin consists of tall grasses and weeds with dense deciduous trees and vegetation. This subbasin ultimately flows to the West Kiowa Creek and is added to Subbasin EX-2 for a final point of concentration at the southern property line.

**Subbasin EX-2** is the 4.78 acre subbasin that consists of the west side of the parcel, the outlet of the standpipe and outlet drainage infrastructure, and the south side of the gravel roadway.

Sub-basin EX-1

As with most of the property, the vast majority of this subbasin consists of tall grasses and weeds. This sub-basin, in combination with Subbasin EX-2, provides a storm water volume within a drainage way to the south of the property which ultimately reaches the West Kiowa Creek.

**Subbasin EX-3** is the 3.85 acre subbasin consisting of some detached structures and gravel roadway. The subbasin flows south through a drainage way in the form of an elevation depression that ultimately flows to the West Kiowa Creek. The survey limits do not show if this delineation meets with Subbasins EX-1 and EX-2 and so it was delineated as its own subbasin.

**Subbasin EX-4** is the 3.47 acre subbasin that consists entirely of tall grasses and weeds that flows to the southeast property corner. This major drainage way includes part of the 4.04 acre parcel also owned by the Loudermilk Living Trust to the east. The subbasin ultimately flows to the West Kiowa Creek.

Please fix typo

**Subbasin EX-5** is the 1.83 acre subbasin to the northeast of the property which includes the 4.04 acre parcel also owned by the Loudermilk Living Trust. The drainage way flows south east to the West Kiowa Creek. The survey limits do not show if this delineation meets with Subbasin EX-4 and so it was delineated as its own subbasin.

Include discussion of offsite flow entering the subbasins.

### C. Proposed Subbasin Descriptions

The proposed subbasins are within the proposed minor subdivision parcel as well as the existing property limits and are delineated according to major drainage ways as determined by the natural topography of the land and any drainage infrastructure. The post-development conditions are shown with the new minor subdivision parcel lines and the subbasins are delineated for proposed conditions. The rest of the parcel is delineated accordingly.

**Development Subbasin 1** is the 1.36 acre subbasin consisting of the northwest corner of the new minor subdivision parcel that flows south to Subbasin EX-2. Sheet flow will go over the driveway and an culvert will be installed at Goshawk Road. The flow ultimately goes to the West Kiowa Creek.

Please indicate the size and type of all culverts and identify them on the drainage plan.

**Development Subbasin 2** is the 3.75 acre subbasin consisting of the proposed house with a concrete driveway turnaround and a gravel driveway. The proposed single-family home will require an on-site wastewater treatment system and grading will be proposed via a grading and drainage plan to convey flow to the drainage way consistent with Subbasin EX-1 which flows to a new culvert pipe under the existing gravel driveway to the existing single-family residence. As with all drainage ways within the minor subdivision parcels, the flow ultimately goes to the West Kiowa Creek.

**Subbasin EX-1** is reduced to a 3.42 acre subbasin in order to delineate between the subdivide dparcels. The flow patterns remain the same as historical conditions.

**Subbasin EX-2** is reduced to a 2.17 acre subbasin in order to delineate between the subdivided parcels. The flow pattern remains the same as historical conditions.

**Subbasin EX-3** is slightly reduced a to 3.81 acre subbasin in order to delineate between the subdivided parcels with some of the development basin delineated to include some of the northern portion. The flow pattern remains the same as historical conditions.

**Subbasin EX-4** is the 3.47 acre subbasin that consists entirely of tall grasses and weeds that flows to the southeast property corner. This major drainage way includes part of the 4.04 acre parcel also owned by the Loudermilk Living Trust to the east. The subbasin ultimately flows to the West Kiowa Creek.

**Subbasin EX-5** is the 1.83 acre subbasin to the northeast of the property which includes the 4.04 acre parcel also owned by the Loudermilk Living Trust. The drainage way flows south east to the West Kiowa Creek. The survey limits do the show if this delineation meets with Subbasin EX-4 and so it was delineated as its own subbasin.

Offsite drainage patterns upstream are not expected to adversely affect development on the new minor subdivision parcel. Engineered grading plans can properly convey the upstream flow away from the building structure and septic area to the historic point of concentration as needed. Downstream drainage patterns will be not changed due to development within the new minor subdivision parcel.

### **III. Drainage Design Criteria**

#### **A. Development Criteria Reference**

Colorado Urban Drainage and Flood Control District Drainage Criteria Manual, Volume I (January 2016)

Colorado Urban Drainage and Flood Control District Drainage Criteria Manual, Volume III (April 2018)

Urban Storm Drainage Criteria Manual, Volume III (November, 2015)

No previous PDR, DBPSs, or master plan drainage reports/studies have been developed for this area. As such, a drainage study in the format of a Preliminary and Final Drainage Report is presented for the application of a minor subdivision in order to demonstrate the hydrological and hydraulic conditions for the existing and post-development conditions within the subdivision.



## B. Hydrologic Criteria

The design rainfall is according to NOAA Rainfall Data provided in Appendix E. The data for the one-hour rainfall depths were used for inputs in the UD-Rational Method calculator for storms 2 through 500. The rational method tabulations and any drainage infrastructure calculations are provided in Appendix E.

The flows in cubic feet per second (cfs) for a 5-year, 10-year, and 100-year storm event per subbasin and design points are summarized in the following table for the existing and post-development conditions:

### Existing Conditions Flows

Subbasin Name	5-Year	10-Year	100-Year
EX-1	0.32	0.44	3.92
EX-2	0.17	0.23	2.87
DP1: EX-1 + EX-2	0.49	0.67	6.79
EX-3	0.18	0.26	2.53
EX-4	0.04	0.06	1.76
EX-5	0.02	0.03	0.97

The total storm water flow from the parcel to the West Kiowa Creek watershed is 0.73 cfs for a 5-year storm event, 1.02 cfs for a 10-year storm event, and 12.05 cfs for a 100-year storm event.

### Post-Developed Conditions Flows

Subbasin Name	5-Year	10-Year	100-Year
DV-1	0.09	0.12	1.07
DV-2	0.24	0.33	2.70
EX-1	0.38	0.51	2.35
DP1: DV-1 + EX-1 (culvert inlet)	0.33	0.63	3.42

EX-2	0.12	0.17	2.11
DP2: DV-1 + DV-2 + EX-1 + EX-2	0.83	1.13	8.23
EX-3	0.18	0.25	2.50
EX-4	0.04	0.06	1.76
EX-5	0.02	0.03	0.97

The total storm water flow from the parcel to the West Kiowa Creek watershed is 1.07 cfs for a 5-year storm event, 1.47 cfs for a 10-year storm event, and 13.46 cfs for a 100-year storm event. These are increases of 0.34 cfs for a 5-year storm event, 0.45 cfs for a 10-year storm event, and 1.41 cfs for a 100-year storm event. These are very minimal increases in storm flow to the West Kiowa Creek watershed. The greatest point of interest is the inlet of the proposed culvert pipe that crosses the existing gravel road and ensuring that the culvert pipe is sized properly for the post-development conditions (DP1).

Please incorporate offsite flow in your analysis

Please indicate the size and type on the drainage plan

#### IV. Drainage Facility Design

##### A. General Concept

The general concept of the drainage across this parcel and within the drainage basin as a whole is to convey storm water sheet flow to the south and southeast to the West Kiowa Creek. The proposed minor subdivision will remain consistent with historical drainage patterns by implementing properly sized culvert pipes and eliminating channelized storm water flow via **level spreaders**. The proposed development will also reduce erosion and sediment runoff by implementing energy dissipation at the outlet of channelized storm flow outlets via **rip-rap** and improve infiltration via plantings and landscaping of the proposed development.

##### B. Specific Details

The hydrologic and hydraulic details are provided in the previous section. The post-development flow increase is 1.41 cfs for a 100-year storm event which is a minimal increase to the downstream properties and watershed. As stated previously, the proposed culvert pipe to replace the stand pipe and daylighted pipe under the existing gravel driveway will be analyzed to prevent standing water at the point of concentration or inlet of the culvert pipe. Rip-rap for energy dissipation and a level spreader will be designed at the outlet to eliminate channelized flow.

The proposed single-family residence will require grading and drainage plan(s) to show sheet flow from upstream areas away from structure foundations, away from the septic field, and to continue the historical drainage pattern to the proposed culvert pipe.

The proposed plan will not require any regular maintenance. It is recommended that the owner(s) inspect their respective culvert pipes to clear debris once a year and after major rainfall events such as 100-year storms or greater. Observing any soil settling that may alter the flowline grade of culvert pipes is also recommended to prevent backflow conditions.

## **V. Drawings**

### **A. General Location Map**

See Appendix A.

### **B. Drainage Plan**

See Attached Exhibits in Appendix D.

Please include an evaluation of the four-step process per ECM section I.7.2. Indicate why water quality capture volume (step 3 of process) is not required for this development.

**Appendix A – General Location Map, Assessor Maps,  
and Survey & Plat Maps**



17115 Goshawk Rd

Vicinity Map

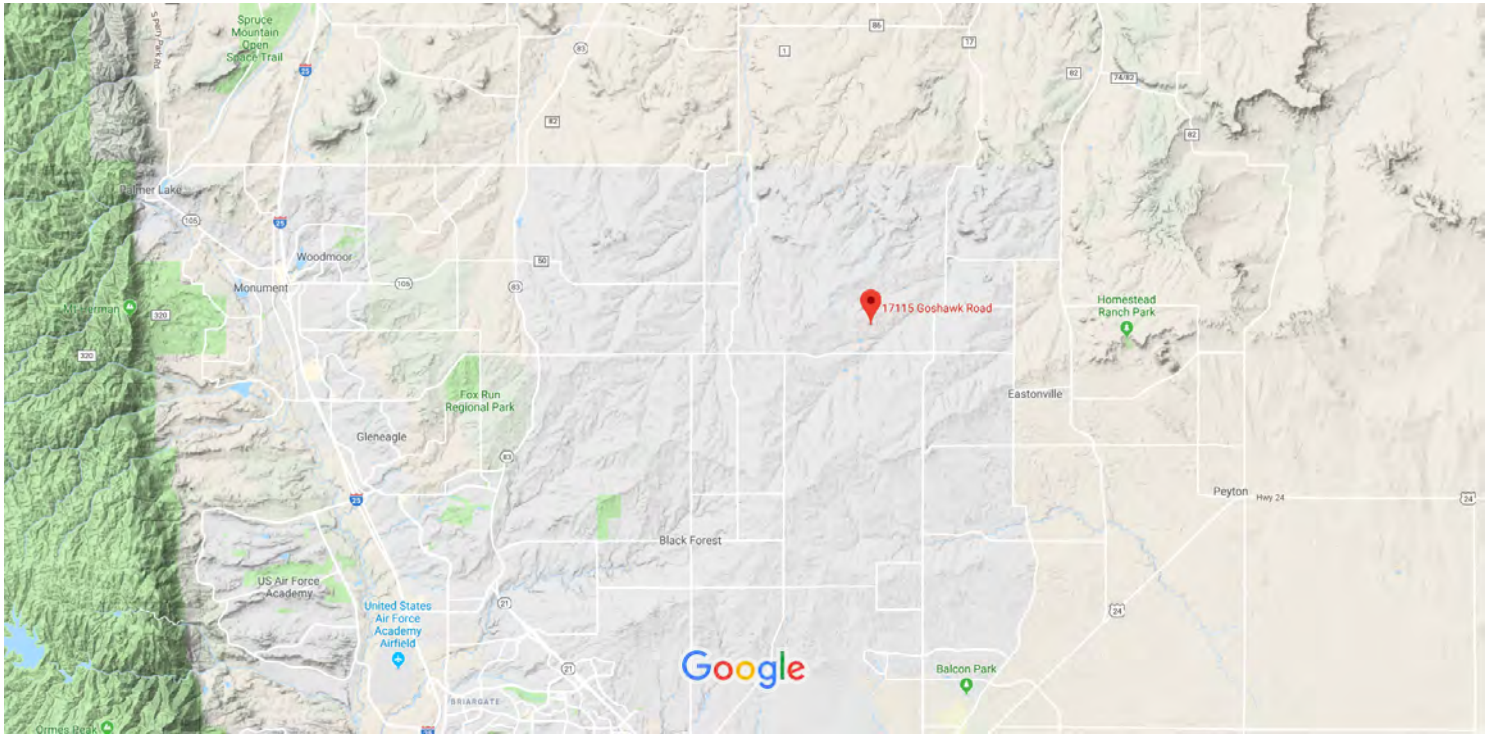

Map data ©2019 Google 2 mi



17115 Goshawk Rd

Colorado Springs, CO 80908



You visited 2 months ago



39HC+QH Black Forest, Colorado

# El Paso County Assessor's Office

**17115 GOSHAWK RD E**

SCHEDULE: 5123000014

OWNER: LOUDERMILK LIVING TRUST

COPYRIGHT 2010 by the Board of County Commissioners, El Paso County, Colorado. All rights reserved. No part of this document or data contained hereon may be reproduced; used to prepare derivative products; or distributed without the specific written approval of the Board of County Commissioner, El Paso County, Colorado. This document was prepared from the best data available at the time of plotting and is for internal use only. El Paso County, Colorado, makes no claim as to the completeness or accuracy of the data contained hereon.

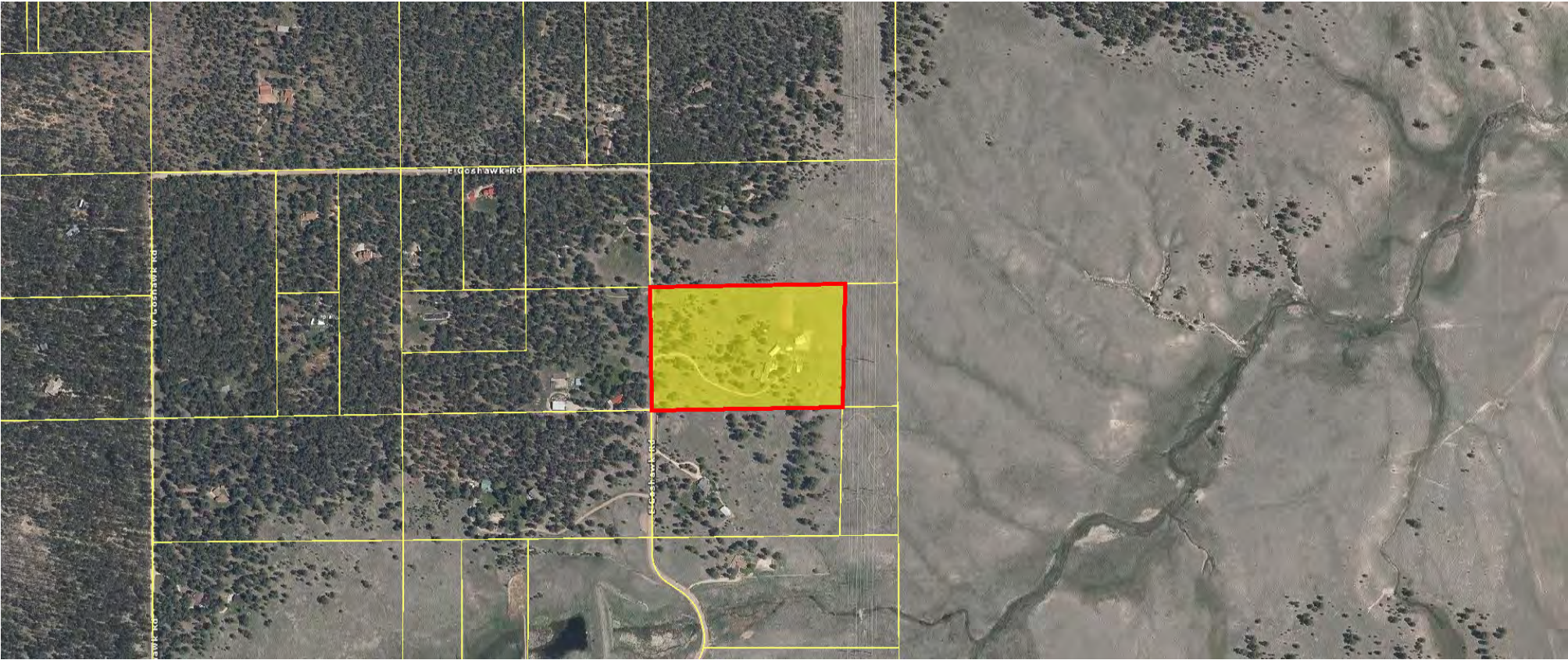

# El Paso County Assessor's Office

**0 GOSHAWK RD E**

SCHEDULE: 5123000013

OWNER: LOUDERMILK LIVING TRUST

COPYRIGHT 2010 by the Board of County Commissioners, El Paso County, Colorado. All rights reserved. No part of this document or data contained hereon may be reproduced; used to prepare derivative products; or distributed without the specific written approval of the Board of County Commissioner, El Paso County, Colorado. This document was prepared from the best data available at the time of plotting and is for internal use only. El Paso County, Colorado, makes no claim as to the completeness or accuracy of the data contained hereon.



# LOUDERMILK SUBDIVISION FILING NO. 1

IN THE NORTHEAST QUARTER OF SECTION 23, T11S, R65W, 6th P.M.  
EL PASO COUNTY, COLORADO

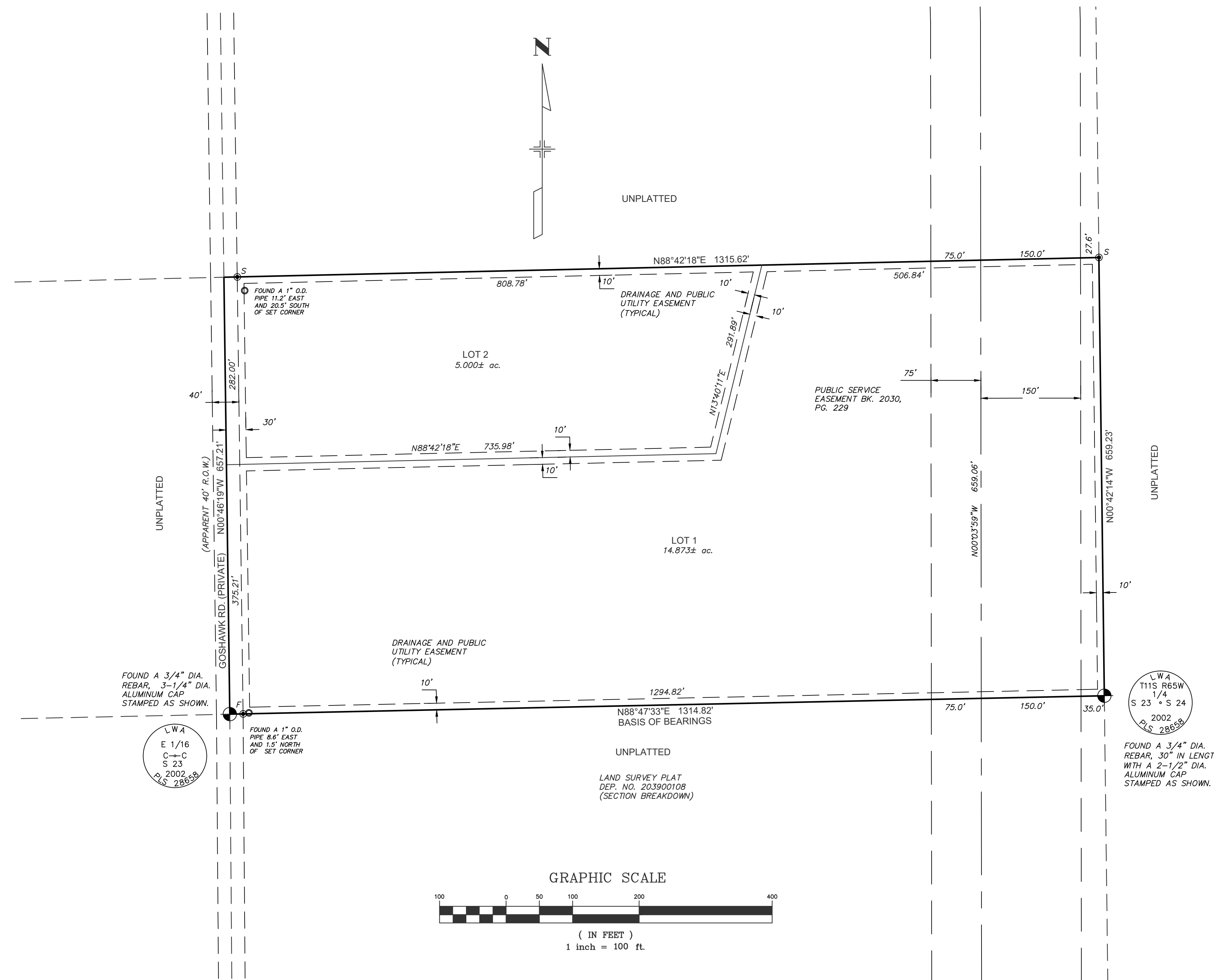

**BE IT KNOWN BY THESE PRESENTS:**

THE LOUDERMILK LIVING TRUST, \_\_\_\_\_, MANAGER, IS THE OWNER OF THE FOLLOWING DESCRIBED TRACT OF LAND, TO WIT:

THE SOUTH HALF OF THE SOUTHEAST QUARTER OF THE NORTHEAST QUARTER SECTION 23, TOWNSHIP 11 SOUTH, RANGE 65 WEST OF THE 6th PM., EL PASO COUNTY, COLORADO.

CONTAINING 19.873 ACRES, MORE OR LESS.

**EASEMENTS:**

SIDE AND REAR LOT LINES ARE HEREBY PLATTED WITH A TEN (10) FOOT EASEMENT FOR DRAINAGE AND PUBLIC UTILITIES ONLY; THE FRONT LOT LINES ARE HEREBY PLATTED WITH A THIRTY (30) FOOT EASEMENT FOR DRAINAGE AND PUBLIC UTILITIES ONLY, WITH THE SOLE RESPONSIBILITY FOR MAINTENANCE BEING VESTED WITH THE PROPERTY OWNERS.

**OWNERS CERTIFICATE:**

THE LOUDERMILK LIVING TRUST, \_\_\_\_\_, MANAGER, BEING THE OWNER, MORTGAGEES, BENEFICIARIES OF DEEDS OF TRUST AND HOLDERS OF OTHER INTERESTS IN THE LAND DESCRIBED HEREIN, HAVE LAID OUT, SUBDIVIDED AND PLATTED SAID LANDS INTO LOTS AND EASEMENTS AS SHOWN HEREON UNDER THE NAME AND SUBDIVISION OF LOUDERMILK SUBDIVISION FILING NO. 1. ALL PUBLIC IMPROVEMENTS SO PLATTED ARE HEREBY DEDICATED TO PUBLIC USE AND SAID OWNER DOES HEREBY COVENANT AND AGREE THAT THE PUBLIC IMPROVEMENTS WILL BE CONSTRUCTED TO EL PASO COUNTY STANDARDS AND THAT PROPER DRAINAGE AND EROSION CONTROL FOR THE SAME WILL BE PROVIDED AT SAID OWNER'S EXPENSE, ALL TO THE SATISFACTION OF THE BOARD OF COUNTY COMMISSIONERS OF EL PASO COUNTY, COLORADO. UPON ACCEPTANCE BY RESOLUTION, ALL PUBLIC IMPROVEMENTS SO DEDICATED WILL BECOME MATTERS OF MAINTENANCE BY EL PASO COUNTY, COLORADO. THE UTILITY EASEMENTS SHOWN HEREON ARE HEREBY DEDICATED FOR PUBLIC UTILITIES, COMMUNICATION SYSTEMS AND OTHER PURPOSES AS SHOWN HEREON. THE ENTITIES RESPONSIBLE FOR PROVIDING THE SERVICES FOR WHICH THE EASEMENTS ARE ESTABLISHED ARE HEREBY GRANTED THE PERPETUAL RIGHT OF INGRESS AND EGRESS FROM AND TO ADJACENT PROPERTIES FOR INSTALLATION, MAINTENANCE AND REPLACEMENT OF UTILITY LINES AND RELATED FACILITIES.

**IN WITNESS WHEREOF:**

THE AFOREMENTIONED THE LOUDERMILK LIVING TRUST, \_\_\_\_\_, MANAGER, HAS EXECUTED THIS INSTRUMENT THIS \_\_\_\_\_ DAY OF \_\_\_\_\_, 2019.

THE LOUDERMILK LIVING TRUST  
\_\_\_\_\_, MANAGER

**NOTARIAL:**

STATE OF COLORADO)  
COUNTY OF EL PASO) SS

THE FOREGOING INSTRUMENT WAS ACKNOWLEDGED BEFORE ME THIS \_\_\_\_\_ DAY OF \_\_\_\_\_, 2019 BY \_\_\_\_\_, MANAGER  
THE LOUDERMILK LIVING TRUST

MY COMMISSION EXPIRES: \_\_\_\_\_ NOTARY PUBLIC

**BOARD OF COUNTY COMMISSIONERS CERTIFICATE:**

THIS PLAT FOR LOUDERMILK SUBDIVISION FILING NO. 1 WAS APPROVED FOR FILING BY THE EL PASO COUNTY, COLORADO BOARD OF COUNTY COMMISSIONERS ON THIS \_\_\_\_\_ DAY OF \_\_\_\_\_, 2019, SUBJECT TO ANY NOTES SPECIFIED HEREON AND ANY CONDITIONS INCLUDED IN THE RESOLUTION OF APPROVAL. THE DEDICATIONS OF LAND TO THE PUBLIC, STREETS, TRACTS AND EASEMENTS ARE ACCEPTED, BUT PUBLIC IMPROVEMENTS THEREON WILL NOT BECOME THE MAINTENANCE RESPONSIBILITY OF EL PASO COUNTY UNTIL PRELIMINARY ACCEPTANCE OF THE PUBLIC IMPROVEMENTS IN ACCORDANCE WITH THE REQUIREMENTS OF THE LAND DEVELOPMENT CODE AND ENGINEERING CRITERIA MANUAL, AND THE SUBDIVISION IMPROVEMENTS AGREEMENT.

PRESIDENT, BOARD OF COUNTY COMMISSIONERS DATE

DIRECTOR, COUNTY PLANNING AND COMMUNITY DEVELOPMENT DATE

COUNTY ASSESSOR DATE

**NOTES:**

THE PROPERTY IS SUBJECT TO AN APPARENT TWENTY (20) FOOT RIGHT OF WAY FOR GOSHAWK ROAD. THE ROAD IS POSTED AS PRIVATE AND MAINTENANCE IS THE RESPONSIBILITY OF THE HOMEOWNERS ASSOCIATION.

THE BASIS OF BEARINGS FOR THIS SURVEY IS THE SOUTH LINE OF THE SOUTHEAST QUARTER OF THE NORTHEAST QUARTER OF SECTION 23, N88°47'33"E - 1314.82'. THE DIRECTION IS BASED ON THE LAND SURVEY PLAT BY LEIGH WHITEHEAD AND ASSOCIATES, 7/2/2003, DEPOSIT NUMBER 203900108, AND THE LINE IS MONUMENTED AS SHOWN.

UNITS OF MEASURE ARE U.S. SURVEY FEET

● FOUND ALIQUOT CORNER AS NOTED

○ FOUND MONUMENT AS NOTED

⊙ FOUND / SET A 5/8" DIAMETER REBAR, 18" IN LENGTH, WITH A 1-1/2" DIAMETER ALUMINUM CAP "LWA PLS 28658"

RESEARCH FOR RECORDED RIGHTS OF WAY AND EASEMENTS WAS DONE BY \_\_\_\_\_

THIS SURVEY DOES NOT CONSTITUTE A TITLE SEARCH BY LWA LAND SURVEYING, INC. OR KEVIN M. O'LEARY.

**SURVEYOR'S CERTIFICATION:**

I, KEVIN M. O'LEARY, A DULY REGISTERED PROFESSIONAL LAND SURVEYOR IN THE STATE OF COLORADO, DO HEREBY CERTIFY THAT THIS PLAT TRULY AND CORRECTLY REPRESENTS THE RESULTS OF A SURVEY MADE ON THE DATE OF THE SURVEY BY ME OR UNDER MY DIRECT SUPERVISION AND THAT ALL MONUMENTS EXIST AS SHOWN HEREON; THAT MATHEMATICAL CLOSURE ERRORS ARE LESS THAN 1:10,000; AND THAT SAID PLAT HAS BEEN PREPARED IN FULL COMPLIANCE WITH ALL APPLICABLE LAWS OF THE STATE OF COLORADO DEALING WITH MONUMENTS, SUBDIVISION, OR SURVEYING OF LAND AND ALL APPLICABLE PROVISIONS OF THE EL PASO COUNTY LAND DEVELOPMENT CODE.

I ATTEST THE ABOVE ON THIS \_\_\_\_\_ DAY OF \_\_\_\_\_, 2019.

KEVIN M. O'LEARY  
COLORADO REGISTERED PLS #28658  
FOR AND ON BEHALF OF  
LWA LAND SURVEYING, INC.

DATE

"NOTICE: ACCORDING TO COLORADO LAW YOU MUST COMMENCE ANY LEGAL ACTION BASED UPON ANY DEFECT IN THIS SURVEY WITHIN THREE YEARS AFTER YOU FIRST DISCOVER SUCH DEFECT. IN NO EVENT MAY ANY ACTION BASED UPON ANY DEFECT IN THIS SURVEY BE COMMENCED MORE THAN TEN YEARS FROM THE DATE OF THE CERTIFICATION SHOWN HEREON."

**RECORDING:**

STATE OF COLORADO) SS  
COUNTY OF EL PASO)

I HEREBY CERTIFY THAT THIS INSTRUMENT WAS FILED FOR RECORD AT MY OFFICE AT \_\_\_\_\_ O'CLOCK \_\_\_\_\_ M., THIS \_\_\_\_\_ DAY OF \_\_\_\_\_, 2019, AND IS DULY RECORDED AT RECEPTION NO. \_\_\_\_\_ OF THE RECORDS OF EL PASO COUNTY, COLORADO.

CHUCK BROERMAN  
BY: \_\_\_\_\_  
COUNTY CLERK AND RECORDER

FEE: \_\_\_\_\_  
SURCHARGE: \_\_\_\_\_

**FEEES:**

DRAINAGE FEES: \_\_\_\_\_  
BRIDGE FEES: \_\_\_\_\_  
SCHOOL FEES: \_\_\_\_\_  
PARK FEES: \_\_\_\_\_

PREPARED BY  
**LWA LAND SURVEYING, INC.**

953 EAST FILLMORE STREET  
COLORADO SPRINGS, COLORADO 80907  
Phone (719) 636-5179

SILVERADO RANCH  
DECEMBER 19, 2018  
PROJECT 18072  
SHEET 1 OF 1

SF-19-\_\_\_\_



**BLACK FOREST**

CONTOUR INTERVAL: 1'  
DATE OF PHOTOGRAPHY: 11-21-2018



MAP AND AUTOCAD FILE MADE IN AMERICA  
BY LANDMARK MAPPING, LTD.  
1650 NORTH OLL DRIVE, PUEBLO WEST, COLORADO, 81007  
PHONE: (303) 922-2417  
LANDMARK MAPPING PROJECT NUMBER: LM1814

- FIRE
- ◆ LPOLE
- MANHOLE
- SIGN
- ◆ UPOLE
- FENCE
- MISC
- TOWER
- PILE
- > < CULVERT
- ROCK
- IRRIGATION
- MAILBOX
- TREE
- TRAFFIC
- RP-RAP
- 3 POLE-ANCHOR

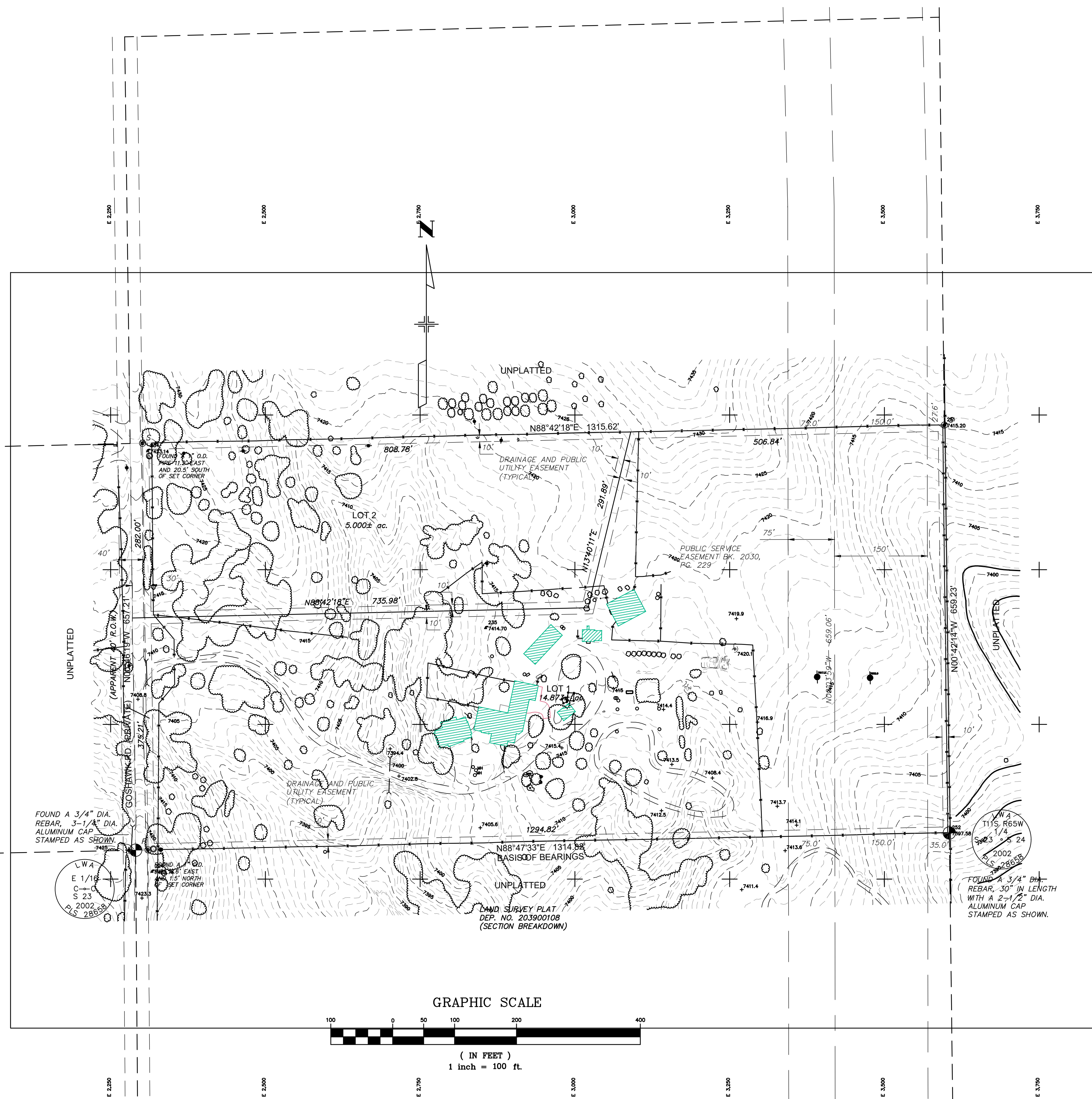

17115 GOSHAWK ROAD EAST  
THE SOUTH HALF OF THE SOUTHEAST QUARTER OF THE  
NORTHEAST QUARTER SECTION 23, TOWNSHIP 11 SOUTH, RANGE 65  
WEST OF THE 6th PM.

THE PROPERTY IS SUBJECT TO AN APPARENT TWENTY (20) FOOT RIGHT OF WAY FOR GOSHAWK ROAD. THE ROAD IS POSTED AS PRIVATE AND MAINTENANCE IS THE RESPONSIBILITY OF THE HOMEOWNERS ASSOCIATION.

THE BASIS OF BEARINGS FOR THIS SURVEY IS THE SOUTH LINE OF THE SOUTHEAST QUARTER OF THE NORTHEAST QUARTER OF SECTION 23, N88°47'33"E - 1314.82'. THE DIRECTION IS BASED ON THE LAND SURVEY PLAT BY LEIGH WHITEHEAD AND ASSOCIATES, 7/2/2003, DEPOSIT NUMBER 203900108, AND THE LINE IS MONUMENTED AS SHOWN.

- UNITS OF MEASURE ARE U.S. SURVEY FEET
- ◆ FOUND ALIQUOT CORNER AS NOTED
  - FOUND MONUMENT AS NOTED
  - FOUND / SET A 5/8" DIAMETER REBAR, 18" IN LENGTH, WITH A 1-1/2" DIAMETER ALUMINUM CAP "LWA PLS 28658"

RESEARCH FOR RECORDED RIGHTS OF WAY AND EASEMENTS WAS DONE BY \_\_\_\_\_  
THIS SURVEY DOES NOT CONSTITUTE A TITLE SEARCH BY LWA LAND SURVEYING, INC. OR KEVIN M. O'LEARY.

## Appendix B – FEMA Floodplain Map

**NOTES TO USERS**

This map is for use in administering the National Flood Insurance Program. It does not necessarily identify all areas subject to flooding, particularly from local drainage sources of small size. The community map repository should be consulted for possible updated or additional flood hazard information.

To obtain more detailed information in areas where **Base Flood Elevations (BFEs)** and/or **floodways** have been determined, users are encouraged to consult the Flood Profiles and Floodway Data and/or Summary of Stillwater Elevations tables contained within the Flood Insurance Study (FIS) report that accompanies this FIRM. Users should be aware that BFEs shown on the FIRM represent rounded whole-foot elevations. These BFEs are intended for flood insurance rating purposes only and should not be used as the sole source of flood elevation information. Accordingly, flood elevation data presented in the FIS report should be utilized in conjunction with the FIRM for purposes of construction and/or floodplain management.

**Coastal Base Flood Elevations** shown on this map apply only landward of 0.0' North American Vertical Datum of 1988 (NAVD88). Users of this FIRM should be aware that coastal flood elevations are also provided in the Summary of Stillwater Elevations table in the Flood Insurance Study report for this jurisdiction. Elevations shown in the Summary of Stillwater Elevations table should be used for construction and/or floodplain management purposes when they are higher than the elevations shown on this FIRM.

Boundaries of the **floodways** were computed at cross sections and interpolated between cross sections. The floodways were based on hydraulic considerations with regard to requirements of the National Flood Insurance Program. Floodway widths and other pertinent floodway data are provided in the Flood Insurance Study report for this jurisdiction.

Certain areas not in Special Flood Hazard Areas may be protected by **flood control structures**. Refer to section 2.4 "Flood Protection Measures" of the Flood Insurance Study report for information on flood control structures for this jurisdiction.

The **projection** used in the preparation of this map was Universal Transverse Mercator (UTM) zone 13. The **horizontal datum** was NAD83, GRS80 spheroid. Differences in datum, spheroid, projection or UTM zones zones used in the production of FIRMs for adjacent jurisdictions may result in slight positional differences in map features across jurisdiction boundaries. These differences do not affect the accuracy of this FIRM.

Flood elevations on this map are referenced to the **North American Vertical Datum of 1988 (NAVD88)**. These flood elevations must be compared to structure and ground elevations referenced to the same **vertical datum**. For information regarding conversion between the National Geodetic Vertical Datum of 1929 and the North American Vertical Datum of 1988, visit the National Geodetic Survey website at <http://www.ngs.noaa.gov/> or contact the National Geodetic Survey at the following address:

NGS Information Services  
NOAA, NINCS12  
National Geodetic Survey  
SSMC-3, #9202  
1315 East-West Highway  
Silver Spring, MD 20910-3282

To obtain current elevation, description, and/or location information for **bench marks** shown on this map, please contact the Information Services Branch of the National Geodetic Survey at (301) 713-3242 or visit its website at <http://www.ngs.noaa.gov/>.

**Base Map** information shown on this FIRM was provided in digital format by El Paso County, Colorado Springs Utilities, City of Fountain, Bureau of Land Management, National Oceanic and Atmospheric Administration, United States Geological Survey, and Anderson Consulting Engineers, Inc. These data are current as of 2006.

This map reflects more detailed and up-to-date **stream channel configurations and floodplain delineations** than those shown on the previous FIRM for this jurisdiction. The floodplains and floodways that were transferred from the previous FIRM may have been adjusted to conform to these new stream channel configurations. As a result, the Flood Profiles and Floodway Data tables in the Flood Insurance Study Report (which contains authoritative hydraulic data) may reflect stream channel distances that differ from what is shown on this map. The profile baselines depicted on this map represent the hydraulic modeling baselines that match the flood profiles and Floodway Data Tables if applicable, in the FIS report. As a result, the profile baselines may deviate significantly from the new base map channel representation and may appear outside of the floodplain.

**Corporate limits** shown on this map are based on the best data available at the time of publication. Because changes due to annexations or de-annexations may have occurred after this map was published, map users should contact appropriate community officials to verify current corporate limit locations.

Please refer to the separately printed **Map Index** for an overview map of the county showing the layout of map panels; community map repository addresses; and a Listing of Communities table containing National Flood Insurance Program dates for each community as well as a listing of the panels on which each community is located.

Contact **FEMA Map Service Center (MSC)** via the FEMA Map Information eXchange (FMIX) 1-877-336-2627 for information on available products associated with this FIRM. Available products may include previously issued Letters of Map Change, a Flood Insurance Study Report, and/or digital versions of this map. The MSC may also be reached by Fax at 1-800-358-9620 and its website at <http://www.msc.fema.gov/>.

If you have **questions about this map** or questions concerning the National Flood Insurance Program in general, please call 1-877-FEMA MAP (1-877-336-2627) or visit the FEMA website at <http://www.fema.gov/business/nfp/>.

**El Paso County Vertical Datum Offset Table**

Flooding Source	Vertical Datum Offset (ft)
REFER TO SECTION 3.3 OF THE EL PASO COUNTY FLOOD INSURANCE STUDY FOR STREAM BY STREAM VERTICAL DATUM CONVERSION INFORMATION	

**Panel Location Map**

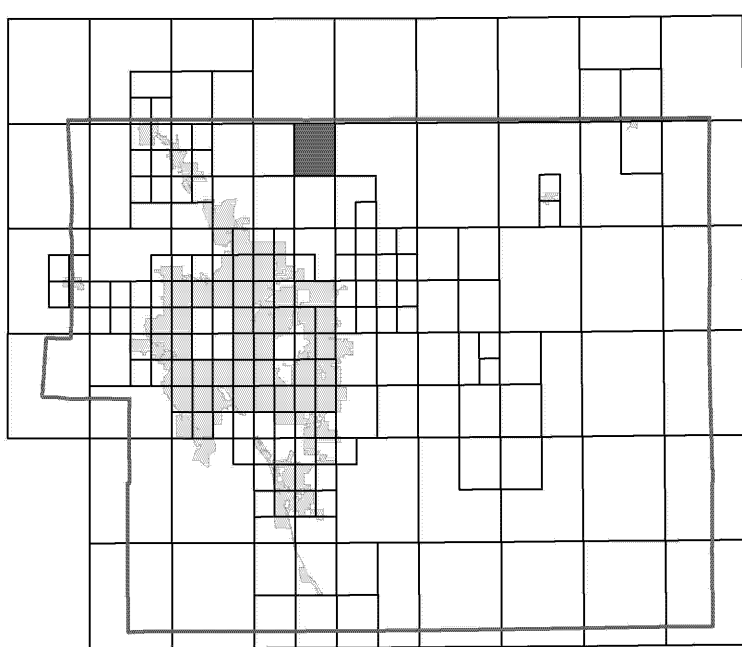

This Digital Flood Insurance Rate Map (DFIRM) was produced through a Cooperating Technical Partner (CTP) agreement between the State of Colorado Water Conservation Board (CWCB) and the Federal Emergency Management Agency (FEMA).



Additional Flood Hazard information and resources are available from local communities and the Colorado Water Conservation Board.

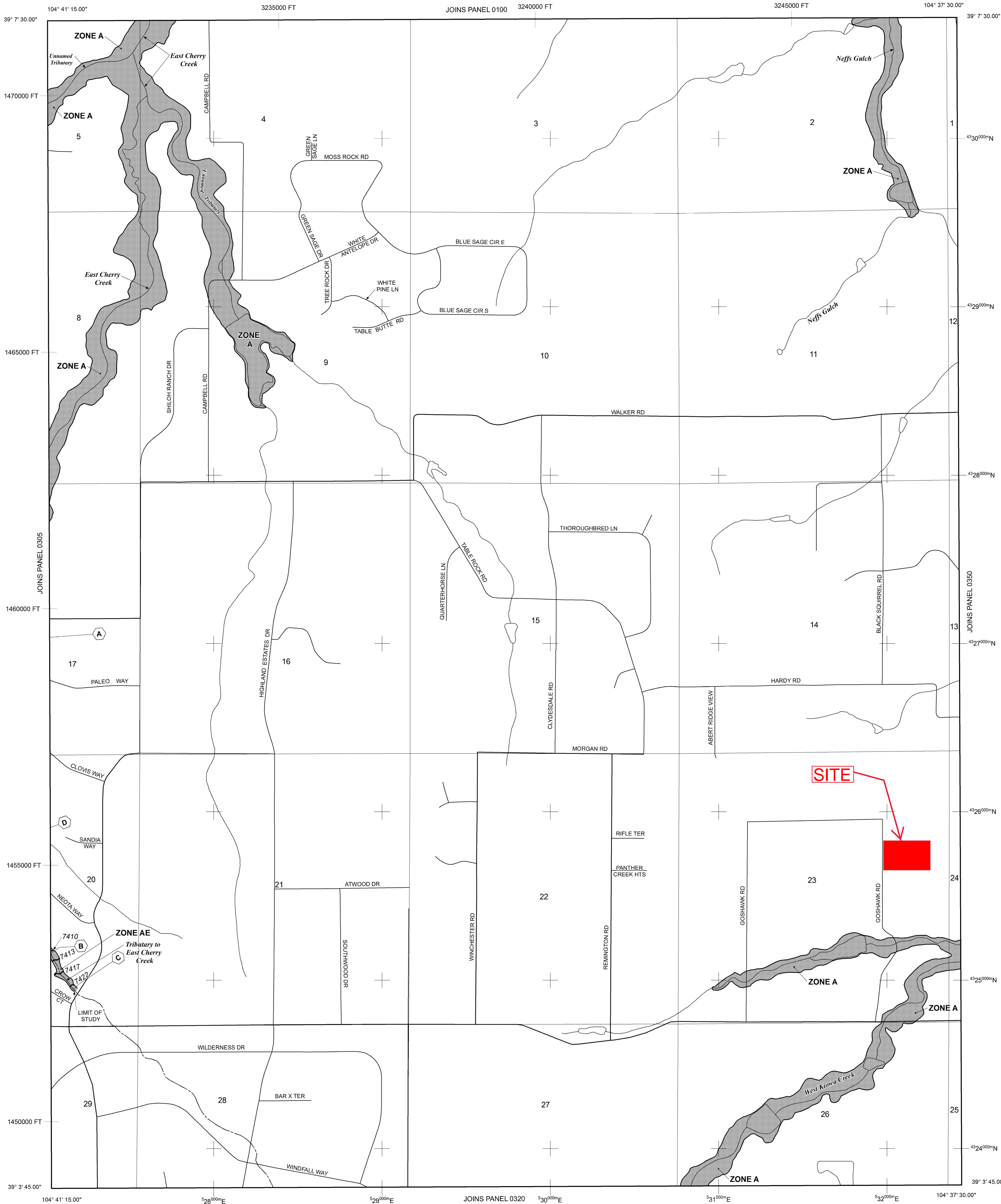

NOTE: MAP AREA SHOWN ON THIS PANEL IS LOCATED WITHIN TOWNSHIP 11 SOUTH, RANGE 65 WEST.

**LEGEND**

**SPECIAL FLOOD HAZARD AREAS (SFHAS) SUBJECT TO INUNDATION BY THE 1% ANNUAL CHANCE FLOOD**

The 1% annual chance flood (100-year flood), also known as the base flood, is the flood that has a 1% chance of being equalled or exceeded in any given year. The Special Flood Hazard Area is the area subject to flooding by the 1% annual chance flood. Areas of Special Flood Hazard include Zones A, AE, AH, AO, AR, A99, V, and VE. The Base Flood Elevation is the water-surface elevation of the 1% annual chance flood.

- ZONE A** No Base Flood Elevations determined.
- ZONE AE** Base Flood Elevations determined.
- ZONE AH** Flood depths of 1 to 3 feet (usually areas of ponding); Base Flood Elevations determined.
- ZONE AO** Flood depths of 1 to 3 feet (usually sheet flow on sloping terrain); average depths determined. For areas of alluvial fan flooding, velocities also determined.
- ZONE AR** Special Flood Hazard Area Formerly protected from the 1% annual chance flood by a flood control system that was subsequently identified. Zone AR indicates that the former flood control system is being restored to provide protection from the 1% annual chance or greater flood.
- ZONE A99** Area to be protected from 1% annual chance flood by a Federal flood protection system under construction; no Base Flood Elevations determined.
- ZONE V** Coastal flood zone with velocity hazard (wave action); no Base Flood Elevations determined.
- ZONE VE** Coastal flood zone with velocity hazard (wave action); Base Flood Elevations determined.

**FLOODWAY AREAS IN ZONE AE**  
The floodway is the channel of a stream plus any adjacent floodplain areas that must be kept free of encroachment so that the 1% annual chance flood can be carried without substantial increases in flood heights.

**OTHER FLOOD AREAS**

**ZONE X** Areas of 0.2% annual chance flood; areas of 1% annual chance flood with average depths of less than 1 foot or with drainage areas less than 1 square mile; and areas protected by levees from 1% annual chance flood.

**OTHER AREAS**

**ZONE X** Areas determined to be outside the 0.2% annual chance floodplain.  
**ZONE D** Areas in which flood hazards are undetermined, but possible.

**COASTAL BARRIER RESOURCES SYSTEM (CBRS) AREAS**

**OTHERWISE PROTECTED AREAS (OPAs)**

CBRS areas and OPAs are normally located within or adjacent to Special Flood Hazard Areas.

- Floodplain boundary
- Floodway boundary
- Zone D Boundary
- CBRS and OPA boundary

Boundary dividing Special Flood Hazard Areas of different Base Flood Elevations, flood depths or flood velocities.

Base Flood Elevation line and value; elevation in feet\* (EL 987)

Base Flood Elevation value where uniform within zone; elevation in feet\*

\* Referenced to the North American Vertical Datum of 1988 (NAVD 88)

— Cross section line

— Transsect line

Geographic coordinates referenced to the North American Datum of 1983 (NAD 83)

1000-meter Universal Transverse Mercator grid ticks, zone 13

5000-foot grid ticks: Colorado State Plane coordinate system, central zone (FIPSZONE 0302), Lambert Conformal Conic Projection

Bench mark (see explanation in Notes to Users section of this FIRM panel)

River Mile

MAP REPOSITORIES  
Refer to Map Repositories list on Map Index

EFFECTIVE DATE OF COUNTYWIDE FLOOD INSURANCE RATE MAP  
**MARCH 17, 1997**

EFFECTIVE DATE(S) OF REVISION(S) TO THIS PANEL  
**DECEMBER 7, 2018** - to update corporate limits, to change Base Flood Elevations and Special Flood Hazard Areas, to update map format, to add roads and road names, and to incorporate previously issued Letters of Map Revision.

For community map revision history prior to countywide mapping, refer to the Community Map History Table located in the Flood Insurance Study report for this jurisdiction.

To determine if flood insurance is available in this community, contact your insurance agent or call the National Flood Insurance Program at 1-800-638-6620.

MAP SCALE 1" = 1000'

500 0 1000 2000 FEET  
300 0 300 600 METERS

**NFIP** **PANEL 0310G**

**FIRM**  
**FLOOD INSURANCE RATE MAP**  
**EL PASO COUNTY, COLORADO AND INCORPORATED AREAS**

**PANEL 310 OF 1300**  
(SEE MAP INDEX FOR FIRM PANEL LAYOUT)

CONTAINS:  
COMMUNITY NUMBER PANEL SUFFIX  
EL PASO COUNTY 08009 0310 0

Notice to User: The Map Number shown below should be used when placing map orders. The Community Number shown above should be used on insurance applications for the subject community.

**MAP NUMBER 08041C0310G**  
**MAP REVISED DECEMBER 7, 2018**  
Federal Emergency Management Agency

## Appendix C – USDA Soils Maps

Soil Map—El Paso County Area, Colorado  
(Loudermilk Minor Subdivision - USDA Soil Map)

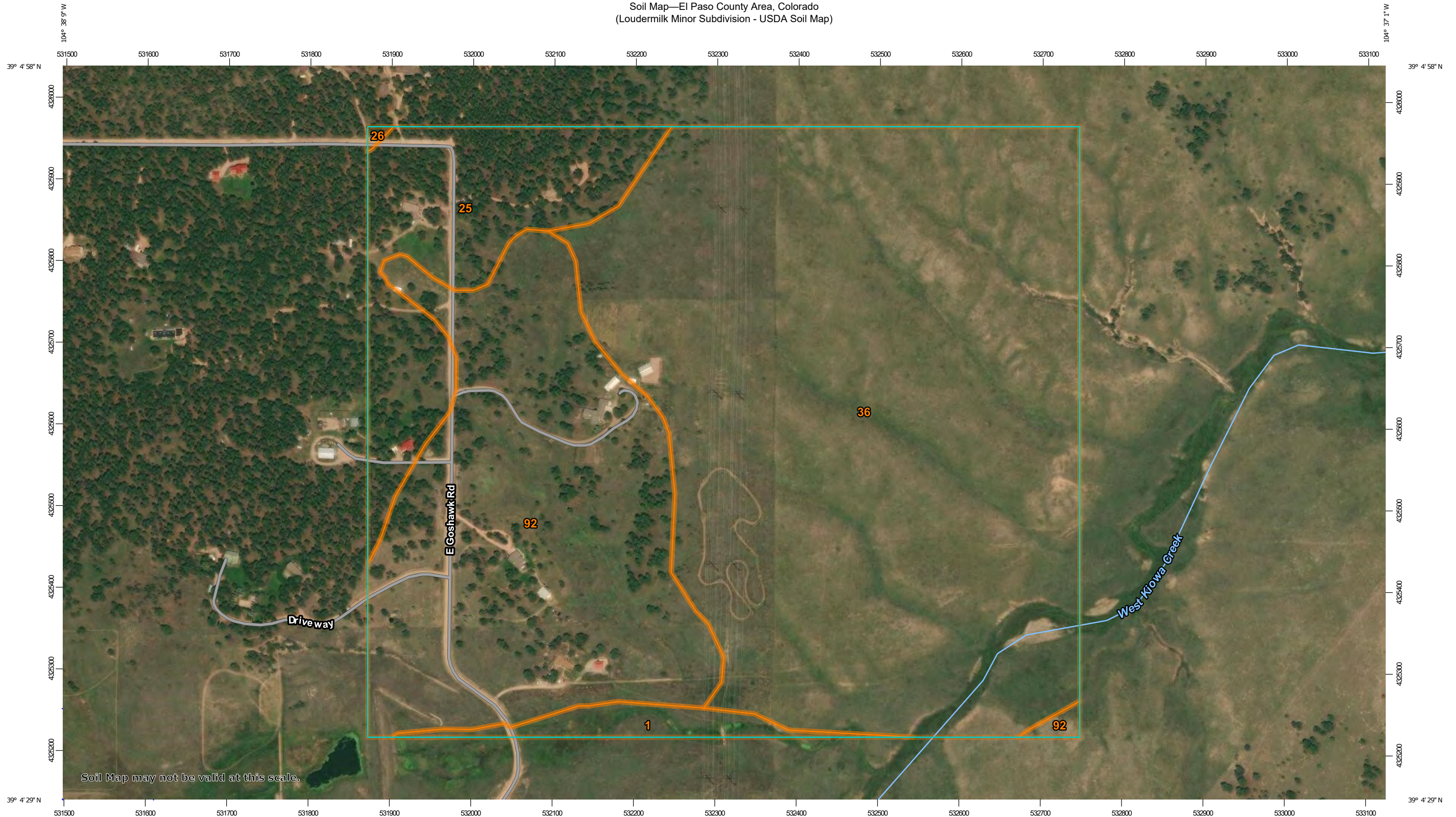

Soil Map may not be valid at this scale.

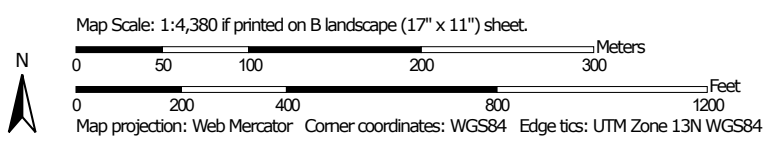

## MAP LEGEND

### Area of Interest (AOI)

 Area of Interest (AOI)

### Soils

 Soil Map Unit Polygons

 Soil Map Unit Lines

 Soil Map Unit Points

### Special Point Features



Blowout



Borrow Pit



Clay Spot



Closed Depression



Gravel Pit



Gravelly Spot



Landfill



Lava Flow



Marsh or swamp



Mine or Quarry



Miscellaneous Water



Perennial Water



Rock Outcrop



Saline Spot



Sandy Spot



Severely Eroded Spot



Sinkhole



Slide or Slip



Sodic Spot



Spoil Area



Stony Spot



Very Stony Spot



Wet Spot



Other



Special Line Features

### Water Features



Streams and Canals

### Transportation



Rails



Interstate Highways



US Routes



Major Roads



Local Roads

### Background



Aerial Photography

## MAP INFORMATION

The soil surveys that comprise your AOI were mapped at 1:24,000.

**Warning:** Soil Map may not be valid at this scale.

Enlargement of maps beyond the scale of mapping can cause misunderstanding of the detail of mapping and accuracy of soil line placement. The maps do not show the small areas of contrasting soils that could have been shown at a more detailed scale.

Please rely on the bar scale on each map sheet for map measurements.

Source of Map: Natural Resources Conservation Service

Web Soil Survey URL:

Coordinate System: Web Mercator (EPSG:3857)

Maps from the Web Soil Survey are based on the Web Mercator projection, which preserves direction and shape but distorts distance and area. A projection that preserves area, such as the Albers equal-area conic projection, should be used if more accurate calculations of distance or area are required.

This product is generated from the USDA-NRCS certified data as of the version date(s) listed below.

Soil Survey Area: El Paso County Area, Colorado

Survey Area Data: Version 16, Sep 10, 2018

Soil map units are labeled (as space allows) for map scales 1:50,000 or larger.

Date(s) aerial images were photographed: Jun 7, 2016—Aug 17, 2017

The orthophoto or other base map on which the soil lines were compiled and digitized probably differs from the background imagery displayed on these maps. As a result, some minor shifting of map unit boundaries may be evident.

## Map Unit Legend

Map Unit Symbol	Map Unit Name	Acres in AOI	Percent of AOI
1	Alamosa loam, 1 to 3 percent slopes	3.3	2.0%
25	Elbeth sandy loam, 3 to 8 percent slopes	18.0	11.1%
26	Elbeth sandy loam, 8 to 15 percent slopes	0.1	0.1%
36	Holderness loam, 8 to 15 percent slopes	96.2	59.3%
92	Tomah-Crowfoot loamy sands, 3 to 8 percent slopes	44.6	27.5%
<b>Totals for Area of Interest</b>		<b>162.2</b>	<b>100.0%</b>

Drainage Class—El Paso County Area, Colorado  
(Loudermilk Minor Subdivision - USDA Soil Map - Drainage Class)

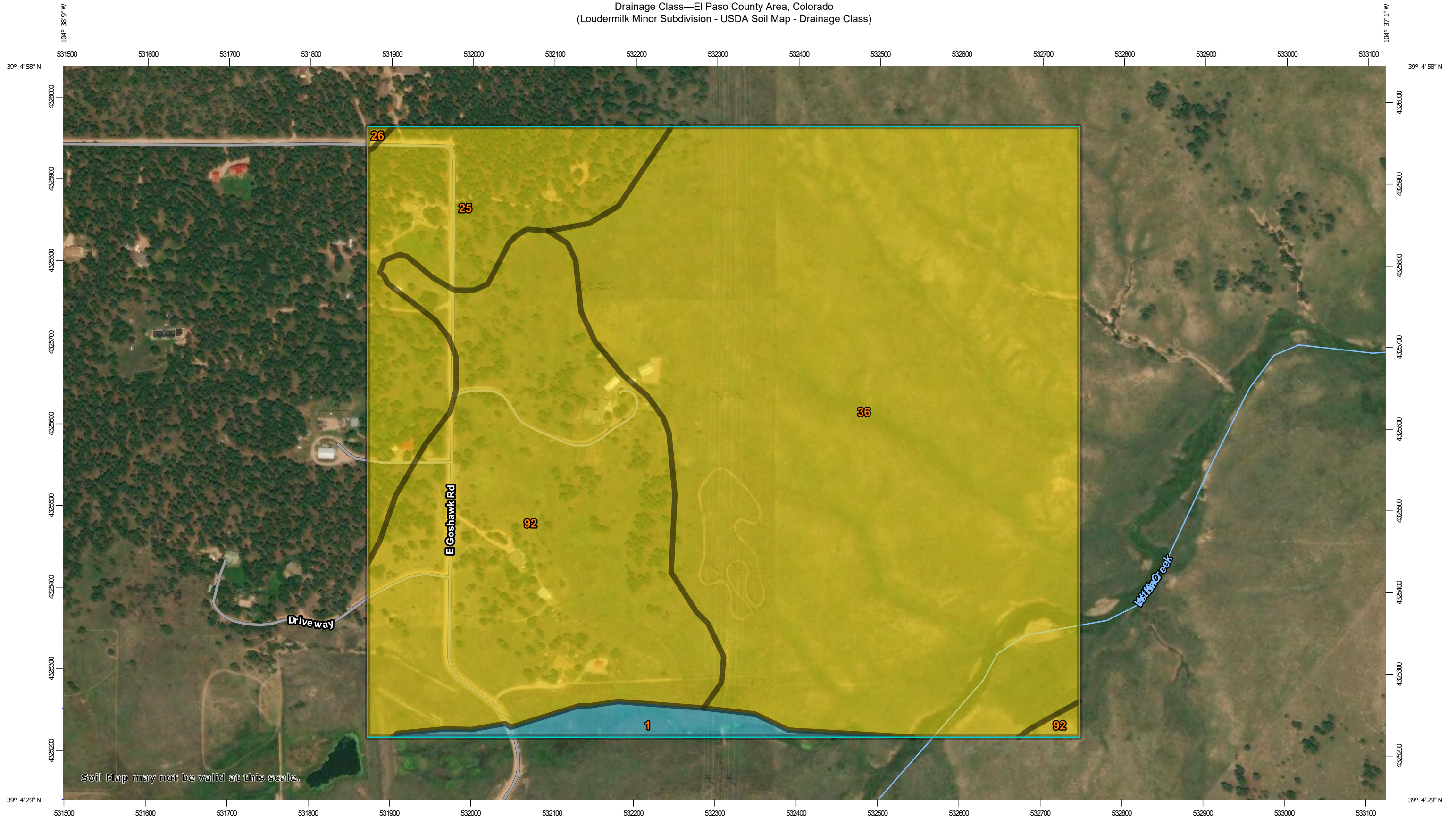

Soil Map may not be valid at this scale.

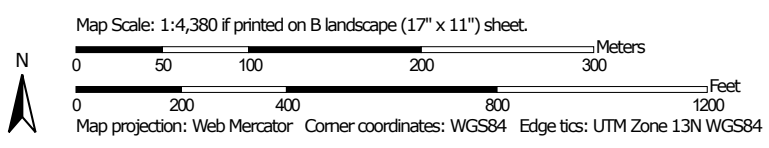



## MAP LEGEND

### Area of Interest (AOI)

 Area of Interest (AOI)

### Soils

#### Soil Rating Polygons

-  Excessively drained
-  Somewhat excessively drained
-  Well drained
-  Moderately well drained
-  Somewhat poorly drained
-  Poorly drained
-  Very poorly drained
-  Subaqueous
-  Not rated or not available

#### Soil Rating Lines

-  Excessively drained
-  Somewhat excessively drained
-  Well drained
-  Moderately well drained
-  Somewhat poorly drained
-  Poorly drained
-  Very poorly drained
-  Subaqueous
-  Not rated or not available



#### Soil Rating Points

-  Excessively drained
-  Somewhat excessively drained
-  Well drained
-  Moderately well drained
-  Somewhat poorly drained
-  Poorly drained
-  Very poorly drained
-  Subaqueous
-  Not rated or not available

### Water Features

 Streams and Canals

### Transportation

-  Rails
-  Interstate Highways
-  US Routes
-  Major Roads
-  Local Roads

### Background

 Aerial Photography

## MAP INFORMATION

The soil surveys that comprise your AOI were mapped at 1:24,000.

Warning: Soil Map may not be valid at this scale.

Enlargement of maps beyond the scale of mapping can cause misunderstanding of the detail of mapping and accuracy of soil line placement. The maps do not show the small areas of contrasting soils that could have been shown at a more detailed scale.

Please rely on the bar scale on each map sheet for map measurements.

Source of Map: Natural Resources Conservation Service  
 Web Soil Survey URL:  
 Coordinate System: Web Mercator (EPSG:3857)

Maps from the Web Soil Survey are based on the Web Mercator projection, which preserves direction and shape but distorts distance and area. A projection that preserves area, such as the Albers equal-area conic projection, should be used if more accurate calculations of distance or area are required.

This product is generated from the USDA-NRCS certified data as of the version date(s) listed below.

Soil Survey Area: El Paso County Area, Colorado  
 Survey Area Data: Version 16, Sep 10, 2018

Soil map units are labeled (as space allows) for map scales 1:50,000 or larger.

Date(s) aerial images were photographed: Jun 7, 2016—Aug 17, 2017

The orthophoto or other base map on which the soil lines were compiled and digitized probably differs from the background imagery displayed on these maps. As a result, some minor shifting of map unit boundaries may be evident.

## Drainage Class

Map unit symbol	Map unit name	Rating	Acres in AOI	Percent of AOI
1	Alamosa loam, 1 to 3 percent slopes	Poorly drained	3.3	2.0%
25	Elbeth sandy loam, 3 to 8 percent slopes	Well drained	18.0	11.1%
26	Elbeth sandy loam, 8 to 15 percent slopes	Well drained	0.1	0.1%
36	Holderness loam, 8 to 15 percent slopes	Well drained	96.2	59.3%
92	Tomah-Crowfoot loamy sands, 3 to 8 percent slopes	Well drained	44.6	27.5%
<b>Totals for Area of Interest</b>			<b>162.2</b>	<b>100.0%</b>

## Description

"Drainage class (natural)" refers to the frequency and duration of wet periods under conditions similar to those under which the soil formed. Alterations of the water regime by human activities, either through drainage or irrigation, are not a consideration unless they have significantly changed the morphology of the soil. Seven classes of natural soil drainage are recognized-excessively drained, somewhat excessively drained, well drained, moderately well drained, somewhat poorly drained, poorly drained, and very poorly drained. These classes are defined in the "Soil Survey Manual."

## Rating Options

*Aggregation Method:* Dominant Condition

*Component Percent Cutoff:* None Specified

*Tie-break Rule:* Higher

## Appendix D – Elevation Exhibit, Subbasin Exhibits

Elevations Table				
Number	Minimum Elevation	Maximum Elevation	Area	Color
1	7385.00	7405.00	263738.01	Dark Red
2	7405.00	7411.00	253743.72	Red
3	7411.00	7415.00	222732.83	Orange
4	7415.00	7420.00	308359.72	Light Orange
5	7420.00	7435.00	278081.02	Yellow

PROJECTNAME

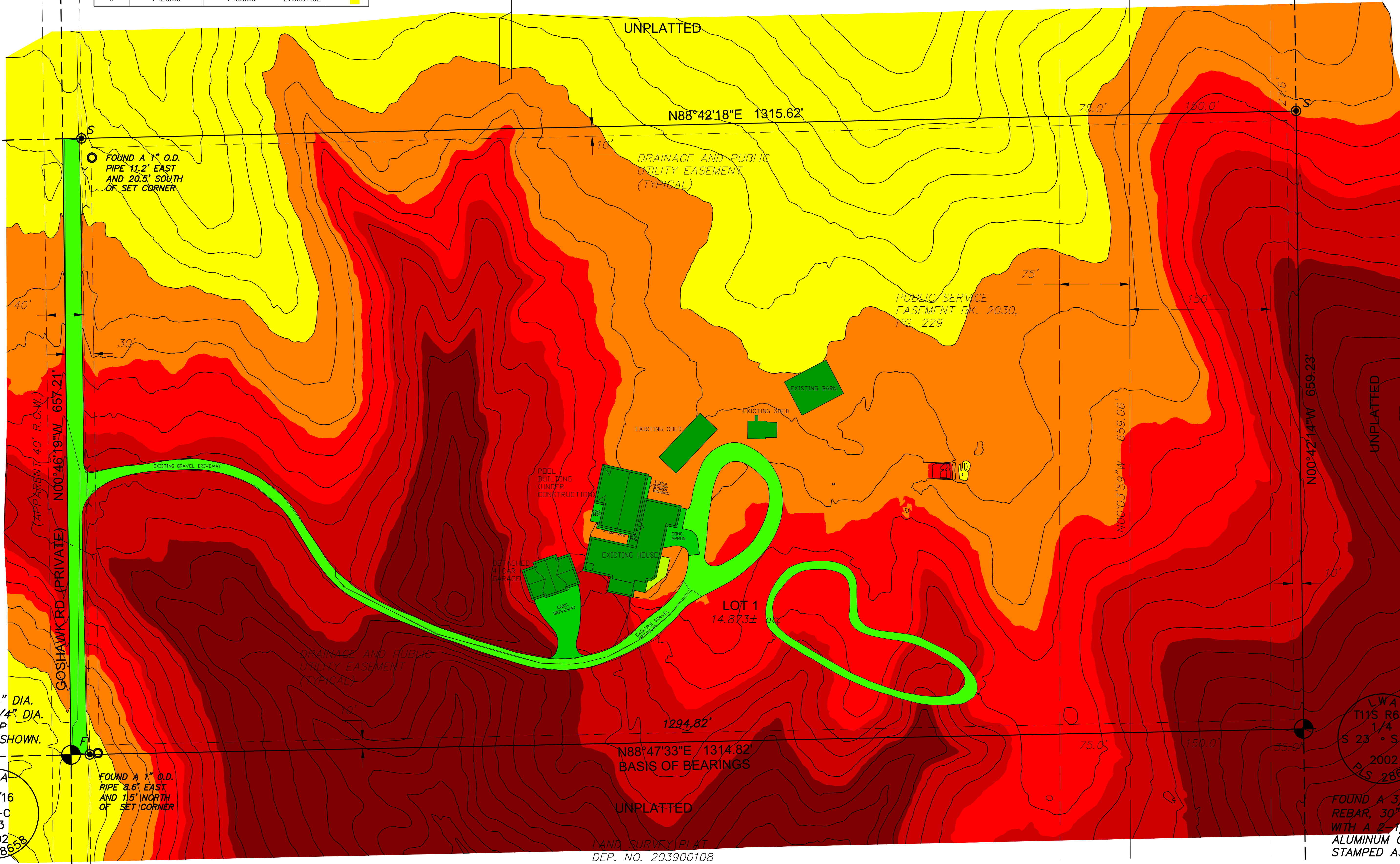
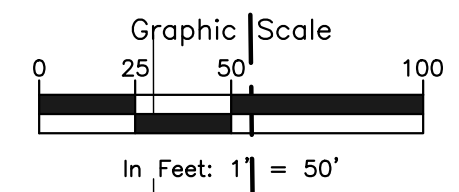

ROCKY MOUNTAIN GROUP  
 ARCHITECTS  
 ENGINEERS  
 Geotechnical, Materials, Testing, Civil, Planning  
 Structural, Forensics  
 SOUTHERN COLORADO  
 19375 BEACON LITE RD., MONUMENT, CO 80132  
 P.O. BOX 145, WWW.RMGENGINEERS.COM  
 Structural Engineers, Surveyors, Architects, Planners

NOT FOR CONSTRUCTION FOR CIVIL ONLY

LOUDERMILK MINOR SUBDIVISION  
 17115 GOSHAWK ROAD  
 COLORADO SPRINGS, CO  
 ARVIN AND CHERYL LOUDERMILK

These plans are copyrighted 2018 by Geotechnical Engineers Inc. dba RMG - Rocky Mountain Group all rights reserved. Any sale, reproduction, creation of derivative works based on these plans, or use of these plans for any purpose without proper compensation to and the express written consent of RMG, is strictly prohibited.

ELEVATIONS EXHIBIT  
 APPLICATION SUBMITTAL

PROJECT STATUS: APPLICATION SUBMITTAL

ENG:	ROL
DRAWN:	ROL
CHECKED:	ROL
DATE:	01/14/19

#	REVISION	DATE
1	SUBO APP	01/14/19
2		
3		
4		
5		
6		
7		
8		
9		
10		

JOB NO. 167392  
 SHEET NO. EXHIBIT 01  
 of 03

LAST SAVED: 11/20/18 4:40:05 PM PATH: C:\Users\arvin\Documents\Projects\2018\LOUdermilk Road\2018\RMG\LOUdermilk - Elevation.dwg

1/4" DIA.  
 -1/4" DIA.  
 CAP  
 S SHOWN.

W A  
 1/16  
 -C  
 23  
 002  
 28658

LWA  
 T11S R6  
 1/4  
 S 23 • S  
 2002  
 PLS 286

FOUND A 3" REBAR, 30" WITH A 2" ALUMINUM STAMPED AS

LAND SURVEY PLAT  
 DEP. NO. 203900108  
 (SECTION BREAKDOWN)

Please show on the drainage plan the design points indicated in the narrative.

Please re-locate all the drainage plans to the end of the drainage report.

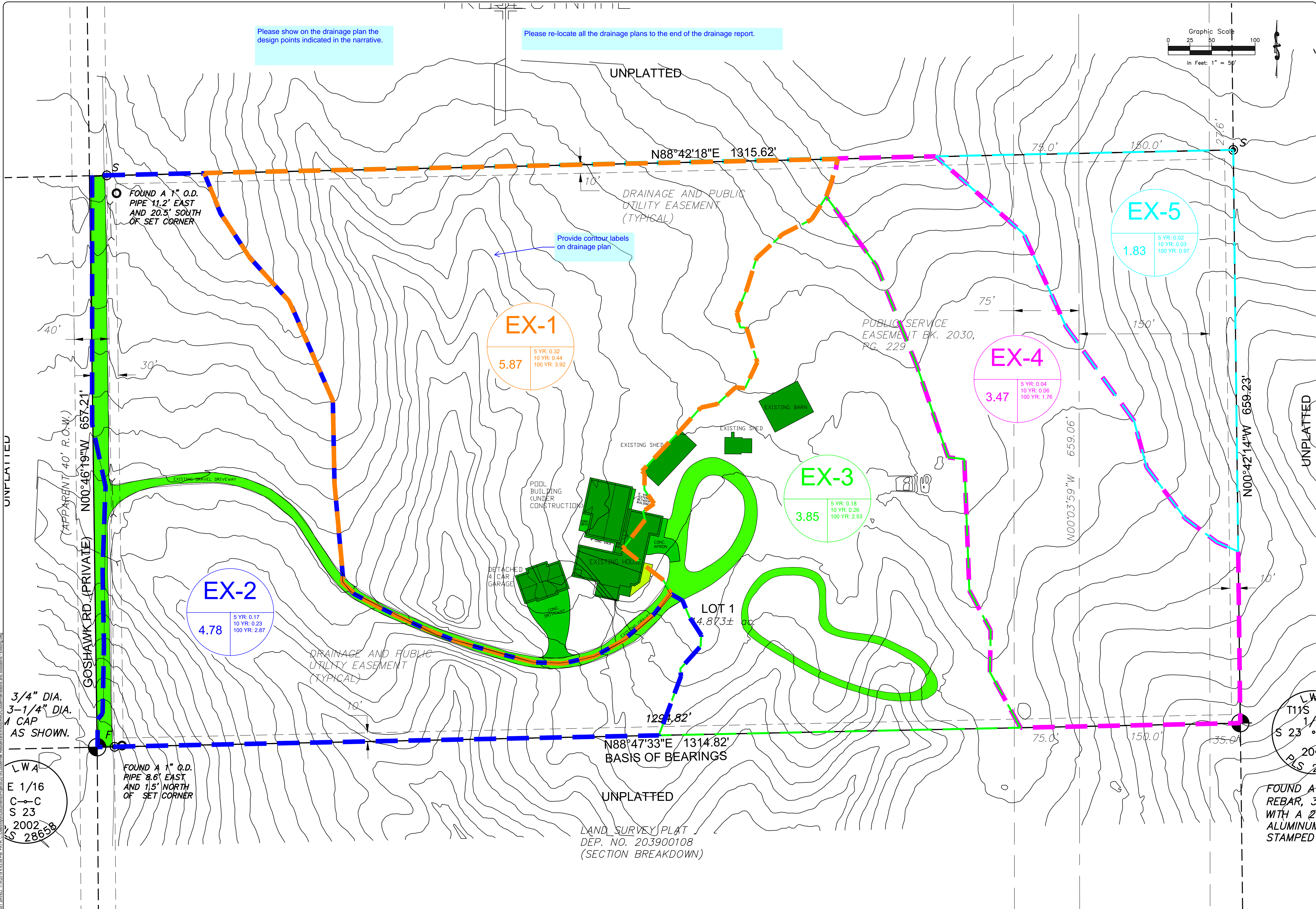
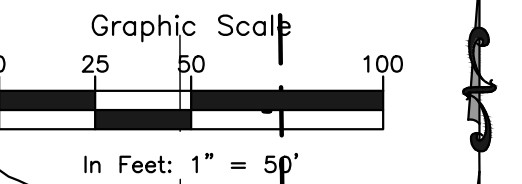

Provide contour labels on drainage plan

UNPLATTED

UNPLATTED

3/4" DIA.  
3-1/4" DIA.  
1" CAP  
AS SHOWN.

LWA  
E 1/16  
C-C  
S 23  
2002  
28658

FOUND A 1" O.D.  
PIPE 8.6' EAST  
AND 1.5' NORTH  
OF SET CORNER

LAND SURVEY PLAT  
DEP. NO. 203900108  
(SECTION BREAKDOWN)

FOUND A  
REBAR,  
WITH A 2"  
ALUMINUM  
STAMPED

**ROCKY MOUNTAIN GROUP**  
ARCHITECTS  
ENGINEERS  
Geotechnical  
Materials Testing  
Civil Planning  
Architectural  
Structural  
Forensics

SOUTHERN COLORADO  
19375 BEACON LITE RD., MONUMENT, CO 80132  
719.585.5145 WWW.ROCKYMOUNTAINENGINEERS.COM  
Sustainable Architecture, Driveway Design, Neighborhood Development

NOT FOR CONSTRUCTION  
FOR CIVIL ONLY

**LOUDERMILK MINOR SUBDIVISION**  
17115 GOSHAWK ROAD  
COLORADO SPRINGS, CO

ARVIN AND CHERYL LOUDERMILK

These plans are copyrighted 2018 by Geotechnical Engineers Inc. dba RMG - Rocky Mountain Group all rights reserved. Any sale, reproduction, creation of derivative works based on these plans, or use of these plans for any purpose without proper compensation is and the express written consent of RMG, is strictly prohibited.

SHEET NAME		EXISTING SUBBASINS	
PROJECT STATUS		APPLICATION SUBMITTAL	
ENG:	RDJ	DATE	01/14/19
DRAWN:	RDJ	#	REVISION
CHECKED:	RDJ	DATE	
		DATE	
		DATE	
		DATE	
		DATE	
JOB NO.	167392		
SHEET NO.	EXHIBIT 02		

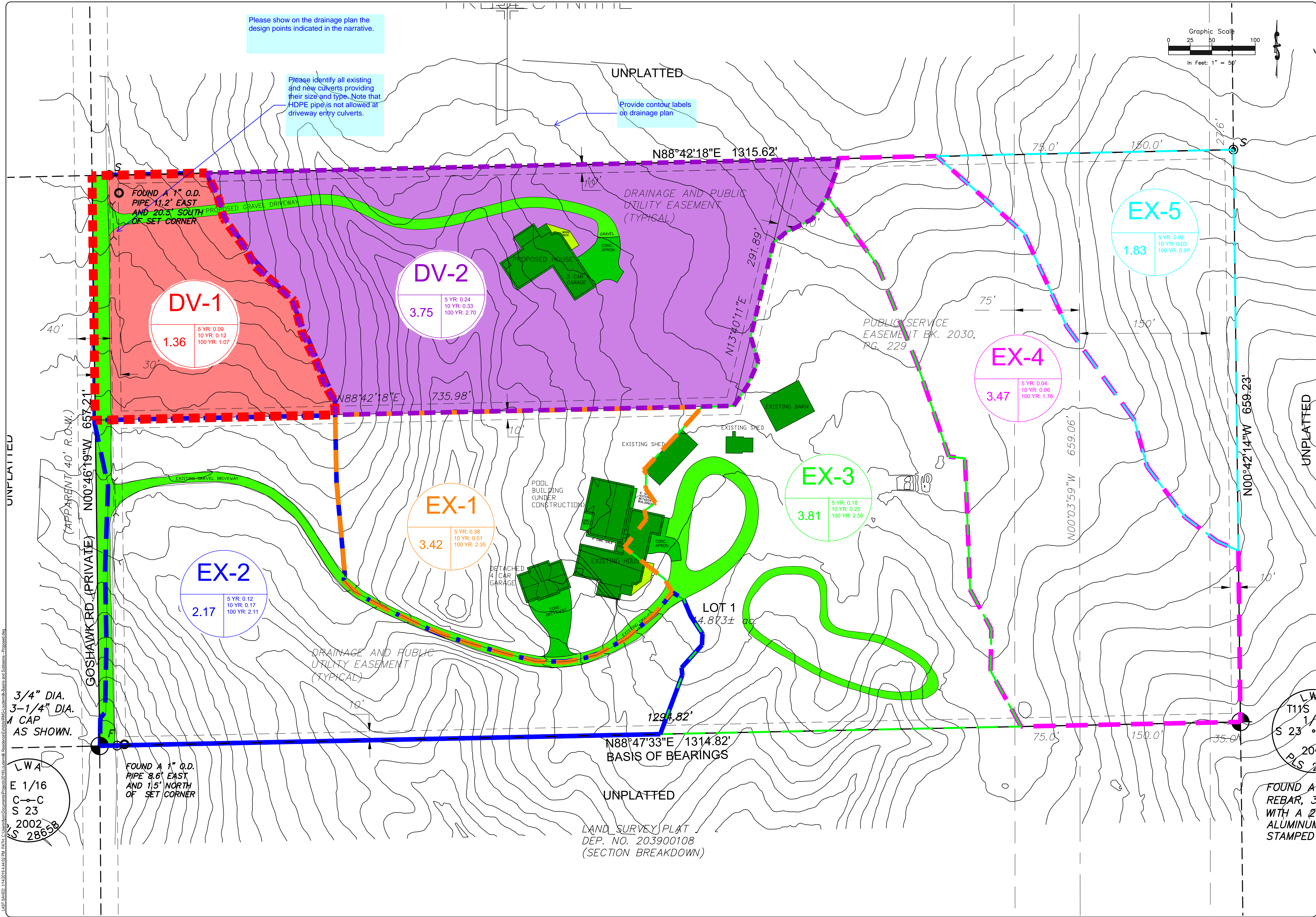

Please show on the drainage plan the design points indicated in the narrative.

Please identify all existing and new culverts providing their size and type. Note that HDPE pipe is not allowed at driveway entry culverts.

Provide contour labels on drainage plan

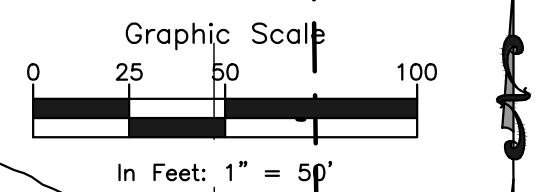

FOUND A 1" O.D. PIPE 11.2' EAST AND 20.5' SOUTH OF SET CORNER

**DV-1**  
1.36  
5 YR: 0.09  
10 YR: 0.12  
100 YR: 1.07

**DV-2**  
3.75  
5 YR: 0.24  
10 YR: 0.33  
100 YR: 2.70

**EX-5**  
1.83  
5 YR: 0.02  
10 YR: 0.03  
100 YR: 0.97

**EX-4**  
3.47  
5 YR: 0.04  
10 YR: 0.06  
100 YR: 1.76

**EX-3**  
3.81  
5 YR: 0.18  
10 YR: 0.25  
100 YR: 2.50

**EX-1**  
3.42  
5 YR: 0.38  
10 YR: 0.51  
100 YR: 2.35

**EX-2**  
2.17  
5 YR: 0.12  
10 YR: 0.17  
100 YR: 2.11

3/4" DIA.  
3-1/4" DIA.  
1" CAP  
AS SHOWN.

LWA  
E 1/16  
C-C  
S 23  
2002  
28658

FOUND A 1" O.D. PIPE 8.6' EAST AND 11.5' NORTH OF SET CORNER

T11S  
S 23  
R 20  
P 15

FOUND A REBAR, WITH A 2" ALUMINUM STAMPED

LAND SURVEY PLAT  
DEP. NO. 203900108  
(SECTION BREAKDOWN)

**ROCKY MOUNTAIN GROUP**  
ARCHITECTS  
Geotechnical  
Materials Testing  
Civil Planning  
**RMG**  
ENGINEERS  
Architectural  
Structural  
Forensics

SOUTHERN COLORADO  
19375 BEACON LITE RD., MONUMENT, CO 80132  
719.385.5145 WWW.ROCKYMOUNTAINENGINEERS.COM  
Sustainable, Equitable, Durable, Inspiring, Innovative, Collaborative

NOT FOR CONSTRUCTION  
FOR CIVIL ONLY

**LOUDERMILK MINOR SUBDIVISION**  
17115 GOSHAWK ROAD  
COLORADO SPRINGS, CO

ARVIN AND CHERYL LOUDERMILK

PROPOSED SUBBASINS  
APPLICATION SUBMITTAL

ENG:	RD	
DRAWN:	RD	
CHECKED:	RD	
DATE	01/14/19	
#	REVISION	DATE
1	SUBD APP	01/14/19
JOB NO.	167392	
SHEET NO.	EXHIBIT 03	

of 03

## Appendix E – Hydrologic and Hydraulic Calculations



**NOAA Atlas 14, Volume 8, Version 2**  
**Location name: Colorado Springs, Colorado, USA\***  
**Latitude: 39.0794°, Longitude: -104.6285°**  
**Elevation: 7417.11 ft\*\***



\* source: ESRI Maps  
 \*\* source: USGS

**POINT PRECIPITATION FREQUENCY ESTIMATES**

Sanja Perica, Deborah Martin, Sandra Pavlovic, Ishani Roy, Michael St. Laurent, Carl Trypaluk, Dale Unruh, Michael Yekta, Geoffery Bonnin

NOAA, National Weather Service, Silver Spring, Maryland

[PF\\_tabular](#) | [PF\\_graphical](#) | [Maps & aeriels](#)

**PF tabular**

<b>PDS-based point precipitation frequency estimates with 90% confidence intervals (in inches)<sup>1</sup></b>										
<b>Duration</b>	<b>Average recurrence interval (years)</b>									
	<b>1</b>	<b>2</b>	<b>5</b>	<b>10</b>	<b>25</b>	<b>50</b>	<b>100</b>	<b>200</b>	<b>500</b>	<b>1000</b>
<b>5-min</b>	<b>0.241</b> (0.189-0.308)	<b>0.292</b> (0.228-0.373)	<b>0.379</b> (0.296-0.487)	<b>0.457</b> (0.354-0.589)	<b>0.570</b> (0.431-0.767)	<b>0.663</b> (0.488-0.901)	<b>0.760</b> (0.541-1.06)	<b>0.863</b> (0.590-1.23)	<b>1.01</b> (0.663-1.48)	<b>1.12</b> (0.718-1.66)
<b>10-min</b>	<b>0.353</b> (0.276-0.451)	<b>0.427</b> (0.334-0.547)	<b>0.556</b> (0.433-0.713)	<b>0.669</b> (0.519-0.862)	<b>0.835</b> (0.630-1.12)	<b>0.970</b> (0.715-1.32)	<b>1.11</b> (0.793-1.55)	<b>1.26</b> (0.865-1.81)	<b>1.48</b> (0.971-2.16)	<b>1.64</b> (1.05-2.43)
<b>15-min</b>	<b>0.430</b> (0.337-0.550)	<b>0.521</b> (0.408-0.667)	<b>0.678</b> (0.529-0.870)	<b>0.816</b> (0.633-1.05)	<b>1.02</b> (0.769-1.37)	<b>1.18</b> (0.872-1.61)	<b>1.36</b> (0.967-1.89)	<b>1.54</b> (1.05-2.20)	<b>1.80</b> (1.18-2.64)	<b>2.00</b> (1.28-2.97)
<b>30-min</b>	<b>0.610</b> (0.478-0.781)	<b>0.739</b> (0.579-0.947)	<b>0.961</b> (0.750-1.23)	<b>1.16</b> (0.897-1.49)	<b>1.44</b> (1.09-1.93)	<b>1.67</b> (1.23-2.27)	<b>1.91</b> (1.36-2.66)	<b>2.17</b> (1.48-3.10)	<b>2.52</b> (1.66-3.70)	<b>2.81</b> (1.80-4.15)
<b>60-min</b>	<b>0.773</b> (0.606-0.989)	<b>0.928</b> (0.726-1.19)	<b>1.20</b> (0.938-1.54)	<b>1.45</b> (1.12-1.87)	<b>1.82</b> (1.38-2.45)	<b>2.12</b> (1.57-2.90)	<b>2.45</b> (1.75-3.42)	<b>2.80</b> (1.92-4.01)	<b>3.30</b> (2.17-4.84)	<b>3.70</b> (2.37-5.47)
<b>2-hr</b>	<b>0.935</b> (0.739-1.19)	<b>1.12</b> (0.881-1.42)	<b>1.44</b> (1.13-1.83)	<b>1.74</b> (1.36-2.22)	<b>2.19</b> (1.68-2.95)	<b>2.58</b> (1.92-3.49)	<b>2.99</b> (2.15-4.15)	<b>3.44</b> (2.38-4.89)	<b>4.07</b> (2.71-5.95)	<b>4.59</b> (2.96-6.75)
<b>3-hr</b>	<b>1.02</b> (0.810-1.29)	<b>1.21</b> (0.957-1.52)	<b>1.55</b> (1.23-1.97)	<b>1.88</b> (1.48-2.39)	<b>2.38</b> (1.84-3.20)	<b>2.82</b> (2.12-3.81)	<b>3.29</b> (2.39-4.56)	<b>3.81</b> (2.66-5.42)	<b>4.56</b> (3.06-6.65)	<b>5.17</b> (3.36-7.58)
<b>6-hr</b>	<b>1.18</b> (0.946-1.48)	<b>1.39</b> (1.11-1.73)	<b>1.77</b> (1.41-2.22)	<b>2.14</b> (1.70-2.70)	<b>2.73</b> (2.13-3.65)	<b>3.25</b> (2.47-4.38)	<b>3.82</b> (2.80-5.27)	<b>4.45</b> (3.14-6.30)	<b>5.38</b> (3.64-7.80)	<b>6.14</b> (4.03-8.94)
<b>12-hr</b>	<b>1.38</b> (1.11-1.71)	<b>1.61</b> (1.30-1.99)	<b>2.05</b> (1.64-2.54)	<b>2.47</b> (1.97-3.08)	<b>3.14</b> (2.48-4.16)	<b>3.73</b> (2.85-4.98)	<b>4.38</b> (3.24-5.99)	<b>5.10</b> (3.62-7.16)	<b>6.15</b> (4.20-8.86)	<b>7.01</b> (4.64-10.1)
<b>24-hr</b>	<b>1.61</b> (1.31-1.98)	<b>1.89</b> (1.53-2.32)	<b>2.40</b> (1.94-2.95)	<b>2.88</b> (2.32-3.56)	<b>3.63</b> (2.87-4.74)	<b>4.28</b> (3.29-5.64)	<b>4.98</b> (3.71-6.74)	<b>5.75</b> (4.12-8.00)	<b>6.87</b> (4.74-9.81)	<b>7.78</b> (5.20-11.2)
<b>2-day</b>	<b>1.88</b> (1.54-2.28)	<b>2.22</b> (1.82-2.69)	<b>2.83</b> (2.31-3.44)	<b>3.38</b> (2.74-4.14)	<b>4.22</b> (3.35-5.43)	<b>4.92</b> (3.81-6.40)	<b>5.67</b> (4.25-7.57)	<b>6.48</b> (4.67-8.91)	<b>7.63</b> (5.30-10.8)	<b>8.56</b> (5.78-12.2)
<b>3-day</b>	<b>2.06</b> (1.70-2.48)	<b>2.44</b> (2.01-2.94)	<b>3.11</b> (2.55-3.77)	<b>3.71</b> (3.03-4.51)	<b>4.61</b> (3.67-5.89)	<b>5.35</b> (4.16-6.92)	<b>6.15</b> (4.63-8.16)	<b>7.00</b> (5.07-9.56)	<b>8.19</b> (5.72-11.5)	<b>9.15</b> (6.22-13.0)
<b>4-day</b>	<b>2.21</b> (1.83-2.66)	<b>2.61</b> (2.16-3.14)	<b>3.32</b> (2.73-4.00)	<b>3.95</b> (3.23-4.78)	<b>4.88</b> (3.90-6.20)	<b>5.66</b> (4.41-7.28)	<b>6.48</b> (4.89-8.57)	<b>7.36</b> (5.35-10.0)	<b>8.60</b> (6.03-12.1)	<b>9.59</b> (6.54-13.6)
<b>7-day</b>	<b>2.62</b> (2.18-3.12)	<b>3.04</b> (2.52-3.62)	<b>3.77</b> (3.12-4.51)	<b>4.43</b> (3.65-5.33)	<b>5.42</b> (4.36-6.83)	<b>6.24</b> (4.90-7.97)	<b>7.11</b> (5.41-9.34)	<b>8.05</b> (5.90-10.9)	<b>9.37</b> (6.62-13.1)	<b>10.4</b> (7.17-14.7)
<b>10-day</b>	<b>2.98</b> (2.49-3.54)	<b>3.43</b> (2.86-4.07)	<b>4.22</b> (3.51-5.02)	<b>4.92</b> (4.07-5.88)	<b>5.96</b> (4.81-7.46)	<b>6.81</b> (5.38-8.66)	<b>7.72</b> (5.91-10.1)	<b>8.70</b> (6.40-11.7)	<b>10.1</b> (7.15-14.0)	<b>11.2</b> (7.71-15.7)
<b>20-day</b>	<b>4.02</b> (3.38-4.72)	<b>4.64</b> (3.90-5.45)	<b>5.67</b> (4.76-6.68)	<b>6.56</b> (5.47-7.76)	<b>7.81</b> (6.33-9.61)	<b>8.80</b> (6.98-11.0)	<b>9.82</b> (7.56-12.6)	<b>10.9</b> (8.06-14.5)	<b>12.3</b> (8.81-16.9)	<b>13.4</b> (9.37-18.8)
<b>30-day</b>	<b>4.84</b> (4.10-5.65)	<b>5.60</b> (4.74-6.54)	<b>6.85</b> (5.77-8.02)	<b>7.88</b> (6.60-9.27)	<b>9.29</b> (7.55-11.3)	<b>10.4</b> (8.27-12.9)	<b>11.5</b> (8.86-14.7)	<b>12.6</b> (9.36-16.6)	<b>14.0</b> (10.1-19.1)	<b>15.1</b> (10.6-21.1)
<b>45-day</b>	<b>5.84</b> (4.96-6.77)	<b>6.75</b> (5.73-7.83)	<b>8.21</b> (6.95-9.56)	<b>9.40</b> (7.92-11.0)	<b>11.0</b> (8.94-13.2)	<b>12.2</b> (9.72-15.0)	<b>13.3</b> (10.3-16.9)	<b>14.5</b> (10.8-18.9)	<b>15.9</b> (11.5-21.5)	<b>17.0</b> (12.0-23.5)
<b>60-day</b>	<b>6.65</b> (5.68-7.68)	<b>7.67</b> (6.54-8.86)	<b>9.28</b> (7.88-10.8)	<b>10.6</b> (8.93-12.3)	<b>12.2</b> (10.00-14.7)	<b>13.5</b> (10.8-16.5)	<b>14.7</b> (11.4-18.5)	<b>15.8</b> (11.9-20.6)	<b>17.3</b> (12.5-23.3)	<b>18.3</b> (13.0-25.3)

<sup>1</sup> Precipitation frequency (PF) estimates in this table are based on frequency analysis of partial duration series (PDS). Numbers in parenthesis are PF estimates at lower and upper bounds of the 90% confidence interval. The probability that precipitation frequency estimates (for a given duration and average recurrence interval) will be greater than the upper bound (or less than the lower bound) is 5%. Estimates at upper bounds are not checked against probable maximum precipitation (PMP) estimates and may be higher than currently valid PMP values. Please refer to NOAA Atlas 14 document for more information.

[Back to Top](#)

**PF graphical**



PDS-based depth-duration-frequency (DDF) curves

Latitude: 39.0794°, Longitude: -104.6285°

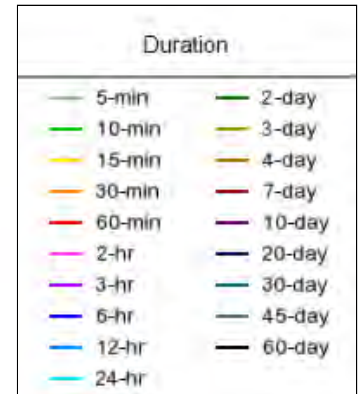
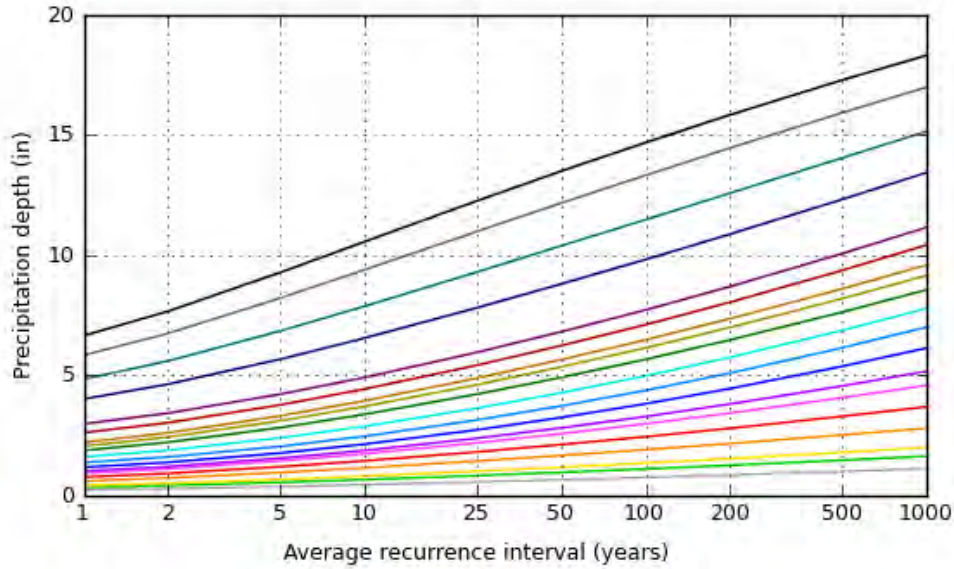
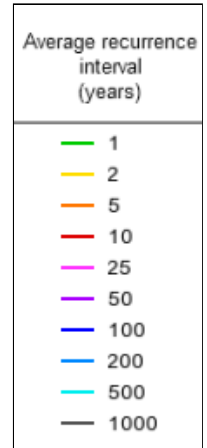
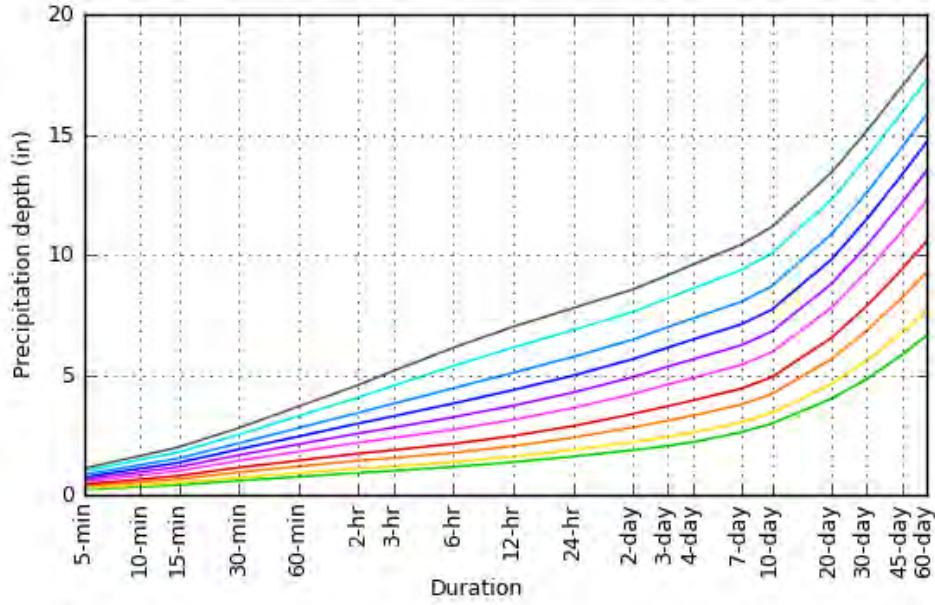

[Back to Top](#)

**Maps & aerials**

**Small scale terrain**

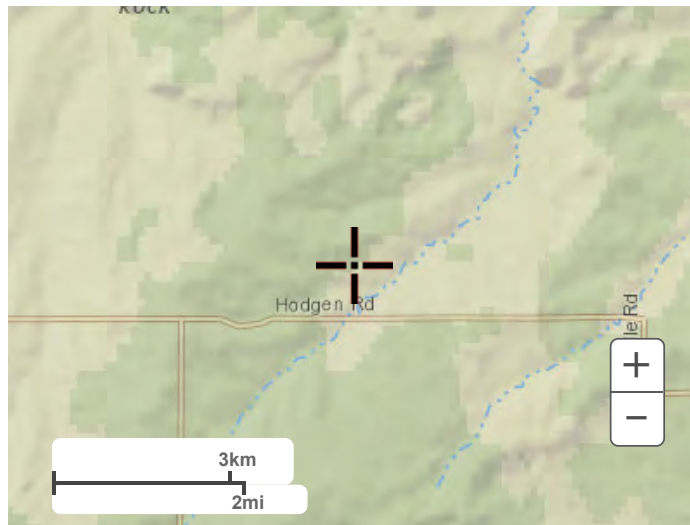

Large scale terrain

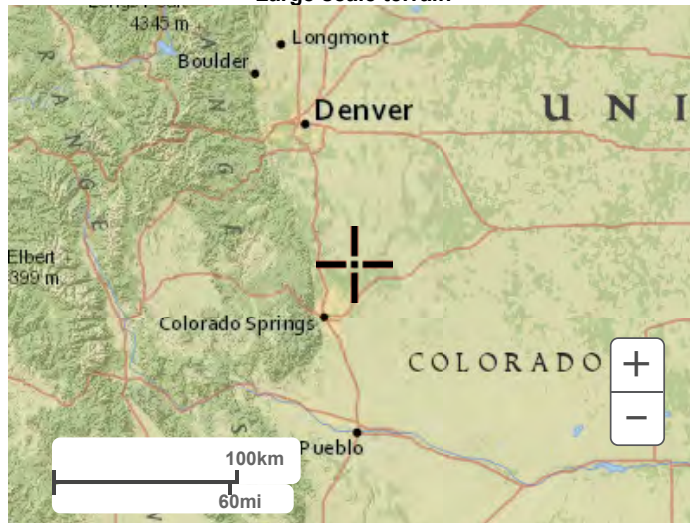

Large scale map



Large scale aerial



[Back to Top](#)

---

[US Department of Commerce](#)  
[National Oceanic and Atmospheric Administration](#)  
[National Weather Service](#)  
[National Water Center](#)  
1325 East West Highway  
Silver Spring, MD 20910  
Questions?: [HDSC.Questions@noaa.gov](mailto:HDSC.Questions@noaa.gov)

[Disclaimer](#)

Calculation of Peak Runoff using Rational Method

Designer: Richard Lyon  
 Company: Rocky Mountain Group  
 Date: 11/5/2019  
 Project: Loudemilk Minor Subdivision  
 Location: Coahawk Road

Version 2.00 released May 2017

$$t_c = \frac{0.395(1.1 - C_p) L^{0.75}}{S^{0.33}}$$

Computed  $t_c = t_o + t_t$

$$t_{c,urban} = 5 \text{ (urban)}$$

$$t_{c,non-urban} = 10 \text{ (non-urban)}$$

Select IDFCD location for NOAA Atlas 14 Rainfall Depths from the pull-down list OR enter your own depth obtained from the NOAA website (click this link)

1-hour rainfall depth, P1 (in)	2-yr	5-yr	10-yr	25-yr	50-yr	100-yr	500-yr
	0.93	1.20	1.45	1.82	2.12	2.45	3.30

Rainfall Intensity Equation Coefficients =

$$I(n/hr) = \frac{a + P_1}{(b + t_c)^c}$$

$Q(cfs) = CIA$

Subcatchment Name	Area (ac)	NRCS Hydrologic Soil Group	Percent Imperviousness	Runoff Coefficient, C							Overland (Initial) Flow Time				Channelized (Travel) Flow Time				Time of Concentration			Rainfall Intensity, I (in/hr)							Peak Flow, Q (cfs)										
				2-yr	5-yr	10-yr	25-yr	50-yr	100-yr	500-yr	Overland Flow Length L <sub>s</sub> (ft)	U/S Elevation (ft) (Optional)	D/S Elevation (ft) (Optional)	Overland Flow Slope S <sub>o</sub> (ft/ft)	Overland Flow Time t <sub>o</sub> (min)	Channelized Flow Length L <sub>c</sub> (ft)	U/S Elevation (ft) (Optional)	D/S Elevation (ft) (Optional)	Channelized Flow Slope S <sub>c</sub> (ft/ft)	NRCS Conveyance Factor K	Channelized Flow Velocity V <sub>c</sub> (ft/sec)	Channelized Flow Time t <sub>c</sub> (min)	Computed t <sub>c</sub> (min)	Regional t <sub>c</sub> (min)	Selected t <sub>c</sub> (min)	2-yr	5-yr	10-yr	25-yr	50-yr	100-yr	500-yr	2-yr	5-yr	10-yr	25-yr	50-yr	100-yr	500-yr
EX-1	5.87	A	6.6	0.02	0.03	0.03	0.04	0.08	0.16	0.30	500.00	7428.00	7404.00	0.048	25.81	200.00	7404.00	7395.00	0.045	5	1.06	3.14	28.98	26.45	26.45	1.57	2.03	2.45	3.07	3.58	4.14	5.57	0.23	0.32	0.44	0.76	1.72	3.92	9.70
EX-2	4.78	A	4.7	0.02	0.02	0.02	0.03	0.07	0.15	0.28	500.00	7430.00	7403.00	0.054	25.05	200.00	7403.00	7395.00	0.040	5	1.00	3.33	28.39	26.93	26.93	1.55	2.00	2.42	3.04	3.54	4.09	5.51	0.12	0.17	0.23	0.41	1.10	2.87	7.50
EX-3	3.85	A	5.9	0.02	0.02	0.03	0.04	0.08	0.16	0.29	500.00	7428.00	7413.00	0.030	30.25	100.00	7413.00	7404.00	0.090	5	1.50	1.11	31.36	25.56	25.56	1.60	2.07	2.50	3.13	3.65	4.22	5.68	0.13	0.18	0.26	0.44	1.08	2.53	6.39
EX-4	3.47	A	2.0	0.01	0.01	0.01	0.01	0.04	0.13	0.27	500.00	7430.00	7412.00	0.036	28.95	255.00	7412.00	7398.00	0.055	5	1.17	3.63	32.57	27.61	27.61	1.53	1.98	2.39	3.00	3.49	4.03	5.43	0.03	0.04	0.06	0.11	0.51	1.76	5.03
EX-5	1.83	A	2.0	0.01	0.01	0.01	0.01	0.04	0.13	0.27	500.00	7430.00	7398.00	0.064	23.94	100.00	7398.00	7394.00	0.040	5	1.00	1.67	29.61	26.56	26.56	1.60	2.06	2.49	3.13	3.64	4.21	5.67	0.02	0.02	0.03	0.06	0.28	0.97	2.77

# Area-Weighted Runoff Coefficient Calculations

Version 2.00 released May 2017

Designer: Richard Lyon

Company: Rocky Mountain Group

Date: 1/15/2019

Project: Loudermilk Minor Subdivision

Location: Goshawk Road

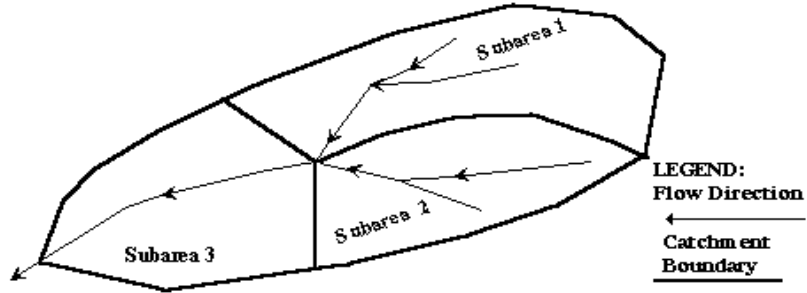

Subcatchment Name
Post-Dev

Cells of this color are for required user-input  
 Cells of this color are for optional override values  
 Cells of this color are for calculated results based on overrides

See sheet "Design Info" for imperviousness-based runoff coefficient values.

Sub-Area ID	Area (ac)	NRCS Hydrologic Soil Group	Percent Imperviousness	Runoff Coefficient, C						
				2-yr	5-yr	10-yr	25-yr	50-yr	100-yr	500-yr
ROOF	0.21	A	90.0	0.73	0.75	0.77	0.79	0.79	0.81	0.83
CONCRETE	0.06	A	90.0	0.73	0.75	0.77	0.79	0.79	0.81	0.83
WOOD	0.01	A	90.0	0.73	0.75	0.77	0.79	0.79	0.81	0.83
GRAVEL	0.07	A	40.0	0.25	0.27	0.28	0.32	0.37	0.42	0.51
FIELD/SOIL	5.51	A	2.0	0.01	0.01	0.01	0.01	0.04	0.13	0.27
<b>Total Area (ac)</b>	<b>5.87</b>			<b>0.04</b>	<b>0.04</b>	<b>0.05</b>	<b>0.05</b>	<b>0.08</b>	<b>0.16</b>	<b>0.30</b>
				<b>0.04</b>	<b>0.04</b>	<b>0.05</b>	<b>0.05</b>	<b>0.08</b>	<b>0.16</b>	<b>0.30</b>

Per El Paso county criteria gravel driveways shall be analyzed based on an imperviousness of 80%. Revise all calculations accordingly.

# Area-Weighted Runoff Coefficient Calculations

Version 2.00 released May 2017

Designer: Richard Lyon

Company: Rocky Mountain Group

Date: 1/15/2019

Project: Loudermilk Minor Subdivision

Location: Goshawk Road

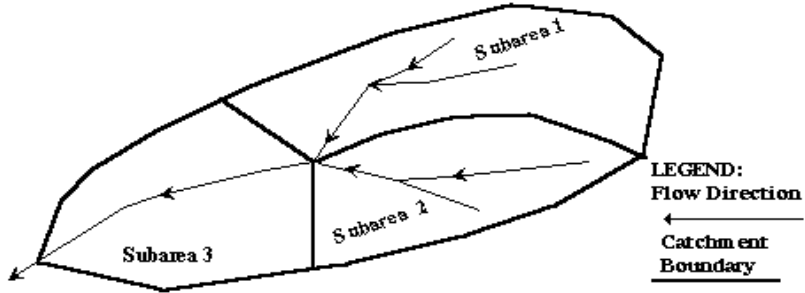

<b>Subcatchment Name</b>
Post-Dev

Cells of this color are for required user-input
Cells of this color are for optional override values
Cells of this color are for calculated results based on overrides

See sheet "Design Info" for imperviousness-based runoff coefficient values.

Sub-Area ID	Area (ac)	NRCS Hydrologic Soil Group	Percent Imperviousness	Runoff Coefficient, C						
				2-yr	5-yr	10-yr	25-yr	50-yr	100-yr	500-yr
GRAVEL	0.34	A	40.0	0.25	0.27	0.28	0.32	0.37	0.42	0.51
FIELD/SOIL	4.45	A	2.0	0.01	0.01	0.01	0.01	0.04	0.13	0.27
<b>Total Area (ac)</b>	<b>4.78</b>			<b>0.02</b>	<b>0.02</b>	<b>0.03</b>	<b>0.03</b>	<b>0.06</b>	<b>0.15</b>	<b>0.28</b>
			<b>Area-Weighted C</b>	<b>0.02</b>	<b>0.02</b>	<b>0.03</b>	<b>0.03</b>	<b>0.06</b>	<b>0.15</b>	<b>0.28</b>
			<b>Area-Weighted Override C</b>	<b>0.02</b>	<b>0.02</b>	<b>0.03</b>	<b>0.03</b>	<b>0.06</b>	<b>0.15</b>	<b>0.28</b>

# Area-Weighted Runoff Coefficient Calculations

Version 2.00 released May 2017

**Designer:** Richard Lyon  
**Company:** Rocky Mountain Group  
**Date:** 1/15/2019  
**Project:** Loudermilk Minor Subdivision  
**Location:** Goshawk Road

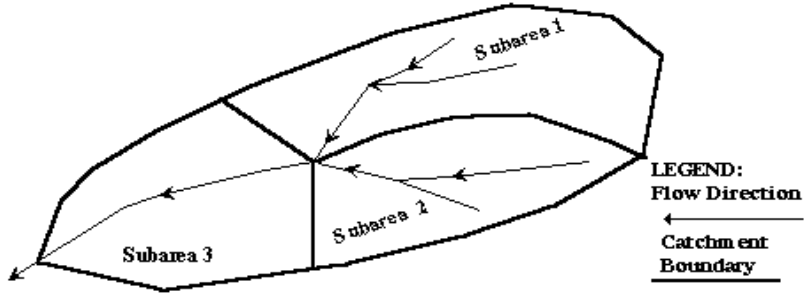

<b>Subcatchment Name</b>
Post-Dev

Cells of this color are for required user-input  
 Cells of this color are for optional override values  
 Cells of this color are for calculated results based on overrides

See sheet "Design Info" for imperviousness-based runoff coefficient values.

Sub-Area ID	Area (ac)	NRCS Hydrologic Soil Group	Percent Imperviousness	Runoff Coefficient, C						
				2-yr	5-yr	10-yr	25-yr	50-yr	100-yr	500-yr
ROOF	0.03	A	90.0	0.73	0.75	0.77	0.79	0.79	0.81	0.83
CONCRETE	0.02	A	90.0	0.73	0.75	0.77	0.79	0.79	0.81	0.83
WOOD	0.001	A	90.0	0.73	0.75	0.77	0.79	0.79	0.81	0.83
GRAVEL	0.27	A	40.0	0.25	0.27	0.28	0.32	0.37	0.42	0.51
FIELD/SOIL	3.54	A	2.0	0.01	0.01	0.01	0.01	0.04	0.13	0.27
<b>Total Area (ac)</b>	<b>3.85</b>			<b>0.03</b>	<b>0.03</b>	<b>0.04</b>	<b>0.04</b>	<b>0.07</b>	<b>0.15</b>	<b>0.29</b>
		<b>Area-Weighted C</b>		<b>0.03</b>	<b>0.03</b>	<b>0.04</b>	<b>0.04</b>	<b>0.07</b>	<b>0.15</b>	<b>0.29</b>
		<b>Area-Weighted Override C</b>		<b>0.03</b>	<b>0.03</b>	<b>0.04</b>	<b>0.04</b>	<b>0.07</b>	<b>0.15</b>	<b>0.29</b>

# Area-Weighted Runoff Coefficient Calculations

Version 2.00 released May 2017

**Designer:** Richard Lyon  
**Company:** Rocky Mountain Group  
**Date:** 1/15/2019  
**Project:** Loudermilk Minor Subdivision  
**Location:** Goshawk Road

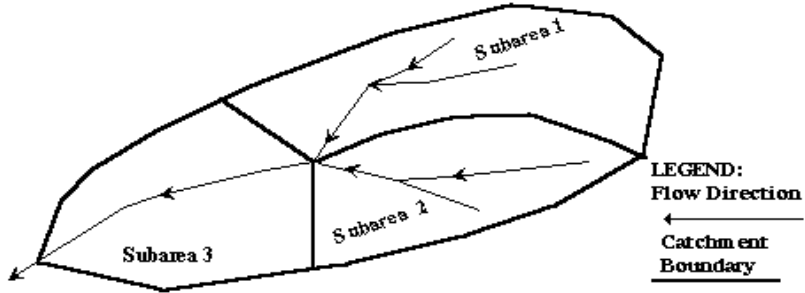

<b>Subcatchment Name</b>
Post-Dev

- Cells of this color are for required user-input
- Cells of this color are for optional override values
- Cells of this color are for calculated results based on overrides

See sheet "Design Info" for imperviousness-based runoff coefficient values.

Sub-Area ID	Area (ac)	NRCS Hydrologic Soil Group	Percent Imperviousness	Runoff Coefficient, C						
				2-yr	5-yr	10-yr	25-yr	50-yr	100-yr	500-yr
FIELD/SOIL	3.47	A	2.0	0.01	0.01	0.01	0.01	0.04	0.13	0.27
<b>Total Area (ac)</b>	<b>3.47</b>	<b>Area-Weighted C</b>		<b>0.01</b>	<b>0.01</b>	<b>0.01</b>	<b>0.01</b>	<b>0.04</b>	<b>0.13</b>	<b>0.27</b>
		<b>Area-Weighted Override C</b>		<b>0.01</b>	<b>0.01</b>	<b>0.01</b>	<b>0.01</b>	<b>0.04</b>	<b>0.13</b>	<b>0.27</b>



# Area-Weighted Runoff Coefficient Calculations

Version 2.00 released May 2017

Designer: Richard Lyon

Company: Rocky Mountain Group

Date: 1/15/2019

Project: Loudermilk Minor Subdivision

Location: Goshawk Road

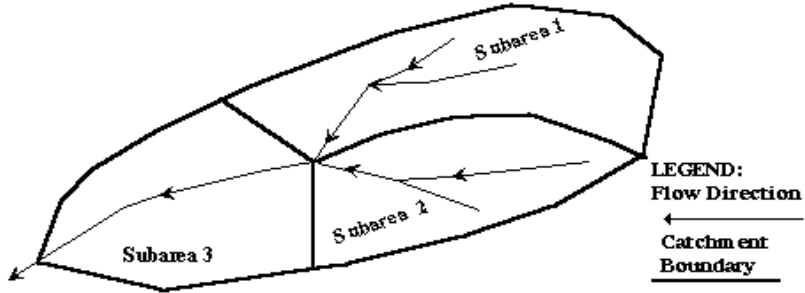

<b>Subcatchment Name</b>
Post-Dev

Cells of this color are for required user-input
Cells of this color are for optional override values
Cells of this color are for calculated results based on overrides

See sheet "Design Info" for imperviousness-based runoff coefficient values.

Sub-Area ID	Area (ac)	NRCS Hydrologic Soil Group	Percent Imperviousness	Runoff Coefficient, C						
				2-yr	5-yr	10-yr	25-yr	50-yr	100-yr	500-yr
FIELD/SOIL	1.83	A	2.0	0.01	0.01	0.01	0.01	0.04	0.13	0.27
<b>Total Area (ac)</b>	<b>1.83</b>			<b>0.01</b>	<b>0.01</b>	<b>0.01</b>	<b>0.01</b>	<b>0.04</b>	<b>0.13</b>	<b>0.27</b>
			<b>Area-Weighted C</b>	<b>0.01</b>	<b>0.01</b>	<b>0.01</b>	<b>0.01</b>	<b>0.04</b>	<b>0.13</b>	<b>0.27</b>
			<b>Area-Weighted Override C</b>	<b>0.01</b>	<b>0.01</b>	<b>0.01</b>	<b>0.01</b>	<b>0.04</b>	<b>0.13</b>	<b>0.27</b>

Calculation of Peak Runoff using Rational Method

Designer: Richard Lyon  
 Company: Rocky Mountain Group  
 Date: 11/5/2019  
 Project: Loudermilk Minor Subdivision  
 Location: Coahawk Road

Version 2.00 released May 2017

Cells of this color are for required user input  
 Cells of this color are for optional override values  
 Cells of this color are for calculated results based on overrides

$$t_c = \frac{0.395(1.1 - C_p) L^{0.75}}{S^{0.33}}$$

$$t_c = \frac{L}{60K\sqrt{S}} = \frac{L}{60V}$$

Computed  $t_c = t_1 + t_2$

$t_{c,urban} = 5$  (urban)  
 $t_{c,non-urban} = 10$  (non-urban)

Regional  $t_c = (26 - 17) + \frac{L}{60(14 + 9\sqrt{S})}$

Selected  $t_c = \max(t_{c,urban}, \min(\text{Computed } t_c, \text{Regional } t_c))$

Select IDFCD location for NOAA Atlas 14 Rainfall Depths from the pull-down list OR enter your own depth obtained from the NOAA website (click this link)

1-hour rainfall depth, P1 (in)	2-yr	5-yr	10-yr	25-yr	50-yr	100-yr	500-yr
	0.93	1.20	1.45	1.82	2.12	2.45	3.30

Rainfall Intensity Equation Coefficients =  $\frac{a}{b + c}$

a	b	c
28.50	10.00	0.786

$I(in/hr) = \frac{a + P_1}{(b + t_c)^c}$

$Q(cfs) = CIA$

Subcatchment Name	Area (ac)	NRCS Hydrologic Soil Group	Percent Imperviousness	Runoff Coefficient, C							Overland (Initial) Flow Time								Channelized (Travel) Flow Time								Time of Concentration			Rainfall Intensity, I (in/hr)							Peak Flow, Q (cfs)						
				2-yr	5-yr	10-yr	25-yr	50-yr	100-yr	500-yr	Overland Flow Length L <sub>s</sub> (ft)	U/S Elevation (ft) (Optional)	D/S Elevation (ft) (Optional)	Overland Flow Slope S <sub>o</sub> (ft/ft)	Overland Flow Time t <sub>1</sub> (min)	Channelized Flow Length L <sub>c</sub> (ft)	U/S Elevation (ft) (Optional)	D/S Elevation (ft) (Optional)	Channelized Flow Slope S <sub>c</sub> (ft/ft)	NRCS Conveyance Factor K	Channelized Flow Velocity V <sub>c</sub> (ft/sec)	Channelized Flow Time t <sub>2</sub> (min)	Computed t <sub>c</sub> (min)	Regional t <sub>c</sub> (min)	Selected t <sub>c</sub> (min)	2-yr	5-yr	10-yr	25-yr	50-yr	100-yr	500-yr	2-yr	5-yr	10-yr	25-yr	50-yr	100-yr	500-yr				
EX-1	2.17	A	14.6	0.07	0.07	0.08	0.10	0.15	0.22	0.35	220.00	7401.00	7395.00	0.027	19.74	0.00	0.00	0.00	1.000	5	5.00	0.00	19.74	23.52	19.74	1.84	2.38	2.87	3.60	4.20	4.85	6.54	0.27	0.38	0.51	0.79	1.36	2.35	4.93				
EX-2	3.42	A	4.6	0.02	0.02	0.02	0.03	0.06	0.15	0.28	500.00	7412.00	7392.00	0.040	27.68	0.00	0.00	0.00	1.000	5	5.00	0.00	27.68	25.23	25.23	1.61	2.08	2.51	3.16	3.68	4.25	5.72	0.08	0.12	0.17	0.30	0.80	2.11	5.55				
EX-3	3.81	A	5.9	0.02	0.02	0.03	0.04	0.08	0.16	0.29	500.00	7428.00	7413.00	0.030	30.26	100.00	7413.00	7404.00	0.090	5	1.50	1.11	31.37	25.57	25.57	1.60	2.08	2.50	3.13	3.65	4.22	5.68	0.13	0.18	0.25	0.44	1.04	2.50	6.31				
EX-4	3.47	A	2.0	0.01	0.01	0.01	0.01	0.04	0.13	0.27	500.00	7430.00	7412.00	0.036	28.95	255.00	7412.00	7398.00	0.055	5	1.17	3.63	32.57	27.61	27.61	1.53	1.98	2.39	3.00	3.49	4.03	5.43	0.03	0.04	0.06	0.11	0.51	1.76	5.03				
EX-5	1.83	A	2.0	0.01	0.01	0.01	0.01	0.04	0.13	0.27	500.00	7430.00	7398.00	0.064	23.94	100.00	7398.00	7394.00	0.040	5	1.00	1.67	29.61	26.56	26.56	1.60	2.06	2.49	3.13	3.64	4.21	5.67	0.02	0.02	0.03	0.06	0.28	0.97	2.77				
DV-1	1.36	A	6.5	0.02	0.03	0.03	0.04	0.08	0.16	0.30	300.00	7428.00	7412.00	0.053	19.33	0.00	0.00	0.00	1.000	5	5.00	0.00	19.33	24.90	19.33	1.86	2.40	2.90	3.64	4.25	4.91	6.61	0.06	0.09	0.12	0.20	0.46	1.07	2.65				
DV-2	3.75	A	7.2	0.03	0.03	0.03	0.05	0.09	0.17	0.30	500.00	7430.00	7401.00	0.058	24.19	0.00	0.00	0.00	1.000	5	5.00	0.00	24.19	24.78	24.19	1.65	2.13	2.57	3.23	3.76	4.35	5.68	0.17	0.24	0.33	0.55	1.22	2.70	6.59				

# Area-Weighted Runoff Coefficient Calculations

Version 2.00 released May 2017

**Designer:** Richard Lyon

**Company:** Rocky Mountain Group

**Date:** 1/15/2019

**Project:** Loudermilk Minor Subdivision

**Location:** Goshawk Road

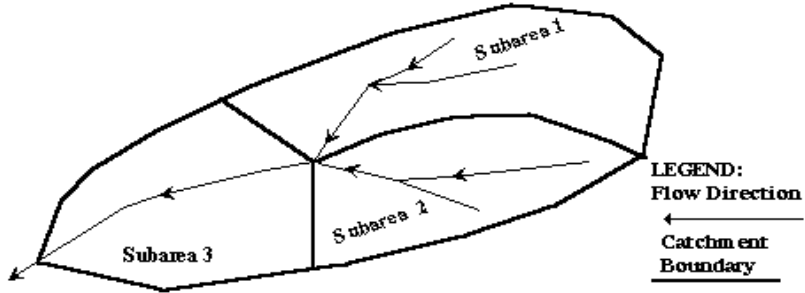

Subcatchment Name
Post-Dev

Cells of this color are for required user-input
Cells of this color are for optional override values
Cells of this color are for calculated results based on overrides

See sheet "Design Info" for imperviousness-based runoff coefficient values.

Sub-Area ID	Area (ac)	NRCS Hydrologic Soil Group	Percent Imperviousness	Runoff Coefficient, C						
				2-yr	5-yr	10-yr	25-yr	50-yr	100-yr	500-yr
GRAVEL	0.16	A	40.0	0.25	0.27	0.28	0.32	0.37	0.42	0.51
FIELD/SOIL	1.20	A	2.0	0.01	0.01	0.01	0.01	0.04	0.13	0.27
<b>Total Area (ac)</b>	<b>1.36</b>	<b>Area-Weighted C</b>		<b>0.03</b>	<b>0.04</b>	<b>0.04</b>	<b>0.05</b>	<b>0.08</b>	<b>0.16</b>	<b>0.30</b>
		<b>Area-Weighted Override C</b>		<b>0.03</b>	<b>0.04</b>	<b>0.04</b>	<b>0.05</b>	<b>0.08</b>	<b>0.16</b>	<b>0.30</b>

# Area-Weighted Runoff Coefficient Calculations

Version 2.00 released May 2017

**Designer:** Richard Lyon  
**Company:** Rocky Mountain Group  
**Date:** 1/15/2019  
**Project:** Loudermilk Minor Subdivision  
**Location:** Goshawk Road

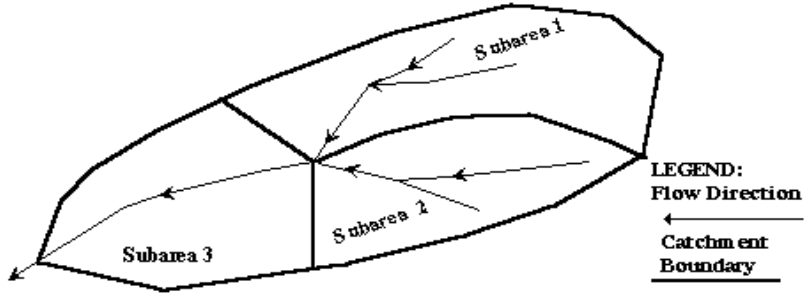

<b>Subcatchment Name</b>
Post-Dev

Cells of this color are for required user-input  
 Cells of this color are for optional override values  
 Cells of this color are for calculated results based on overrides

See sheet "Design Info" for imperviousness-based runoff coefficient values.

Sub-Area ID	Area (ac)	NRCS Hydrologic Soil Group	Percent Imperviousness	Runoff Coefficient, C						
				2-yr	5-yr	10-yr	25-yr	50-yr	100-yr	500-yr
ROOF	0.11	A	90.0	0.73	0.75	0.77	0.79	0.79	0.81	0.83
CONCRETE	0.04	A	90.0	0.73	0.75	0.77	0.79	0.79	0.81	0.83
WOOD	0.01	A	90.0	0.73	0.75	0.77	0.79	0.79	0.81	0.83
GRAVEL	0.14	A	40.0	0.25	0.27	0.28	0.32	0.37	0.42	0.51
FIELD/SOIL	3.45	A	2.0	0.01	0.01	0.01	0.01	0.04	0.13	0.27
<b>Total Area (ac)</b>	<b>3.75</b>			<b>0.05</b>	<b>0.05</b>	<b>0.05</b>	<b>0.06</b>	<b>0.09</b>	<b>0.17</b>	<b>0.30</b>
			<b>Area-Weighted C</b>	<b>0.05</b>	<b>0.05</b>	<b>0.05</b>	<b>0.06</b>	<b>0.09</b>	<b>0.17</b>	<b>0.30</b>
			<b>Area-Weighted Override C</b>	<b>0.05</b>	<b>0.05</b>	<b>0.05</b>	<b>0.06</b>	<b>0.09</b>	<b>0.17</b>	<b>0.30</b>

# Area-Weighted Runoff Coefficient Calculations

Version 2.00 released May 2017

**Designer:** Richard Lyon  
**Company:** Rocky Mountain Group  
**Date:** 1/15/2019  
**Project:** Loudermilk Minor Subdivision  
**Location:** Goshawk Road

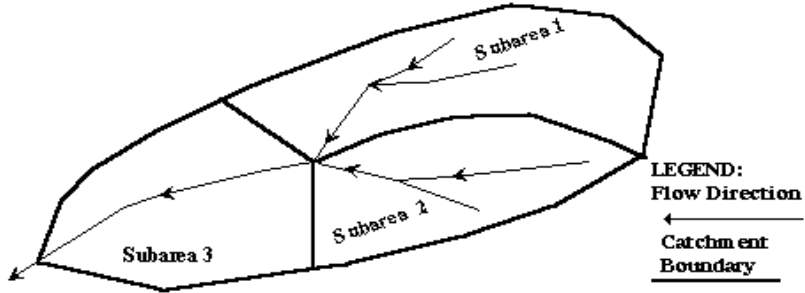

Subcatchment Name
Post-Dev

Cells of this color are for required user-input
Cells of this color are for optional override values
Cells of this color are for calculated results based on overrides

See sheet "Design Info" for imperviousness-based runoff coefficient values.

Sub-Area ID	Area (ac)	NRCS Hydrologic Soil Group	Percent Imperviousness	Runoff Coefficient, C						
				2-yr	5-yr	10-yr	25-yr	50-yr	100-yr	500-yr
ROOF	0.21	A	90.0	0.73	0.75	0.77	0.79	0.79	0.81	0.83
CONCRETE	0.06	A	90.0	0.73	0.75	0.77	0.79	0.79	0.81	0.83
WOOD	0.01	A	90.0	0.73	0.75	0.77	0.79	0.79	0.81	0.83
GRAVEL	0.07	A	40.0	0.25	0.27	0.28	0.32	0.37	0.42	0.51
FIELD/SOIL	1.81	A	2.0	0.01	0.01	0.01	0.01	0.04	0.13	0.27
<b>Total Area (ac)</b>	<b>2.17</b>			<b>0.11</b>	<b>0.11</b>	<b>0.11</b>	<b>0.12</b>	<b>0.15</b>	<b>0.22</b>	<b>0.35</b>
		Area-Weighted C		<b>0.11</b>	<b>0.11</b>	<b>0.11</b>	<b>0.12</b>	<b>0.15</b>	<b>0.22</b>	<b>0.35</b>
		Area-Weighted Override C		<b>0.11</b>	<b>0.11</b>	<b>0.11</b>	<b>0.12</b>	<b>0.15</b>	<b>0.22</b>	<b>0.35</b>

# Area-Weighted Runoff Coefficient Calculations

Version 2.00 released May 2017

**Designer:** Richard Lyon  
**Company:** Rocky Mountain Group  
**Date:** 1/15/2019  
**Project:** Loudermilk Minor Subdivision  
**Location:** Goshawk Road

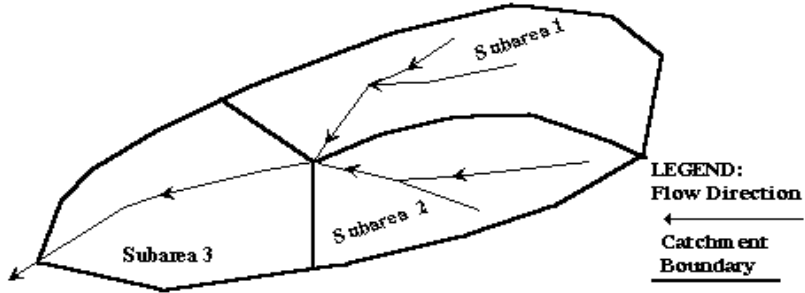

<b>Subcatchment Name</b>
Post-Dev

Cells of this color are for required user-input
Cells of this color are for optional override values
Cells of this color are for calculated results based on overrides

See sheet "Design Info" for imperviousness-based runoff coefficient values.

Sub-Area ID	Area (ac)	NRCS Hydrologic Soil Group	Percent Imperviousness	Runoff Coefficient, C						
				2-yr	5-yr	10-yr	25-yr	50-yr	100-yr	500-yr
GRAVEL	0.23	A	40.0	0.25	0.27	0.28	0.32	0.37	0.42	0.51
FIELD/SOIL	3.19	A	2.0	0.01	0.01	0.01	0.01	0.04	0.13	0.27
<b>Total Area (ac)</b>	<b>3.42</b>									
			Area-Weighted C	0.02	0.02	0.03	0.03	0.06	0.15	0.28
			Area-Weighted Override C	0.02	0.02	0.03	0.03	0.06	0.15	0.28

# Area-Weighted Runoff Coefficient Calculations

Version 2.00 released May 2017

Designer: Richard Lyon

Company: Rocky Mountain Group

Date: 1/15/2019

Project: Loudermilk Minor Subdivision

Location: Goshawk Road

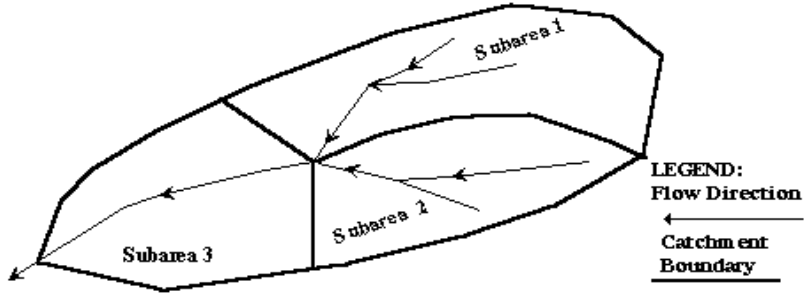

<b>Subcatchment Name</b>
Post-Dev

Cells of this color are for required user-input  
 Cells of this color are for optional override values  
 Cells of this color are for calculated results based on overrides

See sheet "Design Info" for imperviousness-based runoff coefficient values.

Sub-Area ID	Area (ac)	NRCS Hydrologic Soil Group	Percent Imperviousness	Runoff Coefficient, C						
				2-yr	5-yr	10-yr	25-yr	50-yr	100-yr	500-yr
ROOF	0.03	A	90.0	0.73	0.75	0.77	0.79	0.79	0.81	0.83
CONCRETE	0.02	A	90.0	0.73	0.75	0.77	0.79	0.79	0.81	0.83
WOOD	0.001	A	90.0	0.73	0.75	0.77	0.79	0.79	0.81	0.83
GRAVEL	0.27	A	40.0	0.25	0.27	0.28	0.32	0.37	0.42	0.51
FIELD/SOIL	3.49	A	2.0	0.01	0.01	0.01	0.01	0.04	0.13	0.27
<b>Total Area (ac)</b>	<b>3.81</b>			<b>0.03</b>	<b>0.03</b>	<b>0.04</b>	<b>0.04</b>	<b>0.07</b>	<b>0.16</b>	<b>0.29</b>
			<b>Area-Weighted C</b>	<b>0.03</b>	<b>0.03</b>	<b>0.04</b>	<b>0.04</b>	<b>0.07</b>	<b>0.16</b>	<b>0.29</b>
			<b>Area-Weighted Override C</b>	<b>0.03</b>	<b>0.03</b>	<b>0.04</b>	<b>0.04</b>	<b>0.07</b>	<b>0.16</b>	<b>0.29</b>

# Area-Weighted Runoff Coefficient Calculations

Version 2.00 released May 2017

Designer: Richard Lyon

Company: Rocky Mountain Group

Date: 1/15/2019

Project: Loudermilk Minor Subdivision

Location: Goshawk Road

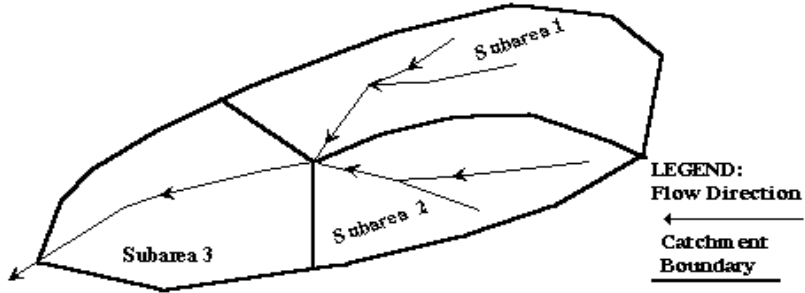

<b>Subcatchment Name</b>
Post-Dev

Cells of this color are for required user-input
Cells of this color are for optional override values
Cells of this color are for calculated results based on overrides

See sheet "Design Info" for imperviousness-based runoff coefficient values.

Sub-Area ID	Area (ac)	NRCS Hydrologic Soil Group	Percent Imperviousness	Runoff Coefficient, C						
				2-yr	5-yr	10-yr	25-yr	50-yr	100-yr	500-yr
FIELD/SOIL	3.47	A	2.0	0.01	0.01	0.01	0.01	0.04	0.13	0.27
<b>Total Area (ac)</b>	<b>3.47</b>			<b>0.01</b>	<b>0.01</b>	<b>0.01</b>	<b>0.01</b>	<b>0.04</b>	<b>0.13</b>	<b>0.27</b>
			<b>Area-Weighted C</b>	<b>0.01</b>	<b>0.01</b>	<b>0.01</b>	<b>0.01</b>	<b>0.04</b>	<b>0.13</b>	<b>0.27</b>
			<b>Area-Weighted Override C</b>	<b>0.01</b>	<b>0.01</b>	<b>0.01</b>	<b>0.01</b>	<b>0.04</b>	<b>0.13</b>	<b>0.27</b>



# Area-Weighted Runoff Coefficient Calculations

Version 2.00 released May 2017

Designer: Richard Lyon

Company: Rocky Mountain Group

Date: 1/15/2019

Project: Loudermilk Minor Subdivision

Location: Goshawk Road

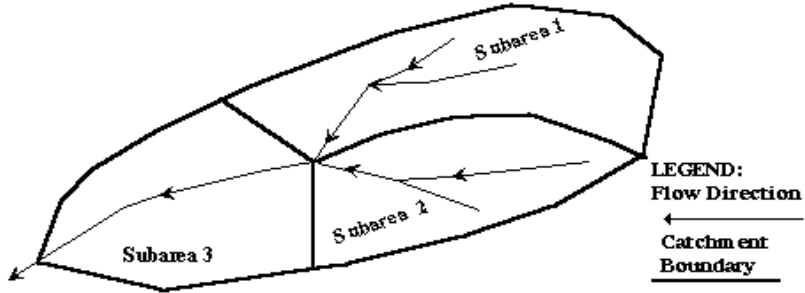

Subcatchment Name
Post-Dev

Cells of this color are for required user-input
Cells of this color are for optional override values
Cells of this color are for calculated results based on overrides

See sheet "Design Info" for imperviousness-based runoff coefficient values.

Sub-Area ID	Area (ac)	NRCS Hydrologic Soil Group	Percent Imperviousness	Runoff Coefficient, C						
				2-yr	5-yr	10-yr	25-yr	50-yr	100-yr	500-yr
FIELD/SOIL	1.83	A	2.0	0.01	0.01	0.01	0.01	0.04	0.13	0.27
<b>Total Area (ac)</b>	<b>1.83</b>	<b>Area-Weighted C</b>		<b>0.01</b>	<b>0.01</b>	<b>0.01</b>	<b>0.01</b>	<b>0.04</b>	<b>0.13</b>	<b>0.27</b>
		<b>Area-Weighted Override C</b>		<b>0.01</b>	<b>0.01</b>	<b>0.01</b>	<b>0.01</b>	<b>0.04</b>	<b>0.13</b>	<b>0.27</b>

## CIRCULAR CONDUIT FLOW (Normal & Critical Depth Computation)

Project: Blue cells are for user data entry

Pipe ID: Green cells are calculated values

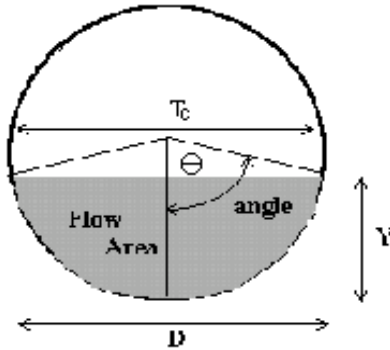

<b>Design Information (Input)</b>	
Pipe Invert Slope	So = <span style="border: 1px solid blue; padding: 2px;">0.0200</span> ft/ft
Pipe Manning's n-value	n = <span style="border: 1px solid blue; padding: 2px;">0.0150</span>
Pipe Diameter	D = <span style="border: 1px solid blue; padding: 2px;">15.00</span> inches
<b>Design discharge</b>	<b>Q = <span style="border: 1px solid blue; padding: 2px;">3.42</span> cfs</b>
<b>Full-flow Capacity (Calculated)</b>	
Full-flow area	Af = <span style="border: 1px solid green; padding: 2px;">1.23</span> sq ft
Full-flow wetted perimeter	Pf = <span style="border: 1px solid green; padding: 2px;">3.93</span> ft
Half Central Angle	Theta = <span style="border: 1px solid green; padding: 2px;">3.14</span> radians
Full-flow capacity	Qf = <span style="border: 1px solid green; padding: 2px;">7.94</span> cfs
<b>Calculation of Normal Flow Condition</b>	
Half Central Angle ( $0 < \theta < 3.14$ )	Theta = <span style="border: 1px solid green; padding: 2px;">1.49</span> radians
Flow area	An = <span style="border: 1px solid green; padding: 2px;">0.55</span> sq ft
Top width	Tn = <span style="border: 1px solid green; padding: 2px;">1.25</span> ft
Wetted perimeter	Pn = <span style="border: 1px solid green; padding: 2px;">1.86</span> ft
Flow depth	Yn = <span style="border: 1px solid green; padding: 2px;">0.57</span> ft
Flow velocity	Vn = <span style="border: 1px solid green; padding: 2px;">6.23</span> fps
Discharge	Qn = <span style="border: 1px solid green; padding: 2px;">3.42</span> cfs
Percent Full Flow	Flow = <span style="border: 1px solid green; padding: 2px;">43.1%</span> of full flow
Normal Depth Froude Number	Fr <sub>n</sub> = <span style="border: 1px solid green; padding: 2px;">1.65</span> supercritical
<b>Calculation of Critical Flow Condition</b>	
Half Central Angle ( $0 < \theta_c < 3.14$ )	Theta-c = <span style="border: 1px solid green; padding: 2px;">1.77</span> radians
Critical flow area	Ac = <span style="border: 1px solid green; padding: 2px;">0.76</span> sq ft
Critical top width	Tc = <span style="border: 1px solid green; padding: 2px;">1.23</span> ft
Critical flow depth	Yc = <span style="border: 1px solid green; padding: 2px;">0.75</span> ft
Critical flow velocity	Vc = <span style="border: 1px solid green; padding: 2px;">4.48</span> fps
Critical Depth Froude Number	Fr <sub>c</sub> = <span style="border: 1px solid green; padding: 2px;">1.00</span>

What culvert is this calculation for? Please label the calculation. Provide calculations for all applicable culverts.

## Determination of Culvert Headwater and Outlet Protection

Project: **Blue cells are for user data entry**

Basin ID: **Green cells are calculated values**

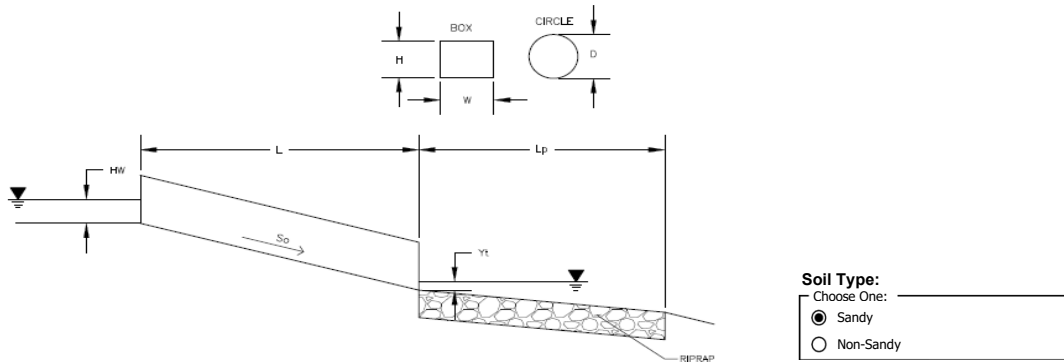

**Soil Type:**  
 Choose One: \_\_\_\_\_  
 Sandy  
 Non-Sandy

**Supercritical Flow! Using  $D_a$  to calculate protection type.**

Design Information (Input):	
Design Discharge	Q = <input style="width: 100px;" type="text" value="3.42"/> cfs
<b>Circular Culvert:</b>	
Barrel Diameter in Inches	D = <input style="width: 100px;" type="text" value="15"/> inches
Inlet Edge Type (Choose from pull-down list)	Grooved End with Headwall
<b>Box Culvert:</b>	<b>OR</b>
Barrel Height (Rise) in Feet	Height (Rise) = <input style="width: 100px;" type="text"/>
Barrel Width (Span) in Feet	Width (Span) = <input style="width: 100px;" type="text"/>
Inlet Edge Type (Choose from pull-down list)	<input style="width: 100px;" type="text"/>
Number of Barrels	No = <input style="width: 100px;" type="text" value="1"/>
Inlet Elevation	Elev IN = <input style="width: 100px;" type="text" value="7395"/> ft
Outlet Elevation <b>OR</b> Slope	Elev OUT = <input style="width: 100px;" type="text" value="7393.8"/> ft
Culvert Length	L = <input style="width: 100px;" type="text" value="60"/> ft
Manning's Roughness	n = <input style="width: 100px;" type="text" value="0.015"/>
Bend Loss Coefficient	$k_b$ = <input style="width: 100px;" type="text" value="0"/>
Exit Loss Coefficient	$k_x$ = <input style="width: 100px;" type="text" value="1"/>
Tailwater Surface Elevation	Elev $Y_t$ = <input style="width: 100px;" type="text"/>
Max Allowable Channel Velocity	V = <input style="width: 100px;" type="text" value="5"/> ft/s
Required Protection (Output):	
Tailwater Surface Height	$Y_t$ = <input style="width: 100px;" type="text" value="0.50"/> ft
Flow Area at Max Channel Velocity	$A_t$ = <input style="width: 100px;" type="text" value="0.68"/> ft <sup>2</sup>
Culvert Cross Sectional Area Available	A = <input style="width: 100px;" type="text" value="1.23"/> ft <sup>2</sup>
Entrance Loss Coefficient	$k_e$ = <input style="width: 100px;" type="text" value="0.20"/>
Friction Loss Coefficient	$k_f$ = <input style="width: 100px;" type="text" value="1.85"/>
Sum of All Losses Coefficients	$k_s$ = <input style="width: 100px;" type="text" value="3.05"/> ft
Culvert Normal Depth	$Y_n$ = <input style="width: 100px;" type="text" value="0.57"/> ft
Culvert Critical Depth	$Y_c$ = <input style="width: 100px;" type="text" value="0.75"/> ft
Tailwater Depth for Design	d = <input style="width: 100px;" type="text" value="1.00"/> ft
Adjusted Diameter <b>OR</b> Adjusted Rise	$D_a$ = <input style="width: 100px;" type="text" value="0.91"/> ft
Expansion Factor	$1/(2*\tan(\theta))$ = <input style="width: 100px;" type="text" value="6.70"/>
Flow/Diameter <sup>2.5</sup> <b>OR</b> Flow/(Span * Rise <sup>1.5</sup> )	$Q/D^{2.5}$ = <input style="width: 100px;" type="text" value="1.96"/> ft <sup>0.5</sup> /s
Froude Number	Fr = <input style="width: 100px;" type="text" value="1.65"/> <span style="color: red; font-weight: bold;">Supercritical!</span>
Tailwater/Adjusted Diameter <b>OR</b> Tailwater/Adjusted Rise	$Y_t/D$ = <input style="width: 100px;" type="text" value="0.55"/>
Inlet Control Headwater	$HW_i$ = <input style="width: 100px;" type="text" value="1.07"/> ft
Outlet Control Headwater	$HW_o$ = <input style="width: 100px;" type="text" value="0.17"/> ft
<b>Design Headwater Elevation</b>	<b>HW</b> = <input style="width: 100px;" type="text" value="7,396.07"/> ft
<b>Headwater/Diameter <b>OR</b> Headwater/Rise Ratio</b>	<b>HW/D</b> = <input style="width: 100px;" type="text" value="0.85"/>
Minimum Theoretical Riprap Size	$d_{50}$ = <input style="width: 100px;" type="text" value="2"/> in
Nominal Riprap Size	$d_{50}$ = <input style="width: 100px;" type="text" value="6"/> in
<b>UDFCD Riprap Type</b>	<b>Type</b> = <input style="width: 100px;" type="text" value="VL"/>
<b>Length of Protection</b>	$L_p$ = <input style="width: 100px;" type="text" value="4"/> ft
<b>Width of Protection</b>	T = <input style="width: 100px;" type="text" value="2"/> ft

## Vertical Profile for the Culvert

Project = **Blue cells are for user data entry**

Box ID = **Green cells are calculated values**

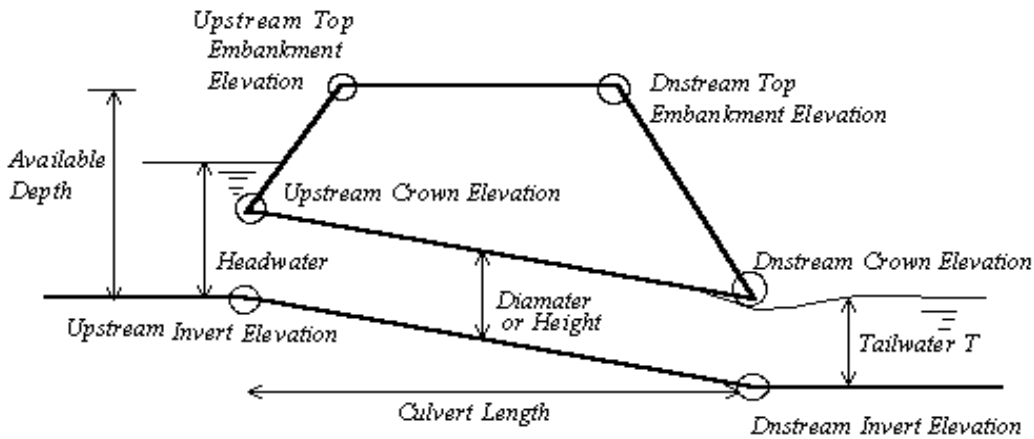

### **Culvert Information (Input)**

Barrel Diameter or Height	D or H =	15.00	inches
Barrel Length	L =	60.00	ft
Barrel Invert Slope	So =	0.0200	ft/ft
Downstream Invert Elevation	EDI =	7393.80	ft
Downstream Top Embankment Elevation	EDT =	7402.00	ft
Upstream Top Embankment Elevation	EUT =	7402.00	ft
Design Headwater Depth (not elev.)	Hw =	6.00	ft
Tailwater Depth (not elev.)	Yt =	7.20	ft

### **Culvert Hydraulics (Calculated)**

Available Headwater Depth	HW-a =	7.00	ft
Design Hw/D ratio	Hw/D =	4.80	

### **Culvert Vertical Profile**

Upstream Invert Elevation	EUI =	7395.00	ft
Upstream Crown Elevation	EUC =	7396.25	ft
Upstream Soil Cover Depth	Upsoil =	5.75	ft
Downstream Invert Elevation	EDI =	7393.80	ft
Downstream Crown Elevation	EDC =	7395.05	ft
Downstream Soil Cover Depth	Dnsoil =	6.95	ft

# Markup Summary

Daniel Torres (19)

**Subject:** Text Box

**Page Label:** 1

**Lock:** Locked

**Author:** Daniel Torres

**Date:** 3/27/2019 12:31:05 PM

**Color:** ■

Add PCD File No. MS192

Add PCD File No. MS192

1 | Page

Engineering Documents  
Reviewed By:  
Daniel Torres  
dantorres@hdpd.com  
EPC Planning & Community  
Development Department

**Subject:** EPC ENG Approval

**Page Label:** 1

**Lock:** Locked

**Author:** Daniel Torres

**Date:** 3/27/2019 12:31:06 PM

**Color:** ■

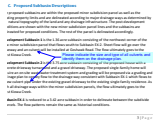

**Subject:** Callout

**Page Label:** 7

**Lock:** Locked

**Author:** Daniel Torres

**Date:** 3/27/2019 12:31:07 PM

**Color:** ■

Please indicate the size and type of all culverts and identify them on the drainage plan.

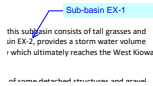

**Subject:** Callout

**Page Label:** 7

**Lock:** Locked

**Author:** Daniel Torres

**Date:** 3/27/2019 12:31:07 PM

**Color:** ■

Sub-basin EX-1

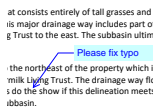

**Subject:** Callout

**Page Label:** 7

**Lock:** Locked

**Author:** Daniel Torres

**Date:** 3/27/2019 12:31:11 PM

**Color:** ■

Please fix typo



**Subject:** Callout

**Page Label:** 10

**Lock:** Locked

**Author:** Daniel Torres

**Date:** 3/27/2019 12:31:12 PM

**Color:** ■

Please indicate the size and type on the drainage plan

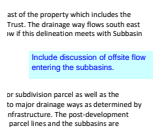

**Subject:** Text Box

**Page Label:** 7

**Lock:** Locked

**Author:** Daniel Torres

**Date:** 3/27/2019 12:31:12 PM

**Color:** ■

Include discussion of offsite flow entering the subbasins.

vent, and 1.41 cfs for a 100-year storm event  
to the West Kiowa Creek watershed. The great  
advent pipe that crosses the existing gravel co-  
reperly for the post-development conditions  
Please incorporate offsite  
flow in your analysis  
Drainage Facility Design  
A. General Concept

**Subject:** Text Box  
**Page Label:** 10  
**Lock:** Locked  
**Author:** Daniel Torres  
**Date:** 3/27/2019 12:31:13 PM  
**Color:** ■

Please incorporate offsite flow in your analysis

is to convey storm w  
proposed minor sub  
implementing prop  
level spreaders. The  
implementing energ  
improve infiltration

**Subject:** Highlight  
**Page Label:** 10  
**Lock:** Locked  
**Author:** Daniel Torres  
**Date:** 3/27/2019 12:31:14 PM  
**Color:** ■

level spreaders

nt runoff by  
via rip-rap and

**Subject:** Highlight  
**Page Label:** 10  
**Lock:** Locked  
**Author:** Daniel Torres  
**Date:** 3/27/2019 12:31:14 PM  
**Color:** ■

rip-rap

Please include an evaluation of the  
four-step process per ECM section 1.7.2.  
Indicate why water quality capture  
volume (step 3 of process) is not  
required for this development.

**Subject:** Text Box  
**Page Label:** 11  
**Lock:** Locked  
**Author:** Daniel Torres  
**Date:** 3/27/2019 12:31:15 PM  
**Color:** ■

Please include an evaluation of the four-step  
process per ECM section 1.7.2. Indicate why water  
quality capture volume (step 3 of process) is not  
required for this development.

Please show on the drainage plan the  
design points indicated in the narrative.



**Subject:** Text Box  
**Page Label:** 29  
**Lock:** Locked  
**Author:** Daniel Torres  
**Date:** 3/27/2019 12:31:16 PM  
**Color:** ■

Please show on the drainage plan the design  
points indicated in the narrative.



**Subject:** Text Box  
**Page Label:** 29  
**Lock:** Locked  
**Author:** Daniel Torres  
**Date:** 3/27/2019 12:31:17 PM  
**Color:** ■

Please re-locate all the drainage plans to the end  
of the drainage report.

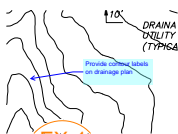

**Subject:** Callout  
**Page Label:** 29  
**Lock:** Locked  
**Author:** Daniel Torres  
**Date:** 3/27/2019 12:31:19 PM  
**Color:** ■

Provide contour labels on drainage plan

Please show on the drainage plan the  
design points indicated in the narrative.



**Subject:** Text Box  
**Page Label:** 30  
**Lock:** Locked  
**Author:** Daniel Torres  
**Date:** 3/27/2019 12:31:20 PM  
**Color:** ■

Please show on the drainage plan the design  
points indicated in the narrative.

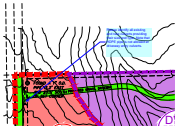

**Subject:** Callout  
**Page Label:** 30  
**Lock:** Locked  
**Author:** Daniel Torres  
**Date:** 3/27/2019 12:31:21 PM  
**Color:** ■

Please identify all existing and new culverts providing their size and type. Note that HDPE pipe is not allowed at driveway entry culverts.



**Subject:** Callout  
**Page Label:** 37  
**Lock:** Locked  
**Author:** Daniel Torres  
**Date:** 3/27/2019 12:31:22 PM  
**Color:** ■

Per El Paso county criteria gravel driveways shall be analyzed based on an imperviousness of 80%. Revise all calculations accordingly.

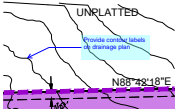

**Subject:** Callout  
**Page Label:** 30  
**Lock:** Locked  
**Author:** Daniel Torres  
**Date:** 3/27/2019 12:31:22 PM  
**Color:** ■

Provide contour labels on drainage plan

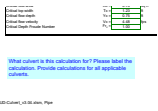

**Subject:** Text Box  
**Page Label:** 50  
**Lock:** Locked  
**Author:** Daniel Torres  
**Date:** 3/27/2019 12:31:23 PM  
**Color:** ■

What culvert is this calculation for? Please label the calculation. Provide calculations for all applicable culverts.