

STORMWATER MANAGEMENT PLAN
for
BENT GRASS PLAZA
A repat of Bent Grass Commercial Filing No. 3
Bent Grass Meadows Drive
Falcon, Colorado

EPC Filing Number: PPR-2342

November, 2023

Prepared For:

Copestone General Contractors
555 Amelia Street, Suite 100
Colorado Springs, CO 80915
Contact: Nathan Derwick

Prepared by:

Drexel, Barrell & Co.
101 Sahwatch St., Suite 100
Colorado Springs, CO 80903
Contact: Tim McConnell, P.E.
(719) 260-0887

Qualified Stormwater Manager

TBD

Contractor:

TBD

**STORMWATER MANAGEMENT PLAN
BENT GRASS PLAZA**

TABLE OF CONTENTS

1.0	STORMWATER QUALITY STATEMENT & OBJECTIVES	2
2.0	SITE DESCRIPTION.....	3
2.1	DESCRIPTION OF CONSTRUCTION ACTIVITIES.....	3
2.2	EXISTING SITE CONDITIONS	3
2.3	ADJACENT AREAS.....	3
2.4	SOILS.....	4
2.5	AREAS AND VOLUME STATEMENT	4
2.6	CONTROLS AND MEASURES DURING CONSTRUCTION.....	4
2.7	POTENTIAL POLLUTION SOURCES	6
2.8	NON-STORMWATER DISCHARGES.....	8
2.9	RECEIVING WATER.....	8
3.0	GRADING & EROSION CONTROL PLA.....	8
4.0	BMP's FOR STORMWATER POLLUTION PREVENTION	9
4.1	EROSION CONTROL – STRUCTURAL PRACTICES.....	9
4.2	EROSION CONTROL – NON-STRUCTURAL PRACTICES.....	11
4.3	MATERIALS HANDLING & SPILL PREVENTION.....	12
4.4	DEDICATED CONCRETE OR ASPHALT BATCH PLANTS.....	13
4.5	GROUNDWATER & STORMWATER DEWATERING	13
5.0	TIMING SCHEDULE.....	13
6.0	FINAL STABILIZATION AND LONG-TERM STORMWATER MANAGEMENT.....	13
7.0	INSPECTION AND MAINTENANCE.....	14
8.0	REFERENCES	15

APPENDICES

VICINITY MAP	APPENDIX A
SOILS INFORMATION	APPENDIX B
SITE MAP	APPENDIX C
INSPECTION FORM TEMPLATE.....	APPENDIX D

1.0 STORMWATER QUALITY STATEMENT & OBJECTIVES

Stormwater quality best management practices shall be implemented to minimize soil erosion, sedimentation, increased pollutant loads and changed water flow characteristics resulting from land disturbing activity, to the maximum extent practicable, so as to minimize pollution of receiving waters.

Per Appendix A of the Colorado Department of Health, Water Quality Control Division's (the Division) "General Permit Application for Stormwater Discharge Associated with Construction Activities", the goal of the Stormwater Management Plan (SWMP) is:

"To identify possible pollutant sources that may contribute pollutants to stormwater, and identify Best Management Practices (BMPs) that, when implemented, will reduce or eliminate any possible water quality impacts. The SWMP must be completed and implemented at the time the project breaks ground, and revised if necessary as construction proceeds to accurately reflect the conditions and practices at the site."

This document is not intended to address training, site specific operational procedures, logistics, or other "means and methods" required to construct this project.

This document must be kept at the construction site at all times. Inspections are to be made at least every 14 days and after any precipitation event, or snowmelt that causes surface erosion. El Paso County requires that the inspector be contacted 48 hours prior to initial and final inspections. An inspection log entry shall be completed with each inspection performed. The inspection log shall be kept with the SWMP. The conditions of the SWMP and General Permit for Stormwater Discharges associated with the construction activity will remain in effect until final stabilization is achieved, and a notice of inactivation is sent to CDPHE Stormwater Quality Division. All pertinent records must be kept for at least 3 years from the date the site is stabilized.

This SWMP shall be viewed as a “living document” that is continuously being reviewed and modified as part of the overall process of evaluating and managing stormwater quality issues at the site. The Qualified Stormwater Manager (QSM) shall amend the SWMP when there is a change in the design, construction, Operations and Maintenance (O&M) of the site which would require the implementation of new or revised BMPs, or if the SWMP proves to be ineffective in achieving the general objectives of controlling pollutants in stormwater discharges associated with construction activity, or when BMPs are no longer necessary and are removed.

Drexel, Barrell & Co. has been retained to provide civil engineering services for the design of this project. Drexel, Barrell & Co. is not responsible for implementation and maintenance of the Stormwater Management Plan.

2.0 SITE DESCRIPTION

2.1 DESCRIPTION OF CONSTRUCTION ACTIVITIES

The project involves the development of a commercial project in Falcon, CO. The total site area consists of approximately 1.85 acres of commercial development with drive aisles, parking and landscaped areas. The project will be split into two phases.

2.2 EXISTING SITE CONDITIONS

The site has been previously overlot graded and utility stubs installed onto the property. Sparse grasses and vegetation currently covers approximately 100% of the site, as determined by visual inspection. The site slopes generally from north to south towards an existing low point in Bent Grass Market View. Site runoff is picked up by an existing inlet located at the low point in Bent Grass Market View before discharging to the south towards an existing detention facility.

2.3 ADJACENT AREAS

The site is bounded on the north by Bent Grass Meadows Drive and the south and west by Bent Grass Market View and to the east by Meridian Park Drive. The surrounding areas will not be affected by the land disturbing and stabilization activities.

2.4 SOILS

From the Natural Resources Conservation Service (NRCS), the soil on the site as mapped by the Soil Conservation Service (SCS) is the Columbine gravelly sandy loam (Soil No. 19). The soil is apart of hydrologic group A, with moderate erosion potential. Hydrologic Soil Group A soils have a high infiltration rate when thoroughly wet. These consist mainly of deep, well drained to excessively drained sands or gravelly sands. These soils have a high rate of water transmission. Potential effects of soil erosion include compaction, loss of soil structure, nutrient degradation, soil salinity and increased sediment load downstream.

2.5 AREAS AND VOLUME STATEMENT

The project site consists of approximately 1.85 acres. Unadjusted overlot earthwork volumes within the construction site are approximately 670 CY of cut and 1260 CY of fill. Sediment traps will be required during the overlot grading stage to ensure that sediment is captured prior to discharge. Once the site storm sewer is installed the sediment traps can be removed.

2.6 CONTROLS AND MEASURES DURING CONSTRUCTION

Stabilization activities are anticipated to begin in the Spring of 2024. A construction schedule will be prepared by the contractor prior to land disturbing activities. Phasing of the installation of stabilization measures will be required. Reference the attached Grading and Erosion Control plans in the appendix for site specific locations and phasing. The general sequence of major construction activities is as follows:

1. Temporary Erosion Control Measures – Temporary erosion control measures, such as silt fence and construction of a vehicle tracking pad and staging area will be completed prior to any other large scale activity. The vehicle tracking pad will ensure a reduction of tracking of soil on and off the construction site. The staging area will house the materials, petroleum product storage (if any), trash dumpster, sanitary facilities and hazardous spill clean-up areas. These are all potential pollutants that are not sediment related.

2. Trash and Debris Removal – Existing trash and debris shall be removed from the site and hauled to designated receiving facility.
3. Site Clearing – The area to be disturbed for construction will be cleared and grubbed, as necessary to the perimeter of erosion control. The sequence of the areas to be cleared and grubbed are subject to the contractor's means and methods of construction of the site; however, the general plan is to work from the south to north where the vehicle tracking pads are located in order to eliminate backtracking over areas that have already been completed.
4. Overlot Grading – Overlot grading will occur to bring the site to the proposed sub-grade elevations in paved areas, and to finished grade elevations in the landscape and detention areas. Spoils from the site will be removed from the site and hauled to a designated receiving facility or location. Sediment Traps will be installed during the overlot grading stage prior to installation of the project storm sewer.
5. Utility Installation – Utility installation will consist of water, sanitary sewer, electric, and telephone and natural gas service lines. Storm drain lines will also be installed. Utility locations will be obtained prior to commencement of construction activities.
6. Final Grading – The site will be brought to final elevations with the installation of the proposed paving and final blending to existing grades on the perimeter of the improvement area.
7. Permanent Re-vegetation – Erosion control blanket will be installed at all areas graded to a 3:1 slope and greater. Areas not paved will be re-vegetated and/or landscaped by the contractor or owner as per the approved landscape plan. Vegetation and stabilization of soil will aid in the trapping of sediment and reducing soil erosion.
8. Removal of Temporary BMP's – Temporary erosion control measures may be removed once the site has achieved final 70 percent of pre disturbance levels and

vegetation cover is capable of reducing soil erosion. All permanent BMPs shall be cleaned and functioning before any temporary BMPs are removed.

9. Housekeeping – The best BMP for a job site is good housekeeping around the site.

- 1) Routine site trash pickup and routine BMP inspection and maintenance are paramount for keeping a job site clean and tidy. Waste disposal bins shall be checked weekly for leaks and emptied weekly or as necessary to prevent overflowing capacity.
- 2) All petroleum storage areas in the staging area should be checked daily for leaks. Any leaks shall be reported to the site foreman for clean up. All personnel on site for both the contractor and subcontractors should be briefed on spill cleanup and containment procedures. Employees shall also be briefed as to where the spill cleanup materials can be found if a spill should occur. The spill plan shall be produced by the general contractor for the project and remain onsite for the duration of the project. Contractor shall coordinate with the County to obtain the necessary contacts in the case that a spill occurs.
- 3) All portable toilets shall be located a minimum of 10ft from stormwater inlets and 50ft from State Waters. Portable toilets shall be secured at all four corners to prevent overturning, cleaned on a weekly basis and inspected daily for spills.

2.7 POTENTIAL POLLUTION SOURCES

Any substances with the potential to contaminate either the ground or ground surface water shall be cleaned up immediately following discovery, or contained until appropriate cleanup methods can be employed. Manufacturer's recommended methods for cleanup shall be followed, along with proper disposal methods. All waste and debris created by construction at the site or removed from the site shall be disposed of in accordance with all laws, regulations and ordinances of the Federal, State and local agencies. The following

is a summary of potential pollution sources and their associated measures intended to minimize the risk of pollution for this project.

- 1) Disturbed and stored soils: Straw wattles/fiber rolls, straw bale check dams and gravel bag check dams, seed and mulch.
- 2) Vehicle tracking and sediments: VTC and Street Sweeping
- 3) Loading and unloading operations: Stabilized staging area, materials storage area, VTC and silt fence.
- 4) Outdoor storage of materials: Stabilized staging area, materials storage area and silt fence.
- 5) Vehicle and equipment maintenance and fueling: Spill prevention procedures.
- 6) Dust or particulate generation from earthmoving activities and vehicle movement: water trucks for site watering.
- 7) On site waste management of solid wastes (construction debris): Waste container placement, covering and disposal.
- 8) Concrete truck/equipment washing: Dedicated concrete washout areas.
- 9) Worker trash and portable toilets: Container placement, covering and disposal.
- 10) Equipment repair or maintenance beyond normal fueling operations: Spill prevention procedures.
- 11) Waste disposal: Container placement, covering and regular disposal. Containers are to be checked daily for capacity and emptied when 3/4-full. At a minimum containers are to be emptied weekly.

12) Off site soil tracking: Contractor to perform street sweeping following storm events and as required to keep adjoining public streets clean

13) Portable toilets will be located a minimum of 10-ft from stormwater inlets and 50-ft from State Waters. They will be secured at all four corners to prevent overturning and are to be cleaned on a weekly basis. They are to be inspected daily for spills.

The following items are not anticipated to be potential pollution sources for this project:

- 1) Management of contaminated soils.
- 2) Outdoor storage of fertilizers, chemicals or potentially polluting construction material.
- 3) Dedicated asphalt or concrete batch plants.

2.8 NON-STORMWATER DISCHARGES

Non-stormwater discharges possibly encountered during construction may include: watering down of the site, construction staging area, and excess dirt storage during high winds to minimize wind erosion and water utilized in soil compaction efforts. These will occur on a site-wide basis.

2.9 RECEIVING WATER

Runoff generated by the proposed project will be passed to the onsite storm sewer system and detention pond prior to discharging into the roadside ditch along Meridian Road, and ultimately joining the unnamed tributary of Black Squirrel Creek.

No streams cross the project area.

3.0 GRADING & EROSION CONTROL PLAN

Attached as part of this plan is a Grading and Erosion Control Plan (See Appendix C). The drawings identify the following:

- 1) Project area boundary and areas of disturbance

- 2) Cut-Fill delineation lines
- 3) Area used for staging
- 4) Location of erosion control facilities or structures (BMP's)
- 5) Boundaries of 100-year floodplains (if applicable)

The following items may not be indicated on the attached drawings, but will be determined by the individual contractors prior to and during construction activities:

- 1) Areas used for storage of construction materials, soils, or wastes
- 2) Location of portable toilets and waste receptacles
- 3) Location of additional BMP's that may become necessary as work progresses

These items shall be added to the Site Map by the Contractor.

4.0 BMP's FOR STORMWATER POLLUTION PREVENTION

Best management practices (BMPs) used throughout the site shall include, but are not limited to: surface roughening, silt fence, inlet protection, vehicle tracking control, mulching and reseeding and concrete washout.

4.1 EROSION CONTROL – STRUCTURAL PRACTICES

A list of the Structural BMP's for erosion and sediment control that may implemented on the site to minimize erosion and sediment are as follows. Refer to the SWMP Drawings for installation and maintenance requirements and location for each structural BMP. For each BMP not shown, reference the Mile High Flood District (MHFD) standard details for reference.

1. Concrete Washout Area (CWA): A shallow excavation with a small perimeter berm to isolate concrete truck washout operations. This is an interim/final BMP intended to be utilized once overlot grading has been completed.

2. Construction Fence (CF): Installed to delineate the perimeter of the site. This is required at the initial stage or pre-disturbance. Construction fence is to remain until project completion or as otherwise determined by the contractor.
3. Drainage Swale/Earth Dike (DS): A small earth, riprap or erosion blanket lined channel used to diver and convey runoff. This is an initial/interim BMP designed for use during grading operations.
4. Erosion Control Blanket (ECB): Slopes steeper than or equal to 3 (horizontal) to 1 (vertical) shall be protected with an erosion control blanket. This is a final stabilization measure to be installed once grading is completed.
5. Inlet Protection (IP): Installed as an initial/interim measure to filter stormwater before entering any watercourses.
6. Reinforced Sock (RS): An initial/interim measure that consists of a linear mass of gravel enclosed in wire mesh to form a porous filter, able to withstand overtopping.
7. Sediment Basin (SB): An initial/interim measure consisting of an impoundment that captures sediment laden runoff and releases it slowly, providing prolonged settling times to capture coarse and fine grained soil particles.
8. Sediment Control Log (SCL): An initial/interim measure that consists of a cylindrical bundle of wood, coconut, compost, excelsior, or straw fiber designed to form a semi-porous filter able to withstand overtopping.
9. Seeding and Mulching (SM): As an interim measure temporary seeding and mulching can be used to stabilize disturbed areas that will be inactive for an extended period of time. As a final measure permanent seeding should be used to stabilize areas at final grade that will not otherwise be stabilized.
10. Silt Fence (SF): A temporary sediment barrier constructed of woven fabric stretched across supporting posts, used as an initial/interim measure.
11. Stabilized Staging Area (SSA): An initial/interim measure that consists of stripping the topsoil and spreading a layer of granular material in the area to be used for a trailer, parking, storage, unloading and loading.
12. Temporary Stockpile Areas (TS): An initial measure for use during grading operations that utilizes temporary stockpiles of excess excavated material and stockpiles for imported materials. Slopes shall not be steeper than 3 to 1.

13. Vehicle Tracking Control (VTC): Consists of a rock pad that is intended to help strip mud from tires prior to vehicles leaving the construction site. Installed as an initial/interim measure at all entrance/exit points to the site. The number of access points shall be minimized.
14. Sediment Trap (ST): Consists of a localized depression intended to capture sediment before discharge via a small riprap berm. Sediment traps are intended to remain in place until the storm sewer system is installed, or the upstream area is stabilized.

Minimal clearing and grubbing may be necessary prior to installing the initial erosion control features.

A pre-construction meeting with El Paso County must be held, initial BMPs installed, and a Notice to Proceed issued before any work can begin.

Once signoff and acceptance is received the approved erosion and sediment control measures must be installed before land-disturbing activities are initiated so that no adverse effect of site alteration will impact surrounding property.

4.2 EROSION CONTROL – NON-STRUCTURAL PRACTICES

Non-structural practices for erosion and sediment control to be used to minimize erosion and sediment transport are:

- a) Seeding and mulching and landscape installation in areas that will not be hard surfaced, while minimizing the amount of vegetation to be removed during construction, leaving native vegetation in place when possible.
- b) Street sweeping around the construction site will be utilized when tracking of mud occurs on paved streets. The sweeping will be required after any significant tracking has occurred; significant meaning any visible amount that cannot be completely cleaned by hand. The adjacent paved drive surfaces will be cleaned at the end of each day of construction activities. Sweeping efforts will continue as necessary until construction operations are completed.

- c) Site watering will be required to mitigate dust control and sediment and to aid in compaction.

4.3 MATERIALS HANDLING & SPILL PREVENTION

The SWMP administrator will inspect daily to ensure proper use and disposal of materials on site including building materials, paints, solvents, fertilizers, chemicals, waste materials and equipment maintenance or fueling procedures. All materials stored onsite will be stored in a neat and orderly manner in the original containers with the original manufacturer's label, and if possible under a roof or other enclosure to prevent contact with stormwater. Chemicals should be stored within berms or other secondary containment devices to prevent leaks and spills from contacting stormwater runoff. Before disposing of the container, all of a product will be used up whenever possible and manufacturer's recommendations for proper disposal will be followed according to state and local regulations.

Material and equipment necessary for spill cleanup will be kept in the material storage area on site. Manufacturer's recommendations for spill cleanup will be posted and site personnel will be made aware of the procedures along with the location of the information and cleanup supplies.

The contractor shall have spill prevention and response procedures that include the following:

- a) Notification procedures to be used in the event of an accident. At the very least, the SWMP administrator should be notified. Depending on the nature of the spill and the material involved, the Colorado Department of Public Health and Environment (24-hour spill reporting line (877) 518-5608), downstream water users or other agencies may also need to be informed.
- b) Instructions for clean up procedures and identification of spill kit location(s).
- c) Provisions for absorbents to be made available for use in fuel areas and for containers to be available for used absorbents.

- d) Procedures for properly washing out concrete truck chutes and other equipment in a manner and location so that the materials and wash water cannot discharge from the site and never into a storm drain system or stream.

4.4 DEDICATED CONCRETE OR ASPHALT BATCH PLANTS

No dedicated concrete or asphalt batch plants will be used.

4.5 GROUNDWATER & STORMWATER DEWATERING

In the event that groundwater is encountered or stormwater enters an excavation and dewatering is necessary, a separate CDPHE construction discharge (dewatering) permit will be required for groundwater dewatering and shall be obtained by the SWMP administrator. During groundwater or stormwater dewatering, locations and practices to be implemented to control stormwater pollution from excavations, etc., must be noted on the SWMP. Construction dewatering cannot be discharged to surface water or to storm sewer systems without separate permit coverage. The discharge of Construction Dewatering water to the ground, under specific conditions, may be allowed by the Stormwater Construction Permit when appropriate BMP's are implemented. Refer to USDCM Volume III (UDFCD) for County acceptable means of dewatering.

5.0 TIMING SCHEDULE

The project is anticipated to begin construction in the Spring of 2024 with final stabilization completion by Spring of 2025. The contractor shall be responsible for producing a schedule that will show at a minimum: start and completion times including site grading operations, utility construction and the removal of the temporary erosion and sediment control measures.

6.0 FINAL STABILIZATION AND LONG-TERM STORMWATER MANAGEMENT

Final stabilization shall not be considered complete until 70% of new or pre-existing vegetated cover condition is established on areas not to be hard-surfaced. Temporary sediment and erosion control measures installed prior to the construction phase will remain in place until this time. Any sediment that collects within the site's drainage

system is considered unstabilized soil and must be removed prior to the site being considered finally stabilized.

At final stabilization, stormwater pollutants will be controlled by on site landscaping, source control best practices and by the detention facility located to the south. The storm inlets will be provided inlet protection and storm lines shall be cleaned and free from sediment once the site becomes stabilized.

Inspections and maintenance of the existing detention facility is by Bent Grass Metropolitan District.

7.0 INSPECTION AND MAINTENANCE

This project does not rely on control measures that are owned or operated by another entity.

A site inspection of all erosion control facilities will be conducted every 14 days and within 24 hours after every precipitation event, or snowmelt event that causes surface erosion. The entrance to the construction site shall be inspected daily and existing street cleaned, as necessary, of all materials tracked out of the site.

The construction site perimeter, disturbed areas, and areas used for material storage that are exposed to precipitation shall be inspected for evidence of, or the potential for, pollutants entering the drainage system. Erosion and sediment control measures identified in the SWMP shall be observed to ensure that they are operating correctly.

Based on the results of the inspection, the description of potential pollutant sources and the pollution prevention and control measures that are identified in this plan shall be revised and modified as appropriate as soon as practicable after such inspection. Modification to control measures shall be implemented in a timely manner, but in no case more than seven (7) calendar days after the inspection.

The operator shall be responsible for documenting inspections and maintaining records. Uncontrolled releases of mud or muddy water or measurable quantities of sediment

found off the site shall be recorded with a brief explanation as to the measures taken to prevent future releases as well as any measure taken to clean up the sediment that has left the site. All signed inspection record/logs should be kept on site and made available to the El Paso County or CDPHE personnel upon request.

All temporary and permanent erosion and sediment control facilities shall be maintained and repaired per manufacturer's specifications to assure continued performance of their intended function. Repairs should be completed within 24 to 48 hours. Silt fences may require periodic replacement.

8.0 REFERENCES

- [1] General Permit Application and Stormwater Management Plan Preparation Guidance for Stormwater Discharges Associated with Construction Activities. Prepared by the Colorado Department of Health, Water Quality Control Division. Revised 7/2009.
- [2] City of Colorado Springs– Drainage Criteria Manual, Volume 2 “Stormwater Quality Procedures and Best Management Practices (BMPs). November 1, 2002, amended August 10, 2010.
- [3] NRCS Web Soil Survey, www.websoilsurvey.nrcs.usda.gov

APPENDIX A
Vicinity Map

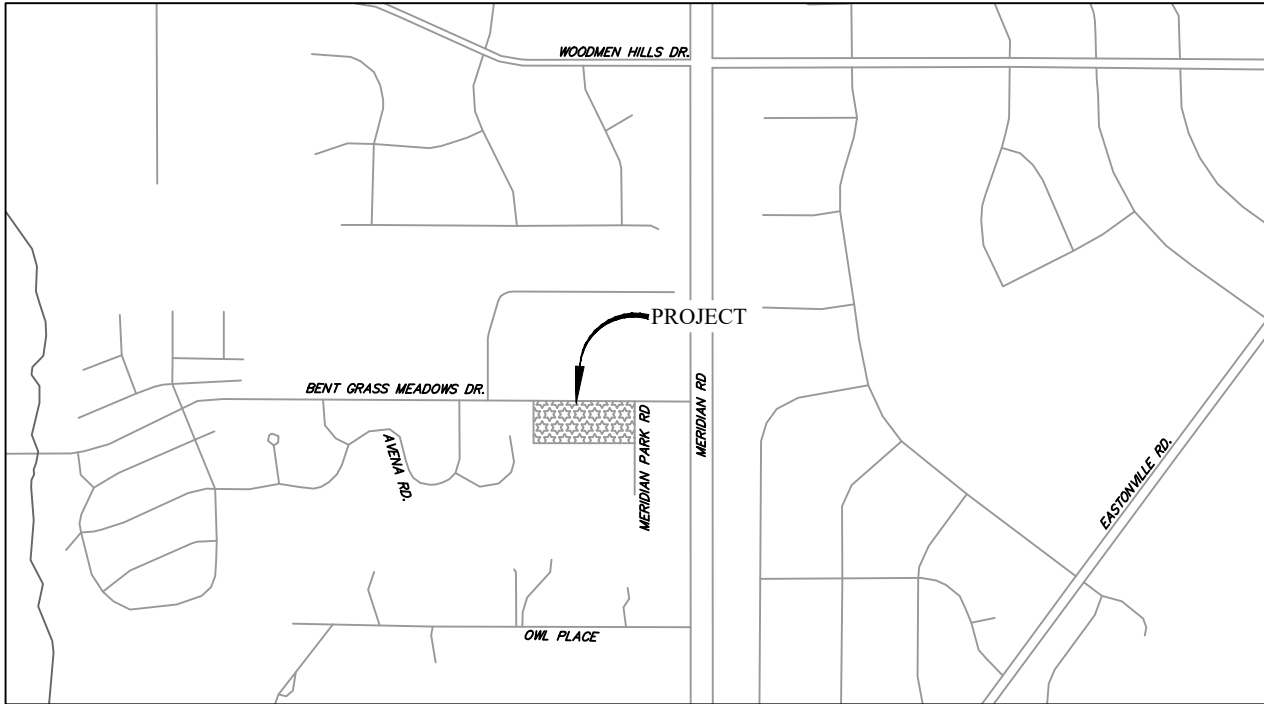

Vicinity Map
Not to scale

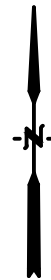

**BENT GRASS PLAZA
PEYTON, CO
VICINITY MAP**

Drexel, Barrell & Co.
Engineers • Surveyors

DATE:
11/17/2023
JOB NO.:
21814-00CSCV

DWG. NO.
VMAP
SHEET 1 OF 1

APPENDIX B
SOILS INFORMATION

Custom Soil Resource Report for El Paso County Area, Colorado



Preface

Soil surveys contain information that affects land use planning in survey areas. They highlight soil limitations that affect various land uses and provide information about the properties of the soils in the survey areas. Soil surveys are designed for many different users, including farmers, ranchers, foresters, agronomists, urban planners, community officials, engineers, developers, builders, and home buyers. Also, conservationists, teachers, students, and specialists in recreation, waste disposal, and pollution control can use the surveys to help them understand, protect, or enhance the environment.

Various land use regulations of Federal, State, and local governments may impose special restrictions on land use or land treatment. Soil surveys identify soil properties that are used in making various land use or land treatment decisions. The information is intended to help the land users identify and reduce the effects of soil limitations on various land uses. The landowner or user is responsible for identifying and complying with existing laws and regulations.

Although soil survey information can be used for general farm, local, and wider area planning, onsite investigation is needed to supplement this information in some cases. Examples include soil quality assessments (<http://www.nrcs.usda.gov/wps/portal/nrcs/main/soils/health/>) and certain conservation and engineering applications. For more detailed information, contact your local USDA Service Center (<https://offices.sc.egov.usda.gov/locator/app?agency=nrcs>) or your NRCS State Soil Scientist (http://www.nrcs.usda.gov/wps/portal/nrcs/detail/soils/contactus/?cid=nrcs142p2_053951).

Great differences in soil properties can occur within short distances. Some soils are seasonally wet or subject to flooding. Some are too unstable to be used as a foundation for buildings or roads. Clayey or wet soils are poorly suited to use as septic tank absorption fields. A high water table makes a soil poorly suited to basements or underground installations.

The National Cooperative Soil Survey is a joint effort of the United States Department of Agriculture and other Federal agencies, State agencies including the Agricultural Experiment Stations, and local agencies. The Natural Resources Conservation Service (NRCS) has leadership for the Federal part of the National Cooperative Soil Survey.

Information about soils is updated periodically. Updated information is available through the NRCS Web Soil Survey, the site for official soil survey information.

The U.S. Department of Agriculture (USDA) prohibits discrimination in all its programs and activities on the basis of race, color, national origin, age, disability, and where applicable, sex, marital status, familial status, parental status, religion, sexual orientation, genetic information, political beliefs, reprisal, or because all or a part of an individual's income is derived from any public assistance program. (Not all prohibited bases apply to all programs.) Persons with disabilities who require

alternative means for communication of program information (Braille, large print, audiotape, etc.) should contact USDA's TARGET Center at (202) 720-2600 (voice and TDD). To file a complaint of discrimination, write to USDA, Director, Office of Civil Rights, 1400 Independence Avenue, S.W., Washington, D.C. 20250-9410 or call (800) 795-3272 (voice) or (202) 720-6382 (TDD). USDA is an equal opportunity provider and employer.

Contents

Preface	2
How Soil Surveys Are Made	5
Soil Map	8
Soil Map.....	9
Legend.....	10
Map Unit Legend.....	11
Map Unit Descriptions.....	11
El Paso County Area, Colorado.....	13
19—Columbine gravelly sandy loam, 0 to 3 percent slopes.....	13
References	15

How Soil Surveys Are Made

Soil surveys are made to provide information about the soils and miscellaneous areas in a specific area. They include a description of the soils and miscellaneous areas and their location on the landscape and tables that show soil properties and limitations affecting various uses. Soil scientists observed the steepness, length, and shape of the slopes; the general pattern of drainage; the kinds of crops and native plants; and the kinds of bedrock. They observed and described many soil profiles. A soil profile is the sequence of natural layers, or horizons, in a soil. The profile extends from the surface down into the unconsolidated material in which the soil formed or from the surface down to bedrock. The unconsolidated material is devoid of roots and other living organisms and has not been changed by other biological activity.

Currently, soils are mapped according to the boundaries of major land resource areas (MLRAs). MLRAs are geographically associated land resource units that share common characteristics related to physiography, geology, climate, water resources, soils, biological resources, and land uses (USDA, 2006). Soil survey areas typically consist of parts of one or more MLRA.

The soils and miscellaneous areas in a survey area occur in an orderly pattern that is related to the geology, landforms, relief, climate, and natural vegetation of the area. Each kind of soil and miscellaneous area is associated with a particular kind of landform or with a segment of the landform. By observing the soils and miscellaneous areas in the survey area and relating their position to specific segments of the landform, a soil scientist develops a concept, or model, of how they were formed. Thus, during mapping, this model enables the soil scientist to predict with a considerable degree of accuracy the kind of soil or miscellaneous area at a specific location on the landscape.

Commonly, individual soils on the landscape merge into one another as their characteristics gradually change. To construct an accurate soil map, however, soil scientists must determine the boundaries between the soils. They can observe only a limited number of soil profiles. Nevertheless, these observations, supplemented by an understanding of the soil-vegetation-landscape relationship, are sufficient to verify predictions of the kinds of soil in an area and to determine the boundaries.

Soil scientists recorded the characteristics of the soil profiles that they studied. They noted soil color, texture, size and shape of soil aggregates, kind and amount of rock fragments, distribution of plant roots, reaction, and other features that enable them to identify soils. After describing the soils in the survey area and determining their properties, the soil scientists assigned the soils to taxonomic classes (units). Taxonomic classes are concepts. Each taxonomic class has a set of soil characteristics with precisely defined limits. The classes are used as a basis for comparison to classify soils systematically. Soil taxonomy, the system of taxonomic classification used in the United States, is based mainly on the kind and character of soil properties and the arrangement of horizons within the profile. After the soil

Custom Soil Resource Report

scientists classified and named the soils in the survey area, they compared the individual soils with similar soils in the same taxonomic class in other areas so that they could confirm data and assemble additional data based on experience and research.

The objective of soil mapping is not to delineate pure map unit components; the objective is to separate the landscape into landforms or landform segments that have similar use and management requirements. Each map unit is defined by a unique combination of soil components and/or miscellaneous areas in predictable proportions. Some components may be highly contrasting to the other components of the map unit. The presence of minor components in a map unit in no way diminishes the usefulness or accuracy of the data. The delineation of such landforms and landform segments on the map provides sufficient information for the development of resource plans. If intensive use of small areas is planned, onsite investigation is needed to define and locate the soils and miscellaneous areas.

Soil scientists make many field observations in the process of producing a soil map. The frequency of observation is dependent upon several factors, including scale of mapping, intensity of mapping, design of map units, complexity of the landscape, and experience of the soil scientist. Observations are made to test and refine the soil-landscape model and predictions and to verify the classification of the soils at specific locations. Once the soil-landscape model is refined, a significantly smaller number of measurements of individual soil properties are made and recorded. These measurements may include field measurements, such as those for color, depth to bedrock, and texture, and laboratory measurements, such as those for content of sand, silt, clay, salt, and other components. Properties of each soil typically vary from one point to another across the landscape.

Observations for map unit components are aggregated to develop ranges of characteristics for the components. The aggregated values are presented. Direct measurements do not exist for every property presented for every map unit component. Values for some properties are estimated from combinations of other properties.

While a soil survey is in progress, samples of some of the soils in the area generally are collected for laboratory analyses and for engineering tests. Soil scientists interpret the data from these analyses and tests as well as the field-observed characteristics and the soil properties to determine the expected behavior of the soils under different uses. Interpretations for all of the soils are field tested through observation of the soils in different uses and under different levels of management. Some interpretations are modified to fit local conditions, and some new interpretations are developed to meet local needs. Data are assembled from other sources, such as research information, production records, and field experience of specialists. For example, data on crop yields under defined levels of management are assembled from farm records and from field or plot experiments on the same kinds of soil.

Predictions about soil behavior are based not only on soil properties but also on such variables as climate and biological activity. Soil conditions are predictable over long periods of time, but they are not predictable from year to year. For example, soil scientists can predict with a fairly high degree of accuracy that a given soil will have a high water table within certain depths in most years, but they cannot predict that a high water table will always be at a specific level in the soil on a specific date.

After soil scientists located and identified the significant natural bodies of soil in the survey area, they drew the boundaries of these bodies on aerial photographs and

Custom Soil Resource Report

identified each as a specific map unit. Aerial photographs show trees, buildings, fields, roads, and rivers, all of which help in locating boundaries accurately.

Soil Map

The soil map section includes the soil map for the defined area of interest, a list of soil map units on the map and extent of each map unit, and cartographic symbols displayed on the map. Also presented are various metadata about data used to produce the map, and a description of each soil map unit.

Custom Soil Resource Report Soil Map

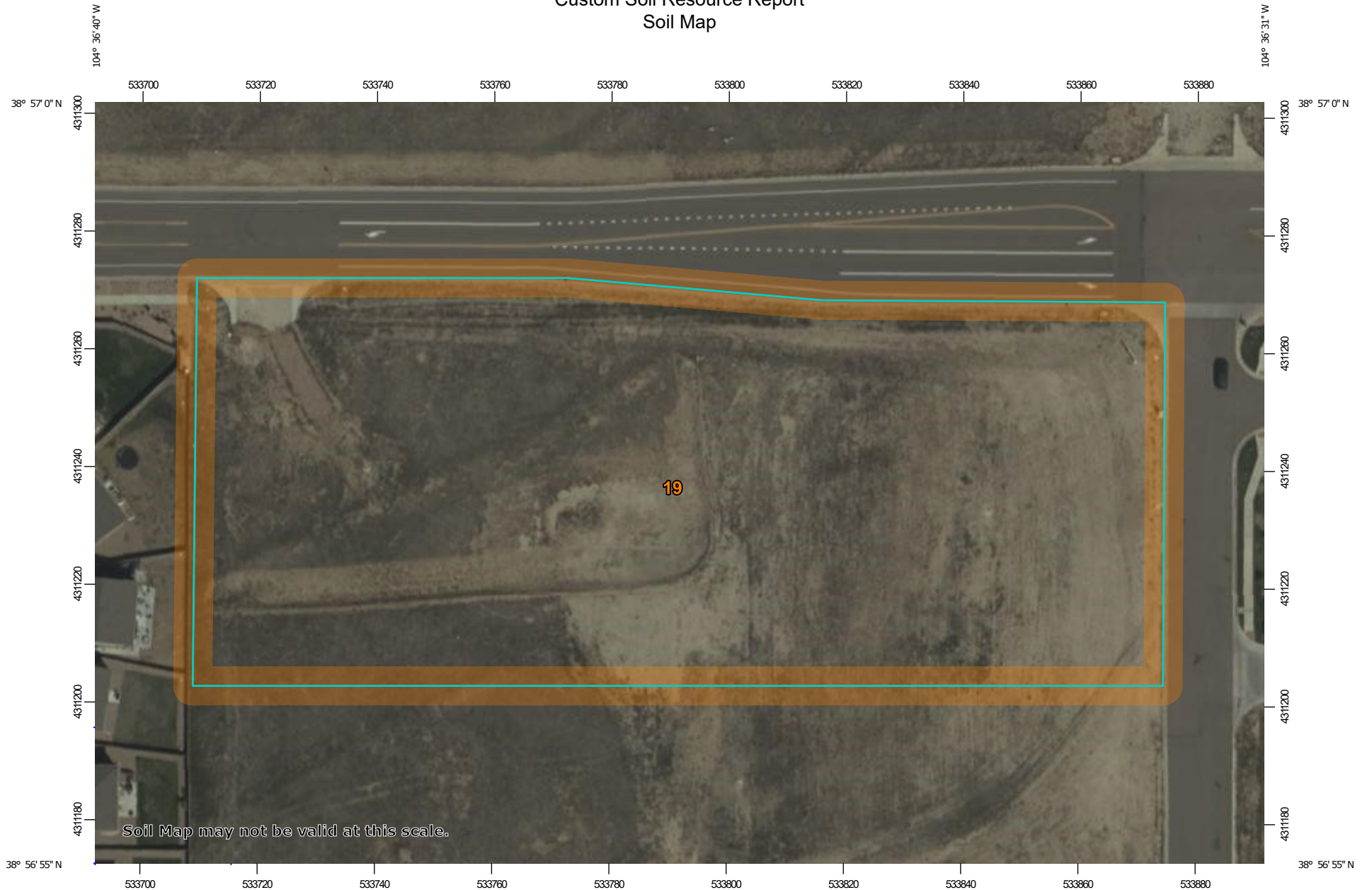

Map Scale: 1:912 if printed on A landscape (11" x 8.5") sheet.

0 10 20 40 60 Meters

0 40 80 160 240 Feet

Map projection: Web Mercator Corner coordinates: WGS84 Edge tics: UTM Zone 13N WGS84

MAP LEGEND

Area of Interest (AOI)

 Area of Interest (AOI)



















Soils







 Soil Map Unit Polygons

 Soil Map Unit Lines

 Soil Map Unit Points

Special Point Features





-  Blowout
-  Borrow Pit
-  Clay Spot
-  Closed Depression
-  Gravel Pit
-  Gravelly Spot
-  Landfill
-  Lava Flow
-  Marsh or swamp
-  Mine or Quarry
-  Miscellaneous Water
-  Perennial Water
-  Rock Outcrop
-  Saline Spot
-  Sandy Spot
-  Severely Eroded Spot
-  Sinkhole
-  Slide or Slip
-  Sodic Spot

-  Spoil Area
-  Stony Spot
-  Very Stony Spot
-  Wet Spot
-  Other
-  Special Line Features

Water Features

 Streams and Canals

Transportation

-  Rails
-  Interstate Highways
-  US Routes
-  Major Roads
-  Local Roads

Background

 Aerial Photography

MAP INFORMATION

The soil surveys that comprise your AOI were mapped at 1:24,000.

Warning: Soil Map may not be valid at this scale.

Enlargement of maps beyond the scale of mapping can cause misunderstanding of the detail of mapping and accuracy of soil line placement. The maps do not show the small areas of contrasting soils that could have been shown at a more detailed scale.

Please rely on the bar scale on each map sheet for map measurements.

Source of Map: Natural Resources Conservation Service
 Web Soil Survey URL:
 Coordinate System: Web Mercator (EPSG:3857)

Maps from the Web Soil Survey are based on the Web Mercator projection, which preserves direction and shape but distorts distance and area. A projection that preserves area, such as the Albers equal-area conic projection, should be used if more accurate calculations of distance or area are required.

This product is generated from the USDA-NRCS certified data as of the version date(s) listed below.

Soil Survey Area: El Paso County Area, Colorado
 Survey Area Data: Version 20, Sep 2, 2022

Soil map units are labeled (as space allows) for map scales 1:50,000 or larger.

Date(s) aerial images were photographed: Sep 11, 2018—Oct 20, 2018

The orthophoto or other base map on which the soil lines were compiled and digitized probably differs from the background imagery displayed on these maps. As a result, some minor shifting of map unit boundaries may be evident.

Map Unit Legend

Map Unit Symbol	Map Unit Name	Acres in AOI	Percent of AOI
19	Columbine gravelly sandy loam, 0 to 3 percent slopes	2.8	100.0%
Totals for Area of Interest		2.8	100.0%

Map Unit Descriptions

The map units delineated on the detailed soil maps in a soil survey represent the soils or miscellaneous areas in the survey area. The map unit descriptions, along with the maps, can be used to determine the composition and properties of a unit.

A map unit delineation on a soil map represents an area dominated by one or more major kinds of soil or miscellaneous areas. A map unit is identified and named according to the taxonomic classification of the dominant soils. Within a taxonomic class there are precisely defined limits for the properties of the soils. On the landscape, however, the soils are natural phenomena, and they have the characteristic variability of all natural phenomena. Thus, the range of some observed properties may extend beyond the limits defined for a taxonomic class. Areas of soils of a single taxonomic class rarely, if ever, can be mapped without including areas of other taxonomic classes. Consequently, every map unit is made up of the soils or miscellaneous areas for which it is named and some minor components that belong to taxonomic classes other than those of the major soils.

Most minor soils have properties similar to those of the dominant soil or soils in the map unit, and thus they do not affect use and management. These are called noncontrasting, or similar, components. They may or may not be mentioned in a particular map unit description. Other minor components, however, have properties and behavioral characteristics divergent enough to affect use or to require different management. These are called contrasting, or dissimilar, components. They generally are in small areas and could not be mapped separately because of the scale used. Some small areas of strongly contrasting soils or miscellaneous areas are identified by a special symbol on the maps. If included in the database for a given area, the contrasting minor components are identified in the map unit descriptions along with some characteristics of each. A few areas of minor components may not have been observed, and consequently they are not mentioned in the descriptions, especially where the pattern was so complex that it was impractical to make enough observations to identify all the soils and miscellaneous areas on the landscape.

The presence of minor components in a map unit in no way diminishes the usefulness or accuracy of the data. The objective of mapping is not to delineate pure taxonomic classes but rather to separate the landscape into landforms or landform segments that have similar use and management requirements. The delineation of such segments on the map provides sufficient information for the development of resource plans. If intensive use of small areas is planned, however, onsite investigation is needed to define and locate the soils and miscellaneous areas.

Custom Soil Resource Report

An identifying symbol precedes the map unit name in the map unit descriptions. Each description includes general facts about the unit and gives important soil properties and qualities.

Soils that have profiles that are almost alike make up a *soil series*. Except for differences in texture of the surface layer, all the soils of a series have major horizons that are similar in composition, thickness, and arrangement.

Soils of one series can differ in texture of the surface layer, slope, stoniness, salinity, degree of erosion, and other characteristics that affect their use. On the basis of such differences, a soil series is divided into *soil phases*. Most of the areas shown on the detailed soil maps are phases of soil series. The name of a soil phase commonly indicates a feature that affects use or management. For example, Alpha silt loam, 0 to 2 percent slopes, is a phase of the Alpha series.

Some map units are made up of two or more major soils or miscellaneous areas. These map units are complexes, associations, or undifferentiated groups.

A *complex* consists of two or more soils or miscellaneous areas in such an intricate pattern or in such small areas that they cannot be shown separately on the maps. The pattern and proportion of the soils or miscellaneous areas are somewhat similar in all areas. Alpha-Beta complex, 0 to 6 percent slopes, is an example.

An *association* is made up of two or more geographically associated soils or miscellaneous areas that are shown as one unit on the maps. Because of present or anticipated uses of the map units in the survey area, it was not considered practical or necessary to map the soils or miscellaneous areas separately. The pattern and relative proportion of the soils or miscellaneous areas are somewhat similar. Alpha-Beta association, 0 to 2 percent slopes, is an example.

An *undifferentiated group* is made up of two or more soils or miscellaneous areas that could be mapped individually but are mapped as one unit because similar interpretations can be made for use and management. The pattern and proportion of the soils or miscellaneous areas in a mapped area are not uniform. An area can be made up of only one of the major soils or miscellaneous areas, or it can be made up of all of them. Alpha and Beta soils, 0 to 2 percent slopes, is an example.

Some surveys include *miscellaneous areas*. Such areas have little or no soil material and support little or no vegetation. Rock outcrop is an example.

El Paso County Area, Colorado

19—Columbine gravelly sandy loam, 0 to 3 percent slopes

Map Unit Setting

National map unit symbol: 367p
Elevation: 6,500 to 7,300 feet
Mean annual precipitation: 14 to 16 inches
Mean annual air temperature: 46 to 50 degrees F
Frost-free period: 125 to 145 days
Farmland classification: Not prime farmland

Map Unit Composition

Columbine and similar soils: 97 percent
Minor components: 3 percent
Estimates are based on observations, descriptions, and transects of the mapunit.

Description of Columbine

Setting

Landform: Fans, fan terraces, flood plains
Down-slope shape: Linear
Across-slope shape: Linear
Parent material: Alluvium

Typical profile

A - 0 to 14 inches: gravelly sandy loam
C - 14 to 60 inches: very gravelly loamy sand

Properties and qualities

Slope: 0 to 3 percent
Depth to restrictive feature: More than 80 inches
Drainage class: Well drained
Runoff class: Very low
Capacity of the most limiting layer to transmit water (Ksat): High to very high (5.95 to 19.98 in/hr)
Depth to water table: More than 80 inches
Frequency of flooding: None
Frequency of ponding: None
Available water supply, 0 to 60 inches: Very low (about 2.5 inches)

Interpretive groups

Land capability classification (irrigated): 4e
Land capability classification (nonirrigated): 6e
Hydrologic Soil Group: A
Ecological site: R049XY214CO - Gravelly Foothill
Hydric soil rating: No

Minor Components

Fluvaquentic haplaquolls

Percent of map unit: 1 percent
Landform: Swales
Hydric soil rating: Yes

Custom Soil Resource Report

Other soils

Percent of map unit: 1 percent

Hydric soil rating: No

Pleasant

Percent of map unit: 1 percent

Landform: Depressions

Hydric soil rating: Yes

References

- American Association of State Highway and Transportation Officials (AASHTO). 2004. Standard specifications for transportation materials and methods of sampling and testing. 24th edition.
- American Society for Testing and Materials (ASTM). 2005. Standard classification of soils for engineering purposes. ASTM Standard D2487-00.
- Cowardin, L.M., V. Carter, F.C. Golet, and E.T. LaRoe. 1979. Classification of wetlands and deep-water habitats of the United States. U.S. Fish and Wildlife Service FWS/OBS-79/31.
- Federal Register. July 13, 1994. Changes in hydric soils of the United States.
- Federal Register. September 18, 2002. Hydric soils of the United States.
- Hurt, G.W., and L.M. Vasilas, editors. Version 6.0, 2006. Field indicators of hydric soils in the United States.
- National Research Council. 1995. Wetlands: Characteristics and boundaries.
- Soil Survey Division Staff. 1993. Soil survey manual. Soil Conservation Service. U.S. Department of Agriculture Handbook 18. http://www.nrcs.usda.gov/wps/portal/nrcs/detail/national/soils/?cid=nrcs142p2_054262
- Soil Survey Staff. 1999. Soil taxonomy: A basic system of soil classification for making and interpreting soil surveys. 2nd edition. Natural Resources Conservation Service, U.S. Department of Agriculture Handbook 436. http://www.nrcs.usda.gov/wps/portal/nrcs/detail/national/soils/?cid=nrcs142p2_053577
- Soil Survey Staff. 2010. Keys to soil taxonomy. 11th edition. U.S. Department of Agriculture, Natural Resources Conservation Service. http://www.nrcs.usda.gov/wps/portal/nrcs/detail/national/soils/?cid=nrcs142p2_053580
- Tiner, R.W., Jr. 1985. Wetlands of Delaware. U.S. Fish and Wildlife Service and Delaware Department of Natural Resources and Environmental Control, Wetlands Section.
- United States Army Corps of Engineers, Environmental Laboratory. 1987. Corps of Engineers wetlands delineation manual. Waterways Experiment Station Technical Report Y-87-1.
- United States Department of Agriculture, Natural Resources Conservation Service. National forestry manual. http://www.nrcs.usda.gov/wps/portal/nrcs/detail/soils/home/?cid=nrcs142p2_053374
- United States Department of Agriculture, Natural Resources Conservation Service. National range and pasture handbook. <http://www.nrcs.usda.gov/wps/portal/nrcs/detail/national/landuse/rangepasture/?cid=stelprdb1043084>

Custom Soil Resource Report

United States Department of Agriculture, Natural Resources Conservation Service. National soil survey handbook, title 430-VI. http://www.nrcs.usda.gov/wps/portal/nrcs/detail/soils/scientists/?cid=nrcs142p2_054242

United States Department of Agriculture, Natural Resources Conservation Service. 2006. Land resource regions and major land resource areas of the United States, the Caribbean, and the Pacific Basin. U.S. Department of Agriculture Handbook 296. http://www.nrcs.usda.gov/wps/portal/nrcs/detail/national/soils/?cid=nrcs142p2_053624

United States Department of Agriculture, Soil Conservation Service. 1961. Land capability classification. U.S. Department of Agriculture Handbook 210. http://www.nrcs.usda.gov/Internet/FSE_DOCUMENTS/nrcs142p2_052290.pdf

APPENDIX C
GRADING & EROSION CONTROL PLAN

BENT GRASS PLAZA

BENT GRASS MEADOWS DRIVE EL PASO COUNTY, COLORADO

GRADING & EROSION CONTROL DOCUMENTS

STANDARD NOTES FOR EL PASO COUNTY GRADING AND EROSION CONTROL PLANS

1. STORMWATER DISCHARGES FROM CONSTRUCTION SITES SHALL NOT CAUSE OR THREATEN TO CAUSE POLLUTION, CONTAMINATION, OR DEGRADATION OF STATE WATERS. ALL WORK AND EARTH DISTURBANCE SHALL BE DONE IN A MANNER THAT MINIMIZES POLLUTION OF ANY ON-SITE OR OFF-SITE WATERS, INCLUDING WETLANDS.
2. NOTWITHSTANDING ANYTHING DEPICTED IN THESE PLANS IN WORDS OR GRAPHIC REPRESENTATION, ALL DESIGN AND CONSTRUCTION RELATED TO ROADS, STORM DRAINAGE AND EROSION CONTROL SHALL CONFORM TO THE STANDARDS AND REQUIREMENTS OF THE MOST RECENT VERSION OF THE RELEVANT ADOPTED EL PASO COUNTY STANDARDS, INCLUDING THE LAND DEVELOPMENT CODE, THE ENGINEERING CRITERIA MANUAL, THE DRAINAGE CRITERIA MANUAL, AND THE DRAINAGE CRITERIA MANUAL VOLUME 2. ANY DEVIATIONS TO REGULATIONS AND STANDARDS MUST BE REQUESTED, AND APPROVED, IN WRITING.
3. A SEPARATE STORMWATER MANAGEMENT PLAN (SMWP) FOR THIS PROJECT SHALL BE COMPLETED AND AN EROSION AND STORMWATER QUALITY CONTROL PERMIT (ESQCP) ISSUED PRIOR TO COMMENCING CONSTRUCTION. MANAGEMENT OF THE SMWP DURING CONSTRUCTION IS THE RESPONSIBILITY OF THE DESIGNATED QUALIFIED STORMWATER MANAGER OR CERTIFIED EROSION CONTROL INSPECTOR. THE SMWP SHALL BE LOCATED ON-SITE AT ALL TIMES DURING CONSTRUCTION AND SHALL BE KEPT UP TO DATE WITH WORK PROGRESS AND CHANGES IN THE FIELD.
4. ONCE THE ESQCP IS APPROVED AND A "NOTICE TO PROCEED" HAS BEEN ISSUED, THE CONTRACTOR MAY INSTALL THE INITIAL STAGE EROSION AND SEDIMENT CONTROL BMPs AS INDICATED ON THE GEC. A PRECONSTRUCTION MEETING BETWEEN THE CONTRACTOR, ENGINEER, AND EL PASO COUNTY WILL BE HELD PRIOR TO ANY CONSTRUCTION. IT IS THE RESPONSIBILITY OF THE APPLICANT TO COORDINATE THE MEETING TIME AND PLACE WITH COUNTY STAFF.
5. CONTROL MEASURES MUST BE INSTALLED PRIOR TO COMMENCEMENT OF ACTIVITIES THAT COULD CONTRIBUTE POLLUTANTS TO STORMWATER. CONTROL MEASURES FOR ALL SLOPES, CHANNELS, DITCHES, AND DISTURBED LAND AREAS SHALL BE INSTALLED IMMEDIATELY UPON COMPLETION OF THE DISTURBANCE.
6. ALL TEMPORARY SEDIMENT AND EROSION CONTROL MEASURES SHALL BE MAINTAINED AND REMAIN IN EFFECTIVE OPERATING CONDITION UNTIL PERMANENT SOIL EROSION CONTROL MEASURES ARE IMPLEMENTED AND FINAL STABILIZATION IS ESTABLISHED. ALL PERSONS ENGAGED IN LAND DISTURBANCE ACTIVITIES SHALL ASSESS THE ADEQUACY OF CONTROL MEASURES AT THE SITE AND IDENTIFY IF CHANGES TO THOSE CONTROL MEASURES ARE NEEDED TO ENSURE THE CONTINUED EFFECTIVE PERFORMANCE OF THE CONTROL MEASURES. ALL CHANGES TO TEMPORARY SEDIMENT AND EROSION CONTROL MEASURES MUST BE INCORPORATED INTO THE STORMWATER MANAGEMENT PLAN.
7. TEMPORARY STABILIZATION SHALL BE IMPLEMENTED ON DISTURBED AREAS AND STOCKPILES WHERE GROUND DISTURBING CONSTRUCTION ACTIVITY HAS PERMANENTLY CEASED OR TEMPORARILY CEASED FOR LONGER THAN 14 DAYS.
8. FINAL STABILIZATION MUST BE IMPLEMENTED AT ALL APPLICABLE CONSTRUCTION SITES. FINAL STABILIZATION IS ACHIEVED WHEN ALL GROUND DISTURBING ACTIVITIES ARE COMPLETE AND ALL DISTURBED AREAS EITHER HAVE A UNIFORM VEGETATIVE COVER WITH INDIVIDUAL PLANT DENSITY OF 70 PERCENT OF PRE-DISTURBANCE LEVELS ESTABLISHED OR EQUIVALENT PERMANENT ALTERNATIVE STABILIZATION METHOD IS IMPLEMENTED. ALL TEMPORARY SEDIMENT AND EROSION CONTROL MEASURES SHALL BE REMOVED UPON FINAL STABILIZATION AND BEFORE PERMIT CLOSURE.
9. ALL PERMANENT STORMWATER MANAGEMENT FACILITIES SHALL BE INSTALLED AS DESIGNED IN THE APPROVED PLANS. ANY PROPOSED CHANGES THAT EFFECT THE DESIGN OR FUNCTION OF PERMANENT STORMWATER MANAGEMENT STRUCTURES MUST BE APPROVED BY THE ECM ADMINISTRATOR PRIOR TO IMPLEMENTATION.
10. EARTH DISTURBANCES SHALL BE CONDUCTED IN SUCH A MANNER SO AS TO EFFECTIVELY MINIMIZE ACCELERATED SOIL EROSION AND RESULTING SEDIMENTATION. ALL DISTURBANCES SHALL BE DESIGNED, CONSTRUCTED, AND COMPLETED SO THAT THE EXPOSED AREA OF ANY DISTURBED LAND SHALL BE LIMITED TO THE SHORTEST PRACTICAL PERIOD OF TIME. PRE-EXISTING VEGETATION SHALL BE PROTECTED AND MAINTAINED WITHIN 50 HORIZONTAL FEET OF A WATERS OF THE STATE UNLESS SHOWN TO BE INFESIBLE AND SPECIFICALLY REQUESTED AND APPROVED.
11. COMPACTION OF SOIL MUST BE PREVENTED IN AREAS DESIGNATED FOR INFILTRATION CONTROL MEASURES OR WHERE FINAL STABILIZATION WILL BE ACHIEVED BY VEGETATIVE COVER. AREAS DESIGNATED FOR INFILTRATION CONTROL MEASURES SHALL ALSO BE PROTECTED FROM SEDIMENTATION DURING CONSTRUCTION UNTIL FINAL STABILIZATION IS ACHIEVED. IF COMPACTION PREVENTION IS NOT FEASIBLE DUE TO SITE CONSTRAINTS, ALL AREAS DESIGNATED FOR INFILTRATION AND VEGETATION CONTROL MEASURES MUST BE LOOSENED PRIOR TO INSTALLATION OF THE CONTROL MEASURE(S).
12. ANY TEMPORARY OR PERMANENT FACILITY DESIGNED AND CONSTRUCTED FOR THE CONVEYANCE OF STORMWATER AROUND, THROUGH, OR FROM THE EARTH DISTURBANCE AREA SHALL BE A STABILIZED CONVEYANCE DESIGNED TO MINIMIZE EROSION AND THE DISCHARGE OF SEDIMENT OFF-SITE.
13. CONCRETE WASH WATER SHALL BE CONTAINED AND DISPOSED OF IN ACCORDANCE WITH THE SMWP. NO WASH WATER SHALL BE DISCHARGED TO OR ALLOWED TO ENTER STATE WATERS, INCLUDING ANY SURFACE OR SUBSURFACE STORM DRAINAGE SYSTEM OR FACILITIES. CONCRETE WASHOUTS SHALL NOT BE LOCATED IN AN AREA WHERE SHALLOW GROUNDWATER MAY BE PRESENT, OR WITHIN 50 FEET OF A SURFACE WATER BODY, CREEK OR STREAM.
14. DURING DEWATERING OPERATIONS, UNCONTAMINATED GROUNDWATER MAY BE DISCHARGED ON-SITE, BUT SHALL NOT LEAVE THE SITE IN THE FORM OF SURFACE RUNOFF UNLESS AN APPROVED STATE DEWATERING PERMIT IS IN PLACE.
15. EROSION CONTROL BLANKETING OR OTHER PROTECTIVE COVERING SHALL BE USED ON SLOPES STEEPER THAN 3:1.
16. CONTRACTOR SHALL BE RESPONSIBLE FOR THE REMOVAL OF ALL WASTES FROM THE CONSTRUCTION SITE FOR DISPOSAL IN ACCORDANCE WITH LOCAL AND STATE REGULATORY REQUIREMENTS. NO CONSTRUCTION DEBRIS, TREE SLASH, BUILDING MATERIAL WASTES OR UNUSED BUILDING MATERIALS SHALL BE BURIED, DUMPED, OR DISCHARGED AT THE SITE.
17. WASTE MATERIALS SHALL NOT BE TEMPORARILY PLACED OR STORED IN THE STREET, ALLEY, OR OTHER PUBLIC WAY, UNLESS IN ACCORDANCE WITH AN APPROVED TRAFFIC CONTROL PLAN. CONTROL MEASURES MAY BE REQUIRED BY EL PASO COUNTY ENGINEERING IF DEEMED NECESSARY, BASED ON SPECIFIC CONDITIONS AND CIRCUMSTANCES.
18. TRACKING OF SOILS AND CONSTRUCTION DEBRIS OFF-SITE SHALL BE MINIMIZED. MATERIALS TRACKED OFF-SITE SHALL BE CLEANED UP AND PROPERLY DISPOSED OF IMMEDIATELY.
19. THE OWNER/DEVELOPER SHALL BE RESPONSIBLE FOR THE REMOVAL OF ALL CONSTRUCTION DEBRIS, DIRT, TRASH, ROCK, SEDIMENT, SOIL, AND SAND THAT MAY ACCUMULATE IN ROADS, STORM DRAINS AND OTHER DRAINAGE CONVEYANCE SYSTEMS AND STORMWATER APPURTENANCES AS A RESULT OF SITE DEVELOPMENT.
20. THE QUANTITY OF MATERIALS STORED ON THE PROJECT SITE SHALL BE LIMITED, AS MUCH AS PRACTICAL, TO THAT QUANTITY REQUIRED TO PERFORM THE WORK IN AN ORDERLY SEQUENCE. ALL MATERIALS STORED ON-SITE SHALL BE STORED IN A NEAT, ORDERLY MANNER, IN THEIR ORIGINAL CONTAINERS, WITH ORIGINAL MANUFACTURER'S LABELS.

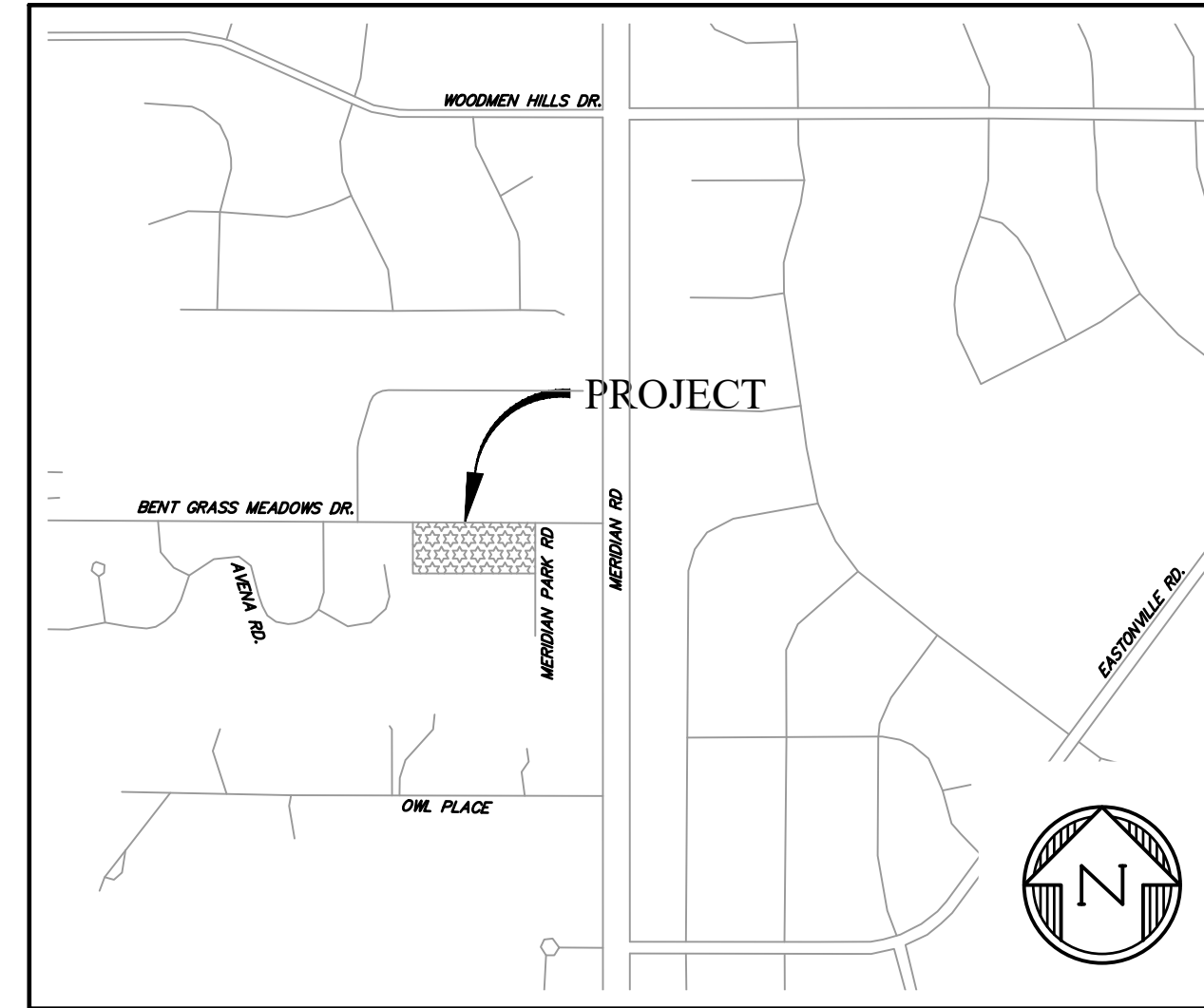

VICINITY MAP
NTS

21. NO CHEMICAL(S) HAVING THE POTENTIAL TO BE RELEASED IN STORMWATER ARE TO BE STORED OR USED ON-SITE UNLESS PERMISSION FOR THE USE OF SUCH CHEMICAL(S) IS GRANTED IN WRITING BY THE ECM ADMINISTRATOR. IN GRANTING APPROVAL FOR THE USE OF SUCH CHEMICAL(S), SPECIAL CONDITIONS AND MONITORING MAY BE REQUIRED.
22. BULK STORAGE OF ALLOWED PETROLEUM PRODUCTS OR OTHER ALLOWED LIQUID CHEMICALS IN EXCESS OF 55 GALLONS SHALL REQUIRE ADEQUATE SECONDARY CONTAINMENT PROTECTION TO CONTAIN ALL SPILLS ON-SITE AND TO PREVENT ANY SPILLED MATERIALS FROM ENTERING STATE WATERS, ANY SURFACE OR SUBSURFACE STORM DRAINAGE SYSTEM OR OTHER FACILITIES.
23. NO PERSON SHALL CAUSE THE IMPEDIMENT OF STORMWATER FLOW IN THE CURB AND GUTTER OR DITCH EXCEPT WITH APPROVED SEDIMENT CONTROL MEASURES.
24. OWNER/DEVELOPER AND THEIR AGENTS SHALL COMPLY WITH THE "COLORADO WATER QUALITY CONTROL ACT" (TITLE 25, ARTICLE 8, CRS), AND THE "CLEAN WATER ACT" (33 USC 1344), IN ADDITION TO THE REQUIREMENTS OF THE LAND DEVELOPMENT CODE, DCM VOLUME II AND THE ECM APPENDIX I. ALL APPROPRIATE PERMITS MUST BE OBTAINED BY THE CONTRACTOR PRIOR TO CONSTRUCTION (1041, NPDES, FLOODPLAIN, 404, FUGITIVE DUST, ETC.). IN THE EVENT OF CONFLICTS BETWEEN THESE REQUIREMENTS AND OTHER LAWS, RULES, OR REGULATIONS OF OTHER FEDERAL, STATE, LOCAL, OR COUNTY AGENCIES, THE MOST RESTRICTIVE LAWS, RULES, OR REGULATIONS SHALL APPLY.
25. ALL CONSTRUCTION TRAFFIC MUST ENTER/EXIT THE SITE ONLY AT APPROVED CONSTRUCTION ACCESS POINTS.
26. PRIOR TO CONSTRUCTION THE PERMITTEE SHALL VERIFY THE LOCATION OF EXISTING UTILITIES.
27. A WATER SOURCE SHALL BE AVAILABLE ON-SITE DURING EARTHWORK OPERATIONS AND SHALL BE UTILIZED AS REQUIRED TO MINIMIZE DUST FROM EARTHWORK EQUIPMENT AND WIND.
28. THE SOILS REPORT FOR THIS SITE HAS BEEN PREPARED BY RMG-ROCKY MOUNTAIN GROUP, DATED SEPTEMBER 26, 2022 AND SHALL BE CONSIDERED A PART OF THESE PLANS
29. AT LEAST TEN (10) DAYS PRIOR TO THE ANTICIPATED START OF CONSTRUCTION, FOR PROJECTS THAT WILL DISTURB ONE (1) ACRE OR MORE, THE OWNER OR OPERATOR OF CONSTRUCTION ACTIVITY SHALL SUBMIT A PERMIT APPLICATION FOR STORMWATER DISCHARGE TO THE COLORADO DEPARTMENT OF PUBLIC HEALTH AND ENVIRONMENT, WATER QUALITY DIVISION. THE APPLICATION CONTAINS CERTIFICATION OF COMPLETION OF A STORMWATER MANAGEMENT PLAN (SMWP), OF WHICH THIS GRADING AND EROSION CONTROL PLAN MAY BE A PART. FOR INFORMATION OR APPLICATION MATERIALS CONTACT:

COLORADO DEPARTMENT OF PUBLIC HEALTH AND ENVIRONMENT
WATER QUALITY CONTROL DIVISION
WGCD - PERMITS
4300 CHERRY CREEK DRIVE SOUTH
DENVER, CO 80246-1530
ATTN: PERMITS UNIT

DESIGN ENGINEER'S STATEMENT

THIS GRADING AND EROSION CONTROL PLAN WAS PREPARED UNDER MY DIRECTION AND SUPERVISION AND IS CORRECT TO THE BEST OF MY KNOWLEDGE AND BELIEF. SAID PLAN HAS BEEN PREPARED ACCORDING TO THE CRITERIA ESTABLISHED BY THE COUNTY FOR GRADING AND EROSION CONTROL PLANS. I ACCEPT RESPONSIBILITY FOR ANY LIABILITY CAUSED BY ANY NEGLIGENT ACTS, ERRORS OR OMISSIONS ON MY PART IN PREPARING THIS PLAN.

KATHERINE VARNUM 12/11/23
P.E.# 53459 DATE

OWNER'S STATEMENT

I, THE OWNER/DEVELOPER HAVE READ AND WILL COMPLY WITH THE REQUIREMENTS OF THE GRADING AND EROSION CONTROL PLAN.

OWNER DATE

EL PASO COUNTY

COUNTY PLAN REVIEW IS PROVIDED ONLY FOR GENERAL CONFORMANCE WITH COUNTY DESIGN CRITERIA. THE COUNTY IS NOT RESPONSIBLE FOR THE ACCURACY AND ADEQUACY OF THE DESIGN, DIMENSIONS, AND/OR ELEVATIONS WHICH SHALL BE CONFIRMED AT THE JOB SITE. THE COUNTY THROUGH THE APPROVAL OF THIS DOCUMENT ASSUMES NO RESPONSIBILITY FOR COMPLETENESS AND/OR ACCURACY OF THIS DOCUMENT.

FILED IN ACCORDANCE WITH THE REQUIREMENTS OF THE EL PASO COUNTY LAND DEVELOPMENT CODE, DRAINAGE CRITERIA MANUAL VOLUMES 1 AND 2, AND ENGINEERING CRITERIA MANUAL, AS AMENDED.

IN ACCORDANCE WITH ECM SECTION 1.12, THESE CONSTRUCTION DOCUMENTS WILL BE VALID FOR CONSTRUCTION FOR A PERIOD OF 2 YEARS FROM THE DATE SIGNED BY THE EL PASO COUNTY ENGINEER. IF CONSTRUCTION HAS NOT STARTED WITHIN THOSE 2 YEARS, THE PLANS WILL NEED TO BE RESUBMITTED FOR APPROVAL, INCLUDING PAYMENT OF REVIEW FEES AT THE PLANNING AND COMMUNITY DEVELOPMENT DIRECTOR'S DISCRETION.

JOSHUA PALMER, DATE
COUNTY ENGINEER

SHEET INDEX

- | | | |
|---|-----|--|
| 1 | CV | COVER SHEET |
| 2 | EC1 | INITIAL GRADING & EROSION CONTROL PLAN |
| 3 | EC2 | INTERIM/FINAL GRADING & EROSION CONTROL PLAN |
| 4 | DT1 | EROSION CONTROL DETAILS |
| 5 | DT2 | EROSION CONTROL DETAILS |

PREPARED BY:

DREXEL, BARRELL & CO.
Engineers • Surveyors
101 SAWATCH ST., SUITE 100
COLORADO SPGS, COLORADO 80903
CONTACT: TIM D. MCCONNELL, P.E.
(719)260-0887
COLORADO SPRINGS • LAFAYETTE

CLIENT:

LAND FIRST, INC
1378 PROMONTORY BLUFF VIEW
COLORADO SPRINGS, CO 80921

GRADING & EROSION CONTROL PLANS FOR:
BENT GRASS PLAZA
BENT GRASS MARKET VIEW
EL PASO COUNTY, COLORADO

ISSUE	DATE
INITIAL ISSUE	10/06/2023
RESUBMITTAL	12/11/2023
DESIGNED BY:	CGH
DRAWN BY:	SDM
CHECKED BY:	KGV
FILE NAME:	21814-01ECCV



PREPARED UNDER MY DIRECT SUPERVISION FOR AND ON BEHALF OF DREXEL, BARRELL & CO.

DRAWING SCALE:
HORIZONTAL: N/A
VERTICAL: N/A

COVER SHEET

PROJECT NO. 21814-00CSCV
DRAWING NO.

CV

SHEET: 1 OF 5

811 Know what's below.
Call before you dig.
CALL 2-BUSINESS DAYS IN ADVANCE BEFORE YOU DIG, GRADE, OR EXCAVATE FOR THE MARKING OF UNDERGROUND MEMBER UTILITIES.
EPC FILE # PPR2342

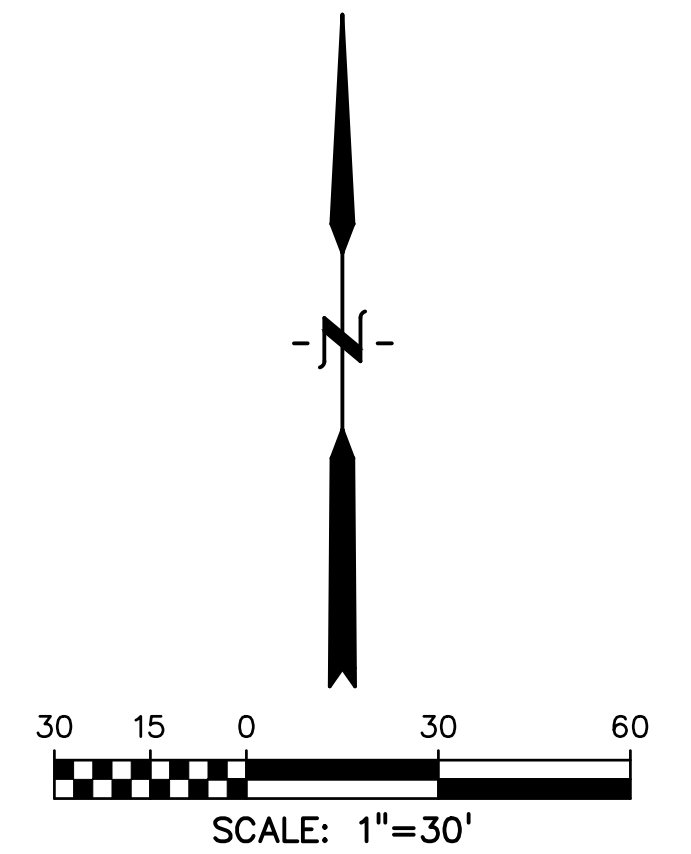
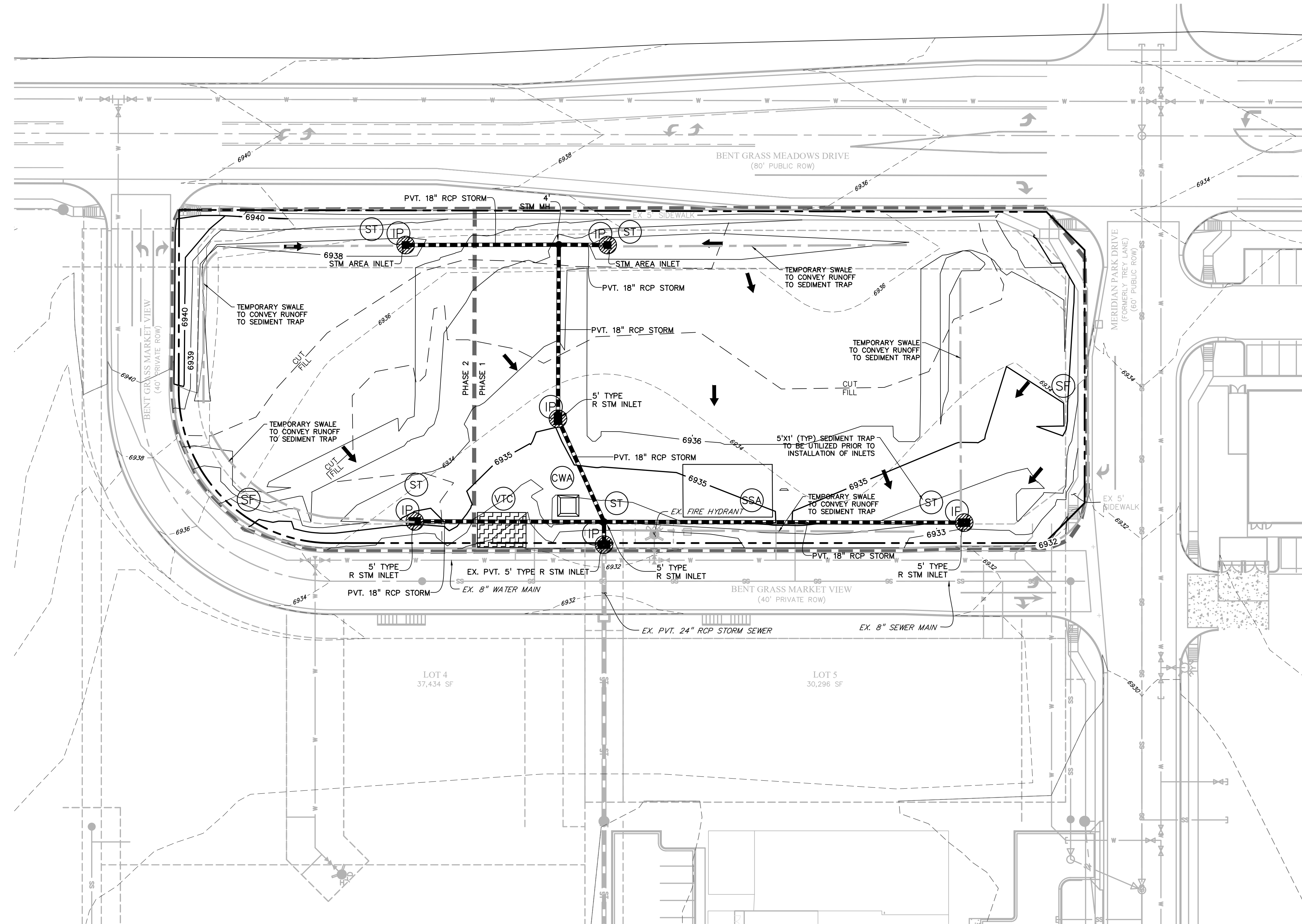

LEGEND

PROPOSED INTERMEDIATE CONTOUR.....	5522
PROPOSED INDEX CONTOUR.....	5520
EX INTERMEDIATE CONTOUR.....	5364
EX INDEX CONTOUR.....	5365
DIRECTION OF FLOW.....	←
HIGH POINT.....	HP
LOW POINT.....	LP
PROPOSED INLET.....	■
PROPOSED MANHOLE.....	●
PROJECT BOUNDARY/PROPERTY LINE.....	— · — · —
ROW.....	— · — · —
LIMITS OF DISTURBANCE/ CONSTRUCTION SITE BOUNDARY.....	— · — · —
TEMPORARY DIVERSION SWALE.....	— · — · —
CUT/FILL LINE.....	— · — · —
FINAL SEEDING/MULCHING.....	SM
INITIAL/INTERIM INLET PROTECTION.....	IP
INITIAL/INTERIM SILT FENCE.....	SF
INITIAL/INTERIM CONCRETE WASHOUT AREA.....	CWA
INITIAL/INTERIM VEHICLE TRACKING CONTROL.....	VTC
INITIAL/INTERIM STABILIZED STAGING AREA.....	SSA
INITIAL SEDIMENT TRAP.....	ST

NOTES:

1. WASTE DISPOSAL BIN LOCATIONS ARE TBD AND WILL BE ADDED TO THE SWMP ONCE DETERMINED BY THE CONTRACTOR.
2. ONSITE LOCATION OF THE SWMP IS TBD AND WILL BE ADDED TO THE SWMP ONCE DETERMINED BY THE CONTRACTOR.
3. THE NEED FOR DEWATERING IS NOT ANTICIPATED. IN THE EVENT THAT DEWATERING BECOMES NECESSARY THE CONTRACTOR, WITH INPUT FROM THE COUNTY STORMWATER INSPECTOR, WILL DESIGN THE LOCATIONS OF DIVERSION, PUMP & DISCHARGES.
4. SITE HAS BEEN RECENTLY OVERLOT GRADED AND RESEEDED. VEGETATION COVERAGE IS CURRENTLY SPARSE GRASSES.
5. NO BATCH PLANTS WILL BE UTILIZED ONSITE.
6. THE SITE IS NOT WITHIN SOFT OF ANY SURFACE WATERS.

PREPARED BY:



DREXEL, BARRELL & CO.
Engineers-Surveyors
101 SAWATCH ST., SUITE 100
COLORADO SPGS, COLORADO 80903
CONTACT: TIM D. MCCONNELL, P.E.
(719)260-0887
COLORADO SPRINGS • LAFAYETTE

CLIENT:

LAND FIRST, INC
1378 PROMONTORY BLUFF VIEW
COLORADO SPRINGS, CO 80921

GRADING & EROSION CONTROL PLANS FOR:
BENT GRASS PLAZA
BENT GRASS MARKET VIEW
EL PASO COUNTY, COLORADO

ISSUE	DATE
INITIAL ISSUE	10/06/2023
RESUBMITTAL	12/11/2023
DESIGNED BY:	CGH
DRAWN BY:	SDM
CHECKED BY:	KGV
FILE NAME:	21814-02EC



PREPARED UNDER MY DIRECT SUPERVISION FOR AND ON BEHALF OF DREXEL, BARRELL & CO.

DRAWING SCALE:
HORIZONTAL: 1"=30'
VERTICAL: N/A

INITIAL GRADING & EROSION CONTROL PLAN

PROJECT NO. 21814-00CSCV
DRAWING NO.

EC1

SHEET: 2 OF 5

811 Know what's below.
Call before you dig.
CALL 2-BUSINESS DAYS IN ADVANCE BEFORE YOU DIG, GRADE, OR EXCAVATE FOR THE MARKING OF UNDERGROUND MEMBER UTILITIES.
EPC FILE # PPR2342

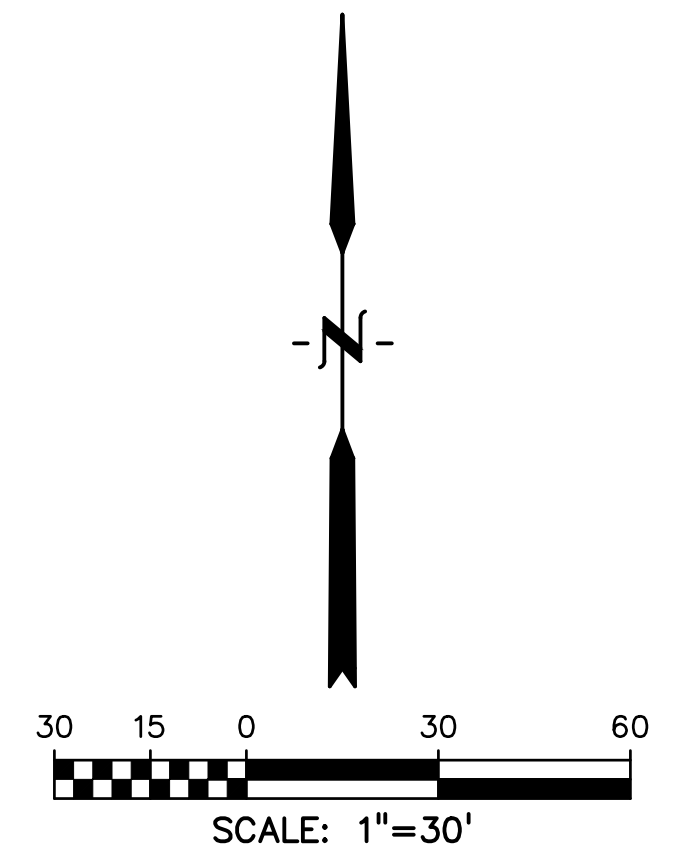
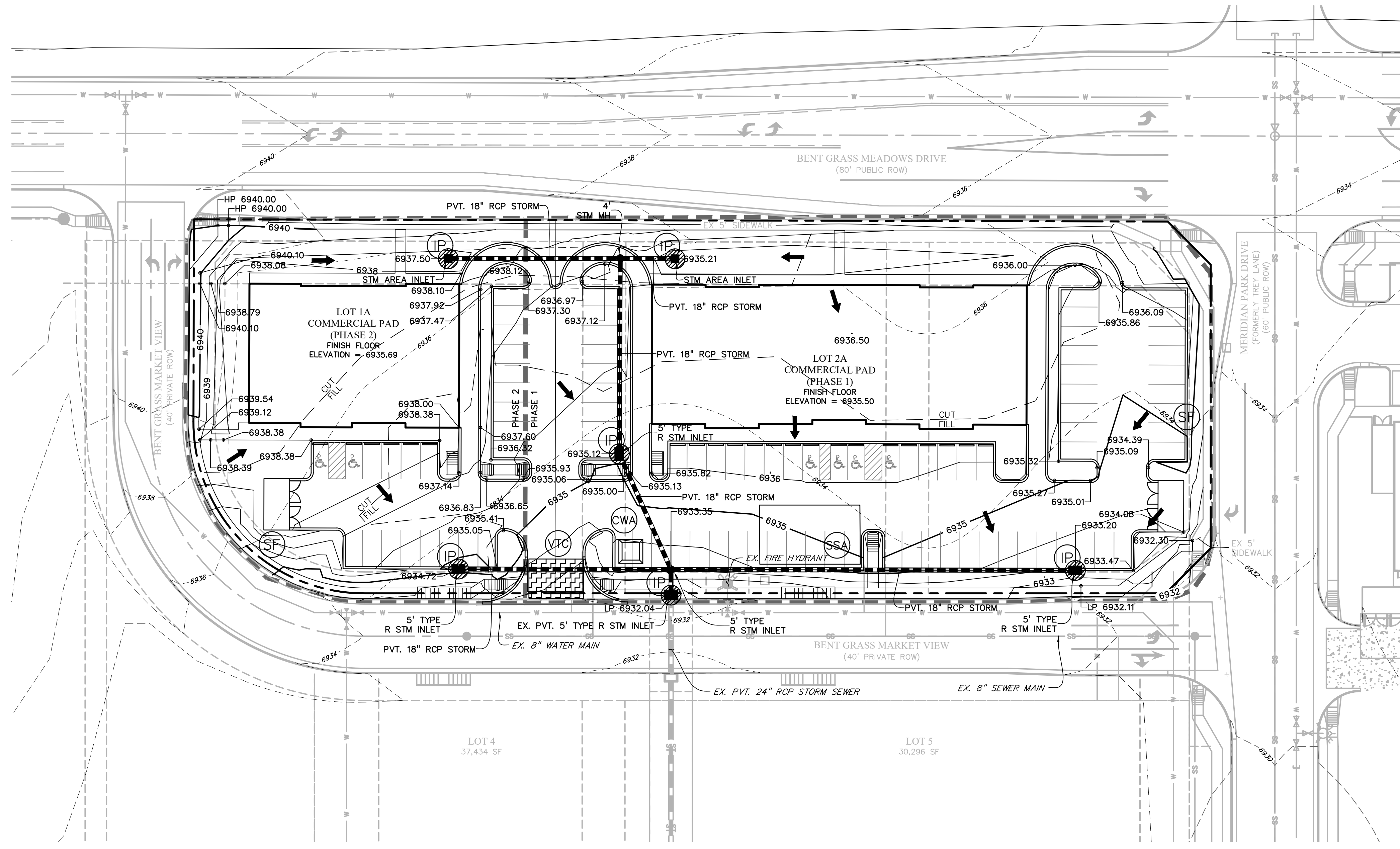

LEGEND

PROPOSED INTERMEDIATE CONTOUR.....	5522
PROPOSED INDEX CONTOUR.....	5520
EX INTERMEDIATE CONTOUR.....	5364
EX INDEX CONTOUR.....	5365
DIRECTION OF FLOW.....	←
HIGH POINT.....	HP
LOW POINT.....	LP
PROPOSED INLET.....	■
PROPOSED MANHOLE.....	●
PROJECT BOUNDARY/PROPERTY LINE.....	— · — · — · — · —
ROW.....	— · — · — · — · —
LIMITS OF DISTURBANCE/ CONSTRUCTION SITE BOUNDARY.....	— · — · — · — · —
CUT/FILL LINE.....	— · — · — · — · —
FINAL SEEDING/MULCHING.....	SM
INITIAL/INTERIM INLET PROTECTION.....	IP
INITIAL/INTERIM SILT FENCE.....	SF
INITIAL/INTERIM CONCRETE WASHOUT AREA.....	CWA
INITIAL/INTERIM VEHICLE TRACKING CONTROL.....	VTC
INITIAL/INTERIM STABILIZED STAGING AREA.....	SSA

NOTES:

1. WASTE DISPOSAL BIN LOCATIONS ARE TBD AND WILL BE ADDED TO THE SWMP ONCE DETERMINED BY THE CONTRACTOR.
2. ONSITE LOCATION OF THE SWMP IS TBD AND WILL BE ADDED TO THE SWMP ONCE DETERMINED BY THE CONTRACTOR.
3. THE NEED FOR DEWATERING IS NOT ANTICIPATED. IN THE EVENT THAT DEWATERING BECOMES NECESSARY THE CONTRACTOR, WITH INPUT FROM THE COUNTY STORMWATER INSPECTOR, WILL DESIGN THE LOCATIONS OF DIVERSION, PUMP & DISCHARGES.
4. SITE HAS BEEN RECENTLY OVERLOT GRADED AND RESEEDED. VEGETATION COVERAGE IS CURRENTLY SPARSE GRASSES.
5. NO BATCH PLANTS WILL BE UTILIZED ONSITE.
6. THE SITE IS NOT WITHIN SOFT OF ANY SURFACE WATERS.

PREPARED BY:



DREXEL, BARRELL & CO.
Engineers-Surveyors
101 SAWATCH ST., SUITE 100
COLORADO SPGS, COLORADO 80903
CONTACT: TIM D. MCCONNELL, P.E.
(719)260-0887
COLORADO SPRINGS • LAFAYETTE

CLIENT:

LAND FIRST, INC
1378 PROMONTORY BLUFF VIEW
COLORADO SPRINGS, CO 80921

GRADING & EROSION CONTROL PLANS FOR:

BENT GRASS PLAZA

BENT GRASS MARKET VIEW
EL PASO COUNTY, COLORADO

ISSUE	DATE
INITIAL ISSUE	10/06/2023
RESUBMITTAL	12/11/2023
DESIGNED BY:	CGH
DRAWN BY:	SDM
CHECKED BY:	KGW
FILE NAME:	21814-02EC



PREPARED UNDER MY DIRECT SUPERVISION FOR AND ON BEHALF OF DREXEL, BARRELL & CO.

DRAWING SCALE:
HORIZONTAL: 1"=30'
VERTICAL: N/A

**INTERIM/FINAL
GRADING & EROSION
CONTROL PLAN**

PROJECT NO. 21814-00CSCV
DRAWING NO.

EC2

SHEET: 3 OF 5

811 Know what's below.
Call before you dig.
CALL 2-BUSINESS DAYS IN ADVANCE BEFORE YOU DIG, GRADE, OR EXCAVATE FOR THE MARKING OF UNDERGROUND MEMBER UTILITIES.
EPC FILE # PPR2342

SC-6 Inlet Protection (IP)

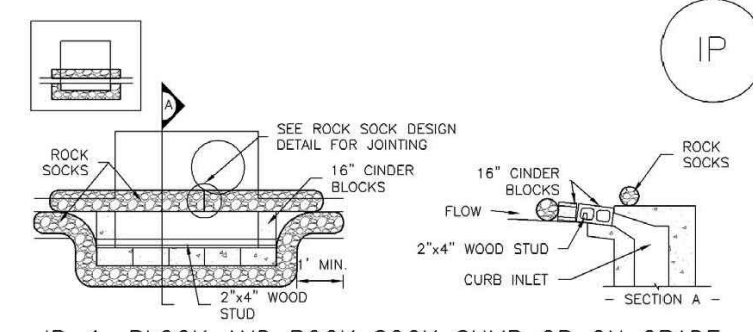

IP-1. BLOCK AND ROCK SOCK SUMP OR ON GRADE INLET PROTECTION

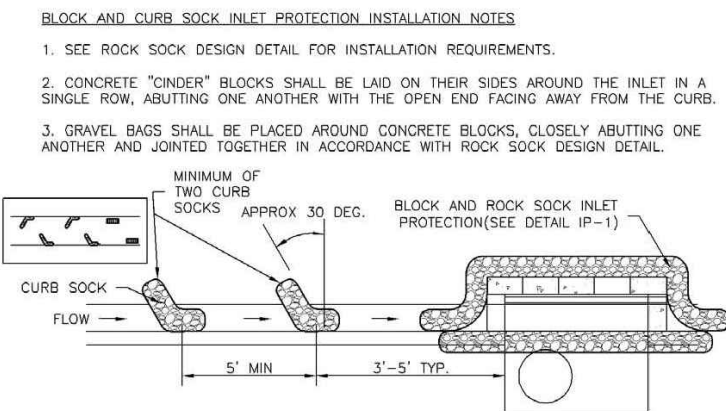

IP-2. CURB ROCK SOCKS UPSTREAM OF INLET PROTECTION

IP-4 Urban Drainage and Flood Control District August 2013
Urban Storm Drainage Criteria Manual Volume 3

Inlet Protection (IP) SC-6

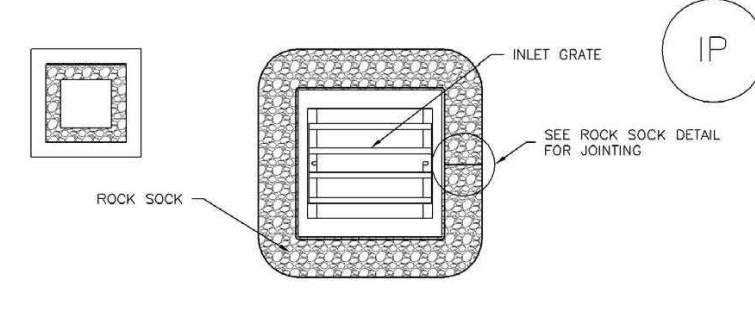

IP-3. ROCK SOCK SUMP/AREA INLET PROTECTION

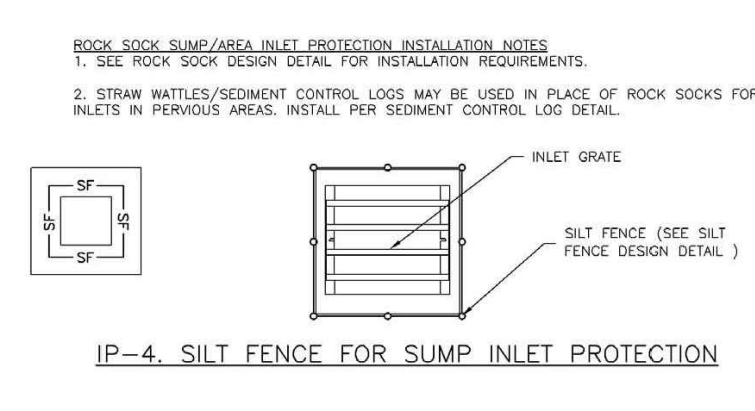

IP-4. SILT FENCE FOR SUMP INLET PROTECTION

August 2013 Urban Drainage and Flood Control District IP-5
Urban Storm Drainage Criteria Manual Volume 3

SC-6 Inlet Protection (IP)

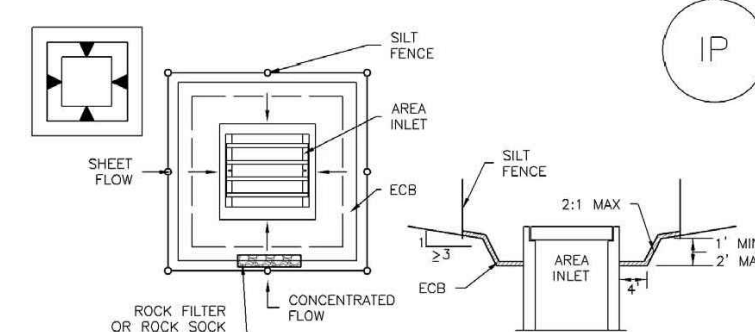

IP-5. OVEREXCAVATION INLET PROTECTION

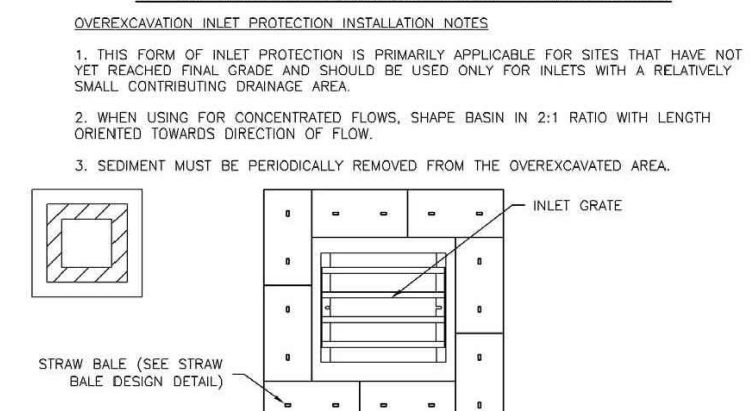

IP-6. STRAW BALE FOR SUMP INLET PROTECTION

IP-6 Urban Drainage and Flood Control District August 2013
Urban Storm Drainage Criteria Manual Volume 3

Inlet Protection (IP) SC-6

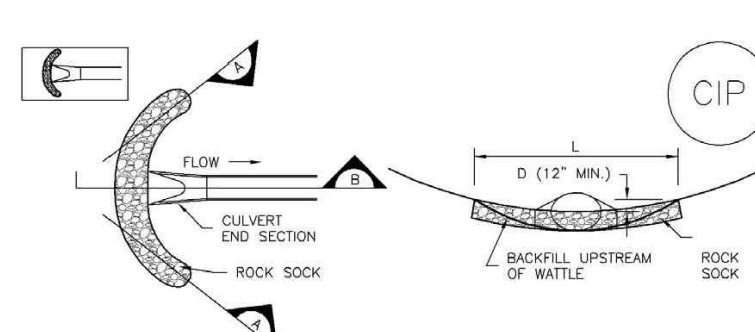

CIP-1. CULVERT INLET PROTECTION

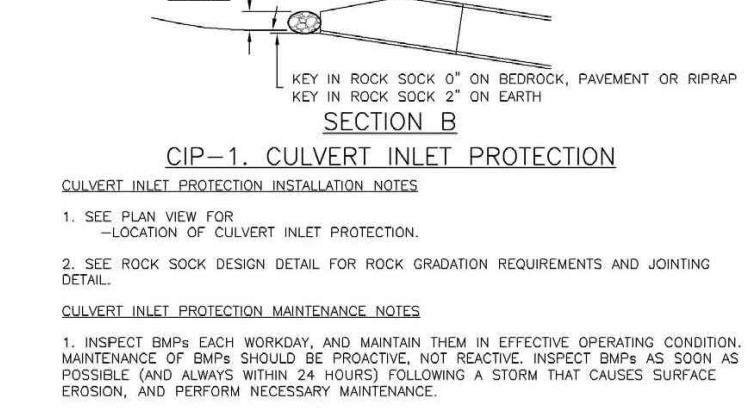

CIP-1. CULVERT INLET PROTECTION

August 2013 Urban Drainage and Flood Control District IP-7
Urban Storm Drainage Criteria Manual Volume 3

SC-6 Inlet Protection (IP)

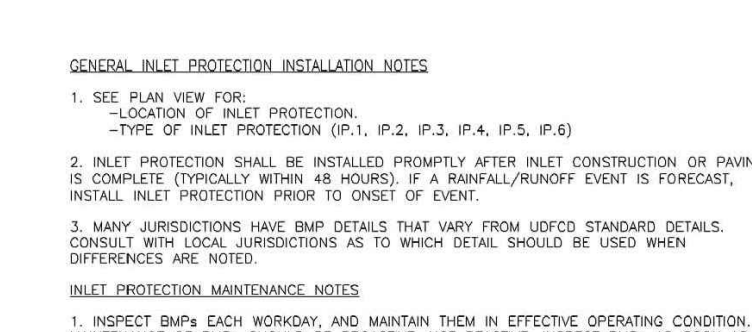

IP-8. INLET PROTECTION

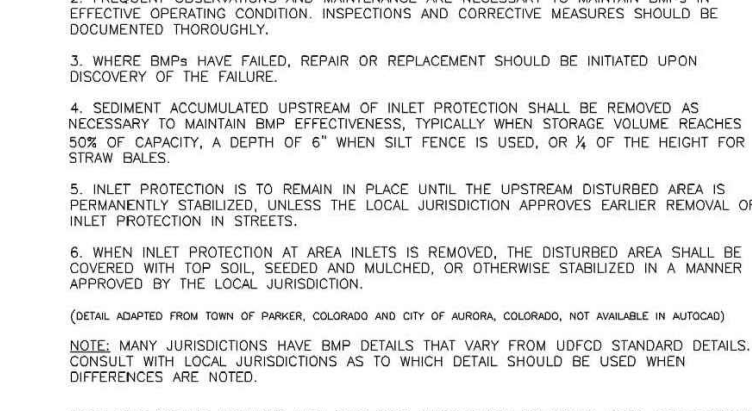

IP-8. INLET PROTECTION

IP-8 Urban Drainage and Flood Control District August 2013
Urban Storm Drainage Criteria Manual Volume 3

PREPARED BY:

DREXEL, BARRELL & CO.
Engineers • Surveyors
101 SAWATCH ST., SUITE 100
COLORADO SPGS, COLORADO 80903
CONTACT: TIM D. MCCONNELL, P.E.
(719)260-0887
COLORADO SPRINGS • LAFAYETTE

CLIENT:

LAND FIRST, INC
1378 PROMONTORY BLUFF VIEW
COLORADO SPRINGS, CO 80921

GRADING & EROSION CONTROL PLANS FOR:
BENT GRASS PLAZA
BENT GRASS MARKET VIEW
EL PASO COUNTY, COLORADO

ISSUE	DATE
INITIAL ISSUE	10/06/2023
RESUBMITTAL	12/11/2023

DESIGNED BY: CGH
DRAWN BY: SDM
CHECKED BY: KGV
FILE NAME: 21814-03DT



PREPARED UNDER MY DIRECT SUPERVISION FOR AND ON BEHALF OF DREXEL, BARRELL & CO.

DRAWING SCALE:
HORIZONTAL: N/A
VERTICAL: N/A

GRADING & EROSION CONTROL DETAILS

PROJECT NO. 21814-00CSCV
DRAWING NO.

DT1

SHEET: 4 OF 5

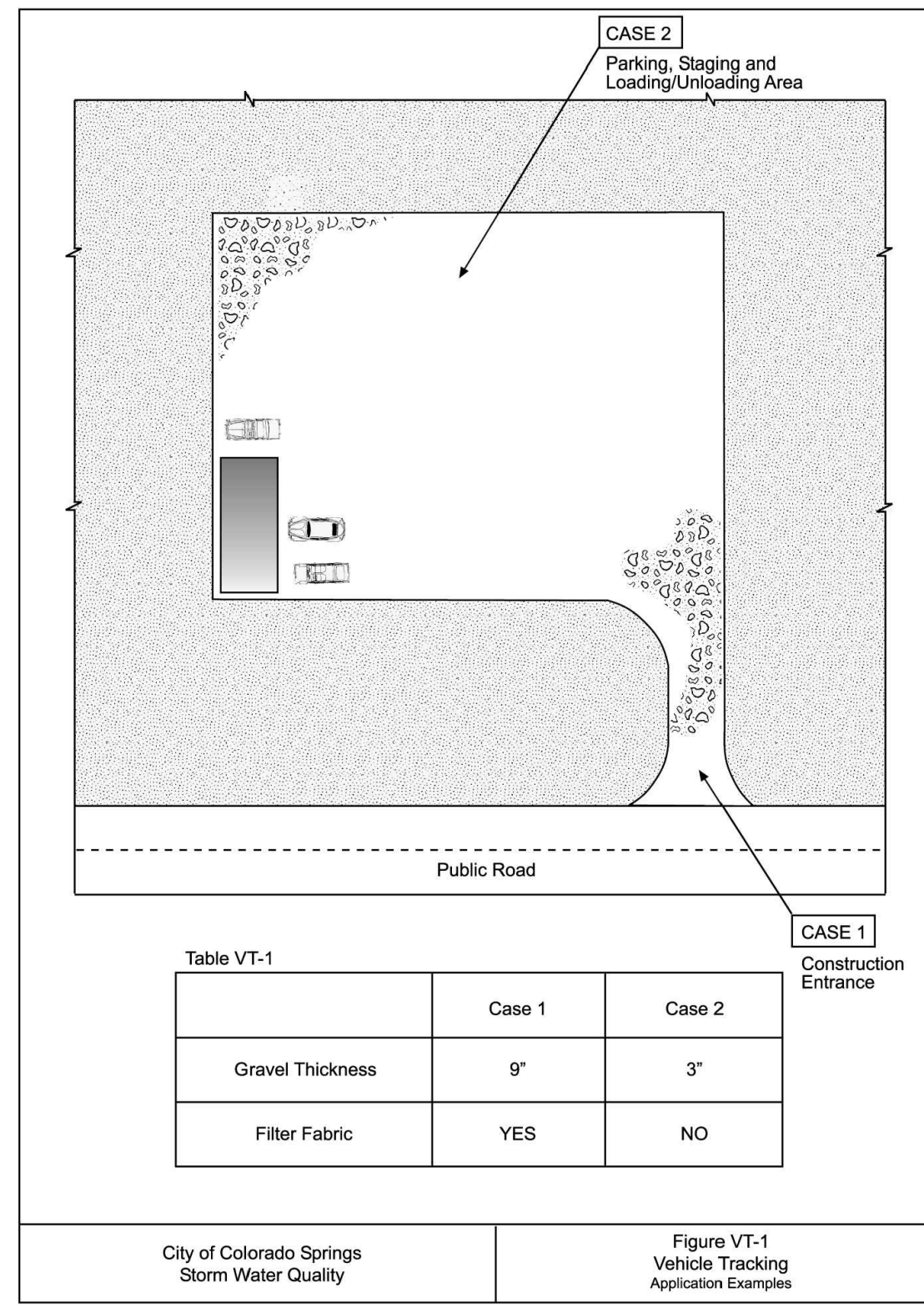
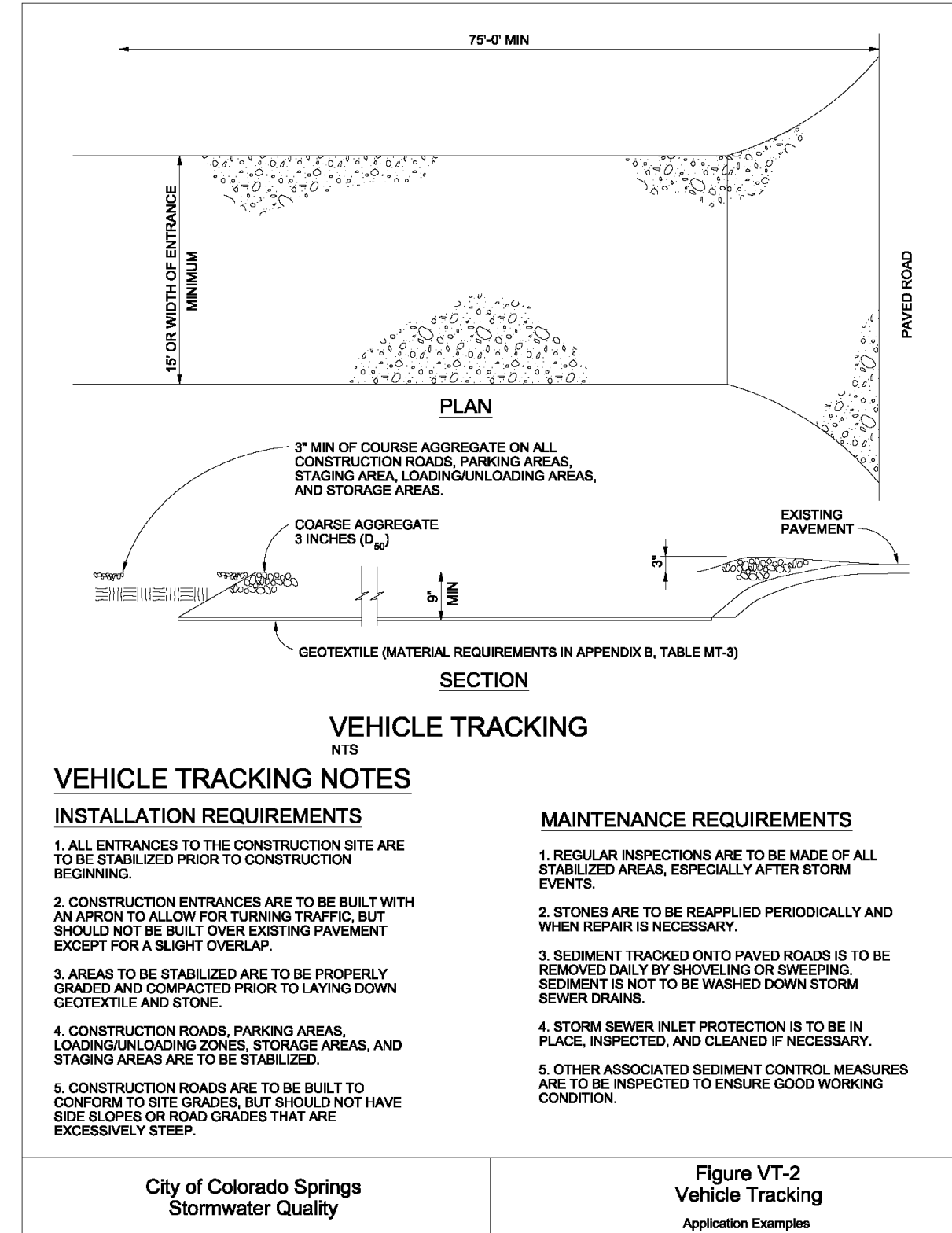

Table VT-1

	Case 1	Case 2
Gravel Thickness	9"	3"
Filter Fabric	YES	NO

City of Colorado Springs Storm Water Quality Figure VT-1 Vehicle Tracking Application Examples



VEHICLE TRACKING NOTES

INSTALLATION REQUIREMENTS

- ALL ENTRANCES TO THE CONSTRUCTION SITE ARE TO BE STABILIZED PRIOR TO CONSTRUCTION BEGINNING.
- CONSTRUCTION ENTRANCES ARE TO BE BUILT WITH AN APRON TO ALLOW FOR TURNING TRAFFIC, BUT SHOULD NOT BE BUILT OVER EXISTING PAVEMENT EXCEPT FOR A SLIGHT OVERLAP.
- AREAS TO BE STABILIZED ARE TO BE PROPERLY GRADED AND COMPACTED PRIOR TO LAYING DOWN GEOTEXTILE AND STONE.
- CONSTRUCTION ROADS, PARKING AREAS, LOADING/UNLOADING ZONES, STORAGE AREAS, AND STAGING AREAS ARE TO BE STABILIZED.
- CONSTRUCTION ROADS ARE TO BE BUILT TO CONFORM TO SITE GRADES, BUT SHOULD NOT HAVE SIDE SLOPES OR ROAD GRADES THAT ARE EXCESSIVELY STEEP.

MAINTENANCE REQUIREMENTS

- REGULAR INSPECTIONS ARE TO BE MADE OF ALL STABILIZED AREAS, ESPECIALLY AFTER STORM EVENTS.
- STONES ARE TO BE REAPPLIED PERIODICALLY AND WHEN REPAIR IS NECESSARY.
- SEDIMENT TRACKED ONTO PAVED ROADS IS TO BE REMOVED DAILY BY SHOVELING OR SWEEPING. SEDIMENT IS NOT TO BE WASHED DOWN STORM SEWER DRAINS.
- STORM SEWER INLET PROTECTION IS TO BE IN PLACE, INSPECTED, AND CLEANED IF NECESSARY.
- OTHER ASSOCIATED SEDIMENT CONTROL MEASURES ARE TO BE INSPECTED TO ENSURE GOOD WORKING CONDITION.

City of Colorado Springs Stormwater Quality Figure VT-2 Vehicle Tracking Application Examples

811 Know what's below.
Call before you dig.
CALL 2-BUSINESS DAYS IN ADVANCE BEFORE YOU DIG, GRADE, OR EXCAVATE FOR THE MARKING OF UNDERGROUND MEMBER UTILITIES.
EPC FILE # PPR2342

PREPARED BY:

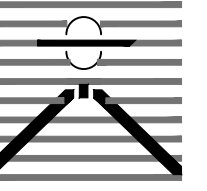

DREXEL, BARRELL & CO.
Engineers • Surveyors
101 SAHAWATCH ST., SUITE 100
COLORADO SPRGS, COLORADO 80903
CONTACT: TIM D. MCCONNELL, P.E.
(719)260-0887
COLORADO SPRINGS • LAFAYETTE

CLIENT:

LAND FIRST, INC
1378 PROMONTORY BLUFF VIEW
COLORADO SPRINGS, CO 80921

GRADING & EROSION CONTROL PLANS FOR:

BENT GRASS PLAZA
BENT GRASS MARKET VIEW
EL PASO COUNTY, COLORADO

Table with 2 columns: ISSUE, DATE. Includes entries for INITIAL ISSUE (10/06/2023) and RESUBMITTAL (12/11/2023). Also includes fields for DESIGNED BY (CGH), DRAWN BY (SDM), CHECKED BY (KGV), and FILE NAME (21814-03DT).



PREPARED UNDER MY DIRECT SUPERVISION FOR AND ON BEHALF OF DREXEL, BARRELL & CO.

DRAWING SCALE:
HORIZONTAL: N/A
VERTICAL: N/A

GRADING & EROSION CONTROL DETAILS

PROJECT NO. 21814-00CSCV
DRAWING NO.

DT2

SHEET: 5 OF 5

TEMPORARY SEEDING NOTES

- 1. SOIL IS TO BE CONDITIONED FOR PLANT GROWTH BY APPLYING TOPSOIL, FERTILIZER OR LIME.
2. SOIL IS TO BE TILLED IMMEDIATELY PRIOR TO APPLYING SEEDS. COMPACT SOILS ESPECIALLY NEED TO BE LOOSENED.
3. SEEDBED DEPTH IS TO BE 4 INCHES FOR SLOPES FLATTER THAN 2:1 AND 1 INCH FOR SLOPES STEEPER THAN 2:1.
4. ANNUAL GRASSES LISTED IN THE TABLE BELOW ARE TO BE USED FOR TEMPORARY SEEDING. SEED MIXES ARE NOT TO CONTAIN ANY NOXIOUS WEED SEEDS INCLUDING RUSSIAN OR CANADIAN THISTLE, KNAPWEED, PURPLE LOOSESTRIPE, EUROPEAN BINDWEED, JOHNSON GRASS, AND LEAFY SPURGE.
5. THE TABLE BELOW ALSO PROVIDES REQUIREMENTS FOR SEEDING RATES, SEEDING DATES, AND PLANTING DEPTHS FOR THE APPROVED TYPES OF ANNUAL GRASSES.
6. SEEDING IS TO BE APPLIED USING MECHANICAL TYPE DRILLS EXCEPT WHERE SLOPES ARE STEEP OR ACCESS IS LIMITED THEN HYDRAULIC SEEDING MAY BE USED.
7. ALL SEEDED AREAS ARE TO BE MULCHED.
8. IF HYDRAULIC SEEDING IS USED THEN HYDRAULIC MULCHING SHALL BE DONE SEPARATELY TO AVOID SEEDS BECOMING ENCAPSULATED IN THE MULCH.

MULCHING NOTES

INSTALLATION REQUIREMENTS

- 1. MATERIAL USED FOR MULCH CAN BE CERTIFIED CLEAN, WEED-AND SEED-FREE LONG STEMMED FIELD OR MARSH HAY, OR STRAW OF OATS, BARLEY, WHEAT, RYE, OR TRITICALE CERTIFIED BY THE COLORADO DEPARTMENT OF AGRICULTURE WEED FREE FORAGE CERTIFICATION PROGRAM.
2. HYDRAULIC MULCHING MATERIAL SHALL CONSIST OF VIRGIN WOOD FIBER MANUFACTURED FROM CLEAN WHOLE WOOD CHIPS. WOOD CHIPS CANNOT CONTAIN ANY GROWTH OR GERMINATION INHIBITORS OR BE PRODUCED FROM RECYCLED MATERIAL.
3. MULCH IS TO BE APPLIED EVENLY AT A RATE OF 2 TONS PER ACRE.
4. MULCH IS TO BE ANCHORED EITHER BY CRIMPING (TUCKING MULCH FIBERS 4 INCHES INTO THE SOIL), USING NETTING (USED ON SMALL AREAS WITH STEEP SLOPES) OR WITH A TACKIFIER.
5. HYDRAULIC MULCHING AND TACKIFIERS ARE NOT TO BE USED IN THE PRESENCE OF FREE SURFACE WATER.

MAINTENANCE REQUIREMENTS

- 6. REGULAR INSPECTIONS ARE TO BE MADE OF ALL MULCHED AREAS.
7. MULCH IS TO BE REPLACED IMMEDIATELY IN THOSE AREAS IT HAS BEEN REMOVED, AND IF NECESSARY THE AREA SHOULD BE RESEEDED.

SEEDING PLAN

NATIVE SEEDING MIX

SOIL PREPARATION, FERTILIZER, SEEDING, MULCHING AND MULCH TACKIFIER WILL BE REQUIRED FOR DISTURBED AREAS EXCLUDING THE RIGHT-OF-WAYS.

THE FOLLOWING TYPES AND RATES SHALL BE USED:

Table with 3 columns: COMMON NAME, SCIENTIFIC NAME, LBS PLS/ACRE. Lists various grasses and their seeding rates.

Table with 2 columns: FERTILIZER, RATE PER ACRE. Lists Nitrogen and Phosphorus (P205) rates.

SEEDING APPLICATION: DRILL SEED 0.25"-0.5" INTO TOPSOIL. AREA NOT ACCESSIBLE TO A DRILL SEEDER AND SLOPES STEEPER THAN 2:1 SHALL BE HAND BROADCAST AT DOUBLE THE ABOVE SEED RATE AND RAKED AT 1/4 TO 1/2 INTO THE TOPSOIL.

MULCHING APPLICATION: 1 1/2 TONS CERTIFIED WEED FREE NATIVE HAY PER ACRE MECHANICALLY CRIMED IN TOPSOIL IN COMBINATION WITH AN ORGANIC MULCH TACKIFIER.

Concrete Washout Area (CWA) MM-1

Concrete Washout Area (CWA) MM-1

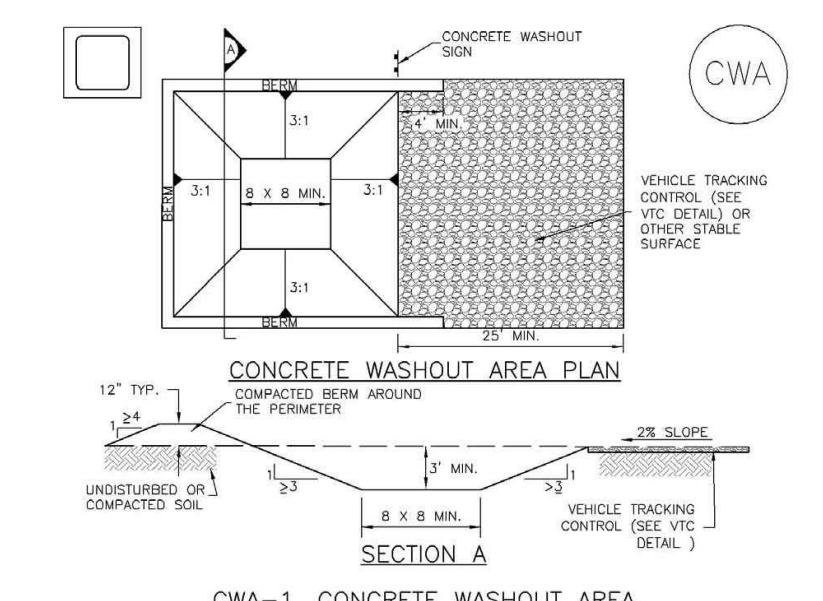

- CWA INSTALLATION NOTES
1. SEE PLAN VIEW FOR CWA REGULATION LOCATION.
2. DO NOT LOCATE AN UNLINED CWA WITHIN 400' OF ANY NATURAL DRAINAGE PATHWAY OR WATERBODY...
3. THE CWA SHALL BE INSTALLED PRIOR TO CONCRETE PLACEMENT ON SITE.
4. CWA SHALL INCLUDE A FLAT SUBSURFACE THAT IS AT LEAST 8" BY 8" SLOPES...
5. BERM SUBSIDIARIES SIDES AND BACK OF THE CWA SHALL HAVE MINIMUM HEIGHT OF 1'.
6. VEHICLE TRACKING PAD SHALL BE SLOPED 2% TOWARD THE CWA.
7. SIGNS SHALL BE PLACED AT THE CONSTRUCTION ENTRANCE, AT THE CWA AND...
8. USE EXCAVATED MATERIAL FOR PERIMETER BERM CONSTRUCTION.

- CWA MAINTENANCE NOTES
1. INSPECT BERMS EACH WORKDAY AND MAINTAIN THEM IN EFFECTIVE OPERATING CONDITION...
2. FREQUENT OBSERVATIONS AND MAINTENANCE ARE NECESSARY TO MAINTAIN BERMS IN EFFECTIVE OPERATING CONDITION...
3. WHERE BERMS HAVE FAILED, REPAIR OR REPLACEMENT SHOULD BE INITIATED UPON DISCOVERY OF THE FAILURE.
4. THE CWA SHALL BE REPAIRED, CLEANED OR ENLARGED AS NECESSARY TO MAINTAIN CAPACITY FOR CONCRETE WASTE...
5. CONCRETE WASHOUT WATER, WASTED PIECES OF CONCRETE AND ALL OTHER DEBRIS...
6. THE CWA SHALL REMAIN IN PLACE UNTIL ALL CONCRETE FOR THE PROJECT IS PLACED.
7. WHEN THE CWA IS REMOVED, COVER THE DISTURBED AREA WITH TOP SOIL, SEED AND MULCH OR OTHERWISE STABILIZED...
8. MULCH APPLIED FROM DOUGLAS COUNTY, COLORADO, NOT AVAILABLE IN AUSTROID.
NOTE: MANY JURISDICTIONS HAVE BMP DETAILS THAT VARY FROM USDC STANDARD DETAILS. CONSULT WITH LOCAL JURISDICTIONS AS TO WHICH DETAIL SHOULD BE USED WHEN DIFFERENCES ARE NOTED.

Stabilized Staging Area (SSA) SM-6

Stabilized Staging Area (SSA) SM-6

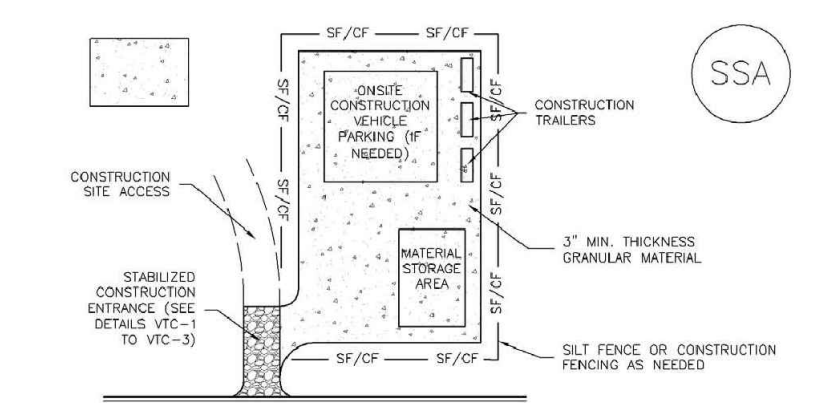

- SSA-1. STABILIZED STAGING AREA
SSA INSTALLATION NOTES
1. SEE PLAN VIEW FOR LOCATION OF STAGING AREAS.
2. STABILIZED STAGING AREA SHOULD BE APPROPRIATE FOR THE NEEDS OF THE SITE...
3. STAGING AREA SHALL BE STABILIZED PRIOR TO OTHER OPERATIONS ON THE SITE.
4. THE STABILIZED STAGING AREA SHALL CONSIST OF A MINIMUM 3" THICK GRANULAR MATERIAL.
5. UNLESS OTHERWISE SPECIFIED BY LOCAL JURISDICTION, ROCK SHALL CONSIST OF SIFT FINE...
6. ADDITIONAL PERIMETER BERMS MAY BE REQUIRED INCLUDING BUT NOT LIMITED TO SIFT FENCE AND CONSTRUCTION FENCING.
SSA MAINTENANCE NOTES
1. INSPECT BERMS EACH WORKDAY AND MAINTAIN THEM IN EFFECTIVE OPERATING CONDITION...
2. FREQUENT OBSERVATIONS AND MAINTENANCE ARE NECESSARY TO MAINTAIN BERMS IN EFFECTIVE OPERATING CONDITION...
3. WHERE BERMS HAVE FAILED, REPAIR OR REPLACEMENT SHOULD BE INITIATED UPON DISCOVERY OF THE FAILURE.
4. ROCK SHALL BE REPAIRED OR REGRANDED AS NECESSARY IF RUTTING OCCURS OR UNDERLYING SUBGRADE BECOMES EXPOSED.

November 2010 Urban Drainage and Flood Control District Urban Storm Drainage Criteria Manual Volume 3 SSA-3

November 2010 Urban Drainage and Flood Control District Urban Storm Drainage Criteria Manual Volume 3 SSA-4

Sediment Trap (ST) SC-8

Sediment Trap (ST) SC-8

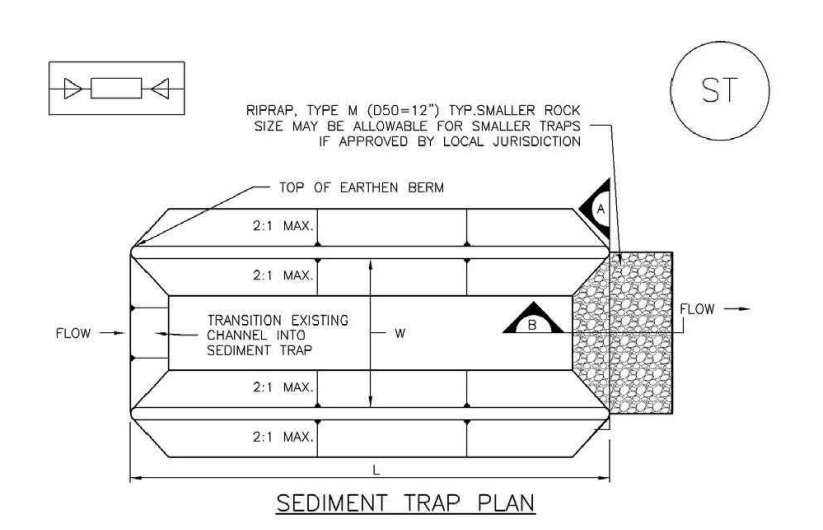

- SEDIMENT TRAP INSTALLATION NOTES
1. SEE PLAN VIEW FOR LOCATION, LENGTH AND WIDTH OF SEDIMENT TRAP.
2. ONLY USE FOR DRAINAGE AREAS LESS THAN 1 ACRE.
3. SEDIMENT TRAPS SHALL BE INSTALLED PRIOR TO ANY UPGRADING LAND-DEVELOPING ACTIVITIES.
4. SEDIMENT TRAP BERM SHALL BE CONSTRUCTED FROM MATERIAL FROM EXCAVATION...
5. SEDIMENT TRAP OUTLET TO BE CONSTRUCTED OF RIPRAP...
6. THE TOP OF THE EARTHEN BERM SHALL BE A MINIMUM OF 6" HIGHER THAN THE TOP OF THE RIPRAP OUTLET STRUCTURE.
7. THE ENDS OF THE RIPRAP OUTLET STRUCTURE SHALL BE A MINIMUM OF 6" HIGHER THAN THE CENTER OF THE OUTLET STRUCTURE.
SEDIMENT TRAP MAINTENANCE NOTES
1. INSPECT BERMS EACH WORKDAY AND MAINTAIN THEM IN EFFECTIVE OPERATING CONDITION...
2. FREQUENT OBSERVATIONS AND MAINTENANCE ARE NECESSARY TO MAINTAIN BERMS IN EFFECTIVE OPERATING CONDITION...
3. WHERE BERMS HAVE FAILED, REPAIR OR REPLACEMENT SHOULD BE INITIATED UPON DISCOVERY OF THE FAILURE.
4. REMOVE SEDIMENT ACCUMULATED IN TRAP AS NEEDED TO MAINTAIN THE FUNCTIONALITY OF THE TRAP...
5. SEDIMENT TRAPS SHALL REMAIN IN PLACE UNTIL THE UPSTREAM DISTURBED AREA IS STABILIZED AND APPROVED BY THE LOCAL JURISDICTION.
6. WHEN SEDIMENT TRAPS ARE REMOVED, THE DISTURBED AREA SHALL BE COVERED WITH TOPSOIL, SEEDED AND MULCHED OR OTHERWISE STABILIZED...
7. WHEN SIFT FENCE IS REMOVED, ALL DISTURBED AREAS SHALL BE COVERED WITH TOPSOIL, SEEDED AND MULCHED OR OTHERWISE STABILIZED...
NOTE: MANY JURISDICTIONS HAVE BMP DETAILS THAT VARY FROM USDC STANDARD DETAILS. CONSULT WITH LOCAL JURISDICTIONS AS TO WHICH DETAIL SHOULD BE USED WHEN DIFFERENCES ARE NOTED.

November 2010 Urban Drainage and Flood Control District Urban Storm Drainage Criteria Manual Volume 3 ST-2

November 2010 Urban Drainage and Flood Control District Urban Storm Drainage Criteria Manual Volume 3 ST-3

Silt Fence (SF) SC-1

Silt Fence (SF) SC-1

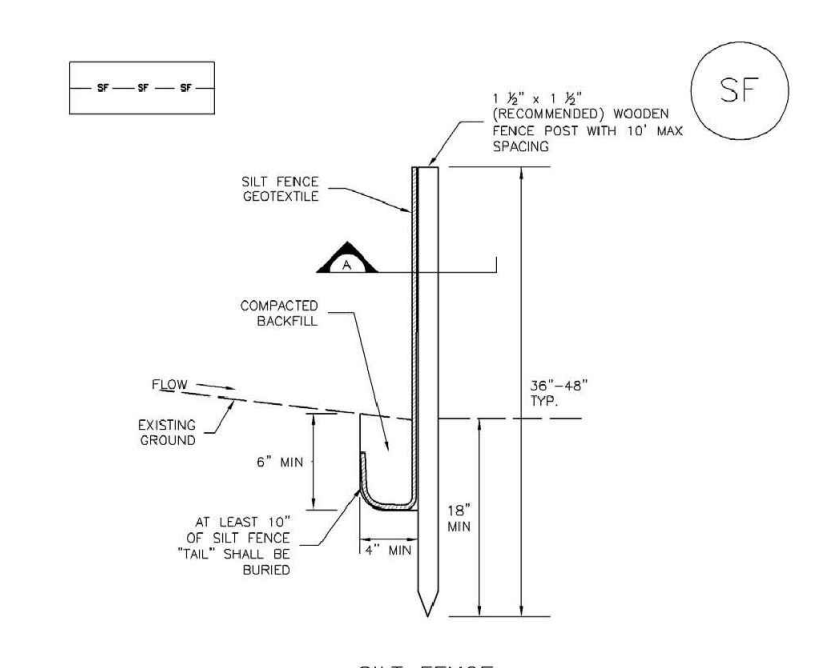

- SILT FENCE INSTALLATION NOTES
1. SILT FENCE MUST BE PLACED AWAY FROM THE TOE OF A SLOPE TO ALLOW FOR WATER FLOWING...
2. A UNIFORM 6" x 4" ANCHOR TRENCH SHALL BE EXCAVATED USING TRENCHER OR SILT FENCE INSTALLATION...
3. COMPACT ANCHOR TRENCH BY HAND WITH A "JUMPING JACK" OR BY WHEEL ROLLING...
4. SILT FENCE SHALL BE PULLED TIGHT AS IT IS ANCHORED TO THE STAKES...
5. SILT FENCE FABRIC SHALL BE ANCHORED TO THE STAKES USING 1" HEAVY DUTY STAPLES...
6. AT THE END OF A RUN OF SILT FENCE ALONG A CONTOUR, THE SILT FENCE SHOULD BE TRAINED PERPENDICULAR TO THE CONTOUR...
7. SILT FENCE SHALL BE INSTALLED PRIOR TO ANY LAND DISTURBING ACTIVITIES.
SILT FENCE MAINTENANCE NOTES
1. INSPECT BERMS EACH WORKDAY AND MAINTAIN THEM IN EFFECTIVE OPERATING CONDITION...
2. FREQUENT OBSERVATIONS AND MAINTENANCE ARE NECESSARY TO MAINTAIN BERMS IN EFFECTIVE OPERATING CONDITION...
3. WHERE BERMS HAVE FAILED, REPAIR OR REPLACEMENT SHOULD BE INITIATED UPON DISCOVERY OF THE FAILURE.
4. SEDIMENT ACCUMULATED UPSTREAM OF THE SILT FENCE SHALL BE REMOVED AS NEEDED...
5. REPAIR OR REPLACE SILT FENCE WHEN THERE ARE SIGNS OF WEAR...
6. SILT FENCE IS TO REMAIN IN PLACE UNTIL THE UPSTREAM DISTURBED AREA IS STABILIZED...
7. WHEN SILT FENCE IS REMOVED, ALL DISTURBED AREAS SHALL BE COVERED WITH TOPSOIL, SEEDED AND MULCHED OR OTHERWISE STABILIZED...
NOTE: MANY JURISDICTIONS HAVE BMP DETAILS THAT VARY FROM USDC STANDARD DETAILS. CONSULT WITH LOCAL JURISDICTIONS AS TO WHICH DETAIL SHOULD BE USED WHEN DIFFERENCES ARE NOTED.

November 2010 Urban Drainage and Flood Control District Urban Storm Drainage Criteria Manual Volume 3 SF-4

November 2010 Urban Drainage and Flood Control District Urban Storm Drainage Criteria Manual Volume 3 SF-3

811 Know what's below. Call before you dig. CALL 2-BUSINESS DAYS IN ADVANCE BEFORE YOU DIG, GRADE, OR EXCAVATE FOR THE MARKING OF UNDERGROUND MEMBER UTILITIES. EPC FILE # PPR2342

APPENDIX D
INSPECTION TEMPLATE