



MDDP & DBPS AMENDMENT

BENT GRASS DEVELOPMENT

El Paso County, Colorado

PREPARED FOR:
Challenger Communities, LLC
8605 Explorer Dr., Suite 250
Colorado Springs, CO 80920

PREPARED BY:
Galloway & Company, Inc.
1155 Kelly Johnson Blvd., Suite 305
Colorado Springs, CO 80920

DATE:
March 2020
Revised: July 2020
Revised: October 2020
Revised: January 2021



ENGINEER'S STATEMENT

The attached drainage plan and report were prepared under my direction and supervision and are correct to the best of my knowledge and belief. Said drainage report has been prepared according to the criteria established by the Drainage Criteria Manual for the City of Colorado Springs and El Paso County. I accept responsibility for any liability caused by any negligent acts, errors or omissions on my part in preparing this report.



Charlene Durham, PE 36727
For and on behalf of Galloway & Company, Inc.

Date

DEVELOPER'S CERTIFICATION

I, the developer, have read and will comply with all of the requirements specified in this drainage report and plan.



By: _____

Date

Address: Challenger Communities, LLC
8605 Explorer Dr., Suite 250
Colorado Springs, CO 80920

EL PASO COUNTY

Filed in accordance with the requirements of the Drainage Criteria Manual, Volumes 1 and 2, El Paso County Engineering Criteria Manual and Land Development Code as amended.

Jennifer Irvine, P.E.
County Engineer/ECM Administrator

Date

Conditions:

TABLE OF CONTENTS

I.	Purpose	1
II.	General Description	1
III.	Previous Reports	1
IV.	Drainage Criteria	1
V.	Current Drainage Conditions	2
	MIDDLE TRIBUTARY	3
	WEST TRIBUTARY	4
VI.	Four Step Process	5
	1. Employ Runoff Reduction Practices	5
	2. Implement BMPs That Provide a Water Quality Capture Volume with Slow Release	5
	3. Stabilize Drainageways.....	5
	4. Implement Site Specific and Other Source Control BMPs.....	6
VII.	Future Drainage Conditions.....	6
	MIDDLE TRIBUTARY	6
	WEST TRIBUTARY	6
VIII.	Proposed Channel Improvements	9
IX.	Proposed & Future Hydrology Modeling (HEC-HMS).....	10
X.	Proposed Water Quality	11
XI.	Maintenance	11
XII.	Wetlands Mitigation.....	11
XIII.	Floodplain Statement	11
XIV.	Fee Development.....	12
XV.	Conclusion	12
XVI.	References	13

Appendices:

- A. Exhibits and Figures
- B. Hydrologic Computations
- C. Hydraulic Computations
- D. Drainage Map

I. Purpose

This document is to serve as an amendment to the previously approved Master Development Drainage Plan (MDDP) for Bent Grass Meadows, approved in 2019, and to the Falcon Drainage Basin Planning Study (DBPS). The changes to the MDDP include the analysis of the flow from Meadows Filing 3 subdivision, which is now routed to the east and through the Middle Tributary of the Falcon Basin, as opposed to the West Tributary as previously studied. Drainage calculations, including an update to the HEC-HMS from the approved DBPS has been included as a portion of this report.

submitted?

II. General Description

The site is located in the Northwest ¼ and Southwest ¼ of Section 1, Township 13S, Range 65W, of the Sixth Principal Meridian, County of El Paso, State of Colorado. This report will incorporate the improvements previously approved with Bent Grass Residential Filing No. 2 FDR, the Meridian Road/Bent Grass Meadows FDR, and the proposed development known as Bent Grass West. A Vicinity Map is included in Appendix A.

The existing soil type within the proposed site as determined by the NRCS Web Soil Survey for El Paso County Area consists of Columbine gravelly sandy loam which is defined as having a hydrologic soil group of A. See the soils map included in Appendix A.

III. Previous Reports

The proposed site has been included in multiple drainage studies in the past. The following is a composite list of the existing reports pertaining to this site and adjacent sites.

1. *Falcon Drainage Basin Planning Study*, by Matrix Design Group, September 2015.
2. *Master Development Drainage Plan – Bent Grass Residential Subdivision*, by Galloway & Company, May 2019.
3. *Master Development Drainage Plan and Preliminary Drainage Plan – Bent Grass Subdivision*, by Kiowa Engineering Corporation, December 2006.
4. *Final Drainage and Erosion Control for The Meadows Filing 3 Subdivision*, by LADD Engineering, July 2000.
5. *Final Drainage Report for Bent Grass Residential (Filing No. 1)*, by Classic Consulting Engineers & Surveyors, LLC, August 2014.
6. *Final Drainage Report Addendum for Bent Grass Residential (Filing No. 1)*, by Classic Consulting Engineers & Surveyors, LLC, August 2015.
7. *Final Drainage Report for Bent Grass Residential Filing No. 2*, by Galloway & Company, April 2020.
8. *Meridian Road & Bent Grass Meadows Drive*, by Galloway & Company, September 2020.
9. *Preliminary Drainage Report Falcon Meadows at Bent Grass*, by Galloway & Company, December 2020.

this is this report; delete

IV. Drainage Criteria

Hydrology calculations were performed using the City of Colorado Springs/El Paso County Drainage Criteria Manual, as revised in November 1991 and October 1994 with County adopted Chapter 6 and

Section 3.2.1 of Chapter 13 of the City of Colorado Springs/El Paso County Drainage Criteria Manual as revised in May 2014.

The drainage calculations were based on the criteria manual Figure 6-5 and IDF equations to determine the intensity and are listed in Table 1 below.

Table 1 - Precipitation Data

Return Period	One Hour Depth (in.)	Intensity (in/hr)
5-year	1.50	5.17
100-year	2.52	8.68

The rational method was used to calculate peak flows as the tributary areas are less than 100 acres. The rational method has been proven to be accurate for basins of this size and is based on the following formula:

$$Q = CIA$$

Where:

- Q = Peak Discharge (cfs)
- C = Runoff Coefficient
- I = Runoff intensity (inches/hour)
- A = Drainage area (acres)

The runoff coefficients are calculated based on land use, percent imperviousness, and design storm for each basin, as shown in the drainage criteria manual (Table 6-6). Composite percent impervious and C values were calculated using the residential, streets, roofs, and lawns coefficients found in Table 6-6 of the manual.

The 100-year event was used as the major storm event and the 5-year event was used as the minor event.

For the analysis of the existing channel adjacent to Meridian Road and the preliminary design of the proposed channel, Bentley Flowmaster was utilized. Flowmaster was used to evaluate velocity, Froude number, and channel depth. A Manning's n value of 0.035 was utilized for the channel which is appropriate for the existing native grass that comprises the channel section. The proposed channel was designed to have a maximum depth of 5' per the criteria manual and have a maximum velocity of 5 ft/s with a maximum Froude number of 0.6.

← Address the main channel as well.

V. Current Drainage Conditions

A historic/existing conditions drainage map has been prepared for this area to analyze the area prior to any of the new Bent Grass residential development. This scenario resembles the existing conditions shown in the previous FDR for Bent Grass Residential Filing No. 2. Hydrology calculations for this scenario have been provided in Appendix B.

A Current Conditions drainage basin map has also been provided. This scenario includes the development of Bent Grass residential Filing No. 2. Hydrology Calculations for this scenario have been

provided in Appendix B. This was also provided as the existing conditions map and calculations in the Bent Grass West PDR.

Individual basin descriptions have not been included here, as they have been addressed in previously stated reports. General overall descriptions of the drainage patterns have been provided.

The Bent Grass development will impact the West Tributary and the Middle Tributary of the Falcon Basin. All development from the east of side of Bent Grass Residential Filing No. 1 and west will be contained within the West Tributary. Everything east of that property line, including the Bent Grass Meadows/Meridian Road intersection, will impact the Middle Tributary.

MIDDLE TRIBUTARY

The Middle Tributary drainage begins at Design Point 30.

Design Point 30 (225.0 AC, $Q_5 = 2.7$ cfs, $Q_{100} = 72.6$ cfs): is the release rate of the existing Meadows Pond #3, located in Meadows Filing No. 3, just north of Woodmen Hills Drive. The flows are based on the revised HEC-HMS, which is located in Appendix B. Flows will cross under Woodmen Hills Drive via an existing culvert, then sheet flow to the southeast, passing through Basin OS-5 to DR 11.

at DP 32

25/31?

Design Point 30 will combine with offsite basins OS-25 & OS-26, until they reach an existing sedimentation pond, located north of Bent Grass Meadows Drive, on what's referred to as the "school" site. The current configuration of the pond has release rates of 85.4 and 166.5 cfs for the 5 and 100-year storm events. These flows will continue south to Bent Grass Meadows Drive. Curb and gutter in the roadway is able to handle 9.4 and 33.2 cfs in the minor and major storms. It is assumed that the max gutter flow will continue to the east and the remaining flow will be directed to the south through the Bent Grass Filing No. 1 development. Based on the local street section and slopes, flows were routed through the development based on overtopping and flows splitting at intersections. The routing of the storm flow can be found in Appendix B, under Surface Routing.

(Q100 133 cfs) - does this all go to Pond 1?

The existing detention pond, Pond 1 Bent Grass Filing No. 1, was analyzed with the additional flow and contributing area. From the FDR for Bent Grass Residential, Pond 1 had a 5-year release rate of 0.4 cfs and a 100-year release rate of 6.8 cfs. The 100-year water surface elevation was 6937.61. With the additional flow being re-routed to Pond 1, the current release rates for Pond 1 are 0.5 cfs for the 5-year event and 22.0 cfs for the 100-year event. The pond will have a 100-year water surface elevation of 6938.08.

Is this over the spillway? what can be done to fix the pond?

Flows in Bent Grass Meadows will continue east, on the north side of the roadway, where they will combine with offsite flows from BG 50 (5-year flow is 280 cfs, 100-year flow=850 cfs), which is the flow obtained from the Falcon DBPS. There are 3 existing 45" x 29" elliptical rcp's. For the current condition, the approved FDR for Meridian Road is allowing 2 additional elliptical rcp's, which will handle the flow from Bent Grass Meadows at Design Point 15n (5-year flow = 13.4 cfs, 100-year flow=62.2 cfs). Design Point 20 (5-year flow=304.8, 100-year flow=961.8 cfs) combines the roadside flow from offsite with the flow from Bent Grass Meadows Drive. Flows will then continue south in a roadside ditch along Meridian Road, on the west side. Flows will eventually be intercepted by a set of existing twin 36" cmp's at Owl Place, at Design Point BG 25. From the Meridian Road/Bent Grass Meadows FDR, it is shown that the existing culverts at Bent Grass Meadows Drive and Owl Place and the channel connecting the culverts are undersized and will need to be improved in the future to properly convey the flows outlined in the DBPS.

Provide a description of the overall areas that drain to each design point down to Pond SR4. The sub-basins can be grouped together for this description.

Provide a plan showing how the flows are split.

Provide a description of the overall areas that drain to each design point on the channel down to Woodmen Road. The sub-basins can be grouped together for this description.

WEST TRIBUTARY

For the West Tributary of Falcon Basin, the hydrology analysis has the Bent Grass Residential Filing No. 2 as being constructed, as it is currently underway. The basins for this development are part of the hydrology calculations which are provided in Appendix B, but a complete description of each of these basins has not been provided, as they can be referenced in the approved FDR for Bent Grass Residential Filing No. 2. With this development, there were 2 water quality ponds built, which release into the West Tributary channel. The offsite basins have also been discussed in the Bent Grass Filing No. 2 FDR.

The currently undeveloped portion of the Bent Grass site, referred to as Bent Grass West, is comprised of 8 undeveloped basins. Below is a brief description of them.

Basin EX-1 (1.19 AC, $Q_5 = 0.4$ cfs, $Q_{100} = 2.5$ cfs): is associated with the northeastern portion of the Bent Grass West site east of the existing channel. The basin is currently undeveloped. Runoff from the basin generally flows to the southwest, into Basin EX-2 at **DP 10**.

Basin EX-2 (1.56 AC, $Q_5 = 0.5$ cfs, $Q_{100} = 3.7$ cfs): is along the eastern boundary portion of the proposed site and is south of Basin EX-1, east of the existing channel. The basin is currently undeveloped and receives flows from Basins OS-4 & OS-5. Runoff from the basin generally flows to the southeast into Basin EX-3 at **DP 14** combined with flows from **DP 11 & 12**.

Basin EX-3 (0.62 AC, $Q_5 = 0.2$ cfs, $Q_{100} = 1.5$ cfs): is along the eastern boundary of the proposed site south of Basin EX-2 and east of the existing channel. The basin currently contains an existing WQCV pond created as part of Bent Grass Residential Filing No. 2. This basin receives flows from **DP 14** and **DP 8**.

Basin EX-4 (12.49 AC, $Q_5 = 3.7$ cfs, $Q_{100} = 25.1$ cfs): is located along the northern boundary, just south of the swale built with Bent Grass Meadows Drive and west of the existing channel. The basin is currently undeveloped. Runoff from the basin generally flows to the south onto Bent Grass Meadows Drive at **DP 6**. From there, it flows via curb & gutter to the east into an existing sump inlet, ultimately discharging into the existing WQCV pond located in Basin EX-3.

Basin EX-5 (5.15 AC, $Q_5 = 1.6$ cfs, $Q_{100} = 10.6$ cfs): is west of Basin EX-4 and north of Bent Grass Meadows Drive. The basin is currently undeveloped. Runoff from the basin generally flows to the south onto Bent Grass Meadows Drive at **DP 7**. From there, it flows via curb & gutter to the east into an existing sump inlet, ultimately discharging into the existing WQCV pond located in Basin EX-3.

Basin EX-6 (9.53 AC, $Q_5 = 2.7$ cfs, $Q_{100} = 17.8$ cfs): is along the west boundary of the site. The basin is currently undeveloped and receives off-site flows from Basins OS-2 & OS-3. Runoff from the basin generally flows to the south into the existing drainage ditch entering an existing inlet at **DP 22** and flowing under Bent Grass Meadows Drive and discharging into an existing drainage swale in Basin EX-8.

Basin EX-7 (9.16 AC, $Q_5 = 2.8$ cfs, $Q_{100} = 18.9$ cfs): is north & west of Bent Grass Meadows Drive, between Basins EX-5 & EX-6. The basin is currently undeveloped. Runoff from the basin generally flows to the southeast into Bent Grass Meadows Drive at **DP 21**. From there, it flows via curb & gutter to the south into an existing sump inlet, ultimately discharging into the existing sediment pond located in Basin EX-8.

Basin EX-8 (21.3 AC, $Q_5 = 6.6$ cfs, $Q_{100} = 43.9$ cfs): is a portion of the site south and east of Bent Grass Meadows Drive, north of the south property line and west of Bent Grass Filing No. 2. The basin is currently undeveloped and contains two drainage ditches, a sediment pond, and a portion of the creek associated with Basin WT200 from the Falcon DBPS. Runoff from the basin generally flows to the southeast into the existing channel.

Overall flows exiting the Bent Grass Site at **DP CC** are 67.0 cfs for the minor storm and 1117.9 cfs for the major storm. This flow will continue south through an existing leg of the West Tributary channel of the Falcon Basin.

Address the whole site west of Filing 1. LID has

VI. Four Step Process not been proposed on any of the projects; revise.

The Four Step Process is used to minimize the adverse impacts of urbanization and is a vital component of developing a balanced, sustainable project. Below identifies the approach to the four-step process:

1. Employ Runoff Reduction Practices

The proposed roadway improvements use Low Impact Development (LID) practices to reduce runoff at the source. All runoff is routed through the pervious areas in the channel to promote infiltration.

Meridian Road

2. Implement BMPs That Provide a Water Quality Capture Volume with Slow Release

This step utilizes formalized water quality capture volume to slow the release of runoff from the site. There is no water quality being proposed with the associated roadway improvements. Per Section 1.7.1.B of the El Paso County *Stormwater Quality Policy & Procedures*, since the site is less than 1 acre, is not a sensitive or high-risk site, and does not directly discharge into State Waters, it is excluded from any water quality requirements.

Currently, the existing roadside ditch, ultimately conveys runoff to the existing detention and water quality pond MN, as shown and discussed in the Falcon DBPS. The Falcon DBPS also shows a future detention and water quality pond SR-4 that is to receive flows from basin MT060 and discharge into basin MT070 ultimately routing to existing Pond MN. Flows from Bent Grass Meadows Drive are listed in basin MT060 but are being routed to the existing roadside ditch along Meridian Road, which is in Basin MT070. The flows from the "School Site" and upstream basins will release into the east side of Pond SR-4 (west of Falcon Market Place). Pond SR-4 is currently under construction. The proposed improvements impact on the existing drainage basin and both Pond MN and Pond SR-4 are discussed later in the report.

3. Stabilize Drainageways

This step implements stabilization to the channel to accommodate developed flows while protecting infrastructure and controlling sediment loading from erosion in the drainageways. Erosion protection in the form of riprap pads at all outfall points to the channel to prevent scouring of the channel from point discharges.

A stability analysis on the existing roadside ditch along Meridian road was conducted with results shown in Appendix C. From the analysis, it was determined that the existing ditch is not in stable condition with existing DBPS flows. Improvements are anticipated to be made in the future, per recommendations from the Falcon DBPS, when additional land is obtained to expand the ROW along the southbound portion of Meridian Road.

In the interim condition, it has been proposed to add a temporary lining to the existing channel to handle the excess velocities and depth associated with the DBPS flows. This analysis has been included in the Appendix.

and Bent Grass development re-routed flows

4. Implement Site Specific and Other Source Control BMPs

Since this project only includes roadway work with no curb and gutter, the potential use of source control BMP's is limited. All runoff, however, will be conveyed through native grass buffers and a native grass channel to promote infiltration and pollutant removal.

Address the commercial zoned areas in Bent Grass East. (address all ECM I.7.2.A requirements for each step above)

VII. Future Drainage Conditions

MIDDLE TRIBUTARY

Design Point 30 and Basins OS-25 and OS-26 are as described under Existing Drainage Conditions. However, Basins OS-25 and OS-26 now route through proposed "future" detention pond, on what's been previously referred to as the "School Site", north of Bent Grass Meadows Drive and just west of Bent Grass Filing No. 2. This "future" pond will replace the current sedimentation pond on the "School Site". Upon any additional development within the Middle Tributary area of the Bent Grass Development and north of Bent Grass Meadows Drive, this pond will need to be constructed to accommodate the re-routed flows from the Meadows Pond #2 at DP 30.

This future facility will need to provide 2.76 ac-ft of water quality, 6.26 ac-ft for EURV and 11.98 ac-ft for 100-year storage volume. Preliminary release rates for the 5 and 100-year storms are 3.8 cfs and 32.2 cfs. These flows were then routed to Bent Grass Meadows to the south. With the decrease in flows, flows will not overtop Bent Grass Meadows Drive and continue east to the future box culvert under Bent Grass Meadows Drive at DP BG20 (5-year flow=291.7 cfs, 100-year flow=914.3 cfs). Flows were still checked against street capacity on the north and south side of Bent Grass Meadows Drive, as it continues to the east. With the construction of the future pond, Bent Grass Meadows Drive will be able to adequately handle the flows and no additional storm infrastructure would need to be built to carry these future developed flows. Any area north of Bent Grass Meadows Drive that will develop in the future will need to provide its own on-site detention.

See comment letter.

At the Bent Grass Meadows Drive/Meridian Road intersection, the elliptical rcp's will need to be replaced with a double 16' x 4' rcbc. The future roadside ditch will have a 15' wide bottom channel with 4:1 side slopes, 6.5' deep and a longitudinal slope of 0.30%. This will result in a flow depth of 5.15' and velocity of 5.04 fps. This channel will direct flows to Owl Place where the existing twin cmp's will be replaced with a 20' x 4' rcbc or equivalent. This structure will need to be built when any development west of Meridian Road at the intersection of Owl Place happens. With future development, it is anticipated that the existing channel conveying flows to the south will be removed to accommodate the new development. The new channel will need to be a 35' wide bottom channel with 4:1 sides, 5' deep and a longitudinal slope of 0.30%. This will produce a flow depth of 3.7' and a velocity of 4.6 fps.

Calculations are provided in Appendix C for the future culverts and roadside channel.

Address what size of storm drain would be required to convey flows to Meridian Road if the sites aren't all raised to be able to drain into BG Meadows Drive.

WEST TRIBUTARY

Offsite flows entering the west tributary location of Bent Grass have not changed from what was discussed under Current Conditions. The 8 undeveloped on-site basins for Bent Grass West have been replaced with 17 developed basins. These basins are found in the Falcon Meadows for Bent Grass PDR. A summary of these basins is provided below and are part of the hydrology analysis provided in Appendix B.

State the calculated/DBPS/FEMA flows entering the north property line and channel.

Describe the DP, total flows and design of the culverts under Bent Grass Meadows Drive.

Basin AA-1 (2.57 AC, Q5 = 4.2 cfs, Q100 = 9.9 cfs): a basin that includes residential lots & east half of Lemon Grass Road. It encompasses single-family residential lots. Runoff will flow from each lot onto the proposed public R.O.W. where proposed mountable curb and gutter will convey flows to **DP 4**. Flows will then enter a proposed CDOT Type 'R' inlet and will be piped into the existing Bent Grass Filing No. 2 WQCV pond located in Basin A-2 at **DP 6**.

Basin AA-2 (2.28 AC, Q5 = 4.2 cfs, Q100 = 9.3 cfs): a basin that includes the west half of Lemon Grass Road and encompasses single-family residential lots. Runoff will flow from each lot onto the proposed public R.O.W. where proposed mountable curb and gutter will convey flows to **DP 5**. Flows will then enter a proposed CDOT Type 'R' inlet where it will be piped into the existing Bent Grass Filing No. 2 WQCV pond located in the south end of the basin.

Basin B-1 (5.43 AC, Q5 = 2.6 cfs, Q100 = 10.8 cfs): a basin that is in the center of the site and encompasses the existing rerouted channel RWT202 and existing improved channel RWT204. Flows will sheet flow into the existing channel where they will then be conveyed to **DP 22**.

Basin CC-1 (9.07 AC, Q5 = 16.9 cfs, Q100 = 36.0 cfs): a basin that includes Sophia Lane, the west half of Sarin Trail, north portion of Kittrick Place, and encompasses single-family residential lots. Runoff will flow from each lot onto the proposed public R.O.W. where proposed mountable curb and gutter will convey flows to **DP 15**. Flows will then enter a proposed CDOT Type 'R' inlet where it will be piped to the proposed north WQCV pond at **DP 13**.

Basin CC-2 (1.35 AC, Q5 = 4.1 cfs, Q100 = 9.0 cfs): It encompasses single-family residential lots including the east half of Sarin Trail. Runoff will flow from each lot onto the proposed public R.O.W. where proposed mountable curb and gutter will convey flows to **DP 12**. Flows will then enter a proposed CDOT Type 'R' inlet where it will be piped to the proposed north WQCV pond at **DP 13**.

Basin CC-3 (1.88 AC, Q5 = 6.4 cfs, Q100 = 12.1 cfs): It encompasses Kittrick Place between Sarin Trail & Daelyn Drive, as well as single-family residential lots. Runoff will flow from each lot onto the proposed public R.O.W. where proposed mountable curb and gutter will convey flows to **DP 8**. Flows will then enter an existing CDOT Type 'R' inlet on the north side of Bent Grass Meadows Drive, where it will then be released into the existing Filing No. 2 North WQCV Pond.

Basin CC-4 (4.34 AC, Q5 = 6.5 cfs, Q100 = 17.8 cfs): It encompasses residential lots and open space between Sarin Trail & Bent Grass Meadows Drive. Runoff will flow from each lot onto the proposed open space, eventually releasing into the public R.O.W. of Bent Grass Meadows Drive, where existing curb and gutter will convey flows to **DP 8**. Flows will then enter an existing CDOT Type 'R' inlet where it will then be released into the existing Filing No. 2 North WQCV Pond.

Basin CC-5 (0.45 AC, Q5 = 0.2 cfs, Q100 = 1.4 cfs): It encompasses the proposed north WQCV pond area. The stormwater within the proposed north WQCV pond will be released at a controlled rate, via an outlet structure with orifice holes, into the existing channel RWT204.

Basin D-1 (9.07 AC, Q5 = 11.2 cfs, Q100 = 26.6 cfs): a basin along the west property line of the site. It encompasses single-family residential lots, Isabel Place, & west half of Daelyn Drive. Runoff will flow from each lot onto the proposed public R.O.W. where proposed mountable curb and gutter will convey flows to **DP 16**. Flows will then enter a proposed CDOT Type 'R' inlet where it will then be piped and ultimately outfall in the proposed south WQCV pond at **DP 31**.

Describe the swale concept along the west and south property lines and culverts under Bent Grass Meadows Drive.

Basin D-2 (6.72 AC, Q5 = 14.3 cfs, Q100 = 29.6 cfs): a basin east of Basin D-1. It encompasses single-family residential lots, Isabel Place, Raylan Loop, Jolie Court, as well as the east half of Daelyn Drive. Runoff will flow from each lot onto the proposed public R.O.W. where proposed mountable curb and gutter will convey flows to **DP 14**. Flows will then enter a proposed CDOT Type 'R' inlet where it will then be piped and ultimately outfall in the proposed south WQCV pond at **DP 31**.

Basin D-3 (2.03 AC, Q5 = 0.8 cfs, Q100 = 2.3 cfs): a basin that is in the southwest corner of the site, south of Basin D-1. It encompasses the backs of several proposed residential lots as well as an existing drainage ditch and proposed Swale D. Runoff will flow from basin OS-2 and OS-3 into Swale D, and convey flows to the existing drainage ditch which will convey flows to an existing area inlet at **DP 11**. From there, flows will be piped and ultimately outfall at the south WQCV pond at **DP 31**.

Basin D-4 (4.38 AC, Q5 = 7.8 cfs, Q100 = 16.6 cfs): a basin that is east of Bent Grass Meadows Drive. It encompasses single-family residential lots, Rowena Way, & portions of Linley Way, Jayla Trail, and Henzlee Place. Runoff will flow from each lot onto the proposed public R.O.W. where proposed mountable curb and gutter will convey flows to **DP 17**. Flows will then enter a proposed CDOT Type 'R' inlet where it will then be piped and ultimately outfall in the proposed south WQCV pond at **DP 31**.

Basin D-5 (1.08 AC, Q5 = 2.2 cfs, Q100 = 4.6 cfs): a basin that is located at the southwest corner of Bent Grass Meadows Drive and Henzlee Place. It includes residential lots, as well as a portion of the north half of Nico Way and west half of Henzlee Place. Flows will be directed towards the public R.O.W. where proposed curb and gutter will convey flows to the south along Henzlee Place to **DP 18**. Flows will then enter a proposed CDOT Type 'R' inlet where it will then be piped and ultimately outfall in the proposed south WQCV pond at **DP 31**.

Basin D-6 (4.01 AC, Q5 = 8.2 cfs, Q100 = 17.2 cfs): a basin that is south of Basin D-5 & east of Basin D-4. It encompasses single-family residential lots & half of Linley Way, Jayla Trail, Henzlee Place, & Nico Way. Runoff will flow from each lot onto the proposed public R.O.W. where proposed mountable curb and gutter will convey flows to **DP 18**. Flows will then enter a proposed CDOT Type 'R' inlet where it will then be piped and ultimately outfall in the proposed south WQCV pond at **DP 31**.

Basin D-7 (6.39 AC, Q5 = 3.2 cfs, Q100 = 14.8 cfs): a basin that is in the south end of the site, east of Bent Grass Meadows Drive & west of the existing channel. It encompasses the back half of several single-family residential lots as well as proposed south WQCV pond, an existing sediment basin, and an existing drainage ditch. Runoff will flow, via sheet flow, until it enters the existing drainage ditch and is conveyed to the proposed south WQCV pond or will directly flow into the proposed south WQCV pond.

Basin D-8 (1.69 AC, Q5 = 1.3 cfs, Q100 = 4.5 cfs): a basin that is west of the existing channel & south of Bent Grass Meadows Drive. It encompasses the back half of single-family residential lots. Runoff will flow from each lot and discharge into a proposed drainage ditch. The drainage ditch (Swale C) will then convey flows, ultimately discharging into the proposed south WQCV pond at **DP 32**.

Basin B-2 (4.16 AC, Q5 = 1.4 cfs, Q100 = 9.1 cfs): a basin that is in the south area of the site and encompasses the existing channel RWT210. Flows will sheet flow into the existing channel where they will then be conveyed to **DP CC** exiting the site.

Basins E-1 thru E-5 are the same as discussed under the Existing Conditions Section, as these basins represent the already built Bent Grass Meadows Drive through the proposed site.

The Bent Grass West development accounts for 2 additional water quality facilities to be built. These items were preliminarily designed in the Falcon Meadows for Bent Grass PDR and will be final designed with the FDR for Bent Grass Meadows Filing No. 3.

provide current flows for comparison

Final flows exiting the site from the West Tributary at **DP CC** are 78.9 cfs for the 5-year storm and 1087.2 cfs for the 100-year storm. These flows are less than the current conditions at this location, due to the additional WQ ponds being built and storm infrastructure with this “future” development. Flows will continue offsite through the West Tributary, eventually reaching the existing Pond WU.

A future conditions drainage map has been prepared for this area. The proposed map is included in Appendix D.

Provide a description of the overall areas that drain to each design point on the channel down to Woodmen Road.

VIII. Proposed Channel Improvements

MIDDLE TRIBUTARY

Although the existing channel and culverts are undersized and improvements will need to be made in the future, minimal channel improvements are being proposed at this time, along Meridian Road. With the construction of the right turn lane on Bent Grass Meadows Drive, the three RCP culverts will be extended approximately 15' to span the extended width of the roadway. Additionally, two more 45"x29" Elliptical RCP pipes will be installed under Bent Grass Meadows Drive to convey the flows for DP 20. The existing channel will need to be lined with a temporary turf reinforcement mat (TRM) due to the excessive velocities (9.91 fps), high shear stress (5.11lbs/ft²) & high Froude Number (1.12). With the TRM added to the channel sides, the allowable velocity is 25 fps and permissible shear stress is 12 lbs/ft². An analysis of the channel with the TRM is provided in the Appendix.

In the future, El Paso County will need to improve the existing culverts and channel to adequately convey the flow outlined in the DBPS. These necessary improvements and associated calculations are described further below. A preliminary grading exhibit has been prepared showing these improvements and included in Appendix C.

Similar to the existing channel, Bentley Flowmaster was also used to design the future proposed channel section. The future channel was designed to have a maximum depth of 5' per the criteria manual and have a maximum velocity of 5 ft/s with a maximum Froude number of 0.6. The flow rate used for the design, 925 cfs, was taken from the Falcon DBPS flow combined with the additional off-site drainage coming from the “School Site” and

The future channel section was designed as trapezoidal shape with a 15' bottom width, 4:1 side slopes, and 0.3% longitudinal slope. The total depth of the channel will be 6', providing 1' of freeboard for the 5' of water depth. The velocity of the proposed channel is 4.93 ft/s.

The Federal Highway Administration's HY-8 program was also utilized to design the future culverts that will run beneath Bent Grass Meadows Drive. The calculations included in Appendix C show that in order to adequately convey the 915 cfs in the future conditions, two 16'x4' concrete box culverts will need to replace the existing elliptical RCP's. In order to construct the box culverts, the channel will need to be flattened from downstream to create roughly 5' of additional clearance below the road.

Address the main channel (RWT 210), DBPS recommendations, MDDP recommendations and differences from the DBPS. Mention the existing downstream agreements that the Bent Grass Metro District has agreed to maintain the channel. Address funding, responsibilities of each development parcel and metro district and proposed timing/phasing of construction.

WEST TRIBUTARY

The Falcon Area DBPS made recommendations for the channels as they run through the project site. RWT202 was rerouted on the north property lone to convey flows to RWT204. Improvements were designed as part of the Bent Grass Residential Filing No. 2 development.

needs to be addressed in the MDDP also, conflicts with the next sentence

The RWT204 is grossly oversized for the actual flows expected through it. The revisions to this section of the channel will be addressed in the FDR for Bent Grass Filing No. 3. Improvements to this section of the channel will adhere and be equivalent to the recommendations in the Falcon Basin DBPS.

RWT204 will generally stay in a location similar to where it is in existing conditions but will have new designed channel sections. The channels will have longitudinal slopes flattened to below 1% in order to reduce the scour potential of the channel. Grouted Sloping Boulder Drops will be utilized within the channel as grade controls (maximum height of 4' with 4:1 slope). describe how many

IX. Proposed & Future Hydrology Modeling (HEC-HMS)

The updated Falcon Basin DBPS by Matrix looked at several design alternatives for the area to help with undersized ponds throughout the area. The preferred method for dealing with this deficiency was the design and construction of sub-regional ponds throughout the area. The Bent Grass development site impacts one of these ponds, SR4.

The HEC-HMS model, which was used in the Falcon DBPS, was updated. Updates to the model included:

The Falcon DBPS surveyed the ponds; address any discrepancies.

- Modifying the Meadows Pond #2 stage/storage & stage/elevation data based on Meadows Filing No. 3 FDR data
- Adding in existing sedimentation pond at "school site" location
- Breaking up Basin MT060 into 2 basins (MT060a & MT060) to account "school site" pond
- Updated Pond SR4 based on approved construction drawing information
- Basin MT070 updated to show future improvements within the basin

As previously mentioned, the DBPS identified a pond named SR3 at the junction of RWT202 and RWT204 near the south end of the Bent Grass Residential Subdivision. Per the approved FDR for Bent Grass Filing No. 2 and the PDR for Falcon Meadows at Bent Grass, 4 separate water quality ponds will be situated through the Bent Grass site to in lieu of the SR3 pond. The 4 ponds were small enough in volume that they were not incorporated into the HMS model, but are accounted for in the rational modeling within the site.

These on-site water quality pond will treat runoff prior to releasing it into the channel. The two water quality ponds associated with the Bent Grass Filing No. 2 have a volume of approximately 1 acre-foot just for water quality and therefore eliminating the SR3 pond, which never provided detention. The existing channel will remain in place. Analysis of the existing channel shows that it is stable in its current state. Any improvements performed as part of the adjacent development will address easements and/or drainage tracts as development occurs.

clarify per comments above

Doesn't make sense. WQ will be required for all development and based on the diversion, detention will be required upstream of Bent Grass Meadows Drive.

X. Proposed Water Quality

Though the Middle Tributary site does not include the addition of any proposed water quality or detention ponds, future Pond SR-4 and existing Pond MN from the Falcon DBPS will receive flows from the improved site. The HEC-HMS has been updated and is included in Appendix B. As discussed previously, the "School Site" have been added as an additional Basin MT060a, which is routed to the regional detention facility SR-4.

Basin MT070, described in the Falcon DBPS, was analyzed to include the improvements made to the site within Basin MT070 and the effects it has on existing Pond MN.

From the analysis, Pond SR-4's 100-yr. receiving flows decreased from 1,000 cfs to 952.3 cfs. Based on the increase in impervious area, Basin MT070's Curve Number increased from 67 to 68. Subsequently, the 100-yr. receiving flows entering existing Pond MN decreased to 825.8 cfs from 850 cfs.

Release rates for SR-4 are 24.3 cfs for the 2-year storm and 696.4 cfs for the 100-year storm. Falcon DBPS has 2-year storm listed as 27 cfs and 100-year storm as 730 cfs. This gives a decrease of 2.7 cfs and 33.6 cfs for the 2 and 100-year events respectively.

Pond MN release rates 30.5 for the 2-year storm and 799.4 cfs for the 100-year storm. The DBPS has release rates listed as 32 cfs for the 2-year storm and 820 cfs for the 100-year storm. This gives a decrease of 1.5 cfs and 20.6 cfs for the 2 and 100-year events respectively.

XI. Maintenance diversion (?)

The proposed channels are to be private facilities. They will be maintained by the Bent Grass Metropolitan district. When completion of future DBPS construction improvements and upon the Board of County Commissioners acceptance the channels will then be owned and maintained by El Paso County along with all drainage facilities within the public Right-of-Way.

XII. Wetlands Mitigation

No wetlands are located on site.

specify reaches
(RWT 204 and 210)

XIII. Floodplain Statement

According to the Federal Emergency Management Agency (FEMA) Flood Insurance Rate Map number 08041C0553G, effective December 7, 2018, there is no floodplain in the project area. A copy of the FIRM Panel is included in Appendix A.

Address the whole
development

The portion of channel that has a floodplain designation is only the RWT210 and RWT204 portions of the channel. It is unknown why the western channel, RWT202 is unmapped since it is the larger contributor regarding flow rates. Since there is a discrepancy between the DPBS and FEMA maps, the RWT202 channel has been rerouted to follow the north Bent Grass property line and connect to the RWT204 channel. No-rise certifications are complete, and permit issued. No LOMR is anticipated or proposed at this time.

XIV. Fee Development

At this time, it is being requested to add the improvement of the culverts at the Bent Grass Meadows Drive/Meridian Road intersection to the reimbursable list of storm facilities presented in the Falcon DBPS. The cost of the current additional elliptical pipes and then the future box culverts would be added to the bridge fees. Based on the estimate shown below, the box culvert would add \$429,749.00 to the overall bridge construction costs.

Item	Quantity	Unit	Unit Cost	Cost
Culvert (Concrete Box Culvert) (Public)				
4' x 16' Concrete Box Culvert	190	LF	\$ 1,600.00	\$ 304,000.00
30" Grouted Boulders	164	SY	\$ 190.00	\$ 31,160.00
Soil Rip Rap - Type M	52.44	CY	\$ 100.00	\$ 5,244.00
Headwalls - Concrete	35	CY	\$ 850.00	\$ 29,750.00
Wingwalls - Concrete	60	CY	\$ 850.00	\$ 51,000.00
Headwalls - Steel Reinforcement	1300	LBS	\$ 1.50	\$ 1,950.00
Wingwalls - Steel Reinforcement	4430	LBS	\$ 1.50	\$ 6,645.00
Total				\$ 429,749.00

In Section 7.0 Fee Development of the Falcon Basin DBPS, it was shown that the Development Cost for Bridge Improvements was \$2,058,474. With the addition of the box culvert at Bent Grass Meadows Drive/Meridian Road, this estimate would raise to \$2,488,223. The Drainage Improvement costs shown in the DBPS for Development were \$14,988,251. The DBPS fees were based off 645.58 impervious acres. (Refer to DBPS for detailed information on area breakdown).

see comment letter

verify with channel design

The Bridge Fee per Impervious acre was \$3,189 and Drainage Fee was \$23,217. There are no improvements to facilities falling under the Drainage Fee criteria. The Bridge fee will increase. Based on the new overall bridge development fee of \$2,488,223, the fee per impervious acre will be \$3,793, an increase of \$604 per impervious acre.

(needs to be verified based on platted areas)

It is requested that the Drainage Board will approve the above increase to the Falcon Basin Bridge Fees.

XV. Conclusion

This report has been prepared using the criteria and methods as described in the El Paso County Drainage Criteria Manual. For the Middle Tributary portion of the site, it has been shown that under current conditions, existing facilities will function. Recommendations for future facilities have been provided for an EURV pond on the "school site", Bent Grass Meadows Drive/Meridian Road intersection and the Owl Place crossing. Also, it has been noted that any new development in this area will need to provide their own on-site water quality and detention. Under the current conditions, there are no adverse impacts to the sub-regional SR4 pond or the Regional Pond MN, further downstream.

For the West Tributary areas, several water quality facilities are being proposed/constructed. These items will treat developed flows prior to being released into the channel for the West Tributary. Upon entering the channel, flows will leave the Bent Grass property and continue south, eventually reaching the Regional Pond WU. There are no adverse impacts to this facility.

XVI. References

1. *City of Colorado Springs/County of El Paso Drainage Criteria Manual*, October 1991.
2. *Drainage Criteria Manual, Volume 2*, City of Colorado Springs, November 2002.
3. *Urban Storm Drainage Criteria Manual*, Urban Drainage and Flood Control District, January 2016 (with current revisions).
4. *Falcon Drainage Basin Planning Study*, by Matrix Design Group, September 2015.
5. *Master Development Drainage Plan and Preliminary Drainage Plan – Bent Grass Subdivision*, by Kiowa Engineering Corporation, December 2006.
6. *Final Drainage Report for Bent Grass Residential (Filing No. 1)*, by Classic Consulting Engineers & Surveyors, LLC, August 2014.
7. *Final Drainage Report Addendum for Bent Grass Residential (Filing No. 1)*, by Classic Consulting Engineers & Surveyors, LLC, August 2015.
8. *Master Development Drainage Plan – Bent Grass Residential Subdivision*, by Galloway & Company, May 2019.
9. *Final Drainage and Erosion Control for The Meadows Filing 3 Subdivision*, by LADD Engineering, July 2000.
10. *Final Drainage Report for Bent Grass Residential Filing No. 2*, by Galloway & Company, April 2020.
11. *Meridian Road & Bent Grass Meadows Drive*, by Galloway & Company, September 2020.
12. *Preliminary Drainage Report Falcon Meadows at Bent Grass*, by Galloway & Company, December 2020.

APPENDIX A
Exhibits and Figures

APPENDIX B
Hydrologic Computations

APPENDIX C
Hydraulic Computations

Provide conceptual channel plan and DBPS
details for RWT 210

APPENDIX D
Drainage Maps

APPENDIX A
Exhibits and Figures

Hydrologic Soil Group—El Paso County Area, Colorado

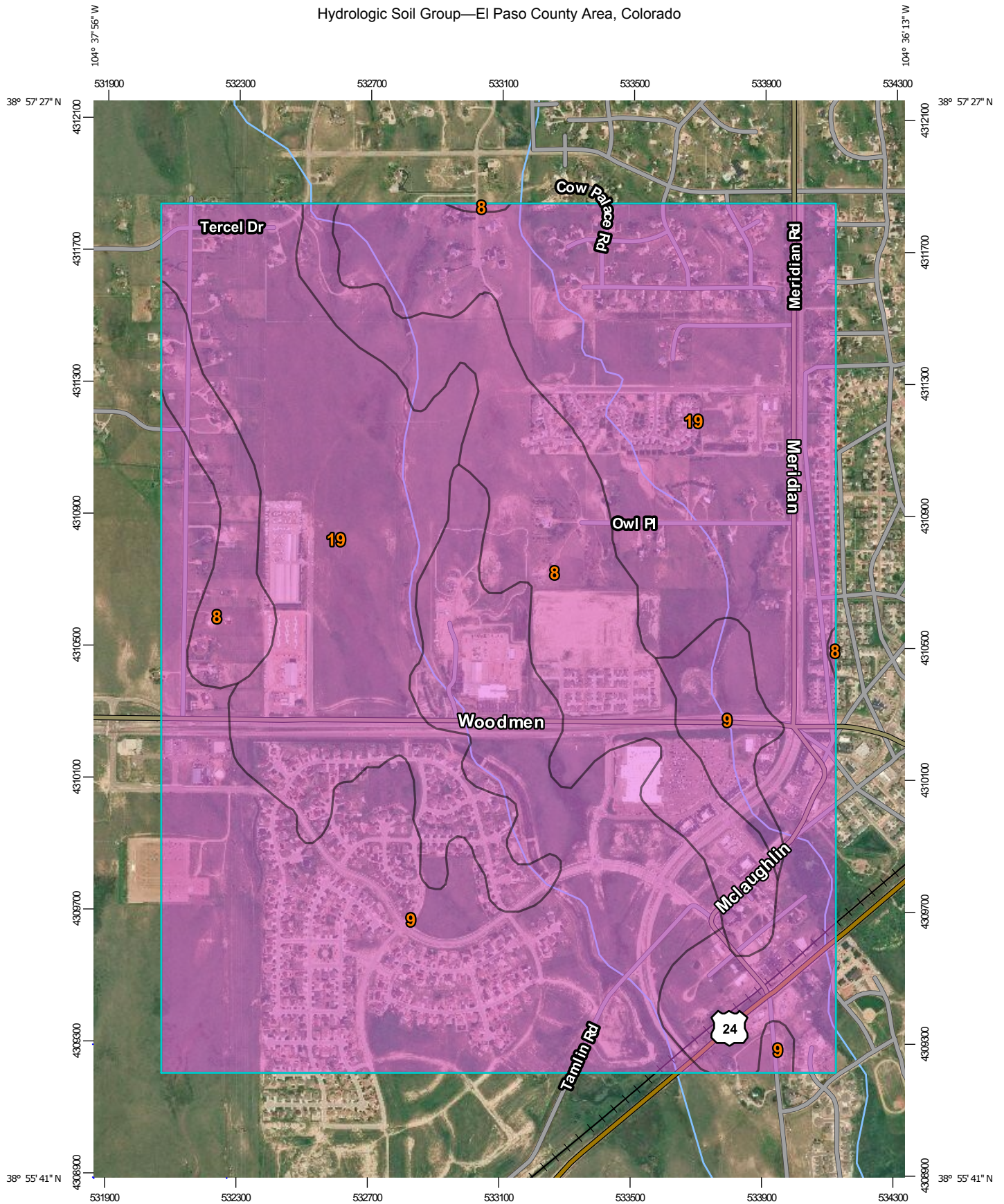

Map Scale: 1:15,900 if printed on A portrait (8.5" x 11") sheet.



Map projection: Web Mercator Corner coordinates: WGS84 Edge tics: UTM Zone 13N WGS84

MAP LEGEND

Area of Interest (AOI)









 Area of Interest (AOI)

Soils

Soil Rating Polygons





 A
 A/D
 B
 B/D
 C
 C/D
 D
 Not rated or not available

Soil Rating Lines

 A
 A/D
 B
 B/D
 C
 C/D
 D
 Not rated or not available

Soil Rating Points





 A
 A/D
 B
 B/D

 C
 C/D
 D
 Not rated or not available

Water Features

 Streams and Canals

Transportation

 Rails
 Interstate Highways
 US Routes
 Major Roads
 Local Roads

Background

 Aerial Photography

MAP INFORMATION

The soil surveys that comprise your AOI were mapped at 1:24,000.

Please rely on the bar scale on each map sheet for map measurements.

Source of Map: Natural Resources Conservation Service
 Web Soil Survey URL:
 Coordinate System: Web Mercator (EPSG:3857)

Maps from the Web Soil Survey are based on the Web Mercator projection, which preserves direction and shape but distorts distance and area. A projection that preserves area, such as the Albers equal-area conic projection, should be used if more accurate calculations of distance or area are required.

This product is generated from the USDA-NRCS certified data as of the version date(s) listed below.

Soil Survey Area: El Paso County Area, Colorado
 Survey Area Data: Version 16, Sep 10, 2018

Soil map units are labeled (as space allows) for map scales 1:50,000 or larger.

Date(s) aerial images were photographed: Jun 7, 2016—Aug 17, 2017

The orthophoto or other base map on which the soil lines were compiled and digitized probably differs from the background imagery displayed on these maps. As a result, some minor shifting of map unit boundaries may be evident.

Hydrologic Soil Group

Map unit symbol	Map unit name	Rating	Acres in AOI	Percent of AOI
8	Blakeland loamy sand, 1 to 9 percent slopes	A	214.3	16.0%
9	Blakeland-Fluvaquentic Haplaquolls	A	465.8	34.7%
19	Columbine gravelly sandy loam, 0 to 3 percent slopes	A	662.6	49.3%
Totals for Area of Interest			1,342.6	100.0%

Description

Hydrologic soil groups are based on estimates of runoff potential. Soils are assigned to one of four groups according to the rate of water infiltration when the soils are not protected by vegetation, are thoroughly wet, and receive precipitation from long-duration storms.

The soils in the United States are assigned to four groups (A, B, C, and D) and three dual classes (A/D, B/D, and C/D). The groups are defined as follows:

Group A. Soils having a high infiltration rate (low runoff potential) when thoroughly wet. These consist mainly of deep, well drained to excessively drained sands or gravelly sands. These soils have a high rate of water transmission.

Group B. Soils having a moderate infiltration rate when thoroughly wet. These consist chiefly of moderately deep or deep, moderately well drained or well drained soils that have moderately fine texture to moderately coarse texture. These soils have a moderate rate of water transmission.

Group C. Soils having a slow infiltration rate when thoroughly wet. These consist chiefly of soils having a layer that impedes the downward movement of water or soils of moderately fine texture or fine texture. These soils have a slow rate of water transmission.

Group D. Soils having a very slow infiltration rate (high runoff potential) when thoroughly wet. These consist chiefly of clays that have a high shrink-swell potential, soils that have a high water table, soils that have a claypan or clay layer at or near the surface, and soils that are shallow over nearly impervious material. These soils have a very slow rate of water transmission.

If a soil is assigned to a dual hydrologic group (A/D, B/D, or C/D), the first letter is for drained areas and the second is for undrained areas. Only the soils that in their natural condition are in group D are assigned to dual classes.

Rating Options

Aggregation Method: Dominant Condition

Component Percent Cutoff: None Specified

Tie-break Rule: Higher

NOTES TO USERS

This map is for use in administering the National Flood Insurance Program. It does not necessarily identify all areas subject to flooding, particularly from local drainage sources of small size. The community map repository should be consulted for possible updated or additional flood hazard information.

To obtain more detailed information in areas where **Base Flood Elevations (BFEs)** and/or **floodways** have been determined, users are encouraged to consult the Flood Profiles and Floodway Data and/or Summary of Stillwater Elevations tables contained within the Flood Insurance Study (FIS) report that accompanies this FIRM. Users should be aware that BFEs shown on the FIRM represent rounded whole-foot elevations. These BFEs are intended for flood insurance rating purposes only and should not be used as the sole source of flood elevation information. Accordingly, flood elevation data presented in the FIS report should be utilized in conjunction with the FIRM for purposes of construction and/or floodplain management.

Coastal Base Flood Elevations shown on this map apply only landward of 0.0' North American Vertical Datum of 1988 (NAVD88). Users of this FIRM should be aware that coastal flood elevations are also provided in the Summary of Stillwater Elevations table in the Flood Insurance Study report for this jurisdiction. Elevations shown in the Summary of Stillwater Elevations table should be used for construction and/or floodplain management purposes when they are higher than the elevations shown on this FIRM.

Boundaries of the **floodways** were computed at cross sections and interpolated between cross sections. The floodways were based on hydraulic considerations with regard to requirements of the National Flood Insurance Program. Floodway widths and other pertinent floodway data are provided in the Flood Insurance Study report for this jurisdiction.

Certain areas not in Special Flood Hazard Areas may be protected by **flood control structures**. Refer to section 2.4 "Flood Protection Measures" of the Flood Insurance Study report for information on flood control structures for this jurisdiction.

The **projection** used in the preparation of this map was Universal Transverse Mercator (UTM) zone 13. The **horizontal datum** was NAD83, GRS80 spheroid. Differences in datum, spheroid, projection or UTM zones used in the production of FIRMs for adjacent jurisdictions may result in slight positional differences in map features across jurisdiction boundaries. These differences do not affect the accuracy of this FIRM.

Flood elevations on this map are referenced to the **North American Vertical Datum of 1988 (NAVD88)**. These flood elevations must be compared to structure and ground elevations referenced to the same vertical datum. For information regarding conversion between the National Geodetic Vertical Datum of 1929 and the North American Vertical Datum of 1988, visit the National Geodetic Survey website at <http://www.ngs.noaa.gov/> or contact the National Geodetic Survey at the following address:

NGS Information Services
NOAA, NINGS12
National Geodetic Survey
SSMC-3, #9202
1315 East-West Highway
Silver Spring, MD 20910-3282

To obtain current elevation, description, and/or location information for **bench marks** shown on this map, please contact the Information Services Branch of the National Geodetic Survey at (301) 713-3242 or visit its website at <http://www.ngs.noaa.gov/>.

Base Map information shown on this FIRM was provided in digital format by El Paso County, Colorado Springs Utilities, City of Fountain, Bureau of Land Management, National Oceanic and Atmospheric Administration, United States Geological Survey, and Anderson Consulting Engineers, Inc. These data are current as of 2006.

This map reflects more detailed and up-to-date **stream channel configurations and floodplain delineations** than those shown on the previous FIRM for this jurisdiction. The floodplains and floodways that were transferred from the previous FIRM may have been adjusted to conform to these new stream channel configurations. As a result, the Flood Profiles and Floodway Data tables in the Flood Insurance Study Report (which contains authoritative hydraulic data) may reflect stream channel distances that differ from what is shown on this map. The profile baselines depicted on this map represent the hydraulic modeling baselines that match the flood profiles and Floodway Data Tables if applicable, in the FIS report. As a result, the profile baselines may deviate significantly from the new base map channel representation and may appear outside of the floodplain.

Corporate limits shown on this map are based on the best data available at the time of publication. Because changes due to annexations or de-annexations may have occurred after this map was published, map users should contact appropriate community officials to verify current corporate limit locations.

Please refer to the separately printed **Map Index** for an overview map of the county showing the layout of map panels; community map repository addresses; and a Listing of Communities table containing National Flood Insurance Program dates for each community as well as a listing of the panels on which each community is located.

Contact **FEMA Map Service Center (MSC)** via the FEMA Map Information eXchange (FMIX) 1-877-336-2627 for information on available products associated with this FIRM. Available products may include previously issued Letters of Map Change, a Flood Insurance Study Report, and/or digital versions of this map. The MSC may also be reached by Fax at 1-800-358-9820 and its website at <http://www.msc.fema.gov/>.

If you have **questions about this map** or **questions concerning the National Flood Insurance Program** in general, please call **1-877-FEMA MAP (1-877-336-2627)** or visit the FEMA website at <http://www.fema.gov/business/nfp>.

El Paso County Vertical Datum Offset Table	
Flooding Source	Vertical Datum Offset (ft)
REFER TO SECTION 3.3 OF THE EL PASO COUNTY FLOOD INSURANCE STUDY FOR STREAM BY STREAM VERTICAL DATUM CONVERSION INFORMATION	

Panel Location Map

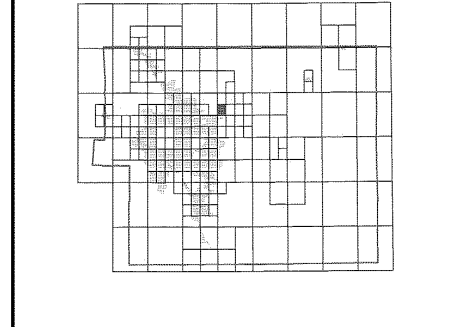

This Digital Flood Insurance Rate Map (DFIRM) was produced through a Cooperating Technical Partner (CTP) agreement between the State of Colorado Water Conservation Board (CWCB) and the Federal Emergency Management Agency (FEMA).

Additional Flood Hazard information and resources are available from local communities and the Colorado Water Conservation Board.

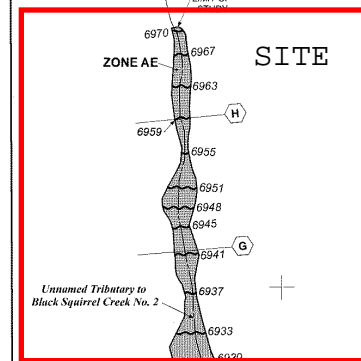
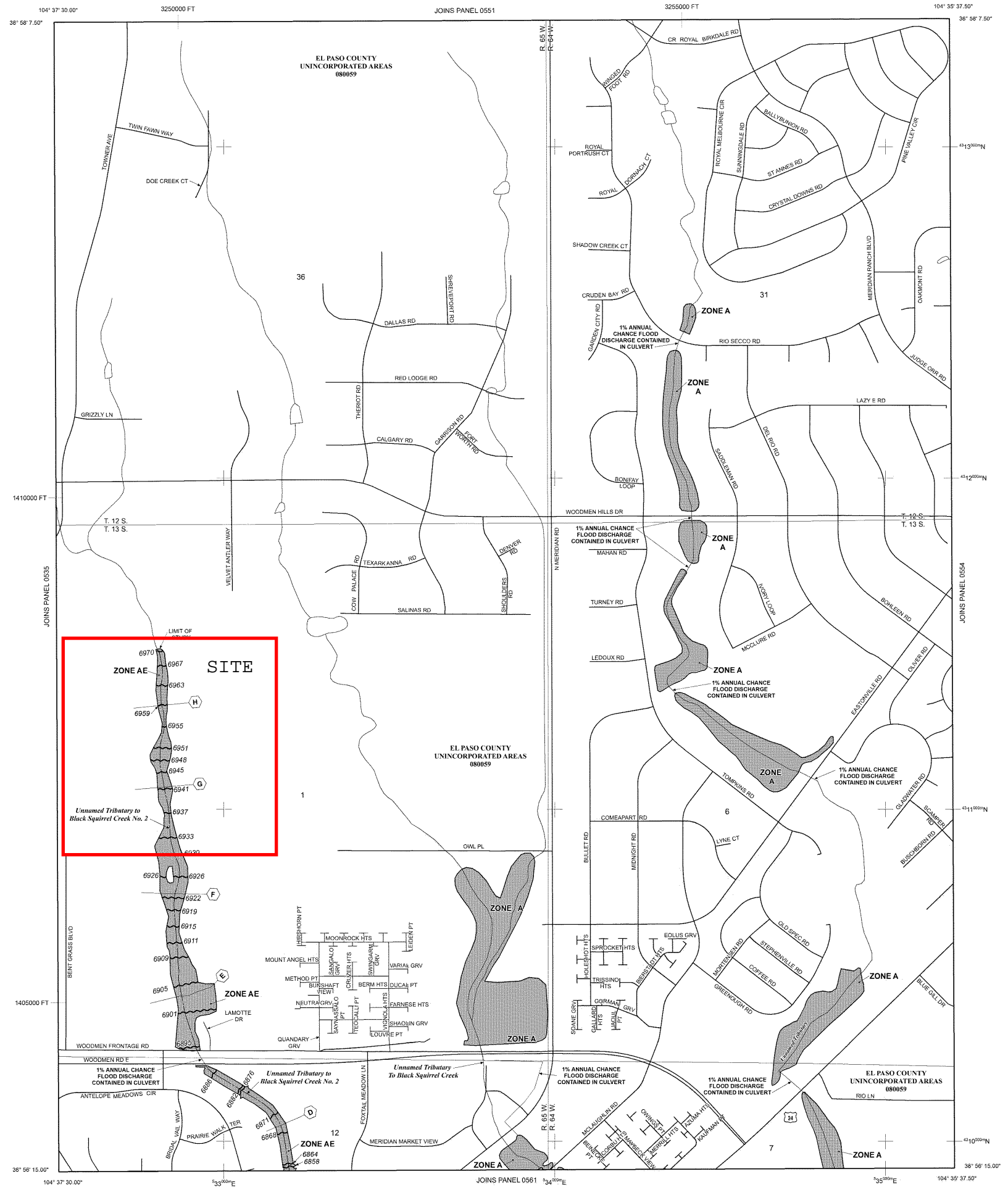

LEGEND

- SPECIAL FLOOD HAZARD AREAS (SFHAS) SUBJECT TO INUNDATION BY THE 1% ANNUAL CHANCE FLOOD**
 - ZONE A** No Base Flood Elevations determined.
 - ZONE AE** Base Flood Elevations determined.
 - ZONE AH** Flood depths of 1 to 3 feet (usually areas of ponding); Base Flood Elevations determined.
 - ZONE AO** Flood depths of 1 to 3 feet (usually sheet flow on sloping terrain); average depths determined. For areas of alluvial fan flooding, velocities also determined.
 - ZONE AR** Special Flood Hazard Area Formerly protected from the 1% annual chance flood by a flood control system that was subsequently decertified. Zone AR indicates that the former flood control system is being restored to provide protection from the 1% annual chance or greater flood.
 - ZONE A99** Area to be protected from 1% annual chance flood by a Federal flood protection system under construction; no Base Flood Elevations determined.
 - ZONE V** Coastal flood zone with velocity hazard (wave action); no Base Flood Elevations determined.
 - ZONE VE** Coastal flood zone with velocity hazard (wave action); Base Flood Elevations determined.
- FLOODWAY AREAS IN ZONE AE**
 - The floodway is the channel of a stream plus any adjacent floodplain areas that must be kept free of encroachment so that the 1% annual chance flood can be carried without substantial increases in flood heights.
- OTHER FLOOD AREAS**
 - ZONE X** Areas of 0.2% annual chance flood; areas of 1% annual chance flood with average depths of less than 1 foot or with drainage areas less than 1 square mile; and areas protected by levees from 1% annual chance flood.
- OTHER AREAS**
 - ZONE X** Areas determined to be outside the 0.2% annual chance floodplain.
 - ZONE D** Areas in which flood hazards are undetermined, but possible.
- COASTAL BARRIER RESOURCES SYSTEM (CBRS) AREAS**
- OTHERWISE PROTECTED AREAS (OPAs)**
 - CBRS areas and OPAs are normally located within or adjacent to Special Flood Hazard Areas.
- Boundaries**
 - Floodplain boundary
 - Floodway boundary
 - Zone D Boundary
 - CBRS and OPA boundary
- Boundary dividing Special Flood Hazard Areas of different Base Flood Elevations, flood depths or flood velocities**
- Base Flood Elevation line and value; elevation in feet* (EL 987)**
- Base Flood Elevation value where uniform within zone; elevation in feet***
- * Referenced to the North American Vertical Datum of 1988 (NAVD 88)**
- Cross section line**
- Transect line**
- Geographic coordinates referenced to the North American Datum of 1983 (NAD 83)**
- 1000-meter Universal Transverse Mercator grid ticks, zone 13**
- 5000-foot grid ticks: Colorado State Plane coordinate system, central zone (FIPSZONE 0502), Lambert Conformal Conic Projection**
- Bench mark (see explanation in Notes to Users section of this FIRM panel)**
- River Mile**
- MAP REPOSITORIES**
 - Refer to Map Repositories list on Map Index
- EFFECTIVE DATE OF COUNTYWIDE FLOOD INSURANCE RATE MAP**
MARCH 17, 1997
- EFFECTIVE DATE(S) OF REVISION(S) TO THIS PANEL**
DECEMBER 7, 2018 - to update corporate limits, to change Base Flood Elevations and Special Flood Hazard Areas, to update map format, to add roads and road names, and to incorporate previously issued Letters of Map Revision.
- For community map revision history prior to countywide mapping, refer to the Community Map History Table located in the Flood Insurance Study report for this jurisdiction.
- To determine if flood insurance is available in this community, contact your insurance agent or call the National Flood Insurance Program at 1-800-638-6620.

MAP SCALE 1" = 500'

NFP

PANEL 0553G

FIRM

FLOOD INSURANCE RATE MAP

EL PASO COUNTY, COLORADO AND INCORPORATED AREAS

PANEL 553 OF 1300

(SEE MAP INDEX FOR FIRM PANEL LAYOUT)

CONTAINS:

COMMUNITY	NUMBER	PANEL	SUFFIX
EL PASO COUNTY	08059	553	G

Noted to User: The Map Number shown below should be used when placing map orders. The Community Number shown above should be used on insurance applications for the subject community.

MAP NUMBER 08041C0553G

MAP REVISED DECEMBER 7, 2018

Federal Emergency Management Agency

FALCON DRAINAGE BASIN PLANNING STUDY
SELECTED PLAN REPORT
FINAL - SEPTEMBER 2015

Prepared for:



El Paso County Public Services Department
3275 Akers Drive
Colorado Springs, CO 80922

Prepared By:



Matrix Design Group
2435 Research Parkway, Suite 300
Colorado Springs, CO 80920

Matrix Project No. 10.122.003

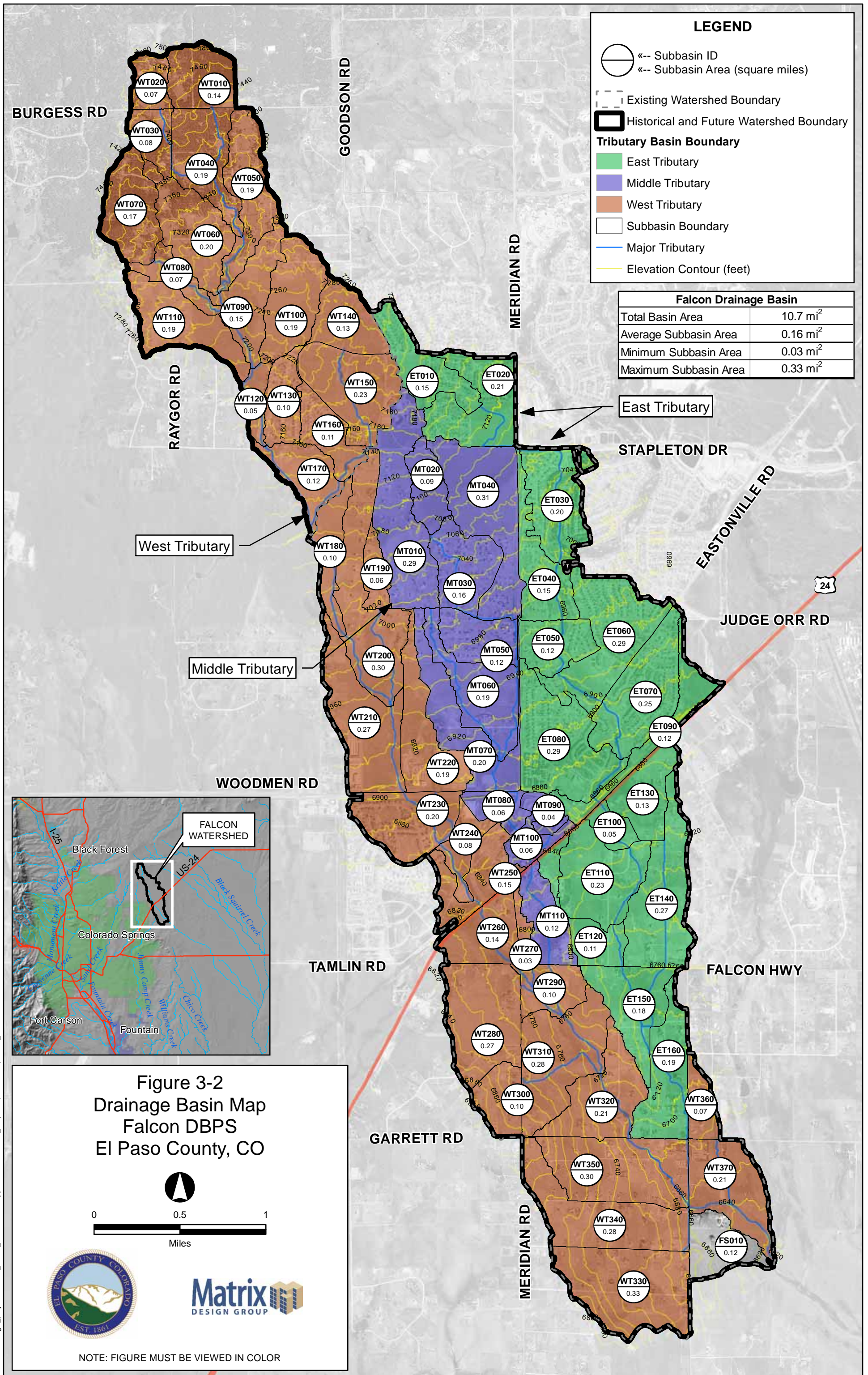
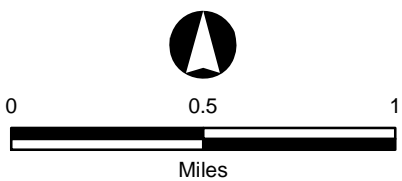

Figure 3-2
 Drainage Basin Map
 Falcon DBPS
 El Paso County, CO



NOTE: FIGURE MUST BE VIEWED IN COLOR

FILE: G:\gis_projects\Falcon_Creek_DBPS\active\apps\20110613\basin_map.mxd, 8/29/2011, wilson_wheeler

Replace Figure 3-13 (with prev. redlines) and add 3-12 if desired

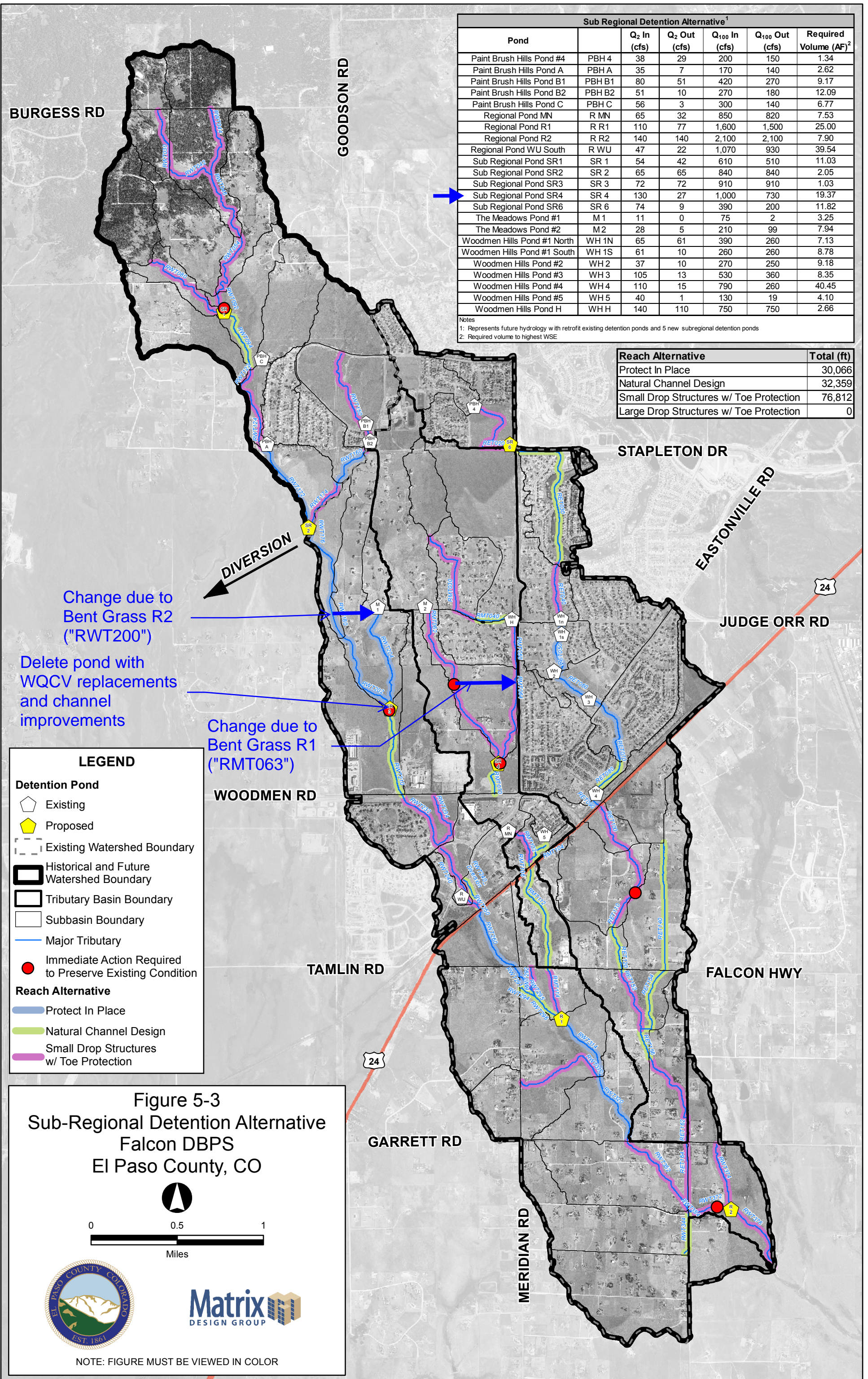

Sub Regional Detention Alternative ¹						
Pond		Q ₂ In (cfs)	Q ₂ Out (cfs)	Q ₁₀₀ In (cfs)	Q ₁₀₀ Out (cfs)	Required Volume (AF) ²
Paint Brush Hills Pond #4	PBH 4	38	29	200	150	1.34
Paint Brush Hills Pond A	PBH A	35	7	170	140	2.62
Paint Brush Hills Pond B1	PBH B1	80	51	420	270	9.17
Paint Brush Hills Pond B2	PBH B2	51	10	270	180	12.09
Paint Brush Hills Pond C	PBH C	56	3	300	140	6.77
Regional Pond MN	R MN	65	32	850	820	7.53
Regional Pond R1	R R1	110	77	1,600	1,500	25.00
Regional Pond R2	R R2	140	140	2,100	2,100	7.90
Regional Pond WU South	R WU	47	22	1,070	930	39.54
Sub Regional Pond SR1	SR 1	54	42	610	510	11.03
Sub Regional Pond SR2	SR 2	65	65	840	840	2.05
Sub Regional Pond SR3	SR 3	72	72	910	910	1.03
Sub Regional Pond SR4	SR 4	130	27	1,000	730	19.37
Sub Regional Pond SR6	SR 6	74	9	390	200	11.82
The Meadows Pond #1	M 1	11	0	75	2	3.25
The Meadows Pond #2	M 2	28	5	210	99	7.94
Woodmen Hills Pond #1 North	WH 1N	65	61	390	260	7.13
Woodmen Hills Pond #1 South	WH 1S	61	10	260	260	8.78
Woodmen Hills Pond #2	WH 2	37	10	270	250	9.18
Woodmen Hills Pond #3	WH 3	105	13	530	360	8.35
Woodmen Hills Pond #4	WH 4	110	15	790	260	40.45
Woodmen Hills Pond #5	WH 5	40	1	130	19	4.10
Woodmen Hills Pond H	WH H	140	110	750	750	2.66

Notes
 1: Represents future hydrology with retrofit existing detention ponds and 5 new subregional detention ponds
 2: Required volume to highest WSE

Reach Alternative	Total (ft)
Protect In Place	30,066
Natural Channel Design	32,359
Small Drop Structures w/ Toe Protection	76,812
Large Drop Structures w/ Toe Protection	0

LEGEND

Detention Pond

- Existing (White pentagon)
- Proposed (Yellow pentagon)

Boundary

- Existing Watershed Boundary (Dashed line)
- Historical and Future Watershed Boundary (Thick black line)
- Tributary Basin Boundary (Thin black line)
- Subbasin Boundary (Thin grey line)

Major Tributary

- Blue line

Immediate Action Required to Preserve Existing Condition

- Red circle

Reach Alternative

- Protect In Place (Blue line)
- Natural Channel Design (Green line)
- Small Drop Structures w/ Toe Protection (Purple line)
- Large Drop Structures w/ Toe Protection (Red line)

Figure 5-3
Sub-Regional Detention Alternative
Falcon DBPS
El Paso County, CO

0 0.5 1
 Miles

NOTE: FIGURE MUST BE VIEWED IN COLOR

Falcon DBPS
Peak Flow Results

Hydrologic Element	Area (sq mi)	Future Peak Flows (cfs)					
		2-year	5-year	10-year	25-year	50-year	100-year
ET010	0.15	38	67	90	140	170	200
ET020	0.21	73	130	170	260	310	360
ET030	0.20	45	81	110	170	210	240
ET040	0.15	28	53	72	120	140	170
ET050	0.12	37	67	89	140	170	200
ET060	0.29	110	190	250	380	450	530
ET070	0.25	94	160	220	330	400	460
ET080	0.29	110	190	250	380	450	520
ET090	0.12	26	46	61	95	110	130
ET100	0.05	11	22	31	50	61	72
ET110	0.23	24	53	76	130	160	200
ET120	0.11	11	24	34	59	74	89
ET130	0.13	11	23	33	57	71	85
ET140	0.27	16	33	48	82	100	120
ET150	0.18	17	37	53	91	110	140
ET160	0.19	19	39	55	92	110	140
FS010	0.12	6	17	26	48	61	75
JET010	0.15	29	49	64	110	130	150
JET020	0.36	74	130	170	270	330	390
JET030	0.56	97	180	250	410	500	580
JET040	0.71	27	85	140	380	500	570
JET050	0.83	11	38	88	210	380	530
JET060	1.11	13	32	68	210	300	430
JET070	1.36	94	170	220	350	420	480
JET080	1.66	15	38	61	200	270	350
JET090	1.78	26	47	81	200	290	390
JET100	1.83	27	49	83	200	290	390
JET110	2.05	40	85	120	210	320	440
JET120	2.16	49	110	160	270	340	450
JET130	0.13	11	23	33	57	71	85
JET140	0.40	26	55	80	140	170	200
JET152	2.57	51	120	180	350	500	650
JET154	2.74	62	140	200	370	530	680
JET160	2.93	66	150	230	410	550	710
JFS010_OUTLET	0.12	6	17	26	48	61	75
JMT010	0.29	1	11	25	62	120	160
JMT020	0.09	26	47	64	100	120	140
JMT030	0.25	50	94	130	200	250	290
JMT040	0.56	110	240	330	520	620	750
JMT050	0.67	120	280	380	590	710	850
JMT060	1.16	130	310	430	700	850	1,000
JMT070	1.36	150	350	490	800	980	1,200
JMT080	1.42	86	330	490	810	980	1,200
JMT090	0.04	9	15	18	25	29	32
JMT102	1.46	91	330	500	820	1,000	1,200
JMT104	0.04	9	15	18	25	29	32
JMT106	1.52	92	320	490	820	1,000	1,200
JMT110	1.64	94	320	500	830	1,000	1,200
JWT010	0.14	9	21	32	58	73	89
JWT020	0.07	4	10	15	27	34	42
JWT030	0.14	9	20	30	55	69	85
JWT042	0.28	15	37	57	110	140	170
JWT044	0.46	24	59	89	170	210	260
JWT050	0.85	43	110	170	310	390	480
JWT070	0.17	14	33	49	87	110	130
JWT080	1.09	54	140	210	400	500	610
JWT090	1.43	68	160	250	480	610	730
JWT110	1.63	77	170	280	530	690	840
JWT120	1.77	85	190	300	570	730	920
JWT140	0.13	32	59	80	130	150	180
JWT150	0.36	15	19	39	97	140	170
JWT160	0.47	35	64	85	130	160	190
JWT172	2.24	99	210	320	600	760	960
JWT174	2.36	100	210	330	610	780	990

Hydrologic Element	Area (sq mi)	Future Peak Flows (cfs) - Regional Detention					
		2-year	5-year	10-year	25-year	50-year	100-year
ET010	0.15	38	0	0	0	0	200
ET020	0.21	73	0	0	0	0	360
ET030	0.20	45	0	0	0	0	240
ET040	0.15	28	0	0	0	0	170
ET050	0.12	37	0	0	0	0	200
ET060	0.29	110	0	0	0	0	530
ET070	0.25	94	0	0	0	0	460
ET080	0.29	110	0	0	0	0	520
ET090	0.12	26	0	0	0	0	130
ET100	0.05	11	0	0	0	0	72
ET110	0.23	24	0	0	0	0	200
ET120	0.11	11	0	0	0	0	89
ET130	0.13	11	0	0	0	0	85
ET140	0.27	16	0	0	0	0	120
ET150	0.18	17	0	0	0	0	140
ET160	0.19	19	0	0	0	0	140
FS010	0.12	6	0	0	0	0	75
JET010	0.15	29	0	0	0	0	150
JET020	0.36	74	0	0	0	0	390
JET030	0.56	97	0	0	0	0	580
JET040	0.71	14	0	0	0	0	620
JET050	0.83	10	0	0	0	0	540
JET060	1.11	14	0	0	0	0	510
JET070	1.36	94	0	0	0	0	660
JET080	1.66	14	0	0	0	0	400
JET090	1.78	30	0	0	0	0	410
JET100	1.83	32	0	0	0	0	410
JET110	2.05	42	0	0	0	0	440
JET120	2.16	50	0	0	0	0	470
JET130	0.13	11	0	0	0	0	85
JET140	0.40	26	0	0	0	0	200
JET152	2.57	55	0	0	0	0	660
JET154	2.74	62	0	0	0	0	690
JET160	2.93	67	0	0	0	0	720
JFS010_OUTLET	0.12	6	0	0	0	0	75
JMT010	0.29	5	0	0	0	0	99
JMT020	0.09	26	0	0	0	0	140
JMT030	0.25	50	0	0	0	0	290
JMT040	0.56	110	0	0	0	0	750
JMT050	0.67	120	0	0	0	0	850
JMT060	1.16	130	0	0	0	0	1,000
JMT070	1.36	150	0	0	0	0	1,200
JMT080	1.42	140	0	0	0	0	1,100
JMT090	0.04	1	0	0	0	0	19
JMT102	1.46	140	0	0	0	0	1,100
JMT104	0.04	1	0	0	0	0	19
JMT106	1.52	140	0	0	0	0	1,100
JMT110	1.64	140	0	0	0	0	1,100
JWT010	0.14	9	0	0	0	0	89
JWT020	0.07	4	0	0	0	0	42
JWT030	0.14	9	0	0	0	0	85
JWT042	0.28	15	0	0	0	0	170
JWT044	0.46	24	0	0	0	0	260
JWT050	0.85	43	0	0	0	0	480
JWT070	0.17	14	0	0	0	0	130
JWT080	1.09	54	0	0	0	0	610
JWT090	1.43	60	0	0	0	0	770
JWT110	1.63	69	0	0	0	0	880
JWT120	1.77	73	0	0	0	0	950
JWT140	0.13	32	0	0	0	0	180
JWT150	0.36	10	0	0	0	0	180
JWT160	0.47	35	0	0	0	0	190
JWT172	2.24	79	0	0	0	0	980
JWT174	2.36	81	0	0	0	0	1,000

Hydrologic Element	Area (sq mi)	Future Peak Flows (cfs) - Sub Regional Detention					
		2-year	5-year	10-year	25-year	50-year	100-year
ET010	0.15	38	0	0	0	0	200
ET020	0.21	73	0	0	0	0	360
ET030	0.20	45	0	0	0	0	240
ET040	0.15	28	0	0	0	0	170
ET050	0.12	37	0	0	0	0	200
ET060	0.29	110	0	0	0	0	530
ET070	0.25	94	0	0	0	0	460
ET080	0.29	110	0	0	0	0	520
ET090	0.12	26	0	0	0	0	130
ET100	0.05	11	0	0	0	0	72
ET110	0.23	24	0	0	0	0	200
ET120	0.11	11	0	0	0	0	89
ET130	0.13	11	0	0	0	0	85
ET140	0.27	16	0	0	0	0	120
ET150	0.18	17	0	0	0	0	140
ET160	0.19	19	0	0	0	0	140
FS010	0.12	6	0	0	0	0	75
JET010	0.15	29	0	0	0	0	150
JET020	0.36	9	0	0	0	0	200
JET030	0.56	45	0	0	0	0	270
JET040	0.71	10	0	0	0	0	260
JET050	0.83	10	0	0	0	0	250
JET060	1.11	13	0	0	0	0	360
JET070	1.36	94	0	0	0	0	640
JET080	1.66	15	0	0	0	0	260
JET090	1.78	30	0	0	0	0	300
JET100	1.83	32	0	0	0	0	300
JET110	2.05	42	0	0	0	0	360
JET120	2.16	50	0	0	0	0	400
JET130	0.13	11	0	0	0	0	85
JET140	0.40	26	0	0	0	0	200
JET152	2.57	55	0	0	0	0	560
JET154	2.74	62	0	0	0	0	590
JET160	2.93	67	0	0	0	0	640
JFS010_OUTLET	0.12	6	0	0	0	0	75
JMT010	0.29	5	0	0	0	0	99
JMT020	0.09	26	0	0	0	0	140
JMT030	0.25	50	0	0	0	0	290
JMT040	0.56	110	0	0	0	0	750
JMT050	0.67	120	0	0	0	0	850
JMT060	1.16	27	0	0	0	0	730
JMT070	1.36	31	0	0	0	0	840
JMT080	1.42	32	0	0	0	0	820
JMT090	0.04	1	0	0	0	0	19
JMT102	1.46	33	0	0	0	0	840
JMT104	0.04	1	0	0	0	0	19
JMT106	1.52	33	0	0	0	0	840
JMT110	1.64	34	0	0	0	0	860
JWT010	0.14	9	0	0	0	0	89
JWT020	0.07	4	0	0	0	0	42
JWT030	0.14	9	0	0	0	0	85
JWT042	0.28	15	0	0	0	0	170
JWT044	0.46	24	0	0	0	0	260
JWT050	0.85	43	0	0	0	0	480
JWT070	0.17	14	0	0	0	0	130
JWT080	1.09	42	0	0	0	0	510
JWT090	1.43	47	0				

**Falcon DBPS
Peak Flow Results**

Hydrologic Element	Area (sq mi)	Future Peak Flows (cfs)					
		2-year	5-year	10-year	25-year	50-year	100-year
JWT180	2.46	100	220	330	620	800	1,000
JWT190	0.06	4	7	12	26	35	43
JWT200	2.82	110	230	360	690	890	1,200
JWT210	3.09	120	250	400	760	990	1,300
JWT220	0.19	47	85	110	180	210	250
JWT232	3.28	120	260	410	790	1,000	1,400
JWT234	3.47	130	270	420	810	1,000	1,400
JWT240	3.55	83	200	380	770	940	1,100
JWT250	3.70	85	210	390	780	950	1,100
JWT260	3.84	86	210	390	790	970	1,100
JWT270	0.03	11	20	27	41	49	57
JWT280	0.27	33	70	100	170	210	250
JWT292	3.87	86	210	390	790	970	1,100
JWT294	4.13	96	210	400	800	990	1,100
JWT296	5.88	160	410	620	1,100	1,400	1,700
JWT300	0.10	12	26	36	62	76	92
JWT310	6.25	160	420	640	1,100	1,400	1,700
JWT320	6.46	160	410	630	1,100	1,400	1,700
JWT330	0.33	32	68	98	170	210	250
JWT352	9.69	210	530	820	1,400	2,000	2,400
JWT354	10.30	230	560	870	1,500	2,000	2,500
JWT360	0.07	7	15	21	37	46	55
JWT372	10.36	230	560	860	1,500	2,000	2,500
JWT374_OUTLET	10.58	230	560	860	1,500	2,000	2,500
MT010	0.29	28	58	82	140	170	210
MT020	0.09	26	47	64	100	120	140
MT030	0.16	39	73	100	160	190	230
MT040	0.31	95	160	220	330	390	460
MT050	0.12	17	33	46	76	92	110
MT060	0.19	30	59	83	140	170	200
MT070	0.20	25	50	69	110	140	170
MT080	0.06	62	92	110	150	170	190
MT090	0.04	40	59	73	100	110	130
MT100	0.06	17	30	40	63	75	88
MT110	0.12	19	36	50	81	99	120
Paint Brush Hills Pond #4	0.15	29	49	64	110	130	150
Paint Brush Hills Pond A	0.10	10	18	24	64	97	130
Paint Brush Hills Pond B1	0.36	51	100	140	190	210	270
Paint Brush Hills Pond B2	0.36	15	19	39	97	140	170
Paint Brush Hills Pond C	0.19	11	14	23	56	74	160
Regional Pond MN	1.42	86	330	490	810	980	1,200
Regional Pond WU Diversion	3.55	83	230	380	770	1,000	1,300
Regional Pond WU North	3.55	110	270	420	810	1,100	1,400
Regional Pond WU South	3.55	55	170	340	730	900	1,000
RET020	0.15	29	49	64	100	130	150
RET030	0.36	71	130	170	270	320	380
RET040	0.56	95	180	250	400	490	580
RET050	0.71	27	85	140	370	490	570
RET060	0.83	11	38	88	210	370	530
RET070	1.11	13	32	68	210	300	430
RET080	1.36	65	120	170	270	340	420
RET090	1.66	15	38	61	200	270	350
RET100	1.78	26	47	81	200	290	390
RET110	1.83	27	49	83	200	290	390
RET120	2.05	39	84	120	210	320	430
RET140	0.13	11	23	33	57	70	85
RET152	2.16	49	110	150	270	340	450
RET154	0.40	26	55	80	140	170	200
RET156	2.57	50	120	180	350	500	650
RET162	2.74	59	130	200	360	530	680
RET164	2.93	66	150	230	410	550	710
RMT030	0.09	25	47	63	100	120	140
RMT040	0.25	49	93	130	200	250	290
RMT050	0.56	110	240	330	520	620	750

Hydrologic Element	Area (sq mi)	Future Peak Flows (cfs) - Regional Detention					
		2-year	5-year	10-year	25-year	50-year	100-year
JWT180	2.46	83	0	0	0	0	1,000
JWT190	0.06	0	0	0	0	0	2
JWT200	2.82	89	0	0	0	0	1,200
JWT210	3.09	97	0	0	0	0	1,300
JWT220	0.19	47	0	0	0	0	250
JWT232	3.28	100	0	0	0	0	1,400
JWT234	3.47	100	0	0	0	0	1,400
JWT240	3.55	50	0	0	0	0	1,200
JWT250	3.70	65	0	0	0	0	1,200
JWT260	3.84	70	0	0	0	0	1,200
JWT270	0.03	11	0	0	0	0	57
JWT280	0.27	33	0	0	0	0	250
JWT292	3.87	73	0	0	0	0	1,200
JWT294	4.13	95	0	0	0	0	1,300
JWT296	5.88	79	0	0	0	0	1,700
JWT300	0.10	12	0	0	0	0	92
JWT310	6.25	81	0	0	0	0	1,700
JWT320	6.46	82	0	0	0	0	1,700
JWT330	0.33	32	0	0	0	0	250
JWT352	9.69	110	0	0	0	0	2,300
JWT354	10.30	140	0	0	0	0	2,400
JWT360	0.07	7	0	0	0	0	55
JWT372	10.36	140	0	0	0	0	2,400
JWT374_OUTLET	10.58	140	0	0	0	0	2,400
MT010	0.29	28	0	0	0	0	210
MT020	0.09	26	0	0	0	0	140
MT030	0.16	39	0	0	0	0	230
MT040	0.31	95	0	0	0	0	460
MT050	0.12	17	0	0	0	0	110
MT060	0.19	30	0	0	0	0	200
MT070	0.20	25	0	0	0	0	170
MT080	0.06	62	0	0	0	0	190
MT090	0.04	40	0	0	0	0	130
MT100	0.06	17	0	0	0	0	88
MT110	0.12	19	0	0	0	0	120
Paint Brush Hills Pond #4	0.15	29	0	0	0	0	150
Paint Brush Hills Pond A	0.10	7	0	0	0	0	140
Paint Brush Hills Pond B1	0.36	51	0	0	0	0	270
Paint Brush Hills Pond B2	0.36	10	0	0	0	0	180
Paint Brush Hills Pond C	0.19	3	0	0	0	0	140
Regional Pond MN	1.42	140	0	0	0	0	1,100
Regional Pond R1	5.88	79	0	0	0	0	1,700
Regional Pond R2	10.36	140	0	0	0	0	2,400
Regional Pond WU Diversion	3.55	68	0	0	0	0	1,300
Regional Pond WU North	3.55	97	0	0	0	0	1,400
Regional Pond WU South	3.55	27	0	0	0	0	1,200
RET020	0.15	29	0	0	0	0	150
RET030	0.36	71	0	0	0	0	380
RET040	0.56	95	0	0	0	0	580
RET050	0.71	14	0	0	0	0	620
RET060	0.83	10	0	0	0	0	540
RET070	1.11	14	0	0	0	0	510
RET080	1.36	65	0	0	0	0	560
RET090	1.66	14	0	0	0	0	400
RET100	1.78	30	0	0	0	0	410
RET110	1.83	32	0	0	0	0	410
RET120	2.05	42	0	0	0	0	440
RET140	0.13	11	0	0	0	0	85
RET152	2.16	49	0	0	0	0	470
RET154	0.40	26	0	0	0	0	200
RET156	2.57	55	0	0	0	0	660
RET162	2.74	59	0	0	0	0	690
RET164	2.93	66	0	0	0	0	720
RMT030	0.09	25	0	0	0	0	140

Hydrologic Element	Area (sq mi)	Future Peak Flows (cfs) - Sub Regional Detention					
		2-year	5-year	10-year	25-year	50-year	100-year
JWT180	2.46	66	0	0	0	0	850
JWT190	0.06	0	0	0	0	0	2
JWT200	2.82	72	0	0	0	0	910
JWT210	3.09	81	0	0	0	0	1,000
JWT220	0.19	47	0	0	0	0	250
JWT232	3.28	85	0	0	0	0	1,100
JWT234	3.47	89	0	0	0	0	1,100
JWT240	3.55	42	0	0	0	0	970
JWT250	3.70	64	0	0	0	0	980
JWT260	3.84	70	0	0	0	0	1,000
JWT270	0.03	11	0	0	0	0	57
JWT280	0.27	33	0	0	0	0	250
JWT292	3.87	73	0	0	0	0	1,000
JWT294	4.13	95	0	0	0	0	1,000
JWT296	5.88	77	0	0	0	0	1,500
JWT300	0.10	12	0	0	0	0	92
JWT310	6.25	79	0	0	0	0	1,500
JWT320	6.46	80	0	0	0	0	1,500
JWT330	0.33	32	0	0	0	0	250
JWT352	9.69	130	0	0	0	0	2,100
JWT354	10.30	140	0	0	0	0	2,100
JWT360	0.07	7	0	0	0	0	55
JWT372	10.36	140	0	0	0	0	2,100
JWT374_OUTLET	10.58	140	0	0	0	0	2,100
MT010	0.29	28	0	0	0	0	210
MT020	0.09	26	0	0	0	0	140
MT030	0.16	39	0	0	0	0	230
MT040	0.31	95	0	0	0	0	460
MT050	0.12	17	0	0	0	0	110
MT060	0.19	30	0	0	0	0	200
MT070	0.20	25	0	0	0	0	170
MT080	0.06	62	0	0	0	0	190
MT090	0.04	40	0	0	0	0	130
MT100	0.06	17	0	0	0	0	88
MT110	0.12	19	0	0	0	0	120
Paint Brush Hills Pond #4	0.15	29	0	0	0	0	150
Paint Brush Hills Pond A	0.10	7	0	0	0	0	140
Paint Brush Hills Pond B1	0.36	51	0	0	0	0	270
Paint Brush Hills Pond B2	0.36	10	0	0	0	0	180
Paint Brush Hills Pond C	0.19	3	0	0	0	0	140
Regional Pond MN	1.42	32	0	0	0	0	820
Regional Pond R1	5.88	77	0	0	0	0	1,500
Regional Pond R2	10.36	140	0	0	0	0	2,100
Regional Pond WU Diversion	3.55	47	0	0	0	0	1,100
Regional Pond WU North	3.55	71	0	0	0	0	1,100
Regional Pond WU South	3.55	22	0	0	0	0	930
RET020	0.15	29	0	0	0	0	150
RET030	0.36	9	0	0	0	0	190
RET040	0.56	45	0	0	0	0	270
RET050	0.71	10	0	0	0	0	260
RET060	0.83	10	0	0	0	0	250
RET070	1.11	13	0	0	0	0	360
RET080	1.36	65	0	0	0		

Falcon DBPS
Peak Flow Results

Hydrologic Element	Area (sq mi)	Future Peak Flows (cfs)					
		2-year	5-year	10-year	25-year	50-year	100-year
RMT062	0.29	1	11	25	62	110	160
RMT064	0.67	120	270	370	590	710	850
RMT070	1.16	130	310	430	690	840	1,000
RMT080	1.36	150	350	490	800	980	1,200
RMT090	0.04	9	15	18	25	29	32
RMT102	1.42	86	320	490	800	980	1,200
RMT104	0.04	9	15	18	25	29	32
RMT106	1.46	91	320	490	810	990	1,200
RMT112	1.52	92	310	490	810	990	1,200
RMT114	1.64	94	320	500	830	1,000	1,200
RWT030	0.07	4	10	15	27	34	42
RWT042	0.14	9	20	30	54	69	85
RWT044	0.14	9	21	32	57	73	89
RWT046	0.28	15	37	57	110	140	170
RWT054	0.46	24	59	89	170	210	260
RWT080	0.17	14	33	48	87	110	130
RWT092	0.85	43	110	170	310	390	480
RWT094	1.09	54	140	210	400	500	610
RWT122	1.43	68	160	250	480	610	730
RWT124	1.63	77	170	280	530	690	840
RWT150	0.13	32	59	79	130	150	180
RWT160	0.36	15	19	39	97	140	170
RWT172	1.77	85	190	300	570	730	920
RWT174	0.47	35	63	84	130	160	180
RWT176	2.24	98	210	320	600	760	960
RWT180	2.36	100	210	330	610	780	990
RWT202	2.46	100	220	330	620	800	1,000
RWT204	0.06	4	7	12	26	34	43
RWT210	2.82	110	230	360	690	890	1,200
RWT232	3.09	120	250	400	760	990	1,300
RWT234	0.19	47	84	110	180	210	250
RWT236	3.28	120	260	410	790	1,000	1,400
RWT240	3.47	130	270	420	810	1,000	1,400
RWT240_Diversion Reach	0.00	30	37	38	38	39	39
RWT250	3.55	83	200	380	770	940	1,100
RWT260	3.70	85	210	380	780	950	1,100
RWT291	3.84	86	210	390	790	970	1,100
RWT292	0.03	11	20	26	41	49	57
RWT294	0.27	33	70	100	170	210	250
RWT295	3.87	86	210	390	790	970	1,100
RWT296	4.13	94	210	400	800	990	1,100
RWT312	0.10	12	25	36	61	76	91
RWT314	5.88	160	400	620	1,100	1,400	1,700
RWT320	6.25	160	400	620	1,100	1,400	1,700
RWT344	0.33	32	68	97	170	210	250
RWT352	6.46	160	400	620	1,100	1,400	1,700
RWT354	9.69	210	530	820	1,400	2,000	2,400
RWT372	10.30	230	560	860	1,500	2,000	2,500
RWT374	0.07	7	15	21	36	45	55
RWT376	10.36	230	550	850	1,500	2,000	2,500
The Meadows Pond #1	0.06	4	7	12	26	35	43
The Meadows Pond #2	0.29	1	11	25	62	120	160
Woodmen Hills Pond #1 North	0.71	88	180	260	420	500	570
Woodmen Hills Pond #1 South	0.71	27	85	140	380	500	570
Woodmen Hills Pond #2	0.83	11	38	88	210	380	530
Woodmen Hills Pond #3	1.11	13	32	68	210	300	430
Woodmen Hills Pond #4	1.66	15	38	61	200	270	350
Woodmen Hills Pond #5	0.04	9	15	18	25	29	32
Woodmen Hills Pond H	0.56	110	240	330	520	620	750
WT010	0.14	9	21	32	58	73	89
WT020	0.07	4	10	15	27	34	42
WT030	0.08	9	20	29	50	62	75
WT040	0.19	9	22	33	60	76	93
WT050	0.19	17	37	54	93	120	140

Hydrologic Element	Area (sq mi)	Future Peak Flows (cfs) - Regional Detention					
		2-year	5-year	10-year	25-year	50-year	100-year
RMT040	0.25	49	0	0	0	0	290
RMT050	0.56	110	0	0	0	0	750
RMT062	0.29	5	0	0	0	0	99
RMT064	0.67	120	0	0	0	0	850
RMT070	1.16	130	0	0	0	0	1,000
RMT080	1.36	150	0	0	0	0	1,200
RMT090	0.04	1	0	0	0	0	19
RMT102	1.42	140	0	0	0	0	1,100
RMT104	0.04	1	0	0	0	0	19
RMT106	1.46	140	0	0	0	0	1,100
RMT112	1.52	140	0	0	0	0	1,100
RMT114	1.64	140	0	0	0	0	1,100
RWT030	0.07	4	0	0	0	0	42
RWT042	0.14	9	0	0	0	0	85
RWT044	0.14	9	0	0	0	0	89
RWT046	0.28	15	0	0	0	0	170
RWT054	0.46	24	0	0	0	0	260
RWT080	0.17	14	0	0	0	0	130
RWT092	0.85	43	0	0	0	0	480
RWT094	1.09	54	0	0	0	0	610
RWT122	1.43	60	0	0	0	0	770
RWT124	1.63	68	0	0	0	0	880
RWT150	0.13	32	0	0	0	0	180
RWT160	0.36	10	0	0	0	0	180
RWT172	1.77	73	0	0	0	0	950
RWT174	0.47	35	0	0	0	0	190
RWT176	2.24	79	0	0	0	0	980
RWT180	2.36	81	0	0	0	0	1,000
RWT202	2.46	83	0	0	0	0	1,000
RWT204	0.06	0	0	0	0	0	2
RWT210	2.82	89	0	0	0	0	1,200
RWT232	3.09	97	0	0	0	0	1,300
RWT234	0.19	47	0	0	0	0	250
RWT236	3.28	100	0	0	0	0	1,400
RWT240	3.47	100	0	0	0	0	1,400
RWT240_Diversion Reach	0.00	28	0	0	0	0	39
RWT250	3.55	50	0	0	0	0	1,200
RWT260	3.70	62	0	0	0	0	1,200
RWT291	3.84	70	0	0	0	0	1,200
RWT292	0.03	11	0	0	0	0	57
RWT294	0.27	33	0	0	0	0	250
RWT295	3.87	73	0	0	0	0	1,200
RWT296	4.13	93	0	0	0	0	1,300
RWT312	0.10	12	0	0	0	0	91
RWT314	5.88	79	0	0	0	0	1,700
RWT320	6.25	81	0	0	0	0	1,700
RWT344	0.33	32	0	0	0	0	250
RWT352	6.46	82	0	0	0	0	1,700
RWT354	9.69	110	0	0	0	0	2,300
RWT372	10.30	140	0	0	0	0	2,400
RWT374	0.07	7	0	0	0	0	55
RWT376	10.36	140	0	0	0	0	2,400
The Meadows Pond #1	0.06	0	0	0	0	0	2
The Meadows Pond #2	0.29	5	0	0	0	0	99
Woodmen Hills Pond #1 North	0.71	65	0	0	0	0	670
Woodmen Hills Pond #1 South	0.71	14	0	0	0	0	620
Woodmen Hills Pond #2	0.83	10	0	0	0	0	540
Woodmen Hills Pond #3	1.11	14	0	0	0	0	510
Woodmen Hills Pond #4	1.66	14	0	0	0	0	400
Woodmen Hills Pond #5	0.04	1	0	0	0	0	19
Woodmen Hills Pond H	0.56	110	0	0	0	0	750
WT010	0.14	9	0	0	0	0	89
WT020	0.07	4	0	0	0	0	42
WT030	0.08	9	0	0	0	0	75

Hydrologic Element	Area (sq mi)	Future Peak Flows (cfs) - Sub Regional Detention					
		2-year	5-year	10-year	25-year	50-year	100-year
RMT040	0.25	49	0	0	0	0	290
RMT050	0.56	110	0	0	0	0	750
RMT062	0.29	5	0	0	0	0	99
RMT064	0.67	120	0	0	0	0	850
RMT070	1.16	27	0	0	0	0	730
RMT080	1.36	31	0	0	0	0	840
RMT090	0.04	1	0	0	0	0	19
RMT102	1.42	32	0	0	0	0	820
RMT104	0.04	1	0	0	0	0	19
RMT106	1.46	33	0	0	0	0	830
RMT112	1.52	33	0	0	0	0	840
RMT114	1.64	34	0	0	0	0	860
RWT030	0.07	4	0	0	0	0	42
RWT042	0.14	9	0	0	0	0	85
RWT044	0.14	9	0	0	0	0	89
RWT046	0.28	15	0	0	0	0	170
RWT054	0.46	24	0	0	0	0	260
RWT080	0.17	14	0	0	0	0	130
RWT092	0.85	43	0	0	0	0	480
RWT094	1.09	42	0	0	0	0	510
RWT122	1.43	47	0	0	0	0	620
RWT124	1.63	51	0	0	0	0	680
RWT150	0.13	32	0	0	0	0	180
RWT160	0.36	10	0	0	0	0	180
RWT172	1.77	54	0	0	0	0	710
RWT174	0.47	35	0	0	0	0	190
RWT176	2.24	63	0	0	0	0	830
RWT180	2.36	65	0	0	0	0	840
RWT202	2.46	66	0	0	0	0	850
RWT204	0.06	0	0	0	0	0	2
RWT210	2.82	71	0	0	0	0	910
RWT232	3.09	81	0	0	0	0	1,000
RWT234	0.19	47	0	0	0	0	250
RWT236	3.28	85	0	0	0	0	1,100
RWT240	3.47	86	0	0	0	0	1,100
RWT240_Diversion Reach	0.00	24	0	0	0	0	39
RWT250	3.55	42	0	0	0	0	970
RWT260	3.70	62	0	0	0	0	980
RWT291	3.84	70	0	0	0	0	1,000
RWT292	0.03	11	0	0	0	0	57
RWT294	0.27	33	0	0	0	0	250
RWT295	3.87	73	0	0	0	0	1,000
RWT296	4.13	93	0	0	0	0	1,000
RWT312	0.10	12	0	0	0	0	91
RWT314	5.88	77	0	0	0	0	1,500
RWT320	6.25	79	0	0	0	0	1,500
RWT344	0.33	32	0	0	0	0	250
RWT352	6.46	80	0	0	0	0	1,500
RWT354	9.69	130	0	0	0	0	2,100
RWT372	10.30	140	0	0	0	0	2,100
RWT374	0.07	7	0	0	0	0	55
RWT376	10.36	140	0	0	0	0	2,100
Sub Regional Pond SR1	1.09	42	0	0	0	0	510
Sub Regional Pond SR2	2.36	65	0	0	0	0	840
Sub Regional Pond							

**Falcon DBPS
Peak Flow Results**

Hydrologic Element	Area (sq mi)	Future Peak Flows (cfs)					
		2-year	5-year	10-year	25-year	50-year	100-year
WT060	0.20	14	30	44	77	96	120
WT070	0.17	14	33	49	87	110	130
WT080	0.07	9	19	27	45	56	67
WT090	0.15	22	46	65	110	140	160
WT100	0.19	56	100	140	210	260	300
WT110	0.19	22	47	67	110	140	170
WT120	0.05	8	16	22	37	46	55
WT130	0.10	35	61	81	120	150	170
WT140	0.13	32	59	80	130	150	180
WT150	0.23	49	86	110	180	210	250
WT160	0.11	35	64	85	130	160	180
WT170	0.12	21	43	60	99	120	140
WT180	0.10	8	17	25	43	54	66
WT190	0.06	11	23	31	51	63	75
WT200	0.30	25	52	74	130	160	190
WT210	0.27	32	60	81	130	160	190
WT220	0.19	47	85	110	180	210	250
WT230	0.20	71	120	160	250	300	350
WT240	0.08	36	61	79	120	140	160
WT250	0.15	63	110	140	210	250	290
WT260	0.14	10	21	30	52	64	78
WT270	0.03	11	20	27	41	49	57
WT280	0.27	33	70	100	170	210	250
WT290	0.10	15	31	44	75	92	110
WT300	0.10	12	26	36	62	76	92
WT310	0.28	31	67	96	170	210	250
WT320	0.21	27	56	80	140	170	200
WT330	0.33	32	68	98	170	210	250
WT340	0.28	19	40	57	98	120	150
WT350	0.30	38	79	110	190	230	280
WT360	0.07	7	15	21	37	46	55
WT370	0.21	7	23	38	76	99	120

Hydrologic Element	Area (sq mi)	Future Peak Flows (cfs) - Regional Detention					
		2-year	5-year	10-year	25-year	50-year	100-year
WT040	0.19	9	0	0	0	0	93
WT050	0.19	17	0	0	0	0	140
WT060	0.20	14	0	0	0	0	120
WT070	0.17	14	0	0	0	0	130
WT080	0.07	9	0	0	0	0	67
WT090	0.15	22	0	0	0	0	160
WT100	0.19	56	0	0	0	0	300
WT110	0.19	22	0	0	0	0	170
WT120	0.05	8	0	0	0	0	55
WT130	0.10	35	0	0	0	0	170
WT140	0.13	32	0	0	0	0	180
WT150	0.23	49	0	0	0	0	250
WT160	0.11	35	0	0	0	0	180
WT170	0.12	21	0	0	0	0	140
WT180	0.10	8	0	0	0	0	66
WT190	0.06	11	0	0	0	0	75
WT200	0.30	25	0	0	0	0	190
WT210	0.27	32	0	0	0	0	190
WT220	0.19	47	0	0	0	0	250
WT230	0.20	71	0	0	0	0	350
WT240	0.08	36	0	0	0	0	160
WT250	0.15	63	0	0	0	0	290
WT260	0.14	10	0	0	0	0	78
WT270	0.03	11	0	0	0	0	57
WT280	0.27	33	0	0	0	0	250
WT290	0.10	15	0	0	0	0	110
WT300	0.10	12	0	0	0	0	92
WT310	0.28	31	0	0	0	0	250
WT320	0.21	27	0	0	0	0	200
WT330	0.33	32	0	0	0	0	250
WT340	0.28	19	0	0	0	0	150
WT350	0.30	38	0	0	0	0	280
WT360	0.07	7	0	0	0	0	55
WT370	0.21	7	0	0	0	0	120

Hydrologic Element	Area (sq mi)	Future Peak Flows (cfs) - Sub Regional Detention					
		2-year	5-year	10-year	25-year	50-year	100-year
Woodmen Hills Pond #5	0.04	1	0	0	0	0	19
Woodmen Hills Pond H	0.56	110	0	0	0	0	750
WT010	0.14	9	0	0	0	0	89
WT020	0.07	4	0	0	0	0	42
WT030	0.08	9	0	0	0	0	75
WT040	0.19	9	0	0	0	0	93
WT050	0.19	17	0	0	0	0	140
WT060	0.20	14	0	0	0	0	120
WT070	0.17	14	0	0	0	0	130
WT080	0.07	9	0	0	0	0	67
WT090	0.15	22	0	0	0	0	160
WT100	0.19	56	0	0	0	0	300
WT110	0.19	22	0	0	0	0	170
WT120	0.05	8	0	0	0	0	55
WT130	0.10	35	0	0	0	0	170
WT140	0.13	32	0	0	0	0	180
WT150	0.23	49	0	0	0	0	250
WT160	0.11	35	0	0	0	0	180
WT170	0.12	21	0	0	0	0	140
WT180	0.10	8	0	0	0	0	66
WT190	0.06	11	0	0	0	0	75
WT200	0.30	25	0	0	0	0	190
WT210	0.27	32	0	0	0	0	190
WT220	0.19	47	0	0	0	0	250
WT230	0.20	71	0	0	0	0	350
WT240	0.08	36	0	0	0	0	160
WT250	0.15	63	0	0	0	0	290
WT260	0.14	10	0	0	0	0	78
WT270	0.03	11	0	0	0	0	57
WT280	0.27	33	0	0	0	0	250
WT290	0.10	15	0	0	0	0	110
WT300	0.10	12	0	0	0	0	92
WT310	0.28	31	0	0	0	0	250
WT320	0.21	27	0	0	0	0	200
WT330	0.33	32	0	0	0	0	250
WT340	0.28	19	0	0	0	0	150
WT350	0.30	38	0	0	0	0	280
WT360	0.07	7	0	0	0	0	55
WT370	0.21	7	0	0	0	0	120

Project Summary

Title	BENT GRASS RESIDENTIAL FILING NO.1
Engineer	MAW
Company	CLASSIC CONSULTING
Date	7/10/2014

Notes	POND 1 2 YEAR
-------	------------------

Table of Contents

	Master Network Summary	2
CO SPRINGS	I-D-F Table, 2 years	3
Pond 1	Elevation-Area Volume Curve, 2 years	4
Composite Outlet Structure - 1		
	Outlet Input Data, 2 years	5
	Individual Outlet Curves, 2 years	9
Pond 1 (OUT)		
	Pond Routed Hydrograph (total out), 2 years	15
Pond 1 (IN)		
	Pond Inflow Summary, 2 years	18
Basins	Modified Rational Graph, 2 years	19

Subsection: Master Network Summary

Catchments Summary

Label	Scenario	Return Event (years)	Hydrograph Volume (ac-ft)	Time to Peak (hours)	Peak Flow (ft ³ /s)
Basins	Post-Development 2 Year	2	0.411	0.300	14.96

Node Summary

Label	Scenario	Return Event (years)	Hydrograph Volume (ac-ft)	Time to Peak (hours)	Peak Flow (ft ³ /s)
O-1	Post-Development 2 Year	2	0.335	0.650	0.32

Pond Summary

Label	Scenario	Return Event (years)	Hydrograph Volume (ac-ft)	Time to Peak (hours)	Peak Flow (ft ³ /s)	Maximum Water Surface Elevation (ft)	Maximum Pond Storage (ac-ft)
Pond 1 (IN)	Post-Development 2 Year	2	0.411	0.300	14.96	(N/A)	(N/A)
Pond 1 (OUT)	Post-Development 2 Year	2	0.335	0.650	0.32	6,934.59	0.402

Subsection: I-D-F Table
Label: CO SPRINGS

Return Event: 2 years
Storm Event: CO SPRINGS - 2 Year

I-D-F Curve

Time (hours)	Intensity (In/h)
0.083	3.710
0.167	2.980
0.250	2.520
0.333	2.190
0.417	1.950
0.500	1.760
0.583	1.610
0.667	1.490
0.750	1.380
0.833	1.290
0.917	1.220
1.000	1.150

Subsection: Elevation-Area Volume Curve
Label: Pond 1

Return Event: 2 years
Storm Event: CO SPRINGS - 2 Year

Elevation (ft)	Planimeter (ft ²)	Area (acres)	A1+A2+sq (A1*A2) (acres)	Volume (ac-ft)	Volume (Total) (ac-ft)
6,932.00	0.0	0.005	0.000	0.000	0.000
6,934.00	0.0	0.292	0.335	0.223	0.223
6,936.00	0.0	0.367	0.986	0.658	0.881
6,938.00	0.0	0.451	1.225	0.817	1.698
6,940.00	0.0	0.545	1.492	0.995	2.692

Subsection: Outlet Input Data
 Label: Composite Outlet Structure - 1

Return Event: 2 years
 Storm Event: CO SPRINGS - 2 Year

Requested Pond Water Surface Elevations	
Minimum (Headwater)	6,932.00 ft
Increment (Headwater)	0.50 ft
Maximum (Headwater)	6,940.00 ft

Outlet Connectivity

Structure Type	Outlet ID	Direction	Outfall	E1 (ft)	E2 (ft)
Inlet Box	Riser - 1	Forward	Culvert - 1	6,937.00	6,940.00
Orifice-Area	Orifice - 1	Forward	Culvert - 1	6,933.00	6,940.00
Culvert-Circular	Culvert - 1	Forward	TW	6,932.00	6,940.00
Tailwater Settings	Tailwater			(N/A)	(N/A)

Subsection: Outlet Input Data
Label: Composite Outlet Structure - 1

Return Event: 2 years
Storm Event: CO SPRINGS - 2 Year

Structure ID: Riser - 1	
Structure Type: Inlet Box	
<hr/>	
Number of Openings	1
Elevation	6,937.00 ft
Orifice Area	10.2 ft ²
Orifice Coefficient	0.600
Weir Length	4.00 ft
Weir Coefficient	3.00 (ft ^{0.5})/s
K Reverse	1.000
Manning's n	0.000
Ke _v , Charged Riser	0.000
Weir Submergence	False
Orifice H to crest	False

Subsection: Outlet Input Data
 Label: Composite Outlet Structure - 1

Return Event: 2 years
 Storm Event: CO SPRINGS - 2 Year

Structure ID: Culvert - 1	
Structure Type: Culvert-Circular	
Number of Barrels	1
Diameter	24.0 in
Length	60.00 ft
Length (Computed Barrel)	60.03 ft
Slope (Computed)	0.033 ft/ft
Outlet Control Data	
Manning's n	0.013
Ke	0.200
Kb	0.012
Kr	0.000
Convergence Tolerance	0.00 ft
Inlet Control Data	
Equation Form	Form 1
K	0.0045
M	2.0000
C	0.0317
Y	0.6900
T1 ratio (HW/D)	0.000
T2 ratio (HW/D)	1.181
Slope Correction Factor	-0.500

Use unsubmerged inlet control 0 equation below T1 elevation.

Use submerged inlet control 0 equation above T2 elevation

In transition zone between unsubmerged and submerged inlet control, interpolate between flows at T1 & T2...

T1 Elevation	6,932.00 ft	T1 Flow	15.55 ft ³ /s
T2 Elevation	6,934.36 ft	T2 Flow	17.77 ft ³ /s

Subsection: Outlet Input Data
Label: Composite Outlet Structure - 1

Return Event: 2 years
Storm Event: CO SPRINGS - 2 Year

Structure ID: Orifice - 1	
Structure Type: Orifice-Area	
<hr/>	
Number of Openings	12
Elevation	6,933.00 ft
Orifice Area	0.0 ft ²
Top Elevation	6,937.00 ft
Datum Elevation	6,933.00 ft
Orifice Coefficient	0.600
<hr/>	
Structure ID: TW	
Structure Type: TW Setup, DS Channel	
<hr/>	
Tailwater Type	Free Outfall
<hr/>	
Convergence Tolerances	
<hr/>	
Maximum Iterations	30
Tailwater Tolerance (Minimum)	0.01 ft
Tailwater Tolerance (Maximum)	0.50 ft
Headwater Tolerance (Minimum)	0.01 ft
Headwater Tolerance (Maximum)	0.50 ft
Flow Tolerance (Minimum)	0.001 ft ³ /s
Flow Tolerance (Maximum)	10.000 ft ³ /s
<hr/>	

Subsection: Individual Outlet Curves
 Label: Composite Outlet Structure - 1

Return Event: 2 years
 Storm Event: CO SPRINGS - 2 Year

RATING TABLE FOR ONE OUTLET TYPE
 Structure ID = Riser - 1 (Inlet Box)

Upstream ID = (Pond Water Surface)
 Downstream ID = Culvert - 1 (Culvert-Circular)

Water Surface Elevation (ft)	Device Flow (ft ³ /s)	(into) Headwater Hydraulic Grade Line (ft)	Converge Downstream Hydraulic Grade Line (ft)	Next Downstream Hydraulic Grade Line (ft)	Downstream Hydraulic Grade Line Error (ft)	Convergence Error (ft ³ /s)	Downstream Channel Tailwater (ft)	Tailwater Error (ft)
6,932.00	0.00	0.00	0.00	0.00	0.00	0.00	(N/A)	0.00
6,932.50	0.00	0.00	0.00	0.00	0.00	0.00	(N/A)	0.00
6,933.00	0.00	0.00	0.00	0.00	0.00	0.00	(N/A)	0.00
6,933.50	0.00	0.00	0.00	6,932.15	0.00	0.00	(N/A)	0.00
6,934.00	0.00	0.00	0.00	6,932.21	0.00	0.00	(N/A)	0.00
6,934.50	0.00	0.00	0.00	6,932.26	0.00	0.00	(N/A)	0.00
6,935.00	0.00	0.00	0.00	6,932.30	0.00	0.00	(N/A)	0.00
6,935.50	0.00	0.00	0.00	6,932.34	0.00	0.00	(N/A)	0.00
6,936.00	0.00	0.00	0.00	6,932.38	0.00	0.00	(N/A)	0.00
6,936.50	0.00	0.00	0.00	6,932.40	0.00	0.00	(N/A)	0.00
6,937.00	0.00	0.00	0.00	6,932.43	0.00	0.00	(N/A)	0.00
6,937.50	4.24	6,937.50	Free Outfall	6,933.15	0.00	0.00	(N/A)	0.00
6,938.00	12.00	6,938.00	Free Outfall	6,933.96	0.00	0.00	(N/A)	0.00
6,938.50	22.05	6,938.50	Free Outfall	6,935.01	0.00	0.00	(N/A)	0.00
6,939.00	33.94	6,939.00	6,937.16	6,937.16	0.00	0.00	(N/A)	0.00
6,939.50	47.43	6,939.50	6,939.50	6,939.50	0.00	0.00	(N/A)	0.00
6,940.00	62.35	6,940.00	6,940.00	6,940.00	0.00	0.00	(N/A)	0.00

Message

WS below an invert; no flow.
 WS below an invert; no flow.
 WS below an invert; no flow.
 WS below an invert; no flow.
 WS below an invert; no flow.
 WS below an invert; no flow.
 WS below an invert; no flow.
 WS below an invert; no flow.
 WS below an invert; no flow.
 WS below an invert; no flow.
 WS below an invert; no flow.
 Weir: H =0.5ft
 Weir: H =1ft
 Weir: H =1.5ft
 FULLY CHARGED RISER: ADJUSTED TO WEIR: H =2ft
 FULLY CHARGED RISER: ADJUSTED TO WEIR: H =2.5ft

Subsection: Individual Outlet Curves
Label: Composite Outlet Structure - 1

Return Event: 2 years
Storm Event: CO SPRINGS - 2 Year

RATING TABLE FOR ONE OUTLET TYPE
Structure ID = Riser - 1 (Inlet Box)

Upstream ID = (Pond Water Surface)
Downstream ID = Culvert - 1 (Culvert-Circular)

Message

FULLY CHARGED RISER: ADJUSTED TO
WEIR: H =3ft

Subsection: Individual Outlet Curves
 Label: Composite Outlet Structure - 1

Return Event: 2 years
 Storm Event: CO SPRINGS - 2 Year

RATING TABLE FOR ONE OUTLET TYPE
 Structure ID = Culvert - 1 (Culvert-Circular)

Mannings open channel maximum capacity: 44.43 ft³/s
 Upstream ID = Riser - 1, Orifice - 1
 Downstream ID = Tailwater (Pond Outfall)

Water Surface Elevation (ft)	Device Flow (ft ³ /s)	(into) Headwater Hydraulic Grade Line (ft)	Converge Downstream Hydraulic Grade Line (ft)	Next Downstream Hydraulic Grade Line (ft)	Downstream Hydraulic Grade Line Error (ft)	Convergence Error (ft ³ /s)	Downstream Channel Tailwater (ft)	Tailwater Error (ft)
6,932.00	0.00	0.00	0.00	Free Outfall	0.00	0.00	(N/A)	0.00
6,932.50	0.00	0.00	0.00	Free Outfall	0.00	0.00	(N/A)	0.00
6,933.00	0.00	0.00	0.00	Free Outfall	0.00	0.00	(N/A)	0.00
6,933.50	0.10	6,932.15	Free Outfall	Free Outfall	0.00	0.00	(N/A)	0.00
6,934.00	0.20	6,932.21	Free Outfall	Free Outfall	0.00	0.00	(N/A)	0.00
6,934.50	0.30	6,932.26	Free Outfall	Free Outfall	0.00	0.00	(N/A)	0.00
6,935.00	0.40	6,932.30	Free Outfall	Free Outfall	0.00	0.00	(N/A)	0.00
6,935.50	0.50	6,932.34	Free Outfall	Free Outfall	0.00	0.00	(N/A)	0.00
6,936.00	0.61	6,932.38	Free Outfall	Free Outfall	0.00	0.00	(N/A)	0.00
6,936.50	0.69	6,932.40	Free Outfall	Free Outfall	0.00	0.00	(N/A)	0.00
6,937.00	0.79	6,932.43	Free Outfall	Free Outfall	0.00	0.00	(N/A)	0.00
6,937.50	5.07	6,933.15	Free Outfall	Free Outfall	0.00	0.00	(N/A)	0.00
6,938.00	12.79	6,933.96	Free Outfall	Free Outfall	0.00	0.00	(N/A)	0.00
6,938.50	22.77	6,935.01	Free Outfall	Free Outfall	0.00	0.02	(N/A)	0.00
6,939.00	34.46	6,937.16	Free Outfall	Free Outfall	0.00	0.02	(N/A)	0.00
6,939.50	43.77	6,939.50	Free Outfall	Free Outfall	0.00	3.67	(N/A)	0.00
6,940.00	45.51	6,940.00	Free Outfall	Free Outfall	0.00	16.84	(N/A)	0.00

Message

WS below an invert; no flow.
 WS below an invert; no flow.
 WS below an invert; no flow.
 CRIT.DEPTH CONTROL Vh= .036ft
 Dcr= .107ft CRIT.DEPTH Hev= .00ft
 FLOW PRECEDENCE SET TO
 UPSTREAM CONTROLLING
 STRUCTURE
 FLOW PRECEDENCE SET TO
 UPSTREAM CONTROLLING
 STRUCTURE
 FLOW PRECEDENCE SET TO
 UPSTREAM CONTROLLING
 STRUCTURE
 CRIT.DEPTH CONTROL Vh= .083ft
 Dcr= .242ft CRIT.DEPTH Hev= .00ft
 FLOW PRECEDENCE SET TO
 UPSTREAM CONTROLLING
 STRUCTURE

Subsection: Individual Outlet Curves
Label: Composite Outlet Structure - 1

Return Event: 2 years
Storm Event: CO SPRINGS - 2 Year

RATING TABLE FOR ONE OUTLET TYPE
Structure ID = Culvert - 1 (Culvert-Circular)

Mannings open channel maximum capacity: 44.43 ft³/s
Upstream ID = Riser - 1, Orifice - 1
Downstream ID = Tailwater (Pond Outfall)

Message

CRIT.DEPTH CONTROL Vh= .099ft Dcr= .286ft CRIT.DEPTH Hev= .00ft CRIT.DEPTH CONTROL Vh= .106ft Dcr= .306ft CRIT.DEPTH Hev= .00ft FLOW PRECEDENCE SET TO UPSTREAM CONTROLLING STRUCTURE CRIT.DEPTH CONTROL Vh= .557ft Dcr= 1.287ft CRIT.DEPTH Hev= .00ft INLET CONTROL... Submerged: HW =3.01 INLET CONTROL... Submerged: HW =5.16 INLET CONTROL... Submerged: HW =7.50 INLET CONTROL... Submerged: HW =8.00
--

Subsection: Individual Outlet Curves
 Label: Composite Outlet Structure - 1

Return Event: 2 years
 Storm Event: CO SPRINGS - 2 Year

RATING TABLE FOR ONE OUTLET TYPE
 Structure ID = Orifice - 1 (Orifice-Area)

Upstream ID = (Pond Water Surface)
 Downstream ID = Culvert - 1 (Culvert-Circular)

Water Surface Elevation (ft)	Device Flow (ft ³ /s)	(Into) Headwater Hydraulic Grade Line (ft)	Converge Downstream Hydraulic Grade Line (ft)	Next Downstream Hydraulic Grade Line (ft)	Downstream Hydraulic Grade Line Error (ft)	Convergence Error (ft ³ /s)	Downstream Channel Tailwater (ft)	Tailwater Error (ft)
6,932.00	0.00	0.00	0.00	0.00	0.00	0.00	(N/A)	0.00
6,932.50	0.00	0.00	0.00	0.00	0.00	0.00	(N/A)	0.00
6,933.00	0.00	0.00	0.00	0.00	0.00	0.00	(N/A)	0.00
6,933.50	0.10	6,933.50	Free Outfall	6,932.15	0.00	0.00	(N/A)	0.00
6,934.00	0.20	6,934.00	Free Outfall	6,932.21	0.00	0.00	(N/A)	0.00
6,934.50	0.30	6,934.50	Free Outfall	6,932.26	0.00	0.00	(N/A)	0.00
6,935.00	0.40	6,935.00	Free Outfall	6,932.30	0.00	0.00	(N/A)	0.00
6,935.50	0.50	6,935.50	Free Outfall	6,932.34	0.00	0.00	(N/A)	0.00
6,936.00	0.60	6,936.00	Free Outfall	6,932.38	0.00	0.00	(N/A)	0.00
6,936.50	0.69	6,936.50	Free Outfall	6,932.40	0.00	0.00	(N/A)	0.00
6,937.00	0.79	6,937.00	Free Outfall	6,932.43	0.00	0.00	(N/A)	0.00
6,937.50	0.83	6,937.50	6,933.15	6,933.15	0.00	0.00	(N/A)	0.00
6,938.00	0.80	6,938.00	6,933.96	6,933.96	0.00	0.00	(N/A)	0.00
6,938.50	0.74	6,938.50	6,935.01	6,935.01	0.00	0.00	(N/A)	0.00
6,939.00	0.54	6,939.00	6,937.16	6,937.16	0.00	0.00	(N/A)	0.00
6,939.50	0.00	6,939.50	6,939.50	6,939.50	0.00	0.00	(N/A)	0.00
6,940.00	0.00	6,940.00	6,940.00	6,940.00	0.00	0.00	(N/A)	0.00

Message

WS below an Invert; no flow.
 WS below an Invert; no flow.
 WS below an Invert; no flow.
 Hi=.50; Ht=4.00; Qt=.07
 Hi=1.00; Ht=4.00; Qt=.07
 Hi=1.50; Ht=4.00; Qt=.07
 Hi=2.00; Ht=4.00; Qt=.07
 Hi=2.50; Ht=4.00; Qt=.07
 Hi=3.00; Ht=4.00; Qt=.07
 Hi=3.50; Ht=4.00; Qt=.07
 H =4.00
 H =4.35
 H =4.04
 H =3.49
 H =1.84
 FLOW PRECEDENCE SET TO
 DOWNSTREAM CONTROLLING
 STRUCTURE

Subsection: Individual Outlet Curves
Label: Composite Outlet Structure - 1

Return Event: 2 years
Storm Event: CO SPRINGS - 2 Year

RATING TABLE FOR ONE OUTLET TYPE

Structure ID = Orifice - 1 (Orifice-Area)

Upstream ID = (Pond Water Surface)

Downstream ID = Culvert - 1 (Culvert-Circular)

Message

FLOW PRECEDENCE SET TO
DOWNSTREAM CONTROLLING
STRUCTURE

Subsection: Modified Rational Graph
 Label: Basins

Return Event: 2 years
 Storm Event: CO SPRINGS - 2 Year

Method Type	Method T
Time of Duration (Modified Rational, Critical)	0.333 hours

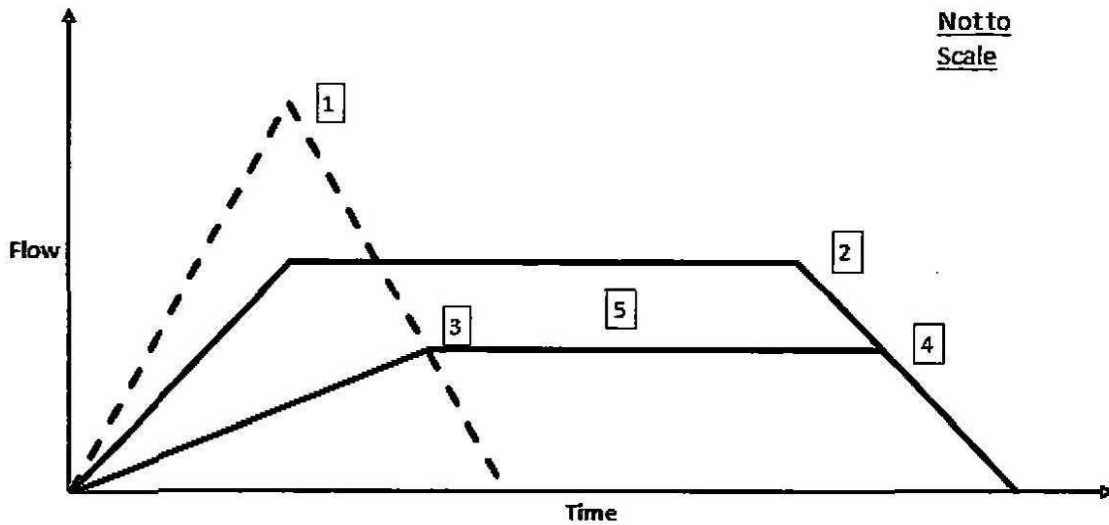

[1]			[2]		
Time of Concentration (Modified Rational, Composite)	0.288	hours	Time of Duration (Modified Rational, Critical)	0.333	hours
Intensity (Modified Rational, Peak)	2.368	in/h	Intensity (Modified Rational, Critical)	2.190	in/h
Flow (Modified Rational, Peak)	16.18	ft ³ /s	Flow (Modified Rational, Critical)	14.96	ft ³ /s

[3]	
First Outflow Breakpoint (Modified Rational, Method T)	0.390 hours
Flow (Modified Rational, Allowable)	12.00 ft ³ /s

[4]			[5]		
Second Outflow Breakpoint (Modified Rational)	0.363	hours	Storage (Modified Rational, Estimated)	0.090	ac-ft
Flow (Modified Rational, Allowable)	12.00	ft ³ /s			

Index

B

Basins (Modified Rational Graph, 2 years)...19

C

CO SPRINGS (I-D-F Table, 2 years)...3

Composite Outlet Structure - 1 (Individual Outlet Curves, 2 years)...9, 10, 11, 12, 13, 14

Composite Outlet Structure - 1 (Outlet Input Data, 2 years)...5, 6, 7, 8

M

Master Network Summary...2

P

Pond 1 (Elevation-Area Volume Curve, 2 years)...4

Pond 1 (IN) (Pond Inflow Summary, 2 years)...18

Pond 1 (OUT) (Pond Routed Hydrograph (total out), 2 years)...15, 16, 17

Project Summary	
Title	BENT GRASS RESIDENTIAL FILING NO.1
Engineer	MAW
Company	CLASSIC CONSULTING
Date	7/10/2014

Notes	POND 1 5 YEAR
--------------	------------------

Table of Contents

	Master Network Summary	2
CO SPRINGS	I-D-F Table, 5 years	3
Pond 1	Elevation-Area Volume Curve, 5 years	4
Composite Outlet Structure - 1		
	Outlet Input Data, 5 years	5
	Individual Outlet Curves, 5 years	9
Pond 1 (OUT)		
	Pond Routed Hydrograph (total out), 5 years	15
Pond 1 (IN)		
	Pond Inflow Summary, 5 years	18
Basins	Modified Rational Graph, 5 years	19

Subsection: Master Network Summary

Catchments Summary

Label	Scenario	Return Event (years)	Hydrograph Volume (ac-ft)	Time to Peak (hours)	Peak Flow (ft ³ /s)
Basins	Post-Development 5 Year	5	0.582	0.300	20.11

Node Summary

Label	Scenario	Return Event (years)	Hydrograph Volume (ac-ft)	Time to Peak (hours)	Peak Flow (ft ³ /s)
O-1	Post-Development 5 Year	5	0.470	0.650	0.42

Pond Summary

Label	Scenario	Return Event (years)	Hydrograph Volume (ac-ft)	Time to Peak (hours)	Peak Flow (ft ³ /s)	Maximum Water Surface Elevation (ft)	Maximum Pond Storage (ac-ft)
Pond 1 (IN)	Post-Development 5 Year	5	0.582	0.300	20.11	(N/A)	(N/A)
Pond 1 (OUT)	Post-Development 5 Year	5	0.470	0.650	0.42	6,935.11	0.569

Subsection: I-D-F Table
Label: CO SPRINGS

Return Event: 5 years
Storm Event: CO SPRINGS - 5 Year

I-D-F Curve

Time (hours)	Intensity (In/h)
0.083	5.100
0.167	4.100
0.250	3.460
0.333	3.010
0.417	2.680
0.500	2.420
0.583	2.210
0.667	2.040
0.750	1.900
0.833	1.780
0.917	1.670
1.000	1.580

Subsection: Elevation-Area Volume Curve
 Label: Pond 1

Return Event: 5 years
 Storm Event: CO SPRINGS - 5 Year

Elevation (ft)	Planimeter (ft ²)	Area (acres)	A1+A2+sqr (A1*A2) (acres)	Volume (ac-ft)	Volume (Total) (ac-ft)
6,932.00	0.0	0.005	0.000	0.000	0.000
6,934.00	0.0	0.292	0.335	0.223	0.223
6,936.00	0.0	0.367	0.986	0.658	0.881
6,938.00	0.0	0.451	1.225	0.817	1.698
6,940.00	0.0	0.545	1.492	0.995	2.692

Subsection: Outlet Input Data
 Label: Composite Outlet Structure - 1

Return Event: 5 years
 Storm Event: CO SPRINGS - 5 Year

Requested Pond Water Surface Elevations	
Minimum (Headwater)	6,932.00 ft
Increment (Headwater)	0.50 ft
Maximum (Headwater)	6,940.00 ft

Outlet Connectivity

Structure Type	Outlet ID	Direction	Outfall	E1 (ft)	E2 (ft)
Inlet Box	Riser - 1	Forward	Culvert - 1	6,937.00	6,940.00
Orifice-Area	Orifice - 1	Forward	Culvert - 1	6,933.00	6,940.00
Culvert-Circular	Culvert - 1	Forward	TW	6,932.00	6,940.00
Tailwater Settings	Tailwater			(N/A)	(N/A)

Subsection: Outlet Input Data
Label: Composite Outlet Structure - 1

Return Event: 5 years
Storm Event: CO SPRINGS - 5 Year

Structure ID: Riser - 1	
Structure Type: Inlet Box	
<hr/>	
Number of Openings	1
Elevation	6,937.00 ft
Orifice Area	10.2 ft ²
Orifice Coefficient	0.600
Weir Length	4.00 ft
Weir Coefficient	3.00 (ft ^{0.5})/s
K Reverse	1.000
Manning's n	0.000
Ke, Charged Riser	0.000
Weir Submergence	False
Orifice H to crest	False

Subsection: Outlet Input Data
 Label: Composite Outlet Structure - 1

Return Event: 5 years
 Storm Event: CO SPRINGS - 5 Year

Structure ID: Culvert - 1	
Structure Type: Culvert-Circular	
Number of Barrels	1
Diameter	24.0 in
Length	60.00 ft
Length (Computed Barrel)	60.03 ft
Slope (Computed)	0.033 ft/ft
Outlet Control Data	
Manning's n	0.013
Ke	0.200
Kb	0.012
Kr	0.000
Convergence Tolerance	0.00 ft
Inlet Control Data	
Equation Form	Form 1
K	0.0045
M	2.0000
C	0.0317
Y	0.6900
T1 ratio (HW/D)	1.079
T2 ratio (HW/D)	1.181
Slope Correction Factor	-0.500

Use unsubmerged inlet control 0 equation below T1 elevation.

Use submerged inlet control 0 equation above T2 elevation

In transition zone between unsubmerged and submerged inlet control, interpolate between flows at T1 & T2...

T1 Elevation	6,934.16 ft	T1 Flow	15.55 ft ³ /s
T2 Elevation	6,934.36 ft	T2 Flow	17.77 ft ³ /s

Subsection: Outlet Input Data
Label: Composite Outlet Structure - 1

Return Event: 5 years
Storm Event: CO SPRINGS - 5 Year

Structure ID: Orifice - 1	
Structure Type: Orifice-Area	
Number of Openings	12
Elevation	6,933.00 ft
Orifice Area	0.0 ft ²
Top Elevation	6,937.00 ft
Datum Elevation	6,933.00 ft
Orifice Coefficient	0.600
Structure ID: TW	
Structure Type: TW Setup, DS Channel	
Tailwater Type	Free Outfall
Convergence Tolerances	
Maximum Iterations	30
Tailwater Tolerance (Minimum)	0.01 ft
Tailwater Tolerance (Maximum)	0.50 ft
Headwater Tolerance (Minimum)	0.01 ft
Headwater Tolerance (Maximum)	0.50 ft
Flow Tolerance (Minimum)	0.001 ft ³ /s
Flow Tolerance (Maximum)	10.000 ft ³ /s

Subsection: Individual Outlet Curves
 Label: Composite Outlet Structure - 1

Return Event: 5 years
 Storm Event: CO SPRINGS - 5 Year

RATING TABLE FOR ONE OUTLET TYPE
 Structure ID = Riser - 1 (Inlet Box)

Upstream ID = (Pond Water Surface)
 Downstream ID = Culvert - 1 (Culvert-Circular)

Water Surface Elevation (ft)	Device Flow (ft ³ /s)	(Into) Headwater Hydraulic Grade Line (ft)	Converge Downstream Hydraulic Grade Line (ft)	Next Downstream Hydraulic Grade Line (ft)	Downstream Hydraulic Grade Line Error (ft)	Convergence Error (ft ³ /s)	Downstream Channel Tailwater (ft)	Tailwater Error (ft)
6,932.00	0.00	0.00	0.00	0.00	0.00	0.00	(N/A)	0.00
6,932.50	0.00	0.00	0.00	0.00	0.00	0.00	(N/A)	0.00
6,933.00	0.00	0.00	0.00	0.00	0.00	0.00	(N/A)	0.00
6,933.50	0.00	0.00	0.00	6,932.15	0.00	0.00	(N/A)	0.00
6,934.00	0.00	0.00	0.00	6,932.21	0.00	0.00	(N/A)	0.00
6,934.50	0.00	0.00	0.00	6,932.26	0.00	0.00	(N/A)	0.00
6,935.00	0.00	0.00	0.00	6,932.30	0.00	0.00	(N/A)	0.00
6,935.50	0.00	0.00	0.00	6,932.34	0.00	0.00	(N/A)	0.00
6,936.00	0.00	0.00	0.00	6,932.38	0.00	0.00	(N/A)	0.00
6,936.50	0.00	0.00	0.00	6,932.40	0.00	0.00	(N/A)	0.00
6,937.00	0.00	0.00	0.00	6,932.43	0.00	0.00	(N/A)	0.00
6,937.50	4.24	6,937.50	Free Outfall	6,933.15	0.00	0.00	(N/A)	0.00
6,938.00	12.00	6,938.00	Free Outfall	6,933.96	0.00	0.00	(N/A)	0.00
6,938.50	22.05	6,938.50	Free Outfall	6,935.01	0.00	0.00	(N/A)	0.00
6,939.00	33.94	6,939.00	6,937.16	6,937.16	0.00	0.00	(N/A)	0.00
6,939.50	47.43	6,939.50	6,939.50	6,939.50	0.00	0.00	(N/A)	0.00
6,940.00	62.35	6,940.00	6,940.00	6,940.00	0.00	0.00	(N/A)	0.00

Message

WS below an invert; no flow.
 WS below an invert; no flow.
 WS below an invert; no flow.
 WS below an invert; no flow.
 WS below an invert; no flow.
 WS below an invert; no flow.
 WS below an invert; no flow.
 WS below an invert; no flow.
 WS below an invert; no flow.
 WS below an invert; no flow.
 WS below an invert; no flow.
 Weir: H =0.5ft
 Weir: H =1ft
 Weir: H =1.5ft
 FULLY CHARGED RISER: ADJUSTED TO WEIR: H =2ft
 FULLY CHARGED RISER: ADJUSTED TO WEIR: H =2.5ft

Subsection: Individual Outlet Curves
Label: Composite Outlet Structure - 1

Return Event: 5 years
Storm Event: CO SPRINGS - 5 Year

RATING TABLE FOR ONE OUTLET TYPE
Structure ID = Riser - 1 (Inlet Box)

Upstream ID = (Pond Water Surface)
Downstream ID = Culvert - 1 (Culvert-Circular)

Message

FULLY CHARGED RISER: ADJUSTED TO
WEIR: H =3ft

Subsection: Individual Outlet Curves
 Label: Composite Outlet Structure - 1

Return Event: 5 years
 Storm Event: CO SPRINGS - 5 Year

RATING TABLE FOR ONE OUTLET TYPE
 Structure ID = Culvert - 1 (Culvert-Circular)

Mannings open channel maximum capacity: 44.43 ft³/s
 Upstream ID = Riser - 1, Orifice - 1
 Downstream ID = Tailwater (Pond Outfall)

Water Surface Elevation (ft)	Device Flow (ft ³ /s)	(into) Headwater Hydraulic Grade Line (ft)	Converge Downstream Hydraulic Grade Line (ft)	Next Downstream Hydraulic Grade Line (ft)	Downstream Hydraulic Grade Line Error (ft)	Convergence Error (ft ³ /s)	Downstream Channel Tailwater (ft)	Tailwater Error (ft)
6,932.00	0.00	0.00	0.00	Free Outfall	0.00	0.00	(N/A)	0.00
6,932.50	0.00	0.00	0.00	Free Outfall	0.00	0.00	(N/A)	0.00
6,933.00	0.00	0.00	0.00	Free Outfall	0.00	0.00	(N/A)	0.00
6,933.50	0.10	6,932.15	Free Outfall	Free Outfall	0.00	0.00	(N/A)	0.00
6,934.00	0.20	6,932.21	Free Outfall	Free Outfall	0.00	0.00	(N/A)	0.00
6,934.50	0.30	6,932.26	Free Outfall	Free Outfall	0.00	0.00	(N/A)	0.00
6,935.00	0.40	6,932.30	Free Outfall	Free Outfall	0.00	0.00	(N/A)	0.00
6,935.50	0.50	6,932.34	Free Outfall	Free Outfall	0.00	0.00	(N/A)	0.00
6,936.00	0.61	6,932.38	Free Outfall	Free Outfall	0.00	0.00	(N/A)	0.00
6,936.50	0.69	6,932.40	Free Outfall	Free Outfall	0.00	0.00	(N/A)	0.00
6,937.00	0.79	6,932.43	Free Outfall	Free Outfall	0.00	0.00	(N/A)	0.00
6,937.50	5.07	6,933.15	Free Outfall	Free Outfall	0.00	0.00	(N/A)	0.00
6,938.00	12.79	6,933.96	Free Outfall	Free Outfall	0.00	0.00	(N/A)	0.00
6,938.50	22.77	6,935.01	Free Outfall	Free Outfall	0.00	0.02	(N/A)	0.00
6,939.00	34.46	6,937.16	Free Outfall	Free Outfall	0.00	0.02	(N/A)	0.00
6,939.50	43.77	6,939.50	Free Outfall	Free Outfall	0.00	3.67	(N/A)	0.00
6,940.00	45.51	6,940.00	Free Outfall	Free Outfall	0.00	16.84	(N/A)	0.00

Message

WS below an invert; no flow.
 WS below an invert; no flow.
 WS below an invert; no flow.
 CRIT.DEPTH CONTROL Vh= .036ft
 Dcr= .107ft CRIT.DEPTH Hev= .00ft
 FLOW PRECEDENCE SET TO
 UPSTREAM CONTROLLING
 STRUCTURE
 FLOW PRECEDENCE SET TO
 UPSTREAM CONTROLLING
 STRUCTURE
 FLOW PRECEDENCE SET TO
 UPSTREAM CONTROLLING
 STRUCTURE
 CRIT.DEPTH CONTROL Vh= .083ft
 Dcr= .242ft CRIT.DEPTH Hev= .00ft
 FLOW PRECEDENCE SET TO
 UPSTREAM CONTROLLING
 STRUCTURE

Subsection: Individual Outlet Curves
Label: Composite Outlet Structure - 1

Return Event: 5 years
Storm Event: CO SPRINGS - 5 Year

RATING TABLE FOR ONE OUTLET TYPE
Structure ID = Culvert - 1 (Culvert-Circular)

Mannings open channel maximum capacity: 44.43 ft³/s
Upstream ID = Riser - 1, Orifice - 1
Downstream ID = Tailwater (Pond Outfall)

Message

CRIT.DEPTH CONTROL Vh= .099ft Dcr= .286ft CRIT.DEPTH Hev= .00ft CRIT.DEPTH CONTROL Vh= .106ft Dcr= .306ft CRIT.DEPTH Hev= .00ft FLOW PRECEDENCE SET TO UPSTREAM CONTROLLING STRUCTURE CRIT.DEPTH CONTROL Vh= .557ft Dcr= 1.287ft CRIT.DEPTH Hev= .00ft INLET CONTROL... Submerged: HW =3.01 INLET CONTROL... Submerged: HW =5.16 INLET CONTROL... Submerged: HW =7.50 INLET CONTROL... Submerged: HW =8.00
--

Subsection: Individual Outlet Curves
 Label: Composite Outlet Structure - 1

Return Event: 5 years
 Storm Event: CO SPRINGS - 5 Year

RATING TABLE FOR ONE OUTLET TYPE
 Structure ID = Orifice - 1 (Orifice-Area)

Upstream ID = (Pond Water Surface)
 Downstream ID = Culvert - 1 (Culvert-Circular)

Water Surface Elevation (ft)	Device Flow (ft ³ /s)	(Into) Headwater Hydraulic Grade Line (ft)	Converge Downstream Hydraulic Grade Line (ft)	Next Downstream Hydraulic Grade Line (ft)	Downstream Hydraulic Grade Line Error (ft)	Convergence Error (ft ³ /s)	Downstream Channel Tailwater (ft)	Tailwater Error (ft)
6,932.00	0.00	0.00	0.00	0.00	0.00	0.00	(N/A)	0.00
6,932.50	0.00	0.00	0.00	0.00	0.00	0.00	(N/A)	0.00
6,933.00	0.00	0.00	0.00	0.00	0.00	0.00	(N/A)	0.00
6,933.50	0.10	6,933.50	Free Outfall	6,932.15	0.00	0.00	(N/A)	0.00
6,934.00	0.20	6,934.00	Free Outfall	6,932.21	0.00	0.00	(N/A)	0.00
6,934.50	0.30	6,934.50	Free Outfall	6,932.26	0.00	0.00	(N/A)	0.00
6,935.00	0.40	6,935.00	Free Outfall	6,932.30	0.00	0.00	(N/A)	0.00
6,935.50	0.50	6,935.50	Free Outfall	6,932.34	0.00	0.00	(N/A)	0.00
6,936.00	0.60	6,936.00	Free Outfall	6,932.38	0.00	0.00	(N/A)	0.00
6,936.50	0.69	6,936.50	Free Outfall	6,932.40	0.00	0.00	(N/A)	0.00
6,937.00	0.79	6,937.00	Free Outfall	6,932.43	0.00	0.00	(N/A)	0.00
6,937.50	0.83	6,937.50	6,933.15	6,933.15	0.00	0.00	(N/A)	0.00
6,938.00	0.80	6,938.00	6,933.96	6,933.96	0.00	0.00	(N/A)	0.00
6,938.50	0.74	6,938.50	6,935.01	6,935.01	0.00	0.00	(N/A)	0.00
6,939.00	0.54	6,939.00	6,937.16	6,937.16	0.00	0.00	(N/A)	0.00
6,939.50	0.00	6,939.50	6,939.50	6,939.50	0.00	0.00	(N/A)	0.00
6,940.00	0.00	6,940.00	6,940.00	6,940.00	0.00	0.00	(N/A)	0.00

Message

WS below an invert; no flow.
 WS below an invert; no flow.
 WS below an invert; no flow.
 Hi=.50; Ht=4.00; Qt=.07
 Hi=1.00; Ht=4.00; Qt=.07
 Hi=1.50; Ht=4.00; Qt=.07
 Hi=2.00; Ht=4.00; Qt=.07
 Hi=2.50; Ht=4.00; Qt=.07
 Hi=3.00; Ht=4.00; Qt=.07
 Hi=3.50; Ht=4.00; Qt=.07
 H =4.00
 H =4.35
 H =4.04
 H =3.49
 H =1.84
 FLOW PRECEDENCE SET TO
 DOWNSTREAM CONTROLLING
 STRUCTURE

Subsection: Individual Outlet Curves
Label: Composite Outlet Structure - 1

Return Event: 5 years
Storm Event: CO SPRINGS - 5 Year

RATING TABLE FOR ONE OUTLET TYPE
Structure ID = Orifice - 1 (Orifice-Area)

Upstream ID = (Pond Water Surface)
Downstream ID = Culvert - 1 (Culvert-Circular)

Message

FLOW PRECEDENCE SET TO
DOWNSTREAM CONTROLLING
STRUCTURE

Subsection: Modified Rational Graph
 Label: Basins

Return Event: 5 years
 Storm Event: CO SPRINGS - 5 Year

Method Type	Method T
Time of Duration (Modified Rational, Critical)	0.350 hours

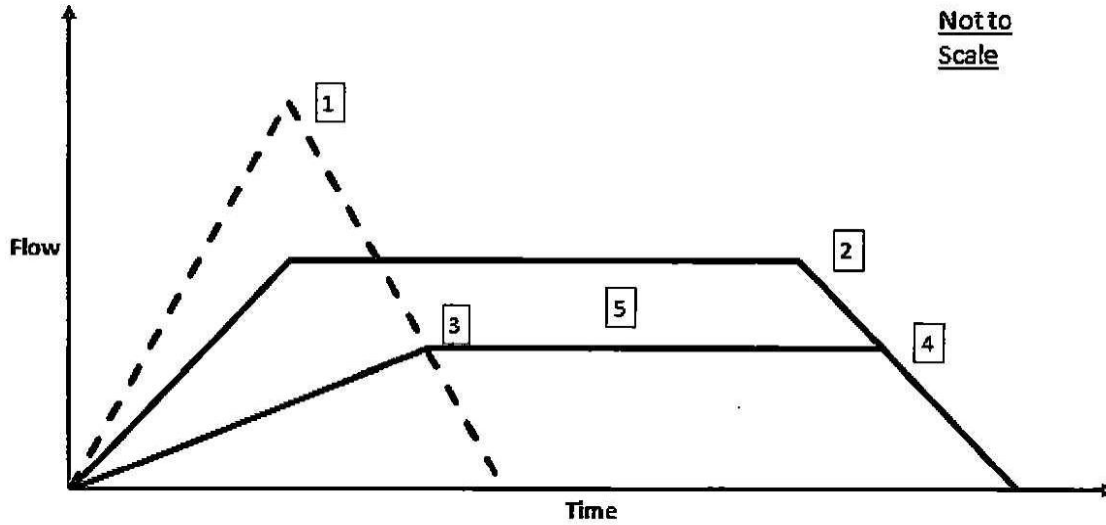

[1]			[2]		
Time of Concentration (Modified Rational, Composite)	0.288	hours	Time of Duration (Modified Rational, Critical)	0.350	hours
Intensity (Modified Rational, Peak)	3.253	in/h	Intensity (Modified Rational, Critical)	2.944	in/h
Flow (Modified Rational, Peak)	22.22	ft ³ /s	Flow (Modified Rational, Critical)	20.11	ft ³ /s

[3]	
First Outflow Breakpoint (Modified Rational, Method T)	0.466 hours
Flow (Modified Rational, Allowable)	12.00 ft ³ /s

[4]			[5]		
Second Outflow Breakpoint (Modified Rational)	0.421	hours	Storage (Modified Rational, Estimated)	0.243	ac-ft
Flow (Modified Rational, Allowable)	12.00	ft ³ /s			

Index

B

Basins (Modified Rational Graph, 5 years)...19

C

CO SPRINGS (I-D-F Table, 5 years)...3

Composite Outlet Structure - 1 (Individual Outlet Curves, 5 years)...9, 10, 11, 12, 13, 14

Composite Outlet Structure - 1 (Outlet Input Data, 5 years)...5, 6, 7, 8

M

Master Network Summary...2

P

Pond 1 (Elevation-Area Volume Curve, 5 years)...4

Pond 1 (IN) (Pond Inflow Summary, 5 years)...18

Pond 1 (OUT) (Pond Routed Hydrograph (total out), 5 years)...15, 16, 17

Project Summary

Title	BENT GRASS RESIDENTIAL FILING NO.1
Engineer	MAW
Company	CLASSIC CONSULTING
Date	7/10/2014

Notes	POND 1 10 YEAR
--------------	---------------------------

Table of Contents

	Master Network Summary	2
CO SPRINGS	I-D-F Table, 10 years	3
Pond 1	Elevation-Area Volume Curve, 10 years	4
Composite Outlet Structure - 1		
	Outlet Input Data, 10 years	5
	Individual Outlet Curves, 10 years	9
Pond 1 (OUT)		
	Pond Routed Hydrograph (total out), 10 years	15
Pond 1 (IN)		
	Pond Inflow Summary, 10 years	18
Basins	Modified Rational Graph, 10 years	19

Subsection: Master Network Summary

Catchments Summary

Label	Scenario	Return Event (years)	Hydrograph Volume (ac-ft)	Time to Peak (hours)	Peak Flow (ft ³ /s)
Basins	Post-Development 10 Year	10	0.710	0.300	22.45

Node Summary

Label	Scenario	Return Event (years)	Hydrograph Volume (ac-ft)	Time to Peak (hours)	Peak Flow (ft ³ /s)
O-1	Post-Development 10 Year	10	0.565	0.700	0.49

Pond Summary

Label	Scenario	Return Event (years)	Hydrograph Volume (ac-ft)	Time to Peak (hours)	Peak Flow (ft ³ /s)	Maximum Water Surface Elevation (ft)	Maximum Pond Storage (ac-ft)
Pond 1 (IN)	Post-Development 10 Year	10	0.710	0.300	22.45	(N/A)	(N/A)
Pond 1 (OUT)	Post-Development 10 Year	10	0.565	0.700	0.49	6,935.48	0.694

Subsection: I-D-F Table
Label: CO SPRINGS

Return Event: 10 years
Storm Event: CO SPRINGS - 10 Year

I-D-F Curve

Time (hours)	Intensity (in/h)
0.083	5.960
0.167	4.790
0.250	4.040
0.333	3.520
0.417	3.130
0.500	2.830
0.583	2.580
0.667	2.390
0.750	2.220
0.833	2.080
0.917	1.950
1.000	1.850

Subsection: Elevation-Area Volume Curve
 Label: Pond 1

Return Event: 10 years
 Storm Event: CO SPRINGS - 10 Year

Elevation (ft)	Planimeter (ft ²)	Area (acres)	A1+A2+sqr (A1*A2) (acres)	Volume (ac-ft)	Volume (Total) (ac-ft)
6,932.00	0.0	0.005	0.000	0.000	0.000
6,934.00	0.0	0.292	0.335	0.223	0.223
6,936.00	0.0	0.367	0.986	0.658	0.881
6,938.00	0.0	0.451	1.225	0.817	1.698
6,940.00	0.0	0.545	1.492	0.995	2.692

Subsection: Outlet Input Data
 Label: Composite Outlet Structure - 1

Return Event: 10 years
 Storm Event: CO SPRINGS - 10 Year

Requested Pond Water Surface Elevations	
Minimum (Headwater)	6,932.00 ft
Increment (Headwater)	0.50 ft
Maximum (Headwater)	6,940.00 ft

Outlet Connectivity

Structure Type	Outlet ID	Direction	Outfall	E1 (ft)	E2 (ft)
Inlet Box	Riser - 1	Forward	Culvert - 1	6,937.00	6,940.00
Orifice-Area	Orifice - 1	Forward	Culvert - 1	6,933.00	6,940.00
Culvert-Circular	Culvert - 1	Forward	TW	6,932.00	6,940.00
Tailwater Settings	Tailwater			(N/A)	(N/A)

Subsection: Outlet Input Data
Label: Composite Outlet Structure - 1

Return Event: 10 years
Storm Event: CO SPRINGS - 10 Year

Structure ID: Riser - 1	
Structure Type: Inlet Box	
<hr/>	
Number of Openings	1
Elevation	6,937.00 ft
Orifice Area	10.2 ft ²
Orifice Coefficient	0.600
Weir Length	4.00 ft
Weir Coefficient	3.00 (ft ^{0.5})/s
K Reverse	1.000
Manning's n	0.000
Ke _v , Charged Riser	0.000
Weir Submergence	False
Orifice H to crest	False

Subsection: Outlet Input Data
 Label: Composite Outlet Structure - 1

Return Event: 10 years
 Storm Event: CO SPRINGS - 10 Year

Structure ID: Culvert - 1	
Structure Type: Culvert-Circular	
Number of Barrels	1
Diameter	24.0 In
Length	60.00 ft
Length (Computed Barrel)	60.03 ft
Slope (Computed)	0.033 ft/ft
Outlet Control Data	
Manning's n	0.013
Ke	0.200
Kb	0.012
Kr	0.000
Convergence Tolerance	0.00 ft
Inlet Control Data	
Equation Form	Form 1
K	0.0045
M	2.0000
C	0.0317
Y	0.6900
T1 ratio (HW/D)	1.079
T2 ratio (HW/D)	1.181
Slope Correction Factor	-0.500

Use unsubmerged inlet control 0 equation below T1 elevation.

Use submerged inlet control 0 equation above T2 elevation

In transition zone between unsubmerged and submerged inlet control, interpolate between flows at T1 & T2...

T1 Elevation	6,934.16 ft	T1 Flow	15.55 ft ³ /s
T2 Elevation	6,934.36 ft	T2 Flow	17.77 ft ³ /s

Subsection: Outlet Input Data
Label: Composite Outlet Structure - 1

Return Event: 10 years
Storm Event: CO SPRINGS - 10 Year

Structure ID: Orifice - 1	
Structure Type: Orifice-Area	
Number of Openings	12
Elevation	6,933.00 ft
Orifice Area	0.0 ft ²
Top Elevation	6,937.00 ft
Datum Elevation	6,933.00 ft
Orifice Coefficient	0.600

Structure ID: TW	
Structure Type: TW Setup, DS Channel	
Tailwater Type	Free Outfall

Convergence Tolerances	
Maximum Iterations	30
Tailwater Tolerance (Minimum)	0.01 ft
Tailwater Tolerance (Maximum)	0.50 ft
Headwater Tolerance (Minimum)	0.01 ft
Headwater Tolerance (Maximum)	0.50 ft
Flow Tolerance (Minimum)	0.001 ft ³ /s
Flow Tolerance (Maximum)	10.000 ft ³ /s

Subsection: Individual Outlet Curves
 Label: Composite Outlet Structure - 1

Return Event: 10 years
 Storm Event: CO SPRINGS - 10 Year

RATING TABLE FOR ONE OUTLET TYPE
 Structure ID = Riser - 1 (Inlet Box)

Upstream ID = (Pond Water Surface)
 Downstream ID = Culvert - 1 (Culvert-Circular)

Water Surface Elevation (ft)	Device Flow (ft ³ /s)	(Into) Headwater Hydraulic Grade Line (ft)	Converge Downstream Hydraulic Grade Line (ft)	Next Downstream Hydraulic Grade Line (ft)	Downstream Hydraulic Grade Line Error (ft)	Convergence Error (ft ³ /s)	Downstream Channel Tailwater (ft)	Tailwater Error (ft)
6,932.00	0.00	0.00	0.00	0.00	0.00	0.00	(N/A)	0.00
6,932.50	0.00	0.00	0.00	0.00	0.00	0.00	(N/A)	0.00
6,933.00	0.00	0.00	0.00	0.00	0.00	0.00	(N/A)	0.00
6,933.50	0.00	0.00	0.00	6,932.15	0.00	0.00	(N/A)	0.00
6,934.00	0.00	0.00	0.00	6,932.21	0.00	0.00	(N/A)	0.00
6,934.50	0.00	0.00	0.00	6,932.26	0.00	0.00	(N/A)	0.00
6,935.00	0.00	0.00	0.00	6,932.30	0.00	0.00	(N/A)	0.00
6,935.50	0.00	0.00	0.00	6,932.34	0.00	0.00	(N/A)	0.00
6,936.00	0.00	0.00	0.00	6,932.38	0.00	0.00	(N/A)	0.00
6,936.50	0.00	0.00	0.00	6,932.40	0.00	0.00	(N/A)	0.00
6,937.00	0.00	0.00	0.00	6,932.43	0.00	0.00	(N/A)	0.00
6,937.50	4.24	6,937.50	Free Outfall	6,933.15	0.00	0.00	(N/A)	0.00
6,938.00	12.00	6,938.00	Free Outfall	6,933.96	0.00	0.00	(N/A)	0.00
6,938.50	22.05	6,938.50	Free Outfall	6,935.01	0.00	0.00	(N/A)	0.00
6,939.00	33.94	6,939.00	6,937.16	6,937.16	0.00	0.00	(N/A)	0.00
6,939.50	47.43	6,939.50	6,939.50	6,939.50	0.00	0.00	(N/A)	0.00
6,940.00	62.35	6,940.00	6,940.00	6,940.00	0.00	0.00	(N/A)	0.00

Message

WS below an invert; no flow.
 WS below an invert; no flow.
 WS below an invert; no flow.
 WS below an invert; no flow.
 WS below an invert; no flow.
 WS below an invert; no flow.
 WS below an invert; no flow.
 WS below an invert; no flow.
 WS below an invert; no flow.
 WS below an invert; no flow.
 WS below an invert; no flow.
 Weir: H =0.5ft
 Weir: H =1ft
 Weir: H =1.5ft
 FULLY CHARGED RISER: ADJUSTED TO WEIR: H =2ft
 FULLY CHARGED RISER: ADJUSTED TO WEIR: H =2.5ft

Subsection: Individual Outlet Curves
Label: Composite Outlet Structure - 1

Return Event: 10 years
Storm Event: CO SPRINGS - 10 Year

RATING TABLE FOR ONE OUTLET TYPE
Structure ID = Riser - 1 (Inlet Box)

Upstream ID = (Pond Water Surface)
Downstream ID = Culvert - 1 (Culvert-Circular)

Message

FULLY CHARGED RISER: ADJUSTED TO WEIR: H = 3ft

Subsection: Individual Outlet Curves
 Label: Composite Outlet Structure - 1

Return Event: 10 years
 Storm Event: CO SPRINGS - 10 Year

RATING TABLE FOR ONE OUTLET TYPE
 Structure ID = Culvert - 1 (Culvert-Circular)

Mannings open channel maximum capacity: 44.43 ft³/s
 Upstream ID = Riser - 1, Orifice - 1
 Downstream ID = Tailwater (Pond Outfall)

Water Surface Elevation (ft)	Device Flow (ft ³ /s)	(into) Headwater Hydraulic Grade Line (ft)	Converge Downstream Hydraulic Grade Line (ft)	Next Downstream Hydraulic Grade Line (ft)	Downstream Hydraulic Grade Line Error (ft)	Convergence Error (ft ³ /s)	Downstream Channel Tailwater (ft)	Tailwater Error (ft)
6,932.00	0.00	0.00	0.00	Free Outfall	0.00	0.00	(N/A)	0.00
6,932.50	0.00	0.00	0.00	Free Outfall	0.00	0.00	(N/A)	0.00
6,933.00	0.00	0.00	0.00	Free Outfall	0.00	0.00	(N/A)	0.00
6,933.50	0.10	6,932.15	Free Outfall	Free Outfall	0.00	0.00	(N/A)	0.00
6,934.00	0.20	6,932.21	Free Outfall	Free Outfall	0.00	0.00	(N/A)	0.00
6,934.50	0.30	6,932.26	Free Outfall	Free Outfall	0.00	0.00	(N/A)	0.00
6,935.00	0.40	6,932.30	Free Outfall	Free Outfall	0.00	0.00	(N/A)	0.00
6,935.50	0.50	6,932.34	Free Outfall	Free Outfall	0.00	0.00	(N/A)	0.00
6,936.00	0.61	6,932.38	Free Outfall	Free Outfall	0.00	0.00	(N/A)	0.00
6,936.50	0.69	6,932.40	Free Outfall	Free Outfall	0.00	0.00	(N/A)	0.00
6,937.00	0.79	6,932.43	Free Outfall	Free Outfall	0.00	0.00	(N/A)	0.00
6,937.50	5.07	6,933.15	Free Outfall	Free Outfall	0.00	0.00	(N/A)	0.00
6,938.00	12.79	6,933.96	Free Outfall	Free Outfall	0.00	0.00	(N/A)	0.00
6,938.50	22.77	6,935.01	Free Outfall	Free Outfall	0.00	0.02	(N/A)	0.00
6,939.00	34.46	6,937.16	Free Outfall	Free Outfall	0.00	0.02	(N/A)	0.00
6,939.50	43.77	6,939.50	Free Outfall	Free Outfall	0.00	3.67	(N/A)	0.00
6,940.00	45.51	6,940.00	Free Outfall	Free Outfall	0.00	16.84	(N/A)	0.00

Message

WS below an invert; no flow.
 WS below an invert; no flow.
 WS below an Invert; no flow.
 CRIT.DEPTH CONTROL Vh= .036ft
 Dcr= .107ft CRIT.DEPTH Hev= .00ft
 FLOW PRECEDENCE SET TO
 UPSTREAM CONTROLLING
 STRUCTURE
 FLOW PRECEDENCE SET TO
 UPSTREAM CONTROLLING
 STRUCTURE
 FLOW PRECEDENCE SET TO
 UPSTREAM CONTROLLING
 STRUCTURE
 CRIT.DEPTH CONTROL Vh= .083ft
 Dcr= .242ft CRIT.DEPTH Hev= .00ft
 FLOW PRECEDENCE SET TO
 UPSTREAM CONTROLLING
 STRUCTURE

Subsection: Individual Outlet Curves
Label: Composite Outlet Structure - 1

Return Event: 10 years
Storm Event: CO SPRINGS - 10 Year

RATING TABLE FOR ONE OUTLET TYPE
Structure ID = Culvert - 1 (Culvert-Circular)

Mannings open channel maximum capacity: 44.43 ft³/s
Upstream ID = Riser - 1, Orifice - 1
Downstream ID = Tailwater (Pond Outfall)

Message

CRIT.DEPTH CONTROL Vh= .099ft Dcr= .286ft CRIT.DEPTH Hev= .00ft CRIT.DEPTH CONTROL Vh= .106ft Dcr= .306ft CRIT.DEPTH Hev= .00ft FLOW PRECEDENCE SET TO UPSTREAM CONTROLLING STRUCTURE CRIT.DEPTH CONTROL Vh= .557ft Dcr= 1.287ft CRIT.DEPTH Hev= .00ft INLET CONTROL... Submerged: HW =3.01 INLET CONTROL... Submerged: HW =5.16 INLET CONTROL... Submerged: HW =7.50 INLET CONTROL... Submerged: HW =8.00
--

Subsection: Individual Outlet Curves
 Label: Composite Outlet Structure - 1

Return Event: 10 years
 Storm Event: CO SPRINGS - 10 Year

RATING TABLE FOR ONE OUTLET TYPE
 Structure ID = Orifice - 1 (Orifice-Area)

Upstream ID = (Pond Water Surface)
 Downstream ID = Culvert - 1 (Culvert-Circular)

Water Surface Elevation (ft)	Device Flow (ft ³ /s)	(Into) Headwater Hydraulic Grade Line (ft)	Converge Downstream Hydraulic Grade Line (ft)	Next Downstream Hydraulic Grade Line (ft)	Downstream Hydraulic Grade Line Error (ft)	Convergence Error (ft ³ /s)	Downstream Channel Tailwater (ft)	Tailwater Error (ft)
6,932.00	0.00	0.00	0.00	0.00	0.00	0.00	(N/A)	0.00
6,932.50	0.00	0.00	0.00	0.00	0.00	0.00	(N/A)	0.00
6,933.00	0.00	0.00	0.00	0.00	0.00	0.00	(N/A)	0.00
6,933.50	0.10	6,933.50	Free Outfall	6,932.15	0.00	0.00	(N/A)	0.00
6,934.00	0.20	6,934.00	Free Outfall	6,932.21	0.00	0.00	(N/A)	0.00
6,934.50	0.30	6,934.50	Free Outfall	6,932.26	0.00	0.00	(N/A)	0.00
6,935.00	0.40	6,935.00	Free Outfall	6,932.30	0.00	0.00	(N/A)	0.00
6,935.50	0.50	6,935.50	Free Outfall	6,932.34	0.00	0.00	(N/A)	0.00
6,936.00	0.60	6,936.00	Free Outfall	6,932.38	0.00	0.00	(N/A)	0.00
6,936.50	0.69	6,936.50	Free Outfall	6,932.40	0.00	0.00	(N/A)	0.00
6,937.00	0.79	6,937.00	Free Outfall	6,932.43	0.00	0.00	(N/A)	0.00
6,937.50	0.83	6,937.50	6,933.15	6,933.15	0.00	0.00	(N/A)	0.00
6,938.00	0.80	6,938.00	6,933.96	6,933.96	0.00	0.00	(N/A)	0.00
6,938.50	0.74	6,938.50	6,935.01	6,935.01	0.00	0.00	(N/A)	0.00
6,939.00	0.54	6,939.00	6,937.16	6,937.16	0.00	0.00	(N/A)	0.00
6,939.50	0.00	6,939.50	6,939.50	6,939.50	0.00	0.00	(N/A)	0.00
6,940.00	0.00	6,940.00	6,940.00	6,940.00	0.00	0.00	(N/A)	0.00

Message

WS below an invert; no flow.
 WS below an invert; no flow.
 WS below an invert; no flow.
 HI=.50; Ht=4.00; Qt=.07
 HI=1.00; Ht=4.00; Qt=.07
 HI=1.50; Ht=4.00; Qt=.07
 HI=2.00; Ht=4.00; Qt=.07
 HI=2.50; Ht=4.00; Qt=.07
 HI=3.00; Ht=4.00; Qt=.07
 HI=3.50; Ht=4.00; Qt=.07
 H =4.00
 H =4.35
 H =4.04
 H =3.49
 H =1.84
 FLOW PRECEDENCE SET TO
 DOWNSTREAM CONTROLLING
 STRUCTURE

Subsection: Individual Outlet Curves
Label: Composite Outlet Structure - 1

Return Event: 10 years
Storm Event: CO SPRINGS - 10 Year

RATING TABLE FOR ONE OUTLET TYPE
Structure ID = Orifice - 1 (Orifice-Area)

Upstream ID = (Pond Water Surface)
Downstream ID = Culvert - 1 (Culvert-Circular)

Message

FLOW PRECEDENCE SET TO
DOWNSTREAM CONTROLLING
STRUCTURE

Subsection: Modified Rational Graph
 Label: Basins

Return Event: 10 years
 Storm Event: CO SPRINGS - 10 Year

Method Type	Method T
Time of Duration (Modified Rational, Critical)	0.383 hours

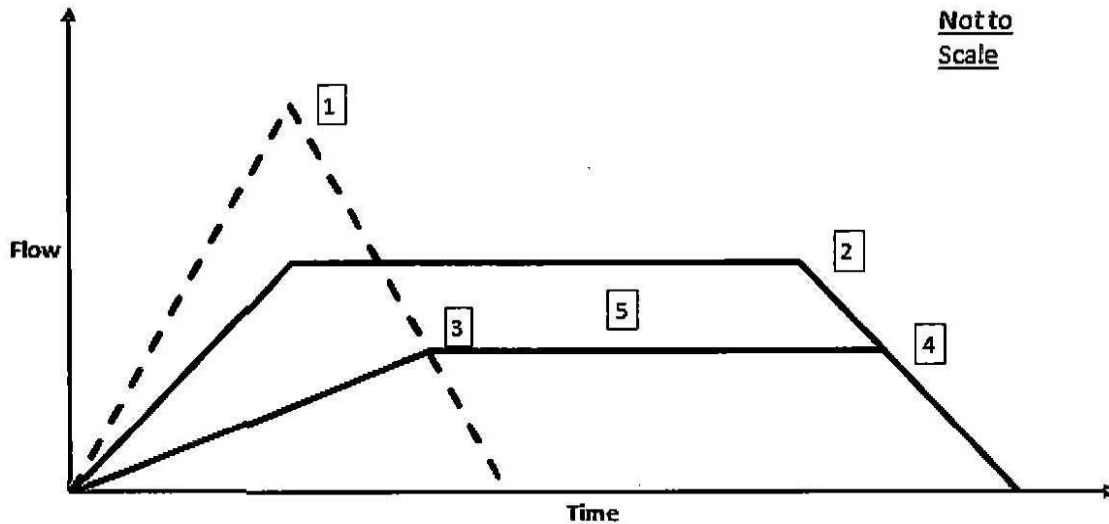

[1]		[2]			
Time of Concentration (Modified Rational, Composite)	0.288	hours	Time of Duration (Modified Rational, Critical)	0.383	hours
Intensity (Modified Rational, Peak)	3.801	in/h	Intensity (Modified Rational, Critical)	3.286	in/h
Flow (Modified Rational, Peak)	25.96	ft ³ /s	Flow (Modified Rational, Critical)	22.45	ft ³ /s

[3]	
First Outflow Breakpoint (Modified Rational, Method T)	0.518 hours
Flow (Modified Rational, Allowable)	12.00 ft ³ /s

[4]		[5]			
Second Outflow Breakpoint (Modified Rational)	0.443	hours	Storage (Modified Rational, Estimated)	0.341	ac-ft
Flow (Modified Rational, Allowable)	12.00	ft ³ /s			

Index

B

Basins (Modified Rational Graph, 10 years)...19

C

CO SPRINGS (I-D-F Table, 10 years)...3

Composite Outlet Structure - 1 (Individual Outlet Curves, 10 years)...9, 10, 11, 12, 13, 14

Composite Outlet Structure - 1 (Outlet Input Data, 10 years)...5, 6, 7, 8

M

Master Network Summary...2

P

Pond 1 (Elevation-Area Volume Curve, 10 years)...4

Pond 1 (IN) (Pond Inflow Summary, 10 years)...18

Pond 1 (OUT) (Pond Routed Hydrograph (total out), 10 years)...15, 16, 17

Project Summary

Title	BENT GRASS RESIDENTIAL FILING NO.1
Engineer	MAW
Company	CLASSIC CONSULTING
Date	7/10/2014

Notes	POND 1 100 YEAR
-------	--------------------

Table of Contents

	Master Network Summary	2
CO SPRINGS	I-D-F Table, 100 years	3
Pond 1	Elevation-Area Volume Curve, 100 years	4
Composite Outlet Structure - 1		
	Outlet Input Data, 100 years	5
	Individual Outlet Curves, 100 years	9
Pond 1 (OUT)		
	Pond Routed Hydrograph (total out), 100 years	15
Pond 1 (IN)		
	Pond Inflow Summary, 100 years	18
Basins	Modified Rational Graph, 100 years	19

Subsection: Master Network Summary

Catchments Summary

Label	Scenario	Return Event (years)	Hydrograph Volume (ac-ft)	Time to Peak (hours)	Peak Flow (ft ³ /s)
Basins	Post-Development 100 Year	100	1.657	0.300	28.64

Node Summary

Label	Scenario	Return Event (years)	Hydrograph Volume (ac-ft)	Time to Peak (hours)	Peak Flow (ft ³ /s)
O-1	Post-Development 100 Year	100	1.305	0.900	6.77

Pond Summary

Label	Scenario	Return Event (years)	Hydrograph Volume (ac-ft)	Time to Peak (hours)	Peak Flow (ft ³ /s)	Maximum Water Surface Elevation (ft)	Maximum Pond Storage (ac-ft)
Pond 1 (IN)	Post-Development 100 Year	100	1.657	0.300	28.64	(N/A)	(N/A)
Pond 1 (OUT)	Post-Development 100 Year	100	1.305	0.900	6.77	6,937.61	1.525

Subsection: I-D-F Table
Label: CO SPRINGS

Return Event: 100 years
Storm Event: CO SPRINGS - 100 Year

I-D-F Curve

Time (hours)	Intensity (in/h)
0.083	9.070
0.167	7.290
0.250	6.160
0.333	5.360
0.417	4.770
0.500	4.310
0.583	3.940
0.667	3.630
0.750	3.380
0.833	3.160
0.917	2.980
1.000	2.810

Subsection: Elevation-Area Volume Curve
Label: Pond 1

Return Event: 100 years
Storm Event: CO SPRINGS - 100 Year

Elevation (ft)	Planimeter (ft ²)	Area (acres)	A1+A2+sq (A1*A2) (acres)	Volume (ac-ft)	Volume (Total) (ac-ft)
6,932.00	0.0	0.005	0.000	0.000	0.000
6,934.00	0.0	0.292	0.335	0.223	0.223
6,936.00	0.0	0.367	0.986	0.658	0.881
6,938.00	0.0	0.451	1.225	0.817	1.698
6,940.00	0.0	0.545	1.492	0.995	2.692

Subsection: Outlet Input Data
 Label: Composite Outlet Structure - 1

Return Event: 100 years
 Storm Event: CO SPRINGS - 100 Year

Requested Pond Water Surface Elevations	
Minimum (Headwater)	6,932.00 ft
Increment (Headwater)	0.50 ft
Maximum (Headwater)	6,940.00 ft

Outlet Connectivity

Structure Type	Outlet ID	Direction	Outfall	E1 (ft)	E2 (ft)
Inlet Box	Riser - 1	Forward	Culvert - 1	6,937.00	6,940.00
Orifice-Area	Orifice - 1	Forward	Culvert - 1	6,933.00	6,940.00
Culvert-Circular	Culvert - 1	Forward	TW	6,932.00	6,940.00
Tailwater Settings	Tailwater			(N/A)	(N/A)

Subsection: Outlet Input Data
Label: Composite Outlet Structure - 1

Return Event: 100 years
Storm Event: CO SPRINGS - 100 Year

Structure ID: Riser - 1	
Structure Type: Inlet Box	
<hr/>	
Number of Openings	1
Elevation	6,937.00 ft
Orifice Area	10.2 ft ²
Orifice Coefficient	0.600
Weir Length	4.00 ft
Weir Coefficient	3.00 (ft ^{0.5})/s
K Reverse	1.000
Manning's n	0.000
Kev, Charged Riser	0.000
Weir Submergence	False
Orifice H to crest	False

Subsection: Outlet Input Data
 Label: Composite Outlet Structure - 1

Return Event: 100 years
 Storm Event: CO SPRINGS - 100 Year

Structure ID: Culvert - 1	
Structure Type: Culvert-Circular	
Number of Barrels	1
Diameter	24.0 In
Length	60.00 ft
Length (Computed Barrel)	60.03 ft
Slope (Computed)	0.033 ft/ft
Outlet Control Data	
Manning's n	0.013
Ke	0.200
Kb	0.012
Kr	0.000
Convergence Tolerance	0.00 ft
Inlet Control Data	
Equation Form	Form 1
K	0.0045
M	2.0000
C	0.0317
Y	0.6900
T1 ratio (HW/D)	1.079
T2 ratio (HW/D)	1.181
Slope Correction Factor	-0.500

Use unsubmerged inlet control 0 equation below T1 elevation.
 Use submerged inlet control 0 equation above T2 elevation

In transition zone between unsubmerged and submerged inlet control, interpolate between flows at T1 & T2...

T1 Elevation	6,934.16 ft	T1 Flow	15.55 ft ³ /s
T2 Elevation	6,934.36 ft	T2 Flow	17.77 ft ³ /s

Subsection: Outlet Input Data
Label: Composite Outlet Structure - 1

Return Event: 100 years
Storm Event: CO SPRINGS - 100 Year

Structure ID: Orifice - 1	
Structure Type: Orifice-Area	
Number of Openings	12
Elevation	6,933.00 ft
Orifice Area	0.0 ft ²
Top Elevation	6,937.00 ft
Datum Elevation	6,933.00 ft
Orifice Coefficient	0.600
Structure ID: TW	
Structure Type: TW Setup, DS Channel	
Tailwater Type	Free Outfall
Convergence Tolerances	
Maximum Iterations	30
Tailwater Tolerance (Minimum)	0.01 ft
Tailwater Tolerance (Maximum)	0.50 ft
Headwater Tolerance (Minimum)	0.01 ft
Headwater Tolerance (Maximum)	0.50 ft
Flow Tolerance (Minimum)	0.001 ft ³ /s
Flow Tolerance (Maximum)	10.000 ft ³ /s

Subsection: Individual Outlet Curves
 Label: Composite Outlet Structure - 1

Return Event: 100 years
 Storm Event: CO SPRINGS - 100 Year

RATING TABLE FOR ONE OUTLET TYPE
 Structure ID = Riser - 1 (Inlet Box)

Upstream ID = (Pond Water Surface)
 Downstream ID = Culvert - 1 (Culvert-Circular)

Water Surface Elevation (ft)	Device Flow (ft ³ /s)	(into) Headwater Hydraulic Grade Line (ft)	Converge Downstream Hydraulic Grade Line (ft)	Next Downstream Hydraulic Grade Line (ft)	Downstream Hydraulic Grade Line Error (ft)	Convergence Error (ft ³ /s)	Downstream Channel Tailwater (ft)	Tailwater Error (ft)
6,932.00	0.00	0.00	0.00	0.00	0.00	0.00	(N/A)	0.00
6,932.50	0.00	0.00	0.00	0.00	0.00	0.00	(N/A)	0.00
6,933.00	0.00	0.00	0.00	0.00	0.00	0.00	(N/A)	0.00
6,933.50	0.00	0.00	0.00	6,932.15	0.00	0.00	(N/A)	0.00
6,934.00	0.00	0.00	0.00	6,932.21	0.00	0.00	(N/A)	0.00
6,934.50	0.00	0.00	0.00	6,932.26	0.00	0.00	(N/A)	0.00
6,935.00	0.00	0.00	0.00	6,932.30	0.00	0.00	(N/A)	0.00
6,935.50	0.00	0.00	0.00	6,932.34	0.00	0.00	(N/A)	0.00
6,936.00	0.00	0.00	0.00	6,932.38	0.00	0.00	(N/A)	0.00
6,936.50	0.00	0.00	0.00	6,932.40	0.00	0.00	(N/A)	0.00
6,937.00	0.00	0.00	0.00	6,932.43	0.00	0.00	(N/A)	0.00
6,937.50	4.24	6,937.50	Free Outfall	6,933.15	0.00	0.00	(N/A)	0.00
6,938.00	12.00	6,938.00	Free Outfall	6,933.96	0.00	0.00	(N/A)	0.00
6,938.50	22.05	6,938.50	Free Outfall	6,935.01	0.00	0.00	(N/A)	0.00
6,939.00	33.94	6,939.00	6,937.16	6,937.16	0.00	0.00	(N/A)	0.00
6,939.50	47.43	6,939.50	6,939.50	6,939.50	0.00	0.00	(N/A)	0.00
6,940.00	62.35	6,940.00	6,940.00	6,940.00	0.00	0.00	(N/A)	0.00

Message

WS below an invert; no flow.
 WS below an invert; no flow.
 WS below an invert; no flow.
 WS below an invert; no flow.
 WS below an invert; no flow.
 WS below an invert; no flow.
 WS below an invert; no flow.
 WS below an invert; no flow.
 WS below an invert; no flow.
 WS below an invert; no flow.
 WS below an invert; no flow.
 Weir: H =0.5ft
 Weir: H =1ft
 Weir: H =1.5ft
 FULLY CHARGED RISER: ADJUSTED TO WEIR: H =2ft
 FULLY CHARGED RISER: ADJUSTED TO WEIR: H =2.5ft

Subsection: Individual Outlet Curves
Label: Composite Outlet Structure - 1

Return Event: 100 years
Storm Event: CO SPRINGS - 100 Year

RATING TABLE FOR ONE OUTLET TYPE
Structure ID = Riser - 1 (Inlet Box)

Upstream ID = (Pond Water Surface)
Downstream ID = Culvert - 1 (Culvert-Circular)

Message

FULLY CHARGED RISER: ADJUSTED TO WEIR: H =3ft
--

Subsection: Individual Outlet Curves
 Label: Composite Outlet Structure - 1

Return Event: 100 years
 Storm Event: CO SPRINGS - 100 Year

RATING TABLE FOR ONE OUTLET TYPE
 Structure ID = Culvert - 1 (Culvert-Circular)

Mannings open channel maximum capacity: 44.43 ft³/s
 Upstream ID = Riser - 1, Orifice - 1
 Downstream ID = Tailwater (Pond Outfall)

Water Surface Elevation (ft)	Device Flow (ft ³ /s)	(into) Headwater Hydraulic Grade Line (ft)	Converge Downstream Hydraulic Grade Line (ft)	Next Downstream Hydraulic Grade Line (ft)	Downstream Hydraulic Grade Line Error (ft)	Convergence Error (ft ³ /s)	Downstream Channel Tailwater (ft)	Tailwater Error (ft)
6,932.00	0.00	0.00	0.00	Free Outfall	0.00	0.00	(N/A)	0.00
6,932.50	0.00	0.00	0.00	Free Outfall	0.00	0.00	(N/A)	0.00
6,933.00	0.00	0.00	0.00	Free Outfall	0.00	0.00	(N/A)	0.00
6,933.50	0.10	6,932.15	Free Outfall	Free Outfall	0.00	0.00	(N/A)	0.00
6,934.00	0.20	6,932.21	Free Outfall	Free Outfall	0.00	0.00	(N/A)	0.00
6,934.50	0.30	6,932.26	Free Outfall	Free Outfall	0.00	0.00	(N/A)	0.00
6,935.00	0.40	6,932.30	Free Outfall	Free Outfall	0.00	0.00	(N/A)	0.00
6,935.50	0.50	6,932.34	Free Outfall	Free Outfall	0.00	0.00	(N/A)	0.00
6,936.00	0.61	6,932.38	Free Outfall	Free Outfall	0.00	0.00	(N/A)	0.00
6,936.50	0.69	6,932.40	Free Outfall	Free Outfall	0.00	0.00	(N/A)	0.00
6,937.00	0.79	6,932.43	Free Outfall	Free Outfall	0.00	0.00	(N/A)	0.00
6,937.50	5.07	6,933.15	Free Outfall	Free Outfall	0.00	0.00	(N/A)	0.00
6,938.00	12.79	6,933.96	Free Outfall	Free Outfall	0.00	0.00	(N/A)	0.00
6,938.50	22.77	6,935.01	Free Outfall	Free Outfall	0.00	0.02	(N/A)	0.00
6,939.00	34.46	6,937.16	Free Outfall	Free Outfall	0.00	0.02	(N/A)	0.00
6,939.50	43.77	6,939.50	Free Outfall	Free Outfall	0.00	3.67	(N/A)	0.00
6,940.00	45.51	6,940.00	Free Outfall	Free Outfall	0.00	16.84	(N/A)	0.00

Message

WS below an invert; no flow.
 WS below an invert; no flow.
 WS below an invert; no flow.
 CRIT.DEPTH CONTROL Vh= .036ft
 Dcr= .107ft CRIT.DEPTH Hev= .00ft
 FLOW PRECEDENCE SET TO
 UPSTREAM CONTROLLING
 STRUCTURE
 FLOW PRECEDENCE SET TO
 UPSTREAM CONTROLLING
 STRUCTURE
 FLOW PRECEDENCE SET TO
 UPSTREAM CONTROLLING
 STRUCTURE
 CRIT.DEPTH CONTROL Vh= .083ft
 Dcr= .242ft CRIT.DEPTH Hev= .00ft
 FLOW PRECEDENCE SET TO
 UPSTREAM CONTROLLING
 STRUCTURE

Subsection: Individual Outlet Curves
Label: Composite Outlet Structure - 1

Return Event: 100 years
Storm Event: CO SPRINGS - 100 Year

RATING TABLE FOR ONE OUTLET TYPE
Structure ID = Culvert - 1 (Culvert-Circular)

Mannings open channel maximum capacity: 44.43 ft³/s
Upstream ID = Riser - 1, Orifice - 1
Downstream ID = Tailwater (Pond Outfall)

Message

CRIT.DEPTH CONTROL Vh= .099ft Dcr= .286ft CRIT.DEPTH Hev= .00ft CRIT.DEPTH CONTROL Vh= .106ft Dcr= .306ft CRIT.DEPTH Hev= .00ft FLOW PRECEDENCE SET TO UPSTREAM CONTROLLING STRUCTURE CRIT.DEPTH CONTROL Vh= .557ft Dcr= 1.287ft CRIT.DEPTH Hev= .00ft INLET CONTROL... Submerged: HW =3.01 INLET CONTROL... Submerged: HW =5.16 INLET CONTROL... Submerged: HW =7.50 INLET CONTROL... Submerged: HW =8.00
--

Subsection: Individual Outlet Curves
 Label: Composite Outlet Structure - 1

Return Event: 100 years
 Storm Event: CO SPRINGS - 100 Year

RATING TABLE FOR ONE OUTLET TYPE
 Structure ID = Orifice - 1 (Orifice-Area)

Upstream ID = (Pond Water Surface)
 Downstream ID = Culvert - 1 (Culvert-Circular)

Water Surface Elevation (ft)	Device Flow (ft ³ /s)	(into) Headwater Hydraulic Grade Line (ft)	Converge Downstream Hydraulic Grade Line (ft)	Next Downstream Hydraulic Grade Line (ft)	Downstream Hydraulic Grade Line Error (ft)	Convergence Error (ft ³ /s)	Downstream Channel Tailwater (ft)	Tailwater Error (ft)
6,932.00	0.00	0.00	0.00	0.00	0.00	0.00	(N/A)	0.00
6,932.50	0.00	0.00	0.00	0.00	0.00	0.00	(N/A)	0.00
6,933.00	0.00	0.00	0.00	0.00	0.00	0.00	(N/A)	0.00
6,933.50	0.10	6,933.50	Free Outfall	6,932.15	0.00	0.00	(N/A)	0.00
6,934.00	0.20	6,934.00	Free Outfall	6,932.21	0.00	0.00	(N/A)	0.00
6,934.50	0.30	6,934.50	Free Outfall	6,932.26	0.00	0.00	(N/A)	0.00
6,935.00	0.40	6,935.00	Free Outfall	6,932.30	0.00	0.00	(N/A)	0.00
6,935.50	0.50	6,935.50	Free Outfall	6,932.34	0.00	0.00	(N/A)	0.00
6,936.00	0.60	6,936.00	Free Outfall	6,932.38	0.00	0.00	(N/A)	0.00
6,936.50	0.69	6,936.50	Free Outfall	6,932.40	0.00	0.00	(N/A)	0.00
6,937.00	0.79	6,937.00	Free Outfall	6,932.43	0.00	0.00	(N/A)	0.00
6,937.50	0.83	6,937.50	6,933.15	6,933.15	0.00	0.00	(N/A)	0.00
6,938.00	0.80	6,938.00	6,933.96	6,933.96	0.00	0.00	(N/A)	0.00
6,938.50	0.74	6,938.50	6,935.01	6,935.01	0.00	0.00	(N/A)	0.00
6,939.00	0.54	6,939.00	6,937.16	6,937.16	0.00	0.00	(N/A)	0.00
6,939.50	0.00	6,939.50	6,939.50	6,939.50	0.00	0.00	(N/A)	0.00
6,940.00	0.00	6,940.00	6,940.00	6,940.00	0.00	0.00	(N/A)	0.00

Message

WS below an invert; no flow.
 WS below an invert; no flow.
 WS below an invert; no flow.
 Hi=.50; Ht=4.00; Qt=.07
 Hi=1.00; Ht=4.00; Qt=.07
 Hi=1.50; Ht=4.00; Qt=.07
 Hi=2.00; Ht=4.00; Qt=.07
 Hi=2.50; Ht=4.00; Qt=.07
 Hi=3.00; Ht=4.00; Qt=.07
 Hi=3.50; Ht=4.00; Qt=.07
 H =4.00
 H =4.35
 H =4.04
 H =3.49
 H =1.84
 FLOW PRECEDENCE SET TO
 DOWNSTREAM CONTROLLING
 STRUCTURE

Subsection: Individual Outlet Curves
Label: Composite Outlet Structure - 1

Return Event: 100 years
Storm Event: CO SPRINGS - 100 Year

RATING TABLE FOR ONE OUTLET TYPE
Structure ID = Orifice - 1 (Orifice-Area)

Upstream ID = (Pond Water Surface)
Downstream ID = Culvert - 1 (Culvert-Circular)

Message

FLOW PRECEDENCE SET TO
DOWNSTREAM CONTROLLING
STRUCTURE

Subsection: Modified Rational Graph
 Label: Basins

Return Event: 100 years
 Storm Event: CO SPRINGS - 100 Year

Method Type	Method T
Time of Duration (Modified Rational, Critical)	0.700 hours

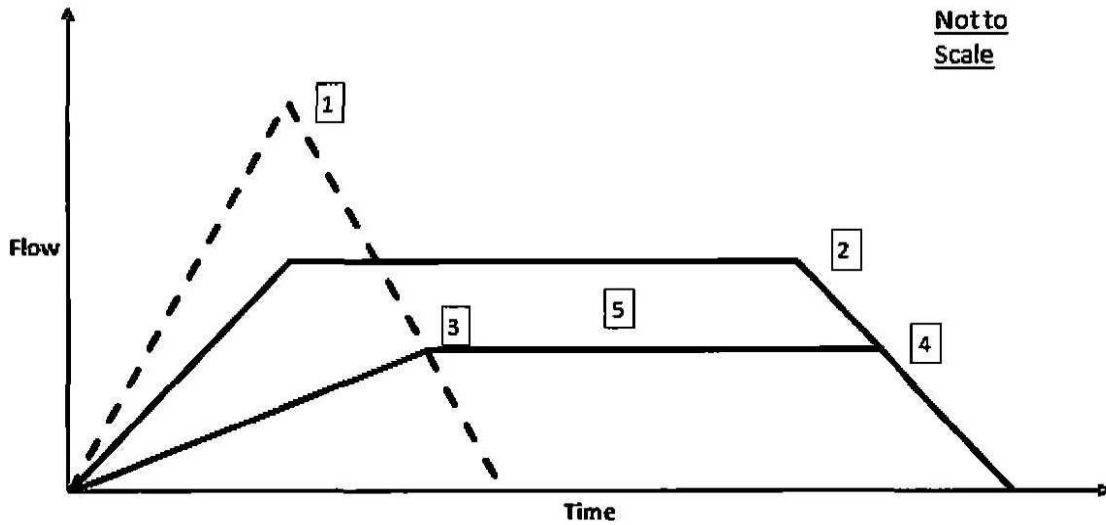

[1]		[2]	
Time of Concentration (Modified Rational, Composite)	0.288 hours	Time of Duration (Modified Rational, Critical)	0.700 hours
Intensity (Modified Rational, Peak)	5.792 in/h	Intensity (Modified Rational, Critical)	3.530 in/h
Flow (Modified Rational, Peak)	46.99 ft ³ /s	Flow (Modified Rational, Critical)	28.64 ft ³ /s

[3]	
First Outflow Breakpoint (Modified Rational, Method T)	0.867 hours
Flow (Modified Rational, Allowable)	12.00 ft ³ /s

[4]		[5]	
Second Outflow Breakpoint (Modified Rational)	0.503 hours	Storage (Modified Rational, Estimated)	0.986 ac-ft
Flow (Modified Rational, Allowable)	12.00 ft ³ /s		

Index

B

Basins (Modified Rational Graph, 100 years)...19

C

CO SPRINGS (I-D-F Table, 100 years)...3

Composite Outlet Structure - 1 (Individual Outlet Curves, 100 years)...9, 10, 11, 12, 13, 14

Composite Outlet Structure - 1 (Outlet Input Data, 100 years)...5, 6, 7, 8

M

Master Network Summary...2

P

Pond 1 (Elevation-Area Volume Curve, 100 years)...4

Pond 1 (IN) (Pond Inflow Summary, 100 years)...18

Pond 1 (OUT) (Pond Routed Hydrograph (total out), 100 years)...15, 16, 17

APPENDIX B
Hydrologic Computations

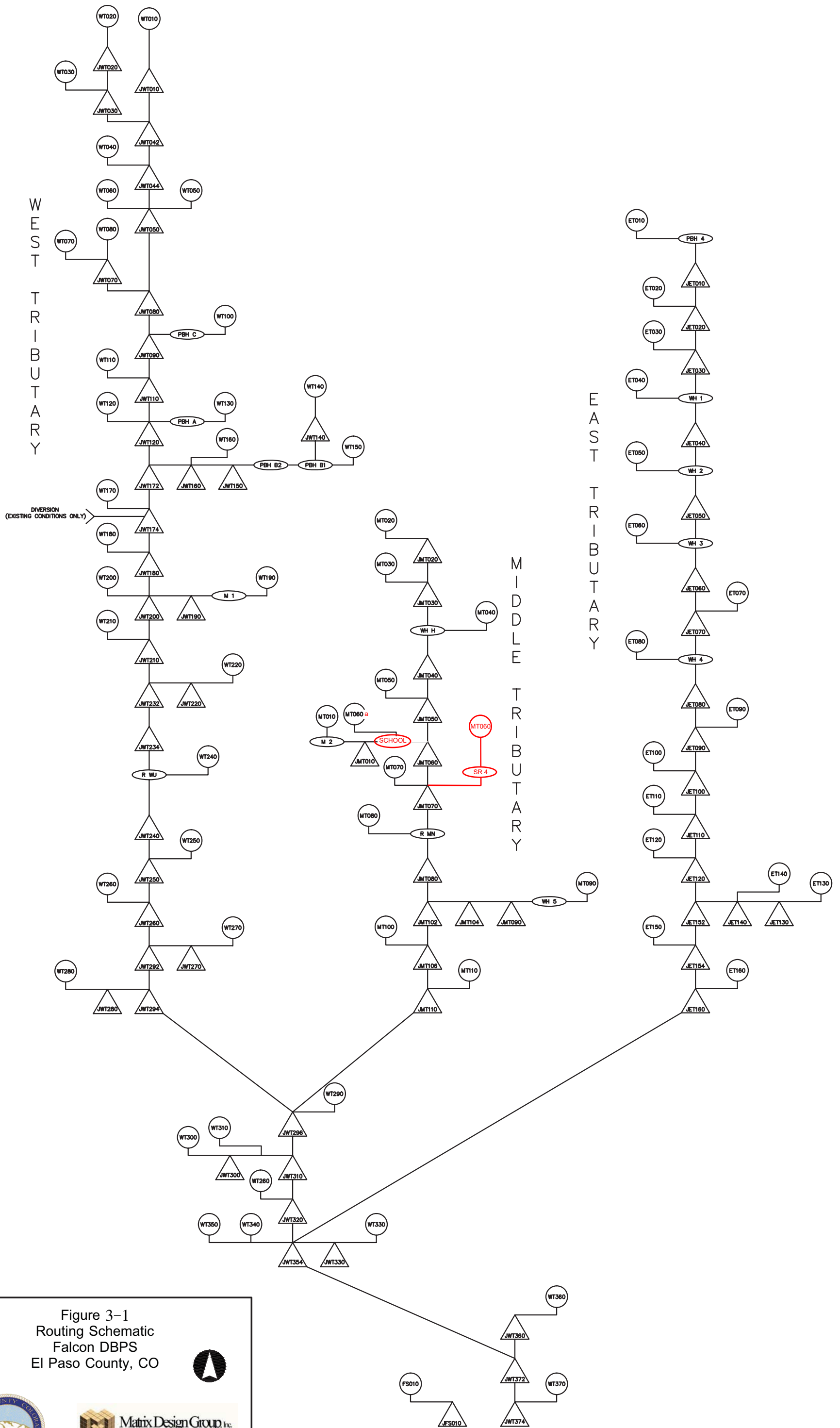

Figure 3-1
Routing Schematic
Falcon DBPS
El Paso County, CO



DRAWING NOT TO SCALE

Current HMS Model

Add label - Future 100-year storm

HEC-HMS 3.5 [H:\Challenger Homes Inc\CO, El Paso County-CLH000017-Bent Grass West\PU.D...

Hydrologic Element	Drainage Area (MI2)	Peak Discharge (CFS)	Time of Peak	Volume (AC-FT)
WT020	0.0671383	41.9	01Jan2011, 06:21	4.8
JWT020	0.0671383	41.9	01Jan2011, 06:21	4.8
RWT030	0.0671383	41.9	01Jan2011, 06:29	4.8
WT030	0.0764732	75.3	01Jan2011, 06:07	5.5
JWT030	0.1436115	85.4	01Jan2011, 06:09	10.3
RWT042	0.1436115	85.3	01Jan2011, 06:15	10.3
WT010	0.1353300	88.9	01Jan2011, 06:17	9.3
JWT010	0.1353300	88.9	01Jan2011, 06:17	9.3
RWT044	0.1353300	88.8	01Jan2011, 06:24	9.3
JWT042	0.2789415	167.0	01Jan2011, 06:21	19.6
RWT046	0.2789415	166.7	01Jan2011, 06:28	19.6
WT040	0.1850600	92.7	01Jan2011, 06:28	12.8
JWT044	0.4640015	259.4	01Jan2011, 06:28	32.4
RWT054	0.4640015	258.8	01Jan2011, 06:35	32.3
WT060	0.1956300	116.8	01Jan2011, 06:26	15.1
WT050	0.1899300	139.4	01Jan2011, 06:19	15.3
JWT050	0.8495615	475.4	01Jan2011, 06:31	62.7
RWT092	0.8495615	475.2	01Jan2011, 06:32	62.7
WT070	0.1711000	133.9	01Jan2011, 06:12	11.8
JWT070	0.1711000	133.9	01Jan2011, 06:12	11.8
RWT080	0.1711000	133.4	01Jan2011, 06:22	11.8
WT080	0.0691596	67.3	01Jan2011, 06:10	5.6
Sub Regional Pond SR1	1.0898211	513.2	01Jan2011, 06:40	78.4
JWT080	1.0898211	513.2	01Jan2011, 06:40	78.4
RWT094	1.0898211	512.4	01Jan2011, 06:45	78.3
WT100-REV	0.1292700	203.0	01Jan2011, 06:04	12.9
W26-REV	0.0720000	103.6	01Jan2011, 06:03	6.4
WS3-1	0.0720000	102.8	01Jan2011, 06:10	6.4
Paint Brush Hills Pond C	0.2012700	64.4	01Jan2011, 06:26	19.2
WT090	0.1533300	162.4	01Jan2011, 06:09	12.8
JWT090	1.4444211	595.9	01Jan2011, 06:44	110.2
RWT122	1.4444211	595.5	01Jan2011, 06:45	110.2
WT110	0.1942800	169.9	01Jan2011, 06:14	16.2
JWT110	1.6387011	651.0	01Jan2011, 06:43	126.4
RWT124	1.6387011	650.8	01Jan2011, 06:47	126.3
WT130-REV	0.1016250	130.0	01Jan2011, 06:11	10.9
Paint Brush Hills Pond A	0.1016250	53.8	01Jan2011, 06:32	10.9
WT120-REV	0.0430300	51.1	01Jan2011, 06:08	3.8
JWT120	1.7833561	703.6	01Jan2011, 06:46	140.9

Hydrologic Element	Drainage Area (MI ²)	Peak Discharge (CFS)	Time of Peak	Volume (AC-FT)
RWT172	1.7833561	702.5	01Jan2011, 06:58	140.5
WT140-REV	0.1445300	194.2	01Jan2011, 06:12	16.8
JWT140	0.1445300	194.2	01Jan2011, 06:12	16.8
RWT150	0.1445300	193.3	01Jan2011, 06:22	16.8
WT150-REV	0.1308100	202.5	01Jan2011, 06:08	15.0
Paint Brush Hills Pond B1	0.2753400	235.6	01Jan2011, 06:29	31.8
W34B2-REV	0.0935900	141.8	01Jan2011, 06:07	10.2
Paint Brush Hills Pond B2	0.3689300	234.3	01Jan2011, 06:43	38.9
JWT150	0.3689300	234.3	01Jan2011, 06:43	38.9
RWT160	0.3689300	234.2	01Jan2011, 06:49	38.8
WT160-REV	0.0734800	109.9	01Jan2011, 06:06	7.5
JWT160	0.4424100	244.8	01Jan2011, 06:48	46.3
RWT174	0.4424100	244.7	01Jan2011, 06:56	46.2
WT170-REV	0.1060150	85.2	01Jan2011, 06:19	9.2
W34-CY-REV	0.0465469	38.1	01Jan2011, 06:16	3.8
JWT172	2.3783280	981.9	01Jan2011, 06:56	199.7
RWT176	2.3783280	981.6	01Jan2011, 06:57	199.7
Sub Regional Pond SR2	2.3783280	972.9	01Jan2011, 07:01	194.8
JWT174	2.3783280	972.9	01Jan2011, 07:01	194.8
RWT180	2.3783280	972.1	01Jan2011, 07:10	194.2
WT180-REV	0.0409400	29.3	01Jan2011, 06:19	3.2
JWT180	2.4192680	978.0	01Jan2011, 07:10	197.4
RWT202	2.4192680	977.3	01Jan2011, 07:21	196.8
WT200	0.3017100	186.8	01Jan2011, 06:30	26.0
WT190	0.0574561	74.7	01Jan2011, 06:05	5.0
The Meadows Pond #1	0.0574561	2.1	01Jan2011, 08:29	2.8
JWT190	0.0574561	2.1	01Jan2011, 08:29	2.8
RWT204	0.0574561	2.1	01Jan2011, 08:55	2.7
JWT200	2.7784341	1041.0	01Jan2011, 07:19	225.5
RWT210	2.7784341	1040.5	01Jan2011, 07:24	225.1
WT210	0.2654600	187.9	01Jan2011, 06:35	28.0
JWT210	3.0438941	1113.0	01Jan2011, 07:23	253.1
RWT232	3.0438941	1112.6	01Jan2011, 07:27	252.7
WT220	0.1895300	250.4	01Jan2011, 06:12	21.3
JWT220	0.1895300	250.4	01Jan2011, 06:12	21.3
RWT234	0.1895300	249.6	01Jan2011, 06:20	21.3
JWT232	3.2334241	1138.4	01Jan2011, 07:26	274.0
RWT236	3.2334241	1138.3	01Jan2011, 07:26	274.0
WT230	0.1981800	346.7	01Jan2011, 06:05	23.1
JWT234	3.4316041	1155.6	01Jan2011, 07:26	297.0



Hydrologic Element	Drainage Area (MI2)	Peak Discharge (CFS)	Time of Peak	Volume (AC-FT)
RWT240	3.4316041	1155.0	01Jan2011, 07:29	296.8
WT240	0.0761461	160.3	01Jan2011, 06:01	9.1
Regional Pond WU North	3.5077502	1160.9	01Jan2011, 07:30	304.7
Regional Pond WU Dive...	3.5077502	1122.2	01Jan2011, 07:30	261.4
Old Meridian	0.0335900	85.0	01Jan2011, 06:07	6.1
RWT-OM	0.0335900	84.2	01Jan2011, 06:12	6.1
Regional Pond WU South	3.5413402	997.3	01Jan2011, 07:47	255.2
RWT240_Diversion Reach	0.0000000	38.8	01Jan2011, 07:35	43.1
JWT240	3.5413402	1036.0	01Jan2011, 07:47	298.4
RWT250	3.5413402	1035.7	01Jan2011, 07:48	298.3
WT250	0.1469500	291.4	01Jan2011, 06:02	17.1
JWT250	3.6882902	1048.0	01Jan2011, 07:48	315.4
RWT260	3.6882902	1047.5	01Jan2011, 07:58	314.3
WT260	0.1388002	77.5	01Jan2011, 06:34	11.5
JWT260	3.8270904	1061.8	01Jan2011, 07:58	325.9
RWT291	3.8270904	1061.7	01Jan2011, 08:00	325.6
WT270	0.0324738	57.1	01Jan2011, 06:04	3.6
JWT270	0.0324738	57.1	01Jan2011, 06:04	3.6
RWT292	0.0324738	56.9	01Jan2011, 06:08	3.5
JWT292	3.8595642	1064.3	01Jan2011, 08:00	329.2
RWT295	3.8595642	1064.2	01Jan2011, 08:01	329.0
WT280	0.2669500	251.8	01Jan2011, 06:12	22.3
JWT280	0.2669500	251.8	01Jan2011, 06:12	22.3
RWT294	0.2669500	251.2	01Jan2011, 06:15	22.2
JWT294	4.1265142	1082.0	01Jan2011, 08:01	351.3
RWT296	4.1265142	1081.4	01Jan2011, 08:07	350.6
MT040	0.3084200	455.2	01Jan2011, 06:11	38.1
MT030	0.1566300	228.6	01Jan2011, 06:05	15.1
MT020	0.0902033	143.1	01Jan2011, 06:04	9.0
JMT020	0.0902033	143.1	01Jan2011, 06:04	9.0
RMT030	0.0902033	141.8	01Jan2011, 06:17	8.9
JMT030	0.2468333	294.4	01Jan2011, 06:07	24.0
RMT040	0.2468333	293.0	01Jan2011, 06:11	24.0
Woodmen Hills Pond H	0.5552533	751.7	01Jan2011, 06:11	61.7
JMT040	0.5552533	751.7	01Jan2011, 06:11	61.7
RMT050	0.5552533	745.8	01Jan2011, 06:14	61.7
MT010	0.2898900	139.9	01Jan2011, 06:24	17.7
The Meadows Pond #2	0.2898900	72.6	01Jan2011, 06:51	14.4
JMT010	0.2898900	72.6	01Jan2011, 06:51	14.4
RMT062	0.2898900	72.5	01Jan2011, 07:02	14.4



Hydrologic Element	Drainage Area (MI ²)	Peak Discharge (CFS)	Time of Peak	Volume (AC-FT)
MT060a	0.0311000	48.5	01Jan2011, 06:03	2.9
School Site	0.3209900	70.2	01Jan2011, 07:12	15.9
JMT060a	0.3209900	70.2	01Jan2011, 07:12	15.9
RMT060a	0.3209900	70.2	01Jan2011, 07:17	15.8
MT050	0.1186100	109.7	01Jan2011, 06:18	11.4
JMT050	0.9948533	852.0	01Jan2011, 06:14	88.9
RMT064	0.9948533	847.2	01Jan2011, 06:21	88.8
MT060	0.1588000	196.8	01Jan2011, 06:08	14.7
Sub Regional Pond SR4	1.1536533	612.5	01Jan2011, 06:38	89.3
JMT060	1.1536533	612.5	01Jan2011, 06:38	89.3
RMT070	1.1536533	609.7	01Jan2011, 06:44	89.1
MT070	0.1994800	170.2	01Jan2011, 06:22	19.6
JMT070	1.3531333	715.5	01Jan2011, 06:42	108.7
RMT080	1.3531333	714.6	01Jan2011, 06:44	108.7
MT080	0.0638371	191.9	01Jan2011, 06:00	11.0
Regional Pond MN	1.4169704	691.1	01Jan2011, 06:49	117.1
JMT080	1.4169704	691.1	01Jan2011, 06:49	117.1
RMT102	1.4169704	688.3	01Jan2011, 06:56	116.9
MT090	0.0435103	127.4	01Jan2011, 06:00	7.1
Woodmen Hills Pond #5	0.0435103	18.6	01Jan2011, 06:07	5.9
JMT090	0.0435103	18.6	01Jan2011, 06:07	5.9
RMT090	0.0435103	18.6	01Jan2011, 06:08	5.9
JMT104	0.0435103	18.6	01Jan2011, 06:08	5.9
RMT104	0.0435103	18.6	01Jan2011, 06:12	5.9
JMT102	1.4604807	703.3	01Jan2011, 06:56	122.8
RMT106	1.4604807	697.7	01Jan2011, 06:58	122.7
MT100	0.0557682	88.2	01Jan2011, 06:05	5.9
JMT106	1.5162489	704.5	01Jan2011, 06:58	128.6
RMT112	1.5162489	701.0	01Jan2011, 07:10	127.9
MT110	0.1163900	117.4	01Jan2011, 06:16	11.5
JMT110	1.6326389	720.0	01Jan2011, 07:10	139.5
RMT114	1.6326389	718.9	01Jan2011, 07:15	139.2
WT290	0.1037800	110.3	01Jan2011, 06:09	8.7
Regional Pond R1	5.8629331	1361.9	01Jan2011, 08:07	490.9
JWT296	5.8629331	1361.9	01Jan2011, 08:07	490.9
RWT314	5.8629331	1361.6	01Jan2011, 08:13	489.9
WT300	0.0970199	91.6	01Jan2011, 06:12	8.1
JWT300	0.0970199	91.6	01Jan2011, 06:12	8.1
RWT312	0.0970199	91.1	01Jan2011, 06:29	8.1
WT310	0.2774200	246.7	01Jan2011, 06:13	22.3



Hydrologic Element	Drainage Area (MI ²)	Peak Discharge (CFS)	Time of Peak	Volume (AC-FT)
JWT310	6.2373730	1385.2	01Jan2011, 08:12	520.3
RWT320	6.2373730	1384.4	01Jan2011, 08:18	519.3
WT320	0.2061400	200.6	01Jan2011, 06:11	17.2
JWT320	6.4435130	1395.9	01Jan2011, 08:17	536.5
RWT352	6.4435130	1395.0	01Jan2011, 08:27	535.3
ET020	0.2131700	360.5	01Jan2011, 06:06	24.8
ET010	0.1451300	198.3	01Jan2011, 06:11	16.4
Paint Brush Hills Pond #4	0.1451300	150.9	01Jan2011, 06:20	16.3
JET010	0.1451300	150.9	01Jan2011, 06:20	16.3
RET020	0.1451300	150.0	01Jan2011, 06:37	16.3
Sub Regional Pond SR6	0.3583000	195.4	01Jan2011, 06:41	37.9
JET020	0.3583000	195.4	01Jan2011, 06:41	37.9
RET030	0.3583000	194.9	01Jan2011, 07:02	37.5
ET030	0.2042800	242.0	01Jan2011, 06:15	23.0
JET030	0.5625800	266.0	01Jan2011, 06:43	60.5
RET040	0.5625800	265.2	01Jan2011, 06:50	60.3
Woodmen Hills Pond #1...	0.7117200	263.5	01Jan2011, 07:09	75.5
ET040	0.1491400	165.7	01Jan2011, 06:14	15.3
Woodmen Hills Pond #1...	0.7117200	261.1	01Jan2011, 07:18	69.5
JET040	0.7117200	261.1	01Jan2011, 07:18	69.5
RET050	0.7117200	261.1	01Jan2011, 07:23	69.4
ET050	0.1171900	197.1	01Jan2011, 06:03	11.6
Woodmen Hills Pond #2	0.8289100	250.3	01Jan2011, 07:46	79.3
JET050	0.8289100	250.3	01Jan2011, 07:46	79.3
RET060	0.8289100	250.3	01Jan2011, 07:53	79.1
ET060	0.2854300	529.3	01Jan2011, 06:01	29.3
Woodmen Hills Pond #3	1.1143400	360.9	01Jan2011, 06:06	105.9
JET060	1.1143400	360.9	01Jan2011, 06:06	105.9
RET070	1.1143400	356.7	01Jan2011, 06:16	105.6
ET070	0.2497500	461.0	01Jan2011, 06:02	27.3
JET070	1.3640900	636.4	01Jan2011, 06:04	132.9
RET080	1.3640900	517.5	01Jan2011, 06:23	131.3
ET080	0.2916400	517.9	01Jan2011, 06:07	37.1
Woodmen Hills Pond #4	1.6557300	288.0	01Jan2011, 07:00	139.2
JET080	1.6557300	288.0	01Jan2011, 07:00	139.2
RET090	1.6557300	287.3	01Jan2011, 07:03	139.0
ET090	0.1242400	133.0	01Jan2011, 06:22	14.9
JET090	1.7799700	330.8	01Jan2011, 06:59	153.9
RET100	1.7799700	330.7	01Jan2011, 07:01	153.8
ET100	0.0480615	72.0	01Jan2011, 06:02	4.0

Hydrologic Element	Drainage Area (MI ²)	Peak Discharge (CFS)	Time of Peak	Volume (AC-FT)
JET100	1.8280315	335.4	01Jan2011, 07:01	157.8
RET110	1.8280315	335.2	01Jan2011, 07:05	157.6
ET110	0.2260300	198.8	01Jan2011, 06:12	17.5
JET110	2.0540615	362.1	01Jan2011, 07:03	175.1
RET120	2.0540615	361.3	01Jan2011, 07:09	174.7
ET120	0.1091300	89.4	01Jan2011, 06:14	8.5
JET120	2.1631915	403.2	01Jan2011, 06:17	183.2
RET152	2.1631915	402.2	01Jan2011, 06:24	182.9
ET130	0.1348100	85.4	01Jan2011, 06:27	11.2
JET130	0.1348100	85.4	01Jan2011, 06:27	11.2
RET140	0.1348100	84.7	01Jan2011, 06:54	11.1
ET140	0.2675900	122.8	01Jan2011, 06:46	22.2
JET140	0.4024000	204.8	01Jan2011, 06:51	33.3
RET154	0.4024000	204.4	01Jan2011, 07:05	33.2
JET152	2.5655915	572.3	01Jan2011, 07:10	216.1
RET156	2.5655915	572.0	01Jan2011, 07:14	215.8
ET150	0.1777300	136.2	01Jan2011, 06:18	14.3
JET154	2.7433215	595.8	01Jan2011, 07:12	230.1
RET162	2.7433215	595.1	01Jan2011, 07:25	228.9
ET160	0.1889200	137.2	01Jan2011, 06:23	16.3
JET160	2.9322415	633.6	01Jan2011, 06:38	245.2
RET164	2.9322415	629.0	01Jan2011, 06:47	244.7
WT350	0.3037700	276.7	01Jan2011, 06:14	26.3
JWT352	9.6795245	1942.0	01Jan2011, 07:42	806.3
RWT354	9.6795245	1941.9	01Jan2011, 07:42	806.3
WT330	0.3266800	249.3	01Jan2011, 06:19	27.2
JWT330	0.3266800	249.3	01Jan2011, 06:19	27.2

Project: Aug15_Working_Falcon_DBPS_S
Simulation Run: FU 100-yr Reservoir: School Site

Start of Run: 01Jan2011, 00:00 Basin Model: Falcon_DBPS_Future
End of Run: 02Jan2011, 00:00 Meteorologic Model: 100-yr
Compute Time: 22Jan2021, 16:58:57 Control Specifications: 24-hr Storm

Volume Units: AC-FT

Computed Results

Peak Inflow :	75.8 (CFS)	Date/Time of Peak Inflow :	01Jan2011, 07:02
Peak Outflow :	70.2 (CFS)	Date/Time of Peak Outflow :	01Jan2011, 07:12
Total Inflow :	17.2 (AC-FT)	Peak Storage :	2.2 (AC-FT)
Total Outflow :	15.9 (AC-FT)	Peak Elevation :	6957.8 (FT)

Project: Aug15_Working_Falcon_DBPS_S
Simulation Run: FU 100-yr Reservoir: Sub Regional Pond SR4

Start of Run: 01Jan2011, 00:00 Basin Model: Falcon_DBPS_Future
End of Run: 02Jan2011, 00:00 Meteorologic Model: 100-yr
Compute Time: 22Jan2021, 16:58:57 Control Specifications: 24-hr Storm

Volume Units: AC-FT

Computed Results

Peak Inflow :	951.4 (CFS)	Date/Time of Peak Inflow :	01Jan2011, 06:20
Peak Outflow :	612.5 (CFS)	Date/Time of Peak Outflow :	01Jan2011, 06:38
Total Inflow :	103.5 (AC-FT)	Peak Storage :	26.2 (AC-FT)
Total Outflow :	89.3 (AC-FT)	Peak Elevation :	6896.9 (FT)

Project: Aug15_Working_Falcon_DBPS_S
Simulation Run: FU 100-yr Reservoir: Regional Pond MN

Start of Run: 01Jan2011, 00:00 Basin Model: Falcon_DBPS_Future
End of Run: 02Jan2011, 00:00 Meteorologic Model: 100-yr
Compute Time: 22Jan2021, 16:58:57 Control Specifications: 24-hr Storm

Volume Units: AC-FT

Computed Results

Peak Inflow :	724.7 (CFS)	Date/Time of Peak Inflow :	01Jan2011, 06:44
Peak Outflow :	691.1 (CFS)	Date/Time of Peak Outflow :	01Jan2011, 06:49
Total Inflow :	119.7 (AC-FT)	Peak Storage :	6.7 (AC-FT)
Total Outflow :	117.1 (AC-FT)	Peak Elevation :	6853.6 (FT)

Add label - Future 5-year storm

HEC-HMS 3.5 [H:\Challenger Homes Inc\CO, El Paso County-CLH000017-Bent Grass West PUD...

Hydrologic Element	Drainage Area (MI ²)	Peak Discharge (CFS)	Time of Peak	Volume (AC-FT)
WT020	0.0671383	10.3	01Jan2011, 06:23	1.4
JWT020	0.0671383	10.3	01Jan2011, 06:23	1.4
RWT030	0.0671383	10.3	01Jan2011, 06:34	1.4
WT030	0.0764732	19.5	01Jan2011, 06:08	1.6
JWT030	0.1436115	20.0	01Jan2011, 06:09	3.0
RWT042	0.1436115	19.9	01Jan2011, 06:18	3.0
WT010	0.1353300	21.2	01Jan2011, 06:19	2.6
JWT010	0.1353300	21.2	01Jan2011, 06:19	2.6
RWT044	0.1353300	21.2	01Jan2011, 06:29	2.6
JWT042	0.2789415	37.2	01Jan2011, 06:24	5.6
RWT046	0.2789415	37.2	01Jan2011, 06:35	5.6
WT040	0.1850600	21.9	01Jan2011, 06:31	3.6
JWT044	0.4640015	58.9	01Jan2011, 06:34	9.2
RWT054	0.4640015	58.7	01Jan2011, 06:43	9.2
WT060	0.1956300	30.1	01Jan2011, 06:29	4.5
WT050	0.1899300	37.3	01Jan2011, 06:21	4.7
JWT050	0.8495615	108.6	01Jan2011, 06:38	18.4
RWT092	0.8495615	108.5	01Jan2011, 06:39	18.4
WT070	0.1711000	32.6	01Jan2011, 06:13	3.4
JWT070	0.1711000	32.6	01Jan2011, 06:13	3.4
RWT080	0.1711000	32.5	01Jan2011, 06:28	3.3
WT080	0.0691596	18.5	01Jan2011, 06:12	1.7
Sub Regional Pond SR1	1.0898211	113.8	01Jan2011, 06:50	21.9
JWT080	1.0898211	113.8	01Jan2011, 06:50	21.9
RWT094	1.0898211	113.7	01Jan2011, 06:58	21.8
WT100-REV	0.1292700	67.7	01Jan2011, 06:05	4.5
W26-REV	0.0720000	33.7	01Jan2011, 06:04	2.1
WS3-1	0.0720000	33.4	01Jan2011, 06:13	2.1
Paint Brush Hills Pond C	0.2012700	14.0	01Jan2011, 06:38	6.5
WT090	0.1533300	46.0	01Jan2011, 06:10	4.0
JWT090	1.4444211	133.8	01Jan2011, 06:57	32.3
RWT122	1.4444211	133.7	01Jan2011, 07:01	32.3
WT110	0.1942800	47.0	01Jan2011, 06:16	5.1
JWT110	1.6387011	144.0	01Jan2011, 07:00	37.4
RWT124	1.6387011	144.0	01Jan2011, 07:08	37.3
WT130-REV	0.1016250	43.5	01Jan2011, 06:12	3.9
Paint Brush Hills Pond A	0.1016250	9.3	01Jan2011, 06:49	3.9
WT120-REV	0.0430300	14.8	01Jan2011, 06:09	1.2

Hydrologic Element	Drainage Area (MI ²)	Peak Discharge (CFS)	Time of Peak	Volume (AC-FT)
JWT120	1.7833561	154.4	01Jan2011, 07:08	42.4
RWT172	1.7833561	154.2	01Jan2011, 07:18	42.2
WT140-REV	0.1445300	65.2	01Jan2011, 06:14	6.1
JWT140	0.1445300	65.2	01Jan2011, 06:14	6.1
RWT150	0.1445300	64.9	01Jan2011, 06:24	6.1
WT150-REV	0.1308100	71.3	01Jan2011, 06:08	5.5
Paint Brush Hills Pond...	0.2753400	110.4	01Jan2011, 06:15	11.6
W34B2-REV	0.0935900	49.1	01Jan2011, 06:08	3.7
Paint Brush Hills Pond...	0.3689300	20.1	01Jan2011, 07:15	13.8
JWT150	0.3689300	20.1	01Jan2011, 07:15	13.8
RWT160	0.3689300	20.0	01Jan2011, 07:24	13.8
WT160-REV	0.0734800	36.3	01Jan2011, 06:07	2.6
JWT160	0.4424100	37.3	01Jan2011, 06:07	16.4
RWT174	0.4424100	36.9	01Jan2011, 06:20	16.3
WT170-REV	0.1060150	24.0	01Jan2011, 06:21	2.9
W34-CY-REV	0.0465469	10.7	01Jan2011, 06:18	1.2
JWT172	2.3783280	181.3	01Jan2011, 07:17	62.6
RWT176	2.3783280	181.2	01Jan2011, 07:18	62.6
Sub Regional Pond SR2	2.3783280	171.7	01Jan2011, 07:30	59.3
JWT174	2.3783280	171.7	01Jan2011, 07:30	59.3
RWT180	2.3783280	171.6	01Jan2011, 07:45	59.0
WT180-REV	0.0409400	7.6	01Jan2011, 06:21	1.0
JWT180	2.4192680	172.6	01Jan2011, 07:45	59.9
RWT202	2.4192680	172.6	01Jan2011, 08:03	59.5
WT200	0.3017100	52.2	01Jan2011, 06:33	8.3
WT190	0.0574561	22.5	01Jan2011, 06:06	1.6
The Meadows Pond #1	0.0574561	0.6	01Jan2011, 10:18	0.9
JWT190	0.0574561	0.6	01Jan2011, 10:18	0.9
RWT204	0.0574561	0.6	01Jan2011, 10:56	0.8
JWT200	2.7784341	182.8	01Jan2011, 08:02	68.6
RWT210	2.7784341	182.7	01Jan2011, 08:10	68.3
WT210	0.2654600	59.7	01Jan2011, 06:38	9.8
JWT210	3.0438941	194.3	01Jan2011, 08:09	78.2
RWT232	3.0438941	194.3	01Jan2011, 08:16	77.9
WT220	0.1895300	84.8	01Jan2011, 06:13	7.8
JWT220	0.1895300	84.8	01Jan2011, 06:13	7.8
RWT234	0.1895300	84.4	01Jan2011, 06:25	7.7
JWT232	3.2334241	200.7	01Jan2011, 08:16	85.7
RWT236	3.2334241	200.7	01Jan2011, 08:16	85.7

Hydrologic Element	Drainage Area (MI ²)	Peak Discharge (CFS)	Time of Peak	Volume (AC-FT)
WT230	0.1981800	124.0	01Jan2011, 06:06	8.5
JWT234	3.4316041	205.6	01Jan2011, 08:15	94.2
RWT240	3.4316041	205.4	01Jan2011, 08:21	94.0
WT240	0.0761461	61.0	01Jan2011, 06:02	3.4
Regional Pond WU No...	3.5077502	206.4	01Jan2011, 08:23	96.3
Regional Pond WU Di...	3.5077502	169.3	01Jan2011, 08:23	64.8
Old Meridian	0.0335900	38.2	01Jan2011, 06:09	2.8
RWT-OM	0.0335900	37.8	01Jan2011, 06:14	2.8
Regional Pond WU So...	3.5413402	144.6	01Jan2011, 08:49	57.2
RWT240_Diversion R...	0.0000000	37.1	01Jan2011, 08:29	31.4
JWT240	3.5413402	180.6	01Jan2011, 08:47	88.6
RWT250	3.5413402	180.6	01Jan2011, 08:48	88.5
WT250	0.1469500	107.5	01Jan2011, 06:03	6.3
JWT250	3.6882902	183.2	01Jan2011, 08:48	94.9
RWT260	3.6882902	183.1	01Jan2011, 09:04	94.3
WT260	0.1388002	21.0	01Jan2011, 06:36	3.6
JWT260	3.8270904	185.4	01Jan2011, 09:03	97.9
RWT291	3.8270904	185.3	01Jan2011, 09:07	97.8
WT270	0.0324738	20.0	01Jan2011, 06:04	1.3
JWT270	0.0324738	20.0	01Jan2011, 06:04	1.3
RWT292	0.0324738	19.9	01Jan2011, 06:10	1.3
JWT292	3.8595642	185.9	01Jan2011, 09:07	99.0
RWT295	3.8595642	185.8	01Jan2011, 09:09	99.0
WT280	0.2669500	70.1	01Jan2011, 06:14	6.9
JWT280	0.2669500	70.1	01Jan2011, 06:14	6.9
RWT294	0.2669500	70.0	01Jan2011, 06:17	6.9
JWT294	4.1265142	189.2	01Jan2011, 09:09	105.9
RWT296	4.1265142	189.1	01Jan2011, 09:17	105.5
MT040	0.3084200	163.5	01Jan2011, 06:12	14.5
MT030	0.1566300	73.4	01Jan2011, 06:06	5.1
MT020	0.0902033	47.3	01Jan2011, 06:05	3.1
JMT020	0.0902033	47.3	01Jan2011, 06:05	3.1
RMT030	0.0902033	46.8	01Jan2011, 06:21	3.1
JMT030	0.2468333	93.6	01Jan2011, 06:07	8.1
RMT040	0.2468333	92.8	01Jan2011, 06:12	8.1
Woodmen Hills Pond H	0.5552533	242.5	01Jan2011, 06:16	22.5
JMT040	0.5552533	242.5	01Jan2011, 06:16	22.5
RMT050	0.5552533	242.2	01Jan2011, 06:19	22.5
MT010	0.2898900	36.7	01Jan2011, 06:26	5.2

Hydrologic Element	Drainage Area (MI ²)	Peak Discharge (CFS)	Time of Peak	Volume (AC-FT)
The Meadows Pond #2	0.2898900	2.7	01Jan2011, 09:12	3.5
JMT010	0.2898900	2.7	01Jan2011, 09:12	3.5
RMT062	0.2898900	2.7	01Jan2011, 09:38	3.4
MT060a	0.0311000	15.6	01Jan2011, 06:03	1.0
School Site	0.3209900	3.0	01Jan2011, 11:20	3.0
JMT060a	0.3209900	3.0	01Jan2011, 11:20	3.0
RMT060a	0.3209900	3.0	01Jan2011, 11:30	3.0
MT050	0.1186100	33.2	01Jan2011, 06:20	3.8
JMT050	0.9948533	275.4	01Jan2011, 06:19	29.3
RMT064	0.9948533	273.1	01Jan2011, 06:29	29.2
MT060	0.1588000	60.1	01Jan2011, 06:09	4.8
Sub Regional Pond SR4	1.1536533	24.1	01Jan2011, 08:42	23.4
JMT060	1.1536533	24.1	01Jan2011, 08:42	23.4
RMT070	1.1536533	24.1	01Jan2011, 08:51	23.2
MT070	0.1994800	51.6	01Jan2011, 06:24	6.6
JMT070	1.3531333	55.6	01Jan2011, 06:25	29.8
RMT080	1.3531333	55.6	01Jan2011, 06:28	29.8
MT080	0.0638371	91.5	01Jan2011, 06:00	5.0
Regional Pond MN	1.4169704	62.4	01Jan2011, 06:32	32.3
JMT080	1.4169704	62.4	01Jan2011, 06:32	32.3
RMT102	1.4169704	62.2	01Jan2011, 06:41	32.0
MT090	0.0435103	59.3	01Jan2011, 06:00	3.2
Woodmen Hills Pond #5	0.0435103	2.2	01Jan2011, 08:01	2.3
JMT090	0.0435103	2.2	01Jan2011, 08:01	2.3
RMT090	0.0435103	2.2	01Jan2011, 08:01	2.3
JMT104	0.0435103	2.2	01Jan2011, 08:01	2.3
RMT104	0.0435103	2.2	01Jan2011, 08:07	2.3
JMT102	1.4604807	64.3	01Jan2011, 06:41	34.4
RMT106	1.4604807	64.0	01Jan2011, 06:43	34.3
MT100	0.0557682	29.8	01Jan2011, 06:06	2.1
JMT106	1.5162489	67.8	01Jan2011, 06:42	36.4
RMT112	1.5162489	66.0	01Jan2011, 07:16	35.5
MT110	0.1163900	36.3	01Jan2011, 06:18	3.9
JMT110	1.6326389	72.0	01Jan2011, 07:16	39.4
RMT114	1.6326389	71.2	01Jan2011, 07:25	39.1
WT290	0.1037800	31.2	01Jan2011, 06:10	2.7
Regional Pond R1	5.8629331	222.9	01Jan2011, 09:27	140.2
JWT296	5.8629331	222.9	01Jan2011, 09:27	140.2
RWT314	5.8629331	222.9	01Jan2011, 09:34	139.5

Hydrologic Element	Drainage Area (MI ²)	Peak Discharge (CFS)	Time of Peak	Volume (AC-FT)
WT300	0.0970199	25.5	01Jan2011, 06:14	2.5
JWT300	0.0970199	25.5	01Jan2011, 06:14	2.5
RWT312	0.0970199	25.4	01Jan2011, 06:34	2.5
WT310	0.2774200	67.1	01Jan2011, 06:14	6.9
JWT310	6.2373730	227.4	01Jan2011, 09:34	148.9
RWT320	6.2373730	227.3	01Jan2011, 09:42	148.1
WT320	0.2061400	56.1	01Jan2011, 06:13	5.4
JWT320	6.4435130	229.8	01Jan2011, 09:42	153.5
RWT352	6.4435130	229.8	01Jan2011, 09:51	152.6
ET020	0.2131700	128.1	01Jan2011, 06:07	9.2
ET010	0.1451300	67.4	01Jan2011, 06:12	5.9
Paint Brush Hills Pond...	0.1451300	48.8	01Jan2011, 06:22	5.9
JET010	0.1451300	48.8	01Jan2011, 06:22	5.9
RET020	0.1451300	48.7	01Jan2011, 06:37	5.9
Sub Regional Pond SR6	0.3583000	19.9	01Jan2011, 07:26	13.5
JET020	0.3583000	19.9	01Jan2011, 07:26	13.5
RET030	0.3583000	19.7	01Jan2011, 08:14	13.1
ET030	0.2042800	81.2	01Jan2011, 06:17	8.4
JET030	0.5625800	81.2	01Jan2011, 06:17	21.5
RET040	0.5625800	80.9	01Jan2011, 06:28	21.4
Woodmen Hills Pond ...	0.7117200	103.5	01Jan2011, 06:35	26.6
ET040	0.1491400	52.6	01Jan2011, 06:15	5.3
Woodmen Hills Pond ...	0.7117200	32.8	01Jan2011, 07:14	21.7
JET040	0.7117200	32.8	01Jan2011, 07:14	21.7
RET050	0.7117200	32.8	01Jan2011, 07:22	21.6
ET050	0.1171900	66.6	01Jan2011, 06:03	4.0
Woodmen Hills Pond #2	0.8289100	29.6	01Jan2011, 08:07	23.9
JET050	0.8289100	29.6	01Jan2011, 08:07	23.9
RET060	0.8289100	29.6	01Jan2011, 08:19	23.7
ET060	0.2854300	185.5	01Jan2011, 06:02	10.2
Woodmen Hills Pond #3	1.1143400	82.1	01Jan2011, 06:08	31.5
JET060	1.1143400	82.1	01Jan2011, 06:08	31.5
RET070	1.1143400	81.0	01Jan2011, 06:18	31.2
ET070	0.2497500	164.1	01Jan2011, 06:03	9.8
JET070	1.3640900	164.5	01Jan2011, 06:03	41.0
RET080	1.3640900	123.5	01Jan2011, 06:29	40.2
ET080	0.2916400	192.2	01Jan2011, 06:08	14.3
Woodmen Hills Pond #4	1.6557300	26.7	01Jan2011, 14:58	26.8
JET080	1.6557300	26.7	01Jan2011, 14:58	26.8

Hydrologic Element	Drainage Area (MI ²)	Peak Discharge (CFS)	Time of Peak	Volume (AC-FT)
RET090	1.6557300	26.7	01Jan2011, 15:03	26.6
ET090	0.1242400	46.0	01Jan2011, 06:23	5.6
JET090	1.7799700	50.6	01Jan2011, 06:24	32.2
RET100	1.7799700	50.6	01Jan2011, 06:28	32.1
ET100	0.0480615	22.3	01Jan2011, 06:02	1.3
JET100	1.8280315	53.2	01Jan2011, 06:28	33.3
RET110	1.8280315	53.1	01Jan2011, 06:35	33.1
ET110	0.2260300	52.7	01Jan2011, 06:13	5.3
JET110	2.0540615	86.0	01Jan2011, 06:13	38.4
RET120	2.0540615	85.1	01Jan2011, 06:19	38.1
ET120	0.1091300	23.5	01Jan2011, 06:16	2.5
JET120	2.1631915	107.9	01Jan2011, 06:19	40.7
RET152	2.1631915	107.7	01Jan2011, 06:25	40.4
ET130	0.1348100	23.2	01Jan2011, 06:30	3.5
JET130	0.1348100	23.2	01Jan2011, 06:30	3.5
RET140	0.1348100	23.1	01Jan2011, 07:00	3.5
ET140	0.2675900	33.4	01Jan2011, 06:49	6.9
JET140	0.4024000	55.3	01Jan2011, 06:56	10.4
RET154	0.4024000	55.2	01Jan2011, 07:19	10.3
JET152	2.5655915	108.6	01Jan2011, 06:26	50.8
RET156	2.5655915	108.3	01Jan2011, 06:30	50.6
ET150	0.1777300	36.6	01Jan2011, 06:20	4.4
JET154	2.7433215	138.8	01Jan2011, 06:29	55.0
RET162	2.7433215	135.5	01Jan2011, 06:54	54.2
ET160	0.1889200	38.5	01Jan2011, 06:25	5.2
JET160	2.9322415	154.7	01Jan2011, 06:53	59.4
RET164	2.9322415	154.3	01Jan2011, 06:58	59.2
WT350	0.3037700	78.7	01Jan2011, 06:16	8.4
JWT352	9.6795245	311.7	01Jan2011, 07:22	220.1
RWT354	9.6795245	311.7	01Jan2011, 07:22	220.1
WT330	0.3266800	68.2	01Jan2011, 06:21	8.5
JWT330	0.3266800	68.2	01Jan2011, 06:21	8.5
RWT344	0.3266800	67.9	01Jan2011, 06:30	8.5
WT340	0.2780000	40.0	01Jan2011, 06:39	7.2
JWT354	10.2842045	350.6	01Jan2011, 07:20	235.7
RWT372	10.2842045	350.4	01Jan2011, 07:24	235.1
WT360	0.0656830	14.8	01Jan2011, 06:17	1.6
JWT360	0.0656830	14.8	01Jan2011, 06:17	1.6
RWT374	0.0656830	14.7	01Jan2011, 06:32	1.6

Hydrologic Element	Drainage Area (MI ²)	Peak Discharge (CFS)	Time of Peak	Volume (AC-FT)
Regional Pond R2	10.3498875	352.6	01Jan2011, 07:26	233.5
JWT372	10.3498875	352.6	01Jan2011, 07:26	233.5
RWT376	10.3498875	351.6	01Jan2011, 07:35	232.3
WT370	0.2147600	23.4	01Jan2011, 06:15	2.8
JWT374_OUTLET	10.5646475	354.7	01Jan2011, 07:35	235.1
FS010	0.1220000	16.6	01Jan2011, 06:18	2.1
JFS010_OUTLET	0.1220000	16.6	01Jan2011, 06:18	2.1

Project: Aug15_Working_Falcon_DBPS_S
Simulation Run: FU 5-yr Reservoir: School Site

Start of Run: 01Jan2011, 00:00 Basin Model: Falcon_DBPS_Future
End of Run: 02Jan2011, 00:00 Meteorologic Model: 5-yr
Compute Time: 22Jan2021, 17:04:18 Control Specifications: 24-hr Storm

Volume Units: AC-FT

Computed Results

Peak Inflow :	15.6 (CFS)	Date/Time of Peak Inflow :	01Jan2011, 06:03
Peak Outflow :	3.0 (CFS)	Date/Time of Peak Outflow :	01Jan2011, 11:20
Total Inflow :	4.4 (AC-FT)	Peak Storage :	1.4 (AC-FT)
Total Outflow :	3.0 (AC-FT)	Peak Elevation :	6957.0 (FT)

Project: Aug15_Working_Falcon_DBPS_S
Simulation Run: FU 5-yr Reservoir: Sub Regional Pond SR4

Start of Run: 01Jan2011, 00:00 Basin Model: Falcon_DBPS_Future
End of Run: 02Jan2011, 00:00 Meteorologic Model: 5-yr
Compute Time: 22Jan2021, 17:04:18 Control Specifications: 24-hr Storm

Volume Units: AC-FT

Computed Results

Peak Inflow :	292.9 (CFS)	Date/Time of Peak Inflow :	01Jan2011, 06:29
Peak Outflow :	24.1 (CFS)	Date/Time of Peak Outflow :	01Jan2011, 08:42
Total Inflow :	34.0 (AC-FT)	Peak Storage :	16.2 (AC-FT)
Total Outflow :	23.4 (AC-FT)	Peak Elevation :	6893.9 (FT)

Project: Aug15_Working_Falcon_DBPS_S
Simulation Run: FU 5-yr Reservoir: Regional Pond MN

Start of Run: 01Jan2011, 00:00 Basin Model: Falcon_DBPS_Future
End of Run: 02Jan2011, 00:00 Meteorologic Model: 5-yr
Compute Time: 22Jan2021, 17:04:18 Control Specifications: 24-hr Storm

Volume Units: AC-FT

Computed Results

Peak Inflow :	99.9 (CFS)	Date/Time of Peak Inflow :	01Jan2011, 06:01
Peak Outflow :	62.4 (CFS)	Date/Time of Peak Outflow :	01Jan2011, 06:32
Total Inflow :	34.8 (AC-FT)	Peak Storage :	2.8 (AC-FT)
Total Outflow :	32.3 (AC-FT)	Peak Elevation :	6851.6 (FT)

Add label - Future 2-year storm

HEC-HMS 3.5 [H:\Challenger Homes Inc\CO, El Paso County-CLH000017-Bent Grass West PUD...

Hydrologic Element	Drainage Area (MI2)	Peak Discharge (CFS)	Time of Peak	Volume (AC-FT)
WT020	0.0671383	4.4	01Jan2011, 06:25	0.7
JWT020	0.0671383	4.4	01Jan2011, 06:25	0.7
RWT030	0.0671383	4.4	01Jan2011, 06:39	0.7
WT030	0.0764732	8.6	01Jan2011, 06:09	0.8
JWT030	0.1436115	8.7	01Jan2011, 06:09	1.5
RWT042	0.1436115	8.7	01Jan2011, 06:20	1.5
WT010	0.1353300	8.8	01Jan2011, 06:21	1.3
JWT010	0.1353300	8.8	01Jan2011, 06:21	1.3
RWT044	0.1353300	8.8	01Jan2011, 06:33	1.3
JWT042	0.2789415	15.1	01Jan2011, 06:26	2.8
RWT046	0.2789415	15.1	01Jan2011, 06:40	2.8
WT040	0.1850600	9.1	01Jan2011, 06:34	1.8
JWT044	0.4640015	23.9	01Jan2011, 06:39	4.5
RWT054	0.4640015	23.8	01Jan2011, 06:50	4.5
WT060	0.1956300	13.6	01Jan2011, 06:30	2.3
WT050	0.1899300	17.3	01Jan2011, 06:23	2.4
JWT050	0.8495615	42.8	01Jan2011, 06:47	9.3
RWT092	0.8495615	42.7	01Jan2011, 06:49	9.3
WT070	0.1711000	13.6	01Jan2011, 06:15	1.6
JWT070	0.1711000	13.6	01Jan2011, 06:15	1.6
RWT080	0.1711000	13.6	01Jan2011, 06:34	1.6
WT080	0.0691596	8.7	01Jan2011, 06:13	0.9
Sub Regional Pond SR1	1.0898211	41.9	01Jan2011, 07:03	10.4
JWT080	1.0898211	41.9	01Jan2011, 07:03	10.4
RWT094	1.0898211	41.9	01Jan2011, 07:14	10.3
WT100-REV	0.1292700	37.0	01Jan2011, 06:05	2.5
W26-REV	0.0720000	18.4	01Jan2011, 06:04	1.2
WS3-1	0.0720000	18.1	01Jan2011, 06:15	1.2
Paint Brush Hills Pond C	0.2012700	10.4	01Jan2011, 06:34	3.7
WT090	0.1533300	22.1	01Jan2011, 06:11	2.1
JWT090	1.4444211	54.5	01Jan2011, 07:12	16.1
RWT122	1.4444211	54.5	01Jan2011, 07:17	16.1
WT110	0.1942800	22.3	01Jan2011, 06:17	2.7
JWT110	1.6387011	58.6	01Jan2011, 07:16	18.7
RWT124	1.6387011	58.6	01Jan2011, 07:26	18.7
WT130-REV	0.1016250	24.0	01Jan2011, 06:13	2.3
Paint Brush Hills Pond A	0.1016250	4.8	01Jan2011, 06:53	2.3
WT120-REV	0.0430300	7.2	01Jan2011, 06:09	0.6
JWT120	1.7833561	63.9	01Jan2011, 07:26	21.6

Hydrologic Element	Drainage Area (MI2)	Peak Discharge (CFS)	Time of Peak	Volume (AC-FT)
RWT172	1.7833561	63.8	01Jan2011, 07:38	21.5
WT140-REV	0.1445300	35.7	01Jan2011, 06:14	3.6
JWT140	0.1445300	35.7	01Jan2011, 06:14	3.6
RWT150	0.1445300	35.5	01Jan2011, 06:25	3.6
WT150-REV	0.1308100	40.8	01Jan2011, 06:09	3.3
Paint Brush Hills Pond B1	0.2753400	58.7	01Jan2011, 06:19	6.8
W34B2-REV	0.0935900	27.9	01Jan2011, 06:08	2.2
Paint Brush Hills Pond B2	0.3689300	9.8	01Jan2011, 07:30	8.0
JWT150	0.3689300	9.8	01Jan2011, 07:30	8.0
RWT160	0.3689300	9.8	01Jan2011, 07:40	8.0
WT160-REV	0.0734800	19.7	01Jan2011, 06:07	1.5
JWT160	0.4424100	20.1	01Jan2011, 06:07	9.5
RWT174	0.4424100	19.8	01Jan2011, 06:23	9.4
WT170-REV	0.1060150	11.6	01Jan2011, 06:22	1.6
W34-CY-REV	0.0465469	5.2	01Jan2011, 06:19	0.6
JWT172	2.3783280	81.2	01Jan2011, 06:39	33.1
RWT176	2.3783280	81.1	01Jan2011, 06:40	33.1
Sub Regional Pond SR2	2.3783280	66.8	01Jan2011, 08:06	30.0
JWT174	2.3783280	66.8	01Jan2011, 08:06	30.0
RWT180	2.3783280	66.8	01Jan2011, 08:25	29.7
WT180-REV	0.0409400	3.4	01Jan2011, 06:22	0.5
JWT180	2.4192680	67.2	01Jan2011, 08:25	30.2
RWT202	2.4192680	67.1	01Jan2011, 08:51	29.9
WT200	0.3017100	25.3	01Jan2011, 06:34	4.4
WT190	0.0574561	11.3	01Jan2011, 06:07	0.9
The Meadows Pond #1	0.0574561	0.3	01Jan2011, 13:19	0.4
JWT190	0.0574561	0.3	01Jan2011, 13:19	0.4
RWT204	0.0574561	0.3	01Jan2011, 14:16	0.4
JWT200	2.7784341	70.6	01Jan2011, 08:50	34.8
RWT210	2.7784341	70.6	01Jan2011, 09:00	34.6
WT210	0.2654600	31.9	01Jan2011, 06:39	5.6
JWT210	3.0438941	74.5	01Jan2011, 08:59	40.2
RWT232	3.0438941	74.5	01Jan2011, 09:08	40.0
WT220	0.1895300	47.1	01Jan2011, 06:14	4.5
JWT220	0.1895300	47.1	01Jan2011, 06:14	4.5
RWT234	0.1895300	46.9	01Jan2011, 06:26	4.5
JWT232	3.2334241	76.6	01Jan2011, 09:08	44.5
RWT236	3.2334241	76.6	01Jan2011, 09:09	44.5
WT230	0.1981800	71.3	01Jan2011, 06:06	5.0
JWT234	3.4316041	84.5	01Jan2011, 06:43	49.5

Hydrologic Element	Drainage Area (MI2)	Peak Discharge (CFS)	Time of Peak	Volume (AC-FT)
RWT240	3.4316041	84.0	01Jan2011, 06:48	49.4
WT240	0.0761461	36.4	01Jan2011, 06:02	2.1
Regional Pond WU North	3.5077502	89.8	01Jan2011, 06:10	50.3
Regional Pond WU Diver...	3.5077502	62.4	01Jan2011, 06:10	27.5
OldMeridian	0.0335900	24.6	01Jan2011, 06:09	1.9
RWT-OM	0.0335900	24.3	01Jan2011, 06:16	1.8
Regional Pond WU South	3.5413402	31.1	01Jan2011, 10:35	19.2
RWT240_Diversion Reach	0.0000000	27.1	01Jan2011, 06:16	22.8
JWT240	3.5413402	51.8	01Jan2011, 10:19	42.0
RWT250	3.5413402	51.8	01Jan2011, 10:20	42.0
WT250	0.1469500	63.0	01Jan2011, 06:03	3.7
JWT250	3.6882902	63.4	01Jan2011, 06:03	45.7
RWT260	3.6882902	61.1	01Jan2011, 06:24	45.4
WT260	0.1388002	9.9	01Jan2011, 06:38	1.9
JWT260	3.8270904	69.2	01Jan2011, 06:24	47.3
RWT291	3.8270904	68.9	01Jan2011, 06:29	47.1
WT270	0.0324738	11.3	01Jan2011, 06:05	0.7
JWT270	0.0324738	11.3	01Jan2011, 06:05	0.7
RWT292	0.0324738	11.2	01Jan2011, 06:11	0.7
JWT292	3.8595642	71.9	01Jan2011, 06:29	47.9
RWT295	3.8595642	71.5	01Jan2011, 06:31	47.8
WT280	0.2669500	33.4	01Jan2011, 06:15	3.7
JWT280	0.2669500	33.4	01Jan2011, 06:15	3.7
RWT294	0.2669500	33.4	01Jan2011, 06:18	3.7
JWT294	4.1265142	94.0	01Jan2011, 06:30	51.5
RWT296	4.1265142	91.9	01Jan2011, 06:40	51.2
MT040	0.3084200	94.6	01Jan2011, 06:13	8.8
MT030	0.1566300	39.0	01Jan2011, 06:06	2.8
MT020	0.0902033	25.8	01Jan2011, 06:05	1.7
JMT020	0.0902033	25.8	01Jan2011, 06:05	1.7
RMT030	0.0902033	25.4	01Jan2011, 06:20	1.7
JMT030	0.2468333	50.1	01Jan2011, 06:10	4.5
RMT040	0.2468333	49.3	01Jan2011, 06:16	4.5
Woodmen Hills Pond H	0.5552533	107.8	01Jan2011, 06:25	13.2
JMT040	0.5552533	107.8	01Jan2011, 06:25	13.2
RMT050	0.5552533	107.4	01Jan2011, 06:28	13.2
MT010	0.2898900	17.3	01Jan2011, 06:28	2.7
The Meadows Pond #2	0.2898900	1.5	01Jan2011, 09:08	1.9
JMT010	0.2898900	1.5	01Jan2011, 09:08	1.9
RMT062	0.2898900	1.5	01Jan2011, 09:48	1.8

Hydrologic Element	Drainage Area (MI ²)	Peak Discharge (CFS)	Time of Peak	Volume (AC-FT)
MT060a	0.0311000	8.3	01Jan2011, 06:04	0.5
School Site	0.3209900	1.5	01Jan2011, 15:29	1.0
JMT060a	0.3209900	1.5	01Jan2011, 15:29	1.0
RMT060a	0.3209900	1.5	01Jan2011, 15:42	1.0
MT050	0.1186100	17.0	01Jan2011, 06:21	2.1
JMT050	0.9948533	123.1	01Jan2011, 06:27	16.3
RMT064	0.9948533	121.2	01Jan2011, 06:40	16.2
MT060	0.1588000	30.7	01Jan2011, 06:10	2.7
Sub Regional Pond SR4	1.1536533	11.2	01Jan2011, 09:34	13.8
JMT060	1.1536533	11.2	01Jan2011, 09:34	13.8
RMT070	1.1536533	11.2	01Jan2011, 09:45	13.7
MT070	0.1994800	26.4	01Jan2011, 06:25	3.7
JMT070	1.3531333	29.0	01Jan2011, 06:26	17.3
RMT080	1.3531333	29.0	01Jan2011, 06:29	17.3
MT080	0.0638371	62.4	01Jan2011, 06:00	3.4
Regional Pond MN	1.4169704	30.9	01Jan2011, 06:37	18.2
JMT080	1.4169704	30.9	01Jan2011, 06:37	18.2
RMT102	1.4169704	30.8	01Jan2011, 06:48	18.0
MT090	0.0435103	39.9	01Jan2011, 06:00	2.1
Woodmen Hills Pond #5	0.0435103	1.4	01Jan2011, 08:02	1.5
JMT090	0.0435103	1.4	01Jan2011, 08:02	1.5
RMT090	0.0435103	1.4	01Jan2011, 08:02	1.5
JMT104	0.0435103	1.4	01Jan2011, 08:02	1.5
RMT104	0.0435103	1.4	01Jan2011, 08:09	1.5
JMT102	1.4604807	32.1	01Jan2011, 06:48	19.6
RMT106	1.4604807	31.8	01Jan2011, 06:51	19.5
MT100	0.0557682	16.5	01Jan2011, 06:06	1.2
JMT106	1.5162489	33.6	01Jan2011, 06:51	20.7
RMT112	1.5162489	33.0	01Jan2011, 07:29	20.0
MT110	0.1163900	18.9	01Jan2011, 06:19	2.2
JMT110	1.6326389	35.8	01Jan2011, 07:29	22.2
RMT114	1.6326389	35.7	01Jan2011, 07:40	22.0
WT290	0.1037800	15.0	01Jan2011, 06:11	1.4
Regional Pond R1	5.8629331	74.9	01Jan2011, 07:54	67.7
JWT296	5.8629331	74.9	01Jan2011, 07:54	67.7
RWT314	5.8629331	74.8	01Jan2011, 08:05	67.1
WT300	0.0970199	12.2	01Jan2011, 06:15	1.3
JWT300	0.0970199	12.2	01Jan2011, 06:15	1.3
RWT312	0.0970199	12.1	01Jan2011, 06:39	1.3
WT310	0.2774200	31.3	01Jan2011, 06:16	3.6

Hydrologic Element	Drainage Area (MI ²)	Peak Discharge (CFS)	Time of Peak	Volume (AC-FT)
JWT310	6.2373730	79.8	01Jan2011, 08:05	72.1
RWT320	6.2373730	79.7	01Jan2011, 08:15	71.5
WT320	0.2061400	26.8	01Jan2011, 06:14	2.8
JWT320	6.4435130	82.2	01Jan2011, 08:14	74.3
RWT352	6.4435130	82.1	01Jan2011, 08:26	73.6
ET020	0.2131700	73.4	01Jan2011, 06:07	5.4
ET010	0.1451300	37.5	01Jan2011, 06:12	3.5
Paint Brush Hills Pond #4	0.1451300	29.4	01Jan2011, 06:21	3.5
JET010	0.1451300	29.4	01Jan2011, 06:21	3.5
RET020	0.1451300	29.3	01Jan2011, 06:37	3.5
Sub Regional Pond SR6	0.3583000	9.3	01Jan2011, 07:43	7.9
JET020	0.3583000	9.3	01Jan2011, 07:43	7.9
RET030	0.3583000	9.3	01Jan2011, 08:37	7.6
ET030	0.2042800	44.9	01Jan2011, 06:17	4.9
JET030	0.5625800	44.9	01Jan2011, 06:17	12.5
RET040	0.5625800	44.6	01Jan2011, 06:30	12.4
Woodmen Hills Pond #1 ...	0.7117200	60.8	01Jan2011, 06:33	15.4
ET040	0.1491400	27.9	01Jan2011, 06:16	3.0
Woodmen Hills Pond #1 ...	0.7117200	9.6	01Jan2011, 12:57	12.0
JET040	0.7117200	9.6	01Jan2011, 12:57	12.0
RET050	0.7117200	9.6	01Jan2011, 13:08	11.8
ET050	0.1171900	36.5	01Jan2011, 06:03	2.2
Woodmen Hills Pond #2	0.8289100	10.4	01Jan2011, 13:06	12.5
JET050	0.8289100	10.4	01Jan2011, 13:06	12.5
RET060	0.8289100	10.4	01Jan2011, 13:21	12.3
ET060	0.2854300	105.0	01Jan2011, 06:02	5.8
Woodmen Hills Pond #3	1.1143400	12.6	01Jan2011, 13:03	15.7
JET060	1.1143400	12.6	01Jan2011, 13:03	15.7
RET070	1.1143400	12.6	01Jan2011, 13:18	15.5
ET070	0.2497500	93.5	01Jan2011, 06:03	5.7
JET070	1.3640900	93.6	01Jan2011, 06:03	21.2
RET080	1.3640900	64.9	01Jan2011, 06:31	20.7
ET080	0.2916400	113.3	01Jan2011, 06:08	8.7
Woodmen Hills Pond #4	1.6557300	9.8	02Jan2011, 00:00	12.0
JET080	1.6557300	9.8	02Jan2011, 00:00	12.0
RET090	1.6557300	9.8	02Jan2011, 00:00	11.9
ET090	0.1242400	26.0	01Jan2011, 06:24	3.3
JET090	1.7799700	29.2	01Jan2011, 06:25	15.3
RET100	1.7799700	29.1	01Jan2011, 06:30	15.2
ET100	0.0480615	11.4	01Jan2011, 06:02	0.7

Hydrologic Element	Drainage Area (MI2)	Peak Discharge (CFS)	Time of Peak	Volume (AC-FT)
JET100	1.8280315	30.6	01Jan2011, 06:30	15.8
RET110	1.8280315	30.6	01Jan2011, 06:38	15.7
ET110	0.2260300	24.0	01Jan2011, 06:15	2.7
JET110	2.0540615	41.4	01Jan2011, 06:32	18.4
RET120	2.0540615	41.4	01Jan2011, 06:39	18.2
ET120	0.1091300	10.7	01Jan2011, 06:17	1.3
JET120	2.1631915	49.7	01Jan2011, 06:21	19.5
RET152	2.1631915	49.5	01Jan2011, 06:29	19.4
ET130	0.1348100	10.9	01Jan2011, 06:31	1.8
JET130	0.1348100	10.9	01Jan2011, 06:31	1.8
RET140	0.1348100	10.9	01Jan2011, 07:06	1.8
ET140	0.2675900	15.9	01Jan2011, 06:51	3.6
JET140	0.4024000	25.8	01Jan2011, 07:01	5.5
RET154	0.4024000	25.7	01Jan2011, 07:27	5.4
JET152	2.5655915	53.7	01Jan2011, 07:01	24.8
RET156	2.5655915	53.5	01Jan2011, 07:06	24.7
ET150	0.1777300	17.0	01Jan2011, 06:21	2.3
JET154	2.7433215	62.3	01Jan2011, 06:34	27.0
RET162	2.7433215	59.6	01Jan2011, 07:07	26.4
ET160	0.1889200	18.6	01Jan2011, 06:26	2.8
JET160	2.9322415	66.8	01Jan2011, 07:06	29.2
RET164	2.9322415	66.5	01Jan2011, 07:12	29.1
WT350	0.3037700	38.3	01Jan2011, 06:17	4.5
JWT352	9.6795245	134.6	01Jan2011, 08:21	107.2
RWT354	9.6795245	134.6	01Jan2011, 08:21	107.2
WT330	0.3266800	32.2	01Jan2011, 06:23	4.5
JWT330	0.3266800	32.2	01Jan2011, 06:23	4.5
RWT344	0.3266800	32.0	01Jan2011, 06:34	4.5
WT340	0.2780000	18.9	01Jan2011, 06:42	3.8
JWT354	10.2842045	143.4	01Jan2011, 08:20	115.4
RWT372	10.2842045	143.3	01Jan2011, 08:26	115.0
WT360	0.0656830	6.9	01Jan2011, 06:18	0.8
JWT360	0.0656830	6.9	01Jan2011, 06:18	0.8
RWT374	0.0656830	6.9	01Jan2011, 06:36	0.8
Regional Pond R2	10.3498875	143.9	01Jan2011, 08:27	112.6
JWT372	10.3498875	143.9	01Jan2011, 08:27	112.6
RWT376	10.3498875	143.7	01Jan2011, 08:37	111.8
WT370	0.2147600	7.2	01Jan2011, 06:17	1.2
JWT374_OUTLET	10.5646475	144.5	01Jan2011, 08:37	113.0
FS010	0.1220000	6.3	01Jan2011, 06:20	1.0

Project: Aug15_Working_Falcon_DBPS_S
Simulation Run: FU 2-yr Reservoir: School Site

Start of Run: 01Jan2011, 00:00 Basin Model: Falcon_DBPS_Future
End of Run: 02Jan2011, 00:00 Meteorologic Model: 2-yr
Compute Time: 22Jan2021, 17:09:00 Control Specifications: 24-hr Storm

Volume Units: AC-FT

Computed Results

Peak Inflow :	8.3 (CFS)	Date/Time of Peak Inflow :	01Jan2011, 06:04
Peak Outflow :	1.5 (CFS)	Date/Time of Peak Outflow :	01Jan2011, 15:29
Total Inflow :	2.4 (AC-FT)	Peak Storage :	1.3 (AC-FT)
Total Outflow :	1.0 (AC-FT)	Peak Elevation :	6957.0 (FT)

Project: Aug15_Working_Falcon_DBPS_S
Simulation Run: FU 2-yr Reservoir: Sub Regional Pond SR4

Start of Run: 01Jan2011, 00:00 Basin Model: Falcon_DBPS_Future
End of Run: 02Jan2011, 00:00 Meteorologic Model: 2-yr
Compute Time: 22Jan2021, 17:09:00 Control Specifications: 24-hr Storm

Volume Units: AC-FT

Computed Results

Peak Inflow :	128.2 (CFS)	Date/Time of Peak Inflow :	01Jan2011, 06:40
Peak Outflow :	11.2 (CFS)	Date/Time of Peak Outflow :	01Jan2011, 09:34
Total Inflow :	18.9 (AC-FT)	Peak Storage :	8.9 (AC-FT)
Total Outflow :	13.8 (AC-FT)	Peak Elevation :	6891.4 (FT)

Project: Aug15_Working_Falcon_DBPS_S
Simulation Run: FU 2-yr Reservoir: Regional Pond MN

Start of Run: 01Jan2011, 00:00 Basin Model: Falcon_DBPS_Future
End of Run: 02Jan2011, 00:00 Meteorologic Model: 2-yr
Compute Time: 22Jan2021, 17:09:00 Control Specifications: 24-hr Storm

Volume Units: AC-FT

Computed Results

Peak Inflow :	64.9 (CFS)	Date/Time of Peak Inflow :	01Jan2011, 06:01
Peak Outflow :	30.9 (CFS)	Date/Time of Peak Outflow :	01Jan2011, 06:37
Total Inflow :	20.7 (AC-FT)	Peak Storage :	2.6 (AC-FT)
Total Outflow :	18.2 (AC-FT)	Peak Elevation :	6851.5 (FT)

tmp#2.txt

Pond 1
100 year, 24 hour storm

Basin Output

Pond Name D:\Land Projects\meadows\hd\pond1.ssc
Distribution Type Type II
Frequency Type 100 years
Area 0.1180 mi²
Peak Inflow 85.4110 cfs
Peak Outflow 69.9000 cfs
Runoff 1.7500 in
Runoff Volume 479929.5062 ft³
Storage Volume 81307.9403 ft³
Maximum Storage Elevation 7010.0000 ft

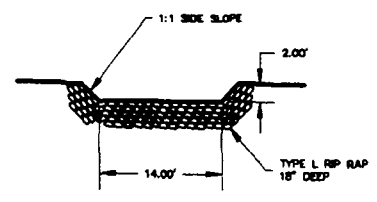
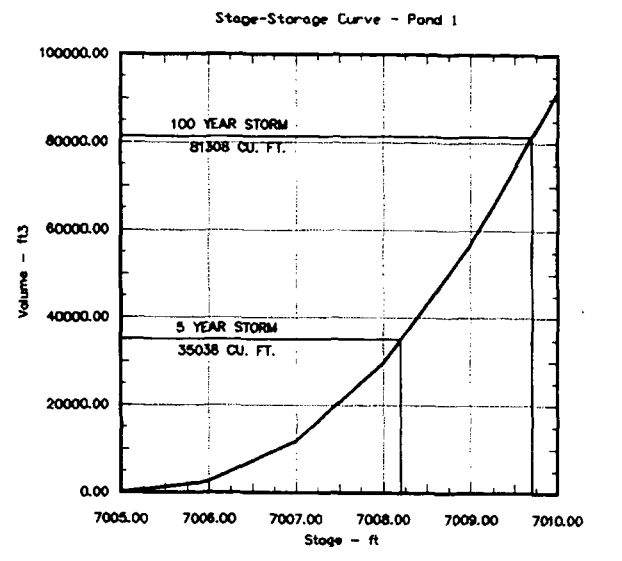
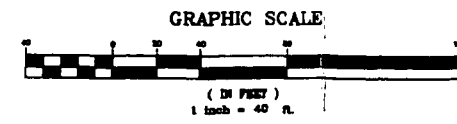
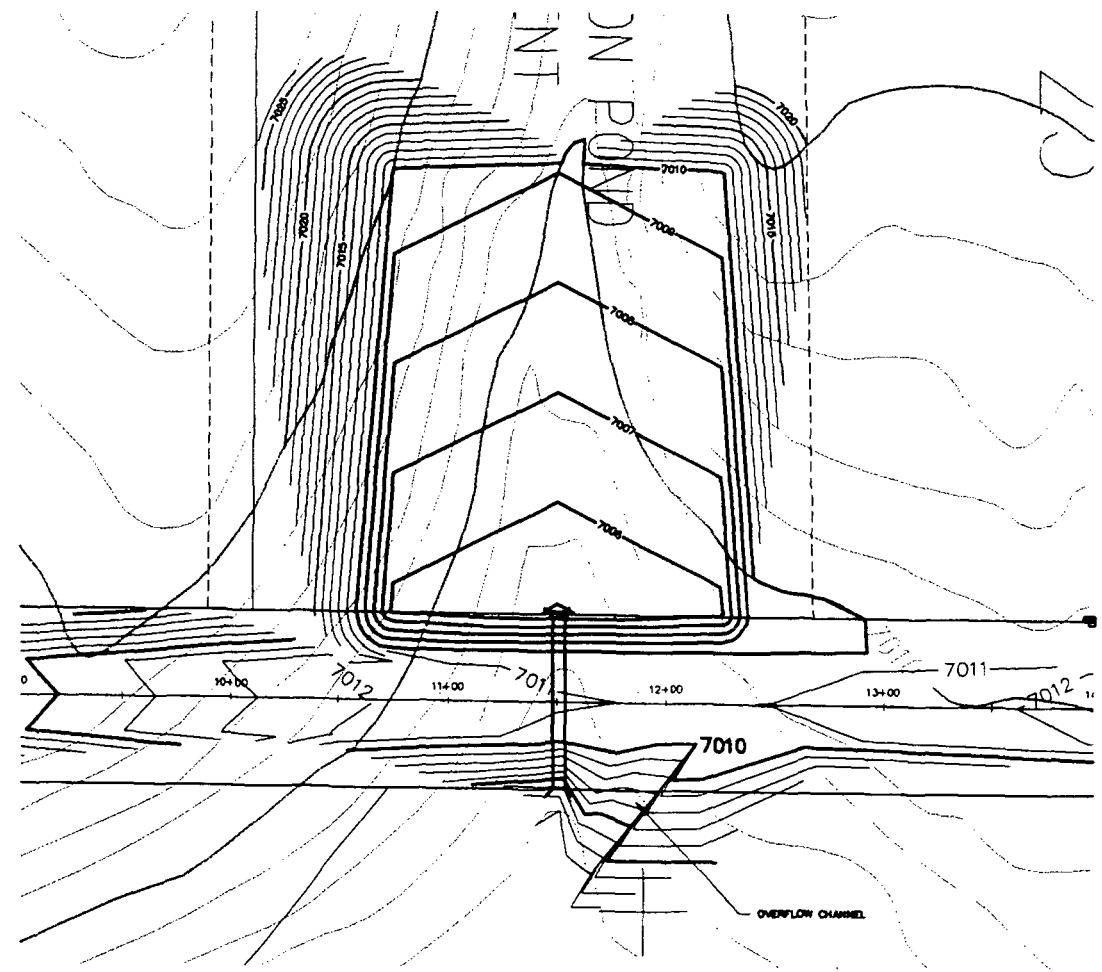

POND 1
OVERFLOW CHANNEL
CROSS SECTION

LOW POINT ELEV = 7010.82
 LOW POINT STA = 12+07.20
 PM STA = 11+50.02
 PM ELEV = 7008.85
 A.D. = 3.23
 K = 92.82

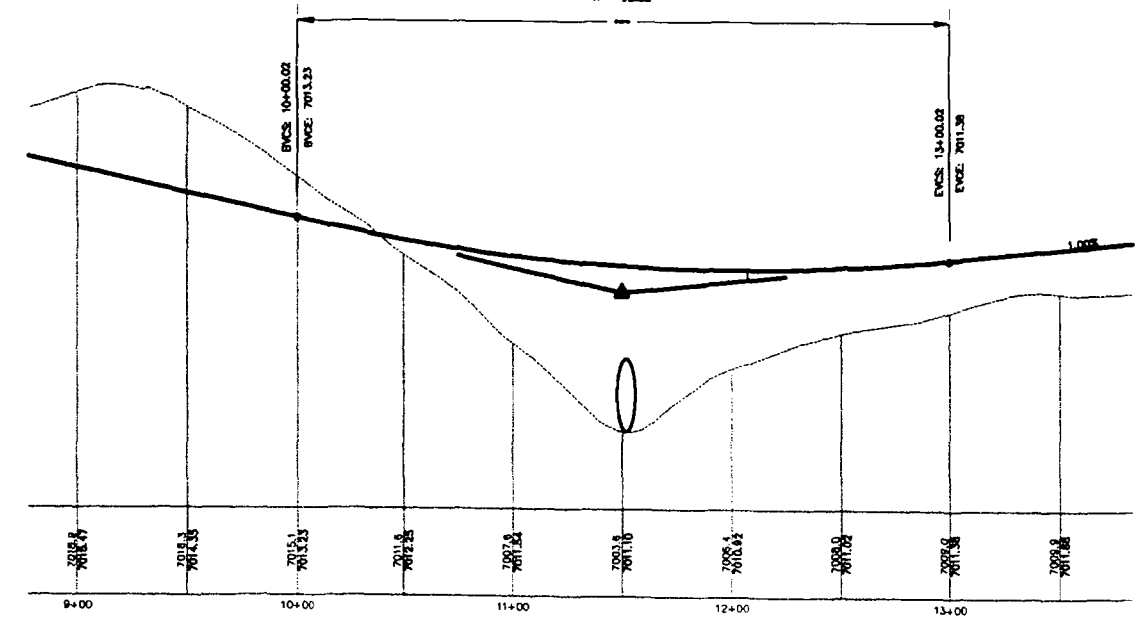

		THE MEADOWS FILING NUMBER THREE	
		DETENTION POND 1	
PROJECT NO.:	DESIGNER: FLDZ	DATE: 05-24-99	DWG. NO. 1 OF 1
DRAFTING: DZ	CHECKED:		

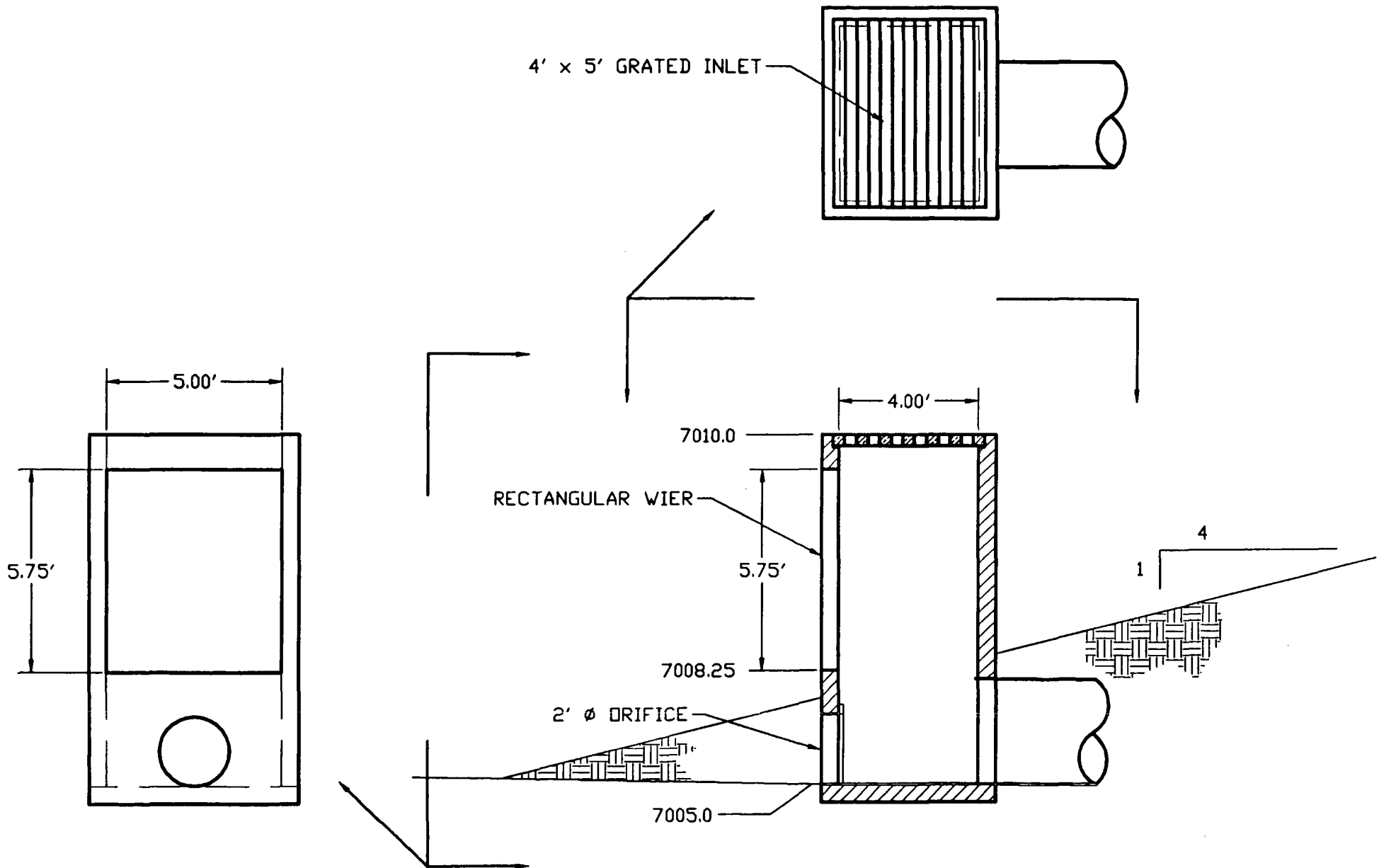

POND 1
OUTLET STRUCTURE

DETENTION BASIN STAGE-STORAGE TABLE BUILDER

UD-Detention, Version 3.07 (February 2017)

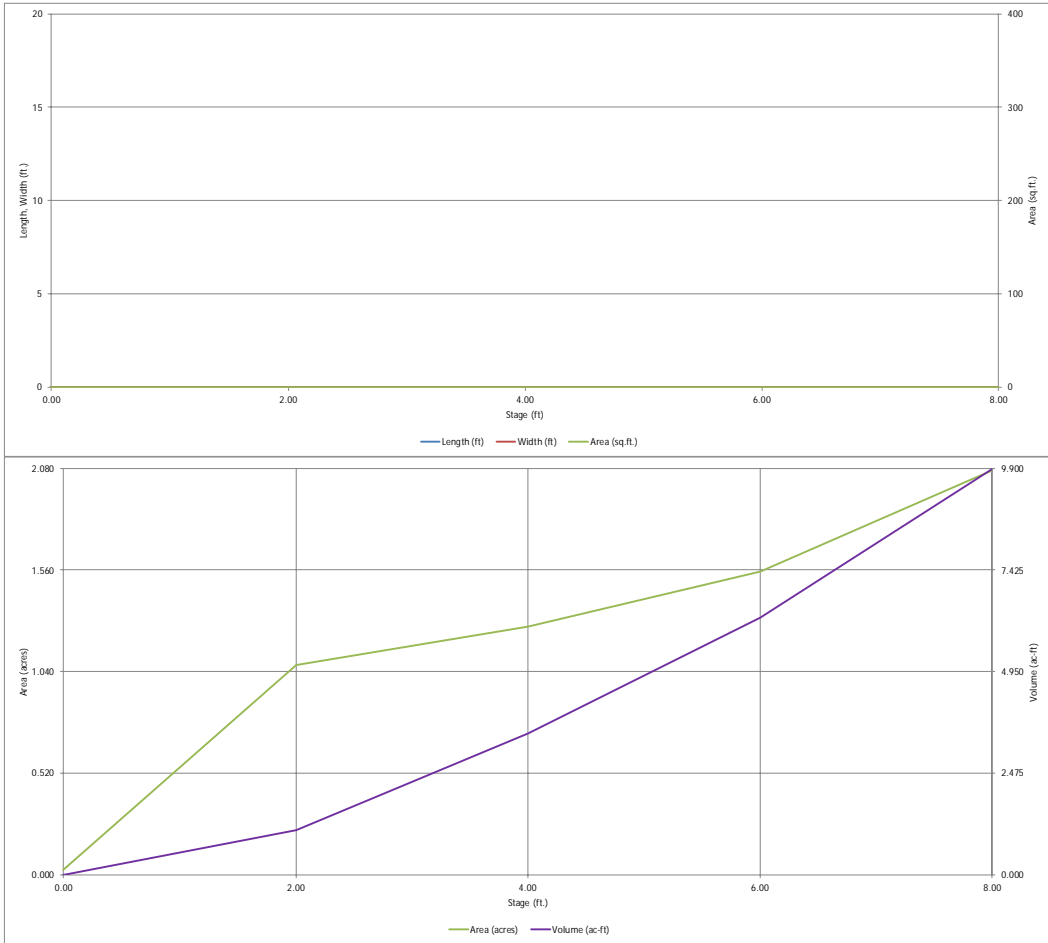

Detention Basin Outlet Structure Design

UD-Detention, Version 3.07 (February 2017)

Project: Meridian Road
Basin ID: Proposed Pond (Diverted Flow)

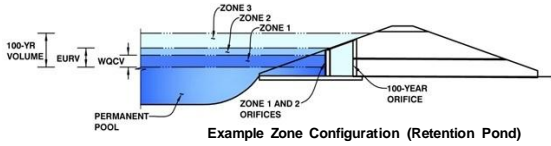

Example Zone Configuration (Retention Pond)

	Stage (ft)	Zone Volume (ac-ft)	Outlet Type
Zone 1 (WOCV)	2.03	1.125	Orifice Plate
Zone 2			
Zone 3			
		1.125	Total

User Input: Orifice at Underdrain Outlet (typically used to drain WOCV in a Filtration BMP)

Underdrain Orifice Invert Depth = ft (distance below the filtration media surface)
 Underdrain Orifice Diameter = inches

Calculated Parameters for Underdrain

Underdrain Orifice Area = ft²
 Underdrain Orifice Centroid = feet

User Input: Orifice Plate with one or more orifices or Elliptical Slot Weir (typically used to drain WOCV and/or EURV in a sedimentation BMP)

Invert of Lowest Orifice = ft (relative to basin bottom at Stage = 0 ft)
 Depth at top of Zone using Orifice Plate = ft (relative to basin bottom at Stage = 0 ft)
 Orifice Plate: Orifice Vertical Spacing = inches
 Orifice Plate: Orifice Area per Row = sq. inches (use rectangular openings)

Calculated Parameters for Plate

WQ Orifice Area per Row = ft²
 Elliptical Half-Width = feet
 Elliptical Slot Centroid = feet
 Elliptical Slot Area = ft²

User Input: Stage and Total Area of Each Orifice Row (numbered from lowest to highest)

	Row 1 (required)	Row 2 (optional)	Row 3 (optional)	Row 4 (optional)	Row 5 (optional)	Row 6 (optional)	Row 7 (optional)	Row 8 (optional)
Stage of Orifice Centroid (ft)	0.17	0.50	0.83	1.17	1.50	1.83	2.17	2.50
Orifice Area (sq. inches)	6.57	6.57	6.57	6.57	6.57	6.57	6.57	6.57

	Row 9 (optional)	Row 10 (optional)	Row 11 (optional)	Row 12 (optional)	Row 13 (optional)	Row 14 (optional)	Row 15 (optional)	Row 16 (optional)
Stage of Orifice Centroid (ft)								
Orifice Area (sq. inches)								

User Input: Vertical Orifice (Circular or Rectangular)

Invert of Vertical Orifice = ft (relative to basin bottom at Stage = 0 ft)
 Depth at top of Zone using Vertical Orifice = ft (relative to basin bottom at Stage = 0 ft)
 Vertical Orifice Diameter = inches

Calculated Parameters for Vertical Orifice

Vertical Orifice Area = ft²
 Vertical Orifice Centroid = feet

User Input: Overflow Weir (Dropbox) and Grate (Flat or Sloped)

Overflow Weir Front Edge Height, Ho = ft (relative to basin bottom at Stage = 0 ft)
 Overflow Weir Front Edge Length = feet
 Overflow Weir Slope = H:V (enter zero for flat grate)
 Horiz. Length of Weir Sides = feet
 Overflow Grate Open Area % = %, grate open area/total area
 Debris Clogging % = %

Calculated Parameters for Overflow Weir

Height of Grate Upper Edge, H₁ = feet
 Over Flow Weir Slope Length = feet
 Grate Open Area / 100-yr Orifice Area = should be ≥ 4
 Overflow Grate Open Area w/o Debris = ft²
 Overflow Grate Open Area w/ Debris = ft²

User Input: Outlet Pipe w/ Flow Restriction Plate (Circular Orifice, Restrictor Plate, or Rectangular Orifice)

Depth to Invert of Outlet Pipe = ft (distance below basin bottom at Stage = 0 ft)
 Circular Orifice Diameter = inches

Calculated Parameters for Outlet Pipe w/ Flow Restriction Plate

Outlet Orifice Area = ft²
 Outlet Orifice Centroid = feet
 Half-Central Angle of Restrictor Plate on Pipe = radians

User Input: Emergency Spillway (Rectangular or Trapezoidal)

Spillway Invert Stage = ft (relative to basin bottom at Stage = 0 ft)
 Spillway Crest Length = feet
 Spillway End Slopes = H:V
 Freeboard above Max Water Surface = feet

Calculated Parameters for Spillway

Spillway Design Flow Depth = feet
 Stage at Top of Freeboard = feet
 Basin Area at Top of Freeboard = acres

Routed Hydrograph Results

	WOCV	EURV	2 Year	5 Year	10 Year	25 Year	50 Year	100 Year	500 Year
Design Storm Return Period									
One-Hour Rainfall Depth (in)	0.53	1.07	1.19	1.50	1.75	2.00	2.25	2.67	3.68
Calculated Runoff Volume (acre-ft)	1.125	1.544	1.005	1.374	1.809	2.654	4.704	9.173	21.246
OPTIONAL Override Runoff Volume (acre-ft)									
Inflow Hydrograph Volume (acre-ft)	1.124	1.542	1.004	1.373	1.808	2.652	4.701	9.160	21.230
Predevelopment Unit Peak Flow, q (cfs/acre)	0.00	0.00	0.00	0.01	0.02	0.03	0.25	0.65	1.59
Predevelopment Peak Q (cfs)	0.0	0.0	0.2	1.2	2.9	6.4	47.4	121.1	296.4
Peak Inflow Q (cfs)	22.2	30.4	19.9	27.1	35.6	51.9	91.1	174.5	391.6
Peak Outflow Q (cfs)	1.2	1.5	1.0	1.3	1.7	2.3	3.2	14.8	152.8
Ratio Peak Outflow to Predevelopment Q	N/A	N/A	N/A	N/A	0.6	0.4	0.1	0.1	0.5
Structure Controlling Flow	Plate	Plate	Plate	Plate	Plate	Plate	Plate	Spillway	N/A
Max Velocity through Grate 1 (fps)	N/A	N/A	N/A	N/A	N/A	N/A	N/A	-0.2	-0.2
Max Velocity through Grate 2 (fps)	N/A	N/A	N/A	N/A	N/A	N/A	N/A	N/A	N/A
Time to Drain 97% of Inflow Volume (hours)	28	30	27	29	30	32	37	43	36
Time to Drain 99% of Inflow Volume (hours)	>120	35	>120	34	36	39	44	51	45
Maximum Ponding Depth (ft)	1.91	2.26	1.80	2.12	2.48	3.15	4.68	7.16	8.00
Area at Maximum Ponding Depth (acres)	1.02	1.10	0.96	1.08	1.12	1.19	1.36	1.85	2.07
Maximum Volume Stored (acre-ft)	0.996	1.383	0.887	1.230	1.627	2.399	4.324	8.216	9.882

Detention Basin Outlet Structure Design

UD-Detention, Version 3.07 (February 2017)

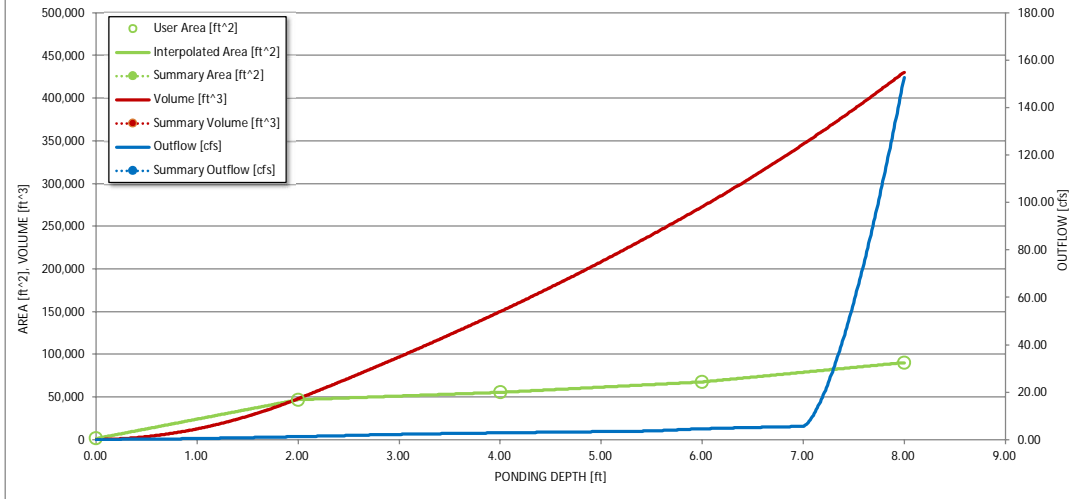
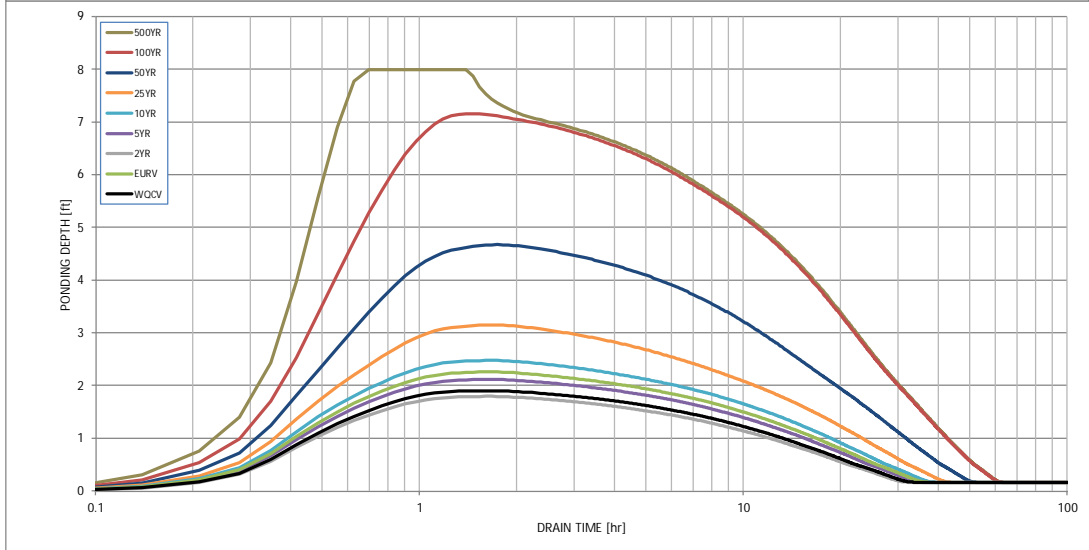
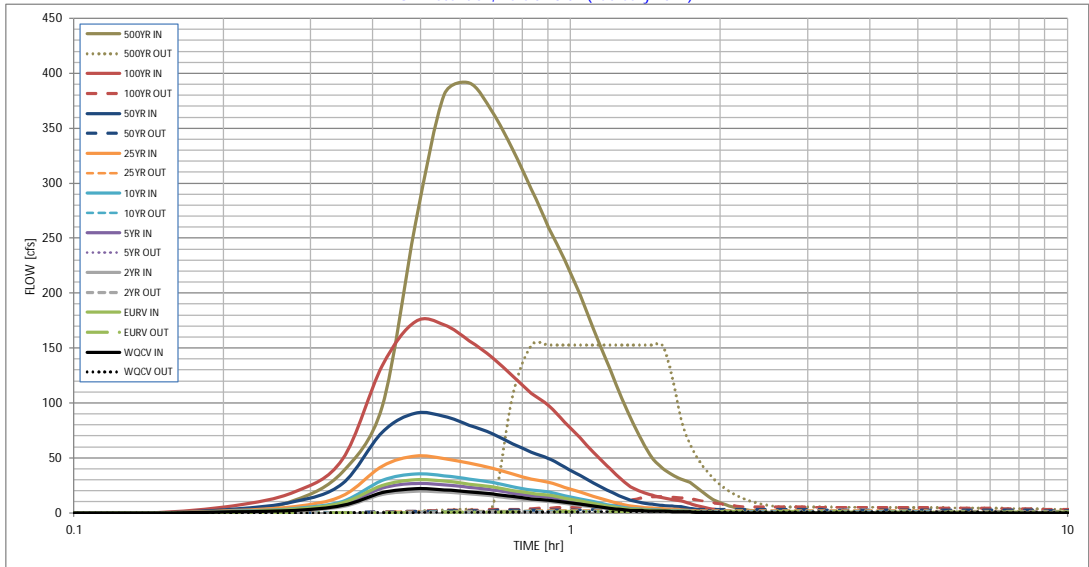

S-A-V-D Chart Axis Override	X-axis	Left Y-Axis	Right Y-Axis
minimum bound			
maximum bound			

RIP RAP NOT APPROVED AT THIS TIME

LEGEND

PROPERTY LINE	---
LOT LINE	----
CURB & GUTTER	=====
SIDEWALK	=====
PRO. WATER LINE	—W—
PRO. FIRE HYDRANT	—F—
PRO. RAW WATER	—R—
PRO. SANITARY SEWER	—S—
PRO. STORM SEWER	—ST—
EX. OVERHEAD ELECTRIC	—OE—
EX. SANITARY SEWER	—SS—
EX. GAS	—G—

PREPARED BY:

DREXEL, BARRELL & CO.
 Engineers-Surveyors
 3 SOUTH 7TH STREET
 COLORADO SPGS, COLORADO 80905
 CONTACT: TIM D. MCCONNELL, P.E.
 (719)260-0887
 BOULDER • COLORADO SPRINGS

CLIENT:
HUMMEL INVESTMENTS, LLC
 8117 PRESTON ROAD, SUITE 120
 DALLAS, TEXAS 75225
 (214) 416-9820

OVERLOT GRADING, POND SR4 & UTILITY
 CONSTRUCTION DRAWINGS FOR
FALCON MARKETPLACE
 FALCON, COLORADO

ISSUE	DATE
1ST SUBMITTAL	6-20-17
RESUBMITTAL	9-6-18

DESIGNED BY: TDM
 DRAWN BY: KGV
 CHECKED BY: TDM
 FILE NAME:



PREPARED UNDER MY DIRECT SUPERVISION FOR AND ON BEHALF OF DREXEL, BARRELL & CO.

DRAWING SCALE:
 HORIZONTAL: 1"=40'
 VERTICAL: N/A

SUB-REGIONAL POND #1 (SR4)

PROJECT NO. 20988-00CSV
 DRAWING NO.

C7.2

SHEET: 9 OF 27

EPC 10/10/18
 EL PASO COUNTY FILE NO: SP-17-001
 CDR-16-007

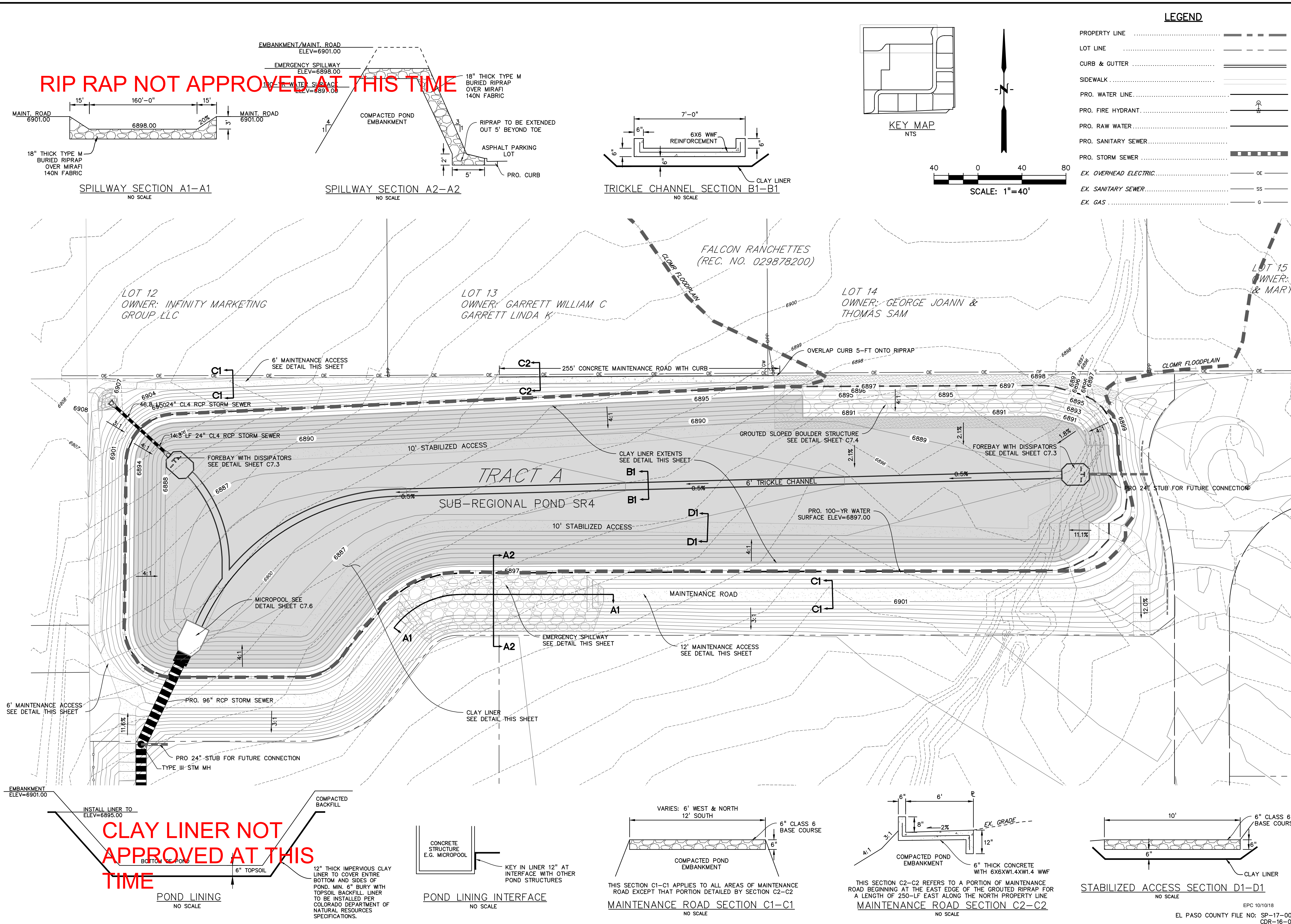

SPILLWAY SECTION A1-A1
NO SCALE

SPILLWAY SECTION A2-A2
NO SCALE

TRICKLE CHANNEL SECTION B1-B1
NO SCALE

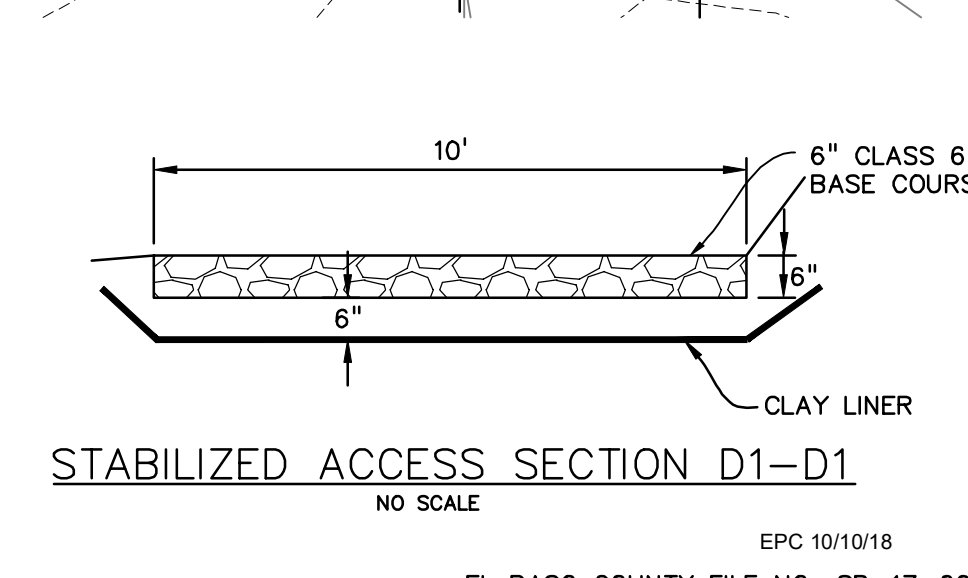
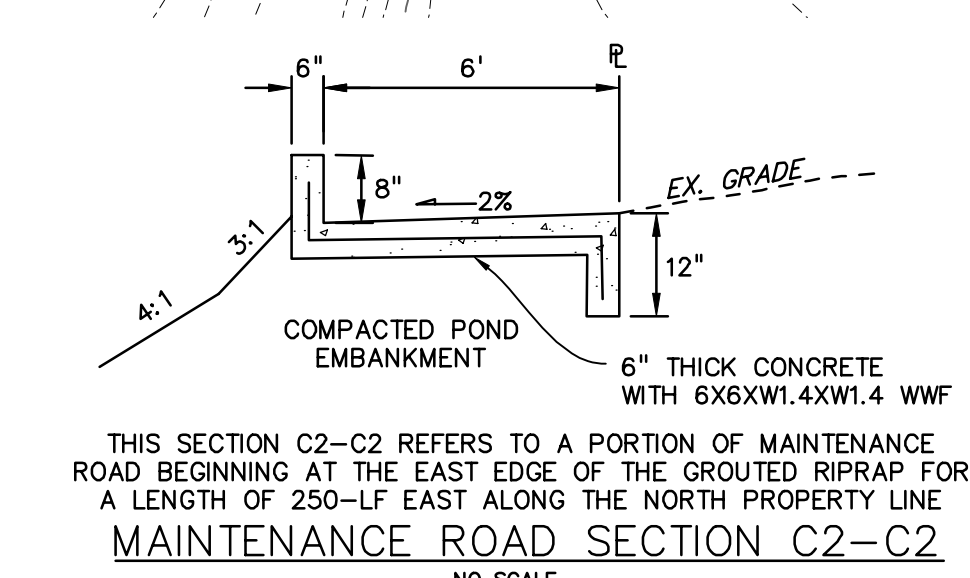
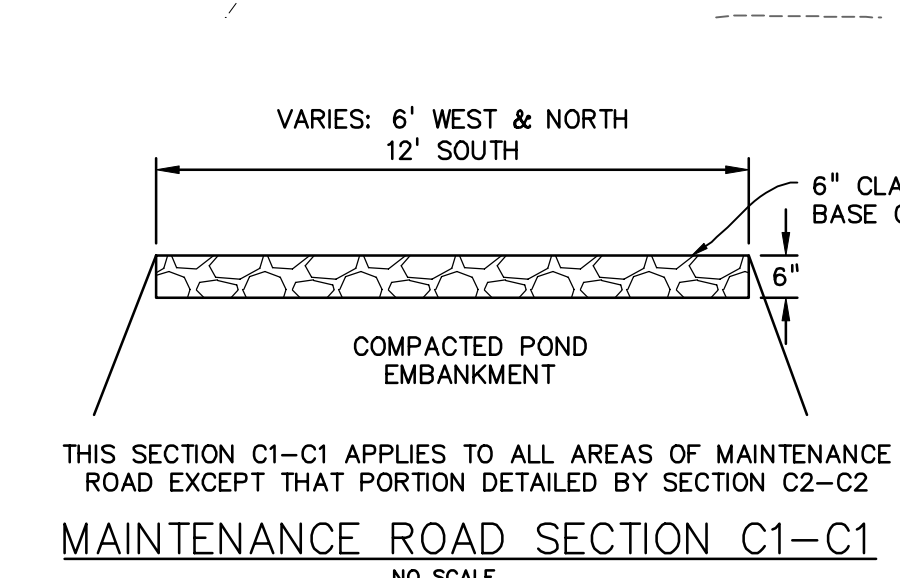
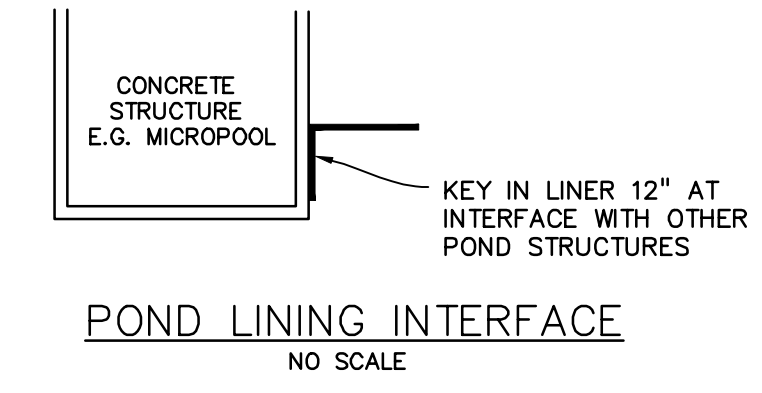
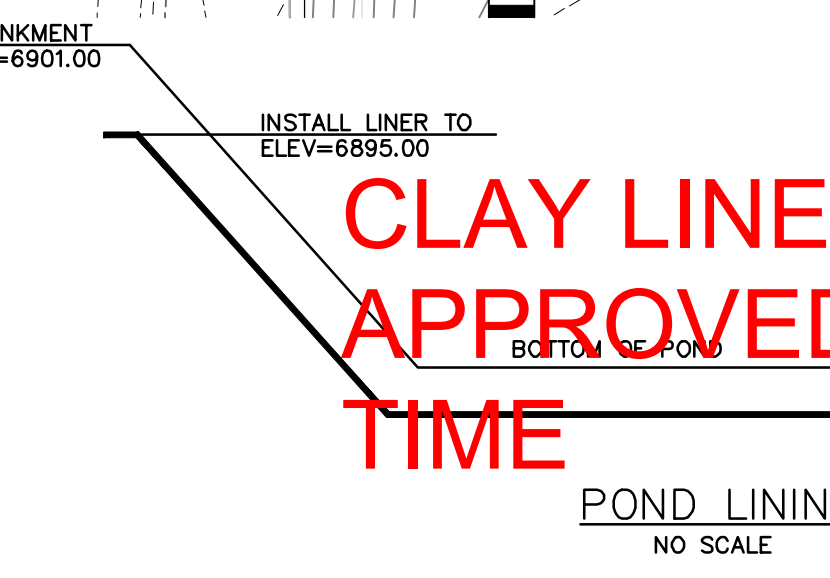

CLAY LINER NOT APPROVED AT THIS TIME

Provide latest plans and copy of Falcon Marketplace pond calcs or summary

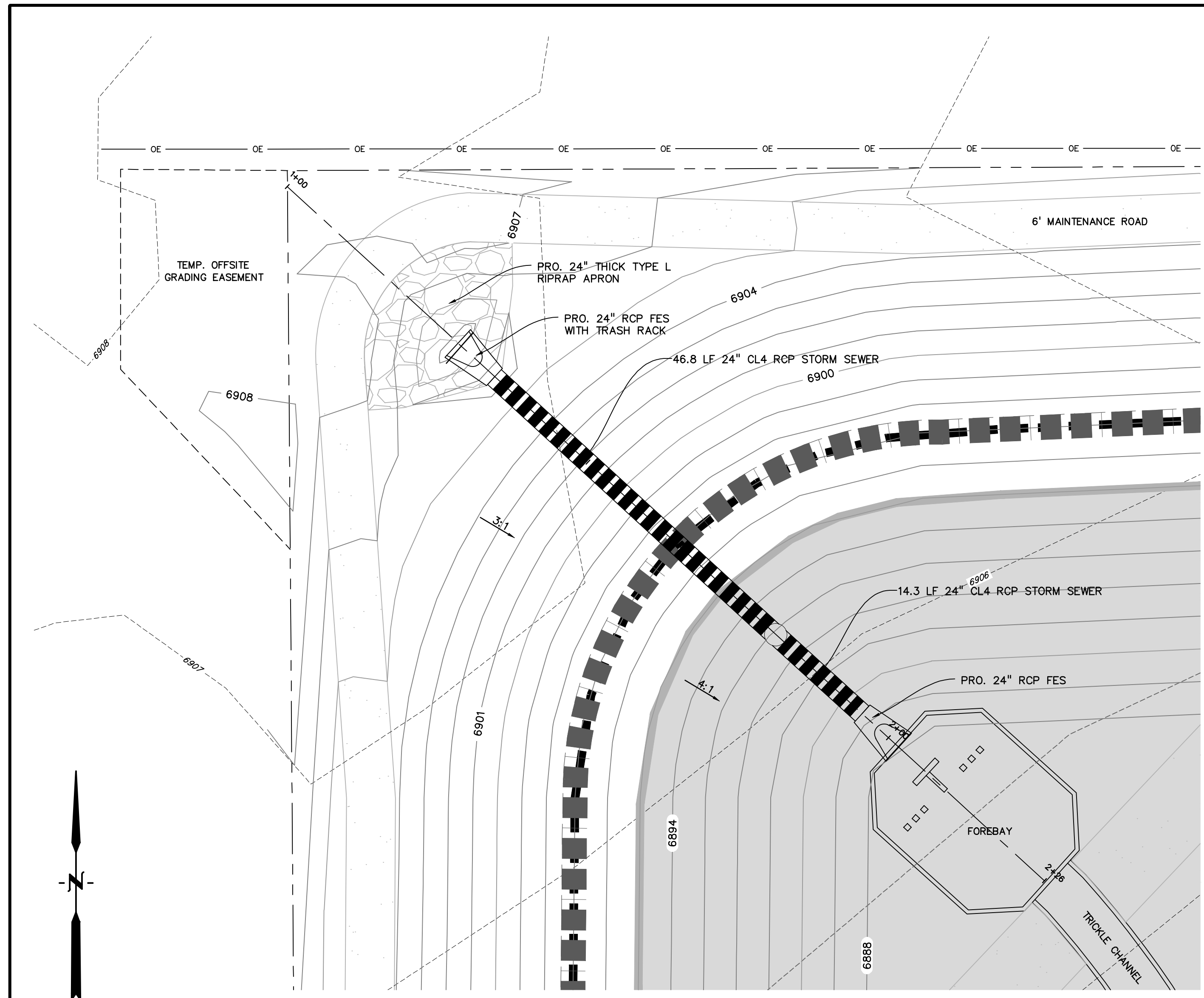

NORTHWEST DRAIN PLAN
1"=10'

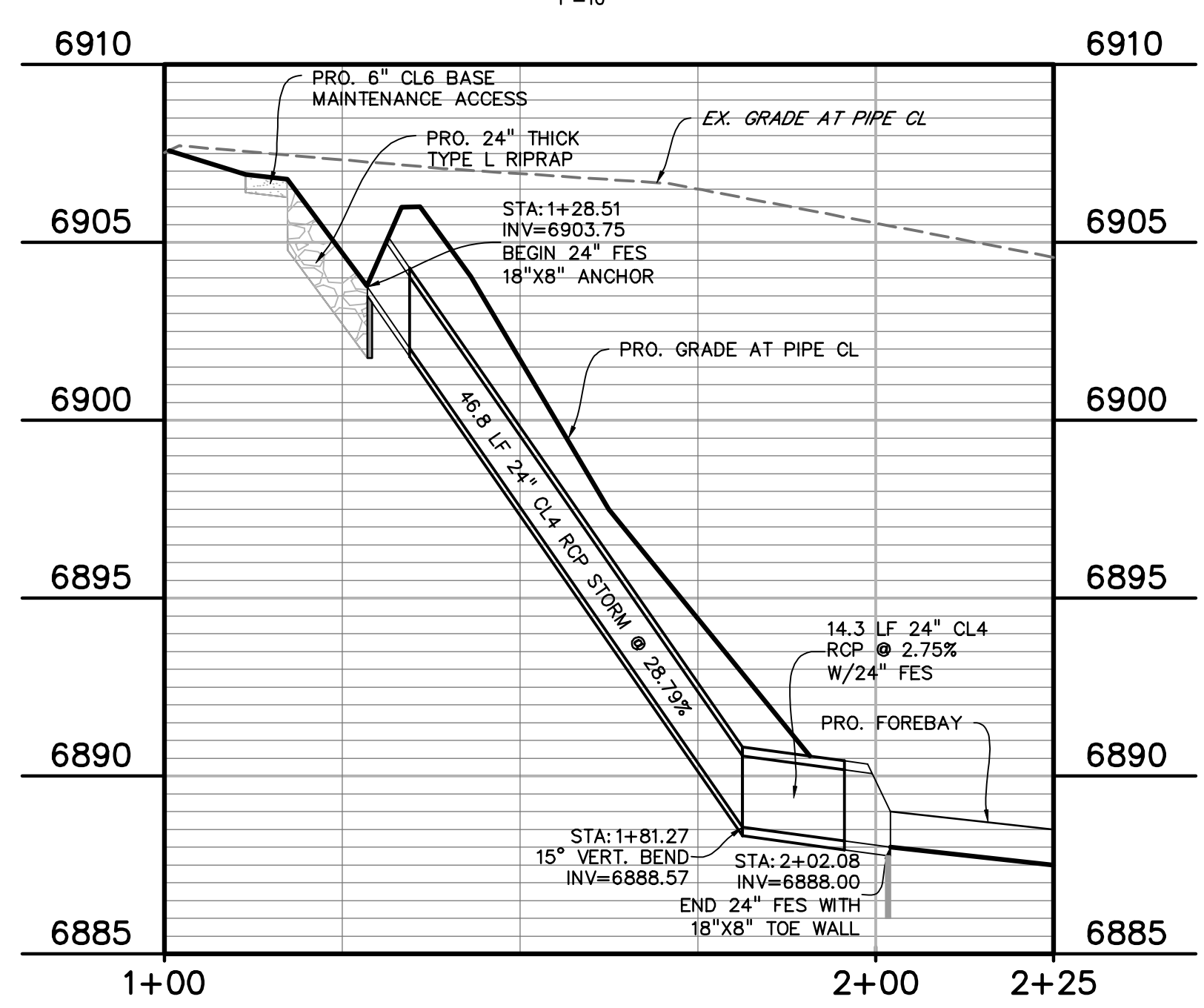

NORTHWEST DRAIN PROFILE
1"=20'

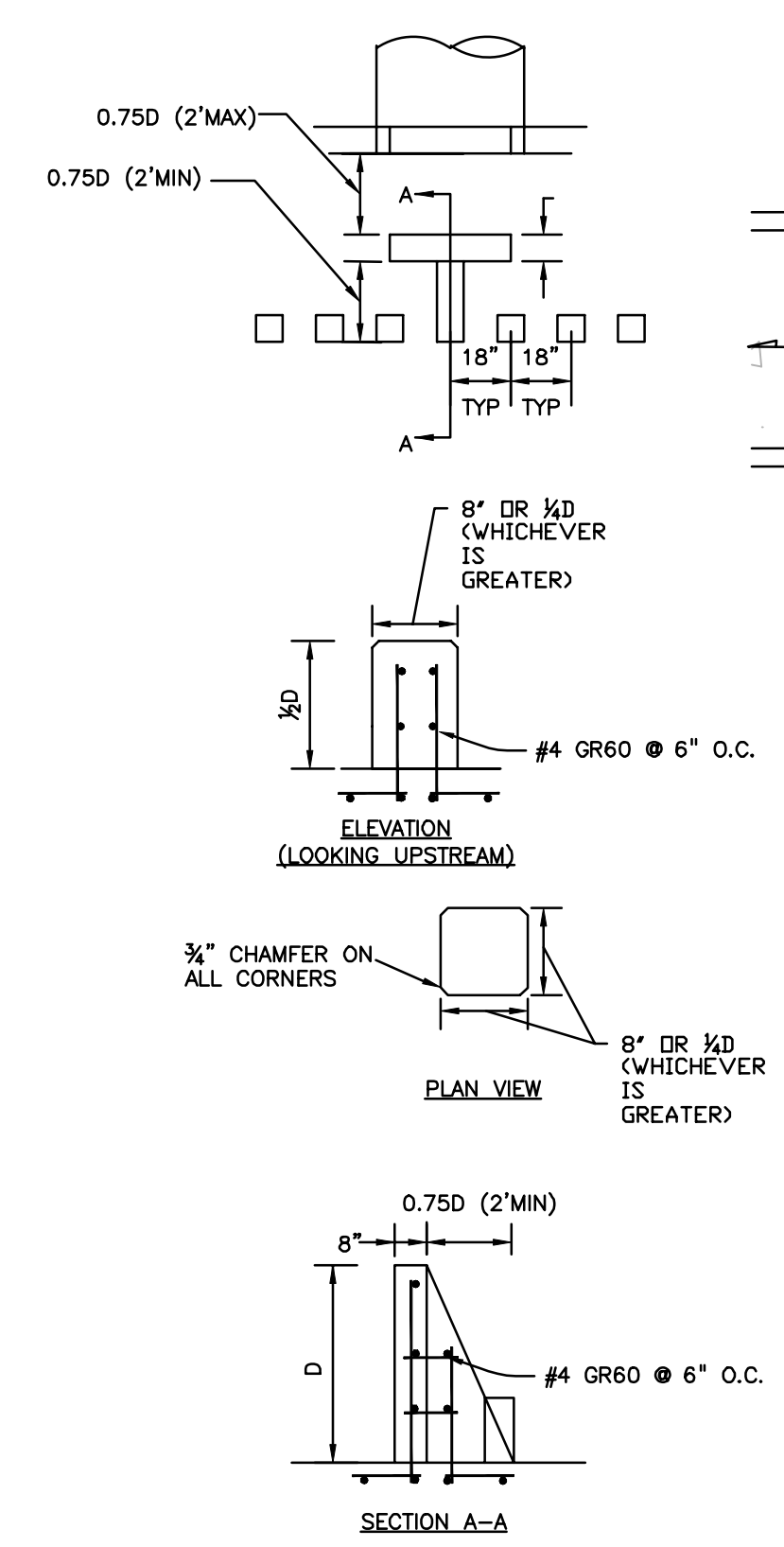

FOREBAY BAFFLE ENERGY DISSIPATORS
NO SCALE

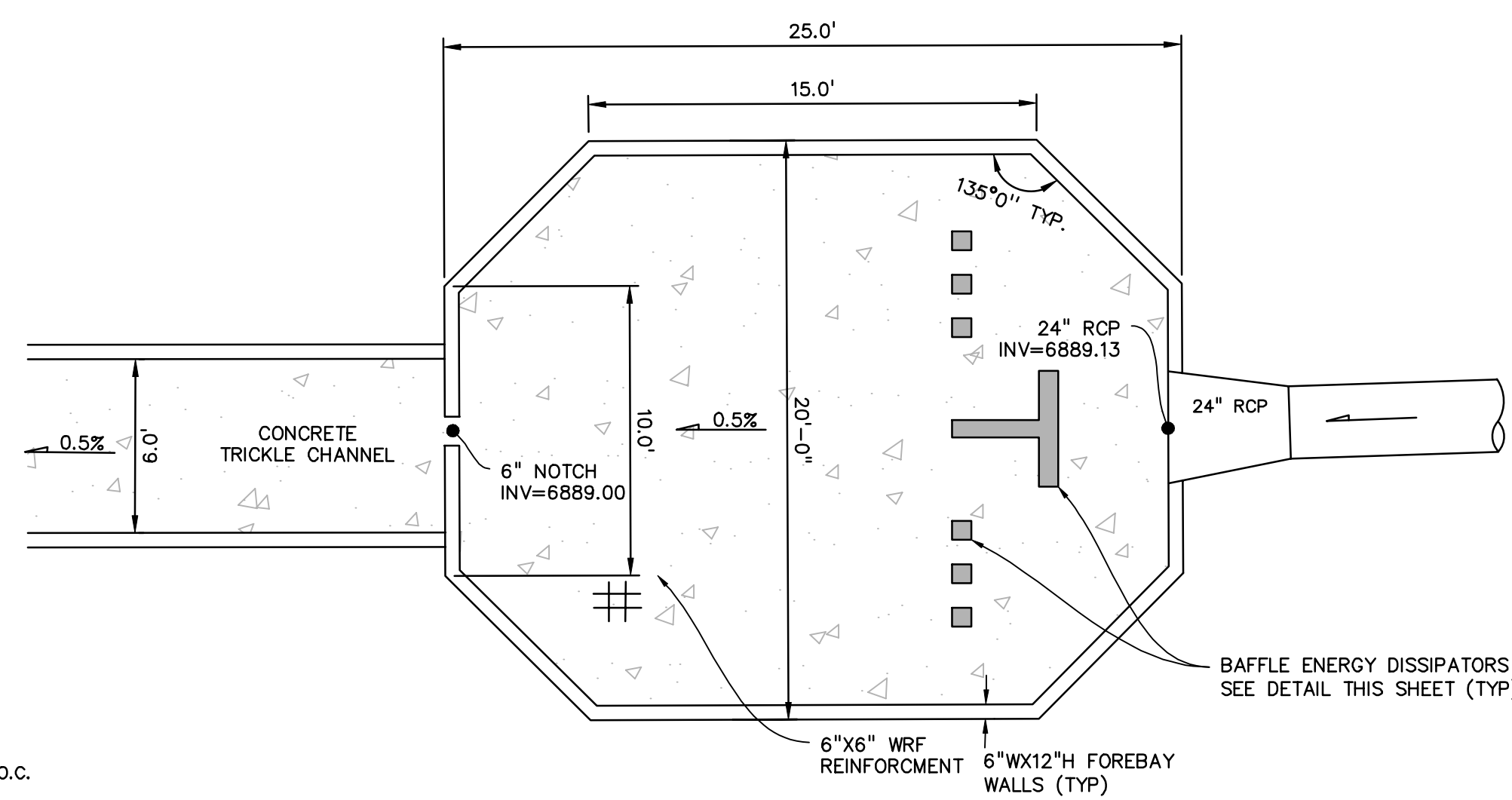

EAST FOREBAY
NO SCALE

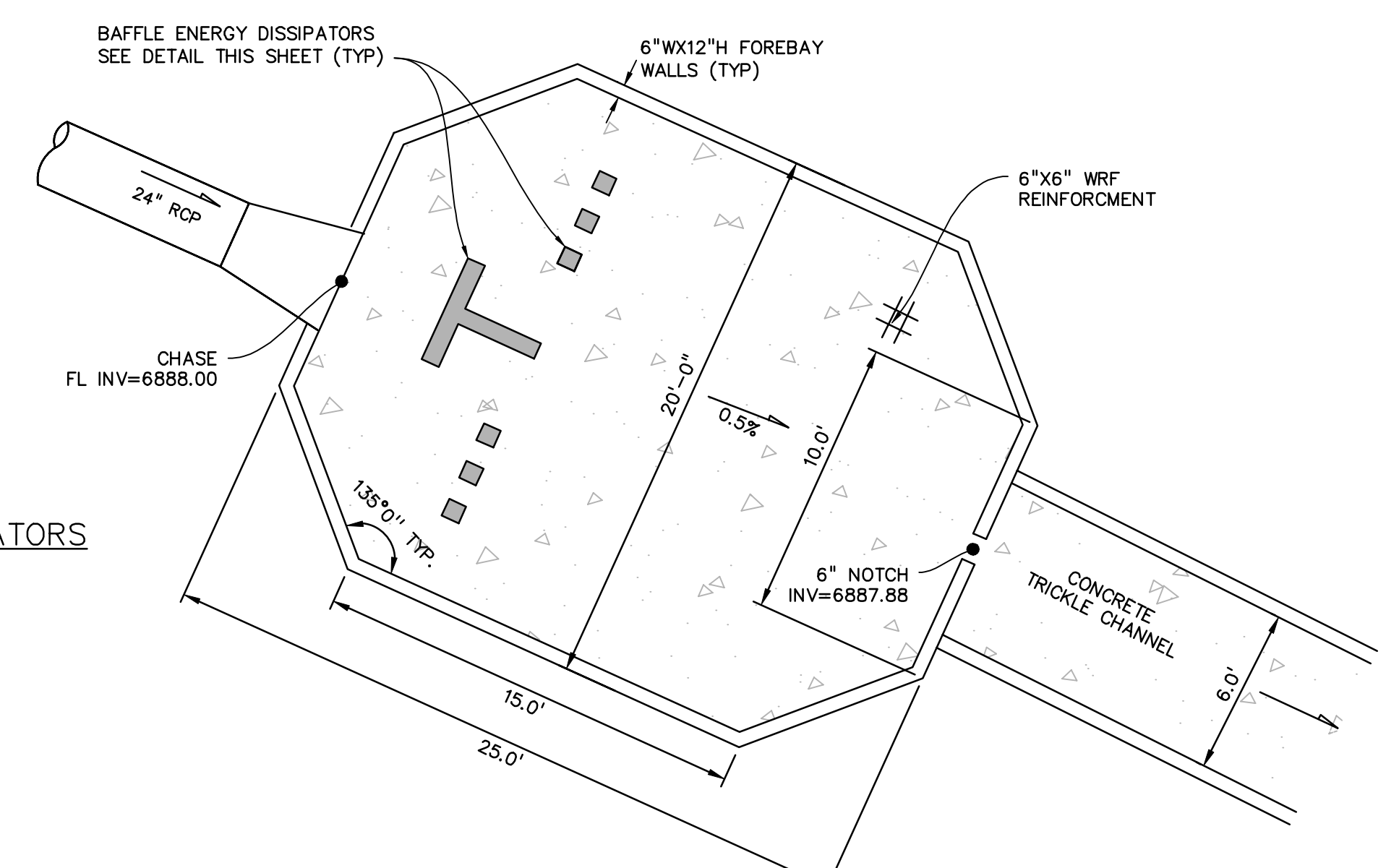

NORTHWEST FOREBAY
NO SCALE

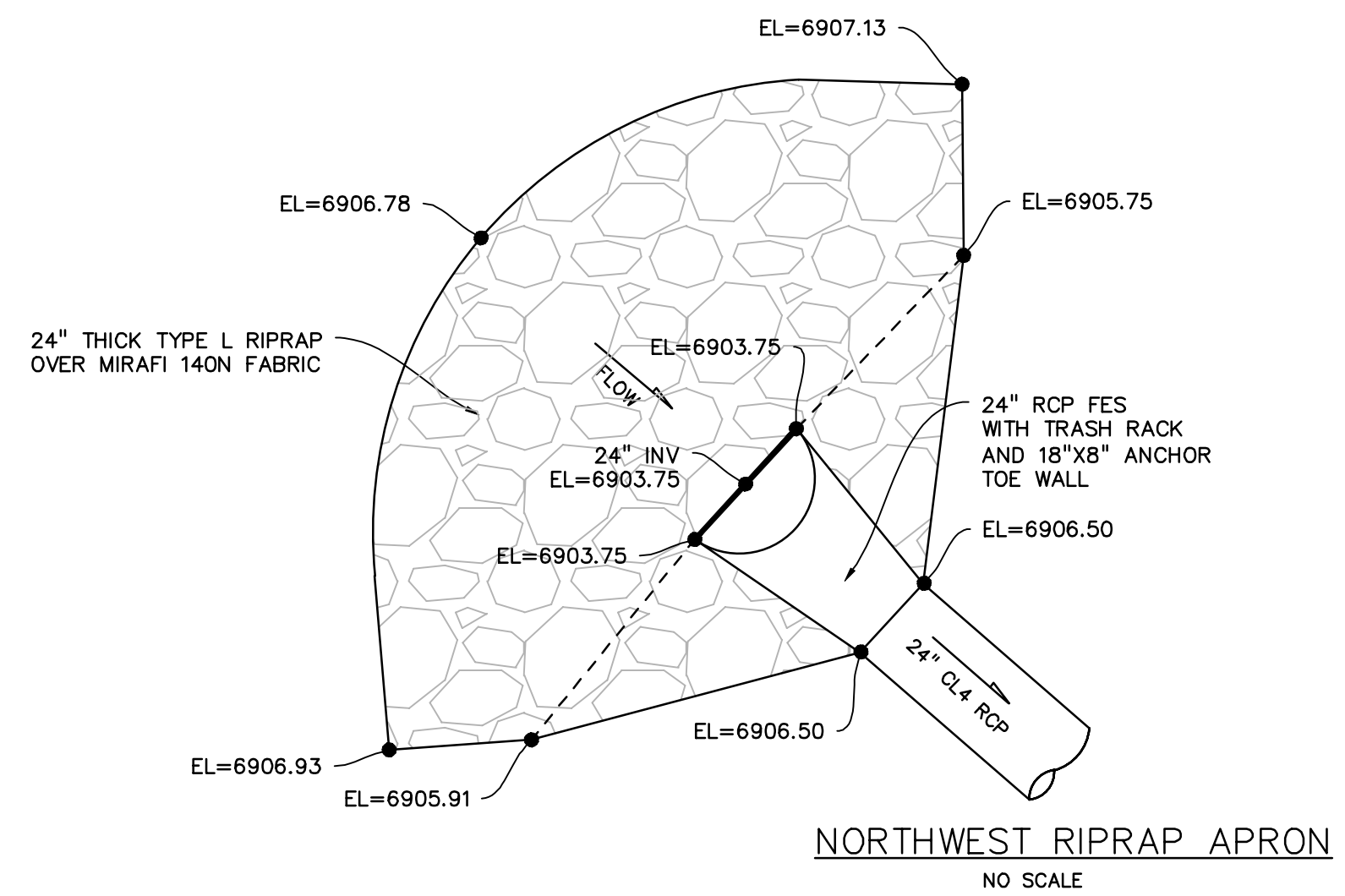

NORTHWEST RIPRAP APRON
NO SCALE

PREPARED BY:



DREXEL, BARRELL & CO.
Engineers-Surveyors
3 SOUTH 7TH STREET
COLORADO SPGS, COLORADO 80905
CONTACT: TIM D. MCCONNELL, P.E.
(719)260-0887
BOULDER • COLORADO SPRINGS

CLIENT:

HUMMEL INVESTMENTS, LLC
8117 PRESTON ROAD, SUITE 120
DALLAS, TEXAS 75225
(214) 416-9820

OVERLOT GRADING, POND SR4 & UTILITY
CONSTRUCTION DRAWINGS FOR
**FALCON
MARKETPLACE**
FALCON, COLORADO

ISSUE	DATE
1ST SUBMITTAL	6-20-17
RESUBMITTAL	9-6-18

DESIGNED BY: TDM
DRAWN BY: KGV
CHECKED BY: TDM
FILE NAME:



PREPARED UNDER MY DIRECT SUPERVISION FOR AND ON BEHALF OF DREXEL, BARRELL & CO.

DRAWING SCALE:
HORIZONTAL: N/A
VERTICAL: N/A

POND #1 (SR4)
DETAILS

PROJECT NO. 20988-00CSCV
DRAWING NO.

C7.3

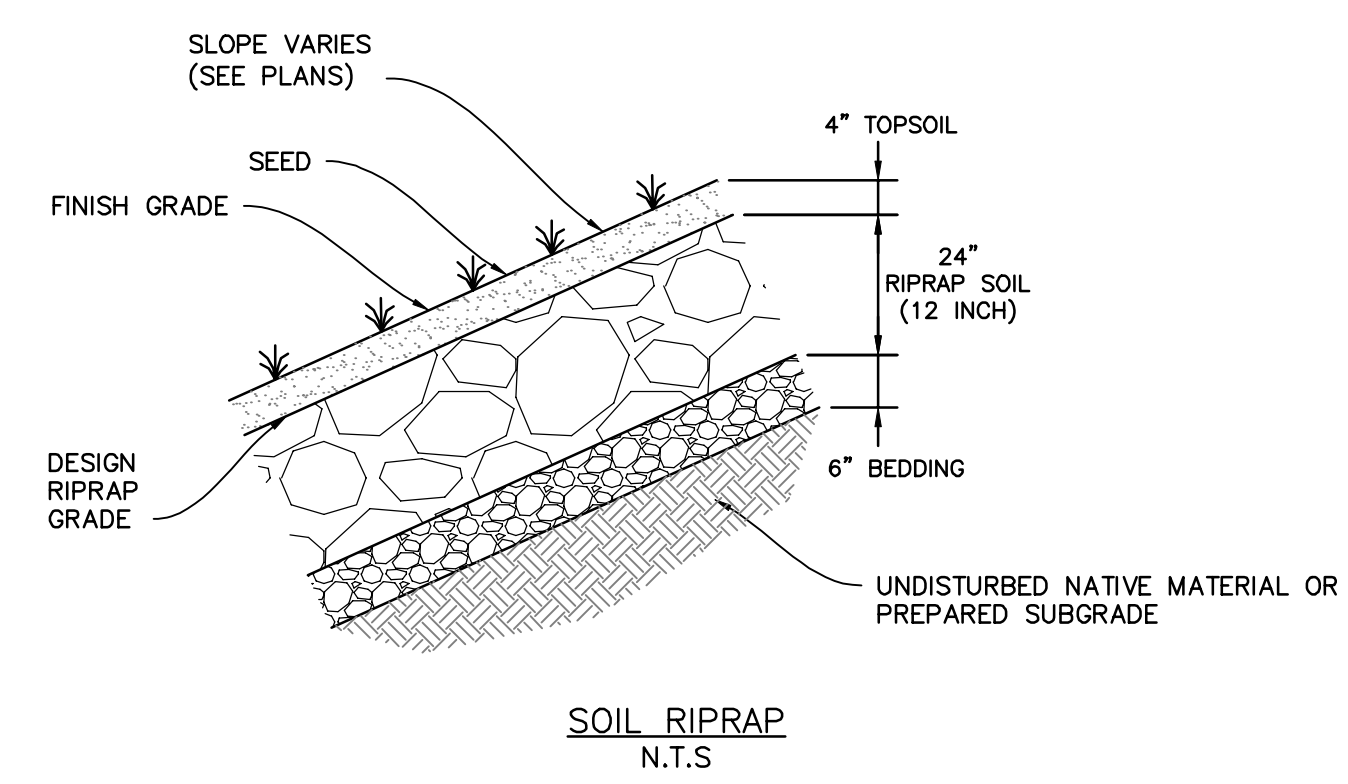
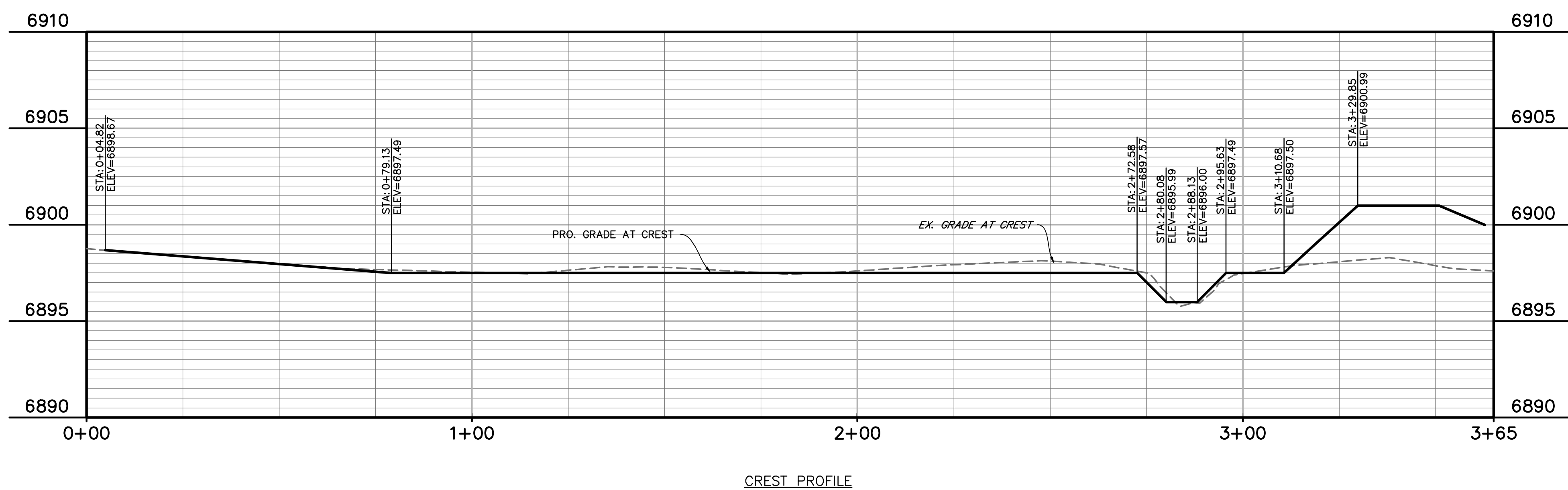
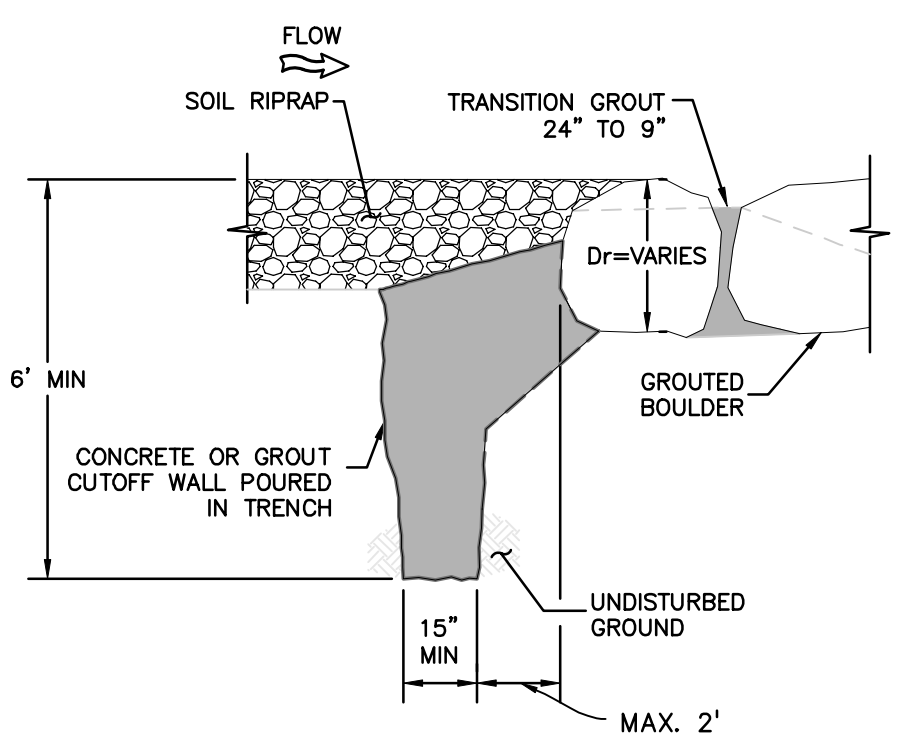
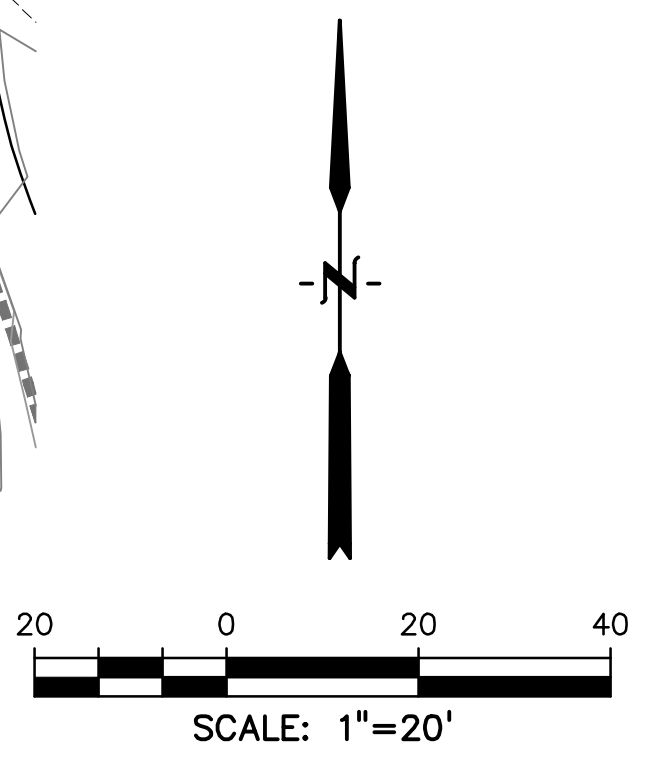
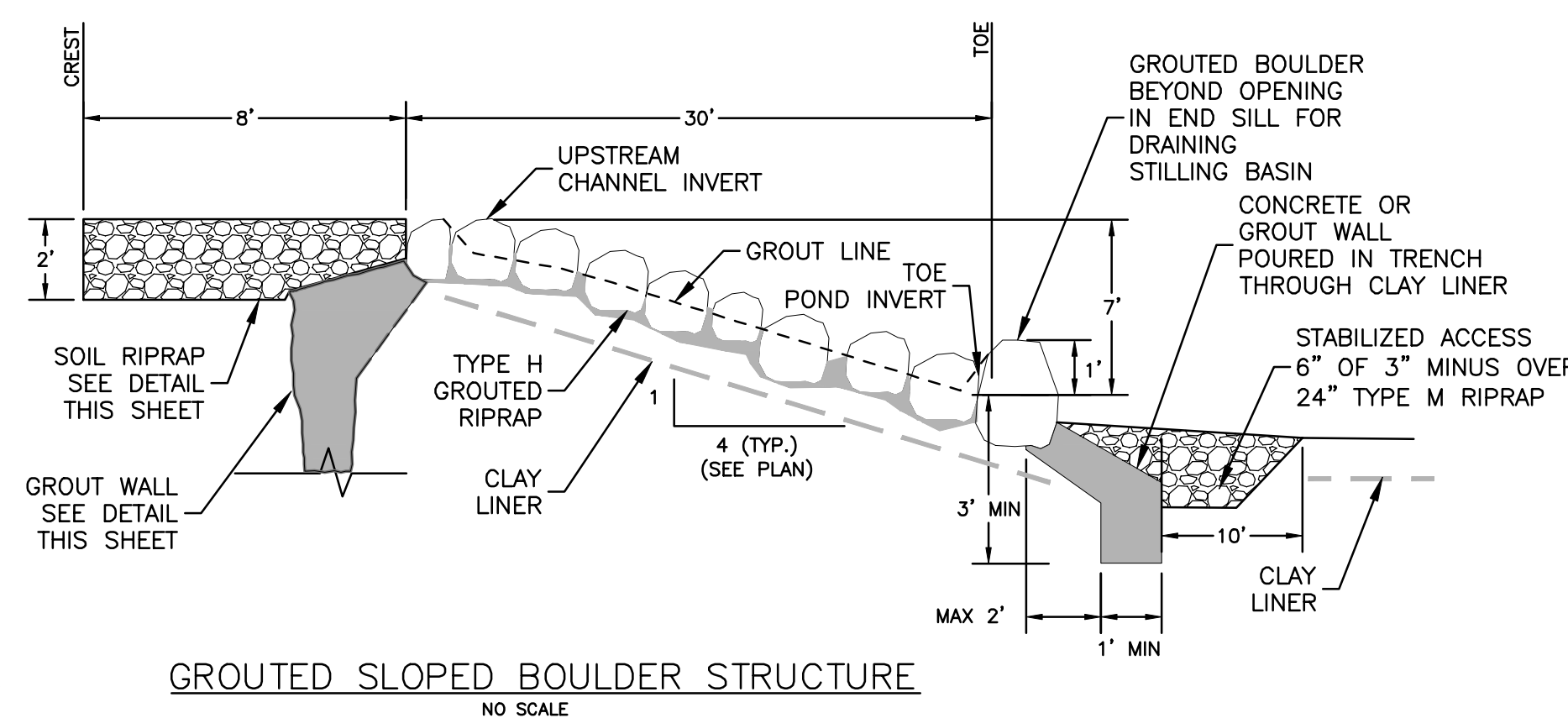
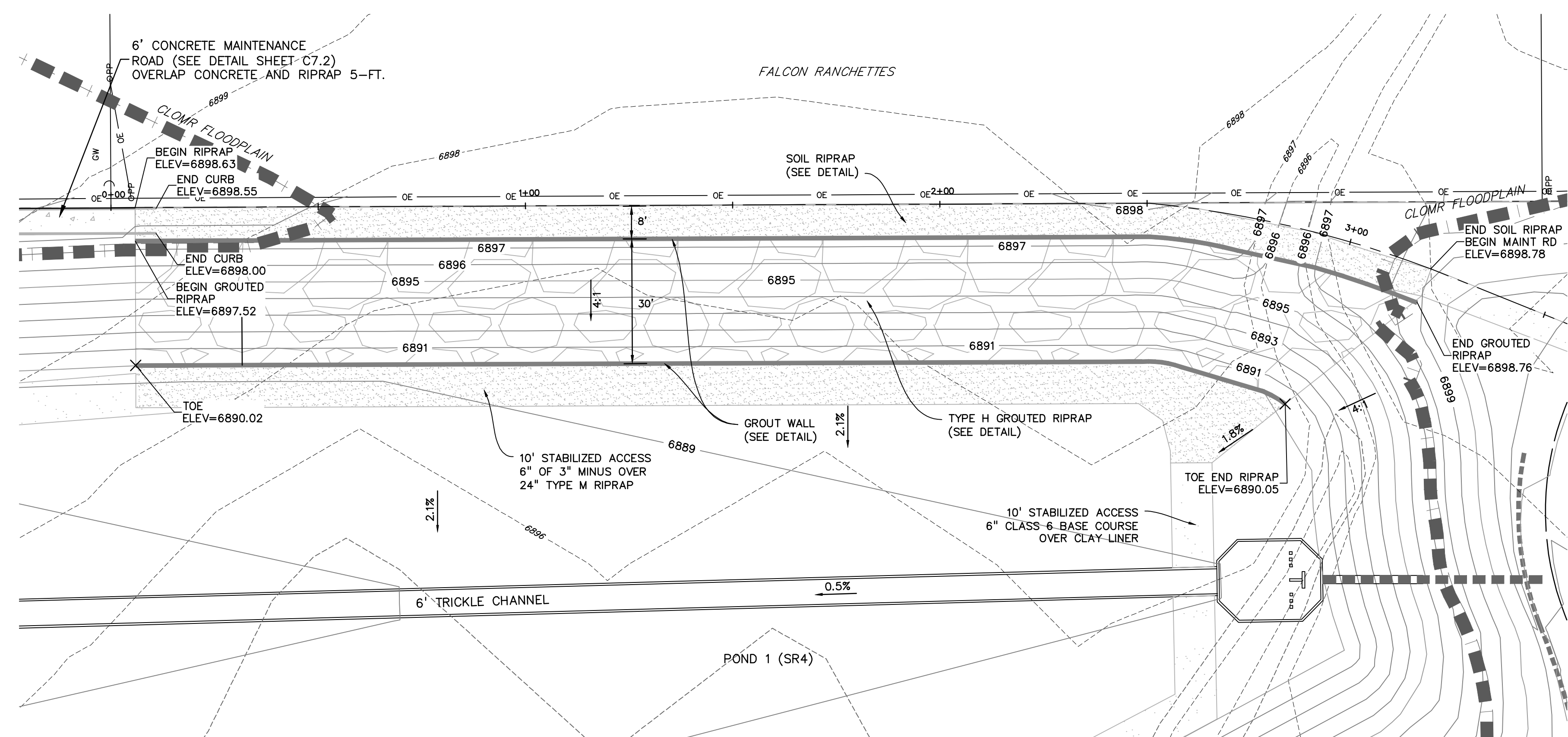

PREPARED BY:

DREXEL, BARRELL & CO.
 Engineers-Surveyors
 3 SOUTH 7TH STREET
 COLORADO SPGS, COLORADO 80905
 CONTACT: TIM D. McCONNELL, P.E.
 (719)260-0887
 BOULDER • COLORADO SPRINGS

CLIENT:
HUMMEL INVESTMENTS, LLC
 8117 PRESTON ROAD, SUITE 120
 DALLAS, TEXAS 75225
 (214) 416-9820

OVERLOT GRADING, POND SR4 & UTILITY
 CONSTRUCTION DRAWINGS FOR
FALCON
MARKETPLACE
 FALCON, COLORADO

ISSUE	DATE
1ST SUBMITTAL	6-20-17
RESUBMITTAL	9-6-18

DESIGNED BY: TDM
 DRAWN BY: KGV
 CHECKED BY: TDM
 FILE NAME:



PREPARED UNDER MY DIRECT SUPERVISION FOR AND ON BEHALF OF DREXEL, BARRELL & CO.

DRAWING SCALE:
 HORIZONTAL: 1"=20'
 VERTICAL: N/A

**POND #1 (SR4)
 GROUTED DROP
 DETAILS**

PROJECT NO. 20988-00CSCV
 DRAWING NO.

C7.4
 SHEET: 11 OF 27

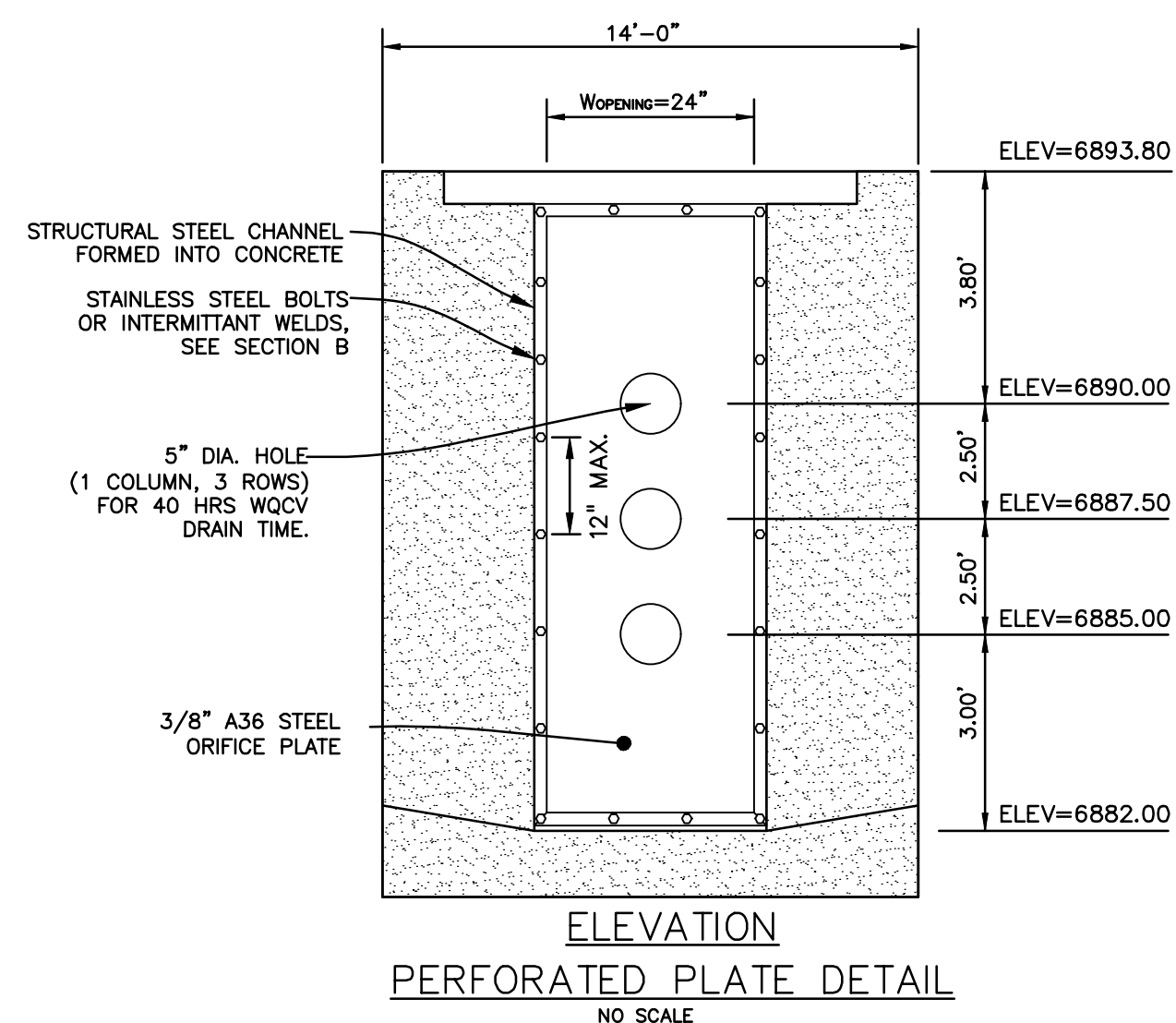

**ELEVATION
PERFORATED PLATE DETAIL**
NO SCALE

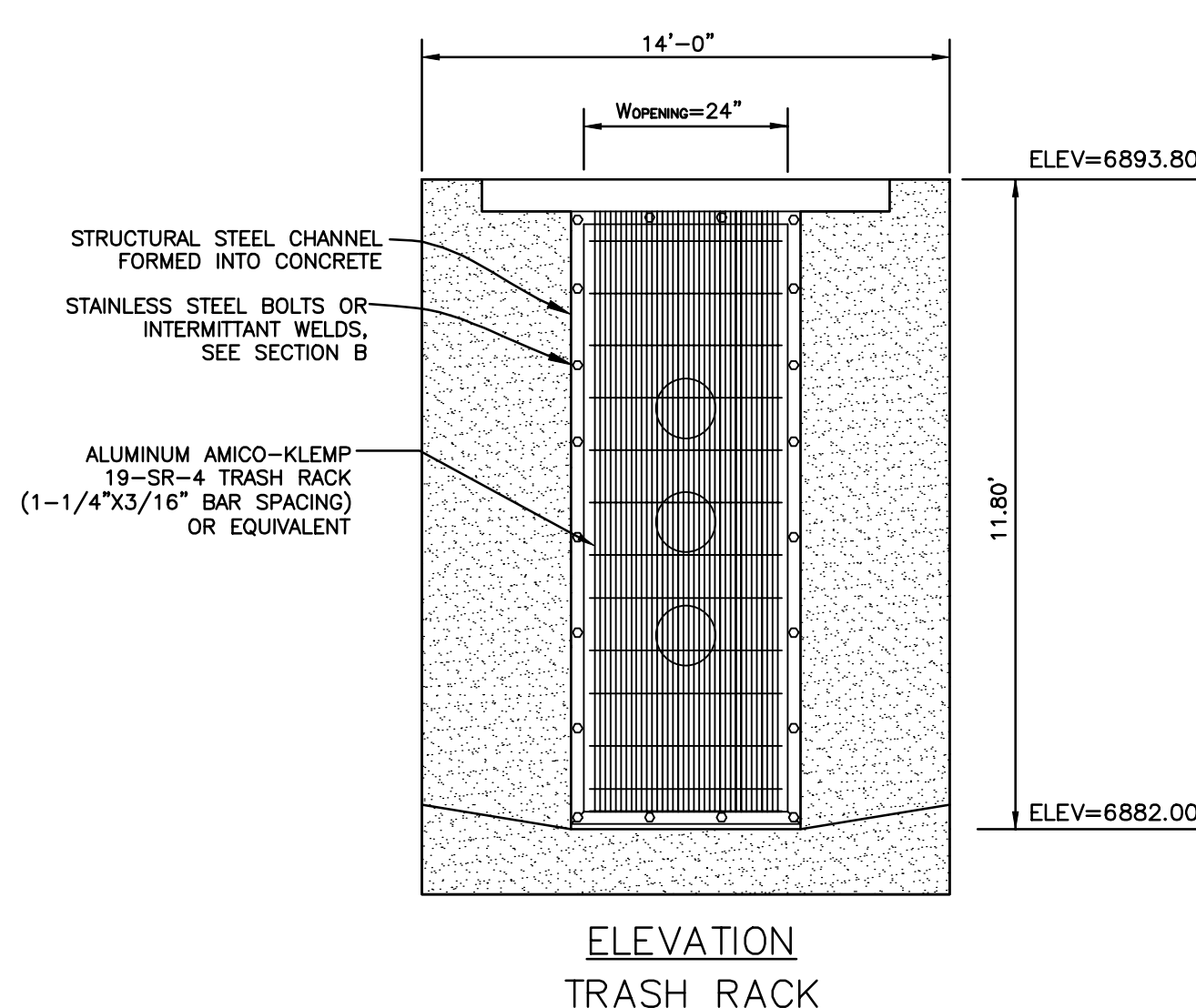

**ELEVATION
TRASH RACK**
NO SCALE

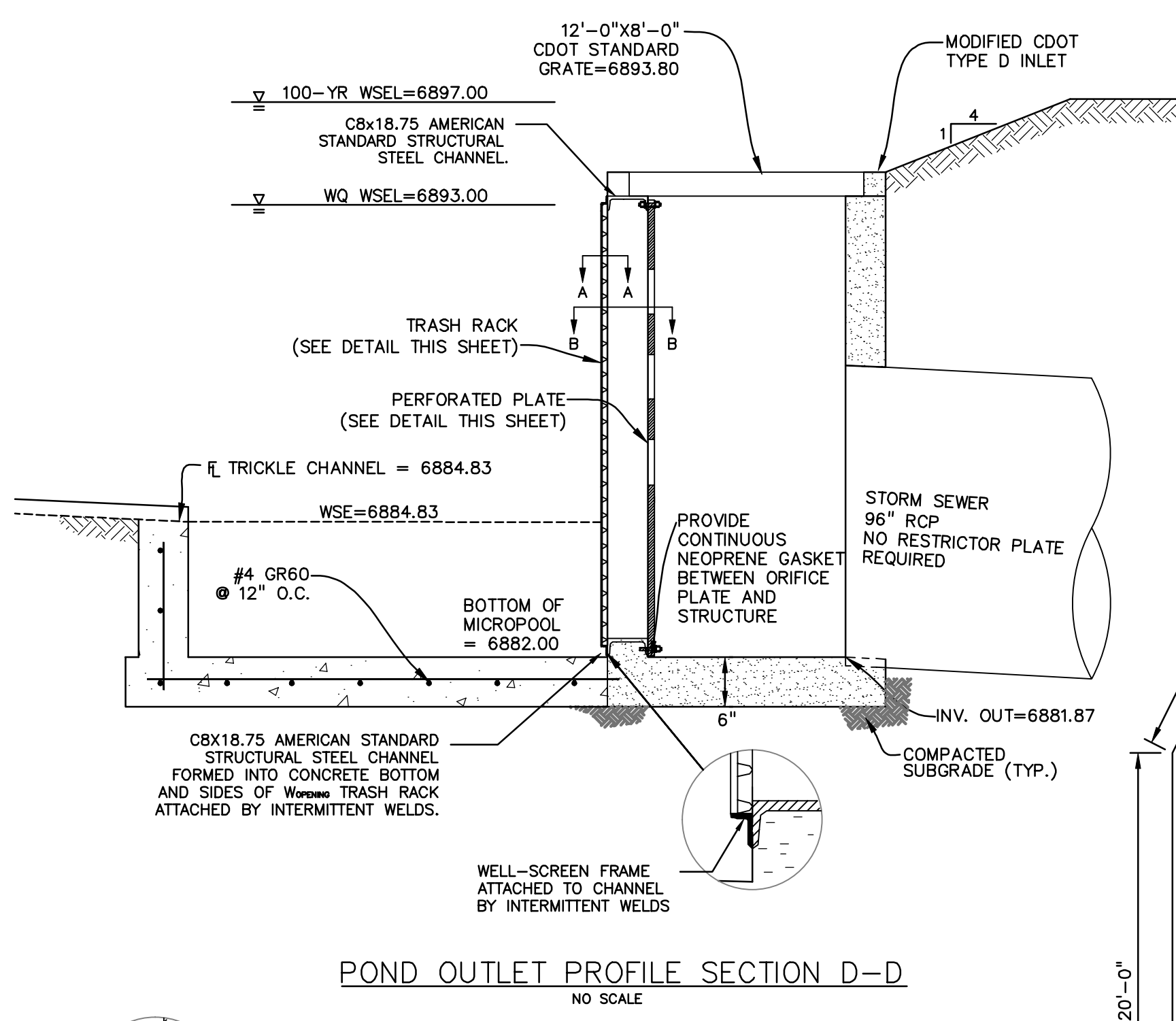

POND OUTLET PROFILE SECTION D-D
NO SCALE

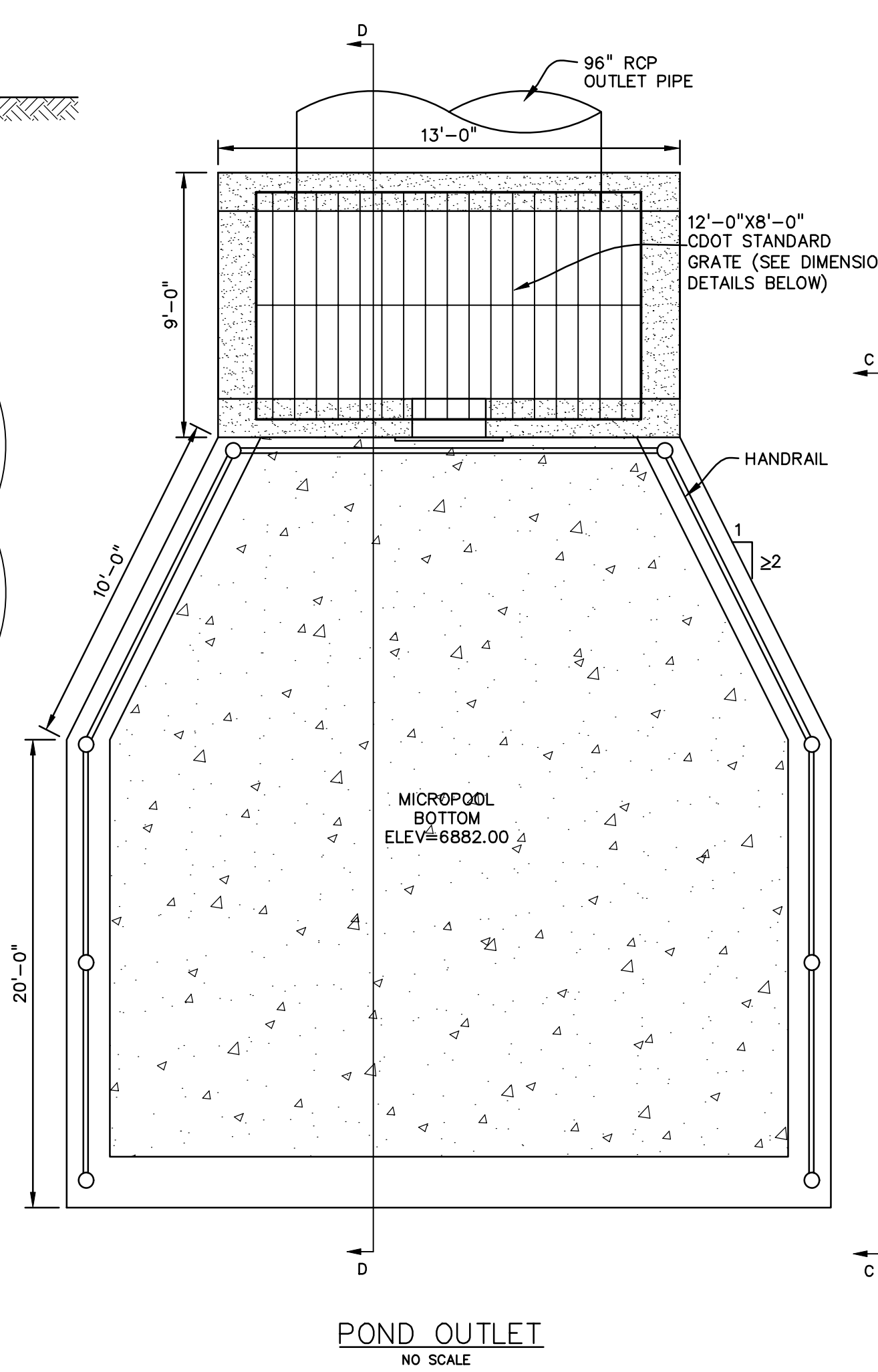

POND OUTLET
NO SCALE

PERFORATED PLATE NOTES:

1. PROVIDE NEOPRENE GASKET MATERIAL OR GROUT BETWEEN THE ORIFICE PLATE AND CONCRETE.
2. BOLT PLATE TO CONCRETE @ 12" MAX. ON CENTER. ORIFICE PLATE IS TO BE REMOVABLE.
3. ALL NON STAINLESS STEEL SURFACES ARE TO BE COATED WITH ZRC COLD GALVANIZING COMPOUND.

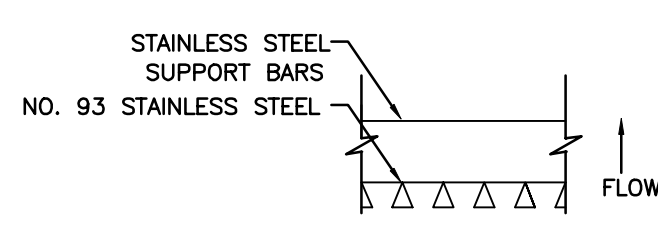

SECTION A-A
NO SCALE

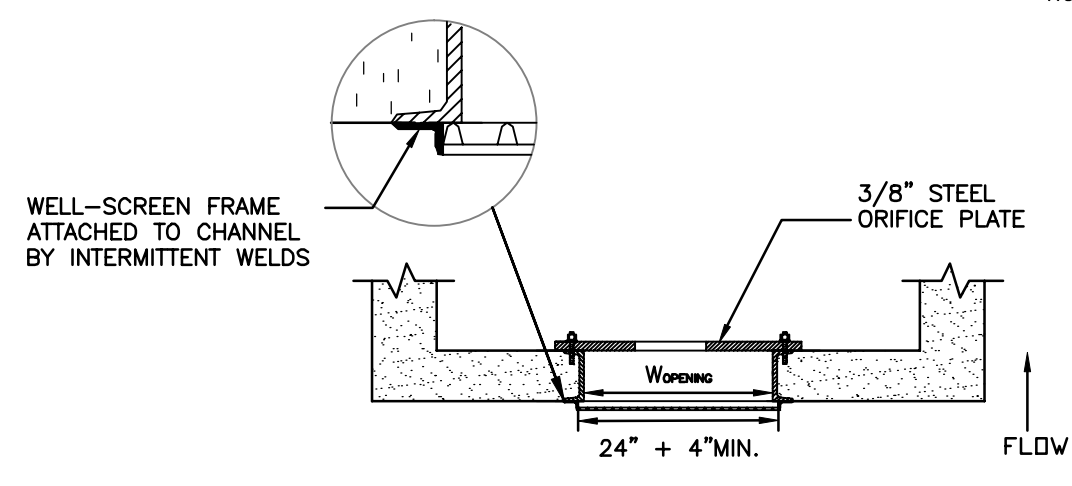

SECTION B-B
NO SCALE

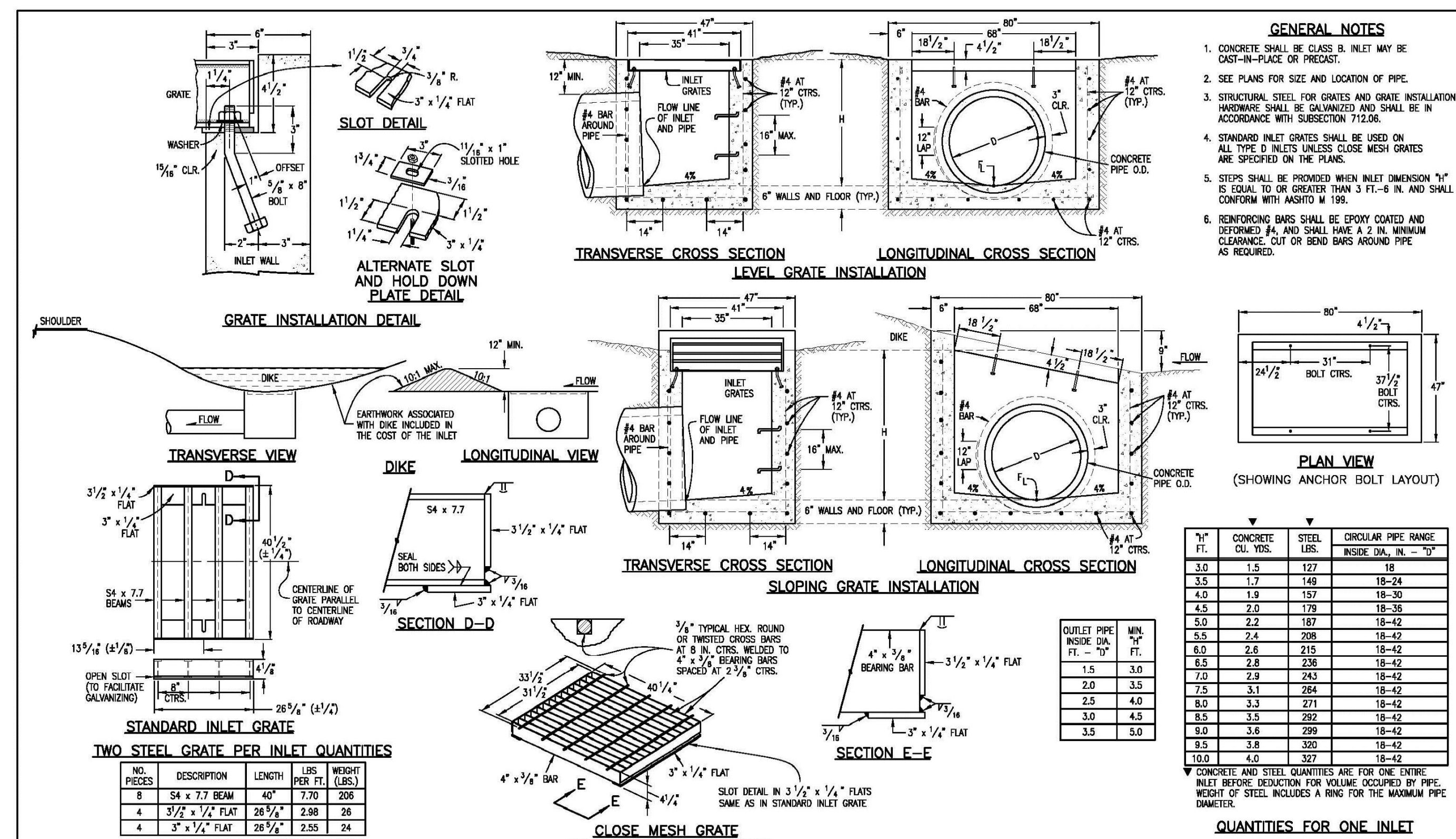

INLET PIPE INSIDE DIA. FT.	MIN. FT.	CONCRETE CU. YDS.	STEEL LBS.	CIRCULAR PIPE RANGE INSIDE DIA. IN. - FT.
3.0	1.5	127	18	18-24
3.5	1.7	140	18-24	18-24
4.0	1.9	157	18-30	18-30
4.5	2.0	179	18-36	18-36
5.0	2.2	187	18-42	18-42
5.5	2.4	206	18-42	18-42
6.0	2.6	215	18-42	18-42
6.5	2.8	236	18-42	18-42
7.0	2.9	243	18-42	18-42
7.5	3.1	264	18-42	18-42
8.0	3.3	271	18-42	18-42
8.5	3.5	292	18-42	18-42
9.0	3.6	299	18-42	18-42
9.5	3.8	320	18-42	18-42
10.0	4.0	327	18-42	18-42

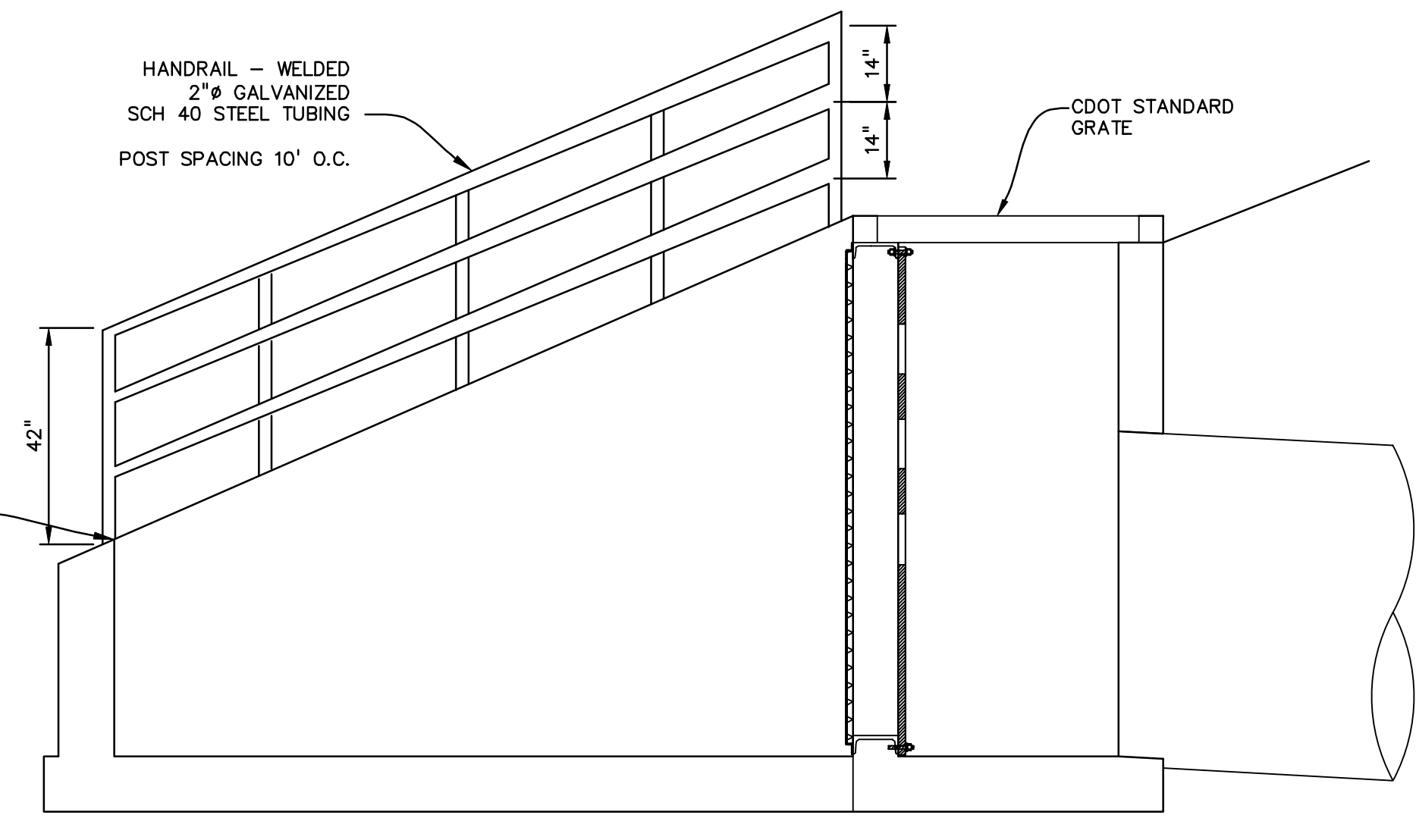

SECTION C-C
NO SCALE

PREPARED BY:
DREXEL, BARRELL & CO.
Engineers-Surveyors
3 SOUTH 7TH STREET
COLORADO SPGS, COLORADO 80905
CONTACT: TIM D. MCCONNELL, P.E.
(719)260-0887
BOULDER • COLORADO SPRINGS

CLIENT:
HUMMEL INVESTMENTS, LLC
8117 PRESTON ROAD, SUITE 120
DALLAS, TEXAS 75225
(214) 416-9820

OVERLOT GRADING, POND SR4 & UTILITY
CONSTRUCTION DRAWINGS FOR
**FALCON
MARKETPLACE**
FALCON, COLORADO

ISSUE	DATE
1ST SUBMITTAL	6-20-17
RESUBMITTAL	9-6-18
DESIGNED BY:	TDM
DRAWN BY:	KGV
CHECKED BY:	TDM
FILE NAME:	



PREPARED UNDER MY DIRECT SUPERVISION FOR AND ON BEHALF OF DREXEL, BARRELL & CO.

DRAWING SCALE:
HORIZONTAL: N/A
VERTICAL: N/A

**POND #1 (SR4)
DETAILS**

PROJECT NO. 20988-00CSV
DRAWING NO.

C7.5

EPIC 10/1/18

EL PASO COUNTY FILE NO: SP-17-001
CDR-16-007

SHEET: 12 OF 27

Computer File Information Creation Date: 07/04/06 Last Modification Date: 07/04/06 Full Path: www.dot.state.co.us/DesignSupport/ Drawing File Name: 6040110101.dwg CAD Ver.: MicroStation V8 Scale: Not to Scale Units: English	Sheet Revisions Date: _____ Comments: _____	Colorado Department of Transportation 4201 East Arkansas Avenue Denver, Colorado 80222 Phone: (303) 757-9983 Fax: (303) 757-9820 Project Development Branch SRJ/LTA	INLET, TYPE D STANDARD PLAN NO. M-604-11 Sheet No. 1 of 1
---	--	---	--

Future HMS Model

Are these sheets duplicates?

Add label - Future 100-year storm

HEC-HMS 3.5 [H:\Challenger Homes Inc\CO, El Paso County-CLH000017-Bent Grass West PUD...

Hydrologic Element	Drainage Area (MI2)	Peak Discharge (CFS)	Time of Peak	Volume (AC-FT)
WT020	0.0671383	41.9	01Jan2011, 06:21	4.8
JWT020	0.0671383	41.9	01Jan2011, 06:21	4.8
RWT030	0.0671383	41.9	01Jan2011, 06:29	4.8
WT030	0.0764732	75.3	01Jan2011, 06:07	5.5
JWT030	0.1436115	85.4	01Jan2011, 06:09	10.3
RWT042	0.1436115	85.3	01Jan2011, 06:15	10.3
WT010	0.1353300	88.9	01Jan2011, 06:17	9.3
JWT010	0.1353300	88.9	01Jan2011, 06:17	9.3
RWT044	0.1353300	88.8	01Jan2011, 06:24	9.3
JWT042	0.2789415	167.0	01Jan2011, 06:21	19.6
RWT046	0.2789415	166.7	01Jan2011, 06:28	19.6
WT040	0.1850600	92.7	01Jan2011, 06:28	12.8
JWT044	0.4640015	259.4	01Jan2011, 06:28	32.4
RWT054	0.4640015	258.8	01Jan2011, 06:35	32.3
WT060	0.1956300	116.8	01Jan2011, 06:26	15.1
WT050	0.1899300	139.4	01Jan2011, 06:19	15.3
JWT050	0.8495615	475.4	01Jan2011, 06:31	62.7
RWT092	0.8495615	475.2	01Jan2011, 06:32	62.7
WT070	0.1711000	133.9	01Jan2011, 06:12	11.8
JWT070	0.1711000	133.9	01Jan2011, 06:12	11.8
RWT080	0.1711000	133.4	01Jan2011, 06:22	11.8
WT080	0.0691596	67.3	01Jan2011, 06:10	5.6
Sub Regional Pond SR1	1.0898211	513.2	01Jan2011, 06:40	78.4
JWT080	1.0898211	513.2	01Jan2011, 06:40	78.4
RWT094	1.0898211	512.4	01Jan2011, 06:45	78.3
WT100-REV	0.1292700	203.0	01Jan2011, 06:04	12.9
W26-REV	0.0720000	103.6	01Jan2011, 06:03	6.4
WS3-1	0.0720000	102.8	01Jan2011, 06:10	6.4
Paint Brush Hills Pond C	0.2012700	64.4	01Jan2011, 06:26	19.2
WT090	0.1533300	162.4	01Jan2011, 06:09	12.8
JWT090	1.4444211	595.9	01Jan2011, 06:44	110.2
RWT122	1.4444211	595.5	01Jan2011, 06:45	110.2
WT110	0.1942800	169.9	01Jan2011, 06:14	16.2
JWT110	1.6387011	651.0	01Jan2011, 06:43	126.4
RWT124	1.6387011	650.8	01Jan2011, 06:47	126.3
WT130-REV	0.1016250	130.0	01Jan2011, 06:11	10.9
Paint Brush Hills Pond A	0.1016250	53.8	01Jan2011, 06:32	10.9
WT120-REV	0.0430300	51.1	01Jan2011, 06:08	3.8
JWT120	1.7833561	703.6	01Jan2011, 06:46	140.9

Hydrologic Element	Drainage Area (MI ²)	Peak Discharge (CFS)	Time of Peak	Volume (AC-FT)
RWT172	1.7833561	702.5	01Jan2011, 06:58	140.5
WT140-REV	0.1445300	194.2	01Jan2011, 06:12	16.8
JWT140	0.1445300	194.2	01Jan2011, 06:12	16.8
RWT150	0.1445300	193.3	01Jan2011, 06:22	16.8
WT150-REV	0.1308100	202.5	01Jan2011, 06:08	15.0
Paint Brush Hills Pond B1	0.2753400	235.6	01Jan2011, 06:29	31.8
W34B2-REV	0.0935900	141.8	01Jan2011, 06:07	10.2
Paint Brush Hills Pond B2	0.3689300	234.3	01Jan2011, 06:43	38.9
JWT150	0.3689300	234.3	01Jan2011, 06:43	38.9
RWT160	0.3689300	234.2	01Jan2011, 06:49	38.8
WT160-REV	0.0734800	109.9	01Jan2011, 06:06	7.5
JWT160	0.4424100	244.8	01Jan2011, 06:48	46.3
RWT174	0.4424100	244.7	01Jan2011, 06:56	46.2
WT170-REV	0.1060150	85.2	01Jan2011, 06:19	9.2
W34-CY-REV	0.0465469	38.1	01Jan2011, 06:16	3.8
JWT172	2.3783280	981.9	01Jan2011, 06:56	199.7
RWT176	2.3783280	981.6	01Jan2011, 06:57	199.7
Sub Regional Pond SR2	2.3783280	972.9	01Jan2011, 07:01	194.8
JWT174	2.3783280	972.9	01Jan2011, 07:01	194.8
RWT180	2.3783280	972.1	01Jan2011, 07:10	194.2
WT180-REV	0.0409400	29.3	01Jan2011, 06:19	3.2
JWT180	2.4192680	978.0	01Jan2011, 07:10	197.4
RWT202	2.4192680	977.3	01Jan2011, 07:21	196.8
WT200	0.3017100	186.8	01Jan2011, 06:30	26.0
WT190	0.0574561	74.7	01Jan2011, 06:05	5.0
The Meadows Pond #1	0.0574561	2.1	01Jan2011, 08:29	2.8
JWT190	0.0574561	2.1	01Jan2011, 08:29	2.8
RWT204	0.0574561	2.1	01Jan2011, 08:55	2.7
JWT200	2.7784341	1041.0	01Jan2011, 07:19	225.5
RWT210	2.7784341	1040.5	01Jan2011, 07:24	225.1
WT210	0.2654600	187.9	01Jan2011, 06:35	28.0
JWT210	3.0438941	1113.0	01Jan2011, 07:23	253.1
RWT232	3.0438941	1112.6	01Jan2011, 07:27	252.7
WT220	0.1895300	250.4	01Jan2011, 06:12	21.3
JWT220	0.1895300	250.4	01Jan2011, 06:12	21.3
RWT234	0.1895300	249.6	01Jan2011, 06:20	21.3
JWT232	3.2334241	1138.4	01Jan2011, 07:26	274.0
RWT236	3.2334241	1138.3	01Jan2011, 07:26	274.0
WT230	0.1981800	346.7	01Jan2011, 06:05	23.1
JWT234	3.4316041	1155.6	01Jan2011, 07:26	297.0
RWT240	3.4316041	1155.0	01Jan2011, 07:29	296.8

Hydrologic Element	Drainage Area (MI ²)	Peak Discharge (CFS)	Time of Peak	Volume (AC-FT)
WT240	0.0761461	160.3	01Jan2011, 06:01	9.1
Regional Pond WU North	3.5077502	1160.9	01Jan2011, 07:30	304.7
Regional Pond WU Diver...	3.5077502	1122.2	01Jan2011, 07:30	261.4
OldMeridian	0.0335900	85.0	01Jan2011, 06:07	6.1
RWT-OM	0.0335900	84.2	01Jan2011, 06:12	6.1
Regional Pond WU South	3.5413402	997.3	01Jan2011, 07:47	255.2
RWT240_Diversion Reach	0.0000000	38.8	01Jan2011, 07:35	43.1
JWT240	3.5413402	1036.0	01Jan2011, 07:47	298.4
RWT250	3.5413402	1035.7	01Jan2011, 07:48	298.3
WT250	0.1469500	291.4	01Jan2011, 06:02	17.1
JWT250	3.6882902	1048.0	01Jan2011, 07:48	315.4
RWT260	3.6882902	1047.5	01Jan2011, 07:58	314.3
WT260	0.1388002	77.5	01Jan2011, 06:34	11.5
JWT260	3.8270904	1061.8	01Jan2011, 07:58	325.9
RWT291	3.8270904	1061.7	01Jan2011, 08:00	325.6
WT270	0.0324738	57.1	01Jan2011, 06:04	3.6
JWT270	0.0324738	57.1	01Jan2011, 06:04	3.6
RWT292	0.0324738	56.9	01Jan2011, 06:08	3.5
JWT292	3.8595642	1064.3	01Jan2011, 08:00	329.2
RWT295	3.8595642	1064.2	01Jan2011, 08:01	329.0
WT280	0.2669500	251.8	01Jan2011, 06:12	22.3
JWT280	0.2669500	251.8	01Jan2011, 06:12	22.3
RWT294	0.2669500	251.2	01Jan2011, 06:15	22.2
JWT294	4.1265142	1082.0	01Jan2011, 08:01	351.3
RWT296	4.1265142	1081.4	01Jan2011, 08:07	350.6
MT040	0.3084200	455.2	01Jan2011, 06:11	38.1
MT030	0.1566300	228.6	01Jan2011, 06:05	15.1
MT020	0.0902033	143.1	01Jan2011, 06:04	9.0
JMT020	0.0902033	143.1	01Jan2011, 06:04	9.0
RMT030	0.0902033	141.8	01Jan2011, 06:17	8.9
JMT030	0.2468333	294.4	01Jan2011, 06:07	24.0
RMT040	0.2468333	293.0	01Jan2011, 06:11	24.0
Woodmen Hills Pond H	0.5552533	751.7	01Jan2011, 06:11	61.7
JMT040	0.5552533	751.7	01Jan2011, 06:11	61.7
RMT050	0.5552533	745.8	01Jan2011, 06:14	61.7
MT010	0.2898900	139.9	01Jan2011, 06:24	17.7
The Meadows Pond #2	0.2898900	72.6	01Jan2011, 06:51	14.4
JMT010	0.2898900	72.6	01Jan2011, 06:51	14.4
RMT062	0.2898900	72.5	01Jan2011, 07:02	14.4
MT060a	0.0311000	48.5	01Jan2011, 06:03	2.9
School Site	0.3209900	15.3	01Jan2011, 09:24	12.3

Hydrologic Element	Drainage Area (MI ²)	Peak Discharge (CFS)	Time of Peak	Volume (AC-FT)
JMT060a	0.3209900	15.3	01Jan2011, 09:24	12.3
RMT060a	0.3209900	15.3	01Jan2011, 09:31	12.3
MT050	0.1186100	109.7	01Jan2011, 06:18	11.4
JMT050	0.9948533	852.6	01Jan2011, 06:14	85.3
RMT064	0.9948533	847.9	01Jan2011, 06:21	85.2
MT060	0.1588000	196.8	01Jan2011, 06:08	14.7
Sub Regional Pond SR4	1.1536533	607.7	01Jan2011, 06:38	85.4
JMT060	1.1536533	607.7	01Jan2011, 06:38	85.4
RMT070	1.1536533	604.8	01Jan2011, 06:44	85.2
MT070	0.1994800	170.2	01Jan2011, 06:22	19.6
JMT070	1.3531333	710.9	01Jan2011, 06:42	104.8
RMT080	1.3531333	709.9	01Jan2011, 06:44	104.7
MT080	0.0638371	191.9	01Jan2011, 06:00	11.0
Regional Pond MN	1.4169704	686.6	01Jan2011, 06:49	113.2
JMT080	1.4169704	686.6	01Jan2011, 06:49	113.2
RMT102	1.4169704	683.7	01Jan2011, 06:56	112.9
MT090	0.0435103	127.4	01Jan2011, 06:00	7.1
Woodmen Hills Pond #5	0.0435103	18.6	01Jan2011, 06:07	5.9
JMT090	0.0435103	18.6	01Jan2011, 06:07	5.9
RMT090	0.0435103	18.6	01Jan2011, 06:08	5.9
JMT104	0.0435103	18.6	01Jan2011, 06:08	5.9
RMT104	0.0435103	18.6	01Jan2011, 06:12	5.9
JMT102	1.4604807	698.8	01Jan2011, 06:56	118.9
RMT106	1.4604807	693.3	01Jan2011, 06:58	118.7
MT100	0.0557682	88.2	01Jan2011, 06:05	5.9
JMT106	1.5162489	700.0	01Jan2011, 06:58	124.6
RMT112	1.5162489	696.5	01Jan2011, 07:10	123.9
MT110	0.1163900	117.4	01Jan2011, 06:16	11.5
JMT110	1.6326389	715.5	01Jan2011, 07:10	135.5
RMT114	1.6326389	714.4	01Jan2011, 07:15	135.2
WT290	0.1037800	110.3	01Jan2011, 06:09	8.7
Regional Pond R1	5.8629331	1339.4	01Jan2011, 08:04	486.8
JWT296	5.8629331	1339.4	01Jan2011, 08:04	486.8
RWT314	5.8629331	1339.1	01Jan2011, 08:10	485.9
WT300	0.0970199	91.6	01Jan2011, 06:12	8.1
JWT300	0.0970199	91.6	01Jan2011, 06:12	8.1
RWT312	0.0970199	91.1	01Jan2011, 06:29	8.1
WT310	0.2774200	246.7	01Jan2011, 06:13	22.3
JWT310	6.2373730	1363.2	01Jan2011, 08:09	516.3
RWT320	6.2373730	1362.4	01Jan2011, 08:15	515.2
WT320	0.2061400	200.6	01Jan2011, 06:11	17.2

Hydrologic Element	Drainage Area (MI ²)	Peak Discharge (CFS)	Time of Peak	Volume (AC-FT)
JWT320	6.4435130	1374.5	01Jan2011, 08:15	532.4
RWT352	6.4435130	1373.7	01Jan2011, 08:24	531.2
ET020	0.2131700	360.5	01Jan2011, 06:06	24.8
ET010	0.1451300	198.3	01Jan2011, 06:11	16.4
Paint Brush Hills Pond #4	0.1451300	150.9	01Jan2011, 06:20	16.3
JET010	0.1451300	150.9	01Jan2011, 06:20	16.3
RET020	0.1451300	150.0	01Jan2011, 06:37	16.3
Sub Regional Pond SR6	0.3583000	195.4	01Jan2011, 06:41	37.9
JET020	0.3583000	195.4	01Jan2011, 06:41	37.9
RET030	0.3583000	194.9	01Jan2011, 07:02	37.5
ET030	0.2042800	242.0	01Jan2011, 06:15	23.0
JET030	0.5625800	266.0	01Jan2011, 06:43	60.5
RET040	0.5625800	265.2	01Jan2011, 06:50	60.3
Woodmen Hills Pond #1 ...	0.7117200	263.5	01Jan2011, 07:09	75.5
ET040	0.1491400	165.7	01Jan2011, 06:14	15.3
Woodmen Hills Pond #1 ...	0.7117200	261.1	01Jan2011, 07:18	69.5
JET040	0.7117200	261.1	01Jan2011, 07:18	69.5
RET050	0.7117200	261.1	01Jan2011, 07:23	69.4
ET050	0.1171900	197.1	01Jan2011, 06:03	11.6
Woodmen Hills Pond #2	0.8289100	250.3	01Jan2011, 07:46	79.3
JET050	0.8289100	250.3	01Jan2011, 07:46	79.3
RET060	0.8289100	250.3	01Jan2011, 07:53	79.1
ET060	0.2854300	529.3	01Jan2011, 06:01	29.3
Woodmen Hills Pond #3	1.1143400	360.9	01Jan2011, 06:06	105.9
JET060	1.1143400	360.9	01Jan2011, 06:06	105.9
RET070	1.1143400	356.7	01Jan2011, 06:16	105.6
ET070	0.2497500	461.0	01Jan2011, 06:02	27.3
JET070	1.3640900	636.4	01Jan2011, 06:04	132.9
RET080	1.3640900	517.5	01Jan2011, 06:23	131.3
ET080	0.2916400	517.9	01Jan2011, 06:07	37.1
Woodmen Hills Pond #4	1.6557300	288.0	01Jan2011, 07:00	139.2
JET080	1.6557300	288.0	01Jan2011, 07:00	139.2
RET090	1.6557300	287.3	01Jan2011, 07:03	139.0
ET090	0.1242400	133.0	01Jan2011, 06:22	14.9
JET090	1.7799700	330.8	01Jan2011, 06:59	153.9
RET100	1.7799700	330.7	01Jan2011, 07:01	153.8
ET100	0.0480615	72.0	01Jan2011, 06:02	4.0
JET100	1.8280315	335.4	01Jan2011, 07:01	157.8
RET110	1.8280315	335.2	01Jan2011, 07:05	157.6
ET110	0.2260300	198.8	01Jan2011, 06:12	17.5
JET110	2.0540615	362.1	01Jan2011, 07:03	175.1

Hydrologic Element	Drainage Area (MI ²)	Peak Discharge (CFS)	Time of Peak	Volume (AC-FT)
RET120	2.0540615	361.3	01Jan2011, 07:09	174.7
ET120	0.1091300	89.4	01Jan2011, 06:14	8.5
JET120	2.1631915	403.2	01Jan2011, 06:17	183.2
RET152	2.1631915	402.2	01Jan2011, 06:24	182.9
ET130	0.1348100	85.4	01Jan2011, 06:27	11.2
JET130	0.1348100	85.4	01Jan2011, 06:27	11.2
RET140	0.1348100	84.7	01Jan2011, 06:54	11.1
ET140	0.2675900	122.8	01Jan2011, 06:46	22.2
JET140	0.4024000	204.8	01Jan2011, 06:51	33.3
RET154	0.4024000	204.4	01Jan2011, 07:05	33.2
JET152	2.5655915	572.3	01Jan2011, 07:10	216.1
RET156	2.5655915	572.0	01Jan2011, 07:14	215.8
ET150	0.1777300	136.2	01Jan2011, 06:18	14.3
JET154	2.7433215	595.8	01Jan2011, 07:12	230.1
RET162	2.7433215	595.1	01Jan2011, 07:25	228.9
ET160	0.1889200	137.2	01Jan2011, 06:23	16.3
JET160	2.9322415	633.6	01Jan2011, 06:38	245.2
RET164	2.9322415	629.0	01Jan2011, 06:47	244.7
WT350	0.3037700	276.7	01Jan2011, 06:14	26.3
JWT352	9.6795245	1938.3	01Jan2011, 07:42	802.2
RWT354	9.6795245	1938.3	01Jan2011, 07:42	802.2
WT330	0.3266800	249.3	01Jan2011, 06:19	27.2
JWT330	0.3266800	249.3	01Jan2011, 06:19	27.2
RWT344	0.3266800	248.4	01Jan2011, 06:25	27.2
WT340	0.2780000	147.3	01Jan2011, 06:37	23.1
JWT354	10.2842045	2011.2	01Jan2011, 07:41	852.4
RWT372	10.2842045	2008.9	01Jan2011, 07:47	851.3
WT360	0.0656830	54.8	01Jan2011, 06:15	5.3
JWT360	0.0656830	54.8	01Jan2011, 06:15	5.3
RWT374	0.0656830	54.6	01Jan2011, 06:24	5.3

Project: Aug15_Working_Falcon_DBPS_S
Simulation Run: FU 100-yr Reservoir: School Site

Start of Run: 01Jan2011, 00:00 Basin Model: Falcon_DBPS_Future
End of Run: 02Jan2011, 00:00 Meteorologic Model: 100-yr
Compute Time: 25Jan2021, 10:31:29 Control Specifications: 24-hr Storm

Volume Units: AC-FT

Computed Results

Peak Inflow :	75.8 (CFS)	Date/Time of Peak Inflow :	01Jan2011, 07:02
Peak Outflow :	15.3 (CFS)	Date/Time of Peak Outflow :	01Jan2011, 09:24
Total Inflow :	17.2 (AC-FT)	Peak Storage :	7.7 (AC-FT)
Total Outflow :	12.3 (AC-FT)	Peak Elevation :	6957.0 (FT)

Project: Aug15_Working_Falcon_DBPS_S
Simulation Run: FU 100-yr Reservoir: Sub Regional Pond SR4

Start of Run: 01Jan2011, 00:00 Basin Model: Falcon_DBPS_Future
End of Run: 02Jan2011, 00:00 Meteorologic Model: 100-yr
Compute Time: 25Jan2021, 10:31:29 Control Specifications: 24-hr Storm

Volume Units: AC-FT

Computed Results

Peak Inflow :	952.1 (CFS)	Date/Time of Peak Inflow :	01Jan2011, 06:20
Peak Outflow :	607.7 (CFS)	Date/Time of Peak Outflow :	01Jan2011, 06:38
Total Inflow :	99.9 (AC-FT)	Peak Storage :	26.2 (AC-FT)
Total Outflow :	85.4 (AC-FT)	Peak Elevation :	6896.9 (FT)

Project: Aug15_Working_Falcon_DBPS_S
Simulation Run: FU 100-yr Reservoir: Regional Pond MN

Start of Run: 01Jan2011, 00:00 Basin Model: Falcon_DBPS_Future
End of Run: 02Jan2011, 00:00 Meteorologic Model: 100-yr
Compute Time: 25Jan2021, 10:31:29 Control Specifications: 24-hr Storm

Volume Units: AC-FT

Computed Results

Peak Inflow :	720.0 (CFS)	Date/Time of Peak Inflow :	01Jan2011, 06:44
Peak Outflow :	686.6 (CFS)	Date/Time of Peak Outflow :	01Jan2011, 06:49
Total Inflow :	115.8 (AC-FT)	Peak Storage :	6.7 (AC-FT)
Total Outflow :	113.2 (AC-FT)	Peak Elevation :	6853.6 (FT)

Add label - Future 5-year storm

HEC-HMS 3.5 [H:\Challenger Homes Inc\CO, El Paso County-CLH000017-Bent Grass West PUD...

Hydrologic Element	Drainage Area (MI2)	Peak Discharge (CFS)	Time of Peak	Volume (AC-FT)
WT020	0.0671383	10.3	01Jan2011, 06:23	1.4
JWT020	0.0671383	10.3	01Jan2011, 06:23	1.4
RWT030	0.0671383	10.3	01Jan2011, 06:34	1.4
WT030	0.0764732	19.5	01Jan2011, 06:08	1.6
JWT030	0.1436115	20.0	01Jan2011, 06:09	3.0
RWT042	0.1436115	19.9	01Jan2011, 06:18	3.0
WT010	0.1353300	21.2	01Jan2011, 06:19	2.6
JWT010	0.1353300	21.2	01Jan2011, 06:19	2.6
RWT044	0.1353300	21.2	01Jan2011, 06:29	2.6
JWT042	0.2789415	37.2	01Jan2011, 06:24	5.6
RWT046	0.2789415	37.2	01Jan2011, 06:35	5.6
WT040	0.1850600	21.9	01Jan2011, 06:31	3.6
JWT044	0.4640015	58.9	01Jan2011, 06:34	9.2
RWT054	0.4640015	58.7	01Jan2011, 06:43	9.2
WT060	0.1956300	30.1	01Jan2011, 06:29	4.5
WT050	0.1899300	37.3	01Jan2011, 06:21	4.7
JWT050	0.8495615	108.6	01Jan2011, 06:38	18.4
RWT092	0.8495615	108.5	01Jan2011, 06:39	18.4
WT070	0.1711000	32.6	01Jan2011, 06:13	3.4
JWT070	0.1711000	32.6	01Jan2011, 06:13	3.4
RWT080	0.1711000	32.5	01Jan2011, 06:28	3.3
WT080	0.0691596	18.5	01Jan2011, 06:12	1.7
Sub Regional Pond SR1	1.0898211	113.8	01Jan2011, 06:50	21.9
JWT080	1.0898211	113.8	01Jan2011, 06:50	21.9
RWT094	1.0898211	113.7	01Jan2011, 06:58	21.8
WT100-REV	0.1292700	67.7	01Jan2011, 06:05	4.5
W26-REV	0.0720000	33.7	01Jan2011, 06:04	2.1
WS3-1	0.0720000	33.4	01Jan2011, 06:13	2.1
Paint Brush Hills Pond C	0.2012700	14.0	01Jan2011, 06:38	6.5
WT090	0.1533300	46.0	01Jan2011, 06:10	4.0
JWT090	1.4444211	133.8	01Jan2011, 06:57	32.3
RWT122	1.4444211	133.7	01Jan2011, 07:01	32.3
WT110	0.1942800	47.0	01Jan2011, 06:16	5.1
JWT110	1.6387011	144.0	01Jan2011, 07:00	37.4
RWT124	1.6387011	144.0	01Jan2011, 07:08	37.3
WT130-REV	0.1016250	43.5	01Jan2011, 06:12	3.9
Paint Brush Hills Pond A	0.1016250	9.3	01Jan2011, 06:49	3.9
WT120-REV	0.0430300	14.8	01Jan2011, 06:09	1.2

Hydrologic Element	Drainage Area (MI ²)	Peak Discharge (CFS)	Time of Peak	Volume (AC-FT)
JWT120	1.7833561	154.4	01Jan2011, 07:08	42.4
RWT172	1.7833561	154.2	01Jan2011, 07:18	42.2
WT140-REV	0.1445300	65.2	01Jan2011, 06:14	6.1
JWT140	0.1445300	65.2	01Jan2011, 06:14	6.1
RWT150	0.1445300	64.9	01Jan2011, 06:24	6.1
WT150-REV	0.1308100	71.3	01Jan2011, 06:08	5.5
Paint Brush Hills Pond...	0.2753400	110.4	01Jan2011, 06:15	11.6
W34B2-REV	0.0935900	49.1	01Jan2011, 06:08	3.7
Paint Brush Hills Pond...	0.3689300	20.1	01Jan2011, 07:15	13.8
JWT150	0.3689300	20.1	01Jan2011, 07:15	13.8
RWT160	0.3689300	20.0	01Jan2011, 07:24	13.8
WT160-REV	0.0734800	36.3	01Jan2011, 06:07	2.6
JWT160	0.4424100	37.3	01Jan2011, 06:07	16.4
RWT174	0.4424100	36.9	01Jan2011, 06:20	16.3
WT170-REV	0.1060150	24.0	01Jan2011, 06:21	2.9
W34-CY-REV	0.0465469	10.7	01Jan2011, 06:18	1.2
JWT172	2.3783280	181.3	01Jan2011, 07:17	62.6
RWT176	2.3783280	181.2	01Jan2011, 07:18	62.6
Sub Regional Pond SR2	2.3783280	171.7	01Jan2011, 07:30	59.3
JWT174	2.3783280	171.7	01Jan2011, 07:30	59.3
RWT180	2.3783280	171.6	01Jan2011, 07:45	59.0
WT180-REV	0.0409400	7.6	01Jan2011, 06:21	1.0
JWT180	2.4192680	172.6	01Jan2011, 07:45	59.9
RWT202	2.4192680	172.6	01Jan2011, 08:03	59.5
WT200	0.3017100	52.2	01Jan2011, 06:33	8.3
WT190	0.0574561	22.5	01Jan2011, 06:06	1.6
The Meadows Pond #1	0.0574561	0.6	01Jan2011, 10:18	0.9
JWT190	0.0574561	0.6	01Jan2011, 10:18	0.9
RWT204	0.0574561	0.6	01Jan2011, 10:56	0.8
JWT200	2.7784341	182.8	01Jan2011, 08:02	68.6
RWT210	2.7784341	182.7	01Jan2011, 08:10	68.3
WT210	0.2654600	59.7	01Jan2011, 06:38	9.8
JWT210	3.0438941	194.3	01Jan2011, 08:09	78.2
RWT232	3.0438941	194.3	01Jan2011, 08:16	77.9
WT220	0.1895300	84.8	01Jan2011, 06:13	7.8
JWT220	0.1895300	84.8	01Jan2011, 06:13	7.8
RWT234	0.1895300	84.4	01Jan2011, 06:25	7.7
JWT232	3.2334241	200.7	01Jan2011, 08:16	85.7
RWT236	3.2334241	200.7	01Jan2011, 08:16	85.7

Hydrologic Element	Drainage Area (MI ²)	Peak Discharge (CFS)	Time of Peak	Volume (AC-FT)
WT230	0.1981800	124.0	01Jan2011, 06:06	8.5
JWT234	3.4316041	205.6	01Jan2011, 08:15	94.2
RWT240	3.4316041	205.4	01Jan2011, 08:21	94.0
WT240	0.0761461	61.0	01Jan2011, 06:02	3.4
Regional Pond WU No...	3.5077502	206.4	01Jan2011, 08:23	96.3
Regional Pond WU Di...	3.5077502	169.3	01Jan2011, 08:23	64.8
Old Meridian	0.0335900	38.2	01Jan2011, 06:09	2.8
RWT-OM	0.0335900	37.8	01Jan2011, 06:14	2.8
Regional Pond WU So...	3.5413402	144.6	01Jan2011, 08:49	57.2
RWT240_Diversion R...	0.0000000	37.1	01Jan2011, 08:29	31.4
JWT240	3.5413402	180.6	01Jan2011, 08:47	88.6
RWT250	3.5413402	180.6	01Jan2011, 08:48	88.5
WT250	0.1469500	107.5	01Jan2011, 06:03	6.3
JWT250	3.6882902	183.2	01Jan2011, 08:48	94.9
RWT260	3.6882902	183.1	01Jan2011, 09:04	94.3
WT260	0.1388002	21.0	01Jan2011, 06:36	3.6
JWT260	3.8270904	185.4	01Jan2011, 09:03	97.9
RWT291	3.8270904	185.3	01Jan2011, 09:07	97.8
WT270	0.0324738	20.0	01Jan2011, 06:04	1.3
JWT270	0.0324738	20.0	01Jan2011, 06:04	1.3
RWT292	0.0324738	19.9	01Jan2011, 06:10	1.3
JWT292	3.8595642	185.9	01Jan2011, 09:07	99.0
RWT295	3.8595642	185.8	01Jan2011, 09:09	99.0
WT280	0.2669500	70.1	01Jan2011, 06:14	6.9
JWT280	0.2669500	70.1	01Jan2011, 06:14	6.9
RWT294	0.2669500	70.0	01Jan2011, 06:17	6.9
JWT294	4.1265142	189.2	01Jan2011, 09:09	105.9
RWT296	4.1265142	189.1	01Jan2011, 09:17	105.5
MT040	0.3084200	163.5	01Jan2011, 06:12	14.5
MT030	0.1566300	73.4	01Jan2011, 06:06	5.1
MT020	0.0902033	47.3	01Jan2011, 06:05	3.1
JMT020	0.0902033	47.3	01Jan2011, 06:05	3.1
RMT030	0.0902033	46.8	01Jan2011, 06:21	3.1
JMT030	0.2468333	93.6	01Jan2011, 06:07	8.1
RMT040	0.2468333	92.8	01Jan2011, 06:12	8.1
Woodmen Hills Pond H	0.5552533	242.5	01Jan2011, 06:16	22.5
JMT040	0.5552533	242.5	01Jan2011, 06:16	22.5
RMT050	0.5552533	242.2	01Jan2011, 06:19	22.5
MT010	0.2898900	36.7	01Jan2011, 06:26	5.2

Hydrologic Element	Drainage Area (MI ²)	Peak Discharge (CFS)	Time of Peak	Volume (AC-FT)
The Meadows Pond #2	0.2898900	2.7	01Jan2011, 09:12	3.5
JMT010	0.2898900	2.7	01Jan2011, 09:12	3.5
RMT062	0.2898900	2.7	01Jan2011, 09:38	3.4
MT060a	0.0311000	15.6	01Jan2011, 06:03	1.0
School Site	0.3209900	1.7	02Jan2011, 00:00	1.7
JMT060a	0.3209900	1.7	02Jan2011, 00:00	1.7
RMT060a	0.3209900	1.7	02Jan2011, 00:00	1.7
MT050	0.1186100	33.2	01Jan2011, 06:20	3.8
JMT050	0.9948533	275.6	01Jan2011, 06:19	28.0
RMT064	0.9948533	273.3	01Jan2011, 06:29	27.9
MT060	0.1588000	60.1	01Jan2011, 06:09	4.8
Sub Regional Pond SR4	1.1536533	24.2	01Jan2011, 08:44	22.9
JMT060	1.1536533	24.2	01Jan2011, 08:44	22.9
RMT070	1.1536533	24.2	01Jan2011, 08:52	22.7
MT070	0.1994800	51.6	01Jan2011, 06:24	6.6
JMT070	1.3531333	55.6	01Jan2011, 06:25	29.3
RMT080	1.3531333	55.6	01Jan2011, 06:28	29.3
MT080	0.0638371	91.5	01Jan2011, 06:00	5.0
Regional Pond MN	1.4169704	62.4	01Jan2011, 06:32	31.8
JMT080	1.4169704	62.4	01Jan2011, 06:32	31.8
RMT102	1.4169704	62.2	01Jan2011, 06:41	31.6
MT090	0.0435103	59.3	01Jan2011, 06:00	3.2
Woodmen Hills Pond #5	0.0435103	2.2	01Jan2011, 08:01	2.3
JMT090	0.0435103	2.2	01Jan2011, 08:01	2.3
RMT090	0.0435103	2.2	01Jan2011, 08:01	2.3
JMT104	0.0435103	2.2	01Jan2011, 08:01	2.3
RMT104	0.0435103	2.2	01Jan2011, 08:07	2.3
JMT102	1.4604807	64.3	01Jan2011, 06:41	33.9
RMT106	1.4604807	64.0	01Jan2011, 06:43	33.9
MT100	0.0557682	29.8	01Jan2011, 06:06	2.1
JMT106	1.5162489	67.8	01Jan2011, 06:42	35.9
RMT112	1.5162489	66.0	01Jan2011, 07:16	35.0
MT110	0.1163900	36.3	01Jan2011, 06:18	3.9
JMT110	1.6326389	72.0	01Jan2011, 07:16	39.0
RMT114	1.6326389	71.2	01Jan2011, 07:25	38.7
WT290	0.1037800	31.2	01Jan2011, 06:10	2.7
Regional Pond R1	5.8629331	223.1	01Jan2011, 09:27	139.8
JWT296	5.8629331	223.1	01Jan2011, 09:27	139.8
RWT314	5.8629331	223.0	01Jan2011, 09:34	139.1

Hydrologic Element	Drainage Area (MI ²)	Peak Discharge (CFS)	Time of Peak	Volume (AC-FT)
WT300	0.0970199	25.5	01Jan2011, 06:14	2.5
JWT300	0.0970199	25.5	01Jan2011, 06:14	2.5
RWT312	0.0970199	25.4	01Jan2011, 06:34	2.5
WT310	0.2774200	67.1	01Jan2011, 06:14	6.9
JWT310	6.2373730	227.5	01Jan2011, 09:34	148.4
RWT320	6.2373730	227.4	01Jan2011, 09:42	147.7
WT320	0.2061400	56.1	01Jan2011, 06:13	5.4
JWT320	6.4435130	230.0	01Jan2011, 09:42	153.0
RWT352	6.4435130	229.9	01Jan2011, 09:51	152.2
ET020	0.2131700	128.1	01Jan2011, 06:07	9.2
ET010	0.1451300	67.4	01Jan2011, 06:12	5.9
Paint Brush Hills Pond...	0.1451300	48.8	01Jan2011, 06:22	5.9
JET010	0.1451300	48.8	01Jan2011, 06:22	5.9
RET020	0.1451300	48.7	01Jan2011, 06:37	5.9
Sub Regional Pond SR6	0.3583000	19.9	01Jan2011, 07:26	13.5
JET020	0.3583000	19.9	01Jan2011, 07:26	13.5
RET030	0.3583000	19.7	01Jan2011, 08:14	13.1
ET030	0.2042800	81.2	01Jan2011, 06:17	8.4
JET030	0.5625800	81.2	01Jan2011, 06:17	21.5
RET040	0.5625800	80.9	01Jan2011, 06:28	21.4
Woodmen Hills Pond ...	0.7117200	103.5	01Jan2011, 06:35	26.6
ET040	0.1491400	52.6	01Jan2011, 06:15	5.3
Woodmen Hills Pond ...	0.7117200	32.8	01Jan2011, 07:14	21.7
JET040	0.7117200	32.8	01Jan2011, 07:14	21.7
RET050	0.7117200	32.8	01Jan2011, 07:22	21.6
ET050	0.1171900	66.6	01Jan2011, 06:03	4.0
Woodmen Hills Pond #2	0.8289100	29.6	01Jan2011, 08:07	23.9
JET050	0.8289100	29.6	01Jan2011, 08:07	23.9
RET060	0.8289100	29.6	01Jan2011, 08:19	23.7
ET060	0.2854300	185.5	01Jan2011, 06:02	10.2
Woodmen Hills Pond #3	1.1143400	82.1	01Jan2011, 06:08	31.5
JET060	1.1143400	82.1	01Jan2011, 06:08	31.5
RET070	1.1143400	81.0	01Jan2011, 06:18	31.2
ET070	0.2497500	164.1	01Jan2011, 06:03	9.8
JET070	1.3640900	164.5	01Jan2011, 06:03	41.0
RET080	1.3640900	123.5	01Jan2011, 06:29	40.2
ET080	0.2916400	192.2	01Jan2011, 06:08	14.3
Woodmen Hills Pond #4	1.6557300	26.7	01Jan2011, 14:58	26.8
JET080	1.6557300	26.7	01Jan2011, 14:58	26.8

Hydrologic Element	Drainage Area (MI ²)	Peak Discharge (CFS)	Time of Peak	Volume (AC-FT)
RET090	1.6557300	26.7	01Jan2011, 15:03	26.6
ET090	0.1242400	46.0	01Jan2011, 06:23	5.6
JET090	1.7799700	50.6	01Jan2011, 06:24	32.2
RET100	1.7799700	50.6	01Jan2011, 06:28	32.1
ET100	0.0480615	22.3	01Jan2011, 06:02	1.3
JET100	1.8280315	53.2	01Jan2011, 06:28	33.3
RET110	1.8280315	53.1	01Jan2011, 06:35	33.1
ET110	0.2260300	52.7	01Jan2011, 06:13	5.3
JET110	2.0540615	86.0	01Jan2011, 06:13	38.4
RET120	2.0540615	85.1	01Jan2011, 06:19	38.1
ET120	0.1091300	23.5	01Jan2011, 06:16	2.5
JET120	2.1631915	107.9	01Jan2011, 06:19	40.7
RET152	2.1631915	107.7	01Jan2011, 06:25	40.4
ET130	0.1348100	23.2	01Jan2011, 06:30	3.5
JET130	0.1348100	23.2	01Jan2011, 06:30	3.5
RET140	0.1348100	23.1	01Jan2011, 07:00	3.5
ET140	0.2675900	33.4	01Jan2011, 06:49	6.9
JET140	0.4024000	55.3	01Jan2011, 06:56	10.4
RET154	0.4024000	55.2	01Jan2011, 07:19	10.3
JET152	2.5655915	108.6	01Jan2011, 06:26	50.8
RET156	2.5655915	108.3	01Jan2011, 06:30	50.6
ET150	0.1777300	36.6	01Jan2011, 06:20	4.4
JET154	2.7433215	138.8	01Jan2011, 06:29	55.0
RET162	2.7433215	135.5	01Jan2011, 06:54	54.2
ET160	0.1889200	38.5	01Jan2011, 06:25	5.2
JET160	2.9322415	154.7	01Jan2011, 06:53	59.4
RET164	2.9322415	154.3	01Jan2011, 06:58	59.2
WT350	0.3037700	78.7	01Jan2011, 06:16	8.4
JWT352	9.6795245	311.7	01Jan2011, 07:22	219.7
RWT354	9.6795245	311.7	01Jan2011, 07:22	219.7
WT330	0.3266800	68.2	01Jan2011, 06:21	8.5
JWT330	0.3266800	68.2	01Jan2011, 06:21	8.5
RWT344	0.3266800	67.9	01Jan2011, 06:30	8.5
WT340	0.2780000	40.0	01Jan2011, 06:39	7.2
JWT354	10.2842045	350.6	01Jan2011, 07:20	235.3
RWT372	10.2842045	350.4	01Jan2011, 07:24	234.7
WT360	0.0656830	14.8	01Jan2011, 06:17	1.6
JWT360	0.0656830	14.8	01Jan2011, 06:17	1.6
RWT374	0.0656830	14.7	01Jan2011, 06:32	1.6

Hydrologic Element	Drainage Area (MI ²)	Peak Discharge (CFS)	Time of Peak	Volume (AC-FT)
Regional Pond R2	10.3498875	352.6	01Jan2011, 07:26	233.1
JWT372	10.3498875	352.6	01Jan2011, 07:26	233.1
RWT376	10.3498875	351.6	01Jan2011, 07:35	231.9
WT370	0.2147600	23.4	01Jan2011, 06:15	2.8

Project: Aug15_Working_Falcon_DBPS_S
Simulation Run: FU 5-yr Reservoir: School Site

Start of Run: 01Jan2011, 00:00 Basin Model: Falcon_DBPS_Future
End of Run: 02Jan2011, 00:00 Meteorologic Model: 5-yr
Compute Time: 25Jan2021, 10:40:43 Control Specifications: 24-hr Storm

Volume Units: AC-FT

Computed Results

Peak Inflow :	15.6 (CFS)	Date/Time of Peak Inflow :	01Jan2011, 06:03
Peak Outflow :	1.7 (CFS)	Date/Time of Peak Outflow :	02Jan2011, 00:00
Total Inflow :	4.4 (AC-FT)	Peak Storage :	2.6 (AC-FT)
Total Outflow :	1.7 (AC-FT)	Peak Elevation :	6955.4 (FT)

Project: Aug15_Working_Falcon_DBPS_S
Simulation Run: FU 5-yr Reservoir: Sub Regional Pond SR4

Start of Run: 01Jan2011, 00:00 Basin Model: Falcon_DBPS_Future
End of Run: 02Jan2011, 00:00 Meteorologic Model: 5-yr
Compute Time: 25Jan2021, 10:40:43 Control Specifications: 24-hr Storm

Volume Units: AC-FT

Computed Results

Peak Inflow :	293.1 (CFS)	Date/Time of Peak Inflow :	01Jan2011, 06:29
Peak Outflow :	24.2 (CFS)	Date/Time of Peak Outflow :	01Jan2011, 08:44
Total Inflow :	32.7 (AC-FT)	Peak Storage :	16.2 (AC-FT)
Total Outflow :	22.9 (AC-FT)	Peak Elevation :	6894.0 (FT)

Project: Aug15_Working_Falcon_DBPS_S
Simulation Run: FU 5-yr Reservoir: Regional Pond MN

Start of Run: 01Jan2011, 00:00 Basin Model: Falcon_DBPS_Future
End of Run: 02Jan2011, 00:00 Meteorologic Model: 5-yr
Compute Time: 25Jan2021, 10:40:43 Control Specifications: 24-hr Storm

Volume Units: AC-FT

Computed Results

Peak Inflow :	99.9 (CFS)	Date/Time of Peak Inflow :	01Jan2011, 06:01
Peak Outflow :	62.4 (CFS)	Date/Time of Peak Outflow :	01Jan2011, 06:32
Total Inflow :	34.3 (AC-FT)	Peak Storage :	2.8 (AC-FT)
Total Outflow :	31.8 (AC-FT)	Peak Elevation :	6851.6 (FT)

Add label - Future 2-year storm

HEC-HMS 3.5 [H:\Challenger Homes Inc\CO, El Paso County-CLH000017-Bent Grass West PUD...

Hydrologic Element	Drainage Area (MI ²)	Peak Discharge (CFS)	Time of Peak	Volume (AC-FT)
WT040	0.1850600	9.1	01Jan2011, 06:34	1.8
JWT044	0.4640015	23.9	01Jan2011, 06:39	4.5
RWT054	0.4640015	23.8	01Jan2011, 06:50	4.5
WT060	0.1956300	13.6	01Jan2011, 06:30	2.3
WT050	0.1899300	17.3	01Jan2011, 06:23	2.4
JWT050	0.8495615	42.8	01Jan2011, 06:47	9.3
RWT092	0.8495615	42.7	01Jan2011, 06:49	9.3
WT070	0.1711000	13.6	01Jan2011, 06:15	1.6
JWT070	0.1711000	13.6	01Jan2011, 06:15	1.6
RWT080	0.1711000	13.6	01Jan2011, 06:34	1.6
WT080	0.0691596	8.7	01Jan2011, 06:13	0.9
Sub Regional Pond SR1	1.0898211	41.9	01Jan2011, 07:03	10.4
JWT080	1.0898211	41.9	01Jan2011, 07:03	10.4
RWT094	1.0898211	41.9	01Jan2011, 07:14	10.3
WT100-REV	0.1292700	37.0	01Jan2011, 06:05	2.5
W26-REV	0.0720000	18.4	01Jan2011, 06:04	1.2
WS3-1	0.0720000	18.1	01Jan2011, 06:15	1.2
Paint Brush Hills Pond C	0.2012700	10.4	01Jan2011, 06:34	3.7
WT090	0.1533300	22.1	01Jan2011, 06:11	2.1
JWT090	1.4444211	54.5	01Jan2011, 07:12	16.1
RWT122	1.4444211	54.5	01Jan2011, 07:17	16.1
WT110	0.1942800	22.3	01Jan2011, 06:17	2.7
JWT110	1.6387011	58.6	01Jan2011, 07:16	18.7
RWT124	1.6387011	58.6	01Jan2011, 07:26	18.7
WT130-REV	0.1016250	24.0	01Jan2011, 06:13	2.3
Paint Brush Hills Pond A	0.1016250	4.8	01Jan2011, 06:53	2.3
WT120-REV	0.0430300	7.2	01Jan2011, 06:09	0.6
JWT120	1.7833561	63.9	01Jan2011, 07:26	21.6
RWT172	1.7833561	63.8	01Jan2011, 07:38	21.5
WT140-REV	0.1445300	35.7	01Jan2011, 06:14	3.6
JWT140	0.1445300	35.7	01Jan2011, 06:14	3.6
RWT150	0.1445300	35.5	01Jan2011, 06:25	3.6
WT150-REV	0.1308100	40.8	01Jan2011, 06:09	3.3
Paint Brush Hills Pond B1	0.2753400	58.7	01Jan2011, 06:19	6.8
W34B2-REV	0.0935900	27.9	01Jan2011, 06:08	2.2
Paint Brush Hills Pond B2	0.3689300	9.8	01Jan2011, 07:30	8.0
JWT150	0.3689300	9.8	01Jan2011, 07:30	8.0
RWT160	0.3689300	9.8	01Jan2011, 07:40	8.0
WT160-REV	0.0734800	19.7	01Jan2011, 06:07	1.5
JWT160	0.4424100	20.1	01Jan2011, 06:07	9.5
RWT174	0.4424100	19.8	01Jan2011, 06:23	9.4

Hydrologic Element	Drainage Area (MI2)	Peak Discharge (CFS)	Time of Peak	Volume (AC-FT)
WT170-REV	0.1060150	11.6	01Jan2011, 06:22	1.6
W34-CY-REV	0.0465469	5.2	01Jan2011, 06:19	0.6
JWT172	2.3783280	81.2	01Jan2011, 06:39	33.1
RWT176	2.3783280	81.1	01Jan2011, 06:40	33.1
Sub Regional Pond SR2	2.3783280	66.8	01Jan2011, 08:06	30.0
JWT174	2.3783280	66.8	01Jan2011, 08:06	30.0
RWT180	2.3783280	66.8	01Jan2011, 08:25	29.7
WT180-REV	0.0409400	3.4	01Jan2011, 06:22	0.5
JWT180	2.4192680	67.2	01Jan2011, 08:25	30.2
RWT202	2.4192680	67.1	01Jan2011, 08:51	29.9
WT200	0.3017100	25.3	01Jan2011, 06:34	4.4
WT190	0.0574561	11.3	01Jan2011, 06:07	0.9
The Meadows Pond #1	0.0574561	0.3	01Jan2011, 13:19	0.4
JWT190	0.0574561	0.3	01Jan2011, 13:19	0.4
RWT204	0.0574561	0.3	01Jan2011, 14:16	0.4
JWT200	2.7784341	70.6	01Jan2011, 08:50	34.8
RWT210	2.7784341	70.6	01Jan2011, 09:00	34.6
WT210	0.2654600	31.9	01Jan2011, 06:39	5.6
JWT210	3.0438941	74.5	01Jan2011, 08:59	40.2
RWT232	3.0438941	74.5	01Jan2011, 09:08	40.0
WT220	0.1895300	47.1	01Jan2011, 06:14	4.5
JWT220	0.1895300	47.1	01Jan2011, 06:14	4.5
RWT234	0.1895300	46.9	01Jan2011, 06:26	4.5
JWT232	3.2334241	76.6	01Jan2011, 09:08	44.5
RWT236	3.2334241	76.6	01Jan2011, 09:09	44.5
WT230	0.1981800	71.3	01Jan2011, 06:06	5.0
JWT234	3.4316041	84.5	01Jan2011, 06:43	49.5
RWT240	3.4316041	84.0	01Jan2011, 06:48	49.4
WT240	0.0761461	36.4	01Jan2011, 06:02	2.1
Regional Pond WU North	3.5077502	89.8	01Jan2011, 06:10	50.3
Regional Pond WU Diversion	3.5077502	62.4	01Jan2011, 06:10	27.5
Old Meridian	0.0335900	24.6	01Jan2011, 06:09	1.9
RWT-OM	0.0335900	24.3	01Jan2011, 06:16	1.8
Regional Pond WU South	3.5413402	31.1	01Jan2011, 10:35	19.2
RWT240_Diversion Reach	0.0000000	27.1	01Jan2011, 06:16	22.8
JWT240	3.5413402	51.8	01Jan2011, 10:19	42.0
RWT250	3.5413402	51.8	01Jan2011, 10:20	42.0
WT250	0.1469500	63.0	01Jan2011, 06:03	3.7
JWT250	3.6882902	63.4	01Jan2011, 06:03	45.7
RWT260	3.6882902	61.1	01Jan2011, 06:24	45.4
WT260	0.1388002	9.9	01Jan2011, 06:38	1.9
JWT260	3.8270904	69.2	01Jan2011, 06:24	47.3

Hydrologic Element	Drainage Area (MI2)	Peak Discharge (CFS)	Time of Peak	Volume (AC-FT)
RWT291	3.8270904	68.9	01Jan2011, 06:29	47.1
WT270	0.0324738	11.3	01Jan2011, 06:05	0.7
JWT270	0.0324738	11.3	01Jan2011, 06:05	0.7
RWT292	0.0324738	11.2	01Jan2011, 06:11	0.7
JWT292	3.8595642	71.9	01Jan2011, 06:29	47.9
RWT295	3.8595642	71.5	01Jan2011, 06:31	47.8
WT280	0.2669500	33.4	01Jan2011, 06:15	3.7
JWT280	0.2669500	33.4	01Jan2011, 06:15	3.7
RWT294	0.2669500	33.4	01Jan2011, 06:18	3.7
JWT294	4.1265142	94.0	01Jan2011, 06:30	51.5
RWT296	4.1265142	91.9	01Jan2011, 06:40	51.2
MT040	0.3084200	94.6	01Jan2011, 06:13	8.8
MT030	0.1566300	39.0	01Jan2011, 06:06	2.8
MT020	0.0902033	25.8	01Jan2011, 06:05	1.7
JMT020	0.0902033	25.8	01Jan2011, 06:05	1.7
RMT030	0.0902033	25.4	01Jan2011, 06:20	1.7
JMT030	0.2468333	50.1	01Jan2011, 06:10	4.5
RMT040	0.2468333	49.3	01Jan2011, 06:16	4.5
Woodmen Hills Pond H	0.5552533	107.8	01Jan2011, 06:25	13.2
JMT040	0.5552533	107.8	01Jan2011, 06:25	13.2
RMT050	0.5552533	107.4	01Jan2011, 06:28	13.2
MT010	0.2898900	17.3	01Jan2011, 06:28	2.7
The Meadows Pond #2	0.2898900	1.5	01Jan2011, 09:08	1.9
JMT010	0.2898900	1.5	01Jan2011, 09:08	1.9
RMT062	0.2898900	1.5	01Jan2011, 09:48	1.8
MT060a	0.0311000	8.3	01Jan2011, 06:04	0.5
School Site	0.3209900	1.0	02Jan2011, 00:00	1.0
JMT060a	0.3209900	1.0	02Jan2011, 00:00	1.0
RMT060a	0.3209900	1.0	02Jan2011, 00:00	0.9
MT050	0.1186100	17.0	01Jan2011, 06:21	2.1
JMT050	0.9948533	123.2	01Jan2011, 06:27	16.2
RMT064	0.9948533	121.3	01Jan2011, 06:40	16.2
MT060	0.1588000	30.7	01Jan2011, 06:10	2.7
Sub Regional Pond SR4	1.1536533	11.2	01Jan2011, 09:39	13.9
JMT060	1.1536533	11.2	01Jan2011, 09:39	13.9
RMT070	1.1536533	11.2	01Jan2011, 09:50	13.7
MT070	0.1994800	26.4	01Jan2011, 06:25	3.7
JMT070	1.3531333	29.0	01Jan2011, 06:26	17.4
RMT080	1.3531333	29.0	01Jan2011, 06:29	17.4
MT080	0.0638371	62.4	01Jan2011, 06:00	3.4
Regional Pond MN	1.4169704	30.9	01Jan2011, 06:37	18.3
JMT080	1.4169704	30.9	01Jan2011, 06:37	18.3

Hydrologic Element	Drainage Area (MI2)	Peak Discharge (CFS)	Time of Peak	Volume (AC-FT)
RMT102	1.4169704	30.8	01Jan2011, 06:48	18.1
MT090	0.0435103	39.9	01Jan2011, 06:00	2.1
Woodmen Hills Pond #5	0.0435103	1.4	01Jan2011, 08:02	1.5
JMT090	0.0435103	1.4	01Jan2011, 08:02	1.5
RMT090	0.0435103	1.4	01Jan2011, 08:02	1.5
JMT104	0.0435103	1.4	01Jan2011, 08:02	1.5
RMT104	0.0435103	1.4	01Jan2011, 08:09	1.5
JMT102	1.4604807	32.1	01Jan2011, 06:48	19.6
RMT106	1.4604807	31.8	01Jan2011, 06:51	19.6
MT100	0.0557682	16.5	01Jan2011, 06:06	1.2
JMT106	1.5162489	33.6	01Jan2011, 06:51	20.8
RMT112	1.5162489	33.0	01Jan2011, 07:29	20.1
MT110	0.1163900	18.9	01Jan2011, 06:19	2.2
JMT110	1.6326389	35.8	01Jan2011, 07:29	22.3
RMT114	1.6326389	35.7	01Jan2011, 07:40	22.1
WT290	0.1037800	15.0	01Jan2011, 06:11	1.4
Regional Pond R1	5.8629331	74.9	01Jan2011, 07:54	67.8
JWT296	5.8629331	74.9	01Jan2011, 07:54	67.8
RWT314	5.8629331	74.8	01Jan2011, 08:05	67.2
WT300	0.0970199	12.2	01Jan2011, 06:15	1.3
JWT300	0.0970199	12.2	01Jan2011, 06:15	1.3
RWT312	0.0970199	12.1	01Jan2011, 06:39	1.3
WT310	0.2774200	31.3	01Jan2011, 06:16	3.6
JWT310	6.2373730	79.8	01Jan2011, 08:05	72.1
RWT320	6.2373730	79.7	01Jan2011, 08:15	71.6
WT320	0.2061400	26.8	01Jan2011, 06:14	2.8
JWT320	6.4435130	82.2	01Jan2011, 08:14	74.4
RWT352	6.4435130	82.1	01Jan2011, 08:26	73.7
ET020	0.2131700	73.4	01Jan2011, 06:07	5.4
ET010	0.1451300	37.5	01Jan2011, 06:12	3.5
Paint Brush Hills Pond #4	0.1451300	29.4	01Jan2011, 06:21	3.5
JET010	0.1451300	29.4	01Jan2011, 06:21	3.5
RET020	0.1451300	29.3	01Jan2011, 06:37	3.5
Sub Regional Pond SR6	0.3583000	9.3	01Jan2011, 07:43	7.9
JET020	0.3583000	9.3	01Jan2011, 07:43	7.9
RET030	0.3583000	9.3	01Jan2011, 08:37	7.6
ET030	0.2042800	44.9	01Jan2011, 06:17	4.9
JET030	0.5625800	44.9	01Jan2011, 06:17	12.5
RET040	0.5625800	44.6	01Jan2011, 06:30	12.4
Woodmen Hills Pond #1 North	0.7117200	60.8	01Jan2011, 06:33	15.4
ET040	0.1491400	27.9	01Jan2011, 06:16	3.0
Woodmen Hills Pond #1 South	0.7117200	9.6	01Jan2011, 12:57	12.0

Hydrologic Element	Drainage Area (MI2)	Peak Discharge (CFS)	Time of Peak	Volume (AC-FT)
JET040	0.7117200	9.6	01Jan2011, 12:57	12.0
RET050	0.7117200	9.6	01Jan2011, 13:08	11.8
ET050	0.1171900	36.5	01Jan2011, 06:03	2.2
Woodmen Hills Pond #2	0.8289100	10.4	01Jan2011, 13:06	12.5
JET050	0.8289100	10.4	01Jan2011, 13:06	12.5
RET060	0.8289100	10.4	01Jan2011, 13:21	12.3
ET060	0.2854300	105.0	01Jan2011, 06:02	5.8
Woodmen Hills Pond #3	1.1143400	12.6	01Jan2011, 13:03	15.7
JET060	1.1143400	12.6	01Jan2011, 13:03	15.7
RET070	1.1143400	12.6	01Jan2011, 13:18	15.5
ET070	0.2497500	93.5	01Jan2011, 06:03	5.7
JET070	1.3640900	93.6	01Jan2011, 06:03	21.2
RET080	1.3640900	64.9	01Jan2011, 06:31	20.7
ET080	0.2916400	113.3	01Jan2011, 06:08	8.7
Woodmen Hills Pond #4	1.6557300	9.8	02Jan2011, 00:00	12.0
JET080	1.6557300	9.8	02Jan2011, 00:00	12.0
RET090	1.6557300	9.8	02Jan2011, 00:00	11.9
ET090	0.1242400	26.0	01Jan2011, 06:24	3.3
JET090	1.7799700	29.2	01Jan2011, 06:25	15.3
RET100	1.7799700	29.1	01Jan2011, 06:30	15.2
ET100	0.0480615	11.4	01Jan2011, 06:02	0.7
JET100	1.8280315	30.6	01Jan2011, 06:30	15.8
RET110	1.8280315	30.6	01Jan2011, 06:38	15.7
ET110	0.2260300	24.0	01Jan2011, 06:15	2.7
JET110	2.0540615	41.4	01Jan2011, 06:32	18.4
RET120	2.0540615	41.4	01Jan2011, 06:39	18.2
ET120	0.1091300	10.7	01Jan2011, 06:17	1.3
JET120	2.1631915	49.7	01Jan2011, 06:21	19.5
RET152	2.1631915	49.5	01Jan2011, 06:29	19.4
ET130	0.1348100	10.9	01Jan2011, 06:31	1.8
JET130	0.1348100	10.9	01Jan2011, 06:31	1.8
RET140	0.1348100	10.9	01Jan2011, 07:06	1.8
ET140	0.2675900	15.9	01Jan2011, 06:51	3.6
JET140	0.4024000	25.8	01Jan2011, 07:01	5.5
RET154	0.4024000	25.7	01Jan2011, 07:27	5.4
JET152	2.5655915	53.7	01Jan2011, 07:01	24.8
RET156	2.5655915	53.5	01Jan2011, 07:06	24.7
ET150	0.1777300	17.0	01Jan2011, 06:21	2.3
JET154	2.7433215	62.3	01Jan2011, 06:34	27.0
RET162	2.7433215	59.6	01Jan2011, 07:07	26.4
ET160	0.1889200	18.6	01Jan2011, 06:26	2.8
JET160	2.9322415	66.8	01Jan2011, 07:06	29.2

Hydrologic Element	Drainage Area (MI2)	Peak Discharge (CFS)	Time of Peak	Volume (AC-FT)
RET164	2.9322415	66.5	01Jan2011, 07:12	29.1
WT350	0.3037700	38.3	01Jan2011, 06:17	4.5
JWT352	9.6795245	134.6	01Jan2011, 08:21	107.3
RWT354	9.6795245	134.6	01Jan2011, 08:21	107.3
WT330	0.3266800	32.2	01Jan2011, 06:23	4.5
JWT330	0.3266800	32.2	01Jan2011, 06:23	4.5
RWT344	0.3266800	32.0	01Jan2011, 06:34	4.5
WT340	0.2780000	18.9	01Jan2011, 06:42	3.8
JWT354	10.2842045	143.4	01Jan2011, 08:20	115.5
RWT372	10.2842045	143.3	01Jan2011, 08:26	115.1
WT360	0.0656830	6.9	01Jan2011, 06:18	0.8
JWT360	0.0656830	6.9	01Jan2011, 06:18	0.8
RWT374	0.0656830	6.9	01Jan2011, 06:36	0.8
Regional Pond R2	10.3498875	143.9	01Jan2011, 08:27	112.7
JWT372	10.3498875	143.9	01Jan2011, 08:27	112.7
RWT376	10.3498875	143.7	01Jan2011, 08:37	111.9
WT370	0.2147600	7.2	01Jan2011, 06:17	1.2
JWT374_OUTLET	10.5646475	144.5	01Jan2011, 08:37	113.1

Project: Aug15_Working_Falcon_DBPS_S
Simulation Run: FU 2-yr Reservoir: School Site

Start of Run: 01Jan2011, 00:00 Basin Model: Falcon_DBPS_Future
End of Run: 02Jan2011, 00:00 Meteorologic Model: 2-yr
Compute Time: 25Jan2021, 10:36:10 Control Specifications: 24-hr Storm

Volume Units: AC-FT

Computed Results

Peak Inflow :	8.3 (CFS)	Date/Time of Peak Inflow :	01Jan2011, 06:04
Peak Outflow :	1.0 (CFS)	Date/Time of Peak Outflow :	02Jan2011, 00:00
Total Inflow :	2.4 (AC-FT)	Peak Storage :	1.4 (AC-FT)
Total Outflow :	1.0 (AC-FT)	Peak Elevation :	6954.9 (FT)

Project: Aug15_Working_Falcon_DBPS_S
Simulation Run: FU 2-yr Reservoir: Sub Regional Pond SR4

Start of Run: 01Jan2011, 00:00 Basin Model: Falcon_DBPS_Future
End of Run: 02Jan2011, 00:00 Meteorologic Model: 2-yr
Compute Time: 25Jan2021, 10:36:10 Control Specifications: 24-hr Storm

Volume Units: AC-FT

Computed Results

Peak Inflow :	128.3 (CFS)	Date/Time of Peak Inflow :	01Jan2011, 06:40
Peak Outflow :	11.2 (CFS)	Date/Time of Peak Outflow :	01Jan2011, 09:39
Total Inflow :	18.8 (AC-FT)	Peak Storage :	9.0 (AC-FT)
Total Outflow :	13.9 (AC-FT)	Peak Elevation :	6891.4 (FT)

Project: Aug15_Working_Falcon_DBPS_S
Simulation Run: FU 2-yr Reservoir: Regional Pond MN

Start of Run: 01Jan2011, 00:00 Basin Model: Falcon_DBPS_Future
End of Run: 02Jan2011, 00:00 Meteorologic Model: 2-yr
Compute Time: 25Jan2021, 10:36:10 Control Specifications: 24-hr Storm

Volume Units: AC-FT

Computed Results

Peak Inflow :	64.9 (CFS)	Date/Time of Peak Inflow :	01Jan2011, 06:01
Peak Outflow :	30.9 (CFS)	Date/Time of Peak Outflow :	01Jan2011, 06:37
Total Inflow :	20.7 (AC-FT)	Peak Storage :	2.6 (AC-FT)
Total Outflow :	18.3 (AC-FT)	Peak Elevation :	6851.5 (FT)

Historic Rational Calculations

COMPOSITE % IMPERVIOUS CALCULATIONS

Subdivision: Bent Grass	Bent Grass
Location: <u>CO, Colorado Springs</u>	<u>CLH017.20</u>
	<u>TJE</u>
	<u>CMD</u>
	<u>12/2/20</u>

Basin ID	Total Area (ac)	Paved Roads			Lawns			Roofs			Basins Total Weighted % Imp.
		% Imp.	Area (ac)	Weighted % Imp.	% Imp.	Area (ac)	Weighted % Imp.	% Imp.	Area (ac)	Weighted % Imp.	
OFFSITE BASINS											
WT200	192.00										10.0
MT060	185.60										10.0
OS-25	14.13	100	0.17	1.2	2	13.71	1.9	90	0.22	1.4	4.5
OS-26	5.81	100	0.00	0.0	2	5.81	2.0	90	0.00	0.0	2.0
H3	11.30	100	0.00	0.0	2	5.81	1.0	90	0.00	0.0	1.0
OS-22	4.42	100	0.00	0.0	2	4.42	2.0	90	0.00	0.0	2.0
OS-23	10.24	100	0.00	0.0	2	10.24	2.0	90	0.00	0.0	2.0
BENT GRASS FILING NO. 1 BASINS											
C1	2.07	100	1.92	92.8	2	0.53	0.5	90	0.00	0.0	93.3
C2	2.15	100	1.66	77.2	2	0.59	0.5	90	0.00	0.0	77.7
D1	5.22	100	1.19	22.8	2	1.54	0.6	90	2.50	43.1	66.5
D2	1.40	100	0.30	21.4	2	2.30	3.3	90	0.26	16.7	41.4
H1	3.00	100	0.61	20.3	2	1.51	1.0	90	0.92	27.6	48.9
H2	1.22	100	0.35	28.7	2	0.73	1.2	90	0.16	11.8	41.7
G	1.70	100	0.00	0.0	2	1.70	2.0	90	0.00	0.0	2.0
BENT GRASS FILING NO. 2 & BENT GRASS WEST BASINS											
A-1	5.42	100	0.16	3.0	2	5.26	1.9	90	0.00	0.0	4.9
A-2	18.00	100	0.00	0.0	2	18.00	2.0	90	0.00	0.0	2.0
A-3	19.59	100	0.00	0.0	2	19.59	2.0	90	0.00	0.0	2.0
A-4	23.81	100	0.57	2.4	2	23.12	1.9	90	0.12	0.5	4.8
B-1	32.53	100	0.00	0.0	2	32.53	2.0	90	0.00	0.0	2.0
B-2	4.51	100	0.00	0.0	2	4.51	2.0	90	0.00	0.0	2.0
B-3	16.18	100	1.00	6.2	2	15.18	1.9	90	0.00	0.0	8.1
OS-1	13.06	100	0.84	6.4	2	11.65	1.8	90	0.57	3.9	12.1
OS-2	17.81	100	2.00	11.2	2	15.18	1.7	90	0.63	3.2	16.1
OS-4	30.69	100	1.42	4.6	2	28.41	1.9	90	0.86	2.5	9.0
MERIDIAN ROAD BASIN											
P-1	2.03	100	1.29	63.5	2	0.74	0.7	90	0.00	0.0	64.2

COMPOSITE RUNOFF COEFFICIENT CALCULATIONS

Subdivision: Bent Grass	Bent Grass
Location: CO, Colorado Springs	CLH017.20
	TJE
	CMD
	12/2/20

Basin ID	Total Area (ac)	Hydrologic Soils Group	Paved Roads			Lawns			Roofs			Composite C ₅	Composite C ₁₀₀
			C ₅	C ₁₀₀	Area (ac)	C ₅	C ₁₀₀	Area (ac)	C ₅	C ₁₀₀	Area (ac)		
OFFSITE BASINS													
WT200	192.00											0.20	0.44
MT060	185.60											0.20	0.44
OS-25	14.13	A	0.90	0.96	0.17	0.09	0.36	13.71	0.73	0.81	0.22	0.11	0.37
OS-26	5.81	A	0.90	0.96	0.00	0.09	0.36	5.81	0.73	0.81	0.00	0.09	0.36
H3	11.30	A	0.90	0.96	0.00	0.09	0.36	5.81	0.73	0.81	0.00	0.05	0.19
OS-22	4.42	A	0.90	0.96	0.00	0.09	0.36	4.42	0.73	0.81	0.00	0.09	0.36
OS-23	10.24	A	0.90	0.96	0.00	0.09	0.36	10.24	0.73	0.81	0.00	0.09	0.36
BENT GRASS FILING NO. 1 BASINS													
C1	2.07	A	0.90	0.96	1.92	0.09	0.36	0.53	0.73	0.81	0.00	0.86	0.98
C2	2.15	A	0.90	0.96	1.66	0.09	0.36	0.59	0.73	0.81	0.00	0.72	0.84
D1	5.22	A	0.90	0.96	1.19	0.09	0.36	1.54	0.73	0.81	2.50	0.58	0.71
D2	1.40	A	0.90	0.96	0.30	0.09	0.36	2.30	0.73	0.81	0.26	0.48	0.95
H1	3.00	A	0.90	0.96	0.61	0.09	0.36	1.51	0.73	0.81	0.92	0.45	0.62
H2	1.22	A	0.90	0.96	0.35	0.09	0.36	0.73	0.73	0.81	0.16	0.41	0.60
G	1.70	A	0.90	0.96	0.00	0.09	0.36	1.70	0.73	0.81	0.00	0.09	0.36
BENT GRASS FILING NO. 2 & BENT GRASS WEST BASINS													
A-1	5.42	A	0.90	0.96	0.16	0.09	0.36	5.26	0.73	0.81	0.00	0.11	0.38
A-2	18.00	A	0.90	0.96	0.00	0.09	0.36	18.00	0.73	0.81	0.00	0.09	0.36
A-3	19.59	A	0.90	0.96	0.00	0.09	0.36	19.59	0.73	0.81	0.00	0.09	0.36
A-4	23.81	A	0.90	0.96	0.57	0.09	0.36	23.12	0.73	0.81	0.12	0.11	0.38
B-1	32.53	A	0.90	0.96	0.00	0.09	0.36	32.53	0.73	0.81	0.00	0.09	0.36
B-2	4.51	A	0.90	0.96	0.00	0.09	0.36	4.51	0.73	0.81	0.00	0.09	0.36
B-3	16.18	A	0.90	0.96	1.00	0.09	0.36	15.18	0.73	0.81	0.00	0.14	0.40
OS-1	13.06	A	0.90	0.96	0.84	0.09	0.36	11.65	0.73	0.81	0.57	0.17	0.42
OS-2	17.81	A	0.90	0.96	2.00	0.09	0.36	15.18	0.73	0.81	0.63	0.20	0.44
OS-4	30.69	A	0.90	0.96	1.42	0.09	0.36	28.41	0.73	0.81	0.86	0.15	0.40
MERIDIAN ROAD BASIN													
P-1	2.03	A	0.90	0.96	1.29	0.09	0.36	0.00	0.73	0.81	0.00	0.57	0.61

**STANDARD FORM SF-2
TIME OF CONCENTRATION**

Subdivision: Bent Grass
Location: CO, Colorado Springs

Project Name: Bent Grass
Project No.: CLH017.20
Calculated By: TJE
Checked By: CMD
Date: 12/2/20

SUB-BASIN DATA						INITIAL/OVERLAND (T _i)			TRAVEL TIME (T _t)					T _c CHECK (URBANIZED BASINS)			FINAL T _c (MIN)	
BASIN ID	D.A. (AC)	Hydrologic Soils Group	Impervious (%)	C5	C ₁₀₀	L (FT)	S (%)	T _i (MIN)	L (FT)	S (%)	C _v	VEL. (FPS)	T _t (MIN)	COMP. T _c (MIN)	TOTAL LENGTH (FT)	Urbanized T _c (MIN)	T _c (MIN)	
OFFSITE BASINS																		
WT200	192.00	A	10.00	0.20	0.44	300	2.0	22.7	2060	2.0	15.0	2.1	16.2	38.8	2360.0	23.1	23.1	
MT060	185.60	A	10.00	0.20	0.44	300	2.0	22.7	2060	2.0	15.0	2.1	16.2	38.8	2360.0	23.1	23.1	
OS-25	14.13	A	4.50	0.11	0.37	300	2.5	23.1	1400	3.0	15.0	2.6	9.0	32.1	1700.0	19.4	19.4	
OS-26	5.81	A	2.00	0.09	0.36	300	2.0	25.4	400	2.0	15.0	2.1	3.1	28.6	700.0	13.9	13.9	
H3	11.30	A	1.00	0.05	0.19	100	6.0	10.6	1460	2.0	15.0	2.1	11.5	22.1	1560.0	18.7	18.7	
OS-22	4.42	A	2.00	0.09	0.36	100	1.0	18.5	650	1.0	10.0	1.0	10.8	29.3	750.0	14.2	14.2	
OS-23	10.24	A	2.00	0.09	0.36	100	1.0	18.5	600	1.0	10.0	1.0	10.0	28.5	700.0	13.9	13.9	
BENT GRASS FILING NO. 1 BASINS																		
C1	2.07	A	93.30	0.86	0.98	5	2.0	0.8	400	1.0	20.0	2.0	3.3	4.1	405.0	12.3	5.0	
C2	2.15	A	77.70	0.72	0.84	10	2.0	1.7	310	2.0	20.0	2.8	1.8	3.6	320.0	11.8	5.0	
D1	5.22	A	66.50	0.58	0.71	50	2.0	5.3	310	2.0	20.0	2.8	1.8	7.2	360.0	12.0	7.2	
D2	1.40	A	41.40	0.48	0.95	5	2.0	2.0	400	1.0	20.0	2.0	3.3	5.3	405.0	12.3	5.3	
H1	3.00	A	48.90	0.45	0.62	10	2.0	3.0	310	2.0	20.0	2.8	1.8	4.8	320.0	11.8	5.0	
H2	1.22	A	41.70	0.41	0.60	50	2.0	7.1	310	2.0	20.0	2.8	1.8	8.9	360.0	12.0	8.9	
G	1.70	A	2.00	0.09	0.36	100	2.0	14.7	485	2.0	20.0	2.8	2.9	17.5	585.0	13.3	13.3	
BENT GRASS FILING NO. 2 & BENT GRASS WEST BASINS																		
A-1	5.42	A	4.90	0.11	0.38	300	2.5	23.0	466	2.5	15.0	2.4	3.3	26.3	766.0	14.3	14.3	
A-2	18.00	A	2.00	0.09	0.36	300	2.4	23.9	1130	2.0	15.0	2.1	8.9	32.8	1430.0	17.9	17.9	
A-3	19.59	A	2.00	0.09	0.36	300	2.7	23.0	760	2.7	15.0	2.5	5.1	28.1	1060.0	15.9	15.9	
A-4	23.81	A	4.80	0.11	0.38	300	2.0	24.9	1500	2.0	15.0	2.1	11.8	36.7	1800.0	20.0	20.0	
B-1	32.53	A	2.00	0.09	0.36	300	2.6	23.3	1100	2.6	15.0	2.4	7.6	30.9	1400.0	17.8	17.8	
B-2	4.51	A	2.00	0.09	0.36	300	3.0	22.2	323	5.0	15.0	3.4	1.6	23.8	623.0	13.5	13.5	
B-3	16.18	A	8.10	0.14	0.40	300	2.9	21.4	780	2.9	15.0	2.6	5.1	26.4	1080.0	16.0	16.0	
OS-1	13.06	A	12.10	0.17	0.42	300	2.5	21.7	1420	2.5	15.0	2.4	10.0	31.7	1720.0	19.6	19.6	
OS-2	17.81	A	16.10	0.20	0.44	300	2.3	21.6	1370	2.3	15.0	2.3	10.0	31.7	1670.0	19.3	19.3	
OS-4	30.69	A	9.00	0.15	0.40	300	2.3	22.8	2600	2.3	15.0	2.3	19.0	41.9	2900.0	26.1	26.1	
PROPOSED:																		
P-1	2.03	A	64.20	0.57	0.61	100	6.0	5.3	1230	1.7	15.0	2.0	10.5	15.8	1330.0	17.4	15.8	

STANDARD FORM SF-3
STORM DRAINAGE SYSTEM DESIGN
(RATIONAL METHOD PROCEDURE)

Subdivision: Bent Grass
Location: CO, Colorado Springs
Design Storm: 5-Year

Project Name: Bent Grass
Project No.: CLH017.20
Calculated By: TJE
Checked By: CMD
Date: 12/2/20

STREET	Design Point	DIRECT RUNOFF							TOTAL RUNOFF				STREET		PIPE			TRAVEL TIME			REMARKS
		Basin ID	Area (Ac)	Runoff Coeff.	Tc (min)	C*A (Ac)	I (in/hr)	Q (cfs)	Tc (min)	C*A (Ac)	I (in/hr)	Q (cfs)	Slope (%)	Street Flow (cfs)	Design Flow (cfs)	Slope (%)	Pipe Size (inches)	Length (ft)	Velocity (fps)	Tt (min)	
		WT200	192.00					25.0													From Falcon DBPS by Matrix
Release rate from Meadows Pond #2		MT060	185.60	0.20	23.1			91.8													Flows from Meadows Filing No. 3
		OS-25	14.13	0.11	19.4	1.55	3.13	4.9													
		OS-26	5.81	0.09	13.9	0.52	3.64	1.9													
		H3	11.30	0.05	18.7	0.57	3.19	1.8													
		OS-22	4.42	0.09	14.2	0.40	3.61	1.4													
		OS-23	10.24	0.09	13.9	0.92	3.64	3.3													
		C1	2.07	0.86	5.0	1.78	5.17	9.2													
		C2	2.15	0.72	5.0	1.55	5.17	8.0													
		D1	5.22	0.58	7.2	3.03	4.63	14.0													
		D2	1.40	0.48	5.3	0.67	5.07	3.4													
		H1	3.00	0.45	5.0	1.35	5.17	7.0													
		H2	1.22	0.41	8.9	0.50	4.30	2.2													
		G	1.70	0.09	13.3	0.15	3.71	0.6													
BENT GRASS FILING NO. 2 & BENT GRASS WEST BASINS																					
		A-1	5.42	0.11	14.3	0.60	3.60	2.2													
		A-2	18.00	0.09	17.9	1.62	3.25	5.3													
		A-3	19.59	0.09	15.9	1.76	3.43	6.0													
		A-4	23.81	0.11	20.0	2.62	3.09	8.1													
		B-1	32.53	0.09	17.8	2.93	3.27	9.6													
		B-2	4.51	0.09	13.5	0.41	3.68	1.5													
		B-3	16.18	0.14	16.0	2.27	3.42	7.8													
		OS-1	13.06	0.17	19.6	2.22	3.12	6.9													
		OS-2	17.81	0.20	19.3	3.56	3.14	11.2													
		OS-4	30.69	0.15	26.1	4.60	2.69	12.4													
MERIDIAN ROAD BASIN																					
		P-1	2.03	0.61	15.8	1.24	3.44	4.3													

**STANDARD FORM SF-3
STORM DRAINAGE SYSTEM DESIGN
(RATIONAL METHOD PROCEDURE)**

Subdivision: Bent Grass
 Location: CO, Colorado Springs
 Design Storm: 100-Year

Project Name: Bent Grass
 Project No.: CLH017.20
 Calculated By: TJE
 Checked By: CMD
 Date: 12/2/20

STREET	Design Point	DIRECT RUNOFF							TOTAL RUNOFF				STREET		PIPE			TRAVEL TIME			REMARKS
		Basin ID	Area (Ac)	Runoff Coeff.	Tc (min)	C*A (Ac)	I (in/hr)	Q (cfs)	Tc (min)	C*A (Ac)	I (in/hr)	Q (cfs)	Slope (%)	Street Flow (cfs)	Design Flow (cfs)	Slope (%)	Pipe Size (inches)	Length (ft)	Velocity (fps)	Tt (min)	
		WT200	192.00	0.44	23.1			1000.0													From Falcon DBPS by Matrix
Release rate from Meadows Pond #2		MT060	185.60	0.44	23.1			226.0													Flows from Meadows Filing No. 3
		OS-25	14.13	0.37	19.4	5.23	5.26	27.5													
		OS-26	5.81	0.36	13.9	2.09	6.10	12.7													
		H3	11.30	0.19	18.7	2.15	5.36	11.5													
		OS-22	4.42	0.36	14.2	1.59	6.05	9.6													
		OS-23	10.24	0.36	13.9	3.69	6.10	22.5													
		C1	2.07	0.98	5.0	2.03	8.68	17.6													
		C2	2.15	0.84	5.0	1.81	8.68	15.7													
		D1	5.22	0.71	7.2	3.71	7.77	28.8													
		D2	1.40	0.95	5.3	1.33	8.51	11.3													
		H1	3.00	0.62	5.0	1.86	8.68	16.1													
		H2	1.22	0.60	8.9	0.73	7.22	5.3													
		G	1.70	0.36	13.3	0.61	6.22	3.8													
BENT GRASS FILING NO. 2 & BENT GRASS WEST BASINS																					
		A-1	5.42	0.38	14.3	2.06	6.04	12.4													
		A-2	18.00	0.36	17.9	6.48	5.46	35.4													
		A-3	19.59	0.36	15.9	7.05	5.77	40.7													
		A-4	23.81	0.38	20.0	9.05	5.19	47.0													
		B-1	32.53	0.36	17.8	11.71	5.48	64.2													
		B-2	4.51	0.36	13.5	1.62	6.18	10.0													
		B-3	16.18	0.40	16.0	6.47	5.75	37.2													
		OS-1	13.06	0.42	19.6	5.49	5.24	28.8													
		OS-2	17.81	0.44	19.3	7.84	5.28	41.4													
		OS-4	30.69	0.40	26.1	12.28	4.51	55.4													
MERIDIAN ROAD BASIN																					
		P-1	2.03	0.61	15.8	1.24	5.78	7.2													

Include all DPs and sub-basins on plans

BENT GRASS/MERIDIAN ROAD - MDDP SURFACE ROUTING - EXISTING CONDITIONS

DESIGN POINT	CONTRIBUTING BASINS	CA (equivalent)		Tc (min.)	INTENSITY		TOTAL FLOWS		NOTES	
		CA(5)	CA(100)		I(5) (in/hr)	I(100) (in/hr)	Q(5) (cfs)	Q(100) (cfs)		
1	OS-1 A-1	2.22	5.49	19.6	2.9	5.2	8.3	38.9		
		0.60	2.06	TRAVEL TIME						
		2.82	7.55	Type/flow	Length (ft)	Velocity (fps)	d. Time (min)	T. Time (min)		
				Sheet	450	2.6	2.9	22.4		
30	MT060			15.0			91.8	226.0	Flows from Meadows Filing No. 3 Pond 2	
				TRAVEL TIME						
				Type/flow	Length (ft)	Velocity (fps)	d. Time (min)	T. Time (min)		
				Sheet	2300	2.1	18.3	33.3		
31	OS-25 DP 30	1.55	5.23	33.3	2.2	3.8	55.9	245.9		
		24.11	59.36	TRAVEL TIME						
		25.66	64.59	Type/flow	Length (ft)	Velocity (fps)	d. Time (min)	T. Time (min)		
				Sheet	700	2.6	4.5	37.7		
32	OS-26 DP 1 DP 11	0.52	2.09	37.7	2.0	3.5	58.5	261.4		
		2.82	7.55	TRAVEL TIME						
		25.66	64.59	Type/flow	Length (ft)	Velocity (fps)	d. Time (min)	T. Time (min)		
		29.00	74.23	Street	1850	5.0	6.2	43.9		
14	C1 H3 OS-22 OS-23 DP 32	1.78	2.03	43.9	1.8	3.2	59.9	267.8		
		0.57	2.15	TRAVEL TIME						
		0.40	1.59	Type/flow	Length (ft)	Velocity (fps)	d. Time (min)	T. Time (min)		
		0.92	3.69	Street	400	5.0	1.3	45.2		
BG1	D1	3.03	3.71	7.2	4.6	8.0	14.0	29.9	Existing Sump Inlet	
		3.03	3.71	TRAVEL TIME						
				Type/flow	Length (ft)	Velocity (fps)	d. Time (min)	T. Time (min)		
						2.5	0.0	7.2		
BG2	D2	0.67	1.33	5.3	5.1	8.9	3.4	11.8	Existing Sump Inlet	
		0.67	1.33	TRAVEL TIME						
				Type/flow	Length (ft)	Velocity (fps)	d. Time (min)	T. Time (min)		
						2.5	0.0	5.3		
BG4	H1	1.35	1.86	5.0	5.2	9.1	7.0	16.9	Existing Sump Inlet	
		1.35	1.86	TRAVEL TIME						
				Type/flow	Length (ft)	Velocity (fps)	d. Time (min)	T. Time (min)		
						2.5	0.0	5.0		
BG5	H2	0.50	0.73	8.9	4.2	7.4	2.1	5.4	Existing Sump Inlet	
		0.50	0.73	TRAVEL TIME						
				Type/flow	Length (ft)	Velocity (fps)	d. Time (min)	T. Time (min)		
						2.5	0.0	8.9		
BG POND	BG1 BG2 BG4 BG5	3.03	3.71	8.9	4.2	7.4	23.6	56.6	Flows into existing Pond at Bent Grass Filing No. 1	
		0.67	1.33	TRAVEL TIME						
		1.35	1.86	Type/flow	Length (ft)	Velocity (fps)	d. Time (min)	T. Time (min)		
		0.50	0.73			2.0	0.0	8.9		
50		111.34	193.50	26.1	2.5	4.4	280.0	850.0	Flow from Falcon DBPS at Meridian Rd & BGMD Intersection	
		111.34	193.50	TRAVEL TIME						
				Type/flow	Length (ft)	Velocity (fps)	d. Time (min)	T. Time (min)		
						2.8	0.0	26.1		
20	DP 50 DP 14	111.34	193.50	45.2	1.8	3.1	201.0	609.6		
		0.50	0.73	TRAVEL TIME						
		111.84	194.23	Type/flow	Length (ft)	Velocity (fps)	d. Time (min)	T. Time (min)		
				Culverts	125	11.2	0.2	45.4		
15	C2 DP 20	1.55	1.81	45.4	1.8	3.1	203.2	613.7		
		111.84	194.23	TRAVEL TIME						
		113.39	196.04	Type/flow	Length (ft)	Velocity (fps)	d. Time (min)	T. Time (min)		
						2.5	0.0	45.4		
25	P-1 DP 15	1.24	1.24	45.4	1.8	3.1	205.4	617.6		
		113.39	196.04	TRAVEL TIME						
		114.63	197.28	Type/flow	Length (ft)	Velocity (fps)	d. Time (min)	T. Time (min)		
						2.5	0.0	45.4		

DESIGN POINT	CONTRIBUTING BASINS	CA (equivalent)		Tc (min.)	INTENSITY		TOTAL FLOWS		NOTES		
		CA(5)	CA(100)		I(5) (in/hr)	I(100) (in/hr)	Q(5) (cfs)	Q(100) (cfs)			
9	WT200	9.28	212.56	23.1	2.7	4.7	25.0	1000.0			
		TRAVEL TIME									
		9.28	212.56	Type/flow	Length (ft)	Velocity (fps)	d. Time (min)	T. Time (min)			
			CHANNEL	1450	7.0	3.5	26.6				
2	OS-2 A-1	3.56	7.84	19.3	3.0	5.2	12.4	51.4			
		0.60	2.06	TRAVEL TIME							
		4.16	9.90	Type/flow	Length (ft)	Velocity (fps)	d. Time (min)	T. Time (min)			
			CHANNEL	1000	5.0	3.3	22.6				
3	A-3 DP 9	1.76	7.05	26.6	2.5	4.3	27.5	955.0			
		9.28	212.56	TRAVEL TIME							
		11.04	219.61	Type/flow	Length (ft)	Velocity (fps)	d. Time (min)	T. Time (min)			
			CHANNEL	1000	5.0	3.3	29.9				
4	OS-4 A-4	4.60	12.28	26.1	2.5	4.4	18.2	93.7	Flows offsite to Latigo Business Center Filing No. 1		
		2.62	9.05	TRAVEL TIME							
		7.22	21.33	Type/flow	Length (ft)	Velocity (fps)	d. Time (min)	T. Time (min)			
					5.0	0.0	26.1				
5	B-1	2.93	11.71	17.8	3.1	5.4	9.1	63.4	Flows offsite at south property line		
		TRAVEL TIME									
		2.93	11.71	Type/flow	Length (ft)	Velocity (fps)	d. Time (min)	T. Time (min)			
					5.0	0.0	17.8				
6	B-2 DP 2 DP 3	0.41	1.62	29.9	2.3	4.1	36.3	938.0			
		4.16	9.90	TRAVEL TIME							
		11.04	219.61	Type/flow	Length (ft)	Velocity (fps)	d. Time (min)	T. Time (min)			
		15.61	231.13	CHANNEL	365	5.0	1.2	31.1			
7	B-3 DP 6	2.27	6.47	16.0	3.3	5.7	58.4	1356.3	Flows exiting site at channel		
		15.61	231.13	TRAVEL TIME							
		17.88	237.60	Type/flow	Length (ft)	Velocity (fps)	d. Time (min)	T. Time (min)			
					5.0	0.0	16.0				

Current Rational Calculations

COMPOSITE % IMPERVIOUS CALCULATIONS

Subdivision: Bent Grass Bent Grass/Meridian Road
 Location: CO, Colorado Springs CLH015.20
 TJE
 CMD
 3/23/20

Basin ID	Total Area (ac)	Paved Roads			Lawns			Roofs			Residential - 1/8 Acre			Residential - 1/4 Acre			Residential - 1/3 Acre			Residential - 1/2 Acre			Residential - 1 Acre			Basins Total Weighted % Imp.
		% Imp.	Area (ac)	Weighted % Imp.	% Imp.	Area (ac)	Weighted % Imp.	% Imp.	Area (ac)	Weighted % Imp.	% Imp.	Area (ac)	Weighted % Imp.	% Imp.	Area (ac)	Weighted % Imp.	% Imp.	Area (ac)	Weighted % Imp.	% Imp.	Area (ac)	Weighted % Imp.	% Imp.	Area (ac)	Weighted % Imp.	
OFFSITE BASINS																										
WT200	192.00																									10.0
MT060	185.60																									10.0
OS-2	20.08	80	0.90	3.6	2	18.62	1.9	90	0.56	2.5	65	0.00	0.0	40	0.00	0.0	30	0.00	0.0	25	0.00	0.0	20	0.00	0.0	8.0
OS-3	10.62	80	0.48	3.6	2	9.84	1.9	90	0.30	2.5	65	0.00	0.0	40	0.00	0.0	30	0.00	0.0	25	0.00	0.0	20	0.00	0.0	8.0
OS-24	2.64	100	0.00	0.0	2	2.64	2.0	90	0.00	0.0	65	0.00	0.0	40	0.00	0.0	30	0.00	0.0	25	0.00	0.0	20	0.00	0.0	2.0
OS-25	14.13	100	0.17	1.2	2	13.71	1.9	90	0.22	1.4	65	0.00	0.0	40	0.00	0.0	30	0.00	0.0	25	0.00	0.0	20	0.00	0.0	4.5
OS-26	5.81	100	0.00	0.0	2	5.81	2.0	90	0.00	0.0	65	0.00	0.0	40	0.00	0.0	30	0.00	0.0	25	0.00	0.0	20	0.00	0.0	2.0
H3	11.30	100	0.00	0.0	2	5.81	1.0	90	0.00	0.0	65	0.00	0.0	40	0.00	0.0	30	0.00	0.0	25	0.00	0.0	20	0.00	0.0	1.0
OS-22	4.42	100	0.00	0.0	2	4.42	2.0	90	0.00	0.0	65	0.00	0.0	40	0.00	0.0	30	0.00	0.0	25	0.00	0.0	20	0.00	0.0	2.0
OS-23	10.24	100	0.00	0.0	2	10.24	2.0	90	0.00	0.0	65	0.00	0.0	40	0.00	0.0	30	0.00	0.0	25	0.00	0.0	20	0.00	0.0	2.0
BENT GRASS FILING NO. 1 BASINS																										
C1a	0.48	100	0.36	75.0	2	0.12	0.5	90	0.00	0.0	65	0.00	0.0	40	0.00	0.0	30	0.00	0.0	25	0.00	0.0	20	0.00	0.0	75.5
C1b	0.88	100	0.68	77.3	2	0.20	0.5	90	0.00	0.0	65	0.00	0.0	40	0.00	0.0	30	0.00	0.0	25	0.00	0.0	20	0.00	0.0	77.7
C1c	1.09	100	0.88	80.7	2	0.21	0.4	90	0.00	0.0	65	0.00	0.0	40	0.00	0.0	30	0.00	0.0	25	0.00	0.0	20	0.00	0.0	81.1
D1a	0.56	100	0.33	58.9	2	0.23	0.8	90	0.00	0.0	65	0.00	0.0	40	0.00	0.0	30	0.00	0.0	25	0.00	0.0	20	0.00	0.0	59.8
D1b	0.68	100	0.17	25.0	2	0.21	0.6	90	0.30	39.7	65	0.00	0.0	40	0.00	0.0	30	0.00	0.0	25	0.00	0.0	20	0.00	0.0	65.3
D1c	1.20	100	0.19	15.8	2	0.34	0.6	90	0.67	50.3	65	0.00	0.0	40	0.00	0.0	30	0.00	0.0	25	0.00	0.0	20	0.00	0.0	66.7
D1d	2.79	100	0.50	17.9	2	0.76	0.5	90	1.53	49.4	65	0.00	0.0	40	0.00	0.0	30	0.00	0.0	25	0.00	0.0	20	0.00	0.0	67.8
C2a	1.26	100	0.74	58.7	2	0.52	0.8	90	0.00	0.0	65	0.00	0.0	40	0.00	0.0	30	0.00	0.0	25	0.00	0.0	20	0.00	0.0	59.6
C2b	0.99	100	0.92	92.9	2	0.07	0.1	90	0.00	0.0	65	0.00	0.0	40	0.00	0.0	30	0.00	0.0	25	0.00	0.0	20	0.00	0.0	93.1
D2a	1.00	100	0.19	19.0	2	0.65	1.3	90	0.16	14.4	65	0.00	0.0	40	0.00	0.0	30	0.00	0.0	25	0.00	0.0	20	0.00	0.0	34.7
D2b	0.41	100	0.11	26.8	2	0.20	1.0	90	0.10	22.0	65	0.00	0.0	40	0.00	0.0	30	0.00	0.0	25	0.00	0.0	20	0.00	0.0	49.8
H1a	0.40	100	0.16	40.0	2	0.20	1.0	90	0.04	9.0	65	0.00	0.0	40	0.00	0.0	30	0.00	0.0	25	0.00	0.0	20	0.00	0.0	50.0
H1b	2.52	100	0.40	15.9	2	1.22	1.0	90	0.86	30.7	65	0.00	0.0	40	0.00	0.0	30	0.00	0.0	25	0.00	0.0	20	0.00	0.0	47.6
H1c	0.16	100	0.05	31.3	2	0.09	1.1	90	0.02	11.3	65	0.00	0.0	40	0.00	0.0	30	0.00	0.0	25	0.00	0.0	20	0.00	0.0	43.6
H2a	1.09	100	0.30	27.5	2	0.63	1.2	90	0.16	13.2	65	0.00	0.0	40	0.00	0.0	30	0.00	0.0	25	0.00	0.0	20	0.00	0.0	41.9
H2b	0.15	100	0.05	33.3	2	0.10	1.3	90	0.00	0.0	65	0.00	0.0	40	0.00	0.0	30	0.00	0.0	25	0.00	0.0	20	0.00	0.0	34.7
BENT GRASS FILING NO. 2 BASINS																										
OS-1	32.28	100	2.15	6.7	2	29.25	1.8	90	0.88	2.5	65	0.00	0.0	40	0.00	0.0	30	0.00	0.0	25	0.00	0.0	20	0.00	0.0	11.0
OS-4	4.46	100	0.00	0.0	2	0.00	0.0	90	0.00	0.0	65	2.28	33.2	40	1.46	13.1	30	0.00	0.0	25	0.00	0.0	20	0.72	3.2	49.5
OS-5	0.46	100	0.00	0.0	2	0.00	0.0	90	0.00	0.0	65	0.46	65.0	40	0.00	0.0	30	0.00	0.0	25	0.00	0.0	20	0.00	0.0	65.0
OS-6	1.17	100	0.00	0.0	2	0.00	0.0	90	0.00	0.0	65	1.17	65.0	40	0.00	0.0	30	0.00	0.0	25	0.00	0.0	20	0.00	0.0	65.0
A-1	2.70	100	0.00	0.0	2	0.00	0.0	90	0.00	0.0	65	1.18	28.4	40	0.68	10.1	30	0.00	0.0	25	0.00	0.0	20	0.84	6.2	44.7
A-2	1.19	100	0.00	0.0	2	0.00	0.0	90	0.00	0.0	65	0.37	20.2	40	0.56	18.8	30	0.00	0.0	25	0.00	0.0	20	0.26	4.4	43.4
A-3	1.57	100	0.00	0.0	2	0.00	0.0	90	0.00	0.0	65	0.59	24.4	40	0.98	25.0	30	0.00	0.0	25	0.00	0.0	20	0.00	0.0	49.4
A-4	2.24	100	0.00	0.0	2	0.00	0.0	90	0.00	0.0	65	0.93	27.0	40	0.88	15.7	30	0.00	0.0	25	0.00	0.0	20	0.43	3.8	46.5
C-1	1.35	100	0.03	2.1	2	0.16	0.2	90	0.00	0.0	65	1.16	55.9	40	0.00	0.0	30	0.00	0.0	25	0.00	0.0	20	0.00	0.0	58.2
C-2	6.80	100	0.00	0.0	2	0.00	0.0	90	0.00	0.0	65	2.61	24.9	40	2.75	16.2	30	0.50	2.2	25	0.94	3.5	20	0.00	0.0	46.8
C-3	2.38	100	0.00	0.0	2	0.00	0.0	90	0.00	0.0	65	1.61	44.0	40	0.77	12.9	30	0.00	0.0	25	0.00	0.0	20	0.00	0.0	56.9
C-4	3.61	100	0.00	0.0	2	0.00	0.0	90	0.00	0.0	65	2.86	51.4	40	0.75	8.4	30	0.00	0.0	25	0.00	0.0	20	0.00	0.0	59.8
C-5	7.86	100	0.00	0.0	2	0.00	0.0	90	0.00	0.0	65	6.53	54.0	40	1.33	6.8	30	0.00	0.0	25	0.00	0.0	20	0.00	0.0	60.8
C-6	5.54	100	0.00	0.0	2	0.00	0.0	90	0.00	0.0	65	3.14	36.8	40	1.60	11.6	30	0.80	4.3	25	0.00	0.0	20	0.00	0.0	52.7
C-7	0.89	100	0.00	0.0	2	0.89	2.0	90	0.00	0.0	65	0.00	0.0	40	0.00	0.0	30	0.00	0.0	25	0.00	0.0	20	0.00	0.0	2.0
C-8	0.42	100	0.00	0.0	2	0.42	2.0	90	0.00	0.0	65	0.00	0.0	40	0.00	0.0	30	0.00	0.0	25	0.00	0.0	20	0.00	0.0	2.0
E-1	1.71	100	0.78	45.6	2	0.23	0.3	90	0.00	0.0	65	0.00	0.0	40	0.70	16.4	30	0.00	0.0	25	0.00	0.0	20	0.00	0.0	62.3
E-2	0.68	100	0.56	82.4	2	0.12	0.4	90	0.00	0.0	65	0.00	0.0	40	0.00	0.0	30	0.00	0.0	25	0.00	0.0	20	0.00	0.0	82.8
E-3	0.78	100	0.69	88.5	2	0.09	0.2	90	0.00	0.0	65	0.00	0.0	40	0.00	0.0	30	0.00	0.0	25	0.00	0.0	20	0.00	0.0	88.7
E-4	0.91	100	0.73	80.2	2	0.18	0.4	90	0.00	0.0	65	0.00	0.0	40	0.00	0.0	30	0.00	0.0	25	0.00	0.0	20	0.00	0.0	80.6
E-5	0.89	100	0.79	88.8	2	0.10	0.2	90	0.00	0.0	65	0.00	0.0	40	0.00	0.0	30	0.00	0.0	25	0.00	0.0	20	0.00	0.0	89.0
F-1	0.44	100	0																							

Basin ID	Total Area (ac)	Paved Roads			Lawns			Roofs			Residential - 1/8 Acre			Residential - 1/4 Acre			Residential - 1/3 Acre			Residential - 1/2 Acre			Residential - 1 Acre			Basins Total Weighted % Imp.
		% Imp.	Area (ac)	Weighted % Imp.	% Imp.	Area (ac)	Weighted % Imp.	% Imp.	Area (ac)	Weighted % Imp.	% Imp.	Area (ac)	Weighted % Imp.	% Imp.	Area (ac)	Weighted % Imp.	% Imp.	Area (ac)	Weighted % Imp.	% Imp.	Area (ac)	Weighted % Imp.	% Imp.	Area (ac)	Weighted % Imp.	
H-1	0.52	100	0.00	0.0	2	0.52	2.0	90	0.00	0.0	65	0.00	0.0	40	0.00	0.0	30	0.00	0.0	25	0.00	0.0	20	0.00	0.0	2.0
I-1	0.31	100	0.22	71.0	2	0.09	0.6	90	0.00	0.0	65	0.00	0.0	40	0.00	0.0	30	0.00	0.0	25	0.00	0.0	20	0.00	0.0	71.6
BENT GRASS WEST BASINS																										
EX-1	1.19	100	0.00	0.0	2	1.19	2.0	2	0.00	0.0	65	0.00	0.0	40	0.00	0.0	30	0.00	0.0	25	0.00	0.0	20	0.00	0.0	2.0
EX-2	1.56	100	0.00	0.0	2	1.56	2.0	90	0.00	0.0	65	0.00	0.0	40	0.00	0.0	30	0.00	0.0	25	0.00	0.0	20	0.00	0.0	2.0
EX-3	0.62	100	0.00	0.0	2	0.62	2.0	1	0.00	0.0	65	0.00	0.0	40	0.00	0.0	30	0.00	0.0	25	0.00	0.0	20	0.00	0.0	2.0
EX-4	12.49	100	0.00	0.0	2	12.49	2.0	90	0.00	0.0	65	0.00	0.0	40	0.00	0.0	30	0.00	0.0	25	0.00	0.0	20	0.00	0.0	2.0
EX-5	5.15	100	0.00	0.0	2	5.15	2.0	10	0.00	0.0	65	0.00	0.0	40	0.00	0.0	30	0.00	0.0	25	0.00	0.0	20	0.00	0.0	2.0
EX-6	9.53	100	0.00	0.0	2	9.53	2.0	90	0.00	0.0	65	0.00	0.0	40	0.00	0.0	30	0.00	0.0	25	0.00	0.0	20	0.00	0.0	2.0
EX-7	9.16	100	0.00	0.0	2	9.16	2.0	18	0.00	0.0	65	0.00	0.0	40	0.00	0.0	30	0.00	0.0	25	0.00	0.0	20	0.00	0.0	2.0
EX-8	21.30	100	0.00	0.0	2	21.30	2.0	90	0.00	0.0	65	0.00	0.0	40	0.00	0.0	30	0.00	0.0	25	0.00	0.0	20	0.00	0.0	2.0
MERIDIAN ROAD BASIN																										
P-1	2.03	100	1.29	63.6	2	0.74	0.7	90	0.00	0.0	65	0.00	0.0	40	0.00	0.0	30	0.00	0.0	25	0.00	0.0	20	0.00	0.0	64.3

COMPOSITE RUNOFF COEFFICIENT CALCULATIONS

Subdivision: Bent Grass
Location: CO, Colorado Springs

Project Name: Bent Grass/Meridian Road
Project No.: CLH015.20
Calculated By: TJE
Checked By: CMD
Date: 3/23/20

Basin ID	Total Area (ac)	Paved/Gravel Roads			Lawns/Undeveloped			Roofs			Residential - 1/8 Acre			Residential - 1/4 Acre			Residential - 1/3 Acre			Residential - 1/2 Acre			Residential - 1 Acre			Composite C ₅	Composite C ₁₀₀
		C ₅	C ₁₀₀	Area (ac)	C ₅	C ₁₀₀	Area (ac)	C ₅	C ₁₀₀	Area (ac)	C ₅	C ₁₀₀	Area (ac)	C ₅	C ₁₀₀	Area (ac)	C ₅	C ₁₀₀	Area (ac)	C ₅	C ₁₀₀	Area (ac)	C ₅	C ₁₀₀	Area (ac)		
OFFSITE BASINS																											
WT200	192.00																									0.20	0.44
MT060	185.60																									0.20	0.44
OS-2	20.08	0.90	0.96	0.90	0.09	0.36	18.62	0.73	0.81	0.56	0.45	0.59	0.00	0.30	0.50	0.00	0.25	0.47	0.00	0.22	0.46	0.00	0.20	0.44	0.00	0.14	0.40
OS-3	10.62	0.90	0.96	0.48	0.09	0.36	9.84	0.73	0.81	0.30	0.45	0.59	0.00	0.30	0.50	0.00	0.25	0.47	0.00	0.22	0.46	0.00	0.20	0.44	0.00	0.14	0.40
OS-24	2.64	0.90	0.96	0.00	0.09	0.36	2.64	0.73	0.81	0.00	0.45	0.59	0.00	0.30	0.50	0.00	0.25	0.47	0.00	0.22	0.46	0.00	0.20	0.44	0.00	0.09	0.36
OS-25	14.13	0.90	0.96	0.17	0.09	0.36	13.71	0.73	0.81	0.22	0.45	0.59	0.00	0.30	0.50	0.00	0.25	0.47	0.00	0.22	0.46	0.00	0.20	0.44	0.00	0.11	0.37
OS-26	5.81	0.90	0.96	0.00	0.09	0.36	5.81	0.73	0.81	0.00	0.45	0.59	0.00	0.30	0.50	0.00	0.25	0.47	0.00	0.22	0.46	0.00	0.20	0.44	0.00	0.09	0.36
H3	11.30	0.90	0.96	0.00	0.09	0.36	5.81	0.73	0.81	0.00	0.45	0.59	0.00	0.30	0.50	0.00	0.25	0.47	0.00	0.22	0.46	0.00	0.20	0.44	0.00	0.05	0.19
OS-22	4.42	0.90	0.96	0.00	0.09	0.36	4.42	0.73	0.81	0.00	0.45	0.59	0.00	0.30	0.50	0.00	0.25	0.47	0.00	0.22	0.46	0.00	0.20	0.44	0.00	0.09	0.36
OS-23	10.24	0.90	0.96	0.00	0.09	0.36	10.24	0.73	0.81	0.00	0.45	0.59	0.00	0.30	0.50	0.00	0.25	0.47	0.00	0.22	0.46	0.00	0.20	0.44	0.00	0.09	0.36
BENT GRASS FILING NO. 1 BASINS																											
C1a	0.48	0.90	0.96	0.36	0.09	0.36	0.12	0.73	0.81	0.00	0.45	0.59	0.00	0.30	0.50	0.00	0.25	0.47	0.00	0.22	0.46	0.00	0.20	0.44	0.00	0.70	0.81
C1b	0.88	0.90	0.96	0.68	0.09	0.36	0.20	0.73	0.81	0.00	0.45	0.59	0.00	0.30	0.50	0.00	0.25	0.47	0.00	0.22	0.46	0.00	0.20	0.44	0.00	0.72	0.82
C1c	1.09	0.90	0.96	0.88	0.09	0.36	0.21	0.73	0.81	0.00	0.45	0.59	0.00	0.30	0.50	0.00	0.25	0.47	0.00	0.22	0.46	0.00	0.20	0.44	0.00	0.74	0.84
D1a	0.56	0.90	0.96	0.33	0.09	0.36	0.23	0.73	0.81	0.00	0.45	0.59	0.00	0.30	0.50	0.00	0.25	0.47	0.00	0.22	0.46	0.00	0.20	0.44	0.00	0.57	0.71
D1b	0.68	0.90	0.96	0.17	0.09	0.36	0.21	0.73	0.81	0.30	0.45	0.59	0.00	0.30	0.50	0.00	0.25	0.47	0.00	0.22	0.46	0.00	0.20	0.44	0.00	0.57	0.71
D1c	1.20	0.90	0.96	0.19	0.09	0.36	0.34	0.73	0.81	0.67	0.45	0.59	0.00	0.30	0.50	0.00	0.25	0.47	0.00	0.22	0.46	0.00	0.20	0.44	0.00	0.58	0.71
D1d	2.79	0.90	0.96	0.50	0.09	0.36	0.76	0.73	0.81	1.53	0.45	0.59	0.00	0.30	0.50	0.00	0.25	0.47	0.00	0.22	0.46	0.00	0.20	0.44	0.00	0.59	0.71
C2a	1.26	0.90	0.96	0.74	0.09	0.36	0.52	0.73	0.81	0.00	0.45	0.59	0.00	0.30	0.50	0.00	0.25	0.47	0.00	0.22	0.46	0.00	0.20	0.44	0.00	0.57	0.71
C2b	0.99	0.90	0.96	0.92	0.09	0.36	0.07	0.73	0.81	0.00	0.45	0.59	0.00	0.30	0.50	0.00	0.25	0.47	0.00	0.22	0.46	0.00	0.20	0.44	0.00	0.84	0.92
D2a	1.00	0.90	0.96	0.19	0.09	0.36	0.65	0.73	0.81	0.16	0.45	0.59	0.00	0.30	0.50	0.00	0.25	0.47	0.00	0.22	0.46	0.00	0.20	0.44	0.00	0.35	0.55
D2b	0.41	0.90	0.96	0.11	0.09	0.36	0.20	0.73	0.81	0.10	0.45	0.59	0.00	0.30	0.50	0.00	0.25	0.47	0.00	0.22	0.46	0.00	0.20	0.44	0.00	0.46	0.63
H1a	0.40	0.90	0.96	0.16	0.09	0.36	0.20	0.73	0.81	0.04	0.45	0.59	0.00	0.30	0.50	0.00	0.25	0.47	0.00	0.22	0.46	0.00	0.20	0.44	0.00	0.48	0.65
H1b	2.52	0.90	0.96	0.40	0.09	0.36	1.22	0.73	0.81	0.86	0.45	0.59	0.00	0.30	0.50	0.00	0.25	0.47	0.00	0.22	0.46	0.00	0.20	0.44	0.00	0.44	0.60
H1c	0.16	0.90	0.96	0.05	0.09	0.36	0.09	0.73	0.81	0.02	0.45	0.59	0.00	0.30	0.50	0.00	0.25	0.47	0.00	0.22	0.46	0.00	0.20	0.44	0.00	0.42	0.60
H2a	1.09	0.90	0.96	0.30	0.09	0.36	0.63	0.73	0.81	0.16	0.45	0.59	0.00	0.30	0.50	0.00	0.25	0.47	0.00	0.22	0.46	0.00	0.20	0.44	0.00	0.41	0.59
H2b	0.15	0.90	0.96	0.05	0.09	0.36	0.10	0.73	0.81	0.00	0.45	0.59	0.00	0.30	0.50	0.00	0.25	0.47	0.00	0.22	0.46	0.00	0.20	0.44	0.00	0.36	0.56
BENT GRASS FILING NO. 2 BASINS:																											
OS-1	32.28	0.90	0.96	2.15	0.09	0.36	29.25	0.73	0.81	0.88	0.45	0.59	0.00	0.30	0.50	0.00	0.25	0.47	0.00	0.22	0.46	0.00	0.20	0.44	0.00	0.16	0.41
OS-4	4.46	0.90	0.96	0.00	0.09	0.36	0.00	0.73	0.81	0.00	0.45	0.59	2.28	0.30	0.50	1.46	0.25	0.47	0.00	0.22	0.46	0.00	0.20	0.44	0.72	0.36	0.54
OS-5	0.46	0.90	0.96	0.00	0.09	0.36	0.00	0.73	0.81	0.00	0.45	0.59	0.46	0.30	0.50	0.00	0.25	0.47	0.00	0.22	0.46	0.00	0.20	0.44	0.00	0.45	0.59
OS-6	1.17	0.90	0.96	0.00	0.09	0.36	0.00	0.73	0.81	0.00	0.45	0.59	1.17	0.30	0.50	0.00	0.25	0.47	0.00	0.22	0.46	0.00	0.20	0.44	0.00	0.45	0.59
A-1	2.70	0.90	0.96	0.00	0.09	0.36	0.00	0.73	0.81	0.00	0.45	0.59	1.18	0.30	0.50	0.68	0.25	0.47	0.00	0.22	0.46	0.00	0.20	0.44	0.84	0.33	0.52
A-2	1.19	0.90	0.96	0.00	0.09	0.36	0.00	0.73	0.81	0.00	0.45	0.59	0.37	0.30	0.50	0.56	0.25	0.47	0.00	0.22	0.46	0.00	0.20	0.44	0.26	0.32	0.51
A-3	1.57	0.90	0.96	0.00	0.09	0.36	0.00	0.73	0.81	0.00	0.45	0.59	0.59	0.30	0.50	0.98	0.25	0.47	0.00	0.22	0.46	0.00	0.20	0.44	0.00	0.36	0.53
A-4	2.24	0.90	0.96	0.00	0.09	0.36	0.00	0.73	0.81	0.00	0.45	0.59	0.93	0.30	0.50	0.88	0.25	0.47	0.00	0.22	0.46	0.00	0.20	0.44	0.43	0.34	0.53
C-1	1.35	0.90	0.96	0.03	0.09	0.36	0.16	0.73	0.81	0.00	0.45	0.59	1.16	0.30	0.50	0.00	0.25	0.47	0.00	0.22	0.46	0.00	0.20	0.44	0.00	0.42	0.57
C-2	6.80	0.90	0.96	0.00	0.09	0.36	0.00	0.73	0.81	0.00	0.45	0.59	2.61	0.30	0.50	2.75	0.25	0.47	0.50	0.22	0.46	0.94	0.20	0.44	0.00	0.34	0.53
C-3	2.38	0.90	0.96	0.00	0.09	0.36	0.00	0.73	0.81	0.00	0.45	0.59	1.61	0.30	0.50	0.77	0.25	0.47	0.00	0.22	0.46	0.00	0.20	0.44	0.00	0.40	0.56
C-4	3.61	0.90	0.96	0.00	0.09	0.36	0.00	0.73	0.81	0.00	0.45	0.59	2.86	0.30	0.50	0.75	0.25	0.47	0.00	0.22	0.46	0.00	0.20	0.44	0.00	0.42	0.57
C-5	7.86	0.90	0.96	0.00	0.09	0.36	0.00	0.73	0.81	0.00	0.45	0.59	6.53	0.30	0.50	1.33	0.25	0.47	0.00	0.22	0.46	0.00	0.20	0.44	0.00	0.42	0.57
C-6	5.54	0.90	0.96	0.00	0.09	0.36	0.00	0.73	0.81	0.00	0.45	0.59	3.14	0.30	0.50	1.60	0.25	0.47	0.80	0.22	0.46	0.00	0.20	0.44	0.00	0.38	0.55
C-7	0.89	0.90	0.96	0.00	0.09	0.36	0.89	0.73	0.81	0.00	0.45	0.59	0.00	0.30	0.50	0.00	0.25	0.47	0.00	0.22	0.46	0.00	0.20	0.44	0.00	0.09	0.36
C-8	0.42	0.90	0.96	0.00	0.09	0.36	0.42	0.73	0.81	0.00	0.45	0.59	0.00	0.30	0.50	0.00	0.25	0.47	0.00	0.22	0.46	0.00	0.20	0.44	0.00	0.09	0.36
E-1	1.71	0.90	0.96	0.78	0.09	0.36	0.23	0.73	0.81	0.00	0.45	0.59	0.00	0.30	0.50	0.70	0.25	0.47	0.00	0.22	0.46	0.00	0.20	0.44	0.00	0.55	0.69
E-2	0.68	0.90	0.96	0.56	0.09	0.36	0.12	0.73	0.81	0.00	0.45	0.59	0.00	0.30	0.50	0.00	0.25	0.47	0.00	0.22	0.46	0.00	0.20	0.44	0.00	0.76	0.85
E-3	0.78	0.90	0.96	0.69	0.09	0.36	0.09	0.73	0.81	0.00	0.45	0.59	0.00	0.30	0.50	0.00	0.25	0.47	0.00	0.22	0.46	0.00	0.20	0.44	0.00	0.81	0.89
E-4	0.91	0.90	0.96																								

Basin ID	Total Area (ac)	Paved/Gravel Roads			Lawns/Undeveloped			Roofs			Residential - 1/8 Acre			Residential - 1/4 Acre			Residential - 1/3 Acre			Residential - 1/2 Acre			Residential - 1 Acre			Composite C ₅	Composite C ₁₀₀
		C ₅	C ₁₀₀	Area (ac)	C ₅	C ₁₀₀	Area (ac)	C ₅	C ₁₀₀	Area (ac)	C ₅	C ₁₀₀	Area (ac)	C ₅	C ₁₀₀	Area (ac)	C ₅	C ₁₀₀	Area (ac)	C ₅	C ₁₀₀	Area (ac)	C ₅	C ₁₀₀	Area (ac)		
EX-3	0.62	0.90	0.96	0.00	0.09	0.36	0.62	0.73	0.81	0.00	0.45	0.59	0.00	0.30	0.50	0.00	0.25	0.47	0.00	0.22	0.46	0.00	0.20	0.44	0.00	0.09	0.36
EX-4	12.49	0.90	0.96	0.00	0.09	0.36	12.49	0.73	0.81	0.00	0.45	0.59	0.00	0.30	0.50	0.00	0.25	0.47	0.00	0.22	0.46	0.00	0.20	0.44	0.00	0.09	0.36
EX-5	5.15	0.90	0.96	0.00	0.09	0.36	5.15	0.73	0.81	0.00	0.45	0.59	0.00	0.30	0.50	0.00	0.25	0.47	0.00	0.22	0.46	0.00	0.20	0.44	0.00	0.09	0.36
EX-6	9.53	0.90	0.96	0.00	0.09	0.36	9.53	0.73	0.81	0.00	0.45	0.59	0.00	0.30	0.50	0.00	0.25	0.47	0.00	0.22	0.46	0.00	0.20	0.44	0.00	0.09	0.36
EX-7	9.16	0.90	0.96	0.00	0.09	0.36	9.16	0.73	0.81	0.00	0.45	0.59	0.00	0.30	0.50	0.00	0.25	0.47	0.00	0.22	0.46	0.00	0.20	0.44	0.00	0.09	0.36
EX-8	21.30	0.90	0.96	0.00	0.09	0.36	21.30	0.73	0.81	0.00	0.45	0.59	0.00	0.30	0.50	0.00	0.25	0.47	0.00	0.22	0.46	0.00	0.20	0.44	0.00	0.09	0.36
PROPOSED:																											
P-1	2.03	0.90	0.96	1.29	0.09	0.36	0.74	0.73	0.81	0.00	0.45	0.59	0.00	0.30	0.50	0.00	0.25	0.47	0.00	0.22	0.46	0.00	0.20	0.44	0.00	0.60	0.74

Lot Type Identification:	
Lot Size (SF)	Lot Size (Acre)
0 - 8,167	<= 1/8 Acre
8,168 - 12,704	1/4 Acre
12,705 - 18,149	1/3 Acre
18,150 - 32,670	1/2 Acre
32,671 - 43,560	1 Acre

NOTES:
C values are taken directly from Table 6-6 in the Colorado Springs DCM Vol. 1, CH. 6 (Referencing UDFCD 2001)
Coefficients use HSG A&B soils - Refer to "Appendix A: Exhibits and Figures" for soil map

**STANDARD FORM SF-2
TIME OF CONCENTRATION**

Subdivision: Bent Grass
Location: CO, Colorado Springs

Project Name: Bent Grass/Meridian Road
Project No.: CLH015.20
Calculated By: TJE
Checked By: CMD
Date: 3/23/20

SUB-BASIN DATA						INITIAL/OVERLAND (T _i)			TRAVEL TIME (T _t)					T _c CHECK (URBANIZED BASINS)			FINAL T _c (MIN)	
BASIN ID	D.A. (AC)	Hydrologic Soils Group	Impervious (%)	C _s	C100	L (FT)	S (%)	T _i (MIN)	L (FT)	S (%)	C _v	VEL. (FPS)	T _t (MIN)	COMP. T _c (MIN)	TOTAL LENGTH (FT)	Urbanized T _c (MIN)	T _c (MIN)	
OFFSITE BASINS																		
WT200	192.00	A	10.0	0.20	0.44	300	2.0	22.7	2060	2.0	15	2.1	16.2	38.8	2360.0	23.1	23.1	
MT060	185.60	A	10.0	0.20	0.44	300	2.0	22.7	2060	2.0	15	2.1	16.2	38.8	2360.0	23.1	23.1	
OS-2	20.08	A	8.0	0.14	0.40	100	2.3	13.3	1400	2.3	15	2.3	10.3	23.6	1500.0	18.3	18.3	
OS-3	10.62	A	8.0	0.14	0.40	100	2.0	14.0	1500	2.0	15	2.1	11.8	25.7	1600.0	18.9	18.9	
OS-24	2.64	A	2.0	0.09	0.36	100	6.0	10.2	1460	2.0	15	2.1	11.5	21.7	1560.0	18.7	18.7	
OS-25	14.13	A	4.5	0.11	0.37	100	6.0	10.0	1230	1.7	15	2.0	10.5	20.5	1330.0	17.4	17.4	
OS-26	5.81	A	2.0	0.09	0.36	100	1.0	18.5	650	1.0	10	1.0	10.8	29.3	750.0	14.2	14.2	
H3	11.30	A	1.0	0.05	0.19	100	1.0	19.2	600	1.0	10	1.0	10.0	29.2	700.0	13.9	13.9	
OS-22	4.42	A	2.0	0.09	0.36	100	1.0	18.5	600	1.0	10	1.0	10.0	28.5	700.0	13.9	13.9	
OS-23	10.24	A	2.0	0.09	0.36	100	1.0	18.5	600	1.0	10	1.0	10.0	28.5	700.0	13.9	13.9	
BENT GRASS FILING NO. 1 BASINS																		
C1a	0.48	A	75.5	0.70	0.81	5	2.0	1.3	400	1.0	20	2.0	3.3	4.6	405.0	12.3	5.0	
C1b	0.88	A	77.7	0.72	0.82	10	2.0	1.7	310	2.0	20	2.8	1.8	3.6	320.0	11.8	5.0	
C1c	1.09	A	81.1	0.74	0.84	50	2.0	3.7	310	2.0	20	2.8	1.8	5.5	360.0	12.0	5.5	
D1a	0.56	A	59.8	0.57	0.71	5	2.0	1.7	400	1.0	20	2.0	3.3	5.1	405.0	12.3	5.1	
D1b	0.68	A	65.3	0.57	0.71	10	2.0	2.4	310	2.0	20	2.8	1.8	4.3	320.0	11.8	5.0	
D1c	1.20	A	66.7	0.58	0.71	50	2.0	5.3	310	2.0	20	2.8	1.8	7.2	360.0	12.0	7.2	
D1d	2.79	A	67.8	0.59	0.71	100	2.0	7.4	485	2.0	20	2.8	2.9	10.3	585.0	13.3	10.3	
C2a	1.26	A	59.6	0.57	0.71	12	2.0	2.7	965	1.0	20	2.0	8.0	10.7	977.0	15.4	10.7	
C2b	0.99	A	93.1	0.84	0.92	12	2.0	1.3	1190	1.0	20	2.0	9.9	11.2	1202.0	16.7	11.2	
D2a	1.00	A	34.7	0.35	0.55	5	2.0	2.4	310	2.0	20	2.8	1.8	4.3	315.0	11.8	5.0	
D2b	0.41	A	49.8	0.46	0.63	5	2.0	2.1	225	2.0	20	2.8	1.3	3.4	230.0	11.3	5.0	
H1a	0.40	A	50.0	0.48	0.65	10	2.0	2.8	310	2.0	20	2.8	1.8	4.7	320.0	11.8	5.0	
H1b	2.52	A	47.6	0.44	0.60	50	2.0	6.8	575	1.0	20	2.0	4.8	11.6	625.0	13.5	11.6	
H1c	0.16	A	43.6	0.42	0.60	5	2.0	2.2	100	1.0	20	2.0	0.8	3.0	105.0	10.6	5.0	
H2a	1.09	A	41.9	0.41	0.59	50	2.0	7.1	575	1.0	20	2.0	4.8	11.9	625.0	13.5	11.9	
H2b	0.15	A	34.7	0.36	0.56	5	2.0	2.4	100	1.0	20	2.0	0.8	3.2	105.0	10.6	5.0	
BENT GRASS FILING NO. 2 BASINS																		
OS-1	32.28	A	11.0	0.16	0.41	100	2.4	12.9	2100	2.2	15	2.2	15.7	28.6	2200.0	22.2	22.2	
OS-4	4.46	A	49.5	0.36	0.54	100	2.0	10.8	910	1.2	20	2.2	6.9	17.7	1010.0	15.6	15.6	
OS-5	0.46	A	65.0	0.45	0.59	15	2.0	3.7	190	1.0	20	2.0	1.6	5.2	205.0	11.1	5.2	
OS-6	1.17	A	65.0	0.45	0.59	85	0.2	18.7	430	0.9	20	1.9	3.8	22.5	515.0	12.9	12.9	
A-1	2.70	A	44.7	0.33	0.52	100	1.3	12.9	550	1.3	20	2.3	4.0	16.9	650.0	13.6	13.6	
A-2	1.19	A	43.4	0.32	0.51	100	4.3	8.8	310	2.3	20	3.0	1.7	10.5	410.0	12.3	10.5	
A-3	1.57	A	49.4	0.36	0.53	70	1.0	11.3	680	1.2	20	2.2	5.2	16.5	750.0	14.2	14.2	
A-4	2.24	A	46.5	0.34	0.53	100	4.2	8.6	650	1.7	20	2.6	4.2	12.8	750.0	14.2	12.8	
C-1	1.35	A	58.2	0.42	0.57	35	2.4	5.5	400	2.4	20	3.1	2.2	7.7	435.0	12.4	7.7	
C-2	6.80	A	46.8	0.34	0.53	100	2.0	11.0	1770	1.5	20	2.4	12.0	23.1	1870.0	20.4	20.4	
C-3	2.38	A	56.9	0.40	0.56	100	1.6	11.0	810	1.0	20	2.0	6.8	17.7	910.0	15.1	15.1	
C-4	3.61	A	59.8	0.42	0.57	100	2.0	9.9	973	2.0	20	2.8	5.7	15.6	1073.0	16.0	15.6	
C-5	7.86	A	60.8	0.42	0.57	100	2.0	9.9	1200	1.3	20	2.3	8.8	18.7	1300.0	17.2	17.2	
C-6	5.54	A	52.7	0.38	0.55	100	3.0	9.1	1230	1.5	20	2.4	8.4	17.5	1330.0	17.4	17.4	
C-7	0.89	A	2.0	0.09	0.36	80	2.5	12.2	150	2.0	15	2.1	1.2	13.4	230.0	11.3	11.3	

**STANDARD FORM SF-2
TIME OF CONCENTRATION**

Subdivision: Bent Grass
Location: CO, Colorado Springs

Project Name: Bent Grass/Meridian Road
Project No.: CLH015.20
Calculated By: TJE
Checked By: CMD
Date: 3/23/20

SUB-BASIN DATA						INITIAL/OVERLAND (T _i)			TRAVEL TIME (T _t)					T _c CHECK (URBANIZED BASINS)			FINAL T _c (MIN)
BASIN ID	D.A. (AC)	Hydrologic Soils Group	Impervious (%)	C _s	C100	L (FT)	S (%)	T _i (MIN)	L (FT)	S (%)	C _v	VEL. (FPS)	T _t (MIN)	COMP. T _c (MIN)	TOTAL LENGTH (FT)	Urbanized T _c (MIN)	T _c (MIN)
C-8	0.42	A	2.0	0.09	0.36	100	2.5	13.6	170	2.5	15	2.4	1.2	14.8	270.0	11.5	11.5
E-1	1.71	A	62.3	0.55	0.69	25	2.0	4.0	940	1.0	20	2.0	7.8	11.8	965.0	15.4	11.8
E-2	0.68	A	82.8	0.76	0.85	25	2.0	2.5	665	1.6	20	2.5	4.4	6.9	690.0	13.8	6.9
E-3	0.78	A	88.7	0.81	0.89	25	2.0	2.1	632	1.0	20	2.0	5.3	7.4	657.0	13.7	7.4
E-4	0.91	A	80.6	0.74	0.84	25	2.0	2.6	913	2.0	20	2.8	5.4	8.0	938.0	15.2	8.0
E-5	0.89	A	89.0	0.81	0.89	25	2.0	2.1	903	2.1	20	2.9	5.2	7.3	928.0	15.2	7.3
F-1	0.44	A	38.7	0.29	0.50	66	2.5	8.9	1	1.0	15	1.5	0.0	8.9	67.0	10.4	8.9
F-2	0.55	A	65.8	0.55	0.69	25	2.0	4.0	464	4.0	20	4.0	1.9	5.9	489.0	12.7	5.9
G-1	1.47	A	23.4	0.21	0.44	20	2.0	5.8	700	3.5	15	2.8	4.2	9.9	720.0	14.0	9.9
H-1	0.52	A	2.0	0.09	0.36	25	2.0	7.3	135	2.0	20	2.8	0.8	8.1	160.0	10.9	8.1
I-1	0.31	A	71.6	0.66	0.79	25	2.0	3.2	135	2.0	20	2.8	0.8	4.0	160.0	10.9	5.0
BENT GRASS WEST BASINS																	
EX-1	1.19	A	2.0	0.09	0.36	300	2.7	23.0	690	2.7	15	2.5	4.7	27.7	990.0	15.5	15.5
EX-2	1.56	A	2.0	0.09	0.36	200	2.7	18.8	100	2.7	15	2.5	0.7	19.5	300.0	11.7	11.7
EX-3	0.62	A	2.0	0.09	0.36	100	5.0	10.8	30	2.7	15	2.5	0.2	11.0	130.0	10.7	10.7
EX-4	12.49	A	2.0	0.09	0.36	100	2.7	13.3	1180	2.7	15	2.5	8.0	21.3	1280.0	17.1	17.1
EX-5	5.15	A	2.0	0.09	0.36	100	2.7	13.3	1000	2.7	15	2.5	6.8	20.0	1100.0	16.1	16.1
EX-6	9.53	A	2.0	0.09	0.36	100	2.7	13.3	1700	2.7	15	2.5	11.5	24.8	1800.0	20.0	20.0
EX-7	9.16	A	2.0	0.09	0.36	90	2.7	12.6	1020	2.7	15	2.5	6.9	19.5	1110.0	16.2	16.2
EX-8	21.30	A	2.0	0.09	0.36	100	2.7	13.3	996	2.7	15	2.5	6.7	20.0	1096.0	16.1	16.1
PROPOSED:																	
P-1	2.03	A	64.3	0.60	0.74	100	6.0	5.0	1230	1.7	15	2.0	10.5	15.5	1330.0	17.4	15.5

NOTES:

$T_i = (0.395 * (1.1 - C_s) * (L)^{0.5}) / ((S)^{0.33})$, S in ft/ft

$T_t = L / 60V$

Velocity $V = C_v * S^{0.5}$, S in ft/ft

$T_c \text{ Check} = 10 + L / 180$

For Urbanized basins a minimum T_c of 5.0 minutes is required.

For non-urbanized basins a minimum T_c of 10.0 minutes is required

Type of Land Surface	C _v
Heavy Meadow	2.5
Tillage/field	5
Short pasture and lawns	7
Nearly bare ground	10
Grassed waterway	15
Paved areas and shallow paved swales	20

STANDARD FORM SF-3
STORM DRAINAGE SYSTEM DESIGN
(RATIONAL METHOD PROCEDURE)

Subdivision: Bent Grass
Location: CO, Colorado Springs
Design Storm: 5-Year

Project Name: Bent Grass/Meridian Road
Project No.: CLH015.20
Calculated By: TJE
Checked By: CMD
Date: 3/23/20

STREET	Design Point	DIRECT RUNOFF							TOTAL RUNOFF				STREET		PIPE			TRAVEL TIME			REMARKS
		Basin ID	Area (Ac)	Runoff Coeff.	Tc (min)	C*A (Ac)	I (in/hr)	Q (cfs)	Tc (min)	C*A (Ac)	I (in/hr)	Q (cfs)	Slope (%)	Street Flow (cfs)	Design Flow (cfs)	Slope (%)	Pipe Size (inches)	Length (ft)	Velocity (fps)	Tt (min)	
OFFSITE BASINS																					
		WT200	192.00	0.20	23.1			25.0												Total flow = 25.0 cfs from Matrix DBPS	
		OS-2	20.08	0.14	18.3	2.81	3.22	9.0													
		OS-3	10.62	0.14	18.9	1.49	3.18	4.7													
	Release rate from Meadows Pond #2	MT060	185.60	0.20	23.1			2.7												Total flow from existing culvert onto Basin OS-5 = 2.7	
		OS-24	2.64	0.09	18.7	0.24	3.19	0.8													
		OS-25	14.13	0.11	17.4	1.55	3.30	5.1													
		OS-26	5.81	0.09	14.2	0.52	3.61	1.9													
		H3	11.30	0.05	13.9	0.57	3.64	2.1													
		OS-22	4.42	0.09	13.9	0.40	3.64	1.5													
		OS-23	10.24	0.09	13.9	0.92	3.64	3.3													
BENT GRASS FILING NO. 1 BASINS																					
		C1a	0.48	0.70	5.0	0.34	5.17	1.8													
		D1a	0.56	0.57	5.1	0.32	5.15	1.6													
		H1a	0.40	0.48	5.0	0.19	5.17	1.0													
		D1b	0.68	0.57	5.0	0.39	5.17	2.0													
		D1c	1.20	0.58	7.2	0.70	4.63	3.2													
		D1d	2.79	0.59	10.3	1.65	4.09	6.7													
		D2a	1.00	0.35	5.0	0.35	5.17	1.8													
		D2b	0.41	0.46	5.0	0.19	5.17	1.0													
		H1b	2.52	0.44	11.6	1.11	3.91	4.3													
		H1c	0.16	0.42	5.0	0.07	5.17	0.4													
		H2a	1.09	0.41	11.9	0.45	3.87	1.7													
		H2b	0.15	0.36	5.0	0.05	5.17	0.3													
		C1b	0.88	0.72	5.0	0.63	5.17	3.3													
		C1c	1.09	0.74	5.5	0.81	5.02	4.1													
		C2a	1.26	0.57	10.7	0.72	4.03	2.9													

STANDARD FORM SF-3
STORM DRAINAGE SYSTEM DESIGN
(RATIONAL METHOD PROCEDURE)

Subdivision: Bent Grass
Location: CO, Colorado Springs
Design Storm: 5-Year

Project Name: Bent Grass/Meridian Road
Project No.: CLH015.20
Calculated By: TJE
Checked By: CMD
Date: 3/23/20

STREET	Design Point	DIRECT RUNOFF							TOTAL RUNOFF				STREET		PIPE			TRAVEL TIME			REMARKS
		Basin ID	Area (Ac)	Runoff Coeff.	Tc (min)	C*A (Ac)	I (in/hr)	Q (cfs)	Tc (min)	C*A (Ac)	I (in/hr)	Q (cfs)	Slope (%)	Street Flow (cfs)	Design Flow (cfs)	Slope (%)	Pipe Size (inches)	Length (ft)	Velocity (fps)	Tt (min)	
		C2b	0.99	0.84	11.2	0.83	3.96	3.3													
BENT GRASS FILING NO. 2 BASINS																					
		OS-1	32.28	0.16	22.2	5.16	2.93	15.1													
		OS-4	4.46	0.36	15.6	1.61	3.46	5.6													
		OS-5	0.46	0.45	5.2	0.21	5.10	1.1													
		OS-6	1.17	0.45	12.9	0.53	3.75	2.0													
		A-1	2.70	0.33	13.6	0.89	3.67	3.3													
		A-2	1.19	0.32	10.5	0.38	4.06	1.5													
		A-3	1.57	0.36	14.2	0.57	3.61	2.1													
		A-4	2.24	0.34	12.8	0.76	3.76	2.9													
		C-1	1.35	0.42	7.7	0.57	4.53	2.6													
		C-2	6.80	0.34	20.4	2.31	3.06	7.1													
		C-3	2.38	0.40	15.1	0.95	3.52	3.3													
		C-4	3.61	0.42	15.6	1.52	3.46	5.3													
		C-5	7.86	0.42	17.2	3.30	3.31	10.9													
		C-6	5.54	0.38	17.4	2.11	3.30	7.0													
		C-7	0.89	0.09	11.3	0.08	3.95	0.3													
		C-8	0.42	0.09	11.5	0.04	3.92	0.2													
		E-1	1.71	0.55	11.8	0.94	3.88	3.6													
		E-2	0.68	0.76	6.9	0.52	4.70	2.4													
		E-3	0.78	0.81	7.4	0.63	4.59	2.9													
		E-4	0.91	0.74	8.0	0.67	4.46	3.0													
		E-5	0.89	0.81	7.3	0.72	4.60	3.3													
		F-1	0.44	0.29	8.9	0.13	4.31	0.6													
		F-2	0.55	0.55	5.9	0.30	4.91	1.5													
		G-1	1.47	0.21	9.9	0.31	4.14	1.3													
		H-1	0.52	0.09	8.1	0.05	4.44	0.2													

STANDARD FORM SF-3
STORM DRAINAGE SYSTEM DESIGN
(RATIONAL METHOD PROCEDURE)

Subdivision: Bent Grass
Location: CO, Colorado Springs
Design Storm: 5-Year

Project Name: Bent Grass/Meridian Road
Project No.: CLH015.20
Calculated By: TJE
Checked By: CMD
Date: 3/23/20

STREET	Design Point	DIRECT RUNOFF							TOTAL RUNOFF				STREET		PIPE			TRAVEL TIME			REMARKS
		Basin ID	Area (Ac)	Runoff Coeff.	Tc (min)	C*A (Ac)	I (in/hr)	Q (cfs)	Tc (min)	C*A (Ac)	I (in/hr)	Q (cfs)	Slope (%)	Street Flow (cfs)	Design Flow (cfs)	Slope (%)	Pipe Size (inches)	Length (ft)	Velocity (fps)	Tt (min)	
		I-1	0.31	0.66	5.0	0.20	5.17	1.0													
BENT GRASS WEST BASINS																					
		EX-1	1.19	0.09	15.5	0.11	3.47	0.4													
		EX-2	1.56	0.09	11.7	0.14	3.90	0.5													
		EX-3	0.62	0.09	10.7	0.06	4.02	0.2													
		EX-4	12.49	0.09	17.1	1.12	3.32	3.7													
		EX-5	5.15	0.09	16.1	0.46	3.41	1.6													
		EX-6	9.53	0.09	20.0	0.86	3.09	2.7													
		EX-7	9.16	0.09	16.2	0.82	3.41	2.8													
		EX-8	21.30	0.09	16.1	1.92	3.42	6.6													
MERIDIAN ROAD BASINS																					
		P-1	2.03	0.60	15.5	1.22	3.47	4.2													

**STANDARD FORM SF-3
STORM DRAINAGE SYSTEM DESIGN
(RATIONAL METHOD PROCEDURE)**

Subdivision: Bent Grass
 Location: CO, Colorado Springs
 Design Storm: 100-Year

Project Name: Bent Grass/Meridian Road
 Project No.: CLH015.20
 Calculated By: TJE
 Checked By: CMD
 Date: 3/23/20

STREET	Design Point	DIRECT RUNOFF							TOTAL RUNOFF				STREET		PIPE			TRAVEL TIME			REMARKS
		Basin ID	Area (Ac)	Runoff Coeff.	Tc (min)	C*A (Ac)	I (in/hr)	Q (cfs)	Tc (min)	C*A (Ac)	I (in/hr)	Q (cfs)	Slope (%)	Street Flow (cfs)	Design Flow (cfs)	Slope (%)	Pipe Size (inches)	Length (ft)	Velocity (fps)	Tt (min)	
OFFSITE BASINS																					
		WT200	192.00	0.44	23.1			1000.0													Total flow = 1000 cfs from Matrix DBPS
		OS-2	20.08	0.40	18.3	8.03	5.41	43.4													
		OS-3	10.62	0.40	18.9	4.25	5.33	22.7													
	Release rate from Meadows Pond #2	MT060	185.60	0.44	23.1			72.6													Total flow from existing culvert onto Basin OS-5 = 72.6
		OS-24	2.64	0.36	18.7	0.95	5.36	5.1													
		OS-25	14.13	0.37	17.4	5.23	5.54	29.0													
		OS-26	5.81	0.36	14.2	2.09	6.05	12.6													
		H3	11.30	0.19	13.9	2.15	6.10	13.1													
		OS-22	4.42	0.36	13.9	1.59	6.10	9.7													
		OS-23	10.24	0.36	13.9	3.69	6.10	22.5													
BENT GRASS FILING NO. 1 BASINS																					
		C1a	0.48	0.81	5.0	0.39	8.68	3.4													
		D1a	0.56	0.71	5.1	0.40	8.65	3.5													
		H1a	0.40	0.65	5.0	0.26	8.68	2.3													
		D1b	0.68	0.71	5.0	0.48	8.68	4.2													
		D1c	1.20	0.71	7.2	0.85	7.77	6.6													
		D1d	2.79	0.71	10.3	1.98	6.87	13.6													
		D2a	1.00	0.55	5.0	0.55	8.68	4.8													
		D2b	0.41	0.63	5.0	0.26	8.68	2.3													
		H1b	2.52	0.60	11.6	1.51	6.56	9.9													
		H1c	0.16	0.60	5.0	0.10	8.68	0.9													
		H2a	1.09	0.59	11.9	0.64	6.50	4.2													
		H2b	0.15	0.56	5.0	0.08	8.68	0.7													
		C1b	0.88	0.82	5.0	0.72	8.68	6.2													
		C1c	1.09	0.84	5.5	0.92	8.43	7.8													
		C2a	1.26	0.71	10.7	0.89	6.76	6.0													
		C2b	0.99	0.92	11.2	0.91	6.64	6.0													

STANDARD FORM SF-3
STORM DRAINAGE SYSTEM DESIGN
 (RATIONAL METHOD PROCEDURE)

Subdivision: Bent Grass
 Location: CO, Colorado Springs
 Design Storm: 100-Year

Project Name: Bent Grass/Meridian Road
 Project No.: CLH015.20
 Calculated By: TJE
 Checked By: CMD
 Date: 3/23/20

STREET	Design Point	DIRECT RUNOFF							TOTAL RUNOFF				STREET		PIPE			TRAVEL TIME			REMARKS
		Basin ID	Area (Ac)	Runoff Coeff.	Tc (min)	C*A (Ac)	I (in/hr)	Q (cfs)	Tc (min)	C*A (Ac)	I (in/hr)	Q (cfs)	Slope (%)	Street Flow (cfs)	Design Flow (cfs)	Slope (%)	Pipe Size (inches)	Length (ft)	Velocity (fps)	Tt (min)	
BENT GRASS FILING NO. 2 BASINS																					
		OS-1	32.28	0.41	22.2	13.23	4.92	65.1													
		OS-4	4.46	0.54	15.6	2.41	5.81	14.0													
		OS-5	0.46	0.59	5.2	0.27	8.56	2.3													
		OS-6	1.17	0.59	12.9	0.69	6.30	4.3													
		A-1	2.70	0.52	13.6	1.40	6.16	8.6													
		A-2	1.19	0.51	10.5	0.61	6.81	4.2													
		A-3	1.57	0.53	14.2	0.83	6.05	5.0													
		A-4	2.24	0.53	12.8	1.19	6.31	7.5													
		C-1	1.35	0.57	7.7	0.77	7.61	5.9													
		C-2	6.80	0.53	20.4	3.60	5.14	18.5													
		C-3	2.38	0.56	15.1	1.33	5.90	7.8													
		C-4	3.61	0.57	15.6	2.06	5.81	12.0													
		C-5	7.86	0.57	17.2	4.48	5.56	24.9													
		C-6	5.54	0.55	17.4	3.05	5.54	16.9													
		C-7	0.89	0.36	11.3	0.32	6.63	2.1													
		C-8	0.42	0.36	11.5	0.15	6.58	1.0													
		E-1	1.71	0.69	11.8	1.18	6.51	7.7													
		E-2	0.68	0.85	6.9	0.58	7.89	4.6													
		E-3	0.78	0.89	7.4	0.69	7.70	5.3													
		E-4	0.91	0.84	8.0	0.76	7.50	5.7													
		E-5	0.89	0.89	7.3	0.79	7.73	6.1													
		F-1	0.44	0.50	8.9	0.22	7.23	1.6													
		F-2	0.55	0.69	5.9	0.38	8.25	3.1													
		G-1	1.47	0.44	9.9	0.65	6.95	4.5													
		H-1	0.52	0.36	8.1	0.19	7.45	1.4													
		I-1	0.31	0.79	5.0	0.24	8.68	2.1													

**STANDARD FORM SF-3
STORM DRAINAGE SYSTEM DESIGN**
(RATIONAL METHOD PROCEDURE)

Subdivision: Bent Grass
 Location: CO, Colorado Springs
 Design Storm: 100-Year

Project Name: Bent Grass/Meridian Road
 Project No.: CLH015.20
 Calculated By: TJE
 Checked By: CMD
 Date: 3/23/20

STREET	Design Point	DIRECT RUNOFF							TOTAL RUNOFF				STREET		PIPE			TRAVEL TIME			REMARKS
		Basin ID	Area (Ac)	Runoff Coeff.	Tc (min)	C*A (Ac)	I (in/hr)	Q (cfs)	Tc (min)	C*A (Ac)	I (in/hr)	Q (cfs)	Slope (%)	Street Flow (cfs)	Design Flow (cfs)	Slope (%)	Pipe Size (inches)	Length (ft)	Velocity (fps)	Tt (min)	
BENT GRASS WEST BASINS																					
		EX-1	1.19	0.36	15.5	0.43	5.83	2.5													
		EX-2	1.56	0.36	11.7	0.56	6.54	3.7													
		EX-3	0.62	0.36	10.7	0.22	6.76	1.5													
		EX-4	12.49	0.36	17.1	4.50	5.58	25.1													
		EX-5	5.15	0.36	16.1	1.85	5.73	10.6													
		EX-6	9.53	0.36	20.0	3.43	5.19	17.8													
		EX-7	9.16	0.36	16.2	3.30	5.72	18.9													
		EX-8	21.30	0.36	16.1	7.67	5.73	43.9													
MERIDIAN ROAD BASIN																					
		P-1	2.03	0.74	15.5	1.50	5.82	8.7													

BENT GRASS/MERIDIAN ROAD - MDDP SURFACE ROUTING - CURRENT CONDITIONS

DESIGN POINT	CONTRIBUTING BASINS	CA (equivalent)		Tc (min.)	INTENSITY		TOTAL FLOWS		NOTES			
		CA(5)	CA(100)		I(5) (in/hr)	I(100) (in/hr)	Q(5) (cfs)	Q(100) (cfs)				
FILING NO. 2:												
	WT200	9.28	212.56	23.1	2.7	4.7	25.0	1000.0				
		TRAVEL TIME										
		9.28	212.56	Type/flow	Length (ft)	Velocity (fps)	d. Time (min)	T. Time (min)				
				CHANNEL	800	5.1	2.6	25.7				
40	OS-1	5.16	13.23	16.1	3.3	5.7	16.8	75.3				
		TRAVEL TIME										
		5.16	13.23	Type/flow	Length (ft)	Velocity (fps)	d. Time (min)	T. Time (min)				
				CHANNEL	800	5.1	2.6	18.7				
1	A-1	0.89	1.40	13.6	3.5	6.2	3.1	8.6				
		TRAVEL TIME										
		0.89	1.40	Type/flow	Length (ft)	Velocity (fps)	d. Time (min)	T. Time (min)				
				STREET	140	2.0	1.2	14.8				
2	A-2 DP 1	0.38	0.61	14.8	3.4	5.9	4.3	11.9				
		0.89	1.40	TRAVEL TIME								
		1.27	2.01	Type/flow	Length (ft)	Velocity (fps)	d. Time (min)	T. Time (min)				
				STREET	275	2.4	1.9	16.7				
3	A-3 DP 2	0.57	0.83	16.7	3.2	5.6	5.9	15.9				
		1.27	2.01	TRAVEL TIME								
		1.84	2.84	Type/flow	Length (ft)	Velocity (fps)	d. Time (min)	T. Time (min)				
				STREET	40	2.4	0.3	17.0				
4	A-4 DP 3	0.76	1.19	17.0	3.2	5.5	8.3	22.3				
		1.84	2.84	TRAVEL TIME								
		2.60	4.03	Type/flow	Length (ft)	Velocity (fps)	d. Time (min)	T. Time (min)				
				STREET	780	2.0	6.5	23.5				
5	EX-5	0.46	1.85	16.1	3.3	5.7	1.5	10.5	@ GRADE INLET			
		TRAVEL TIME										
		0.46	1.85	Type/flow	Length (ft)	Velocity (fps)	d. Time (min)	T. Time (min)				
				STREET	80	2.0	0.7	16.8				
6	EX-4 FB DP 5	1.12	4.50	17.1	3.2	5.5	3.5	34.4	@ GRADE INLET			
		0.00	1.74	TRAVEL TIME								
		1.12	6.24	Type/flow	Length (ft)	Velocity (fps)	d. Time (min)	T. Time (min)				
				STREET	460	2.0	3.8	20.9				
7	E-3	0.63	0.69	7.4	4.6	8.0	2.9	5.5	SUMP INLET			
		TRAVEL TIME										
		0.63	0.69	Type/flow	Length (ft)	Velocity (fps)	d. Time (min)	T. Time (min)				
					2.6	0.0	7.4					
8	E-1 E-2 DP 4 FB DP 6	0.94	1.18	23.5	2.7	4.7	11.2	32.7	SUMP INLET			
		0.52	0.58	TRAVEL TIME								
		2.60	4.03	TRAVEL TIME								
		0.15	1.22	Type/flow	Length (ft)	Velocity (fps)	d. Time (min)	T. Time (min)				
		4.21	7.01			2.6	0.0	23.5				
9	OS-5	0.21	0.27	16.1	3.3	5.7	0.7	1.5				
		TRAVEL TIME										
		0.21	0.27	Type/flow	Length (ft)	Velocity (fps)	d. Time (min)	T. Time (min)				
				SWALE	125	3.2	0.7	16.7				
10	EX-1 DP 9	0.11	0.43	16.7	3.2	5.6	1.0	3.9				
		0.21	0.27	TRAVEL TIME								
		0.32	0.70	Type/flow	Length (ft)	Velocity (fps)	d. Time (min)	T. Time (min)				
				SWALE	295	6.2	0.8	17.5				

DESIGN POINT	CONTRIBUTING BASINS	CA (equivalent)		Tc (min.)	INTENSITY		TOTAL FLOWS		NOTES	
		CA(5)	CA(100)		I(5) (in/hr)	I(100) (in/hr)	Q(5) (cfs)	Q(100) (cfs)		
11	OS-4	1.61	2.41	15.6	3.3	5.8	5.3	13.9		
		TRAVEL TIME								
		1.61	2.41	Type/flow	Length (ft)	Velocity (fps)	d. Time (min)	T. Time (min)		
12	OS-6	0.53	0.69	12.9	3.6	6.3	1.9	4.4		
		TRAVEL TIME								
		0.53	0.69	Type/flow	Length (ft)	Velocity (fps)	d. Time (min)	T. Time (min)		
13	DP 11 DP 12	1.61	2.41	15.6	3.3	5.8	7.1	17.9		
		TRAVEL TIME								
		2.14	3.10	Type/flow	Length (ft)	Velocity (fps)	d. Time (min)	T. Time (min)		
14	EX-2 DP 10 DP 13	0.14	0.56	17.5	3.1	5.5	8.1	23.8		
		TRAVEL TIME								
		2.60	4.36	Type/flow	Length (ft)	Velocity (fps)	d. Time (min)	T. Time (min)		
15	EX-3 DP 8 DP 14	0.06	0.22	23.5	2.7	4.7	18.3	54.1		
		TRAVEL TIME								
		6.87	11.59	Type/flow	Length (ft)	Velocity (fps)	d. Time (min)	T. Time (min)		
15A	NORTH POND RELEASE	2.35	4.08	5.0	5.2	9.1	12.2	37.0		
		TRAVEL TIME								
		2.35	4.08	Type/flow	Length (ft)	Velocity (fps)	d. Time (min)	T. Time (min)		
AA	WT200 DP 40 DP 15A	9.28	212.56	23.5	2.7	4.7	38.6	1053.3		
		TRAVEL TIME								
		14.44	225.79	Type/flow	Length (ft)	Velocity (fps)	d. Time (min)	T. Time (min)		
BB	DP AA DP 7	14.44	225.79	23.9	2.6	4.6	39.8	1045.6		
		TRAVEL TIME								
		15.07	226.48	Type/flow	Length (ft)	Velocity (fps)	d. Time (min)	T. Time (min)		
16	C-5	3.30	4.48	17.2	3.1	5.5	10.4	24.6	@ GRADE INLET	
		TRAVEL TIME								
		3.30	4.48	Type/flow	Length (ft)	Velocity (fps)	d. Time (min)	T. Time (min)		
17	C-6	2.11	3.05	17.4	3.1	5.5	6.6	16.7	@ GRADE INLET	
		TRAVEL TIME								
		2.11	3.05	Type/flow	Length (ft)	Velocity (fps)	d. Time (min)	T. Time (min)		
18	C-3 C-4 FB DP 16	0.95	1.33	15.6	3.3	5.8	9.3	29.0	SUMP INLET	
		TRAVEL TIME								
		2.80	5.02	Type/flow	Length (ft)	Velocity (fps)	d. Time (min)	T. Time (min)		
19	C-1 C-2 FB DP 17	0.57	0.77	20.4	2.9	5.0	9.5	29.7	SUMP INLET	
		TRAVEL TIME								
		3.30	5.90	Type/flow	Length (ft)	Velocity (fps)	d. Time (min)	T. Time (min)		

DESIGN POINT	CONTRIBUTING BASINS	CA (equivalent)		Tc (min.)	INTENSITY		TOTAL FLOWS		NOTES	
		CA(5)	CA(100)		I(5) (in/hr)	I(100) (in/hr)	Q(5) (cfs)	Q(100) (cfs)		
20	G-1	0.31	0.65	9.9	4.1	7.1	1.3	4.6		
		TRAVEL TIME								
		0.31	0.65	Type/flow	Length (ft)	Velocity (fps)	d. Time (min)	T. Time (min)		
20A	C-7 DP 18 DP 19 DP 20	0.08	0.32	20.4	2.9	5.0	18.7	59.9		
		2.80	5.02	TRAVEL TIME						
		3.30	5.90	TRAVEL TIME						
		0.31	0.65	Type/flow	Length (ft)	Velocity (fps)	d. Time (min)	T. Time (min)		
20B	SOUTH POND RELEASE	4.11	7.28	5.0	5.2	9.1	21.3	66.0		
		TRAVEL TIME								
		4.11	7.28	Type/flow	Length (ft)	Velocity (fps)	d. Time (min)	T. Time (min)		
28	OS-2	2.81	8.03	18.3	3.1	5.3	8.6	42.8		
		TRAVEL TIME								
		2.81	8.03	Type/flow	Length (ft)	Velocity (fps)	d. Time (min)	T. Time (min)		
29	OS-3 DP 28	1.49	4.25	21.0	2.8	5.0	12.2	60.9		
		2.81	8.03	TRAVEL TIME						
		4.30	12.28	Type/flow	Length (ft)	Velocity (fps)	d. Time (min)	T. Time (min)		
				SWALE	475	3.5	2.3	23.3		
21	EX-7	0.82	3.30	16.2	3.3	5.7	2.7	18.7	@ GRADE INLET	
		TRAVEL TIME								
		0.82	3.30	Type/flow	Length (ft)	Velocity (fps)	d. Time (min)	T. Time (min)		
22	EX-6 FB DP 21	0.86	3.43	20.0	2.9	5.1	2.5	29.6	@ GRADE INLET	
		0.00	2.38	TRAVEL TIME						
		0.86	5.81	Type/flow	Length (ft)	Velocity (fps)	d. Time (min)	T. Time (min)		
				STREET	515	2.0	4.3	24.3		
23	DP 29	4.30	12.28	23.3	2.7	4.7	11.5	57.6	TYPE C INLET	
		TRAVEL TIME								
		4.30	12.28	Type/flow	Length (ft)	Velocity (fps)	d. Time (min)	T. Time (min)		
24	E-4 OS-24 FB DP 22	0.67	0.76	18.7	3.0	5.3	2.9	21.1	@ GRADE INLET	
		0.24	0.95	TRAVEL TIME						
		0.07	2.29	TRAVEL TIME						
		0.98	4.00	Type/flow	Length (ft)	Velocity (fps)	d. Time (min)	T. Time (min)		
25	E-5 FB DP 24	0.72	0.79	7.3	4.6	8.0	3.3	10.7	@ GRADE INLET	
		0.00	0.55	TRAVEL TIME						
		0.72	1.34	Type/flow	Length (ft)	Velocity (fps)	d. Time (min)	T. Time (min)		
26	DP 23 DP 24 DP 25	4.30	12.28	24.2	2.6	4.6	15.8	80.9		
		0.98	4.00	TRAVEL TIME						
		0.72	1.34	TRAVEL TIME						
		6.00	17.62	Type/flow	Length (ft)	Velocity (fps)	d. Time (min)	T. Time (min)		
27A	EX-8	1.92	7.67	16.1	3.3	5.7	6.3	43.7		
		TRAVEL TIME								
		1.92	7.67	Type/flow	Length (ft)	Velocity (fps)	d. Time (min)	T. Time (min)		

DESIGN POINT	CONTRIBUTING BASINS	CA (equivalent)		Tc (min.)	INTENSITY		TOTAL FLOWS		NOTES	
		CA(5)	CA(100)		I(5) (in/hr)	I(100) (in/hr)	Q(5) (cfs)	Q(100) (cfs)		
27B	C-8	0.04	0.15	11.5	3.8	6.7	0.2	1.0		
		TRAVEL TIME								
		0.04	0.15	Type/flow	Length (ft)	Velocity (fps)	d. Time (min)	T. Time (min)		
						2.6	0.0	11.5		
CC	DP 27A	1.92	7.67	26.9	2.5	4.3	67.0	1117.9	EXITS SITE	
	DP 27B	0.04	0.15							
	DP 20B	4.11	7.28							
	DP 26	6.00	17.62							
	BB	15.07	226.48							
		TRAVEL TIME								
		27.13	259.20	Type/flow	Length (ft)	Velocity (fps)	d. Time (min)	T. Time (min)		
						2.6	0.0	26.9		
EAST OF FILING NO. 2:										
30	MT060			15.0			2.7	72.6	Flows from Meadows Filing No. 3 Pond 2 - Updated HEC HMS model	
		TRAVEL TIME								
				Type/flow	Length (ft)	Velocity (fps)	d. Time (min)	T. Time (min)		
				Sheet	2300	2.1	18.3	33.3		
31	OS-25 DP 30	1.55	5.23	33.3	2.2	3.8	6.1	92.5		
		TRAVEL TIME								
		2.79	24.30	Type/flow	Length (ft)	Velocity (fps)	d. Time (min)	T. Time (min)		
				Sheet	700	2.6	4.5	37.7		
32	OS-26 C1a DP 31	0.52	2.09	37.7	2.0	3.5	7.4	94.3		
		TRAVEL TIME								
		3.65	26.78	Type/flow	Length (ft)	Velocity (fps)	d. Time (min)	T. Time (min)		
						2.0	0.0	37.7		
32-N	DP-32	3.65	9.44	37.7	2.0	3.5	7.4	33.2	Flows remaining in north half of BGMD & continuing east (Max gutter flow allowed 5 Yr=9.4, 100 Yr=33.2)	
		TRAVEL TIME								
		3.65	9.44	Type/flow	Length (ft)	Velocity (fps)	d. Time (min)	T. Time (min)		
				Street	905	2.0	7.5	45.3		
32-S	DP BG 1a OT from DP 32-N	0.32	0.40	37.7	2.0	3.5	0.6	33.2	Flows remaining in south half of BGMD & continuing east (Max gutter flow allowed 5 Yr=9.4 & 100 Yr=33.2)	
		TRAVEL TIME								
		0.32	9.44	Type/flow	Length (ft)	Velocity (fps)	d. Time (min)	T. Time (min)		
						2.5	0.0	37.7		
BG 1a-Os		0.00	8.30	37.7	2.0	3.5	0.0	29.2	Overtopping Flows from DP 12 which will head south through Bent Grass Filing No. 1 in Sea Oats Drive (Sea Oats Dr can carry 2.2 & 11.6 cfs per side)	
		TRAVEL TIME								
		0.00	8.30	Type/flow	Length (ft)	Velocity (fps)	d. Time (min)	T. Time (min)		
						2.5	0.0	37.7		
BG 1a-Ose		0.00	4.15	37.7	2.0	3.5	0.0	14.6	Overtopping Flows from DP 1a-Os which will flow in east half of Sea Oats Drive	
		TRAVEL TIME								
		0.00	4.15	Type/flow	Length (ft)	Velocity (fps)	d. Time (min)	T. Time (min)		
						2.5	0.0	37.7		
BG 1a-Osw		0.00	4.15	37.7	2.0	3.5	0.0	14.6	Overtopping Flows from DP 1a-Os which will flow in west half of Sea Oats Drive	
		TRAVEL TIME								
		0.00	4.15	Type/flow	Length (ft)	Velocity (fps)	d. Time (min)	T. Time (min)		
						2.5	0.0	37.7		
BG 4a	H1a DP BG 1a-Ose	0.19	0.26	37.7	2.0	3.5	0.4	15.5	Flows to west side of Inlet 4	
		TRAVEL TIME								
		0.19	4.41	Type/flow	Length (ft)	Velocity (fps)	d. Time (min)	T. Time (min)		
				Street	600	2.0	5.0	42.7		
BG .1b	D1b DP BG 1a-Osw	0.39	0.48	37.7	2.0	3.5	0.8	16.3		
		TRAVEL TIME								
		0.39	4.63	Type/flow	Length (ft)	Velocity (fps)	d. Time (min)	T. Time (min)		
				Street	575	2.8	3.4	41.2		

DESIGN POINT	CONTRIBUTING BASINS	CA (equivalent)		Tc (min.)	INTENSITY		TOTAL FLOWS		NOTES		
		CA(5)	CA(100)		I(5) (in/hr)	I(100) (in/hr)	Q(5) (cfs)	Q(100) (cfs)			
BG 50		111.34	193.50	26.1	2.5	4.4	280.0	850.0	Flow from Falcon DBPS at Meridian Rd & BGMD Intersection		
		TRAVEL TIME									
		Type/flow	Length (ft)	Velocity (fps)	d. Time (min)	T. Time (min)					
						5.0	0.0	26.1			
BG 20	DP BG 15n DP BG 50	9.85	25.44	26.1	2.5	4.4	304.8	961.8	Combined flow at Culvert Crossing - North side of BGMD		
		111.34	193.50	TRAVEL TIME							
		121.18	218.94	Type/flow	Length (ft)	Velocity (fps)	d. Time (min)	T. Time (min)			
				Culverts	125	11.2	0.2	26.3			
BG 14s	C2a DP 32-S	0.72	0.89	37.7	2.0	3.5	1.5	36.4	Flow continuing in South half of BGMD		
			9.44	TRAVEL TIME							
		0.72	10.33	Type/flow	Length (ft)	Velocity (fps)	d. Time (min)	T. Time (min)			
				Street	300	2.8	1.8	39.5			
BG 15s	C2b DP BG 14s	0.83	0.91	39.5	2.0	3.4	3.0	38.5	Flow continuing in South half of BGMD		
		0.72	10.33	TRAVEL TIME							
		1.55	11.24	Type/flow	Length (ft)	Velocity (fps)	d. Time (min)	T. Time (min)			
						5.0	0.0	39.5			
BG 21	DP 20 DP BG 15s	121.18	218.94	26.3	2.5	4.4	307.4	1007.0	Combined flow at Culvert Crossing - South side of BGMD		
		1.55	11.24	TRAVEL TIME							
		122.73	230.18	Type/flow	Length (ft)	Velocity (fps)	d. Time (min)	T. Time (min)			
				Channel	1250	2.0	10.4	36.7			
BG 25	P-1 DP BG 21	1.22	1.50	36.7	2.1	3.6	254.3	830.2	Flow @ Existing Culvert, north side of Owl Place		
		122.73	230.18	TRAVEL TIME							
		123.95	231.68	Type/flow	Length (ft)	Velocity (fps)	d. Time (min)	T. Time (min)			
						5.0	0.0	36.7			

Future Rational Calculations

COMPOSITE % IMPERVIOUS CALCULATIONS

Subdivision: Bent Grass	Bent Grass
Location: CO, Colorado Springs	CLH015.20
	TJE
	CMD
	3/23/20

Basin ID	Total Area (ac)	Paved Roads			Lawns			Roofs			Residential - 1/8 Acre			Residential - 1/4 Acre			Residential - 1/3 Acre			Residential - 1/2 Acre			Residential - 1 Acre			Basins Total Weighted %
		% Imp.	Area (ac)	Weighted % Imp.	% Imp.	Area (ac)	Weighted % Imp.	% Imp.	Area (ac)	Weighted % Imp.	% Imp.	Area (ac)	Weighted % Imp.	% Imp.	Area (ac)	Weighted % Imp.	% Imp.	Area (ac)	Weighted % Imp.	% Imp.	Area (ac)	Weighted % Imp.	% Imp.	Area (ac)	Weighted % Imp.	
OFFSITE BASINS																										
WT200	192.00																									10.0
MT060	185.60																									10.0
OS-2	20.08	80	0.90	3.6	2	18.62	1.9	90	0.56	2.5	65	0.00	0.0	40	0.00	0.0	30	0.00	0.0	25	0.00	0.0	20	0.00	0.0	8.0
OS-3	10.62	80	0.48	3.6	2	9.84	1.9	90	0.30	2.5	65	0.00	0.0	40	0.00	0.0	30	0.00	0.0	25	0.00	0.0	20	0.00	0.0	8.0
OS-24	2.64	100	0.00	0.0	2	2.64	2.0	90	0.00	0.0	65	0.00	0.0	40	0.00	0.0	30	0.00	0.0	25	0.00	0.0	20	0.00	0.0	2.0
OS-25	14.13	100	0.17	1.2	2	13.71	1.9	90	0.22	1.4	65	0.00	0.0	40	0.00	0.0	30	0.00	0.0	25	0.00	0.0	20	0.00	0.0	4.5
OS-26	5.81	100	0.00	0.0	2	5.81	2.0	90	0.00	0.0	65	0.00	0.0	40	0.00	0.0	30	0.00	0.0	25	0.00	0.0	20	0.00	0.0	2.0
H3	11.30	100	0.00	0.0	2	5.81	1.0	90	0.00	0.0	65	0.00	0.0	40	0.00	0.0	30	0.00	0.0	25	0.00	0.0	20	0.00	0.0	1.0
OS-22	4.42	100	0.00	0.0	2	4.42	2.0	90	0.00	0.0	65	0.00	0.0	40	0.00	0.0	30	0.00	0.0	25	0.00	0.0	20	0.00	0.0	2.0
OS-23	10.24	100	0.00	0.0	2	10.24	2.0	90	0.00	0.0	65	0.00	0.0	40	0.00	0.0	30	0.00	0.0	25	0.00	0.0	20	0.00	0.0	2.0
BENT GRASS FILING NO. 1 BASINS																										
C1a	0.48	100	0.36	75.0	2	0.12	0.5	90	0.00	0.0	65	0.00	0.0	40	0.00	0.0	30	0.00	0.0	25	0.00	0.0	20	0.00	0.0	75.5
C1b	0.88	100	0.68	77.3	2	0.20	0.5	90	0.00	0.0	65	0.00	0.0	40	0.00	0.0	30	0.00	0.0	25	0.00	0.0	20	0.00	0.0	77.7
C1c	1.09	100	0.88	80.7	2	0.21	0.4	90	0.00	0.0	65	0.00	0.0	40	0.00	0.0	30	0.00	0.0	25	0.00	0.0	20	0.00	0.0	81.1
D1a	0.56	100	0.33	58.9	2	0.23	0.8	90	0.00	0.0	65	0.00	0.0	40	0.00	0.0	30	0.00	0.0	25	0.00	0.0	20	0.00	0.0	59.8
D1b	0.68	100	0.17	25.0	2	0.21	0.6	90	0.30	39.7	65	0.00	0.0	40	0.00	0.0	30	0.00	0.0	25	0.00	0.0	20	0.00	0.0	65.3
D1c	1.20	100	0.19	15.8	2	0.34	0.6	90	0.67	50.3	65	0.00	0.0	40	0.00	0.0	30	0.00	0.0	25	0.00	0.0	20	0.00	0.0	66.7
D1d	2.79	100	0.50	17.9	2	0.76	0.5	90	1.53	49.4	65	0.00	0.0	40	0.00	0.0	30	0.00	0.0	25	0.00	0.0	20	0.00	0.0	67.8
C2a	1.26	100	0.74	58.7	2	0.52	0.8	90	0.00	0.0	65	0.00	0.0	40	0.00	0.0	30	0.00	0.0	25	0.00	0.0	20	0.00	0.0	59.6
C2b	0.99	100	0.92	92.9	2	0.07	0.1	90	0.00	0.0	65	0.00	0.0	40	0.00	0.0	30	0.00	0.0	25	0.00	0.0	20	0.00	0.0	93.1
D2a	1.00	100	0.19	19.0	2	0.65	1.3	90	0.16	14.4	65	0.00	0.0	40	0.00	0.0	30	0.00	0.0	25	0.00	0.0	20	0.00	0.0	34.7
D2b	0.41	100	0.11	26.8	2	0.20	1.0	90	0.10	22.0	65	0.00	0.0	40	0.00	0.0	30	0.00	0.0	25	0.00	0.0	20	0.00	0.0	49.8
H1a	0.40	100	0.16	40.0	2	0.20	1.0	90	0.04	9.0	65	0.00	0.0	40	0.00	0.0	30	0.00	0.0	25	0.00	0.0	20	0.00	0.0	50.0
H1b	2.52	100	0.40	15.9	2	1.22	1.0	90	0.86	30.7	65	0.00	0.0	40	0.00	0.0	30	0.00	0.0	25	0.00	0.0	20	0.00	0.0	47.6
H1c	0.16	100	0.05	31.3	2	0.09	1.1	90	0.02	11.3	65	0.00	0.0	40	0.00	0.0	30	0.00	0.0	25	0.00	0.0	20	0.00	0.0	43.6
H2a	1.09	100	0.30	27.5	2	0.63	1.2	90	0.16	13.2	65	0.00	0.0	40	0.00	0.0	30	0.00	0.0	25	0.00	0.0	20	0.00	0.0	41.9
H2b	0.15	100	0.05	33.3	2	0.10	1.3	90	0.00	0.0	65	0.00	0.0	40	0.00	0.0	30	0.00	0.0	25	0.00	0.0	20	0.00	0.0	34.7
BENT GRASS FILING NO. 2 BASINS																										
OS-1	32.28	100	2.15	6.7	2	29.25	1.8	90	0.88	2.5	65	0.00	0.0	40	0.00	0.0	30	0.00	0.0	25	0.00	0.0	20	0.00	0.0	11.0
OS-4	4.46	100	0.00	0.0	2	0.00	0.0	90	0.00	0.0	65	2.28	33.2	40	1.46	13.1	30	0.00	0.0	25	0.00	0.0	20	0.72	3.2	49.5
OS-5	0.46	100	0.00	0.0	2	0.00	0.0	90	0.00	0.0	65	0.46	65.0	40	0.00	0.0	30	0.00	0.0	25	0.00	0.0	20	0.00	0.0	65.0
OS-6	1.17	100	0.00	0.0	2	0.00	0.0	90	0.00	0.0	65	1.17	65.0	40	0.00	0.0	30	0.00	0.0	25	0.00	0.0	20	0.00	0.0	65.0
A-1	2.70	100	0.00	0.0	2	0.00	0.0	90	0.00	0.0	65	1.18	28.4	40	0.68	10.1	30	0.00	0.0	25	0.00	0.0	20	0.84	6.2	44.7
A-2	1.19	100	0.00	0.0	2	0.00	0.0	90	0.00	0.0	65	0.37	20.2	40	0.56	18.8	30	0.00	0.0	25	0.00	0.0	20	0.26	4.4	43.4
A-3	1.57	100	0.00	0.0	2	0.00	0.0	90	0.00	0.0	65	0.59	24.4	40	0.98	25.0	30	0.00	0.0	25	0.00	0.0	20	0.00	0.0	49.4
A-4	2.24	100	0.00	0.0	2	0.00	0.0	90	0.00	0.0	65	0.93	27.0	40	0.88	15.7	30	0.00	0.0	25	0.00	0.0	20	0.43	3.8	46.5
C-1	1.35	100	0.03	2.1	2	0.16	0.2	90	0.00	0.0	65	1.16	55.9	40	0.00	0.0	30	0.00	0.0	25	0.00	0.0	20	0.00	0.0	58.2
C-2	6.80	100	0.00	0.0	2	0.00	0.0	90	0.00	0.0	65	2.61	24.9	40	2.75	16.2	30	0.50	2.2	25	0.94	3.5	20	0.00	0.0	46.8
C-3	2.38	100	0.00	0.0	2	0.00	0.0	90	0.00	0.0	65	1.61	44.0	40	0.77	12.9	30	0.00	0.0	25	0.00	0.0	20	0.00	0.0	56.9
C-4	3.61	100	0.00	0.0	2	0.00	0.0	90	0.00	0.0	65	2.86	51.4	40	0.75	8.4	30	0.00	0.0	25	0.00	0.0	20	0.00	0.0	59.8
C-5	7.86	100	0.00	0.0	2	0.00	0.0	90	0.00	0.0	65	6.53	54.0	40	1.33	6.8	30	0.00	0.0	25	0.00	0.0	20	0.00	0.0	60.8
C-6	5.54	100	0.00	0.0	2	0.00	0.0	90	0.00	0.0	65	3.14	36.8	40	1.60	11.6	30	0.80	4.3	25	0.00	0.0	20	0.00	0.0	52.7
C-7	0.89	100	0.00	0.0	2	0.89	2.0	90	0.00	0.0	65	0.00	0.0	40	0.00	0.0	30	0.00	0.0	25	0.00	0.0	20	0.00	0.0	2.0
E-1	1.71	100	0.78	45.6	2	0.23	0.3	90	0.00	0.0	65	0.00	0.0	40	0.70	16.4	30	0.00	0.0	25	0.00	0.0	20	0.00	0.0	62.3
E-2	0.68	100	0.56	82.4	2	0.12	0.4	90	0.00	0.0	65	0.00	0.0	40	0.00	0.0	30	0.00	0.0	25	0.00	0.0	20	0.00	0.0	82.8
E-3	0.78	100	0.69	88.5	2	0.09	0.2	90	0.00	0.0	65	0.00	0.0	40	0.00	0.0	30	0.00	0.0	25	0.00	0.0	20	0.00	0.0	88.7
E-4	0.91	100	0.73	80.2	2	0.18	0.4	90	0.00	0.0	65	0.00	0.0	40	0.00	0.0	30	0.00	0.0	25	0.00	0.0	20	0.00	0.0	80.6
E-5	0.89	100	0.79	88.8	2	0.10	0.2	90	0.00	0.0	65	0.00	0.0	40	0.00	0.0	30	0.00	0.0	25	0.00	0.0	20	0.00	0.0	89.0
F-1	0.44	100	0.00	0.0	2	0.00	0.0	90	0.00	0.0	65	0.00	0.0	40	0.41	37.3	30	0.00	0.0	25	0.00	0.0	20	0.03		

Basin ID	Total Area (ac)	Paved Roads			Lawns			Roofs			Residential - 1/8 Acre			Residential - 1/4 Acre			Residential - 1/3 Acre			Residential - 1/2 Acre			Residential - 1 Acre			Basins Total	
		% Imp.	Area (ac)	Weighted % Imp.	% Imp.	Area (ac)	Weighted % Imp.	% Imp.	Area (ac)	Weighted % Imp.	% Imp.	Area (ac)	Weighted % Imp.	% Imp.	Area (ac)	Weighted % Imp.	% Imp.	Area (ac)	Weighted % Imp.	% Imp.	Area (ac)	Weighted % Imp.	% Imp.	Area (ac)	Weighted % Imp.	Weighted % Imp.	Weighted % Imp.
CC-2	1.35	100	0.44	32.6	2	0.19	0.3	90	0.00	0.0	65.0	0.72	34.7	40	0.00	0.0	30	0.25	5.6	25	0.00	0.0	20	0.00	0.0	73.2	
CC-3	1.88	100	1.12	59.6	2	0.00	0.0	90	0.00	0.0	65.0	0.76	26.3	40	0.00	0.0	30	0.00	0.0	25	0.00	0.0	20	0.00	0.0	85.9	
CC-4	4.34	100	0.00	0.0	2	1.85	0.9	90	0.00	0.0	65.0	2.49	37.3	40	0.00	0.0	30	0.00	0.0	25	0.00	0.0	20	0.00	0.0	38.2	
CC-5	0.45	100	0.00	0.0	2	0.45	2.0	90	0.00	0.0	65.0	0.00	0.0	40	0.00	0.0	30	0.00	0.0	25	0.00	0.0	20	0.00	0.0	2.0	
D-1	9.07	100	1.52	16.8	2	0.69	0.2	90	0.00	0.0	65.0	2.35	16.8	40	1.86	8.2	30	1.53	5.1	25	1.12	3.1	20	0.00	0.0	50.2	
D-2	6.72	100	2.31	34.4	2	0.76	0.2	90	0.00	0.0	65.0	3.65	35.3	40	0.00	0.0	30	0.00	0.0	25	0.00	0.0	20	0.00	0.0	69.9	
D-3	2.03	100	0.00	0.0	2	0.28	0.3	90	0.00	0.0	65.0	0.36	11.5	40	0.17	3.3	30	0.12	1.8	25	0.00	0.0	20	0.00	0.0	16.9	
D-4	4.38	100	1.21	27.6	2	0.63	0.3	90	0.00	0.0	65.0	2.53	37.5	40	0.00	0.0	30	0.00	0.0	25	0.00	0.0	20	0.00	0.0	65.4	
D-5	1.08	100	0.22	20.4	2	0.11	0.2	90	0.00	0.0	65.0	0.75	45.1	40	0.00	0.0	30	0.00	0.0	25	0.00	0.0	20	0.00	0.0	65.7	
D-6	4.01	100	0.91	22.7	2	0.09	0.0	90	0.00	0.0	65.0	3.01	48.8	40	0.00	0.0	30	0.00	0.0	25	0.00	0.0	20	0.00	0.0	71.5	
D-7	6.39	100	0.00	0.0	2	5.59	1.7	90	0.00	0.0	65.0	0.80	8.1	40	0.00	0.0	30	0.00	0.0	25	0.00	0.0	20	0.00	0.0	9.8	
D-8	1.69	100	0.00	0.0	2	1.13	1.3	90	0.00	0.0	65.0	0.56	21.5	40	0.00	0.0	30	0.00	0.0	25	0.00	0.0	20	0.00	0.0	22.8	
MERIDIAN ROAD BASIN																											
P-1	2.03	100	1.29	63.6	2	0.74	0.7	90	0.00	0.0	65	0.00	0.0	40	0.00	0.0	30	0.00	0.0	25	0.00	0.0	20	0.00	0.0	64.3	

COMPOSITE RUNOFF COEFFICIENT CALCULATIONS

Subdivision: Bent Grass	Bent Grass
Location: CO, Colorado Springs	CLH015.20
	TJE
	CMD
	3/23/20

Basin ID	Total Area (ac)	Paved Roads			Lawns			Roofs			Residential - 1/8 Acre			Residential - 1/4 Acre			Residential - 1/3 Acre			Residential - 1/2 Acre			Residential - 1 Acre			Composite C ₅	Composite C ₁₀₀
		C ₅	C ₁₀₀	Area (ac)	C ₅	C ₁₀₀	Area (ac)	C ₅	C ₁₀₀	Area (ac)	C ₅	C ₁₀₀	Area (ac)	C ₅	C ₁₀₀	Area (ac)	C ₅	C ₁₀₀	Area (ac)	C ₅	C ₁₀₀	Area (ac)	C ₅	C ₁₀₀	Area (ac)		
OFFSITE BASINS																											
WT200	192.00																								0.20	0.44	
MT060	185.60																								0.20	0.44	
OS-2	20.08	0.90	0.96	0.90	0.09	0.36	18.62	0.73	0.81	0.56	0.45	0.59	0.00	0.30	0.50	0.00	0.25	0.47	0.00	0.22	0.46	0.00	0.20	0.44	0.00	0.14	0.40
OS-3	10.62	0.90	0.96	0.48	0.09	0.36	9.84	0.73	0.81	0.30	0.45	0.59	0.00	0.30	0.50	0.00	0.25	0.47	0.00	0.22	0.46	0.00	0.20	0.44	0.00	0.14	0.40
OS-24	2.64	0.90	0.96	0.00	0.09	0.36	2.64	0.73	0.81	0.00	0.45	0.59	0.00	0.30	0.50	0.00	0.25	0.47	0.00	0.22	0.46	0.00	0.20	0.44	0.00	0.09	0.36
OS-25	14.13	0.90	0.96	0.17	0.09	0.36	13.71	0.73	0.81	0.22	0.45	0.59	0.00	0.30	0.50	0.00	0.25	0.47	0.00	0.22	0.46	0.00	0.20	0.44	0.00	0.11	0.37
OS-26	5.81	0.90	0.96	0.00	0.09	0.36	5.81	0.73	0.81	0.00	0.45	0.59	0.00	0.30	0.50	0.00	0.25	0.47	0.00	0.22	0.46	0.00	0.20	0.44	0.00	0.09	0.36
H3	11.30	0.90	0.96	0.00	0.09	0.36	5.81	0.73	0.81	0.00	0.45	0.59	0.00	0.30	0.50	0.00	0.25	0.47	0.00	0.22	0.46	0.00	0.20	0.44	0.00	0.05	0.19
OS-22	4.42	0.90	0.96	0.00	0.09	0.36	4.42	0.73	0.81	0.00	0.45	0.59	0.00	0.30	0.50	0.00	0.25	0.47	0.00	0.22	0.46	0.00	0.20	0.44	0.00	0.09	0.36
OS-23	10.24	0.90	0.96	0.00	0.09	0.36	10.24	0.73	0.81	0.00	0.45	0.59	0.00	0.30	0.50	0.00	0.25	0.47	0.00	0.22	0.46	0.00	0.20	0.44	0.00	0.09	0.36
BENT GRASS FILING NO. 1 BASINS																											
C1a	0.48	0.90	0.96	0.36	0.09	0.36	0.12	0.73	0.81	0.00	0.45	0.59	0.00	0.30	0.50	0.00	0.25	0.47	0.00	0.22	0.46	0.00	0.20	0.44	0.00	0.70	0.81
C1b	0.88	0.90	0.96	0.68	0.09	0.36	0.20	0.73	0.81	0.00	0.45	0.59	0.00	0.30	0.50	0.00	0.25	0.47	0.00	0.22	0.46	0.00	0.20	0.44	0.00	0.72	0.82
C1c	1.09	0.90	0.96	0.88	0.09	0.36	0.21	0.73	0.81	0.00	0.45	0.59	0.00	0.30	0.50	0.00	0.25	0.47	0.00	0.22	0.46	0.00	0.20	0.44	0.00	0.74	0.84
D1a	0.56	0.90	0.96	0.33	0.09	0.36	0.23	0.73	0.81	0.00	0.45	0.59	0.00	0.30	0.50	0.00	0.25	0.47	0.00	0.22	0.46	0.00	0.20	0.44	0.00	0.57	0.71
D1b	0.68	0.90	0.96	0.17	0.09	0.36	0.21	0.73	0.81	0.30	0.45	0.59	0.00	0.30	0.50	0.00	0.25	0.47	0.00	0.22	0.46	0.00	0.20	0.44	0.00	0.57	0.71
D1c	1.20	0.90	0.96	0.19	0.09	0.36	0.34	0.73	0.81	0.67	0.45	0.59	0.00	0.30	0.50	0.00	0.25	0.47	0.00	0.22	0.46	0.00	0.20	0.44	0.00	0.58	0.71
D1d	2.79	0.90	0.96	0.50	0.09	0.36	0.76	0.73	0.81	1.53	0.45	0.59	0.00	0.30	0.50	0.00	0.25	0.47	0.00	0.22	0.46	0.00	0.20	0.44	0.00	0.59	0.71
C2a	1.26	0.90	0.96	0.74	0.09	0.36	0.52	0.73	0.81	0.00	0.45	0.59	0.00	0.30	0.50	0.00	0.25	0.47	0.00	0.22	0.46	0.00	0.20	0.44	0.00	0.57	0.71
C2b	0.99	0.90	0.96	0.92	0.09	0.36	0.07	0.73	0.81	0.00	0.45	0.59	0.00	0.30	0.50	0.00	0.25	0.47	0.00	0.22	0.46	0.00	0.20	0.44	0.00	0.84	0.92
D2a	1.00	0.90	0.96	0.19	0.09	0.36	0.65	0.73	0.81	0.16	0.45	0.59	0.00	0.30	0.50	0.00	0.25	0.47	0.00	0.22	0.46	0.00	0.20	0.44	0.00	0.35	0.55
D2b	0.41	0.90	0.96	0.11	0.09	0.36	0.20	0.73	0.81	0.10	0.45	0.59	0.00	0.30	0.50	0.00	0.25	0.47	0.00	0.22	0.46	0.00	0.20	0.44	0.00	0.46	0.63
H1a	0.40	0.90	0.96	0.16	0.09	0.36	0.20	0.73	0.81	0.04	0.45	0.59	0.00	0.30	0.50	0.00	0.25	0.47	0.00	0.22	0.46	0.00	0.20	0.44	0.00	0.48	0.65
H1b	2.52	0.90	0.96	0.40	0.09	0.36	1.22	0.73	0.81	0.86	0.45	0.59	0.00	0.30	0.50	0.00	0.25	0.47	0.00	0.22	0.46	0.00	0.20	0.44	0.00	0.44	0.60
H1c	0.16	0.90	0.96	0.05	0.09	0.36	0.09	0.73	0.81	0.02	0.45	0.59	0.00	0.30	0.50	0.00	0.25	0.47	0.00	0.22	0.46	0.00	0.20	0.44	0.00	0.42	0.60
H2a	1.09	0.90	0.96	0.30	0.09	0.36	0.63	0.73	0.81	0.16	0.45	0.59	0.00	0.30	0.50	0.00	0.25	0.47	0.00	0.22	0.46	0.00	0.20	0.44	0.00	0.41	0.59
H2b	0.15	0.90	0.96	0.05	0.09	0.36	0.10	0.73	0.81	0.00	0.45	0.59	0.00	0.30	0.50	0.00	0.25	0.47	0.00	0.22	0.46	0.00	0.20	0.44	0.00	0.36	0.56
BENT GRASS FILING NO. 2 BASINS:																											
OS-1	32.28	0.90	0.96	2.15	0.09	0.36	29.25	0.73	0.81	0.88	0.45	0.59	0.00	0.30	0.50	0.00	0.25	0.47	0.00	0.22	0.46	0.00	0.20	0.44	0.00	0.16	0.41
OS-4	4.46	0.90	0.96	0.00	0.09	0.36	0.00	0.73	0.81	0.00	0.45	0.59	2.28	0.30	0.50	1.46	0.25	0.47	0.00	0.22	0.46	0.00	0.20	0.44	0.72	0.36	0.54
OS-5	0.46	0.90	0.96	0.00	0.09	0.36	0.00	0.73	0.81	0.00	0.45	0.59	0.46	0.30	0.50	0.00	0.25	0.47	0.00	0.22	0.46	0.00	0.20	0.44	0.00	0.45	0.59
OS-6	1.17	0.90	0.96	0.00	0.09	0.36	0.00	0.73	0.81	0.00	0.45	0.59	1.17	0.30	0.50	0.00	0.25	0.47	0.00	0.22	0.46	0.00	0.20	0.44	0.00	0.45	0.59
A-1	2.70	0.90	0.96	0.00	0.09	0.36	0.00	0.73	0.81	0.00	0.45	0.59	1.18	0.30	0.50	0.68	0.25	0.47	0.00	0.22	0.46	0.00	0.20	0.44	0.84	0.33	0.52
A-2	1.19	0.90	0.96	0.00	0.09	0.36	0.00	0.73	0.81	0.00	0.45	0.59	0.37	0.30	0.50	0.56	0.25	0.47	0.00	0.22	0.46	0.00	0.20	0.44	0.26	0.32	0.51
A-3	1.57	0.90	0.96	0.00	0.09	0.36	0.00	0.73	0.81	0.00	0.45	0.59	0.59	0.30	0.50	0.98	0.25	0.47	0.00	0.22	0.46	0.00	0.20	0.44	0.00	0.36	0.53
A-4	2.24	0.90	0.96	0.00	0.09	0.36	0.00	0.73	0.81	0.00	0.45	0.59	0.93	0.30	0.50	0.88	0.25	0.47	0.00	0.22	0.46	0.00	0.20	0.44	0.43	0.34	0.53
C-1	1.35	0.90	0.96	0.03	0.09	0.36	0.16	0.73	0.81	0.00	0.45	0.59	1.16	0.30	0.50	0.00	0.25	0.47	0.00	0.22	0.46	0.00	0.20	0.44	0.00	0.42	0.57
C-2	6.80	0.90	0.96	0.00	0.09	0.36	0.00	0.73	0.81	0.00	0.45	0.59	2.61	0.30	0.50	2.75	0.25	0.47	0.50	0.22	0.46	0.94	0.20	0.44	0.00	0.34	0.53
C-3	2.38	0.90	0.96	0.00	0.09	0.36	0.00	0.73	0.81	0.00	0.45	0.59	1.61	0.30	0.50	0.77	0.25	0.47	0.00	0.22	0.46	0.00	0.20	0.44	0.00	0.40	0.56
C-4	3.61	0.90	0.96	0.00	0.09	0.36	0.00	0.73	0.81	0.00	0.45	0.59	2.86	0.30	0.50	0.75	0.25	0.47	0.00	0.22	0.46	0.00	0.20	0.44	0.00	0.42	0.57
C-5	7.86	0.90	0.96	0.00	0.09	0.36	0.00	0.73	0.81	0.00	0.45	0.59	6.53	0.30	0.50	1.33	0.25	0.47	0.00	0.22	0.46	0.00	0.20	0.44	0.00	0.42	0.57
C-6	5.54	0.90	0.96	0.00	0.09	0.36	0.00	0.73	0.81	0.00	0.45	0.59	3.14	0.30	0.50	1.60	0.25	0.47	0.80	0.22	0.46	0.00	0.20	0.44	0.00	0.38	0.55
C-7	0.89	0.90	0.96	0.00	0.09	0.36	0.89	0.73	0.81	0.00	0.45	0.59	0.00	0.30	0.50	0.00	0.25	0.47	0.00	0.22	0.46	0.00	0.20	0.44	0.00	0.09	0.36
E-1	1.71	0.90	0.96	0.78	0.09	0.36	0.23	0.73	0.81	0.00	0.45	0.59	0.00	0.30	0.50	0.70	0.25	0.47	0.00	0.22	0.46	0.00	0.20	0.44	0.00	0.55	0.69
E-2	0.68	0.90	0.96	0.56	0.09	0.36	0.12	0.73	0.81	0.00	0.45	0.59	0.00	0.30	0.50	0.00	0.25	0.47	0.00	0.22	0.46	0.00	0.20	0.44	0.00	0.76	0.85
E-3	0.78	0.90	0.96	0.69	0.09	0.36	0.09	0.73	0.81	0.00	0.45	0.59	0.00	0.30	0.50	0.00	0.25	0.47	0.00	0.22	0.46	0.00	0.20	0.44	0.00	0.81	0.89
E-4	0.91	0.90	0.96	0.73	0.09	0.36	0.18	0.73	0.81	0.00	0.45	0.59	0.00	0.30	0.50	0.00	0.25	0.47	0.00	0.22	0.46	0.00	0.20	0.44	0.00	0.74	0.84
E-5	0.89	0.90																									

Basin ID	Total Area (ac)	Paved Roads			Lawns			Roofs			Residential - 1/8 Acre			Residential - 1/4 Acre			Residential - 1/3 Acre			Residential - 1/2 Acre			Residential - 1 Acre			Composite C ₅	Composite C ₁₀₀
		C ₅	C ₁₀₀	Area (ac)	C ₅	C ₁₀₀	Area (ac)	C ₅	C ₁₀₀	Area (ac)	C ₅	C ₁₀₀	Area (ac)	C ₅	C ₁₀₀	Area (ac)	C ₅	C ₁₀₀	Area (ac)	C ₅	C ₁₀₀	Area (ac)	C ₅	C ₁₀₀	Area (ac)		
AA-2	2.28	0.90	0.96	0.40	0.09	0.36	0.46	0.73	0.81	0.00	0.45	0.59	1.43	0.30	0.50	0.00	0.25	0.47	0.00	0.22	0.46	0.00	0.20	0.44	0.00	0.46	0.61
B-1	5.43	0.90	0.96	0.00	0.09	0.36	4.37	0.73	0.81	0.00	0.45	0.59	1.06	0.30	0.50	0.00	0.25	0.47	0.00	0.22	0.46	0.00	0.20	0.44	0.00	0.16	0.40
B-2	4.16	0.90	0.96	0.00	0.09	0.36	4.41	0.73	0.81	0.00	0.45	0.59	0.00	0.30	0.50	0.00	0.25	0.47	0.00	0.22	0.46	0.00	0.20	0.44	0.00	0.10	0.38
CC-1	9.07	0.90	0.96	2.14	0.09	0.36	0.33	0.73	0.81	0.00	0.45	0.59	4.56	0.30	0.50	1.70	0.25	0.47	0.34	0.22	0.46	0.00	0.20	0.44	0.00	0.51	0.65
CC-2	1.35	0.90	0.96	0.44	0.09	0.36	0.19	0.73	0.81	0.00	0.45	0.59	0.72	0.30	0.50	0.00	0.25	0.47	0.25	0.22	0.46	0.00	0.20	0.44	0.00	0.59	0.77
CC-3	1.88	0.90	0.96	1.12	0.09	0.36	0.00	0.73	0.81	0.00	0.45	0.59	0.76	0.30	0.50	0.00	0.25	0.47	0.00	0.22	0.46	0.00	0.20	0.44	0.00	0.72	0.81
CC-4	4.34	0.90	0.96	0.00	0.09	0.36	1.85	0.73	0.81	0.00	0.45	0.59	2.49	0.30	0.50	0.00	0.25	0.47	0.00	0.22	0.46	0.00	0.20	0.44	0.00	0.30	0.49
CC-5	0.45	0.90	0.96	0.00	0.09	0.36	0.45	0.73	0.81	0.00	0.45	0.59	0.00	0.30	0.50	0.00	0.25	0.47	0.00	0.22	0.46	0.00	0.20	0.44	0.00	0.09	0.36
D-1	9.07	0.90	0.96	1.52	0.09	0.36	0.69	0.73	0.81	0.00	0.45	0.59	2.35	0.30	0.50	1.86	0.25	0.47	1.53	0.22	0.46	1.12	0.20	0.44	0.00	0.41	0.58
D-2	6.72	0.90	0.96	2.31	0.09	0.36	0.76	0.73	0.81	0.00	0.45	0.59	3.65	0.30	0.50	0.00	0.25	0.47	0.00	0.22	0.46	0.00	0.20	0.44	0.00	0.56	0.69
D-3	2.03	0.90	0.96	0.00	0.09	0.36	0.28	0.73	0.81	0.00	0.45	0.59	0.36	0.30	0.50	0.17	0.25	0.47	0.12	0.22	0.46	0.00	0.20	0.44	0.00	0.13	0.22
D-4	4.38	0.90	0.96	1.21	0.09	0.36	0.63	0.73	0.81	0.00	0.45	0.59	2.53	0.30	0.50	0.00	0.25	0.47	0.00	0.22	0.46	0.00	0.20	0.44	0.00	0.52	0.66
D-5	1.08	0.90	0.96	0.22	0.09	0.36	0.11	0.73	0.81	0.00	0.45	0.59	0.75	0.30	0.50	0.00	0.25	0.47	0.00	0.22	0.46	0.00	0.20	0.44	0.00	0.51	0.64
D-6	4.01	0.90	0.96	0.91	0.09	0.36	0.09	0.73	0.81	0.00	0.45	0.59	3.01	0.30	0.50	0.00	0.25	0.47	0.00	0.22	0.46	0.00	0.20	0.44	0.00	0.54	0.67
D-7	6.39	0.90	0.96	0.00	0.09	0.36	5.59	0.73	0.81	0.00	0.45	0.59	0.80	0.30	0.50	0.00	0.25	0.47	0.00	0.22	0.46	0.00	0.20	0.44	0.00	0.14	0.39
D-8	1.69	0.90	0.96	0.00	0.09	0.36	1.13	0.73	0.81	0.00	0.45	0.59	0.56	0.30	0.50	0.00	0.25	0.47	0.00	0.22	0.46	0.00	0.20	0.44	0.00	0.21	0.44
PROPOSED:																											
P-1	2.03	0.90	0.96	1.29	0.09	0.36	0.74	0.73	0.81	0.00	0.45	0.59	0.00	0.30	0.50	0.00	0.25	0.47	0.00	0.22	0.46	0.00	0.20	0.44	0.00	0.60	0.74

**STANDARD FORM SF-2
TIME OF CONCENTRATION**

Subdivision: Bent Grass
Location: CO, Colorado Springs

Project Name: Bent Grass
Project No.: CLH015.20
Calculated By: TJE
Checked By: CMD
Date: 3/23/20

SUB-BASIN DATA						INITIAL/OVERLAND (T _i)			TRAVEL TIME (T _t)					T _c CHECK (URBANIZED BASINS)			FINAL T _c (MIN)
BASIN ID	D.A. (AC)	Hydrologic Soils Group	Impervious (%)	C _s	C100	L (FT)	S (%)	T _i (MIN)	L (FT)	S (%)	C _v	VEL. (FPS)	T _t (MIN)	COMP. T _c (MIN)	TOTAL LENGTH (FT)	Urbanized T _c (MIN)	T _c (MIN)
OFFSITE BASINS																	
WT200	192.00	A	0.0	0.20	0.44	300	2.0	22.7	2060	2.0	15	2.1	16.2	38.8	2360.0	23.1	23.1
MT060	185.60	A	0.0	0.20	0.44	300	2.0	22.7	2060	2.0	15	2.1	16.2	38.8	2360.0	23.1	23.1
OS-2	20.08	A	8.0	0.14	0.40	100	2.3	13.3	1400	2.3	15	2.3	10.3	23.6	1500.0	18.3	18.3
OS-3	10.62	A	8.0	0.14	0.40	100	2.0	14.0	1500	2.0	15	2.1	11.8	25.7	1600.0	18.9	18.9
OS-24	2.64	A	2.0	0.09	0.36	100	2.0	14.7	1460	2.0	15	2.1	11.5	26.1	1560.0	18.7	18.7
OS-25	14.13	A	4.5	0.11	0.37	100	1.7	15.2	1230	1.7	15	2.0	10.5	25.7	1330.0	17.4	17.4
OS-26	5.81	A	2.0	0.09	0.36	100	1.0	18.5	650	1.0	10	1.0	10.8	29.3	750.0	14.2	14.2
H3	11.30	A	1.0	0.05	0.19	100	1.0	19.2	600	1.0	10	2.6	3.8	23.0	700.0	13.9	13.9
OS-22	4.42	A	2.0	0.09	0.36	100	1.0	18.5	600	1.0	10	1.0	10.0	28.5	700.0	13.9	13.9
OS-23	10.24	A	2.0	0.09	0.36	100	1.0	18.5	600	1.0	10	1.0	10.0	28.5	700.0	13.9	13.9
BENT GRASS FILING NO. 1 BASINS																	
C1a	0.48	A	75.5	0.70	0.81	5	2.0	1.3	400	1.0	20	2.0	3.3	4.6	405.0	12.3	5.0
C1b	0.88	A	77.7	0.72	0.82	10	2.0	1.7	310	2.0	20	2.8	1.8	3.6	320.0	11.8	5.0
C1c	1.09	A	81.1	0.74	0.84	50	2.0	3.7	310	2.0	20	2.8	1.8	5.5	360.0	12.0	5.5
D1a	0.56	A	59.8	0.57	0.71	5	2.0	1.7	400	1.0	20	2.0	3.3	5.1	405.0	12.3	5.1
D1b	0.68	A	65.3	0.57	0.71	10	2.0	2.4	310	2.0	20	2.8	1.8	4.3	320.0	11.8	5.0
D1c	1.20	A	66.7	0.58	0.71	50	2.0	5.3	310	2.0	20	2.8	1.8	7.2	360.0	12.0	7.2
D1d	2.79	A	67.8	0.59	0.71	100	2.0	7.4	485	2.0	20	2.8	2.9	10.3	585.0	13.3	10.3
C2a	1.26	A	59.6	0.57	0.71	12	2.0	2.7	965	1.0	20	2.0	8.0	10.7	977.0	15.4	10.7
C2b	0.99	A	93.1	0.84	0.92	12	2.0	1.3	1190	1.0	20	2.0	9.9	11.2	1202.0	16.7	11.2
D2a	1.00	A	34.7	0.35	0.55	5	2.0	2.4	310	2.0	20	2.8	1.8	4.3	315.0	11.8	5.0
D2b	0.41	A	49.8	0.46	0.63	5	2.0	2.1	225	2.0	20	2.8	1.3	3.4	230.0	11.3	5.0
H1a	0.40	A	50.0	0.48	0.65	10	2.0	2.8	310	2.0	20	2.8	1.8	4.7	320.0	11.8	5.0
H1b	2.52	A	47.6	0.44	0.60	50	2.0	6.8	575	1.0	20	2.0	4.8	11.6	625.0	13.5	11.6
H1c	0.16	A	43.6	0.42	0.60	5	2.0	2.2	100	1.0	20	2.0	0.8	3.0	105.0	10.6	5.0
H2a	1.09	A	41.9	0.41	0.59	50	2.0	7.1	575	1.0	20	2.0	4.8	11.9	625.0	13.5	11.9
H2b	0.15	A	34.7	0.36	0.56	5	2.0	2.4	100	1.0	20	2.0	0.8	3.2	105.0	10.6	5.0
BENT GRASS FILING NO. 2 BASINS																	
OS-1	32.28	A	11.0	0.16	0.41	100	2.4	12.9	2100	2.2	15	2.2	15.7	28.6	2200.0	22.2	22.2
OS-4	4.46	A	49.5	0.36	0.54	100	2.0	10.8	910	1.2	20	2.2	6.9	17.7	1010.0	15.6	15.6
OS-5	0.46	A	65.0	0.45	0.59	15	2.0	3.7	190	1.0	20	2.0	1.6	5.2	205.0	11.1	5.2
OS-6	1.17	A	65.0	0.45	0.59	85	0.2	18.7	430	0.9	20	1.9	3.8	22.5	515.0	12.9	12.9
A-1	2.70	A	44.7	0.33	0.52	100	1.3	12.9	550	1.3	20	2.3	4.0	16.9	650.0	13.6	13.6
A-2	1.19	A	43.4	0.32	0.51	100	4.3	8.8	310	2.3	20	3.0	1.7	10.5	410.0	12.3	10.5
A-3	1.57	A	49.4	0.36	0.53	70	1.0	11.3	680	1.2	20	2.2	5.2	16.5	750.0	14.2	14.2
A-4	2.24	A	46.5	0.34	0.53	100	4.2	8.6	650	1.7	20	2.6	4.2	12.8	750.0	14.2	12.8
C-1	1.35	A	58.2	0.42	0.57	35	2.4	5.5	400	2.4	20	3.1	2.2	7.7	435.0	12.4	7.7
C-2	6.80	A	46.8	0.34	0.53	100	2.0	11.0	1770	1.5	20	2.4	12.0	23.1	1870.0	20.4	20.4
C-3	2.38	A	56.9	0.40	0.56	100	1.6	11.0	810	1.0	20	2.0	6.8	17.7	910.0	15.1	15.1
C-4	3.61	A	59.8	0.42	0.57	100	2.0	9.9	973	2.0	20	2.8	5.7	15.6	1073.0	16.0	15.6
C-5	7.86	A	60.8	0.42	0.57	100	2.0	9.9	1200	1.3	20	2.3	8.8	18.7	1300.0	17.2	17.2
C-6	5.54	A	52.7	0.38	0.55	100	3.0	9.1	1230	1.5	20	2.4	8.4	17.5	1330.0	17.4	17.4
C-7	0.89	A	2.0	0.09	0.36	80	2.5	12.2	150	2.0	15	2.1	1.2	13.4	230.0	11.3	11.3

STANDARD FORM SF-2 TIME OF CONCENTRATION

Subdivision: Bent Grass
Location: CO, Colorado Springs

Project Name: Bent Grass
Project No.: CLH015.20
Calculated By: TJE
Checked By: CMD
Date: 3/23/20

SUB-BASIN DATA						INITIAL/OVERLAND (T _i)			TRAVEL TIME (T _t)					T _c CHECK (URBANIZED BASINS)			FINAL T _c (MIN)	
BASIN ID	D.A. (AC)	Hydrologic Soils Group	Impervious (%)	C _s	C100	L (FT)	S (%)	T _i (MIN)	L (FT)	S (%)	C _v	VEL. (FPS)	T _t (MIN)	COMP. T _c (MIN)	TOTAL LENGTH (FT)	Urbanized T _c (MIN)	T _c (MIN)	
E-1	1.71	A	62.3	0.55	0.69	25	2.0	4.0	940	1.0	20	2.0	7.8	11.8	965.0	15.4	11.8	
E-2	0.68	A	82.8	0.76	0.85	25	2.0	2.5	665	1.6	20	2.5	4.4	6.9	690.0	13.8	6.9	
E-3	0.78	A	88.7	0.81	0.89	25	2.0	2.1	632	1.0	20	2.0	5.3	7.4	657.0	13.7	7.4	
E-4	0.91	A	80.6	0.74	0.84	25	2.0	2.6	913	2.0	20	2.8	5.4	8.0	938.0	15.2	8.0	
E-5	0.89	A	89.0	0.81	0.89	25	2.0	2.1	903	2.1	20	2.9	5.2	7.3	928.0	15.2	7.3	
F-1	0.44	A	38.7	0.29	0.50	66	2.5	8.9	1	1.0	15	1.5	0.0	8.9	67.0	10.4	8.9	
F-2	0.55	A	65.8	0.55	0.69	25	2.0	4.0	464	4.0	20	4.0	1.9	5.9	489.0	12.7	5.9	
G-1	1.47	A	23.4	0.21	0.44	20	2.0	5.8	700	3.5	15	2.8	4.2	9.9	720.0	14.0	9.9	
H-1	0.52	A	2.0	0.09	0.36	25	2.0	7.3	135	2.0	20	2.8	0.8	8.1	160.0	10.9	8.1	
I-1	0.31	A	71.6	0.66	0.79	25	2.0	3.2	135	2.0	20	2.8	0.8	4.0	160.0	10.9	5.0	
BENT GRASS WEST BASINS																		
AA-1	2.57	A	49.8	0.42	0.59	100	4.0	7.8	765	2.5	20	3.2	4.0	11.9	865.0	14.8	11.9	
AA-2	2.28	A	58.7	0.46	0.61	60	2.0	7.2	735	2.5	20	3.2	3.9	11.1	795.0	14.4	11.1	
B-1	5.43	A	14.3	0.16	0.40	90	6.4	8.8	2000	1.7	15	2.0	17.0	25.8	2090.0	21.6	21.6	
B-2	4.16	A	2.1	0.10	0.38	160	11.0	10.4	920	1.6	15	1.9	8.1	18.5	1080.0	16.0	16.0	
CC-1	9.07	A	65.0	0.51	0.65	75	2.0	7.4	1160	2.3	20	3.0	6.4	13.9	1235.0	16.9	13.9	
CC-2	1.35	A	73.2	0.59	0.77	10	2.0	2.3	380	4.0	20	4.0	1.6	3.9	390.0	12.2	5.0	
CC-3	1.88	A	85.9	0.72	0.81	10	2.0	1.7	945	2.5	20	3.2	5.0	6.7	955.0	15.3	6.7	
CC-4	4.34	A	38.2	0.30	0.49	5	2.0	2.6	575	2.5	20	3.2	3.0	5.6	580.0	13.2	5.6	
CC-5	0.45	A	2.0	0.09	0.36	5	2.0	3.3		1.0	15	1.5	0.0	3.3	5.0	10.0	5.0	
D-1	9.07	A	50.2	0.41	0.58	100	2.6	9.2	1900	1.3	20	2.3	13.9	23.1	2000.0	21.1	21.1	
D-2	6.72	A	69.9	0.56	0.69	10	2.0	2.5	1355	1.3	20	2.3	9.9	12.4	1365.0	17.6	12.4	
D-3	2.03	A	16.9	0.13	0.22	25	8.0	4.4	1960	1.0	15	1.5	21.8	26.2	1985.0	21.0	21.0	
D-4	4.38	A	65.4	0.52	0.66	100	2.3	8.0	980	1.0	20	2.0	8.2	16.2	1080.0	16.0	16.0	
D-5	1.08	A	65.7	0.51	0.64	100	2.0	8.6	300	1.1	20	2.1	2.4	11.0	400.0	12.2	11.0	
D-6	4.01	A	71.5	0.54	0.67	45	2.0	5.5	835	1.0	20	2.0	7.0	12.4	880.0	14.9	12.4	
D-7	6.39	A	9.8	0.14	0.39	200	7.5	12.7	665	1.0	15	1.5	7.4	20.1	865.0	14.8	14.8	
D-8	1.69	A	22.8	0.21	0.44	125	3.7	11.8	600	1.0	15	1.5	6.7	18.4	725.0	14.0	14.0	
PROPOSED:																		
P-1	2.03	A	64.3	0.60	0.74	100	6.0	5.0	1230	1.7	15	2.0	10.5	15.5	1330.0	17.4	15.5	

NOTES:

$T_i = (0.395 * (1.1 - C_s) * (L)^{0.5}) / ((S)^{0.33})$, S in ft/ft

$T_t = L / 60V$

Velocity $V = C_v * S^{0.5}$, S in ft/ft

$T_c \text{ Check} = 10 + L / 180$

For Urbanized basins a minimum T_c of 5.0 minutes is required.

For non-urbanized basins a minimum T_c of 10.0 minutes is required

Type of Land Surface	C _v
Heavy Meadow	2.5
Tillage/field	5
Short pasture and lawns	7
Nearly bare ground	10
Grassed waterway	15
Paved areas and shallow paved swales	20

STANDARD FORM SF-3
STORM DRAINAGE SYSTEM DESIGN
(RATIONAL METHOD PROCEDURE)

Subdivision: Bent Grass
Location: CO, Colorado Springs
Design Storm: 5-Year

Project Name: Bent Grass
Project No.: CLH015.20
Calculated By: TJE
Checked By: CMD
Date: 3/23/20

STREET	Design Point	DIRECT RUNOFF							TOTAL RUNOFF				STREET		PIPE			TRAVEL TIME			REMARKS
		Basin ID	Area (Ac)	Runoff Coef.	Tc (min)	C-A (Ac)	I (in/hr)	Q (cfs)	Tc (min)	C-A (Ac)	I (in/hr)	Q (cfs)	Slope (%)	Street Flow (cfs)	Design Flow (cfs)	Slope (%)	Pipe Size (inches)	Length (ft)	Velocity (fps)	Tt (min)	
OFFSITE BASINS																					
		WT200	192.00					25.0												From Falcon DBPS by Matrix	
		OS-2	20.08	0.14	18.3	2.81	3.22	9.0													
		OS-3	10.62	0.14	18.9	1.49	3.18	4.7													
	Release rate from Meadows Pond #2	MT060	185.60	0.44	23.1			2.7												Total flow from existing culvert onto Basin OS-5 = 2.7	
		OS-24	2.64	0.09	18.7	0.24	3.19	0.8													
		OS-25	14.13	0.11	17.4	1.55	3.30	5.1													
		OS-26	5.81	0.09	14.2	0.52	3.61	1.9													
		H3	11.30	0.05	13.9	0.57	3.64	2.1													
		OS-22	4.42	0.09	13.9	0.40	3.64	1.5													
		OS-23	10.24	0.09	13.9	0.92	3.64	3.3													
BENT GRASS FILING NO. 1 BASINS																					
		C1a	0.48	0.70	5.0	0.34	5.17	1.8													
		D1a	0.56	0.57	5.1	0.32	5.15	1.6													
		H1a	0.40	0.48	5.0	0.19	5.17	1.0													
		D1b	0.68	0.57	5.0	0.39	5.17	2.0													
		D1c	1.20	0.58	7.2	0.70	4.63	3.2													
		D1d	2.79	0.59	10.3	1.65	4.09	6.7													
		D2a	1.00	0.35	5.0	0.35	5.17	1.8													
		D2b	0.41	0.46	5.0	0.19	5.17	1.0													
		H1b	2.52	0.44	11.6	1.11	3.91	4.3													
		H1c	0.16	0.42	5.0	0.07	5.17	0.4													
		H2a	1.09	0.41	11.9	0.45	3.87	1.7													
		H2b	0.15	0.36	5.0	0.05	5.17	0.3													
		C1b	0.88	0.72	5.0	0.63	5.17	3.3													
		C1c	1.09	0.74	5.5	0.81	5.02	4.1													
		C2a	1.26	0.57	10.7	0.72	4.03	2.9													

STANDARD FORM SF-3
STORM DRAINAGE SYSTEM DESIGN
(RATIONAL METHOD PROCEDURE)

Subdivision: Bent Grass
Location: CO, Colorado Springs
Design Storm: 5-Year

Project Name: Bent Grass
Project No.: CLH015.20
Calculated By: TJE
Checked By: CMD
Date: 3/23/20

STREET	Design Point	DIRECT RUNOFF							TOTAL RUNOFF				STREET		PIPE			TRAVEL TIME			REMARKS
		Basin ID	Area (Ac)	Runoff Coef.	Tc (min)	C-A (Ac)	I (in/hr)	Q (cfs)	Tc (min)	C-A (Ac)	I (in/hr)	Q (cfs)	Slope (%)	Street Flow (cfs)	Design Flow (cfs)	Slope (%)	Pipe Size (inches)	Length (ft)	Velocity (fps)	Tt (min)	
		C2b	0.99	0.84	11.2	0.83	3.96	3.3													
BENT GRASS FILING NO. 2 BASINS																					
		OS-1	32.28	0.16	22.2	5.16	2.93	15.1													
		OS-4	4.46	0.36	15.6	1.61	3.46	5.6													
		OS-5	0.46	0.45	5.2	0.21	5.10	1.1													
		OS-6	1.17	0.45	12.9	0.53	3.75	2.0													
		A-1	2.70	0.33	13.6	0.89	3.67	3.3													
		A-2	1.19	0.32	10.5	0.38	4.06	1.5													
		A-3	1.57	0.36	14.2	0.57	3.61	2.1													
		A-4	2.24	0.34	12.8	0.76	3.76	2.9													
		C-1	1.35	0.42	7.7	0.57	4.53	2.6													
		C-2	6.80	0.34	20.4	2.31	3.06	7.1													
		C-3	2.38	0.40	15.1	0.95	3.52	3.3													
		C-4	3.61	0.42	15.6	1.52	3.46	5.3													
		C-5	7.86	0.42	17.2	3.30	3.31	10.9													
		C-6	5.54	0.38	17.4	2.11	3.30	7.0													
		C-7	0.89	0.09	11.3	0.08	3.95	0.3													
		E-1	1.71	0.55	11.8	0.94	3.88	3.6													
		E-2	0.68	0.76	6.9	0.52	4.70	2.4													
		E-3	0.78	0.81	7.4	0.63	4.59	2.9													
		E-4	0.91	0.74	8.0	0.67	4.46	3.0													
		E-5	0.89	0.81	7.3	0.72	4.60	3.3													
		F-1	0.44	0.29	8.9	0.13	4.31	0.6													
		F-2	0.55	0.55	5.9	0.30	4.91	1.5													
		G-1	1.47	0.21	9.9	0.31	4.14	1.3													
		H-1	0.52	0.09	8.1	0.05	4.44	0.2													
		I-1	0.31	0.66	5.0	0.20	5.17	1.0													

STANDARD FORM SF-3
STORM DRAINAGE SYSTEM DESIGN
(RATIONAL METHOD PROCEDURE)

Subdivision: Bent Grass
Location: CO, Colorado Springs
Design Storm: 5-Year

Project Name: Bent Grass
Project No.: CLH015.20
Calculated By: TJE
Checked By: CMD
Date: 3/23/20

STREET	Design Point	DIRECT RUNOFF							TOTAL RUNOFF				STREET		PIPE			TRAVEL TIME			REMARKS
		Basin ID	Area (Ac)	Runoff Coef.	Tc (min)	C*A (Ac)	I (in/hr)	Q (cfs)	Tc (min)	C*A (Ac)	I (in/hr)	Q (cfs)	Slope (%)	Street Flow (cfs)	Design Flow (cfs)	Slope (%)	Pipe Size (inches)	Length (ft)	Velocity (fps)	Tt (min)	
BENT GRASS WEST BASINS																					
		AA-1	2.57	0.42	11.9	1.08	3.87	4.2													
		AA-2	2.28	0.46	11.1	1.05	3.98	4.2													
		B-1	5.43	0.16	21.6	0.87	2.97	2.6													
		B-2	4.16	0.10	16.0	0.42	3.42	1.4													
		CC-1	9.07	0.51	13.9	4.63	3.64	16.9													
		CC-2	1.35	0.59	5.0	0.80	5.17	4.1													
		CC-3	1.88	0.72	6.7	1.35	4.72	6.4													
		CC-4	4.34	0.30	5.6	1.30	4.99	6.5													
		CC-5	0.45	0.09	5.0	0.04	5.17	0.2													
		D-1	9.07	0.41	21.1	3.72	3.01	11.2													
		D-2	6.72	0.56	12.4	3.76	3.81	14.3													
		D-3	2.03	0.13	21.0	0.26	3.01	0.8													
		D-4	4.38	0.52	16.0	2.28	3.42	7.8													
		D-5	1.08	0.51	11.0	0.55	3.99	2.2													
		D-6	4.01	0.54	12.4	2.17	3.80	8.2													
		D-7	6.39	0.14	14.8	0.89	3.54	3.2													
		D-8	1.69	0.21	14.0	0.35	3.62	1.3													
MERIDIAN ROAD BASINS																					
		P-1	2.03	0.60	15.5	1.22	3.47	4.2													

**STANDARD FORM SF-3
STORM DRAINAGE SYSTEM DESIGN
(RATIONAL METHOD PROCEDURE)**

Subdivision: Bent Grass
 Location: CO, Colorado Springs
 Design Storm: 100-Year

Project Name: Bent Grass
 Project No.: CLH015.20
 Calculated By: TJE
 Checked By: CMD
 Date: 3/23/20

STREET	Design Point	DIRECT RUNOFF							TOTAL RUNOFF				STREET		PIPE			TRAVEL TIME			REMARKS
		Basin ID	Area (Ac)	Runoff Coeff.	Tc (min)	C*A (Ac)	I (in/hr)	Q (cfs)	Tc (min)	C*A (Ac)	I (in/hr)	Q (cfs)	Slope (%)	Street Flow (cfs)	Design Flow (cfs)	Slope (%)	Pipe Size (inches)	Length (ft)	Velocity (fps)	Tt (min)	
OFFSITE BASINS																					
		WT200	192.00	0.44	23.1			1000.0													From Falcon DBPS by Matrix
		OS-2	20.08	0.40	18.3	8.03	5.41	43.4													
		OS-3	10.62	0.40	18.9	4.25	5.33	22.7													
	Release rate from Meadows Pond #2	MT060	185.60	0.44	23.1			72.6													Total flow from existing culvert onto Basin OS-5 = 72.6
		OS-24	2.64	0.36	18.7	0.95	5.36	5.1													
		OS-25	14.13	0.37	17.4	5.23	5.54	29.0													
		OS-26	5.81	0.36	14.2	2.09	6.05	12.6													
		H3	11.30	0.19	13.9	2.15	6.10	13.1													
		OS-22	4.42	0.36	13.9	1.59	6.10	9.7													
		OS-23	10.24	0.36	13.9	3.69	6.10	22.5													
BENT GRASS FILING NO. 1 BASINS																					
		C1a	0.48	0.81	5.0	0.39	8.68	3.4													
		D1a	0.56	0.71	5.1	0.40	8.65	3.5													
		H1a	0.40	0.65	5.0	0.26	8.68	2.3													
		D1b	0.68	0.71	5.0	0.48	8.68	4.2													
		D1c	1.20	0.71	7.2	0.85	7.77	6.6													
		D1d	2.79	0.71	10.3	1.98	6.87	13.6													
		D2a	1.00	0.55	5.0	0.55	8.68	4.8													
		D2b	0.41	0.63	5.0	0.26	8.68	2.3													
		H1b	2.52	0.60	11.6	1.51	6.56	9.9													
		H1c	0.16	0.60	5.0	0.10	8.68	0.9													
		H2a	1.09	0.59	11.9	0.64	6.50	4.2													
		H2b	0.15	0.56	5.0	0.08	8.68	0.7													
		H3	11.30	0.19	13.9	2.15	6.10	13.1													
		C1b	0.88	0.82	5.0	0.72	8.68	6.2													
		C1c	1.09	0.84	5.5	0.92	8.43	7.8													
		C2a	1.26	0.71	10.7	0.89	6.76	6.0													

**STANDARD FORM SF-3
STORM DRAINAGE SYSTEM DESIGN
(RATIONAL METHOD PROCEDURE)**

Subdivision: Bent Grass
 Location: CO, Colorado Springs
 Design Storm: 100-Year

Project Name: Bent Grass
 Project No.: CLH015.20
 Calculated By: TJE
 Checked By: CMD
 Date: 3/23/20

STREET	Design Point	DIRECT RUNOFF							TOTAL RUNOFF				STREET		PIPE			TRAVEL TIME			REMARKS
		Basin ID	Area (Ac)	Runoff Coeff.	Tc (min)	C*A (Ac)	I (in/hr)	Q (cfs)	Tc (min)	C*A (Ac)	I (in/hr)	Q (cfs)	Slope (%)	Street Flow (cfs)	Design Flow (cfs)	Slope (%)	Pipe Size (inches)	Length (ft)	Velocity (fps)	Tt (min)	
		C2b	0.99	0.92	11.2	0.91	6.64	6.0													
BENT GRASS FILING NO. 2 BASINS																					
		OS-1	32.28	0.41	22.2	13.23	4.92	65.1													
		OS-4	4.46	0.54	15.6	2.41	5.81	14.0													
		OS-5	0.46	0.59	5.2	0.27	8.56	2.3													
		OS-6	1.17	0.59	12.9	0.69	6.30	4.3													
		A-1	2.70	0.52	13.6	1.40	6.16	8.6													
		A-2	1.19	0.51	10.5	0.61	6.81	4.2													
		A-3	1.57	0.53	14.2	0.83	6.05	5.0													
		A-4	2.24	0.53	12.8	1.19	6.31	7.5													
		C-1	1.35	0.57	7.7	0.77	7.61	5.9													
		C-2	6.80	0.53	20.4	3.60	5.14	18.5													
		C-3	2.38	0.56	15.1	1.33	5.90	7.8													
		C-4	3.61	0.57	15.6	2.06	5.81	12.0													
		C-5	7.86	0.57	17.2	4.48	5.56	24.9													
		C-6	5.54	0.55	17.4	3.05	5.54	16.9													
		C-7	0.89	0.36	11.3	0.32	6.63	2.1													
		E-1	1.71	0.69	11.8	1.18	6.51	7.7													
		E-2	0.68	0.85	6.9	0.58	7.89	4.6													
		E-3	0.78	0.89	7.4	0.69	7.70	5.3													
		E-4	0.91	0.84	8.0	0.76	7.50	5.7													
		E-5	0.89	0.89	7.3	0.79	7.73	6.1													
		F-1	0.44	0.50	8.9	0.22	7.23	1.6													
		F-2	0.55	0.69	5.9	0.38	8.25	3.1													
		G-1	1.47	0.44	9.9	0.65	6.95	4.5													
		H-1	0.52	0.36	8.1	0.19	7.45	1.4													
		I-1	0.31	0.79	5.0	0.24	8.68	2.1													

STANDARD FORM SF-3
STORM DRAINAGE SYSTEM DESIGN
(RATIONAL METHOD PROCEDURE)

Subdivision: Bent Grass
 Location: CO, Colorado Springs
 Design Storm: 100-Year

Project Name: Bent Grass
 Project No.: CLH015.20
 Calculated By: TJE
 Checked By: CMD
 Date: 3/23/20

STREET	Design Point	DIRECT RUNOFF							TOTAL RUNOFF				STREET		PIPE			TRAVEL TIME			REMARKS
		Basin ID	Area (Ac)	Runoff Coeff.	Tc (min)	C*A (Ac)	I (in/hr)	Q (cfs)	Tc (min)	C*A (Ac)	I (in/hr)	Q (cfs)	Slope (%)	Street Flow (cfs)	Design Flow (cfs)	Slope (%)	Pipe Size (inches)	Length (ft)	Velocity (fps)	Tt (min)	
BENT GRASS WEST BASINS																					
		AA-1	2.57	0.59	11.9	1.52	6.50	9.9													
		AA-2	2.28	0.61	11.1	1.39	6.67	9.3													
		B-1	5.43	0.40	21.6	2.17	4.99	10.8													
		B-2	4.16	0.38	16.0	1.58	5.75	9.1													
		CC-1	9.07	0.65	13.9	5.90	6.11	36.0													
		CC-2	1.35	0.77	5.0	1.04	8.68	9.0													
		CC-3	1.88	0.81	6.7	1.52	7.93	12.1													
		CC-4	4.34	0.49	5.6	2.13	8.38	17.8													
		CC-5	0.45	0.36	5.0	0.16	8.68	1.4													
		D-1	9.07	0.58	21.1	5.26	5.05	26.6													
		D-2	6.72	0.69	12.4	4.64	6.39	29.6													
		D-3	2.03	0.22	21.0	0.45	5.06	2.3													
		D-4	4.38	0.66	16.0	2.89	5.75	16.6													
		D-5	1.08	0.64	11.0	0.69	6.70	4.6													
		D-6	4.01	0.67	12.4	2.69	6.39	17.2													
		D-7	6.39	0.39	14.8	2.49	5.94	14.8													
		D-8	1.69	0.44	14.0	0.74	6.08	4.5													
MERIDIAN ROAD BASINS																					
		P-1	2.03	0.74	15.5	1.50	5.82	8.7													

BENT GRASS/MERIDIAN ROAD - MDDP SURFACE ROUTING - FUTURE CONDITIONS

DESIGN POINT	CONTRIBUTING BASINS	CA (equivalent)		Tc (min.)	INTENSITY		TOTAL FLOWS		NOTES
		CA(5)	CA(100)		I(5) (in/hr)	I(100) (in/hr)	Q(5) (cfs)	Q(100) (cfs)	
FILING NO. 2:									
	WT200	9.28	212.56	23.1	2.7	4.7	25.0	1000.0	
		TRAVEL TIME							
		9.28	212.56	Type/flow	Length (ft)	Velocity (fps)	d. Time (min)	T. Time (min)	
				CHANNEL	800	5.1	2.6	25.7	
40	OS-1	5.16	13.23	22.2	2.8	4.8	14.2	63.6	
		TRAVEL TIME							
		5.16	13.23	Type/flow	Length (ft)	Velocity (fps)	d. Time (min)	T. Time (min)	
				CHANNEL	800	5.1	2.6	24.8	
1	A-1	0.89	1.40	13.6	3.5	6.2	3.1	8.6	
		TRAVEL TIME							
		0.89	1.40	Type/flow	Length (ft)	Velocity (fps)	d. Time (min)	T. Time (min)	
				STREET	140	2.0	1.2	14.8	
2	A-2 DP 1	0.38	0.61	14.8	3.4	5.9	4.3	11.9	
		0.89	1.40	TRAVEL TIME					
		1.27	2.01	Type/flow	Length (ft)	Velocity (fps)	d. Time (min)	T. Time (min)	
				STREET	275	2.4	1.9	16.7	
3	A-3 DP 2	0.57	0.83	16.7	3.2	5.6	5.9	15.9	
		1.27	2.01	TRAVEL TIME					
		1.84	2.84	Type/flow	Length (ft)	Velocity (fps)	d. Time (min)	T. Time (min)	
				STREET	40	2.4	0.3	17.0	
4	A-4 DP 3	0.76	1.19	17.0	3.2	5.5	8.3	22.3	
		1.84	2.84	TRAVEL TIME					
		2.60	4.03	Type/flow	Length (ft)	Velocity (fps)	d. Time (min)	T. Time (min)	
				STREET	780	2.0	6.5	23.5	
9	OS-5	0.21	0.27	5.2	5.1	8.9	1.1	2.4	
		TRAVEL TIME							
		0.21	0.27	Type/flow	Length (ft)	Velocity (fps)	d. Time (min)	T. Time (min)	
				STREET	315	3.2	1.6	6.9	
11	OS-4 DP 9	1.61	2.41	15.6	3.3	5.8	6.0	15.5	
		0.21	0.27	TRAVEL TIME					
		1.82	2.68	Type/flow	Length (ft)	Velocity (fps)	d. Time (min)	T. Time (min)	
				STREET	150	3.2	0.8	16.4	
12	OS-6 DP 11	0.53	0.69	16.4	3.2	5.6	7.6	19.0	
		1.82	2.68	TRAVEL TIME					
		2.35	3.37	Type/flow	Length (ft)	Velocity (fps)	d. Time (min)	T. Time (min)	
				STREET	120	3.2	0.6	17.0	
5	AA-1 DP 12	1.08	1.52	17.0	3.2	5.5	10.9	27.1	
		2.35	3.37	TRAVEL TIME					
		3.43	4.89	Type/flow	Length (ft)	Velocity (fps)	d. Time (min)	T. Time (min)	
						2.4	0.0	17.0	
6	AA-2	1.05	1.39	11.1	3.9	6.8	4.1	9.4	
		TRAVEL TIME							
		1.05	1.39	Type/flow	Length (ft)	Velocity (fps)	d. Time (min)	T. Time (min)	
						2.4	0.0	11.1	
7	E-3	0.63	0.69	7.4	4.6	8.0	2.9	5.5	
		TRAVEL TIME							
		0.63	0.69	Type/flow	Length (ft)	Velocity (fps)	d. Time (min)	T. Time (min)	
						2.4	0.0	7.4	

DESIGN POINT	CONTRIBUTING BASINS	CA (equivalent)		Tc (min.)	INTENSITY		TOTAL FLOWS		NOTES						
		CA(5)	CA(100)		I(5) (in/hr)	I(100) (in/hr)	Q(5) (cfs)	Q(100) (cfs)							
8	E-1	0.94	1.18	11.8	3.8	6.6	25.3	62.1							
	E-2	0.52	0.58												
	CC-3	1.35	1.52												
	CC-4	1.30	2.13												
	DP 4	2.60	4.03												
		6.71	9.44	TRAVEL TIME											
				Type/flow	Length (ft)	Velocity (fps)	d. Time (min)	T. Time (min)							
						2.4	0.0	11.8							
13	CC-1	4.63	5.90	13.9	3.5	6.1	19.0	42.5							
	CC-2	0.80	1.04												
			5.43							6.94	TRAVEL TIME				
				Type/flow	Length (ft)	Velocity (fps)	d. Time (min)	T. Time (min)							
				STREET	60	3.2	0.3	14.2							
14	CC-3	1.35	1.52	6.7	4.7	8.2	6.4	12.5							
			1.35							1.52	TRAVEL TIME				
											Type/flow	Length (ft)	Velocity (fps)	d. Time (min)	T. Time (min)
						2.4	0.0	6.7							
10	CC-5	0.04	0.16	14.2	3.5	6.1	23.6	52.2	TOTAL FLOWS INTO NORTH POND BENT GRASS WEST						
	DP 13	5.43	6.94												
	DP 14	1.35	1.52												
			6.82							8.62	TRAVEL TIME				
				Type/flow	Length (ft)	Velocity (fps)	d. Time (min)	T. Time (min)							
						2.4	0.0	14.2							
10A	BG NORTH POND RELEASE	1.16	2.42	5.0	5.2	9.1	6.0	21.9							
			1.16							2.42	TRAVEL TIME				
				Type/flow	Length (ft)	Velocity (fps)	d. Time (min)	T. Time (min)							
						2.6	0.0	5.0							
15	DP 5	3.43	4.89	17.0	3.2	5.5	37.5	90.8	TOTAL FLOWS INTO NORTH POND FILING NO. 2						
	DP 6	1.05	1.39												
	DP 7	0.63	0.69												
	DP 8	6.71	9.44												
		11.82	16.41	TRAVEL TIME											
				Type/flow	Length (ft)	Velocity (fps)	d. Time (min)	T. Time (min)							
						2.4	0.0	17.0							
15A	F2 NORTH POND RELEASE	2.35	4.08	5.0	5.2	9.1	12.2	37.0							
			2.35							4.08	TRAVEL TIME				
											Type/flow	Length (ft)	Velocity (fps)	d. Time (min)	T. Time (min)
						2.6	0.0	5.0							
AA	WT200	9.28	212.56	25.7	2.5	4.4	68.8	1082.3							
	B-1	0.87	2.17												
	DP 40	5.16	13.23												
	DP 15	11.82	16.41												
			27.13							244.37	TRAVEL TIME				
				Type/flow	Length (ft)	Velocity (fps)	d. Time (min)	T. Time (min)							
				CULVERTS	135	5.1	0.4	26.2							
BB	B-2	0.42	1.58	26.2	2.5	4.4	69.2	1078.8							
	DP AA	27.13	244.37												
			27.55							245.95	TRAVEL TIME				
				Type/flow	Length (ft)	Velocity (fps)	d. Time (min)	T. Time (min)							
				CHANNEL	1000	7.0	2.4	28.5							
16	C-5	3.30	4.48	17.2	3.1	5.5	10.4	24.6	@ GRADE INLET						
			3.30							4.48	TRAVEL TIME				
											Type/flow	Length (ft)	Velocity (fps)	d. Time (min)	T. Time (min)
				STREET	115	2.0	1.0	18.2							
17	C-6	2.11	3.05	17.4	3.1	5.5	6.6	16.7	@ GRADE INLET						
			2.11							3.05	TRAVEL TIME				
											Type/flow	Length (ft)	Velocity (fps)	d. Time (min)	T. Time (min)
				STREET	115	2.0	1.0	18.3							
18	C-3	0.95	1.33	15.6	3.3	5.8	9.3	29.0	SUMP INLET						
	C-4	1.52	2.06												
	FB DP 16	0.33	1.63												
			2.80							5.02	TRAVEL TIME				
				Type/flow	Length (ft)	Velocity (fps)	d. Time (min)	T. Time (min)							
						2.6	0.0	15.6							

DESIGN POINT	CONTRIBUTING BASINS	CA (equivalent)		Tc (min.)	INTENSITY		TOTAL FLOWS		NOTES	
		CA(5)	CA(100)		I(5) (in/hr)	I(100) (in/hr)	Q(5) (cfs)	Q(100) (cfs)		
19	C-1 C-2 FB DP 17	0.57	0.77	20.4	2.9	5.0	9.5	29.7	SUMP INLET	
		2.31	3.60							
		0.42	1.53	TRAVEL TIME						
		3.30	5.90	Type/flow	Length (ft)	Velocity (fps)	d. Time (min)	T. Time (min)		
					2.6	0.0	20.4			
20	G-1	0.31	0.65	9.9	4.1	7.1	1.3	4.6		
		TRAVEL TIME								
		0.31	0.65	Type/flow	Length (ft)	Velocity (fps)	d. Time (min)	T. Time (min)		
					2.6	0.0	9.9			
20A	C-7 DP 18 DP 19 DP 20	0.08	0.32	20.4	2.9	5.0	18.7	59.9	TOTAL FLOW INTO FILING NO. 2 SOUTH POND	
		2.80	5.02							
		3.30	5.90	TRAVEL TIME						
		0.31	0.65	Type/flow	Length (ft)	Velocity (fps)	d. Time (min)	T. Time (min)		
		6.49	11.89			2.6	0.0	20.4		
20B	F2 SOUTH POND RELEASE	4.11	7.28	5.0	5.2	9.1	21.3	66.0		
		TRAVEL TIME								
		4.11	7.28	Type/flow	Length (ft)	Velocity (fps)	d. Time (min)	T. Time (min)		
					2.6	0.0	5.0			
28	OS-2	2.81	8.03	18.3	3.1	5.3	8.6	42.8		
		TRAVEL TIME								
		2.81	8.03	Type/flow	Length (ft)	Velocity (fps)	d. Time (min)	T. Time (min)		
			640	4.0	2.7	21.0				
29	OS-3 DP 28	1.49	4.25	21.0	2.8	5.0	12.2	60.9		
		TRAVEL TIME								
		4.30	12.28	Type/flow	Length (ft)	Velocity (fps)	d. Time (min)	T. Time (min)		
			475	3.5	2.3	23.3				
21	D-2	3.76	4.64	12.4	3.7	6.4	13.9	29.9	@ GRADE INLET	
		TRAVEL TIME								
		3.76	4.64	Type/flow	Length (ft)	Velocity (fps)	d. Time (min)	T. Time (min)		
					4.0	0.0	12.4			
22	D-1	3.72	5.26	21.1	2.8	4.9	10.5	26.0	@ GRADE INLET	
		TRAVEL TIME								
		3.72	5.26	Type/flow	Length (ft)	Velocity (fps)	d. Time (min)	T. Time (min)		
					3.5	0.0	21.1			
23	D-3 DP 29	0.26	0.45	23.3	2.7	4.7	12.2	59.7	TYPE C INLET	
		4.30	12.28	TRAVEL TIME						
		4.56	12.73	Type/flow	Length (ft)	Velocity (fps)	d. Time (min)	T. Time (min)		
					4.0	0.0	23.3			
24	E-4 OS-24 FB DP 22	0.67	0.76	18.7	3.0	5.3	2.9	21.1	@ GRADE INLET	
		0.24	0.95							
		0.07	2.29	TRAVEL TIME						
		0.98	4.00	Type/flow	Length (ft)	Velocity (fps)	d. Time (min)	T. Time (min)		
					3.5	0.0	18.7			
25	E-5 FB DP 24	0.72	0.79	7.3	4.6	8.0	3.3	10.7	@ GRADE INLET	
		0.00	0.55	TRAVEL TIME						
		0.72	1.34	Type/flow	Length (ft)	Velocity (fps)	d. Time (min)	T. Time (min)		
					3.5	0.0	7.3			
26	D-7 DP 24 DP 25	0.89	2.49	14.8	3.4	5.9	8.8	46.4		
		0.98	4.00							
		0.72	1.34	TRAVEL TIME						
		2.59	7.83	Type/flow	Length (ft)	Velocity (fps)	d. Time (min)	T. Time (min)		
					3.5	0.0	14.8			
42	D-4	2.28	2.89	16.0	3.3	5.7	7.5	16.5	SUMP INLET	
		TRAVEL TIME								
		2.28	2.89	Type/flow	Length (ft)	Velocity (fps)	d. Time (min)	T. Time (min)		
					2.0	0.0	16.0			

DESIGN POINT	CONTRIBUTING BASINS	CA (equivalent)		Tc (min.)	INTENSITY		TOTAL FLOWS		NOTES
		CA(5)	CA(100)		I(5) (in/hr)	I(100) (in/hr)	Q(5) (cfs)	Q(100) (cfs)	
43	D-5 D-6	0.55	0.69	12.4	3.7	6.4	10.0	21.8	SUMP INLET
		2.17	2.69	TRAVEL TIME					
		2.72	3.38	Type/flow	Length (ft)	Velocity (fps)	d. Time (min)	T. Time (min)	
						2.0	0.0	12.4	
44	D-8	0.35	0.74	14.0	3.5	6.1	1.2	4.5	
				TRAVEL TIME					
		0.35	0.74	Type/flow	Length (ft)	Velocity (fps)	d. Time (min)	T. Time (min)	
						2.0	0.0	14.0	
45	DP 21 DP 22 DP 23 DP 26 DP 42 DP 43 DP 44	3.76	4.64	23.3	2.7	4.7	53.6	175.7	TOTAL FLOW INTO BENT GRASS WEST SOUTH POND
		3.72	5.26						
		4.56	12.73						
		2.59	7.83						
		2.28	2.89						
		2.72	3.38						
		0.35	0.74	TRAVEL TIME					
		19.98	37.47	Type/flow	Length (ft)	Velocity (fps)	d. Time (min)	T. Time (min)	
						2.6	0.0	23.3	
45A	BG SOUTH POND RELEASE	0.21	5.05	5.0	5.2	9.1	1.1	45.8	
				TRAVEL TIME					
		0.21	5.05	Type/flow	Length (ft)	Velocity (fps)	d. Time (min)	T. Time (min)	
						2.6	0.0	5.0	
CC	DP BB DP 10A DP 20B DP 45A	27.55	245.95	28.5	2.4	4.2	78.9	1087.2	EXITS SITE
		1.16	2.42						
		4.11	7.28						
		0.21	5.05	TRAVEL TIME					
		33.03	260.70	Type/flow	Length (ft)	Velocity (fps)	d. Time (min)	T. Time (min)	
						3.5	0.0	28.5	
EAST OF FILING NO. 2:									
30	MTO60			15.0			2.7	72.6	Flows from Meadows Filing No. 3 Pond 2 - Updated HEC HMS model
				TRAVEL TIME					
				Type/flow	Length (ft)	Velocity (fps)	d. Time (min)	T. Time (min)	
				Sheet	2300	2.1	18.3	33.3	
31	OS-25 DP 30	1.55	5.23	33.3	2.2	3.8	6.1	92.5	
		1.24	19.07						
		2.79	24.30	Type/flow	Length (ft)	Velocity (fps)	d. Time (min)	T. Time (min)	
				Sheet	700	2.6	4.5	37.7	
32	OS-6 DP 31	0.53	0.69	37.7	2.0	3.5	6.7	88.0	Flow into revised pond on "School Site"
		2.79	24.30						
		3.32	24.99	Type/flow	Length (ft)	Velocity (fps)	d. Time (min)	T. Time (min)	
				Sheet	700	2.6	4.5	42.2	
32A	Fut Pond Release C1a	1.11	5.46	15.0	3.4	5.9	4.9	34.5	Designed release rates from Future Pond are 3.8 & 32.2 cfs
		0.34	0.39						
		1.45	5.85	Type/flow	Length (ft)	Velocity (fps)	d. Time (min)	T. Time (min)	
						2.0	0.0	15.0	
32A-N	DP-32	1.45	5.64	15.0	3.4	5.9	4.9	33.2	Flows remaining in north half of BGMD & continuing east (Max gutter flow allowed 5 Yr=9.4, 100 Yr=33.2)
				TRAVEL TIME					
		1.45	5.64	Type/flow	Length (ft)	Velocity (fps)	d. Time (min)	T. Time (min)	
				Street	905	2.0	7.5	22.5	
32A-S	D1a OT from DP 32A-N	0.08	0.40	15.0	3.4	5.9	0.3	3.6	Flows remaining in south half of BGMD & continuing east (Max gutter flow allowed 5 Yr=9.4 & 100 Yr=33.2)
		0.00	0.21						
		0.08	0.61	Type/flow	Length (ft)	Velocity (fps)	d. Time (min)	T. Time (min)	
						2.5	0.0	15.0	
BG 1a-Os		0.00	0.00	15.0	3.4	5.9	0.0	0.0	Overtopping Flows from DP 32A which will head south through Bent Grass Filing No. 1 in Sea Oats Drive (Sea Oats Dr can carry 2.2 & 11.6 cfs per side)
				TRAVEL TIME					
		0.00	0.00	Type/flow	Length (ft)	Velocity (fps)	d. Time (min)	T. Time (min)	
						2.5	0.0	15.0	

DESIGN POINT	CONTRIBUTING BASINS	CA (equivalent)		Tc (min.)	INTENSITY		TOTAL FLOWS		NOTES
		CA(5)	CA(100)		I(5) (in/hr)	I(100) (in/hr)	Q(5) (cfs)	Q(100) (cfs)	
BG 1a-Ose		0.00	0.00	15.0	3.4	5.9	0.0	0.0	Overtopping Flows from DP 1a-Os which will flow in east half of Sea Oats Drive
		TRAVEL TIME							
		0.00	0.00	Type/flow	Length (ft)	Velocity (fps)	d. Time (min)	T. Time (min)	
BG 1a-Osw		0.00	0.00	15.0	3.4	5.9	0.0	0.0	Overtopping Flows from DP 1a-Os which will flow in west half of Sea Oats Drive
		TRAVEL TIME							
		0.00	0.00	Type/flow	Length (ft)	Velocity (fps)	d. Time (min)	T. Time (min)	
BG 4a	H1a DP BG 1a-Ose	0.19	0.26	15.0	3.4	5.9	0.6	1.5	Flows to west side of Inlet 4
		TRAVEL TIME							
		0.19	0.26	Type/flow	Length (ft)	Velocity (fps)	d. Time (min)	T. Time (min)	
BG 1b	D1b DP BG 1a-Osw	0.39	0.48	15.0	3.4	5.9	1.3	2.8	
		TRAVEL TIME							
		0.39	0.48	Type/flow	Length (ft)	Velocity (fps)	d. Time (min)	T. Time (min)	
BG 1c	D1c DP BG 1b	0.70	0.85	18.4	3.0	5.3	3.3	7.1	Flows in Aveno Rd to east side of Inlet 1 (Max gutter allowed 1.6 & 8.6 cfs per side)
		TRAVEL TIME							
		0.39	0.48	Type/flow	Length (ft)	Velocity (fps)	d. Time (min)	T. Time (min)	
BG 1	D1d DP BG 1c	1.65	1.98	18.4	3.0	5.3	8.3	17.6	Existing 10' Sump Inlet - Total flow to Inlet 1
		TRAVEL TIME							
		1.09	1.33	Type/flow	Length (ft)	Velocity (fps)	d. Time (min)	T. Time (min)	
BG 2e	D2a	0.35	0.55	5.0	5.2	9.1	1.8	5.0	Flows in Aveno Rd to east side of Inlet 2 (Max gutter allowed 1.6 & 8.6 cfs per side)
		TRAVEL TIME							
		0.35	0.55	Type/flow	Length (ft)	Velocity (fps)	d. Time (min)	T. Time (min)	
BG 2w	D2b	0.19	0.26	5.0	5.2	9.1	1.0	2.4	Flows in Aveno Rd to west side of Inlet 2 (Max gutter allowed 2.2 & 11.4 cfs per side)
		TRAVEL TIME							
		0.19	0.26	Type/flow	Length (ft)	Velocity (fps)	d. Time (min)	T. Time (min)	
BG 2	DP BG 2e DP BG 2w	0.35	0.55	5.0	5.2	9.1	2.8	7.3	Existing 4' Sump Inlet - Total flow to Inlet 2
		TRAVEL TIME							
		0.19	0.26	Type/flow	Length (ft)	Velocity (fps)	d. Time (min)	T. Time (min)	
BG 4e	H1c	0.07	0.10	5.0	5.2	9.1	0.4	0.9	Flows in Aveno Rd to west side of Inlet 4 (Max gutter allowed 1.8 & 9.8 cfs per side)
		TRAVEL TIME							
		0.07	0.10	Type/flow	Length (ft)	Velocity (fps)	d. Time (min)	T. Time (min)	
BG 4w	H1b DP BG 4a	1.11	1.51	20.0	2.9	5.1	3.8	9.0	Flows in Aveno Rd to east side of Inlet 4 (Max gutter allowed 2.1 & 11.3 cfs per side)
		TRAVEL TIME							
		0.19	0.26	Type/flow	Length (ft)	Velocity (fps)	d. Time (min)	T. Time (min)	
BG 4	DP BG 4e DP BG 4w	0.07	0.10	20.0	2.9	5.1	4.0	9.5	Existing 4' Sump Inlet
		TRAVEL TIME							
		1.30	1.77	Type/flow	Length (ft)	Velocity (fps)	d. Time (min)	T. Time (min)	
BG 5e	H2b	0.05	0.08	5.0	5.2	9.1	0.3	0.7	Flows in Aveno Rd to west side of Inlet 5 (Max gutter allowed 1.8 & 9.8 cfs per side)
		TRAVEL TIME							
		0.05	0.08	Type/flow	Length (ft)	Velocity (fps)	d. Time (min)	T. Time (min)	
BG 5w	H2a	0.45	0.64	11.9	3.8	6.6	1.7	4.2	Flows in Aveno Rd to east side of Inlet 5 (Max gutter allowed 2.1 & 11.3 cfs per side)
		TRAVEL TIME							
		0.45	0.64	Type/flow	Length (ft)	Velocity (fps)	d. Time (min)	T. Time (min)	

DESIGN POINT	CONTRIBUTING BASINS	CA (equivalent)		Tc (min.)	INTENSITY		TOTAL FLOWS		NOTES	
		CA(5)	CA(100)		I(5) (in/hr)	I(100) (in/hr)	Q(5) (cfs)	Q(100) (cfs)		
BG 5	DP BG 5e DP BG 5w	0.05	0.08	11.9	3.8	6.6	1.9	4.7	Existing 4' Sump Inlet	
		0.45	0.64	TRAVEL TIME						
		0.50	0.72	Type/flow	Length (ft)	Velocity (fps)	d. Time (min)	T. Time (min)		
				SUMP		5.0	0.0	11.9		
BG 14n	OS-22 H3 C1b DP BG 32A-N	0.40	1.59	22.5	2.7	4.8	8.3	48.2	Flow continuing in North half of BGMD	
		0.57	2.15	TRAVEL TIME						
		0.63	0.72	TRAVEL TIME						
		1.45	5.64	TRAVEL TIME						
		3.05	10.10	Type/flow	Length (ft)	Velocity (fps)	d. Time (min)	T. Time (min)		
		Street	300	2.8	1.8	24.3				
BG 15n	OS-23 D1c DP BG 14n	0.92	3.69	24.3	2.6	4.6	8.0	46.2	Flow continuing in North half of BGMD	
		0.70	0.85	TRAVEL TIME						
		3.05	10.10	TRAVEL TIME						
		4.67	14.64	Type/flow	Length (ft)	Velocity (fps)	d. Time (min)	T. Time (min)		
				5.0	0.0	24.3				
BG 50		111.34	193.50	26.1	2.5	4.4	280.0	850.0	Flow from Falcon DBPS at Meridian Rd & BGMD Intersection	
				TRAVEL TIME						
				Type/flow	Length (ft)	Velocity (fps)	d. Time (min)	T. Time (min)		
				5.0	0.0	26.1				
BG 20	DP BG 15n DP BG 50	4.67	14.64	26.1	2.5	4.4	291.7	914.3	Combined flow at Culvert Crossing - North side of BGMD	
		111.34	193.50	TRAVEL TIME						
		116.01	208.14	Type/flow	Length (ft)	Velocity (fps)	d. Time (min)	T. Time (min)		
		Culverts	125	11.2	0.2	26.3				
BG 14s	C2a DP BG 12-S	0.72	0.71	15.0	3.4	5.9	2.7	7.8	Flow continuing in South half of BGMD	
		0.08	0.61	TRAVEL TIME						
		0.80	1.32	Type/flow	Length (ft)	Velocity (fps)	d. Time (min)	T. Time (min)		
		Street	300	2.8	1.8	16.8				
BG 15s	C2b DP BG 14s	0.83	0.91	16.8	3.2	5.6	5.2	12.4	Flow continuing in South half of BGMD	
		0.80	1.32	TRAVEL TIME						
		1.63	2.23	Type/flow	Length (ft)	Velocity (fps)	d. Time (min)	T. Time (min)		
				5.0	0.0	16.8				
BG 21	DP BG 20 DP BG 15s	116.01	208.14	26.3	2.5	4.4	294.6	920.3	Combined flow at Culvert Crossing - South side of BGMD	
		1.63	2.23	TRAVEL TIME						
		117.64	210.37	Type/flow	Length (ft)	Velocity (fps)	d. Time (min)	T. Time (min)		
		Channel	1250	2.0	10.4	36.7				
BG 25	P-1 DP BG 21	1.22	0.45	36.7	2.1	3.6	243.8	755.5	Flow @ Existing Culvert, north side of Owl Place	
		117.64	210.37	TRAVEL TIME						
		118.86	210.82	Type/flow	Length (ft)	Velocity (fps)	d. Time (min)	T. Time (min)		
				5.0	0.0	36.7				

APPENDIX C
Hydraulic Computations

ALLOWABLE CAPACITY FOR ONE-HALF OF STREET (Minor & Major Storm)

(Based on Regulated Criteria for Maximum Allowable Flow Depth and Spread)

Bent Grass Residential Filing No. 2

Project:

Street Capacity - 1/2 Street Section of Bent Grass Meadows Drive

Inlet ID:

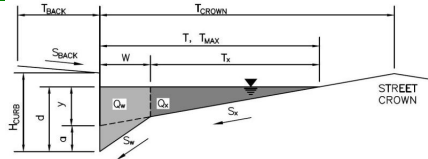

Gutter Geometry (Enter data in the blue cells)

Maximum Allowable Width for Spread Behind Curb
 Side Slope Behind Curb (leave blank for no conveyance credit behind curb)
 Manning's Roughness Behind Curb (typically between 0.012 and 0.020)

T _{BACK} =	14.0	ft
S _{BACK} =	0.020	ft/ft
n _{BACK} =	0.013	

Height of Curb at Gutter Flow Line
 Distance from Curb Face to Street Crown
 Gutter Width
 Street Transverse Slope
 Gutter Cross Slope (typically 2 inches over 24 inches or 0.083 ft/ft)
 Street Longitudinal Slope - Enter 0 for sump condition
 Manning's Roughness for Street Section (typically between 0.012 and 0.020)

H _{CURB} =	6.00	inches
T _{CROWN} =	26.0	ft
W =	2.00	ft
S _x =	0.020	ft/ft
S _w =	0.083	ft/ft
S _o =	0.010	ft/ft
n _{STREET} =	0.016	

Max. Allowable Spread for Minor & Major Storm
 Max. Allowable Depth at Gutter Flowline for Minor & Major Storm
 Allow Flow Depth at Street Crown (leave blank for no)

	Minor Storm	Major Storm	
T _{MAX} =	16.0	26.0	ft
d _{MAX} =	6.0	8.3	inches
	<input type="checkbox"/>	<input type="checkbox"/>	check = yes

Maximum Capacity for 1/2 Street based On Allowable Spread

Water Depth without Gutter Depression (Eq. ST-2)
 Vertical Depth between Gutter Lip and Gutter Flowline (usually 2")
 Gutter Depression (d_c - (W * S_x * 12))
 Water Depth at Gutter Flowline
 Allowable Spread for Discharge outside the Gutter Section W (T - W)
 Gutter Flow to Design Flow Ratio by FHWA HEC-22 method (Eq. ST-7)
 Discharge outside the Gutter Section W, carried in Section T_x
 Discharge within the Gutter Section W (Q_w - Q_x)
 Discharge Behind the Curb (e.g., sidewalk, driveways, & lawns)

	Minor Storm	Major Storm	
y =	3.84	6.24	inches
d _c =	2.0	2.0	inches
a =	1.51	1.51	inches
d =	5.35	7.75	inches
T _x =	14.0	24.0	ft
E _o =	0.372	0.225	
Q _x =	5.9	24.7	cfs
Q _w =	3.5	7.2	cfs
Q _{BACK} =	0.0	1.3	cfs
Q _T =	9.4	33.2	cfs
V =	4.8	6.4	fps
V*d =	2.1	4.1	

Maximum Capacity for 1/2 Street based on Allowable Depth

Theoretical Water Spread
 Theoretical Spread for Discharge outside the Gutter Section W (T - W)
 Gutter Flow to Design Flow Ratio by FHWA HEC-22 method (Eq. ST-7)
 Theoretical Discharge outside the Gutter Section W, carried in Section T_{xTH}
 Actual Discharge outside the Gutter Section W, (limited by distance T_{CROWN})
 Discharge within the Gutter Section W (Q_w - Q_x)
 Discharge Behind the Curb (e.g., sidewalk, driveways, & lawns)
 Total Discharge for Major & Minor Storm (Pre-Safety Factor)
 Average Flow Velocity Within the Gutter Section
 V*d Product: Flow Velocity Times Gutter Flowline Depth
 Slope-Based Depth Safety Reduction Factor for Major & Minor (d ≥ 6") Storm
Max Flow Based on Allowable Depth (Safety Factor Applied)
 Resultant Flow Depth at Gutter Flowline (Safety Factor Applied)
 Resultant Flow Depth at Street Crown (Safety Factor Applied)

	Minor Storm	Major Storm	
T _{TH} =	18.7	28.3	ft
T _{xTH} =	16.7	26.3	ft
E _o =	0.318	0.206	
Q _{xTH} =	9.4	31.5	cfs
Q _x =	9.4	31.5	cfs
Q _w =	4.4	8.2	cfs
Q _{BACK} =	0.0	2.6	cfs
Q =	13.8	42.3	cfs
V =	5.2	6.7	fps
V*d =	2.6	4.7	
R =	1.00	1.00	
Q _d =	13.8	42.3	cfs
d =	6.00	8.30	inches
d _{CROWN} =	0.00	0.55	inches

MINOR STORM Allowable Capacity is based on Spread Criterion
MAJOR STORM Allowable Capacity is based on Spread Criterion

	Minor Storm	Major Storm	
Q _{allow} =	9.4	33.2	cfs

WARNING: MINOR STORM max. allowable capacity is less than the design flow given on sheet 'Inlet Management'
WARNING: MAJOR STORM max. allowable capacity is less than the design flow given on sheet 'Inlet Management'

Current Pond Calculations

DETENTION BASIN STAGE-STORAGE TABLE BUILDER

UD-Detention, Version 3.07 (February 2017)

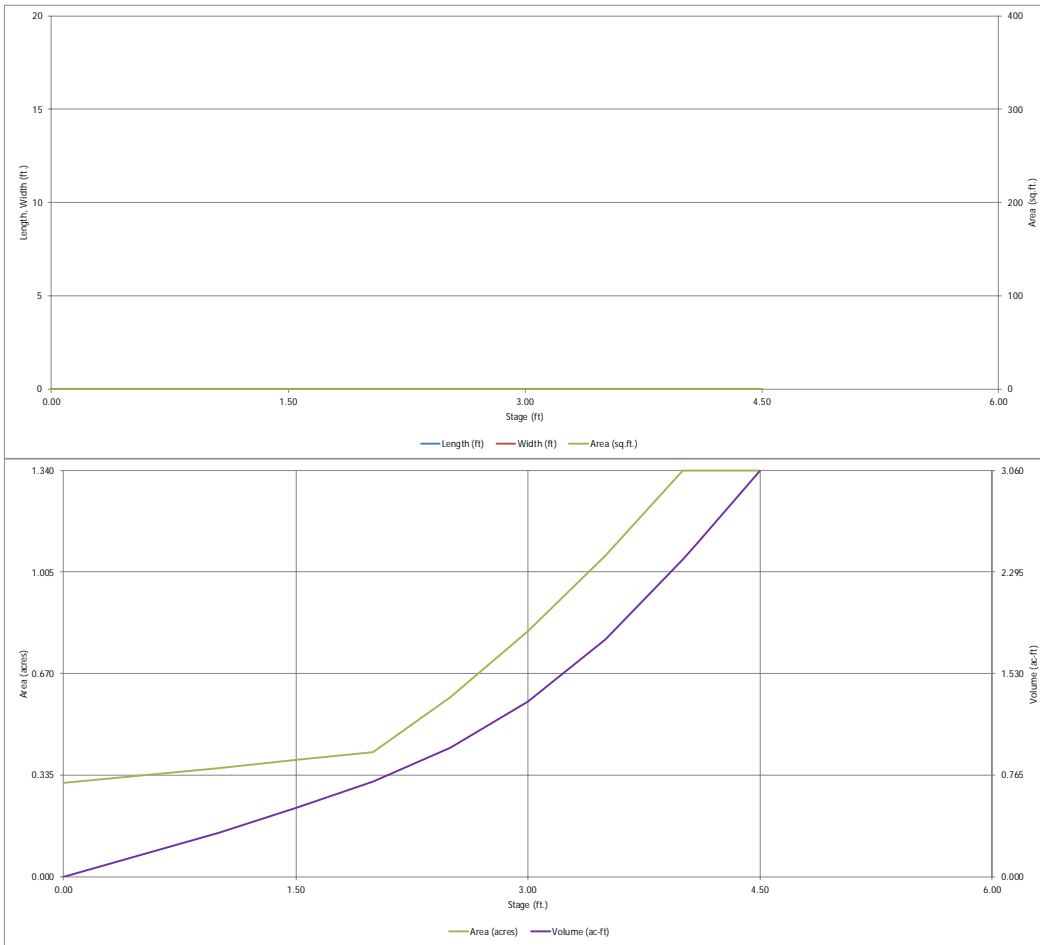

Detention Basin Outlet Structure Design

UD-Detention, Version 3.07 (February 2017)

Project: Bent Grass
Basin ID: Existing Sediment Pond (School Site)

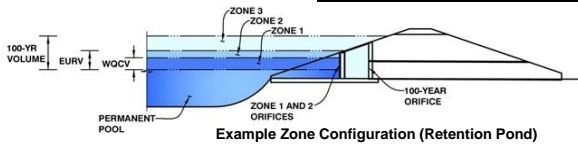

Example Zone Configuration (Retention Pond)

	Stage (ft)	Zone Volume (ac-ft)	Outlet Type
Zone 1 (WQCV)	4.28	2.757	
Zone 2			
Zone 3			
		2.757	Total

User Input: Orifice at Underdrain Outlet (typically used to drain WQCV in a Filtration BMP)

Underdrain Orifice Invert Depth = ft (distance below the filtration media surface)
 Underdrain Orifice Diameter = inches

Calculated Parameters for Underdrain

Underdrain Orifice Area = ft²
 Underdrain Orifice Centroid = feet

User Input: Orifice Plate with one or more orifices or Elliptical Slot Weir (typically used to drain WQCV and/or EURV in a sedimentation BMP)

Invert of Lowest Orifice = ft (relative to basin bottom at Stage = 0 ft)
 Depth at top of Zone using Orifice Plate = ft (relative to basin bottom at Stage = 0 ft)
 Orifice Plate: Orifice Vertical Spacing = inches
 Orifice Plate: Orifice Area per Row = inches

Calculated Parameters for Plate

WQ Orifice Area per Row = ft²
 Elliptical Half-Width = feet
 Elliptical Slot Centroid = feet
 Elliptical Slot Area = ft²

User Input: Stage and Total Area of Each Orifice Row (numbered from lowest to highest)

	Row 1 (optional)	Row 2 (optional)	Row 3 (optional)	Row 4 (optional)	Row 5 (optional)	Row 6 (optional)	Row 7 (optional)	Row 8 (optional)
Stage of Orifice Centroid (ft)	<input type="text"/>	<input type="text"/>	<input type="text"/>	<input type="text"/>	<input type="text"/>	<input type="text"/>	<input type="text"/>	<input type="text"/>
Orifice Area (sq. inches)	<input type="text"/>	<input type="text"/>	<input type="text"/>	<input type="text"/>	<input type="text"/>	<input type="text"/>	<input type="text"/>	<input type="text"/>
	Row 9 (optional)	Row 10 (optional)	Row 11 (optional)	Row 12 (optional)	Row 13 (optional)	Row 14 (optional)	Row 15 (optional)	Row 16 (optional)
Stage of Orifice Centroid (ft)	<input type="text"/>	<input type="text"/>	<input type="text"/>	<input type="text"/>	<input type="text"/>	<input type="text"/>	<input type="text"/>	<input type="text"/>
Orifice Area (sq. inches)	<input type="text"/>	<input type="text"/>	<input type="text"/>	<input type="text"/>	<input type="text"/>	<input type="text"/>	<input type="text"/>	<input type="text"/>

User Input: Vertical Orifice (Circular or Rectangular)

Not Selected Not Selected
 Invert of Vertical Orifice = ft (relative to basin bottom at Stage = 0 ft)
 Depth at top of Zone using Vertical Orifice = ft (relative to basin bottom at Stage = 0 ft)
 Vertical Orifice Diameter = inches

Calculated Parameters for Vertical Orifice

Not Selected Not Selected
 Vertical Orifice Area = ft²
 Vertical Orifice Centroid = feet

User Input: Overflow Weir (Dropbox) and Grate (Flat or Sloped)

Not Selected Not Selected
 Overflow Weir Front Edge Height, H_o = ft (relative to basin bottom at Stage = 0 ft)
 Overflow Weir Front Edge Length = feet
 Overflow Weir Slope = H:V (enter zero for flat grate)
 Horiz. Length of Weir Sides = feet
 Overflow Grate Open Area % = % grate open area/total area
 Debris Clogging % = %

Calculated Parameters for Overflow Weir

Not Selected Not Selected
 Height of Grate Upper Edge, H₁ = feet
 Over Flow Weir Slope Length = feet
 Grate Open Area / 100-yr Orifice Area = should be ≥ 4
 Overflow Grate Open Area w/o Debris = ft²
 Overflow Grate Open Area w/ Debris = ft²

User Input: Outlet Pipe w/ Flow Restriction Plate (Circular Orifice, Restrictor Plate, or Rectangular Orifice)

Not Selected Not Selected
 Depth to Invert of Outlet Pipe = ft (distance below basin bottom at Stage = 0 ft)
 Circular Orifice Diameter = inches

Calculated Parameters for Outlet Pipe w/ Flow Restriction Plate

Not Selected Not Selected
 Outlet Orifice Area = ft²
 Outlet Orifice Centroid = feet
 Half-Central Angle of Restrictor Plate on Pipe = N/A N/A radians

User Input: Emergency Spillway (Rectangular or Trapezoidal)

Spillway Invert Stage = 3.00 ft (relative to basin bottom at Stage = 0 ft)
 Spillway Crest Length = 30.00 feet
 Spillway End Slopes = 0.17 H:V
 Freeboard above Max Water Surface = 1.00 feet

Calculated Parameters for Spillway

Spillway Design Flow Depth = 2.83 feet
 Stage at Top of Freeboard = 6.83 feet
 Basin Area at Top of Freeboard = 1.34 acres

Routed Hydrograph Results

	WQCV	EURV	2 Year	5 Year	10 Year	25 Year	50 Year	100 Year	500 Year
Design Storm Return Period =									
One-Hour Rainfall Depth (in)	0.53	1.07	1.19	1.50	1.75	2.00	2.25	2.67	3.68
Calculated Runoff Volume (acre-ft)	2.757	6.258	4.193	5.596	7.070	9.378	13.092	19.212	35.173
OPTIONAL Override Runoff Volume (acre-ft)									
Inflow Hydrograph Volume (acre-ft)	2.753	6.244	4.187	5.585	7.053	9.361	13.072	19.181	35.120
Predevelopment Unit Peak Flow, q (cfs/acre)	0.00	0.00	0.00	0.01	0.02	0.04	0.27	0.68	1.66
Predevelopment Peak Q (cfs)	0.0	0.0	0.2	1.6	3.7	8.2	60.9	155.2	378.7
Peak Inflow Q (cfs)	65.8	147.0	99.5	131.8	165.5	217.9	300.8	434.3	766.8
Peak Outflow Q (cfs)	29.6	98.8	57.9	85.4	115.9	163.1	166.5	166.5	166.5
Ratio Peak Outflow to Predevelopment Q	N/A	N/A	N/A	53.9	31.4	19.8	2.7	1.1	0.4
Structure Controlling Flow	Spillway	Spillway	Spillway	Spillway	Spillway	Spillway	N/A	N/A	N/A
Max Velocity through Grate 1 (fps)	N/A	N/A	N/A	N/A	N/A	N/A	N/A	N/A	N/A
Max Velocity through Grate 2 (fps)	N/A	N/A	N/A	N/A	N/A	N/A	N/A	N/A	N/A
Time to Drain 97% of Inflow Volume (hours)	>120	>120	>120	>120	>120	>120	>120	>120	>120
Time to Drain 99% of Inflow Volume (hours)	>120	>120	>120	>120	>120	>120	>120	>120	>120
Maximum Ponding Depth (ft)	3.48	4.06	3.74	3.96	4.18	4.48	4.50	4.50	4.50
Area at Maximum Ponding Depth (acres)	1.04	1.34	1.19	1.32	1.34	1.34	1.34	1.34	1.34
Maximum Volume Stored (acre-ft)	1.753	2.464	2.055	2.331	2.612	3.014	3.054	3.054	3.054

Detention Basin Outlet Structure Design

UD-Detention, Version 3.07 (February 2017)

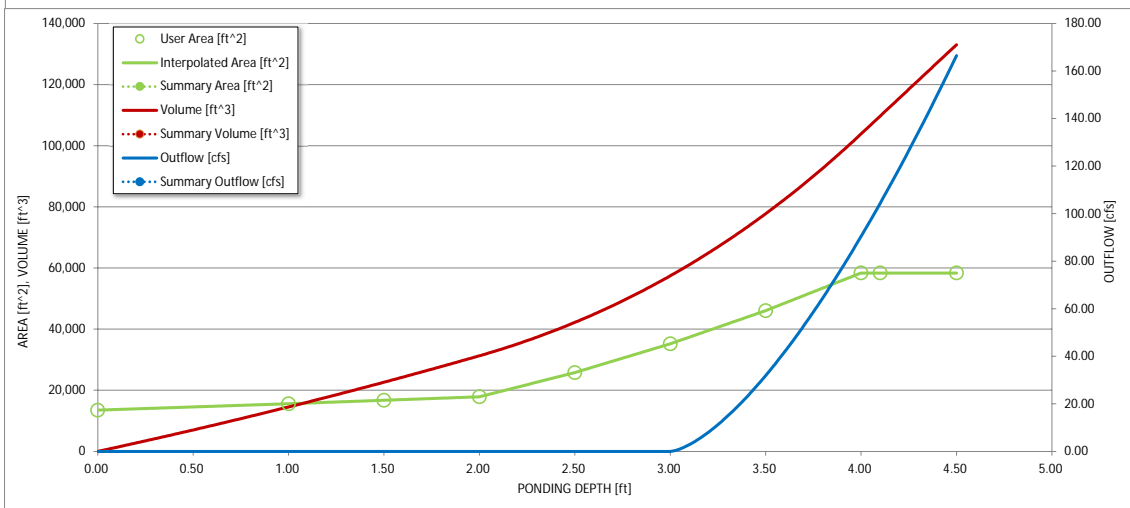
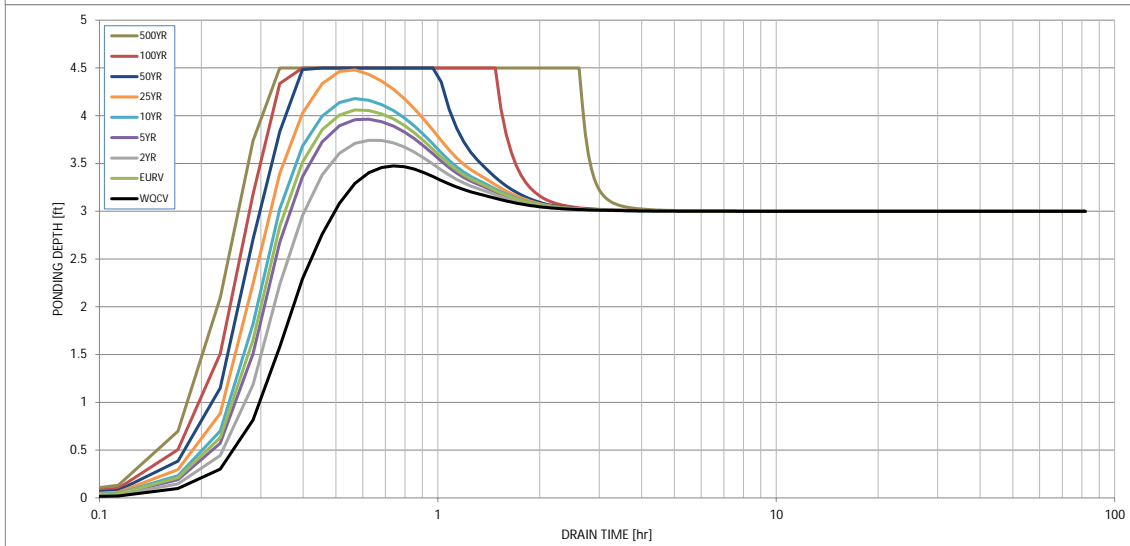
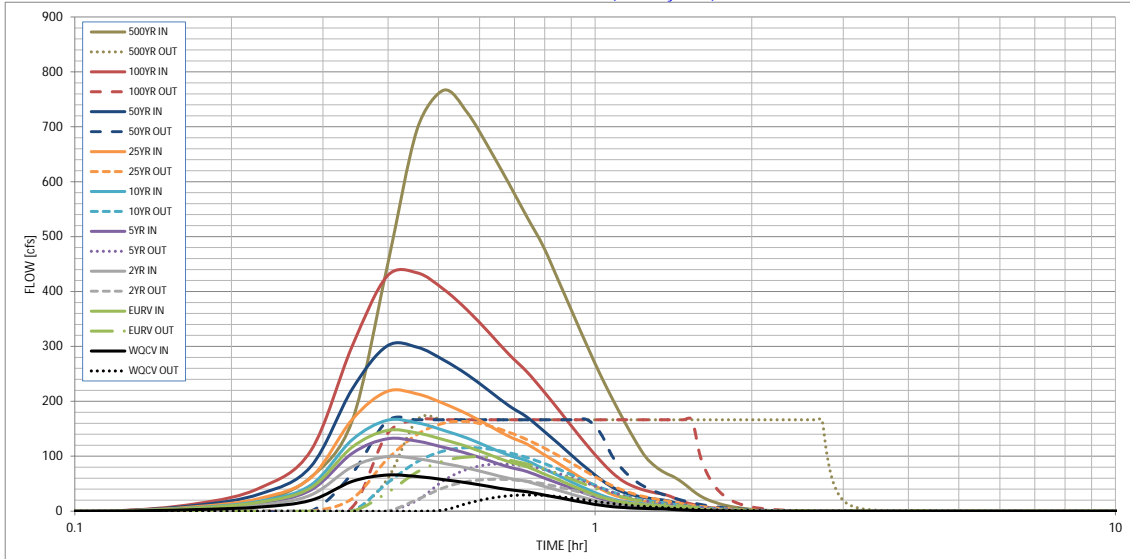

S-A-V-D Chart Axis Override	X-axis	Left Y-Axis	Right Y-Axis
minimum bound			
maximum bound			

DETENTION BASIN STAGE-STORAGE TABLE BUILDER

MHFD- Detention, Version 4.02 (February 2020)

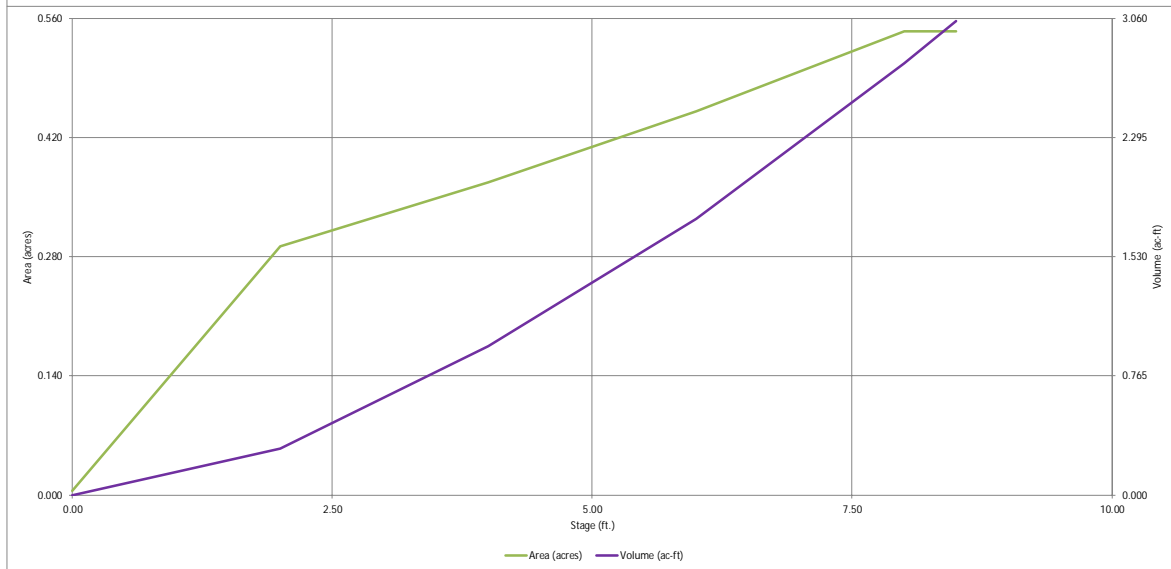
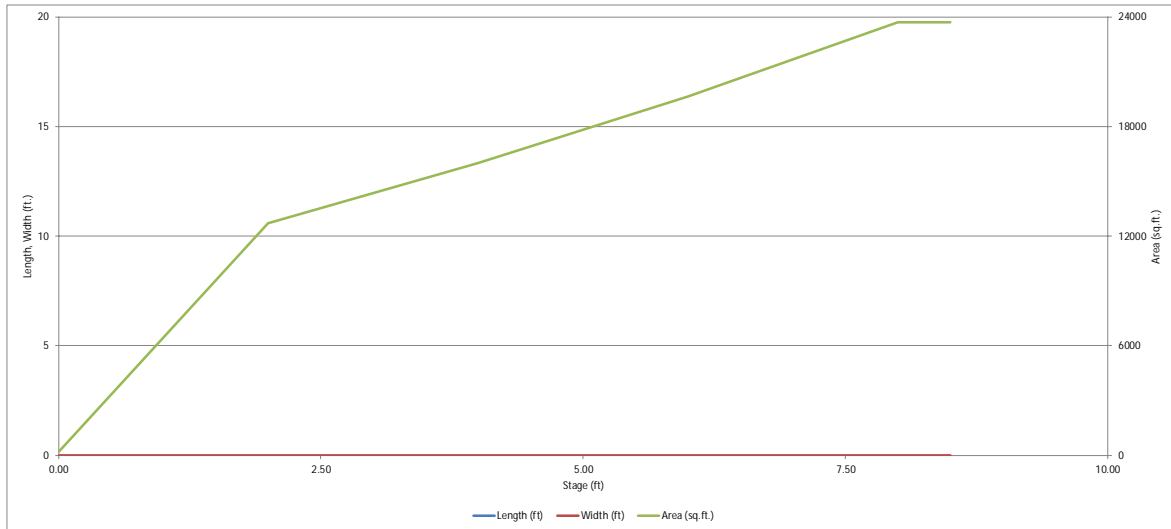

DETENTION BASIN OUTLET STRUCTURE DESIGN

MHFD-*Detention, Version 4.02 (February 2020)*

Project: Meridian Road - Falcon MDDP
Basin ID: BG Filing No. 1 - Ex. Pond 1 - Current Conditions

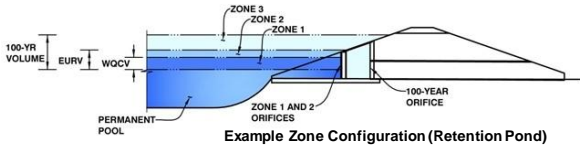

	Estimated Stage (ft)	Estimated Volume (ac-ft)	Outlet Type
Zone 1 (WQCV)	2.38	0.408	Orifice Plate
Zone 2 (EURV)	5.18	1.008	Not Utilized
Zone 3 (100-year)	6.94	0.801	Weir&Pipe (Restrict)
Total (all zones)		2.217	

User Input: Orifice at Underdrain Outlet (typically used to drain WQCV in a Filtration BMP)

Underdrain Orifice Invert Depth =	N/A	ft (distance below the filtration media surface)	Underdrain Orifice Area =	N/A	ft ²
Underdrain Orifice Diameter =	N/A	inches	Underdrain Orifice Centroid =	N/A	feet

User Input: Orifice Plate with one or more orifices or Elliptical Slot Weir (typically used to drain WQCV and/or EURV in a sedimentation BMP)

Invert of Lowest Orifice =	1.00	ft (relative to basin bottom at Stage = 0 ft)	WO Orifice Area per Row =	6.875E-03	ft ²
Depth at top of Zone using Orifice Plate =	4.90	ft (relative to basin bottom at Stage = 0 ft)	Elliptical Half-Width =	N/A	feet
Orifice Plate: Orifice Vertical Spacing =	N/A	inches	Elliptical Slot Centroid =	N/A	feet
Orifice Plate: Orifice Area per Row =	0.99	sq. inches (diameter = 1-1/8 inches)	Elliptical Slot Area =	N/A	ft ²

User Input: Stage and Total Area of Each Orifice Row (numbered from lowest to highest)

	Row 1 (required)	Row 2 (optional)	Row 3 (optional)	Row 4 (optional)	Row 5 (optional)	Row 6 (optional)	Row 7 (optional)	Row 8 (optional)
Stage of Orifice Centroid (ft)	1.00	1.33	1.67	2.00	2.33	2.67	3.00	3.33
Orifice Area (sq. inches)	0.99	0.99	0.99	0.99	0.99	0.99	0.99	0.99

	Row 9 (optional)	Row 10 (optional)	Row 11 (optional)	Row 12 (optional)	Row 13 (optional)	Row 14 (optional)	Row 15 (optional)	Row 16 (optional)
Stage of Orifice Centroid (ft)	3.67	4.00	4.33	4.67				
Orifice Area (sq. inches)	0.99	0.99	0.99	0.99				

User Input: Vertical Orifice (Circular or Rectangular)

	Not Selected	Not Selected			Not Selected	Not Selected
Invert of Vertical Orifice =	N/A	N/A	ft (relative to basin bottom at Stage = 0 ft)	Vertical Orifice Area =	N/A	N/A
Depth at top of Zone using Vertical Orifice =	N/A	N/A	ft (relative to basin bottom at Stage = 0 ft)	Vertical Orifice Centroid =	N/A	N/A
Vertical Orifice Diameter =	N/A	N/A	inches			

User Input: Overflow Weir (Dropbox with Flat or Sloped Gate and Outlet Pipe OR Rectangular/Trapezoidal Weir (and No Outlet Pipe))

	Zone 3 Weir	Not Selected			Zone 3 Weir	Not Selected
Overflow Weir Front Edge Height, Ho =	5.00	N/A	ft (relative to basin bottom at Stage = 0 ft)	Height of Gate Upper Edge, Hi =	5.00	N/A
Overflow Weir Front Edge Length =	4.00	N/A	feet	Overflow Weir Slope Length =	2.55	N/A
Overflow Weir Gate Slope =	0.00	N/A	H:V	Gate Open Area / 100-yr Orifice Area =	2.27	N/A
Horiz. Length of Weir Sides =	2.55	N/A	feet	Overflow Gate Open Area w/o Debris =	7.14	N/A
Overflow Gate Open Area % =	70%	N/A	%, gate open area/total area	Overflow Gate Open Area w/ Debris =	3.57	N/A
Debris Clogging % =	50%	N/A	%			

User Input: Outlet Pipe w/ Flow Restriction Plate (Circular Orifice, Restrictor Plate, or Rectangular Orifice)

	Zone 3 Restrictor	Not Selected			Zone 3 Restrictor	Not Selected
Depth to Invert of Outlet Pipe =	0.00	N/A	ft (distance below basin bottom at Stage = 0 ft)	Outlet Orifice Area =	3.14	N/A
Outlet Pipe Diameter =	24.00	N/A	inches	Outlet Orifice Centroid =	1.00	N/A
Restrictor Plate Height Above Pipe Invert =	24.00		inches	Half-Central Angle of Restrictor Plate on Pipe =	3.14	N/A

User Input: Emergency Spillway (Rectangular or Trapezoidal)

Spillway Invert Stage =	7.61	ft (relative to basin bottom at Stage = 0 ft)	Spillway Design Flow Depth =	0.54	feet
Spillway Crest Length =	24.00	feet	Stage at Top of Freeboard =	8.50	feet
Spillway End Slopes =	3.00	H:V	Basin Area at Top of Freeboard =	0.54	acres
Freeboard above Max Water Surface =	0.35	feet	Basin Volume at Top of Freeboard =	3.04	acre-ft

Routed Hydrograph Results

The user can override the default CUHP hydrographs and runoff volumes by entering new values in the Inflow Hydrographs table (Columns W through AF).

	WQCV	EURV	2 Year	5 Year	10 Year	25 Year	50 Year	100 Year	500 Year
Design Storm Return Period									
One-Hour Rainfall Depth (in)	N/A	N/A	1.19	1.50	1.75	2.00	2.25	2.52	3.68
CUHP Runoff Volume (acre-ft)	0.408	1.416	1.022	1.354	1.619	2.020	2.412	2.906	4.962
Inflow Hydrograph Volume (acre-ft)	N/A	N/A	1.022	1.354	1.619	2.020	2.412	2.906	4.962
CUHP Predevelopment Peak Q (cfs)	N/A	N/A	0.3	0.5	0.7	6.2	12.0	19.6	49.3
OPTIONAL Override Predevelopment Peak Q (cfs)	N/A	N/A							
Predevelopment Unit Peak Flow, q (cfs/acre)	N/A	N/A	0.01	0.02	0.03	0.27	0.53	0.86	2.16
Peak Inflow Q (cfs)	N/A	N/A	19.9	26.3	31.5	41.5	50.8	63.9	108.8
Peak Outflow Q (cfs)	0.1	2.3	0.4	0.5	3.3	8.3	15.1	22.0	47.4
Ratio Peak Outflow to Predevelopment Q	N/A	N/A	N/A	1.0	4.7	1.3	1.3	1.1	1.0
Structure Controlling Flow	Plate	Overflow Weir 1	Plate	Plate	Overflow Weir 1	Overflow Weir 1	Overflow Weir 1	Overflow Weir 1	Spillway
Max Velocity through Gate 1 (fps)	N/A	0.30	N/A	N/A	0.4	1.1	2.0	3.0	4.9
Max Velocity through Gate 2 (fps)	N/A	N/A	N/A	N/A	N/A	N/A	N/A	N/A	N/A
Time to Drain 97% of Inflow Volume (hours)	>120	>120	>120	>120	>120	>120	>120	>120	91
Time to Drain 99% of Inflow Volume (hours)	>120	>120	>120	>120	>120	>120	>120	>120	>120
Maximum Ponding Depth (ft)	2.38	5.18	4.05	4.86	5.21	5.42	5.68	6.08	7.90
Area at Maximum Ponding Depth (acres)	0.31	0.42	0.37	0.40	0.42	0.43	0.44	0.45	0.54
Maximum Volume Stored (acre-ft)	0.411	1.418	0.971	1.283	1.431	1.515	1.627	1.810	2.716

DETENTION BASIN OUTLET STRUCTURE DESIGN

MHFD-Detention, Version 4.00 (December 2019)

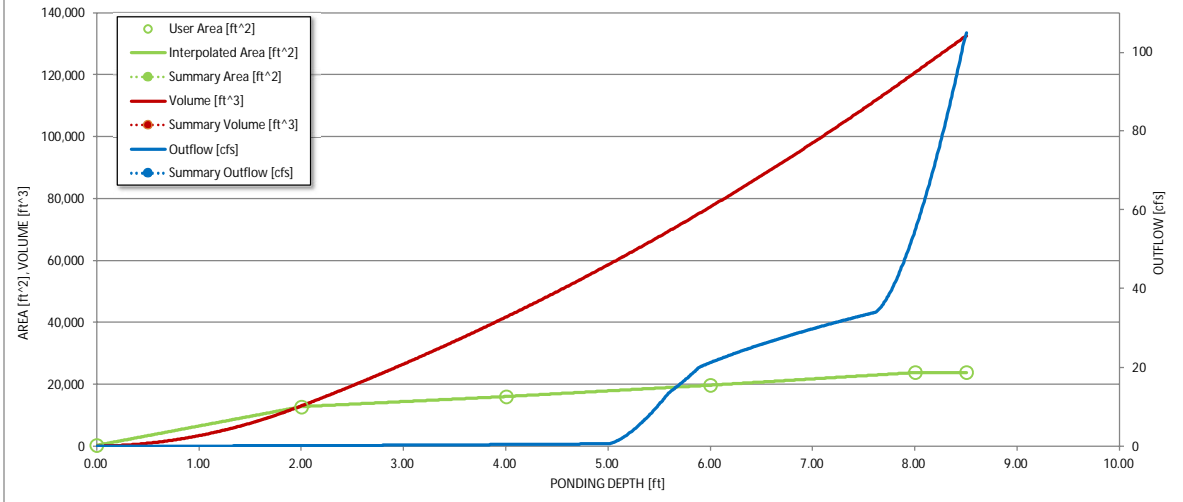
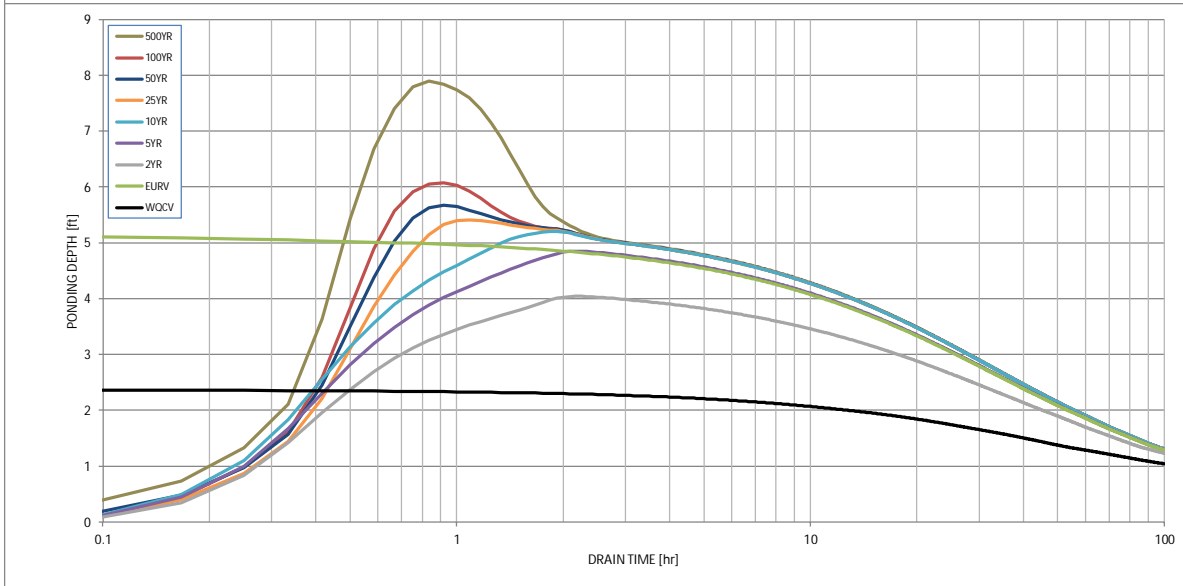
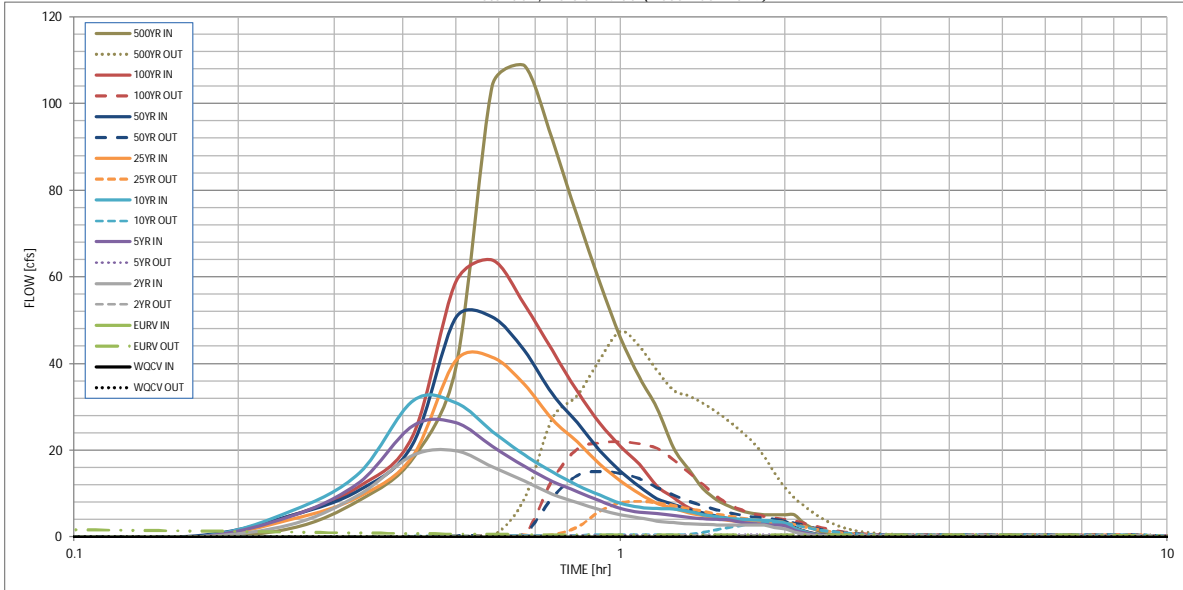

S-A-V-D Chart Axis Override

	X-axis	Left Y-Axis	Right Y-Axis
minimum bound			
maximum bound			

DETENTION BASIN STAGE-STORAGE TABLE BUILDER

UD-Detention, Version 3.07 (February 2017)

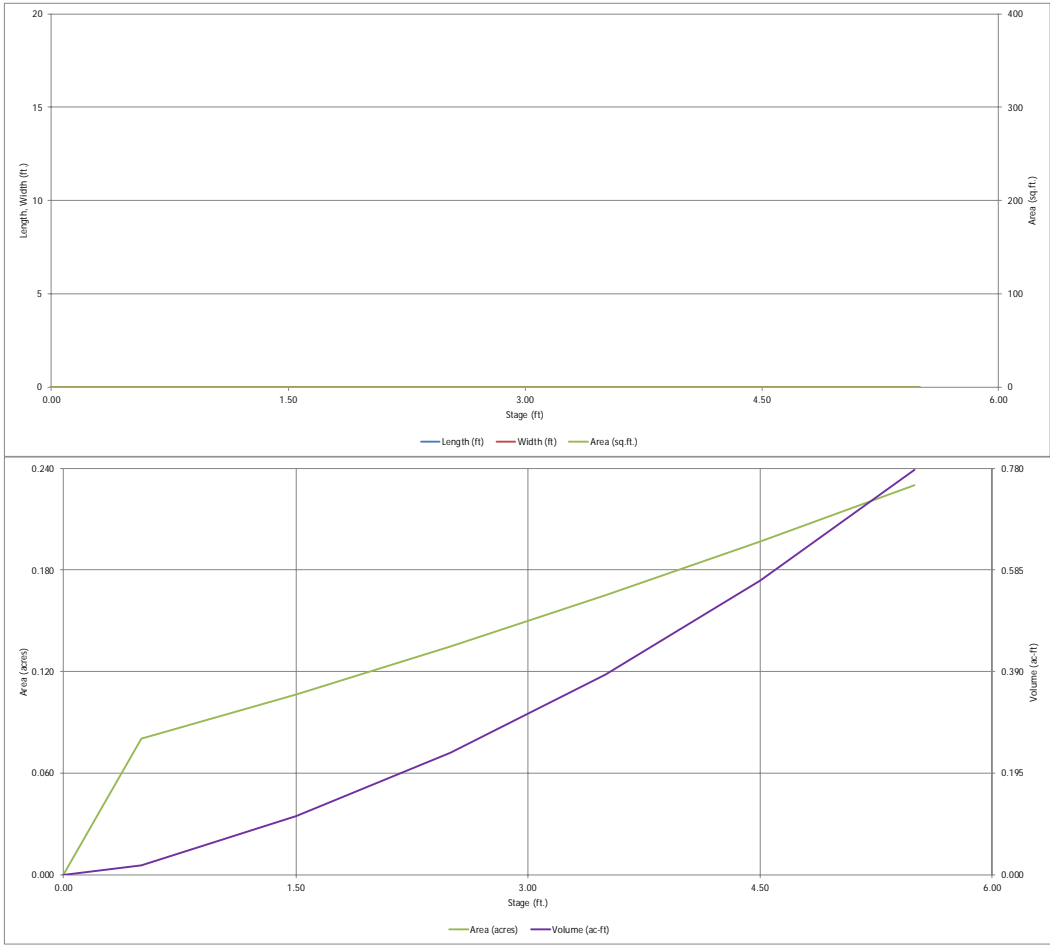

Detention Basin Outlet Structure Design

UD-Detention, Version 3.07 (February 2017)

Project: **Bent Grass Residential Filing No. 2**

Basin ID: **Pond (North)**

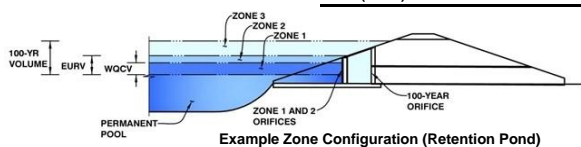

	Stage (ft)	Zone Volume (ac-ft)	Outlet Type
Zone 1 (WOCV)	3.10	0.320	Orifice Plate
Zone 2			
Zone 3			
		0.320	Total

User Input: Orifice at Underdrain Outlet (typically used to drain WOCV in a Filtration BMP)

Underdrain Orifice Invert Depth = ft (distance below the filtration media surface)
 Underdrain Orifice Diameter = inches

Calculated Parameters for Underdrain

Underdrain Orifice Area = ft²
 Underdrain Orifice Centroid = feet

User Input: Orifice Plate with one or more orifices or Elliptical Slot Weir (typically used to drain WOCV and/or EURV in a sedimentation BMP)

Invert of Lowest Orifice = ft (relative to basin bottom at Stage = 0 ft)
 Depth at top of Zone using Orifice Plate = ft (relative to basin bottom at Stage = 0 ft)
 Orifice Plate: Orifice Vertical Spacing = inches
 Orifice Plate: Orifice Area per Row = sq. inches (diameter = 1-7/16 inches)

Calculated Parameters for Plate

WQ Orifice Area per Row = ft²
 Elliptical Half-Width = feet
 Elliptical Slot Centroid = feet
 Elliptical Slot Area = ft²

User Input: Stage and Total Area of Each Orifice Row (numbered from lowest to highest)

	Row 1 (required)	Row 2 (optional)	Row 3 (optional)	Row 4 (optional)	Row 5 (optional)	Row 6 (optional)	Row 7 (optional)	Row 8 (optional)
Stage of Orifice Centroid (ft)	0.00	1.00	2.00					
Orifice Area (sq. inches)	1.66	1.66	1.66					

	Row 9 (optional)	Row 10 (optional)	Row 11 (optional)	Row 12 (optional)	Row 13 (optional)	Row 14 (optional)	Row 15 (optional)	Row 16 (optional)
Stage of Orifice Centroid (ft)								
Orifice Area (sq. inches)								

User Input: Vertical Orifice (Circular or Rectangular)

Invert of Vertical Orifice = ft (relative to basin bottom at Stage = 0 ft)
 Depth at top of Zone using Vertical Orifice = ft (relative to basin bottom at Stage = 0 ft)
 Vertical Orifice Diameter = inches

Calculated Parameters for Vertical Orifice

Vertical Orifice Area = ft²
 Vertical Orifice Centroid = feet

User Input: Overflow Weir (Dropbox) and Grate (Flat or Sloped)

Overflow Weir Front Edge Height, H_o = ft (relative to basin bottom at Stage = 0 ft)
 Overflow Weir Front Edge Length = feet
 Overflow Weir Slope = H:V (enter zero for flat grate)
 Horiz. Length of Weir Sides = feet
 Overflow Grate Open Area % = % grate open area/total area
 Debris Clogging % = %

Calculated Parameters for Overflow Weir

Height of Grate Upper Edge, H₁ = feet
 Over Flow Weir Slope Length = feet
 Grate Open Area / 100-yr Orifice Area = should be ≥ 4
 Overflow Grate Open Area w/o Debris = ft²
 Overflow Grate Open Area w/ Debris = ft²

User Input: Outlet Pipe w/ Flow Restriction Plate (Circular Orifice, Restrictor Plate, or Rectangular Orifice)

Depth to Invert of Outlet Pipe = ft (distance below basin bottom at Stage = 0 ft)
 Circular Orifice Diameter = inches

Calculated Parameters for Outlet Pipe w/ Flow Restriction Plate

Outlet Orifice Area = ft²
 Outlet Orifice Centroid = feet
 Half-Central Angle of Restrictor Plate on Pipe = radians

User Input: Emergency Spillway (Rectangular or Trapezoidal)

Spillway Invert Stage = ft (relative to basin bottom at Stage = 0 ft)
 Spillway Crest Length = feet
 Spillway End Slopes = H:V
 Freeboard above Max Water Surface = feet

Calculated Parameters for Spillway

Spillway Design Flow Depth = feet
 Stage at Top of Freeboard = feet
 Basin Area at Top of Freeboard = acres

Routed Hydrograph Results

	WOCV	EURV	2 Year	5 Year	10 Year	25 Year	50 Year	100 Year	500 Year
Design Storm Return Period									
One-Hour Rainfall Depth (in)	0.53	1.07	1.19	1.50	1.75	2.00	2.25	2.52	3.68
Calculated Runoff Volume (acre-ft)	0.320	1.043	0.711	0.936	1.154	1.445	1.817	2.259	3.846
OPTIONAL Override Runoff Volume (acre-ft)									
Inflow Hydrograph Volume (acre-ft)	0.320	1.043	0.710	0.936	1.154	1.445	1.817	2.259	3.847
Predevelopment Unit Peak Flow, q (cfs/acre)	0.00	0.00	0.00	0.00	0.01	0.02	0.15	0.38	1.02
Predevelopment Peak Q (cfs)	0.0	0.0	0.0	0.1	0.2	0.4	3.0	7.2	19.5
Peak Inflow Q (cfs)	4.5	14.5	9.9	13.0	16.1	20.0	25.1	31.1	52.6
Peak Outflow Q (cfs)	0.2	13.2	8.3	12.2	18.5	19.2	32.9	37.0	68.4
Ratio Peak Outflow to Predevelopment Q	N/A	N/A	N/A	159.6	104.1	48.2	11.1	5.1	3.5
Structure Controlling Flow	Plate	Spillway	Spillway	Spillway	Spillway	Spillway	Spillway	Spillway	Spillway
Max Velocity through Grate 1 (fps)	N/A	N/A	N/A	N/A	N/A	N/A	N/A	N/A	N/A
Max Velocity through Grate 2 (fps)	N/A	N/A	N/A	N/A	N/A	N/A	N/A	N/A	N/A
Time to Drain 97% of Inflow Volume (hours)	38	34	37	35	33	31	28	26	19
Time to Drain 99% of Inflow Volume (hours)	40	40	42	41	40	39	38	37	32
Maximum Ponding Depth (ft)	2.87	3.47	3.41	3.46	3.53	3.54	3.66	3.69	3.91
Area at Maximum Ponding Depth (acres)	0.15	0.16	0.16	0.16	0.17	0.17	0.17	0.17	0.18
Maximum Volume Stored (acre-ft)	0.286	0.379	0.369	0.377	0.389	0.389	0.410	0.416	0.454

Detention Basin Outlet Structure Design

UD-Detention, Version 3.07 (February 2017)

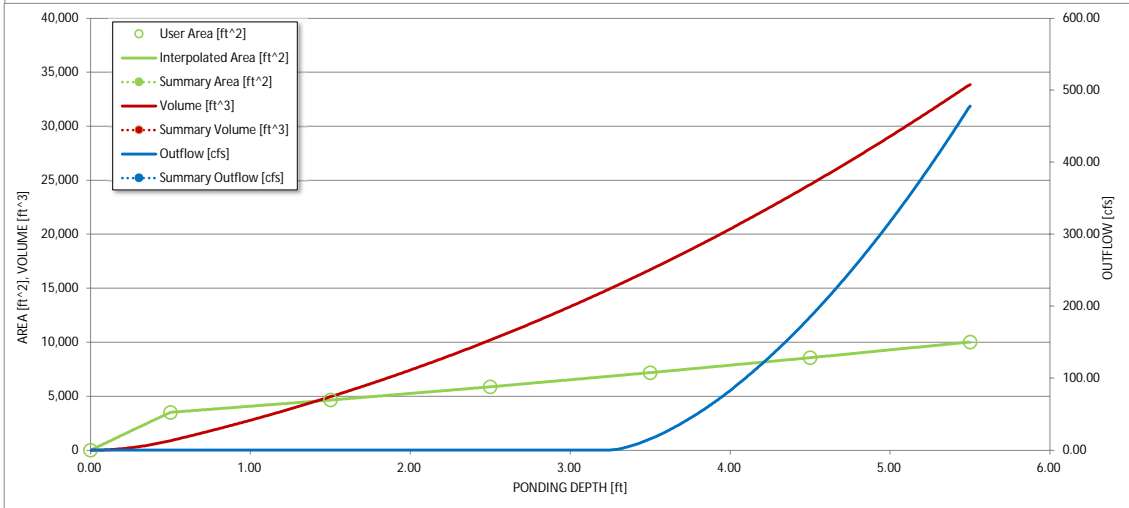
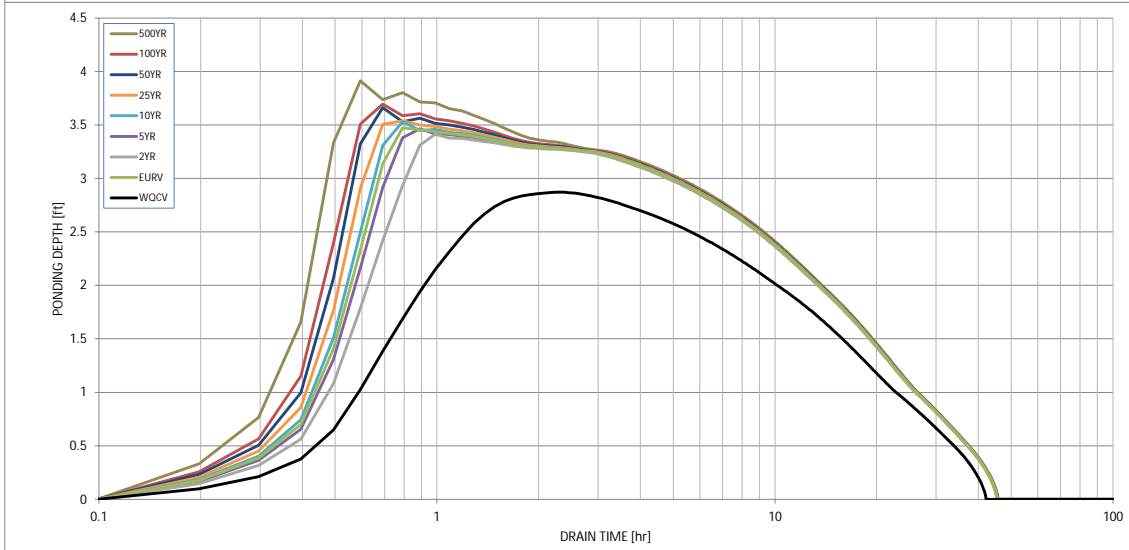
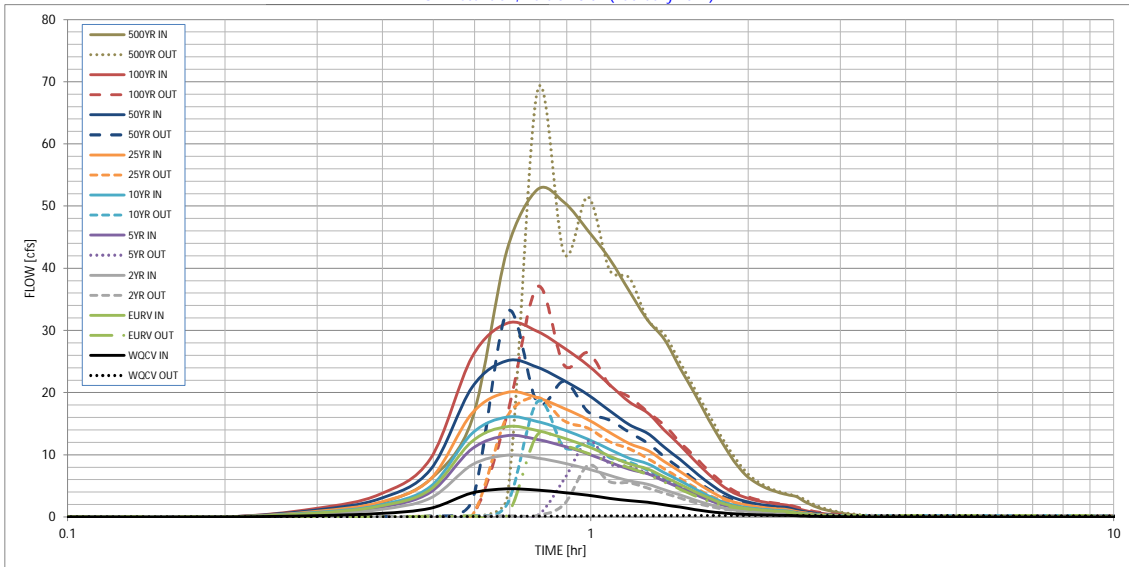

S-A-V-D Chart Axis Override

	X-axis	Left Y-Axis	Right Y-Axis
minimum bound			
maximum bound			

DETENTION BASIN STAGE-STORAGE TABLE BUILDER

UD-Detention, Version 3.07 (February 2017)

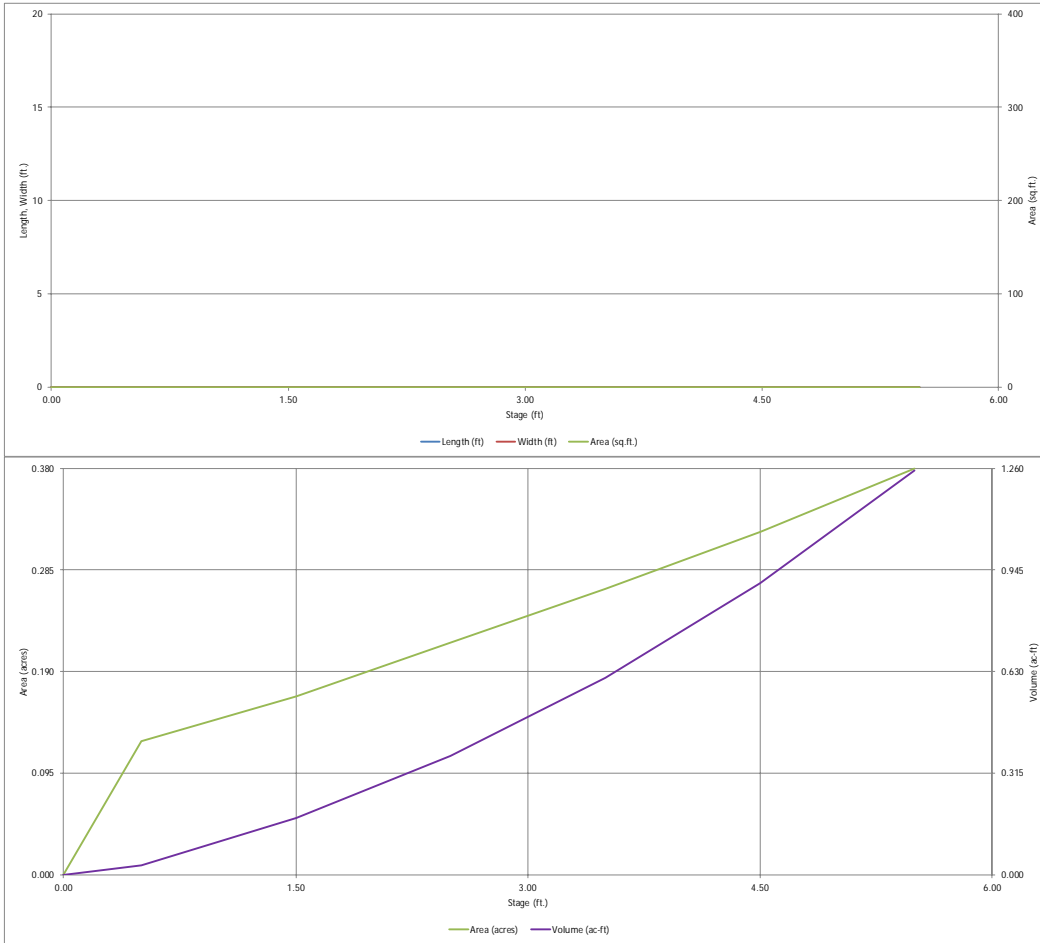

Detention Basin Outlet Structure Design

UD-Detention, Version 3.07 (February 2017)

Project: Bent Grass Residential Filing No. 2
Basin ID: Pond (South)

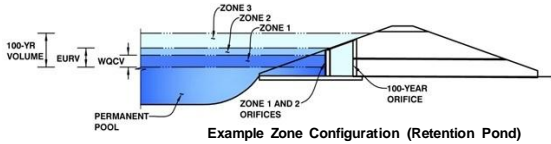

	Stage (ft)	Zone Volume (ac-ft)	Outlet Type
Zone 1 (WQCV)	3.22	0.536	Orifice Plate
Zone 2			Not Utilized
Zone 3			Not Utilized
		0.536	Total

User Input: Orifice at Underdrain Outlet (typically used to drain WQCV in a Filtration BMP)

Underdrain Orifice Invert Depth = ft (distance below the filtration media surface)
 Underdrain Orifice Diameter = inches

Calculated Parameters for Underdrain

Underdrain Orifice Area = ft²
 Underdrain Orifice Centroid = feet

User Input: Orifice Plate with one or more orifices or Elliptical Slot Weir (typically used to drain WQCV and/or EURV in a sedimentation BMP)

Invert of Lowest Orifice = ft (relative to basin bottom at Stage = 0 ft)
 Depth at top of Zone using Orifice Plate = ft (relative to basin bottom at Stage = 0 ft)
 Orifice Plate: Orifice Vertical Spacing = inches
 Orifice Plate: Orifice Area per Row = sq. inches (diameter = 1-7/8 inches)

Calculated Parameters for Plate

WQ Orifice Area per Row = ft²
 Elliptical Half-Width = feet
 Elliptical Slot Centroid = feet
 Elliptical Slot Area = ft²

User Input: Stage and Total Area of Each Orifice Row (numbered from lowest to highest)

	Row 1 (required)	Row 2 (optional)	Row 3 (optional)	Row 4 (optional)	Row 5 (optional)	Row 6 (optional)	Row 7 (optional)	Row 8 (optional)
Stage of Orifice Centroid (ft)	0.00	1.10	2.20					
Orifice Area (sq. inches)	2.75	2.75	2.75					

	Row 9 (optional)	Row 10 (optional)	Row 11 (optional)	Row 12 (optional)	Row 13 (optional)	Row 14 (optional)	Row 15 (optional)	Row 16 (optional)
Stage of Orifice Centroid (ft)								
Orifice Area (sq. inches)								

User Input: Vertical Orifice (Circular or Rectangular)

Invert of Vertical Orifice = ft (relative to basin bottom at Stage = 0 ft)
 Depth at top of Zone using Vertical Orifice = ft (relative to basin bottom at Stage = 0 ft)
 Vertical Orifice Diameter = inches

Calculated Parameters for Vertical Orifice

Vertical Orifice Area = ft²
 Vertical Orifice Centroid = feet

User Input: Overflow Weir (Dropbox) and Grate (Flat or Sloped)

Overflow Weir Front Edge Height, Ho = ft (relative to basin bottom at Stage = 0 ft)
 Overflow Weir Front Edge Length = feet
 Overflow Weir Slope = H:V (enter zero for flat grate)
 Horiz. Length of Weir Sides = feet
 Overflow Grate Open Area % = % , grate open area/total area
 Debris Clogging % = %

Calculated Parameters for Overflow Weir

Height of Grate Upper Edge, H₁ = feet
 Over Flow Weir Slope Length = feet
 Grate Open Area / 100-yr Orifice Area = should be ≥ 4
 Overflow Grate Open Area w/o Debris = ft²
 Overflow Grate Open Area w/ Debris = ft²

User Input: Outlet Pipe w/ Flow Restriction Plate (Circular Orifice, Restrictor Plate, or Rectangular Orifice)

Depth to Invert of Outlet Pipe = ft (distance below basin bottom at Stage = 0 ft)
 Circular Orifice Diameter = inches

Calculated Parameters for Outlet Pipe w/ Flow Restriction Plate

Outlet Orifice Area = ft²
 Outlet Orifice Centroid = feet
 Half-Central Angle of Restrictor Plate on Pipe = radians

User Input: Emergency Spillway (Rectangular or Trapezoidal)

Spillway Invert Stage = ft (relative to basin bottom at Stage = 0 ft)
 Spillway Crest Length = feet
 Spillway End Slopes = H:V
 Freeboard above Max Water Surface = feet

Calculated Parameters for Spillway

Spillway Design Flow Depth = feet
 Stage at Top of Freeboard = feet
 Basin Area at Top of Freeboard = acres

Routed Hydrograph Results

	WQCV	EURV	2 Year	5 Year	10 Year	25 Year	50 Year	100 Year	500 Year
Design Storm Return Period									
One-Hour Rainfall Depth (in)	0.53	1.07	1.19	1.50	1.75	2.00	2.25	2.52	3.68
Calculated Runoff Volume (acre-ft)	0.536	1.866	1.276	1.674	2.056	2.545	3.141	3.840	6.387
OPTIONAL Override Runoff Volume (acre-ft)									
Inflow Hydrograph Volume (acre-ft)	0.536	1.866	1.275	1.674	2.055	2.544	3.141	3.840	6.382
Predevelopment Unit Peak Flow, q (cfs/acre)	0.00	0.00	0.00	0.00	0.01	0.02	0.18	0.43	1.16
Predevelopment Peak Q (cfs)	0.0	0.0	0.0	0.1	0.3	0.7	5.4	13.0	34.7
Peak Inflow Q (cfs)	8.3	28.6	19.6	25.7	31.5	38.8	47.8	58.2	95.7
Peak Outflow Q (cfs)	0.4	30.1	14.5	21.3	32.8	37.3	57.5	66.0	113.4
Ratio Peak Outflow to Predevelopment Q	N/A	N/A	N/A	153.5	101.7	51.7	10.7	5.1	3.3
Structure Controlling Flow	Plate	Spillway	Spillway	Spillway	Spillway	Spillway	Spillway	Spillway	Spillway
Max Velocity through Grate 1 (fps)	N/A	N/A	N/A	N/A	N/A	N/A	N/A	N/A	N/A
Max Velocity through Grate 2 (fps)	N/A	N/A	N/A	N/A	N/A	N/A	N/A	N/A	N/A
Time to Drain 97% of Inflow Volume (hours)	38	33	36	34	32	30	27	25	19
Time to Drain 99% of Inflow Volume (hours)	40	40	41	40	39	38	37	36	32
Maximum Ponding Depth (ft)	3.01	3.58	3.45	3.52	3.60	3.64	3.76	3.81	4.05
Area at Maximum Ponding Depth (acres)	0.24	0.27	0.26	0.27	0.27	0.27	0.28	0.28	0.30
Maximum Volume Stored (acre-ft)	0.483	0.632	0.597	0.613	0.637	0.646	0.682	0.696	0.765

Detention Basin Outlet Structure Design

UD-Detention, Version 3.07 (February 2017)

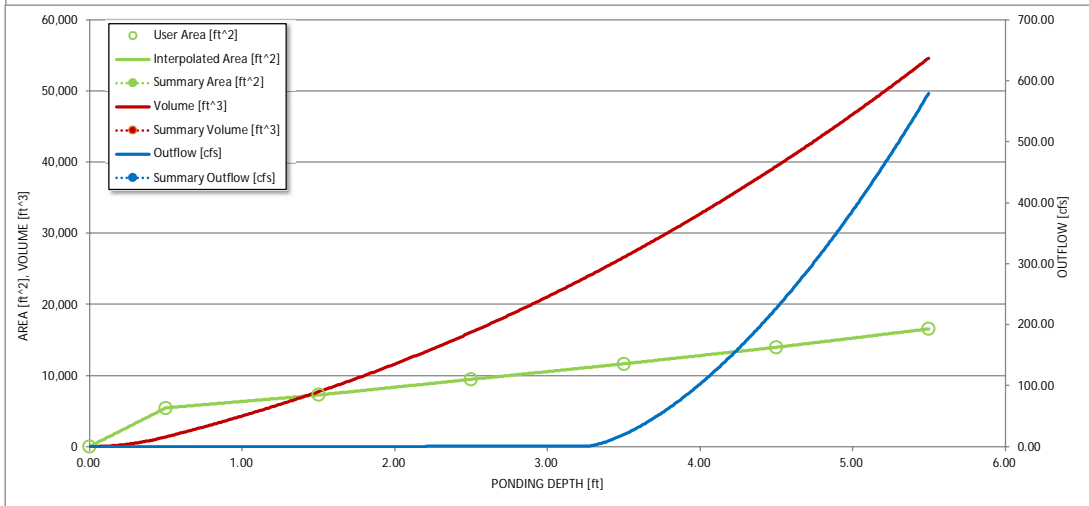
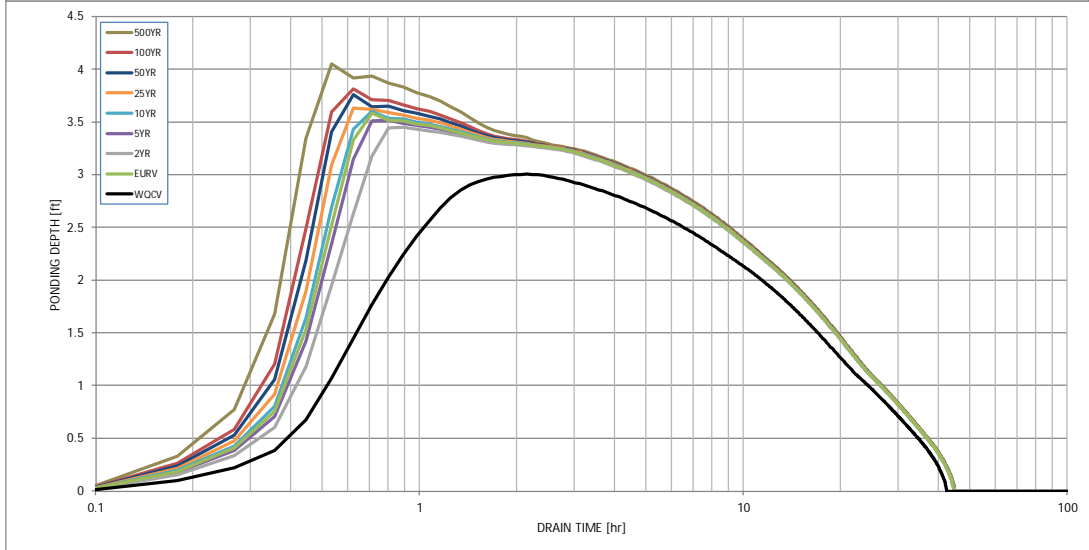
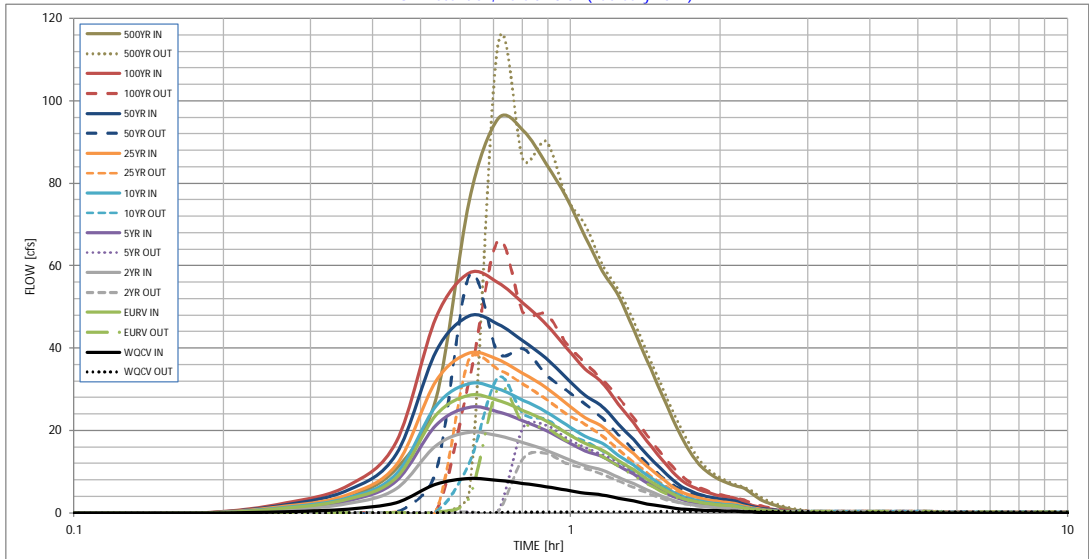

S-A-V-D Chart Axis Override

	X-axis	Left Y-Axis	Right Y-Axis
minimum bound			
maximum bound			

Future Pond Calculations

DETENTION BASIN STAGE-STORAGE TABLE BUILDER

MHFD- Detention, Version 4.02 (February 2020)

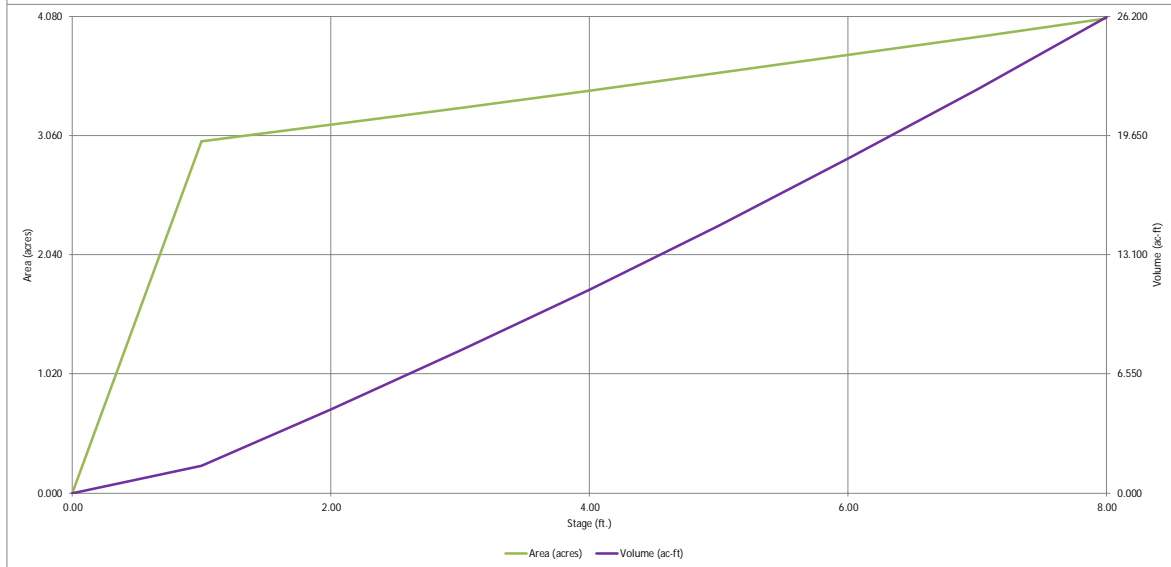
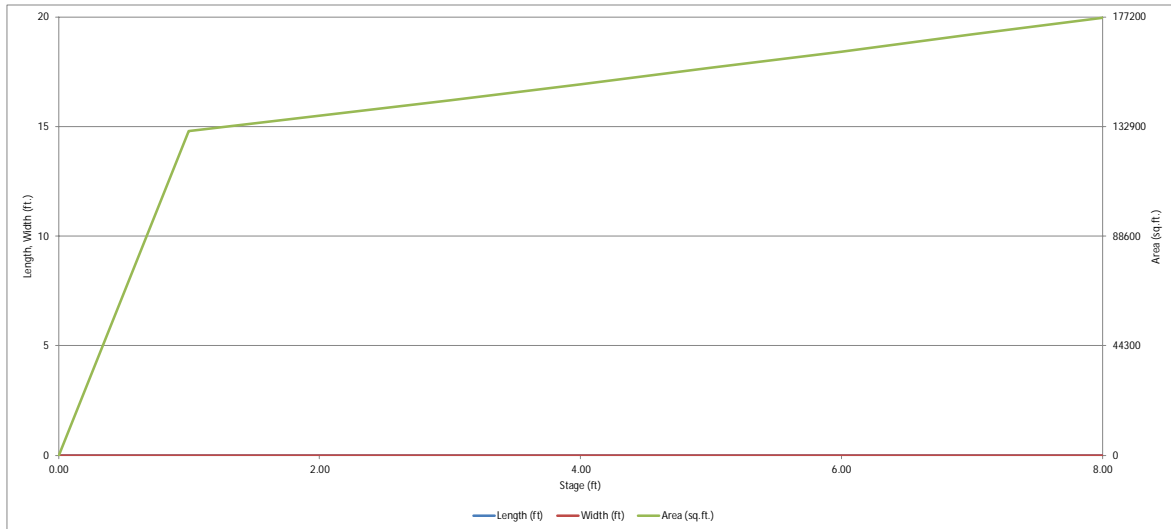

DETENTION BASIN OUTLET STRUCTURE DESIGN

MHFD-Detention, Version 4.02 (February 2020)

Project: Meridian Road - Falcon MDDP
Basin ID: Future Pond for Offsite Flows

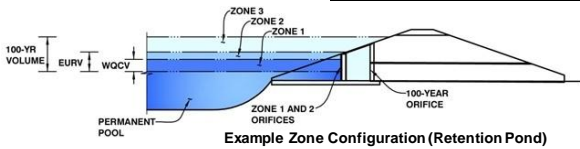

	Estimated Stage (ft)	Estimated Volume (ac-ft)	Outlet Type
Zone 1 (WQCV)	1.42	2.757	Orifice Plate
Zone 2 (EURV)	2.53	3.501	Circular Orifice
Zone 3 (100-year)	4.24	5.720	Weir&Pipe (Restrict)
Total (all zones)		11.977	

User Input: Orifice at Underdrain Outlet (typically used to drain WQCV in a Filtration BMP)

Underdrain Orifice Invert Depth =	N/A	ft (distance below the filtration media surface)
Underdrain Orifice Diameter =	N/A	inches

Calculated Parameters for Underdrain		
Underdrain Orifice Area =	N/A	ft ²
Underdrain Orifice Centroid =	N/A	feet

User Input: Orifice Plate with one or more orifices or Elliptical Slot Weir (typically used to drain WQCV and/or EURV in a sedimentation BMP)

Invert of Lowest Orifice =	0.00	ft (relative to basin bottom at Stage = 0 ft)
Depth at top of Zone using Orifice Plate =	1.42	ft (relative to basin bottom at Stage = 0 ft)
Orifice Plate: Orifice Vertical Spacing =	5.70	inches
Orifice Plate: Orifice Area per Row =	16.00	sq. inches (use rectangular openings)

Calculated Parameters for Plate		
WO Orifice Area per Row =	1.111E-01	ft ²
Elliptical Half-Width =	N/A	feet
Elliptical Slot Centroid =	N/A	feet
Elliptical Slot Area =	N/A	ft ²

User Input: Stage and Total Area of Each Orifice Row (numbered from lowest to highest)

	Row 1 (required)	Row 2 (optional)	Row 3 (optional)	Row 4 (optional)	Row 5 (optional)	Row 6 (optional)	Row 7 (optional)	Row 8 (optional)
Stage of Orifice Centroid (ft)	0.00	0.47	0.95					
Orifice Area (sq. inches)	16.00	16.00	16.00					

	Row 9 (optional)	Row 10 (optional)	Row 11 (optional)	Row 12 (optional)	Row 13 (optional)	Row 14 (optional)	Row 15 (optional)	Row 16 (optional)
Stage of Orifice Centroid (ft)								
Orifice Area (sq. inches)								

User Input: Vertical Orifice (Circular or Rectangular)

	Zone 2 Circular	Not Selected	
Invert of Vertical Orifice =	1.50	N/A	ft (relative to basin bottom at Stage = 0 ft)
Depth at top of Zone using Vertical Orifice =	2.53	N/A	ft (relative to basin bottom at Stage = 0 ft)
Vertical Orifice Diameter =	12.00	N/A	inches

Calculated Parameters for Vertical Orifice		
Vertical Orifice Area =	0.79	N/A
Vertical Orifice Centroid =	0.50	N/A

User Input: Overflow Weir (Dropbox with Flat or Sloped Gate and Outlet Pipe OR Rectangular/Trapezoidal Weir (and No Outlet Pipe))

	Zone 3 Weir	Not Selected	
Overflow Weir Front Edge Height, Ho =	2.60	N/A	ft (relative to basin bottom at Stage = 0 ft)
Overflow Weir Front Edge Length =	2.92	N/A	feet
Overflow Weir Gate Slope =	0.00	N/A	H:V
Horiz. Length of Weir Sides =	5.82	N/A	feet
Overflow Gate Open Area % =	70%	N/A	%, gate open area/total area
Debris Clogging % =	50%	N/A	%

Calculated Parameters for Overflow Weir		
Height of Gate Upper Edge, Hi =	2.60	N/A
Overflow Weir Slope Length =	5.82	N/A
Gate Open Area / 100-yr Orifice Area =	4.71	N/A
Overflow Gate Open Area w/o Debris =	11.90	N/A
Overflow Gate Open Area w/ Debris =	5.95	N/A

User Input: Outlet Pipe w/ Flow Restriction Plate (Circular Orifice, Restrictor Plate, or Rectangular Orifice)

	Zone 3 Restrictor	Not Selected	
Depth to Invert of Outlet Pipe =	2.50	N/A	ft (distance below basin bottom at Stage = 0 ft)
Outlet Pipe Diameter =	24.00	N/A	inches
Restrictor Plate Height Above Pipe Invert =	18.00		inches

Calculated Parameters for Outlet Pipe w/ Flow Restriction Plate		
Outlet Orifice Area =	2.53	N/A
Outlet Orifice Centroid =	0.83	N/A
Half-Central Angle of Restrictor Plate on Pipe =	2.09	N/A

User Input: Emergency Spillway (Rectangular or Trapezoidal)

Spillway Invert Stage =	5.50	ft (relative to basin bottom at Stage = 0 ft)
Spillway Crest Length =	150.00	feet
Spillway End Slopes =	4.00	H:V
Freeboard above Max Water Surface =	1.00	feet

Calculated Parameters for Spillway		
Spillway Design Flow Depth =	0.75	feet
Stage at Top of Freeboard =	7.25	feet
Basin Area at Top of Freeboard =	3.95	acres
Basin Volume at Top of Freeboard =	23.18	acre-ft

Routed Hydrograph Results

The user can override the default CUHP hydrographs and runoff volumes by entering new values in the Inflow Hydrographs table (Columns W through AF).

	WQCV	EURV	2 Year	5 Year	10 Year	25 Year	50 Year	100 Year	500 Year
Design Storm Return Period									
One-Hour Rainfall Depth (in)	N/A	N/A	1.19	1.50	1.75	2.00	2.25	2.52	3.68
CUHP Runoff Volume (acre-ft)	2.757	6.258	4.304	5.972	7.399	11.188	14.721	19.467	39.641
Inflow Hydrograph Volume (acre-ft)	N/A	N/A	4.304	5.972	7.399	11.188	14.721	19.467	39.641
CUHP Predevelopment Peak Q (cfs)	N/A	N/A	2.0	4.1	5.7	50.3	100.5	165.9	426.8
OPTIONAL Override Predevelopment Peak Q (cfs)	N/A	N/A							
Predevelopment Unit Peak Flow, q (cfs/acre)	N/A	N/A	0.01	0.02	0.02	0.22	0.44	0.73	1.87
Peak Inflow Q (cfs)	N/A	N/A	56.1	79.5	98.2	164.6	223.0	297.7	599.5
Peak Outflow Q (cfs)	1.5	5.0	2.1	3.8	5.8	27.2	29.3	32.2	390.1
Ratio Peak Outflow to Predevelopment Q	N/A	N/A	N/A	0.9	1.0	0.5	0.3	0.2	0.9
Structure Controlling Flow	Plate	Vertical Orifice 1	Vertical Orifice 1	Vertical Orifice 1	Overflow Weir 1	Outlet Plate 1	Outlet Plate 1	Outlet Plate 1	Spillway
Max Velocity through Gate 1 (fps)	N/A	N/A	N/A	N/A	0.0	1.7	1.7	1.8	1.9
Max Velocity through Gate 2 (fps)	N/A	N/A	N/A	N/A	N/A	N/A	N/A	N/A	N/A
Time to Drain 97% of Inflow Volume (hours)	41	53	50	54	56	53	52	51	41
Time to Drain 99% of Inflow Volume (hours)	44	59	54	59	62	62	61	61	55
Maximum Ponding Depth (ft)	1.42	2.53	1.80	2.27	2.65	3.33	4.13	5.32	6.34
Area at Maximum Ponding Depth (acres)	3.07	3.23	3.12	3.19	3.24	3.34	3.46	3.64	3.80
Maximum Volume Stored (acre-ft)	2.781	6.275	3.957	5.408	6.631	8.870	11.592	15.819	19.653

DETENTION BASIN OUTLET STRUCTURE DESIGN

MHFD-Detention, Version 4.00 (December 2019)

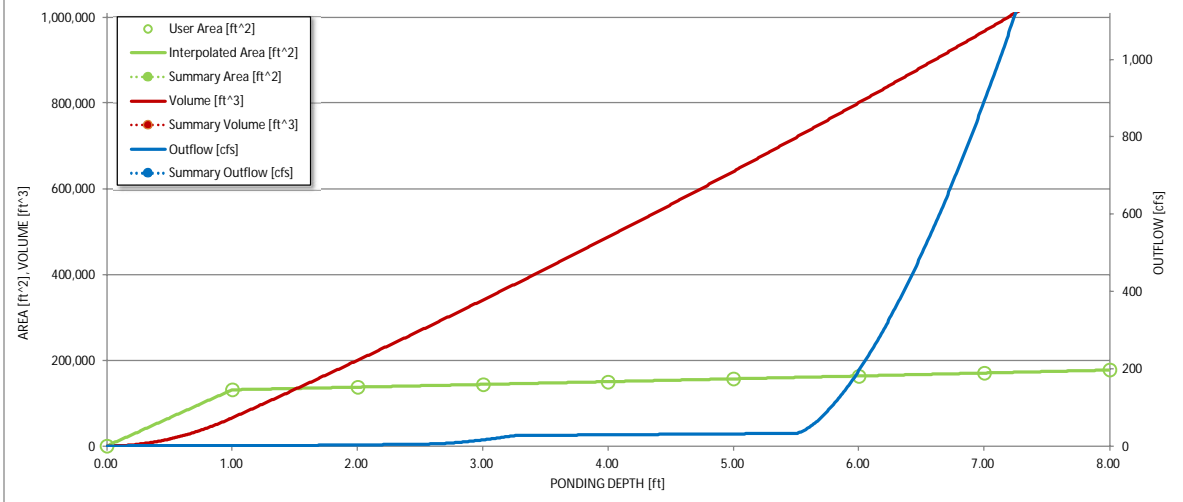
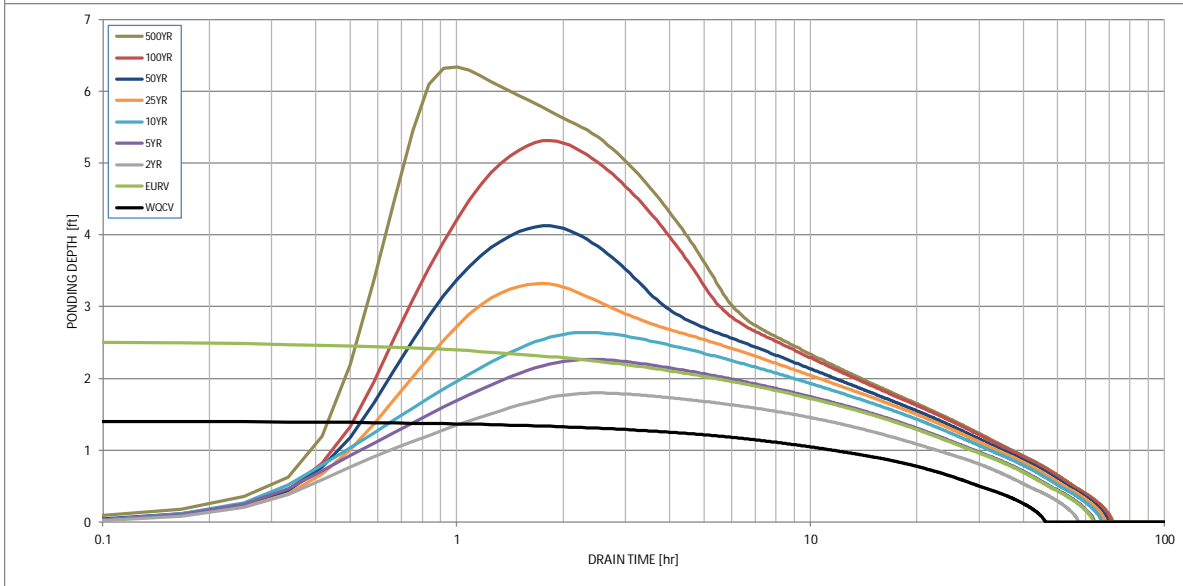
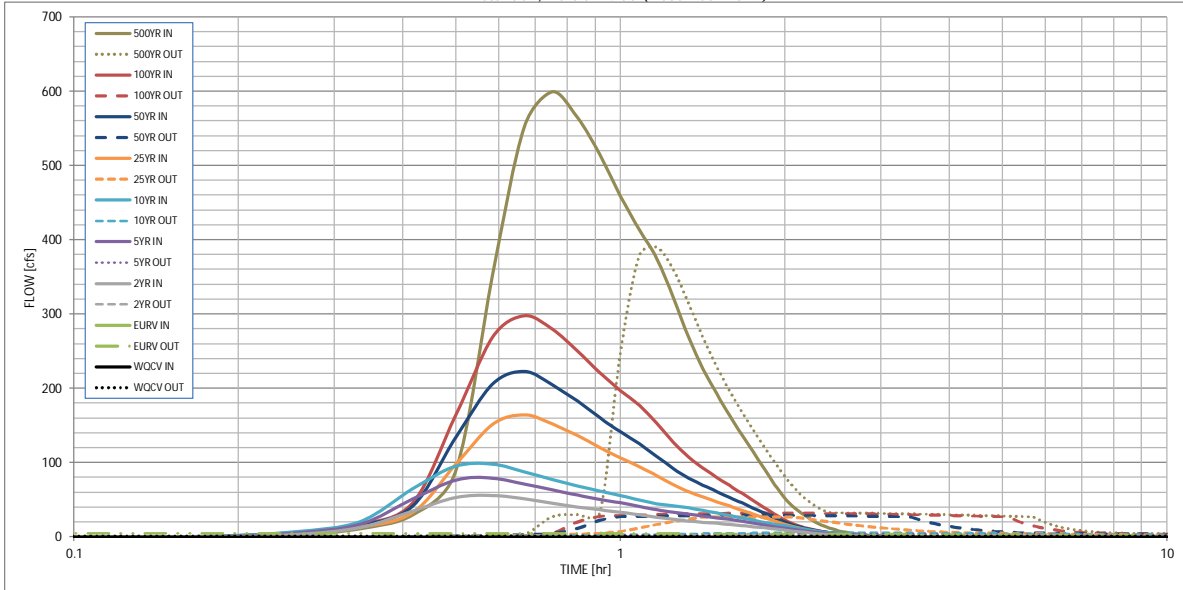

S-A-V-D Chart Axis Override	X-axis	Left Y-Axis	Right Y-Axis
minimum bound			
maximum bound			

DETENTION BASIN STAGE-STORAGE TABLE BUILDER

MHFD-Detention, Version 4.03 (May 2020)

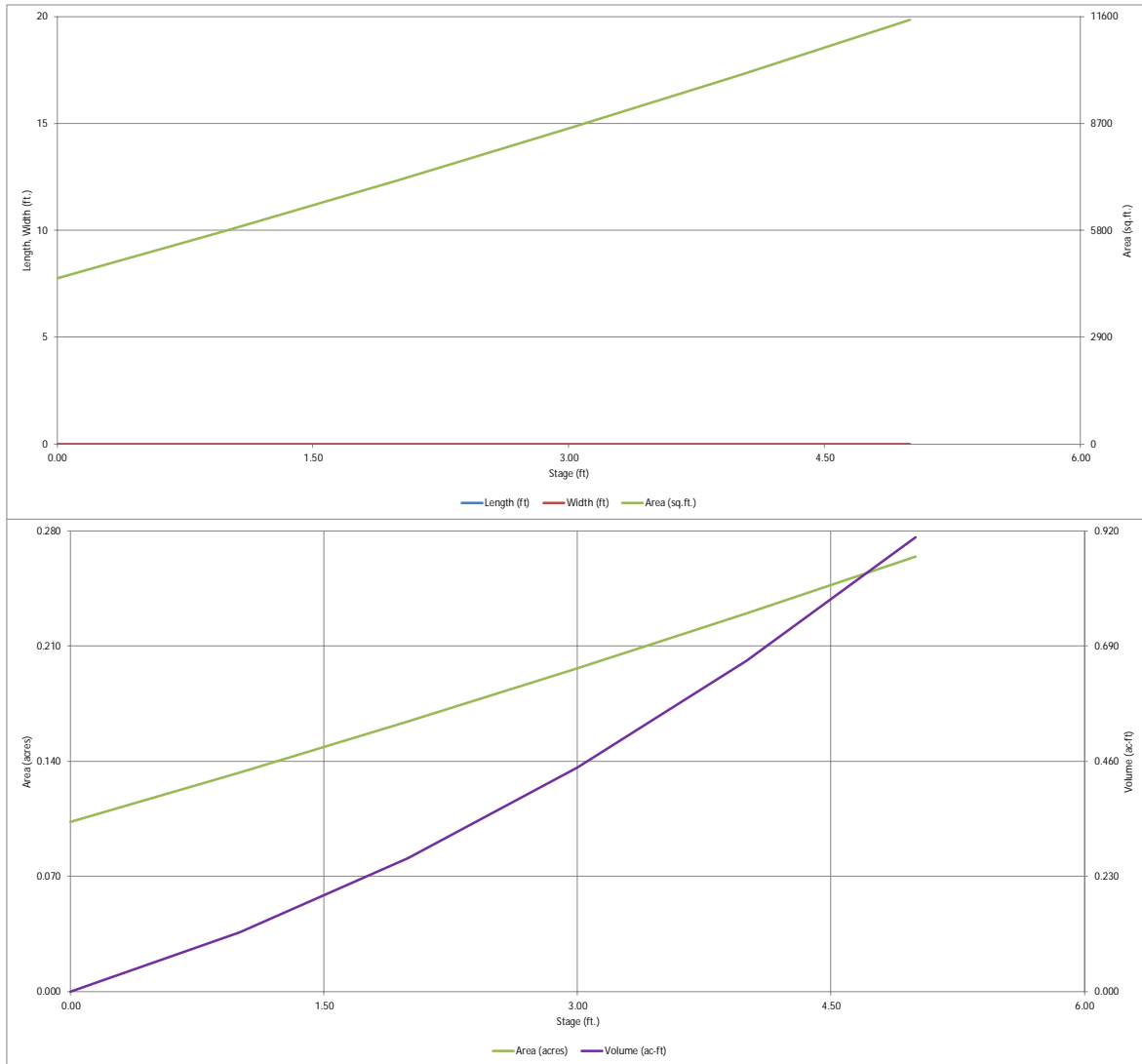

DETENTION BASIN OUTLET STRUCTURE DESIGN

MHFD-Detention, Version 4.03 (May 2020)

Project: Falcon Meadows at Bent Grass
Basin I D: WQCV Pond - North

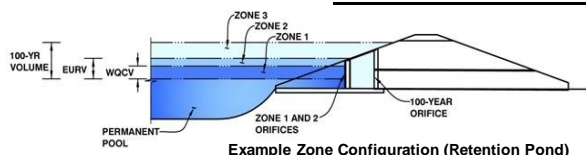

	Estimated Stage (ft)	Estimated Volume (ac-ft)	Outlet Type
Zone 1 (WQCV)	1.74	0.225	Orifice Plate
Zone 2			
Zone 3			
Total (all zones)		0.225	

User Input: Orifice at Underdrain Outlet (typically used to drain WQCV in a Filtration BMP)

Underdrain Orifice Invert Depth = ft (distance below the filtration media surface)
Underdrain Orifice Diameter = inches

Calculated Parameters for Underdrain

Underdrain Orifice Area = ft²
Underdrain Orifice Centroid = feet

User Input: Orifice Plate with one or more orifices or Elliptical Slot Weir (typically used to drain WQCV and/or EURV in a sedimentation BMP)

Invert of Lowest Orifice = ft (relative to basin bottom at Stage = 0 ft)
Depth at top of Zone using Orifice Plate = ft (relative to basin bottom at Stage = 0 ft)
Orifice Plate: Orifice Vertical Spacing = inches
Orifice Plate: Orifice Area per Row = sq. inches (diameter = 1-9/16 inches)

Calculated Parameters for Plate

WQ Orifice Area per Row = ft²
Elliptical Half-Width = feet
Elliptical Slot Centroid = feet
Elliptical Slot Area = ft²

User Input: Stage and Total Area of Each Orifice Row (numbered from lowest to highest)

	Row 1 (required)	Row 2 (optional)	Row 3 (optional)	Row 4 (optional)	Row 5 (optional)	Row 6 (optional)	Row 7 (optional)	Row 8 (optional)
Stage of Orifice Centroid (ft)	0.00	0.80	1.60					
Orifice Area (sq. inches)	2.00	2.00	2.00					

	Row 9 (optional)	Row 10 (optional)	Row 11 (optional)	Row 12 (optional)	Row 13 (optional)	Row 14 (optional)	Row 15 (optional)	Row 16 (optional)
Stage of Orifice Centroid (ft)								
Orifice Area (sq. inches)								

User Input: Vertical Orifice (Circular or Rectangular)

Invert of Vertical Orifice = ft (relative to basin bottom at Stage = 0 ft)
Depth at top of Zone using Vertical Orifice = ft (relative to basin bottom at Stage = 0 ft)
Vertical Orifice Diameter = inches

Calculated Parameters for Vertical Orifice

Vertical Orifice Area = ft²
Vertical Orifice Centroid = feet

User Input: Overflow Weir (Dropbox with Flat or Sloped Gate and Outlet Pipe OR Rectangular/Trapezoidal Weir (and No Outlet Pipe))

Overflow Weir Front Edge Height, Ho = ft (relative to basin bottom at Stage = 0 ft)
Overflow Weir Front Edge Length = feet
Overflow Weir Gate Slope = H:V
Horiz. Length of Weir Sides = feet
Overflow Gate Open Area % = % , grate open area/total area
Debris Clogging % = %

Calculated Parameters for Overflow Weir

Height of Gate Upper Edge, H_i = feet
Overflow Weir Slope Length = feet
Grate Open Area / 100-yr Orifice Area =
Overflow Gate Open Area w/o Debris = ft²
Overflow Gate Open Area w/ Debris = ft²

User Input: Outlet Pipe w/ Flow Restriction Plate (Circular Orifice, Restrictor Plate, or Rectangular Orifice)

Depth to Invert of Outlet Pipe = ft (distance below basin bottom at Stage = 0 ft)
Circular Orifice Diameter = inches

Calculated Parameters for Outlet Pipe w/ Flow Restriction Plate

Outlet Orifice Area = ft²
Outlet Orifice Centroid = feet
Half-Central Angle of Restrictor Plate on Pipe = radians

User Input: Emergency Spillway (Rectangular or Trapezoidal)

Spillway Invert Stage = ft (relative to basin bottom at Stage = 0 ft)
Spillway Crest Length = feet
Spillway End Slopes =
Freeboard above Max Water Surface = feet

Calculated Parameters for Spillway

Spillway Design Flow Depth = feet
Stage at Top of Freeboard = feet
Basin Area at Top of Freeboard = acres
Basin Volume at Top of Freeboard = acre-ft

Routed Hydrograph Results

The user can override the default CUHP hydrographs and runoff volumes by entering new values in the Inflow Hydrographs table (Columns W through AF).

	WQCV	EURV	2 Year	5 Year	10 Year	25 Year	50 Year	100 Year	500 Year
Design Storm Return Period	N/A	N/A	1.19	1.50	1.75	2.00	2.25	2.52	3.68
One-Hour Rainfall Depth (in)	N/A	N/A	1.19	1.50	1.75	2.00	2.25	2.52	3.68
CUHP Runoff Volume (acre-ft)	0.225	0.849	0.622	0.817	0.973	1.180	1.383	1.631	2.666
Inflow Hydrograph Volume (acre-ft)	N/A	N/A	0.622	0.817	0.973	1.180	1.383	1.631	2.666
CUHP Predevelopment Peak Q (cfs)	N/A	N/A	0.1	0.1	0.2	1.6	3.3	5.3	14.0
OPTIONAL Override Predevelopment Peak Q (cfs)	N/A	N/A							
Predevelopment Unit Peak Flow, q (cfs/acre)	N/A	N/A	0.01	0.01	0.02	0.15	0.30	0.49	1.28
Peak Inflow Q (cfs)	N/A	N/A	8.8	11.5	13.5	17.4	20.8	25.1	41.2
Peak Outflow Q (cfs)	0.2	66.0	3.4	6.0	7.9	13.3	16.6	21.9	40.2
Ratio Peak Outflow to Predevelopment Q	N/A	N/A	N/A	47.3	44.7	8.2	5.1	4.1	2.9
Structure Controlling Flow	Plate	Spillway	Spillway	Spillway	Spillway	Spillway	Spillway	Spillway	Spillway
Max Velocity through Gate 1 (fps)	N/A	N/A	N/A	N/A	N/A	N/A	N/A	N/A	N/A
Max Velocity through Gate 2 (fps)	N/A	N/A	N/A	N/A	N/A	N/A	N/A	N/A	N/A
Time to Drain 97% of Inflow Volume (hours)	40	42	44	42	40	38	36	34	27
Time to Drain 99% of Inflow Volume (hours)	44	48	51	49	48	47	46	45	41
Maximum Ponding Depth (ft)	1.74	4.78	2.71	2.81	2.87	3.02	3.09	3.20	3.50
Area at Maximum Ponding Depth (acres)	0.16	0.26	0.19	0.19	0.19	0.20	0.20	0.20	0.21
Maximum Volume Stored (acre-ft)	0.225	0.850	0.392	0.409	0.422	0.449	0.465	0.487	0.550

DETENTION BASIN OUTLET STRUCTURE DESIGN

MHFD-Detention, Version 4.00 (December 2019)

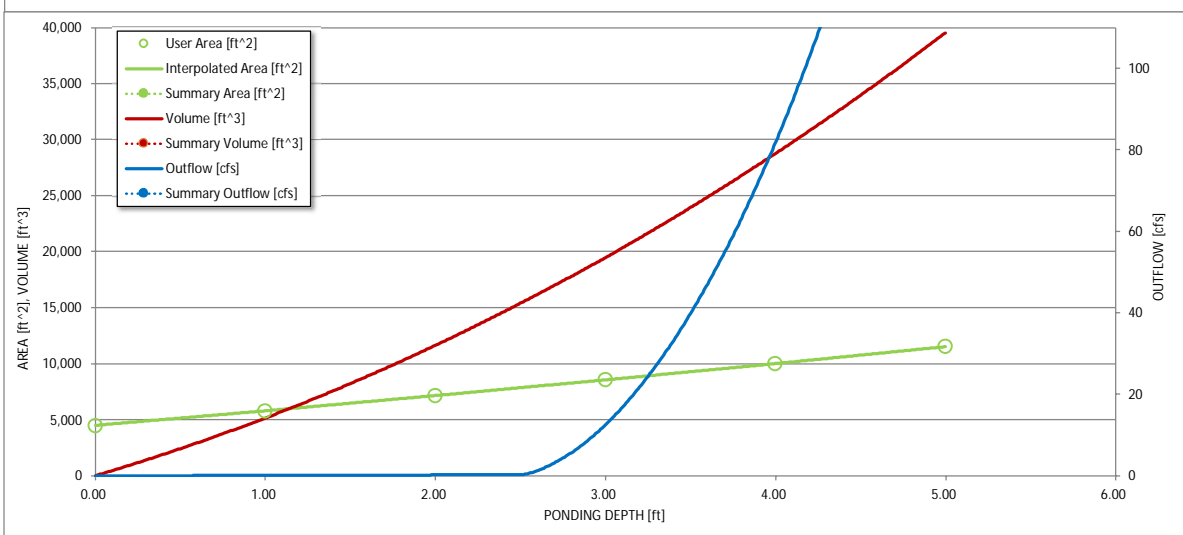
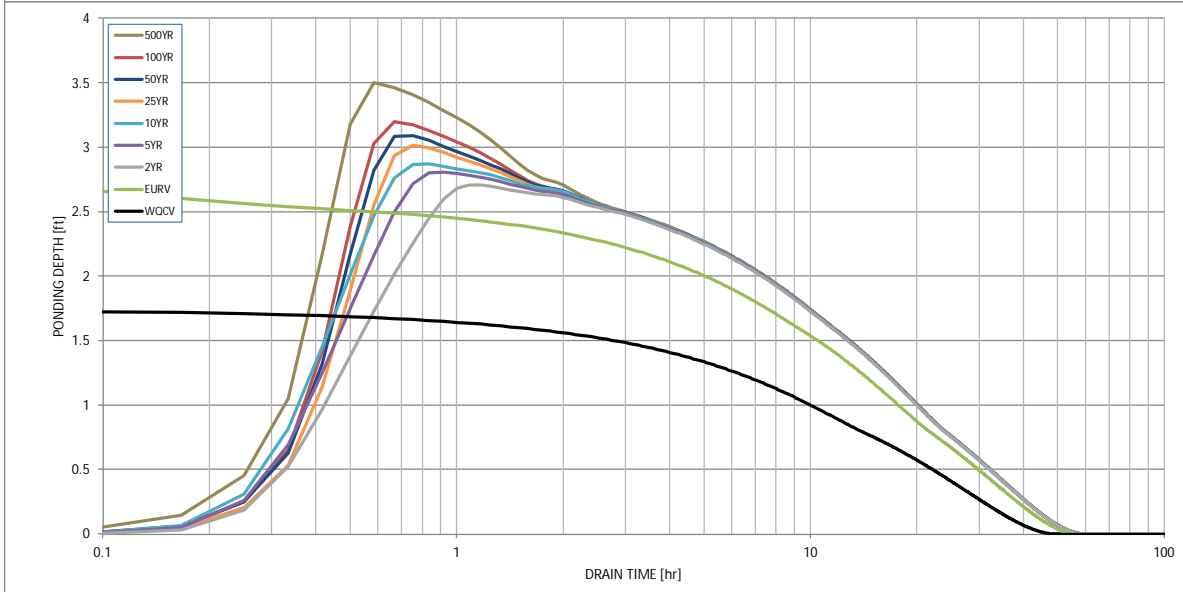
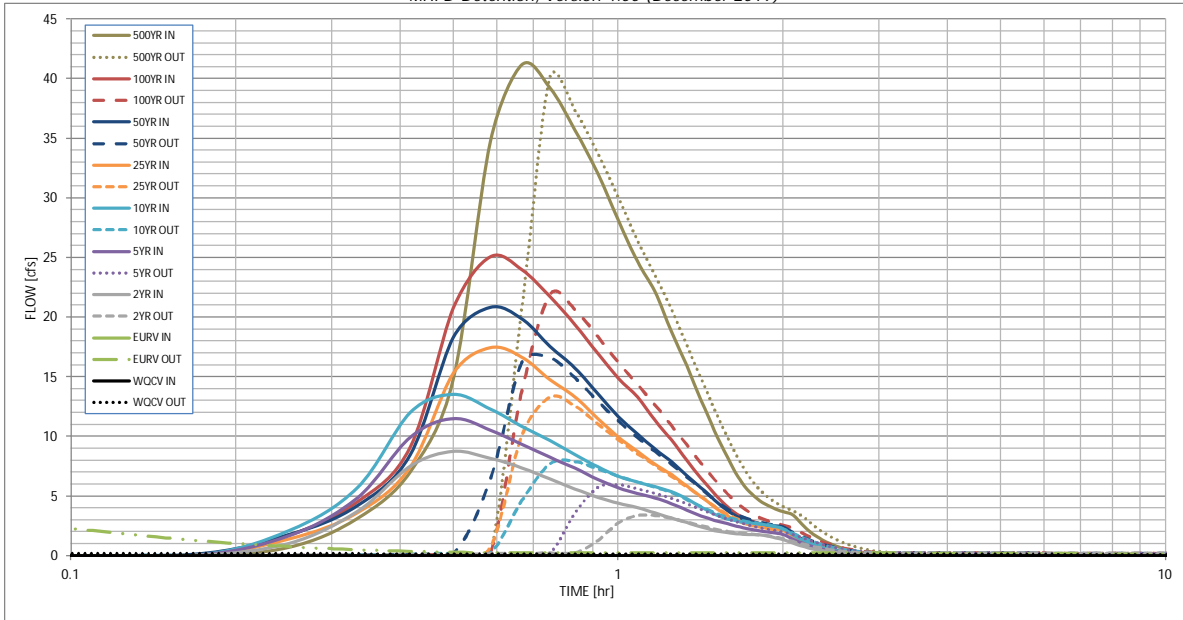

S-A-V-D Chart Axis Override	X-axis	Left Y-Axis	Right Y-Axis
minimum bound			
maximum bound			

DETENTION BASIN OUTLET STRUCTURE DESIGN

Outflow Hydrograph Workbook Filename: _____

Inflow Hydrographs

The user can override the calculated inflow hydrographs from this workbook with inflow hydrographs developed in a separate program.

Time Interval	SOURCE	CUHP	CUHP	CUHP	CUHP	CUHP	CUHP	CUHP	CUHP	CUHP
	TIME	WQCV [cfs]	EURV [cfs]	2 Year [cfs]	5 Year [cfs]	10 Year [cfs]	25 Year [cfs]	50 Year [cfs]	100 Year [cfs]	500 Year [cfs]
5.00_min	0:00:00	0.00	0.00	0.00	0.00	0.00	0.00	0.00	0.00	0.00
	0:05:00	0.00	0.00	0.00	0.00	0.00	0.00	0.00	0.00	0.00
	0:10:00	0.00	0.00	0.00	0.00	0.00	0.00	0.12	0.01	0.70
	0:15:00	0.00	0.00	1.04	1.69	2.10	1.41	1.76	1.72	3.13
	0:20:00	0.00	0.00	3.70	4.86	5.71	3.60	4.20	4.50	7.06
	0:25:00	0.00	0.00	7.52	9.95	12.01	7.45	8.51	9.15	14.81
	0:30:00	0.00	0.00	8.78	11.52	13.54	15.28	18.32	20.76	34.73
	0:35:00	0.00	0.00	8.17	10.54	12.30	17.44	20.83	25.10	41.19
	0:40:00	0.00	0.00	7.38	9.34	10.86	16.66	19.87	23.98	39.26
	0:45:00	0.00	0.00	6.43	8.26	9.66	14.77	17.55	21.72	35.71
	0:50:00	0.00	0.00	5.61	7.34	8.47	13.30	15.76	19.38	32.07
	0:55:00	0.00	0.00	4.91	6.42	7.45	11.52	13.58	16.97	28.11
	1:00:00	0.00	0.00	4.39	5.70	6.68	9.95	11.66	14.89	24.68
	1:05:00	0.00	0.00	4.04	5.23	6.19	8.75	10.21	13.31	22.17
	1:10:00	0.00	0.00	3.59	4.86	5.78	7.69	8.95	11.36	18.81
	1:15:00	0.00	0.00	3.17	4.38	5.37	6.81	7.89	9.72	15.94
	1:20:00	0.00	0.00	2.78	3.85	4.78	5.84	6.74	8.02	13.03
	1:25:00	0.00	0.00	2.42	3.36	4.07	4.96	5.70	6.51	10.48
	1:30:00	0.00	0.00	2.12	2.96	3.48	4.08	4.66	5.19	8.25
	1:35:00	0.00	0.00	1.92	2.70	3.09	3.33	3.77	4.09	6.38
	1:40:00	0.00	0.00	1.83	2.41	2.87	2.84	3.20	3.36	5.19
	1:45:00	0.00	0.00	1.78	2.20	2.73	2.55	2.87	2.93	4.49
	1:50:00	0.00	0.00	1.74	2.05	2.62	2.36	2.66	2.66	4.02
	1:55:00	0.00	0.00	1.55	1.93	2.50	2.23	2.51	2.47	3.69
	2:00:00	0.00	0.00	1.37	1.79	2.29	2.15	2.41	2.34	3.45
	2:05:00	0.00	0.00	1.07	1.40	1.78	1.67	1.88	1.79	2.63
	2:10:00	0.00	0.00	0.82	1.06	1.35	1.26	1.42	1.33	1.94
	2:15:00	0.00	0.00	0.62	0.81	1.02	0.95	1.07	1.00	1.46
	2:20:00	0.00	0.00	0.47	0.61	0.77	0.72	0.81	0.76	1.10
	2:25:00	0.00	0.00	0.35	0.45	0.57	0.53	0.60	0.57	0.82
	2:30:00	0.00	0.00	0.26	0.33	0.42	0.39	0.44	0.42	0.60
	2:35:00	0.00	0.00	0.19	0.23	0.30	0.29	0.32	0.31	0.44
	2:40:00	0.00	0.00	0.13	0.17	0.22	0.21	0.23	0.22	0.32
	2:45:00	0.00	0.00	0.09	0.11	0.15	0.14	0.16	0.15	0.22
	2:50:00	0.00	0.00	0.05	0.07	0.09	0.09	0.10	0.10	0.14
	2:55:00	0.00	0.00	0.02	0.04	0.05	0.05	0.05	0.05	0.07
	3:00:00	0.00	0.00	0.01	0.02	0.02	0.02	0.02	0.02	0.03
	3:05:00	0.00	0.00	0.00	0.00	0.00	0.00	0.00	0.00	0.00
	3:10:00	0.00	0.00	0.00	0.00	0.00	0.00	0.00	0.00	0.00
	3:15:00	0.00	0.00	0.00	0.00	0.00	0.00	0.00	0.00	0.00
	3:20:00	0.00	0.00	0.00	0.00	0.00	0.00	0.00	0.00	0.00
	3:25:00	0.00	0.00	0.00	0.00	0.00	0.00	0.00	0.00	0.00
	3:30:00	0.00	0.00	0.00	0.00	0.00	0.00	0.00	0.00	0.00
	3:35:00	0.00	0.00	0.00	0.00	0.00	0.00	0.00	0.00	0.00
	3:40:00	0.00	0.00	0.00	0.00	0.00	0.00	0.00	0.00	0.00
	3:45:00	0.00	0.00	0.00	0.00	0.00	0.00	0.00	0.00	0.00
	3:50:00	0.00	0.00	0.00	0.00	0.00	0.00	0.00	0.00	0.00
	3:55:00	0.00	0.00	0.00	0.00	0.00	0.00	0.00	0.00	0.00
	4:00:00	0.00	0.00	0.00	0.00	0.00	0.00	0.00	0.00	0.00
	4:05:00	0.00	0.00	0.00	0.00	0.00	0.00	0.00	0.00	0.00
	4:10:00	0.00	0.00	0.00	0.00	0.00	0.00	0.00	0.00	0.00
	4:15:00	0.00	0.00	0.00	0.00	0.00	0.00	0.00	0.00	0.00
	4:20:00	0.00	0.00	0.00	0.00	0.00	0.00	0.00	0.00	0.00
	4:25:00	0.00	0.00	0.00	0.00	0.00	0.00	0.00	0.00	0.00
	4:30:00	0.00	0.00	0.00	0.00	0.00	0.00	0.00	0.00	0.00
	4:35:00	0.00	0.00	0.00	0.00	0.00	0.00	0.00	0.00	0.00
	4:40:00	0.00	0.00	0.00	0.00	0.00	0.00	0.00	0.00	0.00
	4:45:00	0.00	0.00	0.00	0.00	0.00	0.00	0.00	0.00	0.00
	4:50:00	0.00	0.00	0.00	0.00	0.00	0.00	0.00	0.00	0.00
	4:55:00	0.00	0.00	0.00	0.00	0.00	0.00	0.00	0.00	0.00
	5:00:00	0.00	0.00	0.00	0.00	0.00	0.00	0.00	0.00	0.00
	5:05:00	0.00	0.00	0.00	0.00	0.00	0.00	0.00	0.00	0.00
	5:10:00	0.00	0.00	0.00	0.00	0.00	0.00	0.00	0.00	0.00
	5:15:00	0.00	0.00	0.00	0.00	0.00	0.00	0.00	0.00	0.00
	5:20:00	0.00	0.00	0.00	0.00	0.00	0.00	0.00	0.00	0.00
	5:25:00	0.00	0.00	0.00	0.00	0.00	0.00	0.00	0.00	0.00
	5:30:00	0.00	0.00	0.00	0.00	0.00	0.00	0.00	0.00	0.00
	5:35:00	0.00	0.00	0.00	0.00	0.00	0.00	0.00	0.00	0.00
	5:40:00	0.00	0.00	0.00	0.00	0.00	0.00	0.00	0.00	0.00
	5:45:00	0.00	0.00	0.00	0.00	0.00	0.00	0.00	0.00	0.00
	5:50:00	0.00	0.00	0.00	0.00	0.00	0.00	0.00	0.00	0.00
	5:55:00	0.00	0.00	0.00	0.00	0.00	0.00	0.00	0.00	0.00
	6:00:00	0.00	0.00	0.00	0.00	0.00	0.00	0.00	0.00	0.00

DETENTION BASIN STAGE-STORAGE TABLE BUILDER

MHFD-Detention, Version 4.03 (May 2020)

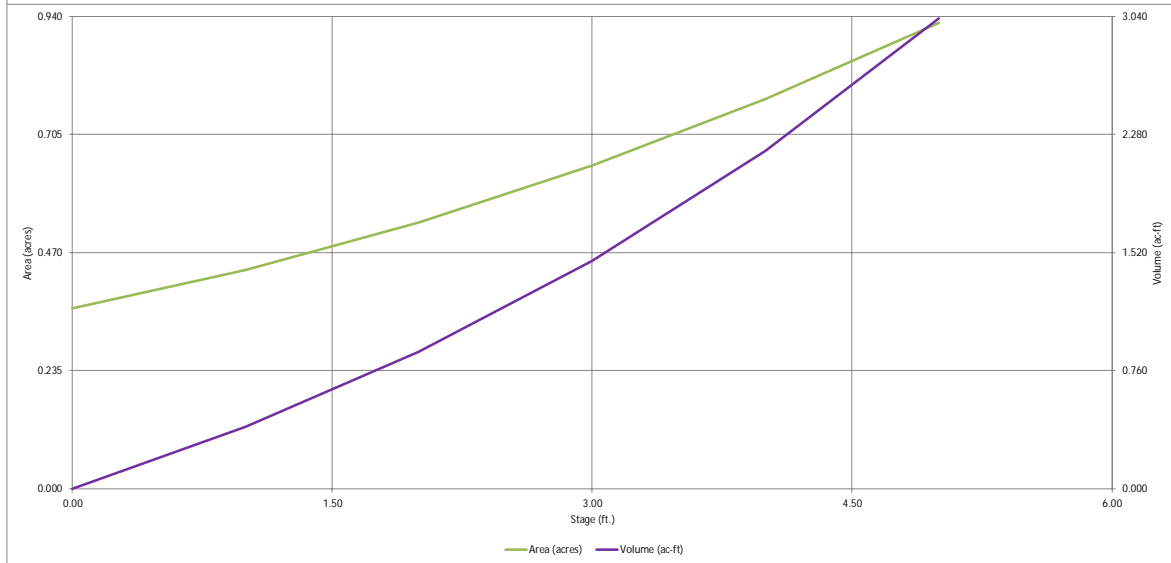
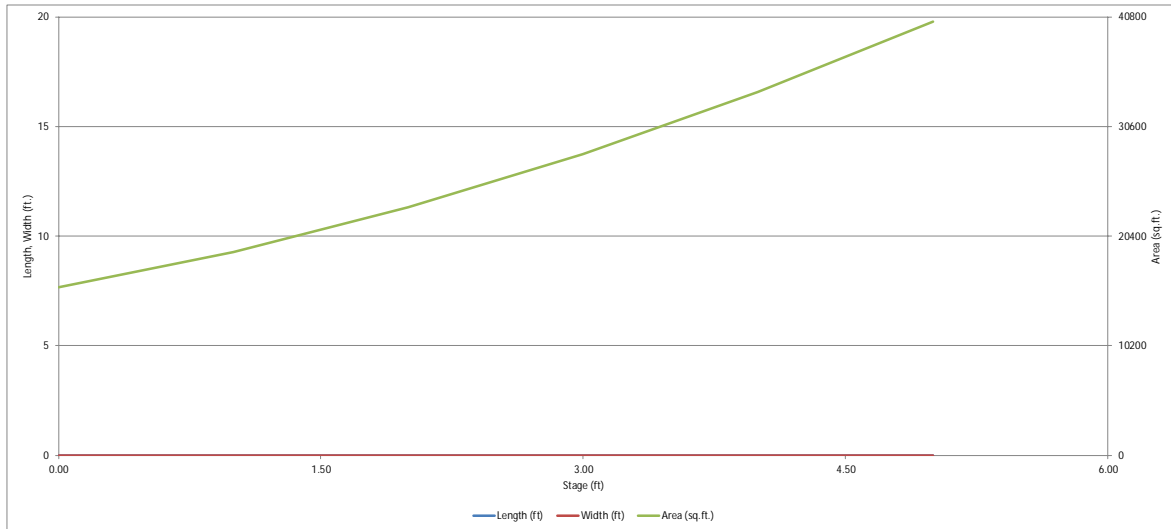

DETENTION BASIN OUTLET STRUCTURE DESIGN

MHFD-Detention, Version 4.03 (May 2020)

Project: Falcon Meadows at Bent Grass
Basin I D: WQCV Pond - South

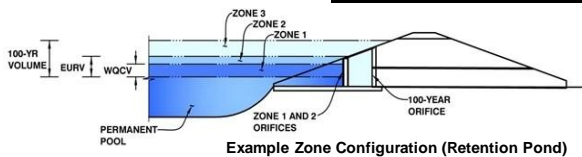

	Estimated Stage (ft)	Estimated Volume (ac-ft)	Outlet Type
Zone 1 (WQCV)	1.90	0.825	Orifice Plate
Zone 2			
Zone 3			
Total (all zones)		0.825	

User Input: Orifice at Underdrain Outlet (typically used to drain WQCV in a Filtration BMP)

Underdrain Orifice Invert Depth =	N/A	ft (distance below the filtration media surface)
Underdrain Orifice Diameter =	N/A	inches

Calculated Parameters for Underdrain

Underdrain Orifice Area =	N/A	ft ²
Underdrain Orifice Centroid =	N/A	feet

User Input: Orifice Plate with one or more orifices or Elliptical Slot Weir (typically used to drain WQCV and/or EURV in a sedimentation BMP)

Invert of Lowest Orifice =	0.00	ft (relative to basin bottom at Stage = 0 ft)
Depth at top of Zone using Orifice Plate =	1.90	ft (relative to basin bottom at Stage = 0 ft)
Orifice Plate: Orifice Vertical Spacing =	9.00	inches
Orifice Plate: Orifice Area per Row =	7.00	sq. inches (use rectangular openings)

Calculated Parameters for Plate

WQ Orifice Area per Row =	4.861E-02	ft ²
Elliptical Half-Width =	N/A	feet
Elliptical Slot Centroid =	N/A	feet
Elliptical Slot Area =	N/A	ft ²

User Input: Stage and Total Area of Each Orifice Row (numbered from lowest to highest)

	Row 1 (required)	Row 2 (optional)	Row 3 (optional)	Row 4 (optional)	Row 5 (optional)	Row 6 (optional)	Row 7 (optional)	Row 8 (optional)
Stage of Orifice Centroid (ft)	0.00	0.80	1.60					
Orifice Area (sq. inches)	7.00	7.00	7.00					

	Row 9 (optional)	Row 10 (optional)	Row 11 (optional)	Row 12 (optional)	Row 13 (optional)	Row 14 (optional)	Row 15 (optional)	Row 16 (optional)
Stage of Orifice Centroid (ft)								
Orifice Area (sq. inches)								

User Input: Vertical Orifice (Circular or Rectangular)

	Not Selected	Not Selected	
Invert of Vertical Orifice =			ft (relative to basin bottom at Stage = 0 ft)
Depth at top of Zone using Vertical Orifice =			ft (relative to basin bottom at Stage = 0 ft)
Vertical Orifice Diameter =			inches

Calculated Parameters for Vertical Orifice

	Not Selected	Not Selected	
Vertical Orifice Area =			ft ²
Vertical Orifice Centroid =			feet

User Input: Overflow Weir (Dropbox with Flat or Sloped Gate and Outlet Pipe OR Rectangular/Trapezoidal Weir (and No Outlet Pipe))

	Not Selected	Not Selected	
Overflow Weir Front Edge Height, Ho =			ft (relative to basin bottom at Stage = 0 ft)
Overflow Weir Front Edge Length =			feet
Overflow Weir Gate Slope =			H:V
Horiz. Length of Weir Sides =			feet
Overflow Gate Open Area % =			% gate open area/total area
Debris Clogging % =			%

Calculated Parameters for Overflow Weir

	Not Selected	Not Selected	
Height of Gate Upper Edge, H ₁ =			feet
Overflow Weir Slope Length =			feet
Gate Open Area / 100-yr Orifice Area =			
Overflow Gate Open Area w/o Debris =			ft ²
Overflow Gate Open Area w/ Debris =			ft ²

User Input: Outlet Pipe w/ Flow Restriction Plate (Circular Orifice, Restrictor Plate, or Rectangular Orifice)

	Not Selected	Not Selected	
Depth to Invert of Outlet Pipe =			ft (distance below basin bottom at Stage = 0 ft)
Circular Orifice Diameter =			inches

Calculated Parameters for Outlet Pipe w/ Flow Restriction Plate

	Not Selected	Not Selected	
Outlet Orifice Area =			ft ²
Outlet Orifice Centroid =			feet
Half-Central Angle of Restrictor Plate on Pipe =	N/A	N/A	radians

User Input: Emergency Spillway (Rectangular or Trapezoidal)

Spillway Invert Stage =	3.50	ft (relative to basin bottom at Stage = 0 ft)
Spillway Crest Length =	20.00	feet
Spillway End Slopes =	4.00	H:V
Freeboard above Max Water Surface =	0.00	feet

Calculated Parameters for Spillway

Spillway Design Flow Depth =	0.95	feet
Stage at Top of Freeboard =	4.45	feet
Basin Area at Top of Freeboard =	0.84	acres
Basin Volume at Top of Freeboard =	2.54	acre-ft

Routed Hydrograph Results

The user can override the default CUHP hydrographs and runoff volumes by entering new values in the Inflow Hydrographs table (Columns W through AF).

	WQCV	EURV	2 Year	5 Year	10 Year	25 Year	50 Year	100 Year	500 Year
Design Storm Return Period =	N/A	N/A	1.19	1.50	1.75	2.00	2.25	2.52	3.68
One-Hour Rainfall Depth (in)	N/A	N/A	1.19	1.50	1.75	2.00	2.25	2.52	3.68
CUHP Runoff Volume (acre-ft)	0.825	1.938	1.351	1.865	2.297	3.405	4.438	5.824	11.682
Inflow Hydrograph Volume (acre-ft)	N/A	N/A	1.351	1.865	2.297	3.405	4.438	5.824	11.682
CUHP Predevelopment Peak Q (cfs)	N/A	N/A	0.4	0.8	1.1	9.8	19.6	32.5	84.9
OPTIONAL Override Predevelopment Peak Q (cfs)	N/A	N/A							
Predevelopment Unit Peak Flow, q (cfs/acre)	N/A	N/A	0.01	0.01	0.02	0.15	0.30	0.49	1.29
Peak Inflow Q (cfs)	N/A	N/A	12.2	17.1	21.3	35.3	47.8	64.0	128.3
Peak Outflow Q (cfs)	0.7	5.2	0.9	1.1	4.7	16.5	28.4	45.8	114.2
Ratio Peak Outflow to Predevelopment Q	N/A	N/A	N/A	1.5	4.4	1.7	1.5	1.4	1.3
Structure Controlling Flow	Plate	Spillway	Plate	Plate	Spillway	Spillway	Spillway	Spillway	Spillway
Max Velocity through Gate 1 (fps)	N/A	N/A	N/A	N/A	N/A	N/A	N/A	N/A	N/A
Max Velocity through Gate 2 (fps)	N/A	N/A	N/A	N/A	N/A	N/A	N/A	N/A	N/A
Time to Drain 97% of Inflow Volume (hours)	40	48	46	49	50	46	43	40	29
Time to Drain 99% of Inflow Volume (hours)	44	54	51	55	56	54	53	51	45
Maximum Ponding Depth (ft)	1.90	3.69	2.55	3.28	3.65	3.89	4.06	4.26	4.84
Area at Maximum Ponding Depth (acres)	0.52	0.73	0.59	0.68	0.73	0.76	0.78	0.81	0.90
Maximum Volume Stored (acre-ft)	0.827	1.941	1.182	1.651	1.904	2.083	2.214	2.374	2.871

DETENTION BASIN OUTLET STRUCTURE DESIGN

MHFD-Detention, Version 4.00 (December 2019)

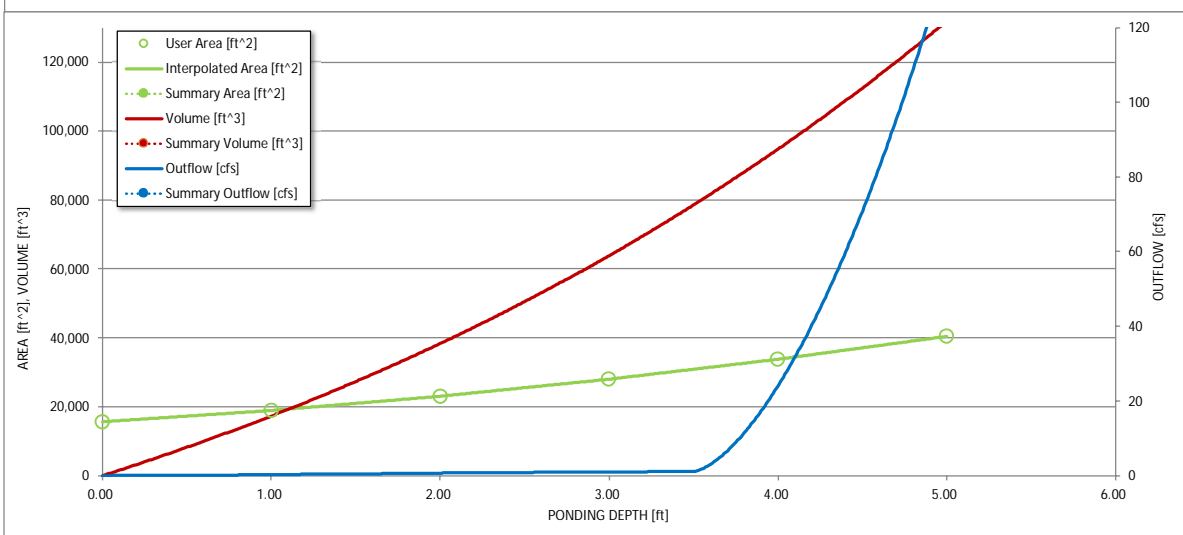
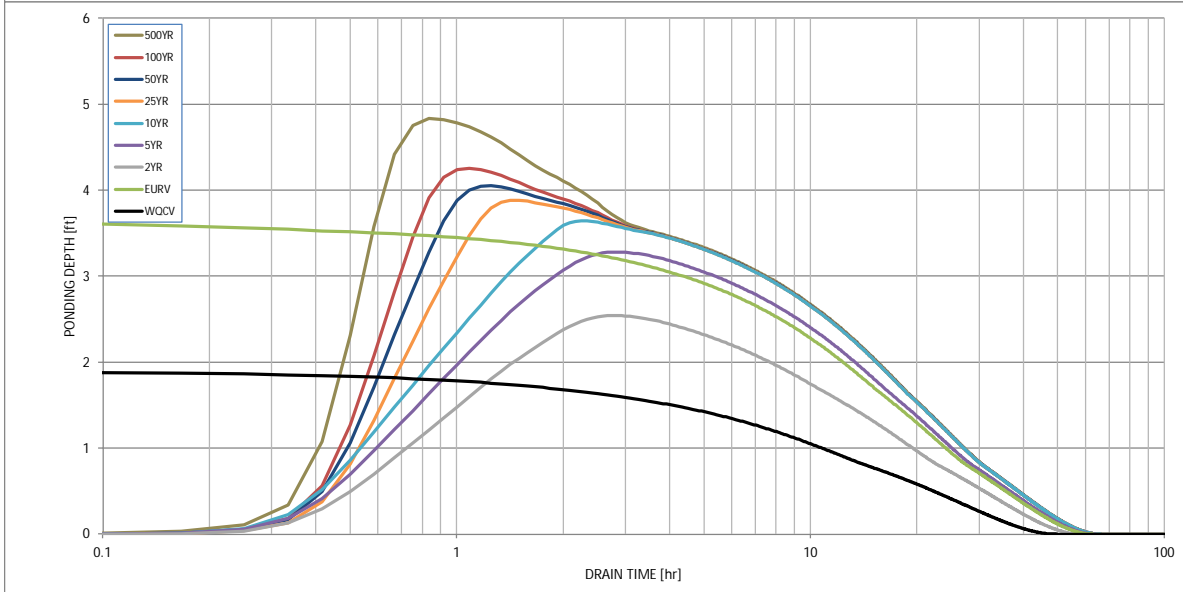
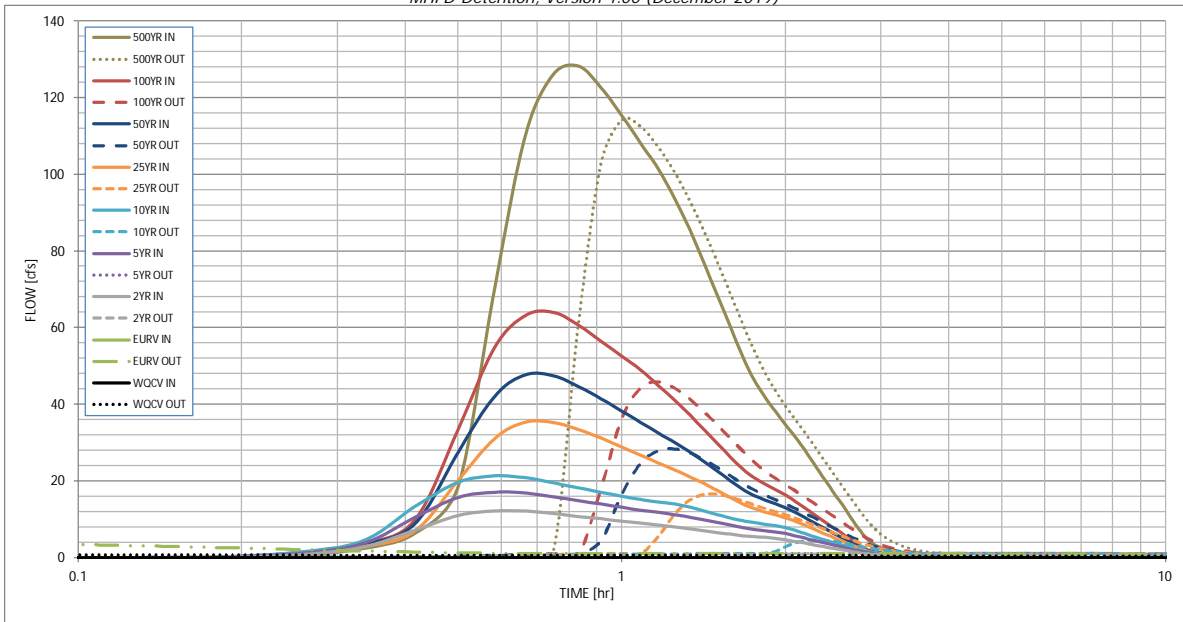

S-A-V-D Chart Axis Override	X-axis	Left Y-Axis	Right Y-Axis
minimum bound			
maximum bound			

DETENTION BASIN OUTLET STRUCTURE DESIGN

Outflow Hydrograph Workbook Filename: _____

Inflow Hydrographs

The user can override the calculated inflow hydrographs from this workbook with inflow hydrographs developed in a separate program.

Time Interval	SOURCE	CUHP	CUHP	CUHP	CUHP	CUHP	CUHP	CUHP	CUHP	CUHP
	TIME	WQCV [cfs]	EURV [cfs]	2 Year [cfs]	5 Year [cfs]	10 Year [cfs]	25 Year [cfs]	50 Year [cfs]	100 Year [cfs]	500 Year [cfs]
5.00_min	0:00:00	0.00	0.00	0.00	0.00	0.00	0.00	0.00	0.00	0.00
	0:05:00	0.00	0.00	0.00	0.00	0.00	0.00	0.00	0.00	0.00
	0:10:00	0.00	0.00	0.00	0.00	0.00	0.00	0.08	0.01	0.49
	0:15:00	0.00	0.00	0.66	1.08	1.36	0.93	1.22	1.17	2.41
	0:20:00	0.00	0.00	2.70	3.64	4.39	2.84	3.40	3.61	6.34
	0:25:00	0.00	0.00	7.15	10.47	13.36	6.99	8.83	9.86	18.69
	0:30:00	0.00	0.00	10.96	15.74	19.72	20.21	27.61	33.65	70.54
	0:35:00	0.00	0.00	12.17	17.12	21.31	31.15	42.17	54.90	110.97
	0:40:00	0.00	0.00	12.12	16.81	20.82	35.35	47.78	63.29	126.34
	0:45:00	0.00	0.00	11.48	15.83	19.47	35.23	47.41	64.02	128.28
	0:50:00	0.00	0.00	10.74	14.86	18.20	33.47	44.65	60.56	122.65
	0:55:00	0.00	0.00	10.11	13.98	17.07	31.17	41.45	56.41	115.35
	1:00:00	0.00	0.00	9.53	13.13	16.01	28.88	38.24	52.55	108.08
	1:05:00	0.00	0.00	9.04	12.39	15.14	26.77	35.31	48.95	101.49
	1:10:00	0.00	0.00	8.55	11.82	14.52	24.72	32.52	44.98	93.68
	1:15:00	0.00	0.00	8.06	11.23	13.97	22.92	30.05	41.12	85.46
	1:20:00	0.00	0.00	7.56	10.57	13.22	21.12	27.56	37.24	76.82
	1:25:00	0.00	0.00	7.07	9.87	12.27	19.31	25.05	33.41	68.26
	1:30:00	0.00	0.00	6.57	9.18	11.27	17.49	22.55	29.79	60.21
	1:35:00	0.00	0.00	6.11	8.53	10.34	15.71	20.09	26.30	52.60
	1:40:00	0.00	0.00	5.73	7.89	9.62	14.06	17.84	23.16	46.40
	1:45:00	0.00	0.00	5.47	7.41	9.13	12.82	16.26	20.93	41.86
	1:50:00	0.00	0.00	5.29	7.02	8.72	11.90	15.07	19.23	38.07
	1:55:00	0.00	0.00	5.01	6.65	8.30	11.14	14.04	17.74	34.70
	2:00:00	0.00	0.00	4.69	6.29	7.83	10.43	13.08	16.36	31.58
	2:05:00	0.00	0.00	4.26	5.74	7.12	9.49	11.86	14.75	28.17
	2:10:00	0.00	0.00	3.81	5.13	6.33	8.47	10.54	13.06	24.73
	2:15:00	0.00	0.00	3.37	4.54	5.57	7.47	9.26	11.44	21.45
	2:20:00	0.00	0.00	2.96	3.99	4.85	6.52	8.03	9.91	18.32
	2:25:00	0.00	0.00	2.58	3.47	4.19	5.62	6.86	8.42	15.29
	2:30:00	0.00	0.00	2.22	2.97	3.56	4.75	5.73	6.98	12.33
	2:35:00	0.00	0.00	1.88	2.50	2.96	3.91	4.64	5.57	9.47
	2:40:00	0.00	0.00	1.55	2.05	2.41	3.11	3.61	4.22	6.79
	2:45:00	0.00	0.00	1.24	1.64	1.91	2.37	2.65	2.98	4.70
	2:50:00	0.00	0.00	0.97	1.28	1.53	1.71	1.90	2.09	3.42
	2:55:00	0.00	0.00	0.79	1.05	1.28	1.29	1.45	1.55	2.55
	3:00:00	0.00	0.00	0.67	0.89	1.08	1.03	1.15	1.19	1.91
	3:05:00	0.00	0.00	0.57	0.75	0.91	0.84	0.93	0.93	1.43
	3:10:00	0.00	0.00	0.48	0.63	0.77	0.68	0.75	0.73	1.07
	3:15:00	0.00	0.00	0.41	0.53	0.65	0.57	0.62	0.58	0.80
	3:20:00	0.00	0.00	0.35	0.45	0.55	0.47	0.51	0.46	0.61
	3:25:00	0.00	0.00	0.29	0.38	0.45	0.38	0.41	0.37	0.49
	3:30:00	0.00	0.00	0.24	0.31	0.37	0.31	0.33	0.30	0.39
	3:35:00	0.00	0.00	0.20	0.25	0.29	0.25	0.27	0.24	0.31
	3:40:00	0.00	0.00	0.16	0.20	0.23	0.20	0.21	0.19	0.24
	3:45:00	0.00	0.00	0.12	0.15	0.18	0.15	0.16	0.14	0.18
	3:50:00	0.00	0.00	0.09	0.12	0.14	0.11	0.12	0.10	0.12
	3:55:00	0.00	0.00	0.07	0.09	0.10	0.08	0.08	0.07	0.08
	4:00:00	0.00	0.00	0.05	0.06	0.07	0.05	0.05	0.05	0.05
	4:05:00	0.00	0.00	0.03	0.04	0.04	0.03	0.03	0.02	0.02
	4:10:00	0.00	0.00	0.02	0.02	0.02	0.02	0.01	0.01	0.01
	4:15:00	0.00	0.00	0.01	0.01	0.01	0.01	0.00	0.00	0.00
	4:20:00	0.00	0.00	0.00	0.00	0.00	0.00	0.00	0.00	0.00
	4:25:00	0.00	0.00	0.00	0.00	0.00	0.00	0.00	0.00	0.00
	4:30:00	0.00	0.00	0.00	0.00	0.00	0.00	0.00	0.00	0.00
	4:35:00	0.00	0.00	0.00	0.00	0.00	0.00	0.00	0.00	0.00
	4:40:00	0.00	0.00	0.00	0.00	0.00	0.00	0.00	0.00	0.00
	4:45:00	0.00	0.00	0.00	0.00	0.00	0.00	0.00	0.00	0.00
	4:50:00	0.00	0.00	0.00	0.00	0.00	0.00	0.00	0.00	0.00
	4:55:00	0.00	0.00	0.00	0.00	0.00	0.00	0.00	0.00	0.00
	5:00:00	0.00	0.00	0.00	0.00	0.00	0.00	0.00	0.00	0.00
	5:05:00	0.00	0.00	0.00	0.00	0.00	0.00	0.00	0.00	0.00
	5:10:00	0.00	0.00	0.00	0.00	0.00	0.00	0.00	0.00	0.00
	5:15:00	0.00	0.00	0.00	0.00	0.00	0.00	0.00	0.00	0.00
	5:20:00	0.00	0.00	0.00	0.00	0.00	0.00	0.00	0.00	0.00
	5:25:00	0.00	0.00	0.00	0.00	0.00	0.00	0.00	0.00	0.00
	5:30:00	0.00	0.00	0.00	0.00	0.00	0.00	0.00	0.00	0.00
	5:35:00	0.00	0.00	0.00	0.00	0.00	0.00	0.00	0.00	0.00
	5:40:00	0.00	0.00	0.00	0.00	0.00	0.00	0.00	0.00	0.00
	5:45:00	0.00	0.00	0.00	0.00	0.00	0.00	0.00	0.00	0.00
	5:50:00	0.00	0.00	0.00	0.00	0.00	0.00	0.00	0.00	0.00
	5:55:00	0.00	0.00	0.00	0.00	0.00	0.00	0.00	0.00	0.00
	6:00:00	0.00	0.00	0.00	0.00	0.00	0.00	0.00	0.00	0.00

Current Channel Calculations

Worksheet for Ex Channel - Pr DBPS 100 Yr Flow-MR

Project Description

Friction Method	Manning Formula
Solve For	Normal Depth

Input Data

Roughness Coefficient	0.035
Channel Slope	1.75 %
Left Side Slope	4.00 ft/ft (H:V)
Right Side Slope	4.00 ft/ft (H:V)
Discharge	850.00 ft ³ /s

Results

Normal Depth	4.68 ft
Flow Area	87.61 ft ²
Wetted Perimeter	38.59 ft
Hydraulic Radius	2.27 ft
Top Width	37.44 ft
Critical Depth	4.89 ft
Critical Slope	0.01379 ft/ft
Velocity	9.70 ft/s
Velocity Head	1.46 ft
Specific Energy	6.14 ft
Froude Number	1.12
Flow Type	Supercritical

GVF Input Data

Downstream Depth	0.00 ft
Length	0.00 ft
Number Of Steps	0

GVF Output Data

Upstream Depth	0.00 ft
Profile Description	
Profile Headloss	0.00 ft
Downstream Velocity	Infinity ft/s
Upstream Velocity	Infinity ft/s
Normal Depth	4.68 ft
Critical Depth	4.89 ft
Channel Slope	1.75 %
Critical Slope	0.01379 ft/ft

Worksheet for Ex Channel - Pr 100 Yr Flow-MR

Project Description

Friction Method	Manning Formula
Solve For	Normal Depth

Input Data

Roughness Coefficient	0.035
Channel Slope	1.75 %
Left Side Slope	4.00 ft/ft (H:V)
Right Side Slope	4.00 ft/ft (H:V)
Discharge	925.00 ft ³ /s

Results

Normal Depth	4.83 ft
Flow Area	93.35 ft ²
Wetted Perimeter	39.84 ft
Hydraulic Radius	2.34 ft
Top Width	38.65 ft
Critical Depth	5.06 ft
Critical Slope	0.01364 ft/ft
Velocity	9.91 ft/s
Velocity Head	1.53 ft
Specific Energy	6.36 ft
Froude Number	1.12
Flow Type	Supercritical

GVF Input Data

Downstream Depth	0.00 ft
Length	0.00 ft
Number Of Steps	0

GVF Output Data

Upstream Depth	0.00 ft
Profile Description	
Profile Headloss	0.00 ft
Downstream Velocity	Infinity ft/s
Upstream Velocity	Infinity ft/s
Normal Depth	4.83 ft
Critical Depth	5.06 ft
Channel Slope	1.75 %
Critical Slope	0.01364 ft/ft

Worksheet for Ex Owl Place

Project Description

Friction Method	Manning Formula
Solve For	Normal Depth

Input Data

Roughness Coefficient	0.050
Channel Slope	1.60 %
Left Side Slope	11.00 ft/ft (H:V)
Right Side Slope	12.00 ft/ft (H:V)
Discharge	850.00 ft ³ /s

Results

Normal Depth	3.64 ft
Flow Area	152.13 ft ²
Wetted Perimeter	83.97 ft
Hydraulic Radius	1.81 ft
Top Width	83.66 ft
Critical Depth	3.21 ft
Critical Slope	0.03128 ft/ft
Velocity	5.59 ft/s
Velocity Head	0.49 ft
Specific Energy	4.12 ft
Froude Number	0.73
Flow Type	Subcritical

GVF Input Data

Downstream Depth	0.00 ft
Length	0.00 ft
Number Of Steps	0

GVF Output Data

Upstream Depth	0.00 ft
Profile Description	
Profile Headloss	0.00 ft
Downstream Velocity	Infinity ft/s
Upstream Velocity	Infinity ft/s
Normal Depth	3.64 ft
Critical Depth	3.21 ft
Channel Slope	1.60 %
Critical Slope	0.03128 ft/ft

Future Channel Calculations

Worksheet for Fut Channel - Pr 100 Yr Flow-MR

Project Description

Friction Method	Manning Formula
Solve For	Normal Depth

Input Data

Roughness Coefficient	0.035
Channel Slope	0.30 %
Left Side Slope	4.00 ft/ft (H:V)
Right Side Slope	4.00 ft/ft (H:V)
Bottom Width	15.00 ft
Discharge	925.00 ft ³ /s

Results

Normal Depth	5.15 ft
Flow Area	183.50 ft ²
Wetted Perimeter	57.49 ft
Hydraulic Radius	3.19 ft
Top Width	56.22 ft
Critical Depth	3.58 ft
Critical Slope	0.01368 ft/ft
Velocity	5.04 ft/s
Velocity Head	0.39 ft
Specific Energy	5.55 ft
Froude Number	0.49
Flow Type	Subcritical

GVF Input Data

Downstream Depth	0.00 ft
Length	0.00 ft
Number Of Steps	0

GVF Output Data

Upstream Depth	0.00 ft
Profile Description	
Profile Headloss	0.00 ft
Downstream Velocity	Infinity ft/s
Upstream Velocity	Infinity ft/s
Normal Depth	5.15 ft
Critical Depth	3.58 ft
Channel Slope	0.30 %

Worksheet for Fut Channel - Pr 100 Yr Flow-MR

GVF Output Data

Critical Slope 0.01368 ft/ft

Worksheet for Fut Owl Place

Project Description

Friction Method	Manning Formula
Solve For	Normal Depth

Input Data

Roughness Coefficient	0.035
Channel Slope	0.30 %
Left Side Slope	4.00 ft/ft (H:V)
Right Side Slope	4.00 ft/ft (H:V)
Bottom Width	35.00 ft
Discharge	925.00 ft ³ /s

Results

Normal Depth	3.86 ft
Flow Area	194.93 ft ²
Wetted Perimeter	66.86 ft
Hydraulic Radius	2.92 ft
Top Width	65.91 ft
Critical Depth	2.52 ft
Critical Slope	0.01424 ft/ft
Velocity	4.75 ft/s
Velocity Head	0.35 ft
Specific Energy	4.21 ft
Froude Number	0.49
Flow Type	Subcritical

GVF Input Data

Downstream Depth	0.00 ft
Length	0.00 ft
Number Of Steps	0

GVF Output Data

Upstream Depth	0.00 ft
Profile Description	
Profile Headloss	0.00 ft
Downstream Velocity	Infinity ft/s
Upstream Velocity	Infinity ft/s
Normal Depth	3.86 ft
Critical Depth	2.52 ft
Channel Slope	0.30 %

Worksheet for Fut Owl Place

GVF Output Data

Critical Slope 0.01424 ft/ft

Current Culvert Calculations

HY-8 Culvert Analysis Report

Crossing Discharge Data

Discharge Selection Method: Specify Minimum, Design, and Maximum Flow

Minimum Flow: 0 cfs

Design Flow: 143 cfs

Maximum Flow: 143 cfs

Table 1 - Summary of Culvert Flows at Crossing: Bent Grass & Meridian Existing Ex

Headwater Elevation (ft)	Total Discharge (cfs)	Ex Culverts - Ex Pipe Capacity Discharge (cfs)	Roadway Discharge (cfs)	Iterations
6928.05	0.00	0.00	0.00	1
6929.11	14.30	14.30	0.00	1
6929.47	28.60	28.60	0.00	1
6929.76	42.90	42.90	0.00	1
6930.02	57.20	57.20	0.00	1
6930.29	71.50	71.50	0.00	1
6930.56	85.80	85.80	0.00	1
6930.86	100.10	100.10	0.00	1
6931.18	114.40	114.40	0.00	1
6931.53	128.70	128.70	0.00	1
6931.90	143.00	143.00	0.00	1
6931.90	143.03	143.03	0.00	Overtopping

Pipe Cap Check

Rating Curve Plot for Crossing: Bent Grass & Meridian Existing Ex Pipe Cap Check

Total Rating Curve

Crossing: Bent Grass & Meridian Existing Ex Pipe Cap Check

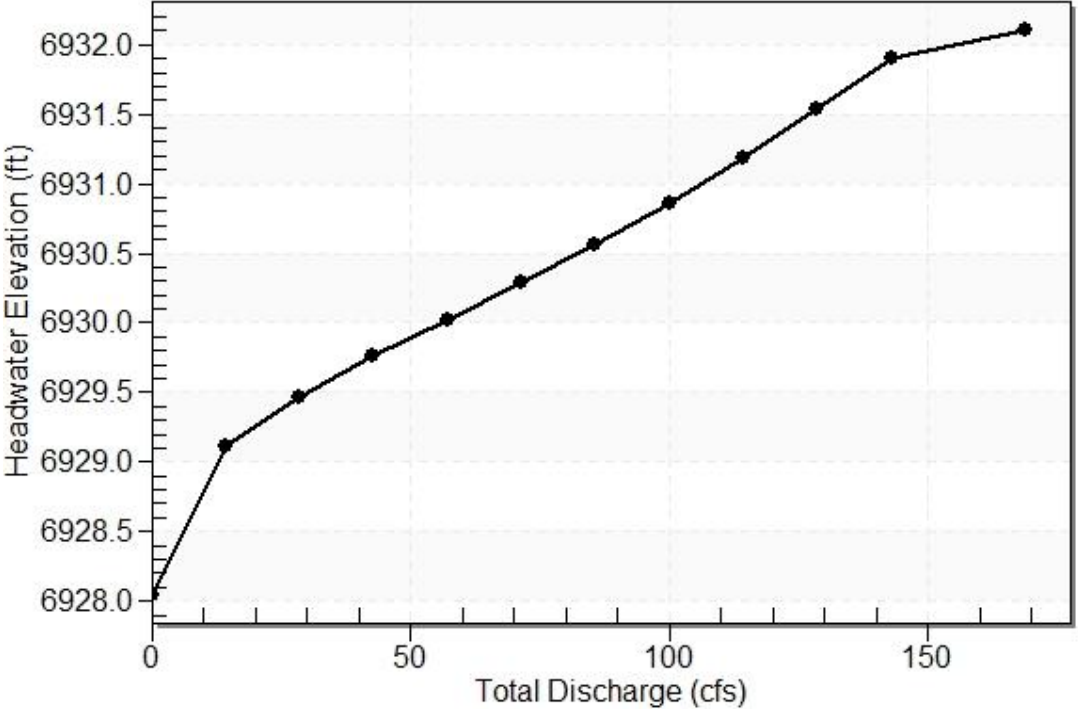

Table 2 - Culvert Summary Table: Ex Culverts - Ex Pipe Capacity

Total Discharge (cfs)	Culvert Discharge (cfs)	Headwater Elevation (ft)	Inlet Control Depth (ft)	Outlet Control Depth (ft)	Flow Type	Normal Depth (ft)	Critical Depth (ft)	Outlet Depth (ft)	Tailwater Depth (ft)	Outlet Velocity (ft/s)	Tailwater Velocity (ft/s)
0.00	0.00	6928.05	0.000	0.000	0-NF	0.000	0.000	0.710	0.000	0.000	0.000
14.30	14.30	6929.11	0.753	1.061	1-S1t	0.481	0.558	1.722	1.012	0.851	3.494
28.60	28.60	6929.47	1.094	1.420	1-S1t	0.678	0.802	2.022	1.312	1.446	4.155
42.90	42.90	6929.76	1.388	1.709	1-S1t	0.835	0.995	2.237	1.527	1.997	4.598
57.20	57.20	6930.02	1.659	1.972	1-S1t	0.973	1.161	2.411	1.701	2.570	4.941
71.50	71.50	6930.29	1.913	2.237	1-S1f	1.100	1.303	2.417	1.850	3.213	5.225
85.80	85.80	6930.56	2.161	2.511	1-S1f	1.213	1.438	2.417	1.981	3.855	5.468
100.10	100.10	6930.86	2.415	2.810	1-S1f	1.321	1.562	2.417	2.098	4.498	5.683
114.40	114.40	6931.18	2.681	3.135	4-FFf	1.433	1.677	2.417	2.206	5.140	5.876
128.70	128.70	6931.53	2.968	3.481	4-FFf	1.545	1.783	2.417	2.306	5.783	6.052
143.00	143.00	6931.90	3.280	3.850	4-FFf	1.659	1.882	2.417	2.399	6.425	6.213

Straight Culvert

Inlet Elevation (invert): 6928.05 ft, Outlet Elevation (invert): 6927.34 ft

Culvert Length: 105.00 ft, Culvert Slope: 0.0068

Culvert Performance Curve Plot: Ex Culverts - Ex Pipe Capacity

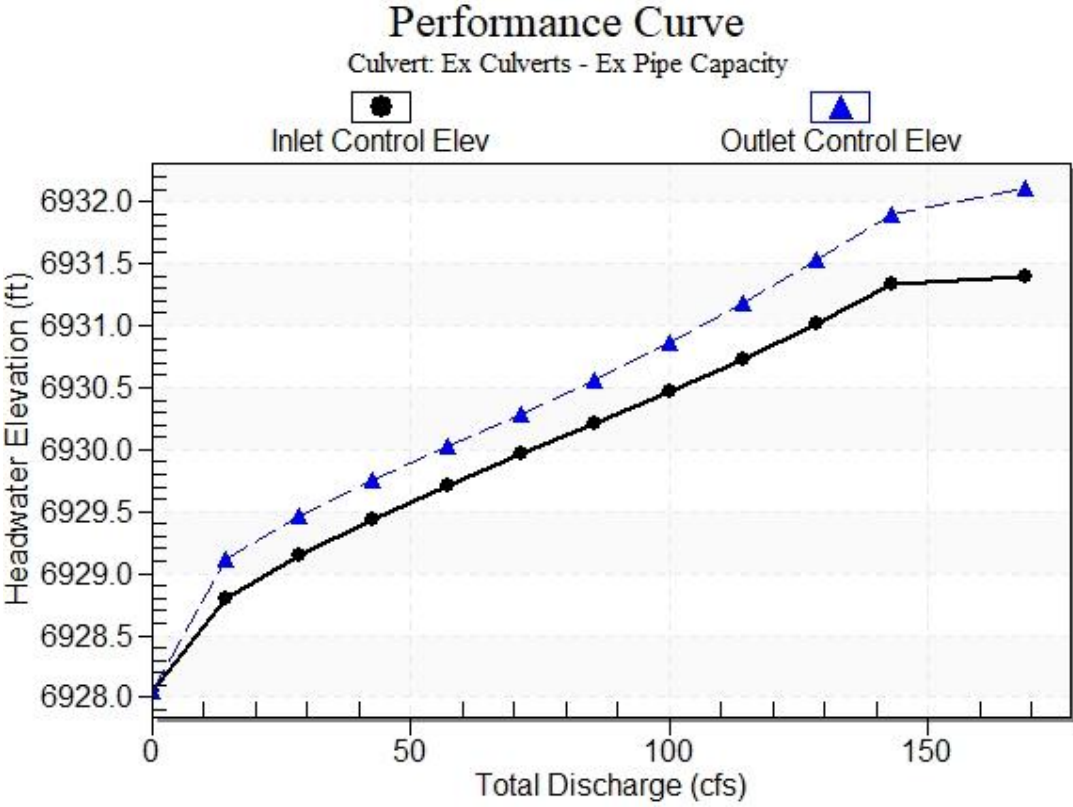

Water Surface Profile Plot for Culvert: Ex Culverts - Ex Pipe Capacity

Crossing - Bent Grass & Meridian Existing Ex Pipe Cap Check, Design Discharge - 143.0 cfs

Culvert - Ex Culverts - Ex Pipe Capacity, Culvert Discharge - 143.0 cfs

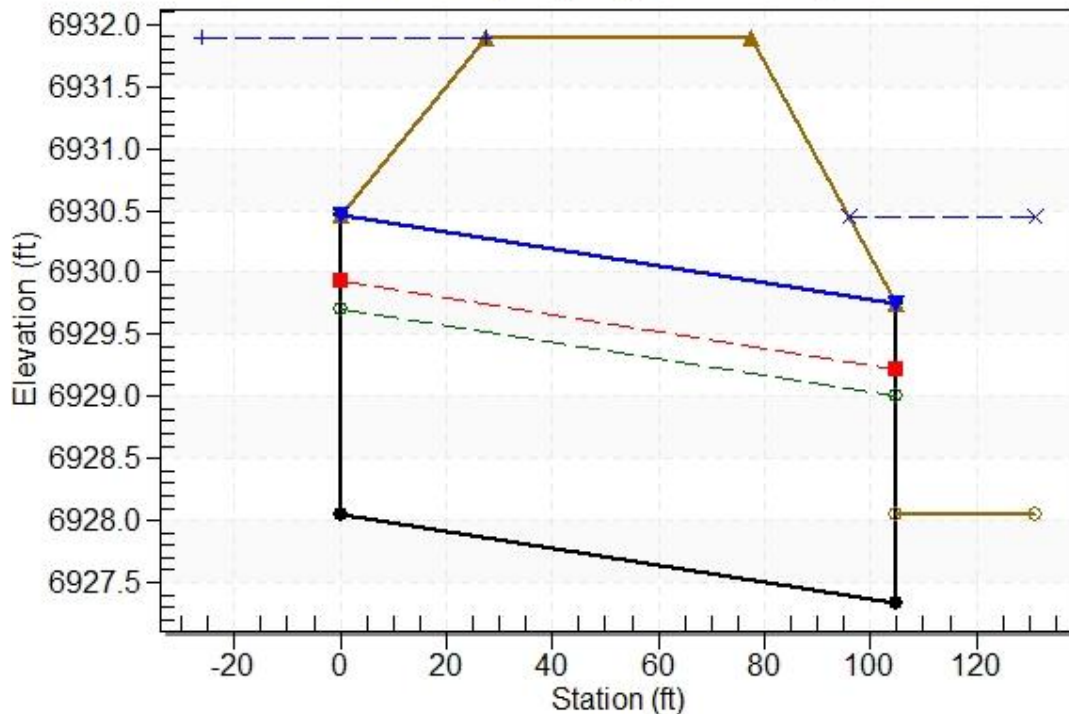

Site Data - Ex Culverts - Ex Pipe Capacity

Site Data Option: Culvert Invert Data

Inlet Station: 0.00 ft

Inlet Elevation: 6928.05 ft

Outlet Station: 105.00 ft

Outlet Elevation: 6927.34 ft

Number of Barrels: 3

Culvert Data Summary - Ex Culverts - Ex Pipe Capacity

Barrel Shape: Elliptical

Barrel Span: 45.00 in

Barrel Rise: 29.00 in

Barrel Material: Concrete

Embedment: 0.00 in

Barrel Manning's n: 0.0130

Culvert Type: Straight

Inlet Configuration: Square Edge with Headwall

Inlet Depression: None

Table 3 - Downstream Channel Rating Curve (Crossing: Bent Grass & Meridian

Flow (cfs)	Water Surface Elev (ft)	Depth (ft)	Velocity (ft/s)	Shear (psf)	Froude Number
0.00	6928.05	0.00	0.00	0.00	0.00
14.30	6929.06	1.01	3.49	1.10	0.87
28.60	6929.36	1.31	4.16	1.43	0.90
42.90	6929.58	1.53	4.60	1.67	0.93
57.20	6929.75	1.70	4.94	1.86	0.94
71.50	6929.90	1.85	5.22	2.02	0.96
85.80	6930.03	1.98	5.47	2.16	0.97
100.10	6930.15	2.10	5.68	2.29	0.98
114.40	6930.26	2.21	5.88	2.41	0.99
128.70	6930.36	2.31	6.05	2.52	0.99
143.00	6930.45	2.40	6.21	2.62	1.00

Existing Ex Pipe Cap Check)

Tailwater Channel Data - Bent Grass & Meridian Existing Ex Pipe Cap Check

Tailwater Channel Option: Triangular Channel

Side Slope (H:V): 4.00 (_:1)

Channel Slope: 0.0175

Channel Manning's n: 0.0350

Channel Invert Elevation: 6928.05 ft

Roadway Data for Crossing: Bent Grass & Meridian Existing Ex Pipe Cap Check

Roadway Profile Shape: Constant Roadway Elevation

Crest Length: 80.00 ft

Crest Elevation: 6931.90 ft

Roadway Surface: Paved

Roadway Top Width: 50.00 ft

HY-8 Culvert Analysis Report

Crossing Discharge Data

Discharge Selection Method: Specify Minimum, Design, and Maximum Flow

Minimum Flow: 0 cfs

Design Flow: 270 cfs

Maximum Flow: 850 cfs

Table 1 - Summary of Culvert Flows at Crossing: Bent Grass & Meridian Existing Pr

Headwater Elevation (ft)	Total Discharge (cfs)	Ex Culverts - Pr DBPS Flow Discharge (cfs)	Roadway Discharge (cfs)	Iterations
6928.05	0.00	0.00	0.00	1
6930.55	85.00	85.00	0.00	1
6932.12	170.00	145.81	24.11	8
6932.55	270.00	143.20	126.70	5
6932.78	340.00	140.88	199.06	5
6933.02	425.00	138.39	286.31	4
6933.23	510.00	136.38	373.41	4
6933.43	595.00	134.77	460.09	4
6933.62	680.00	133.49	546.45	4
6933.79	765.00	132.46	632.08	3
6933.96	850.00	131.74	718.07	3
6931.90	143.05	143.05	0.00	Overtopping

DBPS Flows

Rating Curve Plot for Crossing: Bent Grass & Meridian Existing Pr DBPS Flows

Total Rating Curve

Crossing: Bent Grass & Meridian Existing Pr DBPS Flows

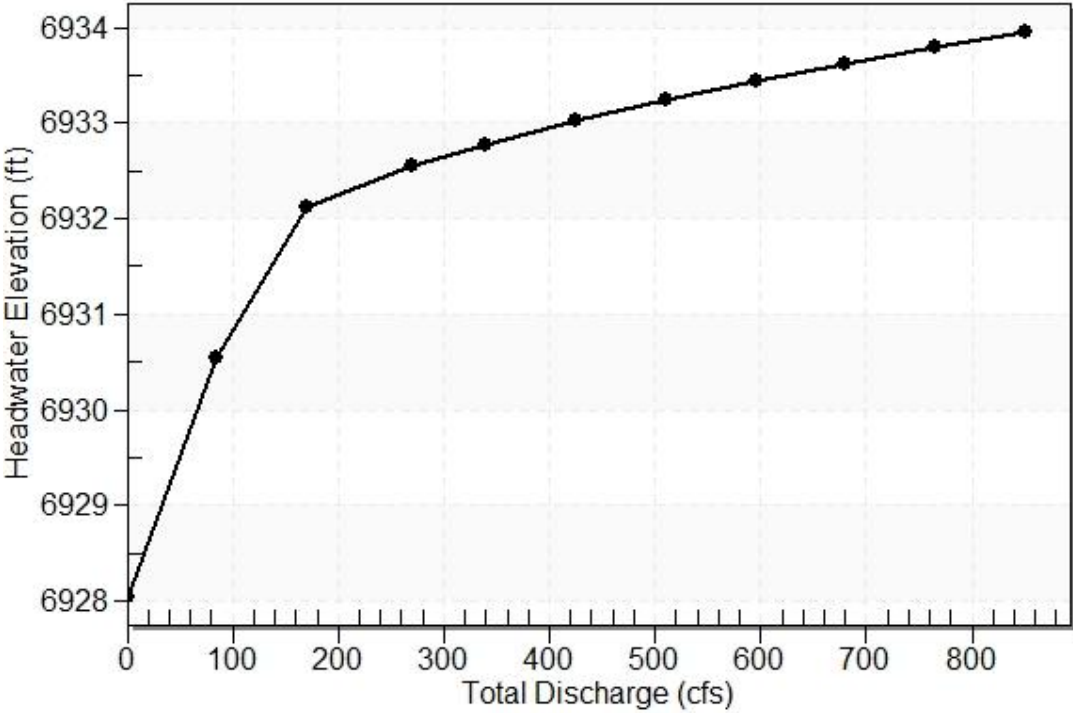

Table 2 - Culvert Summary Table: Ex Culverts - Pr DBPS Flow

Total Discharge (cfs)	Culvert Discharge (cfs)	Headwater Elevation (ft)	Inlet Control Depth (ft)	Outlet Control Depth (ft)	Flow Type	Normal Depth (ft)	Critical Depth (ft)	Outlet Depth (ft)	Tailwater Depth (ft)	Outlet Velocity (ft/s)	Tailwater Velocity (ft/s)
0.00	0.00	6928.05	0.000	0.000	0-NF	0.000	0.000	0.710	0.000	0.000	0.000
85.00	85.00	6930.55	2.148	2.496	1-S1f	1.207	1.431	2.417	1.974	3.819	5.456
170.00	145.81	6932.12	3.345	4.068	4-FFf	1.682	1.900	2.417	2.559	6.551	6.488
270.00	143.20	6932.55	3.285	4.499	4-FFf	1.660	1.883	2.417	3.044	6.434	7.283
340.00	140.88	6932.78	3.232	4.727	4-FFf	1.642	1.868	2.417	3.319	6.330	7.715
425.00	138.39	6933.02	3.176	4.968	4-FFf	1.622	1.851	2.417	3.609	6.218	8.158
510.00	136.38	6933.23	3.132	5.184	4-FFf	1.606	1.837	2.417	3.864	6.128	8.539
595.00	134.77	6933.43	3.097	5.383	4-FFf	1.593	1.826	2.417	4.094	6.055	8.874
680.00	133.49	6933.62	3.069	5.569	4-FFf	1.583	1.817	2.417	4.304	5.998	9.175
765.00	132.46	6933.79	3.047	5.744	4-FFf	1.574	1.810	2.417	4.499	5.951	9.449
850.00	131.74	6933.96	3.032	5.912	4-FFf	1.569	1.805	2.417	4.680	5.919	9.702

Straight Culvert

Inlet Elevation (invert): 6928.05 ft, Outlet Elevation (invert): 6927.34 ft

Culvert Length: 105.00 ft, Culvert Slope: 0.0068

Culvert Performance Curve Plot: Ex Culverts - Pr DBPS Flow

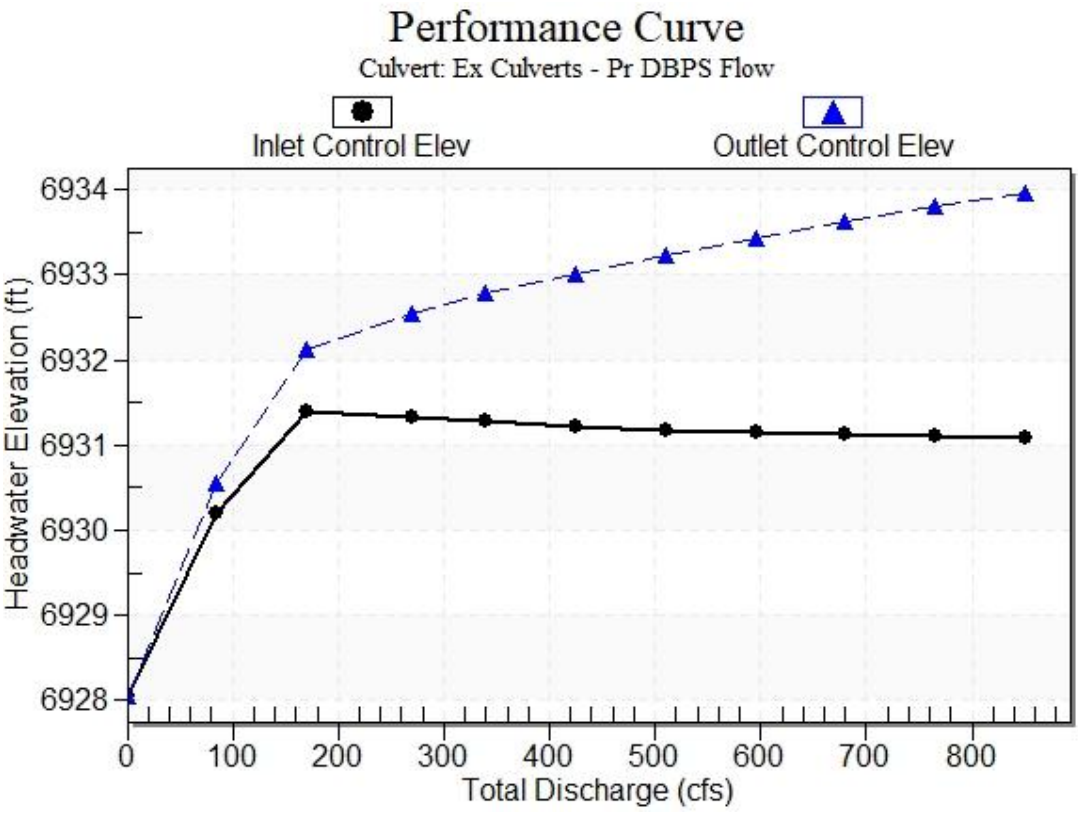

Water Surface Profile Plot for Culvert: Ex Culverts - Pr DBPS Flow

Crossing - Bent Grass & Meridian Existing Pr DBPS Flows, Design Discharge - 270.0 cfs
Culvert - Ex Culverts - Pr DBPS Flow, Culvert Discharge - 143.2 cfs

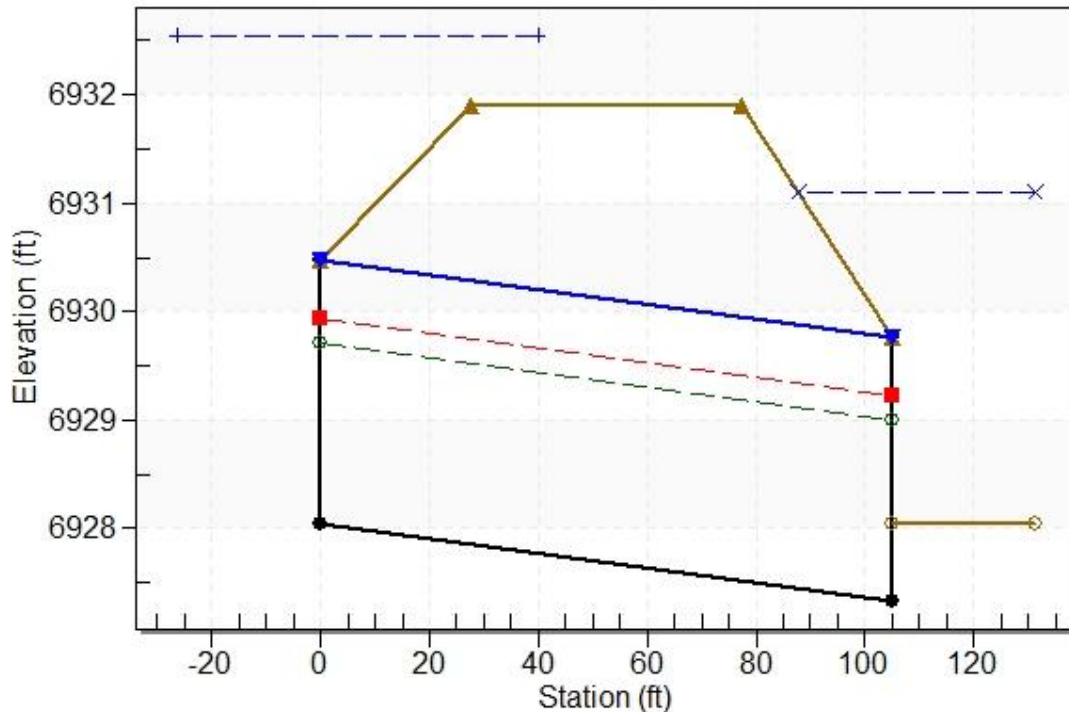

Site Data - Ex Culverts - Pr DBPS Flow

Site Data Option: Culvert Invert Data

Inlet Station: 0.00 ft

Inlet Elevation: 6928.05 ft

Outlet Station: 105.00 ft

Outlet Elevation: 6927.34 ft

Number of Barrels: 3

Culvert Data Summary - Ex Culverts - Pr DBPS Flow

Barrel Shape: Elliptical

Barrel Span: 45.00 in

Barrel Rise: 29.00 in

Barrel Material: Concrete

Embedment: 0.00 in

Barrel Manning's n: 0.0130

Culvert Type: Straight

Inlet Configuration: Square Edge with Headwall

Inlet Depression: None

Table 3 - Downstream Channel Rating Curve (Crossing: Bent Grass & Meridian

Flow (cfs)	Water Surface Elev (ft)	Depth (ft)	Velocity (ft/s)	Shear (psf)	Froude Number
0.00	6928.05	0.00	0.00	0.00	0.00
85.00	6930.02	1.97	5.46	2.16	0.97
170.00	6930.61	2.56	6.49	2.79	1.01
270.00	6931.09	3.04	7.28	3.32	1.04
340.00	6931.37	3.32	7.72	3.62	1.06
425.00	6931.66	3.61	8.16	3.94	1.07
510.00	6931.91	3.86	8.54	4.22	1.08
595.00	6932.14	4.09	8.87	4.47	1.09
680.00	6932.35	4.30	9.18	4.70	1.10
765.00	6932.55	4.50	9.45	4.91	1.11
850.00	6932.73	4.68	9.70	5.11	1.12

Existing Pr DBPS Flows)

Tailwater Channel Data - Bent Grass & Meridian Existing Pr DBPS Flows

Tailwater Channel Option: Triangular Channel

Side Slope (H:V): 4.00 (_:1)

Channel Slope: 0.0175

Channel Manning's n: 0.0350

Channel Invert Elevation: 6928.05 ft

Roadway Data for Crossing: Bent Grass & Meridian Existing Pr DBPS Flows

Roadway Profile Shape: Constant Roadway Elevation

Crest Length: 80.00 ft

Crest Elevation: 6931.90 ft

Roadway Surface: Paved

Roadway Top Width: 50.00 ft

HY-8 Culvert Analysis Report

Crossing Discharge Data

Discharge Selection Method: Specify Minimum, Design, and Maximum Flow

Minimum Flow: 25.8 cfs

Design Flow: 255 cfs

Maximum Flow: 275 cfs

Table 1 - Summary of Culvert Flows at Crossing: Add't Culverts for Add't Offsite Flow

Headwater Elevation (ft)	Total Discharge (cfs)	New Ellp Culverts for Offsite Flow Discharge (cfs)	Roadway Discharge (cfs)	Iterations
6929.35	25.80	25.80	0.00	1
6930.04	50.72	50.72	0.00	1
6930.71	75.64	75.64	0.00	1
6931.51	100.56	100.56	0.00	1
6932.03	125.48	114.03	11.26	9
6932.17	150.40	117.27	32.97	6
6932.28	175.32	119.82	55.38	5
6932.38	200.24	120.43	79.53	4
6932.47	225.16	119.77	105.23	4
6932.58	255.00	118.96	135.95	4
6932.65	275.00	118.48	156.17	3
6931.90	110.74	110.74	0.00	Overtopping

Rating Curve Plot for Crossing: Add't Culverts for Add't Offsite Flow

Total Rating Curve

Crossing: Add't Culverts for Add't Offsite Flow

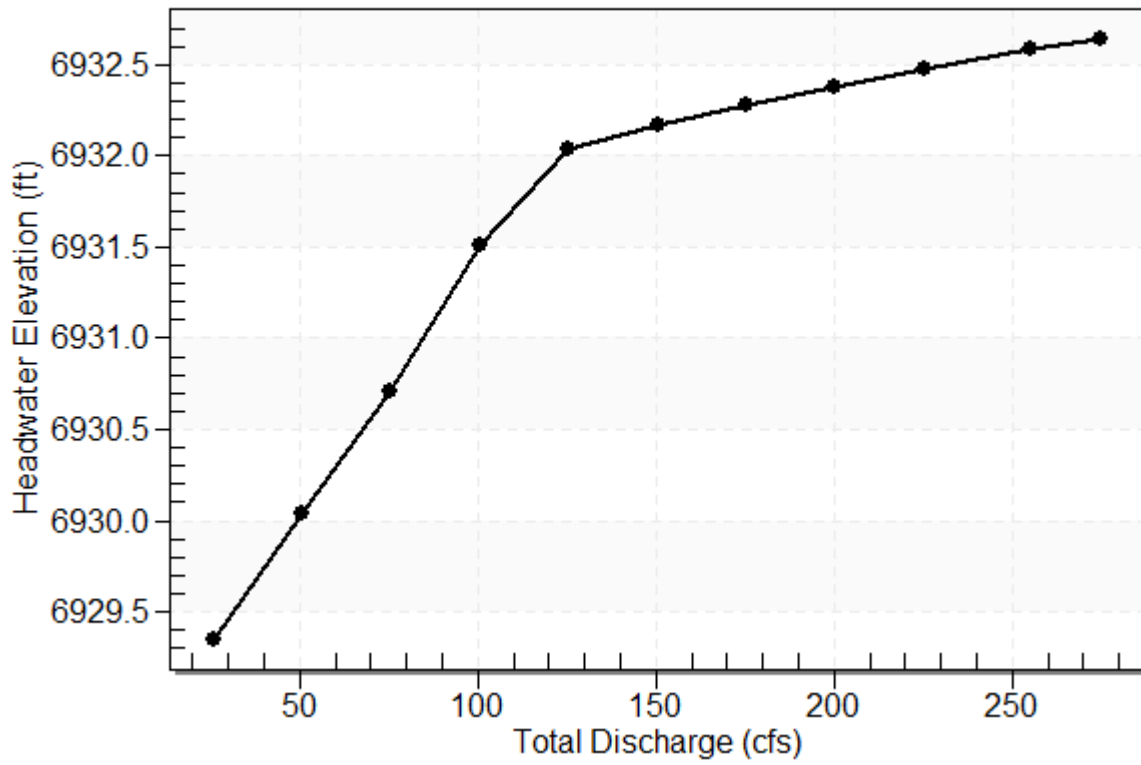

Table 2 - Culvert Summary Table: New Ellp Culverts for Offsite Flow

Total Discharge (cfs)	Culvert Discharge (cfs)	Headwater Elevation (ft)	Inlet Control Depth (ft)	Outlet Control Depth (ft)	Flow Type	Normal Depth (ft)	Critical Depth (ft)	Outlet Depth (ft)	Tailwater Depth (ft)	Outlet Velocity (ft/s)	Tailwater Velocity (ft/s)
25.80	25.80	6929.35	1.303	0.658	1-JS1t	0.792	0.941	1.262	1.262	3.305	4.049
50.72	50.72	6930.04	1.993	1.327	1-S2n	1.139	1.348	1.150	1.626	7.371	4.795
75.64	75.64	6930.71	2.663	2.093	5-S2n	1.426	1.670	1.441	1.889	8.261	5.299
100.56	100.56	6931.51	3.464	3.007	5-S2n	1.723	1.932	1.737	2.102	8.884	5.690
125.48	114.03	6932.03	3.982	3.650	5-JS1t	1.905	2.046	2.284	2.284	7.861	6.014
150.40	117.27	6932.17	4.116	3.930	4-FFf	1.955	2.070	2.417	2.445	7.904	6.292
175.32	119.82	6932.28	4.225	4.171	4-FFf	1.998	2.088	2.417	2.589	8.075	6.538
200.24	120.43	6932.38	4.252	4.327	4-FFf	2.009	2.093	2.417	2.721	8.117	6.759
225.16	119.77	6932.47	4.223	4.424	4-FFf	1.997	2.088	2.417	2.844	8.072	6.960
255.00	118.96	6932.58	4.188	4.529	4-FFf	1.982	2.082	2.417	2.980	8.018	7.180
275.00	118.48	6932.65	4.168	4.596	4-FFf	1.974	2.079	2.417	3.065	7.985	7.317

Straight Culvert

Inlet Elevation (invert): 6928.05 ft, Outlet Elevation (invert): 6927.34 ft

Culvert Length: 105.00 ft, Culvert Slope: 0.0068

Culvert Performance Curve Plot: New Ellp Culverts for Offsite Flow

Performance Curve

Culvert: New Ellp Culverts for Offsite Flow

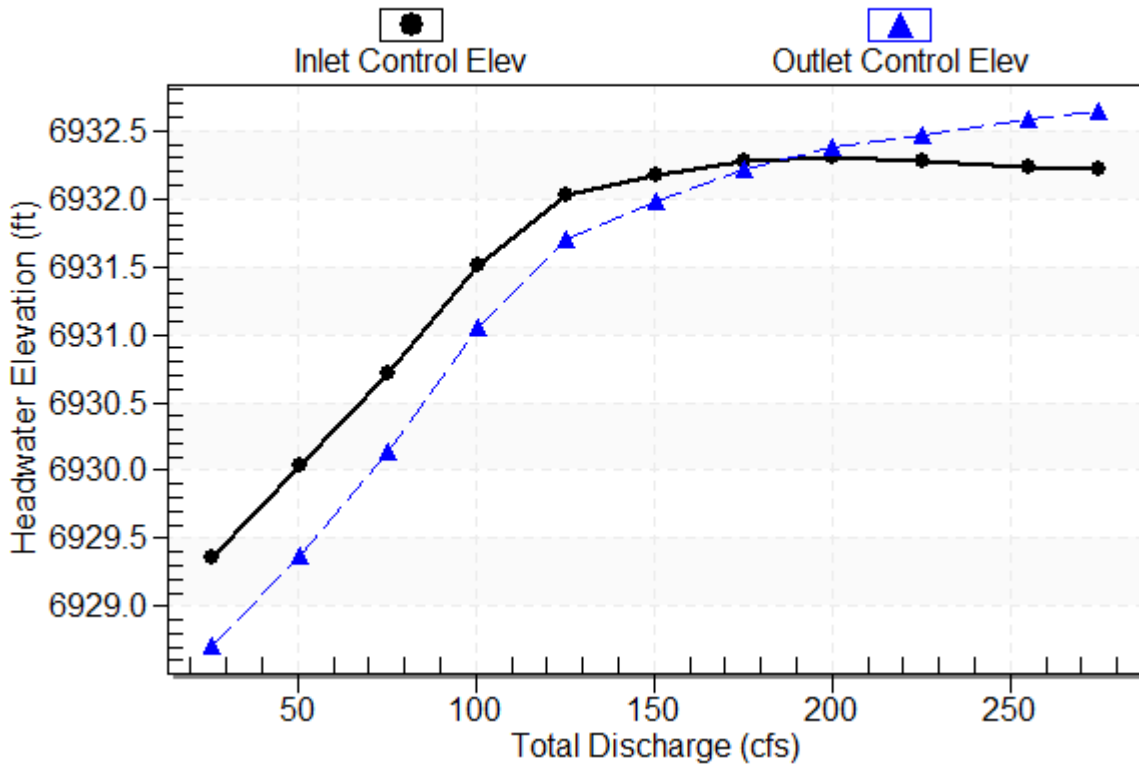

Water Surface Profile Plot for Culvert: New Ellp Culverts for Offsite Flow

Crossing - Add't Culverts for Add't Offsite Flow, Design Discharge - 255.0 cfs

Culvert - New Ellp Culverts for Offsite Flow, Culvert Discharge - 119.0 cfs

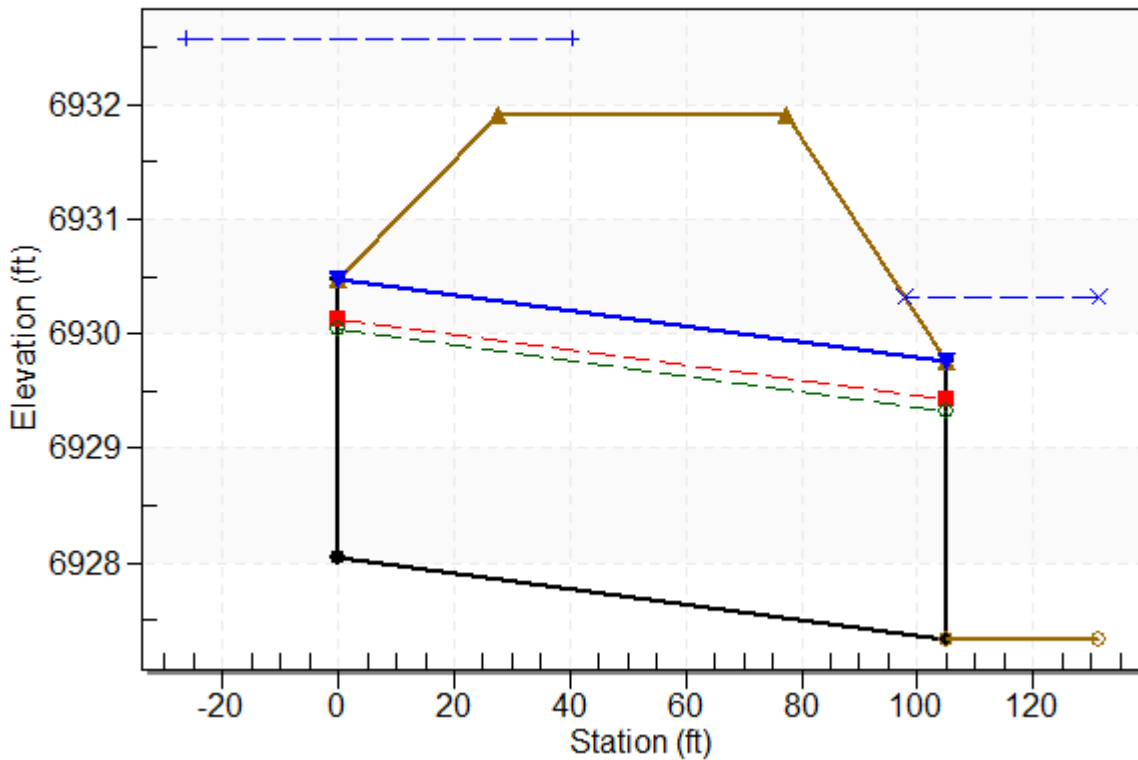

Site Data - New Ellp Culverts for Offsite Flow

Site Data Option: Culvert Invert Data

Inlet Station: 0.00 ft

Inlet Elevation: 6928.05 ft

Outlet Station: 105.00 ft

Outlet Elevation: 6927.34 ft

Number of Barrels: 2

Culvert Data Summary - New Ellp Culverts for Offsite Flow

Barrel Shape: Elliptical

Barrel Span: 45.00 in

Barrel Rise: 29.00 in

Barrel Material: Concrete

Embedment: 0.00 in

Barrel Manning's n: 0.0130

Culvert Type: Straight

Inlet Configuration: Square Edge with Headwall

Inlet Depression: None

Table 3 - Downstream Channel Rating Curve (Crossing: Add't Culverts for Add't

Flow (cfs)	Water Surface Elev (ft)	Depth (ft)	Velocity (ft/s)	Shear (psf)	Froude Number
25.80	6928.60	1.26	4.05	1.38	0.90
50.72	6928.97	1.63	4.79	1.78	0.94
75.64	6929.23	1.89	5.30	2.06	0.96
100.56	6929.44	2.10	5.69	2.30	0.98
125.48	6929.62	2.28	6.01	2.49	0.99
150.40	6929.78	2.44	6.29	2.67	1.00
175.32	6929.93	2.59	6.54	2.83	1.01
200.24	6930.06	2.72	6.76	2.97	1.02
225.16	6930.18	2.84	6.96	3.11	1.03
255.00	6930.32	2.98	7.18	3.25	1.04
275.00	6930.41	3.07	7.32	3.35	1.04

Tailwater Channel Data - Add't Culverts for Add't Offsite Flow

Tailwater Channel Option: Triangular Channel

Side Slope (H:V): 4.00 (1:1)

Channel Slope: 0.0175

Channel Manning's n: 0.0350

Channel Invert Elevation: 6927.34 ft

Roadway Data for Crossing: Add't Culverts for Add't Offsite Flow

Roadway Profile Shape: Constant Roadway Elevation

Crest Length: 80.00 ft

Crest Elevation: 6931.90 ft

Roadway Surface: Paved

Roadway Top Width: 50.00 ft

HY-8 Culvert Analysis Report
Existing Culverts @ Owl Place

Crossing Discharge Data

Discharge Selection Method: Specify Minimum, Design, and Maximum Flow

Minimum Flow: 248.6 cfs

Design Flow: 850 cfs

Maximum Flow: 925 cfs

Table 1 - Summary of Culvert Flows at Crossing: Owl Place - Ex Culvert Fut DBPS

Headwater Elevation (ft)	Total Discharge (cfs)	Ex Twin 36-IN CMPs Discharge (cfs)	Roadway Discharge (cfs)	Iterations
6913.60	248.60	109.05	139.42	7
6913.77	316.24	111.86	204.26	5
6913.92	383.88	114.62	268.95	4
6914.07	451.52	116.94	334.34	4
6914.20	519.16	118.93	400.05	4
6914.33	586.80	121.04	465.66	4
6914.45	654.44	122.77	531.61	4
6914.57	722.08	123.99	597.68	3
6914.69	789.72	124.68	664.77	3
6914.79	850.00	125.03	724.82	3
6914.91	925.00	125.07	799.85	3
6913.00	97.95	97.95	0.00	Overtopping

Flow (850 cfs)

Rating Curve Plot for Crossing: Owl Place - Ex Culvert Fut DBPS Flow (850 cfs)

Total Rating Curve

Crossing: Owl Place - Ex Culvert Fut DBPS Flow (850 cfs)

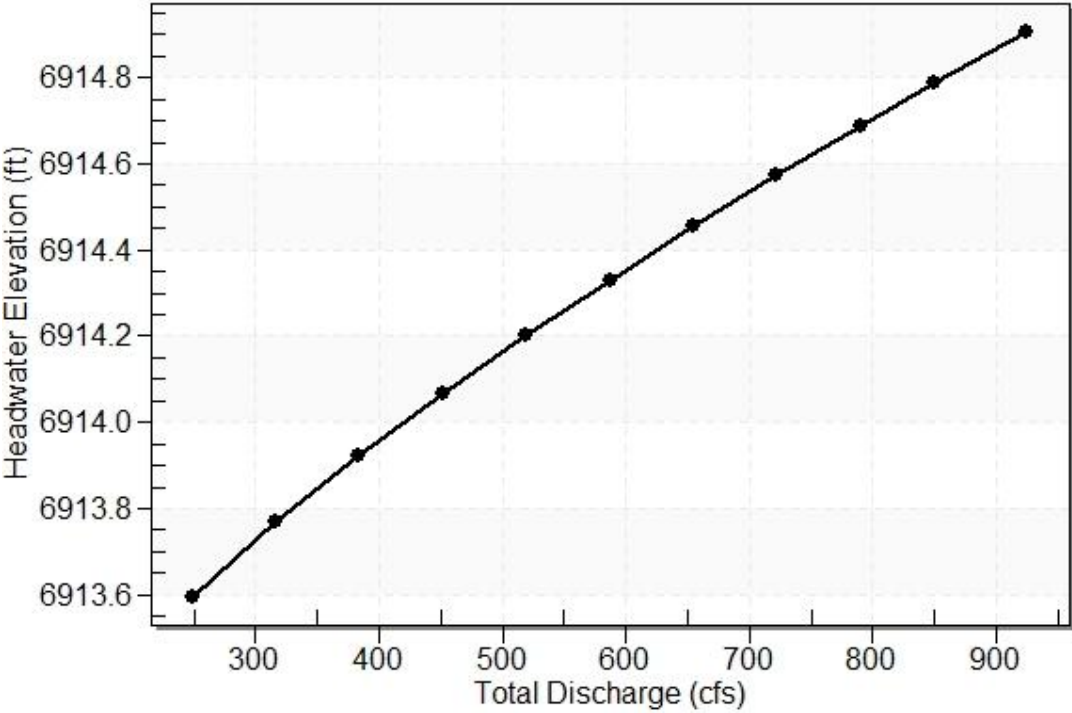

Table 2 - Culvert Summary Table: Ex Twin 36-IN CMPs

Total Discharge (cfs)	Culvert Discharge (cfs)	Headwater Elevation (ft)	Inlet Control Depth (ft)	Outlet Control Depth (ft)	Flow Type	Normal Depth (ft)	Critical Depth (ft)	Outlet Depth (ft)	Tailwater Depth (ft)	Outlet Velocity (ft/s)	Tailwater Velocity (ft/s)
248.60	109.05	6913.60	5.096	5.078	7-M2c	3.000	2.397	2.397	2.361	9.005	4.055
316.24	111.86	6913.77	5.258	5.271	7-M2c	3.000	2.425	2.425	2.584	9.136	4.306
383.88	114.62	6913.92	5.423	5.421	7-M2c	3.000	2.452	2.452	2.779	9.267	4.520
451.52	116.94	6914.07	5.565	5.567	7-M2c	3.000	2.474	2.474	2.953	9.379	4.707
519.16	118.93	6914.20	5.689	5.702	7-M2c	3.000	2.492	2.492	3.112	9.476	4.874
586.80	121.04	6914.33	5.824	5.831	7-M2c	3.000	2.511	2.511	3.258	9.579	5.026
654.44	122.77	6914.45	5.937	5.954	7-M2t	3.000	2.526	2.624	3.394	9.362	5.165
722.08	123.99	6914.57	6.017	6.071	7-M2t	3.000	2.536	2.752	3.522	9.130	5.293
789.72	124.68	6914.69	6.063	6.187	7-M2t	3.000	2.542	2.872	3.642	8.951	5.413
850.00	125.03	6914.79	6.087	6.287	7-M2t	3.000	2.545	2.974	3.744	8.856	5.513
925.00	125.07	6914.91	6.090	6.408	4-FFf	3.000	2.545	3.000	3.864	8.847	5.631

Straight Culvert

Inlet Elevation (invert): 6908.50 ft, Outlet Elevation (invert): 6908.00 ft

Culvert Length: 50.50 ft, Culvert Slope: 0.0099

Culvert Performance Curve Plot: Ex Twin 36-IN CMPs

Performance Curve

Culvert: Ex Twin 36-IN CMPs

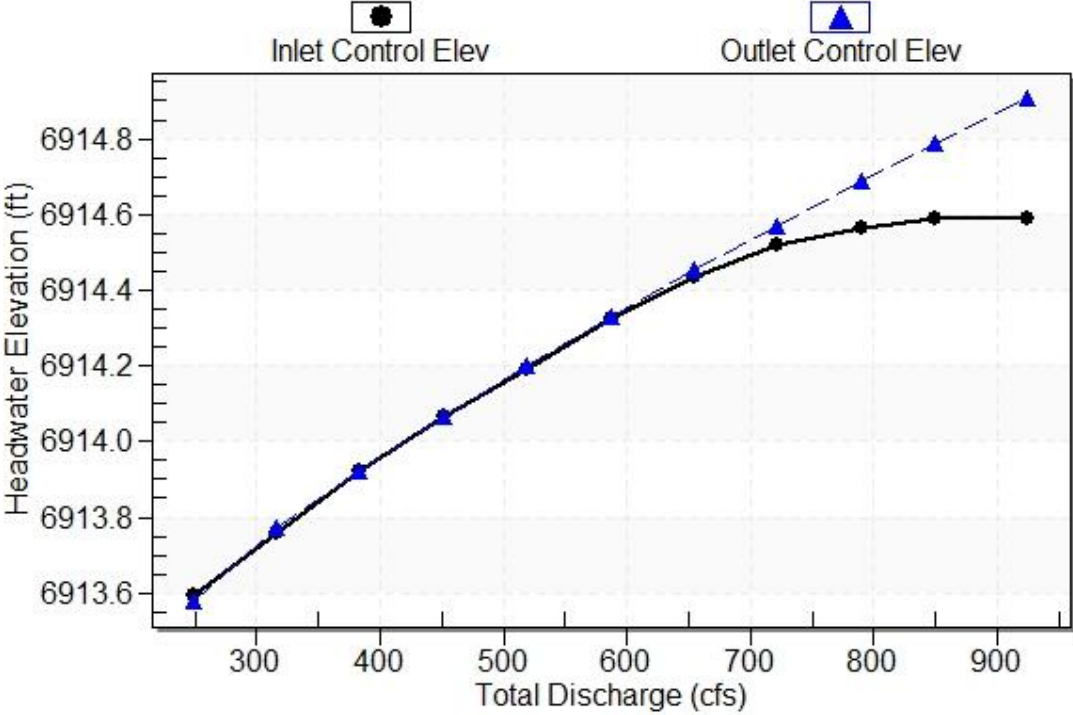

Water Surface Profile Plot for Culvert: Ex Twin 36-IN CMPs

Crossing - Owl Place - Ex Culvert Fut DBPS Flow (850 cfs), Design Discharge - 850.0 cfs

Culvert - Ex Twin 36-IN CMPs, Culvert Discharge - 125.0 cfs

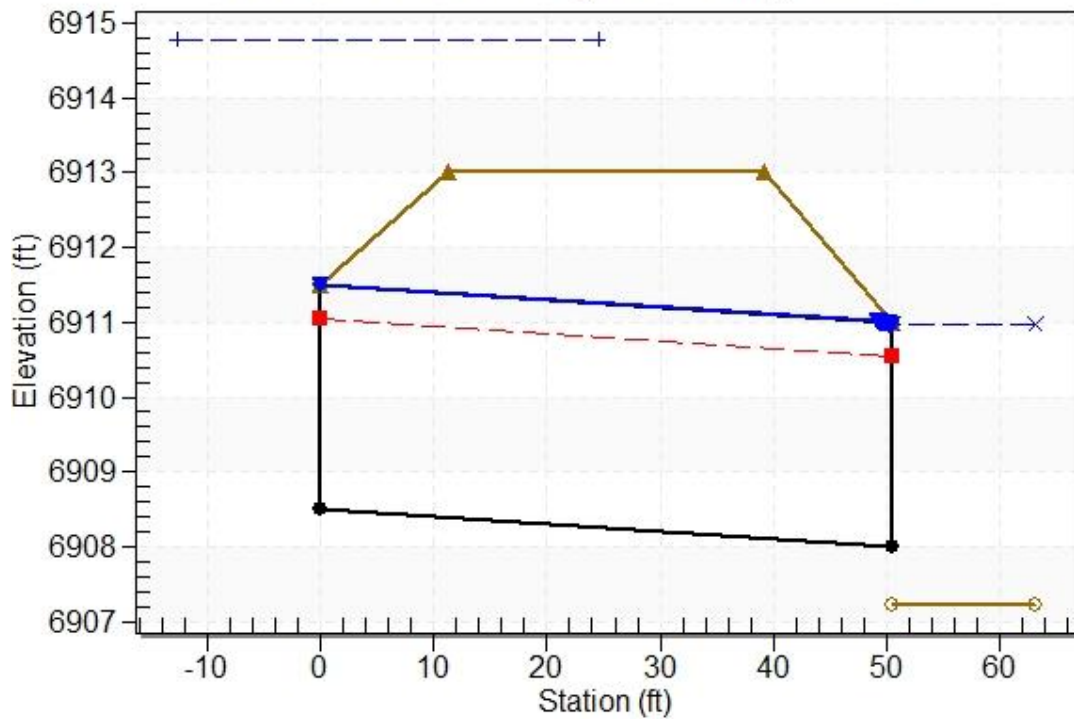

Site Data - Ex Twin 36-IN CMPs

Site Data Option: Culvert Invert Data

Inlet Station: 0.00 ft

Inlet Elevation: 6908.50 ft

Outlet Station: 50.50 ft

Outlet Elevation: 6908.00 ft

Number of Barrels: 2

Culvert Data Summary - Ex Twin 36-IN CMPs

Barrel Shape: Circular

Barrel Diameter: 3.00 ft

Barrel Material: Corrugated Steel

Embedment: 0.00 in

Barrel Manning's n: 0.0240

Culvert Type: Straight

Inlet Configuration: Thin Edge Projecting

Inlet Depression: None

Table 3 - Downstream Channel Rating Curve (Crossing: Owl Place - Ex Culvert Fut

Flow (cfs)	Water Surface Elev (ft)	Depth (ft)	Velocity (ft/s)	Shear (psf)	Froude Number
248.60	6909.59	2.36	4.05	2.21	0.66
316.24	6909.81	2.58	4.31	2.42	0.67
383.88	6910.01	2.78	4.52	2.60	0.68
451.52	6910.18	2.95	4.71	2.76	0.68
519.16	6910.34	3.11	4.87	2.91	0.69
586.80	6910.49	3.26	5.03	3.05	0.69
654.44	6910.62	3.39	5.16	3.18	0.70
722.08	6910.75	3.52	5.29	3.30	0.70
789.72	6910.87	3.64	5.41	3.41	0.71
850.00	6910.97	3.74	5.51	3.50	0.71
925.00	6911.09	3.86	5.63	3.62	0.71

DBPS Flow (850 cfs)**Tailwater Channel Data - Owl Place - Ex Culvert Fut DBPS Flow (850 cfs)**

Tailwater Channel Option: Triangular Channel

Side Slope (H:V): 11.00 (_:1)

Channel Slope: 0.0150

Channel Manning's n: 0.0500

Channel Invert Elevation: 6907.23 ft

Roadway Data for Crossing: Owl Place - Ex Culvert Fut DBPS Flow (850 cfs)

Roadway Profile Shape: Constant Roadway Elevation

Crest Length: 100.00 ft

Crest Elevation: 6913.00 ft

Roadway Surface: Paved

Roadway Top Width: 28.00 ft

Future Culvert Calculations

HY-8 Culvert Analysis Report

**Future Culvert @ Bent Grass
Meadows Drive/Meridian Road**

Crossing Discharge Data

Discharge Selection Method: Specify Minimum, Design, and Maximum Flow

Minimum Flow: 298 cfs

Design Flow: 850 cfs

Maximum Flow: 925 cfs

Table 1 - Summary of Culvert Flows at Crossing: Bent Grass & Meridian Future - Fut

Headwater Elevation (ft)	Total Discharge (cfs)	Future Culvert - Fut Flow Discharge (cfs)	Roadway Discharge (cfs)	Iterations
6927.25	298.00	298.00	0.00	1
6927.54	360.70	360.70	0.00	1
6927.82	423.40	423.40	0.00	1
6928.08	486.10	486.10	0.00	1
6928.34	548.80	548.80	0.00	1
6928.58	611.50	611.50	0.00	1
6928.83	674.20	674.20	0.00	1
6929.08	736.90	736.90	0.00	1
6929.33	799.60	799.60	0.00	1
6929.53	850.00	850.00	0.00	1
6929.85	925.00	925.00	0.00	1
6931.50	1258.18	1258.18	0.00	Overtopping

DBPS Flow (850 cfs)

Rating Curve Plot for Crossing: Bent Grass & Meridian Future - Fut DBPS Flow (850 cfs)

Total Rating Curve

Crossing: Bent Grass & Meridian Future - Fut DBPS Flow (850 cfs)

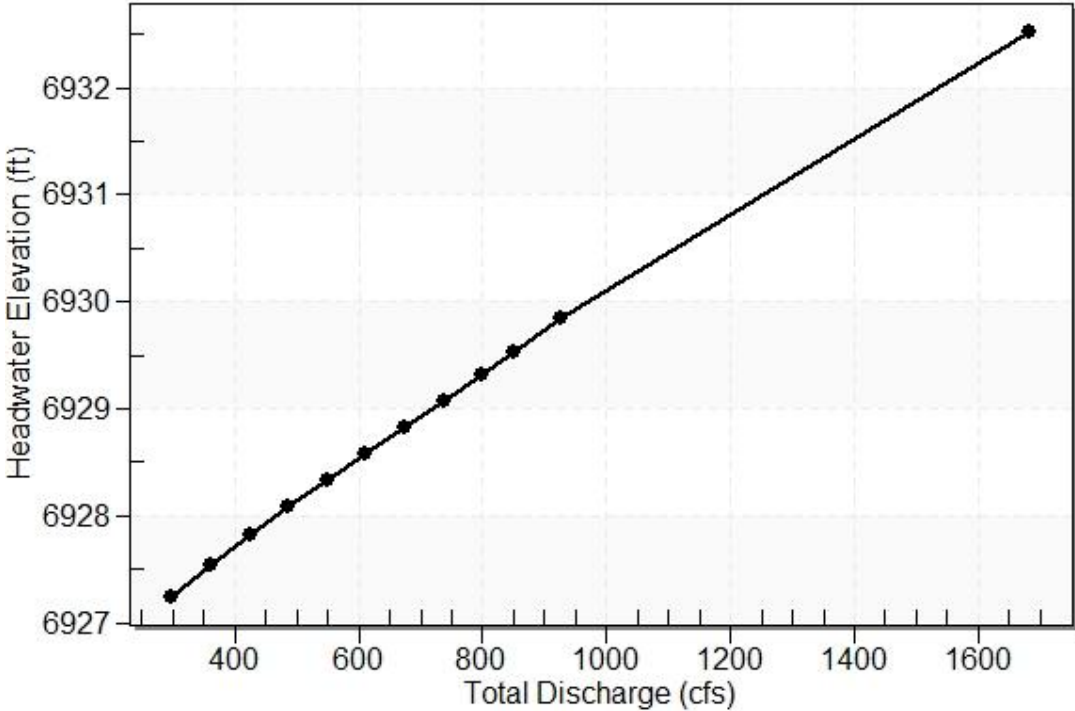

Table 2 - Culvert Summary Table: Future Culvert - Fut Flow

Total Discharge (cfs)	Culvert Discharge (cfs)	Headwater Elevation (ft)	Inlet Control Depth (ft)	Outlet Control Depth (ft)	Flow Type	Normal Depth (ft)	Critical Depth (ft)	Outlet Depth (ft)	Tailwater Depth (ft)	Outlet Velocity (ft/s)	Tailwater Velocity (ft/s)
298.00	298.00	6927.25	2.138	1.250	1-S2n	1.356	1.391	1.356	0.729	6.866	7.728
360.70	360.70	6927.54	2.435	1.504	1-S2n	1.533	1.580	1.535	0.816	7.343	8.298
423.40	423.40	6927.82	2.712	1.759	1-S2n	1.699	1.758	1.702	0.897	7.773	8.808
486.10	486.10	6928.08	2.975	2.017	1-S2n	1.858	1.928	1.861	0.973	8.161	9.267
548.80	548.80	6928.34	3.228	2.281	1-S2n	2.010	2.090	2.015	1.045	8.513	9.688
611.50	611.50	6928.58	3.475	2.551	1-S2n	2.158	2.247	2.163	1.114	8.835	10.078
674.20	674.20	6928.83	3.719	2.828	1-S2n	2.301	2.398	2.307	1.180	9.133	10.441
736.90	736.90	6929.08	3.965	3.113	1-S2n	2.440	2.544	2.447	1.243	9.412	10.781
799.60	799.60	6929.33	4.216	3.406	5-S2n	2.576	2.687	2.583	1.304	9.673	11.102
850.00	850.00	6929.53	4.422	3.647	5-S2n	2.683	2.798	2.691	1.352	9.872	11.347
925.00	925.00	6929.85	4.740	4.018	5-S2n	2.839	2.961	2.848	1.420	10.151	11.695

Straight Culvert

Inlet Elevation (invert): 6925.11 ft, Outlet Elevation (invert): 6924.83 ft

Culvert Length: 95.00 ft, Culvert Slope: 0.0029

Culvert Performance Curve Plot: Future Culvert - Fut Flow

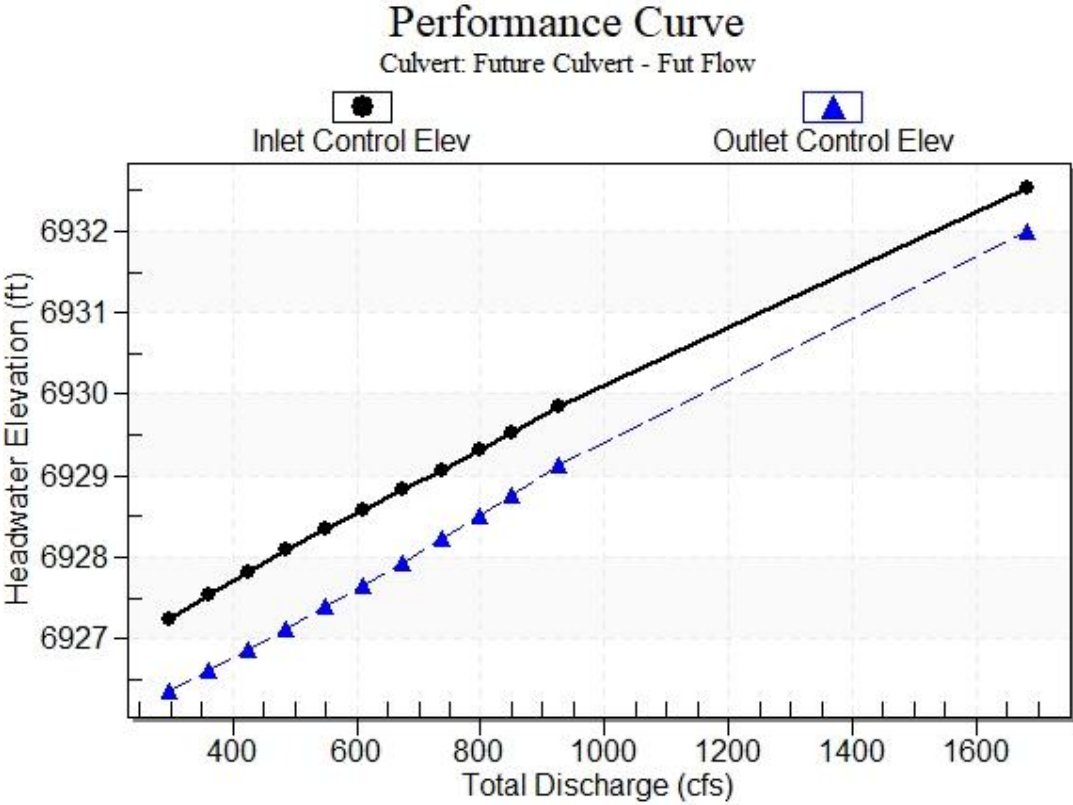

Water Surface Profile Plot for Culvert: Future Culvert - Fut Flow

Crossing - Bent Grass & Meridian Future - Fut DBPS Flow (850 cfs), Design Discharge - 850.0 cfs

Culvert - Future Culvert - Fut Flow, Culvert Discharge - 850.0 cfs

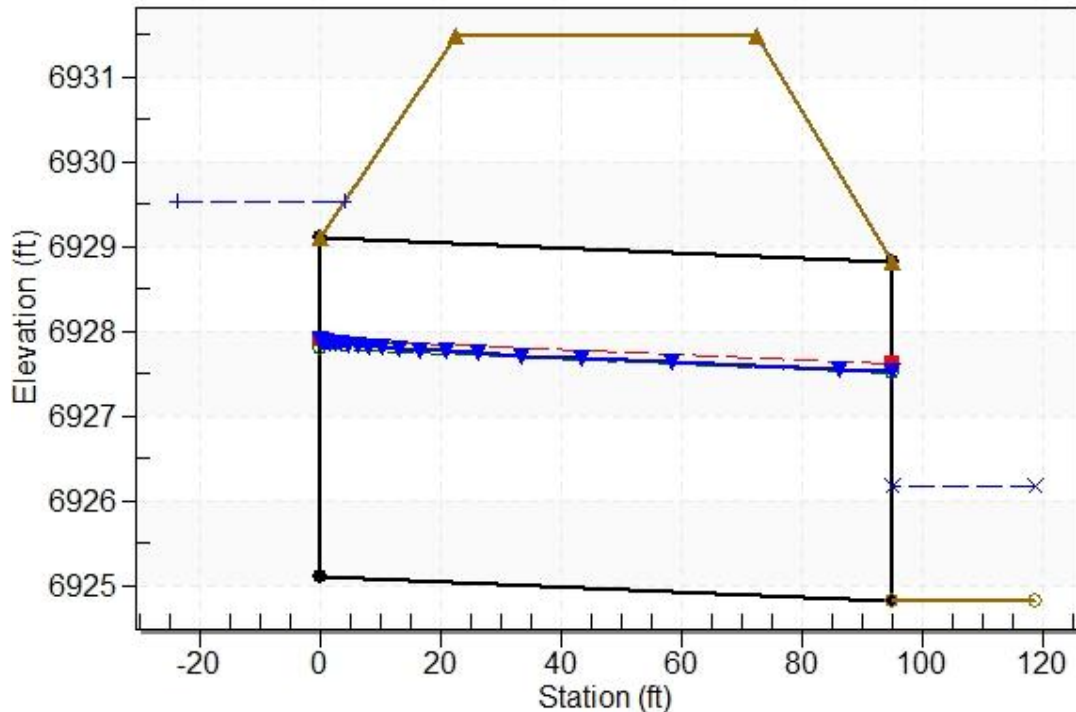

Site Data - Future Culvert - Fut Flow

Site Data Option: Culvert Invert Data

Inlet Station: 0.00 ft

Inlet Elevation: 6925.11 ft

Outlet Station: 95.00 ft

Outlet Elevation: 6924.83 ft

Number of Barrels: 2

Culvert Data Summary - Future Culvert - Fut Flow

Barrel Shape: Concrete Box

Barrel Span: 16.00 ft

Barrel Rise: 4.00 ft

Barrel Material: Concrete

Embedment: 0.00 in

Barrel Manning's n: 0.0130

Culvert Type: Straight

Inlet Configuration: Square Edge (30-75° flare) Wingwall

Inlet Depression: None

Table 3 - Downstream Channel Rating Curve (Crossing: Bent Grass & Meridian)

Flow (cfs)	Water Surface Elev (ft)	Depth (ft)	Velocity (ft/s)	Shear (psf)	Froude Number
298.00	6925.56	0.73	7.73	2.48	1.64
360.70	6925.65	0.82	8.30	2.78	1.67
423.40	6925.73	0.90	8.81	3.05	1.69
486.10	6925.80	0.97	9.27	3.31	1.71
548.80	6925.88	1.05	9.69	3.56	1.73
611.50	6925.94	1.11	10.08	3.79	1.75
674.20	6926.01	1.18	10.44	4.01	1.77
736.90	6926.07	1.24	10.78	4.23	1.78
799.60	6926.13	1.30	11.10	4.44	1.79
850.00	6926.18	1.35	11.35	4.60	1.80
925.00	6926.25	1.42	11.70	4.83	1.82

Future - Fut DBPS Flow (850 cfs)**Tailwater Channel Data - Bent Grass & Meridian Future - Fut DBPS Flow (850 cfs)**

Tailwater Channel Option: Trapezoidal Channel

Bottom Width: 50.00 ft

Side Slope (H:V): 4.00 (_:1)

Channel Slope: 0.0545

Channel Manning's n: 0.0350

Channel Invert Elevation: 6924.83 ft

Roadway Data for Crossing: Bent Grass & Meridian Future - Fut DBPS Flow (850 cfs)

Roadway Profile Shape: Constant Roadway Elevation

Crest Length: 80.00 ft

Crest Elevation: 6931.50 ft

Roadway Surface: Paved

Roadway Top Width: 50.00 ft

HY-8 Culvert Analysis Report

Future Culvert @ Owl Place

Crossing Discharge Data

Discharge Selection Method: Specify Minimum, Design, and Maximum Flow

Minimum Flow: 248.6 cfs

Design Flow: 850 cfs

Maximum Flow: 925 cfs

Table 1 - Summary of Culvert Flows at Crossing: Owl Place - Fut RCBC FutDBPS

Headwater Elevation (ft)	Total Discharge (cfs)	Fut 20 X 4 RCBC Discharge (cfs)	Roadway Discharge (cfs)	Iterations
6911.34	248.60	248.60	0.00	1
6911.83	316.24	316.24	0.00	1
6912.30	383.88	383.88	0.00	1
6912.76	451.52	451.52	0.00	1
6913.24	519.16	519.16	0.00	1
6913.75	586.80	586.80	0.00	1
6914.29	654.44	654.44	0.00	1
6914.88	722.08	722.08	0.00	1
6915.52	789.72	789.72	0.00	1
6916.14	850.00	850.00	0.00	1
6916.99	925.00	925.00	0.00	1
6917.00	926.05	926.05	0.00	Overtopping

Flow (850 cfs)

Rating Curve Plot for Crossing: Owl Place - Fut RCBC FutDBPS Flow (850 cfs)

Total Rating Curve

Crossing: Owl Place - Fut RCBC FutDBPS Flow (850 cfs)

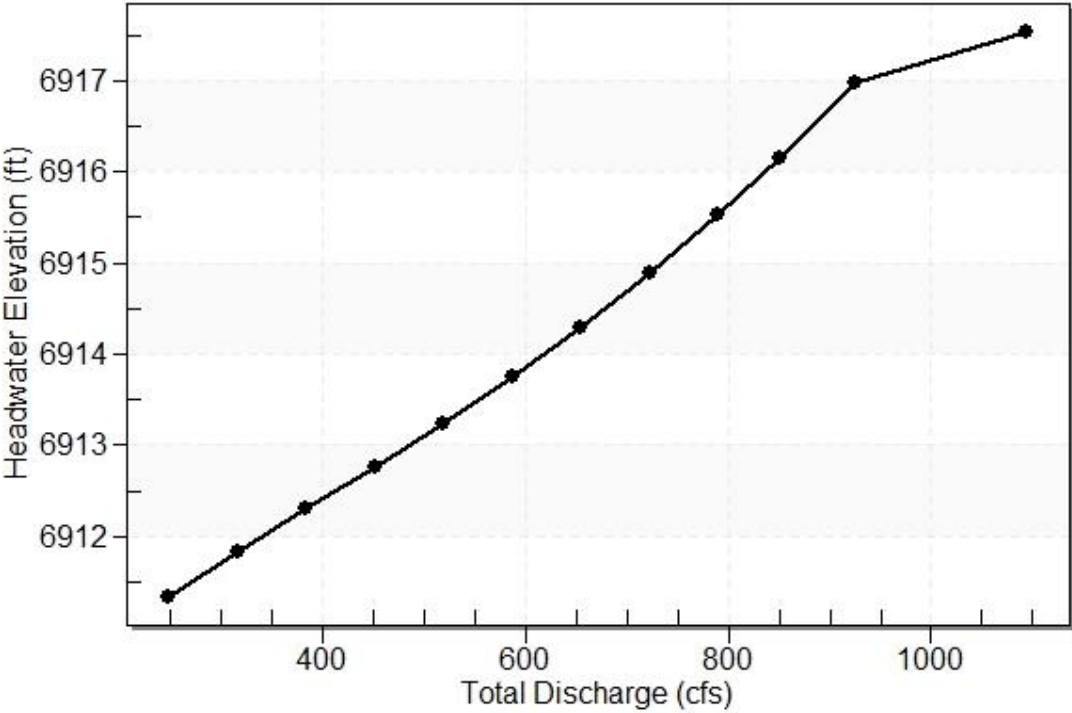

Table 2 - Culvert Summary Table: Fut 20 X 4 RCBC

Total Discharge (cfs)	Culvert Discharge (cfs)	Headwater Elevation (ft)	Inlet Control Depth (ft)	Outlet Control Depth (ft)	Flow Type	Normal Depth (ft)	Critical Depth (ft)	Outlet Depth (ft)	Tailwater Depth (ft)	Outlet Velocity (ft/s)	Tailwater Velocity (ft/s)
248.60	248.60	6911.34	2.843	2.102	1-JS1t	1.044	1.687	2.361	2.361	5.265	4.055
316.24	316.24	6911.83	3.331	2.474	1-S2n	1.214	1.980	1.476	2.584	10.714	4.306
383.88	383.88	6912.30	3.797	2.853	1-S2n	1.371	2.253	1.700	2.779	11.287	4.520
451.52	451.52	6912.76	4.262	3.248	5-S2n	1.520	2.511	1.915	2.953	11.788	4.707
519.16	519.16	6913.24	4.740	3.662	5-S2n	1.661	2.756	2.122	3.112	12.232	4.874
586.80	586.80	6913.75	5.245	4.100	5-S2n	1.795	2.990	2.321	3.258	12.639	5.026
654.44	654.44	6914.29	5.789	4.564	5-S2n	1.925	3.216	2.514	3.394	13.018	5.165
722.08	722.08	6914.88	6.379	5.054	5-S2n	2.051	3.434	2.702	3.522	13.362	5.293
789.72	789.72	6915.52	7.022	5.754	5-S2n	2.173	3.645	2.885	3.642	13.688	5.413
850.00	850.00	6916.14	7.644	6.231	5-S2n	2.279	3.828	3.044	3.744	13.961	5.513
925.00	925.00	6916.99	8.487	6.835	5-S2n	2.407	4.000	3.238	3.864	14.285	5.631

Straight Culvert

Inlet Elevation (invert): 6908.50 ft, Outlet Elevation (invert): 6908.00 ft

Culvert Length: 50.50 ft, Culvert Slope: 0.0099

Culvert Performance Curve Plot: Fut 20 X 4 RCBC

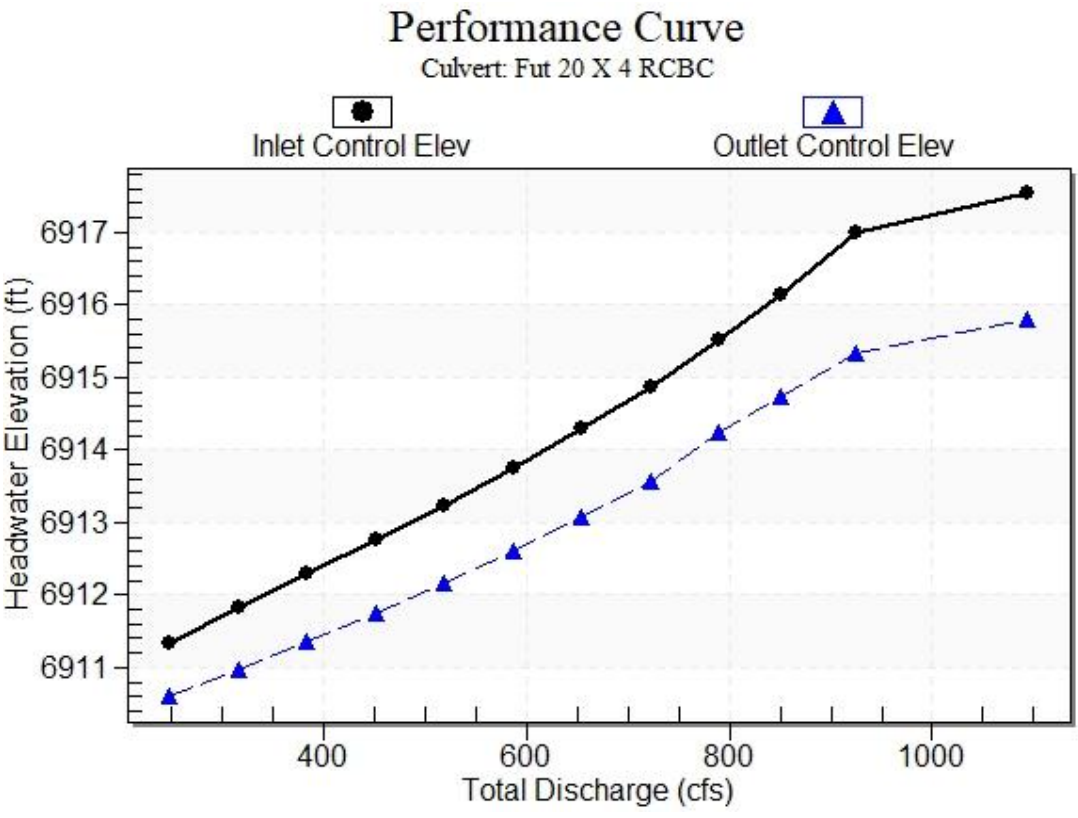

Water Surface Profile Plot for Culvert: Fut 20 X 4 RCBC

Crossing - Owl Place - Fut RCBC FutDBPS Flow (850 cfs), Design Discharge - 850.0 cfs

Culvert - Fut 20 X 4 RCBC, Culvert Discharge - 850.0 cfs

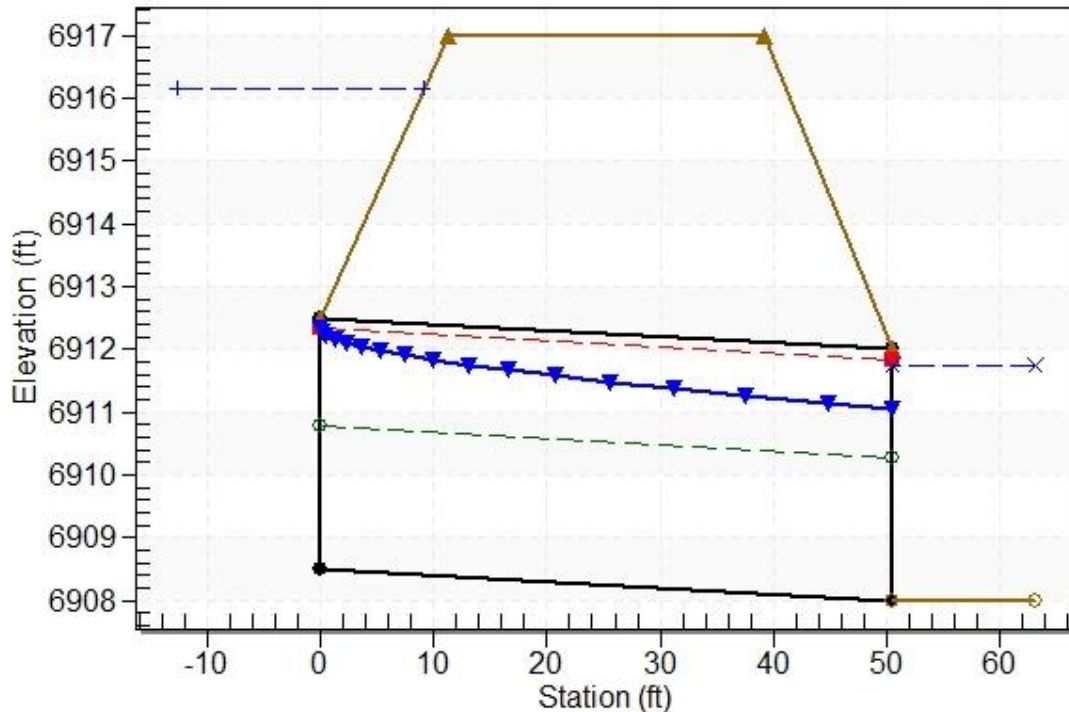

Site Data - Fut 20 X 4 RCBC

Site Data Option: Culvert Invert Data

Inlet Station: 0.00 ft

Inlet Elevation: 6908.50 ft

Outlet Station: 50.50 ft

Outlet Elevation: 6908.00 ft

Number of Barrels: 1

Culvert Data Summary - Fut 20 X 4 RCBC

Barrel Shape: Concrete Box

Barrel Span: 20.00 ft

Barrel Rise: 4.00 ft

Barrel Material: Concrete

Embedment: 0.00 in

Barrel Manning's n: 0.0120

Culvert Type: Straight

Inlet Configuration: Square Edge (90 & 15° flare) Wingwall

Inlet Depression: None

Table 3 - Downstream Channel Rating Curve (Crossing: Owl Place - Fut RCBC

Flow (cfs)	Water Surface Elev (ft)	Depth (ft)	Velocity (ft/s)	Shear (psf)	Froude Number
248.60	6910.36	2.36	4.05	2.21	0.66
316.24	6910.58	2.58	4.31	2.42	0.67
383.88	6910.78	2.78	4.52	2.60	0.68
451.52	6910.95	2.95	4.71	2.76	0.68
519.16	6911.11	3.11	4.87	2.91	0.69
586.80	6911.26	3.26	5.03	3.05	0.69
654.44	6911.39	3.39	5.16	3.18	0.70
722.08	6911.52	3.52	5.29	3.30	0.70
789.72	6911.64	3.64	5.41	3.41	0.71
850.00	6911.74	3.74	5.51	3.50	0.71
925.00	6911.86	3.86	5.63	3.62	0.71

FutDBPS Flow (850 cfs)**Tailwater Channel Data - Owl Place - Fut RCBC FutDBPS Flow (850 cfs)**

Tailwater Channel Option: Triangular Channel

Side Slope (H:V): 11.00 (_:1)

Channel Slope: 0.0150

Channel Manning's n: 0.0500

Channel Invert Elevation: 6908.00 ft

Roadway Data for Crossing: Owl Place - Fut RCBC FutDBPS Flow (850 cfs)

Roadway Profile Shape: Constant Roadway Elevation

Crest Length: 100.00 ft

Crest Elevation: 6917.00 ft

Roadway Surface: Paved

Roadway Top Width: 28.00 ft

APPENDIX D
Drainage Maps

