



# PRELIMINARY DRAINAGE REPORT

## FALCON MEADOWS AT BENT GRASS

El Paso County, Colorado

---

PREPARED FOR:  
**Challenger Homes**  
8605 Explorer Dr., Suite 250  
Colorado Springs, CO 80920

PREPARED BY:  
**Galloway & Company, Inc.**  
1155 Kelly Johnson Blvd., Suite 305  
Colorado Springs, CO 80920

DATE:  
August 5, 2020  
Revised December 2020  
Revised February 2021  
Revised April 2021  
Revised June 2021  
Revised July 2021

PUDSP-20-005



**ENGINEER'S STATEMENT**

The attached drainage plan and report were prepared under my direction and supervision and are correct to the best of my knowledge and belief. Said drainage report has been prepared according to the criteria established by the County for drainage reports and said report is in conformity with the applicable master plan of the drainage basin. I accept responsibility for any liability caused by any negligent acts, errors or omissions on my part in preparing this report.

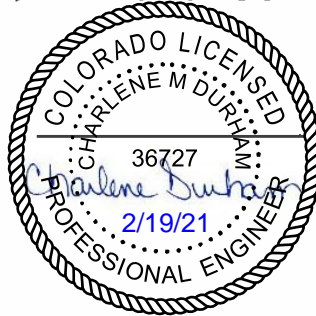

Charlene Durham, P.E. #36727  
For and on behalf of Galloway & Company, Inc.

**DEVELOPER'S CERTIFICATION**

I, The developer, have read and will comply with all of the requirements specified in this drainage report and plan.

By: [Signature]

2/19/21  
Date

Address: Challenger Homes  
8605 Explorer Dr., Suite 250  
Colorado Springs, CO 80920

By: [Signature]

2/19/21  
Date

Address: Better Land LLC  
8605 Explorer Dr., Suite 250  
Colorado Springs, CO 80920

**EL PASO COUNTY CERTIFICATION**

Filed in accordance with the requirements of the Drainage Criteria Manual, Volumes 1 and 2, El Paso County Engineering Criteria Manual and Land Development Code as amended.

Jennifer Irvine, P.E.  
County Engineer/ECM Administrator

**APPROVED**  
**Engineering Department**

08/10/2021 5:29:04 PM  
dsdnijkamp

EPC Planning & Community  
Development Department

Conditions:

Final Drainage Report for Filing 1 shall address any need for additional drainage easements in the lots adjacent to DP18.



## TABLE OF CONTENTS

I.	Purpose.....	1
II.	General Description .....	1
III.	Previous Reports .....	1
IV.	Drainage Criteria .....	2
V.	Historic & Existing (Current) Drainage Conditions.....	3
VI.	Four Step Process .....	6
	1.    Employ Runoff Reduction Practices .....	6
	2.    Stabilize Drainageways.....	6
	3.    Provide Water Quality Capture Volume (WQCV).....	6
	4.    Consider Need for Industrial and Commercial BMPs.....	6
VII.	Proposed Drainage Conditions.....	6
VIII.	Storm Sewer System.....	11
IX.	Proposed Water Quality Detention Ponds.....	11
X.	Proposed Channel Improvements .....	11
XI.	Maintenance .....	12
XII.	Wetlands Mitigation.....	13
XIII.	Floodplain Statement .....	13
XIV.	Drainage Fees & Maintenance .....	13
XV.	Conclusion .....	13
XVI.	References .....	13

Appendices:

- A. Exhibits and Figures
- B. Hydrologic Computations
- C. Hydraulic Computations
- D. Drainage Maps & Water Quality Plan

## I. Purpose

The purpose of this Preliminary Drainage Report is to identify on and offsite drainage patterns, locate and identify tributary or downstream drainage features and facilities that impact the site, and to identify which types of drainage facilities will be needed and where they will be located. This report will remain in general compliance with the MDDP submitted for review in June for the site prepared by Galloway & Company.

## II. General Description

The project is a single-family residential development located in the Falcon area of El Paso County, Colorado. The site is located in the Northwest  $\frac{1}{4}$  and Southwest  $\frac{1}{4}$  of Section 1, Township 13S, Range 65W, of the Sixth Principal Meridian, County of El Paso, State of Colorado. The subject property is bounded by Bent Grass Meadows Filing No.2 to the east, Latigo Business Center Filing No. 1 to the south, The Meadows Filings No. 1 & 2 to the west, and The Meadows Filing No. 3 to the north. A Vicinity Map is included in Appendix A.

This preliminary drainage report was the basis for the drainage facility design contained within the MDDP for the site, which is currently under review. The site consists of approximately 66.6 acres and includes 267 dwelling units.

The existing soil types within the proposed site as determined by the NRCS Web Soil Survey for El Paso County Area consist of Columbine gravelly sandy loam, Blakeland-Fluvaquentic Haplaquolls, and Blakeland loamy sand. All soils are defined as having a hydrologic soil group of A. See the soils map included in Appendix A.

## III. Previous Reports

The proposed site has been included in multiple drainage studies in the past. The following is a composite list of the existing reports pertaining to this site analysis.

1. *Falcon Drainage Basin Planning Study*, by Matrix Design Group, September 2015.
2. *Master Development Drainage Plan – Bent Grass Residential Subdivision*, by Galloway & Company, *Revision in Progress per Meridian Road Intersection Comments*.
3. *Master Development Drainage Plan and Preliminary Drainage Plan – Bent Grass Subdivision*, by Kiowa Engineering Corporation, December 2006.
4. *Final Drainage Report for Bent Grass Residential (Filing No. 1)*, by Classic Consulting Engineers & Surveyors, LLC, August 2014.
5. *Final Drainage Report Addendum for Bent Grass Residential (Filing No. 1)*, by Classic Consulting Engineers & Surveyors, LLC, August 2015.
6. *Master Development Drainage Plan for The Ranch*, by Classic Consulting Engineers & Surveyors, LLC, November 2018.
7. *Falcon Highlands Master Development Drainage Plan & Preliminary Drainage Report & Final Drainage Report for Filing 1*, by URS, January 2005.
8. *Final Drainage Report and Erosion Control Plan – Latigo Business Center Filing No. 1 A Re-subdivision of a Portion of Latigo Business and Research Center Filing No. 1*, by Kiowa Engineering Corporation, November 2004.
9. *Final Drainage Letter Report for Lot 1, Latigo Business Center Filing No. 1*, by Colorado Design Concepts, April 2005.

10. *Final Drainage and Erosion Control for The Meadows Filing Three Subdivision*, by LADD Engineering, July 2000.
11. *Final Drainage Report for Bent Grass Residential (Filing No. 2)*, by Galloway & Company, May 2020.

#### IV. Drainage Criteria

Hydrology calculations were performed using the City of Colorado Springs/El Paso County Drainage Criteria Manual, as revised in November 1991 and October 1994 with County adopted Chapter 6 and Section 3.2.1 of Chapter 13 of the City of Colorado Springs/El Paso County Drainage Criteria Manual as revised in May 2014.

The drainage calculations were based on the criteria manual Figure 6-5 and IDF equations to determine the intensity and are listed in Table 1 below.

**Table 1 - Precipitation Data**

Return Period	One Hour Depth (in.)	Intensity (in/hr)
5-year	1.50	5.17
100-year	2.52	8.68

The rational method was used to calculate peak flows as the tributary areas are less than 100 acres. The rational method has been proven to be accurate for basins of this size and is based on the following formula:

$$Q = CIA$$

Where:

- Q = Peak Discharge (cfs)
- C = Runoff Coefficient
- I = Runoff intensity (inches/hour)
- A = Drainage area (acres)

The runoff coefficients are calculated based on land use, percent imperviousness, and design storm for each basin, as shown in the drainage criteria manual (Table 6-6). Composite percent impervious and C values were calculated using the residential, streets, roofs, and lawns coefficients found in Table 6-6 of the manual.

The 100-year event was used as the major storm event. The 5-year event was used as the minor event.

The UD-Detention v3.07 spreadsheet was utilized for the design of the proposed on-site water quality ponds, Pond (North) and Pond (South).

## V. Historic & Existing (Current) Drainage Conditions

The site is contained fully within one major drainage basin; the West Falcon Tributary. The site generally drains from north to south with an average slope of 2% outside of the channel. The rational method was used to analyze the individual basins within the site because their size permits it.

In addition to the DBPS, The Ranch MDDP to the north and west of the site has revisited their existing conditions as well as existing conditions from the site directly to the north of them. Several detention ponds have been created within the Paint Brush Hills Subdivision which revise the offsite flow entering the site within the major drainageway. This is taken into account with The Ranch MDDP. While The Ranch is still in design stage, they are proposing detention ponds within their site to release at historic rates. This will revise the flow rates in their designed section of the RWT204 channel rates that are lower than those identified within the DBPS. An updated HEC-HMS model was submitted with the MDDP.

Per the DBPS the site lies within the basins, WT200, WT210, and WT220. These basins connect to channel reaches RWT202, RWT204, and RWT210. Both the RWT204 and RWT210 sections of channel currently exist and appear as a drainageway when visiting the site. With Bent Grass Filing No. 2, Reach RWT202 from Basin WT200 was "relocated and improved". The channel reach is now along the north border of the Bent Grass property and drains towards the east, where it combines with channel reach RWT204. The channel is a 26-ft bottom trapezoidal section with 4:1 side slopes and a longitudinal slope of 1.00%. The flows shown for basin WT200 and reaches RWT202 and RWT204, shown throughout the report, are the developed DBPS flows from the approved Matrix report.

A historic basin map has been prepared with the MDDP for this site to analyze the historic basins as well as the offsite basins contributing to the site. The historic map is included in Appendix D and descriptions can be found in the MDDP.

An existing basin map has been prepared for this site to analyze the existing basins as well as the offsite basins contributing to the site. The existing conditions account for Bent Grass Residential Filing No. 2 being built. The existing map is included in Appendix D and basins are described below.

**Basin EX-1** (1.19 AC,  $Q_5 = 0.4$  cfs,  $Q_{100} = 2.5$  cfs): is associated with the northeastern portion of the proposed site east of the existing channel. The basin is currently undeveloped. Runoff from the basin generally flows to the southwest, into Basin EX-2 at **DP 4**.

**Basin EX-2** (1.56 AC,  $Q_5 = 0.5$  cfs,  $Q_{100} = 3.7$  cfs): is along the eastern boundary portion of the proposed site and is south of Basin EX-1, east of the existing channel. The basin is currently undeveloped and receives flows from Basins OS-4 & OS-5. Runoff from the basin generally flows to the southeast into Basin EX-3 at **DP 5** combined with flows from **DP 1, 2, & 4**.

**Basin EX-3** (0.62 AC,  $Q_5 = 0.2$  cfs,  $Q_{100} = 1.5$  cfs): is along the eastern boundary of the proposed site south of Basin EX-2 and east of the existing channel. The basin currently contains an existing WQCV pond created as part of Bent Grass Residential Filing No. 2. This basin receives flows from **DP 5** and **DP 3**.

**Basin EX-4** (12.49 AC,  $Q_5 = 3.7$  cfs,  $Q_{100} = 25.1$  cfs): is located along the northern boundary, just south of the swale built with Bent Grass Meadows Drive and west of the existing channel. The basin is currently undeveloped. Runoff from the basin generally flows to the south onto Bent Grass Meadows Drive at **DP 6**. From there, it flows via curb & gutter to the east into an existing sump inlet, ultimately discharging into the existing WQCV pond located in Basin EX-3.

**Basin EX-5** (5.15 AC,  $Q_5 = 1.6$  cfs,  $Q_{100} = 10.6$  cfs): is west of Basin EX-4 and north of Bent Grass Meadows Drive. The basin is currently undeveloped. Runoff from the basin generally flows to the south

onto Bent Grass Meadows Drive at **DP 7**. From there, it flows via curb & gutter to the east into an existing sump inlet, ultimately discharging into the existing WQCV pond located in Basin EX-3.

**Basin EX-6** (9.53 AC,  $Q_5 = 2.7$  cfs,  $Q_{100} = 17.8$  cfs): is along the west boundary of the site. The basin is currently undeveloped and receives off-site flows from Basins OS-2 & OS-3. Runoff from the basin generally flows to the south into the existing drainage ditch entering an existing area inlet at **DP 11** and flowing under Bent Grass Meadows Drive and discharging into an existing drainage swale in Basin EX-8.

**Basin EX-7** (9.16 AC,  $Q_5 = 2.8$  cfs,  $Q_{100} = 18.9$  cfs): is north & west of Bent Grass Meadows Drive, between Basins EX-5 & EX-6. The basin is currently undeveloped. Runoff from the basin generally flows to the southeast into Bent Grass Meadows Drive at **DP 8**. From there, it flows via curb & gutter to the south into an existing sump inlet, ultimately discharging into the existing sediment pond located in Basin EX-8.

**Basin EX-8** (21.3 AC,  $Q_5 = 6.6$  cfs,  $Q_{100} = 43.9$  cfs): is a portion of the site south and east of Bent Grass Meadows Drive, north of the south property line and west of Bent Grass Filing No. 2. The basin is currently undeveloped and contains two drainage ditches, a sediment pond, and a portion of the creek associated with Basin WT200 from the Falcon DBPS. Runoff from the basin generally flows to the southeast into the existing channel.

**Basin OS-1** (32.28 AC,  $Q_5 = 15.1$  cfs,  $Q_{100} = 65.1$  cfs) is associated with The Meadows Filing No. 3 lots 14, 15, 16, and 17. Runoff from this basin sheet flows to the northern property line of the site and then flow, via an existing drainage ditch, into the existing channel associated with Basin WT200 from the Falcon DBPS entering the site at **DP 12**.

**Basin OS-2** (20.08 AC,  $Q_5 = 9.0$  cfs,  $Q_{100} = 43.4$  cfs) is associated with The Meadows Filing No. 1 lots 1, 2, 3, 4, 5, and 6. Runoff from this basin sheet flows from the northwest to the southeast, crossing the west property line of the site at **DP 9**. The runoff will continue to sheet flow through Basin EX-6 to the south until entering the existing drainage swale on the southern boundary of Basin EX-6 at **DP 11**.

**Basin OS-3** (10.62 AC,  $Q_5 = 4.7$  cfs,  $Q_{100} = 22.7$  cfs) is associated with The Meadows Filing No. 1 lot 11 and The Meadows Filing No. 2 Lots 1 & 2. Runoff from this basin sheet flows from the northwest to the southeast, crossing the west property line of the site at **DP 10**. The runoff will continue to sheet flow through Basin EX-6 to the south until entering the existing drainage ditch on the southern boundary of Basin EX-6 at **DP 11**.

**Basin OS-4** (4.46 AC,  $Q_5 = 5.6$  cfs,  $Q_{100} = 14.0$  cfs) is associated with The Bent Grass Residential Filing No. 2, lots 152-160, lots 163-168, Tract D, and portions of Thedford Court & Willmore Drive. Runoff from this basin flows via curb & gutter south on Thedford Court then continues flowing west along the northern curb & gutter along Willmore Drive before discharging into southeast corner of Basin EX-2 at **DP 1**.

**Basin OS-5** (0.46 AC,  $Q_5 = 1.1$  cfs,  $Q_{100} = 2.3$  cfs): is associated with The Bent Grass Residential Filing No. 2, lots 161 & 162 along with a portion of Silky Thread Road. Runoff from this basin generally flows to the west via curb & gutter along Silky Thread Road before discharging into the northeast corner of Basin EX-2 at **DP 2**.

**Basin OS-6** (1.17 AC,  $Q_5 = 2.0$  cfs,  $Q_{100} = 4.3$  cfs): is associated with The Bent Grass Residential Filing No. 2, the northern halves of Lots 170-178 and a portion of the southern side of Willmore Drive. Runoff from this basin generally flows to the west via curb & gutter along Willmore Drive before discharging into the northeast corner of Basin EX-3 at **DP 3**.

- Basins E-1 thru E-5, C-8 and I-1, are basins from the Bent Grass Filing No. 2 report, which are within the Falcon Meadows project area. The basins were “developed” as part of the Filing No. 2 project and retain the same basin and flow characteristics. Brief summaries from the Filing No. 2 report are included here for reference.

**Basin E-1** (1.71 AC, Q5 = 3.6 cfs, Q100 = 7.7 cfs): a basin that is east of Falcon Meadows and encompasses the north portion of Bent Grass Meadows Drive. A high point on the far East of the basin at the near the Filing No. 2 boundary, forces water to flow to a low point at **DP-8**, which represents an existing 20' CDOT Type R sump inlet, which conveys stormwater via proposed 36" RCP storm sewer to the existing Filing No. 2 north water quality detention pond. Emergency overflow will spill over the crown of the road and enter into an existing 10' CDOT Type R sump inlet on the south side of Bent Grass Meadows Drive.

**Basin E-2** (0.68 AC, Q5 = 2.4 cfs, Q100 = 4.6 cfs): a basin that is in west of Basin E-1 and encompasses a portion of the north section Bent Grass Meadows Drive. A high point on the far West of the basin forces water to flow to a low point at **DP-8**, which represents an existing 20' CDOT Type R sump inlet, which conveys stormwater via a proposed 36" RCP storm sewer to the existing Filing No. 2 north water quality detention pond. Emergency overflow will spill over the crown of the road and enter into an existing 10' CDOT Type R sump inlet on the south side of Bent Grass Meadows Drive.

**Basin E-3** (0.78 AC, Q5 = 2.9 cfs, Q100 = 5.3 cfs): a basin that is south of Basin E-2 and encompasses a portion of the south half of Bent Grass Meadows Drive. A high point on the far West of the basin forces water to flow to a low point, which is an existing 10' CDOT Type R sump inlet at **DP 7**, which then conveys stormwater via an existing 24" storm sewer to **DP 8**. The inlet at **DP 7** receives emergency overflow from DP-8.

**Basin E-4** (0.91 AC, Q5 = 3.0 cfs, Q100 = 5.7 cfs): a basin that is in the Southwest area of the Bent Grass Filing No. 2 site and encompasses a portion of the north and west sections of Bent Grass Meadows Drive. Runoff from this basin is captured by existing curb and gutter and then routed South where the 5 yr. and 100 yr. flows will be captured by an existing 25' CDOT Type R (1-10' and 1-15' inlet) on-grade inlet, **DP-24**. Captured flow will be routed by a 24" RCP storm drain piped to DP-25. A temporary water quality facility will treat this flow for the Bent Grass Filing No. 2 development and will remain in place until further development occurs.

**Basin E-5** (0.89 AC, Q5 = 3.3 cfs, Q100 = 6.1 cfs): a basin that is in the Southwest area of the site and encompasses a portion of south and east sections Bent Grass Meadows Drive. Runoff from this basin is captured by existing curb and gutter and then routed South where the 5 yr. and 100 yr. flows will be captured by a proposed 25' CDOT Type R (1-10' and 1-15' inlet) on-grade inlet, **DP-25**. Captured flow will be routed by a 24" RCP storm drain piped to an outfall at DP-26, where a temporary sediment basin will provide water quality for the basin. Flows will then be routed East by Existing Swale – F until out-falling into RWT210.

**Basin C-8** (0.42 AC, Q5 = 0.2 cfs, Q100 = 1.0 cfs): a basin that is in the South-central area of the site adjacent to RWT204 and RWT 210. It encompasses the rears of single-family residential Type B lots. Runoff will sheet flow West directly into RWT204 and RWT210.

**Design Point CC** is the location in channel reach RWT210, where flows exit the Bent Grass Site, including the offsite flows from RWT202, RWT204 and WT200. The minor flow is 272.5 cfs and the major flow is 1209.6 cfs based on the rational flows. The MDDP (which has been submitted concurrently for

review) has minor flows exiting the site of 278.3 cfs and major flow of 1224.7 cfs based on rational calculations for the project site.

The updated HEC-HMS model (Current Conditions) in the MDDP has flows at the same location as 186.2 cfs and 1044.6 cfs for the minor and major storms, respectively. The DBPS HEC-HMS model has a 100-year developed flow of 1200 cfs in channel reach RWT210, which is the channel location south of the Bent Grass property. Refer to the MDDP report for additional information on the updated HEC-HMS model.

## VI. Four Step Process

The Four Step Process is used to minimize the adverse impacts of urbanization and is a vital component of developing a balanced, sustainable project. Below identifies the approach to the four-step process:

### 1. Employ Runoff Reduction Practices

This step uses low impact development (LID) practices to reduce runoff at the source. Generally, rather than creating point discharges that are directly connected to impervious areas runoff is routed through pervious areas to promote infiltration. The Impervious Reduction Factor (IRF) method was used and calculations can be found in Appendix B.

### 2. Stabilize Drainageways

This step implements stabilization to channels to accommodate developed flows while protecting infrastructure and controlling sediment loading from erosion in the drainageways. Erosion protection in the form of riprap pads at all outfall points to the channel to prevent scouring of the channel from point discharges. A HEC-RAS model will be created and used to evaluate the stability of the existing and proposed channels as part of the Final Drainage Report for the next phase of the site.

### 3. Provide Water Quality Capture Volume (WQCV)

This step utilizes formalized water quality capture volume to slow the release of runoff from the site. The EURV volume will release in 72 hours, while the WQCV will release in no less than 40 hours. On-site water quality control volume detention ponds will provide water quality treatment for all but 0.86 acres of the developed areas, prior to the runoff being released into the channel. For this area of the project, maintenance access could not be obtained if a swale was utilized, therefore the basin is being allowed to release directly to the channel. Per conversations with County staff, this is acceptable. Refer to WQCV Plan in Appendix D.

### 4. Consider Need for Industrial and Commercial BMPs

As this project as all residential development and no commercial or industrial development is proposed, there will be no need for any specialized BMPs which would be associated with an industrial or commercial site.

## VII. Proposed Drainage Conditions

There have been very minor changes to the overall Falcon Area Basin delineation with the proposed condition. This will be discussed with the individual basins. All necessary calculations can be found within the appendices of the report.

According to the DBPS, there are two channels that run through the site. As was discussed within the Existing Conditions portion of the report both the RWT202 and RWT204 run through the site. In the Bent



Grass Filing No. 2 report & CD's, the RWT202 channel was rerouted to run along the north boundary & combine with the existing RWT204 channel. The proposed development will drain to the RWT204 channel, which becomes RWT210 south of Bent Grass Meadows Drive.

The site will provide two WQCV Detention Ponds, North Pond & South Pond, to provide water quality treatment prior to discharging the runoff directly into the West Tributary channel RWT204 - RWT210.

As has been mentioned previously, the site is proposed to be single family residential. The site has been designed to provide a large lot buffer between the existing large lots to the north and west of the site and the proposed site. Beyond this buffer, the remainder of the site is smaller, approximately 1/8 acre lots.

**Basin OS-1** (32.28 AC, Q5 = 15.1 cfs, Q100 = 65.1 cfs) is associated with The Meadows Filing No. 3 lots 14, 15, 16, and 17. Runoff from this basin sheet flows to the northern property line of the site and then flows, via an existing drainage swale, into the existing channel reach RWT204 from the Falcon DBPS at **DP 21**.

**Basin OS-4** (4.46 AC, Q5 = 5.6 cfs, Q100 = 14.0 cfs) is associated with The Bent Grass Residential Filing No. 2, lots 152-160, lots 163-168, Tract D, and portions of Thedford Court & Willmore Drive. Runoff from this basin flows via curb & gutter south on Thedford Court then continues flowing west along the northern curb & gutter along Willmore Drive before discharging into Basin A-1 at **DP 1**.

**Basin OS-5** (0.46 AC, Q5 = 1.1 cfs, Q100 = 2.3 cfs): is associated with The Bent Grass Residential Filing No. 2, lots 161 & 162 along with a portion of Silky Thread Road. Runoff from this basin generally flows to the west via curb & gutter along Silky Thread Road before discharging into Basin A-1 at **DP 2**.

**Basin OS-6** (1.17 AC, Q5 = 2.0 cfs, Q100 = 4.3 cfs): is associated with The Bent Grass Residential Filing No. 2, the northern halves of Lots 170-178 and a portion of the southern side of Willmore Drive. Runoff from this basin generally flows to the west via curb & gutter along Willmore Drive before discharging into Basin A-1 at **DP 3**.

**Basin A-1** (2.16 AC, Q5 = 4.9 cfs, Q100 = 11.7 cfs): a basin that includes residential lots, portions of 2 tracts & the east half of Lemon Grass Road. It encompasses single-family residential lots. Runoff will flow from each lot onto the proposed public R.O.W. where proposed mountable curb and gutter will convey flows to **DP 4**. Flows will then enter a proposed CDOT Type 'R' inlet and will be piped into the existing Bent Grass Filing No. 2 WQCV pond located in Basin A-4 at **DP 6**.

**Basin A-2** (0.86 AC, Q5 = 2.0 cfs, Q100 = 4.4 cfs): a basin that includes the back  $\frac{3}{4}$  of single-family residential lots. Runoff will flow from each lot into the existing channel (RWT204). These flows will not be detained but are less than 1.0 acre max allowed per criteria. Per discussions with County staff, it was acceptable to allow these flows to release to directly to the channel.

**Basin A-3** (0.92 AC, Q5 = 2.6 cfs, Q100 = 5.2 cfs): a basin that includes the west half of Lemon Grass Road and the front  $\frac{1}{4}$  of single-family residential lots. Runoff will flow from each lot onto the proposed public R.O.W. where proposed mountable curb and gutter will convey flows to **DP 5**. Flows will then enter a proposed CDOT Type 'R' inlet where it will be piped into the existing Bent Grass Filing No. 2 WQCV pond at **DP 6**.



**Basin A-4** (0.82 AC, Q5 = 0.4 cfs, Q100 = 2.6 cfs): a basin that includes the existing north water quality facility built with Bent Grass Filing No. 2 (Tract K). This basin will combine with the other flows being diverted to this facility and upon treatment, will be released into the existing channel (RWT204).

**Basin C-6** (1.37 AC, Q5 = 2.1 cfs, Q100 = 5.1 cfs): a basin that includes a portion of residential lots between Henzlee Place and Channel RWT204. These lots drain towards the east, towards the channel. A proposed swale (Swale A) will intercept these flows at the top bank of the channel and divert the flows towards the south to **DP 19**, where an area inlet will capture the flows and release into the proposed north water quality pond.

**Basin B-1** (4.32 AC, Q5 = 1.2 cfs, Q100 = 7.8 cfs): a basin that is in the north-center of the site and encompasses the existing rerouted channel RWT202 and existing improved channel RWT204. Flows will sheet flow into the existing channel where they will then be conveyed to **DP AA**.

**Basin C-1** (9.07 AC, Q5 = 16.9 cfs, Q100 = 36.0 cfs): a basin that includes Sophia Lane, the west half of Henzlee Place, north portion of Kittrick Place, and encompasses single-family residential lots. Runoff will flow from each lot onto the proposed public R.O.W. where proposed mountable curb and gutter will convey flows to **DP 15**. Flows will then enter a proposed CDOT Type 'R' inlet where it will be piped to the proposed north WQCV pond at **DP 13**.

**Basin C-2** (1.11 AC, Q5 = 2.8 cfs, Q100 = 6.2 cfs): It encompasses single-family residential lots including the east half of Henzlee Place. Runoff will flow from each lot onto the proposed public R.O.W. where proposed mountable curb and gutter will convey flows to **DP 12**. Flows will then enter a proposed CDOT Type 'R' inlet where it will be piped to the proposed north WQCV pond at **DP 13**.

**Basin C-3** (1.52 AC, Q5 = 5.3 cfs, Q100 = 9.9 cfs): It encompasses Kittrick Place between Henzlee Place & Daelyn Drive, as well as single-family residential lots. Runoff will flow from each lot onto the proposed public R.O.W. where proposed mountable curb and gutter will convey flows to **DP 15**. Flows will then enter a proposed CDOT Type 'R' inlet where it will be piped to the proposed north WQCV pond at **DP 13**. Any flow-by from the proposed inlet at **DP 15** will be conveyed to Bent Grass Meadows Drive, where it will continue as gutter flow to the east, then enter an existing CDOT Type 'R' inlet on the north side of Bent Grass Meadows Drive, **DP 8**, where it will then be released into the existing Filing No. 2 North WQCV Pond.

**Basin C-4** (3.99 AC, Q5 = 6.6 cfs, Q100 = 17.4 cfs): It encompasses residential lots and open space between Henzlee Place & Bent Grass Meadows Drive. Runoff will flow from each lot onto the proposed open space, eventually releasing into the public R.O.W. of Bent Grass Meadows Drive, where existing curb and gutter will convey flows to **DP 8**. Flows will then enter an existing CDOT Type 'R' inlet where it will then be released into the existing Filing No. 2 North WQCV Pond.

**Basin C-5** (0.51 AC, Q5 = 0.3 cfs, Q100 = 1.6 cfs): It encompasses the proposed north WQCV pond area. The stormwater within the proposed north WQCV pond will be released at a controlled rate, via an outlet structure with orifice holes, into the existing channel RWT204.

**Basin OS-2** (20.07 AC, Q5 = 9.0 cfs, Q100 = 43.4 cfs): is associated with The Meadows Filing No. 1 lots 1, 2, 3, 4, 5, and 6. Runoff from this basin sheet flows from the northwest to the southeast, crossing the west property line of the site at **DP 9**. Flows will then be conveyed via a proposed drainage swale to the south where it will enter Basin D-3 and tie-into the existing drainage swale along the southern boundary

of Basin D-3. It will then continue flowing east before entering an existing area inlet at **DP 11** where it will be piped, ultimately outfalling into the proposed south WQCV pond at **DP 31**.

**Basin OS-3** (10.61 AC, Q5 = 4.7 cfs, Q100 = 24.3 cfs): is associated with The Meadows Filing No. 1 lot 11 and The Meadows Filing No. 2 Lots 1 & 2. Runoff from this basin sheet flows from the northwest to the southeast, crossing the west property line of the site into Basin D-3 at **DP 10**. Flows will then be conveyed via an existing drainage swale to the east where it will enter an existing area inlet at **DP 11** where it will be piped, ultimately outfalling into the proposed south WQCV pond at **DP 31**.

**Basin D-1** (8.13 AC, Q5 = 10.0 cfs, Q100 = 23.8 cfs): a basin along the west property line of the site. It encompasses single-family residential lots, Isabel Place, & west half of Daelyn Drive. Runoff will flow from each lot onto the proposed public R.O.W. where proposed mountable curb and gutter will convey flows to **DP 16**. Flows will then enter a proposed CDOT at grade Type 'R' inlet where captured flows will then be piped and ultimately outfall in the proposed south WQCV pond at **DP 31**. Bypass flows from the inlet will continue to the south in Bent Grass Meadows Drive to be intercepted by the existing CDOT Type R inlet at **DP 24**.

**Basin D-2** (6.62 AC, Q5 = 14.7 cfs, Q100 = 29.7 cfs): a basin east of Basin D-1. It encompasses single-family residential lots, Isabel Place, Raylan Way, Jolie Court, as well as the east half of Daelyn Drive. Runoff will flow from each lot onto the proposed public R.O.W. where proposed mountable curb and gutter will convey flows to **DP 14**. Flows will then enter a proposed at grade CDOT Type 'R' inlet where captured flows will then be piped and ultimately outfall in the proposed south WQCV pond at **DP 31**. Bypass flows from the inlet will release into Bent Grass Meadows Drive and will be directed towards **DP 24**.

**Basin D-9** (0.80 AC, Q5 = 0.8 cfs, Q100 = 2.4 cfs): a basin along the west side of Bent Grass Meadows Drive, north of Rowena Way. It encompasses single-family residential lots and open space. Runoff will flow onto the proposed public R.O.W. where existing vertical curb and gutter will convey flows to **DP 24**. Flows will then enter a proposed at grade CDOT Type 'R' inlet where captured flows will then be piped and ultimately outfall in the proposed south WQCV pond at **DP 31**. Bypass flows from the inlet will release into Bent Grass Meadows Drive and will be directed towards **DP 24**. Captured flow will be routed by an existing 24" RCP storm drain piped to **DP-25**. Flows will ultimately release at **DP 30**, via Swale F, into the proposed South WQ Pond.

**Basin D-3** (2.93 AC, Q5 = 2.0 cfs, Q100 = 5.1 cfs): a basin that is in the southwest corner of the site, south of Basin D-1. It encompasses the backs of several proposed residential lots as well as an existing drainage ditch and proposed Swale D. Runoff will flow from basin OS-2 and OS-3 into Swale D, and convey flows to the existing drainage ditch which will convey flows to an existing area inlet at **DP 11**. From there, flows will be piped and ultimately outfall at the south WQCV pond at **DP 31**.

**Basin D-4** (4.38 AC, Q5 = 7.8 cfs, Q100 = 16.6 cfs): a basin that is east of Bent Grass Meadows Drive. It encompasses single-family residential lots, Rowena Way, & portions of Linley Way, Jayla Trail, and Henzlee Place. Runoff will flow from each lot onto the proposed public R.O.W. where proposed mountable curb and gutter will convey flows to **DP 17**. Overflow from this 30' inlet would be to overtop the curb and then continue via a proposed swale, following the same path as the proposed pipe, to the east until flows are released into the proposed south water quality pond. Flows will then enter a proposed sump CDOT Type 'R' inlet where it will then be piped and ultimately outfall in the proposed south WQCV pond at **DP 31**.

**Basin D-5** (1.08 AC, Q5 = 2.2 cfs, Q100 = 4.6 cfs): a basin that is located at the southwest corner of Bent Grass Meadows Drive and Henzlee Place. It includes residential lots, as well as a portion of the north half of Nico Way and west half of Henzlee Place. Flows will be directed towards the public R.O.W. where proposed curb and gutter will convey flows to the south along Henzlee Place to **DP 18**. Flows will then enter a proposed 30' CDOT Type 'R' inlet where it will then be piped and ultimately outfall in the proposed south WQCV pond at **DP 31**.

**Basin D-6** (4.01 AC, Q5 = 8.2 cfs, Q100 = 17.2 cfs): a basin that is south of Basin D-5 & east of Basin D-4. It encompasses single-family residential lots & half of Linley Way, Jayla Trail, Henzlee Place, & Nico Way. Runoff will flow from each lot onto the proposed public R.O.W. where proposed mountable curb and gutter will convey flows to **DP 18**. Flows will then enter a proposed sump CDOT Type 'R' inlet where it will then be piped and ultimately outfall in the proposed south WQCV pond at **DP 31**.

**Basin D-7** (6.39 AC, Q5 = 3.2 cfs, Q100 = 14.8 cfs): a basin that is in the south end of the site, east of Bent Grass Meadows Drive & west of the existing channel. It encompasses the back half of several single-family residential lots as well as proposed south WQCV pond, an existing sediment basin, and an existing drainage ditch. Runoff will flow, via sheet flow, until it enters the existing drainage ditch and is conveyed to the proposed south WQCV pond or will directly flow into the proposed south WQCV pond at **DP 30**.

**Basin D-8** (1.69 AC, Q5 = 1.3 cfs, Q100 = 4.5 cfs): a basin that is west of the existing channel & south of Bent Grass Meadows Drive. It encompasses the back half of single-family residential lots. Runoff will flow from each lot and discharge into a proposed drainage ditch. The drainage ditch (Swale C) will then convey flows, ultimately discharging into the proposed south WQCV pond at **DP 32**.

**Basin B-2** (1.17 AC, Q5 = 0.4 cfs, Q100 = 2.5 cfs): a basin that is in the south area of the site and encompasses the existing channel RWT210. Flows will sheet flow into the existing channel where they will then be conveyed to **DP CC** exiting the site.

Basins E-1 thru E-5 are the same as discussed under the Existing Conditions Section, as these basins represent the already built Bent Grass Meadows Drive through the proposed site.

Basin RWT202 (1574.4 AC, Q5 = 200 cfs, Q100 = 1000 cfs), RWT204 (38.4 AC, Q5 = 7 cfs, Q100 = 43 cfs) and WT200 (192 AC, Q5 = 52 cfs, Q100 = 190 cfs) represent larger offsite basins to the north of the proposed project. These areas were studied as part of the Falcon Basin DBPS prepared by Matrix and were also part of the Bent Grass MDDP, submitted concurrently for review. Refer to the MDDP for the discussion of the revisions made to the HEC-HMS model.

**Design Point AA** is the location in channel reach RWT204, where flows cross under Bent Grass Meadows Drive. This includes offsite flows from RWT202, RWT204 and WT200. The minor flows (based on rational calculations) are 273.5 cfs and the major flows are 1201.3 cfs.

**Design Point CC** is the location in channel reach RWT210 where flows exit the Bent Grass site. Final flows exiting the site thru the West Tributary, based on rational method calculations, at **DP CC** for the proposed design analysis (based on rational calculations) are 283.3 cfs for the 5-year storm and 1233.8 cfs for the 100-year storm. This does take into account flows from RWT202, RWT 204 and Basin WT200 as well as full development of the Falcon Meadows at Bent Grass site. Flows from the MDDP at this location based on the HEC-HMS model are 1075.3 cfs for the 100-year storm and 191.8 cfs for the 5-year

storm under the proposed/future conditions. The FEMA FIS report had a design flow of 1400 cfs in channel reach RWT210.

## **VIII. Storm Sewer System**

All development is anticipated to be urban and will include storm sewer & street inlets. Storm sewers collect storm water runoff and convey the water to water quality facilities prior to discharging. Storm sewer systems will be designed to the 100-year storm and checked with the 5-year storm. Inlets will be placed at sump areas and intersections where street flow is larger than street capacity. UDFCD Inlet spreadsheet has been used to determine the size of all at-grade and sump inlets. There will be a minimum of 3 proposed storm systems within the site. One will collect flows on the north and east side of the project, prior to entering Bent Grass Meadows Drive. Intercepted flows will be released into the Bent Grass Filing No. 2 existing North water quality pond. Any bypass flows will travel west in Bent Grass Meadows Drive to an existing storm system in the roadway.

The second system will collect the north and west portion of the site, intercepting flows prior to entering Bent Grass Meadows Drive. These flows will be released into the proposed North water quality pond. Any flows bypassed from the storm system will enter Bent Grass Meadows Drive and travel east to the existing storm sewer system.

The final proposed system will be designed for the remaining south and west portion of the project. Flows intercepted by inlets will be released into the proposed South water quality pond. The system will consist of reinforced concrete pipes, CDOT Type R & Area Type C & D inlets.

Final drainage report will include details concerning inlet location, street capacity, storm sewer sizing, outlet protection and location.

## **IX. Proposed Water Quality Detention Ponds**

Two Water Quality Capture Volume Detention Ponds will be provided for the proposed site. One will be provided for the area north of Bent Grass Meadows Drive and the other will be provided for the area to the south. The south pond temporary sedimentation basin will be constructed in conformance with water quality requirements with the early grading. Both ponds are private and will be maintained by Bent Grass Metro District. These detention ponds will only provide water quality. The EURV and 100-year volumes will be conveyed via the emergency overflow weir, which will be lined. The water quality volume release will be controlled with an orifice plate that will release in 40 hours. Outlet structures, forebays, trickle channels, etc. will be designed with the final drainage report during final plat. The required WQCV volume of the North & South pond are 0.280 acre-feet & 0.889 acre-feet, respectively. The north water quality pond will release into RWT204 and the south will release into RWT210. Initial sizing of the ponds has been provided in Appendix C. With the Falcon Meadows development, there have been minor drainage revisions to flows being routed to the existing Bent Grass North Pond. The required WQCV volume increased to 0.378 ac-ft. The existing pond has more than adequate volume to handle this increase. Refer to Appendix C for analysis of the existing pond.

## **X. Proposed Channel Improvements**

The Falcon Area DBPS made recommendations for the channels as they run through the project site. RWT202 was rerouted on the north property lone to convey flows to RWT204. Improvements were designed as part of the Bent Grass Residential Filing No. 2 development.

The RWT204 is grossly oversized for the actual flows expected through it, with a 5-year flow of 7 cfs and a 100-year flow for 43 cfs from the DBPS study. The proposed rational calculations have a total flow of 270 cfs for the 5-year flow and 1189 cfs for the 100-year flow at DP AA, the location of the proposed box culvert crossing at Bent Grass Meadows Drive in Reach RWT204. The FEMA flow reported in this section of channel is 1,400 cfs. Improvements to this section of the channel will adhere and be equivalent to the recommendations in the Falcon Basin DBPS.

RWT204 will generally stay in a location similar to where it is in existing conditions but will have new designed channel sections. The channels will have longitudinal slopes flattened to below 1% in order to reduce the scour potential of the channel. Grouted Sloping Boulder Drops may be utilized within the channel as grade controls (maximum height of 4' with 4:1 slope). It is anticipated that 7 grade control structures will be utilized within the channel. This may change when final design of the channel is completed.

RWT210 is the section of the channel south of Bent Grass Meadows Drive and continues south to Woodmen Road. The channel location will shift slightly to the east and "straighten" out the overall flow path. It will be located within a drainage easement. The channel will have a design with a longitudinal slope less than 1.5%, bottom width of 38', and 4:1 side slopes. The Falcon DBPS recommendations for the channel are to remain as a natural drainage channel. Grade control structures may be utilized within the channel to meet design requirements.

Improvements to the existing channel are outlined in the DBPS. At this time, it is assumed that the DBPS recommended channel improvements will be sufficient to handle the final developed channel flow. At the time of final design of the channel, if it is determined that additional improvements are necessary, they will be designed at that time and will be incorporated into the corresponding Final Drainage Report for the channel improvements. DBPS report and channel plans currently show approximately 16 rock cross vanes in channel Section RWT210. See Appendix C for location and detail of structures.

The West Trib Channel (RWT202, RWT204 & RWT210) will be maintained by the Bent Grass Metropolitan District. For channel improvements offsite of the Falcon Meadows at Bent Grass Filing No. 1 and Bent Grass Residential Filing 2 property, specifically south of the development, it is agreed that the developer will be responsible future channel improvements, south of the development, to the existing improvements north of Woodmen Road if the current property owners have not initiated the future improvements themselves. Or the developer will work with the current property owners to reach an agreement on design/construction, costs, and timing of the channel improvements. An agreement and schedule will be in place prior to approval of Falcon Meadows at Bent Grass Filing No. 1. And improvements shall be complete within three years of the recordation of Falcon Meadows at Bent Grass Filing No. 4.

## **XI. Maintenance**

The proposed channels are to be public facilities. A buffer has been provided along the north boundary of the site between the rerouted channel RWT202 and the back of the proposed lots. After completion of construction and upon the Board of County Commissioners acceptance the West Tributary channel is anticipated to be owned and maintained by El Paso County along with all drainage facilities within the public Right-of-Way. Swale D, which is located along the west property line, will run through a proposed tract through the back of several residential lots. The swale will be maintained by the Bent Grass Metro District.

The existing swale along the north property line, built as part of Bent Grass Filing No. 2, will have a maintenance access road constructed beginning at the north end of the Lemon Grass Road cul-de sac to be maintained by the district.

## **XII. Wetlands Mitigation**

No wetlands are located on site.

## **XIII. Floodplain Statement**

A portion of the project site lies within Zone AE Special Flood Hazard Area as defined by the FIRM Map number 08041C0553G effective December 7, 2018. A copy of the FIRM Panel is included in Appendix A.

The portion of channel that has a floodplain designation is only the RWT210 and RWT204 portions of the channel. It is unknown why the western channel, RWT202 is unmapped since it is the larger contributor regarding flow rates. Discussions have occurred with PPRBD and a no rise certificate will be required for the existing channel. Models have been obtained from FEMA which show that the FEMA discharges are higher than the DBPS. Therefore, the culvert crossing at Bent Grass Meadows Parkway has been sized per the FEMA flows and not the DBPS. The no rise certification will be provided under a separate report.

## **XIV. Drainage Fees & Maintenance**

Falcon Basin is part of the El Paso County drainage basin fee program all applicable fees will be presented in the final drainage report.

A presentation of accurate, complete, and current estimate of cost for proposed facilities will be presented with the final drainage report.

## **XV. Conclusion**

The Falcon Meadows at Bent Grass residential subdivision lies within the West Tributary of the Falcon Area Watershed. Recommendations are made within this report to establish and stabilize multiple drainageways through the project site. Water quality for the site is provided in two on-site WQCV ponds, North Pond & South Pond. All drainage facilities within this report were sized according to the El Paso County Drainage Criteria Manuals. The West Tributary channel segment is proposed to be publicly owned and maintained and shall be the responsibility of El Paso County upon completion of the required improvements. The two WQCV ponds and all of the swales will be maintained by Bent Grass Metro District. A Final Drainage Report will be submitted along with the final plat and construction drawings.

## **XVI. References**

1. *City of Colorado Springs/County of El Paso Drainage Criteria Manual*, October 1991.
2. *Drainage Criteria Manual, Volume 2*, City of Colorado Springs, November 2002.
3. *Urban Storm Drainage Criteria Manual*, Urban Drainage and Flood Control District, January 2016 (with current revisions).
4. *Falcon Drainage Basin Planning Study*, by Matrix Design Group, September 2015.
5. *Master Development Drainage Plan and Preliminary Drainage Plan – Bent Grass Subdivision*, by Kiowa Engineering Corporation, December 2006.



6. *Final Drainage Report for Bent Grass Residential (Filing No. 1)*, by Classic Consulting Engineers & Surveyors, LLC, August 2014.
7. *Final Drainage Report Addendum for Bent Grass Residential (Filing No. 1)*, by Classic Consulting Engineers & Surveyors, LLC, August 2015.
8. *Master Development Drainage Plan for The Ranch*, by Classic Consulting Engineers & Surveyors, LLC, November 2018.
9. *Falcon Highlands Master Development Drainage Plan & Preliminary Drainage Report & Final Drainage Report for Filing 1*, by URS, January 2005.
10. *Final Drainage Report and Erosion Control Plan – Latigo Business Center Filing No. 1 A Re-subdivision of a Portion of Latigo Business and Research Center Filing No. 1*, by Kiowa Engineering Corporation, November 2004.
11. *Final Drainage Report for Bent Grass Residential (Filing No. 2)*, by Galloway & Company, May 2020.

**APPENDIX A**  
**Exhibits and Figures**





**FALCON MEADOWS AT BENT GRASS**

BENT GRASS MEADOWS DRIVE  
SCALE: 1"=2,000'

**VICINITY MAP**

Project No: CLH00017.20

Drawn By: TJE

Checked By: CMD

Date: 06/19/2020



1155 Kelly Johnson Blvd., Suite 305  
Colorado Springs, CO 80920  
719.900.7220 • GallowayUS.com



Hydrologic Soil Group—El Paso County Area, Colorado

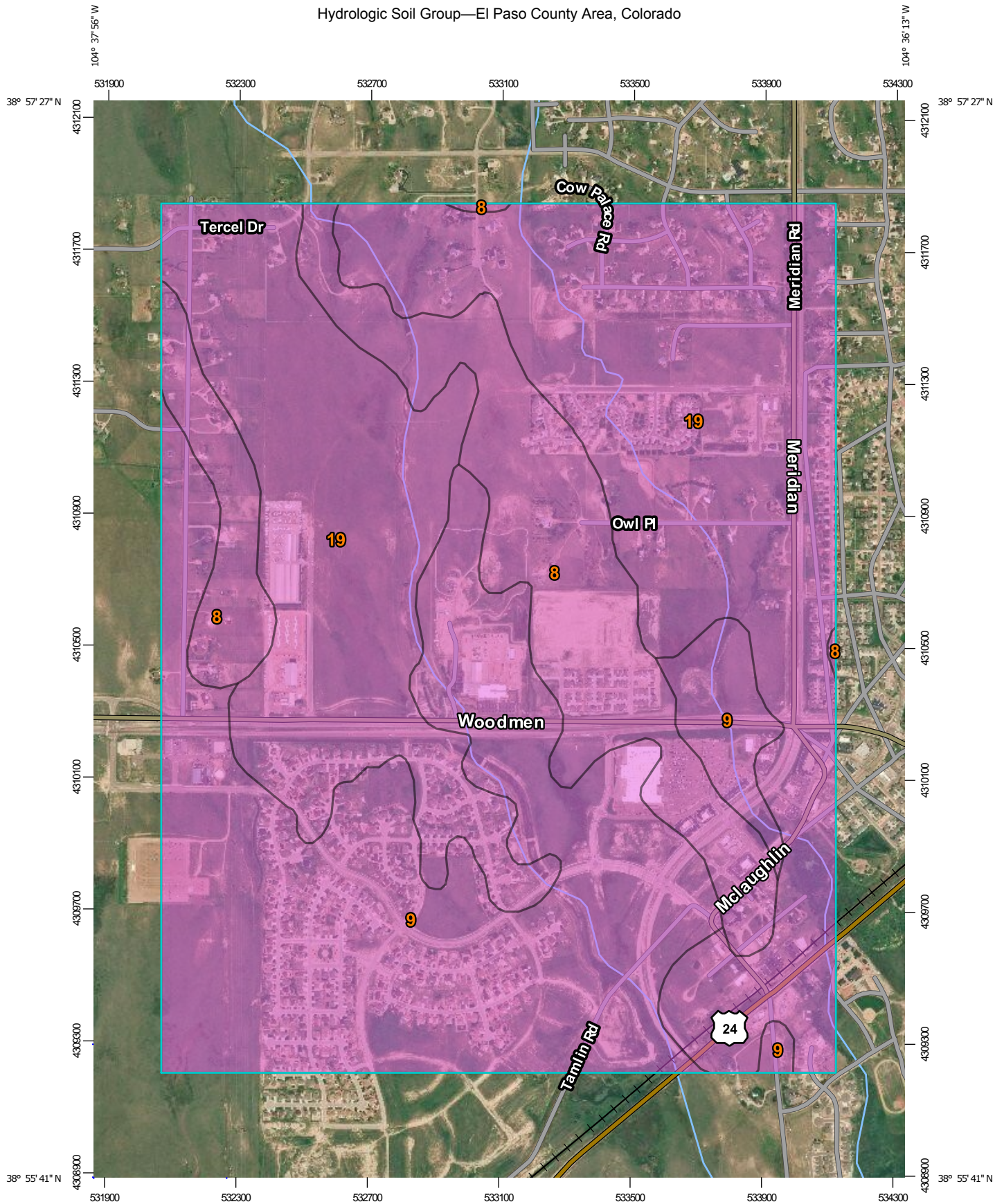

Map Scale: 1:15,900 if printed on A portrait (8.5" x 11") sheet.

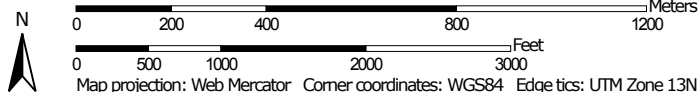

Map projection: Web Mercator Corner coordinates: WGS84 Edge tics: UTM Zone 13N WGS84



Natural Resources  
Conservation Service

Web Soil Survey  
National Cooperative Soil Survey

4/2/2019  
Page 1 of 4

### MAP LEGEND

**Area of Interest (AOI)**









 Area of Interest (AOI)

**Soils**

**Soil Rating Polygons**





-  A
-  A/D
-  B
-  B/D
-  C
-  C/D
-  D
-  Not rated or not available

**Soil Rating Lines**

-  A
-  A/D
-  B
-  B/D
-  C
-  C/D
-  D
-  Not rated or not available

**Soil Rating Points**





-  A
-  A/D
-  B
-  B/D

-  C
-  C/D
-  D
-  Not rated or not available

**Water Features**

 Streams and Canals

**Transportation**

-  Rails
-  Interstate Highways
-  US Routes
-  Major Roads
-  Local Roads

**Background**

 Aerial Photography

### MAP INFORMATION

The soil surveys that comprise your AOI were mapped at 1:24,000.

Please rely on the bar scale on each map sheet for map measurements.

Source of Map: Natural Resources Conservation Service  
 Web Soil Survey URL:  
 Coordinate System: Web Mercator (EPSG:3857)

Maps from the Web Soil Survey are based on the Web Mercator projection, which preserves direction and shape but distorts distance and area. A projection that preserves area, such as the Albers equal-area conic projection, should be used if more accurate calculations of distance or area are required.

This product is generated from the USDA-NRCS certified data as of the version date(s) listed below.

Soil Survey Area: El Paso County Area, Colorado  
 Survey Area Data: Version 16, Sep 10, 2018

Soil map units are labeled (as space allows) for map scales 1:50,000 or larger.

Date(s) aerial images were photographed: Jun 7, 2016—Aug 17, 2017

The orthophoto or other base map on which the soil lines were compiled and digitized probably differs from the background imagery displayed on these maps. As a result, some minor shifting of map unit boundaries may be evident.

## Hydrologic Soil Group

Map unit symbol	Map unit name	Rating	Acres in AOI	Percent of AOI
8	Blakeland loamy sand, 1 to 9 percent slopes	A	214.3	16.0%
9	Blakeland-Fluvaquentic Haplaquolls	A	465.8	34.7%
19	Columbine gravelly sandy loam, 0 to 3 percent slopes	A	662.6	49.3%
<b>Totals for Area of Interest</b>			<b>1,342.6</b>	<b>100.0%</b>

### Description

Hydrologic soil groups are based on estimates of runoff potential. Soils are assigned to one of four groups according to the rate of water infiltration when the soils are not protected by vegetation, are thoroughly wet, and receive precipitation from long-duration storms.

The soils in the United States are assigned to four groups (A, B, C, and D) and three dual classes (A/D, B/D, and C/D). The groups are defined as follows:

Group A. Soils having a high infiltration rate (low runoff potential) when thoroughly wet. These consist mainly of deep, well drained to excessively drained sands or gravelly sands. These soils have a high rate of water transmission.

Group B. Soils having a moderate infiltration rate when thoroughly wet. These consist chiefly of moderately deep or deep, moderately well drained or well drained soils that have moderately fine texture to moderately coarse texture. These soils have a moderate rate of water transmission.

Group C. Soils having a slow infiltration rate when thoroughly wet. These consist chiefly of soils having a layer that impedes the downward movement of water or soils of moderately fine texture or fine texture. These soils have a slow rate of water transmission.

Group D. Soils having a very slow infiltration rate (high runoff potential) when thoroughly wet. These consist chiefly of clays that have a high shrink-swell potential, soils that have a high water table, soils that have a claypan or clay layer at or near the surface, and soils that are shallow over nearly impervious material. These soils have a very slow rate of water transmission.

If a soil is assigned to a dual hydrologic group (A/D, B/D, or C/D), the first letter is for drained areas and the second is for undrained areas. Only the soils that in their natural condition are in group D are assigned to dual classes.

## Rating Options

*Aggregation Method:* Dominant Condition

*Component Percent Cutoff:* None Specified

*Tie-break Rule:* Higher



**NOTES TO USERS**

This map is for use in administering the National Flood Insurance Program. It does not necessarily identify all areas subject to flooding, particularly from local drainage sources of small size. The community map repository should be consulted for possible updated or additional flood hazard information.

To obtain more detailed information in areas where **Base Flood Elevations (BFEs)** and/or **floodways** have been determined, users are encouraged to consult the Flood Profiles and Floodway Data and/or Summary of Stillwater Elevations tables contained within the Flood Insurance Study (FIS) report that accompanies this FIRM. Users should be aware that BFEs shown on the FIRM represent rounded whole-foot elevations. These BFEs are intended for flood insurance rating purposes only and should not be used as the sole source of flood elevation information. Accordingly, flood elevation data presented in the FIS report should be utilized in conjunction with the FIRM for purposes of construction and/or floodplain management.

**Coastal Base Flood Elevations** shown on this map apply only landward of 0.0' North American Vertical Datum of 1988 (NAVD88). Users of this FIRM should be aware that coastal flood elevations are also provided in the Summary of Stillwater Elevations table in the Flood Insurance Study report for this jurisdiction. Elevations shown in the Summary of Stillwater Elevations table should be used for construction and/or floodplain management purposes when they are higher than the elevations shown on this FIRM.

Boundaries of the **floodways** were computed at cross sections and interpolated between cross sections. The floodways were based on hydraulic considerations with regard to requirements of the National Flood Insurance Program. Floodway widths and other pertinent floodway data are provided in the Flood Insurance Study report for this jurisdiction.

Certain areas not in Special Flood Hazard Areas may be protected by **flood control structures**. Refer to section 2.4 "Flood Protection Measures" of the Flood Insurance Study report for information on flood control structures for this jurisdiction.

The **projection** used in the preparation of this map was Universal Transverse Mercator (UTM) zone 13. The **horizontal datum** was NAD83, GRS80 spheroid. Differences in datum, spheroid, projection or UTM zones used in the production of FIRMs for adjacent jurisdictions may result in slight positional differences in map features across jurisdiction boundaries. These differences do not affect the accuracy of this FIRM.

Flood elevations on this map are referenced to the **North American Vertical Datum of 1988 (NAVD88)**. These flood elevations must be compared to structure and ground elevations referenced to the same vertical datum. For information regarding conversion between the National Geodetic Vertical Datum of 1929 and the North American Vertical Datum of 1988, visit the National Geodetic Survey website at <http://www.ngs.noaa.gov/> or contact the National Geodetic Survey at the following address:

NGS Information Services  
NOAA, NINGS12  
National Geodetic Survey  
SSMC-3, #9202  
1315 East-West Highway  
Silver Spring, MD 20910-3282

To obtain current elevation, description, and/or location information for **bench marks** shown on this map, please contact the Information Services Branch of the National Geodetic Survey at (301) 713-3242 or visit its website at <http://www.ngs.noaa.gov/>.

**Base Map** information shown on this FIRM was provided in digital format by El Paso County, Colorado Springs Utilities, City of Fountain, Bureau of Land Management, National Oceanic and Atmospheric Administration, United States Geological Survey, and Anderson Consulting Engineers, Inc. These data are current as of 2006.

This map reflects more detailed and up-to-date **stream channel configurations and floodplain delineations** than those shown on the previous FIRM for this jurisdiction. The floodplains and floodways that were transferred from the previous FIRM may have been adjusted to conform to these new stream channel configurations. As a result, the Flood Profiles and Floodway Data tables in the Flood Insurance Study Report (which contains authoritative hydraulic data) may reflect stream channel distances that differ from what is shown on this map. The profile baselines depicted on this map represent the hydraulic modeling baselines that match the flood profiles and Floodway Data Tables if applicable, in the FIS report. As a result, the profile baselines may deviate significantly from the new base map channel representation and may appear outside of the floodplain.

**Corporate limits** shown on this map are based on the best data available at the time of publication. Because changes due to annexations or de-annexations may have occurred after this map was published, map users should contact appropriate community officials to verify current corporate limit locations.

Please refer to the separately printed **Map Index** for an overview map of the county showing the layout of map panels; community map repository addresses; and a Listing of Communities table containing National Flood Insurance Program dates for each community as well as a listing of the panels on which each community is located.

Contact **FEMA Map Service Center (MSC)** via the FEMA Map Information eXchange (FMIX) 1-877-336-2627 for information on available products associated with this FIRM. Available products may include previously issued Letters of Map Change, a Flood Insurance Study Report, and/or digital versions of this map. The MSC may also be reached by Fax at 1-800-358-9820 and its website at <http://www.msc.fema.gov/>.

If you have **questions about this map** or **questions concerning the National Flood Insurance Program** in general, please call 1-877-FEMA MAP (1-877-336-2627) or visit the FEMA website at <http://www.fema.gov/business/nfp>.

El Paso County Vertical Datum Offset Table	
Flooding Source	Vertical Datum Offset (ft)
REFER TO SECTION 3.3 OF THE EL PASO COUNTY FLOOD INSURANCE STUDY REPORT FOR STREAM BY STREAM VERTICAL DATUM CONVERSION INFORMATION	

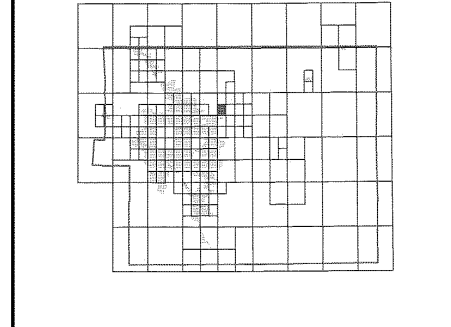

This Digital Flood Insurance Rate Map (DFIRM) was produced through a Cooperating Technical Partner (CTP) agreement between the State of Colorado Water Conservation Board (CWCB) and the Federal Emergency Management Agency (FEMA).

Additional Flood Hazard information and resources are available from local communities and the Colorado Water Conservation Board.

**LEGEND**

**SPECIAL FLOOD HAZARD AREAS (SFHAS) SUBJECT TO INUNDATION BY THE 1% ANNUAL CHANCE FLOOD**

- ZONE A** No Base Flood Elevations determined.
- ZONE AE** Base Flood Elevations determined.
- ZONE AH** Flood depths of 1 to 3 feet (usually areas of ponding); Base Flood Elevations determined.
- ZONE AO** Flood depths of 1 to 3 feet (usually sheet flow on sloping terrain); average depths determined. For areas of alluvial fan flooding, velocities also determined.
- ZONE AR** Special Flood Hazard Area Formerly protected from the 1% annual chance flood by a flood control system that was subsequently decertified. Zone AR indicates that the former flood control system is being restored to provide protection from the 1% annual chance or greater flood.
- ZONE A99** Area to be protected from 1% annual chance flood by a Federal flood protection system under construction; no Base Flood Elevations determined.
- ZONE V** Coastal flood zone with velocity hazard (wave action); no Base Flood Elevations determined.
- ZONE VE** Coastal flood zone with velocity hazard (wave action); Base Flood Elevations determined.

**FLOODWAY AREAS IN ZONE AE**  
The floodway is the channel of a stream plus any adjacent floodplain areas that must be kept free of encroachment so that the 1% annual chance flood can be carried without substantial increases in flood heights.

**OTHER FLOOD AREAS**  
**ZONE X** Areas of 0.2% annual chance flood; areas of 1% annual chance flood with average depths of less than 1 foot or with drainage areas less than 1 square mile; and areas protected by levees from 1% annual chance flood.

**OTHER AREAS**  
**ZONE X** Areas determined to be outside the 0.2% annual chance floodplain.  
**ZONE D** Areas in which flood hazards are undetermined, but possible.

**COASTAL BARRIER RESOURCES SYSTEM (CBRS) AREAS**  
**OTHERWISE PROTECTED AREAS (OPAs)**

CBRS areas and OPAs are normally located within or adjacent to Special Flood Hazard Areas.  
Floodplain boundary  
Floodway boundary  
Zone D Boundary  
CBRS and OPA boundary

Boundary dividing Special Flood Hazard Areas of different Base Flood Elevations, flood depths or flood velocities.  
Base Flood Elevation line and value; elevation in feet\*  
Base Flood Elevation value where uniform within zone; elevation in feet\*

- \* Referenced to the North American Vertical Datum of 1988 (NAVD 88)
- A — A — Cross section line
- 23 — 23 — Transect line
- Geographic coordinates referenced to the North American Datum of 1983 (NAD 83)
- 1000-meter Universal Transverse Mercator grid ticks, zone 13
- 5000-foot grid ticks: Colorado State Plane coordinate system, central zone (FIPSZONE 0502), Lambert Conformal Conic Projection
- DX5510 X Bench mark (see explanation in Notes to Users section of this FIRM panel)
- M1.5 River Mile

MAP REPOSITORIES  
Refer to Map Repositories list on Map Index

EFFECTIVE DATE OF COUNTYWIDE FLOOD INSURANCE RATE MAP  
**MARCH 17, 1997**

EFFECTIVE DATE(S) OF REVISION(S) TO THIS PANEL  
**DECEMBER 7, 2018** - to update corporate limits, to change Base Flood Elevations and Special Flood Hazard Areas, to update map format, to add roads and road names, and to incorporate previously issued Letters of Map Revision.

For community map revision history prior to countywide mapping, refer to the Community Map History Table located in the Flood Insurance Study report for this jurisdiction.

To determine if flood insurance is available in this community, contact your insurance agent or call the National Flood Insurance Program at 1-800-638-6620.



**NFP**

**PANEL 0553G**

**FIRM**  
FLOOD INSURANCE RATE MAP  
EL PASO COUNTY,  
COLORADO  
AND INCORPORATED AREAS

PANEL 553 OF 1300  
(SEE MAP INDEX FOR FIRM PANEL LAYOUT)

CONTAINS:  
COMMUNITY NUMBER PANEL SUFFIX  
EL PASO COUNTY 08059 0553 G

Notice to User: The Map Number shown below should be used when placing map orders. The Community Number shown above should be used on insurance applications for the subject community.

**MAP NUMBER**  
08041C0553G

**MAP REVISED**  
DECEMBER 7, 2018

Federal Emergency Management Agency

**FALCON DRAINAGE BASIN PLANNING STUDY**  
**SELECTED PLAN REPORT**  
**FINAL - SEPTEMBER 2015**

Prepared for:



El Paso County Public Services Department  
3275 Akers Drive  
Colorado Springs, CO 80922

Prepared By:



Matrix Design Group  
2435 Research Parkway, Suite 300  
Colorado Springs, CO 80920

Matrix Project No. 10.122.003

### LEGEND

- «- Subbasin ID
- «- 2-yr & 100-yr Flows (cfs)
- Detention Pond
- Junction
- Existing Watershed Boundary
- Historical and Future Watershed Boundary
- Tributary Basin Boundary
- Subbasin Boundary
- Major Tributary

Hydrologic Element	Area (sq mi)	Existing Peak Flows (cfs)		Hydrologic Element	Area (sq mi)	Existing Peak Flows (cfs)	
		2-year	100-year			2-year	100-year
ET010	0.15	25	150	RET020	0.71	63	480
ET020	0.21	44	260	RET060	0.83	7	400
ET030	0.20	34	190	RET070	1.11	13	340
ET040	0.15	28	170	RET080	1.36	65	420
ET050	0.12	37	220	RET090	1.66	14	320
ET060	0.29	150	530	RET100	1.78	15	320
ET070	0.25	94	460	RET110	1.81	15	380
ET080	0.29	91	440	RET120	2.05	16	410
ET090	0.12	7	63	RET140	0.11	7	62
ET100	0.05	1	34	RET150	2.38	17	430
ET110	0.23	8	130	RET154	0.40	16	150
ET120	0.11	8	70	RET156	2.57	28	570
ET130	0.13	7	62	RET162	2.74	30	500
ET140	0.27	11	89	RET164	2.93	32	620
ET150	0.18	12	100	RET190	0.69	14	100
ET160	0.19	19	140	RMT040	0.25	33	240
ET170	0.12	2	41	RMT050	0.56	40	470
ET180	0.15	23	120	RMT062	0.29	1	160
ET190	0.36	44	280	RMT064	0.07	50	360
ET200	0.56	65	460	RMT090	1.35	64	670
ET210	0.71	23	480	RMT080	1.36	61	760
ET220	0.83	7	410	RMT090	0.04	8	30
ET230	1.11	13	340	RMT102	1.27	40	770
ET240	1.36	94	490	RMT104	0.04	8	30
ET250	1.66	14	320	RMT106	1.46	44	780
ET260	1.78	15	370	RMT112	1.53	44	790
ET270	1.81	15	380	RMT114	1.64	46	820
ET280	2.05	16	410	RMT180	0.07	4	42
ET290	2.38	17	430	RMT182	0.14	9	85
ET300	0.13	7	62	RMT184	0.14	9	89
ET310	0.40	18	130	RMT186	0.28	15	170
ET320	2.57	28	570	RMT188	0.46	24	260
ET330	2.74	31	590	RMT190	0.17	14	130
ET340	2.93	32	620	RMT192	0.85	43	480
ET350	0.93	32	630	RMT194	1.09	54	610
ET360	1.09	54	610	RMT196	1.43	66	740
ET370	1.12	2	41	RMT198	1.63	76	850
ET380	0.29	14	100	RMT199	0.11	14	110
ET390	0.25	34	240	RMT199	0.36	11	91
ET400	0.56	40	470	RMT199	1.77	84	900
ET410	0.67	50	580	RMT199	0.47	35	180
ET420	1.16	54	670	RMT199	2.24	50	390
ET430	1.36	61	760	RMT199	2.36	60	760
ET440	1.42	40	770	RMT199	2.46	0	770
ET450	0.04	8	30	RMT199	0.06	4	43
ET460	1.46	44	790	RMT199	2.82	14	380
ET470	0.04	8	30	RMT199	3.28	39	350
ET480	1.52	45	800	RMT199	0.19	16	130
ET490	1.64	46	830	RMT199	3.28	27	950
ET500	0.14	9	89	RMT199	3.47	50	1,000
ET510	0.07	4	42	RMT199	0.07	7	55
ET520	0.14	9	85	RMT199	0.35	190	1,500
ET530	0.28	15	170	RMT199	0.60	16	39
ET540	0.46	24	260	RMT199	3.55	26	880
ET550	0.85	43	480	RMT199	3.70	38	890
ET560	0.17	14	130	RMT199	3.88	46	510
ET570	0.09	54	610	RMT199	3.93	8	45
ET580	1.43	67	740	RMT199	0.27	33	250
ET590	1.63	76	890	RMT199	3.87	49	910
ET600	1.77	84	910	RMT199	4.13	70	1,030
ET610	0.13	14	110	RMT199	0.12	13	91
ET620	0.36	11	91	RMT199	5.88	93	1,300
ET630	0.47	35	180	RMT199	6.25	120	1,300
ET640	2.24	90	930	RMT199	0.33	16	160
ET650	2.36	92	960	RMT199	6.48	20	1,300
ET660	2.36	0	760	RMT199	9.69	160	1,300
ET670	2.36	0	760	RMT199	10.30	190	1,300
ET680	2.36	0	760	RMT199	0.67	7	55
ET690	2.36	0	760	RMT199	10.35	190	1,300
ET700	0.00	92	200	RMT199	0.65	4	43
ET710	2.46	0	770	RMT199	0.25	1	160
ET720	0.06	4	43	RMT199	0.71	59	480
ET730	2.82	14	880	RMT199	0.71	23	480
ET740	1.09	21	920	RMT199	0.83	7	410
ET750	0.19	16	130	RMT199	1.51	13	340
ET760	3.28	27	990	RMT199	1.66	14	320
ET770	3.47	50	1,000	RMT199	0.04	8	30
ET780	3.55	26	890	RMT199	0.56	40	470
ET790	3.70	39	890	RMT199	0.34	38	89
ET800	3.84	47	910	RMT199	0.67	4	42
ET810	0.03	6	45	RMT199	0.68	9	75
ET820	0.27	33	250	RMT199	0.19	9	93
ET830	3.87	49	910	RMT199	0.29	17	140
ET840	4.13	71	990	RMT199	0.20	14	120
ET850	5.88	94	1,300	RMT199	0.17	14	130
ET860	0.10	12	92	RMT199	0.67	9	67
ET870	6.25	120	1,300	RMT199	0.25	17	130
ET880	6.48	120	1,300	RMT199	0.19	38	210
ET890	0.33	16	160	RMT199	0.19	35	130
ET900	9.69	160	1,300	RMT199	0.65	2	31
ET910	10.30	190	1,300	RMT199	0.30	35	170
ET920	0.67	7	55	RMT199	0.23	14	110
ET930	10.36	190	1,300	RMT199	0.21	20	140
ET940	10.58	190	1,300	RMT199	0.51	35	180
ET950	0.29	28	210	RMT199	0.32	10	96
ET960	0.09	14	100	RMT199	0.30	0	15
ET970	0.16	30	190	RMT199	0.06	11	75
ET980	0.31	34	250	RMT199	0.30	10	110
ET990	0.12	17	110	RMT199	0.27	7	80
ET1000	0.19	8	99	RMT199	0.39	16	130
ET1010	0.20	10	93	RMT199	0.20	50	280
ET1020	0.06	58	190	RMT199	0.68	28	140
ET1030	0.04	36	120	RMT199	0.15	39	220
ET1040	0.06	11	70	RMT199	0.34	10	78
ET1050	0.12	19	120	RMT199	0.63	8	45
ET1060	0.12	19	120	RMT199	0.27	38	250
ET1070	0.15	23	130	RMT199	0.10	15	110
ET1080	0.10	10	130	RMT199	0.20	12	92
ET1090	0.36	23	170	RMT199	0.28	20	180
ET1100	0.36	11	91	RMT199	0.21	18	150
ET1110	0.19	7	63	RMT199	0.33	16	160
ET1120	1.42	40	770	RMT199	0.28	19	150
ET1130	0.30	26	210	RMT199	0.30	26	210
ET1140	3.55	14	970	RMT199	0.67	7	55
ET1150	3.55	30	1,000	RMT199	0.21	1	64
ET1160	0.15	23	130	RMT199			
ET1170	0.36	43	280	RMT199			
ET1180	0.56	62	460	RMT199			

**Figure 3-12**  
Existing Hydrology  
Falcon DBPS  
El Paso County, CO

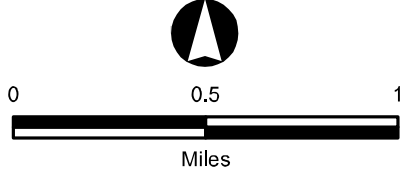

NOTE: FIGURE MUST BE VIEWED IN COLOR



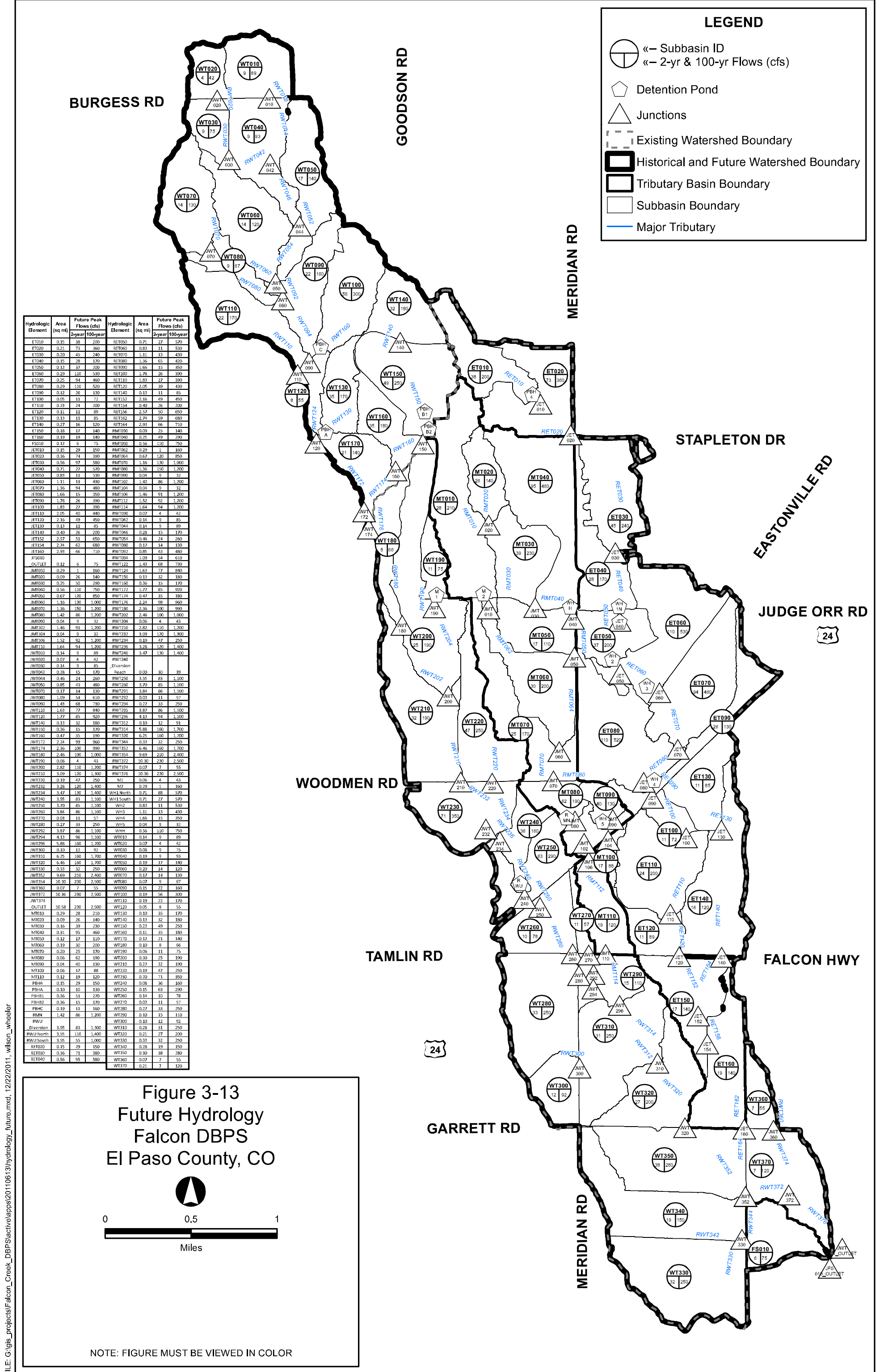

### LEGEND

- «- Subbasin ID
- «- 2-yr & 100-yr Flows (cfs)
- Detention Pond
- Junctions
- Existing Watershed Boundary
- Historical and Future Watershed Boundary
- Tributary Basin Boundary
- Subbasin Boundary
- Major Tributary

Hydrologic Element	Area (sq mi)	Future Peak Flows (cfs)		Hydrologic Element	Area (sq mi)	Future Peak Flows (cfs)	
		2-year	100-year			2-year	100-year
ET010	0.15	38	200	RET050	0.71	27	570
ET020	0.21	73	390	RET060	0.83	11	330
ET030	0.20	45	240	RET070	1.11	13	420
ET040	0.15	28	170	RET080	1.36	65	420
ET050	0.12	37	200	RET090	1.66	15	350
ET060	0.29	140	530	RET100	1.78	26	390
ET070	0.25	94	460	RET110	1.83	27	390
ET080	0.29	130	520	RET120	2.05	39	430
ET090	0.12	26	130	RET130	0.13	11	85
ET100	0.05	11	72	RET140	2.16	49	450
ET110	0.23	74	200	RET150	0.40	26	200
ET120	0.41	11	89	RET160	2.57	50	650
ET130	0.13	11	85	RET170	2.74	59	680
ET140	0.27	16	120	RET180	2.93	66	710
ET150	0.16	17	140	RET190	0.09	75	140
ET160	0.19	19	140	RET200	0.25	49	390
FS010	0.12	6	75	RMT010	0.56	110	750
JET010	0.15	29	150	RMT020	0.29	1	160
JET020	0.36	74	390	RMT030	0.67	120	850
JET030	0.56	67	580	RMT040	1.16	130	1,000
JET040	0.71	27	570	RMT050	0.36	150	1,200
JET050	0.83	11	330	RMT060	0.26	109	610
JET060	1.11	13	420	RMT070	1.42	86	1,200
JET070	1.36	65	420	RMT080	0.01	9	32
JET080	1.66	15	350	RMT090	1.46	91	1,200
JET090	1.78	26	390	RMT100	1.52	92	1,200
JET100	1.83	27	390	RMT110	1.64	94	1,200
JET110	2.05	39	430	RMT120	0.07	6	42
JET120	2.16	49	450	RMT130	0.14	9	85
JET130	0.13	11	85	RMT140	0.14	9	89
JET140	0.40	26	200	RMT150	0.28	15	170
JET150	2.57	51	650	RMT160	0.46	24	260
JET160	2.74	62	680	RMT170	0.17	14	130
JET170	2.93	66	710	RMT180	0.85	43	490
JET180	0.09	11	330	RMT190	1.09	54	610
JET190	0.12	6	75	RMT200	1.43	68	720
JMT010	0.29	1	160	RMT210	1.63	77	840
JMT020	0.09	26	140	RMT220	0.13	32	180
JMT030	0.25	50	290	RMT230	0.36	15	170
JMT040	0.56	110	750	RMT240	1.77	85	920
JMT050	0.67	120	850	RMT250	0.47	13	180
JMT060	1.16	130	1,000	RMT260	2.24	58	960
JMT070	1.36	150	1,200	RMT270	2.36	100	990
JMT080	1.42	86	1,200	RMT280	2.46	100	1,000
JMT090	0.04	9	32	RMT290	0.05	4	43
JMT100	1.46	91	1,200	RMT300	2.82	110	1,200
JMT110	0.04	9	32	RMT310	3.09	130	1,300
JMT120	1.52	52	1,200	RMT320	0.19	47	250
JMT130	1.64	94	1,200	RMT330	3.28	120	1,400
JMT140	0.14	9	89	RMT340	3.47	130	1,400
JMT150	0.07	4	42	RMT350			
JMT160	0.14	9	85	RMT360			
JMT170	0.28	15	170	Reath	0.00	30	39
JMT180	0.46	24	260	RWT010	3.55	84	1,100
JMT190	0.85	43	490	RWT020	3.70	85	1,100
JMT200	0.17	14	130	RWT030	3.84	86	1,100
JMT210	1.09	54	610	RWT040	0.03	11	57
JMT220	1.43	68	720	RWT050	0.27	33	250
JMT230	1.63	77	840	RWT060	3.87	86	1,100
JMT240	1.77	85	920	RWT070	3.69	100	1,200
JMT250	0.13	11	85	RWT080	0.11	10	81
JMT260	0.36	15	170	RWT090	5.88	160	1,700
JMT270	0.47	13	180	RWT100	6.25	160	1,700
JMT280	2.24	58	960	RWT110	0.33	32	250
JMT290	2.36	100	990	RWT120	6.46	160	1,700
JMT300	2.46	100	1,000	RWT130	8.69	210	2,400
JMT310	3.09	130	1,300	RWT140	10.30	230	2,500
JMT320	0.05	4	43	RWT150	0.07	7	55
JMT330	2.82	110	1,200	RWT160	10.36	230	2,500
JMT340	3.09	130	1,300	RWT170	10.36	230	2,500
JMT350	0.19	47	250	M1	0.06	4	43
JMT360	3.28	120	1,400	M2	0.29	1	160
JMT370	3.47	130	1,400	WH1 North	0.71	27	370
JMT380	3.55	84	1,100	WH1 South	0.71	27	370
JMT390	3.70	85	1,100	WH2	0.83	11	530
JMT400	3.84	86	1,100	WH3	1.11	13	430
JMT410	0.03	11	57	WH4	1.46	15	350
JMT420	0.27	33	250	WH5	0.04	9	32
JMT430	3.87	86	1,100	WH6	0.56	110	750
JMT440	4.13	96	1,100	WTD0	0.14	9	89
JMT450	5.88	160	1,700	WTD1	0.07	6	42
JMT460	0.10	12	92	WTD2	0.08	9	75
JMT470	6.25	160	1,700	WTD3	0.19	9	93
JMT480	6.46	160	1,700	WTD4	0.19	17	140
JMT490	0.33	32	250	WTD5	0.20	14	120
JMT500	8.69	210	2,400	WTD6	0.17	14	130
JMT510	10.30	230	2,500	WTD7	0.13	32	180
JMT520	0.07	7	55	WTD8	0.27	32	190
JMT530	10.36	230	2,500	WTD9	0.15	22	160
JMT540	10.36	230	2,500	WTD10	0.19	56	300
JMT550				WTD11	0.19	22	170
JMT560				WTD12	0.05	8	55
JMT570				WTD13	0.10	35	170
JMT580				WTD14	0.13	32	180
JMT590				WTD15	0.23	49	250
JMT600				WTD16	0.11	35	180
JMT610				WTD17	0.12	21	140
JMT620				WTD18	0.10	8	66
JMT630				WTD19	0.06	11	75
JMT640				WTD20	0.30	25	190
JMT650				WTD21	0.27	32	190
JMT660				WTD22	0.19	47	250
JMT670				WTD23	0.20	71	350
JMT680				WTD24	0.08	36	160
JMT690				WTD25	0.15	63	290
JMT700				WTD26	0.14	10	78
JMT710				WTD27	0.03	11	57
JMT720				WTD28	0.27	33	250
JMT730				WTD29	0.10	15	110
JMT740				WTD30	0.10	12	92
JMT750				WTD31	0.28	31	250
JMT760				WTD32	0.21	27	200
JMT770				WTD33	0.23	32	250
JMT780				WTD34	0.08	38	280
JMT790				WTD35	0.07	7	55
JMT800				WTD36	0.07	7	55
JMT810				WTD37	0.21	7	120

Figure 3-13  
 Future Hydrology  
 Falcon DBPS  
 El Paso County, CO

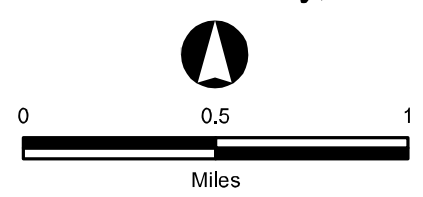

NOTE: FIGURE MUST BE VIEWED IN COLOR

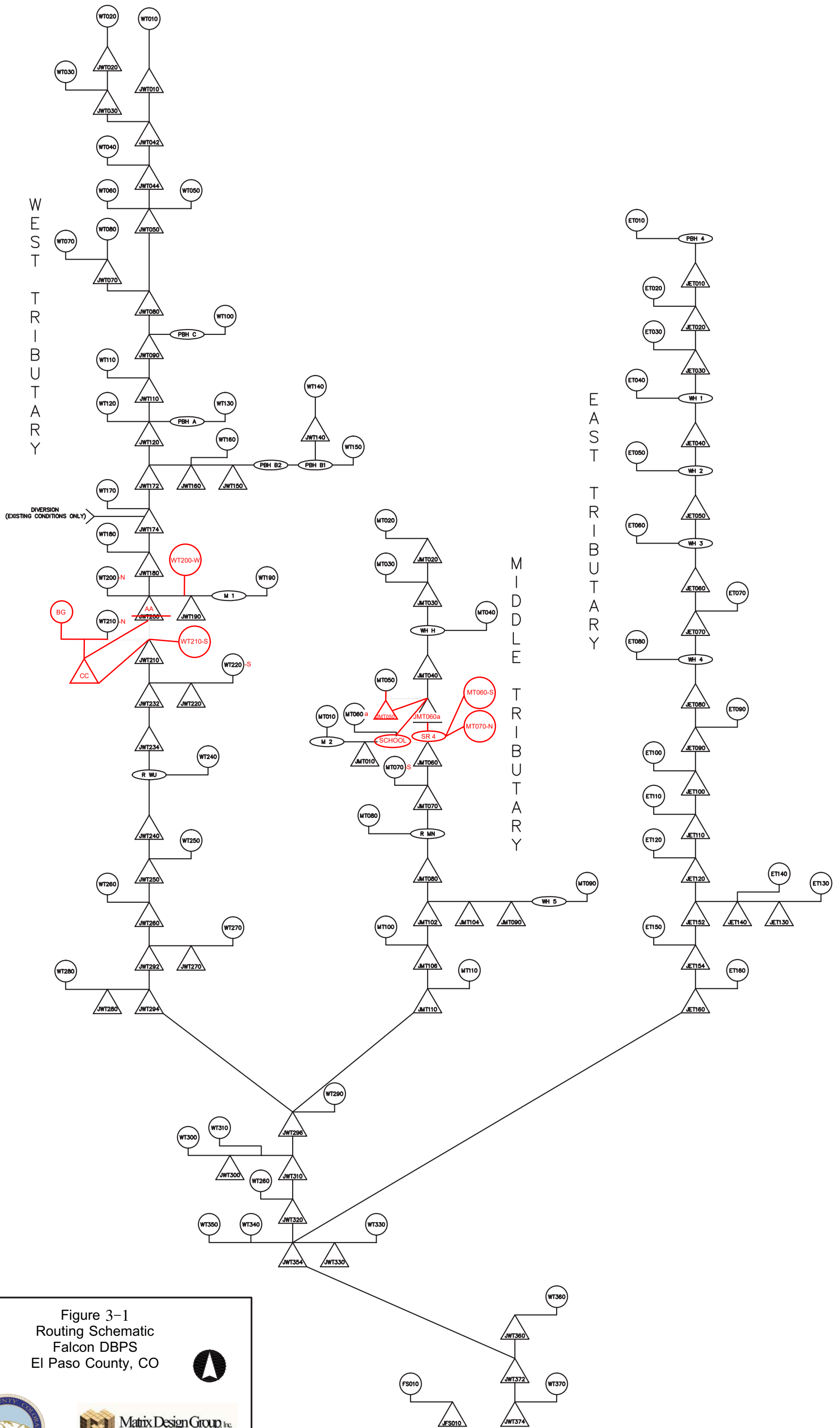

Figure 3-1  
 Routing Schematic  
 Falcon DBPS  
 El Paso County, CO



DRAWING NOT TO SCALE



Sub Regional Detention Alternative <sup>1</sup>						
Pond		Q <sub>2</sub> In (cfs)	Q <sub>2</sub> Out (cfs)	Q <sub>100</sub> In (cfs)	Q <sub>100</sub> Out (cfs)	Required Volume (AF) <sup>2</sup>
Paint Brush Hills Pond #4	PBH 4	38	29	200	150	1.34
Paint Brush Hills Pond A	PBH A	35	7	170	140	2.62
Paint Brush Hills Pond B1	PBH B1	80	51	420	270	9.17
Paint Brush Hills Pond B2	PBH B2	51	10	270	180	12.09
Paint Brush Hills Pond C	PBH C	56	3	300	140	6.77
Regional Pond MN	R MN	65	32	850	820	7.53
Regional Pond R1	R R1	110	77	1,600	1,500	25.00
Regional Pond R2	R R2	140	140	2,100	2,100	7.90
Regional Pond WU South	R WU	47	22	1,070	930	39.54
Sub Regional Pond SR1	SR 1	54	42	610	510	11.03
Sub Regional Pond SR2	SR 2	65	65	840	840	2.05
Sub Regional Pond SR3	SR 3	72	72	910	910	1.03
Sub Regional Pond SR4	SR 4	130	27	1,000	730	19.37
Sub Regional Pond SR6	SR 6	74	9	390	200	11.82
The Meadows Pond #1	M 1	11	0	75	2	3.25
The Meadows Pond #2	M 2	28	5	210	99	7.94
Woodmen Hills Pond #1 North	WH 1N	65	61	390	260	7.13
Woodmen Hills Pond #1 South	WH 1S	61	10	260	260	8.78
Woodmen Hills Pond #2	WH 2	37	10	270	250	9.18
Woodmen Hills Pond #3	WH 3	105	13	530	360	8.35
Woodmen Hills Pond #4	WH 4	110	15	790	260	40.45
Woodmen Hills Pond #5	WH 5	40	1	130	19	4.10
Woodmen Hills Pond H	WH H	140	110	750	750	2.66

Notes  
1: Represents future hydrology with retrofit existing detention ponds and 5 new subregional detention ponds  
2: Required volume to highest WSE

Reach Alternative	Total (ft)
Protect In Place	30,066
Natural Channel Design	32,359
Small Drop Structures w/ Toe Protection	76,812
Large Drop Structures w/ Toe Protection	0

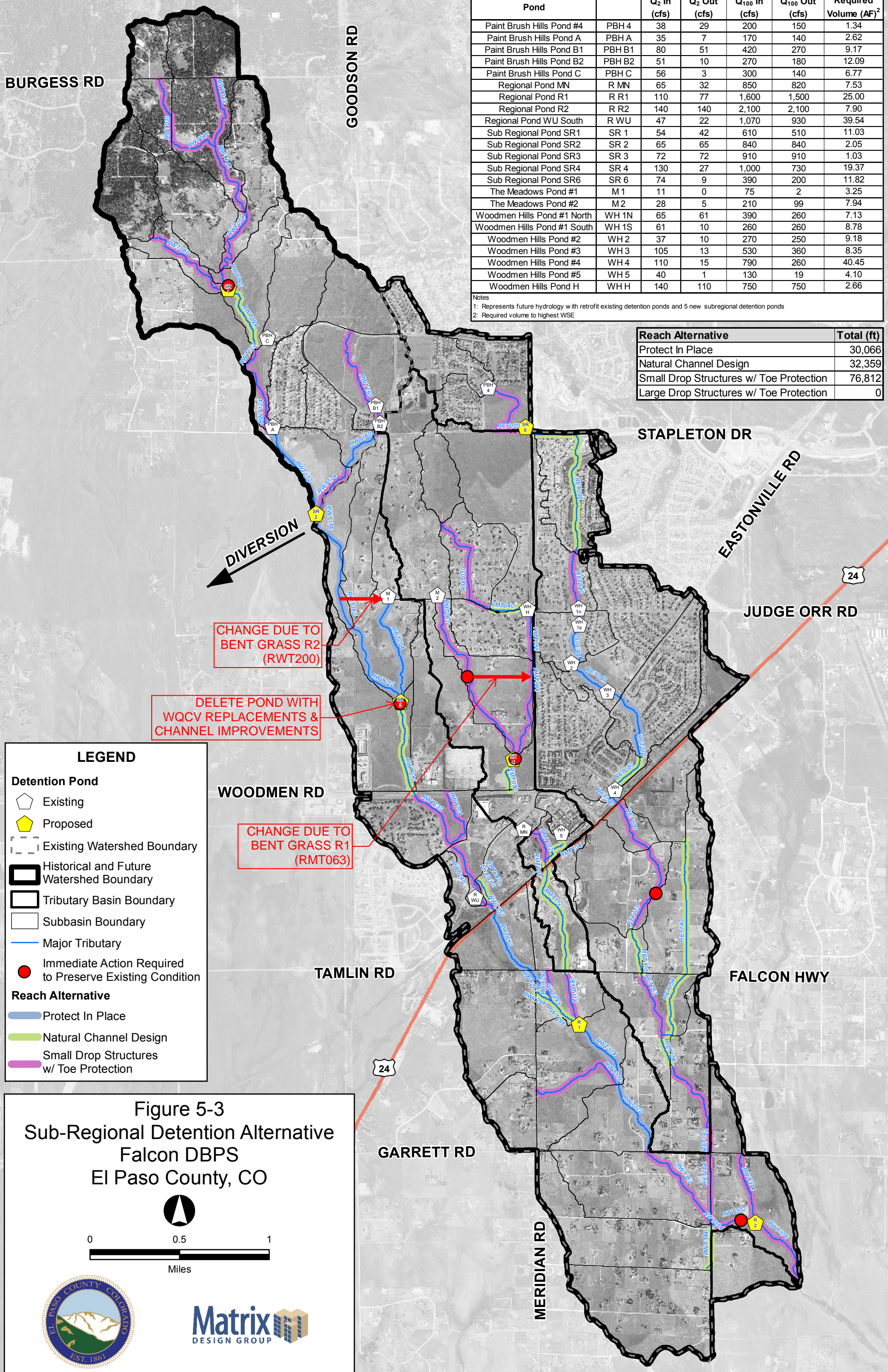

**LEGEND**

**Detention Pond**

- Existing (White pentagon)
- Proposed (Yellow pentagon)

**Boundary**

- Existing Watershed Boundary (Dashed line)
- Historical and Future Watershed Boundary (Thick black line)
- Tributary Basin Boundary (Thin black line)
- Subbasin Boundary (Dashed line)

**Major Tributary**

- Major Tributary (Blue line)

**Immediate Action Required to Preserve Existing Condition**

- Immediate Action Required to Preserve Existing Condition (Red circle)

**Reach Alternative**

- Protect In Place (Blue line)
- Natural Channel Design (Green line)
- Small Drop Structures w/ Toe Protection (Purple line)

**Figure 5-3**  
**Sub-Regional Detention Alternative**  
**Falcon DBPS**  
**El Paso County, CO**

0 0.5 1  
Miles

NOTE: FIGURE MUST BE VIEWED IN COLOR



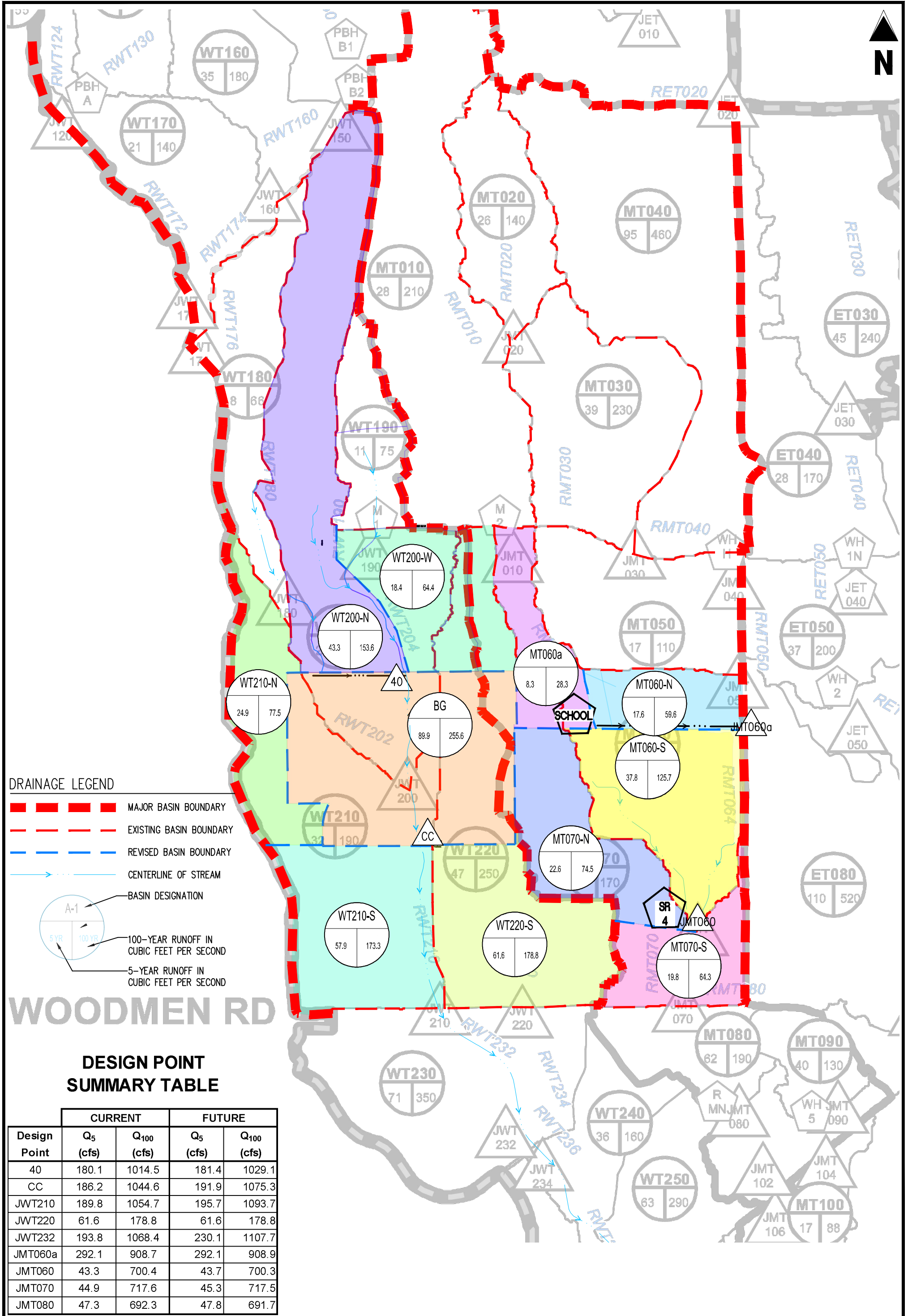

**DRAINAGE LEGEND**

- MAJOR BASIN BOUNDARY
- EXISTING BASIN BOUNDARY
- REVISED BASIN BOUNDARY
- CENTERLINE OF STREAM
- BASIN DESIGNATION
- 100-YEAR RUNOFF IN CUBIC FEET PER SECOND
- 5-YEAR RUNOFF IN CUBIC FEET PER SECOND

**WOODMEN RD**

**DESIGN POINT SUMMARY TABLE**

Design Point	CURRENT		FUTURE	
	Q <sub>5</sub> (cfs)	Q <sub>100</sub> (cfs)	Q <sub>5</sub> (cfs)	Q <sub>100</sub> (cfs)
40	180.1	1014.5	181.4	1029.1
CC	186.2	1044.6	191.9	1075.3
JWT210	189.8	1054.7	195.7	1093.7
JWT220	61.6	178.8	61.6	178.8
JWT232	193.8	1068.4	230.1	1107.7
JMT060a	292.1	908.7	292.1	908.9
JMT060	43.3	700.4	43.7	700.3
JMT070	44.9	717.6	45.3	717.5
JMT080	47.3	692.3	47.8	691.7

FALCON MEADOWS AT BENT GRASS  
MDDP

REVISED BASIN HYDROLOGY - HMS MODEL

Project No: CLH0017  
 Drawn By: CMD  
 Checked By: GD  
 Date: 06/16/21

**Galloway**  
 6162 S. Willow Drive, Suite 320  
 Greenwood Village, CO 80111  
 303.770.8884 • GallowayUS.com

# LOT 1 LATIGO BUSINESS CENTER DEVELOPED BASINS MAP



SCALE: 1"=40'

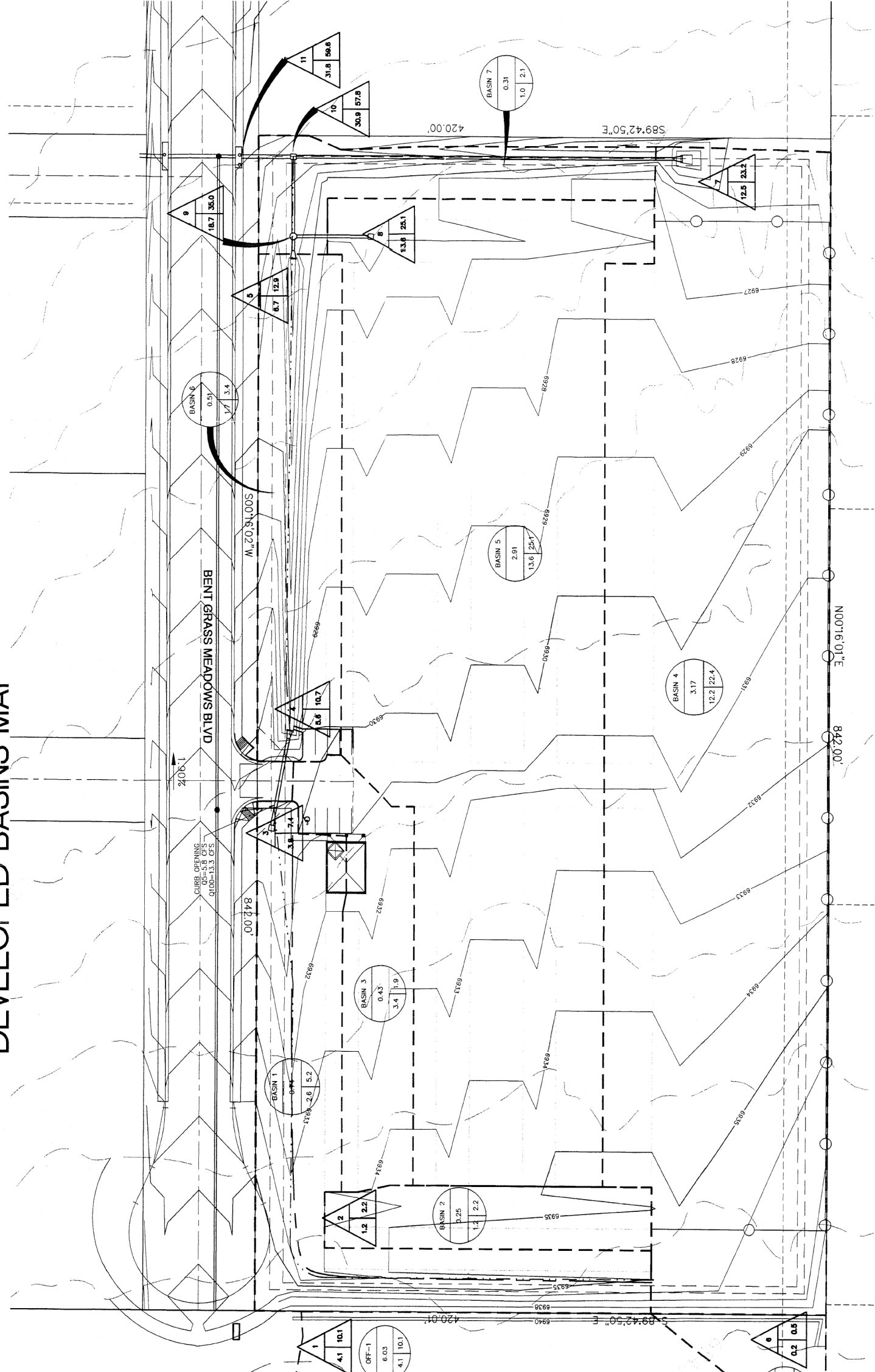

DESIGN POINT	CONTRIBUTING BASINS	TIME OF CONCENTRATION (MINUTES)	Q <sub>5</sub> (CFS)	Q <sub>100</sub> (CFS)
1	DP-1	22.6	4.1	10.1
2	BASIN 2	5.0	1.2	2.2
3	BASIN 1 BASIN 2	5.2	3.8	7.4
4	DP-3, BASIN 3	5.3	5.6	10.7
5	DP-4, BASIN 6	7.3	6.7	12.9
6	DP-2	17.5	0.2	0.5
7	DP-6, BASIN 4	7.1	12.5	23.2
8	BASIN 5	5.0	13.6	25.1
9	BASIN 7	6.4	1.0	2.1
10	DP-9, DP-7	7.4	30.9	57.8
11	DP-10, BASIN 7	7.4	31.8	59.6

REVISIONS:		ENGINEER:	DC	DATE:
NO.	DESCRIPTION	DESIGNED BY:	DC	7/17/04
		DRAWN BY:	DC	7/17/04
		CHECKED BY:	XXX	XX/XX/XX

PROJECT LATIGO BUSINESS CENTER LOT 1  
SHEET TITLE NA  
FROM JOB NO. 2004-1 TO SHEET 2 OF 2

48 HOURS BEFORE YOU DIG,  
CALL UTILITY LOCATORS  
1-800-922-1987  
(CALL YOUR LOCAL UTILITY COMPANIES)

**APPENDIX B**  
**Hydrologic Computations**

## Site-Level Low Impact Development (LID) Design Effective Impervious Calculator LID Credit by Impervious Reduction Factor (IRF) Method

UD-BMP (Version 3.06, November 2016)

User Input			
Calculated cells			
---Design Storm: 1-Hour Rain Depth	WQCV Event	0.60	inches
---Minor Storm: 1-Hour Rain Depth	5-Year Event	1.50	inches
---Major Storm: 1-Hour Rain Depth	100-Year Event	2.52	inches
Optional User Defined Storm	CUHP		
(CUHP) NOAA 1 Hour Rainfall Depth and Frequency for User Defined Storm	100-Year Event		
Max Intensity for Optional User Defined Storm		0	

**Designer:** CMWJ  
**Company:** Galloway & Co.  
**Date:** February 9, 2021  
**Project:** Falcon Meadows at Bent Grass  
**Location:** North WQ Pond

**SITE INFORMATION (USER-INPUT)**

Sub-basin Identifier	C																		
Receiving Pervious Area Soil Type	Sandy Loam																		
Total Area (ac., Sum of DCIA, UIA, RPA, & SPA)	13.580																		
Directly Connected Impervious Area (DCIA, acres)	5.300																		
Unconnected Impervious Area (UIA, acres)	2.900																		
Receiving Pervious Area (RPA, acres)	0.000																		
Separate Pervious Area (SPA, acres)	5.380																		
RPA Treatment Type: Conveyance (C), Volume (V), or Permeable Pavement (PP)	C																		

**CALCULATED RESULTS (OUTPUT)**

Total Calculated Area (ac, check against input)	13.580																		
Directly Connected Impervious Area (DCIA, %)	39.0%																		
Unconnected Impervious Area (UIA, %)	21.4%																		
Receiving Pervious Area (RPA, %)	0.0%																		
Separate Pervious Area (SPA, %)	39.6%																		
A <sub>s</sub> (RPA / UIA)	0.000																		
I <sub>s</sub> Check	1.000																		
f / I for WQCV Event:	1.7																		
f / I for 5-Year Event:	0.5																		
f / I for 100-Year Event:	0.3																		
<b>f / I for Optional User Defined Storm CUHP:</b>																			
IRF for WQCV Event:	1.00																		
IRF for 5-Year Event:	1.00																		
IRF for 100-Year Event:	1.00																		
<b>IRF for Optional User Defined Storm CUHP:</b>																			
Total Site Imperviousness: I <sub>total</sub>	60.4%																		
Effective Imperviousness for WQCV Event:	60.4%																		
Effective Imperviousness for 5-Year Event:	60.4%																		
Effective Imperviousness for 100-Year Event:	60.4%																		
<b>Effective Imperviousness for Optional User Defined Storm CUHP:</b>																			

**LID / EFFECTIVE IMPERVIOUSNESS CREDITS**

WQCV Event CREDIT: Reduce Detention By:	0.0%	N/A	N/A	N/A	N/A	N/A	N/A	N/A	N/A	N/A	N/A	N/A	N/A	N/A	N/A	N/A	N/A	N/A	N/A
This line only for 10-Year Event	N/A	N/A	N/A	N/A	N/A	N/A	N/A	N/A	N/A	N/A	N/A	N/A	N/A	N/A	N/A	N/A	N/A	N/A	N/A
100-Year Event CREDIT**: Reduce Detention By:	0.0%	N/A	N/A	N/A	N/A	N/A	N/A	N/A	N/A	N/A	N/A	N/A	N/A	N/A	N/A	N/A	N/A	N/A	N/A
<b>User Defined CUHP CREDIT: Reduce Detention By:</b>																			

Total Site Imperviousness:	60.4%
Total Site Effective Imperviousness for WQCV Event:	60.4%
Total Site Effective Imperviousness for 5-Year Event:	60.4%
Total Site Effective Imperviousness for 100-Year Event:	60.4%
Total Site Effective Imperviousness for Optional User Defined Storm CUHP:	

**Notes:**  
 \* Use Green-Ampt average infiltration rate values from Table 3-3.  
 \*\* Flood control detention volume credits based on empirical equations from Storage Chapter of USDCM.  
 \*\*\* Method assumes that 1-hour rainfall depth is equivalent to 1-hour intensity for calculation purposes

## Site-Level Low Impact Development (LID) Design Effective Impervious Calculator LID Credit by Impervious Reduction Factor (IRF) Method

UD-BMP (Version 3.06, November 2016)

User Input			
Calculated cells			
---Design Storm: 1-Hour Rain Depth	WQCV Event	0.60	inches
---Minor Storm: 1-Hour Rain Depth	5-Year Event	1.50	inches
---Major Storm: 1-Hour Rain Depth	100-Year Event	2.52	inches
Optional User Defined Storm	CUHP		
(CUHP) NOAA 1 Hour Rainfall Depth and Frequency for User Defined Storm	100-Year Event		
Max Intensity for Optional User Defined Storm		0	

**Designer:** CMWJ  
**Company:** Galloway & Co.  
**Date:** June 24, 2021  
**Project:** Falcon Meadows at Bent Grass  
**Location:** South WQ Pond

**SITE INFORMATION (USER-INPUT)**

Sub-basin Identifier	D	E	Off Site															
Receiving Pervious Area Soil Type	Sandy Loam	Sandy Loam	Sandy Loam															
Total Area (ac., Sum of DCIA, UIA, RPA, & SPA)	36.030	1.800	30.680															
Directly Connected Impervious Area (DCIA, acres)	11.900	1.800	2.400															
Unconnected Impervious Area (UIA, acres)	4.900	0.000	0.000															
Receiving Pervious Area (RPA, acres)	0.000	0.000	0.000															
Separate Pervious Area (SPA, acres)	19.230	0.000	28.280															
RPA Treatment Type: Conveyance (C), Volume (V), or Permeable Pavement (PP)	C	C	C															

**CALCULATED RESULTS (OUTPUT)**

Total Calculated Area (ac, check against input)	36.030	1.800	30.680															
Directly Connected Impervious Area (DCIA, %)	33.0%	100.0%	7.8%															
Unconnected Impervious Area (UIA, %)	13.6%	0.0%	0.0%															
Receiving Pervious Area (RPA, %)	0.0%	0.0%	0.0%															
Separate Pervious Area (SPA, %)	53.4%	0.0%	92.2%															
A <sub>u</sub> (RPA / UIA)	0.000	0.000	0.000															
I <sub>u</sub> Check	1.000	1.000	1.000															
f / I for WQCV Event:	1.7	1.7	1.7															
f / I for 5-Year Event:	0.5	0.5	0.5															
f / I for 100-Year Event:	0.3	0.3	0.3															
<b>f / I for Optional User Defined Storm CUHP:</b>																		
IRF for WQCV Event:	1.00	1.00	1.00															
IRF for 5-Year Event:	1.00	1.00	1.00															
IRF for 100-Year Event:	1.00	1.00	1.00															
<b>IRF for Optional User Defined Storm CUHP:</b>																		
Total Site Imperviousness: I <sub>total</sub>	46.6%	100.0%	7.8%															
Effective Imperviousness for WQCV Event:	46.6%	100.0%	7.8%															
Effective Imperviousness for 5-Year Event:	46.6%	100.0%	7.8%															
Effective Imperviousness for 100-Year Event:	46.6%	100.0%	7.8%															
<b>Effective Imperviousness for Optional User Defined Storm CUHP:</b>																		

**LID / EFFECTIVE IMPERVIOUSNESS CREDITS**

WQCV Event CREDIT: Reduce Detention By:	0.0%	0.0%	0.0%	N/A	N/A	N/A	N/A	N/A	N/A	N/A	N/A	N/A	N/A	N/A	N/A	N/A	N/A	N/A
This line only for 10-Year Event	N/A	N/A	N/A	N/A	N/A	N/A	N/A	N/A	N/A	N/A	N/A	N/A	N/A	N/A	N/A	N/A	N/A	N/A
100-Year Event CREDIT**: Reduce Detention By:	0.0%	0.0%	0.0%	N/A	N/A	N/A	N/A	N/A	N/A	N/A	N/A	N/A	N/A	N/A	N/A	N/A	N/A	N/A
<b>User Defined CUHP CREDIT: Reduce Detention By:</b>																		

Total Site Imperviousness:	30.7%
Total Site Effective Imperviousness for WQCV Event:	30.7%
Total Site Effective Imperviousness for 5-Year Event:	30.7%
Total Site Effective Imperviousness for 100-Year Event:	30.7%
Total Site Effective Imperviousness for Optional User Defined Storm CUHP:	

**Notes:**  
 \* Use Green-Ampt average infiltration rate values from Table 3-3.  
 \*\* Flood control detention volume credits based on empirical equations from Storage Chapter of USDCM.  
 \*\*\* Method assumes that 1-hour rainfall depth is equivalent to 1-hour intensity for calculation purposed



## Historic Computations

## COMPOSITE % IMPERVIOUS CALCULATIONS: HISTORIC

**Subdivision:** Falcon Meadows at Bent Grass  
**Location:** CO, Colorado Springs

**Project Name:** Falcon Meadows at Bent Grass  
**Project No.:** CLH000017.20  
**Calculated By:** CMWJ  
**Checked By:** \_\_\_\_\_  
**Date:** 4/15/21

Basin ID	Total Area (ac)	Paved/Dirt Roads			Lawns			Roofs			Basins Total Weighted % Imp.
		% Imp.	Area (ac)	Weighted % Imp.	% Imp.	Area (ac)	Weighted % Imp.	% Imp.	Area (ac)	Weighted % Imp.	
A-1	5.42	100	0.16	3.00	2	5.26	1.90	90	0.00	0.00	4.9
A-2	18.00	100	0.00	0.00	2	18.00	2.00	90	0.00	0.00	2.0
A-3	19.59	100	0.00	0.00	2	19.59	2.00	90	0.00	0.00	2.0
A-4	23.81	100	0.57	2.40	2	23.12	1.90	90	0.12	0.50	4.8
B-1	32.53	100	0.00	0.00	2	32.53	2.00	90	0.00	0.00	2.0
B-2	4.51	100	0.00	0.00	2	4.51	2.00	90	0.00	0.00	2.0
B-3	16.18	100	1.00	6.20	2	15.18	1.90	90	0.00	0.00	8.1
OS-1	13.06	100	0.84	6.40	2	11.65	1.80	90	0.57	3.90	12.1
OS-2	17.81	100	2.00	11.20	2	15.18	1.70	90	0.63	3.20	16.1
OS-4	30.69	100	1.42	4.60	2	28.41	1.90	90	0.86	2.50	9.0
OS-5	14.13	100	0.17	1.20	2	13.74	1.90	90	0.22	1.40	4.5
OS-6	5.81	100	0.00	0.00	2	5.81	2.00	90	0.00	0.00	2.0

## COMPOSITE RUNOFF COEFFICIENT CALCULATIONS: HISTORIC

**Subdivision:** Falcon Meadows at Bent Grass  
**Location:** CO, Colorado Springs

**Project Name:** Falcon Meadows at Bent Grass  
**Project No.:** CLH000017.20  
**Calculated By:** CMWJ  
**Checked By:** \_\_\_\_\_  
**Date:** 4/15/21

Basin ID	Total Area (ac)	Paved Roads			Lawns/Undeveloped			Roofs			Composite C <sub>5</sub>	Composite C <sub>100</sub>
		C <sub>5</sub>	C <sub>100</sub>	Area (ac)	C <sub>5</sub>	C <sub>100</sub>	Area (ac)	C <sub>5</sub>	C <sub>100</sub>	Area (ac)		
A-1	5.42	0.90	0.96	0.16	0.09	0.36	5.26	0.73	0.81	0.00	0.11	0.38
A-2	18.00	0.90	0.96	0.00	0.09	0.36	18.00	0.73	0.81	0.00	0.09	0.36
A-3	19.59	0.90	0.96	0.00	0.09	0.36	19.59	0.73	0.81	0.00	0.09	0.36
A-4	23.81	0.90	0.96	0.57	0.09	0.36	23.12	0.73	0.81	0.12	0.11	0.38
B-1	32.53	0.90	0.96	0.00	0.09	0.36	32.53	0.73	0.81	0.00	0.09	0.36
B-2	4.51	0.90	0.96	0.00	0.09	0.36	4.51	0.73	0.81	0.00	0.09	0.36
B-3	16.18	0.90	0.96	1.00	0.09	0.36	15.18	0.73	0.81	0.00	0.14	0.40
OS-1	13.06	0.90	0.96	0.84	0.09	0.36	11.65	0.73	0.81	0.57	0.17	0.42
OS-2	17.81	0.90	0.96	2.00	0.09	0.36	15.18	0.73	0.81	0.63	0.20	0.44
OS-4	30.69	0.90	0.96	1.42	0.09	0.36	28.41	0.73	0.81	0.86	0.15	0.40
OS-5	14.13	0.90	0.96	0.17	0.09	0.36	13.74	0.73	0.81	0.22	0.11	0.37
OS-6	5.81	0.90	0.96	0.00	0.09	0.36	5.81	0.73	0.81	0.00	0.09	0.36

*C values are taken directly from Table 6-6 in the Colorado Springs DCM Vol. 1. (Referencing UDFCD 2001)*

## STANDARD FORM SF-2: HISTORIC TIME OF CONCENTRATION

**Subdivision:** Falcon Meadows at Bent Grass  
**Location:** CO, Colorado Springs

**Project Name:** Falcon Meadows at Bent Grass  
**Project No.:** CLH000017.20  
**Calculated By:** CMWJ  
**Checked By:** \_\_\_\_\_  
**Date:** 4/15/21

SUB-BASIN						INITIAL/OVERLAND			TRAVEL TIME					T <sub>c</sub> CHECK			FINAL
DATA						(T <sub>i</sub> )			(T <sub>p</sub> )					(URBANIZED BASINS)			
BASIN ID	D.A. (AC)	Hydrologic Soils Group	Impervious (%)	C <sub>100</sub>	C <sub>5</sub>	L (FT)	S (%)	T <sub>i</sub> (MIN)	L (FT)	S (%)	C <sub>v</sub>	VEL. (FPS)	T <sub>i</sub> (MIN)	COMP. T <sub>c</sub> (MIN)	TOTAL LENGTH(FT)	Urbanized T <sub>c</sub> (MIN)	
A-1	5.42	A	4.90	0.38	0.11	300	2.5	23.0	466	2.5	15.0	2.4	3.3	26.3	766.0	14.3	14.3
A-2	18.00	A	2.00	0.36	0.09	300	2.4	23.9	1130	2.0	15.0	2.1	8.9	32.8	1430.0	17.9	17.9
A-3	19.59	A	2.00	0.36	0.09	300	2.7	23.0	760	2.7	15.0	2.5	5.1	28.1	1060.0	15.9	15.9
A-4	23.81	A	4.80	0.38	0.11	300	2.0	24.9	1500	2.0	15.0	2.1	11.8	36.6	1800.0	20.0	20.0
B-1	32.53	A	2.00	0.36	0.09	300	2.6	23.3	1100	2.6	15.0	2.4	7.6	30.9	1400.0	17.8	17.8
B-2	4.51	A	2.00	0.36	0.09	300	3.0	22.2	323	5.0	15.0	3.4	1.6	23.8	623.0	13.5	13.5
B-3	16.18	A	8.10	0.40	0.14	300	2.9	21.4	780	2.9	15.0	2.6	5.1	26.4	1080.0	16.0	16.0
OS-1	13.06	A	12.10	0.42	0.17	300	2.5	21.7	1420	2.5	15.0	2.4	10.0	31.7	1720.0	19.6	19.6
OS-2	17.81	A	16.10	0.44	0.20	300	2.3	21.6	1370	2.3	15.0	2.3	10.0	31.6	1670.0	19.3	19.3
OS-4	30.69	A	9.00	0.40	0.15	300	2.3	22.9	2600	2.3	15.0	2.3	19.0	42.0	2900.0	26.1	26.1
OS-5	14.13	A	4.50	0.37	0.11	300	2.5	23.1	1400	3.0	15.0	2.6	9.0	32.1	1700.0	19.4	19.4
OS-6	5.81	A	2.00	0.36	0.09	300	2.0	25.4	400	2.0	15.0	2.1	3.1	28.6	700.0	13.9	13.9

**NOTES:**

$T_i = (0.395 * (1.1 - C_5) * (L)^{0.5}) / ((S)^{0.33})$ , S in ft/ft

$T_i = L / 60V$  (Velocity From Fig. 501)

Velocity  $V = C_v * S^{0.5}$ , S in ft/ft

T<sub>c</sub> Check =  $10 + L / 180$

For Urbanized basins a minimum T<sub>c</sub> of 5.0 minutes is required.

For non-urbanized basins a minimum T<sub>c</sub> of 10.0 minutes is required

**STANDARD FORM SF-3: HISTORIC  
STORM DRAINAGE SYSTEM DESIGN  
(RATIONAL METHOD PROCEDURE)**

**Subdivision:** Falcon Meadows at Bent Grass  
**Location:** CO, Colorado Springs  
**Design Storm:** 5-Year

**Project Name:** Falcon Meadows at Bent Grass  
**Project No.:** CLH000017.20  
**Calculated By:** CMWJ  
**Checked By:** \_\_\_\_\_  
**Date:** 4/15/21

STREET	Design Point	DIRECT RUNOFF							TOTAL RUNOFF				STREET		PIPE			TRAVEL TIME			REMARKS
		Basin ID	Area (Ac)	Runoff Coeff.	Tc (min)	C*A (Ac)	I (in/hr)	Q (cfs)	Tc (min)	C*A (Ac)	I (in/hr)	Q (cfs)	Slope (%)	Street Flow (cfs)	Design Flow (cfs)	Slope (%)	Pipe Size (inches)	Length (ft)	Velocity (fps)	Tt (min)	
		OS-1	13.06	0.17	19.6	2.22	3.12	6.9													
		A-1	5.42	0.11	14.3	0.62	3.60	2.2													
	1								19.6	2.84	3.12	8.9									Total flow going offsite to Bent Grass F1 Residential
		OS-2	17.81	0.20	19.3	3.63	3.14	11.4													
		A-2	18.00	0.09	17.9	1.62	3.25	5.3													
	2								19.3	5.25	3.14	16.5									Total Flow entering Junction of RWT202&204
	3	A-3	19.59	0.09	15.9	1.76	3.43	6.0													
		OS-4	30.69	0.15	26.1	4.46	2.69	12.0													
		A-4	23.81	0.11	20.0	2.68	3.09	8.3													
	4								26.1	7.14	2.69	19.2									
	5	B-1	32.53	0.09	17.8	2.93	3.27	9.6													
	6	B-2	4.51	0.09	13.5	0.41	3.68	1.5													
	7	B-3	16.18	0.14	16.0	2.27	3.42	7.8													
	8							29.0													Reach RWT204 & Basin WT200 - Per Matrix DBPS Existing Hydrology
	9							14.0													RWT202 - Per Matrix DBPS Existing Hydrology
	10							32.0													RWT210 - Per Matrix DBPS Existing Hydrology
	20							98.1													Flows into Basin OS-5 from Bent Grass Filing No. 3
		OS-5	14.13	0.11	19.4	1.55	3.13	4.9													
	11											103.0									Flows into Basin OS-6
		OS-6	5.81	0.09	13.9	0.52	3.64	1.9													
	12											104.8									Existing Sediment Pond in Basin and then flows to Bent Grass Meadows Drive

**STANDARD FORM SF-3: HISTORIC  
STORM DRAINAGE SYSTEM DESIGN  
(RATIONAL METHOD PROCEDURE)**

**Subdivision:** Falcon Meadows at Bent Grass

**Location:** CO, Colorado Springs

**Design Storm:** 100-Year

**Project Name:** Falcon Meadows at Bent Grass

**Project No.:** CLH000017.20

**Calculated By:** CMWJ

**Checked By:**

**Date:** 4/15/21

STREET	Design Point	DIRECT RUNOFF							TOTAL RUNOFF				STREET		PIPE			TRAVEL TIME			REMARKS
		Basin ID	Area (Ac)	Runoff Coeff.	Tc (min)	C*A (Ac)	I (in/hr)	Q (cfs)	Tc (min)	C*A (Ac)	I (in/hr)	Q (cfs)	Slope (%)	Street Flow (cfs)	Design Flow (cfs)	Slope (%)	Pipe Size (inches)	Length (ft)	Velocity (fps)	Tt (min)	
		OS-1	13.06	0.42	19.6	5.46	5.24	28.6													
		A-1	5.42	0.38	14.3	2.05	6.04	12.4													
	1								19.6	7.51	5.24	39.4									Total flow going offsite to Bent Grass F1 Residential
		OS-2	17.81	0.44	19.3	7.90	5.28	41.7													
		A-2	18.00	0.36	17.9	6.48	5.46	35.4													
	2								19.3	14.38	5.28	75.9									Total Flow entering Junction of RWT202&204
	3	A-3	19.59	0.36	15.9	7.05	5.77	40.7													
		OS-4	30.69	0.40	26.1	12.29	4.51	55.4													
		A-4	23.81	0.38	20.0	8.97	5.19	46.6													
	4								26.1	21.26	4.51	95.9									
	5	B-1	32.53	0.36	17.8	11.71	5.48	64.2													
	6	B-2	4.51	0.36	13.5	1.62	6.18	10.0													
	7	B-3	16.18	0.40	16.0	6.42	5.75	36.9													
	8																				Reach RWT204 & Basin WT200 - Per Matrix DBPS Existing Hydrology
	9																				RWT202 - Per Matrix DBPS Existing Hydrology
	10																				RWT210 - Per Matrix DBPS Existing Hydrology
	20																				Flows into Basin OS-5 from Bent Grass Filing No. 3
		OS-5	14.13	0.37	19.4	5.29	5.26	27.8													
	11																				Flows into Basin OS-6
		OS-6	5.81	0.36	13.9	2.09	6.10	12.7													
	12																				Existing Sediment Pond in Basin and then flows to Bent Grass Meadows Drive

## Existing/Current Computations



## COMPOSITE RUNOFF COEFFICIENT CALCULATIONS: EXISTING/CURRENT

Subdivision: Falcon Meadows at Bent Grass  
 Location: CO, Colorado Springs

Project Name: Falcon Meadows at Bent Grass  
 Project No.: CLH000017  
 Calculated By: TJE  
 Checked By: CMD  
 Date: 6/19/20

Basin ID	Total Area (ac)	Paved/Gravel Roads			Lawns/Undeveloped			Roofs			Residential - 1/8 Acre			Residential - 1/4 Acre			Residential - 1/3 Acre			Residential - 1/2 Acre			Residential - 1 Acre			Composite C <sub>5</sub>	Composite C <sub>100</sub>
		C <sub>5</sub>	C <sub>100</sub>	Area (ac)	C <sub>5</sub>	C <sub>100</sub>	Area (ac)	C <sub>5</sub>	C <sub>100</sub>	Area (ac)	C <sub>5</sub>	C <sub>100</sub>	Area (ac)	C <sub>5</sub>	C <sub>100</sub>	Area (ac)	C <sub>5</sub>	C <sub>100</sub>	Area (ac)	C <sub>5</sub>	C <sub>100</sub>	Area (ac)	C <sub>5</sub>	C <sub>100</sub>	Area (ac)		
EX-1	1.19	0.90	0.96	0.00	0.09	0.36	1.19	0.73	0.81	0.00	0.45	0.59	0.00	0.30	0.50	0.00	0.25	0.47	0.00	0.22	0.46	0.00	0.20	0.44	0.00	0.09	0.36
EX-2	1.56	0.90	0.96	0.00	0.09	0.36	1.56	0.73	0.81	0.00	0.45	0.59	0.00	0.30	0.50	0.00	0.25	0.47	0.00	0.22	0.46	0.00	0.20	0.44	0.00	0.09	0.36
EX-3	0.62	0.90	0.96	0.00	0.09	0.36	0.62	0.73	0.81	0.00	0.45	0.59	0.00	0.30	0.50	0.00	0.25	0.47	0.00	0.22	0.46	0.00	0.20	0.44	0.00	0.09	0.36
EX-4	12.49	0.90	0.96	0.00	0.09	0.36	12.49	0.73	0.81	0.00	0.45	0.59	0.00	0.30	0.50	0.00	0.25	0.47	0.00	0.22	0.46	0.00	0.20	0.44	0.00	0.09	0.36
EX-5	5.15	0.90	0.96	0.00	0.09	0.36	5.15	0.73	0.81	0.00	0.45	0.59	0.00	0.30	0.50	0.00	0.25	0.47	0.00	0.22	0.46	0.00	0.20	0.44	0.00	0.09	0.36
EX-6	9.53	0.90	0.96	0.00	0.09	0.36	9.53	0.73	0.81	0.00	0.45	0.59	0.00	0.30	0.50	0.00	0.25	0.47	0.00	0.22	0.46	0.00	0.20	0.44	0.00	0.09	0.36
EX-7	9.16	0.90	0.96	0.00	0.09	0.36	9.16	0.73	0.81	0.00	0.45	0.59	0.00	0.30	0.50	0.00	0.25	0.47	0.00	0.22	0.46	0.00	0.20	0.44	0.00	0.09	0.36
EX-8	21.30	0.90	0.96	0.00	0.09	0.36	21.30	0.73	0.81	0.00	0.45	0.59	0.00	0.30	0.50	0.00	0.25	0.47	0.00	0.22	0.46	0.00	0.20	0.44	0.00	0.09	0.36
OS-1	32.28	0.90	0.96	2.15	0.09	0.36	29.25	0.73	0.81	0.88	0.45	0.59	0.00	0.30	0.50	0.00	0.25	0.47	0.00	0.22	0.46	0.00	0.20	0.44	0.00	0.16	0.41
OS-2	20.08	0.90	0.96	0.90	0.09	0.36	18.62	0.73	0.81	0.56	0.45	0.59	0.00	0.30	0.50	0.00	0.25	0.47	0.00	0.22	0.46	0.00	0.20	0.44	0.00	0.14	0.40
OS-3	10.62	0.90	0.96	0.48	0.09	0.36	9.84	0.73	0.81	0.30	0.45	0.59	0.00	0.30	0.50	0.00	0.25	0.47	0.00	0.22	0.46	0.00	0.20	0.44	0.00	0.14	0.40
OS-4	4.46	0.90	0.96	0.00	0.09	0.36	0.00	0.73	0.81	0.00	0.45	0.59	2.28	0.30	0.50	1.46	0.25	0.47	0.00	0.22	0.46	0.00	0.20	0.44	0.72	0.36	0.54
OS-5	0.46	0.90	0.96	0.00	0.09	0.36	0.00	0.73	0.81	0.00	0.45	0.59	0.46	0.30	0.50	0.00	0.25	0.47	0.00	0.22	0.46	0.00	0.20	0.44	0.00	0.45	0.59
OS-6	1.17	0.90	0.96	0.00	0.09	0.36	0.00	0.73	0.81	0.00	0.45	0.59	1.17	0.30	0.50	0.00	0.25	0.47	0.00	0.22	0.46	0.00	0.20	0.44	0.00	0.45	0.59
C-8	0.42	0.90	0.96	0.00	0.09	0.36	0.42	0.73	0.81	0.00	0.45	0.59	0.00	0.30	0.50	0.00	0.25	0.47	0.00	0.22	0.46	0.00	0.20	0.44	0.00	0.09	0.36
E-1	1.71	0.90	0.96	0.78	0.09	0.36	0.23	0.73	0.81	0.00	0.45	0.59	0.00	0.30	0.50	0.70	0.25	0.47	0.00	0.22	0.46	0.00	0.20	0.44	0.00	0.55	0.69
E-2	0.68	0.90	0.96	0.56	0.09	0.36	0.12	0.73	0.81	0.00	0.45	0.59	0.00	0.30	0.50	0.00	0.25	0.47	0.00	0.22	0.46	0.00	0.20	0.44	0.00	0.76	0.85
E-3	0.78	0.90	0.96	0.69	0.09	0.36	0.09	0.73	0.81	0.00	0.45	0.59	0.00	0.30	0.50	0.00	0.25	0.47	0.00	0.22	0.46	0.00	0.20	0.44	0.00	0.81	0.89
E-4	0.91	0.90	0.96	0.73	0.09	0.36	0.18	0.73	0.81	0.00	0.45	0.59	0.00	0.30	0.50	0.00	0.25	0.47	0.00	0.22	0.46	0.00	0.20	0.44	0.00	0.74	0.84
E-5	0.89	0.90	0.96	0.79	0.09	0.36	0.10	0.73	0.81	0.00	0.45	0.59	0.00	0.30	0.50	0.00	0.25	0.47	0.00	0.22	0.46	0.00	0.20	0.44	0.00	0.81	0.89
I-1	0.31	0.90	0.96	0.22	0.09	0.36	0.09	0.73	0.81	0.00	0.45	0.59	0.00	0.30	0.50	0.00	0.25	0.47	0.00	0.22	0.46	0.00	0.20	0.44	0.00	0.66	0.79

Lot Type Identification:	
Lot Size (SF)	Lot Size (Acre)
0 - 8,167	<= 1/8 Acre
8,168 - 12,704	1/4 Acre
12,705 - 18,149	1/3 Acre
18,150 - 32,670	1/2 Acre
32,671 - 43,560	1 Acre

**NOTES:**  
 C values are taken directly from Table 6-6 in the Colorado Springs DCM Vol. 1. CH. 6 (Referencing UDFCD 2001)  
 Coefficients use HSG A&B soils - Refer to "Appendix A: Exhibits and Figures" for soil map

**COMPOSITE % IMPERVIOUS CALCULATIONS: EXISTING/CURRENT**

**Subdivision:** Falcon Meadows at Bent Grass  
**Location:** CO, Colorado Springs

**Project Name:** Falcon Meadows at Bent Grass  
**Project No.:** CLH000017  
**Calculated By:** TJE  
**Checked By:** CMD  
**Date:** 6/19/20

Basin ID	Total Area (ac)	Paved/Gravel Roads			Lawns/Undeveloped			Roofs			Residential - 1/8 Acre			Residential - 1/4 Acre			Residential - 1/3 Acre			Residential - 1/2 Acre			Residential - 1 Acre			Basins Total Weighted % Imp.
		% Imp.	Area (ac)	Weighted % Imp.	% Imp.	Area (ac)	Weighted % Imp.	% Imp.	Area (ac)	Weighted % Imp.	% Imp.	Area (ac)	Weighted % Imp.	% Imp.	Area (ac)	Weighted % Imp.	% Imp.	Area (ac)	Weighted % Imp.	% Imp.	Area (ac)	Weighted % Imp.	% Imp.	Area (ac)	Weighted % Imp.	
EX-1	1.19	100	0.00	0.0	2	1.19	2.0	2	0.00	0.0	65.0	0.00	0.0	40	0.00	0.0	30	0.00	0.0	25	0.00	0.0	20	0.00	0.0	2.0
EX-2	1.56	100	0.00	0.0	2	1.56	2.0	90	0.00	0.0	65.0	0.00	0.0	40	0.00	0.0	30	0.00	0.0	25	0.00	0.0	20	0.00	0.0	2.0
EX-3	0.62	100	0.00	0.0	2	0.62	2.0	1	0.00	0.0	65.0	0.00	0.0	40	0.00	0.0	30	0.00	0.0	25	0.00	0.0	20	0.00	0.0	2.0
EX-4	12.49	100	0.00	0.0	2	12.49	2.0	90	0.00	0.0	65.0	0.00	0.0	40	0.00	0.0	30	0.00	0.0	25	0.00	0.0	20	0.00	0.0	2.0
EX-5	5.15	100	0.00	0.0	2	5.15	2.0	10	0.00	0.0	65.0	0.00	0.0	40	0.00	0.0	30	0.00	0.0	25	0.00	0.0	20	0.00	0.0	2.0
EX-6	9.53	100	0.00	0.0	2	9.53	2.0	90	0.00	0.0	65.0	0.00	0.0	40	0.00	0.0	30	0.00	0.0	25	0.00	0.0	20	0.00	0.0	2.0
EX-7	9.16	100	0.00	0.0	2	9.16	2.0	18	0.00	0.0	65.0	0.00	0.0	40	0.00	0.0	30	0.00	0.0	25	0.00	0.0	20	0.00	0.0	2.0
EX-8	21.30	100	0.00	0.0	2	21.30	2.0	90	0.00	0.0	65.0	0.00	0.0	40	0.00	0.0	30	0.00	0.0	25	0.00	0.0	20	0.00	0.0	2.0
OS-1	32.28	100	2.15	6.7	2	29.25	1.8	90	0.88	2.5	65.0	0.00	0.0	40	0.00	0.0	30	0.00	0.0	25	0.00	0.0	20	0.00	0.0	11.0
OS-2	20.08	80	0.90	3.6	2	18.62	1.9	90	0.56	2.5	65.0	0.00	0.0	40	0.00	0.0	30	0.00	0.0	25	0.00	0.0	20	0.00	0.0	8.0
OS-3	10.62	80	0.48	3.6	2	9.84	1.9	19	0.30	0.5	65.0	0.00	0.0	40	0.00	0.0	30	0.00	0.0	25	0.00	0.0	20	0.00	0.0	6.0
OS-4	4.46	100	0.00	0.0	2	0.00	0.0	90	0.00	0.0	65.0	2.28	33.2	40	1.46	13.1	30	0.00	0.0	25	0.00	0.0	20	0.72	3.2	49.5
OS-5	0.46	100	0.00	0.0	2	0.00	0.0	90	0.00	0.0	65.0	0.46	65.0	40	0.00	0.0	30	0.00	0.0	25	0.00	0.0	20	0.00	0.0	65.0
OS-6	1.17	100	0.00	0.0	2	0.00	0.0	90	0.00	0.0	65.0	1.17	65.0	40	0.00	0.0	30	0.00	0.0	25	0.00	0.0	20	0.00	0.0	65.0
C-8	0.42	100	0.00	0.0	2	0.42	2.0	90	0.00	0.0	65.0	0.00	0.0	40	0.00	0.0	30	0.00	0.0	25	0.00	0.0	20	0.00	0.0	2.0
E-1	1.71	100	0.78	45.6	2	0.23	0.3	90	0.00	0.0	65.0	0.00	0.0	40	0.70	16.4	30	0.00	0.0	25	0.00	0.0	20	0.00	0.0	62.3
E-2	0.68	100	0.56	82.4	2	0.12	0.4	90	0.00	0.0	65.0	0.00	0.0	40	0.00	0.0	30	0.00	0.0	25	0.00	0.0	20	0.00	0.0	82.8
E-3	0.78	100	0.69	88.5	2	0.09	0.2	90	0.00	0.0	65.0	0.00	0.0	40	0.00	0.0	30	0.00	0.0	25	0.00	0.0	20	0.00	0.0	88.7
E-4	0.91	100	0.73	80.2	2	0.18	0.4	90	0.00	0.0	65.0	0.00	0.0	40	0.00	0.0	30	0.00	0.0	25	0.00	0.0	20	0.00	0.0	80.6
E-5	0.89	100	0.79	88.8	2	0.10	0.2	90	0.00	0.0	65.0	0.00	0.0	40	0.00	0.0	30	0.00	0.0	25	0.00	0.0	20	0.00	0.0	89.0
I-1	0.31	100	0.22	71.0	2	0.09	0.6	90	0.00	0.0	65.0	0.00	0.0	40	0.00	0.0	30	0.00	0.0	25	0.00	0.0	20	0.00	0.0	71.6

Lot Type Identification:	
Lot Size (SF)	Lot Size (Acre)
0 - 8,167	1/8 Acre
8,168 - 12,704	1/4 Acre
12,705 - 18,149	1/3 Acre
18,150 - 32,670	1/2 Acre
32,671 - 43,560	1 Acre

**NOTES:**  
 % Impervious values are taken directly from Table 6-6 in the Colorado Springs DCM Vol. 1, CH. 6 (Referencing UDFCD 2001)

## STANDARD FORM SF-2

### TIME OF CONCENTRATION: EXISTING/CURRENT

**Subdivision:** Falcon Meadows at Bent Grass  
**Location:** CO, Colorado Springs

**Project Name:** Falcon Meadows at Bent Grass  
**Project No.:** CLH000017  
**Calculated By:** TJE  
**Checked By:** CMD  
**Date:** 6/19/20

SUB-BASIN DATA						INITIAL/OVERLAND (T <sub>i</sub> )			TRAVEL TIME (T <sub>t</sub> )					T <sub>c</sub> CHECK (URBANIZED BASINS)			FINAL T <sub>c</sub> (MIN)
BASIN ID	D.A. (AC)	Hydrologic Soils Group	Impervious (%)	C <sub>5</sub>	C <sub>100</sub>	L (FT)	S (%)	T <sub>i</sub> (MIN)	L (FT)	S (%)	C <sub>v</sub>	VEL. (FPS)	T <sub>t</sub> (MIN)	COMP. T <sub>c</sub> (MIN)	TOTAL LENGTH(FT)	Urbanized T <sub>c</sub> (MIN)	T <sub>c</sub> (MIN)
EX-1	1.19	A	2.0	0.09	0.36	300	2.7	23.0	690	2.7	15	2.5	4.7	27.7	990.0	15.5	15.5
EX-2	1.56	A	2.0	0.09	0.36	200	2.7	18.8	100	2.7	15	2.5	0.7	19.5	300.0	11.7	11.7
EX-3	0.62	A	2.0	0.09	0.36	100	5.0	10.8	30	2.7	15	2.5	0.2	11.0	130.0	10.7	10.7
EX-4	12.49	A	2.0	0.09	0.36	100	2.7	13.3	1180	2.7	15	2.5	8.0	21.3	1280.0	17.1	17.1
EX-5	5.15	A	2.0	0.09	0.36	100	2.7	13.3	1000	2.7	15	2.5	6.8	20.0	1100.0	16.1	16.1
EX-6	9.53	A	2.0	0.09	0.36	100	2.7	13.3	1700	2.7	15	2.5	11.5	24.8	1800.0	20.0	20.0
EX-7	9.16	A	2.0	0.09	0.36	90	2.7	12.6	1020	2.7	15	2.5	6.9	19.5	1110.0	16.2	16.2
EX-8	21.30	A	2.0	0.09	0.36	100	2.7	13.3	996	2.7	15	2.5	6.7	20.0	1095.5	16.1	16.1
OS-1	32.28	A	11.0	0.16	0.41	100	2.4	12.9	2100	2.2	15	2.2	15.7	28.6	2200.0	22.2	22.2
OS-2	20.08	A	8.0	0.14	0.40	100	2.3	13.3	1400	2.3	15	2.3	10.3	23.6	1500.0	18.3	18.3
OS-3	10.62	A	8.0	0.14	0.40	100	2.0	14.0	1500	2.0	15	2.1	11.8	25.7	1600.0	18.9	18.9
OS-4	4.46	A	49.5	0.36	0.54	100	2.0	10.8	910	1.2	20	2.2	6.9	17.7	1010.0	15.6	15.6
OS-5	0.46	A	65.0	0.45	0.59	15	2.0	3.7	190	1.0	20	2.0	1.6	5.2	205.0	11.1	5.2
OS-6	1.17	A	65.0	0.45	0.59	85	0.2	18.7	430	0.9	20	1.9	3.9	22.6	515.0	12.9	12.9
C-8	0.42	A	2.0	0.09	0.36	100	2.5	13.6	170	2.5	15	2.4	1.2	14.8	270.0	11.5	11.5
E-1	1.71	A	62.3	0.55	0.69	25	2.0	4.0	940	1.0	20	2.0	7.8	11.8	965.0	15.4	11.8
E-2	0.68	A	82.8	0.76	0.85	25	2.0	2.5	665	1.6	20	2.5	4.4	6.9	690.0	13.8	6.9
E-3	0.78	A	88.7	0.81	0.89	25	2.0	2.1	632	1.0	20	2.0	5.3	7.4	657.0	13.7	7.4
E-4	0.91	A	80.6	0.74	0.84	25	2.0	2.6	913	2.0	20	2.8	5.4	8.0	938.0	15.2	8.0
E-5	0.89	A	89.0	0.81	0.89	25	2.0	2.1	903	2.1	20	2.9	5.2	7.3	928.0	15.2	7.3
I-1	0.31	A	71.6	0.66	0.79	25	2.0	3.2	135	2.0	20	2.8	0.8	4.0	160.0	10.9	5.0

**NOTES:**

$T_i = (0.395 * (1.1 - C_5) * (L)^{0.5}) / ((S)^{0.33})$ , S in ft/ft

$T_t = L / 60V$  (Velocity From Fig. 501)

Velocity  $V = C_v * S^{0.5}$ , S in ft/ft

$T_c \text{ Check} = 10 + L / 180$

For Urbanized basins a minimum T<sub>c</sub> of 5.0 minutes is required.

For non-urbanized basins a minimum T<sub>c</sub> of 10.0 minutes is required

**STANDARD FORM SF-3**  
**STORM DRAINAGE SYSTEM DESIGN: EXISTING/CURRENT**  
(RATIONAL METHOD PROCEDURE)

**Subdivision:** Falcon Meadows at Bent Grass  
**Location:** CO, Colorado Springs  
**Design Storm:** 5-Year

**Project Name:** Falcon Meadows at Bent Grass  
**Project No.:** CLH000017  
**Calculated By:** TJE  
**Checked By:** CMD  
**Date:** 6/19/20

STREET	Design Point	DIRECT RUNOFF							TOTAL RUNOFF				STREET		PIPE			TRAVEL TIME			REMARKS
		Basin ID	Area (Ac)	Runoff Coeff.	Tc (min)	C <sup>*A</sup> (Ac)	I (in/hr)	Q (cfs)	Tc (min)	C <sup>*A</sup> (Ac)	I (in/hr)	Q (cfs)	Slope (%)	Street Flow (cfs)	Design Flow (cfs)	Slope (%)	Pipe Size (inches)	Length (ft)	Velocity (fps)	Tt (min)	
		RWT202	1574.40						46.6	120.88	1.82	220.0									From Falcon DBPS by Matrix
		RWT204	38.40						11.37	1.78	3.94	7.0									From Falcon DBPS by Matrix
		WT200	192.00						37.8	24.41	2.13	52.0									From Falcon DBPS by Matrix
		OS-1	32.28	0.16	22.2	5.16	2.93	15.1													Existing off-site flows into creek via existing swale.
	12								46.6	152.23	1.82	277.1						850	5.0	2.8	Combine Offsite basins entering site at north property line (RWT202, RWT204, WT200 & OS-1)
	1	OS-4	4.46	0.36	15.6	1.61	3.46	5.6					1.2	5.6				910	2.2	6.9	Flows from Basin B-1 of Bent Grass Filing No. 2 FDR.
	2	OS-5	0.46	0.45	5.2	0.21	5.10	1.1					1	1.1				190	2.0	1.6	Flows from Basin B-2 of Bent Grass Filing No. 2 FDR
	3	OS-6	1.17	0.45	12.9	0.53	3.75	2.0					0.86	2.0				430	1.9	3.9	Flows from Basin B-3 of Bent Grass Filing No. 2 FDR.
	4	EX-1	1.19	0.09	15.5	0.11	3.47	0.4													
	5	EX-2	1.56	0.09	11.7	0.14	3.90	0.5	15.6	2.60	3.46	9.0									Total flows to DP 5 discharging into existing WQCV Pond.
		EX-3	0.62	0.09	10.7	0.06	4.02	0.2													Existing WQCV Pond.
	6	EX-4	12.49	0.09	17.1	1.12	3.32	3.7													
	7	EX-5	5.15	0.09	16.1	0.46	3.41	1.6	17.1	1.58	3.32	5.2									Total flow from DP 6 & EX-5 flowing onto Bent Grass Meadows Drive.
	8	EX-7	9.16	0.09	16.2	0.82	3.41	2.8													Flows from DP 8 go off-site into Bent Grass Meadows Drive.
	9	OS-2	20.08	0.14	18.3	2.81	3.22	9.0													Flow obtained from Bent Grass Filing No. 2 FDR.
	10	OS-3	10.62	0.14	18.9	1.49	3.18	4.7													Flow obtained from Bent Grass Filing No. 2 FDR.
	11	EX-6	9.53	0.09	20.0	0.86	3.09	2.7	20.0	5.16	3.09	15.9									Total flows entering existing inlet at DP 11. (Basins OS-2, OS-3 & EX-6)
		EX-8	21.30	0.09	16.1	1.92	3.42	6.6													Existing flows from basin discharge into creek.
		E-1	1.71	0.55	11.8	0.94	3.88	3.6													Existing Basin from Filing No. 2(East side of BGMD)
		E-2	0.68	0.76	6.9	0.52	4.70	2.4													Existing Basin from Filing No. 2(West side of BGMD)
	4X								17.3	2.60	3.31	8.6									DP-4 from Bent Grass Filing No. 2 FDR (
	21								17.3	5.18	3.31	17.1									Combine Basins Ex-4, E-1 & E-2 and DP 4X at Existing Inlet from Bent Grass Filing No. 2 FDR
	15A								5.0	2.42	5.17	12.5									Release Rate from Ex WQCV Pond North in Bent Grass Filing No.2 FDR
		E-3	0.78	0.81	7.4	0.63	4.59	2.9													
	AA								49.4	155.28	1.73	268.6						900	5.0	3.0	Combine Basins E-3 w/Design Points 12 & 15A
		E-4	0.91	0.74	8.0	0.67	4.46	3.0													

**STANDARD FORM SF-3**  
**STORM DRAINAGE SYSTEM DESIGN: EXISTING/CURRENT**  
(RATIONAL METHOD PROCEDURE)

**Subdivision:** Falcon Meadows at Bent Grass  
**Location:** CO, Colorado Springs  
**Design Storm:** 5-Year

**Project Name:** Falcon Meadows at Bent Grass  
**Project No.:** CLH000017  
**Calculated By:** TJE  
**Checked By:** CMD  
**Date:** 6/19/20

STREET	Design Point	DIRECT RUNOFF							TOTAL RUNOFF				STREET		PIPE			TRAVEL TIME			REMARKS
		Basin ID	Area (Ac)	Runoff Coeff.	Tc (min)	C*A (Ac)	I (in/hr)	Q (cfs)	Tc (min)	C*A (Ac)	I (in/hr)	Q (cfs)	Slope (%)	Street Flow (cfs)	Design Flow (cfs)	Slope (%)	Pipe Size (inches)	Length (ft)	Velocity (fps)	Tt (min)	
		E-5	0.89	0.81	7.3	0.72	4.60	3.3													
		I-1	0.31	0.66	5.0	0.20	5.17	1.0													
	26								20.0	6.75	3.09	20.9									Combine Basins E-4, E-5 & I-1 w/DP 11 at Existing Inlet from Bent Grass Filing No. 2 FDR
	20B								5.0	4.10	5.17	21.2									Release Rate from Ex WQCV Pond South in Bent Grass Filing No. FDR
		C-8	0.42	0.09	11.5	0.04	3.92	0.2													
	CC								52.4	166.17	1.64	272.5									Flows exiting site - Combined flows from Basin C-8 w/Design Points AA, 26 & 20B

**STANDARD FORM SF-3**  
**STORM DRAINAGE SYSTEM DESIGN: EXISTING/CURRENT**  
(RATIONAL METHOD PROCEDURE)

**Subdivision:** Falcon Meadows at Bent Grass  
**Location:** CO, Colorado Springs  
**Design Storm:** 100-Year

**Project Name:** Falcon Meadows at Bent Grass  
**Project No.:** CLH000017  
**Calculated By:** TJE  
**Checked By:** CMD  
**Date:** 6/19/20

STREET	Design Point	DIRECT RUNOFF							TOTAL RUNOFF				STREET		PIPE			TRAVEL TIME			REMARKS
		Basin ID	Area (Ac)	Runoff Coeff.	Tc (min)	C*A (Ac)	I (in/hr)	Q (cfs)	Tc (min)	C*A (Ac)	I (in/hr)	Q (cfs)	Slope (%)	Street Flow (cfs)	Design Flow (cfs)	Slope (%)	Pipe Size (inches)	Length (ft)	Velocity (fps)	Tt (min)	
		RWT202	1574.40						46.6	327.87	3.05	1000.0									From Falcon DBPS by Matrix
		RWT204	38.40						11.4	6.51	6.61	43.0									From Falcon DBPS by Matrix
		WT200	192.00						37.8	53.07	3.58	190.0									From Falcon DBPS by Matrix
		OS-1	32.28	0.41	22.2	13.23	4.92	65.1													Existing off-site flows into creek via existing swale.
	12								46.6	400.68	3.05	1222.1						850	5.0	2.8	Combine Offsite basins entering site at north property line (RWT202, RWT204, WT200 & OS-1)
	1	OS-4	4.46	0.54	15.6	2.41	5.81	14.0					1.2	14.0				910	2.2	6.9	Flow obtained from Bent Grass Filing No. 2 FDR.
	2	OS-5	0.46	0.59	5.2	0.27	8.56	2.3					1	2.3				190	2.0	1.6	Flow obtained from Bent Grass Filing No. 2 FDR.
	3	OS-6	1.17	0.59	12.9	0.69	6.30	4.3					0.86	4.3				430	1.9	3.9	Flow obtained from Bent Grass Filing No. 2 FDR.
	4	EX-1	1.19	0.36	15.5	0.43	5.83	2.5													
	5	EX-2	1.56	0.36	11.7	0.56	6.54	3.7	15.6	4.36	5.81	25.3									Total flows to DP 5 discharging into existing WQCV Pond.
		EX-3	0.62	0.36	10.7	0.22	6.76	1.5													Existing WQCV Pond.
	6	EX-4	12.49	0.36	17.1	4.50	5.58	25.1													
	7	EX-5	5.15	0.36	16.1	1.85	5.73	10.6	17.1	6.35	5.58	35.4									Total flow from DP 6 & EX-5 flowing onto Bent Grass Meadows Drive.
	8	EX-7	9.16	0.36	16.2	3.30	5.72	18.9													Flows from DP 8 go off-site into Bent Grass Meadows Drive.
	9	OS-2	20.08	0.40	18.3	8.03	5.41	43.4													Flow obtained from Bent Grass Filing No. 2 FDR.
	10	OS-3	10.62	0.40	18.9	4.25	5.33	22.7													Flow obtained from Bent Grass Filing No. 2 FDR.
	11	EX-6	9.53	0.36	20.0	3.43	5.19	17.8	20.0	15.71	5.19	81.5									Total flows entering existing inlet at DP 11. (Basins OS-2, OS-3 & EX-6)
		EX-8	21.30	0.36	16.1	7.67	5.73	43.9													Existing flows from basin discharge into creek.
		E-1	1.71	0.69	11.8	1.18	6.51	7.7													
		E-2	0.68	0.85	6.9	0.58	7.89	4.6													
	4X								17.3	4.03	5.55	22.4									DP-4 from Bent Grass Filing No. 2 FDR (
	21								17.3	10.29	5.55	57.1									Combine Basins Ex-4, E-1 & E-2 at Existing Inlet from Bent Grass Filing No. 2 FDR
	15A								45.0	11.78	3.14	37.0									Release Rate from WQCV Pond North in Bent Grass Filing No. FDR
		E-3	0.78	0.89	7.4	0.69	7.70	5.3													
	AA								49.4	413.15	2.91	1202.3						900	5.0	3.0	Combine Basin E-3 w/Design Points 12, & 15A
		E-4	0.91	0.84	8.0	0.76	7.50	5.7													

**STANDARD FORM SF-3**  
**STORM DRAINAGE SYSTEM DESIGN: EXISTING/CURRENT**  
(RATIONAL METHOD PROCEDURE)

**Subdivision:** Falcon Meadows at Bent Grass  
**Location:** CO, Colorado Springs  
**Design Storm:** 100-Year

**Project Name:** Falcon Meadows at Bent Grass  
**Project No.:** CLH000017  
**Calculated By:** TJE  
**Checked By:** CMD  
**Date:** 6/19/20

STREET	Design Point	DIRECT RUNOFF							TOTAL RUNOFF				STREET		PIPE			TRAVEL TIME			REMARKS
		Basin ID	Area (Ac)	Runoff Coeff.	Tc (min)	C*A (Ac)	I (in/hr)	Q (cfs)	Tc (min)	C*A (Ac)	I (in/hr)	Q (cfs)	Slope (%)	Street Flow (cfs)	Design Flow (cfs)	Slope (%)	Pipe Size (inches)	Length (ft)	Velocity (fps)	Tt (min)	
		E-5	0.89	0.89	7.3	0.79	7.73	6.1													
		I-1	0.31	0.79	5.0	0.24	8.68	2.1													
	26								20.0	17.50	3.09	54.1									Combine Basins E-4, E-5 & I-1 w/DP 11 at Existing Inlet from Bent Grass Filing No. 2 FDR
	20B								5.0	7.48	8.68	64.9									Release Rate from WQCV Pond South in Bent Grass Filing No. FDR
		C-8	0.42	0.36	11.5	0.15	6.58	1.0													
	CC								52.4	438.28	2.76	1209.6									Flows exiting site - Combined flows from Basin C-8 w/Design Points AA, 26 & 20B



## Proposed Computations

## COMPOSITE % IMPERVIOUS CALCULATIONS: PROPOSED

Subdivision: Falcon Meadows at Bent Grass  
 Location: CO, Colorado Springs

Project Name: Falcon Meadows at Bent Grass  
 Project No.: CLH000017  
 Calculated By: TJE  
 Checked By: CMD  
 Date: 6/19/20

Basin ID	Total Area (ac)	Paved/Gravel Roads			Lawns/Undeveloped			Roofs			Residential - 1/8 Acre			Residential - 1/4 Acre			Residential - 1/3 Acre			Residential - 1/2 Acre			Residential - 1 Acre			Basins Total Weighted % Imp.
		% Imp.	Area (ac)	Weighted % Imp.	% Imp.	Area (ac)	Weighted % Imp.	% Imp.	Area (ac)	Weighted % Imp.	% Imp.	Area (ac)	Weighted % Imp.	% Imp.	Area (ac)	Weighted % Imp.	% Imp.	Area (ac)	Weighted % Imp.	% Imp.	Area (ac)	Weighted % Imp.	% Imp.	Area (ac)	Weighted % Imp.	
A-1	2.16	100	0.50	23.1	2	0.00	0.0	90	0.00	0.0	65.0	0.93	28.0	40	0.00	0.0	30	0.73	10.1	25	0.00	0.0	20	0.75	6.9	68.1
A-2	0.86	100	0.00	0.0	2	0.00	0.0	90	0.00	0.0	65.0	0.86	65.0	40	0.00	0.0	30	0.00	0.0	25	0.00	0.0	20	0.00	0.0	65.0
A-3	0.92	100	0.64	69.6	2	0.28	0.6	90	0.00	0.0	65.0	0.00	0.0	40	0.00	0.0	30	0.00	0.0	25	0.00	0.0	20	0.00	0.0	70.2
A-4	0.82	100	0.00	0.0	2	0.82	2.0	90	0.00	0.0	65.0	0.00	0.0	40	0.00	0.0	30	0.00	0.0	25	0.00	0.0	20	0.00	0.0	2.0
B-1	4.32	100	0.00	0.0	2	4.32	2.0	90	0.00	0.0	65.0	0.00	0.0	40	0.00	0.0	30	0.00	0.0	25	0.00	0.0	20	0.00	0.0	2.0
B-2	4.16	100	0.00	0.0	2	4.41	2.1	90	0.00	0.0	65.0	0.00	0.0	40	0.00	0.0	30	0.00	0.0	25	0.00	0.0	20	0.00	0.0	2.1
C-1	9.07	100	2.14	23.6	2	0.33	0.1	90	0.00	0.0	65.0	4.56	32.7	40	1.70	7.5	30	0.34	1.1	25	0.00	0.0	20	0.00	0.0	65.0
C-2	1.11	100	0.37	33.3	2	0.19	0.3	90	0.00	0.0	65.0	0.30	17.6	40	0.00	0.0	30	0.25	6.8	25	0.00	0.0	20	0.00	0.0	58.0
C-3	1.52	100	0.94	61.8	2	0.00	0.0	90	0.00	0.0	65.0	0.58	24.8	40	0.00	0.0	30	0.00	0.0	25	0.00	0.0	20	0.00	0.0	86.6
C-4	3.99	100	0.36	9.0	2	1.75	0.9	90	0.00	0.0	65.0	1.88	30.6	40	0.00	0.0	30	0.00	0.0	25	0.00	0.0	20	0.00	0.0	40.5
C-5	0.51	100	0.00	0.0	2	0.51	2.0	90	0.00	0.0	65.0	0.00	0.0	40	0.00	0.0	30	0.00	0.0	25	0.00	0.0	20	0.00	0.0	2.0
C-6	1.37	100	0.00	0.0	2	0.30	0.4	90	0.00	0.0	65.0	1.07	50.8	40	0.00	0.0	30	0.00	0.0	25	0.00	0.0	20	0.00	0.0	51.2
D-1	8.13	100	1.52	18.7	2	0.69	0.2	90	0.00	0.0	65.0	1.85	14.8	40	1.42	7.0	30	1.53	5.6	25	1.12	3.4	20	0.00	0.0	49.7
D-2	6.62	100	2.31	34.9	2	0.44	0.1	90	0.00	0.0	65.0	3.87	38.0	40	0.00	0.0	30	0.00	0.0	25	0.00	0.0	20	0.00	0.0	73.0
D-3	2.93	100	0.00	0.0	2	0.28	0.2	90	0.00	0.0	65.0	1.26	28.0	40	0.17	2.3	30	0.12	1.2	25	0.00	0.0	20	0.00	0.0	31.7
D-4	4.38	100	1.21	27.6	2	0.63	0.3	90	0.00	0.0	65.0	2.53	37.5	40	0.00	0.0	30	0.00	0.0	25	0.00	0.0	20	0.00	0.0	65.4
D-5	1.08	100	0.22	20.4	2	0.11	0.2	90	0.00	0.0	65.0	0.75	45.1	40	0.00	0.0	30	0.00	0.0	25	0.00	0.0	20	0.00	0.0	65.7
D-6	4.01	100	0.91	22.7	2	0.09	0.0	90	0.00	0.0	65.0	3.01	48.8	40	0.00	0.0	30	0.00	0.0	25	0.00	0.0	20	0.00	0.0	71.5
D-7	6.39	100	0.00	0.0	2	5.59	1.7	90	0.00	0.0	65.0	0.80	8.1	40	0.00	0.0	30	0.00	0.0	25	0.00	0.0	20	0.00	0.0	9.8
D-8	1.69	100	0.00	0.0	2	1.13	1.3	90	0.00	0.0	65.0	0.56	21.5	40	0.00	0.0	30	0.00	0.0	25	0.00	0.0	20	0.00	0.0	22.8
D-9	0.80	100	0.00	0.0	2	0.42	1.1	90	0.00	0.0	65.0	0.38	30.9	40	0.00	0.0	30	0.00	0.0	25	0.00	0.0	20	0.00	0.0	32.0
E-1	1.71	100	0.78	45.6	2	0.23	0.3	90	0.00	0.0	65.0	0.00	0.0	40	0.70	16.4	30	0.00	0.0	25	0.00	0.0	20	0.00	0.0	62.3
E-2	0.68	100	0.56	82.4	2	0.12	0.4	90	0.00	0.0	65.0	0.00	0.0	40	0.00	0.0	30	0.00	0.0	25	0.00	0.0	20	0.00	0.0	82.8
E-3	0.78	100	0.69	88.5	2	0.09	0.2	90	0.00	0.0	65.0	0.00	0.0	40	0.00	0.0	30	0.00	0.0	25	0.00	0.0	20	0.00	0.0	88.7
E-4	0.91	100	0.73	80.2	2	0.18	0.4	90	0.00	0.0	65.0	0.00	0.0	40	0.00	0.0	30	0.00	0.0	25	0.00	0.0	20	0.00	0.0	80.6
E-5	0.89	100	0.79	88.8	2	0.10	0.2	90	0.00	0.0	65.0	0.00	0.0	40	0.00	0.0	30	0.00	0.0	25	0.00	0.0	20	0.00	0.0	89.0
I-1	0.31	100	0.22	71.0	2	0.09	0.6	90	0.00	0.0	65.0	0.00	0.0	40	0.00	0.0	30	0.00	0.0	25	0.00	0.0	20	0.00	0.0	71.6
OS-1	32.28	100	2.15	6.7	2	29.25	1.8	90	0.88	2.5	65.0	0.00	0.0	40	0.00	0.0	30	0.00	0.0	25	0.00	0.0	20	0.00	0.0	11.0
OS-2	20.07	80	0.90	3.6	2	18.62	1.9	90	0.56	2.5	65.0	0.00	0.0	40	0.00	0.0	30	0.00	0.0	25	0.00	0.0	20	0.00	0.0	8.0
OS-3	10.61	80	0.48	3.6	2	9.84	1.9	90	0.30	2.5	65.0	0.00	0.0	40	0.00	0.0	30	0.00	0.0	25	0.00	0.0	20	0.00	0.0	8.0
OS-4	4.46	100	0.00	0.0	2	0.00	0.0	90	0.00	0.0	65.0	2.28	33.2	40	1.46	13.1	30	0.00	0.0	25	0.00	0.0	20	0.72	3.2	49.5
OS-5	0.46	100	0.00	0.0	2	0.00	0.0	90	0.00	0.0	65.0	0.46	65.0	40	0.00	0.0	30	0.00	0.0	25	0.00	0.0	20	0.00	0.0	65.0
OS-6	1.17	100	0.00	0.0	2	0.00	0.0	90	0.00	0.0	65.0	1.17	65.0	40	0.00	0.0	30	0.00	0.0	25	0.00	0.0	20	0.00	0.0	65.0

Lot Type Identification:	
Lot Size (SF)	Lot Size (Acre)
0 - 8,167	1/8 Acre
8,168 - 12,704	1/4 Acre
12,705 - 18,149	1/3 Acre
18,150 - 32,670	1/2 Acre
32,671 - 43,560	1 Acre

**NOTES:**  
 % Impervious values are taken directly from Table 6-6 in the Colorado Springs DCM Vol. 1. CH. 6 (Referencing UDFCD 2001)

## COMPOSITE RUNOFF COEFFICIENT CALCULATIONS: PROPOSED

Subdivision: Falcon Meadows at Bent Grass  
 Location: CO, Colorado Springs

Project Name: Falcon Meadows at Bent Grass  
 Project No.: CLH000017  
 Calculated By: TJE  
 Checked By: CMD  
 Date: 6/19/20

Basin ID	Total Area (ac)	Paved/Gravel Roads			Lawns/Undeveloped			Roofs			Residential - 1/8 Acre			Residential - 1/4 Acre			Residential - 1/3 Acre			Residential - 1/2 Acre			Residential - 1 Acre			Composite C <sub>s</sub>	Composite C <sub>100</sub>
		C <sub>s</sub>	C <sub>100</sub>	Area (ac)	C <sub>s</sub>	C <sub>100</sub>	Area (ac)	C <sub>s</sub>	C <sub>100</sub>	Area (ac)	C <sub>s</sub>	C <sub>100</sub>	Area (ac)	C <sub>s</sub>	C <sub>100</sub>	Area (ac)	C <sub>s</sub>	C <sub>100</sub>	Area (ac)	C <sub>s</sub>	C <sub>100</sub>	Area (ac)	C <sub>s</sub>	C <sub>100</sub>	Area (ac)		
A-1	2.16	0.90	0.96	0.50	0.09	0.36	0.00	0.73	0.81	0.00	0.45	0.59	0.93	0.30	0.50	0.00	0.25	0.47	0.73	0.22	0.46	0.00	0.20	0.44	0.75	0.56	0.79
A-2	0.86	0.90	0.96	0.00	0.09	0.36	0.00	0.73	0.81	0.00	0.45	0.59	0.86	0.30	0.50	0.00	0.25	0.47	0.00	0.22	0.46	0.00	0.20	0.44	0.00	0.45	0.59
A-3	0.92	0.90	0.96	0.64	0.09	0.36	0.28	0.73	0.81	0.00	0.45	0.59	0.00	0.30	0.50	0.00	0.25	0.47	0.00	0.22	0.46	0.00	0.20	0.44	0.00	0.65	0.78
A-4	0.82	0.90	0.96	0.00	0.09	0.36	0.82	0.73	0.81	0.00	0.45	0.59	0.00	0.30	0.50	0.00	0.25	0.47	0.00	0.22	0.46	0.00	0.20	0.44	0.00	0.09	0.36
B-1	4.32	0.90	0.96	0.00	0.09	0.36	4.32	0.73	0.81	0.00	0.45	0.59	0.00	0.30	0.50	0.00	0.25	0.47	0.00	0.22	0.46	0.00	0.20	0.44	0.00	0.09	0.36
B-2	4.16	0.90	0.96	0.00	0.09	0.36	4.41	0.73	0.81	0.00	0.45	0.59	0.00	0.30	0.50	0.00	0.25	0.47	0.00	0.22	0.46	0.00	0.20	0.44	0.00	0.10	0.38
C-1	9.07	0.90	0.96	2.14	0.09	0.36	0.33	0.73	0.81	0.00	0.45	0.59	4.56	0.30	0.50	1.70	0.25	0.47	0.34	0.22	0.46	0.00	0.20	0.44	0.00	0.51	0.65
C-2	1.11	0.90	0.96	0.37	0.09	0.36	0.19	0.73	0.81	0.00	0.45	0.59	0.30	0.30	0.50	0.00	0.25	0.47	0.25	0.22	0.46	0.00	0.20	0.44	0.00	0.49	0.65
C-3	1.52	0.90	0.96	0.94	0.09	0.36	0.00	0.73	0.81	0.00	0.45	0.59	0.58	0.30	0.50	0.00	0.25	0.47	0.00	0.22	0.46	0.00	0.20	0.44	0.00	0.73	0.82
C-4	3.99	0.90	0.96	0.36	0.09	0.36	1.75	0.73	0.81	0.00	0.45	0.59	1.88	0.30	0.50	0.00	0.25	0.47	0.00	0.22	0.46	0.00	0.20	0.44	0.00	0.33	0.52
C-5	0.51	0.90	0.96	0.00	0.09	0.36	0.51	0.73	0.81	0.00	0.45	0.59	0.00	0.30	0.50	0.00	0.25	0.47	0.00	0.22	0.46	0.00	0.20	0.44	0.00	0.09	0.36
C-6	1.37	0.90	0.96	0.00	0.09	0.36	0.30	0.73	0.81	0.00	0.45	0.59	1.07	0.30	0.50	0.00	0.25	0.47	0.00	0.22	0.46	0.00	0.20	0.44	0.00	0.37	0.54
D-1	8.13	0.90	0.96	1.52	0.09	0.36	0.69	0.73	0.81	0.00	0.45	0.59	1.85	0.30	0.50	1.42	0.25	0.47	1.53	0.22	0.46	1.12	0.20	0.44	0.00	0.41	0.58
D-2	6.62	0.90	0.96	2.31	0.09	0.36	0.44	0.73	0.81	0.00	0.45	0.59	3.87	0.30	0.50	0.00	0.25	0.47	0.00	0.22	0.46	0.00	0.20	0.44	0.00	0.58	0.70
D-3	2.93	0.90	0.96	0.00	0.09	0.36	0.28	0.73	0.81	0.00	0.45	0.59	1.26	0.30	0.50	0.17	0.25	0.47	0.12	0.22	0.46	0.00	0.20	0.44	0.00	0.23	0.34
D-4	4.38	0.90	0.96	1.21	0.09	0.36	0.63	0.73	0.81	0.00	0.45	0.59	2.53	0.30	0.50	0.00	0.25	0.47	0.00	0.22	0.46	0.00	0.20	0.44	0.00	0.52	0.66
D-5	1.08	0.90	0.96	0.22	0.09	0.36	0.11	0.73	0.81	0.00	0.45	0.59	0.75	0.30	0.50	0.00	0.25	0.47	0.00	0.22	0.46	0.00	0.20	0.44	0.00	0.51	0.64
D-6	4.01	0.90	0.96	0.91	0.09	0.36	0.09	0.73	0.81	0.00	0.45	0.59	3.01	0.30	0.50	0.00	0.25	0.47	0.00	0.22	0.46	0.00	0.20	0.44	0.00	0.54	0.67
D-7	6.39	0.90	0.96	0.00	0.09	0.36	5.59	0.73	0.81	0.00	0.45	0.59	0.80	0.30	0.50	0.00	0.25	0.47	0.00	0.22	0.46	0.00	0.20	0.44	0.00	0.14	0.39
D-8	1.69	0.90	0.96	0.00	0.09	0.36	1.13	0.73	0.81	0.00	0.45	0.59	0.56	0.30	0.50	0.00	0.25	0.47	0.00	0.22	0.46	0.00	0.20	0.44	0.00	0.21	0.44
D-9	0.80	0.90	0.96	0.00	0.09	0.36	0.42	0.73	0.81	0.00	0.45	0.59	0.38	0.30	0.50	0.00	0.25	0.47	0.00	0.22	0.46	0.00	0.20	0.44	0.00	0.26	0.47
E-1	1.71	0.90	0.96	0.78	0.09	0.36	0.23	0.73	0.81	0.00	0.45	0.59	0.00	0.30	0.50	0.70	0.25	0.47	0.00	0.22	0.46	0.00	0.20	0.44	0.00	0.55	0.69
E-2	0.68	0.90	0.96	0.56	0.09	0.36	0.12	0.73	0.81	0.00	0.45	0.59	0.00	0.30	0.50	0.00	0.25	0.47	0.00	0.22	0.46	0.00	0.20	0.44	0.00	0.76	0.85
E-3	0.78	0.90	0.96	0.69	0.09	0.36	0.09	0.73	0.81	0.00	0.45	0.59	0.00	0.30	0.50	0.00	0.25	0.47	0.00	0.22	0.46	0.00	0.20	0.44	0.00	0.81	0.89
E-4	0.91	0.90	0.96	0.73	0.09	0.36	0.18	0.73	0.81	0.00	0.45	0.59	0.00	0.30	0.50	0.00	0.25	0.47	0.00	0.22	0.46	0.00	0.20	0.44	0.00	0.74	0.84
E-5	0.89	0.90	0.96	0.79	0.09	0.36	0.10	0.73	0.81	0.00	0.45	0.59	0.00	0.30	0.50	0.00	0.25	0.47	0.00	0.22	0.46	0.00	0.20	0.44	0.00	0.81	0.89
I-1	0.31	0.90	0.96	0.22	0.09	0.36	0.09	0.73	0.81	0.00	0.45	0.59	0.00	0.30	0.50	0.00	0.25	0.47	0.00	0.22	0.46	0.00	0.20	0.44	0.00	0.66	0.79
OS-1	32.28	0.90	0.96	2.15	0.09	0.36	29.25	0.73	0.81	0.88	0.45	0.59	0.00	0.30	0.50	0.00	0.25	0.47	0.00	0.22	0.46	0.00	0.20	0.44	0.00	0.16	0.41
OS-2	20.07	0.90	0.96	0.90	0.09	0.36	18.62	0.73	0.81	0.56	0.45	0.59	0.00	0.30	0.50	0.00	0.25	0.47	0.00	0.22	0.46	0.00	0.20	0.44	0.00	0.14	0.40
OS-3	10.61	0.90	0.96	0.48	0.09	0.36	9.84	0.73	0.81	0.30	0.45	0.59	0.00	0.30	0.50	0.00	0.25	0.47	0.00	0.22	0.46	0.00	0.20	0.44	0.00	0.14	0.40
OS-4	4.46	0.90	0.96	0.00	0.09	0.36	0.00	0.73	0.81	0.00	0.45	0.59	2.28	0.30	0.50	1.46	0.25	0.47	0.00	0.22	0.46	0.00	0.20	0.44	0.72	0.36	0.54
OS-5	0.46	0.90	0.96	0.00	0.09	0.36	0.00	0.73	0.81	0.00	0.45	0.59	0.46	0.30	0.50	0.00	0.25	0.47	0.00	0.22	0.46	0.00	0.20	0.44	0.00	0.45	0.59
OS-6	1.17	0.90	0.96	0.00	0.09	0.36	0.00	0.73	0.81	0.00	0.45	0.59	1.17	0.30	0.50	0.00	0.25	0.47	0.00	0.22	0.46	0.00	0.20	0.44	0.00	0.45	0.59

Lot Type Identification:	
Lot Size (SF)	Lot Size (Acre)
0 - 8,167	<= 1/8 Acre
8,168 - 12,704	1/4 Acre
12,705 - 18,149	1/3 Acre
18,150 - 32,670	1/2 Acre
32,671 - 43,560	1 Acre

**NOTES:**  
 C values are taken directly from Table 6-6 in the Colorado Springs DCM Vol. 1, CH. 6 (Referencing UDFCD 2001)  
 Coefficients use HSG A&B soils - Refer to "Appendix A: Exhibits and Figures" for soil map

## STANDARD FORM SF-2: PROPOSED TIME OF CONCENTRATION

**Subdivision:** Falcon Meadows at Bent Grass  
**Location:** CO, Colorado Springs

**Project Name:** Falcon Meadows at Bent Grass  
**Project No.:** CLH000017  
**Calculated By:** TJE  
**Checked By:** CMD  
**Date:** 6/19/20

SUB-BASIN						INITIAL/OVERLAND			TRAVEL TIME					T <sub>c</sub> CHECK			FINAL T <sub>c</sub> (MIN)
DATA						(T <sub>i</sub> )			(T <sub>t</sub> )					(URBANIZED BASINS)			
BASIN ID	D.A. (AC)	Hydrologic Soils Group	Impervious (%)	C <sub>s</sub>	C <sub>100</sub>	L (FT)	S (%)	T <sub>i</sub> (MIN)	L (FT)	S (%)	C <sub>v</sub>	VEL. (FPS)	T <sub>t</sub> (MIN)	COMP. T <sub>c</sub> (MIN)	TOTAL LENGTH(FT)	Urbanized T <sub>c</sub> (MIN)	
A-1	2.16	A	68.1	0.56	0.79	100	4.0	6.2	765	2.5	20	3.2	4.0	10.3	865.0	14.8	10.3
A-2	0.86	A	65.0	0.45	0.59	5	2.0	2.1	110	7.0	20	5.3	0.3	2.5	115.0	10.6	5.0
A-3	0.92	A	70.2	0.65	0.78	60	2.0	5.1	735	2.5	20	3.2	3.9	8.9	795.0	14.4	8.9
A-4	0.82	A	2.0	0.09	0.36	5	2.0	3.3	105	5.7	20	4.8	0.4	3.6	110.0	10.6	5.0
B-1	4.32	A	2.0	0.09	0.36	90	6.4	9.5	2000	1.7	15	2.0	17.0	26.5	2090.0	21.6	21.6
B-2	1.17	A	2.1	0.10	0.38	160	11.0	10.4	920	1.6	15	1.9	8.1	18.5	1080.0	16.0	16.0
C-1	9.07	A	65.0	0.51	0.65	75	2.0	7.4	1160	2.3	20	3.0	6.4	13.9	1235.0	16.9	13.9
C-2	1.11	A	58.0	0.49	0.65	10	2.0	2.8	380	4.0	20	4.0	1.6	4.4	390.0	12.2	5.0
C-3	1.52	A	86.6	0.73	0.82	10	2.0	1.7	945	2.5	20	3.2	5.0	6.7	955.0	15.3	6.7
C-4	3.99	A	40.5	0.33	0.52	5	2.0	2.5	575	2.5	20	3.2	3.0	5.5	580.0	13.2	5.5
C-5	0.51	A	2.0	0.09	0.36	5	2.0	3.3		1.0	15	1.5	0.0	3.3	5.0	10.0	5.0
C-6	1.37	A	51.2	0.37	0.54	100	6.8	7.1	500	3.0	15	2.6	3.2	10.3	600.0	13.3	10.3
D-1	8.13	A	49.7	0.41	0.58	100	2.6	9.2	1900	1.3	20	2.3	13.9	23.1	2000.0	21.1	21.1
D-2	6.62	A	73.0	0.58	0.70	10	2.0	2.4	1355	1.3	20	2.3	9.9	12.3	1365.0	17.6	12.3
D-3	2.93	A	31.7	0.23	0.34	25	8.0	4.0	1960	1.0	15	1.5	21.8	25.8	1985.0	21.0	21.0
D-4	4.38	A	65.4	0.52	0.66	100	2.3	8.0	980	1.0	20	2.0	8.2	16.2	1080.0	16.0	16.0
D-5	1.08	A	65.7	0.51	0.64	100	2.0	8.6	300	1.1	20	2.1	2.4	11.0	400.0	12.2	11.0
D-6	4.01	A	71.5	0.54	0.67	45	2.0	5.5	835	1.0	20	2.0	7.0	12.4	880.0	14.9	12.4
D-7	6.39	A	9.8	0.14	0.39	200	7.5	12.7	665	1.0	15	1.5	7.4	20.1	865.0	14.8	14.8
D-8	1.69	A	22.8	0.21	0.44	125	3.7	11.8	600	1.0	15	1.5	6.7	18.4	725.0	14.0	14.0
D-9	0.80	A	32.0	0.26	0.47	125	6.7	9.1	415	1.0	15	1.5	4.6	13.7	540.0	13.0	13.0
E-1	1.71	A	62.3	0.55	0.69	25	2.0	4.0	940	1.0	20	2.0	7.8	11.8	965.0	15.4	11.8
E-2	0.68	A	82.8	0.76	0.85	25	2.0	2.5	665	1.6	20	2.5	4.4	6.9	690.0	13.8	6.9
E-3	0.78	A	88.7	0.81	0.89	25	2.0	2.1	632	1.0	20	2.0	5.3	7.4	657.0	13.7	7.4
E-4	0.91	A	80.6	0.74	0.84	25	2.0	2.6	913	2.0	20	2.8	5.4	8.0	938.0	15.2	8.0
E-5	0.89	A	89.0	0.81	0.89	25	2.0	2.1	903	2.1	20	2.9	5.2	7.3	928.0	15.2	7.3
I-1	0.31	A	71.6	0.66	0.79	25	2.0	3.2	135	2.0	20	2.8	0.8	4.0	160.0	10.9	5.0
OS-1	32.28	A	11.0	0.16	0.41	100	2.4	12.9	2100	2.2	15	2.2	15.7	28.6	2200.0	22.2	22.2
OS-2	20.07	A	8.0	0.14	0.40	100	2.3	13.3	1400	2.3	15	2.3	10.3	23.6	1500.0	18.3	18.3
OS-3	10.61	A	8.0	0.14	0.40	100	2.0	14.0	1500	2.0	15	2.1	11.8	25.7	1600.0	18.9	18.9
OS-4	4.46	A	49.5	0.36	0.54	100	2.0	10.8	910	1.2	20	2.2	6.9	17.7	1010.0	15.6	15.6
OS-5	0.46	A	65.0	0.45	0.59	15	2.0	3.7	190	1.0	20	2.0	1.6	5.2	205.0	11.1	5.2
OS-6	1.17	A	65.0	0.45	0.59	85	0.2	18.7	430	0.9	20	1.9	3.8	22.5	515.0	12.9	12.9

**NOTES:**

$T_i = (0.395 * (1.1 - C_s) * (L)^{0.5}) / ((S)^{0.33})$ , S in ft/ft

$T_t = L / 60V$  (Velocity From Fig. 501)

Velocity  $V = C_v * S^{0.5}$ , S in ft/ft

$T_c \text{ Check} = 10 + L / 180$

For Urbanized basins a minimum  $T_c$  of 5.0 minutes is required.

For non-urbanized basins a minimum  $T_c$  of 10.0 minutes is required

**STANDARD FORM SF-3: PROPOSED  
STORM DRAINAGE SYSTEM DESIGN  
(RATIONAL METHOD PROCEDURE)**

Subdivision: Falcon Meadows at Bent Grass  
 Location: CO, Colorado Springs  
 Design Storm: 5-Year

Project Name: Falcon Meadows at Bent Grass  
 Project No.: CLH000017  
 Calculated By: TJE  
 Checked By: CMD  
 Date: 6/19/20

STREET	Design Point	DIRECT RUNOFF							TOTAL RUNOFF				STREET		PIPE			TRAVEL TIME			REMARKS
		Basin ID	Area (Ac)	Runoff Coeff.	Tc (min)	C* <sub>a</sub> (Ac)	I (in/hr)	Q (cfs)	Tc (min)	C* <sub>a</sub> (Ac)	I (in/hr)	Q (cfs)	Slope (%)	Street Flow (cfs)	Design Flow (cfs)	Slope (%)	Pipe Size (inches)	Length (ft)	Velocity (fps)	Tt (min)	
		RWT202	1574.40					46.6	120.88	1.82	220.0									From Falcon DBPS by Matrix	
		RWT204	38.40					11.37	1.78	3.94	7.0									From Falcon DBPS by Matrix	
		WT200	192.00					37.8	24.41	2.13	52.0									From Falcon DBPS by Matrix	
		OS-1	32.28	0.16	22.2	5.16	2.93	15.1												Flows obtained from Bent Grass Filing No. 2 FDR. Q=65.1 CFS	
		OS-4	4.46	0.36	15.6	1.61	3.46	5.6				1.2	5.6				910	2.2	6.9	Flows from Basin B-1 of Bent Grass Filing No. 2 FDR.	
		OS-5	0.46	0.45	5.2	0.21	5.10	1.1				1	1.1				190	2.0	1.6	Flows from Basin B-2 of Bent Grass Filing No. 2 FDR	
		OS-6	1.17	0.45	12.9	0.53	3.75	2.0				0.9	2.0				430	1.9	3.8	Flows from Basin B-3 of Bent Grass Filing No. 2 FDR.	
		A-1	2.16	0.56	10.3	1.21	4.09	4.9				2.5	4.9				765	3.2	4.0		
		A-4	0.82	0.09	5.0	0.07	5.17	0.4				5.7	0.4				105	4.8	0.4	Existing North WQ Pond Bent Grass Filing No. 2	
		A-3	0.92	0.65	8.9	0.60	4.30	2.6				2.5	2.6				735	3.2	3.9	Flow into proposed inlet.	
		A-2	0.86	0.45	5.0	0.39	5.17	2.0				7.0	2.0				110	5.3	0.3	Releases directly to Channel	
		C-4	3.99	0.33	5.5	1.32	5.02	6.6				2.5	6.6				575	3.2	3.0	Flow into Ex inlet in BGMD at DP 8	
		E-1	1.71	0.55	11.8	0.94	3.88	3.6												Ex Basin from Filing No. 2(East side of BGMD)	
		E-2	0.68	0.76	6.9	0.52	4.70	2.4												Ex Basin from Filing No. 2(West side of BGMD)	
		B-1	4.32	0.09	21.6	0.39	2.97	1.2													
		C-6	1.37	0.37	10.3	0.51	4.09	2.1													
		C-2	1.11	0.49	5.0	0.54	5.17	2.8				4	2.792				380	4.0	1.6	Flow into proposed inlet.	
		C-1	9.07	0.51	13.9	4.63	3.64	16.9				2.25	16.85				1160	3.0	6.4	Flow into proposed inlet.	
		C-3	1.52	0.73	6.7	1.11	4.73	5.3				2.5	5.3				945	3.2	5.0		
		C-5	0.51	0.09	5.0	0.05	5.17	0.3												North Pond	
		OS-2	20.07	0.14	18.3	2.81	3.22	9.0												Overland flow into Basin D-3. Flow obtained from Bent Grass Filing No. 2 FDR	
		OS-3	10.61	0.14	18.9	1.49	3.18	4.7												Offsite flow into Basin D-3. Flow obtained from Bent Grass Filing No. 2 FDR	
		D-3	2.93	0.23	21.0	0.67	3.01	2.0												Flows conveyed via existing ditch into proposed area inlet.	
		D-2	6.62	0.58	12.3	3.84	3.82	14.7				1.3	14.7				1355	2.3	9.9	Flow into proposed inlet. Piped to DP 14.	
		D-1	8.13	0.41	21.1	3.33	3.01	10.0				1.3	10.0				1900	2.3	13.9	Combined flows from D-1 into proposed inlet.	
		D-4	4.38	0.52	16.0	2.28	3.42	7.8				1	7.8				980	2.0	8.2	Flow into proposed inlet.	
		D-5	1.08	0.51	11.0	0.55	3.99	2.2				1.1	2.2				300	2.1	2.4		
		D-6	4.01	0.54	12.4	2.17	3.80	8.2				1	8.2				835	2.0	7.0		
		D-9	0.80	0.26	13.0	0.21	3.74	0.8													
		E-4	0.91	0.74	8.0	0.67	4.46	3.0												Flow into Ex inlet.	

**STANDARD FORM SF-3: PROPOSED  
STORM DRAINAGE SYSTEM DESIGN  
(RATIONAL METHOD PROCEDURE)**

**Subdivision:** Falcon Meadows at Bent Grass  
**Location:** CO, Colorado Springs  
**Design Storm:** 5-Year

**Project Name:** Falcon Meadows at Bent Grass  
**Project No.:** CLH000017  
**Calculated By:** TJE  
**Checked By:** CMD  
**Date:** 6/19/20

STREET	Design Point	DIRECT RUNOFF							TOTAL RUNOFF				STREET		PIPE			TRAVEL TIME			REMARKS
		Basin ID	Area (Ac)	Runoff Coeff.	Tc (min)	C*A (Ac)	f (in/hr)	Q (cfs)	Tc (min)	C*A (Ac)	f (in/hr)	Q (cfs)	Slope (%)	Street Flow (cfs)	Design Flow (cfs)	Slope (%)	Pipe Size (inches)	Length (ft)	Velocity (fps)	Tt (min)	
		E-5	0.89	0.81	7.3	0.72	4.60	3.3													Flow into Ex inlet.
		I-1	0.31	0.66	5.0	0.20	5.17	1.0													Flow into Ex inlet.
		D-7	6.39	0.14	14.8	0.89	3.54	3.2													
		D-8	1.69	0.21	14.0	0.35	3.62	1.3													Flow in Swale C (Basin D-8) into proposed south pond
		E-3	0.78	0.81	7.4	0.63	4.59	2.9													Flow into Ex Inlet in BGMD (South Side)
		B-2	1.17	0.10	16.0	0.12	3.42	0.4													

**STANDARD FORM SF-3: PROPOSED**  
**STORM DRAINAGE SYSTEM DESIGN**  
(RATIONAL METHOD PROCEDURE)

Subdivision: Falcon Meadows at Bent Grass  
Location: CO, Colorado Springs  
Design Storm: 100-Year

Project Name: Falcon Meadows at Bent Grass  
Project No.: CLH000017  
Calculated By: TJE  
Checked By: CMD  
Date: 6/19/20

STREET	Design Point	DIRECT RUNOFF							TOTAL RUNOFF				STREET		PIPE			TRAVEL TIME			REMARKS
		Basin ID	Area (Ac)	Runoff Coeff.	Tc (min)	C*A (Ac)	I (in/hr)	Q (cfs)	Tc (min)	C*A (Ac)	I (in/hr)	Q (cfs)	Slope (%)	Street Flow (cfs)	Design Flow (cfs)	Slope (%)	Pipe Size (inches)	Length (ft)	Velocity (fps)	Tt (min)	
		RWT202	1574.40					46.6	327.87	3.05	1000.0									From Falcon DBPS by Matrix	
		RWT204	38.40					11.4	6.52	6.60	43.0									From Falcon DBPS by Matrix	
		WT200	192.00					37.8	53.07	3.58	190.0									From Falcon DBPS by Matrix	
		OS-1	32.28	0.41	22.2	13.23	4.92	65.1												Flows obtained from Bent Grass Filing No. 2 FDR. Q=65.1 CFS	
		OS-4	4.46	0.54	15.6	2.41	5.81	14.0				1.2	14.0				910	2.2	6.9	Flows from Basin B-1 of Bent Grass Filing No. 2 FDR.	
		OS-5	0.46	0.59	5.2	0.27	8.56	2.3				1	2.3				190	2.0	1.6	Flows from Basin B-2 of Bent Grass Filing No. 2 FDR	
		OS-6	1.17	0.59	12.9	0.69	6.30	4.3				0.9	4.3				430	1.9	3.8	Flows from Basin B-3 of Bent Grass Filing No. 2 FDR.	
		A-1	2.16	0.79	10.3	1.71	6.87	11.7				2.5	11.7				765	3.2	4.0		
		A-4	0.82	0.36	5.0	0.30	8.68	2.6												Existing North WQ Pond Bent Grass Filing No. 2	
		A-3	0.92	0.78	8.9	0.72	7.21	5.2				2.5	5.2				735	3.2	3.9	Flow into proposed inlet.	
		A-2	0.86	0.59	5.0	0.51	8.68	4.4												Releases directly to Channel	
		C-4	3.99	0.52	5.5	2.07	8.42	17.4				2.5	17.4				575	3.2	3.0	Flow into Ex inlet in BGMD at DP 8	
		E-1	1.71	0.69	11.8	1.18	6.51	7.7	11.8	1.18	6.51	7.7								Ex Basin from Filing No. 2(East side of BGMD)	
		E-2	0.68	0.85	6.9	0.58	7.89	4.6												Ex Basin from Filing No. 2(West side of BGMD)	
		B-1	4.32	0.36	21.6	1.56	4.99	7.8													
		C-6	1.37	0.54	10.3	0.74	6.87	5.1													
		C-2	1.11	0.65	5.0	0.72	8.68	6.2				4	6.25				380	4.0	1.583	Flow into proposed inlet.	
		C-1	9.07	0.65	13.9	5.90	6.11	36.0				2.25	36.05				1160	3.0	6.4	Flow into proposed inlet.	
		C-3	1.52	0.82	6.7	1.25	7.95	9.9				2.5	9.9				945	3.2	5.0		
		C-5	0.51	0.36	5.0	0.18	8.68	1.6												North Pond	
		OS-2	20.07	0.40	18.3	8.03	5.41	43.4												Overland flow into Basin D-3. Flow obtained from Bent Grass Filing No. 2 FDR	
		OS-3	10.61	0.40	18.9	4.24	5.33	24.3												Offsite flow into Basin D-3. Flow obtained from Bent Grass Filing No. 2 FDR	
		D-3	2.93	0.34	21.0	1.00	5.06	5.1	21.0	9.87	5.06	49.9								Flows conveyed via existing ditch into proposed area inlet. Total flow from Basins OS-2, OS-3 & D-3 to existing area inlet at DP 11	
		D-2	6.62	0.70	12.3	4.63	6.41	29.7				1.3	29.68				1355	2.3	9.9	Flow into proposed inlet. Piped to DP 14.	
		D-1	8.13	0.58	21.1	4.72	5.05	23.8				1.3	23.8				1900	2.3	13.9	Combined flows from D-1 into proposed inlet.	
		D-4	4.38	0.66	16.0	2.89	5.75	16.6				1	16.6				980	2.0	8.2	Flow into proposed inlet.	
		D-5	1.08	0.64	11.0	0.69	6.70	4.6				1.1	4.6				300	2.1	2.4		
		D-6	4.01	0.67	12.4	2.69	6.39	17.2				1	17.2				835	2.0	7.0		
		D-9	0.80	0.47	13.0	0.38	6.27	2.4													
		E-4	0.91	0.84	8.0	0.76	7.50	5.7												Flow into Ex inlet.	

**STANDARD FORM SF-3: PROPOSED  
STORM DRAINAGE SYSTEM DESIGN  
(RATIONAL METHOD PROCEDURE)**

**Subdivision:** Falcon Meadows at Bent Grass  
**Location:** CO, Colorado Springs  
**Design Storm:** 100-Year

**Project Name:** Falcon Meadows at Bent Grass  
**Project No.:** CLH000017  
**Calculated By:** TJE  
**Checked By:** CMD  
**Date:** 6/19/20

STREET	Design Point	DIRECT RUNOFF							TOTAL RUNOFF				STREET		PIPE				TRAVEL TIME			REMARKS
		Basin ID	Area (Ac)	Runoff Coeff.	Tc (min)	C*A (Ac)	I (in/hr)	Q (cfs)	Tc (min)	C*A (Ac)	I (in/hr)	Q (cfs)	Slope (%)	Street Flow (cfs)	Design Flow (cfs)	Slope (%)	Pipe Size (inches)	Length (ft)	Velocity (fps)	Tt (min)		
		E-5	0.89	0.89	7.3	0.79	7.73	6.1													Flow into Ex inlet.	
		I-1	0.31	0.79	5.0	0.24	8.68	2.1													Flow into Ex inlet.	
		D-7	6.39	0.39	14.8	2.49	5.94	14.8														
		D-8	1.69	0.44	14.0	0.74	6.08	4.5													Flow in Swale C (Basin D-8) into proposed south pond	
		E-3	0.78	0.89	7.4	0.69	7.70	5.3													Flow into Ex Inlet in BGMD (South Side)	
		B-2	1.17	0.38	16.0	0.44	5.75	2.5														



## BENT GRASS/MERIDIAN ROAD - PDR SURFACE ROUTING - PROPOSED CONDITIONS

DESIGN POINT	CONTRIBUTING BASINS	CA (equivalent)		Tc (min.)	INTENSITY		TOTAL FLOWS		NOTES		
		CA(5)	CA(100)		I(5) (in/hr)	I(100) (in/hr)	Q(5) (cfs)	Q(100) (cfs)			
	RWT202	124.80	324.77	46.6	1.8	3.1	220.0	1000.0			
		TRAVEL TIME									
		124.80	324.77	Type/flow	Length (ft)	Velocity (fps)	d. Time (min)	T. Time (min)			
					5.0	0.0	46.6				
	RWT204	1.83	6.43	11.4	3.8	6.7	7.0	43.0			
		TRAVEL TIME									
		1.83	6.43	Type/flow	Length (ft)	Velocity (fps)	d. Time (min)	T. Time (min)			
					5.0	0.0	11.4				
	WT200	25.81	54.00	37.8	2.0	3.5	52.0	190.0			
		TRAVEL TIME									
		25.81	54.00	Type/flow	Length (ft)	Velocity (fps)	d. Time (min)	T. Time (min)			
					5.0	0.0	37.8				
	OS-1	5.16	13.23	22.2	2.8	4.8	14.2	63.6			
		TRAVEL TIME									
		5.16	13.23	Type/flow	Length (ft)	Velocity (fps)	d. Time (min)	T. Time (min)			
					5.0	0.0	22.2				
21	RWT202	124.80	324.77	46.6	1.8	3.1	277.8	1226.8	Combine all offsite flows entering site @ North Property Line		
	RWT204	1.83	6.43								
	WT200	25.81	54.00								
	OS-1	5.16	13.23								
		157.60	398.43	TRAVEL TIME							
				Type/flow	Length (ft)	Velocity (fps)	d. Time (min)	T. Time (min)			
				Channel	850	4.0	3.5	50.1			
2	OS-4	1.61	2.41	15.6	3.3	5.8	5.3	13.9			
		TRAVEL TIME									
		1.61	2.41	Type/flow	Length (ft)	Velocity (fps)	d. Time (min)	T. Time (min)			
				STREET	200	3.2	1.0	16.7			
1	OS-5 DP 2	0.21	0.27	16.7	3.2	5.6	5.8	15.0			
		1.61	2.41	TRAVEL TIME							
		1.82	2.68	Type/flow	Length (ft)	Velocity (fps)	d. Time (min)	T. Time (min)			
				STREET	55	3.2	0.3	16.9			
3	OS-6 DP 1	0.53	0.69	16.9	3.2	5.5	7.5	18.7			
		1.82	2.68	TRAVEL TIME							
		2.35	3.37	Type/flow	Length (ft)	Velocity (fps)	d. Time (min)	T. Time (min)			
				STREET	115	3.2	0.6	17.5			
4	A-1 DP 3	1.21	1.71	17.5	3.1	5.5	11.1	27.7	@ GRADE INLET		
		2.35	3.37	TRAVEL TIME							
		3.56	5.08	Type/flow	Length (ft)	Velocity (fps)	d. Time (min)	T. Time (min)			
				STREET	40	2.4	0.3	17.8			
5	A-3 FB DP 4	0.60	0.72	8.9	4.2	7.4	3.6	16.5	@ GRADE INLET		
		0.26	1.51	TRAVEL TIME							
		0.86	2.23	Type/flow	Length (ft)	Velocity (fps)	d. Time (min)	T. Time (min)			
				STREET	80	2.0	0.7	9.6			
6	A-4 DP 4 DP 5	0.07	0.30	17.8	3.1	5.4	13.9	41.2	EX BG FIL NO. 2 WQ POND		
		3.56	5.08	TRAVEL TIME							
		0.86	2.23	Type/flow	Length (ft)	Velocity (fps)	d. Time (min)	T. Time (min)			
		4.49	7.61				2.0	0.0		17.8	

DESIGN POINT	CONTRIBUTING BASINS	CA (equivalent)		Tc (min.)	INTENSITY		TOTAL FLOWS		NOTES	
		CA(5)	CA(100)		I(5) (in/hr)	I(100) (in/hr)	Q(5) (cfs)	Q(100) (cfs)		
15A	EX NORTH WQ POND RELEASE	2.35	4.08	5.0	5.2	9.1	12.2	37.0		
		TRAVEL TIME								
		2.35	4.08	Type/flow	Length (ft)	Velocity (fps)	d. Time (min)	T. Time (min)		
7	E-3	0.63	0.69	7.4	4.6	8.0	2.9	5.5	EX SUMP INLET	
		TRAVEL TIME								
		0.63	0.69	Type/flow	Length (ft)	Velocity (fps)	d. Time (min)	T. Time (min)		
8	E-1 E-2 C-4 FB DP 5 FB DP 12 FB DP 15	0.94	1.18	14.2	3.5	6.0	16.5	56.3	EX SUMP INLET	
		0.52	0.58							
		1.32	2.07							
		0.00	1.39							
		0.00	0.00							
		1.99	4.08	TRAVEL TIME						
AA	DP 21 B-1 DP 8 DP 15A	157.60	398.43	50.1	1.7	2.9	273.5	1201.3	CHANNEL FLOW & EX BOX CULVERTS @ BGMD	
		0.39	1.56							
		4.77	9.30	TRAVEL TIME						
BB	B-2 DP AA	0.12	0.44	50.6	1.7	2.9	272.1	1195.7		
		162.76	409.29	TRAVEL TIME						
		162.88	409.73	Type/flow	Length (ft)	Velocity (fps)	d. Time (min)	T. Time (min)		
12	C-2	0.54	0.72	5.0	5.2	9.1	2.8	6.5	@ GRADE INLET	
		TRAVEL TIME								
		0.54	0.72	Type/flow	Length (ft)	Velocity (fps)	d. Time (min)	T. Time (min)		
15	C-1 C-3	4.63	5.90	13.9	3.5	6.1	20.1	43.7	@ GRADE INLET	
		1.11	1.25	TRAVEL TIME						
		5.74	7.15	Type/flow	Length (ft)	Velocity (fps)	d. Time (min)	T. Time (min)		
19	C-6	0.51	0.74	10.3	4.0	7.0	2.0	5.2	AREA INLET	
		TRAVEL TIME								
		0.51	0.74	Type/flow	Length (ft)	Velocity (fps)	d. Time (min)	T. Time (min)		
13	DP 12 DP 15 DP 19	0.54	0.72	14.2	3.5	6.0	23.5	52.1	TOTAL FLOW INTO PR NORTH WQ POND	
		5.74	7.15							
		0.51	0.74	TRAVEL TIME						
13A	NORTH WQ POND RELEASE	0.64	2.47	5.0	5.2	9.1	3.3	22.4		
		TRAVEL TIME								
		0.64	2.47	Type/flow	Length (ft)	Velocity (fps)	d. Time (min)	T. Time (min)		
9	OS-2	2.81	8.03	18.3	3.1	5.3	8.6	42.8		
		TRAVEL TIME								
		2.81	8.03	Type/flow	Length (ft)	Velocity (fps)	d. Time (min)	T. Time (min)		
				SWALE	1150	5.6	3.4	21.8		

DESIGN POINT	CONTRIBUTING BASINS	CA (equivalent)		Tc (min.)	INTENSITY		TOTAL FLOWS		NOTES	
		CA(5)	CA(100)		I(5) (in/hr)	I(100) (in/hr)	Q(5) (cfs)	Q(100) (cfs)		
10	OS-3	1.49	4.24	18.9	3.0	5.2	4.5	22.2		
		TRAVEL TIME								
		1.49	4.24	Type/flow	Length (ft)	Velocity (fps)	d. Time (min)	T. Time (min)		
				SWALE	3.33	6.1	0.0	18.9		
11	D-3 DP 9 DP 10	0.67	1.00	21.8	2.8	4.9	13.8	64.5	AREA INLET	
		2.81	8.03	TRAVEL TIME						
		1.49	4.24	TRAVEL TIME						
		4.97	13.27	Type/flow	Length (ft)	Velocity (fps)	d. Time (min)	T. Time (min)		
					6.0	0.0	21.8			
14	D-2	3.84	4.63	12.3	3.7	6.5	14.2	29.9	@ GRADE INLET	
		TRAVEL TIME								
		3.84	4.63	Type/flow	Length (ft)	Velocity (fps)	d. Time (min)	T. Time (min)		
				STREET	40	2.0	0.3	12.6		
16	D-1	3.33	4.72	21.1	2.8	4.9	9.4	23.3	@ GRADE INLET	
		TRAVEL TIME								
		3.33	4.72	Type/flow	Length (ft)	Velocity (fps)	d. Time (min)	T. Time (min)		
				STREET	900	2.8	5.4	26.5		
17	D-4	2.28	2.89	16.0	3.3	5.7	7.5	16.5	SUMP INLET	
		TRAVEL TIME								
		2.28	2.89	Type/flow	Length (ft)	Velocity (fps)	d. Time (min)	T. Time (min)		
					6.1	0.0	16.0			
18	D-5 D-6	0.55	0.69	12.4	3.7	6.4	10.0	21.8	SUMP INLET	
		2.17	2.69	TRAVEL TIME						
		2.72	3.38	Type/flow	Length (ft)	Velocity (fps)	d. Time (min)	T. Time (min)		
					6.2	0.0	12.4			
31	DP 17 DP 14 DP 16 DP 18	2.28	2.89	26.5	2.5	4.4	30.4	68.1	FLOW INTO PR SOUTH WQ POND	
		3.84	4.63	TRAVEL TIME						
		3.33	4.72	TRAVEL TIME						
		2.72	3.38	TRAVEL TIME						
		12.17	15.62	Type/flow	Length (ft)	Velocity (fps)	d. Time (min)	T. Time (min)		
					6.0	0.0	26.5			
24	E-4 D-9 FB DP 14 FB DP 16	0.67	0.76	26.5	2.5	4.4	7.5	30.8	EX @ GRADE INLET	
		0.21	0.38	TRAVEL TIME						
		1.08	3.01	TRAVEL TIME						
		1.04	2.91	TRAVEL TIME						
		3.00	7.06	Type/flow	Length (ft)	Velocity (fps)	d. Time (min)	T. Time (min)		
					2.6	0.0	26.5			
25	E-5 FB DP 24	0.72	0.79	7.3	4.6	8.0	3.3	11.8	EX @ GRADE INLET	
		0.00	0.69	TRAVEL TIME						
		0.72	1.48	Type/flow	Length (ft)	Velocity (fps)	d. Time (min)	T. Time (min)		
					2.6	0.0	7.3			
26	DP 24 DP 25	3.00	7.06	26.5	2.5	4.4	9.3	37.2	FLOWS INTO SWALE F	
		0.72	1.48	TRAVEL TIME						
		3.72	8.54	Type/flow	Length (ft)	Velocity (fps)	d. Time (min)	T. Time (min)		
				SWALE	740	3.5	3.5	30.0		
30	D-7 DP 26	0.89	2.49	14.8	3.4	5.9	15.7	65.4	FLOW INTO PR SOUTH WQ POND	
		3.72	8.54	TRAVEL TIME						
		4.61	11.03	Type/flow	Length (ft)	Velocity (fps)	d. Time (min)	T. Time (min)		
					2.6	0.0	14.8			
32	D-8	0.35	0.74	14.0	3.5	6.1	1.2	4.5	FLOW INTO PR SOUTH WQ POND	
		TRAVEL TIME								
		0.35	0.74	Type/flow	Length (ft)	Velocity (fps)	d. Time (min)	T. Time (min)		
					6.1	0.0	14.0			

DESIGN POINT	CONTRIBUTING BASINS	CA (equivalent)		Tc (min.)	INTENSITY		TOTAL FLOWS		NOTES
		CA(5)	CA(100)		I(5) (in/hr)	I(100) (in/hr)	Q(5) (cfs)	Q(100) (cfs)	
20	DP 30 DP 31 DP 32	4.61	11.03	26.5	2.5	4.4	42.7	119.3	TOTAL FLOW INTO PR SOUTH WQ POND
		12.17	15.62						
		0.35	0.74	TRAVEL TIME					
		17.13	27.39	Type/flow	Length (ft)	Velocity (fps)	d. Time (min)	T. Time (min)	
				2.6	0.0	26.5			
20A	PR SOUTH WQ POND RELEASE	2.58	5.79	5.0	5.2	9.1	13.4	52.5	
		TRAVEL TIME							
		2.58	5.79	Type/flow	Length (ft)	Velocity (fps)	d. Time (min)	T. Time (min)	
				2.6	0.0	5.0			
20B	EX SOUTH WQ POND RELEASE	4.11	7.28	5.0	5.2	9.1	21.3	66.0	
		TRAVEL TIME							
		4.11	7.28	Type/flow	Length (ft)	Velocity (fps)	d. Time (min)	T. Time (min)	
				2.6	0.0	5.0			
CC	B-2 DP AA DP 20A DP 20B	0.12	0.44	50.6	1.7	2.9	283.3	1233.8	FLOWS EXITING SITE IN CHANNEL
		162.76	409.29						
		2.58	5.79	TRAVEL TIME					
		4.11	7.28	Type/flow	Length (ft)	Velocity (fps)	d. Time (min)	T. Time (min)	
		169.57	422.81			2.6	0.0	50.6	

**APPENDIX C**  
**Hydraulic Computations**

## Swale Calculations

## Worksheet for Swale - A

### Project Description

Friction Method                      Manning Formula  
Solve For                                Normal Depth

### Input Data

Roughness Coefficient	0.030	
Channel Slope	0.02580	ft/ft
Left Side Slope	4.00	ft/ft (H:V)
Right Side Slope	4.00	ft/ft (H:V)
Discharge	5.20	ft <sup>3</sup> /s

### Results

Normal Depth	0.61	ft
Flow Area	1.48	ft <sup>2</sup>
Wetted Perimeter	5.01	ft
Hydraulic Radius	0.29	ft
Top Width	4.86	ft
Critical Depth	0.64	ft
Critical Slope	0.01999	ft/ft
Velocity	3.52	ft/s
Velocity Head	0.19	ft
Specific Energy	0.80	ft
Froude Number	1.13	
Flow Type	Supercritical	

Due to high Fr #, channel will be lined. Final design will be provided in FDR

### GVF Input Data

Downstream Depth	0.00	ft
Length	0.00	ft
Number Of Steps	0	

### GVF Output Data

Upstream Depth	0.00	ft
Profile Description		
Profile Headloss	0.00	ft
Downstream Velocity	Infinity	ft/s
Upstream Velocity	Infinity	ft/s
Normal Depth	0.61	ft
Critical Depth	0.64	ft
Channel Slope	0.02580	ft/ft
Critical Slope	0.01999	ft/ft

## Worksheet for Swale - C

### Project Description

Friction Method                      Manning Formula  
Solve For                                Normal Depth

### Input Data

Roughness Coefficient	0.030	
Channel Slope	0.02400	ft/ft
Left Side Slope	4.00	ft/ft (H:V)
Right Side Slope	4.00	ft/ft (H:V)
Bottom Width	1.00	ft
Discharge	4.50	ft <sup>3</sup> /s

### Results

Normal Depth	0.47	ft
Flow Area	1.37	ft <sup>2</sup>
Wetted Perimeter	4.91	ft
Hydraulic Radius	0.28	ft
Top Width	4.79	ft
Critical Depth	0.49	ft
Critical Slope	0.02033	ft/ft
Velocity	3.28	ft/s
Velocity Head	0.17	ft
Specific Energy	0.64	ft
Froude Number	1.08	
Flow Type	Supercritical	

Due to high Fr #, channel will be lined. Final design will be provided in FDR

### GVF Input Data

Downstream Depth	0.00	ft
Length	0.00	ft
Number Of Steps	0	

### GVF Output Data

Upstream Depth	0.00	ft
Profile Description		
Profile Headloss	0.00	ft
Downstream Velocity	Infinity	ft/s
Upstream Velocity	Infinity	ft/s
Normal Depth	0.47	ft
Critical Depth	0.49	ft
Channel Slope	0.02400	ft/ft
Critical Slope	0.02033	ft/ft



## Worksheet for Swale - D

### Project Description

Friction Method	Manning Formula
Solve For	Normal Depth

### Input Data

Roughness Coefficient	0.030	
Channel Slope	0.02000	ft/ft
Left Side Slope	4.00	ft/ft (H:V)
Right Side Slope	4.00	ft/ft (H:V)
Bottom Width	2.00	ft
Discharge	50.00	ft <sup>3</sup> /s

### Results

Normal Depth	1.26	ft
Flow Area	8.91	ft <sup>2</sup>
Wetted Perimeter	12.42	ft
Hydraulic Radius	0.72	ft
Top Width	12.10	ft
Critical Depth	1.35	ft
Critical Slope	0.01474	ft/ft
Velocity	5.61	ft/s
Velocity Head	0.49	ft
Specific Energy	1.75	ft
Froude Number	1.15	
Flow Type	Supercritical	

Due to high Fr #, channel will be lined. Final design will be provided in FDR

### GVF Input Data

Downstream Depth	0.00	ft
Length	0.00	ft
Number Of Steps	0	

### GVF Output Data

Upstream Depth	0.00	ft
Profile Description		
Profile Headloss	0.00	ft
Downstream Velocity	Infinity	ft/s
Upstream Velocity	Infinity	ft/s
Normal Depth	1.26	ft
Critical Depth	1.35	ft
Channel Slope	0.02000	ft/ft
Critical Slope	0.01474	ft/ft

---

## Worksheet for Swale - E

---

### Project Description

Friction Method	Manning Formula
Solve For	Normal Depth

### Input Data

Roughness Coefficient	0.030	
Channel Slope	0.00500	ft/ft
Left Side Slope	4.00	ft/ft (H:V)
Right Side Slope	4.00	ft/ft (H:V)
Bottom Width	3.00	ft
Discharge	64.50	ft <sup>3</sup> /s

### Results

Normal Depth	1.79	ft
Flow Area	18.15	ft <sup>2</sup>
Wetted Perimeter	17.74	ft
Hydraulic Radius	1.02	ft
Top Width	17.30	ft
Critical Depth	1.42	ft
Critical Slope	0.01426	ft/ft
Velocity	3.55	ft/s
Velocity Head	0.20	ft
Specific Energy	1.98	ft
Froude Number	0.61	
Flow Type	Subcritical	

### GVF Input Data

Downstream Depth	0.00	ft
Length	0.00	ft
Number Of Steps	0	

### GVF Output Data

Upstream Depth	0.00	ft
Profile Description		
Profile Headloss	0.00	ft
Downstream Velocity	Infinity	ft/s
Upstream Velocity	Infinity	ft/s
Normal Depth	1.79	ft
Critical Depth	1.42	ft
Channel Slope	0.00500	ft/ft
Critical Slope	0.01426	ft/ft

---

## Worksheet for Swale - F

---

### Project Description

Friction Method	Manning Formula
Solve For	Normal Depth

### Input Data

Roughness Coefficient	0.030	
Channel Slope	0.01000	ft/ft
Left Side Slope	4.00	ft/ft (H:V)
Right Side Slope	4.00	ft/ft (H:V)
Bottom Width	6.00	ft
Discharge	65.40	ft <sup>3</sup> /s

### Results

Normal Depth	1.30	ft
Flow Area	14.50	ft <sup>2</sup>
Wetted Perimeter	16.69	ft
Hydraulic Radius	0.87	ft
Top Width	16.37	ft
Critical Depth	1.18	ft
Critical Slope	0.01435	ft/ft
Velocity	4.51	ft/s
Velocity Head	0.32	ft
Specific Energy	1.61	ft
Froude Number	0.84	
Flow Type	Subcritical	

### GVF Input Data

Downstream Depth	0.00	ft
Length	0.00	ft
Number Of Steps	0	

### GVF Output Data

Upstream Depth	0.00	ft
Profile Description		
Profile Headloss	0.00	ft
Downstream Velocity	Infinity	ft/s
Upstream Velocity	Infinity	ft/s
Normal Depth	1.30	ft
Critical Depth	1.18	ft
Channel Slope	0.01000	ft/ft

---

## Worksheet for Swale - F

---

### GVF Output Data

Critical Slope 0.01435 ft/ft

## Inlet Calculations

**ALLOWABLE CAPACITY FOR ONE-HALF OF STREET (Minor & Major Storm)**

(Based on Regulated Criteria for Maximum Allowable Flow Depth and Spread)

Project: **Falcon Meadows at Bent Grass**  
 Inlet ID: **DP 4 - At Grade Inlet**

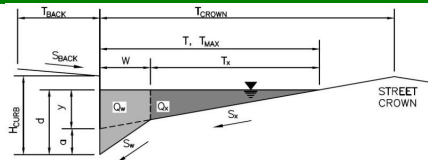

Gutter Geometry (Enter data in the blue cells)													
Maximum Allowable Width for Spread Behind Curb	$T_{BACK} = 8.0$ ft												
Side Slope Behind Curb (leave blank for no conveyance credit behind curb)	$S_{BACK} = 0.020$ ft/ft												
Manning's Roughness Behind Curb (typically between 0.012 and 0.020)	$n_{BACK} = 0.013$												
Height of Curb at Gutter Flow Line	$H_{CURB} = 6.00$ inches												
Distance from Curb Face to Street Crown	$T_{CROWN} = 16.5$ ft												
Gutter Width	$W = 2.00$ ft												
Street Transverse Slope	$S_X = 0.020$ ft/ft												
Gutter Cross Slope (typically 2 inches over 24 inches or 0.083 ft/ft)	$S_W = 0.083$ ft/ft												
Street Longitudinal Slope - Enter 0 for sump condition	$S_0 = 0.051$ ft/ft												
Manning's Roughness for Street Section (typically between 0.012 and 0.020)	$n_{STREET} = 0.016$												
Max. Allowable Spread for Minor & Major Storm	<table border="1"> <thead> <tr> <th></th> <th>Minor Storm</th> <th>Major Storm</th> <th></th> </tr> </thead> <tbody> <tr> <td><math>T_{MAX} =</math></td> <td>7.0</td> <td>16.5</td> <td>ft</td> </tr> <tr> <td><math>d_{MAX} =</math></td> <td>6.0</td> <td>12.0</td> <td>inches</td> </tr> </tbody> </table>		Minor Storm	Major Storm		$T_{MAX} =$	7.0	16.5	ft	$d_{MAX} =$	6.0	12.0	inches
	Minor Storm	Major Storm											
$T_{MAX} =$	7.0	16.5	ft										
$d_{MAX} =$	6.0	12.0	inches										
Max. Allowable Depth at Gutter Flowline for Minor & Major Storm													
Allow Flow Depth at Street Crown (leave blank for no)	<input type="checkbox"/> <input type="checkbox"/> check = yes												
<b>MINOR STORM Allowable Capacity is based on Spread Criterion</b>													
<b>MAJOR STORM Allowable Capacity is based on Spread Criterion</b>													
	<table border="1"> <thead> <tr> <th></th> <th>Minor Storm</th> <th>Major Storm</th> <th></th> </tr> </thead> <tbody> <tr> <td><math>Q_{allow} =</math></td> <td>3.4</td> <td>22.8</td> <td>cfs</td> </tr> </tbody> </table>		Minor Storm	Major Storm		$Q_{allow} =$	3.4	22.8	cfs				
	Minor Storm	Major Storm											
$Q_{allow} =$	3.4	22.8	cfs										
<p><b>WARNING: MINOR STORM max. allowable capacity is less than the design flow given on sheet 'Inlet Management'</b></p> <p><b>WARNING: MAJOR STORM max. allowable capacity is less than the design flow given on sheet 'Inlet Management'</b></p>													

## INLET ON A CONTINUOUS GRADE

Version 4.06 Released August 2018

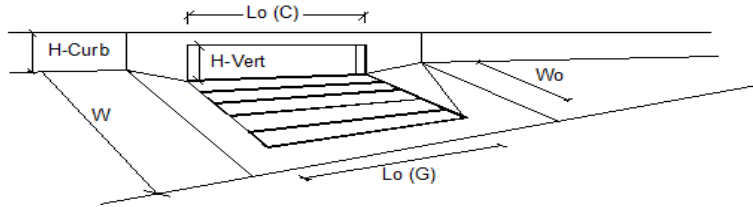

Design Information (Input)	MINOR	MAJOR	
Type of Inlet	CDOT Type R Curb Opening		
Local Depression (additional to continuous gutter depression 'a')	3.0	3.0	inches
Total Number of Units in the Inlet (Grate or Curb Opening)	1	1	
Length of a Single Unit Inlet (Grate or Curb Opening)	15.00	15.00	ft
Width of a Unit Grate (cannot be greater than W, Gutter Width)	N/A	N/A	ft
Clogging Factor for a Single Unit Grate (typical min. value = 0.5)	N/A	N/A	
Clogging Factor for a Single Unit Curb Opening (typical min. value = 0.1)	0.10	0.10	
<b>Street Hydraulics: WARNING: Q &gt; ALLOWABLE Q FOR MINOR &amp; MAJOR STORM</b>			
Total Inlet Interception Capacity	10.0	16.5	cfs
Total Inlet Carry-Over Flow (flow bypassing inlet)	1.1	11.2	cfs
Capture Percentage = $Q_i/Q_o$	90	60	%

**ALLOWABLE CAPACITY FOR ONE-HALF OF STREET (Minor & Major Storm)**

(Based on Regulated Criteria for Maximum Allowable Flow Depth and Spread)

Project: **Falcon Meadows at Bent Grass**  
 Inlet ID: **DP 5 - At Grade Inlet**

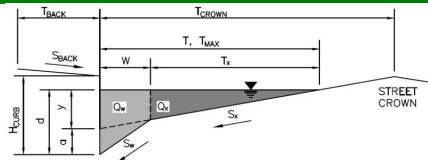

Gutter Geometry (Enter data in the blue cells)					
Maximum Allowable Width for Spread Behind Curb	$T_{BACK} = 8.0$ ft				
Side Slope Behind Curb (leave blank for no conveyance credit behind curb)	$S_{BACK} = 0.020$ ft/ft				
Manning's Roughness Behind Curb (typically between 0.012 and 0.020)	$n_{BACK} = 0.013$				
Height of Curb at Gutter Flow Line	$H_{CURB} = 6.00$ inches				
Distance from Curb Face to Street Crown	$T_{CROWN} = 16.5$ ft				
Gutter Width	$W = 2.00$ ft				
Street Transverse Slope	$S_x = 0.020$ ft/ft				
Gutter Cross Slope (typically 2 inches over 24 inches or 0.083 ft/ft)	$S_w = 0.083$ ft/ft				
Street Longitudinal Slope - Enter 0 for sump condition	$S_0 = 0.051$ ft/ft				
Manning's Roughness for Street Section (typically between 0.012 and 0.020)	$n_{STREET} = 0.016$				
Max. Allowable Spread for Minor & Major Storm	<table border="1"> <tr> <th>Minor Storm</th> <th>Major Storm</th> </tr> <tr> <td><math>T_{MAX} = 7.0</math></td> <td><math>T_{MAX} = 16.5</math></td> </tr> </table>	Minor Storm	Major Storm	$T_{MAX} = 7.0$	$T_{MAX} = 16.5$
Minor Storm	Major Storm				
$T_{MAX} = 7.0$	$T_{MAX} = 16.5$				
Max. Allowable Depth at Gutter Flowline for Minor & Major Storm	<table border="1"> <tr> <th>Minor Storm</th> <th>Major Storm</th> </tr> <tr> <td><math>d_{MAX} = 6.0</math></td> <td><math>d_{MAX} = 12.0</math></td> </tr> </table>	Minor Storm	Major Storm	$d_{MAX} = 6.0$	$d_{MAX} = 12.0$
Minor Storm	Major Storm				
$d_{MAX} = 6.0$	$d_{MAX} = 12.0$				
Allow Flow Depth at Street Crown (leave blank for no)	<input type="checkbox"/> <input type="checkbox"/> check = yes				
<b>MINOR STORM Allowable Capacity is based on Spread Criterion</b>					
<b>MAJOR STORM Allowable Capacity is based on Spread Criterion</b>					
<b>WARNING: MINOR STORM max. allowable capacity is less than the design flow given on sheet 'Inlet Management'</b>					
<b>Major storm max. allowable capacity GOOD - greater than the design flow given on sheet 'Inlet Management'</b>					
	<table border="1"> <tr> <th>Minor Storm</th> <th>Major Storm</th> </tr> <tr> <td><math>Q_{allow} = 3.4</math></td> <td><math>Q_{allow} = 22.8</math></td> </tr> </table>	Minor Storm	Major Storm	$Q_{allow} = 3.4$	$Q_{allow} = 22.8$
Minor Storm	Major Storm				
$Q_{allow} = 3.4$	$Q_{allow} = 22.8$				



## INLET ON A CONTINUOUS GRADE

Version 4.06 Released August 2018

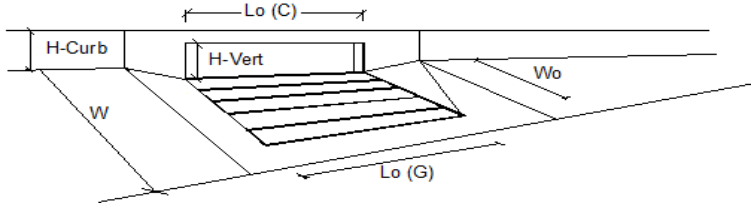

Design Information (Input)	CDOT Type R Curb Opening	MINOR	MAJOR	
Type of Inlet	CDOT Type R Curb Opening	Type =	CDOT Type R Curb Opening	
Local Depression (additional to continuous gutter depression 'a')		$a_{LOCAL} =$	3.0	3.0
Total Number of Units in the Inlet (Grate or Curb Opening)		No =	1	1
Length of a Single Unit Inlet (Grate or Curb Opening)		$L_o =$	10.00	10.00
Width of a Unit Grate (cannot be greater than W, Gutter Width)		$W_o =$	N/A	N/A
Clogging Factor for a Single Unit Grate (typical min. value = 0.5)		$C_r-G =$	N/A	N/A
Clogging Factor for a Single Unit Curb Opening (typical min. value = 0.1)		$C_r-C =$	0.10	0.10
<b>Street Hydraulics: WARNING: Q &gt; ALLOWABLE Q FOR MINOR STORM!</b>				
Total Inlet Interception Capacity		Q =	3.6	9.2
Total Inlet Carry-Over Flow (flow bypassing inlet)		$Q_b =$	0.0	7.3
Capture Percentage = $Q_c/Q_o =$		C% =	100	56
				cfs
				cfs
				%

**ALLOWABLE CAPACITY FOR ONE-HALF OF STREET (Minor & Major Storm)**

(Based on Regulated Criteria for Maximum Allowable Flow Depth and Spread)

Project: **Falcon Meadows at Bent Grass**

Inlet ID: **DP 8 - Existing Sump Inlet (BG Filing No. 2)**

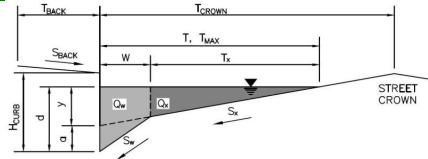

**Gutter Geometry (Enter data in the blue cells)**

Maximum Allowable Width for Spread Behind Curb  
 Side Slope Behind Curb (leave blank for no conveyance credit behind curb)  
 Manning's Roughness Behind Curb (typically between 0.012 and 0.020)

$T_{BACK} = 14.0$  ft  
 $S_{BACK} = 0.020$  ft/ft  
 $n_{BACK} = 0.013$

Height of Curb at Gutter Flow Line  
 Distance from Curb Face to Street Crown  
 Gutter Width  
 Street Transverse Slope  
 Gutter Cross Slope (typically 2 inches over 24 inches or 0.083 ft/ft)  
 Street Longitudinal Slope - Enter 0 for sump condition  
 Manning's Roughness for Street Section (typically between 0.012 and 0.020)

$H_{CURB} = 6.00$  inches  
 $T_{CROWN} = 26.0$  ft  
 $W = 2.00$  ft  
 $S_X = 0.020$  ft/ft  
 $S_W = 0.083$  ft/ft  
 $S_0 = 0.000$  ft/ft  
 $n_{STREET} = 0.016$

Max. Allowable Spread for Minor & Major Storm  
 Max. Allowable Depth at Gutter Flowline for Minor & Major Storm  
 Check boxes are not applicable in SUMP conditions

	Minor Storm	Major Storm	
$T_{MAX} =$	18.0	26.0	ft
$d_{MAX} =$	6.0	12.0	inches
	<input type="checkbox"/>	<input type="checkbox"/>	

**MINOR STORM Allowable Capacity is based on Depth Criterion**  
**MAJOR STORM Allowable Capacity is based on Depth Criterion**

$Q_{allow} =$ 

Minor Storm	Major Storm	
SUMP	SUMP	cfs

## INLET IN A SUMP OR SAG LOCATION

Version 4.06 Released August 2018

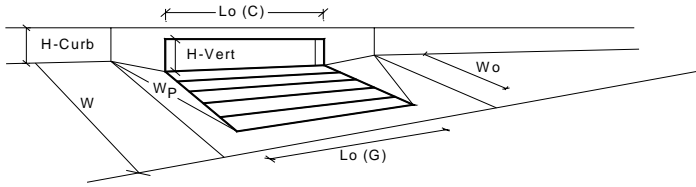

Design Information (Input)	MINOR	MAJOR	
Type of Inlet	CDOT Type R Curb Opening		
Local Depression (additional to continuous gutter depression 'a' from above)	3.00	3.00	inches
Number of Unit Inlets (Grate or Curb Opening)	2	2	
Water Depth at Flowline (outside of local depression)	6.0	12.0	inches
<b>Grate Information</b>	MINOR	MAJOR	<input checked="" type="checkbox"/> Override Depths
Length of a Unit Grate	N/A	N/A	feet
Width of a Unit Grate	N/A	N/A	feet
Area Opening Ratio for a Grate (typical values 0.15-0.90)	N/A	N/A	
Clogging Factor for a Single Grate (typical value 0.50 - 0.70)	N/A	N/A	
Grate Weir Coefficient (typical value 2.15 - 3.60)	N/A	N/A	
Grate Orifice Coefficient (typical value 0.60 - 0.80)	N/A	N/A	
<b>Curb Opening Information</b>	MINOR	MAJOR	
Length of a Unit Curb Opening	10.00	10.00	feet
Height of Vertical Curb Opening in Inches	6.00	6.00	inches
Height of Curb Orifice Throat in Inches	6.00	6.00	inches
Angle of Throat (see USDCM Figure ST-5)	63.40	63.40	degrees
Side Width for Depression Pan (typically the gutter width of 2 feet)	2.00	2.00	feet
Clogging Factor for a Single Curb Opening (typical value 0.10)	0.10	0.10	
Curb Opening Weir Coefficient (typical value 2.3-3.7)	3.60	3.60	
Curb Opening Orifice Coefficient (typical value 0.60 - 0.70)	0.67	0.67	
<b>Low Head Performance Reduction (Calculated)</b>	MINOR	MAJOR	
Depth for Grate Midwidth	N/A	N/A	ft
Depth for Curb Opening Weir Equation	0.33	0.83	ft
Combination Inlet Performance Reduction Factor for Long Inlets	0.57	1.00	
Curb Opening Performance Reduction Factor for Long Inlets	0.79	1.00	
Grated Inlet Performance Reduction Factor for Long Inlets	N/A	N/A	
<b>Total Inlet Interception Capacity (assumes clogged condition)</b>	MINOR	MAJOR	
$Q_a$	14.4	52.7	cfs
$Q_{PEAK REQUIRED}$	16.5	56.3	cfs

WARNING: Inlet Capacity less than Q Peak for Minor and Major Storms

**AREA INLET IN A SWALE**

Falcon Meadows at Bent Grass  
DP 11 - Type D Area Inlet (Relocated)

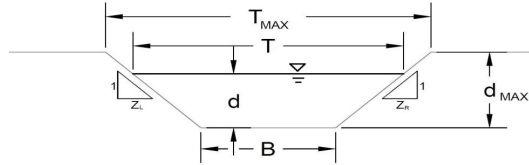

This worksheet uses the NRCS vegetative retardance method to determine Manning's n.  
For more information see Section 7.2.3 of the USDCM.

Analysis of Trapezoidal Grass-Lined Channel Using SCS Method																									
NRCS Vegetal Retardance (A, B, C, D, or E) Manning's n (Leave cell D16 blank to manually enter an n value) Channel Invert Slope Bottom Width Left Side Slope Right Side Slope Check one of the following soil types:	A, B, C, D or E n = 0.030 S <sub>0</sub> = 0.0050 ft/ft B = 3.00 ft Z <sub>1</sub> = 4.00 ft/ft Z <sub>2</sub> = 4.00 ft/ft Choose One: <input type="radio"/> Non-Cohesive <input type="radio"/> Cohesive <input type="radio"/> Paved																								
<table border="1" style="width: 100%; border-collapse: collapse;"> <thead> <tr> <th style="text-align: left;">Soil Type:</th> <th style="text-align: left;">Max. Velocity (V<sub>MAX</sub>)</th> <th style="text-align: left;">Max Froude No. (F<sub>MAX</sub>)</th> </tr> </thead> <tbody> <tr> <td>Non-Cohesive</td> <td>5.0 fps</td> <td>0.60</td> </tr> <tr> <td>Cohesive</td> <td>7.0 fps</td> <td>0.80</td> </tr> <tr> <td>Paved</td> <td>N/A</td> <td>N/A</td> </tr> </tbody> </table>	Soil Type:	Max. Velocity (V <sub>MAX</sub> )	Max Froude No. (F <sub>MAX</sub> )	Non-Cohesive	5.0 fps	0.60	Cohesive	7.0 fps	0.80	Paved	N/A	N/A	<table border="1" style="width: 100%; border-collapse: collapse;"> <thead> <tr> <th></th> <th style="text-align: center;">Minor Storm</th> <th style="text-align: center;">Major Storm</th> <th></th> </tr> </thead> <tbody> <tr> <td>Max. Allowable Top Width of Channel for Minor &amp; Major Storm</td> <td style="text-align: center;">11.00</td> <td style="text-align: center;">18.00</td> <td style="text-align: right;">feet</td> </tr> <tr> <td>Max. Allowable Water Depth in Channel for Minor &amp; Major Storm</td> <td style="text-align: center;">1.00</td> <td style="text-align: center;">2.00</td> <td style="text-align: right;">feet</td> </tr> </tbody> </table>		Minor Storm	Major Storm		Max. Allowable Top Width of Channel for Minor & Major Storm	11.00	18.00	feet	Max. Allowable Water Depth in Channel for Minor & Major Storm	1.00	2.00	feet
Soil Type:	Max. Velocity (V <sub>MAX</sub> )	Max Froude No. (F <sub>MAX</sub> )																							
Non-Cohesive	5.0 fps	0.60																							
Cohesive	7.0 fps	0.80																							
Paved	N/A	N/A																							
	Minor Storm	Major Storm																							
Max. Allowable Top Width of Channel for Minor & Major Storm	11.00	18.00	feet																						
Max. Allowable Water Depth in Channel for Minor & Major Storm	1.00	2.00	feet																						
<b>Allowable Channel Capacity Based On Channel Geometry</b> MINOR STORM Allowable Capacity is based on Depth Criterion MAJOR STORM Allowable Capacity is based on Top Width Criterion																									
<b>Water Depth in Channel Based On Design Peak Flow</b> Design Peak Flow Water Depth	<table border="1" style="width: 100%; border-collapse: collapse;"> <thead> <tr> <th></th> <th style="text-align: center;">Minor Storm</th> <th style="text-align: center;">Major Storm</th> <th></th> </tr> </thead> <tbody> <tr> <td>Q<sub>allow</sub></td> <td style="text-align: center;">17.9</td> <td style="text-align: center;">72.2</td> <td style="text-align: right;">cfs</td> </tr> <tr> <td>d<sub>allow</sub></td> <td style="text-align: center;">1.00</td> <td style="text-align: center;">1.88</td> <td style="text-align: right;">ft</td> </tr> </tbody> </table> <table border="1" style="width: 100%; border-collapse: collapse;"> <tbody> <tr> <td>Q<sub>c</sub></td> <td style="text-align: center;">13.8</td> <td style="text-align: center;">64.5</td> <td style="text-align: right;">cfs</td> </tr> <tr> <td>d</td> <td style="text-align: center;">0.88</td> <td style="text-align: center;">1.79</td> <td style="text-align: right;">feet</td> </tr> </tbody> </table>			Minor Storm	Major Storm		Q <sub>allow</sub>	17.9	72.2	cfs	d <sub>allow</sub>	1.00	1.88	ft	Q <sub>c</sub>	13.8	64.5	cfs	d	0.88	1.79	feet			
	Minor Storm	Major Storm																							
Q <sub>allow</sub>	17.9	72.2	cfs																						
d <sub>allow</sub>	1.00	1.88	ft																						
Q <sub>c</sub>	13.8	64.5	cfs																						
d	0.88	1.79	feet																						
Minor storm max. allowable capacity GOOD - greater than the design flow given on sheet 'Inlet Management' Major storm max. allowable capacity GOOD - greater than the design flow given on sheet 'Inlet Management'																									

## AREA INLET IN A SWALE

Falcon Meadows at Bent Grass  
DP 11 - Type D Area Inlet (Relocated)

Inlet Design Information (Input)																					
Type of Inlet	<input type="text" value="CDOT TYPE D (Parallel &amp; Depressed)"/> <span style="float: right;">Inlet Type = <input type="text" value="CDOT TYPE D (Parallel &amp; Depressed)"/></span>																				
Angle of Inclined Grate (must be <= 30 degrees)	$\theta =$ <input type="text" value="25.00"/> degrees																				
Width of Grate	$W =$ <input type="text" value="6.00"/> feet																				
Length of Grate	$L =$ <input type="text" value="3.00"/> feet																				
Open Area Ratio	$A_{RATIO} =$ <input type="text" value="0.70"/>																				
Height of Inclined Grate	$H_B =$ <input type="text" value="1.27"/> feet																				
Clogging Factor	$C_f =$ <input type="text" value="0.38"/>																				
Grate Discharge Coefficient	$C_d =$ <input type="text" value="0.63"/>																				
Orifice Coefficient	$C_o =$ <input type="text" value="0.42"/>																				
Weir Coefficient	$C_w =$ <input type="text" value="1.34"/>																				
Water Depth at Inlet (for depressed inlets, 1 foot is added for depression)	<table border="1" style="margin-left: auto; margin-right: auto;"> <thead> <tr> <th></th> <th style="text-align: center;">MINOR</th> <th style="text-align: center;">MAJOR</th> <th></th> </tr> </thead> <tbody> <tr> <td><math>d =</math></td> <td style="text-align: center;">1.88</td> <td style="text-align: center;">2.79</td> <td></td> </tr> <tr> <td><math>Q_a =</math></td> <td style="text-align: center;">44.1</td> <td style="text-align: center;">57.2</td> <td style="text-align: right;">cfs</td> </tr> <tr> <td>Bypassed Flow, <math>Q_b =</math></td> <td style="text-align: center;">0.0</td> <td style="text-align: center;">7.3</td> <td style="text-align: right;">cfs</td> </tr> <tr> <td>Capture Percentage = <math>Q_a/Q_o = C\%</math></td> <td style="text-align: center;">100</td> <td style="text-align: center;">89</td> <td style="text-align: right;">%</td> </tr> </tbody> </table>		MINOR	MAJOR		$d =$	1.88	2.79		$Q_a =$	44.1	57.2	cfs	Bypassed Flow, $Q_b =$	0.0	7.3	cfs	Capture Percentage = $Q_a/Q_o = C\%$	100	89	%
	MINOR	MAJOR																			
$d =$	1.88	2.79																			
$Q_a =$	44.1	57.2	cfs																		
Bypassed Flow, $Q_b =$	0.0	7.3	cfs																		
Capture Percentage = $Q_a/Q_o = C\%$	100	89	%																		
<b>Total Inlet Interception Capacity (assumes clogged condition)</b>																					

Warning 04: Froude No. exceeds USDCM Volume I recommendation.

**ALLOWABLE CAPACITY FOR ONE-HALF OF STREET (Minor & Major Storm)**

(Based on Regulated Criteria for Maximum Allowable Flow Depth and Spread)

Project: **Falcon Meadows at Bent Grass**  
 Inlet ID: **DP 12 - At Grade Inlet**

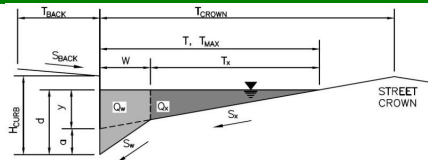

**Gutter Geometry (Enter data in the blue cells)**

Maximum Allowable Width for Spread Behind Curb  
 Side Slope Behind Curb (leave blank for no conveyance credit behind curb)  
 Manning's Roughness Behind Curb (typically between 0.012 and 0.020)

$T_{BACK} = 8.0$  ft  
 $S_{BACK} = 0.020$  ft/ft  
 $n_{BACK} = 0.016$

Height of Curb at Gutter Flow Line  
 Distance from Curb Face to Street Crown  
 Gutter Width  
 Street Transverse Slope  
 Gutter Cross Slope (typically 2 inches over 24 inches or 0.083 ft/ft)  
 Street Longitudinal Slope - Enter 0 for sump condition  
 Manning's Roughness for Street Section (typically between 0.012 and 0.020)

$H_{CURB} = 6.00$  inches  
 $T_{CROWN} = 16.5$  ft  
 $W = 2.00$  ft  
 $S_x = 0.020$  ft/ft  
 $S_w = 0.083$  ft/ft  
 $S_o = 0.013$  ft/ft  
 $n_{STREET} = 0.013$

Max. Allowable Spread for Minor & Major Storm  
 Max. Allowable Depth at Gutter Flowline for Minor & Major Storm  
 Allow Flow Depth at Street Crown (leave blank for no)

	Minor Storm	Major Storm	
$T_{MAX} =$	7.0	16.5	ft
$d_{MAX} =$	6.0	12.0	inches
	<input type="checkbox"/>	<input type="checkbox"/>	check = yes

**MINOR STORM Allowable Capacity is based on Spread Criterion**  
**MAJOR STORM Allowable Capacity is based on Spread Criterion**

$Q_{allow} =$ 

Minor Storm	Major Storm	
2.1	14.2	cfs

**WARNING: MINOR STORM max. allowable capacity is less than the design flow given on sheet 'Inlet Management'**  
**Major storm max. allowable capacity GOOD - greater than the design flow given on sheet 'Inlet Management'**

## INLET ON A CONTINUOUS GRADE

Version 4.06 Released August 2018

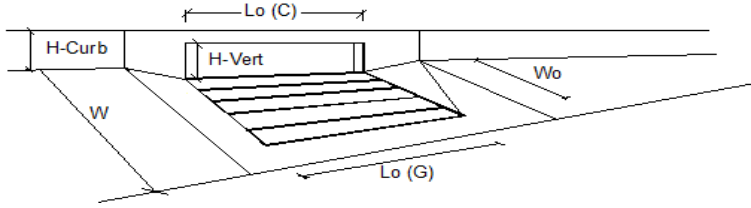

Design Information (Input)	CDOT Type R Curb Opening	MINOR	MAJOR	
Type of Inlet	CDOT Type R Curb Opening	Type =	CDOT Type R Curb Opening	
Local Depression (additional to continuous gutter depression 'a')		$a_{LOCAL}$ =	3.0	3.0
Total Number of Units in the Inlet (Grate or Curb Opening)		No =	1	1
Length of a Single Unit Inlet (Grate or Curb Opening)		$L_o$ =	15.00	15.00
Width of a Unit Grate (cannot be greater than W, Gutter Width)		$W_o$ =	N/A	N/A
Clogging Factor for a Single Unit Grate (typical min. value = 0.5)		$C_r-G$ =	N/A	N/A
Clogging Factor for a Single Unit Curb Opening (typical min. value = 0.1)		$C_r-C$ =	0.10	0.10
<b>Street Hydraulics: WARNING: Q &gt; ALLOWABLE Q FOR MINOR STORM!</b>				
Total Inlet Interception Capacity		Q =	2.8	6.5
Total Inlet Carry-Over Flow (flow bypassing inlet)		$Q_b$ =	0.0	0.0
Capture Percentage = $Q_c/Q_o$ =		C% =	100	99
				cfs
				cfs
				%

**ALLOWABLE CAPACITY FOR ONE-HALF OF STREET (Minor & Major Storm)**

(Based on Regulated Criteria for Maximum Allowable Flow Depth and Spread)

Project: **Falcon Meadows at Bent Grass**  
 Inlet ID: **DP 14 - At Grade Inlet**

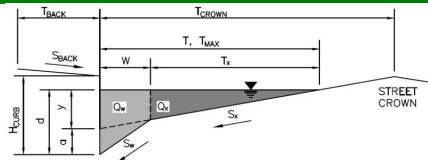

Gutter Geometry (Enter data in the blue cells)													
Maximum Allowable Width for Spread Behind Curb	$T_{BACK} = 8.0$ ft												
Side Slope Behind Curb (leave blank for no conveyance credit behind curb)	$S_{BACK} = 0.020$ ft/ft												
Manning's Roughness Behind Curb (typically between 0.012 and 0.020)	$n_{BACK} = 0.013$												
Height of Curb at Gutter Flow Line	$H_{CURB} = 6.00$ inches												
Distance from Curb Face to Street Crown	$T_{CROWN} = 16.5$ ft												
Gutter Width	$W = 2.00$ ft												
Street Transverse Slope	$S_x = 0.020$ ft/ft												
Gutter Cross Slope (typically 2 inches over 24 inches or 0.083 ft/ft)	$S_w = 0.083$ ft/ft												
Street Longitudinal Slope - Enter 0 for sump condition	$S_o = 0.013$ ft/ft												
Manning's Roughness for Street Section (typically between 0.012 and 0.020)	$n_{STREET} = 0.016$												
Max. Allowable Spread for Minor & Major Storm	<table border="1"> <thead> <tr> <th></th> <th>Minor Storm</th> <th>Major Storm</th> <th></th> </tr> </thead> <tbody> <tr> <td><math>T_{MAX} =</math></td> <td>7.0</td> <td>16.5</td> <td>ft</td> </tr> <tr> <td><math>d_{MAX} =</math></td> <td>6.0</td> <td>12.0</td> <td>inches</td> </tr> </tbody> </table>		Minor Storm	Major Storm		$T_{MAX} =$	7.0	16.5	ft	$d_{MAX} =$	6.0	12.0	inches
	Minor Storm	Major Storm											
$T_{MAX} =$	7.0	16.5	ft										
$d_{MAX} =$	6.0	12.0	inches										
Max. Allowable Depth at Gutter Flowline for Minor & Major Storm													
Allow Flow Depth at Street Crown (leave blank for no)	<input type="checkbox"/> <input type="checkbox"/> check = yes												
<b>MINOR STORM Allowable Capacity is based on Spread Criterion</b>													
<b>MAJOR STORM Allowable Capacity is based on Spread Criterion</b>													
<b>WARNING: MINOR STORM max. allowable capacity is less than the design flow given on sheet 'Inlet Management'</b>													
<b>WARNING: MAJOR STORM max. allowable capacity is less than the design flow given on sheet 'Inlet Management'</b>													
	<table border="1"> <thead> <tr> <th></th> <th>Minor Storm</th> <th>Major Storm</th> <th></th> </tr> </thead> <tbody> <tr> <td><math>Q_{allow} =</math></td> <td>1.7</td> <td>11.5</td> <td>cfs</td> </tr> </tbody> </table>		Minor Storm	Major Storm		$Q_{allow} =$	1.7	11.5	cfs				
	Minor Storm	Major Storm											
$Q_{allow} =$	1.7	11.5	cfs										



## INLET ON A CONTINUOUS GRADE

Version 4.06 Released August 2018

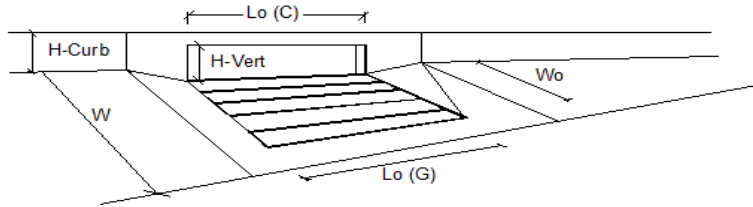

Design Information (Input)	CDOT Type R Curb Opening	MINOR	MAJOR	
Type of Inlet	CDOT Type R Curb Opening	Type =	CDOT Type R Curb Opening	
Local Depression (additional to continuous gutter depression 'a')		$a_{LOCAL} =$	3.0	3.0
Total Number of Units in the Inlet (Grate or Curb Opening)		No =	1	1
Length of a Single Unit Inlet (Grate or Curb Opening)		$L_o =$	15.00	15.00
Width of a Unit Grate (cannot be greater than W, Gutter Width)		$W_o =$	N/A	N/A
Clogging Factor for a Single Unit Grate (typical min. value = 0.5)		$C_r-G =$	N/A	N/A
Clogging Factor for a Single Unit Curb Opening (typical min. value = 0.1)		$C_r-C =$	0.10	0.10
<b>Street Hydraulics: WARNING: Q &gt; ALLOWABLE Q FOR MINOR &amp; MAJOR STORM</b>				
Total Inlet Interception Capacity		Q =	11.5	16.8
Total Inlet Carry-Over Flow (flow bypassing inlet)		$Q_b =$	2.7	13.1
Capture Percentage = $Q_c/Q_o =$		C% =	81	56
				cfs
				cfs
				%

**ALLOWABLE CAPACITY FOR ONE-HALF OF STREET (Minor & Major Storm)**

(Based on Regulated Criteria for Maximum Allowable Flow Depth and Spread)

Project: **Falcon Meadows at Bent Grass**  
 Inlet ID: **DP 15 - At Grade Inlet**

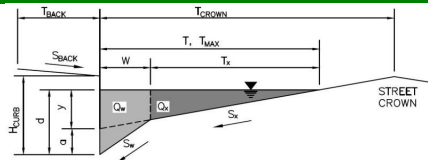

Gutter Geometry (Enter data in the blue cells)					
Maximum Allowable Width for Spread Behind Curb	$T_{BACK} = 8.0$ ft				
Side Slope Behind Curb (leave blank for no conveyance credit behind curb)	$S_{BACK} = 0.020$ ft/ft				
Manning's Roughness Behind Curb (typically between 0.012 and 0.020)	$n_{BACK} = 0.016$				
Height of Curb at Gutter Flow Line	$H_{CURB} = 6.00$ inches				
Distance from Curb Face to Street Crown	$T_{CROWN} = 16.5$ ft				
Gutter Width	$W = 2.00$ ft				
Street Transverse Slope	$S_X = 0.020$ ft/ft				
Gutter Cross Slope (typically 2 inches over 24 inches or 0.083 ft/ft)	$S_W = 0.083$ ft/ft				
Street Longitudinal Slope - Enter 0 for sump condition	$S_O = 0.013$ ft/ft				
Manning's Roughness for Street Section (typically between 0.012 and 0.020)	$n_{STREET} = 0.013$				
Max. Allowable Spread for Minor & Major Storm	<table border="1"> <thead> <tr> <th>Minor Storm</th> <th>Major Storm</th> </tr> </thead> <tbody> <tr> <td><math>T_{MAX} = 7.0</math></td> <td><math>T_{MAX} = 16.5</math></td> </tr> </tbody> </table> ft	Minor Storm	Major Storm	$T_{MAX} = 7.0$	$T_{MAX} = 16.5$
Minor Storm	Major Storm				
$T_{MAX} = 7.0$	$T_{MAX} = 16.5$				
Max. Allowable Depth at Gutter Flowline for Minor & Major Storm	<table border="1"> <thead> <tr> <th>Minor Storm</th> <th>Major Storm</th> </tr> </thead> <tbody> <tr> <td><math>d_{MAX} = 6.0</math></td> <td><math>d_{MAX} = 12.0</math></td> </tr> </tbody> </table> inches	Minor Storm	Major Storm	$d_{MAX} = 6.0$	$d_{MAX} = 12.0$
Minor Storm	Major Storm				
$d_{MAX} = 6.0$	$d_{MAX} = 12.0$				
Allow Flow Depth at Street Crown (leave blank for no)	<input type="checkbox"/> <input type="checkbox"/> check = yes				
<b>MINOR STORM Allowable Capacity is based on Spread Criterion</b>					
<b>MAJOR STORM Allowable Capacity is based on Spread Criterion</b>					
	<table border="1"> <thead> <tr> <th>Minor Storm</th> <th>Major Storm</th> </tr> </thead> <tbody> <tr> <td><math>Q_{allow} = 2.1</math></td> <td><math>Q_{allow} = 14.2</math></td> </tr> </tbody> </table> cfs	Minor Storm	Major Storm	$Q_{allow} = 2.1$	$Q_{allow} = 14.2$
Minor Storm	Major Storm				
$Q_{allow} = 2.1$	$Q_{allow} = 14.2$				
<p><b>WARNING: MINOR STORM max. allowable capacity is less than the design flow given on sheet 'Inlet Management'</b></p> <p><b>WARNING: MAJOR STORM max. allowable capacity is less than the design flow given on sheet 'Inlet Management'</b></p>					

## INLET ON A CONTINUOUS GRADE

Version 4.06 Released August 2018

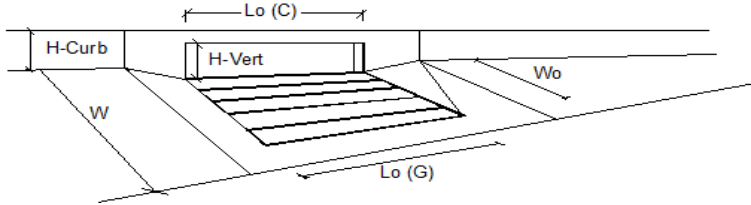

Design Information (Input)	MINOR	MAJOR	
Type of Inlet	CDOT Type R Curb Opening		
Local Depression (additional to continuous gutter depression 'a')	3.0	3.0	inches
Total Number of Units in the Inlet (Grate or Curb Opening)	1	1	
Length of a Single Unit Inlet (Grate or Curb Opening)	15.00	15.00	ft
Width of a Unit Grate (cannot be greater than W, Gutter Width)	N/A	N/A	ft
Clogging Factor for a Single Unit Grate (typical min. value = 0.5)	N/A	N/A	
Clogging Factor for a Single Unit Curb Opening (typical min. value = 0.1)	0.10	0.10	
<b>Street Hydraulics: WARNING: Q &gt; ALLOWABLE Q FOR MINOR &amp; MAJOR STORM</b>			
Total Inlet Interception Capacity	13.2	19.0	cfs
Total Inlet Carry-Over Flow (flow bypassing inlet)	6.9	24.7	cfs
Capture Percentage = $Q_i/Q_o$ =	66	43	%

**ALLOWABLE CAPACITY FOR ONE-HALF OF STREET (Minor & Major Storm)**

(Based on Regulated Criteria for Maximum Allowable Flow Depth and Spread)

Project: **Falcon Meadows at Bent Grass**  
 Inlet ID: **DP 16 - At Grade Inlet**

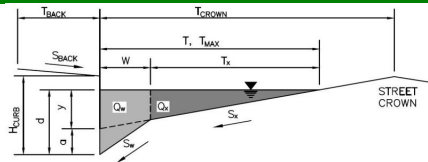

**Gutter Geometry (Enter data in the blue cells)**

Maximum Allowable Width for Spread Behind Curb  
 Side Slope Behind Curb (leave blank for no conveyance credit behind curb)  
 Manning's Roughness Behind Curb (typically between 0.012 and 0.020)

$T_{BACK} = 8.0$  ft  
 $S_{BACK} = 0.020$  ft/ft  
 $n_{BACK} = 0.013$

Height of Curb at Gutter Flow Line  
 Distance from Curb Face to Street Crown  
 Gutter Width  
 Street Transverse Slope  
 Gutter Cross Slope (typically 2 inches over 24 inches or 0.083 ft/ft)  
 Street Longitudinal Slope - Enter 0 for sump condition  
 Manning's Roughness for Street Section (typically between 0.012 and 0.020)

$H_{CURB} = 6.00$  inches  
 $T_{CROWN} = 16.5$  ft  
 $W = 2.00$  ft  
 $S_x = 0.020$  ft/ft  
 $S_w = 0.083$  ft/ft  
 $S_o = 0.013$  ft/ft  
 $n_{STREET} = 0.016$

Max. Allowable Spread for Minor & Major Storm  
 Max. Allowable Depth at Gutter Flowline for Minor & Major Storm  
 Allow Flow Depth at Street Crown (leave blank for no)

	Minor Storm	Major Storm	
$T_{MAX} =$	7.0	16.5	ft
$d_{MAX} =$	6.0	12.0	inches
	<input type="checkbox"/>	<input type="checkbox"/>	check = yes

**MINOR STORM** Allowable Capacity is based on Spread Criterion  
**MAJOR STORM** Allowable Capacity is based on Spread Criterion

	Minor Storm	Major Storm	
$Q_{allow} =$	1.7	11.5	cfs

**WARNING: MINOR STORM max. allowable capacity is less than the design flow given on sheet 'Inlet Management'**  
**WARNING: MAJOR STORM max. allowable capacity is less than the design flow given on sheet 'Inlet Management'**

## INLET ON A CONTINUOUS GRADE

Version 4.06 Released August 2018

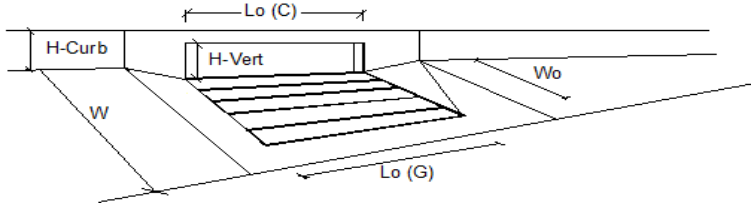

Design Information (Input)	MINOR	MAJOR	
Type of Inlet	CDOT Type R Curb Opening		
Local Depression (additional to continuous gutter depression 'a')	3.0	3.0	inches
Total Number of Units in the Inlet (Grate or Curb Opening)	1	1	
Length of a Single Unit Inlet (Grate or Curb Opening)	10.00	10.00	ft
Width of a Unit Grate (cannot be greater than W, Gutter Width)	N/A	N/A	ft
Clogging Factor for a Single Unit Grate (typical min. value = 0.5)	N/A	N/A	
Clogging Factor for a Single Unit Curb Opening (typical min. value = 0.1)	0.10	0.10	
<b>Street Hydraulics: WARNING: Q &gt; ALLOWABLE Q FOR MINOR &amp; MAJOR STORM</b>			
Total Inlet Interception Capacity	6.8	10.6	cfs
Total Inlet Carry-Over Flow (flow bypassing inlet)	2.6	12.7	cfs
Capture Percentage = $Q_i/Q_o$ =	73	45	%

**ALLOWABLE CAPACITY FOR ONE-HALF OF STREET (Minor & Major Storm)**

(Based on Regulated Criteria for Maximum Allowable Flow Depth and Spread)

Project: **Falcon Meadows at Bent Grass**  
 Inlet ID: **DP 17 - Sump Inlet**

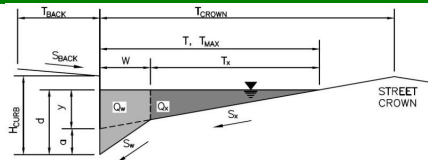

**Gutter Geometry (Enter data in the blue cells)**

Maximum Allowable Width for Spread Behind Curb  
 Side Slope Behind Curb (leave blank for no conveyance credit behind curb)  
 Manning's Roughness Behind Curb (typically between 0.012 and 0.020)

$T_{BACK} = 8.0$  ft  
 $S_{BACK} = 0.020$  ft/ft  
 $n_{BACK} = 0.013$

Height of Curb at Gutter Flow Line  
 Distance from Curb Face to Street Crown  
 Gutter Width  
 Street Transverse Slope  
 Gutter Cross Slope (typically 2 inches over 24 inches or 0.083 ft/ft)  
 Street Longitudinal Slope - Enter 0 for sump condition  
 Manning's Roughness for Street Section (typically between 0.012 and 0.020)

$H_{CURB} = 6.00$  inches  
 $T_{CROWN} = 16.5$  ft  
 $W = 2.00$  ft  
 $S_X = 0.020$  ft/ft  
 $S_W = 0.083$  ft/ft  
 $S_0 = 0.000$  ft/ft  
 $n_{STREET} = 0.016$

Max. Allowable Spread for Minor & Major Storm  
 Max. Allowable Depth at Gutter Flowline for Minor & Major Storm  
 Check boxes are not applicable in SUMP conditions

	Minor Storm	Major Storm	
$T_{MAX} =$	7.0	16.5	ft
$d_{MAX} =$	6.0	12.0	inches
	<input type="checkbox"/>	<input type="checkbox"/>	

**MINOR STORM Allowable Capacity is based on Depth Criterion**  
**MAJOR STORM Allowable Capacity is based on Depth Criterion**

	Minor Storm	Major Storm	
$Q_{allow} =$	SUMP	SUMP	cfs

## INLET IN A SUMP OR SAG LOCATION

Version 4.06 Released August 2018

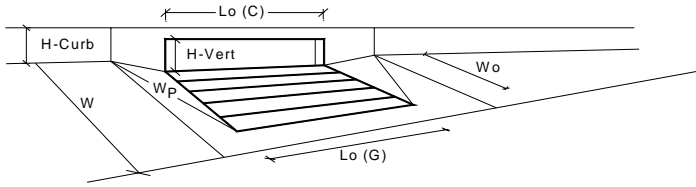

Design Information (Input)	MINOR	MAJOR	
Type of Inlet	CDOT Type R Curb Opening		
Local Depression (additional to continuous gutter depression 'a' from above)	3.00	3.00	inches
Number of Unit Inlets (Grate or Curb Opening)	1	1	
Water Depth at Flowline (outside of local depression)	5.6	12.0	inches
<b>Grate Information</b>	MINOR	MAJOR	<input checked="" type="checkbox"/> Override Depths
Length of a Unit Grate	N/A	N/A	feet
Width of a Unit Grate	N/A	N/A	feet
Area Opening Ratio for a Grate (typical values 0.15-0.90)	N/A	N/A	
Clogging Factor for a Single Grate (typical value 0.50 - 0.70)	N/A	N/A	
Grate Weir Coefficient (typical value 2.15 - 3.60)	N/A	N/A	
Grate Orifice Coefficient (typical value 0.60 - 0.80)	N/A	N/A	
<b>Curb Opening Information</b>	MINOR	MAJOR	
Length of a Unit Curb Opening	15.00	15.00	feet
Height of Vertical Curb Opening in Inches	6.00	6.00	inches
Height of Curb Orifice Throat in Inches	6.00	6.00	inches
Angle of Throat (see USDCM Figure ST-5)	63.40	63.40	degrees
Side Width for Depression Pan (typically the gutter width of 2 feet)	2.00	2.00	feet
Clogging Factor for a Single Curb Opening (typical value 0.10)	0.10	0.10	
Curb Opening Weir Coefficient (typical value 2.3-3.7)	3.60	3.60	
Curb Opening Orifice Coefficient (typical value 0.60 - 0.70)	0.67	0.67	
<b>Low Head Performance Reduction (Calculated)</b>	MINOR	MAJOR	
Depth for Grate Midwidth	N/A	N/A	ft
Depth for Curb Opening Weir Equation	0.30	0.83	ft
Combination Inlet Performance Reduction Factor for Long Inlets	0.53	1.00	
Curb Opening Performance Reduction Factor for Long Inlets	0.76	1.00	
Grated Inlet Performance Reduction Factor for Long Inlets	N/A	N/A	
<b>Total Inlet Interception Capacity (assumes clogged condition)</b>	MINOR	MAJOR	
<b>Q<sub>a</sub></b>	<b>8.0</b>	<b>39.1</b>	<b>cfs</b>
Q <sub>PEAK REQUIRED</sub>	7.5	16.5	cfs

Inlet Capacity IS GOOD for Minor and Major Storms(>Q PEAK)

**ALLOWABLE CAPACITY FOR ONE-HALF OF STREET (Minor & Major Storm)**

(Based on Regulated Criteria for Maximum Allowable Flow Depth and Spread)

Project: **Falcon Meadows at Bent Grass**  
 Inlet ID: **DP 18 - Sump Inlet**

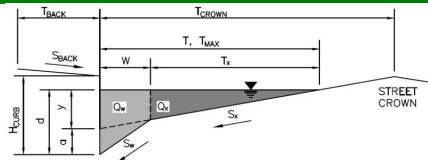

**Gutter Geometry (Enter data in the blue cells)**

Maximum Allowable Width for Spread Behind Curb  
 Side Slope Behind Curb (leave blank for no conveyance credit behind curb)  
 Manning's Roughness Behind Curb (typically between 0.012 and 0.020)

$T_{BACK} = 8.0$  ft  
 $S_{BACK} = 0.020$  ft/ft  
 $n_{BACK} = 0.013$

Height of Curb at Gutter Flow Line  
 Distance from Curb Face to Street Crown  
 Gutter Width  
 Street Transverse Slope  
 Gutter Cross Slope (typically 2 inches over 24 inches or 0.083 ft/ft)  
 Street Longitudinal Slope - Enter 0 for sump condition  
 Manning's Roughness for Street Section (typically between 0.012 and 0.020)

$H_{CURB} = 6.00$  inches  
 $T_{CROWN} = 16.5$  ft  
 $W = 2.00$  ft  
 $S_X = 0.020$  ft/ft  
 $S_W = 0.083$  ft/ft  
 $S_0 = 0.000$  ft/ft  
 $n_{STREET} = 0.016$

Max. Allowable Spread for Minor & Major Storm  
 Max. Allowable Depth at Gutter Flowline for Minor & Major Storm  
 Check boxes are not applicable in SUMP conditions

	Minor Storm	Major Storm	
$T_{MAX} =$	7.0	16.5	ft
$d_{MAX} =$	6.0	6.0	inches
	<input type="checkbox"/>	<input type="checkbox"/>	

**MINOR STORM Allowable Capacity is based on Depth Criterion**  
**MAJOR STORM Allowable Capacity is based on Depth Criterion**

	Minor Storm	Major Storm	
$Q_{allow} =$	SUMP	SUMP	cfs



## INLET IN A SUMP OR SAG LOCATION

Version 4.06 Released August 2018

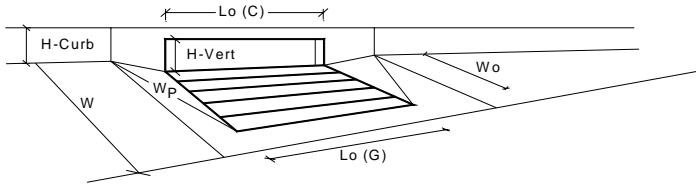

Design Information (Input)	MINOR	MAJOR	
Type of Inlet	CDOT Type R Curb Opening		
Local Depression (additional to continuous gutter depression 'a' from above)	3.00	3.00	inches
Number of Unit Inlets (Grate or Curb Opening)	1	1	
Water Depth at Flowline (outside of local depression)	5.6	12.0	inches
<b>Grate Information</b>	MINOR	MAJOR	<input checked="" type="checkbox"/> Override Depths
Length of a Unit Grate	N/A	N/A	feet
Width of a Unit Grate	N/A	N/A	feet
Area Opening Ratio for a Grate (typical values 0.15-0.90)	N/A	N/A	
Clogging Factor for a Single Grate (typical value 0.50 - 0.70)	N/A	N/A	
Grate Weir Coefficient (typical value 2.15 - 3.60)	N/A	N/A	
Grate Orifice Coefficient (typical value 0.60 - 0.80)	N/A	N/A	
<b>Curb Opening Information</b>	MINOR	MAJOR	
Length of a Unit Curb Opening	15.00	15.00	feet
Height of Vertical Curb Opening in Inches	6.00	6.00	inches
Height of Curb Orifice Throat in Inches	6.00	6.00	inches
Angle of Throat (see USDCM Figure ST-5)	63.40	63.40	degrees
Side Width for Depression Pan (typically the gutter width of 2 feet)	2.00	2.00	feet
Clogging Factor for a Single Curb Opening (typical value 0.10)	0.10	0.10	
Curb Opening Weir Coefficient (typical value 2.3-3.7)	3.60	3.60	
Curb Opening Orifice Coefficient (typical value 0.60 - 0.70)	0.67	0.67	
<b>Low Head Performance Reduction (Calculated)</b>	MINOR	MAJOR	
Depth for Grate Midwidth	N/A	N/A	ft
Depth for Curb Opening Weir Equation	0.30	0.83	ft
Combination Inlet Performance Reduction Factor for Long Inlets	0.53	1.00	
Curb Opening Performance Reduction Factor for Long Inlets	0.76	1.00	
Grated Inlet Performance Reduction Factor for Long Inlets	N/A	N/A	
<b>Total Inlet Interception Capacity (assumes clogged condition)</b>	MINOR	MAJOR	
$Q_a$	8.0	39.1	cfs
$Q_{PEAK REQUIRED}$	10.0	21.8	cfs

WARNING: Inlet Capacity less than Q Peak for Minor Storm

**AREA INLET IN A SWALE**

Falcon Meadows at Bent Grass  
DP 19 - Type C Area Inlet

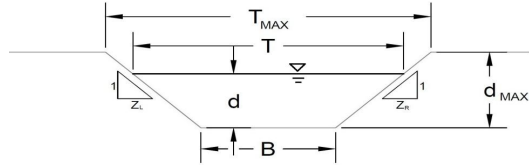

This worksheet uses the NRCS vegetative retardance method to determine Manning's n.  
For more information see Section 7.2.3 of the USDCM.

Analysis of Trapezoidal Grass-Lined Channel Using SCS Method														
NRCS Vegetal Retardance (A, B, C, D, or E)	A, B, C, D or E													
Manning's n (Leave cell D16 blank to manually enter an n value)	n =	0.030												
Channel Invert Slope	S <sub>0</sub> =	0.0260 ft/ft												
Bottom Width	B =	0.00 ft												
Left Side Slope	Z1 =	4.00 ft/ft												
Right Side Slope	Z2 =	4.00 ft/ft												
Check one of the following soil types:	Choose One:													
<table border="1" style="margin: auto;"> <thead> <tr> <th>Soil Type:</th> <th>Max. Velocity (V<sub>MAX</sub>)</th> <th>Max Froude No. (F<sub>MAX</sub>)</th> </tr> </thead> <tbody> <tr> <td>Non-Cohesive</td> <td>5.0 fps</td> <td>0.60</td> </tr> <tr> <td>Cohesive</td> <td>7.0 fps</td> <td>0.80</td> </tr> <tr> <td>Paved</td> <td>N/A</td> <td>N/A</td> </tr> </tbody> </table>	Soil Type:	Max. Velocity (V <sub>MAX</sub> )	Max Froude No. (F <sub>MAX</sub> )	Non-Cohesive	5.0 fps	0.60	Cohesive	7.0 fps	0.80	Paved	N/A	N/A	<input checked="" type="radio"/> Non-Cohesive <input type="radio"/> Cohesive <input type="radio"/> Paved	
Soil Type:	Max. Velocity (V <sub>MAX</sub> )	Max Froude No. (F <sub>MAX</sub> )												
Non-Cohesive	5.0 fps	0.60												
Cohesive	7.0 fps	0.80												
Paved	N/A	N/A												
Max. Allowable Top Width of Channel for Minor & Major Storm	T <sub>MAX</sub> =	<table border="1" style="display: inline-table;"> <tr> <td>Minor Storm</td> <td>16.00</td> <td>Major Storm</td> <td>16.00</td> </tr> </table> feet	Minor Storm	16.00	Major Storm	16.00								
Minor Storm	16.00	Major Storm	16.00											
Max. Allowable Water Depth in Channel for Minor & Major Storm	d <sub>MAX</sub> =	<table border="1" style="display: inline-table;"> <tr> <td>Minor Storm</td> <td>1.00</td> <td>Major Storm</td> <td>1.00</td> </tr> </table> feet	Minor Storm	1.00	Major Storm	1.00								
Minor Storm	1.00	Major Storm	1.00											
<b>Allowable Channel Capacity Based On Channel Geometry</b>														
MINOR STORM Allowable Capacity is based on Depth Criterion	Q <sub>allow</sub> =	<table border="1" style="display: inline-table;"> <tr> <td>Minor Storm</td> <td>19.8</td> <td>Major Storm</td> <td>19.8</td> </tr> </table> cfs	Minor Storm	19.8	Major Storm	19.8								
Minor Storm	19.8	Major Storm	19.8											
MAJOR STORM Allowable Capacity is based on Depth Criterion	d <sub>allow</sub> =	<table border="1" style="display: inline-table;"> <tr> <td>Minor Storm</td> <td>1.00</td> <td>Major Storm</td> <td>1.00</td> </tr> </table> ft	Minor Storm	1.00	Major Storm	1.00								
Minor Storm	1.00	Major Storm	1.00											
<b>Water Depth in Channel Based On Design Peak Flow</b>														
Design Peak Flow	Q <sub>c</sub> =	<table border="1" style="display: inline-table;"> <tr> <td>2.0</td> <td>5.2</td> </tr> </table> cfs	2.0	5.2										
2.0	5.2													
Water Depth	d =	<table border="1" style="display: inline-table;"> <tr> <td>0.42</td> <td>0.61</td> </tr> </table> feet	0.42	0.61										
0.42	0.61													
<p style="color: red; font-weight: bold;">Minor storm max. allowable capacity GOOD - greater than the design flow given on sheet 'Inlet Management'</p> <p style="color: red; font-weight: bold;">Major storm max. allowable capacity GOOD - greater than the design flow given on sheet 'Inlet Management'</p>														

## AREA INLET IN A SWALE

Falcon Meadows at Bent Grass  
DP 19 - Type C Area Inlet

Inlet Design Information (Input)	
Type of Inlet	<div style="border: 1px solid black; padding: 2px; display: inline-block;">CDOT Type C</div> <span style="margin-left: 20px;">Inlet Type = <span style="border: 1px solid black; padding: 2px;">CDOT Type C</span></span>
Angle of Inclined Grate (must be <= 30 degrees)	$\theta = 0.00$ degrees
Width of Grate	$W = 3.00$ feet
Length of Grate	$L = 3.00$ feet
Open Area Ratio	$A_{RATIO} = 0.70$
Height of Inclined Grate	$H_B = 0.00$ feet
Clogging Factor	$C_f = 0.50$
Grate Discharge Coefficient	$C_d = 0.96$
Orifice Coefficient	$C_o = 0.64$
Weir Coefficient	$C_w = 2.05$

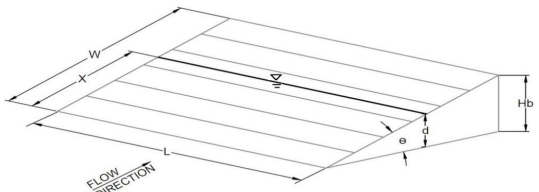

	MINOR	MAJOR	
$d =$	0.42	0.61	
$Q_a =$	5.1	8.7	cfs
Bypassed Flow, $Q_b =$	0.0	0.0	cfs
Capture Percentage = $Q_a/Q_o = C\%$	100	100	%

Warning 04: Froude No. exceeds USDCM Volume I recommendation.

**ALLOWABLE CAPACITY FOR ONE-HALF OF STREET (Minor & Major Storm)**

(Based on Regulated Criteria for Maximum Allowable Flow Depth and Spread)

Project: **Falcon Meadows at Bent Grass**

Inlet ID: **DP 24 - Existing At Grade Inlet (BG Filing No. 2)**

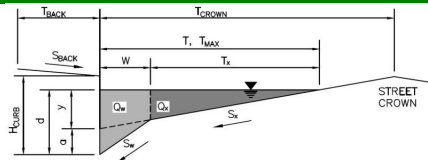

**Gutter Geometry (Enter data in the blue cells)**

Maximum Allowable Width for Spread Behind Curb  
 Side Slope Behind Curb (leave blank for no conveyance credit behind curb)  
 Manning's Roughness Behind Curb (typically between 0.012 and 0.020)

$T_{BACK} = 14.0$  ft  
 $S_{BACK} = 0.020$  ft/ft  
 $n_{BACK} = 0.013$

Height of Curb at Gutter Flow Line  
 Distance from Curb Face to Street Crown  
 Gutter Width  
 Street Transverse Slope  
 Gutter Cross Slope (typically 2 inches over 24 inches or 0.083 ft/ft)  
 Street Longitudinal Slope - Enter 0 for sump condition  
 Manning's Roughness for Street Section (typically between 0.012 and 0.020)

$H_{CURB} = 6.00$  inches  
 $T_{CROWN} = 26.0$  ft  
 $W = 2.00$  ft  
 $S_X = 0.020$  ft/ft  
 $S_W = 0.083$  ft/ft  
 $S_0 = 0.028$  ft/ft  
 $n_{STREET} = 0.016$

Max. Allowable Spread for Minor & Major Storm  
 Max. Allowable Depth at Gutter Flowline for Minor & Major Storm  
 Allow Flow Depth at Street Crown (leave blank for no)

	Minor Storm	Major Storm	
$T_{MAX} =$	18.0	26.0	ft
$d_{MAX} =$	6.0	12.0	inches
	<input type="checkbox"/>	<input type="checkbox"/>	check = yes

**MINOR STORM** Allowable Capacity is based on Depth Criterion  
**MAJOR STORM** Allowable Capacity is based on Spread Criterion

	Minor Storm	Major Storm	
$Q_{allow} =$	18.1	55.5	cfs

**Minor storm max. allowable capacity GOOD - greater than the design flow given on sheet 'Inlet Management'**  
**Major storm max. allowable capacity GOOD - greater than the design flow given on sheet 'Inlet Management'**

## INLET ON A CONTINUOUS GRADE

Version 4.06 Released August 2018

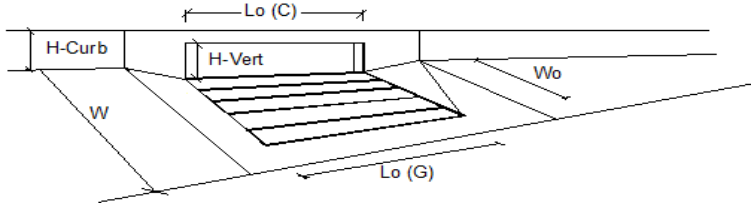

Design Information (Input)	MINOR		MAJOR	
Type of Inlet	CDOT Type R Curb Opening			
Local Depression (additional to continuous gutter depression 'a')	3.0	3.0	inches	
Total Number of Units in the Inlet (Grate or Curb Opening)	1	1		
Length of a Single Unit Inlet (Grate or Curb Opening)	25.00	25.00	ft	
Width of a Unit Grate (cannot be greater than W, Gutter Width)	N/A	N/A	ft	
Clogging Factor for a Single Unit Grate (typical min. value = 0.5)	N/A	N/A		
Clogging Factor for a Single Unit Curb Opening (typical min. value = 0.1)	0.10	0.10		
<b>Street Hydraulics: OK - Q &lt; Allowable Street Capacity.</b>				
Total Inlet Interception Capacity	7.5	25.3	cfs	
Total Inlet Carry-Over Flow (flow bypassing inlet)	0.0	5.5	cfs	
Capture Percentage = $Q_s/Q_o$ =	100	82	%	

**ALLOWABLE CAPACITY FOR ONE-HALF OF STREET (Minor & Major Storm)**

(Based on Regulated Criteria for Maximum Allowable Flow Depth and Spread)

Project:  
Inlet ID:

**Falcon Meadows at Bent Grass**  
**DP 25 - Existing At Grade Inlet (BG Filing No. 2)**

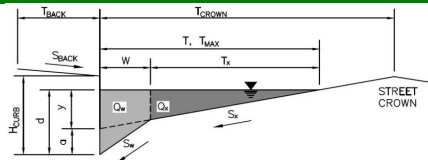

**Gutter Geometry (Enter data in the blue cells)**

Maximum Allowable Width for Spread Behind Curb  
Side Slope Behind Curb (leave blank for no conveyance credit behind curb)  
Manning's Roughness Behind Curb (typically between 0.012 and 0.020)

$T_{BACK} = 14.0$  ft  
 $S_{BACK} = 0.020$  ft/ft  
 $n_{BACK} = 0.013$

Height of Curb at Gutter Flow Line  
Distance from Curb Face to Street Crown  
Gutter Width  
Street Transverse Slope  
Gutter Cross Slope (typically 2 inches over 24 inches or 0.083 ft/ft)  
Street Longitudinal Slope - Enter 0 for sump condition  
Manning's Roughness for Street Section (typically between 0.012 and 0.020)

$H_{CURB} = 6.00$  inches  
 $T_{CROWN} = 26.0$  ft  
 $W = 2.00$  ft  
 $S_X = 0.020$  ft/ft  
 $S_W = 0.083$  ft/ft  
 $S_0 = 0.028$  ft/ft  
 $n_{STREET} = 0.013$

Max. Allowable Spread for Minor & Major Storm  
Max. Allowable Depth at Gutter Flowline for Minor & Major Storm  
Allow Flow Depth at Street Crown (leave blank for no)

	Minor Storm	Major Storm	
$T_{MAX} =$	18.0	26.0	ft
$d_{MAX} =$	6.0	12.0	inches
	<input type="checkbox"/>	<input type="checkbox"/>	check = yes

**MINOR STORM** Allowable Capacity is based on Depth Criterion  
**MAJOR STORM** Allowable Capacity is based on Spread Criterion

	Minor Storm	Major Storm	
$Q_{allow} =$	22.2	68.2	cfs

**Minor storm max. allowable capacity GOOD - greater than the design flow given on sheet 'Inlet Management'**  
**Major storm max. allowable capacity GOOD - greater than the design flow given on sheet 'Inlet Management'**

## INLET ON A CONTINUOUS GRADE

Version 4.06 Released August 2018

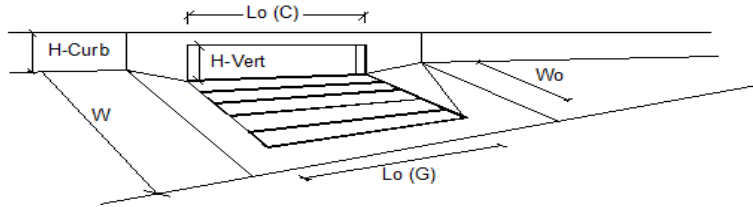

Design Information (Input)	CDOT Type R Curb Opening	MINOR	MAJOR	
Type of Inlet	CDOT Type R Curb Opening	Type =	CDOT Type R Curb Opening	
Local Depression (additional to continuous gutter depression 'a')		$a_{LOCAL} =$	3.0	3.0
Total Number of Units in the Inlet (Grate or Curb Opening)		No =	1	1
Length of a Single Unit Inlet (Grate or Curb Opening)		$L_o =$	25.00	25.00
Width of a Unit Grate (cannot be greater than W, Gutter Width)		$W_o =$	N/A	N/A
Clogging Factor for a Single Unit Grate (typical min. value = 0.5)		$C_r-G =$	N/A	N/A
Clogging Factor for a Single Unit Curb Opening (typical min. value = 0.1)		$C_r-C =$	0.10	0.10
<b>Street Hydraulics: OK - <math>Q &lt; Q_{allowable}</math> Street Capacity.</b>				
Total Inlet Interception Capacity		$Q =$	3.3	11.8
Total Inlet Carry-Over Flow (flow bypassing inlet)		$Q_b =$	0.0	0.0
Capture Percentage = $Q_c/Q_o =$		C% =	100	100
				cfs
				cfs
				%

**StormCAD**



# BG Filing No. 3 Storm

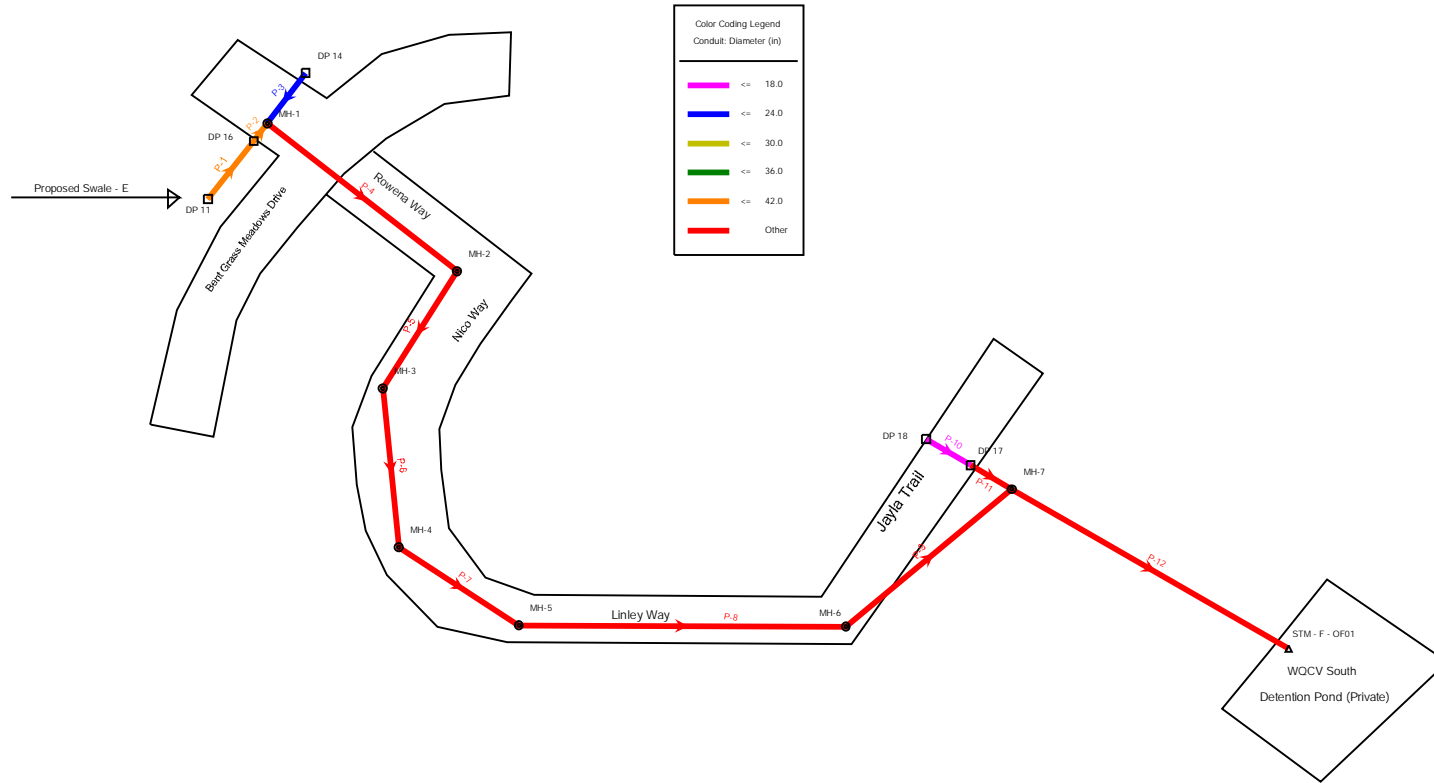

BG Filing No. 3 Storm  
 FlexTable: Conduit Table  
 Active Scenario: 100 YR

Label	Start Node	Stop Node	Length (User Defined) (ft)	Diameter (in)	Manning's n	Capacity (Full Flow) (cfs)	Flow (cfs)	Velocity (ft/s)	Elevation Ground (Start) (ft)	Invert (Start) (ft)	Hydraulic Grade Line (In) (ft)	Elevation Ground (Stop) (ft)	Invert (Stop) (ft)	Hydraulic Grade Line (Out) (ft)	Slope (Calculated) (ft/ft)
P-12	MH-7	Outfall	296.0	54.0	0.013	139.06	129.11	9.93	6,941.75	6,927.48	6,930.91	6,929.00	6,926.00	6,929.34	0.005
P-1	DP 11	DP 16	96.5	42.0	0.013	97.69	56.02	10.50	6,945.00	6,940.50	6,943.92	6,948.24	6,939.59	6,943.63	0.009
P-2	DP 16	MH-1	5.0	42.0	0.013	100.60	86.57	9.00	6,948.24	6,939.29	6,943.00	6,947.98	6,939.24	6,942.97	0.010
P-3	DP 14	MH-1	27.5	24.0	0.013	48.44	24.85	15.52	6,948.24	6,942.50	6,944.26	6,947.98	6,941.24	6,942.46	0.046
P-4	MH-1	MH-2	211.5	48.0	0.013	142.80	106.07	12.45	6,947.98	6,938.74	6,941.86	6,946.72	6,936.65	6,940.56	0.010
P-5	MH-2	MH-3	132.1	48.0	0.013	143.59	105.37	12.49	6,946.72	6,936.35	6,939.46	6,945.39	6,935.03	6,938.93	0.010
P-6	MH-3	MH-4	75.2	48.0	0.013	142.45	104.93	12.40	6,945.39	6,934.73	6,937.83	6,944.74	6,933.99	6,937.91	0.010
P-7	MH-4	MH-5	61.2	48.0	0.013	143.39	104.68	12.45	6,944.74	6,933.69	6,936.88	6,944.50	6,933.08	6,936.97	0.010
P-8	MH-5	MH-6	235.3	48.0	0.013	159.45	104.48	13.53	6,944.50	6,932.78	6,935.88	6,942.08	6,929.88	6,933.75	0.012
P-9	MH-6	MH-7	119.8	48.0	0.013	166.03	103.76	13.94	6,942.08	6,929.58	6,932.66	6,941.75	6,927.98	6,932.13	0.013
P-10	DP 18	DP 17	35.0	18.0	0.013	13.75	13.85	7.83	6,941.57	6,931.23	6,932.82	6,941.57	6,930.63	6,932.21	0.017
P-11	DP 17	MH-7	9.2	48.0	0.013	105.77	29.99	2.39	6,941.57	6,928.13	6,932.14	6,941.75	6,928.08	6,932.13	0.005

**BG Filing No. 3 Storm**  
**FlexTable: Manhole Table**  
**Active Scenario: 100 YR**

Label	Elevation (Rim) (ft)	Headloss Coefficient (Standard)	Headloss Method	Headloss (ft)	Hydraulic Grade Line (Out) (ft)	Hydraulic Grade Line (In) (ft)	Energy Grade Line (In) (ft)	Energy Grade Line (Out) (ft)	Diameter (in)
MH-1	6,947.98	0.700	Standard	1.11	6,941.86	6,942.97	6,945.35	6,943.44	84.0
MH-2	6,946.72	0.700	Standard	1.10	6,939.46	6,940.56	6,941.68	6,941.03	96.0
MH-3	6,945.39	0.700	Standard	1.10	6,937.83	6,938.93	6,940.04	6,939.40	96.0
MH-4	6,944.74	0.700	Standard	1.03	6,936.88	6,937.91	6,939.01	6,938.36	96.0
MH-5	6,944.50	0.700	Standard	1.09	6,935.88	6,936.97	6,938.06	6,937.43	96.0
MH-6	6,942.08	0.700	Standard	1.08	6,932.66	6,933.75	6,934.84	6,934.21	96.0
MH-7	6,941.75	0.800	Standard	1.23	6,930.91	6,932.13	6,933.19	6,932.44	96.0

BG Filing No. 3 Storm  
 FlexTable: Outfall Table  
 Active Scenario: 100 YR

Label	Elevation (Ground) (ft)	Elevation (Invert) (ft)	Boundary Condition Type	Elevation (User Defined Tailwater) (ft)	Hydraulic Grade (ft)	Energy Grade Line (ft)	Flow (Total Out) (cfs)
Outfall	6,929.00	6,926.00	User Defined Tailwater	6,928.46	6,929.34	6,929.34	127.58

**BG Filing No. 3 Storm**  
**Profile Report**  
**Engineering Profile - Profile - 1 (BG Filing 3 StormCAD.stsw)**  
**Active Scenario: 100 YR**

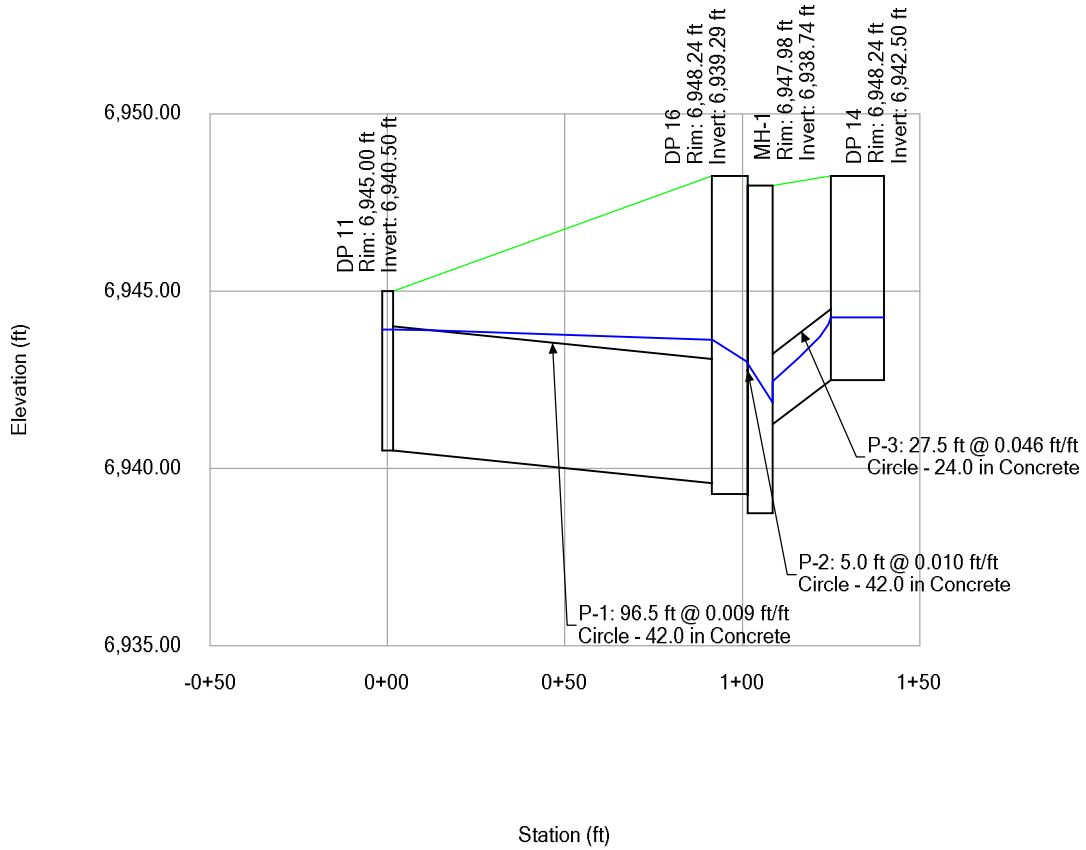

# BG Filing No. 3 Storm Profile Report Engineering Profile - Profile - 2 (BG Filing 3 StormCAD.stsw) Active Scenario: 100 YR

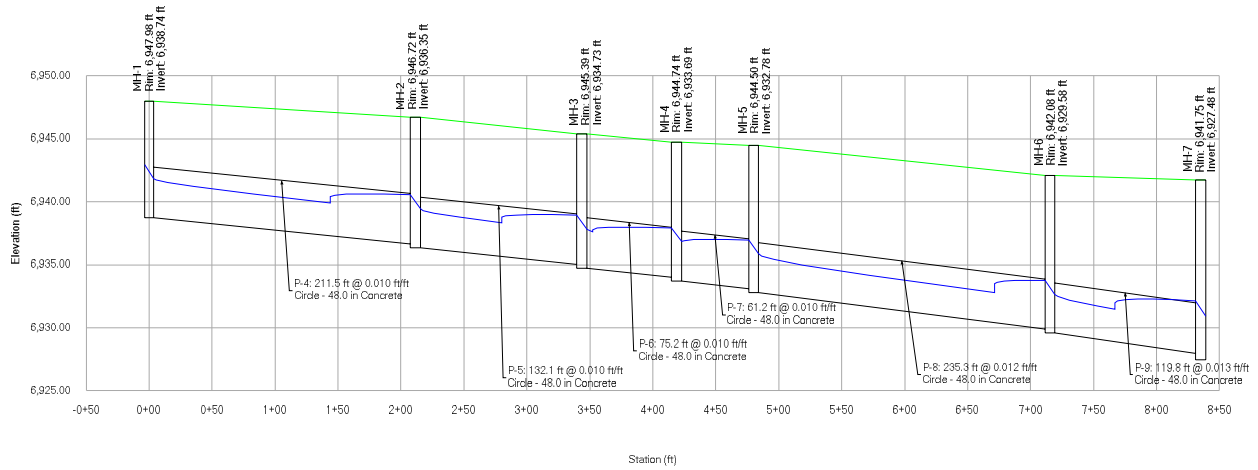

**BG Filing No. 3 Storm**  
**Profile Report**  
**Engineering Profile - Profile - 3 (BG Filing 3 StormCAD.stsw)**  
**Active Scenario: 100 YR**

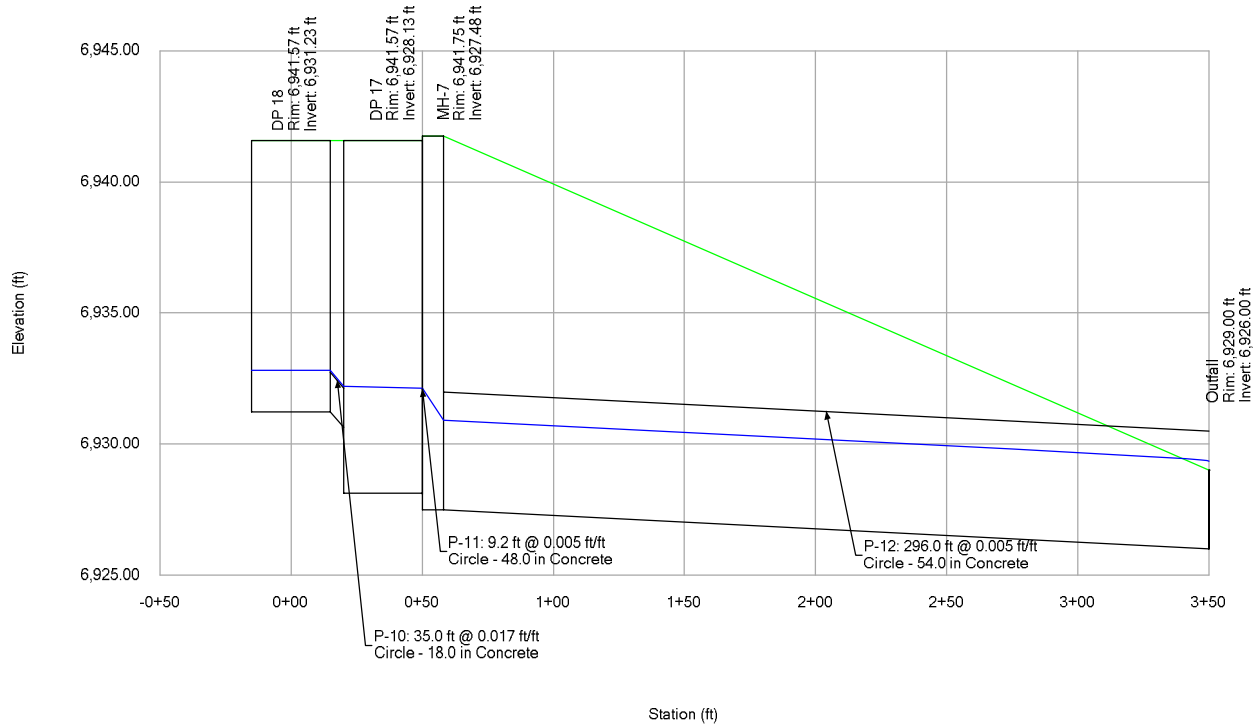

BG Filing No. 3 Storm  
FlexTable: Conduit Table  
Active Scenario: 5 YR

Label	Start Node	Stop Node	Length (User Defined) (ft)	Diameter (in)	Manning's n	Capacity (Full Flow) (cfs)	Flow (cfs)	Velocity (ft/s)	Elevation Ground (Start) (ft)	Invert (Start) (ft)	Hydraulic Grade Line (In) (ft)	Elevation Ground (Stop) (ft)	Invert (Stop) (ft)	Hydraulic Grade Line (Out) (ft)	Slope (Calculated) (ft/ft)
P-12	MH-7	Outfall	296.0	54.0	0.013	139.06	38.32	7.47	6,941.75	6,927.48	6,929.26	6,929.00	6,926.00	6,927.61	0.005
P-1	DP 11	DP 16	96.5	42.0	0.013	97.69	11.00	6.72	6,945.00	6,940.50	6,941.50	6,948.24	6,939.59	6,940.93	0.009
P-2	DP 16	MH-1	5.0	42.0	0.013	100.60	20.45	8.20	6,948.24	6,939.29	6,940.68	6,947.98	6,939.24	6,940.74	0.010
P-3	DP 14	MH-1	27.5	24.0	0.013	48.44	10.55	12.33	6,948.24	6,942.50	6,943.66	6,947.98	6,941.24	6,941.96	0.046
P-4	MH-1	MH-2	211.5	48.0	0.013	142.80	28.71	8.89	6,947.98	6,938.74	6,940.33	6,946.72	6,936.65	6,938.34	0.010
P-5	MH-2	MH-3	132.1	48.0	0.013	143.59	28.45	8.90	6,946.72	6,936.35	6,937.93	6,945.39	6,935.03	6,936.72	0.010
P-6	MH-3	MH-4	75.2	48.0	0.013	142.45	28.28	8.83	6,945.39	6,934.73	6,936.31	6,944.74	6,933.99	6,935.67	0.010
P-7	MH-4	MH-5	61.2	48.0	0.013	143.39	28.19	8.87	6,944.74	6,933.69	6,935.26	6,944.50	6,933.08	6,934.76	0.010
P-8	MH-5	MH-6	235.3	48.0	0.013	159.45	28.11	9.56	6,944.50	6,932.78	6,934.35	6,942.08	6,929.88	6,931.55	0.012
P-9	MH-6	MH-7	119.8	48.0	0.013	166.03	27.84	9.81	6,942.08	6,929.58	6,931.14	6,941.75	6,927.98	6,929.79	0.013
P-10	DP 18	DP 17	35.0	18.0	0.013	13.75	5.72	7.42	6,941.57	6,931.23	6,932.15	6,941.57	6,930.63	6,931.33	0.017
P-11	DP 17	MH-7	9.2	48.0	0.013	105.77	12.53	5.65	6,941.57	6,928.13	6,929.79	6,941.75	6,928.08	6,929.79	0.005



BG Filing No. 3 Storm  
FlexTable: Manhole Table  
Active Scenario: 5 YR

Label	Elevation (Rim) (ft)	Headloss Coefficient (Standard)	Headloss Method	Headloss (ft)	Hydraulic Grade Line (Out) (ft)	Hydraulic Grade Line (In) (ft)	Energy Grade Line (In) (ft)	Energy Grade Line (Out) (ft)	Diameter (in)
MH-1	6,947.98	0.700	Standard	0.42	6,940.33	6,940.74	6,941.16	6,940.92	84.0
MH-2	6,946.72	0.700	Standard	0.41	6,937.93	6,938.34	6,938.84	6,938.52	96.0
MH-3	6,945.39	0.700	Standard	0.41	6,936.31	6,936.72	6,937.21	6,936.89	96.0
MH-4	6,944.74	0.700	Standard	0.41	6,935.26	6,935.67	6,936.17	6,935.85	96.0
MH-5	6,944.50	0.700	Standard	0.41	6,934.35	6,934.76	6,935.25	6,934.94	96.0
MH-6	6,942.08	0.700	Standard	0.41	6,931.14	6,931.55	6,932.05	6,931.73	96.0
MH-7	6,941.75	0.800	Standard	0.53	6,929.26	6,929.79	6,930.19	6,929.93	96.0

BG Filing No. 3 Storm  
 FlexTable: Outfall Table  
 Active Scenario: 5 YR

Label	Elevation (Ground) (ft)	Elevation (Invert) (ft)	Boundary Condition Type	Elevation (User Defined Tailwater) (ft)	Hydraulic Grade (ft)	Energy Grade Line (ft)	Flow (Total Out) (cfs)
Outfall	6,929.00	6,926.00	User Defined Tailwater	6,926.78	6,927.61	6,927.61	37.71

**BG Filing No. 3 Storm**  
**Profile Report**  
**Engineering Profile - Profile - 1 (BG Filing 3 StormCAD.stsw)**  
**Active Scenario: 5 YR**

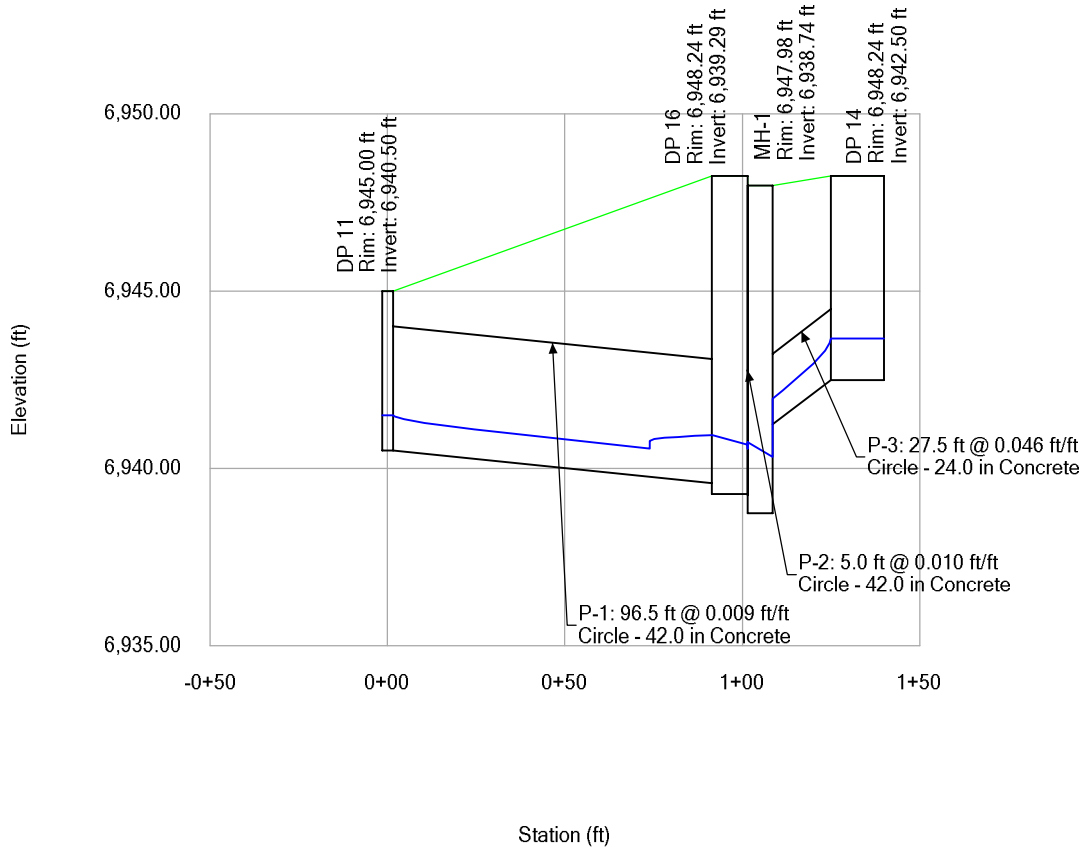

# BG Filing No. 3 Storm Profile Report

## Engineering Profile - Profile - 2 (BG Filing 3 StormCAD.stsw)

### Active Scenario: 5 YR

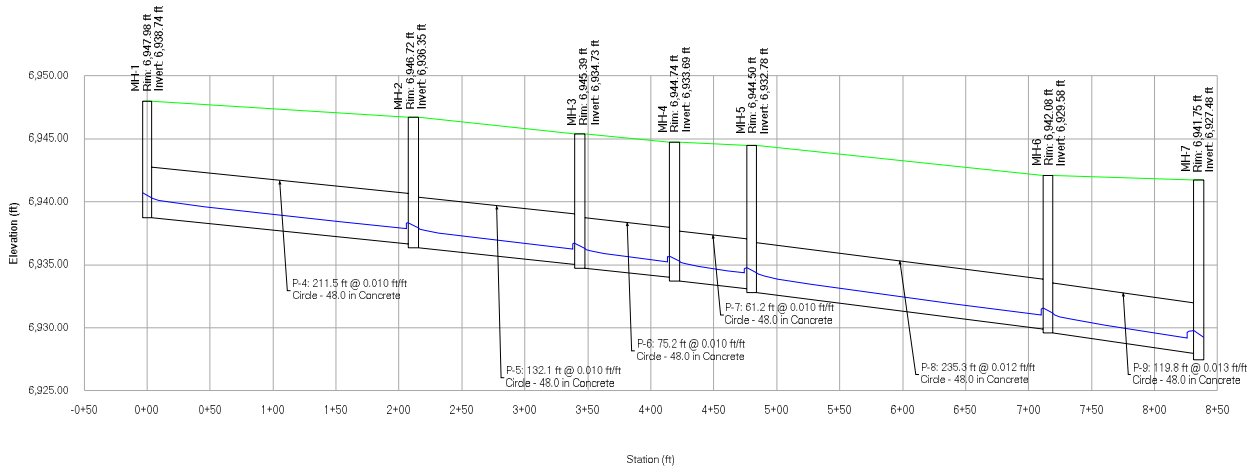

# BG Filing No. 3 Storm Profile Report Engineering Profile - Profile - 3 (BG Filing 3 StormCAD.stsw) Active Scenario: 5 YR

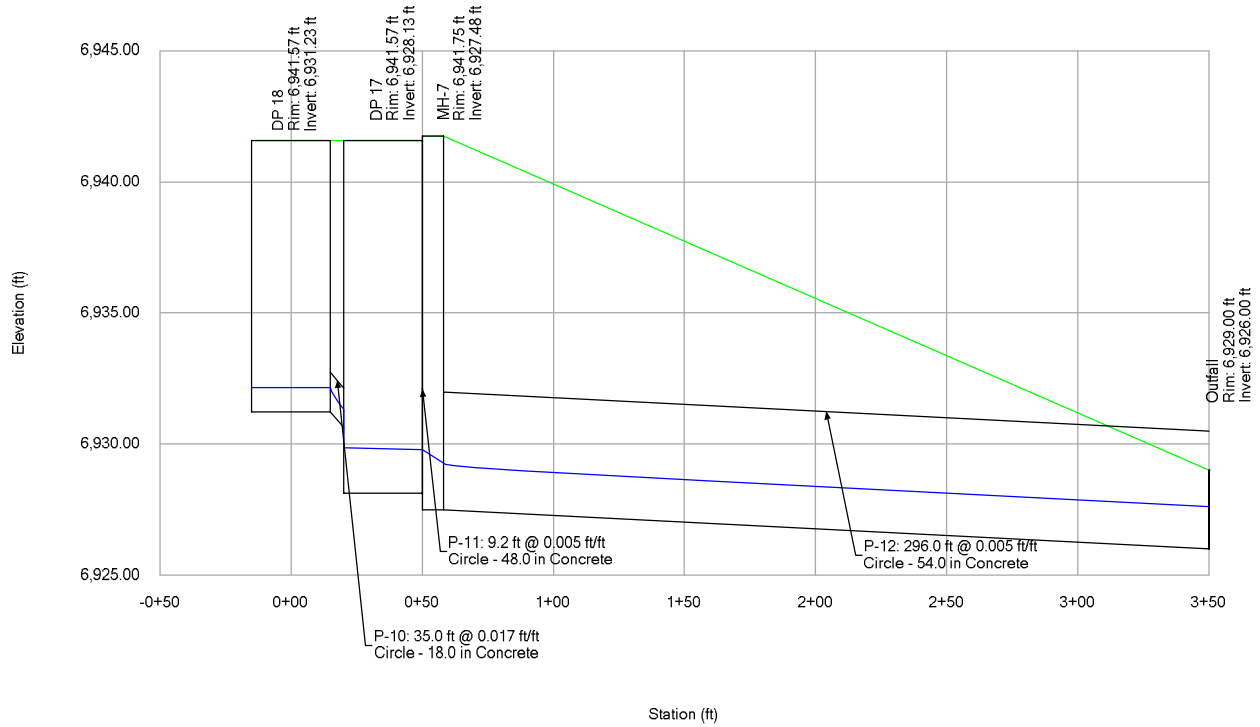

## Pond Calculations

## Detention Pond Tributary Areas

**Subdivision:** Falcon Meadows at Bent Grass  
**Location:** CO, Colorado Springs

**Project Name:** Falcon Meadows at Bent Grass  
**Project No.:** CLH000017  
**Calculated By:** TJE  
**Checked By:** CMD  
**Date:** 6/19/20

### Pond (North)

Basin	Area	% Imp
C-1	9.07	65
C-2	1.11	58
C-3	1.52	86.6
C-5	0.51	2
C-6	1.37	51.2
<b>Total</b>	<b>13.58</b>	<b>63.1</b>

### Pond (South)

Basin	Area	% Imp
D-1	8.13	49.7
D-2	7.42	68.5
D-3	2.93	31.7
D-4	4.38	65.4
D-5	1.08	65.7
D-6	4.01	71.5
D-7	6.39	9.8
D-8	1.69	22.8
E-4	0.91	80.6
E-5	0.89	89
OS-2	20.07	8
OS-3	10.61	8
<b>Total</b>	<b>68.51</b>	<b>31.4</b>

### Existing Pond (North) - Bent Grass Residential Filing No. 1

Basin	Area	% Imp
E-1	1.71	62.3
E-2	0.68	82.8
E-3	0.78	88.7
OS-4	4.46	49.5
OS-5	0.46	65
OS-6	1.17	65
A-1	2.16	68.1
A-3	0.92	70.2
A-4	0.82	2
Basins from BG Filing No. 2 (A-1 thru A-4)	7.70	46
<b>Total</b>	<b>20.86</b>	<b>54.0</b>





# DETENTION BASIN STAGE-STORAGE TABLE BUILDER

*MHFD-Detention, Version 4.03 (May 2020)*

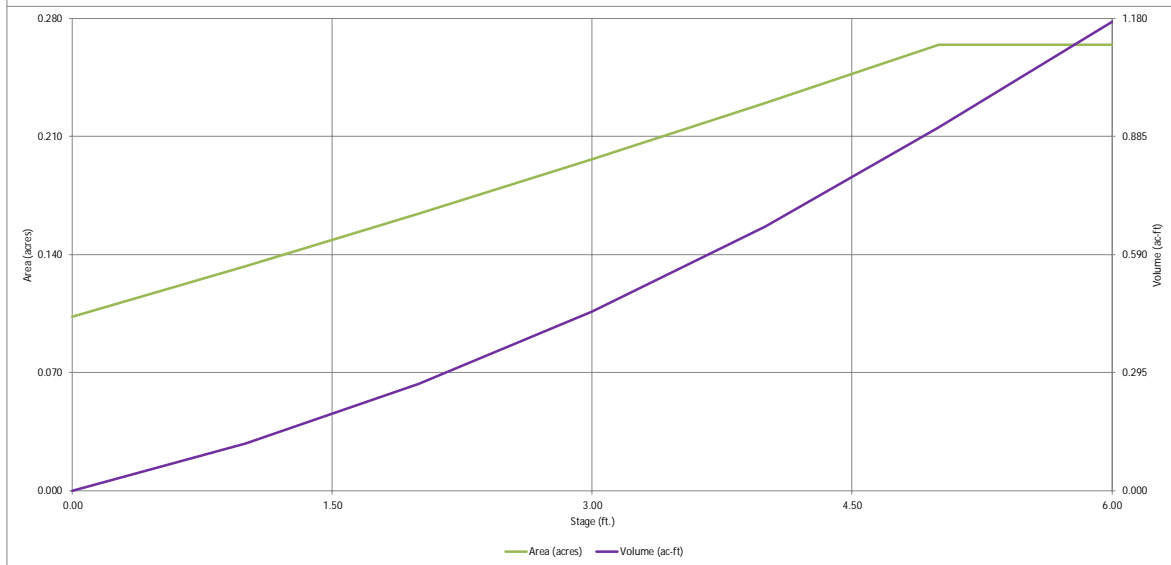
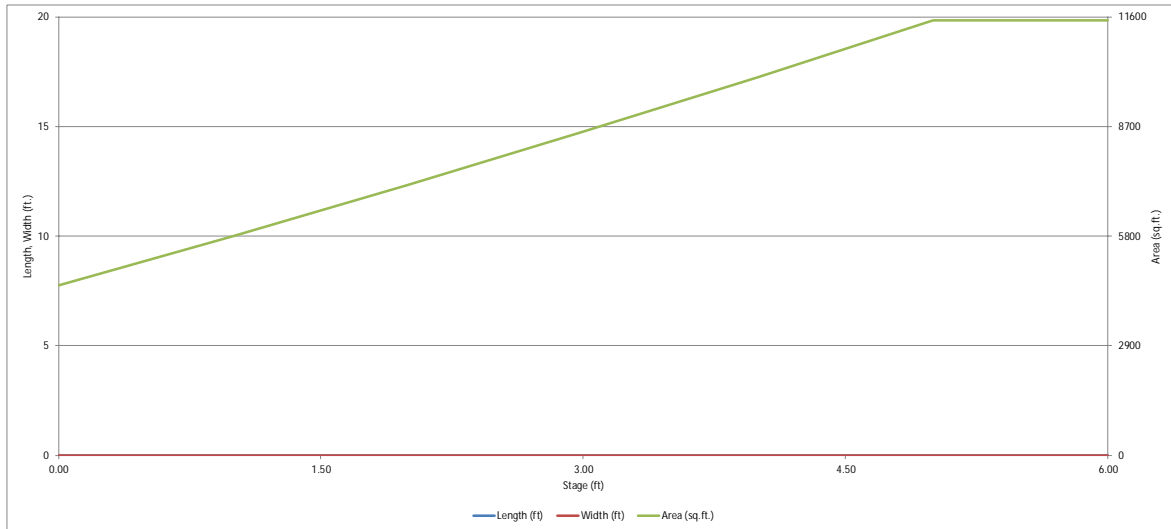

# DETENTION BASIN OUTLET STRUCTURE DESIGN

MHFD-Detention, Version 4.03 (May 2020)

Project: Falcon Meadows at Bent Grass  
Basin ID: WQCV Pond - North

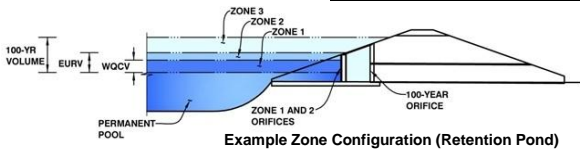

	Estimated Stage (ft)	Estimated Volume (ac-ft)	Outlet Type
Zone 1 (WQCV)	2.08	0.280	Orifice Plate
Zone 2			
Zone 3			
<b>Total (all zones)</b>		<b>0.280</b>	

User Input: Orifice at Underdrain Outlet (typically used to drain WQCV in a Filtration BMP)

Underdrain Orifice Invert Depth =  ft (distance below the filtration media surface)  
Underdrain Orifice Diameter =  inches

Calculated Parameters for Underdrain  
Underdrain Orifice Area =  ft<sup>2</sup>  
Underdrain Orifice Centroid =  feet

User Input: Orifice Plate with one or more orifices or Elliptical Slot Weir (typically used to drain WQCV and/or EURV in a sedimentation BMP)

Invert of Lowest Orifice =  0.00 ft (relative to basin bottom at Stage = 0 ft)  
Depth at top of Zone using Orifice Plate =  1.94 ft (relative to basin bottom at Stage = 0 ft)  
Orifice Plate: Orifice Vertical Spacing =  9.00 inches  
Orifice Plate: Orifice Area per Row =  1.92 sq. inches (diameter = 1-9/16 inches)

Calculated Parameters for Plate  
WQ Orifice Area per Row =  1.332E-02 ft<sup>2</sup>  
Elliptical Half-Width =  N/A feet  
Elliptical Slot Centroid =  N/A feet  
Elliptical Slot Area =  N/A ft<sup>2</sup>

User Input: Stage and Total Area of Each Orifice Row (numbered from lowest to highest)

	Row 1 (required)	Row 2 (optional)	Row 3 (optional)	Row 4 (optional)	Row 5 (optional)	Row 6 (optional)	Row 7 (optional)	Row 8 (optional)
Stage of Orifice Centroid (ft)	0.00	0.80	1.60					
Orifice Area (sq. inches)	1.92	1.92	1.92					

	Row 9 (optional)	Row 10 (optional)	Row 11 (optional)	Row 12 (optional)	Row 13 (optional)	Row 14 (optional)	Row 15 (optional)	Row 16 (optional)
Stage of Orifice Centroid (ft)								
Orifice Area (sq. inches)								

User Input: Vertical Orifice (Circular or Rectangular)

Invert of Vertical Orifice =  Not Selected  Not Selected ft (relative to basin bottom at Stage = 0 ft)  
Depth at top of Zone using Vertical Orifice =  ft (relative to basin bottom at Stage = 0 ft)  
Vertical Orifice Diameter =  inches

Calculated Parameters for Vertical Orifice  
Vertical Orifice Area =  Not Selected  Not Selected ft<sup>2</sup>  
Vertical Orifice Centroid =  Not Selected  Not Selected feet

User Input: Overflow Weir (Dropbox with Flat or Sloped Gate and Outlet Pipe OR Rectangular/Trapezoidal Weir (and No Outlet Pipe))

Overflow Weir Front Edge Height, Ho =  Not Selected  Not Selected ft (relative to basin bottom at Stage = 0 ft)  
Overflow Weir Front Edge Length =  6.00 feet  
Overflow Weir Gate Slope =  0.00 H:V  
Horiz. Length of Weir Sides =  3.00 feet  
Overflow Gate Open Area % =  70% %, gate open area/total area  
Debris Clogging % =  50% %

Calculated Parameters for Overflow Weir  
Height of Gate Upper Edge, Hi =  Not Selected  Not Selected feet  
Overflow Weir Slope Length =  3.00 feet  
Grate Open Area / 100-yr Orifice Area =  7.13  
Overflow Gate Open Area w/o Debris =  12.60 ft<sup>2</sup>  
Overflow Gate Open Area w/ Debris =  6.30 ft<sup>2</sup>

User Input: Outlet Pipe w/ Flow Restriction Plate (Circular Orifice, Restrictor Plate, or Rectangular Orifice)

Depth to Invert of Outlet Pipe =  Not Selected  Not Selected ft (distance below basin bottom at Stage = 0 ft)  
Circular Orifice Diameter =  18.00 inches

Calculated Parameters for Outlet Pipe w/ Flow Restriction Plate  
Outlet Orifice Area =  1.77 ft<sup>2</sup>  
Outlet Orifice Centroid =  0.75 feet  
Half-Central Angle of Restrictor Plate on Pipe =  N/A  N/A radians

User Input: Emergency Spillway (Rectangular or Trapezoidal)

Spillway Invert Stage =  5.75 ft (relative to basin bottom at Stage = 0 ft)  
Spillway Crest Length =  50.00 feet  
Spillway End Slopes =  4.00 H:V  
Freeboard above Max Water Surface =  0.00 feet

Calculated Parameters for Spillway  
Spillway Design Flow Depth =  0.37 feet  
Stage at Top of Freeboard =  6.12 feet  
Basin Area at Top of Freeboard =  0.26 acres  
Basin Volume at Top of Freeboard =  1.17 acre-ft

## Routed Hydrograph Results

*The user can override the default CUHP hydrographs and runoff volumes by entering new values in the Inflow Hydrographs table (Columns W through AF).*

	WQCV	EURV	2 Year	5 Year	10 Year	25 Year	50 Year	100 Year	500 Year
Design Storm Return Period									
One-Hour Rainfall Depth (in)	N/A	N/A	1.19	1.50	1.75	2.00	2.25	2.52	3.68
CUHP Runoff Volume (acre-ft)	0.280	1.055	0.770	1.012	1.205	1.462	1.715	2.024	3.313
Inflow Hydrograph Volume (acre-ft)	N/A	N/A	0.770	1.012	1.205	1.462	1.715	2.024	3.313
CUHP Predevelopment Peak Q (cfs)	N/A	N/A	0.1	0.2	0.2	2.2	4.5	7.3	18.9
OPTIONAL Override Predevelopment Peak Q (cfs)	N/A	N/A							
Predevelopment Unit Peak Flow, q (cfs/acre)	N/A	N/A	0.01	0.01	0.02	0.16	0.33	0.54	1.39
Peak Inflow Q (cfs)	N/A	N/A	11.6	15.2	17.9	23.1	27.6	33.3	54.7
Peak Outflow Q (cfs)	0.2	22.5	0.4	2.9	5.5	10.7	15.1	21.9	42.7
Ratio Peak Outflow to Predevelopment Q	N/A	N/A	N/A	16.7	22.8	4.8	3.4	3.0	2.3
Structure Controlling Flow	Plate	Outlet Plate 1	Plate	Overflow Weir 1	Overflow Weir 1	Overflow Weir 1	Overflow Weir 1	Outlet Plate 1	N/A
Max Velocity through Gate 1 (fps)	N/A	1.79	N/A	0.2	0.4	0.8	1.2	1.7	1.8
Max Velocity through Gate 2 (fps)	N/A	N/A	N/A	N/A	N/A	N/A	N/A	N/A	N/A
Time to Drain 97% of Inflow Volume (hours)	44	56	58	58	56	53	51	49	40
Time to Drain 99% of Inflow Volume (hours)	49	65	66	67	66	64	63	62	57
Maximum Ponding Depth (ft)	2.08	5.56	4.23	4.66	4.76	4.91	5.02	5.18	6.00
Area at Maximum Ponding Depth (acres)	0.17	0.26	0.24	0.25	0.26	0.26	0.26	0.26	0.26
Maximum Volume Stored (acre-ft)	0.280	1.056	0.714	0.820	0.843	0.884	0.913	0.953	1.172

# DETENTION BASIN OUTLET STRUCTURE DESIGN

*MHFD-Detention, Version 4.00 (December 2019)*

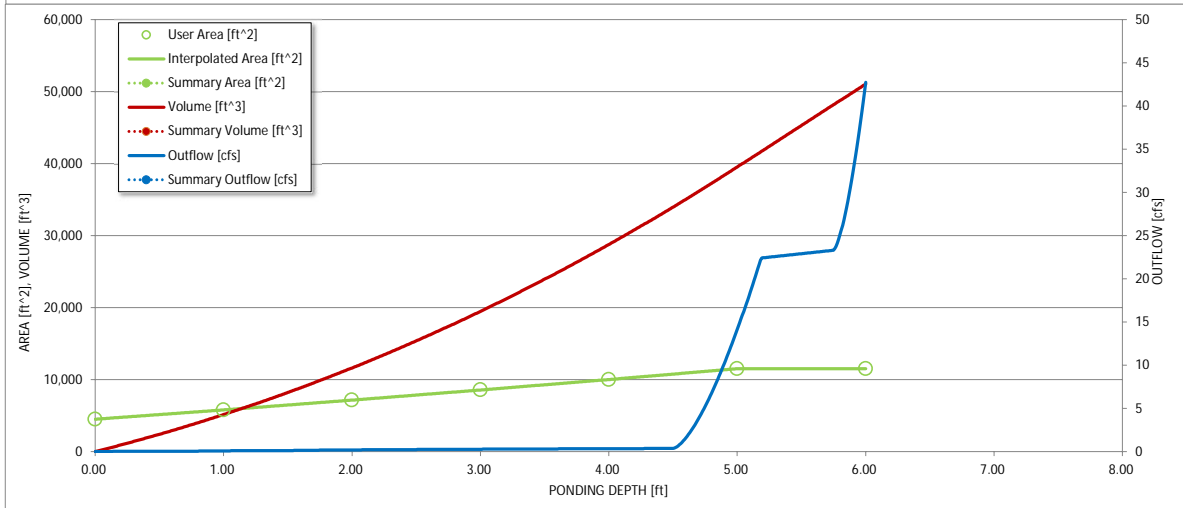
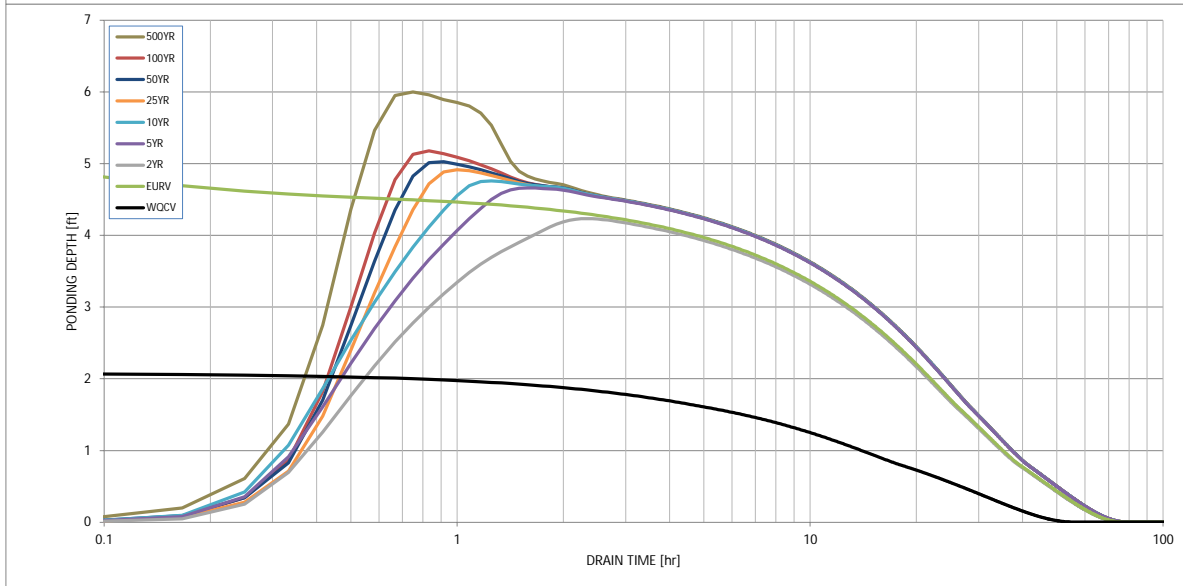
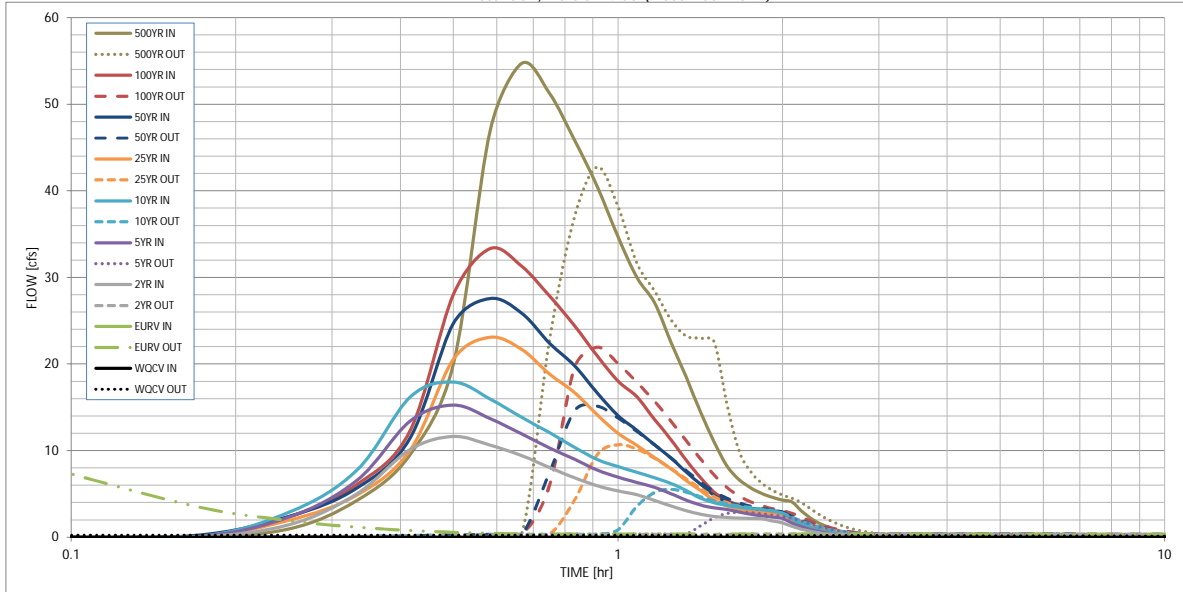

S-A-V-D Chart Axis Override	X-axis	Left Y-Axis	Right Y-Axis
minimum bound			
maximum bound			

# DETENTION BASIN OUTLET STRUCTURE DESIGN

Outflow Hydrograph Workbook Filename: \_\_\_\_\_

**Inflow Hydrographs**

The user can override the calculated inflow hydrographs from this workbook with inflow hydrographs developed in a separate program.

Time Interval	SOURCE	WQCV [cfs]	EURV [cfs]	2 Year [cfs]	5 Year [cfs]	10 Year [cfs]	25 Year [cfs]	50 Year [cfs]	100 Year [cfs]	500 Year [cfs]
5.00 min	0:00:00	0.00	0.00	0.00	0.00	0.00	0.00	0.00	0.00	0.00
	0:05:00	0.00	0.00	0.00	0.00	0.00	0.00	0.00	0.00	0.00
	0:10:00	0.00	0.00	0.00	0.00	0.00	0.00	0.16	0.02	0.96
	0:15:00	0.00	0.00	1.42	2.32	2.87	1.93	2.41	2.35	4.25
	0:20:00	0.00	0.00	5.03	6.58	7.73	4.87	5.67	6.09	9.52
	0:25:00	0.00	0.00	10.13	13.40	16.17	10.03	11.44	12.30	19.93
	0:30:00	0.00	0.00	11.63	15.25	17.92	20.54	24.66	27.99	46.90
	0:35:00	0.00	0.00	10.62	13.70	15.96	23.07	27.57	33.33	54.71
	0:40:00	0.00	0.00	9.42	11.91	13.84	21.67	25.86	31.28	51.24
	0:45:00	0.00	0.00	8.04	10.31	12.06	18.83	22.39	27.84	45.85
	0:50:00	0.00	0.00	6.85	8.99	10.36	16.71	19.80	24.42	40.50
	0:55:00	0.00	0.00	5.93	7.74	8.98	14.13	16.65	20.93	34.69
	1:00:00	0.00	0.00	5.34	6.93	8.14	11.99	14.03	18.04	29.99
	1:05:00	0.00	0.00	4.89	6.32	7.49	10.59	12.34	16.19	27.07
	1:10:00	0.00	0.00	4.23	5.75	6.85	9.17	10.65	13.59	22.51
	1:15:00	0.00	0.00	3.61	5.03	6.21	7.91	9.14	11.27	18.48
	1:20:00	0.00	0.00	3.06	4.28	5.38	6.54	7.52	8.90	14.45
	1:25:00	0.00	0.00	2.63	3.70	4.50	5.37	6.13	6.87	11.00
	1:30:00	0.00	0.00	2.39	3.38	3.97	4.27	4.83	5.21	8.23
	1:35:00	0.00	0.00	2.27	3.21	3.66	3.62	4.08	4.25	6.64
	1:40:00	0.00	0.00	2.20	2.89	3.45	3.22	3.63	3.70	5.69
	1:45:00	0.00	0.00	2.16	2.64	3.29	2.97	3.34	3.32	5.04
	1:50:00	0.00	0.00	2.13	2.46	3.18	2.79	3.14	3.07	4.59
	1:55:00	0.00	0.00	1.87	2.32	3.02	2.67	3.00	2.89	4.28
	2:00:00	0.00	0.00	1.65	2.15	2.76	2.59	2.91	2.76	4.05
	2:05:00	0.00	0.00	1.25	1.63	2.08	1.96	2.20	2.07	3.02
	2:10:00	0.00	0.00	0.93	1.20	1.53	1.44	1.62	1.52	2.22
	2:15:00	0.00	0.00	0.68	0.89	1.12	1.06	1.19	1.12	1.63
	2:20:00	0.00	0.00	0.50	0.64	0.82	0.77	0.87	0.83	1.20
	2:25:00	0.00	0.00	0.36	0.45	0.58	0.55	0.62	0.59	0.86
	2:30:00	0.00	0.00	0.25	0.32	0.41	0.39	0.44	0.42	0.60
	2:35:00	0.00	0.00	0.17	0.22	0.29	0.28	0.31	0.30	0.43
	2:40:00	0.00	0.00	0.11	0.15	0.19	0.19	0.21	0.20	0.28
	2:45:00	0.00	0.00	0.06	0.09	0.11	0.11	0.13	0.12	0.17
	2:50:00	0.00	0.00	0.03	0.05	0.05	0.06	0.06	0.06	0.08
	2:55:00	0.00	0.00	0.01	0.02	0.02	0.02	0.02	0.02	0.03
	3:00:00	0.00	0.00	0.00	0.00	0.00	0.00	0.00	0.00	0.00
	3:05:00	0.00	0.00	0.00	0.00	0.00	0.00	0.00	0.00	0.00
	3:10:00	0.00	0.00	0.00	0.00	0.00	0.00	0.00	0.00	0.00
	3:15:00	0.00	0.00	0.00	0.00	0.00	0.00	0.00	0.00	0.00
	3:20:00	0.00	0.00	0.00	0.00	0.00	0.00	0.00	0.00	0.00
	3:25:00	0.00	0.00	0.00	0.00	0.00	0.00	0.00	0.00	0.00
	3:30:00	0.00	0.00	0.00	0.00	0.00	0.00	0.00	0.00	0.00
	3:35:00	0.00	0.00	0.00	0.00	0.00	0.00	0.00	0.00	0.00
	3:40:00	0.00	0.00	0.00	0.00	0.00	0.00	0.00	0.00	0.00
	3:45:00	0.00	0.00	0.00	0.00	0.00	0.00	0.00	0.00	0.00
	3:50:00	0.00	0.00	0.00	0.00	0.00	0.00	0.00	0.00	0.00
	3:55:00	0.00	0.00	0.00	0.00	0.00	0.00	0.00	0.00	0.00
	4:00:00	0.00	0.00	0.00	0.00	0.00	0.00	0.00	0.00	0.00
	4:05:00	0.00	0.00	0.00	0.00	0.00	0.00	0.00	0.00	0.00
	4:10:00	0.00	0.00	0.00	0.00	0.00	0.00	0.00	0.00	0.00
	4:15:00	0.00	0.00	0.00	0.00	0.00	0.00	0.00	0.00	0.00
	4:20:00	0.00	0.00	0.00	0.00	0.00	0.00	0.00	0.00	0.00
	4:25:00	0.00	0.00	0.00	0.00	0.00	0.00	0.00	0.00	0.00
	4:30:00	0.00	0.00	0.00	0.00	0.00	0.00	0.00	0.00	0.00
	4:35:00	0.00	0.00	0.00	0.00	0.00	0.00	0.00	0.00	0.00
	4:40:00	0.00	0.00	0.00	0.00	0.00	0.00	0.00	0.00	0.00
	4:45:00	0.00	0.00	0.00	0.00	0.00	0.00	0.00	0.00	0.00
	4:50:00	0.00	0.00	0.00	0.00	0.00	0.00	0.00	0.00	0.00
	4:55:00	0.00	0.00	0.00	0.00	0.00	0.00	0.00	0.00	0.00
	5:00:00	0.00	0.00	0.00	0.00	0.00	0.00	0.00	0.00	0.00
	5:05:00	0.00	0.00	0.00	0.00	0.00	0.00	0.00	0.00	0.00
	5:10:00	0.00	0.00	0.00	0.00	0.00	0.00	0.00	0.00	0.00
	5:15:00	0.00	0.00	0.00	0.00	0.00	0.00	0.00	0.00	0.00
	5:20:00	0.00	0.00	0.00	0.00	0.00	0.00	0.00	0.00	0.00
	5:25:00	0.00	0.00	0.00	0.00	0.00	0.00	0.00	0.00	0.00
	5:30:00	0.00	0.00	0.00	0.00	0.00	0.00	0.00	0.00	0.00
	5:35:00	0.00	0.00	0.00	0.00	0.00	0.00	0.00	0.00	0.00
	5:40:00	0.00	0.00	0.00	0.00	0.00	0.00	0.00	0.00	0.00
	5:45:00	0.00	0.00	0.00	0.00	0.00	0.00	0.00	0.00	0.00
	5:50:00	0.00	0.00	0.00	0.00	0.00	0.00	0.00	0.00	0.00
	5:55:00	0.00	0.00	0.00	0.00	0.00	0.00	0.00	0.00	0.00
	6:00:00	0.00	0.00	0.00	0.00	0.00	0.00	0.00	0.00	0.00



# DETENTION BASIN STAGE-STORAGE TABLE BUILDER

*MHFD-Detention, Version 4.03 (May 2020)*

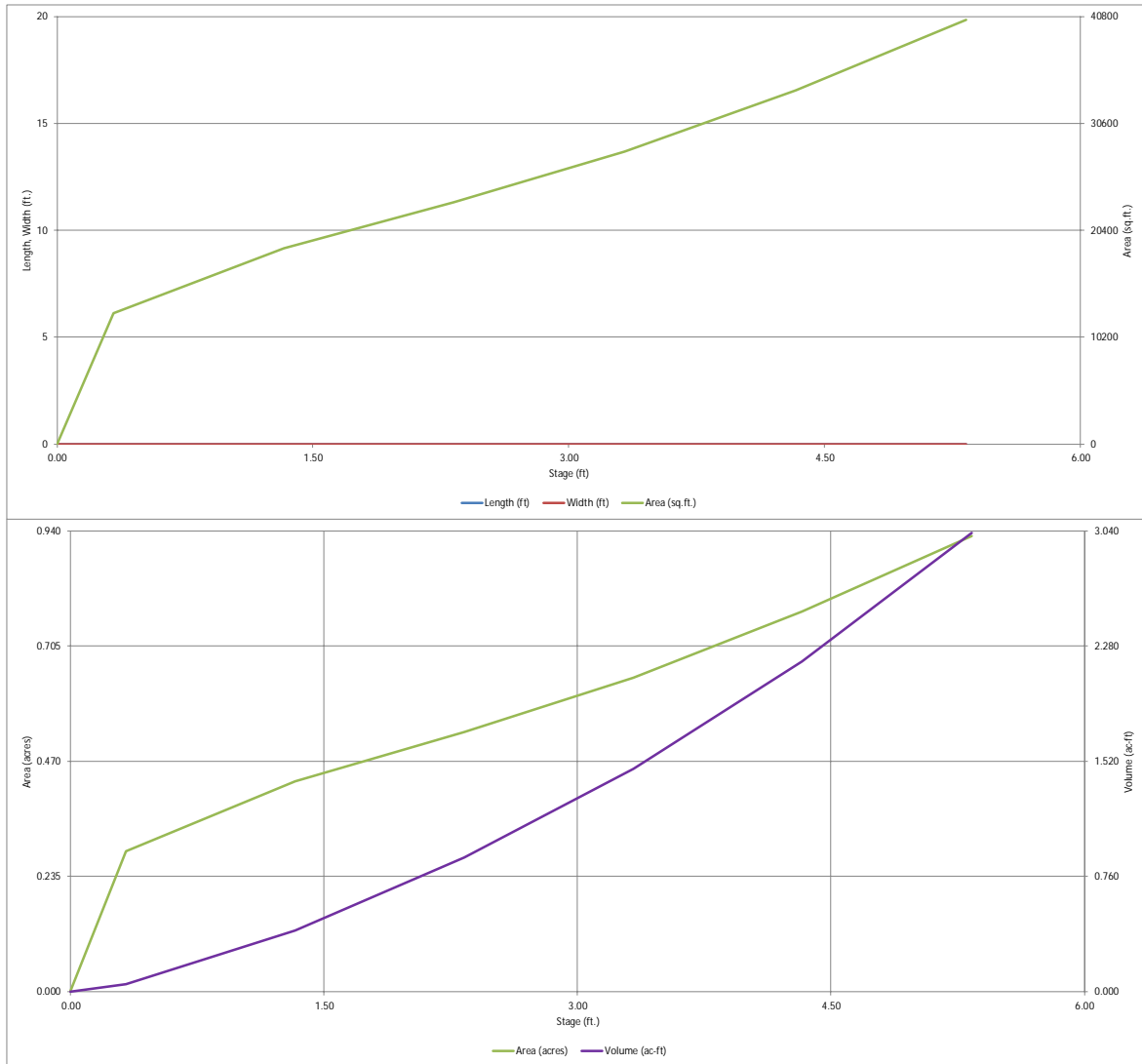

# DETENTION BASIN OUTLET STRUCTURE DESIGN

*MHFD-Detention, Version 4.03 (May 2020)*

Project: Falcon Meadows at Bent Grass  
Basin ID: WQCV Pond - South

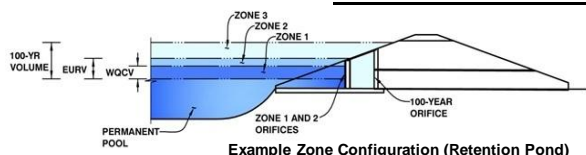

	Estimated Stage (ft)	Estimated Volume (ac-ft)	Outlet Type
Zone 1 (WQCV)	2.34	0.889	Orifice Plate
Zone 2			
Zone 3			
<b>Total (all zones)</b>		0.889	

**User Input: Orifice at Underdrain Outlet (typically used to drain WQCV in a Filtration BMP)**

Underdrain Orifice Invert Depth =  ft (distance below the filtration media surface)  
Underdrain Orifice Diameter =  inches

**Calculated Parameters for Underdrain**

Underdrain Orifice Area =  ft<sup>2</sup>  
Underdrain Orifice Centroid =  feet

**User Input: Orifice Plate with one or more orifices or Elliptical Slot Weir (typically used to drain WQCV and/or EURV in a sedimentation BMP)**

Invert of Lowest Orifice =  ft (relative to basin bottom at Stage = 0 ft)  
Depth at top of Zone using Orifice Plate =  ft (relative to basin bottom at Stage = 0 ft)  
Orifice Plate: Orifice Vertical Spacing =  inches  
Orifice Plate: Orifice Area per Row =  sq. inches (use rectangular openings)

**Calculated Parameters for Plate**

WQ Orifice Area per Row =  ft<sup>2</sup>  
Elliptical Half-Width =  feet  
Elliptical Slot Centroid =  feet  
Elliptical Slot Area =  ft<sup>2</sup>

**User Input: Stage and Total Area of Each Orifice Row (numbered from lowest to highest)**

	Row 1 (required)	Row 2 (optional)	Row 3 (optional)	Row 4 (optional)	Row 5 (optional)	Row 6 (optional)	Row 7 (optional)	Row 8 (optional)
Stage of Orifice Centroid (ft)	0.00	0.80	1.60					
Orifice Area (sq. inches)	5.00	5.00	5.00					

	Row 9 (optional)	Row 10 (optional)	Row 11 (optional)	Row 12 (optional)	Row 13 (optional)	Row 14 (optional)	Row 15 (optional)	Row 16 (optional)
Stage of Orifice Centroid (ft)								
Orifice Area (sq. inches)								

**User Input: Vertical Orifice (Circular or Rectangular)**

Invert of Vertical Orifice =   Not Selected  Not Selected ft (relative to basin bottom at Stage = 0 ft)  
Depth at top of Zone using Vertical Orifice =   Not Selected  Not Selected ft (relative to basin bottom at Stage = 0 ft)  
Vertical Orifice Diameter or Height =   Not Selected  Not Selected inches  
Vertical Orifice Width =   Not Selected  Not Selected inches

**Calculated Parameters for Vertical Orifice**

Vertical Orifice Area =   Not Selected  Not Selected ft<sup>2</sup>  
Vertical Orifice Centroid =   Not Selected  Not Selected feet

**User Input: Overflow Weir (Dropbox with Flat or Sloped Gate and Outlet Pipe OR Rectangular/Trapezoidal Weir (and No Outlet Pipe))**

Overflow Weir Front Edge Height, Ho =   Not Selected  Not Selected ft (relative to basin bottom at Stage = 0 ft)  
Overflow Weir Front Edge Length =   Not Selected  Not Selected feet  
Overflow Weir Gate Slope =   Not Selected  Not Selected H:V  
Horiz. Length of Weir Sides =   Not Selected  Not Selected feet  
Overflow Gate Open Area % =   Not Selected  Not Selected % , gate open area/total area  
Debris Clogging % =   Not Selected  Not Selected %

**Calculated Parameters for Overflow Weir**

Height of Gate Upper Edge, H<sub>i</sub> =   Not Selected  Not Selected feet  
Overflow Weir Slope Length =   Not Selected  Not Selected feet  
Gate Open Area / 100-yr Orifice Area =   Not Selected  Not Selected  
Overflow Gate Open Area w/o Debris =   Not Selected  Not Selected ft<sup>2</sup>  
Overflow Gate Open Area w/ Debris =   Not Selected  Not Selected ft<sup>2</sup>

**User Input: Outlet Pipe w/ Flow Restriction Plate (Circular Orifice, Restrictor Plate, or Rectangular Orifice)**

Depth to Invert of Outlet Pipe =   Not Selected  Not Selected ft (distance below basin bottom at Stage = 0 ft)  
Circular Orifice Diameter =   Not Selected  Not Selected inches

**Calculated Parameters for Outlet Pipe w/ Flow Restriction Plate**

Outlet Orifice Area =   Not Selected  Not Selected ft<sup>2</sup>  
Outlet Orifice Centroid =   Not Selected  Not Selected feet  
Half-Central Angle of Restrictor Plate on Pipe =   Not Selected  Not Selected radians

**User Input: Emergency Spillway (Rectangular or Trapezoidal)**

Spillway Invert Stage =   Not Selected  Not Selected ft (relative to basin bottom at Stage = 0 ft)  
Spillway Crest Length =   Not Selected  Not Selected feet  
Spillway End Slopes =   Not Selected  Not Selected H:V  
Freeboard above Max Water Surface =   Not Selected  Not Selected feet

**Calculated Parameters for Spillway**

Spillway Design Flow Depth =   Not Selected  Not Selected feet  
Stage at Top of Freeboard =   Not Selected  Not Selected feet  
Basin Area at Top of Freeboard =   Not Selected  Not Selected acres  
Basin Volume at Top of Freeboard =   Not Selected  Not Selected acre-ft

## Routed Hydrograph Results

*The user can override the default CUHP hydrographs and runoff volumes by entering new values in the Inflow Hydrographs table (Columns W through AF).*

	WQCV	EURV	2 Year	5 Year	10 Year	25 Year	50 Year	100 Year	500 Year
Design Storm Return Period	N/A	N/A	1.19	1.50	1.75	2.00	2.25	2.52	3.68
One-Hour Rainfall Depth (in)	N/A	N/A	1.19	1.50	1.75	2.00	2.25	2.52	3.68
CUHP Runoff Volume (acre-ft)	0.889	2.177	1.544	2.117	2.595	3.756	4.841	6.293	12.402
Inflow Hydrograph Volume (acre-ft)	N/A	N/A	1.544	2.117	2.595	3.756	4.841	6.293	12.402
CUHP Predevelopment Peak Q (cfs)	N/A	N/A	0.4	0.8	1.1	10.3	20.6	34.2	89.1
OPTIONAL Override Predevelopment Peak Q (cfs)	N/A	N/A							
Predevelopment Unit Peak Flow, q (cfs/acre)	N/A	N/A	0.01	0.01	0.02	0.15	0.30	0.50	1.30
Peak Inflow Q (cfs)	N/A	N/A	14.7	20.5	25.4	41.2	55.0	72.2	142.2
Peak Outflow Q (cfs)	0.6	54.6	5.8	11.0	15.5	30.6	43.9	52.8	120.2
Ratio Peak Outflow to Predevelopment Q	N/A	N/A	N/A	13.9	13.9	3.0	2.1	1.5	1.3
Structure Controlling Flow	Vertical Orifice 1	Spillway	Overflow Weir 1	Overflow Weir 1	Overflow Weir 1	Overflow Weir 1	Overflow Weir 1	Outlet Plate 1	Spillway
Max Velocity through Gate 1 (fps)	N/A	1.59	0.15	0.3	0.4	0.9	1.3	1.5	1.7
Max Velocity through Gate 2 (fps)	N/A	N/A	N/A	N/A	N/A	N/A	N/A	N/A	N/A
Time to Drain 97% of Inflow Volume (hours)	41	39	43	41	40	36	33	29	20
Time to Drain 99% of Inflow Volume (hours)	44	44	48	47	46	44	43	41	35
Maximum Ponding Depth (ft)	2.34	4.33	2.69	2.81	2.89	3.12	3.30	3.75	5.24
Area at Maximum Ponding Depth (acres)	0.53	0.78	0.57	0.58	0.59	0.62	0.64	0.70	0.92
Maximum Volume Stored (acre-ft)	0.889	2.178	1.076	1.145	1.192	1.337	1.444	1.744	2.947

# DETENTION BASIN OUTLET STRUCTURE DESIGN

*MHFD-Detention, Version 4.00 (December 2019)*

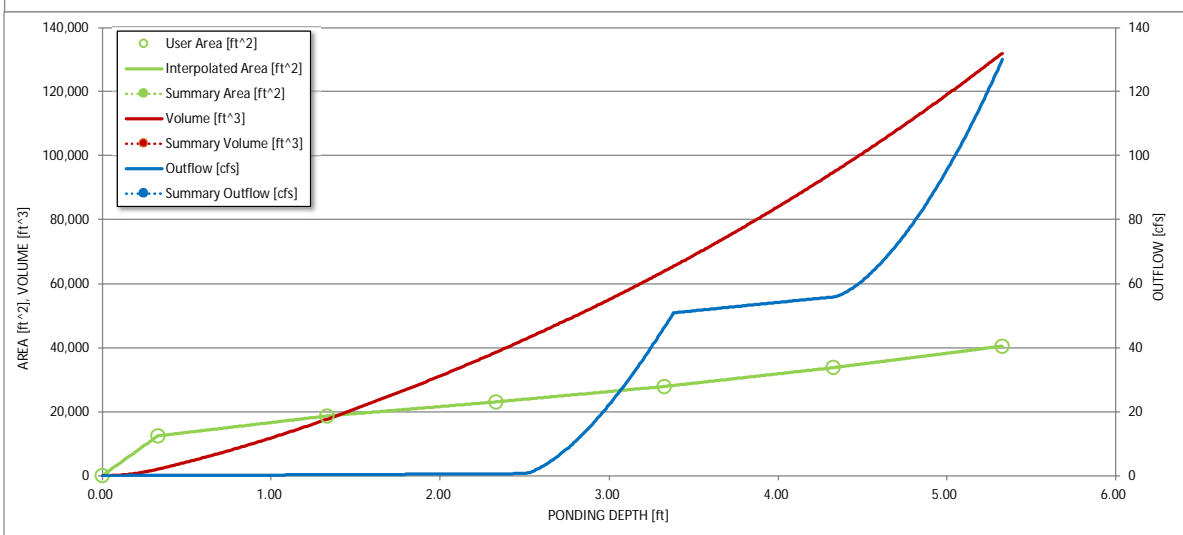
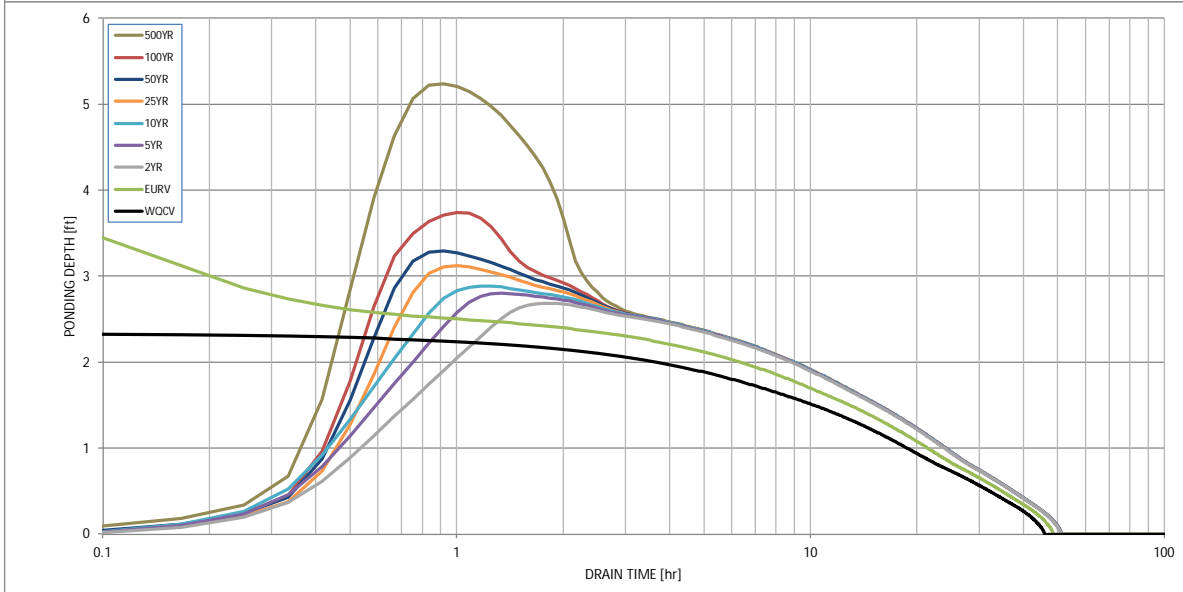
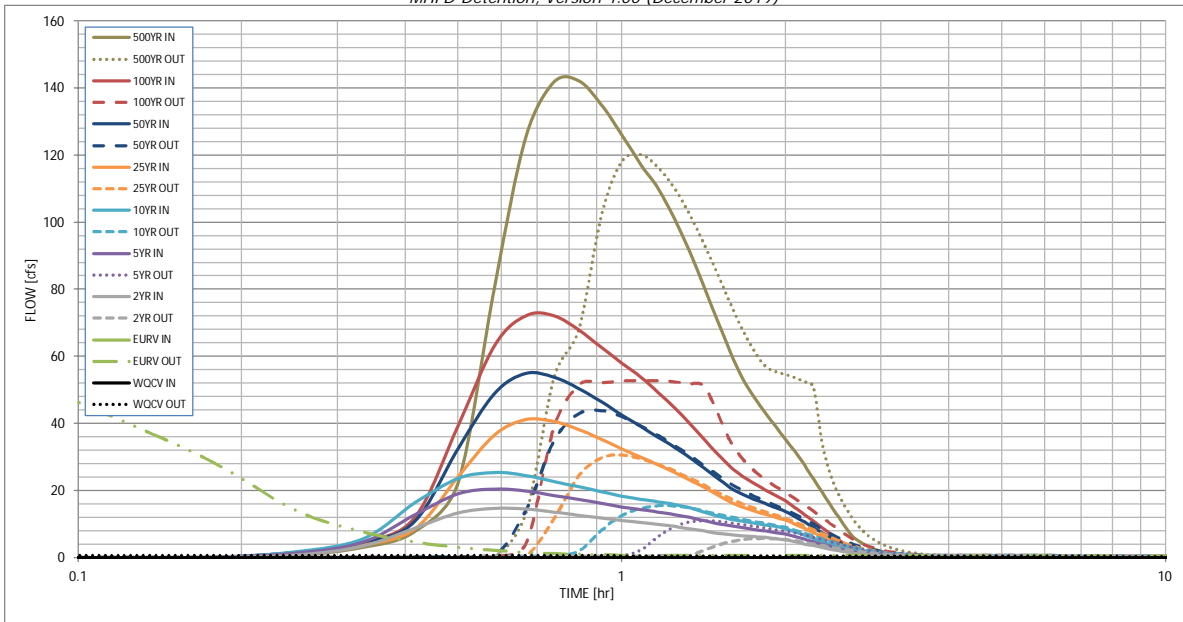

S-A-V-D Chart Axis Override	X-axis	Left Y-Axis	Right Y-Axis
minimum bound			
maximum bound			



# DETENTION BASIN OUTLET STRUCTURE DESIGN

Outflow Hydrograph Workbook Filename: \_\_\_\_\_

## Inflow Hydrographs

The user can override the calculated inflow hydrographs from this workbook with inflow hydrographs developed in a separate program.

Time Interval	SOURCE	CUHP	CUHP	CUHP	CUHP	CUHP	CUHP	CUHP	CUHP	CUHP
	TIME	WQCV [cfs]	EURV [cfs]	2 Year [cfs]	5 Year [cfs]	10 Year [cfs]	25 Year [cfs]	50 Year [cfs]	100 Year [cfs]	500 Year [cfs]
5.00_min	0:00:00	0.00	0.00	0.00	0.00	0.00	0.00	0.00	0.00	0.00
	0:05:00	0.00	0.00	0.00	0.00	0.00	0.00	0.00	0.00	0.00
	0:10:00	0.00	0.00	0.00	0.00	0.00	0.00	0.10	0.01	0.62
	0:15:00	0.00	0.00	0.86	1.39	1.76	1.20	1.56	1.50	3.07
	0:20:00	0.00	0.00	3.47	4.67	5.63	3.64	4.35	4.61	7.85
	0:25:00	0.00	0.00	8.87	12.88	16.33	8.68	10.88	12.09	22.45
	0:30:00	0.00	0.00	13.37	19.03	23.72	24.21	32.63	39.46	81.05
	0:35:00	0.00	0.00	14.70	20.49	25.37	36.66	49.03	63.30	125.79
	0:40:00	0.00	0.00	14.50	19.91	24.51	41.18	54.99	72.22	141.82
	0:45:00	0.00	0.00	13.59	18.56	22.75	40.57	53.91	72.21	142.16
	0:50:00	0.00	0.00	12.65	17.36	21.15	38.27	50.48	67.86	135.15
	0:55:00	0.00	0.00	11.84	16.24	19.71	35.38	46.49	62.77	126.09
	1:00:00	0.00	0.00	11.10	15.16	18.40	32.49	42.51	57.99	117.15
	1:05:00	0.00	0.00	10.55	14.34	17.44	29.95	39.09	53.87	110.05
	1:10:00	0.00	0.00	9.94	13.65	16.63	27.61	35.90	49.34	100.96
	1:15:00	0.00	0.00	9.27	12.86	15.85	25.45	32.92	44.71	91.10
	1:20:00	0.00	0.00	8.60	11.96	14.82	23.18	29.82	39.95	80.74
	1:25:00	0.00	0.00	7.94	11.04	13.59	20.93	26.74	35.31	70.60
	1:30:00	0.00	0.00	7.33	10.19	12.39	18.69	23.70	30.94	61.21
	1:35:00	0.00	0.00	6.86	9.52	11.50	16.59	20.90	27.07	53.54
	1:40:00	0.00	0.00	6.53	8.96	10.86	15.07	18.97	24.30	47.91
	1:45:00	0.00	0.00	6.28	8.44	10.32	13.93	17.47	22.17	43.26
	1:50:00	0.00	0.00	6.05	7.95	9.81	12.95	16.17	20.30	39.10
	1:55:00	0.00	0.00	5.68	7.48	9.28	12.04	14.95	18.57	35.27
	2:00:00	0.00	0.00	5.26	7.00	8.66	11.18	13.80	16.92	31.64
	2:05:00	0.00	0.00	4.70	6.28	7.73	10.00	12.27	14.94	27.60
	2:10:00	0.00	0.00	4.11	5.50	6.72	8.70	10.62	12.89	23.53
	2:15:00	0.00	0.00	3.55	4.74	5.74	7.45	9.02	10.91	19.61
	2:20:00	0.00	0.00	3.02	4.02	4.83	6.24	7.48	8.99	15.82
	2:25:00	0.00	0.00	2.53	3.35	3.98	5.11	6.04	7.16	12.20
	2:30:00	0.00	0.00	2.06	2.73	3.21	4.04	4.67	5.42	8.82
	2:35:00	0.00	0.00	1.65	2.17	2.54	3.06	3.44	3.84	6.18
	2:40:00	0.00	0.00	1.32	1.73	2.08	2.26	2.53	2.76	4.55
	2:45:00	0.00	0.00	1.08	1.43	1.74	1.75	1.96	2.08	3.42
	2:50:00	0.00	0.00	0.91	1.20	1.47	1.40	1.56	1.61	2.57
	2:55:00	0.00	0.00	0.76	1.01	1.23	1.13	1.26	1.26	1.93
	3:00:00	0.00	0.00	0.64	0.85	1.03	0.92	1.02	0.98	1.44
	3:05:00	0.00	0.00	0.54	0.71	0.85	0.75	0.83	0.77	1.08
	3:10:00	0.00	0.00	0.45	0.59	0.71	0.62	0.68	0.61	0.84
	3:15:00	0.00	0.00	0.38	0.49	0.58	0.51	0.55	0.50	0.67
	3:20:00	0.00	0.00	0.31	0.40	0.47	0.41	0.44	0.40	0.54
	3:25:00	0.00	0.00	0.25	0.32	0.38	0.33	0.35	0.32	0.43
	3:30:00	0.00	0.00	0.20	0.25	0.30	0.26	0.28	0.25	0.33
	3:35:00	0.00	0.00	0.16	0.20	0.23	0.20	0.21	0.19	0.24
	3:40:00	0.00	0.00	0.12	0.15	0.17	0.15	0.15	0.14	0.17
	3:45:00	0.00	0.00	0.08	0.10	0.12	0.10	0.11	0.09	0.11
	3:50:00	0.00	0.00	0.05	0.07	0.08	0.07	0.07	0.06	0.06
	3:55:00	0.00	0.00	0.03	0.05	0.05	0.04	0.04	0.03	0.03
	4:00:00	0.00	0.00	0.02	0.03	0.02	0.02	0.02	0.01	0.01
	4:05:00	0.00	0.00	0.01	0.01	0.01	0.01	0.00	0.00	0.00
	4:10:00	0.00	0.00	0.00	0.00	0.00	0.00	0.00	0.00	0.00
	4:15:00	0.00	0.00	0.00	0.00	0.00	0.00	0.00	0.00	0.00
	4:20:00	0.00	0.00	0.00	0.00	0.00	0.00	0.00	0.00	0.00
	4:25:00	0.00	0.00	0.00	0.00	0.00	0.00	0.00	0.00	0.00
	4:30:00	0.00	0.00	0.00	0.00	0.00	0.00	0.00	0.00	0.00
	4:35:00	0.00	0.00	0.00	0.00	0.00	0.00	0.00	0.00	0.00
	4:40:00	0.00	0.00	0.00	0.00	0.00	0.00	0.00	0.00	0.00
	4:45:00	0.00	0.00	0.00	0.00	0.00	0.00	0.00	0.00	0.00
	4:50:00	0.00	0.00	0.00	0.00	0.00	0.00	0.00	0.00	0.00
	4:55:00	0.00	0.00	0.00	0.00	0.00	0.00	0.00	0.00	0.00
	5:00:00	0.00	0.00	0.00	0.00	0.00	0.00	0.00	0.00	0.00
	5:05:00	0.00	0.00	0.00	0.00	0.00	0.00	0.00	0.00	0.00
	5:10:00	0.00	0.00	0.00	0.00	0.00	0.00	0.00	0.00	0.00
	5:15:00	0.00	0.00	0.00	0.00	0.00	0.00	0.00	0.00	0.00
	5:20:00	0.00	0.00	0.00	0.00	0.00	0.00	0.00	0.00	0.00
	5:25:00	0.00	0.00	0.00	0.00	0.00	0.00	0.00	0.00	0.00
	5:30:00	0.00	0.00	0.00	0.00	0.00	0.00	0.00	0.00	0.00
	5:35:00	0.00	0.00	0.00	0.00	0.00	0.00	0.00	0.00	0.00
	5:40:00	0.00	0.00	0.00	0.00	0.00	0.00	0.00	0.00	0.00
	5:45:00	0.00	0.00	0.00	0.00	0.00	0.00	0.00	0.00	0.00
	5:50:00	0.00	0.00	0.00	0.00	0.00	0.00	0.00	0.00	0.00
	5:55:00	0.00	0.00	0.00	0.00	0.00	0.00	0.00	0.00	0.00
	6:00:00	0.00	0.00	0.00	0.00	0.00	0.00	0.00	0.00	0.00



# DETENTION BASIN STAGE-STORAGE TABLE BUILDER

*MHFD-Detention, Version 4.03 (May 2020)*

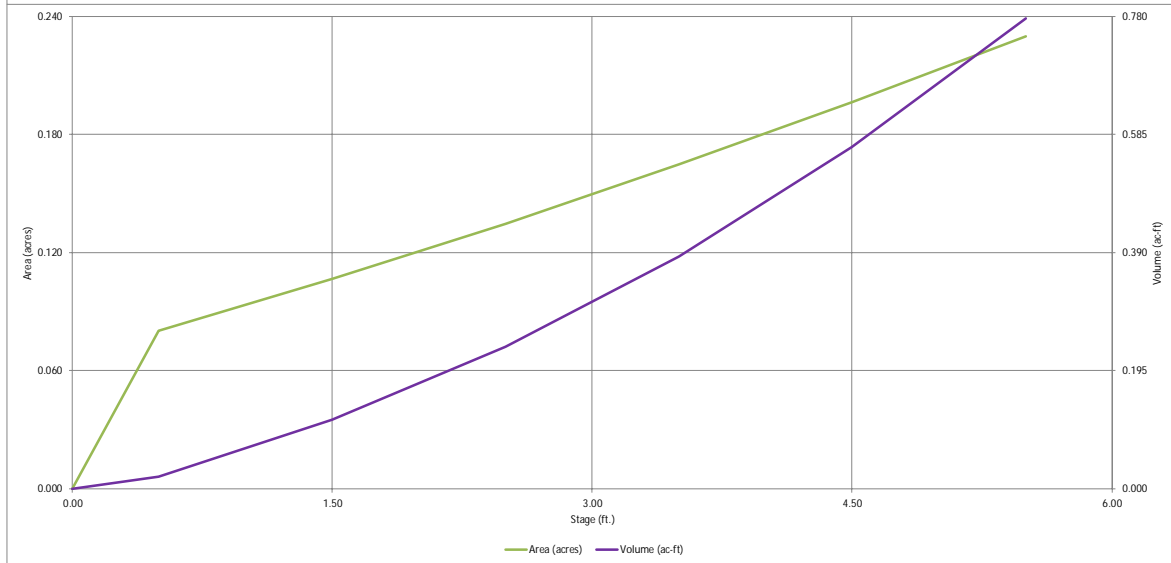
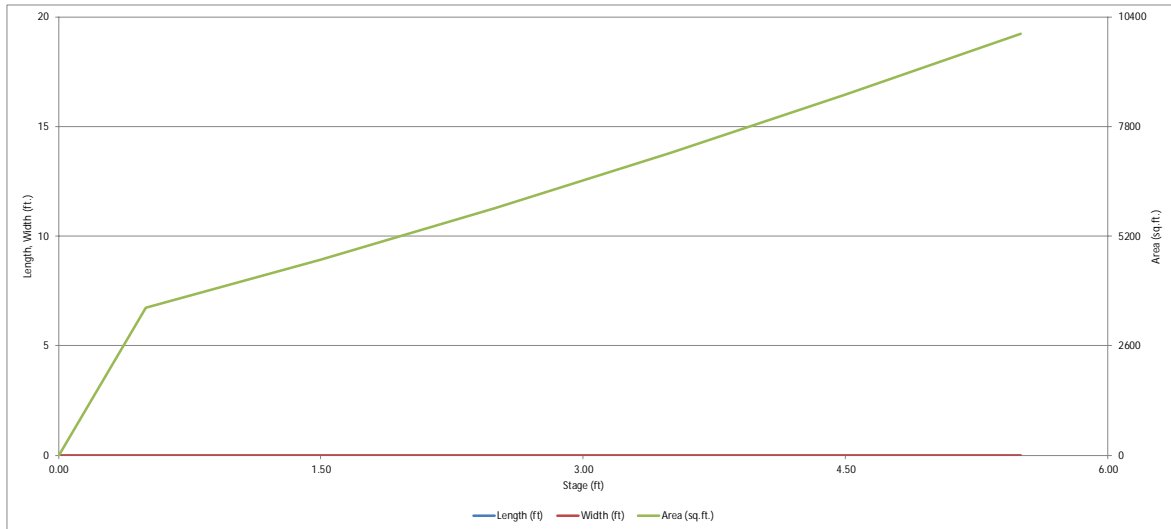

# DETENTION BASIN OUTLET STRUCTURE DESIGN

*MHFD-Detention, Version 4.03 (May 2020)*

Project: Bent Grass Residential Filing No. 2  
Basin ID: Ex WQCV Pond - North

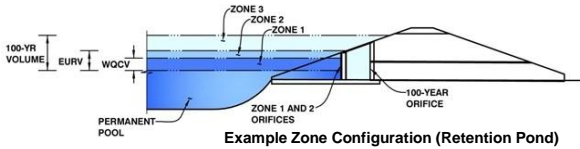

	Estimated Stage (ft)	Estimated Volume (ac-ft)	Outlet Type
Zone 1 (WQCV)	3.47	0.378	Orifice Plate
Zone 2			
Zone 3			
<b>Total (all zones)</b>		<b>0.378</b>	

User Input: Orifice at Underdrain Outlet (typically used to drain WQCV in a Filtration BMP)

Underdrain Orifice Invert Depth =  ft (distance below the filtration media surface)  
Underdrain Orifice Diameter =  inches

Calculated Parameters for Underdrain  
Underdrain Orifice Area =  ft<sup>2</sup>  
Underdrain Orifice Centroid =  feet

User Input: Orifice Plate with one or more orifices or Elliptical Slot Weir (typically used to drain WQCV and/or EURV in a sedimentation BMP)

Invert of Lowest Orifice =  0.00 ft (relative to basin bottom at Stage = 0 ft)  
Depth at top of Zone using Orifice Plate =  3.10 ft (relative to basin bottom at Stage = 0 ft)  
Orifice Plate: Orifice Vertical Spacing =  12.00 inches  
Orifice Plate: Orifice Area per Row =  1.66 sq. inches (diameter = 1-7/16 inches)

Calculated Parameters for Plate  
WQ Orifice Area per Row =  1.153E-02 ft<sup>2</sup>  
Elliptical Half-Width =  N/A feet  
Elliptical Slot Centroid =  N/A feet  
Elliptical Slot Area =  N/A ft<sup>2</sup>

User Input: Stage and Total Area of Each Orifice Row (numbered from lowest to highest)

	Row 1 (required)	Row 2 (optional)	Row 3 (optional)	Row 4 (optional)	Row 5 (optional)	Row 6 (optional)	Row 7 (optional)	Row 8 (optional)
Stage of Orifice Centroid (ft)	0.00	1.00	2.00	3.00				
Orifice Area (sq. inches)	1.66	1.66	1.66					

	Row 9 (optional)	Row 10 (optional)	Row 11 (optional)	Row 12 (optional)	Row 13 (optional)	Row 14 (optional)	Row 15 (optional)	Row 16 (optional)
Stage of Orifice Centroid (ft)								
Orifice Area (sq. inches)								

User Input: Vertical Orifice (Circular or Rectangular)

Invert of Vertical Orifice =  Not Selected  Not Selected ft (relative to basin bottom at Stage = 0 ft)  
Depth at top of Zone using Vertical Orifice =  ft (relative to basin bottom at Stage = 0 ft)  
Vertical Orifice Diameter =  inches

Calculated Parameters for Vertical Orifice  
Vertical Orifice Area =  Not Selected  Not Selected ft<sup>2</sup>  
Vertical Orifice Centroid =  Not Selected  Not Selected feet

User Input: Overflow Weir (Dropbox with Flat or Sloped Gate and Outlet Pipe OR Rectangular/Trapezoidal Weir (and No Outlet Pipe))

Overflow Weir Front Edge Height, Ho =  Not Selected  Not Selected ft (relative to basin bottom at Stage = 0 ft)  
Overflow Weir Front Edge Length =  feet  
Overflow Weir Gate Slope =  H:V  
Horiz. Length of Weir Sides =  feet  
Overflow Gate Open Area % =  % , gate open area/total area  
Debris Clogging % =  %

Calculated Parameters for Overflow Weir  
Height of Gate Upper Edge, H<sub>i</sub> =  Not Selected  Not Selected feet  
Overflow Weir Slope Length =  feet  
Gate Open Area / 100-yr Orifice Area =   
Overflow Gate Open Area w/o Debris =  ft<sup>2</sup>  
Overflow Gate Open Area w/ Debris =  ft<sup>2</sup>

User Input: Outlet Pipe w/ Flow Restriction Plate (Circular Orifice, Restrictor Plate, or Rectangular Orifice)

Depth to Invert of Outlet Pipe =  Not Selected  Not Selected ft (distance below basin bottom at Stage = 0 ft)  
Circular Orifice Diameter =  inches

Calculated Parameters for Outlet Pipe w/ Flow Restriction Plate  
Outlet Orifice Area =  Not Selected  Not Selected ft<sup>2</sup>  
Outlet Orifice Centroid =  Not Selected  Not Selected feet  
Half-Central Angle of Restrictor Plate on Pipe =  N/A  N/A radians

User Input: Emergency Spillway (Rectangular or Trapezoidal)

Spillway Invert Stage =  3.25 ft (relative to basin bottom at Stage = 0 ft)  
Spillway Crest Length =  40.00 feet  
Spillway End Slopes =  4.00 H:V  
Freeboard above Max Water Surface =  1.00 feet

Calculated Parameters for Spillway  
Spillway Design Flow Depth =  0.45 feet  
Stage at Top of Freeboard =  4.70 feet  
Basin Area at Top of Freeboard =  0.20 acres  
Basin Volume at Top of Freeboard =  0.60 acre-ft

## Routed Hydrograph Results

*The user can override the default CUHP hydrographs and runoff volumes by entering new values in the Inflow Hydrographs table (Columns W through AF).*

	WQCV	EURV	2 Year	5 Year	10 Year	25 Year	50 Year	100 Year	500 Year
Design Storm Return Period									
One-Hour Rainfall Depth (in)	N/A	N/A	1.19	1.50	1.75	2.00	2.25	2.52	3.68
CUHP Runoff Volume (acre-ft)	0.378	1.327	0.000	0.000	0.000	0.000	0.000	0.000	0.000
Inflow Hydrograph Volume (acre-ft)	N/A	N/A	0.993	1.315	1.572	1.954	2.328	2.799	4.756
CUHP Predevelopment Peak Q (cfs)	N/A	N/A	0.0	0.0	0.0	0.0	0.0	0.0	0.0
OPTIONAL Override Predevelopment Peak Q (cfs)	N/A	N/A							
Predevelopment Unit Peak Flow, q (cfs/acre)	N/A	N/A	0.00	0.00	0.00	0.00	0.00	0.00	0.00
Peak Inflow Q (cfs)	N/A	N/A	12.1	16.2	19.2	25.7	31.3	38.2	65.4
Peak Outflow Q (cfs)	4.8	214.4	10.3	14.3	21.1	31.4	38.8	45.0	79.7
Ratio Peak Outflow to Predevelopment Q	N/A	N/A	N/A	#DIV/0!	#DIV/0!	#DIV/0!	#DIV/0!	#DIV/0!	#DIV/0!
Structure Controlling Flow	Spillway	Plate	Spillway	Spillway	Spillway	Spillway	Spillway	Spillway	Spillway
Max Velocity through Gate 1 (fps)	N/A	N/A	N/A	N/A	N/A	N/A	N/A	N/A	N/A
Max Velocity through Gate 2 (fps)	N/A	N/A	N/A	N/A	N/A	N/A	N/A	N/A	N/A
Time to Drain 97% of Inflow Volume (hours)	37	>120	34	32	30	27	25	23	16
Time to Drain 99% of Inflow Volume (hours)	40	>120	41	40	39	38	36	35	30
Maximum Ponding Depth (ft)	3.47	0.00	3.44	3.49	3.56	3.65	3.71	3.75	3.98
Area at Maximum Ponding Depth (acres)	0.16	0.00	0.16	0.16	0.17	0.17	0.17	0.17	0.18
Maximum Volume Stored (acre-ft)	0.379	0.000	0.372	0.380	0.392	0.407	0.417	0.426	0.466

# DETENTION BASIN OUTLET STRUCTURE DESIGN

*MHFD-Detention, Version 4.00 (December 2019)*

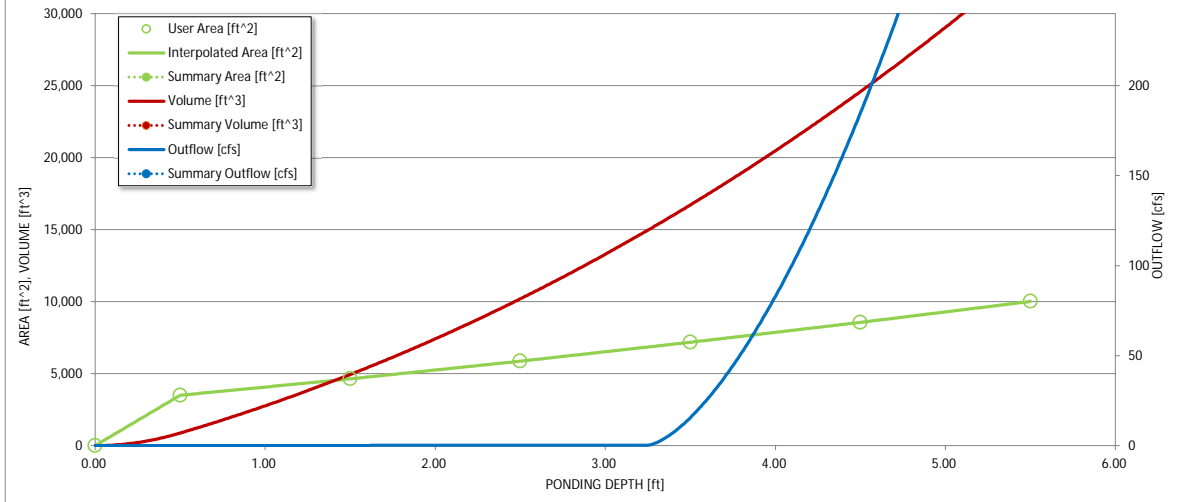
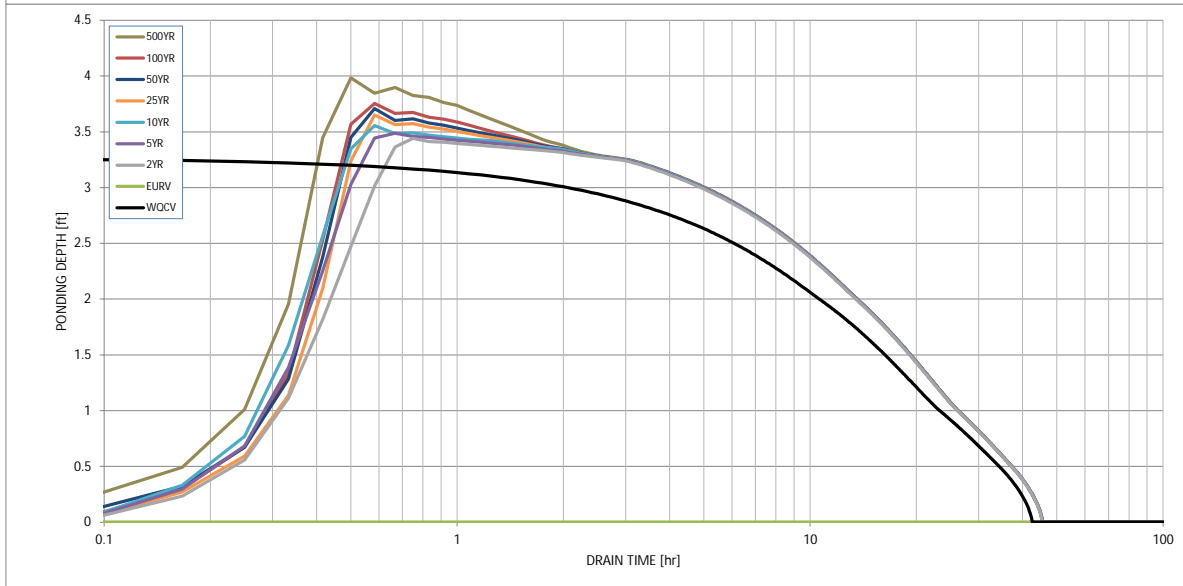
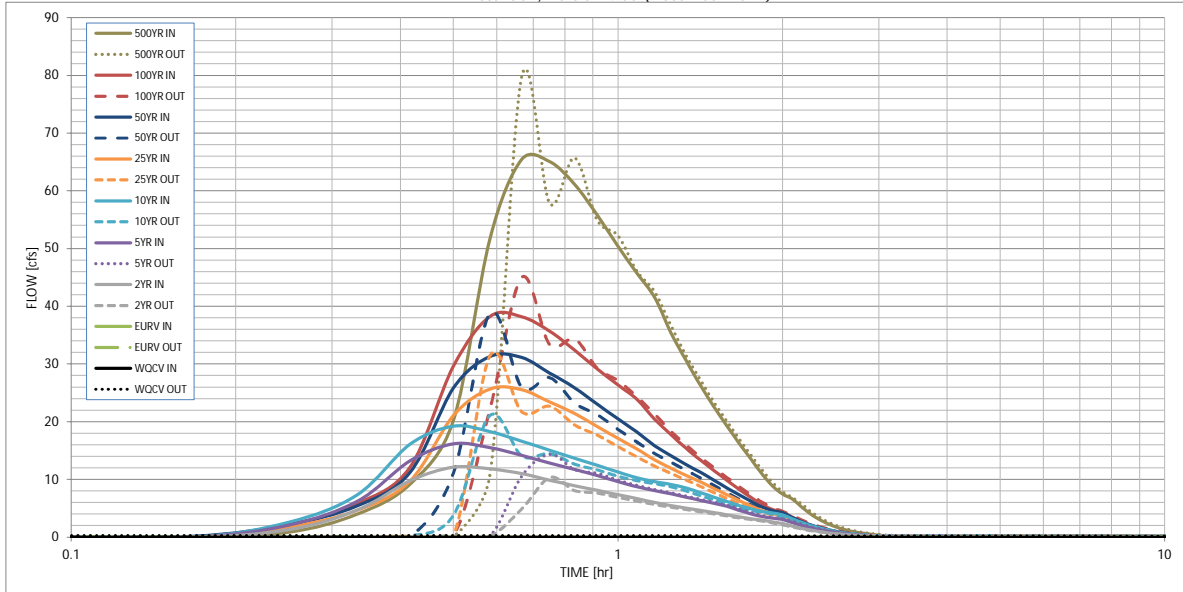

S-A-V-D Chart Axis Override	X-axis	Left Y-Axis	Right Y-Axis
minimum bound			
maximum bound			

# DETENTION BASIN OUTLET STRUCTURE DESIGN

Outflow Hydrograph Workbook Filename: \_\_\_\_\_

**Inflow Hydrographs**

The user can override the calculated inflow hydrographs from this workbook with inflow hydrographs developed in a separate program.

Time Interval	SOURCE	CUHP	CUHP	CUHP	CUHP	CUHP	CUHP	CUHP	CUHP	CUHP
	TIME	WQCV [cfs]	EURV [cfs]	2 Year [cfs]	5 Year [cfs]	10 Year [cfs]	25 Year [cfs]	50 Year [cfs]	100 Year [cfs]	500 Year [cfs]
5.00 min	0:00:00	0.00	0.00	0.00	0.00	0.00	0.00	0.00	0.00	0.00
	0:05:00	0.00	0.00	0.00	0.00	0.00	0.00	0.00	0.00	0.00
	0:10:00	0.00	0.00	0.00	0.00	0.00	0.00	0.15	0.01	0.87
	0:15:00	0.00	0.00	1.28	2.08	2.58	1.74	2.19	2.13	3.98
	0:20:00	0.00	0.00	4.68	6.18	7.30	4.63	5.42	5.79	9.20
	0:25:00	0.00	0.00	9.77	13.20	16.08	9.72	11.20	12.14	20.16
	0:30:00	0.00	0.00	12.12	16.17	19.24	21.06	25.80	29.60	51.77
	0:35:00	0.00	0.00	11.83	15.50	18.25	25.66	31.32	38.24	65.42
	0:40:00	0.00	0.00	10.99	14.16	16.62	25.52	31.12	38.17	65.04
	0:45:00	0.00	0.00	9.86	12.81	15.07	23.40	28.44	35.69	61.13
	0:50:00	0.00	0.00	8.91	11.74	13.69	21.42	25.89	32.38	55.81
	0:55:00	0.00	0.00	8.10	10.65	12.44	19.16	23.04	29.12	50.39
	1:00:00	0.00	0.00	7.33	9.61	11.28	17.10	20.47	26.35	45.73
	1:05:00	0.00	0.00	6.68	8.71	10.27	15.28	18.21	23.86	41.57
	1:10:00	0.00	0.00	6.00	8.07	9.60	13.38	15.84	20.46	35.39
	1:15:00	0.00	0.00	5.47	7.50	9.14	11.95	14.10	17.75	30.55
	1:20:00	0.00	0.00	5.03	6.92	8.51	10.68	12.55	15.37	26.26
	1:25:00	0.00	0.00	4.63	6.37	7.70	9.57	11.21	13.31	22.52
	1:30:00	0.00	0.00	4.25	5.85	6.92	8.42	9.83	11.51	19.28
	1:35:00	0.00	0.00	3.87	5.34	6.18	7.34	8.53	9.84	16.29
	1:40:00	0.00	0.00	3.50	4.66	5.49	6.34	7.32	8.29	13.53
	1:45:00	0.00	0.00	3.18	4.04	4.90	5.42	6.22	6.88	11.02
	1:50:00	0.00	0.00	2.95	3.58	4.48	4.64	5.26	5.67	8.89
	1:55:00	0.00	0.00	2.62	3.30	4.19	4.07	4.60	4.80	7.46
	2:00:00	0.00	0.00	2.35	3.07	3.87	3.75	4.22	4.31	6.62
	2:05:00	0.00	0.00	1.93	2.52	3.18	3.05	3.43	3.44	5.23
	2:10:00	0.00	0.00	1.54	2.02	2.55	2.41	2.71	2.68	4.02
	2:15:00	0.00	0.00	1.24	1.61	2.04	1.91	2.14	2.08	3.09
	2:20:00	0.00	0.00	0.98	1.28	1.62	1.50	1.68	1.60	2.35
	2:25:00	0.00	0.00	0.77	1.02	1.28	1.18	1.32	1.24	1.79
	2:30:00	0.00	0.00	0.61	0.79	0.99	0.92	1.02	0.95	1.37
	2:35:00	0.00	0.00	0.48	0.61	0.76	0.70	0.78	0.73	1.05
	2:40:00	0.00	0.00	0.37	0.46	0.58	0.54	0.60	0.56	0.81
	2:45:00	0.00	0.00	0.28	0.35	0.45	0.42	0.46	0.44	0.63
	2:50:00	0.00	0.00	0.21	0.27	0.34	0.32	0.35	0.34	0.48
	2:55:00	0.00	0.00	0.15	0.19	0.25	0.23	0.26	0.25	0.35
	3:00:00	0.00	0.00	0.10	0.13	0.17	0.16	0.18	0.17	0.24
	3:05:00	0.00	0.00	0.06	0.08	0.11	0.10	0.12	0.11	0.15
	3:10:00	0.00	0.00	0.03	0.05	0.06	0.06	0.06	0.06	0.08
	3:15:00	0.00	0.00	0.01	0.02	0.03	0.03	0.03	0.03	0.03
	3:20:00	0.00	0.00	0.00	0.01	0.01	0.01	0.01	0.01	0.01
	3:25:00	0.00	0.00	0.00	0.00	0.00	0.00	0.00	0.00	0.00
	3:30:00	0.00	0.00	0.00	0.00	0.00	0.00	0.00	0.00	0.00
	3:35:00	0.00	0.00	0.00	0.00	0.00	0.00	0.00	0.00	0.00
	3:40:00	0.00	0.00	0.00	0.00	0.00	0.00	0.00	0.00	0.00
	3:45:00	0.00	0.00	0.00	0.00	0.00	0.00	0.00	0.00	0.00
	3:50:00	0.00	0.00	0.00	0.00	0.00	0.00	0.00	0.00	0.00
	3:55:00	0.00	0.00	0.00	0.00	0.00	0.00	0.00	0.00	0.00
	4:00:00	0.00	0.00	0.00	0.00	0.00	0.00	0.00	0.00	0.00
	4:05:00	0.00	0.00	0.00	0.00	0.00	0.00	0.00	0.00	0.00
	4:10:00	0.00	0.00	0.00	0.00	0.00	0.00	0.00	0.00	0.00
	4:15:00	0.00	0.00	0.00	0.00	0.00	0.00	0.00	0.00	0.00
	4:20:00	0.00	0.00	0.00	0.00	0.00	0.00	0.00	0.00	0.00
	4:25:00	0.00	0.00	0.00	0.00	0.00	0.00	0.00	0.00	0.00
	4:30:00	0.00	0.00	0.00	0.00	0.00	0.00	0.00	0.00	0.00
	4:35:00	0.00	0.00	0.00	0.00	0.00	0.00	0.00	0.00	0.00
	4:40:00	0.00	0.00	0.00	0.00	0.00	0.00	0.00	0.00	0.00
	4:45:00	0.00	0.00	0.00	0.00	0.00	0.00	0.00	0.00	0.00
	4:50:00	0.00	0.00	0.00	0.00	0.00	0.00	0.00	0.00	0.00
	4:55:00	0.00	0.00	0.00	0.00	0.00	0.00	0.00	0.00	0.00
	5:00:00	0.00	0.00	0.00	0.00	0.00	0.00	0.00	0.00	0.00
	5:05:00	0.00	0.00	0.00	0.00	0.00	0.00	0.00	0.00	0.00
	5:10:00	0.00	0.00	0.00	0.00	0.00	0.00	0.00	0.00	0.00
	5:15:00	0.00	0.00	0.00	0.00	0.00	0.00	0.00	0.00	0.00
	5:20:00	0.00	0.00	0.00	0.00	0.00	0.00	0.00	0.00	0.00
	5:25:00	0.00	0.00	0.00	0.00	0.00	0.00	0.00	0.00	0.00
	5:30:00	0.00	0.00	0.00	0.00	0.00	0.00	0.00	0.00	0.00
	5:35:00	0.00	0.00	0.00	0.00	0.00	0.00	0.00	0.00	0.00
	5:40:00	0.00	0.00	0.00	0.00	0.00	0.00	0.00	0.00	0.00
	5:45:00	0.00	0.00	0.00	0.00	0.00	0.00	0.00	0.00	0.00
	5:50:00	0.00	0.00	0.00	0.00	0.00	0.00	0.00	0.00	0.00
	5:55:00	0.00	0.00	0.00	0.00	0.00	0.00	0.00	0.00	0.00
	6:00:00	0.00	0.00	0.00	0.00	0.00	0.00	0.00	0.00	0.00







# DETENTION BASIN STAGE-STORAGE TABLE BUILDER

*MHFD- Detention, Version 4.04 (February 2021)*

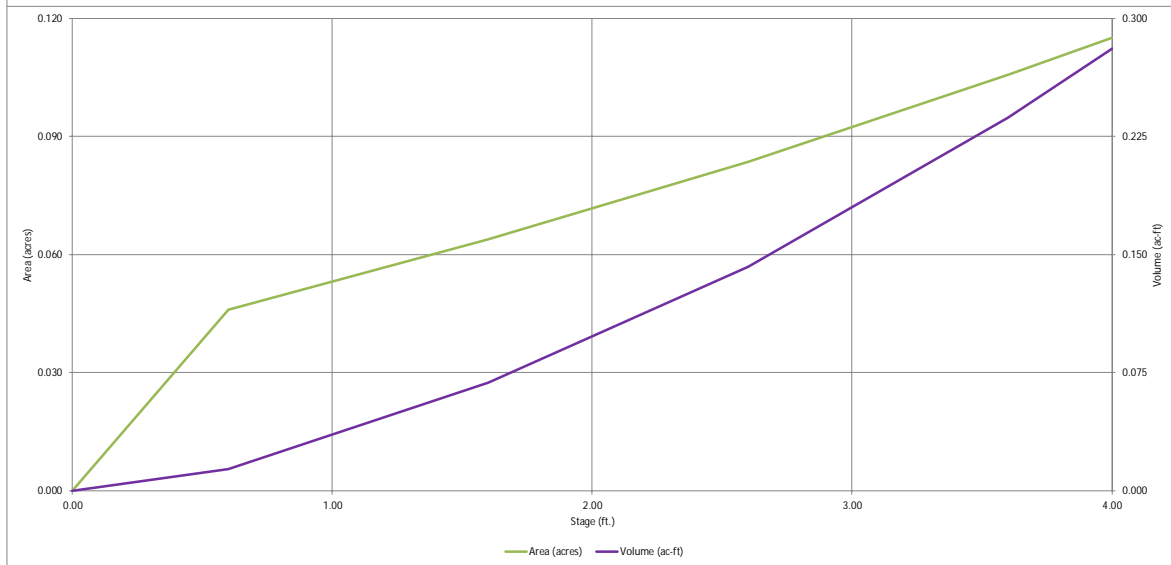
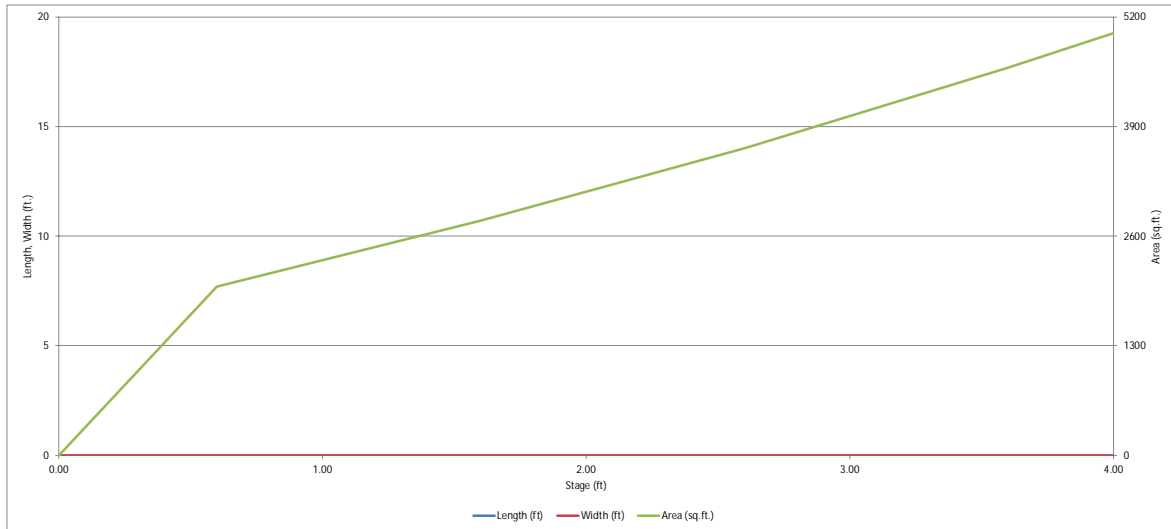

# DETENTION BASIN OUTLET STRUCTURE DESIGN

*MHFD-Detention, Version 4.04 (February 2021)*

Project: Falcon Meadows at Bent Grass  
 Basin ID: Interim (Existing) Sed Basin @ Bent Grass Meadows Drive - Drain Time Analysis

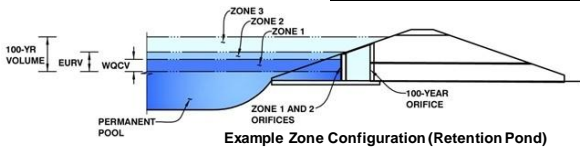

	Estimated Stage (ft)	Estimated Volume (ac-ft)	Outlet Type
Zone 1 (WQCV)	3.69	0.246	Orifice Plate
Zone 2			
Zone 3			
<b>Total (all zones)</b>		<b>0.246</b>	

User Input: Orifice at Underdrain Outlet (typically used to drain WQCV in a Filtration BMP)

Underdrain Orifice Invert Depth =	N/A	ft (distance below the filtration media surface)	Underdrain Orifice Area =	N/A	ft <sup>2</sup>
Underdrain Orifice Diameter =	N/A	inches	Underdrain Orifice Centroid =	N/A	feet

User Input: Orifice Plate with one or more orifices or Elliptical Slot Weir (typically used to drain WQCV and/or EURV in a sedimentation BMP)

Invert of Lowest Orifice =	0.00	ft (relative to basin bottom at Stage = 0 ft)	WO Orifice Area per Row =	N/A	ft <sup>2</sup>
Depth at top of Zone using Orifice Plate =	3.00	ft (relative to basin bottom at Stage = 0 ft)	Elliptical Half-Width =	N/A	feet
Orifice Plate: Orifice Vertical Spacing =	N/A	inches	Elliptical Slot Centroid =	N/A	feet
Orifice Plate: Orifice Area per Row =	N/A	inches	Elliptical Slot Area =	N/A	ft <sup>2</sup>

User Input: Stage and Total Area of Each Orifice Row (numbered from lowest to highest)

	Row 1 (required)	Row 2 (optional)	Row 3 (optional)	Row 4 (optional)	Row 5 (optional)	Row 6 (optional)	Row 7 (optional)	Row 8 (optional)
Stage of Orifice Centroid (ft)	0.00	1.25	1.58	1.92	2.25	2.58	2.92	
Orifice Area (sq. inches)	0.56	2.22	2.22	2.22	2.22	2.22	2.22	

	Row 9 (optional)	Row 10 (optional)	Row 11 (optional)	Row 12 (optional)	Row 13 (optional)	Row 14 (optional)	Row 15 (optional)	Row 16 (optional)
Stage of Orifice Centroid (ft)								
Orifice Area (sq. inches)								

User Input: Vertical Orifice (Circular or Rectangular)

Invert of Vertical Orifice =	Not Selected	Not Selected	ft (relative to basin bottom at Stage = 0 ft)	Vertical Orifice Area =	Not Selected	Not Selected	ft <sup>2</sup>
Depth at top of Zone using Vertical Orifice =			ft (relative to basin bottom at Stage = 0 ft)	Vertical Orifice Centroid =			feet
Vertical Orifice Diameter =			inches				

User Input: Overflow Weir (Dropbox with Flat or Sloped Gate and Outlet Pipe OR Rectangular/Trapezoidal Weir (and No Outlet Pipe))

Overflow Weir Front Edge Height, Ho =	Not Selected	Not Selected	ft (relative to basin bottom at Stage = 0 ft)	Height of Gate Upper Edge, Hi =	Not Selected	Not Selected	feet
Overflow Weir Front Edge Length =	3.00		feet	Overflow Weir Slope Length =	3.00		feet
Overflow Weir Gate Slope =	1.00		H:V	Gate Open Area / 100-yr Orifice Area =	1.00		
Horiz. Length of Weir Sides =	0.00		feet	Overflow Gate Open Area w/o Debris =	1.00		ft <sup>2</sup>
Overflow Gate Type =	No Gate			Overflow Gate Open Area w/ Debris =	0.50		ft <sup>2</sup>
Debris Clogging % =	1.00		%				
	50%						

User Input: Outlet Pipe w/ Flow Restriction Plate (Circular Orifice, Restrictor Plate, or Rectangular Orifice)

Depth to Invert of Outlet Pipe =	Not Selected	Not Selected	ft (distance below basin bottom at Stage = 0 ft)	Outlet Orifice Area =	Not Selected	Not Selected	ft <sup>2</sup>
Circular Orifice Diameter =			inches	Outlet Orifice Centroid =			feet
				Half-Central Angle of Restrictor Plate on Pipe =	N/A	N/A	radians

User Input: Emergency Spillway (Rectangular or Trapezoidal)

Spillway Invert Stage =	3.00	ft (relative to basin bottom at Stage = 0 ft)	Spillway Design Flow Depth =	0.84	feet
Spillway Crest Length =	18.00	feet	Stage at Top of Freeboard =	3.84	feet
Spillway End Slopes =	3.00	H:V	Basin Area at Top of Freeboard =	0.11	acres
Freeboard above Max Water Surface =	0.00	feet	Basin Volume at Top of Freeboard =	0.26	acre-ft

## Routed Hydrograph Results

*The user can override the default CUHP hydrographs and runoff volumes by entering new values in the Inflow Hydrographs table (Columns W through AF).*

	WQCV	EURV	2 Year	5 Year	10 Year	25 Year	50 Year	100 Year	500 Year
Design Storm Return Period									
One-Hour Rainfall Depth (in)	N/A	N/A	1.19	1.50	1.75	2.00	2.25	2.52	3.68
CUHP Runoff Volume (acre-ft)	0.246	0.306	0.000	0.000	0.000	0.000	0.000	0.000	0.000
Inflow Hydrograph Volume (acre-ft)	N/A	N/A	0.148	0.258	0.349	0.994	1.653	2.576	6.681
CUHP Predevelopment Peak Q (cfs)	N/A	N/A	0.0	0.0	0.0	0.0	0.0	0.0	0.0
OPTIONAL Override Predevelopment Peak Q (cfs)	N/A	N/A							
Predevelopment Unit Peak Flow, q (cfs/acre)	N/A	N/A	0.00	0.00	0.00	0.00	0.00	0.00	0.00
Peak Inflow Q (cfs)	N/A	N/A	2.4	4.6	6.2	18.3	30.4	46.3	107.5
Peak Outflow Q (cfs)	11.3	23.0	0.2	1.3	3.4	18.1	36.9	51.1	64.4
Ratio Peak Outflow to Predevelopment Q	N/A	N/A	N/A	#DIV/0!	#DIV/0!	#DIV/0!	#DIV/0!	#DIV/0!	#DIV/0!
Structure Controlling Flow	Spillway	Plate	Plate	Spillway	Spillway	Spillway	Spillway	Spillway	N/A
Max Velocity through Gate 1 (fps)	-0.59	N/A	N/A	-0.4	-0.5	-0.5	-0.6	-0.6	-0.6
Max Velocity through Gate 2 (fps)	N/A	N/A	N/A	N/A	N/A	N/A	N/A	N/A	N/A
Time to Drain 97% of Inflow Volume (hours)	41	40	44	42	40	25	13	8	2
Time to Drain 99% of Inflow Volume (hours)	46	45	47	48	47	40	35	28	10
Maximum Ponding Depth (ft)	3.69	2.65	2.35	3.06	3.13	3.43	3.69	3.86	4.00
Area at Maximum Ponding Depth (acres)	0.11	0.08	0.08	0.09	0.10	0.10	0.11	0.11	0.12
Maximum Volume Stored (acre-ft)	0.247	0.147	0.121	0.182	0.190	0.218	0.247	0.265	0.281

# DETENTION BASIN OUTLET STRUCTURE DESIGN

*MHFD-Detention, Version 4.04 (February 2021)*

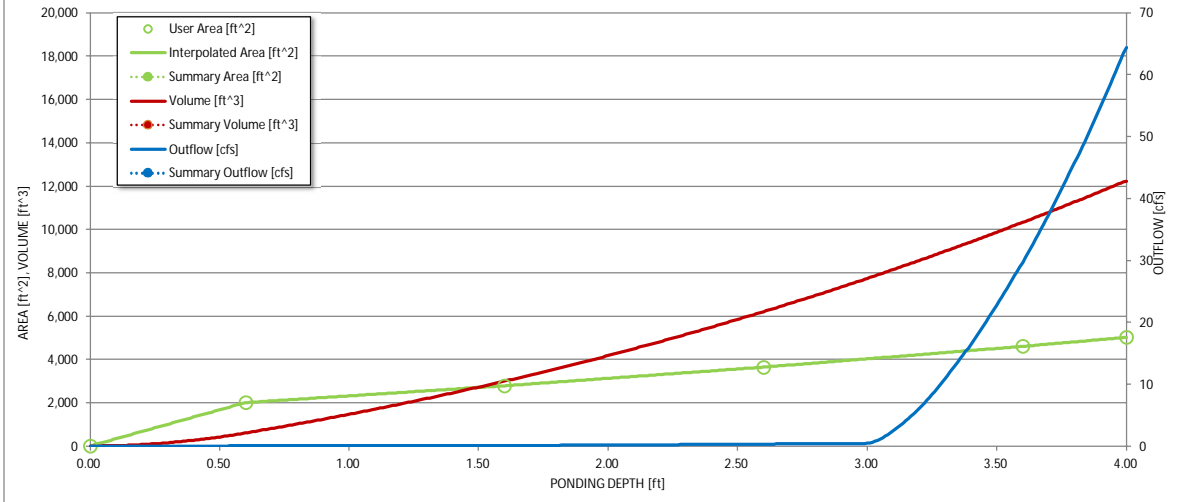
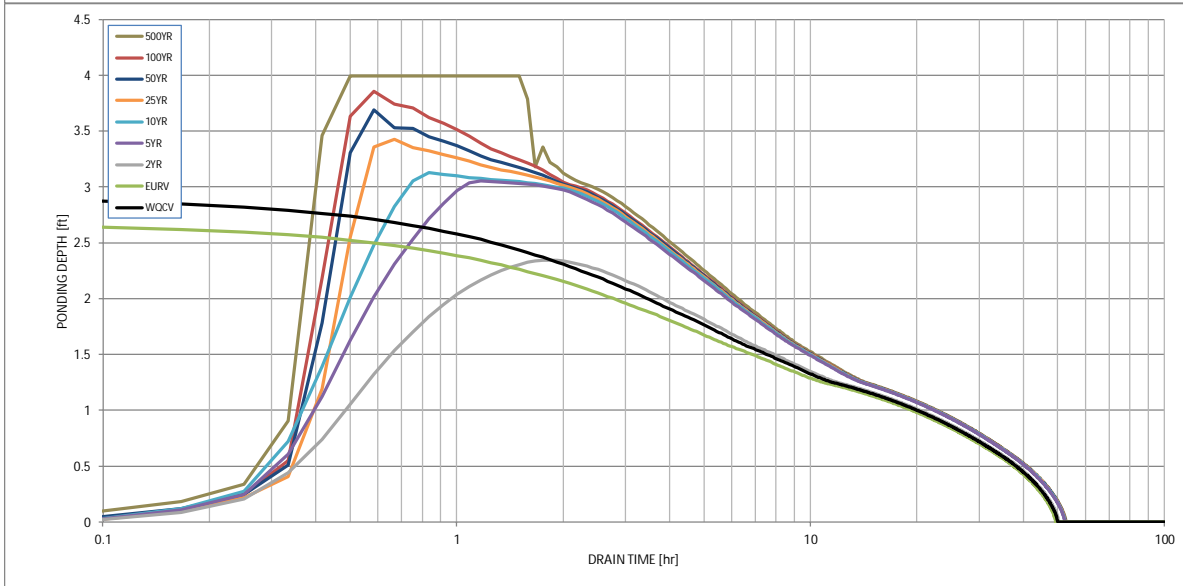
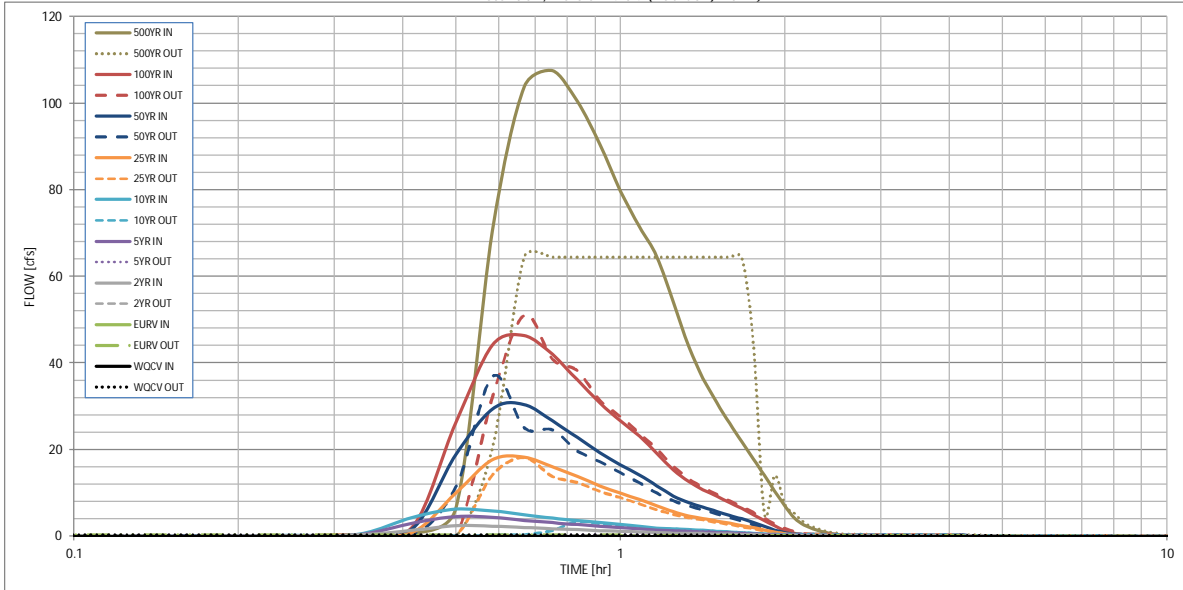

S-A-V-D Chart Axis Override

	X-axis	Left Y-Axis	Right Y-Axis
minimum bound			
maximum bound			

# DETENTION BASIN OUTLET STRUCTURE DESIGN

Outflow Hydrograph Workbook Filename: \_\_\_\_\_

## Inflow Hydrographs

The user can override the calculated inflow hydrographs from this workbook with inflow hydrographs developed in a separate program.

Time Interval	SOURCE	WQCV [cfs]	EURV [cfs]	2 Year [cfs]	5 Year [cfs]	10 Year [cfs]	25 Year [cfs]	50 Year [cfs]	100 Year [cfs]	500 Year [cfs]
5.00 min	0:00:00	0.00	0.00	0.00	0.00	0.00	0.00	0.00	0.00	0.00
	0:05:00	0.00	0.00	0.00	0.00	0.00	0.00	0.00	0.00	0.00
	0:10:00	0.00	0.00	0.00	0.00	0.00	0.00	0.01	0.00	0.06
	0:15:00	0.00	0.00	0.09	0.14	0.18	0.12	0.15	0.15	0.28
	0:20:00	0.00	0.00	0.33	0.44	0.52	0.33	0.38	0.41	0.65
	0:25:00	0.00	0.00	1.37	3.03	4.40	1.02	1.85	2.37	6.44
	0:30:00	0.00	0.00	2.42	4.57	6.22	10.02	18.86	26.26	70.50
	0:35:00	0.00	0.00	2.37	4.30	5.85	17.66	29.42	44.17	103.83
	0:40:00	0.00	0.00	2.07	3.67	4.98	18.26	30.45	46.28	107.49
	0:45:00	0.00	0.00	1.77	3.11	4.21	16.02	26.64	42.03	100.44
	0:50:00	0.00	0.00	1.53	2.68	3.59	13.82	22.83	36.12	90.56
	0:55:00	0.00	0.00	1.34	2.33	3.12	11.67	19.30	30.80	79.79
	1:00:00	0.00	0.00	1.17	2.01	2.69	9.96	16.52	26.64	71.45
	1:05:00	0.00	0.00	1.01	1.71	2.27	8.52	14.13	23.10	64.52
	1:10:00	0.00	0.00	0.85	1.42	1.88	7.06	11.65	19.11	54.02
	1:15:00	0.00	0.00	0.74	1.24	1.69	5.67	9.31	15.29	43.80
	1:20:00	0.00	0.00	0.67	1.12	1.53	4.71	7.77	12.63	36.51
	1:25:00	0.00	0.00	0.60	1.00	1.36	4.09	6.69	10.79	30.90
	1:30:00	0.00	0.00	0.54	0.88	1.18	3.53	5.76	9.23	26.12
	1:35:00	0.00	0.00	0.48	0.77	1.01	3.00	4.87	7.79	21.86
	1:40:00	0.00	0.00	0.41	0.64	0.84	2.49	4.00	6.39	17.88
	1:45:00	0.00	0.00	0.35	0.51	0.67	1.98	3.15	5.02	14.06
	1:50:00	0.00	0.00	0.29	0.39	0.51	1.48	2.30	3.68	10.42
	1:55:00	0.00	0.00	0.23	0.29	0.38	1.00	1.48	2.39	7.02
	2:00:00	0.00	0.00	0.19	0.25	0.32	0.58	0.80	1.29	4.20
	2:05:00	0.00	0.00	0.16	0.20	0.27	0.34	0.45	0.70	2.66
	2:10:00	0.00	0.00	0.13	0.17	0.22	0.24	0.30	0.44	1.75
	2:15:00	0.00	0.00	0.10	0.13	0.18	0.18	0.22	0.29	1.13
	2:20:00	0.00	0.00	0.08	0.11	0.14	0.14	0.16	0.21	0.72
	2:25:00	0.00	0.00	0.07	0.09	0.11	0.11	0.13	0.14	0.42
	2:30:00	0.00	0.00	0.05	0.07	0.09	0.08	0.09	0.10	0.22
	2:35:00	0.00	0.00	0.04	0.05	0.07	0.06	0.07	0.07	0.11
	2:40:00	0.00	0.00	0.03	0.04	0.05	0.05	0.05	0.05	0.08
	2:45:00	0.00	0.00	0.03	0.03	0.04	0.04	0.04	0.04	0.06
	2:50:00	0.00	0.00	0.02	0.02	0.03	0.03	0.03	0.03	0.05
	2:55:00	0.00	0.00	0.01	0.02	0.02	0.02	0.03	0.02	0.04
	3:00:00	0.00	0.00	0.01	0.01	0.02	0.02	0.02	0.02	0.03
	3:05:00	0.00	0.00	0.01	0.01	0.01	0.01	0.01	0.01	0.02
	3:10:00	0.00	0.00	0.00	0.01	0.01	0.01	0.01	0.01	0.01
	3:15:00	0.00	0.00	0.00	0.00	0.00	0.00	0.01	0.00	0.01
	3:20:00	0.00	0.00	0.00	0.00	0.00	0.00	0.00	0.00	0.00
	3:25:00	0.00	0.00	0.00	0.00	0.00	0.00	0.00	0.00	0.00
	3:30:00	0.00	0.00	0.00	0.00	0.00	0.00	0.00	0.00	0.00
	3:35:00	0.00	0.00	0.00	0.00	0.00	0.00	0.00	0.00	0.00
	3:40:00	0.00	0.00	0.00	0.00	0.00	0.00	0.00	0.00	0.00
	3:45:00	0.00	0.00	0.00	0.00	0.00	0.00	0.00	0.00	0.00
	3:50:00	0.00	0.00	0.00	0.00	0.00	0.00	0.00	0.00	0.00
	3:55:00	0.00	0.00	0.00	0.00	0.00	0.00	0.00	0.00	0.00
	4:00:00	0.00	0.00	0.00	0.00	0.00	0.00	0.00	0.00	0.00
	4:05:00	0.00	0.00	0.00	0.00	0.00	0.00	0.00	0.00	0.00
	4:10:00	0.00	0.00	0.00	0.00	0.00	0.00	0.00	0.00	0.00
	4:15:00	0.00	0.00	0.00	0.00	0.00	0.00	0.00	0.00	0.00
	4:20:00	0.00	0.00	0.00	0.00	0.00	0.00	0.00	0.00	0.00
	4:25:00	0.00	0.00	0.00	0.00	0.00	0.00	0.00	0.00	0.00
	4:30:00	0.00	0.00	0.00	0.00	0.00	0.00	0.00	0.00	0.00
	4:35:00	0.00	0.00	0.00	0.00	0.00	0.00	0.00	0.00	0.00
	4:40:00	0.00	0.00	0.00	0.00	0.00	0.00	0.00	0.00	0.00
	4:45:00	0.00	0.00	0.00	0.00	0.00	0.00	0.00	0.00	0.00
	4:50:00	0.00	0.00	0.00	0.00	0.00	0.00	0.00	0.00	0.00
	4:55:00	0.00	0.00	0.00	0.00	0.00	0.00	0.00	0.00	0.00
	5:00:00	0.00	0.00	0.00	0.00	0.00	0.00	0.00	0.00	0.00
	5:05:00	0.00	0.00	0.00	0.00	0.00	0.00	0.00	0.00	0.00
	5:10:00	0.00	0.00	0.00	0.00	0.00	0.00	0.00	0.00	0.00
	5:15:00	0.00	0.00	0.00	0.00	0.00	0.00	0.00	0.00	0.00
	5:20:00	0.00	0.00	0.00	0.00	0.00	0.00	0.00	0.00	0.00
	5:25:00	0.00	0.00	0.00	0.00	0.00	0.00	0.00	0.00	0.00
	5:30:00	0.00	0.00	0.00	0.00	0.00	0.00	0.00	0.00	0.00
	5:35:00	0.00	0.00	0.00	0.00	0.00	0.00	0.00	0.00	0.00
	5:40:00	0.00	0.00	0.00	0.00	0.00	0.00	0.00	0.00	0.00
	5:45:00	0.00	0.00	0.00	0.00	0.00	0.00	0.00	0.00	0.00
	5:50:00	0.00	0.00	0.00	0.00	0.00	0.00	0.00	0.00	0.00
	5:55:00	0.00	0.00	0.00	0.00	0.00	0.00	0.00	0.00	0.00
	6:00:00	0.00	0.00	0.00	0.00	0.00	0.00	0.00	0.00	0.00

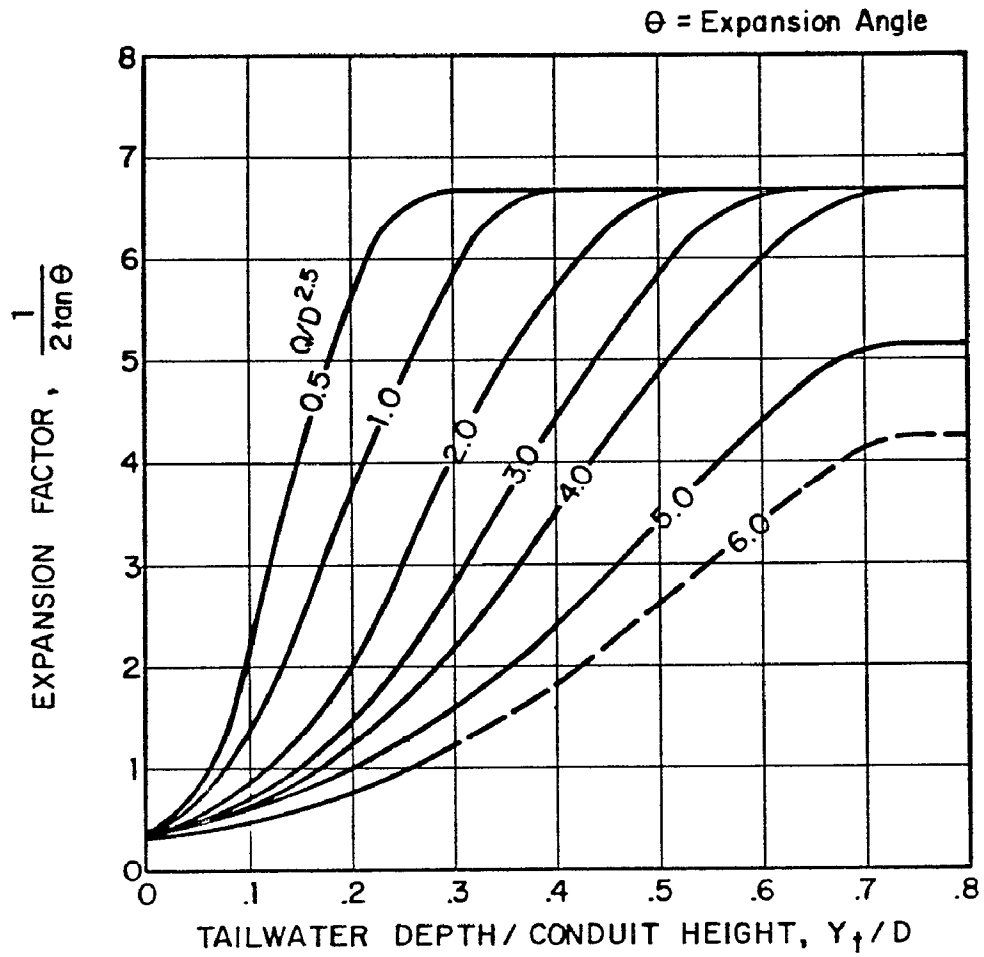

Figure 9-35. Expansion factor for circular conduits

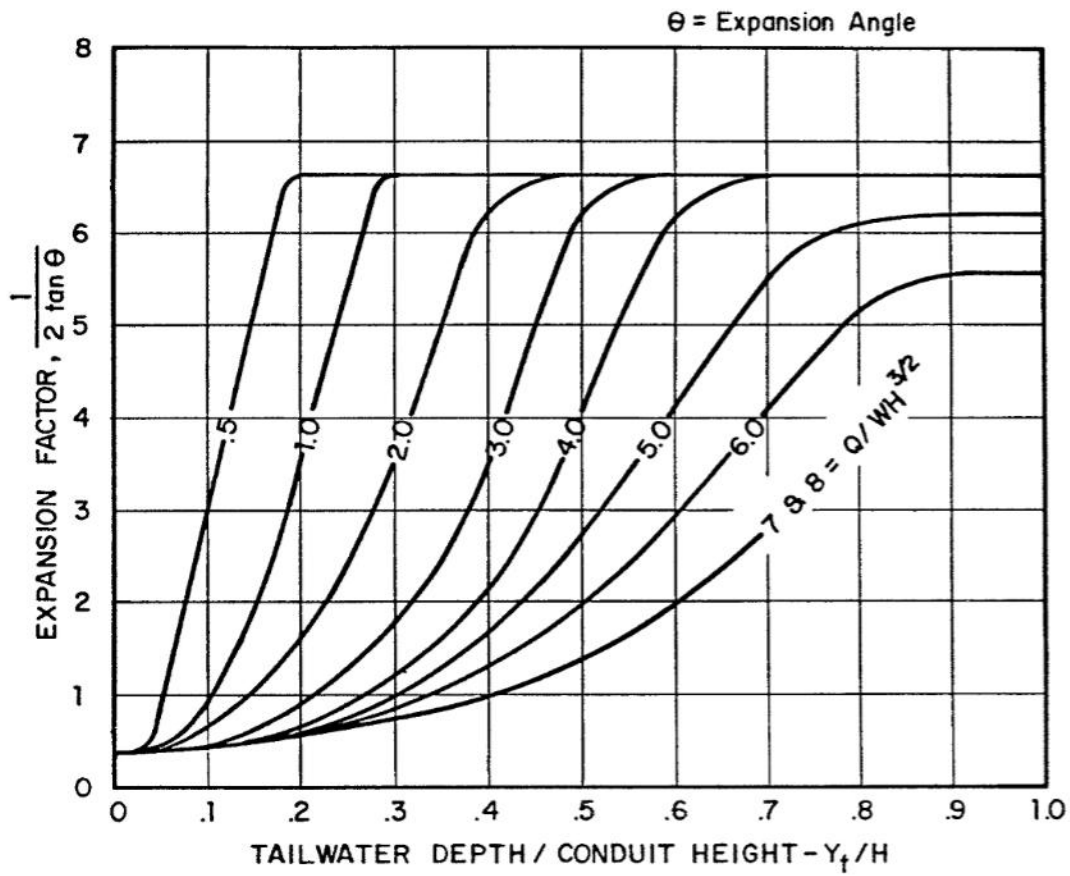

Figure 9-36. Expansion factor for rectangular conduits

**APPENDIX D**  
**Drainage Maps**































## **Conceptual Channel P&P's and Details**















# Sheet 6-10 Falcon DBPS Conceptual Plan West Tributary El Paso County, CO

- |   |  |
|---|--|
| Drainageway Crossing                    | Reach Improvements Natural Channel Design                |
| Stream Centerline                       | Protect in Place   |
| Existing Approximate 100-yr Floodplain* | Roadside Ditch Improvement                               |
| Floodplain Study Limit                  | Small Drop Structures w/ Toe Protection                  |
| Storm Sewer                             | Existing Detention                                       |
| Inlet                                   | Proposed Detention                                       |
| Manhole                                 | Proposed Detention Grading                               |
| Pipe                                    | Small Drop Structure                                     |
|   | Cross Vane   |
|   | Immediate Action Required to Preserve Existing Condition |

\*These approximate 100-yr floodplain boundaries are for planning purposes only. This information is not intended to replace the information provided on the FEMA Flood Insurance Rate Maps for this area.  
\*\*These are conceptual design drawings and are subject to change. These drawings are not intended for construction purposes.

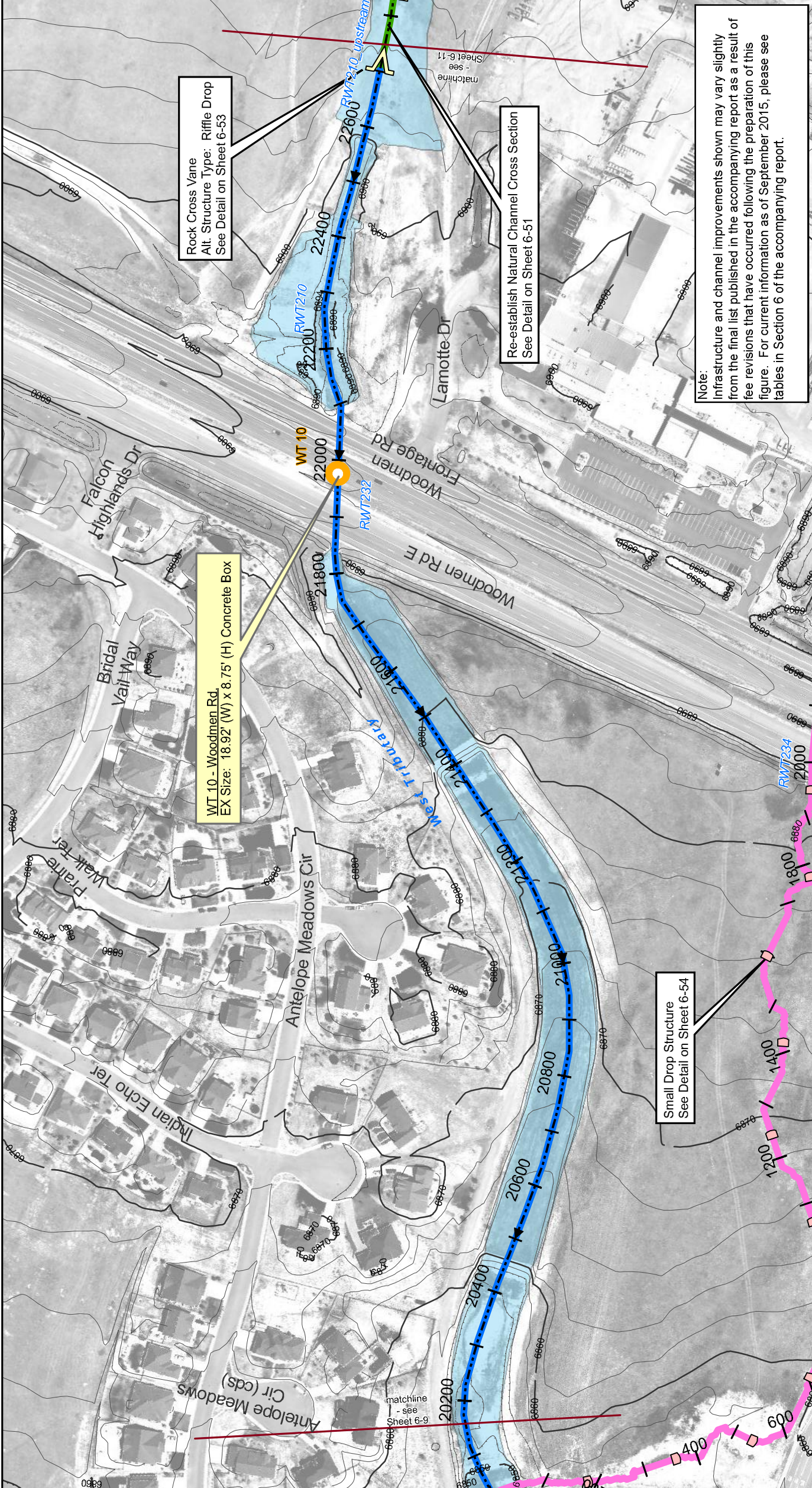
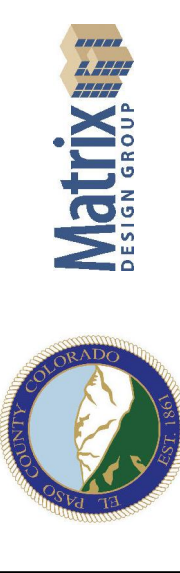

Note:  
Infrastructure and channel improvements shown may vary slightly from the final list published in the accompanying report as a result of fee revisions that have occurred following the preparation of this figure. For current information as of September 2015, please see tables in Section 6 of the accompanying report.

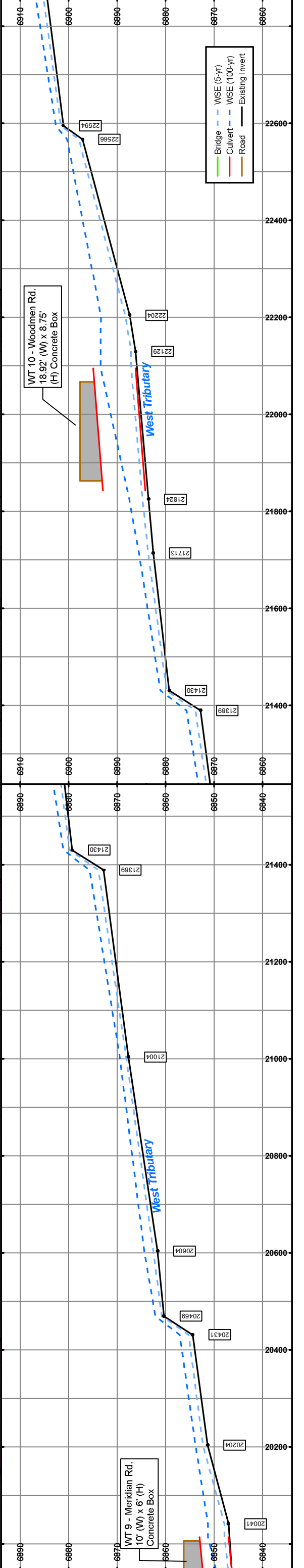



# Sheet 6-11

## Falcon DBPS

### Conceptual Plan

#### West Tributary

#### EI Paso County, CO

**Drainageway Crossing**

- Stream Centerline
- Existing Approximate 100-yr Floodplain\*
- Floodplain Study Limit

**Storm Sewer**

- Inlet
- Manhole
- Pipe

**Reach Improvements**

- Natural Channel Design
- Protect in Place
- Roadside Ditch Improvement
- Small Drop Structures w/ Toe Protection
- Existing Detention
- Proposed Detention
- Proposed Detention Grading
- Small Drop Structure
- Cross Vane
- Immediate Action Required to Preserve Existing Condition

0 100 200 Feet

\*These approximate 100-yr floodplain boundaries are for planning purposes only. This information is not intended to replace the information provided on the FEMA Flood Insurance Rate Maps for this area.  
 \*\*These are conceptual design drawings and are subject to change. These drawings are not intended for construction purposes.

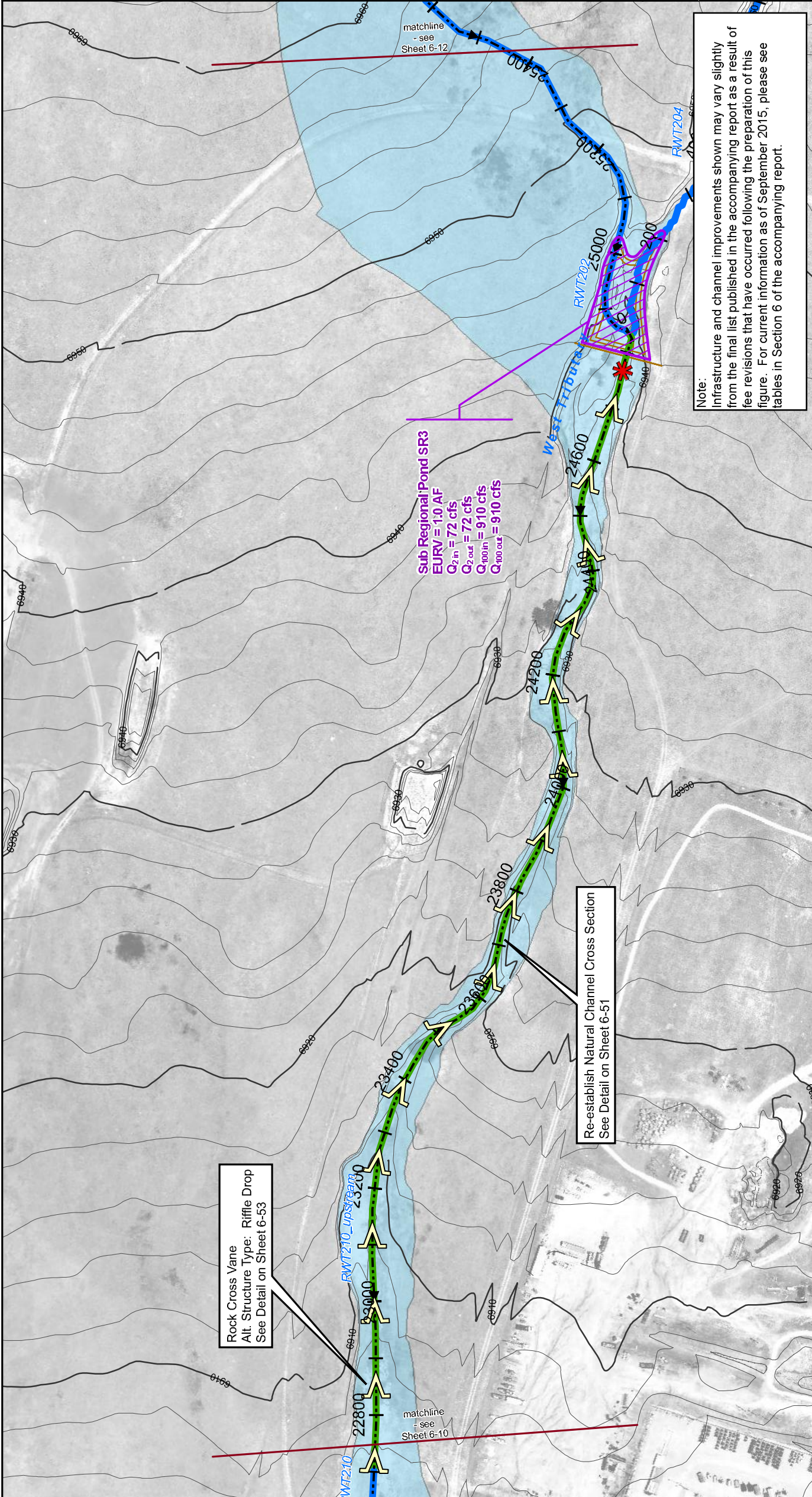

Note:  
 Infrastructure and channel improvements shown may vary slightly from the final list published in the accompanying report as a result of fee revisions that have occurred following the preparation of this figure. For current information as of September 2015, please see tables in Section 6 of the accompanying report.

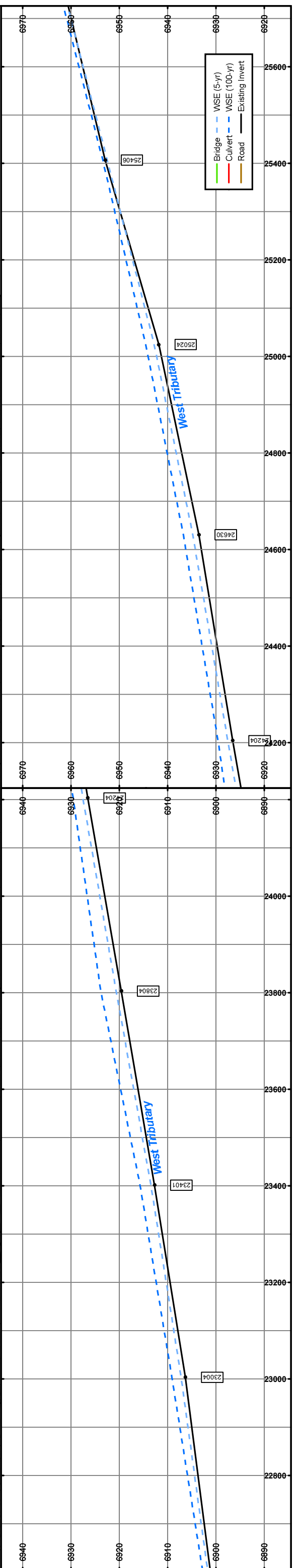



# Sheet 6-12 Falcon DBPS Conceptual Plan West Tributary El Paso County, CO

- |   |  |
|---|--|
| Drainageway Crossing                    | Natural Channel Design                                   |
| Stream Centerline                       | Protect in Place   |
| Existing Approximate 100-yr Floodplain* | Roadside Ditch Improvement                               |
| Floodplain Study Limit                  | Small Drop Structures w/ Toe Protection                  |
| Storm Sewer                             | Existing Detention                                       |
| Inlet                                   | Proposed Detention                                       |
| Manhole                                 | Proposed Detention Grading                               |
| Pipe                                    | Small Drop Structure                                     |
|   | Cross Vane   |
|   | Immediate Action Required to Preserve Existing Condition |

\*These approximate 100-yr floodplain boundaries are for planning purposes only. This information is not intended to replace the information provided on the FEMA Flood Insurance Rate Maps for this area.  
 \*\*These are conceptual design drawings and are subject to change. These drawings are not intended for construction purposes.

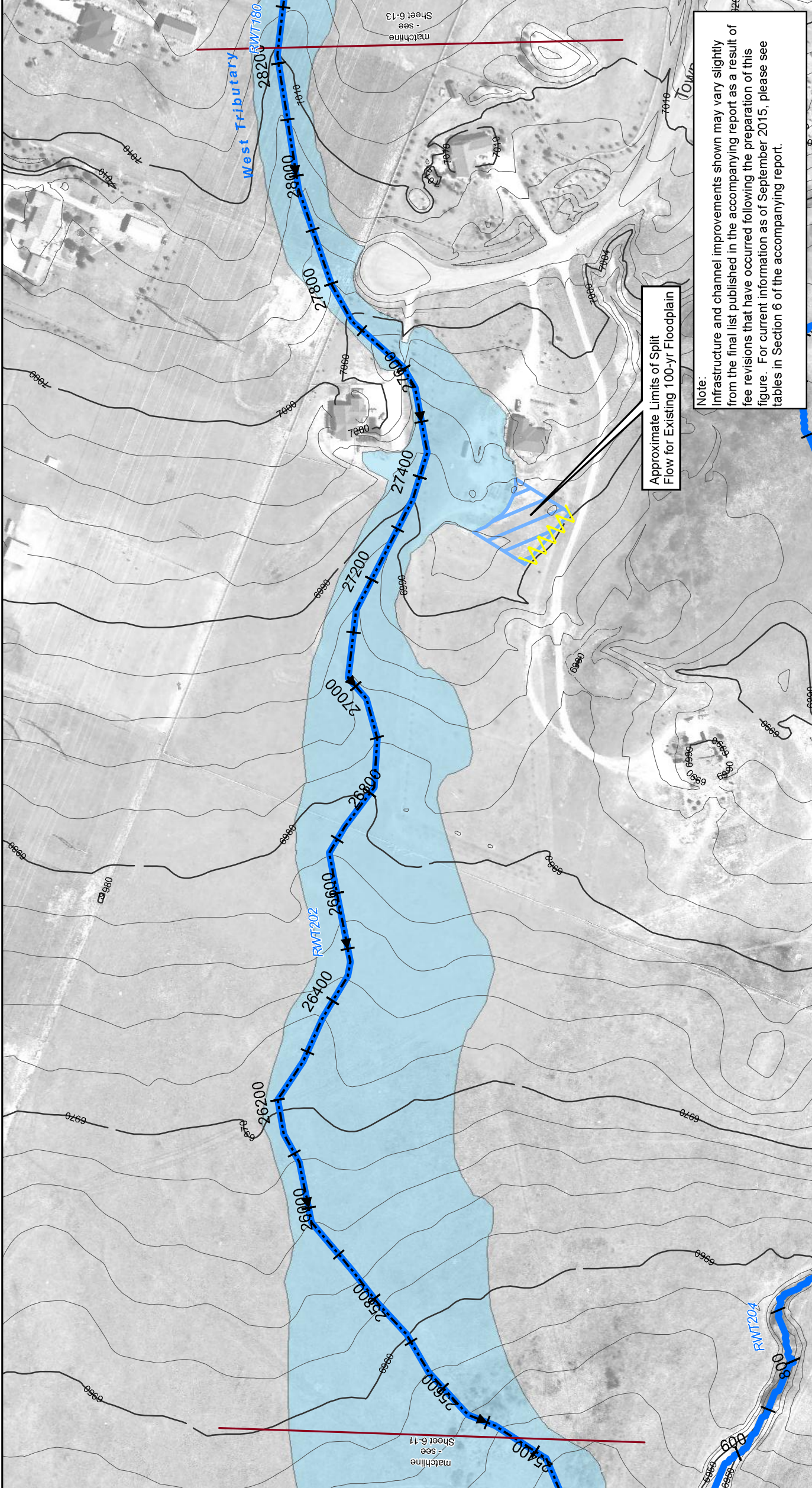
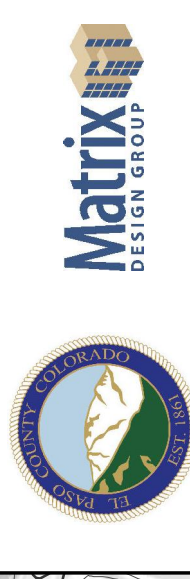

Approximate Limits of Split Flow for Existing 100-yr Floodplain

Note:  
 Infrastructure and channel improvements shown may vary slightly from the final list published in the accompanying report as a result of fee revisions that have occurred following the preparation of this figure. For current information as of September 2015, please see tables in Section 6 of the accompanying report.

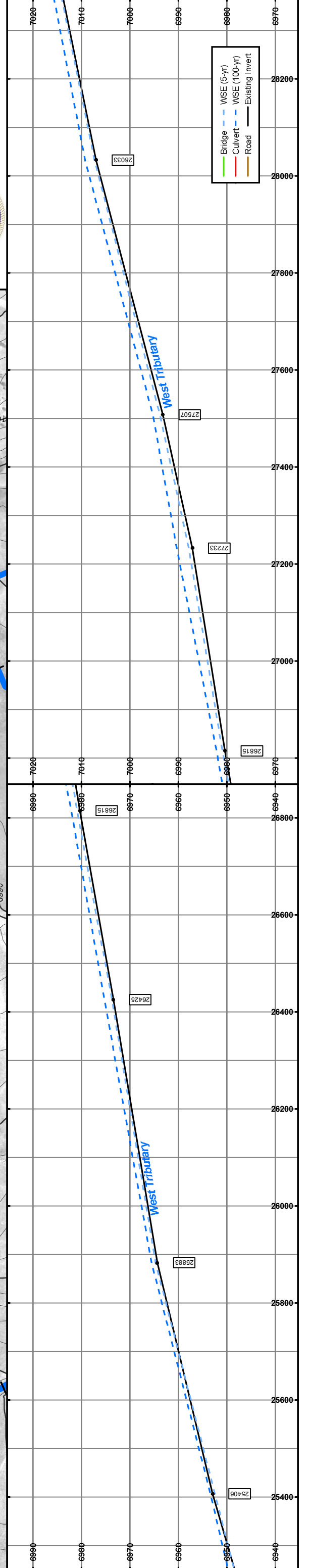

- |         |                 |
|---------|-----------------|
| Bridge  | WSE (5-yr)      |
| Culvert | WSE (100-yr)    |
| Road    | Existing Invert |



# Sheet 6-13 Falcon DBPS Conceptual Plan West Tributary El Paso County, CO

- |   |  |
|---|--|
| Drainageway Crossing                    | Natural Channel Design                                   |
| Stream Centerline                       | Protect In Place Improvement                             |
| Existing Approximate 100-yr Floodplain* | Roadside Ditch Improvement                               |
| Floodplain Study Limit                  | Small Drop Structures w/ Toe Protection                  |
| Storm Sewer                             | Existing Detention                                       |
| Inlet                                   | Proposed Detention                                       |
| Manhole                                 | Proposed Detention Grading                               |
| Pipe                                    | Small Drop Structure                                     |
|   | Cross Vane   |
|   | Immediate Action Required to Preserve Existing Condition |

\*These approximate 100-yr floodplain boundaries are for planning purposes only. This information is not intended to replace the information provided on the FEMA Flood Insurance Rate Maps for this area.  
 \*\*These are conceptual design drawings and are subject to change. These drawings are not intended for construction purposes.

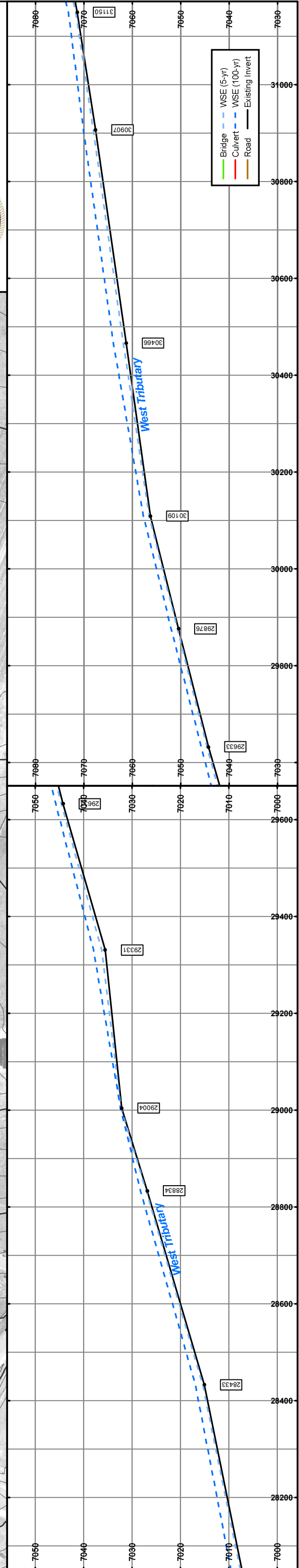
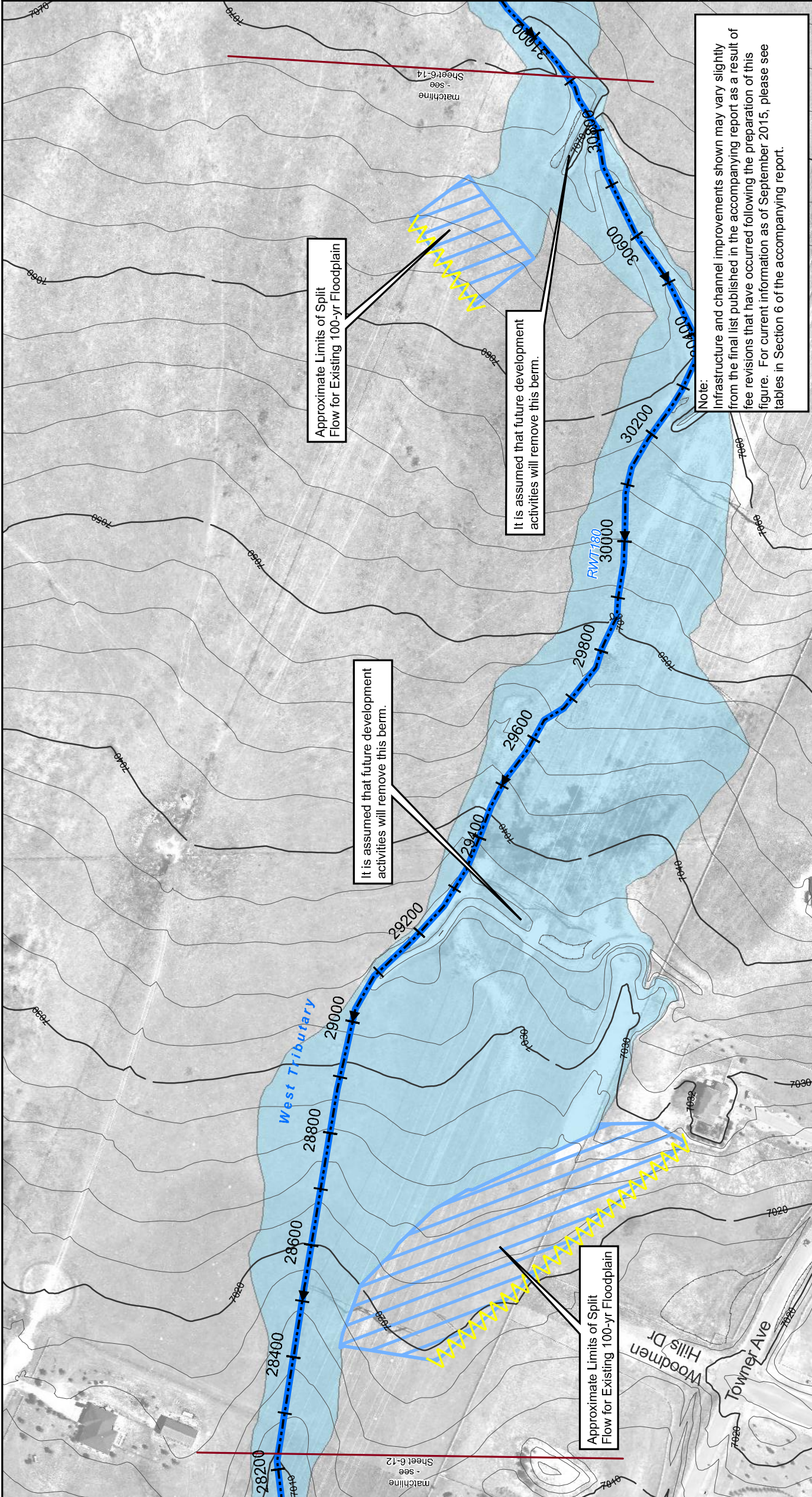
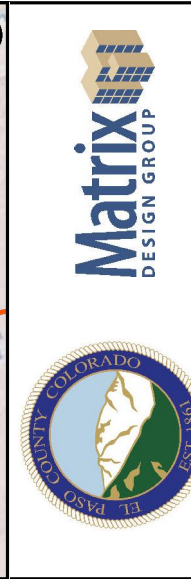



# Sheet 6-23

## Falcon DBPS Conceptual Plan Middle Tributary El Paso County, CO

- |                      |   |  |   |
|----------------------|---|--|---|
| Drainageway Crossing | Natural Channel Design                  | Protect In Place   | Small Drop Structures w/ Toe Protection |
| Stream Centerline    | Existing Approximate 100-yr Floodplain* | Roadside Ditch Improvement                               | Existing Detention                      |
| 100-yr Floodplain*   | Floodplain Study Limit                  | Proposed Detention                                       | Proposed Detention Grading              |
| Storm Sewer          | Inlet                                   | Small Drop Structure                                     | Cross Vane                              |
| Manhole              | Pipe                                    | Immediate Action Required to Preserve Existing Condition |   |

\* These approximate 100-yr floodplain boundaries are for planning purposes only. This information is not intended to replace the information provided on the FEMA Flood Insurance Rate Maps for this area.  
 \*\* These are conceptual design drawings and are subject to change. These drawings are not intended for construction purposes.

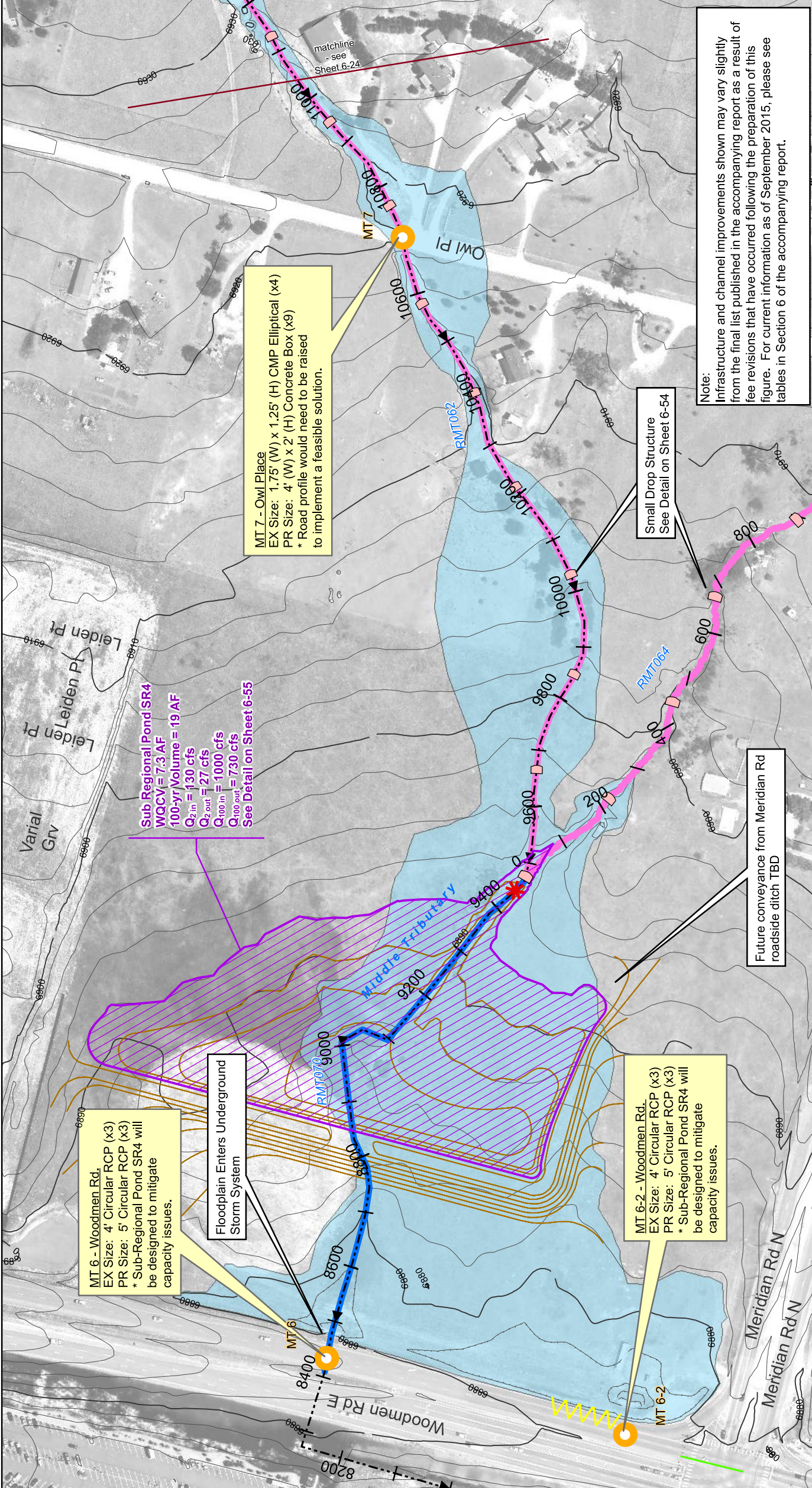
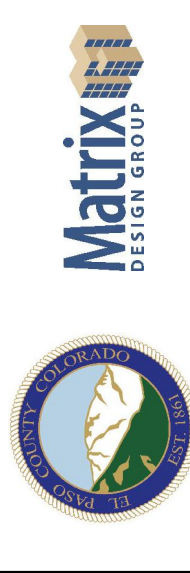

Note:  
 Infrastructure and channel improvements shown may vary slightly from the final list published in the accompanying report as a result of fee revisions that have occurred following the preparation of this figure. For current information as of September 2015, please see tables in Section 6 of the accompanying report.

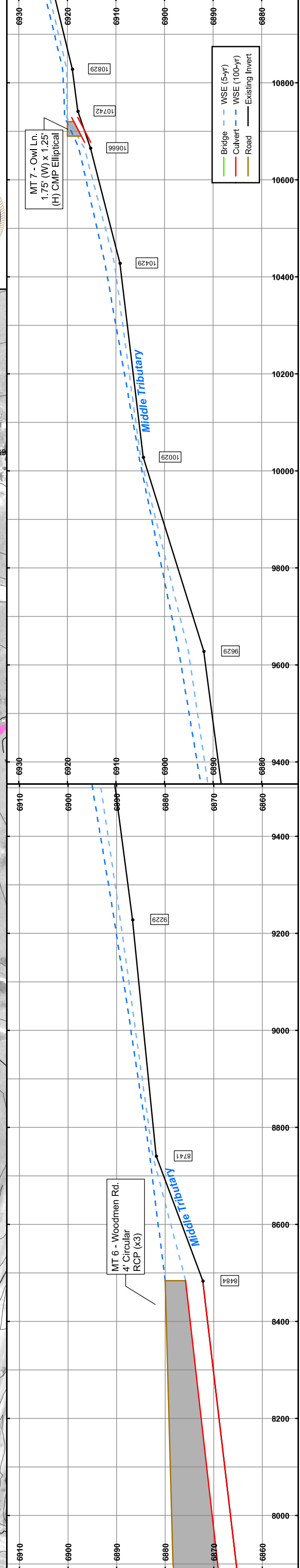



**Sheet 6-24**  
**Falcon DBPS**  
**Conceptual Plan**  
**Middle Tributary**  
**EI Paso County, CO**

- |                      |   |                              |  |                    |                    |         |                      |            |  |
|----------------------|---|------------------------------|--|--------------------|--------------------|---------|----------------------|------------|--|
| Drainageway Crossing | Natural Channel Design                  | Protect In Place Improvement | Small Drop Structure w/ Toe Protection | Existing Detention | Proposed Detention | Grading | Small Drop Structure | Cross Vane | Immediate Action Required to Preserve Existing Condition |
| Stream Centerline    | Existing Approximate 100-yr Floodplain* | Floodplain Study Limit       | Inlet                                  | Manhole            | Pipe               |         |                      |            |  |

\* These approximate 100-yr floodplain boundaries are for planning purposes only. This information is not intended to replace the information provided on the FEMA Flood Insurance Rate Maps for this area.  
 \*\* These are conceptual design drawings and are subject to change. These drawings are not intended for construction purposes.

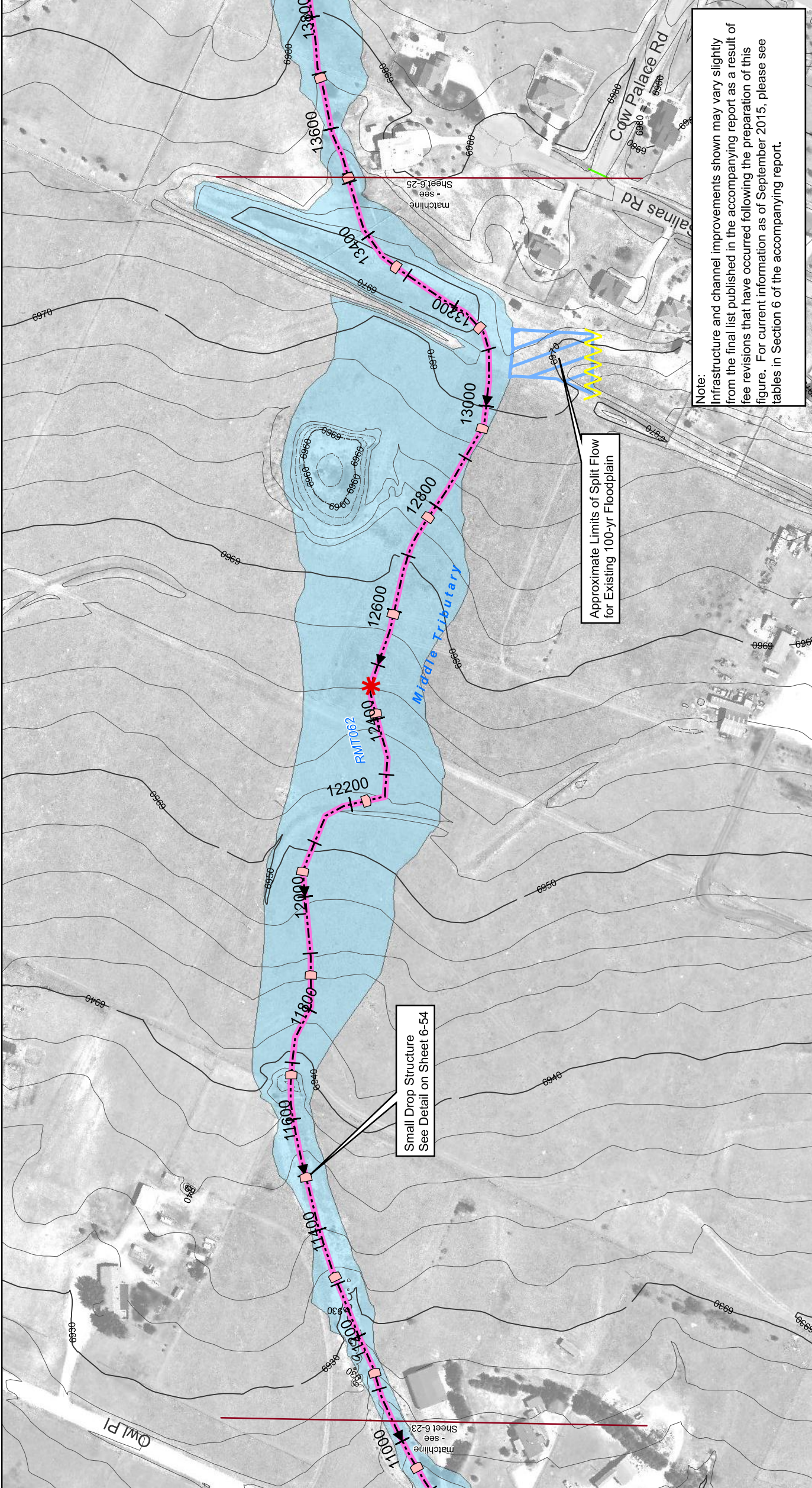
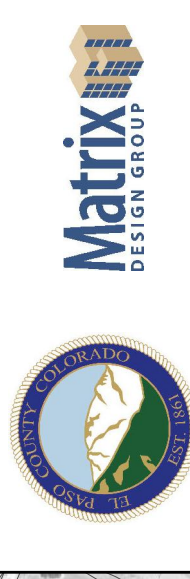

Note:  
 Infrastructure and channel improvements shown may vary slightly from the final list published in the accompanying report as a result of fee revisions that have occurred following the preparation of this figure. For current information as of September 2015, please see tables in Section 6 of the accompanying report.

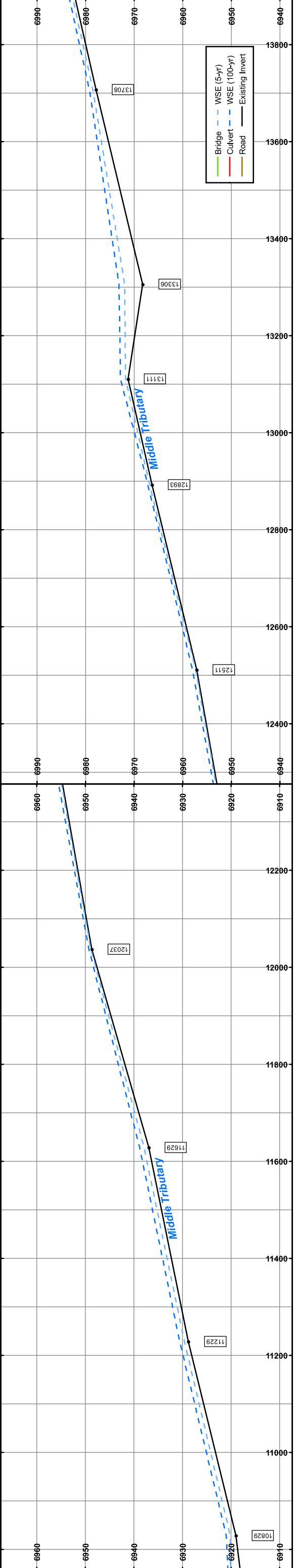



# Sheet 6-25

## Falcon DBPS Conceptual Plan Middle Tributary El Paso County, CO

- |                      |   |                              |                            |   |                    |                    |                            |                      |            |  |
|----------------------|---|------------------------------|----------------------------|---|--------------------|--------------------|----------------------------|----------------------|------------|--|
| Drainageway Crossing | Natural Channel Design                  | Protect In Place Improvement | Roadside Ditch Improvement | Small Drop Structures w/ Toe Protection | Existing Detention | Proposed Detention | Proposed Detention Grading | Small Drop Structure | Cross Vane | Immediate Action Required to Preserve Existing Condition |
| Stream Centerline    | Existing Approximate 100-yr Floodplain* | Floodplain Study Limit       | Storm Sewer Inlet          | Manhole                                 | Pipe               |                    |                            |                      |            |  |

\* These approximate 100-yr floodplain boundaries are for planning purposes only. This information is not intended to replace the information provided on the FEMA Flood Insurance Rate Maps for this area.  
 \*\* These are conceptual design drawings and are subject to change. These drawings are not intended for construction purposes.

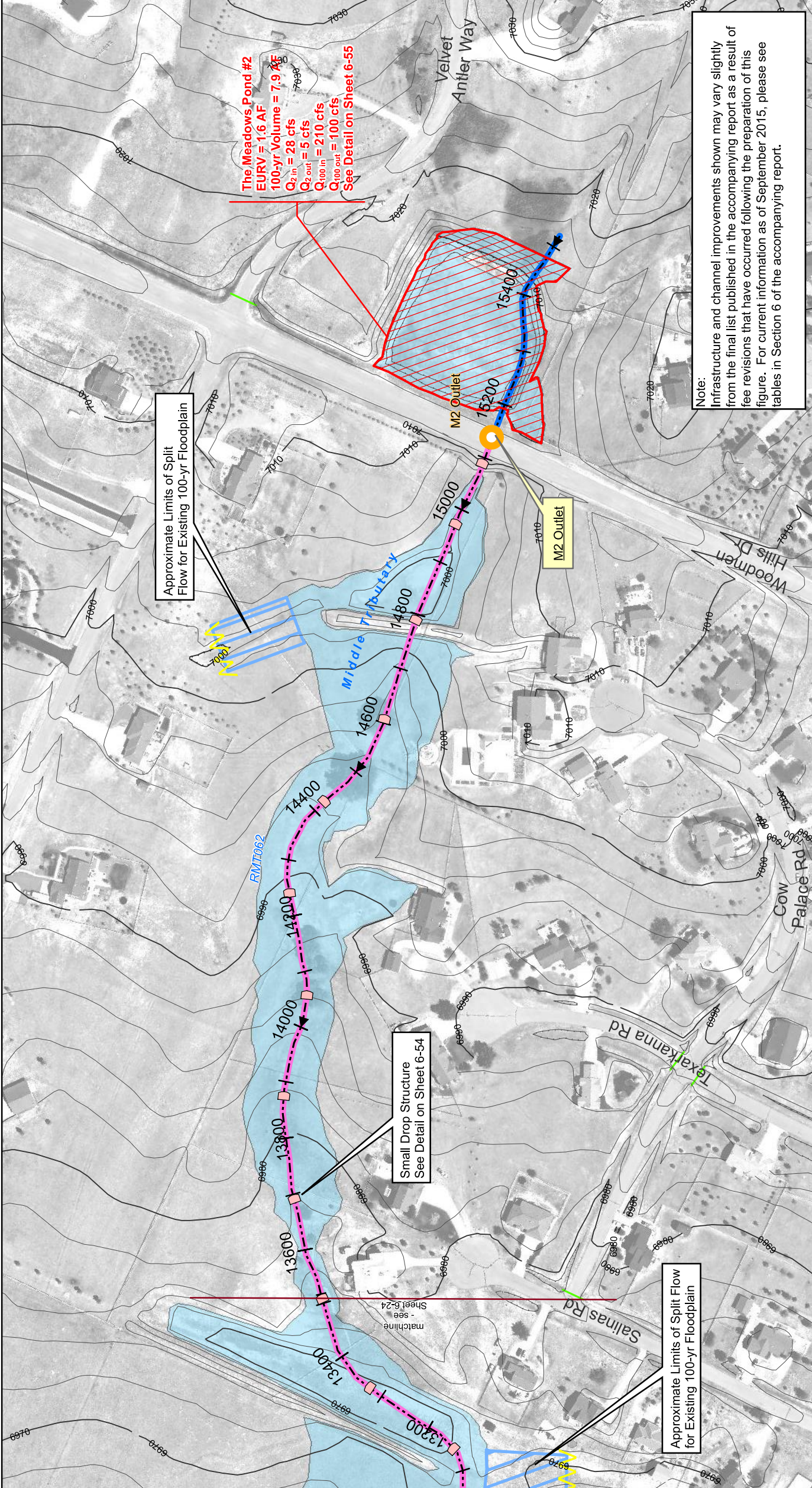
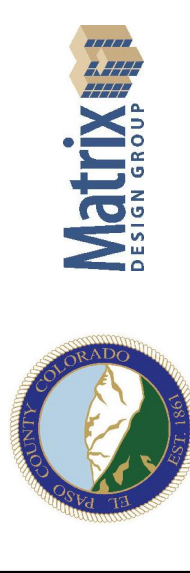

Note: Infrastructure and channel improvements shown may vary slightly from the final list published in the accompanying report as a result of fee revisions that have occurred following the preparation of this figure. For current information as of September 2015, please see tables in Section 6 of the accompanying report.

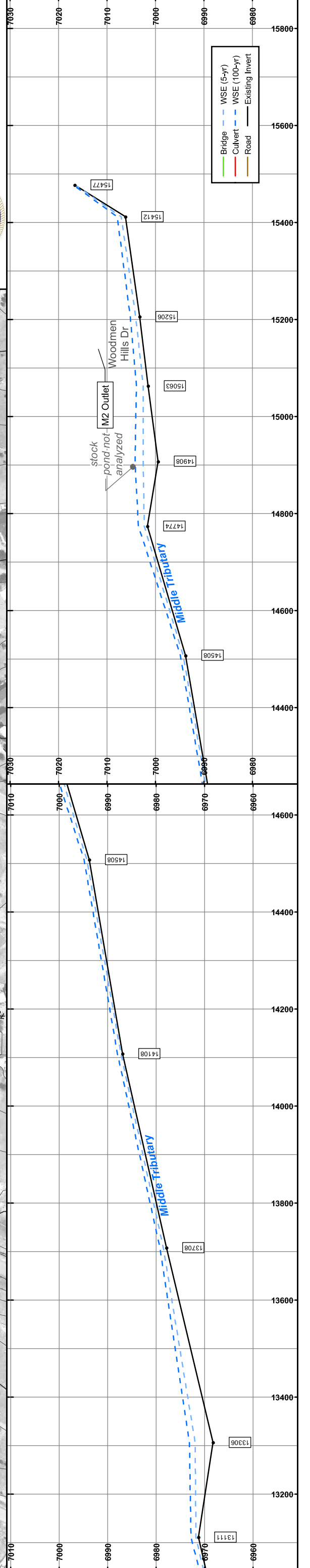



**Sheet 6-46**  
**Falcon DBPS**  
**Conceptual Plan**  
**Small Tributaries**  
**EI Paso County, CO**

- |   |  |
|---|--|
| Drainageway Crossing                    | Reach Improvements Natural Channel Design                |
| Stream Centerline                       | Protect in Place Roadside Ditch Improvement              |
| Existing Approximate 100-yr Floodplain* | Small Drop Structures w/ Toe Protection                  |
| Floodplain Study Limit                  | Existing Detention                                       |
| Storm Sewer Inlet                       | Proposed Detention                                       |
| Manhole                                 | Grading  |
| Pipe                                    | Small Drop Structure                                     |
|   | Cross Vane   |
|   | Immediate Action Required to Preserve Existing Condition |



0 100 200 Feet

\*These approximate 100-yr floodplain boundaries are for planning purposes only. This information is not intended to replace the information provided on the FEMA Flood Insurance Rate Maps for this area.  
 \*\*These are conceptual design drawings and are subject to change. These drawings are not intended for construction purposes.



Note:  
 Infrastructure and channel improvements shown may vary slightly from the final list published in the accompanying report as a result of fee revisions that have occurred following the preparation of this figure. For current information as of September 2015, please see tables in Section 6 of the accompanying report.

Small Drop Structure  
 See Detail on Sheet 6-54

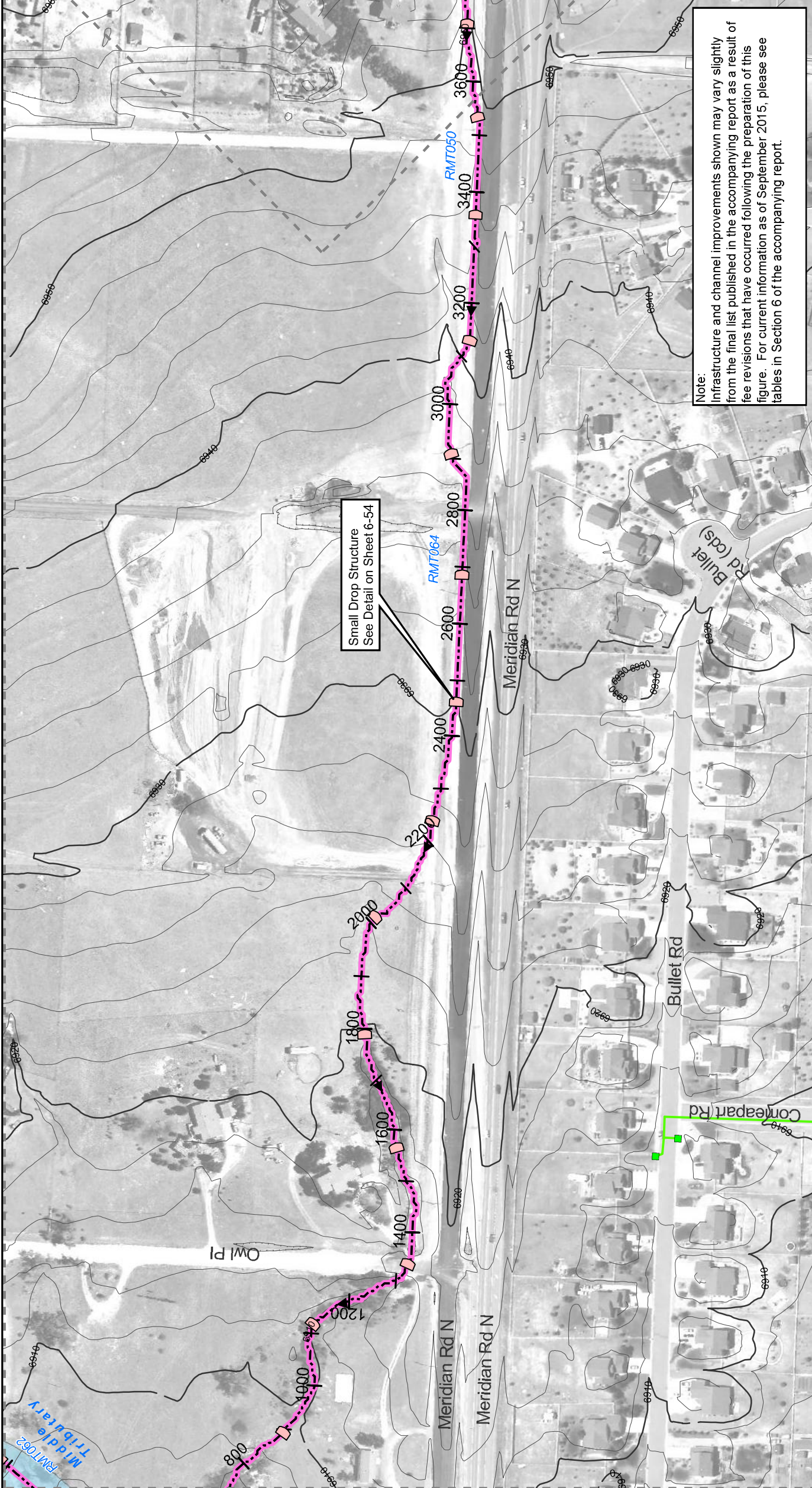

Note:  
 Infrastructure and channel improvements shown may vary slightly from the final list published in the accompanying report as a result of fee revisions that have occurred following the preparation of this figure. For current information as of September 2015, please see tables in Section 6 of the accompanying report.

**NO PROFILES FOR SMALL TRIBUTARIES**

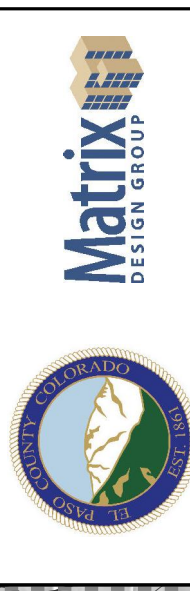



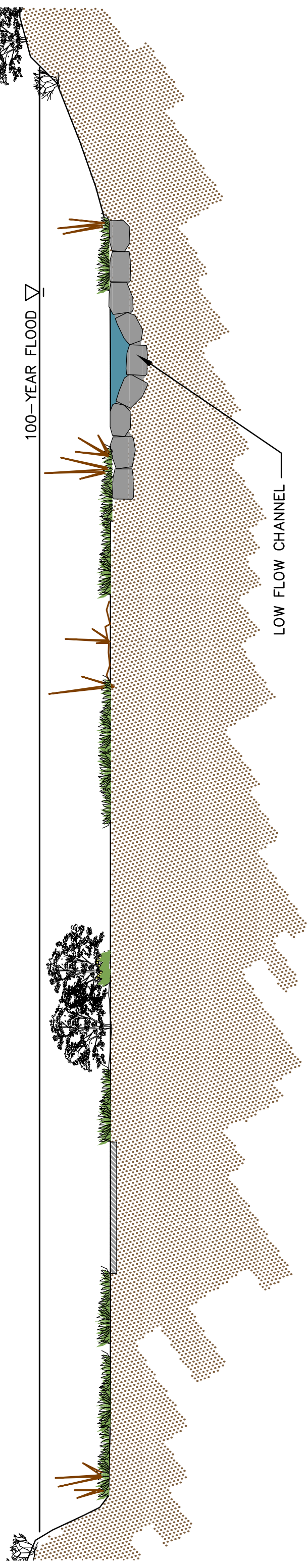
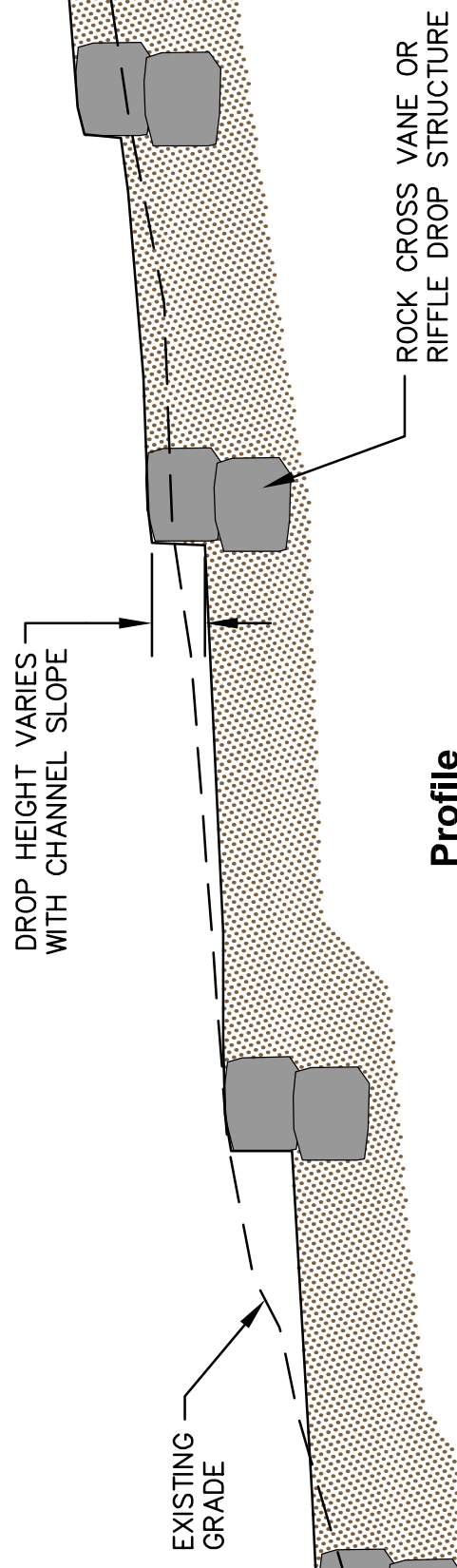

NAME: S:\10.122.003 (Falcon DBFS)\DMC\Channel\_sec-pro\_exhibit.dwg  
 PLOT: Matrix.ctb  
 PLOT DATE: Wed Dec 21, 2011 3:03pm



2435 Research Parkway, Suite 300  
 Colorado Springs, CO 80920  
 Phone 719-575-0100  
 Fax 719-575-0208



**Natural Channel with  
 Grade Control Structures**

**Figure 5-4**



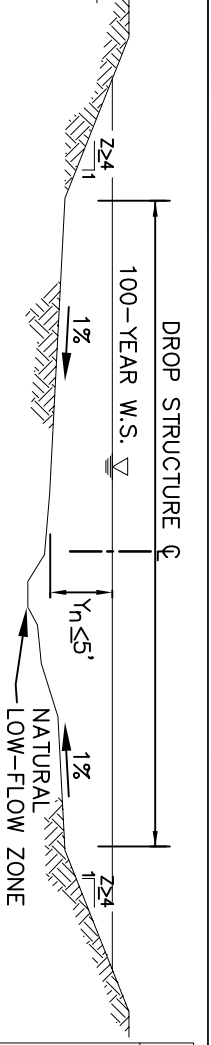
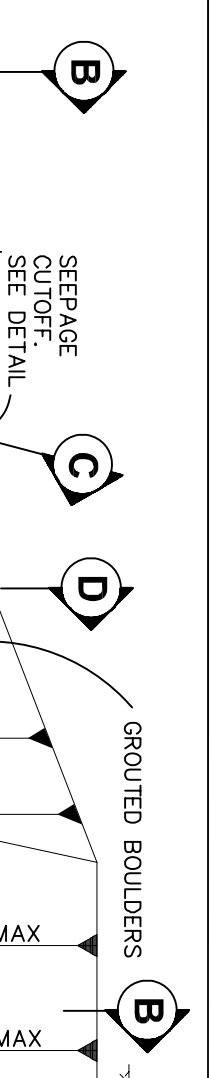

REACH	CREST WIDTH (FT)
RET020	18
RET030	21
RET040	23
RET100	28
RET110	28
RET152	29
RET156	30
RET162	30
RMT050	23
RMT062	20
RMT064	24
RMT102	27
RMT104	15
RMT106	27
RMT112	27
RMT114	27
RWT054	22
RWT080	19
RWT092	25
RWT094	26
RWT122	27
RWT124	27
RWT174	22
RWT234	19
RWT296	32
RWT354	38
RWT372	38

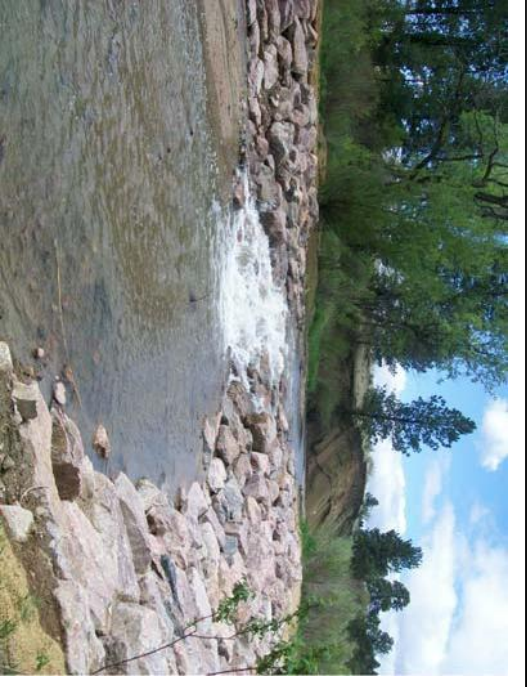

CONSTRUCTED GROUDED SLOPING BOULDER DROP STRUCTURE

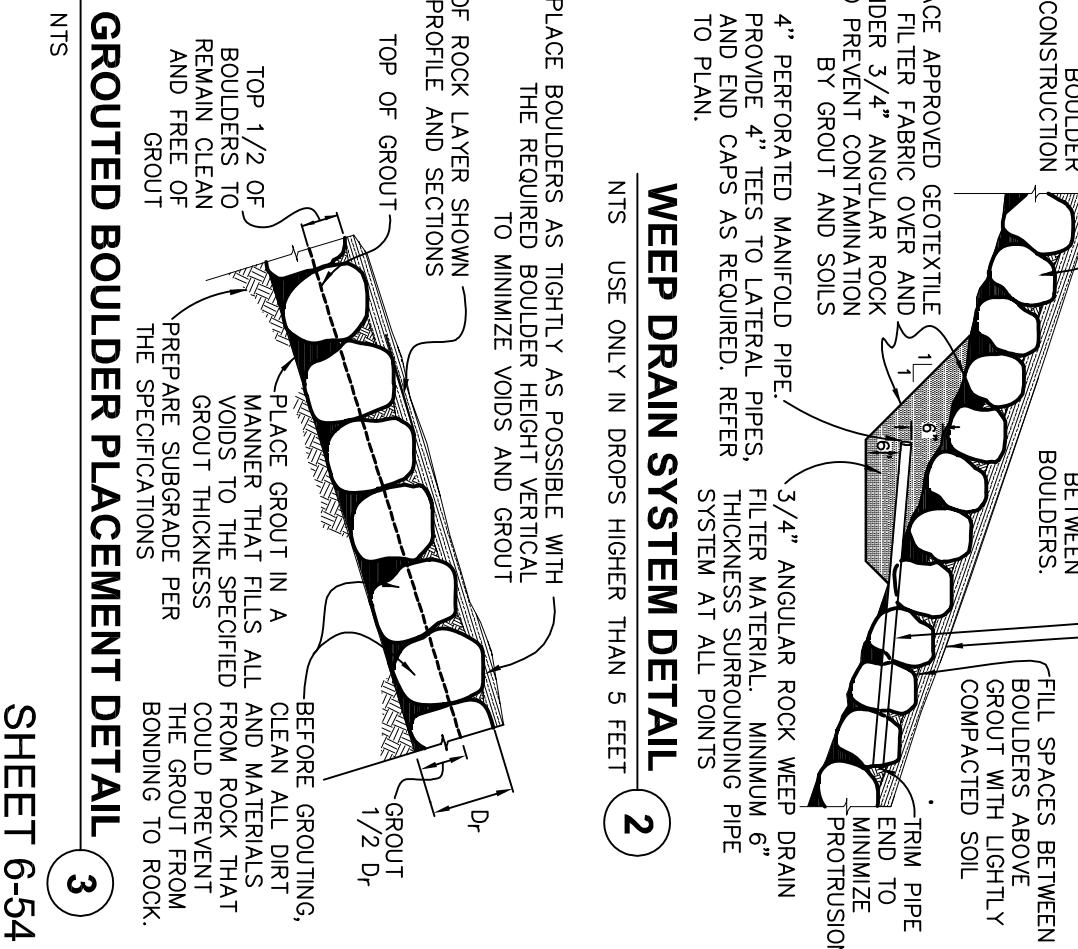
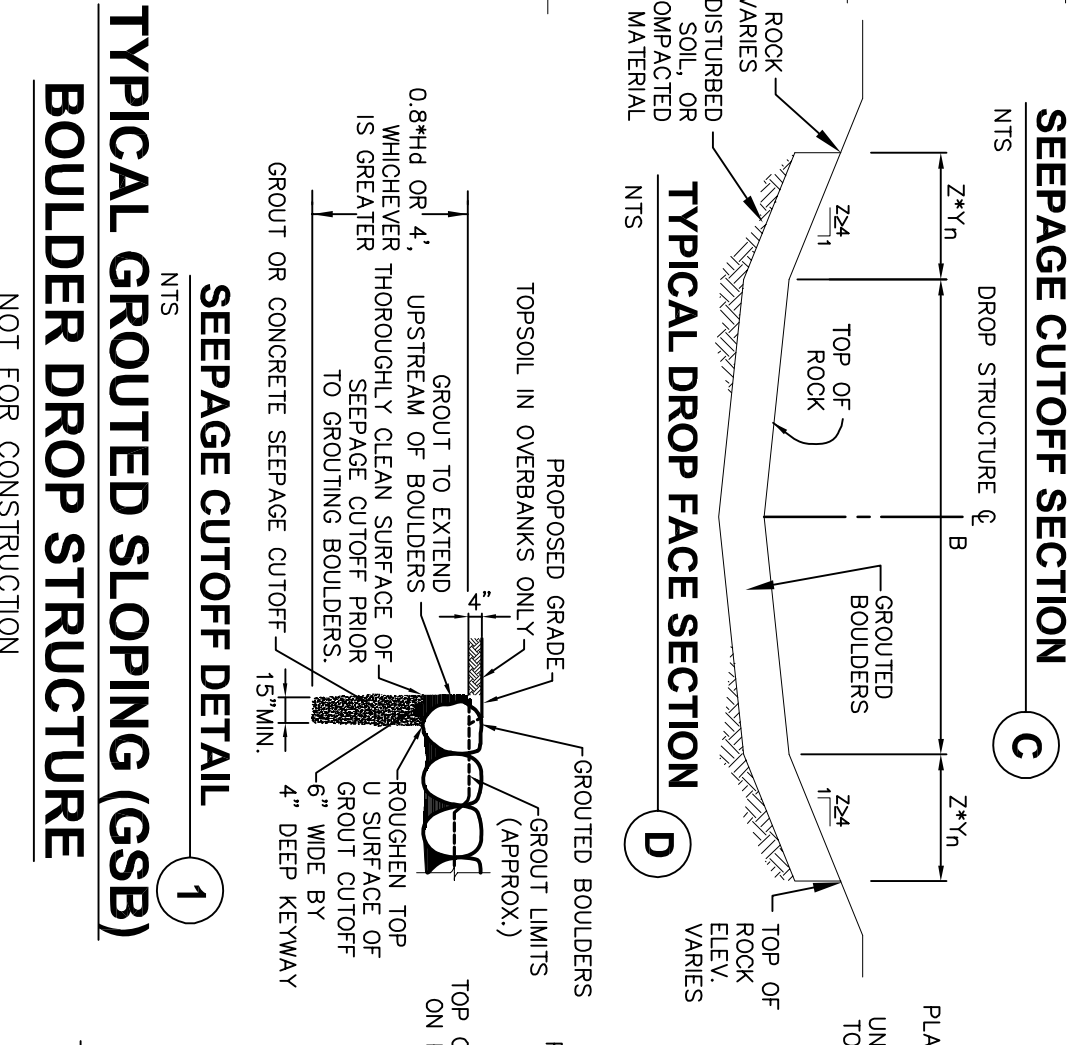
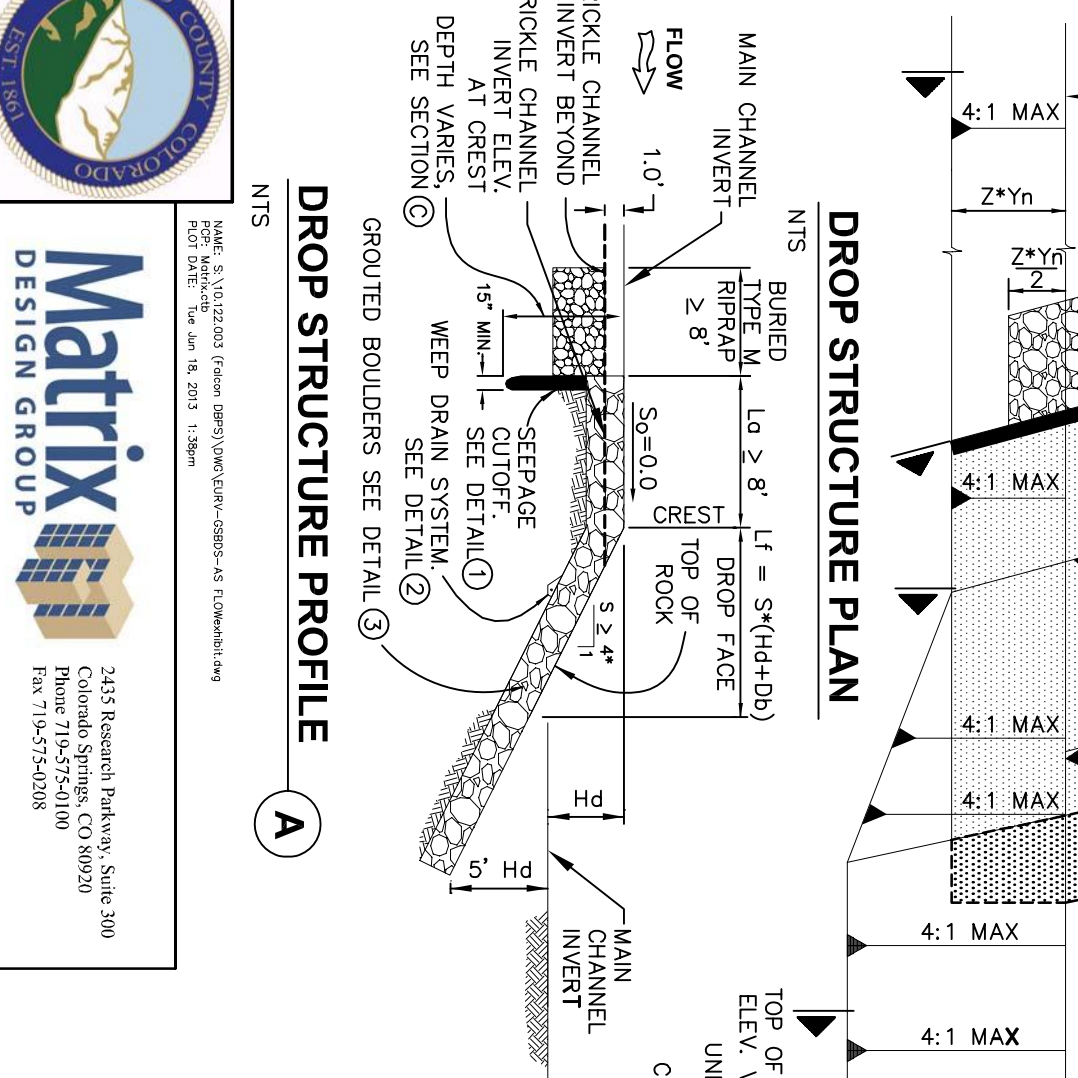
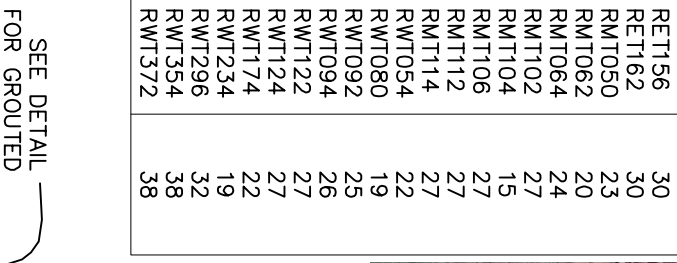
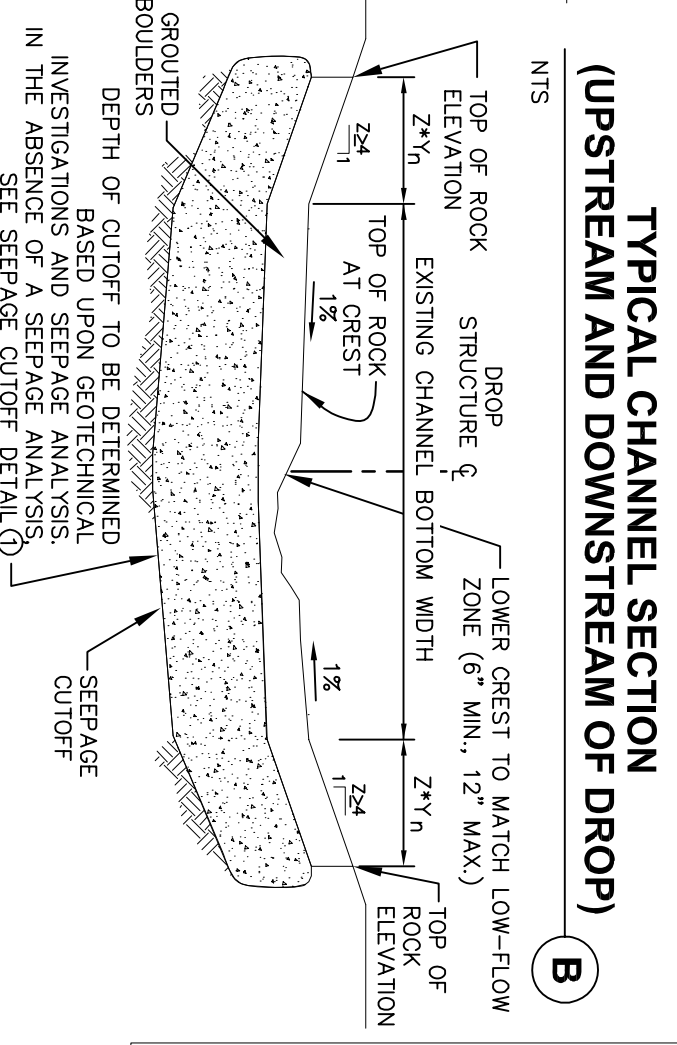
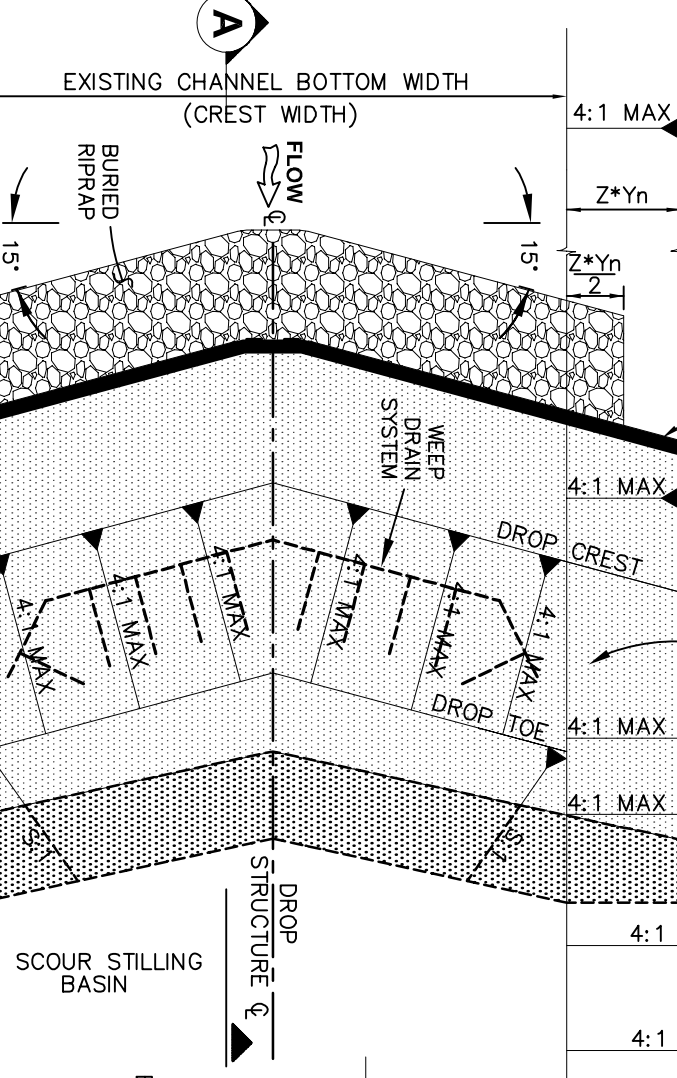

**Matrix**  
DESIGN GROUP

2435 Research Parkway, Suite 300  
Colorado Springs, CO 80920  
Phone 719-575-0100  
Fax 719-575-0208

**TYPICAL GROUDED SLOPING (GSB) BOULDER DROP STRUCTURE**

**GROUDED BOULDER PLACEMENT DETAIL**



- NOTES:
- 1.) REACHES THAT ARE CURRENTLY DEGRADED MUST BE FILLED TO THE EXISTING FLOODPLAIN ELEVATION. THE LOW FLOW CHANNEL SHALL THEN BE CUT OUT OF THE FILL MATERIAL.
  - 2.) DIMENSIONS SHOWN ARE TYPICAL AND VARY WITH THE LOW FLOW CHANNEL WIDTH.
  - 3.) ALL CHANNEL CROSS-SECTIONS SHALL HAVE A LOW FLOW WIDTH TO DEPTH RATIO (W/D) OF 23.
  - 4.) CHANNEL CAPACITY VARIES WITH THE LOW FLOW CHANNEL WIDTH AND SLOPE.
  - 5.) THESE CROSS-SECTIONS SHALL ONLY BE APPLIED TO "NATURAL CHANNEL DESIGN" REACHES.

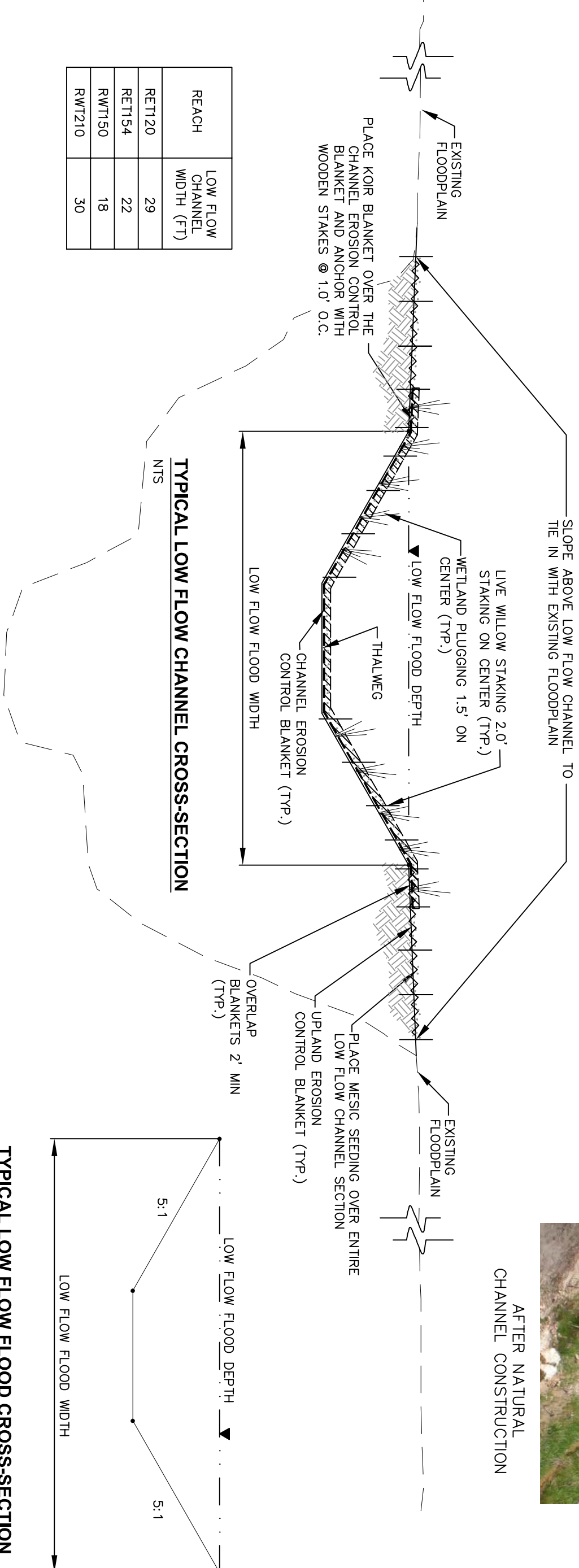

NAME: S:\101222003 (Falcon DPRS)\DWG\YSEC-RCV\AEC-R05\shh1.dwg  
 PLOT DATE: Tue Jun 18, 2013 1:46pm



2435 Research Parkway, Suite 300  
 Colorado Springs, CO 80920  
 Phone 719-575-0100  
 Fax 719-575-0208

**TYPICAL NATURAL CHANNEL CROSS-SECTIONS**  
**FOR USE IN NATURAL CHANNEL DESIGN REACHES**

NOT FOR CONSTRUCTION





CONSTRUCTED RIFFLE DROP STRUCTURE

NOTE:  
REFER TO EROSION CONTROL BLANKET DETAIL FOR BLANKET INSTALLATION  
NEAR STRUCTURES.

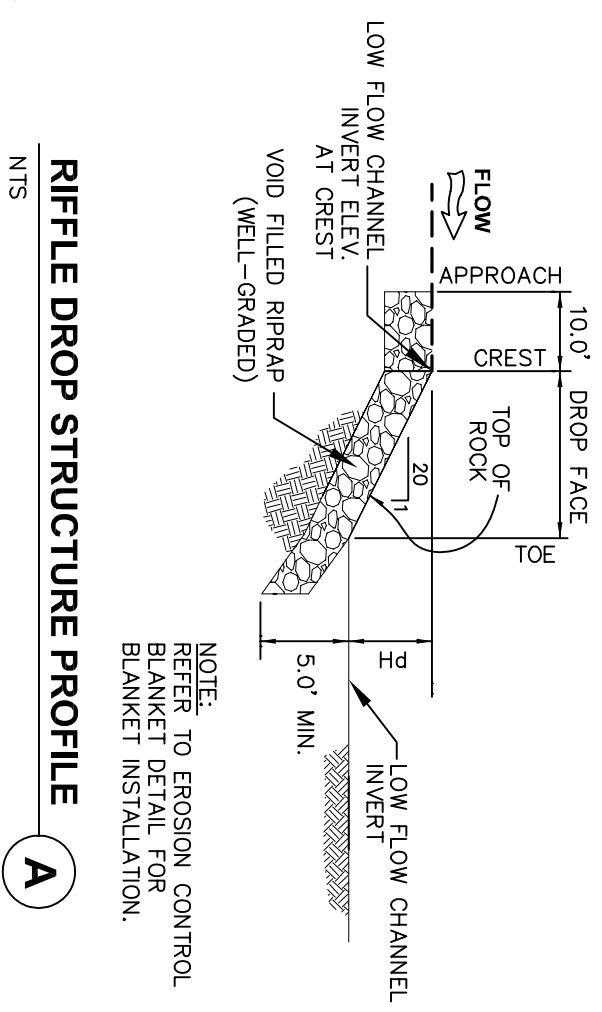

RIFFLE DROP STRUCTURE PROFILE  
NTS  
**A**

NOTE:  
REFER TO EROSION CONTROL  
BLANKET DETAIL FOR  
BLANKET INSTALLATION.

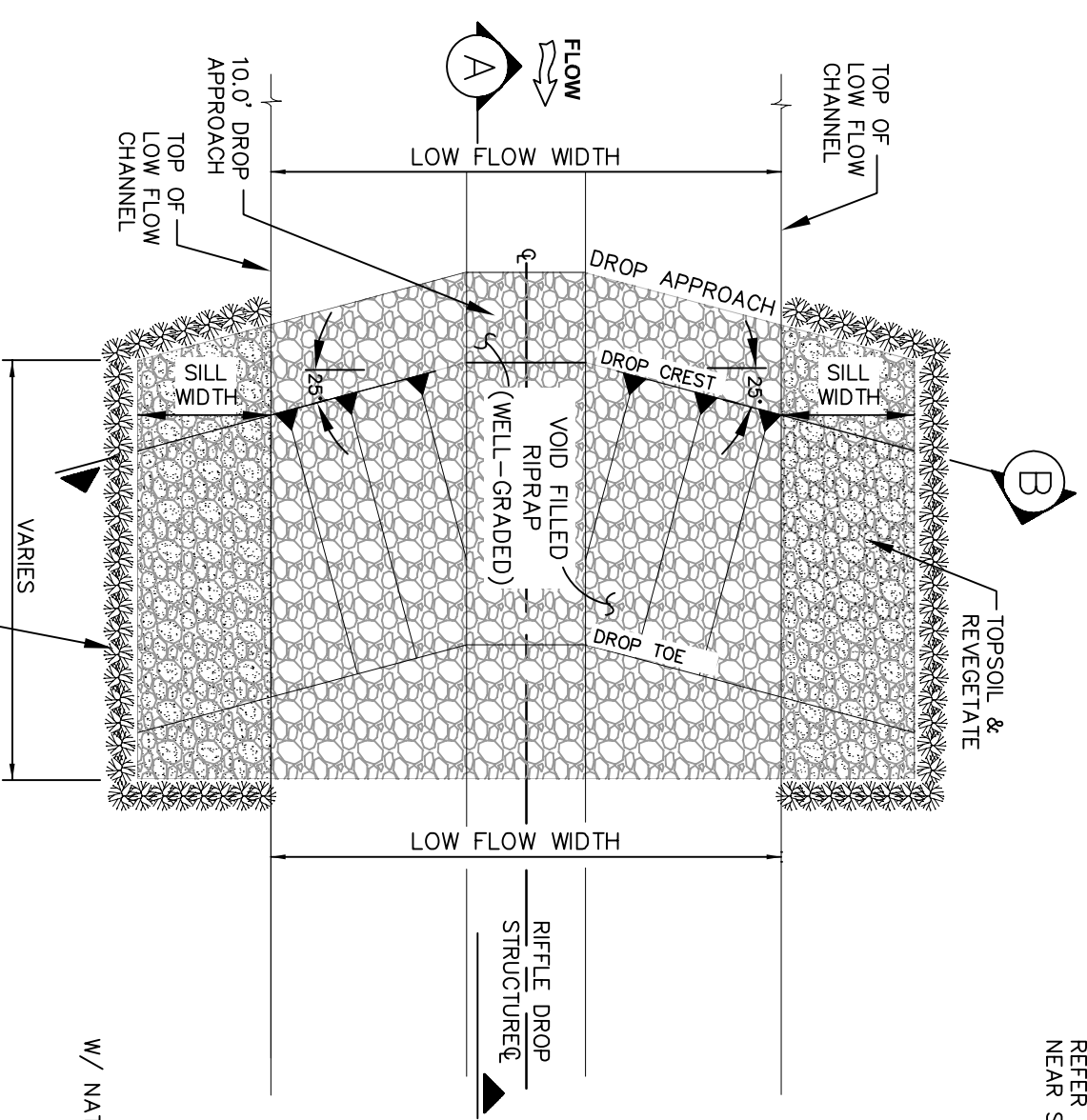

RIFFLE DROP STRUCTURE PLAN  
NTS

IF ACCESS OR AVAILABILITY PRECLUDES \*  
LIVE WILLOW TRANSPLANTS, PLACE  
CONTINUOUS LAYER OF WILLOW STAKES  
VERTICALLY IN SILL TRENCH  
PRIOR TO BACKFILL

REACH	LOW FLOW CHANNEL WIDTH (FT)
RET1120	29
RET1154	22
RWT150	18
RWT210	30

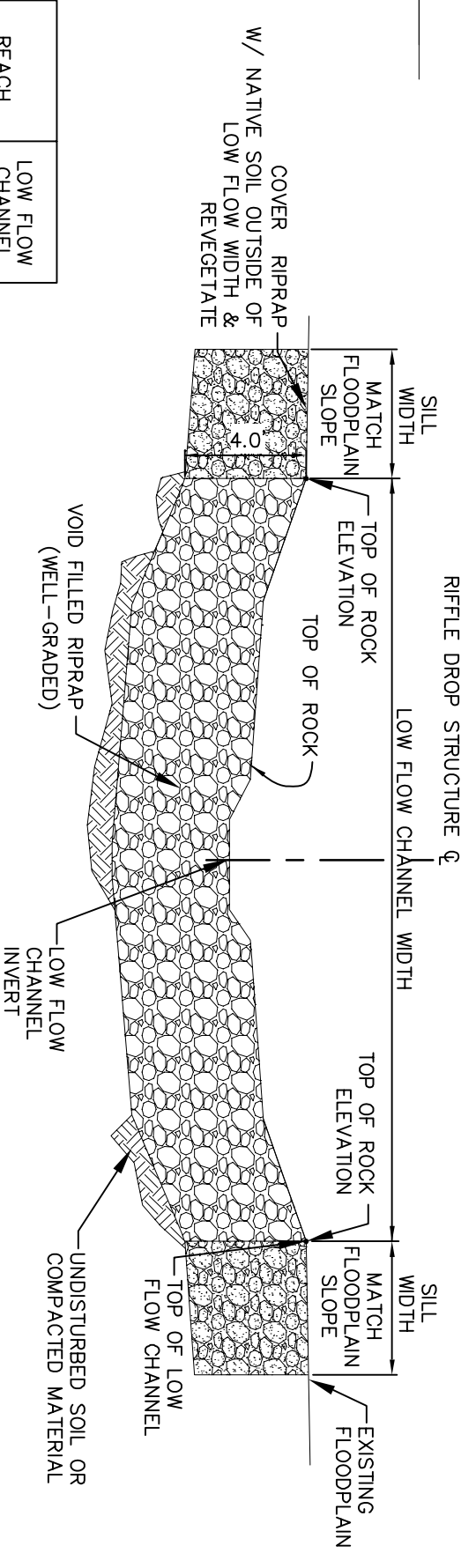

RIFFLE DROP STRUCTURE SECTION  
NTS  
**B**

# TYPICAL RIFFLE DROP STRUCTURE

## FOR USE IN NATURAL CHANNEL DESIGN REACHES

NOT FOR CONSTRUCTION



2435 Research Parkway, Suite 300  
Colorado Springs, CO 80920  
Phone 719-575-0100  
Fax 719-575-0208

NAME: S:\101222003 (Falcon DPRS)\DWG\SSC-RCV\ME-809sahbl.dwg  
PGE: Matrix.cad  
PLOT DATE: Tue Jun 18, 2013 1:49pm





CONSTRUCTED ROCK CROSS VANE

- NOTES:**
- 1.) REACHES THAT ARE CURRENTLY DEGRADED MUST BE FILLED TO THE EXISTING FLOODPLAIN ELEVATION. THE ROCK CROSS VANE SHALL THEN BE CONSTRUCTED IN COMPACTED FILL MATERIAL.
  - 2.) BOULDERS SHALL BE BLOCK SHAPED ACCORDING TO SPECIFICATIONS (NOT ANGULAR).
  - 3.) SURFACE BOULDERS SHALL BE IN COMPRESSION W/ FOOTER BOULDERS IN THE DOWNSTREAM DIRECTION.

**NOTE:**

(E) AND (H) LOW FLOW FLOOD ELEVATION

(F) AND (G) MARK VANE ELEVATION AT HEAD OF VANE

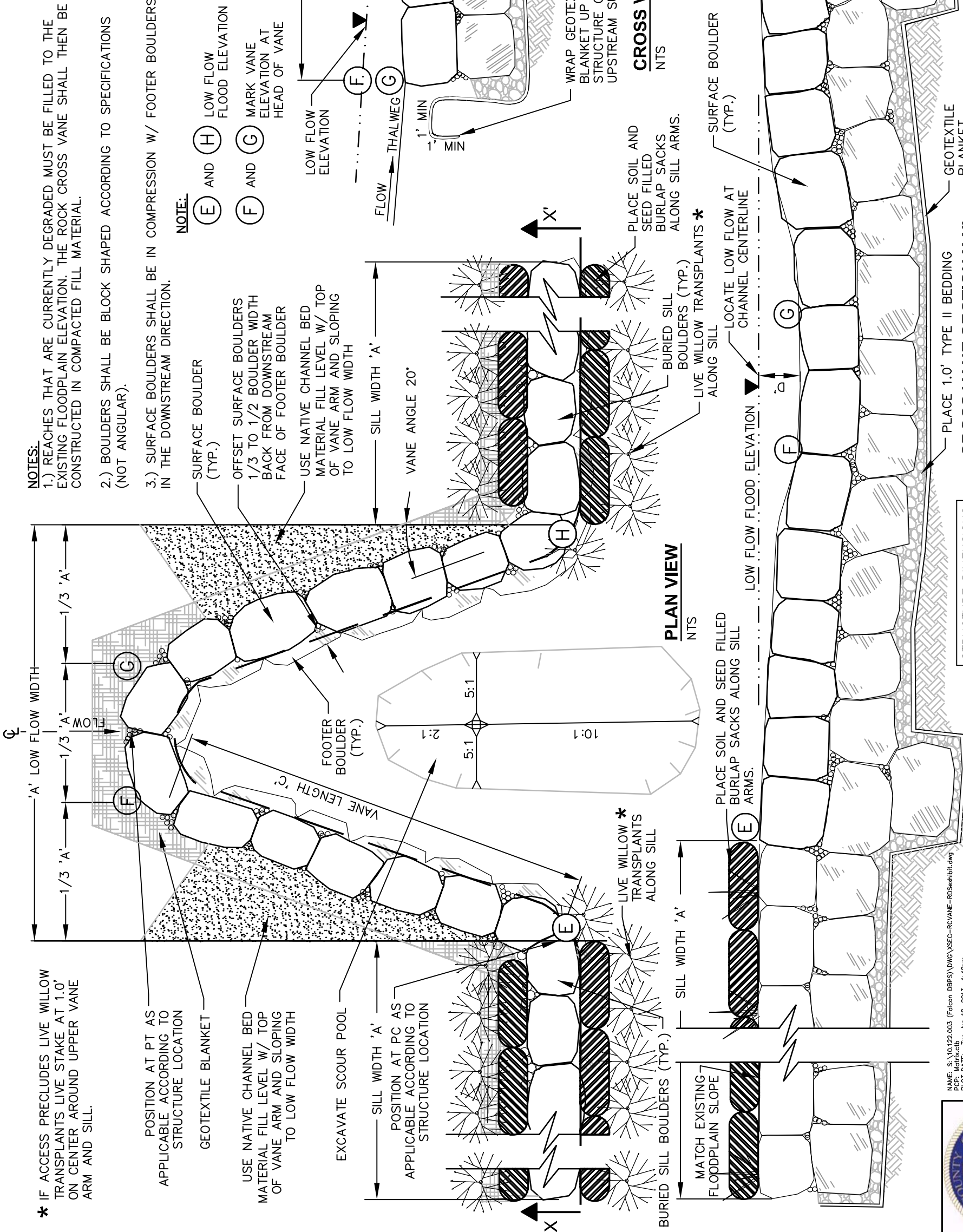

**CROSS VANE LONGITUDINAL PROFILE ALONG VANE**

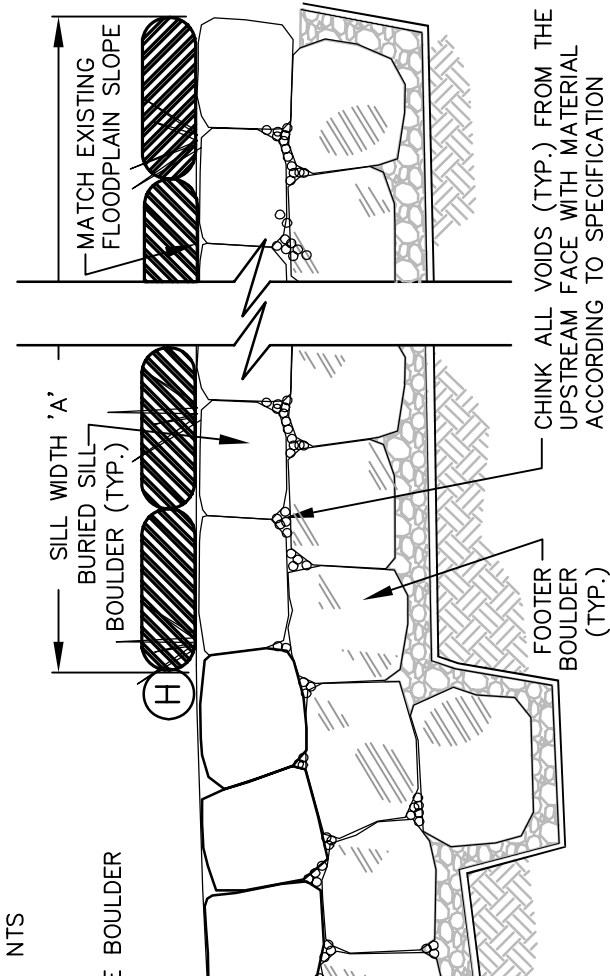

**CROSS VANE SECTION X-X' LOOKING UPSTREAM**

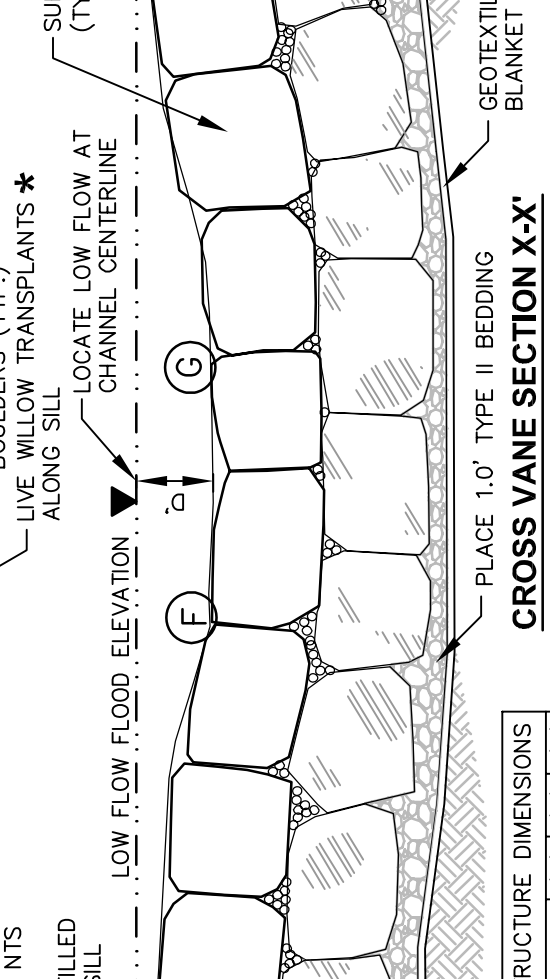

STRUCTURE DIMENSIONS				
REACH	'A'	'C'	'D'	
RET120	29'	26'	1.3'	
RET154	22'	20'	1.0'	
RWT150	18'	16'	0.8'	
RWT210	30'	26'	1.3'	

NAME: S:\10122.003 (Falcon DBPS)\DWG\YSEC-RC\VANE-RDSehbit.dwg  
 PLOT DATE: Tue Jun 18, 2013 1:48pm



**Matrix**  
 DESIGN GROUP

2435 Research Parkway, Suite 300  
 Colorado Springs, CO 80920  
 Phone 719-575-0100  
 Fax 719-575-0208

**TYPICAL ROCK CROSS VANE DETAILS**  
 FOR USE IN NATURAL CHANNEL DESIGN REACHES

NOT FOR CONSTRUCTION



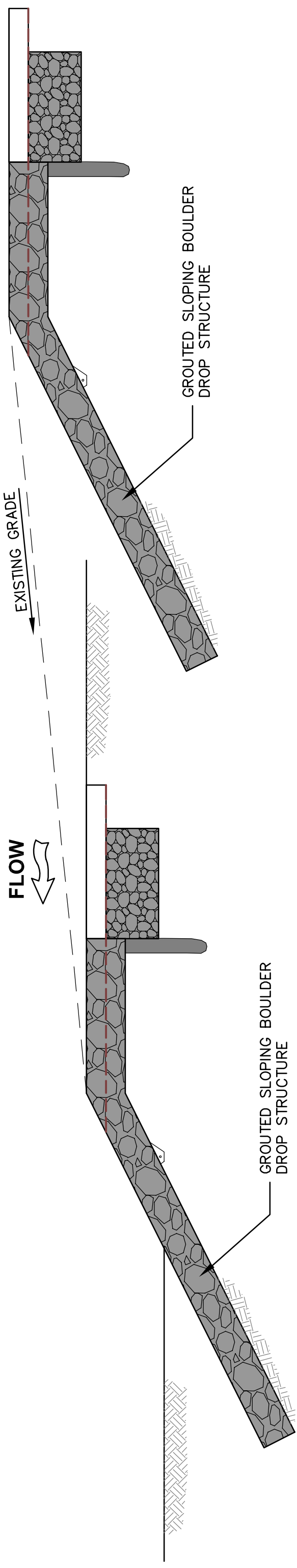

**Profile**

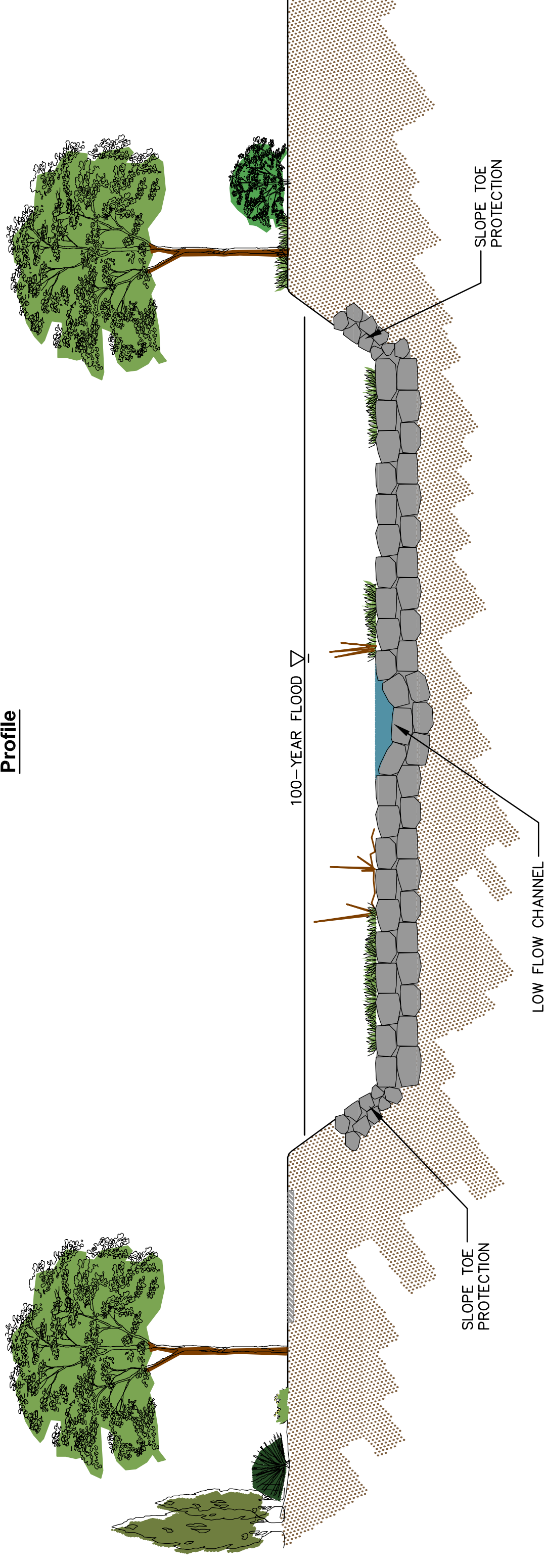

**Section**

NAME: S:\10.122.003 (Falcon DBFS)\DMC\Channel\_sec-pro\_exhibit.dwg  
 PLOT: Matrix.ctb  
 PLOT DATE: Wed Dec 21, 2011 3:03pm

**Matrix**  
DESIGN GROUP

2435 Research Parkway, Suite 300  
 Colorado Springs, CO 80920  
 Phone 719-575-0100  
 Fax 719-575-0208

**Small Drop Structures  
with Toe Protection**

**Figure 5-5**