



Innovative Design. Classic Results.

**GRADING, EROSION
AND
STORMWATER QUALITY CONTROL PLAN
FOR
FALCON HIGH SCHOOL BUILDING ADDITION**

Prepared for:
FALCON DISTRICT NO. 49
10850 E. WOODMEN ROAD
PEYTON CO 80831
(719) 473-5321

Prepared by:
CLASSIC CONSULTING ENGINEERS & SURVEYORS, LLC
619 N. CASCADE AVENUE, SUITE 200
COLORADO SPRINGS CO 80903
(719) 785-0790

Job no. 2366.92
PPR 17-048



GRADING, EROSION AND STORMWATER QUALITY CONTROL PLAN FOR FALCON HIGH SCHOOL BUILDING ADDITION

COLORADO DISCHARGE PERMIT SYSTEM STATEMENT (CDPS)/ EROSION AND STORMWATER QUALITY CONTROL PLAN (ESQCP)

Site Inspector

The following Erosion and Stormwater Quality Control Plan (ESQCP) is a detailed account of the requirements of the City of Colorado Springs and El Paso County Drainage Criteria Manual, Volume 2 – Stormwater Quality Policies, Procedures and Best Management Practices. The main objective of this plan is to help mitigate the increased soil erosion and subsequent deposition of sediment off-site and other potential stormwater quality impacts during the period of construction from start of earth disturbance until final landscaping and other potential permanent stormwater quality measures are effectively in place.

This document must be kept at the construction site at all times and be made available to the public and any representative of the Colorado Department of Health - Water Quality Control Division, if requested.

This report is also proposed to meet all requirements of the Colorado Discharge Permit System for Construction Activity. If any discrepancies between this report and Volume 2 exist, the City/County Manual will prevail.



GRADING, EROSION AND STORMWATER QUALITY CONTROL PLAN FOR FALCON HIGH SCHOOL BUILDING ADDITION

TABLE OF CONTENTS

SITE DESCRIPTION	1
• RECEIVING WATER(S)	1
• PROPOSED CONSTRUCTION ACTIVITY	1
• PROPOSED SEQUENCE OF ACTIVITIES/ CONSTRUCTION TIMING	1
• EROSION & SEDIMENT CONTROL	2
• DEVELOPMENT AREA	2
• SOILS INFORMATION	2
• EXISTING SITE CONDITIONS.	3
SITE MAP (See Appendix)	3
STORMWATER MANAGEMENT CONTROLS	4
• SWMP ADMINISTRATOR	4
• POTENTIAL POLLUTANT SOURCES	4
• BMPS FOR POLLUTION PREVENTION	5
• BMP SELECTION	5
• MATERIAL HANDLING & SPILL PREVENTION	6
• CONCRETE/ASPHALT BATCH PLANTS	6
• WASTE MANAGEMENT & DISPOSAL INCLUDING CONCRETE WASHOUT	6
• DOCUMENTING SELECTED BMPS	6
• NON-STORMWATER DISCHARGES	6
• STORMWATER DEWATERING	7
• REVISING BMPS AND THE SWMP	7
FINAL STABILIZATION AND LONG-TERM STORMWATER MGMT	7
INSPECTION AND MAINTENANCE PROCEDURES	8
• INSPECTION SCHEDULES & PROCEDURES	8
• SWMP OWNER/ADMINISTRATOR INSPECTION PROCEDURES & SCHEDULES	8
• BMP MAINTENANCE/REPLACEMENT & FAILED BMPS	9
• RECORD KEEPING AND DOCUMENTING INSPECTIONS	9
APPENDIX	
VICINITY MAP	
COPY OF GENERAL PERMIT APPLICATION	
CONTRACTOR SEQUENCE OF ACTIVITIES	
OPERATION & MAINTENANCE INSPECTION RECORD	
STANDARD BMP DETAILS w/ INSTALLATION & MAINTENANCE REQUIREMENTS	

GRADING, EROSION AND STORMWATER QUALITY CONTROL PLAN FOR FALCON HIGH SCHOOL BUILDING ADDITION

SITE DESCRIPTION

The existing Falcon High School at 10255 Lambert Road building sits on an approximate 70-acre parcel within the County of El Paso, and State of Colorado. A proposed 15,960 square foot building expansion on the north corner of the existing high school is proposed. The existing school is approximately 141,200 square feet; therefore, the proposed building expansion is approximately 11% of the current building footprint. A new concrete driveway and concrete pad will be installed on the north end of the building expansion, but no other significant modifications to the existing surrounding infrastructure is required. The overall land disturbance area for this project is approximately 2.18 acres. The area of the proposed building expansion currently is undeveloped with native grass seed and an existing gravel driveway that drains to the south-east onto the existing parking lot and drive aisles east of the school.

• RECEIVING WATERS

Name of Receiving Water(s)	Haegler Creek
Size/Type/Location of Outfall(s)	Existing public/private storm facilities & detention facilities
Discuss discharge connection to Municipal system (include system name, location, and ultimate receiving water(s):	On-site grass swales into culverts under Londonderry Road to existing detention facility

• PROPOSED CONSTRUCTION ACTIVITY

Proposed construction activities within this project include grading of 2.18 acres and utility installation for the construction of the building addition.

• PROPOSED SEQUENCE OF ACTIVITY/CONSTRUCTION TIMING

Sequence of activities will be based upon site contractor timing and scheduling. Upon site contractor selection, contractor to include sequence of activities schedule in the section provided in the Appendix of this report.

A standard sequence of events typically includes the following:

- 1) Install perimeter, interior & exterior BMPs
- 2) Clear and grub site
- 3) Overlot Grading
- 4) Excavation & installation of utilities
- 5) Building Addition construction



6) Sidewalk and landscape installation

The anticipated start and completion time period for site grading operations is to start in Fall 2017 with site final site stabilization in Summer 2018. This time schedule could vary depending on construction schedules and weather.

• **EROSION AND SEDIMENT CONTROL**

Erosion control measures shall be implemented in a manner that will protect properties and public facilities from the adverse effects of erosion and sedimentation as a result of construction and earthwork activities. In order to prevent a net increase of sediment load, Best Management Practices will be implemented during the construction life of this project. A silt fence will be built around the perimeter of the disturbed areas (downhill side only). All roads will be inspected to ensure that sediment from on-site construction activity is not being discharged with the stormwater. Roadways shall be swept as needed for controlling tracking of mud onto public roadways. Vehicle tracking control pads will aid in minimizing soil tracking onto roadways. All disturbed areas, not sodded, will be reseeded with a native seed mix and watered until a mature stand is established. All areas disturbed will be protected with silt fence, diversion swales and temporary sediment traps until such time as the site has been re-vegetated. Vegetation and vegetated buffers shall be preserved as much as possible. Wherever feasible, vegetated buffers shall be maintained free from vehicle/equipment parking, storage, stockpiles, or other impacts.

• **DEVELOPMENT AREA/AREAS AND VOLUME STATEMENT**

Total Site Area	<u>70</u> Acres
Initial Site area to be disturbed	<u>2.18</u> Acres
Percent disturbance	<u>3.1</u> %

The total volume of earthwork cut/fill operations is more than 500 CY.

• **SOILS INFORMATION**

The majority of the on-site soils are of Hydrologic Group "A". The soils types are determined by the "Soil Survey of El Paso County Area," prepared by the National Cooperative Soil Survey. Group "A" soils typically have low runoff potential and high infiltration rates and therefore low erosion potential.

Existing disturbed site area runoff coefficient = .25

Developed site runoff coefficient = .25 landscaped/ seeded areas



= .90 building/hardscape

- **EXISTING SITE CONDITIONS**

The majority of the proposed site in its existing (natural) condition drains in a south-easterly direction towards the existing easterly parking lot.

The area of the proposed grading and development is 90% vegetated with native grasses and has existing slopes ranging from approximately 1 to 15 percent. There is an existing (gravel, loose asphalt) fire access drive aisle that will be reconstructed with the new grades and to the proposed building extension. The proposed building will connect to the existing school but only at one hallway location and therefore there is minimal construction within the existing developed area (building, pavement, etc.)

There are no areas designated as wetlands within the development limits for this report.

SITE MAP

Included in the appendix of this report is the approved overlot grading plan for the subject properties which will serve as the SWMP site map. This document contains site specific grading and erosion control BMP measures as required and approved by the El Paso County Development Services Division. Limits of disturbance, areas of cuts/fills, proposed stockpile areas, areas used for storage of materials, equipment, soil, or waste, batch plants, minimum and maximum cut/fill slopes, existing limits of significant vegetation, locations of springs, streams, and/or wetlands, and existing facilities (including but not limited to: detention/drainage facilities, structures, retaining walls, gas main, water main, wastewater main, electric and telecom vaults, fences, sidewalks, trails, curbs and streets) will be represented on this plan (may be added by Contractor in the field). The site map will depict locations of specific interim and ultimate stormwater management BMPs throughout the lifetime of the project. Erosion control cost assurances must be posted to El Paso County in the amount listed on the title page of the grading plan prior to approval of the grading plan. The site map/grading plan shall be amended to include any additional interim or phased BMPs over and above measures included on the site map, as required by contractor's construction schedule. All construction BMP details will be included in the appendix of this report. Detail sheets include installation and maintenance requirements. Also reference "Drainage Criteria Manual, Volume 2 Stormwater Quality Policies, Procedure, and Best Management Practices" for additional information and guidance regarding construction BMPs.



STORMWATER MANAGEMENT

• SWMP ADMINISTRATOR

The SWMP Administrator can be an individual(s), position, or title – this entity is responsible for developing, implementing, maintaining, and revising the SWMP. The Administrator is the contact for all SWMP related issues and is the entity responsible for its accuracy, completeness, and implementation. Therefore, the SWMP Administrator should be a person with authority to adequately manage and direct day to day stormwater quality management activities on the subject site. Reference the Appendix of this report for the SWMP permit application which names the individual/entity applying for the permit and naming the Administrator of the SWMP.

• POTENTIAL POLLUTANT SOURCES

Potential pollutant sources which shall be evaluated for potential to contribute pollutants to stormwater discharge from the subject site may include the following:

- Disturbed and stored soils
- Vehicle tracking of sediments
- Management of contaminated soils
- Loading and unloading operations
- Outdoor storage activities (building materials, fertilizers, chemicals, etc.)
- Vehicle and equipment maintenance and fueling
- Significant dust or particulate generating processes
- Routine maintenance activities involving fertilizers, pesticides, detergents, fuels, solvents, oils, etc.
- On-site waste management practices (waste piles, liquid wastes, dumpsters)
- Concrete truck/equipment washing, including the concrete truck chute associated fixtures and equipment
- Dedicated asphalt and concrete batch plants
- Non-industrial waste sources such as worker trash and portable toilets
- Other areas or procedures where potential spills can occur.

The location and description of these areas are shown on the attached SWMP Site Map.

• BMPS FOR POLLUTANT PREVENTION

The following are common practices to mitigate potential pollutants:



- Wind erosion shall be controlled by sprinkling site roadways and/or temporary stabilizing stockpiles. Each dump truck hauling material from the site will be required to be covered with a tarpaulin.
- Sanitary facilities shall be placed at a minimum of 10' from any curb line and 50' from any inlet. If not feasible for the project, use of a secondary containment shall be implemented.
- Equipment fueling and Maintenance Services – a designated fueling area will be established to contain any spill resulting from fueling, maintenance, or repair of equipment. Contractors will be responsible for containment, cleanup, and disposal of any leak or spill and any costs associated with the cleanup and disposal.
- Chemical products shall be protected from precipitation, free from ground contact, and stored properly to prevent damage from equipment or vehicles.
- Material stockpiles (soils, soil amendments, debris/trash piles) – All construction trash and debris will be deposited in the dumpster.
- Sediment and Migration of Sediment – Sweeping operations will take place as needed to keep roadways maintained. The perimeter of the site will be evaluated for any potential impact resulting from trucking operations or sediment migration from the site. BMP devices will be placed to protect storm system inlets should any roadway tracking or sediment migration occur.
- Snow removal and/or stockpiling will be considered prior to placement at the site. Snow stockpiles must be kept away from any stormwater conveyance system (i.e., inlets, ponds, outfall locations, roadway surfaces, etc.)

- **BMP SELECTION**

Selection of the appropriate BMP will limit the source of the pollutant. Guidance for the selection process can be found by referencing the City of Colorado Springs and El Paso County “Drainage Criteria Manual Volume 2”.

During grading and construction activity for the subject site, silt fence will be installed along the perimeter of the site as well as at the limits of grading within the project. Check dams will be installed along all permanent and temporary diversion swales to minimize erosion in areas of concentrated stormwater. Temporary diversion swales will be installed to a minimum of 1% slope to divert stormwater to several proposed sediment basins intended to collect stormwater and filter the sediment before conveyance into the proposed storm systems. Inlet protection will be installed at all proposed and adjacent inlets to ensure no downstream pollutants will enter storm sewer facilities. Vehicle tracking control pads will be installed at all access points to the addition area. Regular maintenance and inspection of these facilities will be necessary throughout



grading operations and until vegetation is reestablished to ensure proper function of the sediment basin temporary outlet structures.

- **MATERIAL HANDLING & SPILL PREVENTION**

Where materials can impact stormwater runoff, existing and planned practices that reduce the potential for pollution must be included in a spill prevention plan, to be provided by the contractor. Spill prevention plans shall include

- Notification procedures to be used in the event of an accident
- Instruction for clean-up procedures, and identification of a spill kit location
- Provisions for absorbents to be made available for use in fuel areas, and for containers to be available for used absorbents
- Procedures for properly washing out concrete truck chutes and other equipment in a manner and location so that the materials and wash water cannot discharge from the site and never into a storm sewer system or stream.

- **CONCRETE/ASPHALT BATCH PLANTS**

Where applicable, the SWMP must be amended by the contractor to describe and locate on the Site Map all practices used to control stormwater pollution from dedicated asphalt or concrete batch plants.

- **WASTE MANAGEMENT AND DISPOSAL INCLUDING CONCRETE WASHOUT**

Where applicable, the SWMP must be amended by the contractor to describe and locate on the Site Map all practices implemented at the site to control stormwater pollution from all construction site wastes (liquid and solid) including concrete washout activities.

- **DOCUMENTING SELECTED BMPS**

As discussed in the SITE MAP section of this report, documentation of the selected BMPs will be included on the site map / grading plan included in this report. The site map/ grading plan shall be amended to include any additional interim or phased BMPs over and above measures included on the site map, as required by contractor's construction schedule.

- **NON-STORMWATER DISCHARGES**

Except for emergency firefighting activities, landscape irrigation return flow, uncontaminated springs, construction dewatering and concrete washout water, the SWMP permit covers only discharges composed entirely of stormwater.



- **STORMWATER DEWATERING**

The discharge of pumped water, ONLY from excavations, ponds, depressions, etc., to surface waters or to a municipal separate storm-sewer system is allowed by the Stormwater Construction Permit as long as the dewatering activity and associated BMPs are identified in the SWMP (including location of activity), and the BMPs are implemented in accordance with the SWMP. Where applicable, all stormwater and groundwater dewatering practices implemented to control stormwater pollution for dewatering must be amended in the SWMP and Site Map by the contractor.

- **REVISING BMPs AND THE SWMP**

The implemented BMPs will need to be modified and maintained regularly to adapt to changing site conditions and to ensure that all potential stormwater pollutants are properly managed. The BMPs and pollutant sources must be reviewed on an ongoing basis by the Administrator as assigned by the Permit. With any construction project, special attention must be paid to construction phasing and therefore revisions to the SWMP to include any additional or modification to the BMPs and SWMP report. The SWMP must be modified or amended to accurately reflect the field conditions. Examples include - but are not limited to – removal of BMPs, identification of new potential pollutant procedures, and changes to information provided in the site map/overlot grading plan. SWMP revisions must be made prior to changes in site conditions. The SWMP should be viewed as a “living document” throughout the lifetime of the project.

FINAL STABILIZATION AND

LONG-TERM STORMWATER MANAGEMENT

Permanent stabilization of the site includes seeding and mulching the site. Seeding and mulching consists of loosening soil, applying topsoil (if permanent seeding) and drill seeding disturbed areas with grasses and crimping in straw mulch to provide immediate protection from raindrop and wind erosion. As the grass cover becomes established, provide long term stabilization of exposed soils.

Once the construction activity ceases permanently, the area will be stabilized with permanent seed and mulch. All areas that will not be impacted by construction of buildings will be seeded and landscaped as feasible. After seeding, each area will be mulched with straw. The straw mulch is to be tacked into place by a disc with blades set nearly straight. Topsoil stockpiles will be stabilized with temporary seed and mulch. Areas of the site that are to be paved will be temporarily stabilized until asphalt is applied.



The temporary perimeter controls (silt fence or equivalent) will not be removed until all construction activities at the site are complete and soils have been stabilized. Upon completion of construction activities, the site shall be inspected to ensure all equipment, waste materials, and debris have been removed. All other BMPs or other control practices and measure that are to remain after completion of construction will be inspected to ensure they are properly functioning. Final stabilization is reached when all soil disturbing activities at the site have been completed and uniform vegetative cover has been established with a density of at least 70% of pre-disturbance levels. For purposes of the SWMP, establishment of a vegetative cover capable of providing erosion control equivalent to the pre-existing conditions at the site can be considered final stabilized.

INSPECTION AND MAINTENANCE PROCEDURES

All drainage facilities will be monitored using the enclosed "Monitoring and Maintenance Inspection Record" checklist (Appendix II).

• SWMP OWNER/ADMINISTRATOR INSPECTION PROCEDURES & SCHEDULES

The Owner/Administrator shall adhere to the following inspection procedures during the development of the site:

1. Make thorough inspection of the stormwater management system at least every 14 days.
2. Make thorough inspection of the stormwater management system within 24 hrs of each precipitation event that creates runoff.
3. If any system deficiencies are noted, corrective actions must begin immediately. Documentation of inspection must be available if requested.
4. Records of the site inspections or facility replacement modifications must be kept at the site within this report.
5. 30 day inspections must take place on this site where construction activity is complete, but vegetative cover is still being established.

In this report's appendix, a site inspection form has been included for use by the Inspector. Upon completion of this form, the document is to be kept in the provided folder also in the rear of this report.



- **BMP MAINTENANCE / REPLACEMENT & FAILED BMPs**

The Stormwater Construction Permit requires that all erosion and sediment control practices and other protective measures identified in the SWMP be maintained in effective and operation condition. A preventative maintenance program should be in place to prevent BMP breakdowns and failures by proactively maintaining or replacing BMPs and equipment. The inspections process should also include procedures to ensure that BMPs are replaced or new BMPs added to adequately manage the pollutant sources at the site. This procedure is part of the ongoing process of revising the BMPs and SWMP as previously discussed, and any changes shall be recorded in the SWMP.

- **RECORD KEEPING AND DOCUMENTING INSPECTIONS**

The following items must be documented as part of the site inspections:

- Inspection date
- Name(s) and title(s) of personnel making inspection
- Location(s) of discharges of sediment or other pollutants from site
- Location(s) of BMPs that need to be maintained
- Location(s) of BMPs that fail to operate as designed or proved inadequate in a particular location
- Location(s) where additional BMPs are needed that were not in place at time of inspection
- Deviations from the minimum inspection schedule
- Descriptions of corrective action for items above including dates and measures taken to prevent future violations
- Signed statement of compliance added to the report after correction action has been taken

PREPARED BY:

Classic Consulting Engineers & Surveyors, LLC



Kyle R. Campbell, P.E.
Division Manager



VICINITY MAP

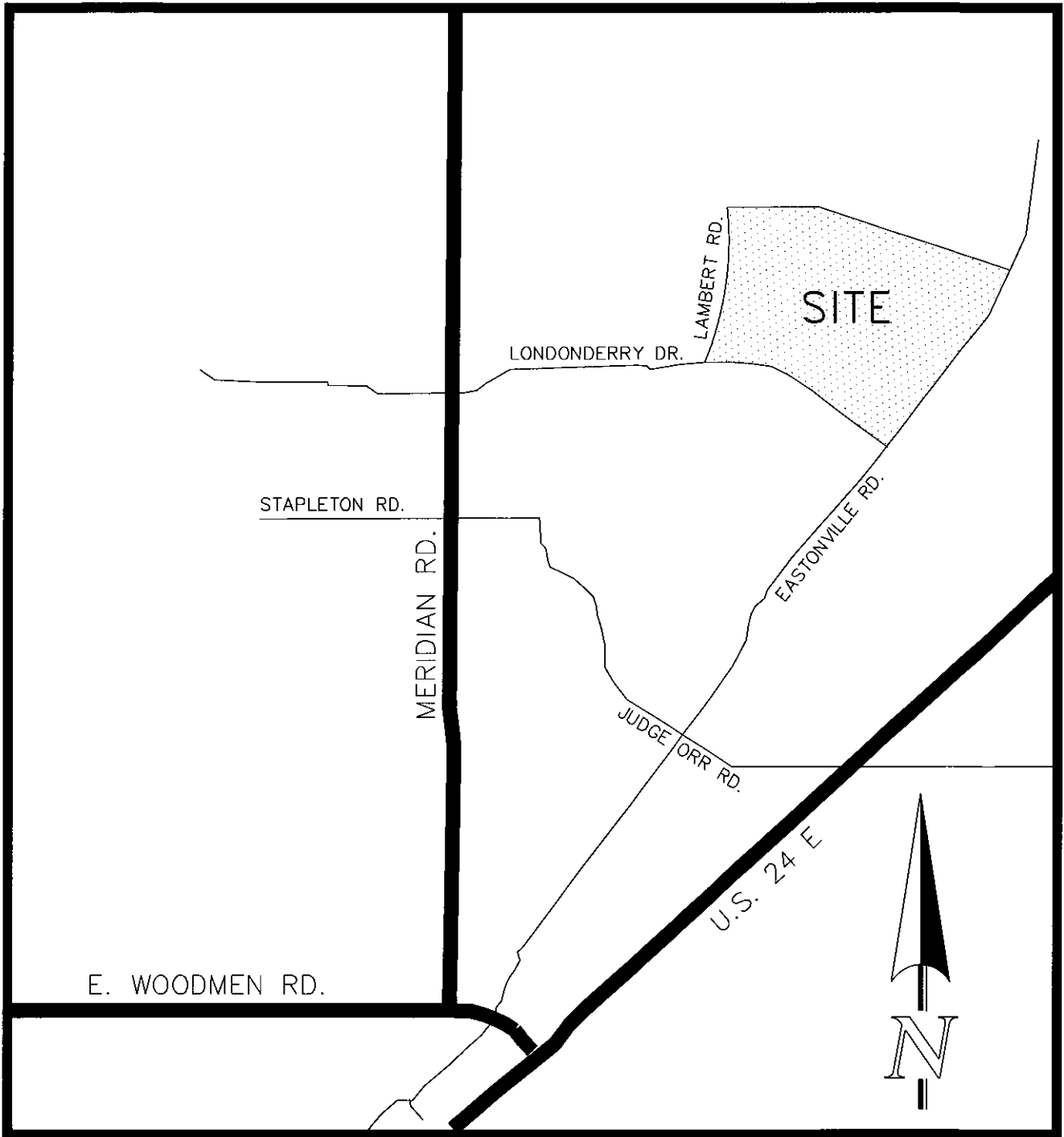

VICINITY MAP
NOT TO SCALE

COPY OF PERMIT APPLICATION

General permit application for stormwater discharges associated with construction activity.

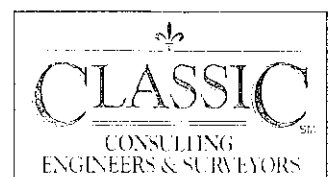



COLORADO
Department of Public
Health & Environment

Dedicated to protecting and improving the health and environment of the people of Colorado

ASSIGNED PERMIT NUMBER
Date Received <u> </u> / <u> </u> / <u> </u>
MM DD YYYY
Revised: 3-2016

STORMWATER DISCHARGE ASSOCIATED WITH CONSTRUCTION ACTIVITIES APPLICATION
COLORADO DISCHARGE PERMIT SYSTEM (CDPS)

PHOTO COPIES, FAXED COPIES, PDF COPIES OR EMAILS WILL NOT BE ACCEPTED.

For Applications submitted on paper - Please print or type. Original signatures are required.
All items must be completed accurately and in their entirety for the application to be deemed complete. Incomplete applications will not be processed until all information is received which will ultimately delay the issuance of a permit. If more space is required to answer any question, please attach additional sheets to the application form. Applications or signature pages for the application may be submitted by mail or hand delivered to:

Colorado Department of Public Health and Environment, 4300 Cherry Creek Drive South, WQCD-P-B2, Denver, CO 80246-1530

For Applications submitted electronically
Please note that you can ONLY complete the feedback form by downloading it to a PC or Mac/Apple computer and opening the Application with Adobe Reader or a similar PDF reader. The form will NOT work with web browsers, Google preview, Mac preview software or on mobile devices using iOS or Android operating systems.

If application is submitted electronically, processing of the application will begin at that time and not be delayed for receipt of the signed document.

Any additional information that you would like the Division to consider in developing the permit should be provided with the application. Examples include effluent data and/or modeling and planned pollutant removal strategies.

Beginning July 1, 2016, invoices will be based on acres disturbed.

DO NOT PAY THE FEES NOW - Invoices will be sent after the receipt of the application.

Disturbed Acreage for this application (see page 4)

- Less than 1 acre (\$83 initial fee, \$165 annual fee)
- 1-30 acres (\$175 initial fee, \$350 annual fee)
- Greater than 30 acres (\$270 initial fee, \$540 annual fee)

PERMIT INFORMATION

Reason for Application: NEW CERT RENEW CERT EXISTING CERT# _____

Applicant is: Property Owner Contractor/Operator

A. CONTACT INFORMATION - *Indicates required

* PERMITTED ORGANIZATION FORMAL NAME: GE Johnson Construction Company

1) * PERMIT OPERATOR - the party that has operational control over day to day activities - may be the same as owner.

Responsible Person (Title): Sr VP

Currently Held By (Person): First Name: Trey Last Name: Nobles

Telephone: 303.221.1249 Email Address: noblest@gejohnson.com

Organization: GE Johnson Construction Company

Mailing Address: 5613 DTC Parkway, Ste 450

City: Greenwood Village State: CO Zip Code: 80111

Per Regulation 61 : All reports required by permits, and other information requested by the Division shall be signed by the permittee or by a duly authorized representative of that person. A person is a duly authorized representative only if:

- (i) The authorization is made in writing by the permittee
- (ii) The authorization specifies either an individual or a position having responsibility for the overall operation of the regulated facility or activity such as the position of plant manager, operator of a well or a well field, superintendent, position of equivalent responsibility, or an individual or position having overall responsibility for environmental matters for the company. (A duly authorized representative may thus be either a named individual or any individual occupying a named position); and
- (iii) The written authorization is submitted to the Division

GE Johnson Construction Company - 13:57:10 - 08/31/2017

01630fce-9059-45c6-aa33-25de04f6d032

2) OWNER - party has ownership or long term lease of property - may be the same as the operator.

Same as 1) Permit Operator

Responsible Person (Title): _____
Currently Held By (Person): First Name: _____ Last Name: _____
Telephone: _____ Email Address: _____
Organization: _____
Mailing Address: _____
City: _____ State: _____ Zip Code: _____

Per Regulation 61 : All reports required by permits, and other information requested by the Division shall be signed by the permittee or by a duly authorized representative of that person. A person is a duly authorized representative only if:

- I. The authorization is made in writing by the permittee.
- II. The authorization specifies either an individual or a position having responsibility for the overall operation of the regulated facility or activity such as the position of plant manager, operator of a well or a well field, superintendent, position of equivalent responsibility, or an individual or position having overall responsibility for environmental matters for the company. (A duly authorized representative may thus be either a named individual or any individual occupying a named position); and
- III. The written authorization is submitted to the Division.

3) *SITE CONTACT local contact for questions relating to the facility & discharge authorized by this permit for the facility

Same as 1) Permit Operator

Responsible Person (Title): Superintendent
Currently Held By (Person): First Name: Dave Last Name: Pastier
Telephone: 719.491.0941 Email Address: pastierd@GEJohnson.com
Organization: GE Johnson Construction Company
Mailing Address: 25 N Cascade Ave, Ste 400
City: Colorado Springs State: CO Zip Code: 80903

4) *BILLING CONTACT if different than the permittee.

Same as 1) Permit Operator

Responsible Person (Title): Project Manager
Currently Held By (Person): First Name: Doug Last Name: Hanney
Telephone: (719) 473-5321 Email Address: hanneyd@GEJohnson.com
Organization: GE Johnson Construction Company
Mailing Address: 25 N Cascade Ave, Ste 400
City: Colorado Springs State: CO Zip Code: 80903

5) OTHER CONTACT TYPES (check below) Add pages if necessary:

Responsible Person (Title): Environmental Specialist
Currently Held By (Person): First Name: Kathy Last Name: Kaiser
Telephone: 720.585.1934 Email Address: kaiserk@gejohnson.com
Organization: GE Johnson Construction Company
Mailing Address: 5613 DTC Parkway, Ste450
City: Greenwood Village State: CO Zip Code: 80111

- Environmental Contact Consultant Stormwater MS4 Responsible Person
 Inspection Facility Contact Compliance Contact Stormwater Authorized Representative

B) PERMITTED PROJECT/FACILITY INFORMATION

Project/Facility Name Falcon High School Addition
Street Address or Cross Streets 10255 Lambert Rd

(e.g., Park St and 5 Ave; CR 21 and Hwy 10; 44 Ave and Clear Creek) ; A street name without an address, intersection, mile marker, or other identifying information describing the location of the project is not adequate. For linear projects, the route of the project should be described as best as possible using the starting point for the address and latitude and longitude - more clearly defined in the required map)

City: Unincorporated County: El Paso Zip Code: 80831

Facility Latitude/Longitude - List the latitude and longitude of the excavation(s) resulting in the discharge(s). If the exact soil disturbing location(s) are not known, list the latitude and longitude of the center point of the construction project. If using the center point, be sure to specify that it is the center point of construction activity. The preferred method is GPS and Decimal Degrees.

Latitude 38 98149 Longitude -104 57633 (e.g., 39.70312°, 104.93348°)
Decimal Degrees (to 5 decimal places) Decimal Degrees (to 5 decimal places)

This information may be obtained from a variety of sources, including:

- Surveyors or engineers for the project should have, or be able to calculate, this information.
- U.S. Geological Survey topographical map(s), available at area map stores.
- Using a Global Positioning System (GPS) unit to obtain a direct reading.
- Google - enter address in search engine, select the map, right click on location, and select "what's here".

Note: the latitude/longitude required above is not the directional degrees, minutes, and seconds provided on a site legal description to define property boundaries.

C) MAP (Attachment) If no map is submitted, the application cannot be submitted.

Map: Attach a map that indicates the site location and that CLEARLY shows the boundaries of the area that will be disturbed. A vicinity map is not adequate for this purpose.

D) LEGAL DESCRIPTION - only for Subdivisions

Legal description: If subdivided, provide the legal description below, or indicate that it is not applicable (do not supply Township/Range/Section or metes and bounds description of site)

Subdivision(s): _____ Lot(s): _____ Block(s) _____

OR Not applicable (site has not been subdivided)

E) AREA OF CONSTRUCTION SITE - SEE PAGE 1 - WILL DETERMINE FEE

Provide both the total area of the construction site, and the area that will undergo disturbance, in acres.

Total area of project disturbance site (acres): 3

Note: aside from clearing, grading and excavation activities, disturbed areas also include areas receiving overburden (e.g., stockpiles), demolition areas, and areas with heavy equipment/vehicle traffic and storage that disturb existing vegetative cover.

Part of Larger Common Plan of Development or Sale, (i.e., total, including all phases, fillings, lots, and infrastructure not covered by this application)

F) NATURE OF CONSTRUCTION ACTIVITY

Check the appropriate box(es) or provide a brief description that indicates the general nature of the construction activities. (The full description of activities must be included in the Stormwater Management Plan.)

- Commercial Development
- Residential Development
- Highway and Transportation Development
- Pipeline and Utilities (including natural gas, electricity, water, and communications)
- Oil and Gas Exploration and Well Pad Development
- Non-structural and other development (i.e. parks, trails, stream realignment, bank stabilization, demolition, etc.)

GE Johnson Construction Company - 13:57:10 - 08/31/2017

01630fce-9059-45c6-aa33-25de04f6d032

G) ANTICIPATED CONSTRUCTION SCHEDULE

Construction Start Date: September 18, 2017 Final Stabilization Date: July 27, 2018

- *Construction Start Date* - This is the day you expect to begin ground disturbing activities, including grubbing, stockpiling, excavating, demolition, and grading activities.
- *Final Stabilization Date* - In terms of permit coverage, this is when the site is finally stabilized. This means that all ground surface disturbing activities at the site have been completed, and all disturbed areas have been either built on, paved, or a uniform vegetative cover has been established with an individual plant density of at least 70 percent of pre-disturbance levels. **Permit coverage must be maintained until the site is finally stabilized. Even if you are only doing one part of the project, the estimated final stabilization date must be for the overall project.** If permit coverage is still required once your part is completed, the permit certification may be transferred or reassigned to a new responsible entity(s).

H) RECEIVING WATERS (If discharge is to a ditch or storm sewer, include the name of the ultimate receiving waters)

Immediate Receiving Water(s): El Paso County MS4

Ultimate Receiving Water(s): Upper Black Squirrel Creek

Identify the receiving water of the stormwater from your site. Receiving waters are any waters of the State of Colorado. This includes all water courses, even if they are usually dry. If stormwater from the construction site enters a ditch or storm sewer system, identify that system and indicate the ultimate receiving water for the ditch or storm sewer. **Note:** a stormwater discharge permit does not allow a discharge into a ditch or storm sewer system without the approval of the owner/operator of that system.

1) SIGNATURE PAGE

1. You may print and sign this document and mail the hard copy to the State along with required documents (address on page one).
2. **Electronic Submission Signature**
 You may choose to submit your application electronically, along with required attachments. To do so, click the SUBMIT button below which will direct you, via e-mail, to sign the document electronically using the DocuSign Electronic Signature process. Once complete, you will receive via e-mail, an electronically stamped Adobe pdf of this application. Print the signature page from the electronically stamped pdf, sign it and mail it to the WQCO Permits Section to complete the application process (address is on page one of the application).
 - The Division encourages use of the electronic submission of the application and electronic signature. This method meets signature requirements as required by the State of Colorado.
 - The ink signed copy of the electronically stamped pdf signature page is also required to meet Federal EPA Requirements.
 - Processing of the application will begin with the receipt of the valid electronic signature.

STORMWATER MANAGEMENT PLAN CERTIFICATION

By checking this box "I certify under penalty of law that a complete Stormwater Management Plan, as described in the stormwater management plan guidance, has been pre-pared for my activity. Based on my inquiry of the person or persons who manage the system, or those persons directly responsible for gathering the information, the Stormwater Management Plan is, to the best of my knowledge and belief, true, accurate, and complete. I am aware that there are significant penalties for falsely certifying the completion of said SWMP, including the possibility of fine and imprisonment for knowing violations."

"I certify under penalty of law that this document and all attachments were prepared under my direction or supervision in accordance with a system designed to assure that qualified personnel properly gather and evaluate the information submitted. Based on my inquiry of the person or persons who manage the system, or those persons directly responsible for gathering the information, the information submitted is to the best of my knowledge and belief, true, accurate and complete. I am aware that there are significant penalties for submitting false information, including the possibility of fine and imprisonment for knowing violations."

"I understand that submittal of this application is for coverage under the State of Colorado General Permit for Stormwater Discharges Associated with Construction Activity for the entirety of the construction site/project described and applied for, until such time as the application is amended or the certification is transferred, inactivated, or expired." [Reg 61.4(1)(h)]

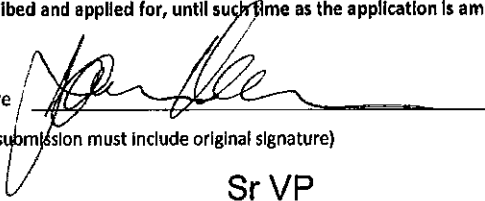
For DocuSign
Electronic Signature Trey Nobles Ink Signature  Date: 08/31/2017

Signature of Legally Responsible Person or Authorized Agent (submission must include original signature)

Trey Nobles Sr VP
Name (printed) Title

Signature: The applicant must be either the owner and operator of the construction site. Refer to Part B of the instructions for additional information.

The application must be signed by the applicant to be considered complete. In all cases, it shall be signed as follows:

(Regulation 61.4 (1e))

- a) In the case of corporations, by the responsible corporate officer is responsible for the overall operation of the facility from which the discharge described in the form originates
- b) In the case of a partnership, by a general partner.
- c) In the case of a sole proprietorship, by the proprietor.
- d) In the case of a municipal, state, or other public facility, by either a principal executive officer, ranking elected official, (a principal executive officer has responsibility for the overall operation of the facility from which the discharge originates).

3rd Party Preparer: If this form was prepared by an authorized agent on behalf of the Permittee, please complete the field below.

Kathy Kaiser kaiserk@gejohnson.com
Preparer Name (printed) Email Address

**DO NOT INCLUDE A COPY OF THE STORMWATER MANAGEMENT PLAN
DO NOT INCLUDE PAYMENT—AN INVOICE WILL BE SENT AFTER THE CERTIFICATION IS ISSUED.**

*** ELECTRONICALLY SUBMITTED STORMWATER CONSTRUCTION APPLICATION ***

GE Johnson Construction Company - 13:57:10 - 08/31/2017

01630fce-9059-45c6-aa33-25de04f6d032

APPLICATION AND PERMIT EROSION AND STORMWATER QUALITY CONTROL PERMIT (ESQCP)

PERMIT NUMBER: ESQ-17-031

COUNTY PROJECT NO. PPR 17-048

APPLICANT INFORMATION

Applicant Contact Information	
Owner	Falcon School District #49
Name (person of responsibility)	Melissa Andrews
Company	Falcon School District #49
Position of Applicant	Manager
Address (physical address, not PO Box)	10850 E. Woodmen Road
City	Peyton
State	CO
Zip Code	80831
Phone	719-495-1100

CONTRACTOR INFORMATION

Contractor	
Name (person of responsibility)	Doug Hanney
Company	G.E. Johnson Construction Company, Inc.
Position of Applicant	Construction Manager
Address	25 N. Cascade Avenue, Suite 400
City	Colorado Springs
State	CO
Zip Code	80903
Phone	719-473-5321

PROJECT INFORMATION

Project Specifications		
Name and Legal Description	Unplatted 70 acre school site	
Name of Subdivision Filing	N/A	
Address (or nearest major cross streets)	North of Highway 24 and Londonderry Drive	
Acreage (total and disturbed)	70	2.18
Schedule (start and finish and date of final stabilization)	Fall 2017	Summer 2018
Description of Project	Existing high school addition	
Tax Schedule Number	42000-00-335	

FOR OFFICE USE ONLY

The following signature from the ECM Administrator signifies the approval of this ESQCP. All work shall be performed in accordance with the permit, the El Paso County ECM Standards, DCM2, Addendum, approved plans, and any attached conditions. The approved plans are an enforceable part of the ESQCP. Construction activity, except for the installation of initial construction BMPs is not permitted until issuance of a Construction permit and Notice to Proceed.

Signature of ECM Administrator: _____ Date: _____

1.1 REQUIRED SUBMISSIONS

In addition to this completed and signed application, the following items must be submitted to obtain an ESQCP:

- Permit fees (Fees are included in the subdivision or commercial plot plan review fees when application is submitted concurrently with subdivision or commercial plot plan application);
- Stormwater Management Plan (SWMP) either as part of the plan set for the development review process or as a separate document;
- Cost estimates of construction and maintenance of construction and permanent stormwater control measures (Cost estimates shall be provided on a unit cost basis for all stormwater BMPs);
- Financial surety in an amount agreeable to the ECM Administrator commensurate with the amount of disturbed area and stormwater quality protection measures and based on the cost estimates provided. The financial surety shall be provided in the form of a Letter of Credit, Surety with a Bonding Company, or other forms acceptable to El Paso County;
- Operation and Maintenance Plan for any proposed permanent BMPs; and
- Signed Private Stormwater Quality Structural Best Management Practices Agreement and Easement, if any private permanent BMPs are proposed.

1.2 RESPONSIBILITY FOR DAMAGE

The County and its officers and employees, including but not limited to the ECM Administrator, shall not be answerable or accountable in any manner, for injury to or death of any person, including but not limited to a permit holder, persons employed by the permit holder, persons acting in behalf of the permit holder, or for damage to property resulting from any activities undertaken by a permit holder or under the direction of a permit holder. The permit holder shall be responsible for any liability imposed by law and for injuries to or death of any person, including but not limited to the permit holder, persons employed by the permit holder, persons acting in behalf of the permit holder, or damage to property arising out of work or other activity permitted and done by the permit holder under a permit, or arising out of the failure on the permit holder's part to perform the obligations under any permit in respect to maintenance or any other obligations, or resulting from defects or obstructions, or from any cause whatsoever during the progress of the work, or other activity, or at any subsequent time work or other activity is being performed under the obligations provided by and contemplated by the permit.

To the extent allowed by law, the permit holder shall indemnify, save, and hold harmless the County and its officers and employees, including but not limited to the BOCC and ECM Administrator, from all claims, suits or actions of every name, kind and description brought for or on account of injuries to or death of any person, including but not limited to the permit holder, persons employed by the permit holder, persons acting in behalf of the permit holder and the public, or damage to property resulting from the performance of work or other activity under the permit, or arising out of the failure on the permit holder's part to perform his obligations under any permit in respect to maintenance or any other obligations, or resulting from defects or obstructions, or from any cause whatsoever during the progress of the work, or other activity or at any subsequent time work or other activity is being performed under the obligations provided by and contemplated by the permit, except as otherwise provided by state law. The permit holder waives any and all rights to any type of expressed or implied indemnity against the County, its officers or employees.

1.3 APPLICATION CERTIFICATION

I, as the Applicant or the representative of the Applicant, hereby certify that this application is correct and complete as per the requirements presented in this application and the El Paso County Engineering Criteria Manual and Drainage Criteria Manual, Volume 2 and El Paso County Addendum.

I, as the Applicant or the representative of the Applicant, have read and will comply with all of the requirements of the specified Stormwater Management Plan and any other documents specifying stormwater best management practices to be used on the site including permit conditions that may be required by the ECM Administrator. I understand that the Best Management Practices are to be maintained on the site and revised as necessary to protect stormwater quality as the project progresses. I further understand that a Construction Permit must be obtained and all necessary stormwater quality control BMPs are to be installed in accordance with the SWMP and the El Paso County Engineering Criteria Manual and Drainage Criteria Manual, Volume 2 and El Paso County Addendum before land disturbance begins and that failure to comply will result in a Stop Work Order and may result in other penalties as allowed by law. I further understand and agree to indemnify, save, and hold harmless the County and its officers and employees, including but not limited to the BOCC and ECM Administrator, from all claims, suits or actions of every name, kind and description as outlined in Section 1.2 Responsibility for Damage.



Signature of Applicant or Representative

Date: 11/9/2017

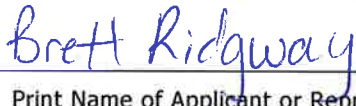

Print Name of Applicant or Representative

CONTRACTOR SEQUENCE OF ACTIVITIES

COLORADO DISCHARGE PERMIT
SYSTEM (CDPS) CHECKLIST
Operation & Maintenance Inspection Record

The following inspection records are to be used at each bi-monthly stormwater management system inspection and after any precipitation or snowmelt event that causes surface runoff. As a result of these inspections, the SWMP may need to be revised. The inspection records and revised SWMP shall be made available to the division upon request. If the construction activity lasts more than 12 months, a copy of the inspection records and revised SWMP shall be sent to the division by May 1 of each year covering April 1 to March 31.

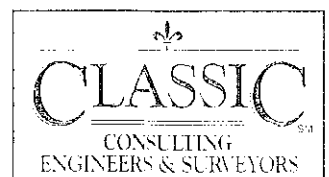

Action: _____ Project Type: _____ Zip Code: _____

Project Name: _____ Subdivision: _____

Address/Location: _____ Assigned Inspector: _____

Action Date: _____ Date Next Routine: _____ Date Next Follow-up: _____

Owner: _____ Owner Phone: _____ Stage of Construction: _____

Rep. Name: _____ Rep. Phone: _____ Inspected By: _____

	Items	Is Used	Maint. Required	Remarks / Actions Necessary
1	Check Dam <ul style="list-style-type: none"> ➤ Has accumulated sediment and debris been removed per maintenance requirements? 	No	No	
2	Erosion Control Blanket <ul style="list-style-type: none"> ➤ Is the erosion control blanket fabric damaged, loose, or in need of repair? 	No	No	
3	Inlet Protection <ul style="list-style-type: none"> ➤ Is the inlet protection damaged, ineffective or in need of repairs? ➤ Does sediment remain in inlets? 	No	No No	
4	Mulching <ul style="list-style-type: none"> ➤ Uneven mulch distribution on disturbed areas? ➤ Is the mulch application rate inadequate? ➤ Any evidence of mulch being blown or washed away? ➤ Do areas require additional mulching? 	No	No No No No	
5	Sediment / Basin Trap <ul style="list-style-type: none"> ➤ Is the sediment basin improperly constructed or inoperable? ➤ Is there sediment and/or debris in the basin? 	No	No No	
6	Silt Fence <ul style="list-style-type: none"> ➤ Is the silt fence damaged, collapsed, un-trenched or ineffective? ➤ Is the excess sediment against the barrier? ➤ Is the silt fence improperly located? 	No	No No No	
7	Slope Drain <ul style="list-style-type: none"> ➤ Is water bypassing or undercutting the inlet or pipe? ➤ Is there any evidence of erosion? 	No	No No	
8	Straw Bale Barrier <ul style="list-style-type: none"> ➤ Are the straw bales damaged, ineffective or un-trenched? ➤ Is there excess sediment against the barrier? ➤ Are the bales installed and positioned incorrectly? 	No	No No No	
9	Surface Roughening <ul style="list-style-type: none"> ➤ Is the surface roughening inconsistent on slopes? ➤ Is there any evidence of surface roughening erosion? 	No	No No	
10	Seeding <ul style="list-style-type: none"> ➤ Are the seedbeds unprotected? ➤ Has any erosion occurred in the seeded area? ➤ Any evidence of vehicle tracking on seeded area? 	No	No No No	
11	Temporary Swales <ul style="list-style-type: none"> ➤ Has any sediment or debris been deposited within the swales? ➤ Have the slopes of the swale eroded or has damage occurred to the lining? ➤ Are the swales improperly located? 	No	No No No	
12	Vehicle Tracking <ul style="list-style-type: none"> ➤ Is gravel surface clogged with mud or sediment? ➤ Is the gravel surface sinking into the ground? ➤ Has sediment been tracked onto any roads? ➤ Is inlet protection missing around curb inlets near construction entrance? 	No	No No No No	
13	Diversion Structure <ul style="list-style-type: none"> ➤ Has the structure been damaged or show signs of erosion? ➤ Is the structure properly located? 	No	No No	

14	Outlet Protection ➤ Is erosion taking place?	No	No	
15	Rough-Cut Street Control ➤ Have structures been properly located and installed? ➤ Is there excess sediment against the structures?	No	No No	
16	Concrete Washout ➤ Has material been removed per maintenance requirements? ➤ Does structure have adequate signage? ➤ Is there adequate tracking-pad material for access, if necessary? ➤ Is there adequate protection around the structure?	No	No No No No	
17	Erosion Logs ➤ Are the erosion logs damaged, collapsed, or ineffective? ➤ Is there excess sediment against the barrier? ➤ Are the erosion logs improperly located?	No	No No No	
18	GEC Management ➤ Is the GEC notebook located on site? ➤ Are changes to the GEC documents noted and approved? ➤ Are the inspection reports retained on-site? ➤ Are corrective actions from the last inspection completed?	No	No No No No	
19	Materials and Pollution ➤ Are stockpiles being managed properly? ➤ Are materials being managed properly? ➤ Is solid waste and trash being managed properly? ➤ Is street sweeping being managed properly? ➤ Are the sanitary facilities being managed properly? ➤ Are the vehicles and equipment being managed properly? ➤ Are there other materials or pollution issues being properly maintained?	No	No No No No No No No	

Project Status: _____ Const. Start Date: _____ Size of Disturbance (acres): _____

Additional Comments:

**COMPLETED OPERATION AND
MAINTENANCE INSPECTION RECORDS**



STANDARD BMP DETAILS
W/ INSTALLATION AND MAINTENANCE REQUIREMENTS
(SEE EL PASO COUNTY DCM VOLUME 2 – STORMWATER QUALITY
POLICIES, PROCEDURES AND BEST MANAGEMENT PRACTICES)



Seeding dates for the highest success probability of perennial species along the Front Range are generally in the spring from April through early May and in the fall after the first of September until the ground freezes. If the area is irrigated, seeding may occur in summer months, as well. See Table TS/PS-3 for appropriate seeding dates.

Table TS/PS-1. Minimum Drill Seeding Rates for Various Temporary Annual Grasses

Species ^a (Common name)	Growth Season ^b	Pounds of Pure Live Seed (PLS)/acre ^c	Planting Depth (inches)
1. Oats	Cool	35 - 50	1 - 2
2. Spring wheat	Cool	25 - 35	1 - 2
3. Spring barley	Cool	25 - 35	1 - 2
4. Annual ryegrass	Cool	10 - 15	½
5. Millet	Warm	3 - 15	½ - ¾
6. Sudangrass	Warm	5-10	½ - ¾
7. Sorghum	Warm	5-10	½ - ¾
8. Winter wheat	Cool	20-35	1 - 2
9. Winter barley	Cool	20-35	1 - 2
10. Winter rye	Cool	20-35	1 - 2
11. Triticale	Cool	25-40	1 - 2

^a Successful seeding of annual grass resulting in adequate plant growth will usually produce enough dead-plant residue to provide protection from wind and water erosion for an additional year. This assumes that the cover is not disturbed or mowed closer than 8 inches.

Hydraulic seeding may be substituted for drilling only where slopes are steeper than 3:1 or where access limitations exist. When hydraulic seeding is used, hydraulic mulching should be applied as a separate operation, when practical, to prevent the seeds from being encapsulated in the mulch.

^b See Table TS/PS-3 for seeding dates. Irrigation, if consistently applied, may extend the use of cool season species during the summer months.

^c Seeding rates should be doubled if seed is broadcast, or increased by 50 percent if done using a Brillion Drill or by hydraulic seeding.

EC-2 Temporary and Permanent Seeding (TS/PS)

Table TS/PS-2. Minimum Drill Seeding Rates for Perennial Grasses

Common ^a Name	Botanical Name	Growth Season ^b	Growth Form	Seeds/ Pound	Pounds of PLS/acre
Alakali Soil Seed Mix					
Alkali sacaton	<i>Sporobolus airoides</i>	Cool	Bunch	1,750,000	0.25
Basin wildrye	<i>Elymus cinereus</i>	Cool	Bunch	165,000	2.5
Sodar streambank wheatgrass	<i>Agropyron riparium 'Sodar'</i>	Cool	Sod	170,000	2.5
Jose tall wheatgrass	<i>Agropyron elongatum 'Jose'</i>	Cool	Bunch	79,000	7.0
Arriba western wheatgrass	<i>Agropyron smithii 'Arriba'</i>	Cool	Sod	110,000	5.5
Total					17.75
Fertile Loamy Soil Seed Mix					
Ephriam crested wheatgrass	<i>Agropyron cristatum 'Ephriam'</i>	Cool	Sod	175,000	2.0
Dural hard fescue	<i>Festuca ovina 'duriuscula'</i>	Cool	Bunch	565,000	1.0
Lincoln smooth brome	<i>Bromus inermis leys 'Lincoln'</i>	Cool	Sod	130,000	3.0
Sodar streambank wheatgrass	<i>Agropyron riparium 'Sodar'</i>	Cool	Sod	170,000	2.5
Arriba western wheatgrass	<i>Agropyron smithii 'Arriba'</i>	Cool	Sod	110,000	7.0
Total					15.5
High Water Table Soil Seed Mix					
Meadow foxtail	<i>Alopecurus pratensis</i>	Cool	Sod	900,000	0.5
Redtop	<i>Agrostis alba</i>	Warm	Open sod	5,000,000	0.25
Reed canarygrass	<i>Phalaris arundinacea</i>	Cool	Sod	68,000	0.5
Lincoln smooth brome	<i>Bromus inermis leys 'Lincoln'</i>	Cool	Sod	130,000	3.0
Pathfinder switchgrass	<i>Panicum virgatum 'Pathfinder'</i>	Warm	Sod	389,000	1.0
Alkar tall wheatgrass	<i>Agropyron elongatum 'Alkar'</i>	Cool	Bunch	79,000	5.5
Total					10.75
Transition Turf Seed Mix^c					
Ruebens Canadian bluegrass	<i>Poa compressa 'Ruebens'</i>	Cool	Sod	2,500,000	0.5
Dural hard fescue	<i>Festuca ovina 'duriuscula'</i>	Cool	Bunch	565,000	1.0
Citation perennial ryegrass	<i>Lolium perenne 'Citation'</i>	Cool	Sod	247,000	3.0
Lincoln smooth brome	<i>Bromus inermis leys 'Lincoln'</i>	Cool	Sod	130,000	3.0
Total					7.5

Temporary and Permanent Seeding (TS/PS)

EC-2

Table TS/PS-2. Minimum Drill Seeding Rates for Perennial Grasses (cont.)

Common Name	Botanical Name	Growth Season ^b	Growth Form	Seeds/Pound	Pounds of PLS/acre
Sandy Soil Seed Mix					
Blue grama	<i>Bouteloua gracilis</i>	Warm	Sod-forming bunchgrass	825,000	0.5
Camper little bluestem	<i>Schizachyrium scoparium</i> 'Camper'	Warm	Bunch	240,000	1.0
Prairie sandreed	<i>Calamovilfa longifolia</i>	Warm	Open sod	274,000	1.0
Sand dropseed	<i>Sporobolus cryptandrus</i>	Cool	Bunch	5,298,000	0.25
Vaughn sideoats grama	<i>Bouteloua curtipendula</i> 'Vaughn'	Warm	Sod	191,000	2.0
Arriba western wheatgrass	<i>Agropyron smithii</i> 'Arriba'	Cool	Sod	110,000	5.5
Total					10.25
Heavy Clay, Rocky Foothill Seed Mix					
Ephriam crested wheatgrass ^d	<i>Agropyron cristatum</i> 'Ephriam'	Cool	Sod	175,000	1.5
Oahe Intermediate wheatgrass	<i>Agropyron intermedium</i> 'Oahe'	Cool	Sod	115,000	5.5
Vaughn sideoats grama ^e	<i>Bouteloua curtipendula</i> 'Vaughn'	Warm	Sod	191,000	2.0
Lincoln smooth brome	<i>Bromus inermis</i> leys 'Lincoln'	Cool	Sod	130,000	3.0
Arriba western wheatgrass	<i>Agropyron smithii</i> 'Arriba'	Cool	Sod	110,000	5.5
Total					17.5
<p>^a All of the above seeding mixes and rates are based on drill seeding followed by crimped straw mulch. These rates should be doubled if seed is broadcast and should be increased by 50 percent if the seeding is done using a Brillion Drill or is applied through hydraulic seeding. Hydraulic seeding may be substituted for drilling only where slopes are steeper than 3:1. If hydraulic seeding is used, hydraulic mulching should be done as a separate operation.</p> <p>^b See Table TS/PS-3 for seeding dates.</p> <p>^c If site is to be irrigated, the transition turf seed rates should be doubled.</p> <p>^d Crested wheatgrass should not be used on slopes steeper than 6H to 1V.</p> <p>^e Can substitute 0.5 lbs PLS of blue grama for the 2.0 lbs PLS of Vaughn sideoats grama.</p>					

EC-2 Temporary and Permanent Seeding (TS/PS)

Table TS/PS-3. Seeding Dates for Annual and Perennial Grasses

Seeding Dates	Annual Grasses (Numbers in table reference species in Table TS/PS-1)		Perennial Grasses	
	Warm	Cool	Warm	Cool
January 1–March 15			✓	✓
March 16–April 30	4	1,2,3	✓	✓
May 1–May 15	4		✓	
May 16–June 30	4,5,6,7			
July 1–July 15	5,6,7			
July 16–August 31				
September 1–September 30		8,9,10,11		
October 1–December 31			✓	✓

Mulch

Cover seeded areas with mulch or an appropriate rolled erosion control product to promote establishment of vegetation. Anchor mulch by crimping, netting or use of a non-toxic tackifier. See the Mulching BMP Fact Sheet for additional guidance.

Maintenance and Removal

Monitor and observe seeded areas to identify areas of poor growth or areas that fail to germinate. Reseed and mulch these areas, as needed.

An area that has been permanently seeded should have a good stand of vegetation within one growing season if irrigated and within three growing seasons without irrigation in Colorado. Reseed portions of the site that fail to germinate or remain bare after the first growing season.

Seeded areas may require irrigation, particularly during extended dry periods. Targeted weed control may also be necessary.

Protect seeded areas from construction equipment and vehicle access.

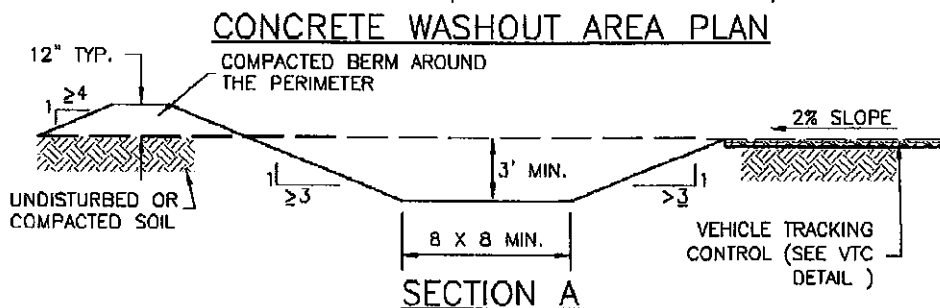
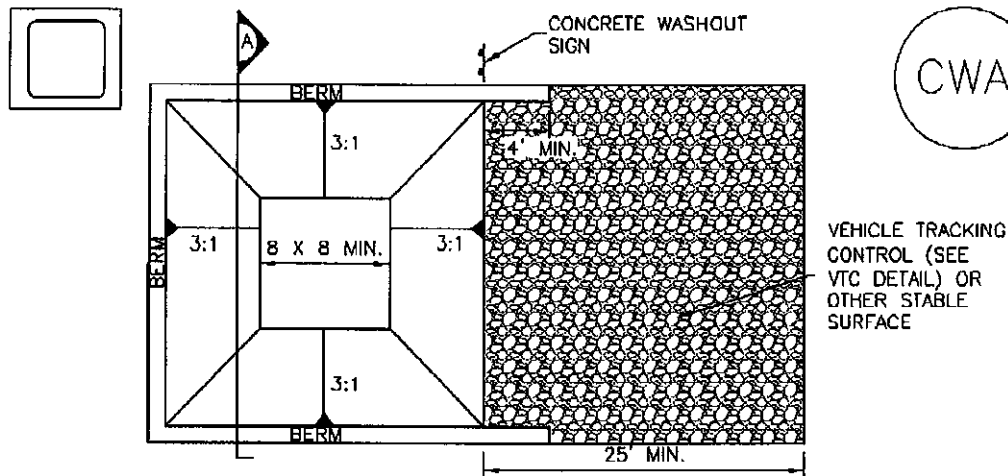

CWA-1. CONCRETE WASHOUT AREA

CWA INSTALLATION NOTES

1. SEE PLAN VIEW FOR:
-CWA INSTALLATION LOCATION.
2. DO NOT LOCATE AN UNLINED CWA WITHIN 400' OF ANY NATURAL DRAINAGE PATHWAY OR WATERBODY. DO NOT LOCATE WITHIN 1,000' OF ANY WELLS OR DRINKING WATER SOURCES. IF SITE CONSTRAINTS MAKE THIS INFEASIBLE, OR IF HIGHLY PERMEABLE SOILS EXIST ON SITE, THE CWA MUST BE INSTALLED WITH AN IMPERMEABLE LINER (16 MIL MIN. THICKNESS) OR SURFACE STORAGE ALTERNATIVES USING PREFABRICATED CONCRETE WASHOUT DEVICES OR A LINED ABOVE GROUND STORAGE ARE SHOULD BE USED.
3. THE CWA SHALL BE INSTALLED PRIOR TO CONCRETE PLACEMENT ON SITE.
4. CWA SHALL INCLUDE A FLAT SUBSURFACE PIT THAT IS AT LEAST 8' BY 8' SLOPES LEADING OUT OF THE SUBSURFACE PIT SHALL BE 3:1 OR FLATTER. THE PIT SHALL BE AT LEAST 3' DEEP.
5. BERM SURROUNDING SIDES AND BACK OF THE CWA SHALL HAVE MINIMUM HEIGHT OF 1'.
6. VEHICLE TRACKING PAD SHALL BE SLOPED 2% TOWARDS THE CWA.
7. SIGNS SHALL BE PLACED AT THE CONSTRUCTION ENTRANCE, AT THE CWA, AND ELSEWHERE AS NECESSARY TO CLEARLY INDICATE THE LOCATION OF THE CWA TO OPERATORS OF CONCRETE TRUCKS AND PUMP RIGS.
8. USE EXCAVATED MATERIAL FOR PERIMETER BERM CONSTRUCTION.

CWA MAINTENANCE NOTES

1. INSPECT BMPs EACH WORKDAY, AND MAINTAIN THEM IN EFFECTIVE OPERATING CONDITION. MAINTENANCE OF BMPs SHOULD BE PROACTIVE, NOT REACTIVE. INSPECT BMPs AS SOON AS POSSIBLE (AND ALWAYS WITHIN 24 HOURS) FOLLOWING A STORM THAT CAUSES SURFACE EROSION, AND PERFORM NECESSARY MAINTENANCE.
2. FREQUENT OBSERVATIONS AND MAINTENANCE ARE NECESSARY TO MAINTAIN BMPs IN EFFECTIVE OPERATING CONDITION. INSPECTIONS AND CORRECTIVE MEASURES SHOULD BE DOCUMENTED THOROUGHLY.
3. WHERE BMPs HAVE FAILED, REPAIR OR REPLACEMENT SHOULD BE INITIATED UPON DISCOVERY OF THE FAILURE.
4. THE CWA SHALL BE REPAIRED, CLEANED, OR ENLARGED AS NECESSARY TO MAINTAIN CAPACITY FOR CONCRETE WASTE. CONCRETE MATERIALS, ACCUMULATED IN PIT, SHALL BE REMOVED ONCE THE MATERIALS HAVE REACHED A DEPTH OF 2'.
5. CONCRETE WASHOUT WATER, WASTED PIECES OF CONCRETE AND ALL OTHER DEBRIS IN THE SUBSURFACE PIT SHALL BE TRANSPORTED FROM THE JOB SITE IN A WATER-TIGHT CONTAINER AND DISPOSED OF PROPERLY.
6. THE CWA SHALL REMAIN IN PLACE UNTIL ALL CONCRETE FOR THE PROJECT IS PLACED.
7. WHEN THE CWA IS REMOVED, COVER THE DISTURBED AREA WITH TOP SOIL, SEED AND MULCH OR OTHERWISE STABILIZED IN A MANNER APPROVED BY THE LOCAL JURISDICTION.

(DETAIL ADAPTED FROM DOUGLAS COUNTY, COLORADO AND THE CITY OF PARKER, COLORADO, NOT AVAILABLE IN AUTOCAD).

NOTE: MANY JURISDICTIONS HAVE BMP DETAILS THAT VARY FROM UDFCD STANDARD DETAILS. CONSULT WITH LOCAL JURISDICTIONS AS TO WHICH DETAIL SHOULD BE USED WHEN DIFFERENCES ARE NOTED.

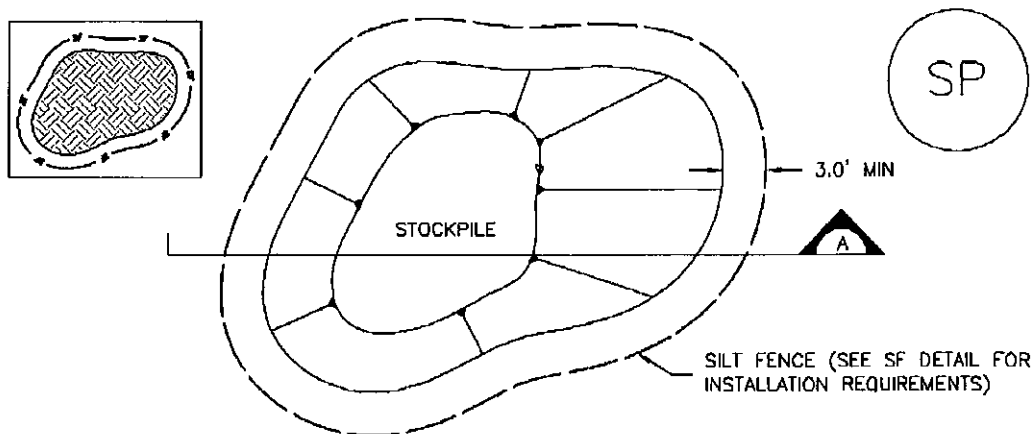

STOCKPILE PROTECTION PLAN

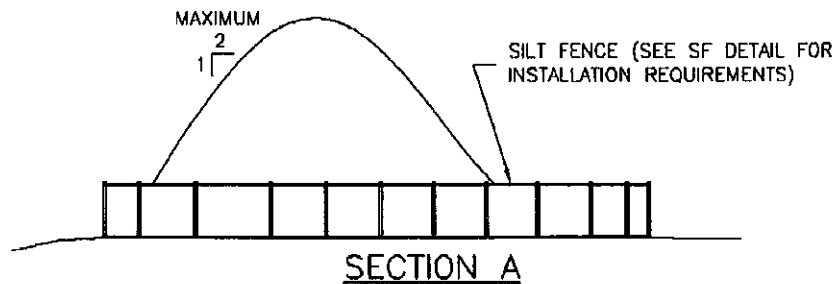

SP-1. STOCKPILE PROTECTION

STOCKPILE PROTECTION INSTALLATION NOTES

1. SEE PLAN VIEW FOR:
 - LOCATION OF STOCKPILES.
 - TYPE OF STOCKPILE PROTECTION.
2. INSTALL PERIMETER CONTROLS IN ACCORDANCE WITH THEIR RESPECTIVE DESIGN DETAILS. SILT FENCE IS SHOWN IN THE STOCKPILE PROTECTION DETAILS; HOWEVER, OTHER TYPES OF PERIMETER CONTROLS INCLUDING SEDIMENT CONTROL LOGS OR ROCK SOCKS MAY BE SUITABLE IN SOME CIRCUMSTANCES. CONSIDERATIONS FOR DETERMINING THE APPROPRIATE TYPE OF PERIMETER CONTROL FOR A STOCKPILE INCLUDE WHETHER THE STOCKPILE IS LOCATED ON A PERVIOUS OR IMPERVIOUS SURFACE, THE RELATIVE HEIGHTS OF THE PERIMETER CONTROL AND STOCKPILE, THE ABILITY OF THE PERIMETER CONTROL TO CONTAIN THE STOCKPILE WITHOUT FAILING IN THE EVENT THAT MATERIAL FROM THE STOCKPILE SHIFTS OR SLUMPS AGAINST THE PERIMETER, AND OTHER FACTORS.
3. STABILIZE THE STOCKPILE SURFACE WITH SURFACE ROUGHENING, TEMPORARY SEEDING AND MULCHING, EROSION CONTROL BLANKETS, OR SOIL BINDERS. SOILS STOCKPILED FOR AN EXTENDED PERIOD (TYPICALLY FOR MORE THAN 60 DAYS) SHOULD BE SEEDED AND MULCHED WITH A TEMPORARY GRASS COVER ONCE THE STOCKPILE IS PLACED (TYPICALLY WITHIN 14 DAYS). USE OF MULCH ONLY OR A SOIL BINDER IS ACCEPTABLE IF THE STOCKPILE WILL BE IN PLACE FOR A MORE LIMITED TIME PERIOD (TYPICALLY 30-60 DAYS).
4. FOR TEMPORARY STOCKPILES ON THE INTERIOR PORTION OF A CONSTRUCTION SITE, WHERE OTHER DOWNGRADE CONTROLS, INCLUDING PERIMETER CONTROL, ARE IN PLACE, STOCKPILE PERIMETER CONTROLS MAY NOT BE REQUIRED.

STOCKPILE PROTECTION MAINTENANCE NOTES

1. INSPECT BMPs EACH WORKDAY, AND MAINTAIN THEM IN EFFECTIVE OPERATING CONDITION. MAINTENANCE OF BMPs SHOULD BE PROACTIVE, NOT REACTIVE. INSPECT BMPs AS SOON AS POSSIBLE (AND ALWAYS WITHIN 24 HOURS) FOLLOWING A STORM THAT CAUSES SURFACE EROSION, AND PERFORM NECESSARY MAINTENANCE.

2. FREQUENT OBSERVATIONS AND MAINTENANCE ARE NECESSARY TO MAINTAIN BMPs IN EFFECTIVE OPERATING CONDITION. INSPECTIONS AND CORRECTIVE MEASURES SHOULD BE DOCUMENTED THOROUGHLY.

3. WHERE BMPs HAVE FAILED, REPAIR OR REPLACEMENT SHOULD BE INITIATED UPON DISCOVERY OF THE FAILURE.

STOCKPILE PROTECTION MAINTENANCE NOTES

4. IF PERIMETER PROTECTION MUST BE MOVED TO ACCESS SOIL STOCKPILE, REPLACE PERIMETER CONTROLS BY THE END OF THE WORKDAY.

5. STOCKPILE PERIMETER CONTROLS CAN BE REMOVED ONCE ALL THE MATERIAL FROM THE STOCKPILE HAS BEEN USED.

(DETAILS ADAPTED FROM PARKER, COLORADO, NOT AVAILABLE IN AUTOCAD)

NOTE: MANY JURISDICTIONS HAVE BMP DETAILS THAT VARY FROM UDFCD STANDARD DETAILS. CONSULT WITH LOCAL JURISDICTIONS AS TO WHICH DETAIL SHOULD BE USED WHEN DIFFERENCES ARE NOTED.

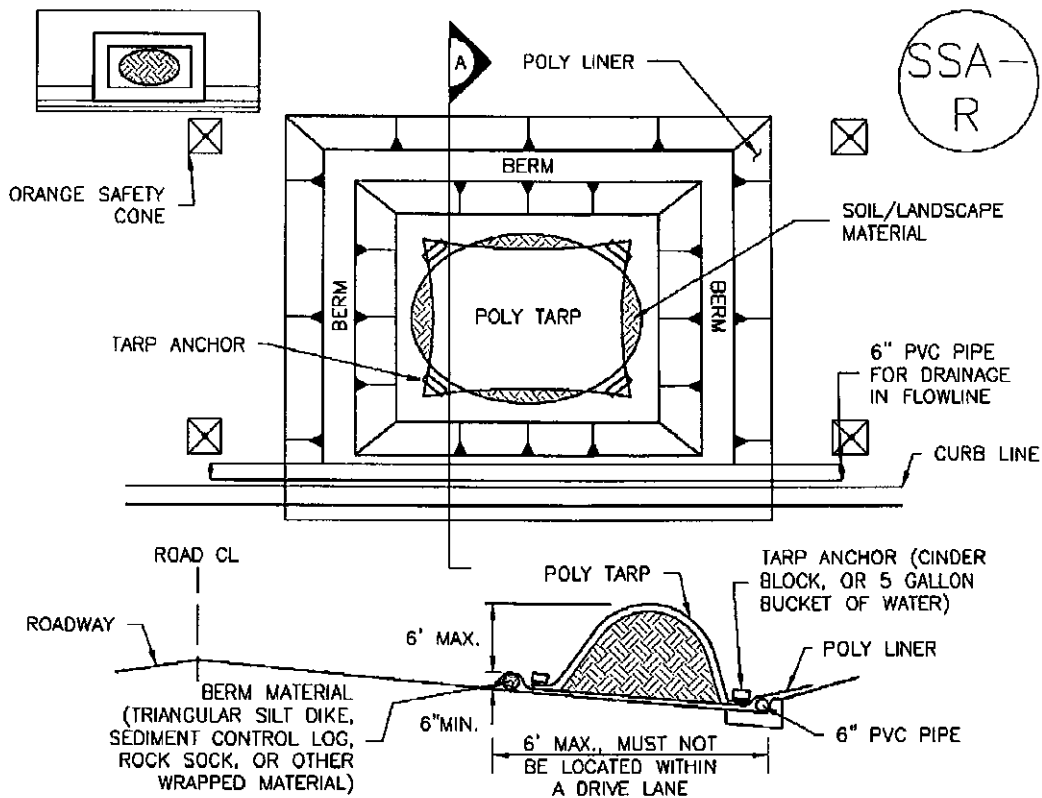

SP-2. MATERIALS STAGING IN ROADWAY

MATERIALS STAGING IN ROADWAYS INSTALLATION NOTES

1. SEE PLAN VIEW FOR
 - LOCATION OF MATERIAL STAGING AREA(S).
 - CONTRACTOR MAY ADJUST LOCATION AND SIZE OF STAGING AREA WITH APPROVAL FROM THE LOCAL JURISDICTION.
2. FEATURE MUST BE INSTALLED PRIOR TO EXCAVATION, EARTHWORK OR DELIVERY OF MATERIALS.
3. MATERIALS MUST BE STATIONED ON THE POLY LINER. ANY INCIDENTAL MATERIALS DEPOSITED ON PAVED SECTION OR ALONG CURB LINE MUST BE CLEANED UP PROMPTLY.
4. POLY LINER AND TARP COVER SHOULD BE OF SIGNIFICANT THICKNESS TO PREVENT DAMAGE OR LOSS OF INTEGRITY.
5. SAND BAGS MAY BE SUBSTITUTED TO ANCHOR THE COVER TARP OR PROVIDE BERMING UNDER THE BASE LINER.
6. FEATURE IS NOT INTENDED FOR USE WITH WET MATERIAL THAT WILL BE DRAINING AND/OR SPREADING OUT ON THE POLY LINER OR FOR DEMOLITION MATERIALS.
7. THIS FEATURE CAN BE USED FOR:
 - UTILITY REPAIRS.
 - WHEN OTHER STAGING LOCATIONS AND OPTIONS ARE LIMITED.
 - OTHER LIMITED APPLICATION AND SHORT DURATION STAGING.

MATERIALS STAGING IN ROADWAY MAINTENANCE NOTES

1. INSPECT BMPs EACH WORKDAY, AND MAINTAIN THEM IN EFFECTIVE OPERATING CONDITION. MAINTENANCE OF BMPs SHOULD BE PROACTIVE, NOT REACTIVE. INSPECT BMPs AS SOON AS POSSIBLE (AND ALWAYS WITHIN 24 HOURS) FOLLOWING A STORM THAT CAUSES SURFACE EROSION, AND PERFORM NECESSARY MAINTENANCE.
2. FREQUENT OBSERVATIONS AND MAINTENANCE ARE NECESSARY TO MAINTAIN BMPs IN EFFECTIVE OPERATING CONDITION. INSPECTIONS AND CORRECTIVE MEASURES SHOULD BE DOCUMENTED THOROUGHLY.
3. WHERE BMPs HAVE FAILED, REPAIR OR REPLACEMENT SHOULD BE INITIATED UPON DISCOVERY OF THE FAILURE.
4. INSPECT PVC PIPE ALONG CURB LINE FOR CLOGGING AND DEBRIS. REMOVE OBSTRUCTIONS PROMPTLY.
5. CLEAN MATERIAL FROM PAVED SURFACES BY SWEEPING OR VACUUMING.

NOTE: MANY JURISDICTIONS HAVE BMP DETAILS THAT VARY FROM UDFCD STANDARD DETAILS. CONSULT WITH LOCAL JURISDICTIONS AS TO WHICH DETAIL SHOULD BE USED WHEN DIFFERENCES ARE NOTED.

(DETAILS ADAPTED FROM AURORA, COLORADO)

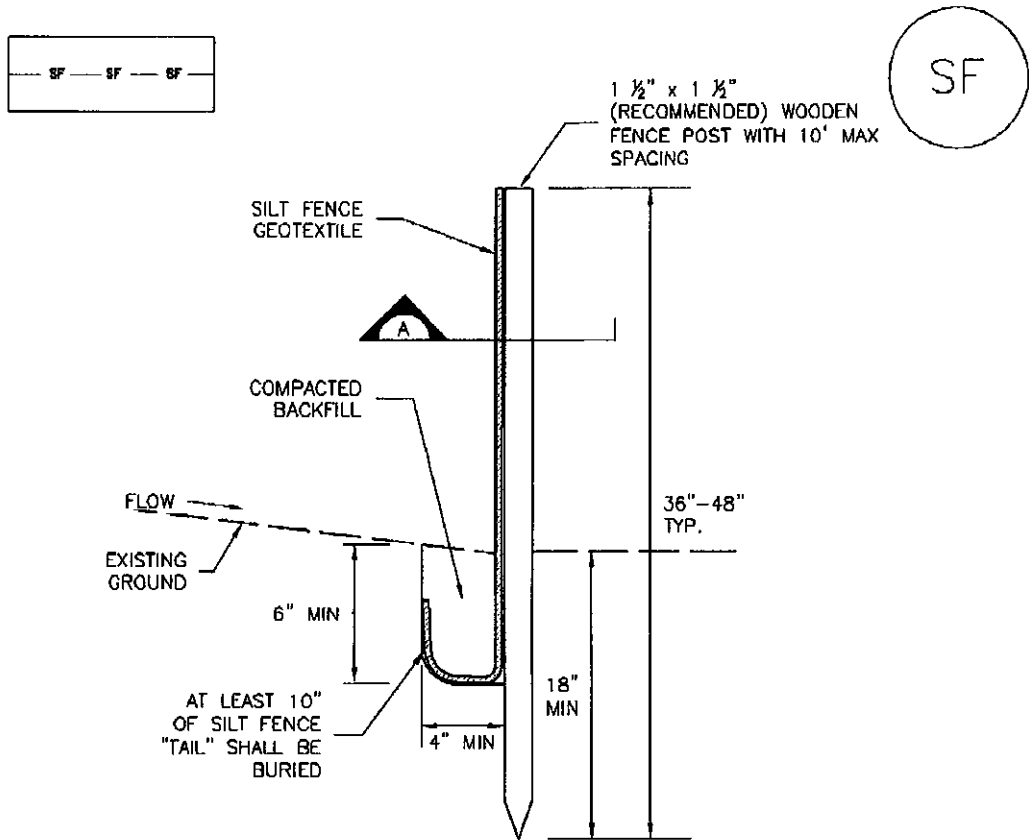

SILT FENCE

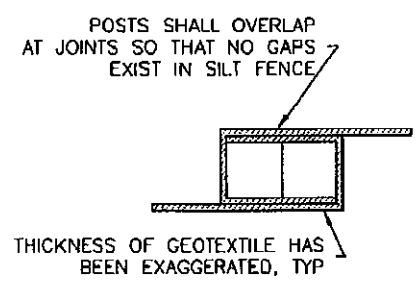
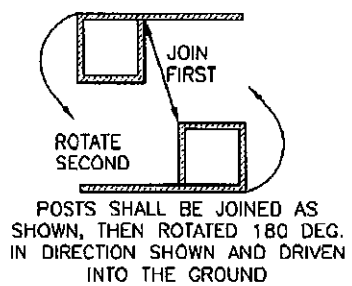

SECTION A

SF-1. SILT FENCE

SILT FENCE INSTALLATION NOTES

1. SILT FENCE MUST BE PLACED AWAY FROM THE TOE OF THE SLOPE TO ALLOW FOR WATER PONDING. SILT FENCE AT THE TOE OF A SLOPE SHOULD BE INSTALLED IN A FLAT LOCATION AT LEAST SEVERAL FEET (2-5 FT) FROM THE TOE OF THE SLOPE TO ALLOW ROOM FOR PONDING AND DEPOSITION.
2. A UNIFORM 6" X 4" ANCHOR TRENCH SHALL BE EXCAVATED USING TRENCHER OR SILT FENCE INSTALLATION DEVICE. NO ROAD GRADERS, BACKHOES, OR SIMILAR EQUIPMENT SHALL BE USED.
3. COMPACT ANCHOR TRENCH BY HAND WITH A "JUMPING JACK" OR BY WHEEL ROLLING. COMPACTION SHALL BE SUCH THAT SILT FENCE RESISTS BEING PULLED OUT OF ANCHOR TRENCH BY HAND.
4. SILT FENCE SHALL BE PULLED TIGHT AS IT IS ANCHORED TO THE STAKES. THERE SHOULD BE NO NOTICEABLE SAG BETWEEN STAKES AFTER IT HAS BEEN ANCHORED TO THE STAKES.
5. SILT FENCE FABRIC SHALL BE ANCHORED TO THE STAKES USING 1" HEAVY DUTY STAPLES OR NAILS WITH 1" HEADS. STAPLES AND NAILS SHOULD BE PLACED 3" ALONG THE FABRIC DOWN THE STAKE.
6. AT THE END OF A RUN OF SILT FENCE ALONG A CONTOUR, THE SILT FENCE SHOULD BE TURNED PERPENDICULAR TO THE CONTOUR TO CREATE A "J-HOOK." THE "J-HOOK" EXTENDING PERPENDICULAR TO THE CONTOUR SHOULD BE OF SUFFICIENT LENGTH TO KEEP RUNOFF FROM FLOWING AROUND THE END OF THE SILT FENCE (TYPICALLY 10' - 20').
7. SILT FENCE SHALL BE INSTALLED PRIOR TO ANY LAND DISTURBING ACTIVITIES.

SILT FENCE MAINTENANCE NOTES

1. INSPECT BMPs EACH WORKDAY, AND MAINTAIN THEM IN EFFECTIVE OPERATING CONDITION. MAINTENANCE OF BMPs SHOULD BE PROACTIVE, NOT REACTIVE. INSPECT BMPs AS SOON AS POSSIBLE (AND ALWAYS WITHIN 24 HOURS) FOLLOWING A STORM THAT CAUSES SURFACE EROSION, AND PERFORM NECESSARY MAINTENANCE.
2. FREQUENT OBSERVATIONS AND MAINTENANCE ARE NECESSARY TO MAINTAIN BMPs IN EFFECTIVE OPERATING CONDITION. INSPECTIONS AND CORRECTIVE MEASURES SHOULD BE DOCUMENTED THOROUGHLY.
3. WHERE BMPs HAVE FAILED, REPAIR OR REPLACEMENT SHOULD BE INITIATED UPON DISCOVERY OF THE FAILURE.
4. SEDIMENT ACCUMULATED UPSTREAM OF THE SILT FENCE SHALL BE REMOVED AS NEEDED TO MAINTAIN THE FUNCTIONALITY OF THE BMP, TYPICALLY WHEN DEPTH OF ACCUMULATED SEDIMENTS IS APPROXIMATELY 6".
5. REPAIR OR REPLACE SILT FENCE WHEN THERE ARE SIGNS OF WEAR, SUCH AS SAGGING, TEARING, OR COLLAPSE.
6. SILT FENCE IS TO REMAIN IN PLACE UNTIL THE UPSTREAM DISTURBED AREA IS STABILIZED AND APPROVED BY THE LOCAL JURISDICTION, OR IS REPLACED BY AN EQUIVALENT PERIMETER SEDIMENT CONTROL BMP.
7. WHEN SILT FENCE IS REMOVED, ALL DISTURBED AREAS SHALL BE COVERED WITH TOPSOIL, SEEDED AND MULCHED OR OTHERWISE STABILIZED AS APPROVED BY LOCAL JURISDICTION.

(DETAIL ADAPTED FROM TOWN OF PARKER, COLORADO AND CITY OF AURORA, NOT AVAILABLE IN AUTOCAD)

NOTE: MANY JURISDICTIONS HAVE BMP DETAILS THAT VARY FROM UDFCD STANDARD DETAILS. CONSULT WITH LOCAL JURISDICTIONS AS TO WHICH DETAIL SHOULD BE USED WHEN DIFFERENCES ARE NOTED.

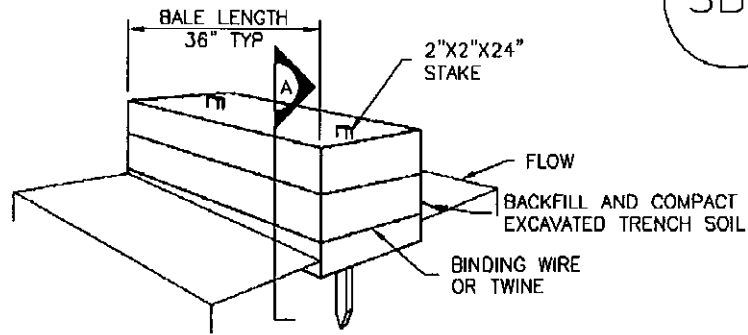
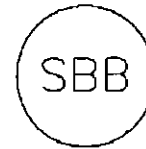
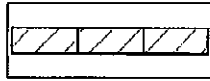

STRAW BALE

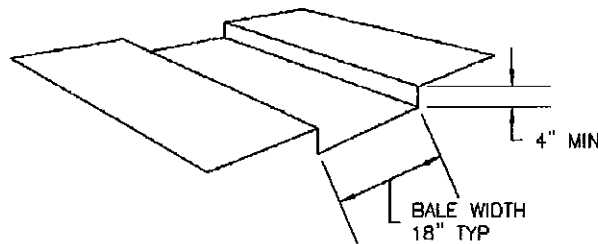

TRENCH FOR STRAW BALE

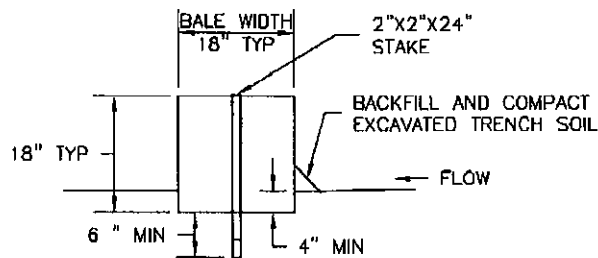

SECTION A

SBB-1. STRAW BALE

STRAW BALE INSTALLATION NOTES

1. SEE PLAN VIEW FOR:
-LOCATION(S) OF STRAW BALES.
2. STRAW BALES SHALL CONSIST OF CERTIFIED WEED FREE STRAW OR HAY. LOCAL JURISDICTIONS MAY REQUIRE PROOF THAT BALES ARE WEED FREE.
3. STRAW BALES SHALL CONSIST OF APPROXIMATELY 5 CUBIC FEET OF STRAW OR HAY AND WEIGH NOT LESS THAN 35 POUNDS.
4. WHEN STRAW BALES ARE USED IN SERIES AS A BARRIER, THE END OF EACH BALE SHALL BE TIGHTLY ABUTTING ONE ANOTHER.
5. STRAW BALE DIMENSIONS SHALL BE APPROXIMATELY 36"X18"X18".
6. A UNIFORM ANCHOR TRENCH SHALL BE EXCAVATED TO A DEPTH OF 4". STRAW BALES SHALL BE PLACED SO THAT BINDING TWINE IS ENCOMPASSING THE VERTICAL SIDES OF THE BALE(S). ALL EXCAVATED SOIL SHALL BE PLACED ON THE UPHILL SIDE OF THE STRAW BALE(S) AND COMPACTED.
7. TWO (2) WOODEN STAKES SHALL BE USED TO HOLD EACH BALE IN PLACE. WOODEN STAKES SHALL BE 2"X2"X24". WOODEN STAKES SHALL BE DRIVEN 6" INTO THE GROUND.

STRAW BALE MAINTENANCE NOTES

1. INSPECT BMPs EACH WORKDAY, AND MAINTAIN THEM IN EFFECTIVE OPERATING CONDITION. MAINTENANCE OF BMPs SHOULD BE PROACTIVE, NOT REACTIVE. INSPECT BMPs AS SOON AS POSSIBLE (AND ALWAYS WITHIN 24 HOURS) FOLLOWING A STORM THAT CAUSES SURFACE EROSION, AND PERFORM NECESSARY MAINTENANCE.
2. FREQUENT OBSERVATIONS AND MAINTENANCE ARE NECESSARY TO MAINTAIN BMPs IN EFFECTIVE OPERATING CONDITION. INSPECTIONS AND CORRECTIVE MEASURES SHOULD BE DOCUMENTED THOROUGHLY.
3. WHERE BMPs HAVE FAILED, REPAIR OR REPLACEMENT SHOULD BE INITIATED UPON DISCOVERY OF THE FAILURE.
4. STRAW BALES SHALL BE REPLACED IF THEY BECOME HEAVILY SOILED, ROTTEN, OR DAMAGED BEYOND REPAIR.
5. SEDIMENT ACCUMULATED UPSTREAM OF STRAW BALE BARRIER SHALL BE REMOVED AS NEEDED TO MAINTAIN FUNCTIONALITY OF THE BMP, TYPICALLY WHEN DEPTH OF ACCUMULATED SEDIMENTS IS APPROXIMATELY $\frac{1}{4}$ OF THE HEIGHT OF THE STRAW BALE BARRIER.
6. STRAW BALES ARE TO REMAIN IN PLACE UNTIL THE UPSTREAM DISTURBED AREA IS STABILIZED AND APPROVED BY THE LOCAL JURISDICTION.
7. WHEN STRAW BALES ARE REMOVED, ALL DISTURBED AREAS SHALL BE COVERED WITH TOPSOIL, SEEDED AND MULCHED OR OTHERWISE STABILIZED AS APPROVED BY LOCAL JURISDICTION.

(DETAILS ADAPTED FROM TOWN OF PARKER, COLORADO, NOT AVAILABLE IN AUTOCAD)

NOTE: MANY JURISDICTIONS HAVE BMP DETAILS THAT VARY FROM UDFCD STANDARD DETAILS. CONSULT WITH LOCAL JURISDICTIONS AS TO WHICH DETAIL SHOULD BE USED WHEN DIFFERENCES ARE NOTED.

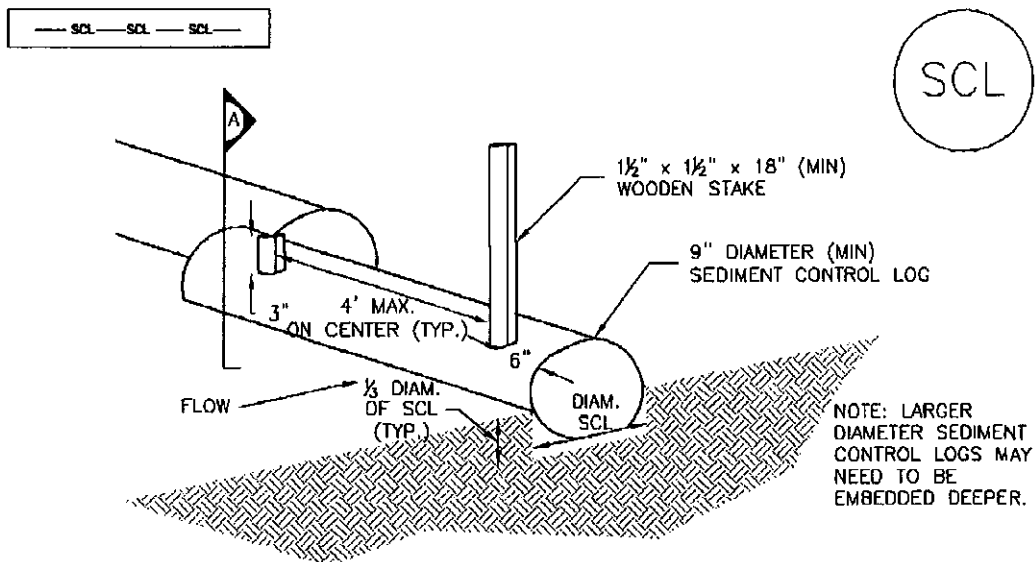

SEDIMENT CONTROL LOG

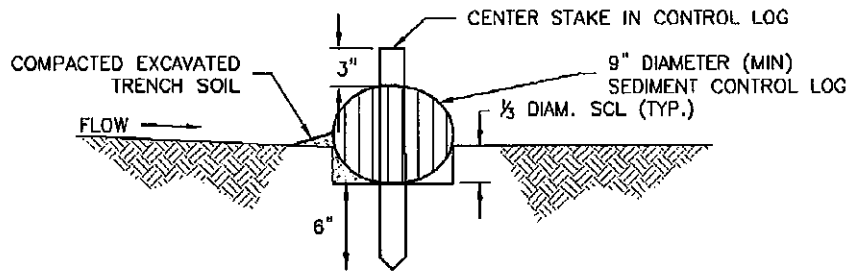

SECTION A

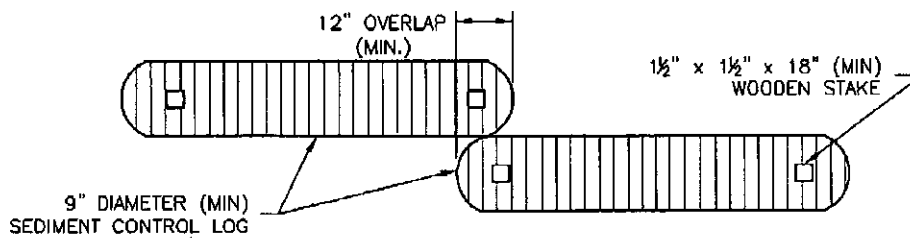

SEDIMENT CONTROL LOG JOINTS

SCL-1. SEDIMENT CONTROL LOG

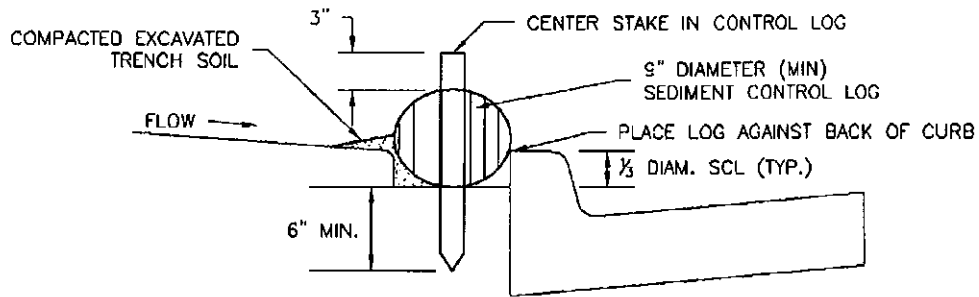

SCL-2. SEDIMENT CONTROL LOG AT BACK OF CURB

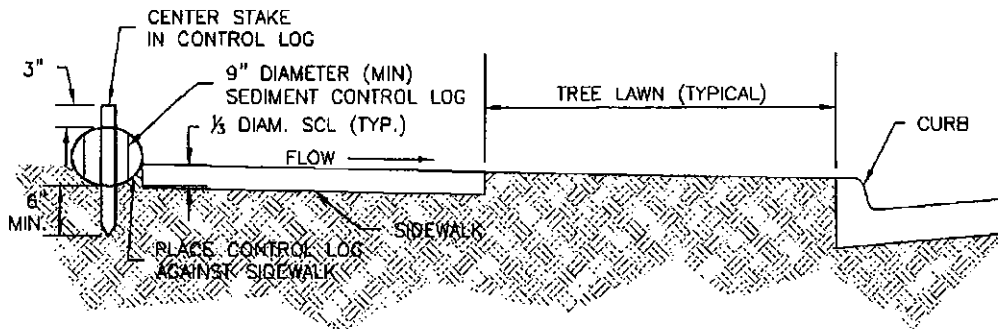

SCL-3. SEDIMENT CONTROL LOG AT SIDEWALK WITH TREE LAWN

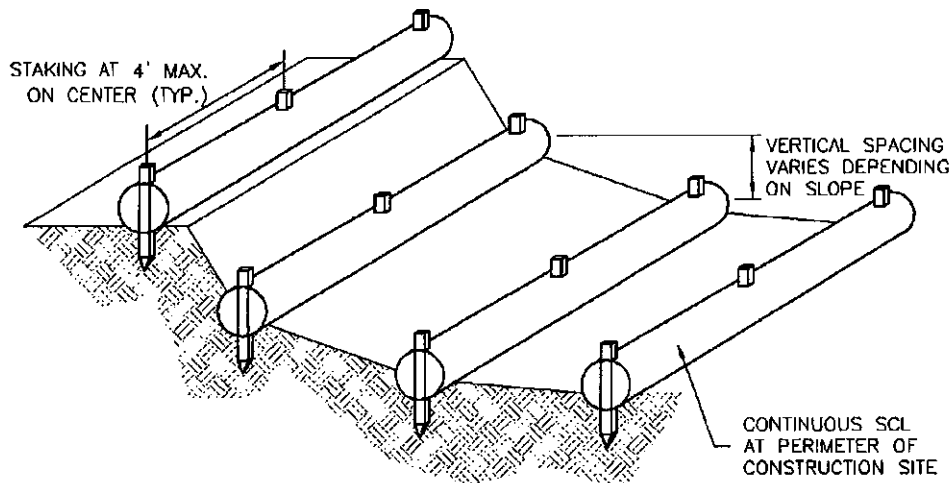

SCL-4. SEDIMENT CONTROL LOGS TO CONTROL SLOPE LENGTH

SEDIMENT CONTROL LOG INSTALLATION NOTES

1. SEE PLAN VIEW FOR LOCATION AND LENGTH OF SEDIMENT CONTROL LOGS.
2. SEDIMENT CONTROL LOGS THAT ACT AS A PERIMETER CONTROL SHALL BE INSTALLED PRIOR TO ANY UPGRADIENT LAND-DISTURBING ACTIVITIES.
3. SEDIMENT CONTROL LOGS SHALL CONSIST OF STRAW, COMPOST, EXCELSIOR OR COCONUT FIBER, AND SHALL BE FREE OF ANY NOXIOUS WEED SEEDS OR DEFECTS INCLUDING RIPS, HOLES AND OBVIOUS WEAR.
4. SEDIMENT CONTROL LOGS MAY BE USED AS SMALL CHECK DAMS IN DITCHES AND SWALES. HOWEVER, THEY SHOULD NOT BE USED IN PERENNIAL STREAMS OR HIGH VELOCITY DRAINAGE WAYS.
5. IT IS RECOMMENDED THAT SEDIMENT CONTROL LOGS BE TRENCHED INTO THE GROUND TO A DEPTH OF APPROXIMATELY $\frac{1}{3}$ OF THE DIAMETER OF THE LOG. IF TRENCHING TO THIS DEPTH IS NOT FEASIBLE AND/OR DESIRABLE (SHORT TERM INSTALLATION WITH DESIRE NOT TO DAMAGE LANDSCAPE) A LESSER TRENCHING DEPTH MAY BE ACCEPTABLE WITH MORE ROBUST STAKING
6. THE UPHILL SIDE OF THE SEDIMENT CONTROL LOG SHALL BE BACKFILLED WITH SOIL THAT IS FREE OF ROCKS AND DEBRIS. THE SOIL SHALL BE TIGHTLY COMPACTED INTO THE SHAPE OF A RIGHT TRIANGLE USING A SHOVEL OR WEIGHTED LAWN ROLLER.
7. FOLLOW MANUFACTURERS' GUIDANCE FOR STAKING. IF MANUFACTURERS' INSTRUCTIONS DO NOT SPECIFY SPACING, STAKES SHALL BE PLACED ON 4' CENTERS AND EMBEDDED A MINIMUM OF 6" INTO THE GROUND. 3" OF THE STAKE SHALL PROTRUDE FROM THE TOP OF THE LOG. STAKES THAT ARE BROKEN PRIOR TO INSTALLATION SHALL BE REPLACED.

SEDIMENT CONTROL LOG MAINTENANCE NOTES

1. INSPECT BMPs EACH WORKDAY, AND MAINTAIN THEM IN EFFECTIVE OPERATING CONDITION. MAINTENANCE OF BMPs SHOULD BE PROACTIVE, NOT REACTIVE. INSPECT BMPs AS SOON AS POSSIBLE (AND ALWAYS WITHIN 24 HOURS) FOLLOWING A STORM THAT CAUSES SURFACE EROSION, AND PERFORM NECESSARY MAINTENANCE.
2. FREQUENT OBSERVATIONS AND MAINTENANCE ARE NECESSARY TO MAINTAIN BMPs IN EFFECTIVE OPERATING CONDITION. INSPECTIONS AND CORRECTIVE MEASURES SHOULD BE DOCUMENTED THOROUGHLY.
3. WHERE BMPs HAVE FAILED, REPAIR OR REPLACEMENT SHOULD BE INITIATED UPON DISCOVERY OF THE FAILURE.
4. SEDIMENT ACCUMULATED UPSTREAM OF SEDIMENT CONTROL LOG SHALL BE REMOVED AS NEEDED TO MAINTAIN FUNCTIONALITY OF THE BMP, TYPICALLY WHEN DEPTH OF ACCUMULATED SEDIMENTS IS APPROXIMATELY $\frac{1}{2}$ OF THE HEIGHT OF THE SEDIMENT CONTROL LOG.
5. SEDIMENT CONTROL LOG SHALL BE REMOVED AT THE END OF CONSTRUCTION. IF DISTURBED AREAS EXIST AFTER REMOVAL, THEY SHALL BE COVERED WITH TOP SOIL, SEEDED AND MULCHED OR OTHERWISE STABILIZED IN A MANNER APPROVED BY THE LOCAL JURISDICTION.

(DETAILS ADAPTED FROM TOWN OF PARKER, COLORADO, JEFFERSON COUNTY, COLORADO, DOUGLAS COUNTY, COLORADO, AND CITY OF AURORA, COLORADO, NOT AVAILABLE IN AUTOCAD)

NOTE: MANY JURISDICTIONS HAVE BMP DETAILS THAT VARY FROM UDFCD STANDARD DETAILS. CONSULT WITH LOCAL JURISDICTIONS AS TO WHICH DETAIL SHOULD BE USED WHEN DIFFERENCES ARE NOTED.

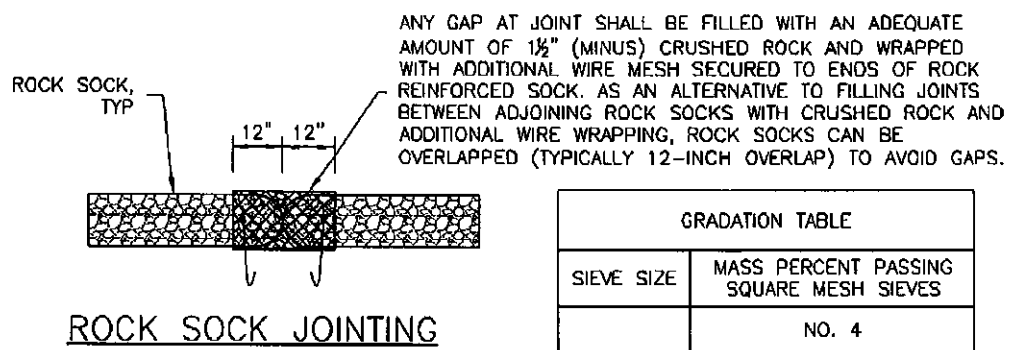
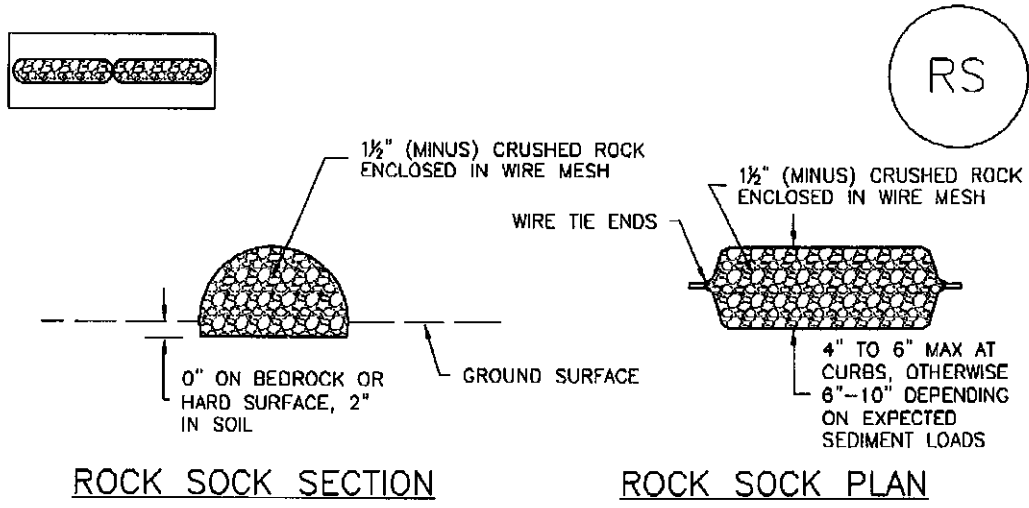

GRADATION TABLE	
SIEVE SIZE	MASS PERCENT PASSING SQUARE MESH SIEVES
	NO. 4
2"	100
1 1/2"	90 - 100
1"	20 - 55
3/4"	0 - 15
3/8"	0 - 5
MATCHES SPECIFICATIONS FOR NO. 4 COARSE AGGREGATE FOR CONCRETE PER AASHTO M43. ALL ROCK SHALL BE FRACTURED FACE, ALL SIDES.	

ROCK SOCK INSTALLATION NOTES

1. SEE PLAN VIEW FOR:
-LOCATION(S) OF ROCK SOCKS.
2. CRUSHED ROCK SHALL BE 1 1/2" (MINUS) IN SIZE WITH A FRACTURED FACE (ALL SIDES) AND SHALL COMPLY WITH GRADATION SHOWN ON THIS SHEET (1 1/2" MINUS).
3. WIRE MESH SHALL BE FABRICATED OF 10 GAGE POULTRY MESH, OR EQUIVALENT, WITH A MAXIMUM OPENING OF 1/2", RECOMMENDED MINIMUM ROLL WIDTH OF 48"
4. WIRE MESH SHALL BE SECURED USING "HOG RINGS" OR WIRE TIES AT 6" CENTERS ALONG ALL JOINTS AND AT 2" CENTERS ON ENDS OF SOCKS.
5. SOME MUNICIPALITIES MAY ALLOW THE USE OF FILTER FABRIC AS AN ALTERNATIVE TO WIRE MESH FOR THE ROCK ENCLOSURE.

RS-1. ROCK SOCK PERIMETER CONTROL

ROCK SOCK MAINTENANCE NOTES

1. INSPECT BMPs EACH WORKDAY, AND MAINTAIN THEM IN EFFECTIVE OPERATING CONDITION. MAINTENANCE OF BMPs SHOULD BE PROACTIVE, NOT REACTIVE. INSPECT BMPs AS SOON AS POSSIBLE (AND ALWAYS WITHIN 24 HOURS) FOLLOWING A STORM THAT CAUSES SURFACE EROSION, AND PERFORM NECESSARY MAINTENANCE.

2. FREQUENT OBSERVATIONS AND MAINTENANCE ARE NECESSARY TO MAINTAIN BMPs IN EFFECTIVE OPERATING CONDITION. INSPECTIONS AND CORRECTIVE MEASURES SHOULD BE DOCUMENTED THOROUGHLY.

3. WHERE BMPs HAVE FAILED, REPAIR OR REPLACEMENT SHOULD BE INITIATED UPON DISCOVERY OF THE FAILURE.

4. ROCK SOCKS SHALL BE REPLACED IF THEY BECOME HEAVILY SOILED, OR DAMAGED BEYOND REPAIR.

5. SEDIMENT ACCUMULATED UPSTREAM OF ROCK SOCKS SHALL BE REMOVED AS NEEDED TO MAINTAIN FUNCTIONALITY OF THE BMP, TYPICALLY WHEN DEPTH OF ACCUMULATED SEDIMENTS IS APPROXIMATELY $\frac{1}{2}$ OF THE HEIGHT OF THE ROCK SOCK.

6. ROCK SOCKS ARE TO REMAIN IN PLACE UNTIL THE UPSTREAM DISTURBED AREA IS STABILIZED AND APPROVED BY THE LOCAL JURISDICTION.

7. WHEN ROCK SOCKS ARE REMOVED, ALL DISTURBED AREAS SHALL BE COVERED WITH TOPSOIL, SEEDED AND MULCHED OR OTHERWISE STABILIZED AS APPROVED BY LOCAL JURISDICTION.

(DETAIL ADAPTED FROM TOWN OF PARKER, COLORADO AND CITY OF AURORA, COLORADO, NOT AVAILABLE IN AUTCCAD)

NOTE: MANY JURISDICTIONS HAVE BMP DETAILS THAT VARY FROM UDFCD STANDARD DETAILS. CONSULT WITH LOCAL JURISDICTIONS AS TO WHICH DETAIL SHOULD BE USED WHEN DIFFERENCES ARE NOTED.

NOTE: THE DETAILS INCLUDED WITH THIS FACT SHEET SHOW COMMONLY USED, CONVENTIONAL METHODS OF ROCK SOCK INSTALLATION IN THE DENVER METROPOLITAN AREA. THERE ARE MANY OTHER SIMILAR PROPRIETARY PRODUCTS ON THE MARKET. UDFCD NEITHER ENDORSES NOR DISCOURAGES USE OF PROPRIETARY PROTECTION PRODUCTS; HOWEVER, IN THE EVENT PROPRIETARY METHODS ARE USED, THE APPROPRIATE DETAIL FROM THE MANUFACTURER MUST BE INCLUDED IN THE SWMP AND THE BMP MUST BE INSTALLED AND MAINTAINED AS SHOWN IN THE MANUFACTURER'S DETAILS.

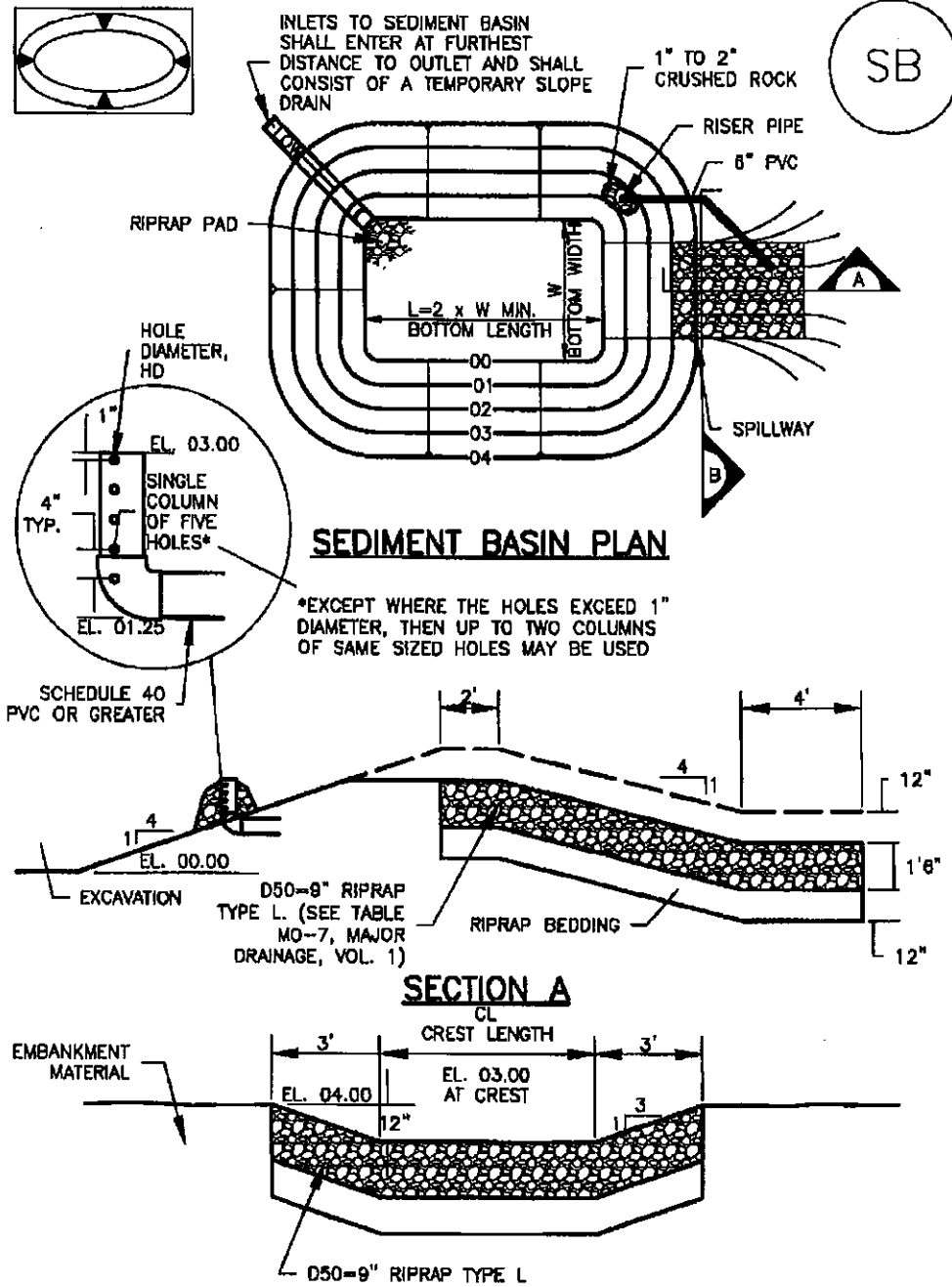

TABLE SB-1. SIZING INFORMATION FOR STANDARD SEDIMENT BASIN

Upstream Drainage Area (rounded to nearest acre), (ac)	Basin Bottom Width (W), (ft)	Spillway Crest Length (CL), (ft)	Hole Diameter (HD), (in)
1	12 1/2	2	9/32
2	21	3	1 1/16
3	28	5	1/4
4	33 1/2	6	9/16
5	38 1/2	8	2 1/32
6	43	9	2 1/32
7	47 1/4	11	2 5/32
8	51	12	2 1/2
9	55	13	7/8
10	58 1/4	15	1 5/16
11	61	16	3 1/32
12	64	18	1
13	67 1/2	19	1 1/16
14	70 1/2	21	1 1/8
15	73 1/4	22	1 3/8

SEDIMENT BASIN INSTALLATION NOTES

1. SEE PLAN VIEW FOR:
 - LOCATION OF SEDIMENT BASIN.
 - TYPE OF BASIN (STANDARD BASIN OR NONSTANDARD BASIN).
 - FOR STANDARD BASIN, BOTTOM WIDTH W, CREST LENGTH CL, AND HOLE DIAMETER, HD.
 - FOR NONSTANDARD BASIN, SEE CONSTRUCTION DRAWINGS FOR DESIGN OF BASIN INCLUDING RISER HEIGHT H, NUMBER OF COLUMNS N, HOLE DIAMETER HD AND PIPE DIAMETER Ø.
2. FOR STANDARD BASIN, BOTTOM DIMENSION MAY BE MODIFIED AS LONG AS BOTTOM AREA IS NOT REDUCED.
3. SEDIMENT BASINS SHALL BE INSTALLED PRIOR TO ANY OTHER LAND-DISTURBING ACTIVITY THAT RELIES ON ON BASINS AS AS A STORMWATER CONTROL.
4. EMBANKMENT MATERIAL SHALL CONSIST OF SOIL FREE OF DEBRIS, ORGANIC MATERIAL, AND ROCKS OR CONCRETE GREATER THAN 3 INCHES AND SHALL HAVE A MINIMUM OF 15 PERCENT BY WEIGHT PASSING THE NO. 200 SIEVE.
5. EMBANKMENT MATERIAL SHALL BE COMPACTED TO AT LEAST 95 PERCENT OF MAXIMUM DENSITY IN ACCORDANCE WITH ASTM D698.
6. PIPE SCH 40 OR GREATER SHALL BE USED.
7. THE DETAILS SHOWN ON THESE SHEETS PERTAIN TO STANDARD SEDIMENT BASIN(S) FOR DRAINAGE AREAS LESS THAN 15 ACRES. SEE CONSTRUCTION DRAWINGS FOR EMBANKMENT, STORAGE VOLUME, SPILLWAY, OUTLET, AND OUTLET PROTECTION DETAILS FOR ANY SEDIMENT BASIN(S) THAT HAVE BEEN INDIVIDUALLY DESIGNED FOR DRAINAGE AREAS LARGER THAN 15 ACRES.

SEDIMENT BASIN MAINTENANCE NOTES

1. INSPECT BMPs EACH WORKDAY, AND MAINTAIN THEM IN EFFECTIVE OPERATING CONDITION. MAINTENANCE OF BMPs SHOULD BE PROACTIVE, NOT REACTIVE. INSPECT BMPs AS SOON AS POSSIBLE (AND ALWAYS WITHIN 24 HOURS) FOLLOWING A STORM THAT CAUSES SURFACE EROSION, AND PERFORM NECESSARY MAINTENANCE.
2. FREQUENT OBSERVATIONS AND MAINTENANCE ARE NECESSARY TO MAINTAIN BMPs IN EFFECTIVE OPERATING CONDITION. INSPECTIONS AND CORRECTIVE MEASURES SHOULD BE DOCUMENTED THOROUGHLY.
3. WHERE BMPs HAVE FAILED, REPAIR OR REPLACEMENT SHOULD BE INITIATED UPON DISCOVERY OF THE FAILURE.
4. SEDIMENT ACCUMULATED IN BASIN SHALL BE REMOVED AS NEEDED TO MAINTAIN BMP EFFECTIVENESS, TYPICALLY WHEN SEDIMENT DEPTH REACHES ONE FOOT (I.E., TWO FEET BELOW THE SPILLWAY CREST).
5. SEDIMENT BASINS ARE TO REMAIN IN PLACE UNTIL THE UPSTREAM DISTURBED AREA IS STABILIZED AND GRASS COVER IS ACCEPTED BY THE LOCAL JURISDICTION.
6. WHEN SEDIMENT BASINS ARE REMOVED, ALL DISTURBED AREAS SHALL BE COVERED WITH TOPSOIL, SEEDED AND MULCHED OR OTHERWISE STABILIZED AS APPROVED BY LOCAL JURISDICTION.

(DETAILS ADAPTED FROM DOUGLAS COUNTY, COLORADO)

NOTE: MANY JURISDICTIONS HAVE BMP DETAILS THAT VARY FROM UDFCD STANDARD DETAILS. CONSULT WITH LOCAL JURISDICTIONS AS TO WHICH DETAIL SHOULD BE USED WHEN DIFFERENCES ARE NOTED.

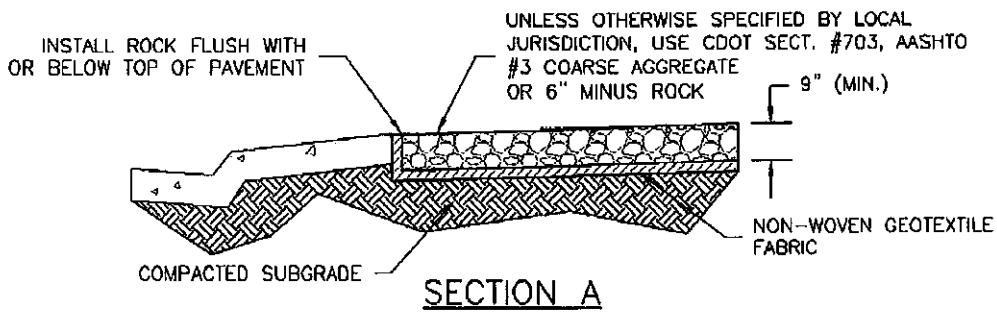
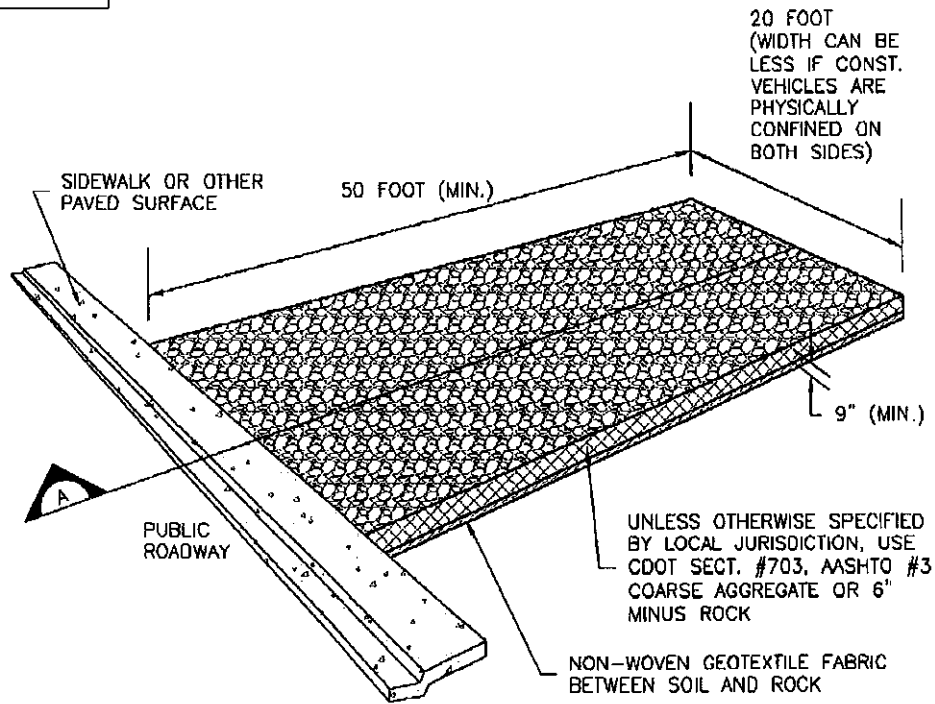
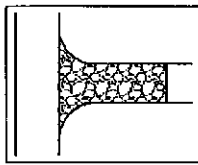

VTC-1. AGGREGATE VEHICLE TRACKING CONTROL

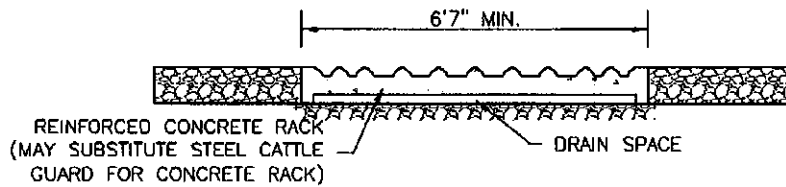
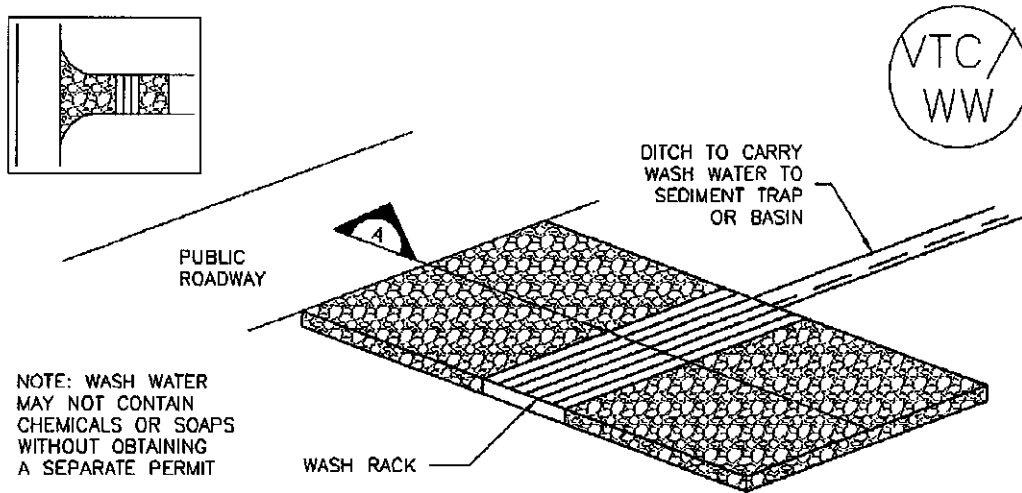

SECTION A

VTC-2. AGGREGATE VEHICLE TRACKING CONTROL WITH WASH RACK

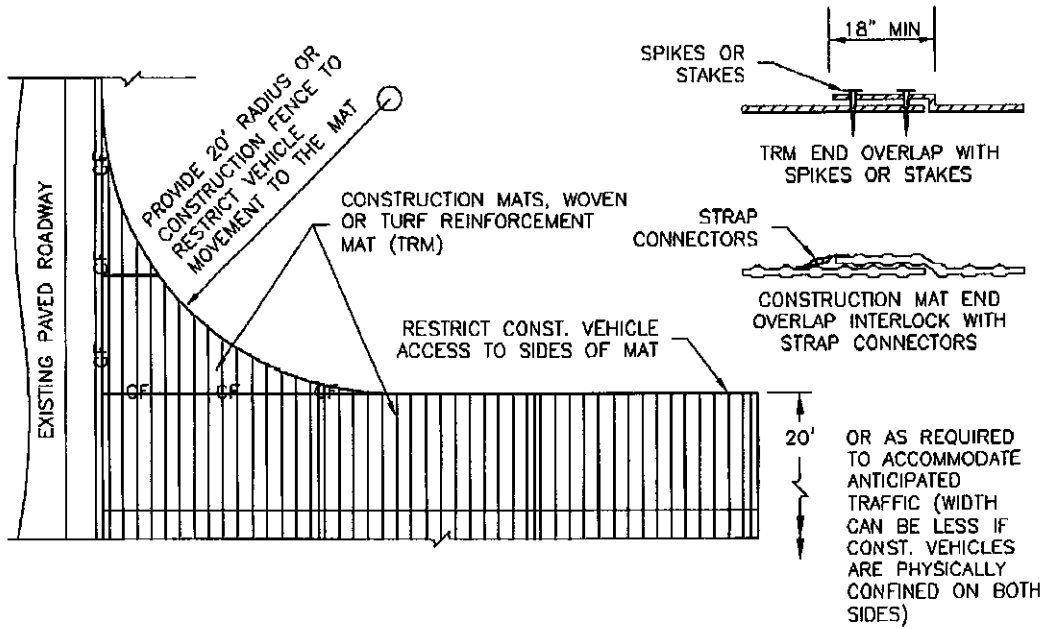
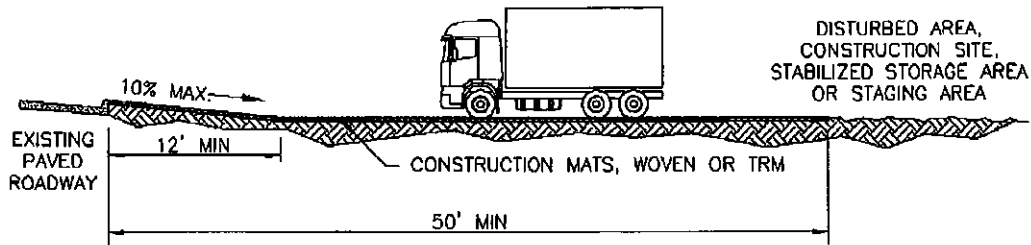
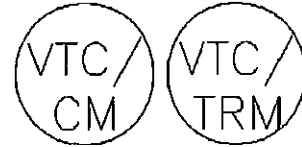
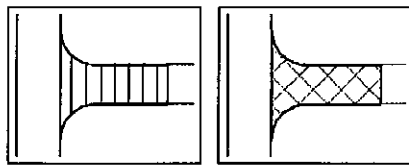

VTC-3. VEHICLE TRACKING CONTROL W/ CONSTRUCTION MAT OR TURF REINFORCEMENT MAT (TRM)

STABILIZED CONSTRUCTION ENTRANCE/EXIT INSTALLATION NOTES

1. SEE PLAN VIEW FOR
 - LOCATION OF CONSTRUCTION ENTRANCE(S)/EXIT(S).
 - TYPE OF CONSTRUCTION ENTRANCE(S)/EXITS(S) (WITH/WITHOUT WHEEL WASH, CONSTRUCTION MAT OR TRM).
2. CONSTRUCTION MAT OR TRM STABILIZED CONSTRUCTION ENTRANCES ARE ONLY TO BE USED ON SHORT DURATION PROJECTS (TYPICALLY RANGING FROM A WEEK TO A MONTH) WHERE THERE WILL BE LIMITED VEHICULAR ACCESS.
3. A STABILIZED CONSTRUCTION ENTRANCE/EXIT SHALL BE LOCATED AT ALL ACCESS POINTS WHERE VEHICLES ACCESS THE CONSTRUCTION SITE FROM PAVED RIGHT-OF-WAYS.
4. STABILIZED CONSTRUCTION ENTRANCE/EXIT SHALL BE INSTALLED PRIOR TO ANY LAND DISTURBING ACTIVITIES.
5. A NON-WOVEN GEOTEXTILE FABRIC SHALL BE PLACED UNDER THE STABILIZED CONSTRUCTION ENTRANCE/EXIT PRIOR TO THE PLACEMENT OF ROCK.
6. UNLESS OTHERWISE SPECIFIED BY LOCAL JURISDICTION, ROCK SHALL CONSIST OF DOT SECT. #703, AASHTO #3 COARSE AGGREGATE OR 6" (MINUS) ROCK.

STABILIZED CONSTRUCTION ENTRANCE/EXIT MAINTENANCE NOTES

1. INSPECT BMPs EACH WORKDAY, AND MAINTAIN THEM IN EFFECTIVE OPERATING CONDITION. MAINTENANCE OF BMPs SHOULD BE PROACTIVE, NOT REACTIVE. INSPECT BMPs AS SOON AS POSSIBLE (AND ALWAYS WITHIN 24 HOURS) FOLLOWING A STORM THAT CAUSES SURFACE EROSION, AND PERFORM NECESSARY MAINTENANCE.
2. FREQUENT OBSERVATIONS AND MAINTENANCE ARE NECESSARY TO MAINTAIN BMPs IN EFFECTIVE OPERATING CONDITION. INSPECTIONS AND CORRECTIVE MEASURES SHOULD BE DOCUMENTED THOROUGHLY.
3. WHERE BMPs HAVE FAILED, REPAIR OR REPLACEMENT SHOULD BE INITIATED UPON DISCOVERY OF THE FAILURE.
4. ROCK SHALL BE REAPPLIED OR REGRADED AS NECESSARY TO THE STABILIZED ENTRANCE/EXIT TO MAINTAIN A CONSISTENT DEPTH.
5. SEDIMENT TRACKED ONTO PAVED ROADS IS TO BE REMOVED THROUGHOUT THE DAY AND AT THE END OF THE DAY BY SHOVELING OR SWEEPING. SEDIMENT MAY NOT BE WASHED DOWN STORM SEWER DRAINS.

NOTE: MANY JURISDICTIONS HAVE BMP DETAILS THAT VARY FROM UDFCD STANDARD DETAILS. CONSULT WITH LOCAL JURISDICTIONS AS TO WHICH DETAIL SHOULD BE USED WHEN DIFFERENCES ARE NOTED.

(DETAILS ADAPTED FROM CITY OF BRONFIELD, COLORADO, NOT AVAILABLE IN AUTOCAD)

SITE MAP/ GRADING, EROSION CONTROL PLAN



GENERAL CONSTRUCTION NOTES:

- ALL CONSTRUCTION WITHIN EL PASO COUNTY PUBLIC RIGHT-WAYS SHALL BE IN ACCORDANCE WITH MOST CURRENT STANDARDS AND SPECIFICATIONS OF EL PASO COUNTY.
- IT SHALL BE THE RESPONSIBILITY OF THE CONTRACTOR TO VERIFY THE EXISTENCE AND LOCATION OF ALL UNDERGROUND UTILITIES ALONG THE ROUTE OF THE WORK. THE OMISSION FROM OR THE INCLUSION OF UTILITY LOCATIONS ON THE PLANS IS NOT TO BE CONSIDERED AS THE NONEXISTENCE OF OR A DEFINITE LOCATION OF EXISTING UNDERGROUND UTILITIES.
- BEFORE COMMENCING ANY EXCAVATION, CALL 811 FOR EXISTING UTILITY LOCATIONS.
- THE CONTRACTOR WILL TAKE THE NECESSARY PRECAUTIONS TO PROTECT EXISTING UTILITIES FROM DAMAGE DUE TO THIS OPERATION. ANY DAMAGE TO THE UTILITIES WILL BE REPAIRED AT THE CONTRACTOR'S EXPENSE, AND ANY SERVICE DISRUPTION WILL BE SETTLED BY THE CONTRACTOR.
- ADDITIONAL EROSION CONTROL STRUCTURES MAY BE REQUIRED AT THE TIME OF CONSTRUCTION.
- ALL BACKFILL, SUB-BASE AND/OR BASE COURSE (CLASS 6) MATERIAL SHALL BE COMPACTED TO THE SOILS ENGINEER'S RECOMMENDATIONS, AND APPROVED BY EL PASO COUNTY DEVELOPMENT SERVICES ENGINEERING DIVISION.
- ALL STATIONING IS CENTERLINE UNLESS OTHERWISE INDICATED. ALL ELEVATIONS ARE FLOWLINE UNLESS OTHERWISE INDICATED.
- ALL DISTURBED PAVEMENT EDGES SHALL BE CUT TO NEAT LINES. REPAIR SHALL CONFORM TO THE EPC EGM APPENDIX K - 1.2C.
- ALL INTERSECTION ACCESSES TO BE CONSTRUCTED WITH A 25 FOOT SIGHT VISIBILITY TRIANGLES.
- ALL CULVERT AND STORM DRAIN PIPES SHALL BE SMOOTH INTERIOR CORRUGATED POLYETHYLENE PIPE (HDPE), REINFORCED CONCRETE PIPE (RCP), OR ALL CULVERTS SHALL BE PLACED COMPLETE WITH FLARED END SECTIONS. ADEQUACY OF MATERIAL THICKNESS FOR ANY CULVERT INSTALLED SHALL BE VERIFIED BY OWNER'S GEOTECHNICAL ENGINEER TO SUPPORT MINIMUM 50 YEAR DESIGN LIFE. CULVERTS MUST CONFORM TO EPC EGM SECTION 3.32 - CULVERTS.
- ASPHALT THICKNESS AND BASE COURSE THICKNESS (COMPACTED) FOR ROADS SHALL BE PER DESIGN REPORT BY OWNER'S GEOTECHNICAL ENGINEER. OWNER'S GEOTECHNICAL ENGINEER TO BE ON SITE AT TIME OF ROAD CONSTRUCTION TO EVALUATE SOIL CONDITIONS AND DETERMINE IF ADDITIONAL MEASURES ARE NECESSARY TO ASSURE STABILITY OF THE NEW ROADS. PAVEMENT DESIGN SHALL BE APPROVED BY EL PASO COUNTY DEVELOPMENT SERVICES ENGINEERING DIVISION PRIOR TO CONSTRUCTION.
- TYPE M RIP-RAP WITH 4" OF TYPE 3 GRANULAR BEDDING AND MIRAIR 180N OR EQUAL MAY BE SUBSTITUTED WHERE TYPE L RIP-RAP WITH MIRAIR PW 700 OR EQUAL IS SPECIFIED.
- ALL MATERIALS AND INSTALLATION PROCEDURES SHALL BE IN COMPLIANCE WITH ANY AND ALL APPLICABLE EL PASO COUNTY STANDARDS.
- ALL POTABLE WATER MAINS SHALL BE AWWA C900-SDR18 PVC WITH PUSH-ON SINGLE GASKET TYPE JOINTS AND SHALL MEET THE REQUIREMENTS OF ANSI/NSF 61.
- ALL WATER MAIN FITTINGS SHALL BE MADE FROM GRAY-IRON OR DUCTILE IRON AND FINISHED WITH MECHANICAL JOINT ENDS. ALL FITTINGS SHALL HAVE A PRESSURE RATING OF 250 PSI AND SHALL MEET THE REQUIREMENTS OF ANSI/NSF 61.
- ALL WATER LINE BENDS, TEES, BLOW-OFFS AND PLUGS AT DEAD-END MAINS SHALL BE PROTECTED FROM THRUST BY USING CONCRETE THRUST BLOCKS AND/OR ROODING AND RESTRAINED PIPE.
- MAXIMUM DEFLECTION OF 8" & 12" PVC WATER MAIN JOINTS IS 4 DEGREES. CORRESPONDING MINIMUM CURVE RADIUS IS 286'. ADDITIONAL 11.25' OR 22.5' BENDS MAY BE REQUIRED FOR PROPER ALIGNMENT.
- CONTRACTOR IS RESPONSIBLE FOR PROVIDING DETAILED AS-BUILTS OF ALL WATER MAIN, STORM SEW AND SAN. SEW. MAIN INSTALLATIONS, INCLUDING ACCURATE DISTANCES OF MAIN LINES, VALVES, FITTINGS, MANHOLES AND LOCATIONS OF WATER AND SEWER SERVICES.
- SANITARY SEWER PIPE AND FITTINGS: PVC 4"-8" ASTM D3034, TYPE PSM, SDR 35; PUSH-ON JOINTS AND MOLDED RUBBER GASKETS MAXIMUM HORIZONTAL DEFLECTION, AFTER INSTALLATION AND BACK FILLING SHALL NOT EXCEED 3% OF THE PIPE DIAMETER. (MINIMUM CURVE RADIUS IS 100' FOR 8" PVC SAN. SEW. MAIN)

EL PASO COUNTY GRADING AND EROSION CONTROL NOTES:

- CONSTRUCTION MAY NOT COMMENCE UNTIL A CONSTRUCTION PERMIT IS OBTAINED FROM PLANNING AND COMMUNITY DEVELOPMENT (POD) AND A PRECONSTRUCTION CONFERENCE IS HELD WITH POD INSPECTORS.
- STORMWATER DISCHARGES FROM CONSTRUCTION SITES SHALL NOT CAUSE OR THREATEN TO CAUSE POLLUTION, CONTAMINATION, OR DEGRADATION OF STATE WATERS. ALL WORK AND EARTH DISTURBANCE SHALL BE DONE IN A MANNER THAT MINIMIZES POLLUTION OF ANY ON-SITE OR OFF SITE WATERS, INCLUDING WETLANDS.
- NOTWITHSTANDING ANYTHING DEPICTED IN THESE PLANS IN WORDS OR GRAPHIC REPRESENTATION, ALL DESIGN AND CONSTRUCTION RELATED TO ROADS, STORM DRAINAGE AND EROSION CONTROL SHALL CONFORM TO THE STANDARDS AND REQUIREMENTS OF THE MOST RECENT VERSION OF THE RELEVANT ADOPTED EL PASO COUNTY STANDARDS, INCLUDING THE LAND DEVELOPMENT CODE, THE ENGINEERING CRITERIA MANUAL, THE DRAINAGE CRITERIA MANUAL, AND THE DRAINAGE CRITERIA MANUAL VOLUME 2. ANY DEVIATIONS TO REGULATIONS AND STANDARDS MUST BE REQUESTED, AND APPROVED, IN WRITING.
- A SEPARATE STORMWATER MANAGEMENT PLAN (SWMP) FOR THIS PROJECT SHALL BE COMPLETED AND AN EROSION AND STORMWATER QUALITY CONTROL PERMIT (ESQCP) ISSUED PRIOR TO COMMENCING CONSTRUCTION. DURING CONSTRUCTION THE SWMP IS THE RESPONSIBILITY OF THE DESIGNATED STORMWATER MANAGER, SHALL BE LOCATED ON SITE AT ALL TIMES AND SHALL BE KEPT UP TO DATE WITH WORK PROGRESS AND CHANGES IN THE FIELD.
- ONCE THE ESQCP HAS BEEN ISSUED, THE CONTRACTOR MAY INSTALL THE INITIAL STAGE EROSION AND SEDIMENT CONTROL BMPs AS INDICATED ON THE DEC. A PRECONSTRUCTION MEETING BETWEEN THE CONTRACTOR, ENGINEER, AND EL PASO COUNTY WILL BE HELD PRIOR TO ANY CONSTRUCTION. IT IS THE RESPONSIBILITY OF THE APPLICANT TO COORDINATE THE MEETING TIME AND PLACE WITH COUNTY POD INSPECTORS STAFF.
- SOIL EROSION CONTROL MEASURES FOR ALL SLOPES, CHANNELS, DITCHES, OR ANY DISTURBED LAND AREA SHALL BE COMPLETED WITHIN 21 CALENDAR DAYS AFTER FINAL GRADING, OR FINAL EARTH DISTURBANCE, HAS BEEN COMPLETED. DISTURBED AREAS AND STOCKPILES WHICH ARE NOT AT FINAL GRADE BUT WILL REMAIN DORMANT FOR LONGER THAN 30 DAYS SHALL ALSO BE MULCHED WITHIN 21 DAYS AFTER INTERIM GRADING. AN AREA THAT IS GOING TO REMAIN IN AN INTERIM STATE FOR MORE THAN 60 DAYS SHALL ALSO BE SEEDED. ALL TEMPORARY SOIL EROSION CONTROL MEASURES AND BMPs SHALL BE MAINTAINED UNTIL PERMANENT SOIL EROSION CONTROL MEASURES ARE IMPLEMENTED AND ESTABLISHED.
- TEMPORARY SOIL EROSION CONTROL FACILITIES SHALL BE REMOVED AND EARTH DISTURBANCE AREAS GRADED AND STABILIZED WITH PERMANENT SOIL EROSION CONTROL MEASURES PURSUANT TO STANDARDS AND SPECIFICATION PRESCRIBED IN THE DCM VOLUME II AND THE ENGINEERING CRITERIA MANUAL (ECM) APPENDIX I.
- ALL PERSONS ENGAGED IN EARTH DISTURBANCE SHALL IMPLEMENT AND MAINTAIN ACCEPTABLE SOIL EROSION AND SEDIMENT CONTROL MEASURES INCLUDING BMPs IN CONFORMANCE WITH THE EROSION CONTROL TECHNICAL STANDARDS OF THE DRAINAGE CRITERIA MANUAL (DCM) VOLUME II AND IN ACCORDANCE WITH THE STORMWATER MANAGEMENT PLAN (SWMP).
- ALL TEMPORARY EROSION CONTROL FACILITIES INCLUDING BMPs AND ALL PERMANENT FACILITIES INTENDED TO CONTROL EROSION OF ANY EARTH DISTURBANCE OPERATIONS, SHALL BE INSTALLED AS DEFINED IN THE APPROVED PLANS, THE SWMP AND THE DCM VOLUME II AND MAINTAINED THROUGHOUT THE DURATION OF THE EARTH DISTURBANCE OPERATION.
- ANY EARTH DISTURBANCE SHALL BE CONDUCTED IN SUCH A MANNER SO AS TO EFFECTIVELY REDUCE ACCELERATED SOIL EROSION AND RESULTING SEDIMENTATION. ALL DISTURBANCES SHALL BE DESIGNED, CONSTRUCTED, AND COMPLETED SO THAT THE EXPOSED AREA OF ANY DISTURBED LAND SHALL BE LIMITED TO THE SHORTEST PRACTICAL PERIOD OF TIME.
- ANY TEMPORARY OR PERMANENT FACILITY DESIGNED AND CONSTRUCTED FOR THE CONVEYANCE OF STORMWATER AREA, THROUGH, OR FROM THE EARTH DISTURBANCE AREA SHALL BE DESIGNED TO LIMIT THE DISCHARGE TO A NON-EROSIVE VELOCITY.
- CONCRETE WASH WATER SHALL BE CONTAINED AND DISPOSED OF IN ACCORDANCE WITH THE SWMP. NO WASH WATER SHALL BE DISCHARGED TO OR ALLOWED TO RUNOFF TO STATE WATERS, INCLUDING ANY SURFACE OR SUBSURFACE STORM DRAINAGE SYSTEM OR FACILITIES.
- EROSION CONTROL BLANKETING IS TO BE USED ON SLOPES STEEPER THAN 3:1.
- BUILDING CONSTRUCTION, EXCAVATION, OR OTHER WASTE MATERIALS SHALL NOT BE TEMPORARILY PLACED OR STORED IN THE STREET, ALLEY, OR OTHER PUBLIC WAY, UNLESS IN ACCORDANCE WITH AN APPROVED TRAFFIC CONTROL PLAN. BMPs MAY BE REQUIRED BY EL PASO COUNTY ENGINEERING IF DEEMED NECESSARY, BASED ON SPECIFIC CONDITIONS AND CIRCUMSTANCES.
- VEHICLE TRACKING OF SOILS AND CONSTRUCTION DEBRIS OFF-SITE SHALL BE MINIMIZED. MATERIALS TRACKED OFFSITE SHALL BE CLEANED UP AND PROPERLY DISPOSED OF IMMEDIATELY.
- CONTRACTOR SHALL BE RESPONSIBLE FOR THE REMOVAL OF ALL WASTES FROM THE CONSTRUCTION SITE FOR DISPOSAL IN ACCORDANCE WITH LOCAL AND STATE REGULATORY REQUIREMENTS. NO CONSTRUCTION DEBRIS, TREE SLASH, BUILDING MATERIAL WASTES OR UNUSED BUILDING MATERIALS SHALL BE BURIED, DUMPED, OR DISCHARGED AT THE SITE.
- THE OWNER, SITE DEVELOPER, CONTRACTOR, AND/OR THEIR AUTHORIZED AGENTS SHALL BE RESPONSIBLE FOR THE REMOVAL OF ALL CONSTRUCTION DEBRIS, DIRT, TRASH, ROCK, SEDIMENT, AND SAND THAT MAY ACCUMULATE IN THE STORM SEWER OR OTHER DRAINAGE CONVEYANCE SYSTEM AND STORMWATER APPURTENANCES AS A RESULT OF SITE DEVELOPMENT.
- THE QUANTITY OF MATERIALS STORED ON THE PROJECT SITE SHALL BE LIMITED, AS MUCH AS PRACTICAL, TO THAT QUANTITY REQUIRED TO PERFORM THE WORK IN AN ORDERLY SEQUENCE. ALL MATERIALS STORED ON-SITE SHALL BE STORED IN A NEAT, ORDERLY MANNER, IN THEIR ORIGINAL CONTAINERS, WITH ORIGINAL MANUFACTURER'S LABELS.
- NO CHEMICALS ARE TO BE USED BY THE CONTRACTOR, WHICH HAVE THE POTENTIAL TO BE RELEASED IN STORMWATER UNLESS PERMISSION FOR THE USE OF A SPECIFIC CHEMICAL IS GRANTED IN WRITING BY THE EGM ADMINISTRATOR. IN GRANTING THE USE OF SUCH CHEMICALS, SPECIAL CONDITIONS AND MONITORING MAY BE REQUIRED.
- BULK STORAGE STRUCTURES FOR PETROLEUM PRODUCTS AND OTHER CHEMICALS SHALL HAVE ADEQUATE PROTECTION SO AS TO CONTAIN ALL SPILLS AND PREVENT ANY SPILLED MATERIAL FROM ENTERING STATE WATERS, INCLUDING ANY SURFACE OR SUBSURFACE STORM DRAINAGE SYSTEM OR FACILITIES.
- NO PERSON SHALL CAUSE THE IMPEDIMENT OF STORMWATER FLOW IN THE FLOW LINE OF THE CURB AND GUTTER OR IN THE DITCHLINE.
- INDIVIDUALS SHALL COMPLY WITH THE "COLORADO WATER QUALITY CONTROL ACT" (TITLE 25, ARTICLE 6, CRS), AND THE "CLEAN WATER ACT" (33 USC 1344), IN ADDITION TO THE REQUIREMENTS INCLUDED IN THE DCM VOLUME II AND THE EGM APPENDIX I. ALL APPROPRIATE PERMITS MUST BE OBTAINED BY THE CONTRACTOR PRIOR TO CONSTRUCTION (NPDES, FLOODPLAIN, 404, FUGITIVE DUST, ETC.). IN THE EVENT OF CONFLICTS BETWEEN THESE REQUIREMENTS AND LAWS, RULES, OR REGULATIONS OF OTHER FEDERAL, STATE, OR COUNTY AGENCIES, THE MORE RESTRICTIVE LAWS, RULES, OR REGULATIONS SHALL APPLY.
- ALL CONSTRUCTION TRAFFIC MUST ENTER/EXIT THE SITE AT APPROVED CONSTRUCTION ACCESS POINTS.
- PRIOR TO ACTUAL CONSTRUCTION THE PERMITEE SHALL VERIFY THE LOCATION OF EXISTING UTILITIES
- A WATER SOURCE SHALL BE AVAILABLE ON SITE DURING EARTHWORK OPERATIONS AND UTILIZED AS REQUIRED TO MINIMIZE DUST FROM EARTHWORK EQUIPMENT AND WIND.
- THE SOILS REPORT FOR THIS SITE HAS BEEN PREPARED BY BWS ENGINEERS GROUP, TITLED "FALCON HS EXPANSION GEOTECHNICAL REPORT", DATED FEBRUARY 3, 2017 AND SHALL BE CONSIDERED A PART OF THESE PLANS.
- AT LEAST TEN DAYS PRIOR TO THE ANTICIPATED START OF CONSTRUCTION, FOR PROJECTS THAT WILL DISTURB 1 ACRE OR MORE, THE OWNER OR OPERATOR OF CONSTRUCTION ACTIVITY SHALL SUBMIT APPLICATION FOR STORMWATER DISCHARGE TO THE COLORADO DEPARTMENT OF PUBLIC HEALTH AND ENVIRONMENT, WATER QUALITY DIVISION. THE APPLICATION CONTAINS CERTIFICATION OF COMPLETION OF A STORMWATER MANAGEMENT PLAN (SWMP), OF WHICH THIS GRADING AND EROSION CONTROL PLAN MAY BE A PART. FOR INFORMATION OR APPLICATION MATERIALS CONTACT:
COLORADO DEPARTMENT OF PUBLIC HEALTH AND ENVIRONMENT
WATER QUALITY CONTROL DIVISION
WOOD - PERMITS
4300 CHERRY CREEK DRIVE SOUTH
DENVER, CO 80246-1530
ATTN: PERMITS UNIT

FALCON HIGH SCHOOL ADDITION

COUNTY OF EL PASO, STATE OF COLORADO

CONSTRUCTION PLANS

PORTION OF SECTION 28 AND 29,
TOWNSHIP 12 SOUTH, RANGE 64
WEST OF THE 6TH P.M.

JULY 2017

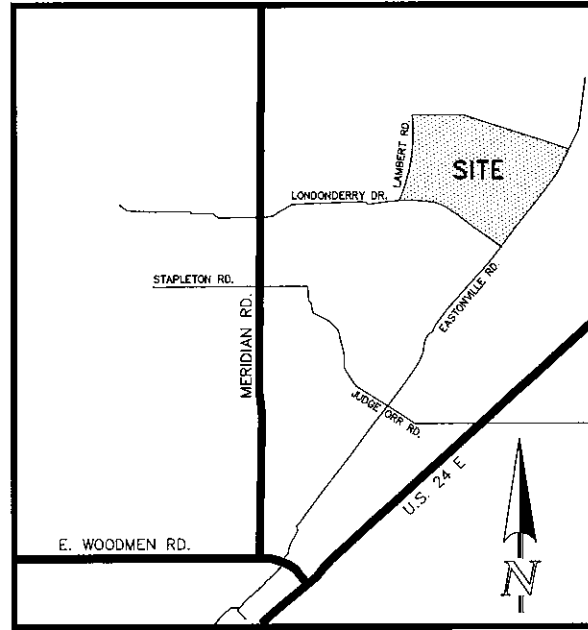

VICINITY MAP
NOT TO SCALE

BENCHMARK:
THIS MONUMENT E-24 A US&GS BRASS CAP BENCHMARK SET IN CONCRETE APPROXIMATELY 50 FEET NORTH OF THE CENTERLINE OF JUDGE ORR ROAD AND APPROXIMATELY 170 FEET NORTHWEST OF THE CENTERLINE OF U.S. HIGHWAY 24. ELEVATION=6986.20'

AGENCIES:

- DEVELOPER: SCHOOL DISTRICT 49
10850 E WOODMEN ROAD
PEYTON, CO 80831
MS. MELISSA ANDREWS (719) 494-8997
- CIVIL ENGINEER: CLASSIC CONSULTING ENGINEERS & SURVEYORS
619 N. CASCADE AVE., SUITE 200
COLORADO SPRINGS, CO 80903
MR. KYLE R. CAMPBELL, P.E. (719) 785-0790
- COUNTY ENGINEERING: DEVELOPMENT SERVICES DEPARTMENT
2880 INTERNATIONAL CIRCLE
COLORADO SPRINGS, COLORADO 80910
MRS. ELIZABETH NIJKAMP, P.E. (719) 520-7852
- WATER & SANITATION DISTRICT: MERIDIAN SERVICE METROPOLITAN DISTRICT
11886 STAPLETON DRIVE
FALCON, CO 80831
(719) 495-6567
- FIRE DISTRICT: FALCON FIRE PROTECTION DISTRICT
7030 OLD MERIDIAN ROAD,
FALCON, CO 80831
(719) 495-4050
- GAS COMPANY: CITY OF COLORADO SPRINGS
101 SOUTH CONEJOS STREET
COLORADO SPRINGS, COLORADO 80903
MR. TIM BENEDICT, (719) 668-3574
- ELECTRIC COMPANY: MOUNTAIN VIEW ELECTRIC
P.O. BOX 1800
LIMON, COLORADO 80828
MR. LES ULFERS, (719) 495-2283
- TELEPHONE COMPANY: CENTURY LINK (LOCATORS) 811
AT & T (LOCATORS) 811

APPROVALS:

ENGINEER'S STATEMENT:

THIS GRADING AND EROSION CONTROL PLAN WAS PREPARED UNDER MY DIRECTION AND SUPERVISION AND IS CORRECT TO THE BEST OF MY KNOWLEDGE AND BELIEF. SAID PLAN HAS BEEN PREPARED ACCORDING TO THE CRITERIA ESTABLISHED BY THE COUNTY FOR GRADING AND EROSION CONTROL PLANS.

I ACCEPT RESPONSIBILITY FOR ANY LIABILITY CAUSED BY ANY NEGLIGENT ACTS, ERRORS OR OMISSIONS ON MY PART IN PREPARING THIS PLAN.

KYLE R. CAMPBELL, COLORADO P.E. #29794
FOR AND ON THE BEHALF OF CLASSIC CONSULTING ENGINEERS & SURVEYORS

OWNER/DEVELOPER STATEMENT:

THE OWNER WILL COMPLY WITH THE REQUIREMENTS OF THE GRADING AND EROSION CONTROL PLAN.

SCHOOL DISTRICT 49
MS. MELISSA ANDREWS

EL PASO COUNTY:

COUNTY PLAN REVIEW IS PROVIDED ONLY FOR GENERAL CONFORMANCE WITH COUNTY DESIGN CRITERIA. THE COUNTY IS NOT RESPONSIBLE FOR THE ACCURACY AND ADEQUACY OF THE DESIGN, DIMENSIONS, AND/OR ELEVATIONS WHICH SHALL BE CONFIRMED AT THE JOB SITE. THE COUNTY THROUGH THE APPROVAL OF THIS DOCUMENT ASSUMES NO RESPONSIBILITY FOR COMPLETENESS AND/OR ACCURACY OF THIS DOCUMENT.

FILED IN ACCORDANCE WITH THE REQUIREMENTS OF THE EL PASO COUNTY LAND DEVELOPMENT CODE, DRAINAGE CRITERIA, AND ENGINEERING CRITERIA MANUAL AS AMENDED.

JENNIFER IRVING, P.E.
COUNTY ENGINEER / EGM ADMINISTRATOR

SHEET INDEX

TITLE SHEET	SHEET 1 OF 5
DETAILED GRADING & EROSION CONTROL PLAN	SHEET 2 OF 5
DETAILED GRADING & EROSION CONTROL PLAN	SHEET 3 OF 5
DETAILS SHEET	SHEET 4 OF 5
INTERCEPTOR DRAIN PLAN	SHEET 5 OF 5

EL PASO COUNTY PROJECT NO. PPR-17-048

NO.	REVISION	DATE	REVIEW:

PREPARED UNDER MY DIRECT SUPERVISION FOR AND ON BEHALF OF CLASSIC CONSULTING ENGINEERS AND SURVEYORS, LLC

KYLE R. CAMPBELL, COLORADO P.E. #29794

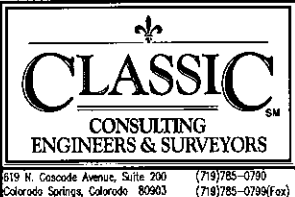

FALCON HIGH SCHOOL ADDITION
FALCON SCHOOL DISTRICT 49
CONSTRUCTION PLANS
TITLE SHEET

DESIGNED BY:	MAI	SCALE:	DATE:	07/28/17
DRAWN BY:	WES	(H) 1"=VARIES	SHEET 1 OF 5	
CHECKED BY:	(V) 1"=N/A	JOB NO.:	2356.92	

48 HOURS BEFORE YOU DIG,
CALL UTILITY LOCATORS
811
UTILITY NOTIFICATION CENTER OF COLORADO
IT'S THE LAW

THE LOCATIONS OF EXISTING UNDERGROUND UTILITIES ARE SHOWN IN AN APPROXIMATE WAY ONLY. THE CONTRACTOR SHALL DETERMINE THE EXACT LOCATION OF ALL EXISTING UTILITIES BEFORE COMMENCING WORK. THE CONTRACTOR SHALL BE FULLY RESPONSIBLE FOR ANY AND ALL DAMAGES WHICH MIGHT BE CAUSED BY HIS FAILURE TO EXACTLY LOCATE AND PRESERVE ANY AND ALL UNDERGROUND UTILITIES.

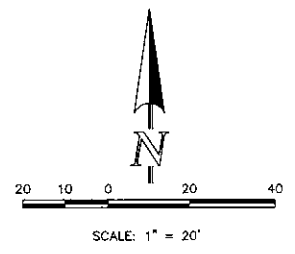
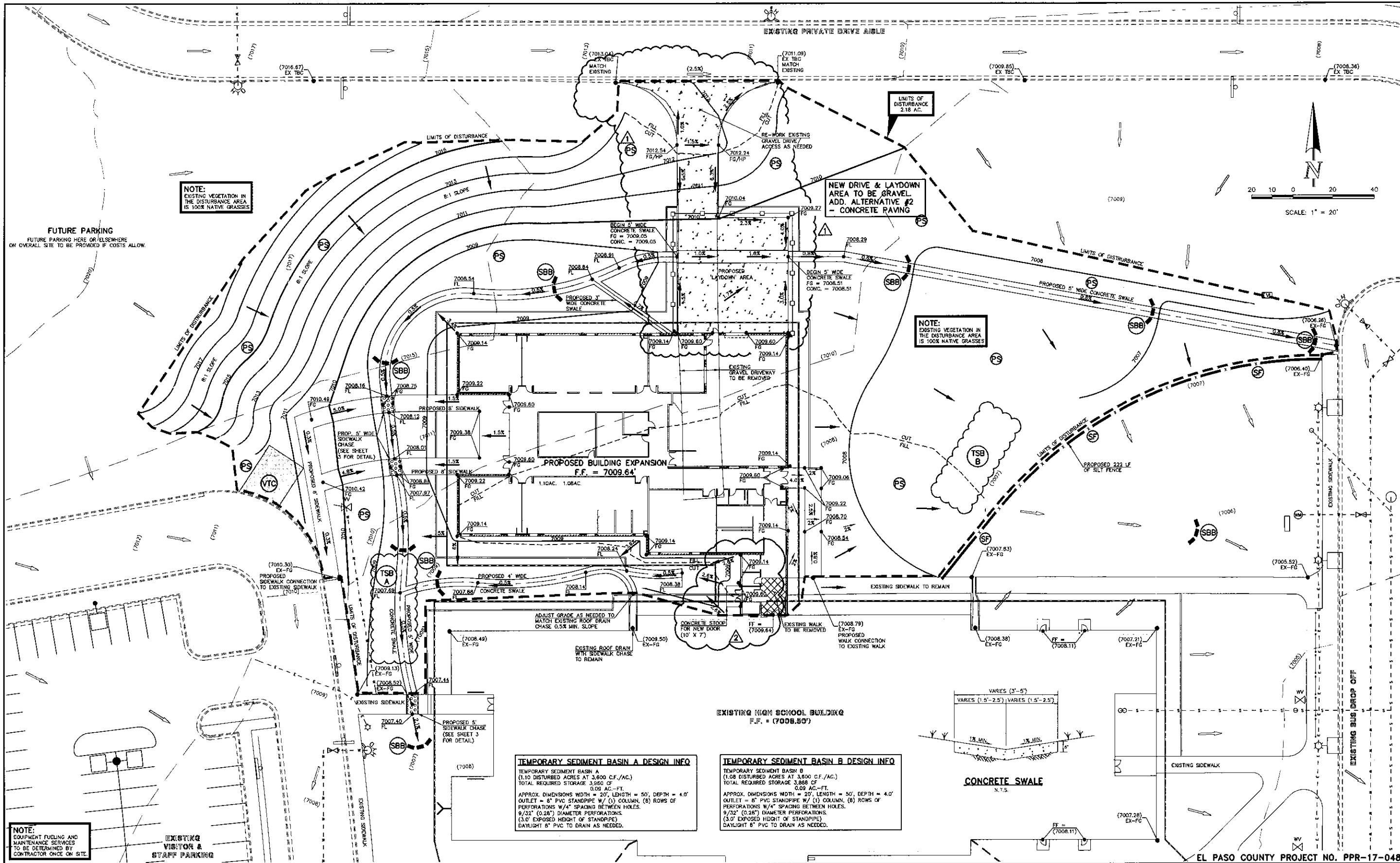

FUTURE PARKING
 FUTURE PARKING HERE OR ELSEWHERE ON OVERALL SITE TO BE PROVIDED IF COSTS ALLOW.

NEW DRIVE & LAYDOWN AREA TO BE GRAVEL. ADD. ALTERNATIVE #2 - CONCRETE PAVING

TEMPORARY SEDIMENT BASIN A DESIGN INFO

TEMPORARY SEDIMENT BASIN A
 (1.10 DISTURBED ACRES AT 3,600 CF./AC.)
 TOTAL REQUIRED STORAGE 3,960 CF.
 0.09 AC.-FT.
 APPROX. DIMENSIONS WIDTH = 20', LENGTH = 50', DEPTH = 4.0'
 OUTLET = 8" PVC STANDPIPE W/ (1) COLUMN, (8) ROWS OF PERFORATIONS W/4" SPACING BETWEEN HOLES.
 9/32" (0.28") DIAMETER PERFORATIONS.
 (3.0' EXPOSED HEIGHT OF STANDPIPE)
 DAYLIGHT 8" PVC TO DRAIN AS NEEDED.

TEMPORARY SEDIMENT BASIN B DESIGN INFO

TEMPORARY SEDIMENT BASIN B
 (1.08 DISTURBED ACRES AT 3,600 CF./AC.)
 TOTAL REQUIRED STORAGE 3,888 CF.
 0.09 AC.-FT.
 APPROX. DIMENSIONS WIDTH = 20', LENGTH = 50', DEPTH = 4.0'
 OUTLET = 8" PVC STANDPIPE W/ (1) COLUMN, (8) ROWS OF PERFORATIONS W/4" SPACING BETWEEN HOLES.
 9/32" (0.28") DIAMETER PERFORATIONS.
 (3.0' EXPOSED HEIGHT OF STANDPIPE)
 DAYLIGHT 8" PVC TO DRAIN AS NEEDED.

CONCRETE SWALE
 N.T.S.

EL PASO COUNTY PROJECT NO. PPR-17-048

48 HOURS BEFORE YOU DIG, CALL UTILITY LOCATORS
811
 UTILITY NOTIFICATION CENTER OF COLORADO
 IT'S THE LAW

THE LOCATIONS OF EXISTING UNDERGROUND UTILITIES ARE SHOWN IN AN APPROXIMATE WAY ONLY. THE CONTRACTOR SHALL DETERMINE THE EXACT LOCATION OF ALL EXISTING UTILITIES BEFORE COMMENCING WORK. THE CONTRACTOR SHALL BE FULLY RESPONSIBLE FOR ANY AND ALL DAMAGES WHICH MIGHT BE CAUSED BY HIS FAILURE TO EXACTLY LOCATE AND PRESERVE ANY AND ALL UNDERGROUND UTILITIES.

NO.	REVISION	DATE
1	DRIVEWAY AND LAYDOWN AREA TO BE GRAVEL.	9/06/17
	ADD. ALTERNATIVE #2 - CONCRETE PAVING	
2	AS-2 - SHIFTED DOOR SLIGHTLY	9/21/17

REVIEW:
 PREPARED UNDER MY DIRECT SUPERVISION FOR AND ON BEHALF OF CLASSIC CONSULTING ENGINEERS AND SURVEYORS, LLC

RYLE R. CAMPBELL, COLORADO P.E. #25794 DATE

CLASSIC
 CONSULTING ENGINEERS & SURVEYORS

618 N. Cascade Avenue, Suite 200
 Colorado Springs, Colorado 80903
 (719)785-0780
 (719)785-0788(Fax)

FALCON HIGH SCHOOL ADDITION
FALCON SCHOOL DISTRICT 49

CONSTRUCTION PLANS
 DETAILED GRADING & EROSION CONTROL PLAN

DESIGNED BY: MAL SCALE DATE 07/28/17

DRAWN BY: MES (H) 1" = 20' SHEET 2 OF 5

CHECKED BY: (V) 1" = N/A JOB NO. 2366.92

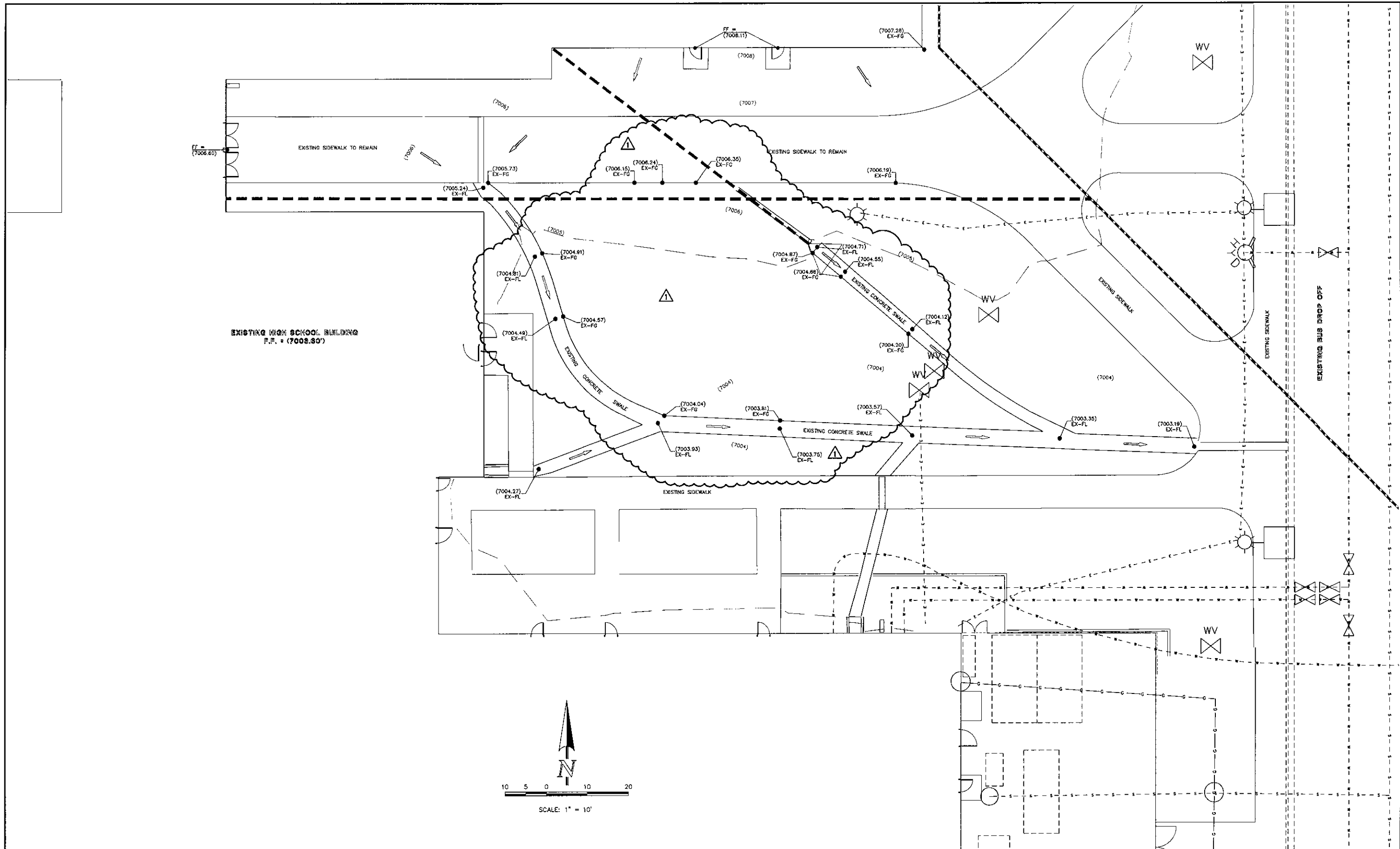

EL PASO COUNTY PROJECT NO. PPR-17-048

LEGEND	
	EXISTING CONTOUR MAJOR
	PROPOSED CONTOUR MAJOR
	SPOT ELEVATION
	FLOW DIRECTION AND GRADE
	EDGE OF ASPHALT
	FLOW LINE OF CURB
	TOP BACK OF CURB
	FINISHED GROUND
	HP HIGH POINT ELEVATION
	LP LOW POINT ELEVATION
	(IP) BLOCK & ROCK SOCK
	(IP) INLET PROTECTION
	(SF) SILT FENCE

48 HOURS BEFORE YOU DIG,
CALL UTILITY LOCATORS
811
UTILITY NOTIFICATION CENTER OF COLORADO
IT'S THE LAW

THE LOCATIONS OF EXISTING UNDERGROUND UTILITIES ARE SHOWN IN AN APPROXIMATE WAY ONLY. THE CONTRACTOR SHALL DETERMINE THE EXACT LOCATION OF ALL EXISTING UTILITIES BEFORE COMMENCING WORK. THE CONTRACTOR SHALL BE FULLY RESPONSIBLE FOR ANY AND ALL DAMAGES WHICH MIGHT BE CAUSED BY HIS FAILURE TO EXACTLY LOCATE AND PRESERVE ANY AND ALL UNDERGROUND UTILITIES.

NO.	REVISION	DATE
1	REMOVED GREENHOUSE (NO WORK TO BE DONE IN THIS AREA)	9/06/17

REVIEW:

PREPARED UNDER MY DIRECT SUPERVISION FOR AND ON BEHALF OF CLASSIC CONSULTING ENGINEERS AND SURVEYORS, LLC

KYLE R. CAMPBELL, COLORADO P.E. #26794 DATE

619 N. Cascade Avenue, Suite 200
Colorado Springs, Colorado 80903
(719) 765-0759
(719) 765-0759 (fax)

FALCON HIGH SCHOOL ADDITION FALCON SCHOOL DISTRICT 49			
CONSTRUCTION PLANS DETAILED GRADING & EROSION CONTROL PLAN			
DESIGNED BY	MAL	SCALE	DATE 07/28/17
DRAWN BY	MES	(1" = 10')	SHEET 3 OF 5
CHECKED BY	(V)	1" = N/A	JOB NO. 2356.92

1. CLASSIC CONSULTING ENGINEERS AND SURVEYORS, LLC
 2. 619 N. CASCADE AVENUE, SUITE 200, COLORADO SPRINGS, CO 80903
 3. (719) 765-0759
 4. (719) 765-0759 (FAX)

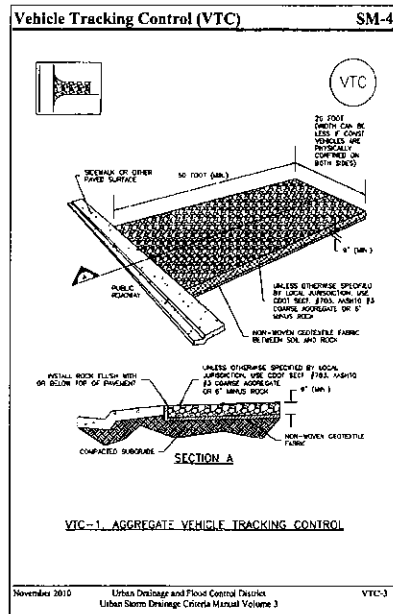

Vehicle Tracking Control (VTC)

SM-4

1. SEE PLAN VIEW FOR LOCATION OF CONSTRUCTION ENTRANCE/EXIT POINTS.

2. CONSTRUCTION OF THE PAVEMENT CONSTRUCTION ENTRANCE AND EXIT TO BE MADE OF STONE OR CONCRETE. PAVEMENT SHALL BE 18" THICK AND SHALL BE FINISHED TO MATCH THE ADJACENT PAVEMENT.

3. A SCHEDULED CONSTRUCTION ENTRANCE/EXIT SHALL BE LOCATED AT ALL ACCESS POINTS TO THE CONSTRUCTION SITE. THESE ENTRANCES/EXITS SHALL BE FINISHED TO MATCH THE ADJACENT PAVEMENT.

4. A SCHEDULED CONSTRUCTION ENTRANCE/EXIT SHALL BE FINISHED TO MATCH THE ADJACENT PAVEMENT.

5. A SCHEDULED CONSTRUCTION ENTRANCE/EXIT SHALL BE FINISHED TO MATCH THE ADJACENT PAVEMENT.

6. A SCHEDULED CONSTRUCTION ENTRANCE/EXIT SHALL BE FINISHED TO MATCH THE ADJACENT PAVEMENT.

7. A SCHEDULED CONSTRUCTION ENTRANCE/EXIT SHALL BE FINISHED TO MATCH THE ADJACENT PAVEMENT.

8. A SCHEDULED CONSTRUCTION ENTRANCE/EXIT SHALL BE FINISHED TO MATCH THE ADJACENT PAVEMENT.

9. A SCHEDULED CONSTRUCTION ENTRANCE/EXIT SHALL BE FINISHED TO MATCH THE ADJACENT PAVEMENT.

10. A SCHEDULED CONSTRUCTION ENTRANCE/EXIT SHALL BE FINISHED TO MATCH THE ADJACENT PAVEMENT.

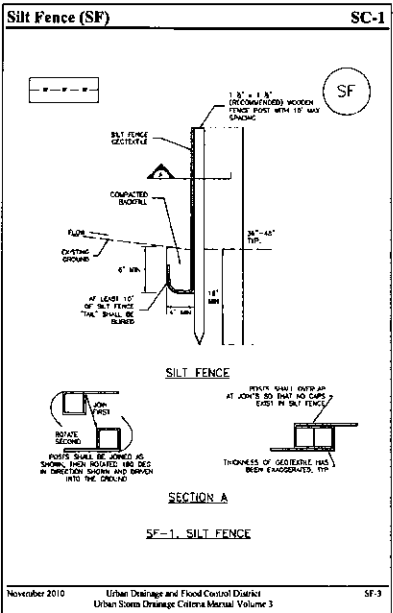

Silt Fence (SF)

SC-1

1. SEE PLAN VIEW FOR LOCATION OF CONSTRUCTION ENTRANCE/EXIT POINTS.

2. CONSTRUCTION OF THE PAVEMENT CONSTRUCTION ENTRANCE AND EXIT TO BE MADE OF STONE OR CONCRETE. PAVEMENT SHALL BE 18" THICK AND SHALL BE FINISHED TO MATCH THE ADJACENT PAVEMENT.

3. A SCHEDULED CONSTRUCTION ENTRANCE/EXIT SHALL BE LOCATED AT ALL ACCESS POINTS TO THE CONSTRUCTION SITE. THESE ENTRANCES/EXITS SHALL BE FINISHED TO MATCH THE ADJACENT PAVEMENT.

4. A SCHEDULED CONSTRUCTION ENTRANCE/EXIT SHALL BE FINISHED TO MATCH THE ADJACENT PAVEMENT.

5. A SCHEDULED CONSTRUCTION ENTRANCE/EXIT SHALL BE FINISHED TO MATCH THE ADJACENT PAVEMENT.

6. A SCHEDULED CONSTRUCTION ENTRANCE/EXIT SHALL BE FINISHED TO MATCH THE ADJACENT PAVEMENT.

7. A SCHEDULED CONSTRUCTION ENTRANCE/EXIT SHALL BE FINISHED TO MATCH THE ADJACENT PAVEMENT.

8. A SCHEDULED CONSTRUCTION ENTRANCE/EXIT SHALL BE FINISHED TO MATCH THE ADJACENT PAVEMENT.

9. A SCHEDULED CONSTRUCTION ENTRANCE/EXIT SHALL BE FINISHED TO MATCH THE ADJACENT PAVEMENT.

10. A SCHEDULED CONSTRUCTION ENTRANCE/EXIT SHALL BE FINISHED TO MATCH THE ADJACENT PAVEMENT.

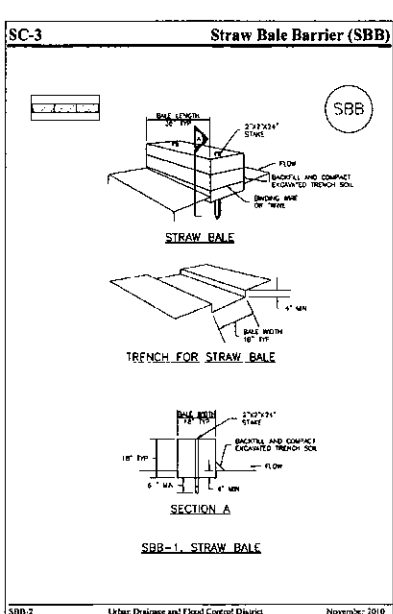

Straw Bale Barrier (SBB)

SC-3

1. SEE PLAN VIEW FOR LOCATION OF CONSTRUCTION ENTRANCE/EXIT POINTS.

2. CONSTRUCTION OF THE PAVEMENT CONSTRUCTION ENTRANCE AND EXIT TO BE MADE OF STONE OR CONCRETE. PAVEMENT SHALL BE 18" THICK AND SHALL BE FINISHED TO MATCH THE ADJACENT PAVEMENT.

3. A SCHEDULED CONSTRUCTION ENTRANCE/EXIT SHALL BE LOCATED AT ALL ACCESS POINTS TO THE CONSTRUCTION SITE. THESE ENTRANCES/EXITS SHALL BE FINISHED TO MATCH THE ADJACENT PAVEMENT.

4. A SCHEDULED CONSTRUCTION ENTRANCE/EXIT SHALL BE FINISHED TO MATCH THE ADJACENT PAVEMENT.

5. A SCHEDULED CONSTRUCTION ENTRANCE/EXIT SHALL BE FINISHED TO MATCH THE ADJACENT PAVEMENT.

6. A SCHEDULED CONSTRUCTION ENTRANCE/EXIT SHALL BE FINISHED TO MATCH THE ADJACENT PAVEMENT.

7. A SCHEDULED CONSTRUCTION ENTRANCE/EXIT SHALL BE FINISHED TO MATCH THE ADJACENT PAVEMENT.

8. A SCHEDULED CONSTRUCTION ENTRANCE/EXIT SHALL BE FINISHED TO MATCH THE ADJACENT PAVEMENT.

9. A SCHEDULED CONSTRUCTION ENTRANCE/EXIT SHALL BE FINISHED TO MATCH THE ADJACENT PAVEMENT.

10. A SCHEDULED CONSTRUCTION ENTRANCE/EXIT SHALL BE FINISHED TO MATCH THE ADJACENT PAVEMENT.

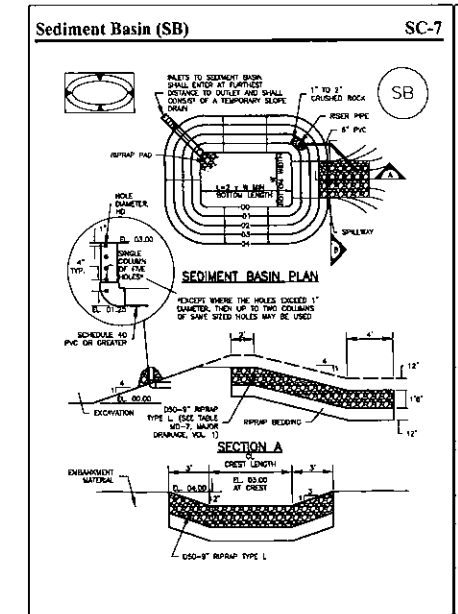

Sediment Basin (SB)

SC-7

1. SEE PLAN VIEW FOR LOCATION OF CONSTRUCTION ENTRANCE/EXIT POINTS.

2. CONSTRUCTION OF THE PAVEMENT CONSTRUCTION ENTRANCE AND EXIT TO BE MADE OF STONE OR CONCRETE. PAVEMENT SHALL BE 18" THICK AND SHALL BE FINISHED TO MATCH THE ADJACENT PAVEMENT.

3. A SCHEDULED CONSTRUCTION ENTRANCE/EXIT SHALL BE LOCATED AT ALL ACCESS POINTS TO THE CONSTRUCTION SITE. THESE ENTRANCES/EXITS SHALL BE FINISHED TO MATCH THE ADJACENT PAVEMENT.

4. A SCHEDULED CONSTRUCTION ENTRANCE/EXIT SHALL BE FINISHED TO MATCH THE ADJACENT PAVEMENT.

5. A SCHEDULED CONSTRUCTION ENTRANCE/EXIT SHALL BE FINISHED TO MATCH THE ADJACENT PAVEMENT.

6. A SCHEDULED CONSTRUCTION ENTRANCE/EXIT SHALL BE FINISHED TO MATCH THE ADJACENT PAVEMENT.

7. A SCHEDULED CONSTRUCTION ENTRANCE/EXIT SHALL BE FINISHED TO MATCH THE ADJACENT PAVEMENT.

8. A SCHEDULED CONSTRUCTION ENTRANCE/EXIT SHALL BE FINISHED TO MATCH THE ADJACENT PAVEMENT.

9. A SCHEDULED CONSTRUCTION ENTRANCE/EXIT SHALL BE FINISHED TO MATCH THE ADJACENT PAVEMENT.

10. A SCHEDULED CONSTRUCTION ENTRANCE/EXIT SHALL BE FINISHED TO MATCH THE ADJACENT PAVEMENT.

Schedule of Anticipated Construction Activity

ACTIVITY	START DATE	END DATE
PRECONSTRUCTION MEETING WITH COUNTY STAFF	07/28/17	07/28/17
INSTALL INITIAL BMP'S BY COUNTY STAFF	07/28/17	07/28/17
RECONSTRUCTION MEETING WITH COUNTY STAFF	07/28/17	07/28/17
ALL SITE GRADING AND UTILITY INSTALLATION	07/28/17	07/28/17
COMPLETION	07/28/17	07/28/17
EROSION CONTROL ALL SHOWN ON GRADING PLAN	07/28/17	07/28/17

EROSION CONTROL CRITERIA:

EROSION CONTROL MEASURES SHALL BE IMPLEMENTED IN A MANNER THAT WILL PROTECT PROPERTIES AND PUBLIC FACILITIES FROM THE ADVERSE EFFECTS OF EROSION AND SEDIMENTATION AS A RESULT OF CONSTRUCTION AND EARTHWORK ACTIVITIES WITHIN THE PROJECT SITE.

1. THE OMISSION FROM OR THE INCLUSION OF UTILITY LOCATIONS ON THE PLANS IS NOT TO BE CONSIDERED AS THE NON-EXISTENCE OF OR A DEFINITE LOCATION OF EXISTING UNDERGROUND UTILITIES.
2. DURING GRADING OPERATIONS, LOCATE AND SET THE STRAW BALE CHECK DAMS AND SILT FENCES AS SHOWN ON THE EROSION CONTROL PLAN. AT THIS TIME RESEED ALL DISTURBED AREAS WITH AN EL PASO COUNTY APPROVED SEED MIX.
3. SEEDING APPLICATION: DRILLED TO A DEPTH OF .25" TO .50" INTO SOIL WHERE POSSIBLE. BROADCAST AND RAKED TO COVER ON STEEPER THAN 3:1 SLOPES WHERE ACCESS IS LIMITED OR UNSAFE FOR EQUIPMENT.
4. MULCHING REQUIREMENT AND APPLICATION: 1.5 TONS PER ACRE NATIVE HAY MECHANICALLY CRIMPED INTO SOIL.
5. THE STRAW BALE CHECK DAMS AND SILT FENCES SHALL BE KEPT IN PLACE AND MAINTAINED UNTIL EROSION AND SEDIMENTATION POTENTIAL IS MITIGATED. REMOVAL OF SILT AND SEDIMENT COLLECTED BY THE STRAW BALES IS REQUIRED ONCE IT REACHES HALF THE HEIGHT OF THE STRAW BALES OR SILT FENCE.
6. DISTURBED SOIL SHALL BE VEGETATED WITHIN 60 DAYS AFTER SUBSTANTIAL FINAL GRADING OPERATIONS. COMPLETE PROTECTIVE TREATMENT TO DISTURBED AREAS THAT WILL HAVE A PERIOD OF EXPOSURE OF 6 MONTHS OR LONGER PRIOR TO FINAL STABILIZATION.
7. ALL FACILITIES, VEGETATION AND OTHER ITEMS REQUIRED BY THE APPROVED FINAL GRADING, EROSION CONTROL, AND RECLAMATION PLAN SHALL BE PROPERLY MAINTAINED BY THE OWNERS OF THE PROPERTY. SUCH MAINTENANCE SHALL INCLUDE, BUT NOT BE LIMITED TO KEEPING ALL EROSION CONTROL FACILITIES IN GOOD ORDER AND FUNCTIONAL, REPAIRING ANY EROSION DAMAGE THAT OCCURS, KEEPING ALL VEGETATION HEALTHY AND IN GROWING CONDITION AND REPLACING ANY DEAD VEGETATION AS SOON AS PRACTICABLE.
8. ALL SILT FENCES ARE TO BE REGULARLY INSPECTED AND REPAIRED AS NEEDED.
9. THE CONTRACTOR SHALL PROVIDE VEHICLE TRACKING CONTROL FACILITIES FOR EACH ENTRANCE/EXIT TO THE SITE. THE CONTRACTOR SHALL SUBMIT A PLAN WHICH WILL ASSURE USAGE OF THIS FACILITY BY ALL VEHICLES LEAVING THE SITE.
10. EROSION CONTROL MEASURES SHALL BE CHECKED AFTER EACH STORM EVENT AND REPAIRED WHEN NECESSARY.
11. CONTRACTOR SHALL MAINTAIN ALL TEMPORARY EROSION CONTROL FACILITIES IN GOOD WORKING ORDER UNTIL SUCH TIME AS PERMANENT FACILITIES ARE IN PLACE AND THE CONSTRUCTION MANAGER HAS APPROVED THEIR REMOVAL.
12. ADDITIONAL EROSION CONTROL STRUCTURES MAY BE REQUIRED AT THE TIME OF CONSTRUCTION.
13. THE EROSION CONTROL MEASURES OUTLINED ON THE PLAN ARE THE RESPONSIBILITY OF THE DEVELOPER TO MONITOR AND REPLACE, REGRADE AND REBUILD AS NECESSARY UNTIL VEGETATION IS ESTABLISHED.
14. MAXIMUM ACREAGE OPEN AT ANY GIVEN TIME IS TO BE 30 ACRES.

SEEDING GUIDELINES

1. **SEEDING PREPARATION**
THE SEEDING SHOULD BE WELL-SETTLED AND FIRM, BUT FRAGILE ENOUGH THAT THE SEED CAN BE PLACED AT THE SPECIFIED DEPTHS. COMPETITIVE STANDS OF WEEDS THAT ARE PRESENT BEFORE SEEDING MUST BE CONTROLLED BY WEEDING OR BY APPLICATION OF HERBICIDES. SOILS THAT HAVE BEEN OVER-COMPACTED BY TRAFFIC OR EQUIPMENT, ESPECIALLY WHEN WET, SHOULD BE BELLED TO BREAK UP ROUTING-RESTRICTIVE LAYERS, THAN HARROWED, ROLLED, OR PACKED TO PREPARE THE REQUIRED FIRM SEEDBED.

2. **FERTILIZER**
FERTILIZER SHOULD BE APPLIED AT A RATE OF 50 POUNDS OF AVAILABLE NITROGEN PER ACRE AND 40 POUNDS OF AVAILABLE PHOSPHATE PER ACRE. THE APPLICATION SHOULD BE IMMEDIATELY PRIOR TO SEEDING, AT THE TIME OF SEEDING, OR IMMEDIATELY PRIOR TO SEEDING, DEPENDING ON THE KIND OF FERTILIZER AND TYPE OF EQUIPMENT USED.

3. **SEEDING**
SEED SHOULD BE PLANTED WITH A GRASS DRILL ON ALL SLOPES OF 3:1 (3:1) OR FLATTER. SEED MAY BE BROADCAST BY HAND, BY MECHANICAL SPREADER, OR BY HYDRAULIC EQUIPMENT ON AREAS THAT ARE SMALL, TOO STEEP, OR NOT ACCESSIBLE FOR SEED DRILL OPERATIONS. SEED PLANTED WITH A DRILL SHOULD BE COVERED WITH SOIL TO A DEPTH OF 3/4 TO 1 1/4 INCH. SEED PLANTED BY BROADCAST METHOD SHOULD BE COVERED TO A DEPTH OF 3/4 INCH BY RAKING, HARROWING, OR OTHER PROVEN METHOD. THE TIME OF SEEDING IS FROM OCTOBER 15TH - MAY 31ST. SEED PLANTED IN THE LATE FALL WILL REMAIN DORMANT UNTIL SPRING, WHEN IT WILL GERMINATE.

4. **MULCHING**
SEEDING AREAS SHOULD BE MULCHED TO CONSERVE MOISTURE; PREVENT SURFACE COMPACTION ON CRUSTING; REDUCE WINDY AND EROSION; CONTROL INSECTS; AND HELP ESTABLISH PLANT COVER. NATIVE HAY OR STRAW SHOULD BE APPLIED AT A RATE OF 4,000 POUNDS PER ACRE AND CRIMPED INTO THE GROUND. ON SLOPES GREATER THAN 3:1, AN AGRONOMY GRAMMEX SHOULD BE USED.

5. **SUPPLEMENTAL WATER**
IN LOW RAINFALL AREAS, WHERE WATER IS AVAILABLE AND WHERE RAPID ESTABLISHMENT IS NEEDED, IRRIGATION OF NEW SEEDING SHOULD BE PERFORMED DURING THE FIRST GROWING SEASON. WATER SHOULD BE APPLIED AT APPROXIMATELY ONE WEEK INTERVALS, AT A RATE OF 3/4 TO 1 INCH PER APPLICATION, WHEN RAINFALL IS DEFICIENT FOR PLANT DEVELOPMENT.

RECOMMENDED EL PASO COUNTY GRASS SEED MIXES

GRASS MIX FOR QUICK VEGETATION - ALL SITES:	GRASS:	VARIETY:	P.L.S. lbs. per acre
CRESTED WHEAT GRASS	PERENNIAL RYE	EPHRAM OR HYOREST	4.0
		LINN	2.0
		BARTON	3.0
		LINCOLN OR MANCHAR	5.0
		EL RENO	2.5
			TOTAL: 16.5
GRASS MIX FOR HEAVY SOIL AREAS:	GRASS:	VARIETY:	P.L.S. lbs. per acre
CRESTED WHEAT GRASS	SLENDER WHEAT GRASS	EPHRAM	3.0
		SODAR	2.5
		BARTON	5.0
		LINCOLN OR MANCHAR	4.0
		EL RENO	3.0
			TOTAL: 17.5
GRASS MIX FOR SANDY SOILS:	GRASS:	VARIETY:	P.L.S. lbs. per acre
SIDEOATS GRAMA	WESTERN WHEATGRASS	EL RENO	3.0
		NATIVE	2.5
		PASTURA	2.0
		NATIVE	0.5
		NEBRASKA 28	3.0
WEeping LOVE GRASS	OPTIONAL: PERENNIAL RYE	MORPHIA	1.0
			2.0
			TOTAL: 14-16

(FROM NRCS MEMO DATED JUNE 19, 2001)

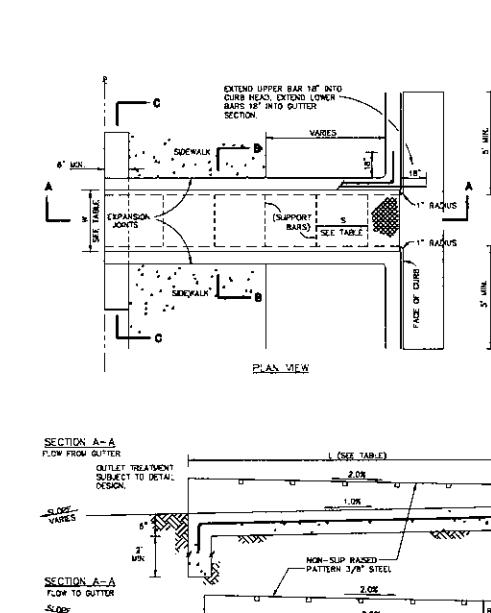

Silt Fence (SF)

SC-1

1. SEE PLAN VIEW FOR LOCATION OF CONSTRUCTION ENTRANCE/EXIT POINTS.

2. CONSTRUCTION OF THE PAVEMENT CONSTRUCTION ENTRANCE AND EXIT TO BE MADE OF STONE OR CONCRETE. PAVEMENT SHALL BE 18" THICK AND SHALL BE FINISHED TO MATCH THE ADJACENT PAVEMENT.

3. A SCHEDULED CONSTRUCTION ENTRANCE/EXIT SHALL BE LOCATED AT ALL ACCESS POINTS TO THE CONSTRUCTION SITE. THESE ENTRANCES/EXITS SHALL BE FINISHED TO MATCH THE ADJACENT PAVEMENT.

4. A SCHEDULED CONSTRUCTION ENTRANCE/EXIT SHALL BE FINISHED TO MATCH THE ADJACENT PAVEMENT.

5. A SCHEDULED CONSTRUCTION ENTRANCE/EXIT SHALL BE FINISHED TO MATCH THE ADJACENT PAVEMENT.

6. A SCHEDULED CONSTRUCTION ENTRANCE/EXIT SHALL BE FINISHED TO MATCH THE ADJACENT PAVEMENT.

7. A SCHEDULED CONSTRUCTION ENTRANCE/EXIT SHALL BE FINISHED TO MATCH THE ADJACENT PAVEMENT.

8. A SCHEDULED CONSTRUCTION ENTRANCE/EXIT SHALL BE FINISHED TO MATCH THE ADJACENT PAVEMENT.

9. A SCHEDULED CONSTRUCTION ENTRANCE/EXIT SHALL BE FINISHED TO MATCH THE ADJACENT PAVEMENT.

10. A SCHEDULED CONSTRUCTION ENTRANCE/EXIT SHALL BE FINISHED TO MATCH THE ADJACENT PAVEMENT.

Schedule of Anticipated Construction Activity

ACTIVITY	START DATE	END DATE
PRECONSTRUCTION MEETING WITH COUNTY STAFF	07/28/17	07/28/17
INSTALL INITIAL BMP'S BY COUNTY STAFF	07/28/17	07/28/17
RECONSTRUCTION MEETING WITH COUNTY STAFF	07/28/17	07/28/17
ALL SITE GRADING AND UTILITY INSTALLATION	07/28/17	07/28/17
COMPLETION	07/28/17	07/28/17
EROSION CONTROL ALL SHOWN ON GRADING PLAN	07/28/17	07/28/17

EL PASO COUNTY PROJECT NO. PPR-17-048

FALCON HIGH SCHOOL ADDITION
FALCON SCHOOL DISTRICT 49

CONSTRUCTION PLANS
DETAILS

DESIGNED BY: MAL SCALE: DATE: 07/28/17

DRAWN BY: MES (1" = 20' SHEET 4 OF 5

CHECKED BY: (V) 1" = N/A JOB NO. 2366.92

CLASSIC CONSULTING ENGINEERS & SURVEYORS

619 N. Cascade Avenue, Suite 200
Colorado Springs, Colorado 80903
(719)785-0750
(719)785-0759(Fax)

PREPARED UNDER MY DIRECT SUPERVISION FOR AND ON BEHALF OF CLASSIC CONSULTING ENGINEERS AND SURVEYORS, LLC

KYLE R. CAMPBELL, CO. GRADO P.E. #29794 GATE

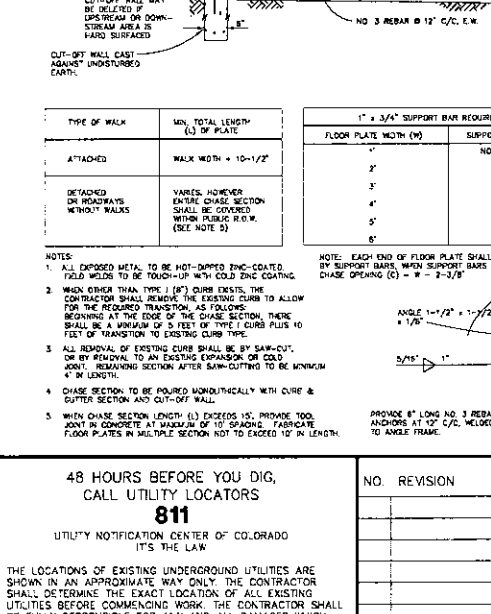

Silt Fence (SF)

SC-1

1. SEE PLAN VIEW FOR LOCATION OF CONSTRUCTION ENTRANCE/EXIT POINTS.

2. CONSTRUCTION OF THE PAVEMENT CONSTRUCTION ENTRANCE AND EXIT TO BE MADE OF STONE OR CONCRETE. PAVEMENT SHALL BE 18" THICK AND SHALL BE FINISHED TO MATCH THE ADJACENT PAVEMENT.

3. A SCHEDULED CONSTRUCTION ENTRANCE/EXIT SHALL BE LOCATED AT ALL ACCESS POINTS TO THE CONSTRUCTION SITE. THESE ENTRANCES/EXITS SHALL BE FINISHED TO MATCH THE ADJACENT PAVEMENT.

4. A SCHEDULED CONSTRUCTION ENTRANCE/EXIT SHALL BE FINISHED TO MATCH THE ADJACENT PAVEMENT.

5. A SCHEDULED CONSTRUCTION ENTRANCE/EXIT SHALL BE FINISHED TO MATCH THE ADJACENT PAVEMENT.

6. A SCHEDULED CONSTRUCTION ENTRANCE/EXIT SHALL BE FINISHED TO MATCH THE ADJACENT PAVEMENT.

7. A SCHEDULED CONSTRUCTION ENTRANCE/EXIT SHALL BE FINISHED TO MATCH THE ADJACENT PAVEMENT.

8. A SCHEDULED CONSTRUCTION ENTRANCE/EXIT SHALL BE FINISHED TO MATCH THE ADJACENT PAVEMENT.

9. A SCHEDULED CONSTRUCTION ENTRANCE/EXIT SHALL BE FINISHED TO MATCH THE ADJACENT PAVEMENT.

10. A SCHEDULED CONSTRUCTION ENTRANCE/EXIT SHALL BE FINISHED TO MATCH THE ADJACENT PAVEMENT.

Schedule of Anticipated Construction Activity

ACTIVITY	START DATE	END DATE
PRECONSTRUCTION MEETING WITH COUNTY STAFF	07/28/17	07/28/17
INSTALL INITIAL BMP'S BY COUNTY STAFF	07/28/17	07/28/17
RECONSTRUCTION MEETING WITH COUNTY STAFF	07/28/17	07/28/17
ALL SITE GRADING AND UTILITY INSTALLATION	07/28/17	07/28/17
COMPLETION	07/28/17	07/28/17
EROSION CONTROL ALL SHOWN ON GRADING PLAN	07/28/17	07/28/17

EL PASO COUNTY PROJECT NO. PPR-17-048

FALCON HIGH SCHOOL ADDITION
FALCON SCHOOL DISTRICT 49

CONSTRUCTION PLANS
DETAILS

DESIGNED BY: MAL SCALE: DATE: 07/28/17

DRAWN BY: MES (1" = 20' SHEET 4 OF 5

CHECKED BY: (V) 1" = N/A JOB NO. 2366.92

CLASSIC CONSULTING ENGINEERS & SURVEYORS

619 N. Cascade Avenue, Suite 200
Colorado Springs, Colorado 80903
(719)785-0750
(719)785-0759(Fax)

PREPARED UNDER MY DIRECT SUPERVISION FOR AND ON BEHALF OF CLASSIC CONSULTING ENGINEERS AND SURVEYORS, LLC

KYLE R. CAMPBELL, CO. GRADO P.E. #29794 GATE

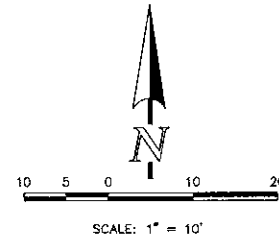
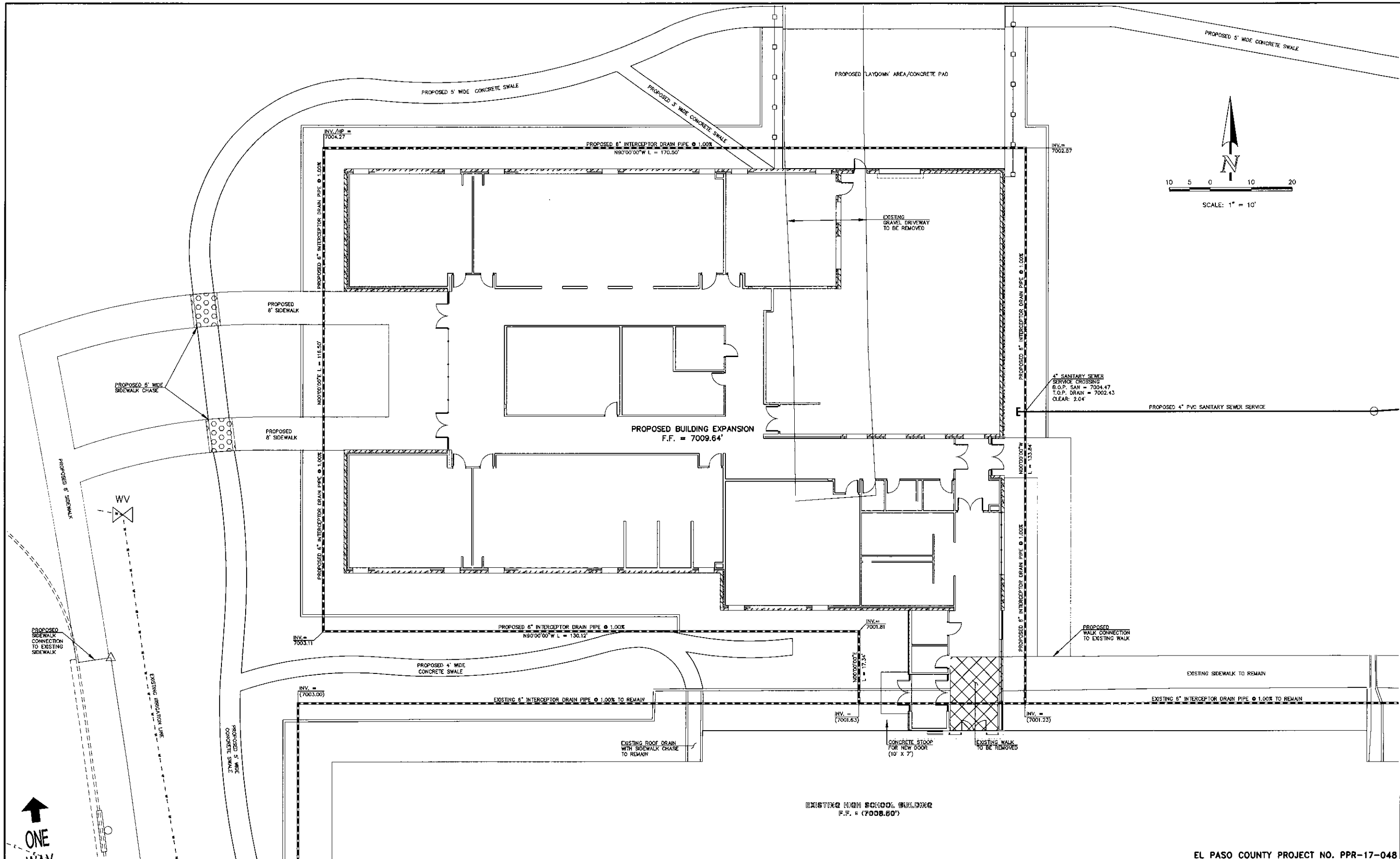

↑
ONE

LEGEND	
	PROPOSED FIRE HYDRANT
	PROPOSED WATER MAIN
	PROPOSED SANITARY SEWER SERVICE
	PROPOSED STORM SEWER
	PROPOSED STORM INLET
	ROW/BOUNDARY LINE
	EXISTING FIRE HYDRANT
	EXISTING WATER MAIN
	EXISTING SANITARY SEWER MAIN
	EXISTING STORM SEWER
	EXISTING STORM INLET
	EXISTING GAS MAIN
	EXISTING ELECTRIC

48 HOURS BEFORE YOU DIG,
CALL UTILITY LOCATORS
811
UTILITY NOTIFICATION CENTER OF COLORADO
ITS THE LAW

THE LOCATIONS OF EXISTING UNDERGROUND UTILITIES ARE SHOWN IN AN APPROPRIATE WAY ONLY. THE CONTRACTOR SHALL DETERMINE THE EXACT LOCATION OF ALL EXISTING UTILITIES BEFORE COMMENCING WORK. THE CONTRACTOR SHALL BE FULLY RESPONSIBLE FOR ANY AND ALL DAMAGES WHICH MIGHT BE CAUSED BY HIS FAILURE TO EXACTLY LOCATE AND PRESERVE ANY AND ALL UNDERGROUND UTILITIES.

NO. REVISION	DATE

REVIEW:

PREPARED UNDER MY DIRECT SUPERVISION FOR AND ON BEHALF OF CLASSIC CONSULTING ENGINEERS AND SURVEYORS, LLC

KYLE R. CAMPBELL, COLORADO P.E. #29784 DATE

618 N. Cascade Avenue, Suite 200
Colorado Springs, Colorado 80903
(719)785-0790
(719)785-0799(fax)

EL PASO COUNTY PROJECT NO. PPR-17-048			
FALCON HIGH SCHOOL ADDITION FALCON SCHOOL DISTRICT 49			
CONSTRUCTION PLANS INTERCEPTOR DRAIN PLAN			
DESIGNED BY	MAL	SCALE	DATE 07/28/17
DRAWN BY	MES	(H) 1" = 10'	SHEET 5 OF 5
CHECKED BY	(V) 1" = N/A	JOB NO.	2366.92