



Final Drainage Report

UDON South El Paso County, Colorado

PCD File No.: PPR2422

Prepared for:
UDON Holdings, LLC
12265 Highway 94
Colorado Springs, Colorado 80929

Prepared by:
Kimley-Horn and Associates, Inc.
2 North Nevada Ave
Suite 900
Colorado Springs, CO 80903
(719) 435-0182
Contact: Kevin Kofford, P.E.

Project #: 196020003

Prepared: August 28, 2024

Kimley»»Horn



Table of Contents

| | |
|---|-----------|
| CERTIFICATION | 3 |
| ENGINEERS STATEMENT | 3 |
| DEVELOPER’S STATEMENT | 3 |
| EL PASO COUNTY STATEMENT | 3 |
| GENERAL LOCATION AND DESCRIPTION | 4 |
| PURPOSE AND SCOPE OF STUDY | 4 |
| LOCATION | 4 |
| VICINITY MAP | 4 |
| DESCRIPTION OF PROPERTY | 4 |
| SOILS DATA | 5 |
| PROJECT CHARACTERISTICS | 5 |
| DRAINAGE DESIGN CRITERIA | 5 |
| DEVELOPMENT CRITERIA REFERENCE | 5 |
| HYDROLOGIC CRITERIA | 5 |
| HYDRAULIC CRITERIA | 6 |
| VARIANCES FROM CRITERIA | 6 |
| DRAINAGE BASINS AND SUB-BASINS | 6 |
| MAJOR BASIN DESCRIPTIONS | 6 |
| FLOODPLAIN STATEMENT | 6 |
| EXISTING DRAINAGE CONDITIONS | 6 |
| <i>Sub-Basin E1</i> | 7 |
| <i>Sub-Basin E2</i> | 7 |
| <i>Sub-Basin E3</i> | 7 |
| <i>Sub-Basin OE1</i> | 7 |
| <i>Sub-Basin OE2</i> | 7 |
| <i>Sub-Basin OE3</i> | 8 |
| PROPOSED DRAINAGE CONDITIONS | 8 |
| <i>Sub-Basin P1</i> | 8 |
| <i>Sub-Basin P2</i> | 8 |
| <i>Sub-Basin P3</i> | 9 |
| <i>Sub-Basin OP1</i> | 9 |
| <i>Sub-Basin OP2</i> | 9 |
| <i>Sub-Basin OP3</i> | 9 |
| DRAINAGE FACILITY DESIGN | 9 |
| DETENTION AND WATER QUALITY | 9 |
| <i>Four-Step Process</i> | 10 |
| <i>Water Quality Design</i> | 11 |
| <i>Outlet Requirements</i> | 12 |
| <i>Emergency Spillway Path</i> | 12 |
| DRAINAGE AND BRIDGE FEES | 12 |

GRADING AND EROSION CONTROL.....12

MAINTENANCE, OPERATIONS, & COST12

OTHER GOVERNMENT AGENCY REQUIREMENTS13

SUMMARY13

Compliance With Standards13

REFERENCES13

APPENDIX15

CERTIFICATION

ENGINEERS STATEMENT

The attached drainage plan and report were prepared under my direction and supervision and are correct to the best of my knowledge and belief. Said drainage report has been prepared according to the criteria established by El Paso County, Colorado for drainage reports and said report is in conformity with the master plan of the drainage basin. I accept responsibility for any liability caused by any negligent acts, errors, or omissions on my part in preparing this report.

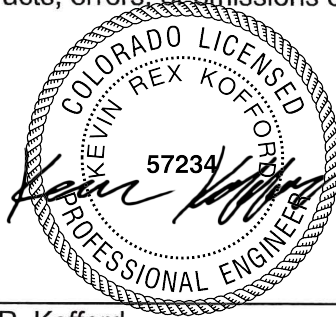

SIGNATURE (Affix Seal): _____ 8/29/2024
Date
Kevin R. Kofford
Colorado P.E. No. 57234

DEVELOPER'S STATEMENT

I, the developer, have read and will comply with all of the requirements specified in this drainage report and plan.

UDON Holdings LLC
Business Name

Ben Wilber
By:

MANAGING MEMBER
Title:

12265 Hwy 94 80929
Address:

EL PASO COUNTY STATEMENT

Filed in accordance with the requirements of the Drainage Criteria Manual, Volumes 1 and 2, El Paso County Engineering Criteria Manual and Land Development Code, as amended.

_____ 1/8/2025
Date
Joshua Palmer, P.E.
County Engineer/ECM Administrator

Conditions:

GENERAL LOCATION AND DESCRIPTION

PURPOSE AND SCOPE OF STUDY

The purpose of this Final Drainage Report (FDR) is to provide the hydrologic and hydraulic calculations in addition to documenting and finalizing the drainage design methodology in support of the proposed UDON South development (“the Project”) for UDON Holdings, LLC. The Project is located within the jurisdictional limits of El Paso County (“the County”). Thus, the guidelines for the hydrologic and hydraulic design components were based on the criteria outlined by the County.

LOCATION

The Project is located at 12265 Highway 94 approximately west southwest of the intersection of N. Franceville Coal Mine Rd. and Colorado Highway 94 in El Paso County, Colorado. More specifically, the Project is within the northeast quarter of the northwest quarter of Section 18, Township 14 South, Range 64 West of the 6th Principal Meridian in El Paso County, Colorado. A vicinity map has been provided below.

VICINITY MAP

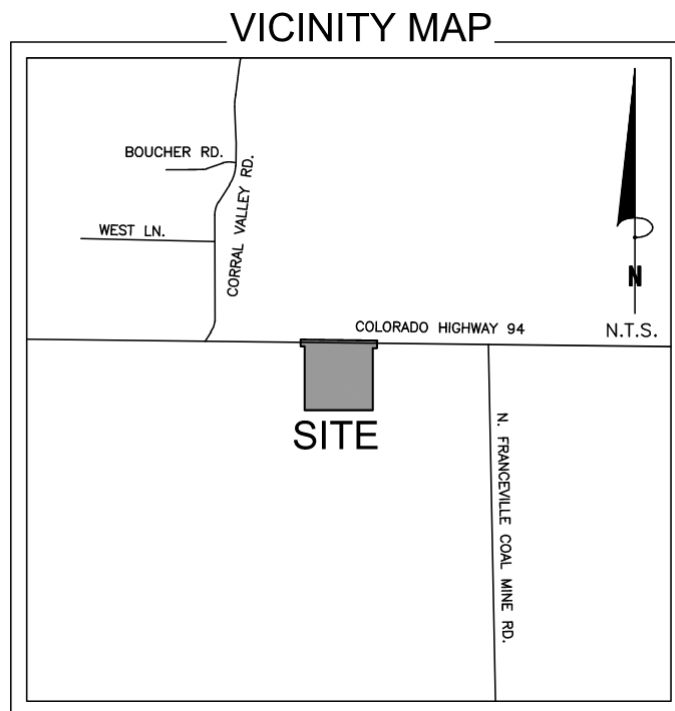

DESCRIPTION OF PROPERTY

The Project is located on approximately ±34.71 ac (Parcel # 4400000237). The entire property consists of partially developed raw land with several existing building structures and associated utilities. The property has private, gravel driveways and most of the property is undeveloped meadow land consisting of natural grasses, shrubs, and other vegetation. The proposed Project consists of RV storage and parking areas with associated driveways, internal roads, sidewalk, stormwater quality and full spectrum extended detention basin, and associated drainage culverts. Currently, the site does not provide stormwater quality or detention. The site generally drains from the north to the south with slopes ranging from 2% to 12%, with the steeper slopes

running through the middle of the site within an existing natural drainage channel. Runoff generally flows throughout the Site as sheet flow and is essentially channelized into a naturally vegetated existing drainage swale within the Project site. The Project is ultimately tributary to Jimmy Camp Creek approximately 1.5 miles to the west. The Project it is not located in any floodplain buffers or floodplains. See the **Appendix** for the floodplain maps.

SOILS DATA

NRCS soil data for the Site is provided in the **Appendix** and most of the onsite soils are generally USCS Hydrologic Soil Group D. Group D soils have high runoff potential when thoroughly wet. Water movement through the soil is restricted or very restricted. Group D soils typically have greater than 40 percent clay, less than 50 percent sand, and have clayey textures. In some areas, they also have high shrink-swell potential.

PROJECT CHARACTERISTICS

The Project limits of disturbance are approximately ± 17.55 ac with a total drainage study area of approximately ± 50.72 ac. The proposed commercial development consists of RV storage and parking areas with associated driveways, internal roads, sidewalk, stormwater quality and full spectrum extended detention basin, and associated drainage culverts. Water quality and detention for the site will be provided by a proposed stormwater full spectrum extended detention basin located at the south property line that will accept flows from the majority of the site. Developed flows within the site will be collected by means of sheet flow and culverts before being captured into the proposed water quality facility. Flows are planned to outfall to the south into the existing drainage swale that runs generally to the southeast and ultimately into Jimmy Camp Creek.

DRAINAGE DESIGN CRITERIA

DEVELOPMENT CRITERIA REFERENCE

The proposed stormwater facilities follow the El Paso County Drainage Criteria Manual (the “CRITERIA”), El Paso Engineering Criteria Manual (the “ECM”), and the Mile High Flood District Urban Storm Drainage Criteria Manual (the “MANUAL”). Further detail regarding proposed onsite drainage patterns is provided in the Proposed Drainage Conditions Section.

HYDROLOGIC CRITERIA

The 5-year and 100-year design storm events were used in determining rainfall and runoff for the proposed drainage system per chapter 6 of the CRITERIA. Table 6-2 of the CRITERIA is the source for rainfall data for the 5-year and 100-year design storm events. Design runoff was calculated using the Rational Method for developed conditions as established in the CRITERIA and MANUAL. Runoff coefficients for the proposed development were determined using Table 6-6 of the CRITERIA by calculating weighted impervious values for each specific site basin. The full spectrum detention sizing was calculated using methods as specified in the CRITERIA and MANUAL. The full spectrum detention orifice structure was designed to release the Water Quality Capture Volume (WQCV) in 40 hours. Based upon this approach, the drainage design provided for the Site is in keeping with the historic drainage patterns for the Site.

HYDRAULIC CRITERIA

The proposed drainage facilities are designed in accordance with the CRITERIA and MANUAL. Floodplain identification was determined using FIRM panels by FEMA and information provided in the CRITERIA. Hydraulic calculations were computed using Flow master, and Storm CAD using the Standard Method. Results of the hydraulic calculations are summarized in the **Appendix**.

VARIANCES FROM CRITERIA

There are no proposed variances from the El Paso County Drainage Criteria.

DRAINAGE BASINS AND SUB-BASINS

MAJOR BASIN DESCRIPTIONS

The Property is located in the Jimmy Camp Creek drainage basin and is tributary to Jimmy Camp Creek. The Drainage Basin Planning Study for the Jimmy Camp Creek drainage basin was prepared March 9th, 2015, by Kiowa Engineering Corporation. See Drainage Basin Planning Study in the **Appendix**. There are no proposed creek improvements within the Project limits. Due to the proposed stormwater water quality full spectrum extended detention basin and distance from Jimmy Camp Creek, the project is not anticipated to adversely affect downstream conditions. There are no identified nearby irrigation facilities or other obstructions which could influence the local drainage.

Currently, there is not an approved drainage report for the Property. All drainage design will comply with the existing Drainage Basin Planning Study for the Jimmy Camp Creek drainage basin.

FLOODPLAIN STATEMENT

The Project Site is located outside the 100-year floodplain and within Zone X (an area of minimal flood hazard) as noted on the FEMA FIRM Map No. 08041C0780G revised on December 7, 2018 (See **Appendix**).

EXISTING DRAINAGE CONDITIONS

The existing Site has been divided into (3) three on-site (E1-E3) and (3) three off-site (OE1-OE3) sub-basins. A description of each sub-basin is listed below. In existing conditions, the total studied drainage area of the site is ±50.72 ac. Flows from stormwater runoff generally travel overland to channelized into an existing depressional swale from northwest to southeast at slopes of 2% to 12%. Runoff flows then travel generally southeast via overland flow and the existing depressional natural vegetated swale that ultimately discharges into Jimmy Camp Creek. Calculations of the existing sub-basins on the Project Site have been completed using current stormwater criteria. An Existing Conditions Drainage Map is provided in the **Appendix** of this report. The weighted imperviousness of the drainage area in existing conditions is 4.2%. Total flows generated in existing conditions are 30.93 cfs for the 5-year event and 153.01 cfs for the 100-year event.

Sub-Basin E1

Sub-basin E1 is 24.05 acres and consists of the generally central portion of the Site. This sub-basin consists of existing native grasses and vegetation, a few dirt roads with parking, and small building structures. The runoff developed within this basin sheet flows overland and generally channelized via an existing natural swale from northwest to southeast at slopes that range approximately 5% to 8%. From design point E1, flows then continue to travel southeastward via the existing depressional swale. The weighted imperviousness of sub-basin E1 is 2.0%. The developed direct runoff from sub-basin E1 is 12.65 cfs for the 5-year event and 66.21 cfs for the 100-year event. Sub-basin E1 also takes on off-site flows from sub-basins OE1, OE2, and OE3. The total flows exiting the site at design point TE1 is 24.11 cfs for the 5-year event and 119.25 cfs for the 100-year event.

Sub-Basin E2

Sub-basin E2 is 2.45 acres and consists of the northeast portion of the Site. This sub-basin consists of existing native grasses and vegetation, and dirt road. The runoff developed within this basin sheet flows overland from southwest to northeast at slopes that range approximately 6% to 7%. From design point E2, flows then continue to travel eastward towards an existing tributary of Jimmy Camp Creek along Colorado State Highway 94. The weighted imperviousness of sub-basin E2 is 6.8%. The developed direct runoff from sub-basin E1 is 1.82 cfs for the 5-year event and 8.31 cfs for the 100-year event.

Sub-Basin E3

Sub-basin E3 is 8.21 acres and consists of the southeast portion of the Site. This sub-basin consists of existing native grasses and vegetation, dirt road, and a building structure. The runoff developed within this basin sheet flows overland from northwest to southeast at slopes that range approximately 5% to 12%. From design point E3, flows then continue to travel southeastward towards an existing tributary of Jimmy Camp Creek. The weighted imperviousness of sub-basin E3 is 3.0%. The developed direct runoff from sub-basin E1 is 5.01 cfs for the 5-year event and 25.45 cfs for the 100-year event.

Sub-Basin OE1

Sub-basin OE1 is 5.60 acres and consists of the off-site portion northwest of the site. This sub-basin consists of an existing gravel road, asphalt, and native grasses. The runoff developed within this basin sheet flows overland from northwest to southeast at approximately 5% to 8% slopes. Flows then convene at design point OE1 where they travel through an existing 24" CMP culvert under Colorado State Highway 94 and enter existing sub-basin E1. The weighted imperviousness of sub-basin OE1 is 7.9%. The developed direct runoff from sub-basin OE1 is 4.02 cfs for the 5-year event and 17.67 cfs for the 100-year event.

Sub-Basin OE2

Sub-basin OE2 is 5.78 acres and consists of the off-site portion west of the site. This sub-basin consists of existing native grasses, and vegetation. The runoff developed within this basin sheet flows overland from northwest to southeast at approximately 5% to 12% slopes. Flows then travel on-site into existing sub-basin E1 at design point OE2. The weighted imperviousness of sub-basin OP2 is 8.5%. The developed direct runoff from sub-basin OP2 is 4.84 cfs for the 5-year event and 20.88 cfs for the 100-year event.

Sub-Basin OE3

Sub-basin OE3 is 4.65 acres and consists of the off-site portion southwest of the site. This sub-basin consists of existing native grasses, and vegetation. The runoff developed within this basin sheet flows overland from west to east at approximately 5% to 8% slopes. Flows then travel on-site into existing sub-basin E1 at design point OE3. The weighted imperviousness of sub-basin OE3 is 0%. The developed direct runoff from sub-basin OE3 is 2.60 cfs for the 5-year event and 14.54 cfs for the 100-year event.

PROPOSED DRAINAGE CONDITIONS

The proposed Site has been divided into (3) three on-site sub-basins, P1-P3, and (3) three off-site sub-basins, OP1-OP3. A description of each sub-basin is listed below. The project involves the construction of RV storage and parking areas with associated driveways, internal roads, sidewalk, landscaping, stormwater quality, full spectrum extended detention basin, and associated drainage infrastructure. The total disturbed area of the site is approximately ± 17.55 acres. Generally, stormwater runoff flows generated from most the drainage area's proposed conditions are to be conveyed via overland sheet flow towards an existing naturally vegetated drainage swale. These flows will then continue to the proposed full spectrum extended detention basin. Flows are released from this proposed full spectrum extended detention basin feature via outlet pipe with orifice plate into the existing shallow natural drainage channel that runs generally southeast over natural meadowlands that ultimately discharges into Jimmy Camp Creek. Flows generated from the proposed conditions will generally follow historic patterns. Under proposed conditions the studied drainage area associated with this project is ± 50.72 acres with a 20.2% weighted imperviousness and 5 and 100-yr flows of 50.25 cfs and 174.75 cfs respectively. A proposed conditions drainage map can be found in the **Appendix**.

Sub-Basin P1

Sub-basin P1 is 23.90 acres and consists of the western half of the Site. This sub-basin consists of proposed gravel parking area, sidewalk, ADA parking stalls, existing building structures, extended detention basin, drainage infrastructure and native grasses. The runoff developed within this basin sheet flows overland from northwest to southeast converging into the existing drainage swale at approximately 3% to 8% slopes. Flows then travel to the proposed stormwater full spectrum extended detention basin via a proposed riprap rock chute. Flows will then continue through the pond via a proposed 4 feet concrete trickle channel and exit through the proposed pond micropool and control structure with orifice plate. Flows will then exit through outlet pipe and emergency spillway in storm events exceeding the 100-year. Flows then travel into the existing drainage swale and ultimately discharge into Jimmy Camp Creek. The weighted imperviousness of sub-basin P1 is 36.4%. The developed direct runoff from sub-basin P1 is 31.41 cfs for the 5-year event and 87.16 cfs for the 100-year event. Sub-basin P1 also takes on off-site flows from sub-basins OP1, OP2, and a part of OP3. Therefore, the total proposed flows at design point P1 is 32.25 cfs for the 5-year event and 105.35 cfs for the 100-year event. The total proposed flows leaving the site at design point TP1 from the pond outfall pipe is 13.4 cfs for the 5-year event and 59.2 cfs for the 100-year event. Flows from sub-basin P1 will generally follow historic drainage patterns.

Sub-Basin P2

Sub-basin P2 is 2.58 acres and consists of the northeastern portion of the Site. This sub-basin consists of proposed gravel roads, and native grasses. The runoff developed within this basin sheet flows overland from west to east at approximately 5% to 8% slopes. Flows then exit the Site at design point P2. Flows will then continue to travel westward adjacent to Colorado State

Highway 94 into the existing tributary that ultimately converges with Jimmy Camp Creek. The weighted imperviousness of sub-basin P2 is 13.3%. The developed direct runoff from sub-basin P2 is 2.24 cfs for the 5-year event and 8.83 cfs for the 100-year event. Flows from sub-basin P2 will generally follow historic drainage patterns.

Sub-Basin P3

Sub-basin P3 is 8.21 acres and consists of the southeastern portion of the Site. This sub-basin consists of existing building structures, existing dirt and gravel roads and native grasses. The runoff developed within this basin sheet flows overland from northwest to southeast at approximately 5% to 12% slopes. Flows then exit the Site at design point P3. Flows will then continue to travel southeastward and eventually southwest into Jimmy Camp Creek. The weighted imperviousness of sub-basin P3 is 3.0%. The developed direct runoff from sub-basin P3 is 5.01 cfs for the 5-year event and 25.45 cfs for the 100-year event. Flows from sub-basin P3 will generally follow historic drainage patterns.

Sub-Basin OP1

Sub-basin OP1 is 5.60 acres and consists of the off-site portion northwest of the site. This sub-basin consists of an existing gravel road, asphalt, and native grasses. The runoff developed within this basin sheet flows overland from northwest to southeast at approximately 5% to 8% slopes. Flows then convene at design point OP1 where they travel through an existing 24" CMP culvert under Colorado State Highway 94 and enter proposed sub-basin P1. The weighted imperviousness of sub-basin P4 is 7.9%. The developed direct runoff from sub-basin OP1 is 4.02 cfs for the 5-year event and 17.67 cfs for the 100-year event. Flows from off-site sub-basin OP1 will follow historic drainage patterns.

Sub-Basin OP2

Sub-basin OP2 is 5.78 acres and consists of the off-site portion west of the site. This sub-basin consists of existing native grasses, and vegetation. The runoff developed within this basin sheet flows overland from northwest to southeast at approximately 5% to 12% slopes. Flows then travel on-site into proposed sub-basin P1 at design point OP2. The weighted imperviousness of sub-basin OP2 is 9.2%. The developed direct runoff from sub-basin OP2 is 4.97 cfs for the 5-year event and 21.11 cfs for the 100-year event. Flows from off-site sub-basin OP2 will follow historic drainage patterns.

Sub-Basin OP3

Sub-basin OP3 is 4.65 acres and consists of the off-site portion southwest of the site. This sub-basin consists of existing native grasses, and vegetation. The runoff developed within this basin sheet flows overland from west to east at approximately 5% to 8% slopes. Flows then travel on-site into proposed sub-basin P1 at design point OP3. The weighted imperviousness of sub-basin OP3 is 0%. The developed direct runoff from sub-basin OP3 is 2.60 cfs for the 5-year event and 14.54 cfs for the 100-year event. Flows from off-site sub-basin OP3 will follow historic drainage patterns.

DRAINAGE FACILITY DESIGN

DETENTION AND WATER QUALITY

The WQCV is required for this Project. This is accomplished through the proposed private above ground full spectrum extended detention basin A located along the southern property line

of the Site. The pond is to be privately maintained by UDON Holdings, LLC. The full spectrum detention basin will also provide attenuation for the 100 Year Storm event.

The proposed full spectrum detention basin is sized to accommodate flows from sub-basins OP1, OP2, OP3, and P1. There is an existing high point or ridge that runs from north to south which separates the eastern half of the site or sub-basins P2 and P3 which will generally follow historic drainage patterns seen in existing conditions.

Overall, site imperviousness moderately increases from 3.6% to 20.2% with flows increasing from 153.01 cfs to 174.75 cfs in the 100-year storm event. The slight increase in flows generated for the Site are controlled with the proposed stormwater full spectrum extended detention basin which reduces the 152.96 cfs in the existing condition to a release of 59.2 cfs, from the proposed detention pond. The proposed pond intends to mitigate the potential for flooding and negative water quality impacts to downstream waterways. The downstream grassy meadow appears stable and healthy with gradual longitudinal and side slopes of approximately 1-2%. In addition, as Jimmy Camp Creek is approximately 1.5 miles to the west from the proposed site.

Four-Step Process

The four-step process per the MANUAL provides guidance and requirements for the selection of siting of structural Construction Control Measures (CCMs) for new development and significant redevelopment.

Step 1: Employ Runoff Reduction Practices

Currently the site is mostly vacant land with some minor development. Additional development of the site will increase current runoff conditions due to increased imperviousness values. However, implementation of gravel instead of pavement throughout the site, utilization of existing and proposed vegetation, and the proposed stormwater full spectrum extended detention basin will help slow runoff and encourage infiltration.

Step 2: Provide Water Quality Capture Volume (WQCV)

The water quality capture volume will be detained using the full spectrum extended detention basin A on the south end of the Site. The outfall from the water quality outlet structure will control the release of the WQCV stormwater to less than historic rates. Due to grading constraints, a portion of the disturbed area cannot be captured and treated in the proposed full spectrum extended detention basin. Per ECM Appendix I Section 1.7.C.1.a., 20% of the development site or less than 1 acre can be excluded from providing water quality. Water quality treatment is being provided for ±17.55 acres which is 98.2% of the total non-exempt disturbed area.

The following table outlines the non-exempt areas receiving water quality treatment, and the disturbed areas flowing offsite that do not receive water quality treatment.

| Condition | Total Area (AC) | Percentage of Total Non-Exempt Disturbed Area (%) | Sub-Basins |
|---|-----------------|---|-------------------|
| Areas Captured and Treated with Proposed Private Full Spectrum Extended Basin | 17.55 | 98.2% | P1, OP1, OP2, OP3 |
| Disturbed Areas That Flow Offsite (No Treatment) | 0.32 | 1.8% | P2 |

Step 3: Stabilize Drainageways

The existing on-site drainageway will be utilized to convey all developed flows to the full spectrum extended detention basin. An analysis using FlowMaster indicated that at a typical section within the existing channel would convey flows at approximately 3.31 feet per second (FPS). Per table 8-1, Chapter 8, Urban Storm Drainage Criteria Manual Volume 1, the maximum allowable flow velocity for natural channels with cohesive soils and vegetation is 7 feet per second (FPS). Therefore, no additional stabilization is anticipated for this existing natural drainage channel. The full analysis and typical section can be found in the appendix.

Additionally, the project will add riprap protection by adding a low tailwater basin at the outfall of the proposed full spectrum detention basin. The low tailwater basin, acts as a riprap stilling basin with a 1.5-foot depression that functions like a level spreader before flows leave the property. This will help mitigate potential future erosion and scour. Additionally, a cross section of the downstream channel, just to the south of the property line was analyzed. The results for velocity downstream, was 3.31 feet per second (FPS), which is below the recommended 7 feet per second (FPS) as discussed previously.

There are no current drainageways conveyed adjacent to the Site. The proposed Site is approximately 1.5 miles from Jimmy Camp Creek. In the proposed conditions the majority of all flows from Site will reach its ultimate outfall on the property within the proposed stormwater facility. No adjacent properties will be negatively impacted with the proposed improvements. No improvements to stabilize drainageways are proposed as part of this Project at this time.

Step 4: Consider need for Industrial and Commercial BMPs

Erosion control features for the final stages of the Project will be designed to reduce contamination. Source control BMPs will include the use of silt fences, concrete washout areas, stockpile management, and stabilized staging areas. The Grading and Erosion Control Plans will be submitted as a separate construction document set.

Water Quality Design

The proposed private full spectrum extended basin is designed with an outlet structure that is fitted with a restrictor plate to release the WQCV in a 40-hour time period per the MANUAL. Calculations included in the **Appendix** provide details regarding the private water quality design. Overall, based on 40-hour drain time 0.719 ac-ft of WQCV is required. The total area contributing to the full spectrum extended basin is 50.72 acres (20.2% imperviousness).

Outlet Requirements

The water quality standards established by the CRITERIA are met by the proposed full spectrum extended basin. The water quality outlet structure was designed per the specifications in the CRITERIA. The orifice plate will allow the WQCV to be drained in 40 hours. A micropool and modified CDOT Type C control structure will slow incoming flows from the riprap rock chute and trickle channel. A system of vertical orifices will slowly control the release rates into the control structure that will outfall into the 36" pipe. Flows then make their way to a low tailwater riprap basin which is intended to further slow and control the release rate. After the stilling basin flows then slowly travel into the naturally vegetated existing swale towards Jimmy Camp Creek.

MHFD UD-Detention v4.06 was utilized for demonstrating volume provided and to determine WQCV WSE for the design of the outlet structure. Please refer to full spectrum extended basin construction details and UD-BMP spreadsheet provided in **Appendix** for full spectrum extended basin outlet structure design and details.

Emergency Spillway Path

The emergency overflow from the full spectrum extended basin is designed to spill over the top of the full spectrum extended basin and flow south into the existing natural shallow channel located in the meadow south of the site. The 25 ft spillway is designed to accommodate the 100-year storm event flows of 59.2 cfs with an additional 1 ft of freeboard. Riprap is proposed along the entire length of the spillway and down to the toe of slope to match existing grades at the bottom. The emergency overflow spillway path can be found on the Proposed Drainage Map.

DRAINAGE AND BRIDGE FEES

The Site is located in the Jimmy Camp Creek Drainage Basin. The site is not currently planned to be platted and as such there are no required drainage and bridge fees.

GRADING AND EROSION CONTROL

The GEC will be submitted in conjunction with this report to El Paso County Planning and Community Development Department for review and approval prior to construction. The GEC plans are consistent with this drainage report.

MAINTENANCE, OPERATIONS, & COST

Twice per year inspections (spring and fall) of the water quality structure is recommended. The owner/operator will be responsible for maintenance. A copy of this report will be provided to the owner/operator. This satisfies the Operation and Maintenance (O&M) Manual.

The estimated opinion of probable cost for the pond infrastructure is depicted below. The overall total includes the cost of riprap for the forebay, trickle channel, micropool, outlet structure, 36" pipe and FES, toe wall, riprap for the outfall pipe, riprap for emergency spillway, cut off wall, and maintenance road. The total cost is estimated at \$112,806.00.

| UDON South - Full Spectrum Extended Detention Basin A | | | | |
|---|------|----------|--------------|---------------|
| Item | Unit | Quantity | Unit Cost | Cost |
| Rip Rap Rock Chute / Forebay | CY | 117 | \$ 210.00 | \$ 24,570.00 |
| Concrete Trickle Channel | LF | 250 | \$ 64.00 | \$ 16,000.00 |
| Concrete Micropool | EA | 1 | \$ 10,000.00 | \$ 10,000.00 |
| Concrete Outlet Structure | EA | 1 | \$ 5,200.00 | \$ 5,200.00 |
| 36" RCP Outfall Pipe | LF | 50 | \$ 151.00 | \$ 7,550.00 |
| 36" RCP FES | EA | 1 | \$ 906.00 | \$ 906.00 |
| Toe Wall (FES) | EA | 1 | \$ 2,000.00 | \$ 2,000.00 |
| Outfall Riprap Protection | CY | 27 | \$ 210.00 | \$ 5,670.00 |
| Rip Rap Emergency Spillway | CY | 147 | \$ 210.00 | \$ 30,870.00 |
| Concrete Cut Off Wall (Spillway) | EA | 1 | \$ 5,000.00 | \$ 5,000.00 |
| Maintenance Road (6" Thick) | CY | 90 | \$ 56.00 | \$ 5,040.00 |
| Total | | | | \$ 112,806.00 |

OTHER GOVERNMENT AGENCY REQUIREMENTS

Approval from other agencies such as the FEMA, the Army Corps of Engineers, Colorado State Engineer, Colorado Water Conservation Board, and others are not required with this Project.

SUMMARY

Overall, site imperviousness moderately increases from 3.6% to 20.2% with flows increasing from 153.01 cfs to 174.75 cfs in the 100-year storm event. In the proposed conditions there is a slight increase to total runoff flows generated from the proposed development. The slight increase in flows generated for the Site are controlled with the proposed stormwater full spectrum extended detention basin that release at less than historic rates. The proposed pond intends to mitigate the potential for flooding and negative water quality impacts to downstream waterways. Furthermore, a low tailwater stilling basin will be installed at the outfall pipe exit from the proposed pond to help mitigate potential erosion to the existing naturally vegetated grassy meadow swale. These natural drainage areas are stable and healthy.

Compliance With Standards

The drainage design presented within this report for UDON South conforms to the El Paso County Drainage Criteria Manual and the Mile High Flood District Urban Storm Drainage Criteria Manual. Additionally, the Site runoff and storm drain facilities will not adversely affect the downstream and surrounding developments.

REFERENCES

1. El Paso County Drainage Criteria Manual, Vol. 1 and 2, October 1994.
2. City of Colorado Springs Drainage Criteria Manual, May 2014, Revised 2021.
3. El Paso County Engineering Criteria Manual, December 2004, Revised 2016
4. Mile High Flood District Drainage Criteria Manual (MHFDCM), Vol. 1, prepared by Wright-McLaughlin Engineers, June 2001, with latest revisions.

5. Flood Insurance Rate Map, El Paso County, Colorado and Incorporated Areas, Map Number 08041C0780G Effective Date December 7, 2018, prepared by the Federal Emergency Management Agency (FEMA).

APPENDIX

SOILS MAP AND FEMA FIRM PANEL

Custom Soil Resource Report Soil Map

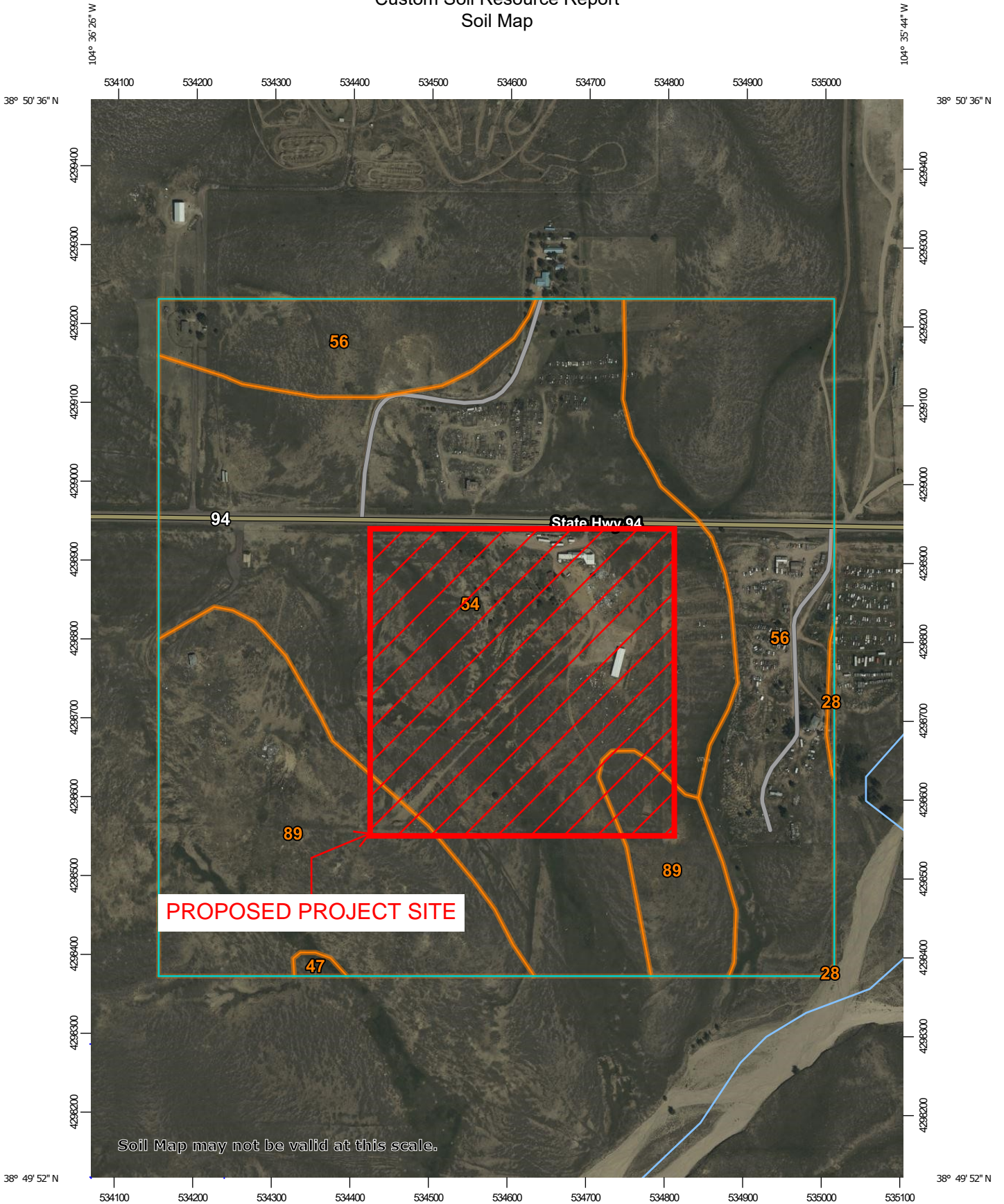

Soil Map may not be valid at this scale.

Map Scale: 1:6,660 if printed on A portrait (8.5" x 11") sheet.

0 50 100 200 300 Meters

0 300 600 1200 1800 Feet

Map projection: Web Mercator Corner coordinates: WGS84 Edge tics: UTM Zone 13N WGS84



MAP LEGEND

Area of Interest (AOI)

 Area of Interest (AOI)



















Soils

 Soil Map Unit Polygons

 Soil Map Unit Lines

 Soil Map Unit Points

Special Point Features





-  Blowout
-  Borrow Pit
-  Clay Spot
-  Closed Depression
-  Gravel Pit
-  Gravelly Spot
-  Landfill
-  Lava Flow
-  Marsh or swamp
-  Mine or Quarry
-  Miscellaneous Water
-  Perennial Water
-  Rock Outcrop
-  Saline Spot
-  Sandy Spot
-  Severely Eroded Spot
-  Sinkhole
-  Slide or Slip
-  Sodic Spot

-  Spoil Area
-  Stony Spot
-  Very Stony Spot
-  Wet Spot
-  Other
-  Special Line Features

Water Features

 Streams and Canals

Transportation

-  Rails
-  Interstate Highways
-  US Routes
-  Major Roads
-  Local Roads

Background

 Aerial Photography

MAP INFORMATION

The soil surveys that comprise your AOI were mapped at 1:24,000.

Warning: Soil Map may not be valid at this scale.

Enlargement of maps beyond the scale of mapping can cause misunderstanding of the detail of mapping and accuracy of soil line placement. The maps do not show the small areas of contrasting soils that could have been shown at a more detailed scale.

Please rely on the bar scale on each map sheet for map measurements.

Source of Map: Natural Resources Conservation Service
 Web Soil Survey URL:
 Coordinate System: Web Mercator (EPSG:3857)

Maps from the Web Soil Survey are based on the Web Mercator projection, which preserves direction and shape but distorts distance and area. A projection that preserves area, such as the Albers equal-area conic projection, should be used if more accurate calculations of distance or area are required.

This product is generated from the USDA-NRCS certified data as of the version date(s) listed below.

Soil Survey Area: El Paso County Area, Colorado
 Survey Area Data: Version 21, Aug 24, 2023

Soil map units are labeled (as space allows) for map scales 1:50,000 or larger.

Date(s) aerial images were photographed: Sep 11, 2018—Oct 20, 2018

The orthophoto or other base map on which the soil lines were compiled and digitized probably differs from the background imagery displayed on these maps. As a result, some minor shifting of map unit boundaries may be evident.

Map Unit Legend

| Map Unit Symbol | Map Unit Name | Acres in AOI | Percent of AOI |
|------------------------------------|--|--------------|----------------|
| 28 | Ellicott loamy coarse sand, 0 to 5 percent slopes | 0.3 | 0.2% |
| 47 | Limon clay, 0 to 3 percent slopes | 0.4 | 0.2% |
| 54 | Midway clay loam, 3 to 25 percent slopes | 91.9 | 50.2% |
| 56 | Nelson-Tassel fine sandy loams, 3 to 18 percent slopes | 49.3 | 26.9% |
| 89 | Tassel fine sandy loam, 3 to 18 percent slopes | 41.3 | 22.5% |
| Totals for Area of Interest | | 183.2 | 100.0% |

Map Unit Descriptions

The map units delineated on the detailed soil maps in a soil survey represent the soils or miscellaneous areas in the survey area. The map unit descriptions, along with the maps, can be used to determine the composition and properties of a unit.

A map unit delineation on a soil map represents an area dominated by one or more major kinds of soil or miscellaneous areas. A map unit is identified and named according to the taxonomic classification of the dominant soils. Within a taxonomic class there are precisely defined limits for the properties of the soils. On the landscape, however, the soils are natural phenomena, and they have the characteristic variability of all natural phenomena. Thus, the range of some observed properties may extend beyond the limits defined for a taxonomic class. Areas of soils of a single taxonomic class rarely, if ever, can be mapped without including areas of other taxonomic classes. Consequently, every map unit is made up of the soils or miscellaneous areas for which it is named and some minor components that belong to taxonomic classes other than those of the major soils.

Most minor soils have properties similar to those of the dominant soil or soils in the map unit, and thus they do not affect use and management. These are called noncontrasting, or similar, components. They may or may not be mentioned in a particular map unit description. Other minor components, however, have properties and behavioral characteristics divergent enough to affect use or to require different management. These are called contrasting, or dissimilar, components. They generally are in small areas and could not be mapped separately because of the scale used. Some small areas of strongly contrasting soils or miscellaneous areas are identified by a special symbol on the maps. If included in the database for a given area, the contrasting minor components are identified in the map unit descriptions along with some characteristics of each. A few areas of minor components may not have been observed, and consequently they are not mentioned in the descriptions, especially where the pattern was so complex that it was impractical to make enough observations to identify all the soils and miscellaneous areas on the landscape.

Custom Soil Resource Report

The presence of minor components in a map unit in no way diminishes the usefulness or accuracy of the data. The objective of mapping is not to delineate pure taxonomic classes but rather to separate the landscape into landforms or landform segments that have similar use and management requirements. The delineation of such segments on the map provides sufficient information for the development of resource plans. If intensive use of small areas is planned, however, onsite investigation is needed to define and locate the soils and miscellaneous areas.

An identifying symbol precedes the map unit name in the map unit descriptions. Each description includes general facts about the unit and gives important soil properties and qualities.

Soils that have profiles that are almost alike make up a *soil series*. Except for differences in texture of the surface layer, all the soils of a series have major horizons that are similar in composition, thickness, and arrangement.

Soils of one series can differ in texture of the surface layer, slope, stoniness, salinity, degree of erosion, and other characteristics that affect their use. On the basis of such differences, a soil series is divided into *soil phases*. Most of the areas shown on the detailed soil maps are phases of soil series. The name of a soil phase commonly indicates a feature that affects use or management. For example, Alpha silt loam, 0 to 2 percent slopes, is a phase of the Alpha series.

Some map units are made up of two or more major soils or miscellaneous areas. These map units are complexes, associations, or undifferentiated groups.

A *complex* consists of two or more soils or miscellaneous areas in such an intricate pattern or in such small areas that they cannot be shown separately on the maps. The pattern and proportion of the soils or miscellaneous areas are somewhat similar in all areas. Alpha-Beta complex, 0 to 6 percent slopes, is an example.

An *association* is made up of two or more geographically associated soils or miscellaneous areas that are shown as one unit on the maps. Because of present or anticipated uses of the map units in the survey area, it was not considered practical or necessary to map the soils or miscellaneous areas separately. The pattern and relative proportion of the soils or miscellaneous areas are somewhat similar. Alpha-Beta association, 0 to 2 percent slopes, is an example.

An *undifferentiated group* is made up of two or more soils or miscellaneous areas that could be mapped individually but are mapped as one unit because similar interpretations can be made for use and management. The pattern and proportion of the soils or miscellaneous areas in a mapped area are not uniform. An area can be made up of only one of the major soils or miscellaneous areas, or it can be made up of all of them. Alpha and Beta soils, 0 to 2 percent slopes, is an example.

Some surveys include *miscellaneous areas*. Such areas have little or no soil material and support little or no vegetation. Rock outcrop is an example.

El Paso County Area, Colorado

28—Ellicott loamy coarse sand, 0 to 5 percent slopes

Map Unit Setting

National map unit symbol: 3680
Elevation: 5,500 to 6,500 feet
Mean annual precipitation: 13 to 15 inches
Mean annual air temperature: 47 to 50 degrees F
Frost-free period: 125 to 145 days
Farmland classification: Not prime farmland

Map Unit Composition

Ellicott and similar soils: 97 percent
Minor components: 3 percent
Estimates are based on observations, descriptions, and transects of the mapunit.

Description of Ellicott

Setting

Landform: Flood plains, stream terraces
Landform position (three-dimensional): Tread
Down-slope shape: Linear
Across-slope shape: Linear
Parent material: Sandy alluvium

Typical profile

A - 0 to 4 inches: loamy coarse sand
C - 4 to 60 inches: stratified coarse sand to sandy loam

Properties and qualities

Slope: 0 to 5 percent
Depth to restrictive feature: More than 80 inches
Drainage class: Somewhat excessively drained
Runoff class: Very low
Capacity of the most limiting layer to transmit water (Ksat): High to very high (5.95 to 19.98 in/hr)
Depth to water table: More than 80 inches
Frequency of flooding: Frequent
Frequency of ponding: None
Available water supply, 0 to 60 inches: Low (about 4.1 inches)

Interpretive groups

Land capability classification (irrigated): None specified
Land capability classification (nonirrigated): 7w
Hydrologic Soil Group: A
Ecological site: R069XY031CO - Sandy Bottomland
Other vegetative classification: SANDY BOTTOMLAND (069AY031CO)
Hydric soil rating: No

Minor Components

Fluvaquentic haplaquoll

Percent of map unit: 1 percent
Landform: Swales
Hydric soil rating: Yes

Other soils

Percent of map unit: 1 percent
Hydric soil rating: No

Pleasant

Percent of map unit: 1 percent
Landform: Depressions
Hydric soil rating: Yes

47—Limon clay, 0 to 3 percent slopes

Map Unit Setting

National map unit symbol: 368p
Elevation: 5,200 to 6,200 feet
Mean annual precipitation: 12 to 14 inches
Mean annual air temperature: 48 to 52 degrees F
Frost-free period: 135 to 155 days
Farmland classification: Not prime farmland

Map Unit Composition

Limon, occasionally flooded, and similar soils: 95 percent
Minor components: 5 percent
Estimates are based on observations, descriptions, and transects of the mapunit.

Description of Limon, Occasionally Flooded

Setting

Landform: Flood plains, alluvial fans
Down-slope shape: Linear
Across-slope shape: Linear
Parent material: Clayey alluvium derived from shale

Typical profile

A - 0 to 4 inches: clay
AC - 4 to 12 inches: silty clay
C - 12 to 60 inches: silty clay loam

Properties and qualities

Slope: 0 to 3 percent
Depth to restrictive feature: More than 80 inches
Drainage class: Well drained
Runoff class: Low
Capacity of the most limiting layer to transmit water (Ksat): Moderately low to moderately high (0.06 to 0.20 in/hr)
Depth to water table: More than 80 inches
Frequency of flooding: Occasional
Frequency of ponding: None
Calcium carbonate, maximum content: 10 percent
Gypsum, maximum content: 2 percent
Maximum salinity: Very slightly saline to moderately saline (2.0 to 8.0 mmhos/cm)

Custom Soil Resource Report

Sodium adsorption ratio, maximum: 10.0
Available water supply, 0 to 60 inches: High (about 9.9 inches)

Interpretive groups

Land capability classification (irrigated): 3e
Land capability classification (nonirrigated): 4e
Hydrologic Soil Group: C
Ecological site: R069XY033CO - Salt Flat
Hydric soil rating: No

Minor Components

Other soils

Percent of map unit: 4 percent
Hydric soil rating: No

Pleasant

Percent of map unit: 1 percent
Landform: Depressions
Hydric soil rating: Yes

54—Midway clay loam, 3 to 25 percent slopes

Map Unit Setting

National map unit symbol: 368y
Elevation: 5,200 to 6,200 feet
Mean annual precipitation: 12 to 14 inches
Mean annual air temperature: 48 to 52 degrees F
Frost-free period: 135 to 155 days
Farmland classification: Not prime farmland

Map Unit Composition

Midway and similar soils: 95 percent
Minor components: 5 percent
Estimates are based on observations, descriptions, and transects of the mapunit.

Description of Midway

Setting

Landform: Hills
Landform position (three-dimensional): Side slope
Down-slope shape: Linear
Across-slope shape: Linear
Parent material: Slope alluvium over residuum weathered from shale

Typical profile

A - 0 to 4 inches: clay loam
C - 4 to 13 inches: clay
Cr - 13 to 17 inches: weathered bedrock

Properties and qualities

Slope: 3 to 25 percent

Custom Soil Resource Report

Depth to restrictive feature: 6 to 20 inches to paralithic bedrock
Drainage class: Well drained
Runoff class: Medium
Capacity of the most limiting layer to transmit water (Ksat): Moderately low to moderately high (0.06 to 0.20 in/hr)
Depth to water table: More than 80 inches
Frequency of flooding: None
Frequency of ponding: None
Calcium carbonate, maximum content: 15 percent
Gypsum, maximum content: 15 percent
Maximum salinity: Very slightly saline to moderately saline (2.0 to 8.0 mmhos/cm)
Sodium adsorption ratio, maximum: 15.0
Available water supply, 0 to 60 inches: Very low (about 2.2 inches)

Interpretive groups

Land capability classification (irrigated): None specified
Land capability classification (nonirrigated): 7e
Hydrologic Soil Group: D
Ecological site: R069XY046CO - Shaly Plains
Other vegetative classification: SHALY PLAINS (069AY046CO)
Hydric soil rating: No

Minor Components

Other soils

Percent of map unit: 4 percent
Hydric soil rating: No

Pleasant

Percent of map unit: 1 percent
Landform: Depressions
Hydric soil rating: Yes

56—Nelson-Tassel fine sandy loams, 3 to 18 percent slopes

Map Unit Setting

National map unit symbol: 3690
Elevation: 5,600 to 6,400 feet
Mean annual precipitation: 12 to 14 inches
Mean annual air temperature: 48 to 52 degrees F
Frost-free period: 135 to 155 days
Farmland classification: Not prime farmland

Map Unit Composition

Nelson and similar soils: 55 percent
Tassel and similar soils: 40 percent
Minor components: 5 percent
Estimates are based on observations, descriptions, and transects of the mapunit.

Description of Nelson

Setting

Landform: Hills

Landform position (three-dimensional): Side slope, crest

Down-slope shape: Linear

Across-slope shape: Linear

Parent material: Calcareous residuum weathered from interbedded sedimentary rock

Typical profile

A - 0 to 5 inches: fine sandy loam

Ck - 5 to 23 inches: fine sandy loam

Cr - 23 to 27 inches: weathered bedrock

Properties and qualities

Slope: 3 to 12 percent

Depth to restrictive feature: 20 to 40 inches to paralithic bedrock

Drainage class: Well drained

Runoff class: Medium

Capacity of the most limiting layer to transmit water (Ksat): Moderately low to high (0.06 to 2.00 in/hr)

Depth to water table: More than 80 inches

Frequency of flooding: None

Frequency of ponding: None

Calcium carbonate, maximum content: 10 percent

Maximum salinity: Nonsaline to very slightly saline (0.0 to 2.0 mmhos/cm)

Available water supply, 0 to 60 inches: Very low (about 2.8 inches)

Interpretive groups

Land capability classification (irrigated): 4e

Land capability classification (nonirrigated): 6e

Hydrologic Soil Group: B

Ecological site: R067BY045CO - Shaly Plains

Other vegetative classification: SHALY PLAINS (069AY046CO)

Hydric soil rating: No

Description of Tassel

Setting

Landform: Hills

Landform position (three-dimensional): Side slope, crest

Down-slope shape: Linear

Across-slope shape: Linear

Parent material: Calcareous slope alluvium over residuum weathered from sandstone

Typical profile

A - 0 to 4 inches: fine sandy loam

C - 4 to 10 inches: fine sandy loam

Cr - 10 to 14 inches: weathered bedrock

Properties and qualities

Slope: 3 to 18 percent

Depth to restrictive feature: 6 to 20 inches to paralithic bedrock

Drainage class: Well drained

Runoff class: Medium

Custom Soil Resource Report

Capacity of the most limiting layer to transmit water (Ksat): Moderately high (0.20 to 0.60 in/hr)

Depth to water table: More than 80 inches

Frequency of flooding: None

Frequency of ponding: None

Calcium carbonate, maximum content: 10 percent

Available water supply, 0 to 60 inches: Very low (about 1.2 inches)

Interpretive groups

Land capability classification (irrigated): None specified

Land capability classification (nonirrigated): 6s

Hydrologic Soil Group: D

Ecological site: R067BY045CO - Shaly Plains

Other vegetative classification: SHALY PLAINS (069AY046CO)

Hydric soil rating: No

Minor Components

Other soils

Percent of map unit: 4 percent

Hydric soil rating: No

Pleasant

Percent of map unit: 1 percent

Landform: Depressions

Hydric soil rating: Yes

89—Tassel fine sandy loam, 3 to 18 percent slopes

Map Unit Setting

National map unit symbol: 36b5

Elevation: 5,600 to 6,400 feet

Mean annual precipitation: 13 to 15 inches

Mean annual air temperature: 47 to 51 degrees F

Frost-free period: 135 to 155 days

Farmland classification: Not prime farmland

Map Unit Composition

Tassel and similar soils: 95 percent

Minor components: 5 percent

Estimates are based on observations, descriptions, and transects of the mapunit.

Description of Tassel

Setting

Landform: Hills

Landform position (three-dimensional): Crest, side slope

Down-slope shape: Linear

Across-slope shape: Linear

Custom Soil Resource Report

Parent material: Calcareous slope alluvium over residuum weathered from sandstone

Typical profile

A - 0 to 4 inches: fine sandy loam

C - 4 to 10 inches: sandy loam

Cr - 10 to 14 inches: weathered bedrock

Properties and qualities

Slope: 3 to 18 percent

Depth to restrictive feature: 6 to 20 inches to paralithic bedrock

Drainage class: Well drained

Runoff class: Medium

Capacity of the most limiting layer to transmit water (Ksat): Moderately high (0.20 to 0.60 in/hr)

Depth to water table: More than 80 inches

Frequency of flooding: None

Frequency of ponding: None

Calcium carbonate, maximum content: 10 percent

Available water supply, 0 to 60 inches: Very low (about 1.2 inches)

Interpretive groups

Land capability classification (irrigated): None specified

Land capability classification (nonirrigated): 6s

Hydrologic Soil Group: D

Ecological site: R067BY024CO - Sandy Plains

Other vegetative classification: SANDY PLAINS (069AY026CO)

Hydric soil rating: No

Minor Components

Other soils

Percent of map unit: 5 percent

Hydric soil rating: No

National Flood Hazard Layer FIRMette



104°36'23"W 38°50'27"N

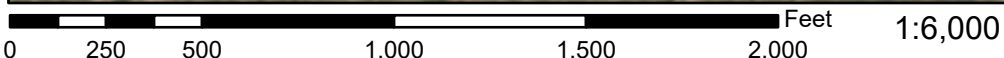

Basemap: USGS National Map: Orthoimagery: Data refreshed October, 2020

Legend

SEE FIS REPORT FOR DETAILED LEGEND AND INDEX MAP FOR FIRM PANEL LAYOUT

| | | |
|-----------------------------|--|---|
| SPECIAL FLOOD HAZARD AREAS | | Without Base Flood Elevation (BFE) Zone A, V, A99 |
| | | With BFE or Depth Zone AE, AO, AH, VE, AR |
| | | Regulatory Floodway |
| OTHER AREAS OF FLOOD HAZARD | | 0.2% Annual Chance Flood Hazard, Areas of 1% annual chance flood with average depth less than one foot or with drainage areas of less than one square mile Zone X |
| | | Future Conditions 1% Annual Chance Flood Hazard Zone X |
| | | Area with Reduced Flood Risk due to Levee. See Notes. Zone X |
| | | Area with Flood Risk due to Levee Zone D |
| OTHER AREAS | | NO SCREEN Area of Minimal Flood Hazard Zone X |
| | | Effective LOMRs |
| GENERAL STRUCTURES | | Area of Undetermined Flood Hazard Zone D |
| | | Channel, Culvert, or Storm Sewer |
| | | Levee, Dike, or Floodwall |
| OTHER FEATURES | | 20.2 Cross Sections with 1% Annual Chance Water Surface Elevation |
| | | 17.5 Coastal Transect |
| | | Base Flood Elevation Line (BFE) |
| | | Limit of Study |
| | | Jurisdiction Boundary |
| MAP PANELS | | Coastal Transect Baseline |
| | | Profile Baseline |
| | | Hydrographic Feature |
| | | Digital Data Available |
| | | No Digital Data Available |
| | | Unmapped |

The pin displayed on the map is an approximate point selected by the user and does not represent an authoritative property location.

This map complies with FEMA's standards for the use of digital flood maps if it is not void as described below. The basemap shown complies with FEMA's basemap accuracy standards

The flood hazard information is derived directly from the authoritative NFHL web services provided by FEMA. This map was exported on 2/10/2022 at 9:13 AM and does not reflect changes or amendments subsequent to this date and time. The NFHL and effective information may change or become superseded by new data over time.

This map image is void if the one or more of the following map elements do not appear: basemap imagery, flood zone labels, legend, scale bar, map creation date, community identifiers, FIRM panel number, and FIRM effective date. Map images for unmapped and unmodernized areas cannot be used for regulatory purposes.

NOTES TO USERS

This map is for use in administering the National Flood Insurance Program. It does not necessarily identify all areas subject to flooding, particularly from local drainage sources of small size. The community map repository should be consulted for possible updated or additional flood hazard information.

To obtain more detailed information in areas where **Base Flood Elevations (BFEs)** and/or **floodways** have been determined, users are encouraged to consult the Flood Profiles and Floodway Data and/or Summary of Stillwater Elevations tables contained within the Flood Insurance Study (FIS) report that accompanies this FIRM. Users should be aware that BFEs shown on the FIRM represent rounded whole-foot elevations. These BFEs are intended for flood insurance rating purposes only and should not be used as the sole source of flood elevation information. Accordingly, flood elevation data presented in the FIS report should be utilized in conjunction with the FIRM for purposes of construction and/or floodplain management.

Coastal Base Flood Elevations shown on this map apply only landward of 0.0' North American Vertical Datum of 1988 (NAVD88). Users of this FIRM should be aware that coastal flood elevations are also provided in the Summary of Stillwater Elevations table in the Flood Insurance Study report for this jurisdiction. Elevations shown in the Summary of Stillwater Elevations table should be used for construction and/or floodplain management purposes when they are higher than the elevations shown on this FIRM.

Boundaries of the **floodways** were computed at cross sections and interpolated between cross sections. The floodways were based on hydraulic considerations with regard to requirements of the National Flood Insurance Program. Floodway widths and other pertinent floodway data are provided in the Flood Insurance Study report for this jurisdiction.

Certain areas not in Special Flood Hazard Areas may be protected by **flood control structures**. Refer to section 2.4 "Flood Protection Measures" of the Flood Insurance Study report for information on flood control structures for this jurisdiction.

The **projection** used in the preparation of this map was Universal Transverse Mercator (UTM) zone 13. The **horizontal datum** was NAD83, GRS80 spheroid. Differences in datum, spheroid, projection or UTM zones zones used in the production of FIRMs for adjacent jurisdictions may result in slight positional differences in map features across jurisdiction boundaries. These differences do not affect the accuracy of this FIRM.

Flood elevations on this map are referenced to the **North American Vertical Datum of 1988 (NAVD88)**. These flood elevations must be compared to structure and ground elevations referenced to the same **vertical datum**. For information regarding conversion between the National Geodetic Vertical Datum of 1929 and the North American Vertical Datum of 1988, visit the National Geodetic Survey website at <http://www.ngs.noaa.gov/> or contact the National Geodetic Survey at the following address:

NGS Information Services
NOAA, NINGS12
National Geodetic Survey
SSMC-3, #9202
1315 East-West Highway
Silver Spring, MD 20910-3282

To obtain current elevation, description, and/or location information for **bench marks** shown on this map, please contact the Information Services Branch of the National Geodetic Survey at (301) 713-3242 or visit its website at <http://www.ngs.noaa.gov/>.

Base Map information shown on this FIRM was provided in digital format by El Paso County, Colorado Springs Utilities, and Anderson Consulting Engineers, Inc. These data are current as of 2008.

This map reflects more detailed and up-to-date **stream channel configurations and floodplain delineations** than those shown on the previous FIRM for this jurisdiction. The floodplains and floodways that were transferred from the previous FIRM may have been adjusted to conform to these new stream channel configurations. As a result, the Flood Profiles and Floodway Data tables in the Flood Insurance Study Report (which contains authoritative hydraulic data) may reflect stream channel distances that differ from what is shown on this map. The profile baselines depicted on this map represent the hydraulic modeling baselines that match the flood profiles and Floodway Data Tables if applicable, in the FIS report. As a result, the profile baselines may deviate significantly from the new base map channel representation and may appear outside of the floodplain.

Corporate limits shown on this map are based on the best data available at the time of publication. Because changes due to annexations or de-annexations may have occurred after this map was published, map users should contact appropriate community officials to verify current corporate limit locations.

Please refer to the separately printed **Map Index** for an overview map of the county showing the layout of map panels; community map repository addresses; and a Listing of Communities table containing National Flood Insurance Program dates for each community as well as a listing of the panels on which each community is located.

Contact **FEMA Map Service Center (MSC)** via the FEMA Map Information eXchange (FIMX) 1-877-336-2627 for information on available products associated with this FIRM. Available products may include previously issued Letters of Map Change, a Flood Insurance Study Report, and/or digital versions of this map. The MSC may also be reached by Fax at 1-800-358-9620 and its website at <http://www.msc.fema.gov/>.

If you have **questions about this map** or questions concerning the National Flood Insurance Program in general, please call 1-877-FEMA MAP (1-877-336-2627) or visit the FEMA website at <http://www.fema.gov/business/nfp>.

El Paso County Vertical Datum Offset Table

| Flooding Source | Vertical Datum Offset (ft) |
|-----------------|----------------------------|
| | |

REFER TO SECTION 3.3 OF THE EL PASO COUNTY FLOOD INSURANCE STUDY FOR STREAM BY STREAM VERTICAL DATUM CONVERSION INFORMATION

Panel Location Map

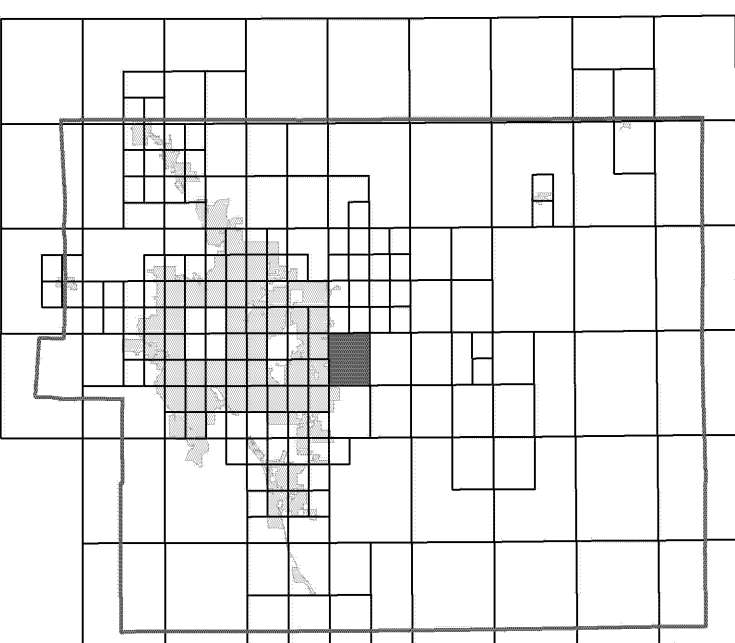

This Digital Flood Insurance Rate Map (DFIRM) was produced through a Cooperating Technical Partner (CTP) agreement between the State of Colorado Water Conservation Board (CWCB) and the Federal Emergency Management Agency (FEMA).



Additional Flood Hazard information and resources are available from local communities and the Colorado Water Conservation Board.

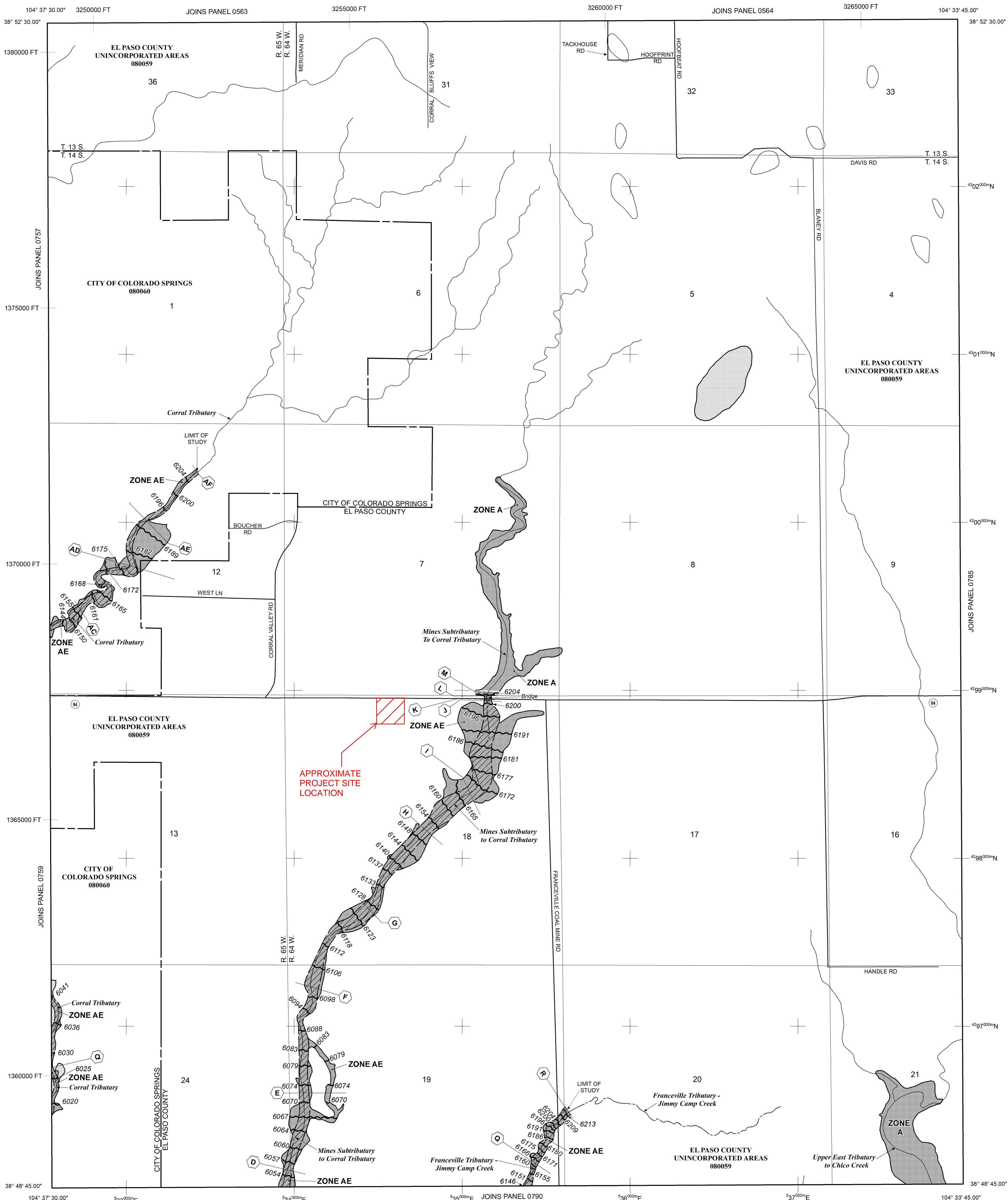

LEGEND

SPECIAL FLOOD HAZARD AREAS (SFHAS) SUBJECT TO INUNDATION BY THE 1% ANNUAL CHANCE FLOOD

The 1% annual chance flood (100-year flood), also known as the base flood, is the flood that has a 1% chance of being equalled or exceeded in any given year. The Special Flood Hazard Area is the area subject to flooding by the 1% annual chance flood. Areas of Special Flood Hazard include Zones A, AE, AH, AO, AR, A99, V, and VE. The Base Flood Elevation is the water-surface elevation of the 1% annual chance flood.

ZONE A No Base Flood Elevations determined.
ZONE AE Base Flood Elevations determined.
ZONE AH Flood depths of 1 to 3 feet (usually areas of ponding); Base Flood Elevations determined.
ZONE AO Flood depths of 1 to 3 feet (usually sheet flow on sloping terrain); average depths determined. For areas of alluvial fan flooding, velocities also determined.
ZONE AR Special Flood Hazard Area Formerly protected from the 1% annual chance flood by a flood control system that was subsequently decertified. Zone AR indicates that the former flood control system is being restored to provide protection from the 1% annual chance or greater flood.
ZONE A99 Area to be protected from 1% annual chance flood by a Federal flood protection system under construction; no Base Flood Elevations determined.
ZONE V Coastal flood zone with velocity hazard (wave action); no Base Flood Elevations determined.
ZONE VE Coastal flood zone with velocity hazard (wave action); Base Flood Elevations determined.

FLOODWAY AREAS IN ZONE AE

The floodway is the channel of a stream plus any adjacent floodplain areas that must be kept free of encroachment so that the 1% annual chance flood can be carried without substantial increases in flood heights.

OTHER FLOOD AREAS

ZONE X Areas of 0.2% annual chance flood; areas of 1% annual chance flood with average depths of less than 1 foot, or with drainage areas less than 1 square mile; and areas protected by levees from 1% annual chance flood.

OTHER AREAS

ZONE X Areas determined to be outside the 0.2% annual chance floodplain.
ZONE D Areas in which flood hazards are undetermined, but possible.

COASTAL BARRIER RESOURCES SYSTEM (CBRS) AREAS

OTHERWISE PROTECTED AREAS (OPAs)

CBRS areas and OPAs are normally located within or adjacent to Special Flood Hazard Areas.

— Floodplain boundary
 --- Floodway boundary
 --- Zone D Boundary
 - - - - - CBRS and OPA boundary
 --- Boundary dividing Special Flood Hazard Areas of different Base Flood Elevations, flood depths or flood velocities.
 (EL 987) Base Flood Elevation line and value; elevation in feet*
 (EL 987) Base Flood Elevation value where uniform within zone; elevation in feet*

* Referenced to the North American Vertical Datum of 1988 (NAVD 88)

(A) --- (A) Cross section line
 (23) --- (23) Transsect line

97° 07' 30.00" Datum of 1983 (NAD 83)
 42° 50' 00" 1000-meter Universal Transverse Mercator grid ticks, zone 13
 6000000 FT 5000-foot grid ticks; Colorado State Plane coordinate system, central zone (FIPSZONE 0502), Lambert Conformal Conic Projection
 DX5510 Bench mark (see explanation in Notes to Users section of this FIRM panel)
 M1.5 River Mile

MAP REPOSITORIES
 Refer to Map Repositories list on Map Index

EFFECTIVE DATE OF COUNTYWIDE FLOOD INSURANCE RATE MAP
MARCH 17, 1997

EFFECTIVE DATE(S) OF REVISION(S) TO THIS PANEL
DECEMBER 7, 2018 to update corporate limits, to change Base Flood Elevations and Special Flood Hazard Areas, to update map format, to add roads and road names, and to incorporate previously issued Letters of Map Revision.

For community map revision history prior to countywide mapping, refer to the Community Map History Table located in the Flood Insurance Study report for this jurisdiction.

To determine if flood insurance is available in this community, contact your insurance agent or call the National Flood Insurance Program at 1-800-638-6620.

MAP SCALE 1" = 1000'

500 0 1000 2000 FEET
 300 0 300 600 METERS

NFIP PANEL 0780G

FIRM FLOOD INSURANCE RATE MAP

EL PASO COUNTY, COLORADO AND INCORPORATED AREAS

PANEL 780 OF 1300
 (SEE MAP INDEX FOR FIRM PANEL LAYOUT)

CONTAINS:

| COMMUNITY | NUMBER | PANEL | SUFFIX |
|---------------------------|--------|-------|--------|
| COLORADO SPRINGS, CITY OF | 08060 | 0780 | G |
| EL PASO COUNTY | 08059 | 0780 | G |

Notice: This map was reissued on 05/15/2020 to make a correction. This version replaces any previous versions. See the Notice-to-User Letter that accompanied this correction for details.

Notice to User: The Map Number shown below should be used when placing map orders. The Community Number shown above should be used on insurance applications for the subject community.

MAP NUMBER 08041C0780G

MAP REVISED DECEMBER 7, 2018

Federal Emergency Management Agency

HYDROLOGIC CALCULATIONS

Weighted Imperviousness Calculations: Existing

| SUB-BASIN | AREA (SF) | AREA (Acres) | GRAVEL ROAD AREA | GRAVEL ROAD IMPERVIOUSNESS | GRAVEL ROAD | | | | PAVED ROAD AREA | PAVED ROAD IMPERVIOUSNESS | PAVED ROAD | | | | LANDSCAPE AREA | LANDSCAPE IMPERVIOUSNESS | LANDSCAPE | | | | ROOF AREA | ROOF IMPERVIOUSNESS | ROOF | | | | WEIGHTED IMPERVIOUSNESS | WEIGHTED COEFFICIENTS | | | |
|-----------|-----------|--------------|------------------|----------------------------|-------------|------|------|------|-----------------|---------------------------|------------|-----|------|------|----------------|--------------------------|-----------|------|------|------|-----------|---------------------|------|------|------|------|-------------------------|-----------------------|------|------|------|
| | | | | | C2 | C5 | C10 | C100 | | | C2 | C5 | C10 | C100 | | | C2 | C5 | C10 | C100 | | | C2 | C5 | C10 | C100 | | C2 | C5 | C10 | C100 |
| E1 | 1,046,970 | 24.04 | 20,055 | 80% | 0.60 | 0.63 | 0.66 | 0.74 | 0 | 100% | 0.89 | 0.9 | 0.92 | 0.96 | 1,021,356 | 0% | 0.04 | 0.15 | 0.25 | 0.5 | 5,559 | 90% | 0.73 | 0.75 | 0.77 | 0.83 | 2.0% | 0.05 | 0.16 | 0.26 | 0.51 |
| E2 | 106,581 | 2.45 | 7,850 | 80% | 0.60 | 0.63 | 0.66 | 0.74 | 937 | 100% | 0.89 | 0.9 | 0.92 | 0.96 | 98,731 | 0% | 0.04 | 0.15 | 0.25 | 0.5 | 0 | 90% | 0.73 | 0.75 | 0.77 | 0.83 | 6.8% | 0.09 | 0.19 | 0.29 | 0.53 |
| E3 | 357,659 | 8.21 | 9,215 | 80% | 0.60 | 0.63 | 0.66 | 0.74 | 0 | 100% | 0.89 | 0.9 | 0.92 | 0.96 | 344,853 | 0% | 0.04 | 0.15 | 0.25 | 0.5 | 3,591 | 90% | 0.73 | 0.75 | 0.77 | 0.83 | 3.0% | 0.06 | 0.17 | 0.27 | 0.51 |
| OE1 | 243,957 | 5.60 | 7,055 | 80% | 0.60 | 0.63 | 0.66 | 0.74 | 13,674 | 100% | 0.89 | 0.9 | 0.92 | 0.96 | 236,902 | 0% | 0.04 | 0.15 | 0.25 | 0.5 | 0 | 90% | 0.73 | 0.75 | 0.77 | 0.83 | 7.9% | 0.11 | 0.21 | 0.31 | 0.56 |
| OE2 | 251,638 | 5.78 | 0 | 80% | 0.60 | 0.63 | 0.66 | 0.74 | 21,405 | 100% | 0.89 | 0.9 | 0.92 | 0.96 | 251,638 | 0% | 0.04 | 0.15 | 0.25 | 0.5 | 0 | 90% | 0.73 | 0.75 | 0.77 | 0.83 | 8.5% | 0.12 | 0.23 | 0.33 | 0.58 |
| OE3 | 202,547 | 4.65 | 0 | 80% | 0.60 | 0.63 | 0.66 | 0.74 | 0 | 100% | 0.89 | 0.9 | 0.92 | 0.96 | 202,547 | 0% | 0.04 | 0.15 | 0.25 | 0.5 | 0 | 90% | 0.73 | 0.75 | 0.77 | 0.83 | 0.0% | 0.04 | 0.15 | 0.25 | 0.50 |
| TOTAL | 2,209,352 | 50.72 | 44,175 | 80% | 0.60 | 0.63 | 0.66 | 0.74 | 36,016 | 100% | 0.89 | 0.9 | 0.92 | 0.96 | 2,156,027 | 0% | 0.04 | 0.15 | 0.25 | 0.5 | 9,150 | 90% | 0.73 | 0.75 | 0.77 | 0.83 | 3.6% | 0.07 | 0.18 | 0.28 | 0.52 |

| UDON South | | | | | | | | | | | | | | | | |
|---|----------------|--------------|----------|------|--------------------------|---------|----------|-----------------------------|---------|--------|--------------|-----------------------------|-------------------------------|--------------|----------|----------------|
| Time of Concentration: Existing Calculations | | | | | | | | | | | | | | | | |
| | | | | | Forest & Meadow | | 2.50 | Short Grass Pasture & Lawns | | 7.00 | | Grassed Waterway | | | 15.00 | |
| | | | | | Fallow or Cultivation | | 5.00 | Nearly Bare Ground | | 10.00 | | Paved Area & Shallow Gutter | | | 20.00 | |
| DESIGN POINT | SUB-BASIN DATA | | | | INITIAL / OVERLAND* TIME | | | TRAVEL TIME T(t) | | | | | T(c) CHECK (URBANIZED BASINS) | | | FINAL T@* min. |
| | DRAIN BASIN | AREA sq. ft. | AREA ac. | C(5) | Length ft. | Slope % | T(i) min | Length ft. | Slope % | Coeff. | Velocity fps | T(t) min. | COMP. T(c) | TOTAL LENGTH | L/180+10 | |
| E1 | E1 | 1,046,970 | 24.04 | 0.16 | 300 | 6.4% | 16.0 | 1157 | 2.5% | 2.50 | 0.4 | 49.1 | 65.1 | 1457 | 18.1 | 18.1 |
| E2 | E2 | 106,581 | 2.45 | 0.19 | 300 | 5.5% | 16.3 | 78 | 9.4% | 2.50 | 0.8 | 1.7 | 18.0 | 378 | 12.1 | 12.1 |
| E3 | E3 | 357,659 | 8.21 | 0.17 | 300 | 7.5% | 15.1 | 422 | 7.2% | 2.50 | 0.7 | 10.5 | 25.6 | 722 | 14.0 | 14.0 |
| OE1 | OE1 | 243,957 | 5.60 | 0.21 | 300 | 3.2% | 19.1 | 927 | 6.9% | 2.50 | 0.7 | 23.5 | 42.6 | 1227 | 16.8 | 16.8 |
| OE2 | OE2 | 251,638 | 5.78 | 0.23 | 300 | 4.0% | 17.4 | 297 | 8.9% | 2.50 | 0.7 | 6.6 | 24.1 | 597 | 13.3 | 13.3 |
| OE3 | OE3 | 202,547 | 4.65 | 0.15 | 300 | 7.3% | 15.6 | 262 | 11.0% | 2.50 | 0.8 | 5.3 | 20.8 | 562 | 13.1 | 13.1 |
| TOTAL | TOTAL | 2,209,352 | 50.72 | 0.18 | | | | | | | | | | | | |

*Note: El Paso County Drainage Manual Chapter 6 indicates that the maximum overland flow length is 100ft for urbanized areas and 300ft for rural areas. The minimum time of concentration is 5 min for developed conditions, 10 min for undeveloped conditions.

| UDON South Time of Concentration: Existing Calculations Design Storm 5 Year Storm Event (Rational Method Procedure) | | | | | | | | | | | | |
|--|-------------|----------|--------------|---------------|-------|---------|-------|--------------------|-------|---------|-------|-------|
| BASIN INFORMATION | | | | DIRECT RUNOFF | | | | CUMMULATIVE RUNOFF | | | | NOTES |
| DESIGN POINT | DRAIN BASIN | AREA ac. | RUNOFF COEFF | T(c) min | C x A | I in/hr | Q cfs | T(c) min | C x A | I in/hr | Q cfs | |
| E1 | E1 | 24.04 | 0.16 | 18.1 | 3.90 | 3.24 | 12.64 | | | | | 0.00 |
| E2 | E2 | 2.45 | 0.19 | 12.1 | 0.47 | 3.84 | 1.82 | | | | | 0.00 |
| E3 | E3 | 8.21 | 0.17 | 14.0 | 1.38 | 3.62 | 5.01 | | | | | |
| OE1 | OE1 | 5.60 | 0.21 | 16.8 | 1.20 | 3.35 | 4.02 | | | | | |
| OE2 | OE2 | 5.78 | 0.23 | 13.3 | 1.31 | 3.70 | 4.84 | | | | | |
| OE3 | OE3 | 4.65 | 0.15 | 13.1 | 0.70 | 3.72 | 2.60 | | | | | |
| TOTAL | TOTAL | 50.72 | | | | | 30.93 | | | | | |

| UDON South Time of Concentration: Existing Calculations Design Storm 100 Year Storm Event (Rational Method Procedure) | | | | | | | | | | | | |
|--|-------------|----------|--------------|---------------|-------|---------|--------|--------------------|-------|---------|-------|-------|
| BASIN INFORMATION | | | | DIRECT RUNOFF | | | | CUMMULATIVE RUNOFF | | | | NOTES |
| DESIGN POINT | DRAIN BASIN | AREA ac. | RUNOFF COEFF | T(c) min | C x A | I in/hr | Q cfs | T(c) min | C x A | I in/hr | Q cfs | |
| E1 | E1 | 24.04 | 0.51 | 18.1 | 12.17 | 5.44 | 66.17 | | | | | |
| E2 | E2 | 2.45 | 0.53 | 12.1 | 1.29 | 6.45 | 8.31 | | | | | |
| E3 | E3 | 8.21 | 0.51 | 14.0 | 4.18 | 6.08 | 25.45 | | | | | |
| OE1 | OE1 | 5.60 | 0.56 | 16.8 | 3.14 | 5.63 | 17.67 | | | | | |
| OE2 | OE2 | 5.78 | 0.58 | 13.3 | 3.36 | 6.21 | 20.88 | | | | | |
| OE3 | OE3 | 4.65 | 0.50 | 13.1 | 2.32 | 6.25 | 14.54 | | | | | |
| TOTAL | TOTAL | 50.72 | | | | | 153.01 | | | | | |

Weighted Imperviousness Calculations: Proposed

| SUB-BASIN | AREA (SF) | AREA (Acres) | GRAVEL ROAD AREA | GRAVEL ROAD IMPERVIOUSNESS | GRAVEL ROAD | | | | PAVED ROAD AREA | PAVED ROAD IMPERVIOUSNESS | PAVED ROAD | | | | LANDSCAPE AREA | LANDSCAPE IMPERVIOUSNESS | LANDSCAPE | | | | ROOF AREA | ROOF IMPERVIOUSNESS | ROOF | | | | WEIGHTED IMPERVIOUSNESS | WEIGHTED COEFFICIENTS | | | |
|-----------|-----------|--------------|------------------|----------------------------|-------------|------|------|------|-----------------|---------------------------|------------|-----|------|------|----------------|--------------------------|-----------|------|------|------|-----------|---------------------|------|------|------|------|-------------------------|-----------------------|------|------|------|
| | | | | | C2 | C5 | C10 | C100 | | | C2 | C5 | C10 | C100 | | | C2 | C5 | C10 | C100 | | | C2 | C5 | C10 | C100 | | C2 | C5 | C10 | C100 |
| P1 | 1,041,107 | 23.90 | 466,903 | 80% | 0.60 | 0.63 | 0.66 | 0.74 | 580 | 100% | 0.89 | 0.9 | 0.92 | 0.96 | 568,645 | 0% | 0.04 | 0.15 | 0.25 | 0.5 | 5,559 | 90% | 0.73 | 0.75 | 0.77 | 0.83 | 36.4% | 0.30 | 0.37 | 0.44 | 0.61 |
| P2 | 112,444 | 2.58 | 17,933 | 80% | 0.60 | 0.63 | 0.66 | 0.74 | 641 | 100% | 0.89 | 0.9 | 0.92 | 0.96 | 94,511 | 0% | 0.04 | 0.15 | 0.25 | 0.5 | 0 | 90% | 0.73 | 0.75 | 0.77 | 0.83 | 13.3% | 0.13 | 0.23 | 0.32 | 0.54 |
| P3 | 357,859 | 8.21 | 9,215 | 80% | 0.60 | 0.63 | 0.66 | 0.74 | 0 | 100% | 0.89 | 0.9 | 0.92 | 0.96 | 344,853 | 0% | 0.04 | 0.15 | 0.25 | 0.5 | 3,591 | 90% | 0.73 | 0.75 | 0.77 | 0.83 | 3.0% | 0.06 | 0.17 | 0.27 | 0.51 |
| OP1 | 243,957 | 5.60 | 7,055 | 80% | 0.60 | 0.63 | 0.66 | 0.74 | 13,674 | 100% | 0.89 | 0.9 | 0.92 | 0.96 | 236,902 | 0% | 0.04 | 0.15 | 0.25 | 0.5 | 0 | 90% | 0.73 | 0.75 | 0.77 | 0.83 | 7.9% | 0.11 | 0.21 | 0.31 | 0.56 |
| OP2 | 251,638 | 5.78 | 0 | 80% | 0.60 | 0.63 | 0.66 | 0.74 | 23,101 | 100% | 0.89 | 0.9 | 0.92 | 0.96 | 251,638 | 0% | 0.04 | 0.15 | 0.25 | 0.5 | 0 | 90% | 0.73 | 0.75 | 0.77 | 0.83 | 9.2% | 0.12 | 0.23 | 0.33 | 0.59 |
| OP3 | 202,547 | 4.65 | 0 | 80% | 0.60 | 0.63 | 0.66 | 0.74 | 0 | 100% | 0.89 | 0.9 | 0.92 | 0.96 | 202,547 | 0% | 0.04 | 0.15 | 0.25 | 0.5 | 0 | 90% | 0.73 | 0.75 | 0.77 | 0.83 | 0.0% | 0.04 | 0.15 | 0.25 | 0.50 |
| TOTAL | 2,209,352 | 50.72 | 501,106 | 80% | 0.60 | 0.63 | 0.66 | 0.74 | 37,996 | 100% | 0.89 | 0.9 | 0.92 | 0.96 | 1,699,096 | 0% | 0.04 | 0.15 | 0.25 | 0.5 | 9,150 | 90% | 0.73 | 0.75 | 0.77 | 0.83 | 20.2% | 0.19 | 0.28 | 0.36 | 0.57 |

| DESIGN POINT | | SUB-BASIN DATA | | | INITIAL / OVERLAND* TIME | | | TRAVEL TIME T(t) | | | | | T(c) CHECK (URBANIZED BASINS) | | | FINAL T©* min. |
|--------------|-------|----------------|--------------|----------|----------------------------|------------|---------|----------------------------------|------------|---------|--------|--------------|-----------------------------------|------------|--------------|----------------|
| | | DRAIN BASIN | AREA sq. ft. | AREA ac. | C(5) | Length ft. | Slope % | T(i) min | Length ft. | Slope % | Coeff. | Velocity fps | T(t) min. | COMP. T(c) | TOTAL LENGTH | |
| | | | | | Forest & Meadow 2.50 | | | Short Grass Pasture & Lawns 7.00 | | | | | Grassed Waterway 15.00 | | | |
| | | | | | Fallow or Cultivation 5.00 | | | Nearly Bare Ground 10.00 | | | | | Paved Area & Shallow Gutter 20.00 | | | |
| P1 | P1 | 1,041,107 | 23.90 | 0.37 | 300 | 3.6% | 15.1 | 533 | 5.2% | 20.00 | 4.6 | 1.9 | 17.1 | 833 | 14.6 | 14.6 |
| P2 | P2 | 112,444 | 2.58 | 0.23 | 300 | 2.7% | 19.8 | 223 | 6.8% | 20.00 | 5.2 | 0.7 | 20.5 | 523 | 12.9 | 12.9 |
| P3 | P3 | 357,659 | 8.21 | 0.17 | 300 | 7.5% | 15.1 | 422 | 7.4% | 2.50 | 0.7 | 10.3 | 25.5 | 722 | 14.0 | 14.0 |
| OP1 | OP1 | 243,957 | 5.60 | 0.21 | 300 | 3.2% | 19.1 | 927 | 6.9% | 2.50 | 0.7 | 23.5 | 42.6 | 1227 | 16.8 | 16.8 |
| OP2 | OP2 | 251,638 | 5.78 | 0.23 | 300 | 4.0% | 17.3 | 297 | 8.9% | 2.50 | 0.7 | 6.6 | 23.9 | 597 | 13.3 | 13.3 |
| OP3 | OP3 | 202,547 | 4.65 | 0.15 | 300 | 7.3% | 15.6 | 262 | 11.0% | 2.50 | 0.8 | 5.3 | 20.8 | 562 | 13.1 | 13.1 |
| TOTAL | TOTAL | 2,209,352 | 50.72 | 0.28 | | | | | | | | | | | | |

*Note: El Paso County Drainage Manual Chapter 6 indicates that the maximum overland flow length is 100ft for urbanized areas and 300ft for rural areas. The minimum time of concentration is 5 min for developed conditions, 10 min for undeveloped conditions.

| UDON South Time of Concentration: Proposed Calculations Design Storm 5 Year Storm Event (Rational Method Procedure) | | | | | | | | | | | | |
|--|-------------|----------|--------------|---------------|-------|---------|-------|--------------------|-------|---------|-------|-------|
| BASIN INFORMATION | | | | DIRECT RUNOFF | | | | CUMMULATIVE RUNOFF | | | | NOTES |
| DESIGN POINT | DRAIN BASIN | AREA ac. | RUNOFF COEFF | T(c) min | C x A | I in/hr | Q cfs | T(c) min | C x A | I in/hr | Q cfs | |
| P1 | P1 | 23.90 | 0.37 | 14.6 | 8.82 | 3.56 | 31.41 | | | | | 0.00 |
| P2 | P2 | 2.58 | 0.23 | 12.9 | 0.60 | 3.75 | 2.24 | | | | | |
| P3 | P3 | 8.21 | 0.17 | 14.0 | 1.38 | 3.62 | 5.01 | | | | | |
| OP1 | OP1 | 5.60 | 0.21 | 16.8 | 1.20 | 3.35 | 4.02 | | | | | |
| OP2 | OP2 | 5.78 | 0.23 | 13.3 | 1.34 | 3.70 | 4.97 | | | | | |
| OP3 | OP3 | 4.65 | 0.15 | 13.1 | 0.70 | 3.72 | 2.60 | | | | | |
| TOTAL | TOTAL | 50.72 | | | | | 50.25 | | | | | |

| UDON South Time of Concentration: Proposed Calculations Design Storm 100 Year Storm Event (Rational Method Procedure) | | | | | | | | | | | | |
|--|-------------|----------|--------------|---------------|-------|---------|--------|--------------------|-------|---------|-------|-------|
| BASIN INFORMATION | | | | DIRECT RUNOFF | | | | CUMMULATIVE RUNOFF | | | | NOTES |
| DESIGN POINT | DRAIN BASIN | AREA ac. | RUNOFF COEFF | T(c) min | C x A | I in/hr | Q cfs | T(c) min | C x A | I in/hr | Q cfs | |
| P1 | P1 | 23.90 | 0.61 | 14.6 | 14.58 | 5.98 | 87.16 | | | | | |
| P2 | P2 | 2.58 | 0.54 | 12.9 | 1.40 | 6.29 | 8.83 | | | | | |
| P3 | P3 | 8.21 | 0.51 | 14.0 | 4.18 | 6.08 | 25.45 | | | | | |
| OP1 | OP1 | 5.60 | 0.56 | 16.8 | 3.14 | 5.63 | 17.67 | | | | | |
| OP2 | OP2 | 5.78 | 0.59 | 13.3 | 3.40 | 6.21 | 21.11 | | | | | |
| OP3 | OP3 | 4.65 | 0.50 | 13.1 | 2.32 | 6.25 | 14.54 | | | | | |
| TOTAL | TOTAL | 50.72 | | | | | 174.75 | | | | | |

StormCAD

UDON South
Active Scenario: 5-yr (30" North Inlet)
FlexTable: Catch Basin Table

| Label | Elevation (Rim) (ft) | Elevation (Invert) (ft) | Flow (Local In) (cfs) | Flow (Total Out) (cfs) | Headloss Coefficient (Standard) |
|------------------|-------------------------|----------------------------|--------------------------|---------------------------|---------------------------------------|
| PR. TYPE D INLET | 6,230.20 | 6,225.13 | 7.00 | 7.00 | 0.050 |

UDON South
Active Scenario: 5-yr (30" North Inlet)

FlexTable: Conduit Table

| Label | Start Node | Stop Node | Invert (Start) (ft) | Invert (Stop) (ft) | Length (User Defined) (ft) | Slope (Calculated) (ft/ft) | Diameter (in) | Flow (cfs) | Velocity (ft/s) | Hydraulic Grade Line (In) (ft) | Hydraulic Grade Line (Out) (ft) |
|-------------|------------------|-------------|---------------------|--------------------|----------------------------|----------------------------|---------------|------------|-----------------|--------------------------------|---------------------------------|
| PR. 30" RCP | PR. TYPE D INLET | PR. 30" FES | 6,225.13 | 6,223.31 | 155.0 | 0.012 | 30.0 | 7.00 | 6.60 | 6,226.01 | 6,223.98 |

UDON South
Active Scenario: 5-yr (30" North Inlet)
FlexTable: Outfall Table

| Label | Elevation (Invert) (ft) | Hydraulic Grade (ft) | Flow (Total Out) (cfs) | Elevation (User Defined Tailwater) (ft) |
|-------------|-------------------------|----------------------|------------------------|---|
| PR. 30" FES | 6,223.31 | 6,223.98 | 7.00 | 0.00 |

Profile Report

Engineering Profile - North Culvert - 5YR (UDON South North Culvert - StormCAD.stsw)

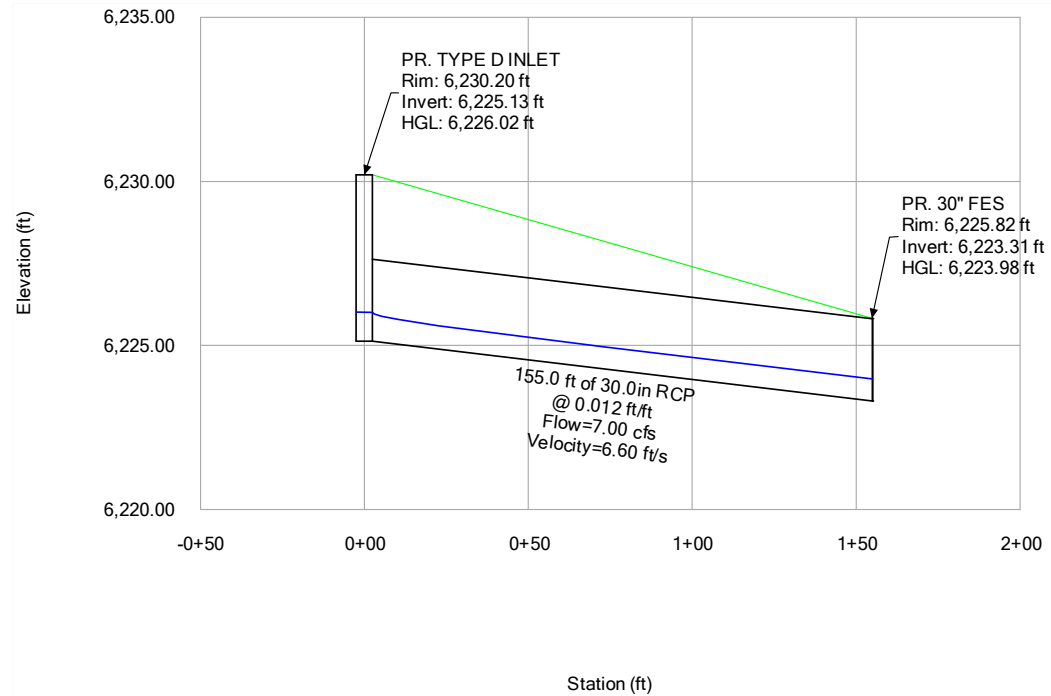

UDON South
Active Scenario: 100-yr (30" North Inlet)
FlexTable: Catch Basin Table

| Label | Elevation (Rim) (ft) | Elevation (Invert) (ft) | Flow (Local In) (cfs) | Flow (Total Out) (cfs) | Headloss Coefficient (Standard) |
|------------------|-------------------------|----------------------------|--------------------------|---------------------------|---------------------------------------|
| PR. TYPE D INLET | 6,230.20 | 6,225.13 | 30.00 | 30.00 | 0.050 |

UDON South
Active Scenario: 100-yr (30" North Inlet)

FlexTable: Conduit Table

| Label | Start Node | Stop Node | Invert (Start) (ft) | Invert (Stop) (ft) | Length (User Defined) (ft) | Slope (Calculated) (ft/ft) | Diameter (in) | Flow (cfs) | Velocity (ft/s) | Hydraulic Grade Line (In) (ft) | Hydraulic Grade Line (Out) (ft) |
|-------------|------------------|-------------|---------------------|--------------------|----------------------------|----------------------------|---------------|------------|-----------------|--------------------------------|---------------------------------|
| PR. 30" RCP | PR. TYPE D INLET | PR. 30" FES | 6,225.13 | 6,223.31 | 155.0 | 0.012 | 30.0 | 30.00 | 9.72 | 6,227.00 | 6,224.81 |

UDON South
Active Scenario: 100-yr (30" North Inlet)
FlexTable: Outfall Table

| Label | Elevation (Invert) (ft) | Hydraulic Grade (ft) | Flow (Total Out) (cfs) | Elevation (User Defined Tailwater) (ft) |
|-------------|-------------------------|----------------------|------------------------|---|
| PR. 30" FES | 6,223.31 | 6,224.81 | 30.00 | 0.00 |

Profile Report

Engineering Profile - North Culvert - 100YR (UDON South North Culvert - StormCAD.stsw)

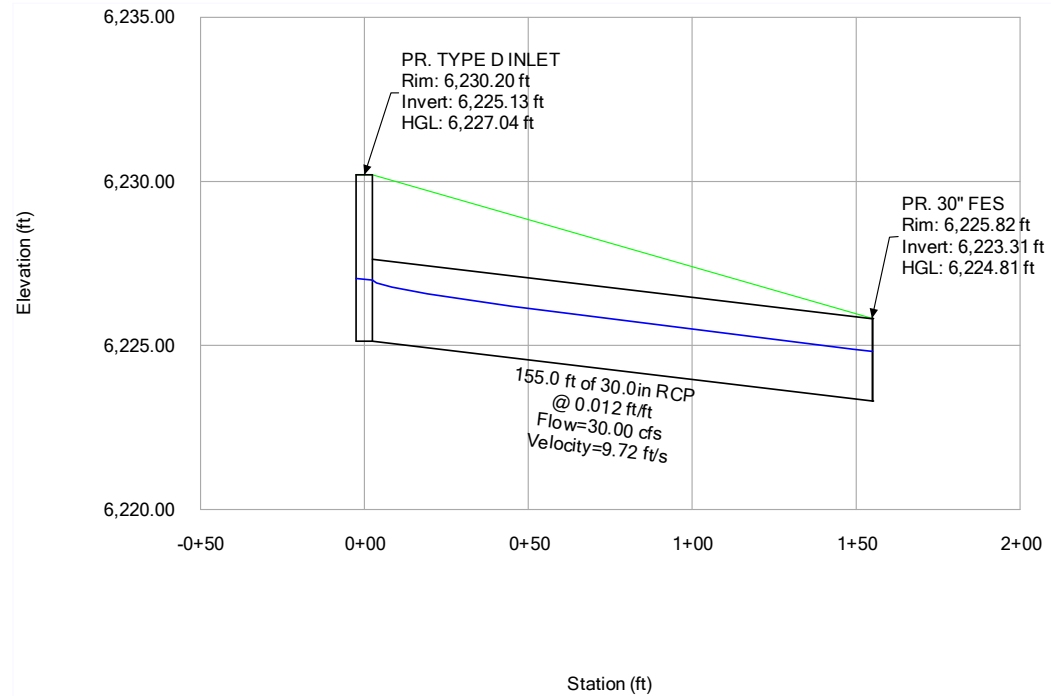

UDON South
Active Scenario: 5-yr
FlexTable: Catch Basin Table

| Label | Elevation (Rim) (ft) | Elevation (Invert) (ft) | Flow (Local In) (cfs) | Flow (Total Out) (cfs) | Headloss Coefficient (Standard) |
|--|-------------------------|-------------------------------|--------------------------|---------------------------|---------------------------------------|
| PR. MOD. CONTROL STRUCTURE TYPE C | 6,194.28 | 6,189.00 | 15.60 | 15.60 | 0.050 |

UDON South
Active Scenario: 5-yr
FlexTable: Conduit Table

| Label | Start Node | Stop Node | Invert (Start) (ft) | Invert (Stop) (ft) | Length (User Defined) (ft) | Slope (Calculated) (ft/ft) | Diameter (in) | Flow (cfs) | Velocity (ft/s) | Hydraulic Grade Line (In) (ft) | Hydraulic Grade Line (Out) (ft) |
|-------------|-----------------------------------|-------------|---------------------|--------------------|----------------------------|----------------------------|---------------|------------|-----------------|--------------------------------|---------------------------------|
| PR. 36" RCP | PR. MOD. CONTROL STRUCTURE TYPE C | PR. 36" FES | 6,189.00 | 6,188.27 | 50.0 | 0.015 | 36.0 | 15.60 | 8.82 | 6,190.26 | 6,189.21 |

UDON South
Active Scenario: 5-yr
FlexTable: Outfall Table

| Label | Elevation (Invert) (ft) | Hydraulic Grade (ft) | Flow (Total Out) (cfs) | Elevation (User Defined Tailwater) (ft) |
|-------------|-------------------------|----------------------|------------------------|---|
| PR. 36" FES | 6,188.27 | 6,189.21 | 15.60 | 0.00 |

UDON South
Active Scenario: 5-yr
Profile Report
Engineering Profile - Outfall Pipe - 5YR (UDON South - StormCAD.stsw)

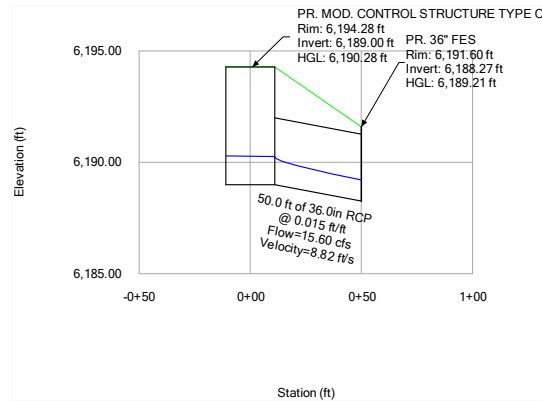

UDON South
Active Scenario: 100-yr
FlexTable: Catch Basin Table

| Label | Elevation (Rim) (ft) | Elevation (Invert) (ft) | Flow (Local In) (cfs) | Flow (Total Out) (cfs) | Headloss Coefficient (Standard) |
|--|-------------------------|-------------------------------|--------------------------|---------------------------|---------------------------------------|
| PR. MOD. CONTROL STRUCTURE TYPE C | 6,194.28 | 6,189.00 | 78.40 | 78.40 | 0.050 |

UDON South
Active Scenario: 100-yr
FlexTable: Conduit Table

| Label | Start Node | Stop Node | Invert (Start) (ft) | Invert (Stop) (ft) | Length (User Defined) (ft) | Slope (Calculated) (ft/ft) | Diameter (in) | Flow (cfs) | Velocity (ft/s) | Hydraulic Grade Line (In) (ft) | Hydraulic Grade Line (Out) (ft) |
|-------------|-----------------------------------|-------------|---------------------|--------------------|----------------------------|----------------------------|---------------|------------|-----------------|--------------------------------|---------------------------------|
| PR. 36" RCP | PR. MOD. CONTROL STRUCTURE TYPE C | PR. 36" FES | 6,189.00 | 6,188.27 | 50.0 | 0.015 | 36.0 | 78.40 | 13.97 | 6,191.75 | 6,190.45 |

UDON South
Active Scenario: 100-yr
FlexTable: Outfall Table

| Label | Elevation (Invert) (ft) | Hydraulic Grade (ft) | Flow (Total Out) (cfs) | Elevation (User Defined Tailwater) (ft) |
|-------------|-------------------------|----------------------|------------------------|---|
| PR. 36" FES | 6,188.27 | 6,190.45 | 78.40 | 0.00 |

UDON South
Active Scenario: 100-yr
Profile Report
Engineering Profile - Outfall Pipe - 100YR (UDON South - StormCAD.stsw)

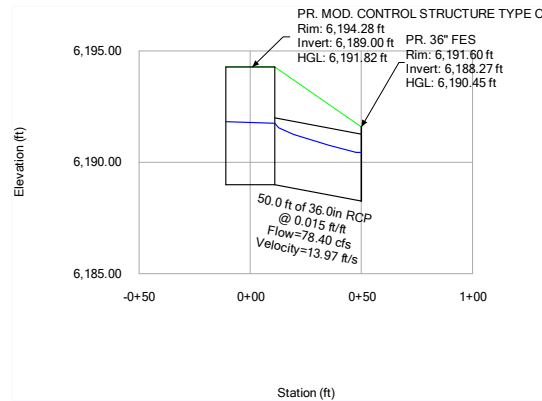

Culverts

CIRCULAR CONDUIT FLOW (Normal & Critical Depth Computation)

MHFD-Culvert, Version 4.00 (May 2020)

Project: **UDON South**

Pipe ID: **Ex. Off-Site North Culvert (24" CMP)**

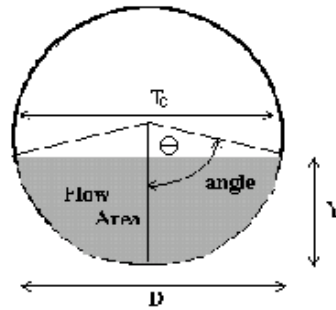

| Design Information (Input) | |
|--|------------------------------------|
| Pipe Invert Slope | So = 0.0195 ft/ft |
| Pipe Manning's n-value | n = 0.0220 * |
| Pipe Diameter | D = 24.00 inches |
| Design discharge | Q = 18.00 cfs |
| Full-Flow Capacity (Calculated) | |
| Full-flow area | Af = 3.14 sq ft |
| Full-flow wetted perimeter | Pf = 6.28 ft |
| Half Central Angle | Theta = 3.14 radians |
| Full-flow capacity | Qf = 18.72 cfs |
| Calculation of Normal Flow Condition | |
| Half Central Angle ($0 < \text{Theta} < 3.14$) | Theta = 2.18 radians |
| Flow area | An = 2.65 sq ft |
| Top width | Tn = 1.64 ft |
| Wetted perimeter | Pn = 4.37 ft |
| Flow depth | Yn = 1.57 ft |
| Flow velocity | Vn = 6.79 fps |
| Discharge | Qn = 18.00 cfs |
| Percent of Full Flow | Flow = 96.2% of full flow |
| Normal Depth Froude Number | Fr _n = 0.94 subcritical |
| Calculation of Critical Flow Condition | |
| Half Central Angle ($0 < \text{Theta-c} < 3.14$) | Theta-c = 2.13 radians |
| Critical flow area | Ac = 2.58 sq ft |
| Critical top width | Tc = 1.70 ft |
| Critical flow depth | Yc = 1.53 ft |
| Critical flow velocity | Vc = 6.99 fps |
| Critical Depth Froude Number | Fr _c = 1.00 |

* Unexpected value for Manning's n

DETERMINATION OF CULVERT HEADWATER AND OUTLET PROTECTION

MHFD-Culvert, Version 4.00 (May 2020)

Project: UDON South
ID: Ex. Off-Site North Culvert (24" CMP)

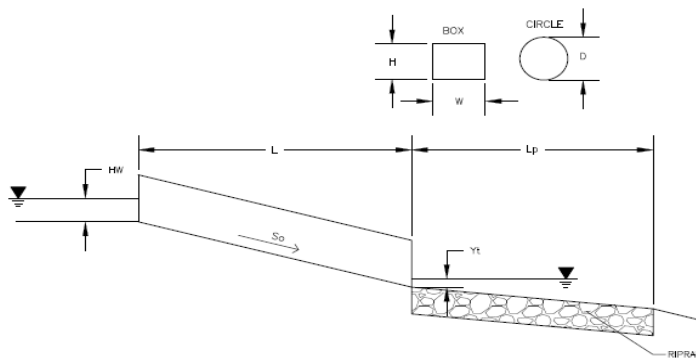

Soil Type:

Choose One:

- Sandy
 Non-Sandy

Design Information:

| | |
|--|---|
| Design Discharge | Q = <input type="text" value="18"/> cfs |
| Circular Culvert: | |
| Barrel Diameter in Inches | D = <input type="text" value="24"/> inches |
| Inlet Edge Type (Choose from pull-down list) | Beveled Edge (1:1) |
| OR: | |
| Box Culvert: | |
| Barrel Height (Rise) in Feet | H (Rise) = <input type="text" value="OR"/> ft |
| Barrel Width (Span) in Feet | W (Span) = <input type="text" value="OR"/> ft |
| Inlet Edge Type (Choose from pull-down list) | |
| Number of Barrels | # Barrels = <input type="text" value="1"/> |
| Inlet Elevation | Elev IN = <input type="text" value="6233.92"/> ft |
| Outlet Elevation OR Slope | So = <input type="text" value="0.0195"/> ft/ft |
| Culvert Length | L = <input type="text" value="71"/> ft |
| Manning's Roughness | n = <input type="text" value="0.022"/> |
| Bend Loss Coefficient | k _b = <input type="text" value="0"/> |
| Exit Loss Coefficient | k _x = <input type="text" value="1"/> |
| Tailwater Surface Elevation | Y _t , Elevation = <input type="text" value="OR"/> ft |
| Max Allowable Channel Velocity | V = <input type="text" value="7"/> ft/s |

Calculated Results:

| | |
|--|---|
| Culvert Cross Sectional Area Available | A = <input type="text" value="3.14"/> ft ² |
| Culvert Normal Depth | Y _n = <input type="text" value="1.57"/> ft |
| Culvert Critical Depth | Y _c = <input type="text" value="1.53"/> ft |
| Froude Number | Fr = <input type="text" value="0.94"/> |
| Entrance Loss Coefficient | k _e = <input type="text" value="0.20"/> |
| Friction Loss Coefficient | k _f = <input type="text" value="2.51"/> |
| Sum of All Loss Coefficients | k _s = <input type="text" value="3.71"/> ft |
| Headwater: | |
| Inlet Control Headwater | HW _I = <input type="text" value="2.49"/> ft |
| Outlet Control Headwater | HW _O = <input type="text" value="2.27"/> ft |
| Design Headwater Elevation | HW = <input type="text" value="6236.41"/> ft |
| Headwater/Diameter <u>OR</u> Headwater/Rise Ratio | HW/D = <input type="text" value="1.24"/> |
| Outlet Protection: | |
| Flow/(Diameter ^{2.5}) | Q/D ^{2.5} = <input type="text" value="3.18"/> ft ^{0.5} /s |
| Tailwater Surface Height | Y _t = <input type="text" value="0.80"/> ft |
| Tailwater/Diameter | Y _t /D = <input type="text" value="0.40"/> |
| Expansion Factor | 1/(2*tan(Θ)) = <input type="text" value="4.22"/> |
| Flow Area at Max Channel Velocity | A _t = <input type="text" value="2.57"/> ft ² |
| Width of Equivalent Conduit for Multiple Barrels | W _{eq} = <input type="text" value="-"/> ft |
| Length of Riprap Protection | L_p = <input type="text" value="6"/> ft |
| Width of Riprap Protection at Downstream End | T = <input type="text" value="4"/> ft |
| Adjusted Diameter for Supercritical Flow | Da = <input type="text" value="-"/> ft |
| Minimum Theoretical Riprap Size | d ₅₀ min = <input type="text" value="5"/> in |
| Nominal Riprap Size | d ₅₀ nominal = <input type="text" value="6"/> in |
| MHFD Riprap Type | Type = <input type="text" value="VL"/> |

CIRCULAR CONDUIT FLOW (Normal & Critical Depth Computation)

MHFD-Culvert, Version 4.00 (May 2020)

Project: UDON South

Pipe ID: Pr. North Culvert (30" RCP)

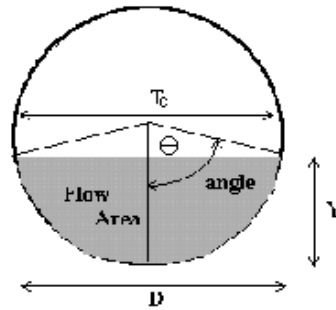

| <u>Design Information (Input)</u> | |
|--|--|
| Pipe Invert Slope | So = <input style="width: 80px;" type="text" value="0.0120"/> ft/ft |
| Pipe Manning's n-value | n = <input style="width: 80px;" type="text" value="0.0130"/> |
| Pipe Diameter | D = <input style="width: 80px;" type="text" value="30.00"/> inches |
| Design discharge | Q = <input style="width: 80px;" type="text" value="30.00"/> cfs |
| <u>Full-Flow Capacity (Calculated)</u> | |
| Full-flow area | Af = <input style="width: 80px;" type="text" value="4.91"/> sq ft |
| Full-flow wetted perimeter | Pf = <input style="width: 80px;" type="text" value="7.85"/> ft |
| Half Central Angle | Theta = <input style="width: 80px;" type="text" value="3.14"/> radians |
| Full-flow capacity | Qf = <input style="width: 80px;" type="text" value="45.05"/> cfs |
| <u>Calculation of Normal Flow Condition</u> | |
| Half Central Angle ($0 < \text{Theta} < 3.14$) | Theta = <input style="width: 80px;" type="text" value="1.77"/> radians |
| Flow area | An = <input style="width: 80px;" type="text" value="3.05"/> sq ft |
| Top width | Tn = <input style="width: 80px;" type="text" value="2.45"/> ft |
| Wetted perimeter | Pn = <input style="width: 80px;" type="text" value="4.41"/> ft |
| Flow depth | Yn = <input style="width: 80px;" type="text" value="1.49"/> ft |
| Flow velocity | Vn = <input style="width: 80px;" type="text" value="9.82"/> fps |
| Discharge | Qn = <input style="width: 80px;" type="text" value="30.00"/> cfs |
| Percent of Full Flow | Flow = <input style="width: 80px;" type="text" value="66.6%"/> of full flow |
| Normal Depth Froude Number | Fr _n = <input style="width: 80px;" type="text" value="1.55"/> supercritical |
| <u>Calculation of Critical Flow Condition</u> | |
| Half Central Angle ($0 < \text{Theta-c} < 3.14$) | Theta-c = <input style="width: 80px;" type="text" value="2.09"/> radians |
| Critical flow area | Ac = <input style="width: 80px;" type="text" value="3.93"/> sq ft |
| Critical top width | Tc = <input style="width: 80px;" type="text" value="2.17"/> ft |
| Critical flow depth | Yc = <input style="width: 80px;" type="text" value="1.87"/> ft |
| Critical flow velocity | Vc = <input style="width: 80px;" type="text" value="7.63"/> fps |
| Critical Depth Froude Number | Fr _c = <input style="width: 80px;" type="text" value="1.00"/> |

DETERMINATION OF CULVERT HEADWATER AND OUTLET PROTECTION

MHFD-Culvert, Version 4.00 (May 2020)

Project: UDON South
ID: Pr. North Culvert (30" RCP)

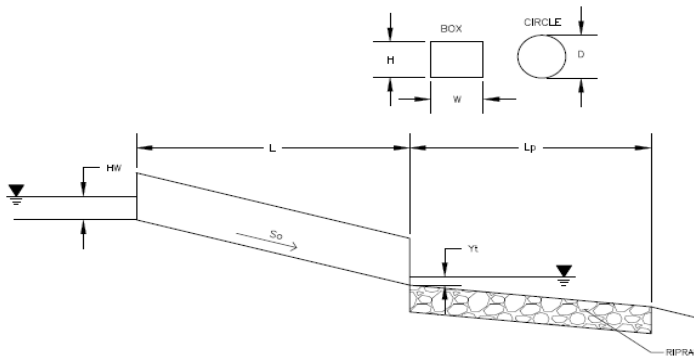

Soil Type:
 Choose One:
 Sandy
 Non-Sandy

Supercritical Flow! Using Adjusted Diameter to calculate protection type.

| Design Information: | |
|--|--|
| Design Discharge | Q = <input type="text" value="30"/> cfs |
| Circular Culvert: | |
| Barrel Diameter in Inches | D = <input type="text" value="30"/> inches |
| Inlet Edge Type (Choose from pull-down list) | Beveled Edge (1:1) |
| OR: | |
| Box Culvert: | |
| Barrel Height (Rise) in Feet | H (Rise) = <input type="text"/> ft |
| Barrel Width (Span) in Feet | W (Span) = <input type="text"/> ft |
| Inlet Edge Type (Choose from pull-down list) | |
| Number of Barrels | # Barrels = <input type="text" value="1"/> |
| Inlet Elevation | Elev IN = <input type="text" value="6225.13"/> ft |
| Outlet Elevation OR Slope | So = <input type="text" value="0.012"/> ft/ft |
| Culvert Length | L = <input type="text" value="150"/> ft |
| Manning's Roughness | n = <input type="text" value="0.013"/> |
| Bend Loss Coefficient | k _b = <input type="text" value="0"/> |
| Exit Loss Coefficient | k _x = <input type="text" value="1"/> |
| Tailwater Surface Elevation | Y _t , Elevation = <input type="text"/> ft |
| Max Allowable Channel Velocity | V = <input type="text" value="7"/> ft/s |
| Calculated Results: | |
| Culvert Cross Sectional Area Available | A = <input type="text" value="4.91"/> ft ² |
| Culvert Normal Depth | Y _n = <input type="text" value="1.49"/> ft |
| Culvert Critical Depth | Y _c = <input type="text" value="1.87"/> ft |
| Froude Number | Fr = <input type="text" value="1.55"/> Supercritical! |
| Entrance Loss Coefficient | k _e = <input type="text" value="0.20"/> |
| Friction Loss Coefficient | k _f = <input type="text" value="1.38"/> |
| Sum of All Loss Coefficients | k _s = <input type="text" value="2.58"/> ft |
| Headwater: | |
| Inlet Control Headwater | HW _I = <input type="text" value="2.99"/> ft |
| Outlet Control Headwater | HW _O = <input type="text" value="1.88"/> ft |
| Design Headwater Elevation | HW = <input type="text" value="6228.12"/> ft |
| Headwater/Diameter OR Headwater/Rise Ratio | HW/D = <input type="text" value="1.20"/> |
| Outlet Protection: | |
| Flow/(Diameter ^{2.5}) | Q/D ^{2.5} = <input type="text" value="3.04"/> ft ^{0.5} /s |
| Tailwater Surface Height | Y _t = <input type="text" value="1.00"/> ft |
| Tailwater/Diameter | Y _t /D = <input type="text" value="0.40"/> |
| Expansion Factor | 1/(2*tan(θ)) = <input type="text" value="4.35"/> |
| Flow Area at Max Channel Velocity | A _t = <input type="text" value="4.29"/> ft ² |
| Width of Equivalent Conduit for Multiple Barrels | W _{eq} = <input type="text" value="-"/> ft |
| Length of Riprap Protection | L_p = <input type="text" value="8"/> ft |
| Width of Riprap Protection at Downstream End | T = <input type="text" value="5"/> ft |
| Adjusted Diameter for Supercritical Flow | Da = <input type="text" value="2.00"/> ft |
| Minimum Theoretical Riprap Size | d ₅₀ min = <input type="text" value="7"/> in |
| Nominal Riprap Size | d ₅₀ nominal = <input type="text" value="9"/> in |
| MHFD Riprap Type | Type = <input type="text" value="L"/> |

Rock Chute

Rock Chute Design Data

(Version WI-July-2010, Based on Design of Rock Chutes by Robinson, Rice, Kadavy, ASAE, 1998)

Project: Pond Rock Chute
Designer: KRK
Date: August 20, 2024

County: El Paso County
Checked by: _____
Date: _____

Input Geometry:

| Upstream Channel | Chute | Downstream Channel |
|---|--|----------------------------|
| Bw = 10.0 ft. | Bw = 10.0 ft. | Bw = 6.0 ft. |
| Side slopes = 4.0 (m:1) | Factor of safety = 1.20 (F_s) 1.2 Min | Side slopes = 1.5 (m:1) |
| Velocity n-value = 0.035 | Side slopes = 4.0 (m:1) → 2.0:1 max. | Velocity n-value = 0.035 |
| Bed slope = 0.0165 ft./ft. | Bed slope (4:1) = 0.250 ft./ft → 3.0:1 max. | Bed slope = 0.0100 ft./ft. |
| <i>Note: n value = a) velocity n from waterway program or b) computed manning's n for channel</i> | Freeboard = 0.5 ft. → | Base flow = 0.0 cfs |
| | Outlet apron depth, d = 1.5 ft. | |

Design Storm Data (Table 2, FOTG, WI-NRCS Grade Stabilization Structure No. 410):

| | | |
|--|---|---|
| Apron elev. --- Inlet = 197.0 ft. ----- Outlet 192.5 ft. --- ($H_{drop} = 3$ ft.) | | Note: The total required capacity is routed through the chute (principal spillway) or in combination with an auxiliary spillway. |
| Q_{high} = Runoff from design storm capacity from Table 2, FOTG Standard 410 | Input tailwater (T_w): 0.25 1.20 | |
| Q_5 = Runoff from a 5-year, 24-hour storm. | | |
| $Q_{high} = 105.0$ cfs | High flow storm through chute → T_w (ft.) = Program | |
| $Q_5 = 32.0$ cfs | Low flow storm through chute → T_w (ft.) = Program | |

Profile and Cross Section (Output):

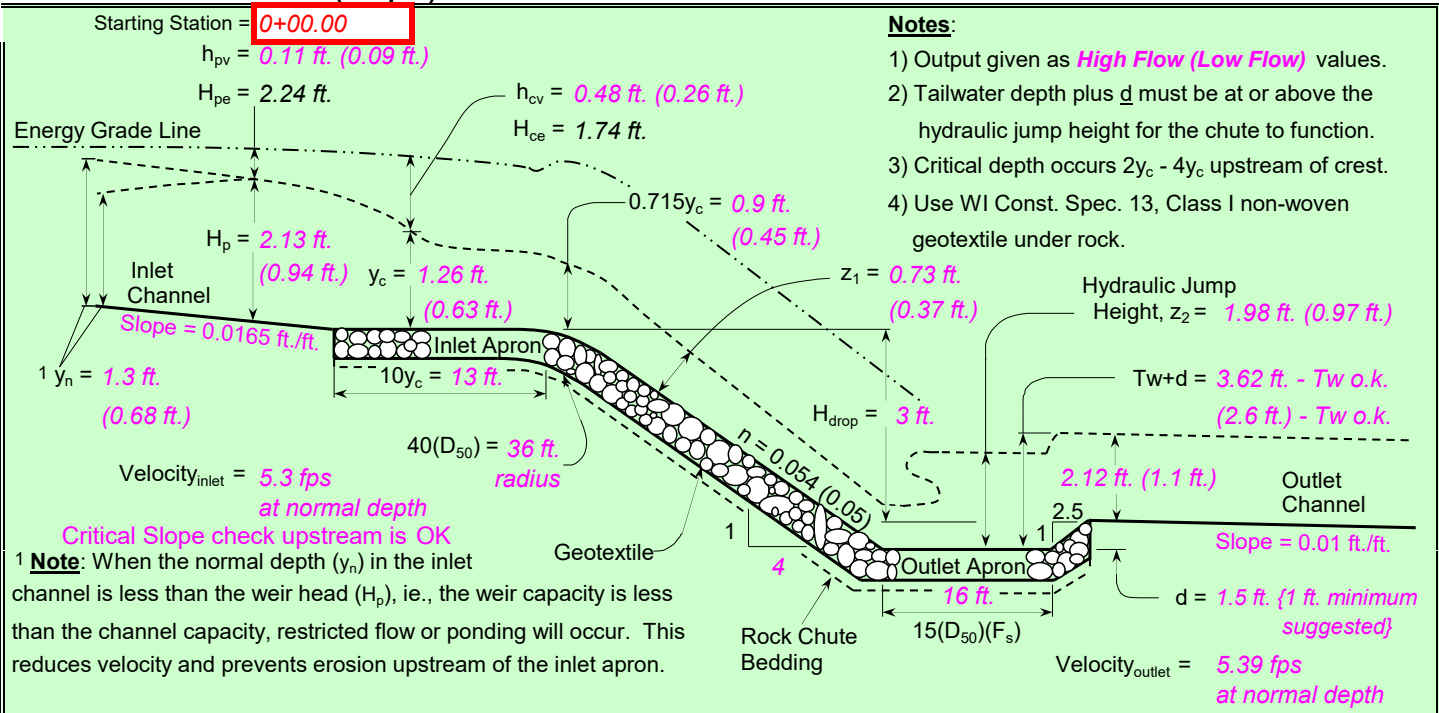

Profile Along Centerline of Chute

Typical Cross Section

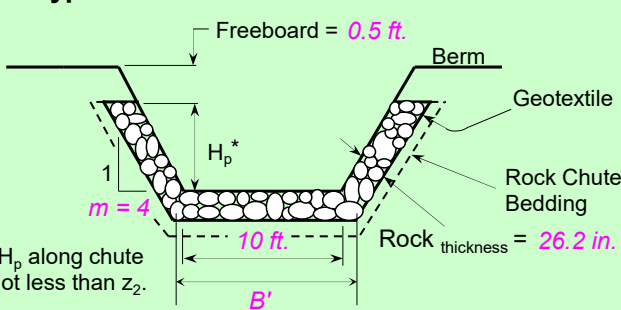

| | |
|--|---------------------------------|
| $F_s =$ 1.20 | Factor of safety (multiplier) |
| $n =$ 0.054 | Manning's roughness coefficient |
| $D_{50}(F_s) =$ 13.1 in. | Minimum Design D_{50} * |
| $2(D_{50})(F_s) =$ 26.2 in. | Rock chute thickness |
| $T_w + d =$ 3.62 ft. | Tailwater above outlet apron |
| $z_2 =$ 1.98 ft. | Hydraulic jump height |
| *** The outlet will function adequately | |

High Flow Storm Information

Equivalent unit discharge = **8.06 cfs/ft.**

| Forebay A | | | |
|--|----------|-------------------------|--------------|
| Forebay Release and Configuration | Required | Flow: Q_{100} = (cfs) | Release Rate |
| Release 2% of the undetained 100-year peak discharge by way of a wall/notch or berm/pipe configuration | 105.00 | 105.00 | 2.10 |

| Minimum Forebay Volume Required | Required (CF) | Provided (CF) |
|---|---------------|---------------|
| 2% of the WQCV 40hr drain time, $a = 1$ $l = 0.202$ $A = 40.01$ AC | 338.41 | 675.00 |

| Maximum Forebay Depth | Required | Provided |
|-----------------------|----------|----------|
| 18" Max | 18" | 18" |

| Forebay Notch Calculations | | |
|-----------------------------|------------------------|---|
| $Q = C_o A_o (2gH_o)^{0.5}$ | | |
| Q_a | 2.10 cfs | 2% of Peak 100 YR Discharge for contributing Sub-Basins |
| C_o | 0.6 | |
| H_o | 1.5 ft | |
| g | 32.2 ft/s ² | |
| A_a | 0.36 ft ² | |
| L_a | 0.24 ft | |
| | 2.85 in | 3" Minimum per Criteria |

$WQCV = a(0.91l^3 - 1.19l^2 + 0.78l)$ Equation 3-1

Where:

- $WQCV$ = Water Quality Capture Volume (watershed inches)
- a = Coefficient corresponding to WQCV drain time (Table 3-2)
- l = Imperviousness (%/100) (see Figures 3-3 through 3-5 [single family land use] and /or the *Runoff* chapter of Volume 1 [other typical land uses])

Table 3-2. Drain Time Coefficients for WQCV Calculations

| Drain Time (hrs) | Coefficient, a |
|------------------|----------------|
| 12 hours | 0.8 |
| 24 hours | 0.9 |
| 40 hours | 1.0 |

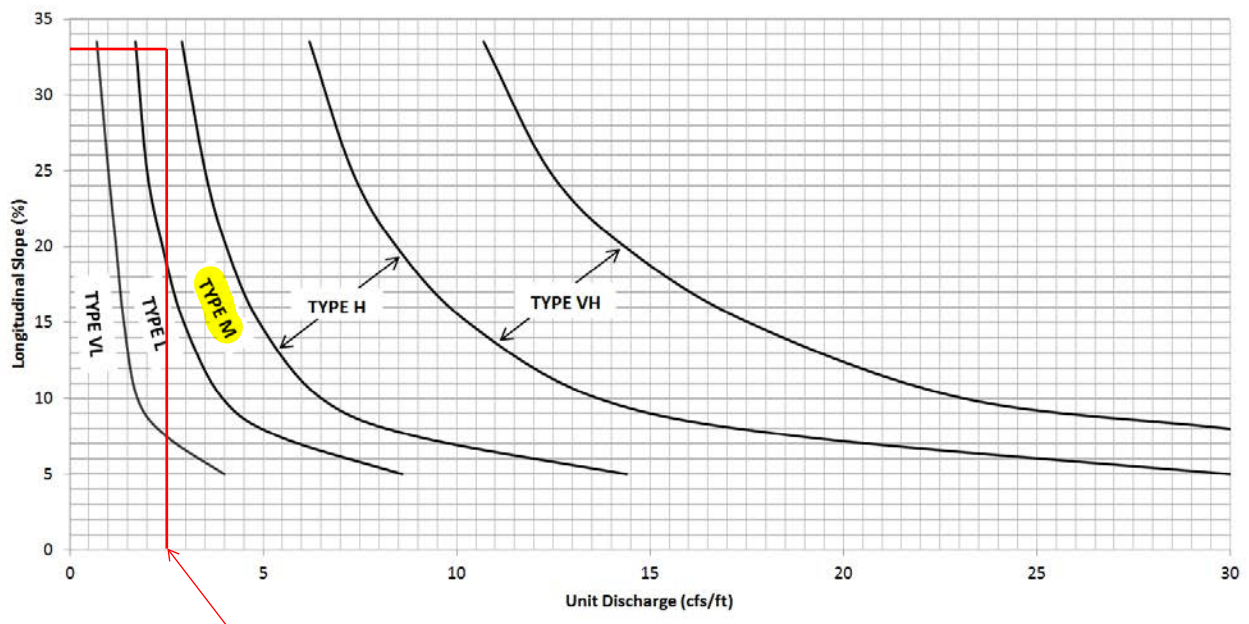
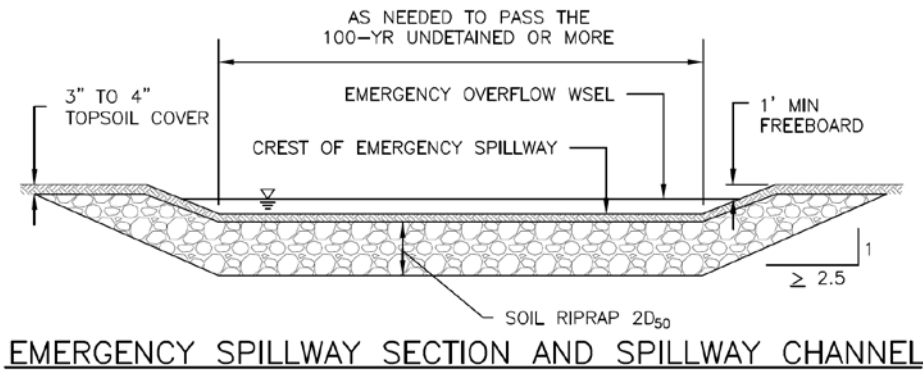
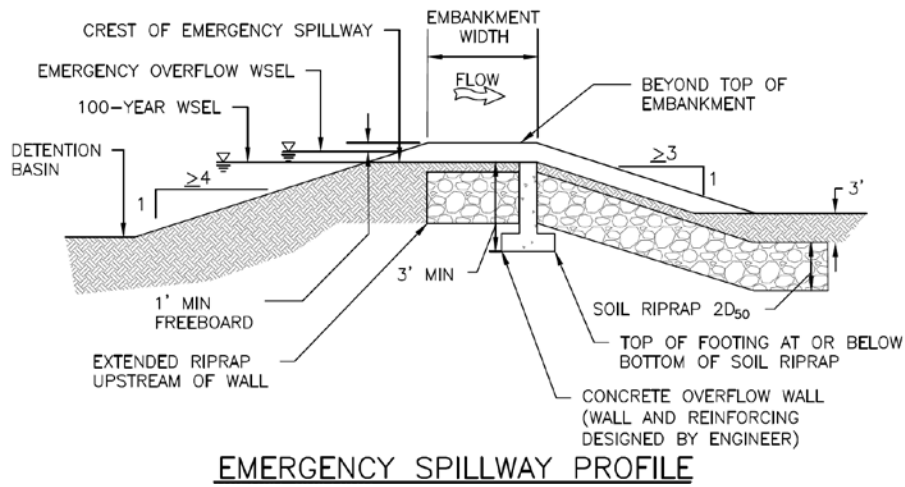

Figure 12-21. Embankment protection details and rock sizing chart (adapted from Arapahoe County)

59.2 cfs/25 ft = 2.4

Ex. Drainageways-Flowmaster Analysis

Ex. Drainage Channel_On-Site

| | |
|---------------------|-----------------|
| Project Description | |
| Friction Method | Manning Formula |
| Solve For | Normal Depth |
| Input Data | |
| Channel Slope | 0.035 ft/ft |
| Discharge | 105.00 cfs |

Section Definitions

| Station (ft) | Elevation (ft) |
|--------------|----------------|
| 0+00 | 6,215.82 |
| 0+85 | 6,213.38 |
| 1+00 | 6,209.05 |
| 2+15 | 6,208.57 |
| 2+39 | 6,213.18 |
| 3+36 | 6,214.96 |

Roughness Segment Definitions

| Start Station | Ending Station | Roughness Coefficient |
|------------------|------------------|-----------------------|
| (0+00, 6,215.82) | (0+85, 6,213.38) | 0.035 |
| (0+85, 6,213.38) | (1+00, 6,209.05) | 0.035 |
| (1+00, 6,209.05) | (2+15, 6,208.57) | 0.035 |
| (2+15, 6,208.57) | (2+39, 6,213.18) | 0.035 |
| (2+39, 6,213.18) | (3+36, 6,214.96) | 0.035 |

Options

| | |
|-----------------------------------|---------------------|
| Current Roughness Weighted Method | Pavlovskii's Method |
| Open Channel Weighting Method | Pavlovskii's Method |
| Closed Channel Weighting Method | Pavlovskii's Method |

Results

| | |
|-----------------------|-----------------------|
| Normal Depth | 6.1 in |
| Roughness Coefficient | 0.035 |
| Elevation | 6,209.08 ft |
| Elevation Range | 6,208.6 to 6,215.8 ft |
| Flow Area | 31.7 ft ² |
| Wetted Perimeter | 118.1 ft |
| Hydraulic Radius | 3.2 in |
| Top Width | 118.09 ft |
| Normal Depth | 6.1 in |
| Critical Depth | 6.4 in |
| Critical Slope | 0.027 ft/ft |

Ex. Drainage Channel_On-Site

Results

| | |
|-----------------|---------------|
| Velocity | 3.31 ft/s |
| Velocity Head | 0.17 ft |
| Specific Energy | 0.68 ft |
| Froude Number | 1.125 |
| Flow Type | Supercritical |

GVF Input Data

| | |
|-----------------|--------|
| Upstream Depth | 0.0 in |
| Length | 0.0 ft |
| Number Of Steps | 0 |

GVF Output Data

| | |
|---------------------|-------------|
| Downstream Depth | 0.0 in |
| Profile Description | N/A |
| Profile Headloss | 0.00 ft |
| Downstream Velocity | 0.00 ft/s |
| Upstream Velocity | 0.00 ft/s |
| Normal Depth | 6.1 in |
| Critical Depth | 6.4 in |
| Channel Slope | 0.035 ft/ft |
| Critical Slope | 0.027 ft/ft |

Ex. Drainage Channel_On-Site

| Project Description | |
|---------------------|-----------------|
| Friction Method | Manning Formula |
| Solve For | Normal Depth |

| Input Data | |
|---------------|-------------|
| Channel Slope | 0.035 ft/ft |
| Normal Depth | 6.1 in |
| Discharge | 105.00 cfs |

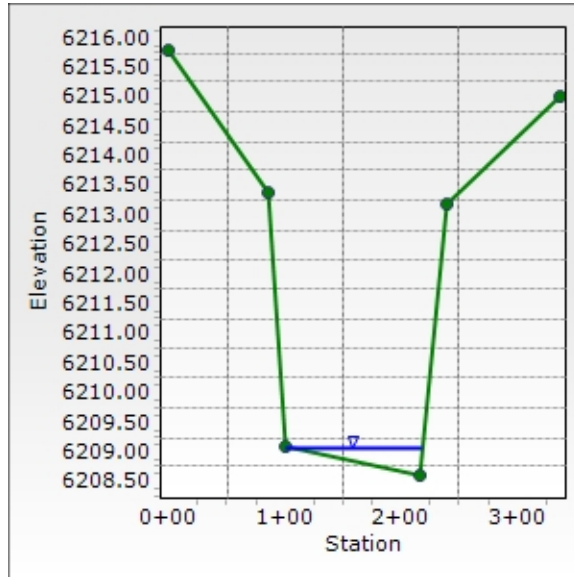

Ex. Drainage Channel_Off-Site

| Project Description | |
|---------------------|-----------------|
| Friction Method | Manning Formula |
| Solve For | Normal Depth |
| Input Data | |
| Channel Slope | 0.035 ft/ft |
| Discharge | 59.20 cfs |

Section Definitions

| | Station (ft) | Elevation (ft) |
|--|--------------|----------------|
| | 0+00 | 6,220.00 |
| | 5+00 | 6,188.00 |
| | 6+20 | 6,186.80 |
| | 8+22 | 6,195.74 |

Roughness Segment Definitions

| Start Station | Ending Station | Roughness Coefficient |
|------------------|------------------|-----------------------|
| (0+00, 6,220.00) | (5+00, 6,188.00) | 0.035 |
| (5+00, 6,188.00) | (6+20, 6,186.80) | 0.035 |
| (6+20, 6,186.80) | (8+22, 6,195.74) | 0.035 |

Options

| | |
|-----------------------------------|---------------------|
| Current Roughness Weighted Method | Pavlovskii's Method |
| Open Channel Weighting Method | Pavlovskii's Method |
| Closed Channel Weighting Method | Pavlovskii's Method |

Results

| | |
|-----------------------|-----------------------|
| Normal Depth | 6.5 in |
| Roughness Coefficient | 0.035 |
| Elevation | 6,187.34 ft |
| Elevation Range | 6,186.8 to 6,220.0 ft |
| Flow Area | 17.9 ft ² |
| Wetted Perimeter | 66.2 ft |
| Hydraulic Radius | 3.2 in |
| Top Width | 66.19 ft |
| Normal Depth | 6.5 in |
| Critical Depth | 6.8 in |
| Critical Slope | 0.027 ft/ft |
| Velocity | 3.31 ft/s |
| Velocity Head | 0.17 ft |
| Specific Energy | 0.71 ft |
| Froude Number | 1.124 |

Ex. Drainage Channel_Off-Site

| Results | |
|---------------------|---------------|
| Flow Type | Supercritical |
| GVF Input Data | |
| Downstream Depth | 0.0 in |
| Length | 0.0 ft |
| Number Of Steps | 0 |
| GVF Output Data | |
| Upstream Depth | 0.0 in |
| Profile Description | N/A |
| Profile Headloss | 0.00 ft |
| Downstream Velocity | Infinity ft/s |
| Upstream Velocity | Infinity ft/s |
| Normal Depth | 6.5 in |
| Critical Depth | 6.8 in |
| Channel Slope | 0.035 ft/ft |
| Critical Slope | 0.027 ft/ft |

Ex. Drainage Channel Off-Site

| Project Description | |
|---------------------|-----------------|
| Friction Method | Manning Formula |
| Solve For | Normal Depth |

| Input Data | |
|---------------|-------------|
| Channel Slope | 0.035 ft/ft |
| Normal Depth | 6.5 in |
| Discharge | 59.20 cfs |

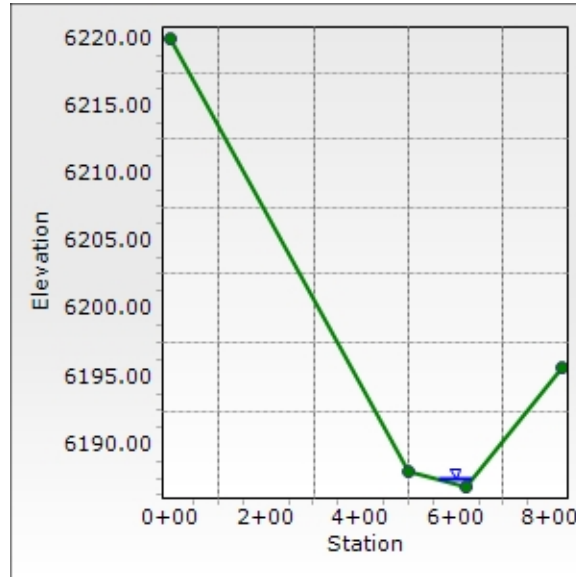

DETENTION BASIN STAGE-STORAGE TABLE BUILDER

MHFD-DETENTION, Version 4.06 (July 2022)

Project: UDON South - Full Spectrum Extended Detention Basin A

Basin ID: OP1, OP2, OP3, P1

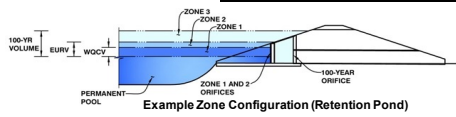

Example Zone Configuration (Retention Pond)

Watershed Information

Table with watershed information inputs: Selected BMP Type (EDB), Watershed Area (39.94 acres), Watershed Length (2,008 ft), Watershed Length to Centroid (1,004 ft), Watershed Slope (0.050 ft/ft), Watershed Imperviousness (20.20%), etc.

After providing required inputs above including 1-hour rainfall depths, click 'Run CUHP' to generate runoff hydrographs using the embedded Colorado Urban Hydrograph Procedure.

Table with water quality and volume inputs: Water Quality Capture Volume (0.388 acre-feet), Excess Urban Runoff Volume (0.710 acre-feet), 2-yr Runoff Volume (1.159 acre-feet), etc.

Optional User Overrides

Optional User Overrides table with columns for volume and length in various units (acre-feet, inches).

6189.5

Main stage-storage table with columns: Stage - Storage Description, Stage (ft), Optional Override Stage (ft), Length (ft), Width (ft), Area (ft^2), Optional Override Area (ft^2), Area (acre), Volume (ft^3), Volume (ac-ft). Rows include Top of Micropool and stages 6190 through 6197.5.

DETENTION BASIN STAGE-STORAGE TABLE BUILDER

MHFD-Detention, Version 4.06 (July 2022)

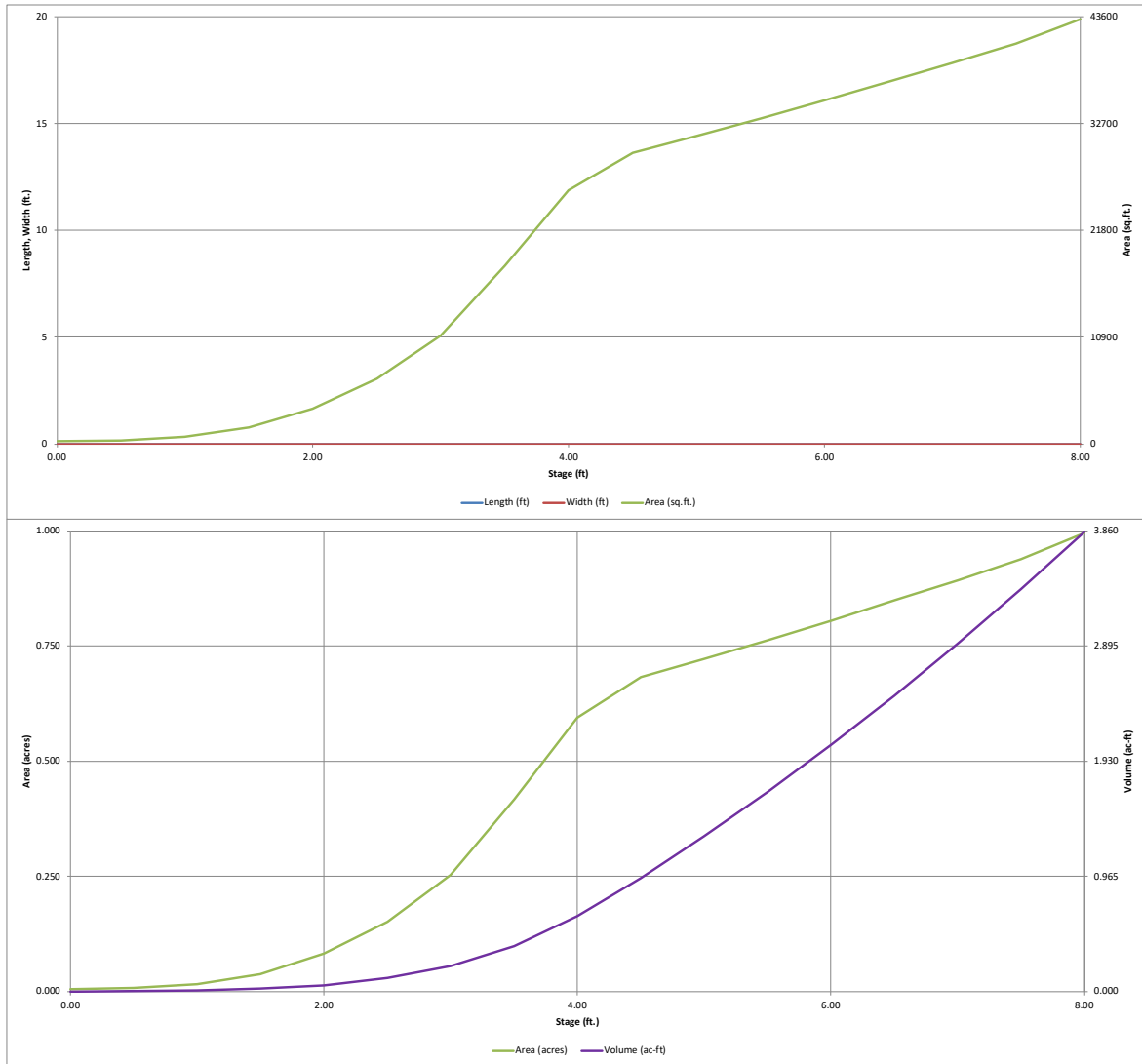

DETENTION BASIN OUTLET STRUCTURE DESIGN

MHFD- Detention, Version 4.06 (July 2022)

Project: UDON South - Full Spectrum Extended Detention Basin A

Basin ID: OP1, OP2, OP3, P1

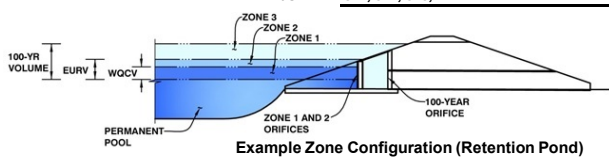

| | Estimated Stage (ft) | Estimated Volume (ac-ft) | Outlet Type |
|--------------------------|----------------------|--------------------------|----------------------|
| Zone 1 (WQCV) | 3.52 | 0.388 | Orifice Plate |
| Zone 2 (EURV) | 4.13 | 0.322 | Orifice Plate |
| Zone 3 (100-year) | 6.03 | 1.378 | Weir&Pipe (Restrict) |
| Total (all zones) | | 2.088 | |

User Input: Orifice at Underdrain Outlet (typically used to drain WQCV in a Filtration BMP)

| | | | | | |
|-----------------------------------|-----|--|-------------------------------|-----|-----------------|
| Underdrain Orifice Invert Depth = | N/A | ft (distance below the filtration media surface) | Underdrain Orifice Area = | N/A | ft ² |
| Underdrain Orifice Diameter = | N/A | inches | Underdrain Orifice Centroid = | N/A | feet |

User Input: Orifice Plate with one or more orifices or Elliptical Slot Weir (typically used to drain WQCV and/or EURV in a sedimentation BMP)

| | | | | | |
|--|-------|---|----------------------------|-----------|-----------------|
| Centroid of Lowest Orifice = | 0.00 | ft (relative to basin bottom at Stage = 0 ft) | WQ Orifice Area per Row = | 8.681E-03 | ft ² |
| Depth at top of Zone using Orifice Plate = | 4.13 | ft (relative to basin bottom at Stage = 0 ft) | Elliptical Half-Width = | N/A | feet |
| Orifice Plate: Orifice Vertical Spacing = | 16.50 | inches | Elliptical Slot Centroid = | N/A | feet |
| Orifice Plate: Orifice Area per Row = | 1.25 | sq. inches (diameter = 1-1/4 inches) | Elliptical Slot Area = | N/A | ft ² |

User Input: Stage and Total Area of Each Orifice Row (numbered from lowest to highest)

| | Row 1 (required) | Row 2 (optional) | Row 3 (optional) | Row 4 (optional) | Row 5 (optional) | Row 6 (optional) | Row 7 (optional) | Row 8 (optional) |
|--------------------------------|------------------|------------------|------------------|------------------|------------------|------------------|------------------|------------------|
| Stage of Orifice Centroid (ft) | 0.00 | 1.40 | 2.80 | | | | | |
| Orifice Area (sq. inches) | 1.25 | 1.25 | 1.25 | | | | | |

| | Row 9 (optional) | Row 10 (optional) | Row 11 (optional) | Row 12 (optional) | Row 13 (optional) | Row 14 (optional) | Row 15 (optional) | Row 16 (optional) |
|--------------------------------|------------------|-------------------|-------------------|-------------------|-------------------|-------------------|-------------------|-------------------|
| Stage of Orifice Centroid (ft) | | | | | | | | |
| Orifice Area (sq. inches) | | | | | | | | |

User Input: Vertical Orifice (Circular or Rectangular)

| | | | | | | | |
|---|--------------|--------------|---|-----------------------------|--------------|--------------|-----------------|
| Invert of Vertical Orifice = | Not Selected | Not Selected | ft (relative to basin bottom at Stage = 0 ft) | Vertical Orifice Area = | Not Selected | Not Selected | ft ² |
| Depth at top of Zone using Vertical Orifice = | N/A | N/A | ft (relative to basin bottom at Stage = 0 ft) | Vertical Orifice Centroid = | N/A | N/A | feet |
| Vertical Orifice Diameter = | N/A | N/A | inches | | | | |

User Input: Overflow Weir (Dropbox with Flat or Sloped Grate and Outlet Pipe OR Rectangular/Trapezoidal Weir and No Outlet Pipe)

| | | | | | | | |
|---|--------------|--------------|---|--|-------------|--------------|-----------------|
| Overflow Weir Front Edge Height, H _o = | Zone 3 Weir | Not Selected | ft (relative to basin bottom at Stage = 0 ft) | Height of Grate Upper Edge, H _t = | Zone 3 Weir | Not Selected | feet |
| Overflow Weir Front Edge Length = | 20.00 | N/A | feet | Overflow Weir Slope Length = | 6.03 | N/A | feet |
| Overflow Weir Grate Slope = | 10.00 | N/A | H:V | Grate Open Area / 100-yr Orifice Area = | 14.76 | N/A | |
| Horiz. Length of Weir Sides = | 6.00 | N/A | feet | Overflow Grate Open Area w/o Debris = | 83.94 | N/A | ft ² |
| Overflow Grate Type = | Type C Grate | N/A | | Overflow Grate Open Area w/ Debris = | 41.97 | N/A | ft ² |
| Debris Clogging % = | 50% | N/A | % | | | | |

User Input: Outlet Pipe w/ Flow Restriction Plate (Circular Orifice, Restrictor Plate, or Rectangular Orifice)

| | | | | | | | |
|---|-------------------|--------------|--|--|-------------------|--------------|-----------------|
| Depth to Invert of Outlet Pipe = | Zone 3 Restrictor | Not Selected | ft (distance below basin bottom at Stage = 0 ft) | Outlet Orifice Area = | Zone 3 Restrictor | Not Selected | ft ² |
| Outlet Pipe Diameter = | 36.00 | N/A | inches | Outlet Orifice Centroid = | 1.24 | N/A | feet |
| Restrictor Plate Height Above Pipe Invert = | 27.00 | | inches | Half-Central Angle of Restrictor Plate on Pipe = | 2.09 | N/A | radians |

User Input: Emergency Spillway (Rectangular or Trapezoidal)

| | | | | | |
|-------------------------------------|-------|---|------------------------------------|------|---------|
| Spillway Invert Stage = | 5.50 | ft (relative to basin bottom at Stage = 0 ft) | Spillway Design Flow Depth = | 0.89 | feet |
| Spillway Crest Length = | 25.00 | feet | Stage at Top of Freeboard = | 7.39 | feet |
| Spillway End Slopes = | 4.00 | H:V | Basin Area at Top of Freeboard = | 0.93 | acres |
| Freeboard above Max Water Surface = | 1.00 | feet | Basin Volume at Top of Freeboard = | 3.27 | acre-ft |

Routed Hydrograph Results

The user can override the default CUHP hydrographs and runoff volumes by entering new values in the Inflow Hydrographs table (Columns W through AF).

| | WQCV | EURV | 2 Year | 5 Year | 10 Year | 25 Year | 50 Year | 100 Year | 500 Year |
|---|-------|-----------------|-----------------|-----------------|-----------------|-----------------|-----------------|----------------|----------|
| Design Storm Return Period = | N/A | N/A | 1.19 | 1.50 | 1.75 | 2.00 | 2.25 | 2.52 | 3.14 |
| One-Hour Rainfall Depth (in) = | N/A | N/A | 1.19 | 1.50 | 1.75 | 2.00 | 2.25 | 2.52 | 3.14 |
| CUHP Runoff Volume (acre-ft) = | 0.388 | 0.710 | 1.159 | 2.018 | 2.799 | 3.811 | 4.648 | 5.762 | 7.885 |
| Inflow Hydrograph Volume (acre-ft) = | N/A | N/A | 1.159 | 2.018 | 2.799 | 3.811 | 4.648 | 5.762 | 7.885 |
| CUHP Predevelopment Peak Q (cfs) = | N/A | N/A | 9.3 | 19.2 | 26.5 | 40.6 | 50.1 | 62.1 | 85.4 |
| OPTIONAL Override Predevelopment Peak Q (cfs) = | N/A | N/A | | | | | | | |
| Predevelopment Unit Peak Flow, q (cfs/acre) = | N/A | N/A | 0.23 | 0.48 | 0.66 | 1.02 | 1.26 | 1.56 | 2.14 |
| Peak Inflow Q (cfs) = | N/A | N/A | 15.8 | 26.4 | 34.1 | 49.3 | 59.3 | 71.4 | 96.2 |
| Peak Outflow Q (cfs) = | 0.2 | 0.2 | 4.0 | 13.4 | 21.0 | 35.8 | 45.6 | 59.2 | 80.6 |
| Ratio Peak Outflow to Predevelopment Q = | N/A | N/A | N/A | 0.7 | 0.8 | 0.9 | 0.9 | 1.0 | 0.9 |
| Structure Controlling Flow = | Plate | Overflow Weir 1 | Overflow Weir 1 | Overflow Weir 1 | Overflow Weir 1 | Overflow Weir 1 | Overflow Weir 1 | Outlet Plate 1 | Spillway |
| Max Velocity through Grate 1 (fps) = | N/A | N/A | 0.05 | 0.2 | 0.2 | 0.4 | 0.5 | 0.7 | 0.7 |
| Max Velocity through Grate 2 (fps) = | N/A | N/A | N/A | N/A | N/A | N/A | N/A | N/A | N/A |
| Time to Drain 97% of Inflow Volume (hours) = | 37 | 56 | 58 | 55 | 52 | 48 | 46 | 42 | 37 |
| Time to Drain 99% of Inflow Volume (hours) = | 40 | 59 | 63 | 61 | 59 | 58 | 57 | 55 | 53 |
| Maximum Ponding Depth (ft) = | 3.52 | 4.13 | 4.38 | 4.67 | 4.83 | 5.10 | 5.25 | 5.45 | 5.88 |
| Area at Maximum Ponding Depth (acres) = | 0.42 | 0.62 | 0.66 | 0.70 | 0.71 | 0.73 | 0.74 | 0.76 | 0.79 |
| Maximum Volume Stored (acre-ft) = | 0.389 | 0.712 | 0.866 | 1.063 | 1.182 | 1.369 | 1.487 | 1.629 | 1.971 |

DETENTION BASIN OUTLET STRUCTURE DESIGN

MHFD-Detention, Version 4.06 (July 2022)

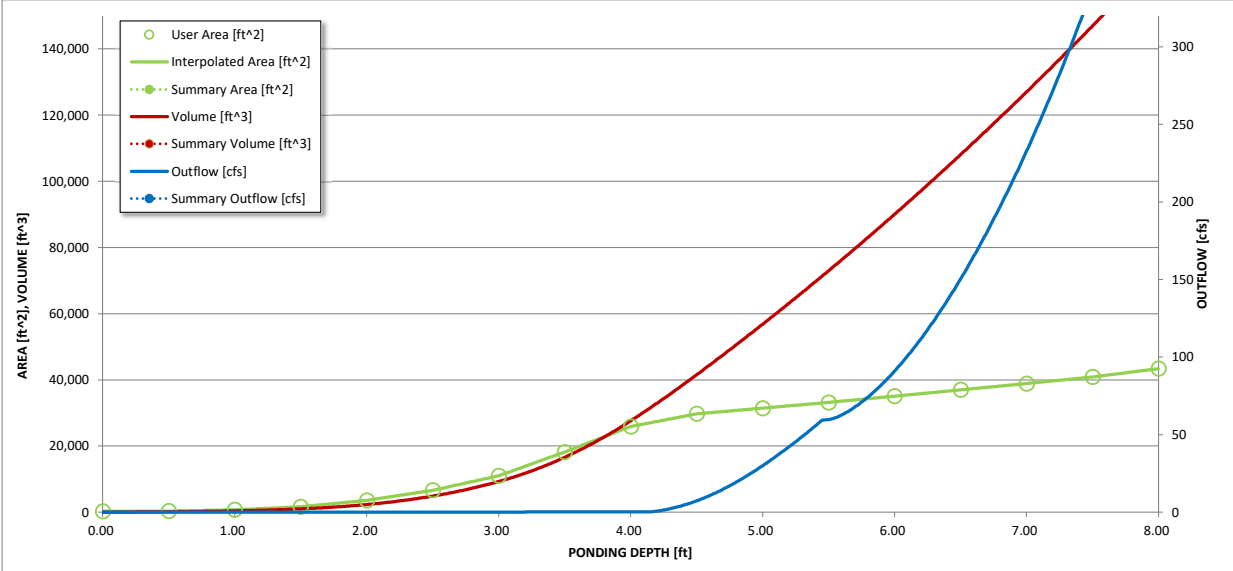
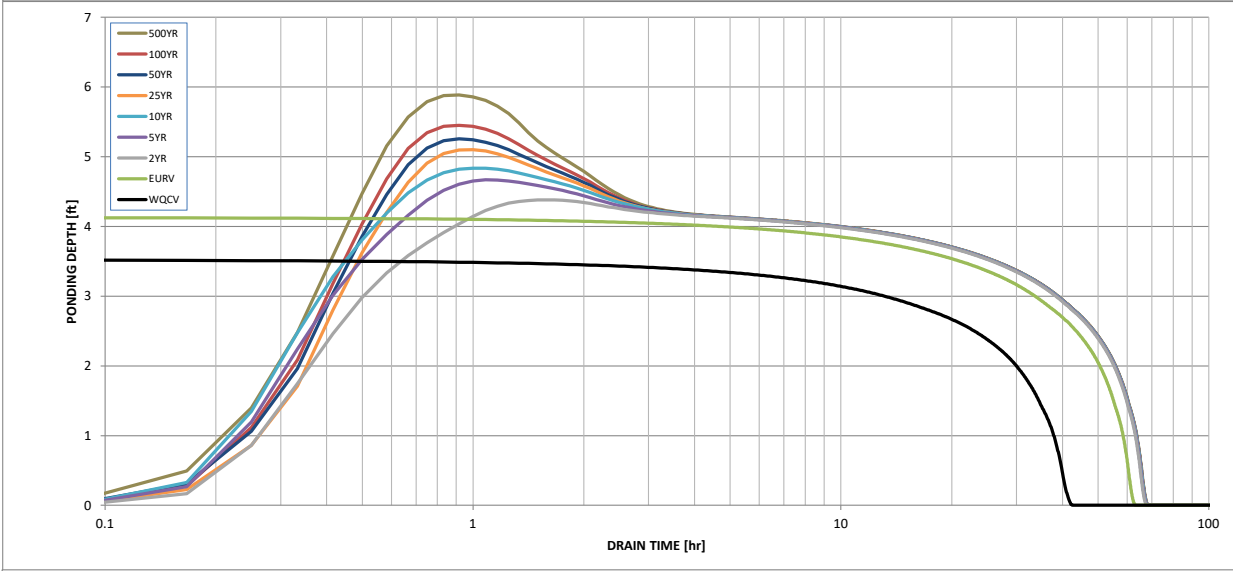
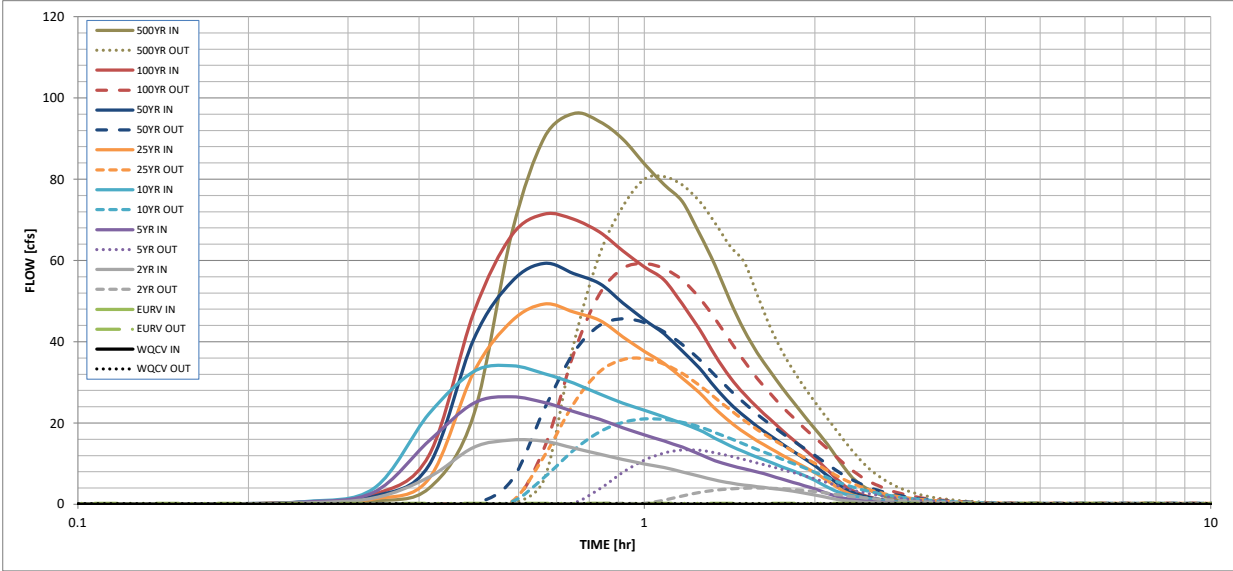

S-A-V-D Chart Axis Override
 X-axis Left Y-Axis Right Y-Axis
 minimum bound

DETENTION BASIN OUTLET STRUCTURE DESIGN

Outflow Hydrograph Workbook Filename: _____

Inflow Hydrographs

The user can override the calculated inflow hydrographs from this workbook with inflow hydrographs developed in a separate program.

| Time Interval | SOURCE | CUHP | CUHP | CUHP | CUHP | CUHP | CUHP | CUHP | CUHP | CUHP |
|---------------|---------|------------|------------|--------------|--------------|---------------|---------------|---------------|----------------|----------------|
| | TIME | WQCV [cfs] | EURV [cfs] | 2 Year [cfs] | 5 Year [cfs] | 10 Year [cfs] | 25 Year [cfs] | 50 Year [cfs] | 100 Year [cfs] | 500 Year [cfs] |
| 5.00 min | 0:00:00 | 0.00 | 0.00 | 0.00 | 0.00 | 0.00 | 0.00 | 0.00 | 0.00 | 0.00 |
| | 0:05:00 | 0.00 | 0.00 | 0.00 | 0.00 | 0.00 | 0.00 | 0.00 | 0.00 | 0.00 |
| | 0:10:00 | 0.00 | 0.00 | 0.00 | 0.00 | 0.00 | 0.00 | 0.04 | 0.00 | 0.12 |
| | 0:15:00 | 0.00 | 0.00 | 0.33 | 0.54 | 0.66 | 0.45 | 0.56 | 0.54 | 0.80 |
| | 0:20:00 | 0.00 | 0.00 | 1.56 | 2.97 | 3.96 | 1.33 | 1.99 | 2.41 | 3.93 |
| | 0:25:00 | 0.00 | 0.00 | 6.66 | 15.58 | 22.25 | 6.27 | 9.60 | 12.01 | 22.04 |
| | 0:30:00 | 0.00 | 0.00 | 14.03 | 24.89 | 32.64 | 32.55 | 40.65 | 47.18 | 66.81 |
| | 0:35:00 | 0.00 | 0.00 | 15.79 | 26.44 | 34.13 | 45.10 | 54.82 | 66.21 | 90.34 |
| | 0:40:00 | 0.00 | 0.00 | 15.50 | 25.01 | 32.15 | 49.30 | 59.30 | 71.41 | 96.18 |
| | 0:45:00 | 0.00 | 0.00 | 13.83 | 22.83 | 29.83 | 47.29 | 56.79 | 70.12 | 94.20 |
| | 0:50:00 | 0.00 | 0.00 | 12.33 | 20.92 | 27.15 | 45.29 | 54.32 | 66.97 | 89.86 |
| | 0:55:00 | 0.00 | 0.00 | 10.99 | 18.85 | 24.91 | 41.21 | 49.56 | 62.35 | 83.81 |
| | 1:00:00 | 0.00 | 0.00 | 9.95 | 17.12 | 23.14 | 37.67 | 45.44 | 58.42 | 78.69 |
| | 1:05:00 | 0.00 | 0.00 | 9.06 | 15.55 | 21.52 | 34.67 | 41.94 | 55.22 | 74.46 |
| | 1:10:00 | 0.00 | 0.00 | 7.99 | 14.05 | 19.89 | 31.06 | 37.73 | 49.26 | 66.73 |
| | 1:15:00 | 0.00 | 0.00 | 6.93 | 12.33 | 18.29 | 27.45 | 33.52 | 43.13 | 58.78 |
| | 1:20:00 | 0.00 | 0.00 | 5.96 | 10.73 | 16.25 | 23.56 | 28.81 | 36.65 | 50.09 |
| | 1:25:00 | 0.00 | 0.00 | 5.24 | 9.58 | 14.44 | 20.27 | 24.84 | 31.26 | 42.87 |
| | 1:30:00 | 0.00 | 0.00 | 4.75 | 8.72 | 12.91 | 17.71 | 21.72 | 27.14 | 37.28 |
| | 1:35:00 | 0.00 | 0.00 | 4.34 | 7.96 | 11.57 | 15.62 | 19.16 | 23.82 | 32.73 |
| | 1:40:00 | 0.00 | 0.00 | 3.96 | 7.07 | 10.36 | 13.80 | 16.92 | 20.90 | 28.72 |
| | 1:45:00 | 0.00 | 0.00 | 3.59 | 6.21 | 9.23 | 12.16 | 14.90 | 18.27 | 25.09 |
| | 1:50:00 | 0.00 | 0.00 | 3.22 | 5.38 | 8.16 | 10.63 | 13.02 | 15.82 | 21.72 |
| | 1:55:00 | 0.00 | 0.00 | 2.75 | 4.59 | 7.06 | 9.18 | 11.23 | 13.52 | 18.55 |
| | 2:00:00 | 0.00 | 0.00 | 2.28 | 3.78 | 5.87 | 7.78 | 9.51 | 11.36 | 15.58 |
| | 2:05:00 | 0.00 | 0.00 | 1.78 | 2.91 | 4.58 | 6.19 | 7.56 | 9.03 | 12.34 |
| | 2:10:00 | 0.00 | 0.00 | 1.30 | 2.10 | 3.40 | 4.64 | 5.65 | 6.75 | 9.19 |
| | 2:15:00 | 0.00 | 0.00 | 0.92 | 1.53 | 2.61 | 3.21 | 3.94 | 4.69 | 6.48 |
| | 2:20:00 | 0.00 | 0.00 | 0.69 | 1.18 | 2.09 | 2.31 | 2.88 | 3.37 | 4.74 |
| | 2:25:00 | 0.00 | 0.00 | 0.55 | 0.93 | 1.69 | 1.70 | 2.15 | 2.47 | 3.52 |
| | 2:30:00 | 0.00 | 0.00 | 0.44 | 0.75 | 1.36 | 1.28 | 1.63 | 1.80 | 2.59 |
| | 2:35:00 | 0.00 | 0.00 | 0.36 | 0.59 | 1.08 | 0.96 | 1.22 | 1.29 | 1.88 |
| | 2:40:00 | 0.00 | 0.00 | 0.28 | 0.47 | 0.84 | 0.72 | 0.92 | 0.91 | 1.34 |
| | 2:45:00 | 0.00 | 0.00 | 0.23 | 0.37 | 0.65 | 0.53 | 0.68 | 0.63 | 0.93 |
| | 2:50:00 | 0.00 | 0.00 | 0.18 | 0.28 | 0.49 | 0.39 | 0.50 | 0.43 | 0.65 |
| | 2:55:00 | 0.00 | 0.00 | 0.15 | 0.21 | 0.37 | 0.30 | 0.38 | 0.33 | 0.49 |
| | 3:00:00 | 0.00 | 0.00 | 0.12 | 0.16 | 0.28 | 0.23 | 0.29 | 0.26 | 0.38 |
| | 3:05:00 | 0.00 | 0.00 | 0.09 | 0.12 | 0.21 | 0.18 | 0.23 | 0.21 | 0.30 |
| | 3:10:00 | 0.00 | 0.00 | 0.07 | 0.09 | 0.16 | 0.14 | 0.17 | 0.16 | 0.24 |
| | 3:15:00 | 0.00 | 0.00 | 0.05 | 0.06 | 0.12 | 0.10 | 0.13 | 0.12 | 0.18 |
| | 3:20:00 | 0.00 | 0.00 | 0.03 | 0.04 | 0.08 | 0.08 | 0.09 | 0.09 | 0.13 |
| | 3:25:00 | 0.00 | 0.00 | 0.02 | 0.03 | 0.05 | 0.05 | 0.06 | 0.06 | 0.08 |
| | 3:30:00 | 0.00 | 0.00 | 0.01 | 0.02 | 0.03 | 0.03 | 0.04 | 0.03 | 0.05 |
| | 3:35:00 | 0.00 | 0.00 | 0.00 | 0.01 | 0.01 | 0.02 | 0.02 | 0.02 | 0.03 |
| | 3:40:00 | 0.00 | 0.00 | 0.00 | 0.00 | 0.00 | 0.01 | 0.01 | 0.01 | 0.01 |
| | 3:45:00 | 0.00 | 0.00 | 0.00 | 0.00 | 0.00 | 0.00 | 0.00 | 0.00 | 0.00 |
| | 3:50:00 | 0.00 | 0.00 | 0.00 | 0.00 | 0.00 | 0.00 | 0.00 | 0.00 | 0.00 |
| | 3:55:00 | 0.00 | 0.00 | 0.00 | 0.00 | 0.00 | 0.00 | 0.00 | 0.00 | 0.00 |
| | 4:00:00 | 0.00 | 0.00 | 0.00 | 0.00 | 0.00 | 0.00 | 0.00 | 0.00 | 0.00 |
| | 4:05:00 | 0.00 | 0.00 | 0.00 | 0.00 | 0.00 | 0.00 | 0.00 | 0.00 | 0.00 |
| | 4:10:00 | 0.00 | 0.00 | 0.00 | 0.00 | 0.00 | 0.00 | 0.00 | 0.00 | 0.00 |
| | 4:15:00 | 0.00 | 0.00 | 0.00 | 0.00 | 0.00 | 0.00 | 0.00 | 0.00 | 0.00 |
| | 4:20:00 | 0.00 | 0.00 | 0.00 | 0.00 | 0.00 | 0.00 | 0.00 | 0.00 | 0.00 |
| | 4:25:00 | 0.00 | 0.00 | 0.00 | 0.00 | 0.00 | 0.00 | 0.00 | 0.00 | 0.00 |
| | 4:30:00 | 0.00 | 0.00 | 0.00 | 0.00 | 0.00 | 0.00 | 0.00 | 0.00 | 0.00 |
| | 4:35:00 | 0.00 | 0.00 | 0.00 | 0.00 | 0.00 | 0.00 | 0.00 | 0.00 | 0.00 |
| | 4:40:00 | 0.00 | 0.00 | 0.00 | 0.00 | 0.00 | 0.00 | 0.00 | 0.00 | 0.00 |
| | 4:45:00 | 0.00 | 0.00 | 0.00 | 0.00 | 0.00 | 0.00 | 0.00 | 0.00 | 0.00 |
| | 4:50:00 | 0.00 | 0.00 | 0.00 | 0.00 | 0.00 | 0.00 | 0.00 | 0.00 | 0.00 |
| | 4:55:00 | 0.00 | 0.00 | 0.00 | 0.00 | 0.00 | 0.00 | 0.00 | 0.00 | 0.00 |
| | 5:00:00 | 0.00 | 0.00 | 0.00 | 0.00 | 0.00 | 0.00 | 0.00 | 0.00 | 0.00 |
| | 5:05:00 | 0.00 | 0.00 | 0.00 | 0.00 | 0.00 | 0.00 | 0.00 | 0.00 | 0.00 |
| | 5:10:00 | 0.00 | 0.00 | 0.00 | 0.00 | 0.00 | 0.00 | 0.00 | 0.00 | 0.00 |
| | 5:15:00 | 0.00 | 0.00 | 0.00 | 0.00 | 0.00 | 0.00 | 0.00 | 0.00 | 0.00 |
| | 5:20:00 | 0.00 | 0.00 | 0.00 | 0.00 | 0.00 | 0.00 | 0.00 | 0.00 | 0.00 |
| | 5:25:00 | 0.00 | 0.00 | 0.00 | 0.00 | 0.00 | 0.00 | 0.00 | 0.00 | 0.00 |
| | 5:30:00 | 0.00 | 0.00 | 0.00 | 0.00 | 0.00 | 0.00 | 0.00 | 0.00 | 0.00 |
| | 5:35:00 | 0.00 | 0.00 | 0.00 | 0.00 | 0.00 | 0.00 | 0.00 | 0.00 | 0.00 |
| | 5:40:00 | 0.00 | 0.00 | 0.00 | 0.00 | 0.00 | 0.00 | 0.00 | 0.00 | 0.00 |
| | 5:45:00 | 0.00 | 0.00 | 0.00 | 0.00 | 0.00 | 0.00 | 0.00 | 0.00 | 0.00 |
| | 5:50:00 | 0.00 | 0.00 | 0.00 | 0.00 | 0.00 | 0.00 | 0.00 | 0.00 | 0.00 |
| | 5:55:00 | 0.00 | 0.00 | 0.00 | 0.00 | 0.00 | 0.00 | 0.00 | 0.00 | 0.00 |
| | 6:00:00 | 0.00 | 0.00 | 0.00 | 0.00 | 0.00 | 0.00 | 0.00 | 0.00 | 0.00 |

EXISTING AND PROPOSED DRAINAGE MAP

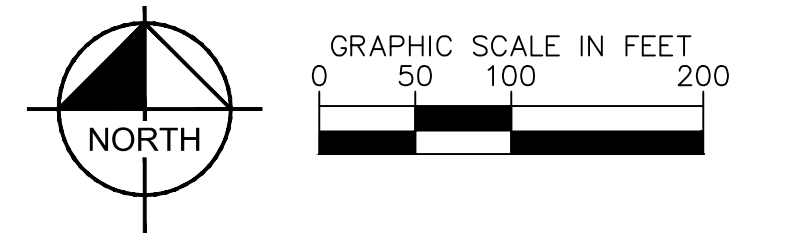

- LEGEND**
- — — — — PROPERTY LINE
 - - - - - EX. MAJOR CONTOUR
 - - - - - EX. MINOR CONTOUR
 - - - - - EX. DRAINAGE BASIN BOUNDARY

- (A/B C/D) A = BASIN DESIGNATION
B = AREA IN ACRES
C = 5-YR RUNOFF
D = 100-YR RUNOFF
- # # = DESIGN POINT DESIGNATION
- X.XX% EXISTING SLOPE ARROW

SUMMARY - EXISTING RUNOFF TABLE

| DESIGN POINT | BASIN DESIGNATION | BASIN AREA (ACRES) | DIRECT 5-YR RUNOFF (CFS) | DIRECT 100-YR RUNOFF (CFS) |
|--------------|-------------------|--------------------|--------------------------|----------------------------|
| E1 | E1 | 24.04 | 12.64 | 66.17 |
| E2 | E2 | 2.45 | 1.82 | 8.31 |
| E3 | E3 | 8.21 | 5.01 | 25.45 |
| OE1 | OE1 | 5.60 | 4.02 | 17.67 |
| OE2 | OE2 | 5.78 | 4.84 | 20.88 |
| OE3 | OE3 | 4.65 | 2.60 | 14.54 |
| TOTAL | | 50.72 | 30.93 | 153.01 |

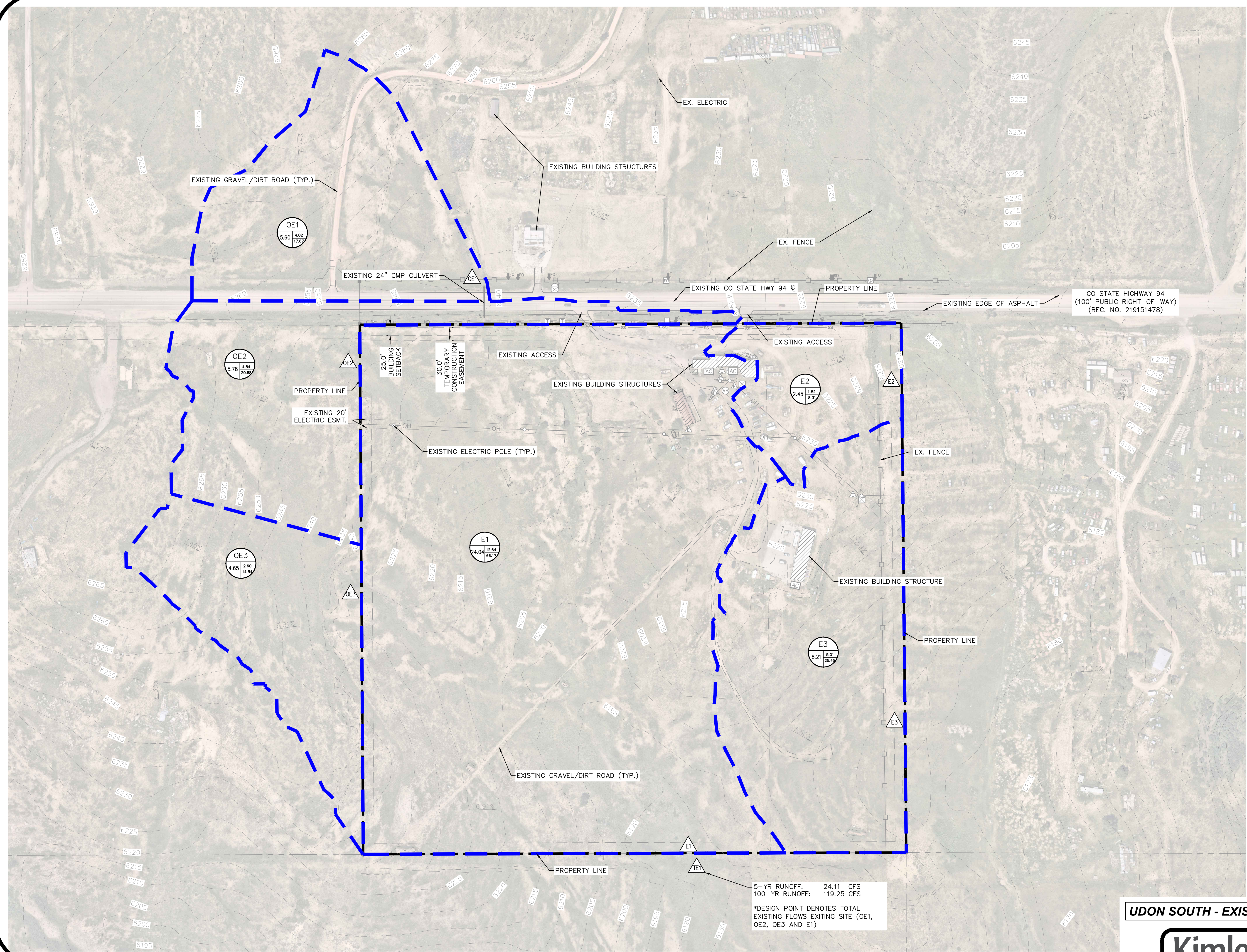

UDON SOUTH - EXISTING DRAINAGE EXHIBIT

Date: August 20, 2024 - 1:35pm / User: Drew McClain
 Path: K:\GIS_Civil\19602003_000N_South\CADD\Exhibits\Drainage\Existing Conditions_Drainage_Map.dwg

© 2024 KIMLEY-HORN AND ASSOCIATES, INC.
 2 N NEVADA AVE., SUITE 900, COLORADO SPRINGS, 80903
 PHONE: 719-453-0180

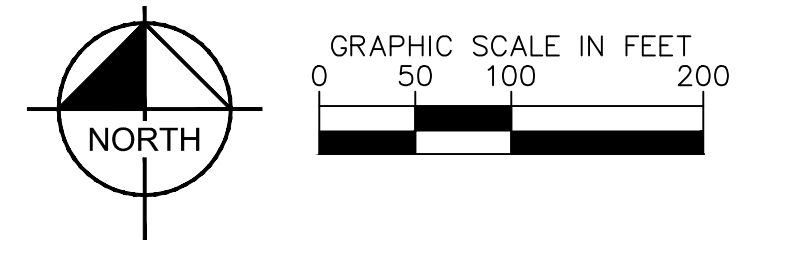

- LEGEND**
- PROPERTY LINE
 - - - - - EX. MAJOR CONTOUR
 - - - - - EX. MINOR CONTOUR
 - PR. MAJOR CONTOUR
 - PR. MINOR CONTOUR
 - PR. DRAINAGE BASIN BOUNDARY

- ⊙ A
⊙ B
⊙ C
⊙ D
- A = BASIN DESIGNATION
B = AREA IN ACRES
C = 5-YR RUNOFF
D = 100-YR RUNOFF

- △ #
- # = DESIGN POINT DESIGNATION

- X.XX%
 - X.XX%
- EXISTING SLOPE ARROW
PROPOSED SLOPE ARROW

- █
- DRAINAGE EXCLUSION AREA

SUMMARY - PROPOSED RUNOFF TABLE

| DESIGN POINT | BASIN DESIGNATION | BASIN AREA (ACRES) | DIRECT 5-YR RUNOFF (CFS) | DIRECT 100-YR RUNOFF (CFS) |
|--------------|-------------------|--------------------|--------------------------|----------------------------|
| P1 | P1 | 23.90 | 31.41 | 87.16 |
| P2 | P2 | 2.58 | 2.24 | 8.83 |
| P3 | P3 | 8.21 | 5.01 | 25.45 |
| OP1 | OP1 | 5.60 | 4.02 | 17.67 |
| OP2 | OP2 | 5.78 | 4.97 | 21.11 |
| OP3 | OP3 | 4.65 | 2.60 | 14.54 |
| TOTAL | | 50.72 | 50.25 | 174.75 |

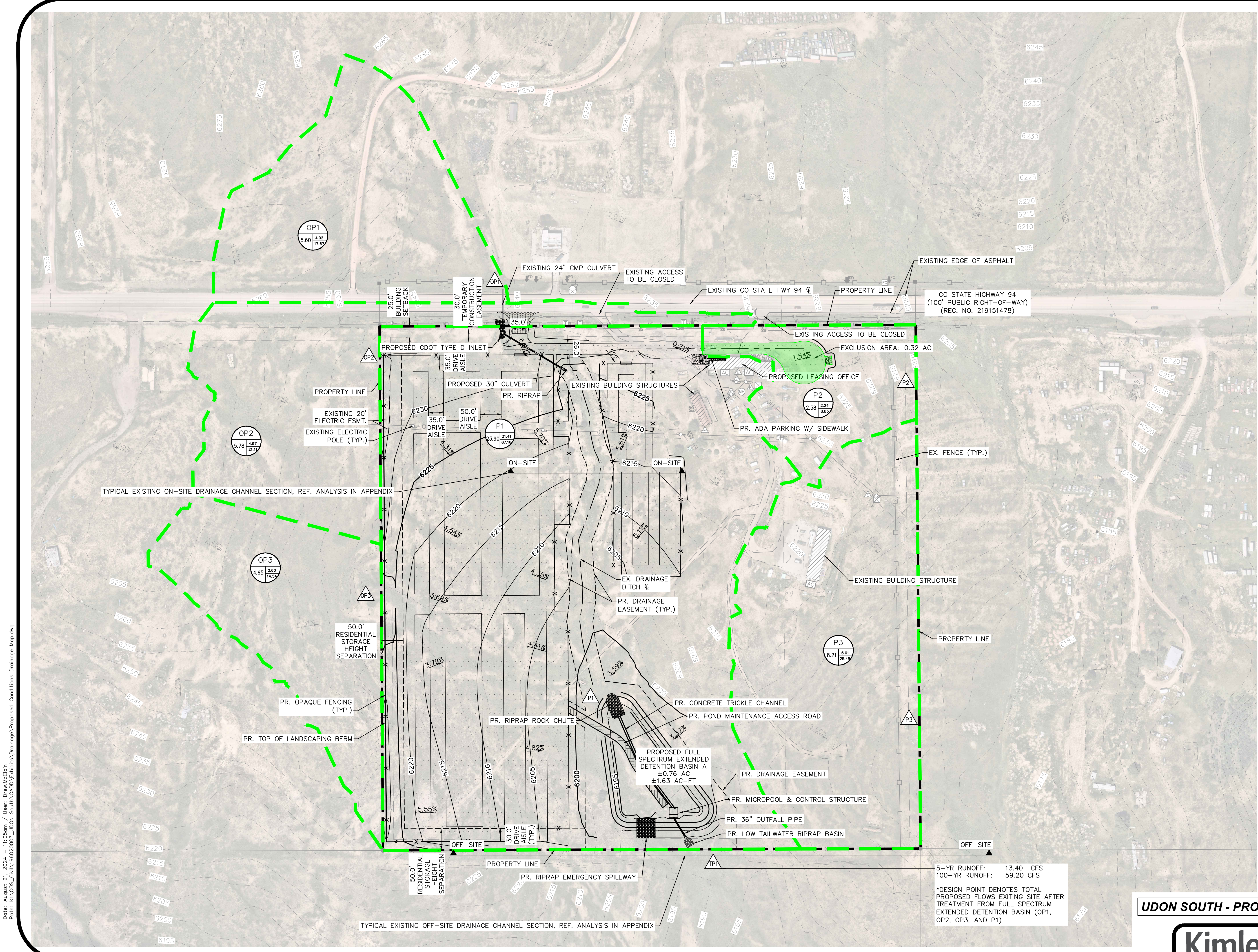

UDON SOUTH - PROPOSED DRAINAGE EXHIBIT



© 2024 KIMLEY-HORN AND ASSOCIATES, INC.
2 N NEVADA AVE., SUITE 900, COLORADO SPRINGS, 80903
PHONE: 719-453-0180

Date: August 21, 2024 - 11:05am / User: DrewMcClain
Path: K:\GIS_Civil\19602003_UDON_SOUTH\CADD\Exhibits\Drainage\Proposed_Drainage_Map.dwg