



STORMWATER MANAGEMENT PLAN (SWMP)

UDON South El Paso County, Colorado

Prepared for:

UDON Holdings, LLC
12265 Highway 94
Colorado Springs, Colorado 80929

Prepared by:

Kimley-Horn and Associates, Inc.
2 North Nevada Avenue, Suite 900
Colorado Springs, Colorado 80903
(719) 453-0182
Contact: Kevin R. Kofford, P.E

Qualified Stormwater Manager

Company: _____
Address: _____
Contact: _____

Contractor

Company: _____
Address: _____
Contact: _____

PCD FILING NO.: ~~XXX~~ **PPR2422**



Project #: 196020003

Prepared: June 26, 2024



STORMWATER MANAGEMENT PLAN (SWMP)

FOR

Project:
UDON South
El Paso County, Colorado
Site Development Plan No. XXXX

PPR2422

Prepared For:
UDON Holdings, LLC
12265 Highway 94
Colorado Springs, Colorado 80929

Prepared By:
Kimley-Horn and Associates, Inc.
2 North Nevada Avenue,
Suite 900
Colorado Springs, CO 80903

June 26, 2024

DEVELOPER/OWNER’S STATEMENT4

ENGINEER’S STATEMENT5

PERMITTEE / OPERATOR RESPONSIBILITIES6

PERMITTEE CERTIFICATION.....7

OPERATOR CERTIFICATION7

SUBCONTRACTOR CERTIFICATION7

INTRODUCTION8

 PERMIT COVERAGE AND APPLICATIONS.....8

 DEFINITIONS8

SITE DESCRIPTION9

 GENERAL PROJECT DESCRIPTION.....9

 PROJECT CONTACTS9

 PROJECT LOCATION.....9

 VICINITY MAP9

SITE CONDITIONS10

 VEGETATION10

 DRAINAGE CHARACTERISTICS10

 SOILS.....11

AREAS & VOLUMES11

EROSION & SEDIMENT CONTROL MEASURES11

TIMING & SCHEDULE13

STORMWATER MANAGEMENT CONTROLS15

 SWMP ADMINISTRATOR.....15

 SITE SPECIFIC POLLUTION SOURCES.....15

 IDENTIFICATION OF POLLUTANT SOURCES.....15

 BEST MANAGEMENT PRACTICES FOR STORMWATER POLLUTION PREVENTION.....16

FINAL STABILIZATION AND LONG-TERM STORMWATER MANAGEMENT19

INSPECTION AND MAINTENANCE19

TERM AND CONDITIONS OF THE CDPS GENERAL PERMIT20

 GENERAL LIMITATIONS20

 PROHIBITION OF NON-STORMWATER DISCHARGES.....20

 SWMP RETENTION REQUIREMENTS21

 SWMP REVIEW / CHANGES21

 RESPONSIVE SWMP CHANGES21

CONCLUSIONS.....22

REFERENCES22

STORMWATER MANAGEMENT PLANS / SITE MAPS.....24

- APPENDIX A – STORMWATER MANAGEMENT PLANS / SITE MAPS**
- APPENDIX B – CDPHE STORMWATER PERMIT**
- APPENDIX C – FEMA FIRM MAP**
- APPENDIX D – SOILS INFORMATION**
- APPENDIX E – IDENTIFICATION OF POLLUTANT SOURCES**
- APPENDIX F – LAND DISTURBANCE / CONTROL MEASURE / STABILIZATION LOG**
- APPENDIX G – CDPHE ENVIRONMENTAL SPILL REPORTING / CONTROL MEASURE**
- APPENDIX H – STORM EVENT LOG**
- APPENDIX I – INSPECTION AND SAMPLING REPORTS**
- APPENDIX J – SWMP AMENDMENT LOG**
- APPENDIX K – GEOTECH REPORT**

DEVELOPER/OWNER’S STATEMENT

“The owner will comply with the requirements of the Erosion and Stormwater Quality Control Plan including temporary BMP inspection requirements and final stabilization requirements. I acknowledge the responsibility to determine whether the construction activities on these plans require Colorado Discharge Permit System (CDPS) permitting for Stormwater discharges associated with Construction Activity.”

Developer/Owner Signature: _____

Name of Developer/Owner: _____ Date: _____

DBA: _____ Phone: _____

Title: _____ Email: _____

Address: _____ Fax: _____

ENGINEER'S STATEMENT

"This Erosion and Stormwater Quality Control/Grading Plan was prepared under my direction and supervision and is correct to the best of my knowledge and belief. If such work is performed in accordance with the grading and erosion control plan, the work will not become a hazard to life and limb, endanger property, or adversely affect the safety, use, or stability of a public way, drainage channel, or other property."

Signature: _____ Date: _____

Printed Name: Kevin Kofford, P.E.

PERMITTEE / OPERATOR RESPONSIBILITIES

This Stormwater Management Plan (SWMP) is prepared for UDON Holdings, LLC (the Owner) to fulfill the Colorado Discharge Permit System (CDPS) requirements for El Paso County and the State of Colorado Department of Public Health and Environment (CDPHE) for UDON - South (the Project). This narrative, in conjunction with the Stormwater Management Plan, examines measures taken onsite to improve stormwater quality leaving the Site, and also addresses important erosion control measures implemented prior to and during construction. A general overview of the procedures outlined in the SWMP which the Operator (the Contractor) shall follow is provided below for reference.

| | Responsibility <u>Operator</u> |
|--|-----------------------------------|
| 1. Submit and Receive the Colorado Discharge Permit System (CDPS) General Permit through CDPHE | <input type="checkbox"/> |
| 2. Complete the Permittee / Operator SWMP Certifications provided within the SWMP Narrative. | <input type="checkbox"/> |
| 3. Complete the Operator / SWMP Administrator Contact Information identified in the SWMP Narrative. | <input type="checkbox"/> |
| 4. Post the Site in accordance with the requirements identified on the SWMP Site Map included in the appendices of this report. | <input type="checkbox"/> |
| 5. Commence BMP installation and construction in accordance with the Phased BMP Implementation. | <input type="checkbox"/> |
| 6. Complete Land Disturbance / BMP / Site Stabilization Log, a copy of which is included in the appendices of this report. | <input type="checkbox"/> |
| 7. Complete Inspections in accordance with the SWMP Inspection Schedule and Procedures outlined within the SWMP Narrative. | <input type="checkbox"/> |
| 8. Complete field maintenance or field modifications to Stormwater Management Practices based upon the results of the Inspection. | <input type="checkbox"/> |
| 9. Maintain current records of the SWMP Inspections in accordance with the Inspection Record Keeping identified in the SWMP Narrative. | <input type="checkbox"/> |
| 10. Maintain current records of the Land Disturbance / BMP / Site Stabilization Log, a copy of which is included in the appendices of this report. | <input type="checkbox"/> |
| 11. Maintain current records of the BMP Corrective Action Log, a copy of which is included in the appendices of this report. | <input type="checkbox"/> |
| 12. Maintain current records of the SWMP Amendment Log, a copy which is included in the appendices of this report. | <input type="checkbox"/> |
| 13. Achieve Final Stabilization in accordance with the Final Stabilization practices outlined within the SWMP Narrative. | <input type="checkbox"/> |
| 14. File the County and State Construction Stormwater Inactivation Notice. | <input type="checkbox"/> |

This summary is provided for Permittee / Operator convenience only and shall not be considered all-inclusive with respect to stormwater management responsibilities. The Permittee / Operator shall familiarize themselves with the County and CDPS General Permit and SWMP, and implement storm

water management strategies based upon the recommendations identified herein and varying Site conditions.

PERMITTEE CERTIFICATION

I certify under penalty of law that this document and all attachments were prepared under my direction or supervision in accordance with a system designed to assure that qualified personnel properly gather and evaluate the information submitted. Based on my inquiry of the person or persons who manage the system, or those persons directly responsible for gathering the information, the information submitted is to the best of my knowledge and belief, true, accurate and complete. I am aware that there are significant penalties for submitting false information, including the possibility of fine and imprisonment for knowing violations.

Owner's Authorized Agent:

Date:

OPERATOR CERTIFICATION

I certify under penalty of law that a complete Stormwater Management Plan, has been prepared for my activity. Based on my inquiry of the person or persons who manage the system, or those persons directly responsible for gathering the information, the Stormwater Management Plan is, to the best of my knowledge and belief, true, accurate, and complete. I am aware that there are significant penalties for falsely certifying the completion of said SWMP, including the possibility of fine and imprisonment for knowing violations.

Operator's Authorized Agent:

Date:

SUBCONTRACTOR CERTIFICATION

Subcontractor Certification

I certify under penalty of law that a complete Stormwater Management Plan, has been prepared for my activity. Based on my inquiry of the person or persons who manage the system, or those persons directly responsible for gathering the information, the Stormwater Management Plan is, to the best of my knowledge and belief, true, accurate, and complete. I am aware that there are significant penalties for falsely certifying the completion of said SWMP, including the possibility of fine and imprisonment for knowing violations.

Subcontractor's Authorized Agent:

Date:

Note: Additional Subcontractor Certifications shall be completed as necessary.

INTRODUCTION

The purpose of this report is to outline the SWMP plan for the UDON – South development (herein the “Project”), located within the jurisdictional limits of El Paso County (“the County”).

PERMIT COVERAGE AND APPLICATIONS

Based upon a Site Disturbance Area of one (1) acre or more, this Site requires the approval of this Stormwater Management Plan and a Grading and Erosion Control Plan with the County and the issuance of a Colorado Discharge Permit System (CDPS) - Stormwater Discharge Associated with Construction Activities Application (the General Permit) through the Colorado Department of Public Health and Environment (CDPHE).

A copy of the CDPS General Permit is included in the Appendices of this report.

DEFINITIONS

CDPHE – Colorado Department of Public Health and Environment

Operator – The group or individual that is responsible for day-to-day operations on the Project Site. The Operator will be assigned the SWMP Administrator role, and these terms are used interchangeably in the SWMP.

SWMP – Construction Activities Stormwater Management Plan

SWMP Administrator – The specific individual(s), position or title that is responsible for developing, implementing, maintaining, and revising the SWMP. The activities and responsibilities of the Administrator shall address all aspects of the facility’s SWMP. The Operator will be assigned the SWMP Administrator role, and these terms are used interchangeably in the SWMP.

Permittee – The specific individual(s), position or title that is legally responsible for compliance with the permit. The Permittee is authorized to sign and certify the permit application.

SITE DESCRIPTION

GENERAL PROJECT DESCRIPTION

The proposed Project is located at 12265 Highway 94, More specifically, the Project is located in Section 18, Township 14 South, Range 64 West of the 6th Principal Meridian, County of El Paso, State of Colorado. The site is approximately 5 miles east of State Highway 24 and bounded by Highway 94 to the North, N. Franceville Coal Mine Rd. to the east, and vacant properties to the west and south. A vicinity map has been provided in the **Appendix** of this report.

The Project property is approximately 34.71 acres with approximately 18.06 acres of disturbance (Parcel # 4400000237). The entire property consists of partially developed land with 3 existing buildings and other various structures and has private, dirt/gravel roadways; most of the property is undeveloped natural grasses and meadow land. The proposed Project consists of gravel parking areas, drive aisles, and associated landscaping. The site currently does not provide stormwater quality or detention. The site generally drains from the northwest to southeast with slopes ranging from 2% to 15%. Runoff flows across the Site as sheet flow and is channelized in a shallow natural grassy drainage swale that generally runs north to south through the middle of the Project site. The Project is ultimately tributary to Jimmy Camp Creek and approximately 1.5 miles away. The Project Site is located outside any flood plain buffers or flood plains.

PROJECT CONTACTS

SWMP Preparer

Company: Kimley-Horn and Associates, Inc.
Contact: Kevin Kofford, P.E.
Address: 2 North Nevada Avenue- Suite 900
Colorado Springs, CO 80903
Phone: 719.435.0181
Email: Kevin.Kofford@kimley-horn.com

SWMP Administrator

Company: _____
Contact: _____
Address: _____

Phone: _____

PROJECT LOCATION

The Project is located at 12265 Highway 94 approximately west southwest of the intersection of N. Franceville Coal Mine Rd. and Colorado Highway 94 in El Paso County, Colorado. More specifically, the Project is within the northeast quarter of the northwest quarter of Section 18, Township 14 South, Range 64 West of the 6th Principal Meridian in El Paso County, Colorado.

VICINITY MAP

A vicinity map is provided below for reference:

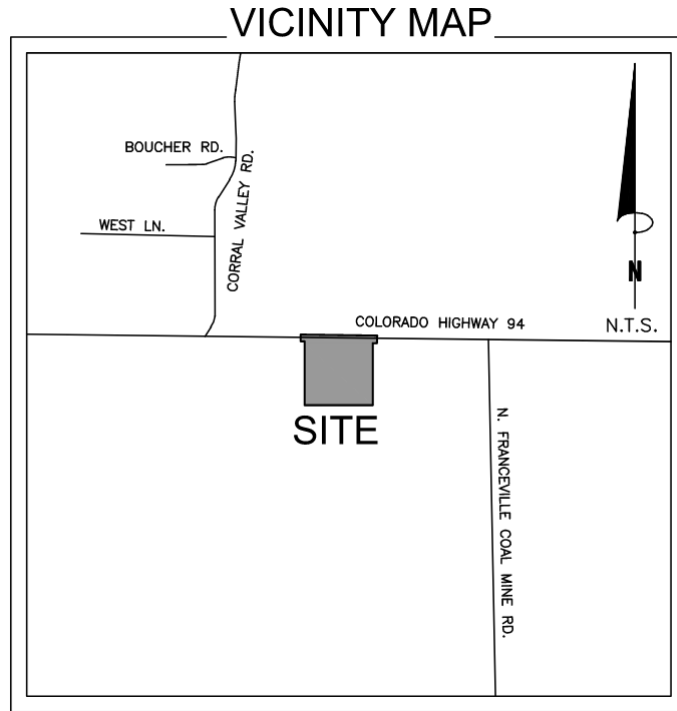

SITE CONDITIONS

VEGETATION

The existing site is currently partially developed. The site contains primarily field grasses, weeds, yucca, and some scattered trees in the drainage and planted as landscaping surrounding the residence. Based on visual inspection from site photos and aerial imagery the site currently is 85% vegetated.

DRAINAGE CHARACTERISTICS

Under existing conditions, the total studied drainage area of the site is approximately 50.73 acres. The topography of the site is gradually to moderately sloping to the south, with steeper slopes along the drainage in the central portion of the site, and along the cut/fill slope in the eastern portion of the site. Flows from stormwater runoff generally travel overland to channelized into an existing depressional swale from northwest to southeast at slopes of 2% to 12%. Runoff flows then travel generally southwestward via overland flow and the existing depressional natural vegetated swale that ultimately discharges into Jimmy Camp Creek.

The proposed gravel parking areas, internal drives, and other minor impervious surfaces comprise approximately 31.6% (10.97 acres) of the overall Project Site. Landscape internal to the Site consist of small areas adjacent to the property lines and parking areas while leaving much of the existing natural landscape surrounding the site intact.

Generally, site drainage flows from northwest to southeast at slopes of approximately 2-12%. This historic runoff pattern will generally be maintained with the proposed Project.

The 5-year and 100-year design storm events were used in determining rainfall and runoff for the proposed drainage system per chapter 6 of the El Paso County Drainage Criteria. *Table 6-2* of the El Paso County Drainage Criteria is the source for rainfall data for the 5-year and 100-year design storm events. Design runoff was calculated using the Rational Method for developed conditions as established in the El Paso County Drainage Criteria Manual and the Mile-High Flood District Manual. Runoff coefficients for the proposed development were determined using *Table 6-6* of the El Paso County Drainage Manual by calculating weighted impervious values for each specific site basin.

Water quality treatment will be provided by a proposed private aboveground full spectrum extended detention basin. The proposed stormwater facility is designed with an outlet structure that is fitted with a restrictor plate to release the WQCV in a 12-hour time period per the Drainage Criteria Manual. The release from the outlet structure will be discharged at the south property line into the existing natural drainage swale with an **ultimate outfall into Jimmy Camp Creek**.

The Site is located outside the 100-year floodplain and within Zone X (an area of minimal flood hazard) as noted on the FEMA FIRM Map No. 08041C0780G revised on December 7, 2018 (See Appendix). Additionally, no streams or state waters are located within the proposed project site area.

SOILS

In general, the soils consist of loamy sand and sandy loam. The soils have been described to have moderate to rapid permeabilities. The soils are described as well suited for use as home sites. Possible hazards with soils erosion are present on the site. The erosion potential can be controlled with vegetation. The soils have been described to have moderate erosion hazards. NRCS soil data is available for the Site (See Appendix) and the onsite soils are 100% USCS Hydrologic Soil Group D. Group D soils have high runoff potential when thoroughly wet. Water movement through the soil is restricted or very restricted. Group D soils typically have greater than 40 percent clay, less than 50 percent sand, and have clayey textures. In some areas, they also have high shrink-swell potential. A NRCS web soil survey can be found in the **Appendix**.

AREAS & VOLUMES

The gross Site area is approximately ±34.71 acres. The total anticipated Project disturbance area is approximately ±18.06 acres, which includes ±0.08 acres of offsite disturbance. A fill factor of 1.2 was used on the following estimations. The estimated earthwork quantities are as follows:

Cut: ±32,976 cubic yards

Fill: ±35,828 cubic yards

Net: FILL ±2,852 cubic yards

EROSION & SEDIMENT CONTROL MEASURES

Construction operations including grading, hauling of soil, drainage, gravel work, and final stabilization shall implement erosion and sediment control measures as described below and in the Timing section of this report. Additional measures shall be implemented as appropriate.

Erosion and sediment control measures shall be implemented during construction of the Project. One construction entrance with vehicle tracking control (VTC) shall be implemented to reduce off-site sediment tracking. It will be located at the proposed entrance off the existing private gravel drive internal to the property. Temporary Soil Stockpiles (SP) shall be protected from stormwater using SF or other perimeter control to inhibit soil transport as well as at material storage areas. A Silt Fence (SF) and Construction Fence (CF) shall be used for perimeter control. Concrete Washout (CWA) shall be used. In addition to those measures noted above, Perimeter Control and Portable Toilets will also be utilized on Site. Portable toilets shall be located on flat surfaces away from drainage paths, tie-downed or stake-downed, emptied regularly, and where possible secondary containment pans shall be provided under the portable toilets. Please see the Grading and Erosion Control Plans for locations and sizing of recommended erosion control measures.

All persons engaged in earth disturbances shall design, implement, and maintain acceptable soil erosion and sedimentation control measures in conformance with the erosion and sediment control technical standards adopted by the County. All temporary erosion and sediment control facilities, and all permanent facilities intended to control erosion of any earth disturbance operation shall be installed before any earth disturbance operations take place. Any earth disturbances shall be conducted in such a manner to effectively control runoff volumes, reduce accelerated soil erosion, sediment movement, and deposition off-site. All earth disturbances shall be completed in such a manner so that the total amount of soil exposed at any given time shall be minimized, and the exposed area of any disturbed land shall be limited to the shortest possible period of time. Temporary soil erosion control facilities shall be removed, and earth disturbance areas graded and stabilized with permanent soil erosion control measures pursuant to approved plans and specifications.

Permanent soil erosion control measures for all slopes, channels, ditches, or any disturbed land area shall be completed within fourteen (14) calendar days after final grading or the final earth disturbances have been completed. When it is not possible to permanently stabilize a disturbed area after an earth disturbance has been completed or where significant earth disturbance activity ceases, temporary soil erosion control measures shall be implemented within fourteen (14) calendar days. All temporary soil erosion control measures shall be maintained until permanent soil erosion measures are implemented.

Paved and impervious surfaces which are adjacent to construction sites must be swept on a daily basis and as needed during the day when sediment and other materials are tracked or discharged onto them. Either sweeping by hand or use of street sweepers is acceptable. Street sweepers using water while sweeping is preferred in order to minimize dust. Flushing off paved surfaces with water is prohibited. All construction site operators shall control waste such as discarded building materials, hazardous chemicals (to include but not be limited to, heavy equipment maintenance fluids, motor oil, antifreeze, and secondary containment of vehicle fuel), litter, and sanitary waste at the construction Site that may cause adverse impacts to water quality. Chemicals, paints, solvents, fertilizers, and other toxic materials must be stored in weatherproof containers. Except during application, the contents must be kept in trucks or within storage facilities. Runoff containing such material must be collected, removed from the Site, treated, and disposed at an approved solid waste or chemical disposal facility. On-site fueling is not expected with this Project.

Throughout build-out, the developer shall be responsible for implementing and maintaining Best Management Practices (BMPs) to control erosion and sediment problems on all idle lots.

All stockpiles shall require erosion and sediment control. All stockpiles shall:

- Not be located adjacent to a waterway.

- Be stabilized within 14 days after establishment. Stabilization shall include, but not be limited to, surface roughening, seeding, and mulching.
- Not exceed 10 feet in height.
- Utilize silt fence in all down slope sides of the stockpile.

TIMING & SCHEDULE

The proposed project will begin in Fall 2024 to Summer 2025. The general sequence of the phasing of the related construction activities will occur according to the following anticipated sequence:

Project sequence:

Phased BMP Implementation – Initial and Interim Phase

The initial phase shall consist of the temporary construction BMPs to minimize potential for erosion and sediment transfer while mobilizing and preparing the Site for construction activities. The operator shall complete the anticipated initial phase sequencing as follows:

1. Prepare and submit the state of Colorado, Colorado department of public health and environment (CDPHE) application. A copy of the permit shall be provided to the owner upon receipt from the CDPHE.
2. Install SWMP information sign in accordance with applicable city, state, and owner requirements.
3. Ensure that general construction BMPs which are required throughout the Project at locations shown on the GEC plans or as dictated by construction activities are operational.
4. Install perimeter controls (CF) and ensure that the limits of construction (LOC) are defined as necessary or known by all parties which will be responsible for construction on the Site.
5. Install sump inlet protection (IP), on-grade inlet protection and curb socks (CS) for existing stormwater conveyance facilities as indicated on the GEC plans or as necessitated by field conditions.
6. Install stabilized vehicle tracking control pad (VTC) as indicated on the GEC plans.
7. Construct Temporary Sediment Bains with spillways and outfall standpipes as shown on the GEC Plans.
8. Install Diversion Swales and outfall the diversion swales into the Temporary Sediment Basins. Check Dams should be installed in the diversion swales for every 1.5' of vertical fall as shown on the GEC Plans.
9. Construct required stabilized staging area (SSA).
10. Install silt fence (SF) as shown on the GEC plans.

11. Upon completion of the initial BMP installation the operator shall schedule a pre-construction meeting with the owner and the County erosion control inspector to confirm BMPs installed are adequate prior to proceeding with additional land disturbing activities.
12. Complete demolition of existing site improvements and clearing and grubbing of the Site as necessary to proceed with initial grading operations. Stockpile materials in accordance with the stockpile management (SP) BMP.

Phased BMP Implementation - Final Phase

The final phase shall consist of the temporary construction BMPs to minimize potential for erosion and sediment transfer during the construction of the proposed parking structure and associated limited site improvements. The operator shall complete the anticipated final phase sequencing as follows:

1. Confirm existing BMPs from the initial phase, which are to be maintained throughout construction, are in working order and compliant with applicable regulations.
2. Repair and/or replace any existing BMPs which are deemed inadequate.
3. Complete required temporary grading operations necessary for construction. Conduct excavation as needed for the underground utilities. Stockpile materials in accordance with the stockpile management (SP) BMP.
4. Temporary stabilize (TS) all areas of the Site which will remain inactive for a period greater than 30 days. Temporary stabilization shall be implemented within 14 days of disturbance.
5. Install concrete washout area (CWA) prior to construction of concrete improvements.
6. Complete required grading operations necessary for construction of the proposed commercial building and associated site and utility improvements. Stockpile materials in accordance with the stockpile management (SP) BMP.
7. Construct underground utilities.
8. Complete fine grading and proceed with temporary stabilization (TS) and permanent stabilization (PS) practices in accordance with approved landscape plans.
9. Achieve permanent stabilization in accordance with El Paso County, CDPHE and owner requirements.
10. Remove remaining BMPs once permanent stabilization (PS) has been achieved. Repair and stabilize areas disturbed through BMP removal.
11. Notify the owner of intent to file the notice of inactivation with the EL PASO COUNTY and CDPHE and receive owner acceptance to proceed with stormwater management close-out.
12. Notify the EL PASO COUNTY of the intent to file the notice of inactivation and receive EL PASO COUNTY field acceptance prior to proceeding with filing the notice of inactivation with the EL PASO COUNTY.

13. Proceed with filing the notice of inactivation with the EL PASO COUNTY and CDPHE.
15. Provide the owner with a copy of all stormwater documentation (permits, inspection reports, logs, etc.). Upon completion of Project, file the notice of inactivation.

STORMWATER MANAGEMENT CONTROLS

SWMP ADMINISTRATOR

The SWMP Administrator is the Operator selected for the Project and will be sufficiently qualified for the required duties per the ECM Appendix I.5. The SWMP Administrator is responsible for developing, implementing, maintaining, and revising the SWMP. The activities and responsibilities of the Administrator shall address all aspects of the facility's SWMP.

SITE SPECIFIC POLLUTION SOURCES

Further identification of site-specific pollutants that fall within the categories outlined in the next section may be field noted using the corresponding log included in the appendices of this report. The logs are intended to record site-specific pollutants, the date of arrival on the Site, the date removed from the Site, and the methods of treatment.

IDENTIFICATION OF POLLUTANT SOURCES

Evaluation of general sediment and non-sediment pollution sources associated with Site construction activities, as outlined within the General Permit, consist of the following:

- **Disturbed and Stored Soils** – Earth disturbing activities (grading, excavation, etc.) will be necessary for this Project; therefore, the potential exists for disturbed site soils to contribute sediment to stormwater discharges.
- **Vehicle Tracking and Sediment** – Construction traffic will be entering and exiting the Site; therefore, the potential exists for vehicle tracking to contribute sediment to stormwater discharges.
- **Management of Contaminated Soils** – Contaminated soils are not anticipated on this Site. If encountered, the SWMP Administrator shall take appropriate containment and treatment measures.
- **Loading and Unloading Operations** – Loading and unloading operations will be taking place at the Site; therefore, the potential exists for these operations to introduce sediment and non-sediment pollutants to stormwater discharges.
- **Outdoor Storage of Materials** – Limited outdoor storage of materials is anticipated with construction of this Site; however, outdoor storage of chemicals, fertilizers, etc. is not anticipated.
- **Vehicle and Equipment Maintenance and Fueling** – Routine maintenance and fueling of vehicles and equipment is not anticipated with this Site.
- **Significant Dust or Particulate Generating Processes** – Earth disturbing activities (grading, excavation, etc.) will be necessary for this Project; therefore, the potential exists for windblown site soils to contribute sediment to stormwater discharges.
- **Routine Maintenance** – Routine maintenance involving fertilizers, pesticides, detergents, fuels, solvents, oils, etc., other than those identified within Vehicle and Equipment Maintenance and Fueling are not anticipated with this Project. If encountered, the SWMP Administrator shall take appropriate containment and treatment measures.

- **Onsite Waste Management** – Waste management consisting of solid waste piles, liquid wastes, dumpsters, etc. are anticipated onsite; therefore, the potential exists for these operations to introduce sediment and non-sediment pollutants to stormwater discharges.
- **Concrete Truck / Equipment Washing** – Concrete truck and equipment washing are anticipated with this Project. The SWMP Administrator shall take appropriate containment and treatment measures.
- **Dedicated Asphalt and Concrete Batch Plants** – Dedicated asphalt and/or concrete batch plants are not anticipated with this Project. If encountered, the SWMP Administrator shall take appropriate containment and treatment measures and document as necessary.
- **Non-Industrial Waste Sources** – Non-Industrial waste sources limited to portable sanitary facilities are anticipated with this Project.
- **Additional Pollutant Sources** – Additional areas or procedures where potential spills could occur are not anticipated with this Project.

Logs for the identification of pollutant sources are included in the Appendices for reference and use.

Based on the following, the potential to contribute pollutants to stormwater discharges is not significant for most of the pollutants identified above:

- Relatively Low Frequency of the Activities
- The Ability to Schedule Activities During Dry Weather
- Existing Site Topography
- The Ability to Implement Primary and Secondary Containment for Product Storage
- The Ability to Locate Activities Away from Drainage Ways

Potential pollutant sources noted below shall be mitigated by use of Best Management Practices (BMPs) as noted in the following sections:

- Disturbed and Stored Soils
- Vehicle Tracking and Sediment
- Loading and Unloading Operations
- Outdoor Storage
- Vehicle Equipment and Maintenance Fueling
- Significant Dust or Particulate Generating Processes
- Non-Industrial Waste Sources

BEST MANAGEMENT PRACTICES FOR STORMWATER POLLUTION PREVENTION

Structural Practices for Erosion and Sediment Control

Structural BMPs shall be implemented onsite to minimize erosion and sediment transport. Recommended BMPs based upon a limited site review may be seen within the SWMP Site Map included in the Appendices of this report. Additional BMPs shall be implemented by the SWMP Administrator if necessary to prevent sediment-laden runoff from leaving the Project Site. The SWMP shall be updated to reflect any changes or revisions enacted in the field.

Non-Structural Practices for Erosion and Sediment Control

Non-Structural BMPs shall be implemented onsite to minimize erosion and sediment transport. Recommended BMPs based upon a limited site review may be seen within the SWMP Site Map included in the Appendices of this report. Additional BMPs shall be implemented by the SWMP

Administrator if necessary to prevent sediment-laden runoff from leaving the Project Site. The SWMP shall be updated to reflect any changes or revisions enacted in the field.

Phased BMP Implementation

Construction of the identified improvements will take place under two main phases of construction anticipated as identified within the construction sequencing included within this report.

A Land Disturbance, BMP Installation, and Stabilization Log is provided in the Appendices and shall be filled out accordingly during BMP implementation.

Materials Handling and Spill Prevention

Any hazardous or potentially hazardous material that is brought onto the construction Site shall be handled properly in order to reduce the potential for stormwater pollution. In an effort to minimize the potential for a spill of petroleum product or hazardous materials to come in contact with stormwater, the following steps shall be implemented:

- Material Safety Data Sheets (MSDS) information shall be kept on Site for any and all applicable materials.
- All materials with hazardous properties (such as pesticides, petroleum products, fertilizers, detergents, construction chemicals, acids, paints, paint solvents, additives for soil stabilization, concrete, curing compounds and additives, etc.) shall be stored in a secure location, under cover and in appropriate, tightly sealed containers when not in use.
- The minimum practical quantity of all such materials shall be kept on the job Site and scheduled for delivery as close to time of use as practical.
- A spill control and containment kit (containing, for example, absorbent material, acid neutralizing agent, brooms, dust pans, mops, rags, gloves, goggles, plastic and metal trash containers, etc.) shall be provided on the construction Site and location(s) shown on Site Maps.
- All of the product in a container shall be used before the container is disposed of. All such containers shall be triple rinsed with water prior to disposal. The rinse water used in these containers shall be disposed of in a manner in compliance with State and Federal regulations and shall not be allowed to mix with stormwater discharges.
- All products shall be stored in and used from the original container with the original product label and used in strict compliance with the instructions on the product label.
- The disposal of excess or used products shall be in strict compliance with instructions on the product label.

Temporary onsite fuel tanks for construction vehicles shall meet all state and federal regulations. Tanks shall have approved spill containment with the capacity required by the applicable regulations. From NFPA 30: All tanks shall be provided with secondary containment (i.e. containment external to and separate from primary containment). Secondary containment shall be constructed of materials of sufficient thickness, density and composition so as not to be structurally weakened as a result of contact with the fuel stored and capable of containing discharged fuel for a period of time equal to or longer than the maximum anticipated time sufficient to allow recovery of discharged fuel.

The tanks shall be in sound condition free of rust or other damage which might compromise containment. Fuel storage areas shall meet all Environmental Protection Agency (EPA), OSHA and other regulatory requirements for signage, fire extinguisher, etc. Hoses, valves, fittings, caps, filler nozzles and associated hardware shall be maintained in proper working condition at all times. The location of fuel tanks shall be shown on the Site Maps and shall be located to minimize exposure to weather and surface water drainage features.

The Operator shall develop and implement a Materials Handling and Spill Prevention Plan (MHSPP) in accordance with the EPA and State of Colorado requirements. In the event of an accidental spill, immediate action shall be undertaken by the Operator to contain and remove the spilled material. All hazardous materials, including contaminated soil, shall be disposed of by the Operator in the manner specified by federal, state, and local regulations and by the manufacturer of such products. As soon as possible, the spill shall be reported to the appropriate agencies. As required under the provisions of the Clean Water Act, any spill or discharge entering waters of the United States shall be properly reported. The Operator shall prepare a written record of any spill and associated clean-up activities of petroleum products or hazardous materials in excess of 1 gallon or reportable quantities, whichever is less.

Any spills of petroleum products or hazardous materials in excess of Reportable Quantities as defined by EPA or the state or local agency regulations shall be immediately reported to the Colorado Department of Public Health and Environment spill reporting lines.

- CDPHE Environmental Release and Incident Reporting Line (877) 518-5608.

For reference, a bulletin on Environmental Spill Reporting published by the CDPHE, has been included in the Appendices of this report.

Vehicle Tracking and Dust Control

Vehicle Tracking Control BMPs (structural and non-structural) shall be implemented in order to control potential sediment discharges from vehicle tracking. Practices shall be implemented for all areas of potential vehicle tracking which include but are not limited to reduced Site access and utilization of designated haul routes.

Areas of soil that are denuded of vegetation and have little protection from particles being picked up and carried by wind should be protected with a temporary cover or kept under control with water or other soil adhering products to limit wind transported particles exiting the Site perimeter.

Waste Management and Disposal

An effective first step towards preventing pollution in stormwater from work sites involves using a commonsense approach to improve the facility's basic housekeeping methods. Poor housekeeping practices result in increased waste and potential for stormwater contamination.

No solid materials are allowed to be discharged from the Site with stormwater. All solid waste, including disposable materials incidental to the construction activities, must be collected, and placed in containers. Secure covers for the containers shall be provided at all times to meet state and local requirements. The location of solid waste receptacles shall be identified on the SWMP by the Operator. Storage containers are to be checked regularly for leaks and appropriate capacity weekly. Storage containers are to have a secure cover on at all times. If the cover cannot be secured shut it shall be emptied more regularly than the weekly inspection.

Concrete waste is anticipated with this Project; and therefore, a dedicated concrete washout is required. The SWMP Administrator shall take appropriate containment and treatment measures and document as necessary.

Portable Toilets

Portable toilets shall be provided on-site as necessary for construction personnel. Portable toilets shall be located on flat surfaces away from drainage paths with a minimum of 10' of clearance from

stormwater inlets and 50' from state waters. They must be secured on at all four corners to prevent overturning, emptied on a weekly basis, inspected daily for spills, and where possible, secondary containment pans shall be provided under the portable toilets. In the event of a spill, the Permittee shall follow spill prevention measures as noted in Appendix G. Toilets shall be located away from anticipated stormwater discharges. Proper and regular maintenance and cleaning shall occur as a preventive measure.

Groundwater and Stormwater Dewatering

Except as noted below, all discharges covered by this permit shall be composed entirely of stormwater associated with construction activity.

- Emergency Fire Fighting Activities
- Uncontaminated Spring Water

Groundwater dewatering is not anticipated. Before excavation, or if encountered, the operator shall file for appropriate permits with the CDPHE.

FINAL STABILIZATION AND LONG-TERM STORMWATER MANAGEMENT

Permanent stabilization will be achieved on the Site with concrete hardscaping or landscaping. Permanent seeding and stabilization will occur on side slopes and areas without permanent landscaping. Stormwater will be managed by a Proposed Extended Detention Basin and a Proposed Rain Garden. These permanent BMPs will provide water quality and detention for the Site. All stormwater on the site will be captured and routed to either of the permanent BMPs.

SWMP Checklist Item 23 - Specify that final vegetative cover density is to be 70% of pre-disturbed levels.

INSPECTION AND MAINTENANCE

Permittee or contractor shall produce written and signed inspection records every seven (7) days and after significant precipitation events. All necessary maintenance and repair shall be completed immediately. This project does not rely on the control measures owned or operated by another entity. The purpose of Site inspections is to assess performance of pollutant controls. The inspections will be conducted by the contractor's Storm Water Coordinator. Based on these inspections, it is the responsibility of the contractor to revise or implement additional Best Management Practices, repair erosion control measures, modify, maintain, supplement, or take additional steps as necessary to achieve effective pollutant control measures.

Examples of specific items to evaluate during Site inspections are listed below. This list is not intended to be comprehensive. During each inspection, the inspector must evaluate overall pollutant control system performance as well as particular details of individual system components. Additional factors should be considered as appropriate to the circumstances.

- A. Locations where vehicles enter and exit the Site must be inspected for evidence of off-site sediment tracking. A stabilized VTC shall be constructed where vehicles enter and exit. Exits shall be maintained or supplemented as necessary to prevent the release of sediment from vehicles leaving the Site.
- B. Sediment barriers must be inspected, and they must be extended, repaired or cleaned at such time as their original capacity has been reduced by 33 percent. All material excavated from behind sediment barriers shall be stockpiled on the up-slope side. Additional sediment barriers must be constructed as needed.

- C. Inspections shall evaluate disturbed areas and areas used for storing materials that are exposed to rainfall for evidence of, or the potential for, pollutants entering the drainage system or discharging from the Site. If necessary, the materials must be covered or original covers must be repaired or supplemented. Also, protective berms must be constructed, if needed, in order to contain runoff from material storage areas, and/or run-on.
- D. All discharge points must be inspected to determine whether erosion control measures are effective in preventing significant impacts to receiving waters.

A sample report from the EPA has been included in the Appendices E and F for reference.

SWMP Checklist Item 25 - State that signatures are required on inspection logs.

TERM AND CONDITIONS OF THE CDPS GENERAL PERMIT

GENERAL LIMITATIONS

The following limitations shall apply to discharges associated with construction activities:

- Stormwater discharges from construction activities shall not cause, have the reasonable potential to cause, or measurably contribute to an exceedance of any water quality standard, including narrative standards for water quality.
- Concrete washout water shall not be discharged to state surface waters or to storm sewer systems. Onsite permanent disposal of concrete washout waste is not authorized by this permit. Discharge to the ground of concrete washout waste that will subsequently be disposed of offsite is authorized by this permit. See Part I.D.3.c of the permit.
- Bulk storage structures for petroleum products and any other chemicals shall have secondary containment or equivalent adequate protection so as to contain all spills and prevent any spilled material from entering State Waters.
- No chemicals are to be added to the discharge unless permission for the use of a specific chemical is granted by CDPHE. In granting the use of such chemicals, special conditions and monitoring may be addressed by separate correspondence.
- CDPHE reserves the right to require sampling and testing, on a case-by-case basis, in the event that there is reason to suspect that compliance with the SWMP is a problem, or to measure the effectiveness of the BMPs in removing pollutants in the effluent. Such monitoring may include Whole Effluent Toxicity testing.
- All Site wastes must be properly managed to prevent potential pollution of State Waters. This permit does not authorize onsite waste disposal.
- All dischargers must comply with the lawful requirements of federal agencies, municipalities, counties, drainage districts and other local agencies regarding any discharges of stormwater to storm drain systems or other water courses under their jurisdiction, including applicable requirements in municipal stormwater management programs developed to comply with CDPS permits. Dischargers must comply with local stormwater management requirements, policies, or guidelines including erosion and sediment control.

The above information is taken directly from the CDPHE General Permit.

PROHIBITION OF NON-STORMWATER DISCHARGES

Except as identified within the Terms and Conditions of the General Permit (Section D.3 – Prohibition of Non-Stormwater Discharges), all discharges covered by this permit shall be composed entirely of stormwater associated with construction activity. Discharges of material other than stormwater must be addressed in a separate CDPS permit issued for that discharge. No non-stormwater discharges are

anticipated at this site.

Discharges to the ground from construction dewatering activities that do not meet the referenced criteria must be covered under a separate CDPS discharge permit. Contaminated groundwater requiring coverage under a separate CDPS discharge permit may include groundwater contaminated with pollutants from a landfill, mining activity, industrial pollutant plume, underground storage tank, or other source.

The above information is taken from the CDPHE General Permit.

SWMP RETENTION REQUIREMENTS

The permittee must document inspection results and maintain a record of the results for a period of 3 years following expiration or inactivation of permit coverage. These records must be made available to the City, County, CDPHE or EPA upon request.

In order to fulfill this requirement, the SWMP Administrator shall retain a copy of the SWMP and provide the original to the owner/permittee upon inactivation of the permit.

SWMP REVIEW / CHANGES

At nearly every site, the recommended and/or implemented BMPs will need to be modified to adapt to changing site conditions, or to ensure that the potential pollutants are consistently and properly managed. The Operator shall amend the SWMP:

- When there is a change in design, construction, operation, or maintenance of the Site, which would require the implementation of new or revised BMPs; or
- If the SWMP proves to be ineffective in achieving the general objectives of controlling pollutants in stormwater discharges associated with construction activity; or
- When BMPs are no longer necessary and removed.

SWMP changes shall be made prior to changes in Site conditions, except as noted below. Revisions may include, but are not limited to, potential pollutant source identification, selection of appropriate BMPs for Site conditions, BMP maintenance procedures and interim and final stabilization practices. The SWMP changes may include a schedule for further BMP design and implementation, provided that, if any interim BMPs are needed to comply with the permit, they are also included in the SWMP and implemented during the interim period.

RESPONSIVE SWMP CHANGES

SWMP changes addressing BMP installation and/or implementation are often required to be made in response to changing conditions, or when current BMPs are determined ineffective. The majority of these SWMP revisions can be made immediately with quick in-the-field revisions to the SWMP. In the less common situation where more complex development of materials to modify the SWMP is necessary, the revisions shall be made in accordance with the following requirements:

- The SWMP shall be revised as soon as practicable, but in no case more than 72 hours after the change(s) in BMP installation/implementation occur at the Site; and
- A notation must be included in the SWMP prior to the Site change(s) that includes the time and date of the change(s) in the field, an identification of the BMP(s) removed or added and the location(s) of those BMP(s).

Any BMP deficiencies, replacement or additional BMPs that may be required shall be documented on the Stormwater Management Plans and in the appropriate logs. Copies of the Corrective Action Log and SWMP Amendment Log have been included in the Appendices for reference and use.

CONCLUSIONS

Temporary erosion control measures and BMPs will enhance stormwater quality within the Project area by capturing and detaining sediment-laden runoff prior to discharging off-site.

REFERENCES

El Paso County Erosion Control, and Stormwater Quality Plan Checklist, Engineering Criteria Manual, El Paso County, CO, Revised January 2022

Colorado Discharge Permit System (CDPS) – Stormwater Discharge Associated with Construction Activities Application - Prepared by Water Quality Control Division, Colorado Department of Public Health and Environment; Revised March 2016.

Colorado Discharge Permit System (CDPS) General Permit – Stormwater Discharges Associated with Construction Activity - Prepared by Water Quality Control Division, Colorado Department of Public Health and Environment; signed and issued on May 31, 2007 and administratively continued effective July 1, 2012.

Stormwater Discharges Associated with Construction Activity – Stormwater Management Plan Preparation Guidance - Prepared by Water Quality Control Division, Colorado Department of Public Health and Environment; Revised April 2011.

Urban Storm Drainage Criteria Manual, Volume 3 – Mile High Flood District, Denver, CO.; November 2010.

APPENDICES

APPENDIX A
STORMWATER MANAGEMENT PLANS / SITE MAPS

**APPENDIX B
CDPHE STOMWATER PERMIT**

**APPENDIX C
FEMA FIRM MAP**

National Flood Hazard Layer FIRMette



104°36'23"W 38°50'27"N

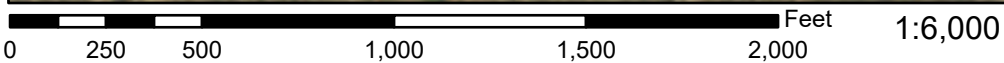

Basemap: USGS National Map: Orthoimagery: Data refreshed October, 2020

Legend

SEE FIS REPORT FOR DETAILED LEGEND AND INDEX MAP FOR FIRM PANEL LAYOUT

- | | | |
|-----------------------------|--|--|
| SPECIAL FLOOD HAZARD AREAS | | Without Base Flood Elevation (BFE) <i>Zone A, V, A99</i> |
| | | With BFE or Depth <i>Zone AE, AO, AH, VE, AR</i> |
| | | Regulatory Floodway |
| OTHER AREAS OF FLOOD HAZARD | | 0.2% Annual Chance Flood Hazard, Areas of 1% annual chance flood with average depth less than one foot or with drainage areas of less than one square mile <i>Zone X</i> |
| | | Future Conditions 1% Annual Chance Flood Hazard <i>Zone X</i> |
| | | Area with Reduced Flood Risk due to Levee. See Notes. <i>Zone X</i> |
| | | Area with Flood Risk due to Levee <i>Zone D</i> |
| OTHER AREAS | | NO SCREEN Area of Minimal Flood Hazard <i>Zone X</i> |
| | | Effective LOMRs |
| GENERAL STRUCTURES | | Area of Undetermined Flood Hazard <i>Zone D</i> |
| | | Channel, Culvert, or Storm Sewer |
| | | Levee, Dike, or Floodwall |
| OTHER FEATURES | | 20.2 Cross Sections with 1% Annual Chance Water Surface Elevation |
| | | 17.5 Coastal Transect |
| | | Base Flood Elevation Line (BFE) |
| | | Limit of Study |
| | | Jurisdiction Boundary |
| | | Coastal Transect Baseline |
| MAP PANELS | | Profile Baseline |
| | | Hydrographic Feature |
| | | Digital Data Available |
| | | No Digital Data Available |
| | | Unmapped |
- The pin displayed on the map is an approximate point selected by the user and does not represent an authoritative property location.

This map complies with FEMA's standards for the use of digital flood maps if it is not void as described below. The basemap shown complies with FEMA's basemap accuracy standards

The flood hazard information is derived directly from the authoritative NFHL web services provided by FEMA. This map was exported on 2/10/2022 at 9:13 AM and does not reflect changes or amendments subsequent to this date and time. The NFHL and effective information may change or become superseded by new data over time.

This map image is void if the one or more of the following map elements do not appear: basemap imagery, flood zone labels, legend, scale bar, map creation date, community identifiers, FIRM panel number, and FIRM effective date. Map images for unmapped and unmodernized areas cannot be used for regulatory purposes.

NOTES TO USERS

This map is for use in administering the National Flood Insurance Program. It does not necessarily identify all areas subject to flooding, particularly from local drainage sources of small size. The community map repository should be consulted for possible updated or additional flood hazard information.

To obtain more detailed information in areas where **Base Flood Elevations (BFEs)** and/or **floodways** have been determined, users are encouraged to consult the Flood Profiles and Floodway Data and/or Summary of Stillwater Elevations tables contained within the Flood Insurance Study (FIS) report that accompanies this FIRM. Users should be aware that BFEs shown on the FIRM represent rounded whole-foot elevations. These BFEs are intended for flood insurance rating purposes only and should not be used as the sole source of flood elevation information. Accordingly, flood elevation data presented in the FIS report should be utilized in conjunction with the FIRM for purposes of construction and/or floodplain management.

Coastal Base Flood Elevations shown on this map apply only landward of 0.0' North American Vertical Datum of 1988 (NAVD88). Users of this FIRM should be aware that coastal flood elevations are also provided in the Summary of Stillwater Elevations table in the Flood Insurance Study report for this jurisdiction. Elevations shown in the Summary of Stillwater Elevations table should be used for construction and/or floodplain management purposes when they are higher than the elevations shown on this FIRM.

Boundaries of the **floodways** were computed at cross sections and interpolated between cross sections. The floodways were based on hydraulic considerations with regard to requirements of the National Flood Insurance Program. Floodway widths and other pertinent floodway data are provided in the Flood Insurance Study report for this jurisdiction.

Certain areas not in Special Flood Hazard Areas may be protected by **flood control structures**. Refer to section 2.4 "Flood Protection Measures" of the Flood Insurance Study report for information on flood control structures for this jurisdiction.

The **projection** used in the preparation of this map was Universal Transverse Mercator (UTM) zone 13. The **horizontal datum** was NAD83, GRS80 spheroid. Differences in datum, spheroid, projection or UTM zones zones used in the production of FIRMs for adjacent jurisdictions may result in slight positional differences in map features across jurisdiction boundaries. These differences do not affect the accuracy of this FIRM.

Flood elevations on this map are referenced to the **North American Vertical Datum of 1988 (NAVD88)**. These flood elevations must be compared to structure and ground elevations referenced to the same **vertical datum**. For information regarding conversion between the National Geodetic Vertical Datum of 1929 and the North American Vertical Datum of 1988, visit the National Geodetic Survey website at <http://www.ngs.noaa.gov/> or contact the National Geodetic Survey at the following address:

NGS Information Services
NOAA, NIMS12
National Geodetic Survey
SSMC-3, #9202
1315 East-West Highway
Silver Spring, MD 20910-3282

To obtain current elevation, description, and/or location information for **bench marks** shown on this map, please contact the Information Services Branch of the National Geodetic Survey at (301) 713-3242 or visit its website at <http://www.ngs.noaa.gov/>.

Base Map information shown on this FIRM was provided in digital format by El Paso County, Colorado Springs Utilities, and Anderson Consulting Engineers, Inc. These data are current as of 2008.

This map reflects more detailed and up-to-date **stream channel configurations and floodplain delineations** than those shown on the previous FIRM for this jurisdiction. The floodplains and floodways that were transferred from the previous FIRM may have been adjusted to conform to these new stream channel configurations. As a result, the Flood Profiles and Floodway Data tables in the Flood Insurance Study Report (which contains authoritative hydraulic data) may reflect stream channel distances that differ from what is shown on this map. The profile baselines depicted on this map represent the hydraulic modeling baselines that match the flood profiles and Floodway Data Tables if applicable, in the FIS report. As a result, the profile baselines may deviate significantly from the new base map channel representation and may appear outside of the floodplain.

Corporate limits shown on this map are based on the best data available at the time of publication. Because changes due to annexations or de-annexations may have occurred after this map was published, map users should contact appropriate community officials to verify current corporate limit locations.

Please refer to the separately printed **Map Index** for an overview map of the county showing the layout of map panels; community map repository addresses; and a Listing of Communities table containing National Flood Insurance Program dates for each community as well as a listing of the panels on which each community is located.

Contact **FEMA Map Service Center (MSC)** via the FEMA Map Information eXchange (FIMX) 1-877-338-2627 for information on available products associated with this FIRM. Available products may include previously issued Letters of Map Change, a Flood Insurance Study Report, and/or digital versions of this map. The MSC may also be reached by Fax at 1-800-358-9620 and its website at <http://www.msc.fema.gov/>.

If you have **questions about this map** or questions concerning the National Flood Insurance Program in general, please call 1-877-FEMA MAP (1-877-338-2627) or visit the FEMA website at <http://www.fema.gov/business/nfp>.

El Paso County Vertical Datum Offset Table

| Flooding Source | Vertical Datum Offset (ft) |
|-----------------|----------------------------|
| | |

REFER TO SECTION 3.3 OF THE EL PASO COUNTY FLOOD INSURANCE STUDY FOR STREAM BY STREAM VERTICAL DATUM CONVERSION INFORMATION

Panel Location Map

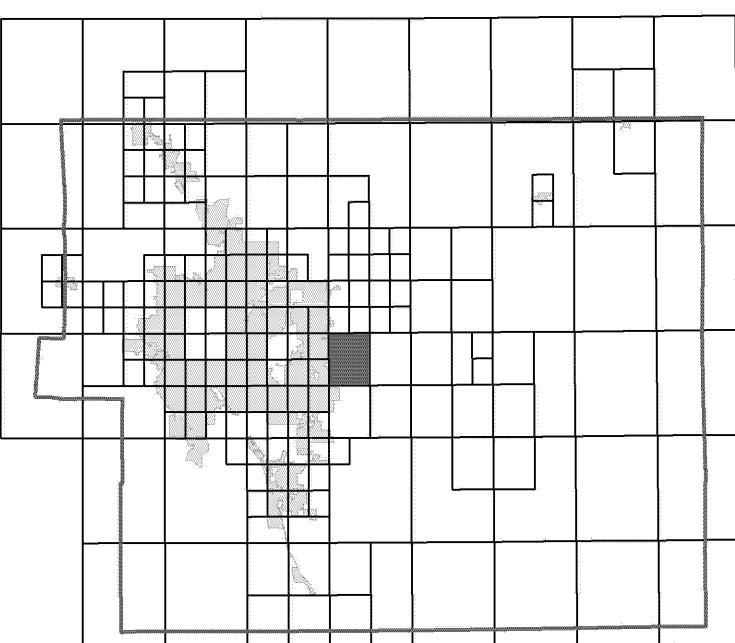

This Digital Flood Insurance Rate Map (DFIRM) was produced through a Cooperating Technical Partner (CTP) agreement between the State of Colorado Water Conservation Board (CWCB) and the Federal Emergency Management Agency (FEMA).



Additional Flood Hazard information and resources are available from local communities and the Colorado Water Conservation Board.

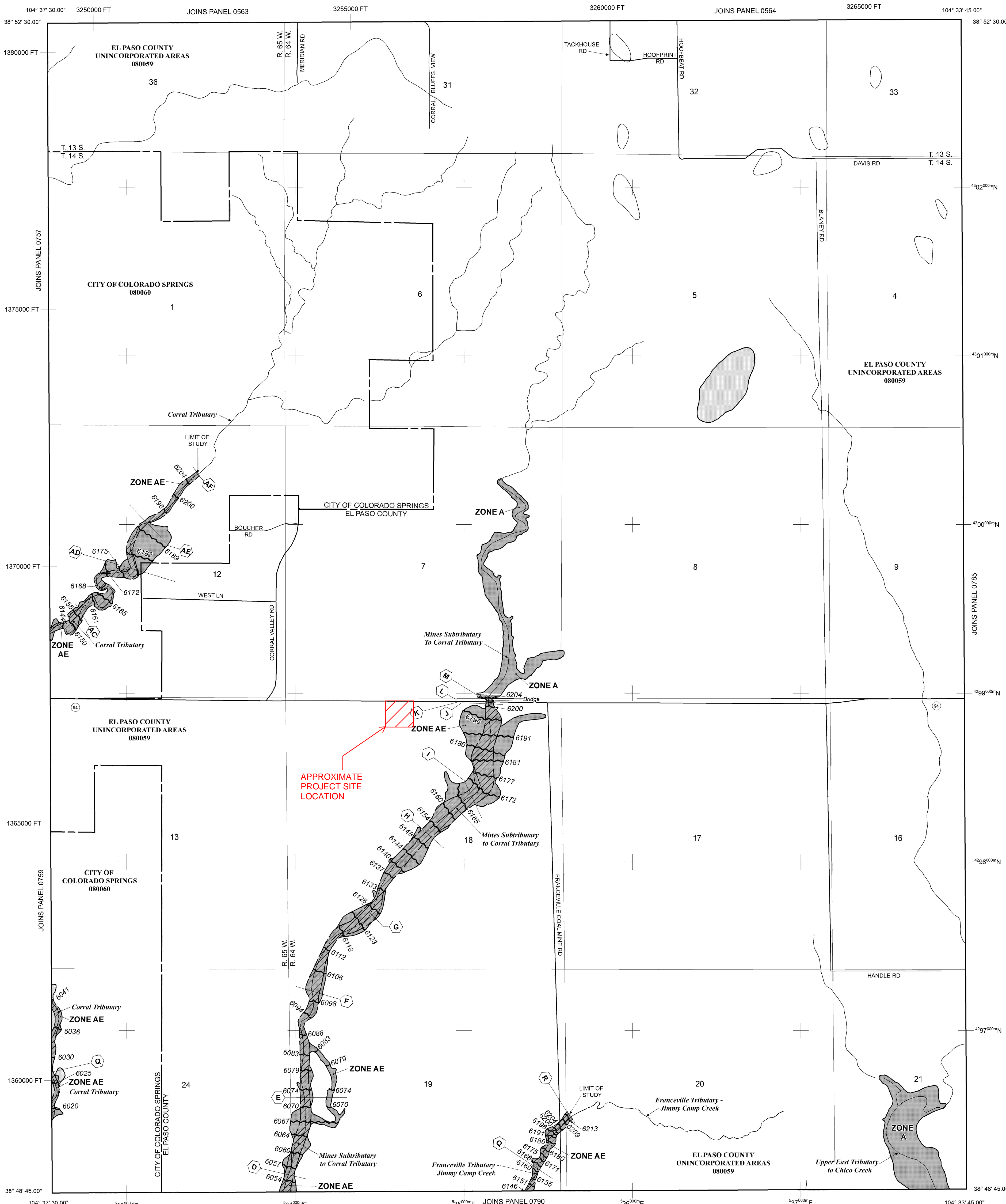

LEGEND

- SPECIAL FLOOD HAZARD AREAS (SFHAs) SUBJECT TO INUNDATION BY THE 1% ANNUAL CHANCE FLOOD
- The 1% annual chance flood (100-year flood), also known as the base flood, is the flood that has a 1% chance of being equalled or exceeded in any given year. The Special Flood Hazard Area is the area subject to flooding by the 1% annual chance flood. Areas of Special Flood Hazard include Zones A, AE, AH, AO, AR, A99, V, and VE. The Base Flood Elevation is the water-surface elevation of the 1% annual chance flood.
- ZONE A** No Base Flood Elevations determined.
- ZONE AE** Base Flood Elevations determined.
- ZONE AH** Flood depths of 1 to 3 feet (usually areas of ponding); Base Flood Elevations determined.
- ZONE AO** Flood depths of 1 to 3 feet (usually sheet flow on sloping terrain); average depths determined. For areas of alluvial fan flooding, velocities also determined.
- ZONE AR** Special Flood Hazard Area Formerly protected from the 1% annual chance flood by a flood control system that was subsequently decertified. Zone AR indicates that the former flood control system is being restored to provide protection from the 1% annual chance or greater flood.
- ZONE A99** Area to be protected from 1% annual chance flood by a Federal flood protection system under construction; no Base Flood Elevations determined.
- ZONE V** Coastal flood zone with velocity hazard (wave action); no Base Flood Elevations determined.
- ZONE VE** Coastal flood zone with velocity hazard (wave action); Base Flood Elevations determined.
- FLOODWAY AREAS IN ZONE AE
- The floodway is the channel of a stream plus any adjacent floodplain areas that must be kept free of encroachment so that the 1% annual chance flood can be carried without substantial increases in flood heights.
- OTHER FLOOD AREAS
- ZONE X** Areas of 0.2% annual chance flood; areas of 1% annual chance flood with average depths of less than 1 foot, or with drainage areas less than 1 square mile; and areas protected by levees from 1% annual chance flood.
- OTHER AREAS
- ZONE X** Areas determined to be outside the 0.2% annual chance floodplain.
- ZONE D** Areas in which flood hazards are undetermined, but possible.
- COASTAL BARRIER RESOURCES SYSTEM (CBRS) AREAS
- OTHERWISE PROTECTED AREAS (OPAs)

- CBRS areas and OPAs are normally located within or adjacent to Special Flood Hazard Areas.
- Floodplain boundary
- Floodway boundary
- Zone D boundary
- CBRS and OPA boundary

- Boundary dividing Special Flood Hazard Areas of different Base Flood Elevations, flood depths or flood velocities.
- Base Flood Elevation line and value; elevation in feet* (EL 987)
- Base Flood Elevation value where uniform within zone; elevation in feet*

- * Referenced to the North American Vertical Datum of 1988 (NAVD 88)
- Cross section line
- Transsect line

- 97° 07' 30.00" Datum of 1983 (NAD 83)
- 42° 50' 00" 1000-meter Universal Transverse Mercator grid ticks, zone 13
- 6000000 FT 5000-foot grid ticks; Colorado State Plane coordinate system, central zone (FIPS CODE 5002), Lambert Conformal Conic Projection

- Bench mark (see explanation in Notes to Users section of this FIRM panel)
- River Mile

- MAP REPOSITORIES
- Refer to Map Repositories list on Map Index
- EFFECTIVE DATE OF COUNTYWIDE FLOOD INSURANCE RATE MAP
- MARCH 17, 1997

- EFFECTIVE DATE(S) OF REVISION(S) TO THIS PANEL
- DECEMBER 7, 2018 - to update corporate limits, to change Base Flood Elevations and Special Flood Hazard Areas, to update map format, to add roads and road names, and to incorporate previously issued Letters of Map Revision.

For community map revision history prior to countywide mapping, refer to the Community Map History Table located in the Flood Insurance Study report for this jurisdiction.

To determine if flood insurance is available in this community, contact your insurance agent or call the National Flood Insurance Program at 1-800-638-6620.

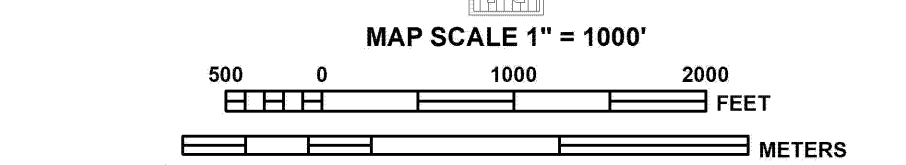

NFIP PANEL 0780G

FIRM
FLOOD INSURANCE RATE MAP
EL PASO COUNTY,
COLORADO
AND INCORPORATED AREAS

PANEL 780 OF 1300
(SEE MAP INDEX FOR FIRM PANEL LAYOUT)

CONTAINS:

| COMMUNITY | NUMBER | PANEL | SUFFIX |
|---------------------------|--------|-------|--------|
| COLORADO SPRINGS, CITY OF | 08080 | 0780 | G |
| EL PASO COUNTY | 08059 | 0780 | G |

Notice: This map was released on 05/15/2020 to make a correction. This version replaces any previous versions. See the Notice-to-User Letter that accompanied this correction for details.

Notice to User: The Map Number shown below should be used when placing map orders. The Community Number shown above should be used on insurance applications for the subject community.

MAP NUMBER
08041C0780G

MAP REVISED
DECEMBER 7, 2018

Federal Emergency Management Agency

**APPENDIX D
SOILS INFORMATION**

Custom Soil Resource Report Soil Map

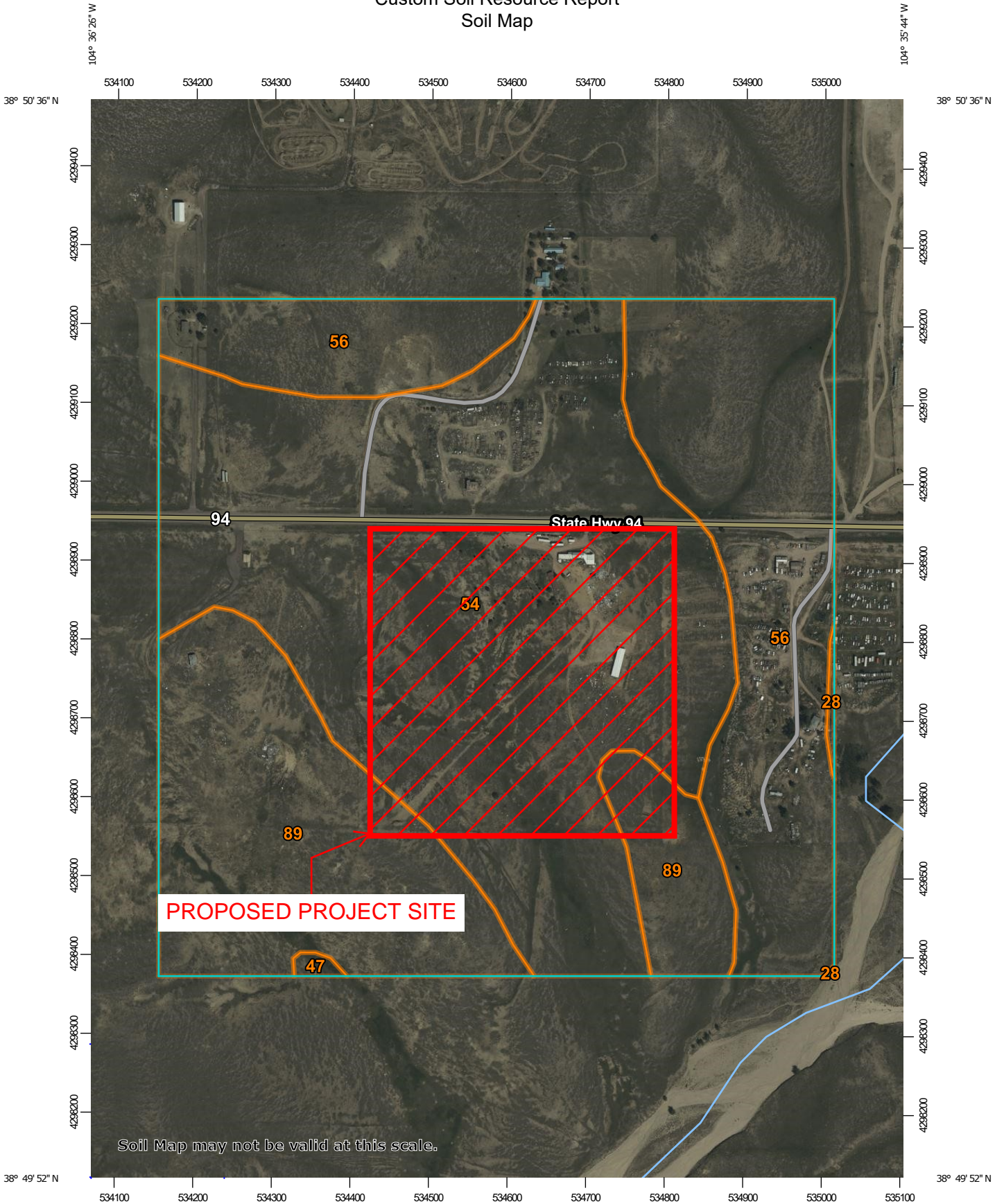

Soil Map may not be valid at this scale.

Map Scale: 1:6,660 if printed on A portrait (8.5" x 11") sheet.

0 50 100 200 300 Meters

0 300 600 1200 1800 Feet

Map projection: Web Mercator Corner coordinates: WGS84 Edge tics: UTM Zone 13N WGS84



MAP LEGEND

Area of Interest (AOI)

 Area of Interest (AOI)



















Soils







 Soil Map Unit Polygons

 Soil Map Unit Lines

 Soil Map Unit Points

Special Point Features





-  Blowout
-  Borrow Pit
-  Clay Spot
-  Closed Depression
-  Gravel Pit
-  Gravelly Spot
-  Landfill
-  Lava Flow
-  Marsh or swamp
-  Mine or Quarry
-  Miscellaneous Water
-  Perennial Water
-  Rock Outcrop
-  Saline Spot
-  Sandy Spot
-  Severely Eroded Spot
-  Sinkhole
-  Slide or Slip
-  Sodic Spot

-  Spoil Area
-  Stony Spot
-  Very Stony Spot
-  Wet Spot
-  Other
-  Special Line Features

Water Features

 Streams and Canals

Transportation

-  Rails
-  Interstate Highways
-  US Routes
-  Major Roads
-  Local Roads

Background

 Aerial Photography

MAP INFORMATION

The soil surveys that comprise your AOI were mapped at 1:24,000.

Warning: Soil Map may not be valid at this scale.

Enlargement of maps beyond the scale of mapping can cause misunderstanding of the detail of mapping and accuracy of soil line placement. The maps do not show the small areas of contrasting soils that could have been shown at a more detailed scale.

Please rely on the bar scale on each map sheet for map measurements.

Source of Map: Natural Resources Conservation Service
 Web Soil Survey URL:
 Coordinate System: Web Mercator (EPSG:3857)

Maps from the Web Soil Survey are based on the Web Mercator projection, which preserves direction and shape but distorts distance and area. A projection that preserves area, such as the Albers equal-area conic projection, should be used if more accurate calculations of distance or area are required.

This product is generated from the USDA-NRCS certified data as of the version date(s) listed below.

Soil Survey Area: El Paso County Area, Colorado
 Survey Area Data: Version 21, Aug 24, 2023

Soil map units are labeled (as space allows) for map scales 1:50,000 or larger.

Date(s) aerial images were photographed: Sep 11, 2018—Oct 20, 2018

The orthophoto or other base map on which the soil lines were compiled and digitized probably differs from the background imagery displayed on these maps. As a result, some minor shifting of map unit boundaries may be evident.

Map Unit Legend

| Map Unit Symbol | Map Unit Name | Acres in AOI | Percent of AOI |
|------------------------------------|--|--------------|----------------|
| 28 | Ellicott loamy coarse sand, 0 to 5 percent slopes | 0.3 | 0.2% |
| 47 | Limon clay, 0 to 3 percent slopes | 0.4 | 0.2% |
| 54 | Midway clay loam, 3 to 25 percent slopes | 91.9 | 50.2% |
| 56 | Nelson-Tassel fine sandy loams, 3 to 18 percent slopes | 49.3 | 26.9% |
| 89 | Tassel fine sandy loam, 3 to 18 percent slopes | 41.3 | 22.5% |
| Totals for Area of Interest | | 183.2 | 100.0% |

Map Unit Descriptions

The map units delineated on the detailed soil maps in a soil survey represent the soils or miscellaneous areas in the survey area. The map unit descriptions, along with the maps, can be used to determine the composition and properties of a unit.

A map unit delineation on a soil map represents an area dominated by one or more major kinds of soil or miscellaneous areas. A map unit is identified and named according to the taxonomic classification of the dominant soils. Within a taxonomic class there are precisely defined limits for the properties of the soils. On the landscape, however, the soils are natural phenomena, and they have the characteristic variability of all natural phenomena. Thus, the range of some observed properties may extend beyond the limits defined for a taxonomic class. Areas of soils of a single taxonomic class rarely, if ever, can be mapped without including areas of other taxonomic classes. Consequently, every map unit is made up of the soils or miscellaneous areas for which it is named and some minor components that belong to taxonomic classes other than those of the major soils.

Most minor soils have properties similar to those of the dominant soil or soils in the map unit, and thus they do not affect use and management. These are called noncontrasting, or similar, components. They may or may not be mentioned in a particular map unit description. Other minor components, however, have properties and behavioral characteristics divergent enough to affect use or to require different management. These are called contrasting, or dissimilar, components. They generally are in small areas and could not be mapped separately because of the scale used. Some small areas of strongly contrasting soils or miscellaneous areas are identified by a special symbol on the maps. If included in the database for a given area, the contrasting minor components are identified in the map unit descriptions along with some characteristics of each. A few areas of minor components may not have been observed, and consequently they are not mentioned in the descriptions, especially where the pattern was so complex that it was impractical to make enough observations to identify all the soils and miscellaneous areas on the landscape.

Custom Soil Resource Report

The presence of minor components in a map unit in no way diminishes the usefulness or accuracy of the data. The objective of mapping is not to delineate pure taxonomic classes but rather to separate the landscape into landforms or landform segments that have similar use and management requirements. The delineation of such segments on the map provides sufficient information for the development of resource plans. If intensive use of small areas is planned, however, onsite investigation is needed to define and locate the soils and miscellaneous areas.

An identifying symbol precedes the map unit name in the map unit descriptions. Each description includes general facts about the unit and gives important soil properties and qualities.

Soils that have profiles that are almost alike make up a *soil series*. Except for differences in texture of the surface layer, all the soils of a series have major horizons that are similar in composition, thickness, and arrangement.

Soils of one series can differ in texture of the surface layer, slope, stoniness, salinity, degree of erosion, and other characteristics that affect their use. On the basis of such differences, a soil series is divided into *soil phases*. Most of the areas shown on the detailed soil maps are phases of soil series. The name of a soil phase commonly indicates a feature that affects use or management. For example, Alpha silt loam, 0 to 2 percent slopes, is a phase of the Alpha series.

Some map units are made up of two or more major soils or miscellaneous areas. These map units are complexes, associations, or undifferentiated groups.

A *complex* consists of two or more soils or miscellaneous areas in such an intricate pattern or in such small areas that they cannot be shown separately on the maps. The pattern and proportion of the soils or miscellaneous areas are somewhat similar in all areas. Alpha-Beta complex, 0 to 6 percent slopes, is an example.

An *association* is made up of two or more geographically associated soils or miscellaneous areas that are shown as one unit on the maps. Because of present or anticipated uses of the map units in the survey area, it was not considered practical or necessary to map the soils or miscellaneous areas separately. The pattern and relative proportion of the soils or miscellaneous areas are somewhat similar. Alpha-Beta association, 0 to 2 percent slopes, is an example.

An *undifferentiated group* is made up of two or more soils or miscellaneous areas that could be mapped individually but are mapped as one unit because similar interpretations can be made for use and management. The pattern and proportion of the soils or miscellaneous areas in a mapped area are not uniform. An area can be made up of only one of the major soils or miscellaneous areas, or it can be made up of all of them. Alpha and Beta soils, 0 to 2 percent slopes, is an example.

Some surveys include *miscellaneous areas*. Such areas have little or no soil material and support little or no vegetation. Rock outcrop is an example.

El Paso County Area, Colorado

28—Ellicott loamy coarse sand, 0 to 5 percent slopes

Map Unit Setting

National map unit symbol: 3680
Elevation: 5,500 to 6,500 feet
Mean annual precipitation: 13 to 15 inches
Mean annual air temperature: 47 to 50 degrees F
Frost-free period: 125 to 145 days
Farmland classification: Not prime farmland

Map Unit Composition

Ellicott and similar soils: 97 percent
Minor components: 3 percent
Estimates are based on observations, descriptions, and transects of the mapunit.

Description of Ellicott

Setting

Landform: Flood plains, stream terraces
Landform position (three-dimensional): Tread
Down-slope shape: Linear
Across-slope shape: Linear
Parent material: Sandy alluvium

Typical profile

A - 0 to 4 inches: loamy coarse sand
C - 4 to 60 inches: stratified coarse sand to sandy loam

Properties and qualities

Slope: 0 to 5 percent
Depth to restrictive feature: More than 80 inches
Drainage class: Somewhat excessively drained
Runoff class: Very low
Capacity of the most limiting layer to transmit water (Ksat): High to very high (5.95 to 19.98 in/hr)
Depth to water table: More than 80 inches
Frequency of flooding: Frequent
Frequency of ponding: None
Available water supply, 0 to 60 inches: Low (about 4.1 inches)

Interpretive groups

Land capability classification (irrigated): None specified
Land capability classification (nonirrigated): 7w
Hydrologic Soil Group: A
Ecological site: R069XY031CO - Sandy Bottomland
Other vegetative classification: SANDY BOTTOMLAND (069AY031CO)
Hydric soil rating: No

Minor Components

Fluvaquentic haplaquoll

Percent of map unit: 1 percent
Landform: Swales
Hydric soil rating: Yes

Other soils

Percent of map unit: 1 percent
Hydric soil rating: No

Pleasant

Percent of map unit: 1 percent
Landform: Depressions
Hydric soil rating: Yes

47—Limon clay, 0 to 3 percent slopes

Map Unit Setting

National map unit symbol: 368p
Elevation: 5,200 to 6,200 feet
Mean annual precipitation: 12 to 14 inches
Mean annual air temperature: 48 to 52 degrees F
Frost-free period: 135 to 155 days
Farmland classification: Not prime farmland

Map Unit Composition

Limon, occasionally flooded, and similar soils: 95 percent
Minor components: 5 percent
Estimates are based on observations, descriptions, and transects of the mapunit.

Description of Limon, Occasionally Flooded

Setting

Landform: Flood plains, alluvial fans
Down-slope shape: Linear
Across-slope shape: Linear
Parent material: Clayey alluvium derived from shale

Typical profile

A - 0 to 4 inches: clay
AC - 4 to 12 inches: silty clay
C - 12 to 60 inches: silty clay loam

Properties and qualities

Slope: 0 to 3 percent
Depth to restrictive feature: More than 80 inches
Drainage class: Well drained
Runoff class: Low
Capacity of the most limiting layer to transmit water (Ksat): Moderately low to moderately high (0.06 to 0.20 in/hr)
Depth to water table: More than 80 inches
Frequency of flooding: Occasional
Frequency of ponding: None
Calcium carbonate, maximum content: 10 percent
Gypsum, maximum content: 2 percent
Maximum salinity: Very slightly saline to moderately saline (2.0 to 8.0 mmhos/cm)

Custom Soil Resource Report

Sodium adsorption ratio, maximum: 10.0
Available water supply, 0 to 60 inches: High (about 9.9 inches)

Interpretive groups

Land capability classification (irrigated): 3e
Land capability classification (nonirrigated): 4e
Hydrologic Soil Group: C
Ecological site: R069XY033CO - Salt Flat
Hydric soil rating: No

Minor Components

Other soils

Percent of map unit: 4 percent
Hydric soil rating: No

Pleasant

Percent of map unit: 1 percent
Landform: Depressions
Hydric soil rating: Yes

54—Midway clay loam, 3 to 25 percent slopes

Map Unit Setting

National map unit symbol: 368y
Elevation: 5,200 to 6,200 feet
Mean annual precipitation: 12 to 14 inches
Mean annual air temperature: 48 to 52 degrees F
Frost-free period: 135 to 155 days
Farmland classification: Not prime farmland

Map Unit Composition

Midway and similar soils: 95 percent
Minor components: 5 percent
Estimates are based on observations, descriptions, and transects of the mapunit.

Description of Midway

Setting

Landform: Hills
Landform position (three-dimensional): Side slope
Down-slope shape: Linear
Across-slope shape: Linear
Parent material: Slope alluvium over residuum weathered from shale

Typical profile

A - 0 to 4 inches: clay loam
C - 4 to 13 inches: clay
Cr - 13 to 17 inches: weathered bedrock

Properties and qualities

Slope: 3 to 25 percent

Custom Soil Resource Report

Depth to restrictive feature: 6 to 20 inches to paralithic bedrock
Drainage class: Well drained
Runoff class: Medium
Capacity of the most limiting layer to transmit water (Ksat): Moderately low to moderately high (0.06 to 0.20 in/hr)
Depth to water table: More than 80 inches
Frequency of flooding: None
Frequency of ponding: None
Calcium carbonate, maximum content: 15 percent
Gypsum, maximum content: 15 percent
Maximum salinity: Very slightly saline to moderately saline (2.0 to 8.0 mmhos/cm)
Sodium adsorption ratio, maximum: 15.0
Available water supply, 0 to 60 inches: Very low (about 2.2 inches)

Interpretive groups

Land capability classification (irrigated): None specified
Land capability classification (nonirrigated): 7e
Hydrologic Soil Group: D
Ecological site: R069XY046CO - Shaly Plains
Other vegetative classification: SHALY PLAINS (069AY046CO)
Hydric soil rating: No

Minor Components

Other soils

Percent of map unit: 4 percent
Hydric soil rating: No

Pleasant

Percent of map unit: 1 percent
Landform: Depressions
Hydric soil rating: Yes

56—Nelson-Tassel fine sandy loams, 3 to 18 percent slopes

Map Unit Setting

National map unit symbol: 3690
Elevation: 5,600 to 6,400 feet
Mean annual precipitation: 12 to 14 inches
Mean annual air temperature: 48 to 52 degrees F
Frost-free period: 135 to 155 days
Farmland classification: Not prime farmland

Map Unit Composition

Nelson and similar soils: 55 percent
Tassel and similar soils: 40 percent
Minor components: 5 percent
Estimates are based on observations, descriptions, and transects of the mapunit.

Description of Nelson

Setting

Landform: Hills

Landform position (three-dimensional): Side slope, crest

Down-slope shape: Linear

Across-slope shape: Linear

Parent material: Calcareous residuum weathered from interbedded sedimentary rock

Typical profile

A - 0 to 5 inches: fine sandy loam

Ck - 5 to 23 inches: fine sandy loam

Cr - 23 to 27 inches: weathered bedrock

Properties and qualities

Slope: 3 to 12 percent

Depth to restrictive feature: 20 to 40 inches to paralithic bedrock

Drainage class: Well drained

Runoff class: Medium

Capacity of the most limiting layer to transmit water (Ksat): Moderately low to high (0.06 to 2.00 in/hr)

Depth to water table: More than 80 inches

Frequency of flooding: None

Frequency of ponding: None

Calcium carbonate, maximum content: 10 percent

Maximum salinity: Nonsaline to very slightly saline (0.0 to 2.0 mmhos/cm)

Available water supply, 0 to 60 inches: Very low (about 2.8 inches)

Interpretive groups

Land capability classification (irrigated): 4e

Land capability classification (nonirrigated): 6e

Hydrologic Soil Group: B

Ecological site: R067BY045CO - Shaly Plains

Other vegetative classification: SHALY PLAINS (069AY046CO)

Hydric soil rating: No

Description of Tassel

Setting

Landform: Hills

Landform position (three-dimensional): Side slope, crest

Down-slope shape: Linear

Across-slope shape: Linear

Parent material: Calcareous slope alluvium over residuum weathered from sandstone

Typical profile

A - 0 to 4 inches: fine sandy loam

C - 4 to 10 inches: fine sandy loam

Cr - 10 to 14 inches: weathered bedrock

Properties and qualities

Slope: 3 to 18 percent

Depth to restrictive feature: 6 to 20 inches to paralithic bedrock

Drainage class: Well drained

Runoff class: Medium

Custom Soil Resource Report

Capacity of the most limiting layer to transmit water (Ksat): Moderately high (0.20 to 0.60 in/hr)

Depth to water table: More than 80 inches

Frequency of flooding: None

Frequency of ponding: None

Calcium carbonate, maximum content: 10 percent

Available water supply, 0 to 60 inches: Very low (about 1.2 inches)

Interpretive groups

Land capability classification (irrigated): None specified

Land capability classification (nonirrigated): 6s

Hydrologic Soil Group: D

Ecological site: R067BY045CO - Shaly Plains

Other vegetative classification: SHALY PLAINS (069AY046CO)

Hydric soil rating: No

Minor Components

Other soils

Percent of map unit: 4 percent

Hydric soil rating: No

Pleasant

Percent of map unit: 1 percent

Landform: Depressions

Hydric soil rating: Yes

89—Tassel fine sandy loam, 3 to 18 percent slopes

Map Unit Setting

National map unit symbol: 36b5

Elevation: 5,600 to 6,400 feet

Mean annual precipitation: 13 to 15 inches

Mean annual air temperature: 47 to 51 degrees F

Frost-free period: 135 to 155 days

Farmland classification: Not prime farmland

Map Unit Composition

Tassel and similar soils: 95 percent

Minor components: 5 percent

Estimates are based on observations, descriptions, and transects of the mapunit.

Description of Tassel

Setting

Landform: Hills

Landform position (three-dimensional): Crest, side slope

Down-slope shape: Linear

Across-slope shape: Linear

Custom Soil Resource Report

Parent material: Calcareous slope alluvium over residuum weathered from sandstone

Typical profile

A - 0 to 4 inches: fine sandy loam

C - 4 to 10 inches: sandy loam

Cr - 10 to 14 inches: weathered bedrock

Properties and qualities

Slope: 3 to 18 percent

Depth to restrictive feature: 6 to 20 inches to paralithic bedrock

Drainage class: Well drained

Runoff class: Medium

Capacity of the most limiting layer to transmit water (Ksat): Moderately high (0.20 to 0.60 in/hr)

Depth to water table: More than 80 inches

Frequency of flooding: None

Frequency of ponding: None

Calcium carbonate, maximum content: 10 percent

Available water supply, 0 to 60 inches: Very low (about 1.2 inches)

Interpretive groups

Land capability classification (irrigated): None specified

Land capability classification (nonirrigated): 6s

Hydrologic Soil Group: D

Ecological site: R067BY024CO - Sandy Plains

Other vegetative classification: SANDY PLAINS (069AY026CO)

Hydric soil rating: No

Minor Components

Other soils

Percent of map unit: 5 percent

Hydric soil rating: No

**APPENDIX E
IDENTIFICATION OF POLLUTANT SOURCES**

**APPENDIX F
LAND DISTURBANCE / CONTROL MEASURE / STABILIZATION
LOG**

**APPENDIX G
CDPHE ENVIRONMENTAL SPILL REPORTING / CONTROL
MEASURE**

involving a radioactive or infectious material, or there is a release of a marine pollutant.

Spills and incidents that have or may result in a spill along a highway must be reported to the nearest law enforcement agency immediately. The Colorado State Patrol and CDPHE must also be notified as soon as possible. In the event of a spill of hazardous waste at a transfer facility, the transporter must notify CDPHE within 24 hours if the spill exceeds 55 gallons or if there is a fire or explosion.

The National Response Center should be notified as soon as possible after discovery of a release of a hazardous liquid or carbon dioxide from a pipeline system if a person is killed or injured, there is a fire or explosion, there is property damage of \$50,000 or more, or any nearby water body is contaminated.

The National Response Center and the Colorado Public Utilities Commission Gas Pipeline Safety Section must be notified as soon as possible, but not more than two hours after discovery of a release of gas from a natural gas pipeline or liquefied natural gas facility if a person is killed or injured, there is an emergency shutdown of the facility, or there is property damage of \$50,000 or more. The Colorado Public Utilities Commission should also be notified if there is a gas leak from a pipeline, liquefied natural gas system, master meter system or a propane system that results in the evacuation of 50 or more people from an occupied building or the closure of a roadway.

Oil and Gas Exploration

All Class I major events on federal lands, including releases of hazardous substances in excess of the CERCLA reportable quantity and spills of more than 100 barrels of fluid and/or 500 MCF of gas released, must be reported to the Bureau of Land Management (BLM) immediately. Spills of oil, gas, salt water, toxic liquids and waste materials must also be reported to the BLM and the surface management agency.

Spills of exploration and production (E&P) waste on state or private lands in excess of 20 barrels, and spills of any size that impact or threaten to impact waters of the state, an occupied structure, or public byway must be reported to the Colorado Oil and Gas Conservation Commission as soon as practicable, but not more than 24 hours after discovery. Spills of any

size that impact or threaten to impact waters of the state must be reported to CDPHE immediately. Spills that impact or threaten to impact a surface water intake must be reported to the emergency contact for that facility immediately after discovery. Spills of more than five (5) barrels of E&P waste must be reported in writing to the Oil and Gas Conservation Commission within 10 days of discovery.

REPORTING NUMBERS

National Response Center (24-hour)
1-800-424-8802

CDPHE Colorado Environmental Release and Incident Reporting Line (24-hour)
1-877-518-5608

Radiation Incident Reporting Line (24-hour)
303-877-9757

Colorado State Patrol (24-hour)
303-239-4501

Division of Oil and Public Safety
(business hours)
303-318-8547

Oil and Gas Conservation Commission
(business hours)
303-894-2100

Colorado Public Utilities Commission Gas Pipeline Safety Section (business hours)
303-894-2851

Local Emergency Planning Committees
(to obtain list, business hours)
720-852-6603



**Colorado Department
of Public Health
and Environment**

Environmental Spill Reporting

Colorado Department of Public
Health and Environment
4300 Cherry Creek Drive South
Denver, CO 80246-1530

<http://www.cdphe.state.co.us>

January 2009

When a release of a hazardous material or other substance occurs to the environment, there are a number of reporting and notification requirements that must be followed by the company or individual responsible for the release. Most spills are covered by more than one reporting requirement, and **all** requirements must be met. In addition to verbal notification, written reports are generally required. This brochure briefly explains the major requirements. A more detailed description is provided in the "Reporting Environmental Releases in Colorado" Guidance Document, available on the web.

Releases that must be reported to the Colorado Department of Public Health and Environment (CDPHE) may be reported to the Colorado Environmental Release and Incident Reporting Line.

ENVIRONMENTAL SPILL REPORTING

CERCLA, EPCRA and RCRA

The Comprehensive Environmental Response, Compensation and Liability Act (CERCLA) and the Emergency Planning and Community Right-to-Know Act (EPCRA) require that a release of a reportable quantity or more of a hazardous substance to the environment be reported immediately to the appropriate authorities when the release is discovered.

Under CERCLA, reportable quantities were established for hazardous substances listed or designated under other environmental statutes. These include:

- all hazardous air pollutants (HAPs) listed under Section 112(b) of the Clean Air Act.
- all toxic pollutants designated under Section 307(a) or Section 311(b)(2)(A) of the Clean Water Act.
- all Resource Conservation and Recovery Act (RCRA) characteristic and listed hazardous wastes.
- any element, compound, or substance designated under Section 102 of CERCLA.

EPCRA established a list of extremely hazardous substances (EHS) that could cause serious irreversible health effects from accidental releases. Many substances appear on both the CERCLA and EPCRA lists. EPCRA extremely hazardous substances that are also CERCLA hazardous substances have the same reportable quantity (RQ) as under CERCLA. EPCRA extremely hazardous substances that are not listed under CERCLA have a reportable quantity that is equal to their threshold planning quantity (TPQ). A list of CERCLA reportable quantities is included in 40 CFR Section 302.4. A list of EPCRA threshold planning quantities is included in 40 CFR Part 355 Appendices A & B.

CERCLA-reportable releases must be reported immediately to the National Response Center (NRC), while EPCRA-reportable releases must be reported immediately to the National Response Center, the State Emergency Response Commission (SERC) and the affected Local Emergency Planning Committee (LEPC). If the release is an EPCRA extremely

hazardous substance, but not a CERCLA hazardous substance, and there is absolutely no potential to affect off-site persons, then only the State Emergency Planning Commission (represented by CDPHE for reporting purposes) and the Local Emergency Planning Committee need to be notified.

In the case of a release of hazardous waste stored in tanks, RCRA-permitted facilities and large quantity generators must also notify CDPHE within 24 hours of any release to the environment that is greater than one (1) pound.

Radiation Control

Each licensee or registrant must report to the Radiation Incident Reporting Line in the event of lost, stolen or missing licensed or registered radioactive materials or radiation machines, releases of radioactive materials, contamination events, and fires or explosions involving radioactive materials. Releases of radionuclides are reportable under CERCLA.

Clean Water Act

The Clean Water Act requires the person in charge of a facility or vessel to immediately report to the National Response Center all discharges of oil or designated hazardous substances to water. Oil means oil of any kind or form. Designated hazardous substances are included in the CERCLA list.

The Clean Water Act also requires that facilities with a National Pollutant Discharge Elimination System (NPDES) permit report to the National Response Center within 24 hours of becoming aware of any unanticipated bypasses or upsets that cause an exceedance of the effluent limits in their permit and any violations of their maximum daily discharge limits for pollutants listed in their permit.

A release of any chemical, oil, petroleum product, sewage, etc., which may enter waters of the state of Colorado (which include surface water, ground water and dry gullies and storm sewers leading to surface water) must be reported immediately to CDPHE. Any accidental discharge to the sanitary sewer system must be reported immediately to the local sewer authority and the affected wastewater treatment plant. For additional regarding releases to water, please see "Guidance for Reporting Spills under the Colorado

Water Quality Control Act and Colorado Discharge Permits" at <http://www.cdph.state.co.us/op/wqcc/Resources/Guidance/spillguidance.pdf>.

Clean Air Act

Hazardous air pollutants (HAPs) are designated as hazardous substances under CERCLA. If a facility has an air permit but the permit does not allow for or does not specify the release of a substance, or if the facility does not have an air permit, then all releases in excess of the CERCLA / EPCRA reportable quantity for that substance must be reported to the National Response Center and CDPHE. If the facility releases more of a substance than is allowed under its air permit, the facility must also report the release. Discharges of a substance that are within the allowable limits specified in the facility's permit do not need to be reported.

Regulated Storage Tanks

Owners and operators of regulated storage tank systems must report a release or suspected release of regulated substances to the Division of Oil and Public Safety at the Colorado Department of Labor and Employment within 24 hours. Under this program, the reportable quantity for petroleum releases is 25 gallons or more, or any amount that causes a sheen on nearby surface water. Spills of less than 25 gallons of petroleum must be immediately contained and cleaned up. If cleanup cannot be accomplished within 24 hours, the Division of Oil and Public Safety must be notified immediately.

Spills of hazardous substances from tanks in excess of the CERCLA or EPCRA reportable quantity must be reported immediately to the National Response Center, CDPHE and the local fire authority, and to the Division of Oil and Public Safety within 24 hours.

Transportation and Pipelines

The person in physical possession of a hazardous material must notify the National Response Center as soon as practical, but not to exceed 12 hours after the incident, if as a direct result of the hazardous material, a person is killed or injured, there is an evacuation of the general public lasting more than an hour, a major transportation artery is shut down for an hour or more, the flight pattern of an aircraft is altered, there is fire, spillage or suspected contamination

**APPENDIX H
STORM EVENT LOG**

**APPENDIX I
INSPECTION AND SAMPLING REPORTS**

CONSTRUCTION STORMWATER SITE INSPECTION REPORT

| | | | | | | | |
|--|--------------------------|--------------------|--|-----|----|--------------------------|--------------------------|
| Facility Name | | Permittee | | | | | |
| Date of Inspection | | Weather Conditions | | | | | |
| Permit Certification # | | Disturbed Acreage | | | | | |
| Phase of Construction | | Inspector Title | | | | | |
| Inspector Name | | | | | | | |
| Is the above inspector a qualified stormwater manager? (permittee is responsible for ensuring that the inspector is a qualified stormwater manager) | | | <table border="1" style="width: 100%; border-collapse: collapse;"> <tr> <td style="width: 50%; text-align: center;">YES</td> <td style="width: 50%; text-align: center;">NO</td> </tr> <tr> <td style="text-align: center;"><input type="checkbox"/></td> <td style="text-align: center;"><input type="checkbox"/></td> </tr> </table> | YES | NO | <input type="checkbox"/> | <input type="checkbox"/> |
| YES | NO | | | | | | |
| <input type="checkbox"/> | <input type="checkbox"/> | | | | | | |

| INSPECTION FREQUENCY | | | | | |
|---|--|-----|----|--------------------------|--------------------------|
| Check the box that describes the minimum inspection frequency utilized when conducting each inspection | | | | | |
| At least one inspection every 7 calendar days | <input type="checkbox"/> | | | | |
| At least one inspection every 14 calendar days, with post-storm event inspections conducted within 24 hours after the end of any precipitation or snowmelt event that causes surface erosions | <input type="checkbox"/> | | | | |
| <ul style="list-style-type: none"> • This is this a post-storm event inspection. Event Date: _____ | <input type="checkbox"/> | | | | |
| Reduced inspection frequency - Include site conditions that warrant reduced inspection frequency | <input type="checkbox"/> | | | | |
| <ul style="list-style-type: none"> • Post-storm inspections at temporarily idle sites | <input type="checkbox"/> | | | | |
| <ul style="list-style-type: none"> • Inspections at completed sites/area | <input type="checkbox"/> | | | | |
| <ul style="list-style-type: none"> • Winter conditions exclusion | <input type="checkbox"/> | | | | |
| Have there been any deviations from the minimum inspection schedule? If yes, describe below. | <table border="1" style="width: 100%; border-collapse: collapse;"> <tr> <td style="width: 50%; text-align: center;">YES</td> <td style="width: 50%; text-align: center;">NO</td> </tr> <tr> <td style="text-align: center;"><input type="checkbox"/></td> <td style="text-align: center;"><input type="checkbox"/></td> </tr> </table> | YES | NO | <input type="checkbox"/> | <input type="checkbox"/> |
| YES | NO | | | | |
| <input type="checkbox"/> | <input type="checkbox"/> | | | | |
| | | | | | |

| INSPECTION REQUIREMENTS* |
|---|
| i. Visually verify all implemented control measures are in effective operational condition and are working as designed in the specifications |
| ii. Determine if there are new potential sources of pollutants |
| iii. Assess the adequacy of control measures at the site to identify areas requiring new or modified control measures to minimize pollutant discharges |
| iv. Identify all areas of non-compliance with the permit requirements, and if necessary, implement corrective action |
| *Use the attached Control Measures Requiring Routine Maintenance and Inadequate Control Measures Requiring Corrective Action forms to document results of this assessment that trigger either maintenance or corrective actions |

| AREAS TO BE INSPECTED | | | |
|---|--------------------------|--------------------------|--|
| Is there evidence of, or the potential for, pollutants leaving the construction site boundaries, entering the stormwater drainage system or discharging to state waters at the following locations? | | | |
| | NO | YES | If "YES" describe discharge or potential for discharge below. Document related maintenance, inadequate control measures and corrective actions Inadequate Control Measures Requiring Corrective Action form |
| Construction site perimeter | <input type="checkbox"/> | <input type="checkbox"/> | |
| All disturbed areas | <input type="checkbox"/> | <input type="checkbox"/> | |
| Designated haul routes | <input type="checkbox"/> | <input type="checkbox"/> | |
| Material and waste storage areas exposed to precipitation | <input type="checkbox"/> | <input type="checkbox"/> | |
| Locations where stormwater has the potential to discharge offsite | <input type="checkbox"/> | <input type="checkbox"/> | |
| Locations where vehicles exit the site | <input type="checkbox"/> | <input type="checkbox"/> | |
| Other: _____ | <input type="checkbox"/> | <input type="checkbox"/> | |

REPORTING REQUIREMENTS

The permittee shall report the following circumstances orally within twenty-four (24) hours from the time the permittee becomes aware of the circumstances, and shall mail to the division a written report containing the information requested within five (5) working days after becoming aware of the following circumstances. The division may waive the written report required if the oral report has been received within 24 hours.

| | | |
|---|--|--|
| All Noncompliance Requiring 24-Hour Notification per Part II.L.6 of the Permit | | |
| a. Endangerment to Health or the Environment Circumstances leading to any noncompliance which may endanger health or the environment regardless of the cause of the incident (See Part II.L.6.a of the Permit) <i>This category would primarily result from the discharge of pollutants in violation of the permit</i> | | |
| b. Numeric Effluent Limit Violations <ul style="list-style-type: none"> o Circumstances leading to any unanticipated bypass which exceeds any effluent limitations (See Part II.L.6.b of the Permit) o Circumstances leading to any upset which causes an exceedance of any effluent limitation (See Part II.L.6.c of the Permit) o Daily maximum violations (See Part II.L.6.d of the Permit) <i>Numeric effluent limits are very uncommon in certifications under the COR400000 general permit. This category of noncompliance only applies if numeric effluent limits are included in a permit certification.</i> | | |

| | | | |
|---|--------------------------|--------------------------|-------------------------|
| Has there been an incident of noncompliance requiring 24-hour notification? | NO | YES | |
| | <input type="checkbox"/> | <input type="checkbox"/> | If "YES" document below |

| Date and Time of Incident | Location | Description of Noncompliance | Description of Corrective Action | Date and Time of 24 Hour Oral Notification | Date of 5 Day Written Notification * |
|---------------------------|----------|------------------------------|----------------------------------|--|--------------------------------------|
| | | | | | |
| | | | | | |

*Attach copy of 5 day written notification to report. Indicate if written notification was waived, including the name of the division personnel who granted waiver.

After adequate corrective action(s) and maintenance have been taken, or where a report does not identify any incidents requiring corrective action or maintenance, the individual(s) designated as the Qualified Stormwater Manager, shall sign and certify the below statement:

“I verify that, to the best of my knowledge and belief, all corrective action and maintenance items identified during the inspection are complete, and the site is currently in compliance with the permit.”

Name of Qualified Stormwater Manager

Title of Qualified Stormwater Manager

Signature of Qualified Stormwater Manager

Date

Notes/Comments

**APPENDIX J
SWMP AMENDMENT LOG**

Description

A stabilized staging area is a clearly designated area where construction equipment and vehicles, stockpiles, waste bins, and other construction-related materials are stored. The contractor office trailer may also be located in this area. Depending on the size of the construction site, more than one staging area may be necessary.



Photograph SSA-1. Example of a staging area with a gravel surface to prevent mud tracking and reduce runoff. Photo courtesy of Douglas County.

Appropriate Uses

Most construction sites will require a staging area, which should be clearly designated in SWMP drawings. The layout of the staging area may vary depending on the type of construction activity. Staging areas located in roadways due to space constraints require special measures to avoid materials being washed into storm inlets.

Design and Installation

Stabilized staging areas should be completed prior to other construction activities beginning on the site. Major components of a stabilized staging area include:

- Appropriate space to contain storage and provide for loading/unloading operations, as well as parking if necessary.
- A stabilized surface, either paved or covered, with 3-inch diameter aggregate or larger.
- Perimeter controls such as silt fence, sediment control logs, or other measures.
- Construction fencing to prevent unauthorized access to construction materials.
- Provisions for Good Housekeeping practices related to materials storage and disposal, as described in the Good Housekeeping BMP Fact Sheet.
- A stabilized construction entrance/exit, as described in the Vehicle Tracking Control BMP Fact Sheet, to accommodate traffic associated with material delivery and waste disposal vehicles.

Over-sizing the stabilized staging area may result in disturbance of existing vegetation in excess of that required for the project. This increases costs, as well as requirements for long-term stabilization following the construction period. When designing the stabilized staging area, minimize the area of disturbance to the extent practical.

| Stabilized Staging Area | |
|--------------------------------|----------|
| Functions | |
| Erosion Control | Yes |
| Sediment Control | Moderate |
| Site/Material | Yes |

Minimizing Long-Term Stabilization Requirements

- Utilize off-site parking and restrict vehicle access to the site.
- Use construction mats in lieu of rock when staging is provided in an area that will not be disturbed otherwise.
- Consider use of a bermed contained area for materials and equipment that do not require a stabilized surface.
- Consider phasing of staging areas to avoid disturbance in an area that will not be otherwise disturbed.

See Detail SSA-1 for a typical stabilized staging area and SSA-2 for a stabilized staging area when materials staging in roadways is required.

Maintenance and Removal

Maintenance of stabilized staging areas includes maintaining a stable surface cover of gravel, repairing perimeter controls, and following good housekeeping practices.

When construction is complete, debris, unused stockpiles and materials should be recycled or properly disposed. In some cases, this will require disposal of contaminated soil from equipment leaks in an appropriate landfill. Staging areas should then be permanently stabilized with vegetation or other surface cover planned for the development.

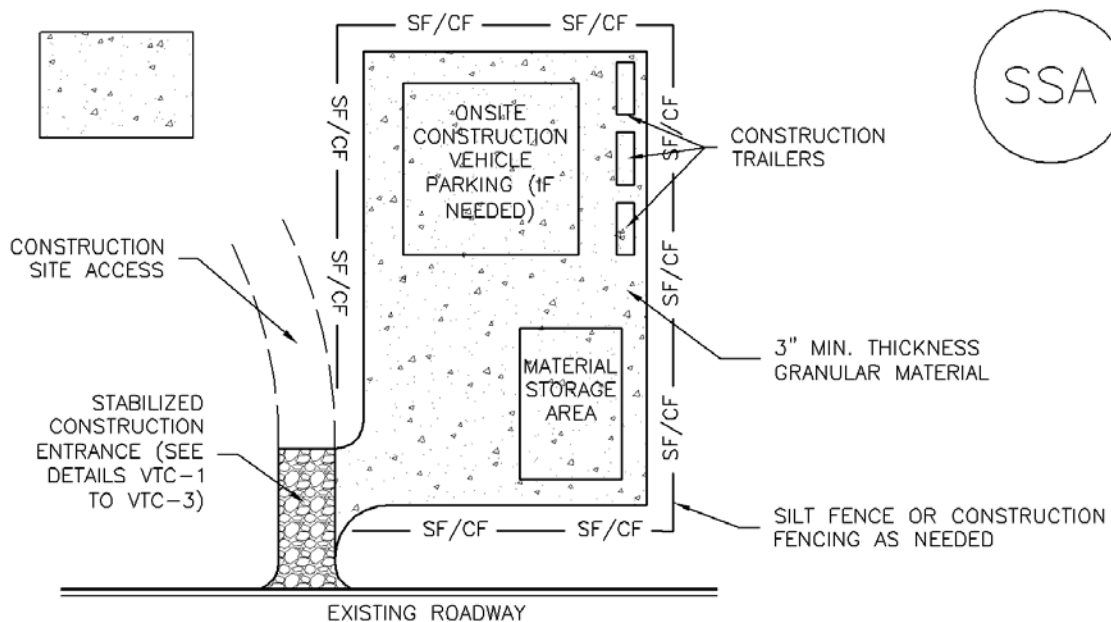

SSA-1. STABILIZED STAGING AREA

STABILIZED STAGING AREA INSTALLATION NOTES

1. SEE PLAN VIEW FOR
 - LOCATION OF STAGING AREA(S).
 - CONTRACTOR MAY ADJUST LOCATION AND SIZE OF STAGING AREA WITH APPROVAL FROM THE LOCAL JURISDICTION.
2. STABILIZED STAGING AREA SHOULD BE APPROPRIATE FOR THE NEEDS OF THE SITE. OVERSIZING RESULTS IN A LARGER AREA TO STABILIZE FOLLOWING CONSTRUCTION.
3. STAGING AREA SHALL BE STABILIZED PRIOR TO OTHER OPERATIONS ON THE SITE.
4. THE STABILIZED STAGING AREA SHALL CONSIST OF A MINIMUM 3" THICK GRANULAR MATERIAL.
5. UNLESS OTHERWISE SPECIFIED BY LOCAL JURISDICTION, ROCK SHALL CONSIST OF DOT SECT. #703, AASHTO #3 COARSE AGGREGATE OR 6" (MINUS) ROCK.
6. ADDITIONAL PERIMETER BMPs MAY BE REQUIRED INCLUDING BUT NOT LIMITED TO SILT FENCE AND CONSTRUCTION FENCING.

STABILIZED STAGING AREA MAINTENANCE NOTES

1. INSPECT BMPs EACH WORKDAY, AND MAINTAIN THEM IN EFFECTIVE OPERATING CONDITION. MAINTENANCE OF BMPs SHOULD BE PROACTIVE, NOT REACTIVE. INSPECT BMPs AS SOON AS POSSIBLE (AND ALWAYS WITHIN 24 HOURS) FOLLOWING A STORM THAT CAUSES SURFACE EROSION, AND PERFORM NECESSARY MAINTENANCE.
2. FREQUENT OBSERVATIONS AND MAINTENANCE ARE NECESSARY TO MAINTAIN BMPs IN EFFECTIVE OPERATING CONDITION. INSPECTIONS AND CORRECTIVE MEASURES SHOULD BE DOCUMENTED THOROUGHLY.
3. WHERE BMPs HAVE FAILED, REPAIR OR REPLACEMENT SHOULD BE INITIATED UPON DISCOVERY OF THE FAILURE.
4. ROCK SHALL BE REAPPLIED OR REGRADED AS NECESSARY IF RUTTING OCCURS OR UNDERLYING SUBGRADE BECOMES EXPOSED.

STABILIZED STAGING AREA MAINTENANCE NOTES

5. STABILIZED STAGING AREA SHALL BE ENLARGED IF NECESSARY TO CONTAIN PARKING, STORAGE, AND UNLOADING/LOADING OPERATIONS.

6. THE STABILIZED STAGING AREA SHALL BE REMOVED AT THE END OF CONSTRUCTION. THE GRANULAR MATERIAL SHALL BE REMOVED OR, IF APPROVED BY THE LOCAL JURISDICTION, USED ON SITE, AND THE AREA COVERED WITH TOPSOIL, SEEDED AND MULCHED OR OTHERWISE STABILIZED IN A MANNER APPROVED BY LOCAL JURISDICTION.

NOTE: MANY MUNICIPALITIES PROHIBIT THE USE OF RECYCLED CONCRETE AS GRANULAR MATERIAL FOR STABILIZED STAGING AREAS DUE TO DIFFICULTIES WITH RE-ESTABLISHMENT OF VEGETATION IN AREAS WHERE RECYCLED CONCRETE WAS PLACED.

NOTE: MANY JURISDICTIONS HAVE BMP DETAILS THAT VARY FROM UDFCD STANDARD DETAILS. CONSULT WITH LOCAL JURISDICTIONS AS TO WHICH DETAIL SHOULD BE USED WHEN DIFFERENCES ARE NOTED.

(DETAILS ADAPTED FROM DOUGLAS COUNTY, COLORADO, NOT AVAILABLE IN AUTOCAD)

Description

Implement construction site good housekeeping practices to prevent pollution associated with solid, liquid and hazardous construction-related materials and wastes. Stormwater Management Plans (SWMPs) should clearly specify BMPs including these good housekeeping practices:

- Provide for waste management.
- Establish proper building material staging areas.
- Designate paint and concrete washout areas.
- Establish proper equipment/vehicle fueling and maintenance practices.
- Control equipment/vehicle washing and allowable non-stormwater discharges.
- Develop a spill prevention and response plan.

Acknowledgement: This Fact Sheet is based directly on EPA guidance provided in *Developing Your Stormwater Pollution Prevent Plan (EPA 2007)*.

Appropriate Uses

Good housekeeping practices are necessary at all construction sites.

Design and Installation

The following principles and actions should be addressed in SWMPs:

- **Provide for Waste Management.** Implement management procedures and practices to prevent or reduce the exposure and transport of pollutants in stormwater from solid, liquid and sanitary wastes that will be generated at the site. Practices such as trash disposal, recycling, proper material handling, and cleanup measures can reduce the potential for stormwater runoff to pick up construction site wastes and discharge them to surface waters. Implement a comprehensive set of waste-management practices for hazardous or toxic materials, such as paints, solvents, petroleum products, pesticides, wood preservatives, acids, roofing tar, and other materials. Practices should include storage, handling, inventory, and cleanup procedures, in case of spills. Specific practices that should be considered include:

Solid or Construction Waste

- Designate trash and bulk waste-collection areas on-site.



Photographs GH-1 and GH-2. Proper materials storage and secondary containment for fuel tanks are important good housekeeping practices. Photos courtesy of CDOT and City of Aurora.

| Good Housekeeping | |
|--------------------------|-----|
| Functions | |
| Erosion Control | No |
| Sediment Control | No |
| Site/Material Management | Yes |

- Recycle materials whenever possible (e.g., paper, wood, concrete, oil).
- Segregate and provide proper disposal options for hazardous material wastes.
- Clean up litter and debris from the construction site daily.
- Locate waste-collection areas away from streets, gutters, watercourses, and storm drains. Waste-collection areas (dumpsters, and such) are often best located near construction site entrances to minimize traffic on disturbed soils. Consider secondary containment around waste collection areas to minimize the likelihood of contaminated discharges.
- Empty waste containers before they are full and overflowing.

Sanitary and Septic Waste

- Provide convenient, well-maintained, and properly located toilet facilities on-site.
- Locate toilet facilities away from storm drain inlets and waterways to prevent accidental spills and contamination of stormwater.
- Maintain clean restroom facilities and empty portable toilets regularly.
- Where possible, provide secondary containment pans under portable toilets.
- Provide tie-downs or stake-downs for portable toilets.
- Educate employees, subcontractors, and suppliers on locations of facilities.
- Treat or dispose of sanitary and septic waste in accordance with state or local regulations. Do not discharge or bury wastewater at the construction site.
- Inspect facilities for leaks. If found, repair or replace immediately.
- Special care is necessary during maintenance (pump out) to ensure that waste and/or biocide are not spilled on the ground.

Hazardous Materials and Wastes

- Develop and implement employee and subcontractor education, as needed, on hazardous and toxic waste handling, storage, disposal, and cleanup.
- Designate hazardous waste-collection areas on-site.
- Place all hazardous and toxic material wastes in secondary containment.



Photograph GH-3. Locate portable toilet facilities on level surfaces away from waterways and storm drains. Photo courtesy of WWE.

- Hazardous waste containers should be inspected to ensure that all containers are labeled properly and that no leaks are present.
- **Establish Proper Building Material Handling and Staging Areas.** The SWMP should include comprehensive handling and management procedures for building materials, especially those that are hazardous or toxic. Paints, solvents, pesticides, fuels and oils, other hazardous materials or building materials that have the potential to contaminate stormwater should be stored indoors or under cover whenever possible or in areas with secondary containment. Secondary containment measures prevent a spill from spreading across the site and may include dikes, berms, curbing, or other containment methods. Secondary containment techniques should also ensure the protection of groundwater. Designate staging areas for activities such as fueling vehicles, mixing paints, plaster, mortar, and other potential pollutants. Designated staging areas enable easier monitoring of the use of materials and clean up of spills. Training employees and subcontractors is essential to the success of this pollution prevention principle. Consider the following specific materials handling and staging practices:
 - Train employees and subcontractors in proper handling and storage practices.
 - Clearly designate site areas for staging and storage with signs and on construction drawings. Staging areas should be located in areas central to the construction site. Segment the staging area into sub-areas designated for vehicles, equipment, or stockpiles. Construction entrances and exits should be clearly marked so that delivery vehicles enter/exit through stabilized areas with vehicle tracking controls (See Vehicle Tracking Control Fact Sheet).
 - Provide storage in accordance with Spill Protection, Control and Countermeasures (SPCC) requirements and plans and provide cover and impermeable perimeter control, as necessary, for hazardous materials and contaminated soils that must be stored on site.
 - Ensure that storage containers are regularly inspected for leaks, corrosion, support or foundation failure, or other signs of deterioration and tested for soundness.
 - Reuse and recycle construction materials when possible.
- **Designate Concrete Washout Areas.** Concrete contractors should be encouraged to use the washout facilities at their own plants or dispatch facilities when feasible; however, concrete washout commonly occurs on construction sites. If it is necessary to provide for concrete washout areas on-site, designate specific washout areas and design facilities to handle anticipated washout water. Washout areas should also be provided for paint and stucco operations. Because washout areas can be a source of pollutants from leaks or spills, care must be taken with regard to their placement and proper use. See the Concrete Washout Area Fact Sheet for detailed guidance.

Both self-constructed and prefabricated washout containers can fill up quickly when concrete, paint, and stucco work are occurring on large portions of the site. Be sure to check for evidence that contractors are using the washout areas and not dumping materials onto the ground or into drainage facilities. If the washout areas are not being used regularly, consider posting additional signage, relocating the facilities to more convenient locations, or providing training to workers and contractors.

When concrete, paint, or stucco is part of the construction process, consider these practices which will help prevent contamination of stormwater. Include the locations of these areas and the maintenance and inspection procedures in the SWMP.

- Do not washout concrete trucks or equipment into storm drains, streets, gutters, uncontained areas, or streams. Only use designated washout areas.
- Establish washout areas and advertise their locations with signs. Ensure that signage remains in good repair.
- Provide adequate containment for the amount of wash water that will be used.
- Inspect washout structures daily to detect leaks or tears and to identify when materials need to be removed.
- Dispose of materials properly. The preferred method is to allow the water to evaporate and to recycle the hardened concrete. Full service companies may provide dewatering services and should dispose of wastewater properly. Concrete wash water can be highly polluted. It should not be discharged to any surface water, storm sewer system, or allowed to infiltrate into the ground in the vicinity of waterbodies. Washwater should not be discharged to a sanitary sewer system without first receiving written permission from the system operator.
- **Establish Proper Equipment/Vehicle Fueling and Maintenance Practices.** Create a clearly designated on-site fueling and maintenance area that is clean and dry. The on-site fueling area should have a spill kit, and staff should know how to use it. If possible, conduct vehicle fueling and maintenance activities in a covered area. Consider the following practices to help prevent the discharge of pollutants to stormwater from equipment/vehicle fueling and maintenance. Include the locations of designated fueling and maintenance areas and inspection and maintenance procedures in the SWMP.
 - Train employees and subcontractors in proper fueling procedures (stay with vehicles during fueling, proper use of pumps, emergency shutoff valves, etc.).
 - Inspect on-site vehicles and equipment regularly for leaks, equipment damage, and other service problems.
 - Clearly designate vehicle/equipment service areas away from drainage facilities and watercourses to prevent stormwater run-on and runoff.
 - Use drip pans, drip cloths, or absorbent pads when replacing spent fluids.
 - Collect all spent fluids, store in appropriate labeled containers in the proper storage areas, and recycle fluids whenever possible.
- **Control Equipment/Vehicle Washing and Allowable Non-Stormwater Discharges.** Implement practices to prevent contamination of surface and groundwater from equipment and vehicle wash water. Representative practices include:
 - Educate employees and subcontractors on proper washing procedures.
 - Use off-site washing facilities, when available.
 - Clearly mark the washing areas and inform workers that all washing must occur in this area.
 - Contain wash water and treat it using BMPs. Infiltrate washwater when possible, but maintain separation from drainage paths and waterbodies.

- Use high-pressure water spray at vehicle washing facilities without detergents. Water alone can remove most dirt adequately.
- Do not conduct other activities, such as vehicle repairs, in the wash area.
- Include the location of the washing facilities and the inspection and maintenance procedures in the SWMP.
- **Develop a Spill Prevention and Response Plan.** Spill prevention and response procedures must be identified in the SWMP. Representative procedures include identifying ways to reduce the chance of spills, stop the source of spills, contain and clean up spills, dispose of materials contaminated by spills, and train personnel responsible for spill prevention and response. The plan should also specify material handling procedures and storage requirements and ensure that clear and concise spill cleanup procedures are provided and posted for areas in which spills may potentially occur. When developing a spill prevention plan, include the following:
 - Note the locations of chemical storage areas, storm drains, tributary drainage areas, surface waterbodies on or near the site, and measures to stop spills from leaving the site.
 - Provide proper handling and safety procedures for each type of waste. Keep Material Safety Data Sheets (MSDSs) for chemical used on site with the SWMP.
 - Establish an education program for employees and subcontractors on the potential hazards to humans and the environment from spills and leaks.
 - Specify how to notify appropriate authorities, such as police and fire departments, hospitals, or municipal sewage treatment facilities to request assistance. Emergency procedures and contact numbers should be provided in the SWMP and posted at storage locations.
 - Describe the procedures, equipment and materials for immediate cleanup of spills and proper disposal.
 - Identify personnel responsible for implementing the plan in the event of a spill. Update the spill prevention plan and clean up materials as changes occur to the types of chemicals stored and used at the facility.

Spill Prevention, Control, and Countermeasure (SPCC) Plan

Construction sites may be subject to 40 CFR Part 112 regulations that require the preparation and implementation of a SPCC Plan to prevent oil spills from aboveground and underground storage tanks. The facility is subject to this rule if it is a non-transportation-related facility that:

- Has a total storage capacity greater than 1,320 gallons or a completely buried storage capacity greater than 42,000 gallons.
- Could reasonably be expected to discharge oil in quantities that may be harmful to navigable waters of the United States and adjoining shorelines.

Furthermore, if the facility is subject to 40 CFR Part 112, the SWMP should reference the SPCC Plan. To find out more about SPCC Plans, see EPA's website on SPPC at www.epa.gov/oilspill/spcc.htm.

Reporting Oil Spills

In the event of an oil spill, contact the National Response Center toll free at 1-800-424- 8802 for assistance, or for more details, visit their website: www.nrc.uscg.mil.

Maintenance and Removal

Effective implementation of good housekeeping practices is dependent on clear designation of personnel responsible for supervising and implementing good housekeeping programs, such as site cleanup and disposal of trash and debris, hazardous material management and disposal, vehicle and equipment maintenance, and other practices. Emergency response "drills" may aid in emergency preparedness.

Checklists may be helpful in good housekeeping efforts.

Staging and storage areas require permanent stabilization when the areas are no longer being used for construction-related activities.

Construction-related materials, debris and waste must be removed from the construction site once construction is complete.

Design Details

See the following Fact Sheets for related Design Details:

MM-1 Concrete Washout Area

MM-2 Stockpile Management

SM-4 Vehicle Tracking Control

Design details are not necessary for other good housekeeping practices; however, be sure to designate where specific practices will occur on the appropriate construction drawings.

Description

A construction fence restricts site access to designated entrances and exits, delineates construction site boundaries, and keeps construction out of sensitive areas such as natural areas to be preserved as open space, wetlands and riparian areas.

Appropriate Uses

A construction fence can be used to delineate the site perimeter and locations within the site where access is restricted to protect natural resources such as wetlands, waterbodies, trees, and other natural areas of the site that should not be disturbed.



Photograph CF-1. A construction fence helps delineate areas where existing vegetation is being protected. Photo courtesy of Douglas County.

If natural resource protection is an objective, then the construction fencing should be used in combination with other perimeter control BMPs such as silt fence, sediment control logs or similar measures.

Design and Installation

Construction fencing may be chain link or plastic mesh and should be installed following manufacturer’s recommendations. See Detail CF-1 for typical installations.

Do not place construction fencing in areas within work limits of machinery.

Maintenance and Removal

- Inspect fences for damage; repair or replace as necessary.
- Fencing should be tight and any areas with slumping or fallen posts should be reinstalled.
- Fencing should be removed once construction is complete.

| Construction Fence | |
|---------------------------|-----|
| Functions | |
| Erosion Control | No |
| Sediment Control | No |
| Site/Material Management | Yes |

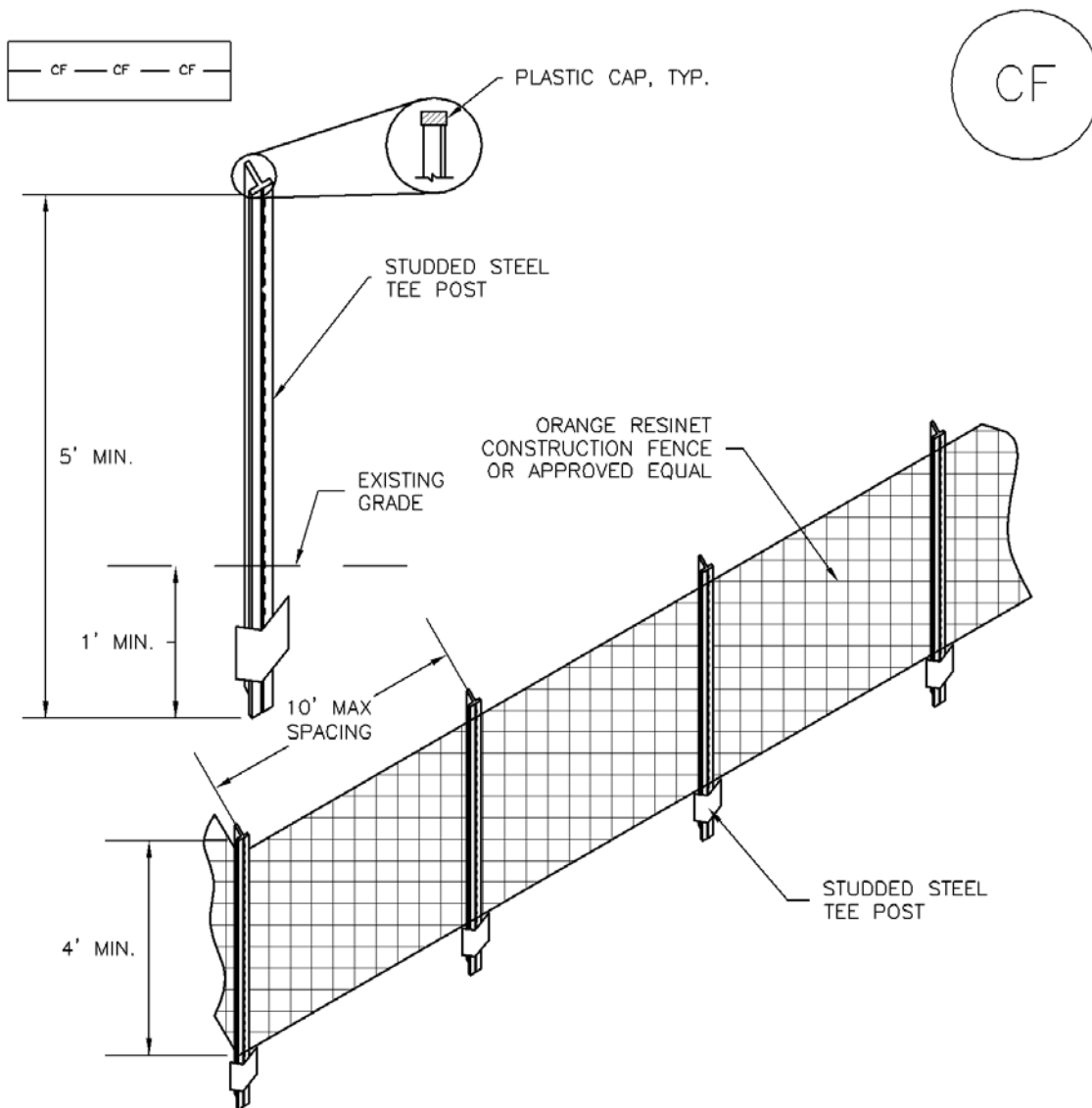

CF-1. PLASTIC MESH CONSTRUCTION FENCE

CONSTRUCTION FENCE INSTALLATION NOTES

1. SEE PLAN VIEW FOR:
-LOCATION OF CONSTRUCTION FENCE.
2. CONSTRUCTION FENCE SHOWN SHALL BE INSTALLED PRIOR TO ANY LAND DISTURBING ACTIVITIES.
3. CONSTRUCTION FENCE SHALL BE COMPOSED OF ORANGE, CONTRACTOR-GRADE MATERIAL THAT IS AT LEAST 4' HIGH. METAL POSTS SHOULD HAVE A PLASTIC CAP FOR SAFETY.
4. STUDED STEEL TEE POSTS SHALL BE UTILIZED TO SUPPORT THE CONSTRUCTION FENCE. MAXIMUM SPACING FOR STEEL TEE POSTS SHALL BE 10'.
5. CONSTRUCTION FENCE SHALL BE SECURELY FASTENED TO THE TOP, MIDDLE, AND BOTTOM OF EACH POST.

CONSTRUCTION FENCE MAINTENANCE NOTES

1. INSPECT BMPs EACH WORKDAY, AND MAINTAIN THEM IN EFFECTIVE OPERATING CONDITION. MAINTENANCE OF BMPs SHOULD BE PROACTIVE, NOT REACTIVE. INSPECT BMPs AS SOON AS POSSIBLE (AND ALWAYS WITHIN 24 HOURS) FOLLOWING A STORM THAT CAUSES SURFACE EROSION, AND PERFORM NECESSARY MAINTENANCE.
2. FREQUENT OBSERVATIONS AND MAINTENANCE ARE NECESSARY TO MAINTAIN BMPs IN EFFECTIVE OPERATING CONDITION. INSPECTIONS AND CORRECTIVE MEASURES SHOULD BE DOCUMENTED THOROUGHLY.
3. WHERE BMPs HAVE FAILED, REPAIR OR REPLACEMENT SHOULD BE INITIATED UPON DISCOVERY OF THE FAILURE.
4. CONSTRUCTION FENCE SHALL BE REPAIRED OR REPLACED WHEN THERE ARE SIGNS OF DAMAGE SUCH AS RIPS OR SAGS. CONSTRUCTION FENCE IS TO REMAIN IN PLACE UNTIL THE UPSTREAM DISTURBED AREA IS STABILIZED AND APPROVED BY THE LOCAL JURISDICTION.
5. WHEN CONSTRUCTION FENCES ARE REMOVED, ALL DISTURBED AREAS ASSOCIATED WITH THE INSTALLATION, MAINTENANCE, AND/OR REMOVAL OF THE FENCE SHALL BE COVERED WITH TOPSOIL, SEEDED AND MULCHED, OR OTHERWISE STABILIZED AS APPROVED BY LOCAL JURISDICTION.

NOTE: MANY JURISDICTIONS HAVE BMP DETAILS THAT VARY FROM UDFCD STANDARD DETAILS. CONSULT WITH LOCAL JURISDICTIONS AS TO WHICH DETAIL SHOULD BE USED WHEN DIFFERENCES ARE NOTED.

(DETAIL ADAPTED FROM TOWN OF PARKER, COLORADO, NOT AVAILABLE IN AUTOCAD)

Description

Street sweeping and vacuuming remove sediment that has been tracked onto roadways to reduce sediment transport into storm drain systems or a surface waterway.

Appropriate Uses

Use this practice at construction sites where vehicles may track sediment offsite onto paved roadways.

Design and Installation

Street sweeping or vacuuming should be conducted when there is noticeable sediment accumulation on roadways adjacent to the construction site. Typically, this will be concentrated at the entrance/exit to the construction site. Well-maintained stabilized construction entrances, vehicle tracking controls and tire wash facilities can help reduce the necessary frequency of street sweeping and vacuuming.

On smaller construction sites, street sweeping can be conducted manually using a shovel and broom. Never wash accumulated sediment on roadways into storm drains.

Maintenance and Removal

- Inspect paved roads around the perimeter of the construction site on a daily basis and more frequently, as needed. Remove accumulated sediment, as needed.
- Following street sweeping, check inlet protection that may have been displaced during street sweeping.
- Inspect area to be swept for materials that may be hazardous prior to beginning sweeping operations.



Photograph SS-1. A street sweeper removes sediment and potential pollutants along the curb line at a construction site. Photo courtesy of Tom Gore.

| Street Sweeping/ Vacuuming | |
|-----------------------------------|-----|
| Functions | |
| Erosion Control | No |
| Sediment Control | Yes |
| Site/Material Management | Yes |

Description

A silt fence is a woven geotextile fabric attached to wooden posts and trenched into the ground. It is designed as a sediment barrier to intercept sheet flow runoff from disturbed areas.

Appropriate Uses

A silt fence can be used where runoff is conveyed from a disturbed area as sheet flow. Silt fence is not designed to receive concentrated flow or to be used as a filter fabric. Typical uses include:

- Down slope of a disturbed area to accept sheet flow.
- Along the perimeter of a receiving water such as a stream, pond or wetland.
- At the perimeter of a construction site.



Photograph SF-1. Silt fence creates a sediment barrier, forcing sheet flow runoff to evaporate or infiltrate.

Design and Installation

Silt fence should be installed along the contour of slopes so that it intercepts sheet flow. The maximum recommended tributary drainage area per 100 lineal feet of silt fence, installed along the contour, is approximately 0.25 acres with a disturbed slope length of up to 150 feet and a tributary slope gradient no steeper than 3:1. Longer and steeper slopes require additional measures. This recommendation only applies to silt fence installed along the contour. Silt fence installed for other uses, such as perimeter control, should be installed in a way that will not produce concentrated flows. For example, a "J-hook" installation may be appropriate to force runoff to pond and evaporate or infiltrate in multiple areas rather than concentrate and cause erosive conditions parallel to the silt fence.

See Detail SF-1 for proper silt fence installation, which involves proper trenching, staking, securing the fabric to the stakes, and backfilling the silt fence. Properly installed silt fence should not be easily pulled out by hand and there should be no gaps between the ground and the fabric.

Silt fence must meet the minimum allowable strength requirements, depth of installation requirement, and other specifications in the design details. Improper installation of silt fence is a common reason for silt fence failure; however, when properly installed and used for the appropriate purposes, it can be highly effective.

| Silt Fence | |
|--------------------------|-----|
| Functions | |
| Erosion Control | No |
| Sediment Control | Yes |
| Site/Material Management | No |

Maintenance and Removal

Inspection of silt fence includes observing the material for tears or holes and checking for slumping fence and undercut areas bypassing flows. Repair of silt fence typically involves replacing the damaged section with a new section. Sediment accumulated behind silt fence should be removed, as needed to maintain BMP effectiveness, typically before it reaches a depth of 6 inches.

Silt fence may be removed when the upstream area has reached final stabilization.



Photograph SF-2. When silt fence is not installed along the contour, a "J-hook" installation may be appropriate to ensure that the BMP does not create concentrated flow parallel to the silt fence. Photo courtesy of Tom Gore.

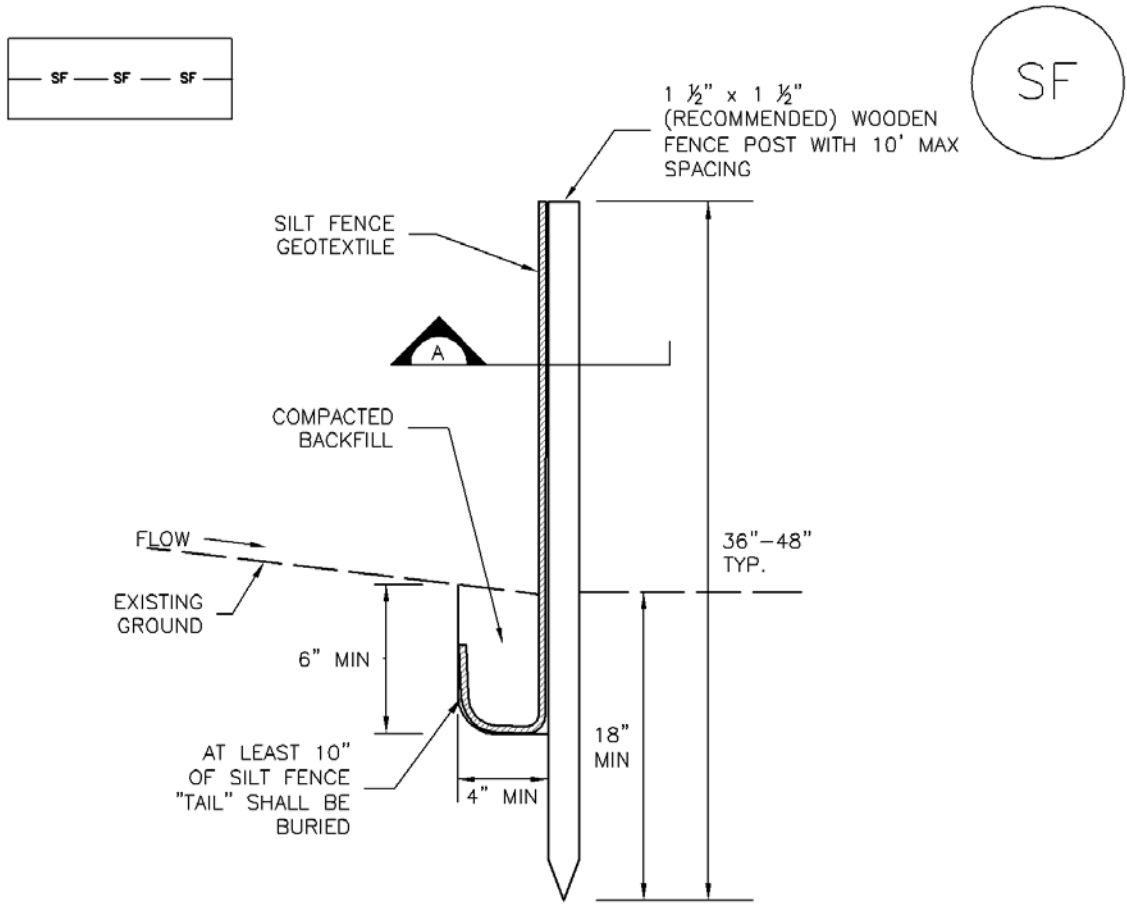

SILT FENCE

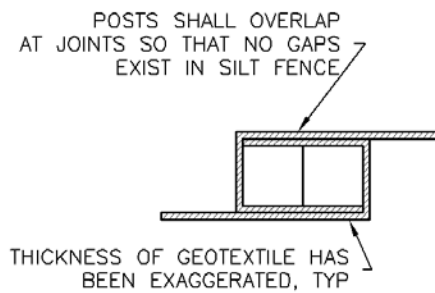
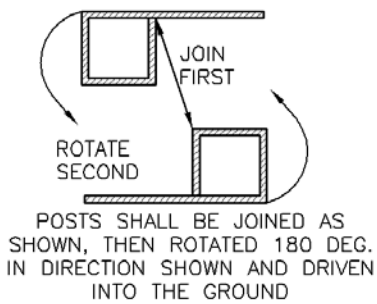

SECTION A

SF-1. SILT FENCE

SILT FENCE INSTALLATION NOTES

1. SILT FENCE MUST BE PLACED AWAY FROM THE TOE OF THE SLOPE TO ALLOW FOR WATER PONDING. SILT FENCE AT THE TOE OF A SLOPE SHOULD BE INSTALLED IN A FLAT LOCATION AT LEAST SEVERAL FEET (2-5 FT) FROM THE TOE OF THE SLOPE TO ALLOW ROOM FOR PONDING AND DEPOSITION.
2. A UNIFORM 6" X 4" ANCHOR TRENCH SHALL BE EXCAVATED USING TRENCHER OR SILT FENCE INSTALLATION DEVICE. NO ROAD GRADERS, BACKHOES, OR SIMILAR EQUIPMENT SHALL BE USED.
3. COMPACT ANCHOR TRENCH BY HAND WITH A "JUMPING JACK" OR BY WHEEL ROLLING. COMPACTION SHALL BE SUCH THAT SILT FENCE RESISTS BEING PULLED OUT OF ANCHOR TRENCH BY HAND.
4. SILT FENCE SHALL BE PULLED TIGHT AS IT IS ANCHORED TO THE STAKES. THERE SHOULD BE NO NOTICEABLE SAG BETWEEN STAKES AFTER IT HAS BEEN ANCHORED TO THE STAKES.
5. SILT FENCE FABRIC SHALL BE ANCHORED TO THE STAKES USING 1" HEAVY DUTY STAPLES OR NAILS WITH 1" HEADS. STAPLES AND NAILS SHOULD BE PLACED 3" ALONG THE FABRIC DOWN THE STAKE.
6. AT THE END OF A RUN OF SILT FENCE ALONG A CONTOUR, THE SILT FENCE SHOULD BE TURNED PERPENDICULAR TO THE CONTOUR TO CREATE A "J-HOOK." THE "J-HOOK" EXTENDING PERPENDICULAR TO THE CONTOUR SHOULD BE OF SUFFICIENT LENGTH TO KEEP RUNOFF FROM FLOWING AROUND THE END OF THE SILT FENCE (TYPICALLY 10' - 20').
7. SILT FENCE SHALL BE INSTALLED PRIOR TO ANY LAND DISTURBING ACTIVITIES.

SILT FENCE MAINTENANCE NOTES

1. INSPECT BMPs EACH WORKDAY, AND MAINTAIN THEM IN EFFECTIVE OPERATING CONDITION. MAINTENANCE OF BMPs SHOULD BE PROACTIVE, NOT REACTIVE. INSPECT BMPs AS SOON AS POSSIBLE (AND ALWAYS WITHIN 24 HOURS) FOLLOWING A STORM THAT CAUSES SURFACE EROSION, AND PERFORM NECESSARY MAINTENANCE.
2. FREQUENT OBSERVATIONS AND MAINTENANCE ARE NECESSARY TO MAINTAIN BMPs IN EFFECTIVE OPERATING CONDITION. INSPECTIONS AND CORRECTIVE MEASURES SHOULD BE DOCUMENTED THOROUGHLY.
3. WHERE BMPs HAVE FAILED, REPAIR OR REPLACEMENT SHOULD BE INITIATED UPON DISCOVERY OF THE FAILURE.
4. SEDIMENT ACCUMULATED UPSTREAM OF THE SILT FENCE SHALL BE REMOVED AS NEEDED TO MAINTAIN THE FUNCTIONALITY OF THE BMP, TYPICALLY WHEN DEPTH OF ACCUMULATED SEDIMENTS IS APPROXIMATELY 6".
5. REPAIR OR REPLACE SILT FENCE WHEN THERE ARE SIGNS OF WEAR, SUCH AS SAGGING, TEARING, OR COLLAPSE.
6. SILT FENCE IS TO REMAIN IN PLACE UNTIL THE UPSTREAM DISTURBED AREA IS STABILIZED AND APPROVED BY THE LOCAL JURISDICTION, OR IS REPLACED BY AN EQUIVALENT PERIMETER SEDIMENT CONTROL BMP.
7. WHEN SILT FENCE IS REMOVED, ALL DISTURBED AREAS SHALL BE COVERED WITH TOPSOIL, SEEDED AND MULCHED OR OTHERWISE STABILIZED AS APPROVED BY LOCAL JURISDICTION.

(DETAIL ADAPTED FROM TOWN OF PARKER, COLORADO AND CITY OF AURORA, NOT AVAILABLE IN AUTOCAD)

NOTE: MANY JURISDICTIONS HAVE BMP DETAILS THAT VARY FROM UDFCD STANDARD DETAILS. CONSULT WITH LOCAL JURISDICTIONS AS TO WHICH DETAIL SHOULD BE USED WHEN DIFFERENCES ARE NOTED.

Description

Inlet protection consists of permeable barriers installed around an inlet to filter runoff and remove sediment prior to entering a storm drain inlet. Inlet protection can be constructed from rock socks, sediment control logs, silt fence, block and rock socks, or other materials approved by the local jurisdiction. Area inlets can also be protected by over-excavating around the inlet to form a sediment trap.



Photograph IP-1. Inlet protection for a curb opening inlet.

Appropriate Uses

Install protection at storm sewer inlets that are operable during construction. Consider the potential for tracked-out sediment or temporary stockpile areas to contribute sediment to inlets when determining which inlets must be protected. This may include inlets in the general proximity of the construction area, not limited to downgradient inlets. Inlet protection is not a stand-alone BMP and should be used in conjunction with other upgradient BMPs.

Design and Installation

To function effectively, inlet protection measures must be installed to ensure that flows do not bypass the inlet protection and enter the storm drain without treatment. However, designs must also enable the inlet to function without completely blocking flows into the inlet in a manner that causes localized flooding. When selecting the type of inlet protection, consider factors such as type of inlet (e.g., curb or area, sump or on-grade conditions), traffic, anticipated flows, ability to secure the BMP properly, safety and other site-specific conditions. For example, block and rock socks will be better suited to a curb and gutter along a roadway, as opposed to silt fence or sediment control logs, which cannot be properly secured in a curb and gutter setting, but are effective area inlet protection measures.

Several inlet protection designs are provided in the Design Details. Additionally, a variety of proprietary products are available for inlet protection that may be approved for use by local governments. If proprietary products are used, design details and installation procedures from the manufacturer must be followed. Regardless of the type of inlet protection selected, inlet protection is most effective when combined with other BMPs such as curb socks and check dams. Inlet protection is often the last barrier before runoff enters the storm sewer or receiving water.

Design details with notes are provided for these forms of inlet protection:

- IP-1. Block and Rock Sock Inlet Protection for Sump or On-grade Inlets
- IP-2. Curb (Rock) Socks Upstream of Inlet Protection, On-grade Inlets

| Inlet Protection (various forms) | |
|---|-----|
| Functions | |
| Erosion Control | No |
| Sediment Control | Yes |
| Site/Material Management | No |

IP-3. Rock Sock Inlet Protection for Sump/Area Inlet

IP-4. Silt Fence Inlet Protection for Sump/Area Inlet

IP-5. Over-excavation Inlet Protection

IP-6. Straw Bale Inlet Protection for Sump/Area Inlet

CIP-1. Culvert Inlet Protection

Proprietary inlet protection devices should be installed in accordance with manufacturer specifications.

More information is provided below on selecting inlet protection for sump and on-grade locations.

Inlets Located in a Sump

When applying inlet protection in sump conditions, it is important that the inlet continue to function during larger runoff events. For curb inlets, the maximum height of the protective barrier should be lower than the top of the curb opening to allow overflow into the inlet during larger storms without excessive localized flooding. If the inlet protection height is greater than the curb elevation, particularly if the filter becomes clogged with sediment, runoff will not enter the inlet and may bypass it, possibly causing localized flooding, public safety issues, and downstream erosion and damage from bypassed flows.

Area inlets located in a sump setting can be protected through the use of silt fence, concrete block and rock socks (on paved surfaces), sediment control logs/straw wattles embedded in the adjacent soil and stacked around the area inlet (on pervious surfaces), over-excavation around the inlet, and proprietary products providing equivalent functions.

Inlets Located on a Slope

For curb and gutter inlets on paved sloping streets, block and rock sock inlet protection is recommended in conjunction with curb socks in the gutter leading to the inlet. For inlets located along unpaved roads, also see the Check Dam Fact Sheet.

Maintenance and Removal

Inspect inlet protection frequently. Inspection and maintenance guidance includes:

- Inspect for tears that can result in sediment directly entering the inlet, as well as result in the contents of the BMP (e.g., gravel) washing into the inlet.
- Check for improper installation resulting in untreated flows bypassing the BMP and directly entering the inlet or bypassing to an unprotected downstream inlet. For example, silt fence that has not been properly trenched around the inlet can result in flows under the silt fence and directly into the inlet.
- Look for displaced BMPs that are no longer protecting the inlet. Displacement may occur following larger storm events that wash away or reposition the inlet protection. Traffic or equipment may also crush or displace the BMP.
- Monitor sediment accumulation upgradient of the inlet protection.

- Remove sediment accumulation from the area upstream of the inlet protection, as needed to maintain BMP effectiveness, typically when it reaches no more than half the storage capacity of the inlet protection. For silt fence, remove sediment when it accumulates to a depth of no more than 6 inches. Remove sediment accumulation from the area upstream of the inlet protection as needed to maintain the functionality of the BMP.
- Proprietary inlet protection devices should be inspected and maintained in accordance with manufacturer specifications. If proprietary inlet insert devices are used, sediment should be removed in a timely manner to prevent devices from breaking and spilling sediment into the storm drain.

Inlet protection must be removed and properly disposed of when the drainage area for the inlet has reached final stabilization.

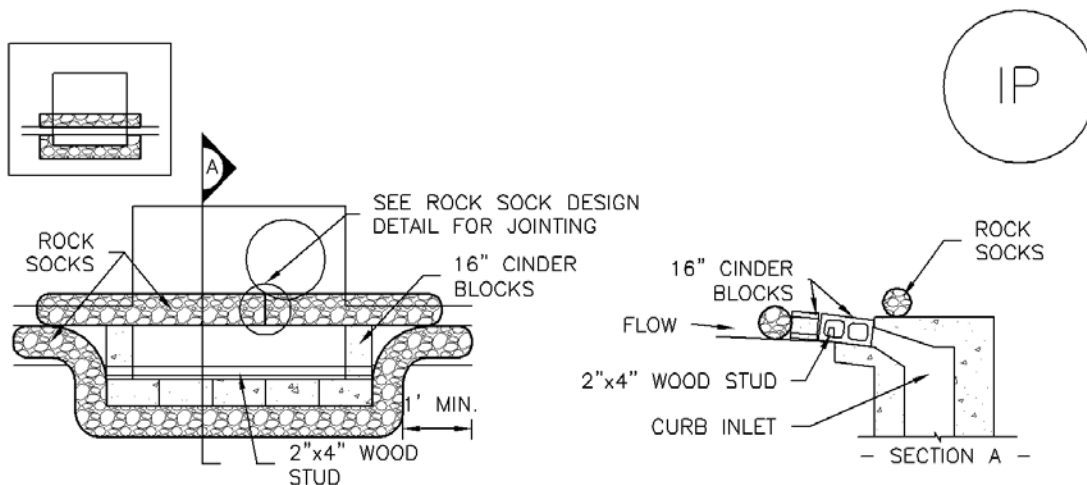

IP-1. BLOCK AND ROCK SOCK SUMP OR ON GRADE INLET PROTECTION

BLOCK AND CURB SOCK INLET PROTECTION INSTALLATION NOTES

1. SEE ROCK SOCK DESIGN DETAIL FOR INSTALLATION REQUIREMENTS.
2. CONCRETE "CINDER" BLOCKS SHALL BE LAID ON THEIR SIDES AROUND THE INLET IN A SINGLE ROW, ABUTTING ONE ANOTHER WITH THE OPEN END FACING AWAY FROM THE CURB.
3. GRAVEL BAGS SHALL BE PLACED AROUND CONCRETE BLOCKS, CLOSELY ABUTTING ONE ANOTHER AND JOINTED TOGETHER IN ACCORDANCE WITH ROCK SOCK DESIGN DETAIL.

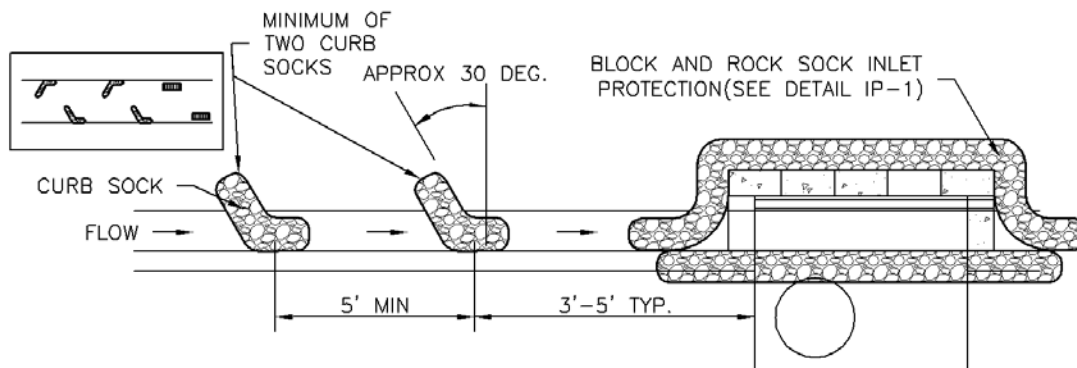

IP-2. CURB ROCK SOCKS UPSTREAM OF INLET PROTECTION

CURB ROCK SOCK INLET PROTECTION INSTALLATION NOTES

1. SEE ROCK SOCK DESIGN DETAIL INSTALLATION REQUIREMENTS.
2. PLACEMENT OF THE SOCK SHALL BE APPROXIMATELY 30 DEGREES FROM PERPENDICULAR IN THE OPPOSITE DIRECTION OF FLOW.
3. SOCKS ARE TO BE FLUSH WITH THE CURB AND SPACED A MINIMUM OF 5 FEET APART.
4. AT LEAST TWO CURB SOCKS IN SERIES ARE REQUIRED UPSTREAM OF ON-GRADE INLETS.

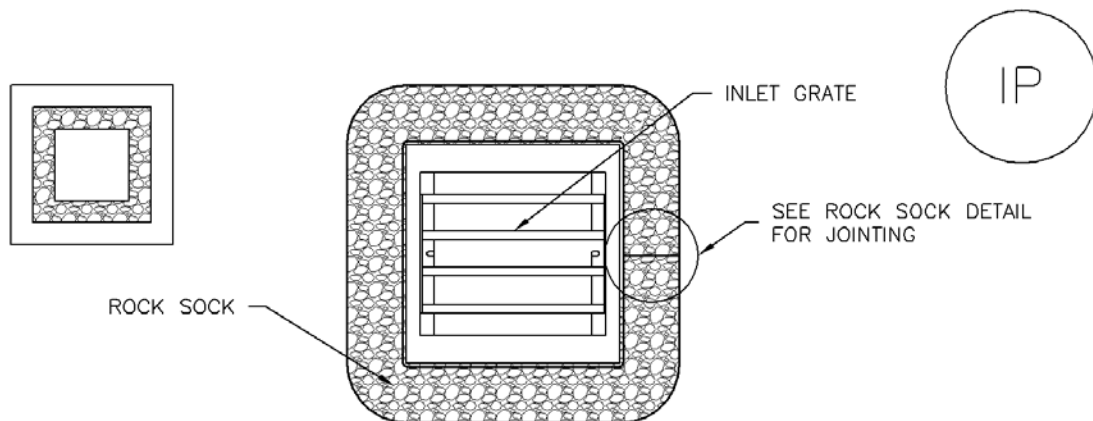

IP-3. ROCK SOCK SUMP/AREA INLET PROTECTION

ROCK SOCK SUMP/AREA INLET PROTECTION INSTALLATION NOTES

1. SEE ROCK SOCK DESIGN DETAIL FOR INSTALLATION REQUIREMENTS.
2. STRAW WATTLES/SEDIMENT CONTROL LOGS MAY BE USED IN PLACE OF ROCK SOCKS FOR INLETS IN PERVIOUS AREAS. INSTALL PER SEDIMENT CONTROL LOG DETAIL.

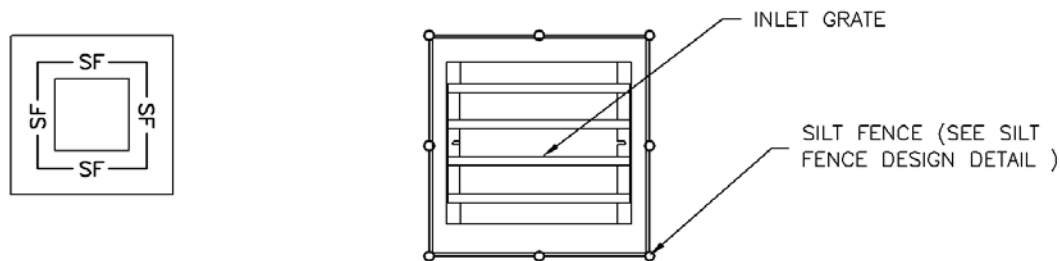

IP-4. SILT FENCE FOR SUMP INLET PROTECTION

SILT FENCE INLET PROTECTION INSTALLATION NOTES

1. SEE SILT FENCE DESIGN DETAIL FOR INSTALLATION REQUIREMENTS.
2. POSTS SHALL BE PLACED AT EACH CORNER OF THE INLET AND AROUND THE EDGES AT A MAXIMUM SPACING OF 3 FEET.
3. STRAW WATTLES/SEDIMENT CONTROL LOGS MAY BE USED IN PLACE OF SILT FENCE FOR INLETS IN PERVIOUS AREAS. INSTALL PER SEDIMENT CONTROL LOG DETAIL.

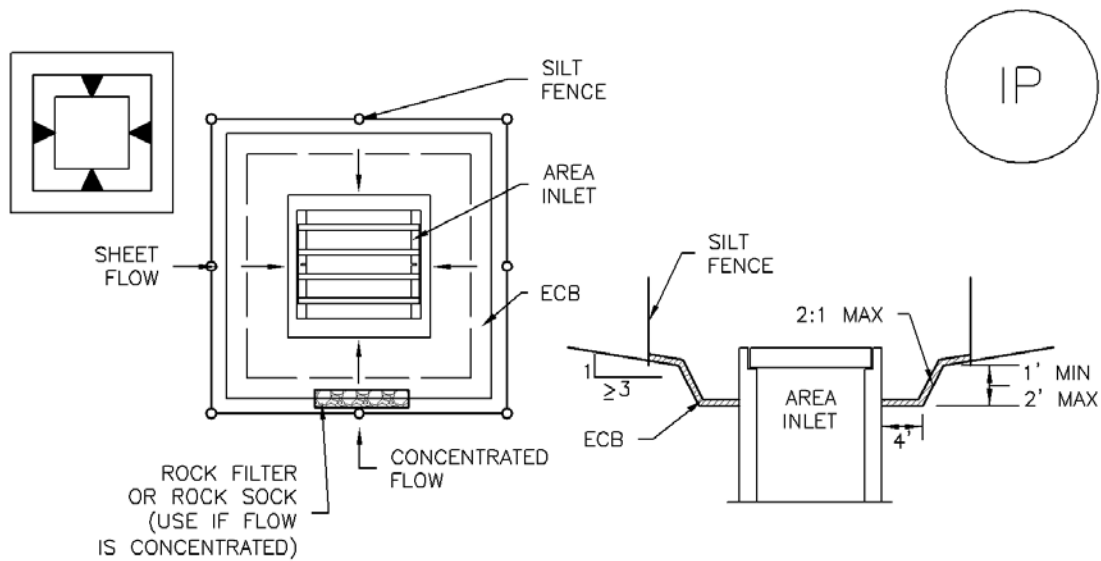

IP-5. OVEREXCAVATION INLET PROTECTION

OVEREXCAVATION INLET PROTECTION INSTALLATION NOTES

1. THIS FORM OF INLET PROTECTION IS PRIMARILY APPLICABLE FOR SITES THAT HAVE NOT YET REACHED FINAL GRADE AND SHOULD BE USED ONLY FOR INLETS WITH A RELATIVELY SMALL CONTRIBUTING DRAINAGE AREA.
2. WHEN USING FOR CONCENTRATED FLOWS, SHAPE BASIN IN 2:1 RATIO WITH LENGTH ORIENTED TOWARDS DIRECTION OF FLOW.
3. SEDIMENT MUST BE PERIODICALLY REMOVED FROM THE OVEREXCAVATED AREA.

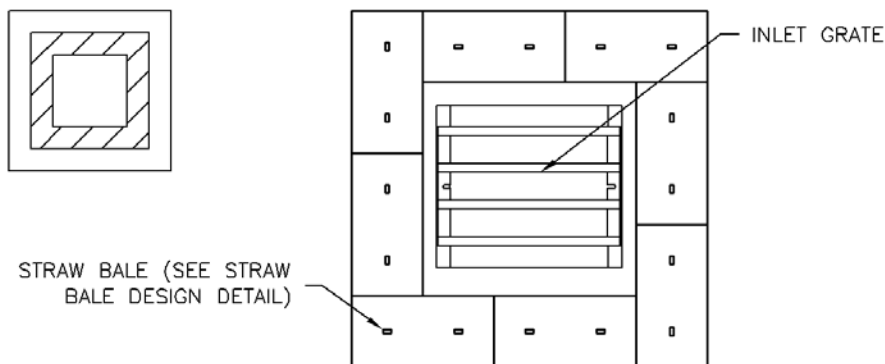

IP-6. STRAW BALE FOR SUMP INLET PROTECTION

STRAW BALE BARRIER INLET PROTECTION INSTALLATION NOTES

1. SEE STRAW BALE DESIGN DETAIL FOR INSTALLATION REQUIREMENTS.
2. BALES SHALL BE PLACED IN A SINGLE ROW AROUND THE INLET WITH ENDS OF BALES TIGHTLY ABUTTING ONE ANOTHER.

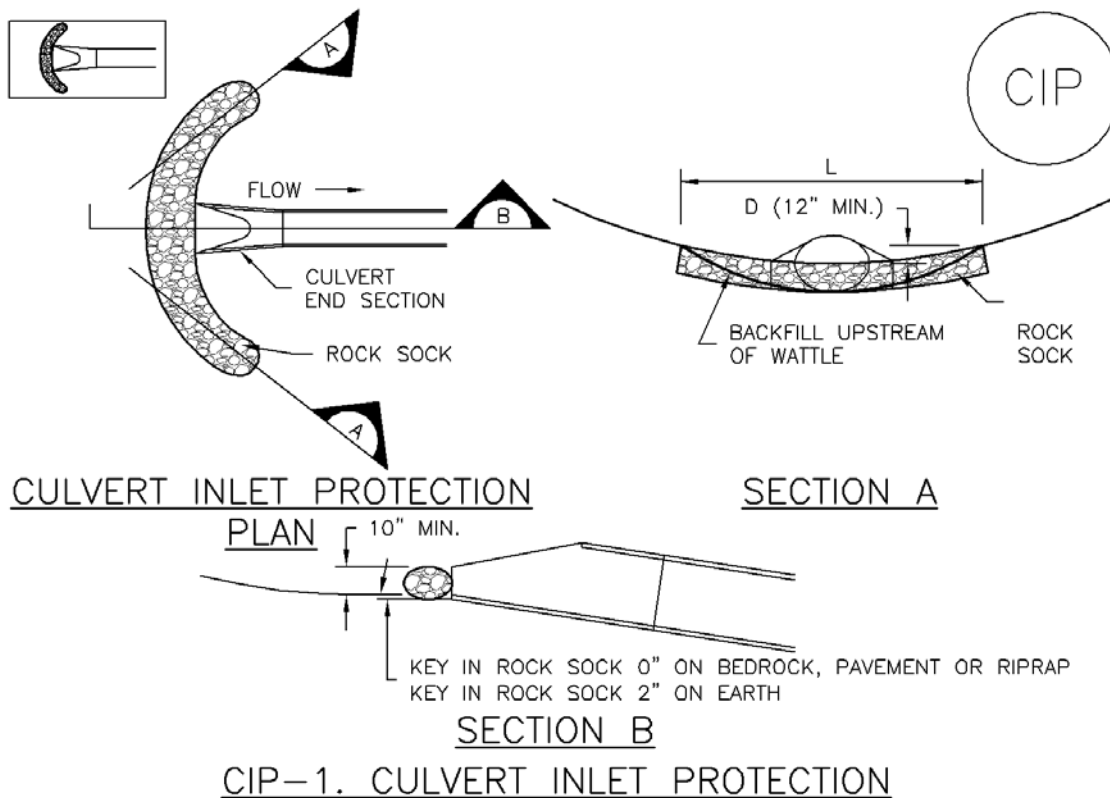

CULVERT INLET PROTECTION INSTALLATION NOTES

1. SEE PLAN VIEW FOR
-LOCATION OF CULVERT INLET PROTECTION.
2. SEE ROCK SOCK DESIGN DETAIL FOR ROCK GRADATION REQUIREMENTS AND JOINTING DETAIL.

CULVERT INLET PROTECTION MAINTENANCE NOTES

1. INSPECT BMPs EACH WORKDAY, AND MAINTAIN THEM IN EFFECTIVE OPERATING CONDITION. MAINTENANCE OF BMPs SHOULD BE PROACTIVE, NOT REACTIVE. INSPECT BMPs AS SOON AS POSSIBLE (AND ALWAYS WITHIN 24 HOURS) FOLLOWING A STORM THAT CAUSES SURFACE EROSION, AND PERFORM NECESSARY MAINTENANCE.
2. FREQUENT OBSERVATIONS AND MAINTENANCE ARE NECESSARY TO MAINTAIN BMPs IN EFFECTIVE OPERATING CONDITION. INSPECTIONS AND CORRECTIVE MEASURES SHOULD BE DOCUMENTED THOROUGHLY.
3. WHERE BMPs HAVE FAILED, REPAIR OR REPLACEMENT SHOULD BE INITIATED UPON DISCOVERY OF THE FAILURE.
4. SEDIMENT ACCUMULATED UPSTREAM OF THE CULVERT SHALL BE REMOVED WHEN THE SEDIMENT DEPTH IS 1/2 THE HEIGHT OF THE ROCK SOCK.
5. CULVERT INLET PROTECTION SHALL REMAIN IN PLACE UNTIL THE UPSTREAM DISTURBED AREA IS PERMANENTLY STABILIZED AND APPROVED BY THE LOCAL JURISDICTION.

(DETAILS ADAPTED FROM AURORA, COLORADO, NOT AVAILABLE IN AUTOCAD)

NOTE: MANY JURISDICTIONS HAVE BMP DETAILS THAT VARY FROM UDFCD STANDARD DETAILS. CONSULT WITH LOCAL JURISDICTIONS AS TO WHICH DETAIL SHOULD BE USED WHEN DIFFERENCES ARE NOTED.

GENERAL INLET PROTECTION INSTALLATION NOTES

1. SEE PLAN VIEW FOR:
 - LOCATION OF INLET PROTECTION.
 - TYPE OF INLET PROTECTION (IP.1, IP.2, IP.3, IP.4, IP.5, IP.6)
2. INLET PROTECTION SHALL BE INSTALLED PROMPTLY AFTER INLET CONSTRUCTION OR PAVING IS COMPLETE (TYPICALLY WITHIN 48 HOURS). IF A RAINFALL/RUNOFF EVENT IS FORECAST, INSTALL INLET PROTECTION PRIOR TO ONSET OF EVENT.
3. MANY JURISDICTIONS HAVE BMP DETAILS THAT VARY FROM UDFCD STANDARD DETAILS. CONSULT WITH LOCAL JURISDICTIONS AS TO WHICH DETAIL SHOULD BE USED WHEN DIFFERENCES ARE NOTED.

INLET PROTECTION MAINTENANCE NOTES

1. INSPECT BMPs EACH WORKDAY, AND MAINTAIN THEM IN EFFECTIVE OPERATING CONDITION. MAINTENANCE OF BMPs SHOULD BE PROACTIVE, NOT REACTIVE. INSPECT BMPs AS SOON AS POSSIBLE (AND ALWAYS WITHIN 24 HOURS) FOLLOWING A STORM THAT CAUSES SURFACE EROSION, AND PERFORM NECESSARY MAINTENANCE.
2. FREQUENT OBSERVATIONS AND MAINTENANCE ARE NECESSARY TO MAINTAIN BMPs IN EFFECTIVE OPERATING CONDITION. INSPECTIONS AND CORRECTIVE MEASURES SHOULD BE DOCUMENTED THOROUGHLY.
3. WHERE BMPs HAVE FAILED, REPAIR OR REPLACEMENT SHOULD BE INITIATED UPON DISCOVERY OF THE FAILURE.
4. SEDIMENT ACCUMULATED UPSTREAM OF INLET PROTECTION SHALL BE REMOVED AS NECESSARY TO MAINTAIN BMP EFFECTIVENESS, TYPICALLY WHEN STORAGE VOLUME REACHES 50% OF CAPACITY, A DEPTH OF 6" WHEN SILT FENCE IS USED, OR ¼ OF THE HEIGHT FOR STRAW BALES.
5. INLET PROTECTION IS TO REMAIN IN PLACE UNTIL THE UPSTREAM DISTURBED AREA IS PERMANENTLY STABILIZED, UNLESS THE LOCAL JURISDICTION APPROVES EARLIER REMOVAL OF INLET PROTECTION IN STREETS.
6. WHEN INLET PROTECTION AT AREA INLETS IS REMOVED, THE DISTURBED AREA SHALL BE COVERED WITH TOP SOIL, SEEDED AND MULCHED, OR OTHERWISE STABILIZED IN A MANNER APPROVED BY THE LOCAL JURISDICTION.

(DETAIL ADAPTED FROM TOWN OF PARKER, COLORADO AND CITY OF AURORA, COLORADO, NOT AVAILABLE IN AUTOCAD)

NOTE: MANY JURISDICTIONS HAVE BMP DETAILS THAT VARY FROM UDFCD STANDARD DETAILS. CONSULT WITH LOCAL JURISDICTIONS AS TO WHICH DETAIL SHOULD BE USED WHEN DIFFERENCES ARE NOTED.

NOTE: THE DETAILS INCLUDED WITH THIS FACT SHEET SHOW COMMONLY USED, CONVENTIONAL METHODS OF INLET PROTECTION IN THE DENVER METROPOLITAN AREA. THERE ARE MANY PROPRIETARY INLET PROTECTION METHODS ON THE MARKET. UDFCD NEITHER ENDORSES NOR DISCOURAGES USE OF PROPRIETARY INLET PROTECTION; HOWEVER, IN THE EVENT PROPRIETARY METHODS ARE USED, THE APPROPRIATE DETAIL FROM THE MANUFACTURER MUST BE INCLUDED IN THE SWMP AND THE BMP MUST BE INSTALLED AND MAINTAINED AS SHOWN IN THE MANUFACTURER'S DETAILS.

NOTE: SOME MUNICIPALITIES DISCOURAGE OR PROHIBIT THE USE OF STRAW BALES FOR INLET PROTECTION. CHECK WITH LOCAL JURISDICTION TO DETERMINE IF STRAW BALE INLET PROTECTION IS ACCEPTABLE.

Description

Vehicle tracking controls provide stabilized construction site access where vehicles exit the site onto paved public roads. An effective vehicle tracking control helps remove sediment (mud or dirt) from vehicles, reducing tracking onto the paved surface.



Photograph VTC-1. A vehicle tracking control pad constructed with properly sized rock reduces off-site sediment tracking.

Appropriate Uses

Implement a stabilized construction entrance or vehicle tracking control where frequent heavy vehicle traffic exits the construction site onto a paved roadway. An effective vehicle tracking control is particularly important during the following conditions:

- Wet weather periods when mud is easily tracked off site.
- During dry weather periods where dust is a concern.
- When poorly drained, clayey soils are present on site.

Although wheel washes are not required in designs of vehicle tracking controls, they may be needed at particularly muddy sites.

Design and Installation

Construct the vehicle tracking control on a level surface. Where feasible, grade the tracking control towards the construction site to reduce off-site runoff. Place signage, as needed, to direct construction vehicles to the designated exit through the vehicle tracking control. There are several different types of stabilized construction entrances including:

VTC-1. Aggregate Vehicle Tracking Control. This is a coarse-aggregate surfaced pad underlain by a geotextile. This is the most common vehicle tracking control, and when properly maintained can be effective at removing sediment from vehicle tires.

VTC-2. Vehicle Tracking Control with Construction Mat or Turf Reinforcement Mat. This type of control may be appropriate for site access at very small construction sites with low traffic volume over vegetated areas. Although this application does not typically remove sediment from vehicles, it helps protect existing vegetation and provides a stabilized entrance.

| Vehicle Tracking Control | |
|---------------------------------|----------|
| Functions | |
| Erosion Control | Moderate |
| Sediment Control | Yes |
| Site/Material Management | Yes |

VTC-3. Stabilized Construction Entrance/Exit with Wheel Wash. This is an aggregate pad, similar to VTC-1, but includes equipment for tire washing. The wheel wash equipment may be as simple as hand-held power washing equipment to more advanced proprietary systems. When a wheel wash is provided, it is important to direct wash water to a sediment trap prior to discharge from the site.

Vehicle tracking controls are sometimes installed in combination with a sediment trap to treat runoff.

Maintenance and Removal

Inspect the area for degradation and replace aggregate or material used for a stabilized entrance/exit as needed. If the area becomes clogged and ponds water, remove and dispose of excess sediment or replace material with a fresh layer of aggregate as necessary.

With aggregate vehicle tracking controls, ensure rock and debris from this area do not enter the public right-of-way.

Remove sediment that is tracked onto the public right of way daily or more frequently as needed. Excess sediment in the roadway indicates that the stabilized construction entrance needs maintenance.

Ensure that drainage ditches at the entrance/exit area remain clear.

A stabilized entrance should be removed only when there is no longer the potential for vehicle tracking to occur. This is typically after the site has been stabilized.

When wheel wash equipment is used, be sure that the wash water is discharged to a sediment trap prior to discharge. Also inspect channels conveying the water from the wash area to the sediment trap and stabilize areas that may be eroding.

When a construction entrance/exit is removed, excess sediment from the aggregate should be removed and disposed of appropriately. The entrance should be promptly stabilized with a permanent surface following removal, typically by paving.



Photograph VTC-2. A vehicle tracking control pad with wheel wash facility. Photo courtesy of Tom Gore.

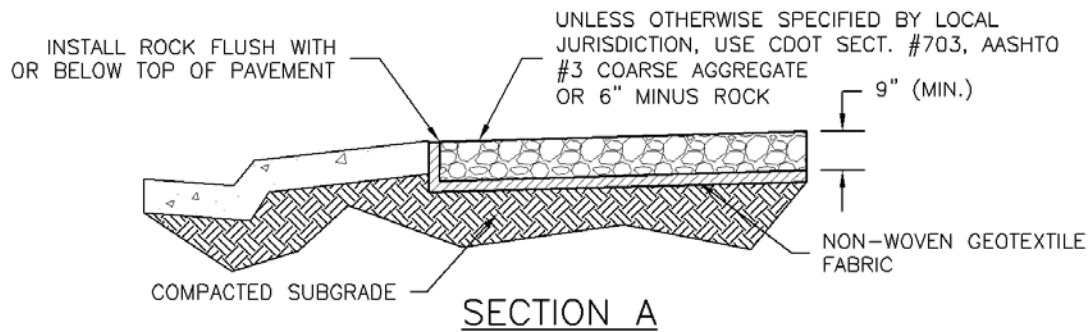
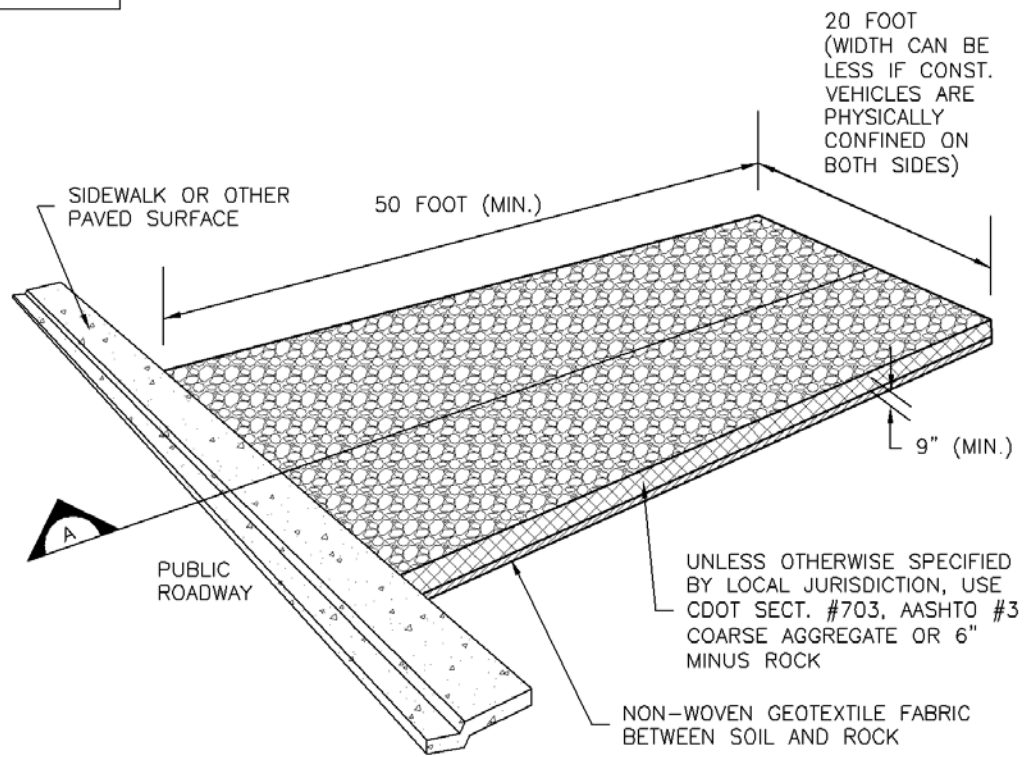
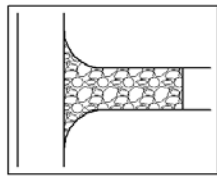

VTC-1. AGGREGATE VEHICLE TRACKING CONTROL

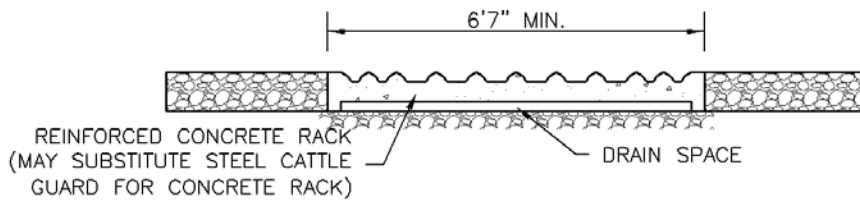
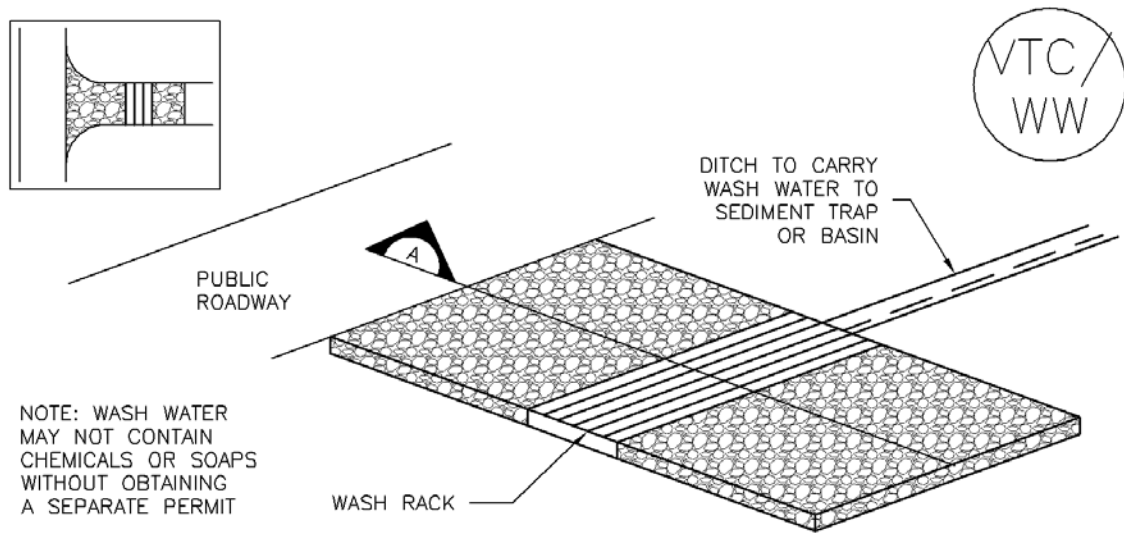

SECTION A

VTC-2. AGGREGATE VEHICLE TRACKING CONTROL WITH WASH RACK

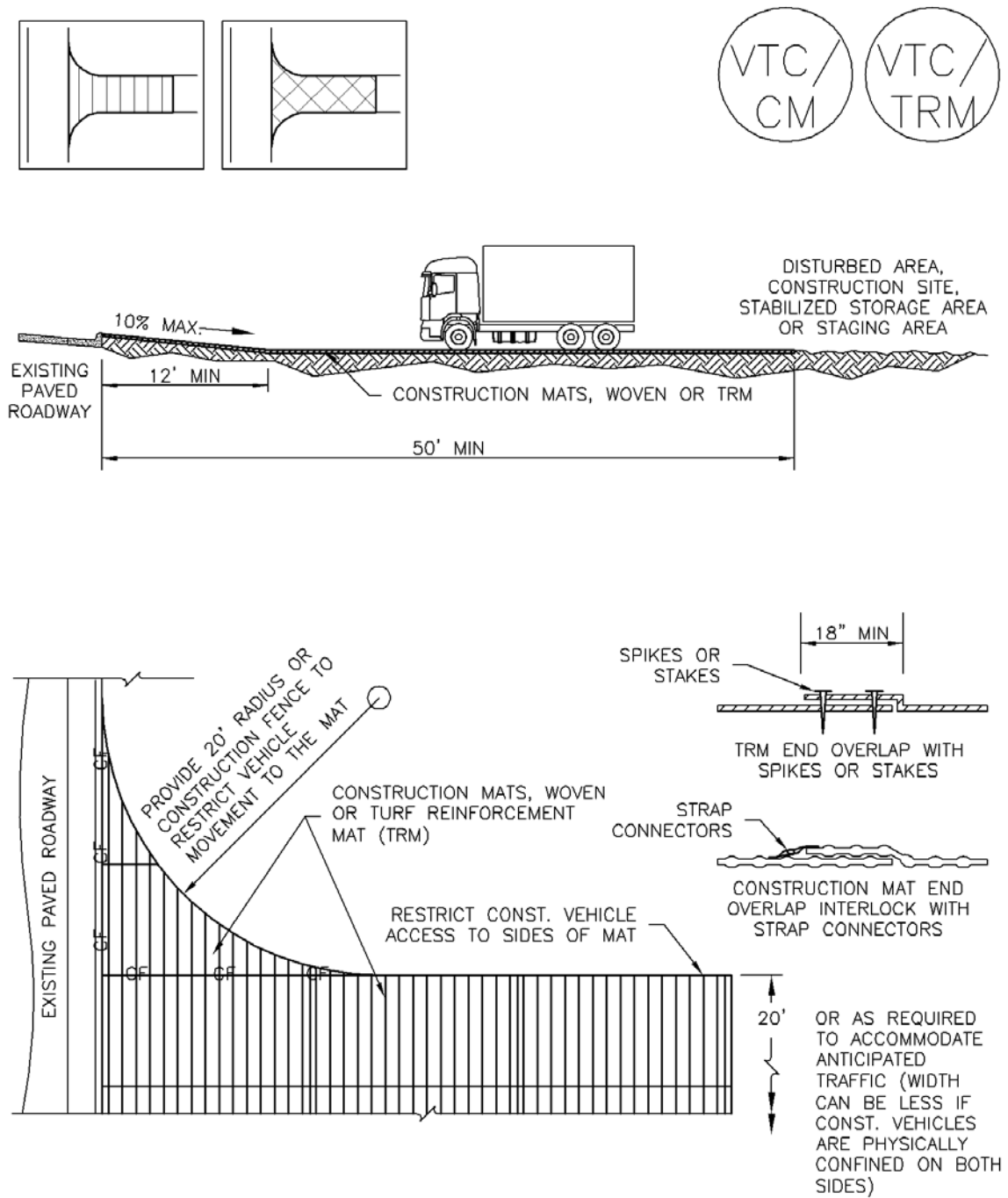

VTC-3. VEHICLE TRACKING CONTROL W/ CONSTRUCTION MAT OR TURF REINFORCEMENT MAT (TRM)

STABILIZED CONSTRUCTION ENTRANCE/EXIT INSTALLATION NOTES

1. SEE PLAN VIEW FOR
 - LOCATION OF CONSTRUCTION ENTRANCE(S)/EXIT(S).
 - TYPE OF CONSTRUCTION ENTRANCE(S)/EXITS(S) (WITH/WITHOUT WHEEL WASH, CONSTRUCTION MAT OR TRM).
2. CONSTRUCTION MAT OR TRM STABILIZED CONSTRUCTION ENTRANCES ARE ONLY TO BE USED ON SHORT DURATION PROJECTS (TYPICALLY RANGING FROM A WEEK TO A MONTH) WHERE THERE WILL BE LIMITED VEHICULAR ACCESS.
3. A STABILIZED CONSTRUCTION ENTRANCE/EXIT SHALL BE LOCATED AT ALL ACCESS POINTS WHERE VEHICLES ACCESS THE CONSTRUCTION SITE FROM PAVED RIGHT-OF-WAYS.
4. STABILIZED CONSTRUCTION ENTRANCE/EXIT SHALL BE INSTALLED PRIOR TO ANY LAND DISTURBING ACTIVITIES.
5. A NON-WOVEN GEOTEXTILE FABRIC SHALL BE PLACED UNDER THE STABILIZED CONSTRUCTION ENTRANCE/EXIT PRIOR TO THE PLACEMENT OF ROCK.
6. UNLESS OTHERWISE SPECIFIED BY LOCAL JURISDICTION, ROCK SHALL CONSIST OF DOT SECT. #703, AASHTO #3 COARSE AGGREGATE OR 6" (MINUS) ROCK.

STABILIZED CONSTRUCTION ENTRANCE/EXIT MAINTENANCE NOTES

1. INSPECT BMPs EACH WORKDAY, AND MAINTAIN THEM IN EFFECTIVE OPERATING CONDITION. MAINTENANCE OF BMPs SHOULD BE PROACTIVE, NOT REACTIVE. INSPECT BMPs AS SOON AS POSSIBLE (AND ALWAYS WITHIN 24 HOURS) FOLLOWING A STORM THAT CAUSES SURFACE EROSION, AND PERFORM NECESSARY MAINTENANCE.
2. FREQUENT OBSERVATIONS AND MAINTENANCE ARE NECESSARY TO MAINTAIN BMPs IN EFFECTIVE OPERATING CONDITION. INSPECTIONS AND CORRECTIVE MEASURES SHOULD BE DOCUMENTED THOROUGHLY.
3. WHERE BMPs HAVE FAILED, REPAIR OR REPLACEMENT SHOULD BE INITIATED UPON DISCOVERY OF THE FAILURE.
4. ROCK SHALL BE REAPPLIED OR REGRADED AS NECESSARY TO THE STABILIZED ENTRANCE/EXIT TO MAINTAIN A CONSISTENT DEPTH.
5. SEDIMENT TRACKED ONTO PAVED ROADS IS TO BE REMOVED THROUGHOUT THE DAY AND AT THE END OF THE DAY BY SHOVELING OR SWEEPING. SEDIMENT MAY NOT BE WASHED DOWN STORM SEWER DRAINS.

NOTE: MANY JURISDICTIONS HAVE BMP DETAILS THAT VARY FROM UDFCD STANDARD DETAILS. CONSULT WITH LOCAL JURISDICTIONS AS TO WHICH DETAIL SHOULD BE USED WHEN DIFFERENCES ARE NOTED.

(DETAILS ADAPTED FROM CITY OF BROOMFIELD, COLORADO, NOT AVAILABLE IN AUTOCAD)

Description

Temporary seeding can be used to stabilize disturbed areas that will be inactive for an extended period. Permanent seeding should be used to stabilize areas at final grade that will not be otherwise stabilized. Effective seeding includes preparing a seedbed, selecting an appropriate seed mixture, using proper planting techniques, and protecting the seeded area with mulch, geotextiles, or other appropriate measures.



Photograph TS/PS -1. Equipment used to drill seed. Photo courtesy of Douglas County.

Appropriate Uses

When the soil surface is disturbed and will remain inactive for an extended period (typically determined by local government requirements), proactive stabilization measures, including planting a temporary seed mix, should be implemented. If the inactive period is short-lived (on the order of two weeks), techniques such as surface roughening may be appropriate. For longer periods of inactivity of up to one year, temporary seeding and mulching can provide effective erosion control. Permanent seeding should be used on finished areas that have not been otherwise stabilized.

The USDCM Volume 2 *Revegetation* Chapter contains suggested annual grains and native seed mixes to use for temporary seeding. Alternatively, local governments may have their own seed mixes and timelines for seeding. Check jurisdictional requirements for seeding and temporary stabilization.

Design and Installation

Effective seeding requires proper seedbed preparation, selecting an appropriate seed mixture, using appropriate seeding equipment to ensure proper coverage and density, and protecting seeded areas with mulch or fabric until plants are established.

The USDCM Volume 2 *Revegetation* Chapter contains detailed seed mixes, soil preparation practices, and seeding and mulching recommendations that should be referenced to supplement this Fact Sheet.

Drill seeding is the preferred seeding method. Hydroseeding is not recommended except in areas where steep slopes prevent use of drill seeding equipment, and even in these instances it is preferable to hand seed and mulch. Some jurisdictions do not allow hydroseeding or hydromulching.

Seedbed Preparation

Prior to seeding, ensure that areas to be revegetated have soil conditions capable of supporting vegetation. Overlot grading can result in loss of topsoil and compaction, resulting in poor quality subsoils at the ground surface that

| Temporary and Permanent Seeding | |
|---------------------------------|-----|
| Functions | |
| Erosion Control | Yes |
| Sediment Control | No |
| Site/Material Management | No |

EC-2 Temporary and Permanent Seeding (TS/PS)

have low nutrient value, little organic matter content, few soil microorganisms, rooting restrictions, and conditions less conducive to infiltration of precipitation. As a result, it is typically necessary to provide stockpiled topsoil, compost, or other soil amendments and rototill them into the soil to a depth of 6 inches or more.

Topsoil should be salvaged during grading operations for use and spread on areas to be revegetated later. Topsoil should be viewed as an important resource to be utilized for vegetation establishment, due to its water-holding capacity, structure, texture, organic matter content, biological activity, and nutrient content. The rooting depth of most native grasses in the semi-arid Denver metropolitan area is 6 to 18 inches. If present, at a minimum of the upper 6 inches of topsoil should be stripped, stockpiled, and ultimately respread across areas that will be revegetated.

Where topsoil is not available, subsoils should be amended to provide an appropriate plant-growth medium. Organic matter, such as well digested compost, can be added to improve soil characteristics conducive to plant growth. Other treatments can be used to adjust soil pH conditions when needed. Soil testing, which is typically inexpensive, should be completed to determine and optimize the types and amounts of amendments that are required.

If the disturbed ground surface is compacted, rip or rototill the upper 12 inches of the surface prior to placing topsoil. If adding compost to the existing soil surface, rototilling is necessary. Surface roughening will assist in placing a stable topsoil layer on steeper slopes, and allow infiltration and root penetration to greater depth. Topsoil should not be placed when either the salvaged topsoil or receiving ground are frozen or snow covered.

Prior to seeding, the soil surface should be rough and the seedbed should be firm, but neither too loose nor compacted. The upper layer of soil should be in a condition suitable for seeding at the proper depth and conducive to plant growth. Seed-to-soil contact is the key to good germination.

Refer to MHFD's Topsoil Management Guidance for detailed information on topsoil assessment, design, and construction.

Temporary Vegetation

To provide temporary vegetative cover on disturbed areas which will not be paved, built upon, or fully landscaped or worked for an extended period (typically 30 days or more), plant an annual grass appropriate for the time of planting and mulch the planted areas. Temporary grain seed mixes suitable for the Denver metropolitan area are listed in Table TS/PS-1. Native temporary seed mixes are provided in USDCM Volume 2, Chapter 13, Appendix A. These are to be considered only as general recommendations when specific design guidance for a particular site is not available. Local governments typically specify seed mixes appropriate for their jurisdiction.

Permanent Revegetation

To provide vegetative cover on disturbed areas that have reached final grade, a perennial grass mix should be established. Permanent seeding should be performed promptly (typically within 14 days) after reaching final grade. Each site will have different characteristics and a landscape professional or the local jurisdiction should be contacted to determine the most suitable seed mix for a specific site. In lieu of a specific recommendation, one of the perennial grass mixes appropriate for site conditions and growth season listed in seed mix tables in the USDCM Volume 2 *Revegetation* Chapter can be used. The pure live seed (PLS) rates of application recommended in these tables are considered to be absolute minimum rates for seed applied using proper drill-seeding equipment. These are to be considered only as general

recommendations when specific design guidance for a particular site is not available. Local governments typically specify seed mixes appropriate for their jurisdiction.

If desired for wildlife habitat or landscape diversity, shrubs such as rubber rabbitbrush (*Chrysothamnus nauseosus*), fourwing saltbush (*Atriplex canescens*) and skunkbrush sumac (*Rhus trilobata*) could be added to the upland seed mixes at 0.25, 0.5 and 1 pound PLS/acre, respectively. In riparian zones, planting root stock of such species as American plum (*Prunus americana*), woods rose (*Rosa woodsii*), plains cottonwood (*Populus sargentii*), and willow (*Salix spp.*) may be considered. On non-topsoiled upland sites, a legume such as Ladak alfalfa at 1 pound PLS/acre can be included as a source of nitrogen for perennial grasses.

Timing of seeding is an important aspect of the revegetation process. For upland and riparian areas on the Colorado Front Range, the suitable timing for seeding is from October through May. The most favorable time to plant non-irrigated areas is during the fall, so that seed can take advantage of winter and spring moisture. Seed should not be planted if the soil is frozen, snow covered, or wet.

Seeding dates for the highest success probability of perennial species along the Front Range are generally in the spring from April through early May and in the fall after the first of September until the ground freezes. If the area is irrigated, seeding may occur in summer months, as well. See Table TS/PS-2 for appropriate seeding dates.

EC-2 Temporary and Permanent Seeding (TS/PS)

Table TS/PS-1. Minimum Drill Seeding Rates for Various Temporary Annual Grasses

| Species ^a (Common name) | Growth Season ^b | Pounds of Pure Live Seed (PLS)/acre ^c | Planting Depth (inches) |
|---------------------------------------|----------------------------|--|-------------------------|
| 1. Oats | Cool | 35 - 50 | 1 - 2 |
| 2. Spring wheat | Cool | 25 - 35 | 1 - 2 |
| 3. Spring barley | Cool | 25 - 35 | 1 - 2 |
| 4. Annual ryegrass | Cool | 10 - 15 | ½ |
| 5. Millet | Warm | 3 - 15 | ½ - ¾ |
| 6. Winter wheat | Cool | 20-35 | 1 - 2 |
| 7. Winter barley | Cool | 20-35 | 1 - 2 |
| 8. Winter rye | Cool | 20-35 | 1 - 2 |
| 9. Triticale | Cool | 25-40 | 1 - 2 |

^a Successful seeding of annual grass resulting in adequate plant growth will usually produce enough dead-plant residue to provide protection from wind and water erosion for an additional year. This assumes that the cover is not disturbed or mowed closer than 8 inches.

Hydraulic seeding may be substituted for drilling only where slopes are steeper than 3:1 or where access limitations exist. When hydraulic seeding is used, hydraulic mulching should be applied as a separate operation, when practical, to prevent the seeds from being encapsulated in the mulch.

^b See Table TS/PS-2 for seeding dates. Irrigation, if consistently applied, may extend the use of cool season species during the summer months.

^c Seeding rates should be doubled if seed is broadcast, or increased by 50 percent if done using a Brillion Drill or by hydraulic seeding.

Table TS/PS-2. Seeding Dates for Annual and Perennial Grasses

| Seeding Dates | Annual Grasses (Numbers in table reference species in Table TS/PS-1) | | Perennial Grasses | |
|--------------------------|---|------------|-------------------|------|
| | Warm | Cool | Warm | Cool |
| January 1–March 15 | | | ✓ | ✓ |
| March 16–April 30 | | 1,2,3 | ✓ | ✓ |
| May 1–May 15 | | | ✓ | |
| May 16–June 30 | 5 | | | |
| July 1–July 15 | 5 | | | |
| July 16–August 31 | | | | |
| September 1–September 30 | | 6, 7, 8, 9 | | |
| October 1–December 31 | | | ✓ | ✓ |

Mulch

Cover seeded areas with mulch or an appropriate rolled erosion control product to promote establishment of vegetation. Anchor mulch by crimping, netting or use of a non-toxic tackifier. See the USDCM Volume 2 *Revegetation* Chapter and Volume 3 Mulching BMP Fact Sheet (EC-04) for additional guidance.

Maintenance and Removal

Monitor and observe seeded areas to identify areas of poor growth or areas that fail to germinate. Reseed and mulch these areas, as needed.

If a temporary annual seed was planted, the area should be reseeded with the desired perennial mix when there will be no further work in the area. To minimize competition between annual and perennial species, the annual mix needs time to mature and die before seeding the perennial mix. To increase success of the perennial mix, it should be seeded during the appropriate seeding dates the second year after the temporary annual mix was seeded. Alternatively, if this timeline is not feasible, the annual mix seed heads should be removed and then the area seeded with the perennial mix.

An area that has been permanently seeded should have a good stand of vegetation within one growing season if irrigated and within three growing seasons without irrigation in Colorado. Reseed portions of the site that fail to germinate or remain bare after the first growing season.

Seeded areas may require irrigation, particularly during extended dry periods. Targeted weed control may also be necessary.

Protect seeded areas from construction equipment and vehicle access.

Description

A sediment control log is a linear roll made of natural materials such as straw, coconut fiber, or compost. The most common type of sediment control log has straw filling and is often referred to as a "straw wattle." All sediment control logs are used as a sediment barrier to intercept sheet flow runoff from disturbed areas.



Appropriate Uses

Sediment control logs can be used in the following applications to trap sediment:

- As perimeter control for stockpiles and the site.
- As part of inlet protection designs.
- As check dams in small drainage ditches. (Sediment control logs are not intended for use in channels with high flow velocities.)
- On disturbed slopes to shorten flow lengths (as an erosion control).
- As part of multi-layered perimeter control along a receiving water such as a stream, pond or wetland.



Photographs SCL-1 and SCL-2. Sediment control logs used as 1) a perimeter control around a soil stockpile; and, 2) as a "J-hook" perimeter control at the corner of a construction site.

Sediment control logs work well in combination with other layers of erosion and sediment controls.

Design and Installation

Sediment control logs should be installed along the contour to avoid concentrating flows. The maximum allowable tributary drainage area per 100 lineal feet of sediment control log, installed along the contour, is approximately 0.25 acres with a disturbed slope length of up to 150 feet and a tributary slope gradient no steeper than 3:1. Longer and steeper slopes require additional measures. This recommendation only applies to sediment control logs installed along the contour. When installed for other uses, such as perimeter control, it should be installed in a way that will not produce concentrated flows. For example, a "J-hook" installation may be appropriate to force runoff to pond and evaporate or infiltrate in multiple areas rather than concentrate and cause erosive conditions parallel to the BMP.

| Sediment Control Log | |
|--------------------------|----------|
| Functions | |
| Erosion Control | Moderate |
| Sediment Control | Yes |
| Site/Material Management | No |

Although sediment control logs initially allow runoff to flow through the BMP, they can quickly become a barrier and should be installed as if they are impermeable.

Design details and notes for sediment control logs are provided in the following details. Sediment logs must be properly installed per the detail to prevent undercutting, bypassing and displacement. When installed on slopes, sediment control logs should be installed along the contours (i.e., perpendicular to flow).

Improper installation can lead to poor performance. Be sure that sediment control logs are properly trenched (if lighter than 8 lb/foot), anchored and tightly jointed.

Maintenance and Removal

Be aware that sediment control logs will eventually degrade. Remove accumulated sediment before the depth is one-half the height of the sediment log and repair damage to the sediment log, typically by replacing the damaged section.

Once the upstream area is stabilized, remove and properly dispose of the logs. Areas disturbed beneath the logs may need to be seeded and mulched. Sediment control logs that are biodegradable may occasionally be left in place (e.g., when logs are used in conjunction with erosion control blankets as permanent slope breaks). However, removal of sediment control logs after final stabilization is typically appropriate when used in perimeter control, inlet protection and check dam applications. Compost from compost sediment control logs may be spread over the area and seeded as long as this does not cover newly established vegetation.

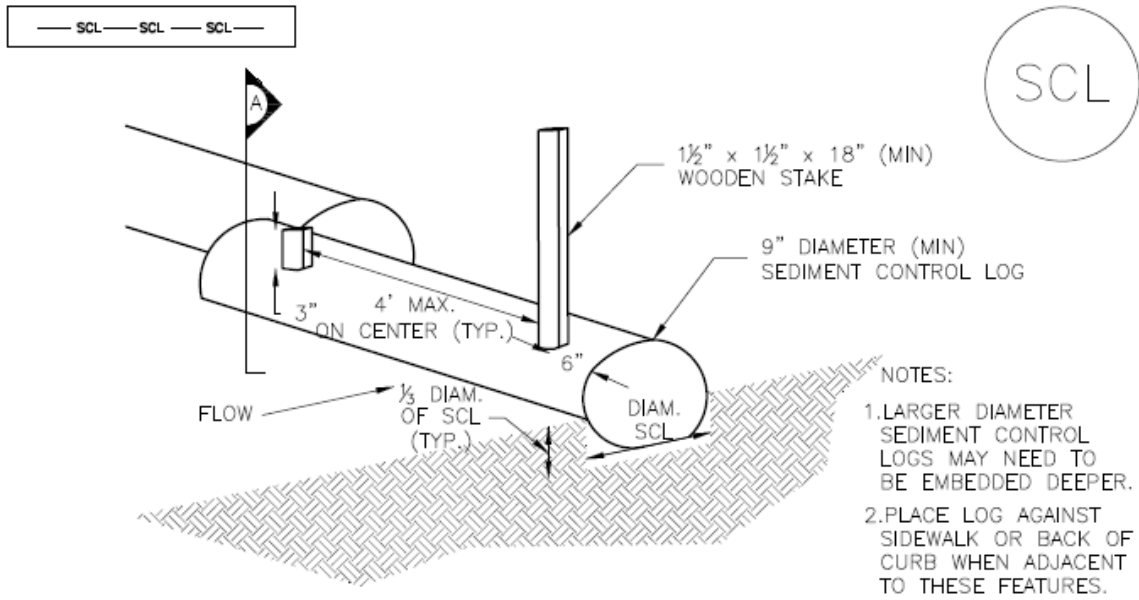

TRENCHED SEDIMENT CONTROL LOG

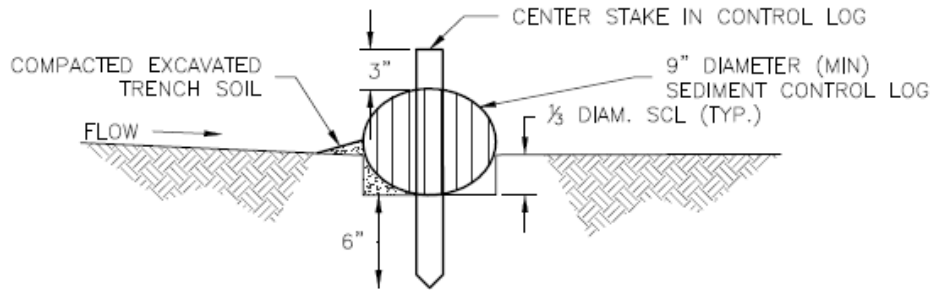

SECTION A TRENCHED SEDIMENT CONTROL LOG

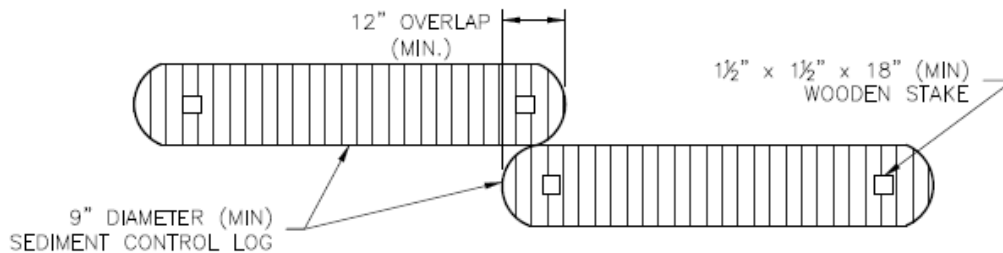

LOG JOINTS

SCL-1. TRENCHED SEDIMENT CONTROL LOG

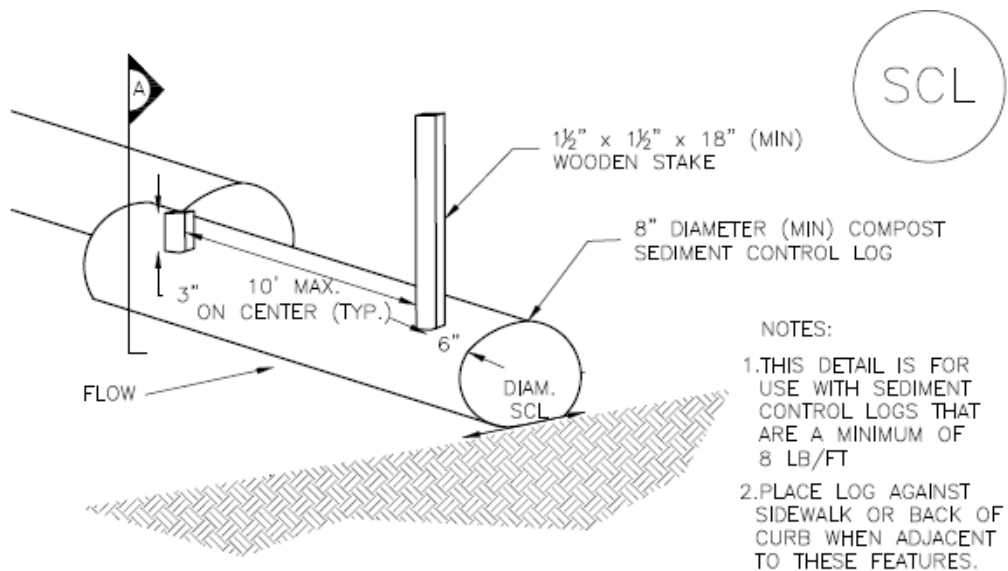

COMPOST SEDIMENT CONTROL LOG (WEIGHTED)

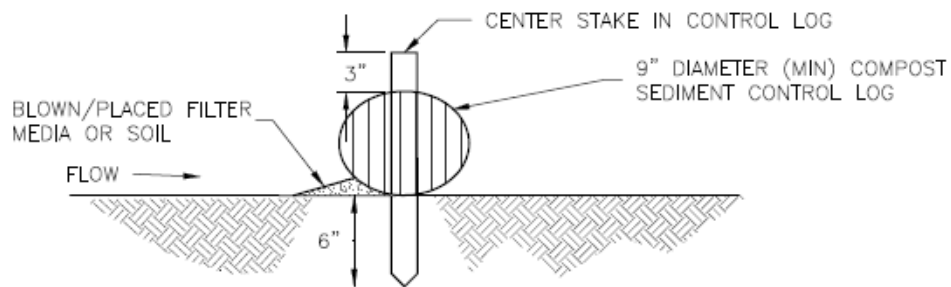

SECTION A
COMPOST SEDIMENT CONTROL LOG

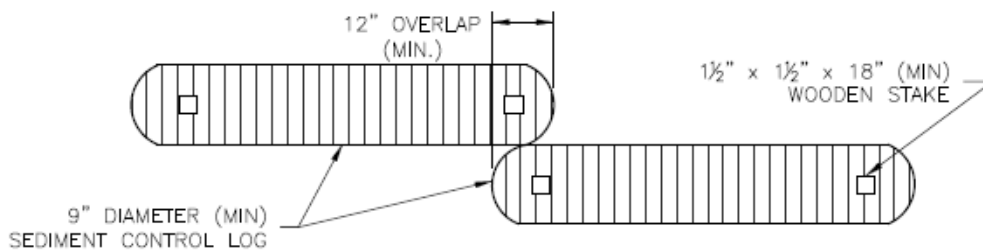

LOG JOINTS

SCL-2. COMPOST SEDIMENT CONTROL LOG (WEIGHTED)

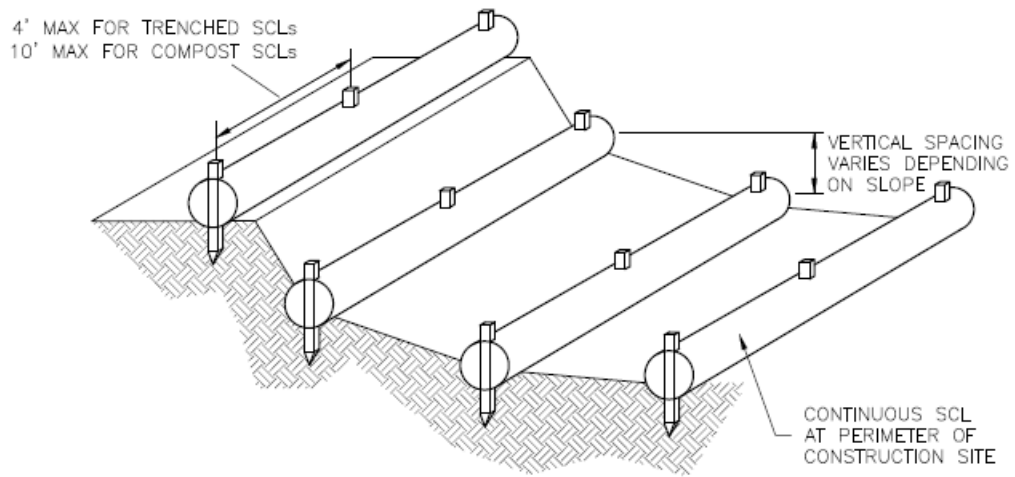

SCL-3. SEDIMENT CONTROL LOGS TO CONTROL SLOPE LENGTH

SEDIMENT CONTROL LOG INSTALLATION NOTES

1. SEE PLAN VIEW FOR LOCATION AND LENGTH OF SEDIMENT CONTROL LOGS.
2. SEDIMENT CONTROL LOGS THAT ACT AS A PERIMETER CONTROL SHALL BE INSTALLED PRIOR TO ANY UPGRADIENT LAND-DISTURBING ACTIVITIES.
3. SEDIMENT CONTROL LOGS SHALL CONSIST OF STRAW, COMPOST, EXCELSIOR OR COCONUT FIBER, AND SHALL BE FREE OF ANY NOXIOUS WEED SEEDS OR DEFECTS INCLUDING RIPS, HOLES AND OBVIOUS WEAR.
4. SEDIMENT CONTROL LOGS MAY BE USED AS SMALL CHECK DAMS IN DITCHES AND SWALES. HOWEVER, THEY SHOULD NOT BE USED IN PERENNIAL STREAMS.
5. IT IS RECOMMENDED THAT SEDIMENT CONTROL LOGS BE TRENCHED INTO THE GROUND TO A DEPTH OF APPROXIMATELY $\frac{1}{3}$ OF THE DIAMETER OF THE LOG. IF TRENCHING TO THIS DEPTH IS NOT FEASIBLE AND/OR DESIRABLE (SHORT TERM INSTALLATION WITH DESIRE NOT TO DAMAGE LANDSCAPE) A LESSER TRENCHING DEPTH MAY BE ACCEPTABLE WITH MORE ROBUST STAKING. COMPOST LOGS THAT ARE 8 LB/FT DO NOT NEED TO BE TRENCHED.
6. THE UPHILL SIDE OF THE SEDIMENT CONTROL LOG SHALL BE BACKFILLED WITH SOIL OR FILTER MATERIAL THAT IS FREE OF ROCKS AND DEBRIS. THE SOIL SHALL BE TIGHTLY COMPACTED INTO THE SHAPE OF A RIGHT TRIANGLE USING A SHOVEL OR WEIGHTED LAWN ROLLER OR BLOWN IN PLACE.
7. FOLLOW MANUFACTURERS' GUIDANCE FOR STAKING. IF MANUFACTURERS' INSTRUCTIONS DO NOT SPECIFY SPACING, STAKES SHALL BE PLACED ON 4' CENTERS AND EMBEDDED A MINIMUM OF 6" INTO THE GROUND. 3" OF THE STAKE SHALL PROTRUDE FROM THE TOP OF THE LOG. STAKES THAT ARE BROKEN PRIOR TO INSTALLATION SHALL BE REPLACED. COMPOST LOGS SHOULD BE STAKED 10' ON CENTER.

SEDIMENT CONTROL LOG MAINTENANCE NOTES

1. INSPECT BMPs EACH WORKDAY, AND MAINTAIN THEM IN EFFECTIVE OPERATING CONDITION. MAINTENANCE OF BMPs SHOULD BE PROACTIVE, NOT REACTIVE. INSPECT BMPs AS SOON AS POSSIBLE (AND ALWAYS WITHIN 24 HOURS) FOLLOWING A STORM THAT CAUSES SURFACE EROSION, AND PERFORM NECESSARY MAINTENANCE.
2. FREQUENT OBSERVATIONS AND MAINTENANCE ARE NECESSARY TO MAINTAIN BMPs IN EFFECTIVE OPERATING CONDITION. INSPECTIONS AND CORRECTIVE MEASURES SHOULD BE DOCUMENTED THOROUGHLY.
3. WHERE BMPs HAVE FAILED, REPAIR OR REPLACEMENT SHOULD BE INITIATED UPON DISCOVERY OF THE FAILURE.
4. SEDIMENT ACCUMULATED UPSTREAM OF SEDIMENT CONTROL LOG SHALL BE REMOVED AS NEEDED TO MAINTAIN FUNCTIONALITY OF THE BMP, TYPICALLY WHEN DEPTH OF ACCUMULATED SEDIMENTS IS APPROXIMATELY $\frac{1}{2}$ OF THE HEIGHT OF THE SEDIMENT CONTROL LOG.
5. SEDIMENT CONTROL LOG SHALL BE REMOVED AT THE END OF CONSTRUCTION. COMPOST FROM COMPOST LOGS MAY BE LEFT IN PLACE AS LONG AS BAGS ARE REMOVED AND THE AREA SEEDED. IF DISTURBED AREAS EXIST AFTER REMOVAL, THEY SHALL BE COVERED WITH TOP SOIL, SEEDED AND MULCHED OR OTHERWISE STABILIZED IN A MANNER APPROVED BY THE LOCAL JURISDICTION.

(DETAILS ADAPTED FROM TOWN OF PARKER, COLORADO, JEFFERSON COUNTY, COLORADO, DOUGLAS COUNTY, COLORADO, AND CITY OF AURORA, COLORADO, NOT AVAILABLE IN AUTOCAD)

NOTE: MANY JURISDICTIONS HAVE BMP DETAILS THAT VARY FROM UDFCD STANDARD DETAILS. CONSULT WITH LOCAL JURISDICTIONS AS TO WHICH DETAIL SHOULD BE USED WHEN DIFFERENCES ARE NOTED.

Description

Concrete waste management involves designating and properly managing a specific area of the construction site as a concrete washout area. A concrete washout area can be created using one of several approaches designed to receive wash water from washing of tools and concrete mixer chutes, liquid concrete waste from dump trucks, mobile batch mixers, or pump trucks. Three basic approaches are available: excavation of a pit in the ground, use of an above ground storage area, or use of prefabricated haul-away concrete washout containers. Surface discharges of concrete washout water from construction sites are prohibited.



Photograph CWA-1. Example of concrete washout area. Note gravel tracking pad for access and sign.

Appropriate Uses

Concrete washout areas must be designated on all sites that will generate concrete wash water or liquid concrete waste from onsite concrete mixing or concrete delivery.

Because pH is a pollutant of concern for washout activities, when unlined pits are used for concrete washout, the soil must have adequate buffering capacity to result in protection of state groundwater standards; otherwise, a liner/containment must be used. The following management practices are recommended to prevent an impact from unlined pits to groundwater:

- The use of the washout site should be temporary (less than 1 year), and
- The washout site should be not be located in an area where shallow groundwater may be present, such as near natural drainages, springs, or wetlands.

Design and Installation

Concrete washout activities must be conducted in a manner that does not contribute pollutants to surface waters or stormwater runoff. Concrete washout areas may be lined or unlined excavated pits in the ground, commercially manufactured prefabricated washout containers, or aboveground holding areas constructed of berms, sandbags or straw bales with a plastic liner.

Although unlined washout areas may be used, lined pits may be required to protect groundwater under certain conditions.

Do not locate an unlined washout area within 400 feet of any natural drainage pathway or waterbody or within 1,000 feet of any wells or drinking water sources. Even for lined concrete washouts, it is advisable to locate the facility away from waterbodies and drainage paths. If site constraints make these

| Concrete Washout Area | |
|--------------------------|-----|
| Functions | |
| Erosion Control | No |
| Sediment Control | No |
| Site/Material Management | Yes |

setbacks infeasible or if highly permeable soils exist in the area, then the pit must be installed with an impermeable liner (16 mil minimum thickness) or surface storage alternatives using prefabricated concrete washout devices or a lined aboveground storage area should be used.

Design details with notes are provided in Detail CWA-1 for pits and CWA-2 for aboveground storage areas. Pre-fabricated concrete washout container information can be obtained from vendors.

Maintenance and Removal

A key consideration for concrete washout areas is to ensure that adequate signage is in place identifying the location of the washout area. Part of inspecting and maintaining washout areas is ensuring that adequate signage is provided and in good repair and that the washout area is being used, as opposed to washout in non-designated areas of the site.

Remove concrete waste in the washout area, as needed to maintain BMP function (typically when filled to about two-thirds of its capacity). Collect concrete waste and deliver offsite to a designated disposal location.

Upon termination of use of the washout site, accumulated solid waste, including concrete waste and any contaminated soils, must be removed from the site to prevent on-site disposal of solid waste. If the wash water is allowed to evaporate and the concrete hardens, it may be recycled.



Photograph CWA-2. Prefabricated concrete washout. Photo courtesy of CDOT.



Photograph CWA-3. Earthen concrete washout. Photo courtesy of CDOT.

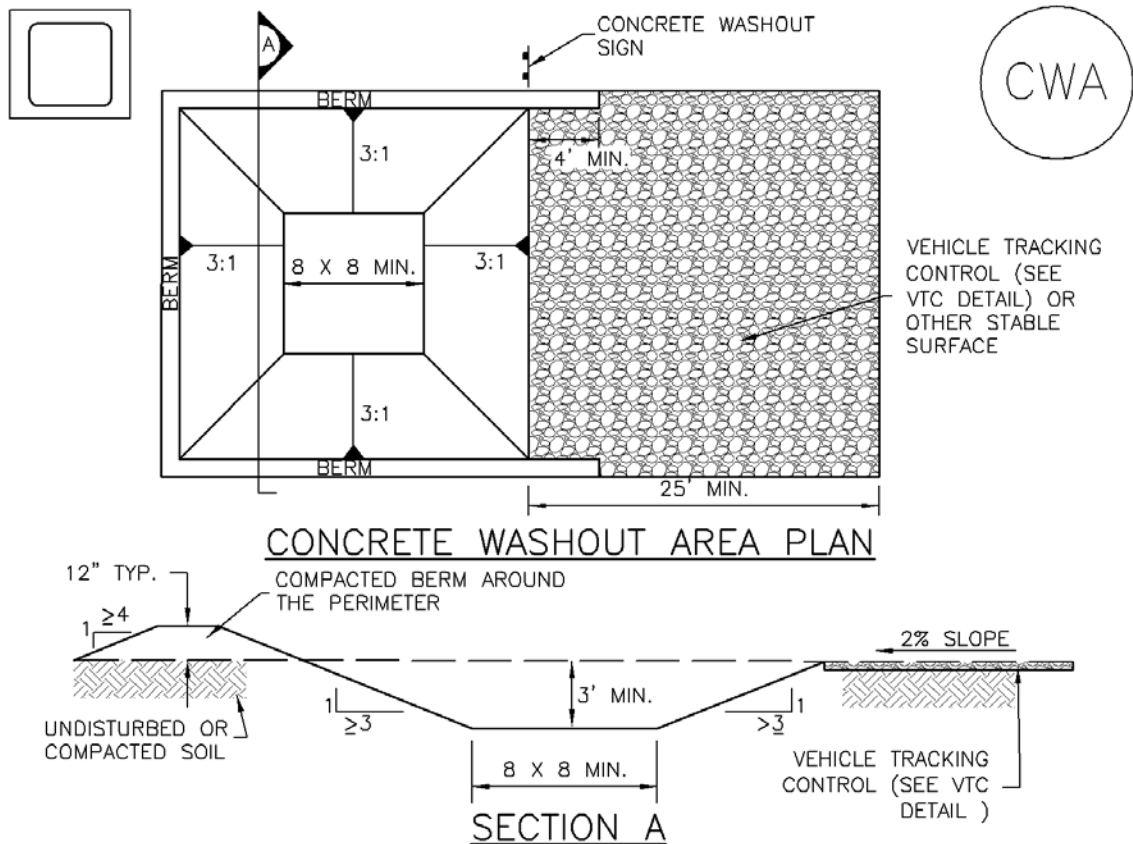

CWA-1. CONCRETE WASHOUT AREA

CWA INSTALLATION NOTES

1. SEE PLAN VIEW FOR:
-CWA INSTALLATION LOCATION.
2. DO NOT LOCATE AN UNLINED CWA WITHIN 400' OF ANY NATURAL DRAINAGE PATHWAY OR WATERBODY. DO NOT LOCATE WITHIN 1,000' OF ANY WELLS OR DRINKING WATER SOURCES. IF SITE CONSTRAINTS MAKE THIS INFEASIBLE, OR IF HIGHLY PERMEABLE SOILS EXIST ON SITE, THE CWA MUST BE INSTALLED WITH AN IMPERMEABLE LINER (16 MIL MIN. THICKNESS) OR SURFACE STORAGE ALTERNATIVES USING PREFABRICATED CONCRETE WASHOUT DEVICES OR A LINED ABOVE GROUND STORAGE ARE SHOULD BE USED.
3. THE CWA SHALL BE INSTALLED PRIOR TO CONCRETE PLACEMENT ON SITE.
4. CWA SHALL INCLUDE A FLAT SUBSURFACE PIT THAT IS AT LEAST 8' BY 8' SLOPES LEADING OUT OF THE SUBSURFACE PIT SHALL BE 3:1 OR FLATTER. THE PIT SHALL BE AT LEAST 3' DEEP.
5. BERM SURROUNDING SIDES AND BACK OF THE CWA SHALL HAVE MINIMUM HEIGHT OF 1'.
6. VEHICLE TRACKING PAD SHALL BE SLOPED 2% TOWARDS THE CWA.
7. SIGNS SHALL BE PLACED AT THE CONSTRUCTION ENTRANCE, AT THE CWA, AND ELSEWHERE AS NECESSARY TO CLEARLY INDICATE THE LOCATION OF THE CWA TO OPERATORS OF CONCRETE TRUCKS AND PUMP RIGS.
8. USE EXCAVATED MATERIAL FOR PERIMETER BERM CONSTRUCTION.

CWA MAINTENANCE NOTES

1. INSPECT BMPs EACH WORKDAY, AND MAINTAIN THEM IN EFFECTIVE OPERATING CONDITION. MAINTENANCE OF BMPs SHOULD BE PROACTIVE, NOT REACTIVE. INSPECT BMPs AS SOON AS POSSIBLE (AND ALWAYS WITHIN 24 HOURS) FOLLOWING A STORM THAT CAUSES SURFACE EROSION, AND PERFORM NECESSARY MAINTENANCE.
2. FREQUENT OBSERVATIONS AND MAINTENANCE ARE NECESSARY TO MAINTAIN BMPs IN EFFECTIVE OPERATING CONDITION. INSPECTIONS AND CORRECTIVE MEASURES SHOULD BE DOCUMENTED THOROUGHLY.
3. WHERE BMPs HAVE FAILED, REPAIR OR REPLACEMENT SHOULD BE INITIATED UPON DISCOVERY OF THE FAILURE.
4. THE CWA SHALL BE REPAIRED, CLEANED, OR ENLARGED AS NECESSARY TO MAINTAIN CAPACITY FOR CONCRETE WASTE. CONCRETE MATERIALS, ACCUMULATED IN PIT, SHALL BE REMOVED ONCE THE MATERIALS HAVE REACHED A DEPTH OF 2'.
5. CONCRETE WASHOUT WATER, WASTED PIECES OF CONCRETE AND ALL OTHER DEBRIS IN THE SUBSURFACE PIT SHALL BE TRANSPORTED FROM THE JOB SITE IN A WATER-TIGHT CONTAINER AND DISPOSED OF PROPERLY.
6. THE CWA SHALL REMAIN IN PLACE UNTIL ALL CONCRETE FOR THE PROJECT IS PLACED.
7. WHEN THE CWA IS REMOVED, COVER THE DISTURBED AREA WITH TOP SOIL, SEED AND MULCH OR OTHERWISE STABILIZED IN A MANNER APPROVED BY THE LOCAL JURISDICTION.

(DETAIL ADAPTED FROM DOUGLAS COUNTY, COLORADO AND THE CITY OF PARKER, COLORADO, NOT AVAILABLE IN AUTOCAD).

NOTE: MANY JURISDICTIONS HAVE BMP DETAILS THAT VARY FROM UDFCD STANDARD DETAILS. CONSULT WITH LOCAL JURISDICTIONS AS TO WHICH DETAIL SHOULD BE USED WHEN DIFFERENCES ARE NOTED.

Description

A sediment basin is a temporary pond built on a construction site to capture eroded or disturbed soil transported in storm runoff prior to discharge from the site. Sediment basins are designed to capture site runoff and slowly release it to allow time for settling of sediment prior to discharge. Sediment basins are often constructed in locations that will later be modified to serve as post-construction stormwater basins.



Photograph SB-1. Sediment basin at the toe of a slope. Photo courtesy of WWE.

Appropriate Uses

Most large construction sites (typically greater than 2 acres) will require one or more sediment basins for effective management of construction site runoff. On linear construction projects, sediment basins may be impractical; instead, sediment traps or other combinations of BMPs may be more appropriate.

Sediment basins should not be used as stand-alone sediment controls. Erosion and other sediment controls should also be implemented upstream.

When feasible, the sediment basin should be installed in the same location where a permanent post-construction detention pond will be located.

Design and Installation

The design procedure for a sediment basin includes these steps:

- **Basin Storage Volume:** Provide a storage volume of at least 3,600 cubic feet per acre of drainage area. To the extent practical, undisturbed and/or off-site areas should be diverted around sediment basins to prevent “clean” runoff from mixing with runoff from disturbed areas. For undisturbed areas (both on-site and off-site) that cannot be diverted around the sediment basin, provide a minimum of 500 ft³/acre of storage for undeveloped (but stable) off-site areas in addition to the 3,600 ft³/acre for disturbed areas. For stable, developed areas that cannot be diverted around the sediment basin, storage volume requirements are summarized in Table SB-1.
- **Basin Geometry:** Design basin with a minimum length-to-width ratio of 2:1 (L:W). If this cannot be achieved because of site space constraints, baffling may be required to extend the effective distance between the inflow point(s) and the outlet to minimize short-circuiting.
- **Dam Embankment:** It is recommended that embankment slopes be 4:1 (H:V) or flatter and no steeper than 3:1 (H:V) in any location.

| Sediment Basins | |
|--------------------------|-----|
| Functions | |
| Erosion Control | No |
| Sediment Control | Yes |
| Site/Material Management | No |

- **Inflow Structure:** For concentrated flow entering the basin, provide energy dissipation at the point of inflow.

Table SB-1. Additional Volume Requirements for Undisturbed and Developed Tributary Areas Draining through Sediment Basins

| Imperviousness (%) | Additional Storage Volume (ft³) Per Acre of Tributary Area |
|---------------------------|--|
| Undeveloped | 500 |
| 10 | 800 |
| 20 | 1230 |
| 30 | 1600 |
| 40 | 2030 |
| 50 | 2470 |
| 60 | 2980 |
| 70 | 3560 |
| 80 | 4360 |
| 90 | 5300 |
| 100 | 6460 |

- **Outlet Works:** The outlet pipe shall extend through the embankment at a minimum slope of 0.5 percent. Outlet works can be designed using one of the following approaches:
 - **Riser Pipe (Simplified Detail):** Detail SB-1 provides a simplified design for basins treating no more than 15 acres.
 - **Orifice Plate or Riser Pipe:** Follow the design criteria for Full Spectrum Detention outlets in the EDB Fact Sheet provided in Chapter 4 of this manual for sizing of outlet perforations with an emptying time of approximately 72 hours. In lieu of the trash rack, pack uniformly sized 1½ - to 2-inch gravel in front of the plate or surrounding the riser pipe. This gravel will need to be cleaned out frequently during the construction period as sediment accumulates within it. The gravel pack will need to be removed and disposed of following construction to reclaim the basin for use as a permanent detention facility. If the basin will be used as a permanent extended detention basin for the site, a trash rack will need to be installed once contributing drainage areas have been stabilized and the gravel pack and accumulated sediment have been removed.
 - **Floating Skimmer:** If a floating skimmer is used, install it using manufacturer's recommendations. Illustration SB-1 provides an illustration of a Faircloth Skimmer Floating Outlet™, one of the more commonly used floating skimmer outlets. A skimmer should be designed to release the design volume in no less than 48 hours. The use of a floating skimmer outlet can increase the sediment capture efficiency of a basin significantly. A floating outlet continually decants cleanest water off the surface of the pond and releases cleaner water than would discharge from a perforated riser pipe or plate.

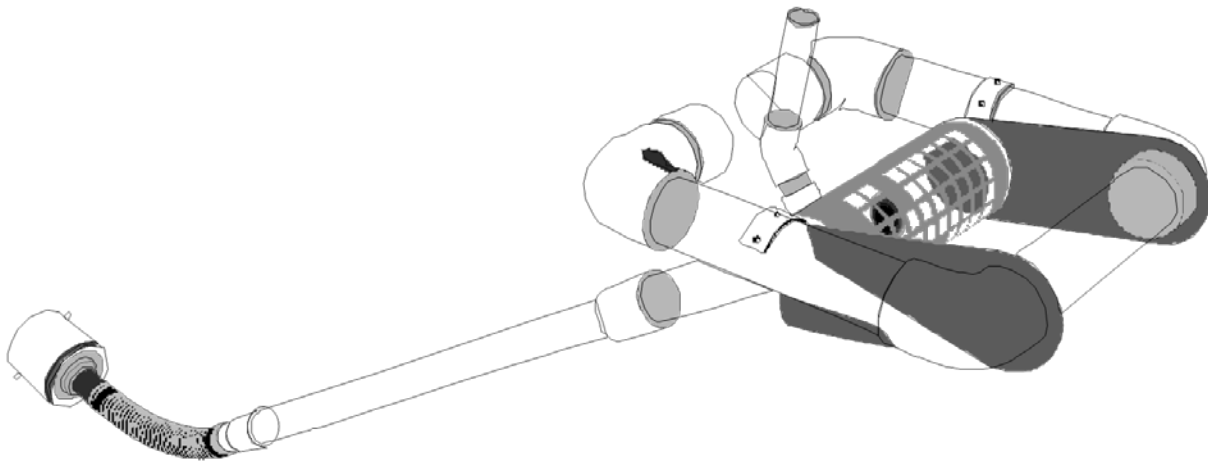

Illustration SB-1. Outlet structure for a temporary sediment basin - Faircloth Skimmer Floating Outlet. Illustration courtesy of J. W. Faircloth & Sons, Inc., FairclothSkimmer.com.

- **Outlet Protection and Spillway:** Consider all flow paths for runoff leaving the basin, including protection at the typical point of discharge as well as overtopping.
 - **Outlet Protection:** Outlet protection should be provided where the velocity of flow will exceed the maximum permissible velocity of the material of the waterway into which discharge occurs. This may require the use of a riprap apron at the outlet location and/or other measures to keep the waterway from eroding.
 - **Emergency Spillway:** Provide a stabilized emergency overflow spillway for rainstorms that exceed the capacity of the sediment basin volume and its outlet. Protect basin embankments from erosion and overtopping. If the sediment basin will be converted to a permanent detention basin, design and construct the emergency spillway(s) as required for the permanent facility. If the sediment basin will not become a permanent detention basin, it may be possible to substitute a heavy polyvinyl membrane or properly bedded rock cover to line the spillway and downstream embankment, depending on the height, slope, and width of the embankments.

Maintenance and Removal

Maintenance activities include the following:

- Dredge sediment from the basin, as needed to maintain BMP effectiveness, typically when the design storage volume is no more than one-third filled with sediment.
- Inspect the sediment basin embankments for stability and seepage.
- Inspect the inlet and outlet of the basin, repair damage, and remove debris. Remove, clean and replace the gravel around the outlet on a regular basis to remove the accumulated sediment within it and keep the outlet functioning.
- Be aware that removal of a sediment basin may require dewatering and associated permit requirements.
- Do not remove a sediment basin until the upstream area has been stabilized with vegetation.

Final disposition of the sediment basin depends on whether the basin will be converted to a permanent post-construction stormwater basin or whether the basin area will be returned to grade. For basins being converted to permanent detention basins, remove accumulated sediment and reconfigure the basin and outlet to meet the requirements of the final design for the detention facility. If the sediment basin is not to be used as a permanent detention facility, fill the excavated area with soil and stabilize with vegetation.

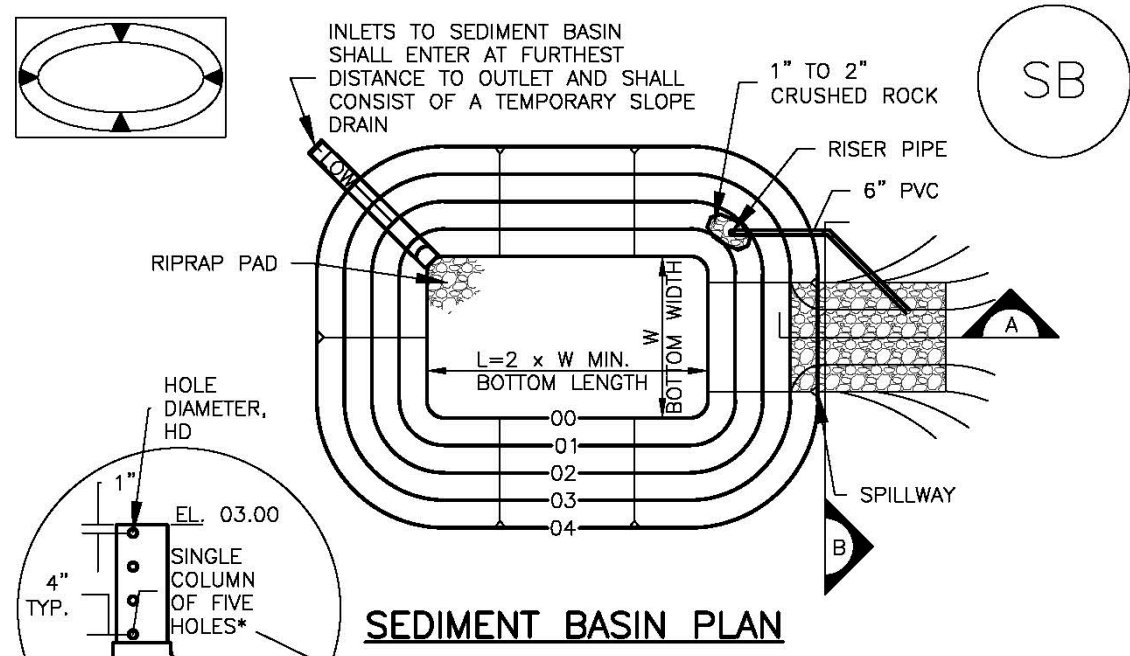

*EXCEPT WHERE THE HOLES EXCEED 1" DIAMETER, THEN UP TO TWO COLUMNS OF SAME SIZED HOLES MAY BE USED

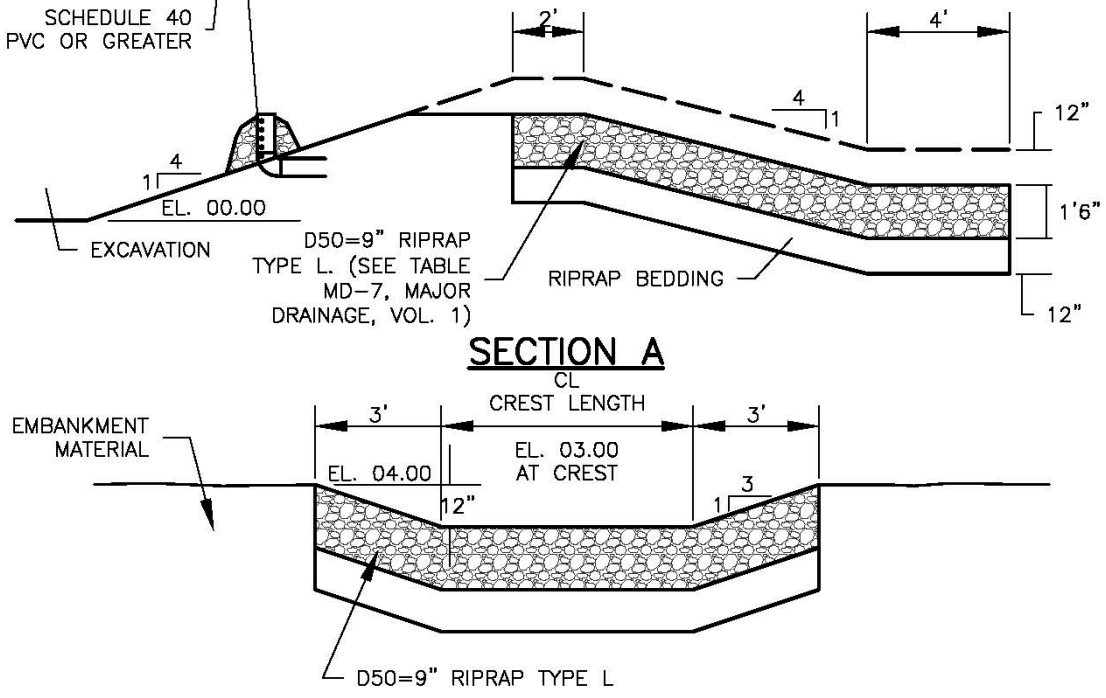

| TABLE SB-1. SIZING INFORMATION FOR STANDARD SEDIMENT BASIN | | | |
|--|------------------------------|----------------------------------|--------------------------|
| Upstream Drainage Area (rounded to nearest acre), (ac) | Basin Bottom Width (W), (ft) | Spillway Crest Length (CL), (ft) | Hole Diameter (HD), (in) |
| 1 | 12 1/2 | 2 | 9/32 |
| 2 | 21 | 3 | 13/16 |
| 3 | 28 | 5 | 1/2 |
| 4 | 33 1/2 | 6 | 9/16 |
| 5 | 38 1/2 | 8 | 2 1/32 |
| 6 | 43 | 9 | 2 1/32 |
| 7 | 47 1/4 | 11 | 2 5/32 |
| 8 | 51 | 12 | 2 7/32 |
| 9 | 55 | 13 | 7/8 |
| 10 | 58 1/4 | 15 | 1 5/16 |
| 11 | 61 | 16 | 3 1/32 |
| 12 | 64 | 18 | 1 |
| 13 | 67 1/2 | 19 | 1 1/16 |
| 14 | 70 1/2 | 21 | 1 1/8 |
| 15 | 73 1/4 | 22 | 1 3/16 |

SEDIMENT BASIN INSTALLATION NOTES

1. SEE PLAN VIEW FOR:
 - LOCATION OF SEDIMENT BASIN.
 - TYPE OF BASIN (STANDARD BASIN OR NONSTANDARD BASIN).
 - FOR STANDARD BASIN, BOTTOM WIDTH W, CREST LENGTH CL, AND HOLE DIAMETER, HD.
 - FOR NONSTANDARD BASIN, SEE CONSTRUCTION DRAWINGS FOR DESIGN OF BASIN INCLUDING RISER HEIGHT H, NUMBER OF COLUMNS N, HOLE DIAMETER HD AND PIPE DIAMETER D.
2. FOR STANDARD BASIN, BOTTOM DIMENSION MAY BE MODIFIED AS LONG AS BOTTOM AREA IS NOT REDUCED.
3. SEDIMENT BASINS SHALL BE INSTALLED PRIOR TO ANY OTHER LAND-DISTURBING ACTIVITY THAT RELIES ON ON BASINS AS AS A STORMWATER CONTROL.
4. EMBANKMENT MATERIAL SHALL CONSIST OF SOIL FREE OF DEBRIS, ORGANIC MATERIAL, AND ROCKS OR CONCRETE GREATER THAN 3 INCHES AND SHALL HAVE A MINIMUM OF 15 PERCENT BY WEIGHT PASSING THE NO. 200 SIEVE.
5. EMBANKMENT MATERIAL SHALL BE COMPACTED TO AT LEAST 95 PERCENT OF MAXIMUM DENSITY IN ACCORDANCE WITH ASTM D698.
6. PIPE SCH 40 OR GREATER SHALL BE USED.
7. THE DETAILS SHOWN ON THESE SHEETS PERTAIN TO STANDARD SEDIMENT BASIN(S) FOR DRAINAGE AREAS LESS THAN 15 ACRES. SEE CONSTRUCTION DRAWINGS FOR EMBANKMENT, STORAGE VOLUME, SPILLWAY, OUTLET, AND OUTLET PROTECTION DETAILS FOR ANY SEDIMENT BASIN(S) THAT HAVE BEEN INDIVIDUALLY DESIGNED FOR DRAINAGE AREAS LARGER THAN 15 ACRES.

SEDIMENT BASIN MAINTENANCE NOTES

1. INSPECT BMPs EACH WORKDAY, AND MAINTAIN THEM IN EFFECTIVE OPERATING CONDITION. MAINTENANCE OF BMPs SHOULD BE PROACTIVE, NOT REACTIVE. INSPECT BMPs AS SOON AS POSSIBLE (AND ALWAYS WITHIN 24 HOURS) FOLLOWING A STORM THAT CAUSES SURFACE EROSION, AND PERFORM NECESSARY MAINTENANCE.
2. FREQUENT OBSERVATIONS AND MAINTENANCE ARE NECESSARY TO MAINTAIN BMPs IN EFFECTIVE OPERATING CONDITION. INSPECTIONS AND CORRECTIVE MEASURES SHOULD BE DOCUMENTED THOROUGHLY.
3. WHERE BMPs HAVE FAILED, REPAIR OR REPLACEMENT SHOULD BE INITIATED UPON DISCOVERY OF THE FAILURE.
4. SEDIMENT ACCUMULATED IN BASIN SHALL BE REMOVED AS NEEDED TO MAINTAIN BMP EFFECTIVENESS, TYPICALLY WHEN SEDIMENT DEPTH REACHES ONE FOOT (I.E., TWO FEET BELOW THE SPILLWAY CREST).
5. SEDIMENT BASINS ARE TO REMAIN IN PLACE UNTIL THE UPSTREAM DISTURBED AREA IS STABILIZED AND GRASS COVER IS ACCEPTED BY THE LOCAL JURISDICTION.
6. WHEN SEDIMENT BASINS ARE REMOVED, ALL DISTURBED AREAS SHALL BE COVERED WITH TOPSOIL, SEEDED AND MULCHED OR OTHERWISE STABILIZED AS APPROVED BY LOCAL JURISDICTION.

(DETAILS ADAPTED FROM DOUGLAS COUNTY, COLORADO)

NOTE: MANY JURISDICTIONS HAVE BMP DETAILS THAT VARY FROM UDFCD STANDARD DETAILS. CONSULT WITH LOCAL JURISDICTIONS AS TO WHICH DETAIL SHOULD BE USED WHEN DIFFERENCES ARE NOTED.

Description

Check dams are temporary grade control structures placed in drainage channels to limit the erosivity of stormwater by reducing flow velocity. Check dams are typically constructed from rock, gravel bags, sand bags, or sometimes, proprietary devices. Reinforced check dams are typically constructed from rock and wire gabion. Although the primary function of check dams is to reduce the velocity of concentrated flows, a secondary benefit is sediment trapping upstream of the structure.



Photograph CD-1. Rock check dams in a roadside ditch. Photo courtesy of WWE.

Appropriate Uses

Use as a grade control for temporary drainage ditches or swales until final soil stabilization measures are established upstream and downstream. Check dams can be used on mild or moderately steep slopes. Check dams may be used under the following conditions:

- As temporary grade control facilities along waterways until final stabilization is established.
- Along permanent swales that need protection prior to installation of a non-erodible lining.
- Along temporary channels, ditches or swales that need protection where construction of a non-erodible lining is not practicable.
- Reinforced check dams should be used in areas subject to high flow velocities.

Design and Installation

Place check dams at regularly spaced intervals along the drainage swale or ditch. Check dams heights should allow for pools to develop upstream of each check dam, extending to the downstream toe of the check dam immediately upstream.

When rock is used for the check dam, place rock mechanically or by hand. Do not dump rocks into the drainage channel. Where multiple check dams are used, the top of the lower dam should be at the same elevation as the toe of the upper dam.

When reinforced check dams are used, install erosion control fabric under and around the check dam to prevent erosion on the upstream and downstream sides. Each section of the dam should be keyed in to reduce the potential for washout or undermining. A rock apron upstream and downstream of the dam may be necessary to further control erosion.

| Check Dams | |
|--------------------------|----------|
| Functions | |
| Erosion Control | Yes |
| Sediment Control | Moderate |
| Site/Material Management | No |

Design details with notes are provided for the following types of check dams:

- Rock Check Dams (CD-1)
- Reinforced Check Dams (CD-2)

Sediment control logs may also be used as check dams; however, silt fence is not appropriate for use as a check dam. Many jurisdictions also prohibit or discourage use of straw bales for this purpose.

Maintenance and Removal

Replace missing rocks causing voids in the check dam. If gravel bags or sandbags are used, replace or repair torn or displaced bags.

Remove accumulated sediment, as needed to maintain BMP effectiveness, typically before the sediment depth upstream of the check dam is within $\frac{1}{2}$ of the crest height. Remove accumulated sediment prior to mulching, seeding, or chemical soil stabilization. Removed sediment can be incorporated into the earthwork with approval from the Project Engineer, or disposed of at an alternate location in accordance with the standard specifications.

Check dams constructed in permanent swales should be removed when perennial grasses have become established, or immediately prior to installation of a non-erodible lining. All of the rock and accumulated sediment should be removed, and the area seeded and mulched, or otherwise stabilized.

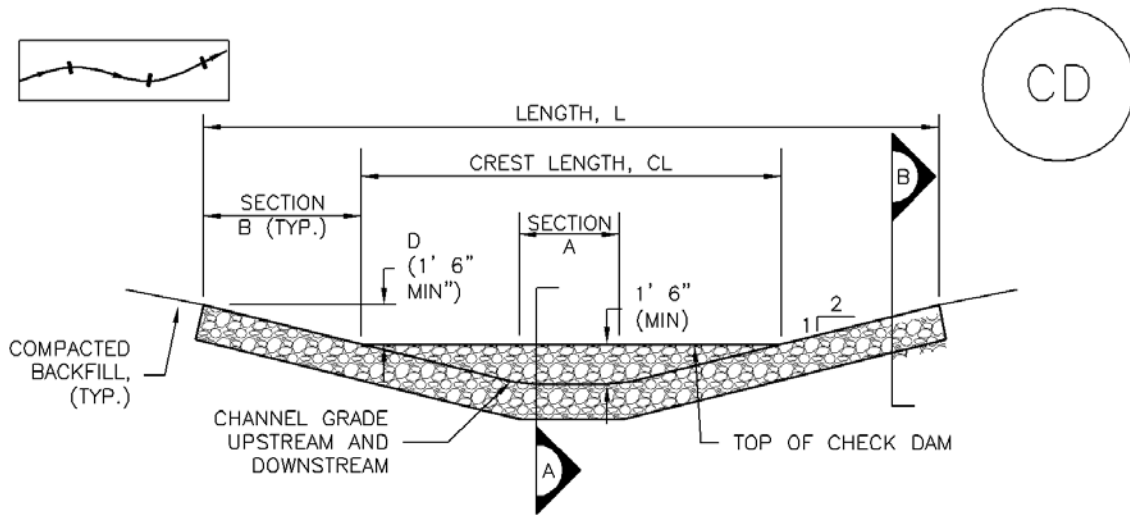

CHECK DAM ELEVATION VIEW

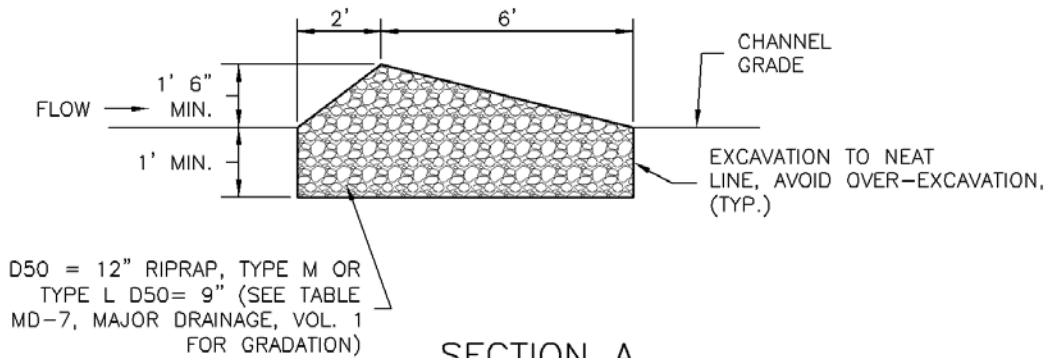

SECTION A

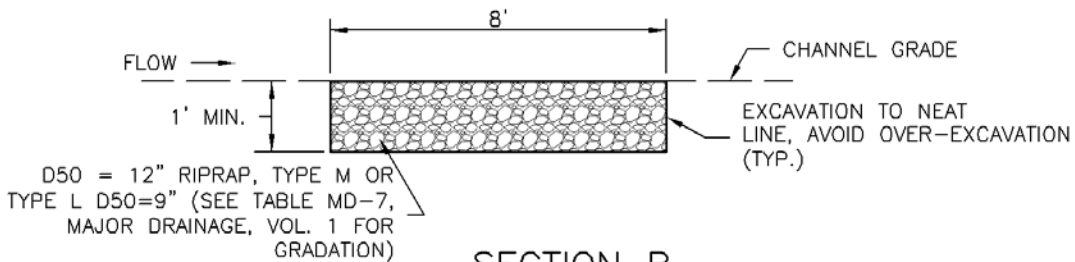

SECTION B

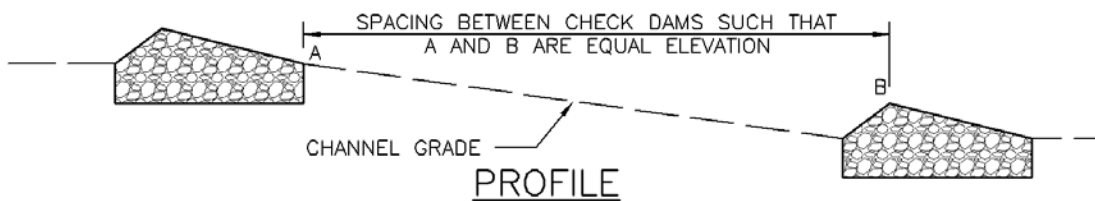

PROFILE

CD-1. CHECK DAM

CHECK DAM INSTALLATION NOTES

1. SEE PLAN VIEW FOR:
 - LOCATION OF CHECK DAMS.
 - CHECK DAM TYPE (CHECK DAM OR REINFORCED CHECK DAM).
 - LENGTH (L), CREST LENGTH (CL), AND DEPTH (D).
2. CHECK DAMS INDICATED ON INITIAL SWMP SHALL BE INSTALLED AFTER CONSTRUCTION FENCE, BUT PRIOR TO ANY UPSTREAM LAND DISTURBING ACTIVITIES.
3. RIPRAP UTILIZED FOR CHECK DAMS SHOULD BE OF APPROPRIATE SIZE FOR THE APPLICATION. TYPICAL TYPES OF RIPRAP USED FOR CHECK DAMS ARE TYPE M (D50 12") OR TYPE L (D50 9").
4. RIPRAP PAD SHALL BE TRENCHED INTO THE GROUND A MINIMUM OF 1'.
5. THE ENDS OF THE CHECK DAM SHALL BE A MINIMUM OF 1' 6" HIGHER THAN THE CENTER OF THE CHECK DAM.

CHECK DAM MAINTENANCE NOTES

1. INSPECT BMPs EACH WORKDAY, AND MAINTAIN THEM IN EFFECTIVE OPERATING CONDITION. MAINTENANCE OF BMPs SHOULD BE PROACTIVE, NOT REACTIVE. INSPECT BMPs AS SOON AS POSSIBLE (AND ALWAYS WITHIN 24 HOURS) FOLLOWING A STORM THAT CAUSES SURFACE EROSION, AND PERFORM NECESSARY MAINTENANCE.
2. FREQUENT OBSERVATIONS AND MAINTENANCE ARE NECESSARY TO MAINTAIN BMPs IN EFFECTIVE OPERATING CONDITION. INSPECTIONS AND CORRECTIVE MEASURES SHOULD BE DOCUMENTED THOROUGHLY.
3. WHERE BMPs HAVE FAILED, REPAIR OR REPLACEMENT SHOULD BE INITIATED UPON DISCOVERY OF THE FAILURE.
4. SEDIMENT ACCUMULATED UPSTREAM OF THE CHECK DAMS SHALL BE REMOVED WHEN THE SEDIMENT DEPTH IS WITHIN $\frac{1}{2}$ OF THE HEIGHT OF THE CREST.
5. CHECK DAMS ARE TO REMAIN IN PLACE UNTIL THE UPSTREAM DISTURBED AREA IS STABILIZED AND APPROVED BY THE LOCAL JURISDICTION.
6. WHEN CHECK DAMS ARE REMOVED, EXCAVATIONS SHALL BE FILLED WITH SUITABLE COMPACTED BACKFILL. DISTURBED AREA SHALL BE SEEDED AND MULCHED AND COVERED WITH GEOTEXTILE OR OTHERWISE STABILIZED IN A MANNER APPROVED BY THE LOCAL JURISDICTION.

(DETAILS ADAPTED FROM DOUGLAS COUNTY, COLORADO, NOT AVAILABLE IN AUTOCAD)

NOTE: MANY JURISDICTIONS HAVE BMP DETAILS THAT VARY FROM UDFCD STANDARD DETAILS. CONSULT WITH LOCAL JURISDICTIONS AS TO WHICH DETAIL SHOULD BE USED WHEN DIFFERENCES ARE NOTED.

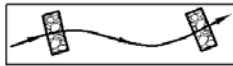

ALTERNATIVE TO STEPS ON BANKS ABOVE CREST:
DEFORM GABIONS AS NECESSARY TO ALIGN TOP OF GABIONS
WITH GROUND SURFACE: AVOID GAPS BETWEEN GABIONS

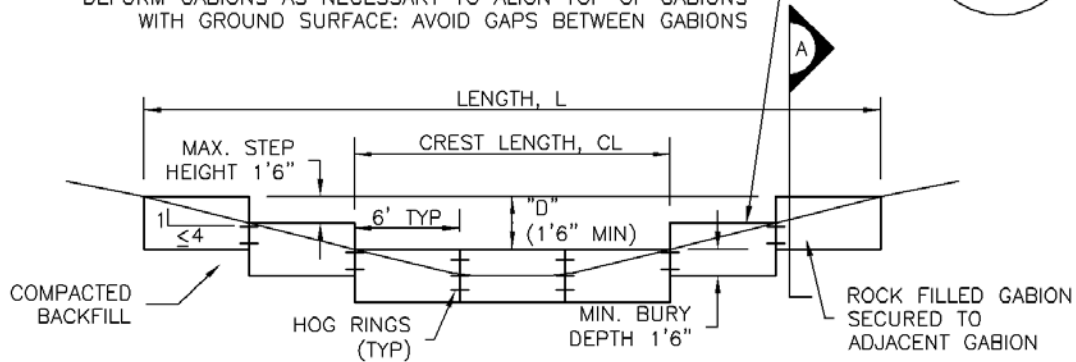

REINFORCED CHECK DAM ELEVATION VIEW

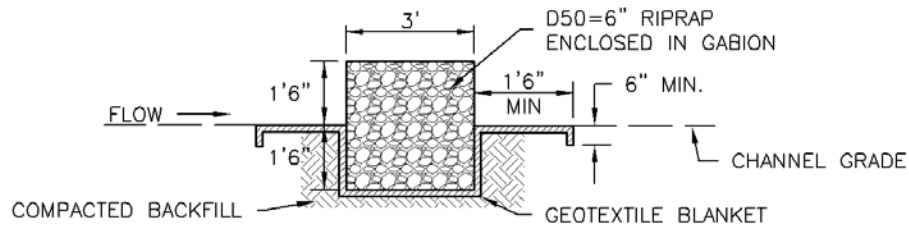

SECTION A

REINFORCED CHECK DAM INSTALLATION NOTES

1. SEE PLAN VIEW FOR:
 - LOCATIONS OF CHECK DAMS.
 - CHECK DAM TYPE (CHECK DAM OR REINFORCED CHECK DAM).
 - LENGTH (L), CREST LENGTH (CL), AND DEPTH (D).
2. CHECK DAMS INDICATED ON THE SWMP SHALL BE INSTALLED PRIOR TO AN UPSTREAM LAND-DISTURBING ACTIVITIES.
3. REINFORCED CHECK DAMS, GABIONS SHALL HAVE GALVANIZED TWISTED WIRE NETTING WITH A MAXIMUM OPENING DIMENSION OF $4\frac{1}{2}$ " AND A MINIMUM WIRE THICKNESS OF 0.10". WIRE "HOG RINGS" AT 4" SPACING OR OTHER APPROVED MEANS SHALL BE USED AT ALL GABION SEAMS AND TO SECURE THE GABION TO THE ADJACENT SECTION.
4. THE CHECK DAM SHALL BE TRENCHED INTO THE GROUND A MINIMUM OF 1' 6".
5. GEOTEXTILE BLANKET SHALL BE PLACED IN THE REINFORCED CHECK DAM TRENCH EXTENDING A MINIMUM OF 1' 6" ON BOTH THE UPSTREAM AND DOWNSTREAM SIDES OF THE REINFORCED CHECK DAM.

CD-2. REINFORCED CHECK DAM

REINFORCED CHECK DAM MAINTENANCE NOTES

1. INSPECT BMPs EACH WORKDAY, AND MAINTAIN THEM IN EFFECTIVE OPERATING CONDITION. MAINTENANCE OF BMPs SHOULD BE PROACTIVE, NOT REACTIVE. INSPECT BMPs AS SOON AS POSSIBLE (AND ALWAYS WITHIN 24 HOURS) FOLLOWING A STORM THAT CAUSES SURFACE EROSION, AND PERFORM NECESSARY MAINTENANCE.
2. FREQUENT OBSERVATIONS AND MAINTENANCE ARE NECESSARY TO MAINTAIN BMPs IN EFFECTIVE OPERATING CONDITION. INSPECTIONS AND CORRECTIVE MEASURES SHOULD BE DOCUMENTED THOROUGHLY.
3. WHERE BMPs HAVE FAILED, REPAIR OR REPLACEMENT SHOULD BE INITIATED UPON DISCOVERY OF THE FAILURE.
4. SEDIMENT ACCUMULATED UPSTREAM OF REINFORCED CHECK DAMS SHALL BE REMOVED AS NEEDED TO MAINTAIN THE EFFECTIVENESS OF BMP, TYPICALLY WHEN THE UPSTREAM SEDIMENT DEPTH IS WITHIN ½ THE HEIGHT OF THE CREST.
5. REPAIR OR REPLACE REINFORCED CHECK DAMS WHEN THERE ARE SIGNS OF DAMAGE SUCH AS HOLES IN THE GABION OR UNDERCUTTING.
6. REINFORCED CHECK DAMS ARE TO REMAIN IN PLACE UNTIL THE UPSTREAM DISTURBED AREA IS STABILIZED AND APPROVED BY THE LOCAL JURISDICTION.
7. WHEN REINFORCED CHECK DAMS ARE REMOVED, ALL DISTURBED AREAS SHALL BE COVERED WITH TOPSOIL, SEEDED AND MULCHED, AND COVERED WITH A GEOTEXTILE BLANKET, OR OTHERWISE STABILIZED AS APPROVED BY LOCAL JURISDICTION.

(DETAIL ADAPTED FROM DOUGLAS COUNTY, COLORADO AND CITY OF AURORA, COLORADO, NOT AVAILABLE IN AUTOCAD)

NOTE: MANY JURISDICTIONS HAVE BMP DETAILS THAT VARY FROM UDFCD STANDARD DETAILS. CONSULT WITH LOCAL JURISDICTIONS AS TO WHICH DETAIL SHOULD BE USED WHEN DIFFERENCES ARE NOTED.

Description

Stockpile management includes measures to minimize erosion and sediment transport from soil stockpiles.

Appropriate Uses

Stockpile management should be used when soils or other erodible materials are stored at the construction site. Special attention should be given to stockpiles in close proximity to natural or manmade storm systems.



Photograph SP-1. A topsoil stockpile that has been partially revegetated and is protected by silt fence perimeter control.

Design and Installation

Locate stockpiles away from all drainage system components including storm sewer inlets. Where practical, choose stockpile locations that that will remain undisturbed for the longest period of time as the phases of construction progress. Place sediment control BMPs around the perimeter of the stockpile, such as sediment control logs, rock socks, silt fence, straw bales and sand bags. See Detail SP-1 for guidance on proper establishment of perimeter controls around a stockpile. For stockpiles in active use, provide a stabilized designated access point on the upgradient side of the stockpile.

Stabilize the stockpile surface with surface roughening, temporary seeding and mulching, erosion control blankets, or soil binders. Soils stockpiled for an extended period (typically for more than 60 days) should be seeded and mulched with a temporary grass cover once the stockpile is placed (typically within 14 days). Use of mulch only or a soil binder is acceptable if the stockpile will be in place for a more limited time period (typically 30-60 days). Timeframes for stabilization of stockpiles noted in this fact sheet are "typical" guidelines. Check permit requirements for specific federal, state, and/or local requirements that may be more prescriptive.

Stockpiles should not be placed in streets or paved areas unless no other practical alternative exists. See the Stabilized Staging Area Fact Sheet for guidance when staging in roadways is unavoidable due to space or right-of-way constraints. For paved areas, rock socks must be used for perimeter control and all inlets with the potential to receive sediment from the stockpile (even from vehicle tracking) must be protected.

Maintenance and Removal

Inspect perimeter controls and inlet protection in accordance with their respective BMP Fact Sheets. Where seeding, mulch and/or soil binders are used, reseeding or reapplication of soil binder may be necessary.

When temporary removal of a perimeter BMP is necessary to access a stockpile, ensure BMPs are reinstalled in accordance with their respective design detail section.

| Stockpile Management | |
|--------------------------|-----|
| Functions | |
| Erosion Control | Yes |
| Sediment Control | Yes |
| Site/Material Management | Yes |

When the stockpile is no longer needed, properly dispose of excess materials and revegetate or otherwise stabilize the ground surface where the stockpile was located.

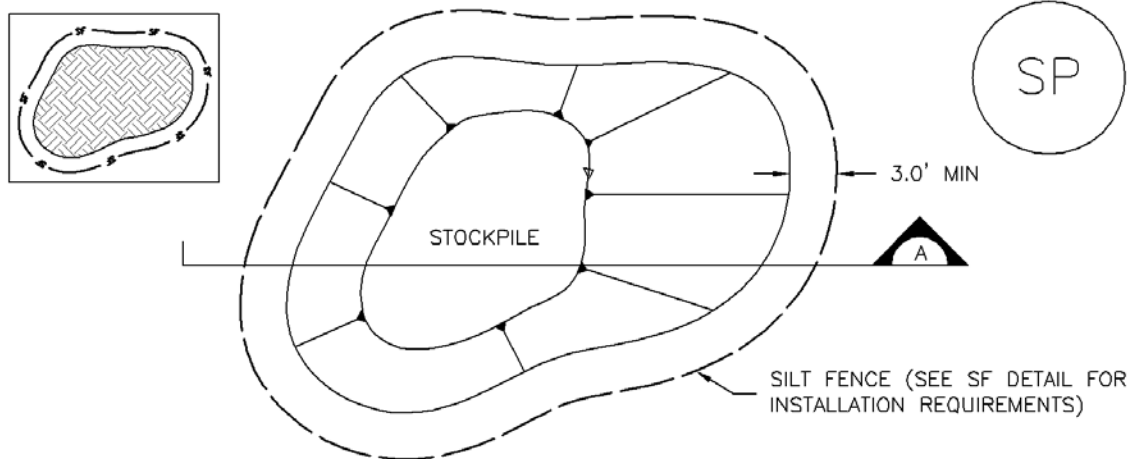

STOCKPILE PROTECTION PLAN

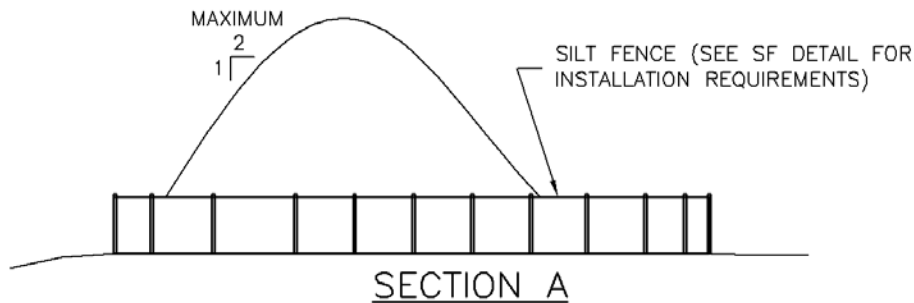

SP-1. STOCKPILE PROTECTION

STOCKPILE PROTECTION INSTALLATION NOTES

1. SEE PLAN VIEW FOR:
 - LOCATION OF STOCKPILES.
 - TYPE OF STOCKPILE PROTECTION.
2. INSTALL PERIMETER CONTROLS IN ACCORDANCE WITH THEIR RESPECTIVE DESIGN DETAILS. SILT FENCE IS SHOWN IN THE STOCKPILE PROTECTION DETAILS; HOWEVER, OTHER TYPES OF PERIMETER CONTROLS INCLUDING SEDIMENT CONTROL LOGS OR ROCK SOCKS MAY BE SUITABLE IN SOME CIRCUMSTANCES. CONSIDERATIONS FOR DETERMINING THE APPROPRIATE TYPE OF PERIMETER CONTROL FOR A STOCKPILE INCLUDE WHETHER THE STOCKPILE IS LOCATED ON A PERVIOUS OR IMPERVIOUS SURFACE, THE RELATIVE HEIGHTS OF THE PERIMETER CONTROL AND STOCKPILE, THE ABILITY OF THE PERIMETER CONTROL TO CONTAIN THE STOCKPILE WITHOUT FAILING IN THE EVENT THAT MATERIAL FROM THE STOCKPILE SHIFTS OR SLUMPS AGAINST THE PERIMETER, AND OTHER FACTORS.
3. STABILIZE THE STOCKPILE SURFACE WITH SURFACE ROUGHENING, TEMPORARY SEEDING AND MULCHING, EROSION CONTROL BLANKETS, OR SOIL BINDERS. SOILS STOCKPILED FOR AN EXTENDED PERIOD (TYPICALLY FOR MORE THAN 60 DAYS) SHOULD BE SEEDING AND MULCHED WITH A TEMPORARY GRASS COVER ONCE THE STOCKPILE IS PLACED (TYPICALLY WITHIN 14 DAYS). USE OF MULCH ONLY OR A SOIL BINDER IS ACCEPTABLE IF THE STOCKPILE WILL BE IN PLACE FOR A MORE LIMITED TIME PERIOD (TYPICALLY 30-60 DAYS).
4. FOR TEMPORARY STOCKPILES ON THE INTERIOR PORTION OF A CONSTRUCTION SITE, WHERE OTHER DOWNGRADIENT CONTROLS, INCLUDING PERIMETER CONTROL, ARE IN PLACE, STOCKPILE PERIMETER CONTROLS MAY NOT BE REQUIRED.

STOCKPILE PROTECTION MAINTENANCE NOTES

1. INSPECT BMPs EACH WORKDAY, AND MAINTAIN THEM IN EFFECTIVE OPERATING CONDITION. MAINTENANCE OF BMPs SHOULD BE PROACTIVE, NOT REACTIVE. INSPECT BMPs AS SOON AS POSSIBLE (AND ALWAYS WITHIN 24 HOURS) FOLLOWING A STORM THAT CAUSES SURFACE EROSION, AND PERFORM NECESSARY MAINTENANCE.

2. FREQUENT OBSERVATIONS AND MAINTENANCE ARE NECESSARY TO MAINTAIN BMPs IN EFFECTIVE OPERATING CONDITION. INSPECTIONS AND CORRECTIVE MEASURES SHOULD BE DOCUMENTED THOROUGHLY.

3. WHERE BMPs HAVE FAILED, REPAIR OR REPLACEMENT SHOULD BE INITIATED UPON DISCOVERY OF THE FAILURE.

STOCKPILE PROTECTION MAINTENANCE NOTES

4. IF PERIMETER PROTECTION MUST BE MOVED TO ACCESS SOIL STOCKPILE, REPLACE PERIMETER CONTROLS BY THE END OF THE WORKDAY.

5. STOCKPILE PERIMETER CONTROLS CAN BE REMOVED ONCE ALL THE MATERIAL FROM THE STOCKPILE HAS BEEN USED.

(DETAILS ADAPTED FROM PARKER, COLORADO, NOT AVAILABLE IN AUTOCAD)

NOTE: MANY JURISDICTIONS HAVE BMP DETAILS THAT VARY FROM UDFCD STANDARD DETAILS. CONSULT WITH LOCAL JURISDICTIONS AS TO WHICH DETAIL SHOULD BE USED WHEN DIFFERENCES ARE NOTED.

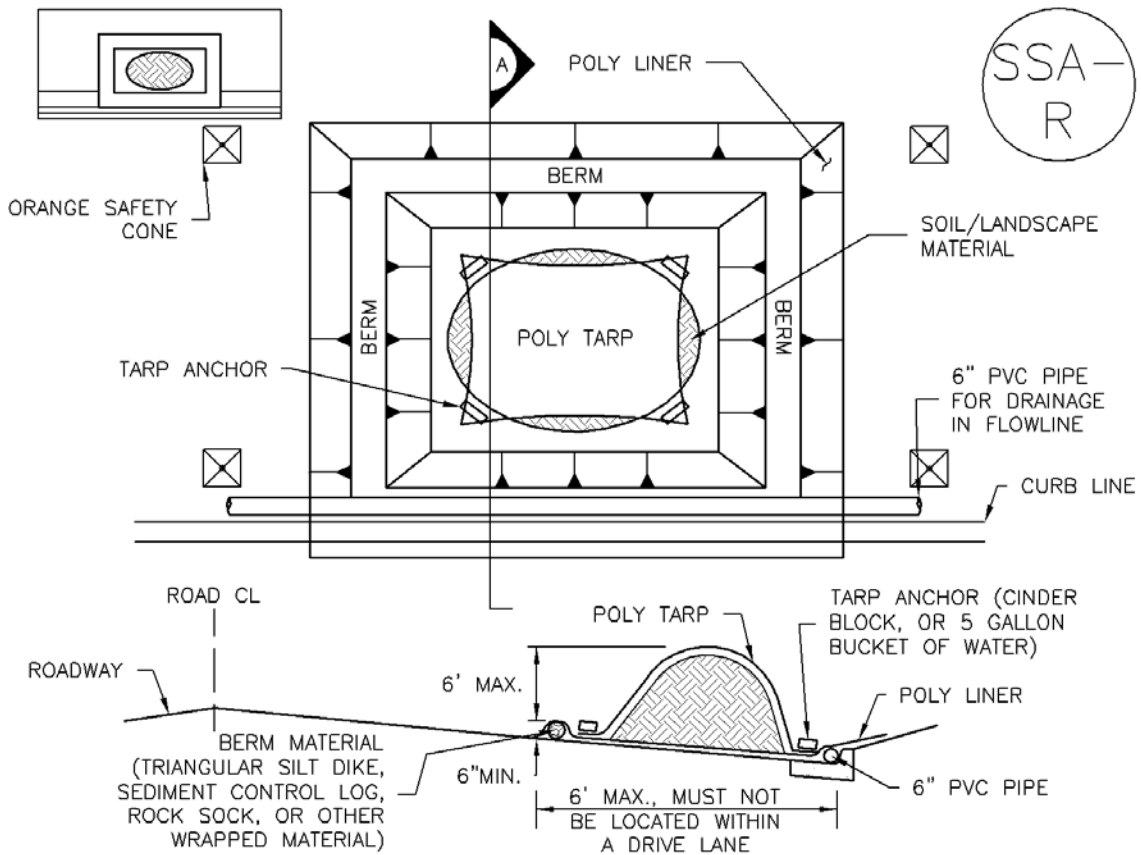

SP-2. MATERIALS STAGING IN ROADWAY

MATERIALS STAGING IN ROADWAYS INSTALLATION NOTES

1. SEE PLAN VIEW FOR
 - LOCATION OF MATERIAL STAGING AREA(S).
 - CONTRACTOR MAY ADJUST LOCATION AND SIZE OF STAGING AREA WITH APPROVAL FROM THE LOCAL JURISDICTION.
2. FEATURE MUST BE INSTALLED PRIOR TO EXCAVATION, EARTHWORK OR DELIVERY OF MATERIALS.
3. MATERIALS MUST BE STATIONED ON THE POLY LINER. ANY INCIDENTAL MATERIALS DEPOSITED ON PAVED SECTION OR ALONG CURB LINE MUST BE CLEANED UP PROMPTLY.
4. POLY LINER AND TARP COVER SHOULD BE OF SIGNIFICANT THICKNESS TO PREVENT DAMAGE OR LOSS OF INTEGRITY.
5. SAND BAGS MAY BE SUBSTITUTED TO ANCHOR THE COVER TARP OR PROVIDE BERMING UNDER THE BASE LINER.
6. FEATURE IS NOT INTENDED FOR USE WITH WET MATERIAL THAT WILL BE DRAINING AND/OR SPREADING OUT ON THE POLY LINER OR FOR DEMOLITION MATERIALS.
7. THIS FEATURE CAN BE USED FOR:
 - UTILITY REPAIRS.
 - WHEN OTHER STAGING LOCATIONS AND OPTIONS ARE LIMITED.
 - OTHER LIMITED APPLICATION AND SHORT DURATION STAGING.

MATERIALS STAGING IN ROADWAY MAINTENANCE NOTES

1. INSPECT BMPs EACH WORKDAY, AND MAINTAIN THEM IN EFFECTIVE OPERATING CONDITION. MAINTENANCE OF BMPs SHOULD BE PROACTIVE, NOT REACTIVE. INSPECT BMPs AS SOON AS POSSIBLE (AND ALWAYS WITHIN 24 HOURS) FOLLOWING A STORM THAT CAUSES SURFACE EROSION, AND PERFORM NECESSARY MAINTENANCE.
2. FREQUENT OBSERVATIONS AND MAINTENANCE ARE NECESSARY TO MAINTAIN BMPs IN EFFECTIVE OPERATING CONDITION. INSPECTIONS AND CORRECTIVE MEASURES SHOULD BE DOCUMENTED THOROUGHLY.
3. WHERE BMPs HAVE FAILED, REPAIR OR REPLACEMENT SHOULD BE INITIATED UPON DISCOVERY OF THE FAILURE.
4. INSPECT PVC PIPE ALONG CURB LINE FOR CLOGGING AND DEBRIS. REMOVE OBSTRUCTIONS PROMPTLY.
5. CLEAN MATERIAL FROM PAVED SURFACES BY SWEEPING OR VACUUMING.

NOTE: MANY JURISDICTIONS HAVE BMP DETAILS THAT VARY FROM UDFCD STANDARD DETAILS. CONSULT WITH LOCAL JURISDICTIONS AS TO WHICH DETAIL SHOULD BE USED WHEN DIFFERENCES ARE NOTED.

(DETAILS ADAPTED FROM AURORA, COLORADO)

**APPENDIX K
GEOTECH REPORT**