



FINAL DRAINAGE REPORT

**LOT 2 ELM GROVE VILLA SUBDIVISION
SMITH PLUMBING & HEATING
PCD Filing No.: PPR2143**

1875 Main Street, Colorado Springs
El Paso County, Colorado

PREPARED FOR:
Smith Plumbing
1895 Main Street
Colorado Springs, CO 80911

PREPARED BY:
Galloway & Company, Inc.
1155 Kelly Johnson Blvd., Suite 305
Colorado Springs, CO 80920

DATE:
March 2022

PCD Filing No. PPR2143



ENGINEER'S STATEMENT

The attached drainage plan and report were prepared under my direction and supervision and are correct to the best of my knowledge and belief. Said drainage report has been prepared according to the criteria established by the County for drainage reports and said report is in conformity with the applicable master plan of the drainage basin. I accept responsibility for any liability caused by any negligent acts, errors or omissions on my part in preparing this report.



Scott Brown, PE 45900

Date

For and on behalf of Galloway & Company, Inc.

02/02/2022

DEVELOPER'S CERTIFICATION

I, The developer, have read and will comply with all of the requirements specified in this drainage report and plan.

By: _____
[Signature]

2/7/22
Date

Address: Great Dane Ventures, LLC
5903 High Noon Ave
Colorado Springs, CO 80923

EL PASO COUNTY CERTIFICATION

Filed in accordance with the requirements of the Drainage Criteria Manual, Volumes 1 and 2, El Paso County Engineering Criteria Manual and Land Development Code as amended.

Jennifer Irvine, P.E.
County Engineer/ECM Administrator

APPROVED
Engineering Department
05/18/2022 9:41:09 AM
dsdnijkamp
EPC Planning & Community
Development Department

Conditions:

TABLE OF CONTENTS

I.	Purpose	1
II.	General Description	1
III.	Previous Reports	1
IV.	Drainage Criteria	1
V.	Existing Drainage Conditions	2
VI.	Four Step Process	4
	1. Employ Runoff Reduction Practices	4
	2. Stabilize Drainageways.....	4
	3. Provide Water Quality Capture Volume (WQCV).....	4
	4. Consider Need for Industrial and Commercial BMP's	4
VII.	Proposed Drainage Conditions.....	4
VIII.	Proposed Water Quality Detention Ponds.....	5
IX.	Channels and Swales.....	6
	Swales	6
	Existing Channel	6
X.	Maintenance	7
XI.	Wetlands Mitigation.....	7
XII.	Floodplain Statement	7
XIII.	Drainage/Bridge Fees and Credits/Reimbursements	7
XIV.	Conclusion	8
XV.	References	8

Appendices:

- A. Exhibits and Figures
- B. Hydrologic Computations
- C. Hydraulic Computations
- D. Drainage Maps

I. Purpose

This document is for the proposed development of Lot 2 Elm Grove Villa Subdivision, located at 1875 Main Street, with the construction of a new 75' x 160' office building with associated parking. The purpose of this Final Drainage Report is to identify on and offsite drainage patterns, locate and identify tributary or upstream drainage features and facilities that impact the site, and to identify which types of drainage facilities will be needed and where they will be located.

II. General Description

Lot 2 of Elm Grove Villa Subdivision is approximately 1.51 acres of undeveloped land, located 1875 Main Street, Colorado Springs within El Paso County, Colorado. The project site is located east of Main Street, which is also designated as Hancock Expressway and south/southwest of Bradley Road. The parcel number for the site is 6501312002 and is currently zoned CC CAD-O. South of the site is multi-family residential development and commercial property is to the west. Canal No. 4 runs parallel and on the opposite side of Bradley Road. A Vicinity Map is included in Appendix A.

The existing site is currently vacant. An existing asphalt access exists, located between two existing commercial properties, off of Main Street. The site generally drains from the northeast to the southwest at approximately 2%.

The existing soil types within the proposed site as determined by the NRCS Web Soil Survey for El Paso County Area consist of Blakeland loamy sand. This soil type is defined as having a hydrologic soil group of A. See the soils map included in Appendix A.

There are no major drainage ways or irrigation facilities located on the site. There is an existing inlet located near the southeast portion of the site. This structure is filled with debris and dirt and no outlet or invert information was able to be determined. A second inlet is located near the northwest section of the site. This structure has an existing pipe entering on the northeast and a pipe releasing flows to the southwest.

III. Previous Reports

The proposed site has been included in a previous drainage report for the Elm Grove Villa Subdivision. A copy of this report has been included in Appendix A.

1. *Drainage Report for Elm Grove Villa*, by Weiss Consulting Engineers, February 1983 (**FDR**).

IV. Drainage Criteria

Hydrology calculations were performed using the City of Colorado Springs/El Paso County Drainage Criteria Manual, as revised in November 1991 and October 1994 with County adopted Chapter 6 and Section 3.2.1 of Chapter 13 of the City of Colorado Springs/El Paso County Drainage Criteria Manual as revised in May 2014 and the El Paso County Engineering Criteria Manual (ECM) as revised in July 2019.

The drainage calculations were based on the criteria manual Figure 6-5 and IDF equations to determine the intensity and are listed in Table 1 below.

Table 1 - Precipitation Data

Return Period	One Hour Depth (in).	Intensity (in/hr)
5-year	1.50	5.17
100-year	2.52	8.68

The rational method was used to calculate peak flows as the tributary areas are less than 100 acres. The rational method has been proven to be accurate for basins of this size and is based on the following formula:

$$Q = CIA$$

Where:

- Q = Peak Discharge (cfs)
- C = Runoff Coefficient
- I = Runoff intensity (inches/hour)
- A = Drainage area (acres)

The runoff coefficients are calculated based on land use, percent imperviousness, and design storm for each basin, as shown in the drainage criteria manual (Table 6-6). Composite percent impervious and C values were calculated using the streets, roofs, and lawns coefficients found in Table 6-6 of the manual.

The 100-year event was used as the major storm event for pipes and inlets. The 5-year event was used as the minor event.

The UD-Detention spreadsheet was utilized for sizing the water quality orifices on the proposed water quality portion of the detention pond. This spreadsheet was also utilized for the design of the proposed water quality pond.

Flow Master was utilized to size drainage swales, curb cuts and other drainage features.

V. Existing Drainage Conditions

The proposed project site is located within the Security Drainage Basin and was studied as part of the Drainage Report for Elm Grove Villa. In this report, there are two major drainage basins (A-6 & A-7) which account for the project site. In this report, each basin was released to the south, at opposite corners of the project site, onto the existing Elm Grove Villas townhome site. As the development site is higher than the development to the south, the flow from Basins A-6 and A-7 were added together to get a total release rate for the site. Basin A-6 had flows of 3.0 and 5.9 cfs for the 5 and 100-year flows and Basin A-7 had flows of 2.7 and 5.4 cfs for the 5 and 100-year flows. Basin A-5 represented the off-site basin, associated with Bradley Road, along the northeast property line. The previous report did not account for any of the off site flow traveling through the site. This gives a combined release rate of 5.7 cfs and 11.3 cfs exiting the project site, with Basin A-6 exiting through the existing inlet and into the concrete channel, and Basin A-7 overland flowing into the Elm Grove Villas townhome site.

This approved report has flows of 20.7 cfs for the minor storm and 32.5 cfs for the major storm from an existing storm system entering just downstream of the site into the existing concrete channel. The existing channel also accepts an assumed flow of 3.4 cfs and 6.7 cfs from Basin A-4 to the west. With these

additional flows and the site flows from existing Basins A-1, A-2, A-3, A-4, and A-6, the existing downstream channel had a flow of 24.1 cfs and 38.4 cfs for the 5 and 100-year storms. An analysis of the channel (6' cross pan with street section) has been included in Appendix C. The channel will have a flow depth of 0.63' and a top width of 25.23'. In the existing conditions, the flow is just short of the existing curb and gutter on the east side but will use the full "roadway" section to convey flows.

An updated existing conditions basin map has been prepared for the development site. An existing drainage map is included in Appendix E and the basins are described below.

Basin OS-1 (0.34 AC, $Q_5 = 1.0$ cfs, $Q_{100} = 2.0$ cfs) is associated with the off-site basin encompassing Bradley Road (Cable Lane) along the northeast property line. This accounts for flows which will release directly onto the site.

Basin OS-2 (0.34 AC, $Q_5 = 1.1$ cfs, $Q_{100} = 2.2$ cfs) is associated with the off-site basin encompassing the existing Smith Plumbing building and lot within existing Basin A-6. This accounts for flows which will release directly into Basin E-2.

Basin E-1 (0.02 AC, $Q_5 = 0.1$ cfs, $Q_{100} = 0.2$ cfs): is associated with the western most portion of the existing drive access off of Main Street. This basin releases back towards the west into Main Street, where it is intercepted by an existing inlet.

Basin E-2 (0.10 AC, $Q_5 = 0.5$ cfs, $Q_{100} = 0.9$ cfs): is the remainder of the existing drive access. This basin flows directly to the south, remaining in the existing asphalt parking lot. It is assumed that this flow is intercepted by one of the 2 existing storm sewer systems which release into the existing drainage channel south of the site.

Basin E-3 (0.14 AC, $Q_5 = 0.1$ cfs, $Q_{100} = 0.4$ cfs): is a portion of the site, just east of the drive access with a gravel parking area, which flows directly to the existing drainage inlet at the southwest corner at **DP 6**. This intercepted flow will release through an existing 18" RCP to the existing drainage channel in the townhome development to the south.

Basin E-4 (1.19 AC, $Q_5 = 0.5$ cfs, $Q_{100} = 3.5$ cfs): is the bulk of the site which drains towards a local low point with an existing area inlet. This inlet is currently filled with dirt and debris, so no outlet direction or invert information was determined. It was assumed that this flow will combine flow from Basin E-3 at **DP 6**. Flows are released through the existing pipe to the drainage channel to the south.

Basin E-5 (0.02 AC, $Q_5 = 0.0$ cfs, $Q_{100} = 0.1$ cfs): is along the eastern property line and consists of the area between the existing fence and the property line. There is an existing concrete block wall, which has this basin "sitting" several feet below the overall project site. It is assumed this flow will travel to the south releasing directly offsite.

Basin E-6 (0.05 AC, $Q_5 = 0.0$ cfs, $Q_{100} = 0.2$ cfs): is located along the southern boundary line and consists of the area between the existing fence and the property line. There is an existing concrete block wall, which has this basin "sitting" several feet below the overall project site. It is assumed this flow will travel to the south, releasing directly offsite.

Total flows leaving the development site at **DP 6** (Basins OS-1, E-3 and E-4) are 1.3 cfs for the 5-year storm and 5.2 cfs for the 100-year storm.

VI. Four Step Process

The Four Step Process is recommended for selecting structural BMP's in developing areas. It used to minimize the adverse impacts of urbanization and is a vital component of developing a balanced, sustainable project. Below identifies the approach to the four-step process:

1. Employ Runoff Reduction Practices

The purpose of this step is to reduce runoff peaks and volumes from urbanizing areas through MDCIA (minimizing directly connected impervious areas). The intent of MDCIA is to reduce impervious area and route runoff from impervious areas through pervious areas to promote infiltration. The proposed development uses Low Impact Development (LID) practices to reduce runoff at the source. Rather than creating point discharges that are directly connected to impervious areas, runoff is routed through pervious areas.

2. Stabilize Drainageways

This step implements stabilization to existing natural channels to accommodate developed flows while protecting infrastructure and controlling sediment loading from erosion in the drainageways. This site releases into an existing concrete drainage swale, there by not needing any additional stabilization or erosion controls.

3. Provide Water Quality Capture Volume (WQCV)

This step utilizes formalized water quality capture volume to slow the release of runoff from the site and provide permanent stormwater quality control measures. The WQCV will release slowly to provide for long-term settling of sediment particles, but in no less than 40 hours. On-site water quality control volume detention ponds will provide water quality treatment prior to the runoff being released into the channel.

4. Consider Need for Industrial and Commercial BMP's

As this site is a commercial development, the area will need to consider the need for Industrial and Commercial BMPs. No industrial uses are proposed for the site, but storage of some equipment and vehicles may be done. Source control BMPs protect the release of pollutants from outdoor storage areas. Trash enclosures will be provided near the building. Drainage flows from this portion of the site will be routed through the water quality pond prior to exiting the site, minimizing contaminants into the downstream system.

VII. Proposed Drainage Conditions

The general overall existing drainage patterns have been maintained, in that the majority of the site is to be detained on site with a proposed water quality facility, releasing through the existing 18" RCP to the concrete channel to the south.

Basins OS-2, E-1 and E-2 have not changed from their descriptions in the existing conditions section. The general location and description of each proposed basin is described below. The major and minor basins and their proposed size, shape, and orientation can be seen on the proposed drainage map found in Appendix D. Hydrology calculations are included in Appendix B

Basin OS-1 (0.34 AC, $Q_5 = 1.0$ cfs, $Q_{100} = 2.0$ cfs) is associated with the off-site basin encompassing Bradley Road (Cable Lane) along the northeast property line. In the current conditions, the basin releases directly onsite. In the proposed condition, flow will be directed along the property line to the southeast, as indicated per the Approved Existing Report Basin A-5, reference Appendix A.

Basin E-3 (0.13 AC, $Q_5 = 0.4$ cfs, $Q_{100} = 0.8$ cfs): is a portion of the site, just east of the drive access, consisting of drive aisle and parking as well as some landscaped areas. The basin flows directly to the existing drainage inlet at the southwest corner at **DP 8**. This basin will not be treated by the water quality facility.

Basin E-4 (0.72 AC, $Q_5 = 2.6$ cfs, $Q_{100} = 4.7$ cfs): is the bulk of the site, which will include the proposed building and the majority of the drive aisle and parking lot. A new high point will be located at the southeast corner of the site, with flows being directed back for the north to proposed curb and gutter along the drive aisle. The gutter flow will be directed back towards the west to a proposed concrete cross pan, which will carry flow across the drive aisle to a proposed curb cut at **DP 4**. A riprap swale will direct this flow directly to the proposed water quality pond.

Basin E-5 (0.11 AC, $Q_5 = 0.5$ cfs, $Q_{100} = 0.9$ cfs): is located between the proposed building the water quality pond. The basin consists of proposed parking. Flows will sheet flow across the parking area to a proposed curb cut at **DP 5**. A riprap swale will direct this flow directly to the proposed water quality pond.

Basin E-6 (0.26 AC, $Q_5 = 0.1$ cfs, $Q_{100} = 0.6$ cfs): is representative of the landscape areas around the south, east and west of the proposed site, including Existing Basins E-5 and E-6. Flow from the basin will release directly to the off-site townhome development to the south, with the majority of the basin draining through a Grass Buffer (Reference Appendix C for Grass Buffer and runoff reduction calculations). While there is a negligible increase from the Existing E-5 and E-6 basins (0.3 cfs in the 100-year storm), the proposed runoff is less than the approved design runoff from Approved Existing Report Basin A-7 ($Q_5 = 0.1$ cfs, $Q_{100} = 0.79$ cfs). The townhome development should have sufficient capacity for runoff from Basin A-7, and therefore will have the capacity for the direct runoff from Basin E-6.

Basin E-7 (0.06 AC, $Q_5 = 0.1$ cfs, $Q_{100} = 0.2$ cfs): is the basin associated with the proposed pond.

Basin E-8 (0.12 AC, $Q_5 = 0.3$ cfs, $Q_{100} = 0.6$ cfs): is located north of the proposed water quality pond adjacent to Basin E-3. The Basin consists of drive aisle with parking and landscape area. Flows will sheet flow across the drive aisle to a proposed curb cut at **DP 6**. A riprap swale will direct this flow directly to the proposed water quality pond.

VIII. Proposed Water Quality Detention Pond

One Water Quality Capture Volume Detention Pond will be provided for the project site. The pond will be private and will provide water quality with some additional storage capacity to reduce developed runoff by 1 cfs. Detention for this site is provided by the existing unnamed detention pond which was built as part of the Elm Grove Villa development (PCD Filing No. MS83004) in 1983. The EURV and 100-year volumes will be conveyed via the Modified CDOT Type C Outlet structure to the existing inlet, downstream to the existing concrete flume, and outfalls into the existing 6' concrete valley pan flowing in a southward direction within the townhome site. Per the approved **FDR**, runoff is presently directed to the existing 6' concrete pan ($Q_5 = 23.7$ cfs, $Q_{100} = 38.4$ cfs; see map in Appendix A), where flows are directed downstream via channelized flow within the 6' concrete pan and Elm Grove Drive roadway section with curb & gutter). The proposed development does not increase runoff being discharged from the site ($Q_5 = 24.1$ cfs, $Q_{100} = 38.4$ cfs). There is no increase in flow rates and therefore the pond release flows can sufficiently be handled by the existing conveyance system as originally intended. Runoff then sheet flows across Elm Grove Drive (to the east) to an existing low point on the east side of Elm Grove Drive (existing concrete chase), to the existing concrete rundown structure and into the existing pond situated to the

south of the existing townhomes. Storm events larger than the 100-year storm will overtop the emergency overflow weir and free release into the structures as described below.

The water quality volume release will be controlled with an orifice plate that will release over a period of 40 hours. The water quality pond will release treated flows into the existing flume and existing 6' concrete valley pan within the Elm Grove Villa townhome development to the south as described above. Final design of the pond and its components are provided in Appendix D. According to the approved **FDR**, the proposed site as represented by sub-basins A-1 (2.07 AC, $Q_5 = 1.62$ cfs, $Q_{100} = 2.55$ cfs) & A-6 (0.97 AC, $Q_5 = 1.97$ cfs, $Q_{100} = 3.91$ cfs) along with a conducted field investigation, the existing detention pond was designed to accommodate runoff from this development and is functioning as intended.

There are portions of four basins which are not provided with on-site water quality. Basins E-1 and E-2 are excluded as existing roadway areas per ECM Appendix I.7.1.B. Basin E-3 and a portion of Basin E-6 are unable to be treated due to grading constraints. In order to maintain existing drainage patterns and not alter existing drainage facilities, Basin E-3 shall drain to the existing inlet as it did in the existing conditions. A portion of Basin E-6 will drain through a Grass Buffer along the southwest boundary of the property. The Grass Buffer will provide the water quality for a portion of the basin. The remainder of Basin E-6 along the property lines cannot be treated due to grading constraints and will free release offsite as it does in the existing conditions. The untreated areas within Basins E-3 and E-6 account for 0.28 acres, 18.5% of the project area.

Total area which will not be treated via the on-site facility is less than 1.0 acre, as required.

IX. Channels and Swales

Swales

There are 2 swales associated with the proposed development, at DP 4 and DP 5. The swales have been designed to meet the 100-year design storm. Appendix C contains the design of these facilities.

The swale from DP 4 is located at a proposed 4' curb cut along the drive aisle. The swale will be a v-ditch, minimum depth of 0.5' and 4:1 side slope. Longitudinal slope will be 10.5%, generating a flow depth of 0.48' and a velocity of 5.183.7 fps. The swale will be lined with Type VL riprap. Flows release directly to the water quality pond.

The swale from DP 5 is located at a proposed 1' curb cut with in the parking area, west of the proposed building. The swale will be a v-ditch with a minimum depth of 1.0' and 4:1 side slope. Longitudinal slope will be 0.5%, generating a flow depth of 0.5' and a velocity of 0.93 fps. The swale will be lined with Type VL riprap. Flows will combine with the swale from DP 4 and release into the water quality pond.

Refer to Appendix C for swale design calculations.

Existing Runoff Conveyance

In the approved Drainage Report for Elm Grove Villa by Weiss Consulting (**FDR**), an existing concrete flume which transitions to a 6' concrete valley pan was designed and built to convey flows from the proposed project site, downstream through the townhome development in a southward direction along the western boundary, ultimately to the existing unnamed detention pond. It was assumed that the existing 6' concrete valley pan had a cross slope of 1" per 1', for a total depression of 3" and a longitudinal slope of 1.3%. This general section was used in Flowmaster to determine the flow through this "channel" section. From the approved Elm Grove Villa Report, flows through the channel was calculated to be 38.4 cfs for

the 100-year storm. These flows were determined by using the site flows along with the flows from the two existing storm systems which also release into the channel. Based on this information, the channel had a flow depth of 0.63' a velocity of 5.77 fps, and a spread of 25.43'. At the depth of 0.63', this existing spread is contained within the Elm Grove Drive access road and does not overtop the adjacent curbs (approximately 5' short horizontally) in the major storm event.

With the proposed flow of 38.4 cfs for the major storm, the flow depth, velocity, and spread do not change from the existing condition and will not adversely impact the valley pan and present means of conveyance in any way.

Appendix C contains the analysis of the existing "channel" facility based on the design flows from the Elm Grove Villa report and proposed flows with this report.

X. Maintenance

The proposed water quality pond is to be a private facility, which will be maintained by the property owner.

XI. Wetlands Mitigation

No wetlands are located on site.

XII. Floodplain Statement

The project site lies within Zone X, area of minimal flood hazard as defined by the FIRM Map number 08041C0763G effective December 7, 2018. A copy of the FIRM Panel is included in Appendix A.

XIII. Drainage/Bridge Fees and Credits/Reimbursements

The site lies within the Security Drainage Basin and was platted in 1983 prior to the implementation of the EPC drainage basin fee program. The DBPS was approved in 2013 and has bridge fees associated with the basin. Drainage fees are not assessed with the site plan application, and therefore, no drainage fee is due for this project.

The project site has a total area of 1.51 acres.

The percent impervious for the subdivision has been calculated with this report to be approximately 69.6 percent.

$1.51 \text{ acres} \times 69.6\% = 1.05 \text{ Impervious Acres}$

Below is a cost estimate for the improvements proposed with this filing.

Item	Quantity	Unit	Unit Cost	Cost
WQCV Detention Pond (Private)				
Pond	1	EA	\$ 30,000.00	\$ 30,000.00
Subtotal				\$ 30,000.00
Total				\$ 30,000.00
Contingency			10%	\$ 3,000.00
Grand Total				\$ 33,000.00

XIV. Conclusion

This report for Lot 2 Elm Grove Villa has been prepared using the criteria and methods

Detention for the site is provided in an existing off-site detention pond. Water quality is provided through a proposed on-site WQCV pond and an on-site Grass Buffer. The proposed development will not have any adverse impacts on downstream developments or existing drainageways.

All drainage facilities within this report were sized according to the Drainage Criteria Manuals. This report is in general conformance with all previous approved reports that include the site.

XV. References

1. *City of Colorado Springs/County of El Paso Drainage Criteria Manual*, October 1991.
2. *Drainage Criteria Manual, Volume 2*, City of Colorado Springs, November 2002.
3. *Urban Storm Drainage Criteria Manual*, Urban Drainage and Flood Control District, January 2016 (with current revisions).
4. *Drainage Report for Elm Grove Villa*, by Weiss Consulting Engineers, February 1983.

APPENDIX A
Exhibits and Figures

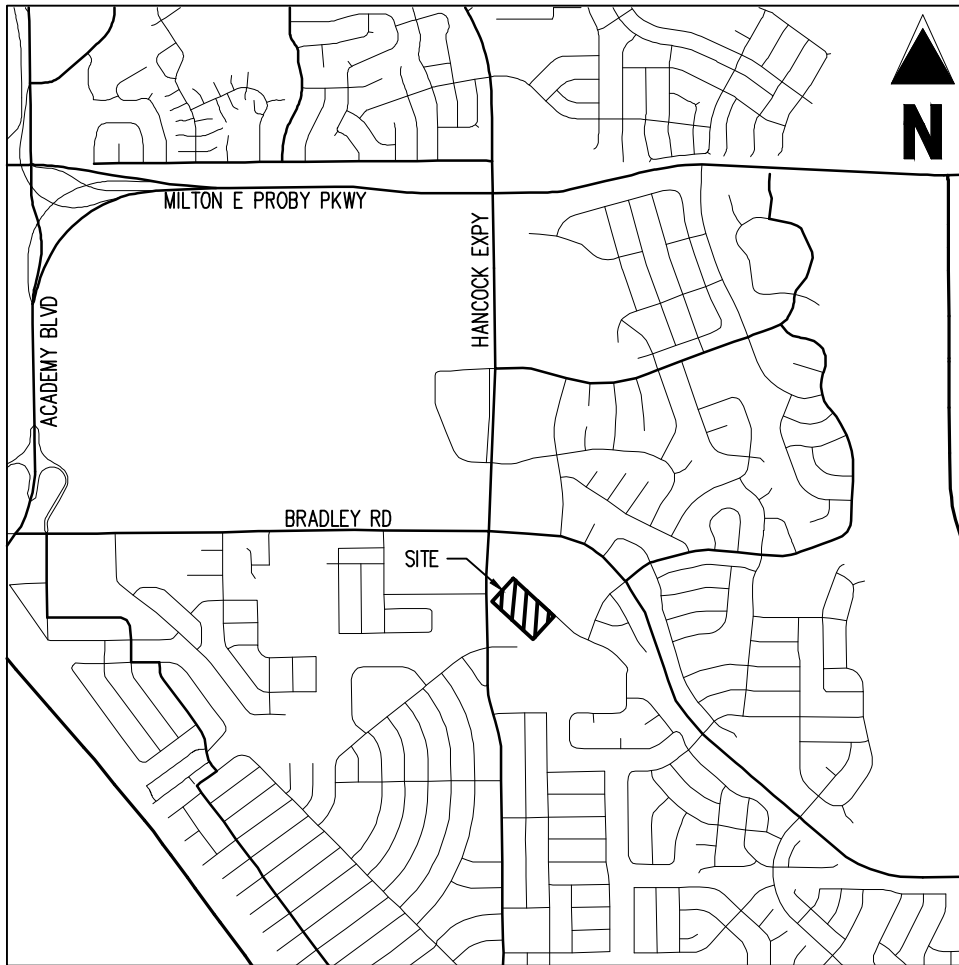

VICINITY MAP

SCALE: 1"=500'

LOT 2 ELM GROVE VILLA

1875 MAIN STREET
 SCALE: 1"=1,000'
 VICINITY MAP

Project No: HCI000008.20

Drawn By: TJE

Checked By: CMD

Date: 06/19/2020

Galloway

1155 Kelly Johnson Blvd., Suite 305
 Colorado Springs, CO 80920
 719.900.7220 • GallowayUS.com

Soil Map—El Paso County Area, Colorado
(1875 Main Street USGS Soil Survey Map)



Soil Map may not be valid at this scale.

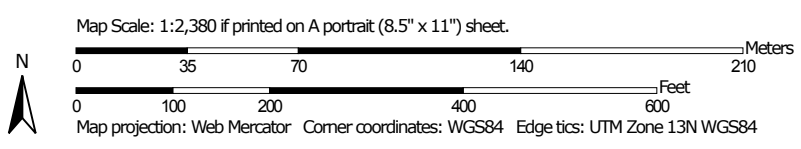

MAP LEGEND

Area of Interest (AOI)

 Area of Interest (AOI)

Soils

 Soil Map Unit Polygons

 Soil Map Unit Lines

 Soil Map Unit Points

Special Point Features



Blowout



Borrow Pit



Clay Spot



Closed Depression



Gravel Pit



Gravelly Spot



Landfill



Lava Flow



Marsh or swamp



Mine or Quarry



Miscellaneous Water



Perennial Water



Rock Outcrop



Saline Spot



Sandy Spot



Severely Eroded Spot



Sinkhole



Slide or Slip



Sodic Spot



Spoil Area



Stony Spot



Very Stony Spot



Wet Spot



Other



Special Line Features

Water Features



Streams and Canals

Transportation



Rails



Interstate Highways



US Routes



Major Roads



Local Roads

Background



Aerial Photography

MAP INFORMATION

The soil surveys that comprise your AOI were mapped at 1:24,000.

Warning: Soil Map may not be valid at this scale.

Enlargement of maps beyond the scale of mapping can cause misunderstanding of the detail of mapping and accuracy of soil line placement. The maps do not show the small areas of contrasting soils that could have been shown at a more detailed scale.

Please rely on the bar scale on each map sheet for map measurements.

Source of Map: Natural Resources Conservation Service

Web Soil Survey URL:

Coordinate System: Web Mercator (EPSG:3857)

Maps from the Web Soil Survey are based on the Web Mercator projection, which preserves direction and shape but distorts distance and area. A projection that preserves area, such as the Albers equal-area conic projection, should be used if more accurate calculations of distance or area are required.

This product is generated from the USDA-NRCS certified data as of the version date(s) listed below.

Soil Survey Area: El Paso County Area, Colorado

Survey Area Data: Version 16, Sep 10, 2018

Soil map units are labeled (as space allows) for map scales 1:50,000 or larger.

Date(s) aerial images were photographed: Jun 3, 2014—Jun 17, 2014

The orthophoto or other base map on which the soil lines were compiled and digitized probably differs from the background imagery displayed on these maps. As a result, some minor shifting of map unit boundaries may be evident.

Map Unit Legend

Map Unit Symbol	Map Unit Name	Acres in AOI	Percent of AOI
8	Blakeland loamy sand, 1 to 9 percent slopes	24.4	100.0%
Totals for Area of Interest		24.4	100.0%

NOTES TO USERS

This map is for use in administering the National Flood Insurance Program. It does not necessarily identify all areas subject to flooding, particularly from local drainage sources of small size. The community map repository should be consulted for possible updated or additional flood hazard information.

To obtain more detailed information in areas where **Base Flood Elevations (BFEs)** and/or **floodways** have been determined, users are encouraged to consult the Flood Profiles and Floodway Data and/or Summary of Stillwater Elevations tables contained within the Flood Insurance Study (FIS) report that accompanies this FIRM. Users should be aware that BFEs shown on the FIRM represent rounded whole-foot elevations. These BFEs are intended for flood insurance rating purposes only and should not be used as the sole source of flood elevation information. Accordingly, flood elevation data presented in the FIS report should be utilized in conjunction with the FIRM for purposes of construction and/or floodplain management.

Coastal Base Flood Elevations shown on this map apply only landward of 0.0' North American Vertical Datum of 1988 (NAVD88). Users of this FIRM should be aware that coastal flood elevations are also provided in the Summary of Stillwater Elevations table in the Flood Insurance Study report for this jurisdiction. Elevations shown in the Summary of Stillwater Elevations table should be used for construction and/or floodplain management purposes when they are higher than the elevations shown on this FIRM.

Boundaries of the **floodways** were computed at cross sections and interpolated between cross sections. The floodways were based on hydraulic considerations with regard to requirements of the National Flood Insurance Program. Floodway widths and other pertinent floodway data are provided in the Flood Insurance Study report for this jurisdiction.

Certain areas not in Special Flood Hazard Areas may be protected by **flood control structures**. Refer to section 2.4 "Flood Protection Measures" of the Flood Insurance Study report for information on flood control structures for this jurisdiction.

The **projection** used in the preparation of this map was Universal Transverse Mercator (UTM) zone 13. The **horizontal datum** was NAD83, GRS80 spheroid. Differences in datum, spheroid, projection or UTM zones zones used in the production of FIRMs for adjacent jurisdictions may result in slight positional differences in map features across jurisdiction boundaries. These differences do not affect the accuracy of this FIRM.

Flood elevations on this map are referenced to the **North American Vertical Datum of 1988 (NAVD88)**. These flood elevations must be compared to structure and ground elevations referenced to the same **vertical datum**. For information regarding conversion between the National Geodetic Vertical Datum of 1929 and the North American Vertical Datum of 1988, visit the National Geodetic Survey website at <http://www.ngs.noaa.gov/> or contact the National Geodetic Survey at the following address:

NGS Information Services
 NOAA, NINGS12
 National Geodetic Survey
 SSMC-3, #9202
 1315 East-West Highway
 Silver Spring, MD 20910-3282

To obtain current elevation, description, and/or location information for **bench marks** shown on this map, please contact the Information Services Branch of the National Geodetic Survey at (301) 713-3242 or visit its website at <http://www.ngs.noaa.gov/>.

Base Map information shown on this FIRM was provided in digital format by El Paso County, Colorado Springs Utilities, City of Fountain, Bureau of Land Management, National Oceanic and Atmospheric Administration, United States Geological Survey, and Anderson Consulting Engineers, Inc. These data are current as of 2006.

This map reflects more detailed and up-to-date **stream channel configurations** and **floodplain delineations** than those shown on the previous FIRM for this jurisdiction. The floodplains and floodways that were transferred from the previous FIRM may have been adjusted to conform to these new stream channel configurations. As a result, the Flood Profiles and Floodway Data tables in the Flood Insurance Study Report (which contains authoritative hydraulic data) may reflect stream channel distances that differ from what is shown on this map. The profile baselines depicted on this map represent the hydraulic modeling baselines that match the flood profiles and Floodway Data Tables if applicable, in the FIS report. As a result, the profile baselines may deviate significantly from the new base map channel representation and may appear outside of the floodplain.

Corporate limits shown on this map are based on the best data available at the time of publication. Because changes due to annexations or de-annexations may have occurred after this map was published, map users should contact appropriate community officials to verify current corporate limit locations.

Please refer to the separately printed **Map Index** for an overview map of the county showing the layout of map panels; community map repository addresses; and a Listing of Communities table containing National Flood Insurance Program dates for each community as well as a listing of the panels on which each community is located.

Contact **FEMA Map Service Center (MSC)** via the FEMA Map Information eXchange (FMIX) 1-877-336-2627 for information on available products associated with this FIRM. Available products may include previously issued Letters of Map Change, a Flood Insurance Study Report, and/or digital versions of this map. The MSC may also be reached by Fax at 1-800-358-9620 and its website at <http://www.msc.fema.gov/>.

If you have **questions about this map** or questions concerning the National Flood Insurance Program in general, please call 1-877-FEMA MAP (1-877-336-2627) or visit the FEMA website at <http://www.fema.gov/business/nfp>.

El Paso County Vertical Datum Offset Table	
Flooding Source	Vertical Datum Offset (ft)
REFER TO SECTION 3.3 OF THE EL PASO COUNTY FLOOD INSURANCE STUDY FOR STREAM BY STREAM VERTICAL DATUM CONVERSION INFORMATION	

Panel Location Map

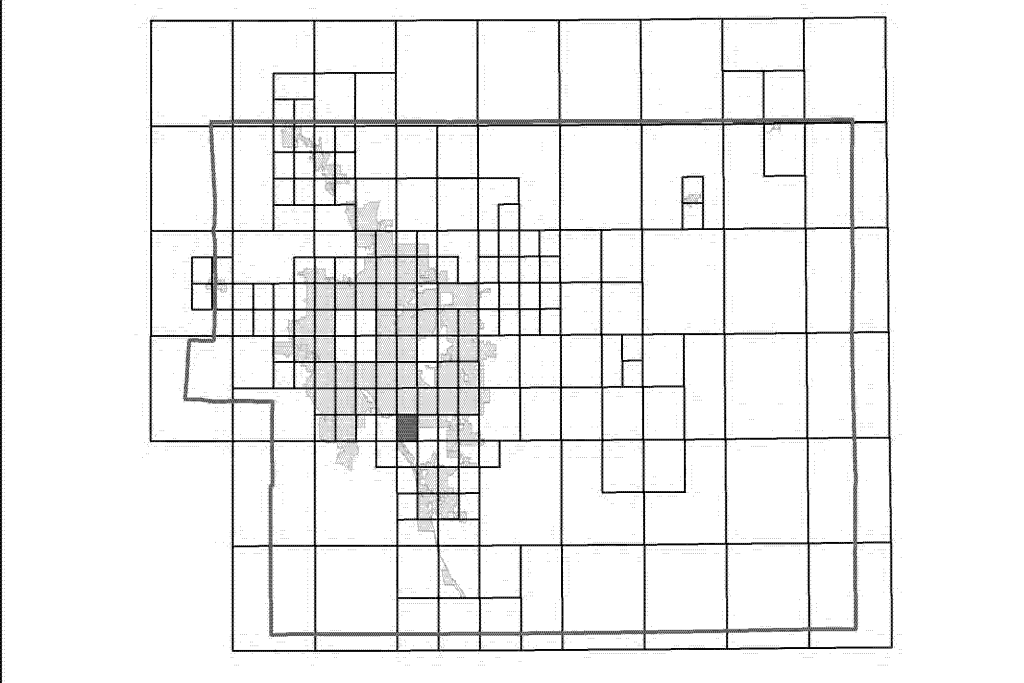

This Digital Flood Insurance Rate Map (DFIRM) was produced through a Cooperating Technical Partner (CTP) agreement between the State of Colorado Water Conservation Board (CWCB) and the Federal Emergency Management Agency (FEMA).



Additional Flood Hazard information and resources are available from local communities and the Colorado Water Conservation Board.

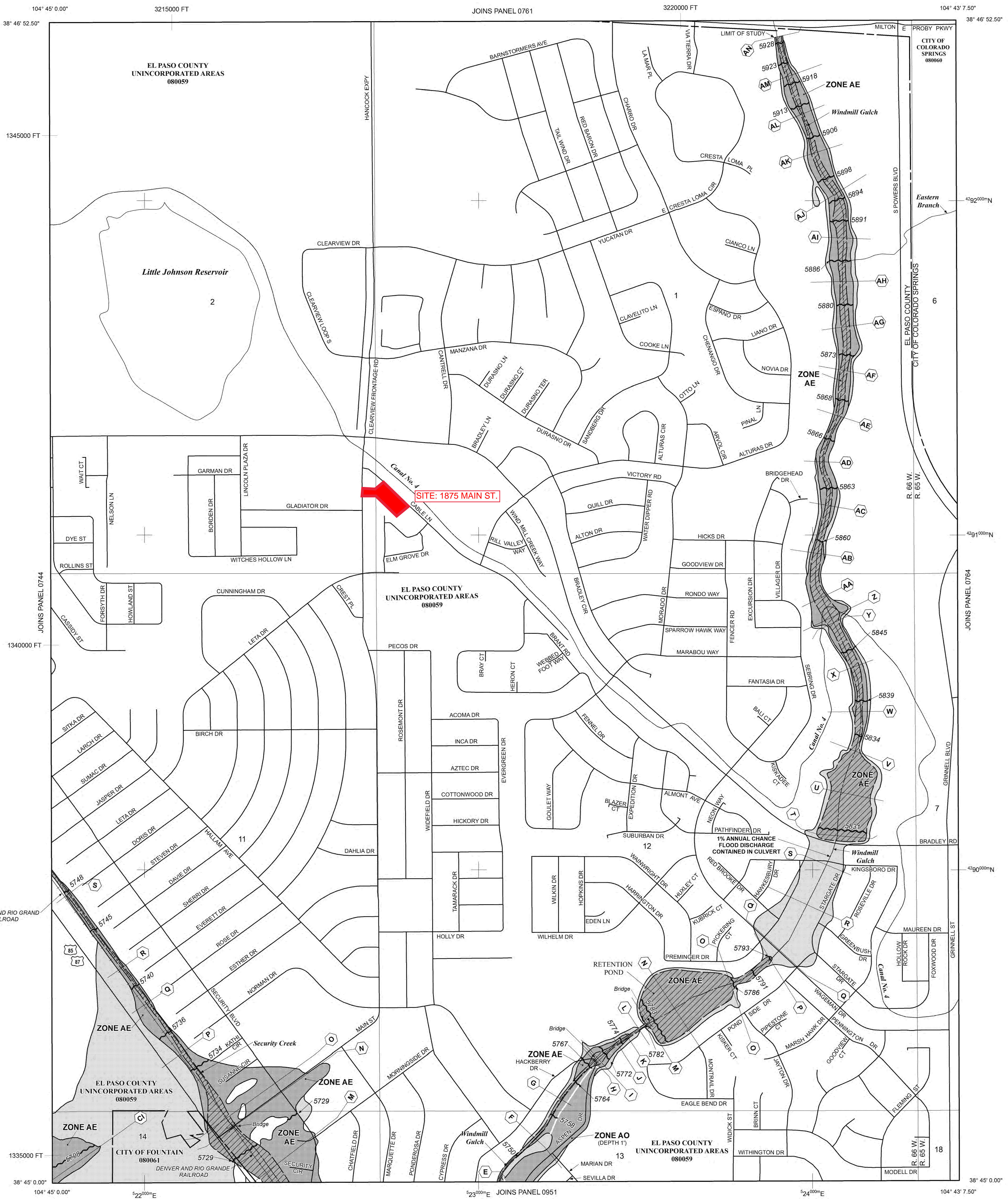

NOTE: MAP AREA SHOWN ON THIS PANEL IS LOCATED WITHIN TOWNSHIP 15 SOUTH, RANGE 65 WEST, AND TOWNSHIP 15 SOUTH, RANGE 66 WEST.

LEGEND

- SPECIAL FLOOD HAZARD AREAS (SFHAS) SUBJECT TO INUNDATION BY THE 1% ANNUAL CHANCE FLOOD
- The 1% annual chance flood (100-year flood), also known as the base flood, is the flood that has a 1% chance of being equalled or exceeded in any given year. The Special Flood Hazard Area is the area subject to flooding by the 1% annual chance flood. Areas of Special Flood Hazard include Zones A, AE, AH, AO, AR, AV, and VE. The Base Flood Elevation is the water-surface elevation of the 1% annual chance flood.
- ZONE A** No Base Flood Elevations determined.
- ZONE AE** Base Flood Elevations determined.
- ZONE AH** Flood depths of 1 to 3 feet (usually areas of ponding); Base Flood Elevations determined.
- ZONE AO** Flood depths of 1 to 3 feet (usually sheet flow on sloping terrain); average depths determined. For areas of alluvial fan flooding, velocities also determined.
- ZONE AR** Special Flood Hazard Area Formerly protected from the 1% annual chance flood by a flood control system that was subsequently dewatered. Zone AR indicates that the former flood control system is being restored to provide protection from the 1% annual chance or greater flood.
- ZONE AV** Area to be protected from 1% annual chance flood by a Federal flood protection system under construction; no Base Flood Elevations determined.
- ZONE VE** Coastal flood zone with velocity hazard (wave action); no Base Flood Elevations determined.
- FLOODWAY AREAS IN ZONE AE
- The floodway is the channel of a stream plus any adjacent floodplain areas that must be kept free of encroachment so that the 1% annual chance flood can be carried without substantial increases in flood heights.
- OTHER FLOOD AREAS
- ZONE X** Areas of 0.2% annual chance flood; areas of 1% annual chance flood with average depths of less than 1 foot, or with drainage areas less than 1 square mile, and areas protected by levees from 1% annual chance flood.
- OTHER AREAS
- ZONE X** Areas determined to be outside the 0.2% annual chance floodplain.
- ZONE D** Areas in which flood hazards are undetermined, but possible.
- COASTAL BARRIER RESOURCES SYSTEM (CBRS) AREAS
- OTHERWISE PROTECTED AREAS (OPAs)
- CBRS areas and OPAs are normally located within or adjacent to Special Flood Hazard Areas.
- Floodplain boundary
- Floodway boundary
- Zone D Boundary
- CBRS and OPA boundary
- Boundary dividing Special Flood Hazard Areas of different Base Flood Elevations, flood depths or flood velocities.
- Base Flood Elevation line and value; elevation in feet* (EL 987)
- Base Flood Elevation value where uniform within zone; elevation in feet**
- * Referenced to the North American Vertical Datum of 1988 (NAVD 88)
- Cross section line
- Transsect line
- 97° 07' 30.00" 32° 22' 30.00" Geographic coordinates referenced to the North American Datum of 1983 (NAD 83)
- 4726500N 1000-meter Universal Transverse Mercator grid ticks, zone 13
- 6000000 FT 5000-foot grid ticks; Colorado State Plane coordinate system, central zone (FIPSZONE 0902), Lambert Conformal Conic Projection
- DX5510 Bench mark (see explanation in Notes to Users section of this FIRM panel)
- M1.5 River Mile
- MAP REPOSITORIES
- Refer to Map Repositories list on Map Index
- EFFECTIVE DATE OF COUNTYWIDE FLOOD INSURANCE RATE MAP MARCH 17, 1997
- EFFECTIVE DATE(S) OF REVISION(S) TO THIS PANEL DECEMBER 7, 2018 - to update corporate limits, to change Base Flood Elevations and Special Flood Hazard Areas, to update map format, to add roads and road names, and to incorporate previously issued Letters of Map Revision.
- For community map revision history prior to countywide mapping, refer to the Community Map History Table located in the Flood Insurance Study report for this jurisdiction.
- To determine if flood insurance is available in this community, contact your insurance agent or call the National Flood Insurance Program at 1-800-638-6620.

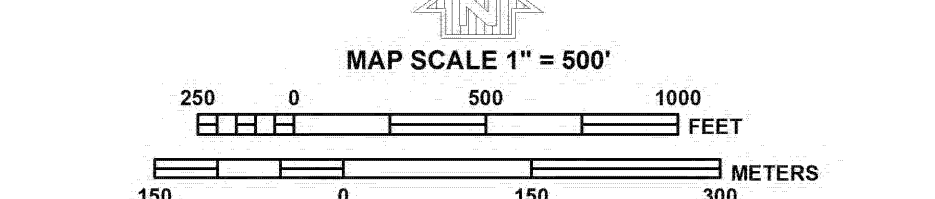

NFP

PANEL 0763G

FIRM

FLOOD INSURANCE RATE MAP

EL PASO COUNTY, COLORADO AND INCORPORATED AREAS

PANEL 763 OF 1300

(SEE MAP INDEX FOR FIRM PANEL LAYOUT)

CONTAINS:

COMMUNITY	NUMBER	PANEL	SUFFIX
COLORADO SPRINGS, CITY OF	08060	0763	G
EL PASO COUNTY	08059	0763	G
FOUNTAIN, CITY OF	08081	0763	G

Notice to User: The Map Number shown below should be used when placing map orders. The Community Number shown above should be used on insurance applications for the subject community.

MAP NUMBER
08041C0763G

MAP REVISED
DECEMBER 7, 2018

Federal Emergency Management Agency

RECEIVED

By

FEB 17 1983

El Paso County
Planning Department

DRAINAGE REPORT

FOR

ELM GROVE VILLA

SECURITY, COLORADO

WEISS CONSULTING ENGINEERS, INC.

Professional Engineer and Land Surveyor

February 17, 1983

Mr. John Fisher
Land Use Administrator
County of El Paso
27 East Vermijo
Colorado Springs, Colorado 80903

Dear Mr. Fisher,

Transmitted herewith is a Drainage Report for Elm Grove Villa lying south of Bradley Road and east of Hancock Road at the north edge of Security, Colorado.

If you have any questions, please call me.

Sincerely,
WEISS CONSULTING ENGINEERS, INC.

G. J. Weiss
G. J. Weiss PE-4124

GENERAL

Elm Grove Villa lies in the Southwest quarter of Section 1 and the Southeast quarter of Section 2, Township 15 South, Range 66 West of the 6th P.M. in the Town of Security, Colorado. The site contains 5.225 acres and is planned for a townhouse development. The drainage from the site will flow south through Security and will eventually outfall into Fountain Creek.

A soils report for the site was prepared by Summerlee and Associates on July 19, 1973. The soils on the site consist of selty to clayey sands and very sandy clays. The SCS soil classification is Blakeland, and it falls in Hydrologic Group A.

Reference in made to a drainage report for Benchmark Sub-division, which was made for this site in a report dated February 13, 1973 by H. J. Kraettli and Sons.

METHOD OF RUNOFF COMPUTATION

The method of runoff computation utilized in this report is the S.C.S. method as outlined in the subdivision criteria manual for El Paso County and the areawide urban runoff control manual for P.P.A.C.G. The calculations are shown separately. The five year frequency, 24 hour duration storm was used in the calculations. The 100 year storm was also calculated.

EXTERIOR FLOWS

Basins A-1 through A-7 discharge flows into the site as shown on the drainage map for a total of 32.6 CFS for the 5 year flow and 57.9 CFS for the 100 year flow. This report assumes that drainage from the west side of Hancock will enter the site from Manzana Drive south, but that the east half of Hancock will have its drainage intercepted by the canal. It is also assumed that the developer north of the canal will make provisions for his own developed drainage and that it will not enter the site.

The two catchbasins in Main Street and their 24" C.M.P. outfall have a capacity of about 18 CFS and are undersized for the 5 year storm. The site east of the catchbasins is graded to permit an overflow around the buildings where it will sheet flow into Elm Grove Villa.

INTERIOR FLOWS

Basin B has a 5 year flow of 7.8 CFS and a 100 year flow of 20.8 CFS. The undeveloped flows for this site are 0.8 CFS and 6.5 CFS respectively. The difference between the 100 year flows

is 14.3 CFS, which must be detained on site. A detailed design of the detention facility will be designed upon acceptance of this report by the County Engineer. It is hoped that detention storage can be provided for more than that required for the Elm Grove Villa site.

DRAINAGE FACILITIES

This site is lower than the adjacent land on the west, north and east. Drainage from the west will enter the site through the existing 24" CMP and as an overflow. This will be carried through the site in the private street to the detention pond. Drainage from the north will flow into the site and be carried in the private streets and swales to the detention pond. It is planned that a swale or curb be constructed by the owner on the east side of this property to prevent it from entering the site.

Due to the low elevation of the site relative to the adjacent properties, it is essential that the developer and builder place the buildings on the site as high as possible above the private streets and swales to prevent any damage from flooding.

No detailed drainage cost can be prepared until the detention facility has been designed. The earthwork required to construct the detention pond can be done as part of the overall site grading. An outfall pipe must be constructed from the pond across Leta Drive. We would make a preliminary cost estimate for these facilities to be \$6000.00

DRAINAGE REPORT STATEMENTS

ENGINEERS STATEMENT

The attached drainage plan and report were prepared under my direction and supervision and are correct to the best of my knowledge and belief. This report was prepared in accordance with the El Paso County Subdivision Criteria Manual.

Gerald J. Weiss PE-4124

OWNERS STATEMENT

The developer has read and will comply with all of the requirements specified in this drainage report.

JDK CONSTRUCTION, INC.
Developer

John D. Keely
By

Pres.
Title

EL PASO COUNTY

Approved By _____

Date _____

MAJOR BASIN	SUB BASIN	AREA		BASIN		Tc	K	SOIL GROUP	DEV. TYPE	CURVE NO.	FLOW		Q _{effs}		
		Planim. Read. AC	MILE	LENGTH	HEIGHT						Q	qp	5 YR	100	
A	1	2.07	0.003228	900	32	0.09		A		90	1.62	2.55	1000	5.2	8.2
	2	2.59	0.00405	480	10	0.06		"		90	1.62	2.55	"	6.6	10.3
	3	3.51	0.00548	480	10	0.06		"		90	1.62	2.55	"	8.9	14.0
	4	1.10	0.00172	100	4	0.03		"		94	1.97	3.91	"	3.4	6.7
	5	1.85	0.002898	800	10	0.10		"		80	0.94	2.55	"	2.8	7.0
	6	0.97	0.00152	180	2	0.05		"		94	1.97	3.91	"	3.0	5.9
	7	0.88	0.00138	260	3	0.04		"		94	1.97	3.91	"	2.7	5.4
B		5.22	0.0082	700	5	0.10		"		80	0.94	2.55	"	7.8	20.8

HYDROLOGIC COMPUTATION - BASIC DATA

PROJ: ELM GROVE VILLA

By: *J. Weiss*
Date: 2-16-83

WEISS DEVELOPED
CONSULTING CONDITION
ENGINEERS, INC. 24 HR STORM

Page 1
of
Pages 2

P = 2.6 5 YR 24 HR
P = 4.6 100 YR 24 HR

MAJOR BASIN	SUB BASIN	AREA		BASIN		Tc	K	SOIL GROUP	DEV. TYPE	CURVE NO.	FLOW		<i>J</i> <i>CFS</i>		
		Planim. Read.	MILE	LENGTH	HEIGHT						Q	qp			
A	6	0.97	0.00152	150	2			A		55	0.10	0.79	1000	0.15	1.20
	7	0.88	0.00138	260	3			"		"	0.10	0.79	1000	0.14	1.10
B		5.22	0.0082	700	5			"		"	0.10	0.79	1000	0.82	6.5

HYDROLOGIC COMPUTATION - BASIC DATA
 PROJ: ELM GROVE VILLA
 By: *J. Weiss*
 Date: 2/16/83

WEISS UNDEVELOPED
 CONSULTING CONDITION
 ENGINEERS, INC.

Page 2
 of
 Pages 2

ELM GROVE VILLA

R3 LAND USE SCHEDULE

AREA	227,601 S.F.
TOTAL NO. OF UNITS	44
UNITS TO BE BUILT	64
UNIT BREAKDOWN	24 No. 102 2 1/2 BDR. GARAGE 2 1/2" HIGH
	16 No. 202 2 BDR. GARAGE 28" HIGH
	7 No. 203 1 BDR. GARAGE 28" HIGH
OFF STREET PARKING	11 SPACES
COVERAGE:	
BUILDINGS	52.15 %
PARKING	12.10 %
TOTAL	64.25 %
STREETS	12.10 %
TOTAL	76.35 %
OPEN AREA	23.65 %

LANDSCAPE SYMBOLS

- 5" to 8" PONDEROSA PINE
- 5 GAL FITZER
- BIRCH
- 100 to 150 LB BRONZE LEAVES
- 5 GAL SCHRUBS W/ CORNED BAY
- DOCK WALL
- ALL OTHER AREAS TO BE
- W/ SHRUBBELY SYSTEM
- STEEL LITE

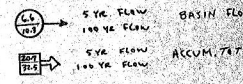
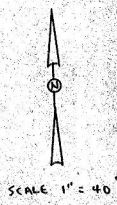

EXIST. 6 CONCRETE PAN

DETENTION REQUIRED FOR

BASIN B	20.8 cfs	DEVELOPED
	6.5 cfs	NATURAL
	14.3 cfs	DETAINED

SPILLWAY MUST BE DESIGNED FOR 100 YR FLOW

DRAINAGE PLAN

ELM GROVE VILLA

PE-424 2-16-8

outlet pipe to be designed for 26.1 cfs
JDK CONSTRUCTION, INC.

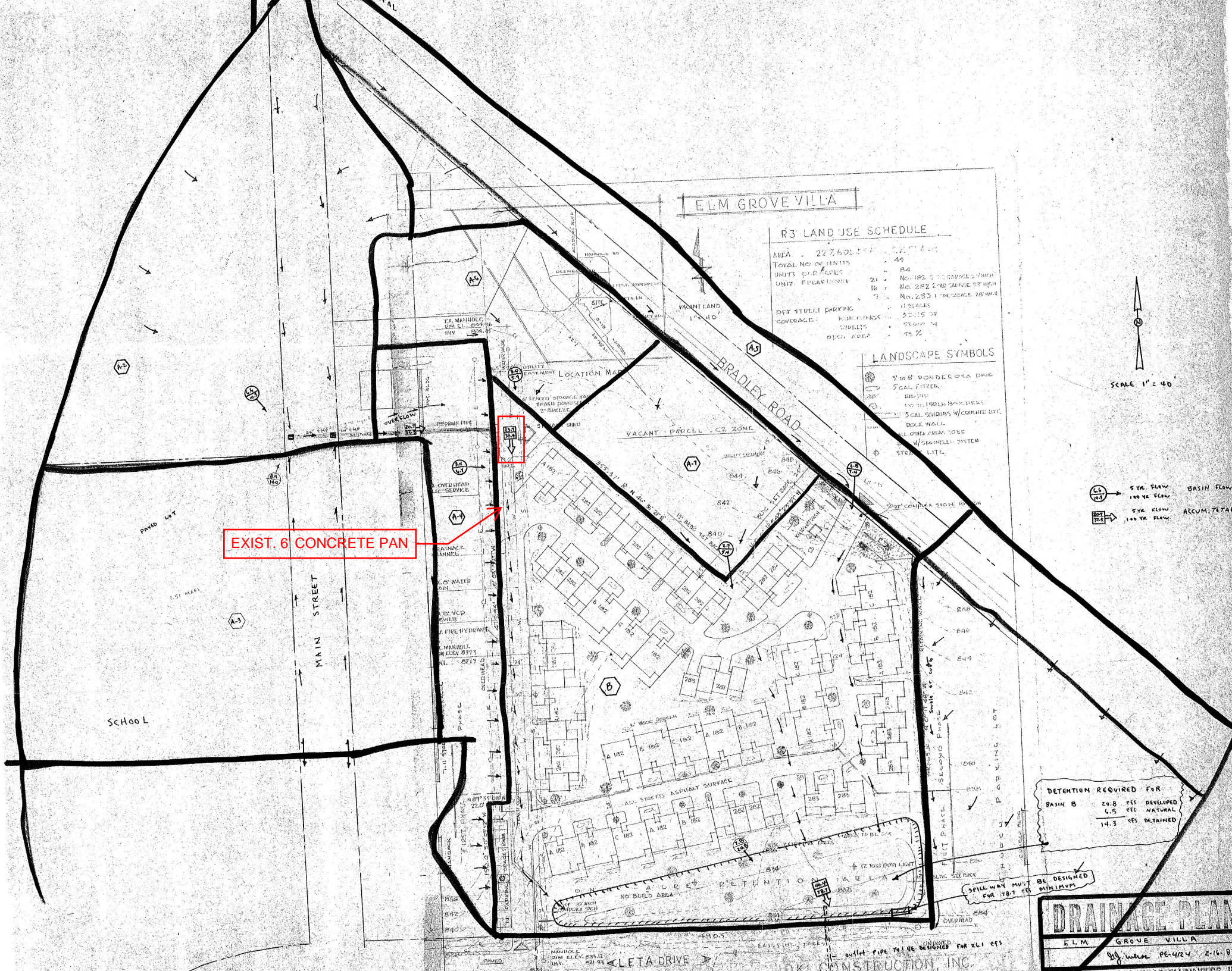

APPENDIX B
Hydrologic Computations

Existing Computations

COMPOSITE % IMPERVIOUS CALCULATIONS: EXISTING CONDITIONS

Subdivision: Elm Grove Villa
Location: CO, Colorado Springs

Project Name: Smith Plumbing
Project No.: HCI000008
Calculated By: DDJ
Checked By: GD
Date: 11/12/21

1	2	3	4	5	6	7	8	9	10	11	27
Basin ID	Total Area (ac)	Paved/Gravel Roads			Undeveloped			Roofs			Basins Total Weighted % Imp.
		% Imp.	Area (ac)	Weighted % Imp.	% Imp.	Area (ac)	Weighted % Imp.	% Imp.	Area (ac)	Weighted % Imp.	
OS-1	0.34	100	0.20	58.8	2	0.14	0.8	90	0.00	0.0	59.6
OS-2	0.34	100	0.18	52.9	2	0.08	0.5	90	0.08	21.2	74.6
E-1	0.02	100	0.02	100.0	2	0.00	0.0	90	0.00	0.0	100.0
E-2	0.10	100	0.10	100.0	2	0.00	0.0	90	0.00	0.0	100.0
E-3	0.14	100	0.00	0.0	2	0.14	2.0	90	0.00	0.0	2.0
E-4	1.19	100	0.00	0.0	2	1.19	2.0	90	0.00	0.0	2.0
E-5	0.02	100	0.00	0.0	2	0.02	2.0	90	0.00	0.0	2.0
E-6	0.05	100	0.00	0.0	2	0.05	2.0	90	0.00	0.0	2.0

NOTES:

% Impervious values are taken directly from Table 6-6 in the Colorado Springs DCM Vol. 1. CH. 6 (Referencing UDFCD 2001)

COMPOSITE RUNOFF COEFFICIENT CALCULATIONS: EXISTING CONDITIONS

Subdivision: Elm Grove Villa
Location: CO, Colorado Springs

Project Name: Smith Plumbing
Project No.: HCI000008
Calculated By: DDJ
Checked By: GD
Date: 11/12/21

Basin ID	Total Area (ac)	Paved/Gravel Roads			Lawns/Undeveloped			Roofs			Composite C ₅	Composite C ₁₀₀
		C ₅	C ₁₀₀	Area (ac)	C ₅	C ₁₀₀	Area (ac)	C ₅	C ₁₀₀	Area (ac)		
OS-1	0.34	0.90	0.96	0.20	0.09	0.36	0.14	0.73	0.81	0.00	0.57	0.71
OS-2	0.34	0.90	0.96	0.18	0.09	0.36	0.08	0.73	0.81	0.08	0.67	0.78
E-1	0.02	0.90	0.96	0.02	0.09	0.36	0.00	0.73	0.81	0.00	0.90	0.96
E-2	0.10	0.90	0.96	0.10	0.09	0.36	0.00	0.73	0.81	0.00	0.90	0.96
E-3	0.14	0.90	0.96	0.00	0.09	0.36	0.14	0.73	0.81	0.00	0.09	0.36
E-4	1.19	0.90	0.96	0.00	0.09	0.36	1.19	0.73	0.81	0.00	0.09	0.36
E-5	0.02	0.90	0.96	0.00	0.09	0.36	0.02	0.73	0.81	0.00	0.09	0.36
E-6	0.05	0.90	0.96	0.00	0.09	0.36	0.05	0.73	0.81	0.00	0.09	0.36

NOTES:

*C values are taken directly from Table 6-6 in the Colorado Springs DCM Vol. 1, CH. 6 (Referencing UDFCD 2001)
Coefficients use HSG A&B soils - Refer to "Appendix A: Exhibits and Figures" for soil map*

STANDARD FORM SF-2: EXISTING CONDITIONS TIME OF CONCENTRATION

Subdivision: Elm Grove Villa
Location: CO, Colorado Springs

Project Name: Smith Plumbing
Project No.: HCI000008
Calculated By: DDJ
Checked By: GD
Date: 11/12/21

SUB-BASIN						INITIAL/OVERLAND			TRAVEL TIME					T _c CHECK			FINAL
DATA						(T _i)			(T _t)					(URBANIZED BASINS)			
BASIN ID	D.A. (AC)	Hydrologic Soils Group	Impervious (%)	C ₅	C ₁₀₀	L (FT)	S (%)	T _i (MIN)	L (FT)	S (%)	C _v	VEL. (FPS)	T _t (MIN)	COMP. T _c (MIN)	TOTAL LENGTH(FT)	Urbanized T _c (MIN)	
OS-1	0.34	A	59.6	0.57	0.71	35	1.2	5.4	0	0.0	15	0.0	0.0	5.4	35.0	10.2	5.4
OS-2	0.34	A	74.6	0.67	0.78	75	2.0	5.4	100	2.0	20	2.8	0.6	6.0	175.0	11.0	6.0
E-1	0.02	A	100.0	0.90	0.96	30	4.5	1.2	0	0.0	20	0.0	0.0	1.2	30.0	10.2	5.0
E-2	0.10	A	100.0	0.90	0.96	30	4.5	1.2	0	0.0	20	0.0	0.0	1.2	30.0	10.2	5.0
E-3	0.14	A	2.0	0.09	0.36	5	4.0	2.6	185	3.3	15	2.7	1.1	3.7	190.0	11.1	5.0
E-4	1.19	A	2.0	0.09	0.36	5	4.0	2.6	375	1.3	15	1.7	3.7	6.3	380.0	12.1	6.3
E-5	0.02	A	2.0	0.09	0.36	5	50.0	1.1	0	0.0	15	0.0	0.0	1.1	5.0	10.0	5.0
E-6	0.05	A	2.0	0.09	0.36	5	50.0	1.1	0	0.0	15	0.0	0.0	1.1	5.0	10.0	5.0

NOTES:

$T_i = (0.395 * (1.1 - C_5) * (L)^{0.5}) / ((S)^{0.33})$, S in ft/ft

$T_t = L / 60V$ (Velocity From Fig. 501)

Velocity $V = C_v * S^{0.5}$, S in ft/ft

$T_c \text{ Check} = 10 + L / 180$

For Urbanized basins a minimum T_c of 5.0 minutes is required.

For non-urbanized basins a minimum T_c of 10.0 minutes is required

Type of Land Surface	C _v
Heavy Meadow	2.5
Tillage/field	5
Short pasture and lawns	7
Nearly bare ground	10
Grassed waterway	15
Paved areas and shallow paved swales	20

STANDARD FORM SF-3: EXISTING CONDITIONS
STORM DRAINAGE SYSTEM DESIGN
(RATIONAL METHOD PROCEDURE)

Subdivision: Elm Grove Villa
Location: CO, Colorado Springs
Design Storm: 5-Year

Project Name: Smith Plumbing
Project No.: HC1000008
Calculated By: DDJ
Checked By: GD
Date: 11/12/21

STREET	Design Point	DIRECT RUNOFF							TOTAL RUNOFF				STREET		PIPE			TRAVEL TIME			REMARKS
		Basin ID	Area (Ac)	Runoff Coeff.	Tc (min)	C*A (Ac)	I (in/hr)	Q (cfs)	Tc (min)	C*A (Ac)	I (in/hr)	Q (cfs)	Slope (%)	Street Flow (cfs)	Design Flow (cfs)	Slope (%)	Pipe Size (inches)	Length (ft)	Velocity (fps)	Tt (min)	
	1	OS-1	0.34	0.57	5.4	0.19	5.05	1.0													Offsite flows north of property flowing onto site
	2	E-1	0.02	0.90	5.0	0.02	5.17	0.1					1.3					350	1.7	3.4	Existing basin at entrance which reach Hanock Expressway
	7	OS-2	0.34	0.67	6.0	0.23	4.90	1.1					2					150	2.1	1.2	Offsite flows northwest of property flowing onto site
	3	E-2	0.10	0.90	5.0	0.09	5.17	0.5	7.2	0.32	4.63	1.5									Existing basin through entrance which flows offsite (across existing parking lot)
		E-3	0.14	0.09	5.0	0.01	5.17	0.1													Basin located along western edge of property line, reaches existing inlet
	4	E-4	1.19	0.09	6.3	0.11	4.83	0.5	8.8	0.30	4.32	1.3									Bulk of site which flows towards existing low point on-site (plugged inlet, direction unknown)
	5	E-5	0.02	0.09	5.0	0.00	5.17	0.0										350	1.1	5.5	Basin along east property line which drains offsite to the east
		E-6	0.05	0.09	5.0	0.00	5.17	0.0					0.5					20	1.1	0.3	Basin along south property line which drains offsite to the south.
	6								8.8	0.31	4.32	1.3									Basins OS-1, E-3 and E-4

STANDARD FORM SF-3: EXISTING CONDITIONS
STORM DRAINAGE SYSTEM DESIGN
(RATIONAL METHOD PROCEDURE)

Subdivision: Elm Grove Villa
Location: CO, Colorado Springs
Design Storm: 100-Year

Project Name: Smith Plumbing
Project No.: HCI000008
Calculated By: DDJ
Checked By: GD
Date: 11/12/21

STREET	Design Point	DIRECT RUNOFF							TOTAL RUNOFF				STREET		PIPE			TRAVEL TIME			REMARKS
		Basin ID	Area (Ac)	Runoff Coeff.	Tc (min)	C*A (Ac)	I (in/hr)	Q (cfs)	Tc (min)	C*A (Ac)	I (in/hr)	Q (cfs)	Slope (%)	Street Flow (cfs)	Design Flow (cfs)	Slope (%)	Pipe Size (inches)	Length (ft)	Velocity (fps)	Tt (min)	
	1	OS-1	0.34	0.71	5.4	0.24	8.48	2.0					1.3					350	1.7	3.4	Offsite flows north of property flowing onto site
	2	E-1	0.02	0.96	5.0	0.02	8.68	0.2													Existing basin at entrance which reach Hanock Expressway
	7	OS-2	0.34	0.78	6.0	0.27	8.22	2.2					2					150	2.1	1.2	Offsite flows northwest of property flowing onto site
	3	E-2	0.10	0.96	5.0	0.10	8.68	0.9	7.2	0.37	7.77	2.9									Existing basin through entrance which flows offsite (across existing parking lot)
		E-3	0.14	0.36	5.0	0.05	8.68	0.4													Basin located along western edge of property line, reaches existing inlet
	4	E-4	1.19	0.36	6.3	0.43	8.11	3.5	8.8	0.67	7.25	4.9									Bulk of site which flows towards existing low point on-site (plugged inlet, direction unknown)
	5	E-5	0.02	0.36	5.0	0.01	8.68	0.1					0.5					350	1.1	5.5	Basin along east property line which drains offsite to the east
		E-6	0.05	0.36	5.0	0.02	8.68	0.2					0.5					20	1.1	0.3	Basin along south property line which drains offsite to the south.
	6								8.8	0.72	7.25	5.2									Basins OS-1, E-3 and E-4

Proposed Computations

COMPOSITE % IMPERVIOUS CALCULATIONS: PROPOSED CONDITIONS

Subdivision: Elm Grove Villa
Location: CO, Colorado Springs

Project Name: Smith Plumbing
Project No.: HCI000008
Calculated By: DDJ
Checked By: GD
Date: 11/12/21

Basin ID	Total Area (ac)	Paved/Gravel Roads			Undeveloped			Roofs			Basins Total Weighted % Imp.
		% Imp.	Area (ac)	Weighted % Imp.	% Imp.	Area (ac)	Weighted % Imp.	% Imp.	Area (ac)	Weighted % Imp.	
OS-1	0.34	100	0.20	58.8	2	0.14	0.8	90	0.00	0.0	59.6
OS-2	0.34	100	0.18	52.9	2	0.08	0.5	90	0.08	21.2	74.6
E-1	0.02	100	0.02	100.0	2	0.00	0.0	90	0.00	0.0	100.0
E-2	0.10	100	0.10	100.0	2	0.00	0.0	90	0.00	0.0	100.0
E-3	0.13	100	0.07	51.6	2	0.06	1.0	90	0.00	0.0	52.6
E-4	0.72	100	0.44	61.8	2	0.00	0.0	90	0.27	34.4	96.2
E-5	0.11	100	0.11	96.3	2	0.00	0.0	90	0.00	0.0	96.3
E-6	0.26	100	0.00	0.0	2	0.26	2.0	90	0.00	0.0	2.0
E-7	0.06	100	0.00	0.0	2	0.06	2.0	90	0.00	0.0	2.0
E-8	0.12	100	0.05	44.4	2	0.07	1.1	90	0.00	0.0	45.5

NOTES:

% Impervious values are taken directly from Table 6-6 in the Colorado Springs DCM Vol. 1, CH. 6 (Referencing UDFCD 2001)

COMPOSITE RUNOFF COEFFICIENT CALCULATIONS: PROPOSED CONDITIONS

Subdivision: Elm Grove Villa
Location: CO, Colorado Springs

Project Name: Smith Plumbing
Project No.: HCI000008
Calculated By: DDJ
Checked By: GD
Date: 11/12/21

Basin ID	Total Area (ac)	Paved/Gravel Roads			Lawns/Undeveloped			Roofs			Composite C ₅	Composite C ₁₀₀
		C ₅	C ₁₀₀	Area (ac)	C ₅	C ₁₀₀	Area (ac)	C ₅	C ₁₀₀	Area (ac)		
OS-1	0.34	0.90	0.96	0.20	0.09	0.36	0.14	0.73	0.81	0.00	0.57	0.71
OS-2	0.34	0.90	0.96	0.18	0.09	0.36	0.08	0.73	0.81	0.08	0.67	0.78
E-1	0.02	0.90	0.96	0.02	0.09	0.36	0.00	0.73	0.81	0.00	0.90	0.96
E-2	0.10	0.90	0.96	0.10	0.09	0.36	0.00	0.73	0.81	0.00	0.90	0.96
E-3	0.13	0.90	0.96	0.07	0.09	0.36	0.06	0.73	0.81	0.00	0.51	0.67
E-4	0.72	0.90	0.96	0.44	0.09	0.36	0.00	0.73	0.81	0.27	0.84	0.90
E-5	0.11	0.90	0.96	0.11	0.09	0.36	0.00	0.73	0.81	0.00	0.87	0.94
E-6	0.26	0.90	0.96	0.00	0.09	0.36	0.26	0.73	0.81	0.00	0.09	0.36
E-7	0.06	0.90	0.96	0.00	0.09	0.36	0.06	0.73	0.81	0.00	0.09	0.36
E-8	0.12	0.90	0.96	0.05	0.09	0.36	0.07	0.73	0.81	0.00	0.45	0.63

NOTES:

*C values are taken directly from Table 6-6 in the Colorado Springs DCM Vol. 1, CH. 6 (Referencing UDFCD 2001)
Coefficients use HSG A&B soils - Refer to "Appendix A: Exhibits and Figures" for soil map*

STANDARD FORM SF-2: PROPOSED CONDITIONS TIME OF CONCENTRATION

Subdivision: Elm Grove Villa
Location: CO, Colorado Springs

Project Name: Smith Plumbing
Project No.: HCI000008
Calculated By: DDJ
Checked By: GD
Date: 11/12/21

SUB-BASIN						INITIAL/OVERLAND			TRAVEL TIME					T _c CHECK			FINAL
DATA						(T _i)			(T _t)					(URBANIZED BASINS)			
BASIN ID	D.A. (AC)	Hydrologic Soils Group	Impervious (%)	C ₅	C ₁₀₀	L (FT)	S (%)	T _i (MIN)	L (FT)	S (%)	C _v	VEL. (FPS)	T _t (MIN)	COMP. T _c (MIN)	TOTAL LENGTH(FT)	Urbanized T _c (MIN)	
OS-1	0.34	A	59.6	0.57	0.71	35	1.2	5.4	0	0.0	15	0.0	0.0	5.4	35.0	10.2	5.4
OS-2	0.34	A	74.6	0.67	0.78	75	2.0	5.4	100	2.0	20	2.8	0.6	6.0	175.0	11.0	6.0
E-1	0.02	A	100.0	0.90	0.96	30	4.5	1.2	0	0.0	20	0.0	0.0	1.2	30.0	10.2	5.0
E-2	0.10	A	100.0	0.90	0.96	30	4.5	1.2	0	0.0	20	0.0	0.0	1.2	30.0	10.2	5.0
E-3	0.13	A	52.6	0.51	0.67	5	4.0	1.5	185	3.3	20	3.6	0.8	2.4	190.0	11.1	5.0
E-4	0.72	A	96.2	0.84	0.90	100	0.7	5.4	300	0.5	20	1.4	3.5	8.9	400.0	12.2	8.9
E-5	0.11	A	96.3	0.87	0.94	65	1.4	3.0	45	0.5	20	1.4	0.5	3.6	110.0	10.6	5.0
E-6	0.26	A	2.0	0.09	0.36	10	25.0	2.0	450	0.5	15	1.1	7.1	9.1	460.0	12.6	9.1
E-7	0.06	A	2.0	0.09	0.36	10	25.0	2.0	50	0.5	15	1.1	0.8	2.8	60.0	10.3	5.0
E-8	0.12	A	45.5	0.45	0.63	5	2.0	2.1	65	2.0	20	2.8	0.4	2.5	70.0	10.4	5.0

NOTES:

$$T_i = (0.395 * (1.1 - C_5) * (L)^{0.5}) / ((S)^{0.33}), \text{ S in ft/ft}$$

$$T_t = L / 60V \text{ (Velocity From Fig. 501)}$$

$$\text{Velocity } V = C_v * S^{0.5}, \text{ S in ft/ft}$$

$$T_c \text{ Check} = 10 + L / 180$$

For Urbanized basins a minimum T_c of 5.0 minutes is required.

For non-urbanized basins a minimum T_c of 10.0 minutes is required

Type of Land Surface	C _v
Heavy Meadow	2.5
Tillage/field	5
Short pasture and lawns	7
Nearly bare ground	10
Grassed waterway	15
Paved areas and shallow paved swales	20

STANDARD FORM SF-3: PROPOSED CONDITIONS
STORM DRAINAGE SYSTEM DESIGN
(RATIONAL METHOD PROCEDURE)

Subdivision: Elm Grove Villa
Location: CO, Colorado Springs
Design Storm: 5-Year

Project Name: Smith Plumbing
Project No.: HC1000008
Calculated By: DDJ
Checked By: GD
Date: 3/24/22

STREET	Design Point	DIRECT RUNOFF							TOTAL RUNOFF				STREET		PIPE			TRAVEL TIME			REMARKS
		Basin ID	Area (Ac)	Runoff Coeff.	Tc (min)	C ^a (Ac)	I (in/hr)	Q (cfs)	Tc (min)	C ^a (Ac)	I (in/hr)	Q (cfs)	Slope (%)	Street Flow (cfs)	Design Flow (cfs)	Slope (%)	Pipe Size (inches)	Length (ft)	Velocity (fps)	Tt (min)	
	1	OS-1	0.34	0.57	5.4	0.19	5.05	1.0													Offsite flows north of property directed southeast per existing report
	9	OS-2	0.34	0.67	6.0	0.23	4.90	1.1													Offsite flows northwest of property flowing through site
	2	E-1	0.02	0.90	5.0	0.02	5.17	0.1													Existing basin at entrance which reach Hancock Expressway
	3	E-2	0.10	0.90	5.0	0.09	5.17	0.5													Existing basin through entrance which flows offsite (across existing parking lot)
	8	E-3	0.13	0.51	5.0	0.07	5.17	0.4													Basin located along western edge of property line, reaches existing inlet through curb cut
	4	E-4	0.72	0.84	8.9	0.60	4.30	2.6													Bulk of site which flows towards proposed curb cut-north side pond
	5	E-5	0.11	0.87	5.0	0.10	5.17	0.5													Basin along east of pond-releases through curb cut
	6	E-8	0.12	0.45	5.0	0.05	5.17	0.3													Basin along north of pond-releases through curb cut
		E-6	0.26	0.09	9.1	0.02	4.28	0.1													Basin along north, east & south property line which drains to the the townhome property per the existing report
		E-7	0.06	0.09	5.0	0.01	5.17	0.1													Pond area
	7								8.9	0.76	4.30	3.3									All flows entering pond (Basins E-4, E-5, E-7, E-8) Detained for a 0.2 cfs reduction
									Pond Detained Release =			3.1									
Total Release Into Conc. Pan												24.1									EX 23.7 cfs Basin B - 3 cfs (Basin A-6) + DP8 + DP7

STANDARD FORM SF-3: PROPOSED CONDITIONS
STORM DRAINAGE SYSTEM DESIGN
(RATIONAL METHOD PROCEDURE)

Subdivision: Elm Grove Villa
Location: CO, Colorado Springs
Design Storm: 100-Year

Project Name: Smith Plumbing
Project No.: HCI000008
Calculated By: DDJ
Checked By: GD
Date: 3/24/22

STREET	Design Point	DIRECT RUNOFF							TOTAL RUNOFF				STREET		PIPE			TRAVEL TIME			REMARKS
		Basin ID	Area (Ac)	Runoff Coeff.	Tc (min)	C* A (Ac)	I (in/hr)	Q (cfs)	Tc (min)	C* A (Ac)	I (in/hr)	Q (cfs)	Slope (%)	Street Flow (cfs)	Design Flow (cfs)	Slope (%)	Pipe Size (inches)	Length (ft)	Velocity (fps)	Tt (min)	
	1	OS-1	0.34	0.71	5.4	0.24	8.48	2.0													Offsite flows north of property directed southeast per existing report
	9	OS-2	0.34	0.78	6.0	0.27	8.22	2.2													Offsite flows northwest of property flowing through site
	2	E-1	0.02	0.96	5.0	0.02	8.68	0.2													Existing basin at entrance which reach Hanock Expressway
	3	E-2	0.10	0.96	5.0	0.10	8.68	0.9													Existing basin through entrance which flows offsite (across existing parking lot)
	8	E-3	0.13	0.67	5.0	0.09	8.68	0.8													Basin located along western edge of property line, reaches existing inlet through curb cut
	4	E-4	0.72	0.90	8.9	0.65	7.23	4.7													Bulk of site which flows towards proposed curb cut-north side pond
	5	E-5	0.11	0.94	5.0	0.10	8.68	0.9													Basin along east of pond-releases through curb cut
	6	E-8	0.12	0.63	5.0	0.07	8.68	0.6													Basin along north of pond-releases through curb cut
		E-6	0.26	0.36	9.1	0.09	7.18	0.6													Basin along north, east & south property line which drains to the the townhome property per the existing report
		E-7	0.06	0.36	5.0	0.02	8.68	0.2													Pond area
	7								8.9	0.84	7.23	6.1									All flows entering pond (Basins E-4, E-5, E-7, E-8) Detained to release 1 cfs lower
									Pond Detained Release =			5.1									
Total Release Into Conc. Pan												38.4									EX 38.4 cfs Basin B - 5.9 cfs (Basin A-6) + DP8 + DP7

APPENDIX C
Hydraulic Computations

Worksheet for Cross Pan to DP 4

Project Description

Friction Method	Manning Formula
Solve For	Normal Depth

Input Data

Roughness Coefficient	0.013	
Channel Slope	0.01600	ft/ft
Left Side Slope	6.00	ft/ft (H:V)
Right Side Slope	6.00	ft/ft (H:V)
Discharge	4.70	ft ³ /s

Results

Normal Depth	0.40	ft
Flow Area	0.96	ft ²
Wetted Perimeter	4.87	ft
Hydraulic Radius	0.20	ft
Top Width	4.80	ft
Critical Depth	0.52	ft
Critical Slope	0.00393	ft/ft
Velocity	4.90	ft/s
Velocity Head	0.37	ft
Specific Energy	0.77	ft
Froude Number	1.93	
Flow Type	Supercritical	

GVF Input Data

Downstream Depth	0.00	ft
Length	0.00	ft
Number Of Steps	0	

GVF Output Data

Upstream Depth	0.00	ft
Profile Description		
Profile Headloss	0.00	ft
Downstream Velocity	Infinity	ft/s
Upstream Velocity	Infinity	ft/s
Normal Depth	0.40	ft
Critical Depth	0.52	ft
Channel Slope	0.01600	ft/ft
Critical Slope	0.00393	ft/ft

Worksheet for Curb Cut - DP 4

Project Description

Friction Method	Manning Formula
Solve For	Bottom Width

Input Data

Roughness Coefficient	0.013	
Channel Slope	0.00500	ft/ft
Normal Depth	0.50	ft
Discharge	4.70	ft ³ /s

Results

Bottom Width	2.34	ft
Flow Area	1.17	ft ²
Wetted Perimeter	3.34	ft
Hydraulic Radius	0.35	ft
Top Width	2.34	ft
Critical Depth	0.50	ft
Critical Slope	0.00499	ft/ft
Velocity	4.02	ft/s
Velocity Head	0.25	ft
Specific Energy	0.75	ft
Froude Number	1.00	
Flow Type	Supercritical	

GVF Input Data

Downstream Depth	0.00	ft
Length	0.00	ft
Number Of Steps	0	

GVF Output Data

Upstream Depth	0.00	ft
Profile Description		
Profile Headloss	0.00	ft
Downstream Velocity	Infinity	ft/s
Upstream Velocity	Infinity	ft/s
Normal Depth	0.50	ft
Critical Depth	0.50	ft
Channel Slope	0.00500	ft/ft
Critical Slope	0.00499	ft/ft

Worksheet for RR Swale-DP 4 to Pond

Project Description

Friction Method	Manning Formula
Solve For	Normal Depth

Input Data

Roughness Coefficient	0.035	
Channel Slope	0.10500	ft/ft
Left Side Slope	4.00	ft/ft (H:V)
Right Side Slope	4.00	ft/ft (H:V)
Discharge	4.70	ft ³ /s

Results

Normal Depth	0.48	ft
Flow Area	0.91	ft ²
Wetted Perimeter	3.93	ft
Hydraulic Radius	0.23	ft
Top Width	3.81	ft
Critical Depth	0.61	ft
Critical Slope	0.02758	ft/ft
Velocity	5.18	ft/s
Velocity Head	0.42	ft
Specific Energy	0.89	ft
Froude Number	1.87	
Flow Type	Supercritical	

GVF Input Data

Downstream Depth	0.00	ft
Length	0.00	ft
Number Of Steps	0	

GVF Output Data

Upstream Depth	0.00	ft
Profile Description		
Profile Headloss	0.00	ft
Downstream Velocity	Infinity	ft/s
Upstream Velocity	Infinity	ft/s
Normal Depth	0.48	ft
Critical Depth	0.61	ft
Channel Slope	0.10500	ft/ft
Critical Slope	0.02758	ft/ft

Worksheet for Curb Cut - DP 5

Project Description

Friction Method Manning Formula
Solve For Bottom Width

Input Data

Roughness Coefficient	0.013	
Channel Slope	0.00500	ft/ft
Normal Depth	0.50	ft
Discharge	1.00	ft ³ /s

Results

Bottom Width	0.71	ft
Flow Area	0.35	ft ²
Wetted Perimeter	1.71	ft
Hydraulic Radius	0.21	ft
Top Width	0.71	ft
Critical Depth	0.40	ft
Critical Slope	0.00914	ft/ft
Velocity	2.83	ft/s
Velocity Head	0.12	ft
Specific Energy	0.62	ft
Froude Number	0.71	
Flow Type	Subcritical	

GVF Input Data

Downstream Depth	0.00	ft
Length	0.00	ft
Number Of Steps	0	

GVF Output Data

Upstream Depth	0.00	ft
Profile Description		
Profile Headloss	0.00	ft
Downstream Velocity	Infinity	ft/s
Upstream Velocity	Infinity	ft/s
Normal Depth	0.50	ft
Critical Depth	0.40	ft
Channel Slope	0.00500	ft/ft
Critical Slope	0.00914	ft/ft

Worksheet for RR Swale-DP 5 to Pond

Project Description

Friction Method	Manning Formula
Solve For	Normal Depth

Input Data

Roughness Coefficient	0.045	
Channel Slope	0.00500	ft/ft
Left Side Slope	4.00	ft/ft (H:V)
Right Side Slope	4.00	ft/ft (H:V)
Discharge	1.00	ft ³ /s

Results

Normal Depth	0.52	ft
Flow Area	1.08	ft ²
Wetted Perimeter	4.27	ft
Hydraulic Radius	0.25	ft
Top Width	4.15	ft
Critical Depth	0.33	ft
Critical Slope	0.05604	ft/ft
Velocity	0.93	ft/s
Velocity Head	0.01	ft
Specific Energy	0.53	ft
Froude Number	0.32	
Flow Type	Subcritical	

GVF Input Data

Downstream Depth	0.00	ft
Length	0.00	ft
Number Of Steps	0	

GVF Output Data

Upstream Depth	0.00	ft
Profile Description		
Profile Headloss	0.00	ft
Downstream Velocity	Infinity	ft/s
Upstream Velocity	Infinity	ft/s
Normal Depth	0.52	ft
Critical Depth	0.33	ft
Channel Slope	0.00500	ft/ft
Critical Slope	0.05604	ft/ft

Worksheet for Curb Cut - DP 6

Project Description

Friction Method	Manning Formula
Solve For	Bottom Width

Input Data

Roughness Coefficient	0.013	
Channel Slope	0.00500	ft/ft
Normal Depth	0.50	ft
Discharge	0.40	ft ³ /s

Results

Bottom Width	0.37	ft
Flow Area	0.19	ft ²
Wetted Perimeter	1.37	ft
Hydraulic Radius	0.14	ft
Top Width	0.37	ft
Critical Depth	0.33	ft
Critical Slope	0.01380	ft/ft
Velocity	2.14	ft/s
Velocity Head	0.07	ft
Specific Energy	0.57	ft
Froude Number	0.53	
Flow Type	Subcritical	

GVF Input Data

Downstream Depth	0.00	ft
Length	0.00	ft
Number Of Steps	0	

GVF Output Data

Upstream Depth	0.00	ft
Profile Description		
Profile Headloss	0.00	ft
Downstream Velocity	Infinity	ft/s
Upstream Velocity	Infinity	ft/s
Normal Depth	0.50	ft
Critical Depth	0.33	ft
Channel Slope	0.00500	ft/ft
Critical Slope	0.01380	ft/ft

Worksheet for RR Swale-DP 6 to Pond

Project Description

Friction Method	Manning Formula
Solve For	Normal Depth

Input Data

Roughness Coefficient	0.045	
Channel Slope	0.00500	ft/ft
Left Side Slope	4.00	ft/ft (H:V)
Right Side Slope	4.00	ft/ft (H:V)
Discharge	0.40	ft ³ /s

Results

Normal Depth	0.37	ft
Flow Area	0.54	ft ²
Wetted Perimeter	3.03	ft
Hydraulic Radius	0.18	ft
Top Width	2.94	ft
Critical Depth	0.23	ft
Critical Slope	0.06335	ft/ft
Velocity	0.74	ft/s
Velocity Head	0.01	ft
Specific Energy	0.38	ft
Froude Number	0.30	
Flow Type	Subcritical	

GVF Input Data

Downstream Depth	0.00	ft
Length	0.00	ft
Number Of Steps	0	

GVF Output Data

Upstream Depth	0.00	ft
Profile Description		
Profile Headloss	0.00	ft
Downstream Velocity	Infinity	ft/s
Upstream Velocity	Infinity	ft/s
Normal Depth	0.37	ft
Critical Depth	0.23	ft
Channel Slope	0.00500	ft/ft
Critical Slope	0.06335	ft/ft

Worksheet for Ex Pan & Street-Existing Flow

Project Description

Friction Method Manning Formula
 Solve For Normal Depth

Input Data

Channel Slope 0.01300 ft/ft
 Discharge 38.40 ft³/s
 Section Definitions

Station (ft)	Elevation (ft)
0+00	1.50
0+00	0.00
0+03	-0.25
0+06	0.00
0+30	0.48
0+31	0.52
0+32	1.02
0+33	1.02

Roughness Segment Definitions

Start Station	Ending Station	Roughness Coefficient
(0+00, 1.50)	(0+06, 0.00)	0.012
(0+06, 0.00)	(0+30, 0.48)	0.012
(0+30, 0.48)	(0+31, 0.52)	0.016
(0+31, 0.52)	(0+32, 1.02)	0.012
(0+32, 1.02)	(0+33, 1.02)	0.012

Options

Current Roughness Weighted Method Pavlovskii's Method
 Open Channel Weighting Method Pavlovskii's Method
 Closed Channel Weighting Method Pavlovskii's Method

Results

Normal Depth 0.63 ft

Worksheet for Ex Pan & Street-Existing Flow

Results

Elevation Range	-0.25 to 1.50 ft	
Flow Area	6.65	ft ²
Wetted Perimeter	25.43	ft
Hydraulic Radius	0.26	ft
Top Width	25.02	ft
Normal Depth	0.63	ft
Critical Depth	0.79	ft
Critical Slope	0.00302	ft/ft
Velocity	5.77	ft/s
Velocity Head	0.52	ft
Specific Energy	1.15	ft
Froude Number	1.97	
Flow Type	Supercritical	

GVF Input Data

Downstream Depth	0.00	ft
Length	0.00	ft
Number Of Steps	0	

GVF Output Data

Upstream Depth	0.00	ft
Profile Description		
Profile Headloss	0.00	ft
Downstream Velocity	Infinity	ft/s
Upstream Velocity	Infinity	ft/s
Normal Depth	0.63	ft
Critical Depth	0.79	ft
Channel Slope	0.01300	ft/ft
Critical Slope	0.00302	ft/ft

Cross Section for Ex Pan & Street-Existing Flow

Project Description

Friction Method Manning Formula
Solve For Normal Depth

Input Data

Channel Slope	0.01300	ft/ft
Normal Depth	0.63	ft
Discharge	38.40	ft ³ /s

Cross Section Image

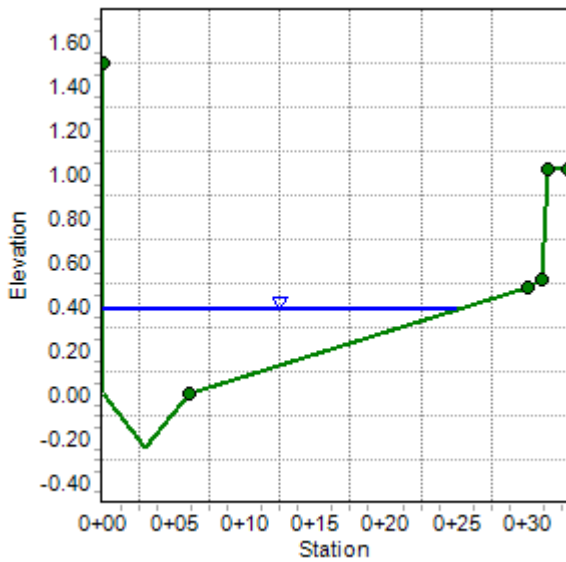

Worksheet for Ex Pan & Street-Proposed Flow

Project Description

Friction Method Manning Formula
 Solve For Normal Depth

Input Data

Channel Slope 0.01300 ft/ft
 Discharge 38.40 ft³/s
 Section Definitions

Station (ft)	Elevation (ft)
0+00	1.50
0+00	0.00
0+03	-0.25
0+06	0.00
0+30	0.48
0+31	0.52
0+32	1.02
0+33	1.02

Roughness Segment Definitions

Start Station	Ending Station	Roughness Coefficient
(0+00, 1.50)	(0+06, 0.00)	0.012
(0+06, 0.00)	(0+30, 0.48)	0.012
(0+30, 0.48)	(0+31, 0.52)	0.016
(0+31, 0.52)	(0+32, 1.02)	0.012
(0+32, 1.02)	(0+33, 1.02)	0.012

Options

Current Roughness Weighted Method Pavlovskii's Method
 Open Channel Weighting Method Pavlovskii's Method
 Closed Channel Weighting Method Pavlovskii's Method

Results

Normal Depth 0.63 ft

Worksheet for Ex Pan & Street-Proposed Flow

Results

Elevation Range	-0.25 to 1.50 ft	
Flow Area	6.65	ft ²
Wetted Perimeter	25.43	ft
Hydraulic Radius	0.26	ft
Top Width	25.02	ft
Normal Depth	0.63	ft
Critical Depth	0.79	ft
Critical Slope	0.00302	ft/ft
Velocity	5.77	ft/s
Velocity Head	0.52	ft
Specific Energy	1.15	ft
Froude Number	1.97	
Flow Type	Supercritical	

GVF Input Data

Downstream Depth	0.00	ft
Length	0.00	ft
Number Of Steps	0	

GVF Output Data

Upstream Depth	0.00	ft
Profile Description		
Profile Headloss	0.00	ft
Downstream Velocity	Infinity	ft/s
Upstream Velocity	Infinity	ft/s
Normal Depth	0.63	ft
Critical Depth	0.79	ft
Channel Slope	0.01300	ft/ft
Critical Slope	0.00302	ft/ft

Cross Section for Ex Pan & Street-Proposed Flow

Project Description

Friction Method Manning Formula
Solve For Normal Depth

Input Data

Channel Slope	0.01300	ft/ft
Normal Depth	0.64	ft
Discharge	39.40	ft ³ /s

Cross Section Image

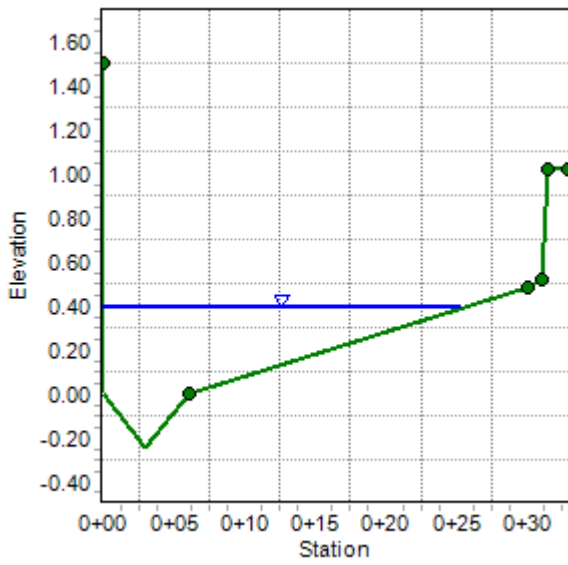

Worksheet for Existing Inlet Capacity

Project Description

Solve For Discharge

Input Data

Headwater Elevation	3.70	ft
Crest Elevation	3.20	ft
Tailwater Elevation	0.00	ft
Weir Coefficient	3.00	US
Crest Length	15.00	ft
Number Of Contractions	0	

Results

Discharge	15.91	ft ³ /s
Headwater Height Above Crest	0.50	ft
Tailwater Height Above Crest	-3.20	ft
Flow Area	7.50	ft ²
Velocity	2.12	ft/s
Wetted Perimeter	16.00	ft
Top Width	15.00	ft

Design Procedure Form: Grass Buffer (GB)

UD-BMP (Version 3.06, November 2016)

Sheet 1 of 1

Designer: DDJ
Company: Galloway
Date: November 11, 2021
Project: HVI000007
Location: 1875 Main Street

1. Design Discharge A) 2-Year Peak Flow Rate of the Area Draining to the Grass Buffer	$Q_2 = \underline{0.1} \text{ cfs}$
2. Minimum Width of Grass Buffer	$W_G = \underline{1} \text{ ft}$
3. Length of Grass Buffer (14' or greater recommended)	$L_G = \underline{237} \text{ ft}$
4. Buffer Slope (in the direction of flow, not to exceed 0.1 ft / ft)	$S_G = \underline{0.100} \text{ ft / ft}$
5. Flow Characteristics (sheet or concentrated) A) Does runoff flow into the grass buffer across the entire width of the buffer? B) Watershed Flow Length C) Interface Slope (normal to flow) D) Type of Flow Sheet Flow: $F_L * S_i \leq 1$ Concentrated Flow: $F_L * S_i > 1$	<div style="border: 1px solid black; padding: 5px; margin-bottom: 10px;"> Choose One <input checked="" type="radio"/> Yes <input type="radio"/> No </div> $F_L = \underline{12} \text{ ft}$ $S_i = \underline{0.001} \text{ ft / ft}$ <div style="background-color: #e0ffe0; padding: 2px; text-align: center; margin-top: 5px;"> SHEET FLOW </div>
6. Flow Distribution for Concentrated Flows	<div style="border: 1px solid black; padding: 5px; margin-bottom: 10px;"> Choose One <input checked="" type="radio"/> None (sheet flow) <input type="radio"/> Slotted Curbing <input type="radio"/> Level Spreader <input type="radio"/> Other (Explain): </div> <hr/> <hr/> <hr/>
7. Soil Preparation (Describe soil amendment)	<hr/> <hr/> <hr/>
8. Vegetation (Check the type used or describe "Other")	<div style="border: 1px solid black; padding: 5px; margin-bottom: 10px;"> Choose One <input type="radio"/> Existing Xeric Turf Grass <input checked="" type="radio"/> Irrigated Turf Grass <input type="radio"/> Other (Explain): </div> <hr/> <hr/> <hr/>
9. Irrigation (*Select None if existing buffer area has 80% vegetation AND will not be disturbed during construction.)	<div style="border: 1px solid black; padding: 5px; margin-bottom: 10px;"> Choose One <input type="radio"/> Temporary <input checked="" type="radio"/> Permanent <input type="radio"/> None* </div>
10. Outflow Collection (Check the type used or describe "Other")	<div style="border: 1px solid black; padding: 5px; margin-bottom: 10px;"> Choose One <input type="radio"/> Grass Swale <input type="radio"/> Street Gutter <input type="radio"/> Storm Sewer Inlet <input checked="" type="radio"/> Other (Explain): </div> Sheet flow offsite per the existing drainage report, ultimately ending up in the existing Detention Pond.
Notes: _____ _____ _____	

Design Procedure Form: Runoff Reduction

UD-BMP (Version 3.07, March 2018)

Sheet 1 of 1

Designer: CMD
Company: Galloway & Co.
Date: March 14, 2022
Project: Lot 2 Elm Grove Villa - Smith Plumbing - WQCV Pond Grass Buffer
Location: El Paso County, CO

SITE INFORMATION (User Input in Blue Cells)

WQCV Rainfall Depth = 0.60 inches
 Depth of Average Runoff Producing Storm, d_6 = 0.43 inches (for Watersheds Outside of the Denver Region, Figure 3-1 in USDCM Vol. 3)

Area Type	UIA:RPA																			
Area ID	E-6																			
Downstream Design Point ID																				
Downstream BMP Type	None																			
DCIA (ft ²)	--																			
UIA (ft ²)	5																			
RPA (ft ²)	11,326																			
SPA (ft ²)	--																			
HSG A (%)	100%																			
HSG B (%)	0%																			
HSG C/D (%)	0%																			
Average Slope of RPA (ft/ft)	0.250																			
UIA:RPA Interface Width (ft)	330.00																			

CALCULATED RUNOFF RESULTS

Area ID	E-6																			
UIA:RPA Area (ft ²)	11,331																			
L / W Ratio	0.10																			
UIA / Area	0.0004																			
Runoff (in)	0.00																			
Runoff (ft ³)	0																			
Runoff Reduction (ft ³)	0																			

CALCULATED WQCV RESULTS

Area ID	E-6																			
WQCV (ft ³)	0																			
WQCV Reduction (ft ³)	0																			
WQCV Reduction (%)	100%																			
Untreated WQCV (ft ³)	0																			

CALCULATED DESIGN POINT RESULTS (sums results from all columns with the same Downstream Design Point ID)

Downstream Design Point ID																				
DCIA (ft ²)																				
UIA (ft ²)																				
RPA (ft ²)																				
SPA (ft ²)																				
Total Area (ft ²)																				
Total Impervious Area (ft ²)																				
WQCV (ft ³)																				
WQCV Reduction (ft ³)																				
WQCV Reduction (%)																				
Untreated WQCV (ft ³)																				

CALCULATED SITE RESULTS (sums results from all columns in worksheet)

Total Area (ft ²)	
Total Impervious Area (ft ²)	
WQCV (ft ³)	
WQCV Reduction (ft ³)	
WQCV Reduction (%)	
Untreated WQCV (ft ³)	

Pond Calculations

Detention Pond Tributary Areas

Subdivision: Elm Grove Villa
Location: CO, Colorado Springs

Project Name: Elm Grove Villa
Project No.: HCI000008
Calculated By: DDJ
Checked By: GD
Date: 11/12/21

Pond

Basin	Area	% Imp
E-4	0.72	96.2
E-5	0.11	96.3
E-7	0.06	2
E-8	0.12	45.5
Total	1.00	84.6

DETENTION BASIN STAGE-STORAGE TABLE BUILDER

MHFD-Detention, Version 4.05 (January 2022)

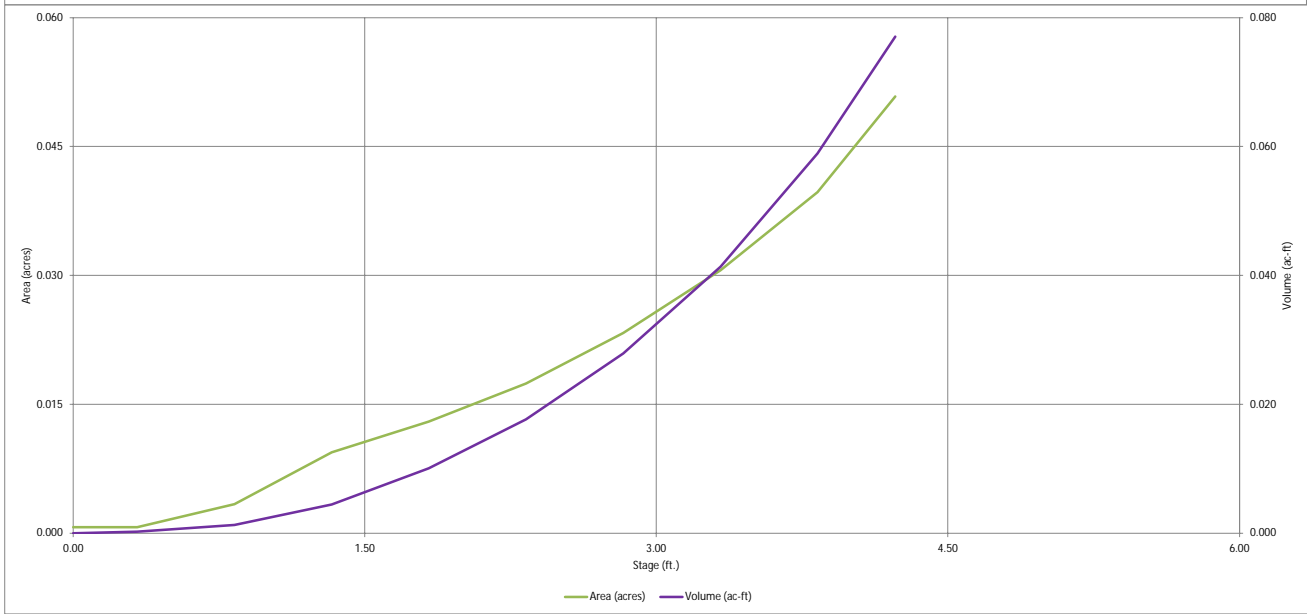
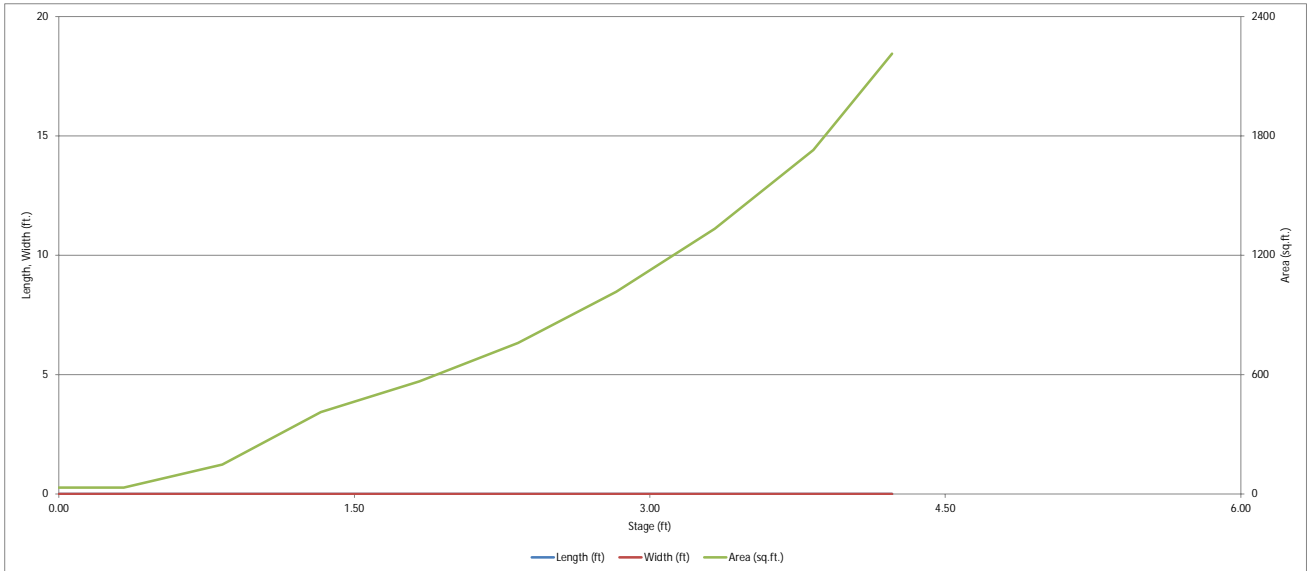

DETENTION BASIN OUTLET STRUCTURE DESIGN

MHFD- Detention, Version 4.05 (January 2022)

Project: Smith Plumbing
Basin ID: WQCV Pond

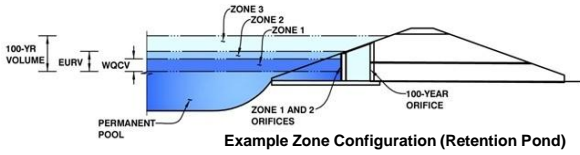

	Estimated Stage (ft)	Estimated Volume (ac-ft)	Outlet Type
Zone 1 (WQCV)	2.92	0.030	Orifice Plate
Zone 2 (User)	3.59	0.020	Weir&Pipe (Restrict)
Zone 3			
Total (all zones)		0.050	

User Input: Orifice at Underdrain Outlet (typically used to drain WQCV in a Filtration BMP)

Underdrain Orifice Invert Depth = ft (distance below the filtration media surface)
Underdrain Orifice Diameter = inches

Calculated Parameters for Underdrain
Underdrain Orifice Area = ft²
Underdrain Orifice Centroid = feet

User Input: Orifice Plate with one or more orifices or Elliptical Slot Weir (typically used to drain WQCV and/or EURV in a sedimentation BMP)

Centroid of Lowest Orifice = 0.00 ft (relative to basin bottom at Stage = 0 ft)
Depth at top of Zone using Orifice Plate = 2.92 ft (relative to basin bottom at Stage = 0 ft)
Orifice Plate: Orifice Vertical Spacing = 13.00 inches
Orifice Plate: Orifice Area per Row = 0.12 sq. inches (diameter = 3/8 inch)

Calculated Parameters for Plate
WQ Orifice Area per Row = 8.333E-04 ft²
Elliptical Half-Width = N/A feet
Elliptical Slot Centroid = N/A feet
Elliptical Slot Area = N/A ft²

User Input: Stage and Total Area of Each Orifice Row (numbered from lowest to highest)

	Row 1 (required)	Row 2 (optional)	Row 3 (optional)	Row 4 (optional)	Row 5 (optional)	Row 6 (optional)	Row 7 (optional)	Row 8 (optional)
Stage of Orifice Centroid (ft)	0.00	1.10	2.20					
Orifice Area (sq. inches)	0.12	0.12	0.12					

	Row 9 (optional)	Row 10 (optional)	Row 11 (optional)	Row 12 (optional)	Row 13 (optional)	Row 14 (optional)	Row 15 (optional)	Row 16 (optional)
Stage of Orifice Centroid (ft)								
Orifice Area (sq. inches)								

User Input: Vertical Orifice (Circular or Rectangular)

Invert of Vertical Orifice = Not Selected Not Selected ft (relative to basin bottom at Stage = 0 ft)
Depth at top of Zone using Vertical Orifice = ft (relative to basin bottom at Stage = 0 ft)
Vertical Orifice Diameter = inches

Calculated Parameters for Vertical Orifice
Vertical Orifice Area = Not Selected Not Selected ft²
Vertical Orifice Centroid = feet

User Input: Overflow Weir (Dropbox with Flat or Sloped Gate and Outlet Pipe OR Rectangular/Trapezoidal Weir and No Outlet Pipe)

Overflow Weir Front Edge Height, Ho = Zone 2 Weir Not Selected ft (relative to basin bottom at Stage = 0 ft)
Overflow Weir Front Edge Length = 2.92 feet
Overflow Weir Gate Slope = 0.00 H:V
Horiz. Length of Weir Sides = 2.92 feet
Overflow Gate Type = Close Mesh Gate
Debris Clogging % = 50% %

Calculated Parameters for Overflow Weir
Height of Gate Upper Edge, H₁ = Zone 2 Weir Not Selected feet
Overflow Weir Slope Length = 2.92 feet
Gate Open Area / 100-yr Orifice Area = 29.40
Overflow Gate Open Area w/o Debris = 6.74 ft²
Overflow Gate Open Area w/ Debris = 3.37 ft²

User Input: Outlet Pipe w/ Flow Restriction Plate (Circular Orifice, Restrictor Plate, or Rectangular Orifice)

Depth to Invert of Outlet Pipe = Zone 2 Restrictor Not Selected ft (distance below basin bottom at Stage = 0 ft)
Outlet Pipe Diameter = 18.00 inches
Restrictor Plate Height Above Pipe Invert = 3.38 inches

Calculated Parameters for Outlet Pipe w/ Flow Restriction Plate
Outlet Orifice Area = Zone 2 Restrictor Not Selected ft²
Outlet Orifice Centroid = 0.17 feet
Half-Central Angle of Restrictor Plate on Pipe = 0.90 N/A radians

User Input: Emergency Spillway (Rectangular or Trapezoidal)

Spillway Invert Stage = 3.83 ft (relative to basin bottom at Stage = 0 ft)
Spillway Crest Length = 12.00 feet
Spillway End Slopes = 4.00 H:V
Freeboard above Max Water Surface = 0.00 feet

Calculated Parameters for Spillway
Spillway Design Flow Depth = 0.21 feet
Stage at Top of Freeboard = 4.04 feet
Basin Area at Top of Freeboard = 0.05 acres
Basin Volume at Top of Freeboard = 0.07 acre-ft

Routed Hydrograph Results

The user can override the default CUHP hydrographs and runoff volumes by entering new values in the Inflow Hydrographs table (Columns W through AF).

	WQCV	EURV	2 Year	5 Year	10 Year	25 Year	50 Year	100 Year	500 Year
Design Storm Return Period	N/A	N/A	1.19	1.50	1.75	2.00	2.25	2.52	3.68
One-Hour Rainfall Depth (in)	N/A	N/A	0.073	0.094	0.111	0.131	0.150	0.171	0.262
CUHP Runoff Volume (acre-ft)	0.030	0.113	0.073	0.094	0.111	0.131	0.150	0.171	0.262
Inflow Hydrograph Volume (acre-ft)	N/A	N/A	0.073	0.094	0.111	0.131	0.150	0.171	0.262
CUHP Predevelopment Peak Q (cfs)	N/A	N/A	0.0	0.0	0.0	0.3	0.5	0.8	2.0
OPTIONAL Override Predevelopment Peak Q (cfs)	N/A	N/A							
Predevelopment Unit Peak Flow, q (cfs/acre)	N/A	N/A	0.01	0.02	0.03	0.25	0.48	0.79	1.97
Peak Inflow Q (cfs)	N/A	N/A	1.6	2.1	2.4	2.9	3.4	3.8	5.8
Peak Outflow Q (cfs)	0.0	11.1	1.1	1.9	2.1	2.6	2.6	2.7	5.2
Ratio Peak Outflow to Predevelopment Q	N/A	N/A	N/A	91.4	76.0	10.4	5.5	3.4	2.6
Structure Controlling Flow	Overflow Weir 1	Overflow Weir 1	Overflow Weir 1	Overflow Weir 1	Overflow Weir 1	Outlet Plate 1	Outlet Plate 1	Outlet Plate 1	Spillway
Max Velocity through Gate 1 (fps)	N/A	0.13	0.17	0.3	0.3	0.4	0.4	0.4	0.4
Max Velocity through Gate 2 (fps)	N/A	N/A	N/A	N/A	N/A	N/A	N/A	N/A	N/A
Time to Drain 97% of Inflow Volume (hours)	38	34	36	34	33	32	31	30	26
Time to Drain 99% of Inflow Volume (hours)	40	39	41	40	40	39	38	38	35
Maximum Ponding Depth (ft)	2.92	3.05	3.07	3.13	3.15	3.24	3.42	3.61	3.99
Area at Maximum Ponding Depth (acres)	0.02	0.03	0.03	0.03	0.03	0.03	0.03	0.04	0.04
Maximum Volume Stored (acre-ft)	0.030	0.033	0.034	0.035	0.036	0.038	0.044	0.050	0.066

DETENTION BASIN OUTLET STRUCTURE DESIGN

MHFD-Detention, Version 4.05 (January 2022)

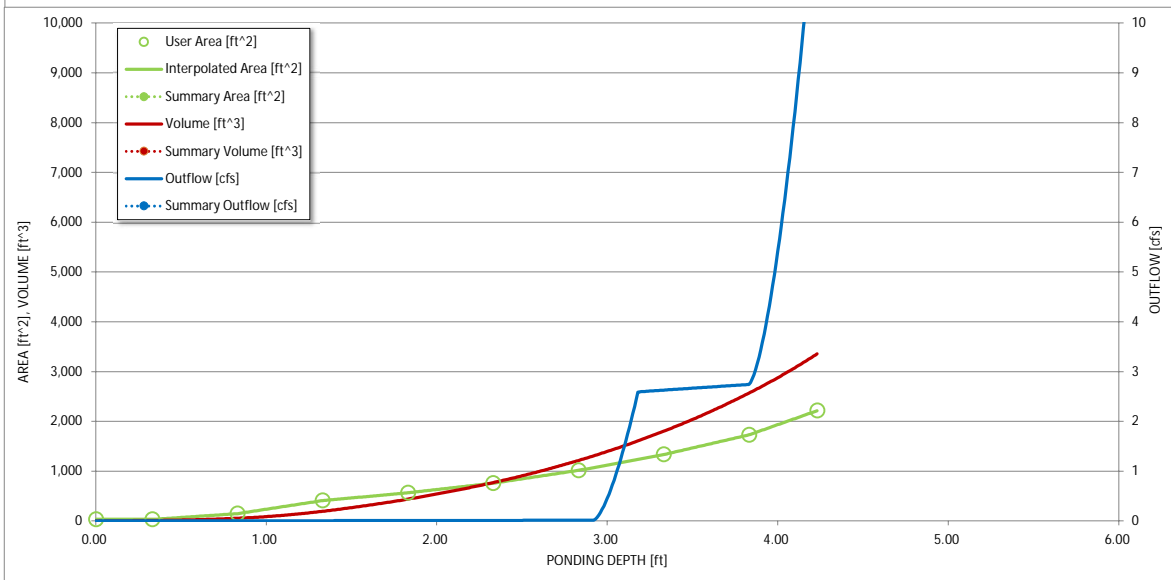
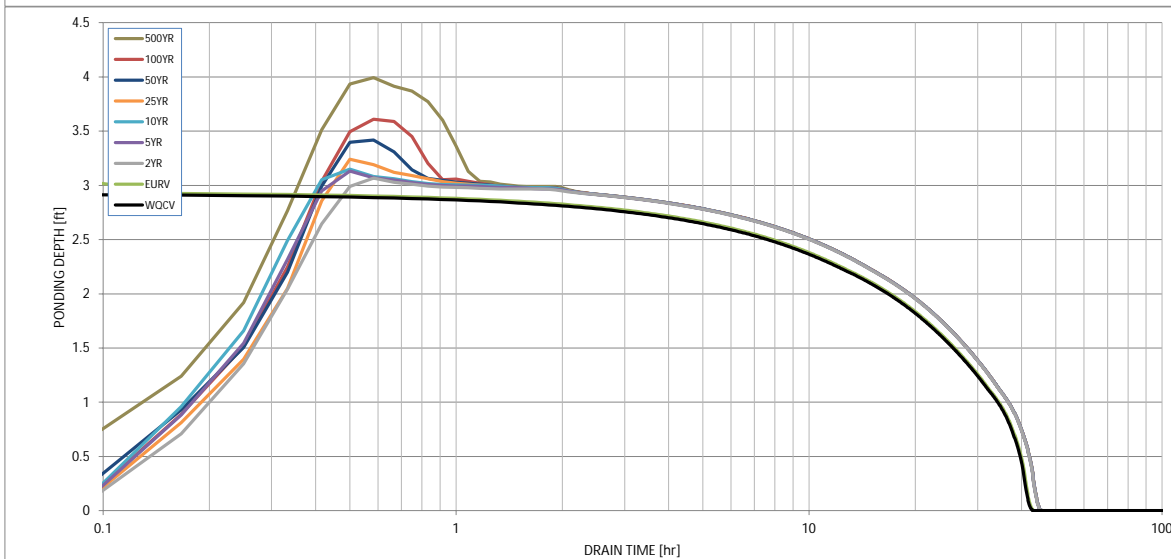
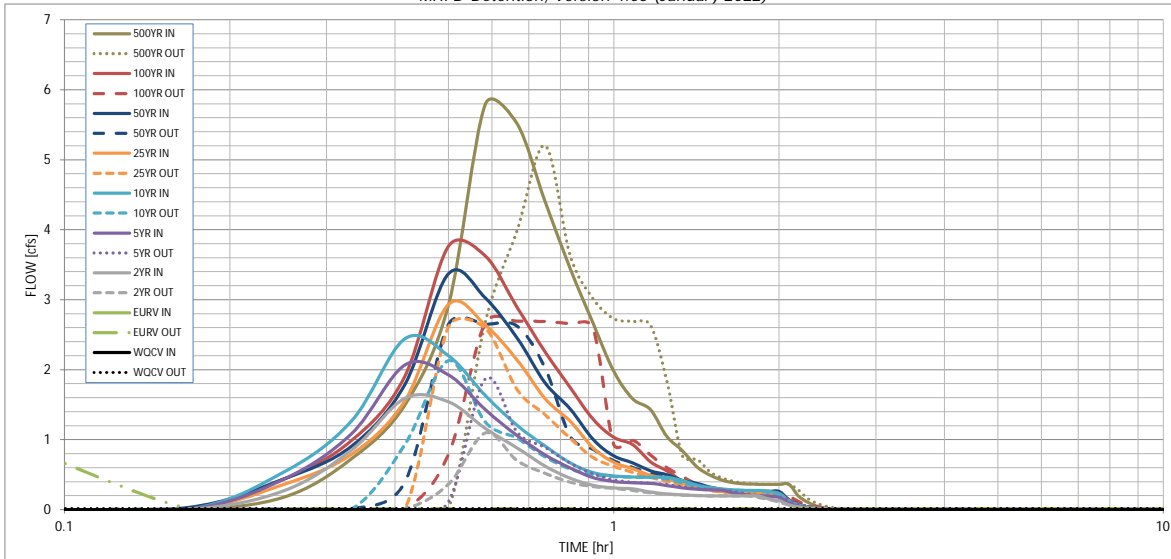

S-A-V-D Chart Axis Override	X-axis	Left Y-Axis	Right Y-Axis
minimum bound			
maximum bound			

DETENTION BASIN OUTLET STRUCTURE DESIGN

Outflow Hydrograph Workbook Filename: _____

Inflow Hydrographs

The user can override the calculated inflow hydrographs from this workbook with inflow hydrographs developed in a separate program.

Time Interval	SOURCE	CUHP	CUHP	CUHP	CUHP	CUHP	CUHP	CUHP	CUHP	CUHP
	TIME	WOCV [cfs]	EURV [cfs]	2 Year [cfs]	5 Year [cfs]	10 Year [cfs]	25 Year [cfs]	50 Year [cfs]	100 Year [cfs]	500 Year [cfs]
5.00 min	0:00:00	0.00	0.00	0.00	0.00	0.00	0.00	0.00	0.00	0.00
	0:05:00	0.00	0.00	0.00	0.00	0.00	0.00	0.00	0.00	0.00
	0:10:00	0.00	0.00	0.00	0.00	0.00	0.00	0.03	0.00	0.18
	0:15:00	0.00	0.00	0.26	0.43	0.53	0.36	0.43	0.43	0.73
	0:20:00	0.00	0.00	0.85	1.09	1.26	0.79	0.91	0.99	1.50
	0:25:00	0.00	0.00	1.59	2.07	2.44	1.56	1.79	1.91	2.92
	0:30:00	0.00	0.00	1.54	1.92	2.20	2.93	3.37	3.76	5.79
	0:35:00	0.00	0.00	1.16	1.43	1.63	2.64	3.03	3.63	5.52
	0:40:00	0.00	0.00	0.88	1.06	1.21	2.14	2.45	2.90	4.40
	0:45:00	0.00	0.00	0.62	0.78	0.91	1.58	1.81	2.26	3.44
	0:50:00	0.00	0.00	0.45	0.60	0.67	1.26	1.44	1.74	2.67
	0:55:00	0.00	0.00	0.35	0.46	0.53	0.88	1.01	1.29	1.98
	1:00:00	0.00	0.00	0.31	0.40	0.48	0.68	0.77	1.03	1.58
	1:05:00	0.00	0.00	0.30	0.38	0.47	0.59	0.67	0.93	1.43
	1:10:00	0.00	0.00	0.25	0.38	0.46	0.49	0.55	0.68	1.04
	1:15:00	0.00	0.00	0.23	0.34	0.46	0.44	0.50	0.55	0.84
	1:20:00	0.00	0.00	0.21	0.31	0.42	0.37	0.42	0.41	0.61
	1:25:00	0.00	0.00	0.20	0.29	0.35	0.33	0.38	0.33	0.49
	1:30:00	0.00	0.00	0.20	0.28	0.31	0.28	0.32	0.28	0.41
	1:35:00	0.00	0.00	0.20	0.28	0.29	0.26	0.29	0.26	0.38
	1:40:00	0.00	0.00	0.20	0.23	0.28	0.24	0.27	0.25	0.37
	1:45:00	0.00	0.00	0.20	0.21	0.28	0.23	0.26	0.25	0.36
	1:50:00	0.00	0.00	0.20	0.20	0.27	0.23	0.26	0.25	0.36
	1:55:00	0.00	0.00	0.15	0.19	0.26	0.23	0.26	0.25	0.36
	2:00:00	0.00	0.00	0.13	0.18	0.23	0.23	0.26	0.25	0.36
	2:05:00	0.00	0.00	0.07	0.10	0.12	0.13	0.14	0.14	0.20
	2:10:00	0.00	0.00	0.04	0.05	0.07	0.07	0.08	0.07	0.11
	2:15:00	0.00	0.00	0.02	0.03	0.03	0.04	0.04	0.04	0.05
	2:20:00	0.00	0.00	0.01	0.01	0.01	0.02	0.02	0.02	0.02
	2:25:00	0.00	0.00	0.00	0.00	0.00	0.00	0.00	0.00	0.01
	2:30:00	0.00	0.00	0.00	0.00	0.00	0.00	0.00	0.00	0.00
	2:35:00	0.00	0.00	0.00	0.00	0.00	0.00	0.00	0.00	0.00
	2:40:00	0.00	0.00	0.00	0.00	0.00	0.00	0.00	0.00	0.00
	2:45:00	0.00	0.00	0.00	0.00	0.00	0.00	0.00	0.00	0.00
	2:50:00	0.00	0.00	0.00	0.00	0.00	0.00	0.00	0.00	0.00
	2:55:00	0.00	0.00	0.00	0.00	0.00	0.00	0.00	0.00	0.00
	3:00:00	0.00	0.00	0.00	0.00	0.00	0.00	0.00	0.00	0.00
	3:05:00	0.00	0.00	0.00	0.00	0.00	0.00	0.00	0.00	0.00
	3:10:00	0.00	0.00	0.00	0.00	0.00	0.00	0.00	0.00	0.00
	3:15:00	0.00	0.00	0.00	0.00	0.00	0.00	0.00	0.00	0.00
	3:20:00	0.00	0.00	0.00	0.00	0.00	0.00	0.00	0.00	0.00
	3:25:00	0.00	0.00	0.00	0.00	0.00	0.00	0.00	0.00	0.00
	3:30:00	0.00	0.00	0.00	0.00	0.00	0.00	0.00	0.00	0.00
	3:35:00	0.00	0.00	0.00	0.00	0.00	0.00	0.00	0.00	0.00
	3:40:00	0.00	0.00	0.00	0.00	0.00	0.00	0.00	0.00	0.00
	3:45:00	0.00	0.00	0.00	0.00	0.00	0.00	0.00	0.00	0.00
	3:50:00	0.00	0.00	0.00	0.00	0.00	0.00	0.00	0.00	0.00
	3:55:00	0.00	0.00	0.00	0.00	0.00	0.00	0.00	0.00	0.00
	4:00:00	0.00	0.00	0.00	0.00	0.00	0.00	0.00	0.00	0.00
	4:05:00	0.00	0.00	0.00	0.00	0.00	0.00	0.00	0.00	0.00
	4:10:00	0.00	0.00	0.00	0.00	0.00	0.00	0.00	0.00	0.00
	4:15:00	0.00	0.00	0.00	0.00	0.00	0.00	0.00	0.00	0.00
	4:20:00	0.00	0.00	0.00	0.00	0.00	0.00	0.00	0.00	0.00
	4:25:00	0.00	0.00	0.00	0.00	0.00	0.00	0.00	0.00	0.00
	4:30:00	0.00	0.00	0.00	0.00	0.00	0.00	0.00	0.00	0.00
	4:35:00	0.00	0.00	0.00	0.00	0.00	0.00	0.00	0.00	0.00
	4:40:00	0.00	0.00	0.00	0.00	0.00	0.00	0.00	0.00	0.00
	4:45:00	0.00	0.00	0.00	0.00	0.00	0.00	0.00	0.00	0.00
	4:50:00	0.00	0.00	0.00	0.00	0.00	0.00	0.00	0.00	0.00
	4:55:00	0.00	0.00	0.00	0.00	0.00	0.00	0.00	0.00	0.00
	5:00:00	0.00	0.00	0.00	0.00	0.00	0.00	0.00	0.00	0.00
	5:05:00	0.00	0.00	0.00	0.00	0.00	0.00	0.00	0.00	0.00
	5:10:00	0.00	0.00	0.00	0.00	0.00	0.00	0.00	0.00	0.00
	5:15:00	0.00	0.00	0.00	0.00	0.00	0.00	0.00	0.00	0.00
	5:20:00	0.00	0.00	0.00	0.00	0.00	0.00	0.00	0.00	0.00
	5:25:00	0.00	0.00	0.00	0.00	0.00	0.00	0.00	0.00	0.00
	5:30:00	0.00	0.00	0.00	0.00	0.00	0.00	0.00	0.00	0.00
	5:35:00	0.00	0.00	0.00	0.00	0.00	0.00	0.00	0.00	0.00
	5:40:00	0.00	0.00	0.00	0.00	0.00	0.00	0.00	0.00	0.00
	5:45:00	0.00	0.00	0.00	0.00	0.00	0.00	0.00	0.00	0.00
	5:50:00	0.00	0.00	0.00	0.00	0.00	0.00	0.00	0.00	0.00
	5:55:00	0.00	0.00	0.00	0.00	0.00	0.00	0.00	0.00	0.00
	6:00:00	0.00	0.00	0.00	0.00	0.00	0.00	0.00	0.00	0.00

Stormwater Detention and Infiltration Design Data Sheet

Workbook Protected

Worksheet Protected

Stormwater Facility Name: Private WQCV Pond - Lot 2 Elm Grove Villa

Facility Location & Jurisdiction: 1895 Main Street; Colorado Springs, CO 80911 Security Basin - El Paso County

User Input: Watershed Characteristics

Watershed Slope = ft/ft
 Watershed Length = ft
 Watershed Area = acres
 Watershed Imperviousness = percent
 Percentage Hydrologic Soil Group A = percent
 Percentage Hydrologic Soil Group B = percent
 Percentage Hydrologic Soil Groups C/D = percent

Location for 1-hr Rainfall Depths (use dropdown):

WQCV Treatment Method =

User Defined Stage [ft]	User Defined Area [ft^2]	User Defined Stage [ft]	User Defined Discharge [cfs]
0.00	32	0.00	0.00
0.33	32	0.33	0.00
0.83	148	0.83	0.00
1.33	411	1.33	0.01
1.83	566	1.83	0.01
2.33	759	2.33	0.01
2.83	1,016	2.83	0.02
2.92	1,073	2.92	0.02
3.33	1,333	3.33	0.02
3.83	1,729	3.83	3.01
4.23	2,214	4.23	13.18

After completing and printing this worksheet to a pdf, go to:
<https://maperture.digitaldataservices.com/gvh/?viewer=cswdif>
 create a new stormwater facility, and
 attach the pdf of this worksheet to that record.

Routed Hydrograph Results

	WQCV	2 Year	5 Year	10 Year	50 Year	100 Year	
Design Storm Return Period =							
One-Hour Rainfall Depth =	0.53	1.19	1.50	1.75	2.25	2.52	in
Calculated Runoff Volume =	0.030	0.078	0.102	0.122	0.164	0.189	acre-ft
OPTIONAL Override Runoff Volume =							
Inflow Hydrograph Volume =	0.030	0.078	0.101	0.121	0.164	0.189	acre-ft
Time to Drain 97% of Inflow Volume =	>146	39.2	37.7	36.8	35.2	34.3	hours
Time to Drain 99% of Inflow Volume =	>146	0.0	0.0	0.0	42.2	40.9	hours
Maximum Ponding Depth =	2.79	3.44	3.50	3.55	3.65	3.72	ft
Maximum Poned Area =	0.02	0.03	0.03	0.03	0.04	0.04	acres
Maximum Volume Stored =	0.027	0.045	0.047	0.049	0.052	0.054	acre-ft

Stormwater Detention and Infiltration Design Data Sheet

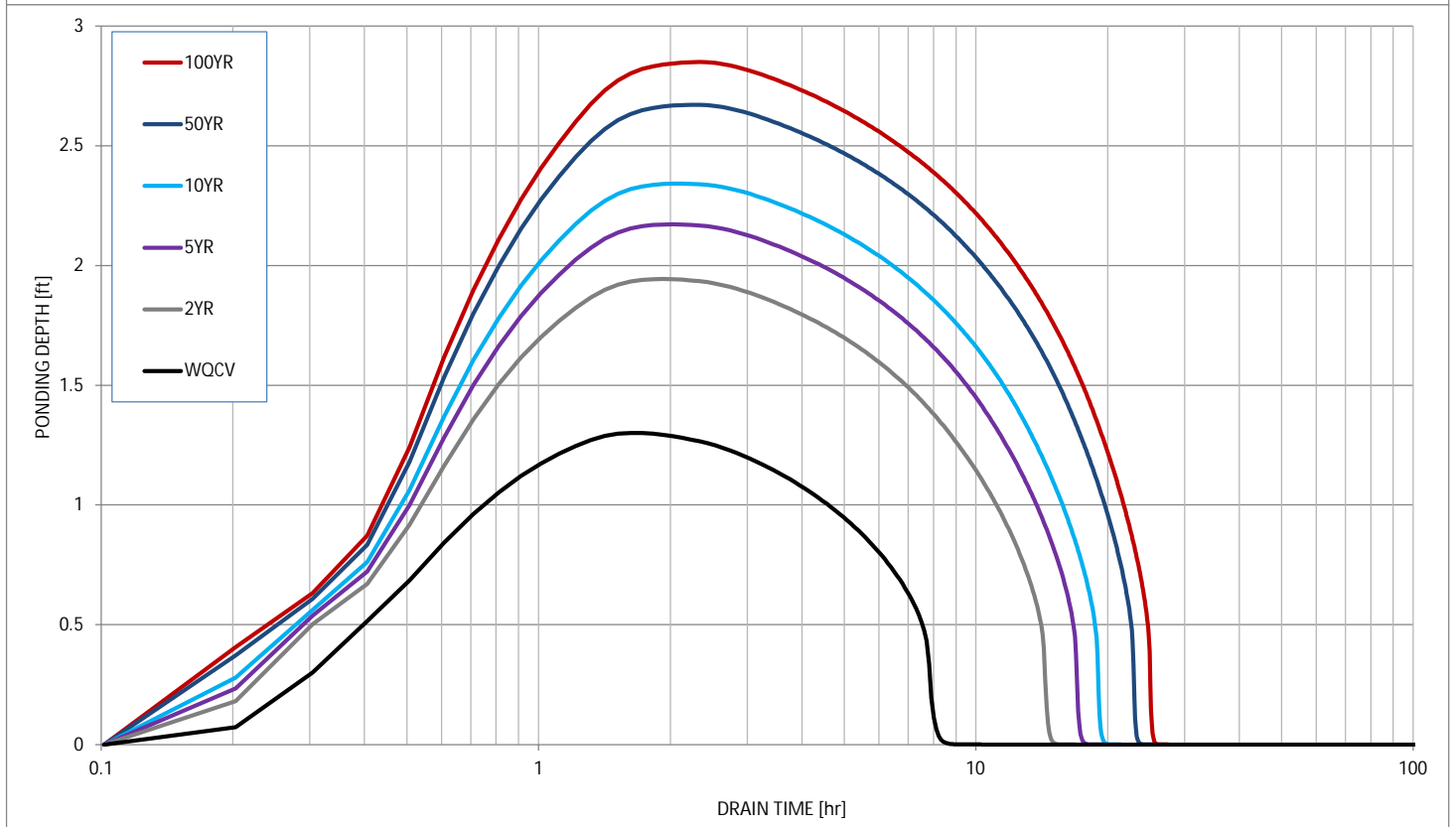
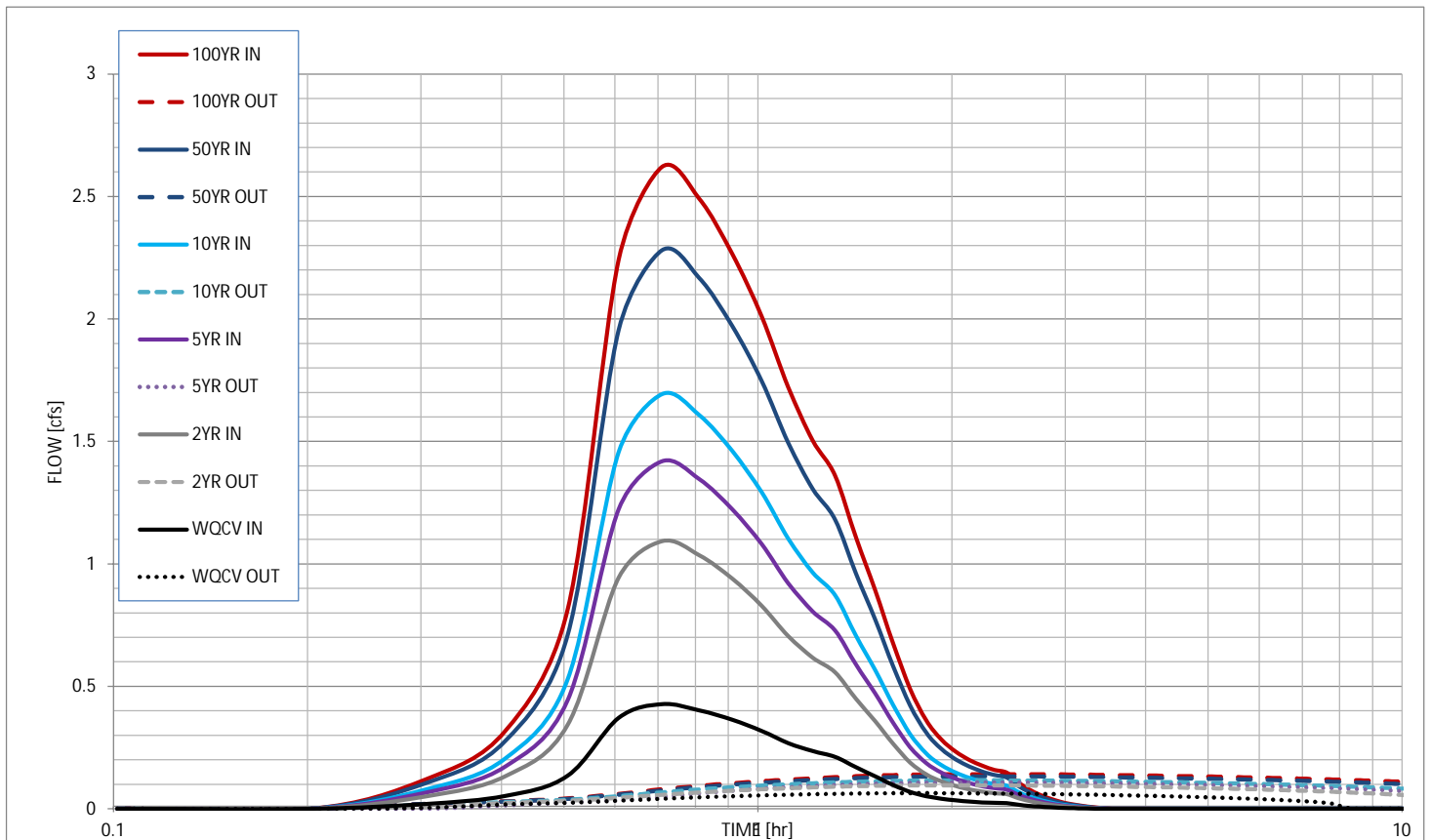

FOREBAY CALCULATIONS (SMITH PLUMBING)

1) $WQCV \text{ (inches)} = a(.91I^3 - 1.19I^2 + .78I)$

I = impervious percentage =

85%

a = Coefficient corresponding to WQCV drain time =

1 (40 hours)

WQCV (inches) = 0.36 inches

2) $WQCV \text{ (ac-ft)} = (WQCV \text{ (inches)})/12 \times A$

Area = tributary area =

1 acres

WQCV (ac-ft) = 0.03

WQCV (cubic feet) = 1,304

3) Forebay Volume

Per Table EDB-4, Section T-5 of USDCM Volume 3 - Forebay Volume = 1% of WQCV and be 12" max depth since watershed is between 1 and 2 impervious acres

Forebay Volume = 1% of WQCV =

13 cubic feet

with pond depth at 1.0', Forebay Area =

13.0 sq-ft (minimum)

4) Forebay Discharge

Per Table EDB-4, Section T-5 of USDCM Volume 3 - Forebay Discharge = 2% of 100-yr Flow into pond

Q₁₀₀ = 6.1 cfs

Forebay discharge = 0.12 cfs

Worksheet for Forebay Release Slots

Project Description

Solve For Crest Length

Input Data

Discharge	0.42	ft ³ /s
Headwater Elevation	0.75	ft
Crest Elevation	0.00	ft
Tailwater Elevation	0.00	ft
Weir Coefficient	3.00	US
Number Of Contractions	0	

Results

Crest Length	0.22	ft
Headwater Height Above Crest	0.75	ft
Tailwater Height Above Crest	0.00	ft
Flow Area	0.16	ft ²
Velocity	2.60	ft/s
Wetted Perimeter	1.72	ft
Top Width	0.22	ft

Worksheet for Forebay Weir

Project Description

Solve For Discharge

Input Data

Headwater Elevation	1.00	ft
Crest Elevation	0.75	ft
Tailwater Elevation	0.00	ft
Weir Coefficient	3.00	US
Crest Length	2.92	ft
Number Of Contractions	0	

Results

Discharge	1.10	ft ³ /s
Headwater Height Above Crest	0.25	ft
Tailwater Height Above Crest	-0.75	ft
Flow Area	0.73	ft ²
Velocity	1.50	ft/s
Wetted Perimeter	3.42	ft
Top Width	2.92	ft

POND RIPRAP EMBANKMENT SIZING

Subdivision: Elm Grove Villa
Location: El Paso County

Project Name: Smith Plumbing
Project No.: HCI000008
Calculated By: CMD
Checked By: CD
Date: 5/3/21

Pond	Riprap Type	D50*	Slope, S	Concentration Factor	Unit discharge	Spillway Flow***	Spillway Width
		(in)	(ft/ft)	(1.0 to 3.0)	(cfs/ft)**	(cfs)	(ft)
North Pond	VL	2.8	25.00%	2	0.35	4.2	12

*From DCM Chapter 13 Eqn 13-9

** Spillway Flow/Spillway Width

***Peak Inflow Q100

Worksheet for Trickle Channel

Project Description

Friction Method	Manning Formula
Solve For	Normal Depth

Input Data

Roughness Coefficient	0.013	
Channel Slope	0.50000	ft/ft
Bottom Width	2.00	ft
Discharge	0.42	ft ³ /s

Results

Normal Depth	0.03	ft
Flow Area	0.06	ft ²
Wetted Perimeter	2.06	ft
Hydraulic Radius	0.03	ft
Top Width	2.00	ft
Critical Depth	0.11	ft
Critical Slope	0.00589	ft/ft
Velocity	7.36	ft/s
Velocity Head	0.84	ft
Specific Energy	0.87	ft
Froude Number	7.69	
Flow Type	Supercritical	







GVF Input Data

Downstream Depth	0.00	ft
Length	0.00	ft
Number Of Steps	0	

GVF Output Data

Upstream Depth	0.00	ft
Profile Description		
Profile Headloss	0.00	ft
Downstream Velocity	Infinity	ft/s
Upstream Velocity	Infinity	ft/s
Normal Depth	0.03	ft
Critical Depth	0.11	ft
Channel Slope	0.50000	ft/ft
Critical Slope	0.00589	ft/ft

Smith Plumbing
Pond Outlet

Color Coding Legend	
Conduit: Diameter (in)	
	<= 18.0
	<= 24.0
	<= 30.0
	<= 36.0
	<= 42.0
	Other

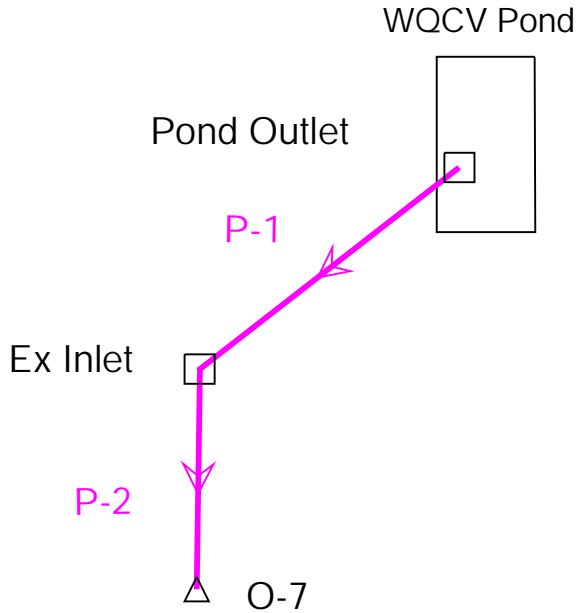

Smith Plumbing
Pond Outlet
Active Scenario: 100 YR

Label	Start Node	Invert (Start) (ft)	Stop Node	Invert (Stop) (ft)	Length (User Defined) (ft)	Slope (Calculated) (ft/ft)	Diameter (in)	Manning's n	Flow (cfs)	Velocity (ft/s)	Capacity (Full Flow) (cfs)	Flow / Capacity (Design) (%)	Hydraulic Grade Line (In) (ft)	Hydraulic Grade Line (Out) (ft)	Energy Grade Line (In) (ft)	Energy Grade Line (Out) (ft)
P-1	Pond Outlet	5,843.49	Ex Inlet	5,843.00	36.0	0.014	18.0	0.013	3.00	5.73	12.26	24.5	5,844.15	5,843.51	5,844.40	5,844.01
P-2	Ex Inlet	5,842.60	O-7	5,841.63	20.2	0.048	18.0	0.013	6.00	10.95	23.00	26.1	5,843.55	5,842.22	5,843.95	5,843.54

Smith Plumbing
Pond Outlet
Active Scenario: 100 YR

Label	Elevation (Ground) (ft)	Elevation (Invert) (ft)	Boundary Condition Type	Elevation (User Defined Tailwater) (ft)	Hydraulic Grade (ft)	Energy Grade Line (ft)	Flow (Total Out) (cfs)
O-7	5,845.00	5,841.63	Free Outfall		5,842.22	5,842.22	6.00

Smith Plumbing
Pond Outlet
Active Scenario: 100 YR

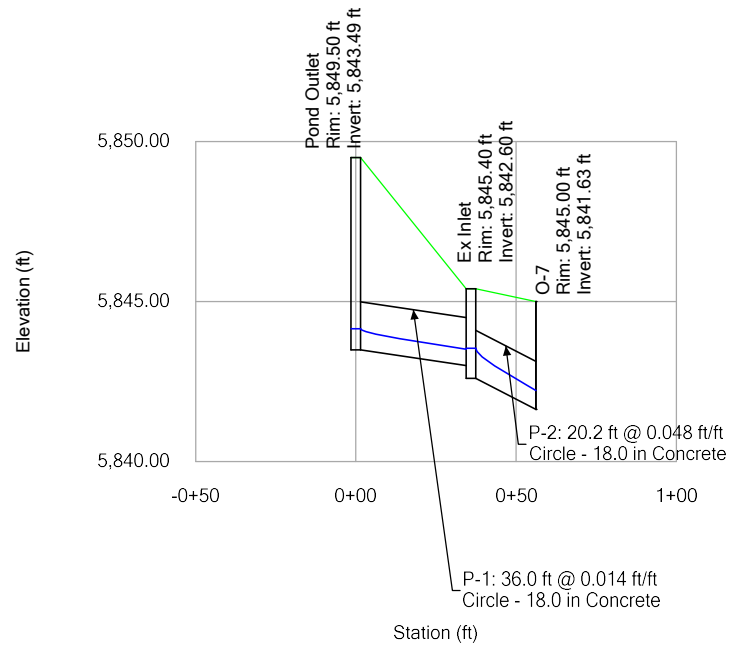

Smith Plumbing
Pond Outlet
Active Scenario: 5 YR

Label	Start Node	Invert (Start) (ft)	Stop Node	Invert (Stop) (ft)	Length (User Defined) (ft)	Slope (Calculated) (ft/ft)	Diameter (in)	Manning's n	Flow (cfs)	Velocity (ft/s)	Capacity (Full Flow) (cfs)	Flow / Capacity (Design) (%)	Hydraulic Grade Line (In) (ft)	Hydraulic Grade Line (Out) (ft)	Energy Grade Line (In) (ft)	Energy Grade Line (Out) (ft)
P-1	Pond Outlet	5,843.49	Ex Inlet	5,843.00	36.0	0.014	18.0	0.013	1.10	4.30	12.26	9.0	5,843.88	5,843.30	5,844.02	5,843.59
P-2	Ex Inlet	5,842.60	O-7	5,841.63	20.2	0.048	18.0	0.013	2.60	8.63	23.00	11.3	5,843.21	5,841.99	5,843.44	5,842.95

Smith Plumbing
Pond Outlet
Active Scenario: 5 YR

Label	Elevation (Ground) (ft)	Elevation (Invert) (ft)	Boundary Condition Type	Elevation (User Defined Tailwater) (ft)	Hydraulic Grade (ft)	Energy Grade Line (ft)	Flow (Total Out) (cfs)
O-7	5,845.00	5,841.63	Free Outfall		5,841.99	5,841.99	2.60

Smith Plumbing
 Pond Outlet
 Active Scenario: 5 YR

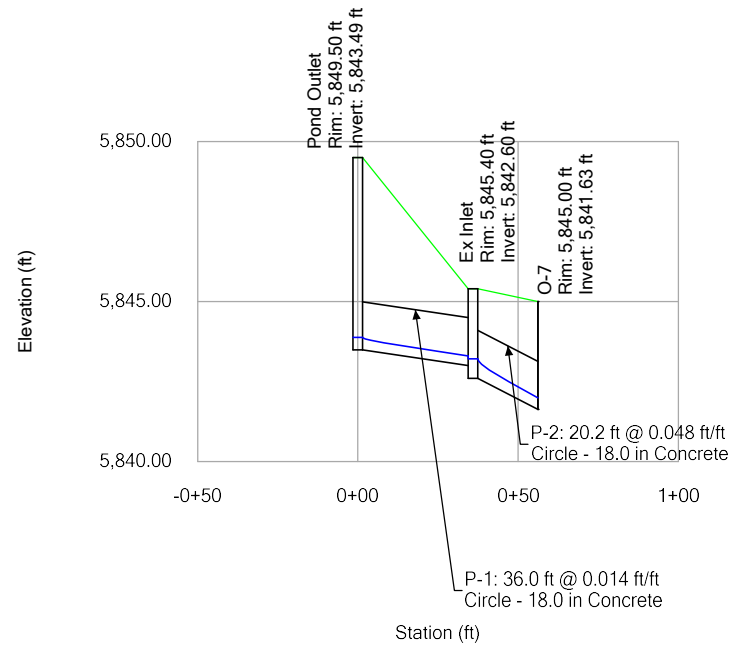

APPENDIX D
Drainage Maps

PRELIMINARY
NOT FOR BIDDING
NOT FOR CONSTRUCTION

COPYRIGHT
THESE PLANS ARE AN INSTRUMENT OF SERVICE AND ARE THE PROPERTY OF GALLOWAY, AND MAY NOT BE DUPLICATED, DISCLOSED, OR REPRODUCED WITHOUT THE WRITTEN CONSENT OF GALLOWAY. COPYRIGHTS AND INFRINGEMENTS WILL BE ENFORCED AND PROSECUTED.

**FINAL DRAINAGE REPORT
SMITH PLUMBING & HEATING
FOR
HAMMERS CONSTRUCTION**
1875 MAIN STREET
COLORADO SPRINGS, CO 80911 - EL PASO COUNTY

#	Date	Issue / Description	Init.

Project No: HCI000007
Drawn By: DDJ
Checked By: GD
Date: 11/12/2021

EXISTING DRAINAGE MAP

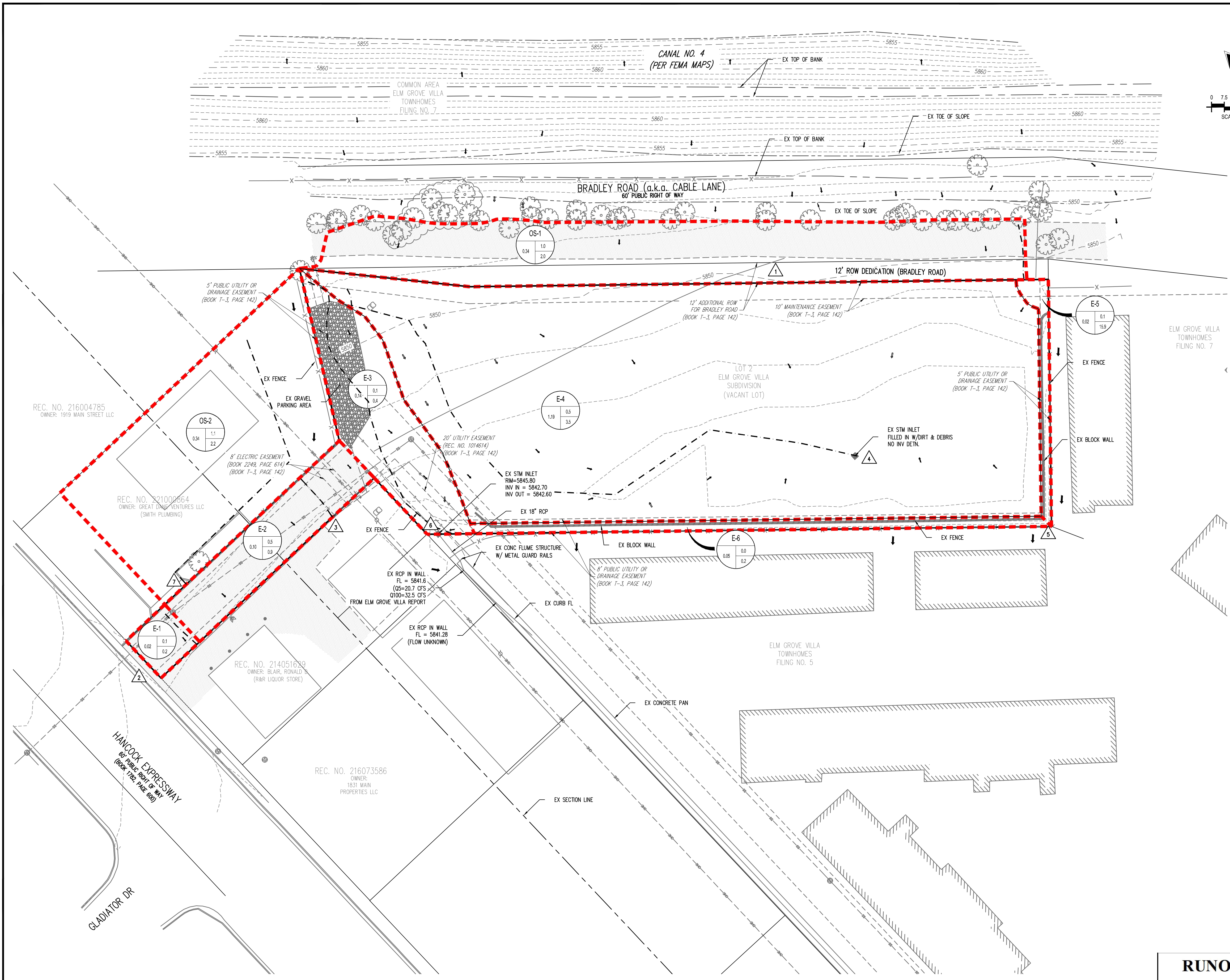

DRAINAGE LEGEND

- PROPERTY LINE
- - - ADJACENT PROPERTY LINE
- - - SECTION LINE
- - - EXISTING MAJOR CONTOUR
- - - EXISTING MINOR CONTOUR
- - - BASIN BOUNDARY LINE
- - - DRAINAGE TRAVEL PATH
- - - TOE OF SLOPE
- - - TOP OF SLOPE
- [Hatched] EXISTING BUILDING
- [Dotted] EXISTING GRAVEL PARKING AREA
- [Stippled] EXISTING ACCESS
- (Circle with numbers) BASIN DESIGNATION
- (Circle with numbers) 5-YEAR RUNOFF IN CUBIC FEET PER SECOND
- (Circle with numbers) 100-YEAR RUNOFF IN CUBIC FEET PER SECOND
- (Circle with numbers) BASIN AREA IN ACRES
- (Triangle with number) DESIGN POINT
- (Arrow) DIRECTION OF RUNOFF

RUNOFF SUMMARY TABLE

Basin ID	Area (acres)	Q ₅ (cfs)	Q ₁₀₀ (cfs)
E-1	0.02	0.1	0.2
E-2	0.10	0.5	0.9
E-3	0.14	0.1	0.4
E-4	1.19	0.5	3.5
E-5	0.02	0.0	0.1
E-6	0.05	0.0	0.2

DESIGN POINT SUMMARY TABLE

Design Point	Q ₅ (cfs)	Q ₁₀₀ (cfs)
1	1.0	2.0
2	0.1	0.2
3	1.5	2.9
4	1.3	4.9
5	0.0	0.1
6	1.2	5.1
7	1.1	2.2

SMITH PLUMBING & HEATING CONSULTANTS INC. 11/12/2021 11:15:00 AM C:\Users\ddj\OneDrive\Documents\Projects\Hammer\DR-1.dwg

PRELIMINARY
NOT FOR BIDDING
NOT FOR CONSTRUCTION

COPYRIGHT
THESE PLANS ARE AN INSTRUMENT OF SERVICE AND ARE THE PROPERTY OF GALLOWAY, AND MAY NOT BE DUPLICATED, DISCLOSED, OR REPRODUCED WITHOUT THE WRITTEN CONSENT OF GALLOWAY. COPYRIGHTS AND INFRINGEMENTS WILL BE ENFORCED AND PROSECUTED.

**FINAL DRAINAGE REPORT
SMITH PLUMBING & HEATING
FOR
HAMMERS CONSTRUCTION**
1875 MAIN STREET
COLORADO SPRINGS, CO 80911 - EL PASO COUNTY

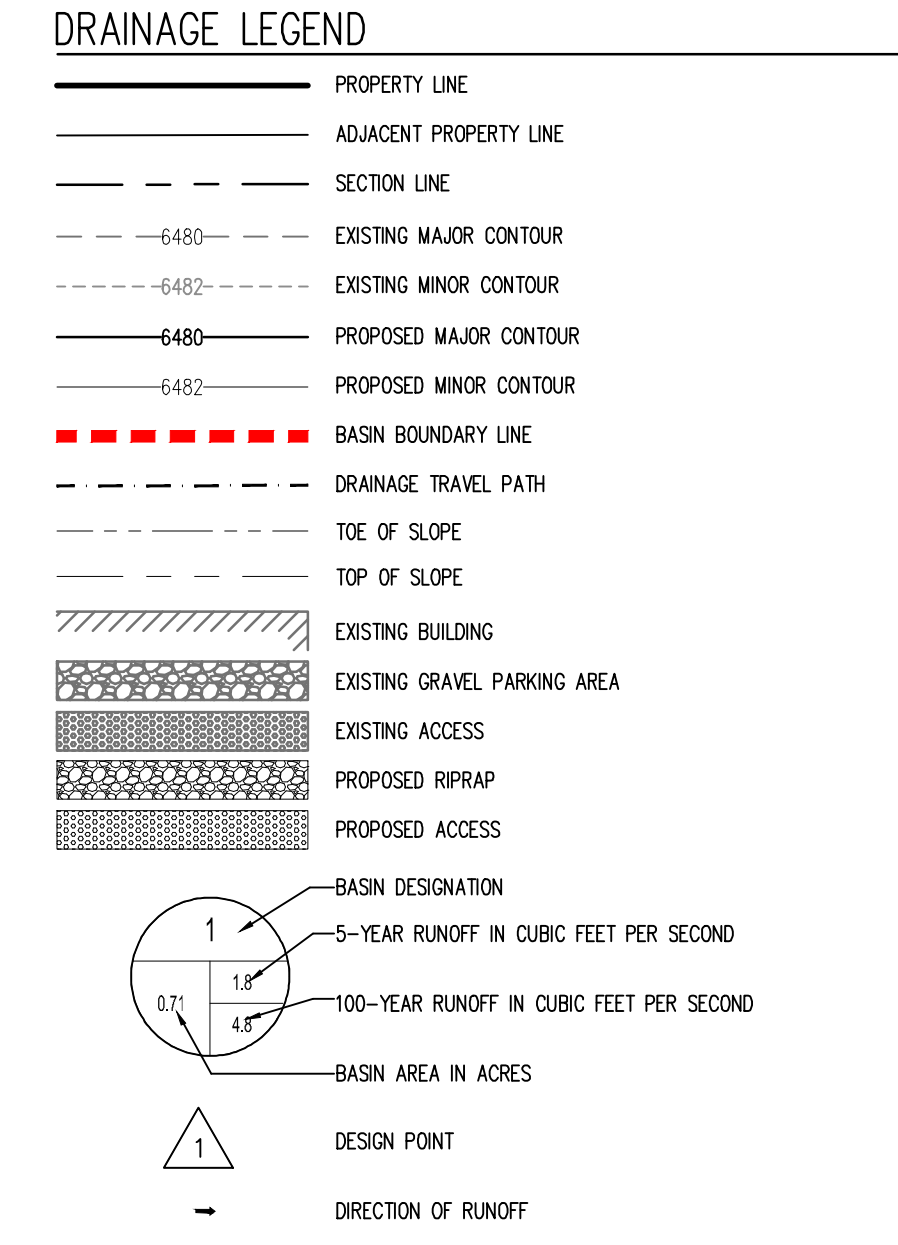
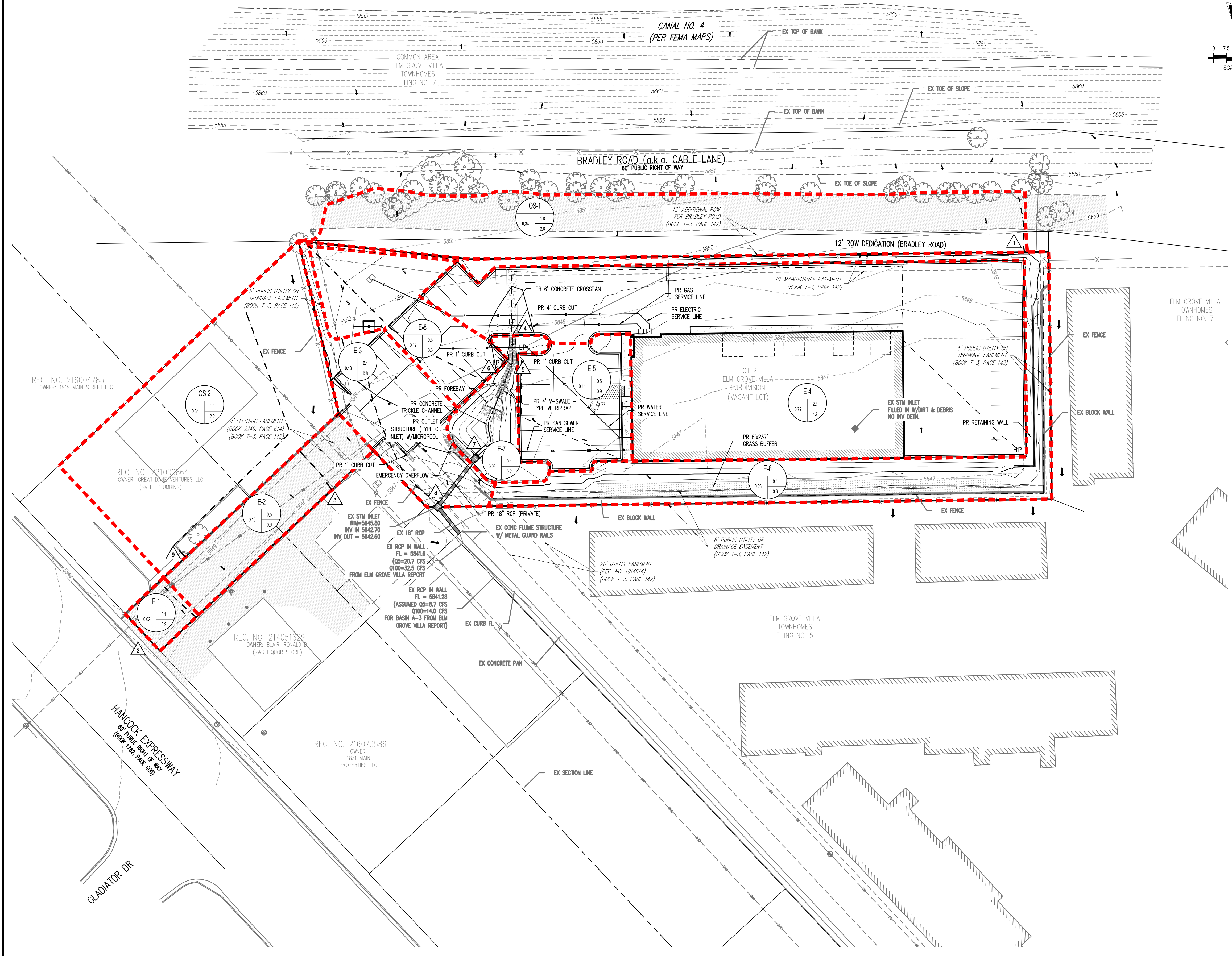
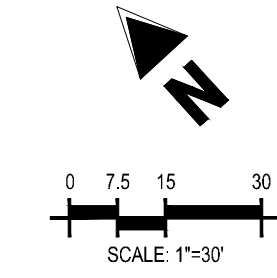

RUNOFF SUMMARY TABLE				DESIGN POINT SUMMARY TABLE		
Basin ID	Area (acres)	Q ⁵ (cfs)	Q ¹⁰⁰ (cfs)	Design Point	Q ⁵ (cfs)	Q ¹⁰⁰ (cfs)
OS-1	0.34	1.0	2.0	1	1.0	2.0
OS-2	0.34	1.1	2.2	2	0.1	0.2
E-1	0.02	0.1	0.2	3	0.5	0.9
E-2	0.10	0.5	0.9	4	2.6	4.7
E-3	0.13	0.4	0.8	5	0.5	0.9
E-4	0.72	2.6	4.7	6	0.3	0.6
E-5	0.11	0.5	0.9	7	0.0	6.1
E-6	0.26	0.1	0.6	8	0.4	0.8
E-7	0.06	0.1	0.2	9	1.1	2.2
E-8	0.12	0.3	0.6			

#	Date	Issue / Description	Init.

Project No: HCl000007
Drawn By: DDJ
Checked By: GD
Date: 03/24/2022

PROPOSED DRAINAGE MAP

DR-2

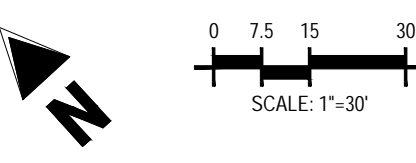

DRAINAGE LEGEND

- - - - - PROPERTY LINE
- - - - - EXISTING MAJOR CONTOUR
- - - - - EXISTING MINOR CONTOUR
- - - - - PROPOSED MAJOR CONTOUR
- - - - - PROPOSED MINOR CONTOUR
- - - - - BASIN BOUNDARY LINE
- - - - - FEMA EFFECTIVE 100-YR FLOODPLAIN
- - - - - CENTERLINE OF STREAM
- HP HIGH POINT
- LP LOW POINT
- - - - - DIRECTION OF RUNOFF
- [Pink Box] AREA OF OFFSITE FLOWS
- [Purple Box] AREA TO BE DETAINED IN PMP
- [Green Box] AREA TO BE TREATED WITH GRASS BUFFER
- [Orange Box] AREA (UNCHANGED) NOT DETAINED IN PMP PER SECTION 17.1.C.1
- [Blue Box] AREA (DEVELOPED) NOT DETAINED IN PMP PER SECTION 17.1.C.1 (20% UP TO 1 AC. OF DEVELOPMENT SITE CAN BE EXCLUDED, DUE TO TOPOGRAPHY)
- (1) BASIN DESIGNATION
- (1) 5-YEAR RUNOFF IN CUBIC FEET PER SECOND
- (1) 100-YEAR RUNOFF IN CUBIC FEET PER SECOND
- (1) BASIN AREA IN ACRES
- (1) DESIGN POINT



1155 Kelly Johnson Blvd., Suite 305
 Colorado Springs, CO 80920
 719.900.7220
 GallowayUS.com

PRELIMINARY
 NOT FOR BIDDING
 NOT FOR CONSTRUCTION

COPYRIGHT
 THESE PLANS ARE AN INSTRUMENT OF SERVICE AND ARE THE PROPERTY OF GALLOWAY, AND MAY NOT BE DUPLICATED, DISCLOSED, OR REPRODUCED WITHOUT THE WRITTEN CONSENT OF GALLOWAY. COPYRIGHTS AND INFRINGEMENTS WILL BE ENFORCED AND PROSECUTED.

FINAL DRAINAGE REPORT
 SMITH PLUMBING & HEATING
 FOR
 HAMMERS CONSTRUCTION
 1875 MAIN STREET
 COLORADO SPRINGS, CO 80911 - EL PASO COUNTY

#	Date	Issue / Description	Init.

Project No: HCI000007
 Drawn By: DDJ
 Checked By: GD
 Date: 11/12/2021
 WQ PLAN

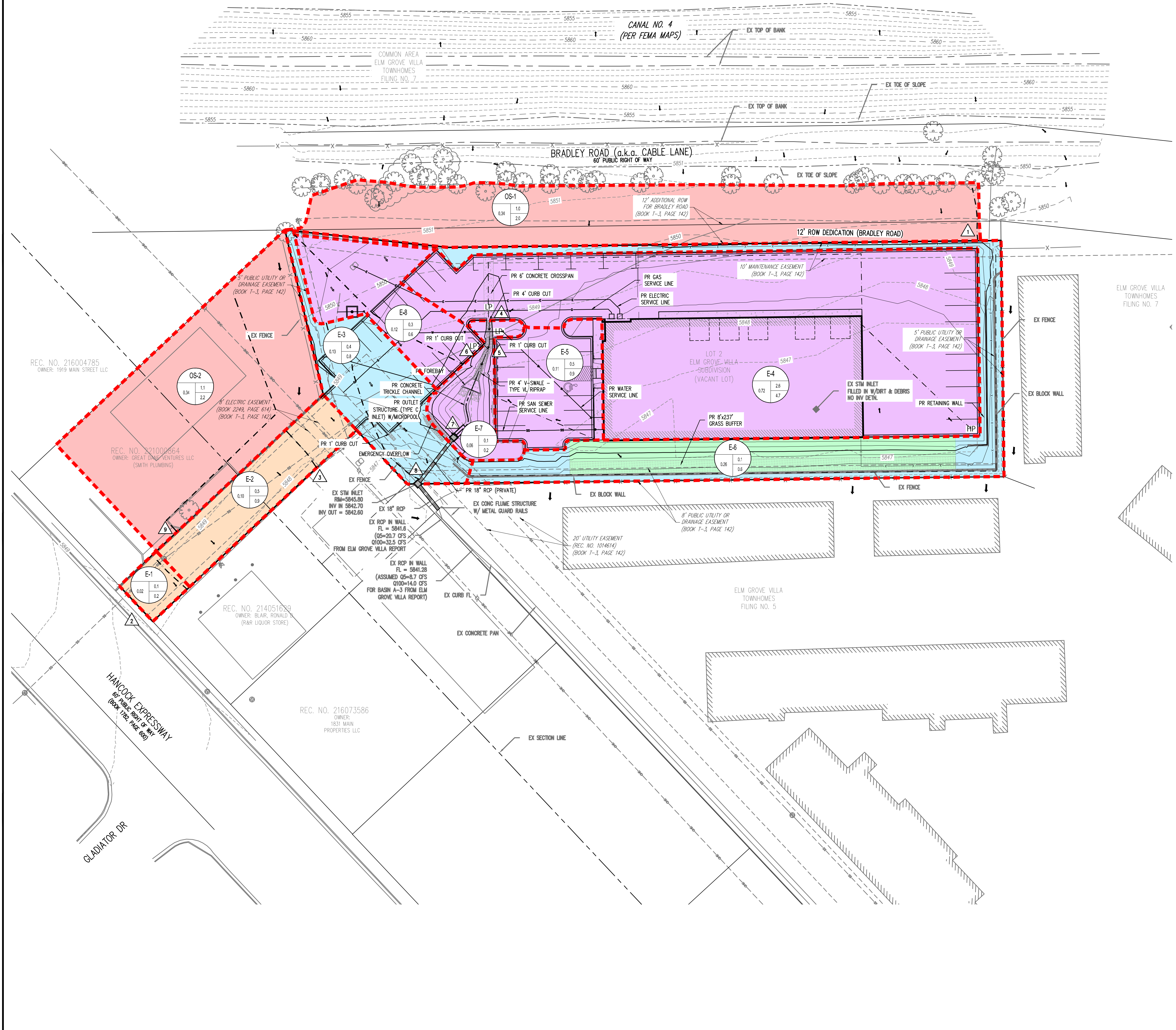

G:\110001\Hammers Construction\110001\110001.dwg
 11/12/2021 11:05:20 AM
 Smith Plumbing & Heating
 1875 Main Street
 Colorado Springs, CO 80911
 719.900.7220
 GallowayUS.com
 Project No: HCI000007
 Drawn By: DDJ
 Checked By: GD
 Date: 11/12/2021
 WQ PLAN

DR-3