



MVE, INC.
ENGINEERS SURVEYORS

1903 kelaray street, suite 200
colorado springs, co 80909
719.635.5736

Final Drainage Report

**St. John the
Baptist Orthodox
Church**

Project No. 61200

September 28, 2023

PCD File No. PPR-22-55

Statements and Acknowledgments

Engineer's Statement

This report and plan for the drainage design of St. John the Baptist Orthodox Church was prepared by me (or under my direct supervision) and is correct to the best of my knowledge and belief. Said report and plan has been prepared in accordance with the City / County Drainage Report Criteria and is in conformity with the master plan of the drainage basin. I accept responsibility for any liability caused by any negligent acts, errors or omissions on my part in preparing this report.

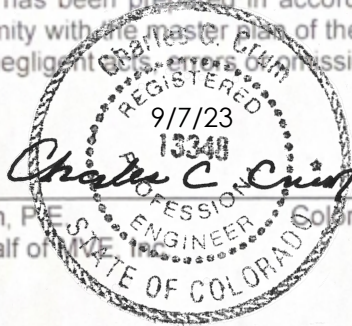

Charles C. Crum, P.E., Colorado No. 13348
For and on Behalf of

9/7/2023

Date

Developer's Statement

I, the owner/developer have read and will comply with all of the requirements specified in this drainage report and plan.

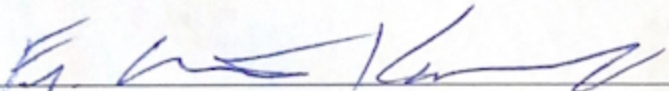
Father Anthony
SS Constantine & Helen Orthodox Church
2770 N. Chestnut Street
Colorado Springs, CO 80907

9/6/23
Date

El Paso County

Filed in accordance with the requirements of the Drainage Criteria Manual, Volumes 1 and 2, El Paso County Engineering Criteria Manual and Land Development Code as amended.

Approved

By: **Gilbert LaForce, P.E.**
Engineering Manager

Date: **10/12/2023 9:23:13 AM**

El Paso County Department of Public Works



Date

Contents

Statements and Acknowledgments.....	iii
Contents.....	v
Final Drainage Report.....	1
1 General Location and Description.....	1
1.1 Location.....	1
1.2 Description of Property.....	1
2 Drainage Basins and Sub-Basins.....	2
2.1 Major Basin Descriptions.....	2
2.2 Sub-Basin Description.....	2
3 Drainage Design Criteria.....	3
3.1 Development Criteria Reference.....	3
3.2 Previous Drainage Studies.....	3
3.3 Hydrologic and Hydraulic Criteria.....	3
4 Drainage Facility Design.....	4
4.1 General Concept.....	4
4.2 Specific Details.....	4
4.3 Four Step Process.....	6
5 Drainage and Bridge Fees.....	6
6 Conclusion.....	6
References.....	7

Appendices.....	8
7 General Maps and Supporting Data.....	8
8 Hydrologic Calculations.....	9
9 Hydraulic Calculations.....	41
10 Report Maps.....	43

Final Drainage Report

The purpose of this Final Drainage Report is to identify drainage patterns and quantities within and affecting the proposed St. John the Baptist Orthodox Church site. The report will identify specific solutions to problems on-site and off-site resulting from the proposed project. The report and included maps present results of hydrologic and drainage facilities analyses. The report will discuss the recommended drainage improvements to the site and identify drainage requirements relative to the proposed project. This report has been prepared and submitted in accordance with the requirements of the El Paso County development approval process. An Appendix is included with this report with pertinent calculations and graphs used in the drainage analyses and design.

1 General Location and Description

1.1 Location

St. John the Baptist Orthodox Church will be located within Lot 4, Block 2, Pawnee Rancheros Filing No. 1 which is within the east half of the southeast quarter of Section 4, Township 14 South, Range 63 West of the 6th Principal Meridian, El Paso County, Colorado. The site is 4.79± acres in area and has a tax schedule number of 53040 05 008 (7530 Mohawk Road). The site is located north of East Woodmen Road and west of Mohawk Road in El Paso County. The site is zoned Rural Residential - 5 Acres with Commercial Airport District Overlay (RR-5 CAD-O) and is vacant. A **Vicinity Map** is included in the **Appendix**. The site is located in the Sand Creek Major Drainage Basin.

1.2 Description of Property

Pawnee Rancheros Filing No. 1 is a platted residential subdivision in El Paso County, Colorado. Lot 4, Block 2 of the subdivision is located to the northwest of the intersection of Mohawk Drive and the Woodmen Road East Frontage Road. Site development activities within the subdivision have been residential construction. The Lot 4 site is adjacent to property with buildings and appurtenances to the east & west, and by vacant property to the north. The existing site topography generally slopes to the east, west, and southerly with grades of about 3% to 10%. The existing ground cover is in fair to good condition and consists of native grasses and sparse brush for Lot 4. The site is split by a ridge line traversing the site from the south to the north. Stormwater drainage patterns on the site flow easterly and westerly from the ridge line and in a southerly direction. The westerly overland flows exit the said along the westerly line of said Lot 4. The easterly overland flows ultimately end up in El Paso County drainage culverts at the southeast corner of said Lot 4 within the El Paso County road right of way draining southerly under the existing Woodmen Road East Frontage Road.

The proposed Site Development Plan for said Lot 4 consists of a new 3475 square-foot Church building along with sidewalks, parking lot, entrance drive, permanent landscaping, and other related site improvements. Access to the Church lot will be provided by one connection to Mohawk Road on the east side of the site.

This report is intended to meet El Paso County requirements for a Final Drainage Report in support of the proposed Development Plan for the St. John the Baptist Orthodox Church on Lot 4. No Drainage Report for Pawnee Rancheros Filing No. 1 has been found in the El Paso County records.

According to the National Resource Conservation Service, there are three (3) soil types in the Lot 4, Block 2, Pawnee Rancheros Filing No. 1 site. Blakeland loamy sand (map unit 8) makes up a very small portion of the eastern side of the site. The soil is deep and somewhat excessively drained. Permeability is rapid, surface runoff is slow, and the hazard of erosion is slight to moderate. Blakeland loamy sand is classified as being part of Hydrologic Soil Group A. Blakeland-Fluvaquentic Halplaquolls (map unit 9) makes up the eastern portion of the soil on the site. The soil is deep and somewhat excessively drained. Permeability is rapid, surface runoff is slow, and the hazard of erosion is slight to moderate. Blakeland-Fluvaquentic Halplaquolls is classified as being part of Hydrologic Soil Group A. Columbine (map unit 19) makes up the western portion of the site. The soil is deep and somewhat well drained. Permeability is rapid, surface runoff is slow, and the hazard of erosion is slight to moderate. Columbine is classified as being part of Hydrologic Soil Group A. A portion of the Soil Map and data tables from the National Cooperative Soil Survey and relevant Official Soil Series Descriptions (OSD) are included in the **Appendix**.^{1 2}

2 Drainage Basins and Sub-Basins

2.1 Major Basin Descriptions

The St. John the Baptist Orthodox Church site is located within the Sand Creek Drainage Basin (FOFO4000). The Sand Creek Drainage Basin Covers an area of approximately 61 square miles and drains to Fountain Creek. The *Sand Creek Drainage Basin Planning Study* (DBPS) was prepared in 1996 by Kiowa Engineering Corporation and provides development recommendations and requirements for drainage development in the Sand Creek Drainage Basin.³ The Sand Creek Drainage Basin encompasses a small portion of central El Paso County. The drainage basin drains southwesterly into Fountain Creek. The St. John the Baptist Orthodox Church site is located north of Fountain Creek. The site is located within the upper portion of the Drainage Basin Planning Study. No improvements are recommended on or near the project site. The proposed St. John the Baptist Orthodox Church project is in conformance with the DBPS.

The current Flood Insurance Study of the region includes Flood Insurance Rate Maps (FIRM), effective on December 7, 2018.⁴ The proposed subdivision is included in the Community Panel Number 08041C0533G of the Flood Insurance Rate Maps for the El Paso County. No part of the site is shown to be included in a 100-year flood hazard area as determined by FEMA. A portion of the current FEMA Flood Insurance Rate Maps with the site delineated is included in the **Appendix**.

2.2 Sub-Basin Description

The existing drainage patterns of the St. John the Baptist Orthodox Church project site are described by three (3) on-site drainage basins, and three (3) off-site drainage basins. All of these basins are previously undisturbed or disturbed to a degree as described below. All existing basin delineations and data are depicted on the attached **Existing Drainage Map**.

2.2.1 Existing Drainage Patterns (Off-Site)

St. John the Baptist Orthodox Church directly receives drainage flows from one (1) offsite sub-basin while two (2) additional offsite drainage basins flow onto the property from the El Paso County roadways adjacent to the east side and south side of the site. The roadways, Mowhawk Road & Woodmen Frontage Road, were constructed with fill slopes, no ditches, and ultimately sheet flow onto said Lot 4.

Sub-basin OS-1 is located south and east of the site and contains the northern portion of asphalt pavement and roadside of Woodmen Frontage Road and the western portion of pavement and roadside of Mohawk Road. The sub-basin drains easterly and southerly towards the existing 2- 27" Reinforced Concrete Pipes (RCP's) draining southerly under said frontage road.

1 WSS
2 OSD
3 DBPS
4 FIRM

Sub-basin OS-2 is located northerly of the site, is vacant and contains pasture/meadow type ground cover. This sub-basin drains southerly onto the site and join with on-site Basin B.

Sub-basin OS-3 contains a residence, detached garage, a shed, and graveled entrance drives. The remainder of the basin is established pasture/meadow areas and is located northerly of the site. The sub-basin drains easterly then southerly, west of Mohawk Road. These flows continue southerly joining the flows from Sub-basin OS-1 at said existing 2-27" RCP's which drain southerly under said frontage road.

Woodmen Frontage Road and Mohawk Road adjacent to the property do not have roadside ditches. Drainage from the pavement drains off the shoulder and into the subject property.

2.2.2 Existing Drainage Patterns (On-Site)

Existing Sub-basin A, located on the western portion of the site, contains pasture/meadow area. The stormwater flows westerly overland and exit the site along the western lot line.

Existing Sub-basin B makes up a small portion of the northeastern area of the site and currently contains established pasture/meadow area. The sub-basin accepts flows from sub-basin OS-2. The combined runoff drains southeasterly and combines with the flows from OS-3.

Existing Sub-basin C makes up a substantial portion of the southeastern portion of the site and currently contains established pasture/meadow area. The Sub-basin currently drains southeasterly towards the northwest corner of Mohawk Road and Woodmen Frontage Road combining with Sub-basins B, OS-1, OS-2 & OS-3 at said existing 2-27" RCP's which drain southerly under said frontage road.

3 Drainage Design Criteria

3.1 Development Criteria Reference

This Final Drainage Report for development of Lot 4, Block 2, Pawnee Rancheros Filing No. 1 has been prepared according to the report guidelines presented in the latest edition of *El Paso County Drainage Criteria Manual (DCM)*⁵. This manual adopts portions of the City of Colorado Springs Drainage Criteria Manual Volumes 1 and 2, especially concerning the calculation of rainfall runoff flow rates.^{6 7} The hydrologic analysis is based on a collection of data from the DCM, the NRCS Web Soil Survey⁸, and existing topographic data by Alessi and Associates, Inc. and Colorado Springs Utilities FIMS.

3.2 Previous Drainage Studies

Besides the previously mentioned DBPS, we have not found a Final Drainage Report for Pawnee Rancheros Filing No. 1.

3.3 Hydrologic and Hydraulic Criteria

The Rational Method as described in the *El Paso County Drainage Criteria Manual* has been used for all Storm Runoff calculations, as the development and all sub-basins are less than 130 acres in area. "Colorado Springs Rainfall Intensity Duration Frequency" curves, Figure 6-5 in the DCM, was used to obtain the design rainfall values; a copy is included in the **Appendix**. The "Overland (Initial) Flow Equation" (Eq. 6-8) in the DCM, and Manning's equation with estimated depths were used in time of concentration calculations. "Runoff Coefficients for Rational Method", Table 6-6 in the DCM, was utilized as a guide in estimating runoff coefficient and Percent Impervious values; a copy is included in the **Appendix**. Peak runoff discharges were calculated for each drainage sub-basin for

5 EPC DCM
6 CS DCM Vol 1
7 CS DCM Vol 2
8 WSS

both the 5-year storm event and the 100-year storm event with the Rational Method formula, (Eq. 6-5) in the DCM.⁹

Storm drain pipes and Inlets are analyzed and designed using the procedures in Chapter 7, Sections 3.0 and 4.0 of the *Mile High Flood District (MHFD) Urban Storm Drainage Criteria Manual, Volume 1*.¹⁰ Calculations are done with the aid of the MHFD Street and Inlet Hydraulics Workbook Version 5.01 and UD-Sewer 2009 Version 1.2.1. Culverts are analyzed and designed using the procedures found in Chapter 11, Sections 3.0 and 4.0 of the *Mile High Flood District (MHFD) Urban Storm Drainage Criteria Manual, Volume 2*.¹¹ The MHFD Culvert Design Worksheet V4.00 or the HY-8 computer program Version 7.60 by the Federal Highway Administration were used as an aid.

4 Drainage Facility Design

4.1 General Concept

The intent of the drainage concept presented in this Final Drainage Report is to allow for the development of a new 3475 square-foot Church building along with sidewalks, parking lot, entrance drive, permanent landscaping, and other related site improvements and safely routing developed flows through the site to the previously constructed drainage piping system under said Woodmen Frontage Road. Existing drainage patterns will be maintained as much a practically possible.

The existing percent imperviousness of the site is 0.0%. The proposed improvements will increase the imperviousness of the site to 9.8%.

The existing and proposed drainage hydrologic conditions are described in more detail below. Input data and results for all calculations are included in the **Appendix**. Drainage maps for the hydrology are also included in the **Appendix**.

4.2 Specific Details

4.2.1 Existing Hydrologic Conditions

As shown on the included **Existing Drainage Map** the existing site has been delineated with three (3) on-site sub-basins (A, B, & C) and three (3) offsite sub-basins (OS-1, OS-2, & OS-3, all draining as previously described above. Storm runoff concerning the subject site has been calculated for this report as discussed below.

Existing **Design Point (EX-1)**: Offsite **Sub-basin OS-2** located adjacent to the northern lot line of the subject site contains 1.66 acres. The sub-basin contains established pasture/meadow ground cover. The sub-basin generates runoff flows of $Q_5 = 0.5$ cfs and $Q_{100} = 3.8$ cfs that drain southerly into the site along said Lot line to existing Sub-basin B.

Existing **Design Point (EX-2)**: Offsite **Sub-basin OS-3** is located north and east of OS-2 and is 2.51 acres in area. The sub-basin contains established a portion of the developed residential lot, the west edge of Mohawk Road and pasture/meadow ground cover. The sub-basin generates runoff flows of $Q_5 = 2.3$ cfs and $Q_{100} = 7.0$ cfs that drain southerly to Design Point EX-2. **Sub-basin B** is 0.82 acres and contains established pasture/meadow ground cover in the undeveloped northeastern portion Lot 4, Pawnee Rancheros Filing No. 1. The Sub-basin drains southeasterly and combines with flows from Sub-basin OS-2 and OS-3 for combined area of 4.99 acres. Peak runoff discharges at Design Point EX-2 are $Q_5 = 3.0$ cfs and $Q_{100} = 12.1$ cfs which continue southerly into Sub-basin C.

Existing **Design Point (EX-3)**: **Sub-basin C** is 2.24 acres and contains established pasture/meadow ground cover in the undeveloped southeastern portion Lot 4, Pawnee Rancheros Filing No. 1. The sub-basin produces flows of $Q_5 = 0.7$ cfs and $Q_{100} = 5.0$ cfs which drain to the northwest corner of the intersection of Mohawk Road and Woodmen Frontage Road.

9 EPC DCM
10 MHFD V1
11 MHFD V2

Existing **Design Point (EX-4): Sub-basin A** is 1.73 acres and contains established pasture/meadow ground cover in the undeveloped western portion of Lot 4, Pawnee Rancheros Filing No. 1. The peak runoff is $Q_5 = 0.6$ cfs and $Q_{100} = 4.0$ cfs which drain westerly and exit said Lot 4 along the westerly boundary.

Existing **Design Point (EX-5):** Combined Sub-basins OS-1, OS-2, OS-3, B, & C contain a total of 7.83 acres. The flows from these Sub-basins combine in the area of the southeast corner of Lot 4, Pawnee Rancheros Filing No. 1. These combined Sub-basins drains southerly through the existing 2 – 27" RCP's under Woodmen Frontage Road. The combined peak runoff discharges of $Q_5 = 4.5$ cfs and $Q_{100} = 18.2$ cfs flow southerly through said pipes. After crossing under the Woodmen Frontage Road, flows enter the existing storm drain system along Woodmen Road before crossing south under Woodmen Road and into Sand Creek. Analysis of this Woodmen Road storm drain system is beyond the scope of this Report.

4.2.2 Proposed Hydrologic Conditions

As shown on the enclosed **Proposed Drainage Map**, the developed site has been delineated into eight (8) on-site sub-basins A1, A2, B1, C1, C2, C3, C4, and C5. There are also three (3) offsite sub-basins OS-1, OS-2, and OS-3. The existing and proposed calculations for offsite Sub-basins OS-1, OS-2 and OS-3 are the same in both the existing and proposed conditions. Storm flows from the "A" Sub-basins will drain westerly, exiting Lot 4 along its western Lot line. The "B" Sub-basin drains easterly toward Mohawk Road. The "C" Sub-basins will combine their storm flows and drain southwesterly towards the southeast corner of Lot 4. The collected flows of Sub-basins B1, C1, C2, C3, C4, and C5 combined with those of OS-1, OS-2 and OS-3 will be carried southerly through the existing 2 – 27" RCP's under Woodmen Frontage Road.

Design Point 1 (DP1): Sub-basin A1, containing 0.06 acres with new sidewalk and grassed ground cover producing storm runoff flows of $Q_5 = 0.2$ cfs and $Q_{100} = 0.4$ cfs that drain westerly into Sub-basin A-2.

Design Point 2 (DP2): Sub-basin A2 is 1.71 acres in area located adjacent to the western edge of the site. The sub-basin contains established pasture/meadow ground cover producing storm runoff flows of $Q_5 = 0.5$ cfs and $Q_{100} = 4.0$ cfs. These flows combine with from Sub-basin A1 at **DP1** for a combined area of 1.77 acres. The combined peak discharges of $Q_5 = 0.7$ cfs and $Q_{100} = 4.3$ cfs flow overland exiting Lot 4 along the western Lot line. The increase in flows from existing to proposed are $Q_5 = 0.1$ cfs and $Q_{100} = 0.3$ cfs.

Design Point 3 (DP3): Sub-basin B1 is 0.82 acres in area and located in the northeastern portion of Lot 4. The Sub-basin contains established pasture/meadow ground cover and the proposed driveway with overland flows and flows from the proposed drive producing storm runoff flows of $Q_5 = 0.4$ cfs and $Q_{100} = 2.1$ cfs. The flows combine with those of OS-2 and OS-3 at **DP3**, where they cross a low point in the driveway with peak runoff discharges of $Q_5 = 3.1$ cfs and $Q_{100} = 12.0$ cfs. Calculations for this low point in the driveway are included in the **Appendix**. Note that the entire Sub-basin B1 was used in this calculation.

Design Point 4 (DP4): Sub-basins C1, C2 & C4 combine to be 1.17 acres located in the central portion of Lot 4. **C1** is 0.74 acres and contains established pasture/meadow ground cover with overland flows to the southeast and sheets across the proposed sidewalk entering the proposed drive and parking lot with peak flows of $Q_5 = 0.2$ cfs and $Q_{100} = 1.8$ cfs. **C2** is 0.13 acres and contains established pasture/meadow ground cover and proposed sidewalk which will flow to the southeast along the sidewalk before spreading out and sheeting across the proposed walkway into the proposed parking lot with peak flows of $Q_5 = 0.1$ cfs and $Q_{100} = 0.5$ cfs. **C4** is 0.31 acres containing the new parking lot a portion of the entrance drive. These three Sub-basins combine at **DP4** for a peak runoff discharge of $Q_5 = 1.4$ cfs and $Q_{100} = 3.9$ cfs which exits the southeast corner of said parking Lot through a 2' wide curb opening. Calculations for this opening and riprap outfall are included in the **Appendix**. Flows continue into Sub-basin C-5 towards DP5.

Sub-basin C3, containing 0.45 acres, consists of the proposed building, walks and landscape along with grassed ground cover producing storm runoff flows of $Q_5 = 0.6$ cfs and $Q_{100} = 1.6$ cfs that drain south and east where they join with the flows from DP4 and continue into Sub-basin C5.

Sub-basin C5, containing 0.58 acres, consists of pasture/meadow ground cover at the southeast corner of the site producing storm runoff flows of $Q_5 = 0.2$ cfs and $Q_{100} = 1.3$ cfs that drain south to a low point at the northwest corner of the Woodmen Frontage Road and Mohawk Road at DP5.

Design Point 5 (DP5): Sub-basins OS-1, OS-2, OS-3, B1, & C1-C5 combine to be 7.79 acres located in the central southeastern portion of Lot 4 and represent the entirety of flows entering the existing double 27" RCP. The sub-basins are a combination of existing established pasture/meadow ground cover and hard surfacing from the proposed new construction. The combined sub-basins will produce flows of $Q_5 = 5.9$ cfs and $Q_{100} = 19.8$ cfs at **DP5** which drain southerly to the existing 2 – 27" RCP's under Woodmen Frontage Road. The increase in flows from existing to proposed are $Q_5 = 1.4$ cfs and $Q_{100} = 1.6$ cfs. The existing double 27" RCP is in good condition but need vegetative clearing at the entrance. The culverts are calculated to be sufficient to convey the minor increased flows from this development. Calculations for these existing pipes are included in the **Appendix**.

4.3 Four Step Process

The El Paso County Engineering Criteria Manual (Appendix I, Section I.7.2) requires the consideration of a "Four Step Process for receiving water protection that focuses on reducing runoff volumes, treating the water quality capture volume (WQCV), stabilizing drainageways, and implementing long term source controls".

- 1) Runoff Reduction Practices are employed in this project. Impervious surfaces have been reduced as much as practically possible. There are minimal proposed concrete or other hard surfaces as required for the effective use of the property. Also, some of the proposed roof surfaces and paved surfaces will drain onto grass buffers and/or swales before entering El Paso County right of ways.
- 2) There are no drainage paths on the site that are required to be stabilized as they are well vegetated with no visual signs of erosion. There are no significant areas of concentrated flows.
- 3) Lot 4 is a 4.7+/- acre site. The development will disturb 0.99 acres. The proposed disturbance is less than one acre. No water quality treatment with WQCV is required and no stormwater control measures are required for this Lot as the disturbance area is less than one acre.
- 4) The project contains no potentially hazardous uses. The site is not anticipated to contain storage of potentially harmful substances or support the use of potentially harmful substances. No site specific or other source control BMPs are required.

5 Drainage and Bridge Fees

Lot 4, Block 2, Pawnee Rancheros Filing No. 1 is currently a platted lot. No Drainage Fees are due for the St. John the Baptist Orthodox Church project since no new platting action is proposed or requested.

6 Conclusion

This Final Drainage Report presents existing and proposed drainage conditions for the proposed St. John the Baptist Orthodox Church project in Lot 4, Block 2, Pawnee Rancheros Filing No. 1. The development will have negligible and inconsequential effects on the existing site drainage and drainage conditions downstream. The existing percent imperviousness of the site is 0.0%. The proposed improvements will increase the imperviousness of the site to 11.7%. The proposed project will not, with respect to stormwater runoff, negatively impact the adjacent properties and downstream properties.

References

- NCSS Web Soil Survey*. United States Department of Agriculture, Natural Resources Conservation Service ("<http://websoilsurvey.nrcs.usda.gov/app/WebSoilSurvey.aspx>", accessed May 19, 2021).
- NRCS Official Soil Series Descriptions*. United States Department of Agriculture, Natural Resources Conservation Service ("<http://soils.usda.gov/technical/classification/osd/index.html>", accessed May 19, 2021).
- Sand Creek Drainage Basin Planning Study*. Kiowa Engineering Corp. (Colorado Springs: El Paso County, January 1996).
- Flood Insurance Rate Map*. Federal Emergency Management Agency, National Flood Insurance Program (Washington D.C.: FEMA, December 7, 2018).
- Drainage Criteria Manual Volume 2, Stormwater Quality Policies, Procedures and Best Management Practices (BMPs)*. City of Colorado Spring Engineering Division (Colorado Springs: , May 2014).
- City of Colorado Springs Drainage Criteria Manual, Volume 1*. City of Colorado Springs Engineering Division Staff, Matrix Design Group/Wright Water Engineers (Colorado Springs: , May 2014).
- Drainage Criteria Manual for County of El Paso, Colorado*. El Paso County Department of Public Works Engineering Division, HDR Infrastructure Inc., City of Colorado Springs Department of Public Works Engineering Division (: , Updated October 31, 2018).
- City of Colorado Springs Drainage Criteria Manual Volume 1*. City of Colorado Springs Engineering Division with Matrix Design Group and Wright Water Engineers (Colorado Springs, Colorado: , May 2014).
- Urban Storm Drainage Criteria Manual: Volume 2, Structures, Storage, and Recreation*. Urban Drainage and Flood Control District (Denver, Colorado: , Revised September, 2017).
- Urban Storm Drainage Criteria Manual: Volume 1, Management, Hydrology and Hydraulics*. Urban Drainage and Flood Control District (Denver, Colorado: , Revised August, 2018).

| Appendices

7 General Maps and Supporting Data

- Vicinity Map
- Portions of Flood Insurance Rate Map
- NRCS Soil Map and Tables
- SCS Soil Type Descriptions
- Hydrologic Soil Group Map and Tables

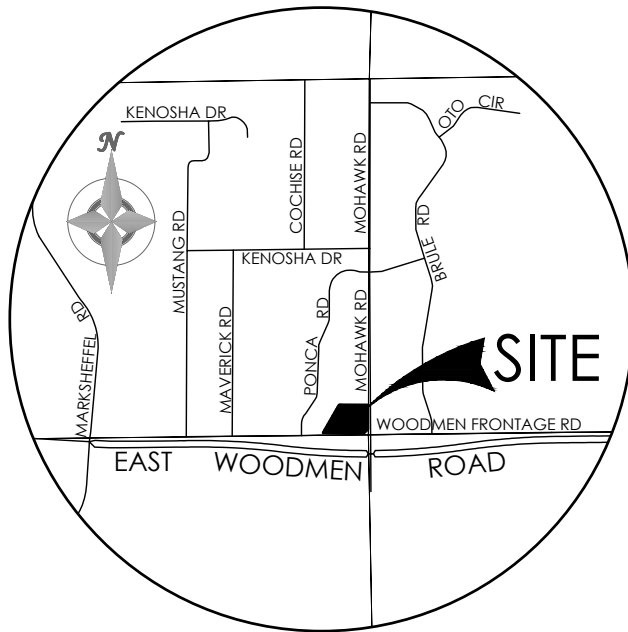

VICINITY MAP

NOT TO SCALE

National Flood Hazard Layer FIRMette



104°40'10"W 38°56'44"N



Legend

SEE FIS REPORT FOR DETAILED LEGEND AND INDEX MAP FOR FIRM PANEL LAYOUT

SPECIAL FLOOD HAZARD AREAS	Without Base Flood Elevation (BFE) Zone A, V, A99	With BFE or Depth Zone AE, AO, AH, VE, AR
	Regulatory Floodway	

OTHER AREAS OF FLOOD HAZARD	0.2% Annual Chance Flood Hazard, Areas of 1% annual chance flood with average depth less than one foot or with drainage areas of less than one square mile Zone X
	Future Conditions 1% Annual Chance Flood Hazard Zone X
	Area with Reduced Flood Risk due to Levee. See Notes. Zone X
	Area with Flood Risk due to Levee Zone D

OTHER AREAS	NO SCREEN Area of Minimal Flood Hazard Zone X
	Effective LOMRs
	Area of Undetermined Flood Hazard Zone D

GENERAL STRUCTURES	Channel, Culvert, or Storm Sewer
	Levee, Dike, or Floodwall

OTHER FEATURES	Cross Sections with 1% Annual Chance Water Surface Elevation
	20.2
	17.5
	Coastal Transect
	Base Flood Elevation Line (BFE)
	Limit of Study
	Jurisdiction Boundary
	Coastal Transect Baseline
	Profile Baseline
	Hydrographic Feature

MAP PANELS	Digital Data Available
	No Digital Data Available
	Unmapped

The pin displayed on the map is an approximate point selected by the user and does not represent an authoritative property location.

This map complies with FEMA's standards for the use of digital flood maps if it is not void as described below. The basemap shown complies with FEMA's basemap accuracy standards

The flood hazard information is derived directly from the authoritative NFHL web services provided by FEMA. This map was exported on 5/11/2023 at 12:14 PM and does not reflect changes or amendments subsequent to this date and time. The NFHL and effective information may change or become superseded by new data over time.

This map image is void if the one or more of the following map elements do not appear: basemap imagery, flood zone labels, legend, scale bar, map creation date, community identifiers, FIRM panel number, and FIRM effective date. Map images for unmapped and unmodernized areas cannot be used for regulatory purposes.

Custom Soil Resource Report Soil Map

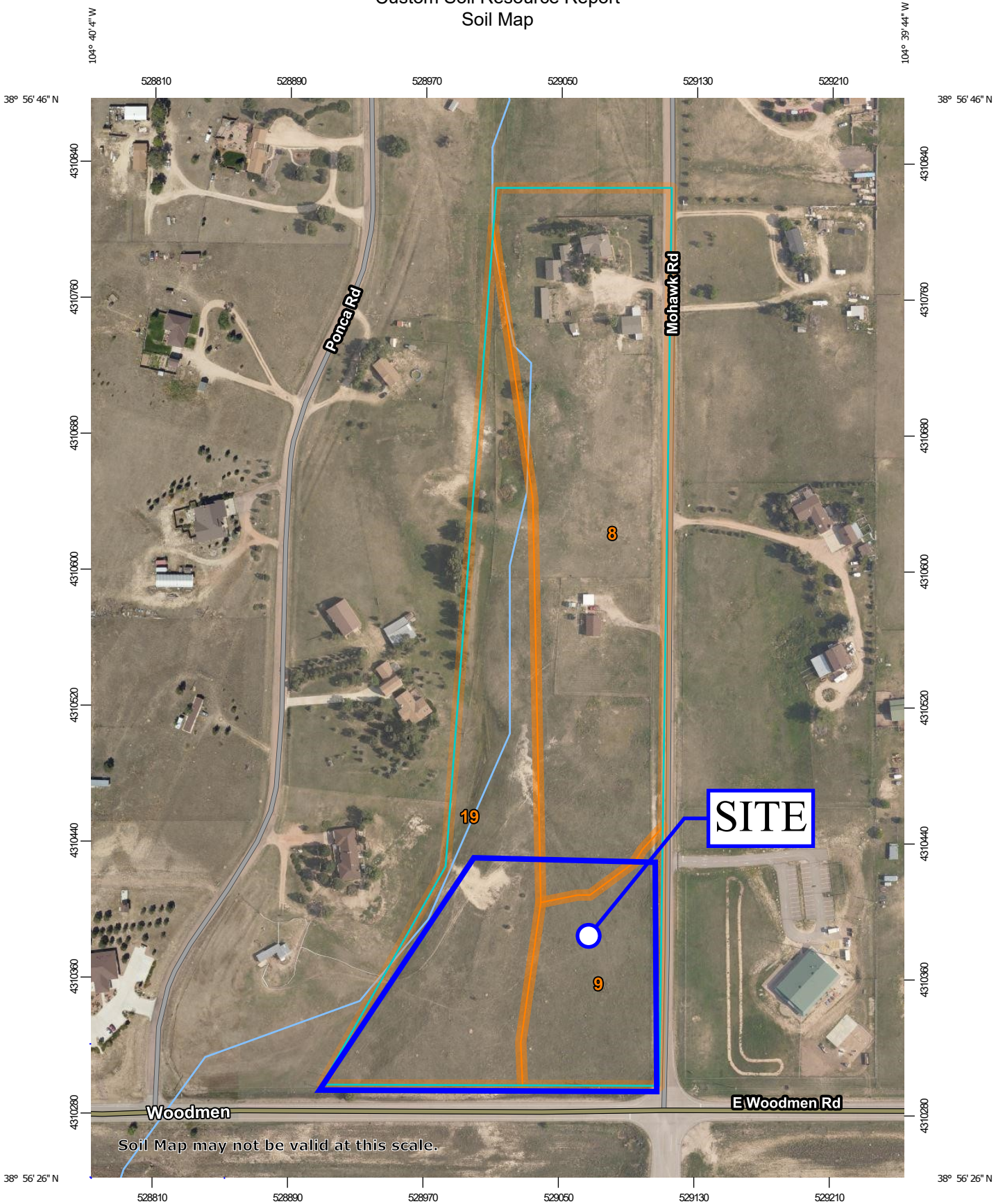

Map Scale: 1:3,100 if printed on A portrait (8.5" x 11") sheet.



Map projection: Web Mercator Corner coordinates: WGS84 Edge tics: UTM Zone 13N WGS84



MAP LEGEND

Area of Interest (AOI)

 Area of Interest (AOI)

Soils







 Soil Map Unit Polygons

 Soil Map Unit Lines

 Soil Map Unit Points

Special Point Features





-  Blowout
-  Borrow Pit
-  Clay Spot
-  Closed Depression
-  Gravel Pit
-  Gravelly Spot
-  Landfill
-  Lava Flow
-  Marsh or swamp
-  Mine or Quarry
-  Miscellaneous Water
-  Perennial Water
-  Rock Outcrop
-  Saline Spot
-  Sandy Spot
-  Severely Eroded Spot
-  Sinkhole
-  Slide or Slip
-  Sodic Spot

-  Spoil Area
-  Stony Spot
-  Very Stony Spot
-  Wet Spot
-  Other
-  Special Line Features

Water Features

 Streams and Canals

Transportation

-  Rails
-  Interstate Highways
-  US Routes
-  Major Roads
-  Local Roads

Background

 Aerial Photography

MAP INFORMATION

The soil surveys that comprise your AOI were mapped at 1:24,000.

Warning: Soil Map may not be valid at this scale.

Enlargement of maps beyond the scale of mapping can cause misunderstanding of the detail of mapping and accuracy of soil line placement. The maps do not show the small areas of contrasting soils that could have been shown at a more detailed scale.

Please rely on the bar scale on each map sheet for map measurements.

Source of Map: Natural Resources Conservation Service
 Web Soil Survey URL:
 Coordinate System: Web Mercator (EPSG:3857)

Maps from the Web Soil Survey are based on the Web Mercator projection, which preserves direction and shape but distorts distance and area. A projection that preserves area, such as the Albers equal-area conic projection, should be used if more accurate calculations of distance or area are required.

This product is generated from the USDA-NRCS certified data as of the version date(s) listed below.

Soil Survey Area: El Paso County Area, Colorado
 Survey Area Data: Version 20, Sep 2, 2022

Soil map units are labeled (as space allows) for map scales 1:50,000 or larger.

Date(s) aerial images were photographed: Aug 19, 2018—Sep 23, 2018

The orthophoto or other base map on which the soil lines were compiled and digitized probably differs from the background imagery displayed on these maps. As a result, some minor shifting of map unit boundaries may be evident.

Map Unit Legend

Map Unit Symbol	Map Unit Name	Acres in AOI	Percent of AOI
8	Blakeland loamy sand, 1 to 9 percent slopes	8.5	50.6%
9	Blakeland-Fluvaquentic Haplaquolls	2.3	14.0%
19	Columbine gravelly sandy loam, 0 to 3 percent slopes	5.9	35.4%
Totals for Area of Interest		16.7	100.0%

Map Unit Descriptions

The map units delineated on the detailed soil maps in a soil survey represent the soils or miscellaneous areas in the survey area. The map unit descriptions, along with the maps, can be used to determine the composition and properties of a unit.

A map unit delineation on a soil map represents an area dominated by one or more major kinds of soil or miscellaneous areas. A map unit is identified and named according to the taxonomic classification of the dominant soils. Within a taxonomic class there are precisely defined limits for the properties of the soils. On the landscape, however, the soils are natural phenomena, and they have the characteristic variability of all natural phenomena. Thus, the range of some observed properties may extend beyond the limits defined for a taxonomic class. Areas of soils of a single taxonomic class rarely, if ever, can be mapped without including areas of other taxonomic classes. Consequently, every map unit is made up of the soils or miscellaneous areas for which it is named and some minor components that belong to taxonomic classes other than those of the major soils.

Most minor soils have properties similar to those of the dominant soil or soils in the map unit, and thus they do not affect use and management. These are called noncontrasting, or similar, components. They may or may not be mentioned in a particular map unit description. Other minor components, however, have properties and behavioral characteristics divergent enough to affect use or to require different management. These are called contrasting, or dissimilar, components. They generally are in small areas and could not be mapped separately because of the scale used. Some small areas of strongly contrasting soils or miscellaneous areas are identified by a special symbol on the maps. If included in the database for a given area, the contrasting minor components are identified in the map unit descriptions along with some characteristics of each. A few areas of minor components may not have been observed, and consequently they are not mentioned in the descriptions, especially where the pattern was so complex that it was impractical to make enough observations to identify all the soils and miscellaneous areas on the landscape.

The presence of minor components in a map unit in no way diminishes the usefulness or accuracy of the data. The objective of mapping is not to delineate pure taxonomic classes but rather to separate the landscape into landforms or

Custom Soil Resource Report

landform segments that have similar use and management requirements. The delineation of such segments on the map provides sufficient information for the development of resource plans. If intensive use of small areas is planned, however, onsite investigation is needed to define and locate the soils and miscellaneous areas.

An identifying symbol precedes the map unit name in the map unit descriptions. Each description includes general facts about the unit and gives important soil properties and qualities.

Soils that have profiles that are almost alike make up a *soil series*. Except for differences in texture of the surface layer, all the soils of a series have major horizons that are similar in composition, thickness, and arrangement.

Soils of one series can differ in texture of the surface layer, slope, stoniness, salinity, degree of erosion, and other characteristics that affect their use. On the basis of such differences, a soil series is divided into *soil phases*. Most of the areas shown on the detailed soil maps are phases of soil series. The name of a soil phase commonly indicates a feature that affects use or management. For example, Alpha silt loam, 0 to 2 percent slopes, is a phase of the Alpha series.

Some map units are made up of two or more major soils or miscellaneous areas. These map units are complexes, associations, or undifferentiated groups.

A *complex* consists of two or more soils or miscellaneous areas in such an intricate pattern or in such small areas that they cannot be shown separately on the maps. The pattern and proportion of the soils or miscellaneous areas are somewhat similar in all areas. Alpha-Beta complex, 0 to 6 percent slopes, is an example.

An *association* is made up of two or more geographically associated soils or miscellaneous areas that are shown as one unit on the maps. Because of present or anticipated uses of the map units in the survey area, it was not considered practical or necessary to map the soils or miscellaneous areas separately. The pattern and relative proportion of the soils or miscellaneous areas are somewhat similar. Alpha-Beta association, 0 to 2 percent slopes, is an example.

An *undifferentiated group* is made up of two or more soils or miscellaneous areas that could be mapped individually but are mapped as one unit because similar interpretations can be made for use and management. The pattern and proportion of the soils or miscellaneous areas in a mapped area are not uniform. An area can be made up of only one of the major soils or miscellaneous areas, or it can be made up of all of them. Alpha and Beta soils, 0 to 2 percent slopes, is an example.

Some surveys include *miscellaneous areas*. Such areas have little or no soil material and support little or no vegetation. Rock outcrop is an example.

El Paso County Area, Colorado

8—Blakeland loamy sand, 1 to 9 percent slopes

Map Unit Setting

National map unit symbol: 369v
Elevation: 4,600 to 5,800 feet
Mean annual precipitation: 14 to 16 inches
Mean annual air temperature: 46 to 48 degrees F
Frost-free period: 125 to 145 days
Farmland classification: Not prime farmland

Map Unit Composition

Blakeland and similar soils: 98 percent
Minor components: 2 percent
Estimates are based on observations, descriptions, and transects of the mapunit.

Description of Blakeland

Setting

Landform: Flats, hills
Landform position (three-dimensional): Side slope, talf
Down-slope shape: Linear
Across-slope shape: Linear
Parent material: Alluvium derived from sedimentary rock and/or eolian deposits derived from sedimentary rock

Typical profile

A - 0 to 11 inches: loamy sand
AC - 11 to 27 inches: loamy sand
C - 27 to 60 inches: sand

Properties and qualities

Slope: 1 to 9 percent
Depth to restrictive feature: More than 80 inches
Drainage class: Somewhat excessively drained
Runoff class: Low
Capacity of the most limiting layer to transmit water (Ksat): High to very high (5.95 to 19.98 in/hr)
Depth to water table: More than 80 inches
Frequency of flooding: None
Frequency of ponding: None
Calcium carbonate, maximum content: 5 percent
Available water supply, 0 to 60 inches: Low (about 4.5 inches)

Interpretive groups

Land capability classification (irrigated): 3e
Land capability classification (nonirrigated): 6e
Hydrologic Soil Group: A
Ecological site: R049XB210CO - Sandy Foothill
Hydric soil rating: No

Minor Components

Other soils

Percent of map unit: 1 percent

Hydric soil rating: No

Pleasant

Percent of map unit: 1 percent

Landform: Depressions

Hydric soil rating: Yes

9—Blakeland-Fluvaquentic Haplaquolls

Map Unit Setting

National map unit symbol: 36b6

Elevation: 3,500 to 5,800 feet

Mean annual precipitation: 13 to 17 inches

Mean annual air temperature: 46 to 55 degrees F

Frost-free period: 110 to 165 days

Farmland classification: Not prime farmland

Map Unit Composition

Blakeland and similar soils: 60 percent

Fluvaquentic haplaquolls and similar soils: 38 percent

Minor components: 2 percent

Estimates are based on observations, descriptions, and transects of the mapunit.

Description of Blakeland

Setting

Landform: Flats, hills

Landform position (three-dimensional): Side slope, talf

Down-slope shape: Linear

Across-slope shape: Linear

Parent material: Sandy alluvium derived from arkose and/or eolian deposits
derived from arkose

Typical profile

A - 0 to 11 inches: loamy sand

AC - 11 to 27 inches: loamy sand

C - 27 to 60 inches: sand

Properties and qualities

Slope: 1 to 9 percent

Depth to restrictive feature: More than 80 inches

Drainage class: Somewhat excessively drained

Runoff class: Low

Capacity of the most limiting layer to transmit water (Ksat): High to very high (5.95
to 19.98 in/hr)

Depth to water table: More than 80 inches

Frequency of flooding: None

Frequency of ponding: None

Calcium carbonate, maximum content: 5 percent

Available water supply, 0 to 60 inches: Low (about 4.5 inches)

Interpretive groups

Land capability classification (irrigated): 3e
Land capability classification (nonirrigated): 6e
Hydrologic Soil Group: A
Ecological site: R049XB210CO - Sandy Foothill
Hydric soil rating: No

Description of Fluvaquentic Haplaquolls

Setting

Landform: Swales
Down-slope shape: Linear
Across-slope shape: Linear
Parent material: Alluvium

Typical profile

H1 - 0 to 12 inches: variable
H2 - 12 to 60 inches: stratified very gravelly sand to loam

Properties and qualities

Slope: 1 to 2 percent
Depth to restrictive feature: More than 80 inches
Drainage class: Poorly drained
Runoff class: Very high
Capacity of the most limiting layer to transmit water (Ksat): Moderately high to high
(0.20 to 6.00 in/hr)
Depth to water table: About 0 to 24 inches
Frequency of flooding: Occasional
Frequency of ponding: None
Maximum salinity: Nonsaline to slightly saline (0.0 to 4.0 mmhos/cm)
Available water supply, 0 to 60 inches: Moderate (about 6.2 inches)

Interpretive groups

Land capability classification (irrigated): 6w
Land capability classification (nonirrigated): 6w
Hydrologic Soil Group: D
Ecological site: R048AY241CO - Mountain Meadow
Hydric soil rating: Yes

Minor Components

Other soils

Percent of map unit: 1 percent
Hydric soil rating: No

Pleasant

Percent of map unit: 1 percent
Landform: Depressions
Hydric soil rating: Yes

19—Columbine gravelly sandy loam, 0 to 3 percent slopes

Map Unit Setting

National map unit symbol: 367p
Elevation: 6,500 to 7,300 feet
Mean annual precipitation: 14 to 16 inches
Mean annual air temperature: 46 to 50 degrees F
Frost-free period: 125 to 145 days
Farmland classification: Not prime farmland

Map Unit Composition

Columbine and similar soils: 97 percent
Minor components: 3 percent
Estimates are based on observations, descriptions, and transects of the mapunit.

Description of Columbine

Setting

Landform: Fans, fan terraces, flood plains
Down-slope shape: Linear
Across-slope shape: Linear
Parent material: Alluvium

Typical profile

A - 0 to 14 inches: gravelly sandy loam
C - 14 to 60 inches: very gravelly loamy sand

Properties and qualities

Slope: 0 to 3 percent
Depth to restrictive feature: More than 80 inches
Drainage class: Well drained
Runoff class: Very low
Capacity of the most limiting layer to transmit water (Ksat): High to very high (5.95 to 19.98 in/hr)
Depth to water table: More than 80 inches
Frequency of flooding: None
Frequency of ponding: None
Available water supply, 0 to 60 inches: Very low (about 2.5 inches)

Interpretive groups

Land capability classification (irrigated): 4e
Land capability classification (nonirrigated): 6e
Hydrologic Soil Group: A
Ecological site: R049XY214CO - Gravelly Foothill
Hydric soil rating: No

Minor Components

Fluvaquentic haplaquolls

Percent of map unit: 1 percent

Landform: Swales

Hydric soil rating: Yes

Other soils

Percent of map unit: 1 percent

Hydric soil rating: No

Pleasant

Percent of map unit: 1 percent

Landform: Depressions

Hydric soil rating: Yes

References

- American Association of State Highway and Transportation Officials (AASHTO). 2004. Standard specifications for transportation materials and methods of sampling and testing. 24th edition.
- American Society for Testing and Materials (ASTM). 2005. Standard classification of soils for engineering purposes. ASTM Standard D2487-00.
- Cowardin, L.M., V. Carter, F.C. Golet, and E.T. LaRoe. 1979. Classification of wetlands and deep-water habitats of the United States. U.S. Fish and Wildlife Service FWS/OBS-79/31.
- Federal Register. July 13, 1994. Changes in hydric soils of the United States.
- Federal Register. September 18, 2002. Hydric soils of the United States.
- Hurt, G.W., and L.M. Vasilas, editors. Version 6.0, 2006. Field indicators of hydric soils in the United States.
- National Research Council. 1995. Wetlands: Characteristics and boundaries.
- Soil Survey Division Staff. 1993. Soil survey manual. Soil Conservation Service. U.S. Department of Agriculture Handbook 18. http://www.nrcs.usda.gov/wps/portal/nrcs/detail/national/soils/?cid=nrcs142p2_054262
- Soil Survey Staff. 1999. Soil taxonomy: A basic system of soil classification for making and interpreting soil surveys. 2nd edition. Natural Resources Conservation Service, U.S. Department of Agriculture Handbook 436. http://www.nrcs.usda.gov/wps/portal/nrcs/detail/national/soils/?cid=nrcs142p2_053577
- Soil Survey Staff. 2010. Keys to soil taxonomy. 11th edition. U.S. Department of Agriculture, Natural Resources Conservation Service. http://www.nrcs.usda.gov/wps/portal/nrcs/detail/national/soils/?cid=nrcs142p2_053580
- Tiner, R.W., Jr. 1985. Wetlands of Delaware. U.S. Fish and Wildlife Service and Delaware Department of Natural Resources and Environmental Control, Wetlands Section.
- United States Army Corps of Engineers, Environmental Laboratory. 1987. Corps of Engineers wetlands delineation manual. Waterways Experiment Station Technical Report Y-87-1.
- United States Department of Agriculture, Natural Resources Conservation Service. National forestry manual. http://www.nrcs.usda.gov/wps/portal/nrcs/detail/soils/home/?cid=nrcs142p2_053374
- United States Department of Agriculture, Natural Resources Conservation Service. National range and pasture handbook. <http://www.nrcs.usda.gov/wps/portal/nrcs/detail/national/landuse/rangepasture/?cid=stelprdb1043084>

Custom Soil Resource Report

United States Department of Agriculture, Natural Resources Conservation Service. National soil survey handbook, title 430-VI. http://www.nrcs.usda.gov/wps/portal/nrcs/detail/soils/scientists/?cid=nrcs142p2_054242

United States Department of Agriculture, Natural Resources Conservation Service. 2006. Land resource regions and major land resource areas of the United States, the Caribbean, and the Pacific Basin. U.S. Department of Agriculture Handbook 296. http://www.nrcs.usda.gov/wps/portal/nrcs/detail/national/soils/?cid=nrcs142p2_053624

United States Department of Agriculture, Soil Conservation Service. 1961. Land capability classification. U.S. Department of Agriculture Handbook 210. http://www.nrcs.usda.gov/Internet/FSE_DOCUMENTS/nrcs142p2_052290.pdf

8 Hydrologic Calculations

Runoff Coefficients and Percent Imperviousness Table 6-6

Colorado Springs Rainfall Intensity Duration Frequency Figure 6-5

Hydrologic Calculations Summary Form SF-1 for Existing & Developed Conditions

Hydrologic Calculations Summary 5-yr Form SF-2 for Existing & Developed Conditions

Hydrologic Calculations Summary 100-yr Form SF-2 for Existing & Developed Conditions

Job No.: **61200**
 Project: **St. John's Orthodox Church**

Date: **9/8/2023 10:40**
 Calcs By: **OA**
 Checked By: _____

Time of Concentration (Modified from Standard Form SF-1)

Sub-Basin	Sub-Basin Data				Overland			Shallow Channel				Channelized				t _c Check		t _c
	Area (Acres)	C ₅	C ₁₀₀ /CN	% Imp.	L ₀ (ft)	S ₀ (%)	t _i (min)	L _{0t} (ft)	S _{0t} (ft/ft)	v _{0sc} (ft/s)	t _t (min)	L _{0c} (ft)	S _{0c} (ft/ft)	v _{0c} (ft/s)	t _c (min)	L (min)	t _{c,alt} (min)	
OFFSITE																		
OS-1	0.60	0.53	0.68	55%	67	3%	5.7	0	0.000	0.0	0.0	0	0.000	0.0	0.0	67	10.4	5.7
OS-2	1.66	0.08	0.35	0%	100	5%	11.2	140	0.059	1.7	1.4	94	0.045	3.0	0.5	334	11.9	11.9
OS-3	2.51	0.26	0.48	26%	85	3%	10.0	447	0.047	1.5	4.9	470	0.038	3.3	2.4	1002	15.6	15.6
EXISTING ONSITE																		
A	1.73	0.08	0.35	0%	100	5%	10.6	93	0.097	2.2	0.7	0	0.000	0.0	0.0	193	11.1	11.1
B	0.82	0.08	0.35	0%	100	7%	9.7	210	0.036	1.3	2.6	60	0.017	1.7	0.6	370	12.1	12.1
C	2.24	0.08	0.35	0%	100	7%	9.7	180	0.056	1.6	1.8	163	0.018	2.3	1.2	443	12.5	12.5
PROPOSED ONSITE																		
A1	0.06	0.74	0.84	80%	62	0%	6.5	0	0.000	0.0	0.0	0	0.000	0.0	0.0	62	10.3	6.5
A2	1.71	0.08	0.35	0%	100	5%	10.6	93	0.097	2.2	0.7	0	0.000	0.0	0.0	193	11.1	11.1
B1	0.82	0.13	0.39	6%	100	16%	7.0	210	0.036	1.3	2.6	117	0.009	0.9	2.1	427	12.4	11.7
C1	0.74	0.08	0.35	0%	100	7%	9.7	88	0.074	1.9	0.8	0	0.000	0.0	0.0	188	11.0	10.5
C2	0.13	0.22	0.46	17%	40	12%	4.4	115	0.054	1.6	1.2	0	0.000	0.0	0.0	155	10.9	5.6
C3	0.45	0.31	0.52	31%	100	4%	9.1	103	0.075	1.9	0.9	48	0.052	2.5	0.3	251	11.4	10.3
C4	0.31	0.88	0.94	97%	75	2%	2.8	0	0.000	0.0	0.0	145	0.012	2.3	1.1	220	11.2	5.0
C5	0.58	0.08	0.35	0%	100	2%	14.1	77	0.026	1.1	1.1	89	0.017	1.6	0.9	266	11.5	11.5

Job No.: **61200**
 Project: **St. John's Orthodox Church**
 Design Storm: **5-Year Storm (20% Probability)**
 Jurisdiction: **DCM**

Date: **9/8/2023 10:40**
 Calcs By: **OA**
 Checked By: _____

Sub-Basin and Combined Flows (Modified from Standard Form SF-2)

DP	Sub-Basin	Area (Acres)	C5	Direct Runoff				Combined Runoff				Streetflow			Pipe Flow					Travel Time		
				t _c	CA	I5	Q5	t _c	CA	I5	Q5	Slope	Length	Q	Q	Slope	Mnngs n	Length (ft)	D _{Pipe} (in)	Length (ft)	V _{osc} (ft/s)	t _t (min)
				(min)	(Acres)	(in/hr)	(cfs)	(min)	(Acres)	(in/hr)	(cfs)	(%)	(ft)	(cfs)	(cfs)	(%)						
OFFSITE SUB-BASINS																						
DP EX-1	OS-1	0.60	0.53	5.7	0.32	4.97	1.6															
	OS-2	1.66	0.08	11.9	0.13	3.87	0.5															
	OS-3	2.51	0.26	15.6	0.66	3.47	2.3															
EXISTING ONSITE																						
DP EX-4	A	1.73	0.08	11.1	0.14	3.98	0.6															
	B	0.82	0.08	12.1	0.07	3.85	0.3															
DP EX-3	C	2.24	0.08	12.5	0.18	3.80	0.7															
DP EX-2	OS-2, OS-3, B	4.99	0.17					15.6	0.86	3.47	3.0											
DP EX-5	OS-1-3, B, C	7.83	0.17					17.2	1.36	3.32	4.5											
PROPOSED ONSITE																						
DP 1	A1	0.06	0.74	6.5	0.04	4.77	0.2															
	A2	1.71	0.08	11.1	0.14	3.98	0.5															
	B1	0.82	0.13	11.7	0.11	3.89	0.4															
	C1	0.74	0.08	10.5	0.06	4.06	0.2															
	C2	0.13	0.22	5.6	0.03	4.99	0.1															
	C3	0.45	0.31	10.3	0.14	4.08	0.6															
	C4	0.31	0.88	5.0	0.27	5.17	1.4															
	C5	0.58	0.08	11.5	0.05	3.92	0.2															
DP 2	A1, A2	1.77	0.10					11.1	0.18	3.98	0.7											
DP 3	OS-2, OS-3, B1	4.99	0.18					16.2	0.90	3.41	3.1											
DP 4	C1, C2, C4	1.17	0.31					12.1	0.36	3.84	1.4											
DP 5	OS1-3, B1, C1-C5	7.79	0.23					17.1	1.76	3.32	5.9											

DCM: $I = C1 * \ln(tc) + C2$
 C1: 1.5
 C2: 7.583

Job No.: **61200**
 Project: **St. John's Orthodox Church**
 Design Storm: **100-Year Storm (1% Probability)**
 Jurisdiction: **DCM**

Date: **9/8/2023 10:40**
 Calcs By: **OA**
 Checked By: _____

Sub-Basin and Combined Flows (Modified from Standard Form SF-2)

DP	Sub-Basin	Area (Acres)	C100	Direct Runoff				Combined Runoff				Streetflow			Pipe Flow				Travel Time		
				t _c (min)	CA (Acres)	I100 (in/hr)	Q100 (cfs)	t _c (min)	CA (Acres)	I100 (in/hr)	Q100 (cfs)	Slope (%)	Length (ft)	Q (cfs)	Q (cfs)	Slope (%)	Mnngs n	Length (ft)	D _{Pipe} (in)	Length (ft)	V _{osc} (ft/s)
OFFSITE SUB-BASINS																					
DP EX-1	OS-1	0.60	0.68	5.7	0.41	8.35	3.4														
	OS-2	1.66	0.35	11.9	0.58	6.50	3.8														
	OS-3	2.51	0.48	15.6	1.21	5.82	7.0														
EXISTING ONSITE																					
DP EX-4	A	1.73	0.35	11.1	0.61	6.68	4.0														
	B	0.82	0.35	12.1	0.29	6.46	1.8														
DP EX-3	C	2.24	0.35	12.5	0.79	6.38	5.0														
DP EX-2	OS-2, OS-3, B	4.99	0.42					15.6	2.08	5.82	12.1										
DP EX-5	OS-1-3, B, C	7.83	0.42					17.2	3.27	5.57	18.2										
PROPOSED ONSITE																					
DP 1	A1	0.06	0.84	6.5	0.05	8.00	0.4														
	A2	1.71	0.35	11.1	0.60	6.68	4.0														
	B1	0.82	0.39	11.7	0.32	6.53	2.1														
	C1	0.74	0.35	10.5	0.26	6.82	1.8														
	C2	0.13	0.46	5.6	0.06	8.38	0.5														
	C3	0.45	0.52	10.3	0.23	6.85	1.6														
	C4	0.31	0.94	5.0	0.29	8.68	2.5														
	C5	0.58	0.35	11.5	0.20	6.59	1.3														
DP 2	A1, A2	1.77	0.37					11.1	0.65	6.68	4.3										
DP 3	OS-2, OS-3, B1	4.99	0.42					16.2	2.11	5.72	12.0										
DP 4	C1, C2, C4	1.17	0.52					12.1	0.61	6.44	3.9										
DP 5	OS1-3, B1, C1-C5	7.79	0.46					17.1	3.56	5.57	19.8										

DCM: $I = C1 * \ln(tc) + C2$
 C1: 2.52
 C1: 12.735

Sub-Basin OS-1 Runoff Calculations

Job No.: **61200**

Date: **9/8/2023 10:40**

Project: **St. John's Orthodox Church**

Calcs by: **OA**

Jurisdiction: **DCM**
Runoff Coefficient: **Surface Type**

Checked by: _____
Soil Type: **A**
Urbanization: **Urban**

Basin Land Use Characteristics

Surface	Area		Runoff Coefficient						% Imperv.
	(SF)	(Acres)	C2	C5	C10	C25	C50	C100	
Paved	14,214	0.33	0.89	0.9	0.92	0.94	0.95	0.96	100%
Pasture/Meadow	11,733	0.27	0.02	0.08	0.15	0.25	0.3	0.35	0%
Combined	25,947	0.60	0.50	0.53	0.57	0.63	0.66	0.68	54.8%

25947

Basin Travel Time

Shallow Channel Ground Cover		Short Pasture/Lawns				
$L_{max,Overland}$	100 ft	C_v	7			
L (ft)	ΔZ_0 (ft)	S_0 (ft/ft)	v (ft/s)	t (min)	t_{Alt} (min)	
Total	67	2	-	-	-	
Initial Time	67	2	0.033	-	5.7	10.4 DCM Eq. 6-8
Shallow Channel			0.000	0.0	0.0	- DCM Eq. 6-9
Channelized			0.000	0.0	0.0	- V-Ditch
			t_c	5.7 pl		

Rainfall Intensity & Runoff

	2-Yr	5-Yr	10-Yr	25-Yr	50-Yr	100-Yr
Intensity (in/hr)	3.96	4.97	5.80	6.63	7.46	8.35
Runoff (cfs)	1.2	1.6	2.0	2.5	2.9	3.4
Release Rates (cfs/ac)	-	-	-	-	-	-
Allowed Release (cfs)	1.2	1.6	2.0	2.5	2.9	3.4

DCM: $I = C1 * \ln(tc) + C2$

C1	1.19	1.5	1.75	2	2.25	2.52
C2	6.035	7.583	8.847	10.111	11.375	12.735

Notes

Sub-Basin OS-2 Runoff Calculations

Job No.: **61200**

Date: **9/8/2023 10:40**

Project: **St. John's Orthodox Church**

Calcs by: **OA**

Jurisdiction: **DCM**
Runoff Coefficient: **Surface Type**

Checked by: _____
Soil Type: **A**
Urbanization: **Urban**

Basin Land Use Characteristics

Surface	Area		Runoff Coefficient						% Imperv.
	(SF)	(Acres)	C2	C5	C10	C25	C50	C100	
Pasture/Meadow	72,518	1.66	0.02	0.08	0.15	0.25	0.3	0.35	0%
Combined	72,518	1.66	0.02	0.08	0.15	0.25	0.30	0.35	0.0%

Basin Travel Time

	Shallow Channel Ground Cover		Short Pasture/Lawns			
	$L_{max,Overland}$				C_v	
	L (ft)	ΔZ_0 (ft)	S_0 (ft/ft)	v (ft/s)	t (min)	t_{Alt} (min)
Total	334	17	-	-	-	-
Initial Time	100	5	0.045	-	11.2	11.9 DCM Eq. 6-8
Shallow Channel	140	8	0.059	1.7	1.4	- DCM Eq. 6-9
Channelized	94	4	0.045	3.0	0.5	- V-Ditch
				t_c		11.9 min.

Rainfall Intensity & Runoff

	2-Yr	5-Yr	10-Yr	25-Yr	50-Yr	100-Yr
Intensity (in/hr)	3.09	3.87	4.52	5.17	5.81	6.50
Runoff (cfs)	0.1	0.5	1.1	2.1	2.9	3.8
Release Rates (cfs/ac)	-	-	-	-	-	-
Allowed Release (cfs)	0.1	0.5	1.1	2.1	2.9	3.8

DCM: $I = C1 * \ln(tc) + C2$

C1	1.19	1.5	1.75	2	2.25	2.52
C2	6.035	7.583	8.847	10.111	11.375	12.735

Notes

Sub-Basin OS-3 Runoff Calculations

Job No.: **61200**

Date: **9/8/2023 10:40**

Project: **St. John's Orthodox Church**

Calcs by: **OA**

Jurisdiction: **DCM**
Runoff Coefficient: **Surface Type**

Checked by: _____
Soil Type: **A**
Urbanization: **Urban**

Basin Land Use Characteristics

Surface	Area		Runoff Coefficient						% Imperv.
	(SF)	(Acres)	C2	C5	C10	C25	C50	C100	
Pasture/Meadow	77,339	1.78	0.02	0.08	0.15	0.25	0.3	0.35	0%
Gravel	18,572	0.43	0.57	0.59	0.63	0.66	0.68	0.7	80%
Roofs	1,530	0.04	0.71	0.73	0.75	0.78	0.8	0.81	90%
Paved	11,749	0.27	0.89	0.9	0.92	0.94	0.95	0.96	100%
Combined	109,190	2.51	0.22	0.26	0.32	0.40	0.44	0.48	25.6%

109190

Basin Travel Time

	Shallow Channel		Ground Cover		Short Pasture/Lawns		
	$L_{max,Overland}$	100 ft			C_v	7	
	L (ft)	ΔZ_0 (ft)	S_0 (ft/ft)	v (ft/s)	t (min)	t_{Alt} (min)	
Total	1,002	41	-	-	-	-	
Initial Time	85	2	0.027	-	10.0	15.6	DCM Eq. 6-8
Shallow Channel	447	21	0.047	1.5	4.9	-	DCM Eq. 6-9
Channelized	470	18	0.038	3.3	2.4	-	V-Ditch
				t_c	15.6 min.		

Rainfall Intensity & Runoff

	2-Yr	5-Yr	10-Yr	25-Yr	50-Yr	100-Yr
Intensity (in/hr)	2.77	3.47	4.04	4.62	5.20	5.82
Runoff (cfs)	1.5	2.3	3.3	4.6	5.8	7.0
Release Rates (cfs/ac)	-	-	-	-	-	-
Allowed Release (cfs)	1.5	2.3	3.3	4.6	5.8	7.0

DCM: $I = C1 * \ln(tc) + C2$

C1	1.19	1.5	1.75	2	2.25	2.52
C2	6.035	7.583	8.847	10.111	11.375	12.735

Notes

Sub-Basin A Runoff Calculations (Exist - DP EX-4)

Job No.: 61200

Date: 9/8/2023 10:40

Project: St. John's Orthodox Church

Calcs by: OA

Jurisdiction: DCM
Runoff Coefficient: Surface Type

Checked by: _____
Soil Type: A
Urbanization: Urban

Basin Land Use Characteristics

Surface	Area		Runoff Coefficient						% Imperv.
	(SF)	(Acres)	C2	C5	C10	C25	C50	C100	
Pasture/Meadow	75,346	1.73	0.02	0.08	0.15	0.25	0.3	0.35	0%
Combined	75,346	1.73	0.02	0.08	0.15	0.25	0.30	0.35	0.0%

Basin Travel Time

Shallow Channel Ground Cover		Short Pasture/Lawns				
$L_{max,Overland}$	100 ft	C_v	7			
L (ft)	ΔZ_0 (ft)	S_0 (ft/ft)	v (ft/s)	t (min)	t_{Alt} (min)	
Total	193	14	-	-	-	-
Initial Time	100	5	0.053	-	10.6	11.1 DCM Eq. 6-8
Shallow Channel	93	9	0.097	2.2	0.7	- DCM Eq. 6-9
Channelized			0.000	0.0	0.0	- V-Ditch
				t_c	11.1 min.	

Rainfall Intensity & Runoff

	2-Yr	5-Yr	10-Yr	25-Yr	50-Yr	100-Yr
Intensity (in/hr)	3.17	3.98	4.64	5.30	5.97	6.68
Runoff (cfs)	0.1	0.6	1.2	2.3	3.1	4.0
Release Rates (cfs/ac)	-	-	-	-	-	-
Allowed Release (cfs)	0.1	0.6	1.2	2.3	3.1	4.0

DCM: $I = C1 * \ln(tc) + C2$

C1	1.19	1.5	1.75	2	2.25	2.52
C2	6.035	7.583	8.847	10.111	11.375	12.735

Notes

Sub-Basin B Runoff Calculations (Exist)

Job No.: **61200**

Date: **9/8/2023 10:40**

Project: **St. John's Orthodox Church**

Calcs by: **OA**

Jurisdiction: **DCM**
Runoff Coefficient: **Surface Type**

Checked by: _____
Soil Type: **A**
Urbanization: **Urban**

Basin Land Use Characteristics

Surface	Area		Runoff Coefficient						% Imperv.
	(SF)	(Acres)	C2	C5	C10	C25	C50	C100	
Pasture/Meadow	35,632	0.82	0.02	0.08	0.15	0.25	0.3	0.35	0%
Combined	35,632	0.82	0.02	0.08	0.15	0.25	0.30	0.35	0.0%

Basin Travel Time

	Shallow Channel Ground Cover		Short Pasture/Lawns			
	$L_{max,Overland}$				C_v	
	L (ft)	ΔZ_0 (ft)	S_0 (ft/ft)	v (ft/s)	t (min)	t_{Alt} (min)
Total	370	16	-	-	-	-
Initial Time	100	7	0.070	-	9.7	12.1 DCM Eq. 6-8
Shallow Channel	210	8	0.036	1.3	2.6	- DCM Eq. 6-9
Channelized	60	1	0.017	1.7	0.6	- V-Ditch
				t_c	12.1 min.	

Rainfall Intensity & Runoff

	2-Yr	5-Yr	10-Yr	25-Yr	50-Yr	100-Yr
Intensity (in/hr)	3.07	3.85	4.49	5.13	5.77	6.46
Runoff (cfs)	0.1	0.3	0.6	1.0	1.4	1.8
Release Rates (cfs/ac)	-	-	-	-	-	-
Allowed Release (cfs)	0.1	0.3	0.6	1.0	1.4	1.8

DCM: $I = C1 * \ln(tc) + C2$

C1	1.19	1.5	1.75	2	2.25	2.52
C2	6.035	7.583	8.847	10.111	11.375	12.735

Notes

Sub-Basin C Runoff Calculations (Exist - DP EX-3)

Job No.: 61200

Date: 9/8/2023 10:40

Project: St. John's Orthodox Church

Calcs by: OA

Jurisdiction: DCM
Runoff Coefficient: Surface Type

Checked by: _____
Soil Type: A
Urbanization: Urban

Basin Land Use Characteristics

Surface	Area		Runoff Coefficient						% Imperv.
	(SF)	(Acres)	C2	C5	C10	C25	C50	C100	
Pasture/Meadow	97,787	2.24	0.02	0.08	0.15	0.25	0.3	0.35	0%
Combined	97,787	2.24	0.02	0.08	0.15	0.25	0.30	0.35	0.0%

Basin Travel Time

	Shallow Channel Ground Cover		Short Pasture/Lawns			
	$L_{max,Overland}$	100 ft			C_v	7
	L (ft)	ΔZ_0 (ft)	S_0 (ft/ft)	v (ft/s)	t (min)	t_{Alt} (min)
Total	443	20	-	-	-	-
Initial Time	100	7	0.070	-	9.7	12.5 DCM Eq. 6-8
Shallow Channel	180	10	0.056	1.6	1.8	- DCM Eq. 6-9
Channelized	163	3	0.018	2.3	1.2	- V-Ditch
				t_c	12.5 min.	

Rainfall Intensity & Runoff

	2-Yr	5-Yr	10-Yr	25-Yr	50-Yr	100-Yr
Intensity (in/hr)	3.03	3.80	4.43	5.07	5.70	6.38
Runoff (cfs)	0.1	0.7	1.5	2.8	3.8	5.0
Release Rates (cfs/ac)	-	-	-	-	-	-
Allowed Release (cfs)	0.1	0.7	1.5	2.8	3.8	5.0

DCM: $I = C1 * \ln(tc) + C2$

C1	1.19	1.5	1.75	2	2.25	2.52
C2	6.035	7.583	8.847	10.111	11.375	12.735

Notes

Combined Sub-Basin Runoff Calculations (Exist - DP EX-2)

Includes Basins OS-2 OS-3 B

Job No.:	61200	Date:	9/8/2023 10:40
Project:	St. John's Orthodox Church	Calcs by:	OA
Jurisdiction	DCM	Checked by:	
Runoff Coefficient	Surface Type	Soil Type	B
		Urbanization	Urban

Basin Land Use Characteristics

Surface	Area		Runoff Coefficient						% Imperv.
	(SF)	(Acres)	C2	C5	C10	C25	C50	C100	
Pasture/Meadow	185,489	4.26	0.02	0.08	0.15	0.25	0.3	0.35	0%
Gravel	18,572	0.43	0.57	0.59	0.63	0.66	0.68	0.7	80%
Roofs	1,530	0.04	0.71	0.73	0.75	0.78	0.8	0.81	90%
Paved	11,749	0.27	0.89	0.9	0.92	0.94	0.95	0.96	100%
Combined	217,340	4.99	0.12	0.17	0.24	0.33	0.37	0.42	12.9%

Basin Travel Time

	Sub-basin or Channel Type	Material Type	L (ft)	Elev. ΔZ ₀ (ft)	Q _i (cfs)	Base or Dia (ft)	Sides z:1 (ft/ft)	v (ft/s)	t (min)
Furthest Reach	OS-3	-	1,002	41	-	-	-	-	15.6
Channelized-1									
Channelized-2									
Channelized-3									
Total			1,002	41					
								t_c (min)	15.6

Contributing Offsite Flows (Added to Runoff and Allowed Release, below.)

Contributing Basins/Areas: _____

Q_{Minor}: _____ (cfs) - 5-year Storm

Q_{Major}: _____ (cfs) - 100-year Storm

Rainfall Intensity & Runoff

	2-Yr	5-Yr	10-Yr	25-Yr	50-Yr	100-Yr
Intensity (in/hr)	2.77	3.47	4.04	4.62	5.20	5.82
Site Runoff (cfs)	1.64	2.98	4.78	7.52	9.63	12.08
OffSite Runoff (cfs)	-	0.00	-	-	-	0.00
Release Rates (cfs/ac)	-	-	-	-	-	-
Allowed Release (cfs)	-	3.0	-	-	-	12.1

DCM: $I = C1 * \ln(tc) + C2$

C1	1.19	1.5	1.75	2	2.25	2.52
C2	6.035	7.583	8.847	10.111	11.375	12.735

Notes

Runoff from Offsite basins have been assumed constant, despite additional times of concentration.

Combined Sub-Basin Runoff Calculations (Exist - DP EX-5)

Includes Basins OS-1 OS-2 OS-3 B C

Job No.:	61200	Date:	9/8/2023 10:40
Project:	St. John's Orthodox Church	Calcs by:	OA
Jurisdiction	DCM	Checked by:	
Runoff Coefficient	Surface Type	Soil Type	B
		Urbanization	Urban

Basin Land Use Characteristics

Surface	Area		Runoff Coefficient						% Imperv.
	(SF)	(Acres)	C2	C5	C10	C25	C50	C100	
Pasture/Meadow	295,009	6.77	0.02	0.08	0.15	0.25	0.3	0.35	0%
Gravel	18,572	0.43	0.57	0.59	0.63	0.66	0.68	0.7	80%
Roofs	1,530	0.04	0.71	0.73	0.75	0.78	0.8	0.81	90%
Paved	25,963	0.60	0.89	0.9	0.92	0.94	0.95	0.96	100%
Combined	341,074	7.83	0.12	0.17	0.24	0.33	0.37	0.42	12.4%

Basin Travel Time

	Sub-basin or Channel Type	Material Type	L (ft)	Elev. ΔZ ₀ (ft)	Q _i (cfs)	Base or Dia (ft)	Sides z:1 (ft/ft)	v (ft/s)	t (min)
Furthest Reach	OS-3	-	1,002	41	-	-	-	-	15.6
Channelized-1	V-Ditch	2	235	4	7	0	4	2.4	1.6
Channelized-2									
Channelized-3									
Total			1,237	45					

2 = Natural, Winding, minimal vegetation/shallow grass

t_c (min) 17.2

Contributing Offsite Flows (Added to Runoff and Allowed Release, below.)

Contributing Basins/Areas

Q_{Minor} (cfs) - 5-year Storm

Q_{Major} (cfs) - 100-year Storm

Rainfall Intensity & Runoff

	2-Yr	5-Yr	10-Yr	25-Yr	50-Yr	100-Yr
Intensity (in/hr)	2.65	3.32	3.87	4.42	4.97	5.57
Site Runoff (cfs)	2.47	4.49	7.19	11.33	14.51	18.20
OffSite Runoff (cfs)	-	0.00	-	-	-	0.00
Release Rates (cfs/ac)	-	-	-	-	-	-
Allowed Release (cfs)	-	4.5	-	-	-	18.2

DCM: I = C1 * ln(tc) + C2

C1	1.19	1.5	1.75	2	2.25	2.52
C2	6.035	7.583	8.847	10.111	11.375	12.735

Notes

Runoff from Offsite basins have been assumed constant, despite additional times of concentration.

Sub-Basin A1 Runoff Calculations (Dev DP1)

Job No.: **61200**

Date: **9/8/2023 10:40**

Project: **St. John's Orthodox Church**

Calcs by: **OA**

Jurisdiction: **DCM**
Runoff Coefficient: **Surface Type**

Checked by: _____
Soil Type: **A**
Urbanization: **Urban**

Basin Land Use Characteristics

Surface	Area		Runoff Coefficient						% Imperv.
	(SF)	(Acres)	C2	C5	C10	C25	C50	C100	
Pasture/Meadow	175	0.00	0.02	0.08	0.15	0.25	0.3	0.35	0%
Landscaping	343	0.01	0.03	0.09	0.17	0.26	0.31	0.36	2%
Paved	2,084	0.05	0.89	0.9	0.92	0.94	0.95	0.96	100%
Combined	2,602	0.06	0.72	0.74	0.77	0.80	0.82	0.84	80.4%

Basin Travel Time

	L (ft)	ΔZ_0 (ft)	S_0 (ft/ft)	v (ft/s)	t (min)	t_{Alt} (min)	
Shallow Channel	62	0	-	-	-	-	
Ground Cover							Short Pasture/Lawns
$L_{max,Overland}$	100 ft						C_v 7
Total	62	0	-	-	-	-	
Initial Time	62	0	0.005	-	6.5	10.3	DCM Eq. 6-8
Shallow Channel			0.000	0.0	0.0	-	DCM Eq. 6-9
Channelized			0.000	0.0	0.0	-	V-Ditch
				t_c	6.5 min.		

Rainfall Intensity & Runoff

	2-Yr	5-Yr	10-Yr	25-Yr	50-Yr	100-Yr
Intensity (in/hr)	3.80	4.77	5.56	6.36	7.15	8.00
Runoff (cfs)	0.2	0.2	0.3	0.3	0.4	0.4
Release Rates (cfs/ac)	-	-	-	-	-	-
Allowed Release (cfs)	0.2	0.2	0.3	0.3	0.4	0.4

DCM: $I = C1 * \ln(tc) + C2$

C1	1.19	1.5	1.75	2	2.25	2.52
C2	6.035	7.583	8.847	10.111	11.375	12.735

Notes

Sub-Basin A2 Runoff Calculations (Dev)

Job No.: **61200**

Date: **9/8/2023 10:40**

Project: **St. John's Orthodox Church**

Calcs by: **OA**

Jurisdiction: **DCM**
Runoff Coefficient: **Surface Type**

Checked by: _____
Soil Type: **A**
Urbanization: **Urban**

Basin Land Use Characteristics

Surface	Area		Runoff Coefficient						% Imperv.
	(SF)	(Acres)	C2	C5	C10	C25	C50	C100	
Pasture/Meadow	74,448	1.71	0.02	0.08	0.15	0.25	0.3	0.35	0%
Combined	74,448	1.71	0.02	0.08	0.15	0.25	0.30	0.35	0.0%

Basin Travel Time

Shallow Channel Ground Cover		Short Pasture/Lawns				
$L_{max,Overland}$	100 ft	C_v	7			
L (ft)	ΔZ_0 (ft)	S_0 (ft/ft)	v (ft/s)	t (min)	t_{Alt} (min)	
Total	193	14	-	-	-	-
Initial Time	100	5	0.053	-	10.6	11.1 DCM Eq. 6-8
Shallow Channel	93	9	0.097	2.2	0.7	- DCM Eq. 6-9
Channelized			0.000	0.0	0.0	- V-Ditch
				t_c	11.1 min.	

Rainfall Intensity & Runoff

	2-Yr	5-Yr	10-Yr	25-Yr	50-Yr	100-Yr
Intensity (in/hr)	3.17	3.98	4.64	5.30	5.97	6.68
Runoff (cfs)	0.1	0.5	1.2	2.3	3.1	4.0
Release Rates (cfs/ac)	-	-	-	-	-	-
Allowed Release (cfs)	0.1	0.5	1.2	2.3	3.1	4.0

DCM: $I = C1 * \ln(tc) + C2$

C1	1.19	1.5	1.75	2	2.25	2.52
C2	6.035	7.583	8.847	10.111	11.375	12.735

Notes

Sub-Basin B1 Runoff Calculations (Dev)

Job No.: **61200**

Date: **9/8/2023 10:40**

Project: **St. John's Orthodox Church**

Calcs by: **OA**

Jurisdiction: **DCM**
Runoff Coefficient: **Surface Type**

Checked by: _____
Soil Type: **A**
Urbanization: **Urban**

Basin Land Use Characteristics

Surface	Area		Runoff Coefficient						% Imperv.
	(SF)	(Acres)	C2	C5	C10	C25	C50	C100	
Pasture/Meadow	33,473	0.77	0.02	0.08	0.15	0.25	0.3	0.35	0%
Paved	2,115	0.05	0.89	0.9	0.92	0.94	0.95	0.96	100%
Combined	35,588	0.82	0.07	0.13	0.20	0.29	0.34	0.39	5.9%

35588

Basin Travel Time

	Shallow Channel Ground Cover		Short Pasture/Lawns			
	$L_{max,Overland}$				C_v	
	L (ft)	ΔZ_0 (ft)	S_0 (ft/ft)	v (ft/s)	t (min)	t_{Alt} (min)
Total	427	25	-	-	-	-
Initial Time	100	16	0.160	-	7.0	12.4 DCM Eq. 6-8
Shallow Channel	210	8	0.036	1.3	2.6	- DCM Eq. 6-9
Channelized	117	1	0.009	0.9	2.1	- Trap Ditch
				t_c	11.7 min.	

Rainfall Intensity & Runoff

	2-Yr	5-Yr	10-Yr	25-Yr	50-Yr	100-Yr
Intensity (in/hr)	3.10	3.89	4.54	5.19	5.83	6.53
Runoff (cfs)	0.2	0.4	0.7	1.2	1.6	2.1
Release Rates (cfs/ac)	-	-	-	-	-	-
Allowed Release (cfs)	0.2	0.4	0.7	1.2	1.6	2.1

DCM: $I = C1 * \ln(tc) + C2$

C1	1.19	1.5	1.75	2	2.25	2.52
C2	6.035	7.583	8.847	10.111	11.375	12.735

Notes

Sub-Basin C1 Runoff Calculations (Dev)

Job No.: **61200**

Date: **9/8/2023 10:40**

Project: **St. John's Orthodox Church**

Calcs by: **OA**

Jurisdiction: **DCM**
Runoff Coefficient: **Surface Type**

Checked by: _____
Soil Type: **A**
Urbanization: **Urban**

Basin Land Use Characteristics

Surface	Area		Runoff Coefficient						% Imperv.
	(SF)	(Acres)	C2	C5	C10	C25	C50	C100	
Pasture/Meadow	32,203	0.74	0.02	0.08	0.15	0.25	0.3	0.35	0%
Combined	32,203	0.74	0.02	0.08	0.15	0.25	0.30	0.35	0.0%

32203

Basin Travel Time

Shallow Channel Ground Cover		Short Pasture/Lawns				
$L_{max,Overland}$	100 ft	C_v	7			
L (ft)	ΔZ_0 (ft)	S_0 (ft/ft)	v (ft/s)	t (min)	t_{Alt} (min)	
Total	188	14	-	-	-	-
Initial Time	100	7	0.070	-	9.7	11.0 DCM Eq. 6-8
Shallow Channel	88	7	0.074	1.9	0.8	- DCM Eq. 6-9
Channelized			0.000	0.0	0.0	- V-Ditch
				t_c	10.5 min.	

Rainfall Intensity & Runoff

	2-Yr	5-Yr	10-Yr	25-Yr	50-Yr	100-Yr
Intensity (in/hr)	3.24	4.06	4.74	5.42	6.09	6.82
Runoff (cfs)	0.0	0.2	0.5	1.0	1.4	1.8
Release Rates (cfs/ac)	-	-	-	-	-	-
Allowed Release (cfs)	0.0	0.2	0.5	1.0	1.4	1.8

DCM: $I = C1 * \ln(tc) + C2$

C1	1.19	1.5	1.75	2	2.25	2.52
C2	6.035	7.583	8.847	10.111	11.375	12.735

Notes

Sub-Basin C2 Runoff Calculations (Dev)

Job No.: **61200**

Date: **9/8/2023 10:40**

Project: **St. John's Orthodox Church**

Calcs by: **OA**

Jurisdiction: **DCM**
Runoff Coefficient: **Surface Type**

Checked by: _____
Soil Type: **A**
Urbanization: **Urban**

Basin Land Use Characteristics

Surface	Area		Runoff Coefficient						% Imperv.
	(SF)	(Acres)	C2	C5	C10	C25	C50	C100	
Pasture/Meadow	4,529	0.10	0.02	0.08	0.15	0.25	0.3	0.35	0%
Paved	945	0.02	0.89	0.9	0.92	0.94	0.95	0.96	100%
Combined	5,474	0.13	0.17	0.22	0.28	0.37	0.41	0.46	17.3%

5474

Basin Travel Time

	Shallow Channel Ground Cover		Short Pasture/Lawns			
	$L_{max,Overland}$		S_0	v	t	t_{Alt}
	L (ft)	ΔZ_0 (ft)	(ft/ft)	(ft/s)	(min)	(min)
Total	155	11	-	-	-	-
Initial Time	40	5	0.118	-	4.4	10.9 DCM Eq. 6-8
Shallow Channel	115	6	0.054	1.6	1.2	- DCM Eq. 6-9
Channelized			0.000	0.0	0.0	- V-Ditch
				t_c	5.6 min.	

Rainfall Intensity & Runoff

	2-Yr	5-Yr	10-Yr	25-Yr	50-Yr	100-Yr
Intensity (in/hr)	3.98	4.99	5.82	6.66	7.49	8.38
Runoff (cfs)	0.1	0.1	0.2	0.3	0.4	0.5
Release Rates (cfs/ac)	-	-	-	-	-	-
Allowed Release (cfs)	0.1	0.1	0.2	0.3	0.4	0.5

DCM: $I = C1 * \ln(tc) + C2$

C1	1.19	1.5	1.75	2	2.25	2.52
C2	6.035	7.583	8.847	10.111	11.375	12.735

Notes

Sub-Basin C3 Runoff Calculations (Dev)

Job No.: **61200**

Date: **9/8/2023 10:40**

Project: **St. John's Orthodox Church**

Calcs by: **OA**

Jurisdiction: **DCM**
Runoff Coefficient: **Surface Type**

Checked by: _____
Soil Type: **A**
Urbanization: **Urban**

Basin Land Use Characteristics

Surface	Area		Runoff Coefficient						% Imperv.
	(SF)	(Acres)	C2	C5	C10	C25	C50	C100	
Pasture/Meadow	8,657	0.20	0.02	0.08	0.15	0.25	0.3	0.35	0%
Landscaping	4,626	0.11	0.03	0.09	0.17	0.26	0.31	0.36	2%
Paved	2,131	0.05	0.89	0.9	0.92	0.94	0.95	0.96	100%
Roofs	3,605	0.08	0.71	0.73	0.75	0.78	0.8	0.81	90%
Gravel	778	0.02	0.57	0.59	0.63	0.66	0.68	0.7	80%
Combined	19,797	0.45	0.26	0.31	0.37	0.44	0.48	0.52	30.8%

19797

Basin Travel Time

	Shallow Channel Ground Cover		Short Pasture/Lawns			
	$L_{max,Overland}$				C_v	
	L (ft)	ΔZ_0 (ft)	S_0 (ft/ft)	v (ft/s)	t (min)	t_{Alt} (min)
Total	251	14	-	-	-	-
Initial Time	100	4	0.039	-	9.1	11.4 DCM Eq. 6-8
Shallow Channel	103	8	0.075	1.9	0.9	- DCM Eq. 6-9
Channelized	48	3	0.052	2.5	0.3	- V-Ditch
				t_c		10.3 min.

Rainfall Intensity & Runoff

	2-Yr	5-Yr	10-Yr	25-Yr	50-Yr	100-Yr
Intensity (in/hr)	3.26	4.08	4.76	5.44	6.12	6.85
Runoff (cfs)	0.4	0.6	0.8	1.1	1.3	1.6
Release Rates (cfs/ac)	-	-	-	-	-	-
Allowed Release (cfs)	0.4	0.6	0.8	1.1	1.3	1.6

DCM: $I = C1 * \ln(tc) + C2$

C1 1.19 1.5 1.75 2 2.25 2.52

C2 6.035 7.583 8.847 10.111 11.375 12.735

Notes

Sub-Basin C4 Runoff Calculations (Dev)

Job No.: **61200**

Date: **9/8/2023 10:40**

Project: **St. John's Orthodox Church**

Calcs by: **OA**

Jurisdiction: **DCM**
Runoff Coefficient: **Surface Type**

Checked by: _____
Soil Type: **A**
Urbanization: **Urban**

Basin Land Use Characteristics

Surface	Area		Runoff Coefficient						% Imperv.
	(SF)	(Acres)	C2	C5	C10	C25	C50	C100	
Landscaping	350	0.01	0.03	0.09	0.17	0.26	0.31	0.36	2%
Paved	13,125	0.30	0.89	0.9	0.92	0.94	0.95	0.96	100%
Combined	13,475	0.31	0.87	0.88	0.90	0.92	0.93	0.94	97.5%

Basin Travel Time

	L (ft)	ΔZ_0 (ft)	S_0 (ft/ft)	v (ft/s)	t (min)	t_{Alt} (min)	
Shallow Channel	220	3	-	-	-	-	
Initial Time	75	1	0.019	-	2.8	11.2	DCM Eq. 6-8
Shallow Channel			0.000	0.0	0.0	-	DCM Eq. 6-9
Channelized	145	2	0.012	2.3	1.1	-	C&G
				t_c	5.0 min.		

Rainfall Intensity & Runoff

	2-Yr	5-Yr	10-Yr	25-Yr	50-Yr	100-Yr
Intensity (in/hr)	4.12	5.17	6.03	6.89	7.75	8.68
Runoff (cfs)	1.1	1.4	1.7	2.0	2.2	2.5
Release Rates (cfs/ac)	-	-	-	-	-	-
Allowed Release (cfs)	1.1	1.4	1.7	2.0	2.2	2.5

DCM: $I = C1 * \ln(tc) + C2$

C1	1.19	1.5	1.75	2	2.25	2.52
C2	6.035	7.583	8.847	10.111	11.375	12.735

Notes

Sub-Basin C5 Runoff Calculations (Dev)

Job No.: **61200**

Date: **9/8/2023 10:40**

Project: **St. John's Orthodox Church**

Calcs by: **OA**

Jurisdiction: **DCM**
Runoff Coefficient: **Surface Type**

Checked by: _____
Soil Type: **A**
Urbanization: **Urban**

Basin Land Use Characteristics

Surface	Area		Runoff Coefficient						% Imperv.
	(SF)	(Acres)	C2	C5	C10	C25	C50	C100	
Pasture/Meadow	25,019	0.57	0.02	0.08	0.15	0.25	0.3	0.35	0%
Paved	110	0.00	0.89	0.9	0.92	0.94	0.95	0.96	100%
Combined	25,129	0.58	0.02	0.08	0.15	0.25	0.30	0.35	0.4%

25129

Basin Travel Time

	Shallow Channel Ground Cover		Short Pasture/Lawns			
	$L_{max,Overland}$				C_v	
	L (ft)	ΔZ_0 (ft)	S_0 (ft/ft)	v (ft/s)	t (min)	t_{Alt} (min)
Total	266	6	-	-	-	-
Initial Time	100	2	0.022	-	14.1	11.5 DCM Eq. 6-8
Shallow Channel	77	2	0.026	1.1	1.1	- DCM Eq. 6-9
Channelized	89	2	0.017	1.6	0.9	- V-Ditch
				t_c	11.5 min.	

Rainfall Intensity & Runoff

	2-Yr	5-Yr	10-Yr	25-Yr	50-Yr	100-Yr
Intensity (in/hr)	3.13	3.92	4.58	5.23	5.88	6.59
Runoff (cfs)	0.0	0.2	0.4	0.8	1.0	1.3
Release Rates (cfs/ac)	-	-	-	-	-	-
Allowed Release (cfs)	0.0	0.2	0.4	0.8	1.0	1.3

DCM: $I = C1 * \ln(tc) + C2$

C1: 1.19 1.5 1.75 2 2.25 2.52

C2: 6.035 7.583 8.847 10.111 11.375 12.735

Notes

Combined Sub-Basin Runoff Calculations (Dev DP2)

Includes Basins A1 A2

Job No.: **61200**

Date: **9/8/2023 10:40**

Project: **St. John's Orthodox Church**

Calcs by: **OA**

Jurisdiction: **DCM**
Runoff Coefficient: **Surface Type**

Checked by: _____
Soil Type: **B**
Urbanization: **Urban**

Basin Land Use Characteristics

Surface	Area		Runoff Coefficient						% Imperv.
	(SF)	(Acres)	C2	C5	C10	C25	C50	C100	
Pasture/Meadow	74,623	1.71	0.02	0.08	0.15	0.25	0.3	0.35	0%
Landscaping	343	0.01	0.03	0.09	0.17	0.26	0.31	0.36	2%
Paved	2,084	0.05	0.89	0.9	0.92	0.94	0.95	0.96	100%
Combined	77,050	1.77	0.04	0.10	0.17	0.27	0.32	0.37	2.7%

Basin Travel Time

	Sub-basin or Channel Type	Material Type	L (ft)	Elev. ΔZ ₀ (ft)	Q _i (cfs)	Base or Dia (ft)	Sides z:1 (ft/ft)	v (ft/s)	t (min)
Furthest Reach	A2	-	193	14	-	-	-	-	11.1
Channelized-1									
Channelized-2									
Channelized-3									
Total			193	14					
								t_c (min)	11.1

Contributing Offsite Flows (Added to Runoff and Allowed Release, below.)

Contributing Basins/Areas	
Q _{Minor}	(cfs) - 5-year Storm
Q _{Major}	(cfs) - 100-year Storm

Rainfall Intensity & Runoff

	2-Yr	5-Yr	10-Yr	25-Yr	50-Yr	100-Yr
Intensity (in/hr)	3.17	3.98	4.64	5.30	5.97	6.68
Site Runoff (cfs)	0.24	0.72	1.40	2.52	3.35	4.33
OffSite Runoff (cfs)	-	0.00	-	-	-	0.00
Release Rates (cfs/ac)	-	-	-	-	-	-
Allowed Release (cfs)	-	0.7	-	-	-	4.3

DCM: $I = C1 * \ln(tc) + C2$

C1	1.19	1.5	1.75	2	2.25	2.52
C2	6.035	7.583	8.847	10.111	11.375	12.735

Notes

Runoff from Offsite basins have been assumed constant, despite additional times of concentration.

Combined Sub-Basin Runoff Calculations (Dev DP3)

Includes Basins OS-2 OS-3 B1

Job No.:	61200	Date:	9/8/2023 10:40
Project:	St. John's Orthodox Church	Calcs by:	OA
Jurisdiction	DCM	Checked by:	
Runoff Coefficient	Surface Type	Soil Type	B
		Urbanization	Urban

Basin Land Use Characteristics

Surface	Area		Runoff Coefficient						% Imperv.
	(SF)	(Acres)	C2	C5	C10	C25	C50	C100	
Pasture/Meadow	183,330	4.21	0.02	0.08	0.15	0.25	0.3	0.35	0%
Gravel	18,572	0.43	0.57	0.59	0.63	0.66	0.68	0.7	80%
Roofs	1,530	0.04	0.71	0.73	0.75	0.78	0.8	0.81	90%
Paved	13,864	0.32	0.89	0.9	0.92	0.94	0.95	0.96	100%
Combined	217,296	4.99	0.13	0.18	0.24	0.33	0.38	0.42	13.9%

Basin Travel Time

	Sub-basin or Channel Type	Material Type	L (ft)	Elev. ΔZ ₀ (ft)	Q _i (cfs)	Base or Dia (ft)	Sides z:1 (ft/ft)	v (ft/s)	t (min)
Furthest Reach	OS-3	-	1,002	41	-	-	-	-	15.6
Channelized-1	Trap Ditch	2	83	1	7	2	2	2.2	0.6
Channelized-2									
Channelized-3									
Total			1,085	43					

2 = Natural, Winding, minimal vegetation/shallow grass

t_c (min) 16.2

Contributing Offsite Flows (Added to Runoff and Allowed Release, below.)

Contributing Basins/Areas

Q_{Minor} (cfs) - 5-year Storm

Q_{Major} (cfs) - 100-year Storm

Rainfall Intensity & Runoff

	2-Yr	5-Yr	10-Yr	25-Yr	50-Yr	100-Yr
Intensity (in/hr)	2.72	3.41	3.97	4.54	5.11	5.72
Site Runoff (cfs)	1.73	3.07	4.85	7.54	9.62	12.04
OffSite Runoff (cfs)	-	0.00	-	-	-	0.00
Release Rates (cfs/ac)	-	-	-	-	-	-
Allowed Release (cfs)	-	3.1	-	-	-	12.0

DCM: I = C1 * ln(tc) + C2

C1	1.19	1.5	1.75	2	2.25	2.52
C2	6.035	7.583	8.847	10.111	11.375	12.735

Notes

Runoff from Offsite basins have been assumed constant, despite additional times of concentration.

Combined Sub-Basin Runoff Calculations (Dev DP4)

Includes Basins C1 C2 C4

Job No.:	61200	Date:	9/8/2023 10:40
Project:	St. John's Orthodox Church	Calcs by:	OA
Jurisdiction	DCM	Checked by:	
Runoff Coefficient	Surface Type	Soil Type	B
		Urbanization	Urban

Basin Land Use Characteristics

Surface	Area		Runoff Coefficient						% Imperv.
	(SF)	(Acres)	C2	C5	C10	C25	C50	C100	
Pasture/Meadow	36,732	0.84	0.02	0.08	0.15	0.25	0.3	0.35	0%
Landscaping	350	0.01	0.03	0.09	0.17	0.26	0.31	0.36	2%
Paved	14,070	0.32	0.89	0.9	0.92	0.94	0.95	0.96	100%
Combined	51,152	1.17	0.26	0.31	0.36	0.44	0.48	0.52	27.5%

Basin Travel Time

	Sub-basin or Channel Type	Material Type	L (ft)	Elev. ΔZ ₀ (ft)	Q _i (cfs)	Base or Dia (ft)	Sides z:1 (ft/ft)	v (ft/s)	t (min)
Furthest Reach	C1	-	188	14	-	-	-	-	10.5
Channelized-1	V-Ditch	1	71	2	2	0	10	2.2	0.5
Channelized-2	C&G	Concrete	145	2	2	0	0	2.1	1.1
Channelized-3									
Total			404	17					

1 = Man-made, Smooth, Straight

t_c (min) 12.1

Contributing Offsite Flows (Added to Runoff and Allowed Release, below.)

Contributing Basins/Areas _____

Q_{Minor} _____ (cfs) - 5-year Storm

Q_{Major} _____ (cfs) - 100-year Storm

Rainfall Intensity & Runoff

	2-Yr	5-Yr	10-Yr	25-Yr	50-Yr	100-Yr
Intensity (in/hr)	3.06	3.84	4.48	5.12	5.76	6.44
Site Runoff (cfs)	0.93	1.38	1.90	2.64	3.24	3.92
OffSite Runoff (cfs)	-	0.00	-	-	-	0.00
Release Rates (cfs/ac)	-	-	-	-	-	-
Allowed Release (cfs)	-	1.4	-	-	-	3.9

DCM: I = C1 * ln(tc) + C2

C1	1.19	1.5	1.75	2	2.25	2.52
C2	6.035	7.583	8.847	10.111	11.375	12.735

Notes

Runoff from Offsite basins have been assumed constant, despite additional times of concentration.

Combined Sub-Basin Runoff Calculations (Dev DP5)

Includes Basins OS-1 OS-2 OS-3 B1 C1 C2 C3 C4 C5

Job No.:	61200	Date:	9/8/2023 10:40
Project:	St. John's Orthodox Church	Calcs by:	OA
Jurisdiction	DCM	Checked by:	
Runoff Coefficient	Surface Type	Soil Type	B
		Urbanization	Urban

Basin Land Use Characteristics

Surface	Area		Runoff Coefficient						% Imperv.
	(SF)	(Acres)	C2	C5	C10	C25	C50	C100	
Pasture/Meadow	265,471	6.09	0.02	0.08	0.15	0.25	0.3	0.35	0%
Landscaping	4,976	0.11	0.03	0.09	0.17	0.26	0.31	0.36	2%
Paved	44,389	1.02	0.89	0.9	0.92	0.94	0.95	0.96	100%
Roofs	5,135	0.12	0.71	0.73	0.75	0.78	0.8	0.81	90%
Gravel	19,350	0.44	0.57	0.59	0.63	0.66	0.68	0.7	80%
Combined	339,321	7.79	0.18	0.23	0.29	0.37	0.41	0.46	19.0%

Basin Travel Time

	Sub-basin or Channel Type	Material Type	L (ft)	Elev. ΔZ ₀ (ft)	Q _i (cfs)	Base or Dia (ft)	Sides z:1 (ft/ft)	v (ft/s)	t (min)
Furthest Reach	DP 3	-	1,085	43	-	-	-	-	16.2
Channelized-1	V-Ditch	2	189	4	12	0	2	3.3	1.0
Channelized-2									
Channelized-3									
Total			1,274	46					

2 = Natural, Winding, minimal vegetation/shallow grass

t_c (min) 17.1

Contributing Offsite Flows (Added to Runoff and Allowed Release, below.)

Contributing Basins/Areas

Q_{Minor} (cfs) - 5-year Storm

Q_{Major} (cfs) - 100-year Storm

Rainfall Intensity & Runoff

	2-Yr	5-Yr	10-Yr	25-Yr	50-Yr	100-Yr
Intensity (in/hr)	2.65	3.32	3.87	4.43	4.98	5.57
Site Runoff (cfs)	3.63	5.85	8.68	12.82	16.08	19.84
OffSite Runoff (cfs)	-	0.00	-	-	-	0.00
Release Rates (cfs/ac)	-	-	-	-	-	-
Allowed Release (cfs)	-	5.9	-	-	-	19.8

DCM: I = C1 * ln(tc) + C2

C1	1.19	1.5	1.75	2	2.25	2.52
C2	6.035	7.583	8.847	10.111	11.375	12.735

Notes

Runoff from Offsite basins have been assumed constant, despite additional times of concentration.

9 Hydraulic Calculations

18" RCP Hydraulic Grade Line Calculation

Channel Report

Driveway Low Point - Design Point 3 (DP3)

Triangular

Side Slopes (z:1) = 50.00, 50.00
Total Depth (ft) = 0.40

Invert Elev (ft) = 100.00
Slope (%) = 2.00
N-Value = 0.015

Calculations

Compute by: Known Q
Known Q (cfs) = 12.00

Highlighted

Depth (ft) = 0.26
Q (cfs) = 12.00
Area (sqft) = 3.38
Velocity (ft/s) = 3.55
Wetted Perim (ft) = 26.01
Crit Depth, Yc (ft) = 0.33
Top Width (ft) = 26.00
EGL (ft) = 0.46

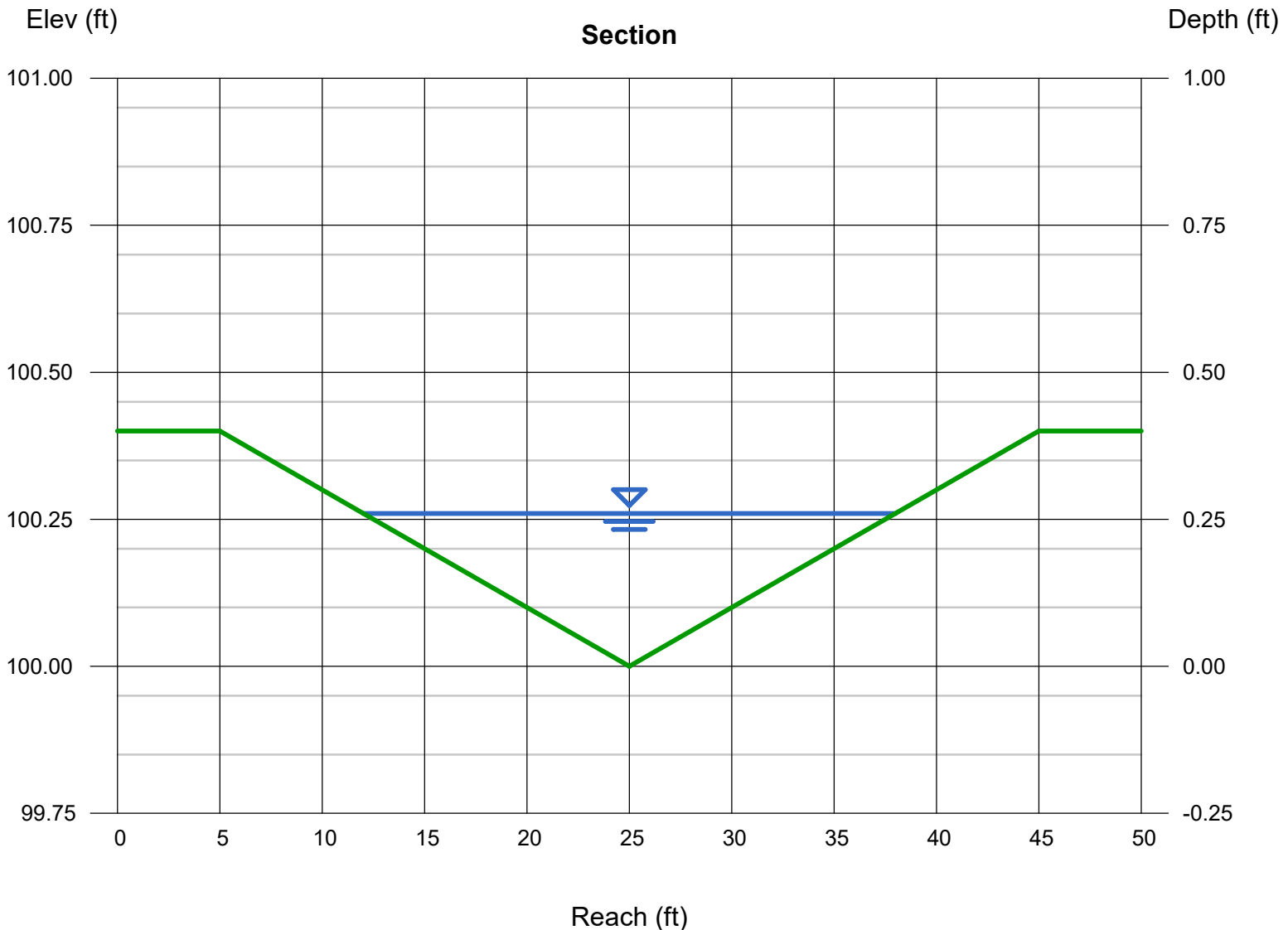

Channel Report

Curb Opening - Design Point 4 (DP4)

Rectangular

Bottom Width (ft) = 2.00
Total Depth (ft) = 0.50

Invert Elev (ft) = 100.00
Slope (%) = 2.00
N-Value = 0.013

Calculations

Compute by: Known Q
Known Q (cfs) = 3.90

Highlighted

Depth (ft) = 0.32
Q (cfs) = 3.900
Area (sqft) = 0.64
Velocity (ft/s) = 6.09
Wetted Perim (ft) = 2.64
Crit Depth, Y_c (ft) = 0.50
Top Width (ft) = 2.00
EGL (ft) = 0.90

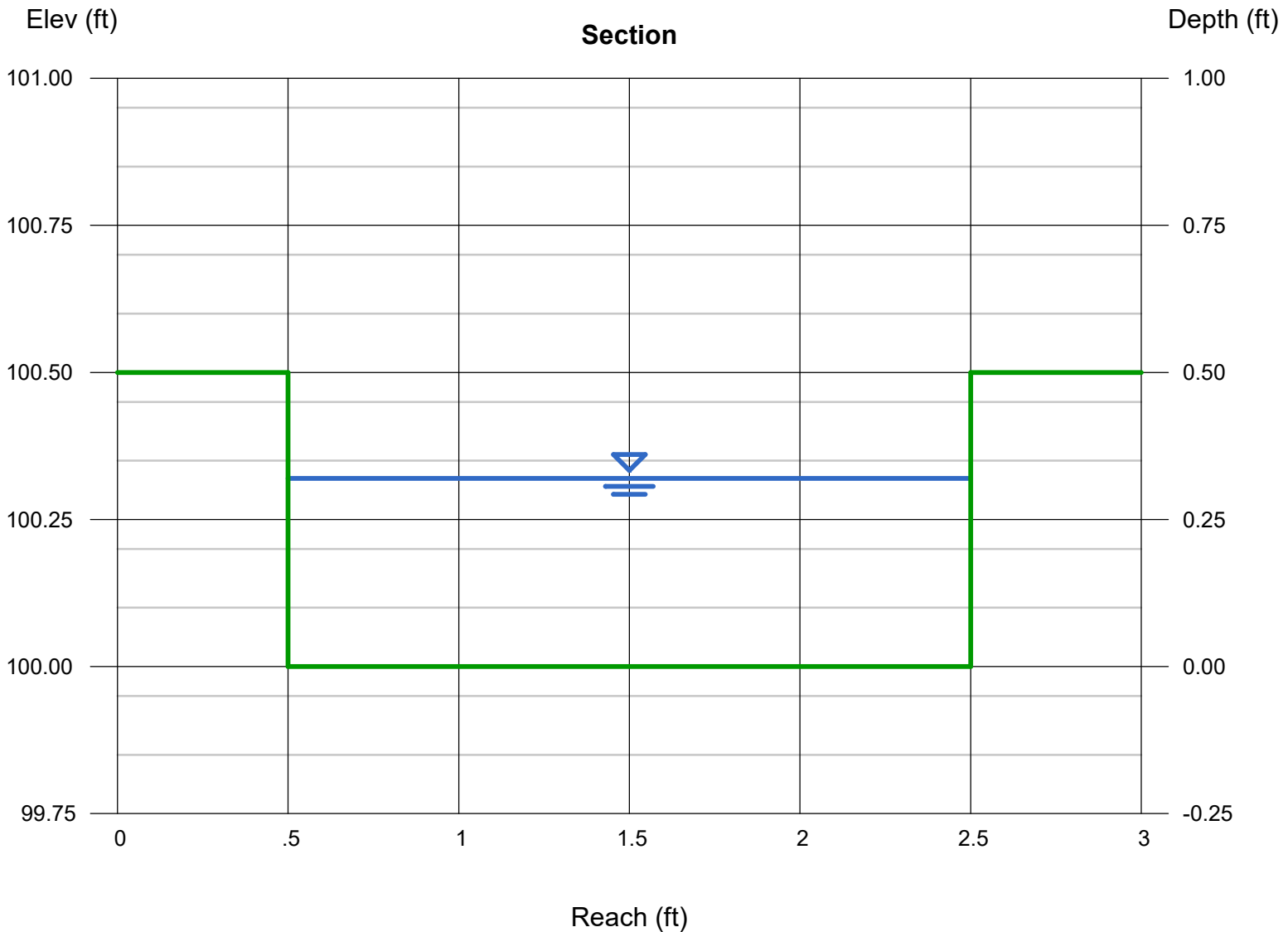

Determination of Culvert Headwater and Outlet Protection

Project: **61200**

Basin ID: **Design Point 4 (DP4): Curb Opening Riprap Calculation**

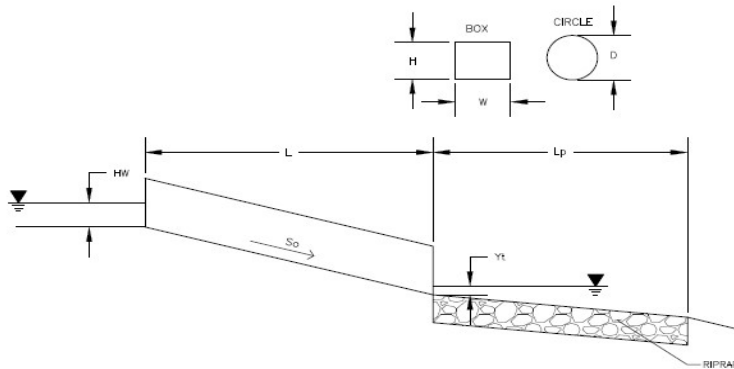

Soil Type:

Choose One:

- Sandy
 Non-Sandy

Supercritical Flow! Using Ha to calculate protection type.

Design Information (Input):

Design Discharge	Q = <input style="width: 100px;" type="text" value="3.9"/> cfs
Circular Culvert:	
Barrel Diameter in Inches	D = <input style="width: 100px;" type="text"/> inches
Inlet Edge Type (Choose from pull-down list)	<input type="text" value="OR"/>
Box Culvert:	
Barrel Height (Rise) in Feet	Height (Rise) = <input style="width: 100px;" type="text" value="0.5"/> ft
Barrel Width (Span) in Feet	Width (Span) = <input style="width: 100px;" type="text" value="2"/> ft
Inlet Edge Type (Choose from pull-down list)	<input type="text" value="Square Edge w/ 0 deg. Flared Wingwall"/>
Number of Barrels	No = <input style="width: 100px;" type="text" value="1"/>
Inlet Elevation	Elev IN = <input style="width: 100px;" type="text" value="6909.8"/> ft
Outlet Elevation OR Slope	Elev OUT = <input style="width: 100px;" type="text" value="6909.3"/> ft
Culvert Length	L = <input style="width: 100px;" type="text" value="3"/> ft
Manning's Roughness	n = <input style="width: 100px;" type="text" value="0.013"/>
Bend Loss Coefficient	k _b = <input style="width: 100px;" type="text" value="0"/>
Exit Loss Coefficient	k _x = <input style="width: 100px;" type="text" value="1"/>
Tailwater Surface Elevation	Elev Y _t = <input style="width: 100px;" type="text"/>
Max Allowable Channel Velocity	V = <input style="width: 100px;" type="text" value="5"/> ft/s

Required Protection (Output):

Tailwater Surface Height	Y _t = <input style="width: 100px;" type="text" value="0.20"/> ft
Flow Area at Max Channel Velocity	A _t = <input style="width: 100px;" type="text" value="0.78"/> ft ²
Culvert Cross Sectional Area Available	A = <input style="width: 100px;" type="text" value="1.00"/> ft ²
Entrance Loss Coefficient	k _e = <input style="width: 100px;" type="text" value="0.70"/>
Friction Loss Coefficient	k _f = <input style="width: 100px;" type="text" value="0.24"/>
Sum of All Losses Coefficients	k _s = <input style="width: 100px;" type="text" value="1.94"/> ft
Culvert Normal Depth	Y _n = <input style="width: 100px;" type="text" value="0.16"/> ft
Culvert Critical Depth	Y _c = <input style="width: 100px;" type="text" value="0.49"/> ft
Tailwater Depth for Design	d = <input style="width: 100px;" type="text" value="0.50"/> ft
Adjusted Diameter OR Adjusted Rise	H _a = <input style="width: 100px;" type="text" value="0.33"/> ft
Expansion Factor	1/(2*tan(θ)) = <input style="width: 100px;" type="text" value="3.63"/>
Flow/Diameter ^{2.5} OR Flow/(Span * Rise ^{1.5})	Q/WH ^{1.5} = <input style="width: 100px;" type="text" value="5.52"/> ft ^{0.5} /s
Froude Number	Fr = <input style="width: 100px;" type="text" value="5.50"/> Supercritical!
Tailwater/Adjusted Diameter OR Tailwater/Adjusted Rise	Y _t /H = <input style="width: 100px;" type="text" value="0.61"/>
Inlet Control Headwater	HW _i = <input style="width: 100px;" type="text" value="1.04"/> ft
Outlet Control Headwater	HW _o = <input style="width: 100px;" type="text" value="0.45"/> ft
Design Headwater Elevation	HW = <input style="width: 100px;" type="text" value="6,910.84"/> ft
Headwater/Diameter OR Headwater/Rise Ratio	HW/H = <input style="width: 100px;" type="text" value="2.08"/> HW/H > 1.5!
Minimum Theoretical Riprap Size	d ₅₀ = <input style="width: 100px;" type="text" value="1"/> in
Nominal Riprap Size	d ₅₀ = <input style="width: 100px;" type="text" value="6"/> in
UDFCD Riprap Type	Type = <input style="width: 100px;" type="text" value="VL"/>
Length of Protection	L_p = <input style="width: 100px;" type="text" value="5"/> ft
Width of Protection	T = <input style="width: 100px;" type="text" value="4"/> ft

Culvert Report

Woodmen Frontage Road Double 27in RCP - Design Point 5 (DP5)

Invert Elev Dn (ft)	= 6903.75
Pipe Length (ft)	= 65.40
Slope (%)	= 3.90
Invert Elev Up (ft)	= 6906.30
Rise (in)	= 27.0
Shape	= Circular
Span (in)	= 27.0
No. Barrels	= 2
n-Value	= 0.013
Culvert Type	= Circular Concrete
Culvert Entrance	= Groove end projecting (C)
Coeff. K,M,c,Y,k	= 0.0045, 2, 0.0317, 0.69, 0.2

Embankment	
Top Elevation (ft)	= 6910.74
Top Width (ft)	= 37.50
Crest Width (ft)	= 0.00

Calculations	
Qmin (cfs)	= 5.90
Qmax (cfs)	= 19.80
Tailwater Elev (ft)	= (dc+D)/2

Highlighted	
Qtotal (cfs)	= 19.80
Qpipe (cfs)	= 19.80
Qovertop (cfs)	= 0.00
Veloc Dn (ft/s)	= 3.13
Veloc Up (ft/s)	= 5.22
HGL Dn (ft)	= 6905.42
HGL Up (ft)	= 6907.39
Hw Elev (ft)	= 6907.79
Hw/D (ft)	= 0.66
Flow Regime	= Inlet Control

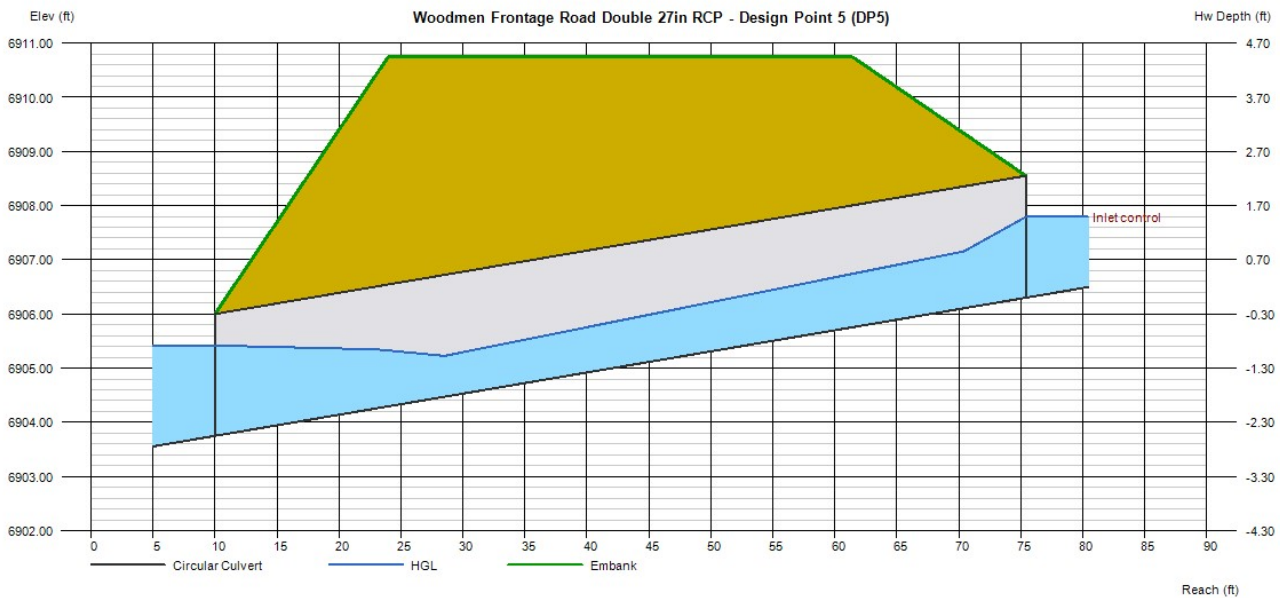

10 Report Maps

Offsite & Existing Drainage Map (Map Pocket)
Developed Drainage Map (Map Pocket)

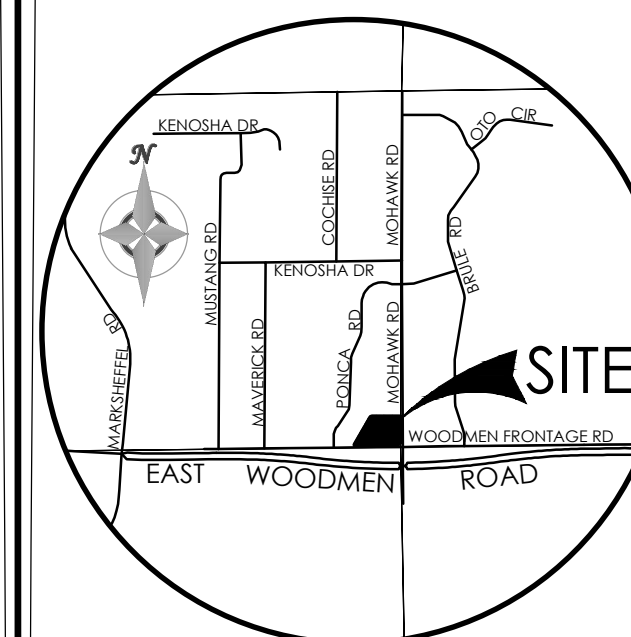

VICINITY MAP
NOT TO SCALE

BENCHMARK
FOUND 1" od PIPE FLUSH GROUND LEVEL TOP
OF EL = 6915'

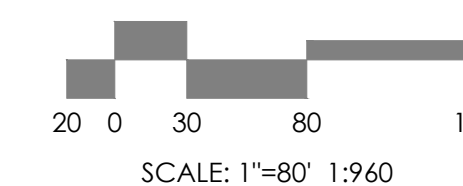
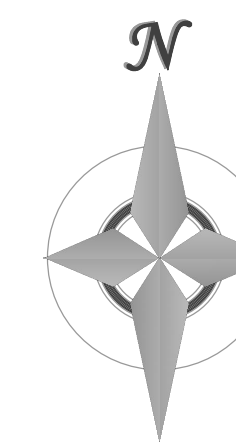

SCALE: 1"=80' 1:960

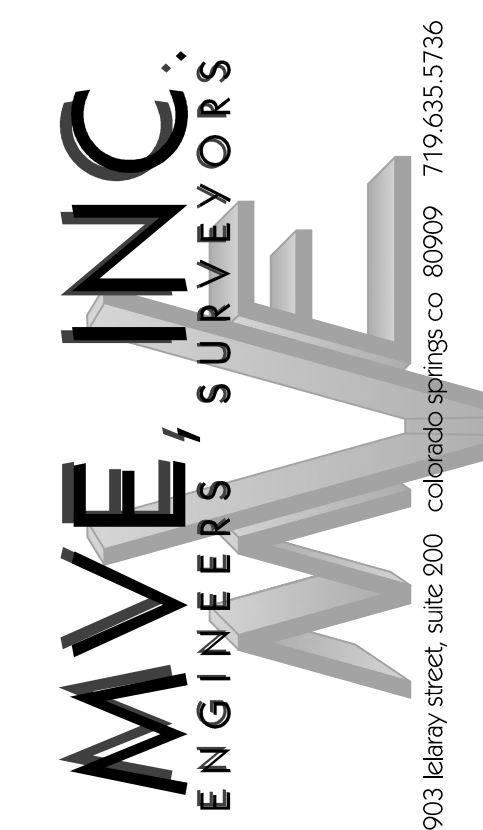

REVISIONS

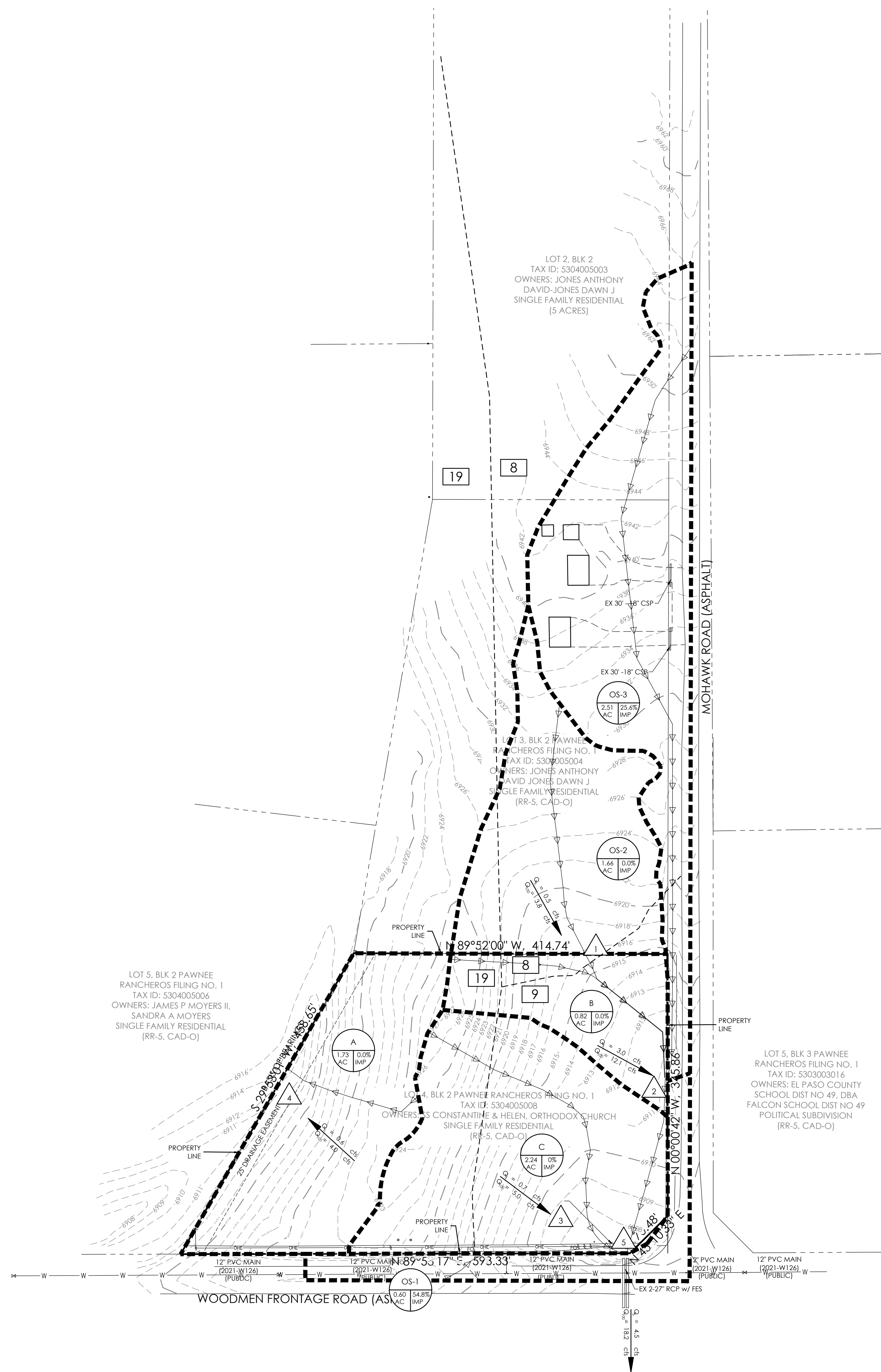

LEGAL DESCRIPTION
LOT 4, BLOCK 2, PAWNEE RANCHEROS, FILING NO. 1, EXCEPT THAT PORTION DESCRIBED IN WARRANTY DEED RECORDED JUNE 4, 2003 UNDER RECEPTION NO. 203123405, COUNTY OF EL PASO, STATE OF COLORADO.

LEGEND

- PROPERTY LINE
- EASEMENT LINE
- LOT LINE
- EXISTING**
- ASPHALT AREA
- GRAVEL AREA
- 5985 INDEX CONTOUR
- 84 INTERMEDIATE CONTOUR
- BASIN BOUNDARY
- GENERAL FLOW/DIRECTION
- TIME OF CONCENTRATION PATH
- BASIN LABEL
AREA IN ACRES
PERCENT IMPERVIOUS
- DESIGN POINT
- LIMITS OF SOIL TYPE
- LIMITS OF SOIL TYPE

DRAINAGE BASIN SUMMARY TABLE

DESIGN POINT	INCLUDED BASINS	AREA (AC)	T _c (MIN)	RUNOFF	
				Q5	Q100
	OS-1	0.60	5.7	1.6	3.4
DP EX-1	OS-2	1.66	11.9	0.5	3.8
	OS-3	2.51	15.6	2.3	7.0
DP EX-4	A	1.73	11.1	0.6	4.0
	B	0.82	12.1	0.3	1.8
DP EX-2	OS-2, OS-3, B	4.99	15.6	3.0	12.1
DP EX-3	C	2.24	12.5	0.7	5.0
DP EX-5	OS-1, OS-2, OS-3, B, C	7.83	17.2	4.5	18.2

FLOODPLAIN STATEMENT

NO PORTION OF THE SUBJECT PROPERTY IS LOCATED WITHIN A FEMA DESIGNATED SPECIAL FLOOD HAZARD AREA (SFHA) AS INDICATED ON THE FLOOD INSURANCE RATE MAPS (FIRM) FOR EL PASO COUNTY, COLORADO AND INCORPORATED AREAS - MAP NUMBERS 08041C0533G, EFFECTIVE DECEMBER 7, 2018.

ST. JOHN THE BAPTIST
ORTHODOX CHURCH

DRAINAGE MAP
(EXISTING)

LEGAL DESCRIPTION
 LOT 4, BLOCK 2, FAWNEE RANCHEROS, FILING NO. 1, EXCEPT THAT PORTION DESCRIBED IN WARRANTY DEED RECORDED JUNE 4, 2003 UNDER RECEPTION NO. 203123405, COUNTY OF EL PASO, STATE OF COLORADO.

LEGEND

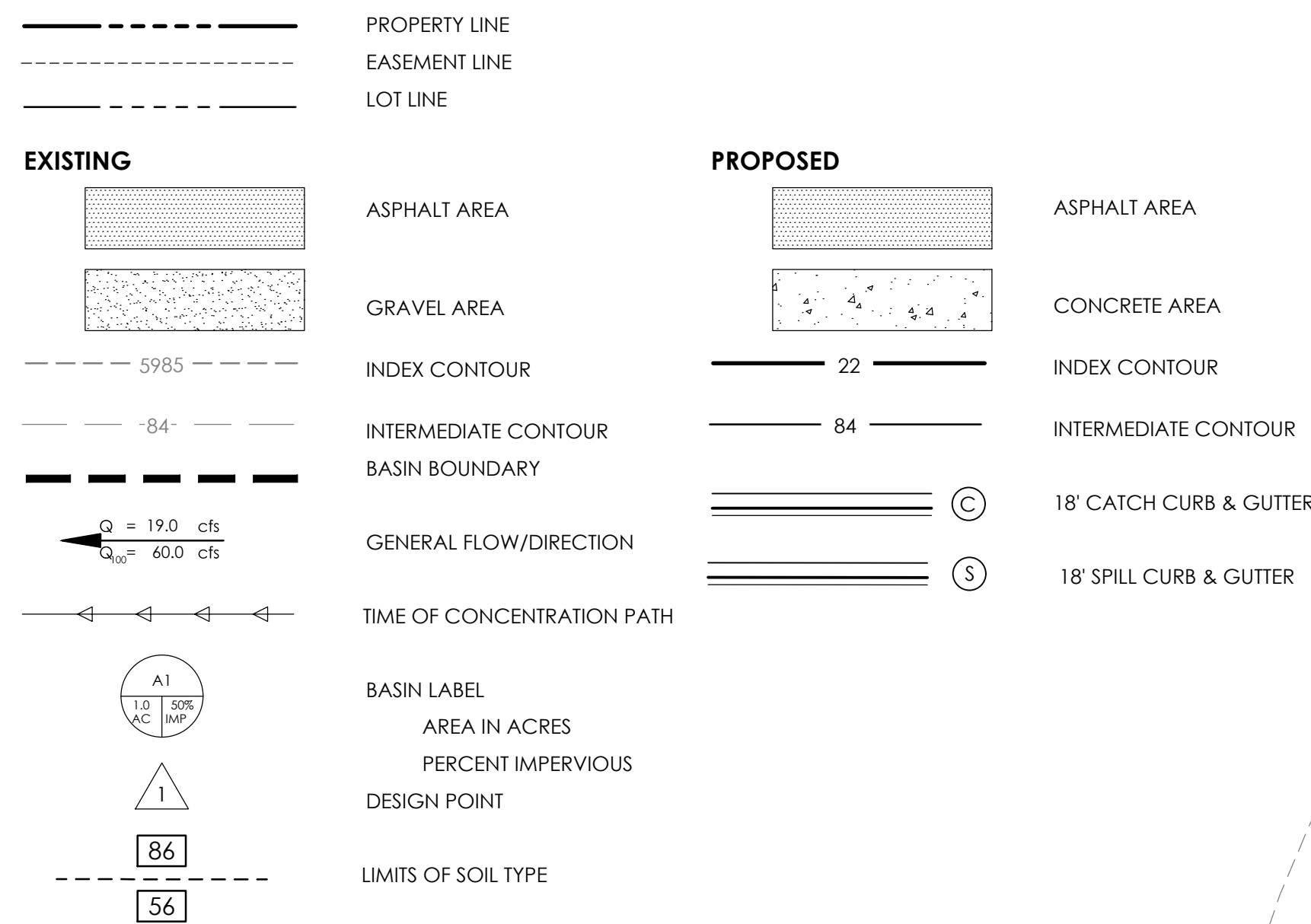

DRAINAGE BASIN SUMMARY TABLE

DESIGN POINT	INCLUDED BASINS	AREA (AC)	Tc (MIN)	RUNOFF	
				Q5	Q100
	OS-1	0.60	5.7	1.6	3.4
	OS-2	1.66	11.9	0.5	3.8
	OS-3	2.51	15.6	2.3	7.0
1	A1	0.06	6.5	0.2	0.4
	A2	1.71	11.1	0.5	4.0
2	A1, A2	1.77	11.1	0.7	4.3
	B1	0.82	11.7	0.4	2.1
3	OS-2, OS-3, B1	4.99	16.2	3.1	12.0
	C1	0.74	10.5	0.2	1.8
	C2	0.13	5.6	0.1	0.5
	C3	0.45	10.3	0.6	1.6
	C4	0.31	5.0	1.4	2.5
4	C1, C2, C4	1.17	12.1	1.4	3.9
	C5	0.58	11.5	0.2	1.3
5	OS-1, OS-2, OS-3, B1, C1-C5	7.79	17.1	5.9	19.8

FLOODPLAIN STATEMENT

NO PORTION OF THE SUBJECT PROPERTY IS LOCATED WITHIN A FEMA DESIGNATED SPECIAL FLOOD HAZARD AREA (SFHA) AS INDICATED ON THE FLOOD INSURANCE RATE MAPS (FIRM) FOR EL PASO COUNTY, COLORADO AND INCORPORATED AREAS - MAP NUMBERS 08041C0533G, EFFECTIVE DECEMBER 7, 2018.

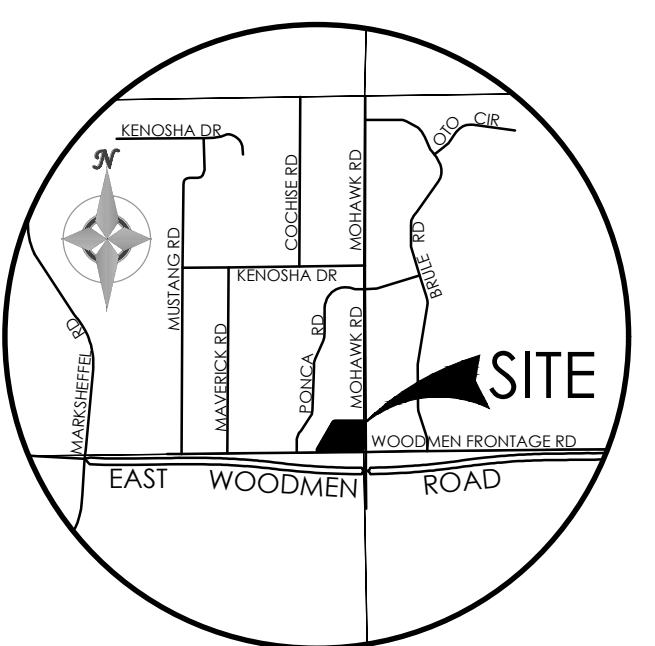
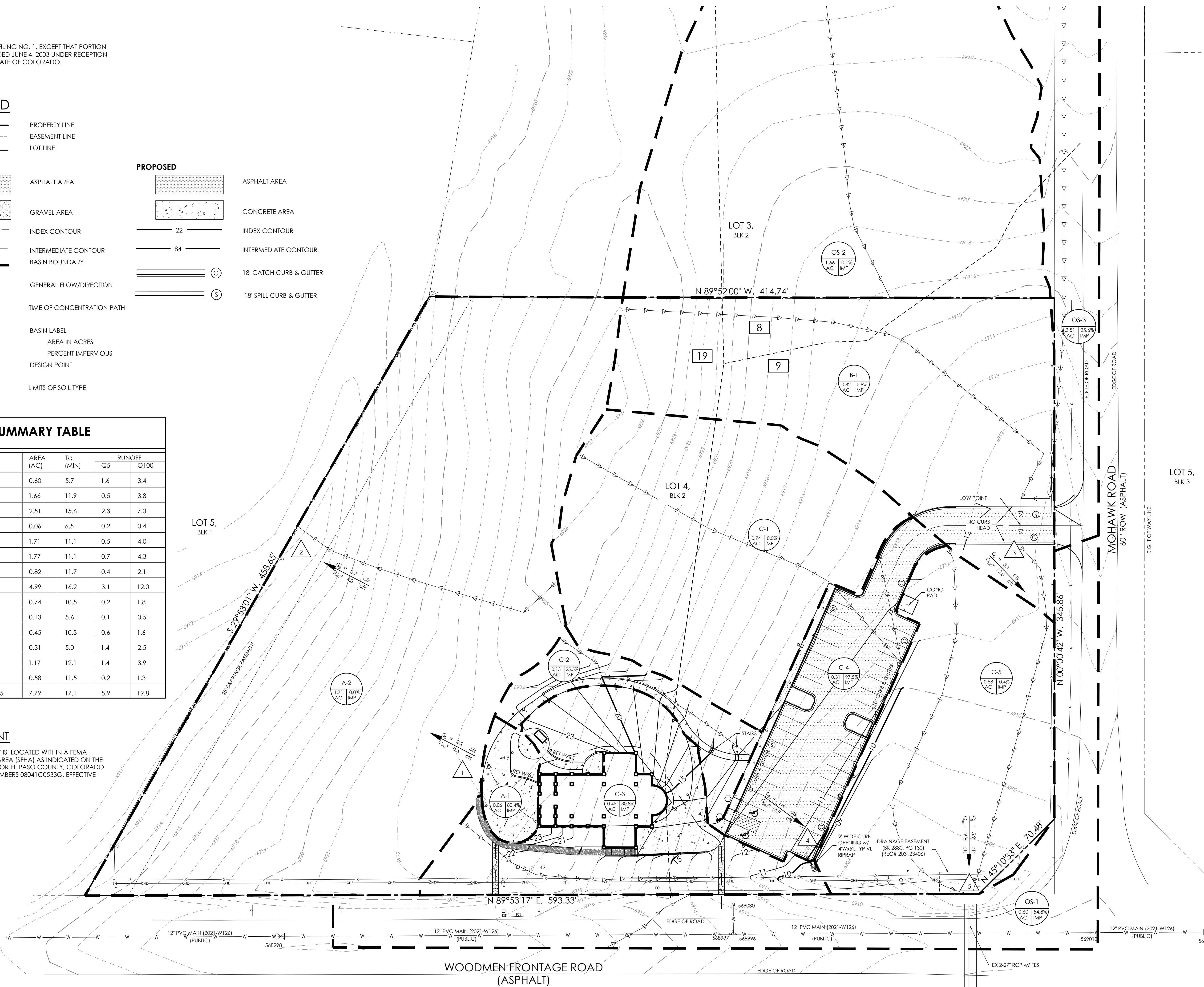

VICINITY MAP
NOT TO SCALE

BENCHMARK FOUND 1" od PIPE FLUSH GROUND LEVEL TOP OF EL = 6915'

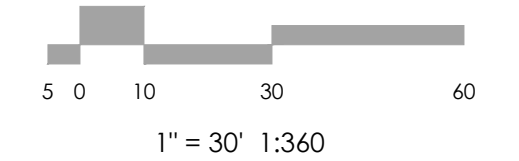
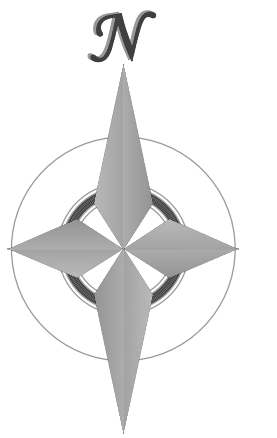

1" = 30' 1:360

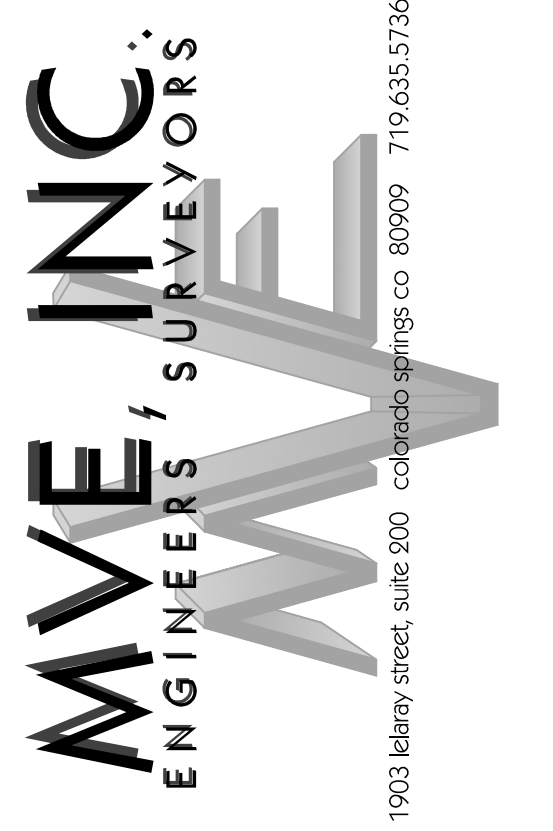

REVISIONS

DESIGNED BY _____
 DRAWN BY _____
 CHECKED BY _____
 AS-BUILT BY _____
 CHECKED BY _____

**ST. JOHN THE BAPTIST
 ORTHODOX CHURCH**

**DRAINAGE MAP
 (PROPOSED)**

MVE PROJECT 61200
 MVE DRAWING DRAIN-PP

SEPTEMBER 8, 2023
 SHEET 1 OF 1