

**PAINT BRUSH HILLS FILING NO. 14**  
 A REPLAT OF TRACT E, PAINT BRUSH HILLS FILING 13E, BEING A PORTION  
 OF THE NE 1/4 SECTION 26, TOWNSHIP 12 SOUTH, RANGE 65 WEST OF  
 THE SIXTH PRINCIPAL MERIDIAN, EL PASO COUNTY, COLORADO

**BE IT KNOWN BY THESE PRESENTS:**

THAT AEROPLAZA FOUNTAIN LLC, A COLORADO LIMITED LIABILITY COMPANY, AND HEIDI LLC, A COLORADO LIMITED LIABILITY COMPANY, BEING THE OWNERS OF THE FOLLOWING DESCRIBED TRACT OF LAND TO WIT:

**LEGAL DESCRIPTION:**

A PARCEL OF LAND IN THE NORTHEAST QUARTER (NE 1/4) OF SECTION 26, T12S, R65W OF THE 6TH P. M., EL PASO COUNTY, COLORADO, SAID PARCEL BEING TRACT E, "PAINT BRUSH HILLS FILING NO. 13E", RECORDED UNDER RECEPTION NO. 219714420 IN THE RECORDS OF EL PASO COUNTY, COLORADO, BEING MORE PARTICULARLY DESCRIBED AS FOLLOWS:

BEGINNING AT THE QUARTER CORNER COMMON TO SECTIONS 23 AND 26, T12S, R65W OF THE 6TH P. M.; THENCE N88°44'51"E ALONG THE SOUTH LINE OF "PAINT BRUSH HILLS FILING NO. 3" RECORDED IN PLAT BOOK U-3 AT PAGE 79 OF THE EL PASO COUNTY RECORDS 2289.18 FEET;  
 THENCE S00°23'09"E ALONG THE WEST LINE OF TRACT A "PAINT BRUSH HILLS FILING NO. 13E" A DISTANCE OF 847.61 FEET;  
 THENCE ALONG THE NORTHERLY LINES OF LOTS 117 THROUGH 120, "PAINT BRUSH HILLS FILING NO. 13E" THE FOLLOWING FIVE (5) COURSES;

- (1) THENCE N60°39'45"W A DISTANCE OF 136.44 FEET;
- (2) THENCE N75°42'34"W A DISTANCE OF 136.62 FEET;
- (3) THENCE S82°53'35"W A DISTANCE OF 58.52 FEET;
- (4) THENCE S74°48'58"W A DISTANCE OF 68.80 FEET;
- (5) THENCE S25°20'15"W A DISTANCE OF 45.28 FEET TO THE RIGHT-OF-WAY LINE OF DEVENCORVE DRIVE AS PLATTED ON "PAINT BRUSH HILLS FILING NO. 13E";

THENCE ALONG SAID RIGHT-OF-WAY LINE THE FOLLOWING THREE (3) COURSES:

- (1) THENCE N64°40'00"W A DISTANCE OF 56.87 FEET;
- (2) THENCE S25°20'00"W A DISTANCE OF 50.00 FEET;
- (3) THENCE S64°40'00"E A DISTANCE OF 16.86 FEET TO THE WEST RIGHT-OF-WAY LINE OF KEATING DRIVE AS PLATTED ON "PAINT BRUSH HILLS FILING NO. 13E";

THENCE ALONG SAID WEST RIGHT-OF-WAY LINE THE FOLLOWING FIVE (5) COURSES:

- (1) THENCE S25°20'15"W A DISTANCE OF 823.72 FEET TO A POINT OF CURVE;
- (2) THENCE 264.76 FEET ALONG THE ARC OF A CURVE TO THE RIGHT, SAID CURVE HAVING A RADIUS OF 470.00 FEET, A CENTRAL ANGLE OF 32°16'34", THE CHORD OF 261.28 FEET BEARS S41°28'32"W TO A POINT OF REVERSE CURVE;
- (3) THENCE 430.28 FEET ON THE ARC OF A CURVE TO THE LEFT, SAID CURVE HAVING A RADIUS OF 861.00 FEET, A CENTRAL ANGLE OF 28°38'00", THE CHORD OF 425.82 FEET BEARS S43°17'49"W TO A POINT OF COMPOUND CURVE;
- (4) THENCE 123.89 FEET ALONG THE ARC OF A CURVE TO THE LEFT, SAID CURVE HAVING A RADIUS OF 530.00 FEET, A CENTRAL ANGLE OF 13°23'34", THE CHORD OF 123.60 FEET BEARS S22°17'02"W TO A POINT OF TANGENT;
- (5) THENCE S15°35'15"W A DISTANCE OF 76.75 FEET;

THENCE ALONG THE NORTH LINES OF LOT 2 THROUGH LOT 5 AND ALONG THE NORTH LINE OF TRACT A "PAINT BRUSH HILLS FILING NO. 12" AS RECORDED UNDER RECEPTION NO. 205077511 IN THE EL PASO COUNTY RECORDS THE FOLLOWING SIX (6) COURSES;

- (1) THENCE N74°25'08"W A DISTANCE OF 231.02 FEET;
- (2) THENCE S34°46'45"W A DISTANCE OF 75.34 FEET;
- (3) THENCE S62°22'54"W A DISTANCE OF 141.21 FEET;
- (4) THENCE N80°50'04"W A DISTANCE OF 149.93 FEET;
- (5) THENCE N42°52'08"W A DISTANCE OF 142.64 FEET;
- (6) THENCE S89°26'02"W A DISTANCE OF 299.04 FEET TO THE NORTH-SOUTH CENTERLINE OF SECTION 26;

THENCE N00°34'35"W ALONG SAID NORTH-SOUTH CENTERLINE 2169.63 FEET TO THE POINT OF BEGINNING.

CONTAINING A CALCULATED AREA OF 3,860,479 S. F. (88.624 ACRES MORE OR LESS).

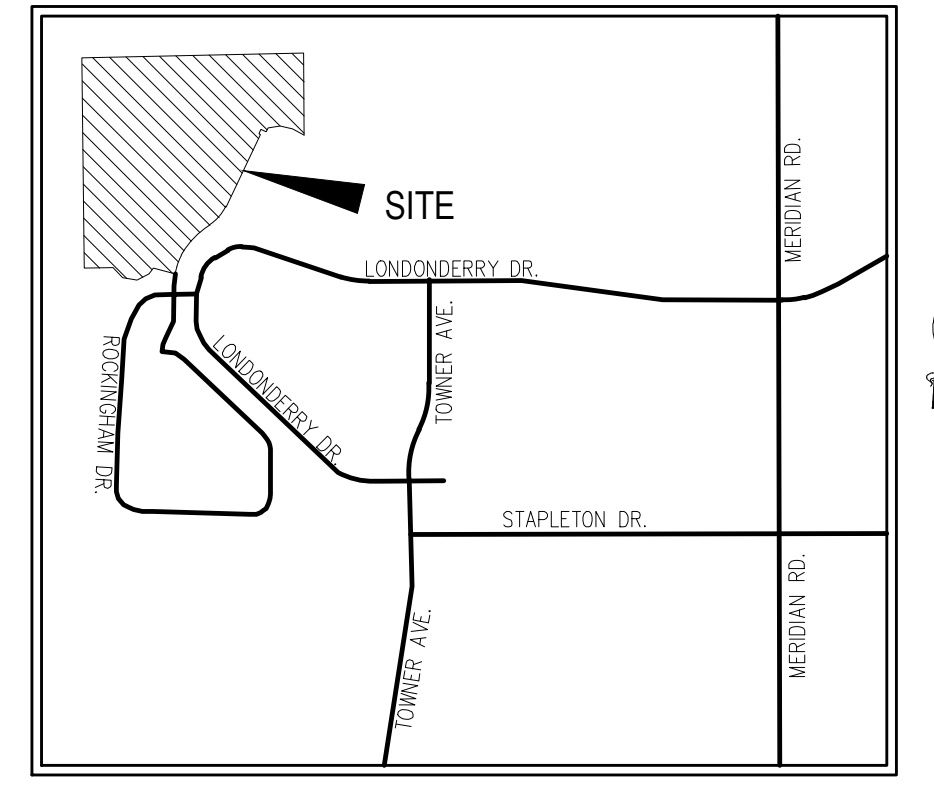

**VICINITY MAP**  
N.T.S.

**OWNERS CERTIFICATE/DEDICATION STATEMENT:**

THE UNDERSIGNED, BEING ALL THE OWNERS, MORTGAGEES, BENEFICIARIES OF DEEDS OF TRUST AND HOLDERS OF OTHER INTERESTS IN THE LAND DESCRIBED HEREIN, HAVE LAID OUT, SUBDIVIDED, AND PLATTED SAID LANDS INTO LOTS, TRACTS, STREETS, AND EASEMENTS AS SHOWN HEREON UNDER THE NAME AND SUBDIVISION OF "PAINT BRUSH HILLS FILING NO. 14". ALL PUBLIC IMPROVEMENTS SO PLATTED ARE HEREBY DEDICATED TO PUBLIC USE AND SAID OWNER DOES HEREBY COVENANT AND AGREE THAT THE PUBLIC IMPROVEMENTS WILL BE CONSTRUCTED TO EL PASO COUNTY STANDARDS AND THAT PROPER DRAINAGE AND EROSION CONTROL FOR SAME WILL BE PROVIDED AT SAID OWNER'S EXPENSE, ALL TO THE SATISFACTION OF THE BOARD OF COUNTY COMMISSIONERS OF EL PASO COUNTY, COLORADO. UPON ACCEPTANCE BY RESOLUTION, ALL PUBLIC IMPROVEMENTS SO DEDICATED WILL BECOME MATTERS OF MAINTENANCE BY EL PASO COUNTY, COLORADO. THE UTILITY EASEMENTS SHOWN HEREON ARE HEREBY DEDICATED FOR PUBLIC UTILITIES AND COMMUNICATION SYSTEMS AND OTHER PURPOSES AS SHOWN HEREON. THE ENTITIES RESPONSIBLE FOR PROVIDING THE SERVICES FOR WHICH THE EASEMENTS ARE ESTABLISHED ARE HEREBY GRANTED THE PERPETUAL RIGHT OF INGRESS AND EGRESS FROM AND TO ADJACENT PROPERTIES FOR INSTALLATION, MAINTENANCE AND REPLACEMENT OF UTILITY LINES AND RELATED FACILITIES.

THE AFOREMENTIONED AEROPLAZA FOUNTAIN LLC, A COLORADO LIMITED LIABILITY COMPANY, HAS EXECUTED THIS INSTRUMENT THIS \_\_\_\_\_ DAY OF \_\_\_\_\_, 2020, A.D.

BY: \_\_\_\_\_

PRINTED NAME: \_\_\_\_\_

AS: \_\_\_\_\_ OF AEROPLAZA FOUNTAIN LLC, A COLORADO LIMITED LIABILITY COMPANY  
 STATE OF COLORADO )  
 ) SS  
 COUNTY OF EL PASO )

THE FOREGOING INSTRUMENT WAS ACKNOWLEDGED BEFORE ME THIS THIS \_\_\_\_\_ DAY OF \_\_\_\_\_, 2020, A.D. BY \_\_\_\_\_

AS \_\_\_\_\_, OF AEROPLAZA FOUNTAIN LLC, A COLORADO LIMITED LIABILITY COMPANY

WITNESS MY HAND AND OFFICIAL SEAL:

MY COMMISSION EXPIRES: \_\_\_\_\_ NOTARY PUBLIC

THE AFOREMENTIONED HEIDI LLC, A COLORADO LIMITED LIABILITY COMPANY, HAS EXECUTED THIS INSTRUMENT THIS \_\_\_\_\_ DAY OF \_\_\_\_\_, 2020, A.D.

BY: \_\_\_\_\_

PRINTED NAME: \_\_\_\_\_

AS: \_\_\_\_\_ OF HEIDI LLC, A COLORADO LIMITED LIABILITY COMPANY  
 STATE OF COLORADO )  
 ) SS  
 COUNTY OF EL PASO )

THE FOREGOING INSTRUMENT WAS ACKNOWLEDGED BEFORE ME THIS THIS \_\_\_\_\_ DAY OF \_\_\_\_\_, 2020, A.D. BY \_\_\_\_\_

AS \_\_\_\_\_, OF HEIDI LLC, A COLORADO LIMITED LIABILITY COMPANY

WITNESS MY HAND AND OFFICIAL SEAL:

MY COMMISSION EXPIRES: \_\_\_\_\_ NOTARY PUBLIC

TRACT TABLE			
TRACT	SIZE (ACRES)	OWNERSHIP / MAINTENANCE	USE <span style="background-color: #90EE90;">Regional Trail Easement?</span>
A	1.316	PBHMD	DRAINAGE/PUBLIC IMPROVEMENT/PUBLIC UTILITY/LANDSCAPING/OPEN SPACE
B	0.247	PBHMD	DRAINAGE/PUBLIC IMPROVEMENT/PUBLIC UTILITY/LANDSCAPING/OPEN SPACE
TOTAL	1.563		
PBHMD = PAINT BRUSH HILLS METRO DISTRICT			

**EASEMENTS:**

UNLESS SHOWN OTHERWISE, ALL SIDE LOT LINES ARE HEREBY PLATTED WITH A FIVE (5) FEET WIDE PUBLIC UTILITY AND DRAINAGE EASEMENT. REAR LOT LINES ARE HEREBY PLATTED WITH A TEN (10) FEET WIDE PUBLIC UTILITY AND DRAINAGE EASEMENT. ALL FRONT LOT LINES ARE PLATTED WITH A FIVE (5) FEET WIDE PUBLIC UTILITY AND PUBLIC IMPROVEMENT EASEMENT.

AN ADDITIONAL TEN (10) FOOT WIDE EASEMENT FOR PUBLIC UTILITIES, DIRECTLY ADJACENT TO THE FIVE (5) FOOT FRONT LOT LINE EASEMENT REFERRED TO ABOVE.

A TWENTY (20) FOOT WIDE PUBLIC UTILITY AND DRAINAGE EASEMENT ALONG ALL LOTS ADJACENT TO THE SUBDIVISION BOUNDARY.

SIGHT VISIBILITY EASEMENTS AS SHOWN HEREON ARE HEREBY GRANTED TO EL PASO COUNTY. NO IMPROVEMENTS ARE ALLOWED WITHIN THE EASEMENT THAT EXCEED A HEIGHT OF 30 INCHES AS MEASURED ABOVE THE FLOWLINE OF CURB AND GUTTER.

THE SOLE RESPONSIBILITY FOR SURFACE MAINTENANCE OF THESE EASEMENTS IS HEREBY VESTED WITH THE INDIVIDUAL PROPERTY OWNER.

ALL EASEMENTS THAT ARE DEDICATED HEREON FOR PUBLIC UTILITY PURPOSES SHALL BE SUBJECT TO THOSE TERMS AND CONDITIONS AS SPECIFIED IN THE INSTRUMENT RECORDED AT RECEPTION NO. 212112548 OF THE RECORDS OF EL PASO COUNTY, COLORADO. ALL OTHER EASEMENTS OR INTERESTS OF RECORD AFFECTING ANY OF THE PLATTED PROPERTY DEPICTED HEREON SHALL NOT BE AFFECTED AND SHALL REMAIN IN FULL FORCE AND EFFECT.

**SURVEYORS CERTIFICATE**

I VERNON P. TAYLOR, A DULY REGISTERED PROFESSIONAL LAND SURVEYOR IN THE STATE OF COLORADO, DO HEREBY CERTIFY THAT THIS PLAT TRULY AND CORRECTLY REPRESENTS THE RESULTS OF A SURVEY MADE ON DATE OF SURVEY, BY ME OR UNDER MY DIRECT SUPERVISION AND THAT ALL MONUMENTS EXIST AS SHOWN HEREON; THAT MATHEMATICAL CLOSURE ERRORS ARE LESS THAN 1:10,000; AND THAT SAID PLAT HAS BEEN PREPARED IN FULL COMPLIANCE WITH ALL APPLICABLE LAWS OF THE STATE OF COLORADO DEALING WITH MONUMENTS, SUBDIVISION, OR SURVEYING OF LAND AND ALL APPLICABLE PROVISIONS OF THE EL PASO COUNTY LAND DEVELOPMENT CODE.

I ATTEST THE ABOVE ON THIS \_\_\_\_\_ DAY OF \_\_\_\_\_, 2020.

VERNON P. TAYLOR  
 COLORADO PLS NO. 25966, FOR AND  
 ON BEHALF OF M&S CIVIL CONSULTANTS, INC  
 102 E. PIKES PEAK AVE., 5TH FLOOR  
 COLORADO SPRINGS, COLORADO 80903

**NOTICE:**

ACCORDING TO COLORADO LAW, YOU MUST COMMENCE ANY LEGAL ACTION BASED UPON ANY DEFECT IN THIS SURVEY WITHIN THREE YEARS AFTER YOU FIRST DISCOVER SUCH DEFECT. IN NO EVENT, MAY ANY ACTION BASED UPON ANY DEFECT IN THIS SURVEY BE COMMENCED MORE THAN TEN YEARS FROM THE DATE OF THE CERTIFICATION SHOWN HEREON.

**PCD DIRECTOR CERTIFICATE:**

THIS PLAT FOR "PAINT BRUSH HILLS FILING NO. 14" WAS APPROVED FOR FILING BY THE EL PASO COUNTY PLANNING AND COMMUNITY DEVELOPMENT DEPARTMENT DIRECTOR ON THIS \_\_\_\_\_ DAY OF \_\_\_\_\_, 2020, SUBJECT TO ANY NOTES OR CONDITIONS SPECIFIED HEREON.

\_\_\_\_\_  
 DIRECTOR, PLANNING AND COMMUNITY DEVELOPMENT DEPARTMENT DATE

**BOARD OF COUNTY COMMISSIONERS CERTIFICATE:**

THIS PLAT FOR "PAINT BRUSH HILLS FILING NO. 14" WAS APPROVED FOR FILING BY THE EL PASO COUNTY, COLORADO BOARD OF COUNTY COMMISSIONERS ON THE \_\_\_\_\_ DAY OF \_\_\_\_\_, 2020. SUBJECT TO If there is not anything on the final plat that would require BoCC approval, N OF APPROVAL. that was not already approved with the Prelim Plan, the final plat can be ED, BUT PUBLIC IMPF approved administratively and the BoCC Certificate would not be needed. COUNTY JUREMENTS UNTIL PRELIM OF THE LAND DEVELOPMENT CODE AND ENGINEERING CRITERIA MANUAL AND THE SUBDIVISION IMPROVEMENTS AGREEMENT.

\_\_\_\_\_  
 PRESIDENT, BOARD OF COUNTY COMMISSIONERS DATE

**CLERK AND RECORDER:**

STATE OF COLORADO )  
 ) SS  
 COUNTY OF EL PASO )

I HEREBY CERTIFY THAT THIS INSTRUMENT WAS FILED FOR RECORD IN MY OFFICE AT \_\_\_\_\_ O'CLOCK \_\_\_\_\_M., THIS \_\_\_\_\_ DAY OF \_\_\_\_\_, 2020, A.D., AND DULY RECORDED UNDER RECEPTION NO. \_\_\_\_\_ OF THE RECORDS OF EL PASO COUNTY, COLORADO.

BY: \_\_\_\_\_  
 CHUCK BROERMAN, EL PASO COUNTY CLERK AND RECORDER

**FEES:**

DRAINAGE FEE: \_\_\_\_\_  
 BRIDGE FEE: \_\_\_\_\_  
 SCHOOL FEE: \_\_\_\_\_  
 PARK FEE: \_\_\_\_\_

**SUMMARY:**

224 LOTS	74,188 ACRES	83.71%
2 TRACTS	1,563 ACRES	1.76%
RIGHTS-OF-WAY	12,873 ACRES	14.53%
TOTAL	88,624 ACRES	100.00%

**Soil and Geology Conditions:**  
 Geologic Hazard Note-Final Plat: (to be customized based upon the individual circumstances)  
 The following lots have been found to be impacted by geologic hazards. Mitigation measures and a map of the hazard area can be found in the report (Title of Report, generally from the Preliminary Plan file) by (author of the report) (date of report) in file (name of file and file number) available at the El Paso County Planning and Community Development Department:  
 •Downslope Creep: (name lots or location of area)  
 •Rockfall Source: (name lots or location of area)  
 •Rockfall Runout Zone: (name lots or location of area)  
 •Potentially Seasonally High Groundwater: (name lots or location of area)  
 •Other Hazard:  
 In Areas of High Groundwater:  
 Due to high groundwater in the area, all foundations shall incorporate an underground drainage system.

Please revise the plat note above per the comments on the soils and geology report from the Prelim and CGS review comments from the prelim plan review.

SF2024

PCD FILE NUMBER SF-20-XXX



102 E. PIKES PEAK AVE., 5TH FLOOR  
 COLORADO SPRINGS, CO 80903  
 PHONE: 719.955.5485



PAINT BRUSH HILLS FILING NO. 14  
A REPLAT OF TRACT E, PAINT BRUSH HILLS FILING 13E, BEING A PORTION  
OF THE NE 1/4 SECTION 26, TOWNSHIP 12 SOUTH, RANGE 65 WEST OF  
THE SIXTH PRINCIPAL MERIDIAN, EL PASO COUNTY, COLORADO

GENERAL PLAT NOTES:

1. **BASIS OF BEARINGS:** THE SECTION LINE BEING THE NORTH LINE OF TRACT A, TRACT E, AND A PORTION OF TRACT F "PAINT BRUSH HILLS FILING NO. 13E", AS RECORDED UNDER RECEPTION NO. 219714420, BEING MONUMENTED AT THE QUARTER CORNER COMMON TO SECTIONS 23 AND 26, T12S, R65W OF THE 6TH P. M. WITH A 2.5" ALUMINUM CAP ON NO. 6 REBAR STAMPED "1/4 COR, S23 S26, 1999, PLS 4842", AND AT THE SECTION CORNER COMMON TO SECTIONS 23, 24, 25 AND 26 WITH A 1.5" ALUMINUM CAP ON NO. 5 REBAR STAMPED "(PARTIALLY ILLEGIBLE) LS 9646", SAID LINE BEARS N88°44'51"E A DISTANCE OF 2640.30 FEET.
2. **FLOODPLAIN STATEMENT:** THE FLOOD INSURANCE RATE MAP (FIRM) PANEL NO. 08041C05350 DATED DECEMBER 7, 2018, HAS BEEN EXAMINED AS IT RELATES TO THE PROPERTY BEING PLATTED. THE PROPERTY LIES WITHIN ZONE X, AREA OF MINIMAL FLOOD HAZARD.
3. **TITLE COMMITMENT:** A COMMITMENT FOR TITLE INSURANCE ISSUED BY UNIFIED TITLE COMPANY, LLC AS AGENT FOR STEWART TITLE GUARANTEE COMPANY WITH AN EFFECTIVE DATE OF AUGUST 5, 2020 AT 7:30AM, FILE NO. 59079 UTC, AMENDMENT NO. 2, HAS BEEN EXAMINED AS IT RELATES TO THE PROPERTY BEING PLATTED.
  - i. (TC#9) THE PROPERTY MAY BE SUBJECT TO THE EFFECT OF NOTICE OF INCLUSION OF SUBJECT PROPERTY WITHIN THE FALCON FIRE PROTECTION DISTRICT, AS SET FORTH IN ORDER AND DECREE RECORDED DECEMBER 2, 1980 IN BOOK 3380 AT PAGE 670 AND RECORDED DECEMBER 2, 1980 IN BOOK 3380 AT PAGE 675, AND RECORDED FEBRUARY 17, 1981 IN BOOK 3404 AT PAGE 582, AND RECORDED FEBRUARY 17, 1981 IN BOOK 3404 AT PAGE 587.
  - ii. (TC#10) THE PROPERTY MAY BE SUBJECT TO NOTICE CONCERNING UNDERGROUND UTILITIES AS SET FORTH IN INSTRUMENT RECORDED MAY 9, 1983 IN BOOK 3718 AT PAGE 812.
  - iii. (TC#11) THE PROPERTY MAY BE SUBJECT TO TERMS, AGREEMENTS, PROVISIONS, CONDITIONS, OBLIGATIONS AND EASEMENTS AS CONTAINED IN POTABLE WATER SUPPLY AND SANITARY SEWER SERVICE AGREEMENT, RECORDED SEPTEMBER 14, 1987 IN BOOK 5421 AT PAGE 132. QUIT CLAIM IN CONNECTION THEREWITH RECORDED JANUARY 29, 1999 AT RECEPTION NO. 99014798.
  - iv. (TC#12) THE PROPERTY MAY BE SUBJECT TO THE EFFECT OF NOTICE OF INCLUSION OF SUBJECT PROPERTY WITHIN THE PAINT BRUSH HILLS METROPOLITAN DISTRICT, AS SET FORTH IN INSTRUMENT RECORDED SEPTEMBER 17, 1987 IN BOOK 5423 AT PAGE 2 AND RECORDED JANUARY 19, 2005 AT RECEPTION NO. 205008854 AND CORRECTION RECORDED FEBRUARY 3, 2005 AT RECEPTION NO. 205016961. AMENDED AND RESTATED RESOLUTION RECORDED MARCH 14, 2014 AT RECEPTION NO. 214020993. AMENDED AND RESTATED RESOLUTION RECORDED JUNE 7, 2016 AT RECEPTION NO. 216061171. AMENDED AND RESTATED RESOLUTION RECORDED MARCH 26, 2018 AT RECEPTION NO. 218033519. AMENDED AND RESTATED RESOLUTION RECORDED MAY 9, 2018 AT RECEPTION NO. 218052891.
  - v. (TC#13) THE PROPERTY MAY BE SUBJECT TO COVENANTS, CONDITIONS, RESTRICTIONS AND EASEMENTS, IF ANY, WHICH DO NOT CONTAIN A FORFEITURE OR REVERTER CLAUSE, (DELETING ANY RESTRICTIONS INDICATING ANY PREFERENCE, LIMITATION OR DISCRIMINATION BASED ON RACE, COLOR, RELIGION, SEX, HANDICAP, FAMILIAL STATUS OR NATIONAL ORIGIN) AS CONTAINED IN INSTRUMENT RECORDED SEPTEMBER 15, 1988 IN BOOK 5554 AT PAGE 514 AND ANY AND ALL AMENDMENTS AND/OR SUPPLEMENTS THERETO. ASSIGNMENT RECORDED JANUARY 22, 2018 AT RECEPTION NO. 218008145. FIRST AMENDMENT RECORDED JANUARY 29, 2018 AT RECEPTION NO. 2180180888.
  - vi. (TC#14) THE PROPERTY MAY BE SUBJECT TO TERMS, AGREEMENTS, PROVISIONS, CONDITIONS, OBLIGATIONS AND EASEMENTS AS CONTAINED IN RIGHT-OF-WAY EASEMENT TO MOUNTAIN VIEW ELECTRIC ASSOCIATION, INC., RECORDED MARCH 7, 1983 IN BOOK 3684 AT PAGE 492 AND RELEASE OF RIGHT OF WAY AND QUIT CLAIM DEED RECORDED NOVEMBER 21, 2005 AT RECEPTION NO. 205186521.
  - vii. (TC#15) THE PROPERTY MAY BE SUBJECT TO THE EFFECT RESOLUTION NO. 04-490, BY AND BEFORE THE BOARD OF COUNTY COMMISSIONERS, COUNTY OF EL PASO COUNTY, STATE OF COLORADO, AS SET FORTH IN INSTRUMENT RECORDED JANUARY 24, 2005 AT RECEPTION NO. 205011637.
  - viii. (TC#16) THE PROPERTY MAY BE SUBJECT TO THE EFFECT RESOLUTION NO. 04-491, BY AND BEFORE THE BOARD OF COUNTY COMMISSIONERS, COUNTY OF EL PASO COUNTY, STATE OF COLORADO, AS SET FORTH IN INSTRUMENT RECORDED JANUARY 31, 2005 AT RECEPTION NO. 205015059.
  - ix. (TC#17) THE PROPERTY MAY BE SUBJECT TO THE EFFECT RESOLUTION NO. 04-489, BY AND BEFORE THE BOARD OF COUNTY COMMISSIONERS, COUNTY OF EL PASO COUNTY, STATE OF COLORADO, AS SET FORTH IN INSTRUMENT RECORDED FEBRUARY 4, 2005 AT RECEPTION NO. 205017889.
  - x. (TC#18) THE PROPERTY MAY BE SUBJECT TO THE EFFECT RESOLUTION NO. 04-547, BY AND BEFORE THE BOARD OF COUNTY COMMISSIONERS, COUNTY OF EL PASO COUNTY, STATE OF COLORADO, AS SET FORTH IN INSTRUMENT RECORDED MARCH 9, 2005 AT RECEPTION NO. 205033555.
  - xi. (TC#19) THE PROPERTY MAY BE SUBJECT TO THE EFFECT OF THE COLORADO GROUND WATER COMMISSION FINDINGS AND ORDER, REGARDING THE PAINT BRUSH HILLS METROPOLITAN DISTRICT, AS SET FORTH IN INSTRUMENT RECORDED OCTOBER 05, 2005 AT RECEPTION NO. 205157500.
  - xii. (TC#20) THE PROPERTY MAY BE SUBJECT TO THE EFFECT RESOLUTION NO. 13-296, BY AND BEFORE THE BOARD OF COUNTY COMMISSIONERS, COUNTY OF EL PASO COUNTY, STATE OF COLORADO, REGARDING PUBLIC IMPROVEMENT DISTRICT NO. 2, AND PETITION OF INCLUSION, AS SET FORTH IN INSTRUMENT RECORDED JUNE 26, 2013 AT RECEPTION NO. 213083051.

GENERAL PLAT NOTES: (CONT.)

- xiii. (TC#21) THE PROPERTY MAY BE SUBJECT TO COVENANTS, CONDITIONS, RESTRICTIONS AND EASEMENTS, IF ANY, WHICH DO NOT CONTAIN A FORFEITURE OR REVERTER CLAUSE, (DELETING ANY RESTRICTIONS INDICATING ANY PREFERENCE, LIMITATION OR DISCRIMINATION BASED ON RACE, COLOR, RELIGION, SEX, HANDICAP, FAMILIAL STATUS OR NATIONAL ORIGIN) AS CONTAINED IN DECLARATION OF COVENANTS, CONDITIONS AND RESTRICTIONS, RECORDED SEPTEMBER 13, 2013 AT RECEPTION NO. 213117119 AND FIRST AMENDMENT RECORDED JANUARY 22, 2018 AT RECEPTION NO. 218008146 AND ASSIGNMENT RECORDED JANUARY 22, 2018 AT RECEPTION NO. 218008145 AND ANY AND ALL AMENDMENTS AND/OR SUPPLEMENTS THERETO. TRANSFER OF ARCHITECTURAL CONTROL COMMITTEE RECORDED NOVEMBER 29, 2017 AT RECEPTION NO. 217140585.
- xiv. (TC#22) THE PROPERTY MAY BE SUBJECT TO THE EFFECT OF MASTER PLAT OF PAINT BRUSH HILLS FILING NO. 13, AS SET FORTH IN INSTRUMENT RECORDED DECEMBER 9, 2013 AT RECEPTION NO. 213145991.
- xv. (TC#23) THE PROPERTY MAY BE SUBJECT TO TERMS, AGREEMENTS, PROVISIONS, CONDITIONS AND OBLIGATIONS AS CONTAINED IN SUBDIVISION IMPROVEMENTS AGREEMENT RECORDED DECEMBER 9, 2013 AT RECEPTION NO. 213145992.
- xvi. (TC#24) THE PROPERTY MAY BE SUBJECT TO NOTES, EASEMENTS AND RESTRICTIONS AS SHOWN ON THE PLAT OF PAINT BRUSH HILLS FILING NO. 13A RECORDED DECEMBER 9, 2013 AT RECEPTION NO. 213713413.
- xvii. (TC#25) THE PROPERTY MAY BE SUBJECT TO TERMS, AGREEMENTS, PROVISIONS, CONDITIONS AND OBLIGATIONS AS CONTAINED IN RESOLUTION NO.13-295 RECORDED DECEMBER 17, 2013 AT RECEPTION NO. 213148273.
- xviii. (TC#26) THE PROPERTY MAY BE SUBJECT TO TERMS, AGREEMENTS, PROVISIONS, CONDITIONS AND OBLIGATIONS AS CONTAINED IN RESOLUTION NO. 2013-12-01, CONCERNING THE IMPOSITION OF VARIOUS FEES, RATES, PENALTIES AND CHARGES FOR WATER AND SEWER SERVICES AND FACILITIES, RECORDED FEBRUARY 6, 2014 AT RECEPTION NO. 214010107. AMENDED AND RESTATED RESOLUTION NO. 2014-02-0-1, RECORDED JUNE 20, 2014 AT RECEPTION NO. 214053382. AMENDED AND RESTATED RESOLUTION NO. 2014-07-02 RECORDED JULY 23, 2014 AT RECEPTION NO. 214065368. CORRECTION RECORDED AUGUST 18, 2014 AT RECEPTION NO. 214074789 AND AUGUST 20, 2014 AT RECEPTION NO. 214075501. AMENDED AND RESTATED RESOLUTION NO. 2016-02-03 RECORDED FEBRUARY 23, 2016 AT RECEPTION NO. 216017724. RECORDED JUNE 5, 2017 AT RECEPTION NO. 217064880.
- xix. (TC#27) THE PROPERTY MAY BE SUBJECT TO TERMS, AGREEMENTS, PROVISIONS, CONDITIONS AND OBLIGATIONS AS CONTAINED IN RESOLUTION NO. 2015-11-06, RECORDED DECEMBER 3, 2015 AT RECEPTION NO. 215130544.
- xx. (TC#28) THE PROPERTY MAY BE SUBJECT TO TERMS, AGREEMENTS, PROVISIONS, CONDITIONS AND OBLIGATIONS AS CONTAINED IN RESOLUTION NO. 2015-06-01, RECORDED DECEMBER 4, 2015 AT RECEPTION NO. 215130828.
- xxi. (TC#29) THE PROPERTY MAY BE SUBJECT TO TERMS, AGREEMENTS, PROVISIONS, CONDITIONS AND OBLIGATIONS AS CONTAINED IN THE INFRASTRUCTURE CONSTRUCTION AND CONVEYANCE AGREEMENT RECORDED JANUARY 20, 2016 AT RECEPTION NO. 216005635.
- xxii. (TC#30) THE PROPERTY MAY BE SUBJECT TO TERMS, AGREEMENTS, PROVISIONS, CONDITIONS AND OBLIGATIONS AS CONTAINED IN THE INFRASTRUCTURE CONSTRUCTION AND CONVEYANCE AGREEMENT RECORDED JANUARY 20, 2016 AT RECEPTION NO. 216005637. PARTIAL ASSIGNMENT OF AND AMENDMENT RECORDED JULY 29, 2016 AT RECEPTION NO. 216084765. TERMINATION IN CONNECTION THEREWITH RECORDED FEBRUARY 23, 2017 AT RECEPTION NO. 217021665.
- xxiii. (TC#31) THE PROPERTY MAY BE SUBJECT TO TERMS, AGREEMENTS, PROVISIONS, CONDITIONS AND OBLIGATIONS AS CONTAINED IN RESOLUTION NO. 16-047 RECORDED FEBRUARY 9, 2016 AT RECEPTION NO. 216013026.
- xxiv. (TC#32) THE PROPERTY MAY BE SUBJECT TO TERMS, AGREEMENTS, PROVISIONS, CONDITIONS AND OBLIGATIONS AS CONTAINED IN RESOLUTION NO.2016-04-02 AS AMENDED AND RESTATED RESOLUTION OF THE BOARD OF DIRECTIONS OF THE PAINT BRUSH HILLS METROPOLITAN DISTRICT RECORDED JUNE 3, 2016 AT RECEPTION NO. 216060144 AND JUNE 7, 2016 AT RECEPTION NO. 216061171.
- xxv. (TC#33) THE PROPERTY MAY BE SUBJECT TO MINERAL QUIT CLAIM DEED CONVEYED TO BRADLEY MARKSHEFFEL, LLC, RECORDED OCTOBER 17, 2016 AT RECEPTION NO. 216119819.
- xxvi. (TC#34) THE PROPERTY MAY BE SUBJECT TO ANY TAXES OR ASSESSMENTS BY REASON OF THE INCLUSION OF THE LAND INTO THE EL PASO COUNTY PUBLIC IMPROVEMENT DISTRICT NO. 2 AS EVIDENCED BY RESOLUTION NO. 17-060, RECORDED FEBRUARY 2, 2017 AT RECEPTION NO. 217013713.
- xxvii. (TC#35) THE PROPERTY MAY BE SUBJECT TO TERMS, AGREEMENTS, PROVISIONS, CONDITIONS AND OBLIGATIONS AS CONTAINED IN INFRASTRUCTURE CONSTRUCTION, CONVEYANCE AND REIMBURSEMENT AGREEMENT RECORDED FEBRUARY 23, 2017 AT RECEPTION NO. 217021672. FIRST AMENDMENT RECORDED SEPTEMBER 28, 2017 AT RECEPTION NO. 217117401.
- xxviii. (TC#36) THE PROPERTY MAY BE SUBJECT TO TERMS, AGREEMENTS, PROVISIONS, CONDITIONS, OBLIGATIONS AND EASEMENTS AS CONTAINED IN PRIVATE DETENTIONS BASIN / STORMWATER QUALITY BEST MANAGEMENT PRACTICE MAINTENANCE AGREEMENT AND EASEMENT, RECORDED DECEMBER 20, 2017 AT RECEPTION NO. 217153396 AND AS AMENDED TO INCLUDE THE SUBJECT PROPERTY RECORDED \_\_\_\_\_.

GENERAL PLAT NOTES: (CONT.)

- xxix. (TC#37) THE PROPERTY MAY BE SUBJECT TO COVENANTS, CONDITIONS, RESTRICTIONS AND EASEMENTS, IF ANY, WHICH DO NOT CONTAIN A FORFEITURE OR REVERTER CLAUSE, (DELETING ANY RESTRICTIONS INDICATING ANY PREFERENCE, LIMITATION OR DISCRIMINATION BASED ON RACE, COLOR, RELIGION, SEX, HANDICAP, FAMILIAL STATUS OR NATIONAL ORIGIN) AS CONTAINED IN INSTRUMENT RECORDED DECEMBER 20, 2017 AT RECEPTION NO. 217153397 AND AS AMENDED TO INCLUDE THE SUBJECT PROPERTY RECORDED \_\_\_\_\_ AND ANY AND ALL AMENDMENTS AND/OR SUPPLEMENTS THERETO.
4. ALL REPORTS PERTAINING TO "PAINT BRUSH HILLS FILING NO. 14" ARE ON FILE AT THE PLANNING AND COMMUNITY DEVELOPMENT DEPARTMENT.
5. TRACT A AND B ARE FOR OPEN SPACE, PUBLIC DRAINAGE, PUBLIC UTILITIES, AND PUBLIC TRAILS TO BE OWNED AND MAINTAINED BY THE PAINT BRUSH HILLS METROPOLITAN DISTRICT. SAID TRACTS ARE TO BE CONVEYED BY SEPARATE DOCUMENT.
6. A DRIVEWAY PERMIT IS REQUIRED TO BE APPLIED FOR AND APPROVED BY EL PASO COUNTY PLANNING AND COMMUNITY DEVELOPMENT DEPARTMENT PRIOR TO THE ESTABLISHMENT OF ANY DRIVEWAY.
7. THE ADDRESSES EXHIBITED ON THIS PLAT ARE FOR INFORMATIONAL PURPOSES ONLY. THEY ARE NOT THE LEGAL DESCRIPTION AND ARE SUBJECT TO CHANGE.
8. ALL PROPERTY OWNERS ARE RESPONSIBLE FOR MAINTAINING PROPER STORM WATER DRAINAGE IN AND THROUGH THEIR PROPERTY. PUBLIC DRAINAGE EASEMENTS AS SPECIFICALLY NOTED ON THE PLAT SHALL BE MAINTAINED BY THE INDIVIDUAL LOT OWNERS UNLESS OTHERWISE INDICATED. STRUCTURES, FENCES, MATERIALS OR LANDSCAPING THAT COULD IMPEDE THE FLOW OF RUNOFF SHALL NOT BE PLACED IN DRAINAGE EASEMENTS.
9. MAILBOXES SHALL BE INSTALLED IN ACCORDANCE WITH THE EL PASO COUNTY DEPARTMENT OF TRANSPORTATION AND THE UNITED STATES POSTAL SERVICE REGULATIONS.
10. NO LOT OR INTEREST THEREIN, SHALL BE SOLD, CONVEYED, OR TRANSFERRED WHETHER BY DEED OR BY CONTRACT, NOR SHALL BUILDING PERMITS BE ISSUED, UNTIL AND UNLESS EITHER THE REQUIRED PUBLIC AND COMMON DEVELOPMENT IMPROVEMENTS HAVE BEEN CONSTRUCTED AND COMPLETED AND PRELIMINARILY ACCEPTED IN ACCORDANCE WITH THE SUBDIVISION IMPROVEMENTS AGREEMENT BETWEEN THE APPLICANT / OWNER AND EL PASO COUNTY AS RECORDED UNDER RECEPTION NUMBER \_\_\_\_\_ IN THE OFFICE OF THE CLERK AND RECORDER OF EL PASO COUNTY, COLORADO OR, IN THE ALTERNATIVE, OTHER COLLATERAL IS PROVIDED TO MAKE PROVISION FOR THE COMPLETION OF SAID IMPROVEMENTS IN ACCORDANCE WITH THE EL PASO COUNTY LAND DEVELOPMENT CODE AND ENGINEERING CRITERIA MANUAL. ANY SUCH ALTERNATIVE COLLATERAL MUST BE APPROVED BY THE BOARD OF COUNTY COMMISSIONERS OR, IF PERMITTED BY THE SUBDIVISION IMPROVEMENTS AGREEMENT, BY THE DEVELOPMENT SERVICES DEPARTMENT DIRECTOR AND MEET THE POLICY AND PROCEDURE REQUIREMENTS OF EL PASO COUNTY PRIOR TO THE RELEASE BY THE COUNTY OF ANY LOTS FOR SALE, CONVEYANCE OR TRANSFER. THIS PLAT RESTRICTION MAY BE REMOVED OR RESCINDED BY THE BOARD OF COUNTY COMMISSIONERS OR, IF PERMITTED BY THE SUBDIVISION IMPROVEMENTS AGREEMENT, BY THE DEVELOPMENT SERVICES DEPARTMENT DIRECTOR UPON EITHER APPROVAL OF AN ALTERNATIVE FORM OF COLLATERAL OR COMPLETION AND PRELIMINARY ACCEPTANCE BY THE EL PASO BOARD OF COUNTY COMMISSIONERS OF ALL IMPROVEMENTS REQUIRED TO BE CONSTRUCTED AND COMPLETED IN ACCORDANCE WITH SAID SUBDIVISION IMPROVEMENTS AGREEMENT. THE PARTIAL RELEASE OF LOTS FOR SALE, CONVEYANCE OR TRANSFER MAY ONLY BE GRANTED IN ACCORDANCE WITH ANY PLANNED PARTIAL RELEASE OF LOTS AUTHORIZED BY THE SUBDIVISION IMPROVEMENTS AGREEMENT.
11. ALL STRUCTURAL FOUNDATIONS SHALL BE LOCATED AND DESIGNED BY A PROFESSIONAL ENGINEER, CURRENTLY LICENSED IN THE STATE OF COLORADO.
12. ALL STORM SEWER FACILITIES LYING OUTSIDE OF THE PUBLIC RIGHT-OF-WAY SHALL BE MAINTAINED BY THE PAINT BRUSH HILLS METROPOLITAN DISTRICT.
13. DEVELOPER SHALL COMPLY WITH FEDERAL AND STATE LAWS, REGULATIONS, ORDINANCES, REVIEW AND PERMIT REQUIREMENTS, AND OTHER AGENCY REQUIREMENTS, IF ANY, OF APPLICABLE AGENCIES INCLUDING, BUT NOT LIMITED TO, THE COLORADO DIVISION OF PARKS AND WILDLIFE, COLORADO DEPARTMENT OF TRANSPORTATION, U.S. ARMY CORPS OF ENGINEERS AND THE U.S. FISH AND WILDLIFE SERVICE REGARDING THE ENDANGERED SPECIES ACT, PARTICULARLY AS IT RELATES TO THE LISTED SPECIES.

When the Property is Subject to Existing or Proposed Covenants:  
All property within this subdivision is subject to a Declaration of Covenants as recorded at Reception No. \_\_\_\_\_, of the records of the El Paso County Clerk and Recorder.

Wastewater:  
Water and wastewater service for this subdivision is provided by the \_\_\_\_\_ (District or provider name(s)) subject to the District's (Providers) rules, regulations and specifications. (Combined note, which can be broken into separate notes for water or sewer in the case of different providers)

Drainage:  
The individual lot purchaser(s) shall be responsible for final design, construction, and maintenance of private detention pond/water quality BMP(s) as described in the approved Preliminary/Final Drainage Report for this subdivision. Final design, construction drawings and drainage report updates for the detention pond/water quality BMP(s) serving each lot shall be provided with Site Development Plan submittals. The detention pond/water quality BMP(s) shall be constructed and completed prior to the issuance of any building permits for the subject lots. The subdivision developer is responsible for providing financial assurances as indicated in the Subdivision Improvements Agreement and Estimate of Guaranteed Funds for all detention ponds/water quality BMPs. All detention ponds/water quality BMPs shall be constructed prior to the release of said financial assurances. Individual lot purchasers shall enter into a Private Detention Basin / Stormwater Quality BMP Maintenance Agreement and Easement ("Agreement") prior to the issuance of any building permits for the subject lots. In the case that the developer constructs the detention pond(s), the developer shall enter into an Agreement for each pond constructed.

For the PID and road impact fees, please use the more detailed notes in green below.

Pursuant to Resolution \_\_\_\_\_, approved by the Board of Directors, El Paso County Public Improvement District \_\_\_\_\_ and recorded in the records of the El Paso County Clerk and Recorder at Reception Number \_\_\_\_\_, the parcels within the platted boundaries of (subdivision) are included within the boundaries of the El Paso County Public Improvement District \_\_\_\_\_ and as such is subject to applicable road impact fees and mill levy.

The Subdivider(s) agrees on behalf of him/herself and any developer or builder successors and assignees that Subdivider and/or said successors and assignees shall be required to pay traffic impact fees in accordance with the El Paso County Road Impact Fee Program Resolution (Resolution No. 19-471), or any amendments thereto, at or prior to the time of building permit submittal. The fee obligation, if not paid at final plat recording, shall be documented on all sales documents and on plat notes to ensure that a title search would find the fee obligation before sale of the property.

Add the following plat note:  
All property within this subdivision is subject to road impact fees in accordance with the El Paso County road impact fee program (Resolution No. 19-471), as amended, at the time of building permit(s). The parcels within the platted boundaries of Paint Brush Hills Filing 14 are included within the boundaries of the El Paso County Public Improvement District 2 and as such is subject to applicable road impact fees and mill levy.

Environmental:  
Developer shall comply with federal and state laws, regulations, ordinances, review and permit requirements, and other agency requirements, if any, of applicable agencies including, but not limited to, the Colorado Division of Wildlife, Colorado Department of Transportation, U.S. Army Corps of Engineers and the U.S. Fish and Wildlife Service regarding the Endangered Species Act, particularly as it relates to the listed species (e.g., Preble's Meadow Jumping Mouse).

Add the following note:  
"The sight distance easement shall be dedicated to the County. Maintenance of sight distance easement shall be the responsibility of the \_\_\_\_\_ (identify if it's property owner or Paint Brush Hills Metropolitan District or both). Any object within the sight distance triangle or easement more than 30 inches above the flowline elevation of the adjacent roadway shall constitute a sight obstruction, and shall be removed or lowered. The object may include but are not limited to berms, buildings, parked vehicles on private property, cut slopes, hedges, trees, bushes, utility cabinets or tall crops."

Note Regarding Reports on File:  
The following reports have been submitted in association with the Final Plat for this subdivision and are on file at the County Planning and Community Development Department: Transportation Impact Study; Drainage Report; Water Resources Report; Wastewater Disposal Report; Geology and Soils Report; Fire Protection Report; Wildfire Hazard Report; Natural Features Report; (other, modify based upon specific reports)

FINAL PLAT  
PAINT BRUSH HILLS FILING NO. 14  
JOB NO. 10-014  
DATE PREPARED: 06/26/2020  
DATE REVISED:



102 E. PIKES PEAK AVE., 5TH FLOOR  
COLORADO SPRINGS, CO 80903  
PHONE: 719.955.5485



**PAINT BRUSH HILLS FILING NO. 14**  
 A REPLAT OF TRACT E, PAINT BRUSH HILLS FILING 13E, BEING A PORTION  
 OF THE NE 1/4 SECTION 26, TOWNSHIP 12 SOUTH, RANGE 65 WEST OF  
 THE SIXTH PRINCIPAL MERIDIAN, EL PASO COUNTY, COLORADO

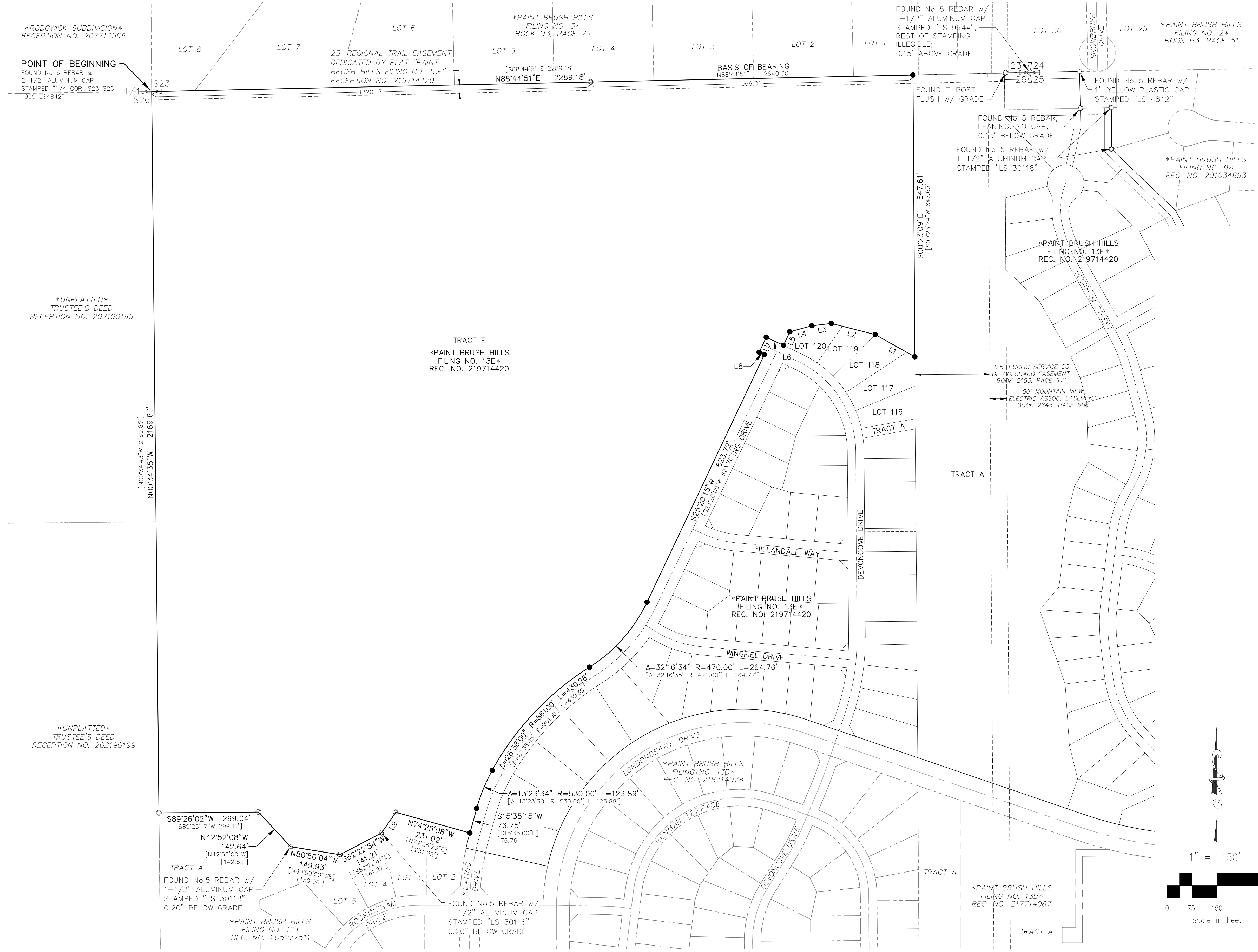

**BOUNDARY LINE TABLE**

LINE #	DISTANCE	BEARING
L1	136.44 [136.45]	N60°39'45"W [N60°40'00"W]
L2	136.62 [136.63]	N75°42'34"W [N75°42'49"W]
L3	58.52 [58.52]	S82°53'35"W [S82°53'20"W]
L4	68.80 [68.80]	S74°48'58"W [S74°48'43"W]
L5	45.28 [45.27]	S25°20'15"W [S25°20'00"W]
L6	56.87 [56.93]	N64°40'00"W [N64°40'00"W]
L7	50.00 [50.00]	S25°20'00"W [S25°20'00"W]
L8	16.86 [16.93]	S64°40'00"E [S64°40'00"E]
L9	75.34 [75.37]	S34°46'45"W [S34°44'45"W]

- LEGEND:**
- SF SQUARE FEET
  - (R) RADIAL BEARING
  - (xxxx) ADDRESS
  - [B-D] RECORD DIMENSIONS
  - SET No 5 REBAR AND 1.25" ORANGE CAP STAMPED "M&S CIVIL PLS 25966" FLUSH W/ EXISTING GRADE UNLESS NOTED OTHERWISE
  - FOUND No 5 REBAR AND 1-1/2" ALUMINUM CAP STAMPED "LS 30118", FLUSH W/ EXISTING GRADE UNLESS NOTED OTHERWISE
  - BOUNDARY LINE
  - PROPERTY LINE
  - RIGHT OF WAY LINE
  - CENTERLINE
  - EASEMENT LINE
  - ADJACENT SUBDIVISION LINE
  - ADJACENT PROPERTY LINE
  - EXISTING RIGHT OF WAY LINE
  - EXISTING CENTERLINE
  - EXISTING EASEMENT
  - MATCHLINE
- \*NOT A PART\*

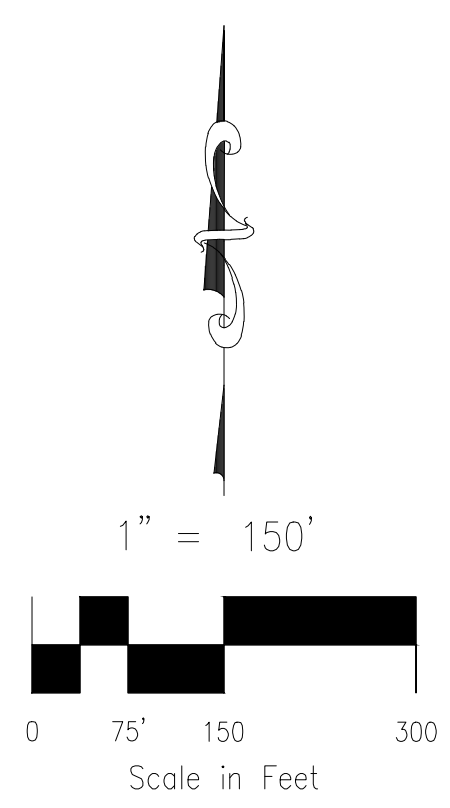

**AS PLATTED**

FINAL PLAT  
 PAINT BRUSH HILLS FILING NO. 14  
 JOB NO. 10-014  
 DATE PREPARED: 06/26/2020  
 DATE REVISED:



102 E. PIKES PEAK AVE., 5TH FLOOR  
 COLORADO SPRINGS, CO 80903  
 PHONE: 719.955.5465

PCD FILE NUMBER **SF-20-024**

SHEET 3 OF 9

File: C:\100144-FBH 14\FBH 14.dwg (Survey) Plot: 10-014 FBH #14 Final Plot.dwg Plotstamp: 8/19/2020 2:13 PM



**PAINT BRUSH HILLS FILING NO. 14**  
 A REPLAT OF TRACT E, PAINT BRUSH HILLS FILING 13E, BEING A PORTION  
 OF THE NE 1/4 SECTION 26, TOWNSHIP 12 SOUTH, RANGE 65 WEST OF  
 THE SIXTH PRINCIPAL MERIDIAN, EL PASO COUNTY, COLORADO

**PAINT BRUSH HILLS FILING NO. 14**  
 TOTAL AREA = 3,860,801 S.F.  
 88.632 AC +/-





**PAINT BRUSH HILLS FILING NO. 14**  
 A REPLAT OF TRACT E, PAINT BRUSH HILLS FILING 13E, BEING A PORTION  
 OF THE NE 1/4 SECTION 26, TOWNSHIP 12 SOUTH, RANGE 65 WEST OF  
 THE SIXTH PRINCIPAL MERIDIAN, EL PASO COUNTY, COLORADO

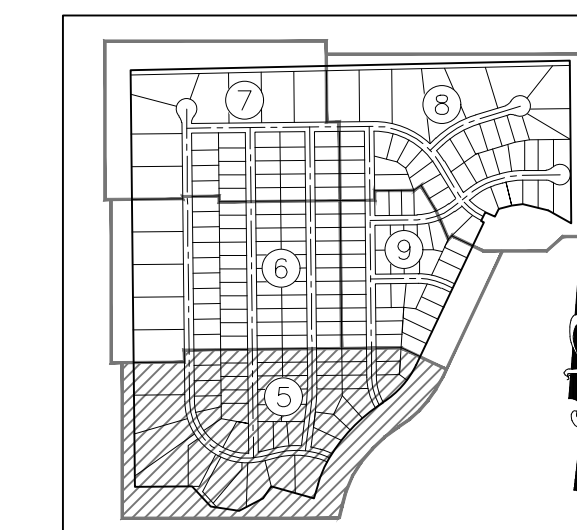

**SHEET INDEX**  
NOT TO SCALE

CENTERLINE CURVE TABLE			
CURVE #	RADIUS	DELTA	LENGTH
QC1	300.00	4'43"53"	24.77
QC2	300.00	11'04"07"	57.96
QC3	300.00	5'45"42"	30.17

RIGHT-OF-WAY CURVE TABLE			
CURVE #	RADIUS	DELTA	LENGTH
RC1	861.00	3'20"19"	50.17
RC2	275.00	10'43"11"	51.45
RC3	325.00	11'29"34"	65.19
RC4	425.00	4'23"31"	32.58
RC5	275.00	1'52"47"	9.02
RC6	861.00	3'16"12"	49.14
RC7	470.00	0'07"17"	1.00

LOT & TRACT CURVE TABLE			
CURVE #	RADIUS	DELTA	LENGTH
C1	861.00	0'05"07"	1.28
C2	325.00	5'17"27"	30.01
C3	325.00	7'03"26"	40.03
C4	325.00	5'17"27"	30.01
C5	700.00	0'34"57"	7.12
C6	700.00	0'40"09"	8.18
C7	750.00	0'37"29"	8.18

RADIAL BEARING TABLE	
LINE #	BEARING
(R)1	N06°19'21"W
(R)2	N00°38'43"W
(R)3	N04°38'43"E
(R)4	N25°04'26"E
(R)5	N32°07'52"E
(R)6	N52°21'17"E
(R)7	N57°38'43"E
(R)8	N83°20'48"W
(R)9	N89°54'51"W
(R)10	N89°57'31"W
(R)11	N78°59'55"E

CENTERLINE LINE TABLE		
LINE #	DISTANCE	BEARING
QL1	5.42	N59°12'00"W
QL2	18.91	S75°00'00"E

RIGHT-OF-WAY LINE TABLE		
LINE #	DISTANCE	BEARING
RL1	18.91	N75°00'00"W
RL2	18.91	S75°00'00"E

LOT & TRACT LINE TABLE		
LINE #	DISTANCE	BEARING
L1	32.79	N02°00'00"E

MATCHLINE - SEE SHEET 6 OF 9

MATCHLINE - SEE SHEET 9 OF 9

MATCHLINE - SEE SHEET 9 OF 9

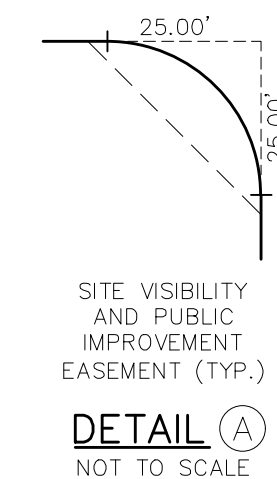
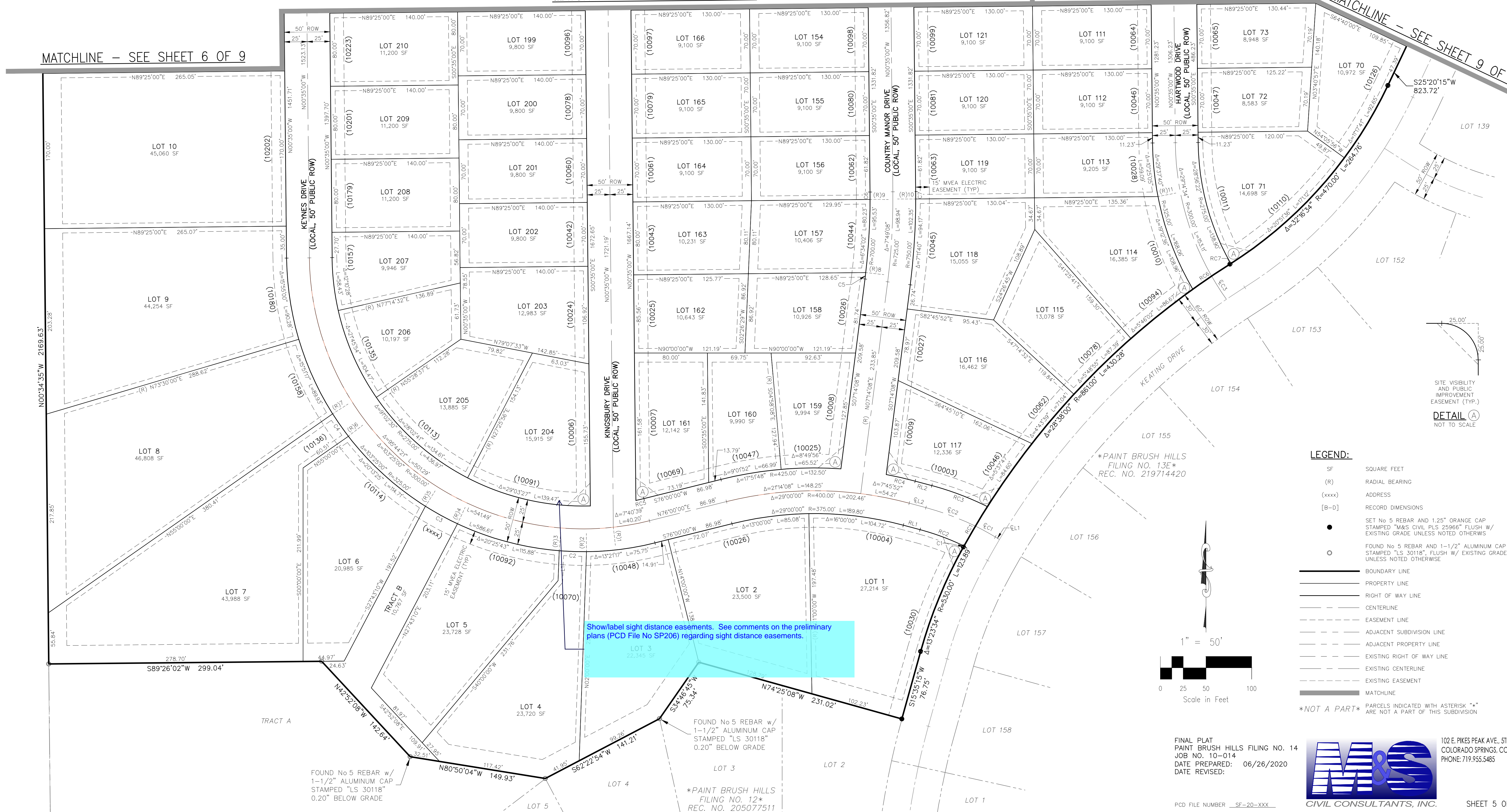

**DETAIL A**  
NOT TO SCALE

**LEGEND:**

- SF SQUARE FEET
- (R) RADIAL BEARING
- (xxxx) ADDRESS
- [B-D] RECORD DIMENSIONS
- SET No. 5 REBAR AND 1.25" ORANGE CAP STAMPED "MS CIVIL PLS 2596" FLUSH W/ EXISTING GRADE UNLESS NOTED OTHERWISE
- FOUND No. 5 REBAR AND 1-1/2" ALUMINUM CAP STAMPED "LS 30118" FLUSH W/ EXISTING GRADE UNLESS NOTED OTHERWISE
- BOUNDARY LINE
- PROPERTY LINE
- RIGHT OF WAY LINE
- CENTERLINE
- EASEMENT LINE
- - - ADJACENT SUBDIVISION LINE
- - - ADJACENT PROPERTY LINE
- - - EXISTING RIGHT OF WAY LINE
- - - EXISTING CENTERLINE
- - - EXISTING EASEMENT
- MATCHLINE
- \*NOT A PART\* PARCELS INDICATED WITH ASTERISK "\*" ARE NOT A PART OF THIS SUBDIVISION

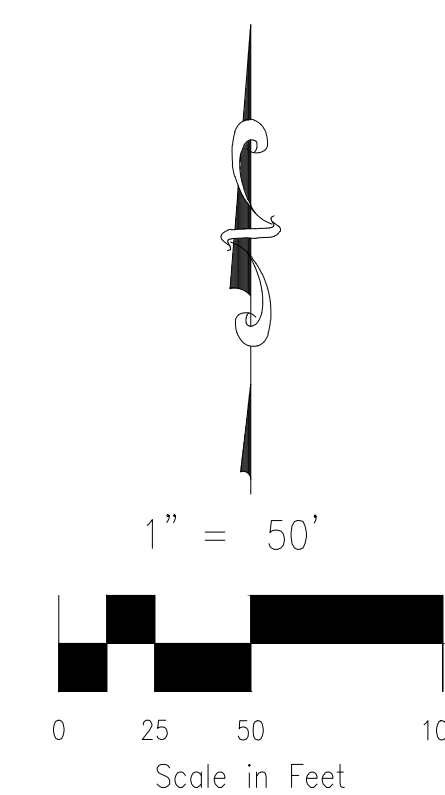

Show/label sight distance easements. See comments on the preliminary plans (PCD File No SP206) regarding sight distance easements.

FOUND No. 5 REBAR w/ 1-1/2" ALUMINUM CAP STAMPED "LS 30118" 0.20" BELOW GRADE

\*PAINT BRUSH HILLS FILING NO. 12\* REC. NO. 205077511

FINAL PLAT  
 PAINT BRUSH HILLS FILING NO. 14  
 JOB NO. 10-014  
 DATE PREPARED: 06/26/2020  
 DATE REVISED:



102 E. PIKES PEAK AVE., 5TH FLOOR  
 COLORADO SPRINGS, CO 80903  
 PHONE: 719.555.5485

PCD FILE NUMBER SF-20-XXX

SHEET 5 OF 9



**PAINT BRUSH HILLS FILING NO. 14**  
 A REPLAT OF TRACT E, PAINT BRUSH HILLS FILING 13E, BEING A PORTION  
 OF THE NE 1/4 SECTION 26, TOWNSHIP 12 SOUTH, RANGE 65 WEST OF  
 THE SIXTH PRINCIPAL MERIDIAN, EL PASO COUNTY, COLORADO

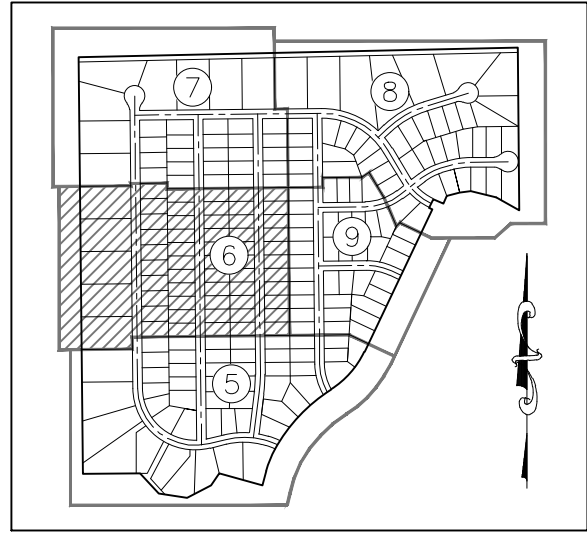

**SHEET INDEX**  
NOT TO SCALE

- LEGEND:**
- SF SQUARE FEET
  - (R) RADIAL BEARING
  - (xxxx) ADDRESS
  - [B-D] RECORD DIMENSIONS
  - SET No 5 REBAR AND 1.25" ORANGE CAP STAMPED "M&S CIVIL PLS 25966" FLUSH W/ EXISTING GRADE UNLESS NOTED OTHERWISE
  - FOUND No 5 REBAR AND 1-1/2" ALUMINUM CAP STAMPED "LS 30118", FLUSH W/ EXISTING GRADE UNLESS NOTED OTHERWISE
  - BOUNDARY LINE
  - PROPERTY LINE
  - RIGHT OF WAY LINE
  - CENTERLINE
  - - - EASEMENT LINE
  - - - ADJACENT SUBDIVISION LINE
  - - - ADJACENT PROPERTY LINE
  - - - EXISTING RIGHT OF WAY LINE
  - - - EXISTING CENTERLINE
  - - - EXISTING EASEMENT
  - MATCHLINE
- \*NOT A PART\*** PARCELS INDICATED WITH ASTERISK "\*" ARE NOT A PART OF THIS SUBDIVISION

MATCHLINE – SEE SHEET 7 OF 9

MATCHLINE – SEE SHEET 7 OF 9

MATCHLINE – SEE SHEET 9 OF 9



\*UNPLATTED\* TRUSTEE'S DEED REC. NO. 202190199

\*UNPLATTED\* TRUSTEE'S DEED REC. NO. 202190199

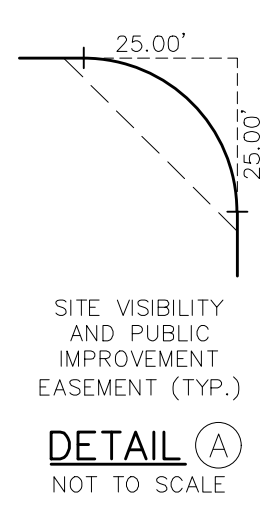
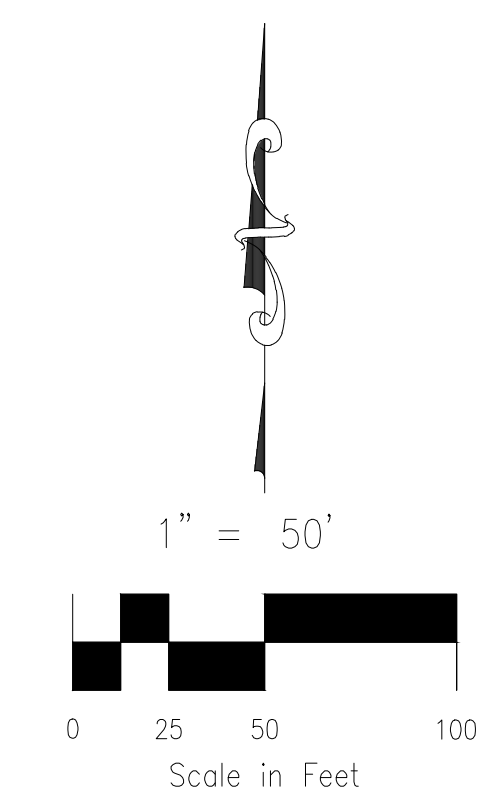

MATCHLINE – SEE SHEET 5 OF 9

MATCHLINE – SEE SHEET 5 OF 9

FINAL PLAT  
 PAINT BRUSH HILLS FILING NO. 14  
 JOB NO. 10-014  
 DATE PREPARED: 06/26/2020  
 DATE REVISED:



102 E. PIKES PEAK AVE., 5TH FLOOR  
 COLORADO SPRINGS, CO 80903  
 PHONE: 719.555.5465

File: C:\100144-FBH 1A\FBH 1A\Survey\Subd\10-014 FBH #14 Final Plat.dwg Plotstamp: 8/19/2020 2:15 PM



**PAINT BRUSH HILLS FILING NO. 14**  
 A REPLAT OF TRACT E, PAINT BRUSH HILLS FILING 13E, BEING A PORTION  
 OF THE NE 1/4 SECTION 26, TOWNSHIP 12 SOUTH, RANGE 65 WEST OF  
 THE SIXTH PRINCIPAL MERIDIAN, EL PASO COUNTY, COLORADO

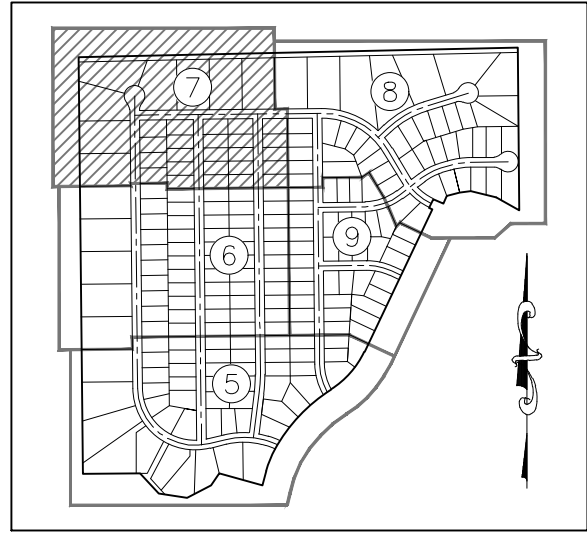

**SHEET INDEX**  
NOT TO SCALE

**LEGEND:**

- SF SQUARE FEET
  - (R) RADIAL BEARING
  - (xxxx) ADDRESS
  - [B-D] RECORD DIMENSIONS
  - SET No 5 REBAR AND 1.25" ORANGE CAP STAMPED "M&S CIVIL PLS 25966" FLUSH W/ EXISTING GRADE UNLESS NOTED OTHERWISE
  - FOUND No 5 REBAR AND 1-1/2" ALUMINUM CAP STAMPED "LS 30118", FLUSH W/ EXISTING GRADE UNLESS NOTED OTHERWISE
  - BOUNDARY LINE
  - PROPERTY LINE
  - RIGHT OF WAY LINE
  - CENTERLINE
  - - - EASEMENT LINE
  - - - ADJACENT SUBDIVISION LINE
  - - - ADJACENT PROPERTY LINE
  - - - EXISTING RIGHT OF WAY LINE
  - - - EXISTING CENTERLINE
  - - - EXISTING EASEMENT
  - MATCHLINE
- \*NOT A PART\* PARCELS INDICATED WITH ASTERISK "\*" ARE NOT A PART OF THIS SUBDIVISION

\*RODGWICK SUBDIVISION\*  
RECEPTION NO. 207712566

**POINT OF BEGINNING**  
FOUND No 6 REBAR & 2-1/2" ALUMINUM CAP STAMPED "1/4 COR, S23 S26, 1999 LS4842"

25' REGIONAL TRAIL EASEMENT DEDICATED BY PLAT "PAINT BRUSH HILLS FILING NO. 13E" RECEPTION NO. 219714420

\*PAINT BRUSH HILLS FILING NO. 3\*  
BOOK U3, PAGE 79

**BASIS OF BEARING**  
N88°44'51"E 2289.18'

MATCHLINE — SEE SHEET 8 OF 9

The drainage report identified a drainage swale along the northern lots at the back of sidewalk. Provide sufficient drainage easement for the swale.

RIGHT-OF-WAY CURVE TABLE			
CURVE #	RADIUS	DELTA	LENGTH
RC8	45.00	45°34'23"	35.79
RC9	45.00	45°34'23"	35.79

RIGHT-OF-WAY LINE TABLE		
LINE #	DISTANCE	BEARING
RL3	4.02	S00°35'00"E

Revise all intersection ROW per ECM detail SD\_240. See snippet to the right

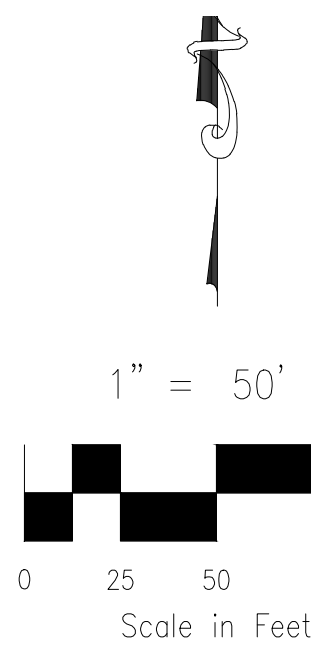
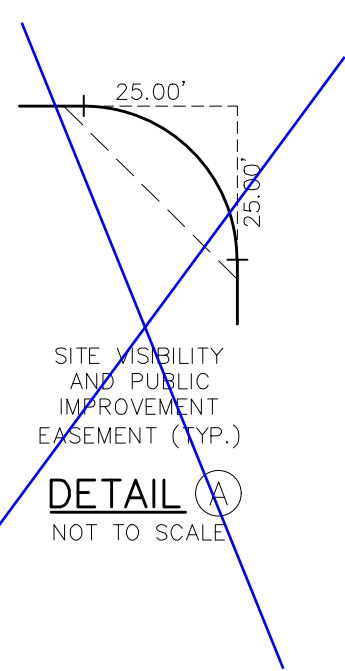
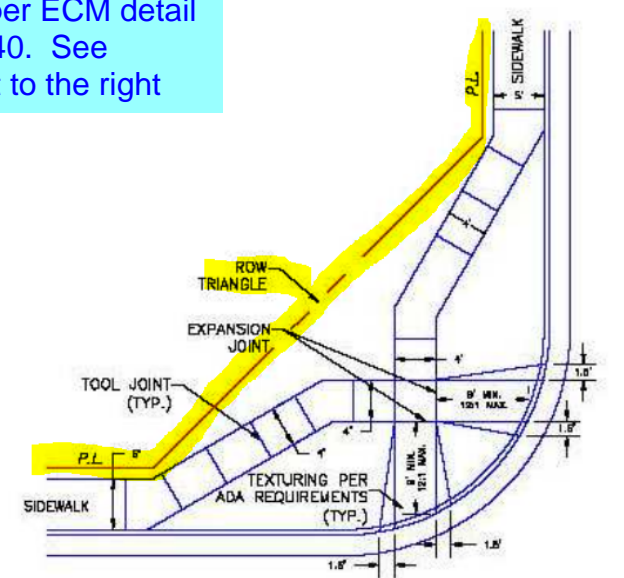

MATCHLINE — SEE SHEET 6 OF 9

MATCHLINE — SEE SHEET 6 OF 9

FINAL PLAT  
PAINT BRUSH HILLS FILING NO. 14  
JOB NO. 10-014  
DATE PREPARED: 06/26/2020  
DATE REVISED:



102 E. PIKES PEAK AVE., 5TH FLOOR  
COLORADO SPRINGS, CO 80903  
PHONE: 719.955.5485

PCD FILE NUMBER SF-20-XXX

File: C:\100144-FBH 1A\FBH 14\ang Survey\Plot\10-014 FBH #14 Final Plot.dwg Plotstamp: 8/19/2020 2:15 PM



**PAINT BRUSH HILLS FILING NO. 14**  
 A REPLAT OF TRACT E, PAINT BRUSH HILLS FILING 13E, BEING A PORTION  
 OF THE NE 1/4 SECTION 26, TOWNSHIP 12 SOUTH, RANGE 65 WEST OF  
 THE SIXTH PRINCIPAL MERIDIAN, EL PASO COUNTY, COLORADO

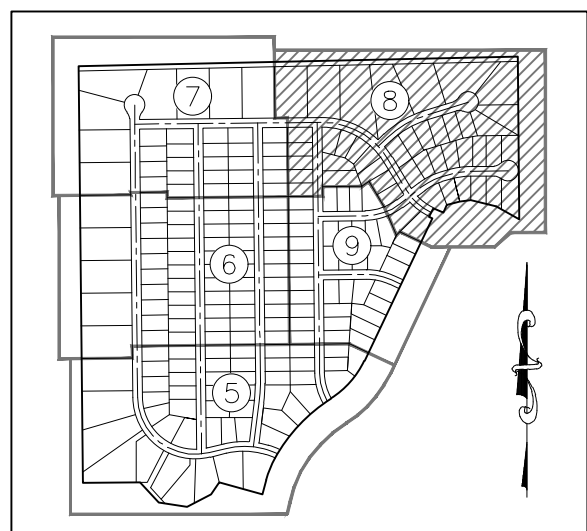

**SHEET INDEX**  
NOT TO SCALE

**RADIAL BEARING TABLE**

LINE #	BEARING
(R)12	S12°36'10"W
(R)13	S37°26'40"E
(R)14	N74°29'50"W
(R)15	N42°15'48"W
(R)16	N10°11'04"W
(R)17	S38°15'14"E
(R)18	N39°58'47"E
(R)19	N22°10'01"W

**RIGHT-OF-WAY CURVE TABLE**

CURVE #	RADIUS	DELTA	LENGTH
RC10	45.00	45°34'23"	35.79
RC11	45.00	45°34'23"	35.79
RC12	425.00	9°07'40"	67.71
RC13	275.00	1°34'01"	7.52
RC14	325.00	2°22'16"	13.45
RC15	45.00	45°34'23"	35.79
RC16	45.00	45°34'23"	35.79

**LOT & TRACT CURVE TABLE**

CURVE #	RADIUS	DELTA	LENGTH
C8	55.00	32°14'01"	30.94
C9	55.00	32°04'44"	30.79
C10	325.00	3°54'34"	22.18
C11	425.00	0°12'03"	1.49
C12	55.00	7°42'32"	7.40
C13	55.00	5°12'13"	5.00
C14	375.00	2°52'04"	18.77
C15	275.00	4°10'24"	20.03
C16	375.00	4°41'35"	30.72

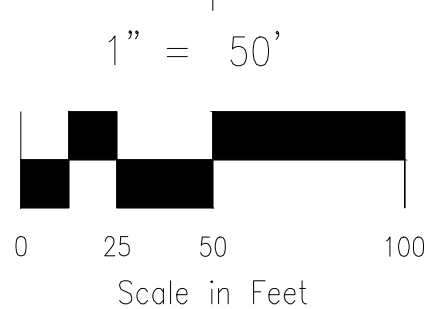

- LEGEND:**
- SF SQUARE FEET
  - (R) RADIAL BEARING
  - (xxxx) ADDRESS
  - [B-D] RECORD DIMENSIONS
  - SET No 5 REBAR AND 1.25" ORANGE CAP STAMPED "M&S CIVIL PLS 25966" FLUSH W/ EXISTING GRADE UNLESS NOTED OTHERWISE
  - FOUND No 5 REBAR AND 1-1/2" ALUMINUM CAP STAMPED "LS 30118" FLUSH W/ EXISTING GRADE UNLESS NOTED OTHERWISE
  - BOUNDARY LINE
  - PROPERTY LINE
  - RIGHT OF WAY LINE
  - CENTERLINE
  - - - EASEMENT LINE
  - - - ADJACENT SUBDIVISION LINE
  - - - ADJACENT PROPERTY LINE
  - - - EXISTING RIGHT OF WAY LINE
  - - - EXISTING CENTERLINE
  - - - EXISTING EASEMENT
  - MATCHLINE
- \*NOT A PART\* PARCELS INDICATED WITH ASTERISK "\*" ARE NOT A PART OF THIS SUBDIVISION

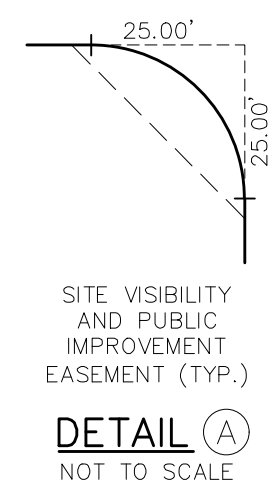

**EASEMENT LINE TABLE**

LINE #	DISTANCE	BEARING
L1	25.22	N44°25'00"E

**EASEMENT CURVE TABLE**

CURVE #	RADIUS	DELTA	LENGTH
C1	425.00	2°27'29"	18.23
C2	425.00	2°47'11"	20.67

**BOUNDARY LINE TABLE**

LINE #	DISTANCE	BEARING
L1	56.87	N64°40'00"W
L2	50.00	S25°20'00"W
L3	16.86	S64°40'00"E

MATCHLINE - SEE SHEET 7 OF 9

MATCHLINE - SEE SHEET 7 OF 9

MATCHLINE -

MATCHLINE - SEE SHEET 9 OF 9

SEE SHEET 9 OF 9

SEE SHEET 9 OF 9

The drainage report identified a drainage swale along the northern lots at the back of sidewalk. Provide sufficient drainage easement for the swale. Verify with the design if the drainage easement is the responsibility of PBHMD or the lot owner per plat note 8 on sheet 2

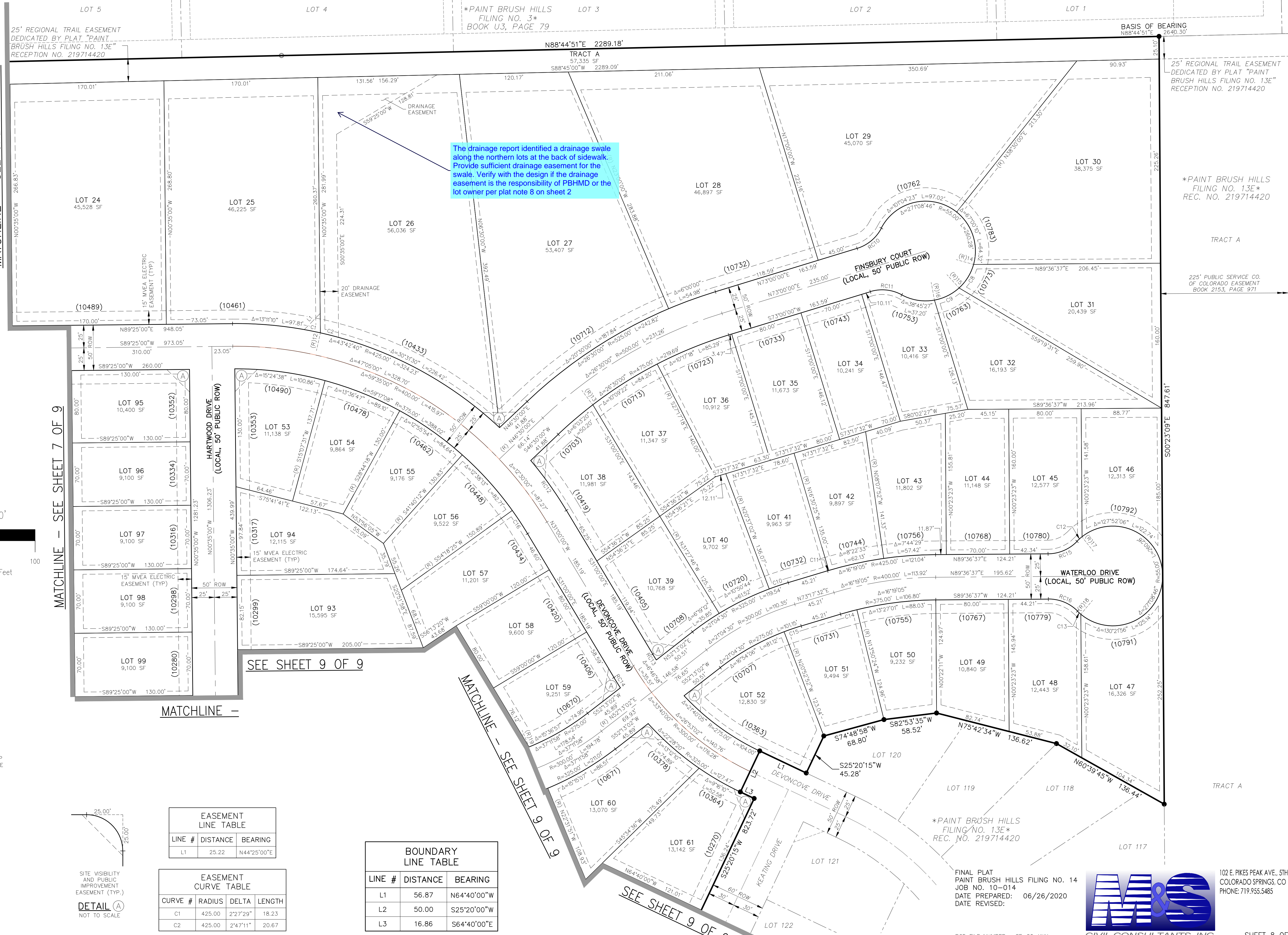

\*PAINT BRUSH HILLS FILING NO. 13E\* REC. NO. 219714420

FINAL PLAT  
 PAINT BRUSH HILLS FILING NO. 14  
 JOB NO. 10-014  
 DATE PREPARED: 06/26/2020  
 DATE REVISED:



102 E. PIKES PEAK AVE., 5TH FLOOR  
 COLORADO SPRINGS, CO 80903  
 PHONE: 719.955.5485

File: C:\100144-FBH 1A\FBH 14\Map\Survey\Plot\10-014 FBH #14 Final Plot.dwg Plotstamp: 8/19/2020 2:18 PM



**PAINT BRUSH HILLS FILING NO. 14**  
 A REPLAT OF TRACT E, PAINT BRUSH HILLS FILING 13E, BEING A PORTION  
 OF THE NE 1/4 SECTION 26, TOWNSHIP 12 SOUTH, RANGE 65 WEST OF  
 THE SIXTH PRINCIPAL MERIDIAN, EL PASO COUNTY, COLORADO

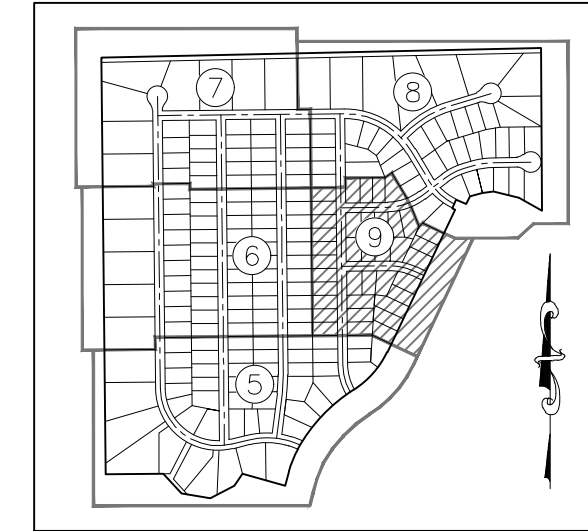

**SHEET INDEX**  
NOT TO SCALE

- LEGEND:**
- SF SQUARE FEET
  - (R) RADIAL BEARING
  - (xxxx) ADDRESS
  - [B-D] RECORD DIMENSIONS
  - SET No. 5 REBAR AND 1.25" ORANGE CAP STAMPED "M&S CIVIL PLS 25966" FLUSH W/ EXISTING GRADE UNLESS NOTED OTHERWISE
  - FOUND No. 5 REBAR AND 1-1/2" ALUMINUM CAP STAMPED "LS 30118", FLUSH W/ EXISTING GRADE UNLESS NOTED OTHERWISE
  - BOUNDARY LINE
  - PROPERTY LINE
  - RIGHT OF WAY LINE
  - CENTERLINE
  - EASEMENT LINE
  - ADJACENT SUBDIVISION LINE
  - ADJACENT PROPERTY LINE
  - EXISTING RIGHT OF WAY LINE
  - EXISTING CENTERLINE
  - EXISTING EASEMENT
  - MATCHLINE
- \*NOT A PART\* PARCELS INDICATED WITH ASTERISK "\*" ARE NOT A PART OF THIS SUBDIVISION

**RADIAL BEARING TABLE**

LINE #	BEARING
(R)19	N22°10'01"W
(R)20	S00°41'03"E
(R)21	S11°26'43"W
(R)22	S08°48'21"W

**LOT & TRACT LINE TABLE**

LINE #	DISTANCE	BEARING
L2	25.76	N45°34'36"E

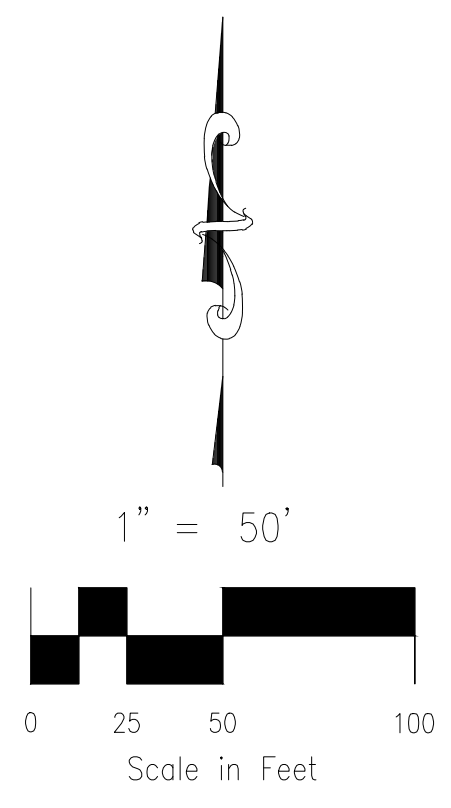
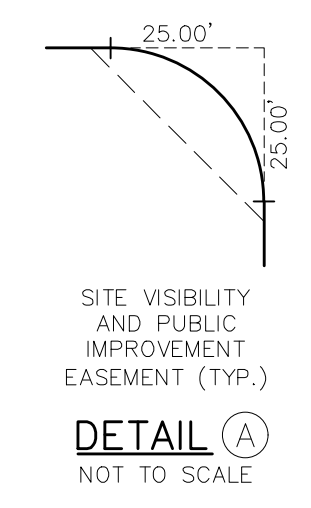

FINAL PLAT  
 PAINT BRUSH HILLS FILING NO. 14  
 JOB NO. 10-014  
 DATE PREPARED: 06/26/2020  
 DATE REVISED:



102 E. PIKES PEAK AVE., 5TH FLOOR  
 COLORADO SPRINGS, CO 80903  
 PHONE: 719.555.5485

File: C:\100144-FBH 1A\FBH 1A\Survey\Plot\10-014 FBH #14 Final Plat.dwg Plotstamp: 8/19/2020 2:18 PM